

NASA Technical Memorandum 83629

N 84 - 2 4 8 0 8

# Low Wear Partially Fluorinated Polyimides

Robert L. Fusaro and William F. Hady  
*Lewis Research Center*  
*Cleveland, Ohio*

Prepared for the  
Joint Lubrication Conference  
cosponsored by the American Society of Mechanical Engineers  
and the American Society of Lubrication Engineers  
San Diego, California, October 22-24, 1984

**NASA**



## LOW WEAR PARTIALLY FLUORINATED POLYIMIDES

Robert L. Fusaro and William F. Hady  
National Aeronautics and Space Administration  
Lewis Research Center  
Cleveland, Ohio 44135

### ABSTRACT

Tribological studies were conducted on five different polyimide solid bodies formulated from the diamine 2,2-bis [4-(4-aminophenoxy)phenyl] hexafluoropropane (4-BDAF) and the dianhydrides pyromellitic acid (PMDA) and benzophenonetetracarboxylic acid (BTDA). The following polyimides were evaluated 4-BDAF/PMDA, 4-BDAF/BTDA, 4-BDAF/80 mole percent PMDA, 20 mole percent BTDA, 4-BDAF/60 mole percent BTDA. Friction coefficients, polyimide wear rates, polyimide surface morphology, and transfer films were evaluated at sliding speeds of 0.31 to 11.6 m/s and at temperatures of 25° to 300° C. The results indicate that the tribological properties are highly dependent on the composition of the polyimide and on the experimental conditions. Two of the polyimides produced very low wear rates but very high friction coefficients (greater than 0.85) under ambient conditions. They offer considerable potential for high-traction applications such as brakes.

### INTRODUCTION

The use of polymers for tribological applications is continually increasing, with ever increasing demands being placed on the performance of these polymers. Polymers are needed with improved tribological properties from cryogenic to the highest possible temperature. One class of thermally stable organic polymers that has demonstrated increased capabilities in this area is polyimide.

Polyimides are being used or considered for use in bearings, gears, seals, brakes, and prosthetic human joints.(1-8) A part can be machined or molded from the polyimide or a film of polyimide can be applied to a metallic part.



In many instances polyimide by itself will be sufficient to improve the tribological properties of the component. However, solid lubricant additives can further improve the tribological properties. For example, to improve the load carrying capacity, polyimide solid bodies can be reinforced with fibers. If graphite fibers are used, improved lubricating performances can also be obtained, because of the good tribological properties of graphite fibers.(9,16)

Polyimide does not refer to one particular polymer, however, but to a class of long-chained polymers that have repeating imide groups as an integral part of the main chain. By varying the monomeric starting materials, polyimides of different chemical composition and structure can be obtained. The polyimide chains consist of aromatic rings alternated with heterocyclic groups. Because of the multiple bonds between these groups, the polyimides have high thermal stability. On decomposition, they crumble to a fine powder without melting. They have high radiation stability and can withstand exposure to neutrons, electrons, ultraviolet light, and gamma radiation. They are resistant to most common chemicals and solvents, but are attacked by alkalis. For a more detailed discussion of the physical properties see Refs. 17 to 21.

In 1975 a polyimide was formulated from partially fluorinated polyimide resins prepared from the diamine 2,2-bis [4-(4-aminophenoxy)phenyl] hexafluoropropane (4-BDAF),(22) which possessed great potential for long-term service in highly oxidative environments up to 370° C.(23,24) Because of the promise shown in the preliminary physical properties testing program, two polyimides were formulated using the 4-BDAF diamine for tribological evaluation: One using the dianhydride of benzophenonetetracarboxylic acid (BTDA), and one using 50 mole percent of BTDA and 50 mole percent of the dianhydride of pyromellitic acid (PMDA). In addition to solid bodies of the polyimides, graphite-fiber-reinforced composites were made using the 50/50 PMDA/BTDA polyimide.



Very good tribological results were found both with the solid body materials and with the composites.(25) The results indicated that higher amounts of the PMDA dianhydride in the polyimide would produce polymers with improved tribological properties. Thus, the purpose of this study was to evaluate polyimides made from the 4-BDAF diamine and 60 mole percent PMDA, 80 mole percent PMDA, and 100 mole percent PMDA (BTDA was the other component.)

Friction coefficients, wear rates, wear surface morphology, and transfer film formation were studied for the three polyimides (made into hemispherically tipped pins) which slid against disks made of the cobalt alloy, Haynes 6B. Both the effect of sliding speed and temperature were evaluated.

#### MATERIALS

New polyimides based on a novel aromatic diamine 2,2-bis [4-(4-aminophenoxy)phenyl] hexafluoropropane (4-BDAF) were formulated using the dianhydrides of benzophenonetetracarboxylic acid (BTDA) and of pyromellitic acid (PMDA) (see structure, Fig. 1). Two polyimides and three copolyimides were prepared from the above components. The two polyimides were polymerized from their respective polyamic acid solutions of 4-BDAF/PMDA and 4-BDAF/BTDA. The copolyimides were prepared by adding the dianhydrides, in the correct proportions, to the 4-BDAF diamine during the polymerization procedure. The copolyimides contained 80 percent (by mole) PMDA and 20 percent BTDA, 60 percent PMDA and 40 percent BTDA, and 50 percent PMDA and 50 percent BTDA. Each polyimide contains the 4-BDAF diamine, but for convenience it will not be included in the designations. The designations will be PMDA, BTDA, 80/20 PMDA/BTDA, 60/40 PMDA/BTDA, and 50/50 PMDA/BTDA. The preparation of the 4-BDAF diamine and the polyimides made from it are described in Refs. 23 and 24. The polyimides were molded into pins 2.0 cm long and 0.95 cm in diameter. A 0.476-cm-radius hemisphere was machined on one end. The hemispherical tip was slid against disks made from the Haynes 6B (cobalt alloy). Each disks had a



Rockwell C hardness of 44 and a lapped and polished surface finish of  $0.070 \pm 0.005 \mu\text{m} R_a$  (arithmetic mean). Cleaning with levigated alumina did not affect this value.

#### APPARATUS

A diagram of the high-temperature pin-on-disk tribometer used in this investigation is shown in Fig. 2. The loads were applied through a lever arm. The same lever arm was also used to transmit the friction force to a strain gage whose output was continuously recorded on a strip-chart recorder (Fig. 2). The disks were heated by induction heating. The temperature was monitored by a thermocouple when the disk was not rotating and by an infrared optical pyrometer when it was. The friction specimens were enclosed in a chamber to control the atmosphere.

#### PROCEDURE

##### Specimen Cleaning

The Haynes 6B disks were washed with ethyl alcohol and then scrubbed with a water-based paste of levigated alumina. They were then scrubbed with a brush under running distilled water to remove the alumina and dried with clean compressed air.

The polyimide or polyimide composite pins were scrubbed with a nonabrasive detergent, rinsed with distilled water, and dried with clean compressed air.

##### Experimental Testing

After the pin and disk specimens were inserted into the test apparatus, the chamber was sealed. Moist air (50 percent relative humidity (10 000 ppm  $\text{H}_2\text{O}$ ) at  $25^\circ\text{C}$ ) was pumped into the chamber for 15 min before each test and continuously throughout the test. After purging at  $25^\circ\text{C}$ , the disk was rotated at speeds of 0.31, 3.1, 6.2, and 11.6 m/s (100, 1000, 2000, and 3700 rpm). For the constant temperature tests of  $100^\circ$ ,  $200^\circ$ ,  $240^\circ$ , or  $300^\circ\text{C}$ , the disk was slowly heated to the desired temperature using induction heating and held for



10 min at temperature to allow the temperature to stabilize. The load (9.8 N) was then gradually applied to a disk rotating at 3.1 m/s. The pin slid on a 6-cm-diameter track on the disk.

At various times during the experiments, the tests were stopped and the specimens removed and examined by optical microscopy. The wear scar on each pin tip was measured and the wear volume calculated. The pin was not removed from the holder, and locating pins insured that it was returned to its original position in the apparatus.

For the tests in which friction coefficient was determined as a function of constantly increasing or decreasing temperature, the procedure was to run-in the polyimide pins under a 9.8-N load at 3.1 m/s and 25° C for 30 min. Then the temperature was gradually increased at the rate of 4° C/min to a temperature as high as 350° C, and then it was decreased at the same rate to about 100° C. Below 100° C the heat was turned off, and the disk was allowed to cool at its own rate, which was slower than 4° C/min. One pin was reheated to 350° C under the same stepping procedure, except for the run-in.

## RESULTS AND DISCUSSION

### Polyimide Wear

The wear volume of the five different polyimide pins as a function of sliding distance is shown in Fig. 3. For comparison, data for a commercial polyimide are also shown. The experiments were conducted in 50-percent-relative humidity air at 25° C, at a sliding speed of 3.1 m/s, and under a load of 9.8 N.

Initially, there was a run-in phenomenon during which the high contact pressures associated with this geometry were reduced and a transfer film was produced. The run-in lasted for up to 500 m of sliding, thus the need for long experiments. After the run-in, a constant wear regime (constant wear as a function of sliding distance) was obtained. Wear rate was calculated for

the constant wear regime by taking a linear regression fit (least squares) of the curves of Fig. 3. The lowest wear rate ( $5 \times 10^{-15} \text{ m}^3/\text{m}$  of sliding) was found with both the 80/20 and the 60/40 PMDA/BTDA polyimides. The 50/50 PMDA/BTDA and the PMDA polyimides gave wear rates of  $27 \times 10^{-15} \text{ m}^3/\text{m}$ ; the BTDA polyimide gave a wear rate of  $71 \times 10^{-15} \text{ m}^3/\text{m}$ ; and the commercial polyimide,  $48 \times 10^{-15} \text{ m}^3/\text{m}$  of sliding.

To determine the effect of sliding speed on the wear rates, similar experiments were conducted on the six polyimide pins. The wear rate of the PMDA polyimide varied considerably with sliding speed, but the 80/20 PMDA/BTDA, 60/40 PMDA/BTDA, and the commercial polyimide pins were relatively unaffected by sliding speed (Fig. 4). Wear rate data as a function of temperature curves are shown in Fig. 5. The best results were obtained with the 80/20 PMDA/BTDA polyimide at all test temperatures. The 60/40 PMDA/BTDA gave equivalent results up to  $200^\circ \text{C}$ , but at  $300^\circ \text{C}$  its wear rate increased to about four times the wear rate of the 80/20 PMDA/BTDA polyimide. The BTDA polyimide gave the highest wear rate at all temperatures, with a very marked increase occurring at  $240^\circ \text{C}$ , indicating a lower temperature stability than the polyimides formulated with larger amounts of PMDA. A similarly large increase (although not as large) occurred for the 50/50 PMDA/BTDA. The wear behavior of the PMDA polyimide was very erratic, both as a function of temperature (Fig. 5) and as a function of sliding speed (Fig. 4). The best polyimide, the 80/20 PMDA/BTDA, gave up to 10 times lower wear than the commercial polyimide at temperatures to  $300^\circ \text{C}$ .

#### Coefficient of Friction

Average values of the friction coefficient for each polyimide are shown in Fig. 6 as a function of temperature, and the variation is given in table I. In general, the friction coefficients for all the polyimides tended to drop off as a function of increasing temperature to some temperature between



100° to 200° C and then to level off. This is not surprising, since earlier work on other polyimides by one of the present authors indicated that at least some polyimides possess friction and wear transitions.(26,27) Below the transition (25° and 100° C) the two polyimides that gave the lowest wear rates (60/40 and 80/20 PMDA/BTDA) also produced the highest friction coefficients, indicating that these polyimides may have useful applications where high traction forces are desired.

To study the friction transition in more detail, experiments were conducted to measure the friction coefficient as the temperature of the metallic disk counterface was raised or lowered at the rate of 4° C/min. To minimize the effect of friction heating, a speed of 0.14 m/s was used, and a load of 9.8 N applied. Figure 7 gives the results of that study. The figure indicates that the friction transition is a gradual process and appears to be both time and temperature dependent. For most of the polyimides, a low relatively stable value occurred as the temperature exceeded 160° C. The exception to this was the commercial polyimide, which did not produce a low value until about 200° C and, on reducing the temperature to 25° C after reaching 300° C, did not markedly increase.

In earlier experiments the BTDA polyimide degraded above 300° C, to the extent that meaningless friction data were produced on reducing the temperature. For that reason the temperature was only raised to 200° C for this work (Fig. 7(e)).

The temperature of the PMDA, 80/20 PMDA/BTDA, and 60/40 PMDA/BTDA polyimides was increased to 350° C without markedly affecting their performances. To show the repeatability, the 60/40 PMDA/BTDA polyimide was increased in temperature a second time after it was lowered to 25° C. The same absolute values were not obtained, but the same general trends are present (Fig. 7(c)).

Figure 8 shows plots of friction coefficient as a function of sliding speed for sliding intervals of 1 and 5 km. The commercial polyimide had a tendency to decrease as a function of sliding speed for both sliding durations. The decrease being about 25 percent from a speed of 0.31 to 11.6 m/s. At the slowest sliding speed (0.31 m/s) the friction coefficient, instead of remaining constant as a function of sliding duration (as was found for all other speeds) tended to decrease.

The PMDA polyimide produced friction coefficients that were not dependent on sliding duration but that did increase with increasing sliding speed. Friction coefficients for the 80/20 PMDA/BTDA polyimide were independent of sliding duration and speed at slower speeds ( $\leq 3.1$  m/s), but, above 3.1 m/s, decreased with sliding duration and speed. Except for the 0.31-m/s sliding speed, the friction coefficient for the 60/40 PMDA/BTDA polyimide decreased both with sliding duration and speed.

It is postulated that the decreases in friction as a function of increasing sliding speed and duration for the 80/20 and 60/40 PMDA/BTDA polyimide are due to frictional heating, which raised the temperature above the transition temperature. The temperature of the actual contact could not be determined, but the temperature of the metallic counterface reached 90° C for the high-friction, 11.6-m/s experiments run at 25° C. Whenever the friction dropped so did the temperature; thus the temperature data do not give a clear cut analysis, and the data are, therefore, not presented.

#### Polyimide Wear Surface Morphology

The PMDA, 50/50 PMDA/BTDA, and BTDA polyimide pin wear surfaces were very smooth at all sliding speeds and temperatures. To varying degrees, plastically flowing back-transfer polyimide particles and layers were observed. Figure 9 shows representative photomicrographs of back-transfer material on the PMDA polyimide wear surfaces. Also seen in the photograph are wandering

lines running throughout the wear scar. These lines appear to be boundaries separating the polyimide microstructure. Only the PMDA exhibited this microstructure. From a tribological viewpoint, this structure is undesirable since such areas could weaken the structure and serve as initiation points for wear particle production. Adjusting the polymerization procedure may eliminate this microstructure and produce an improved tribological material.

The 80/20 and 60/40 PMDA/BTDA polyimides gave exceptionally low wear rates but very high friction coefficients. The high friction is reflected in the wear surface morphology by the production of tensile cracks. These cracks were found under all conditions except for 300° C at 3.1 m/s sliding speed and for 25° C at 11.6 m/s sliding speed. Figure 10 gives representative photomicrographs of the wear surfaces produced under these conditions.

Despite the wandering lines formed, they did not appear to accelerate the wear process of these polyimides. Again, by adjusting the polymerization procedure or by incorporating proper additives into these polyimides, it may be possible to improve the tribological properties.

Since some of the polyimides appeared to be harder or more brittle than others, Vickers hardness tests were performed on the wear scars using a 0.098-N load. Tests could not be performed on the polyimide surfaces themselves since they were too rough. Table I lists the average hardnesses obtained for the six polyimides evaluated. The table indicates that the 80/20 and 60/40 PMDA/BTDA polyimides were slightly harder than the others.

#### Polyimide Transfer Films

The polyimide transfer to the metallic counterfaces was studied with a light microscope to magnifications of 1600 after selected intervals of sliding. The type of transfer observed depended, to various degrees, on the sliding duration. To simplify the discussion, transfer will be characterized as to short sliding durations (less than 100 m of sliding) and long sliding distances



(greater than 2000 m of sliding). Four types of transfer were characterized. Table II characterizes the polyimides evaluated in this study into these classifications.

Generally, the best wearing materials exhibited a thin continuous layer type of transfer. Eventually, this type of transfer can buildup over longer periods of sliding and lead to thick ridge-like transfer. In this study the buildup did not noticeably affect the friction and wear properties. The higher wearing polyimides either tended to produce the thin, platelet transfer particles or the thick, flattened transfer particles. In working with many different solid lubricant materials, the authors have observed that the ability of a material "to flow into itself" is an important indicator of whether it is a good tribological material. This is true whether the solid is an applied film or a transfer film formed during sliding.

#### Comparison With Other Polymers and Composites

Average friction coefficients and wear rates of the polyimides evaluated in this study are compared with other polymer materials and composites evaluated by the authors under the same conditions. Except for the graphite-fiber-reinforced BTDA polyimide composite, the 80/20 and 60/40 PMDA/BTDA polyimides gave equivalent or lower wear rates than the commercial materials despite the fact that their friction coefficients are much higher and that they did not contain solid lubricant additives.

Two of the commercial materials were evaluated in a different geometry than the others; that is, a metallic pin was slid against the composite materials. This may have some effect on the comparability of the wear rate values obtained. Reference 28 reports that a graphite-fiber-reinforced polyimide composite produces lower wear when evaluated as a pin than as a disk. Thus, if these two commercial materials were evaluated as pins, lower wear rates may have been obtained.

## SUMMARY OF RESULTS

Friction, wear, polyimide wear surface morphology, and polyimide transfer film studies on five new polyimides made by the polymerization of a new diamine (4-BDAF) with different dianhydrides (PMDA and BTDA) indicate that

(1) The polyimide formulated using 80 mole percent PMDA and 20 mole percent BTDA (80/20 PMDA/BTDA) gave exceptionally low wear rates over all experimental conditions. At ambient temperatures and slower sliding speeds, it gave friction coefficients of 0.90 or higher; this, coupled with the low wear characteristics, indicates that the polymer may be useful for applications requiring high traction.

(2) The copolyimide 60/40 PMDA/BTDA was nearly as good as the 80/20 PMDA/BTDA polyimide, except that the wear rate was higher at 300° C.

(3) All the 4-BDAF polyimides possessed a transition in the friction properties between 100° and 150° C. The transition appeared to be both time and temperature dependent, and no correlation between the transition and the amount of either dianhydride (PMDA or BTDA) was observed.

(4) The wear rates of the 80/20 and 60/40 PMDA/BTDA polyimides were relatively unaffected by sliding speed in the range of 0.31 to 11.6 m/s; friction coefficient tended to decrease at the higher sliding speeds, however.

(5) The PMDA polyimide had higher thermal stability than the 80/20 and 60/40 PMDA/BTDA, but its tribological properties are not quite as good. Thus, the choice of which polyimide to use should be based on which factor is more important in a particular application.

(6) The BTDA and 50/50 PMDA/BTDA had poorer tribological properties than the other three polyimides.

#### ACKNOWLEDGMENT

The authors would like to thank Robert J. Jones and Howard E. Green of TRW for developing and supplying the polyimides and for their helpful consultations. We also thank Edward A. Willis and Phillip R. Meng of NASA for helping to initiate the project.



## REFERENCES

1. Lancaster, J. K., "Dry Bearings: A Survey of Materials and Factors Affecting Their Performance," Tribology, 6, 6, pp. 219-251 (1973).
2. Hermanek, F. J., Jr., "Coatings Lengthen Jet Engine Life," Met. Prog., 97, 3, pp. 104-106 (1970).
3. Theberge, J. E., "Properties of Internally Lubricated Glass-Fortified Thermoplastics for Gears and Bearings," ASLE Proceedings - International Conference on Solid Lubrication 1971, ASLE-SP-3, American Society of Lubrication Engineers, Park Ridge, IL, (1971), Ed. Boyd, J., pp. 166-184.
4. Brown, R. D., and Blackstone, W. R., "Evaluation of Graphite Fiber Reinforced Plastic Composites for Use in Unlubricated Sliding Bearings," Composite Materials: Testing and Design (Third Conference), ASTM STP-546, American Society for Testing and Materials, Philadelphia, (1974), pp. 457-476.
5. Sliney, H. E., and Johnson, R. L., "Graphite-Fiber - Polyimide Composites for Spherical Bearings to 340° C (650° F)," NASA TN D-7078 (1972).
6. Bangs, S., "Foil Bearings Help Air Passengers Keep Their Cool," Power Transm. Des., 15, 2, pp. 27-31 (1973).
7. Gardos, M. N., and McConnell, B. D., "Development of a High-Load, High-Temperature, Self-Lubricating Composite - Part I: Polymer Matrix Selection," ASLE Preprint No. 81-LC-3A-3 (1981).
8. Sekiguchi, I., Yamaguchi, Y., Katsu, Y., Kamoshida, H., and Suzuki, T., "Study on Plastic Composites for Brake Shoes - On the Melamine Resin, Silicone Resin, Polyimide and Polyphenylene Oxide," Journal of JSLE, International Edition, No. 4, pp. 17-22 (1983).

9. Giltrow, J. P., and Lancaster, J. K., "Properties of Carbon-Fibre-Reinforced Polymers Relevant to Applications in Tribology," International Conference on Carbon Fibres, Their Composites and Applications, Plastics Institute, London, (1971), Paper 31.
10. Giltrow, J. P., and Lancaster, J. K., "Friction and Wear of Polymers Reinforced with Carbon Fibres," Nature (London), 214, 5093, pp. 1106-1107 (1967).
11. Lancaster, J. K., "The Effect of Carbon Fibre Reinforcement on the Friction and Wear of Polymers," J. Phys. D, 1, pp. 549-559 (1968).
12. Simon, R. A., and Prosen, S. P., "Graphite Fiber Composites: Shear Strength and Other Properties," Twenty-Third Annual Technical Conference, SPI Reinforced Plastics/Composite Division, Society of the Plastics Industry, Inc., New York (1968), Section 16-B, pp. 1-10.
13. Herrick, J. W., "Bearing Materials from Graphite Fiber Composites," Reinforced Plastics - Ever New; Proceedings of the Twenty-Eighth Annual Technical Conference, Society of the Plastics Industry, Inc., New York (1973), Section 17-D, pp. 1-6.
14. Giltrow, J. P., "The Influence of Temperature on the Wear of Carbon Fiber Reinforced Resins," ASLE Trans., 16, 2, pp. 83-90 (1973).
15. Gardos, M. N., and McConnell, B. D., "Development of a High-Load High-Temperature, Self-Lubricating Composite - Part II: Reinforcement Selection," ASLE Preprint No. 81-LC-3A-4 (1981); Part III: "Additives Selection," ASLE Preprint No. 81-LC-3A-5 (1981); Part IV: Formulation and Performance of the Best Compositions," ASLE Preprint No. 81-LC-3A-6 (1981).
16. Sliney, H. E., "Some Load Limits and Self-Lubricating Properties of Plain Spherical Bearings with Molded Graphite Fiber-Reinforced Polyimide Liners to 320° C," Lubr. Eng., 35, 9, pp. 497-502 (1979).

17. Adrova, N. A., Bessonov, M. I., Latus, L. A., and Rudakov, A. P., Polyimides: A New Class of Thermally Stable Polymers, Technomic Publishing Co., Inc., Stamford, CT (1970).
18. Sroog, C. E., Endrey, A. L., Abramo, S. V., Berr, C. E., Edwards, W. M., and Olivier, K. L., "Aromatic Polypyromellitimides from Aromatic Polyamic Acids," J. Polym. Sci., Part A, 3, 4, pp. 1373-1390 (1965).
19. Heacock, J. F., and Berr, C. E., "Polyimides-New High Temperature Polymers: H-Film, a Polypyromellitimide Film," SPE Trans., 5, 2, pp. 105-110 (1965).
20. Todd, N. W., and Wolff, F. A., "Polyimide Plastics Withstand High Temperatures," Mater. Des. Eng., 60, 2, pp. 86-91 (1964).
21. Fusaro, R. L., "Comparison of the Weight Loss and Adherence of Nine Different Polyimide Films Thermally Aged at 315° C and 350° C in Air," NASA TM-81381, (1980).
22. Vaughan, R. W., Jones, R. J., O'Rell, M. K., and Zakrzewski, G. A., "Development of Autoclave Moldable Addition-Type Polyimides," TRW Systems Group, TRW-26446-6015-RU-00, NASA CR-134900 (1976).
23. Jones, R. J., O'Rell, M. K., and Hom, J. M., "Polyimides Prepared from Perfluoroisopropylidene Diamine," U.S. Patent 4 111 906 (Sep. 5, 1978).
24. Jones, R. J., O'Rell, M. K., and Hom, J. M., "Fluorinated Aromatic Diamine," U.S. Patent 4 203 922 (May 20, 1980).
25. Fusaro, R. L., "Polyimides Formulated from a Partially Fluorinated Diamine for Aerospace Tribological Applications," NASA TM-83339 (1983).
26. Fusaro, R. L., "Molecular Relaxations, Molecular Orientation, and the Friction Characteristics of Polyimide Films," ASLE Trans., 20, 1, pp. 1-14 (1977).



27. Fusaro, R. L., "Effect of Atmosphere and Temperature on Wear, Friction, and Transfer of Polyimide Films," ASLE Trans., 21, 2, pp. 125-132 (1978).
28. Fusaro, R. L., "Geometrical Aspects of the Tribological Properties of Graphite Fiber Reinforced Polyimide Composites," ASLE Trans., 26, 2, pp. 209-221 (1983).

TABLE I. - AVERAGE VICKERS HARDNESS AND VARIATION OF FRICTION COEFFICIENT

[Sliding speed, 3.1 m/s.]

Polyimide	Average Vickers hardness <sup>a</sup> , kg/mm <sup>2</sup>	Temperature, °C			
		25	100	200	300
		Variation of friction coefficient			
PMDA	20.6	0.60±0.05	0.43±0.05	0.12±0.02	0.22±0.08
80/20 PMDA/BTDA	24.5	.90±0.10	.70±0.10	.13±0.03	.18±0.06
60/40 PMDA/BTDA	23.5	.80±0.10	.80±0.15	.15±0.04	.21±0.05
50/50 PMDA/BTDA	19.5	.48±0.03	.16±0.05	.07±0.03	-----
BTDA	22.1	.54±0.05	.60±0.06	.25±0.10	-----
Commercial polyimide	19.4	.73±0.10	.62±0.09	.25±0.05	.30±0.10

<sup>a</sup>At a 10 g load.

TABLE II. - CHARACTERIZATION OF POLYIMIDE TRANSFER

Code	Description
A	Thin, platelets (<1 μm)
B	Thin, continuous layer (<1 μm)
C	Thick, flattened particles (>2 μm)
D	Thick, "ridge-like layers (>2 μm)

Temperature, °C	Sliding speed, m/s	Polyimide type											
		PMDA		80/20 PMDA/BTDA		60/40 PMDA/BTDA		50/50 PMDA/BTDA		BTDA		Commercial polyimide	
		Sliding duration											
		Short	Long	Short	Long	Short	Long	Short	Long	Short	Long	Short	Long
25	.31	A	A	B	B-D	B	B-D	A	A-C	A	A-C	-	C
25	3.1	C	D	B	B-D	B	B-D	-	B-D	-	C	-	A
25	6.3	-	B-D	A-B	D	-	B-D	-	-	-	-	-	D
25	11.6	-	B	-	C-D	-	B-D	-	-	-	-	-	B-D
100	3.1	A-C	C	-	B-D	-	B-D	-	-	-	-	-	A
200	3.1	B	B-D	A-B	B	A	B-D	-	B-D	-	-	-	A
300	3.1	C	D	A	B	B	D	-	-	-	-	-	B-D

TABLE III. - AVERAGE FRICTION COEFFICIENTS AND WEAR RATES FOR  
COMMERCIAL AND EXPERIMENTAL POLYMERS

[Test temperature, 25° C; load, 9.8 N; sliding speed, 2.7 to 3.1 m/s;  
relative humidity, 50 percent.]

Pin material	Disk material	Average friction coefficient	Average wear rate, m <sup>3</sup> /m of sliding
Commercial polymers			
440C HT stainless steel	Polyphenylene sulfide with 40 percent graphite fibers	0.30	620x10 <sup>-15</sup>
440C HT stainless steel	Poly(amide-imide) PTFE and graphite powders	.37	180x10 <sup>-15</sup>
Polyimide	440C HT stainless steel	.48	48x10 <sup>-15</sup>
Ultra high molecular weight polyethylene	440C HT stainless steel	.30	6x10 <sup>-15</sup>
Polyimide with graphite powder	440C HT stainless steel	.64	5x10 <sup>-15</sup>
Experimental polymers			
PMDA Graphite-fiber-reinforced, addition type polyimide <sup>a</sup>	Haynes 6B	0.60	27x10 <sup>-15</sup>
	440C HT stainless steel	.30	12x10 <sup>-15</sup>
80/20 PMDA/BTDA 60/40 PMDA/BTDA Graphite-fiber-reinforced BTDA <sup>a</sup>	Haynes 6B	.90	5x10 <sup>-15</sup>
	Haynes 6B	.80	5x10 <sup>-15</sup>
	440C HT stainless steel	.30	2x10 <sup>-15</sup>

<sup>a</sup>Data from Ref. 25.

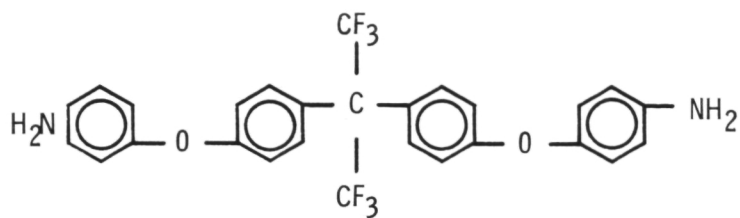

(a) Diamine - (4-BDAF).

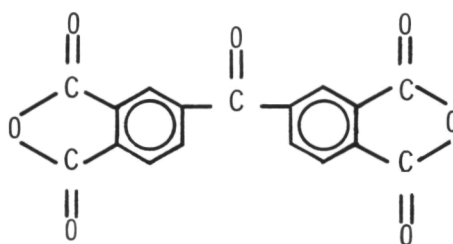

(b) Dianhydride - (BTDA).

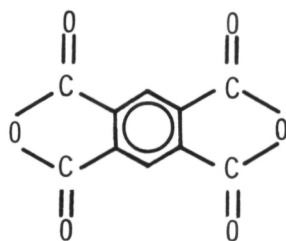

(c) Dianhydride - (PMDA).

Figure 1. - Monomers used to formulate new polyimides.

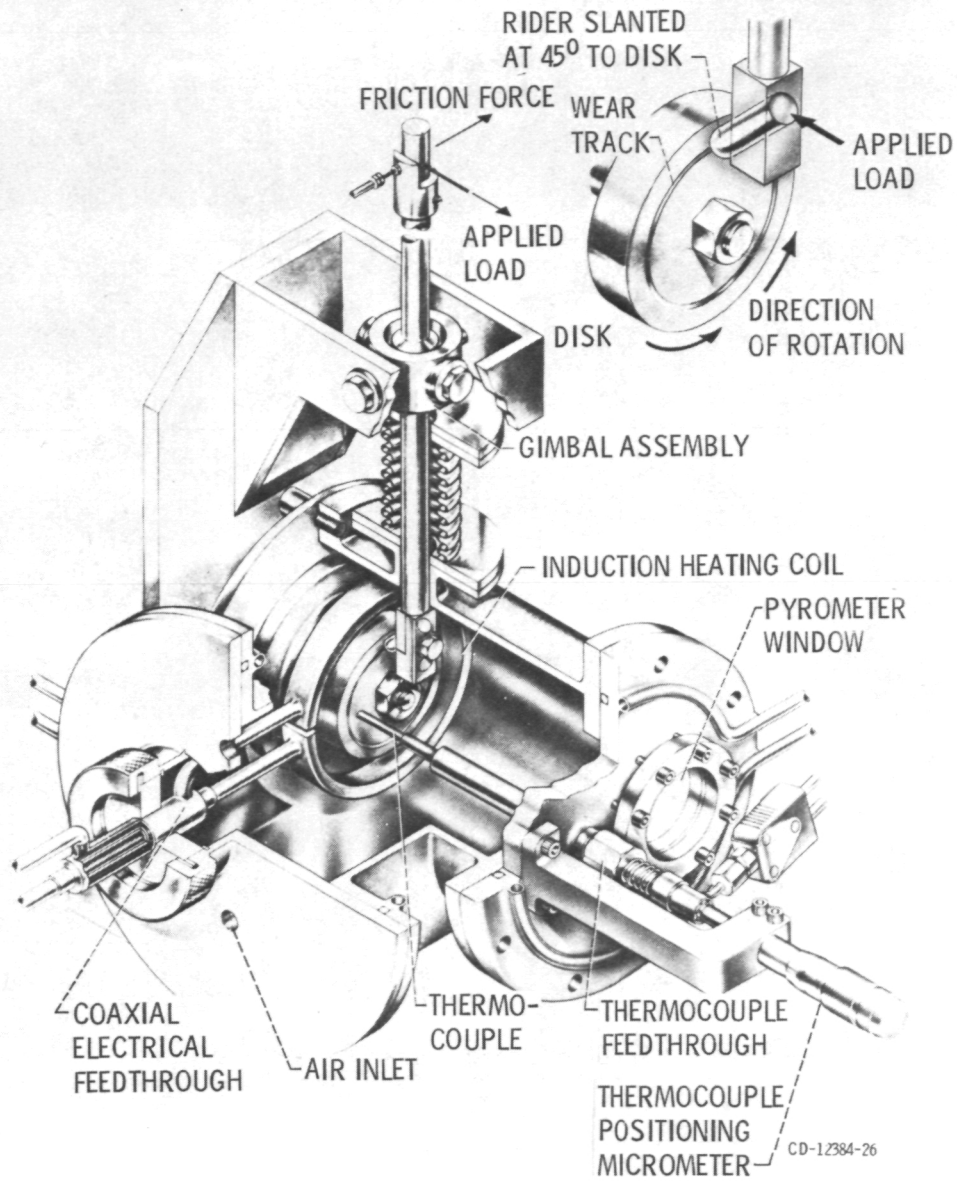

Figure 2. - High-speed friction and wear rig.

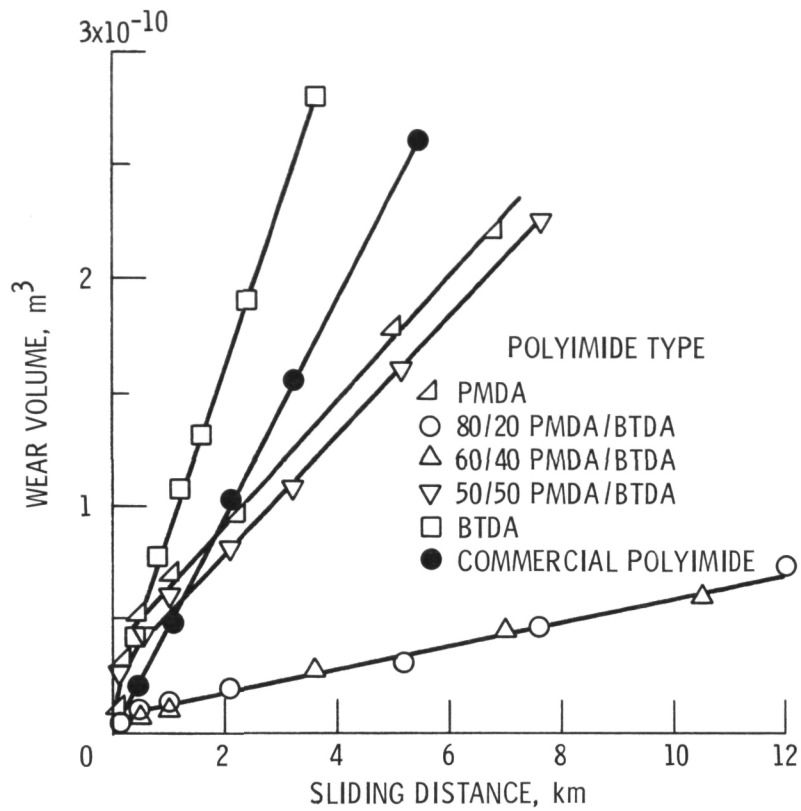

Figure 3. - Polyimide wear volume as function of sliding distance. Temperature,  $25^{\circ}C$ ; sliding speed, 3.1 m/s.

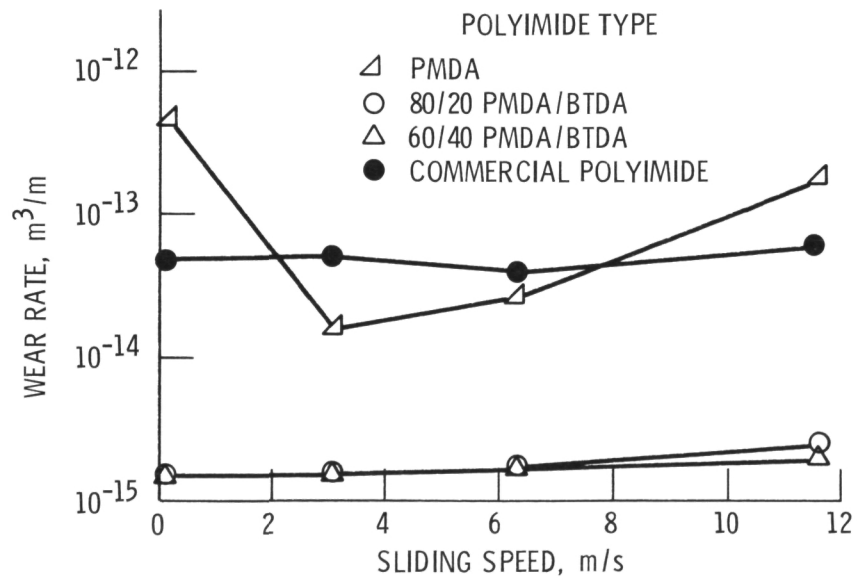

Figure 4. - Polyimide wear rate as a function of sliding speed. Temperature,  $25^{\circ}C$ .



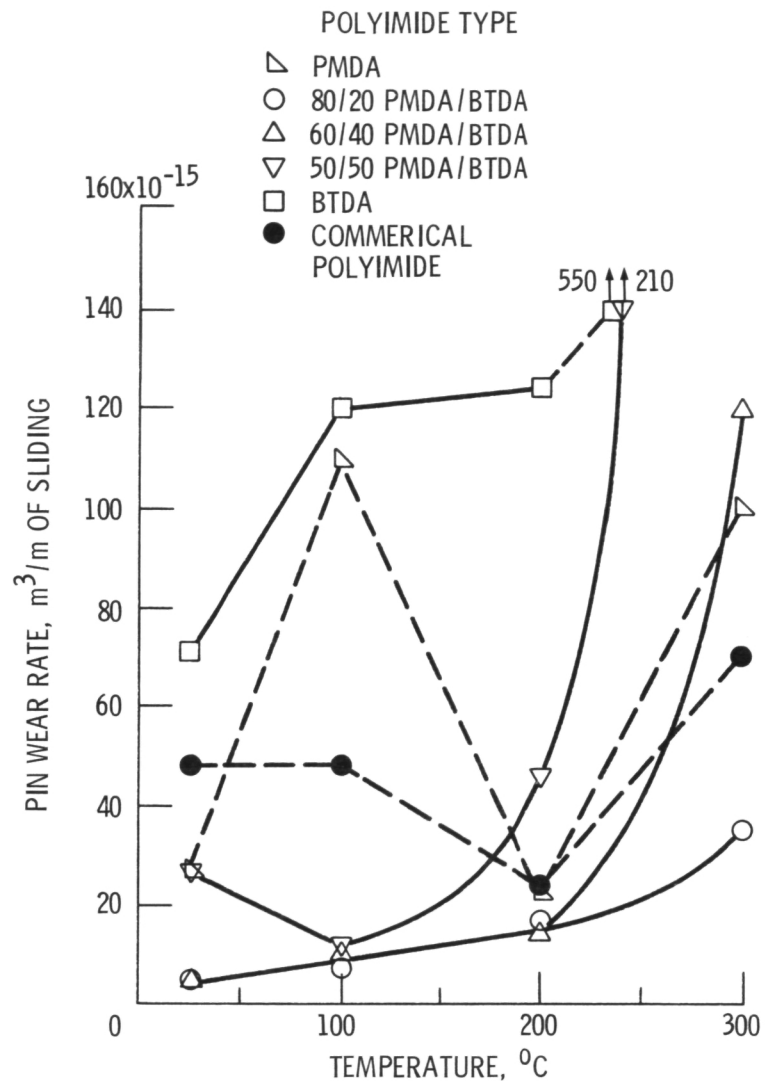

Figure 5. - Polyimide wear rate as function of temperature. Sliding speed, 3.1 m/s.

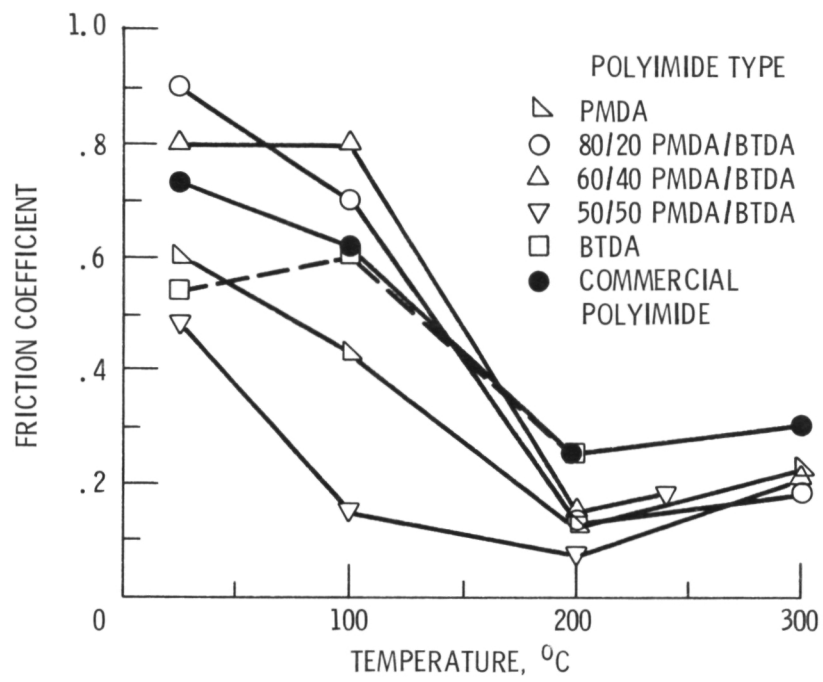

Figure 6. - Average polyimide friction coefficient as function of temperature. Sliding speed, 3.1 m/s.

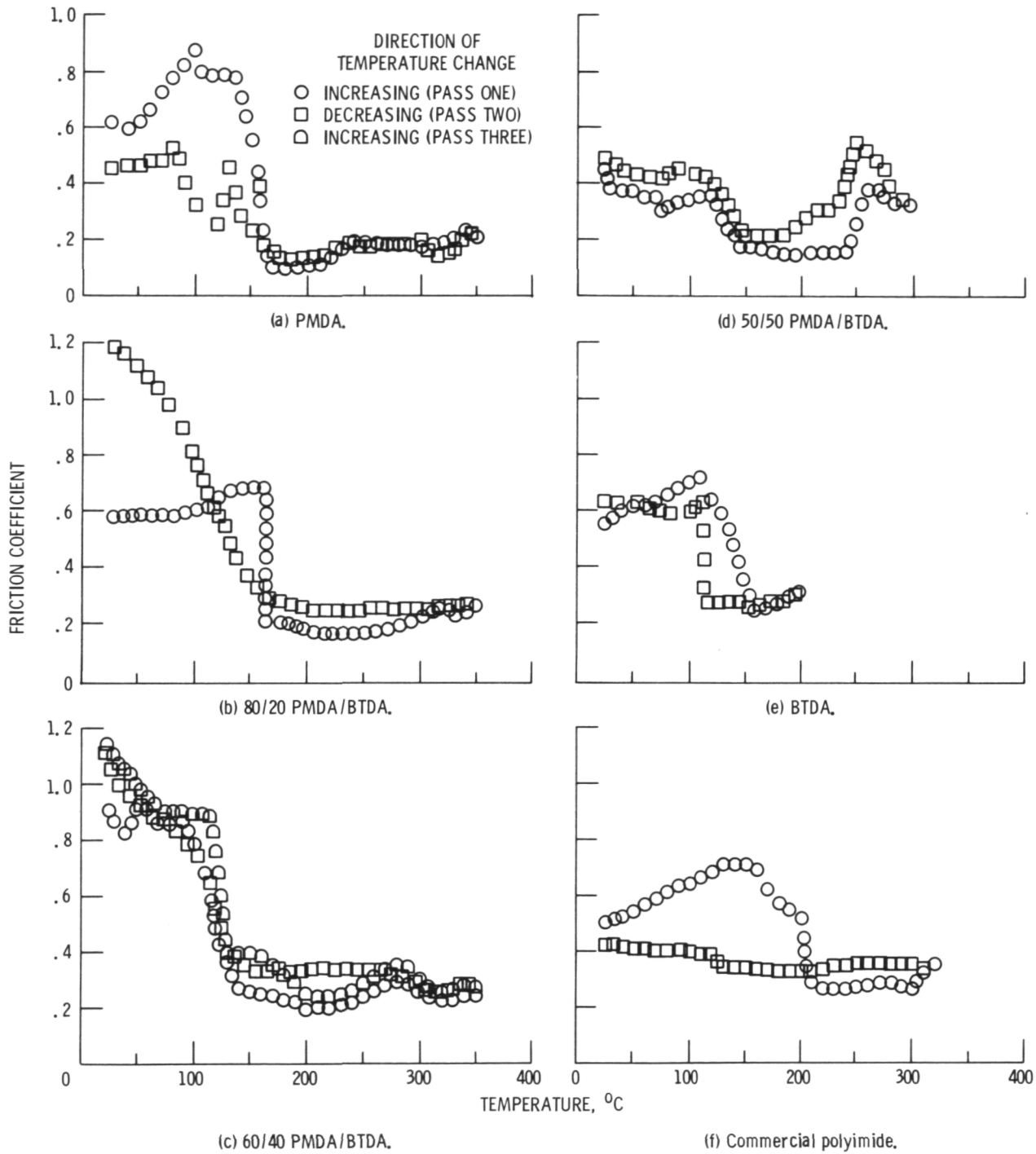

Figure 7. - Friction coefficient as function of temperature. Temperature rate of change, 4<sup>0</sup> C/min; sliding speed, 0.14 m/s.

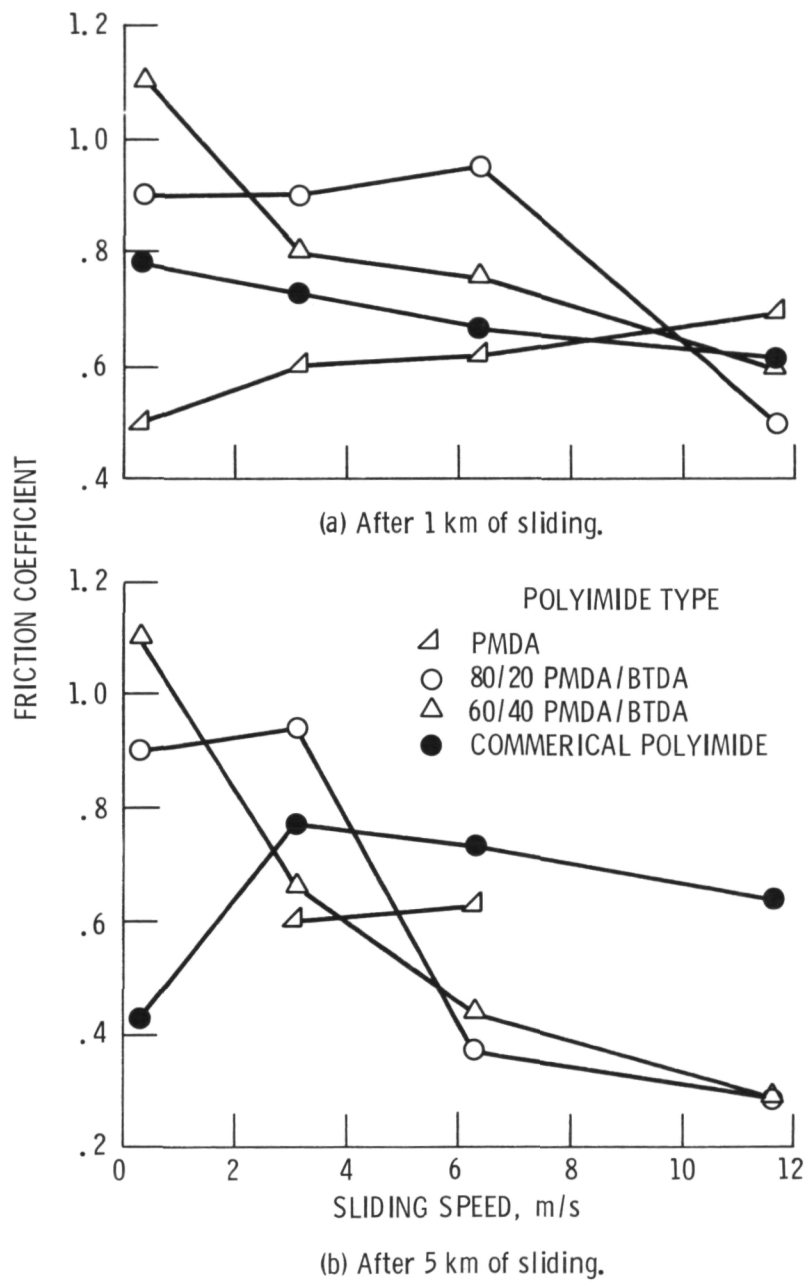

Figure 8. - Mean friction coefficient as function of sliding speed.

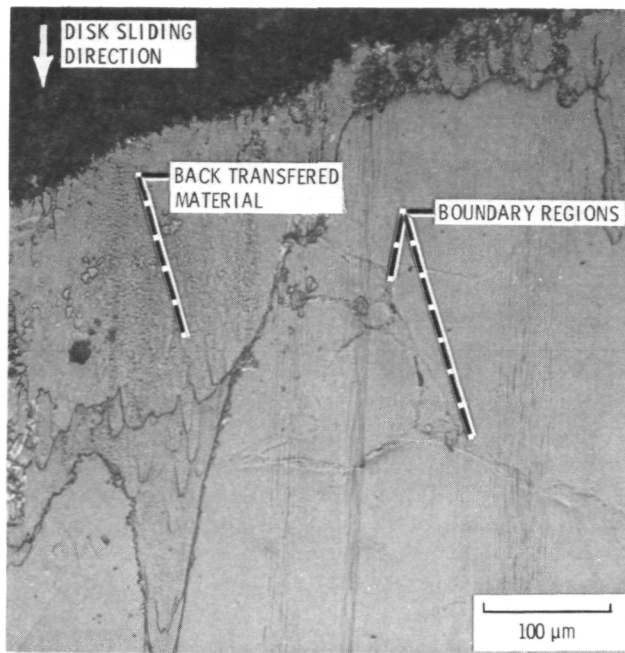
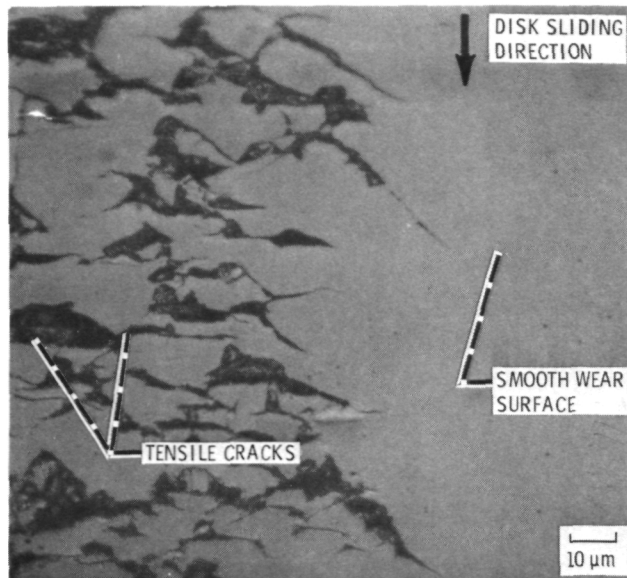
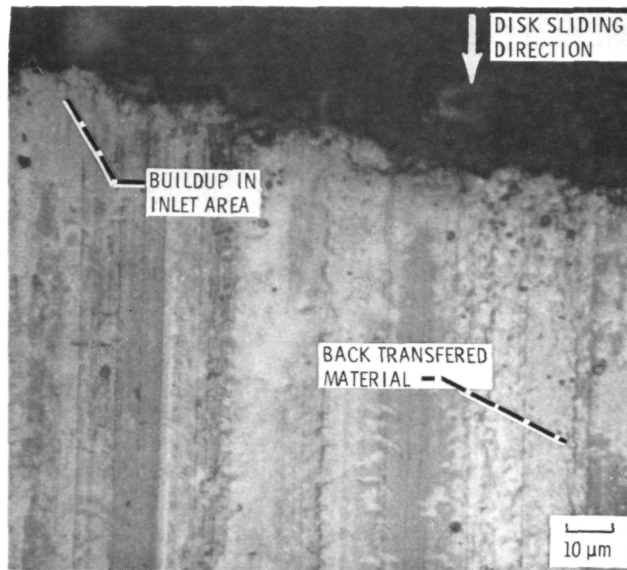

Figure 9. - Representative photomicrograph of the PMDA polyimide pin wear surfaces.



(a) 25<sup>0</sup> to 200<sup>0</sup> C at slower sliding speeds.



(b) 300<sup>0</sup> C at 3.1 m/s or 25<sup>0</sup> C at 11.6 m/s.

Figure 10. - 80/20 and 60/40 PMDA/BTDA polyimide pin wear surfaces.



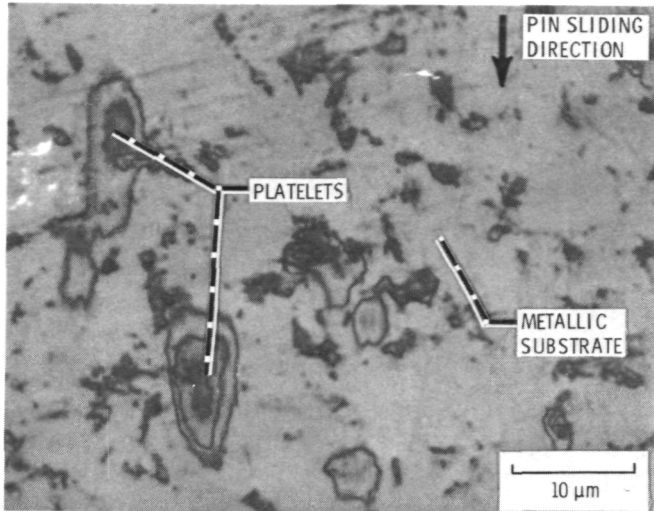

(a) Type A, thin ( $<1\ \mu\text{m}$ ) platelets.

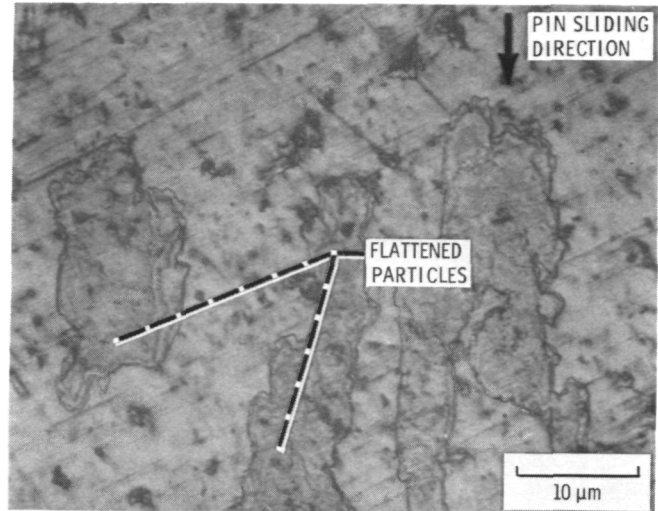

(c) Type C, thick ( $>2\ \mu\text{m}$ ), flattened wear particles.

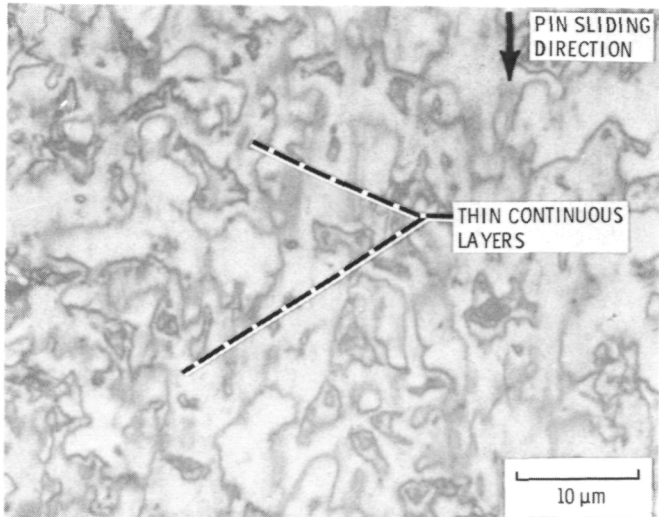

(b) Type B, thin ( $<1\ \mu\text{m}$ ), continuous layers.

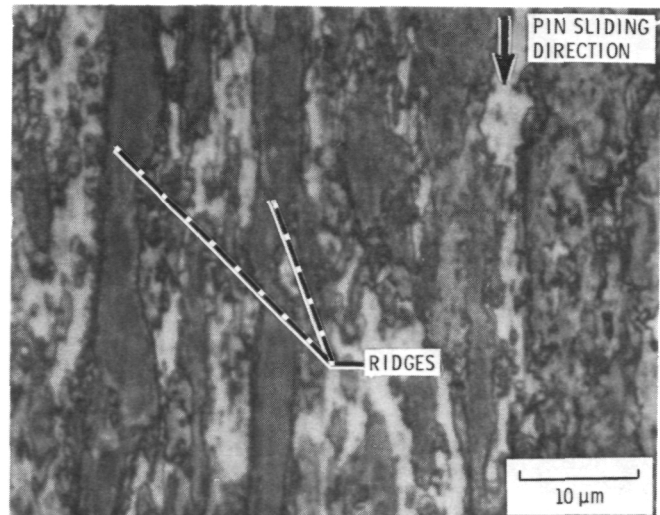

(d) Type D, thick ( $>2\ \mu\text{m}$ ), ridge-like layers.

Figure 11. - Four types of polyimide transfer to the metallic counterface.

1. Report No. NASA TM-83629	2. Government Accession No.	3. Recipient's Catalog No.	
4. Title and Subtitle  Low Wear Partially Fluorinated Polyimides		5. Report Date	
		6. Performing Organization Code 505-33-1B	
7. Author(s)  Robert L. Fusaro and William F. Hady		8. Performing Organization Report No. E-2066	
		10. Work Unit No.	
9. Performing Organization Name and Address National Aeronautics and Space Administration Lewis Research Center Cleveland, Ohio 44135		11. Contract or Grant No.	
		13. Type of Report and Period Covered Technical Memorandum	
12. Sponsoring Agency Name and Address National Aeronautics and Space Administration Washington, D.C. 20546		14. Sponsoring Agency Code	
15. Supplementary Notes Prepared for the Joint Lubrication Conference cosponsored by the American Society of Mechanical Engineers and the American Society of Lubrication Engineers, San Diego, California, October 22-24, 1984.			
16. Abstract Tribological studies were conducted on five different polyimide solid bodies formulated from the diamine 2,2-bis [4-(4-aminophenoxy)phenyl] hexafluoropropane (4-BDAF) and the dianhydrides pyromellitic acid (PMDA) and benzophenonetetracarboxylic acid (BTDA). The following polyimides were evaluated 4-BDAF/PMDA, 4-BDAF/BTDA, 4-BDAF/80 mole percent PMDA, 20 mole percent BTDA, 4-BDAF/60 mole percent BTDA. Friction coefficients, polyimide wear rates, polyimide surface morphology and transfer films were evaluated at sliding speeds of 0.31 to 11.6 m/s and at temperatures of 25° to 300° C. The results indicate that the tribological properties are highly dependent on the composition of the polyimide and on the experimental conditions. Two polyimides were found which produced very low wear rates but very high friction coefficients (greater than 0.85) under ambient conditions. They offer considerable potential for high traction types of application such as brakes.			
17. Key Words (Suggested by Author(s)) Polyimide; Friction; Wear; Solid lubricant; Polymer, Self-lubricating		18. Distribution Statement Unclassified - unlimited STAR Category 27	
19. Security Classif. (of this report) Unclassified	20. Security Classif. (of this page) Unclassified	21. No. of pages	22. Price*

National Aeronautics and  
Space Administration

Washington, D.C.  
20546

Official Business  
Penalty for Private Use, \$300

SPECIAL FOURTH CLASS MAIL  
BOOK

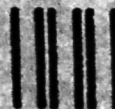

Postage and Fees Paid  
National Aeronautics and  
Space Administration  
NASA-451

**NASA**

**POSTMASTER:** If Undeliverable (Section 158  
Postal Manual) Do Not Return

---