



Technical Memorandum 80258

(DP4-10153) HEAT CAPACITY MAPPING
RADIOMETER (HCRM) DATA PROCESSING ALGORITHM,
CALIBRATION, AND FLIGHT PERFORMANCE
EVALUATION (NASA) 173 P. MC ACB/MF A01

834-27245

JUL 1984

CSCL 14B 63/43 J0153

HEAT CAPACITY MAPPING RADIOMETER (HCRM) DATA PROCESSING ALGORITHM, CALIBRATION, AND FLIGHT PERFORMANCE EVALUATION

J. R. Bohse, M. Bewtra, and
W. L. Barnes

APRIL 1979



National Aeronautics and
Space Administration

Goddard Space Flight Center
Greenbelt, Maryland 20771

(+)

TM 80253

HEAT CAPACITY MAPPING RADIOMETER (HCMR)
DATA PROCESSING ALGORITHM, CALIBRATION,
AND FLIGHT PERFORMANCE EVALUATION

J. R. Bohse
Systems and Applied Sciences Corporation

M. Bewtra
Computer Sciences Corporation

W. L. Barnes
Goddard Space Flight Center

April 1979

National Aeronautics and Space Administration
Goddard Space Flight Center
Greenbelt, Maryland

HEAT CAPACITY MAPPING RADIOMETER (HCMR)
DATA PROCESSING ALGORITHM, CALIBRATION,
AND FLIGHT PERFORMANCE EVALUATION

J. R. Bohse*
Systems and Applied Sciences Corporation

M. Bewtra
Computer Sciences Corporation

W. L. Barnes
Goddard Space Flight Center

ABSTRACT

This document presents the rationale and procedures used in the radiometric calibration and correction of Heat Capacity Mapping Mission (HCMM) data.

Instrument-level testing and calibration of the Heat Capacity Mapping Radiometer (HCMR) were performed by the sensor contractor ITT Aerospace/Optical Division. The principal results are included in this document. From the instrumental characteristics and calibration data obtained during ITT acceptance tests, an algorithm for post-launch processing was developed.

Integrated spacecraft-level sensor calibration was performed at Goddard Space Flight Center (GSFC) approximately 2 months before launch. This calibration provided an opportunity to validate the data calibration algorithm. Instrumental parameters and results of the validation are presented in this document. In addition, the performances of the instrument and the data system after launch are examined with respect to the radiometric results. Anomalies and their consequences are discussed. Flight data indicated a loss in sensor sensitivity with time. The loss was shown to be recoverable by an outgassing procedure performed approximately 65 days after the infrared channel was turned on. It is planned to repeat this procedure periodically.

*This work performed while affiliated with Computer Sciences Corporation.

Results of comparisons between satellite measurements and surface measurements taken at White Sands, New Mexico, are also presented. Surface IR measurements are approximately 6 degrees Kelvin higher than satellite measurements. Due to a lack of alternative solution, the calibrated data were offset to ensure agreement with surface measurements. The validity of this change will be verified by comparing the data with the surface values obtained by various experimenters and from additional White Sands data.

FOREWORD

The algorithm and software development and testing and analysis described in this document were performed by two of the authors (JB and MB) under contract NAS5-24350 Task 403. Portions of the document are taken from the final report of this work (CSC/TM-79/6016).

Instrumental parameters and calibration data were compiled from the HCMR Final Engineering Report (Contract NAS5-20621) of the ITT Aerospace/Optical Division, Fort Wayne, Indiana.

The authors wish to acknowledge the valuable support of Dr. J. C. Price, Heat Capacity Mapping Mission Project Scientist and Mr. H. F. Shaw, Heat Capacity Mapping Radiometer Technical Officer.

TABLE OF CONTENTS

	<u>Page</u>
<u>Section 1 - Introduction</u>	1
1.1 Background	1
1.2 HCMR	1
1.3 Document Overview	2
<u>Section 2 - Instrumental Parameters and Calibration Data From</u> <u>ITT Acceptance Tests</u>	12
2.1 Telemetry and Electronic Performance	12
2.2 Visible Channel Data	12
2.3 Infrared Channel Data	17
2.4 Optical Registration Data	29
<u>Section 3 - Data Processing Algorithm for Radiometric Calibration</u> <u>and Correction</u>	31
3.1 Functional Description of HCMM Primary Data Processing	31
3.2 Basis of HCMR Radiometric Correction Algorithm	32
3.3 Master Output Table Concept	36
3.4 Housekeeping Data Extraction	37
3.5 Scan Data Calibration	38
3.5.1 Count-To-Voltage Conversion	40
3.5.2 Channel 1 Data Calibration	44
3.5.3 Channel 2 Data Calibration	44
3.6 Master Output Tables	48
3.6.1 Primary Tables	50
3.6.2 Secondary Tables	54
<u>Section 4 - Integrated Spacecraft Thermal-Vacuum Calibration</u>	59
4.1 Near-Real-Time Data Processing System	59
4.1.1 Infrared Channel	60
4.1.2 Visible Channel	63
4.2 Summary of Results	65
4.2.1 Infrared Channel	65
4.2.2 Visible Channel	73
4.3 Testing of Preflight Calibration Constants	73
4.4 Conclusions	82

TABLE OF CONTENTS (Cont'd)

	<u>Page</u>
<u>Section 5 - Flight Performance Evaluation</u>	87
5.1 Processing System for Noise and Performance Analysis	87
5.2 Summary of Results	88
5.3 Master Data Processor Simulation Software	93
5.3.1 Results of Noise Analysis for Calibrated Data	93
5.3.2 Ground Truth Comparisons	99
5.4 Conclusions	101
5.4.1 Cooler Temperature Regulation	101
5.4.2 Postlaunch Sensor Sensitivity	102
5.4.3 Postlaunch Value of Thermal Gradient ΔT_{BB}	103
5.4.4 Losses in Optical Transmission	103
5.4.5 Compensation for Changes in Sensor Performance	105
<u>References</u>	106
<u>Appendix A</u>	107
Program CCTANL	108
Program MDPSIM	115
Program CORECT	123
<u>Program Listings</u>	128

LIST OF ILLUSTRATIONS

<u>Figure</u>		<u>Page</u>
1-1	HCMR Pertinent Features (Front View)	5
1-2	HCMR Pertinent Features (Back View)	6
1-3	HCMR Functional Block Diagram	7
1-4	HCMR Scan Sequence	8
1-5	HCMR Analog Data Formant	9
2-1	HCMR Detector Response for Channel 1	18
2-2	Near-Infrared Calibration	20
2-3	Spectral Response of HCMR HgCdTe (Serial Number T-1) at 115 degrees K	22
2-4	Transmission Characteristics of Germanium Band Pass Filter	23
2-5	HCMR Spectral Response, Infrared Channel	24
2-6	Family of Curves Obtained by Plotting Calibration Values of Table 2-7	27
2-7	Average Difference Between Blackbody Temperature From Signal Line and Blackbody Temperature Read From Signal	28
3-1	HCMR Data Format	39
3-2	HCMR Radiometric Calibration and Correction	41
3-3	Channel 1 Calibration (General)	45
3-4	Channel 2 Calibration (General)	46
3-5	Channel 2 Calibration (Internal Blackbody)	49
5-1	Sample Report	89
5-2	Actual and Fitted Loss in Sensitivity Prior to Undervoltage Condition	94
5-3	Actual and Fitted Loss in Sensitivity After Recovery From Undervoltage Condition	96
A1	Subprograms for CCTANL	109
A2	Flowchart for CCTANL	110
A3	Subprograms for MDPSIM	116
A4	Flowchart for MDPSIM	117
A5	Subprograms for CORECT	124
A6	Flowchart for CORECT	125

LIST OF TABLES

<u>Table</u>		<u>Page</u>
1-1	HCMR System Characteristics	3
1-2	HCMR Telemetry List	10
2-1	Analog Telemetry Data	13
2-2	HCMR Calibration Steps	14
2-3	Measured Values of $NE\Delta T$ and Signal-to-Noise Ratio	15
2-4	Measured Spectral Data	16
2-5	Near-Infrared Calibration	19
2-6	HCMR Spectral Response Parameters, Infrared Channel	21
2-7	Infrared Analog Calibration Data	25
2-8	HCMR IFOV and Registration Data	30
3-1	Preflight Constants for HCMM Radiometric Calibration	35
3-2	Nominal Volts for Input and Output Calibration Steps	43
4-1	Constants for Processing Spacecraft Calibration Data	61
4-2	Coefficients for Converting Infrared Video Output to Temperature	64
4-3	Comparison of Temperatures Using ITT Calibration and Spacecraft Calibration - Hot Cycle	66
4-4	Comparison of Temperatures Using ITT Calibration and Spacecraft Calibration - Ambient Cycle	67
4-5	Comparison of Temperatures Using ITT Calibration and Spacecraft Calibration - Cold Cycle	68
4-6	Spacecraft Calibration Data (Infrared) - Hot Cycle	69
4-7	Spacecraft Calibration Data (Infrared) - Ambient Cycle	70
4-8	Spacecraft Calibration Data (Infrared) - Cold Cycle	71
4-9	Typical rms Noise Values for Spacecraft Test (Infrared)	72
4-10	Comparison of Spacecraft Calibration Data With ITT Data for Infrared Input Calibration Steps - Hot Cycle.	74
4-11	Comparison of Spacecraft Calibration Data With ITT Data for Infrared Input Calibration Steps - Ambient Cycle	75
4-12	Comparison of Spacecraft Calibration Data With ITT Data for Infrared Input Calibration Steps - Cold Cycle	76
4-13	Visible Calibration Prior to Spacecraft Test	77
4-14	Visible Calibration After Spacecraft Test	78
4-15	Typical rms Noise Values for Visible Channel	79
4-16	Comparison of Spacecraft Data With ITT Data for Visible Input Calibration Steps (January 30, 1978)	80
4-17	Comparison of Spacecraft Data With ITT Data for Visible Input Calibration Steps (March 1, 1978)	81
4-18	Comparison of Calibrated Target Temperatures and Measured Target Temperatures - Hot Cycle	83
4-19	Comparison of Calibrated Target Temperatures and Measured Target Temperatures - Ambient Cycle	84

SECTION 1 - INTRODUCTION

1.1 BACKGROUND

The Heat Capacity Mapping Mission (HCMM) is the first of a series of scheduled missions to support the Applications Explorer Mission (AEM) project and has been designated AEM-A. The AEM-A spacecraft carries a Heat Capacity Mapping Radiometer (HCMR) instrument designed to monitor infrared radiation from the Earth in two spectral bands. The spacecraft is composed of two distinct modules: (1) the base module, which contains the attitude control, power, and data handling equipment (except for science sensor equipment), and (2) the instrument module, which contains the HCMR and its supporting electronics, structure, and thermal control.

In April 1978, the AEM-A spacecraft was launched and injected into a near-Earth, 600-kilometer, circular, Sun-synchronous orbit with a nominal 2 p.m. ascending node and a 97.79-degree inclination. The expected scientific lifetime of the spacecraft is 1 year from launch. HCMM is a real-time-only mission. Science data, consisting of data from two analog radiometer channels, are subcarrier-multiplexed on a real-time S-band link. Housekeeping data, including attitude and some radiometer calibration data, are formatted into biphasic pulse code modulation (PCM) and transmitted on a very-high-frequency (VHF) link. These PCM data are also transmitted on a subcarrier of the S-band link. Subcarrier assignments for the link are as follows:

- 800 kilohertz: HCMR thermal channel
- 480 kilohertz: HCMR visible channel
- 70 kilohertz: spacecraft PCM

1.2 HCMR

The HCMR is a two-channel scanning/imaging radiometer. The two channels contain the spectral intervals of 0.55 to 1.1 microns and 10.5 to 12.5 microns

and share a common collecting optical system having an instantaneous field of view of 0.83 ± 0.17 milliradian. Table 1-1 describes HCMR system characteristics. Figures 1-1 and 1-2 show the locations of the pertinent features of the HCMR.

Figure 1-3 is a simplified block diagram of the HCMR electronics. The HCMR electronics transmits to the spacecraft two channels of video data synchronized with the spacecraft clock and the rotation of the HCMR scan mirror. The input signals to the HCMR are the spacecraft +28.0-volts-direct-current (VDC) bus; clock signals of 70 kilohertz, 14 kilohertz, and 560 hertz two-phase; and spacecraft commands to the HCMR to implement the available modes of operation. The HCMR electronics provides power conversion, timing and control, signal generation, digital and analog telemetry for verification of operation, and signal amplification for required operation.

The basic blocks of the HCMR electronics are as follows:

1. Infrared data amplifiers
2. Visible data amplifiers
3. Power converter
4. Voltage regulators
5. Timing and control circuits
6. Calibration signal generation circuits
7. Analog telemetry circuits
8. Command and digital telemetry circuits

The HCMR scan sequence, angular representations for various quantities, and the corresponding times are provided in Figures 1-4 and 1-5. Table 1-2 provides digital and analog telemetry listings.

1.3 DOCUMENT OVERVIEW

Section 2 of this document presents instrumental parameters and calibration data from ITT Aerospace acceptance tests. Only those results that pertain to

Table 1-1. HCMR System Characteristics (1 of 2)

PARAMETER	VALUE/DESCRIPTION
DESIGN PARAMETERS	
WAVELENGTH BAND AT HALF-POWER POINTS	0.55 TO 1.1 MICRONS, 10.5 TO 12.5 MICRONS
FIELD OF VIEW	0.83 MILLIRADIAN
GROUND RESOLUTION (SUBSATELLITE POINT AT 800 KILOMETERS)	0.5 KILOMETER
OPTICAL SPEED	f/0.82
COLLECTING APERTURE DIAMETER	8.0 INCHES
DETECTOR TYPE	HgCdTe-SILICON
OPERATING TEMPERATURE	115 DEGREES KELVIN (K) (AMBIENT)
SCAN RATE	14.0 REVOLUTIONS PER SECOND
INFORMATION BANDWIDTH	53.0 KILOHERTZ
DYNAMIC RANGE	
CHANNEL 2	280 TO 340 DEGREES K
CHANNEL 1	0- TO 100-PERCENT ALBEDO
PERFORMANCE CHARACTERISTICS	
NOISE EQUIVALENT TEMPERATURE DIFFERENCE (NETD) (CHANNEL 2)	0.3 DEGREE K AT 280 DEGREES K
SIGNAL-TO-NOISE RATIO (CHANNEL 1)	10 AT 1.0-PERCENT ALBEDO
PHYSICAL CHARACTERISTICS	
WEIGHT	53.8 POUNDS
SIZE	22 BY 12 BY 17 INCHES
POWER (HIGH-LOW)	24.0 WATTS-21.0 WATTS
OPTICAL PARAMETERS	
INSTANTANEOUS FIELD OF VIEW	SQUARE, 0.83 MILLIRADIAN ON AN EDGE
TELESCOPE	
TYPE	AFOCAL DALL-KIRKAM
CLEAR APERTURE DIAMETER	8.00 INCHES
F-NUMBER (PRIMARY)	0.92
EXIT BEAM DIAMETER	1.00 INCH
MIRROR SUBSTRATE MATERIAL	CERVIT
PRIMARY-SECONDARY SPACER MATERIAL	INVAR
COATING	ALUMINIZED WITH KANIGEN PROCESSING COATING
SYSTEM OPTICAL PARAMETERS, NEAR-INFRARED CHANNEL	
RELAY	AIRSPACE TRIPLET; 32-MILLIMETER FOCAL LENGTH
EFFECTIVE SYSTEM FOCAL LENGTH	286.0 MILLIMETERS

Table 1-1. HCMR System Characteristics (2 of 2)

PARAMETER	VALUE/DESCRIPTION
OPTICAL PARAMETERS (CONT'D)	
F-NUMBER ^a	1.26
FIELD STOP EDGE WIDTH	0.0084 INCH
DIAMETER OF BLUR SPOT, ON AXIS	0.0016 INCH ^b
DIAMETER OF BLUR SPOT, FIELD CORNER	0.0022 INCH ^b
MODULAR TRANSFER FUNCTION (ON AXIS) AT THREE LINE PAIRS PER MILLIMETER	99.3 PERCENT
MODULAR TRANSFER FUNCTION (FIELD CORNER) AT THREE LINE PAIRS PER MILLI- METER	99.2 PERCENT
FOCUS ADJUSTMENT	±0.0326 INCH
CLEAR APERTURE	6.56 INCHES ^c
SYSTEM OPTICAL PARAMETERS, FAR INFRARED CHANNEL	
RELAY	SINGLE GERMANIUM FOCUS LENS WITH GERMANIUM APLANAT LENS; 23.775-MILLI- METER FOCAL LENGTH
EFFECTIVE SYSTEM FOCAL LENGTH	190.2 MILLIMETERS
FIELD STOP EDGE WIDTH	0.0062 INCH
F-NUMBER	0.936
DIAMETER OF BLUR SPOT, ON AXIS	0.0012 INCH ^d
DIAMETER OF BLUR SPOT, FIELD CORNER	0.0042 INCH ^d
MODULAR TRANSFER FUNCTION (ON AXIS) AT 3.6 LINE PAIRS PER MILLIMETER	99.0 PERCENT
MODULAR TRANSFER FUNCTION (FIELD CORNER) AT 3.6 LINE PAIRS PER MILLI- METER	95.5 PERCENT
FOCUS ADJUSTMENT (AIR SPACE BETWEEN FOCUS LENS AND APLANAT)	±0.141 INCH
CLEAR APERTURE	8 INCHES

^aF-NUMBER DEFINED AS EFFECTIVE FOCAL LENGTH DIVIDED BY CLEAR APERTURE DIAMETER

^bFOR SPECTRAL BAND FROM 0.80 TO 1.10 MICROMETERS AND 100-PERCENT ENERGY

^cLIMITED BY SIZE OF RELAY LENS; COULD NOT BE CHANGED WITHOUT EXTENSIVE REDESIGN

^dFOR 100-PERCENT ENERGY

ORIGINAL PAGE IS
OF POOR QUALITY

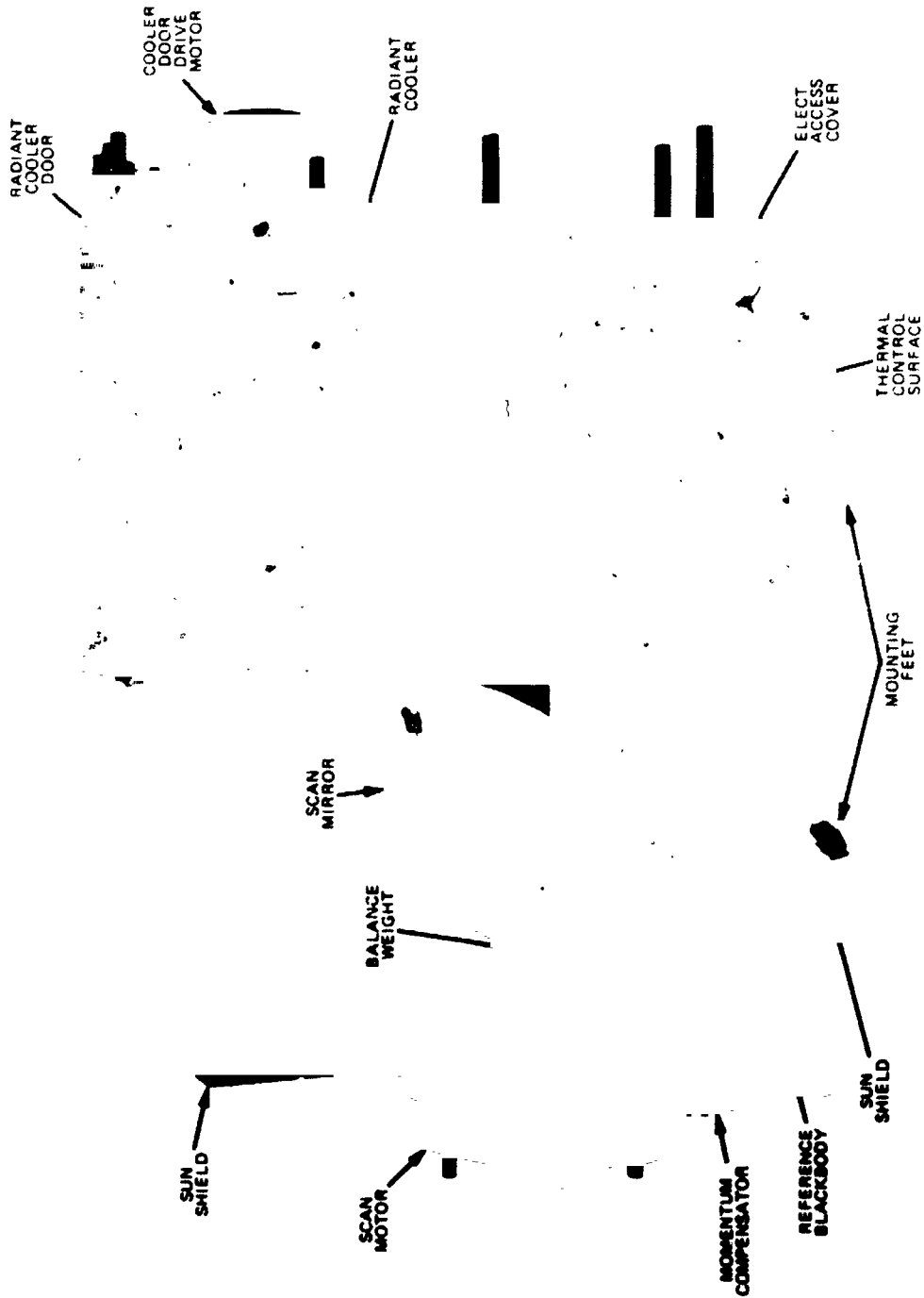

Figure 1-1. HCMR Pertinent Features (Front View)

ORIGINAL PAGE IS
OF POOR QUALITY

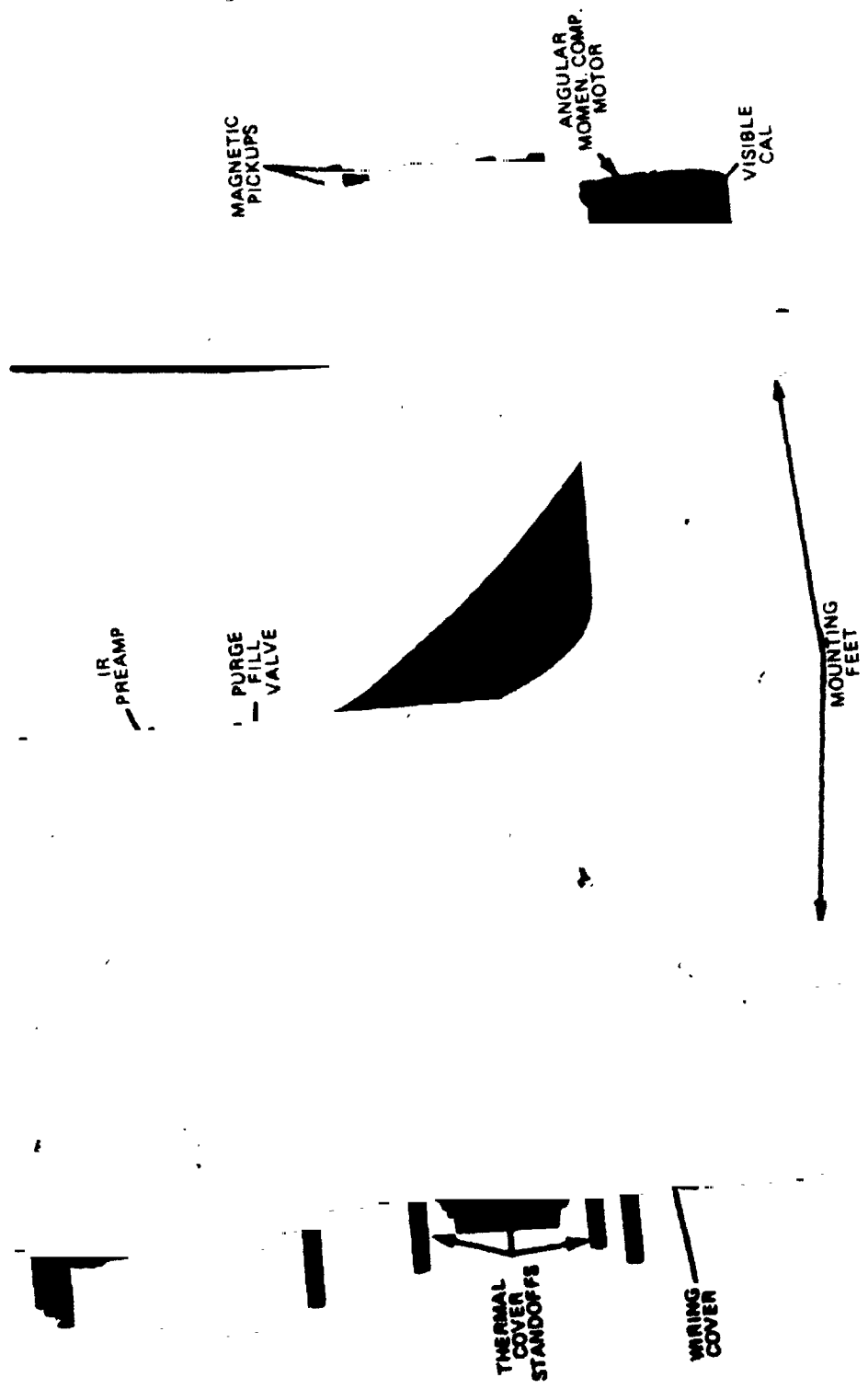

Figure 1-2. HCMR Pertinent Features (Back View)

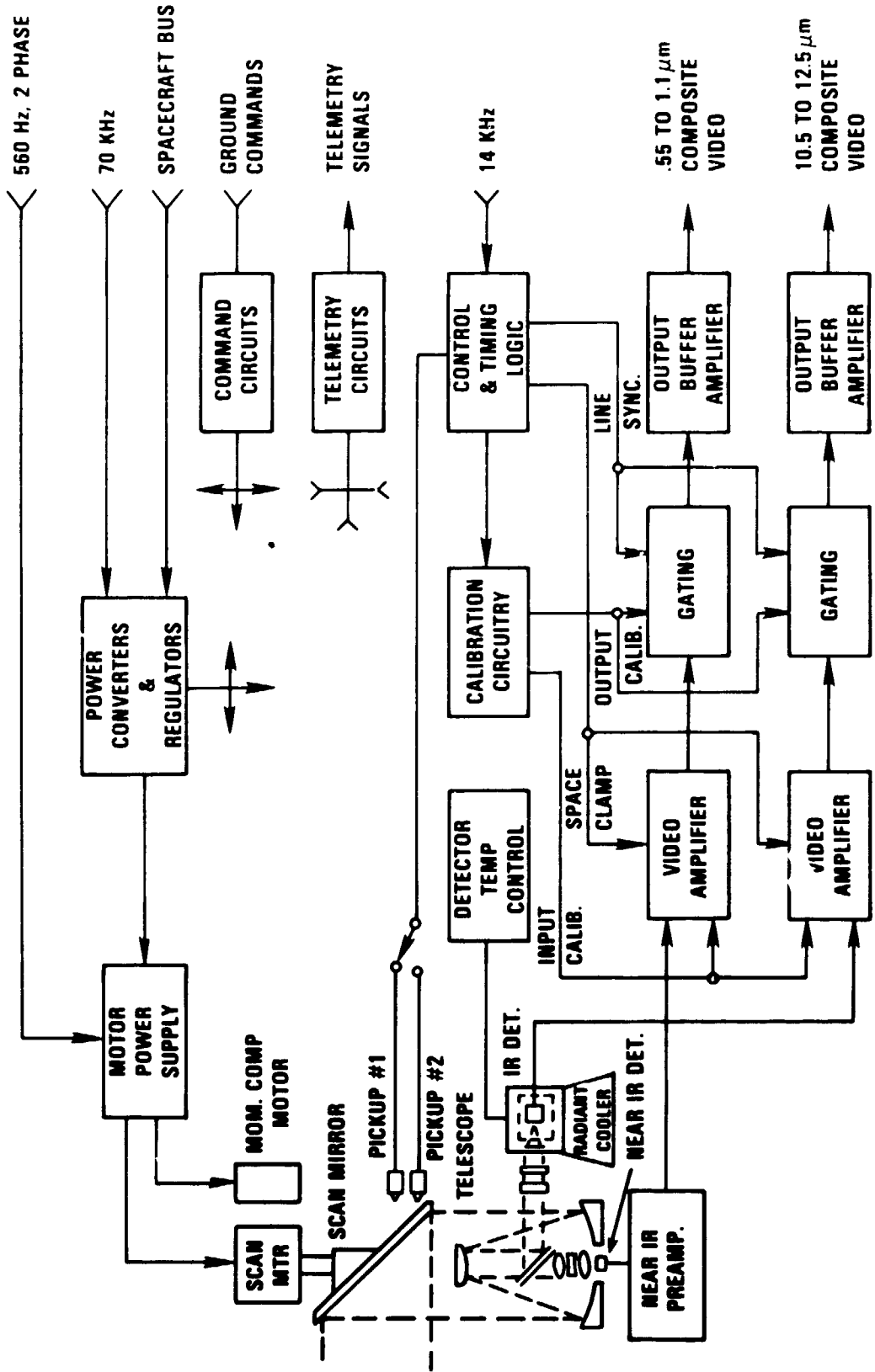
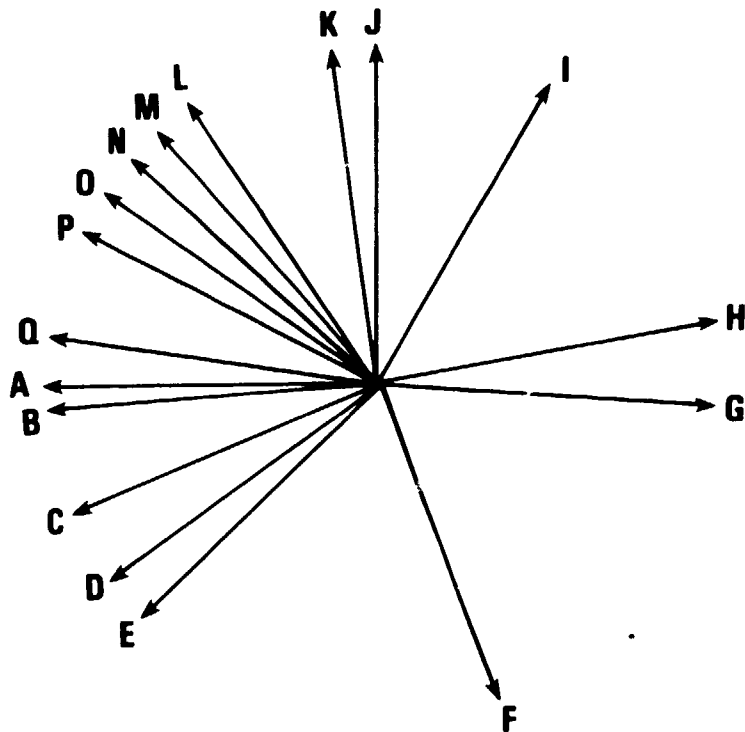

Figure 1-3. HCMR Functional Block Diagram

ORIGINAL PAGE IS
OF POOR QUALITY



REFERENCE LETTER	ANGLE (DEGREES)	TIME (ms)	EVENT
A	0	0	BEGIN SYNC PULSE #1
B	3.6	0.714	END SYNC PULSE #1
C	21.6	4.28	BEGIN INPUT CALIBRATION
D	34.2	6.79	END INPUT CALIBRATION
E	42.9	8.51	BEGIN EARTH SCAN
F	109	21.63	NADIR
G	175.1	34.74	END EARTH SCAN
H	189	37.5	BEGIN OUTPUT CALIBRATION
I	239.4	47.5	END OUTPUT CALIBRATION
J	270.4	53.65	BEGIN INTERNAL TARGET VIEW
K	278.3	55.22	COMPLETE INTERNAL TARGET VIEW
L	304.2	60.36	BEGIN INTERNAL TARGET TEMPERATURE TELEMETRY
M	311.4	61.78	END INTERNAL TARGET TEMPERATURE TELEMETRY
N	318.6	63.21	BEGIN SYNC PULSE #2
O	325.8	64.64	END SYNC PULSE #2
P	333.0	66.07	BEGIN PRECURSOR BURST
Q	351.0	69.64	END PRECURSOR BURST

Figure 1-4. HCMR Scan Sequence

ORIGINAL QUALITY
OF POOR QUALITY

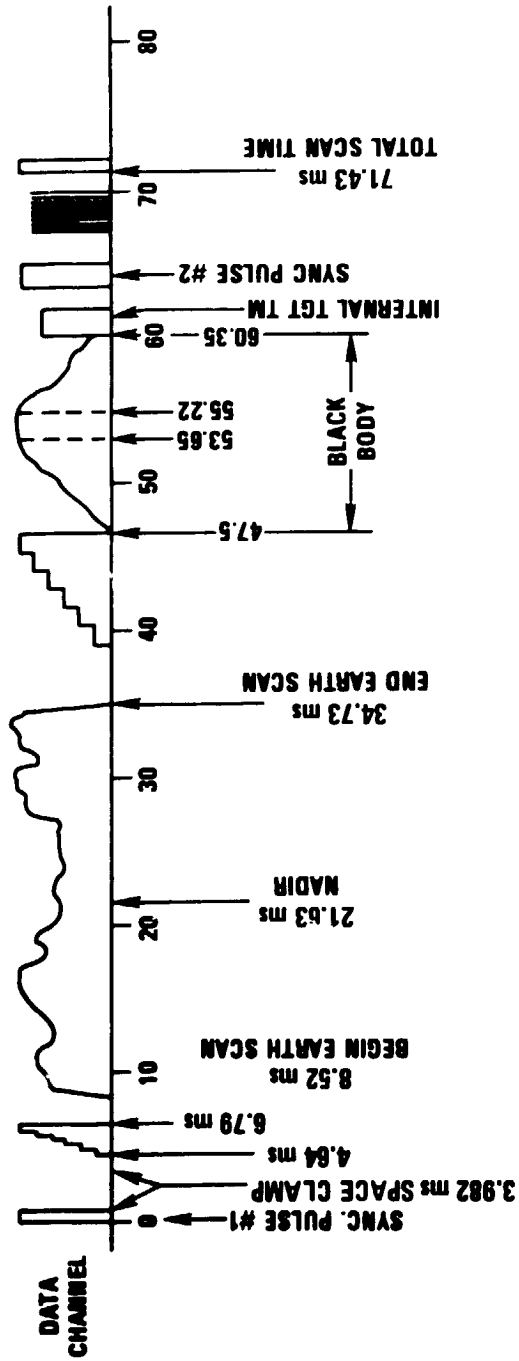

Figure 1-5. HCMR Analog Data Format

Table 1-2. HCMR Telemetry List

FUNCTION	SAMPLE RATE (PER SECOND)
ANALOG TELEMETRY	
+15-VOLT MONITOR	1
+5-VOLT MONITOR	1
-15-VOLT MONITOR	1
TELEMETRY POWER	1
MOTOR DRIVE CURRENT	1
CONE COVER POSITION	1
ELECTRONICS TEMPERATURE	1/8
BASEPLATE TEMPERATURE	1/8
CONE TEMPERATURE	1/8
PATCH TEMPERATURE	1
BLACKBODY TEMPERATURE 1	1
BLACKBODY TEMPERATURE 2	1
PURGE PRESSURE	1
CONE WALL HOUSING TEMPERATURE	1/8
PATCH POWER	1
ELECTRONICS CURRENT	1
OFFSET VOLTAGE	1
MOMENTUM COMPENSATOR SPEED	1
SCAN MOTOR SPEED	1
MOTOR HOUSING TEMPERATURE	1/8
DIGITAL TELEMETRY	
MOTOR STATUS	1
ELECTRONICS STATUS	1
MOTOR POWER STATUS	1
PATCH HEATER STATUS	1
CONE HEATER STATUS 1	1
PURGE VALVE STATUS	1
CONE COVER STATUS 2	1

the radiometric calibration and correction of HCMM data are included. Section 3 contains a review of the entire HCMM primary processing scheme and describes the basis and development of the HCMM radiometric correction algorithm. Section 4 presents the results from the integrated spacecraft calibration performed at Goddard Space Flight Center (GSFC). Data taken during this calibration were used to validate the algorithm developed earlier. Results of this validation are also included in Section 4. Section 5 examines the performance of the instrument and the data system after launch with respect to the radiometric results. Anomalies and their consequences discovered in the performance of the sensor are discussed. Results of comparisons between satellite and ground measurements taken at White Sands, New Mexico, are also presented.

SECTION 2 - INSTRUMENTAL PARAMETERS AND CALIBRATION
DATA FROM ITT ACCEPTANCE TESTS

The final performance characteristics of the HCMR were determined by ITT Aerospace, the instrument manufacturer, in a series of tests conducted at the ITT facility as part of the acceptance procedures. The test results and supplemental information on the HCMR were presented in two reports by ITT (References 1 and 2). Because the algorithm developed for interpreting the data was a function of the particular characteristics of the instrument, it is necessary to refer to these data frequently. To facilitate this, many of the results and calibrations presented by ITT are reproduced in this section as a reference source for following sections. Because this document deals primarily with the radiometric calibration, only those results pertinent to a radiometric evaluation of the data are presented. Additional information may be found in the original documents (References 1 and 2).

2.1 TELEMETRY AND ELECTRONIC PERFORMANCE

Table 2-1 lists all of the analog telemetry parameters associated with the HCMR and presents measured values of these parameters as functions of baseplate temperature covering the test range of 5 degrees Celsius (C) to 40 degrees C.

Table 2-2 records the measured voltages for the input and output calibration steps for both channels as functions of baseplate temperature.

Table 2-3 lists the measured values of the noise equivalent temperature (NE Δ T) in the infrared channel and the signal-to-noise ratio in the visible channel at selected baseplate temperatures.

2.2 VISIBLE CHANNEL DATA

Table 2-4 lists the measured spectral data for the various optical components of the visible/near-infrared channel.

Table 2-1. Analog Telemetry Data

ANALOG TELEMETRY NUMBER	FUNCTION	BASEPLATE TEMPERATURE (DEGREES C)								
		+5	+10	+15	+20	+25	+30	+35	+40	
1	ELECTRONICS TEMPERATURE (DEGREES C)	5.9	9.0	12.2	14.7	17.7	20.3	24.0	27.1	
2	CONE TEMPERATURE (DEGREES K)	161.3	161.71	162.05	162.36	162.70	163.1	163.41	164.05	
3	BASEPLATE TEMPERATURE (DEGREES C)	+5.5	11.0	15.6	20.0	24.6	29.5	34.1	39.5	
4	BLACKBODY TEMPERATURE 1 (DEGREES C)	5.91	10.79	14.93	18.86	23.08	27.15	31.28	35.88	
5	BLACKBODY TEMPERATURE 2 (DEGREES C)	5.86	10.79	14.98	18.94	23.18	27.27	31.42	36.05	
6	PATCH TEMPERATURE (DEGREES K)	115.49	115.51	115.53	115.55	115.56	115.58	115.61	115.63	
7	MOTOR DRIVE CURRENT (AMPERES)	0.297	0.293	0.286	0.282	0.276	0.269	0.264	0.258	
8	+15-VOLT MONITOR (+ VOLTS)	+14.67	-	-	-	-	-	-	+14.67	
9	-15-VOLT MONITOR (- VOLTS)	-13.56	-	-	-	-	-	-	-13.56	
10	+5-VOLT MONITOR (+ VOLTS)	+5.084	5.092	5.092	5.090	5.090	5.088	5.086	5.084	
11	SPARE	-	-	-	-	-	-	-	-	
12	PREAMP POWER TELEMETRY (+ VOLTS)	10.9	-	-	-	-	-	-	10.09	
13	TELEMETRY POWER (+ VOLTS)	14.81	-	-	-	-	-	-	14.81	
14	CONE COVER POSITION (DEGREES)	10.4	-	-	-	-	-	-	10.4	
15	PATCH POWER (MILLIWATTS)	7.53	7.24	7.00	6.77	6.80	6.28	5.97	5.64	
16	COOLER HOUSING TEMPERATURE (DEGREES C)	-6.5	-5.5	-4.5	-4.5	-3.0	-2.5	-0.7	0	
17	PURGE PRESSURE (POUNDS PER SQUARE INCH GAGE)	87	-	-	-	-	-	-	87	
18	ELECTRONIC CURRENT (+ AMPERES)	0.394	-	-	-	-	-	-	0.394	
19	SIGNAL GROUND	-	-	-	-	-	-	-	-	
20	SIGNAL GROUND	-	-	-	-	-	-	-	-	
21	MOTOR HOUSING TEMPERATURE (DEGREES C)	+6	+11	+15	+19	+23.3	+27.5	+31.5	36.3	
22	+28-VOLT RETURN	-	-	-	-	-	-	-	-	
23	OFFSET VOLTAGE (VOLTS)	7.54	-	-	-	-	-	-	7.54	
24	COMPENSATOR MOTOR SPEED TELEMETRY (REVOLUTIONS PER MINUTE)	4794	4794	4794	4794	4823	4823	4823	4823	
25	SCAN MOTOR SPEED TELEMETRY (REVOLUTIONS PER MINUTE)	839.9	-	-	-	-	-	-	839.9	

Table 2-2. HCMR Calibration Steps

STEP NUMBER	BASEPLATE TEMPERATURE (DEGREES C)							
	+5	+10	+15	+20	+25	+30	+35	+40
NEAR-INFRARED INPUT (VOLTS)								
1	-	-0.002	-0.002	0.002	-0.002	0.001	0.007	0.003
2	-	1.003	1.004	1.006	0.997	1.001	1.000	1.002
3	-	1.982	1.982	1.986	1.976	1.979	1.986	1.980
4	-	2.989	2.990	2.989	2.980	2.983	2.939	2.984
5	-	3.957	3.968	3.967	3.958	3.961	3.967	3.964
6	-	4.983	4.987	4.983	4.974	4.977	4.984	4.977
7	-	5.957	5.964	5.962	5.952	5.953	5.962	5.953
NEAR-INFRARED OUTPUT (VOLTS)								
1	-	0.011	0.002	0.006	0.006	0.002	0.008	0.008
2	-	0.978	0.969	0.969	0.970	0.969	0.969	0.969
3	-	1.976	1.967	1.972	1.969	1.966	1.970	1.9687
4	-	2.951	2.947	2.948	2.947	2.945	2.947	2.945
5	-	3.958	3.954	3.954	3.956	3.952	3.952	3.954
6	-	4.934	4.929	4.928	4.929	4.926	4.929	4.927
7	-	5.928	5.926	5.924	5.922	5.923	5.925	5.923
INFRARED INPUT (VOLTS)								
1	0.102	0.104	0.102	0.104	0.102	0.102	0.101	0.098
2	1.062	1.062	1.060	1.056	1.058	1.057	1.060	1.053
3	1.987	1.991	1.988	1.986	1.991	1.990	1.991	1.988
4	2.945	2.945	2.942	2.940	2.943	2.944	2.946	2.942
5	3.887	3.883	3.874	3.877	3.875	3.875	3.875	3.873
6	4.855	4.852	4.848	4.842	4.847	4.849	4.852	4.843
7	5.789	5.783	5.778	5.778	5.780	5.783	5.783	5.777
INFRARED OUTPUT (VOLTS)								
1	0.012	0.008	0.007	0.010	0.011	0.008	0.007	0.010
2	0.975	0.970	0.966	0.969	0.969	0.969	0.966	0.968
3	1.966	1.964	1.964	1.962	1.962	1.962	1.961	1.960
4	2.940	2.938	2.936	2.935	2.938	2.936	2.936	2.935
5	3.949	3.947	3.947	3.944	3.944	3.944	3.942	3.942
6	4.926	4.922	4.919	4.921	4.919	4.917	4.919	4.914
7	5.921	5.915	5.915	5.914	5.917	5.912	5.913	5.910

Table 2-3. Measured Values of NEAT and Signal-to-Noise Ratio

BASEPLATE TEMPERATURE (DEGREES C)	INFRARED SCENE TEMPERATURE				DAYLIGHT	
	67 DEGREES C		-13 DEGREES C		100-PERCENT ALBEDO	SIGNAL-TO-NOISE RATIO AT 1-PERCENT ALBEDO
	rms (MILLIVOLTS)	NEAT (DEGREES K)	rms (MILLIVOLTS)	NEAT (DEGREES K)	rms (MILLIVOLTS)	
+46	13.0	0.15	8.3	0.18	8.3	7.2
+40	11.5	0.13	7.0	0.13	8.0	7.5
+36	13.3	0.15	8.3	0.16	8.3	7.2
+30	14.0	0.15	9.0	0.155	8.3	7.2
+26	15.8	0.17	12.5	0.21	8.3	7.2
+20	15.0	0.16	11.5	0.22	7.0	8.6
+15	15.0	0.16	14.0	0.27	8.3	7.2
+10	15.8	0.17	15.0	0.28	8.3	7.2
+ 5	16.6	0.18	13.3	0.25	-	-
0	15.0	0.17	14.0	0.25	-	-

ORIGINAL PAGE IS
OF POOR QUALITY

Table 2-4. Measured Spectral Data

WAVELENGTH (MILLIMETERS)	FOCUS LENS		SCAN MIRROR	GOLD BEAM- SPLITTER	OG 550 SPECTRAL FILTER	TELESCOPE MIRRORS ^a	TOTAL OPTICS TRANSMISSION	SILICON DETECTOR RESPONSE ^b	OPTICS TRANSMISSION DETECTOR RESPONSE	MCMR RELATIVE RESPONSE
	ONE LENS	TRIPLET								
500	0.910	0.754	0.930	0.750	0.0	0.907	0.0	0.22	0.0	0.0
525	0.918	0.774	0.930	0.780	0.140	0.920	0.072	0.24	0.0173	0.062
550	0.925	0.791	0.930	0.800	0.845	0.931	0.463	0.26	0.120	0.432
575	0.933	0.812	0.930	0.819	0.920	0.943	0.535	0.28	0.150	0.540
600	0.938	0.825	0.930	0.829	0.929	0.958	0.566	0.29	0.164	0.590
650	0.946	0.844	0.922	0.838	0.930	0.976	0.592	0.32	0.189	0.680
700	0.952	0.863	0.910	0.830	0.930	0.984	0.596	0.42	0.250	0.899
750	0.957	0.876	0.895	0.802	0.930	0.984	0.575	0.44	0.253	0.910
800	0.960	0.882	0.868	0.780	0.930	0.986	0.534	0.46	0.245	0.885
850	0.960	0.882	0.852	0.708	0.930	0.978	0.486	0.57	0.277	0.996
900	0.960	0.885	0.855	0.643	0.930	0.980	0.443	0.62	0.278	1.000
950	0.960	0.885	0.860	0.580	0.930	0.980	0.400	0.57	0.228	0.824
1000	0.960	0.885	0.860	0.537	0.930	0.978	0.374	0.52	0.193	0.894
1050	0.960	0.885	0.858	0.481	0.930	0.974	0.331	0.37	0.122	0.439
1100	0.960	0.885	0.858	0.438	0.930	0.972	0.301	0.10	0.03	0.108
1150	0.960	0.882	0.860	0.401	0.930	0.976	0.276	0.03	0.008	0.079
1200	0.928	0.878	0.862	0.368	0.930	0.972	0.51	0.0	0.0	0.0

^aPRODUCT OF PRIMARY AND SECONDARY MIRROR REFLECTANCE
^bMARSHALL CHEMICAL COMPANY DETECTOR S N 001

Figure 2-1 shows the relative spectral response of the HCMR detector for channel 1.

Table 2-5 presents the results of the visible channel calibration in units of equivalent albedo. The albedo has been adjusted to account for differences in brightness temperature between the calibration target and the solar spectrum by normalizing solar spectrum. Figure 2-2 presents these data in a graphical format.

2.3 INFRARED CHANNEL DATA

Table 2-6 lists the measured spectral data for the various optical components in the spectral range of the infrared channel.

Figure 2-3 is a plot of the relative spectral response of the HgCdTe detector at 115 degrees K. Figure 2-4 is a plot of the transmission characteristics of the germanium band pass filter used with this detector. Figure 2-5 is a plot of the total relative response of the infrared channel.

Table 2-7 lists the calibration results for the infrared channel with 17 scene temperatures and 10 baseplate temperatures. Figure 2-6 shows the family of curves obtained by plotting the calibration values of Table 2-7.

Figure 2-7 is a plot of the difference between the blackbody temperature as indicated by the thermistors in channel 2 and the temperature obtained from the blackbody located in the backscan position of the radiometer. This quantity, ΔT_{BB} , is assumed to be the result of a thermal gradient between the thermal location on the backstructure of the reference blackbody and the radiating surface of this blackbody. It should be noted that this thermal gradient, ΔT_{BB} , will remain as presented in Figure 2-7 unless the thermal environment of the instrument changes. Thus the preflight values will be the proper values for postflight processing if the space environment has been properly simulated in these thermal-vacuum tests.

ORIGINAL PAGE 19
OF POOR QUALITY

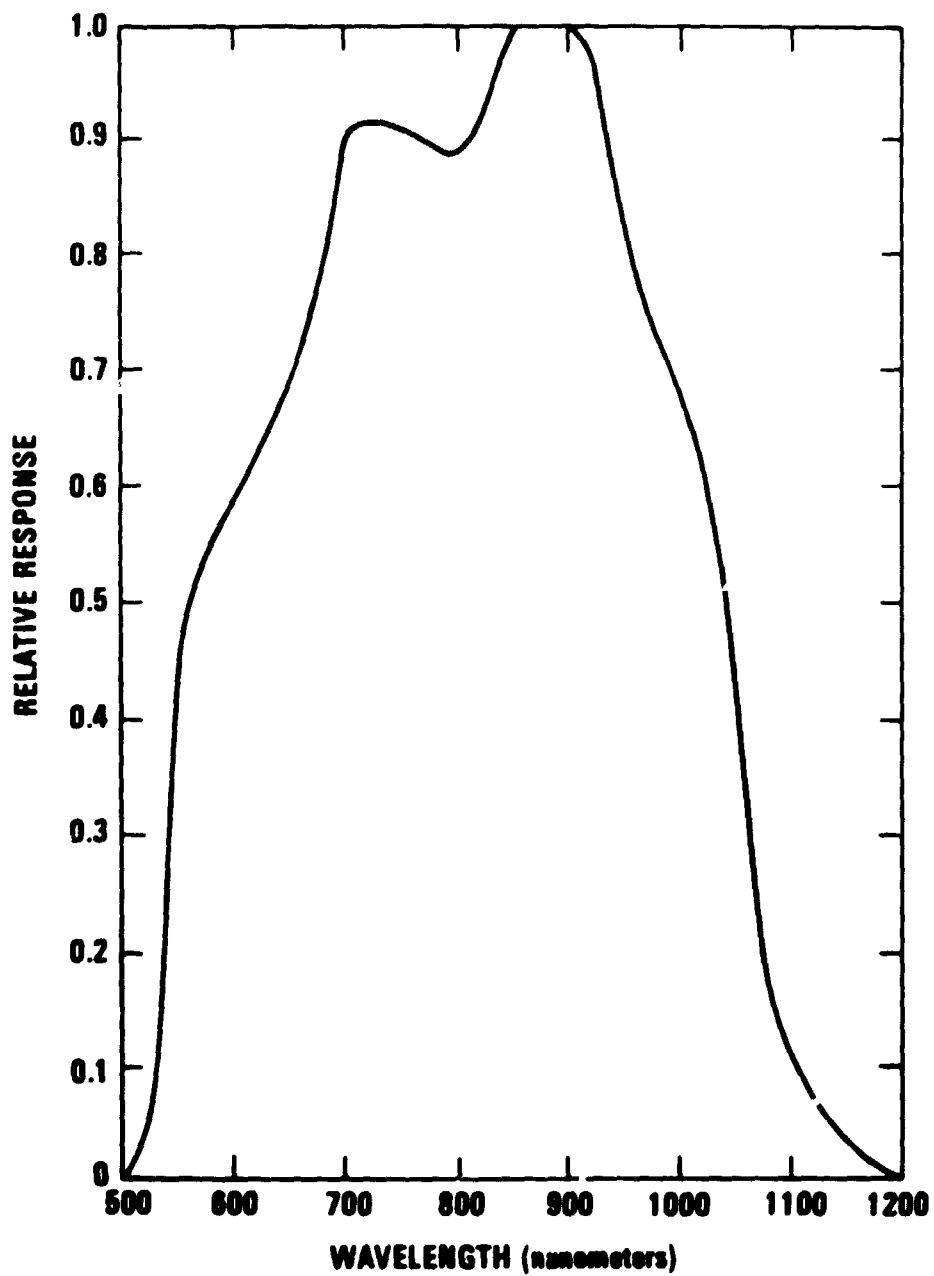

Figure 2-1. HCMR Detector Response for Channel 1

Table 2-5. Near-Infrared Calibration

NUMBER OF LAMPS ON ^a	EQUIVALENT ALBEDO	NEAR-INFRARED OUTPUT (VOLTS)
8	102.3	6.0890
7	89.3	5.3186
6	76.2	4.5534
5	63.6	3.7870
4	51.4	3.0438
3	38.1	2.2546
2	25.1	1.4869
1	12.3	0.7235
0	0	0.0194

^aGSFC 30-INCH INTEGRATION SPHERE NUMBER 61400-6-7

ORIGINAL PAGE IS
OF POOR QUALITY

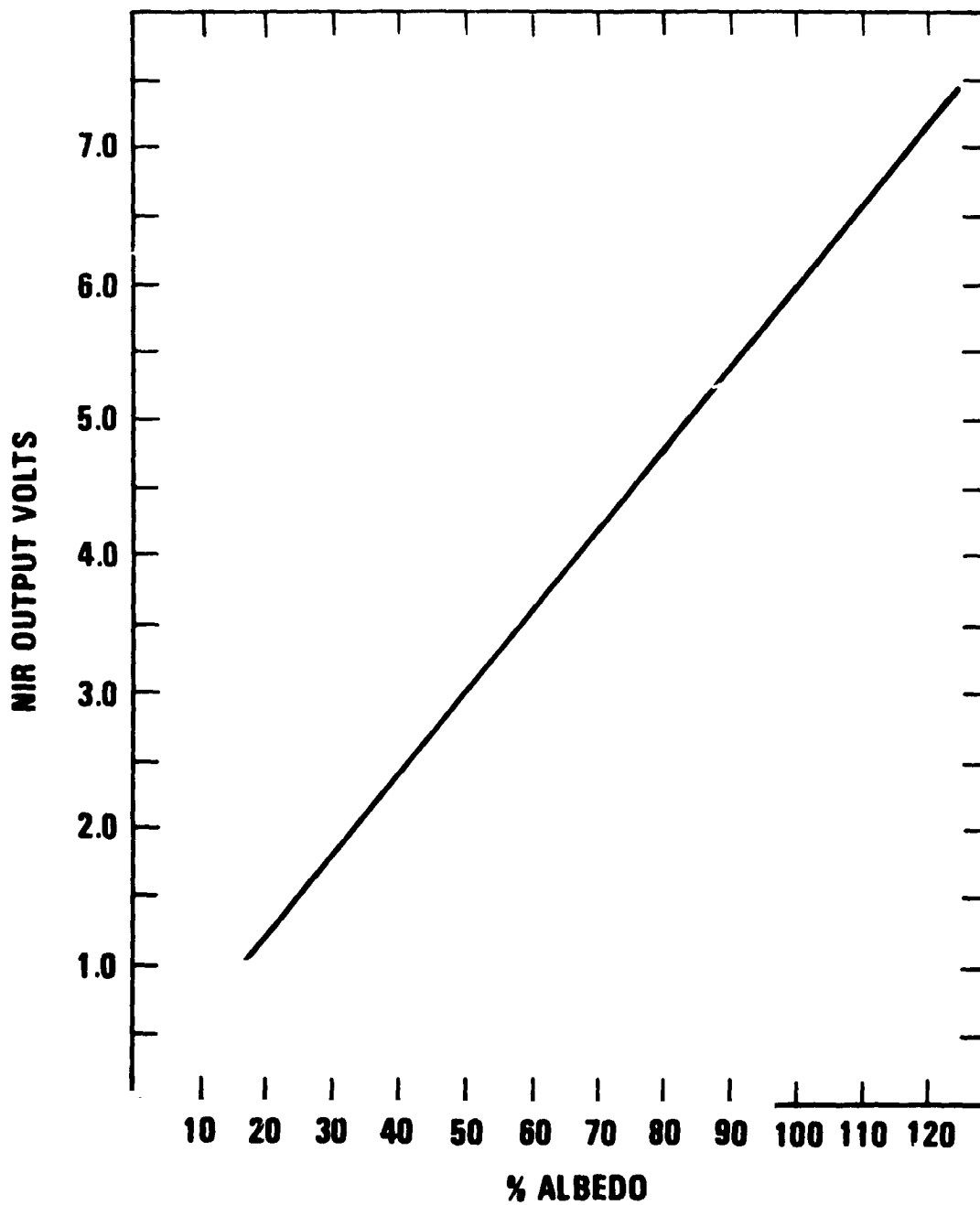

Figure 2-2. Near-Infrared Calibration

Table 2-6. HCMR Spectral Response Parameters, Infrared Channel

WAVELENGTH (MICROMETERS)	λ (PER CENTIMETER)	BANDPASS FILTER	FOCUS LENS	APLANAT LENS	COOLER WINDOW, HOUSING	COOLER WINDOW, CONE	HgCdTe DETECTOR, (1115 DEGREES K)	PRODUCT	RELATIVE RESPONSE
10.29	972-1	0.0	-	-	-	-	-	-	0.0
10.4	961	0.11	0.910	0.920	0.902	0.890	0.945	0.070	0.118
10.5	952	0.46	0.915	0.925	0.899	0.889	0.955	0.297	0.500
10.6	543	0.58	0.920	0.930	0.892	0.881	0.968	0.377	0.635
10.7	935	0.74	0.922	0.935	0.88E	0.873	0.978	0.485	0.816
10.8	926	0.83	0.923	0.939	0.879	0.875	0.989	0.547	0.921
10.88	919	0.881	0.925	0.941	0.87E	0.871	0.992	0.580	0.976
11.01	908	0.842	0.930	0.945	0.870	0.870	1.000	0.560	0.943
11.17	895	0.898	0.932	0.950	0.867	0.870	0.991	0.594	1.000
11.34	882	0.866	0.939	0.950	0.869	0.873	0.958	0.561	0.944
11.47	872	0.895	0.940	0.950	0.872	0.881	0.920	0.565	0.951
11.60	862	0.81	0.940	0.950	0.879	0.879	0.84C	0.469	0.790
11.75	851	0.70	0.940	0.948	0.882	0.890	0.748	0.366	0.617
11.90	840	0.81	0.930	0.942	0.880	0.887	0.650	0.360	0.606
12.06	830	0.89	0.931	0.940	0.869	0.880	0.560	0.334	0.561
12.19	820	0.886	0.932	0.939	0.859	0.875	0.490	0.286	0.481
12.34	810	0.80	0.931	0.931	0.848	0.871	0.405	0.207	0.349
12.50	800	0.15	0.921	0.922	0.831	0.870	0.310	0.028	0.048
12.58	795	0.0	-	-	-	-	-	-	0.0

NOTES 1. DICHOIC BEAMSPLITTER, SCAN MIRROR, AND TELESCOPE MIRRORS ALL HAVE UNIFORM TRANSMISSION/REFLECTION OVER THIS SPECTRAL REGION

2. WAVELENGTHS WERE SELECTED IN-BAND AT PEAKS AND VALLEYS OF BANDPASS FILTER TRANSMISSION CURVE. RELATIVE RESPONSE SHAPE (OF HCMR) FOLLOWS SHAPE OF BANDPASS FILTER BETWEEN WAVELENGTHS IN TABLE

ORIGINAL PAGE 19
OF POOR QUALITY

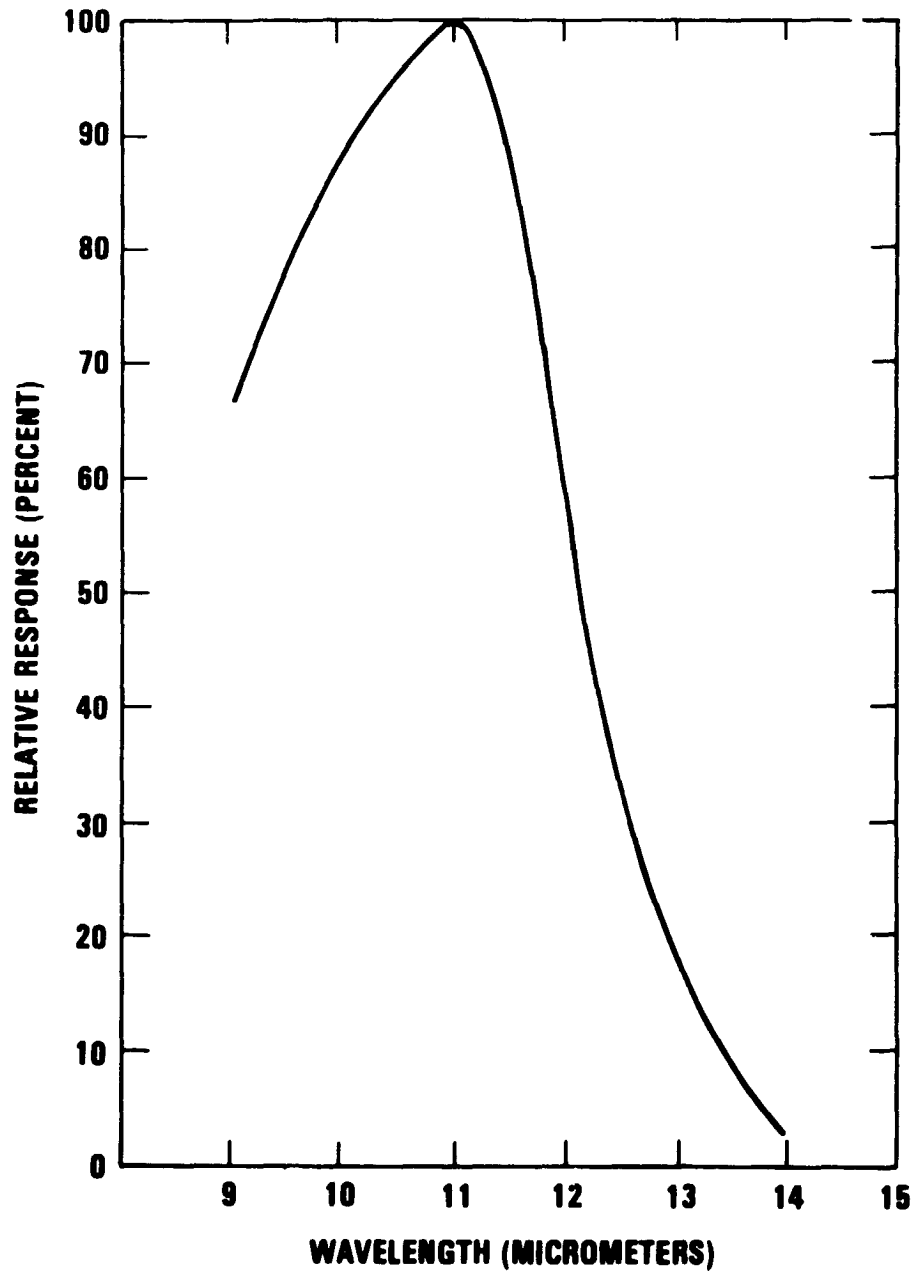

Figure 2-3. Spectral Response of HgCdTe
(Serial Number T-1) at 115 degrees K

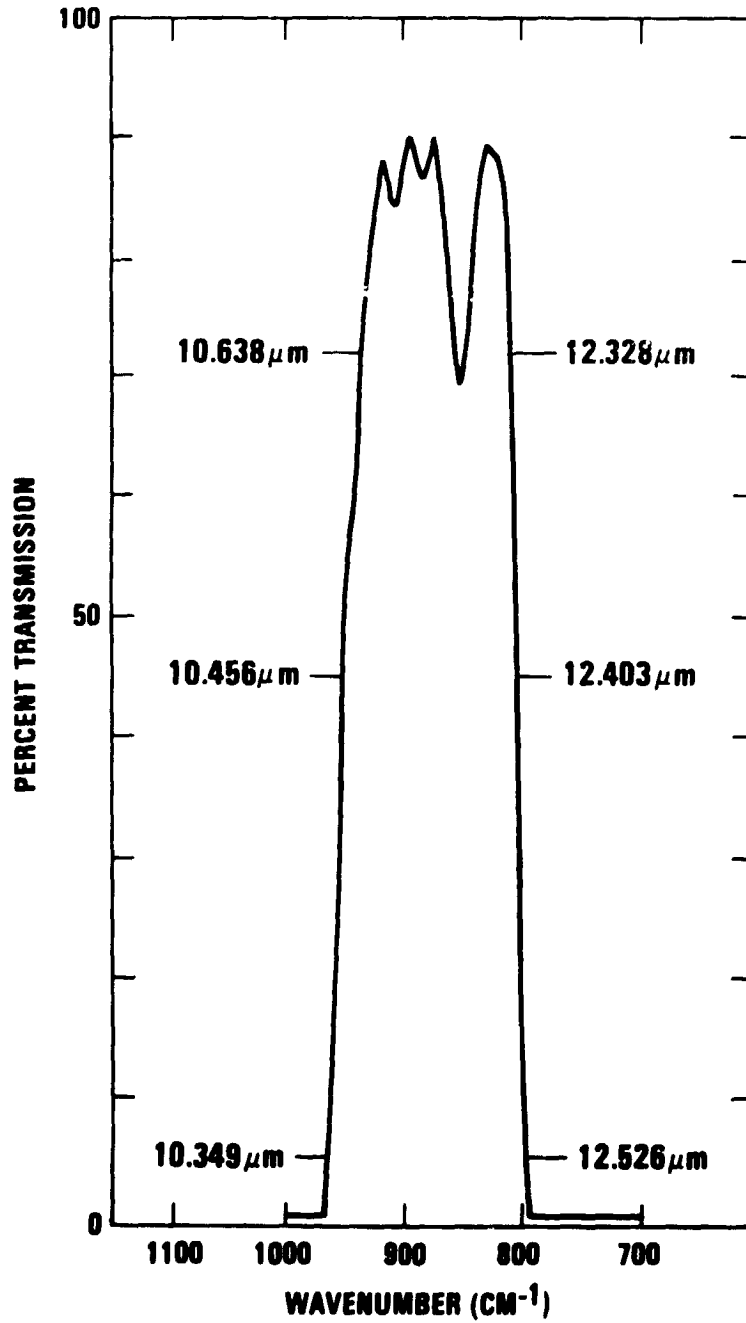

Figure 2-4. Transmission Characteristics of Germanium Band Pass Filter

ORIGINAL PAGE IS
OF POOR QUALITY

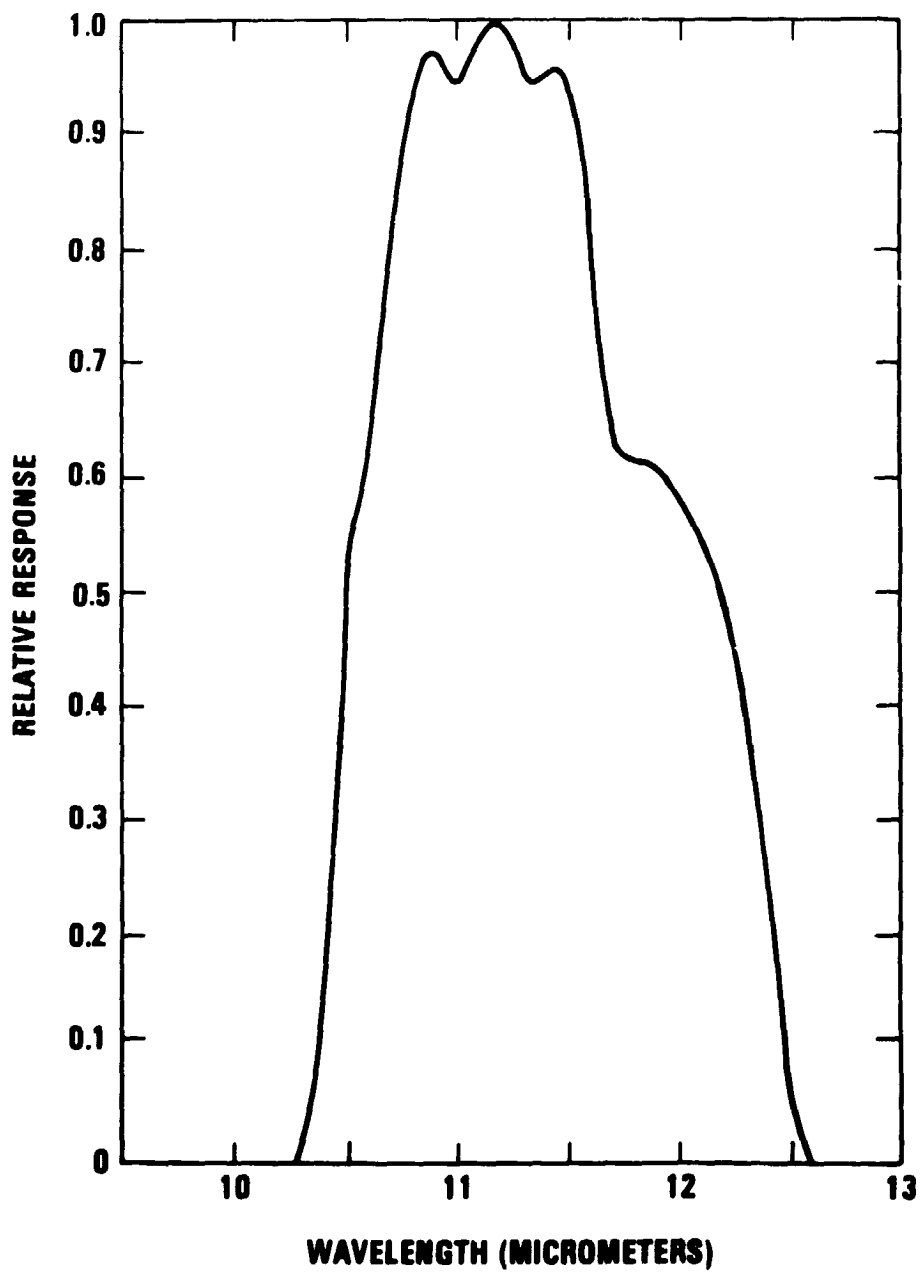

Figure 2-5. HCMR Spectral Response, Infrared Channel

ORIGINAL PAGE IS
OF POOR QUALITY

Table 2-7. Infrared Analog Calibration Data (1 of 2)

NOMINAL TARGET TEMPERATURE (DEGREES K)	BASEPLATE TEMPERATURE														
	0 DEGREES C			+5 DEGREES C			+10 DEGREES C			+15 DEGREES C			+20 DEGREES C		
	AVERAGE CALIBRATION TARGET TEMPERATURE	INFRARED SIGNAL (VOLTS)	INFRARED SIGNAL (VOLTS)	AVERAGE CALIBRATION TARGET TEMPERATURE	INFRARED SIGNAL (VOLTS)	INFRARED SIGNAL (VOLTS)	AVERAGE CALIBRATION TARGET TEMPERATURE	INFRARED SIGNAL (VOLTS)	INFRARED SIGNAL (VOLTS)	AVERAGE CALIBRATION TARGET TEMPERATURE	INFRARED SIGNAL (VOLTS)	INFRARED SIGNAL (VOLTS)	AVERAGE CALIBRATION TARGET TEMPERATURE	INFRARED SIGNAL (VOLTS)	INFRARED SIGNAL (VOLTS)
260	-12.92	0.1240	0.1009	-12.95	0.0964	0.0879	-12.93	0.0879	-13.00	0.0675	0.0879	-13.00	0.0675	0.0879	
265	-8.02	0.3925	0.3779	-8.95	0.3590	0.3514	-8.03	0.3514	-8.01	0.3331	0.3514	-8.01	0.3331	0.3514	
270	-2.91	0.6753	0.6534	-2.96	0.6390	0.6246	-2.97	0.6246	-2.98	0.6085	0.6246	-2.98	0.6085	0.6246	
275	+1.94	0.9657	0.9496	+2.20	0.9423	0.9249	+2.12	0.9249	+2.09	0.9046	0.9249	+2.09	0.9046	0.9249	
280	7.85	1.3337	1.2620	7.18	1.2477	1.2286	7.04	1.2286	7.17	1.2168	1.2286	7.17	1.2168	1.2286	
285	12.20	1.6143	1.5856	12.08	1.5667	1.5564	12.32	1.5667	12.14	1.5361	1.5667	12.14	1.5361	1.5667	
290	17.00	1.9482	1.9264	17.05	1.9019	1.8904	17.08	1.8904	17.09	1.8640	1.8904	17.09	1.8640	1.8904	
295	22.04	2.3051	2.2822	22.05	2.2531	2.2458	22.10	2.2531	22.17	2.2207	2.2458	22.17	2.2207	2.2458	
300	27.14	2.6792	2.7063	27.10	2.6214	2.5855	26.88	2.6214	27.06	2.5721	2.5855	27.06	2.5721	2.5855	
305	32.05	3.0451	3.0275	31.96	2.9913	2.9815	32.10	2.9913	32.03	2.9481	2.9815	32.03	2.9481	2.9815	
310	37.04	3.4368	3.4172	36.97	3.3774	3.3657	37.00	3.3774	36.98	3.3280	3.3657	36.98	3.3280	3.3657	
315	42.01	3.8459	3.8200	42.04	3.7864	3.7650	42.06	3.7864	42.06	3.7301	3.7650	42.06	3.7301	3.7650	
320	47.08	4.2723	4.2357	47.04	4.2054	4.1778	47.02	4.2054	47.15	4.1601	4.1778	47.15	4.1601	4.1778	
325	52.01	4.7009	4.6678	51.96	4.6276	4.6052	52.05	4.6276	52.05	4.5735	4.6052	52.05	4.5735	4.6052	
330	56.36	5.1583	5.1025	57.07	5.0684	5.0442	57.07	5.0684	57.08	5.0080	5.0442	57.08	5.0080	5.0442	
335	61.98	5.5881	5.5672	62.01	5.5194	5.4921	62.07	5.5194	62.09	5.4616	5.4921	62.09	5.4616	5.4921	
340	67.14	6.0704	6.0255	66.97	5.9810	5.9459	66.95	5.9810	67.02	5.9116	5.9459	67.02	5.9116	5.9459	

ORIGINAL PAGE 19
OF POOR QUALITY

Table 2-7. Infrared Analog Calibration Data (2 of 2)

NOMINAL TARGET TEMPERATURE (DEGREES K)	BASEPLATE TEMPERATURE													
	+25 DEGREES C			+30 DEGREES C			+35 DEGREES C			+40 DEGREES C			+45 DEGREES C	
	AVERAGE CALIBRATION TARGET TEMPERATURE	INFRARED SIGNAL (VOLTS)	AVERAGE CALIBRATION TARGET TEMPERATURE	INFRARED SIGNAL (VOLTS)	AVERAGE CALIBRATION TARGET TEMPERATURE	INFRARED SIGNAL (VOLTS)	AVERAGE CALIBRATION TARGET TEMPERATURE	INFRARED SIGNAL (VOLTS)	AVERAGE CALIBRATION TARGET TEMPERATURE	INFRARED SIGNAL (VOLTS)	AVERAGE CALIBRATION TARGET TEMPERATURE	INFRARED SIGNAL (VOLTS)	AVERAGE CALIBRATION TARGET TEMPERATURE	INFRARED SIGNAL (VOLTS)
260	-13.01	0.0643	-13.02	0.0357	-12.85	0.0229	-13.14	-0.0006	-11.88	0.0357				
265	-8.00	0.3155	-8.01	0.2965	-8.00	0.2618	-7.99	0.2573	-7.99	0.2369				
270	-2.80	0.5826	-2.96	0.5752	-2.92	0.5607	-2.97	0.5287	-2.98	0.5084				
275	+2.13	0.8927	+2.16	0.8695	+2.27	0.8580	+2.12	0.8201	+2.10	0.7925				
280	7.15	1.2098	7.16	1.1762	7.17	1.1575	7.05	1.1138	7.11	1.0906				
285	12.16	1.5230	12.14	1.4868	12.15	1.4736	12.12	1.4375	12.17	1.4090				
290	17.10	1.8438	17.05	1.8176	17.04	1.7930	17.03	1.7553	17.23	1.7365				
295	22.16	2.1968	22.19	2.1673	22.03	2.1382	22.13	2.1051	22.21	2.0730				
300	27.03	2.5400	27.18	2.5266	27.11	2.5034	27.15	2.4561	27.15	2.4284				
305	31.99	2.9171	32.05	2.8972	31.97	2.8559	32.11	2.8181	32.06	2.7800				
310	37.02	3.3016	36.97	3.2690	36.90	3.2375	37.01	3.1917	37.20	3.1687				
315	42.08	3.7043	42.08	3.6832	42.02	3.6427	42.08	3.5879	42.07	3.5366				
320	47.12	4.1249	47.20	4.0924	47.16	4.0565	47.15	3.9973	47.18	3.9500				
325	52.09	4.5471	52.10	4.5002	52.04	4.4629	52.22	4.4196	52.12	4.3617				
330	57.08	4.9888	57.04	4.9229	57.12	4.8987	57.10	4.8361	56.93	4.7803				
335	62.10	5.4251	62.05	5.3750	62.04	5.3314	62.11	5.2758	62.16	5.2211				
340	67.06	5.8765	67.00	5.8231	67.06	5.7887	67.01	5.7119	67.05	5.6535				

ORIGINAL PAGE IS
OF POOR QUALITY

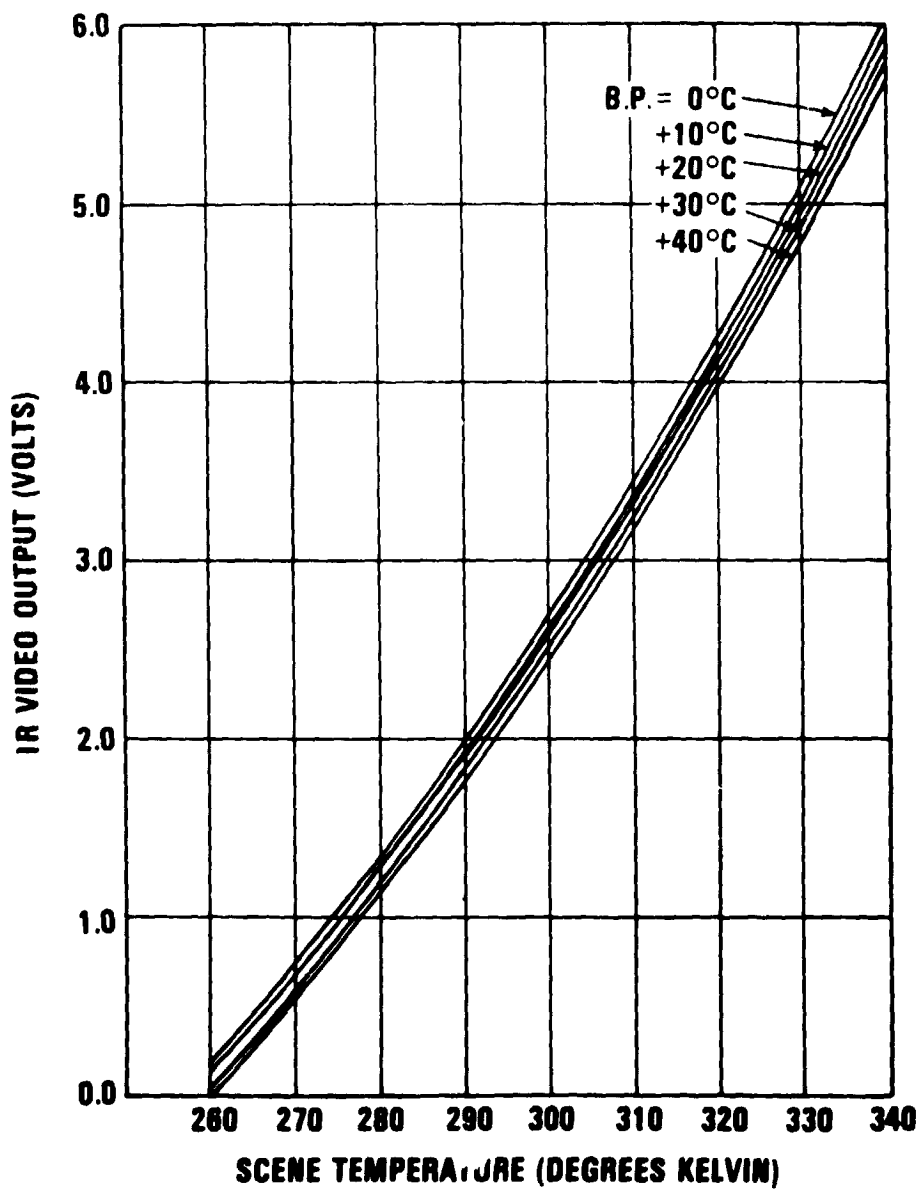

Figure 2-6. Family of Curves Obtained by Plotting Calibration Values of Table 2-7

ORIGINAL PAGE 13
OF POOR QUALITY

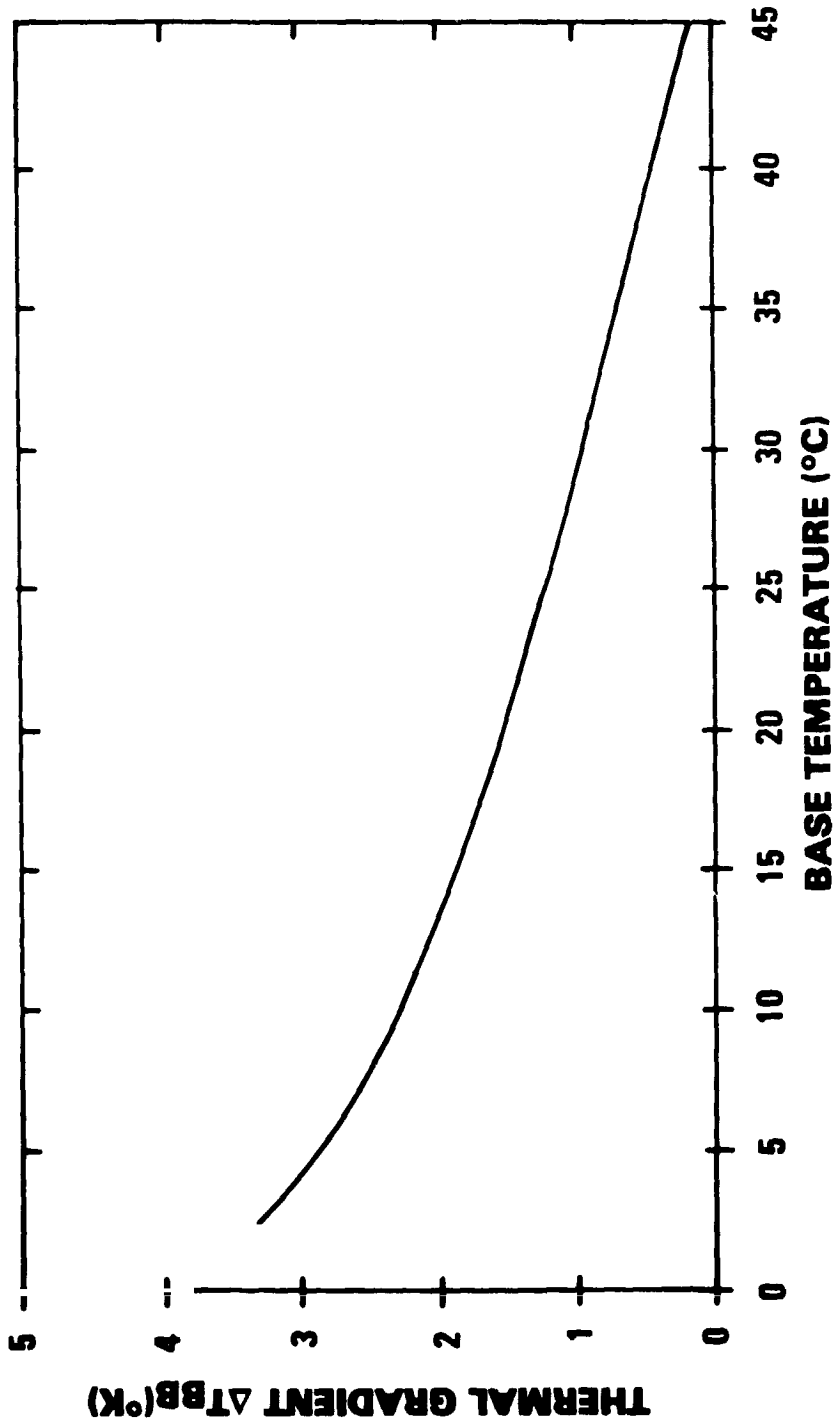

Figure 2-7. Average Difference Between Blackbody Temperature From Signal Line and Blackbody Temperature Read From Signal

2.4 OPTICAL REGISTRATION DATA

Table 2-8 presents the instantaneous field of view (IFOV), the channel registration, and the system modular transfer function (MTF) for both channels for three baseplate temperatures.

ORIGINAL PAGE IS
OF POOR QUALITY

Table 2-8. HCMR IFOV and Registration Data

PARAMETER	BASEPLATE TEMPERATURE								
	0 DEGREES C		25 DEGREES C		45 DEGREES C		45 DEGREES C		
	NEAR- INFRARED CHANNEL	INFRARED CHANNEL	NEAR- INFRARED CHANNEL	INFRARED CHANNEL	NEAR- INFRARED CHANNEL	INFRARED CHANNEL	NEAR- INFRARED CHANNEL	INFRARED CHANNEL	
IFOV									
BENCHTEST									
SCAN DIRECTION (MILLI- RADIANS)	ND	ND	0.837	0.99	ND	ND	ND	ND	ND
CROSS-SCAN DIRECTION (MILLIRADIANS)	ND	ND	0.86	0.97	ND	ND	ND	ND	ND
CHAMBER 1 ± FOV TARGET									
SCAN DIRECTION (MILLI- RADIANS)	1.16	1.50	1.05	1.27	1.16	1.40	1.16	1.40	1.40
CROSS-SCAN DIRECTION (MILLIRADIANS)	1.075	1.30	1.08	1.36	1.28	1.45	1.28	1.45	1.45
REGISTRATION									
SCAN DIRECTION (MILLI- RADIANS)	0.026	-	0.063	-	0.1	-	0.1	-	-
CROSS-SCAN DIRECTION (MILLIRADIANS)	-	0.063	-	0.032	-	0	-	0	0
MTF AT IFOV TARGET (PERCENT)	55	38	50	35	56	46	56	46	46

NOTE: ND = NO DATA

SECTION 3 - DATA PROCESSING ALGORITHM FOR RADIOMETRIC
CALIBRATION AND CORRECTION

3.1 FUNCTIONAL DESCRIPTION OF HCMM PRIMARY DATA PROCESSING

To understand the context in which the radiometric calibration and correction is performed, it is useful to review the entire HCMM primary processing scheme. The two data channels from the experiment are transmitted to the ground as analog signals multiplexed on the 2248.0-megahertz S-band link. The PCM housekeeping telemetry stream is also multiplexed on this data link. To make the data available for the extensive digital processing that it will eventually undergo, a significant amount of preprocessing is required. Apart from the original reception of the data and its recording, most of this preprocessing is performed in a special-purpose system developed to handle the data stream.

The specific functions performed by the preprocessor are the demultiplexing of the composite video that has been received and recorded at the ground station, a scan line synchronization of both the visible and infrared scan lines, and an analog-to-digits¹ conversion of each of the two scan lines at 125 kilohertz. Because not all of the scan line is used in later processing, the preprocessor selectively extracts for digitization only those portions of the scan line that will be later processed. Because the housekeeping telemetry is processed as part of the VHF link, this processing is not duplicated for the S-band link. Several housekeeping parameters do affect the radiometric calibration; these parameters are extracted from the PCM contained on the composite video and are processed and included with the channel 1 and channel 2 digitized output. The primary output of the preprocessor, then, is a high-density tape that will be used as an input to the second step; this tape contains the digitized data from channel 1 and channel 2 as well as selected housekeeping parameters. In addition, this preprocessing phase produces statistics and hardcopies of selected image data for quick-look assessment.

The second phase of the processing, which is performed on the Master Data Processor (MDP), accepts the output high-density tape from the preprocessor, computes radiometric calibration coefficients, and radiometrically corrects the data. The MDP then computes geometric correction coefficients, geometrically corrects the data, frames the input data into approximately 700-kilometer-by-700-kilometer frames, and generates the necessary annotation. Finally the MDP produces a fully corrected archival high-density tape. Further processing of the data (e.g., for night/day registration) is performed on a selected basis by other systems. The radiometric correction discussed in detail in this section is one of the two corrections applied in the main processing cycle.

3.2 BASIS OF HCMR RADIOMETRIC CORRECTION ALGORITHM

The calibration procedure described here has the specific purpose of accepting the digitized radiometer scan data developed by the preprocessor and converting them to values that can be directly interpreted as measurements of scientifically significant parameters such as radiance and brightness temperature.

The input to this processing step received from the preprocessor consists of three separate sets of data:

1. Instrument data from channel 1 (visible/near infrared, 0.5 to 1.1 micrometers)
2. Instrument data from channel 2 (infrared, 10.5 to 12.5 micrometers)
3. Selected housekeeping parameters

The two data channels each produce a full scan every 1/14 second, whereas housekeeping returns instrumental parameters only once every 1 to 8 seconds when in the orbital mode. Housekeeping data used in the reduction of the data channels will be processed on a currently available basis.

The instrument data channels contain two types of information: primary scan data and calibration and performance data. Because the calibration and house-keeping data are relatively stable, an averaging scheme is employed to minimize random noise in these parameters. Because of the possibility of scan-to-scan bounce, however, the averaging scheme will allow averaging over a requested number of scans (N). If N is set to 1, no averaging is performed.

The radiometric calibration of the HCMR is predicated on the following assumptions:

1. The response of the instrument will be as detailed in the system calibration data presented in Reference 1, with the appropriate modifications obtained from the system thermal-vacuum testing and the in-flight calibration data. The system performance during the ITT acceptance testing and calibration will be regarded as nominal, and the calibration values recorded in the supporting documents will be accepted as the nominal values for the mission.
2. The onboard electronic calibration sequence will be used to calibrate current instrument voltages, and the voltage levels of the calibration staircase will be assumed to remain at their nominal values during the mission.
3. A cubic expression may be used to transform current instrument voltages to calibrated values.
4. The near-linear character of the voltage response of the infrared detector with respect to radiant energy input, as indicated in the acceptance calibration, will persist throughout the mission even if the sensitivity of the detector should change.
5. For the visible channel (channel 1), because no in-flight calibration is performed, the preflight calibration will not change during the mission.

6. The space clamp will maintain the output voltage at zero volts for the visible channel and minus the offset bias voltage (V_{OFF}) for the infrared channel when the radiometer has the near-zero radiance input of space. (The $-V_{OFF}$ level will be out of range for the telemetry data and will be represented by the limiting value of zero volts.)

7. For the infrared channel (channel 2), the offset bias voltage (V_{OFF}) applied to the output to maintain the proper range will be proportional to the monitored supply voltage and is not expected to change during the mission.

8. The response of the thermistors and the emissivity of the internal calibration blackbody will not change from nominal during the mission. In addition, the thermal characteristics of the calibration blackbody will not change from nominal unless the instrumental environment changes and independent data confirms that such a change has occurred.

9. The internal calibration blackbody will be used to verify the nominal calibration for the infrared channel (channel 2) as well as to modify the nominal calibration as necessary. Should the blackbody temperature derived from the thermistor measurements be significantly different from that obtained from the radiometer with the nominal calibration, however, an unanticipated system change would be indicated, and the calibration would be subject to reexamination and possible modification using other data such as ground truth measurements.

The validity of these assumptions will be continuously verified to some extent by the calibration program itself so that remedial procedures can be determined and implemented as the need arises.

Preflight constants for HCMM radiometric calibration are presented in Table 3-1.

Table 3-1. Preflight Constants for HCMM Radiometric Calibration

QUANTITY ^a	CONSTANT							
	i = 0	i = 1	i = 2	i = 3	i = 4	i = 5	i = 6	i = 7
N								
W _s		0.001	1.003	1.982	2.986	3.963	4.981	5.958
V1 _i	0.1	0.102	1.058	1.989	2.943	3.877	4.848	5.781
V2 _i		0.006	0.970	1.970	2.947	3.954	4.929	5.924
V01 _i		0.009	0.969	1.963	2.937	3.945	4.920	5.915
V02 _i		43.26225	-0.0728287					
a _i		332.8817	1.772	-0.1917				
τ _{1i}								
W _{BP}	0.2							
τ _{2i}		59.7317	1.772	-0.1917				
τ _{3i}		332.8817	1.772	-0.1917				
τ _{4i}		333.2296	1.772	-0.1917				
W _{Ti}		0.1105	0.1105	0.0790				
σ _i		3.5308	0.26176 X 10 ⁻²	-0.27394 X 10 ⁻⁴				
ε _i		0.71325	-3.125 X 10 ⁻⁶	1.2511591 X 10 ³				
W ₀	0.1							
ρ _i		5.7096	-0.69922					
b _i		-114.7019	14238.17					
V _{Ci}		0.11	2.51	5.01				

^aTHESE QUANTITIES ARE SPECIFIED IN REFERENCE 4.

3.3 MASTER OUTPUT TABLE CONCEPT

Because of system limitations such as instrumental precision and the processing characteristics of the data handling system, both the input and the output of the calibration process will be contained in an eight-bit word. To properly represent the physical quantities that are being sought, master output tables will be used in which appropriate values in radiance units as well as equivalent blackbody temperature and normalized albedo will be listed. These tables are generated so that they include the range of values the instrument is to measure with a maximum increment between successive values that are less than or equal to the system precision. Because these tables need only be updated if profound changes occur in the instrumental characteristics, they are expected to remain fixed during the entire mission. The scan data calibration, then, consists of transforming the counts digitized from the video data stream for both channels 1 and 2 to indices for the master calibration tables, thus eliminating the necessity of several repeated calculations. The eight-bit format dictates that the table will have 256 entries.

For the visible channel (channel 1), one table will give the normalized albedo for each of the 256 outputs covering the range of the instrument. The albedo entries will extend from 0.00 to 1.00 and will represent the ratio of the radiance values measured to the radiance expected from a perfectly reflecting Lambertian surface illuminated by the Sun at vertical incidence. The table entries will be uniformly distributed in albedo. A secondary table will provide the equivalent radiance for each of the albedo values.

For the infrared channel (channel 2), there will be two tables, the first representing the equivalent blackbody temperature and the second giving the radiance values as determined by the Planck function. Because of the channel's near-linearity, the 256 values will be approximately uniformly distributed in radiance with the corresponding nonuniform distribution for the temperature table. The

limits for both tables will be set by the condition that the extreme values for the equivalent blackbody temperature table will be 260 degrees K and 340 degrees K.

Once the master calibration tables are completely defined, they will not be changed during the mission unless profound and currently unexpected changes occur in the system. Expressions for evaluating all table entries for both visible and infrared channels will be presented in a subsequent subsection.

3.4 HOUSEKEEPING DATA EXTRACTION

All of the instrumental housekeeping parameters available are listed in Table 1-2; the nominal values for the analog parameters are summarized in Table 2-1. These data are normally processed with the other housekeeping telemetry. The following four parameters, however, are required for the radiometric calibration procedure and are directly extracted by the preprocessors:

- T_{BP} (baseplate temperature)
- T_{BB1} (blackbody temperature 1)
- T_{BB2} (blackbody temperature 2)
- V_{OFFS} (offset voltage supply)

The first three temperatures (T_{BP} , T_{BB1} , T_{BB2}) are obtained from the corresponding telemetry voltage values (V_{TM}) by the relation

$$T_{TM} = 332.8817 - 15.556 V_{TM} + 1.772 (V_{TM})^2 - 0.1917 (V_{TM})^3$$

The offset supply voltage (V_{OFFS}) uses the relation

$$V_{OFFS} = 2V_{TM} - 14.329$$

Because all of these parameters are expected to be quite stable physically, an exponentially decaying averaging process will be applied to eliminate noise from these observations. Any dramatic change in these parameters in flight should be regarded with great concern, because it may significantly affect the processing algorithm.

3.5 SCAN DATA CALIBRATION

The primary instrument data are transmitted from the spacecraft as two analog signals multiplexed on a signal subcarrier. The scan rate is 14 lines per second with both the visible (channel 1) and the infrared (channel 2) synchronized to the scan mirror. The data scan format is nearly identical for both channels and is presented in Figure 3-1. The only difference in format is that for channel 1 the blackbody thermistor measurement is not reported and that portion of the scan is blanked out.

During the preprocessing phase the scan lines are synchronized and digitized, with the two channels being interleaved to provide comparable infrared and visible data. Because not all of the data scan is used in subsequent processing, only six selected intervals are digitized and carried over for further processing. The nominal digitizing intervals are indicated in Figure 3-1. The numbers in parentheses indicate the number of final average values obtained from the scan line. The 6 significant parameters that are digitized are (1) the space view, (2) the input calibration staircase, which consists of 7 levels, (3) the Earth scan measurement, for which 1500 samples cover approximately ± 35 degrees from the nadir direction, (4) the 7 values of the output calibration staircase, (5) the blackbody view measurement, and (6) the blackbody thermistor measurement. The preprocessor also extracts the current values of seven parameters from the housekeeping PCM data and includes them with the scan line data. This set of data provides the starting point for the scan line calibration.

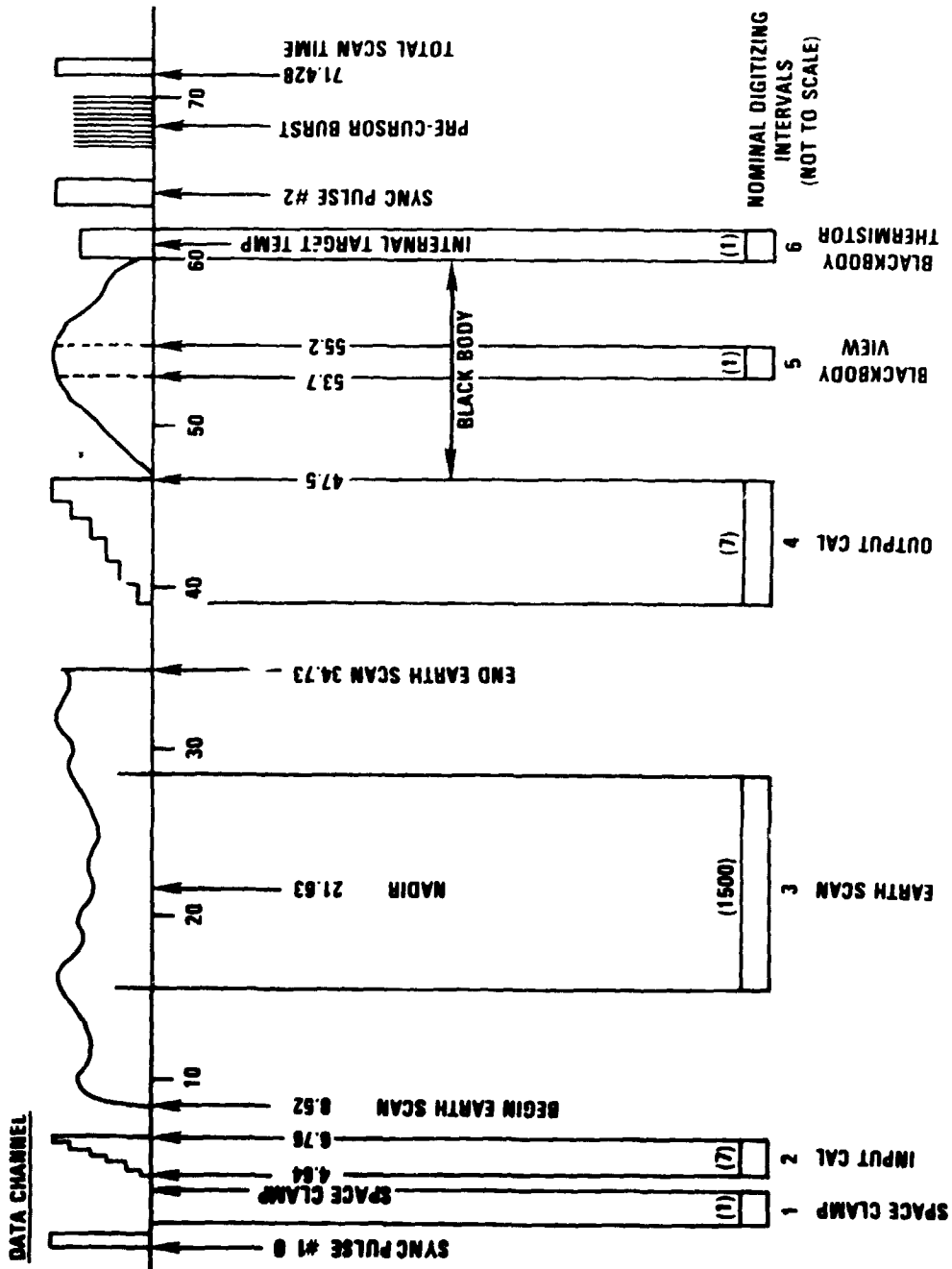

Figure 3-1. HCMR Data Format (not to scale)

An overview of the next processing step is provided in Figure 3-2, which is a schematic representation of the calibration and correction procedure. Starting from the left of that figure, the scan data just described enter the system in a scaled count format (0 to 255). Five of the six digitized measurements are routed to the calibration module; the Earth scan data go directly to the correction module. In addition to the direct scan data, the selected housekeeping data (as well as a number of preflight calibration constants) enter the calibration module. The primary output of this calibration module is the four coefficients that provide the functional transformation of count values to an appropriate radiance or albedo-related index. That transformation function is then transferred to the correction module, where it is applied to each of the Earth scan samples, producing 1500 calibrated indices to the appropriate master output table, which are then output to tape or other processing steps. Ancillary calibration data are also produced for special analysis.

Typically, two levels of conversion are applied to the data in sequence. In the first, a raw voltage count is taken from the data scan and is corrected for instrumental errors using the calibration staircases to obtain a calibrated scan voltage. The second level of conversion transforms the calibrated output voltage to a scaled, physically significant quantity (e.g., temperature, voltage, albedo) using some physical calibration. To clarify the two steps in the following descriptions, the corrected and calibrated voltages are designated by a subscripted V. The second level of conversion uses variable names suggestive of the physical quantities involved.

3.5.1 Count-To-Voltage Conversion

The first level of conversion in which calibrated scan voltages are obtained applies to both channels in exactly the same way. This step is thus discussed here before proceeding to those elements that are unique to each channel. The calibration reference for the count-to-voltage conversion is obtained from the two calibration voltage staircases that are inserted into the signal in each of

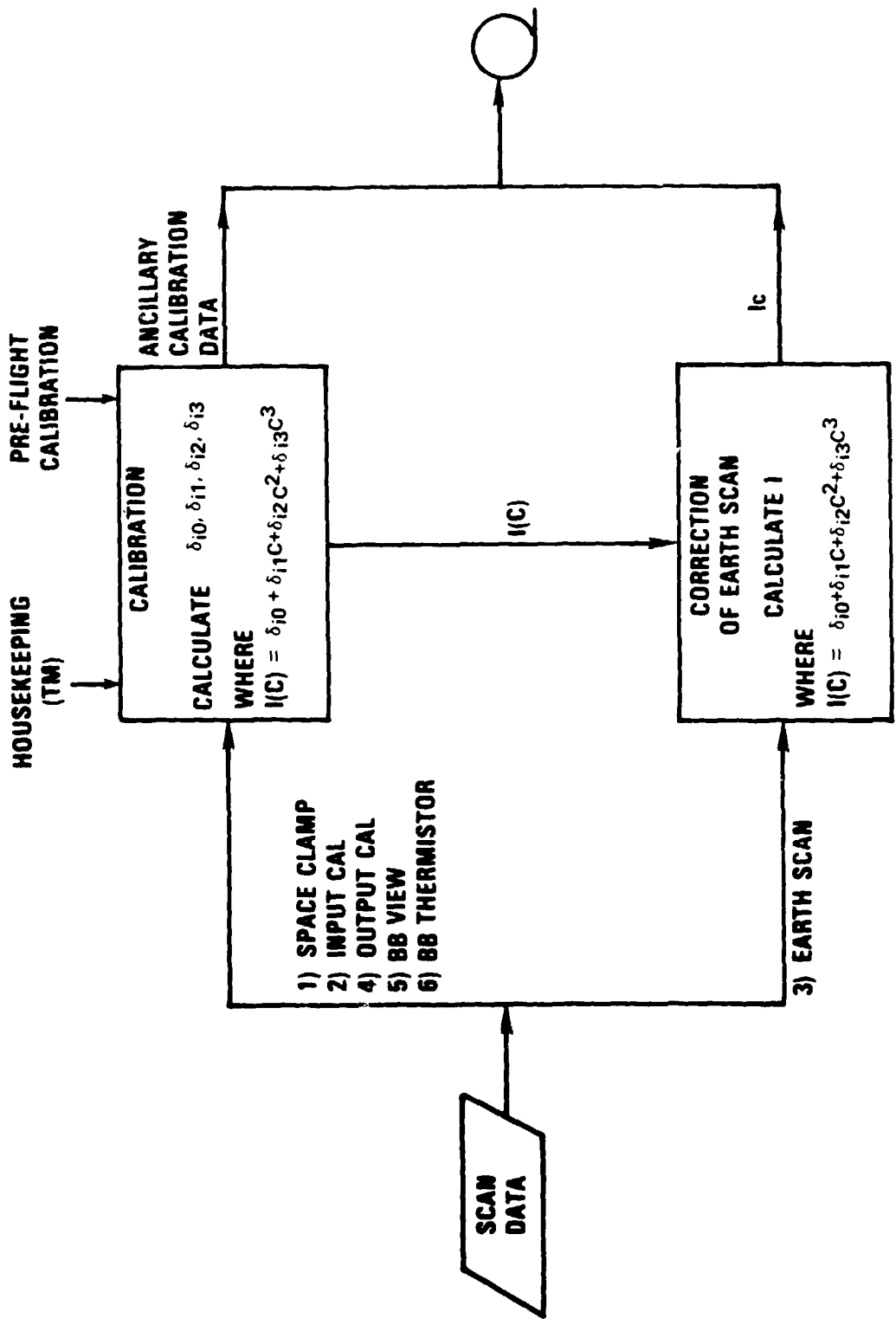

Figure 3-2. HCMR Radiometric Calibration and Correction

the channels. The input calibration sequence is injected into the system immediately after the detector and at the input to the preamplifier. It consists of a set of seven voltage levels, the nominal values of which are 0 to 6 volts in 1-volt steps. The actual values measured by the ITT acceptance test are presented in Reference 1 and are reproduced in Table 2-2. This calibration signal allows for correction of any level of drift or nonlinearities introduced into the system from the preamplifier or through the amplifier, the telemetry system, the downlink, the ground station, or the preprocessor. A second set of seven calibration steps is inserted at the output of the final amplifier and at the input to the telemetry system. This output calibration staircase provides largely redundant information and is used only for amplifier linearity checks and to calibrate the thermistor measurement on the second channel.

Because the voltage levels could not be measured in the spacecraft system configuration, the reference values will be the ITT final acceptance values (as indicated in Section 3.2). These values will be assumed to be unchanged during the mission. Table 2-2 presents these measured values for a range of baseplate temperatures from 5 degrees C to 40 degrees C. Close inspection reveals that the variation of the step values with baseplate temperature is less than or of the order of 0.1 percent of the 6-volt range. For this reason the nominal values for the step voltage can be considered to be independent of baseplate temperature, and the average values for all baseplate temperatures have been used in the calibration processing. These are provided in Table 3-2.

Because of constraints imposed by the processing system, it was determined that a cubic expression would be used to approximate the count-to-voltage relationship for the calibration staircases. This approximation provides an acceptable accuracy level for the preflight data. Unless the system changes dramatically in flight, this approximation is expected to be quite adequate for the life of the mission.

Table 3-2. Nominal Volts for Input and Output Calibration Steps

STEP NUMBER	NEAR-IR INFRARED INPUT (VOLTS)	NEAR-IR INFRARED OUTPUT (VOLTS)	IR INFRARED INPUT (VOLTS)	IR INFRARED OUTPUT (VOLTS)
1	0.001	0.006	0.102	0.009
2	1.003	0.970	1.059	0.969
3	1.982	1.970	1.989	1.963
4	2.986	2.947	2.943	2.937
5	3.963	3.954	3.877	3.945
6	4.981	4.929	4.849	4.920
7	5.968	5.924	5.781	5.915

3.5.2 Channel 1 Data Calibration (Visible/Near-Infrared Sensor)

As previously indicated, the processing is divided between two modules, one that performs a recalibration and generates functional transformation coefficients and a second that applies that transformation to each sample in the Earth scan. The form of the transformation has been established as a cubic polynomial for both channels, so the correction module need not be discussed further. The module that requires further explanation, however, is the calibration module that develops the transformation coefficients. Figure 3-3 presents a schematic representation of this module for channel 1. In this case the procedure is straightforward, with only two significant elements. The first, a voltage calibration, accepts as input the seven input calibration steps and uses a least-squares procedure to fit these values to the nominal voltage values given in Table 3-2. The resultant cubic expression is passed to the next element, where it is combined with a quadratic expression for the albedo index as a function of calibrated voltage. This last expression was obtained by a least-squares fit to the data in Table 2-5. The final expression gives the albedo as a function of raw count values with all terms beyond cubic discarded. The cubic coefficients are then transferred to the correction module. Reference conversions are performed on several additional data elements in the scan for special analysis on noise and performance. The simplicity of this calibration is attributable to the fact that there is no onboard calibration of the channel 1 sensor, and therefore the sensor performance is assumed to remain fixed during the mission. Only the voltage calibration can be introduced into the processing.

3.5.3 Channel 2 Data Calibration (Infrared Sensor)

Because the infrared detector has onboard calibration capabilities, the calibration module for this channel is significantly more involved than that for the visible channel. Figure 3-4, a schematic representation of this module, illustrates the point. The voltage calibration element functions just as for

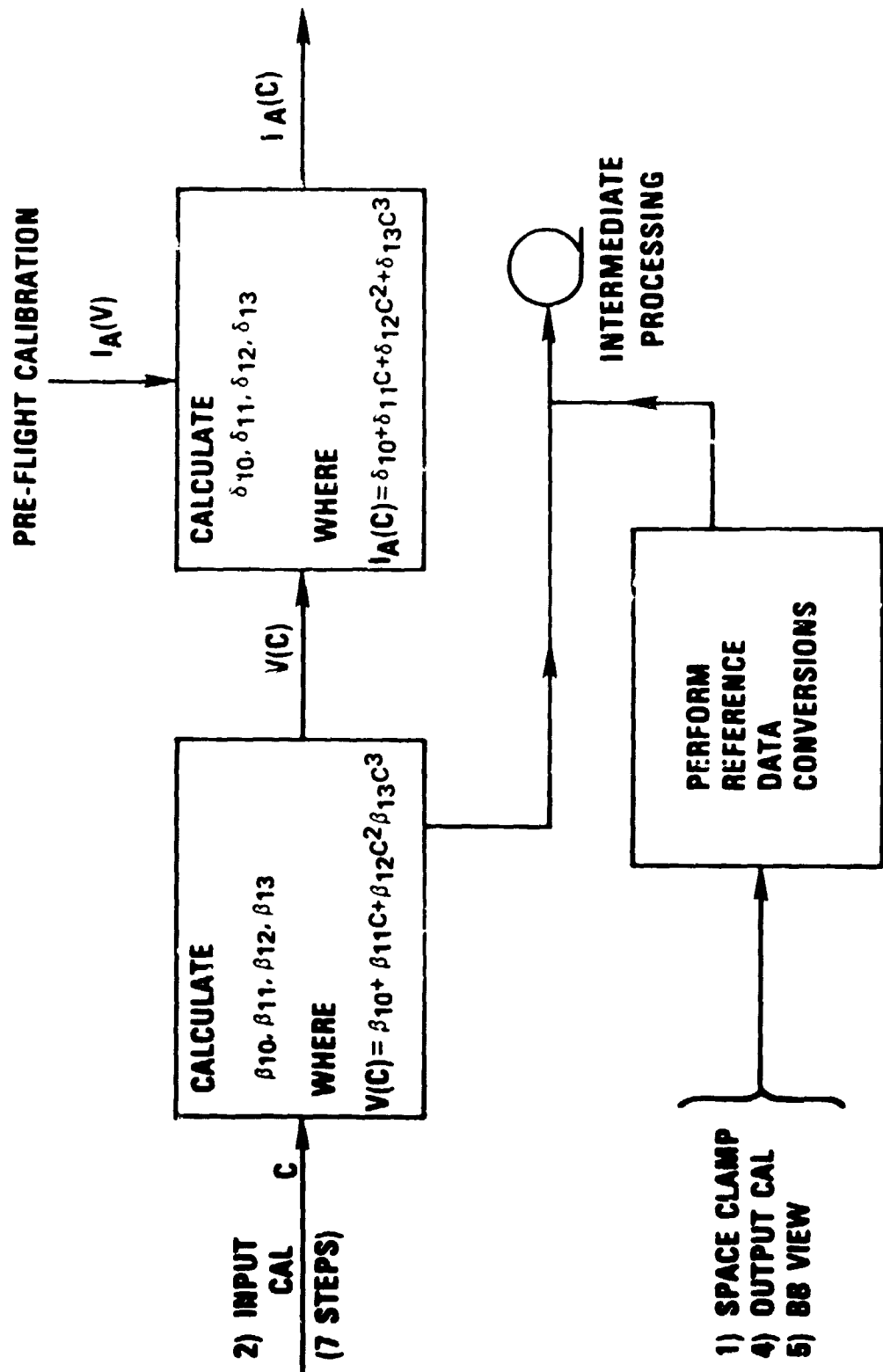

Figure 3-3. Channel 1 Calibration (General)

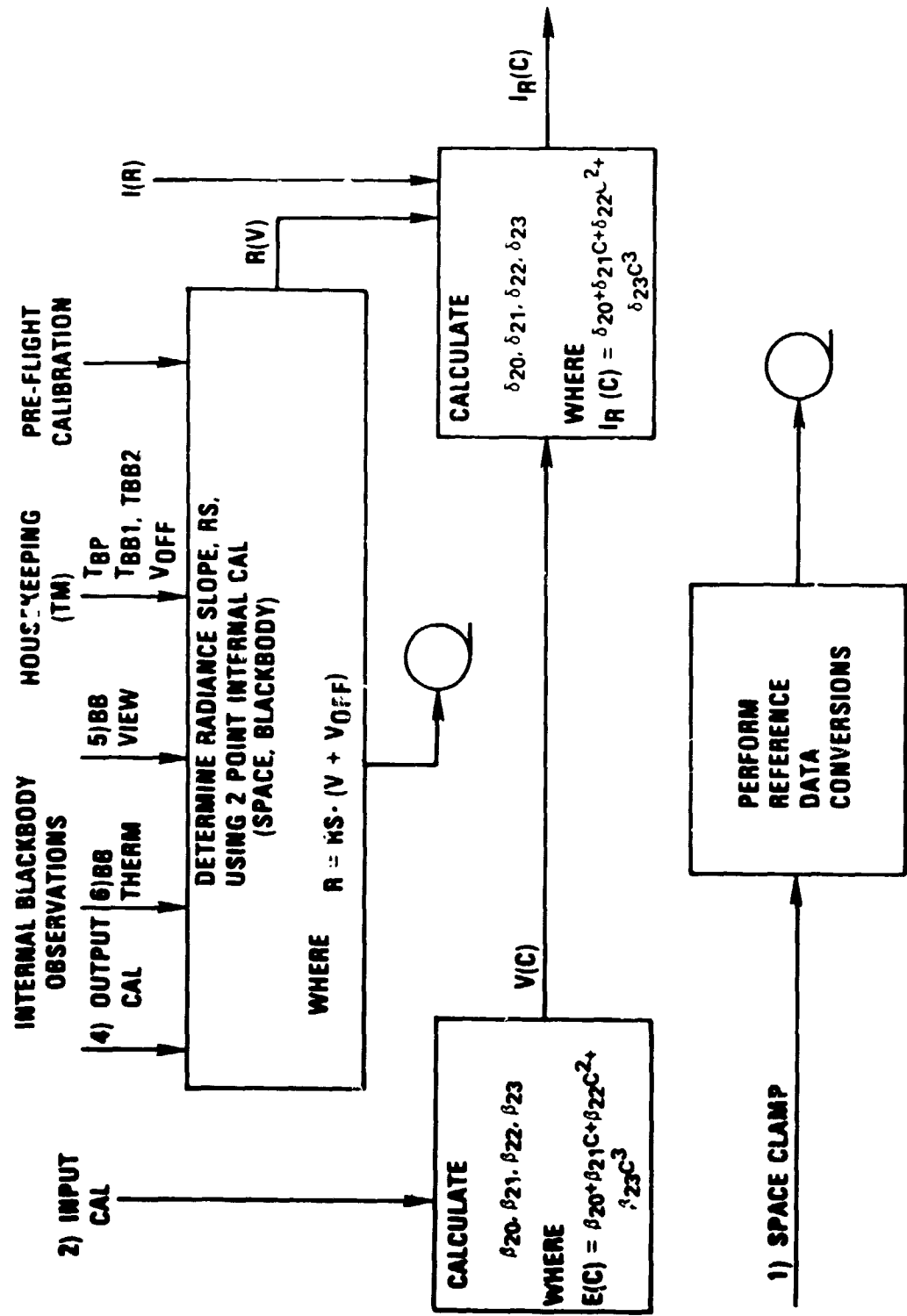

Figure 3-4. Channel 2 Calibration (General)

channel 1, accepting input calibration steps and using at least-squares procedure to fit a cubic polynomial to the preflight data of Table 3-2.

For the second element it is useful to review the relevant features of the instrument as well as some of the assumptions made in Section 3.2. When the calibration data contained in Table 2-7 are reformatted to use radiance rather than temperature as an input parameter, the voltage response is found to be a nearly linear function of radiance. With a slight modification of the Planck function it is possible to obtain a quantity, R , which is more nearly linear with voltage. This function, defined by

$$R = \frac{\epsilon_0 + \epsilon_1 T + \epsilon_2 T^2}{\left(e^{\epsilon_3/T} - 1 \right)} \quad (3-1)$$

is used as the basic quantity for recalibrating the data. Assumption 4 of Section 3.2 implies that this quantity will remain linear with respect to voltage throughout the mission even if the gain of the detector changes. It is thus possible to determine the gain by using two known points to locate this line in the R - V plane. The two points that are available are the near-zero temperature of space, which is automatically incorporated into the scan reference, and the internal blackbody, which has a monitored temperature determined by the baseplate temperature. To set the telemetry range to 260 degrees K to 340 degrees K, a bias of magnitude V_{OFF} volts is introduced into the system. This implies that when the instrument is looking at space, the infrared channel has a true output of $-V_{\text{OFF}}$ volts. The slope (RS) of the straight line containing the space point $(-V_{\text{OFF}}, 0)$ and the blackbody with an R value of $R(T)$ with voltage output of V would be

$$RS = \frac{R - 0}{V - (-V_{\text{OFF}})}$$

or

$$RS = \frac{R}{V + V_{OFF}} \quad (3-2)$$

Given the thermistor-measured temperature of the blackbody and the instrument response to the blackbody, this fundamental relationship is used to recompute the gain of the sensor.

A more detailed diagram of the internal blackbody calibration is presented in Figure 3-5. Starting in the upper-left corner, the first block averages the measurements of the blackbody temperature that are received from the telemetry and from data channel 2 with previously received values using an exponential averaging method. Once a suitably averaged value of the blackbody temperature is obtained, a correction that is a function of baseplate temperature is applied. This correction, determined by ITT and verified in the thermal-vacuum test, is presented in Figure 2-7. It should be noted, however, that flight data suggest that this correction has changed. This is discussed in Section 5.3.2.

The corrected value of the blackbody temperature is used to calculate a value of R . This value, R_{BB} , is then used in Equation (3-2) to obtain a slope, RS . Combining the electronics calibration with the R relationship, a conversion from counts to R is obtained. Finally, an index function can be obtained via this result with a scaling function that also converts the R values to values defined by the Planck function. This last correction is necessary to effect an easily calculated relationship between the master output table and T . After the final set of coefficients has been determined, it is transferred to the correction module for processing of the Earth scan samples.

3.6 MASTER OUTPUT TABLES

This section describes the expressions for evaluating the primary and secondary table entries for both visible and infrared channels. The master output

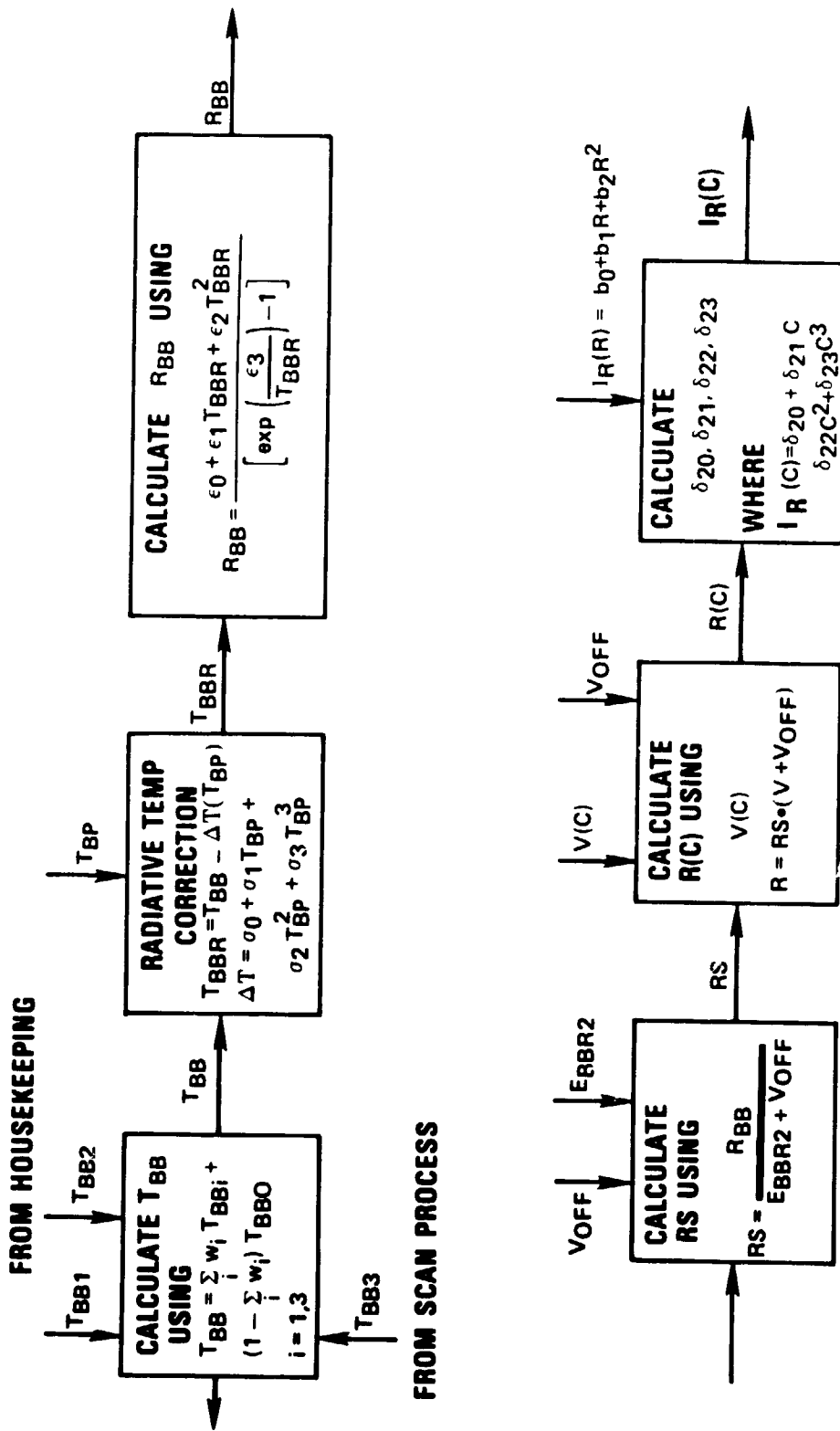

Figure 3-5. Channel 2 Calibration (Internal Blackbody)

table concept was described in Section 3.3. Section 3.6.1 gives the expression for converting output indices to the normalized albedo for the visible channel and to equivalent blackbody temperature for the infrared channel. Section 3.6.2 presents the expression for converting output indices to equivalent radiance values for both channels.

3.6.1 Primary Tables

3.6.1.1 Channel 1 (Visible/Near-Infrared)

The albedo is proportional to the output index

$$A = \alpha I_1$$

where A is the albedo, and I_1 is the output index, with limiting conditions

$$I_1 = 0 \text{ when } A = 0.00$$

$$I_1 = 255 \text{ when } A = 1.00$$

This gives

$$A = (3.9215686 \times 10^{-3}) I_1$$

Some sample values are given below:

<u>I_1</u>	<u>A</u>
0	0.0
100	0.392157
200	0.784314
255	1.000000

3.6.1.2 Channel 2 (Infrared)

The Planck function can be written

$$W_{\lambda} = \frac{C_1 \lambda^{-5}}{[\exp(C_2 / \lambda T) - 1]}$$

where $C_1 = 37418.44$ watts per centimeter per micrometer⁴
 $C_2 = 14388.33$ micrometers per degree K

(These values are from Reference 3.)

If

$$\lambda = 11.5 \mu\text{m}$$

$$\Delta\lambda = 2.0 \mu\text{m}$$

and

$$\Delta W_{\lambda}(T) = W_{\lambda}(T) \Delta\lambda$$

where T is the temperature, the output index can be defined by

$$I_2 = \Delta W_{\lambda}(T) + W_0 \quad (3-3)$$

where W_0 is a constant, and I_2 is the output index for the infrared channel.

Combining constants, Equation (3-3) can be written as

$$I_2 = \frac{K_1}{\exp(K_2/T) - 1} + K_3 \quad (3-4)$$

where K_1 , K_2 and K_3 are constants, with

$$K_2 = \frac{C_2}{11.5} = 1251.1591 \text{ deg K}$$

Using the limiting conditions

$$I_2 = 0 \text{ when } T = 260 \text{ degree K}$$

$$I_2 = 255 \text{ when } T = 340 \text{ degree K}$$

Equation (3-4) can be solved for K_1 and K_3 as follows:

$$0 = \frac{K_1}{\exp(K_2/260) - 1} + K_3$$

$$K_1 = -K_3 [\exp(K_2/260) - 1]$$

$$255 = \frac{K_1}{\exp(K_2/340) - 1} + K_3$$

$$255 = \left\{ -\frac{[\exp(K_2/260) - 1]}{[\exp(K_2/340) - 1]} + 1 \right\} K_3$$

Thus

$$K_3 = -118.21378$$

$$K_1 = 14421.587$$

Solving Equation (3-4) for T ,

$$I_2 - K_3 = \frac{K_1}{\exp(K_2/T) - 1}$$

$$\exp(K_2/T) = \frac{K_1}{I_2 - K_3} + 1$$

$$\frac{K_2}{T} = \ln \left\{ \frac{K_1}{I_2 - K_3} + 1 \right\}$$

$$T = \frac{K_2}{\ln \left\{ \frac{K_1}{I_2 - K_3} + 1 \right\}}$$

Thus

$$T = \frac{K_2}{\ln \left\{ \frac{K_1}{I_2 - K_3} + 1 \right\}}$$

where $K_1 = 14421.587$

$K_2 = 1251.1591$ degrees K

$K_3 = -118.21378$

Some sample values are given below:

<u>I₂</u>	<u>T</u>
0	260.000
100	297.468
200	326.198
255	340.000

3.6.2 Secondary Tables

3.6.2.1 Channel 1 (Visible/Near-Infrared)

The HCMR has been calibrated using a source to simulate the effect of diffusely reflected solar radiation.

The defining expression relating albedo and radiance for a given wavelength as used for this experiment is

$$R(\lambda) = A \frac{H(\lambda)}{\pi}$$

where $R(\lambda)$ = spectral radiance (watts per square centimeter per micrometer per steradian)

A = albedo (dimensionless)

$H(\lambda)$ = spectral irradiance of the Sun outside the atmosphere (watts per square centimeter per micrometer)

To obtain the effective response over the spectral width of the instrument response function ($T_1(\lambda)$), a weighted mean of the radiance is obtained from the expression

$$\bar{R} = \frac{\int_{\lambda_1}^{\lambda_2} T_1(\lambda) R(\lambda) d\lambda}{\int_{\lambda_1}^{\lambda_2} T_1(\lambda) d\lambda}$$

$$= \frac{A}{\pi} \frac{\int_{\lambda_1}^{\lambda_2} T_1(\lambda) H(\lambda) d\lambda}{\int_{\lambda_1}^{\lambda_2} T_1(\lambda) d\lambda}$$

Using the solar spectrum and the response function that was used by ITT in the original calibration, the following is obtained:

$$\bar{R} = \frac{A}{\pi} \cdot 0.112437$$

$$= 3.579 \times 10^{-2} A$$

where \bar{R} is the mean radiance viewed by channel 1 (watts per square centimeter per micrometer per steradian), and A is the albedo (0 to 1.0).

Using the defining relation for the albedo table,

$$A = (I_1/255) = 3.9215686 \times 10^{-3} I_1$$

the following is obtained:

$$\bar{R} = 14.035 \times 10^{-5} I_1 \text{ watts cm}^{-2} \mu\text{m}^{-2} \text{ sr}^{-1}$$

where I_1 is the index value for channel 1.

The effective mean wavelength is

$$\bar{\lambda} = \frac{\int T_1(\lambda) \lambda d\lambda}{\int T_1(\lambda) d\lambda} = 0.814 \mu\text{m}$$

where the half-maximum points of the response function occur at

$$\lambda_1 = 0.560 \mu\text{m}$$

and

$$\lambda_2 = 1.040 \mu\text{m}$$

and where the instrument response function $T_1(\lambda)$ is given in Table 2-4.

3.6.2.2 Channel 2 (Infrared)

For this channel the radiance values are obtained by assuming a blackbody source at the temperature obtained from the primary calibration table. This expression is of the form

$$T(I_2) = \frac{K_2}{\ln \left\{ \frac{K_1}{I_2 - K_3} + 1 \right\}}$$

where T is the temperature for an output index value of I_2 from channel 2, and K_1 , K_2 , and K_3 are as defined in Section 3.6.1.

The mean radiance is then obtained from the expression

$$\bar{W}(T) = \frac{1}{\pi} \frac{\int_{\lambda_1}^{\lambda_2} T_2(\lambda) W(\lambda, T) d\lambda}{\int_{\lambda_1}^{\lambda_2} T_2(\lambda) d\lambda}$$

where $T_2(\lambda)$ is the response function given in Table 2-6 for channel 2, and $W(\lambda, T)$ is the Planck function for temperature T .

The values of $\bar{W}(T)$ or $\bar{W}(I_2)$ can be represented in tabular form.

The relationship between I_2 , the output from channel 2, and $\bar{W}(I)$ can be approximated by the following linear expression to better than 0.25 percent:

$$\bar{W}(I) = 4.823047586 \times 10^{-4} + 4.2097918 \times 10^{-6} I_2$$

where \bar{W} is the mean radiance in watts per square centimeter per micrometer per steradian.

A better approximation (0.1 percent) can be obtained by using the primary table to obtain T as a function of I_2 and evaluating the following expression:

$$\bar{W}(I_2) = \frac{1}{\pi} \left\{ \frac{C_1' (11.33564)^{-5}}{\left[\exp\left(\frac{C_2}{11.33564T}\right) - 1 \right]} + 1.09803 \times 10^{-8} I_2 - 7.2 \times 10^{-6} \right\}$$

The effective mean wavelength for channel 2 is given by

$$\bar{\lambda} = \frac{\int T_2(\lambda) \lambda d\lambda}{\int T_2(\lambda) d\lambda} = 11.3356 \mu\text{m}$$

The half-maximum points for the response function occur at

$$\lambda_1 = 10.50 \mu\text{m}$$

and

$$\lambda_2 = 12.12 \mu\text{m}$$

SECTION 4 - INTEGRATED SPACECRAFT
THERMAL-VACUUM CALIBRATION

The integrated AEM-A spacecraft thermal-vacuum test was conducted in February 1978 at GSFC. A detailed description of the procedures may be found in Reference 5. Data for the infrared channel were taken at three base-plate temperatures: hot (33.8 degrees C), ambient (19.7 degrees C), and cold (approximately -2.0 degrees C). During each of the three cycles, data were taken for nine Epply target temperatures in the range from 260 degrees K to 340 degrees K in steps of 10 degrees K. For each target temperature approximately 5 PCM snapshots, 10 full scans, and 50 partial scans were recorded. A full scan sequence is described in Figures 1-4 and 1-5. A partial scan contains the data from the Earth scan region. PCM snapshots contain various housekeeping data. Data was recorded on the Mini-Computer Checkout System (MICOS) developed by the Electronic Systems Branch at GSFC. Processing was performed on the GSFC IBM S/360-91 and S/360-75 computers. Using a GSFC-furnished 30-inch-diameter integrating sphere, calibration data for the visible channel were taken outside the thermal-vacuum environment on January 30, 1978, and March 1, 1978, at GSFC. A description of various processing systems and a summary of results are presented in Sections 4.1 through 4.3.

4.1 NEAR-REAL-TIME DATA PROCESSING SYSTEM

A processing system to be implemented on the IBM S/360-91 and S/360-75 computers was developed to analyze the data recorded on MICOS.

4.1.1 Infrared Channel

4.1.1.1 Full Scans

The following five steps are performed to process a full scan:

1. Raw voltages are averaged over the appropriate number of samples for each of the physically significant quantities. The various quantities and the number of samples used for averaging are as follows:

<u>Quantity</u>	<u>Number of Samples</u>
Seven input calibration steps	14 for each
Seven output calibration steps	74 for each
Space clamp	14
Earth scan (Epply calibration target)	30
Blackbody view	62
Blackbody thermistor	74

The root-mean-square (rms) noise for each of the parameters is also calculated.

2. The offset voltage, the baseplate thermistor voltage, and the two blackbody thermistor voltages are obtained and averaged for all PCM snapshots recorded prior to the first full scan. The baseplate and blackbody thermistor voltages are calibrated and converted to temperatures (degrees K) using the following formulas:

$$CV = \frac{56.6 - RV}{10.81}$$

$$T = \sum_{i=1}^4 D_i (CV)^{i-1}$$

where RV is the raw voltage, CV is the calibrated voltage, and T is the temperature. Coefficients D_i are given in Table 4-1.

Table 4-1. Constants for Processing Spacecraft Calibration Data

FUNCTION	VALUE OF i						
	1	2	3	4	5	6	7
V11 _i	0.001	1.003	1.982	2.986	3.983	4.981	5.958
V12 _i	0.102	1.058	1.989	2.943	3.877	4.848	5.781
V01 _i	0.006	0.970	1.970	2.947	3.954	4.929	5.924
V02 _i	0.009	0.969	1.963	2.937	3.945	4.920	5.915
D _i	332.8817	-15.556	1.772	-0.1917	-	-	-
E _i	0.03121	16.79190	-	-	-	-	-

3. Raw averaged voltages for each of the seven input calibration steps, space clamp, Earth scan, and blackbody view are calibrated using linear interpolation or extrapolation. Specifically,

$$CV = VI2_i + \frac{VI2_{i+1} - VI2_i}{RVI2_{i+1} - RVI2_i} (RV - RVI2_i)$$

where RV and CV are typical raw and calibrated voltages, respectively; RVI2_i and VI2_i are raw and calibrated voltages, respectively, for the seven input calibration steps; and RVI2_i ≤ RV < RVI2_{i+1}. Raw averaged voltages for the seven output calibration steps and the blackbody thermistor are calibrated in a similar manner using the seven output calibration step values from each scan and the predetermined voltage levels given in Table 4-1. Calibrated rms noise for each of the parameters is determined by the following formula:

$$CRMS = \frac{VI2_{i+1} - VI2_i}{RVI2_{i+1} - RVI2_i} (RRMS)$$

where CRMS and RRMS are calibrated and raw rms noise values, respectively, and the other quantities are as previously described.

4. Calibrated voltages and rms noise from the space clamp, Earth scan, and blackbody views are converted to temperatures (degrees K) and noise equivalent temperature (NEΔT) using the following formulas:

$$T = \sum_{i=1}^5 C_i (CV)^{i-1}$$

$$NE\Delta T = \left[\sum_{i=2}^5 (i-1) C_i (CV)^{i-2} (CRMS) \right]$$

where T is the temperature, and C_i is the appropriate set of coefficients described in Table 4-2.

Coefficients D_i , as presented in Table 4-1, are used for converting blackbody thermistor voltage to temperature.

5. A summary for all full scans processed is generated in two parts. The first part contains the averaged calibrated voltage, the scan-to-scan noise in calibrated voltage, and the calibrated rms noise for each of the parameters. The second part contains the averaged temperature, the scan-to-scan noise, and $NE\Delta T$ for Earth scan, blackbody view, and blackbody thermistor. The difference between the averaged blackbody thermistor and the blackbody view temperatures (ΔT_{BB}) is also calculated.

4.1.1.2 Partial Scans

Samples in partial scans represent the Epply target region. Steps 1 through 4 of Section 4.1.1.1 are performed for each partial scan for Earth scan data. A summary is prepared for Earth scan data as described in step 5.

4.1.2 Visible Channel

Procedures for processing the near-infrared channel data are very similar to those for the infrared channel. Differences are as follows:

1. There are no blackbody thermistor data.
2. Calibrated voltages and rms noise for space clamp, Earth scan, and blackbody views are converted to albedo and $NE\Delta A$ (noise-equivalent albedo) using the following formulas:

$$A = E_1 + E_2 \text{ (CV)}$$

$$NE\Delta A = E_2 \text{ (CRMS)}$$

Table 4-2. Coefficients for Converting Infrared Video Output to Temperature

BASEPLATE TEMPERATURE (DEGREES C)	C ₁	C ₂	C ₃	C ₄	C ₅
0	257.997	18.4691	0.942917	-4.37050E-2	1.07279E-2
5	258.520 ^a	19.2108	-0.980259	-0.86905E-1	0.15648E-1
10	258.019	19.6024	-1.9052	0.227264	-1.25476E-2
15	258.263	19.7513	-1.97098	0.242068	-1.37652E-2
20	258.479	19.6741	-1.91159	0.228179	-1.26373E-2
25	258.794	19.6036	-1.82114	0.202648	-1.04669E-2
30	259.532 ^a	21.9840	-3.57012	0.615378	-0.43859E-1
35	259.081	19.7079	-1.89414	0.223598	-1.23276E-2
40	259.382	19.6976	-1.8863	0.226533	-1.28293E-2
45	259.797	19.4749	-1.75711	0.199049	-1.07760E-2
	258.857 ^a	19.1720	-1.33345	0.64255E-1	0.46033E-3
	260.007	20.0119	-1.98857	0.242128	-1.35799E-2
	260.529	19.73	-1.78309	0.191249	-9.31209E-3

^aA SECOND SET OF COEFFIC WAS CALCULATED USING THE MEASURED TARGET TEMPERATURES.

where CV is the calibrated voltage, A is albedo, E_i is as described in Table 4-1, and $CRMS$ and $NE\Delta A$ are rms noise in calibrated voltages and albedo, respectively.

3. Signal-to-noise ratio is calculated using Earth scan (visible target) data.

4.2 SUMMARY OF RESULTS

Tables 4-1 and 4-2 describe various predetermined quantities (based on ITT calibration) used for analyzing data taken during the thermal-vacuum test at GSFC.

4.2.1 Infrared Channel

When the infrared signal was converted to scene temperature using the first set of coefficients C_i determined by ITT, discrepancies between the calibrated temperatures and the measured temperatures were observed. Deviations for the hot cycle ranged from 0.01 degree K to 2.05 degrees K; for the ambient cycle, from 0.64 degree K to 1.87 degrees K; and for the cold cycle, from 0.91 degree K to 2.14 degrees K. Measured target temperatures and the infrared signal values were used, and a new set of coefficients C_i was obtained using least-squares fit techniques. Tables 4-2 through 4-5 contain the signal, the measured target temperature, and the calibrated scene temperatures obtained using the old and new sets of coefficients for the three cycles. Tables 4-6 through 4-8 contain the signal, the measured target temperature, the calibrated scene temperature obtained using the new set of coefficients, and various noise values, including $NE\Delta T$. Values for ΔT_{BB} (the difference between the blackbody thermistor and the blackbody view) are also included. Table 4-9 represents typical rms noise values for various parameters at all three baseplate temperatures.

The seven input and output calibration voltage levels could not be measured during the spacecraft system configuration. However, the data taken during

Table 4-3. Comparison of Temperatures Using ITT Calibration and Spacecraft Calibration - Hot Cycle

NOMINAL TARGET TEMPERATURE (DEGREES K)	TYPE OF SCAN	SIGNAL (VOLTS)	MEASURED TARGET TEMPERATURE (DEGREES K)	INFRARED TEMPERATURE (OLD CALIBRATION) (DEGREES K)	INFRARED TEMPERATURE (NEW CALIBRATION) (DEGREES K)
260	FULL	0.072	260.18	261.19	260.23
	PARTIAL	0.075	260.18	261.25	260.29
270	FULL	0.606	270.33	270.99	269.99
	PARTIAL ^a	-	-	-	-
280	FULL	1.224	280.41	281.35	280.45
	PARTIAL	1.219	280.41	281.26	280.36
290	FULL	1.877	290.38	291.35	290.58
	PARTIAL	1.879	290.41	291.37	290.60
300	FULL	2.540	300.05	300.74	300.02
	PARTIAL	2.540	300.04	300.73	300.02
310	FULL	3.296	310.05	310.75	309.91
	PARTIAL	3.295	310.05	310.73	309.90
320	FULL	4.159	320.16	321.49	320.29
	PARTIAL	4.146	320.18	321.34	320.14
330	FULL	5.038	330.04	331.82	330.11
	PARTIAL ^a	-	-	-	-
340	FULL	5.980	340.17	342.20	340.14
	PARTIAL	5.981	340.17	342.22	340.16

^a DATA NOT AVAILABLE

Table 4-4. Comparison of Temperatures Using ITT Calibration and Spacecraft Calibration - Ambient Cycle

NOMINAL TARGET TEMPERATURE (DEGREES K)	TYPE OF SCAN	SIGNAL (VOLTS)	MEASURED TARGET TEMPERATURE (DEGREES K)	INFRARED TEMPERATURE (OLD CALIBRATION) (DEGREES K)	INFRARED TEMPERATURE (NEW CALIBRATION) (DEGREES K)
260	FULL	0.044	260.59	259.65	260.49
	PARTIAL	0.052	260.62	259.81	260.67
270	FULL	0.534	270.37	268.77	270.34
	PARTIAL	0.541	270.37	268.89	270.46
280	FULL	1.115	280.36	278.66	280.40
	PARTIAL	1.115	280.38	278.65	280.39
290	FULL	1.751	289.94	288.53	290.00
	PARTIAL	1.744	289.96	288.42	289.89
300	FULL	2.504	300.30	299.23	300.25
	PARTIAL	2.492	300.29	299.07	300.09
310	FULL	3.274	310.00	309.36	310.14
	PARTIAL	3.265	310.01	309.25	310.03
320	FULL	4.085	320.27	319.38	320.32
	PARTIAL	4.090	320.28	319.44	320.39
330	FULL	4.821	329.57	328.02	329.41
	PARTIAL	4.831	329.58	328.14	329.53
340	FULL	5.748	340.13	338.36	340.20
	PARTIAL	5.739	340.13	338.26	340.10

Table 4-5. Comparison Temperatures Using ITT Calibration and Spacecraft Calibration - Cold Cycle

NOMINAL TARGET TEMPERATURE (DEGREES K)	TYPE OF SCAN	SIGNAL (VOLTS)	MEASURED TARGET TEMPERATURE (DEGREES K)	INFRARED TEMPERATURE (OLD CALIBRATION) (DEGREES K)	INFRARED TEMPERATURE (NEW CALIBRATION) (DEGREES K)
260	FULL	0.085	260.47	259.56	260.54
	PARTIAL	0.077	260.47	259.41	260.39
270	FULL	0.607	270.24	268.86	270.21
	PARTIAL	0.605	270.23	268.82	270.19
280	FULL	1.186	280.07	278.52	280.21
	PARTIAL	1.191	280.08	278.61	280.30
290	FULL	1.788	289.98	287.87	289.80
	PARTIAL	1.787	289.99	287.85	289.78
300	FULL	2.507	300.19	298.10	300.16
	PARTIAL	2.509	300.18	298.14	300.20
310	FULL	3.285	310.00	308.19	310.20
	PARTIAL	3.277	310.00	308.09	310.09
320	FULL	4.151	320.22	318.47	320.20
	PARTIAL	4.137	320.25	318.31	320.05
330	FULL	5.067	330.01	328.01	330.10
	PARTIAL	5.054	329.98	328.61	329.96
340	FULL	5.968	340.10	338.95	340.03
	PARTIAL	5.982	340.14	339.12	340.20

Table 4-6. Spacecraft Calibration Data (Infrared) - Hot Cycle
(Baseplate Temperature: 33.8 Degrees C)

NOMINAL TARGET TEMPERATURE (DEGREES K)	SCAN TYPE	MEASURED TARGET TEMPERATURE (DEGREES K)	INFRARED TEMPERATURE (NEW CALIBRATION) (DEGREES K)	ΔT (CALIBRATION MINUS MEASURED) (DEGREES K)	$ME \Delta T$		SIGNAL (VOLTS)	NOISE		ΔT_{TB} (NEW CALIBRATION) (DEGREES K)
					SIGNAL (DEGREES K)	SCAN TO-SCAN (DEGREES K)		SIGNAL (MILLI-VOLTS)	SCAN TO SCAN (MILLI-VOLTS)	
260	FULL	260.18	260.23	0.05	0.27	0.07	0.072	14.2	3.5	0.45
	PARTIAL	260.18	260.29	0.11	0.27	0.04	0.075	14.4	1.8	
270	FULL	270.33	269.99	-0.34	0.25	0.09	0.606	14.2	5.1	0.92
	PARTIAL ^a	-	-	-	-	-	-	-	-	
280	FULL	280.41	280.45	0.04	0.28	0.06	1.224	17.4	3.7	0.68
	PARTIAL	280.41	280.36	-0.06	0.29	0.03	1.219	17.7	2.1	
280	FULL	280.38	280.58	0.20	0.24	0.06	1.877	16.3	3.8	0.81
	PARTIAL	280.41	290.60	0.19	0.25	0.04	1.879	16.6	2.4	
300	FULL	300.06	300.02	-0.03	0.17	0.03	2.540	12.6	2.3	1.18
	PARTIAL	300.04	300.02	-0.02	0.19	0.03	2.540	13.8	2.5	
310	FULL	310.06	308.91	-0.14	0.25	0.06	3.296	19.6	5.0	1.16
	PARTIAL	310.06	308.90	-0.15	0.26	0.06	3.295	21.0	4.8	
320	FULL	320.16	320.29	0.13	0.29	0.06	4.159	25.2	4.9	0.77
	PARTIAL	320.18	320.14	-0.04	0.26	0.03	4.146	22.5	3.0	
330	FULL	330.04	330.11	0.07	0.35	0.07	5.038	32.0	6.2	0.50
	PARTIAL ^a	-	-	-	-	-	-	-	-	
340	FULL	340.17	340.14	-0.03	0.34	0.06	5.980	32.4	5.6	0.58
	PARTIAL	340.17	340.16	-0.01	0.35	0.04	5.981	33.6	3.8	

^aDATA NOT AVAILABLE

Table 4-7. Spacecraft Calibration Data (Infrared) - Ambient Cycle
(Baseplate Temperature: 19.7 Degrees C)

NOMINAL TARGET TEMPERATURE (DEGREES K)	SCAN TYPE	MEASURED TARGET TEMPERATURE (DEGREES K)	INFRARED TEMPERATURE (NEW CALIBRATION) (DEGREES K)	ΔT (CALIBRATION MINUS MEASURED) (DEGREES K)	NEAT		SIGNAL (VOLTS)	NOISE		ΔT_{TB} (NEW CALIBRATION) (DEGREES K)
					SIGNAL (DEGREES K)	SCAN TO SCAN (DEGREES K)		SIGNAL (MILLI VOLTS)	SCAN TO SCAN (MILLI VOLTS)	
260	FULL	260.59	260.49	-0.10	0.27	0.11	0.044	12.2	5.0	1.34
	PARTIAL	260.62	260.67	0.05	0.27	0.05	0.052	12.4	2.2	
270	FULL	270.37	270.34	-0.03	0.20	0.05	0.534	10.6	2.9	1.89
	PARTIAL	270.37	270.46	0.09	0.19	0.04	0.541	10.1	2.2	
280	FULL	280.36	280.40	0.04	0.16	0.06	1.115	10.2	3.5	1.89
	PARTIAL	280.38	280.39	0.01	0.17	0.03	1.115	10.5	1.7	
280	FULL	288.94	290.00	0.06	0.16	0.04	1.751	11.4	2.8	1.59
	PARTIAL	288.96	289.89	-0.07	0.18	0.03	1.744	12.9	1.9	
300	FULL	300.30	300.25	-0.05	0.20	0.07	2.504	15.1	5.6	1.07
	PARTIAL	300.29	300.09	-0.20	0.19	0.03	2.492	14.4	2.2	
310	FULL	310.00	310.14	0.14	0.18	0.07	3.274	13.9	2.5	0.70
	PARTIAL	310.01	310.03	0.02	0.19	0.03	3.265	15.3	2.5	
320	FULL	320.27	320.32	0.05	0.21	0.08	4.085	17.2	6.5	0.83
	PARTIAL	320.28	320.39	0.11	0.23	0.05	4.090	18.7	4.0	
330	FULL	329.57	329.41	-0.16	0.25	0.09	4.821	20.3	7.2	1.31
	PARTIAL	329.58	329.53	-0.05	0.27	0.03	4.831	22.3	2.8	
340	FULL	340.13	340.20	0.07	0.16	0.04	5.748	14.3	3.3	1.53
	PARTIAL	340.13	340.10	-0.03	0.19	0.02	5.739	17.6	2.2	

Table 4-8. Spacecraft Calibration Data (Infrared) - Cold Cycle (Baseplate Temperature: Approximately -2.0 Degrees C)

NOMINAL TARGET TEMPERATURE (DEGREES K)	SCAN TYPE	MEASURED TARGET TEMPERATURE (DEGREES K)	INFRARED TEMPERATURE (NEW CALIBRATION) (DEGREES K)	ΔT (CALIBRATION MINUS MEASURED) (DEGREES K)	NE ΔT		SIGNAL (VOLTS)	NOISE		ΔT_{BB} (NEW CALIBRATION) (DEGREES K)
					SIGNAL (DEGREES K)	SCAN-TO-SCAN (DEGREES K)		SIGNAL (MILLI-VOLTS)	SCAN-TO-SCAN (MILLI-VOLTS)	
280	FULL	280.47	280.54	0.07	0.37	0.43	0.085	19.3	22.4	3.35
	PARTIAL	280.47	280.39	-0.08	0.37	0.31	0.077	19.2	16.4	
270	FULL	270.24	270.21	-0.03	0.45	0.10	0.607	25.0	5.5	3.43
	PARTIAL	270.23	270.19	-0.04	0.47	0.06	0.605	26.5	3.3	
290	FULL	290.07	290.21	0.14	0.21	0.04	1.186	12.6	2.6	3.71
	PARTIAL	290.06	290.30	0.22	0.15	0.02	1.191	8.9	1.3	
290	FULL	299.98	299.80	0.18	0.34	0.09	1.788	22.1	5.8	4.37
	PARTIAL	299.99	299.78	-0.21	0.31	0.04	1.787	20.7	2.9	
300	FULL	300.19	300.16	-0.03	0.22	0.03	2.507	15.9	1.9	4.45
	PARTIAL	300.18	300.20	0.02	0.23	0.02	2.509	16.6	1.8	
310	FULL	310.00	310.20	0.20	0.24	0.04	3.285	20.6	3.5	4.00
	PARTIAL	310.00	310.09	0.09	0.29	0.04	3.277	23.8	3.2	
320	FULL	320.27	320.70	0.43	0.23	0.07	4.151	20.5	6.0	3.43
	PARTIAL	320.26	320.05	-0.20	0.24	0.03	4.137	22.0	3.2	
330	FULL	330.01	330.10	0.09	0.30	0.06	5.067	28.1	5.5	3.10
	PARTIAL	329.98	329.95	-0.02	0.33	0.03	5.054	31.0	3.2	
340	FULL	340.10	340.03	-0.07	0.28	0.10	5.968	24.2	9.1	3.26
	PARTIAL	340.14	340.20	0.06	0.25	0.03	5.982	21.5	2.7	

ORIGINAL PRINTING OF POOR QUALITY

Table 4-9. Typical rms Noise Values for Spacecraft Test (Infrared)

PARAMETER	rms NOISE (MILLIVOLTS)		
	HOT CYCLE	AMBIENT CYCLE	COLD CYCLE
SPACE CLAMP	26.3	11.8	9.2
INPUT CALIBRATION 1	8.6	12.4	11.4
INPUT CALIBRATION 2	2.6	12.8	2.9
INPUT CALIBRATION 3	12.4	12.5	25.6
INPUT CALIBRATION 4	27.0	10.9	2.2
INPUT CALIBRATION 5	26.0	13.3	14.8
INPUT CALIBRATION 6	5.5	20.9	20.5
INPUT CALIBRATION 7	17.1	16.0	26.4
EARTH SCAN	32.0	11.4	28.1
OUTPUT CALIBRATION 1	21.7	14.0	23.6
OUTPUT CALIBRATION 2	2.0	9.3	10.9
OUTPUT CALIBRATION 3	22.1	10.1	10.5
OUTPUT CALIBRATION 4	26.6	9.2	0.0
OUTPUT CALIBRATION 5	17.8	13.0	12.9
OUTPUT CALIBRATION 6	3.7	17.8	21.3
OUTPUT CALIBRATION 7	25.9	12.7	15.9
BLACKBODY VIEW	7.8	14.2	26.0
BLACKBODY THERMISTOR	28.1	12.4	27.4

this test was used to determine the change in input calibration steps relative to the output calibration steps. All seven raw input voltages were calibrated using the output calibration voltages as reference. The calibrated voltages were then subtracted from the corresponding input voltage level as determined by ITT; these are provided in Table 3-2. The step number for which maximum difference was observed as well as the difference (referred to as "old minus new" in Tables 4-10 through 4-12) are presented in Tables 4-10 through 4-12. The tables also include the scan-to-scan noise corresponding to that step. This procedure was followed for all three baseplate temperatures. All differences noted are within acceptable limits.

4.2.2 Visible Channel

A summary of the analysis on the two sets of data for the visible channel is presented in Tables 4-13 and 4-14. The tables contain the number of bulbs that were on in the integrating sphere source, the signal, the equivalent albedo, and various noise values. Table 4-15 gives typical rms noise values for various parameters.

Analysis of the data was also performed to determine the change in input calibration steps relative to the output calibration steps. The procedure adopted was similar to the one described in Section 4.2.1. Results are presented in Tables 4-16 and 4-17.

4.3 TESTING OF PREFLIGHT CALIBRATION CONSTANTS

The data taken during the integrated spacecraft thermal-vacuum test were used to verify the calibration algorithm and the preflight constants described in Section 3. The data from 10 full scans for all 9 target temperatures taken at each of the 3 baseplate temperatures were written on 3 disk data sets to be input to a simulation program. Each record of these data sets represents an infrared scan line and contains the channel 2 items 1 through 14 described in Table D.1-1a of Reference 4. Item 16 of the table is represented by 1 Earth

Table 4-10. Comparison of Spacecraft Calibration Data With ITT Data for Infrared Input Calibration Steps - Hot Cycle (Baseplate Temperature: Approximately 33.8 Degrees C)

TARGET TEMPERATURE (DEGREES K)	STEP NUMBER ^a	NOISE (SCAN-TO-SCAN) (MILLIVOLTS)	DIFFERENCE (OLD MINUS NEW) (MILLIVOLTS)	DIFFERENCE WITH RESPECT TO 6 VOLTS (PERCENT)
260	7	2.8	17.0	0.28
270	7	5.7	16.5	0.28
280	7	4.2	16.2	0.27
290	7	3.9	16.9	0.28
300	7	2.8	17.5	0.29
310	4	7.6	24.8	0.41
320	5	4.5	18.9	0.32
330	4	4.9	20.3	0.34
340	4	4.6	20.1	0.34

^aSTEP CORRESPONDING TO MAXIMUM DIFFERENCE

Table 4-11. Comparison of Spacecraft Calibration Data With ITT Data for Infrared Input Calibration Steps - Ambient Cycle (Baseplate Temperature: Approximately 19.7 Degrees C)

TARGET TEMPERATURE (DEGREES K)	STEP NUMBER ^a	NOISE (SCAN-TO-SCAN) (MILLIVOLTS)	DIFFERENCE (OLD MINUS NEW) (MILLIVOLTS)	DIFFERENCE WITH RESPECT TO 6 VOLTS (PERCENT)
260	3	1.9	9.0	0.15
270	3	1.7	3.2	0.15
280	3	2.2	8.5	0.14
290	3	3.0	8.9	0.15
300	7	2.9	9.1	0.15
310	7	3.4	7.8	0.13
320	3	1.9	9.1	0.15
330	3	2.7	9.0	0.15
340	3	2.5	8.4	0.14

^aSTEP CORRESPONDING TO MAXIMUM DIFFERENCE

Table 4-12. Comparison of Spacecraft Calibration Data With ITT Data for Infrared Input Calibration Steps - Cold Cycle (Baseplate Temperature: Approximately -2.0 Degrees C)

TARGET TEMPERATURE (DEGREES K)	STEP NUMBER ^a	NOISE (SCAN-TO-SCAN) (MILLIVOLTS)	DIFFERENCE (OLD MINUS NEW) (MILLIVOLTS)	DIFFERENCE WITH RESPECT TO 6 VOLTS (PERCENT)
260	1	8.3	-10.9	-0.18
270	3	6.5	-11.7	-0.20
280	3	4.3	-12.0	-0.20
290	1	8.7	-12.7	-0.21
300	2	1.1	11.5	0.19
310	2	1.7	10.7	0.18
320	2	1.4	11.0	0.18
330	2	0.1	10.1	0.17
340	3	5.7	-10.8	0.18

^aSTEP CORRESPONDING TO MAXIMUM DIFFERENCE

Table 4-13. Visible Calibration Prior to Spacecraft Test (January 30, 1978)

FILE NUMBER	NUMBER OF BULBS	SCAN TYPE	SIGNAL (VOLTS)	NOISE		ALBEDO (PERCENT)	NEAA		SIGNAL-TO-NOISE RATIO
				SIGNAL (MILLI-VOLTS)	SCAN-TO-SCAN (MILLI-VOLTS)		SIGNAL (PERCENT)	SIGNAL (PERCENT)	
1	8	FULL	5.5572	15.8	5.5	83.35	0.26	0.09	352.68
		PARTIAL	5.5595	15.5	3.7	93.39	0.26	0.06	359.83
2	8	FULL	5.3487	14.5	4.5	89.85	0.24	0.08	367.78
		PARTIAL	5.3401	14.2	5.4	89.70	0.24	0.09	376.89
3	7	FULL	4.6981	12.0	7.5	78.92	0.20	0.12	392.82
		PARTIAL	4.7064	12.4	5.4	79.06	0.21	0.09	378.25
4	6	FULL	3.9976	10.8	12.2	67.16	0.18	0.20	368.76
		PARTIAL	3.9914	10.6	5.3	67.05	0.17	0.09	376.86
5	5	FULL	3.3286	9.3	19.2	55.92	0.16	0.32	341.31
		PARTIAL	3.3096	9.7	5.1	55.61	0.16	0.09	341.06
6	4	FULL	2.8572	9.5	6.8	44.65	0.16	0.11	280.07
		PARTIAL	2.8593	8.9	4.4	44.69	0.15	0.07	297.83
7	3	FULL	1.3891	8.5	3.3	33.43	0.14	0.06	234.23
		PARTIAL	1.9885	8.1	3.7	33.42	0.14	0.06	245.08
8	2	FULL	1.3274	7.8	4.0	22.32	0.13	0.07	171.06
		PARTIAL	1.3259	7.3	3.5	22.29	0.12	0.06	181.04
9	1	FULL	0.6731	9.2	8.0	11.33	0.15	0.13	73.18
		PARTIAL	0.6725	9.2	4.6	11.32	0.16	0.08	72.98
10	C	FULL	0.0085	18.7	3.7	0.17	0.31	0.06	0.55
		PARTIAL	0.0086	20.8	3.4	0.18	0.35	0.06	0.50

Table 4-14. Visible Calibration After Spacecraft Test (March 1, 1978)

FILE NUMBER	NUMBER OF BULBS	SCAN TYPE	SIGNAL (VOLTS)	NOISE		ALBEDO (PERCENT)	NE _{JA}		SIGNAL TO NOISE RATIO
				SIGNAL (MILLI-VOLTS)	SCAN-TO-SCAN (MILLI-VOLTS)		SIGNAL (PERCENT)	SCAN-TO-SCAN (PERCENT)	
1	8	FULL	5.2727	29.9	1.8	88.57	0.50	0.03	177.14
2	7	PARTIAL	5.2879	31.0	3.0	88.82	0.52	0.05	170.81
3	6	FULL	4.8065	26.1	4.8	77.38	0.44	0.08	175.86
3	6	PARTIAL	4.5854	26.7	2.4	77.03	0.45	0.04	171.18
3	6	FULL	3.9334	26.3	18.3	66.06	0.42	0.31	157.33
3	6	PARTIAL	3.9236	27.0	5.4	66.92	0.45	0.09	146.49
4	5	FULL	3.2573	14.7	2.9	54.73	0.25	0.05	218.92
4	5	PARTIAL	3.2279	28.0	4.2	54.23	0.47	0.07	115.38
5	4	FULL	2.6951	6.8	1.8	45.29	0.12	0.03	377.42
5	4	PARTIAL	2.6943	5.9	0.8	45.27	0.10	0.01	452.70
6	3	FULL	2.0130	25.5	6.7	33.83	0.43	0.01	78.67
6	3	PARTIAL	2.0095	23.8	4.0	33.77	0.40	0.07	84.43
7	2	FULL	1.3582	4.4	2.1	22.80	0.07	0.03	325.71
7	2	PARTIAL	1.3584	4.7	1.2	22.84	0.02	0.08	1142.00
8	1	FULL	0.6682	0.8	3.9	11.25	0.01	0.06	1125.00
8	1	PARTIAL	0.6710	3.3	0.3	11.30	0.06	0.01	188.33
9	0	FULL	0.0149	22.0	3.7	0.28	0.37	0.06	0.76
9	0	PARTIAL	0.0176	27.0	2.0	0.33	0.45	0.03	0.73

Table 4-15. Typical rms Noise Values for Visible Channel

PARAMETER	NOISE (SIGNAL) (MILLIVOLTS)
SP CLAMP	27.9
INPUT CALIBRATION 1	28.3
INPUT CALIBRATION 2	16.4
INPUT CALIBRATION 3	9.8
INPUT CALIBRATION 4	7.8
INPUT CALIBRATION 5	7.9
INPUT CALIBRATION 6	11.2
INPUT CALIBRATION 7	12.9
EARTH SCAN	25.9
OUTPUT CALIBRATION 1	26.2
OUTPUT CALIBRATION 2	14.4
OUTPUT CALIBRATION 3	10.7
OUTPUT CALIBRATION 4	10.6
OUTPUT CALIBRATION 5	8.9
OUTPUT CALIBRATION 6	12.4
OUTPUT CALIBRATION 7	9.3
BLACKBODY VIEW	39.6

Table 4-16. Comparison of Spacecraft Data With ITT Data for Visible Input Calibration Steps (January 30, 1978)

NUMBER OF SULBS	STEP NUMBER ^a	NOISE (SCAN- TO-SCAN) (MILLIVOLTS)	DIFFERENCE (OLD MINUS NEW) (MILLIVOLTS)	DIFFERENCE WITH RESPECT TO 6 VOLTS (PERCENT)
8	1	1.9	8.4	0.14
8	6	1.0	-15.5	0.26
7	5	12.7	-14.9	0.25
6	3	4.9	-16.9	0.28
5	3	17.4	-18.3	0.31
4	3	6.0	-11.8	0.20
3	4	4.5	-13.6	0.23
2	3	4.0	-13.1	0.22
1	6	3.6	-17.6	0.29
0	6	4.1	-12.6	0.21

^aSTEP CORRESPONDING TO MAXIMUM DIFFERENCE

Table 4-17. Comparison of Spacecraft Data With ITT Data for Visible Input Calibration Steps (March 1, 1978)

NUMBER OF BULBS	STEP NUMBER ^a	NOISE (SCAN-TO-SCAN) (MILLIVOLTS)	DIFFERENCE (OLD MINUS NEW) (MILLIVOLTS)	DIFFERENCE WITH RESPECT TO 6 VOLTS (PERCENT)
8	4	1.2	20.0	0.33
7	1	1.7	-6.9	0.12
6	2	0.8	-16.7	0.28
5	4	4.0	20.9	0.35
4	4	2.1	19.3	0.32
3	4	3.5	19.3	0.32
2	4	3.9	20.9	0.35
1	4	4.8	18.4	0.31
0	7	7.3	13.1	0.22

^aSTEP CORRESPONDING TO MAXIMUM DIFFERENCE

scan value, which is determined by averaging over 30 samples obtained while viewing the Epply target. The simulation program applies the calibration algorithm described in Section 3 and generates a cubic polynomial for all 10 scan lines representing 1 target temperature. The cubic polynomial is applied to each of the 10 Earth scan values (in counts), and the radiance indices are averaged. The averaged index is converted to a temperature using the formula described in Section 3.6. The procedure is then repeated for the next target temperature. Results are summarized in Tables 4-18 through 4-20. The final column in each table indicates the difference in the platinum resistor values from the Epply calibration target and the calibrated value from the HCMR. Because these differences were minimal, the algorithm and the preflight constants presented in Section 3 appeared to be adequate.

4.4 CONCLUSIONS

Overall, the infrared channel performance was found to be satisfactory and did not change significantly from the performance during ITT calibration. Some differences are noted below:

1. Thermal-vacuum data suggest that the sensitivity of the infrared sensor increased during the hot cycle and decreased during the ambient and cold cycles as compared to the sensitivity during ITT calibration. Because the processing algorithm is designed to adjust for a change in sensitivity, this does not necessitate changing any of the constants presented in Table 3-2.

2. Although for a fixed baseplate temperature variations were observed in ΔT_{BB} as the Epply target temperature varied from 260 degrees K to 340 degrees K, the average values for each of the three baseplate temperatures were not significantly different from the ITT values. The average thermal-vacuum test values were 0.78, 1.35, and 3.68 (degrees K) as compared to ITT values of 0.77, 1.60, and 3.81 (degrees K) for the hot, ambient, and cold temperatures, respectively.

Table 4-18. Comparison of Calibrated Target Temperatures and Measured Target Temperatures - Hot Cycle

NOMINAL TARGET TEMPERATURE (DEGREES K)	MEASURED TARGET TEMPERATURE (DEGREES K)	CALIBRATED TARGET TEMPERATURE (DEGREES K)	DIFFERENCE (DEGREES K)
260	260.18	260.06	-0.12
270	270.33	270.19	-0.14
280	280.41	280.60	0.19
290	290.38	290.36	-0.02
300	300.05	300.06	0.01
310	310.05	310.11	0.06
320	320.16	320.31	0.15
330	330.04	329.98	-0.06
340	340.17	340.00	-0.17

Table 4-19. Comparison of Calibrated Target Temperatures and Measured Target Temperatures - Ambient Cycle

NOMINAL TARGET TEMPERATURE (DEGREES K)	MEASURED TARGET TEMPERATURE (DEGREES K)	CALIBRATED TARGET TEMPERATURE (DEGREES K)	DIFFERENCE (DEGREES K)
260	260.59	260.75	0.16
270	270.37	270.81	0.44
280	280.36	280.55	0.19
290	289.94	290.11	0.17
300	300.30	300.79	0.49
310	310.00	310.50	0.50
320	320.27	320.54	0.27
330	329.57	329.51	-0.06
340	340.13	340.00	-0.13

Table 4-20. Comparison of Calibrated Target Temperatures and Measured Target Temperatures - Cold Cycle

NOMINAL TARGET TEMPERATURE (DEGREES K)	MEASURED TARGET TEMPERATURE (DEGREES K)	CALIBRATED TARGET TEMPERATURE (DEGREES K)	DIFFERENCE (DEGREES K)
260	260.47	260.00	-0.47
270	270.24	269.64	-0.60
280	280.07	279.64	-0.43
290	289.98	289.92	-0.06
300	300.19	299.98	-0.21
310	310.00	310.08	0.08
320	320.22	319.71	-0.51
330	330.01	330.34	0.33
340	340.10	340.00	-0.10

3. The $NE\Delta T$ values presented in Tables 4-6 and 4-7 were slightly higher than those observed during ITT calibration (as presented in Table 2-3). Most of this increase could have been added by the spacecraft and MICOS. Thus these data suggest no significant increase in the noise coming from the detector.

4. Tables 4-10 through 4-12 indicate that the changes in the input calibration step voltages relative to the output calibration voltages were insignificant.

SECTION 5 - FLIGHT PERFORMANCE EVALUATION

This section describes the results of the analysis performed by processing the computer-compatible tapes (CCTs) generated by the Information Processing Division (IPD) after the launch of AEM-A. Various programs are used to monitor the noise characteristics of the data, determine the sensitivity of the sensor system, provide ground truth comparisons, and test the preflight constants described in Section 3.

5.1 PROCESSING SYSTEM FOR NOISE AND PERFORMANCE ANALYSIS

The processing system for analyzing the data taken during the spacecraft thermal-vacuum test was modified to analyze flight data. Rather than accepting input from MICO, this program takes input from an HCMM preprocessor CCT (F-tape), the format for which can be found in Reference 6. Each record contains raw sensor data, calibration data, and preprocessor data quality statistics. The system works very much as described in Section 4.1. Major differences are as follows:

1. Housekeeping data are picked from each record rather than from PCM snapshots.
2. There are no partial scans.
3. The number of samples used for averaging various physical parameters is different, as noted below:

<u>Parameter</u>	<u>Samples</u>
Space clamp	12
Input and output calibration steps	12
Blackbody view	30
Blackbody thermistor	30



4. Up to 2000 scan lines can be processed in one run, and a summary is generated.

5.2 SUMMARY OF RESULTS

As each tape is processed, a two-page reporting form, the HCMM Flight Tape Analysis, is prepared. The form contains the rms noise in millivolts for various physical parameters, the noise equivalent temperature ($NE\Delta T$), and various other temperatures. Noise values from thermal-vacuum data and a preflight recording are also included for comparison. A sample report is shown in Figure 5-1. Table 5-1, a summary of the analysis performed on the CCTs received from IPD for channel 2, includes tape ID, Julian day, type of pass, $NE\Delta T$, $\Delta T'_{BB}$, and minimum and maximum rms noise in the input and output calibration steps. Blackbody view data are used to calculate $NE\Delta T$.

$\Delta T'_{BB}$ is the apparent ΔT_{BB} (apparent difference between blackbody thermometer and blackbody view temperature). The blackbody view temperature is obtained by using the prelaunch measured C_1 's for a baseplate temperature of 10 degrees C, as taken from Table 4-2. It can be seen that $\Delta T'_{BB}$ changes with time. This change could be due to a change in the sensitivity of the instrument, a change in the thermal gradient (ΔT_{BB}), or both. To separate the contribution from the two conditions, independent ground measurements are needed. This is further discussed in Sections 5.3.2 and 5.4. For the present, the assumption is made that although thermal gradient ΔT_{BB} may have changed from the original value, it remains constant throughout the flight, because once established, onboard thermal environment does not change. Under this assumption, values in column 5 of Table 5-1 can be used to obtain the loss in sensitivity relative to Julian day 131, the day when the infrared channel was operational. Thus by day 193 a loss in sensitivity of approximately 3.7 degrees K (from a range of 80 degrees K) had occurred. A cubic polynomial was fit to represent loss of sensitivity as a function of day. Table 5-2 lists the coefficients obtained as well as actual and calculated losses in sensitivity. For days when more than

HCMM FLIGHT TAPE ANALYSIS

Tape No: ETC00326-01 (266 day)

Date Received: 11/6/78

THERMAL CHANNEL

Minimum in cal RMS noise (mV): 14.3 @ 2V
 Maximum in cal RMS noise (mV): 19.1 @ 5V
 Minimum out cal RMS noise (mV): 13.5 @ 2V
 Maximum out cal RMS noise (mV): 22.3 @ 5V
 Ins:rument Sensitivity Quotient (°K/V):

Temperature Baseplate (°K): 284.71

Temperature BB View (°K): 280.12

Temperature BB Thermistor (°K): 286.87

ΔT_{BB} (°K): +6.55

NE ΔT (BB View) (°K): 0.24

RMS noise (BB Th) (°K): 0.17

Comments:

Total saturation in input and output calibration at 6V level (all values 255)

Comments:

Total saturation in input and output calibration at 6V level (all values 255)

VISIBLE CHANNEL

Minimum in cal RMS noise (mV): 15.0 @ 3V
 Maximum in cal RMS noise (mV): 22.8 @ 5V
 Minimum out cal RMS noise (mV): 15.4 @ 3V
 Maximum out cal RMS noise (mV): 22.0 @ 5V
 S/N (BB View - 1% Equivalent): 2.34

C-2

Figure 5-1. Sample Report (1 of 2)

THERMAL CHANNEL

RMS noise in MV

VISIBLE CHANNEL

RMS noise in mV

Function	T/V-Micos Ambient	Preflight Recording	Flight Tape	Function	T/V-Micos Ambient	Preflight Recording	Flight Tape
Space Clamp	12.7	1.3 ¹	15.5	Space Clamp	27.9	21.8	22.4
INCA L 1	13.7	19.5	16.3	INCA L 1	28.3	25.8	22.5
2	11.9	18.8	14.8	2	16.4	14.4	18.6
3	12.4	18.9	14.3	3	9.8	14.5	16.7
4	10.9	18.9	14.7	4	7.8	13.6	15.0
5	12.8	18.1	16.0	5	7.9	14.3	16.8
6	19.3	20.2	19.1	6	11.2	16.0	22.8
7	16.6	21.0	0.02	7	12.9	17.9	0.02
OUTCAL 1	14.1	6.1 ¹	15.5	OUTCAL 1	26.2	22.0	22.0
2	9.7	18.5	13.7	2	14.4	15.6	19.0
3	10.4	19.5	13.5	3	10.7	14.9	16.6
4	9.5	17.0	13.8	4	10.6	13.3	15.4
5	12.7	16.7	15.9	5	8.9	13.0	16.4
6	18.3	20.6	22.3	6	12.4	16.2	21.5
7	12.5	21.8	0.02	7	9.3	17.8	0.0
BB View	11.4	1.7 ¹	15.1	BB View	39.6	20.8	26.7
BB Thermistor	10.9	19.5	16.0				

Notes:

1. Anomalous value due to extreme saturation effect.
2. Anomalous value due to total saturation.

Figure 5-1. Sample Report (2 of 2)

ORIGINAL RECORDS
OF POOR QUALITY

Table 5-1. Summary of HCMM Flight Tape Analysis (Infrared Channel)

TAPE ID	JULIAN DAY	PASS	NEAT (DEGREES K)	ΔT_{BB} (DEGREES K)	INPUT CALIBRATION rms NOISE		OUTPUT CALIBRATION rms NOISE	
					MINIMUM (MILLI-VOLTS)	MAXIMUM (MILLI-VOLTS)	MINIMUM (MILLI-VOLTS)	MAXIMUM (MILLI-VOLTS)
AA13181	131	DAY	0.43	-0.74	27.9	44.2	27.4	38.6
MAD00027	131	NIGHT	0.26	+1.19	15.0	18.0	14.6	21.5
MAD00028	131	DAY	0.21	-0.69	14.2	18.1	13.5	17.2
ETC00033	131	DAY	0.28	-0.79	16.4	19.8	15.7	21.3
GDS00072	132	DAY	0.25	-0.81	15.4	19.0	14.2	18.7
MAD00029	132	NIGHT	0.35	-0.73	19.7	27.9	20.7	28.0
MAD00030	132	NIGHT	0.37	-0.59	20.7	27.8	21.2	28.7
GDS00029	132	NIGHT	0.46	-0.54	21.9	31.1	21.5	29.8
GD600031	132	DAY	0.28	-0.77	15.0	22.0	14.5	20.6
GD600034	133	DAY	0.47	-0.48	31.6	46.0	30.1	46.5
ETC00048	135	DAY	0.56	-0.21	37.7	50.8	36.6	49.4
GD600040	136	NIGHT	0.45	+0.29	24.4	30.0	24.4	29.7
GD600049	138	DAY	0.38	+0.42	20.0	28.5	20.5	27.6
MAD00048	138	DAY	0.64	+0.51	32.1	38.5	32.7	37.8
MAD00052	138	DAY	1.56	+0.52	84.2	120.5	70.2	130.6
MAD00056	140	DAY	0.77	+0.77	42.7	62.5	42.5	61.7
MAD00059	141	DAY	0.83	+0.90	48.8	72.0	47.5	56.3
GD600066	141	NIGHT	0.40	+1.11	21.1	29.1	21.4	27.0
GD600065	143	DAY	0.43	+1.26	21.6	30.9	23.4	28.2
ETC00072	143	DAY	0.30	+1.32	19.4	25.6	19.0	25.4
ULA00127	144	DAY	0.39	+1.36	23.6	54.6	23.2	58.6
ULA00133	145	DAY	0.57	+1.61	31.0	42.7	30.3	44.4
GD600071	146	NIGHT	0.48	+1.89	22.3	33.9	25.6	31.1
ETC00088	148	DAY	0.92	+2.08	50.3	98.5	47.8	110.2
ETC00096	150	DAY	1.38	+2.35	59.9	122.3	55.7	118.3
GD600091	152	NIGHT	0.41	+2.86	23.0	28.5	22.5	27.0
GD600100	153	NIGHT	0.66	+2.80	38.5	60.2	36.4	63.4
GD600100	154	DAY	0.46	+2.96	23.4	28.6	23.7	28.5
ETC00117	157	DAY	0.52	+3.54	17.8	49.0	17.7	50.2
MIL00097	161	DAY	0.33	+4.21	20.4	28.1	19.7	34.5
MIL00099	162	NIGHT	0.34	+4.36	21.5	31.0	21.2	36.8
GD600146	169	DAY	0.28	+5.34	17.7	23.0	17.4	28.4
ETC00238	193	DAY	0.28	+7.97	15.0	23.3	14.1	28.5
MIL-181-32-1	197	DAY	0.30	-0.87	19.9	43.3	19.5	46.5
ETC-181-32-2	199	DAY	0.28	-0.37	16.4	30.8	16.6	34.7
GD600255	207	DAY	0.43	+0.23	26.9	67.8	27.6	89.3
GD600273	228	DAY	0.31	+2.72	19.5	26.3	18.9	30.5
ORR00288-01	247	NIGHT	0.27	+4.49	16.2	21.2	15.8	24.3
GD600290-04	250	DAY	0.28	+4.94	17.3	23.1	16.2	25.5
ETC328-01	268	DAY	0.24	+6.55	14.3	19.1	13.5	22.3
ETC366-01	302	NIGHT	0.37	+10.65	20.3	29.6	20.0	36.0

Table 5-2. Loss in Sensitivity Prior to Undervoltage Condition

DAY (RELATIVE TO 131)	LOSS (DEGREES K)	
	ACTUAL	CALCULATED
1	0.0	-0.04
2	0.05	0.13
3	0.26	0.30
5	0.53	0.65
6	1.03	0.82
8	1.21	1.16
9	1.26	1.33
10	1.51	1.50
11	1.75	1.67
13	2.03	2.01
14	2.10	2.18
15	2.35	2.34
16	2.63	2.51
18	2.82	2.84
20	3.09	3.17
22	3.60	3.50
23	3.54	3.66
24	3.70	3.82
27	4.28	4.29
31	4.95	4.91
32	5.10	5.06
39	6.08	6.06
63	8.71	8.72

NOTE: 0-DEGREE COEFFICIENT = -0.208769
 1-DEGREE COEFFICIENT = 0.171133
 2-DEGREE COEFFICIENT = 0.616915E-04
 3-DEGREE COEFFICIENT = -0.840492E-06

one data point was available, all values were averaged to obtain a single value. The plotted data is shown in Figure 5-2. After the completion of the recovery from an undervoltage condition during which the passive cooler door was closed and the cooler patch warmed to approximately 200 degrees K, the instrument was back to initial sensitivity of day 131. This is suggested by the value -0.67 degree K for $\Delta T'_{BB}$ for day 197. Since then, a loss of approximately 11.2 degrees K has occurred to day 302. Data for this period is described in Table 5-3 and Figure 5-3. A linear fit is made to the data in this case.

Table 5-4, a summary for channel 1, includes tape ID, Julian day, type of pass, signal-to-noise ratio (at 1-percent equivalent albedo), and minimum and maximum rms noise in the input and output calibration steps.

5.3 MASTER DATA PROCESSOR SIMULATION SOFTWARE

A program was developed that accepts input from a preprocessor CCT and applies the data processing algorithm described in Section 3 to generate a cubic polynomial for converting raw counts to radiance indices. This program was used to study the effect of varying N (the number of scans used for averaging calibration data, as described in Section 3.2) on the rms noise in corrected data. It was also used for ground truth comparisons.

5.3.1 Results of Noise Analysis for Calibrated Data

Because very few full scans of thermal-vacuum data were recorded, these data could not be used to study the effect of varying N on the noise in corrected data. Initial flight data were used for this purpose. Approximately 200 scan lines were used. A cubic polynomial was generated for sets of N scan lines, where N varied from 1 to 10. The rms noise in corrected counts for each value in the range 0 to 255 was calculated. Table 5-5 gives rms noise for various values of N for counts 45, 100, 160, 220, and 250 for two tapes; it also includes noise values for N = 10 for two more tapes. The results indicate that value of 10 for N is adequate.

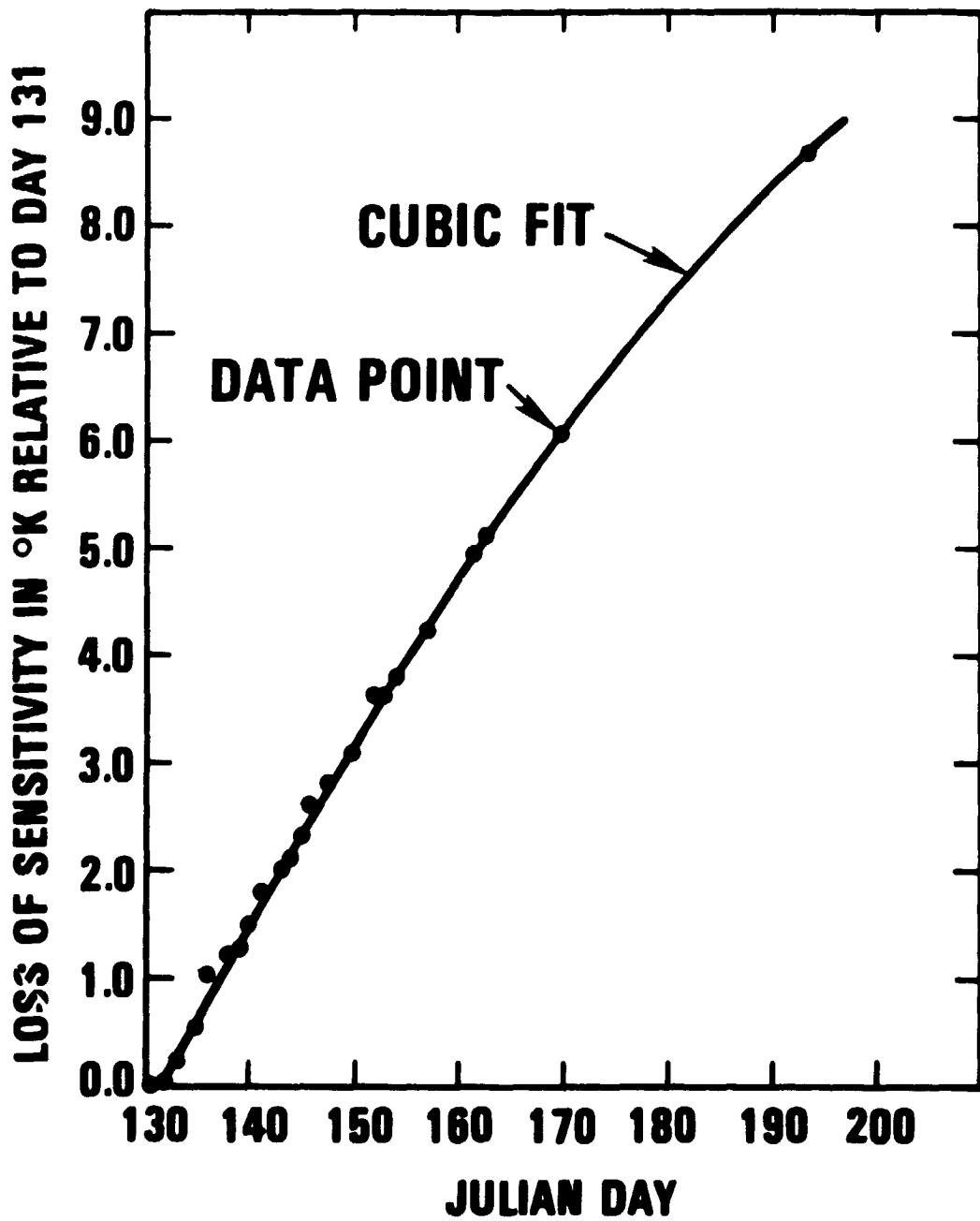

Figure 5-2. Actual and Fitted Loss in Sensitivity Prior to Undervoltage Condition

Table 5-3. Loss in Sensitivity After Recovery From Undervoltage Condition

DAY (RELATIVE TO 197)	LOSS (DEGREES K)	
	ACTUAL	CALCULATED
1	0.0	-0.02
3	0.30	0.19
11	0.90	1.04
32	3.39	3.27
51	5.16	5.29
54	5.61	5.61
70	7.22	7.31
106	11.22	11.13

NOTE: 0-DEGREE COEFFICIENT = -0.130374
 1-DEGREE COEFFICIENT = 0.106229

ORIGINAL PAGE IS
OF POOR QUALITY

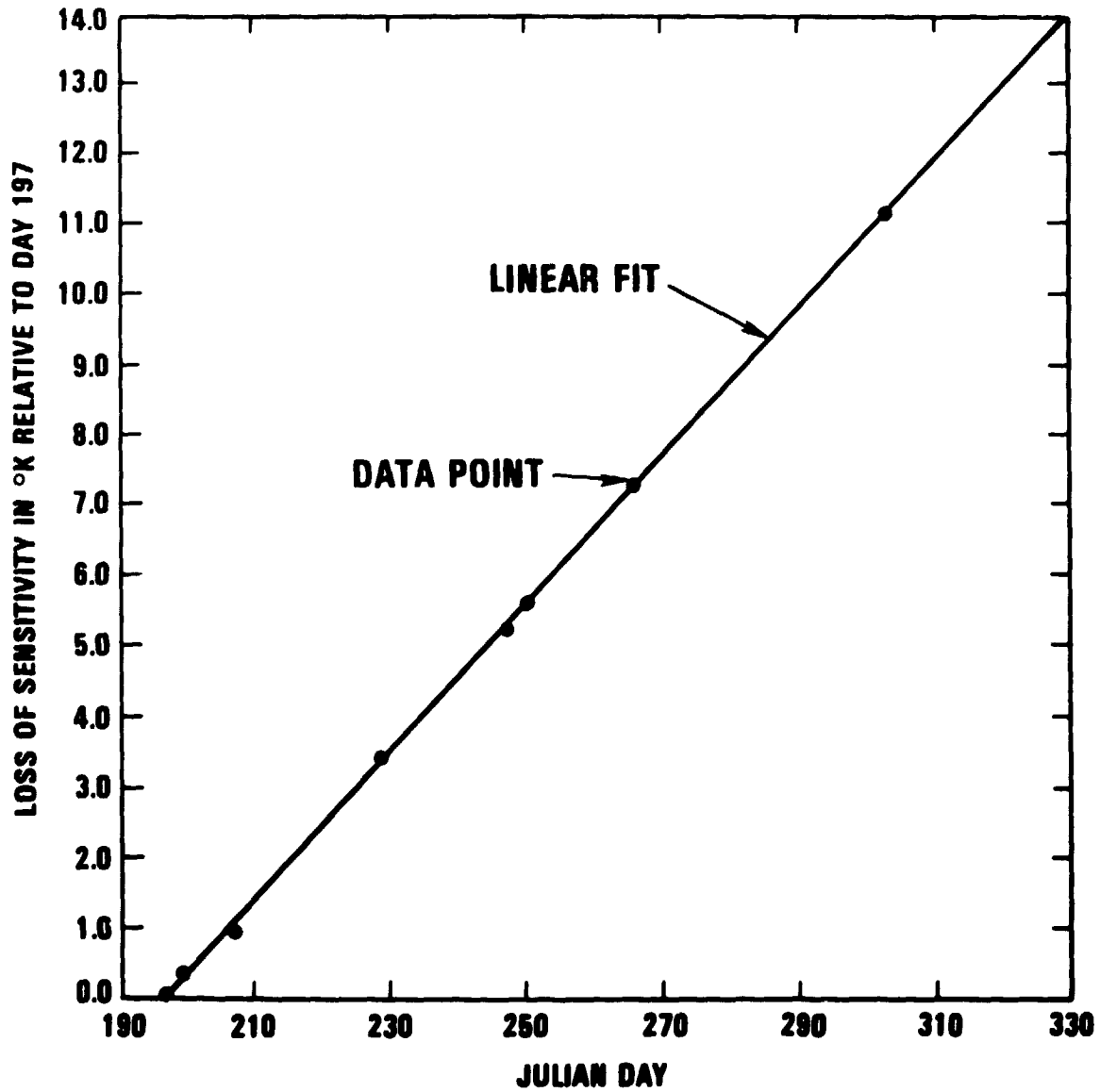

Figure 5-3. Actual and Fitted Loss in Sensitivity After Recovery From Undervoltage Condition

ORIGINAL PAGE 19
OF POOR QUALITY

Table 5-4. Summary of HCMM Flight Tape Analysis Near Infrared Channel

TAPE ID	JULIAN DAY	PASS	SIGNAL-TO-NOISE RATIO (1-PERCENT EQUIVALENT)	INPUT CALIBRATION r_{rms} NOISE (MILLIVOLTS)		OUTPUT CALIBRATION r_{rms} NOISE (MILLIVOLTS)	
				MINIMUM	MAXIMUM	MINIMUM	MAXIMUM
AA113181	131	DAY	2.23	17.5	26.3	18.6	25.4
MAD00027	131	NIGHT	2.67	18.6	42.3	17.7	42.2
MAD00028	131	DAY	2.93	16.6	19.5	15.6	19.3
ETC00033	131	DAY	2.96	15.0	22.5	14.8	21.2
GD000072	132	DAY	2.37	13.8	18.6	14.7	18.8
MAD00029	132	NIGHT	1.40	26.4	40.7	30.0	41.3
MAD00030	132	NIGHT	1.48	26.2	40.5	26.9	40.8
GD000028	132	NIGHT	2.07	16.6	23.3	16.2	23.4
GD000031	132	DAY	2.54	17.2	22.1	17.9	22.0
GD000034	133	DAY	0.96	35.0	50.6	35.0	50.9
ETC00048	135	DAY	1.04	45.7	78.5	46.1	70.6
GD000040	136	NIGHT	1.86	18.4	24.5	19.5	23.8
GD000048	138	DAY	1.84	14.8	21.8	16.1	21.2
MAD00048	138	DAY	1.64	24.5	69.2	23.0	66.5
MAD00052	139	DAY	0.17	175.6	332.7	167.0	1532.2
MAD00056	140	DAY	1.16	31.3	46.0	29.5	43.8
MAD00058	141	DAY	1.12	38.4	44.6	37.7	45.2
GD000066	141	NIGHT	2.00	19.1	23.2	18.3	23.1
GD000085	143	DAY	1.81	20.0	25.7	19.0	25.2
ETC00072	143	DAY	2.42	20.0	29.3	19.8	30.6
ULA00127	144	DAY	1.66	35.3	122.0	35.7	127.4
ULA00133	146	DAY	1.00	54.9	112.2	54.7	108.3
GD000071	146	NIGHT	2.01	18.8	26.1	18.1	24.8
ETC00098	148	DAY	0.23	88.9	182.7	89.3	281.1
ETC00096	150	DAY	0.17	86.6	1799.9	83.3	864.5
GD000091	152	NIGHT	1.82	18.4	23.8	18.9	23.9
GD000095	153	NIGHT	1.34	44.1	557.0	43.5	710.0
GD000100	154	DAY	1.96	20.6	25.5	20.9	25.9
ETC00117	157	DAY	0.48	32.9	90.8	33.9	88.8
MIL00097	161	DAY	2.48	18.8	27.4	18.9	26.6
MIL00099	162	NIGHT	2.51	18.6	27.7	18.4	27.0
GD000146	169	DAY	2.01	20.4	26.7	20.6	30.0
ETC00238	183	DAY	2.73	16.8	21.5	16.9	24.2
MIL-181-32-01	197	DAY	2.28	18.2	26.9	18.3	25.9
ETC-181-32-02	199	DAY	2.85	16.5	23.3	16.4	22.1
GD000265	207	DAY	0.99	27.0	89.7	25.2	209.3
GD000273	228	DAY	1.41	22.9	39.0	23.0	39.0
ORR209-01	247	NIGHT	2.30	16.4	16.4	16.4	23.9
GD0200-04	260	DAY	1.42	18.2	35.9	18.2	34.6
ETC128-01	286	DAY	2.34	15.0	22.8	15.4	22.0
ETC364-01	302	NIGHT	1.78	23.8	39.6	23.7	36.6

ORIGINAL PAGE IS
OF POOR QUALITY

Table 5-5. Root-Mean-Square Noise in Calibrated Data

N	rms NOISE (COUNTS)				
	45	100	160	220	250
TAPE ID: MAD00029					
1	0.60	0.70	1.16	1.75	2.06
3	0.21	0.44	0.45	0.68	0.77
5	0.16	0.38	0.27	0.49	0.48
7	0.0	0.36	0.0	0.48	0.53
10	0.0	0.22	0.0	0.48	0.37
TAPE ID: GDS00034					
1	0.26	0.58	0.75	1.08	1.21
3	0.0	0.46	0.47	0.52	0.62
5	0.0	0.42	0.46	0.35	0.55
7	0.0	0.32	0.46	0.36	0.42
10	0.0	0.31	0.37	0.41	0.44
TAPE ID: MAD00059					
10	0.0	0.37	0.0	0.50	0.37
TAPE ID: GDS00146					
10	0.0	0.0	0.45	0.21	0.21

5.3.2 Ground Truth Comparisons

To validate the data processing algorithm described in Section 3, ground measurements made at White Sands, New Mexico, were used. It is planned to continue making these measurements throughout the life of the HCMM mission. These measurements are made in the middle of Elephant Butte Reservoir in White Sands using an infrared radiometer and at the time of an HCMM overpass. Data from radiosondes released at the time coinciding with the HCMM pass are used to derive the atmospheric correction. Work for obtaining the ground measurements and the atmospheric correction was preformed by another contractor. Details of this work are provided in Reference 7.

Master Data Processor (MDP) simulation software was used for converting raw Earth scan pixel values to radiance indices. These indices can be converted to temperatures using the formula given in Section 3.6.1. Satellite-observed temperatures and ground truth temperatures are presented in Table 5-6. As indicated in this table, all ground temperatures obtained at White Sands are considerably lower than the satellite temperatures. Temperatures from Chesapeake Bay and from the Gulf Stream south of Cape Hatteras were also obtained for comparisons. In these two cases ground truth is closer to satellite-observed temperatures.

Satellite temperatures were obtained by using the original thermal gradient ΔT_{BB} , as presented in Table 2-7. It was decided to modify thermal gradient ΔT_{BB} so that the satellite temperatures and ground temperatures would be closer. The last two rows in Table 5-6 were not used because radiosonde data was not adequate. The atmospheric correction was obtained by using the radiosonde data from the shore rather than from the middle of the water body.

For each data point, R_{BB} is calculated using the equation

$$\frac{R_{BB}}{E_{BBR2} + V_{OFF}} = \frac{R_G}{E_G + V_{OFF}}$$

Table 5-6. HCMR Data Validation

DATE (1978)	SATELLITE OBSERVED		ATMOSPHERIC CORRECTION (DEGREES C)	CORRECTED TEMPERATURE (DEGREES K)	OBSERVED TEMPERATURE AT GROUND (DEGREES K)	OBSERVED TEMPERATURE CORRECTED TEMPERATURE (DEGREES C)	THERMAL GRADIENT DIFFERENCE (DEGREES C)	COMMENTS
	RAIN COUNT	RADIANCE INDEX						
ELEPHANT BUTTE RESERVOIR								
MAY 12	117	93	0.7	295.9	289.5	-6.4	6.14	ON MAY 23, THE RADIOMETER WAS AIMED AT THE LAKE FROM SHORE (DUE TO HIGH WINDS, THE OBSERVER COULD NOT GO OUT ON THE LAKE).
MAY 23	112	90	0.3	294.5	289.6	-4.9	4.57	
JUNE 1	100	81	4.5	295.8	291.7	-4.1	4.15	
JUNE 3	116	96	1.7	298.5	292.5	-6.0	5.57	
JUNE 10	122	108	2.2	302.2	296.0	-6.2	5.78	
NEAR ENTRANCE TO CHESAPEAKE BAY								
MAY 11	92	68	0.3	287.5	285.2	-2.3	-	FOR MAY 11, THE GROUND TRUTH WAS EXTRACTED FROM THE GULF STREAM 7-DAY COMPOSITE ISOTHERMAL ANALY- SIS
SOUTH OF CAPE MATTERS NEAR GULF STREAM								
MAY 11	117	93	0.3	295.5	293.2	-2.3	-	

where R_G is the radiance for the ground temperature (observed temperature at the ground-atmospheric correction) obtained from Planck equation

$$R = \frac{\epsilon_0 + \epsilon_1 T + \epsilon_2 T^2}{\left(e^{\epsilon_3/T} - 1 \right)} \quad (\epsilon_1 \text{'s are taken from Table 3-1)}$$

E_G is the calibrated voltage for the pixel representing ground measurement location, V_{OFF} is the offset voltage, and E_{BBR2} is the calibrated blackbody view voltage. An iterative procedure is used to obtain the temperature corresponding to R_{BB} . This temperature is then subtracted from the corrected blackbody thermistor temperature obtained by using earlier values of σ_1^S (as given in Table 3-1). The average for the five differences is 5.24. It was decided to modify the original thermal gradient ΔT_{BB} by 5.24. The value 5.24 is then added to the constant term of the polynomial (σ_0) for the blackbody temperature correction. Thus the original value of σ_0 (3.5309), as given in Table 3-1, is changed to 8.7709. Other σ_1 's remain the same.

5.4 CONCLUSIONS

After launch and a 2-week outgassing period, the HCMR was fully operational on Julian day 131 (May 11, 1978). During the operational checkout period that followed, examination of the telemetry and the results from the software described earlier in this section led to the conclusion that there were several minor anomalies in the performance of the sensor. These discrepancies and their consequences are discussed in the following subsections.

5.4.1 Cooler Temperature Regulation

The passive radiative cooler used on the HCMR to cool the infrared detector uses a feedback network to maintain the detector at a constant 115 degrees K.

After launch the telemetry indicated that the control point was 117.8 degrees K. This value has remained constant for over 200 days, having returned to the same value after the cooler door was closed, the cooler warmed, and the door reopened during a 24-hour period approximately 70 days after initial operation. An increase in the operating temperature of the detector should result in a corresponding decrease in detector response. However, other indications are that the response of the sensor increased after launch.

5.4.2 Postlaunch Sensor Sensitivity

Independent surface measurements are necessary to compare HCMR sensitivity after launch with the sensitivity determined during thermal-vacuum tests at ITT. Such measurements, taken at White Sands, New Mexico, are described in Section 5.3.2 and Table 5-6. Using the values from day 132 (May 12, 1978), the raw count of 117 is first converted to calibrated voltage and then to temperature using the prelaunch measured C_i 's for a baseplate temperature of 10 degrees C; the values of C_i , as taken from Table 4-2, were obtained by fitting the calibration data of Table 2-7. After adding 0.7 degree K to this value to account for water-vapor absorption, a value of 299.7 degrees K is obtained; this is 10.2 degrees K higher than the corresponding surface temperature of 289.5 degrees K. Because the sensor-measured temperature was determined by using the prelaunch ITT curves, thereby circumventing the use of the inflight calibration blackbody, the 10.2 degrees K higher value was not due to a change in thermal gradient ΔT_{BB} (the difference in the thermistor-measured and radiatively measured temperature of the inflight blackbody). The difference between the two measurements could be caused by either an increase in the sensitivity of the HCMR after launch or an error in the surface measurements. Both possibilities have been examined, and there is currently no reason to choose one rather than the other.

5.4.3 Postlaunch Value of Thermal Gradient ΔT_{BB}

Using Figure 2-7 and the postlaunch baseplate temperature, thermal gradient ΔT_{BB} should have been approximately 2.3 degrees C. However, as discussed in Section 5.2, the apparent ΔT_{BB} , denoted by $\Delta T'_{BB}$, was found to be approximately -0.7 degree C for Julian day 132, a difference of 3.0 degrees C from the expected value. Assuming the validity of measurements from White Sands, this difference can be attributed to a combination of a change in the sensitivity of the instrument and a change in thermal gradient ΔT_{BB} . Using ground measurement for Julian day 132, the difference in sensitivity (at the blackbody temperature) was 9.0 degrees C, and the difference in thermal gradient ΔT_{BB} was 6.0 degrees C. This is consistent with an overall difference of 3.0 degrees C between the original thermal gradient ΔT_{BB} and the apparent ΔT_{BB} observed on Julian day 132. Details of the calculation of the change in thermal gradient ΔT_{BB} are provided in Section 5.3.2. The average value of the change in thermal gradient ΔT_{BB} for five data points is 5.2 degrees C.

5.4.4 Losses in Optical Transmission

As discussed in Section 5.2, flight data indicate a loss in sensor sensitivity with time. Similar time-dependency is also indicated by the Table 5-7 column representing the differences between the ITT-calibrated temperatures and the surface temperatures. As discussed in Section 5.2 and shown in Figures 5-2 and 5-3, this loss in sensitivity was reversible by a warming cycle of the passive radiative cooler. Therefore, it is believed that this time-dependent loss of sensitivity is, in reality, a loss in optical transmission caused by the deposition of water vapor on the cooled optics of the radiative cooler. This loss is compensated for by the calibration software, but it does result in a gradual increase in the sensor NE ΔT and will therefore be reversed periodically.

Table 5-7. Ground Truth Comparison

DATE (1978)	TEMPERATURE, ITT CALIBRATION (DEGREES K)	ATMOSPHERIC CORRECTION (DEGREES C)	CORRECTED TEMPERATURE (DEGREES K)	SURFACE TEMPERATURE (DEGREES K)	DIFFERENCE (DEGREES K)
MAY 12	299.0	0.7	299.7	289.5	10.2
MAY 23	295.6	0.3	295.9	289.6	6.3
JUNE 1	291.3	4.5	295.8	291.7	4.1
JUNE 3	296.3	1.7	298.0	292.5	5.5
JUNE 19	297.2	2.2	299.4	296.0	3.4

5.4.5 Compensation for Changes in Sensor Performance

The preceding discussion indicates that a change in the HCMR probably occurred during launch. That this change manifests itself as an apparent increase in the sensitivity of the sensor is disturbing. However, because no alternative solution was available, it was decided to offset the calibrated data to force them to agree with the surface measurements from White Sands, New Mexico. This was done by increasing σ_0 by the average difference of 5.2 in thermal gradient ΔT_{BB} . The validity of this change will be verified by comparing the data with the surface values obtained by various experimenters and from additional White Sands data.

REFERENCES

1. ITT Aerospace/Optical Division, Heat Capacity Mapping Radiometer for AEM Spacecraft, Final Engineering Report, G. E. Sonnek et al. , March 1977
2. --, Acceptance Test Book for Heat Capacity Mapping Radiometer, G. E. Sonnek et al. , June 1977
3. B. N. Taylor, W. H. Parker, and D. N. Langenberg, "Determination of e/h , Using Macroscopic Quantum Phase Coherence in Superconductors: Implications for Quantum Electrodynamics and the Fundamental Physical Constants," Reviews of Modern Physics, July 1969, vol. 41, no. 3, pp 375-496
4. International Business Machines Corporation, "HCMM Data Processing Specification," Appendix D.1, August 1978
5. National Aeronautics and Space Administration, Goddard Space Flight Center, Thermal Vacuum Test Procedures for the AEM-A (HCMM) Spacecraft, N. Witek et al , February 1978
6. --, HCMM Test Computer Compatible Tape Format Description, Information Processing Division, April 1978
7. --, Calibration of the Radiometer on the AEM-A Mission, J. Price and S. Jakkempudi (in preparation)
8. Interface Control Document between the Image Processing Facility and the Master Data Processor System for AEM-A. Partially processed Heat Capacity Mapping Mission partial Output Tape (CCM-RU), May 31, 1978, IBM, Federal Systems Division under Contract NAS5-24285, prepared for GSFC.

APPENDIX A

This appendix contains flowcharts, subprogram inter-relationships, functional descriptions, and source listings for the programs CCTANL, CORECT, and MDPSIM. Each flowchart presents a broad overview of the program. Functional description and major logical steps for each subprogram are explained through inline comment cards. A description of variables in various COMMON blocks and NAMELISTS is also included in this appendix.

Program CCTANL is the processing system for flight data analysis described in Section 5.1. This program was never designed independently for this purpose. Due to unanticipated circumstances, software to monitor the performance of the instrument and ground stations was needed. The processing system developed for analyzing data taken during the integrated spacecraft testing (described in Section 4) was modified and used for testing flight data. Thus, the methods adopted may not be the best possible in certain cases.

Programs CORECT and MDPSIM constitute the Master Data Processor (MDP) simulation software. Program CORECT generates look-up tables for converting raw counts to calibrated indices for master output tables. Program MDPSIM verifies the calibration processing implemented by the MDP. Since many of the functions performed by the two programs are similar, software was coded so that certain subprograms including the COMMON blocks could be shared by the two programs. Common block VALUE is used by both programs, whereas STAT is used only by MDPSIM. There is one block data subprogram for both of these. MDPSIM uses a subprogram BCD5 that converts ASCII characters to EBCDIC characters and is available on SACC (Science and Application Computer Center) computers.

PROGRAM CCTANL

Functional Description and Method

Program CCTANL reads a preprocessor CCT and generates certain quantities that can be used to verify the performance of the instrument in flight and related data handling systems. The program analyzes data in units of blocks of scan lines. The user inputs the size of block, number of first block, and total number of blocks to be analyzed. MAIN first reads through the scan lines to be skipped, and then reads the first scan line to be processed. Data are transferred from the LOGICAL *1 to REAL *4 array so that various arithmetic operations can be performed on them. Counts from the two blackbody and baseplate thermistors are converted to temperatures. Subroutines CCTAVR and CCTBAS are called to calculate averages and standard deviations in counts for various physically significant parameters for each scan line. Subroutine CCTAVR also averages the raw counts for both input and output calibration steps over the requested number of scans to be used later by CCTCNV. An option for no averaging is also available. Subroutine CCTCNV is called to convert raw averages and standard deviations to averages and standard deviations in volts and physical units (temperature for channel 2, albedo for channel 1). When the number of scan lines in a block are processed, a summary for that block is generated. The summary contains averages and standard deviations of the averages and averages of the standard deviations in counts, volts, and physical units. When the requested number of blocks is processed, a summary for all the blocks is generated.

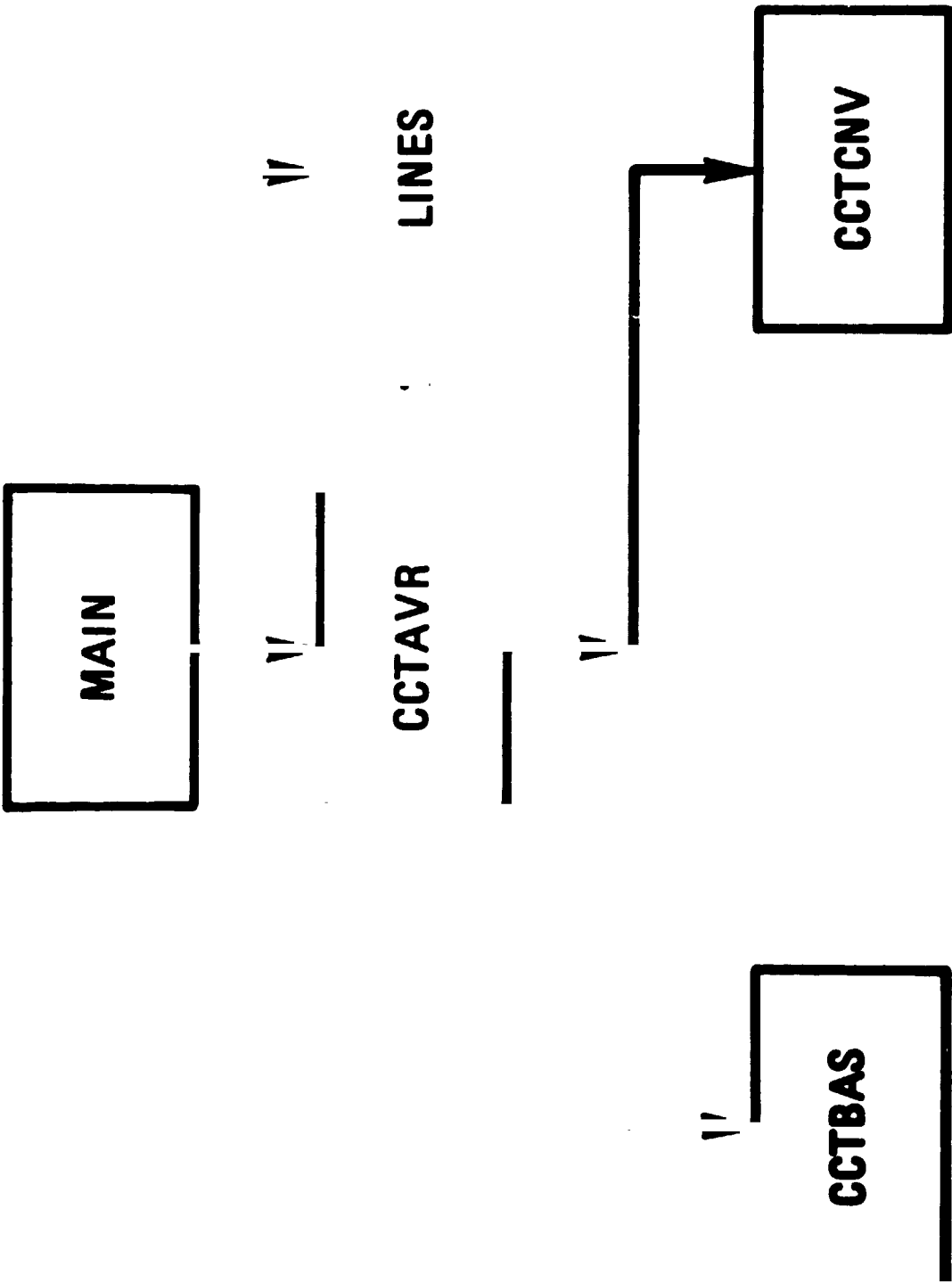

Figure A1 Subprograms For CCTANL

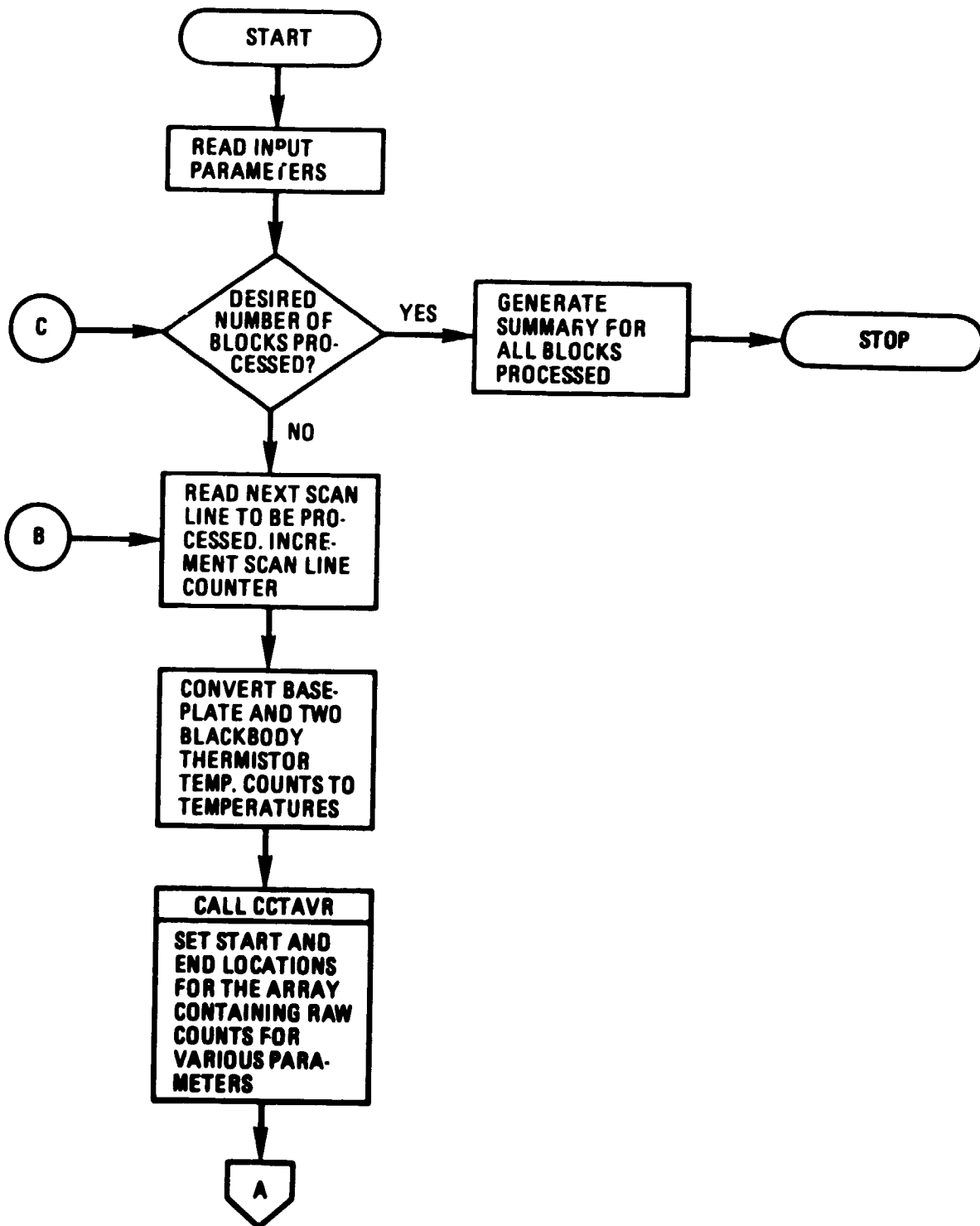

Figure A2 Flowchart For CCTANL (Part 1.)

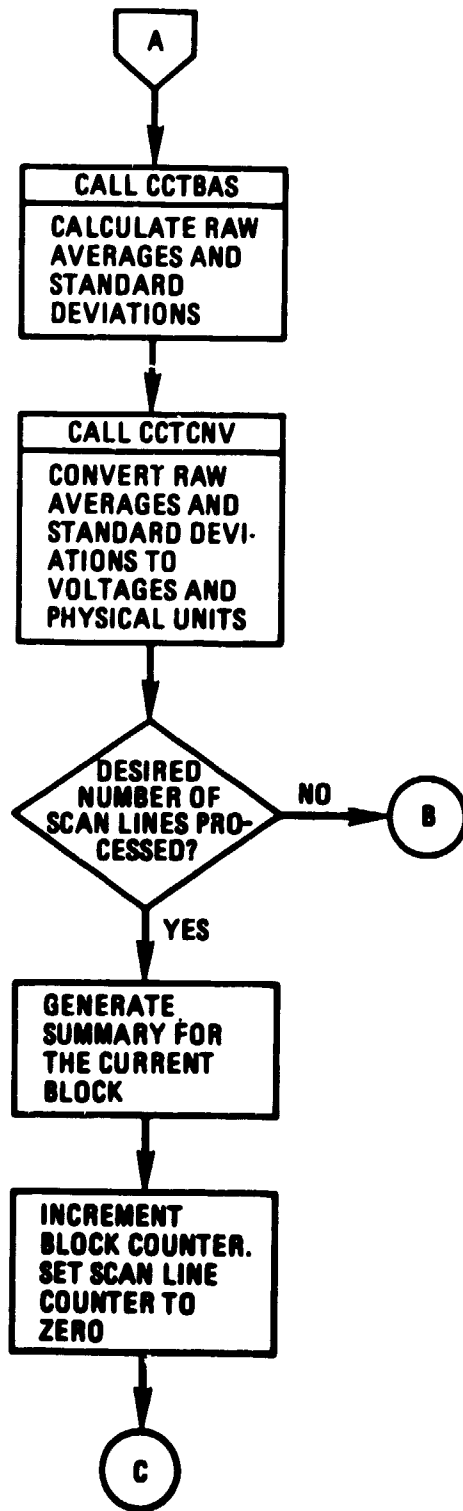

Figure A2 (Cont.) Flowchart For CCTANL (Part 2.)

Table A1 COMMON BLOCK CCINF

Variable	Dimension	Type	Definition
X	2000	R*4	Sensor and calibration data (one location per sample).
ISC	1	I*4	Starting location in array X for space clamp samples.
IES	3	I*4	IES(n) is the starting location in X for the nth set of Earth scan samples.
IOUT	1	I*4	Starting location in array X for output calibration samples.
IBB	1	I*4	Starting location in array X for blackbody view samples.
ITH	1	I*4	Starting location in array X for blackbody thermistor samples.
NSC	1	I*4	Number of samples for space clamp and each of the seven input calibrations steps.
NES	3	I*4	NES(n) is the number of Earth Scan samples in the nth set.
NOOUT	1	I*4	Number of samples for each of the seven output calibration steps.
NBB	1	I*4	Number of samples for blackbody view.
NTH	1	I*4	Number of samples for blackbody thermistor.
ITYPE	1	I*4	=1, visible channel =2, thermal channel
NUMES	1	I*4	Number of sets of Earth Scan data to be processed. (Maximum = 3).
QDATA	4500	L*1	Array to hold one CCT record.
QSTR	131	L*1	All elements = character *
FULAV	200,20	R*4	Averages in calibrated volts for various parameters for one scan line. First index is for scan line, Second is for the parameter.
FULSD	200,20	R*4	Standard deviations in calibrated volts.
RFULAV	200,20	R*4	Raw averages.
RFULSD	200,20	R*4	Raw standard deviations.
PUFLAV	200,5	R*4	Averages in physical units.
PUFLSD	200,5	R*4	Standard deviations in physical units.
IFULSC	1	I*4	Scan line counter in a block.
ITMP	1	I*4	Baseplate temperature.
D	4	R*4	Coefficients for converting blackbody thermistor voltage to temperature.
ISCAN	1	I*4	Counter for the scan lines for which raw input and output calibration steps have been averaged.
NSCAN	1	I*4	Number of scan lines over which raw input and output calibration steps have to be averaged prior to calibration (Maximum = 10).
NSET	1	I*4	Counter for sets of NSCAN lines processed.
QTIME	6,10	L*1	STADAN time code.

Table A2 COMMON BLOCK ANALYS

Variable	Dimension	Type	Definition
ZNAME	20	R*8	Names for 20 physically significant parameters.
AVER	20,10	R*4	Raw averages for the parameters for one scan line. First index is for the parameter, second is for scan line.
SD	20,10	R*4	Raw standard deviation (rms).
CV	20,10	R*4	Averages in volts.
CSD	20,10	R*4	Standard deviation in volts.
PU	20,10	R*4	Averages in physical units.
PUSD	20,10	R*4	Standard deviations in physical units.
VIN	7,2	R*4	Raw averages for seven input calibration steps. First index is for step, second for channel.
VOUT	7,2	R*4	Raw averages for seven output calibration steps.
C	5,10	R*4	Coefficients for converting IR volts to temperature. First index is for the coefficient, second for baseplate temperature.
CVIN	7,2	R*4	Predetermined volts for seven input calibration steps.
CVOUT	7,2	R*4	Predetermined volts for seven output calibration steps.
VOFFA	1	R*4	Offset voltage for one scan line.
BPA	1	R*4	Baseplate temperature for one scan line.
BB1A	1	R*4	Blackbody 1 temperature for one scan line.
BB2A	1	R*4	Blackbody 2 temperature for one scan line.

Table A3 NAMELIST SAMPLE

Variables belonging to one of the two COMMON blocks described previously are not included.

Variable	Dimension	Type	Definition
NBLK	1	I*4	Number of blocks to be analyzed (Maximum = 10).
NSTBLK	1	I*4	Starting block to be analyzed.
NSIZE	1	I*4	Number of scan lines in each block (Maximum = 200).
NTYPE	1	I*4	=1, process odd records* =2, process even records

NAMELIST VOLT

All the variables in this NAMELIST have been described in the COMMON BLOCK ANALYS.

***Ordinarily a CCT has all odd records for channel 1, and even records for channel 2. Hence, if the user specifies ITYPE = 1, NTYPE should be 1, and for ITYPE =2, NTYPE should be 2. Occasionally, a CCT has the order reversed. In that case, the combinations to be used are ITYPE = 1, NTYPE = 2, and ITYPE = 2, NTYPE = 1.**

PROGRAM MDPSIM

Functional Description and Method

Program MDPSIM verifies the calibration processing implemented by the Master Data Processor (MDP). Data is obtained from a computer compatible tape (CCT-RU) generated by the MDP. This tape contains the input data as well as the output generated by the MDP. The output consists of certain intermediate quantities and the cubic polynomials for converting raw counts to calibrated indices. The user enters input parameters through the NAMELIST INPUT. Subroutine MDPRED is called to read one record at a time, (a single record contains data from both channels unlike a preprocessor CCT), containing input calibration data. Subroutine SMOOTH is called to smooth data. When the data are smoothed over the requested number of scan lines (N), subroutine INTVAL is called to generate certain intermediate quantities and the cubic polynomials referred to above. Subroutine COMPAR then reads the output record from the tape and compares the outputs generated by MDP and MDPSIM. The process described is referred to as processing one calibration set. When the requested number of sets is processed a summary is generated. The format for a CCT-RU tape may be found in Reference 8.

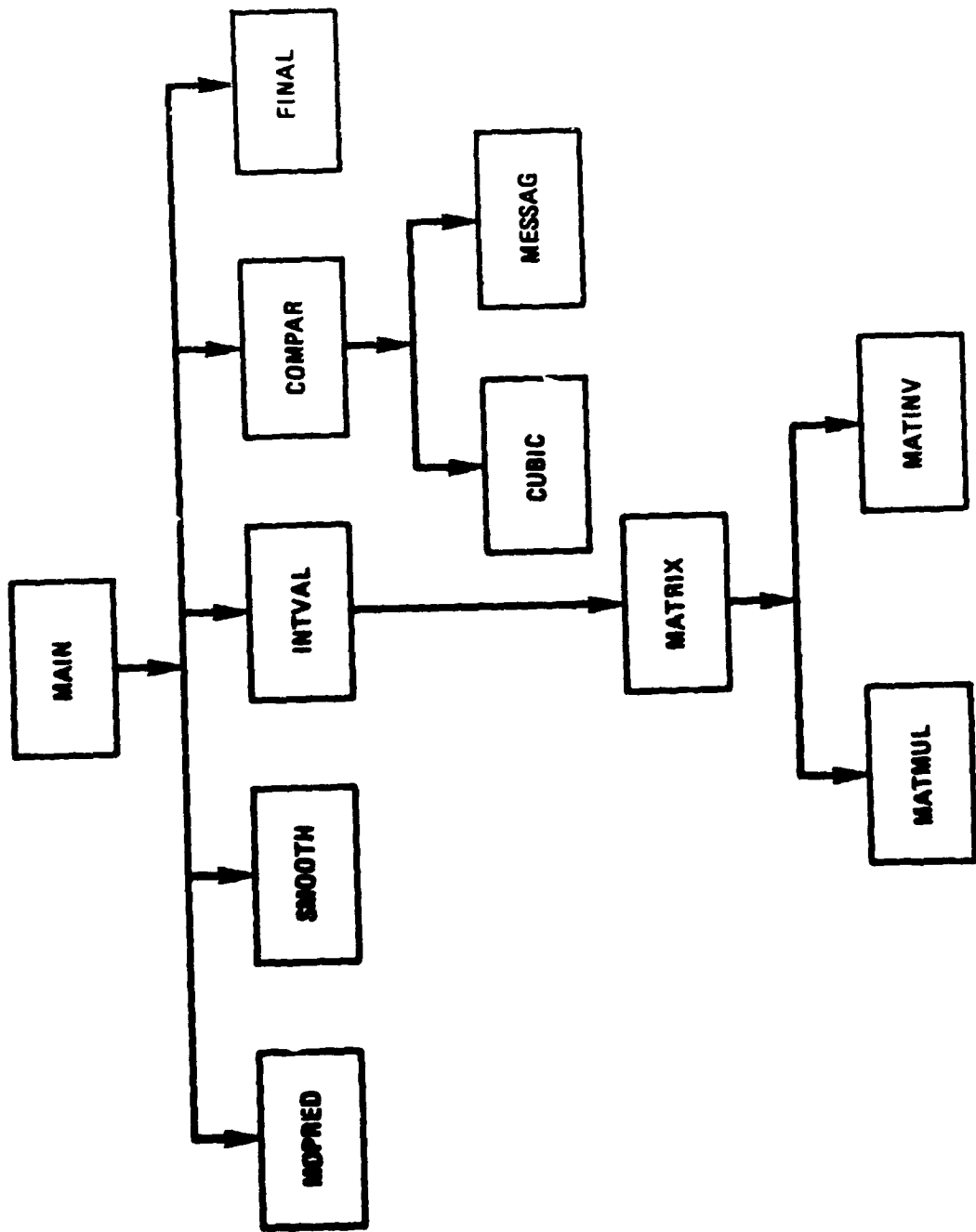

Figure A3 Subprograms For MDPsim

ORIGINAL PAGE IS
OF POOR QUALITY

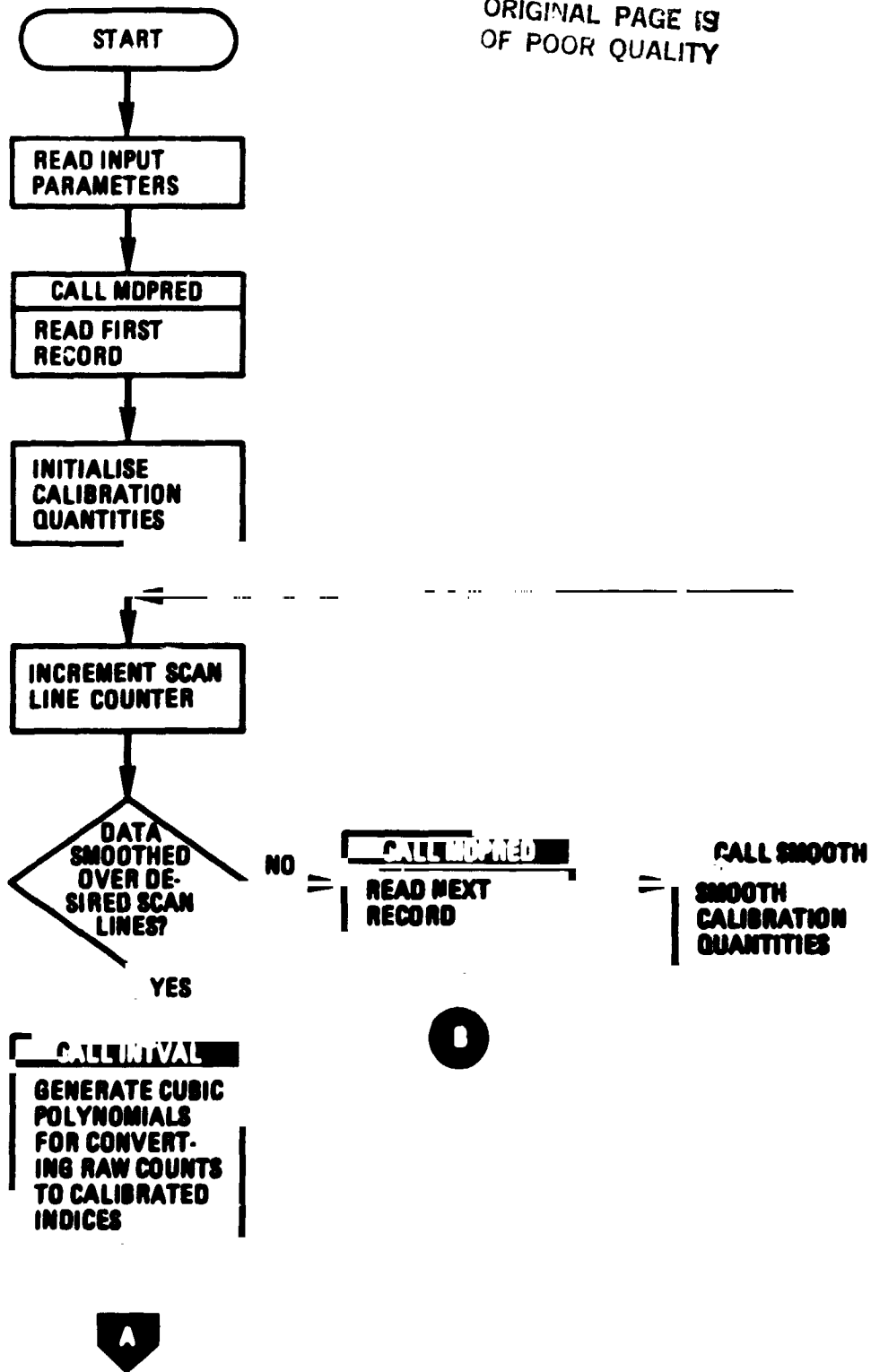

Figure A4 Flowchart for MDPSIM (Part 1.)

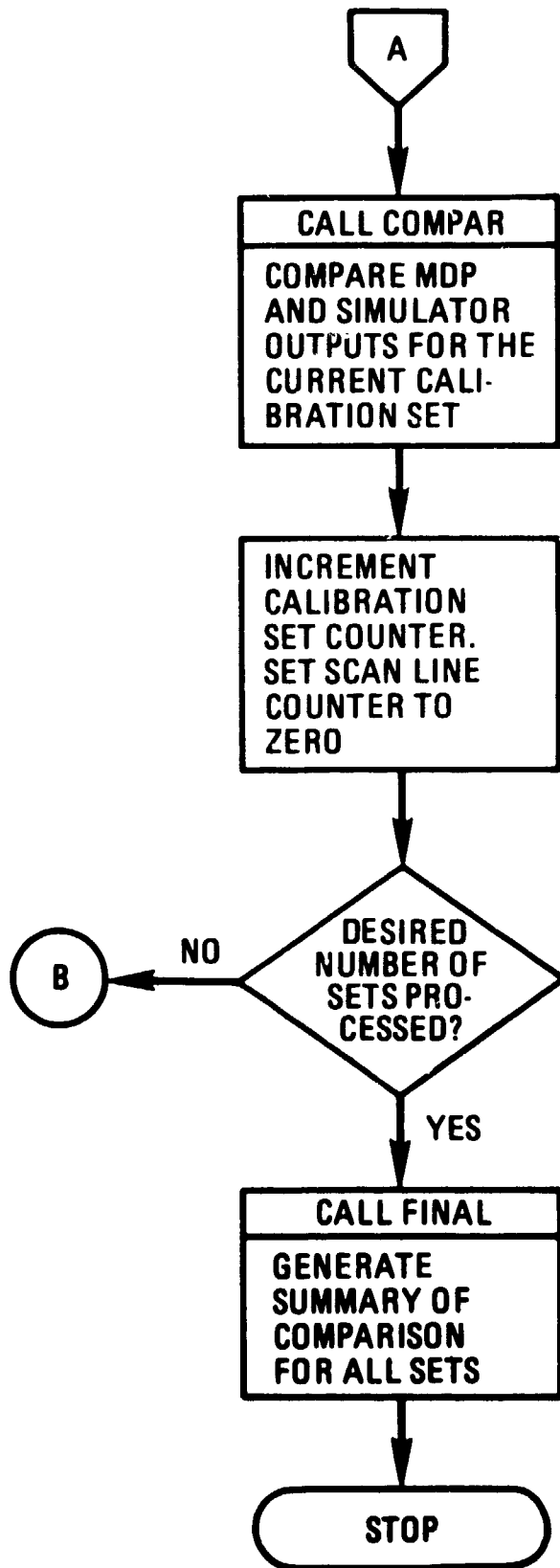

Figure A4 (Cont.) Flowchart for MDPSIM (Part 2.)

Table A4 COMMON BLOCK VALUE

Variable	Dimension	Type	Definition
SCIN1	7	R*8	Smoothed counts from input calibration steps for Channel 1.
SCIN2	7	R*8	Smoothed counts from input calibration steps for Channel 2.
SCOUT1	7	A*8	Smoothed counts from output calibration steps for Channel 1.
SCOUT2	7	R*8	Smoothed counts from output calibration steps for Channel 2.
EC	3	R*8	Telemetry encoder calibration data.
SCBBR1	1	R*8	Smoothed count of blackbody view for Channel 1.
SCSC1	1	R*8	Smoothed space clamp count for Channel 1.
SCBBR2	1	R*8	Smoothed count of blackbody view for Channel 2.
SCSC2	1	R*8	Smoothed count for blackbody thermistor for Channel 2.
EBP	1	R*8	Baseplate voltage.
EBB1	1	R*8	Thermistor 1 blackbody voltage.
EBB2	1	R*8	Thermistor 2 blackbody voltage.
EOFFS	1	R*8	Offset voltage.
WS	1	R*8	Calibration scan filter weight (Default = 0.1)
PWS	1	R*8	1-WS
ALPHA1	4	R*8	Coefficients of polynomial giving count as a function of voltage at input to amplifier on Channel 1.
ALPHA2	4	R*8	Coefficients of polynomial giving count as a function of voltage at input to Channel 2 amplifier.
ALPHA3	4	R*8	Coefficients of polynomial giving count as a function of voltage at output of Channel 1 amplifier.
ALPHA4	4	R*8	Coefficients of polynomial giving count as a function of voltage at output of Channel 2 amplifier.
DELTA1	4	R*8	Coefficients of polynomial converting raw counts to be calibrated indices for Channel 1.
DELTA2	4	R*8	Coefficients of polynomial converting raw counts to calibrated indices for Channel 2.
C	2	R*8	Telemetry voltage correction coefficients.
EBBR1	1	R*8	Blackbody view voltage on Channel 1.
ESC1	1	R*8	Space clamp voltage on Channel 1.
EBBR2	1	R*8	Blackbody view voltage on Channel 2.
ESC2	1	R*8	Space clamp voltage on Channel 2.
TBB3	1	R*8	Blackbody thermistor temperature from Channel 2 scan.
TBP	1	R*8	Baseplate temperature.
TBB1	1	R*8	Blackbody temperature from thermistor #1.
TBB2	1	R*8	Blackbody temperature from thermistor #2.
VOFF	1	R*8	Offset voltage.
BETA1	4	R*8	Coefficients of polynomial giving voltage at input to Channel 1 amplifier as a function of received count.

Table A4 COMMON BLOCK VALUE (Continued)

Variable	Dimension	Type	Definition
BETA2	1	R*8	Coefficients of polynomial giving voltage at input to Channel 2 amplifier as a function of received count.
VI1	7	R*8	Predetermined voltages for seven input calibration steps for Channel 1.
VI2	7	R*8	Predetermined voltages for seven input calibration steps for Channel 2.
VO1	7	R*8	Predetermined voltages for seven output calibration steps for Channel 1.
VO2	7	R*8	Predetermined voltages for seven output calibration steps for Channel 2.
A	3	R*8	Albedo intensity function coefficients.
TAU1	4	R*8	Thermistor voltage to temperature polynomial coefficients for SCBB3.
TAU2	4	R*8	Thermistor voltage to temperature polynomial coefficients for baseplate.
TAU3	4	R*8	Thermistor voltage to temperature polynomial coefficients for blackbody thermistor #1.
TAU4	4	R*8	Thermistor voltage to temperature polynomial coefficients for blackbody thermistor #2.
WT	3	R*8	Coefficients used in weighted sum of blackbody temperatures.
SIGMA	4	R*8	Coefficients of polynomial used to correct blackbody temperature for baseplate temperature.
EPSILN	4	R*8	Coefficients in Planck equation used to convert blackbody temperature to radiance.
RHO	2	R*8	Polynomial coefficients used to compute offset voltage.
B	3	R*8	Coefficients for converting radiance to calibrated indices for Channel 2.
VC	3	R*8	A/D conversion levels.
WBP	1	R*8	Filter weight used to smooth baseplate voltage.
WØ	1	R*8	Filter weight used to smooth offset voltage.
NUM	1	I*4	Not used.
N	1	I*4	Number of scan lines to be used for smoothing calibration data (Default = 10).
ICALL	1	I*4	Calibration set being processed.
COUNT	40	I*2	Calibration quantities described in items 1 through 14 in Table D. 1-la, Reference 4 for the current pair of scan lines.
QGOOD	1	L*1	=True, no I/O error in reading the tape =False, I/O error

Table A5 COMMON BLOCK STAT

Variable	Dimension	Type	Definition
AVER1	256	R*8	Average of the differences between the calibrated indices generated by MDP and the program MDPSIM for Channel 1.
AVER2	256	R*8	Same as above for Channel 2.
SD1	256	R*8	Standard deviation of the differences between the calibrated indices generated by MDP and the program MDPSIM for channel 2.
SD2	256	R*8	Same as above for Channel 2.
DFMIN1	256	R*4	Minimum of the differences for Channel 1.
DFMIN2	256	R*4	Minimum of the differences for Channel 2.
DFMAX1	256	R*4	Maximum of the differences for Channel 1.
DFMAX2	256	R*4	Maximum of the differences for Channel 2.
LAV	1	I*4	Number of calibration sets for which MDP and MDPSIM outputs were compared.
QTYPE1	1000	L*1	=1, difference between MDP and MDPSIM outputs exceeded predefined limits for Channel 1. =0, difference within limits for Channel 1.
QTYPE2	1000	L*1	Same as above for Channel 2.

Table A6 NAMelist INPUT

Variable ISETS is defined below, rest of the variables are described in the COMMON BLOCK VALUE.

Variable	Dimension	Type	Definition
ISETS	1	I*4	Number of calibration sets to be processed (Maximum = 1000).

PROGRAM CORECT

Functional Description and Method

Program CORECT reads calibration data from a preprocessor Computer Compatible Tape (CCT) and generates look-up tables for converting raw counts (0-255) to calibrated indices for master output tables. These indices can then be converted to desired physical units as described in Section 3. The user enters input parameters through the NAMELIST INPUT. Subroutine CCTRED is called to read the records to be skipped before processing and to read the first pair of records (one for each channel). Subroutine SMOOTH is called to smooth the calibration data. When the data are smoothed over the requested number of scan lines (N), subroutine INTVAL is called to generate certain intermediate quantities and the cubic polynomials for converting raw counts to calibrated indices for both channels. Subroutine CONVRT is called to convert counts (0-255) to be calibrated indices using the polynomials generated. Thus, a look-up table is generated for each set of N scan lines referred to as one calibration set. When the requested number of calibration sets are processed, averages and standard deviations for calibrated indices are calculated. Look-up tables, averages, and standard deviations are then printed.

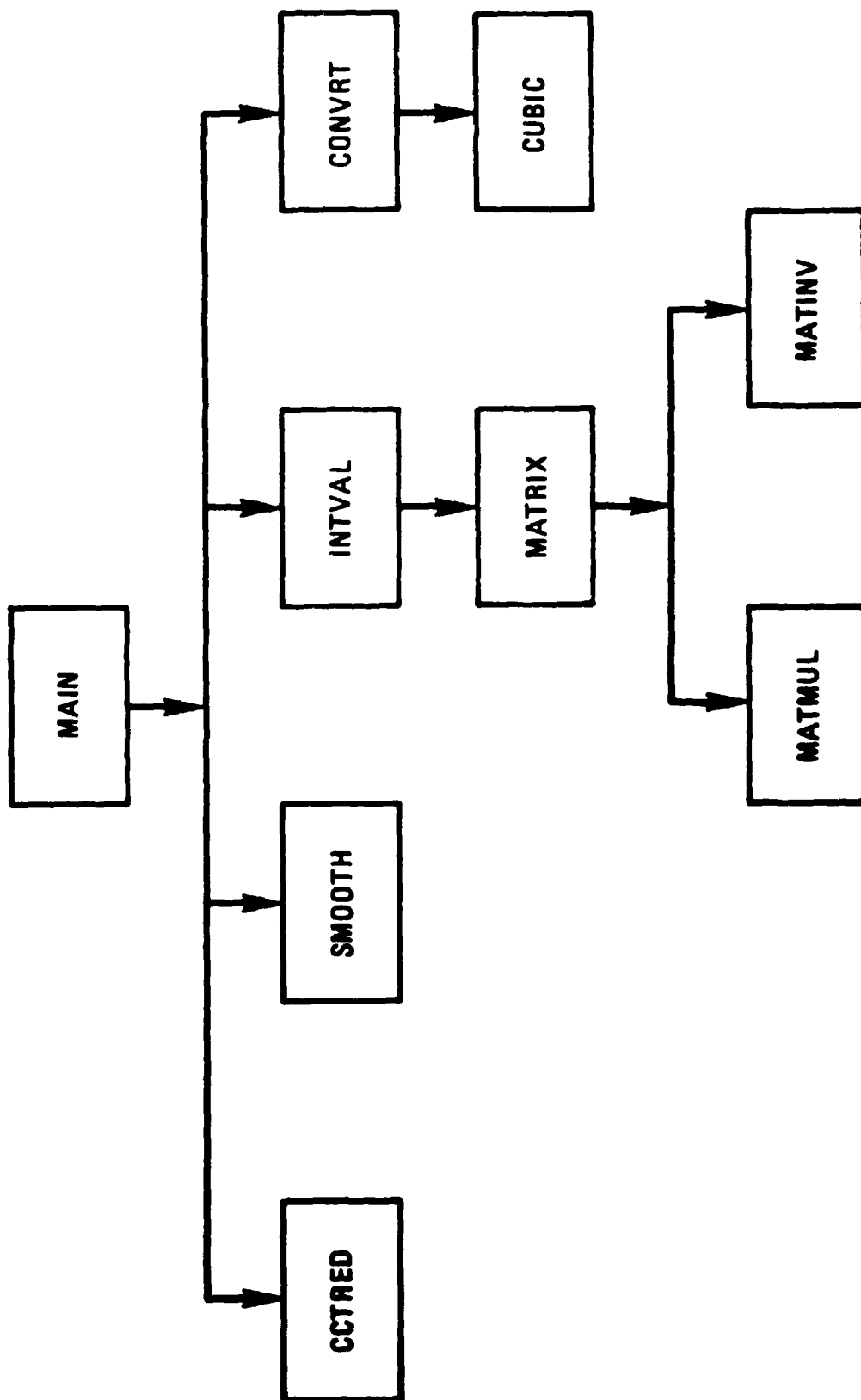

Figure A5 Subprograms for CORECT

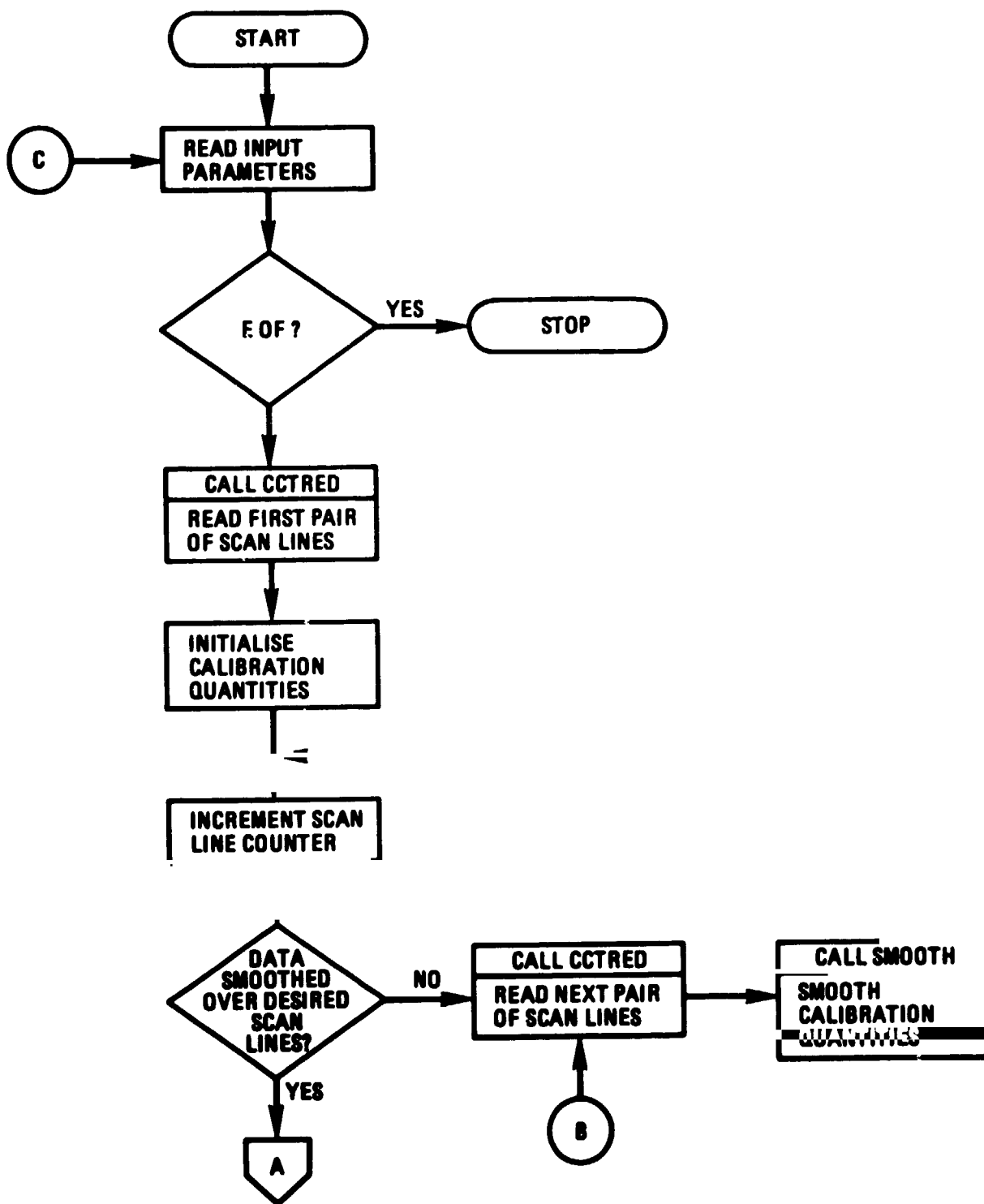

Figure A6 Flowchart for CORECT (Part 1.)

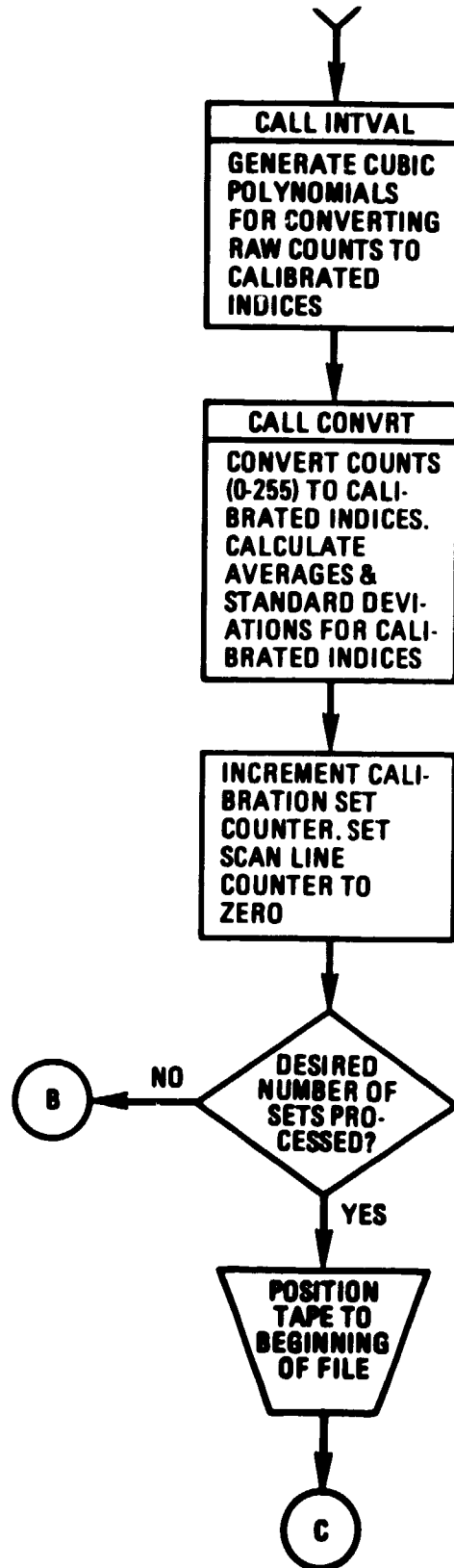

Figure A6 (Cont.) Flowchart for CORECT (Part 2.)

Table A7 NAMelist INPUT

Variables that belong to the COMMON BLOCK VALUE are not included.

Variable	Dimension	Type	Definition
ISKIP	1	I*4	Number of records to be skipped before processing.
MSETS	1	I*4	Number of calibration sets to be processed (Maximum = 200).
NFILE	1	I*4	Tape file number containing image and calibration data.
MST	1	I*4	First calibration set for which look up tables are to be printed.

09MAR79 14.59.42 - VOL=DISK06, DSN=ZBMMB.LIB.CNTL

```

C*****00000005
C*****MAIN FOR PROGRAM C.TANL 00000007
C***** 10/16/78 00000100
C*****PROGRAM TO MONITOR PERFORMANCE OF THE RADIOMETER, & NOISE 00000200
C*****IN DATA. 00000210
C*****INPUT FROM PREPROCESSOR CCT 00000300
C*****DEVELOPED BY M.BENIRA, COMPUTER SCIENCES CORPORATION 00000400
C*****00000410
-----
IMPLICIT LOGICAL*1 (0) 00000500
INTEGER*2 ICOUNT,C1,C2 00000600
REAL*8 ZNAME,ZNAME2 00000700
COMMON/CCTINF/X(2000) 00000800
COMMON/CCTINF/ISC,IES(3),IOUT,IBB,ITH,NSC,NES(3),NOUT,NBB,NTH, 00000900
I,TYPE,NUMES 00001000
COMMON/CCTINF/QDATA(4500),QSTR(131) 00001100
COMMON/ANALYS/ZNAME(20) 00001200
COMMON/ANALYS/AVERT(20),T(10),SD(20,10),CV(20,10),CSD(20,10), 00001200
*PU(20,10),PUSD(20,10), 00001300
IVIN(7,2),VOUT(7,2),C(5,10),CVIN(7,2),CVOUT(7,2),VOFFA,BPA,BB1A, 00001400
2B32A,FULAV(200,20),FULSD(200,20),RFULAV(200,20),RFULSD(200,20), 00001500
3PUFLAV(200,5),PUFLSD(200,5),IFULSC,ITAMP,D(4),ISCAN,NSCAN,NSET, 00001600
ACTIME(4,10), 00001620
DIMENSION AVFUL(10,20),SDFUL(10,20),AVSDFL(10,20),IND(5) 00001700
DIMENSION SDPUFL(10,5),APUSDF(10,5),AVPUFL(10,5),TPUSDA(5) 00001800
DIMENSION TOTAV(20),TOTSD(20),TOTSDA(20),TPAV(5),TPUSDA(5) 00001900
DIMENSION RAVFUL(10,20),RSDFUL(10,20),RAVSDF(10,20),RTOTAV(20), 00002000
RTOTSD(20),RTOTSDA(20) 00002100
DIMENSION BASEPL(200),BASEAV(10) 00002200
DIMENSION VBBV(10),RBBV(10),PBBV(10) 00002202
DATA IND/0,10,11,10,20/,AVPUFL/50*0.0/,SDPUFL/50*0.0/, 00002300
1AVFUL/200*0.0/,SDFUL/200*0.0/,AVSDFL/200*0.0/, 00002400
2APUSDF/50*0.0/,D1/333.2296/ 00002500
DATA RAVFUL/200*0.0/,RSDFUL/200*0.0/,RAVSDF/200*0.0/ 00002600
DATA VBBV/10*0.0/,RBBV/10*0.0/,PBBV/10*0.0/ 00002610
DATA TVBBV/0.0/,TRBBV/0.0/,TPBBV/0.0/ 00002620
DATA ZNAME/'BASEPLAT'/ 00002700
NAMELIST/SAMPLE/ISC,IES,IOUT,IBB,ITH,NSC,NES,NOUT,NBB,NTH, 00002800
I,TYPE,NUMES,NBLK,NSTBLK,NSIZE,NIYPE,NSCAN 00002900
1/VOLT/VIN,VOUT,C,D,CVIN,CVOUT,ITMP 00003000
DIMENSION ISTQ(18),ISTX(18),INUM(18),COUNT(3),VOLTS(3),Y(4) 00003100
DATA ISTQ/12,1070,2222,2240,2270,2290,2318,2342,2368,2774, 00003200
12798,2822,2846,2870,2894,2918,3226,3878/,ISTX/169,1809,29, 00003300
249,69,89,109,129,149,169,1689,1709,1729,1749,1769,1789, 00003400
31859/,INUM/1500,50,15*20,50/,COUNT/5.0,125.0,250.0/,VOLTS/0,11, 00003500
42,51,5.01/,IREC/0/ 00003600
DATA VMINI/1.E-10/,VMINO/1.E-10/,VMAXI/1.E-10/,VMAXO/1.E-10/ 00003700
C*****SET START LOCATIONS AND NUMBER OF SAMPLES FOR VARIOUS 00003800
C*****PARAMETERS 00003900
ISCAN=0 00003910
NSET=0 00003920
IBLK=0 00004000
ISC=10 00004100
IOUT=1670 00004200
IES(1)=600 00004300
IBB=1810 00004400
ITH=1860 00004500
NSC=20 00004600
NOUT=20 00004700
NES(1)=300 00004800
NBB=50 00004900
NTH=50 00005000
READ(5,SAMPLE) 00005100
READ(5,VOLT) 00005200
WRITE(8,SAMPLE) 00005300
WRITE(8,VOLT) 00005400
NREC=NSIZE*(NSTBLK-1)*2 00005500
IF(NREC.EQ.0) GO TO 4 00005600
C*****READ RECORDS NOT TO BE PROCESSED 00005700
DO 3 I=1,NREC 00005800
CALL READ(OCATAL),LO,LEN,CZ,CB) 00005900
3 CONTINUE 00006000
GO TO 4 00006100
P WRITE(8,90071) 00006200
GO TO 1100 00006300
B WRITE(8,92011) 00006400
GO TO 3 00006500
C*****TEST IF NUMBER OF DESIRED BLOCKS ARE ANALYSED 00006600

```

09MAR74 14.59.42 - VOL=DISK06. DSN=ZBMM3.LIB.CNTL

```

4 IBLK=IBLK+1                                00006700
IF(IIBLK.GT.NBLK) GO TO 1000                00006800
C+++++READ RECORDS TO BE PROCESSED.OF SCARD ALTERNATE RECPD.S. 00006900
5 CALL FREAD(QDATA(1),10,LEN,6735,6610)      00007000
.IREC=IREC+1                                00007100
IF(MOD(IREC-NYPE,2).NE.0) GO TO 5           00007200
GO TO 10                                     00007300
610 IREC=IREC+1                               00007400
WRITE(8,920)IREC                            00007500
GO TO 5                                       00007600
10 IFULSC=IFULSC+1                           00007700
ISCAN=ISCAN+1                               00007710
C1=QDATA(7)                                 00007800
C2=QDATA(8)                                 00007900
ICOUNT=C1*256+C2                            00008000
C+++++TRANSFER DATA FRJM L*1 ARRAY TO R*4 ARRAY 00008100
DJ 25 I=1,18                                00008200
IF(I.E.Q.1.AND.NUMES.EQ.0) GO TO 25        00008300
K=INUM(I)                                    00008400
DO 20 J=1,K                                  00008500
X(ISTX(I)+J)=QDATA(ISTQ(I)+J)              00008600
20 CONTINUE                                  00008700
25 CONTINUE                                  00008800
C+++++STORE BB1,BB2,BASEPLATE,OFFSET VOLTAGE 00008900
DO 30 I=1,4                                  00009000
Y(I)=QDATA(3938+I*2)                         00009100
30 CONTINUE                                  00009200
C+++++CONVERT BB1,BB2,BASEPLATE, TEMPERATURE TO VOLTAGES & THEN ID 00009300
C+++++TEMPERATURES                          00009310
C DO 35 I=1,3                                00009400
C COUNT(I)=QDATA(3932+I*2)                  00009500
C 35 CONTINUE                                00009600
DO 60 I=1,4                                  00009700
IF(Y(I).LT.COUNT(I)) GO TO 42               00009800
IF(Y(I).GE.COUNT(3)) GO TO 44               00009900
DO 40 J=1,2                                  00100000
IF(Y(I).GE.COUNT(J).AND.Y(I).LT.COUNT(J+I)) GO TO 50 00101000
40 CONTINUE                                  00102000
42 J=1                                        00103000
GO TO 50                                     00104000
44 J=2                                        00105000
50 FRAC=(VOLTS(J+1)-VOLTS(J))/(COUNT(J+1)-COUNT(J)) 00106000
Y(I)=VOLTS(J)+FRAC*(Y(I)-COUNT(J))         00107000
60 CONTINUE                                  00108000
BB1A=D(1)+D(2)*Y(1)+D(3)+Y(1)*Y(1)+D(4)*Y(1)*Y(1)+Y(1)*Y(1) 00109000
BB2A=D(1)+D(2)*Y(2)+D(3)+Y(2)*Y(2)+D(4)*Y(2)*Y(2)+Y(2)*Y(2) 00110000
BPA=D(1)+D(2)*Y(4)+D(3)+Y(4)*Y(4)+D(4)*Y(4)*Y(4)+Y(4)*Y(4) 00111000
BASEPL=(IFULSC)*BPA                          00112000
VOFFA=2.0*Y(3)-14.33                         00C11300
ITMP=BPA-273.15+2*Y3                          00114000
C+++++SAVE SCAN LINE TIME FOR PRINTING LATER 00115000
DO 70 I=1,6                                  00116000
QTIME(I,ISCAN)=QDATA(1740+I)                00116100
70 CONTINUE                                  00116200
IF(IFULSC.EQ.1) WRITE(8,944) ICOUNT,(QDATA(J),J=1741,1746) 00116300
CALL LINES(1)                                 00120000
C+++++CALL AVERAGING ROUTINES                00121000
CALL CTAVER                                  00122000
C+++++HAVE BE PROCESSED ALL SCANS IN A BLOCK 00123000
IF(IFULSC.NE.NSIZE) GO TO 5                 00124000
735 WRITE(8,944) ICOUNT,(QDATA(J),J=1741,1746) 00125000
WRITE(8,926) (QSTR(J),J=1,25)                00126000
J=NSTBLK+IBLK-1                              00127000
WRITE(8,927) J                                00128000
WRITE(8,926) (QSTR(J),J=1,25)                00129000
C+++++FIND AVERAGES IN COUNTS & VOLTS FOR EACH BLOCK 00130000
IF(IFULSC.EQ.0) GO TO 780                   00131000
K=IFULSC                                      00132000
DO 745 I=1,20                                00133000
IF(FULAV(I,1).EQ.-1.0) GO TO 745            00134000
DO 740 J=1,IFULSC                            00135000
AVFUL(IBLK,I)=AVFUL(IBLK,I)+FULAV(J,I)      00136000
RAVFUL(IBLK,I)=RAVFUL(IBLK,I)+RFULAV(J,I)   00140000
AVSDF(IBLK,I)=AVSDF(IBLK,I)+FULSD(J,I)      00141000
RAVSDF(IBLK,I)=RAVSDF(IBLK,I)+RFULSD(J,I)   00142000
740 CONTINUE                                  00143000
AVFUL(IBLK,I)=AVFUL(IBLK,I)/IFULSC          00144000
AVSDF(IBLK,I)=AVSDF(IBLK,I)/IFULSC          00145000

```

ORIGINAL SOURCE
OF POOR QUALITY

09MAR79 11.59.42 - VOL=DISK06, DSN=ZEMMB.LIB.CNTL

RAVFUL (IBLK, I)=RAVFUL (IBLK, I)/IFULSC	00014600
RAVSDF (IBLK, I)=RAVSDF (IBLK, I)/IFULSC	00014700
DO 742 J=1, IFULSC	00014800
SDFUL (IBLK, I)=SDFUL (IBLK, I)+(FULAV (J, I)-AVFUL (IBLK, I))*2	00014900
RSDFJL (IBLK, I)=RSDFJL (IBLK, I)+(RFULAV (J, I)-RAVFUL (IBLK, I))*2	00015000
742 CONTINUE	00015100
RSDFJL (IBLK, I)=SQRT (RSDFUL (IBLK, I)/(K))	00015200
SDFUL (IBLK, I)=SQRT (SDFUL (IBLK, I)/(K))	00015300
745 CONTINUE	00015400
DO 746 I=1, IFULSC	00015500
VBBV (IBLK)=VBBV (IBLK)+FULSD (I, 19)*FULSD (I, 19)+(FULAV (I, 19)-	00015404
IAVFUL (IBLK, 19))*2	00015406
RBBV (IBLK)=RBBV (IBLK)+RFULSD (I, 19)*RFULSD (I, 19)+(RFULAV (I, 19)-	00015408
IAVFUL (IBLK, 19))*2	00015410
746 CONTINUE	00015412
VBBV (IBLK)=SQRT (VBBV (IBLK)/IFULSC)	00015414
RBBV (IBLK)=SQRT (RBBV (IBLK)/IFULSC)	00015416
C++++PRINT AVERAGES IN COUNTS & VOLTS	00015500
WRITE (8, 928) (QSTR (J), J=1, 50)	00015600
WRITE (8, 934)	00015700
WRITE (8, 928) (QSTR (J), J=1, 50)	00015800
WRITE (8, 930)	00015900
DO 750 I=1, 20	00016000
IF (FULAV (I, I).EQ.-1.0) GO TO 750	00016100
WRITE (8, 931) ZNAME (I), AVFUL (IBLK, I), SDFUL (IBLK, I),	00016200
IAVSDF (IBLK, I), ZNAME (I), RAVFUL (IBLK, I), RSDFUL (IBLK, I), RAVSDF (IBLK,	00016300
I)	00016400
750 CONTINUE	00016500
WRITE (8, 933) VBBV (IBLK), RBBV (IBLK)	00016510
CALL LINES (3)	00016600
C++++CALCULATE P.U. AVERAGES FOR EACH BLOCK	00016700
DO 758 I=1, 5	00016800
IF (PUFLAV (I, I).EQ.-1.0) GO TO 758	00016900
DO 756 J=1, IFULSC	00017000
AVPUFL (IBLK, I)=AVPUFL (IBLK, I)+PUFLAV (J, I)	00017100
APUSDF (IBLK, I)=APUSDF (IBLK, I)+PUFLSD (J, I)	00017200
756 CONTINUE	00017300
AVPUFL (IBLK, I)=AVPUFL (IBLK, I)/IFULSC	00017400
APUSDF (IBLK, I)=APUSDF (IBLK, I)/IFULSC	00017500
DO 757 J=1, IFULSC	00017600
SDPUFL (IBLK, I)=SDPUFL (IBLK, I)+(PUFLAV (J, I)-AVPUFL (IBLK, I))*2	00017700
757 CONTINUE	00017800
SDPUFL (IBLK, I)=SQRT (SDPUFL (IBLK, I)/K)	00017900
758 CONTINUE	00018000
DO 747 I=1, IFULSC	00018002
PBBV (IBLK)=PBBV (IBLK)+PUFLSD (I, 4)*PUFLSD (I, 4)+(PUFLAV (I, 4)-	00018004
IAVPUFL (IBLK, 4))*2	00018006
747 CONTINUE	00018010
PBBV (IBLK)=SQRT (PBBV (IBLK)/IFULSC)	00018055
BASEAV (IBLK)=0.0	00018100
DO 760 I=1, IFULSC	00018200
BASEAV (IBLK)=BASEAV (IBLK)+BASEPL (I)	00018300
760 CONTINUE	00018400
BASEAV (IBLK)=BASEAV (IBLK)/IFULSC	00018500
WRITE (8, 928) (QSTR (J), J=1, 50)	00018600
WRITE (8, 938)	00018700
WRITE (8, 928) (QSTR (J), J=1, 50)	00018800
WRITE (8, 930)	00018900
C++++WRITE P.U. AVERAGES	00019000
DO 759 I=1, 5	00019100
IF (PUFLAV (I, I).EQ.-1.0) GO TO 759	00019200
WRITE (8, 931) ZNAME (IND (I)), AVPUFL (IBLK, I), SDPUFL (IBLK, I),	00019300
APUSDF (IBLK, I)	00019400
C++++PRINT S/N FOR VISIBLE CHANNEL	00019500
IF (ITYPE.NE.1.OR.I.GT.3) GO TO 759	00019600
RATIO=AVPUFL (IBLK, I)/APUSDF (IBLK, I)	00019700
WRITE (8, 940) RATIO	00019800
759 CONTINUE	00019900
WRITE (8, 933) PBBV (IBLK)	00019910
WRITE (8, 931) ZNAME2, BASEAV (IBLK)	00020000
CALL LINES (3)	00020100
IF (ITYPE.EQ.1) GO TO 761	00020200
C++++PRINT DIFF BETWEEN BB TH 688 VIEW	00020300
DIFF=AVPUFL (IBLK, 5)-AVPUFL (IBLK, 4)	00020400
WRITE (8, 939) DIFF	00020500
RATIO=AVFUL (IBLK, 19)/(AVPUFL (IBLK, 5)-260.0)	00020600
WRITE (8, 947) RATIO	00020700
GO TO 763	00020800

ORIGINAL FILED
OF FOUR QUALITY

09MAR79 14.59.42 - VOL=DISK06. DSN=ZBMMB.LIB.CNTL

```

761 SIGTON=1.0/APUSDF(1BLK,4) 00020900
WRITE(8,918) SIGTON 00021100
763 WRITE(8,925) QSTR 00021100
CALL LINES(20) 00021200
C+++++REINITIALISE VARIABLES BEFORE PROCESSING NEXT BLOCK 00021300
762 IFULSC=0 00021400
NS&T=0 00021410
GO TO 4 00021500
780 NBLK=1BLK-1 00021600
C+++++FIND AVERAGES FOR ALL BLOCKS 00021700
C+++++FIRST IN COUNTS & VOLTS 00021800
1000 DO 810 I=1,20 00021900
IF(FULAV(1,I).EQ.-1.0) GO TO 810 00022000
TOTAV(I)=0.0 00022100
TOTSD(I)=0.0 00022200
TOTSDA(I)=0.0 00022300
RTOTAV(I)=0.0 00022400
RTOTSD(I)=0.0 00022500
RTTSDA(I)=0.0 00022600
DO 800 J=1,NBLK 00022700
TOTAV(I)=TOTAV(I)+AVFUL(J,I) 00022800
TOTSDA(I)=TOTSDA(I)+AVSDFL(J,I) 00022900
TOTSD(I)=TOTSD(I)+SDFUL(J,I)*SDFUL(J,I) 00023000
RTOTAV(I)=RTOTAV(I)+RAVFUL(J,I) 00023100
RTTSDA(I)=RTTSDA(I)+RAVSDF(J,I) 00023200
RTOTSD(I)=RTOTSD(I)+RSDFUL(J,I)*RSDFUL(J,I) 00023300
800 CONTINUE 00023400
TOTAV(I)=TOTAV(I)/NBLK 00023500
TOTSDA(I)=TOTSDA(I)/NBLK 00023600
RTOTAV(I)=RTOTAV(I)/NBLK 00023700
RTTSDA(I)=RTTSDA(I)/NBLK 00023800
DO 805 J=1,NBLK 00023900
TJTSO(I)=TOTSD(I)+(AVFUL(J,I)-TOTAV(I))*2 00024000
RTJTSO(I)=RTOTSD(I)+(RAVFUL(J,I)-RTOTAV(I))*2 00024100
805 CONTINUE 00024200
RTOTSD(I)=SQRT(RTOTSD(I)/NBLK) 00024300
TOTSD(I)=SQRT(TOTSD(I)/NBLK) 00024400
810 CONTINUE 00024500
DO 815 J=1,NBLK 00024510
TVBBV=VBBV(J)*VBBV(J)+(AVFUL(J,19)-TOTAV(19))*2+TVBBV 00024512
TRBBV=RBBV(J)*RBBV(J)+(RAVFUL(J,19)-RTOTAV(19))*2+TRBBV 00024512
815 CONTINUE 00024600
TVBBV=SQRT(TVBBV/NBLK) 00024510
TRBBV=SQRT(TRBBV/NBLK) 00024512
C+++++WRITE AVERAGES IN COUNTS & VOLTS 00024600
WRITE(8,926) (QSTR(J),J=1,25) 00024700
WRITE(8,946) 00024800
WRITE(8,926) (QSTR(J),J=1,25) 00024900
WRITE(8,928) (QSTR(J),J=1,50) 00025000
WRITE(8,934) 00025100
WRITE(8,928) (QSTR(J),J=1,50) 00025200
WRITE(8,930) 00025300
DO 820 I=1,20 00025400
IF(FULAV(1,I).EQ.-1.0) GO TO 820 00025500
WRITE(8,931) ZNAME(I),TOTAV(I),TOTSD(I),TOTSDA(I) 00025600
I,ZNAME(I),RTOTAV(I),RTOTSD(I),RTTSDA(I) 00025700
820 CONTINUE 00025800
WRITE(8,933) TVBBV,TRBBV 00025810
CALL LINES(2) 00025900
C+++++CALCULATE MAX & MIN RMS NOISE IN CAL STEPS IN MV 00026000
DO 825 I=1,7 00026100
IF(TOTSDA(I+1).LT.VMINI) VMINI=I-1 00026200
VMINI=AMINI(VMINI,TOTSDA(I+1)) 00026300
IF(TOTSDA(I+1).GT.VMAXI) VMAXI=I-1 00026400
VMAXI=AMAXI(VMAXI,TOTSDA(I+1)) 00026500
IF(TOTSDA(I+1).LT.VMINO) VMINO=I-1 00026600
VMINO=AMINI(VMINO,TOTSDA(I+1)) 00026700
IF(TOTSDA(I+1).GT.VMAXO) VMAXO=I-1 00026800
VMAXO=AMAXI(VMAXO,TOTSDA(I+1)) 00026900
825 CONTINUE 00027000
VMINI=VMINI*1000 00027100
VMAXI=VMAXI*1000 00027200
VMINO=VMINO*1000 00027300
VMAXO=VMAXO*1000 00027400
WRITE(8,949) VMINI,MINI 00027500
WRITE(8,950) VMAXI,MAXI 00027600
WRITE(8,951) VMINO,MINO 00027700
WRITE(8,952) VMAXO,MAXO 00027800

```

09MAR79 14.59.42 - VOL=DISK06, DSK=Z0MMB.LIB.CNTL

```

CALL LINES(3)
WRITE(8,928) (QSTR(J),J=1,50)
WRITE(8,938)
WRITE(8,928) (QSTR(J),J=1,50)
WRITE(8,930)
C++++CALCULATE P.U.AVERAGES
DJ 840 I=1,5
IF(PJFLAV(1,I).EQ.-1.0) GO TO 840
TPUAV(I)=0.0
TPUSDA(I)=0.0
TPUSD(I)=0.0
DU 830 J=1,NBLK
TPUAV(I)=TPUAV(I)+AVPUFL(J,I)
TPUSDA(I)=TPUSDA(I)+APUSDF(J,I)
TPUSD(I)=TPUSD(I)+SDPUFL(J,I)*SDPUFL(J,I)
830 CONTINUE
TPUAV(I)=TPUAV(I)/NBLK
TPUSDA(I)=TPUSDA(I)/NBLK
JJ 835 J=1,NBLK
TPUSD(I)=TPUSD(I)+(AVPUFL(J,I)-TPUAV(I))**2
835 CONTINUE
TPUSD(I)=SQRT(TPUSD(I)/NBLK)
840 CONTINUE
DU 841 J=1,NBLK
TPBBV=PBBV(J)*PBBV(J)+(AVPUFL(J,4)-TPUAV(4))**2+TPBBV
841 CONTINUE
TPBBV=SQRT(TPBBV/NBLK)
TBPA=0.0
DU 842 I=1,NBLK
TPA=TBPA+BASEAV(I)
842 CONTINUE
TBPA=TBPA/NBLK
C++++WRITE P.U.AVERAGES
DU 850 I=1,5
IF(PUFLAV(1,I).EQ.-1.0) GO TO 850
WRITE(8,931) ZNAME(IND(I)),TPUAV(I),TPUSD(I),TPUSDA(I)
850 CONTINUE
WRITE(8,933) TPBBV
WRITE(8,931) ZNAME2,TBPA
IF(IATYPE.EQ.1) GO TO 860
C++++CALCULATE BB TH-BASEPLATE, BB TH-BB VIEW IN P.U.
DIFF=TPUAV(5)-TBPA
WRITE(8,932) DIFF
DIFF=TPUAV(5)-TPUAV(4)
WRITE(8,939) DIFF
RATIO=TOTAV(19)/(TPUAV(5)-260.0)
WRITE(8,947) RATIO
GO TO 1100
860 SIGTON=1.0/TPUSDA(4)
WRITE(8,948) SIGTON
1100 STOP
900 FORMAT(1X,'END OF DATA',I5)
910 FORMAT(2I3)
920 FORMAT(1X,'I/O ERROR',I5)
925 FORMAT(1X,I3I1)
926 FORMAT(54X,25A1)
927 FORMAT(///54X,'SUMMARY FOR BLOCK',I4)
928 FORMAT(25X,50A1)
930 FORMAT(///1X,'FUNCTION',2X,'AVERAGE',5X,'S.D.',7X,'AV S.D.',
130X,'FUNCTION',2X,'AVERAGE',5X,'S.D.',7X,'AV S.D.')
931 FORMAT(2X,A8,3F9.4,32X,A8,3F9.2)
932 FORMAT(1X,'BB THERMISTOR-BASEPLATE=',F9.4)
933 FORMAT(28X,F9.4,58X,F9.4)
934 FORMAT(25X,'CALIBRATED & RAW AVERAGES FOR FULL SCANS(VOLTS)')
938 FORMAT(25X,'P.U. AVERAGES FOR FULL SCANS')
939 FORMAT(1X,'BB THERMISTOR-BB VIEW=',F8.4)
940 FORMAT(1X,42X,'S/N=',F12.4)
942 FORMAT(54X,78A1)
944 FORMAT(54X,'SCAN',I5,2X,'TIME',2X,622)
946 FORMAT(///54X,'FINAL SUMMARY')
947 FORMAT(1X,'SENSITIVITY QUOTIENT',F10.4)
948 FORMAT(1X,'S/N(BB VIEW-1X EQUIVALENT)',F10.4)
949 FORMAT(1X,'MIN INPUT CAL RMS NOISE=',F8.1,'MV',2X,'8',I1,'V')
950 FORMAT(1X,'MAX INPUT CAL RMS NOISE=',F8.1,'MV',2X,'8',I1,'V')
951 FORMAT(1X,'MIN OUTPUT CAL RMS NOISE=',F8.1,'MV',2X,'8',I1,'V')
952 FORMAT(1X,'MAX OUTPUT CAL RMS NOISE=',F8.1,'MV',2X,'8',I1,'V')
END

```

09MAR79 14.59.42 - VOL=DISK06, DSN=ZBMMB.LIB.CNTL

*** END OF MEMBER *** 388 RECORDS PROCESSED *****

```

C+++++*****F00000005
C+++++SUBROUTINE CCTAVR 00000007
C+++++ROUTINE TO SET START & END LOCATIONS FOR X ARRAY FOR 00000100
C+++++CALCULATING AVERAGES & STANDARD DEVIATIONS FOR VARIOUS 00000200
C+++++TYPES OF SAMPLES.IT ALSO PRINTS RAW,CALIBRATED &P.U. 00000300
C+++++AVERAGES &S.D.SAVE AVERAGES &S.D.(CALIBRATED &P.U.&RAW) FOR 00000400
C+++++CALCULATING AVERAGES WHEN ALL SCANS ARE PROCESSED 00000500
C+++++ 11/15/78 00000600
C+++++DEVELOPED BY M.BEWTRA , COMPUTER SCIENCES CORPORATION 00000700
C+++++*****00000710
SUBROUTINE CCTAVR 00000800
IMPLICIT LOGICAL*1(Q) 00000900
REAL*8 ZNAME 00001000
COMMON/CCTINF/X(2000) 00001100
COMMON/CCTINF/ISC,IES(3),IOUT,IBB,ITH,NSC,NES(3),NOUT,NBB,NTH, 00001200
ITYPE,NUMES 00001300
COMMON/CCTINF/ODATA(4500),QSTR(131) 00001400
COMMON/ANALYS/ZNAME(20) 00001500
COMMON/ANALYS/AVER(20,10),SD(20,10),CV(20,10),CSD(20,10), 00001550
*PU(20,10),PUSD(20,10), 00001600
1VIN(7,2),VOUT(7,2),C(5,10),CVIN(7,2),CVOUT(7,2),VOFFA,BPA,BB1A, 00001650
2BB2A,FULAV(200,20),FULSD(200,20),RFULAV(200,20),RFULSD(200,20), 00001700
3PUFLAV(200,5),PUFLSD(200,5),IFULSC,ITMP,D(4),ISCAN,NSCAN,NSET, 00001750
4QTIME(6,10) 00001800
DIMENSION ISMP(7),SN(3,10),IND(5) 00002000
DATA IND/9,10,11,19,20/ 00002100
C+++++INITIALISE VARIABLES 00002200
IF(ISCAN.NE.1) GO TO 130 00002210
DO 120 I=1,20 00002220
DO 120 J=1,NSCAN 00002230
AVER(I,J)=-1.0 00002240
SJ(I,J)=-1.0 00002250
CV(I,J)=-1.0 00002260
CSD(I,J)=-1.0 00002270
PU(I,J)=-1.0 00002280
PUSD(I,J)=-1.0 00002290
120 CONTINUE 00002300
DO 122 I=1,7 00002310
VIN(I,ITYPE)=0.0 00002320
VOUT(I,ITYPE)=0.0 00002330
122 CONTINUE 00002340
C+++++CALCULATE RAW AVERAGES CALIBRATED AVERAGES ,CONVERT TO PHYSICAL 00003500
C+++++UNITS FOR VARIOUS PARAMETERS 00003600
C+++++SPACE CLAMP &INPUT CAL 00003700
130 J=0 00003800
DO 200 I=1,8 00003900
M=NSC-8 00004000
IBEG=ISC+NSC*(I-1)+4 00004100
IEND=IBEG+M-1 00004200
J=J+1 00004300
CALL CCTBAS(IBEG,IEND,J) 00004400
IF(I.EQ.1) GO TO 200 00004500
VIN(I-1,ITYPE)=AVER(I,ISCAN)+VIN(I-1,ITYPE) 00004600
200 CONTINUE 00004700
IF(ISCAN.NE.NSCAN) GO TO 220 00004710
DO 205 I=1,7 00004720
VIN(I,ITYPE)=VIN(I,ITYPE)/NSCAN 00004730
205 CONTINUE 00004740
DO 210 I=1,8 00004800
CALL CCTCNV(I) 00004900
210 CONTINUE 00005000
ISMP(I)=M 00005100
C+++++EARTH SCAN 00005200
220 J=8 00005300
IF(NUMES.EQ.0) GO TO 265 00005400
DO 260 L=1,NUMES 00005500
J=J+1 00005600
M=NES(L)-6 00005700
ISMP(L+1)=M 00005800
IBEG=IES(L)+3 00005900
IEND=IBEG+M-1 00006000
CALL CCTBAS(IBEG,IEND,J) 00006100
IF(ISCAN.NE.NSCAN) GO TO 260 00006110
CALL CCTCNV(J) 00006200
DO 230 M=1,NSCAN 00006210
IF(PUSD(J,M).EQ.0.0) PUSD(J,M)=1.0 00006300
SN(L,M)=PU(J,M)/PUSD(J,M) 00006310

```

ORIGINAL FILED
OF POOR QUALITY

09MAR79 14.59.42 - VOL=DISK06, DSN=ZBMMB.LIB.CNTL

230	CONTINUE	00006400
240	CONTINUE	00006500
C++++	JJTPUT CAL	00006600
265	J=11	00006700
	DO 300 I=1,7	00006800
	M=NOUT-8	00006900
	IBEG=IOUT+NOUT*(I-1)+4	00007000
	IEND=IBEG+M-1	00007100
	J=J+1	00007200
	CALL CCTBAS(IBEG,IEND,J)	00007300
	VOUT(I,ITYPE)=AVER(11+I,ISCAN)+VOUT(I,ITYPE)	00007400
300	CONTINUE	00007500
	IF(ISCAN.NE.NSCAN) GO TO 310	00007510
	DO 302 I=1,7	00007520
	VOUT(I,ITYPE)=VOUT(I,ITYPE)/NSCAN	00007530
302	CONTINUE	00007540
	ISMP(5)=M	00007600
	DO 305 I=12,18	00007700
	CALL CCTCNV(I)	00007800
305	CONTINUE	00007900
C++++	BLACKBODY VIEW	00008000
310	J=19	00008100
	M=NBB-20	00008200
	IBEG=IBB+10	00008300
	IEND=IBEG+M-1	00008400
	ISMP(6)=M	00008500
	CALL CCTBAS(IBEG,IEND,J)	00008600
	IF(ISCAN.NE.NSCAN) GO TO 320	00008610
	CALL CCTCNV(J)	00008700
C++++	BLACKBODY THERMISTOR	00008800
320	IF(ITYPE.EQ.1) GO TO 330	00008900
	J=20	00009000
	M=NTH-20	00009100
	IBEG=ITH+10	00009200
	IEND=IBEG+M-1	00009300
	ISMP(7)=M	00009400
	CALL CCTBAS(IBEG,IEND,J)	00009500
	IF(ISCAN.NE.NSCAN) GO TO 845	00009510
	CALL CCTCNV(J)	00009600
330	IF(ISCAN.NE.NSCAN) GO TO 845	00009610
	DO 500 M=1,NSCAN	00009611
	WRITE(6,942) (OSTR(I),I=1,78)	00009612
	II=NSET*NSCAN+M	00009614
	WRITE(6,944) II,(OTIME(I,M),I=1,6)	00009616
	WRITE(6,942) (OSTR(I),I=1,78)	00009618
C++++	PRINT INPJT CALS	00009700
	WRITE(6,956) VOFFA,BPA,BB1A,BB2A	00009800
	CALL LINES(1)	00009900
	WRITE(6,922) (VIN(K,ITYPE),K=1,7)	00010000
	WRITE(6,950) ISMP(1)	00010100
	WRITE(6,952) (SD(K,M),K=2,8)	00010200
	WRITE(6,922) (CV(K,M),K=2,8)	00010300
	WRITE(6,952) (CSD(K,M),K=2,8)	00010400
	CALL LINES(1)	00010500
C++++	PRINT OUTPUT CALS	00010600
	WRITE(6,926) (VOUT(K,ITYPE),K=1,7)	00010700
	WRITE(6,950) ISMP(5)	00010800
	WRITE(6,952) (SD(K,M),K=12,18)	00010900
	WRITE(6,926) (CV(K,M),K=12,18)	00011000
	WRITE(6,952) (CSD(K,M),K=12,18)	00011100
	CALL LINES(1)	00011200
	WRITE(6,912)	00011300
C++++	PRINT SPACE CLANE	00011400
	WRITE(6,920) AVER(1,M),CV(1,M),PU(1,M)	00011600
	WRITE(6,950) ISMP(1)	00011700
	WRITE(6,951) SD(1,M),CSD(1,M),PLSD(1,M)	00011800
	CALL LINES(1)	00011900
C++++	PRINT EARTH SCAN	00012000
	IF(NUMES.EQ.0) GO TO 460	00012100
	DO 450 L=1,NUMES	00012200
	IF(AVER(L+8,M).EQ.-1.0) GO TO 450	00012300
	GO TO (420,430,440),L	00012400
420	WRITE(6,923) AVER(9,M),CV(9,M),PU(9,M)	00012500
	WRITE(6,950) ISMP(2)	00012600
	WRITE(6,951) SD(9,M),CSD(9,M),PLSD(9,M)	00012700
	IF(ITYPE.EQ.1) WRITE(6,954) SN(1,M)	00012800
	GO TO 450	00012900
430	WRITE(6,924) AVER(10,M),CV(10,M),PU(10,M)	00013000

ORIGINAL PAGE IS
OF POOR QUALITY

09MAR79 14.59.42 - VOL=DISK06, DSN=ZBMMB.LIB.CNTL

```

WRITE(6,950) ISMP(3) 00013100
WRITE(6,951) SD(10,M),CSD(10,M),PUSD(10,M) 00013200
IF(IITYPE.EQ.1) WRITE(6,954) SN(2,M) 00013300
GO TO 450 00013400
440 WRITE(6,925) AVER(11,M),CV(11,M),PU(11,M) 00013500
WRITE(6,950) ISMP(4) 00013600
WRITE(6,951) SD(11,M),CSD(11,M),PUSD(11,M) 00013700
IF(IITYPE.EQ.1) WRITE(6,954) SN(3,M) 00013800
450 CONTINUE 00013900
CALL LINES(I) 00014000
C++++PRINT BLACKBODY VIEW 00014100
460 IF(AVER(19,M).EQ.-1.0) GO TO 470 00014200
WRITE(6,928) AVER(19,M),CV(19,M),PU(19,M) 00014300
WRITE(6,950) ISMP(6) 00014400
WRITE(6,951) SD(19,M),CSD(19,M),PUSD(19,M) 00014500
CALL LINES(I) 00014600
C++++PRINT BLACKBODY THERMISTOR 00014700
470 IF(AVER(20,M).EQ.-1.0) GO TO 500 00014800
WRITE(6,930) AVER(20,M),CV(20,M),PU(20,M) 00014900
WRITE(6,950) ISMP(7) 00015000
WRITE(6,951) SD(20,M),CSD(20,M),PUSD(20,M) 00015100
CALL LINES(I) 00015200
C++++CALCULATE AND PRINT DIFF. BETWEEN BB TH & BB VIEW 00015300
IF(IITYPE.EQ.1) GO TO 500 00015400
DIFF=PU(20,M)-PU(19,M) 00015500
WRITE(6,953) DIFF 00015600
CALL LINES(I) 00015700
500 CONTINUE 00015710
C++++SAVE AVERAGES & S.O.FOR CALCULATING AVERAGES 00015800
C++++AFTER ALL SCANS ARE PROCESSED 00015900
DO 840 I=1,20 00016000
DO 840 J=1,NSCAN 00016002
FULAV(NSET*NSCAN+J,I)=CV(I,J) 00016100
FULSD(NSET*NSCAN+J,I)=CSD(I,J) 00016200
RFULAV(NSET*NSCAN+J,I)=AVER(I,J) 00016300
RFULSD(NSET*NSCAN+J,I)=SD(I,J) 00016400
840 CONTINUE 00016500
DO 841 I=1,5 00016600
DO 841 J=1,NSCAN 00016602
PUFLAV(NSET*NSCAN+J,I)=PU(IND(I),J) 00016700
PUFLSD(NSET*NSCAN+J,I)=PUSD(IND(I),J) 00016800
841 CONTINUE 00016900
NSET=NSET+1 00016910
ISCAN=0 00016920
845 RETURN 00017000
C 900 FORMAT(1X,10F10.4) 00017100
912 FORMAT(23X,'RAW',13X,'CALIB',9X,'P.U.') 00017200
920 FORMAT('0', 'SPACE CLAMP ',3F16.4) 00017300
922 FORMAT('0', 'INPUT CAL ',7F14.4) 00017400
923 FORMAT('0', 'EARTH SCAN 1 ',3F16.4) 00017500
924 FORMAT('0', 'EARTH SCAN 2 ',3F16.4) 00017600
925 FORMAT('0', 'EARTH SCAN 3 ',3F16.4) 00017700
926 FORMAT('0', 'OUTPUT CAL ',7F14.4) 00017800
928 FORMAT('0', 'BB VIEW ',3F16.4) 00017900
930 FORMAT('0', 'BB THERMISTOR ',3F16.4) 00018000
942 FORMAT(54X,78A1) 00018010
944 FORMAT(54X,'SCAN',15.2X,'TIME',6Z2) 00018020
950 FORMAT('++',12X,16) 00018100
951 FORMAT(23X,3('(',F8.4,')',6X)) 00018200
952 FORMAT(20X,7('(',F8.4,')',4X)) 00018300
953 FORMAT('0', 'BB THERMISTOR-BB VIEW=',F8.4) 00018400
954 FORMAT('+',70X,'S/N=',F12.4) 00018500
956 FORMAT(1X, 'LV-OFFSET=',F10.4,'(V)',2X,'BASEPLATE=',F10.4,'(K)',1X, 00018600
12X,'BB1=',F10.4,'(K)',2X,'BB2=',F10.4,'(K)') 00018700
END 00018800

```

*** END OF MEMBER *** 220 RECORDS PROCESSED *****

ORIGINAL PAGE 19
OF PCOR QUALITY

09MAR79 14.59.42 - VOL=DISK06, USN=ZBMMB.LIB.CNTL

```

C*****00000100
C*****SUBROUTINE CCTBAS 00000200
C*****      2/22/75/ 00000300
C*****ROUTINE TO CALCULATE AVERAGES & STANDARD DEVIATIONS 00000400
C*****OF SAMPLES REPRESENTING VARIOUS PHYSICALLY SIGNIFICANT PARAMETERS 00000500
C      IBEG=START LOCATION OF X ARRAY FOR THE PARAMETER BEING PROCESSED 00000600
C      IEND=LAST LOCATION OF X ARRAY FOR THE PARAMETER BEING PROCESSED 00000700
C      J=INDEX CORRESPONDING TO THE PARAMETER BEING PROCESSED 00000800
C-----00000900
C*****DEVELOPED BY M.BEWTRA , COMPUTER SCIENCES CORPORATION 00001000
C*****SUBROUTINE CCTBAS( IBEG, IEND, J) 00001100
C      IMPLICIT LOGICAL*1 (Q) 00001200
C      REAL*8 ZNAME 00001300
C      COMMON/CTINF/X(2000) 00001400
C      COMMON/CTINF/ISC,IES(3),IOUT,IBB,ITH,NSC,NES(3),NOUT,NBB,NTH, 00001500
C-----00001600
C      TYPECTNAMES 00001700
C      COMMON/CTINF/QUATA(4500),QSTR(131) 00001800
C      COMMON/ANALYS/ZNAME(20) 00001900
C      COMMON/ANALYS/AVER(20,10),SD(20,10),CV(20,10),CSD(20,10), 00002000
C      *PU(20,10),PUSD(20,10), 00002100
C      *VIN(7,2),VOUT(7,2),C(5,10),CVIN(7,2),CVOUT(7,2),VOFFA,BPA,BB1A, 00002200
C      2BH2A,FULAV(200,20),FULSD(200,20),RFULAV(200,20),RFULSD(200,20), 00002300
C      3PUFLAV(200,5),PUFLSD(200,5),IFULSC,ITMP,D(4),ISCAN,NSCAN,NSET, 00002400
C      *OTIME(8,10) 00002500
C      WRITE(6,900) IBEG, IEND, J 00002600
C      WRITE(6,910) (X(I), I=IBEG, IEND) 00002700
C      AVER(J, ISCAN)=0.0 00002800
C      SD(J, ISCAN)=0.0 00002900
C      N=IEND-IBEG+1 00003000
C*****CALCULATE AVERAGE 00003100
C      DO 100 I=IBEG, IEND 00003200
C      AVER(J, ISCAN)=AVER(J, ISCAN)+X(I) 00003300
C      CONTINUE 00003400
C      WRITE(6,910) AVER(J, ISCAN) 00003500
C      AVER(J, ISCAN)=AVER(J, ISCAN)/N 00003600
C      WRITE(6,910) AVER(J, ISCAN) 00003700
C      WRITE(6,900) N 00003800
C*****CALCULATE S.D. 00003900
C      DO 200 I=IBEG, IEND 00004000
C      SD(J, ISCAN)=SD(J, ISCAN)+(X(I)-AVER(J, ISCAN))**2 00004100
C      CONTINUE 00004200
C      WRITE(6,920) SD(J, ISCAN) 00004300
C      SD(J, ISCAN)=SQRT(SD(J, ISCAN)/(N)) 00004400
C      WRITE(6,920) SD(J, ISCAN) 00004500
C      RETURN 00004600
C 900 FORMAT(1X,3I6) 00004700
C 910 FORMAT(1X,12F10.6) 00004800
C 920 FORMAT(1X,2F20.6) 00004900
C      END 00005000

```

*** END OF MEMBER *** 50 RECORDS PROCESSED *****

09MAR79 14.59.42 - VOL=DISK06, DSN=ZBMMB.LIB.CNTL

```

C+++++*****00000100
C++++SUBROUTINE CCTCNV00000200
C+++2/22/79/00000250
C++++SUBROUTINE TO CONVERT FROM RAW TO CALIBRATED VOLTAGES00000300
C++++AND THEN TO PHYSICAL UNITS00000400
C    J=INDEX FOR THE PARAMETER BEING PROCESSED00000500
C00000510
C++++DEVELOPED BY M.BEWTRA , COMPUTER SCIENCES CORPORATION00000600
C++++*****00000700
SUBROUTINE CCTCNV(J)00000800
  IMPLICIT LOGICAL*1(Q)00000900
  REAL*8 ZNAME00001000
  COMMON/CCTINF/X(2000)00001100
  COMMON/CCTINF/ISC,IES(3),IOUT,IBB,ITH,NSC,NES(3),NOUT,NBB,NTH,00001200
  IITYPE,NUMES00001300
  COMMON/CCTINF/QCATA(4500),QSTR(131)00001400
  COMMON/ANALYS/ZNAME(20)00001500
  COMMON/ANALYS/AVER(20,10),SD(20,10),CV(20,10),CSD(20,10),00001600
  PU(20,10),PUSD(20,10),00001700
  IVIN(7,2),VOUT(7,2),C(5,10),CVIN(7,2),CVOUT(7,2),VOFFA,BPA,BBIA,00001800
  ZB2A,FULAV(200,20),FULSD(200,20),RFULAV(200,20),RFULSD(200,20),00001900
  3PUFLAY(200,5),PUFLSD(200,5),IFULSC,ITMP,D(4),ISCAN,NSCAN,NSET,00002000
  4QTIME(6,10)00002100
C++++CONVERT FROM RAW TO CALIBRATED VOLTS USING LINEAR INTERPOLATION00002200
C++++FOR INPUT CAL STEPS,SPACE CLAMP,EARTH SCAN &BB VIEW00002300
  IF(J.EQ.20.OR.(J.GE.12.AND.J.LE.18)) GO TO 18000002400
  DD 175 M=1,NSCAN00002500
  IF(AVER(J,M).LT.VIN(1,IITYPE)) GO TO 10500002600
  IF(AVER(J,M).GE.VIN(7,IITYPE)) GO TO 11000002700
  DD 100 I=1,600002800
  IF(AVER(J,M).GE.VIN(I,IITYPE).AND.AVER(J,M).LT.VIN(I+1,IITYPE))00002900
  1GD TO 11500003000
-----00003100
100 CONTINUE00003100
105 I=100003200
  GO TO 11500003300
110 I=600003300
  I=600003400
115 FRAC=(CVIN(I+1,IITYPE)-CVIN(I,IITYPE))/(VIN(I+1,IITYPE)00003500
  1-VIN(I,IITYPE))00003600
  CV(J,M)=CVIN(I,IITYPE)+FRAC*(AVER(J,M)-VIN(I,IITYPE))00003700
  CSD(J,M)=ABS(SD(J,M))*FRAC00003800
C++++CONVERT FROM CALIBRATED VOLTS TO PHYSICAL UNITS FOR SPACE CLAMP,00003900
C++++EARTH SCAN &BB VIEW,USE FOUR DEGREE POLYNOMIAL FOR THERMAL &00004000
C++++LINEAR FOR VISIBLE00004100
  IF(J.GE.2.AND.J.LE.8) GO TO 17500004200
  IF(IITYPE.EQ.1) GO TO 17000004300
  I=1+ITMP/5+100004400
  PU(J,M)=C(1,I)*CV(J,M)+C(2,I)*CV(J,M)+C(3,I)*CV(J,M)+C(4,I)*CV(J,M)+00004500
  1C(5,I)*CV(J,M)+C(6,I)*CV(J,M)+C(7,I)*CV(J,M)+C(8,I)*CV(J,M)+00004600
  1CV(J,M)00004700
  PUSD(J,M)=C(2,I)+2.0*C(3,I)*CV(J,M)+3.0*C(4,I)*CV(J,M)+00004800
  14.0*C(5,I)*CV(J,M)+C(6,I)*CV(J,M)+C(7,I)*CV(J,M)+00004900
  PUSD(J,M)=ABS(PUSD(J,M))*CSD(J,M)00005000
  GO TO 17500005100
170 PU(J,M)=0.03121+16.79190*CV(J,M)00005200
  PUSD(J,M)=16.79190*CSD(J,M)00005300
175 CONTINUE00005400
  GO TO 30000005500
C++++CONVERT FROM RAW TO CALIBRATED VOLTAGES FOR OUTPUT CAL STEPS &00005600
C++++BB THERMISTOR00005700
180 DD 250 M=1,NSCAN00005800
  IF(AVER(J,M).LT.VOUT(1,IITYPE)) GO TO 20500005900
  IF(AVER(J,M).GE.VOUT(7,IITYPE)) GO TO 21000006000
  DD 200 I=1,600006100
  IF(AVER(J,M).GE.VOUT(I,IITYPE).AND.AVER(J,M).LT.VOUT(I+1,IITYPE))00006200
  1GD TO 21500006300
200 CONTINUE00006400
205 I=100006500
  GO TO 21500006600
210 I=600006700
215 FRAC=(CVOUT(I+1,IITYPE)-CVOUT(I,IITYPE))/(VOUT(I+1,IITYPE)00006800
  1-VOUT(I,IITYPE))00006900
  CV(J,M)=CVOUT(I,IITYPE)+FRAC*(AVER(J,M)-VOUT(I,IITYPE))00007000
  CSD(J,M)=ABS(SD(J,M))*FRAC00007100
C++++CONVERT FROM CALIBRATED VOLTS TO PHYSICAL UNITS FOR BB THERMISTOR00007200
C++++USING CUBIC POLYNOMIAL00007300
  IF(J.NE.20) GO TO 25000007400
  PU(J,M)=D(1)+D(2)*CV(J,M)+D(3)*CV(J,M)*CV(J,M)+D(4)*CV(J,M)*00007500
  CV(J,M)*CV(J,M)

```

ORIGINAL PAGE 19
OF POOR QUALITY

09MAR79 14.59.42 - VOL=DISK06, DSN=ZEMMB.LIB.CNTL

```
1CV(J,M)*CV(J,M) 00007600
PUSD(J,M)=0(2)+2*0*D(3)*CV(J,M)+3.0*D(4)*CV(J,M)*CV(J,M) 00007700
PUSC(J,M)=ABS(PUSD(J,M))*CSD(J,M) 00007800
250 CONTINUE 00007900
300 RETURN 00008000
900 FORMAT(1X,6F12.5) 00008100
END 00008200
```

*** END OF MEMBER *** 84 RECORDS PROCESSED *****

09 MAR 79 14.59.42
BY POKK QALC

09MAR79 14.59.42 - VOL=DISK06, DSN=ZEMMB.LIB.CNTL

```
C*****00000005
C++++BLUCK DATA FOR CCTINF,ANALYS 00000100
C++++ 10/16/78/ 00000200
C++++DEVELOPED BY M.BEWTRA , COMPUTER SCIENCES CORPORATION 00000300
C*****00000310
BLOCK DATA 00000400
IMPLICIT LOGICAL*1(0) 00000500
REAL*8 ZNAME 00000600
COMMON/CCTINF/*12000 00000700
COMMON/CCTINF/ISC,IES(3),IOUT,IBB,ITH,NSC,NES(3),NOUT,NBB,NTH, 00000800
ITYPE,NUMES 00000900
COMMON/CCTINF/QDATA(4500),QSTR(131) 00001000
COMMON/ANALYS/ZNAME(20) 00001100
COMMON/ANALYS/AVER(20,10),SD(20,10),CV(20,10),CSD(20,10), 00001200
*PU(20,10),PUSD(20,10), 00001300
1VIN(7,2),VOUT(7,2),C(5,10),CVIN(7,2),CVOUT(7,2),VOFFA,BPA,BBIA, 00001400
2PULAV(200,20),FULSD(200,20),RFULAV(200,20),RFULSD(200,20), 00001500
3PUFLAV(200,5),PUFLSD(200,5),IFULSC,ITMP,D(4),ISCAN,NSCAN,NSET, 00001600
4QTIME(6,10) 00001700
DATA IITYPE/27,NUMES/07 00001800
DATA IFULSC/0/ 00001900
DATA C/258.920,19.2108,-0.980259,-0.86905E-1,0.15648E-1, 00002000
*258.019,19.6024,-1.9052,0.227264,-1.25476E-2, 00002100
*258.263,19.7513,-1.97098,0.242068,-1.37652E-2, 00002200
*258.479,19.8741,-1.91139,0.228179,-1.26373E-2, 00002300
*259.532,21.9840,-3.57012,0.615378,-0.40859E-1, 00002400
*259.981,19.7079,-1.89414,0.223598,-1.23276E-2, 00002500
*259.382,19.6976,-1.8863,0.226533,-1.28293E-2, 00002600
*258.857,19.1720,-1.33345,0.64255E-01,0.46033E-3, 00002700
*260.007,20.0119,-1.98857,0.242128,-1.35799E-2, 00002800
*260.529,19.73,-1.78309,0.191249,-9.31209E-3/, 00002900
3D/332.8817,-15.556,1.772,-0.1917/ 00003000
DATA CVIN/0.001,1.003,1.982,2.986,3.983,4.981,5.958, 00003100
1 0.102,1.058,1.989,2.943,3.877,4.848,5.781/ 00003200
DATA CVOUT/0.006,0.970,1.970,2.947,3.954,4.929,5.924, 00003300
1 0.009,0.969,1.963,2.937,3.945,4.920,5.915/ 00003400
DATA QSTR/131*'/ 00003500
DATA ZNAME/'SR CLAMP','IN CAL 1','IN CAL 2','IN CAL 3', 00003600
1 'IN CAL 4','IN CAL 5','IN CAL 6','IN CAL 7', 00003700
2 'E SCAN 1','E SCAN 2','E SCAN 3','OUTCAL 1', 00003800
3 'OUTCAL 2','OUTCAL 3','OUTCAL 4','OUTCAL 5', 00003900
4 'OUTCAL 6','OUTCAL 7','BB VIEW ','BB TH '/ 00004000
END 00004100
*** END OF MEMBER *** 43 RECORDS PROCESSED *****
```

09MAR79 14.59.42 - VOL=DISK06. DSN=ZBMMB.LIB.CNTL

```
C*****00000100
C++++SUBROUTINE LINES 00000200
C++++ 2/22/79/ 00000300
C++++SUBROUTINE TO SKIP DESIRED NUMBER OF LINES ON THE LINE PRINTER 00000400
C++++N=NUMBER OF LINES TO BE SKIPPED 00000500
C+ 00000600
C++++WRITTEN BY M.BEWTRA,COMPUTER SCIENCES CORPORATION 00000700
C*****00000710
SUBROUTINE LINES(N) 00000800
  DO 100 I=1,N 00000900
  WRITE(6,900) 00001000
100 CONTINUE 00001100
900 FORMAT(IX) 00001200
  RETURN 00001300
  END 00001400
```

*** END OF MEMBER *** 15 RECORDS PROCESSED *****

```

C+++++*****00000100
C+++++MAIN FOR PROGRAM MDPSIM 00000200
C+++++ 2/22/79/ 00000300
C+++++THIS PROGRAM READS CALIBRATION DATA FROM A CCT-RU,PRODUCED BY MDP. 00000400
C+++++AND GENERATES CERTAIN INTERMEDIATE QUANTITIES & POLYNOMIALS FOR 00000500
C+++++CONVERTING RAW COUNTS TO CALIBRATED INDICES.OUTPUT THUS GENERATED 00000600
C+++++IS COMPARED WITH THE OUTPUT FROM MDP FOR EACH CALIBRATION SET. 00000700
C+++++A SUMMARY IS GENERATED IN THE END. 00000800
-----
C+++++WRITTEN BY N.BEWTRA,COMPUTER SCIENCES CORPORATION 00001000
C+++++*****00001100
IMPLICIT REAL*8(A-H,O Z) 00001200
INTEGER*2 COUNT 00001300
LOGICAL*1 QGOOD,QTYPE1,QTYPE2 00001400
REAL*4 DF,IM1,DFMIN2,DFMAX1,DFMAX2 00001500
COMMON/VALUL/SCIN1(7),SCIN2(7),SCOUT1(7),SCOUT2(7),EC(3),SCBBR1, 00001600
1SCSC1,SCBBK2,SCSC2,SCBB3,EBP,EBB1,EBB2,EOPFS,WS,PWS, 00001700
2ALPHA1(4),ALPHA2(4),ALPHA3(4),ALPHA4(4),DELTA1(4), 00001800
3DELTA2(4),C(2),EUBR1,ESC1,EBR2,ESC2,TBB3,TBJ1,TBB2,VOFF, 00001900
4BETA1(4),BETA2(4),VI1(7),VI2(7),VO1(7),VO2(7),A(3),TAU1(4),TAU2(4) 00002000
5,TAU3(4),TAU4(4),WT(3),SIGMA(4),EPSILN(4),RHO(2),B(3),VC(3),WBP,W0 00002100
6,NUM,M,ICALL,COUNT(40),QGOOD 00002200
COMMON/STAT/AVER1(256),AVER2(256),SD1(256),SD2(256), 00002300
1DFMIN1(256),DFMIN2(256),DFMAX1(256),DFMAX2(256),IAV, 00002400
2QTYPE1(1000),QTYPE2(1000) 00002500
INTEGER*2 IFILL,ISL 00002600
REAL*4 CONST 00002700
LOGICAL*1 QDATA 00002800
DIMENSION IFILL(4),CONST(176),QDATA(32) 00002900
EQUIVALENCE (IFILL(1),CONST(175)) 00003000
C 00003100
NAMELIST/INPUT/ISETS,VI1,VI2,VO1,VO2,A,TAU1,TAU2,TAU3,TAU4,WT, 00003200
1STON,EPSTEN,RHO2,B,VC,W0,W3,PWS,N,WOP 00003300
N=10 00003400
WS=0. 00003500
PWS=0.9 00003600
READ(5,INPUT) 00003700
WRITE(6,INPUT) 00003800
PWS=1.0-WS 00003900
C+++++READ & WRITE HEADER RECORD 00004000
WRITE(6,800) 00004100
CALL FREAD(QDATA(1),10,L,6250,650) 00004200
WRITE(6,900) (QDATA(J),J=1,32) 00004300
CALL BCOS(QDATA,QDATA,32) 00004400
WRITE(6,901) (QDATA(J),J=1,32) 00004500
GO TO 60 00004600
50 WRITE(6,902) 00004700
60 CALL LINES(2) 00004800
C+++++READ & WRITE SYSTEM CONSTANTS 00004900
WRITE(6,805) 00005000
CALL FREAD(CONST(1),10,L,6250,670) 00005100
WRITE(6,810) (IFILL(I),CONST(I),CONST(142),CONST(166) 00005200
WRITE(6,812) (CONST(I),I=58,64) 00005300
WRITE(6,814) (CONST(I),I=135,141) 00005400
WRITE(6,816) (CONST(I),I=96,102) 00005500
WRITE(6,818) (CONST(I),I=65,67) 00005600
WRITE(6,820) (CONST(I),I=103,106) 00005700
WRITE(6,822) (CONST(I),I=143,146) 00005800
WRITE(6,824) (CONST(I),I=147,150) 00005900
WRITE(6,826) (CONST(I),I=151,154) 00006000
WRITE(6,828) (CONST(I),I=155,157) 00006100
WRITE(6,830) (CONST(I),I=158,161) 00006200
WRITE(6,832) (CONST(I),I=162,165) 00006300
WRITE(6,834) (CONST(I),I=167,168) 00006400
WRITE(6,836) (CONST(I),I=169,171) 00006500
WRITE(6,838) (CONST(I),I=172,174) 00006600
WRITE(6,840) 00006700
WRITE(6,842) (CONST(I),I=30,57),(CONST(I),I=107,134), 00006800
1(CONST(I),I=2,29),(CONST(I),I=68,95) 00006900
GO TO 80 00007000
70 WRITE(6,904) 00007100
80 CALL LINES(5) 00007200
ICALL=1 00007300
I=0 00007400
C+++++READ FIRST RECORD,INITIALISE CALIBRATION QUANTITIES 00007500
90 CALL WDPRED(I,ISL) 00007600
I=I+1 00007700

```

09MAR79 14.59.42 - VOL=DISK06, DSN=ZBMM8.LIB.CNTL

```

IF (.NOT.QGOOD) GO TO 90                                00007800
DO 100 J=1,7                                           00007900
SCIN1(J)=COUNT(J+1)                                   00008000
SCIN2(J)=COUNT(J+17)                                  00008100
SCOUT1(J)=COUNT(J+8)                                  00008200
SCOUT2(J)=COUNT(J+24)                                 00008300
100 CONTINUE                                           00008400
SCBBR1=COUNT(16)                                       00008500
SCSC1=COUNT(1)                                        00008600
SCBBR2=COUNT(32)                                       00008700
SCSC2=COUNT(17)                                       00008800
SCBB3=COUNT(33)                                       00008900
IF(N.EQ.1) GO TO 210                                   00009000
200 CALL MDPRED(1,1DL)                                  00009100
I=I+1                                                  00009200
C++++CAL_ SMOOTHING ROUTINE                             00009300
IF(QGOOD) CALL SMOOTH                                  00009400
C++++CALCULATE INTERMEDIATE QUANTITIES & POLYNOMIALS FOR CONVERSION 00009500
C++++IF N RECORDS PROCESSED                             00009600
IF(I.NE.N) GO TO 200                                   00009700
210 WRITE(6,906)TSL                                    00009800
WRITE(6,908) ICALL                                     00009900
WRITE(6,909)                                           00010000
CALL LINES(1)                                         00010100
WRITE(6,910)SCIN1,SCOUT1,SCIN2,SCOUT2                00010200
WRITE(6,910)SCSC1,SCBBR1,SCSC2,SCBBR2,SCBB3,EC,EP,EBB1,EBB2,EOPFS 00010300
CALL INTVAL                                           00010400
I=0                                                    00010500
C++++COMPARE SIMULATOR OUTPUT WITH MDP OUTPUT        00010600
CALL COMPAR                                           00010700
IF(ICALL.EQ.ISETS) GO TO 260                           00010800
ICALL=ICALL+1                                         00010900
GO TO 200                                              00011000
250 WRITE(6,940)                                       00011100
GO TO 300                                              00011200
800 FORMAT(/55X,'****HEADER RECORD****')             00011300
805 FORMAT(/55X,'****MDP SYSTEM CONSTANTS****')      00011400
810 FORMAT(/1X,'N=',I5,5X,'MS=',F8.4,5X,'MBP=',F8.4,5X,'W0=', 00011500
LEA,A)                                                00011600
812 FORMAT(/1X,'VI1=',7F10.3)                        00011700
814 FORMAT(1X,'VI2=',7F10.3)                          00011800
816 FORMAT(1X,'V02=',7F10.3)                          00011900
818 FORMAT(/1X,'A=',3F14.7)                           00012000
820 FORMAT(/1X,'TAU1=',4F12.4)                         00012100
822 FORMAT(1X,'TAU2=',4F12.4)                         00012200
824 FORMAT(1X,'TAU3=',4F12.4)                         00012300
826 FORMAT(1X,'TAU4=',4F12.4)                         00012400
828 FORMAT(/1X,'WT=',3F10.4)                          00012500
830 FORMAT(/1X,'SIGMA=',4(1PE15.5))                  00012600
832 FORMAT(/1X,'EPSILON=',4(1PE10.0))                00012700
834 FORMAT(/1X,'RHO=',2F10.5)                         00012800
836 FORMAT(/1X,'B=',3F12.4)                           00012900
838 FORMAT(/1X,'VC=',3F8.2)                           00013000
840 FORMAT(/1X,'M1,M2,M3,M4=')                        00013100
842 FORMAT(1X,2F15.7)                                  00013200
900 FORMAT(1X,32Z2)                                     00013300
901 FORMAT(1X,32A1)                                    00013400
902 FORMAT(1X,'ERROR IN READING HEADER RECORD')       00013500
904 FORMAT(1X,'ERROR IN READING SYSTEM CONSTANTS RECORD') 00013600
906 FORMAT(/55X,'****SCAN LINE #',I5,'****')         00013700
908 FORMAT(55X,'****CALIBRATION SET #',I5,'****')    00013800
909 FORMAT(1X,'SIMULATOR OUTPUT')                    00013900
910 FORMAT(1X,14F9.2)                                  00014000
920 FORMAT(1X,I5)                                       00014100
940 FORMAT(1X,'END OF FILE')                           00014200
260 ENCL FINAL                                        00014300
300 STOP                                              00014400
END                                                    00014500

```

*** END OF MEMBER *** 145 RECORDS PROCESSED *****

ORIGINAL PAGE IS
OF POOR QUALITY

09MAR79 14.59.42 - VOL=DISK06, DSN=ZEMMB.LIB.CNTL

```

E*****00000100
C++++SUBROUTINE MDPRED 00000200
C++++      2/22/79 00000300
C++++ROUTINE TO READ CCT-RU GENERATED BY MDP, AND TRANSFER 00000400
C++++CALIBRATION DATA FROM L*1 ARRAY TO I*2 ARRAY. 00000500
C      IREC=SCAN LINE COUNTER IN THE CURRENT CALIBRATION SET 00000520
C      ISL=ABSOLUTE SCAN LINE COUNTER 00000600
C      00000600
C++++WRITTEN BY M.BEWTRA, COMPUTER SCIENCES CORPORATION 00000700
L*****
SUBROUTINE MDPRED(IREC, ISL) 00000900
  IMPLICIT REAL*8(A-H, O-Z) 00001000
  INTEGER*2 COUNT 00001100
  LOGICAL*1 QGOOD, QTYPE1, QTYPE2 00001200
  REAL*4 DFMIN1, DFMIN2, DFMAX1, DFMAX2 00001300
  COMMON/VALUE/SCIN1(7), SCIN2(7), SCOUT1(7), SCOUT2(7), EC(3), SCBRR1, 00001400
  1SCSC1, SCBRR2, SCSC2, SCBRR3, EBP, EBB1, EBB2, EOPPS, WS, PWS, 00001500
  2ALPHA1(4), ALPHA2(4), ALPHA3(4), ALPHA4(4), DELTA1(4), 00001600
  3DELTA2(4), C(2), EBBR1, ESC1, EBBR2, ESC2, TBB3, TBP, TBB1, TBB2, VOFF, 00001700
  4BETA1(4), BETA2(4), V11(7), V12(7), V01(7), V02(7), A(3), TAU1(4), TAU2(4) 00001800
  5, TAU3(4), TAU4(4), WT(3), SIGMA(4), EPSILN(4), RHO(2), E(3), VC(3), WBP, W 00001900
  6, NUMIN, ICALL, COUNT(40), QGOOD 00002000
  COMMON/STAT/AVER1(256), AVER2(256), SD1(256), SD2(256), 00002100
  1DFMIN1(256), DFMIN2(256), DFMAX1(256), DFMAX2(256), IAV, 00002200
  2QTYPE1(1000), QTYPE2(1000) 00002300
  LOGICAL*1 QDATA 00002400
  INTEGER*2 ISL, NSL 00002500
  DIMENSION QDATA(1304) 00002600
  EQUIVALENCE (NSL, QDATA(1257)) 00002700
  QGOOD=.TRUE. 00002800
  CALL FREAD(QDATA(1), 10, L, E260, E250) 00002900
C++++TRANSFER CALIBRATION QUANTITIES FROM L*1 ARRAY TO I*2 ARRAY 00003000
  COUNT(1)=QDATA(1) 00003100
  COUNT(16)=QDATA(2) 00003200
  COUNT(17)=QDATA(1074) 00003300
  COUNT(32)=QDATA(1634) 00003400
  COUNT(33)=QDATA(1178) 00003500
  DO 100 J=1, Z 00003600
    COUNT(J+1)=QDATA(82+J*24) 00003700
    COUNT(J+8)=QDATA(250+J*24) 00003800
    COUNT(J+17)=QDATA(714+J*24) 00003900
    COUNT(J+24)=QDATA(882+J*24) 00004000
  100 CONTINUE 00004100
  ISL=NSL 00004200
  IF (IREC.GT.0) GO TO 300 00004300
C++++TRANSFER 7 TELEMETRY VALUES 00004400
  EBB1=QDATA(1240) 00004500
  EBB2=QDATA(1242) 00004600
  EOPPS=QDATA(1244) 00004700
  EBP=QDATA(1246) 00004800
  DO 200 I=1, 3 00004900
    EC(I)=QDATA(1232+I*2) 00005000
  200 CONTINUE 00005100
  GO TO 300 00005200
C++++MESSAGE FOR I/O ERROR 00005300
  250 J=IREC+1 00005400
  QGOOD=.FALSE. 00005500
  WRITE(6, 900) JREC, ICALL 00005600
  GO TO 300 00005700
C++++MESSAGE FOR END OF FILE 00005800
  260 WRITE(6, 902) 00005900
  CALL FINAL 00006000
  STOP 00006100
  300 RETURN 00006200
  900 FORMAT(IX, 'I/O ERROR IN READING RECORD #', I6, ' FOR CALIBRATION', 00006300
  1SET #', I6) 00006400
  902 FORMAT(IX, 'END OF FILE') 00006500
  END 00006600

```

*** END OF MEMBER *** 68 RECORDS PROCESSED *****

```
C***** 00000100
C*****SUBROUTINE SMOOTH 00000200
C***** 2/22/79/ 00000300
C*****ROUTINE TO SMOOTH CALIBRATION DATA 00000400
C 00000500
C*****WRITTEN BY M.BEMTRA,COMPUTER SCIENCES CORPORATION 00000600
C***** 00000700
SUBROUTINE SMOOTH 00000800
IMPLICIT REAL*8(A-H,O-Z)----- 00000900
INTEGER*2 COUNT 00001000
LOGICAL*1 QGOOD 00001100
COMMON/VALUE/SCIN1(7),SCIN2(7),SCOUT1(7),SCOUT2(7),EC(3),SCBBR1, 00001200
1SCSC1,SCBBR2,SCSC2,SCBB3,EBP,EBE1,EBB2,EFFS,WS,PWS, 00001300
2ALPHA1(4),ALPHA2(4),ALPHA3(4),ALPHA4(4),DELTA1(4), 00001400
3DELTA2(4),C(2),EBBR1,ESC1,EBBR2,ESC2,TBB3,TBP,TBB1,TBB2,VOFF, 00001500
4BETA1(4),BETA2(4),V11(7),V12(7),V01(7),V02(7),A(3),TAU1(4),TAU2(4)00001600
5,TAU3(4),TAU4(4),WT(3),SIGMA(4),EPSLN(*),RHO(2),B(*),VC(3),WBP,W 00001700
6,NJM,N,ICALL,COUNT(40),QGOOD 00001800
DO 100 J=1,7 00001900
SCIN1(J)=WS*COUNT(J+1)+(PWS)*SCIN1(J) 00002000
SCIN2(J)=WS*COUNT(J+17)+(PWS)*SCIN2(J) 00002100
SCOUT1(J)=WS*COUNT(J+8)+(PWS)*SCOUT1(J) 00002200
SCOUT2(J)=WS*COUNT(J+24)+(PWS)*SCOUT2(J) 00002300
100 CONTINUE 00002400
SCSC1=WS*COUNT(1)+(PWS)*SCSC1 00002500
SCSC2=WS*COUNT(17)+(PWS)*SCSC2 00002600
SCBBR1=WS*COUNT(16)+(PWS)*SCBBR1 00002700
SCBBR2=WS*COUNT(32)+(PWS)*SCBBR2 00002800
SCBB3=WS*COUNT(33)+(PWS)*SCBB3 00002900
RETURN 00003000
END 00003100
```

*** END OF MEMBER *** 31 RECORDS PROCESSED *****

09MAR79 14.59.42 - VOL=DISK06, DSN=ZBMMB.LIB.CNTL

```

C*****00000100
C++++SUBROUTINE INTVAL 00000200
C++++ 2/22/79/ 00000300
C++++ROUTINE TO GENERATE VARIOUS INTERMEDIATE QUANTITIES & POLYNOMIALS 00000400
C++++FOR CONVERTING RAW COUNTS TO CALIBRATED INDICES. 00000500
C 00000600
C*****WRITTEN BY M.BEWTRA,COMPUTER SCIENCES CORPORATION 00000700
C***** 00000800
-----
SUBROUTINE INTVAL 00000900
IMPLICIT REAL*8(A-H,O-Z) 00001000
INTEGER*2 COUNT 00001100
LOGICAL*1 QGOOD,QTYPE1,QTYPE2 00001200
REAL*4 DFMIN1,DFMIN2,DFMAX1,DFMAX2 00001300
COMMON/VALUE/SCIN1(7),SCIN2(7),SCOUT1(7),SCOUT2(7),EC(J), EBB1, 00001400
1SCSC1,SCBBR2,SCSC2,SCBB3,EBP,EBB1,EBB2,EOFFS,WS,PWS, 00001500
2ALPHA1(4),ALPHA2(4),ALPHA3(4),ALPHA4(4),DELTA1(4), 00001600
3DELTA2(4),C(2),EBBR1,ESC1,EBBR2,ESC2,TBB3,TBP,TBB1,TBB2,VOPP, 00001700
4BETA1(4),BETA2(4),V11(7),V12(7),VC1(7),VO2(7),A(3),TAU1(4),TAU2(4) 00001800
5,TAU3(4),TAL4(4),WT(3),SIGMA(4),EPSILN(4),RHO(2),B(3),VC(3),WBP,W 00001900
6,NUM,N,ICALL,COUNT(40),QGOOD 00002000
COMMON/STAT/AVER1(256),AVER2(256),SD1(256),SD2(256), 00002100
1DFMIN1(256),DFMIN2(256),DFMAX1(256),DFMAX2(256),IAV, 00002200
2QTYPE1(1000),QTYPE2(1000) 00002300
DIMENSION VM1(4,7),VM2(4,7),VM3(4,7),VM4(4,7),VM(4,7) 00002400
-----
C*****CHANNEL 1 VISIBLE 00002500
C WRITE(6,900) 00002600
C++++CALCULATE MATRICES FOR OBTAINING COEFFICIENTS OF CUBIC POLYNOMIALS 00002700
C++++GIVING COUNT AS A FUNCTION OF VOLTAGE FOR INPUT & OUTPUT CALS 00002800
IF(ICALL.NE.1) GO TO 100 00002900
NII=1.0-WT(1)-WT(2)-WT(3) 00003000
CALL MATRIX(VI1,VM1) 00003100
CALL MATRIX(VO1,VM3) 00003200
C WRITE(6,902) 00003300
C WRITE(6,904) ((VM1(I,J),J=1,7),I=1,4) 00003400
C WRITE(6,908) 00003500
C WRITE(6,904) ((VM3(I,J),J=1,7),I=1,4) 00003600
C++++CALCULATE COEFFICIENTS 00003700
100 CALL MATMUL(VM1,SCIN1,ALPHA1,4,7,1) 00003800
CALL MATMUL(VM3,SCOUT1,ALPHA3,4,7,1) 00003900
C WRITE(6,906) 00004000
C WRITE(6,904) ALPHA1 00004100
C WRITE(6,910) 00004200
C WRITE(6,904) ALPHA3 00004300
C++++CALCULATE MATRIX C COEFFICIENTS FOR CUBIC POLYNOMIAL GIVING 00004400
C++++VOLTAGE AS A FUNCTION OF COUNTS FOR INPUT CALS 00004500
CALL MATRIX(SCIN1,VM) 00004600
CALL MATMUL(VM,V11,BETA1,4,7,1) 00004700
C WRITE(6,912) 00004800
C WRITE(6,904) ((VM(I,J),J=1,7),I=1,4) 00004900
C++++COMPUTE SPACE CLAMP EBB VIEW VOLTAGES FROM COUNTS 00005000
ESC1=CUBIC(BETA1,SCSC1) 00005100
EBBR1=CUBIC(BETA1,SCBBR1) 00005200
WRITE(6,916) ESC1,EBBR1 00005300
C++++DETERMINE COEFFICIENTS OF CUBIC POLYNOMIAL TRANSFERING RAW COUNTS 00005400
C++++TO CALIBRATED INDICES 00005500
DELTA1(1)=A(1)+A(2)*BETA1(1)+A(3)*BETA1(1)*BETA1(1) 00005600
DELTA1(2)=A(2)+BETA1(2)+2.0*A(3)*BETA1(1)*BETA1(2) 00005700
DELTA1(3)=A(2)*BETA1(3)+A(3)*(2.0*BETA1(1)*BETA1(3)+BETA1(2)* 00005800
1BETA1(2)) 00005900
DELTA1(4)=A(2)*BETA1(4)+A(3)*(2.0*BETA1(1)*BETA1(4)+2.0*BETA1(2) 00006000
1*BETA1(3)) 00006100
WRITE(6,918) BETA1,DELTA1 00006200
C++++CHANNEL 2 THERMAL 00006300
C WRITE(6,920) 00006400
-----
C*****CALCULATE MATRICES FOR OBTAINING COEFFICIENTS OF CUBIC POLYNOMIALS 00006500
C++++GIVING COUNT AS A FUNCTION OF VOLTAGE FOR INPUT & OUTPUT CALS 00006600
IF(ICALL.NE.1) GO TO 150 00006700
CALL MATRIX(VI2,VM2) 00006800
CALL MATRIX(VO2,VM4) 00006900
C WRITE(6,902) 00007000
C WRITE(6,904) ((VM2(I,J),J=1,7),I=1,4) 00007100
C WRITE(6,908) 00007200
C WRITE(6,904) ((VM4(I,J),J=1,7),I=1,4) 00007300
C+++CALCULATE COEFFICIENTS 00007400
150 CALL MATMUL(VM2,SCIN2,ALPHA2,4,7,1) 00007500
CALL MATMUL(VM4,SCOUT2,ALPHA4,4,7,1) 00007600
C WRITE(6,906) 00007700
-----

```

ORIGINAL PAGE IS
OF POOR QUALITY

09MAR79 14.59.42 - VOL=DISK06, DSN=ZBMMB.LIB.CNTL

```

C      WRITE(6,904) ALPHA2                00007800
C      WRITE(6,910) -                      00007900
C      WRITE(6,904) ALPHA4                00008000
C+++++CALCULATE MATRIX & COEFFICIENTS FOR CUBIC POLYNOMIAL GIVING 00008100
C+++++VOLTAGE AS A FUNCTION OF COUNTS FOR INPUT CALS                00008200
      CALL MATRIX(SCIN2,VM)                00008300
      CALL MATMUL(VM,VI2,BETA2,4,7,1)      00008400
C      WRITE(6,912)                        00008500
C      WRITE(6,904) ((VM(I,J),J=1,7),I=1,4) 00008600
C+++++CONVERT BB THERMISTOR FROM COUNTS TO VOLTS USING LINEAR --- 00008700
C+++++INTERPOLATION
      IF(SCB3.LT.SCOUT2(1)) GO TO 205
      IF(SCB3.GE.SCOUT2(7)) GO TO 210
      DO 200 I=1,6
      IF(SCB3.GE.SCOUT2(I).AND.SCB3.LT.SCOUT2(I+1)) GO TO 215
200 CONTINUE
205 I=1
      GO TO 215
210 I=6
215 IF(DABS(SCOUT2(I+1)-SCOUT2(I)).LT..001) GO TO 217
      FRAC=(V02(I+1)-V02(I))/(SCOUT2(I+1)-SCOUT2(I))
      EBB3=V02(I)+FRAC*(SCB3-SCOUT2(I))
      IBB3=CUBIC(TAU1,EBB3)
      GO TO 216
217 WRITE(8,942) ICALL                    00009300
218 EBB2=CUBIC(BETA2,SCBB2)                00009400
      ESC2=CUBIC(BETA2,SCSC2)              00010400
      WRITE(6,922) EBB3                    00010500
      WRITE(6,923) ESC2,EBBR2              00010600
C+++++COMPUTE THERMISTOR VOLTAGE CORRECTION COEFFICIENTS AND ADJUST 00010700
C+++++THERMISTOR VOLTAGES,SMOOTH BASEPLATE VOLTAGE
      IF(DABS(EC(3)-EC(1)).LT..001) GO TO 218
      C(2)=(VC(3)-VC(1))/(EC(3)-EC(1))
      C(1)=VC(1)-C(2)*EC(1)
      VBP=C(1)+C(2)*EBP
      VBB1=C(1)+C(2)*EBB1
      VBB2=C(1)+C(2)*EBB2
      VOFFS=C(1)+C(2)*EOFFS
      GO TO 219
218 WRITE(8,940) ICALL                    00011500
219 WRITE(6,924) C                        00011600
      WRITE(6,926) VBP,VBB1,VBB2,VOFFS    00011700
      IF(ICALL.EQ.1) PVBP=VBP             00011800
      VBP=VBP*VBP+(1-VBP)*PVBP           00012000
      PVBP=VBP                            00012100
      VBB1=VBB1*VBB1+(1-VBB1)*PVBB1     00012200
      PVBB1=VBB1                          00012300
C+++++COMPUTE TEMPERATURES FROM THERMISTOR VOLTAGES &SMOOTHED BASEPLATE 00012400
C+++++VOLTAGE
      TBP=CUBIC(TAU2,VBP)                  00012500
      TBB1=CUBIC(TAU3,VBB1)                00012600
      TBB2=CUBIC(TAU4,VBB2)                00012700
      IF(ICALL.EQ.1) GO TO 240
      TBB=WT(1)*TBB1+WT(2)*TBB2+WT(3)*TBB3+WT4*PTBB
      PTBB=TBB
      GO TO 250
240 TBB=(TBB1+TBB2+TBB3)/3.0              00012800
      PTBB=TBB                             00012900
250 CONTINUE                              00013000
C+++++CORRECT TBB FOR BASEPLATE TEMP
      TBBR=TBB-CUBIC(SIGMA,TBP)            00013100
      WRITE(6,928) TBP,TBB1,TBB2,TBB3,TBB,TBBR 00013200
C+++++COMPUTE RADIANCE
      RBB=EPSLN(1)+EPSLN(2)*TBBR+EPSLN(3)*TBBR+TBBR
      RBB=RBB/(DEXP(EPSLN(4)/TBBR)-1)     00013300
C+++++SMOOTH OFFSET VOLTAGE
      IF(ICALL.EQ.1) PVOFFS=VOFFS         00013400
      VOFFS=V0+VOFFS+(1-V0)*PVOFFS       00013500
      PVOFFS=VOFFS                        00013600
      VOFF=RHO(1)+RHO(2)*VOFFS            00013700
      RS=RBB/(EBBR2+VOFF)                  00013800
      WRITE(6,936) VOFFS,VOFF,RS,RBB      00013900
C+++++DETERMINE COEFFICIENTS OF POLYNOMIAL TRANSFORMING RAW COUNT TO 00014000
C+++++CALIBRATED INDICES
      BETA=BETA2(1)+VOFF                   00014100
      Z=B(2)+Z*B(3)+RS*BETA                00014200
      DELTA2(1)=B(1)+RS*BETA*(B(2)+B(3)+RS*BETA) 00014300
      DELTA2(2)=BETA2(2)+RS*Z              00014400
      DELTA2(3)=BETA2(3)+RS*Z+RS*RS*BETA2(2)+BETA2(2)*B(3) 00014500
      DELTA2(4)=BETA2(4)+RS*Z+2.0*RS*RS*BETA2(2)+BETA2(3)*B(3) 00014600

```

INPUT DATA
IF GOOD QUALITY

09MAY79 14.59.42 - VOL=DISK06, DSN=ZEMMD.LIB.CNTL

```
C      WRITE(6,918)                                00015600
      WRITE(6,938)BETA2,DELTA2                    00015700
900  FORMAT(/1X,'CHANNEL 1      VISIBLE')        00015800
902  FORMAT(/20X,'MATRIX FOR INPUT CALS(GIVES COUNTS FROM VOLTS)') 00015900
904  FORMAT(/7G18.8)                              00016000
906  FORMAT(/10X,'COEFFICIENTS OF CUBIC POLYNOMIAL FOR INPUT CALS(
      GIVES COUNTS FROM VOLTS)')                00016100
908  FORMAT(/20X,'MATRIX FOR OUTPUT CALS(GIVES COUNTS FROM VOLTS)') 00016200
910  FORMAT(/10X,'COEFFICIENTS OF CUBIC POLYNOMIAL FOR OUTPUT CALS
      GIVES COUNTS FROM VOLTS)')                00016300
912  FORMAT(/20X,'MATRIX FOR INPUT CALS(GIVES VOLTS FROM COUNTS)') 00016400
913  FORMAT(1X,'BETA1=',4G14.6,2X,'DELTA1=',4G14.6) 00016500
916  FORMAT(/1X,'ESC1=',F11.4,2X,'EBB1=',F11.4)    00016600
920  FORMAT(/1X,'CHANNEL 2      THERMAL')        00016700
938  FORMAT(/1X,'BETA2=',4G14.6,2X,'DELTA2=',4G14.6) 00016800
922  FORMAT(/1X,'EBB3=',F11.4)                  00016900
923  FORMAT('+'',19X,'ESC2=',F11.4,2X,'EBB2=',F11.4) 00017000
924  FORMAT(1X'C=',2F11.4)                      00017100
926  FORMAT('+'',30X,'VBP=',F9.4,2X,'VBB1=',F9.4,2X,'VBB2=',F9.4,2X,
      1'VBB3=',F9.4)                            00017200
928  FORMAT(1X'TBP=',F9.2,2X,'TBB1=',F9.2,2X,'TBB2=',F9.2,2X,'TBB3=',F9.2,2X,
      1.2,2X,'TBB=',F9.2,2X,'TBBR=',F9.2)      00017300
936  FORMAT(1X'VOFFS=',F9.4,2X,'VOFF=',F10.5,2X,'RS=',G18.8,2X,'RBB=',
      1G18.8)                                    00017400
942  FORMAT(/1X,'DIVIDE CHECK FOR BB THERMISTOR CALCULATION FOR SET #',
      1I8)                                       00017500
940  FORMAT(/1X,'DIVIDE CHECK FOR TELEMETRY VALUES CALCULATION FOR',
      1' SET #',I8)                             00017600
      RETURN                                     00017700
      END                                         00017800
```

*** END OF MEMBER *** 185 RECORDS PROCESSED *****

ORIGINAL PAGE IS
OF POOR QUALITY

09MAR79 14.59.42 - VOL=DISK06, DSN=ZBMMB.LIB.CNTL

```

C*****00000100
C++++SUBROUTINE MATRIX                                0000200
C++++      2/22/79/                                    0000300
C++++GIVEN A 7-ELEMENT VECTOR C THIS ROUTINE WILL GENERATE A SPECIAL
C++++PURPOSE MATRIX D OF SIZE 4X7.FOR A DESCRIPTION OF THE MATRIX  0000400
C++++SEE APPENDIX D.1 OF "HCM DATA PROCESSING SPECIFICATION",IBM.  0000500
C                                                              0000600
C                                                              0000700
C++++WRITTEN BY M.BEWTRA,COMPUTER SCIENCES CORPORATION          0000800
C*****0000900
C++++
SUBROUTINE MATRIX(C,D)                                     0001000
IMPLICIT REAL*8(A-H,O-Z)                                0001100
DIMENSION A(4,7),B(7,4),A1(4,4),D(4,7),C(7)           0001200
DO 50 I2=1,7                                           0001300
A(I,I2)=1.0                                           0001400
50 CONTINUE                                           0001500
-----0001700
DO 110 I1=2,4
DU 100 I2=1,7
A(I1,I2)=C(I2)**(I1-1)                                0001800
100 CONTINUE                                           0001900
110 CONTINUE                                           0002000
C-----0002100
WRITE(6,900)A
DU 130 I1=1,4
DU 120 I2=1,7
-----0002200
BT(I2,I1)=A(I1,I2)
120 CONTINUE                                           0002300
130 CONTINUE                                           0002400
C-----0002500
WRITE(6,900)B
CALL MATMUL(A,B,A1,4,7,4)                              0002600
-----0002700
CALL MATINV(A1,4,DET)
CALL MATMUL(A1,A,D,4,4,7)                              0002800
C-----0002900
WRITE(6,900)D
C-----0003000
C-----0003100
C-----0003200
C-----0003300
C-----0003400
C-----0003500
END

```

*** END OF MEMBER *** 35 RECORDS PROCESSED *****

```
C+++++SUBROUTINE MATMUL                                00000100
C+++++SUBROUTINE MATMUL                                00000200
C+++++ 02/22/79                                       00000300
C+++++SUBROUTINE FOR MATRIX MULTIPLICATION           00000400
C      C=AB, WHERE SIZE OF A IS LXM, SIZE OF B IS MXN 00000410
C                                                    00000500
C+++++WRITTEN BY M.BEWTRA, COMPUTER SCIENCES CORPORATION 00000600
C+++++SUBROUTINE MATMUL(A,B,C,L,M,N)                 00000700
-----SUBROUTINE MATMUL(A,B,C,L,M,N)                 00000800
      REAL*8 A,B,C                                     00000900
      DIMENSION A(L,M),B(M,N),C(L,N)                 00001000
      DO 110 I=1,L                                     00001100
      DO 100 J=1,N                                     00001200
      C(I,J)=0.0                                       00001300
100 CONTINUE                                          00001400
110 CONTINUE                                          00001500
C      WRITE(6,900)A                                   00001600
C      WRITE(6,900)B                                   00001700
C      WRITE(6,900)C                                   00001800
C      WRITE(6,910)L,M,N                               00001900
C 900 FORMAT(1X,8F12.2)                               00002000
C 910 FORMAT(1X,3I2)                                   00002100
      DO 130 I=1,L                                     00002200
      DO 125 J=1,N                                     00002300
      DO 120 II=1,M                                    00002400
      C(I,J)=C(I,J)+A(I,II)*B(II,J)                  00002500
C      WRITE(6,900)C(I,J)                             00002600
120 CONTINUE                                          00002700
125 CONTINUE                                          00002800
130 CONTINUE                                          00002900
      RETURN                                           00003000
      END                                              00003100
```

*** END OF MEMBER *** 32 RECORDS PROCESSED *****

ORIGINAL PAGE IS
OF POOR QUALITY

09MAY79 14.59.42 - VOL=DISK06, DSN=ZBMMB.LIB.CNTL

```

SUBROUTINE MATINV(ARRAY,NORDER,DET)
IMPLICIT REAL*8(A-H,U-Z)
C SEE PAGES 302-303 OF "DATA REDUCTION & ERROR ANALYSIS FOR THE
C PHYSICAL SCIENCES", P.H.BEVINGTON FOR COMMENTS
DIMENSION ARRAY(NORDER,NORDER),IK(10),JK(10)
10 DET=1.
11 DO 100 K=1,NORDER
   AMAX=0.
21 DO 30 I=K,NORDER
   DU 30 J=K,NORDER
23 IF(DABS(AMAX)-DABS(ARRAY(I,J))) 24,24,30
24 AMAX=ARRAY(I,J)
   IK(K)=I
   JK(K)=J
30 CONTINUE
31 IF(AMAX) 41,32,41
32 DET=0.
   GO TO 140
41 I=IK(K)
   IF(I-K) 21,51,43
43 DO 50 J=1,NORDER
   SAVE=ARRAY(K,J)
   ARRAY(K,J)=ARRAY(I,J)
   ARRAY(I,J)=-SAVE
50 J=JK(K)
51 IF(J-K) 21,61,53
53 DO 60 I=1,NORDER
   SAVE=ARRAY(I,K)
   ARRAY(I,K)=ARRAY(I,J)
60 ARRAY(I,J)=-SAVE
61 DO 70 I=1,NORDER
   IF(I-K) 63,70,63
63 ARRAY(I,K)=ARRAY(I,K)/AMAX
70 CONTINUE
71 DO 80 I=1,NORDER
   DO 80 J=1,NORDER
   IF(I-K) 74,80,74
74 IF(J-K) 75,80,75
75 ARRAY(I,J)=ARRAY(I,J) + ARRAY(I,K)*ARRAY(K,J)
80 CONTINUE
81 DO 90 J=1,NORDER
   IF(J-K) 83,90,83
83 ARRAY(K,J)=ARRAY(K,J)/AMAX
90 CONTINUE
   ARRAY(K,K)=1./AMAX
100 DET=DET*AMAX
101 DO 130 L=1,NORDER
   K=NORDER-L+1
   J=IK(K)
   IF(J-K) 111,111,105
105 DO 110 I=1,NORDER
   SAVE=ARRAY(I,K)
   ARRAY(I,K)=-ARRAY(I,J)
110 ARRAY(I,J)=SAVE
111 I=JK(K)
   IF(I-K) 130,130,113
113 DO 120 J=1,NORDER
   SAVE=ARRAY(K,J)
   ARRAY(K,J)=-ARRAY(I,J)
120 ARRAY(I,J)=SAVE
130 CONTINUE
140 RETURN
END
00000100
00000200
00000300
00000310
00000400
00000500
00000600
00000700
00000800
00000900
00001000
00001100
00001200
00001300
00001400
00001500
00001600
00001700
00001800
00001900
00002000
00002100
00002200
00002300
00002400
00002500
00002600
00002700
00002800
00002900
00003000
00003100
00003200
00003300
00003400
00003500
00003600
00003700
00003800
00003900
00004000
00004100
00004200
00004300
00004400
00004500
00004600
00004700
00004800
00004900
00005000
00005100
00005200
00005300
00005400
00005500
00005600
00005700
00005800
00005900
00006000
00006100
00006200

```

*** END OF MEMBER *** 63 RECORDS PROCESSED *****

```

C+++++*****00000100
C+++++SUBROUTINE CMPAR 00000200
C+++++ 2/22/79 00000300
C+++++ROUTINE TO COMPARE MDP OUTPUT WITH SIMULATOR'S OUTPUT 00000400
C 00000500
C+++++WRITTEN BY M.BLUMTRA, COMPUTER SCIENCES CORPORATION 00000600
C+++++*****00000700
SUBROUTINE CMPAR 00000800
IMPLICIT REAL*8(A-M,O-Z) 00000900
INTEGER*2 COUNT 00001000
LOGICAL*1 QGOOD,QTYPE1,QTYPE2 00001100
REAL*4 DFMIN1,DFMIN2,DFMAX1,DFMAX2,DIFF 00001200
COMMON/VALUE/SCIN1(7),SCIN2(7),SCOUT1(7),SCOUT2(7),EC(3),SCBBR1, 00001300
1SCSC1,SCBBR2,SCSC2,SCBB3,EBP,EBE1,EBB2,EOFFS,WS,PWS, 00001400
2ALPHA1(4),ALPHA2(4),ALPHA3(4),ALPHA4(4),DELTA1(4), 00001500
3DELTA2(4),C(2),EBBR1,ESC1,EBR2,ESC2,TBB3,TBP,TBB1,TBB2,VOFF, 00001600
4DELTA1(4),BETA2(4),V1(7),V2(7),V01(7),V02(7),A(3),TAU1(4),TAU2(4) 00001700
5,TAU3(4),TAU4(4),WT(3),SIGMA(4),EPSILN(4),RHO(2),B(3),VC(3),WBP,W0 00001800
6,NJM,N,ICALL,COUNT(40),QGOOD 00001900
COMMON/STAT/AVR1(256),AVR2(256),SD1(256),SD2(256), 00002000
1DFMIN1(256),DFMIN2(256),DFMAX1(256),DFMAX2(256),IAV, 00002100
2QTYPE1(1000),QTYPE2(1000) 00002200
REAL*4 OUT,X1 00002300
DIMENSION OUT(44),D1(4),D2(4) 00002400
C+++++READ 5 WRITE MDP DUPUT RECORD 00002500
CALL FREAD(OUT(1),10,L,6260,6250) 00002600
WRITE(6,901) 00002700
WRITE(6,800) (OUT(I),I=1,8) 00002800
WRITE(6,810) OUT(9),OUT(10) 00002900
WRITE(6,815) (OUT(I),I=36,39),(OUT(I),I=11,14) 00003000
WRITE(6,825) (OUT(I),I=15,18),(OUT(I),I=20,23) 00003100
WRITE(6,835) (OUT(I),I=24,27) 00003200
WRITE(6,840) (OUT(I),I=28,30),OUT(19),OUT(31) 00003300
WRITE(6,845) (OUT(I),I=40,43),(OUT(I),I=32,35) 00003400
INUM=0 00003500
ITYPE=0 00003600
C+++++TRANSFER COEFFICIENTS OF FINAL CUBIC FROM R*4 TO R*8 ARRAY 00003700
DO 50 J=1,4 00003800
D1(J)=OUT(10+J) 00003900
D2(J)=OUT(31+J) 00004000
50 CONTINUE 00004100
C WRITE(6,902) 00004200
C+++++COMPARE TEMPERATURES & VOLTAGES 00004300
IF(DABS(OUT(9)-EBBR1).GT..01) 00004400
1CALL MESSAG(OUT(9),EBBR1,X,INUM,ITYPE,'EBBR1 ') 00004500
IF(DABS(OUT(10)-ESC1).GT..01) 00004600
1CALL MESSAG(OUT(10),ESC1,X,INUM,ITYPE,'ESC1 ') 00004700
IF(DABS(OUT(24)-EBBR2).GT..01) 00004800
1CALL MESSAG(OUT(24),EBBR2,X,INUM,ITYPE,'EBBR2 ') 00004900
IF(DABS(OUT(25)-ESC2).GT..01) 00005000
1CALL MESSAG(OUT(25),ESC2,X,INUM,ITYPE,'ESC2 ') 00005100
IF(DABS(OUT(19)-TBB3).GT..1) 00005200
1CALL MESSAG(OUT(19),TBB3,X,INUM,ITYPE,'TBB3 ') 00005300
IF(DABS(OUT(28)-TBP).GT..1) 00005400
1CALL MESSAG(OUT(28),TBP,X,INUM,ITYPE,'TBP ') 00005500
IF(DABS(OUT(29)-TBB1).GT..1) 00005600
1CALL MESSAG(OUT(29),TBB1,X,INUM,ITYPE,'TBB1 ') 00005700
IF(DABS(OUT(30)-TBB2).GT..1) 00005800
1CALL MESSAG(OUT(30),TBB2,X,INUM,ITYPE,'TBB2 ') 00005900
IF(DABS(OUT(31)-VOFF).GT..01) 00006000
1CALL MESSAG(OUT(31),VOFF,X,INUM,ITYPE,'VOFF ') 00006100
CALL LINES(1) 00006200
IF(INUM.GT.0) QTYPE1(ICALL)=1 00006300
IF(INUM.EQ.0) WRITE(6,905) 00006400
C CALL LINES(1) 00006500
INUM=0 00006600
ITYPE=1 00006700
WRITE(6,906) 00006800
C+++++COMPARE CALIBRATED COUNTS FOR CH 1 00006900
IAV=IAV+1 00007000
DO 100 J=1,256 00007100
X=J-1 00007200
X2=CUBIC(DELTA1,X) 00007300
IF(X2.LT.0.0)X2=0.0 00007400
IF(X2.GT.255.0)X2=255.0 00007500
X1=CUBIC(D1,X) 00007600
IF(X1.LT.0.0)X1=0.0 00007700

```

ORIGINAL FILE
OF POOR QUALITY

09MAR79 14.59.42 - VOL=DISK06, DSN=ZBMMB.LIB.CNTL

```

IF(X1.GT.255.0)X1=255.0
DIFF=X2-X1
DFMIN1(J)=AMIN1(DFMIN1(J),DIFF)
DFMAX1(J)=AMAX1(DFMAX1(J),DIFF)
AVER1(J)=AVER1(J)+DIFF
SD1(J)=SD1(J)+DIFF*DIFF
IF(X1.EQ.0.0) GO TO 100
IF(DABS(X1-X2).GT..5) CALL MESSAGE(X1,X2,X,INUM,ITYPE,' ')
100 CONTINUE
IF(INUM.GT.0) QTYPE2(ICALL)=1
IF(INUM.EQ.0) WRITE(6,907)
INJM=0
WRITE(6,910)
C++++ COMPARE CALIBRATED COUNTS FOR CH 2
DO 200 J=1,256
X=J-1
X2=CUBIC(Delta2,X)
IF(X2.LT.0.0)X2=0.0
IF(X2.GT.255.0)X2=255.0
X1=CUBIC(D2,X)
IF(X1.LT.0.0)X1=0.0
IF(X1.GT.255.0)X1=255.0
DIFF=X2-X1
DFMIN2(J)=AMIN1(DFMIN2(J),DIFF)
DFMAX2(J)=AMAX1(DFMAX2(J),DIFF)
AVER2(J)=AVER2(J)+DIFF
SD2(J)=SD2(J)+DIFF*DIFF
IF(DABS(X1-X2).GT..5) CALL MESSAGE(X1,X2,X,INUM,ITYPE,' ')
C
200 CONTINUE
IF(INUM.GT.0) QTYPE2(ICALL)=1
IF(INUM.EQ.0) WRITE(6,912)
GO TO 300
250 WRITE(6,913) ICALL
GO TO 300
260 WRITE(6,920)
800 FORMAT(7X,'ALPHA3=',F11.4,2X,'ALPHA1=',F11.4)
810 FORMAT(1X,'EBBR1=',F11.4,2X,'ESC1=',F11.4)
815 FORMAT(1X,'BETA1=',F11.4,2X,'DELTA1=',F11.4)
825 FORMAT(1X,'ALPHA4=',F11.4,2X,'ALPHA2=',F11.4)
835 FORMAT(1X,'EBBR2=',F11.4,2X,'ESC2=',F11.4,2X,'C=',F11.4)
840 FORMAT(1X,'TBB1=',F9.2,2X,'TBB2=',F9.2,2X,
1'TBB3=',F9.2,2X,'VOFF=',F10.5)
845 FORMAT(1X,'BETA2=',F11.4,2X,'DELTA2=',F11.4)
901 FORMAT(/55X,'*****NDP OUTPUT RECORD*****')
902 FORMAT(33X,'*****COMPARISON FOR TEMPERATURES & VOLTAGES*****')
905 FORMAT(33X,'*****NO TEMPERATURES OR VOLTAGES OUT OF RANGE*****')
906 FORMAT(33X,'*****COMPARISON FOR CALIBRATED COUNTS FOR CH 1*****')
907 FORMAT(33X,'*****NO CALIBRATED COUNTS OUT OF RANGE FOR CH 1*****')
910 FORMAT(33X,'*****COMPARISON FOR CALIBRATED COUNTS FOR CH 2*****')
912 FORMAT(33X,'*****NO CALIBRATED COUNTS OUT OF RANGE FOR CH 2*****')
915 FORMAT(1X,'ERROR IN READING OUTPUT RECORD FOR CALIBRATION
ISET #',I6)
920 FORMAT(1X,'END OF FILE')
300 RETURN
END

```

*** END OF MEMBER *** 153 RECORDS PROCESSED *****

```
C***** 00000010
C++++FUNCTION CUBIC 00000020
C++++ 2/22/79 00000030
C++++FUNCTION TO EVALUATE A CUBIC POLYNOMIAL 00000040
C A=COEFFICIENTS OF THE CUBIC POLYNOMIAL 00000041
C X=VALUE AT WHICH POLYNOMIAL IS TO BE EVALUATED 00000042
C 00000050
C++++WRITTEN BY M.BEWTRA,COMPUTER SCIENCES CORPORATION 00000060
C***** 00000070
REAL FUNCTION CUBIC*(A,X) 00000080
REAL*8 A(4),X 00000090
CUBIC=A(1)+A(2)*X+A(3)*X*X+A(4)*X*X*X 00000100
RETURN 00000110
END 00000120
```

*** END OF MEMBER *** 14 RECORDS PROCESSED *****

09MAR79 14.59.42 - VOL=DISK06, DSN=ZBMM8.LIB.CNTL

```

C*****00000100
C*****SUBROUTINE MESSAG 00000200
C***** 2/22/79 00000300
C*****ROUTINE TO WRITE MESSAGE IF MDP VALUE DIFFERS FROM SIMULATOR 00000400
C*****VALUE BY MORE THAN SET LIMIT 00000500
C A=MDP VALUE 00000510
C B=MDPSIM VALUE 00000520
C C=RAW COUNT(0-255) 00000530
C I=NUMBER OF QUANTITIES FOR WHICH MDP & MDPSIM OUTPUTS DIFFER BY 00000540
C MORE THAN SET LIMIT 00000550
C J=0, QUANTITY IS A TEMPERATURE OR A VOLTAGE 00000560
C J=1, QUANTITY IS A CALIBRATED INDEX 00000570
C NAME=LOGIACL*1 ARRAY CONTAINING NAME OF THE QUANTITY 00000580
C***** 00000600
C*****WRITTEN BY M.BEWTRA, COMPUTER SCIENCES CORPORATION 00000700
C***** 00000800
SUBROUTINE MESSAG(A,B,C,I,J,NAME) 00000900
REAL*8 B,C 00001000
LOGICAL*1 NAME(B) 00001100
DIFF=B-A 00001200
IF(J.EQ.1) GO TO 100 00001300
C*****MESSAGE FOR TEMPERATURES & VOLTAGES 00001400
IF(A.EQ.0.0) GO TO 200 00001500
WRITE(6,900) NAME,A,B,DIFF 00001600
1=1+1 00001700
GO TO 200 00001800
C*****MESSAGE FOR CALIBRATED COUNTS 00001900
100 WRITE(6,910) C,A,B,DIFF 00002000
1=1+1 00002100
200 RETURN 00002200
900 FORMAT(1X,8A1,'MDP VALUE=',F12.4,2X,'SIM VALUE=',F12.4,2X,'DIFF=' 00002300
1',F12.4) 00002400
910 FORMAT(1X,'RAW COUNT=',F6.0,2X,'MDP VALUE=',F12.2,2X,'SIM VALUE=', 00002500
IF12.2,2X,'DIFF=',F12.2) 00002600
END 00002700

*** END OF MEMBER *** 35 RECORDS PROCESSED *****

```

```

C+++++*****00000005
C+++++SUBROUTINE FINAL                                00000007
C+++++      10/6/78/                                  00000100
C+++++SUBROUTINE TO GENERATE SUMMARY OF COMPARISON BETWEEN MDP OUTPUT 00000200
C+++++& SIMULATOR OUTPUT                             00000250
C                                                    00000260
C+++++WRITTEN BY M.B.ETRA,COMPUTER SCIENCES CORPORATION 00000270
C+++++*****00000280
-----SUBROUTINE FINAL                                00000300
      IMPLICIT REAL*8(A-H,O-Z)                        00000400
      INTEGER*2 COUNT                                 00000500
      LOGICAL*1 QGOOD,QTYPE1,QTYPE2                 00000600
      REAL*4 DFMIN1,DFMIN2,DFMAX1,DFMAX2            00000700
      COMMON/VALUE/SCIN1(7),SCIN2(7),SCOUT1(7),SCOUT2(7),EC(3),SCBBR1, 00000800
      1,SCC1,SCBBR2,SCSC2,SCBB3,EBP,ERE1,EBB2,EOFFS,WS,PWS, 00000900
      2,ALPHA1(4),ALPHA2(4),ALPHA3(4),ALPHA4(4),DELTA1(4), 00001000
      3,ETAZ(4),C(2),EBB1,ESC1,EBB2,ESC2,TBB3,TBP,TBB1,TBB2,VOFF, 00001100
      4,BETA1(4),BETA2(4),V11(7),V12(7),V01(7),V02(7),A(3),TAU1(4),TAU2(4) 00001200
      5,TAU3(4),TAU4(4),WT(3),SIGMA(4),EPSILN(4),RHO(2),B(3),VC(3),WRP,W0 00001300
      6,NUM,N,ICALL,COUNT(40),QGOOD 00001400
      COMMON/STAT/AVER1(256),AVER2(256),SD1(256),SD2(256), 00001500
      1,DFMIN1(256),DFMIN2(256),DFMAX1(256),DFMAX2(256),IAV, 00001600
      2,QTYPE1(1000),QTYPE2(1000) 00001700
C+++++LIST CALIBRATION SETS TO BE CHECKED FOR TEMPERATURES & VOLTAGES 00001710
-----WRITE(6,900) 00001800
      INUM=0 00001900
      DO 100 I=1,ICALL 00002000
      IF(QTYPE1(I).EQ.0) GO TO 100 00002100
      WRITE(6,910) I 00002200
      INUM=INUM+1 00002300
100 CONTINUE 00002400
      INUM=INUM*100/IAV 00002450
-----WRITE(6,920) INUM 00002500
      INUM=0 00002600
      WRITE(6,930) 00002700
C+++++LIST CALIBRATION SETS TO BE CHECKED FOR CALIBRATED INDICES 00002750
      DO 200 I= 1,ICALL 00002800
      IF(QTYPE2(I).EQ.0) GO TO 200 00002900
      WRITE(6,910) I 00003000
      INUM=INUM+1 00003100
-----200 CONTINUE 00003200
      INUM=INUM*100/IAV 00003250
      WRITE(6,920) INUM 00003300
      WRITE(6,940) 00003400
      WRITE(6,950) 00003500
C+++++CALCULATE AVERAGES & S.D. FOR THE DIFFERENCES IN CALIBRATED 00003550
C+++++INDICES FOR ALL SETS 00003560
      DO 300 I=1,256 00003600
-----AVER1(I)=AVER1(I)/IAV 00003700
      SD1(I)=(SD1(I)-IAV*AVER1(I)+AVER1(I))/(IAV-1) 00003800
      SD1(I)=DSORT(SD1(I)) 00003900
      K=I-1 00004000
      WRITE(6,960) K,DFMIN1(I),DFMAX1(I),AVER1(I),SD1(I) 00004100
300 CONTINUE 00004200
      WRITE(6,970) 00004300
      WRITE(6,950) 00004400
-----DO 400 I=1,256 00004500
      AVER2(I)=AVER2(I)/IAV 00004600
      SD2(I)=(SD2(I)-IAV*AVER2(I)+AVER2(I))/(IAV-1) 00004700
      SD2(I)=DSORT(SD2(I)) 00004800
      K=I-1 00004900
      WRITE(6,960) K,DFMIN2(I),DFMAX2(I),AVER2(I),SD2(I) 00005000
400 CONTINUE 00005100
900 FORMAT(///20X,'***CALIBRATION SETS TO BE CHECKED FOR', 00005200
1' TEMPERATURES AND VOLTAGES***') 00005300
910 FORMAT(1X,15) 00005400
920 FORMAT(//1X,15,' & SETS LISTED ABOVE') 00005500
930 FJRMAT(///20X,'***CALIBRATION SETS TO BE CHECKED FOR', 00005600
1' CALIBRATED INDICES***') 00005700
940 FJRMAT(///20X,'***SUMMARY OF DIFFERENCES BETWEEN SIMULATOR', 00005800
1' AND MDP CALIBRATED INDICES FOR CH 1****') 00005900
950 FORMAT(//1X,'RAW COUNT',4X,'MINIMUM',4X,'MAXIMUM',4X,'AVERAGE', 00006000
1X,'S.D.') 00006100
960 FORMAT(//1X,13,10X,F7.2,3(4X,F7.2)) 00006200
970 FORMAT(///20X,'***SUMMARY OF DIFFERENCES BETWEEN SIMULATOR', 00006300
1' AND MDP CALIBRATED INDICES FOR CH 2****') 00006400
      RETURN 00006500

```

ORIGINAL FACETS
OF POOR QUALITY

09MAR79 14.59.42 - VOL=DISK06, DSN=ZEMMB.LIB.CNTL

END

00006600

*** END OF MEMBER ***

78 RECORDS PROCESSED

ORIGINAL FACILITY
OF POOR QUALITY

09MAR79 14.59.42 - VOL=DISK06, DSN=ZBMMB.LIB.CNTL

```

C*****00000100
C++++BLCK DATA FOR COMMON BLCKS VALUE & STAT 00000200
C++++ 2/22/79 00000300
C 00000400
C*****WRITTEN BY M.BEWTRA, COMPUTER SCIENCES CORPORATION 00000500
C*****00000600
BLCK DATA 00000700
IMPLICIT REAL*(A-H,O-Z) 00000800
-----
INTEGER*2 COUNT 00000900
LOGICAL*1 QGOOD,QTYPE1,QTYPE2 00001000
REAL*4 DFMIN1,DFMIN2,DFMAX1,DFMAX2 00001100
COMMON/VALUE/SCIN1(7),SCIN2(7),SCOUT1(7),SCOUT2(7),EC(3),SCBRR1, 00001200
1SCSC1,SCBRR2,SCSC2,SCBRR3,EBP,EBE1,EBB2,EOFFS,WS,PWS, 00001300
2ALPHA1(4),ALPHA2(4),ALPHA3(4),ALPHA4(4),DELTA1(4), 00001400
3DELTA2(4),C(2),EBRR1,ESC1,EBRR2,ESC2,TBB3,TBP,TBB1,TBB2,VOFF, 00001500
4BETA1(4),BETA2(4),V11(7),V12(7),V01(7),V02(7),A(3),TAU1(4),TAU2(4), 00001600
5,TAU3(4),TAU4(4),WT(5),SIGMA(4),EPSLN(4),RMO(2),Z(3),VCT(3),WBP,W0 00001700
6,NUM,N,ICALL,CCUNT(40),QGOOD 00001800
COMMON/STAT/AVER1(256),AVER2(256),SD1(256),SD2(256), 00001900
1DFMIN1(256),DFMIN2(256),DFMAX1(256),DFMAX2(256),IAV, 00002000
2QTYPE1(1000),QTYPE2(1000) 00002100
DATA N/10/,WS/1/ 00002200
DATA V11,V12,V01,V02/0.001,1.003,1.982,2.986,3.963,4.981,5.958, 00002300
10.102,1.058,1.989,2.943,3.877,4.848,5.781,0.006,0.970,1.970, 00002400
22.967,3.954,4.929,5.924,0.005,0.969,1.963,2.937,3.945,4.920,5.915/ 00002500
DATA A/-0.3124250,43.252250,-0.07282870/,TAU1,TAU2,TAU3,TAU4/ 00002600
132.8817,-15.556,1.772,-0.1917,59.7317,-15.556,1.772,-0.1917, 00002700
2332.8817,-15.556,1.772,-0.1917,333.2296,-15.556,1.772,-0.1917/ 00002800
DATA WT/2,1105,0790/,SIGMA/3.5309,-0.13892,.261760,2,-.273940,4 00002900
1/,EPSLN/0.71325,1.90-3,-3.1250-6,1.251159103/,RMC/5,0096,-0.6992200002900
2/,WBP/0.2/,W0/0.1/,8/-114.7019,13944.13,14238.17/,VC/.11,2.51,5.01 00003000
3/ 00003100
DATA QTYPE1/1000*0/,QTYPE2/1000*0/,DFMIN1/256*1.0E10/, 00003200
1DFMIN2/256*1.0E10/,DFMAX1/256*-1.0E10/,DFMAX2/256*-1.0E10/, 00003300
2AVER1/256*0.0/,AVER2/256*0.0/,SD1/256*0.0/,SD2/256*0.0/, 00003400
3IAV/0/ 00003500
END 00003600

```

*** END OF MEMBER *** 37 RECORDS PROCESSED *****

09MAR79 14.59.42 - VOL=DISK06, DSN=ZBMMB.LIB.CN1L

```

C*****
C***** 2/22/79
C*****MAIN FOR PROGRAM CORECT
C*****MAIN FOR GENERATING CALIBRATION LOOKUP TABLES FOR CONVERTING RAW
C*****COUNTS(0-255) TO CALIBRATED INDICES FOR MASTER OUTPUT TABLES.
C*****IT ALSO CALCULATES AVERAGES & S.D. FOR CALIBRATED INDICES.
C
C*****WRITTEN BY M.BEWTRA, COMPUTER SCIENCES CORPORATION
C*****
IMPLICIT REAL*8(A-H,O-Z)
INTEGER*2 COUNT
LOGICAL*1 QGOOD,QBBV(50)
COMMON/VALUE/SCIN1(7),SCIN2(7),SCOUT1(7),SCOUT2(7),EC(3),SCB8R1,
1SCSC1,SCB8R2,SCSC2,SCB83,EBP,EBB1,EBB2,EOFFS,WS,PWS,
2ALPHA1(4),ALPHA2(4),ALPHA3(4),ALPHA4(4),DELTA1(4),
3DELTA2(4),C(2),EUBR1,ESC1,EBR2,ESC2,TBB3,TBP,TBB1,TBB2,VOFF,
4BETA1(4),BETA2(4),VIT(7),VI2(7),VO1(7),VO2(7),A(3),TAU1(4),TAU2(4)
5,TAU3(4),TAU4(4),WT(3),SIGMA(4),EPSILN(4),RHO(2),E(3),VC(3),WBP,W0
6,NUM,N,ICALL,COUNT(40),QGOOD
C
C
NAMELIST/INPUT/ISKIP,MSETS,N,WS,NFILE,MST,SIGMA,VI1,VI2,VO1,VO2,A,
1TAU1,TAU2,TAU3,TAU4,WT,LPSILN,RHO,B,VC,WBP,W0
100 ICALL=0
I=0
READ(5,INPUT,END=1200)
WRITE(6,INPUT)
PWS=1.0-WS
C*****READ FIRST SCAN LINE FOR EACH CHANNEL & INITIALISE CALIBRATION
C*****QUANTITIES
105 CALL CCTRED(ISKIP,I)
I=I+1
IF(I.NE.N) GO TO 105
DO 110 J=1,7
SCIN1(J)=COUNT(J+1)
SCIN2(J)=COUNT(17+J)
SCOUT1(J)=COUNT(J+8)
SCOUT2(J)=COUNT(J+24)
110 CONTINUE
SCB8R1=COUNT(16)
SCSC1=COUNT(17)
SCB8R2=COUNT(32)
SCSC2=COUNT(17)
SCB83=COUNT(33)
QBBV(1)=COUNT(32)
C*****DO LOOP FOR NUMBER OF SETS OF CALIBRATION DESIRED
DO 1000 K=1,MSETS
ICALL=ICALL+1
IF(I.NE.1.AND.ICALL.EQ.1) GO TO 300
C*****READ NEXT SCAN LINE FOR EACH CHANNEL
200 CALL CCTRED(ISKIP,I)
I=I+1
QBBV(I)=COUNT(32)
C*****SMOOTH DATA IF LINE IS GOOD
IF(QGOOD) CALL SMOOTH
IF(I.NE.N) GO TO 200
300 WRITE(6,910)SCIN1,SCOUT1,SCIN2,SCOUT2
WRITE(6,910)SCSC1,SCB8R1,SCSC2,SCB8R2,SCB83,EC,EBP,EBB1,EBB2,EOFFS
C*****CALCULATE INTERMEDIATE QUANTITIES & POLYNOMIALS FOR CONVERSION
C*****WHEN N SCAN LINES ARE SMOOTHED
CALL INTVAL
C*****CALCULATE CALIBRATED INDICES,AVERAGES & S.D. FOR THEM
CALL CONVRT(MSETS,MST,ISKIP,QBBV)
I=0
1000 CONTINUE
C*****POSITION TAPE TO BEGINNING OF FILE WHEN DESIRED NUMBER OF SETS
C*****ARE CALIBRATED
CALL REWIND(10)
CALL POSN(1,10,NFILE)
GO TO 100
900 FORMAT(////)
910 FORMAT((1X,14F9.2))
920 FORMAT(7)
1200 STOP
END

```

*** END OF MEMBER *** 75 RECORDS PROCESSED *****

OF P...

09MAR79 14.59.42 - VOL=DISK06, DSN=ZBMMB.LIB.CNTL

```

C+++++00000100
C+++++SUBROUTINE CCTRED                                C0000200
C+++++                2/22/79/                          00000300
C+++++ROUTINE TO READ RECORDS FROM PREPROCESSOR CCT & TRANSFER DATA FROM00000400
C+++++LOGICAL*1 ARRAY TO I*2 ARRAY                    00000500
C      ISKIP=NUMBER OF RECORDS TO BE SKIPPED BEFORE PROCESSING 00000510
C      IREC=SCAN LINE COUNTER IN A CALIBRATION SET          00000520
C                                                         00000600
C+++++WRITTEN BY M.BEWTRA, COMPUTER SCIENCES CORPORATION 00000700
C+++++SUBROUTINE CCTRED(ISKIP,IREC)                    00000800
C+++++IMPLICIT REAL*8(A-H,O-Z)                          00000900
C+++++INTEGER*2 COUNT                                  00001000
C+++++LOGICAL*1 QDATA(4500),QGOOD                       00001100
C+++++COMMON/VALUE/SCIN1(7),SCIN2(7),SCOUT1(7),SCOUT2(7),EC(3),SCBBR1, 00001200
C+++++1,SCC1,SCJBR2,SCSC2,SCBB3,EBP,EBB1,EBB2,EOFFS,WS,PWS, 00001300
C+++++2,ALPHA1(4),ALPHA2(4),ALPHA3(4),ALPHA4(4),DELTA1(4), 00001400
C+++++3,DELTA2(4),C(2),EBBR1,ESC1,EBBR2,ESC2,TBB3,TBP,TBB1,TBB2,VOFF, 00001500
C+++++4,BETA1(4),BETA2(4),V1(7),V2(7),V3(7),V4(7),A(3),TAU1(4),TAU2(4) 00001600
C+++++5,TAU3(4),TAU4(4),WT(3),SIGMA(4),EPSILN(4),RHO(2),B(3),VC(3),WBP, 00001700
C+++++6,NUM,N,ICALL,CCOUNT(40),QGOOD                    00001800
C+++++QGOOD=.TRUE.                                       00001900
C+++++READ RECORDS TO BE SKIPPED                         00002000
C+++++IF(ICALL.EQ.0.AND.IREC.EQ.0) GO TO 20              00002100
C+++++GO TO 40                                           00002200
C+++++20 DO 30 I=1,ISKIP                                  00002300
C+++++CALL FREAD(QDATA(1),10,LEN,630,630)                00002400
C+++++30 CONTINUE                                       00002500
C+++++READ A PAIR OF RECORDS ONE FOR EACH CHANNEL       00002600
C+++++40 DO 100 K=1,2                                    00002700
C+++++CALL FREAD(QDATA(1),10,LEN,6600,6610)              00002800
C+++++IF(MOD(K,2).EQ.0) GO TO 65                          00002900
C+++++TRANSFER FROM L*1 TO I*2 ARRAY FOR CH 1           00003000
C+++++COUNT(1)=QDATA(3326)                              00003100
C+++++DO 50 J=1,7                                         00003200
C+++++COUNT(J+1)=QDATA(2198+J*24)                       00003300
C+++++COUNT(J+8)=QDATA(2750+J*24)                       00003400
C+++++50 CONTINUE                                       00003500
C+++++COUNT(16)=QDATA(1670)                             00003600
C+++++GO TO 100                                          00003700
C+++++65 IF(.NOT.QGOOD) GO TO 200                          00003800
C+++++TRANSFER FROM L*1 TO I*2 ARRAY FOR CH 2           00003900
C+++++COUNT(17)=QDATA(3326)                              00004000
C+++++DO 70 J=1,7                                         00004100
C+++++COUNT(17+J)=QDATA(2198+J*24)                      00004200
C+++++COUNT(24+J)=QDATA(2750+J*24)                      00004300
C+++++70 CONTINUE                                       00004400
C+++++COUNT(32)=QDATA(1670)                             00004500
C+++++COUNT(33)=QDATA(3678)                             00004600
C+++++TRANSFER 7 TELEMETRY VALUES                       00004700
C+++++DO 80 J=1,7                                         00004800
C+++++COUNT(33+J)=QDATA(3932+J*2)                       00004900
C+++++80 CONTINUE                                       00005000
C+++++100 CONTINUE                                      00005100
C+++++EBB1=COUNT(37)                                    00005200
C+++++EBB2=COUNT(38)                                    00005300
C+++++EOFFS=COUNT(39)                                   00005400
C+++++EBP=COUNT(40)                                     00005500
C+++++DO 120 I=1,3                                       00005600
C+++++EC(I)=COUNT(33+I)                                  00005700
C+++++120 CONTINUE                                      00005800
C+++++GO TO 200                                          00005900
C+++++MESSAGE FOR END OF FILE                            00006000
C+++++600 WRITE(6,900)                                    00006100
C+++++GO TO 180                                          00006200
C+++++MESSAGE FOR I/O ERROR                             00006300
C+++++610 WRITE(6,910)                                    00006400
C+++++QGOOD=.FALSE.                                     00006500
C+++++GO TO 100                                          00006600
C+++++900 FORMAT(IX,'END OF FILE')                       00006700
C+++++910 FORMAT(IX,'I/O ERROR')                        00006800
C+++++180 STOP                                           00006900
C+++++200 RETURN                                        00007000
C+++++END                                               00007100
C+++++END                                               00007200

```

*** END OF MEMBER *** 74 RECORDS PROCESSED *****

ORIGINAL PAGE IS
OF POOR QUALITY

09MAR79 14.59.42 - VOL=DISK06, DSK=ZEMMB.LIB.CNTL

```

C*****SUBROUTINE CONVRT                                00000100
C*****      2/22/79/                                    00000200
C*****      SUBROUTINE TO CONVERT RAW COUNTS TO CALIBRATED INDICES. 00000300
C*****      ALSO CALCULATES AVERAGES & S.D. FOR CALIBRATED INDICES 00000400
C      MSETS=NUMBER OF CALIBRATION SETS TO BE PROCESSED      00000510
C      MST=FIRST CALIBRATION SET FOR WHICH LOOKUP TABLES TO BE PRINTED 00000520
C      ISKIP=NUMBER OF RECORDS SKIPPED BEFORE PROCESSING     00000530
C      QBBV=COUNT OF BLACKBODY VIEW FOR CHANNEL              00000540
C*****WRITTEN BY M.BENRA, COMPUTER SCIENCES CORPORATION 00000600
C*****      SUBROUTINE CONVRT(MSETS,MST,ISKIP,QBBV)          00000700
C*****      IMPLICIT REAL*8(A-H,O-Z)                        00000800
C*****      INTEGER*2 COUNT                                  00000900
C*****      LOGICAL*1 QINT1(256,200),QINT2(256,200),QG00D,QBBV(50) 00001000
C*****      COMMON/VALUE/SCIN1(7),SCIN2(7),SCOUT1(7),SCOUT2(7),EC(3),SCBBR1, 00001100
C*****      1SCSC1,SCBBR2,SCSC2,SCBB3,EBP,EBE1,EBB2,EOFFS,WS,PMS, 00001200
C*****      2ALPHA1(4),ALPHA2(4),ALPHA3(4),ALPHA4(4),DELTA1(4), 00001300
C*****      3DELTA2(4),C(2),EBR1,ESC1,EBR2,ESC2,TBB3,TBP,TBB1,TBB2,VOFF, 00001400
C*****      4BETA1(4),BETA2(4),V11(7),V12(7),V01(7),V02(7),A(3),TAU1(4),TAU2(4) 00001500
C*****      5,TAU3(4),TAU4(4),MT(3),SIGMA(4),EPSILN(4),RHO(2),B(3),VC(3),WBP,W 00001600
C*****      6,NUM,N,ICALL,COUNT(40),QG00D                    00001700
C*****      DIMENSION AVERV(256),AVERT(256),STDDV(256),STDDT(256) 00001800
C*****      DIMENSION INDEX(200)                             00001900
C*****      DATA AVRBBV/0.0/,AVRT/256*0.0/,STDDV/256*0.0/,STDDT/256*0.0/ 00002000
C*****      DATA AVRBBV/0.0/,STDBBV/0.0/                    00002100
C*****CONVERT COUNTS FOR CH 1                               00002200
DO 100 I=1,256                                             00002300
X=I-1                                                       00002400
X=CUBIC(DELTA1,X)                                          00002500
IF(X.LE.0.0) X=0.0                                        00002600
IF(X.GE.255.0) X=255.0                                    00002700
QINT1(I,ICALL)=X                                          00002800
C*****RUNNING SUM FOR AVERAGES & S.D.SKIP THE FIRST SET OF CALIBRATION 00002900
IF(ICALL.EQ.1) GO TO 100                                   00003000
J=X                                                         00003100
X=X                                                         00003200
AVERV(I)=AVERV(I)+N*X                                     00003300
STDDV(I)=STDDV(I)+N*X*X                                   00003400
100 CONTINUE                                              00003500
C*****CONVERT COUNTS FOR CH 2                               00003600
DO 200 I=1,256                                             00003700
X=I-1                                                       00003800
X=CUBIC(DELTA2,X)                                          00003900
IF(X.LE.0.0) X=0.0                                        00004000
IF(X.GE.255.0) X=255.0                                    00004100
QINT2(I,ICALL)=X                                          00004200
C*****RUNNING SUM FOR AVERAGES & S.D.SKIP THE FIRST SET OF CALIBRATION 00004300
IF(ICALL.EQ.1) GO TO 200                                   00004400
J=X                                                         00004500
X=X                                                         00004600
AVERT(I)=AVERT(I)+N*X                                     00004700
STDDT(I)=STDDT(I)+N*X*X                                   00004800
200 CONTINUE                                              00004900
C*****CONVERT BLACKBODY VIEW COUNT                         00005000
DO 210 I=1,N                                              00005100
X=QBBV(I)                                                  00005200
X=CUBIC(DELTA2,X)                                          00005300
J=X                                                         00005400
X=X                                                         00005500
AVRBBV=AVRBBV+X                                          00005600
STDBBV=STDBBV+X*X                                         00005700
210 CONTINUE                                              00005800
C*****CALCULATE AVERAGES & S.D. WHEN DESIRED NUMBER OF SETS ARE 00005900
CALIBRATED                                                00006000
IF(ICALL.NE.MSETS) GO TO 300                              00006100
ISCAN=(MSETS-1)*N                                         00006200
DO 250 I=1,256                                           00006300
AVERV(I)=AVERV(I)/ISCAN                                   00006400
AVERT(I)=AVERT(I)/ISCAN                                   00006500
STDDV(I)=DSQRT((STDDV(I)-ISCAN*AVERV(I)*AVERV(I))/(ISCAN-1)) 00006600
STDDT(I)=DSQRT((STDDT(I)-ISCAN*AVERT(I)*AVERT(I))/(ISCAN-1)) 00006700
250 CONTINUE                                              00006800
JSC=ISCAN+1                                               00006900
AVRBBV=AVRBBV/JSC                                        00007000
STDBBV=DSQRT((STDBBV-JSC*AVRBBV*AVRBBV)/(JSC-1))        00007100

```

```

C++++CALCULATE START LINE NUMBER FOR EACH SET OF N LINES CALIBRATED      00007400
KK=MSETS-MST+1-----                                                    00007500
DO 255 I=1,KK                                                              00007600
  INDEX(I)=ISKIP/2+(MST+I-2)*N+1                                          00007700
  255 CONTINUE                                                              00007800
C++++WRITE HEADER CONTAINING LINE NUMBERS                                  00007900
  WRITE(6,960)                                                              00008000
  WRITE(6,965) (INDEX(I),I=1,KK)                                          00008100
C++++WRITE CALIBRATED INDICES,AVERAGES & S.D. FOR CH 1                    00008200
DO 200 I=1,256-----                                                    00008300
  K=I-1                                                                      00008400
  WRITE(6,950) K                                                            00008500
  WRITE(6,952) (QINT1(I,J),J=MST,MSETS)                                   00008500
  WRITE(6,955) AVERV(I),STDDV(I)                                          00008700
  260 CONTINUE                                                              00008800
C++++WRITE HEADER CONTAING LINE NUMBERS                                  00008900
  WRITE(6,960)                                                              00009000
  WRITE(6,965) (INDEX(I),I=1,KK)                                          00009100
C++++WRITE CALIBRATED INDICES,AVERAGES & S.D. FOR CH 2                    00009200
DO 270 I=1,256-----                                                    00009300
  K=I-1                                                                      00009400
  WRITE(6,950) K                                                            00009500
  WRITE(6,952) (QINT2(I,J),J=MST,MSETS)                                   00009600
  WRITE(6,955) AVERT(I),STDDT(I)                                          00009700
  270 CONTINUE                                                              00009800
  WRITE(6,970) AVRBBV,STDBBV-----                                       00009900
C++++REINITIALISE VARIABLES                                              00100000
DO 280 I=1,256-----                                                    00101000
  AVERV(I)=0.0                                                            00102000
  AVERT(I)=0.0                                                            00103000
  STDDV(I)=0.0                                                            00104000
  STDDT(I)=0.0                                                            00105000
  280 CONTINUE                                                              00106000
  AVRBBV=0.0                                                                00107000
  STDBBV=0.0                                                                00108000
  900 FORMAT(/1X,'V',25I5)                                                00109000
  910 FORMAT(/1X,'T',25I5)                                                00110000
  920 FORMAT(/2X,25I5)                                                    00111000
  930 FORMAT(2X,25F5.1)-----                                           00112000
  940 FORMAT(2X,25F5.2)                                                    00113000
  950 FORMAT(/1X,15)-----                                               00114000
  952 FORMAT(6X,20I5)-----                                              00115000
  955 FORMAT('+',107X,2F8.2)-----                                       00116000
  960 FORMAT(////)-----                                                 00117000
  965 FORMAT(8X,20I5)-----                                              00118000
  970 FORMAT(/1X,'AVERAGE BB VIEW=',F9.2,'S.D.=',F9.2)                00119000
  300 RETURN-----                                                       00120000
  END                                                                       00121000

```

*** END OF MEMBER *** 125 RECORDS PROCESSED *****