

NASA Technical Memorandum 85828

NASA-TM-85828 19840021176

STRUCTURES AND DYNAMICS DIVISION

RESEARCH AND TECHNOLOGY PLANS FOR FY 1984
AND ACCOMPLISHMENTS FOR FY 1983

Kay S. Bales

June 1984



National Aeronautics and
Space Administration

Langley Research Center
Hampton, Virginia 23665

LIBRARY COPY

JUN 6 1984

LANGLEY RESEARCH CENTER
LIBRARY, NASA
HAMPTON, VIRGINIA

STRUCTURES AND DYNAMICS DIVISION
RESEARCH AND TECHNOLOGY PLANS FOR FY 1984
AND ACCOMPLISHMENTS FOR FY 1983

BY

KAY S. BALES

SUMMARY

The purpose of this report is to present the Structures and Dynamics Division's research plans for FY 1984 and accomplishments for FY 1983. The work under each branch/office is shown by RTR Objectives, Expected Results, Approach, Milestones, and FY 1983 Accomplishments. Logic charts show elements of research and rough relationship to each other. This information is useful in program coordination with other government organizations in areas of mutual interest.

TABLE OF CONTENTS

I	STRUCTURES AND DYNAMICS DIVISION ORGANIZATION CHART	
II	FACILITIES	
III	IPAD PROJECT OFFICE	
	RTOP 505-37-33	Computer-Aided Design
	RTR 505-37-33-01	Finite Element Machine
	RTR 505-37-33-02	CAD/CAM Engineering Information Management
	RTR 505-37-33-50	Navy CAM Data Base
	RTOP 506-58-18	Methods for Developing Space Station Data Base Requirements
	RTR 506-58-18-08	Methods for Developing Space Station Data Base Requirements
IV	IMPACT DYNAMICS BRANCH	
	RTOP 505-33-53	Advanced Aircraft Structures and Dynamics Research
	RTR 505-33-53-05	B-720 Crash Test
	RTR 505-33-53-09	Composite Crash Dynamics
	RTR 505-33-53-58/59	AF/NASA F-111 Full-Scale Capsule Tests
	RTOP 505-42-23	Rotorcraft Airframe Systems
	RTR 505-42-23-04	Composite Impact Dynamics
	RTOP 505-45-14	Aircraft Landing Dynamics
	RTR 505-45-14-01	Aircraft Landing Dynamics
	RTR 505-45-23-53	Joint FAA/NASA Aircraft/Ground Vehicle Runway Friction Program
	RTOP 533-02-93	Advanced High-Speed Aircraft Concepts
	RTR 533-02-93-01	Flight Test of F-4C Active Control Landing Gears
V	STRUCTURAL MECHANICS BRANCH	
	RTOP 505-33-33	Composites for Airframe Structures
	RTR 505-33-33-06	Composite Structures Design Technology
	RTOP 534-06-23	Composite Materials and Structures
	RTR 534-06-23-08	Failsafe Composite Structures
	RTOP 505-33-53	Advanced Aircraft Structures and Dynamics Research
	RTR 505-33-53-10	Structural Mechanics Analysis

VI STRUCTURAL DYNAMICS BRANCH

RTOP 506-53-53	Analysis and Design
RTR 506-53-53-08	Vibration Control
RTR 506-53-53-09	Space Station Dynamics
RTOP 542-03-15	Space Flight Experiments (STEP Development)
RTR 542-03-15-07	LSS Deployable Flight Experiment Development
RTR 506-62-49-01	Solar Array Dynamics

VII STRUCTURAL CONCEPTS BRANCH

RTOP 506-53-43	Advanced Space Structures
RTR 506-53-43-01	Advanced Space Structures Concepts
RTR 506-53-43-02	STS Structural Concepts
RTR 506-53-43-14	ACCESS Flight Experiment Develop- ment
RTOP 505-33-53	Advanced Aircraft Structures and Dynamics Research
RTR 505-33-53-11	High-Speed Aircraft Structural Concepts
RTR 505-33-53-60	Navy--Thermal Management of Hydro- carbon-Fueled Scramjet Engine
RTOP 505-43-83	High-Speed (Super/Hypersonic) Technology
RTR 505-43-83-07	Hypersonic Aircraft Structural Concepts
RTOP 505-43-23	High-Speed Aerodynamics and Propulsion Integration
RTR 505-43-23-12	Missile Structural Concepts

VIII ACCOMPLISHMENT HIGHLIGHTS

I STRUCTURES AND DYNAMICS DIVISION ORGANIZATION CHART

**STRUCTURES AND DYNAMICS
DIVISION**

M. F. CARD
H. G. McCOMB, JR.

IPAD

R. E. FULTON

COMPUTER-AIDED
DESIGN

**IMPACT
DYNAMICS
BRANCH**

R. G. THOMSON

**STRUCTURAL
MECHANICS
BRANCH**

J. H. STARNES, JR.

**STRUCTURAL
DYNAMICS
BRANCH**

L. D. PINSON
B. R. HANKS

**STRUCTURAL
CONCEPTS
BRANCH**

M. M. MIKULAS, JR.
P. A. COOPER

CRASH
DYNAMICS
LANDING
DYNAMICS

COMPOSITE
STRUCTURES
NONLINEAR
MECHANICS

SPACE
VEHICLE
DYNAMICS

LARGE SPACE
STRUCTURES
THERMAL
STRUCTURE
CONCEPTS

II FACILITIES

II FACILITIES

The Structures and Dynamics Division has four major facilities to support its research (shown in figure 1).

The Structures and Materials Laboratory equipment includes a 1,200,000 lbf capacity testing machine for tensile and compressive specimens up to 6 feet wide and 18 feet long; lower capacity testing machines of 300,000, 120,000, 100,000 and 10,000 lbf capacity; torsion machine of approximately 60,000 in.-lbf capacity; combined load testing machine; hydraulic and pneumatic pressurization equipment; and vertical abutment-type backstop for supporting and/or anchoring large structural test specimens.

The Impact Dynamics Research Facilities consist of the Aircraft Landing Dynamics Facility (ALDF) currently being upgraded under a \$15M CoF project, and the Impact Dynamics Research Facility. The ALDF will consist of a rail system 2,500 ft. long x 30 ft. wide, a 1.73 Mlbs. thrust propulsion system, a test carriage capable of approximately 220 knots, and an arrestment system. A wide variety of runway surface conditions, ranging from dry and flooded concrete or asphalt to solid ice, can be duplicated in the track test section. In addition, unprepared surfaces such as clay or sod can be installed for tests to provide data on aircraft off-runway operations.

The Impact Dynamics Research Facility simulates crashes of full-scale general aviation aircraft and helicopters under controlled conditions. Simulation is accomplished by swinging the aircraft by cables, pendulum-style, into the ground from an A-frame structure approximately 400 ft. long x 240 ft. high. A Vertical Test Apparatus is attached to one leg of the A-frame for drop-testing structural components.

The Structural Dynamics Research Laboratory is designed for carrying out research on spacecraft and aircraft structures, equipment, and materials under various environmental conditions, including vibration, shock, acceleration, thermal and vacuum. Equipment in the laboratory includes a 55-ft. (inside diameter) thermal vacuum chamber with a removable 5-ton crane, a flat floor 70 feet from the dome peak, and whirl tables.



**STRUCTURES AND MATERIALS
RESEARCH LABORATORY**

STRUCTURES AND DYNAMICS

DIVISION

FACILITIES

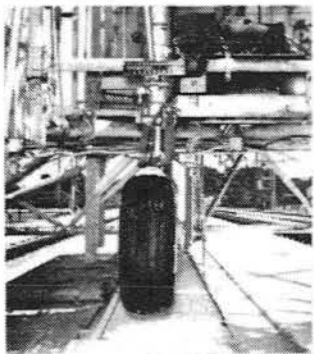

**IMPACT DYNAMICS
RESEARCH FACILITIES**

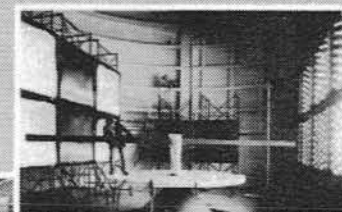
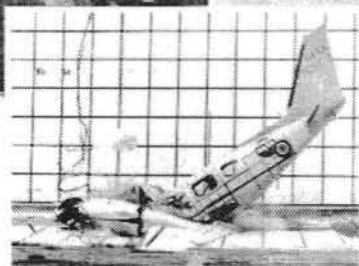

**STRUCTURAL DYNAMICS
RESEARCH LABORATORY**

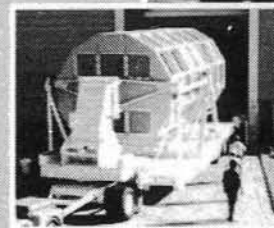

Figure 1.

III IPAD PROJECT OFFICE

COMPUTER AIDED DESIGN

RESEARCH THRUST	83	84	85	86	87	GOALS
INTEGRATED DESIGN	▼ PRIDE					INTEGRATED ENGINEERING ANALYSIS AND DESIGN METHODOLOGY
	SPACE STRUCTURE APPLICATION					
	▽ IPIP					
	INTEGRATED DESIGN SYSTEM DEVELOPMENT					
ENGINEERING DATA MANAGEMENT	▽ IPIP					ADVANCED ENGINEERING DATA MANAGEMENT METHODOLOGY
	MULTI SCHEMA ENGR DATA MANAGEMENT SYSTEM					
	▼ SYMPOSIUM					
	DISTRIBUTED ENGR. DATA MGT. SYSTEM					
	GEOMETRY DATA MANAGEMENT SYSTEM					
	ARTIFICIAL INTELLIGENCE DATA MGT.					
COMPUTER HARDWARE	EXPERIMENTAL FEM					SPECIALIZE COMPUTER HARDWARE FOR STRUCTURAL ANALYSIS AND DESIGN
	FEM					
	ADVANCED FEM CONCEPTS					
	COMPUTER HARDWARE/SOFTWARE METHODOLOGY FOR STRUCTURAL ANALYSIS/DESIGN					
	IDEAS. PH 1			IDEAS. PH 2		

III IPAD PROJECT OFFICE

RTOP 505-37-33 Computer-Aided Design

RTR 505-37-33-01 Finite Element Machine

OBJECTIVE:

Develop and evaluate an initial prototype finite element machine to demonstrate efficient structural computations.

EXPECTED RESULTS:

Develop and evaluate a prototype 36 node finite element machine (FEM) to demonstrate efficient computational methods for large-scale structural analysis applications by end of FY 1985

Develop a second-level prototype finite element machine (FEM 2) based on advanced MIMD (multiple instruction, multiple data) distributed architecture concepts to demonstrate several orders of magnitude reductions in time and cost for finite element/finite difference calculations typical of solid/fluid mechanics applications by end of FY 1987

APPROACH:

To understand possible advantages of parallel processing, the feasibility of obtaining structural analysis solutions using microprocessors will be investigated. Under the FEM program, microprocessors will be assembled in a concurrent array and used to solve a variety of structural analysis problems. Various methods of solution including relaxation techniques and direct inversion will be studied to determine which solution techniques are most suitable for rapid solutions.

MILESTONES:

- o Complete board checkout for 36 nodes (108 boards), October 1983
- o Complete fabrication of tree boards to permit up to 36 processors, December 1983
- o Document parallel algorithms for linear static problems, February 1984
- o Document nonlinear dynamic response applications, April 1984
- o Complete 16-node FEM, September 1984

FY 1983 ACCOMPLISHMENTS:

- o Constructed and tested 8-node FEM (24 boards)
- o 108 boards constructed for 36 nodes being tested, and interface boards (tree boards) being constructed
- o System software for both controller and array written and documented in user manuals
- o Compared efficiency of several algorithms for solving static stress analysis with speedups of three times typical for four processors
- o Research on parallel methods for nonlinear transient response under way
- o FEM overview paper presented at Structures meeting, and six other papers published in computer science publications (IEEE) have appeared recently; additional application-oriented publications are planned

RTR 505-37-33-02 CAD/CAM Engineering Information Management

OBJECTIVE:

To demonstrate initial CAD/CAM data management system with geometry capability in a multihost environment.

EXPECTED RESULTS:

Demonstrate initial CAD/CAM data management system with geometry capability in a multihost environment by end of FY 1985

Develop and validate a distributed IPAD engineering/scientific data management software capability for a network of mainframe/mini/microcomputers which supports design/analysis and geometry data for representative aerospace configurations by end of FY 1989

APPROACH:

Using combinations of contracts, grants, and in-house research, software will be designed and developed to demonstrate advances in the area of engineering/manufacturing data base management, and provide proof-of-concept software modules. In FY 1984, program emphasis will be on developing a distributed data base management design which has the capability of interfacing with commercial data based management systems. Effort will be jointly sponsored by NASA and Navy Material Command.

MILESTONES:

- o Preliminary design of distributed data management capability, March 1984
- o Develop local network distributed processing executive, June 1984
- o Develop initial transaction processor (RIM based), July 1984
- o Interface to commercial CAD/CAM data base management operational, August 1984
- o Multi-threading IPIP operational, November 1984

FY 1983 ACCOMPLISHMENTS:

- o Initiated Software Acquisition Management Plan for Data Management Group for Space Station Technology Workshop
- o Initiated Navy sponsored CAM data management requirements task and long-range planning
- o Established government committee to track CAM data management requirements and planning
- o Began development of in-house microcomputer-based local network
- o Completed position paper on distributed computing research
- o Co-sponsored Computer-Aided Geometry Modeling Symposium (51 papers; 400 attendees)
- o Completed initial installation and test of IPIP 4.0 on CDC 6400; initiated hardware upgrade to CDC 730
- o Initiated in-house research program on artificial intelligence applications to data base management
- o Completed wire frame geometry version of IPIP

RTOP 506-58-18 Methods for Developing Space Station
Data Base Requirements

RTR 506-58-18-08 Methods for Developing Space Station
Data Base Requirements

OBJECTIVE:

Provide methodology and software capability for acquiring and accessing evolving requirements for data bases and data base management systems needed for space station design, development, and operation.

EXPECTED RESULTS:

Define initial set of space station core data management requirements

APPROACH:

Using a combination of contracts and in-house research, modify and document for space station application methodology developed under the IPAD program for gathering and analysis of requirements for data base management systems. Extend IPAD project developed Relational Data Base Management Software (RIM) to provide user friendly data entry and query access for space station application, providing prototype software for evaluation of data management requirements. Acquire and enter into data base high-level characteristics of space station data base systems. The resulting RIM-based system will allow update and expansion of the requirements data to provide software system design at increasing levels of complexity.

MILESTONES:

- o Preliminary requirements methodology, CY 1984
- o System requirements software package composed of RIM plus user interface software, CY 1984
- o Data base containing basic characteristics for space station data base management systems, CY 1985

IV IMPACT DYNAMICS BRANCH

IMPACT DYNAMICS PROGRAM

DISCIPLINE	FY 83	FY 84	FY 85	FY 86	FY 87	GOAL
LANDING DYNAMICS						
TIRE BEHAVIOR	TIRE THERMAL STUDIES		HIGH-SPEED FRICTION			IMPROVED TIRE AND GEAR DESIGNS
	TIRE CONTACT STUDIES		NATIONAL TIRE MODELING PROGRAM			
LANDING SYSTEMS	LANDING LOADS TRACK UPDATE					REDUCED RUNWAY AND AIRFRAME LOADINGS
	F-4 ACTIVE GEAR FLIGHT TESTS		HIGH-SPEED IMPACT			
	AIR CUSHION					
GROUND OPERATIONS	GROUND-HANDLING SIMULATOR		HIGH-SPEED GEAR BEHAVIOR			SAFE ALL-WEATHER OPERATIONS
	JOINT NASA/FAA RUNWAY FRICTION STUDIES					
CRASH DYNAMICS						
NONLINEAR STRUCTURAL ANALYSIS	AIRFRAME					ACCURATE PREDICTIVE METHODS
	SEAT AND OCCUPANT					
LOAD-LIMITING AND FUEL CONTAINMENT CONCEPTS	METALS					IMPROVED SURVIVABILITY
	COMPOSITES					
FULL-SCALE TESTING	TRANSPORT COMPONENTS					DEMONSTRATION AND VERIFICATION
	G. A.	TRANSPORT	△ B-720			

IV IMPACT DYNAMICS BRANCH

RTOP 505-33-53 Advanced Aircraft Structures and Dynamics
Research

RTR 505-33-53-05 B-720 Crash Test

OBJECTIVE:

To enhance passenger safety through improvement of analysis methods, airframe structural concepts, and seat/restraint system concepts for future airframe under crash conditions.

EXPECTED RESULTS:

Define and demonstrate improved static and new dynamic seat test methods in FY 1984

Develop and validate multiple occupant/seat/restraints system simulation by FY 1985

Determine definitive crash loads by full-scale testing and compare with analytical predictions by FY 1985

APPROACH:

Nonlinear analytical techniques potentially suited to integration into design methods will be used to predict crash dynamic response of fuselage sections, multi-seat/restraints/occupant systems, and complete airplanes. From studies of load-limiting structures the most promising seat and fuselage concepts will be selected and dynamically tested. A data acquisition system will be designed, fabricated, and installed in the B-720 test article. A large-scale crash test will be performed to provide archival crash response data as a metal baseline for future composite structures research. The analytical predictions will be compared to the measured quantities.

MILESTONES:

- o Delivery of first 176-channel Data Acquisition System to Dryden Flight Research Facility (DFRF), October 1983
- o Conduct third vertical drop test of B-707 fuselage section, November 1983
- o Delivery of Photographic System to DFRF, January 1984
- o Delivery of second 176-channel Data Acquisition System to DFRF, February 1984

- o Conduct full-scale B-720 crash test, July 1984
- o Joint NASA/FAA executive summary report (quick look), September 1984

FY 1983 ACCOMPLISHMENTS:

- o Sensors and tape recorders selected and procured
- o Camera procurement awarded to Teledyne
- o Pallet for first 176-channel Data Acquisition System delivered to Flight Electronics Division
- o Quality Assurance and Inspection plan coordinated between DFRF and LaRC
- o Decision made to augment the Data Acquisition System by 60 channels (4/83)
- o Integrated instrumentation plan developed by NASA and FAA
- o Conducted first (4/26/83) and second (6/8/83) vertical drop tests of B-707 fuselage sections
- o Conducted Major Design Review of LaRC TCT Project
- o Preliminary DYCAST modeling of B-720 aircraft and B-707 fuselage sections by Boeing Commercial Airplane Company completed

RTR 505-33-53-09 Composite Crash Dynamics

OBJECTIVE:

To establish a data base, develop a better understanding of the behavior, and generate or verify analytical and empirical tools to predict global response characteristics of composite structures under crash loading conditions.

EXPECTED RESULTS:

Develop a data base on composite structural behavior under crash loading conditions by FY 1986

APPROACH:

Develop in-house test methods, procedures and apparatus to conduct static and dynamic combined crash loading tests on representative composite components. Develop a data base to evaluate the effect of combined loadings on global response, stiffness and failure, and residual strength after failure. Analytical predictions using existing modified

nonlinear computer programs will be compared to the experimental results. Supportive contractual efforts will be used mainly to fabricate composite components requiring special tooling.

MILESTONES:

- o Design and initiate fabrication of composite curved frames for crash type loading tests (Lockheed-California), June 1983
- o Complete laboratory abrasion tests of various composite and aluminum coupons, October 1983
- o Design and fabricate test apparatus and conduct abrasion tests on composite beams and stiffened skin components on runway surface, December 1983
- o Predict behavior of composite curved frames for comparison with experiments (NASTRAN), February 1984
- o Initiate test program on composite curved frames under crash type loadings, March 1984

FY 1983 ACCOMPLISHMENTS:

- o Developed analysis, fabricated composite arches, conducted static tests under snap-through, and compared analytical and experimental results (VPI&SU)
- o Conducted abrasion tests on composite and aluminum coupons specimens for evaluating wear rate and friction characteristics under crash loads
- o Conducted in-plane and out-of-plane tearing tests of composite skin components (Lockheed-Georgia)
- o Received composite beam and stiffened panel components from contractor for abrasion testing
- o Initiated the design and fabrication of composite curved beams (Lockheed-California)

RTOP 505-42-23 Rotorcraft Airframe Systems

RTR 505-42-23-04 Composite Impact Dynamics

OBJECTIVE:

To understand better the response characteristics of generic composite components subjected to crash loading conditions.

EXPECTED RESULTS:

Develop in-house test methods, procedures and apparatus to conduct static and dynamic combined loading tests on representative composite beam elements

APPROACH:

To collect and assess the data, evaluate the effect of combined loading on global response, stiffness and failure, and define residual strength after failure. Analytical predictions using DYCAST will be compared to the experimental results. Supportive contractual efforts will be used mainly to fabricate composite components requiring special tooling.

MILESTONES:

- o Conduct abrasion tests on composite beams and stiffened skin components on runway surfaces, December 1983
- o Initiate MSC-NASTRAN analysis of dynamically loaded composite beams and arches, June 1984

FY 1983 ACCOMPLISHMENTS:

- o Received composite beam and panel components from contractor (Lockheed-California) for abrasion testing on runway surfaces
- o Obtained MSC-NASTRAN computer program for analysis of composite beam elements

RTOP 505-45-14 Aircraft Landing Dynamics

RTR 505-45-14-01 Aircraft Landing Dynamics

OBJECTIVE:

To advance the technology for safe, economical all-weather aircraft ground operations, including the development of new landing systems.

EXPECTED RESULTS:

Conclude study of thermal effects on tire integrity by FY 1984

Develop family of analytical tire models to facilitate tire and gear designs by FY 1985

Develop and validate software simulation of ACLS and active gear concepts by FY 1984

Develop improved aircraft/ground runway friction modeling capability to better predict stopping performance under all-weather conditions by FY 1986

APPROACH:

Coordinate in-house research, grants, and contracts with U.S. tire industry experimental effort to carry out National Tire Modeling Program. Conduct spray ingestion tests and initial nose wheel spray pattern model studies. With the aid of data from full-scale vehicle tests validate analytical ACLS stability predictions. Extend active control landing gear studies for military aircraft applications by conducting flight tests. Perform runway friction measurements in-house and in cooperation with FAA to validate prediction theory for aircraft stopping performance.

MILESTONES:

- o Conduct flight and ground vehicle friction measurements in joint NASA/FAA runway friction program, October 1983
- o Conduct detailed studies of forces and moments in 40x14 tire footprint for comparison with analytical tire models, October 1983
- o Implement National Tire Modeling Program, November 1983
- o Publish 40x14 tire modeling study, January 1984
- o Conduct spray ingestion tests in Towing Tank #1, January 1984
- o Complete full-scale and model studies supporting track update, February 1984
- o Initiate experimental measurements of tire material properties, March 1984
- o Publish test results from 1/3-scale model ACLS, August 1984
- o Complete ACLS stability analysis, September 1984

FY 1983 ACCOMPLISHMENTS:

- o Tire Modeling Workshop proceedings publication (NASA CP 2264)
- o National Tire Modeling Program initiated with Industry
- o Tire contact algorithm developed; initiated footprint pressure measurements

- o Validated active gear, flexible airframe, takeoff and landing analysis published
- o Air cushion braking and cornering program completed; report published (NASA TP 2196)
- o Tire thermal modeling report published (NASA CR 3629); tire thermal measurements report published (NASA TP 2195)
- o Towing Tank #1 operational and readied for spray ingestion tests
- o Held session on Aircraft Wheels, Brakes, and Tires at SAE Aerospace Congress and Exposition in October 1982
- o Supported NASA, FAA, and NTSB by: participating in DC-10 Logan and T-38 Ellington AFB accident investigations; conducting friction tests at Byrd Airport, Richmond
- o Completed plans and arrangements for joint NASA/FAA runway friction program
- o Supported track update with tests on: flow straighteners, L-vessel/nozzle area ratios, and shutter valve; Monthly Status Review, April 1983

V STRUCTURAL MECHANICS BRANCH

STRUCTURAL MECHANICS

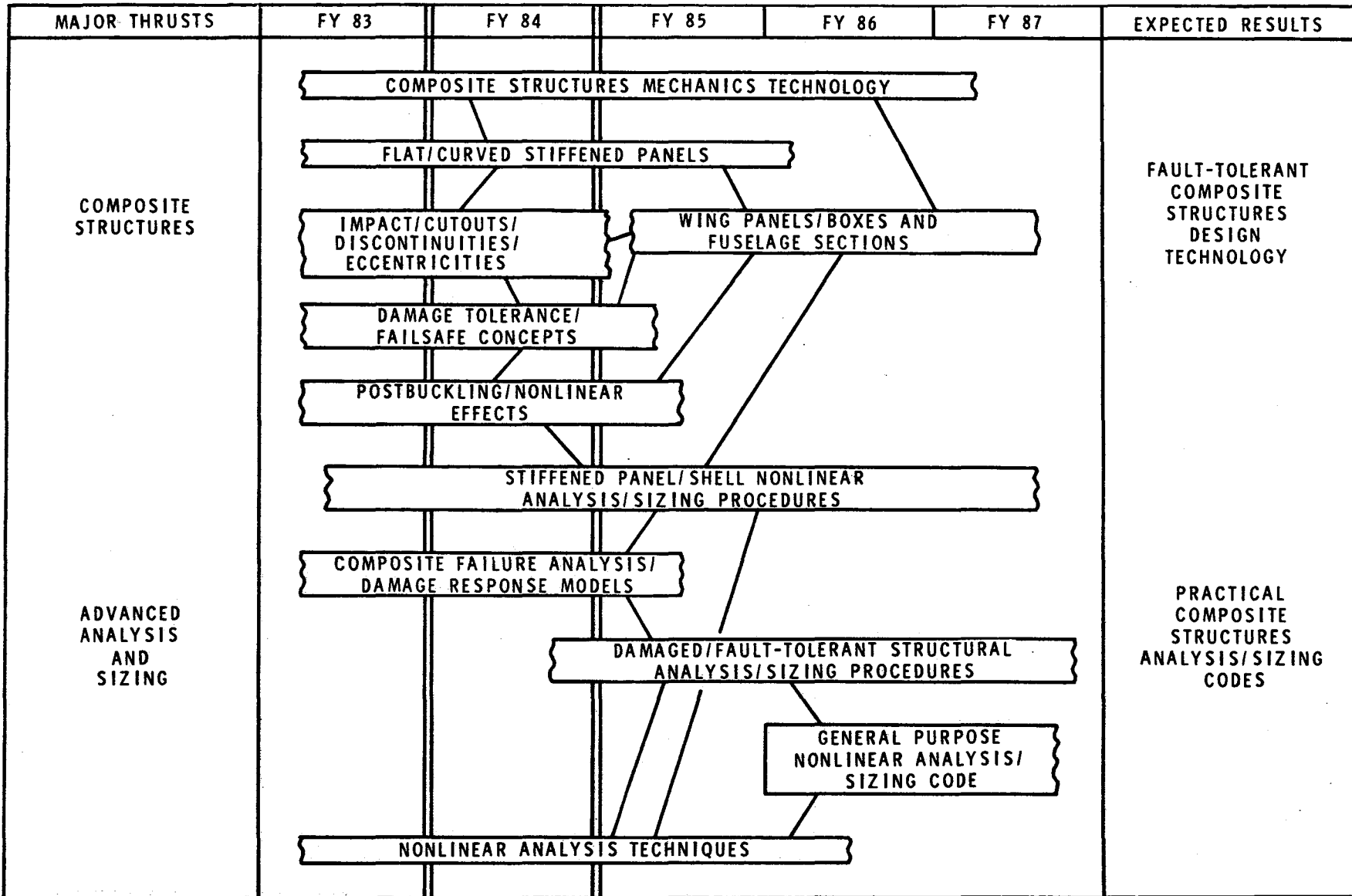

V STRUCTURAL MECHANICS BRANCH

RTOP 505-33-33 Composites for Airframe Structures

RTR 505-33-33-06 Composite Structures Design Technology

OBJECTIVE:

Develop mechanics technology required for the verified design of efficient, fault-tolerant advanced-composite aircraft structural components subject to combined loads, impact, postbuckling effects and local discontinuities.

EXPECTED RESULTS:

Understand mechanics of buckling and effects of flaws and damage on strength predictions for composite structures in FY 1985

Demonstrate the ability to predict the postbuckling response of complex composite structures in FY 1986

APPROACH:

The advanced structural concepts and configurations that exploit the advantages of composites as well as advanced design methods for advanced composite flat and curved panels and stiffened shell structures will be developed. Compression, tension, shear, and combined loads representative of aircraft primary wing and fuselage components will be considered. Methods will be developed for predicting strength, buckling, and stiffness of composite components including the effects of foreign-object damage, cutouts, and postbuckling. An experimental data base will be established for composite airframe structural components including damage, cutouts, and post-buckling and correlated with analytical predictions. FY 1984 emphasis is on reinforcement requirements for composite structural components.

MILESTONES:

- o Complete tests of modified graphite-epoxy stiffened shear panels with postbuckling strength, March 1984
- o Conduct preliminary study of composite stiffener crippling, March 1984
- o Complete study of load introduction effects on compression strength of laminates with holes, May 1984
- o Develop analytical model for predicting strength of multi-directional laminates loaded in compression, May 1984

- o Develop failure criterion for skin-stringer separation mode, July 1984
- o Develop efficient methods for reinforcing cutouts in composite panels, September 1984
- o Complete preliminary study of effects of impact damage and holes on the behavior of composite shear webs, September 1984
- o Conduct combined load test of curved composite stiffened panels, September 1984
- o Initiate development of prototype computer code that simultaneously performs nonlinear analysis and structural optimization

FY 1983 ACCOMPLISHMENTS:

- o Preliminary tests show that graphite straps are more effective than titanium or boron-aluminum straps for arresting damage in pressurized composite fuselage structure
- o Preliminary sizing code for stiffened composite panels with buckled skins documented
- o Padded skin concept demonstrated to reduce sensitivity of composite compression panels with postbuckling behavior to stiffener pull-off mode
- o Preliminary tests show that impact damage and holes can reduce strength of graphite-epoxy shear webs
- o Preliminary study of pressurization effects on curved composite panels shows nonlinear analysis of response correlates with tests
- o Interlaminar failures in stiffener re-entrant corners identified as critical failure mode
- o Efficient analysis developed for the buckling loads of finite-width orthotropic plates with cutouts
- o Preliminary study of effects of stiffener eccentricity and skin discontinuities on stiffened panel response indicates a progressive failure analysis is needed to predict the ultimate load of complex structural components
- o Initial tests identified stiffener attachment problems with stiffened shear panels with postbuckling strength. Modifications to stiffener attachment concepts currently under way

- o Preliminary study of effect of curvature on compressive strength reduction of thick laminates with low-speed impact damage indicates results are similar to flat, thick laminates when initial damage width is small compared to plate radius of curvature
- o Analytical method for predicting the shear and normal stresses at the skin stiffener interface of buckled fuselage panels developed
- o Preliminary primary structures technology readiness plan developed for pressurized composite fuselage structure. Damage tolerance, postbuckled structure, shell cutouts, and combined load testing are some of the technical issues addressed

RTOP 534-06-23 Composite Materials and Structures

RTR 534-06-23-08 Failsafe Composite Structures

OBJECTIVE:

Develop structures technology and damage containment concepts required for the design of efficient, damage-tolerant advanced-composite aircraft structural components subject to combined loads, impact, local discontinuities and nonlinear effects.

EXPECTED RESULTS:

Develop nonlinear procedures for reduced degree-of-freedom and time-integration analyses of aerospace structures with large deflections in FY 1984

Develop and verify fault-tolerant structural concepts for composite wing and fuselage structure in FY 1986

APPROACH:

Damage-tolerant structural concepts and configurations will be developed for low-strain fuselage components with buckled skins and high-strain buckling-resistant wing components. Compression, tension, shear, and combined loads representative of aircraft primary structures will be considered. Methods will be developed for predicting strength and response characteristics of damage-tolerant structural concepts, including the effects of damage, cutouts, post-buckling, and internal pressure. Failure mechanisms will be identified and analytical procedures will be verified by testing structural components of the appropriate size. FY 1984 emphasis is on understanding panel failure mechanisms and exploring methods for failure containment.

MILESTONES:

- o Complete in-house testing of L-1011 composite fin PRVT spars and covers with and without damage, December 1983
- o Award competitive contract for damage-tolerant wing panel specimens and failure analysis research, March 1984
- o Conduct tests to assess effectiveness of longitudinal splice joints for containing propagating damage in composite compression panels, March 1984
- o Complete development of local interlaminar stress analysis of composite plates with adhesively bonded stiffeners with tapered attachment flanges, May 1984
- o Conduct tests to evaluate advanced damage-containment concepts for heavily-loaded stiffened compression panels, May 1984
- o Conduct microbuckling experiments to determine the effect of different material properties on the shear-crippling failure mode, September 1984
- o Conduct study of interlaminar strain distribution in multispan beam bending specimens, September 1984
- o Identify failure mechanisms in ± 45 compression laminates with local discontinuities and develop analytical prediction of behavior, September 1984
- o Investigate effect of transverse stitching on shear crippling failure mechanism, September 1984

FY 1983 ACCOMPLISHMENTS:

- o Test fixtures designed for in-house testing of L-1011 PRVT spar and cover components and fixture fabrication under way
- o Completed two designs for stiffened panels with advanced damage-containment concepts, and panel fabrication is under way
- o Bilinear compression behavior of Kevlar-epoxy panels identified as potential ductile-like mechanism for damage-tolerant compression panels
- o Kevlar-epoxy-skin graphite-epoxy-stiffener hybrid compression panel concept shown to be impact-damage tolerant and approximately 30 percent lighter in weight than comparable metal designs
- o High-strain graphite fibers shown to increase slightly the strength of compression-loaded laminates with holes

indicating that fiber properties can influence laminate compressive strength

- o Developed a method for comparing the effect of impact damage with the effect of open holes on laminate compressive strength
- o Design of stiffened composite fuselage panel for combined load testing under way and specimen fabrication to begin before end of FY 1983

RTOP 505-33-53 Advanced Aircraft Structures and Dynamics Research

RTR 505-33-53-10 Structural Mechanics Analysis

OBJECTIVE:

Develop structural analysis and sizing methods for predicting and designing for the nonlinear behavior of aerospace structures including postbuckling phenomena and ultimate strength.

EXPECTED RESULTS:

Develop pilot nonlinear analysis and sizing procedures for composite structural components in FY 1986

APPROACH:

Advanced structural analysis and sizing procedures for aerospace structures with nonlinear responses will be developed. Procedures for analyzing flat and curved composite stiffened structural components will be developed that account for large deflections and rotations. Approximate analysis procedures based on a reduced set of generalized coordinates will be developed and assessed. Analytical procedures will be verified with available test data. Results will be compared with failure criteria that predict ultimate strength. New failure criteria will be developed as needed. FY 1984 emphasis is on implementing advanced in-house-developed nonlinear analysis theory into STAGSC-1/RRSYS general purposes analysis code.

MILESTONES:

- o Develop an accurate and efficient analysis computer program for calculating buckling loads of flat composite panels with transverse stiffeners, December 1983
- o Develop analysis for postbuckling response of orthotropic plates subjected to biaxial compression, combined tension

and compression and combined shear and transverse compression, March 1984

- o Document basic theory of partitioning nonlinear mechanics problems and application of theory to simply supported plates with modal interaction, March 1984
- o Document VICON computer code for predicting shear buckling loads of stiffened composite panels, April 1984
- o Initiate analytical study of lamina and local stresses and strains in optimized stiffened composite panels with nonlinear deformations, April 1984
- o Develop modeling methodology for predicting postbuckling response of stiffened curved composite panels and compare analytical results with tests, May 1984
- o Introduce an advanced analysis procedure based on generalized Newton's method into a prototype analysis code, May 1984
- o Implement partitioning theory into general purpose computer code for nonlinear structures problems and initiate study of substructuring in STAGS as an alternate to finite element mesh refinement, May 1984
- o Derive an efficient algorithm for computing eigenvalues of $M\lambda^2 + c\lambda + K = 0$, September 1984

FY 1983 ACCOMPLISHMENTS:

- o Use of collapse techniques for design with global damage tolerant constraints documented. Work is under way to reduce computational effort by simultaneous optimization of structural parameters and element forces
- o Prototype procedure developed for obtaining optimum designs of unstiffened and stiffened panels subject to crack propagation constraints. Designs are being generated for panels with several stiffeners
- o Application of reduction methods to the postbuckling behavior of composite panels subjected to combined compression and shear demonstrated. Reduction methods also demonstrated for nonlinear structures problems with large rotations
- o Modified modal method for nonlinear transient dynamic problems demonstrated for deep and shallow spherical caps subjected to step loading and results documented
- o Documented matrix partitioning algorithm for small eigenvalues of tangent stiffness matrix

- o Corotational elements with large rotations developed for STAGSC-1/RRSYS and results are being generated
- o Analysis developed for postbuckling response of orthotropic plates subjected to combined compression and shear. Results also show the reduction in shear stiffness of plates in compression and the reduction of compression stiffness of plates buckled in shear
- o Preliminary studies show analysis based on generalized Newton's method accurately predicts postbuckling response of unstiffened orthotropic panels by using a linear combination of the prebuckling solution and the lowest eigenvector

VI STRUCTURAL DYNAMICS BRANCH

DYNAMICS OF ADVANCED SPACE STRUCTURES

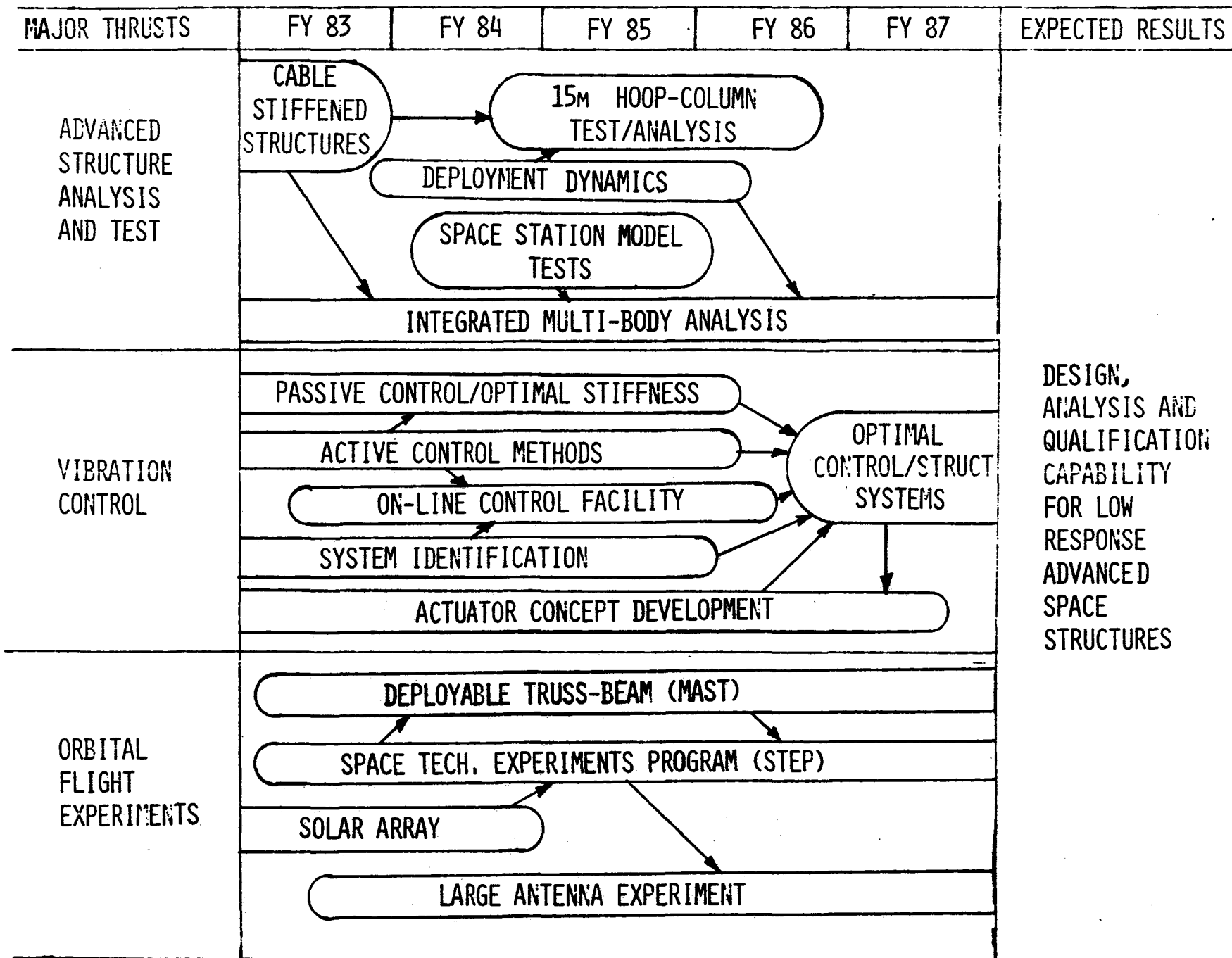

VI STRUCTURAL DYNAMICS BRANCH

RTOP 506-53-53 Analysis and Design

RTR 506-53-53-08 Vibration Control

OBJECTIVE:

Accomplish validated capability to control excessive responses of large flexible space structures by active and passive methods.

EXPECTED RESULTS:

Develop and validate methods for predicting and reducing the response of large flexible space structures by FY 1987

APPROACH:

Active and passive control techniques for reducing the response of low-frequency flexible structures will be developed using a large joint-dominated truss-beam as a focus. A coordinated analysis and test program will be conducted at both element and system levels. Mathematical elements including systems identification, response prediction, and design analyses will be developed and integrated in a systems approach where trade-offs between structures and controls may be made. Physical elements such as joints, actuators, and electronic components which provide mathematically-defined optimal performance will be built and analyzed individually and as parts of systems. Laboratory tests on hardware elements, simple structures, and on the truss beam will be conducted to verify and improve analyses. Test methods which satisfactorily compensate for gravity effects on low-frequency structures will be developed. Results will be extended to more complex structures where feasible.

MILESTONES:

- o Initiate study of automated model reduction, November 1983
- o Initiate control/structure trade-off study for free beam, December 1983
- o Initiate grillage tests using new actuators, January 1984
- o Demonstrate complex mode model improvement method, February 1984
- o Complete system identification study on Galileo, March 1984

- o Complete flexible body slewing control analyses, May 1984
- o Install truss-beam in test facility, June 1984
- o Complete documentation of ITD analysis, July 1984
- o Complete development of automated model improvement, August 1984

FY 1983 ACCOMPLISHMENTS:

- o Developed ground test criteria for long booms
- o Completed nonlinear studies using ITD
- o Developed and tested new linear actuator design
- o Completed tip damper study for long beam
- o Completed close-mode study of ITD analysis
- o Initiated study of design to specified response
- o Developed new solution method for terminal control problems
- o Demonstrated PDE identification for non-uniform beam

RTR 506-53-53-09 Space Station Dynamics

OBJECTIVE:

Develop and validate analytical methods for predicting the coupled structural dynamics and control of multibody space station configurations with flexible components, interfaces and dissipative mechanisms.

EXPECTED RESULTS:

Develop new analysis procedures for deployment dynamics of flexible member truss-like structures by end of FY 1986.

Develop and validate by FY 1986 efficient methods for analysis of large rigid/flexible motions of coupled bodies

Develop an integrated analysis/synthesis capability which addresses the dynamics and controls interactions of large aerospace structures by FY 1987

APPROACH:

Complete assessment of state-of-the-art methods for multi-body dynamics/control and comparison with fundamental

multibody problems. Formulate new or improved analytical methods for predicting controlled transient and steady-state response of multibodies having a large number of flexible components and interfaces, accounting for coupled rigid body options and flexible deformations, interface and joint connections. Extend exact element technology to include nonlinear prestress including gravity effects for ground testing. Fabricate and perform tests of relatively simple space station models and components for comparison with analyses. Develop and pursue systematic plan for assembling new and existing interdisciplinary analyses into a computerized user accessible integrated analysis.

MILESTONES:

- o Identify analytical needs for dynamics/control of multibodies, November 1983
- o Establish plan for integrated analysis and design, November 1983
- o Investigate deployment and slewing of flexible appendages, December 1983
- o Develop and perform transient model synthesis analysis for generic space station model, December 1983
- o Develop exact element for nonlinear prestress, February 1984
- o Develop nonlinear algorithms suitable for truss deployment analysis, July 1984
- o Develop nonlinear steady-state finite element model for membranes, September 1984
- o Establish dissipative laws for interfaces and joints, September 1984

FY 1983 ACCOMPLISHMENTS:

- o Exploratory thermal flutter tests conducted. Modifications and reanalysis for non-collimated heat under way
- o Nonlinear dynamic characteristics of simple cable-stiffened structure completed. GWU paper presented and J. Computer and Structures paper published
- o Vibration studies of hexagonal radial rib and hoop platforms completed (SDM paper)
- o Investigation of dynamics and collapse of guyed slender booms performed (SDM paper)

- o Specialized in-house program developed for large angle convected transient analysis of two-dimensional frames. Presently being used for comparison with DISCOS.
- o Nonlinear steady-state finite element model, developed for beams (ODU)

RTOP 542-03-15 Space Flight Experiments (STEP Development)

RTR 542-03-15-07 LSS Deployable Flight Experiment Development

OBJECTIVE:

Define and prepare for a deployable large space structures flight experiment.

EXPECTED RESULTS:

Improve test and analysis methods for large truss space structures

APPROACH:

Complete technical specification, RFP, and project plan defining deployable flight experiment. Construct flight-type deployable boom having general physical characteristics of expected flight article for tests in the Structural Dynamics Research Lab. Also construct two-bay subassembly and several joints and joint-member subassemblies for component test. In support of flight preparation, conduct well-instrumented static, dynamic and deployment tests at component, subassembly, and assembly level and compare with design analyses. Vary atmospheric environment and approaches for gravity compensation to assess the validity of candidate test methods. Evaluate the usefulness of component and subassembly tests in determination of overall response of full structure. Study instrumentation problems of flight-length beams by mass augmentation to reduce natural frequencies and extend test program to flight-length beam in larger facility as feasible.

MILESTONES:

- o Initiate prototype beam procurement, October 1983
- o Submit project plan for review and approval, February 1984
- o Complete experiment technical specification, February 1984
- o Release flight experiment RFP, April 1984

- o Begin component ground test program, April 1984
- o Complete facility test readiness, May 1984
- o Begin beam tests, June 1984

RTR 506-62-49-01 Solar Array Dynamics

OBJECTIVE:

Use Shuttle video system to obtain video taped images of the solar array during orbital tests and analyze video images post-flight to study structural dynamics of a deployable solar array.

EXPECTED RESULTS:

Comparison of flight results with analytical prediction of the solar array dynamics

To prove techniques for remote measurement/detection of dynamics of large flexible structures

APPROACH:

This is a joint effort with the Marshall Space Flight Center in conjunction with their Solar Array Experiment. The Shuttle closed circuit television system will be used to obtain video taped optical observations of a pattern of passive targets on the solar array during specific periods of testing on orbit. A video analysis system is being developed to analyze the video tapes post-flight to produce a time history of the motion of targets in a camera image plane. A photogrammetry system (using stereo triangulation techniques) will be used to analyze the image data to determine the spatial displacements of targets in solar array coordinates. This spatial displacement time history will be used in a time domain analysis to study the solar array dynamics.

MILESTONES:

- o Complete operational video analysis system, March 1984
- o Complete photogrammetry analysis procedures, March 1984
- o Participate in final integration and operations of flight test, June 1984
- o Preliminary results of structural dynamics analysis, October 1984

FY 1983 ACCOMPLISHMENTS:

- o Lab demo video system almost complete. Algorithm development and implementation in the microprocessor is in progress
- o Stereo triangulation system has been received and in use in simulation mode
- o Large-scale model assembly expected to start by end of May 1984 in preparation for commencing tests by end of June 1984
- o MSFC/JSC integration still in progress. First draft of orbital experimental procedures in review process

VII STRUCTURAL CONCEPTS BRANCH

STRUCTURAL CONCEPTS ADVANCED SPACE STRUCTURES

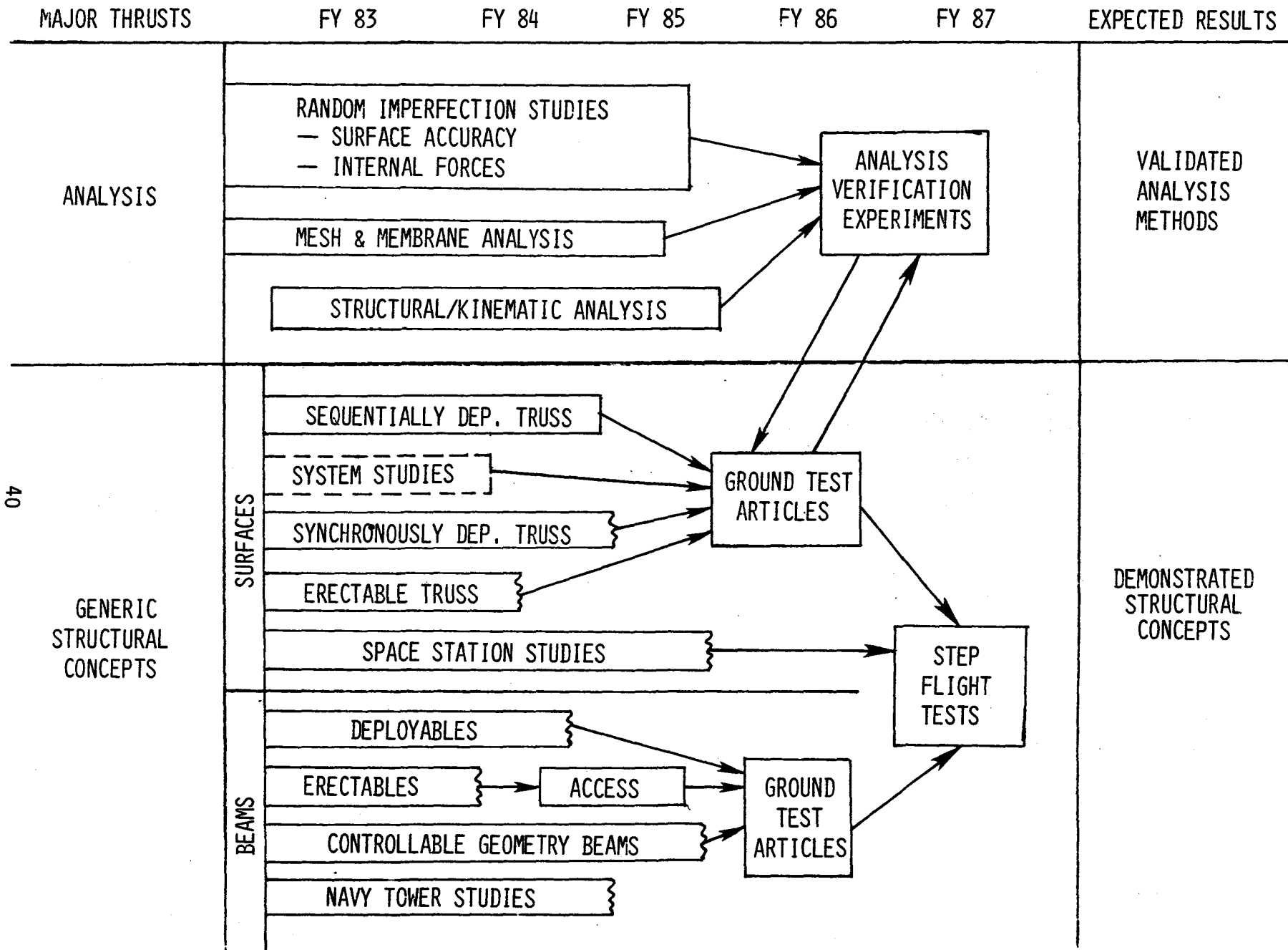

STRUCTURAL CONCEPTS - TRANSPORTATION

MAJOR THRUSTS	FY 83	FY 84	FY 85	FY 86	FY 87	EXPECTED RESULTS
STRUCTURAL CONCEPTS	H2 COOLED SCRAMJET STRUT					ADVANCE ENABLING TECHNOLOGY FOR FUTURE TRANSPORTATION SYSTEMS
	RAMJET INLET, DIFFUSER AND COMBUSTOR					
	HYDROCARBON SCRAM JET STRUCTURE					
	COMPOSITE COMPONENTS					
	WING AND FUSELAGE COMPRESSION PANELS					
	LONG LIFE CRYOGENIC TANKS					
CARBON-CARBON SECONDARY STRUCTURE AND TPS						
THERMAL STRUCTURES LAB	ADVOCACY & DEFINITION					PROVIDE STATIC TEST CAPABILITY FOR STRUCTURE SUBJECT TO SEVERE THERMAL ENVIRONMENTS
	PREL. ENG RPT.					
	CONSTRUCT					
SYSTEM STUDIES	FSTS					IDENTIFICATION OF STRUCTURAL RESEARCH NEEDS FOR ADVANCED SYSTEMS
	ON DEMAND VEHICLE					
	HIGH SPEED CRUISE MISSILES					
	AEROASSIST OTV					
	FUTURE AERO & SPACE SYSTEMS					

VII STRUCTURAL CONCEPTS BRANCH

RTOP 506-53-43 Advanced Space Structures

RTR 506-53-43-01 Advanced Space Structures Concepts

OBJECTIVE:

Develop deployable and erectable structural concepts and associated design technology for future large space structures.

EXPECTED RESULTS:

Validated analysis and design capability for large spacecraft by end of FY 1984

Establish, by end of 1985, structural concepts, deployment schemes, and packaging techniques that will permit planar structures on the order of 100 to 200 meters in size to be carried into orbit in one Shuttle flight and automatically deployed

Establish erectable concepts and assembly methods for structures of 100 to 1000 meters in size by end of FY 1985

APPROACH:

In the structural concepts area, folding and packaging techniques for very lightweight deployable structures will be investigated. The effects of using very slender members to achieve high packaging efficiency will be evaluated. A slender strut beam truss structure will be constructed for static and dynamic tests to confirm theoretical predictions. Research will also be carried out on erectable beams which are capable of being rapidly assembled on orbit.

Structural parametric studies will be conducted on large, faceted antenna concepts. Studies of achievable accuracy in erectable and deployable concepts will be investigated. Selected problems in construction/operational dynamics will be performed. Parametric studies also will be conducted on structures appropriate for use on low earth orbit space stations.

Conceptual studies including hardware development will be conducted on new deployable structural configurations with an emphasis on providing highly controlled research and reliable on-orbit deployment. The major activities in this year's research will be to establish the final design and begin fabrication of a three-ring deployable truss test component, and to develop an advanced deployable precision beam. Exploratory studies will be made of introducing multiple actuation devices into the structure

such that its geometry can be controlled at will. Initial efforts will be on a controlled geometry boom.

MILESTONES:

- o Design advanced precision deployable beam, November 1983
- o Test 4-cell sequentially deployable truss, December 1983
- o Conceive and design an advanced beam assembly device, January 1984
- o Test and evaluate geodesic serpentine beam, February 1984
- o Conduct neutral buoyancy beam assembly tests, March 1984
- o Establish mesh attachment concept (LMSC), June 1984
- o Establish detail design for and begin fabrication of a 3-ring synchronously deployable truss, September 1984

FY 1983 ACCOMPLISHMENTS:

- o 10-bay tetrahedral serpentine beam fabricated and tested
- o 8-bay 2-D synchronously deployable beam fabricated and being prepared for deployable tests
- o Antenna truss and mesh accuracy analysis completed and documented
- o First generation (aluminum wrapped) slender strut fabricated
- o Mockup of erectable beam fabricated; test hardware and assembly-aid currently being fabricated
- o Design for 3-ring model of a synchronously deployable truss near completion
- o Four-cell (.5 in. diameter, one-meter struts) test article of a sequentially deployable truss fabricated and being prepared for initial testing

OBJECTIVE:

Develop and validate through analysis and test efficient structural concepts and thermal management techniques critical to the design of future space transportation systems.

EXPECTED RESULTS:

Develop concepts for hot advanced carbon-carbon (ACC) body flap designs and conduct component tests by the end of FY 1985

Define and provide test data of effective cryotankage structure for advanced STS by the end of FY 1986

APPROACH:

Fabrication of panel and joint components of lightweight cryogenic tankage structural concepts will continue on contract. Completed panel test specimens will be tested in tension and compression stability tests to validate concepts. Fastener concepts for advanced carbon-carbon/superalloy attachments will be tested under contract and in-house. Manpower under this RTR will support an in-house study of a range of concepts for on-demand transatmospheric vehicles and orbital transfer vehicles. Results of these studies will be used to identify critical structural and material research requirements.

MILESTONES:

- o Complete extended ACC fastener tests, February 1984
- o Initiate cryogenic tankage tests, March 1984
- o Initiate carbon/carbon impact damage tests, April 1984
- o Complete preliminary studies of on-demand vehicle concept matrix, June 1984

FY 1983 ACCOMPLISHMENTS:

- o Completed FSTS two-stage vehicle study
- o Completed horizontal take-off on-demand transatmospheric vehicle study
- o Developed low-thermal-stress fastener concept for high-temperature applications with orthotropic material
- o Initiated tests of ACC fasteners

RTR 506-53-43-14 ACCESS Flight Experiment Development

OBJECTIVE:

Design, development, fabrication, test, integration, flight, and evaluation of a simple erectable space structure to demonstrate in space flight an EVA-assisted, work station oriented, element-by-element assembly concept.

EXPECTED RESULTS:

Gain on-orbit EVA construction experience

Correlate orbital EVA assembly rates and techniques with simulated 0-G ground test data

APPROACH:

Based on existing requirements and concepts, design, build, and test hardware for a simple, inexpensive flight experiment. Neutral buoyancy tests will be conducted using the training hardware. Flight-qualified experiment hardware for STS integration will be delivered.

MILESTONES:

- o Complete Preliminary Design Review, January 1984
- o Complete 1-G lab tests, May 1984
- o Training hardware fabrication complete, May 1984
- o Initial neutral buoyancy test, June 1984

RTOP 505-33-53 Advanced Aircraft Structures and Dynamics Research

RTR 505-33-53-11 High-Speed Aircraft Structural Concepts

OBJECTIVE:

Develop and evaluate airframe structural concepts and thermal management techniques appropriate for aircraft which cruise in the flight regime ranging from supersonic to hypersonic.

EXPECTED RESULTS:

Develop and validate structural concepts, joining techniques, and thermal management methods for Mach 4-7 aircraft by end of FY 1985

APPROACH:

Initiate in-house and Dryden tests of curved-cap and box-stiffened fuselage compression panels to validate SPF titanium fabrication procedures and structural efficiency projections. Initiate tests of LID bonded titanium sandwich structures with diffusion bonded end closures to validate fabrication procedures for high-temperature wing panel designs and verify projected structural efficiencies. Develop structural and thermal management concepts for Mach 5 cruise aircraft. Initiate contractual study to fabricate specimens for in-house characterization of carbon/carbon attachment concepts and damage tolerance.

MILESTONES:

- o Initiate tests of in-house SPF curved-cap Ti panels, December 1983
- o Delivery of Ti sandwich test panels, March 1984
- o Delivery of box-stiffened compression test panels, March 1984
- o Initiate tests of Ti sandwich panels (Dryden), June 1984
- o Initiate tests of carbon/carbon impact specimens, June 1984

FY 1983 ACCOMPLISHMENTS:

- o In-house fabrication of curved-cap panel initiated
- o Task initiated to fabricate boxed-stiffened panels
- o Task initiated to fabricate Ti sandwich panels
- o Fatigue tests completed to demonstrate feasibility of LID bonding honeycomb core to face sheet
- o Tests completed which indicate that LID bonding of sandwich end closures is unacceptable because of limited fatigue life

RTOP 505-43-83 High-Speed (Super/Hypersonic) Technology

RTR 505-43-83-07 Hypersonic Aircraft Structural Concepts

OBJECTIVE:

Develop and evaluate engine structural and thermal management concepts suitable for long-life air-breathing engines which operate in speed regimes greater than Mach 4.

EXPECTED RESULTS:

Define and provide test data on effective structural concepts and thermal management techniques for fuel injection strut Scramjet engine component by end of FY 1986

APPROACH:

A contractual thermo/structural study of Ramjet engine combustor and nozzle concepts is currently under way with emphasis on a methane-fueled Mach 5 cruise design. Investigation will continue in-house on high temperature thermal management techniques applicable to internal insulation concepts for a Mach 5 Ramjet, including the use of zirconia tubes as thermal isolators for the combustion liner. A fuel-injection strut for a hydrogen fueled Scramjet engine is under fabrication and scheduled for delivery early in FY 1984. The intent is to test the strut the following fiscal year with applied heat loads under laboratory conditions to determine the expected life of the strut when exposed to cyclic thermal stress.

MILESTONES:

- o Take delivery of the Scramjet fuel-injection strut, December 1983
- o Complete initial series of tests of zirconia tubes, March 1984
- o Delivery of Ramjet regenerative cooling study results, June 1984

FY 1983 ACCOMPLISHMENTS:

- o Task initiated to study thermal management of JP fueled Ramjet engine combustor
- o Task initiated to study braze procedure for Scramjet strut
- o Full-scale Scramjet strut demonstration model fabricated
- o In-house structural and thermal design study of reusable Ramjet engine completed

RTOP 505-43-23 High-Speed Aerodynamics and Propulsion
Integration

RTR 505-43-23-12 Missile Structural Concepts

OBJECTIVE:

Develop and evaluate engine and airframe structural components and thermal management concepts for air-breathing cruise missiles.

EXPECTED RESULTS:

Develop lightweight structural concepts and thermal management techniques for short lived hypersonic cruise missiles powered by hydrocarbon-fueled supersonic combustion Ramjet engines

APPROACH:

Funding will be used to support a manyear of nonpersonal services tasks. The tasks will be directed toward the design of a structural and thermal management system for an advanced cruise missile with a given desired weight-limit, total volume limit, range, and mission block time. This design will be used to identify thermal, structural and material requirements which will help establish critical research requirements.

MILESTONES:

- o Evaluate in-house Wide Area Defense Missile preliminary designs, February 1984
- o Develop preliminary design of underslung engine concept, July 1984

FY 1983 ACCOMPLISHMENTS:

- o Evaluation of Navy Far Term Wide Area Defense Missile (FTWADM) contractor drafts completed
- o Initial preliminary structural design of underslung engine FTWADM completed

VIII ACCOMPLISHMENT HIGHLIGHTS

IPAD PROJECT OFFICE

JAPAN TRIP OBSERVATIONS

R. E. FULTON

(NOVEMBER 13-27, 1982)

- INVITED AS 1 OF 12 U.S. SPEAKERS AT FIRST NIPPON COMPUTER GRAPHICS CONF. (NICOGRAPH '82)
- 8 TECHNICAL VISITS IN 7 WORKING DAYS (GOVT. LABS, COMPUTER INDUSTRY, SHIPBUILDING, AUTOMOTIVE)
- JAPAN DEVELOPING VERY COMPETITIVE SCIENTIFIC COMPUTERS
 - HITACHI/FUJITSU 1983 HARDWARE COMPARABLE TO CRAY (500-630 M FLOPS)
 - MITI-SPONSORED SUPER COMPUTER PROJECT AIMS AT 10B FLOPS FOR 1990'S
 - MITI-SPONSORED FIFTH GENERATION PROJECT AIMS AT FUTURE "LOGIC" BASED COMPUTER USING ARTIFICIAL INTELLIGENCE
- INTEGRATED CAD/CAM TECHNOLOGY ADEQUATE TO EXCELLENT
 - CADAM 2-D GEOMETRY SYSTEM IN WIDESPREAD USE DUE TO IBM COMPATIBILITY
 - LARGE STABLE OF APPLICATION PROGRAMS WIDELY USED (NASTRAN, MARC, ETC.)
 - SHIPBUILDING DECLINE HAS SLOWED CAD/CAM GROWTH
 - AUTOMOTIVE INDUSTRY CAD/CAM VERY STRONG; HAVE DEVELOPED OWN 3-D GEOMETRY SYSTEMS AND FACTORY AUTOMATION
 - DATA MANAGEMENT NEEDED FOR CAD/CAM INTEGRATION NOT VISIBLE; PROBABLY LAGS U.S.
- TECHNICAL STAFF ARE HARDWORKING, TEAM-ORIENTED, AND SCHEDULE-DRIVEN WITH NO 'NIH' FEELINGS
- FUTURE CONTACTS BENEFICIAL; GUIDELINES NEEDED WHICH FACILITATE APPROPRIATE TECH. COMMUNICATION

COMPUTER-AIDED GEOMETRY MODELING SYMPOSIUM ATTRACTS LARGE AUDIENCE

APRIL 20-22, 1983

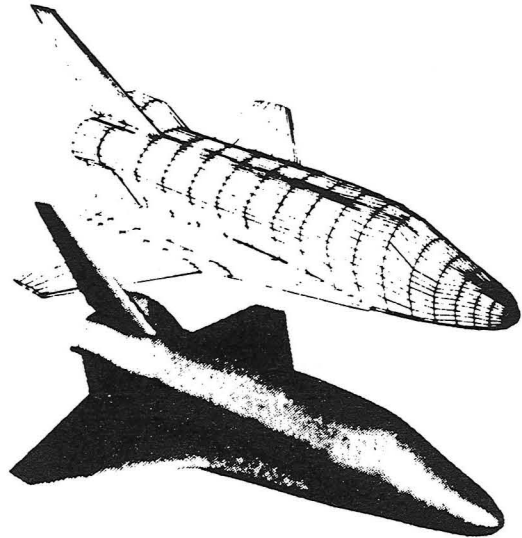

- . FUNDING PROVIDED BY CODE RTF
- . 13 INVITED NATIONAL EXPERTS
- . 38 CONTRIBUTED PAPERS
- . 400 ATTENDEES FROM UNIV/INDUSTRY/GOVT ORGNS.
- . CO-CHAIRMEN (SHOOSMITH/FULTON)
INVITED TO ORGANIZE KEY PAPERS AS
SPECIAL EDITION OF IEEE COMPUTER GRAPHICS
AND APPLICATIONS JOURNAL
- . INFORMAL FEEDBACK HIGHLY COMPLIMENTARY
- . RESULTS SHOULD IMPACT LRC RESEARCH AND
INSTITUTIONAL NEEDS

RESEARCH TOPICS

MATHEMATICAL MODELING
SOLID GEOMETRY
GRAPHICS INTERACTIVE MODELING
GEOMETRY DATA MANAGEMENT
NATIONAL STANDARDS
APPLICATIONS

IMPACT DYNAMICS BRANCH

LANGLEY AGREES TO IMPACT TEST THE F-111 CREW ESCAPE CAPSULE

Claude B. Castle
Impact Dynamics Branch
Extension 3795
November 17, 1982

(RTOP 505-42-23)

Research Objective

The purpose of this research effort is to compare the impact behavior of the crew seats and restraint system of the current operational F-111 escape capsule (pictured in enclosed figure) to behavior of a capsule with proposed modifications. The proposed modifications are to reduce the present injury level during ejection and landing from 30 percent to 10 percent.

Approach

The experimental effort is designed to measure differences in the impact responses of structure and anthropomorphic dummies as a function of restraint configuration, seat configuration, and subject anthropometry. The influence of the angle of the inertia reel and restraint straps on the impact responses of the subjects is also of particular interest. The redesign of the capsule's seat and restraint system is to be completed by mid-1983 and tested shortly thereafter.

Accomplishment Description

A joint effort with the Air Force, U.S. Army's Applied Technology Laboratory, FAA-CAMI, and NASA has been initiated. The F-111 crew seats will be analyzed and modified by Simula Corporation. The modified seat is then scheduled to be tested at FAA's CAMI facility, further modified if necessary, and installed in the capsule and impact tested at the Impact Dynamics Research Facility in the July-September 1983 time-frame.

Future Plans

Sole source contract to be let to Simula Corporation for seat analysis and modifications to provide a load attenuating seat for the F/FB-111 crew capsule. Eight full-scale impact tests of the crew capsule with modified crew seats are scheduled to be conducted at the Impact Dynamics Research Facility to simulate various impact attitudes at parachute escape descent velocities.

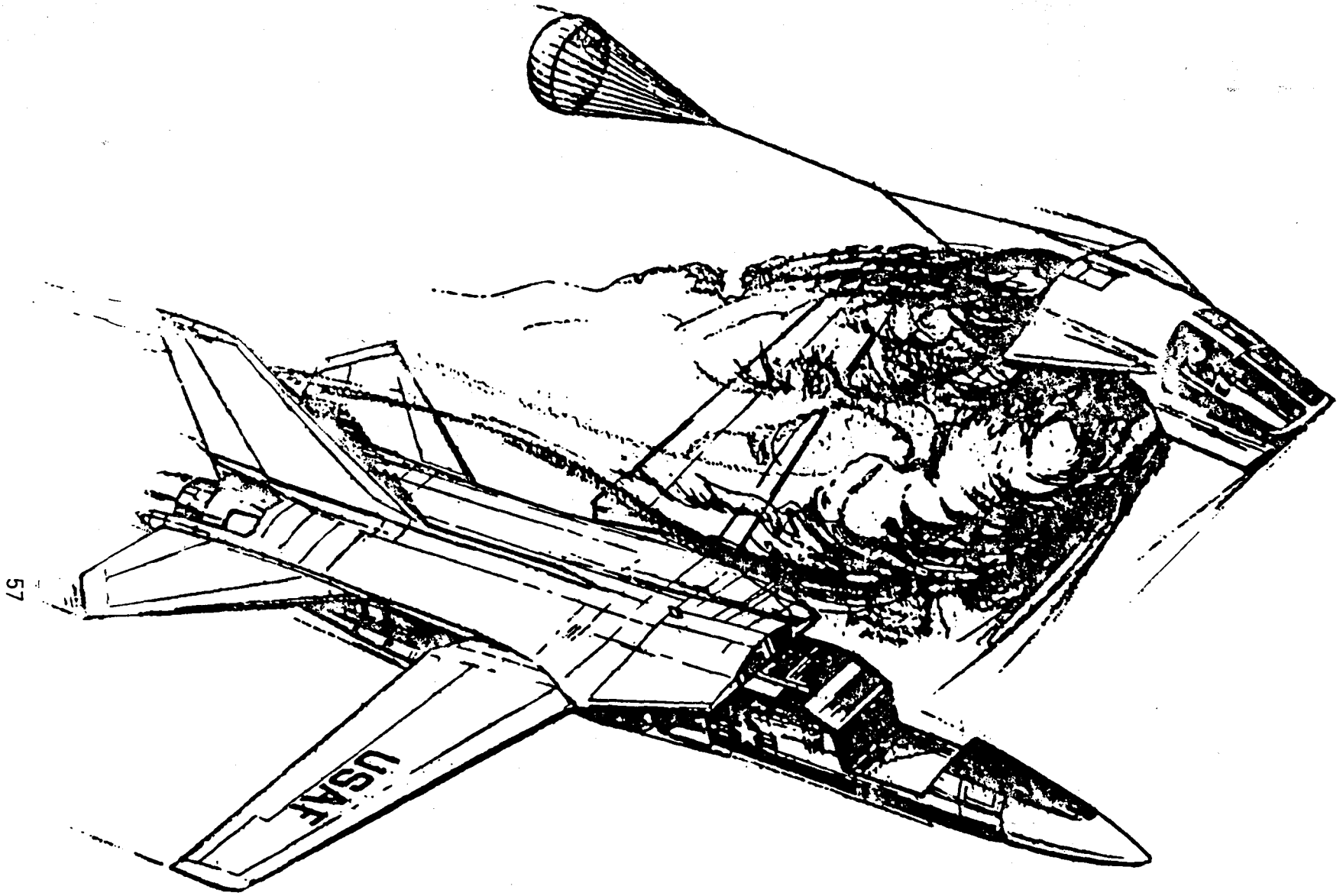

57

F-111 CREW ESCAPE CAPSULE

TECHNICAL HIGHLIGHT

SIMPLE TECHNIQUE TO PREDICT MEAN CRUSHING STRENGTH OF CRUCIFORMS DEVELOPED

Robert J. Hayduk
Impact Dynamics Branch, SDD
Extension 3795
February 18, 1983

RTOP 505-33-53

Research Objective

The objective of this research is to develop simple closed-form solutions to predict the mean crushing-force levels of general aviation subfloor designs that would be useful in engineering practice.

Approach

The cruciform sections, considered to be two "L" - sections joined at the center bends, were analyzed by a simple kinematical, rigid perfectly plastic, hinge analysis technique accounting for both bending and extensional deformation. The kinematical modes for "L" sections were considered where both extensional and bending plastic deformations occur. In an asymmetric mode bending predominates with extensional deformations occurring in a small toroidal region at the center of the 90 degree bend. Extensional deformation predominates in the symmetric mode with stretching occurring in the flanges of the "L" section. These modes are labeled EXTENSION and BENDING in the attached figure even though both types of deformations occur in both modes.

Accomplishment Description

The extensional mode is considered the upper bound because maximum internal plastic work occurs in that mode. The lower bound considers primarily bending deformation which results in the least internal plastic work. The mixed-mode combination, which falls between the bounding solutions, yields the best prediction of the strength of cruciforms with the present understanding of the crushing phenomenon and the mathematical assumptions used.

The experimental data for joined copper cruciforms reveal considerable scatter, indicating that there are many collapse mechanisms in which the cruciforms fail and that the collapse is imperfection sensitive.

Future Plans

These results represent a starting point in the analysis and optimum design of riveted cruciforms and other more complicated structural elements.

SIMPLE TECHNIQUE TO PREDICT MEAN CRUSHING STRENGTH OF CRUCIFORMS DEVELOPED

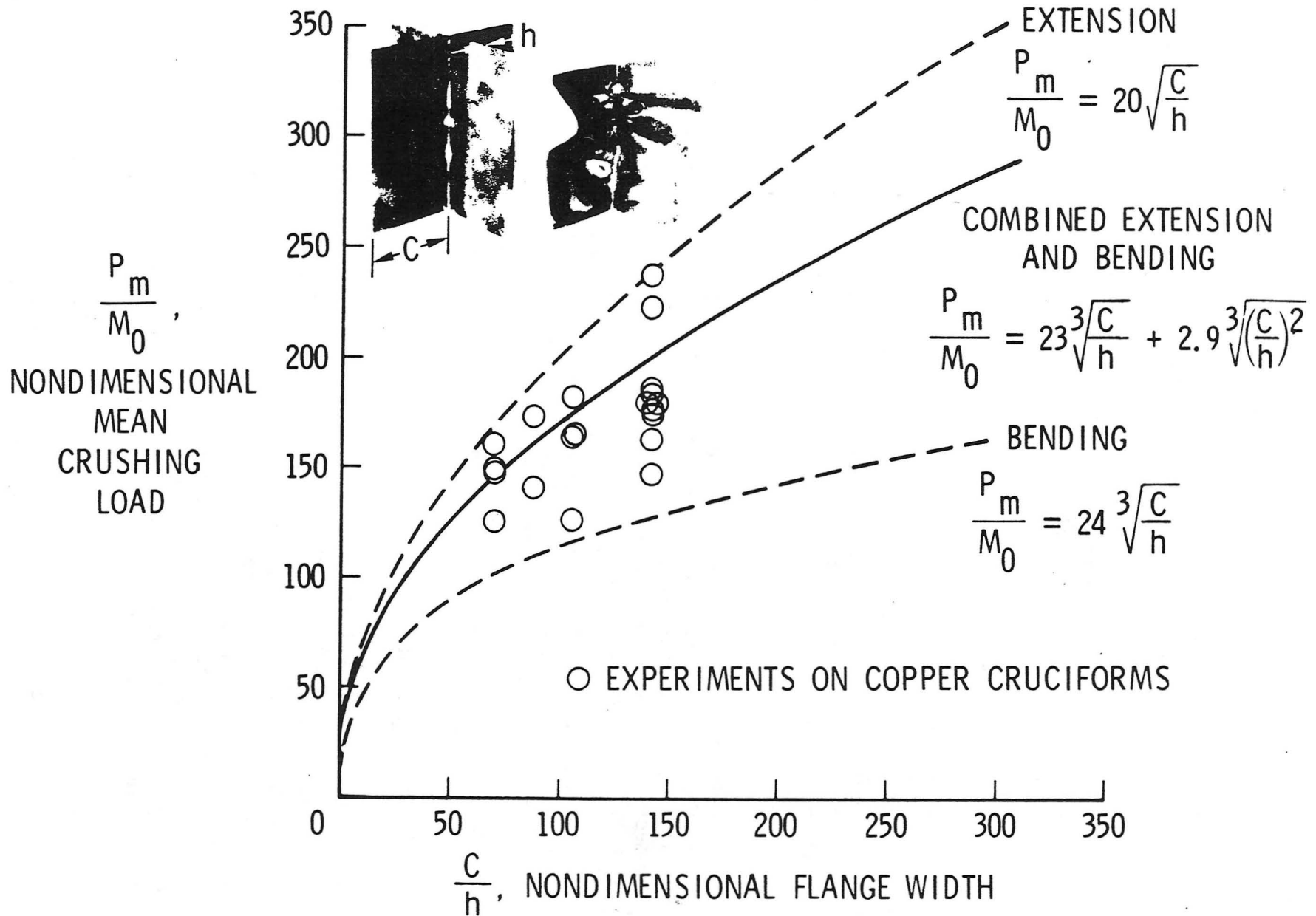

TECHNICAL HIGHLIGHT

INITIAL TESTS COMPARE FRICTION AND WEAR BEHAVIOR OF COMPOSITE AND ALUMINUM AIRPLANE SKINS

Karen E. Jackson
Impact Dynamics Branch
Extension 3795
June 22, 1983

RTOP 505-33-53

Research Objective

The purpose of this research is to characterize the wear and abrasive behavior of aluminum and advanced composite coupons under loading conditions typical of those which would occur on a transport aircraft skin during slide out on a runway surface.

Approach

The experimental apparatus used in abrasion testing of aluminum and composite skin coupons is shown in the attached figure. A Rockwell belt sander provides the sliding surface for the tests. Grease sample techniques used to determine the macrotexture depth of runway surfaces were performed on standard aluminum oxide belts of various grit sizes. 36-60 grit belts were determined to have texture depths comparable to typical runway surfaces and were therefore chosen for the abrading material. The load cell located in the lower arm of the test apparatus measures tensile forces developed during test runs. Normal and frictional forces are calculated from a static analysis of the specimen holder and are used to determine the coefficient of dynamic friction. Specimens are weighed following test runs of 5 second duration to determine wear rates under loads ranging from 2-5 psi.

Accomplishment Description

The average coefficient of dynamic friction for each of the materials tested is shown in the attached figure. Under identical test conditions the standard graphite/epoxy materials exhibited a coefficient of friction of approximately 0.1, which is about half that obtained for aluminum, while the kevlar and toughened resin composites have values comparable to aluminum. The wear rate vs. load curves are also illustrated. These plots show a linear increase of wear rate with applied load. Note the order of magnitude increase in wear rate of the composite materials as compared with aluminum under a 3.2 psi load. The toughened resin composites, which have a coefficient of friction comparable to aluminum, show the highest wear rate of the materials tested.

Future Plans

Additional testing is planned to determine the effect of varying the surface texture and velocity on specimen wear rate and coefficient of friction.

COMPARISONS OF THE FRICTION AND WEAR BEHAVIOR OF ALUMINUM AND COMPOSITE AIRPLANE SKINS

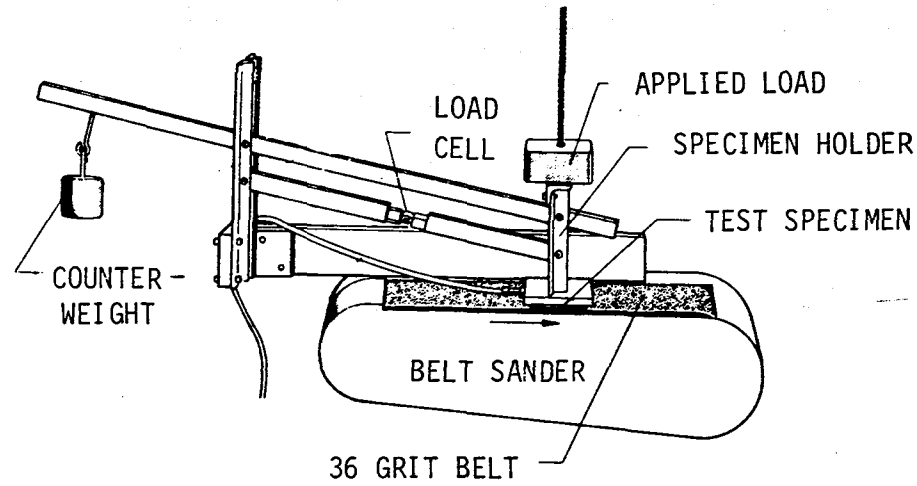

61

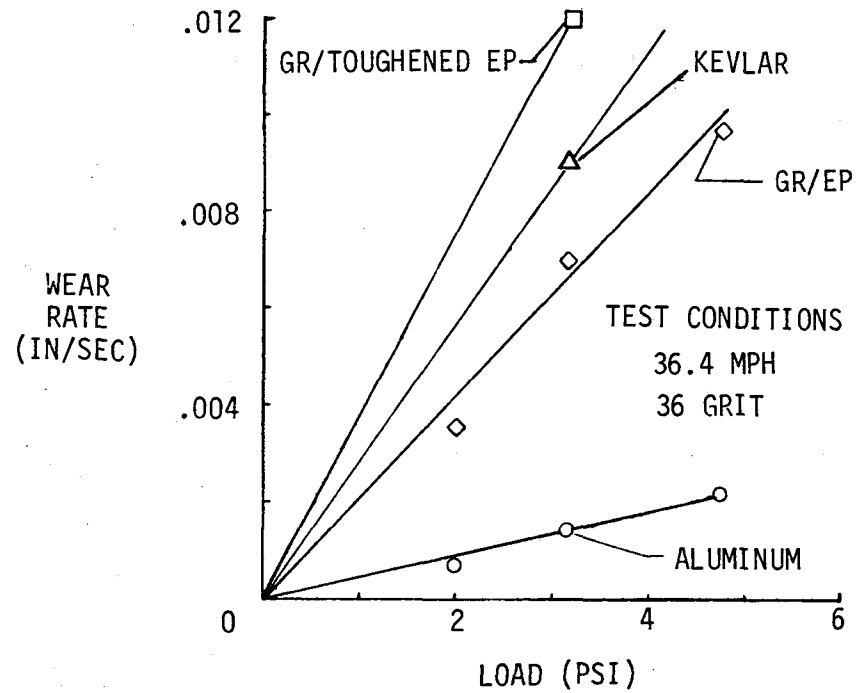
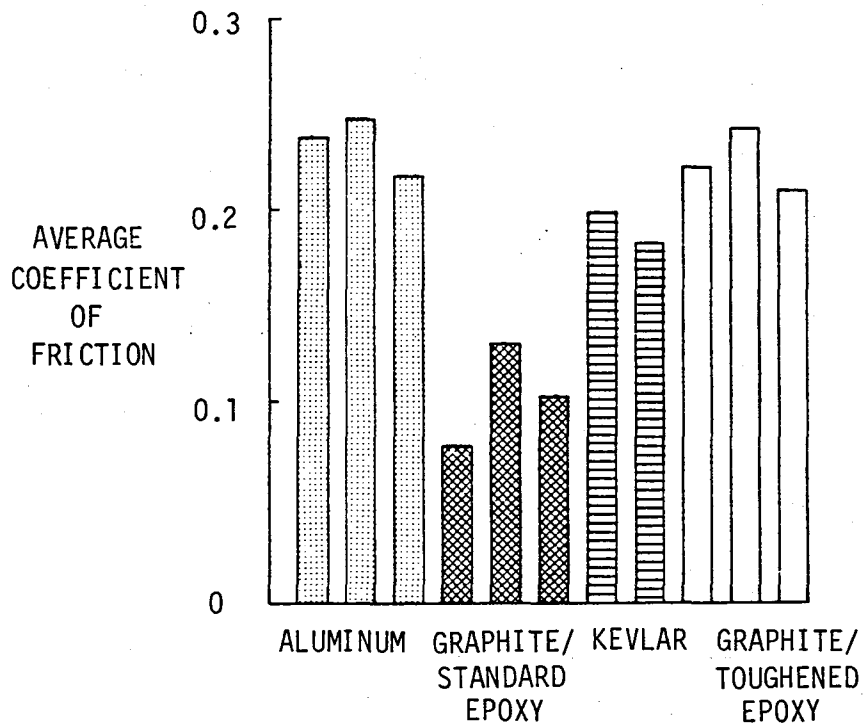

TECHNICAL HIGHLIGHT

FIRST VERTICAL DROP TEST OF B-707 FUSELAGE SECTION HELPS PREPARE FOR FULL-SCALE TRANSPORT CRASH TEST

M. Susan Williams
Impact Dynamics Branch
Extension 3795
June 22, 1983

RTOP 505-33-53

Research Objective

The objectives of the transport section drop test are to determine structural, seat, and occupant response to vertical crash loads in preparation for a full-scale crash test of a remotely piloted transport aircraft in July, 1984, and to obtain data to corroborate the DYCAST computer program being developed for crash analysis of aircraft structures.

Approach

Various fuselage sections from Boeing 707 transport aircraft were acquired for dynamic drop testing. The first section tested was located just forward of the wing. The 12 foot-long section, weighing approximately 5000 lbs when loaded with seats, anthropomorphic dummies, and instrumentation, was suspended in the Vertical Test Apparatus at the Impact Dynamics Research Facility and dropped to obtain a vertical impact velocity of 20 ft/sec. DC accelerometers were placed in the dummies and on the aircraft structure to obtain continuous recordings of accelerations during the dynamic drop test. High speed motion pictures were taken onboard the section and on the ground during the experiment.

Accomplishment Description

Post-test inspection showed that the fuselage beneath the floor collapsed inward approximately 2 ft. Bending failures occurred along the center line of the baggage compartment floor and on both sides of the fuselage about 4 ft below the floor. No apparent damage occurred to the upper fuselage, floor, or seats during the test. Acceleration data were characterized by two distinct pulses; the first pulse occurred as the baggage compartment floor buckled and the second when the lower-fuselage sides failed in bending. Maximum normal acceleration of the first pulse measured on the bottom of the fuselage was approximately 20 g's (20 Hz filter) for 0.03 sec. Secondary pulses were in the 6 to 12g range. Crushing of the fuselage structure in the baggage area resulted in lower normal accelerations at the floor level where the first pulse was 10 g for 0.03 sec and the second pulse was 12 g for 0.06 sec. Normal pelvic accelerations ranged from 6.5 to 8 g. Normal accelerations in the roof indicated an oscillatory rather than pulse response. Nearly 24 g for 0.04 sec was measured during the first half wave. The oscillatory response of the roof is in the 10 to 12 cycle per second range, clearly at structural vibration frequency levels.

Future Plans

Future plans include vertical drop testing of two additional transport sections containing various components to be used in the full-scale airplane test.

NASA
L-63-4,191

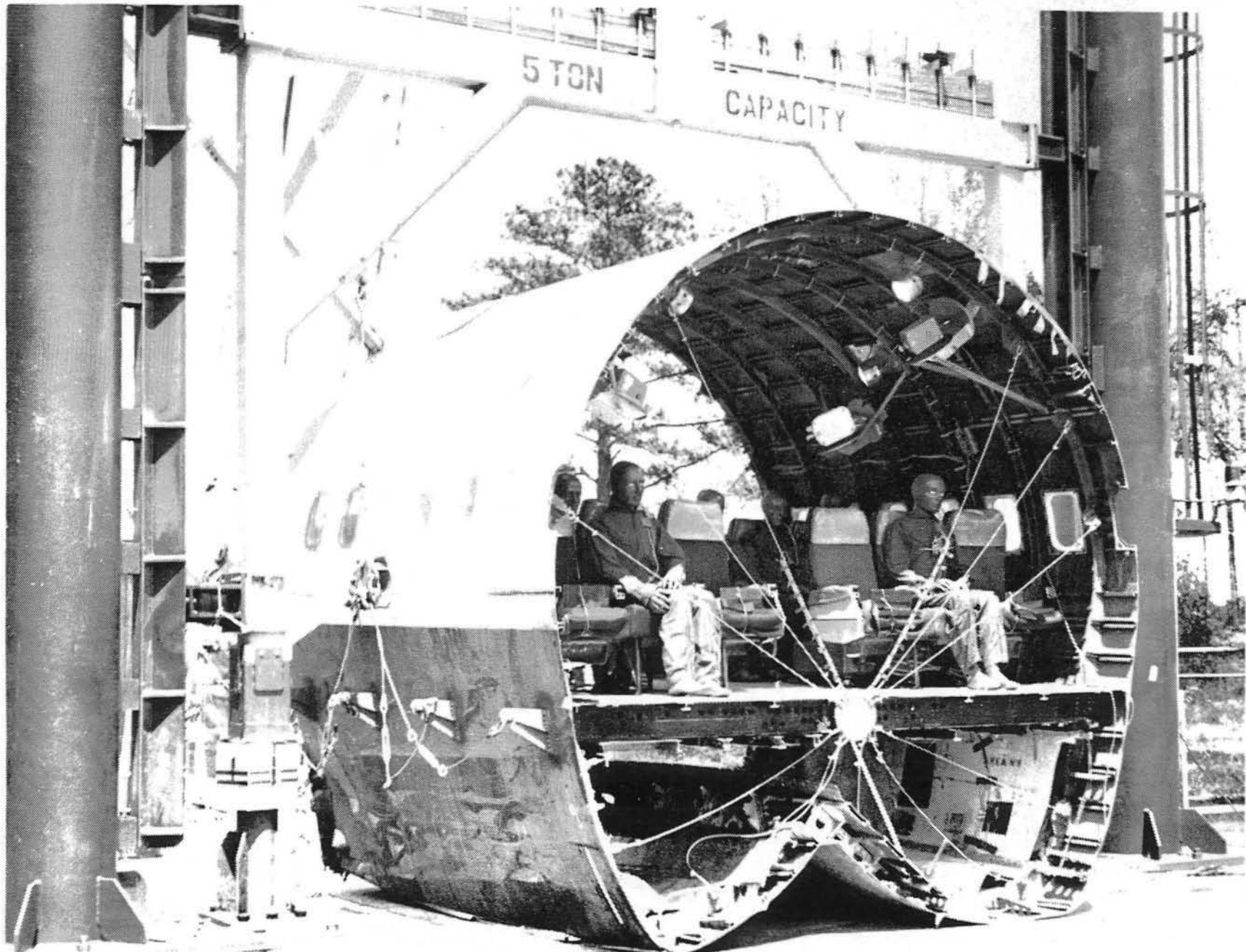

ANALYSIS PREDICTS TIRE CARCASS TEMPERATURE
DURING BRAKED ROLLING CONDITIONS

John A. Tanner
Impact Dynamics Branch, SDD
2796
September 14, 1983

505-45-14

Research Objective

To define strength and fatigue limitations of aircraft tire carcass structures, Langley Research Center has been involved in a major program to determine temperature profiles in aircraft tires under a variety of operating conditions. Both experimental and analytical efforts have been conducted.

Approach

The experiments were conducted on size 22x5.5 and 40x14 aircraft tires equipped with thermocouples located within the tire carcass, and temperature data were acquired while the tire operated under free rolling, light braking, and yawed-rolling conditions. The analytical effort to model the heat generation mechanisms within aircraft tires is being conducted by the University of Michigan under NASA grant. The model employs a finite element representation of the tire cross-section and treats the heat generated within the tire as a function of the strain energy associated with the predicted tire flexure and the energy dissipation associated with tire slippage in the footprint under braked rolling conditions.

Accomplishment Description

Results from the analytical studies are compared with experimental measurements obtained for a 12-ply 22x5.5 tire in the figure. The measured temperature rise, denoted by the solid line, and the calculated temperature rise, denoted by the dashed line, are plotted as a function of time for a tire subjected to a braking effort of 0.5 g at a speed of 17 knots under a 25 percent deflection condition. Results from thermocouples positioned on the outer surface and inner surface along the tire tread centerline are shown. The data indicate a more rapid temperature rise along the outer surface than along the inner surface for this braked rolling condition and the agreement between the experimental measurements and the analytical results is good.

Future Plans

Current analytical efforts are investigating yawed-rolling cases and it is anticipated that this tire carcass temperature prediction model, when fully developed, will be a very useful tire design tool.

ANALYSIS PREDICTS TIRE CARCASS TEMPERATURE DURING BRAKED-ROLLING CONDITIONS

22 X 5.5 12-PLY TIRE; BRAKING EFFORT = 0.5 g;
SPEED = 17 KNOTS; TIRE DEFLECTION = 25%

59

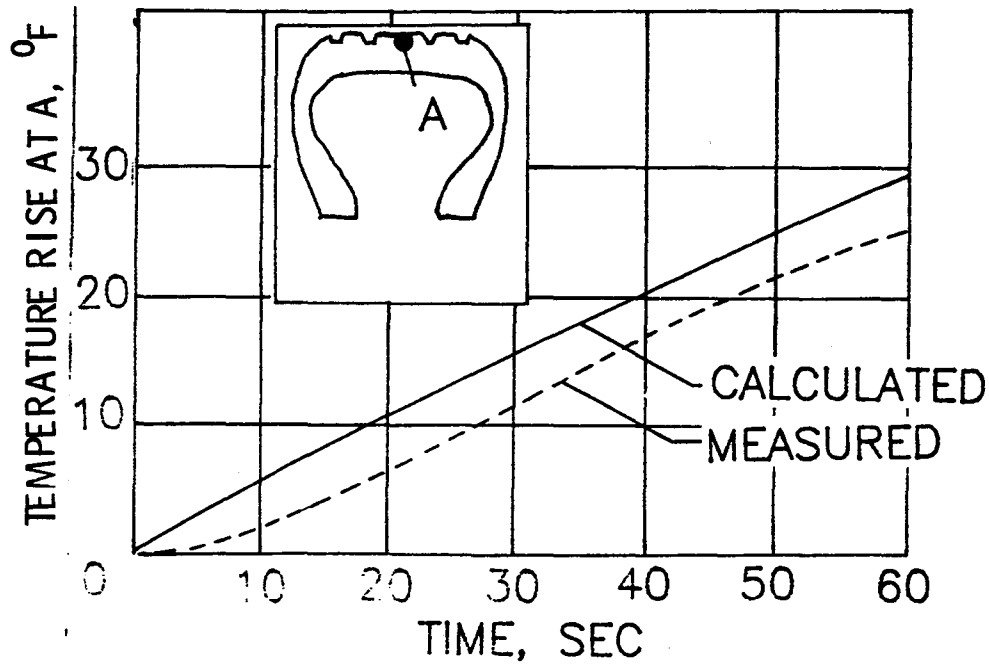

OUTER SURFACE

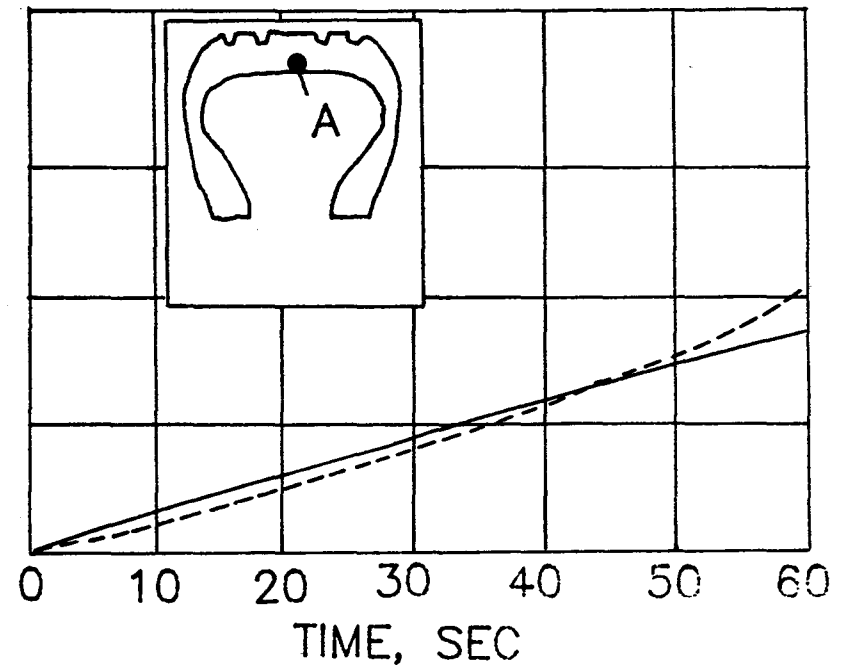

INNER SURFACE

STRUCTURAL MECHANICS BRANCH

NASA-GWU SYMPOSIUM ON ADVANCES IN STRUCTURAL
AND SOLID MECHANICS OVERVIEW

DATE HELD: OCTOBER 4-7, 1982, ARLINGTON, VA

ATTENDANCE: 300 FROM UNIVERSITY, INDUSTRY, AND GOVERNMENT LABORATORIES

FORMAT:

- o 24 SESSIONS AND A PANEL DISCUSSION, COVERING COMPOSITES, SPACE STRUCTURES, CRASH DYNAMICS, AND NONLINEAR ANALYSIS
- o PROCEEDINGS CONTAIN 85 PAPERS

OBSERVATIONS:

- o GOOD OPPORTUNITY TO SEE CURRENT THEORETICAL RESEARCH IN UNIVERSITIES
- o INTERESTING INTERACTION AMONG LEADING EXPERTS IN SPECIALIZED ANALYTICAL METHODS AND FINITE ELEMENT METHODS (FEM)

CONCLUSIONS:

- o NEW FINITE ELEMENT DEVELOPMENTS ARE STILL FORTHCOMING
- o ERROR ASSESSMENTS AND SENSITIVITY DERIVATIVES SHOULD BE INCLUDED IN FUTURE ANALYSES
- o CLASSICAL MECHANICS SHOULD ENCOMPASS NUMERICAL METHODS AND EMBRACE THE COMPUTER
- o GOOD PROGRESS IS BEING MADE IN CHOOSING APPROXIMATE FUNCTIONS TO SOLVE LARGE-SCALE NONLINEAR PROBLEMS
- o STRUCTURES ARE COMPLEX BECAUSE OF TOPOLOGY NOT BEHAVIOR

LOAD INTRODUCTION EFFECT IDENTIFIED FOR COMPRESSION-LOADED
LAMINATES WITH HOLES

Mark J. Shuart
Structural Mechanics Branch, SDD
Extension 2813
November 17, 1982

(RTOP 505-33-33)

Research Objective

To determine why an existing failure prediction technique gives accurate results for one class of quasi-isotropic laminates but gives inaccurate results for another class of quasi-isotropic laminates.

Approach

The failure strain for compression-loaded $[0, \pm 45, 90]_S$ quasi-isotropic graphite-epoxy laminates with holes can be accurately predicted as a function of hole diameter. The prediction technique was used for another class of quasi-isotropic laminates, $[\pm 30, 90]_S$, and gave inaccurate results for specimens with hole diameter to plate width ratios greater than 0.2. Apparently, a mechanism not accounted for in the previous analysis initiated the failure of these laminates. A study was undertaken to determine this mechanism and to define the extent of its effects.

Accomplishment Description

The attached chart illustrates the difference between theoretical and experimental compressive failure strains for 5-inch-wide by 10-inch-long $[\pm 30, 90]_S$ quasi-isotropic laminates and the mechanism that caused the difference in results. For the figure on the left side of the chart, the open squares represent test results for 5-inch-wide by 10-inch-long $[\pm 30, 90]_S$ specimens, and some of these data are less than the established lower bound. This behavior is due to the interaction between the load diffusion into the specimen and the load distribution around the hole. For a laminate with $\pm 45^\circ$ plies, this interaction does not occur as shown on the chart by the $\pm 45^\circ$ original specimen. In a $[\pm 30, 90]_S$ laminate, the principal load-carrying layers are the $\pm 30^\circ$ plies. As indicated on the $\pm 30^\circ$ original specimen for a 10-inch-long specimen with a large enough hole, a 30° fiber beginning in the specimen corner intersects the hole before intersecting the specimen side causing a nonuniform load introduction into the interior of the laminate. By increasing the specimen length to 15 inches, none of the 30° fibers from the loaded edge intersects the hole, and the interaction between the load diffusion into the specimen and the load distribution around the hole is eliminated. To verify this effect, longer specimens were tested (filled squares on far left figure), and the results of the tests agree with failure predictions. This study illustrates the importance of sub-laminate phenomenon on laminates with holes.

Future Plans

Additional tests on specimens with various hole diameters and hole locations are being performed to further characterize this mechanism.

LOAD INTRODUCTION EFFECT IDENTIFIED FOR COMPRESSION-LOADED LAMINATES WITH HOLES

71

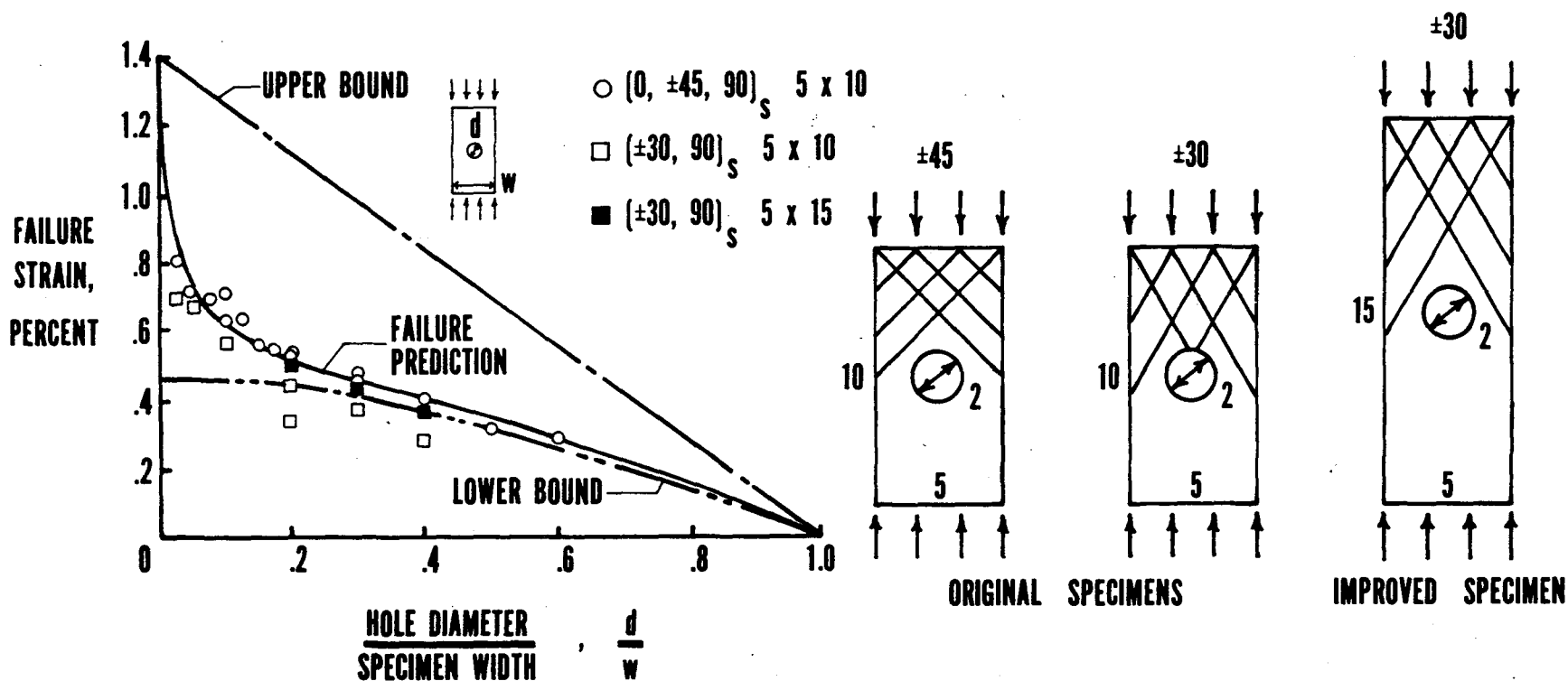

TRANSVERSE STITCHING IMPROVES STRENGTH OF GRAPHITE
EPOXY BONDED SINGLE LAP JOINTS

James Wayne Sawyer
Structural Concepts Branch, SDD
Extension 2239
April 13, 1983

(RTOP 506-53-43)

Research Objective

The objective of this program is to determine the effect of stitching on static and fatigue strength of secondary bonded and co-cured composite single lap joints.

Approach

Conduct static and fatigue tests on secondary bonded and co-cured composite single lap joint specimens with and without stitch reinforcement to determine ultimate strength and fatigue life. Stitch the specimens before curing with zero tension applied to the stitch thread. Static test variables include two adherend thicknesses, single and multiple rows of stitching, three stitch spacings, and four overlap lengths. Conduct fatigue tests on specimens with a two inch overlap length, with and without a single row of stitching, and with the minimum to maximum cyclic load level ratio $R = .1$.

Accomplishment Description

Test results show that up to a 38 percent improvement in static failure load compared to unstitched results is obtained by a single row of stitches near each end of the overlap. The improvement in static failure load is generally greater for longer overlap lengths and for thicker adherends. Stitch spacing (pitch) does not have a significant effect on the static failure load for the range investigated. Additional rows of stitching do not result in any further improvement in joint failure load. Co-cured and bonded joints had the same static failure loads and showed the same improvement with a single row of stitching. For joints with a two inch overlap length, stitching also increased the fatigue life by an order of magnitude or more compared to unstitched joints.

The stitched specimens used for this investigation do not represent optimum configurations and the results probably represent a lower bound for improvements in joint failure load due to stitching. Improved manufacturing and stitching procedures would probably result in larger improvements in joint failure load due to stitching.

Future Plans

This work will be presented in a paper at the 24th SDM Conference, May 2-4, 1983, Lake Tahoe, Nevada.

TRANSVERSE STITCHING IMPROVES STRENGTH OF GRAPHITE/EPOXY BONDED SINGLE LAP JOINTS

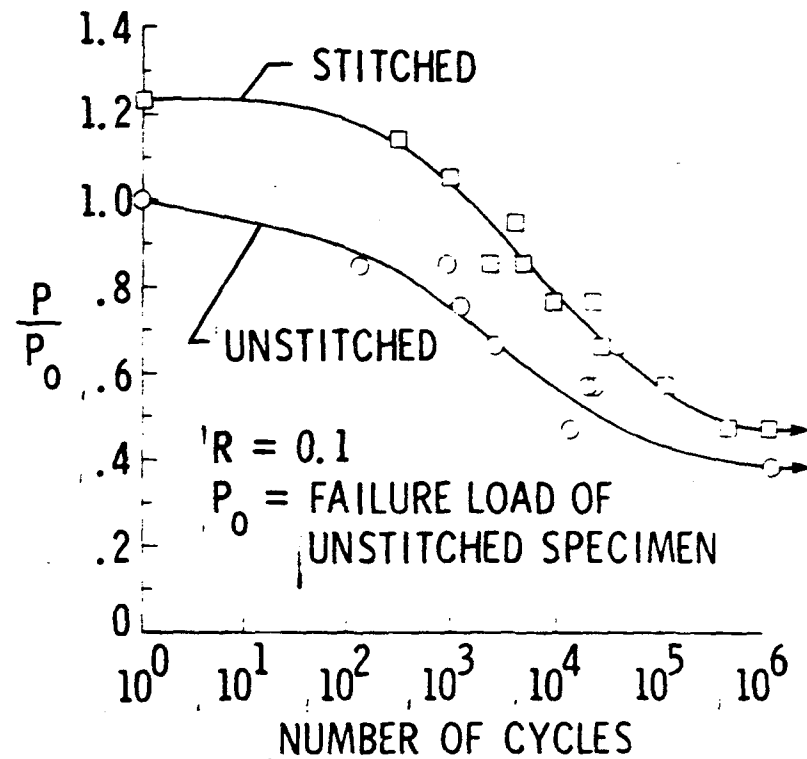
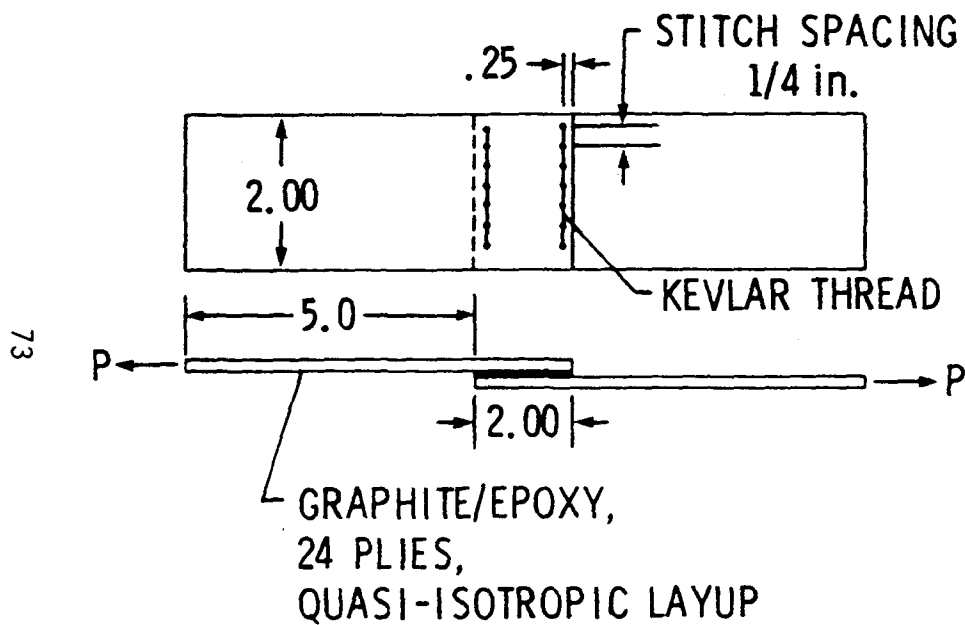

STITCHING OF BONDED SINGLE LAP JOINTS RESULTS IN:

- UP TO A 38 PERCENT INCREASE IN ULTIMATE LOAD
- AN ORDER OF MAGNITUDE INCREASE IN FATIGUE LIFE

DELAMINATION FAILURES IDENTIFIED FOR GRAPHITE-EPOXY
SAGE II AZIMUTH STOP

Mark J. Shuart and James H. Starnes, Jr.
Structural Mechanics Branch, SDD
Extensions 2813 and 2552
April 13, 1983

(RTOP 534-03-23)

Research Objective

To identify the failure mechanisms for the graphite-epoxy SAGE II telescope-tube azimuth stop that failed unexpectedly during component check-out.

Approach

An experimental study was undertaken to determine how the azimuth stop failed and to recommend a candidate replacement design.

Accomplishment Description

Three graphite-epoxy component designs were tested in this study. The original design was a 16-ply-thick azimuth stop. A modified design was a 24-ply-thick azimuth stop, and this design is shown in the upper left of the attached figure. A reinforced design was a 24-ply-thick azimuth stop reinforced with mechanical fasteners at the edges and steel supports in the reentrant corners. Delaminations at the edge and in the reentrant corner caused the failure of all designs. For the original design, failure initiated in the thin reentrant corner at 92 lbs., and component failure occurred when the edge delaminated at 108 lbs. For the other designs, the telescope tube is thinner and more flexible than the azimuth stop which raises the failure load for the reentrant corner delamination to more than twice that for the edge delamination. When a load is applied, local bending of the telescope skin at the edges of the azimuth stop occurs. To relieve the tensile interlaminar stresses associated with this deformation, the azimuth stop cracks at the edge but continues to carry the applied load. As more load is applied and the reentrant corner opens, the azimuth stop cracks in the reentrant corner to form delaminations that eventually fail the specimen. The edge delaminations occur at 150 lbs. and 194 lbs., and the reentrant corner delamination occur at 337 lbs. and 443 lbs. for the modified design and the reinforced design, respectively. The reinforced design satisfies the azimuth stop design load requirements.

Future Plans

Several generic issues associated with the failure of composite structures have been identified in the study and will be the focus of future research. To predict reentrant corner failures requires a better understanding of changes in load path directions and the resulting interlaminar stresses. To predict free edge failures requires a better understanding of the effect of total system deformation on component failures. Finally the effect of separating local failure modes on component ultimate strength must be understood for structural design.

DELAMINATION FAILURES IDENTIFIED FOR GRAPHITE-EPOXY SAGE II AZIMUTH STOP

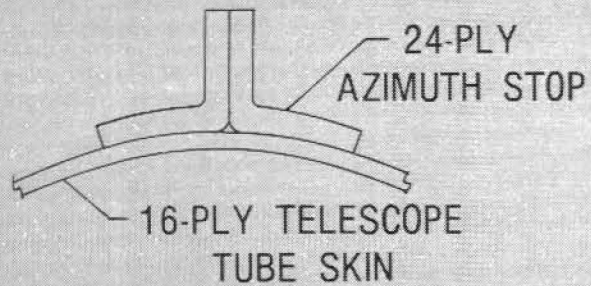

UNDEFORMED

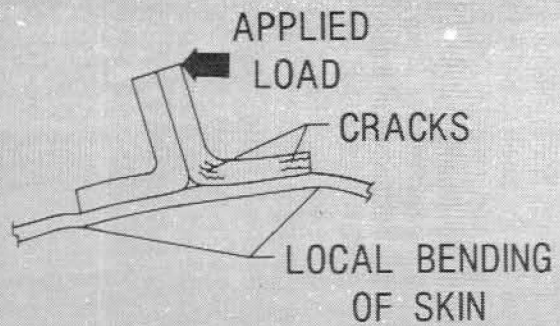

DEFORMED

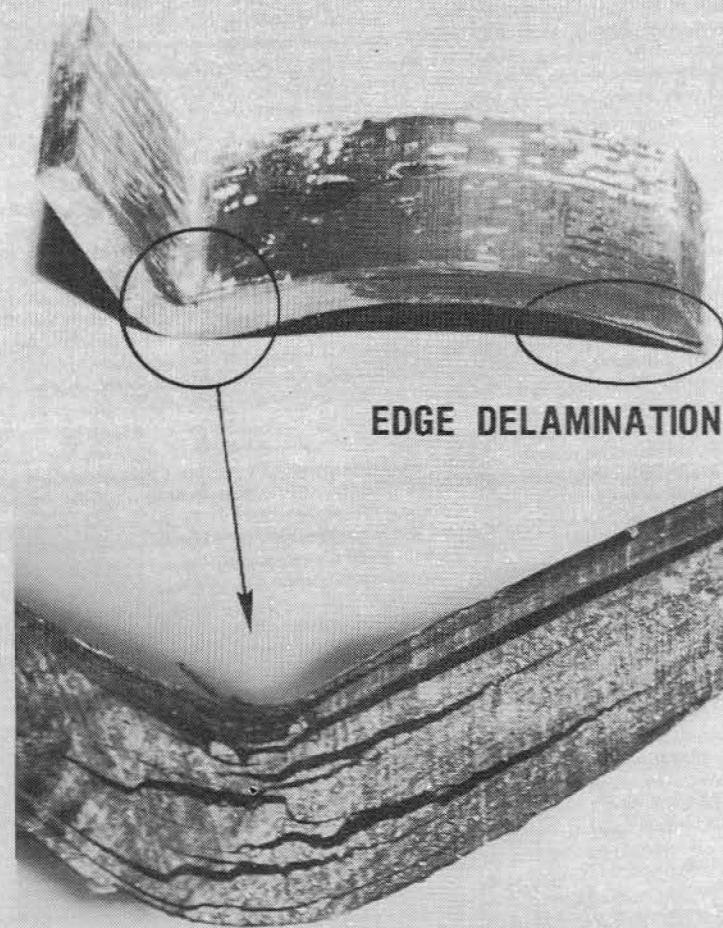

ROLE OF SHEAR CRIPPLING IDENTIFIED IN COMPRESSION FAILURE OF GRAPHITE-EPOXY PLATES

Jerry G. Williams
Structural Mechanics Branch, SDD
Extension 3524
May 18, 1983

(RTOP 534-03-23)

Research Objectives

To understand the basic failure mechanisms which cause failure in graphite-epoxy structures and to predict the response and the effect on strength.

Accomplishment Description

Earlier studies have shown that the failure strain of graphite-epoxy laminates with impact damage can be improved by altering the matrix properties (see figure upper left). However, these "tough resin" materials do not provide similar improvements in the compression failure strain for laminates with open holes (see figure upper right). The explanation for this apparent paradox involves understanding the different failure modes for the two types of local discontinuities. Impact damage can cause considerable delamination for laminates constructed of a brittle resin. Compression loading causes the delaminations to buckle locally and the damage to propagate due to high stress concentrations at the delamination interface. A tough resin suppresses the extent of delamination due to impact and relieves local stress concentrations by the nonlinear deformation response of the resin. The fact the failure-strain curves for the two material systems are identical for equal size holes suggests the failure mechanism with holes may be different from delamination and fundamentally the same for the two material systems. To explore this hypothesis further, hole specimens were loaded to slightly less than the established failure load and the region in the vicinity of the hole examined microscopically. A small section was cut from the region adjacent to the hole where high strain concentrations exist. The outer plies were ground away to expose an inner 0-degree layer (the direction of the applied compression load) and scanning electron photomicrographs of this region are shown in the lower portion of the figure. The pattern of broken fibers at the microscopic level represents the shear crippling or kinking failure mode. Apparently, the strain concentration at the edge of the hole is sufficiently large to cause local microbuckling of the 0-degree fibers, and the combination of bending and axial strain causes these fibers to fail in the shear crippling mode. Although this mode of failure has been observed before with other composite materials such as glass-epoxy, early investigators indicated it probably would not occur for material systems with properties typical of graphite-epoxy.

Future Plans

Understanding the shear crippling failure mode is essential to predicting the failure of compression loaded composites and this mode is being studied in-house and under grant with Washington University (St. Louis). This program will provide a structural perspective to guide material scientists in tailoring material properties to meet future requirements.

ROLE OF SHEAR CRIPPLING FAILURE MODE IDENTIFIED FOR GRAPHITE-EPOXY

48 PLY LAMINATE; $(\pm 45/0_2/\pm 45/0_2/\pm 45/0/90)_2s$

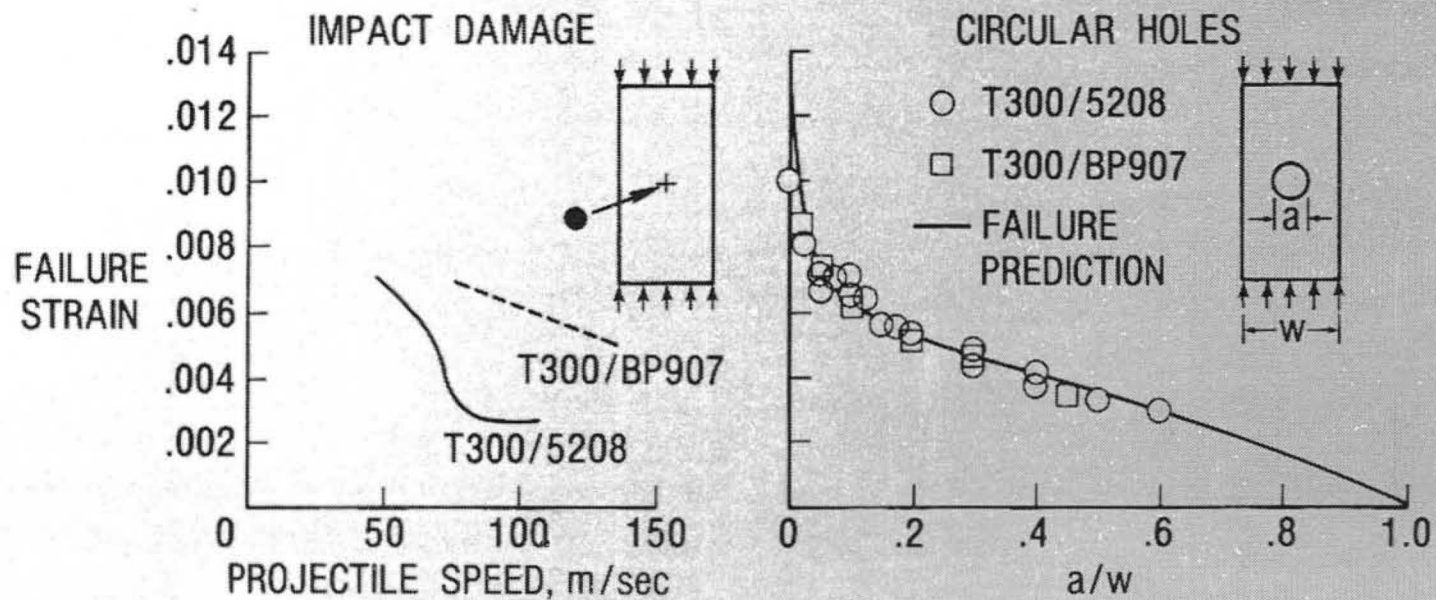

77

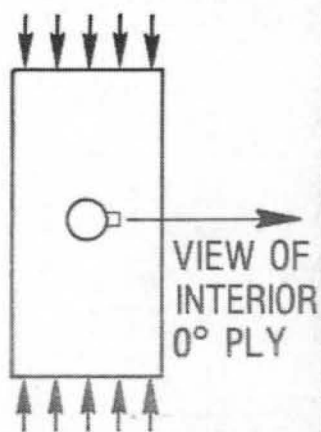

ANALYTICAL RESULTS FOR POSTBUCKLING BEHAVIOR OF
ORTHOTROPIC COMPOSITE PLATES IN SHEAR

Manuel Stein
Structural Mechanics Branch, SDD
Extension 2813
August 16, 1983

(RTOP 534-03-23)

Research Objective

Present postbuckling results for long plates loaded in shear with constraints at the edges of the plate that might be an upper limit to the constraints expected in actual structures and in experiment.

Approach

A Levy-type approach has been developed for long plates in the postbuckling range which involves choosing trigonometric functions for the unknowns in one direction of the plate and solving a set of simultaneous nonlinear ordinary differential equations in the other direction.

Accomplishment Description

Results indicate that the postbuckling slopes of the characteristic curves (and, therefore, the postbuckling stiffness) depends to a great extent upon the inplane boundary condition along the long edges for long panels loaded in shear. Shown are three sets of curves for a $+45^\circ$ laminated plate with clamped and simply supported boundary conditions on the out-of-plane deflections w . This stiffest panels are those for which the edges are not free to move in or out in the lateral direction as represented by the condition that $v = 0$ at the edges. Panels which are attached to a rigid frame that is pin connected at the corners and, thus, causes compression across the width are also very stiff. The weakest panels considered are those which have edges that remain straight but, on the average, are free of normal edge load; $N_{yav} = 0$ at the edges. A similar spread in stiffness occurs for a quasi-isotropic panel. This influence of inplane boundary conditions on the postbuckling behavior of panels loaded in shear does not occur for panels loaded in longitudinal compression.

Future Plans

These results will be presented at the Ninth Annual Mechanics of Composites Review sponsored by the Air Force in Dayton, OH, in October and in a book in honor of Professor W. H. Wittrick in Birmingham (England).

CHARACTERISTIC CURVES FOR POSTBUCKLING BEHAVIOR OF ORTHOTROPIC COMPOSITE
 PLATES IN SHEAR. $+45^\circ$ LAMINATE RESULTS

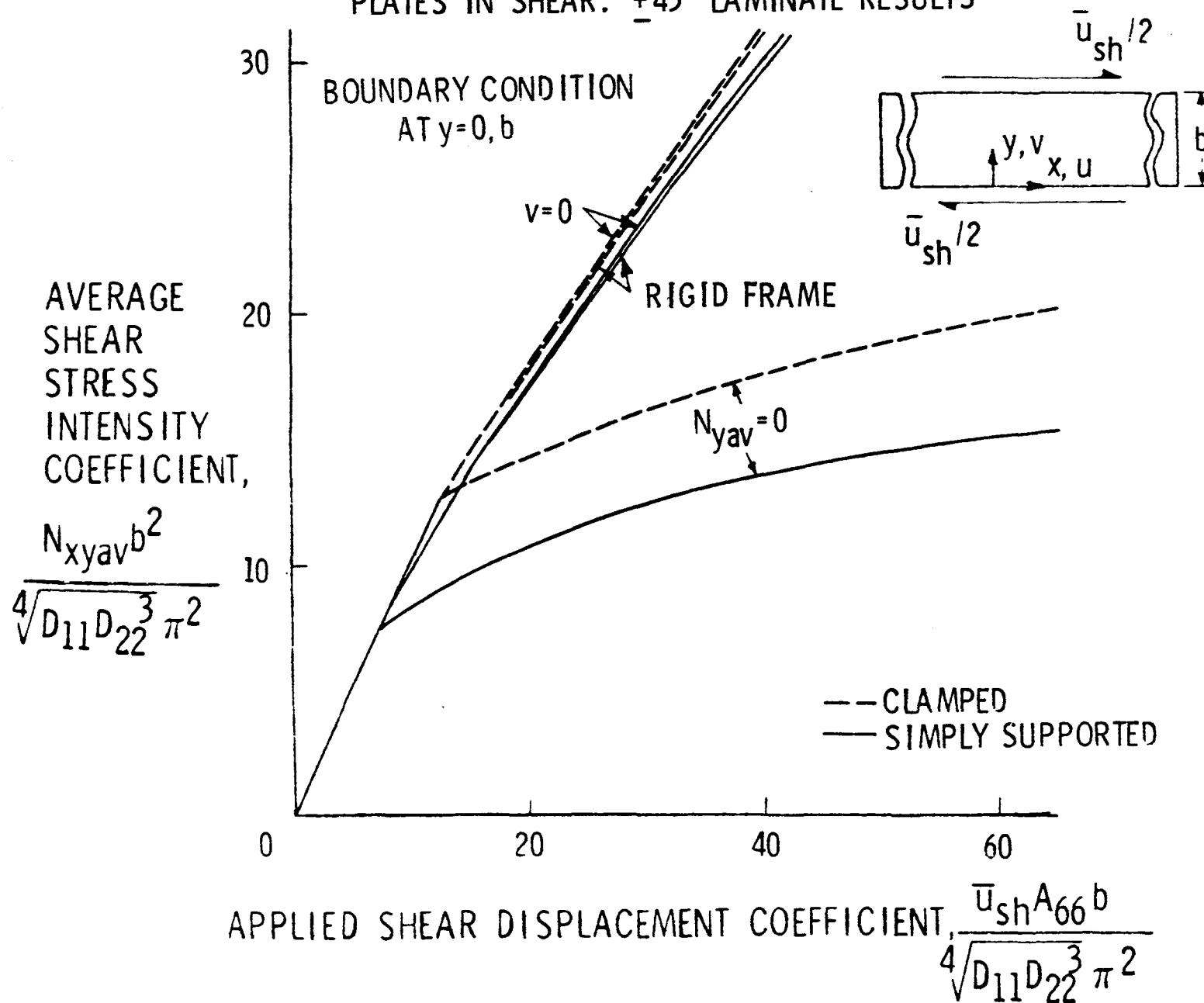

APPLICATION OF MODIFIED MODAL METHOD TO TWO-DIMENSIONAL
NONLINEAR STRUCTURAL DYNAMICS PROBLEMS

Norman F. Knight, Jr.
Structural Mechanics Branch, SDD
Extension 4585
August 12, 1983

(RTOP 505-33-53-10)

Research Objective:

To develop an effective reduction method for nonlinear dynamic analyses of plates subjected to a step loading.

Approach:

The modified modal method is a reduction method that reduces the number of degrees of freedom required for accurate nonlinear dynamic analyses. The method uses a combination of two sets of free vibration mode shapes as the reduced set of generalized coordinates for the problem as indicated by the equation on the upper right of the slide. The first set of mode shapes consists of the initial free vibration mode shapes Y_i . These mode shapes correspond to the eigenvectors of the traditional free vibration problem and are based on the linear stiffness matrix $[K]$. The other set of mode shapes consists of the steady-state free vibration mode shapes Y_j associated with small harmonic vibrations about a nonlinear static equilibrium configuration. These steady-state mode shapes are the eigenvectors of the free vibration problem where the stiffness matrix is associated with the nonlinear static solution for a distributed load of intensity P_0 . This choice of generalized coordinates characterizes both the initial linear behavior and the steady-state nonlinear behavior of the structure for the case of step a loading.

Accomplishment Description:

The method is demonstrated by applying it to the clamped circular plate subjected to a uniform pressure load shown in the lower left figure. The figure on the lower right shows the nonlinear dynamic response of the plate to a step loading. The solid curve is the accurate solution for the full system of governing equations (120 degrees of freedom). The crosses represent the solution obtained with the modified modal method (14 generalized coordinates; 5 initial and 9 steady-state modes) which compare well with the full-system results. The dashed curve represents the solution obtained from the traditional modal superposition approach (also with 14 modes) which does not compare with the accurate results. No updating of the generalized coordinates of the modified modal method was required for the solution and the number of degrees of freedom was reduced by a factor of nearly nine. The modified modal method significantly reduced the computational time required to solve the example problem.

Future Plans:

To apply the modified modal method to problems involving shells to study the effects of curvature on the application of the method.

APPLICATION OF MODIFIED MODAL METHOD TO TWO-DIMENSIONAL NONLINEAR STRUCTURAL DYNAMICS PROBLEMS

SOLVE NONLINEAR EQUATIONS OF MOTION

$$[M]\{\ddot{X}\} + [K]\{X\} + \{Q_{nl}\} = \{P\} \quad (\text{FULL SYSTEM})$$

USING GENERALIZED COORDINATES, $\{u\}$

TRADITIONAL APPROACH
MODAL SUPERPOSITION METHOD

$$\{X\} = [Y_i]\{u_i\}$$

WHERE Y_i = LINEAR FREE VIBRATION MODES

IMPROVED APPROACH
MODIFIED MODAL METHOD

$$\{X\} = \begin{bmatrix} Y_i & \bar{Y}_j \end{bmatrix} \begin{Bmatrix} u_i \\ \bar{u}_j \end{Bmatrix}$$

WHERE \bar{Y}_j = FREE VIBRATION MODES USING STIFFNESS AT P_0

18

CLAMPED CIRCULAR PLATE

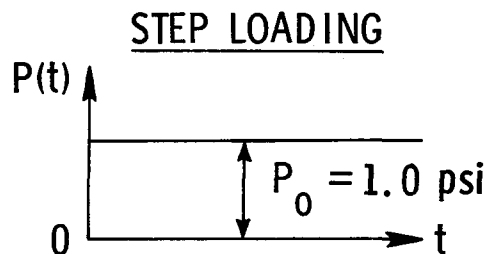
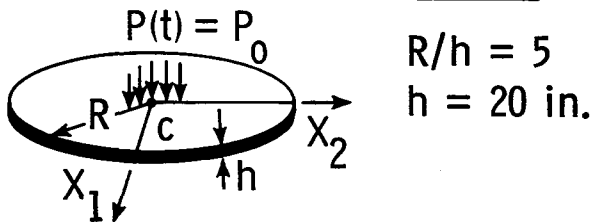

CENTER VERTICAL DISPLACEMENT w_c/h

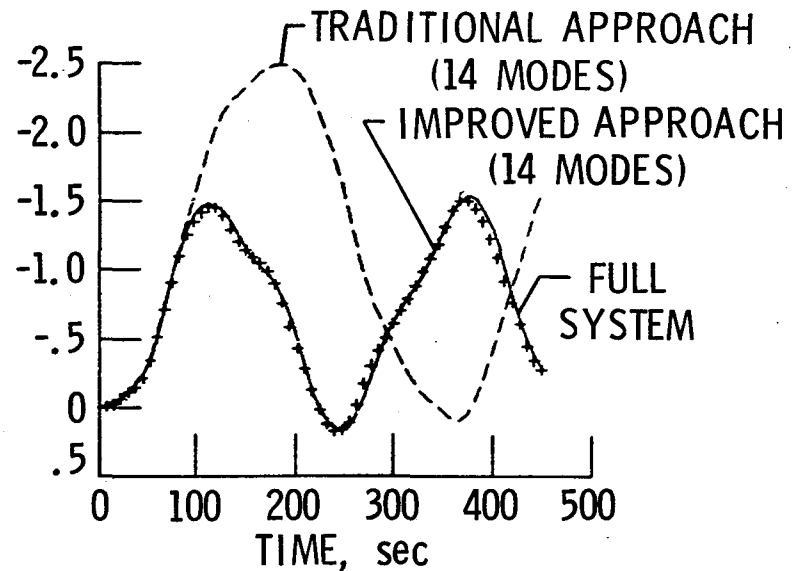

DAMAGE CONTAINMENT DEMONSTRATED FOR COMPRESSION
PANEL WITH TOUGH RESIN

Jerry G. Williams
Structural Mechanics Branch, SDD
Extension 3524
September 20, 1983

(RTOP 534-03-23-08)

Research Objectives

To develop damage-tolerant composite panel design technology and to understand the effects of local damage on structural performance.

Approach

As part of a research effort to study the failure mechanisms and damage containment capabilities of locally damaged compression components, a honeycomb-blade stiffened panel (shown on the left of the figure) was designed to satisfy heavily-loaded wing-panel requirements. Two specimens were fabricated, each from a different resin, and tested to evaluate their structural performance with local damage at a critical location. One specimen was fabricated using a delamination-prone brittle resin (Narmco 5208) that has been used by industry for several years and the other specimen was fabricated using a tough, delamination-resistant resin (American Cyanamide BP907) that has been shown on the coupon level to be less sensitive to impact damage. Local damage was simulated by 0.5-inch-deep sawcuts in the cap of an interior stiffener of each specimen at panel midlength (shown in the upper middle of the figure).

Accomplishment Description

Test results indicate that the damaged stiffeners of both panels failed locally by a shear crippling failure mode when the strain gages near the end of the sawcuts recorded strains of approximately 0.011 in/in. The local failure in the stiffener cap of both panels propagated across the honeycomb web to the skin-stiffener interface region in the same manner, but the global response of the two panels was different. Upon reaching the skin-stiffener interface, the damage continued to propagate by delamination into and across the skin of the brittle-resin panel and failed the panel globally (upper right photograph) at about 13,000 lb/in. For the tough-resin panel, the propagating local damage was arrested at the skin-stiffener interface and the panel subsequently carried a higher applied load of about 15,000 lb/in without failure. Arresting the local damage in the tough-resin panel allowed a major internal load redistribution and large out-of-plane deformations of the skin to occur without failing the panel (moire pattern in lower right represents out-of-plane deflection contours and graph at the lower middle of the chart compares the out-of-plane deflections for the two specimens). These results indicate that a combination of damage tolerant structural concepts and tough material systems are required to contain damage in heavily-loaded structural components.

Future Plans

Analysis of the local strain distribution near the sawcuts, internal load redistribution following local failure and panel global response is underway. A repair concept for the damaged stiffener has been developed and the discontinuities and eccentricities associated with the local repair are being analyzed.

DAMAGE CONTAINMENT DEMONSTRATED FOR COMPRESSION PANEL WITH TOUGH RESIN

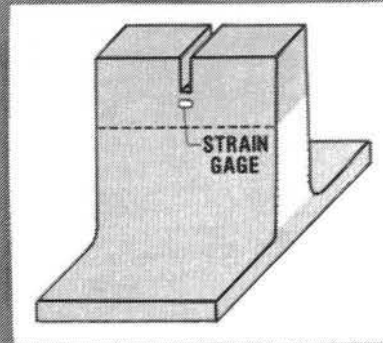

BRITTLE RESIN

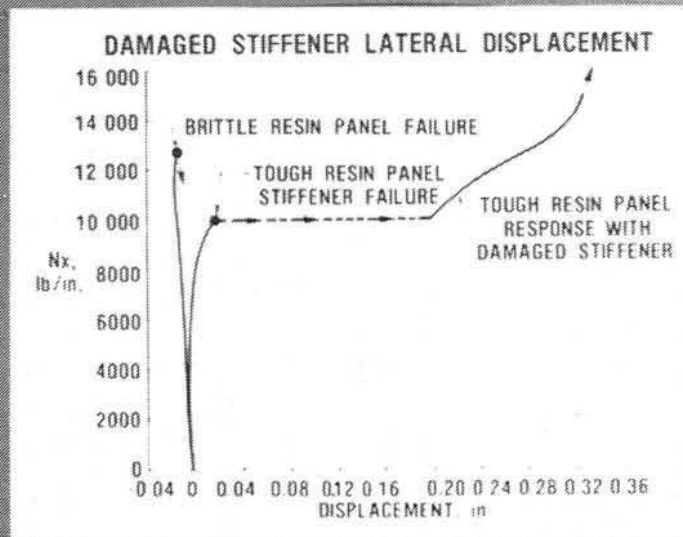
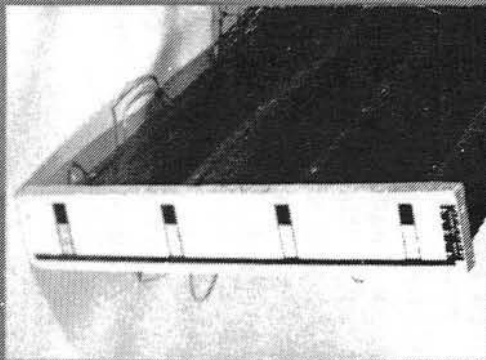
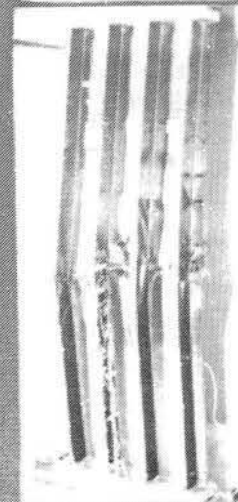

TOUGH RESIN



POSTBUCKLING PANEL STIFFENER ATTACHMENT CONCEPTS

James H. Starnes, Jr.
Structural Mechanics Branch,
SDD, Extension 2552

and

John N. Dickson
Lockheed Georgia Company
Contract NAS1-15949

September 22, 1983

(RTOP 505-33-33)

Research Objective

Develop stiffener attachment concepts that suppress the skin-stiffener separation failure mode for stiffened graphite-epoxy fuselage compression panels designed to operate in the postbuckling load range.

Approach

Graphite-epoxy panels with a single I stiffener (upper left photograph) representing four stiffener attachment concepts were fabricated and tested to determine their compressive failure loads.

Accomplishment Description

Failure of recent stiffened graphite-epoxy compression panels loaded in the postbuckling range has been occurring when the local stress and deflection gradients in the skin-stiffener interface region causes stiffeners to separate from the skins. Four stiffener attachment concepts have been evaluated experimentally to determine their effectiveness in suppressing the skin-stiffener separation failure mode and raising the panel failure loads. One concept was to adhesively bond the stiffener to the panel skin by a secondary bonding operation. Two concepts reinforced the skin-stiffener interface region by mechanical fasteners or by stitching the attachment flange to the skin with high strength Kevlar thread and then cocuring the stiffener and the skin. The final concept was to thicken the panel skin under the stiffener with 12 additional plies of material and adhesively bonding the stiffener to the thicker or "padded" skin region (lower left figure). The results of the tests are shown in the lower right figure. The two reinforcing concepts (mechanical fasteners and stitching) improved panel performance 13 and 23 percent respectively when compared to the adhesively bonded concept and the padded skin concept improved performance by 30 percent. The padded skin concept stiffens the skin region under the stiffener attachment flange and moves the local stress and deflection gradients away from the skin-stiffener interface region where failure occurs for other concepts. Suppressing the skin-stiffener separation mode leads to the stiffener crippling failure mode shown in the upper right photograph.

Future Plans

Additional tests are being conducted to determine the effect of damage on the performance of panels with padded skins. Research on the crippling of graphite-epoxy stiffeners has also been started. A nonlinear analysis of the post-buckling response of panels with padded skins is planned.

POSTBUCKLING PANEL STIFFENER ATTACHMENT CONCEPTS

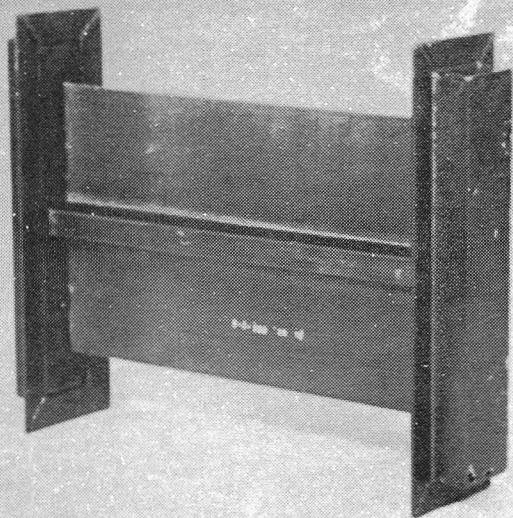

PANEL

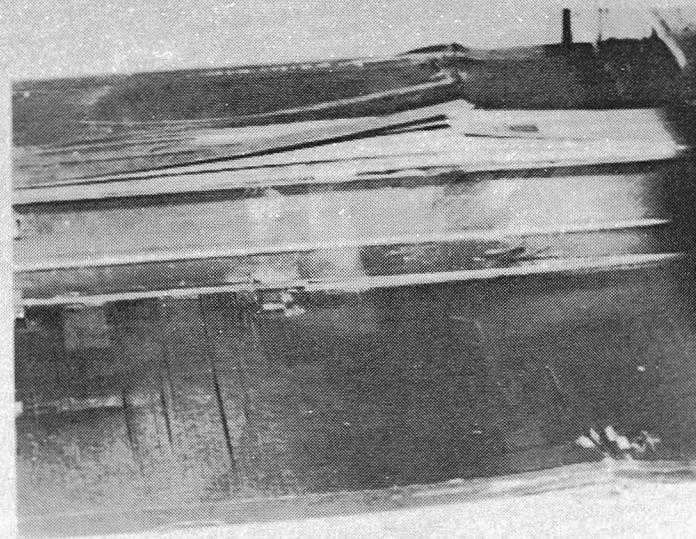

LOCAL FAILURE

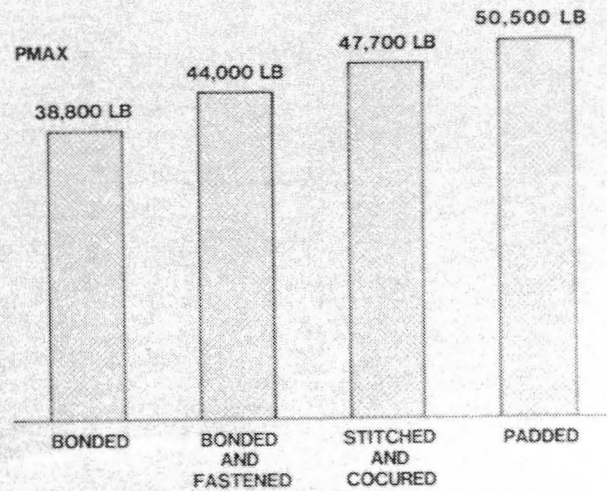
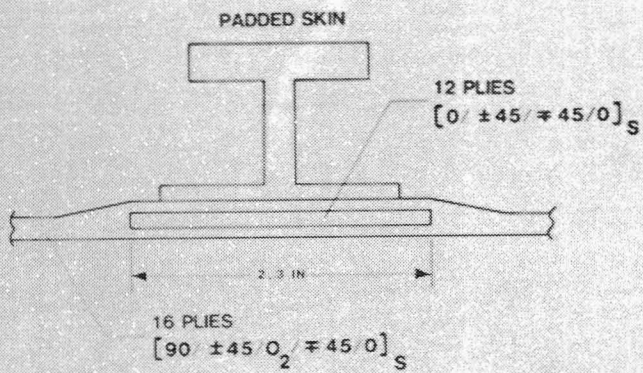

POSTBUCKLING RESPONSE PREDICTED ACCURATELY FOR STIFFENED GRAPHITE-EPOXY PANEL

Norman I. Knight, Jr. and James H. Starnes, Jr.
Structural Mechanics Branch, SDD
Extension 4585 and 2552
September 6, 1983

(RTOP 505-33-53)

Research Objective

To predict accurately the postbuckling response of a flat stiffened graphite-epoxy panel loaded in compression.

Approach

The STAGSC-1 nonlinear finite element analysis code was used to predict the post-buckling response of the panel. The panel skin, stiffener web and attachment flanges were modeled as shell elements to allow local bending in the skin and stiffener attachment flanges to occur and to allow cross-sectional deformation of the stiffener webs to occur.

Accomplishment Description

A comparison between test results and nonlinear analysis results are shown on the chart. The upper left shows a photograph of a moire-fringe pattern of the out-of-plane deflections of the test specimens and an analytically determined contour plot of the out-of-plane deflections of the same panel. This comparison shows the global mode shapes correspond accurately. The upper right figure compares test and analysis results for end shortening u (normalized by end shortening at buckling u_{CR}) as a function of applied load P (normalized by buckling load P_{CR}). The lower left figure compares out-of-plane-deflection w (normalized by skin thickness t) at a point on the skin and lower center figure compares surface strains e (normalized by the strain at buckling e_{CR}) at a point on the skin as a function of applied load. The lower right figure compares the membrane strain distribution in the skin between stiffeners for several values of the applied load P (normalized by the buckling load P_{CR}). These figures show that test and analysis results correlate very accurately up to failure for both global and local quantities. Careful attention to local modeling is required to achieve this level of accuracy in predicting nonlinear panel response.

Future Plans

An analytical effort to predict panel failure is being formulated. A refined analysis that includes interlaminar stresses and transverse shear effects is being considered. This refined analysis will be used in an attempt to predict panel failure.

POSTBUCKLING RESPONSE OF STIFFENED GRAPHITE-EPOXY PANEL PREDICTED ACCURATELY

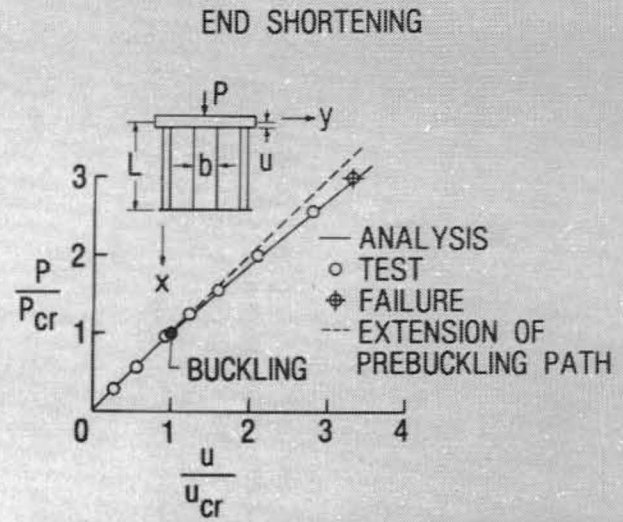
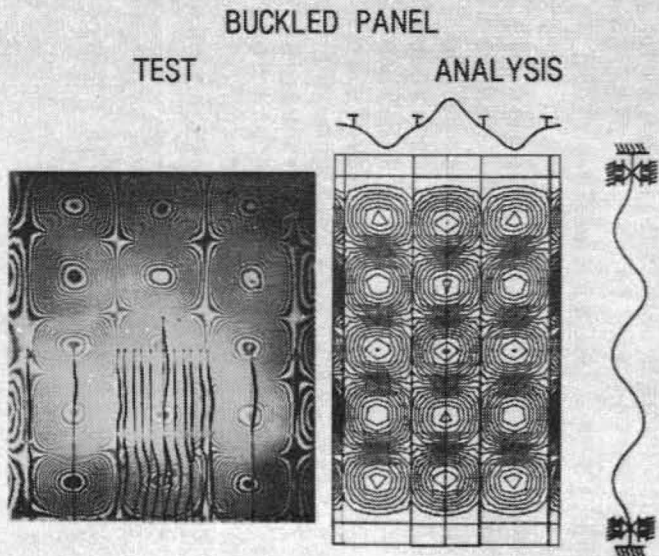

OUT-OF-PLANE DEFLECTION

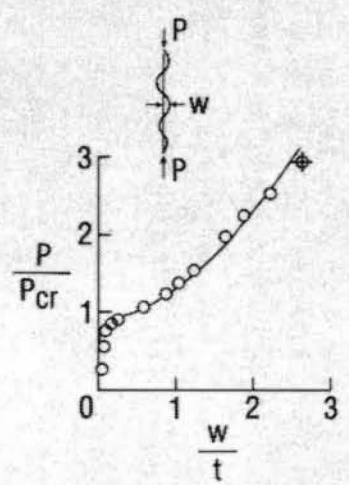

SURFACE STRAINS

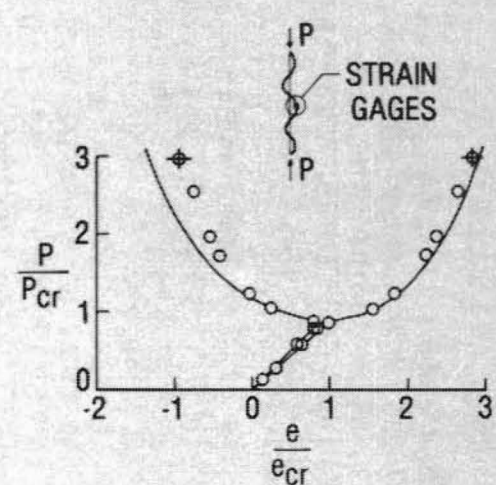

MEMBRANE STRAIN DISTRIBUTION
ACROSS CENTER BAY

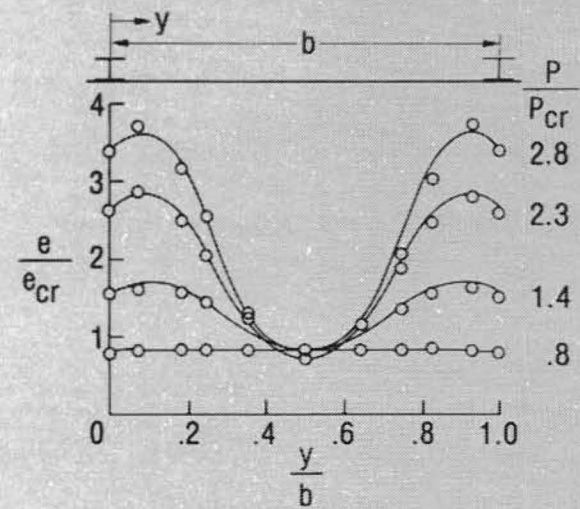

MATRIX-SHEARING FAILURE MECHANISM IDENTIFIED
FOR $[\pm 45]_s$ LAMINATES WITH HOLES

Mark J. Shuart and Jerry G. Williams
Structural Mechanics Branch, SDD
Extensions 2813 and 3524

November 21, 1983

(RTOP 534-03-23)

Research Objective

To characterize the fundamental failure mechanism for compression-loaded laminates constructed primarily of $\pm 45^\circ$ laminae and containing local discontinuities including holes.

Approach

Leading damage tolerant concepts proposed for composite wing design incorporate a low-axial/high-shear stiffness skin element composed primarily of $\pm 45^\circ$ laminae. This type of laminate has been shown to be highly tolerant to impact damage. The current investigation is an analytical and experimental study to determine the failure characteristics of compression-loaded $[\pm 45]_{12s}$ laminates with open holes.

Accomplishment Description

The attached chart illustrates current analytical and experimental results. Under Analysis, the contour plot shows the high local shear stress concentrations that exist in 45° laminae with holes. This contour plot was obtained using a classical closed-form solution for the stress distribution in an infinite anisotropic plate with a hole. The shear stress is normalized by the far-field shear stress for a 45° lamina. The shear stress at the edge of the hole is a maximum at 90° to the applied load, and this stress decreases until it is negligible at 45° to the applied load. The analytical results suggest that the high shear stress in the matrix near the edge of the hole could initiate local failure. Under Experiment, C-scan data for a compression-loaded $[\pm 45]_{12s}$ graphite-epoxy specimen illustrate the existence of a matrix-shearing failure mode. The C-scan photographs on the right of the chart were taken at two different load levels and show matrix-shearing failure initiating at the cutout boundary and growing with increasing load to the specimen free edge. The width of the matrix-shearing bands corresponds to the predicted region of high shear stress, and the growth locus is along a plus or minus 45° path. Once the matrix-shearing bands reach the free-edge, triangular wedges of the specimen (bounded by the failure bands and the free edge) translate laterally with negligible increase in applied load. A plot of the specimen's residual edge displacement after unloading is shown adjacent to C-scan 2 and illustrates this lateral translation of the triangular wedge.

Future Plans

Additional analyses and tests are being performed, and the study is being extended to other soft-skin laminate families ($45/90$) to determine the generic nature of the failure mode and to establish the necessary cross-ply requirements to suppress the matrix-shearing failure mode.

MATRIX-SHEARING FAILURE MECHANISM IDENTIFIED FOR $[\pm 45]_s$ LAMINATES WITH HOLES

ANALYSIS

EXPERIMENT

68

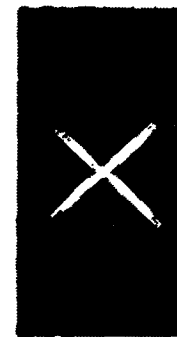
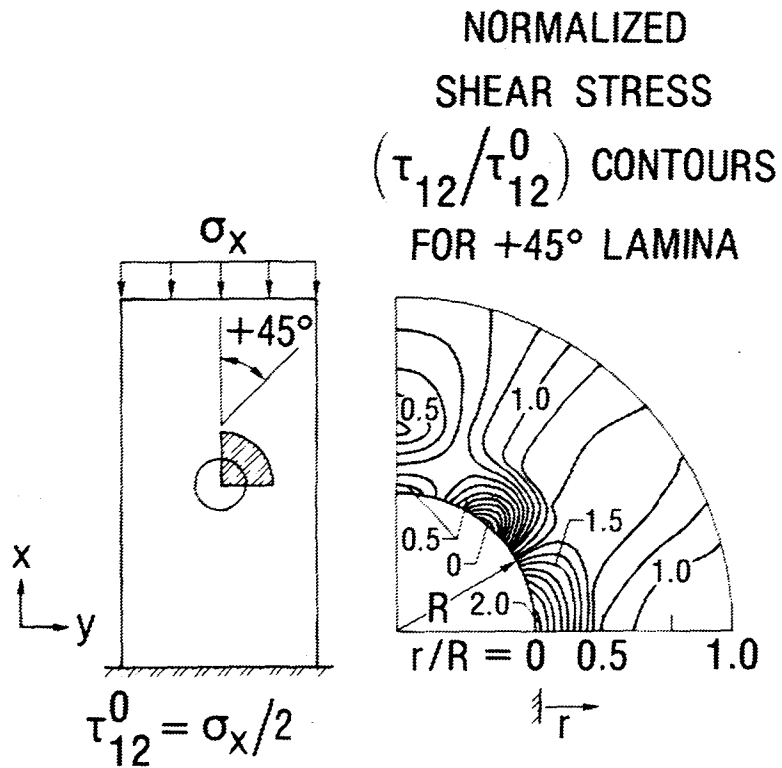

C-SCAN 1



C-SCAN 2

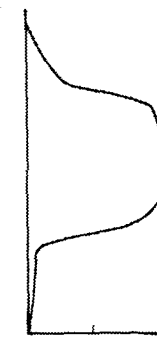

RESIDUAL EDGE
DISPLACEMENT, in.

STRUCTURAL DYNAMICS BRANCH

TECHNICAL HIGHLIGHT

GROUND MODAL VIBRATION TEST LIMITS ON LONG BEAMS

Brantley R. Hanks
Structural Dynamics Branch
Extension 2738
January 17, 1983

(RTOP 506-53-53)

Research Objective

The objective of this study is to determine the validity of conventional structural dynamics ground modal vibration test methods for application to large space structures.

Approach

Conduct analytical studies of the requirements imposed on conventional modal vibration test approaches when very-low-frequency, low-density structures are to be tested. Evaluate requirements in terms of facility and hardware limits. A long truss-type beam is used as an example test structure.

Accomplishment Description

A frequent method of conducting modal vibration tests on structures is to suspend them in a low-frequency support system comprised of long cables and/or soft mechanical or air springs. The general requirement on the support system is that it have no natural frequencies within a factor of five (or more for highly-damped structures) of the test structure modes of interest. For structures such as long beams, for example, testing in a pendulum configuration, as shown on the attached figure, is frequently used. However, requiring the pendulum frequency to be a factor of five below that of the first flexible mode of the beam limits the lowest natural frequency of a structure which can be tested for a given suspension cable length. This limit is the lower curve on the plot of pendulum suspension length versus beam frequency shown on the right hand side of the figure. Note that for a beam 60 meters long and a diameter of 1.2m ($D/L = .02$) a test facility height of about 50m is required. On the other hand, long cables have their own natural frequencies which produce the upper limit shown on the figure. Hence, high frequency limits of the test set-up are below most of the modes of the beam and only one or two modes can be obtained for low frequency beams. The IDEF spacecraft modal tests were conducted on a 2m suspension for a first bending frequency of 21 Hz as shown on the figure. Its 10-ton weight minimized upper frequency cable interference. The SAFE mast on the other hand would fall at about the 10 meter point off the left-hand side of the plot (.08 Hz). The third mode of that lightweight structure was significantly affected by suspension cable dynamics. Two alternatives are available, mathematically removing the effects of the test set-up and/or the use of special test set-ups and narrow-band testing for each mode desired. For structures more complicated than a beam, even these approaches are not promising. Similar difficulties have been found in other commonly used test suspensions including soft springs and air springs.

Future Plans

Experimental studies in which mathematical compensation for test suspension effects will be attempted.

GROUND MODAL VIBRATION TEST LIMITS ON LONG BOOMS

93

CANTILEVER BEAM IN TEST SET-UP

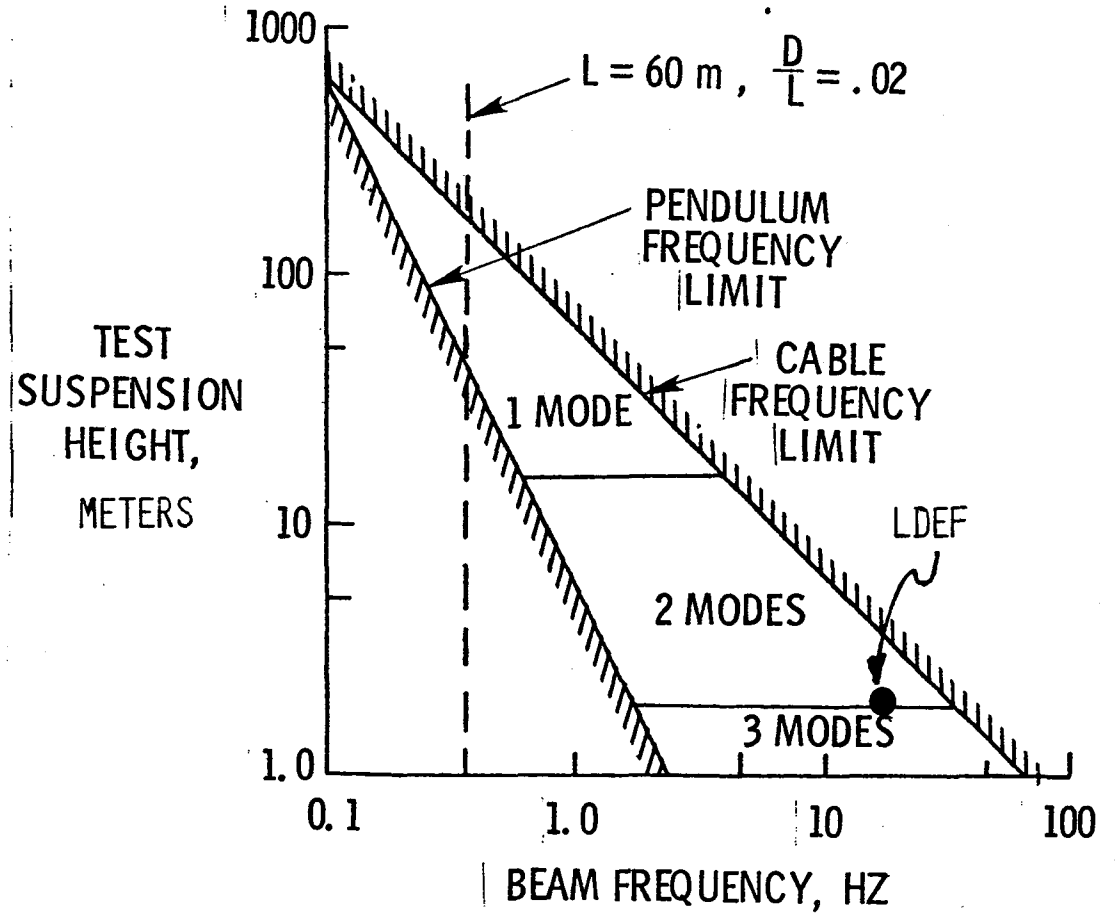
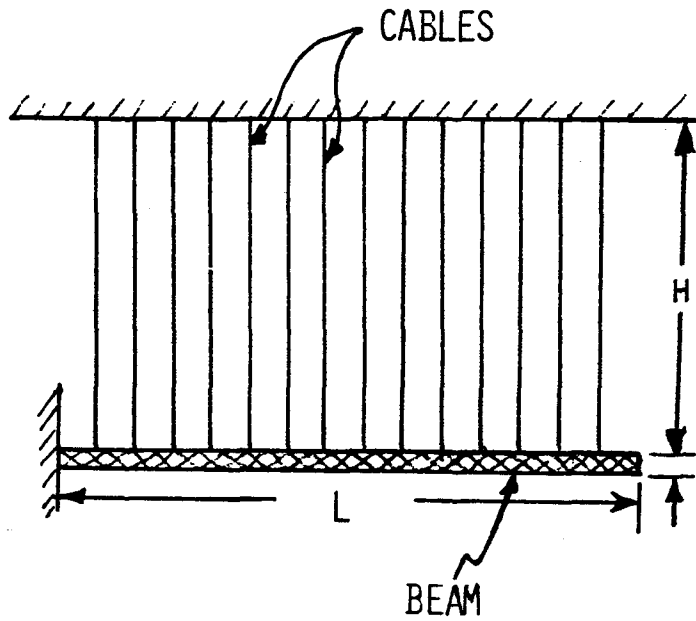

TECHNICAL HIGHLIGHT

SIMPLE CABLE STIFFENED STRUCTURE PROVIDES INSIGHT TO NONLINEAR VIBRATION CABLE MODEL REQUIREMENTS

Jerrold M. Housner and W. Keith Belvin
Structural Dynamics Branch
Extension 2446
February 18, 1983

RTOP 506-53-53

Research Objective

Determine the cable modeling requirements necessary to analyze nonlinear vibrations of cable-stiffened structures.

Approach

Develop a simplified quasi-linear analysis and a more complete nonlinear analysis. Investigate accuracy of the quasi-linear analysis versus the nonlinear analysis on a relatively simple cable-stiffened parameters of structure and cables.

Accomplishment Description

Both analyses have been applied to the cable-stiffened structure shown in the accompanying slide. The quasi-linear model approximates the cables as linear springs which are removed from the structure when the joint motion exceeds a static slackening state and large lateral deformations due to cable inertia. The overall unstiffened structural mode occurs at a normalized frequency of 0.42 while that of the cable-stiffened mode occurs at 1.5. However, as the amplitude of vibration increases, this mode softens due to folding-up of the cable as it goes slack. The nonlinear analysis predicts the onset of softening at approximately 10 percent of the amplitude that would produce static slackening based on the initial strain of the cable. Quasi-linear analysis only predicts softening when the static slackening amplitude is exceeded. After which, it provides a reasonable approximation to the reduced frequency predicted by the nonlinear analysis. In addition to the softening mode, another nonlinear mode exists near the normalized frequency of unity, (unity represents the first linear cable mode). This mode may be thought of as a local nonlinear mode that involves cable-joint interaction. Large lateral cable deformations produce hardening of this mode as a result of increasing axial cable loads. Quasi-linear analysis does not predict the existence of this mode because effects of lateral cable deformations are neglected.

These results indicate that quasi-linear analysis may be used with reasonable accuracy to obtain the frequency and amplitude of the overall structural mode, however, nonlinear analysis is required to predict cable-structure interaction modes. These modes become significant at large amplitudes of motion and can become the fundamental mode of the cable-stiffened structure.

Future Plans

Development of a hybrid model which uses both quasi-linear and nonlinear analyses to predict the overall structure and cable-structure interaction modes accurately and efficiently. Extension of the analysis to slender compression members also is anticipated where local buckling is analogous to cable slackening.

SIMPLE CABLE STIFFENED STRUCTURE PROVIDES INSIGHT TO NONLINEAR VIBRATION CABLE MODEL REQUIREMENTS

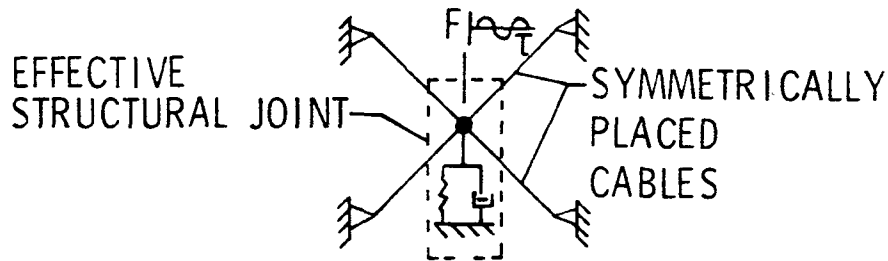

NONLINEAR MODEL
 QUASI-LINEAR MODEL

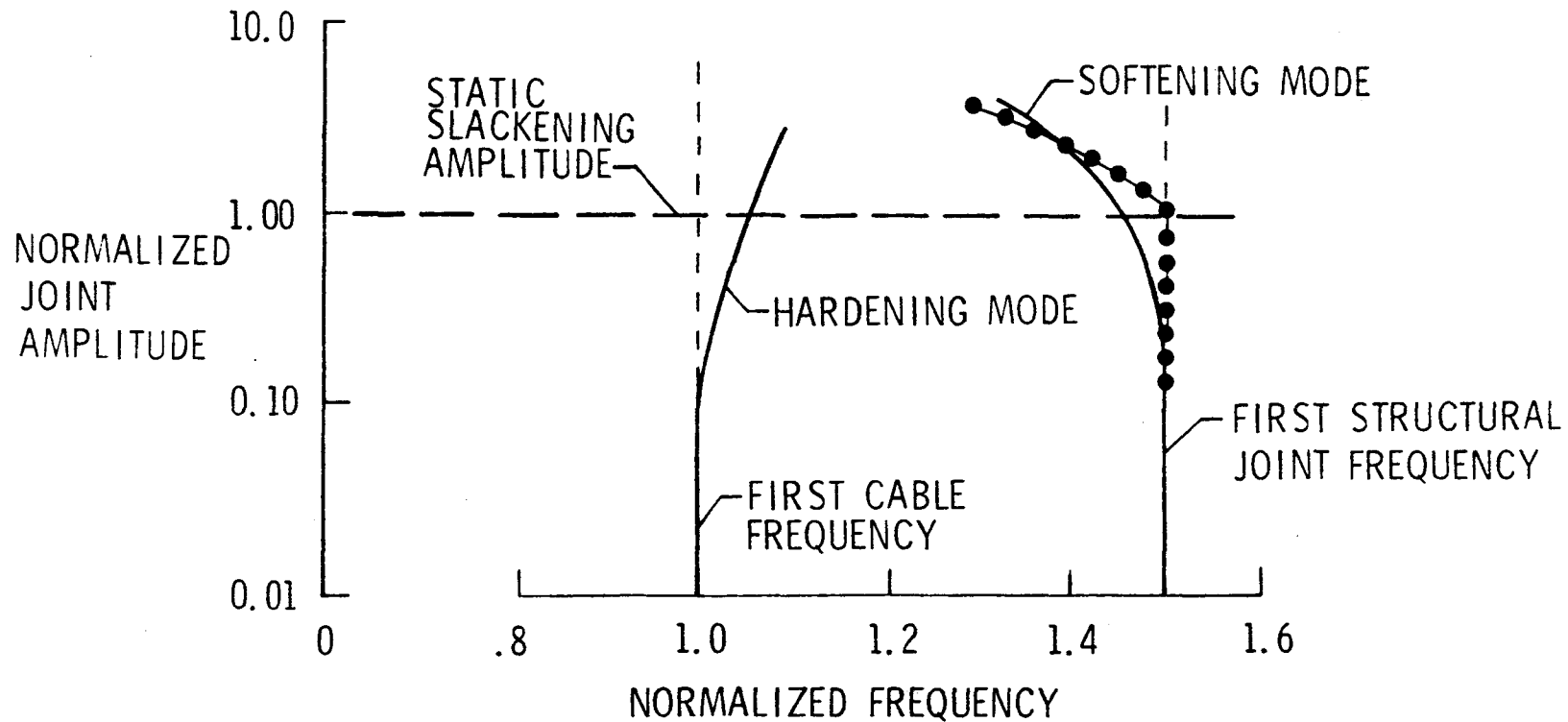

TECHNICAL HIGHLIGHT

AVERAGING TECHNIQUE SUBSTANTIALLY IMPROVES ITD-IDENTIFIED DAMPING VALUES FROM NOISY DATA

Richard S. Pappa
Structural Dynamics Branch
Extension 3196
February 18, 1983
(RTOP 506-53-53)

Research Objective

To optimize the performance of a modern modal identification technique--the Ibrahim Time-Domain (ITD) method.

Approach

The ITD technique identifies the modal parameters (natural frequencies, damping factors, and mode shapes) of a test structure using multiple free-response measurements simultaneously in a unique matrix eigensolution approach. Controlled laboratory experiments and numerical simulations are being conducted to thoroughly understand and optimize the performance of the method.

Accomplishment Description

Using the traditional solution approach developed by Dr. Ibrahim (under Langley sponsorship), state-of-the-art identification performance is typically achieved for those modes having high signal-to-noise ratio (SNR). The parameters for these modes are accurately identified when the number of computational degrees-of-freedom allowed in the analysis reaches approximately twice the number of modes that were excited in the test. For those modes of low SNR, however, a higher number of degrees-of-freedom is required. A plot showing the typical convergence of identified damping factors toward their true values as the number of degrees-of-freedom is increased appears on the left side of the accompanying figure. Although the true value is asymptotically approached at all noise levels, the required computer time for these analyses increases as the square of the number of degrees-of-freedom.

Recent simulations have shown that noise causes the identified damping values to be consistently high because a positive time shift was arbitrarily selected when the method was first devised between the two data matrices that are used in the analysis. If a negative time shift is selected instead, the bias reverses to the opposite direction. When the identified damping values from a second analysis using this negative shift are averaged with those using the standard positive shift, the bias can be completely removed. A typical example of the resulting improvement is shown on the right side of the figure for the 100% noise case.

Future Plans

Work is continuing to ensure the reliability of this new averaging technique. Results to-date show it to be a valuable enhancement to the ITD modal identification technique.

AVERAGING TECHNIQUE SUBSTANTIALLY IMPROVES ITD-IDENTIFIED DAMPING VALUES FROM NOISY DATA

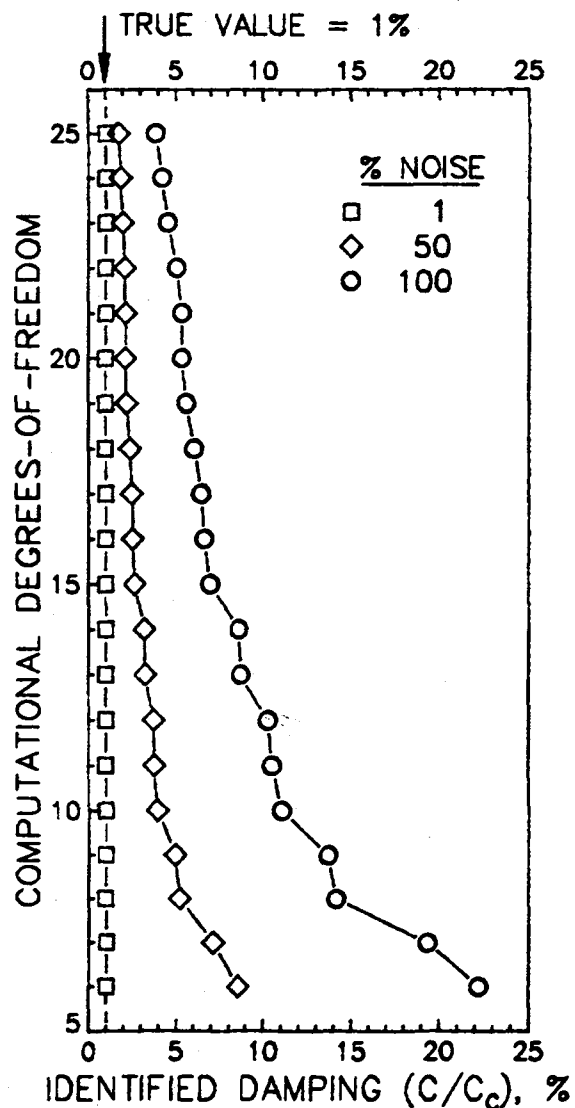

DAMPING FROM NOISY DATA -
STD. METHOD.

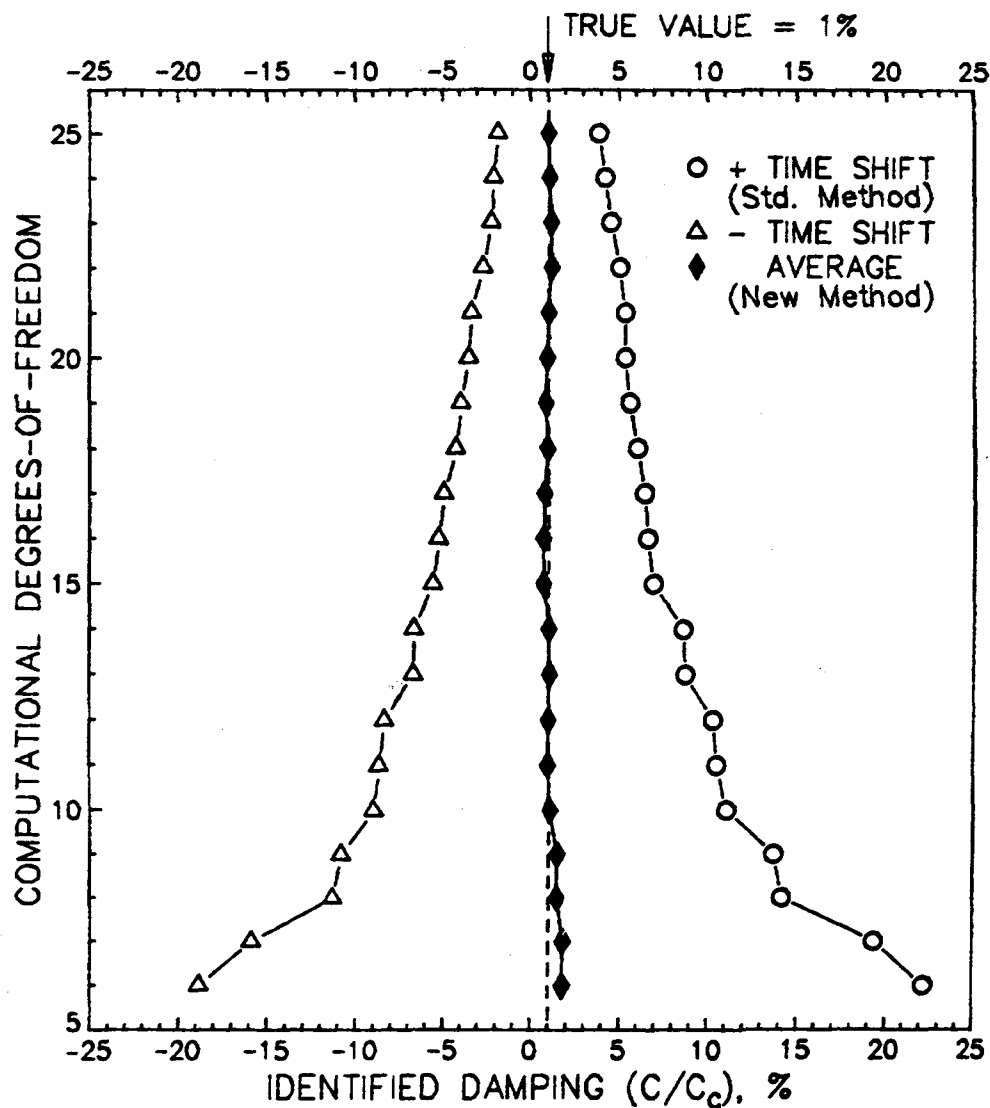

DAMPING USING NEW AVERAGING TECHNIQUE -
RESULTS FOR 100% NOISE.

TECHNICAL HIGHLIGHT

ANALYSIS DEVELOPED TO PREDICT NONLINEAR DYNAMIC RESPONSE OF GUYED SPACE BOOM

Jerrold Housner and Keith Belvin
Structural Dynamics Branch
Extension 2446
May 18, 1983
(RTOP 506-53-53)

Research Objective

Develop and apply a verified nonlinear dynamic analysis for performing routine parameter studies on initially eccentric slender guyed space booms subject to maneuver loads and accounting for cable slackening and boom dynamic buckling.

Approach

Correlate analysis with experimental measurements on a two-dimensional guyed boom configuration over a range of simulated maneuver loads. Since the experiment is carried out in the laboratory, gravity effects must be included in the analysis for correlation purposes.

Accomplishment Description

Guyed boom structures are presently being considered for space application as antenna feed masts. In guyed booms, the guys must be pretensioned to provide stiffness to the boom. In space application the pretension loads are small to avoid buckling the slender boom. Hence, relatively small deflections of the boom tip due to maneuver or external disturbances can cause a guy to slacken. Once slack, the guy provides no stiffness to the boom. Further deflection of the boom can cause the remaining taut guy(s) to overload the boom in compression resulting in yet larger boom deflections and possibly collapse.

An analysis has been developed to parametrically study this problem for different configurations, material properties and pretension levels of the system. Since the problem involves considerable nonlinearities, experimental verification was performed. The chart shows the comparison of experimental measurements with linear and nonlinear analytical predictions. In the experiment maneuver loads are simulated by an applied step load at the tip concentrated mass. Peak lateral deflection values for various load levels are shown on the chart. Also shown is the force level which would cause a guy to slacken were the load applied statically. Due to the dynamic response of the system, slackening actually occurs at a lower force level. This is reflected in the deviation of the linear and nonlinear predictions below the static slack force level. The nonlinear prediction follows the same trend as the experimental data, but overpredicts peak deflections by 13-15%. The cause for this discrepancy is unknown; however, in view of the highly nonlinear nature of the system, the correlation is considered quite good. The analysis has also been used to establish design regions for combinations of pulse level and duration for which tip deflections do not exceed given performance allowables.

Future Plans

Develop analytical capability for maneuvers of flexible interconnected booms allowing for large geometry changes in configuration and nonlinear kinematics.

ANALYSIS DEVELOPED TO PREDICT NONLINEAR DYNAMIC RESPONSE OF GUYED SPACE BOOM

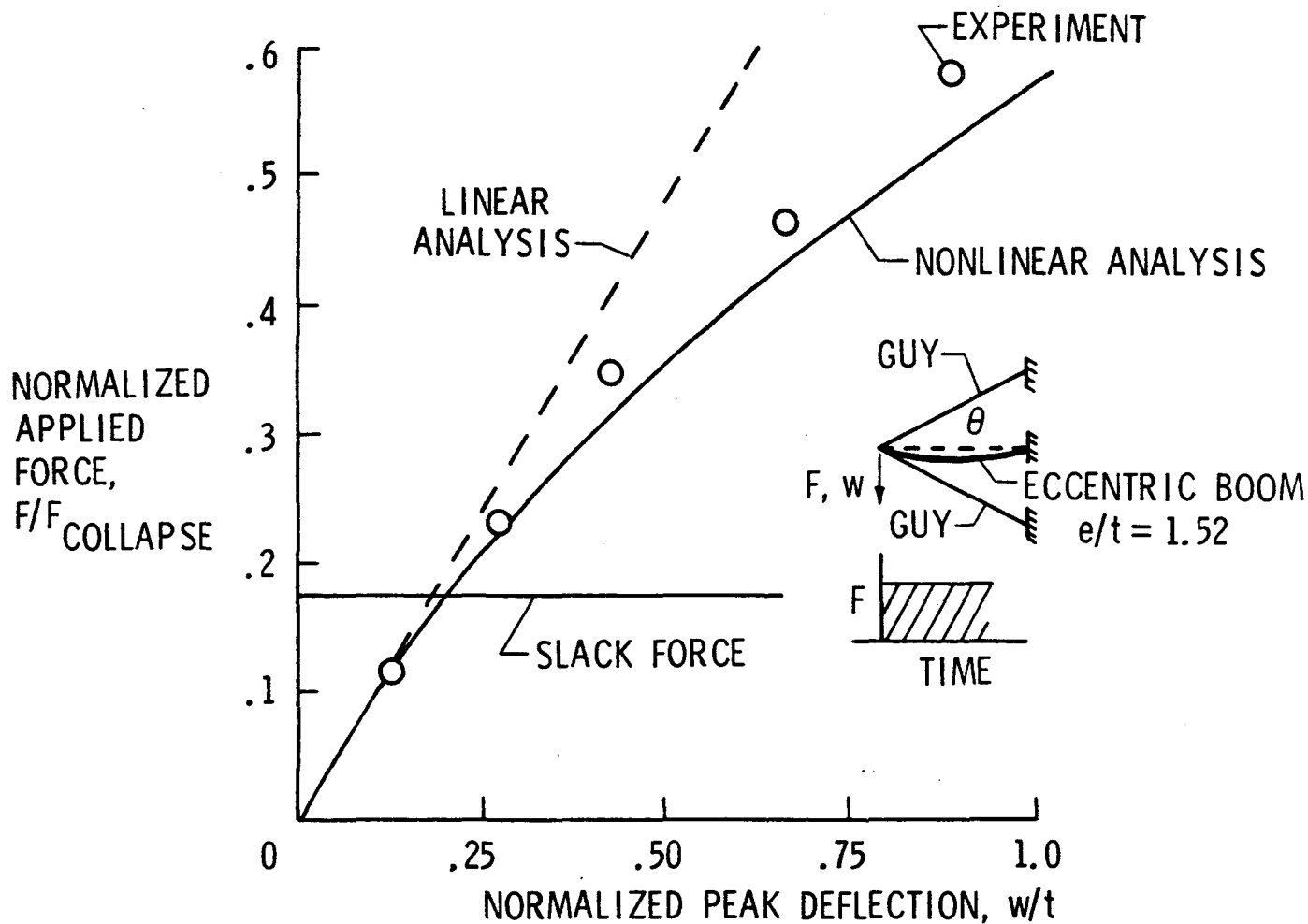

SPACE TECHNOLOGY EXPERIMENTS PLATFORM (STEP)
EXPERIMENT REQUIREMENTS WORKSHOP JUNE 29-JULY 1, 1983

Larry D. Pinson and M. Larry Brumfield
Structural Dynamics Branch
Extension 3196
August 15, 1983
RTOP 542-03-15

Objective

To present NASA plans and preliminary design for the STEP Program and review proposed experiments. From this interchange, review STEP design for compatibility with proposed experiments.

Approach/Results

All respondents to the February 1983 solicitation for potential STEP experiments were invited to attend and present a review of their experiment concept and requirements. In addition, a general invitation to attend was extended to others in the academic, industrial and government communities with an interest in large space structures technology. In response a total of 102 persons attended representing a cross-section of the scientific community. Of those attending, 54 were non-NASA personnel and 48 were NASA personnel. A total of 34 presentations were made covering STEP Program overview, subsystems design, and experiment proposals. Proposed experiments included deployable/erectable structures, structural dynamics/controls antennas, zero-G fluid-structure interaction, thermal control, and solar array technology/dynamics.

Conclusions

1. The STEP design is workable and responsive to experimenter needs. Some design changes in the data/command subsystems will be incorporated to reduce design complexity, increase operational flexibility and improve reliability/redundance.

2. Attendees were enthusiastic in their assessment that STEP offers a significant benefit to large space structures technology development.

Issues/Questions/Recommendations

1. Increase the number of data channels
2. Incorporate an excitation capability
3. Provide a position/displacement measurement system.
4. How will experiments be evaluated for selection? (LaRC proposed the announcement of opportunity (AO) process under direction of OAST)
5. How should developed flight hardware be reused to meet multi-purpose experiment objective?

SPACE TECHNOLOGY EXPERIMENTS PLATFORM (STEP)
REQUIREMENTS WORKSHOP JUNE 29 - JULY 1, 1983

OBJECTIVE: PRESENT NASA PLANS FOR DEVELOPMENT OF STEP AND REVIEW PROPOSED EXPERIMENTS

- 0 34 PRESENTATIONS COVERED OVERVIEW, SUBSYSTEM DESIGN, AND EXPERIMENT PROPOSALS INCLUDING EXPERIMENTS IN DEPLOYABLE/ERECTABLE STRUCTURES, STRUCTURAL DYNAMICS/CONTROLS, ANTENNAS, ZERO-G FLUID-STRUCTURE INTERACTION, THERMAL AND SOLAR ARRAY

- 0 102 ATTENDED (54 NON-NASA, 48 NASA)

CONCLUSIONS:

- STEP DESIGN IS WORKABLE AND RESPONSIVE TO EXPERIMENTER NEEDS
- STEP OFFERS SIGNIFICANT BENEFIT TO LARGE SPACE STRUCTURE TECHNOLOGY
- ISSUES REMAIN ON IMPLEMENTATION AND EXPERIMENT SELECTION

PAGE102 MISSING FROM ORIGINAL DOCUMENT

ACTUATOR PLACEMENT ON A TWO-DIMENSIONAL GRILLAGE

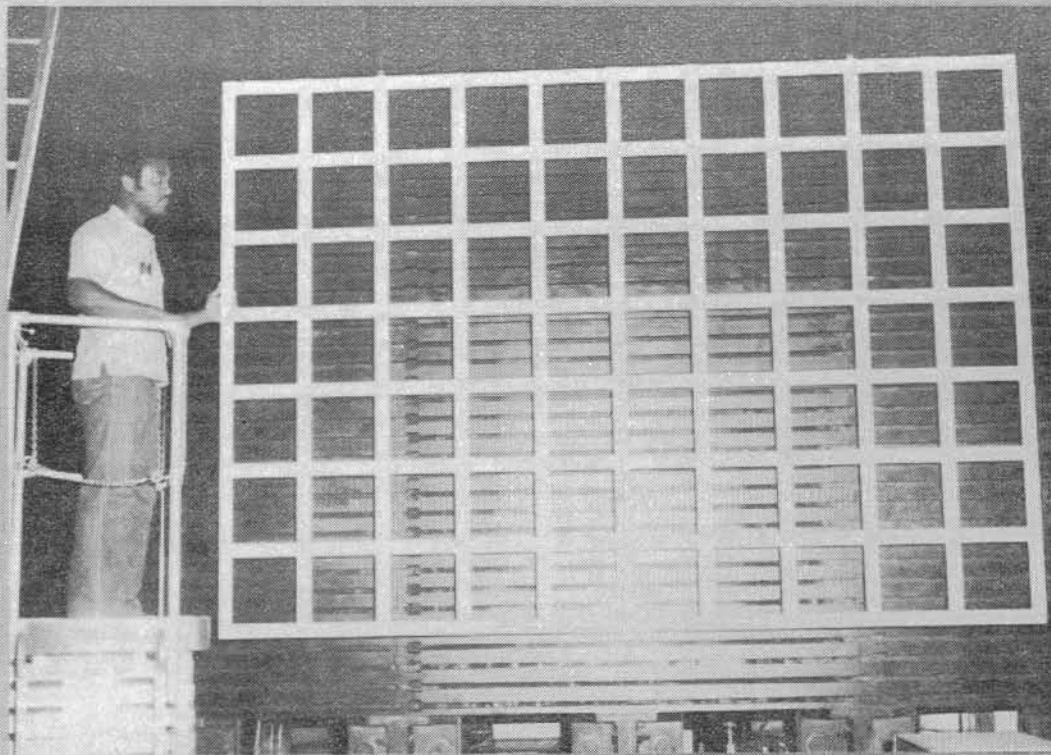

103

FORCE ACTUATORS

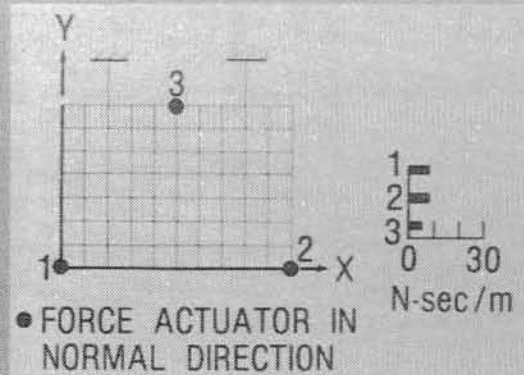

TORQUE ACTUATORS

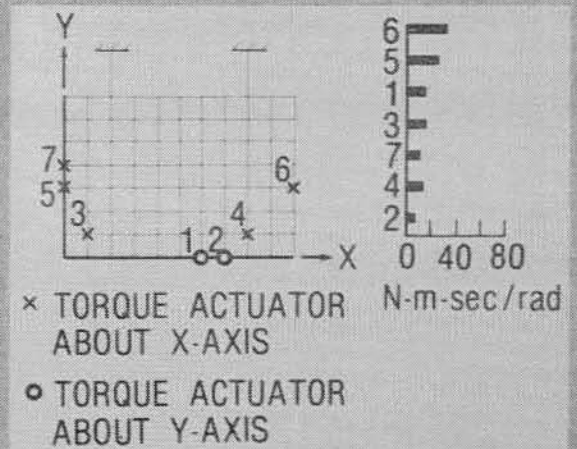

GENERIC SPACE STATION DYNAMICS MODEL IN FABRICATION

W. Keith Belvin

Structural Dynamics Branch

Extension 2446

Sept. 1, 1983

RTOP 506-53-53

RESEARCH OBJECTIVES

To determine the dynamic characteristics and modeling requirements of multi-body structures undergoing transient response. To develop and validate active vibration suppression of solar array response due to slewing maneuvers.

APPROACH

Design multi-body space station model for dynamics and active controls experiments. Perform component tests to obtain substructure modal data including damping. Exercise modal synthesis procedures to predict assembled space station transient response due to slewing and docking maneuvers. Experimentally investigate vibration suppression of low frequency components by active controls technology.

MODEL DESCRIPTION

The generic space station model, now in fabrication, consists of four major components; a habitation module, two solar arrays and a radiator. A universal interface is used which permits up to six components to be joined. This universal interface enables the space station architecture to be readily changed from symmetric to asymmetric configurations. The model has been designed to simulate the generic characteristics associated with networks consisting of stiff and flexible bodies. The habitation module acts as a stiff body with the first natural frequency frequency being $f=90$ Hz. The solar arrays are highly flexible with $f=1.3$ Hz, whereas, the radiator represents components of moderate stiffness, $f=6$ Hz. Thin wall aluminum construction is used in the habitation module and the interface. Sandwiched honeycomb panels are used for the solar arrays and radiator. Overall dimensions are:

Habitation Module	length=2.6m	diameter=0.65m
Radiator	length=1.3m	width =1.30m
Solar Arrays (each)	length=3.0m	width =0.65m

PLANS

Component tests will be performed to ascertain the accuracy of substructure dynamic analysis models. Verified substructure models will be synthesized to predict the experimental response of the assembled space station model due to transient loading. Slewing maneuvers of the solar panels will be actively controlled to minimize vibration amplitude.

GENERIC SPACE STATION DYNAMICS MODEL IN FABRICATION

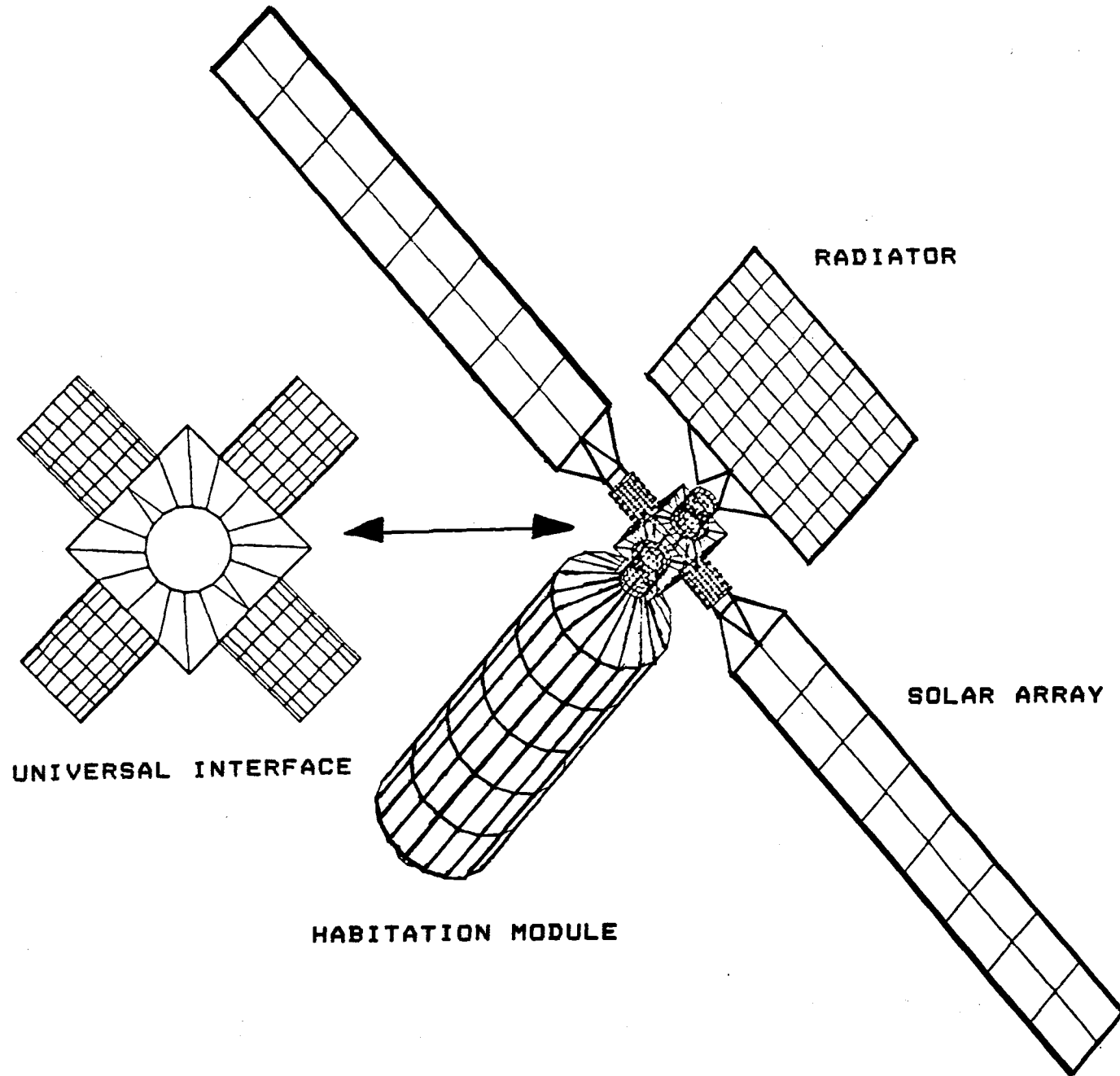

STRUCTURAL CONCEPTS BRANCH

CHARACTERIZATION OF TITANIUM 6242 ALLOY WITH SILICON SHOWS SIGNIFICANTLY IMPROVED CREEP PROPERTIES FOR MACH 5 CRUISE AIRPLANES

L. Robert Jackson
Structural Concepts Branch, SDD
Extension 2414
October 15, 1982

(RTOP 505-33-53)

Research Objectives

Provide materials characterization by tests of welded and liquid interface diffusion (LID) bonded joints for both Ti-6Al-2Sn-4Zr-2Mo (Ti-6242) and Ti-6242 with 0.09% silicon (Ti-6242S) alloys. These materials data are necessary to design and fabricate honeycomb-core sandwich panels and a new Langley structural concept consisting of double-sine-wave web, flanged cap-stiffened skin panels for the wing of Mach 5 cruise airplanes.

Approach

Mach 5 airplane wings are bi-axially loaded, thus honeycomb-core sandwich and bi-axially oriented stiffeners bonded to a face sheet are two structural concepts being studied. However, Mach 5 flight produces a lower surface temperature of 900°F, which is approaching the upper temperature limit of advanced titanium alloys. At this temperature, excessive creep deformation can be the failure mode, but creep data on these alloys was scarce and non-existent for welded and LID-bonded material. Consequently, a test program has been performed under contract to the Lockheed California Company on Ti-6242 and Ti-6242S for strength, fatigue, crack growth and creep with parent metal, LID coated, and welded specimens at room temperature and at 900°F.

Accomplishment Description

The creep tests indicate that the Ti-6242 alloy has an unacceptably low allowable stress of 27,000 psi at 900°F for 500 hrs. exposure. The airload stress is 40,000 psi, and the allowable creep deformation is 0.20%. At this stress the Ti-6242 creep would be 0.45%, which as indicated in the figure produces an excessive permanent deformation of the wing. However, the creep tests indicate that the Ti-6242S alloy has an acceptable allowable stress of 50,000 psi. Therefore, in 500 hrs. the creep strain would be 0.13%, which is well within the 0.20% allowable deformation. Or, as seen in the graph, the Ti-6242S alloy almost doubles the allowable stress (50,000 psi vs. 27,000 psi) for the 0.2% creep over that of the Ti-6242 alloy.

Future Plans

Several honeycomb-core sandwich panels and bi-axially stiffened-skin panels are being fabricated by Rohr Industries, Inc. for testing by Lockheed-California Company and by Dryden Flight Research Center. These panels will be made of the Ti-6242S alloy and tested at 900°F to verify the suitability of the structures and material selection for the Mach 5 airplane wing structure.

CHARACTERIZATION OF TITANIUM 6242 ALLOY WITH SILICON SHOWS SIGNIFICANTLY IMPROVED CREEP PROPERTIES FOR MACH 5 CRUISE AIRPLANES

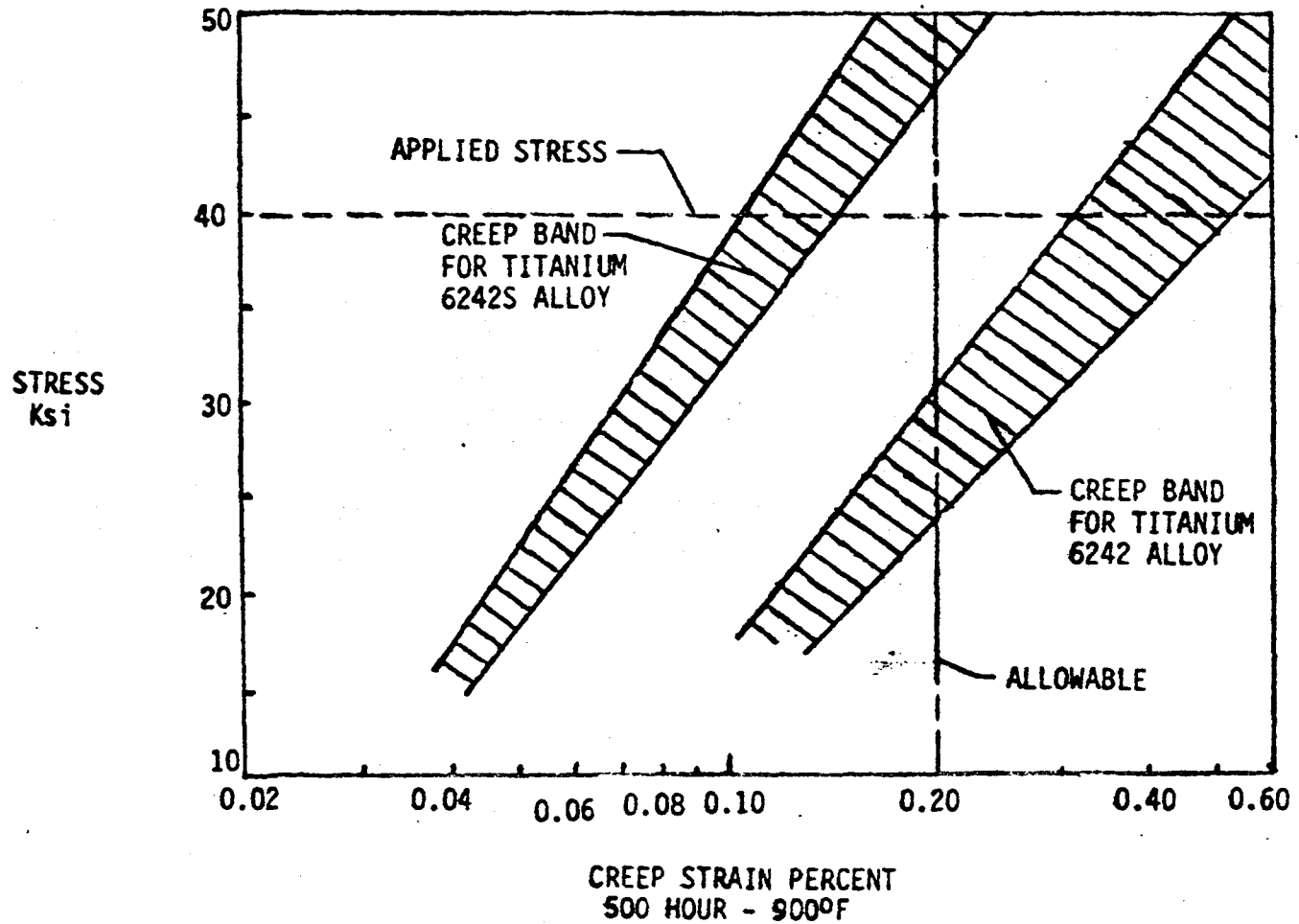
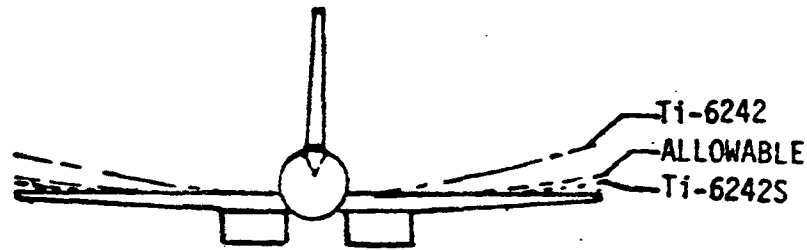

NOVEL AEROSHELL STRUCTURAL ARRANGEMENT IMPROVES
SERVICEABILITY OF SPACECRAFT

Allan H. Taylor and L. Robert Jackson
Structural Concepts Branch, SDD
Jeffrey A. Cerro and Stephen J. Scotti
Kentron International, Inc., Kentron Technical Center
Extensions 2414 and 2405

April 13, 1983

(RTOP 506-53-43)

Research Objective

To provide a long life, low weight, economical structure for reuseable space launch vehicles which has all-weather operational flexibility, minimal refurbishment and is readily serviced in operation.

Approach

An aeroshell structural arrangement incorporating a separate tank/thrust structure and airframe is envisioned that incorporates the advantages of the integral and non-integral structural arrangements. The tank/thrust structure is suspended within the airframe by an aft trunnion and forward hinged supports. This support system accommodates the differential thermal growth while transmitting the inertial loads through the simple supports. The thrust is applied directly to the tanks as with an integral tank arrangement. Moreover, the aeroshell structural arrangement allows removal of the airframe from the tank/thrust structure for maintenance and inspection by disconnecting the attachments between the structures.

Accomplishment Description

The analyses of several aeroshell wall constructions indicate that a hot structure aeroshell consisting of an internally insulated hybrid carbon-carbon airframe and an aluminum tank/thrust structure is about 6 percent heavier than a more structural efficient integral tank arrangement; however, the integral tank arrangement requires a cumbersome TPS which must be removed to inspect the structure. Moreover, a durable TPS insulated, graphite polyimide aeroshell structure, while not as all-weather capable as the hybrid carbon-carbon aeroshell, is an excellent alternative should the development of hybrid carbon-carbon structures prove to be too costly. Thus, the aeroshell structural arrangement provides serviceability regardless of its wall construction.

Future Plans

The present data base on hybrid carbon-carbon is very small, however, the carbon-carbon materials are rapidly developing. The Vought Corporation is currently under contract to NASA Langley to develop design allowables for the DAZE fastener concept which will pace the fabrication technologies for carbon-carbon. Industry and government funded research is being focused on improving the mechanical properties, coating technology, structural efficiency, minimum gage and manufacturing technology of carbon-carbon. The aeroshell structural arrangement with either a hot or insulated structure is the subject of a patent disclosure and is being evaluated for future space launch vehicle systems.

AEROSHELL STRUCTURAL CONCEPT

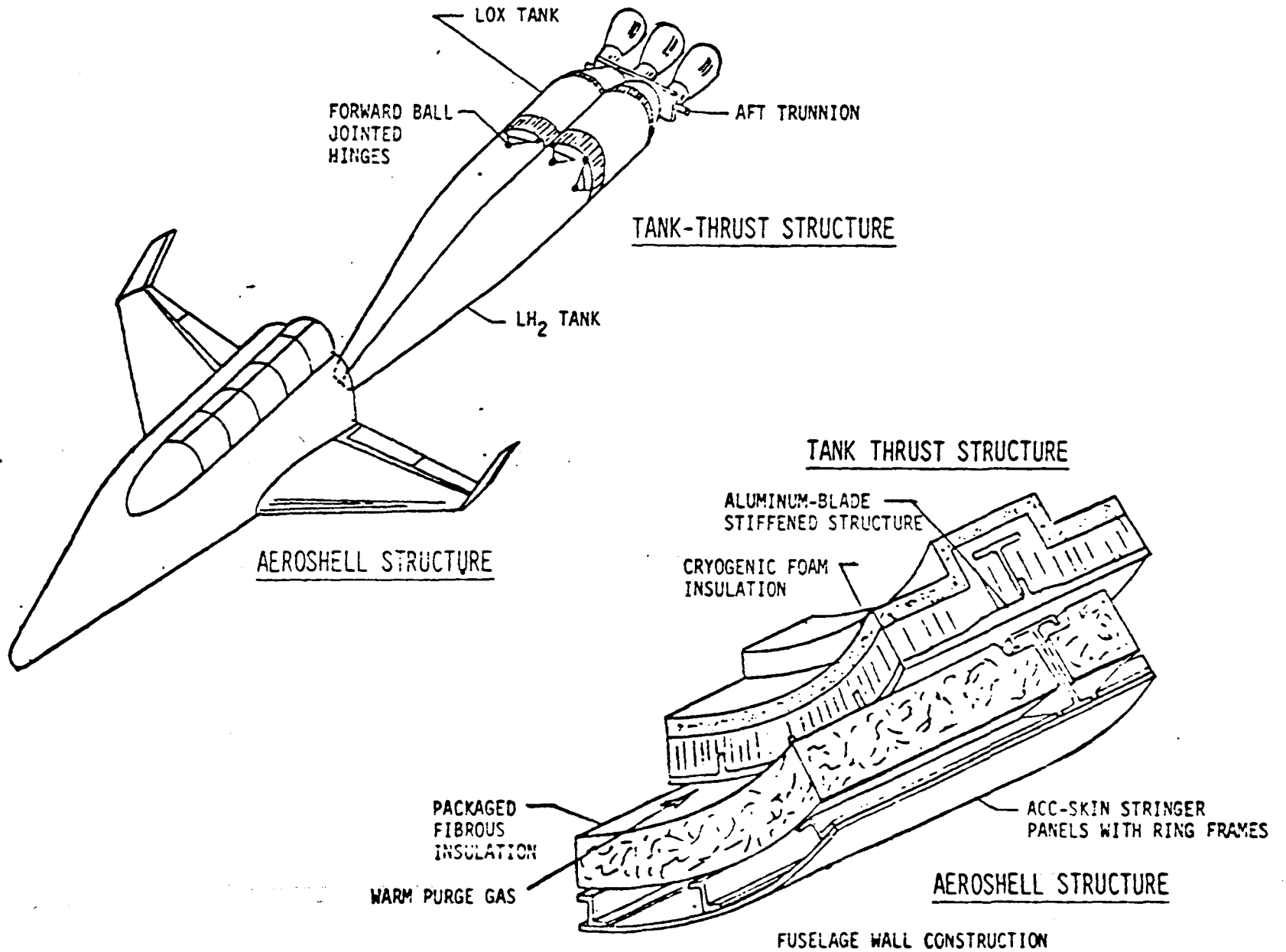

AEROSHELL STRUCTURE

TANK-THRUST STRUCTURE

TANK THRUST STRUCTURE

AEROSHELL STRUCTURE

FUSELAGE WALL CONSTRUCTION

ELEVATED TEMPERATURE THERMAL-STRESS-FREE FASTENERS ARE
CONCEIVED FOR JOINTS HAVING ORTHOTROPIC
FASTENER AND STRUCTURAL MATERIALS

Robert R. McWithey and Max L. Blosser
Structural Concepts Branch, SDD
Extensions 2414 and 2239
April 13, 1983

(RTOP 506-53-43)

Research Objective

Development of carbon-carbon hot structures requires development of joining concepts that will not adversely affect the integrity of the structure. One such concept uses metal fasteners to attach carbon-carbon stiffeners to a flat sheet of carbon-carbon as shown in the figure. The carbon-carbon material has unequal thermal coefficients of expansion (COE) in the inplane and thickness directions (denoted in the figure as β_r and β_z , respectively) which also differ greatly from the inplane and thickness COE's of the fastener material (α_r and α_z , respectively). These conditions will cause adverse thermal stresses in the joint if conventionally shaped fasteners are used. The research objective of the study is to determine fastener shapes that will maintain a thermal-stress-free joint while the joint undergoes a uniform temperature change.

Approach

Thermal deformations of the common interface between the fastener and structural material were examined to determine the initial surface shape required to prevent interference of the fastener and structural material during subsequent thermal growths of each material. The unequal COE's of the fastener and structural material were assumed independent of temperature in the analysis.

Accomplishment Descriptions

The equation defining the initial interface shape is shown in the figure as a power curve of the parabolic type in which the exponent is dependent on the COE's of the fastener and of the structural material. Suitable minimum and maximum fastener diameters are obtained by varying the carbon-carbon washer thickness and the coefficient of the powered term. Varying the COE values result in shapes having either negative curvature ($0 < N < 1$), conical shapes (the shape of the DAZE fastener with $N = 1$), or positive curvature ($N > 1$) as shown in this figure.

Future Plans

An in-house analytical study is being conducted to investigate the interference in joints with COE's that are moderately dependent on temperature. Vought Aircraft Co. is under contract to fabricate joints of this type using carbon-carbon as the structural material and metallic fasteners. Using IRAD funds Rockwell International Corp. is investigating this concept for use on the space shuttle vehicle.

ELEVATED TEMPERATURE THERMAL-STRESS-FREE FASTENERS ARE CONCEIVED FOR JOINTS HAVING ORTHOTROPIC FASTENER AND STRUCTURAL MATERIALS

EQUATION DEFINING FASTENER SHAPE: $Z = AR^N$ WHERE $N = \frac{\alpha_Z - \beta_Z}{\alpha_R - \beta_R}$

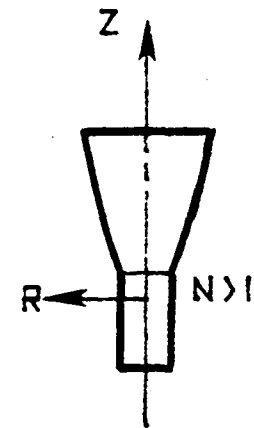
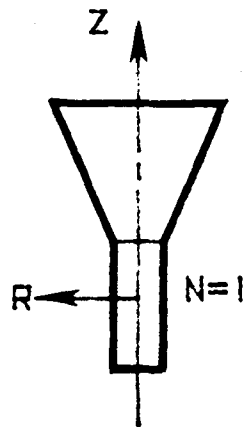
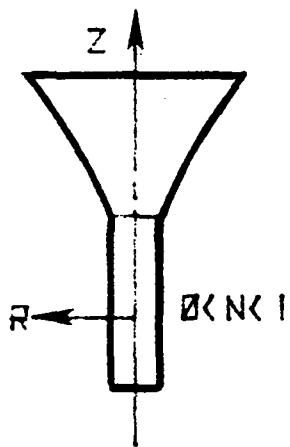
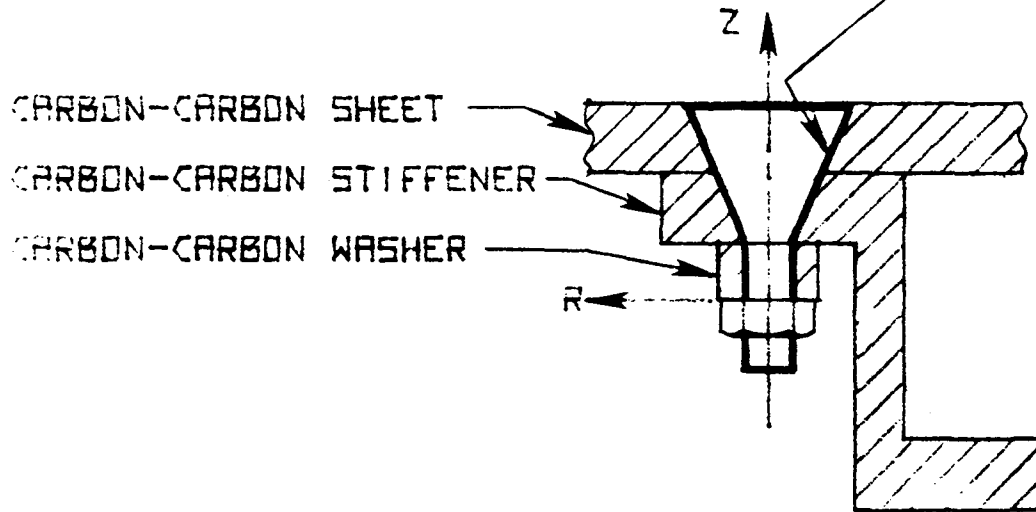

FASTENER SHAPES

STRUCTURAL TECHNOLOGY NEEDS DETERMINED FOR HTOL
TRANSATMOSPHERIC VEHICLE

L. Robert Jackson
Structural Concepts Branch, SDD
Extension 2414
May 18, 1983

(RTOP 506-53-43)

Research Objective

Provide a list of structural technology needs for a fully reusable, two-stage-to-orbit, horizontal takeoff transatmospheric vehicle.

Approach

Identify vehicle performance criteria, perform a system study to determine what is required to satisfy the criteria, define the aerothermal environments encountered, define for the aeroshell structural arrangement the best wall construction for the orbiter and define the best wall construction for the booster. Perform analyses to assist in the definition of the better structures including the structure of the air-breathing propulsion system, and evaluate the state-of-the-art of structural technologies to identify structural technology needs.

Accomplishment Description

Preliminary performance criteria have been identified, a system study is nearing completion wherein the impact of the performance criteria on gross weight is being assessed. The aeroshell structural concept has been identified as the better structural arrangement since it is only slightly heavier than an integral tank arrangement, but considerably more serviceable. A durable TPS insulated, graphite/polyimide aeroshell offers the better wall construction for the orbiter. Nickel-alloy heat pipes for the orbiter nose cap and leading edges offer all-weather service and low drag for high cross range. Carbon-carbon hot structures for movable control surfaces offers least weight for these structures, as well as, high temperature operation. A further technology need is a closed-cell cryogenic foam that has a higher reuse temperature than polyurethane foam, which is limited to 175°F. Box-stiffened-skin panels of titanium offer an efficient structure for the booster.

Future Plans

Complete the system study and report results. Pursue technology improvements for the aeroshell structure to reduce its weight. Study a water-tight carbon-carbon TPS tile for durable TPS. Perform analyses and cyclic tests of nickel-alloy heat pipes to determine their cycle life. Continue study of carbon-carbon hot structures for control surfaces, and continue R&T of box-stiffened-skin panels. Support the development of closed-cell polyimide foam for cryogenic tanks.

**A FULLY REUSABLE, TWO-STAGE, HORIZONTAL TAKEOFF
TRANSATMOSPHERIC VEHICLE**

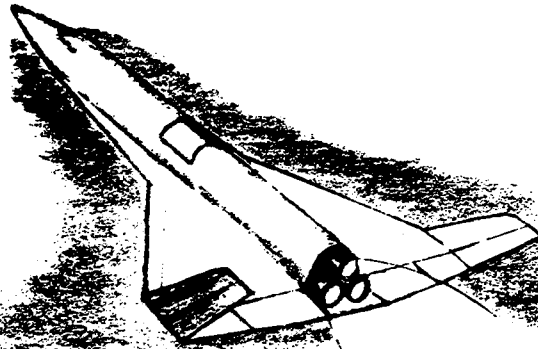

10 000 lb PAYLOAD (POLAR)
MACH 3 STAGING
GTOW — 2 400 000 lb
HARDENED STRUCTURE

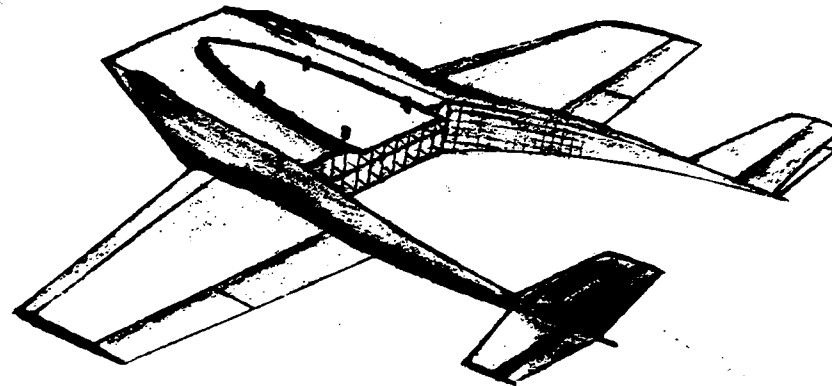

CRITICAL STRUCTURAL NEEDS

AEROSHELL CONCEPT
DURABLE TPS
HEAT PIPE LEADING EDGES
CARBON-CARBON CONTROLS
BOX-STIFFENED-SKIN PANELS
GRAPHITE/POLYIMIDE
STRUCTURE
CLOSED-CELL POLYIMIDE FOAM

CHARACTERIZATION STUDIES OF ADVANCED HYBRID METAL MATRIX
COMPOSITES SHOW SIGNIFICANT WEIGHT REDUCTION
FOR AIRCRAFT WINGS

Allan H. Taylor
Structural Concepts Branch, SDD
Extension 2414
June 22, 1983

(RTOP 505-33-53)

Research Objective

To design fabricate and test representative spar caps of advanced hybrid metal matrix composite materials to verify the fabrication process, material characterization and weight reduction potential for applications of these materials as structural components operating at 400°F.

Approach

Under a contract to Lockheed California Company, tee-shaped titanium (6Al-4V) spar cap reinforced with boron carbide coated boron filaments (B₄C-B) in an aluminum matrix was designed as a replacement for an all titanium upper spar cap for a representative supersonic cruise aircraft. The spar cap design was analyzed, fabricated and tested and the resulting weight reduction compared with the all titanium reference aircraft was assessed. A series of material evaluation tests using coupon size specimens was conducted. Static tension and compression strength and fatigue life including spar cap element tests were performed at both room and elevated temperatures to evaluate the compression load-carrying capability of the advanced spar cap designs.

Accomplishment Description

The application of advanced hybrid metal matrix composites for wing upper surface spar caps was verified. The static strength of the representative spar cap elements show good correlation between analysis and test. The B₄C-B/aluminum upper surface spar cap application resulted in a 8130 pound or 10.7% wing weight reduction or a 4.9% reduction in take-off gross weight for a 650,000 pound class supersonic cruise aircraft. The gross take off weight reductions assume a constant payload-range capability for each design.

Future Plans

As part of this contractual effort three spar caps of the B₄C-B/aluminum hybrid each three feet long were fabricated. Tension tests are currently planned at DFRC in order to obtain data on the static tension performance of this hybrid MMC after repeated thermal cycling.

CHARACTERIZATION STUDIES OF ADVANCED HYBRID METAL MATRIX COMPOSITES
 SHOW SIGNIFICANT WEIGHT REDUCTION FOR HIGH SPEED AIRCRAFT WINGS

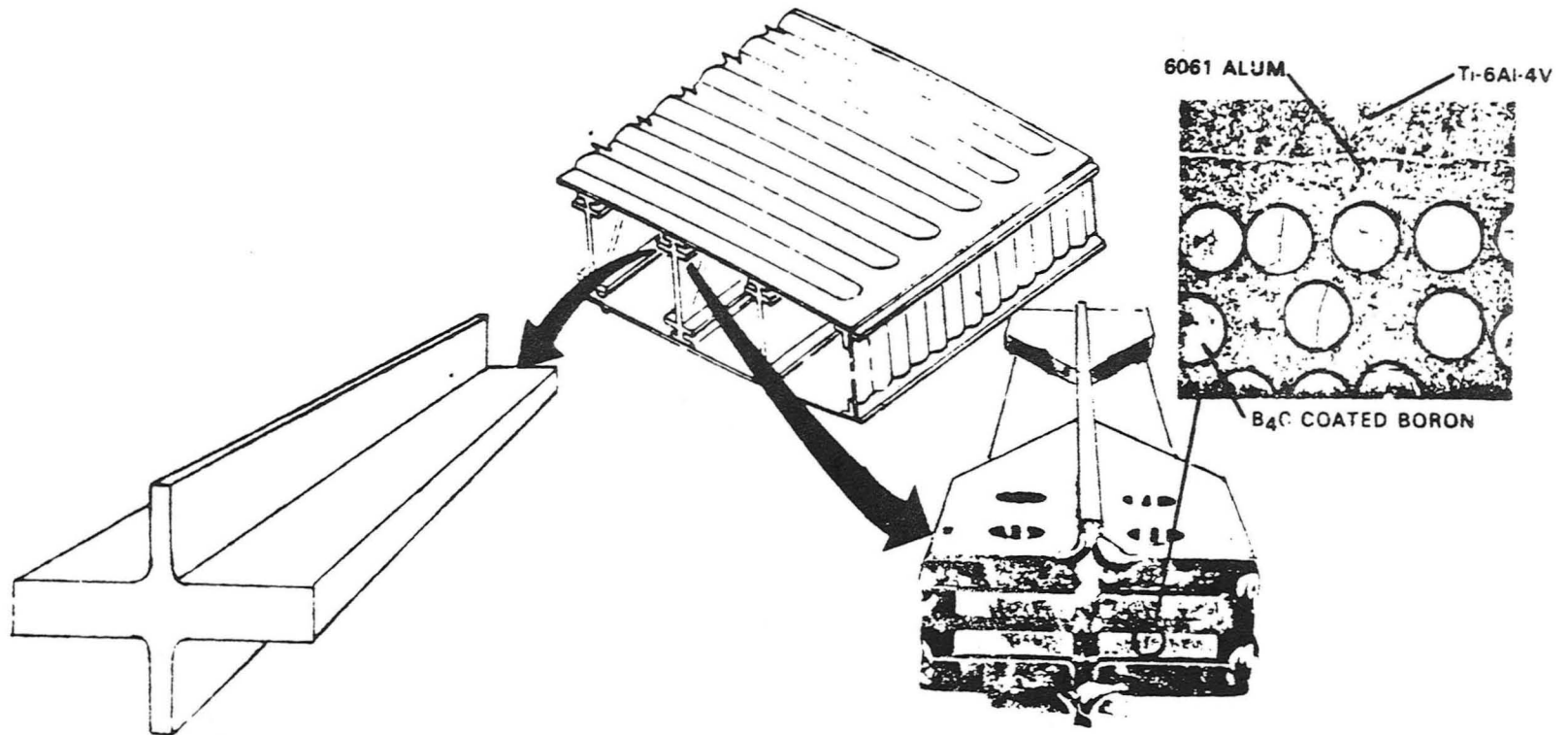

ALL TITANIUM (6AL-4V)
 BASELINE SPAR CAP

F_{ULT} = 143 KSI
 E = 16.4 MSI

WING WEIGHT = 75992 LB

B_4C -B/AL REINFORCEMENTS
 SPAR CAP

F_{ULT} = 266 KSI
 E = 22.0 MSI

RESIZED AIRCRAFT WING WEIGHT = 63425 LB (-12567 LB)

TENDON-CONTROLLED BOOM CONCEIVED

Martin M. Mikulas, Jr.
Structural Concepts Branch, SDD
Extension 2551
November 17, 1982

(RTOP 506-53-43)

Research Objectives

Deployable, controllable-geometry beams represent a class of structures with the potential of providing highly mobile and compactly packageable manipulator systems for space operations. One category of beam structure which appears to be particularly well suited for manipulator-boom applications is the tendon beam, which makes use of a segmented central column and flexible longerons ("tendons") supported on frames. The objective of this study is to formulate a concept for a deployable tendon beam by which the beam geometry can be controlled by varying the lengths of the tendons.

Approach

A concept development program was established under a task agreement contract with the Virginia Associated Research Campus (VARC), with Al Kyser as the principal investigator. The engineering program consisted of the design and fabrication of a series of simple working models suitable for the kind of experimentation needed to develop an understanding of the basic characteristics of this kind of structure.

Accomplishment Description

A workable concept for a tendon-controlled boom has been developed, and a working model has been designed and fabricated to demonstrate the concept. The model is shown in the accompanying figure in three representative shapes: straight, bending upward in an S-curve, and bending laterally in a C-curve. The model is made of Plexiglass tubing and Dacron line. There are six moveable segments, each of which has six tendon lines to control its angular orientation with respect to the adjacent supporting segment. The thirty-six tendons are lead to the root of the beam and thereby constitute the tension elements of the beam. The model is controlled from the base by means of a three-arm lever on which the tendons are anchored. The lever control system, which is intended for concept demonstration only, constrains the motion of the model to four structural degrees of freedom (modes). The model has proven to be stable and controllable throughout the range of shapes permitted by the four modes. The concept is, therefore, considered to be suitable for further development.

Future Plans

Work has begun on the design of a deployment system for the tendon-controlled beam, and a model to demonstrate the deployability is being designed. Work has also begun on the development of a computer-based control system by which a motorized model could be manipulated through commands from a joystick. Future plans are to continue the development of the deployment system and the control system toward the demonstration of deployable, remotely controlled "breadboard" model.

TENDON CONTROLLED BOOM CONCEIVED

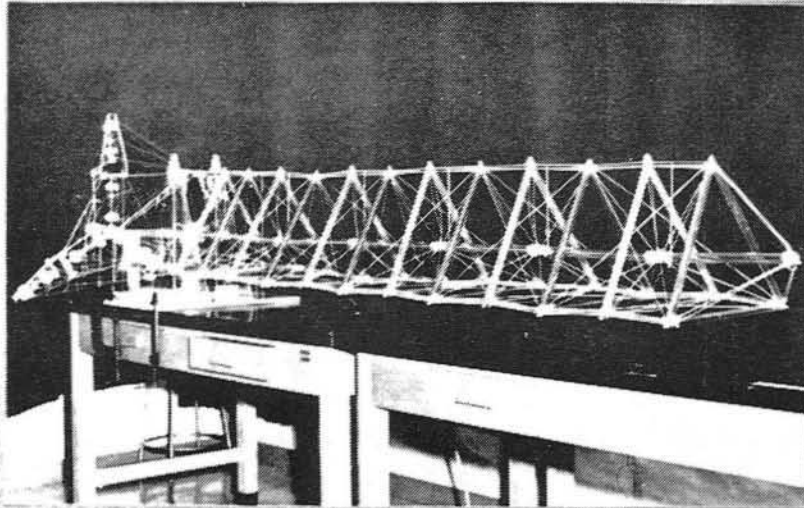

ADVANTAGES

- SIMPLE JOINTS
- SIMPLE ACTUATORS
- EFFICIENT PACKAGING

DISADVANTAGE

- COMPLEX DEPLOYMENT

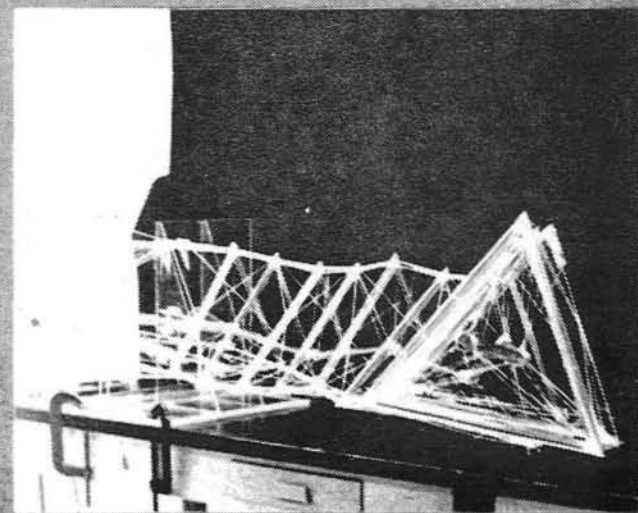
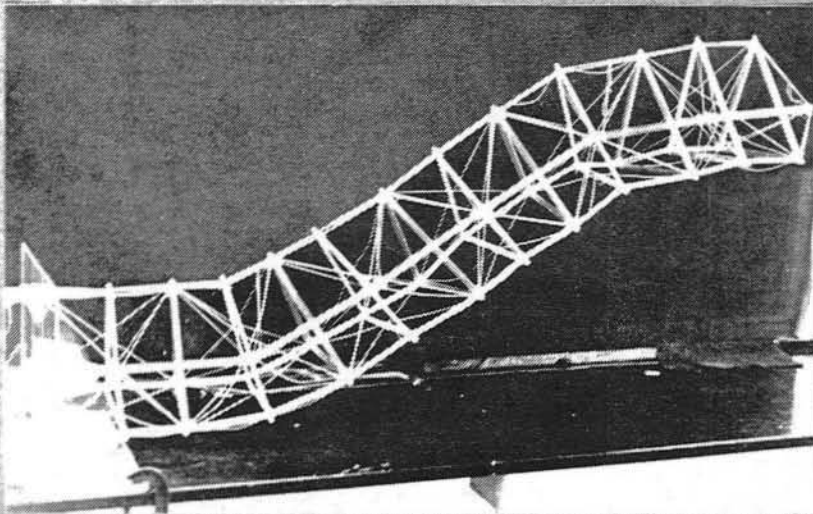

IMPACT DAMPING SUBSTANTIALLY REDUCES
SLENDER STRUT VIBRATIONS

Harold G. Bush, and R. T. Volland (Co-op)
Structural Concepts Branch, SDD
Extension 2498
January 17, 1983

RTOP 506-53-43

Research Objectives

To achieve high packaging efficiency for deployable truss antennas or platforms, structural elements of extreme slenderness must be used. Such slender struts will vibrate easily, consequently, concepts are needed for damping these vibrations. The objective of this study is to identify practical damping concepts which will fit within the constraints of very slender struts.

Approach

A slender steel tube, 12 ft. long by 1/2 in. diameter, was supported vertically on elastic end fixtures as shown in the attached figure. A target was bonded to the tube and a proximity gage was externally supported to measure lateral mid-point displacement (X) of the tube. The tube was "plucked" and the resultant vibratory displacement history recorded on a strip chart. Small diameter lead shot was suspended on one lightweight monofilament fishing line from the top to hang at various levels along the length of the tube. The inset on the figure shows a typical location of the split lead shot which merely clamped on the line.

Accomplishment Description

In the figure, the displacement history of a bare steel tube is shown. A small amount of damping is shown to be present, typical of support friction effects and/or inherent material damping. To obtain an experimental data base on preliminary damping concepts, various combinations of lead shot were investigated. The displacement history shown on the figure for the damped tube resulted from one lead shot located at each of the quarter points (3 total) suspended on a single line from the tube top. Damping coefficients (C) were calculated by the logarithmic decrement method for both the bare tube and the lead shot damped tube. The ratio of damping coefficients given on the figure show that the lead shot combination cited increased the damping over a bare tube by approximately an order of magnitude. This result illustrates that relatively simple passive concepts can yield significant increases in system damping and should not be overlooked in a search for ways to control space structure vibrations.

Future Plans

Other damping concepts for slender struts will be investigated using graduate student services through a grant with Dr. Razzaq at Old Dominion University.

IMPACT DAMPING SHOWS PROMISE FOR SUBSTANTIALLY REDUCING SLENDER STRUT VIBRATIONS

121

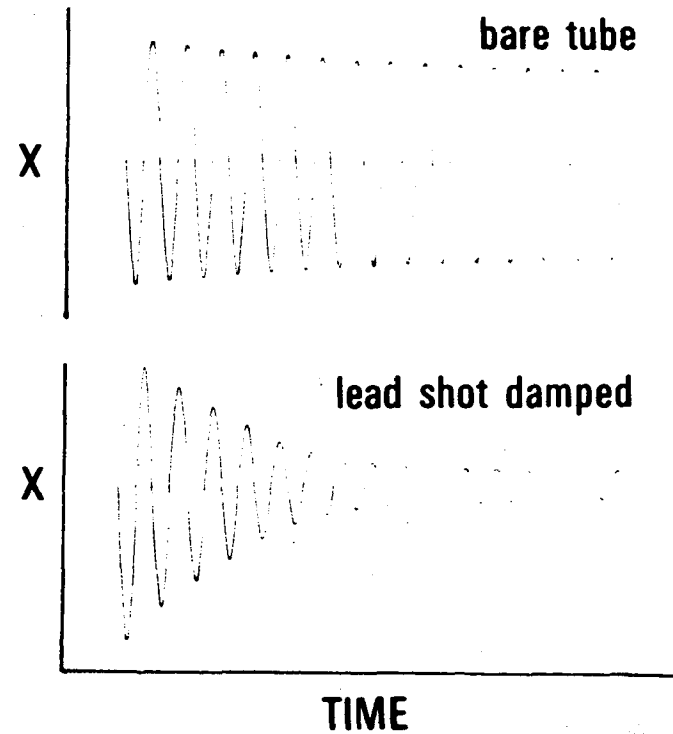
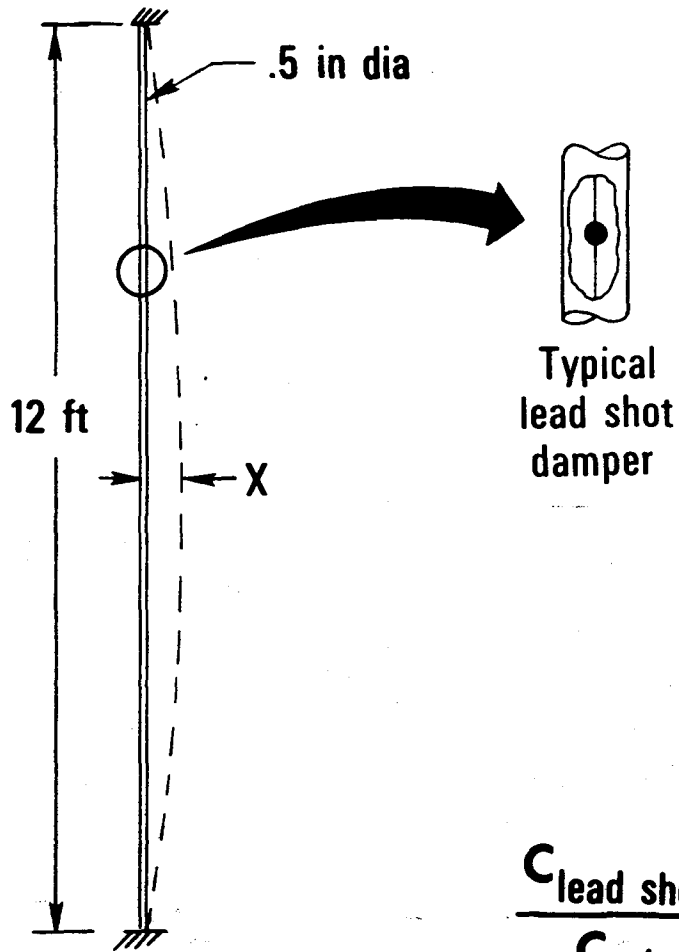

$$\frac{C_{\text{lead shot}}}{C_{\text{tube}}} = 9.35$$

SEQUENTIALLY DEPLOYING TRUSS

W. B. Fichter
Structural Concepts Branch, SDD
Extension 3596
January 5, 1983

(RTOP 506-53-43)

Research Objective

Deployable trusses represent a class of structures with the potential for providing compactly packaging support systems for space operations. The objective of this study is to develop a sequentially deployable, three-dimensional truss which possesses the following features:

1. At all times during erection, most of the structure is either securely stowed or fully erected.
2. At any time, only a small number of members are in transition.
3. Parts in transition can be carefully controlled.

Approach

A concept-development program was established through a contract with Astro Research Corporation, with John M. Hedgepeth as the principal investigator. The engineering program consisted of the necessary geometrical analysis to establish the type of truss and appropriate hinge angles and locations, and the construction of a concept-validation model.

Accomplishment Description

A three-dimensional geometrical analysis for determining member lengths and hinge location and orientation has been conducted. Also, a high-fidelity working model of a single-bay, three-dimensional truss has been constructed in order to validate the concept and supporting analysis. The figure shows the high-fidelity model in various stages of erection from fully folded to fully deployed. The deployed-to-packaged volume ratio is obviously high.

Future Plans

Currently under construction is a three-bay model containing one-meter-long, 0.5-inch-diameter graphite epoxy members, which is scheduled for delivery in early 1983. Near-future plans are for the design of a robotic device to effect truss deployment in a manner which exploits the reliability advantages of sequential deployment.

SEQUENTIALLY DEPLOYING TRUSS MODEL

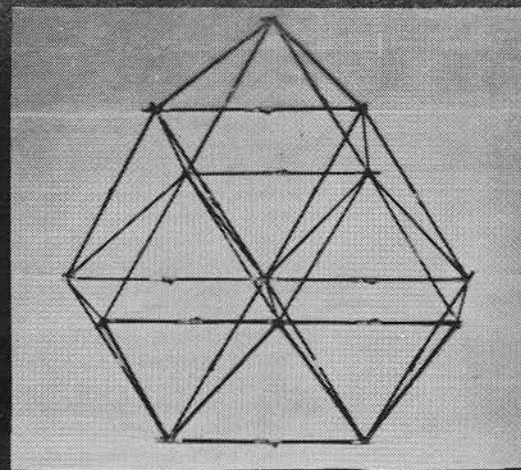
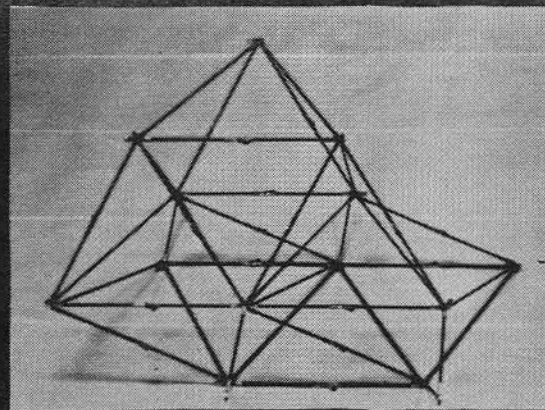
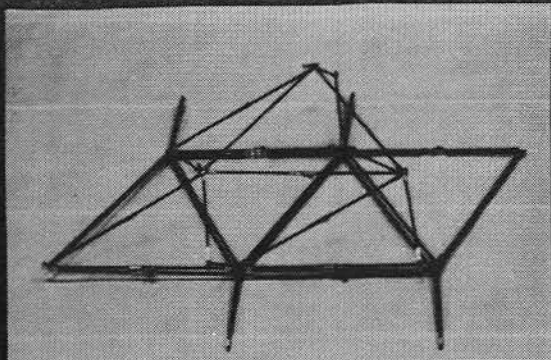
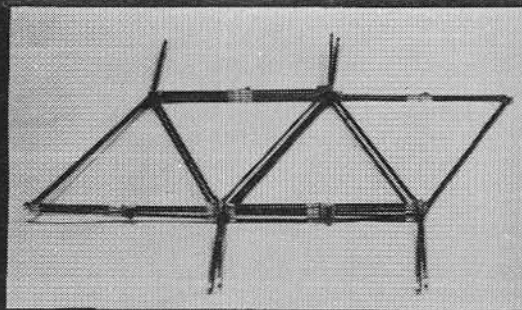
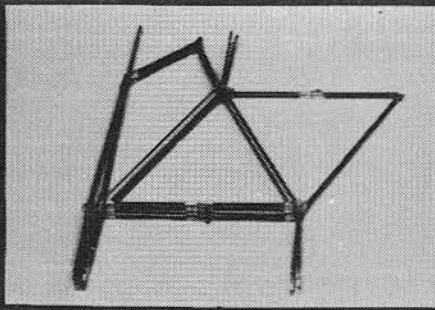
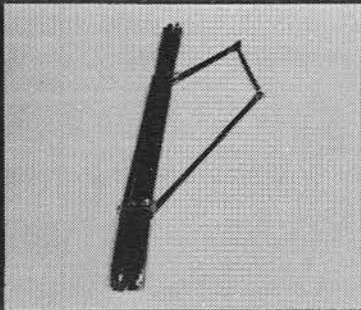
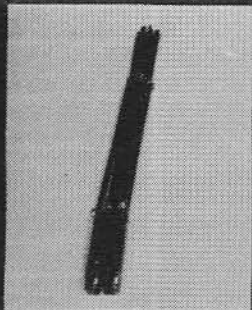

FINITE-ELEMENT ANALYSIS ACCURATELY PREDICTS WRINKLING
IN FLAT RECTANGULAR MEMBRANE

W. B. Fichter
Structural Concepts Branch, SDD
Extension 3719
February 18, 1983

(RTOP 506-53-43)

Research Objective

To develop a general finite-element analysis capability for predicting the mechanical behavior of membrane structures, including nonlinear geometric effects and wrinkling in an averaged sense. Several envisioned large reflectors incorporate some type of membrane structure. Wrinkling is expected to impact reflector accuracy.

Approach

Initially, through a research grant to the University of Southern California, develop finite-element algorithms for stress-strain behavior in taut, wrinkled and flat regions of wrinkled membranes. Incorporate these algorithms into a general purpose finite element program at the University of Southern California. Generalize the existing triangular-element algorithm to facilitate the use of eight-noded and possibly higher-order quadrilateral elements, thereby improving computational efficiency. Demonstrate progress through analysis of benchmark problems for which analytical solutions exist. Also, extend the algorithm capability to three-dimensional membrane wrinkling problems.

Accomplishment Description

The finite-element algorithm incorporating eight-noded quadrilateral elements has been developed and used to investigate the wrinkling of a stretched rectangular membrane under in-plane bending (NASA TN D-813). As shown in the figure, the finite-element analysis accurately predicts the moment-curvature relation for the partly wrinkled membrane when at least 70% ($b = 0.7$) of the \bar{h} membrane has wrinkled. In addition, generalization of the algorithm to the case of large deformations has been accomplished, but has not yet been tested.

Future Plans

The large-deformation generalization will be tested. The finite-element algorithm is to be tested against existing analytical solutions to other problems, such as the wrinkling of a stretched flat membrane by the rotation of an attached hub. Also planned is the extension of the analysis to three-dimensional membrane problems such as the wrinkling of shallow membrane shells. In addition, further improvements in computational efficiency are being pursued.

FINITE-ELEMENT ANALYSIS ACCURATELY PREDICTS WRINKLING IN FLAT STRETCHED RECTANGULAR MEMBRANE

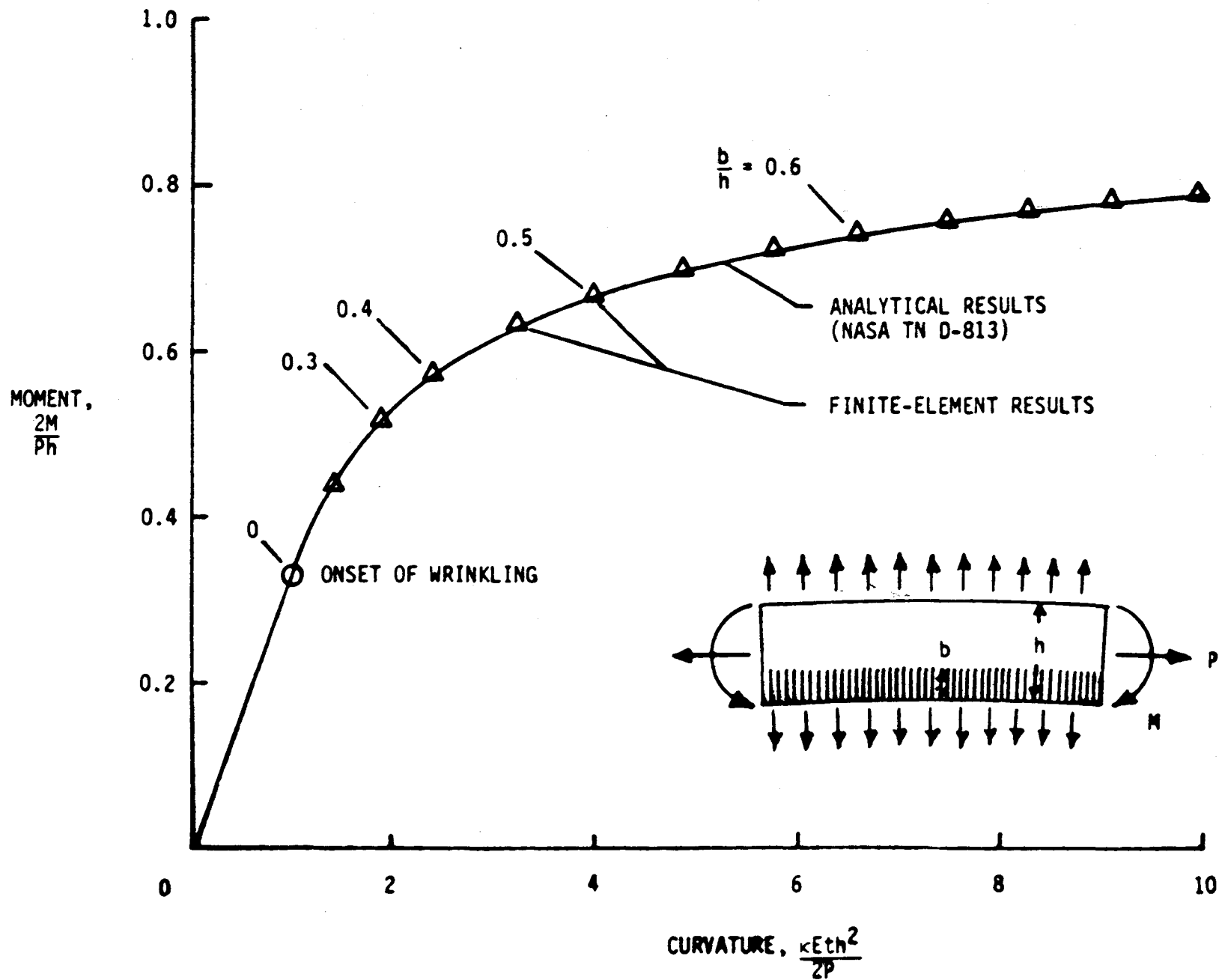

CONTROLLABLE GEOMETRY GEODESIC TRUSS BEAM MODEL DEVELOPED

Marvin D. Rhodes and Martin M. Mikulas, Jr.
Structural Concepts Branch, SDD
Extensions 3596 and 2551
September 22, 1983

(RTOP 506-53-43)

Research Objective

Highly packageable and deployable beam concepts having controllable geometry are being developed for use as manipulator arms, docking and module pointing devices, and positioning platforms for use in space applications. One concept which has considerable potential for all of these applications is the geodesic truss beam which is formed from triangular frames joined together at the apexes. The research objective of this study is to develop efficient structural joints which have the required degrees of freedom to permit deployability and controllable geometry and demonstrate the concept in a working model.

Approach

An in-house investigation was initiated which examined a number of joint configurations and evaluated their potential for use in a laboratory model. Several joint configurations were examined in a closely coordinated activity between the responsible research engineer and highly skilled machinist in Langley's Advanced Machining Development Section. This permitted an efficient exchange of ideas and full understanding of the basic structural requirements.

Accomplishment Description

A working two bay model has been designed and fabricated which clearly demonstrates the potential of the concept as a controllable geometry structure. This model is shown in the accompanying figure in three representative shapes: deployed straight, canted to the left in a C curve, and fully retracted in a compact package. This model is fabricated from aluminum tubing using the joints that were machined from aluminum and steel components. The deployment and geometry of each bay is controlled by the independent telescopic action of three members. The model has been recently retrofitted with motor-driven actuators and has been evaluated in a number of structural tests for different geometric configurations. A simplified finite element model has also been developed for comparison with test results. The concept has proven to be stable and highly controllable throughout the range desired and is considered to be acceptable for use in all applications for which it was developed.

Future Plans

A refined analysis which includes detail modeling of the joints is being considered. The development of future models which incorporate refinements and have feedback control systems to accurately position the beam tip and do so in the most structurally efficient manner are also under consideration.

TWO BAY CONTROLLABLE GEOMETRY GEODESIC TRUSS MODEL

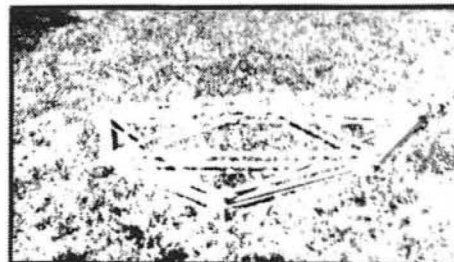
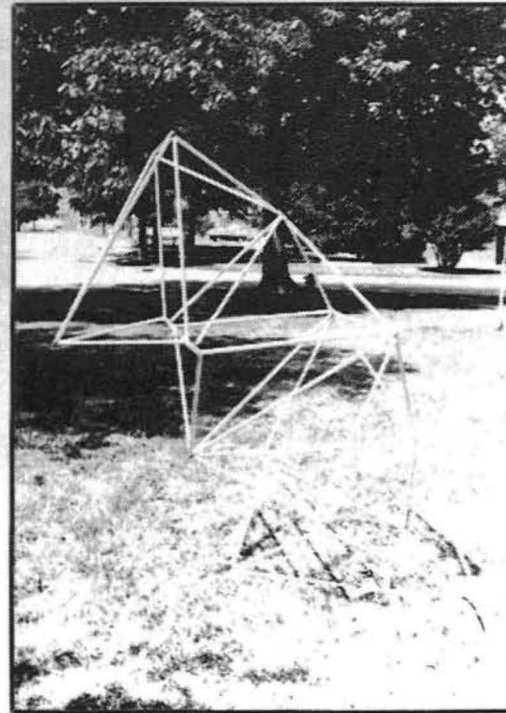
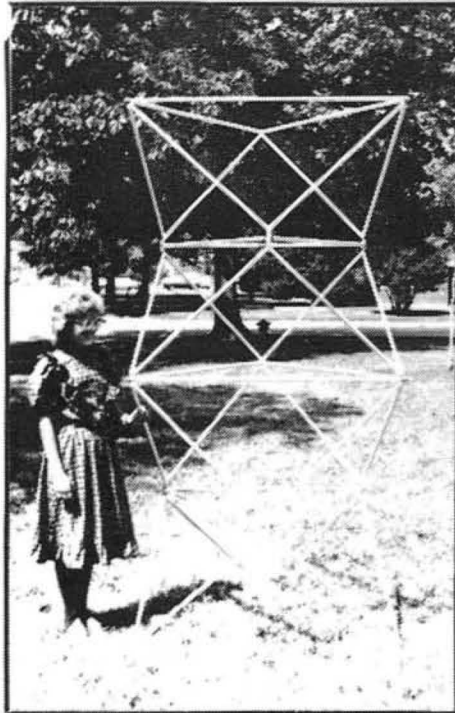

1. Report No. NASA TM-85828		2. Government Accession No.		3. Recipient's Catalog No.	
4. Title and Subtitle Structures and Dynamics Division Research and Technology Plans for FY 1984 and Accomplishments for FY 1982				5. Report Date June 1984	
				6. Performing Organization Code 505-33-33-06	
7. Author(s) Kay S. Bales				8. Performing Organization Report No.	
9. Performing Organization Name and Address NASA Langley Research Center Hampton, VA 23665				10. Work Unit No.	
				11. Contract or Grant No.	
12. Sponsoring Agency Name and Address National Aeronautics and Space Administration Washington, DC 20546				13. Type of Report and Period Covered Technical Memorandum	
				14. Sponsoring Agency Code	
15. Supplementary Notes					
16. Abstract This paper presents the Objectives, Expected Results, Approach, and FY 1984 Milestones for the Structures and Dynamics Division's research programs. FY 1983 Accomplishments are presented where applicable. This information is useful in program coordination with other government organizations in areas of mutual interest.					
17. Key Words (Suggested by Author(s)) Computer-aided design; IPAD; General aviation/transport crash dynamics; Aircraft ground performance; Composite structures; Failure analysis; Space vehicle dynamics; Large space structures				18. Distribution Statement Unclassified - Unlimited Subject Category 39	
19. Security Classif. (of this report) Unclassified		20. Security Classif. (of this page) Unclassified		21. No. of Pages 132	22. Price A07

