

1984-01-15

JPL PUBLICATION 84-43

NASA-CR-173893  
19840024333

# Telecommunications and Data Acquisition Support for the Pioneer Venus Project

## Pioneers 12 and 13, Prelaunch Through March 1984

R.B. Miller  
R.E. Ryan  
N.A. Renzetti  
M.R. Traxler

July 1, 1984

**LIBRARY COPY**

SEP 10 1984



National Aeronautics and  
Space Administration

Jet Propulsion Laboratory  
California Institute of Technology  
Pasadena, California

LANGLEY RESEARCH CENTER  
LIBRARY, NASA  
HAMPTON, VIRGINIA

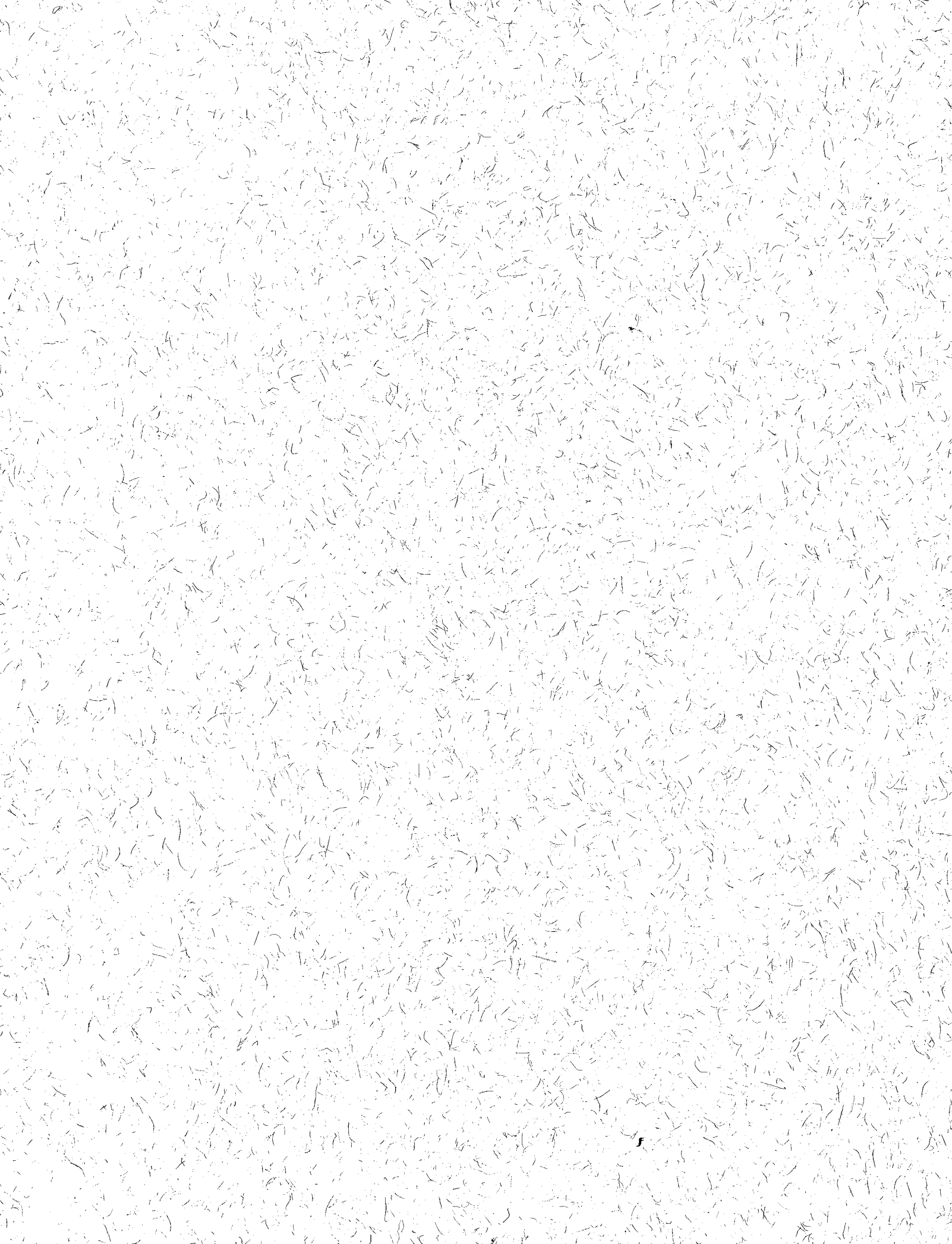

DISPLAY 01/2/1

84N32403\*\* ISSUE 22 PAGE 3539 CATEGORY 12 RPT#: NASA-CR-173893  
JPL-PUB-84-43 NAS 1.26:173893 84/07/01 70 PAGES UNCLASSIFIED DOCUMENT

UTTL: Telecommunications and data acquisition support for the Pioneer Venus  
Project: Pioneers 12 and 13, prelaunch through March 1984 TLSP: Final  
Report

AUTH: A/MILLER, R. B.; B/RYAN, R. E.; C/RENZETTI, M. A.; D/TRAXLER, M. R.  
CORP: Jet Propulsion Lab., California Inst. of Tech., Pasadena. AVAIL. NTIS  
SAP: HC A04/MF A01

MAJS: /\*DATA ACQUISITION/\*DEEP SPACE NETWORK/\*PIONEER VENUS SPACECRAFT/\*  
SPACECRAFT COMMUNICATION/\*TELEMETRY/\*VENUS PROBES/\*VERY LONG BASE  
INTERFEROMETRY

MINS: / ATMOSPHERIC COMPOSITION/ DATA TRANSMISSION/ DEEP SPACE INSTRUMENTATION  
FACILITY/ IONOSPHERE/ PIONEER VENUS 2 ENTRY PROBES/ PULSE MODULATION/  
UPLINKING/ VENUS ATMOSPHERE/ WIND VELOCITY MEASUREMENT

ABA: Author

ABS: The support provided by the Telecommunications and Data Acquisition  
organization of the Jet Propulsion Laboratory (JPL) to the Pioneer Venus  
missions is described. The missions were the responsibility of the Ames  
Research Center (ARC). The Pioneer 13 mission and its spacecraft design  
presented one of the greatest challenges to the Deep Space Network (DSN)  
in the implementation and operation of new capabilities. The four probes  
that were to enter the atmosphere of Venus were turned on shortly before

ENTER:

DISPLAY 01/2/1

arrival at Venus, and the DSN had to acquire each of these probes in order  
to recover the telemetry being transmitted. Furthermore, a science  
experiment involving these probes descending through the atmosphere  
required a completed new data type to be generated at the ground stations.  
This new data type is known as the differential very long baseline  
interferometry. Discussions between ARC and JPL of the implementation  
requirements involved trade-offs in spacecraft design and led to a very  
successful return of science data. Specific implementation and operational  
techniques are discussed, not only for the prime mission, but also for the  
extended support to the Pioneer 12 spacecraft (in orbit around Venus) with  
its science instruments including that for radar observations of the  
planet.



# Telecommunications and Data Acquisition Support for the Pioneer Venus Project

Pioneers 12 and 13, Prelaunch Through March 1984

R.B. Miller  
R.E. Ryan  
N.A. Renzetti  
M.R. Traxler

July 1, 1984



National Aeronautics and  
Space Administration

**Jet Propulsion Laboratory**  
California Institute of Technology  
Pasadena, California

1984-32403#



# Telecommunications and Data Acquisition Support for the Pioneer Venus Project

Pioneers 12 and 13, Prelaunch Through March 1984

R.B. Miller  
R.E. Ryan  
N.A. Renzetti  
M.R. Traxler

July 1, 1984



National Aeronautics and  
Space Administration

**Jet Propulsion Laboratory**  
California Institute of Technology  
Pasadena, California

The research described in this publication was carried out by the Jet Propulsion Laboratory, California Institute of Technology, under a contract with the National Aeronautics and Space Administration.

Reference herein to any specific commercial product, process, or service by trade name, trademark, manufacturer, or otherwise, does not constitute or imply its endorsement by the United States Government or the Jet Propulsion Laboratory, California Institute of Technology.



## ABSTRACT

This is the final report on the support provided by the Telecommunications and Data Acquisition organization of the Jet Propulsion Laboratory (JPL) to the Pioneer Venus missions. The missions were the responsibility of the Ames Research Center (ARC).

The Pioneer 13 mission and its spacecraft design presented one of the greatest challenges to the Deep Space Network (DSN) in the implementation and operation of new capabilities. The four probes that were to enter the atmosphere of Venus were turned on shortly before arrival at Venus, and the DSN had to acquire each of these probes in order to recover the telemetry being transmitted. Furthermore, a science experiment involving these probes descending through the atmosphere required a completely new data type to be generated at the ground stations. This new data type is known as the differential very long baseline interferometry.

Discussions between ARC and JPL of the implementation requirements involved trade-offs in spacecraft design and led to a very successful return of science data. Specific implementation and operational techniques are discussed in the report, not only for the prime mission, but also for the extended support to the Pioneer 12 spacecraft (in orbit around Venus) with its science instruments including that for radar observations of the planet.

## PREFACE

Since its establishment in 1958, NASA has conducted 13 spaceflight missions bearing the name Pioneer. Pioneers 1 through 5, launched between 1958 and 1960, were the first lunar exploration missions initiated by the U.S. The management and direction of these first generation missions was delegated by NASA to the Air Force (Pioneers 1, 2, and 5) and the Army (Pioneers 3 and 4). In 1962, the NASA Office of Space Science and Applications assigned the Pioneer Program to the Ames Research Center (ARC). Pioneers 6 through 9, launched between 1965 and 1969, were second generation space missions designed by ARC to investigate the plasma, particles, and fields in the regions between Venus, Earth, and Mars. All four spacecraft are still in operation, reporting periodically on space weather conditions. The Pioneer 10 and 11 missions were designed to investigate the environmental and atmospheric characteristics of the planet Jupiter. Pioneer 10 encountered Jupiter in December 1973 and is now following a trajectory that has made it the first man-made object to go beyond the known planets of our solar system. Pioneer 11 encountered Jupiter in December 1974 and was targeted for Saturn, which it encountered in September 1979. Both spacecraft are still operating. The Pioneer 11 eventually will also leave the solar system, but in a nearly opposite direction from Pioneer 10. Pioneers 12 and 13, which make up the mission known as Pioneer Venus, are the subject of this document.

This report covers the Telecommunications and Data Acquisition support of the Pioneer Venus mission from its inception through launch and primary mission, and extended missions through March 1984.

N. A. Renzetti, Manager  
Mission Support Office

## ACKNOWLEDGEMENT

The authors wish to acknowledge the considerable efforts of the staff of the TDA organization; the staff of the Pioneer Project at the Ames Research Center, and the NASA Headquarters personnel in the Office of Space Tracking and Data Systems, particularly M. E. Binkley and A. C. Belcher, for making it possible to achieve both the technical configuration of the DSN and its operational capabilities to carry out one of its most demanding missions.



## CONTENTS

I.	INTRODUCTION . . . . .	1-1
A.	OVERVIEW . . . . .	1-1
B.	PIONEER VENUS PROJECT BACKGROUND . . . . .	1-2
C.	PIONEER VENUS PROJECT ORGANIZATION . . . . .	1-4
D.	THE SCIENTIFIC BACKGROUND . . . . .	1-4
II.	TRACKING AND DATA SYSTEMS ORGANIZATION AND RESOURCES . . . . .	2-1
A.	INTRODUCTION . . . . .	2-1
B.	NEAR-EARTH PHASE . . . . .	2-5
C.	DEEP SPACE PHASE . . . . .	2-7
1.	DSN Facilities . . . . .	2-7
2.	DSN Systems . . . . .	2-8
D.	TDS-PIONEER VENUS INTERFACE CONFIGURATIONS . . . . .	2-9
III.	MISSION PROFILE . . . . .	3-1
A.	MISSION DESCRIPTION . . . . .	3-1
1.	Multiprobe Mission Design . . . . .	3-1
2.	Orbiter Mission Design . . . . .	3-3
B.	SPACECRAFT DESCRIPTION . . . . .	3-5
1.	The Basic Buses . . . . .	3-5
2.	Orbiter Spacecraft . . . . .	3-5
3.	Multiprobe Spacecraft . . . . .	3-8
IV.	PROJECT REQUIREMENTS . . . . .	4-1
A.	INTRODUCTION . . . . .	4-1
1.	Multiprobe Entry Telemetry Recovery . . . . .	4-1
2.	Multiprobe Data Acquisition for Atmospheric Wind Velocity Measurements . . . . .	4-5
3.	Orbiter Occultation Data Recording . . . . .	4-6
V.	OPERATIONS AND PERFORMANCE SUMMARY . . . . .	5-1
A.	MISSION PROFILE . . . . .	5-1

CONTENTS (Cont'd)

1.	Multiprobe Encounter . . . . .	5-1
2.	Orbiter . . . . .	5-1
B.	DSN SUPPORT . . . . .	5-6
C.	SPACECRAFT STATUS . . . . .	5-8
VI. EPILOGUE . . . . .		
		6-1
VII. REFERENCES . . . . .		
		7-1
APPENDIX		
A.	PIONEER VENUS 1978 MISSION SUPPORT . . . . .	A-1
<u>Figures</u>		
1-1.	Pioneer Venus Project Structure . . . . .	1-5
2-1.	Pioneer Venus Project and the Tracking and Data Systems Relationship . . . . .	2-2
2-2.	JPL Office of Tracking and Data Acquisition 1978 . . . . .	2-4
2-3.	JPL Organization Supporting Pioneer Venus 1978 . . . . .	2-10
2-4.	Telemetry and Command Ground Data System Configuration . . .	2-11
2-5.	TDS Radio Metric Data Configuration for Pioneer Venus . . .	2-12
3-1.	Pioneer Venus Mission Profile . . . . .	3-2
3-2.	Orbit Design . . . . .	3-4
3-3.	Orbiter Spacecraft Configuration . . . . .	3-6
3-4.	Multiprobe Spacecraft Configuration . . . . .	3-9
3-5.	Large Probe . . . . .	3-11
3-6.	Small Probes . . . . .	3-11
3-7.	Sectional View of Large Probe Descent Module . . . . .	3-12
3-8.	Sectional View of Small Probe Pressure Vessel . . . . .	3-12
4-1.	Pioneer Venus Multiprobe Entry Data Recovery Configuration at the Deep Space Stations . . . . .	4-3
4-2.	Study Team Functional Concept Decimation Process . . . . .	4-8
4-3.	Actual and Predicted Occultation Signal Profiles . . . . .	4-9
4-4.	Real-time Bandwidth Reduction Overview Block Diagram . . . .	4-11

CONTENTS (Cont'd)

5-1.	View From Earth of Multiprobe Entry Locations . . . . .	5-2
5-2.	Typical Orbital Operations Through the Mission . . . . .	5-4
5-3.	Special Activities Supported on Pioneer Venus . . . . .	5-7

Tables

1-1.	Spacecraft Missions to Venus up to 1978 . . . . .	1-7
5-1.	Probe Entry Events . . . . .	5-2
5-2.	Planned and Initial Orbit Parameters . . . . .	5-3





## SECTION I

### INTRODUCTION

#### A. OVERVIEW

This report describes the Telecommunications and Data Acquisition (TDA) support of the Pioneer 12 and 13 missions to Venus, which was in some respects the most challenging mission support required to date of NASA's Deep Space Network (DSN).

The Pioneer Program is a part of a NASA solar system exploration program under the direction of the Office of Space Science and Applications. The program (beginning with Pioneer 6) was managed and technically directed by the Ames Research Center (ARC) located at Moffett Field, California. The TDA support, the subject of this report, was the responsibility of JPL under the direction of the Office of Space Tracking and Data Acquisition (OSTDS). The earlier projects consisted of four heliocentric orbiter missions, Pioneers 6 through 9, and the Pioneer 10 and 11 missions to Jupiter and Saturn. Pioneer Venus is the sixth project in the program. It consists of two scientifically related spacecraft missions: an orbiter and a multiprobe which were launched to encounter Venus during early December 1978. Prior to encounter, the multiprobe separated into five vehicles: four probes and a bus which were designed for atmospheric entry and descent to the surface of the planet. The broad scientific objectives were:

1. Global mapping of the Venusian clouds, atmosphere, and ionosphere.
2. Investigation of the composition, structure and dynamics of the clouds and atmosphere down to the planetary surface.
3. Mapping of the planetary surface.
4. Determination of the gravitational field.
5. Study of the Venus solar wind interaction.

To accomplish these objectives, the orbiter and multiprobe conducted 27 scientific experiments involving 30 separate instruments. Seven Earth-based radio science experiments were performed using the S- and X-band radio signals transmitted by the spacecraft.

Two unique Pioneer Venus requirements that were particularly demanding on TDA were the simultaneous recovery of the four multiprobe telemetry streams during atmospheric entry and the execution of a state-of-the art interferometry experiment. This recovery involved the simultaneous operation of eighteen receivers located at two ground stations and special receivers at two other ground stations that supported the one-time-only, two-hour entry event.

Both spacecraft were launched from Cape Canaveral Launch Complex 36, using Atlas Centaur (SLV-3D/D-1AR) launch vehicles. The orbiter was launched on May 20, 1978 on a Type II transit trajectory\* and arrived at Venus on December 4, 1978. The spacecraft was successfully inserted into orbit on that date to begin the primary mission of 243 earth days (one Venus day).

The multiprobe was launched on August 8, 1978 on a Type I trajectory and arrived at Venus on December 9, 1978. The four probe vehicles were released from the bus and successfully transmitted data to Earth as they descended to the surface of the planet. The bus vehicle entered after the probes and, before its destruction by heating in the upper atmosphere, successfully transmitted data to Earth as planned. Three of the four probes ceased operation on impact with the surface of Venus as expected. The fourth probe, however, continued transmitting after impact for approximately one hour.

The orbiter completed its primary mission on August 4, 1979, and as of January 1984 is still operating in an extended mission phase. The spacecraft is expected to remain operable until 1992, when its orbit is predicted to enter the Venusian atmosphere.

## B. PIONEER VENUS PROJECT BACKGROUND

In 1967 a team of scientists under the auspices of the National Academy of Sciences joined with the Goddard Space Flight Center (GSFC) to study the

---

\*Interplanetary spacecraft trajectories are classified by the heliocentric transfer angle, which is the angle between the Sun-Earth line at launch and the Sun-planet line at encounter. The arc between these two lines is the path traveled by the spacecraft from Earth to planet encounter. Type I trajectories have a transfer angle less than  $180^{\circ}$ . Type II trajectories have an angle between  $180^{\circ}$  and  $360^{\circ}$ .

feasibility of a small Venus atmospheric probe. However, during 1968, the Space Science Board of the National Academy of Sciences conducted a study of the purpose and future direction of planetary exploration. The Board recommended that NASA avoid single scientific goals and emphasize the contribution planetary exploration can make to a broad range of scientific disciplines. To achieve broader scientific participation, the Board emphasized the need for modest, relatively low-cost missions. These recommendations resulted in engineering studies at GSFC into the feasibility of using existing spacecraft technology and launch vehicle systems to develop small, relatively low-cost planetary orbiters. These studies led to the concept of a universal bus, or basic spacecraft design, that would adapt to either an atmospheric probe entry mission or a planetary orbiter. Using this concept, GSFC proceeded with planning for a Venus mission sequence consisting of a dual-multiprobe followed by an orbiter, and then a second entry probe mission. In June 1970, the Space Science Board and NASA's Lunar and Planetary Missions Board recommended that the exploration of Venus play a prominent part in the 1970-80 NASA programs, beginning with the dual-multiprobe mission in 1975. Congressional approval for a new start to meet a 1975 launch schedule did not materialize and the program was rescheduled to begin with a dual multiprobe launch in 1976/77. In November 1971, the Pioneer Venus exploration program was transferred from Goddard to ARC. In January 1972, ARC organized a Pioneer Venus Study Team and a Science Steering Group to define the mission and the scientific payload. Their recommendations were to proceed with plans for a two-launch multiprobe mission in 1976/77, followed by a single orbiter in 1978 and another probe-type mission in 1980 that would be based on the scientific findings of the 1976 probe mission. Spacecraft development and the selection process for the scientific payload proceeded in parallel. In August 1972 it again became clear that Congressional allocations for space would prevent approval of the 1974 start needed to meet the 1976/77 launches.

The mission design was reduced to two spacecraft, a single multiprobe and a single orbiter, both to be launched during the 1978 opportunity. Developmental studies of the revised mission design, which included cost-saving changes in the launch vehicle system (from Delta to Centaur), were continued through 1973. The industrial team of Hughes Aircraft Company-General Electric Company was selected in February 1974, Hughes for the spacecraft and General

Electric for the probe entry system. Congressional approval was given on August 2, 1974 and the Program Approval document was signed by NASA Headquarters on October 16, 1974.

#### C. PIONEER VENUS PROJECT ORGANIZATION

The organizational structure for the Pioneer Venus Project is shown in Figure 1-1. The Project Office at the Ames Research Center was headed by a manager who was supported by a staff. Both the Tracking and Data Systems Manager and the Navigation Manager resided at the Jet Propulsion Laboratory (JPL) but functioned as staff members technically responsible to the Project Manager. The navigation and mission analysis function is not part of this report.

The definition of the science objectives and the selection of the science payload were the responsibility of the Pioneer Venus Science Steering Group which was composed of the principal investigators and a team of interdisciplinary scientists/theorists who participated in all phases of the science effort but did not have direct responsibility for an experiment (for details such as instrument descriptions, science results, and a list of the members of the Science Steering Group, see Reference 1). The group was organized into six working groups which addressed the key scientific questions associated with Venus. The working groups were:

1. Atmospheric Composition and Structure
2. Cloud Composition and Structure
3. Atmosphere Dynamics
4. Thermal Balance
5. Ionosphere and Solar Wind
6. Surface and Interior

#### D. THE SCIENTIFIC BACKGROUND

Significant amounts of scientific data about the atmosphere of Venus have been collected from Earth-based observations in the ultraviolet, visible light, and infrared spectra. Data on the lower atmosphere and the surface of the

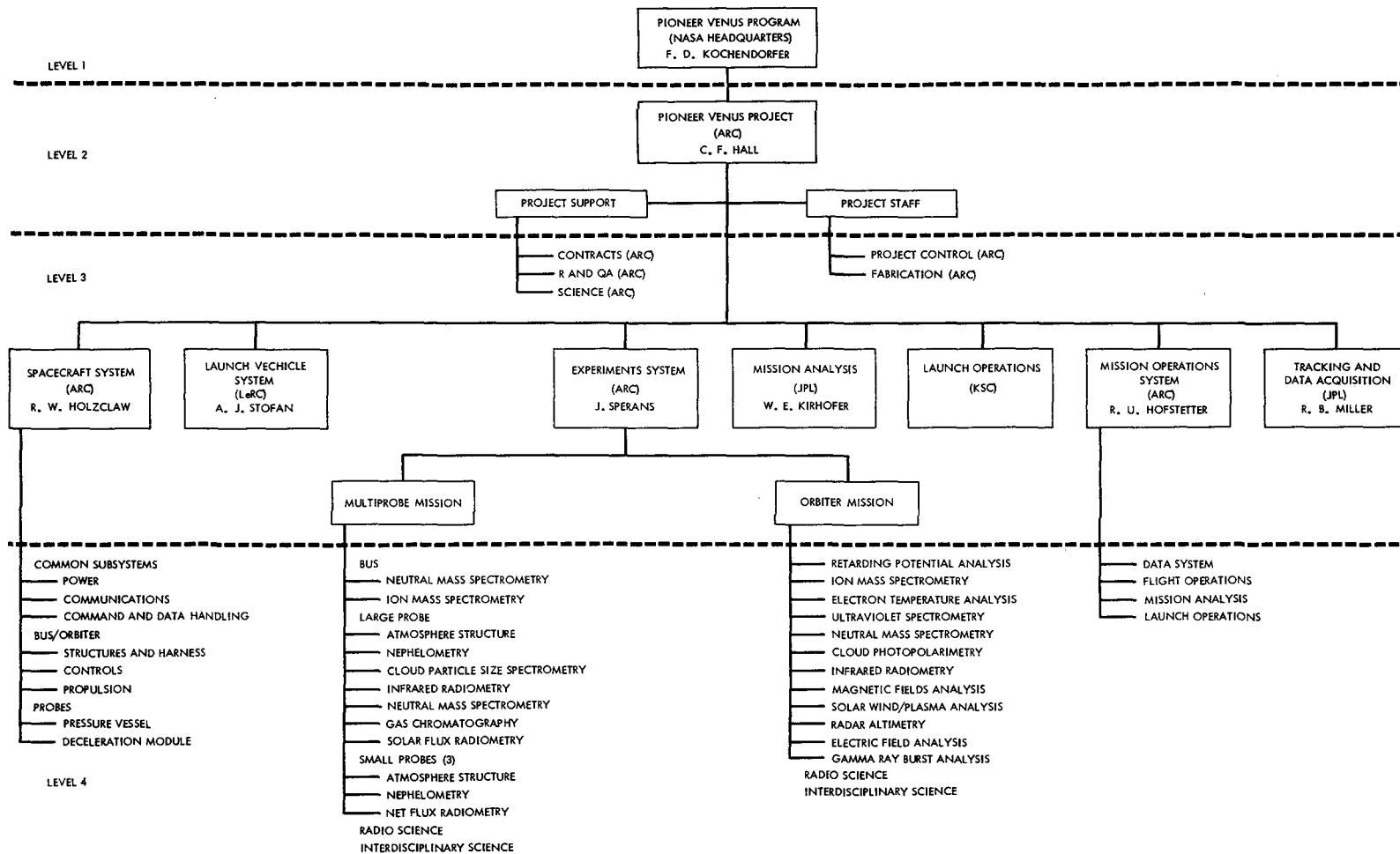

Figure 1-1. Pioneer Venus Project Structure

planet have been collected by Earth-based radio metric, radio interferometric, and radar observations. The clearest and most important sources of data have been the spacecraft missions conducted by both the U.S. and the U.S.S.R. These missions are summarized in Table 1-1.

The important scientific questions raised by Venus concern its almost twin-like similarity to Earth as a planetary body. Venus is approximately 5% smaller than the Earth and differs in density by only 6%. If both planets were stripped of their atmospheres and their surface reflectivities were the same, the two surface temperatures would differ by approximately 15%. And yet very radical differences exist between these planets. Earth has an atmosphere that is 80% nitrogen and 10% oxygen. The surface is covered with oceans of water and the temperature is comfortable at temperate latitudes -- conditions that have spawned and supported life as we know it. In contrast, Venus has a hot, dry atmosphere composed of 90% carbon dioxide, and a surface pressure that is 100 times greater than that on Earth. The temperature at the surface is 482°C (980°F). There is almost no oxygen and only traces of water in the atmosphere. Venus is surrounded by thick layers of clouds, with a top layer that consists of sulphuric acid droplets. The planet rotates only once every 243 Earth days, yet cloud layers near the top appear to travel at wind speeds as high as 100 meters per second. Venus has no magnetic field but evidence points to the likelihood that, like Earth, it possesses a molten core.

Scientists have established that the atmospheres of terrestrial planets are the result of outgassing from their mantles and crusts. It appears possible that the Earth has outgassed as much carbon dioxide as Venus. The intriguing difference is that most of the CO<sub>2</sub> is in the atmosphere at Venus, while in the Earth's crust it is in the form of carbonate rocks.

Studies of the Earth's atmosphere suggest that for the first three billion years, it consisted of various gases, carbon dioxide, and water vapor. As the water vapor underwent chemical changes due to thermal and other mechanisms, oxygen slowly accumulated in the atmosphere while the hydrogen steadily escaped. This early oxygen gradually became sufficient to form an ozone layer and allow the development of respiratory forms of life. Before the formation of the ozone shield, which screens out 95% of the Sun's ultraviolet radiation, life could not have emerged from the ocean, developed a respiratory system, and begun to convert atmospheric carbon dioxide into oxygen by photosynthesis.

Table 1-1. Spacecraft Missions to Venus up to 1978

Spacecraft	Launch	Encounter	Type	Encounter Characteristics
Mariner 2	Aug. 27, 1962	Dec. 14, 1962	Flyby	Closest approach: 34,833 km
Venera 4	Jun. 12, 1967	Oct. 18, 1967	Bus and Entry Probe	Entry to destruction Lower atmosphere, hard lander, nightside
Mariner 5	Jun. 14, 1967	Oct. 19, 1967	Flyby	Closest approach: 2100 km
Venera 5	Jan. 5, 1969	May 16, 1969	Bus and Entry Probe	Entry to destruction Lower atmosphere, hard lander, nightside
Venera 6	Jan. 10, 1969	May 17, 1969	Bus and Entry Probe	Entry to destruction Lower atmosphere, hard lander, nightside
Venera 7	Aug. 17, 1970	Dec. 15, 1970	Bus and Entry Probe	Entry to destruction Lower atmosphere, `soft` lander, nightside
Venera 8	Mar. 27, 1972	Jul. 22, 1972	Bus and Entry Probe	Entry to destruction Lower atmosphere, `soft` lander, nightside
Mariner 10	Nov. 2, 1973	Feb. 5, 1974	Flyby	Closest approach: 5785 km
Venera 9	Jun. 8, 1975	Oct. 22, 1975	Orbiter and Entry Probe	Periapsis: 1560 km; Apoapsis: 112,000 km; Period 48 h 18 m; Incl: 34°10' Lower atmosphere, `soft` lander, dayside
Venera 10	Jun. 14, 1975	Oct. 25, 1975	Orbiter and Entry Probe	Periapsis: 1620 km; Apoapsis: 113,900 km; Period 49 h 23 m; Incl: 29°30' Lower atmosphere, `soft` lander, dayside
Pioneer Venus	May 20, 1978	Dec. 4, 1978	Orbiter	Periapsis: 200 km; Apoapsis: 66,614 km; Period 24 h; Incl: 105° retrograde
Pioneer Venus	Aug. 8, 1978	Dec. 9, 1978	Bus and Entry Probe	Entry to destruction Lower atmosphere, 4 hard landers, night/day

The paleontological record indicates that this process began in abundance about 600 million years ago. Questions that concern Man include: "What happened, or did not happen, on Venus?", "Why is our virtual twin so hostile to life?", "Did both planets begin with certain inherent differences that will forever keep them on separate evolutionary paths or is the Earth following a path similar to that of Venus?", and "Man burns fossil fuels and thereby contributes heavily to the accumulation of carbon dioxide in the atmosphere. He is also releasing other chemical substances that are now depleting the ozone layer. Are there vital lessons to be learned from Venus?"

Answers to these questions will contribute greatly to understanding the evolutionary process taking place on our own planet, where it is leading, and if there is anything that man can, or need do about it.

For more detailed information on the objectives and design of the Pioneer Venus instruments, see Reference 2. Reference 3 contains descriptions of the scientific results. For very detailed scientific results, see Reference 4. Information on the detailed engineering results of the scientific instruments may be found in Reference 5.



## SECTION II

### TRACKING AND DATA SYSTEMS ORGANIZATION AND RESOURCES

#### A. INTRODUCTION

Telecommunications and data acquisition for planetary programs is a separate responsibility of OSTDS. JPL was selected by OSTDS to be the Tracking and Data Systems (TDS) support center for lunar and planetary flight projects, and has provided support for all NASA deep space exploration projects since 1962. The Project-TDS programmatic relationship is shown in Figure 2-1. This document describes the organization of the TDS and the support provided to the Pioneer Venus Project by the Jet Propulsion Laboratory.

The TDS consists of an operationally unified collection of ground facilities, personnel, and operations necessary to transmit commands to the spacecraft and to receive, process, and deliver spacecraft telemetry and radio receiver data to the Pioneer Mission Operations Control Center (PMOCC) at Moffett Field, California. Radio metric data is also generated but is delivered to the Pioneer Venus Navigation Team located at the Jet Propulsion Laboratory.

The major resources employed by the TDS consist of elements of five agencies: the Department of Defense Air Force Eastern Test Range (AFETR), the NASA Spaceflight Tracking and Data Network (STDN), the John F. Kennedy Space Center (KSC), the NASA Deep Space Network (DSN), and the NASA Communications System (NASCOM). The configuration of these elements is determined by the mission support requirements and the two basic phases of the mission: the near-Earth phase and the deep space phase. Each phase requires different spacecraft tracking capabilities. The near-Earth phase begins with the launch of the spacecraft and continues until two-way communication is established by the Deep Space Network at approximately 16,000 km (10,000 miles) from Earth, which normally occurs approximately 40 minutes after launch. The deep space phase continues until the end of the mission. For Pioneer Venus, the duration of the prime mission was 243 Earth days after reaching Venus, or one Venusian day.

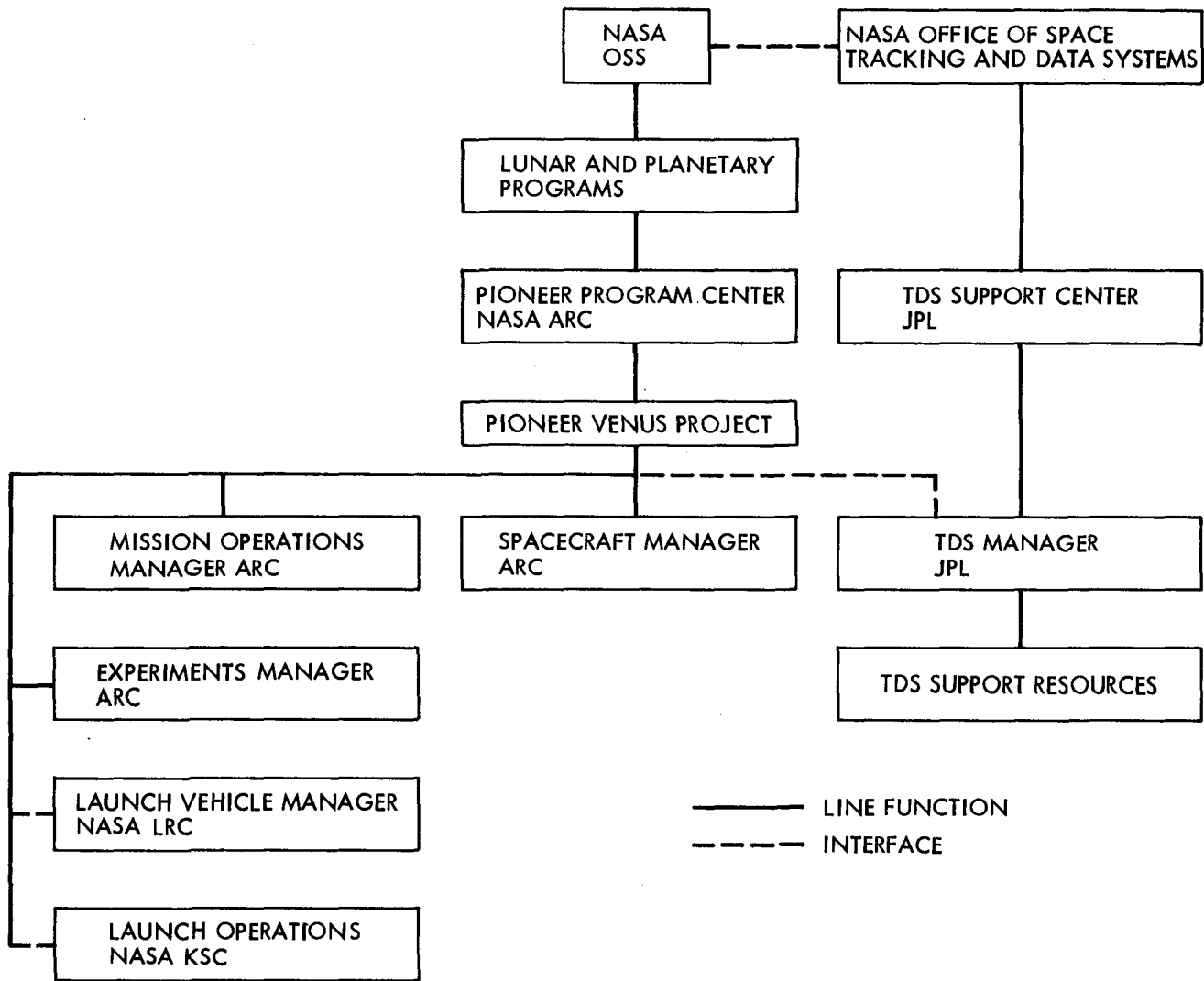

Figure 2-1. Pioneer Venus Project and the Tracking and Data Systems Relationship

Management of the TDS function resides in the JPL Office of Telecommunications and Data Acquisition. The TDS support organization is shown in Figure 2-2. The principal TDS interface with the project is the TDS Manager. His first function is to receive and evaluate the project mission support requirements for telecommunications and data acquisition and to negotiate and confirm an acceptable set of support commitments by the TDS organization. The TDS Manager then monitors and oversees mission support planning, implementation, and testing, and is responsible to the project for the readiness of the TDS to support the mission. He is supported by the Near-Earth Phase Coordinator, who is responsible for the planning and coordination of the near-Earth phase resources, and the Network Operations Project Engineer (NOPE) representing the Mission Support Operations Division, which operates and maintains the Deep Space Network. The NOPE is responsible for mission operations planning and support for the deep space phase of the mission. The functional capabilities of the DSN are the responsibility of the TDA Engineering Office. The TDS Manager coordinates with each of the DSN system and subsystem engineers to plan and implement capabilities to meet support commitments. Navigational support (spacecraft orbit determination) is separately provided to the project by the Navigation Systems Section and is not a TDS responsibility. A Pioneer Ground Data System Engineer, provided by the Operations Division and funded by the Pioneer Venus Project, is the Project representative for day-to-day operations and planning. The Mission Control and Computing Center data processing facilities for the navigation function are also provided separately to the project by the Flight Projects Support Office at JPL.

The TDS function consists of the acquisition and/or generation of the following types of data and their delivery to the flight project:

Telemetry:	Coded messages containing engineering and scientific data measurements made by the spacecraft.
Radio Metric Data:	Antenna pointing angles, doppler frequency measurements, and range measurements generated at the ground station and used for spacecraft navigation and for radio science.
Radio Science Data:	A record of the frequency and amplitude of spacecraft signals as affected by passage through

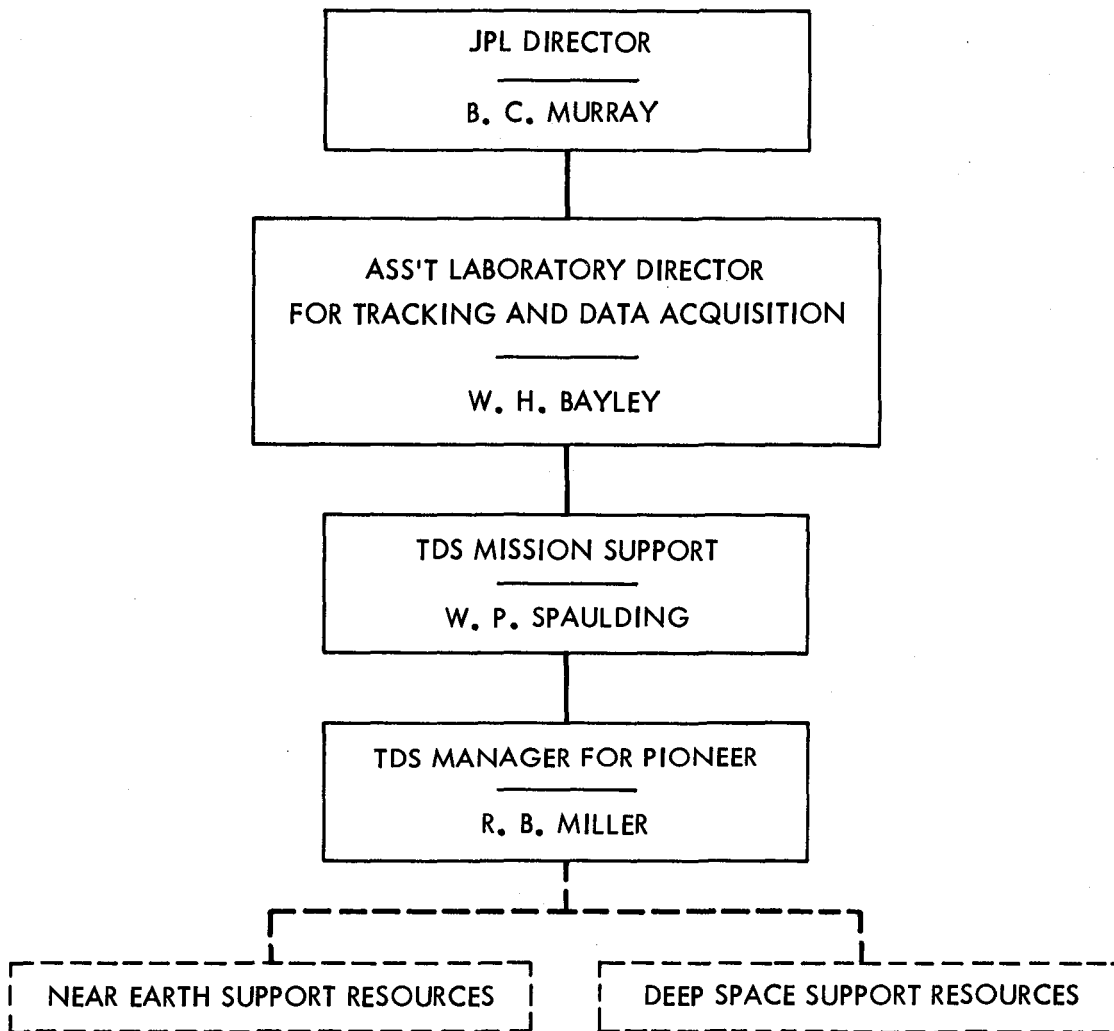

Figure 2-2. JPL Office of Tracking and Data Acquisition 1978

media, such as the solar corona, planetary atmospheres, charged particles, and gravitational fields.

Command: Coded messages containing command instructions generated by the flight project are transmitted to the spacecraft by the DSN and the transmission is verified to the flight project.

Very Long Baseline Interferometry Data: A record of antenna pointing angles and radio signal time delay information that is used geometrically to determine changes in the position and velocity of the spacecraft precisely.

The purpose of the TDS function is to provide the Pioneer mission operations team and scientific experimenters with spacecraft information in real time and in a manner and format suitable for monitoring and directing the progress of the mission. Complete scientific data records were delivered after the fact. Off-line, or non-real-time data processing was then performed at the Pioneer Mission Operations Control Center to convert the raw scientific data into the various refined formats required by the experimenters.

## B. NEAR-EARTH PHASE

The near-Earth phase configuration requires support from all TDS agencies. This phase involves preflight testing, launch operations, and the acquisition, processing, display, and retransmission of launch vehicle and spacecraft data during approximately the first forty minutes of flight. The nominal events occurring during this period are the launch, separation of the first and second stage vehicles, second stage parking orbit, spacecraft separation and flight until acquisition by the DSN and start of the deep space phase.

There are three types of near-Earth data: metric data, launch vehicle telemetry, and spacecraft telemetry. The major uses are to:

1. Quickly establish the normalcy of the mission.
2. Determine the instantaneous status of the launch vehicle and spacecraft.

3. Assist the AFETR, STDN, and DSN stations in acquiring the launch vehicle and/or spacecraft.
4. Provide information and assistance to the project in the event of a non-standard mission.
5. Enable early post-launch analysis.

The following paragraphs describe the five agencies who support the near-Earth phase:

Air Force Eastern Test Range (AFETR) - The AFETR, managed and operated by the U.S. Air Force, provides tracking stations, a real-time computer system, and range instrumentation ships and aircraft. Ranging begins at Cape Canaveral, Florida, and follows a southeasterly direction across the Atlantic Ocean to Ascension Island. Ships and aircraft are deployed where needed along the launch azimuth to fill viewing gaps between the land-based tracking stations.

Spaceflight Tracking and Data Network (STDN) - The STDN is managed and technically directed by the NASA Goddard Space Flight Center and is primarily designed to support manned and unmanned Earth-orbiting satellites. The Network provides support from lift-off until acquisition by the DSN, covering the first leg of the trajectory which is much like the flight paths of Earth-orbiting satellites. The supporting STDN stations are located along the launch corridor in proximity to the AFETR stations. AFETR and STDN stations provide back-up support for each other in case of failure or poor data reception. Special use was made of two STDN stations during the deep space phase to support the multiprobe entry event. The event and the use of these stations is described later.

Kennedy Space Center (KSC) - KSC provides launch operations support, communications, test facilities, and accommodations for DSN pre-launch preparations.

NASA Communications (NASCOM) - NASCOM, managed and operated for NASA by the Goddard Space Flight Center, provides the worldwide network of communications circuits that carry data and voice communications between the tracking stations, the various network control centers, and the Pioneer Mission Operations Control Center at the Ames Research Center. NASCOM provides voice, high-speed data and teletype transmission lines, and equipment for both the near-Earth and deep space phases.

Deep Space Network (DSN) - For the near-Earth phase, the DSN provides spacecraft pre-launch test facilities at the Kennedy Space Center.

### C. DEEP SPACE PHASE

The deep space phase of the mission is normally supported only by the Deep Space Network, which is managed and technically directed for NASA by the Jet Propulsion Laboratory. The Pioneer Venus interferometric Wind Measurement experiment represented a special case for which two stations of the STDN were called upon for the first and only time to support a critical deep space phase of a mission. The DSN is an operational state-of-the-art global telecommunications network designed to provide concurrent support to multiple spaceflight projects. The DSN acquires telemetry from the spacecraft, transmits commands, generates radio metric data, very long baseline interferometry data, and calibration data for Earth-based navigation of the spacecraft, and generates radio science data. Except for telemetry bit synchronization and formatting necessary for ground transmission, all data is delivered to the project in unprocessed, raw form.

To support these primary activities, the DSN schedules spacecraft tracking periods, predicts tracking and RF transmission and reception parameters, configures the Network to support the mission, and tests and validates DSN performance.

#### 1. DSN Facilities

The DSN facilities consist of three Deep Space Communications Complexes (DSCC) located in California, Australia, and Spain, a Network Operations Control Center (NOCC) located at the Jet Propulsion Laboratory, and a Ground Communications Facility (GCF) that links the Complexes and the NOCC. Spacecraft-DSN compatibility test facilities are located at JPL and at the Kennedy Space Center in Florida. A Mission Control and Computer Center (MCCC) located at JPL houses the NOCC function and provides computers and data processing services to the DSN and to flight projects. For Pioneer Venus, these computers were committed only to support the Pioneer navigation function residing at JPL. The following paragraphs describe the DSN facilities.

Deep Space Communication Complexes - Each complex contains three Deep Space Stations (DSSs) with different capabilities which provide the RF communication link with the spacecraft. The most identifiable differences between the stations are the diameter of the parabolic dish antennas and the receiver frequencies. There are a 26m-diameter antenna station that operates at S-band frequencies, and a 34m and 64m station that operate at both S and X-band.

Network Operations Control Center (NOCC) - The NOCC is located at JPL and is essentially the DSN operations hub. Its functions are to monitor and control operations, analyze and validate Network performance for flight project users, provide information for the configuration and control of the Network, and to participate in Network testing.

Ground Communications Facility (GCF) - The GCF located at JPL provides the communications circuits between the DSN and the NOCC at JPL and to the project mission operations control centers, whether at JPL or remotely located. The types of circuits are teletype, voice, wideband, and high-speed data lines. The GCF capabilities are engineered and provided as needed by NASCOM.

Compatibility Test Facilities - The DSN maintains a Compatibility Test Area (CTA 21) at JPL for verifying radio frequency and data message compatibility between the spacecraft and the DSN, and between the DSN and remote mission operations centers. The DSN also provides a launch support and compatibility test station (MIL 71) at the Kennedy Space Center in Florida.

## 2. DSN Systems

For each major function the DSN performs, there is a corresponding network system that incorporates the hardware and software necessary to perform that function from end-to-end and within the DSN. For the Pioneer Venus mission, the following systems provided data:

1. DSN Tracking System - generates and delivers radio metric data (antenna pointing angles, one and two-way doppler, and range).
2. DSN Command System - accepts commands from the flight project, directs them to the appropriate station for transmission to the spacecraft, self-checks and verifies that commands are transmitted without error.



3. DSN Radio Science System - generates and delivers radio science data.
4. DSN Very Long Baseline Interferometry System (VLBI) - generates and delivers VLBI data.

The following systems supported testing, training, and Network operations control:

1. DSN Monitor and Control System - provides data and displays of DSN status and performance information which is used for monitoring and controlling the Network.
2. DSN Test and Training System - generates and delivers simulated data for testing and training within the DSN and for flight project tests.

#### D. TDS-PIONEER VENUS INTERFACE CONFIGURATIONS

The interface configuration for the TDS/DSN and the PMOCC is shown in Figure 2-3. For reception of telemetry and transmission of commands (Figure 2-4), the PMOCC connects directly to the appropriate deep space station via the GCF located at JPL. The NOCC receives portions of these transmissions off line as necessary to monitor and control operational configurations and performance. The GCF produces an intermediate data record (IDR) of spacecraft science and engineering telemetry that is sent to the PMOCC and used in the production of a complete off line master data record (MDR). Radio metric data (Figure 2-5) is generated at the stations and sent to JPL via the GCF. A radio metric IDR is produced and delivered to the Pioneer navigation function residing at JPL, where the data is processed, orbits are determined, and the results sent to the PMOCC for analysis and subsequent action.

The overall ground configuration is identified by the Pioneer Venus Project as the Pioneer Ground Data System. The major ground facilities which comprise the Pioneer Ground Data System are: the DSN stations at Goldstone, California, Madrid, Spain, and Canberra, Australia; the Kennedy Space Center in Florida; stations in Santiago, Chile and Guam; the Ames Research Center and the Jet Propulsion Laboratory in California; and the NASCOM, which is managed by the Goddard Space Flight Center.

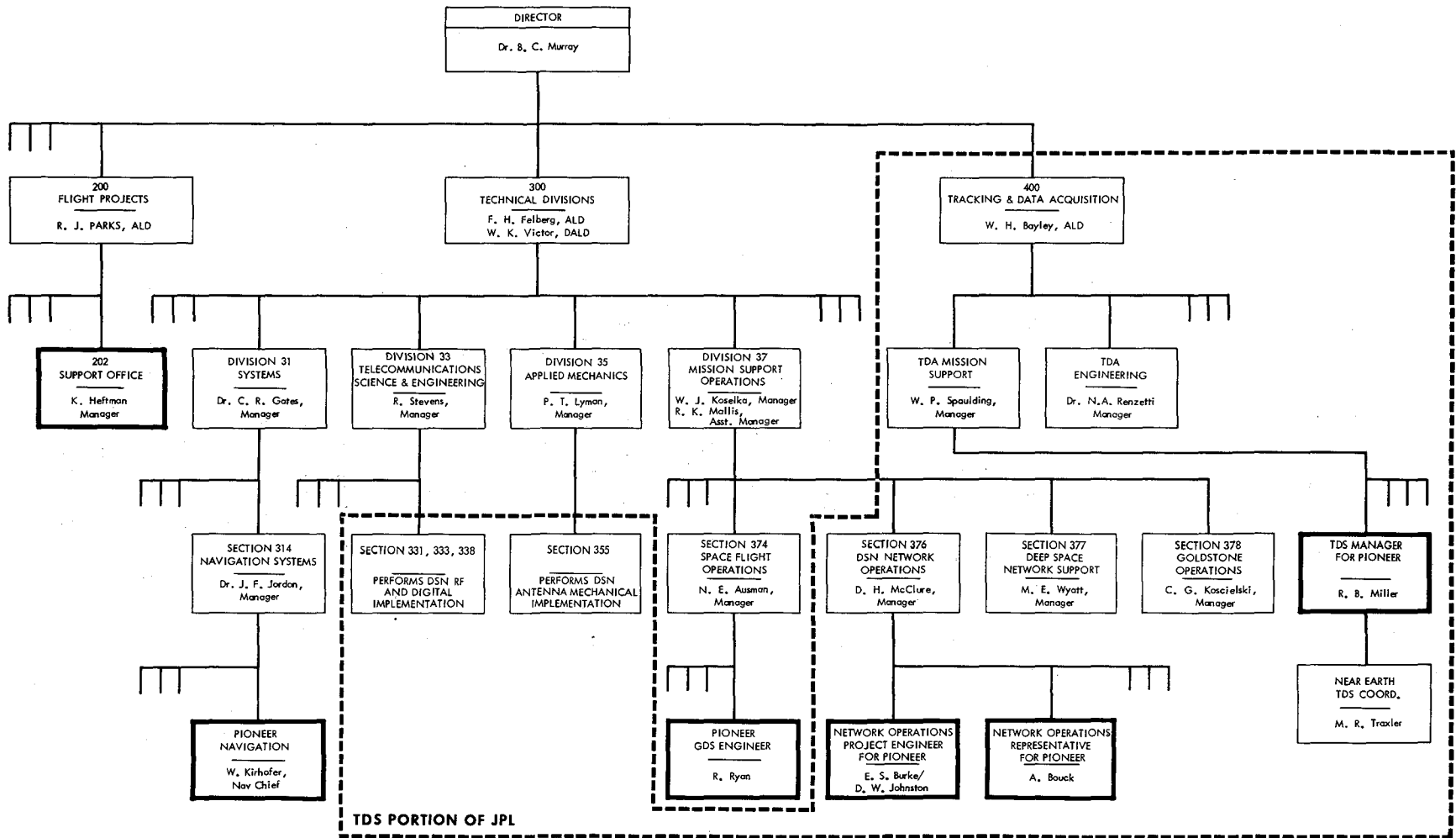

Figure 2-3. JPL Organization Supporting Pioneer Venus 1978

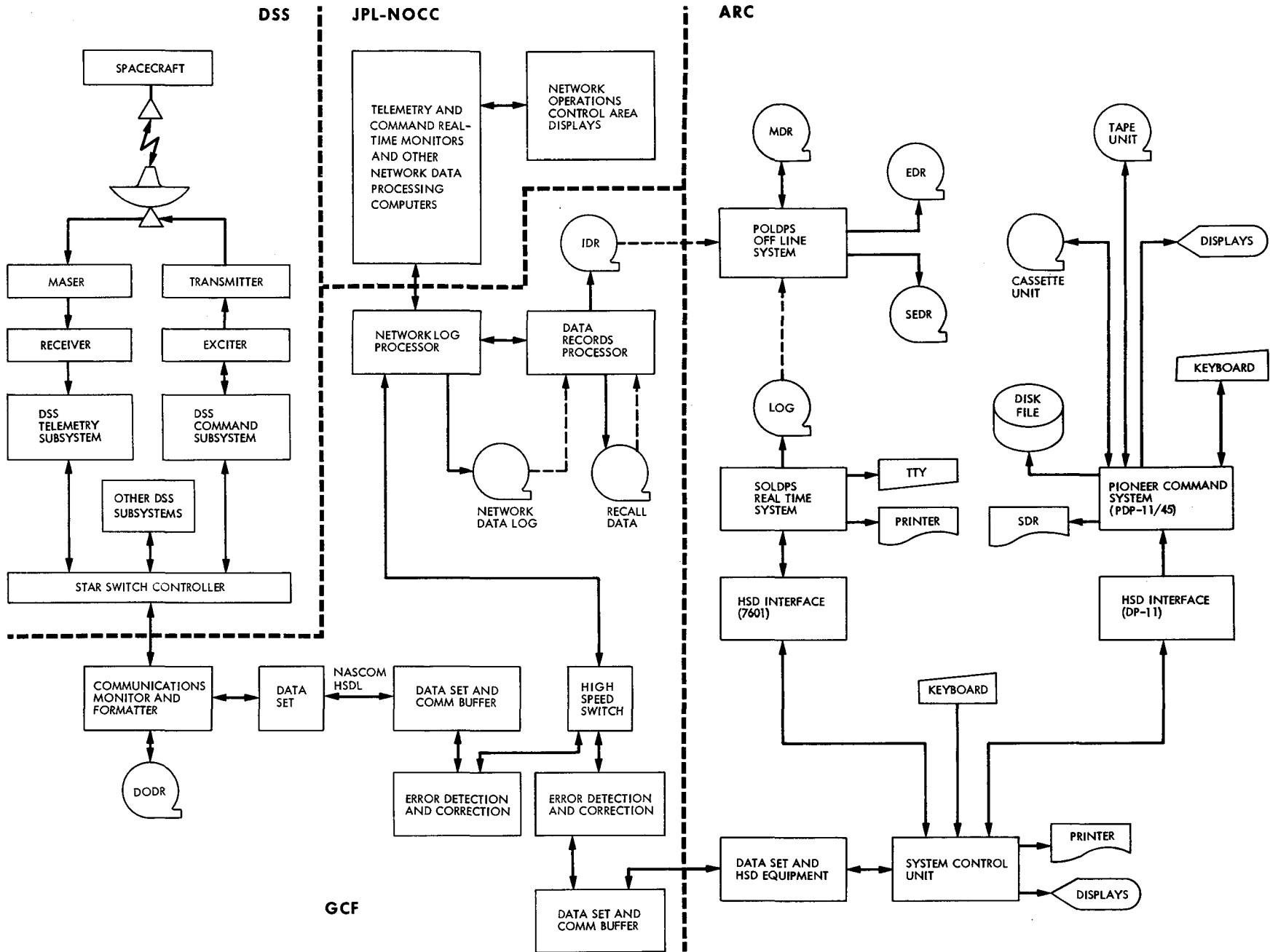

Figure 2-4. Telemetry and Command Ground Data System Configuration

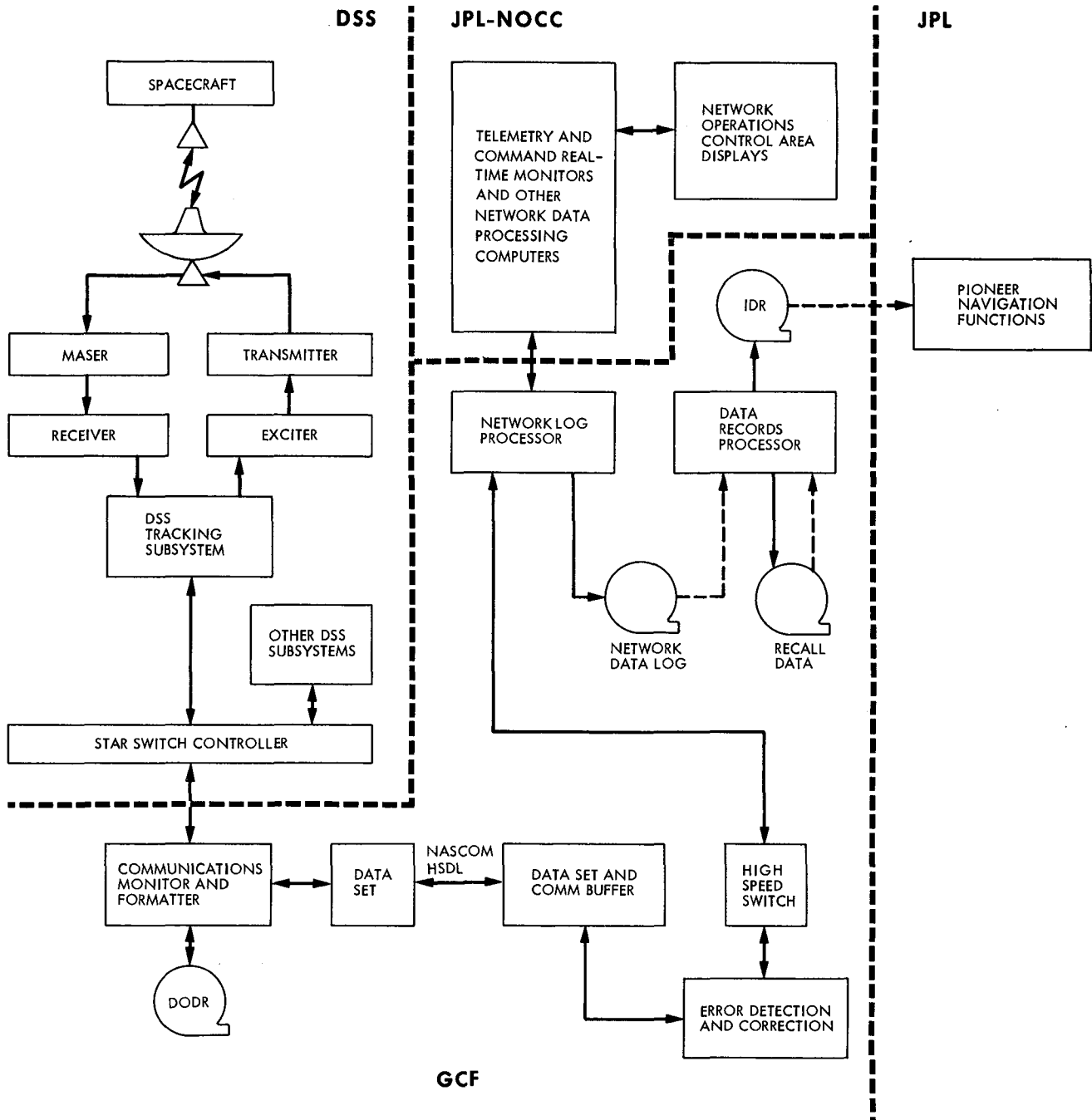

Figure 2-5. TDS Radio Metric Data Configuration for Pioneer Venus

## SECTION III

### MISSION PROFILE

#### A. MISSION DESCRIPTION

The Pioneer Venus Project consisted of two spacecraft, an orbiter and a multiprobe, carrying related science payloads and operating in concert to acquire the desired scientific data. The science objectives were to conduct a detailed investigation of the Venusian atmosphere and weather system, survey large areas of the planetary surface, map the gravity field to calculate the density distribution in the planet's interior, and determine its global shape.

The Orbiter Mission was planned for launch in late May on a Type II transit trajectory to encounter Venus on approximately December 4, 1978, beginning a nominal mission of at least 243 days. The Multiprobe Mission was to launch in August 1978 on a Type I transit trajectory, and to arrive at Venus five days after the orbiter to conduct an atmospheric entry mission that would last about two hours. The mission profile is shown in Figure 3-1.

##### 1. Multiprobe Mission Design

The spin-stabilized multiprobe spacecraft consisted of a cylindrical bus equipped with four atmospheric entry probes: a large sounder probe and three identical smaller probes identified as North, Day, and Night. The mission design required the probes to be targeted and released from the bus 20 days prior to arrival at Venus.

The sounder probe was designed to conduct a detailed sounding of the lower atmosphere, making measurements of the composition, structure, and wind dynamics during the descent. The three smaller probes, entering the atmosphere at widely separated points, were designed to provide local-scale information on the composition and structure of the clouds and lower atmosphere. The probes were not designed to function after impacting the planetary surface. The bus scientific payload was to provide data on the upper atmosphere and ionosphere before burning up at an altitude of about 120 km (75 miles). After separation of the probes, the bus velocity was to be reduced, so that it would enter the

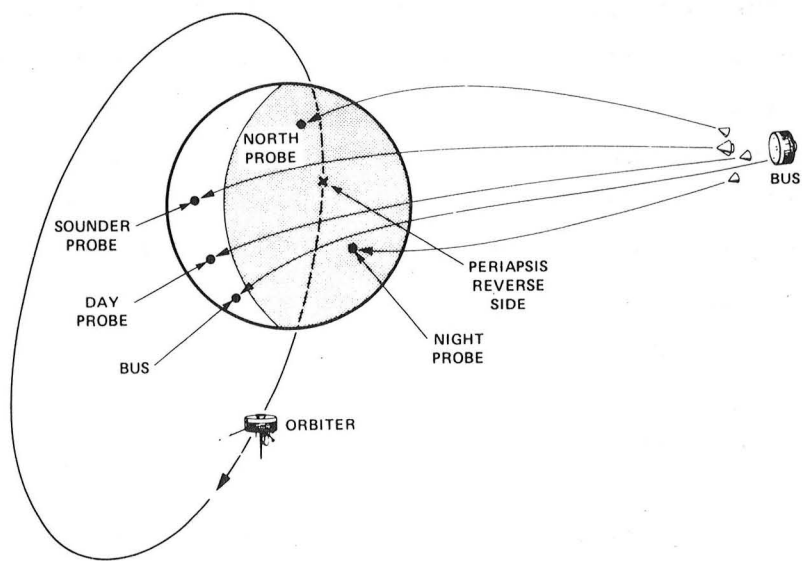

Figure 3-1. Pioneer Venus Mission Profile

atmosphere after the probe entries were completed, enabling the bus signal to serve as a frequency reference for an interferometric tracking experiment to determine wind velocities and atmospheric circulation patterns.

The probes were designed for direct communication with Earth. The large sounder probe and bus were equipped with transponders for two-way doppler tracking. The three smaller probes were equipped with highly stable oscillator-controlled transmitters ( $10^{-9}$  stability). Due to the limited battery power supply, the probes would be turned on for the first time only 20 minutes before atmospheric entry -- meaning that the probe frequencies would not be made available to the ground stations from launch in August 1978 until just before the entry event in December. All four probes entered nearly simultaneously, with a communications blackout due to atmospheric heating occurring from 120 km down to 80 km altitude. To accomplish the wind drift experiment, the bus and four probes were to be tracked simultaneously by at least three ground stations each equipped to receive all five signals simultaneously.

## 2. Orbiter Mission Design

The Orbiter Mission was designed to globally map the Venusian atmosphere, and directly measure the upper atmosphere, ionosphere and the solar wind-ionosphere interaction. In combination with the lower altitude measurements made by the multiprobe, both spacecraft would provide a substantial characterization of the entire Venus atmosphere on a planetary scale. The orbiter was also equipped with a radar mapper for remote sensing and mapping of the planet's surface structure. The duration of the orbiter prime mission was to be one Venusian day, which is equivalent to 243 Earth days, during which Venus would complete slightly more than one orbit around the Sun and one complete rotation on its axis. The orbiter was to be placed in a highly inclined elliptical orbit (Figure 3-2) with its closest point (periapsis) in the mid-northern latitudes and an orbital period of 24 Earth hours. A low periapsis was to be maintained between 150 and 260 km altitude, and the latitude of periapsis between 15 and 32 degrees north. The orbit design would result in prime Earth occultations (those at periapsis) occurring from day zero to day 160 and lasting about 25 minutes. There would also be periods of solar occultation.

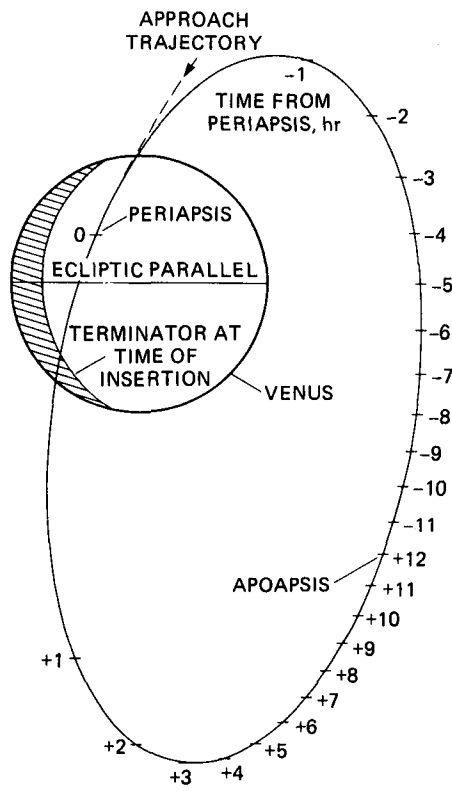

Figure 3-2. Orbit Design



Maintaining the low periapsis altitude would require orbital adjustment maneuvers at intervals between once a week and once a month throughout the primary mission.

## B. SPACECRAFT DESCRIPTION

### 1. The Basic Buses

The Pioneer Venus Orbiter and Venus Multiprobe were constructed by Hughes Aircraft Company, under contract to the Ames Research Center. To minimize cost, both spacecraft shared the same basic bus design. The bus portion consisted of identical spin-stabilized cylinders which contained most spacecraft systems. Three-quarters of the bus components were common to both spacecraft. These included an equipment and scientific instruments compartment, a solar cell array mounted on the cylindrical surface, batteries and power distribution subsystem, forward and aft omnidirectional antennas, communications subsystem, data handling subsystem, and sun and star sensors for attitude reference. Both buses incorporated a monopropellant hydrazine propulsion system with six thrusters for attitude control, velocity correction, and spin rate control.

A spin rate of 15 rpm maintained the bus spin axis perpendicular to the ecliptic plane during cruise. In Venus orbit, the orbiter spin rate was reduced to 5 rpm.

Both cylindrical spacecraft were approximately 2.5 meters (8.3 feet) in diameter. The orbiter, including its high-gain antenna array, was nearly 4.5 meters in height (14.75 feet). The multiprobe was 2.2 meters (7.5 feet) in height. The orbiter launch weight was approximately 582 kg (1280 lbs), including 45 kg (100 lbs) of scientific instruments. The weight in orbit was 386 kg (810 lbs). The multiprobe weight was 904 kg (1990 lbs), including 49 kg (108 lbs) of scientific instruments.

### 2. Orbiter Spacecraft

The orbiter spacecraft shown in Figure 3-3 consisted of the basic bus adapted to the Orbiter Mission. The high-gain, parabolic dish antenna was mounted on a ten-foot mast aligned with the spin axis. A bearing assembly

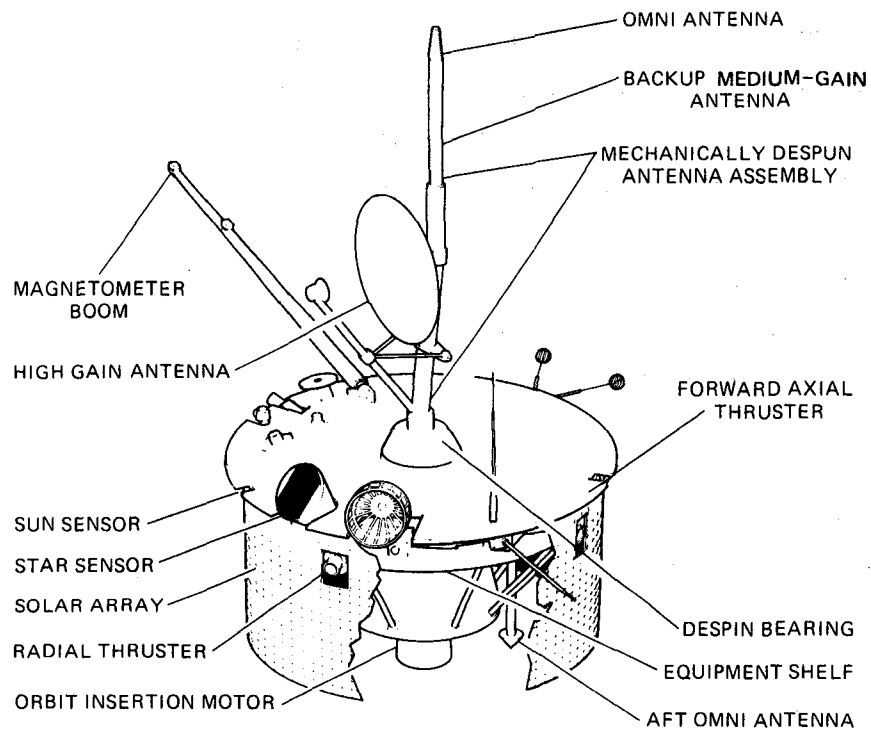

Figure 3-3. Orbiter Spacecraft Configuration

mechanically despun the antenna so that the reflector focused on the Earth throughout the mission. A sleeve dipole antenna provided a medium-gain backup to the high-gain reflector. A solid propellant orbit insertion motor was positioned on the spin axis below the equipment compartment.

The orbiter's 12 scientific instruments were carried inside the equipment compartment. Two magnetometer sensors were mounted on a boom to avoid magnetic interference from the spacecraft.

The communications subsystem received the S-band command uplink of approximately 2115 MHz through two S-band transponders connected to the two omnidirectional antennas. The receivers were automatically reversed if no command was received for 36 hours. The transponder generated a coherent carrier for two-way lock or a local auxiliary carrier for one-way lock. The S-band downlink of approximately 2295 MHz was provided by a transmitter via any one of four ten-watt power amplifiers, and was assignable by command to any one of the spacecraft antennas. An X-band frequency transmitter, phase coherent with the S-band transmitter, was provided for radio science use only (e.g., occultation measurements). The X-band signal was unmodulated and transmitted via the high-gain antenna only. The X-band transmitter power was 750 mW; S-band power was selectable at 10 or 20 W. The despun sleeve dipole antenna had a gain of 8 dBi, and the two omnidirectional antennas had a gain of slightly more than -6 dBi. The high-gain antenna was adjustable up to 17 degrees in elevation, measured perpendicularly to the spin axis. The beamwidths were  $2.2^\circ$  at X-band and  $7.6^\circ$  at S-band.

The data handling subsystem sequentially sampled and encoded up to 248 telemetry data channels which could have been analog, serial digital, or binary discrete information. The encoded data were frame formatted into one of thirteen command-selectable formats. All frames were 512 bits in length, consisted of 64 multiplexed 8-bit words and incorporated a 24-bit synchronization word. The data frames were designed so that format changes during the mission were transparent to the DSN Telemetry System. The subsystem output was a PCM/PSK convolutionally encoded data stream biphase modulated on a 16.384 kHz subcarrier which phase modulated the downlink S-band carrier. There were thirteen available data rates, from 8 to 4096 bits/second. A data storage capability of  $1.048 \times 10^6$  bits allowed the continuously collected telemetry data to be stored during each orbit and transmitted during the scheduled once-a-day ground station view period.

The command subsystem accepted a pulse code modulated/frequency shift keyed/phase modulated data stream at a fixed rate of 4 bits/second. The command was either stored for later execution or routed to the addressed destination and executed in real time. Individual commands were 48 bits long, including 13 bits for synchronization to provide a less than  $10^{-9}$  probability of executing a false command. There were 381 different commands, with the majority being redundant. The command memory stored up to 128 commands, either a specific instruction or a delta time which was counted down before executing the next instruction. The redundant command storage units were operated either in parallel for highly critical mission events or in series to double the on-board storage capability effectively.

### 3. Multiprobe Spacecraft

The multiprobe spacecraft shown in Figure 3-4 was the basic bus adapted to carry the large sounder probe and the three identical small probes. The large probe was centered on the spin axis and was ejected by springs in the axial direction. The small probes were equally spaced around the large probe and retained by hinged clamps. The small probes were excited by centrifugal force and were released in a tangential direction. Some 70% commonality was claimed between the orbiter and the multiprobe buses.

The multiprobe science payload consisted of two instruments installed on the bus, seven instruments on the large probe, and three identical instruments on each small probe. The weight breakdown for the bus and probes was:

Bus	290 kg (641 lbs)
Large Probe	315 kg (695 lbs)
Each Small Probe	90 kg (198 lbs)

The bus communications subsystem was essentially identical to the orbiter with one exception: there was no X-band transmitter. The antenna configuration consisted of forward and aft omnidirectional antennas and a medium-gain horn antenna mounted on the aft side of the equipment shelf. The bus command and data handling subsystems were similar to the orbiter. Major differences were in the number of commands (509 vs. 381; 43 commands were dedicated to the large probe).

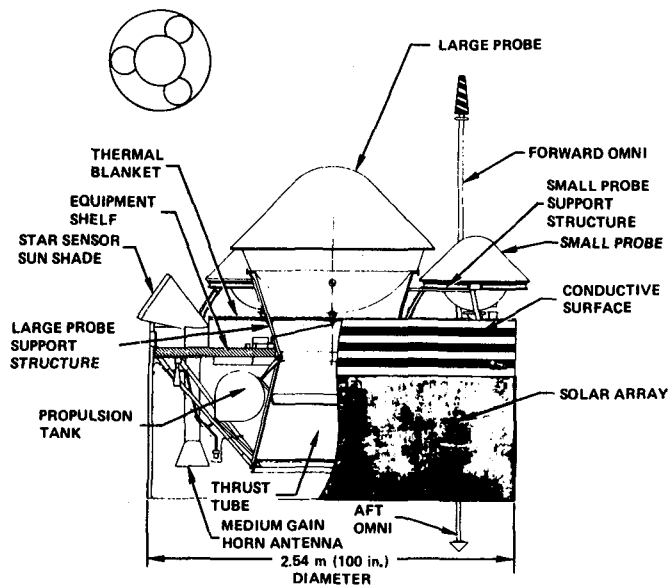

Figure 3-4. Multiprobe Spacecraft Configuration

The data handling subsystem did not include a data storage unit. The subsystem provided 197 telemetry data channels which included engineering checkout data channels for each of the four probes while they remained attached to the bus. There was no uplink command capability to the probes after they were released. After release, all four probes functioned as individual spacecraft and transmitted directly to Earth.

The large and small probes (Figures 3-5 and 3-6) were geometrically similar. Each consisted of a sealed, spherical titanium pressure vessel which housed the scientific instruments and the operating subsystems, communications data, command and power. During atmospheric entry, stabilization and heat protection were provided by a blunt-nosed aeroshell/heat shield and by an elastomeric coating on all afterbody surfaces.

The large probe configuration measured 142 cm (56") in diameter by 94 cm (37") high, and was designed to enter the Venusian atmosphere and absorb a peak deceleration of 280 g's at about 78 km above the planet. At about 67 km altitude, the probe ejected its aft cover and deployed a parachute. After stabilizing, the forward aeroshell/heat shield was separated from the spherical descent module, giving the scientific instruments access to the atmosphere. At about 47 km altitude, the parachute was jettisoned and the descent module fell free to the surface, approximately 20 minutes after entry. Figure 3-7 is a sectional view of the large probe descent module.

In contrast to the large probe, the small probes (Figure 3-6) were not equipped with parachutes and the heat shields remained in place to the surface. The small probe configuration measured 76 cm (30") in diameter by 60 cm (24") high, and was designed to absorb a steep entry deceleration of 458 g's and a shallow entry deceleration of 223 g's. The probe deployed its scientific instrument covers, erected external sensors and fell free to the surface approximately 60 minutes after entry. Figure 3-8 is a sectional view of the small probe pressure vessel.

The probe communication subsystems provided a direct downlink via hemispherical coverage antennas. The large probe subsystem provided a 40-watt power output which delivered 44.5 dBm at the antenna. The large probe also received an uplink signal (carrier only; no commands) for two-way doppler tracking. The small probe communications subsystem employed an identical antenna but a 10-watt power output delivered only 29.7 dBm at the antenna.

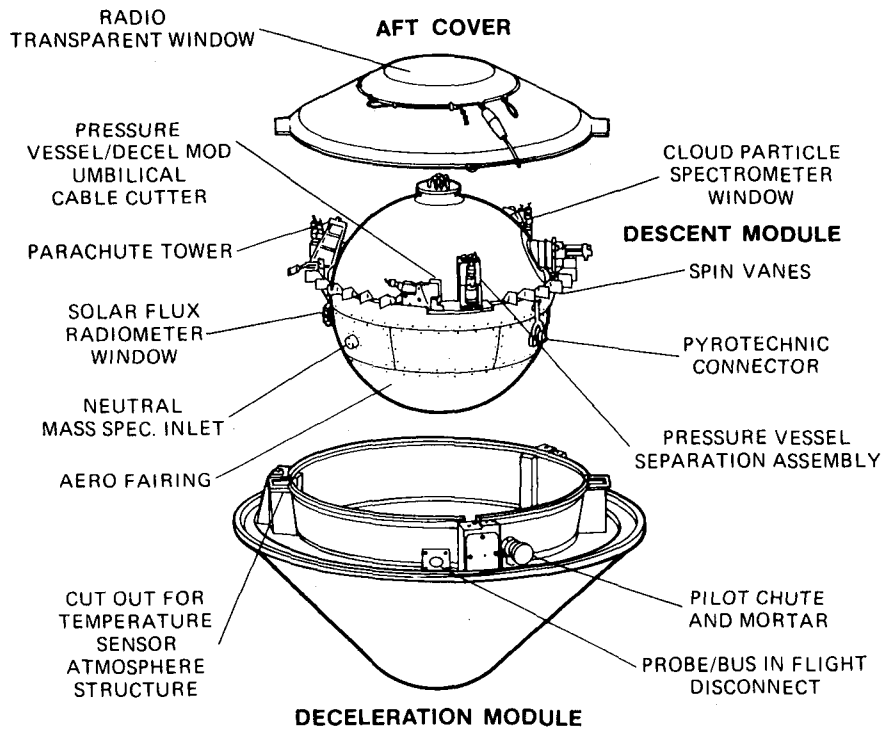

Figure 3-5. Large Probe

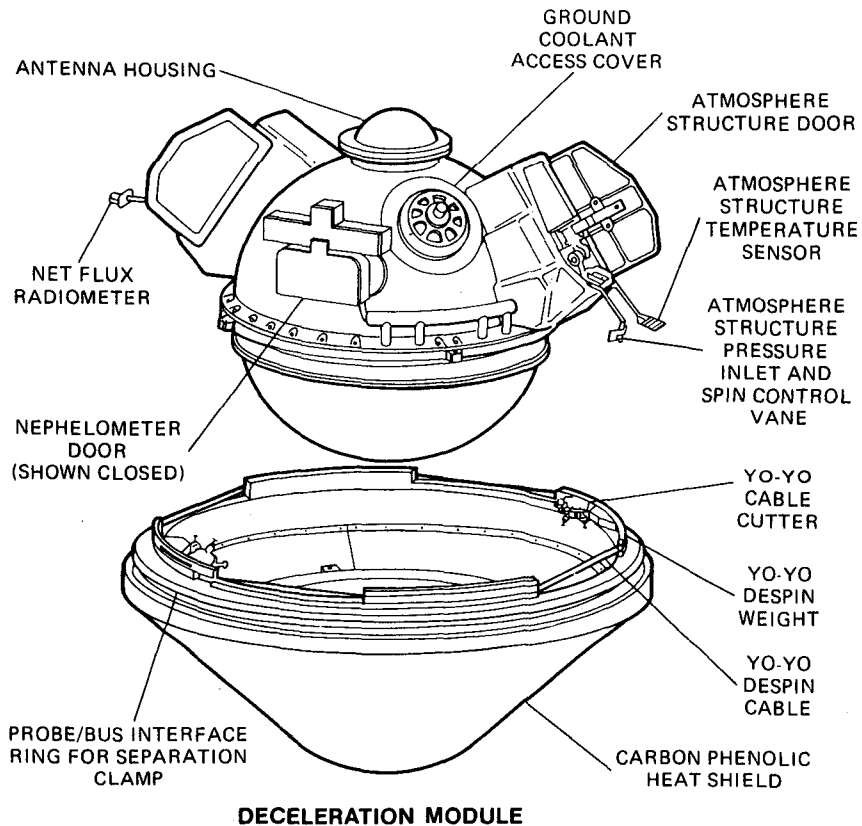

Figure 3-6. Small Probes

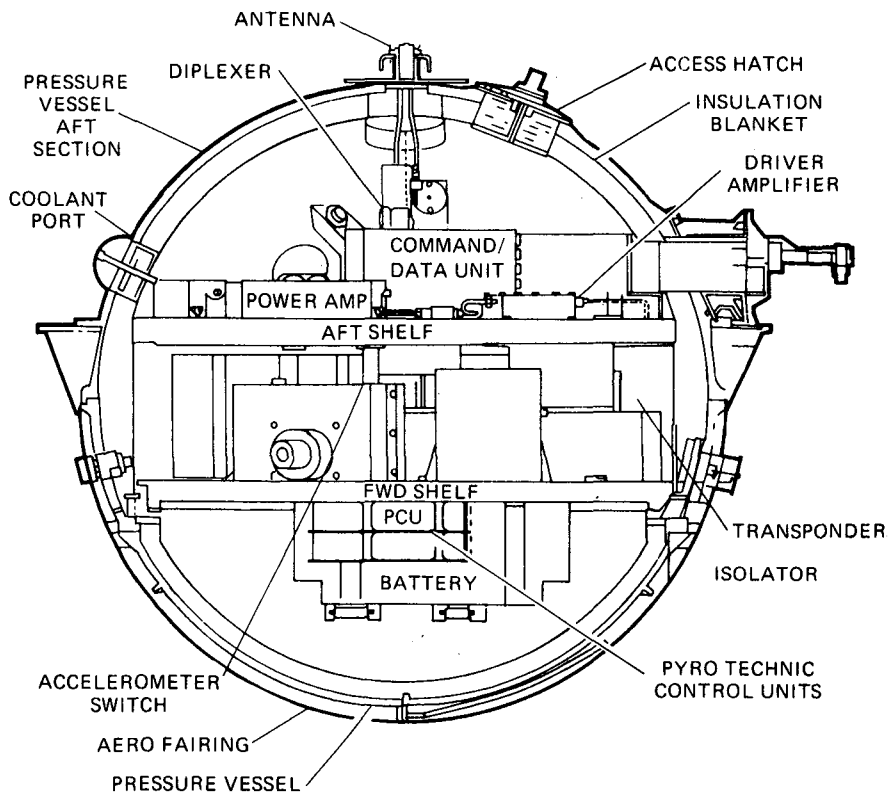

Figure 3-7. Sectional View of Large Probe Descent Module

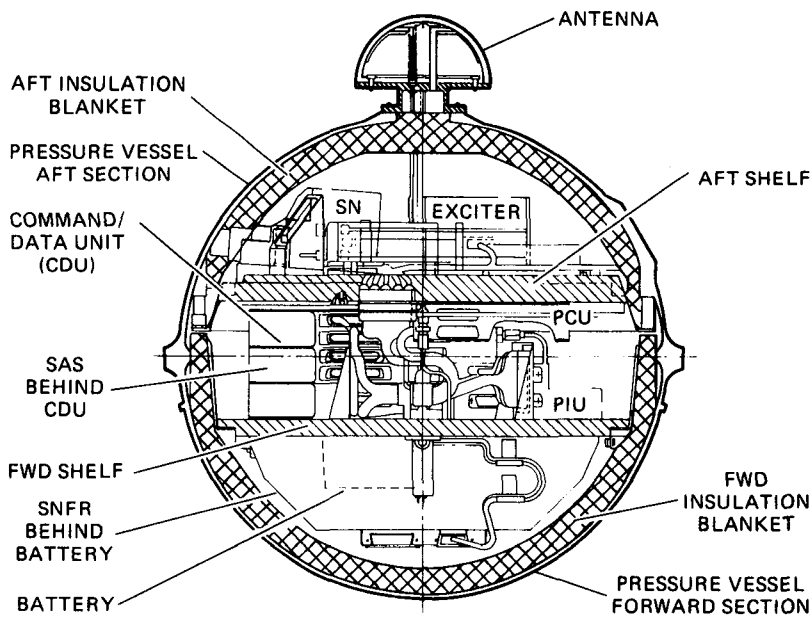

Figure 3-8. Sectional View of Small Probe Pressure Vessel



Since the small probe did not have a receiver, the transmitter reference frequency was provided by an oscillator with  $10^{-9}$  stability for one-way doppler tracking.

The probe command and data handling subsystem consisted of a command unit, a pyrotechnic control unit, a data handling unit, and the necessary sensors for detecting the entry and descent events. The command position consisted of a cruise timer which activated an entry sequence programmer (ESP). The ESP then transmitted a fixed sequence of commands that controlled the probe from entry to impact. For the large probe, the data handling portion provided a 256 bits/second (b/s) data rate during the descent except for five minutes before entry to 30 seconds after entry, when the rate was 64 b/s. The small probe data rate was 64 b/s to approximately 29 km altitude and then 16 b/s to impact. The data output for both probes consisted of a convolutionally coded PCM/PSK/PM frame format. A data storage capability of 3072 bits stored the telemetry during the entry blackout for subsequent transmission during the descent.

The probes were equipped with silver zinc battery power systems that provided a nominal bus voltage of 28 volts. The large probe battery provided 40 A/hr and the small probe 11 A/hr.



## SECTION IV

### PROJECT REQUIREMENTS

#### A. INTRODUCTION

Telecommunications and data acquisition requirements for Pioneer Venus were developed and detailed over a five-year period that began in 1972, two years before the Project Approval Document was signed in October of 1974. The scientific objectives and proposed mission design were first communicated informally by the Project in mission design studies and in information and planning meetings that involved representative members of the Pioneer Venus Project, scientific experimenters, the TDS Manager and the members of the TDS support organization at JPL.

Requirements for telemetry and metric data acquisition during the launch and cruise phases of the Orbiter and Multiprobe Missions and the in-orbit phase of the orbiter, were essentially a standard set of requirements that could be accommodated with existing near-Earth support capabilities and the existing DSN Mark III multimission configuration. The major impact of the Pioneer Venus mission involved data acquisition and recording capabilities necessary to support:

1. Multiprobe entry telemetry recovery
2. Multiprobe data acquisition for atmospheric wind velocity measurements
3. Orbiter occultation data recording

These three capabilities will be discussed below.

#### 1. Multiprobe Entry Telemetry Recovery

The design of the multiprobe entry event involved the near simultaneous acquisition of four probe signals during a one-chance event that would last only 90 minutes. During the descent there would be a total of five signals, from the bus plus the four probes, that must be acquired and tracked

simultaneously. The probe signals would be transmitted directly to Earth rather than relayed via the bus, so that only the data captured in real time during the one-and-only transmission would ever be recovered. The timing of the entry event was to provide a maximum overlap view for each of two 64-meter DSN stations located at Goldstone (DSS 14) and Canberra (DSS 43), and a similar overlapping view for at least two non-DSN stations needed for radio interferometry atmospheric wind measurements. The targeting and release of the probes approximately three weeks before arrival was to place the time of entry for all four probes within a thirty-minute period. Because of the limited battery supplied power, the probe transmitters would not be turned on until 22 minutes before entry, which meant the ground stations were faced with the near simultaneous acquisition of four spacecraft from which there had been no transmission since before launch. Normally, spacecraft are tracked every day during the cruise period, so that the ground stations become quite familiar with the signal characteristics and the acquisition technique. Upon entry, a communications blackout due to atmospheric heating would begin at about 120 km altitude and would last about 40 seconds down to 80 km altitude. During the blackout, a large doppler pulse of over 80 kHz would occur. The DSN was expected to acquire the four probe signals within five minutes after they had begun transmitting, to reacquire within three minutes after the communications blackout and the doppler pulse, to establish two-way communication with the bus and to maintain communication until the bus and probes ceased transmitting. The total signal power received at the DSN antennas would be approximately  $5 \times 10^{-19}$  to  $1.6 \times 10^{-18}$  watts.

The fundamental support objective was for the DSN to recover and deliver the multiprobe telemetry either in real time or after the fact with as little data loss as possible. The loss of two minutes of data would amount to two percent (2%) of the entire 90-minute period for any one probe.

The standard DSN technique for real-time telemetry recovery is coherent detection of the carrier, then the subcarrier and then bit synchronization. A simplified block diagram of the process is shown in Figure 4-1. The first step is acquisition of the probe downlink carrier by a phase-coherent or "closed-loop" receiver, which must be tuned until the receiver frequency matches the carrier frequency, putting the receiver "in lock." The lockup process requires a period of time and a skilled operator. The second step is

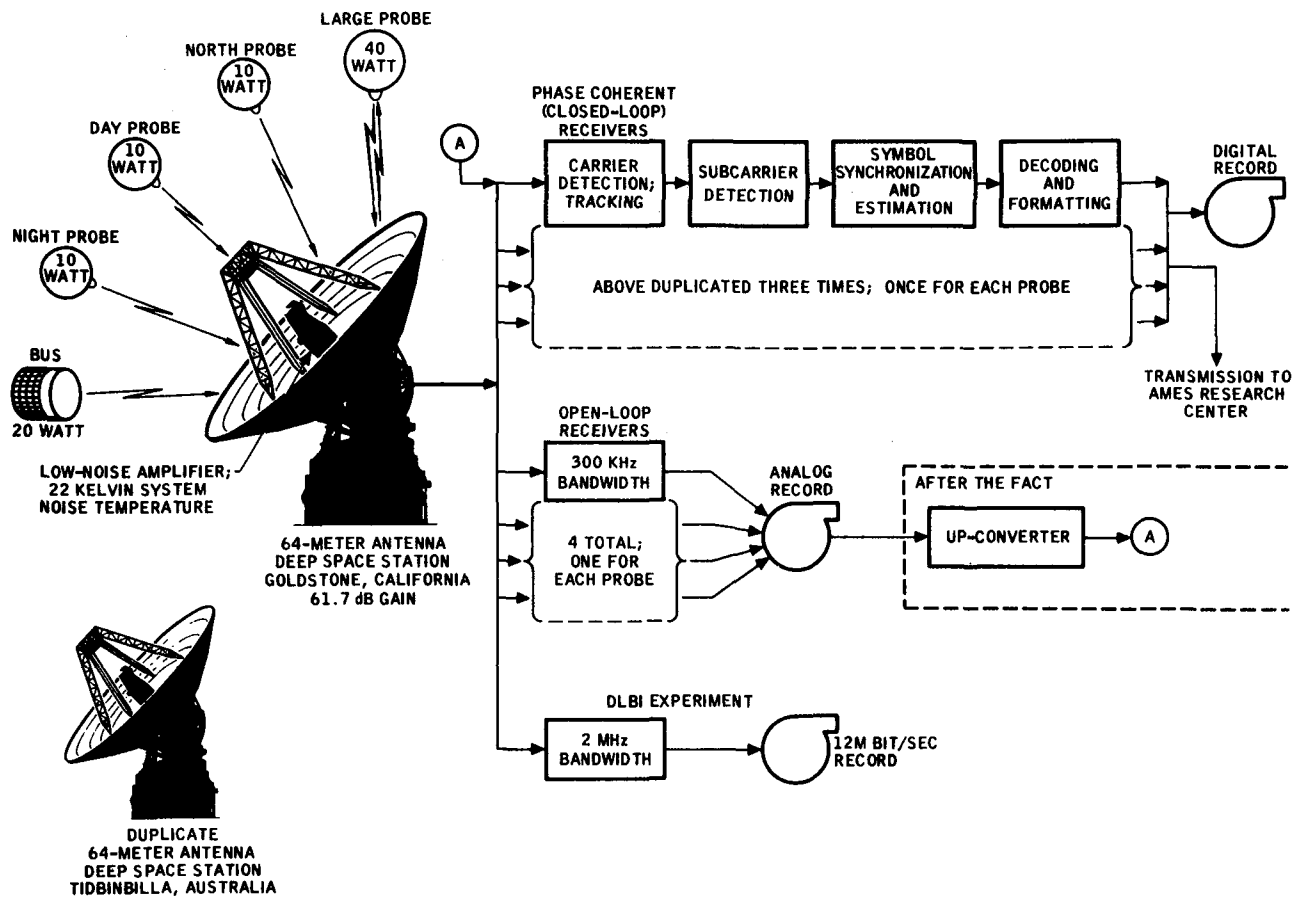

Figure 4-1. Pioneer Venus Multiprobe Entry Data Recovery Configuration at the Deep Space Stations

subcarrier detection, another closed-loop process that does not require an operator but again is time-dependent. The output is an integrated symbol stream, which passes to a symbol synchronizer where the bit timing is estimated, acquired, and tracked by another time-dependent closed-loop process. The symbols are passed to a telemetry processor, which synchronizes with the telemetry frames, decodes and formats the data. The decoded and formatted telemetry is then recorded as part of the station's original data record and transmitted to the project control center (Ames Research Center) in real time.

To support the multiprobe entry, the real-time telemetry equipment would need to be duplicated four times, one string per probe, at two ground stations -- a large amount of equipment that would have to operate without failure and would be highly dependent on operator skill to achieve rapid lockup. It was readily apparent at the conceptual design stage for the Multiprobe Mission that to depend solely on real-time telemetry recovery represented a very high risk to the mission. During discussions in 1972, DSN engineers were asked to study the feasibility of using an open-loop receiver\* to capture the probe signals and to record the receiver output, which could be replayed later to recover the telemetry data. The primary obstacle was an unavoidable degradation of the signal by the recording process, which could distort the data or render it unrecoverable. In May 1973, DSN engineers, after some breadboard testing and analysis, informed the Pioneer Venus study team that a precarrier detection recording approach might prove feasible. By November 1973, the DSN had gained sufficient confidence through its testing experience to commit to the implementation of a precarrier detection recording capability that would contribute no more than 1.5 dB loss, when compared to the real-time telemetry recovery technique. The additional loss was accepted by the Pioneer Venus Project as part of the multiprobe telecommunication design. It was agreed that both techniques (real-time telemetry recovery and predetection recording) would be implemented. Additional real-time telemetry equipment would be installed at DSS 14 and DSS 43 to attempt real-time recovery for all four probes. At the same time, work would continue on the development of an

---

\* A receiver that maintains the center position (frequency) of its receiver bandwidth to match a fixed oscillator setting. The usual DSN receiver uses a feedback control loop (i.e., "closed loop") to use the detected signal to control the center position of the receiver.

acceptable recording system for open-loop recovery. The open-loop recovery technique is also shown in Figure 4-1. There are four open-loop receivers, one for each probe. The 300 kHz bandwidth of each receiver encompasses doppler shift, subcarrier harmonics and uncertainties. The receivers are set at a fixed frequency for each probe in advance of the encounter with no other operator action required except to activate the analog tape recorder. The output of each receiver is recorded as a separate track on the tape recording. Recovery of the telemetry data is accomplished by playing one probe track at a time through an upconverter back to S-band frequency and then into a conventional closed-loop receiver and telemetry recovery string. (See Reference 6 for more detailed information.)

## 2. Multiprobe Data Acquisition for Atmospheric Wind Velocity Measurements

The multiprobe entry also included a differential long baseline interferometry (DLBI) experiment designed to measure vector wind velocities by providing precise three-dimensional velocity profiles of all four probes as they fell through the atmosphere. The experiment was suggested in 1971 by I. I. Shapiro of the Massachusetts Institute of Technology (MIT) and was eventually included as part of the mission plan through the efforts of G. H. Pettengill, Chairman of the Pioneer Venus Radio Science Team. C. C. Counselman of MIT was the Principal Investigator. The experiment involved the use of Doppler shift observations to measure the velocity along the "line of sight" (from the spacecraft to Earth) combined with long baseline interferometry to measure the two horizontal components across the line of sight. The instrumentation necessary to support this experiment turned out to be one of the greater challenges to the DSN. In particular, the long baseline interferometry experiment required simultaneous reception of all four probe carriers as well as the carrier on the bus by at least three earth stations. The instrumentation is described in Appendix A, which also includes a discussion of the measurement of the Doppler effect on each of the five radio signals.

After release of the probes the bus velocity was to be reduced so that it entered the atmosphere after all four probes had impacted the surface of the planet. The bus thereby provided a reference signal that was unaffected by

the Venusian atmosphere. A corrected difference taken between the bus signal and each of the probe signals received at a single earth station is used to eliminate the effects of the Earth's ionosphere and interplanetary media. A second difference taken between a pair of earth stations produces a measure of the angle subtended by the two stations and a probe. The rate of change of that angle is the measure of the probe velocity perpendicular to the line of sight. In addition to the challenge of the engineering configuration of the ground stations, which included the Deep Space Stations and the Spaceflight Tracking and Data Network stations, was the operational challenge of finding each of the probes' signals which came on sometime before entry into the Venusian atmosphere. The very short time available to acquire all of the probe signals in order to recover the telemetry and carry out the interferometry experiment was unique in the history of deep space missions supported by the DSN (see Reference 7 for more information).

### 3. Orbiter Occultation Data Recording

The occultation of a spacecraft signal by a planetary atmosphere is used to generate important scientific information. Changes in the signal amplitude and Doppler frequency, caused by the signal's passage through the planetary atmosphere, are used to construct a refractivity profile with height, from which a number of atmospheric parameters are deduced such as temperature and pressure profiles, mean molecular mass, turbulence and atmospheric constituents abundance ratios. When a spacecraft is equipped to transmit at both S-band (2.3 GHz) and X-band (8.4 GHz), a planetary ionospheric electron density profile can be constructed from differenced Doppler measurements.

Previous to Pioneer Venus, the DSN technique for acquiring occultation data was to record the analog output signal of an open-loop receiver that passes a bandwidth wide enough to accommodate all expected frequency shifts during the occultation plus uncertainties. The wide bandwidth analog recordings were then shipped to the compatibility test area at JPL, where they were digitized and recorded on computer-compatible magnetic tape for delivery to radio science experimenters. The first processing step performed by the experimenter, termed a decimation process, involved reducing the bandwidth by multiplying the digitized wide bandwidth signal by an estimate of that signal and



then filtering the product to obtain a recording of only that portion of the bandwidth containing occultation frequency information.

The problem presented by the Pioneer Venus Orbiter Mission was the large number of occultations (over 100) and the predicted large frequency shifts caused by the Venusian atmosphere (on the order of 100 kHz at S-band and 300 kHz at X-band). The frequency shifts meant that each analog recording would result in an excessively large number of digital tape recordings and much decimation processing. The combined S and X-band bandwidth of 400 kHz, recorded at two 64-meter stations during each occultation period (ranging from 20 minutes to 3 hours), would produce approximately  $2 \times 10^{10}$  bits of digitized data per occultation. Multiplied by 100 occultations, the amount of processing time and computer expense to simply separate the raw frequency information from the total volume of recorded bandwidth data was prohibitive.

In May 1976, a study team was formed to investigate ways of reducing the volume of data without compromising the scientific content. The team's analysis of the overall technique produced a method of rearranging the steps so that the decimation process (bandwidth reduction) could be performed on the analog signal at the time of reception. The functional concept suggested by the team is shown in Figure 4-2.

Instead of a fixed local oscillator and a fixed wide bandwidth, a computer-controlled programmable local oscillator was used to drive the first local oscillator of the open-loop receiver with a predicted estimate of the occultation signal frequency and its doppler excursions. As shown in Figure 4-3, the mixed frequency product of the actual frequency ( $f_a$ ) and the predicted signal frequency ( $f_p$ ) provides a new, much less dynamic baseband frequency ( $f_a - f_p$ ), which can be passed through a correspondingly narrow filter. Depending on the accuracy of the predicted doppler frequency profile (approximately 1 - 10 kHz at S-band), the baseband frequency bandwidth is reduced by a factor of between 10 and 100, which allows the output analog signal to be digitized and recorded on computer-compatible magnetic tape in real time at the receiving deep space stations, thus eliminating the costly time-consuming decimation process performed by the experimenter.

The functional concept was presented in June 1976 and accepted by both OSTDS and the Project. The new technique, identified as "real-time bandwidth

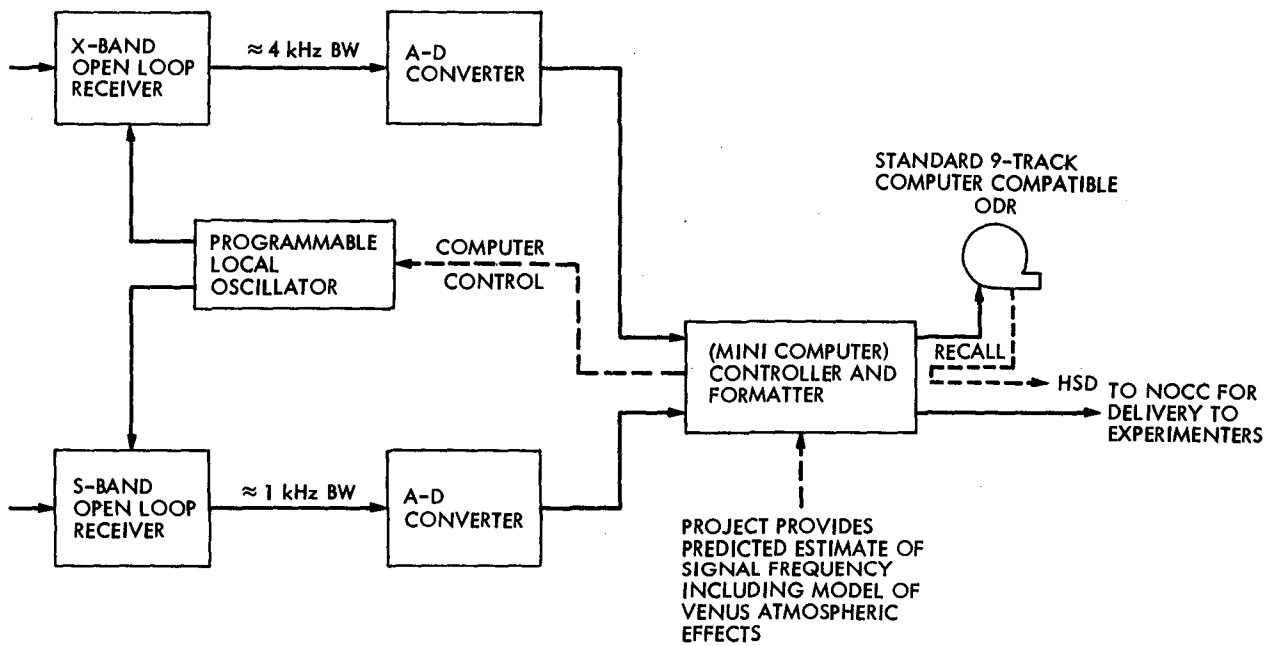

Figure 4-2. Study Team Functional Concept Decimation Process

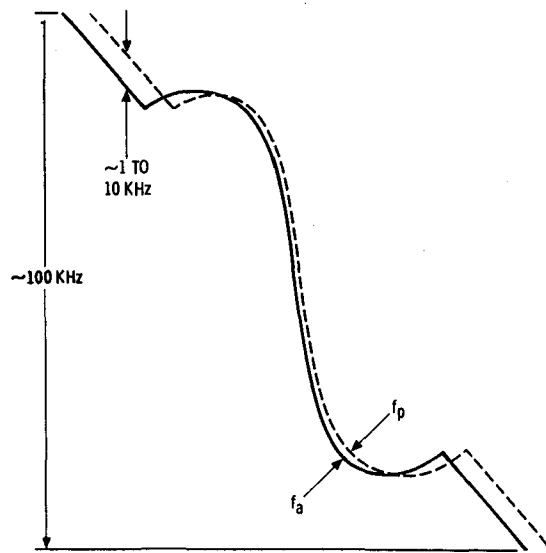

Figure 4-3. Actual and Predicted Occultation Signal Profiles

reduction," was approved for implementation as the first operational capability of a new DSN Radio Science System. The capability, as implemented and delivered in November 1978, is shown in Figure 4-4. Doppler frequency predictions containing the estimated effects of planetary atmospheric refraction are generated by software programs at JPL and transmitted to the DSS via high-speed data line. The predicts are reformatted by the DSS Radio Science Subsystem Occultation Data Assembly (ODA) and delivered to the digitally controlled oscillator in the open-loop receiver. The bandwidth-reduced analog baseband signal is returned to the ODA, where it is digitized and recorded directly on computer-compatible tape. The tape is either shipped by mail or transmitted via high-speed data line to the GCF Data Records Subsystem, where it is recorded on an Intermediate Data Record and subsequently delivered to the radio science experimenter (for more information, see Reference 8).





## SECTION V

### OPERATIONS AND PERFORMANCE SUMMARY

#### A. MISSION PROFILE

##### 1. Multiprobe Encounter

The multiprobe spacecraft was sent on a type I trajectory (less than halfway around the Sun) from its launch on August 8, 1978. On November 16 the bus was pointed and the large probe released. Four and one-half days later, on November 20, the bus was adjusted again and the three small probes were released at a precise time and spin rate for their planned entry points.

The Goldstone and Canberra stations were configured, tested and set for the five separated spacecraft of the multiprobe on December 9, 1978 for a mission that was to last for 2.5 hours. The entrances of the first four probes were staggered in time over an interval of about ten minutes to allow the tracking stations to lock up sequentially to the signal. The bus entered some 90 minutes later, lasting just over one minute before burning up in the atmosphere. The probe signals appeared on time and the Network started recording telemetry data as planned. Table 5-1 lists the entry event times in time at the spacecraft. Remarkably, the day probe (SP-2 in Figure 5-1 showing entry locations) continued to transmit telemetry for more than one hour after impact on the surface.

Data tapes were expedited to JPL from Goldstone and Canberra for further processing. The stations' efforts had recovered over 85 percent of all the data transmitted by the four probes. A unique telemetry recovery technique of forward and backward playback of precarrier detection recordings provided a 100% recovery of all the available data.

##### 2. Orbiter

With the Multiprobe Mission successfully completed, the emphasis was now on the support of the daily orbits of Pioneer 12. The spacecraft went into Venus orbit on December 4 with the firing of the solid-propellant rocket

Table 5-1. Probe Entry Events

Event	Time at Spacecraft, UT (HHMM:SS)			
	Large Probe	North Probe	Day Probe	Night Probe
Coast timer time-out	1824:26	1827:57	1830:27	1834:08
Telemetry initiation	1829:27	1832:55	1835:27	1839:08
Entry (200 km)	1845:32	1849:40	1852:18	1856:13
Loss of signal (blackout)	1845:53	1849:58	1852:40	1856:27
Relock signal	1846:55	1850:55	1853:46	1857:48
Jettison chute	1903:28	NA	NA	NA
Impact	1939:53	1942:40	1947:59	1952:05
Loss of signal	1939:53	1942:40	2055:34	1952:07
Decent time*	54:21	53:00	55:41	55:52
Blackout time†	:62	:57	:66	:81
Time on chute	~17:07			
Operating time on surface‡	0	0	67:37	00:02

\* Calculated by subtracting the values for entry time from those of impact time.  
 † Calculated by subtracting the loss of signal time from the relock signal time.  
 ‡ Calculated by subtracting the impact time from loss of signal time.

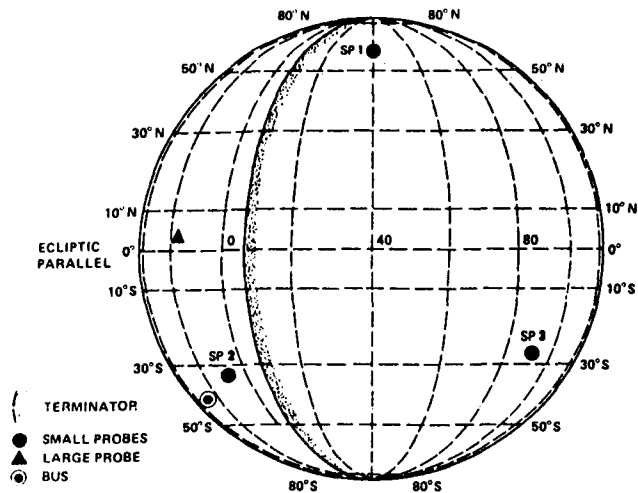

Figure 5-1. View from Earth of Multiprobe Entry Locations



motor. The maneuver took place behind the planet as viewed from Earth so there was no communication during the crucial event. At Goldstone, DSS 14, with DSS 11 as backup, covered this event. There could be two different carrier frequencies on exit from occultation based on whether the 30-second burn took place or not (Doppler difference). At Goldstone, DSS 14 had two receivers tuned to the appropriate frequencies. At about 1617 UT the right receiver locked to the downlink showing the spacecraft was in Venus orbit. Subsequent tracking data showed the retrorocket had performed better than expected, which resulted in a slightly lower apoapsis altitude and a slightly shorter period (see Table 5-2).

Figure 5-2 shows typical orbital operations through the mission.

Table 5-2. Planned and Initial Orbit Parameters

Parameter	Planned	Actual
Periapsis altitude, km (miles)	350(217.5)	378.7(235.3)
Periapsis latitude, deg	18.5N	18.64N
Periapsis longitude, deg	203-223	207.990
Inclination, deg	105	105.021
Period, hr:min:sec	24:0:0	23:11:26

a. Phase I (Low Altitude). The nominal mission of the orbiter was to complete one full rotation of the planet, which would take 243 Earth days. The orbit had been adjusted to 214 hours and was divided into apoapsis and periapsis segments, 20 hours long and 4 hours long, respectively. The periapsis was gradually moved into the Goldstone-Australia tracking overlap to obtain the best coverage for this more intense period of the orbit. Through a series of propulsive maneuvers, periapsis altitude was maintained between 142 and 180 km. The nominal mission lasted until August 4, 1979 and excellent data were obtained. After two weeks in orbit, the radar instrument failed, causing considerable concern. A month later, when it was turned on, it was working again. Continuous operation seemed to be the problem; turning it off when not in use seemed to clear up the problem. Unfortunately, the infrared radiometer

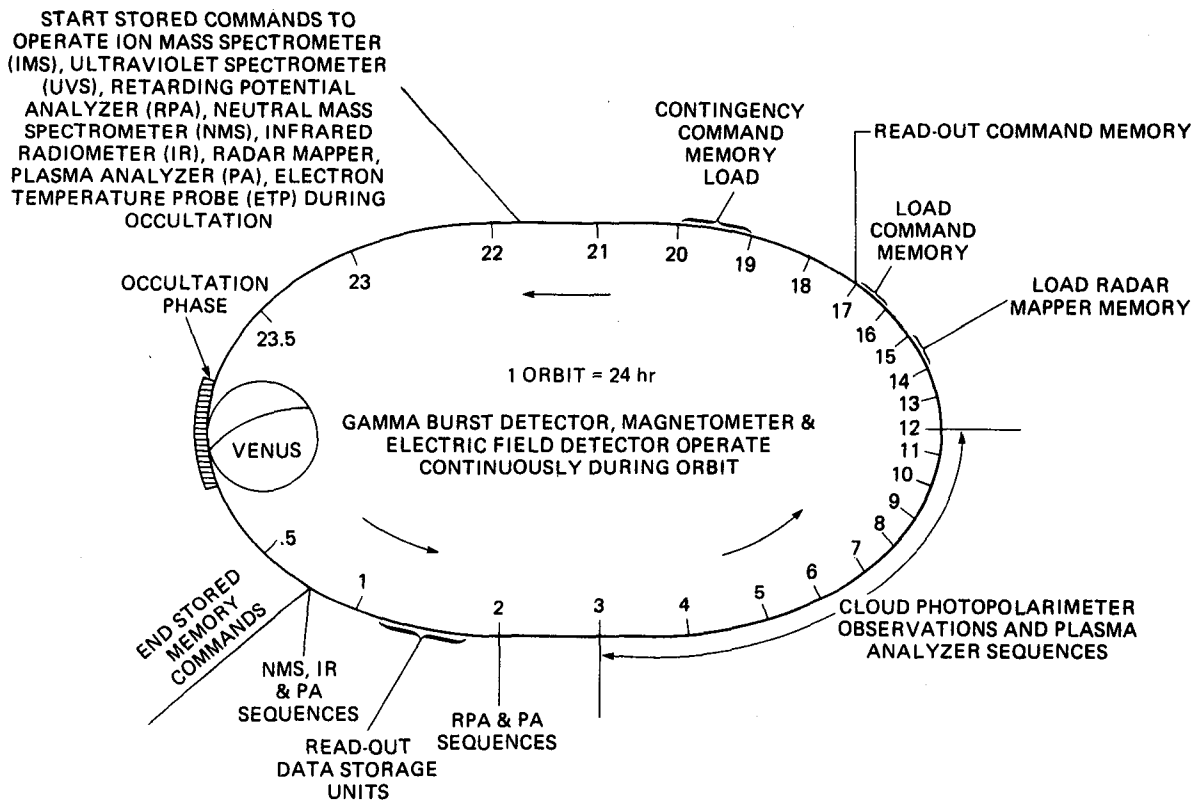

Figure 5-2. Typical Orbital Operations Through the Mission

which failed on the 70th orbit never became operable again. The rest of the spacecraft and instruments have continued to perform very well. Science data taking was curtailed during the superior conjunction on August 25, 1979, which was also the period of the Pioneer 11 Saturn Encounter. Tracking was kept to a minimum during this period, but activity picked up again on September 9, starting into the second Venusian year. Propellant usage had been minimized by keeping periapsis altitude in the 150 km range but sometimes allowing it to go as high as 250 km. It was decided to maintain this control until orbit 600, July 27, 1980. Extensive coverage was provided by the DSN during this period to enhance the science return of the atmospheric and radar data. Two radio science occultation sessions were covered in this phase also, using the DSN Tracking System.

b. Phase II (High Altitude). The high altitude phase of the mission, which could be described as the propellant conservation period, started on July 27, 1980. The plan is to let the periapsis altitude rise gradually from natural causes and use propellant only as necessary to maintain attitude. This period provides a new series of science data not available during Phase I. It also provides the unique opportunity to observe solar interactions with the planetary atmosphere during a complete solar cycle.

Long-term cloud study and precise gravitational data will also be obtained. In January through March 1986 the orbiter will have the unique opportunity to make ultraviolet spectrometer observations of Halley's Comet in the pre-perihelion period. Periapsis altitude will continue to rise to a maximum of 2290 km, to be reached on June 29, 1986. The same solar gravity effect will then cause a gradual decrease until periapsis altitude reenters the ionosphere in 1992, ending Phase II. The radar mapper was turned off on March 19, 1981, as the increasing altitude precludes usable data from the instrument. It will be turned on again in Phase III when the periapsis altitude drops low enough for good resolution data.

c. Phase III (Reentry). From May 23 until August 21, 1992, periapsis altitude will be controlled. The remaining propellant will be expended by that time and atmospheric entry and incineration of the spacecraft will occur.

It is planned to maintain periapsis between 150 and 250 km during this period. What sets this period apart from Phase I is that the periapsis latitude will be in the Southern Hemisphere, opening up regions that have not been seen before. The radar topographic map will be extended and the southern ionosphere can be sampled. A more complete picture of the entire Venusian environment will result from this final phase of the mission.

## B. DSN SUPPORT

The Pioneer Venus Ground Data System, previously described, has supported the Orbiter Mission through Phase I and into Phase II. The early orbits involved longer pre- and post-calibrations and close monitoring until the effects of orbital operation were better understood. This settled quickly enough into a routine, and the stations were able to reduce calibrations to a minimum. The spacecraft maneuvers to maintain the desired periapsis altitude required close coordination between the Analysis Group, Navigation and the Spacecraft Attitude Team to insure the generation of predicts. Throughout the first orbits and on through Phase I, this was accomplished without loss of data. In Phase II, with only small attitude maneuvers, the orbital perturbations have eased the predict generation activity.

There have been three superior conjunction passages since orbit insertion. No usable science data can be obtained for about three weeks during these periods. The Project looks at engineering data as long as possible, but there is a blackout period that requires the 64-meter stations to use the high-power transmitter to get a command into the spacecraft at least once a day to prevent its receiver from switching. That has been successfully accomplished.

There have been seven occultation periods so far that have required the use of special procedures and equipment, as described in Section 4.3 (see also Figure 5-3). Radio science data for atmospheric study has been taken during these periods, which have lasted from seven days to over a month. The two-way S-band signal and an X-band beacon signal are recorded for the Radio Science Team.

The DSN has supported nine eclipse sessions for the orbiter. While there is no loss of signal from the spacecraft, commanding is critical as the spacecraft moves through the planet's shadow. Various systems must be shut down to

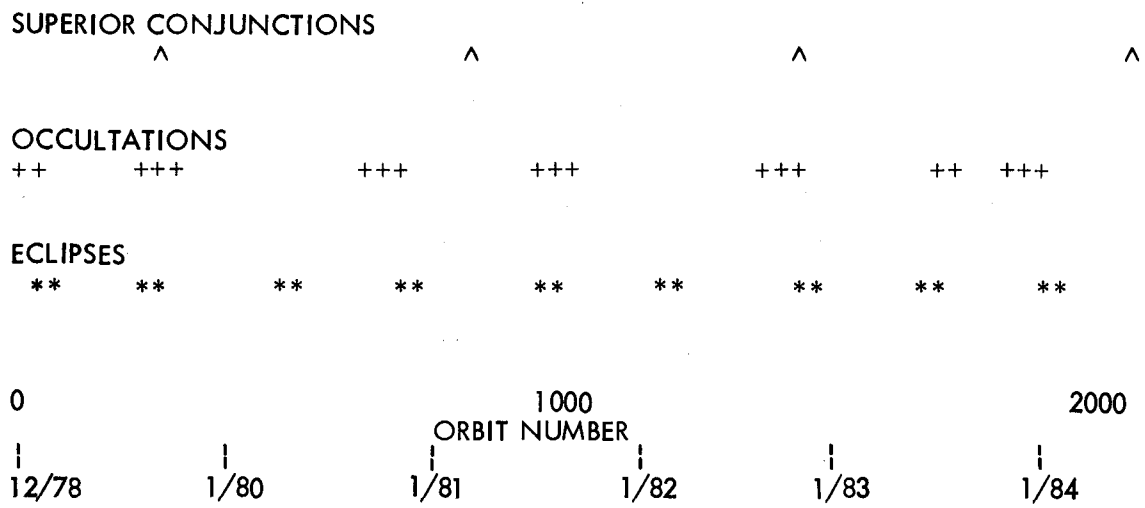

Figure 5-3. Special Activities Supported on Pioneer Venus

allow the battery to power the RF System until the solar panels are in sunlight again. The more difficult long eclipses require the high-gain antenna to be allowed to spin up, and communication must be maintained through the backup medium-gain antenna.

Tracking support has been provided by the 26, 34 and 64-meter stations. In the early phase the 26-meter stations could support the maximum 2048 bit rate for about 3 months of the Venus year. At superior conjunction only the 64-meter stations can maintain communications. At the present time the 34-meter stations track at acceptable science return rates for all but about 2 months of the Venus year.

The Mark IVA is a consolidation and upgrade of the Deep Space Network. To accomplish this major task, the 26-meter network had to be decommitted from support, and the 34 and 64-meter stations had to be removed from support at various times. As each station is returned to operational status, a series of compatibility tests are run, followed by demonstration tracks, to insure continued support of the orbiter spacecraft. In this interim period there has been less support than desired by the project; however, the minimum support for spacecraft survival has always been provided without risk. The project is also in the process of upgrading its software so it will be compatible with the new DSN Mark IV System.

#### C. SPACECRAFT STATUS

In general, all the spacecraft systems are operating nominally. The two limiting factors are power and propellant.

The solar panel output was 13 amps at orbit insertion; however, there has been a slow degradation due to solar effects. Larger drops in output have occurred which coincide with solar flares. The present output averages 9 amps; full spacecraft operation requires 7 amps. When the panel output drops below that level, selected spacecraft and instrument systems will be turned off. The large reductions should decrease as solar minimum approaches with reduced solar flare activity. The spacecraft battery which is necessary for eclipses continues to operate properly. Projections indicate enough power will remain for the completion of Phase III.

The spacecraft was launched with 70 lbs of propellant and had 52 lbs at orbit insertion; Phase I of periapsis altitude control used 42 lbs; Phase II attitude maintenance has used negligible amounts; and 10 lbs remain. About 1 lb will be used during the encounter of Halley's Comet to invert the spacecraft and maneuver it for observations. Phase III will require 4 lbs for periapsis control. The propellant reserve seems adequate, but low tank pressures can be unpredictable.

In April 1983 a problem developed in the spacecraft radio: Receiver 2 was non-responsive. Subsequent tests showed a drastically reduced frequency response. A shorted capacitor was suspected, as the symptoms were the same as the Voyager 2 receiver problem. This capacitor was the same design as the Voyager capacitor but came out of a different manufacturing run. Tests have shown that it was possible to get commands in through the receiver by careful use of a tuning procedure. Receiver 1 was being exercised to prevent a similar failure.





## SECTION VI

### EPILOGUE

A significant aspect of the Pioneer Venus Missions was the relationship between the Pioneer Venus Project personnel and the Deep Space Network personnel which was unique among deep space missions. A large percentage of the project personnel, from the project manager on down, had been a part of the Pioneer missions from the early to mid 1960's days of Pioneer 6 on through the Jupiter encounters of Pioneer 10 and 11. This continuity of project personnel also provided continuity in the project-to-DSN interface and engendered the development of mutual trust between the flight project and the DSN.

Typical of this atmosphere of mutual trust and confidence were the ways that the Pioneer Venus Project levied project requirements on the DSN at a very broad and general level, and the minimal requirement for formal reporting and documentation between the DSN and the project. This environment enabled the sum of the Pioneer Venus Project and associated DSN costs to be minimized to NASA's benefit. The basic project requirement on the DSN was "get us the telemetry data when the probes enter." The detailed implementation, configuration requirements, and procedures were left up to the DSN. The sole exception to this was a project request in the very early stage of the mission (prior to formal project approval) in which the project asked the DSN if it could commit to some form of pre-carrier detection recording for telemetry recovery during the probe entry. This early commitment by the DSN enabled the project to accept the risk and attendant low cost of the system contractors' proposal for all probe links to be direct to the Earth. The alternative would have been reception and recording by either the multi-probe carrier or the Pioneer Venus orbiter spacecraft. The mission design of having the probe links direct to the Earth put the DSN in the highest mission risk position it has ever found itself before or since the Pioneer Venus Mission. On every other mission supported by the DSN, an equipment failure or procedural error could cause the loss of some valuable mission or science data, but in the case of the multi-probe entry, such failures or errors could indeed cost the entire mission to fail. The total investment by the DSN in mission-unique capabilities for Pioneer Venus support (which principally included the multi-probe telemetry recovery, the

DLBI experiment, and the implementation for the orbiter occultations) was slightly less than \$7 million in 1975 dollars. This investment by the DSN and the mutual acceptance of risk for the multi-probe entry saved NASA many tens of millions of dollars over what it would have cost to put receivers and tape recorders on the Pioneer Venus Orbiter spacecraft for the sake of probe telemetry recovery. In addition, much of the investment originally made for Pioneer Venus was later modified and adapted for the support of the Voyager Jupiter and Saturn encounters.

Another example of how NASA benefited from the mutual trust and acceptance of risk between the Pioneer Project and the DSN occurred in the extended mission phase of Pioneer Venus. This example occurred when Pioneer Venus was having a superior conjunction while Pioneer 11 was in its post periapsis Saturn encounter phase. Pioneer Venus had a built-in error recovery mode in which major components in the radio subsystem would be switched if a ground command was not successfully decoded at least once every 36 hours. During the particular superior conjunction in question, a command had to be sent to Pioneer Venus at least once a day using 100 kW transmit power out of a 64-meter antenna. The problem was that the control center computers and personnel at Ames Research Center were fully occupied supporting the Saturn encounter, and there were no resources to spare without sacrificing some of the Saturn science in order to get the daily command into Pioneer Venus. The DSN agreed to come up on Pioneer Venus once a day and attempt a ground command and to look for the successful receipt of the ground command in the return telemetry from Pioneer Venus without any data flowing to, or any participation by, Ames Research Center personnel. At the time this kind of "in-line" operation was against DSN policy, but the mutual trust aspect involved the understanding that the commanding of Pioneer Venus was on a best efforts basis and if any command ever failed to get in, there would be no major complaint out of the Pioneer Venus Project. The Pioneer 11 Saturn encounter and the solar conjunction were both successful when the alternative would have been either a compromise in the Saturn science return or the need for additional resources in the Pioneer Venus Project.

## SECTION VII

### REFERENCES

1. Fimmel, R.O., L. Colin, and E. Burgess, Pioneer Venus, NASA SP-461, NASA Scientific and Technical Information Branch, Washington, D.C., 1983.
2. Science, 203 (4382), 743-808, 1979.
3. Science, 205 (4401), 41-121, 1979.
4. American Geophysical Union, Pioneer Venus, reprints from the Journal of Geophysical Research, 85 (A13), December 30, 1980.
5. IEEE Geoscience and Remote Sensing Society, IEEE Transactions on Geoscience and Remote Sensing, GE-18, January 1980.
6. Miller, R.B., and R. Ramos, Pioneer Venus multiprobe entry telemetry recovery, IEEE Transactions on Geoscience and Remote Sensing, GE-18, 15-19, January 1980.
7. Smith, J.R., and R. Ramos, Data acquisition for measuring the wind on Venus from Pioneer Venus,, IEEE Transactions on Geoscience and Remote Sensing, GE-18, 126-130, January 1980.
8. Berman, A.L., and R. Ramos, Pioneer Venus occultation radio science generation, IEEE Transactions on Geoscience and Remote Sensing, GE-18, 11-14, January 1980.



# Pioneer Venus 1978 Mission Support

R. B. Miller  
DSN Systems Engineering Office

*The differential long baseline interferometry experiment for the purpose of measuring the wind velocities in the atmosphere of Venus as a part of the Pioneer Venus 1978 multiprobe mission is described.*

## 1. Introduction

The Pioneer Venus multiprobe mission includes a differential long baseline interferometry experiment, which will attempt to measure the wind velocity in the atmosphere of Venus as four probes descend through the atmosphere. Basically, the experiment will be using interferometry techniques to measure the components of the wind velocity perpendicular to the line of sight (Earth-spacecraft direction) and established doppler techniques to measure the velocity components along the line of sight. As described in previous articles, the bus spacecraft is retarded by a trajectory correction after it releases the four probes, so that it will enter the Venusian atmosphere after all four probes have reached the surface of the planet. In this way, the bus serves as a reference signal, undisturbed by the Venusian atmosphere. A corrected difference is taken between the bus signal and each of the probe signals at a particular tracking station to eliminate ionospheric and interplanetary effects, and a second

difference is taken between pairs of tracking stations which produces a measure of the rate of change of the angle subtended by the two stations and a probe.

Each pair of stations resolves only one component of the velocity. In order to resolve both components of the wind velocity perpendicular to the line of sight and to provide some measure of redundancy, four stations will be equipped to support this experiment. The two 64-meter DSN stations located at Goldstone, California, and Canberra, Australia, will be utilized, along with 12-meter Spaceflight Tracking and Data Network (STDN) stations located at Santiago, Chile, and Guam. The Principal Investigator for this experiment is Dr. Counselman and the Co-Investigator is Dr. Pettengill, both of the Massachusetts Institute of Technology. The Tracking and Data Acquisition Office of the Jet Propulsion Laboratory is responsible for seeing that all four ground stations are equipped for this experiment. The experimenters will be responsible for all nonreal-time processing of the data.

## II. Basis of Differential Long Baseline Interferometry

The fundamental concept of interferometry and its application in the Pioneer Venus case are illustrated in Fig. 1. Pictured are two tracking stations located on the surface of Earth and two signal sources located near the planet Venus. For simplicity, consider that the two spacecraft and the two tracking stations are located on lines which are perpendicular to the Earth-Venus line of sight. Looking first at a single spacecraft, since the distance from Earth to Venus,  $r$ , is very much greater than the displacement of the spacecraft from the line-of-sight,  $y$ , then using similar triangles, the angles  $\phi$  and  $\theta$  are approximately equal. The difference in path length from the spacecraft to the two stations is shown as the distance  $\delta$ ;  $\delta$  equals  $\phi d$ , where  $d$  is the distance separating the two stations. Similarly,  $y$  is equal to  $r\theta$ . Since  $\phi$  is approximately equal to  $\theta$ , then  $y$  is approximately equal to  $(r/d)\delta$ .  $\delta$  represents the phase difference between the single spacecraft signal received simultaneously at the two tracking stations. As an indication of the potential power of the interferometry technique, if it were possible to measure  $\delta$  to within 1 degree of phase at S-band, using the fact that 1 Hz at S-band is approximately 13 cm, an Earth-Venus distance of 50,000,000 km and a station separation of 8,000 km in the expression derived above, the displacement of the spacecraft could be resolved to within 3 meters at Venus. Unfortunately, there are several sources of error which would prevent making such a direct measurement. The two most significant effects are that the signal will have traveled through two completely different locations in Earth's ionosphere and, second, that in order to process the received signal, it is necessary to beat the signal against a local oscillator at each of the two stations. Differences in the local oscillators at the two stations would map directly into an error in the determination of  $\delta$ . The differential technique is utilized to virtually eliminate both of these error sources.

Returning to Fig. 1, if a second spacecraft located in the vicinity of the spacecraft of interest is tracked simultaneously, then the same expression as derived above could be used to derive a differential expression:

$$y_1 - y_2 \cong \frac{r}{d} (\delta_1 - \delta_2)$$

Now, with a differential measurement, two important things happen. First, because the two spacecraft are located close to each other compared to the Venus-Earth distance, their signals will follow essentially the same ray

path through Earth's ionosphere; therefore, differencing the signals will cancel out the ionospheric and atmospheric effects of Earth. Second, if the two signals are received through a single receiver at each of the stations, then at a particular station, both signals will have been beat against the same oscillator, and therefore, when they are differenced, the variations in the local oscillator will cancel out. This latter point is very important when considering the requirements on the ground equipment. In looking at the error sources of the experiment due to contributions from station equipment, because of this differential effect, only error sources which introduce a differential phase error between the two received signals have a significant effect on the experiment. Error sources which cause equal changes in the two received signals (such as local oscillator drift) have no first-order effect on the experiment.

In the above simplified discussion, one point which was ignored is the fact that  $\delta$  in practice contains an unresolvable ambiguity. In practice,  $\delta$  is many wavelengths long (one S-band wavelength is approximately 13 cm, where  $\delta$  can be on the order of hundreds of kilometers) and should be better represented by the expression

$$\delta = n\lambda + \frac{p\lambda}{2\pi}$$

where  $\lambda$  is the signal wavelength,  $n$  is an unknown integer, and  $p$  is the fractional phase difference expressed in radians.  $p$  is defined as the fringe phase. Since it is not possible to determine  $n$  to sufficient accuracy, only the time variation of  $p$  is meaningful, and it is the time variation of  $p$  which is termed the fringe frequency in radio interferometry. However, in the Pioneer Venus case, that is exactly what is desired. Determining the time rate of change of  $p$ , we have the time rate of change of  $\delta$  and therefore the derivative of  $y$ , which represents the velocity of the spacecraft perpendicular to the line-of-sight:

$$\frac{d(y_1 - y_2)}{dt} \cong \frac{r}{d} \frac{d(\delta_1 - \delta_2)}{dt} = \frac{r}{d} \frac{\lambda}{2\pi} \frac{dp}{dt}$$

where  $dp/dt$ , the fringe frequency, is the observable.

## III. Differential Long Baseline Interferometry Requirements

The key requirements for the Pioneer Venus 1978 differential long baseline interferometry wind measurement experiment will be briefly described.

The objective of the experiment is to be able to measure the wind velocities as the probes fall through the atmosphere of Venus to about a 10-cm-per-second accuracy using a 100-second integration time for the signal-to-noise ratios expected at the DSN 64-meter antennas. It is fairly easy to show that this requirement translates into the need to be able to determine the phase difference between pairs of signals when averaged over 100 seconds to within 1 degree of phase at S-band. For the 9-meter STDN stations, which will have a significantly less favorable signal-to-noise ratio, it will clearly be necessary for the experimenters to integrate over much longer times in order to achieve the same accuracy, therefore sacrificing time resolution in the rate of change of the velocity. It is this 1 degree of relative phase error versus time over the bandwidth of interest requirement that will be the most difficult to meet, and the DSN and the STDN have not yet determined what can actually be achieved. Pre- and post-experiment calibration of the station equipment involved in the experiment will be necessary, as well as some form of calibration signals recorded along with the actual data. The experimenters are confident that a number of that order can be achieved based on similar experiments that were performed at lunar distances using ALSEP signals.

As was described in previous Progress Report articles, the total bandwidth which the five signals from the multi-probe mission might occupy (four probes plus the bus) is 1.7 MHz. It is therefore necessary to have receivers which can pass a 2-MHz bandwidth, and open-loop receivers will be modified for this purpose. Analog recording is felt to be incapable of meeting the differential phase requirement of this experiment, and therefore digital recordings will be made in real-time. Three-bit quantization is required, and this, together with the 2-MHz bandwidth, means that the recorders will have to be able to operate at at least 12 megabits per second. These recorders represent the most significant implementation for the Pioneer Venus mission.

The experiment also requires that the mean rate fractional accuracy of the sampling be three parts in  $10^{12}$  and that the jitter on the samples be held to 10 nanoseconds

root-mean-square. Additionally, the calibration tones which will be inserted in real-time should have an absolute accuracy of three parts in  $10^{12}$ . This requirement will be met by hydrogen masers set with cesium standards at the DSN stations and cesium standards at the STDN stations.

#### IV. Ground Station Configuration

Four stations will be equipped for the Pioneer Venus 1978 differential long baseline interferometry wind measurement experiment. Figure 2 is a block diagram of the configuration which will be implemented at the DSN 64-meter Goldstone and Canberra stations and the STDN 9-meter Santiago and Guam stations. The five spacecraft signals will be detected by low-noise amplifiers, which at the STDN stations will be parametric amplifiers with a total system temperature of  $100^\circ$ , and at the DSN stations ruby masers with a total system temperature of less than  $24^\circ$ . Some form of yet-to-be-determined calibration reference frequencies will be inserted at this point in order to calibrate out drifts in the system. The five signals plus calibration tones will then pass through the open-loop receivers, which will pass a 2-MHz bandwidth. Signals will then go through an analog-to-digital converter and sampler and onto the 12-megabit-per-second digital recorders. The recorders will be redundant at each of the stations. The recorders will be able to record the 12-megabit-per-second rate at 76 cm (30 inches) per second, and therefore 80 minutes of recording will be possible between tape changes.

There are two principal remaining open areas in the differential long baseline interferometry wind measurement experiment. First is the determination by the DSN and the STDN of what is the actual differential phase error achievable by the ground equipment at a given signal-to-noise ratio. The second area concerns the details of both the pre- and post-experiment and real-time calibration. The complexity and sophistication of the required calibration will be dictated by the DSN and the STDN determined error contributions introduced by each of the elements in the ground station configuration.

### Acknowledgment

The author is indebted to T. L. Grant of the NASA Ames Research Center for use of material from unpublished correspondence.

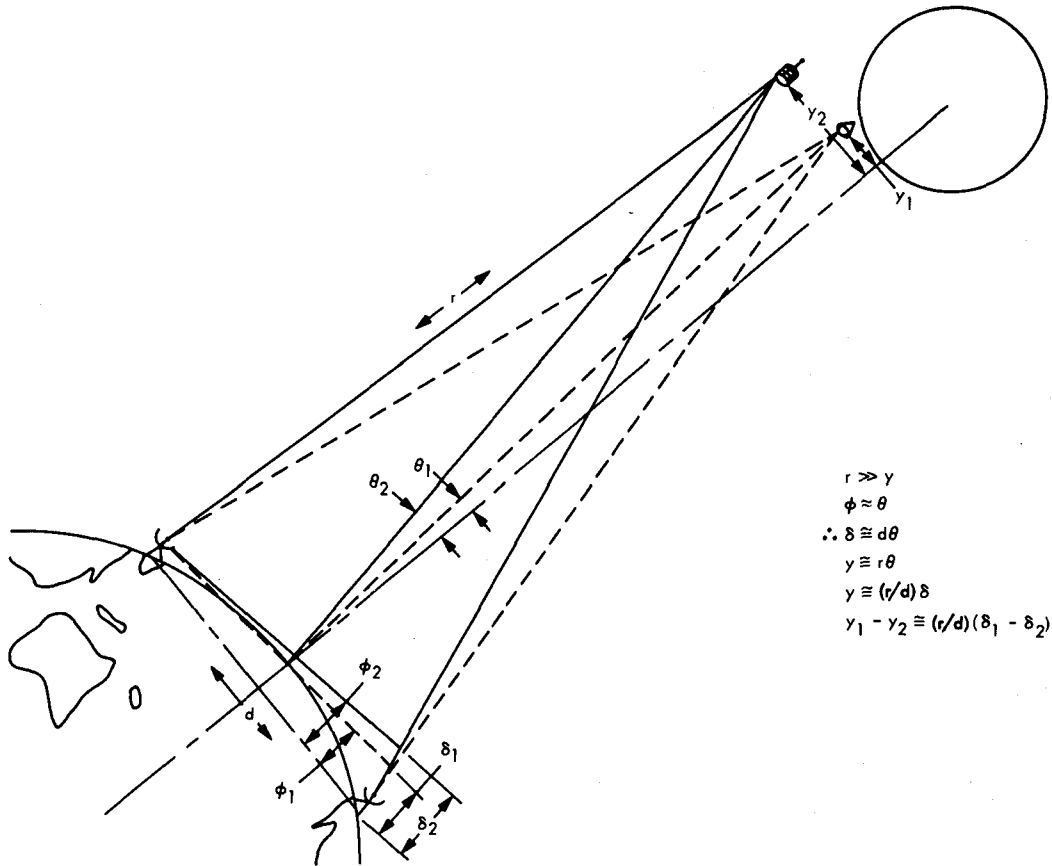

Fig. 1. Differential long baseline interferometry

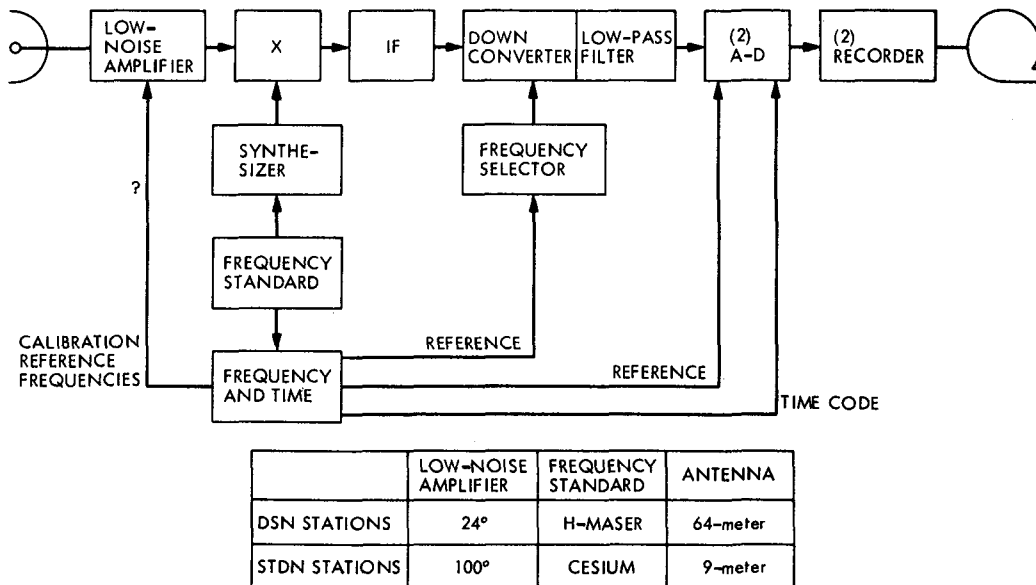

Fig. 2. Differential long baseline interferometry configuration for Pioneer Venus 1978 multiprobe wind measurement



