

NASA CR-175,269  
105

NASA-CR-175269  
19850007465

# A Reproduced Copy

OF

*NASA CR-175,269*

---

Reproduced for NASA

*by the*

**NASA Scientific and Technical Information Facility**

**LIBRARY COPY**

MAR 24 1988

LANGLEY RESEARCH CENTER  
LIBRARY NASA  
HAMPTON, VIRGINIA



NASA-CR-175269

(NASA-CR-175269) UPPER ATMOSPHERE RESEARCH  
SATELLITE (UARS) TRADE ANALYSIS Final  
Report (Engineering and Economics Research,  
Inc.) 95 p HC A05/MF A01 CSCI 22B

N85-15774

Unclas  
G3/15 23276

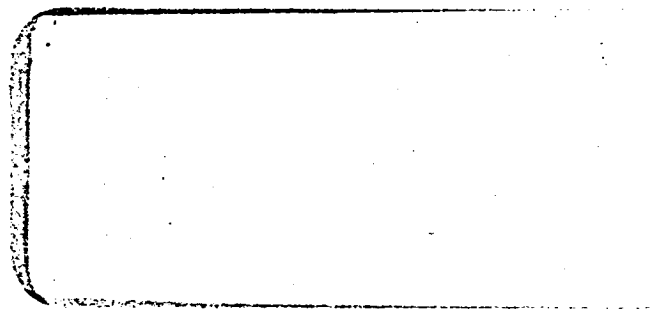

ENGINEERING & ECONOMICS RESEARCH, INC.

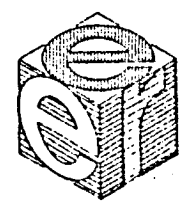

N85-15774 #

UPPER ATMOSPHERE RESEARCH SATELLITE  
(UARS)  
TRADE ANALYSIS  
(FINAL)

Prepared for:

National Aeronautics and Space Administration  
Goddard Space Flight Center  
Greenbelt, MD 20771

Under Contract Number: NASS-26962  
(Modification No. 7)

By:

Maura M. Fox  
Dr. Jack Nebb

Engineering and Economics Research, Inc.  
1951 Kidwell Drive  
Vienna, Virginia 22180

November 30, 1983

## TABLE OF CONTENTS

<u>Section</u>	<u>Page</u>
List of Figures . . . . .	iii
List of Tables . . . . .	iv
1.0 Introduction . . . . .	1-1
2.0 The Upper Atmosphere Research Satellite System Overview . . . . .	2-1
2.1 UARS Ground System Elements . . . . .	2-2
2.2 UARS Data Estimates . . . . .	2-2
3.0 Central Data Handling Facility Strawman Configurations . . . . .	3-1
3.1 IBM 3081 Strawman Configuration . . . . .	3-2
3.2 UNIVAC 1100/92 Strawman Configuration . . . . .	3-2
3.3 VAX 11/780 CLUSTER Strawman Configuration . . . . .	3-4
3.3.1 VAX 11/780 CLUSTER Hardware . . . . .	3-4
3.3.2 VAX 11/780 CLUSTER Software . . . . .	3-10
3.3.3 VAX 11/780 CLUSTER Estimates . . . . .	3-12
4.0 Remote Analysis Computer System Strawman Configurations . . . . .	4-1
4.1 IBM RACS Configuration . . . . .	4-1
4.2 UNIVAC RACS Configuration . . . . .	4-1
4.3 VAX 11/780 RACS Configuration . . . . .	4-5
5.0 Mass Storage Analysis . . . . .	5-1
5.1 Braegan Automated Tape Library . . . . .	5-3
5.2 RCA Optical Disk Data Storage . . . . .	5-5
5.3 Automated Tape/Cartridge Mass Storage Systems . . . . .	5-9
5.3.1 IBM 3850 Mass Storage System . . . . .	5-10
5.3.2 MASSTOR Mass Storage System (MSS) . . . . .	5-12
6.0 Mass Storage System Incorporation into the Strawman Configurations . . . . .	6-1
6.1 IBM 3081 CDHF - Mass Storage System . . . . .	6-1
6.2 UNIVAC 1100/92 CDHF - Mass Storage System . . . . .	6-2
6.3 VAX 11/780 CLUSTER CDHF - Mass Storage System . . . . .	6-2
7.0 Parameterization of Strawman Configurations . . . . .	7-1
7.1 IBM Strawman Configuration Parameterization . . . . .	7-1
7.2 UNIVAC Strawman Configuration Parameterization . . . . .	7-2
7.3 VAX 11/780 CLUSTER Strawman Configuration Parameterization . . . . .	7-4
APPENDIX A	
Strawman Configuration Cost Data . . . . .	A-1
APPENDIX B	
UNIVAC CDHF - VAX RACS . . . . .	B-1
REFERENCES	

LIST OF FIGURES

<u>Figure</u>		<u>Page</u>
2-1	Major Elements of the UARS Ground System . . . . .	2-3
3-1	IBM 3081 System Diagram . . . . .	3-3
3-2	UNIVAC 1100/92 System Diagram . . . . .	3-5
3-3	VAX 11/780 System Components . . . . .	3-7
3-4	VAX 11/780 CLUSTER Topology . . . . .	3-13
4-1	IBM RACS-CDHF Configuration . . . . .	4-4
4-2	UNIVAC RACS-CDHF Configuration . . . . .	4-7
4-3	VAX RACS-CDHF Configuration . . . . .	4-10
5-1	IBM 3850 MASS Storage System Data Flow . . . . .	5-11
5-2	MASSTOR Mass Storage System with 110 GB Capacity . . . . .	5-15
6-1	IBM 3081-IBM 3850 System Diagram . . . . .	6-3
6-2	IBM 3081-MASSTOR MSS System Diagram . . . . .	6-4
6-3	UNIVAC 1100/92-MASSTOR MSS System Diagram . . . . .	6-5
6-4	VAX 11/780 CLUSTER-MASSTOR MSS System Diagram . . . . .	6-6

## LIST OF TABLES

<u>Table</u>	<u>Page</u>
2-1 UARS Data Volume Estimates . . . . .	2-4
2-2 Daily UARS Production Processing Estimates . . . . .	2-5
3-1 VAX 11/780 Characteristics . . . . .	3-6
4-1 RACS Processing and Memory Requirements . . . . .	4-2
4-2 IBM RACS Configurations . . . . .	4-3
4-3 UNIVAC RACS Configurations . . . . .	4-6
4-4 VAX 11/780 RACS Configurations . . . . .	4-9
5-1 UARS On-Line Data Storage Requirements . . . . .	5-2
5-2 Optical Disk System Specifications . . . . .	5-7
5-3 Optical Disk Media Format Specifications . . . . .	5-8
5-4 IBM 3850-MASSTOR MSS Comparisons . . . . .	5-16
A-1 Cost Data IEM CDHF System Configuration . . . . .	A-2
A-2 Cost Data IBM RACS Components . . . . .	A-3
A-3 Cost Data IEM RACS Configuration . . . . .	A-4
A-4 Cost Data UNIVAC CDHF System Configuration . . . . .	A-5
A-5 Cost Data UNIVAC RACS Components . . . . .	A-6
A-6 Cost Data UNIVAC RACS Configuration . . . . .	A-7
A-7 Cost Data VAX CLUSTER System Configuration . . . . .	A-8
A-8 Cost Data VAX RACS Components . . . . .	A-9
A-9 Cost Data VAX RACS Configuration . . . . .	A-10
A-10 Cost Data Mass Storage Systems . . . . .	A-11
A-11 Cost Data Summary of Strawman Configurations . . . . .	A-12
B-1 UNIX Advantages and Disadvantages . . . . .	B-2

1.0 INTRODUCTION



## 1.0 INTRODUCTION

The Upper Atmosphere Research Satellite (UARS) will collect data pertinent to the earth's upper atmosphere. This collected data will be sent to the Central Data Handling Facility (CDHF) located at Goddard Space Flight Center (GSFC) via the UARS ground system. Once received by the CDHF, the data will be processed and distributed to the Remote Analysis Computer Systems (RACS.) An overview of the UARS ground system is presented in Section 2.0.

In this Trade Analysis, three configurations have been developed for the CDHF-RACS system. Section 3.0 describes the CDHF configurations. The IBM CDHF configuration is presented in Section 3.1. The UNIVAC CDHF configuration is presented in Section 3.2. The VAX CLUSTER CDHF configuration is presented in Section 3.3.

RACS configurations are presented in Section 4.0. The IBM RACS configurations are detailed in Section 4.1, UNIVAC RACS in Section 4.2 and VAX RACS in Section 4.3.

Due to the large on-line data estimate of approximately 100 GB, a mass storage system is considered essential to the UARS CDHF. An analysis of several mass storage systems is performed in Section 5.0. Specifically, the Braegan ATL is discussed in Section 5.1, the RCA optical disk in Section 5.2, the IBM 3850 in Section 5.3.1 and the MASSTOR M860 in Section 5.3.2.

The type of mass storage system most suitable to UARS was determined to be the automated tape/cartridge device. Two devices of this type, the IBM 3850 and the MASSTOR MSS were analyzed in this Trade Analysis. In Section 6.0, the applicable tape/cartridge device is incorporated into the three CDHF-RACS configurations.

In Section 7.0, the resulting CDHF-RACS configurations are parameterized according to the following trade factors:

- o performance capability
- o availability
- o compatibility with existing requirements
- o compatibility with existing/planned institutional systems
- o implementation risks
- o ease of use and user friendliness.

Costing of the configurations is performed in Appendix A.

Of the three configurations developed for the CDHF-RACS system, all are uni-vendor designs. However, there has been some discussion of the possibility of a multi-vendor configuration. The most likely prospect would be a UNIVAC CDHF and VAX RACS with both utilizing the UNIX operating system. This is an idea that may well serve the needs of the UARS mission. More research would need to be performed to establish the feasibility of utilizing such a system. Appendix B discusses a UNIVAC CDHF-VAX RACS system in more detail.

## 2.0 UPPER ATMOSPHERE RESEARCH SATELLITE SYSTEM OVERVIEW

## 2.0 UPPER ATMOSPHERE RESEARCH SATELLITE SYSTEM OVERVIEW

The Upper Atmosphere Research Satellite (UARS) mission is to be configured with 11 experimental instruments, designed by mission investigators, which will collect data pertinent to the chemistry, dynamics and thermodynamics of the earth's atmosphere. Each mission investigator is responsible for his respective instrument design and operation, software development, and interpretation of data collected. All data collected by the instruments will be routed through NASA networks and the UARS ground system to the UARS Central Data Handling Facility (CDHF) which will be located at Goddard Space Flight Center. The CDHF is to be designed so as to process data in a batch environment, thus allowing mission investigators to devote their efforts to data analysis. To date, the following major CDHF requirements have been established:

- o Production Processing of one day's worth of data in one work shift (i.e., 8 hrs.)
- o Data Ingest. from Data Capture Facility via a dedicated high-speed data transfer link
- o L0, L1, L2, L3 production
- o Communication Interface and Data Transfer to/from RACS
- o RACS batch services
- o Data Management
- o Interfaces to other necessary ground system components
- o Interface to Mass Storage System.

Mission investigators will be provided with Remote Analysis Computer Systems (RACS) which will communicate with the CDHF by means of a UARS project-provided network of processors, telecommunications controllers, leased lines, modems and other components as is necessary. RACS will be oriented toward algorithm development, data interpretation and graphic display. To most effectively accomplish these tasks, the RACS must be software compatible with the CDHF processing computers.

For analytical purposes, such of the data produced by UARS will have to be kept on-line and available to the mission investigators at the RACS. Because of the size of this on-line data base (most recent estimates place this figure at 100 GBytes), a mass storage system will be incorporated into the CDHF configuration.

## 2.1 UARS Ground System Elements

In addition to the RACS, the CDHF will have to communicate with the other components of the UARS ground system. Major elements of the UARS ground system are shown in Figure 2-1. The RACS and the CDHF are the only facilities in the UARS ground system whose principle goals are scientific in nature. The other elements of the ground system are intended to support the UARS spacecraft, the CDHF and the RACS. Details of the ground system interfaces have been addressed in other UARS documents and will not be elaborated upon in this Trade Analysis. (Reference 1 and 2)

## 2.2 UARS Data Estimates

The UARS data will be delivered to the CDHF via the ground system network described in the previous paragraph. The UARS data base will consist of

- o instrument data
- o orbit and attitude data
- o engineering data
- o on board computer data
- o system software
- o processing coefficients
- o data analysis results
- o other (TBD).

Estimates have been determined for these data types and are summarized in Table 2-1. The levels of production processing have also been estimated and are summarized in Table 2-2.

# MAJOR ELEMENTS OF THE UARS GROUND SYSTEM

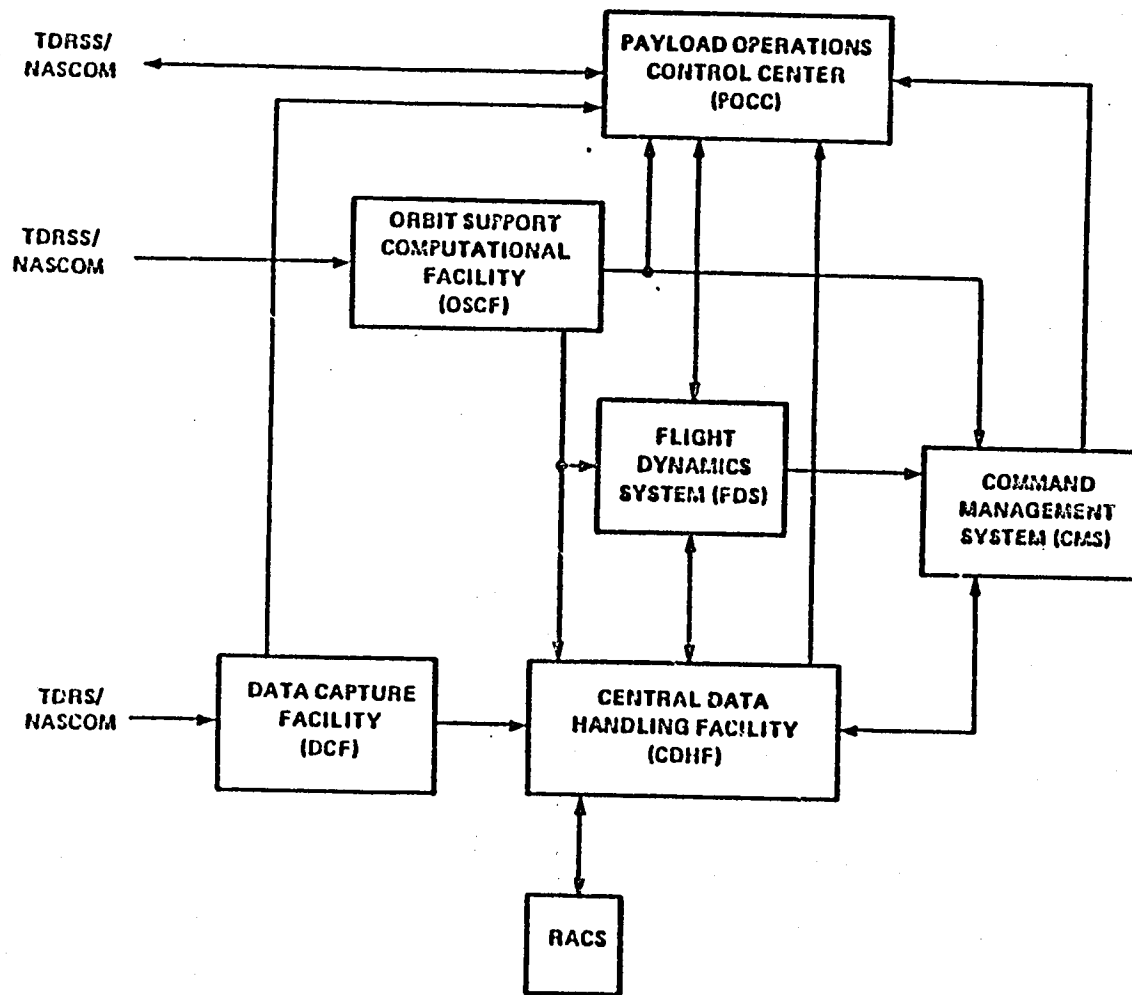

2-3

FIGURE 2-1

Table 2-1

UARS DATA VOLUME ESTIMATES

<u>Type of Data</u>	<u>Volume Per Day</u>
Level 0	202.1 MByte
Level 1	173.5 MByte
Level 2	79.7 MByte
Level 3	24.0 MByte
Quicklook	69.0 MByte
Engineering	10.8 MByte
Orbit/Attitude	7.0 MByte
On Board Computer (OBC) Data	32.4 MByte
Other	TBD
Calculated Volume	598.5 MByte/day
Contingency 50%	<u>299.2 MByte/day</u>
Total Estimated Volume	899.7 MByte/day

Table 2-2

DAILY UARS PRODUCTION PROCESSING ESTIMATES

<u>Type of Processing</u>	<u>Time Required</u> <u>(based upon a 1 MIPS machine)</u>
L1 Processing and I/O	11,474 seconds
L2 Processing and I/O	126,352 seconds
L3 Processing and I/O	2,333 seconds
Total	140,159 seconds

$$\frac{140159 \text{ seconds}}{3600 \text{ seconds/hr} \times 8 \text{ hrs/shift}} = 4.87 \text{ shifts/day} \quad (1 \text{ MIPS machine})$$



**3.0 CENTRAL DATA HANDLING FACILITY  
STRAWMAN CONFIGURATIONS**

### 3.0 CENTRAL DATA HANDLING FACILITY STRAWMAN CONFIGURATIONS

The Central Data Handling Facility (CDHF) for the Upper Atmosphere Research Satellite (UARS) will be located at Goddard Space Flight Center and is to serve as the prime data processing center and as the central data repository.

The traditional configuration for a CDHF centers around a very large and powerful mainframe computer. Other components normally include a large magnetic tape library, many disk drives and same-vendor remote facilities. For the UARS mission, several innovative ideas are being considered for incorporation into the CDHF configuration. First, a network of super-mini computers, capable of satisfying all CDHF requirements, is being investigated. Second, an on-line mass storage system is being analyzed. These points are addressed later in this document.

While a super-mini network is being given serious consideration by the UARS planning committees, the traditional large mainframe configuration has a definite advantage: the mainframe is a proven configuration. Mainframe configurations have been utilized in the past and have established a track record. Two different mainframe configurations are being considered for the UARS CDHF. Section 3.1 addresses the strawman for the IBM mainframe configuration. The strawman outline of a UNIVAC mainframe configuration is described in Section 3.2.

The super-mini chosen for the CDHF super-mini design is Digital's Equipment Corporation's VAX 11/780. Digital has just recently announced a new networking technique known as "CLUSTERING." With a VAX CLUSTER, many of the problems associated with super-mini networks such as a lack of hierarchical storage management, queuing problems, failure recovery risks and repair difficulties have been avoided. In addition, the VAX CLUSTER retains the super-mini advantages such as user friendliness, growth capability and networking features. The strawman configuration of the VAX CLUSTER is presented in Section 3.3.

The IBM, UNIVAC and VAX CLUSTER configurations are uni-vendor configurations. Having one vendor does simplify certain aspects of a design. For instance, two systems manufactured by the same vendor and processing under the same operating system are often software compatible. Thus, interfacing is much less complicated. However, dictating a uni-vendor restriction for the UARS Data Handling Facility may not best serve mission needs. There has been some discussion among Goddard personnel concerning the possibility of a multi-vendor configuration. The most likely candidates would be VAX RACS linked to a UNIVAC CDHF with both utilizing the UNIX operating system. Since this configuration has been mentioned as a possibility, some preliminary research has been conducted. (Appendix B further explores this area.)

3.1 IBM 3081 Strawman Configuration

The IBM 3081 is a mainframe rated at 10.4 MIPS and with a 16 MByte memory. This particular computer is well known among Goddard Space Flight Center Data Handling facilities. For the RACS, the IBM 4300 series mini-computers are being researched. The specific model chosen would depend upon the particular needs of the investigators. The IBM RACS configurations are more thoroughly discussed in Section 4.1 Figure 3-1 provides a system diagram of the IBM 3081 CDHF configuration.

3.2 UNIVAC 1100/92 Strawman Configuration

The UNIVAC 1100/90 series is a multi-processor mainframe. The particular configuration most suited to the UARS CDHF seems to be the 1100/92 which has two CPUs and two I/O processors. It is rated at approximately 11 MIPS with 12.6 MBytes of main memory. For the RACS, either the UNIVAC 1100/70 or the "Chaparral"<sup>1</sup> will be utilized. The Chaparral will be used for PACS

---

Note 1: The "Chaparral" was the code name used by UNIVAC for the UNIVAC System 11 DDP before the System 11 DDP was formally announced. Sperry/UNIVAC announced the System 11/DDP in November, 1983.

# IBM 3081 SYSTEM DIAG

ORIGINAL PAGE IS  
OF POOR QUALITY.

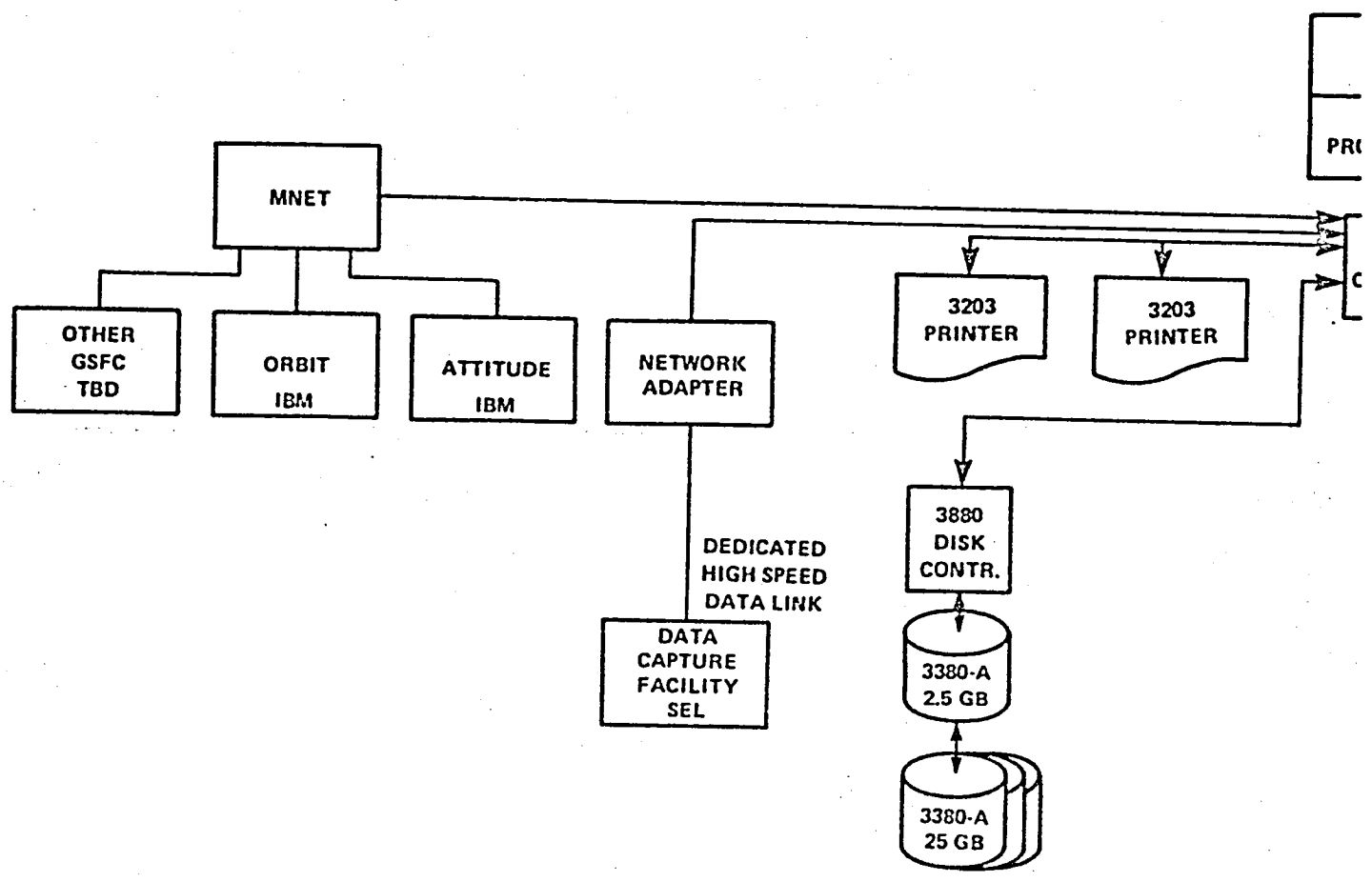

FOLDED NAME

ORIGINAL PAGE IS  
OF POOR QUALITY

# 1 SYSTEM DIAGRAM

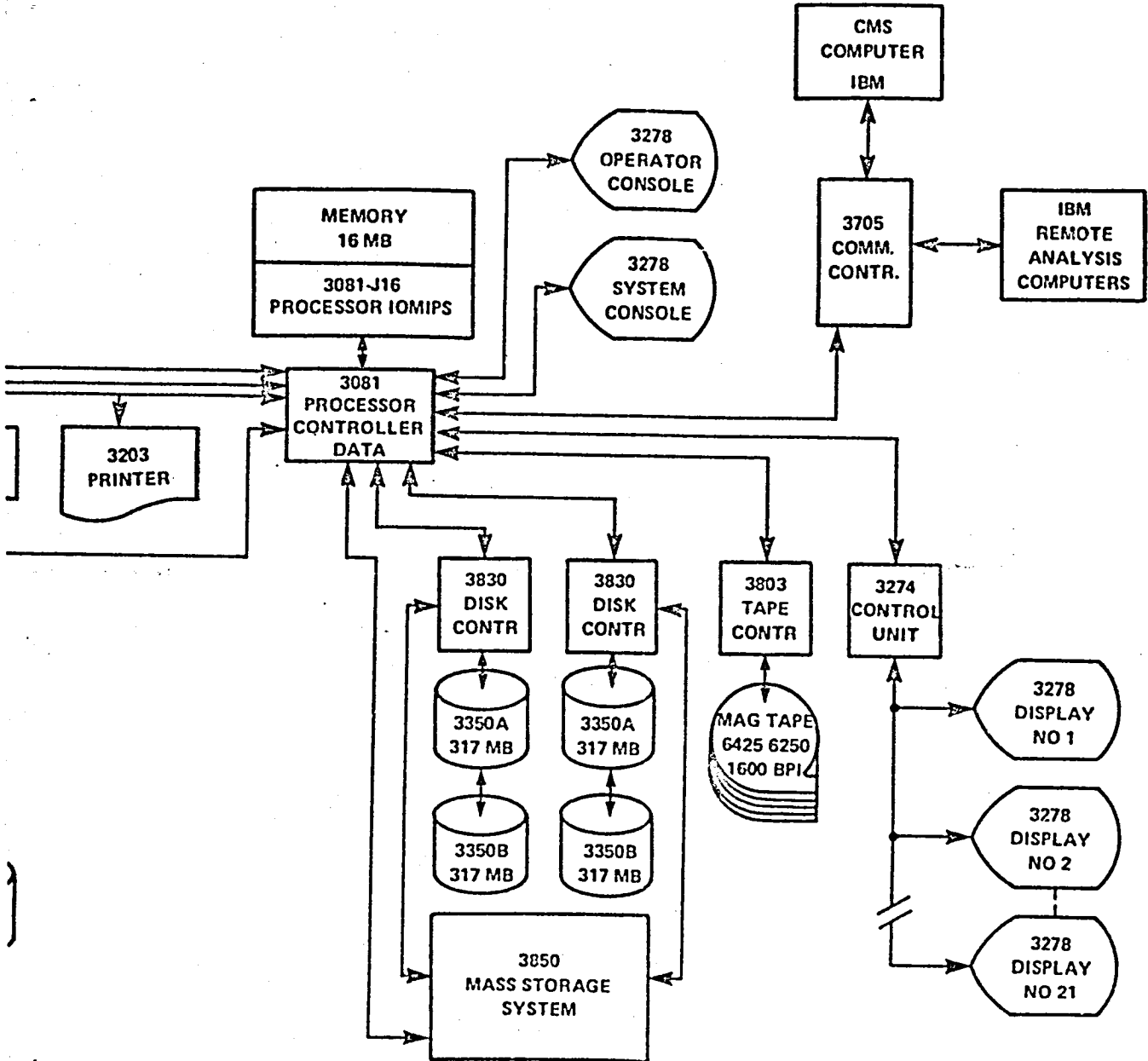

FIGURE 3-1

with MIPS requirements of 0.5 MIPS or less. The 1100/70 series will be used for those RACS with processing requirements greater than 0.5 MIPS. Figure 3-2 provides a UNIVAC CDHF system diagram. Detailed information concerning the individual UNIVAC RACS configuration is presented in Section 4.2.

### 3.3 VAX 11/780 CLUSTER Strawnan Configuration

The super-mini configuration proposed for the UARS CDHF consists of Digital Equipment Corporation's VAX 11/780s in a CLUSTER arrangement. The VAX configuration is being considered primarily due to its popularity among the mission investigators. The majority of mission investigators have worked with the VAX and find it both an effective analytical tool and a "friendly" computer. The CLUSTER is a new networking technique just recently announced by Digital. The CLUSTER arrangement is the only VAX configuration under consideration because it was determined to be the only arrangement capable of handling the extensive processing needs of UARS. Other network schemes offered by Digital, including DECnet and ETHERnet, were determined to be too slow. In addition, CLUSTER is the only scheme which avoids the standard super-mini network problems with storage management, access time, and failure recovery.

Table 3-1 summarizes the VAX 11/780 characteristics. Figure 3-3 depicts the VAX 11/780 system components.

#### 3.3.1 VAX 11/780 CLUSTER Hardware

The VAX 11/780 CLUSTER hardware consists of the following elements:

- o VAX 11/780 processors
- o Mass Storage System
- o Intelligent Hierarchical Storage Controller HSC50
- o CI Computer Interconnect
- o CI Interfaces

# UNIVAC 1100/92 SYSTEM DIAGRAM

3-5

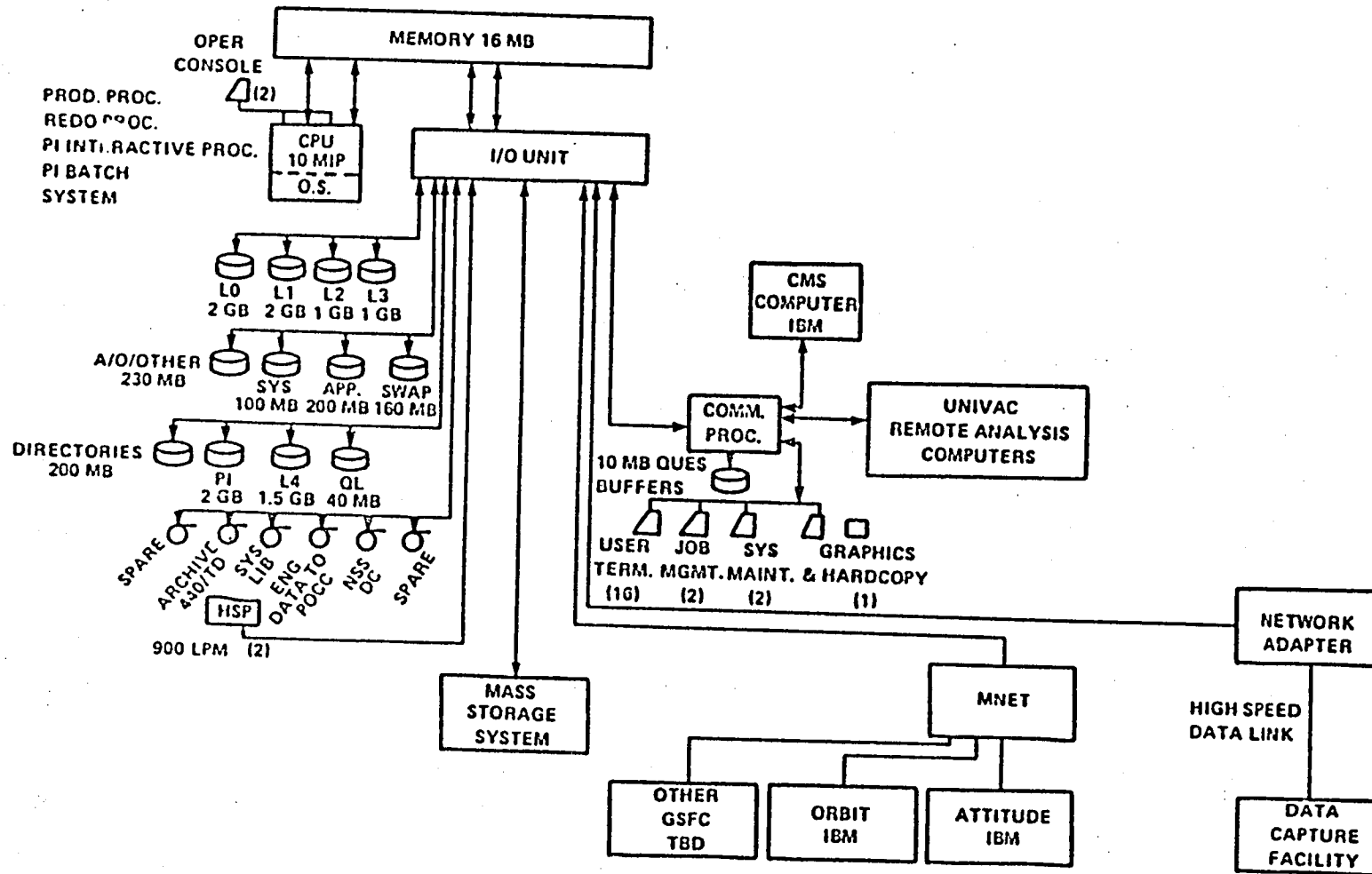

FIGURE 3-2

Table 3-1

VAX 11/780 CHARACTERISTICS

<u>Parameter</u>	<u>Rating</u>
Word Length	32 bits
Computer Speed (Million Instructions Per Second)	0.70 MIPS
I/O Rate (max)	13.3 MBytes/sec
Logical Address	4 GBytes
Program Size (max)	2 GBytes
Synchronous Communications	1 Mbps
Asynchronous Communications	9.6 Kbps
Communications Interface	56 Kbps



ORIGINAL PAGE IS OF POOR QUALITY

# VAX 11/780 SYSTEM CONFIGURATION

FOLDOUT FRAME

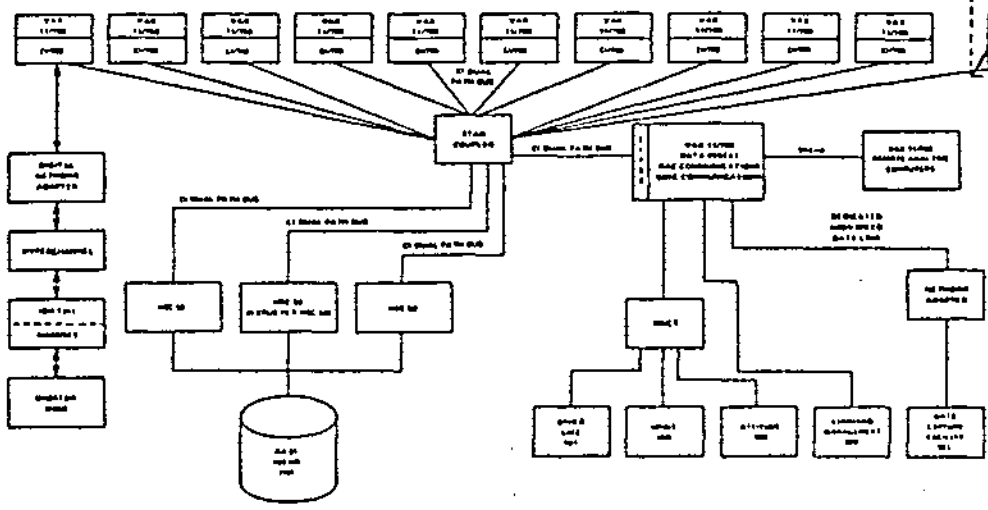
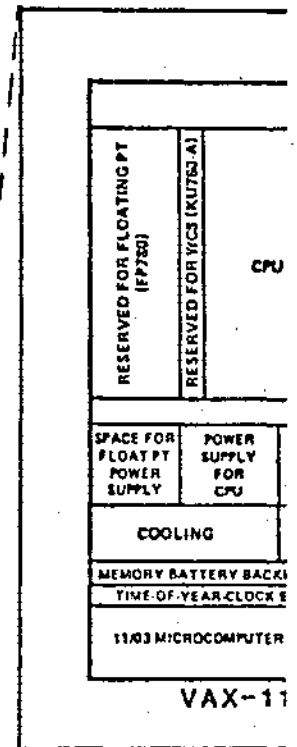

ORIGINAL PAGE IS  
OF POOR QUALITY

# SYSTEM COMPONENTS

2 FOLDCUT FRAME

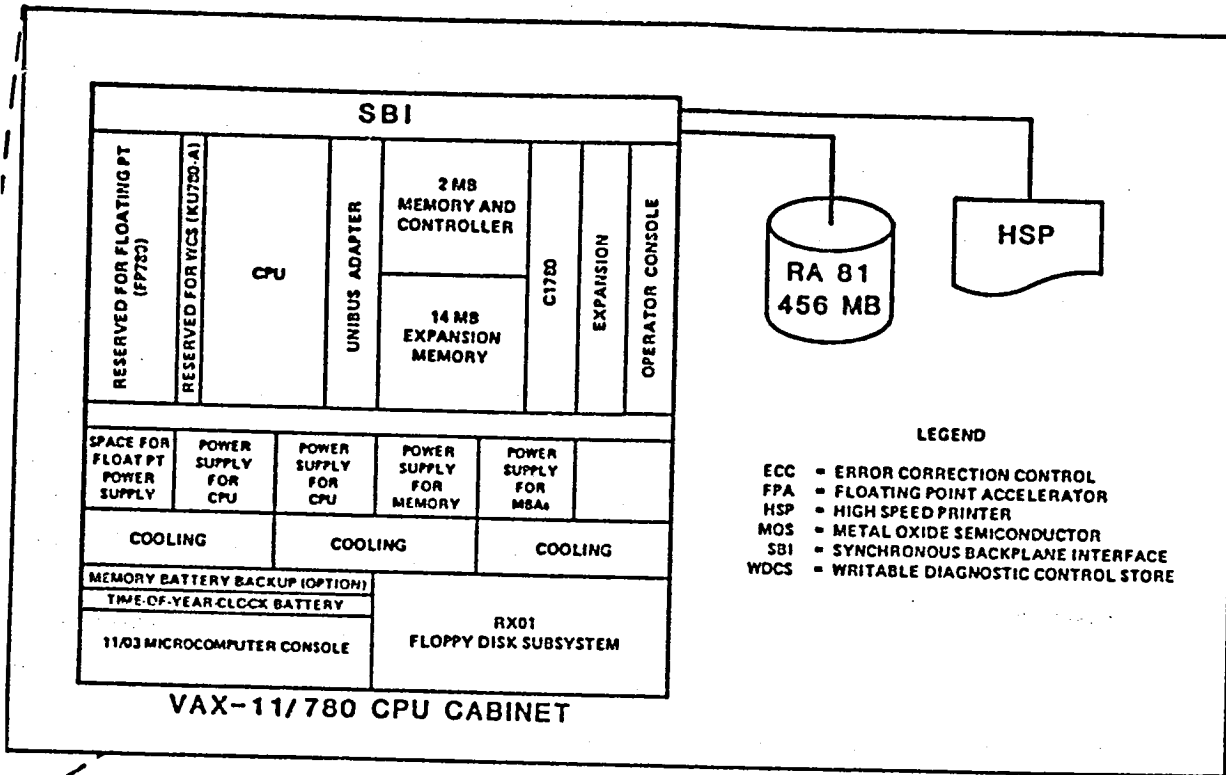

- LEGEND**
- ECC = ERROR CORRECTION CONTROL
  - FPA = FLOATING POINT ACCELERATOR
  - HSP = HIGH SPEED PRINTER
  - MOS = METAL OXIDE SEMICONDUCTOR
  - SBI = SYNCHRONOUS BACKPLANE INTERFACE
  - WDCS = WRITABLE DIAGNOSTIC CONTROL STORE

FIGURE 3-3

o Star Coupler

VAX Processors:

The processors and storage system components are known as CLUSTER nodes. The VAX 11/780 processor runs on VAX/VMS operating system.

Mass Storage System:

The UARS VAX CLUSTER would utilize the MASSTOR Mass Storage System (MSS). MASSTOR has teamed with Systems Industries to implement a configuration which will enable the VAX CLUSTER to effectively utilize the MASSTOR MSS.

HSC50:

The HSC50 (Hierarchical Storage Controller) is a self-contained, intelligent, mass storage subsystem that connects one or more processors to a set of mass storage disks, tapes. The HSC50, itself a CLUSTER node, communicates with CPU(s) by way of the CI and uses Digital's Mass Storage Control Protocol for communications. Communication between the HSC50 and the mass storage drives is through the Standard Disk Interface (SDI) and the Standard Tape Interface (STI). The HSC50 offloads utility operations such as disk shadowing, volume image copying, and image backups from the hosts, by performing these operations itself. To maximize throughput, the HSC50 handles multiple, concurrent operations on multiple drives and optimizes the physical operations, such as track seeks and rotational positioning.

The SDI/STI interfaces also use passive coupling, so they can be disconnected and reconnected without disrupting other VAX CLUSTER device operations. Each HSC50 can support a combination of up to six SDI or STI interfaces.

#### Computer Interconnect:

The CI (Computer Interconnect) is a high-speed, fault-tolerant, dual-path bus. It allows processor nodes and intelligent I/O subsystem nodes to be connected. Nodes in a VAX CLUSTER use a multiaccess bus topology that allows any VAX processor node in the CLUSTER to talk to any other VAX processor node.

The CI bandwidth is 70 Mbits per second. The CI has an immediate acknowledgement scheme wherein channel time is reserved at the end of each message for the destination to acknowledge receipt.

#### CI Interfaces:

The CI interfaces are intelligent controllers that connect processors to the CI. Each interface attaches to one CI bus, the bus consisting of two transmit and two receive cables. Traffic is transmitted on whichever path is available.

#### Star Coupler:

The Star Coupler is the common connection point for all CLUSTER nodes connected to the CI. It connects together all CI cables from the individual nodes with a maximum radius of 45 meters. The Star Coupler can be configured to support VAX CLUSTER systems of up to 16 nodes. The Star Coupler provides passive coupling of the signals from all CLUSTER nodes by means of power splitter/combiner transformers. In addition, the dual paths of the CI are electrically isolated from each other.

For each node, IN and OUT connectors are provided for each CI path. A signal received from an IN connector is distributed to all OUT connectors. The Star Coupler terminates all cables with their characteristic impedance. This allows nodes to be connected or disconnected

during normal CLUSTER operations without affecting the rest of the CLUSTER.

### 3.3.2 VAX 11/780 CLUSTER Software

The VAX CLUSTER software yields transparent sharing of data among the CLUSTER nodes. The five major components of the CLUSTER software are:

- o VAX 11/780 Record Management Service (RMS)
- o Distributed File System
- o Distributed Lock Manager
- o Mass Storage Control Protocol (MSCP)
- o Job Queuing

#### Record Management Service:

RMS provides capabilities for data storage, retrieval, and modification; file manipulation; access mode switching, and record formatting.

#### Distributed File System:

The Distributed File System allows VMS processors in a VAX CLUSTER to share disk mass storage. A disk volume shared like this appears to be a local disk to each CPU. All access to the disk from any level above the disk driver works transparently.

The shared disk can be directly connected to one of the CLUSTER processors. In this instance, the MSCP Server on the processor with the local disk transparently provides the equivalent MSCP services. RMS uses the Distributed File System and the Distributed Lock Manager to provide file level and record level access to disk storage throughout the CLUSTER.

With the MSCP server, such a shared file system allows for incremental growth by enabling additional CPUs with their own local disk storage to be added to the CLUSTER and then allowing users on the existing VAX CLUSTER CPUs to share the new local processor owned file system.

#### Distributed Lock Manager:

The VMS Distributed Lock Manager synchronizes access to resources for processes. The Lock Manager provides a namespace in which processes can lock and unlock resource names. It provides a queuing mechanism so that processes can be put into a wait state until a particular resource is available.

#### Mass Storage Control Protocol:

The MSCP is a protocol for logical access to disks and tapes. It permits any VAX/VMS processor in the CLUSTER to access disks that are connected locally to another VAX processor CLUSTER node. The MSCP Server also includes volume shadowing capability disk drives. These disks appear as if they were logically error free. Incoming I/O requests from other processors in the CLUSTER are received by the MSCP Server. The MSCP Server uses the standard VAX/VMS device driver interface to communicate with the local disks and passes the data back over the CI to the requesting CPU.

#### Job Queuing:

Generic batch queues, coupled with batch execution queues that execute on specific systems within the CLUSTER, enable the batch workload to be shared. The VMS default scheduling policy balances the shared batch workload across the CLUSTER. It does this by keeping the ratio of active batch jobs to available batch slots as equal as possible on each processor node.

### 3.3.3 VAX 11/780 CLUSTER Estimates

Based upon the 0.70 MIPS effective throughput rating of the VAX 11/780 and the requirement that the CDHF configuration be sized so as to process one day's worth of data in one eight-hour shift, the following calculations were performed:

Required time (based upon 1 MIPS machine)	140,159.0 seconds
VAX MIPS Rating	0.70 MIPS

$$\frac{140,159 \text{ 1 MIPS-second}}{.70 \text{ MIPS/VAX} \times 3600 \text{ seconds/hr} \times 8 \text{ hours/shift}} = 6.96 \text{ VAX-shifts}$$

With a contingency factor of 50% and the requirement for a spare, this increases the estimate to eleven VAXs. In addition, one VAX would be needed to serve as the communications base for the RACS, the CDHF and Command Management. Thus, an estimated twelve VAX 11/780s will be necessary to satisfy CDHF requirements. Figure 3-4 shows a topology of the proposed VAX CLUSTER.

ORIGINAL PAGE IS  
OF POOR QUALITY

# VAX 11/780 CLUSTER

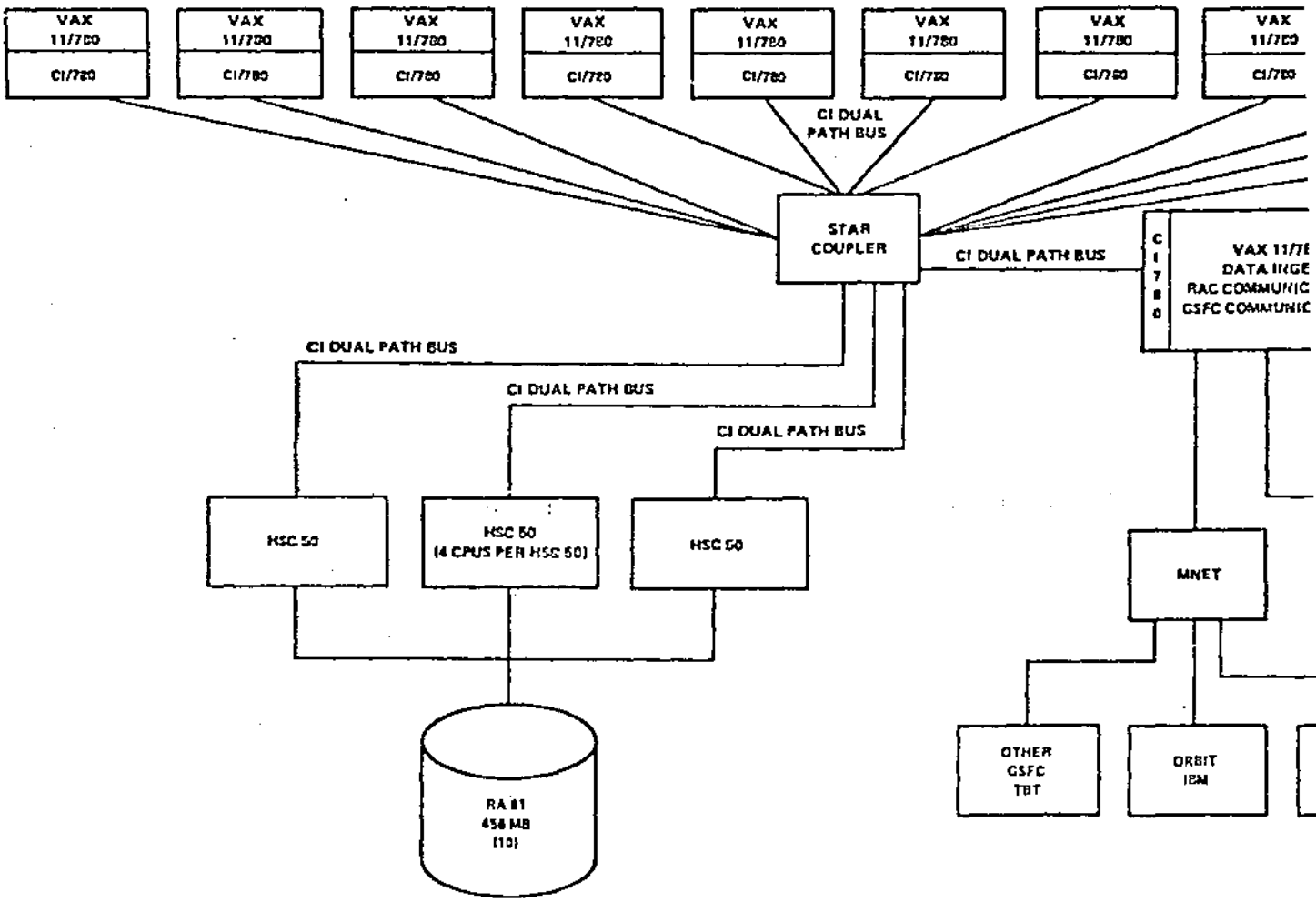

FOLDOUT FRAME



# SYSTEM TOPOLOGY

ORIGINAL PAGE IS  
OF POOR QUALITY

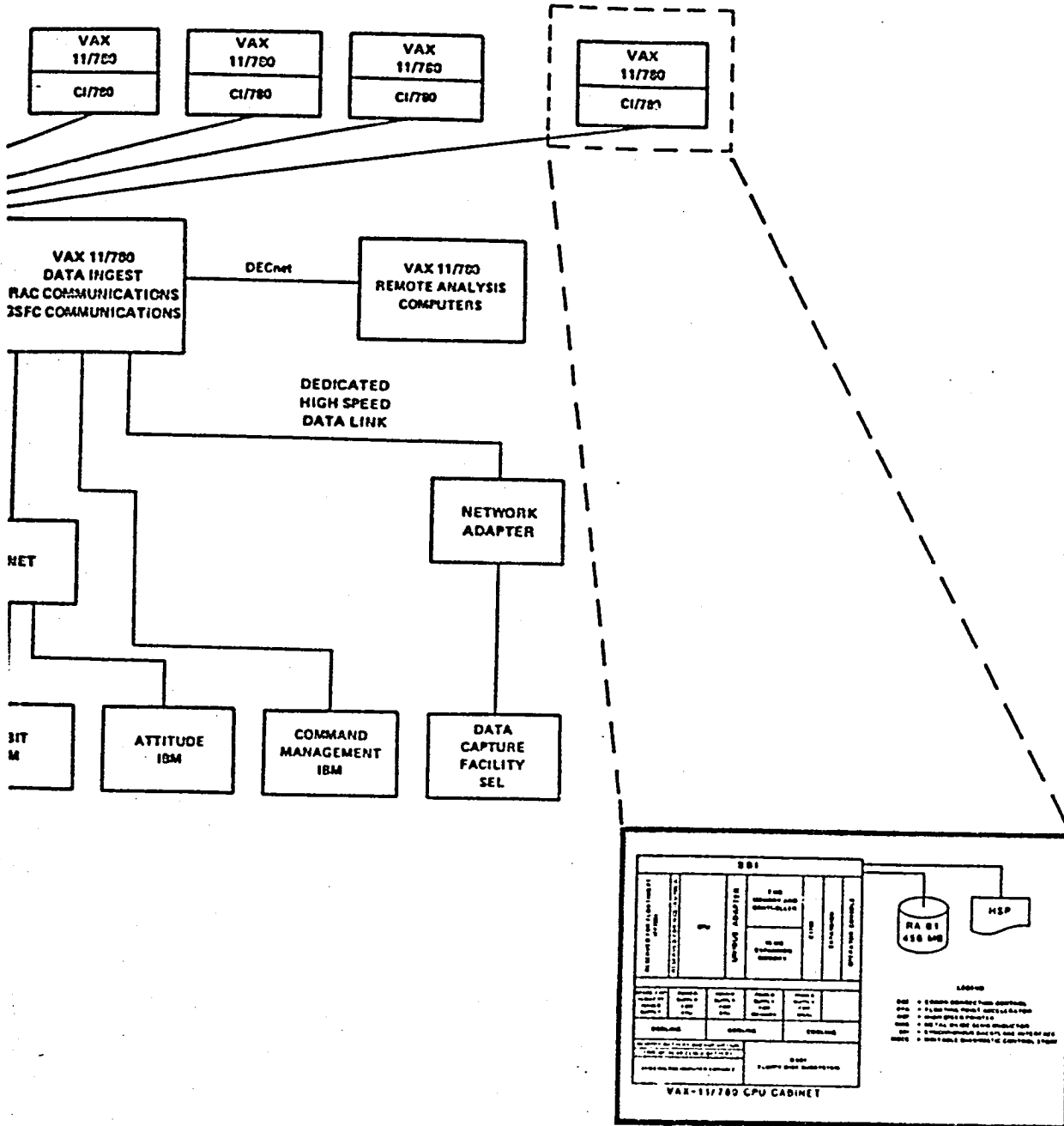

FIGURE 3-4

4.0 REMOTE ANALYSIS COMPUTER SYSTEM  
STRAWMAN CONFIGURATIONS

#### 4.0 REMOTE ANALYSIS COMPUTER SYSTEM STRAWMAN CONFIGURATIONS

Due to the varying nature of the UARS experiments, the thirteen Remote Analysis Computer Systems (RACS) have varying processing and memory requirements. Table 4-1 summarizes these requirements.

##### 4.1 IBM RACS Configuration

The IBM 4300 series computers are being considered for the proposed IBM RACS configuration. There are four computers in the 4300 series:

<u>Model</u>	<u>MIPS</u>	<u>Storage</u>
IBM 4331 Model 1	< 1/2 MIPS	1MB storage
IBM 4331 Model 2	1/2 MIPS	4MB storage
IBM 4341 Model 1	1 MIPS	4MB storage
IBM 4341 Model 2	> 1MIPS	4MB storage

Table 4-2 lists the RACS and their corresponding IBM configurations. Figure 4-1 depicts the IBM RACS-CDHP configuration.

As indicated in Figure 4-1, the 3705 Communications Controller provides for the physical management of the communication network. The 3705 can serve four host system channels. In addition, the 3705 can operate as a remote communications controller or as an intermediate network node in a multi-system networking environment. The 3705 can be configured to operate either as a local or remote communications controller. External modems are supported for up to 230 Kbps. Local attachments are available without modems for speeds up to 57.6 Kbps.

##### 4.2 UNIVAC RACS Configuration

Two UNIVAC computers are being considered for the proposed UNIVAC RACS configuration the UNIVAC 1100/70 and the "Chaparral". The 1100/70 series is a

Table 4-1  
RACS PROCESSING AND MEMORY REQUIREMENTS

<u>RACS</u>	<u>Processing (MIPS)</u>	<u>Memory (MBytes)</u>
Naval Research Lab (NRL)	0.4 MIPS	1 MB
Georgia Institute of Technology (GIOT)	0.4 MIPS	1 MB
University of Washington	0.4 MIPS	1 MB
Lawrence Livermore Laboratory (LLL)	0.4 MIPS	1 MB
National Oceanic and Atmospheric Administration (NOAA)	0.4 MIPS	4 MB
National Center for Atmospheric Research (NCAR)	0.5 MIPS	1 MB
Univeristy of Colorado	0.8 MIPS	6 MB
University of Michigan	1.0 MIPS	5 MB
NASA/Langley Research Center (LaRC)	1.0 MIPS	2 MB
NASA/Jet Propulsion Lab (JPL)	1.0 MIPS	1.3 MB
Southwest Research Institute (SRI)	1.0 MIPS	1 MB
Lockheed Palo Alto Research Laboratory (LPARL)	2.0 MIPS	1 MB
NASA/Goddard Space Flight Center (GSFC)	2.0 MIPS	4 MB

Table 4-2  
IBM RACS CONFIGURATIONS

<u>RACS</u>	<u>IBM</u> <u>Computer</u>	<u>Model</u>
Naval Research Lab (NRL)	4331	Model 2
Georgia Institute of Technology (GIOT)	4331	Model 2
University of Washington	4331	Model 2
Lawrence Livermore Laboratory (LLL)	4331	Model 2
National Oceanic and Atmospheric Administration (NOAA)	4331	Model 2
National Center for Atmospheric Research (NCAR)	4331	Model 2
Univeristy of Colorado	4341	Model 2
University of Michigan	4341	Model 2
NASA/Langley Research Center (LaRC)	4341	Model 1
NASA/Jet Propulsion Lab (JPL)	4341	Model 1
Southwest Research Institute (SRI)	4341	Model 1
Lockheed Palo Alto Research Laboratory (LPARL)	4341	Model 2
NASA/Goddard Space Flight Center (GSFC)	4341	Model 2

# IBM RACS-CDHF CONFIGURATION

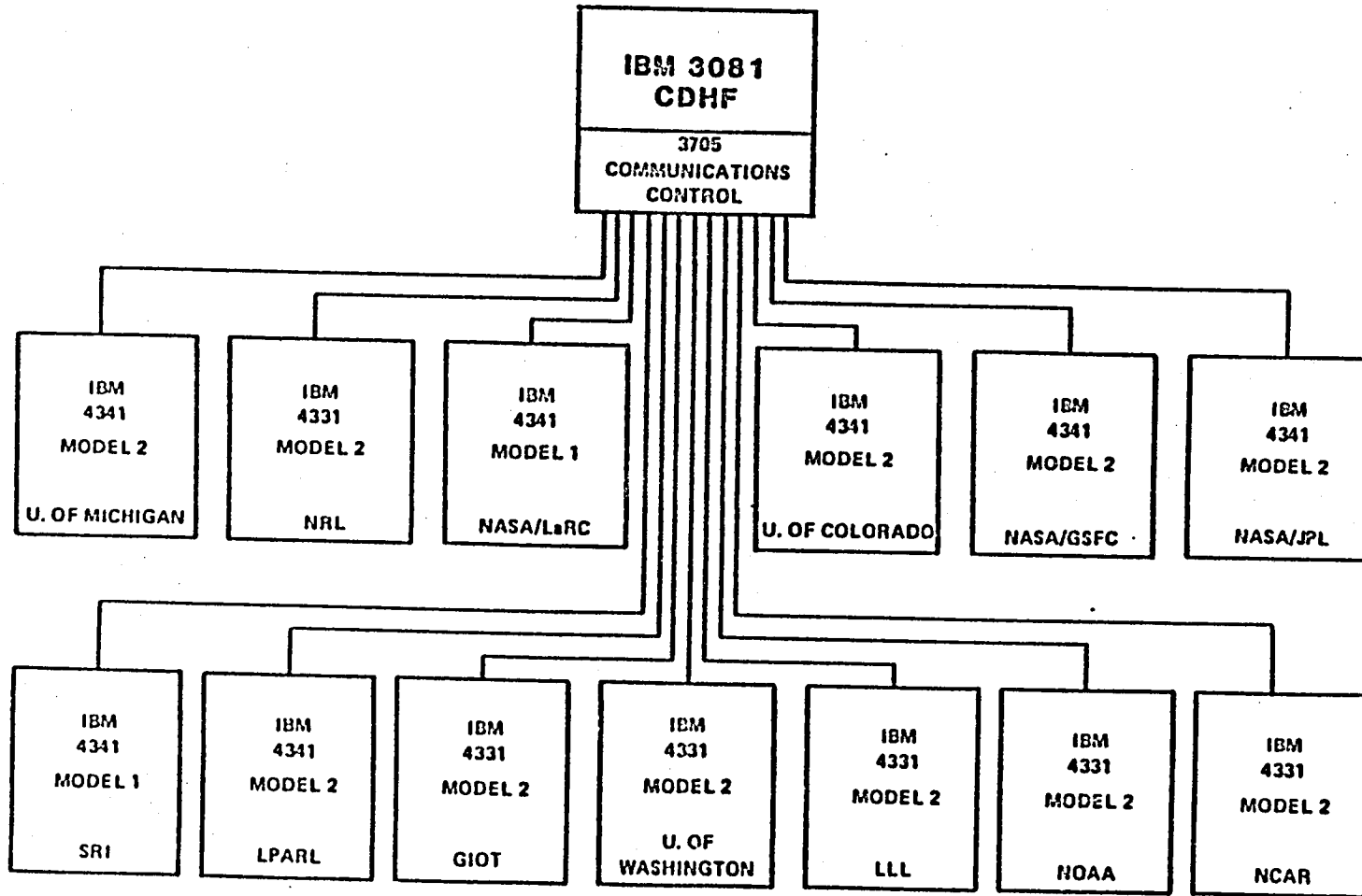

FIGURE 4-1

more powerful computer than the Chaparral and will be utilized for those RACS with processing needs greater than 0.5 MIPS. Both the 1100/70 series and the Chaparral run on the same operating system as the proposed UNIVAC CDHF 1100/92 mainframe computer.

Communications between the RACS and the CDHF will be accomplished via Distributed Communication Processors (DCP) sized to meet the needs of each individual RACS. The DCP can perform either as a front-end processor or as a remote processor. As a front-end processor, it supports a direct-channel interface to a host processing system and provides software controls for transferring data between the host and the communications network. As a remote communications processor, the DCP transfers data over serial communications lines to a central host processor or other remote processing or terminal equipment. There are three available sizes of DCPs:

- o DCP 10 (smallest)
- o DCP 20
- o DCP 40 (largest)

All models of the DCP utilize two processing elements: a communications processor and a port processor. The communications processor controls network access and performs message processing. The port processor performs I/O processing. The CDHF 1100/92 will utilize the largest DCP, the DCP 40. Table 4-3 lists the RACS with their corresponding UNIVAC computer configurations. Figure 4-2 depicts the UNIVAC RACS-CDHF configuration.

#### 4.3 VAX 11/780 RACS Configuration

With this basic 11/780, one can expect a processing rate of 0.7 MIPS and memory of 2 MBytes. With optional expansions, the VAX 11/780 can be configured to meet the needs of most of the RACS. For the two largest RACS, LPARL and GSFC, a VAX 11/782 would be utilized. The VAX 11/782 is a dual processor with approximately twice the processing capability of the VAX 11/780. Processing speeds of both the 11/780 and 11/782 can be

Table 4-3  
UNIVAC RACS CONFIGURATIONS

<u>RACS</u>	<u>UNIVAC Computer</u>	<u>Distributed Communications Processor</u>
Naval Research Lab (NRL)	Chaparral	DCP 10
Georgia Institute of Technology (GIOT)	Chaparral	DCP 10
University of Washington	Chaparral	DCP 10
Lawrence Livermore Laboratory (LLL)	Chaparral	DCP 10
National Oceanic and Atmospheric Administration (NOAA)	Chaparral	DCP 10
National Center for Atmospheric Research (NCAR)	Chaparral	DCP 10
University of Colorado	1100/71 Model H1	DCP 20
University of Michigan	1100/71 Model H1	DCP 20
NASA/Langley Research Center (LaRC)	1100/71 Model H1	DCP 20
NASA/Jet Propulsion Lab (JPL)	1100/71 Model H1	DCP 20
Southwest Research Institute (SRI)	1100/71 Model H1	DCP 20
Lockheed Palo Alto Research Laboratory (LPARL)	1100/70 Model H1	DCP 20
NASA/Goddard Space Flight Center (GSFC)	1100/70 Model H1	DCP 20



# UNIVAC RACS-CDHF CONFIGURATION

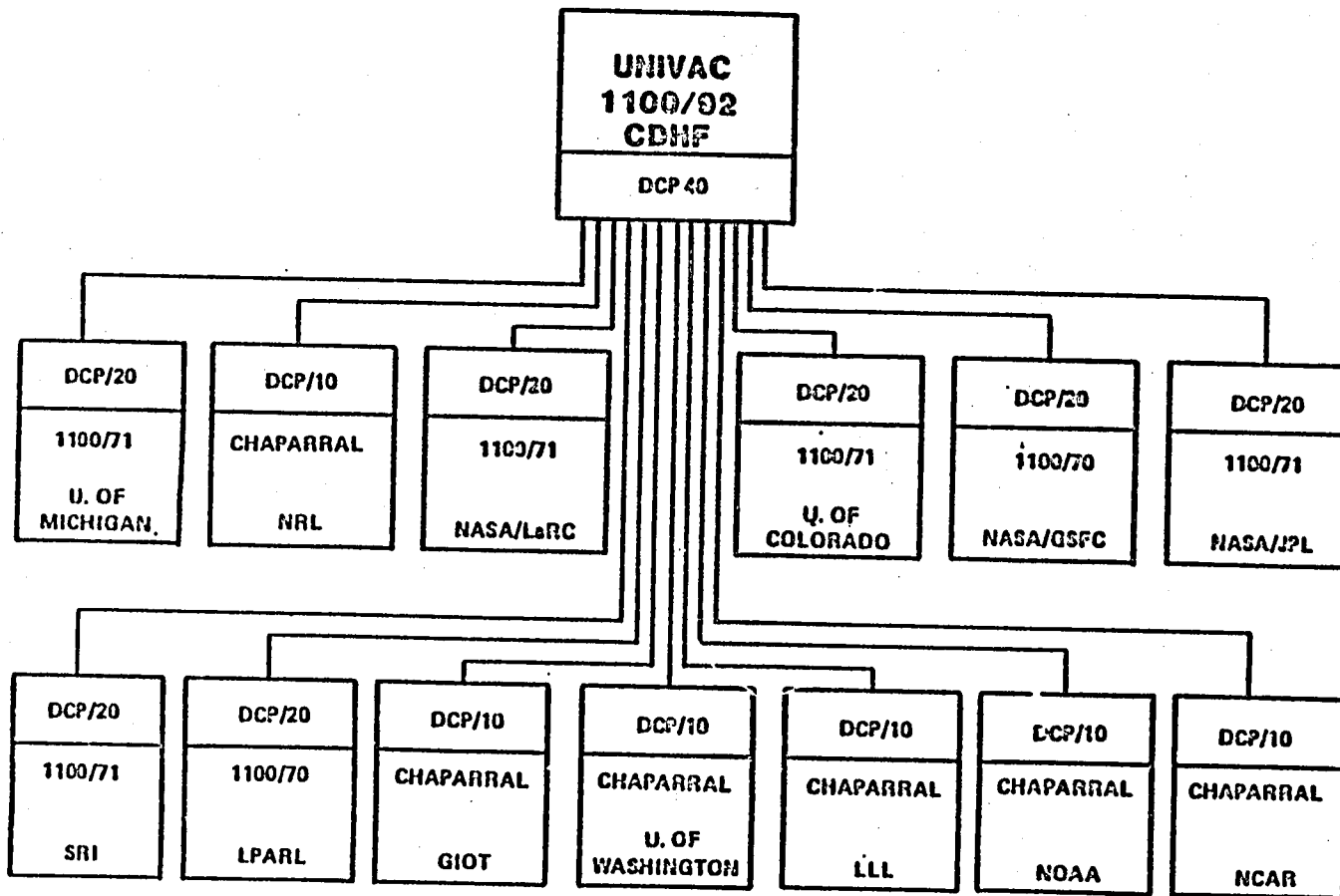

4-7

FIGURE 4-2

increased with the addition of a Floating Point Accelerator (FPA). Also, memory can be increased to 16 MBytes in 2 MByte increments.

Communications from the RACS to the CDHF communications base could be accomplished via DECnet. DECnet provides a layered structure of protocols which allow the RACS VAXs to communicate with the CDHF VAX CLUSTER and to retrieve data from the mass storage system. Table 4-4 lists the RACS and their corresponding VAX configurations. Figure 4-3 depicts the VAX RACS-CDHF configuration.

Table 4-4  
VAX 11/780 RACS CONFIGURATIONS

<u>RACS</u>	<u>VAX Model</u>	<u>FPA</u>	<u>Memory Expansion</u>
Naval Research Lab (NRL)	11/780	-	-
Georgia Institute of Technology (GIOT)	11/780	-	-
University of Washington	11/780	-	-
Lawrence Livermore Laboratory (LLL)	11/780	-	-
National Oceanic and Atmospheric Administration (NOAA)	11/780	-	2MB
National Center for Atmospheric Research (NCAR)	11/780	-	-
Univeristy of Colorado	11/780	TBD	4MB
University of Michigan	11/780	FPA	4MB
NASA/Langley Research Center (LaRC)	11/780	FPA	-
NASA/Jet Propulsion Lab (JPL)	11/780	FPA	-
Southwest Research Institute (SRI)	11/780	FPA	-
Lockheed Palo Alto Research Laboratory (LPARL)	11/782	FPA	-
NASA/Goddard Space Flight Center (GSFC)	11/782	FPA	2MB

# VAX RACS-CDHF CONFIGURATION

4-10

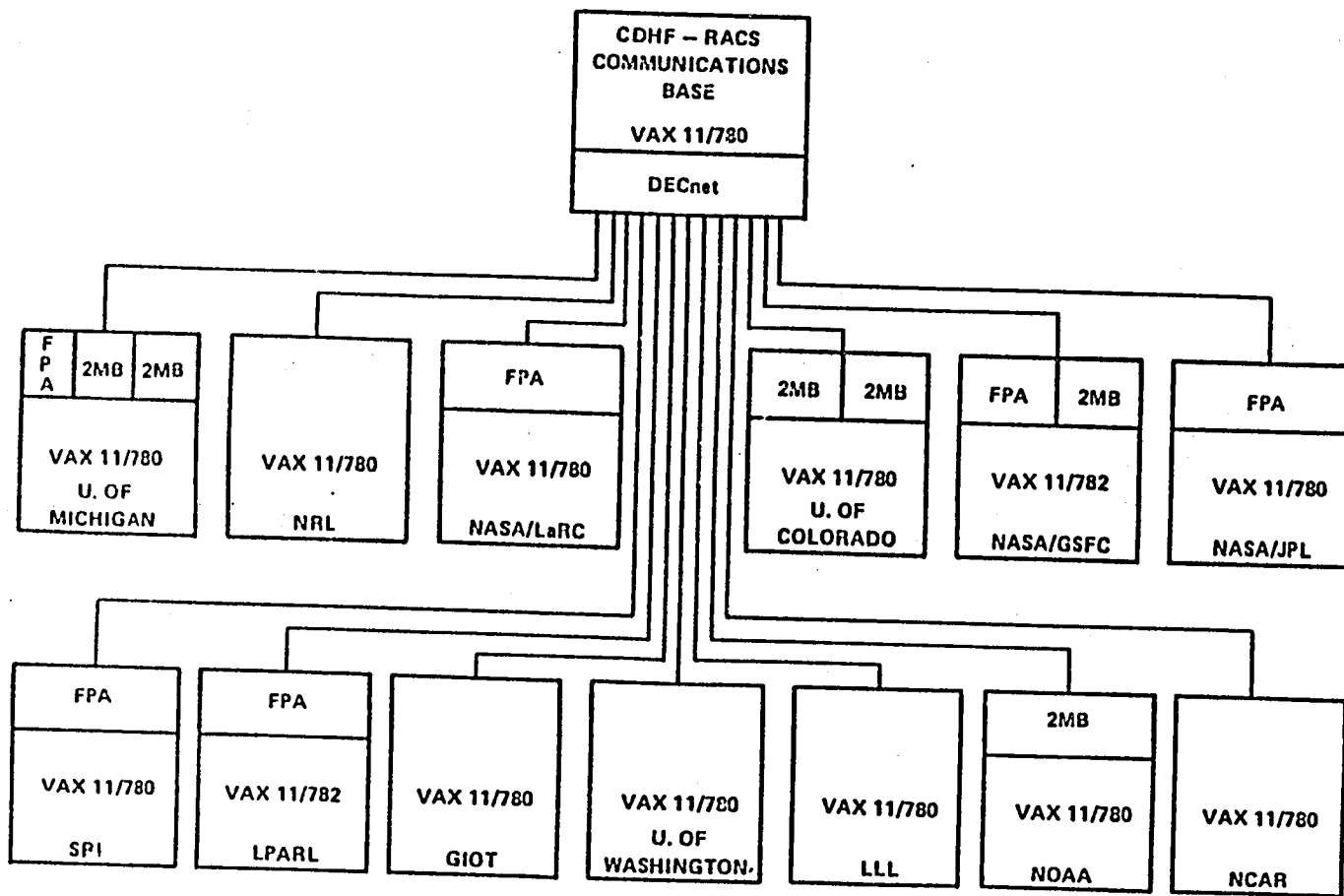

FIGURE 4-3

**5.0 MASS STORAGE ANALYSIS**

## 5.0 MASS STORAGE ANALYSIS

One of the the principal functions of the UARS CDHF is to serve as the central repository of the various levels and types of UARS data. Traditionally, data storage has been achieved via magnetic tape libraries. As data is requested, data center personnel must manually mount the tape onto the tape drive. Data is then transferred from the tape to the disk for processing. However, this process is labor intensive, error-prone and extremely time-consuming. In addition, tape libraries require tremendous floor space.

The goal of the CDHF is to provide an accurate and complete data base capable of being accessed in a timely manner. To satisfy this objective, massive volumes of UARS data must be kept "on-line". Table 5-1 summarizes the UARS on-line data storage requirements. Before the advent of the mass storage system, data bases were kept on-line by storing the data on spinning magnetic disks. Although this storage technique did succeed in allowing timely access to data, it retained the floor space problem of the tape library. It also consumed a tremendous amount of power and the disk media was very expensive. For these reasons, efforts were made to design a storage system which would have the following properties:

- o storage capacity in the GByte range
- o timely access of data
- o low personnel requirement
- o efficient use of floor space
- o low power consumption

Mass storage systems are available which can alleviate the inadequacies of the traditional manual magnetic tape library. They also are designed to be much less costly than traditional disk storage. Three basic types of mass storage systems were analyzed for this report:

Table 5-1

UARS ON-LINE DATA STORAGE REQUIREMENTS

<u>Type of Data</u>	<u>Volume Per Day</u>	<u>On-Line Retention Time</u>	<u>Storage Requirements</u>
Level 0	202.1 MByte	10 days	2.02 GByte
Level 1	173.5 MByte	90 days	15.62 GByte
Level 2	79.7 MByte	90 days	7.17 GByte
Level 3	24.0 MByte	540 days	12.96 GByte
Quicklook	69.0 MByte	1 day	0.07 GByte
Engineering	10.8 MByte	540 days	5.83 GByte
Orbit/Attitude	7.0 MByte	540 days	3.78 GByte
On Board Computer (OBC) Data	32.4 MByte	540 days	17.50 GByte
Other	TBD	TBD	TBD

Calculated Storage Requirement	64.95 GByte
Contingency 50%	<u>32.47</u> GByte
Total Estimated Storage Requirement	98.42 GByte

- o automated tape library
- o optical disks
- o automated tape/cartridge device

Section 5.1 provides information on the Braegan Automated Tape Library, Section 5.2 concerns the RCA Optical Disk Data Storage and Section 3.3 discusses both the IBM 3850 and the MASSTOR MSS automated tape/cartridge devices.

Four mass storage systems were analyzed for this analysis effort. The type of mass storage system most feasible for UARS purpose is the automated tape/cartridge system. Both the IBM and the MASSTOR tape/cartridge product should be considered for UARS. Ultimately, the choice of mass storage product vendor will depend upon the CDHF computer configuration chosen.

#### 5.1 Braegan Automated Tape Library

The automated tape library investigated was the Braegan ATL 7110. The ATL 7110 consists of a housing module that provides physical storage space for magnetic tape reels, a mechanical retrieval device, mounting and dismounting components, and software to manage the system. In addition to the storage module, this system requires a sufficient number of tape drives to handle the data load. These tape drives must be placed adjacent to the storage module.

The maximum ATL 7110 configuration consists of 16 storage units and 32 tape drives. Each storage unit provides space for 440 standard reels; however, each automatic reel-mounting device reduces capacity by 28 reels. If the maximum configuration (i.e., 16 storage units and 32 tape drives) is utilized, the system can handle 6144 standard reels. The corresponding data capacity is approximately 1100 GBytes:

$6144 \text{ reels} \times 2400 \text{ feet/reel} \times 12 \text{ inches/feet} \times 6250 \text{ Byte/inch} = 1100 \text{ GBytes.}$



However, with normal use, inter-record gaps would reduce capacity by 33%. Thus, the adjusted data capacity would be:

$$1100 \text{ GBytes} \times 66\% \text{ efficiency} = 726 \text{ GBytes}$$

This figure corresponds to 45.4GByte/storage unit. Since the best estimate of on-line storage required for UARS is 100 GBytes, the required number of storage units is three.

As opposed to a traditional tape library, the ATL 7110 offers several advantages to the user:

- o decrease in manpower
- o low hardware costs
- o modularity, add-on capacity
- o "fail-soft" capability
- o no media conversion

While these features make the ATL 7110 preferable to a traditional tape library, several prohibitive disadvantages make this system unsuitable for the UARS mass storage system.

The primary disadvantage of the ATL 7110 lies in the physical space required by the system. Each storage module measures 79 inches high, 63 inches wide, and 67.5 inches deep. For each unit the required floor space is 29.5 ft<sup>2</sup>. Thus, the floor space required for the three units which are needed to satisfy UARS requirements is 88.6 ft<sup>2</sup>. To this figure must be added the floor space needed for hallways, maintenance access and the tape drives which are placed adjacent to the storage modules. In total, the floor space required is extensive.

In addition to the floor space problem, the data access time of the ATL 7110 is less than desirable for the UARS program. Braegan specifications list the average mount time as 20 seconds. Adding request time and time

for the transfer of data to "on-line" status pushes total data access time to well over 20 seconds. The combination of slow access time and massive floor space requirements make the ATL 7110 unsuitable for use as the UARS mass storage system.

## 5.2 RCA Optical Disk Data Storage

Optical disk systems<sup>2</sup> record data by ablating the thin metal surface of a rotating disk with a high-power, modulated laser beam. The recorded data can then be read with light sensors that detect the reflected light of a low-power, unmodulated laser beam. Once recorded, the optical disk may not be re-used for write purposes. It is a write-once, read many times device. In the past, this drawback has discouraged many from pursuing optical disk storage. However, much of the UARS data will require only a write-once capacity. For example, L0 and L1 data are normally recorded once and then used many times in order to perform additional analyses. For this particular situation, the optical disk would be desirable.

The RCA product is configured as a control processor unit (CPU) and a disk drive unit (DDU). The CPU provides for interfacing, data formatting, error management and function control. The DDU provides for cartridge disk handling, drive, servos, electro-optics and built-in-test. The system has been configured as an intelligent controller. This configuration minimizes the load upon the host system. Multi-vendor capability is provided via Network Systems Corporation's HYPERchannel adapter. A master processor manages interfaces and performs data conversion.

---

Note 2: This analysis of optical disk data storage for UARS mass storage needs has been based primarily on notes obtained from an RCA study report. RCA has recently concluded a study of optical disk systems for NASA's Image Processing Facility. The study has not yet been published; however, RCA did agree to supply outline notes.

The optical disc format has been configured using a 14-inch diameter disc. It has three partitioned areas. The innermost is used for test pattern and diagnosis internal to the equipment. The middle region, comprising in excess of 99 percent of the area, is for the user and overhead data. The outer edge is used for file directory. A file directory is entered each time the disc is removed from the system.

Tables 5-2 and 5-3 give technical specifications for the optical disk system and the optical disk media respectively.

There are several major disadvantages inherent in optical disk storage. The first is the write-once limitation. While this would probably not affect L0 and L1 data storage, it could lead to problems if used for L2 and L3 storage. L2 and L3 data are derived from algorithms that will likely be adjusted several times throughout the UARS mission. Each time an algorithm is adjusted, data must be recalculated. Since the old data could not be purged and then recorded over with updated data, a new file would have to be established. With several files of the "same" data floating around, bookkeeping would be much more complex. Also, having outdated and incorrect data available to the users encourages mistakes leading to invalid analyses.

Since optical storage appears to be suitable for storage of L0 and L1 data, but not for L3 or L4 data (among other types of data), it appears that if optical storage were still desired, two different mass storage systems would have to be designed into the UARS system. However, such a design is not available off-the-shelf and would be very costly.

The other major disadvantage of using optical disk storage for UARS lies in the fact that this is new technology. It has no track record to speak of. One of the basic premises in the design of the UARS CDHF was that the technology must be known and commercially available. Although the RCA study and prototype design seems to be promising, it cannot be claimed that optical disk storage is a readily-available, off-the-shelf product with a proven track record.

Table 5-2

OPTICAL DISC SYSTEM SPECIFICATIONS

<u>Parameter</u>	<u>Study Results</u>
Laser Type (Write/Read)	GaAs/HeNe
Write/Read Data Rate	0 - 24 Mbps
Disc Size	14 in (dia.)
Disc Capacity (1 Side)	$4 \times 10^{10}$ Bits
Access Time (worst case)	500 msec
Bit Error Rate	$<10^{-10}$
Disc Spin-up Time	$<2.5$ sec
Data Block Size	16 KBits
Disc Handling	Cartridge Loading
Disc Carrier	Cartridge
Media Life	10 yrs.
Data Storage Format	Concentric

Table 5-3

OPTICAL DISK MEDIA FORMAT SPECIFICATIONS

<u>Parameter</u>	<u>Performance</u>
User Data Rate	24 Mbps
Disc Speed	32.7 rev/sec
Disc Data Rate	38.5 Mbps/Channel
User Capacity	$4.0 \times 10^{10}$ Bits
Format Overhead	28.5%
Disc Diameter	14.0 inches
Number of Tracks	$43.5 \times 10^3$
Min. Pit Size	0.66 $\mu$ m
Track Spacing	1.8 $\mu$ m
Track Type	Concentric

### 5.3 Automated Tape/Cartridge Mass Storage Systems

The automated tape/cartridge system is composed of:

- o data cartridges arranged in "honeycomb" storage cells
- o accessor units
- o data recording devices
- o staging adaptors
- o staging disk drives

The data cartridge consists of a strip of magnetic tape, wound on a plastic spool and enclosed in a protective plastic shell. Data is recorded on the magnetic tape in disk image format in segments called stripes. Storage cells hold the data cartridges when they are not in use, and the accessor transports the data cartridges between the cartridge storage cells and the data-recording devices, which transfer data to and from the cartridges.

A request for data from the central processor goes to the storage facility, which loads the proper data cartridge into a data-recording device. From the cartridge, the data is transferred to the staging disk drives, where it is then available for use by the central processor. No reformatting is required, because the data are stored on the magnetic tape in disk format. When the job is complete, if the records or files have been updated, the data are returned ("destaged") to the data-cartridge tape. If the data have not been modified, destaging is not required.

The automated tape/cartridge device offers the user some distinct advantages. In most cases, disk or tape capacity is used inefficiently. Typically a very large portion holds sequential batch data or infrequently used "convenience" data sets of small to medium size. Such data could be stored on magnetic tape and mounted on tape drives when needed, but the additional labor and tape drive costs, plus built-in time delays and the high probability of mishandling make that approach impractical. These types of data sets will compose a large part of the UARS data base and are ideal candidates for storage in an automated tape/cartridge device. Two

automated tape/cartridge systems were analyzed for this report. Section 5.3.1 presents details of the IBM 3850 mass storage system. In Section 5.3.2, the MASSTOR MSS mass storage system is presented.

### 5.3.1 IBM 3850 Mass Storage System

The IBM 3850 mass storage system is a tape/cartridge device. Each cartridge holds 50 MBytes on 2.7 x 667-inch strip of magnetic tape. The maximum configuration holds 472 GBytes of data.

The IBM 3850 mass storage system is composed of:

- o Mass Storage Control
- o Data Recording Control
- o Data Recording Service
- o Cartridge Storage Module
- o Staging Adapter
- o Direct Access Storage Device and Control
- o Accessor Unit

The data flow among these components is shown in Figure 5-1.

The IBM 3850 uses the virtual device concept in which mass storage appears to the operating system as having more direct access storage devices available than are actually present. When data is requested by the user program or the operating system, the mass storage obtains the data from either its location on physical direct access storage or from data cartridges in the mass storage modules. If the data was in cartridge storage and not in physical direct access, the following would occur:

1. Data is requested
2. Accessor moves to the appropriate storage cell
3. Cartridge is removed from cell and transported to the data recording device

# IBM 3850 MASS STORAGE SYSTEM DATA FLOW

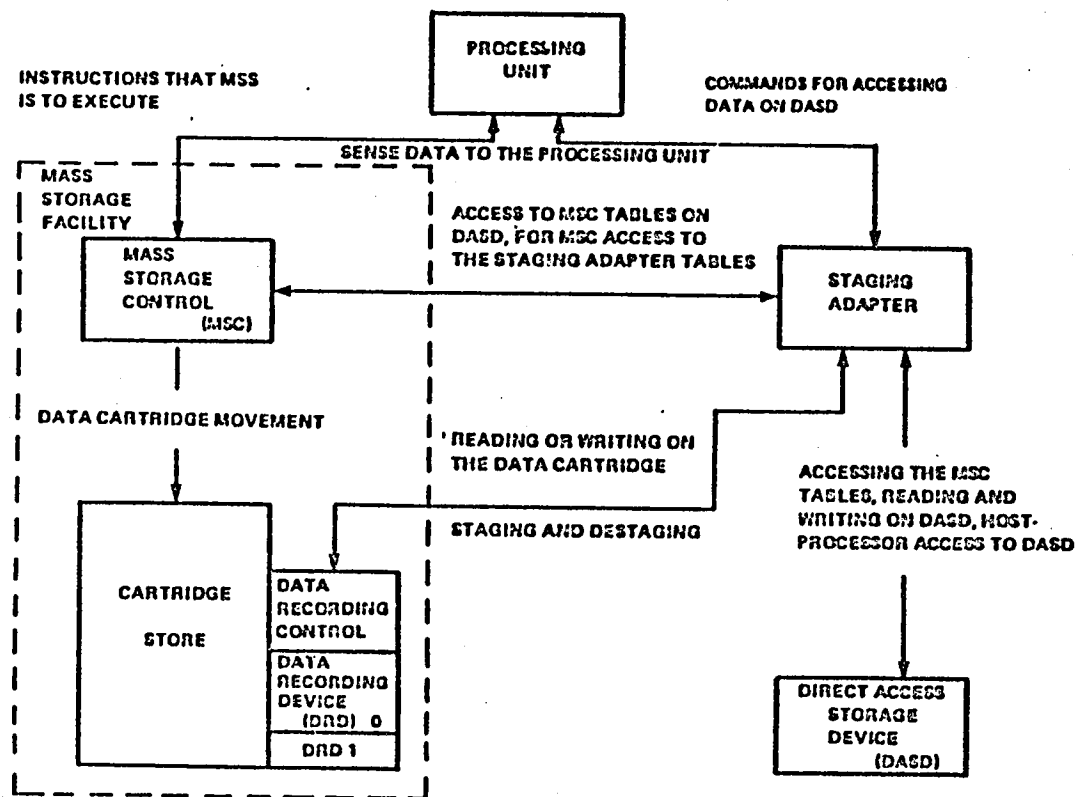

11-5

FIGURE 5-1



4. Data is read from the tape
5. Data is transmitted through data recording control to a staging adapter
6. Data is staged onto direct access storage device
7. Data cartridge is returned to its cell.

Because the disk controller can directly transfer the data directly from cartridge to disk, the host processing unit can be bypassed. This step decreases access time and helps to off-load the host computer.

One of the main disadvantages of the IBM 3850 is its lack of multi-vendor capability. This product is designed to interface with IBM components only. This fact will greatly influence the final choice of the UARS mass storage system. Also, the IBM 3850 is not as space efficient as other mass storage systems available. These, and other factors, are further discussed in the next paragraph.

### 5.3.2 The MASSTOR Mass Storage System (MSS)

The MASSTOR MSS is very similar to the IBM 3850 in that it is a tape/cartridge device with magnetic tape cartridges stored in a "honey comb" storage module. Like the IBM 3850, the MSS also has automatic accessor arms. However, where the IBM accessor travels horizontally and vertically, the MASSTOR accessor has a third coordinate of direction. This feature allows the MASSTOR accessor to reach both the front and back wall of the honeycomb-like storage module, thereby reducing the required number of accessor units.

The MASSTOR MSS is composed of the following:

- o MASSTOR M860
- o MASSTOR Networking Facility (MASSNET)
- o Shared Virtual Storage System (SVSS)

These components are discussed in the following paragraphs.

The M860 mass storage system is composed of:

- o storage control software
- o cartridge storage module
- o storage control
- o data recording control and device
- o staging adapter
- o direct access storage control device

Each storage module holds 316 cartridges. With a data capacity of 175 MB/cartridge, the resulting data capacity per module is 55.3 GByte. A maximum configuration allows for 8 storage modules. Thus, 440 GBytes capacity is possible. Since the estimated UARS storage requirement is approximately 100 GBytes, two storage modules should be sufficient. Each storage module measures 43 inches wide x 36 inches deep x 67 inches high. At 10.75 ft<sup>2</sup>/module, the required floor space for the storage modules would be 21.50 ft<sup>2</sup>.

The M860 is capable of 500 cartridge mounts per hour. Average calculated access time is 10 seconds. This is more than twice as fast as the Braegan ATL 7110 and averages a couple of seconds less than the IBM.

MASSNET is composed of the following:

- o HYPERchannel
- o Network Adapters
- o Transfer Software

HYPERchannel is a high speed data network which provides transmission speeds at CPU channel rates. (More detailed information concerning HYPERchannel is provided in Appendix B of this report.)

The Network Adapters are IBM plug-compatible and allow non-IBM host computers to access the MASSTOR MSS. Protocol Levels 1 through 3 of the International Standards Organization (ISO) specifications are handled by the Network Adapters.

The Transfer Software handles ISO Levels 4 and 5 specifications, thus allowing the transparent sharing of data among unlike-vendor network entities.

SVSS in the MASSTOR MSS allows for the extensive back-end file management required by UARS.

The SVSS is driven by a control processor which is in the IBM 4341, Level 1, class. (The applicable figures in this document depict the MSS control processor as an IBM 4341; however, depending upon the particular application MASSTOR often uses IBM 4341-like control processors.) The control processor provides 6-8MB main storage along with both byte and block multiplexor channels. The control processor is supported by a color CRT, printer and card reader.

Figure 5-2 depicts a MASSTOR MSS configuration with a capacity of 110 GByte. Data flow and component functions are similar to the IBM 3850.

Table 5-4 presents a brief comparison of the MASSTOR MSS and the IBM 3850.

# MASSTOR MASS STORAGE SYSTEM WITH 110 GB CAPACITY

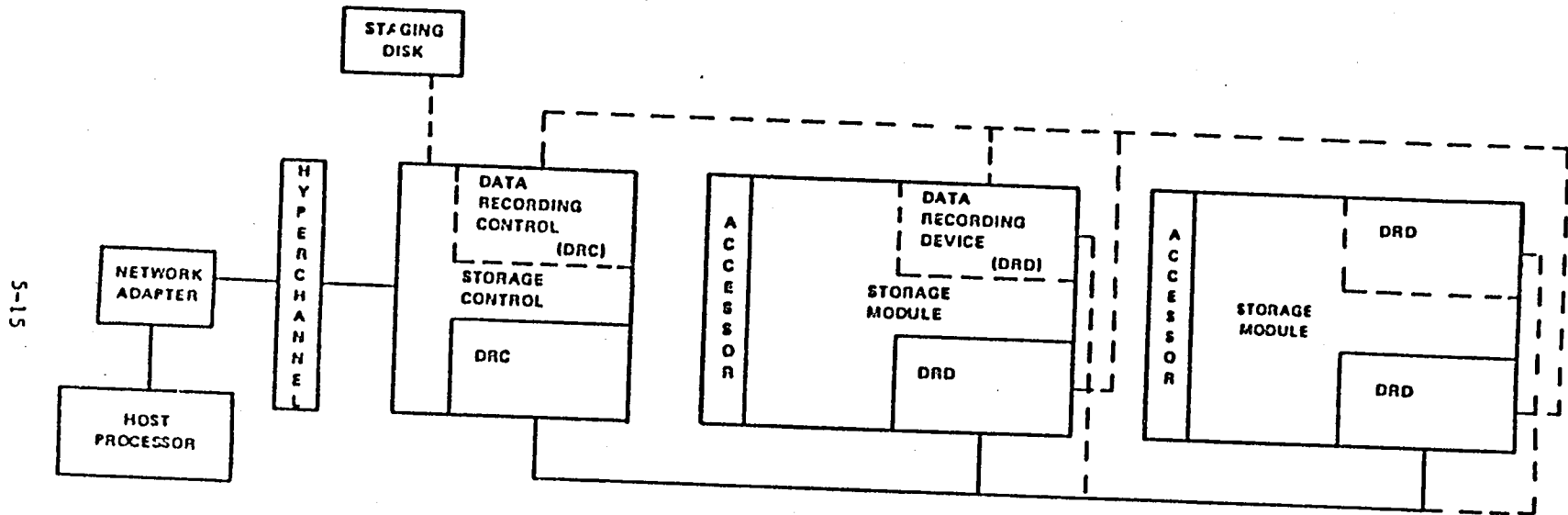

FIGURE 5-2

TABLE 5-4

IBM 3850 - MASSTOR MSS COMPARISONS

<u>Characteristic</u>	<u>IBM 3850</u>	<u>MASSTOR MSS</u>
Maximum Storage	472 GBytes	440 GBytes
MByte/Cartridge	50 MB/cartridge	175 MB/cartridge
GByte/Square foot of floor space	1.4 GB/ft <sup>2</sup>	5.0 GB/ft <sup>2</sup>
IBM Compatibility	Yes	Yes
UNIVAC Compatibility	No	Yes
VAX Compatibility	No	Yes

6.0 MASS STORAGE SYSTEM INCORPORATION INTO  
THE STRAUMAN CONFIGURATIONS

## 6.0 MASS STORAGE SYSTEM INCORPORATION INTO STRAWMAN CONFIGURATIONS

In the mass storage analysis section of this report four mass storage systems were analyzed for the UARS CDHF:

- o Braegan ATL 7110
- o RCA optical disk data storage
- o IBM 3850 Mass Storage System
- o MASSTOR Mass Storage System

The Braegan ATL 7110 was determined to be unsuitable for UARS due to its slow access time and massive floor space requirements.

The RCA optical disk, while considered a promising technology, was tentatively determined to possess prohibitive disadvantages:

- o new technology with no proven track record
- o write-once limitation.

Thus, as of the time of this analysis, optical disk storage was not determined to be the best mass storage system available to UARS.

The two automated tape/cartridge mass storage systems analyzed, the IBM 3850 and the MASSTOR MSS were determined to be especially suitable for UARS. Ultimately, the mass storage system chosen will depend upon the CDHF configuration. In this section, the mass storage systems are incorporated into the strawman configurations.

### 6.1 IBM 3081 CDHF - Mass Storage System

Should the IBM 3081 be chosen as the UARS CDHF, either the IBM 3850 or the MASSTOR MSS could be utilized. Both systems could competently handle the estimated UARS data volume.

Table 5-4 of this report compared characteristics of the two mass storage systems. From this information it is immediately apparent that the MASSTOR MSS is a more compact system. However, there are advantages to utilizing a system designed and supplied by one vendor. For example, often prices are reduced when a multi-component configuration is purchased from one vendor. Also, support, maintenance and repair personnel could be supplied from one company. These are just two advantages that would have to be weighed against the technical advantages of the MASSTOR system.

Figures 6-1 and 6-2 depict the IBM 3081-IBM 3850 and the IBM 3081-MASSTOR MSS system, respectively.

#### 6.2 UNIVAC 1100/92 CDHF - Mass Storage System

Should the UNIVAC 1100/90 be chosen as the UARS CDHF, the MASSTOR MSS would be the preferred choice. In August 1983, MASSTOR and SPERRY/UNIVAC announced a joint marketing agreement. This agreement offers the M860, MASSNET and corresponding SVSS capability as an expansion unit to the UNIVAC 1100 series system. This agreement should alleviate difficulties such as confusion with vendor responsibility and support services often encountered when utilizing a multi-vendor environment. Figure 6-3 depicts the proposed UNIVAC-MASSTOR system.

#### 6.3 VAX 11/780 CLUSTER CDHF - Mass Storage System

Should the VAX 11/780 CLUSTER configuration be chosen as the UARS CDHF configuration, the MASSTOR MSS would be the preferred mass storage system. The MASSTOR MSS provides a Digital network adapter which allows for communications between the MSS and the VAX CLUSTER. Figure 6-4 depicts the proposed VAX CLUSTER-MASSTOR system.



ORIGINAL PRINTING  
OF POOR QUALITY.

# IBM 3081-IBM 3850 SYSTEM

FOLDOUT FRAME

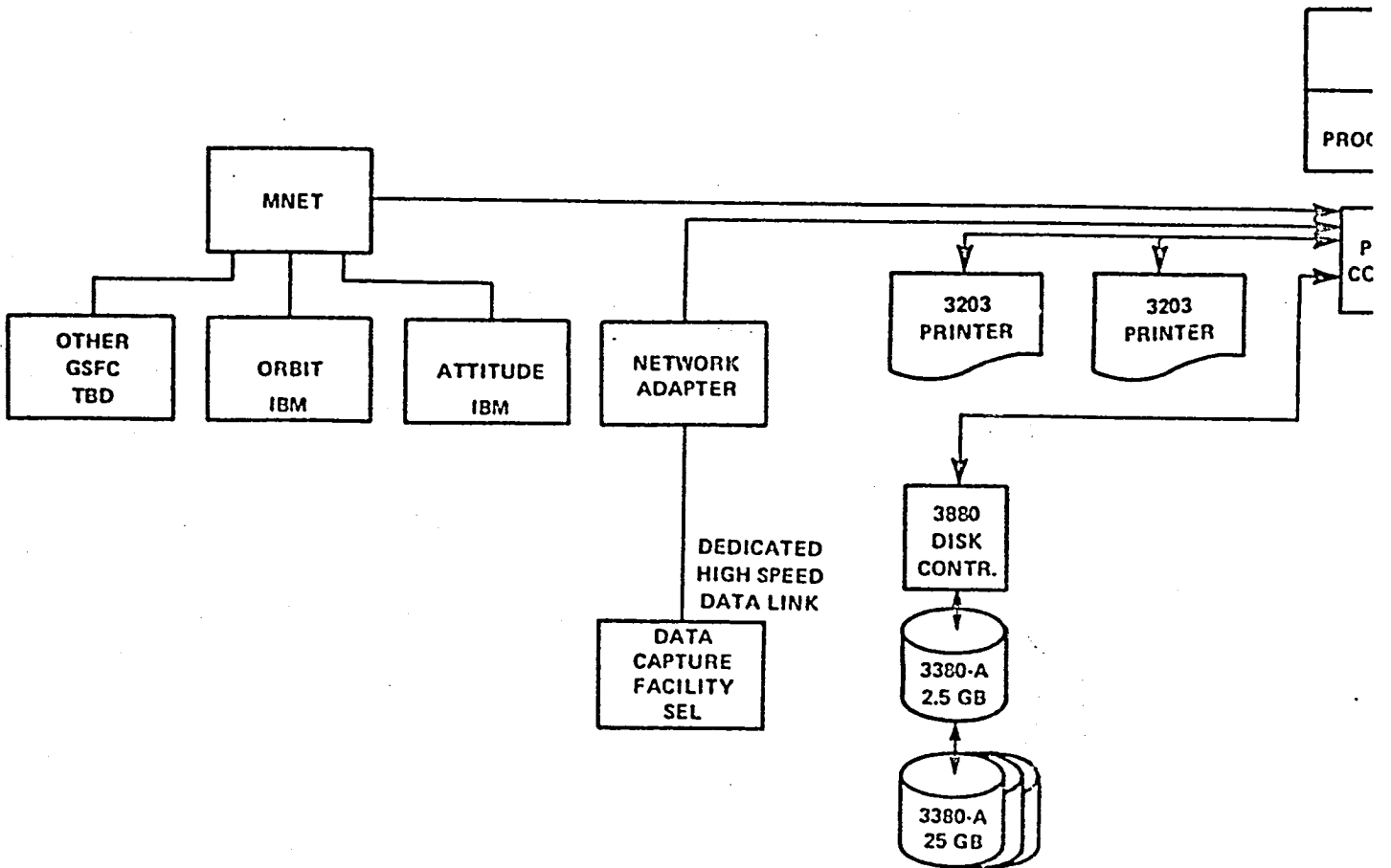

FOLDOUT FRAME

# 3850 SYSTEM DIAGRAM

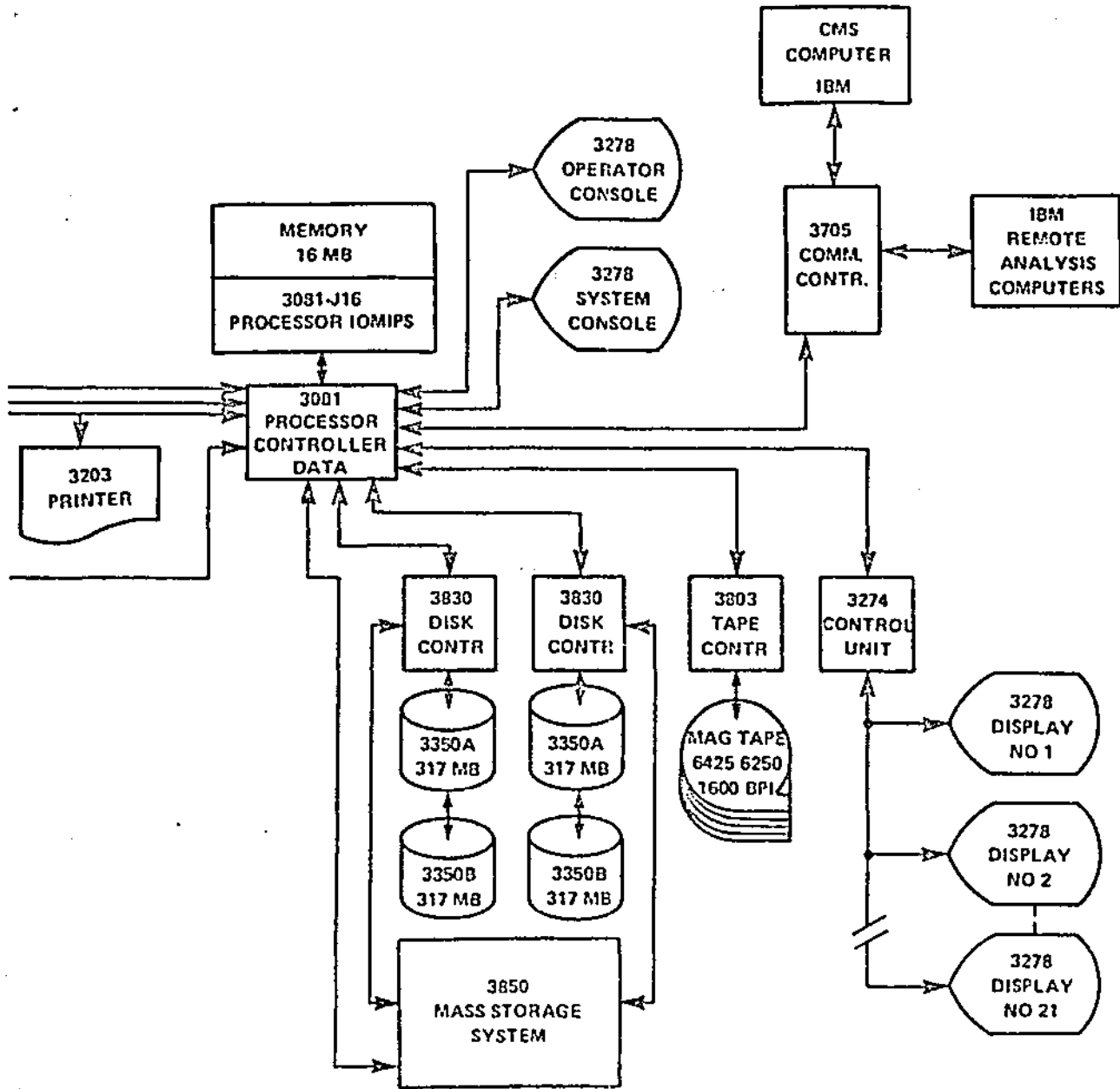
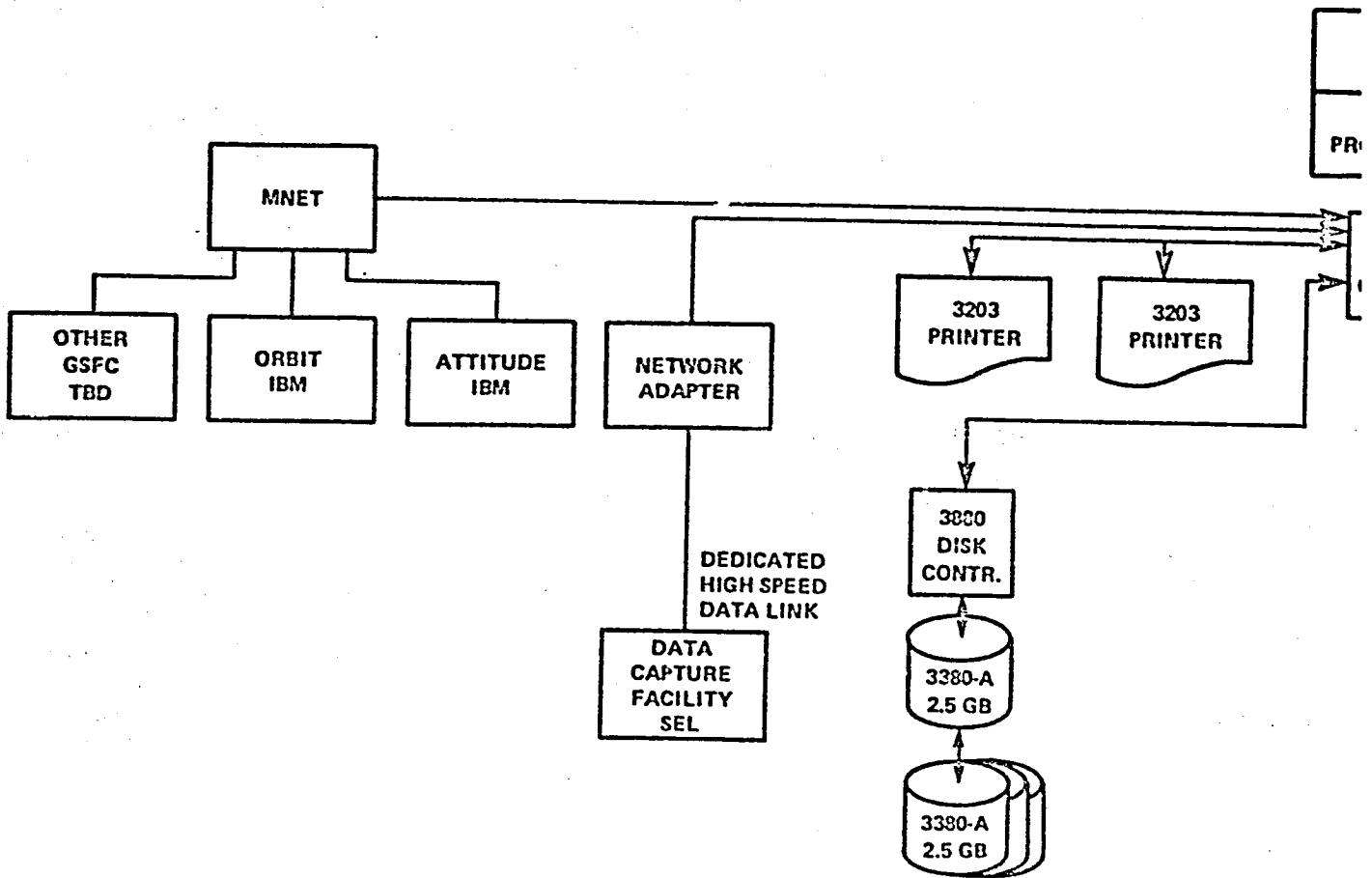

FIGURE 6-1

# IBM 3081-MASSTOR MSS SYST

ORIGINAL PAGE IS  
OF POOR QUALITY



FOLDOUT FRAME

# MSS SYSTEM DIAGRAM

ORIGINAL PAGE IS  
OF POOR QUALITY

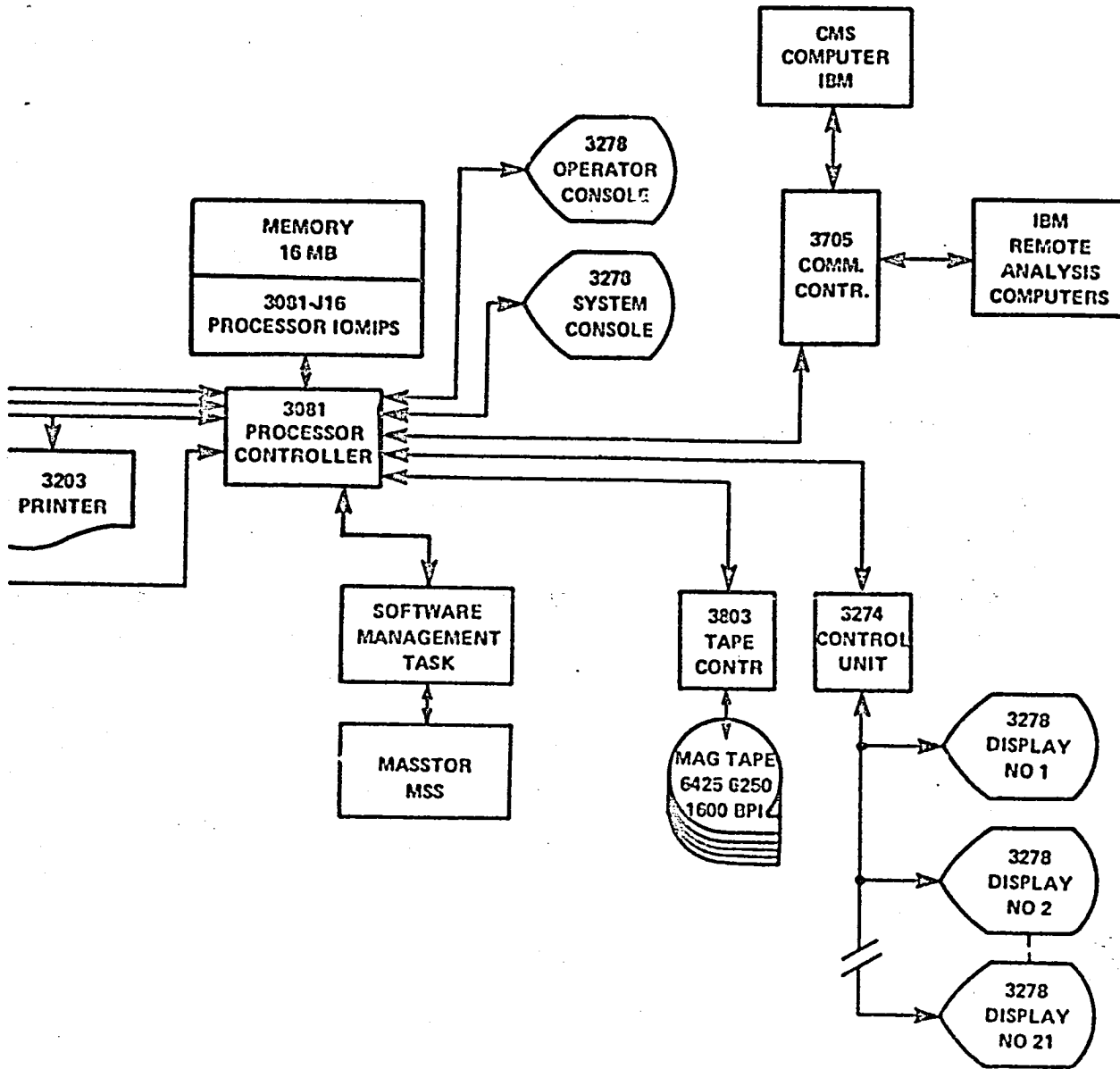

FOLDOUT FRAME

FIGURE 6-2

# UNIVAC 1100/92-MASSTOR MSS SYSTEM DIAGRAM

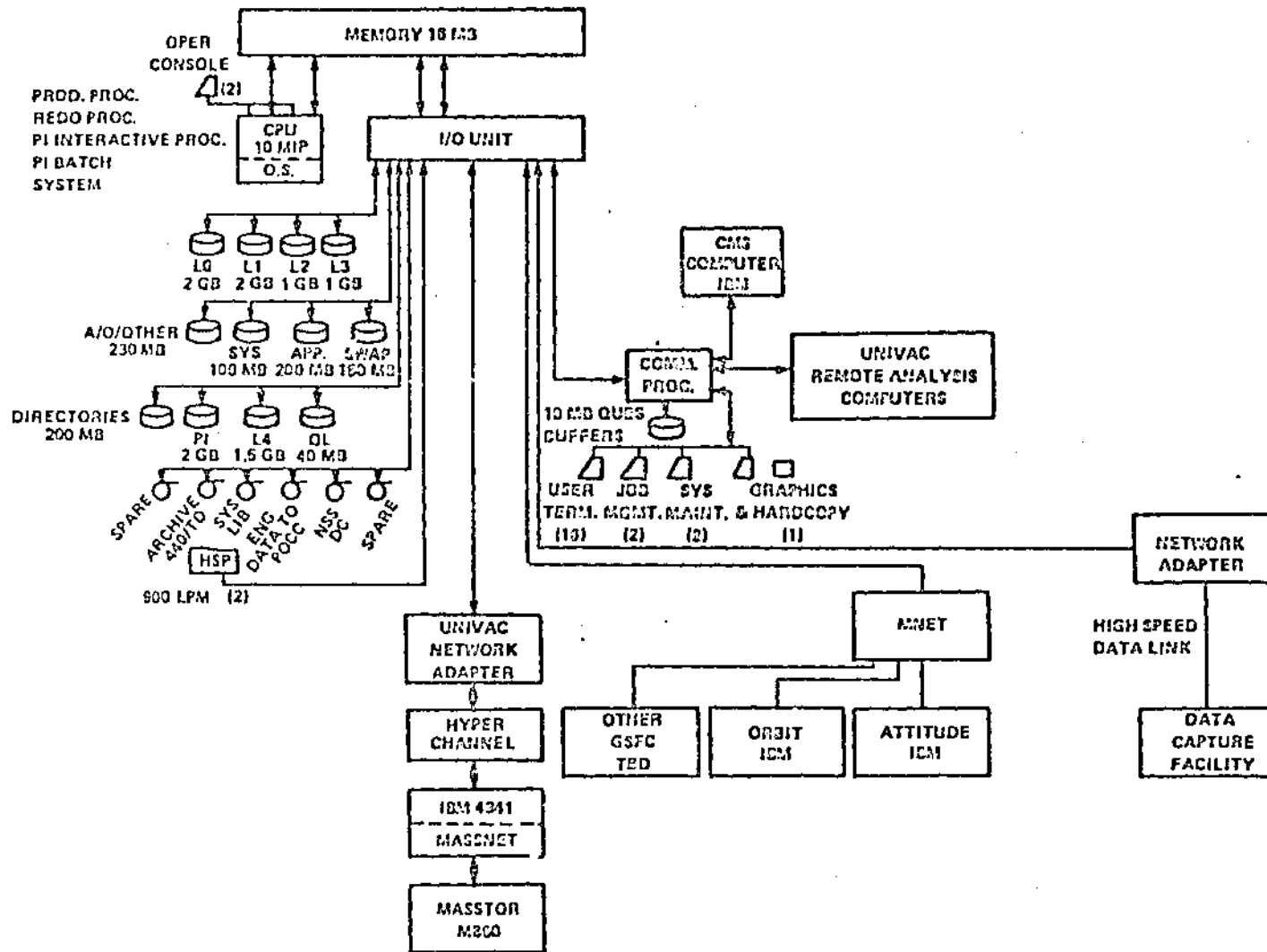

6-5

FIGURE 6-3

# VAX 11/780 CLUSTER-MASSTC

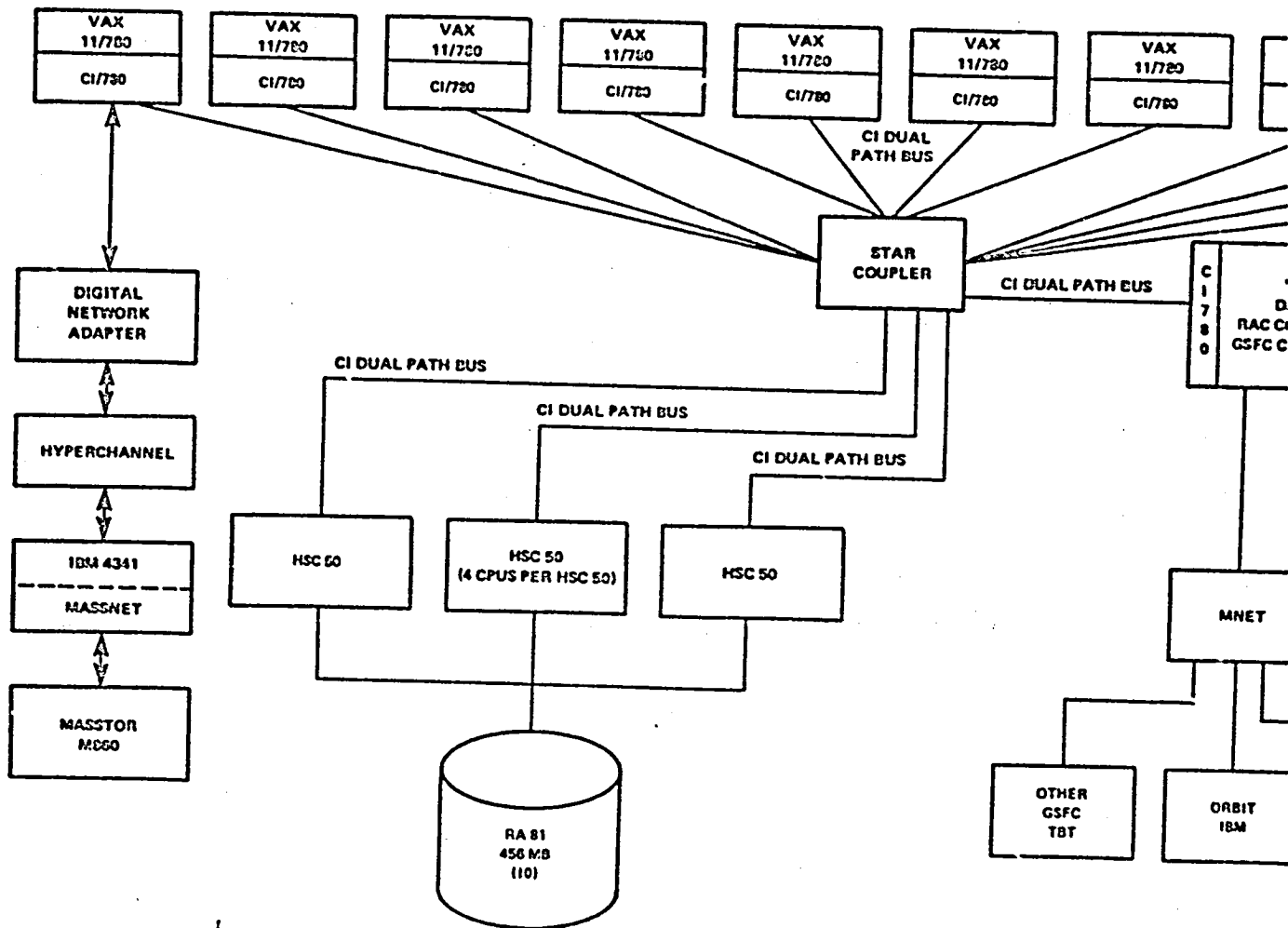

FOLDCUT FRAME

ORIGINAL PAGE IS  
OF POOR QUALITY

# ASSTOR MSS SYSTEM DIAGRAM

ORIGINAL DRAWING IS OF POOR QUALITY

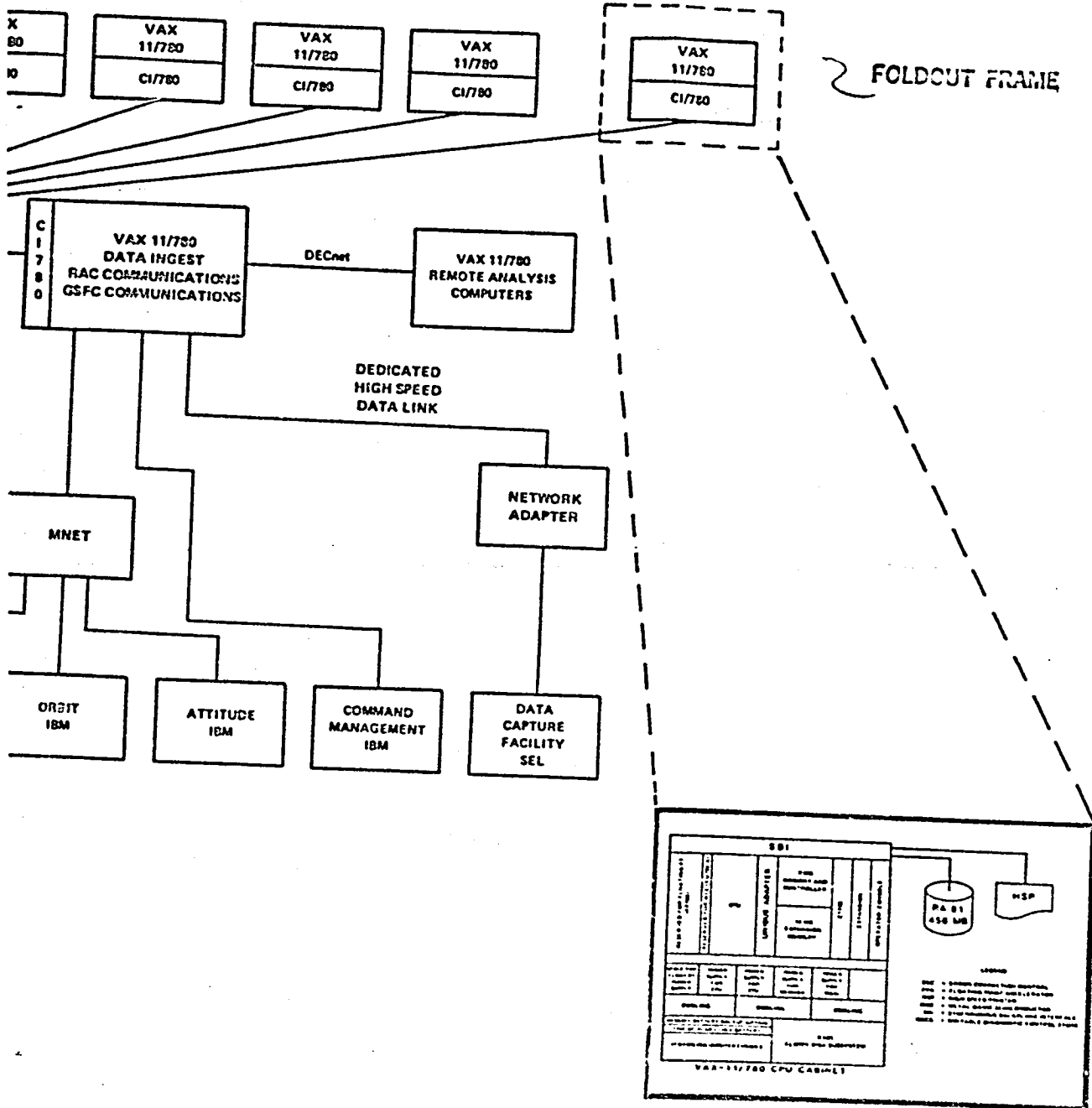

FIGURE 6-4

7.0 PARAMETERIZATION OF STRAWMAN CONFIGURATIONS



## 7.0 PARAMETERIZATION OF STRAWMAN CONFIGURATIONS

In this section, the strawman configurations are parameterized according to the following factors:

- o performance capability
- o availability
- o adaptability to changing requirements
- o compatibility with existing/planned systems
- o implementation risks
- o user friendliness and ease of use.

### 7.1 IBM Strawman Configuration Parameterization

#### Performance Capability:

Paragraphs 3.1 and 4.1 of this document provided performance characteristics of the IBM 3081 mainframe and IBM 4300 series mini-computer. To briefly summarize, the IBM 3081 being considered for the UARS CDHF is a 10.4 MIPS machine with 16 MB memory. The IBM 4300 series ranges from less than 0.5 MIPS to over 1 MIPS with 1 to 4MB memory.

#### Availability:

The IBM 3081 computer and the 4300 series minicomputer are currently operational in other projects at Goddard Space Flight Center; thus, no problem is foreseen with UARS timetable.

#### Adaptability:

The IBM 3081 is a large enough mainframe with enough processing power (10.4 MIPS) to handle foreseeable changes in UARS requirements. The 4300 series can be upgraded incrementally, so changes in UARS requirements should be manageable.

**Compatibility:**

IBM is a major manufacturer of computer goods and services. Many GSFC systems are IBM-based. For non-IBM systems, Network Adapters are commercially available. Thus, data transfer and communication with existing and/or planned systems is not seen as a problem.

**Implementation Risks:**

The IBM 3081 mainframe and the 4300 series being considered for the RACS, are known quantities among Goddard Space Flight Center personnel. Implementation risks are considered to be very low.

**Ease of Use:**

The IBM operating system is not known for its user friendliness. Many advances made within the computer environment concerning ease of use have not been incorporated into the IBM systems. Thus, there is a general lack of enthusiasm among RACS users and also some hesitation among Goddard Space Flight Center personnel concerning the prospect of learning the IBM operating system.

**7.2 UNIVAC Strawn Configuration Parameterization**

**Performance Capability:**

The UNIVAC 1100 series computers are well-suited to the interactive processing required by UARS. They also have the advantage of incremental growth and multi-processing capability. As discussed in Section 3.2, the UNIVAC 1100/92 being considered for the UARS CDHF is a multi-processor mainframe with 10 MIPS processing capability and 12.6 MB main memory. The various UNIVAC RACS Configurations, including the Chaparral and the 1100/70 series, range from 0.5 to more than 2.0 MIPS with 1 to more than 6 MB memory.

**Availability:**

Although the 1100/92 mainframe, the 1100/70 series minicomputer and the Chaparral minicomputer are recent Sperry/UNIVAC introductions, no problem is foreseen with the UARS timetable. The 1100/70 series configurations have been implemented, the 1100/90 series configurations are scheduled to be operational by the end of 1983 and the Chaparral is scheduled to be operational by June, 1984.

**Adaptability:**

The UNIVAC configurations proposed for the UARS CDHF and RACS can be incrementally expanded. Thus, they are adaptable to changes in the UARS requirements. The UNIVAC 1100/90 multi-processor series capability can be expanded with fully compatible Instruction Processors. As Instruction Processors are added, additional I/O Processors can be utilized allowing for increased system capability. The UNIVAC RACS minicomputers can also be expanded incrementally so as to grow concurrently with increased user needs.

**Compatibility:**

UNIVAC is a major manufacturer of computer goods and services. 1100 series computers are currently found in Goddard Space Flight Center computer facilities. Network adapters are commercially available which allow for data transfer to un-like vendor computers. Thus, compatibility doesn't seem to pose a problem.

**Implementation Risk:**

Although the 1100/90 series is a recent introduction, it is in essence an enhancement of the highly successful 1100/80 series mainframes with an increased number of available channels and much quicker transfer and switching rates than the 1100/80. In the same way, the 1100/70

series minicomputers are an enhancement of the 1100/60 series. While the Chaparral utilizes a distributed data processing concept, it is compatible with the 1100 series UNIVACS and should have little inherent risks. The UNIVAC 1100 series computers are well-regarded at Goddard Space Flight Center.

#### Ease of Use:

While the UNIVAC operating system is familiar to Goddard Space Flight Center personnel, many RACS users would have to be trained in the UNIVAC operating system. Still, while re-training is undesirable, it is to be expected to some degree when implementing a system such as UARS.

### 7.3 VAX 11/780 CLUSTER Strawman Configuration Parameterization

#### Performance Capability:

General performance characteristics of the VAX 11/780 were presented in sections 3.3 and 4.3 of this report. To briefly summarize, the VAX 11/780 is a 0.7 MIPS machine which can be configured with a maximum of 16 MB memory.

The VAX CLUSTER software is designed to allow transparent sharing of data among the Central Processing Units (CPUs) of the CLUSTER. At least one VAX would need to serve as the RACS communications base and task scheduler. Along with the CLUSTER software (i.e., Record Management Service, Distributed File System, Distributed Lock Manager and Mass Storage Control Protocol), some UARS-specific software would certainly need to be developed to accomplish efficient task scheduling.

The VAX CLUSTER is a new concept for Digital Equipment Corporation (DEC). Although DEC has utilized DECnet and ETHERnet networking schemes in the past, CLUSTER is different in that it will attempt to

enable transparent sharing of data. Throughout the course of researching this document, DEC has yet to validate this concept of transparent, efficient and fast sharing of data among CLUSTER nodes in a UARS-like environment. To date, VAX CLUSTER suitability for UARS remains speculative.

**Availability:**

The VAX CLUSTER concept was announced by DEC in June, 1983. At that time, DEC provided detailed descriptions of CLUSTER Hardware and general information pertaining to CLUSTER Software. However, the CLUSTER concept, as it pertains to the UARS mission, has not yet been demonstrated. DEC has announced that CLUSTER configurations will be operational by the end of 1983. However, due to the expected debugging stage of this new concept and any resulting redesign, the realistic operational date remains uncertain.

**Adaptability to Changing requirements:**

The VAX CLUSTER concept was created, in part, as an answer to incremental growth of a computing environment. With minor adjustments in software and with the proper hardware adapters, additional VAXs could be added to the CLUSTER should it be necessary to increase processing capability.

The VAX is a competent and flexible computing machine. Should the CLUSTER prove to be a viable concept, changes in processing needs that can reasonably be foreseen should not adversely affect the VAX CLUSTER Configuration.

**Compatibility:**

DEC is a major manufacturer of computer goods and services. VAXs are currently found in many computer configurations at GSFC and network

adapters are commercially available which allow for data transfer between computers of un-like vendors. Thus, compatibility doesn't seem to pose a problem.

#### Implementation Risks:

While the VAX 11/780 is a proven super-mini computer, utilizing a CLUSTER of VAXs is a new idea with risks inherent to any unproven concept. The two major concerns lie in processing speed and task scheduling.

Even with a Floating Point Accelerator, the MIPS rating of the VAX (0.7 MIPS) is much less than that of a mainframe. Clustering 10 1-MIPS machines does not yield a 10 MIPS machine. Also, although the software was designed to perform task scheduling in an efficient manner, no program similar to UARS currently utilizes the VAX CLUSTER and thus task scheduling capability is unknown.

While the CLUSTER concept appears theoretically promising, it is a new concept which has yet to be debugged, has not experienced a shakedown period and has no past history to substantiate its capabilities.

#### Ease of Use:

The VAX is an extremely friendly computer. It is also very popular among the RACS users. Since many of the investigators are familiar with the VAX/VMS operating system, extensive retraining could be avoided.

APPENDIX A  
STRAWMAN CONFIGURATION COST DATA

#### A.0 Strawman Configuration Cost Data

Cost data have been obtained for the major system components of the strawman configurations. These cost data are presented in tabular form in this section. Table A-11 presents a summary of cost data for the CDFE-RACS-Mass Storage configurations.



TABLE A-1  
 COST DATA  
 IBM CDHF SYSTEM CONFIGURATION

<u>IBM CDHF</u>	<u>GSA PURCHASE PRICE (\$)</u>
o IBM 3081 Processor	4,040,874
- 10.4 MIPS	
- 16 MByte Memory	
- 16 Channels	
- Power Unit	
- Coolant Distribution Unit	
- Operator Console	
o Disk	1,721,440
- 10 GByte (Total)	
- 2 Disk Subsystems (DDS)	
- Each DSS	
2 3880-003 Controllers	
2 3380-A04 Disks	
6 3380-B04 Disks	
o Tape	170,350
- 4 3420-006 Tape Units	
(125 ips, 1600/6250 bpi)	
- 2 3803-002 Control Units	
- 1 3803-1792 Two Control Switching Option	
o Terminals	62,367
- 1 3274-D31 Control Unit	
(1 each 6901, 6902 Adapters)	
- 10 3278-002 KB/CRT's	
- 4 3287-002 Printers (Friction Feed)	
o Line Printers	82,500
- 2 3203-005 (1200 lpm, train cartridge)	
o Communications	<u>86,890</u>
- 3705-F04 (24 Bi-sync lines @ 9.6 Kbps)	
 IBM CDHF COST	 <u><u>6,164,421</u></u>

TABLE A-2  
COST DATA  
IBM RACS COMPONENTS

<u>Components</u>	<u>GSA Purchase Price(\$)</u>
o IBM 4331 - Level 1	60,000
o IBM 4331 - Level 2	90,000
o IBM 4341 - Level 1	190,000
o IBM 4341 - Level 2	310,000
o 1 Graphics Terminal/RACS (Tektronics 4012 with Hardcopy Device Tektronics 4631)	30,000
o 2 Magtape Controller and Tape Units/RACS - 800/1600 bpi	40,000
o 3 Consoles/RACS - 1 OP. Console - 2 Alphanumeric Terminals	7,000
o 1 400 lpm Printer (IBM-3289)/RACS	13,140

Individual IBM RACS COST      \$ (4300 minicomputer) + 90,140

TABLE A-3  
 COST DATA  
 IBM RACS CONFIGURATION

<u>RACS</u>	<u>IBM Computer</u>	<u>Model</u>	<u>GSA Purchase Price (\$)</u>
Naval Research Lab (NRL)	4331	Model 2	180K
Georgia Institute of Technology (GIOT)	4331	Model 2	180K
University of Washington	4331	Model 2	180K
Lawrence Livermore Laboratory (LLL)	4331	Model 2	180K
National Oceanic and Atmospheric Administration (NOAA)	4331	Model 2	130K
National Center for Atmospheric Research (NCAR)	4331	Model 2	180K
Univeristy of Colorado	4341	Model 2	400K
University of Michigan	4341	Model 2	400K
NASA/Langley Research Center (LaRC)	4341	Model 1	280K
NASA/Jet Propulsion Lab (JPL)	4341	Model 1	280K
Southwest Research Institute (SRI)	4341	Model 1	280K
Lockheed Palo Alto Research Laboratory	4341	Model 2	400K
NASA/Goddard Space Flight Center (GSFC)	4341	Model 2	400K
TOTAL IBM RACS			<u>3,520,000</u>

TABLE A-4  
 COST DATA  
 UNIVAC CDHF SYSTEM CONFIGURATION

<u>UNIVAC CDHF</u>	<u>GSA Purchase Price (\$)</u>
o UNIVAC 1100/92 Processor	4,877,460
- 11 MIPS	
- 12.6 MByte Memory	
- 16 Channels	
- Power Unit	
- Cooling Unit	
- Operator Console	
o Disk	900,560
- 10.5 GByte (Total)	
- 2 Disk Sub Systems w/expansion	
- 10 MB Disk Drive	
o Tape	210,380
- 2 UNISERVO Control Units	
- 6 Tape Units (125 ips, 6250 bpi)	
o Terminals	33,740
- 10 UTS 20/expanded KB	
- 4 printers	
o Line Printers	83,380
- 2 Printers and Control	
o Communications	<u>73,170</u>
- DCP40	
 UNIVAC CDHF Cost	 <u><u>6,178,690</u></u>

TABLE A-5  
 COST DATA  
 UNIVAC RACS COMPONENTS

<u>Component</u>	<u>GSA Purchase Price (\$)</u>
o DCP 20	45,870
o Chaparral	180,650
- Instruction Processor	
- System Support Complex	
- Console	
- 4 MB Memory	
- I/O Channels	
- DCP 10	
o 1100/71 - Model H1	340,440
- Processor	
- I/O Channels	
- Disk Expansion	
o 1100/70 - Model H1	573,310
- Processor	
- MSU Expansion	
- I/O Channels	
- Disk Expansion	
o Terminal/RACS	35,850
- UTS 20 with expanded KB	
- Printer	
- Hardcopy Device	
o Tape/RACS	57,950
- 1 UNISERVO Control	
- 2 UNISERVO Tape Units	
Individual IBM RACS Cost	\$(minicomputer) + \$(communications) + 93,810

TABLE A-6  
 COST DATA  
 UNIVAC RACS CONFIGURATION

<u>RACS</u>	<u>UNIVAC Computer</u>	<u>GSA Purchase Price (\$)</u>
Naval Research Lab (NRL)	Chaparral	274,460
Georgia Institute of Technology (GIOT)	Chaparral	274,460
University of Washington	Chaparral	274,460
Lawrence Livermore Laboratory (LLL)	Chaparral	274,460
National Oceanic and Atmospheric Administration (NOAA)	Chaparral	274,460
National Center for Atmospheric Research (NCAR)	Chaparral	274,460
University of Colorado	1100/71-H1	489,120
University of Michigan	1100/71-H1	489,120
NASA/Langley Research Center (LARC)	1100/71-H1	489,120
NASA/Jet Propulsion Lab (JPL)	1100/71-H1	489,120
Southwest Research Institute (SRI)	1100/71-H1	489,120
Lockheed Palo Alto Research Laboratory (LPARL)	1100/70-H1	712,990
NASA/Goddard Space Flight Center (GSFC)	1100/70-H1	712,990
TOTAL UNIVAC RACS		<u>5,518,340</u>

TABLE A-7  
 COST DATA  
 VAX CLUSTER SYSTEM CONFIGURATION

<u>VAX 11/780 Cluster CDHF</u>	<u>GSA Purchase Price (\$)</u>
o VAX Cluster Software	*
o 12 - VAX 11/780 Cluster Building Blocks (@ 217K/Unit)	2,604,000
- 1 VAX 11/780	
- 2MB Main Storage	
- 1 - HSC 50 (4 CPUs/HSC50)	
- 1 - Star Coupler	
- 1 - disk	
- 1 - tape	
- Computer Interconnect	
o 12 - RAS1 456 MB Disk (@ 21K)	252,000
o 12 - LA100 HSP (@ 2.3K)	27,600
o 12 - 2 MB expansion (@9.0K)	108,000
o 12 - FPA (@ 10.8K)	<u>129,600</u>
VAX Cluster CDHF	\$3,121,200 + VAX Cluster Software Cost

\* The Cluster Concept is a "phased announcement" product. The concept itself was announced in June, 1983. Also at that time, Hardware for the VAX 11/780 Cluster was fully described and tentatively priced. The next portion of the Cluster concept, i.e., the VAX 11/780 Cluster Software, is scheduled to be announced in early 1984. Cluster details pertaining to VAX 11/782 and other DEC equipment will be announced sometime in 1984.

TABLE A-8  
 COST DATA  
 VAX RACS COMPONENTS

<u>Component</u>	<u>GSA Purchase Price (\$)</u>
VAX 11/780	180,000
Terminal	
- Monochrome Graphics	10,000
- Keyboard	
2 MB Memory Expansion	9,000
Floating Point Accelerator	10,800
DECnet Hardware	4,000
DECnet Software (initial license included)	3,000
DECnet Software (Additional RACS)	1,000



TABLE A-9  
 COST DATA  
 VAX RACS CONFIGURATION

<u>RACS</u>	<u>VAX Model</u>	<u>FPA</u>	<u>Memory Expansion</u>	<u>Costs</u>
Naval Research Lab (NRL)	11/780	-	-	198,000
Georgia Institute of Technology (GIOT)	11/780	-	-	198,000
University of Washington	11/780	-	-	198,000
Lawrence Livermore Laboratory (LLL)	11/780	-	-	198,000
National Oceanic and Atmospheric Administration (NOAA)	11/780	-	2MB	207,000
National Center for Atmospheric Research	11/780	-	-	198,000
Univeristy of Colorado	11/780	-	4MB	216,000
University of Michigan	11/780	FPA	4MB	227,000
NASA/Langley Research Center (LaRC)	11/780	FPA	-	209,000
NASA/Jet Propulsion Lab (JPL)	11/780	FPA	-	209,000
Southwest Research Institute (SRI)	11/780	FPA	-	209,000
Lockheed Palo Alto Research Laboratory (LPARL)	11/782	FPA	-	389,000
NASA/Goddard Space Flight Center (GSFC)	11/782	FPA	2MB	397,000
				<hr/>
		TOTAL RACS		3,053,000

TABLE A-10  
COST DATA  
MASS STORAGE SYSTEMS

<u>MASSTOR MSS (440 GB)</u>	<u>COSTS**</u>
o MSS	1,200,000
- M860	
- SVSS	
- MASSNET	
- Network Adapter	
- Control Unit	
o 7-55GB Expansion Units @ 275,000/unit	1,925,000
o 1 - Control Unit	<u>225,000</u>
TOTAL MASSTOR MSS	3,350,000

<u>IBM Mass Storage System (472 GB)</u>	<u>COSTS **</u>
- 2-3851-A04 Mass Storage Facilities (MSF)	
236 Billion Bytes (each MSF)	
4 Data Recording controls (each MSF)	
8 Data Recording Devices (each MSF)	
4720 Cartridges (Each MSF) @ \$35 each	
- 2 3830-003 Storage Control Units	
- 2.536 Billion Bytes Staging Disk (2 3350-A02, 2 3350-B02)	
TOTAL	<u>3,374,714</u>

\*\* To accurately compare the two Mass Storage Systems, we are using a base of approximately 450 GB capacity even though UARS currently requires 110 GB.



TABLE A-11  
 COST DATA  
 SUMMARY OF STRAWMAN CONFIGURATIONS

<u>Configuration</u>	<u>CDHF</u>	<u>RACS</u>	<u>Mass Storage (450GB)</u>	<u>Total</u>
IBM 3081 IBM RACS IBM 3850	6.2M	3.5M	3.4M	13.1M
IBM 3081 IBM RACS MASSTOR M860	6.2M	3.5M	3.3M	13.0M
UNIVAC 1100/92 UNIVAC RACS MASSTOR M860	6.2M	5.5M	3.3M	15.0M
VAX 11/780 CLUSTER VAX RACS MASSTOR M860	3.1M + \$ Software	3.0M	3.3M	9.4 + \$ Software



APPENDIX B  
UNIVAC CDHF - VAX RACS

## B.0 UNIVAC CDHF - VAX RACS

One idea explored in UARS preliminary design meetings was the possibility of a multi-vendor environment for the CDHF. Since the mission investigators are very enthusiastic regarding VAX computers and Goddard Space Flight Center personnel are comfortable with and confident of UNIVAC mainframes, there is much interest directed towards a UNIVAC/VAX Data Handling Facility. Much progress has been made in regards to the hardware interfacing of multi-vendor computers. However, for UARS, the major obstacle to a multi-vendor Data Handling Facility seems to be in software compatibility. Not only must RACS hardware link with the computer processors at the CDHF, the RACS must also perform algorithm development and modification, instrument commands, etc. These tasks require extensive software capability. There are several areas being researched which may provide the software compatibility needed to make a multi-vendor Data Handling Facility possible.

## B.1 THE UNIX OPERATING SYSTEM

First, the utilization of the UNIX operating system for both the UNIVAC mainframe and the VAX RACS is being considered. UNIX is a flexible, modular operating system already familiar to many of the mission investigators. Table A-1 provides a brief comparison of the advantages and disadvantages that the UNIX operating system would offer a UNIVAC/VAX configuration.

While UNIX looks promising in the multi-vendor environment, further research is needed to determine its feasibility for the UARS CDHF.

## B.2 HYPERchannel

A second item explored in regards to a multi-vendor environment was HYPERchannel. HYPERchannel is a high speed digital communications interface which provides multi-vendor interface of computers. The networking of

Table B-1  
UNIX Advantages and Disadvantages

<u>Advantages</u>	<u>Disadvantages</u>
File Sharing	Fragile File Structure
"Canned" Processing Tools	Inconsistencies in Lanuage
Compatibility With Many Computer Systems	Unfriendly Language
Daily Conveniences (Mail, Calendar)	

computer processors is provided at full channel rate. HYPERchannel uses a coaxial cable at 50 Mbps with network adapters that provide both electrical and logical interface.

There are three types of adapters available with HYPERchannel: processor adapter, device adapter, and link adapter. The processor adapter functions as a buffered communications controller to move network messages on the network. The device adapter functions as a data channel for the linkage of peripheral units. The link adapter is used to interconnect a remote unit to the HYPERchannel via wideband communications links. (Either a terrestrial or a satellite link adapter may be used.) These three types of adapters are collectively utilized to network computer processors and peripherals.

A major disadvantage of Hyperchannel is that it is not transparent to host processor software. Device adapters do not have direct memory access and require the development of special channel programs. Since software development is very time-consuming, expensive and risky, this requirement is of major concern. However, since HYPERchannel does provide networking capability for both Digital and UNIVAC, it would be worthwhile to further investigate the feasibility of using a direct physical link such as HYPERchannel in a VAX RACS-UNIVAC CDHF configuration.

### B.3 CONCLUSION

This appendix briefly summarized our efforts to date regarding multi-vendor possibilities for the UARS CDHF. A multi-vendor configuration, and in particular the UNIVAC/VAX configuration appears to be a possible workable situation for UARS. It is not, however, without its disadvantages. Further research would have to be performed before it could be stated that the benefits of such a configuration would outweigh the disadvantages.

#### REFERENCES

1. "Upper Atmosphere Research Satellite (UARS) Data Handling Facility (DHF) Requirements", Computer Science Corp., CSC/TM-83-6004, February 1983.
2. "Requirements For the Upper Atmosphere Research Satellite (UARS) Remote Analysis Computer (RAC) Systems", Computer Science Corp., CSC/TM-83/6001, March, 1983.
3. "UARS and OPEN Data System Concept and Analysis Study", Engineering and Economics Research, Inc., March 1983.
4. "UARS Configurations", Thomas Ruff, Sperry Corporation, August 1983.
5. "VAX CLUSTER - Technical Summary", Digital Equipment Corporation, 1983.
6. "All About Superminis", DATAPRO Research Corporation. May 1981.
7. "VAX 11/780 - A Virtual Address Extension to the DEC PDP-11 Family", W.D. Stecker, Digital Equipment Corporation, 1978.
8. "VAX Hardware Handbook", Digital Equipment Corporation, 1983.
9. "VAX Software Handbook", Digital Equipment Corporation, 1983.
10. "IBM 3850 Mass Storage System Introduction and Preinstallation Planning", IBM Corporation, GA32-0038-1, April 1980.
11. "IBM 3850 Mass Storage System Principles of Operation", IBM Corporation, GA 32-0035-1, November 1981.
12. "M860 Mass Storage System", MASSTOR Systems Corporation, 1980.



13. "Braegan 7110 Automated Tape Library System Overview", The Braegan Corporation, 1980.
14. "RCA Optical Disk Systems Study, Final Report - Executive Summary", RCA, May 1983.
15. "The MASSTOR MASS Storage Product at Brookhaven National Laboratory", Computer Magazine, July 1982.
16. Digital Equipment Corp., Edward Freedman, Bob Williams (Conversations with.)
17. Sperry/UNIVAC, Thomas Ruff, John Bressler (Conversations with.)
18. MASSTOR Systems Corp., Kenneth Wylie (Conversations with.)
19. Network Systems Corp., Mark Klein (Conversations with.)
20. Systems Industries, D. Chandler Hill (Conversations with.)

END

DATE

FILMED

MAR 15 1985

LANGLEY RESEARCH CENTER



3 1176 01322 9761



11  
12