

N85-16911

D22

AERODYNAMIC CHALLENGES OF ALT

Ivy Hooks, David Homan, Paul Romere
NASA
Johnson Space Center

ABSTRACT

The Approach and Landing Test (ALT) of the Space Shuttle Orbiter presented a number of unique challenges in the area of aerodynamics. The purpose of the ALT program was both to confirm the use of the Boeing 747 as a transport vehicle for ferrying the Orbiter across the country and to demonstrate the flight characteristics of the Orbiter in its approach and landing phase. Concerns for structural fatigue and performance dictated a tailcone be attached to the Orbiter for ferry and for the initial landing tests. The Orbiter with a tailcone attached presented additional challenges to the normal aft sting concept of wind tunnel testing. The landing tests required that the Orbiter be separated from the 747 at approximately 20,000 feet using aerodynamic forces to fly the vehicles apart. This concept required a complex test program to determine the relative effects of the two vehicles on each other. Also of concern, and tested, was the vortex wake created by the 747 and the means for the Orbiter to avoid it following separation.

NOMENCLATURE

- \bar{c} Mean aerodynamic chord
- cg Center of gravity
- C_D Drag coefficient
- C_L Lift coefficient
- FF Free flight
- h_w Main landing gear wheel height above ground
- IML Interface mold line
- LE Leading edge
- L/D Lift-to-drag ratio
- M Mach number
- MAC Mean aerodynamic chord
- \bar{q} Dynamic pressure
- X_0, Y_0, Z_0 Orbiter vehicle body coordinate system
- α Angle of attack, degrees
- δ_{BF} Body flap deflection, degrees
- δ_{SB} Speedbrake deflection, degrees

INTRODUCTION

When the Space Shuttle design was begun, in 1969, the concept included aircraft type jet engines on the Orbiter vehicle. The engines would have provided a more flexible landing operation and a means to ferry the vehicle from manufacturing or landing sites to the launch site. This design concept proved not to be feasible for a number of reasons. While the need to have engines for landing was overcome, the need to ferry the Orbiter across the country still existed. Further, most felt that the Orbiter approach and landing phase needed checkout prior to the first entry from orbit. Alternate solutions involved the use of strap-on engines to the wings and a plan to put a kit, containing both fuel and engines, in the payload bay. Neither was considered a viable concept.

At this point, NASA really had built a "boat in the basement". Not only could the approach and landing phase not be tested, but transporting the Orbiter from the manufacturing site at Palmdale, California to the Kennedy Space Center in Florida had no practical solution.

It was then suggested by John W. Kiker of the Johnson Space Center (JSC) in Houston, that the Orbiter be ferried by another vehicle in a mode similar to that used to launch the X-15 aircraft. Consideration was given to existing aircraft; ie., the Lockheed C5A and the Boeing 747, as well as to developing a new airplane for that explicit purpose. Configurations were considered with the Orbiter positioned atop and also below the carrier aircraft. Trade studies were performed which indicated that it was feasible to carry the Orbiter aboard an aircraft in a piggyback fashion. It was also believed possible to launch the Orbiter from such a position in order to do an Approach and Landing Test (ALT), and the Boeing 747 was selected as the carrier aircraft.

The solution also produced new problems. The blunt aft section of the Orbiter would produce considerable drag and create disturbances which could cause fatigue to the vertical tail of the carrier. Thus, for ferry purposes, it was concluded that an aft fairing would be required on the Orbiter. One of the first considerations was the design of the fairing, or tailcone.

Also of concern was the performance of the mated vehicle, both from a range stand point for ferry and from altitude and relative aerodynamics for separation. The primary emphasis was on the relative attitude of the two vehicles to obtain an optimum configuration for both ferry flight and separation. Restrictions included the Orbiter attach points, clearance of the tailcone, and loads on the carrier aircraft.

The need to perform an aerodynamic separation between two maneuverable vehicles required considerable aerodynamic testing and analysis. Again, other variables, originally unsuspected, arose. One example was the concern for the vortex wake produced by the carrier and the possibility of upsetting the Orbiter if it encountered the vortex wake following separation.

The Orbiter's subsonic aerodynamic characteristics required early testing and definition to allow for design of the complex flight control system. Further complicating the situation was the desire to also fly the Orbiter with a tailcone attached for the first landing. With the tailcone, the Orbiter lift-to-drag ratio was significantly improved, and it was felt that the other Orbiter systems could be tested with less risk if the initial flights were performed with the tailcone attached. Thus, the aerodynamicists were required to develop a data base for not only a basic flight Orbiter, but also an Orbiter with a tailcone attached. Similarly, the separation testing had to be done with both configurations.

The testing required to select a mated configuration and to obtain the separation aerodynamics are covered, as is the testing of the vortex wake created by the carrier. The problems associated with wind tunnel testing the Orbiter, with the tailcone attached, are discussed. Comparisons of flight test and wind tunnel-derived predicted aerodynamics are described with particular emphasis on performance, ground effects, and landing gear effects for the Orbiter, with and without the tailcone attached.

THE EVOLUTION OF THE ALT PROGRAM

The initial design of the Orbiter included jet engines to enable the Orbiter to land like a conventional aircraft. In the usual NASA manner of redundancy, it was felt that the Orbiter should be able to land safely even if the jet engines could not be started; ie, if powered flight were the nominal mode for the final landing phase, the Orbiter must be designed to fly unpowered for contingency situations. The cost of the engines was a considerable factor. In addition to the added weight penalty for the engines themselves, there were structural weight penalties for designing the wing to carry the engines. There were cost risks because of the technical unknowns of the environmental effects on the engines - the launch loads and heating, the extreme temperature environment on-orbit, and the effects of entry heating and accelerations. These concerns, and the requirement to design for an unpowered landing, led to the design modification to build an unpowered Orbiter.

This decision to design an unpowered Orbiter, for the Space Shuttle launch and entry configuration, affected two other areas. First, the need still existed to ferry the Orbiter between sites - manufacturing and landing sites to launch sites. When the Orbiter was conceived as a powered flight vehicle, it could have transported itself between sites. With the decision not to incorporate engines, the ferry technique was unresolved. Secondly, there was a plan to flight test the Orbiter in its subsonic regime. There were no unmanned flights in the program, and to have the first landing be that of the Orbiter from an entry point seemed an extreme option.

Consideration was given to engines which could be attached/removed for the purposes of ferry and subsonic testing. The cost and complexity of this system caused it to be rejected. Further, the design optimization, for the unpowered landing characteristics, resulted in an airplane which was not designed for takeoff.

It was at this time that the carrier aircraft concept was proposed. A multitude of ideas were evaluated. The extension of a large aircraft's landing gear, necessary to carry the Orbiter in an X-15 fashion seemed unreasonably complex. The idea of developing a new carrier, with the single purpose of carrying the Orbiter, was unreasonably costly. The options were reduced to carrying the Orbiter piggyback on either a Boeing 747 or a Lockheed C-5A. The technical concerns with both vehicles were related to clearances of the carrier vertical tail and relative aerodynamic effects during separation. The T-tail on the C-5A presented additional complications over the Boeing 747 aircraft. Of particular concern was the effect of the Orbiter wake on the C5A T-tail immediately following separation.

The actual decision to fly the Boeing 747 was based more on logistics than on technical rationale. The only C-5A available would have been loaned to NASA by the Air Force. Since the Air Force could recall the plane at any time, NASA would not be able to schedule operations without risk. During the feasibility assessment, it was found that the Orbiter's blunt aft end (see Figure 1) would severely affect Orbiter/carrier performance both for climb and for ferry range. Further, it was believed that the carrier vertical tail would suffer structural fatigue due to the flow behind the Orbiter. Therefore, a drag reducing attach structure, a tailcone, was proposed (see Figure 2). This structure was to both reduce drag for performance improvements and to lessen the fatigue factor. Because the extent of these problems was not known, plans to flight test the Orbiter in its final landing phase also included retaining the tailcone.

At the time that the Orbiter/carrier aircraft program development was initiated, it was thought that nothing of this type had been attempted previously. It was as a great surprise to learn that the Europeans had flown piggyback configurations, even before World War II. The English, French and Germans each had some type of flight system which utilized two aircraft, one attached to the back of the other. The English had used their aircraft on mail runs to Greenland prior to World War II. The French, who had begun their program before the war, hid their airplanes until after the war. Films of the flight of the French configuration were made available to NASA. Of interest was the relative incidence angle, the attach structure and the pitchover maneuver to achieve separation. All were very similar to the design selected for the ALT program. Whether any wind tunnel testing was ever performed on these European airplanes is not known.

ORBITER/SHUTTLE CARRIER AIRCRAFT WIND TUNNEL TEST PROGRAM

The decision to fly an Orbiter/Shuttle Carrier Aircraft (SCA) configuration required that the precise configuration be established in a relatively short period of time. Following the selection of the Boeing 747 as the SCA, the initial wind tunnel tests were designed to gather data on proposed configurations to optimize the Orbiter/SCA with respect to both climb and separation performance. A number of drag-reducing attach structure fairings were assessed to select the tailcone configuration. The testing involved the Orbiter, with and without a tailcone, and a wide range of Orbiter incidence angles and elevon deflections. Two model scales, three facilities, and a range of Mach numbers and Reynolds numbers were tested to provide a means for correlating and abbreviating future tests throughout the program. The information gained from this series of tests led to the establishment of a mated configuration data base. One modification was made to the SCA, the addition of vertical stabilizers on the tips of the horizontal tail, to compensate for the loss of stability with the Orbiter blanketing the vertical tail.

A test was then conducted which provided performance, stability, and control data for the mated vehicle in the launch configuration. That same test was used to gather isolated SCA data and proximity data for each vehicle at the instant of separation by equipping each model with a balance. The SCA balance also read total vehicle data when the Orbiter was attached. Only the Orbiter with tailcone attached was used for this test, because at this time no tailcone-off flights were being considered. Deflections of the Orbiter elevon and body flap and the SCA stabilizer were evaluated for their effects on the proximity data. From this test came the data to establish the initial target conditions for separation and the performance estimates for the ferry flights.

A verification test was conducted on the Orbiter/SCA configuration using the same model as the test used to establish the data base, but a different facility. Runs were replicated from the earlier test to establish confidence in the data. The Orbiter, without the tailcone, was at this time incorporated into the testing, since the ALT program had been modified to include flight tests with the flight type Orbiter; ie, without tailcone. Data from these tests can be found in Ref. 1.

SEPARATION WIND TUNNEL TEST PROGRAM

The technical community expressed calm assurance that a mated flight program was a feasible undertaking. The separation of two vehicles in flight did not produce the same response. Some of the community had experienced bombs floating into aircraft after deployment, due to the influence of the aircraft on the bomb's aerodynamic characteristics. Those types of experiences and other horror stories abounded as the planning for the aerodynamic separation between the Orbiter and the SCA began.

The Space Shuttle already had two parallel separations with which to contend; that of separating the solid rocket boosters from the external tank and of separating the external tank from the orbiter. Both required knowledge of the aerodynamic effects when the vehicles were in proximity, but used external forces to affect the separation. Knowledge had been gained in testing these launch separation configurations, which required supersonic test facilities. The Orbiter/SCA

separation required testing at subsonic speeds and so required that different support mechanisms, stings, and facilities be utilized.

The wind tunnel tests for separation were conducted with the Orbiter and SCA mounted on separate balances and stings. The two models were then positioned at various distances apart and at various relative incidence angles to obtain the data necessary to simulate the separation maneuver.

The amount and quality of the data obtained from these tests, and the analysis of the separation trajectory sensitivity to the data, resulted in the elimination of two complete tests scheduled in the wind tunnel test program. As an example, the analysis showed that the Orbiter elevon would be deflected only a small amount for either pitch or roll during the separation maneuver. This reduced the number of elevon positions required to be tested. The deletion of those tests and streamlining of others resulted in considerable savings to the program.

A matrix of the basic configurations tested during the ALT program is shown in figure 3. The mated Orbiter/SCA basic dimensions and configuration details are shown in figure 4.

The utilization of mated configuration, separation and isolated aerodynamic data in computer simulations provided trajectory information about the relative separation distances between the vehicles. Structural clearance was the initial concern, but this was expanded to include clearance between the Orbiter and the vortex wake of the SCA.

The problems associated with a trailing vehicle encountering the vortex wake of a large aircraft prompted concerns with the planned separation maneuver. Separation was to be accomplished by the Orbiter/SCA entering a dive maneuver to increase airspeed, followed by a reduction of power and deployment of spoilers to reduce lift and increase the drag of the SCA. Such a configuration was necessary to create the relative motion required to aerodynamically drive the two vehicles apart. This also resulted in a near maximum vortex wake condition since the SCA was now closely configured to a landing configuration.

No vortex wake test was scheduled; however, a Boeing 747 model was available in an ongoing Langley wind tunnel test. The sponsors of the test program granted JSC one evening to test the separation configuration for vortex wake information. A "wing" model was positioned in the vortex wake area behind the Boeing 747, and rolling moment induced on the wing was recorded. This information was used to define a turbulence boundary area. Design of the separation maneuver restricted the Orbiter's flight path to remain outside the area of turbulence. Figure 5 depicts the area of the vortex wake. Data from the vortex wake and separation tests are in Ref. 1.

ALT FLIGHT TEST PROGRAM OVERVIEW

The ultimate aims of the flight test program were to certify the Orbiter/SCA configuration for ferry flight and to test the Orbiter approach and landing phase. In order to flight test the Orbiter, a separation maneuver was required and an initial part of the flight test program was designed to assure that the separation was viable.

The first test of the mated vehicles consisted of taxi testing only. This was followed by flight tests of the Orbiter, unpowered and unpowered, atop the SCA. The Orbiter with tailcone attached was used for these initial flights since this was the most conservative configuration with respect to buffet on the SCA. This was also the selected ferry configuration.

A load measurement system was developed for the Orbiter/SCA to measure and record the attach forces between the two vehicles during the mated portion of each flight. Load cells instrumented to measure axial and shear forces were located on each of the three Orbiter/SCA attach struts shown on Figure 4.

Relative vertical and side forces were measured at the forward attach strut. Relative vertical and drag forces were measured at the left aft strut, while relative vertical, drag, and side forces were measured at the right aft strut. By combining these measurements mathematically, the relative normal and axial accelerations between the Orbiter and SCA and the instantaneous Orbiter pitch acceleration were determined. This data in strip chart form was utilized as quicklook information for post flight analysis and subsequently as a basis for allowing a realtime decision to separate on the initial tailcone-off flight.

A computer program was developed (Ref. 2) which could take the aerodynamic data base and flight conditions, such as airspeed, and compute the expected loads in each load cell, and conversely, could take the load cell data and extract the aerodynamic coefficients. Using the computer program and the planned flight maneuvers, a prediction of load cell readouts could be made prior to the flight. Comparison of actual and predicted load cell data could then be quickly analyzed. Further refinement of aerodynamic data was also possible from actual flight test results.

Because of the concern for the SCA vortex wake, several flight tests were made to confirm the wind tunnel test results. The initial tests consisted of a Lear jet and a T-37 flown behind the SCA. The SCA was equipped with smoke generators and the aircraft were purposely flown into the smoke area to determine the affect of the turbulence. The results clearly indicated that the Orbiter should remain clear of this area. Subsequently, an F-104 was flown with the SCA in a simulated separation maneuver. In this test, the F-104 was positioned at a point off the SCA wing, approximately one wing span away, and both vehicles flew in formation through a simulated separation maneuver. When the SCA reached its conditions for separation, the F-104 pulled away and replicated the planned Orbiter maneuver following the separation. The test confirmed that adequate clearance between the SCA vortex wake and the Orbiter flight path would be maintained.

ORBITER/SCA FLIGHT TEST RESULTS

The initial flights of the Orbiter/SCA were inert tests in that the Orbiter was unpowered and unmanned. Five flights were flown in this series. The first four flights were used to obtain takeoff and climb performance data; to investigate stability and control envelopes, flutter response, and buffet and loads boundaries; and to perform airspeed calibration checks. The fourth flight also focused on evaluating configuration variables associated with the launch maneuver. During this flight, the SCA inflight spoilers were deployed for the first time and the aircraft performance was assessed based on the special thrust ratings on the engines. This flight provided engineers their first look at a separation-related parameter in the form of the incremental effect of the inflight spoilers on each vehicle in close proximity.

The fifth flight of the inert series obtained data during two simulated launch maneuvers starting at ceiling altitude and terminating after approximately 20 seconds of steady-state data following the "launch ready" call by the SCA pilot. Both vehicles were configured as they would be for an actual separation with the exception of the Orbiter elevon. The elevon was positioned at -1 degree for emergency jettison for these early flights.

An error in the SCA data base was discovered during these tests. The error was a result of the incorrect use of wind tunnel incremental data, and the aerodynamic data base was updated to the actual flight data. The inert tests verified that (1) the Orbiter/SCA configuration could achieve and stabilize on the separation parameters using the prescribed procedures without exceeding Orbiter or SCA constraints, (2) safe separation initial conditions could be achieved with the baseline separation configuration and airspeed, and (3) the mated configuration could recover from an aborted separation maneuver within the vehicle constraints. (Figure 6)

Three captive-active flights were then flown with the Orbiter manned. The objectives of these flights were to verify (1) the separation configuration and procedures; (2) the integrated structure, aerodynamics, and flight control system; and (3) the Orbiter integrated system operations.

The first captive-active flight was restricted in airspeed and provided no separation data. The second flight included a full separation simulation. While the SCA maintained the separation conditions, the Orbiter crew moved the rotational hand controller (RHC) full forward and full aft to obtain elevon effectiveness data. Software limits restricted the elevon to move up 1.5 degrees and down 1.5 degrees from the zero degree position for full RHC movement. Each position was held for 5 seconds to obtain steady-state data. Data from the load cells during this flight test were processed through the computer program to assess the elevon effectiveness. The results indicated a shift between the predicted values and the flight test data; equivalent to an approximately -1 degree bias in the Orbiter elevon position. Otherwise, the effectiveness of the elevon was in excellent agreement with preflight predictions.

The third captive-active flight was a dress rehearsal for the actual separation. The elevon was moved from the climb position (-2 degrees) to the separation position (0 degrees) during the maneuver. The elevon bias did not appear during this test. This gave rise to questions regarding data repeatability and elevon position calibration accuracy. Fortunately, the first two separations were relatively insensitive to small elevon dispersions; i.e. the one degree uncertainty still provided an adequate separation window. During the pre-separation maneuvers on these flights, more data could be obtained regarding the elevon bias for use in establishing separation conditions for more sensitive separations.

To design the separation maneuver, off-line simulations were run to evaluate clearances and sensitivities. Manned simulations, for crew training were made for the Orbiter and the SCA. In these manned simulations, the trainer vehicle, either Orbiter or SCA, was modeled to reflect the proximity aerodynamics. The SCA was modeled as the mated vehicle until separation and then was influenced by predefined proximity aerodynamic effects as it was flown away from the Orbiter. The

Orbiter flew a predefined profile to the separation point. After separation, predefined proximity aerodynamics were applied while it was under the influence of the SCA.

While the designers felt comfortable with their work, upper management was still concerned. To better represent the separation to management, off-line simulations were run and coupled with computer graphics to provide a moving picture of how separation would be accomplished. After the film was shown, no one questioned the separation maneuver.

To assess the performance of the first separation, the off-line simulation was used to recreate the flight conditions, using load cell, downlist, and recorded data from the flight. The maneuver differed from planned due to a larger than expected Orbiter pitch up rate immediately following separation. This was probably due to the fact that an onboard computer failed at the instant of separation and distracted the crew. Comparison of the off-line simulation, using the flight conditions and the aerodynamic data base, closely paralleled the flight results. A discrepancy in the SCA normal load factor following separation was attributable to the difference between the post separation steering maneuver used by the SCA pilots and that programmed into the off-line simulation. The elevon bias was not evident on this flight.

The second separation of the Orbiter with tailcone attached also confirmed the preflight predictions. On this flight, the Orbiter pitch up acceleration was as planned.

The third flight in this series had the Orbiter ballasted to a more negative center of gravity. To compensate, the elevon at separation was set at 2.5 degrees and the airspeed at separation was decreased to prevent overloading the Orbiter during the pitch up maneuver following separation. The comparison of off-line to flight results was again in close agreement. (Figure 7)

The Orbiter without the tailcone attached presented two major problems with the separation phase of flight. First, the increased buffet level could possibly result in an SCA cockpit environment that would make it impossible for the SCA to attain the specified target conditions. Second, with the removal of the tailcone, the change in Orbiter pitching moment required +7 degrees of down elevon, which was well outside the elevon range tested in the preceding flights. The SCA tail loads and climb performance degradation created by the increased buffet and drag levels, respectively, were also unknowns. A fourth captive-active flight was originally planned to investigate the flight envelope of the tailcone-off configuration but was deleted. The objectives of the canceled captive-active flight were combined with free flight 4 and were evaluated in the first half of the flight. The optimum incidence for tailcone off was 5 degrees as opposed to the 6 degrees for tailcone attached. However, to reduce the number of variables, it was decided to leave the incidence angle at 6 degrees.

The first portion of the flight was dedicated to a realtime assessment of the buffet-induced loads and verification of the separation configuration and target conditions. A realtime GO/NO-GO decision for separation was based on load cell data telemetered to the ground and displayed on strip-charts in the Dryden Flight Research Center control room.

The buffet levels were determined to be acceptable from takeoff to maximum airspeed and a separation rehearsal maneuver was initiated. Had the data not matched the preflight predictions, a second rehearsal would have been flown to obtain elevon effectiveness over the untested range. The data in the first rehearsal, with the elevon deflected to +7 degrees, confirmed the preflight predictions and all parameters were within the acceptable separation window. A realtime decision was made to continue with the actual separation maneuver. Again, post flight analysis in off-line simulations agreed well with actual flight data.

The fifth flight of the free flight series was a duplicate of the first from the separation viewpoint. Again, the trajectory reconstruction showed excellent agreement between flight data, including photographic time histories, and off-line simulation data. (Figure 7)

DEVELOPMENT OF ORBITER TAILCONE-ON AERODYNAMIC DATA BASE

The decision to fly the initial ALT flights with the tailcone on the Orbiter was made approximately one year prior to the scheduled flight dates. The short lead time to acquire a preflight tailcone-on aerodynamic data base prompted a flurry of wind tunnel testing over the ALT flight regime of Mach 0.8 down to touchdown. Due to the shape and location of the tailcone, much of the testing involved evaluation of various model support systems such that a primary support system could be selected. This testing also involved evaluation of alternate support systems such that tares on the primary support system could be determined. A summary of the support systems evaluated is presented in figure 8.

Following the decision to utilize a sting as the primary support system, sting tares were determined in a subsonic wind tunnel test while supporting the model with wing tip mounted dual

struts, as shown in configuration 6 of figure 8. Those tares were applied to the test results for the Mach 0.4 to 0.8 regime, assuming Mach effects to be negligible. Further testing utilizing support configuration 5 of figure 8 provided verification of the validity of that assumption.

Wind tunnel testing at Mach 0.20 to 0.25 was not only accomplished through use of the previously mentioned wing tip mounted dual struts and sting support systems, but involved utilization of a triple-strut mounted 0.36-scale model, figure 9, in the Ames Research Center 40x80-ft facility. Previously determined triple-strut tares from Orbiter tailcone-off testing were utilized during the 0.36-scale tailcone-on test.

ORBITER AERODYNAMIC PERFORMANCE COMPARISONS

Orbiter flight test data from the ALT program were obtained from both quasi-steady state and dynamic flight test conditions. Flight data utilized herein was determined from references 3, 4, and 5. The dynamic test maneuver occurred with tailcone off and consisted of a pushover-pullup maneuver providing an angle of attack range from 2 to 16 degrees in a relatively short time. Mach number was virtually unchanged during the maneuver.

The predicted data used for comparison with the flight test data was determined from the Aerodynamic Design Data Books (ADDB), references 6 and 7, using given flight attitudes, Mach numbers, and control surface deflections. Aerodynamic "tolerances" and "variations" shown on the performance comparison figures were also obtained from the referenced ADDB's. "Variations" were derived utilizing past flight test experience from many representative aircraft and represents an uncertainty between wind tunnel-derived and flight-derived aerodynamic coefficients. "Tolerances" represent only the uncertainty related to the wind tunnel predictions due to data scatter and scatter resulting from testing with various models and in various wind tunnel facilities.

The aerodynamic analyst is faced with a dilemma in the comparison of preflight predictions and flight test data. In wind tunnel testing, which is the basis of the preflight predictions, the independent parameters are known precisely while the aerodynamics are questionable. In flight testing, the aerodynamics are known exactly, by definition, but the accuracy of the independent parameters may be in question. To minimize the impact of this dilemma, the aerodynamic comparisons were selected such that errors in the flight-independent parameters are minimized. Thus, lift-to-drag ratio (L/D) was selected for comparisons of predicted and flight aerodynamic performance, since it is independent of flight dynamic pressure (q).

Tailcone-on L/D, illustrated in figure 10, indicates a slight reduction in flight data relative to the predictions. The lift and drag coefficients presented in figure 11 indicate that at the same lift coefficient, drag coefficient from flight is slightly higher than that predicted, thus reducing L/D from the predicted levels. It should also be noted that both lift and drag coefficients are well within the predicted tolerance and variation limits indicated.

Figure 12 presents tailcone-off L/D at an average Mach number of 0.4. The maximum flight L/D is approximately the same as predicted; however at the lower values of lift coefficient the flight L/D is slightly higher than predicted. As seen in figure 13, both lift and drag coefficients as a function of angle of attack are slightly less than predicted, although the flight lift curve slope is very close to predicted. Comparison of drag coefficient at the same lift coefficient does indicate that flight drag coefficient is slightly less than predicted, thus the slight increase in flight L/D. Again, both lift and drag coefficients are well within the predicted tolerance and variation limits indicated.

An area of concern which has been verified by the flight test data is ground effects, which were primarily confined to main gear wheel heights (h_w) of less than twenty feet, as illustrated in figure 14. For both tailcone-on and tailcone-off configurations, the flight incremental lift due to ground effects compared well with predicted data. The ground effect on drag coefficient is negligible and, therefore, is not presented.

Estimates of flight landing gear axial force and drag indicate that the incremental effect of landing gear was over predicted, due probably to not correcting the low-speed, low-Reynolds number wind tunnel test results to flight Reynolds number. A post flight wind tunnel test was conducted utilizing a large (0.05-scale) high fidelity model at a high Reynolds number. The results of that test are shown in figure 15 and agree quite well with the landing gear axial force and drag coefficients as derived from the flight tests.

CONCLUSIONS

The analytical prediction techniques and mathematical modeling incorporated in the design of the separation procedures for the Orbiter/SCA were based on scale-model wind tunnel test data. These techniques proved to be extremely accurate and useful throughout the Approach and Landing Test Program.

The load measurement system installed aboard the SCA provided a means for extracting the proximity aerodynamics and was a reliable source for making realtime assessments of separation and loads parameters. The load measurement system also allowed some wind tunnel tests to be deleted from the program, with actual flight data completing the aerodynamic data base. The Orbiter separated from the SCA, successfully and as predicted, five times during the ALT program.

During the Approach and Landing Test Program the Space Shuttle Orbiter was flown as both tailcone-on and tailcone-off configurations. Due to the shape and location of the tailcone on the Space Shuttle Orbiter, much of the initial wind tunnel testing required to support the Approach and Landing Test Program requirement to fly some flights with the tailcone on involved evaluation of various model support systems. From these tests a primary support system consisting of an aft mounted sting was selected. Support systems consisting of both wingtip mounted struts and lower forward fuselage strut were utilized to evaluate and verify sting tares.

Comparisons of predicted and flight test performance data indicate that lift-to-drag ratio, lift coefficient, and drag coefficient were well within predicted tolerance and variation limits for both tailcone-on and tailcone-off. The flight incremental lift due to ground effects also compared well with predicted data.

The flight-derived axial force and drag indicate that the incremental effect of the landing gear was over predicted, due probably to not correcting the low-speed, low-Reynolds number wind tunnel results to flight conditions. A post flight high-Reynolds number wind tunnel test confirmed the flight test results.

REFERENCES

1. Orbiter/747 Carrier Separation Aerodynamic Data Book-SDM Baseline. SD75-SH-0033C, Rockwell International Space Division, Nov. 1976.
2. Homan, D.J.; Denison, D.E.; and Elchert, K.C.: Orbiter/Shuttle Carrier Aircraft Separation: Wind Tunnel, Simulation, and Flight Test Overview and Results. NASA Technical Memorandum 55223, May 1980.
3. Romere, P.O.; Eichblatt, D.L.; Underwood, J.M.; and Howes, D.B.: The Space Shuttle Orbiter Approach and Landing Tests - A Correlation of Flight and Predicted Performance Data. Presented as paper 78-793 at AIAA 10th Aerodynamic Testing Conference, San Diego, CA, April 19-21, 1978.
4. Romere, P.O.; Eichblatt, D.L.; Underwood, J.M.; and Howes, D.B.: Orbiter Approach and Landing Tests Correlation of Flight and Predicted Performance Data. AIAA Journal of Aircraft, Volume 16, Number 4, April 1979, pp. 233-238.
5. AFFTC Evaluation of the Space Shuttle Orbiter and Carrier Aircraft, NASA Approach and Landing Test, AFFTC-TR-78-14, May 1978.
6. Aerodynamic Design Data Book, Orbiter 101, SD72-SH-0060, Volume IV, Rockwell International, Space Division, Downey, CA, Revision 2, May 31, 1977.
7. Aerodynamic Design Data Book, Orbiter Vehicle, SD72-SH-0060-1J December 1975 plus Revisions 1 through 6, Rockwell International, Space Division, Downey, CA.

GEOMETRY	COMPONENT	
	WING	VERTICAL TAIL
AREA	2690 FT ² (249.9092 m ²)	413.25 FT ² (38.3922 m ²)
SPAN	936.68 (23.8425)	315.72 (8.0193)
ASPECT RATIO	2.265	1.675
TAPER RATIO	0.2	0.404
SWEEP (LE)	81/45 DEG	45 DEG
DIHEDRAL	3.5	— —
INCIDENCE	0.5 DEG	— —
MAC	474.81 (12.0602)	199.81 (5.0752)

NOTE: UNLESS OTHERWISE NOTED, ALL DIMENSIONS ARE IN INCHES (METERS)

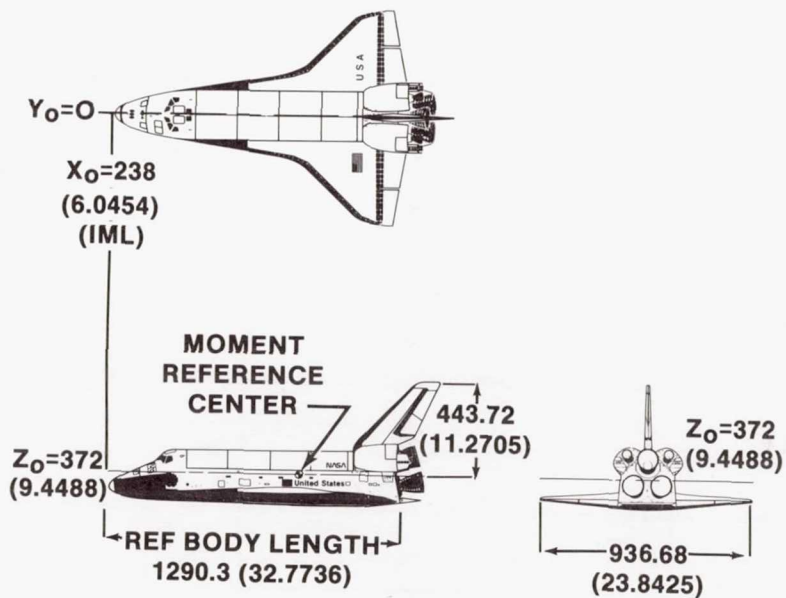

Figure 1. Space Shuttle Orbiter Tailcone-off Configuration.

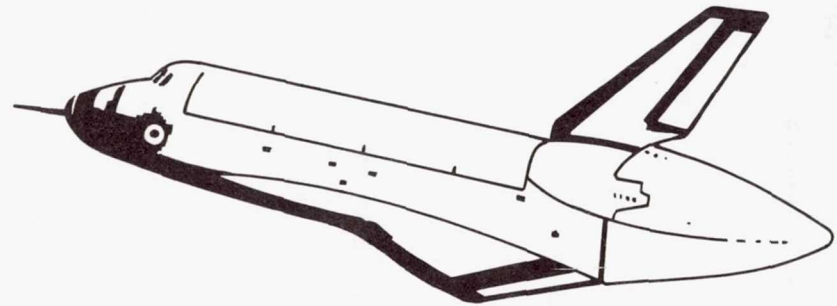

Figure 2. Space Shuttle Orbiter Tailcone-on Configuration.











TEST CONFIGURATION	1974												1975												1976											
	J	F	M	A	M	J	J	A	S	O	N	D	J	F	M	A	M	J	J	A	S	O	N	D	J	F	M	A	M	J	J	A	S	O	N	D
									11	1	16	19		6			8	5		20			7			12	1		18						12	
ISOLATED CARRIER																																				
ISOLATED ORBITER																																				
MATED (TAILCONE ON)																																				
MATED (TAILCONE OFF)																																				
SEPARATION II																																				

Figure 3. Ferry and Approach and Landing Test Program Wind Tunnel Configuration Matrix.

MEASUREMENT	SCA			ORBITER	
	WING	VERTICAL	HORIZONTAL	WING	VERTICAL
AREA, m ²	511	77.1	136.6	249.9	38.4
SPAN, m	59.6	9.8	21.9	23.8	8
ASPECT RATIO	6.96	1.25	3.60	2.265	1.675
TAPER RATIO	0.356	0.340	0.250	0.200	0.404
SWEEP, DEG	37.5 (1/4 c)	45.0 (1/4 c)	37.5 (1/4 c)	^a 45	^a 45
DIHEDRAL, DEG	7.0	—	7.0	^b 3.5	—
INCIDENCE, DEG	2.0	—	+5 TO -10	0.5	—
MAC, c _m	8.3	8.5	6.9	12.1	5.1

^aLEADING EDGE.

^bTRAILING EDGE.

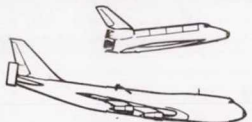
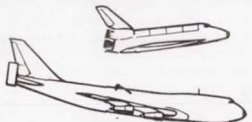
^cMEAN AERODYNAMIC CHORD.

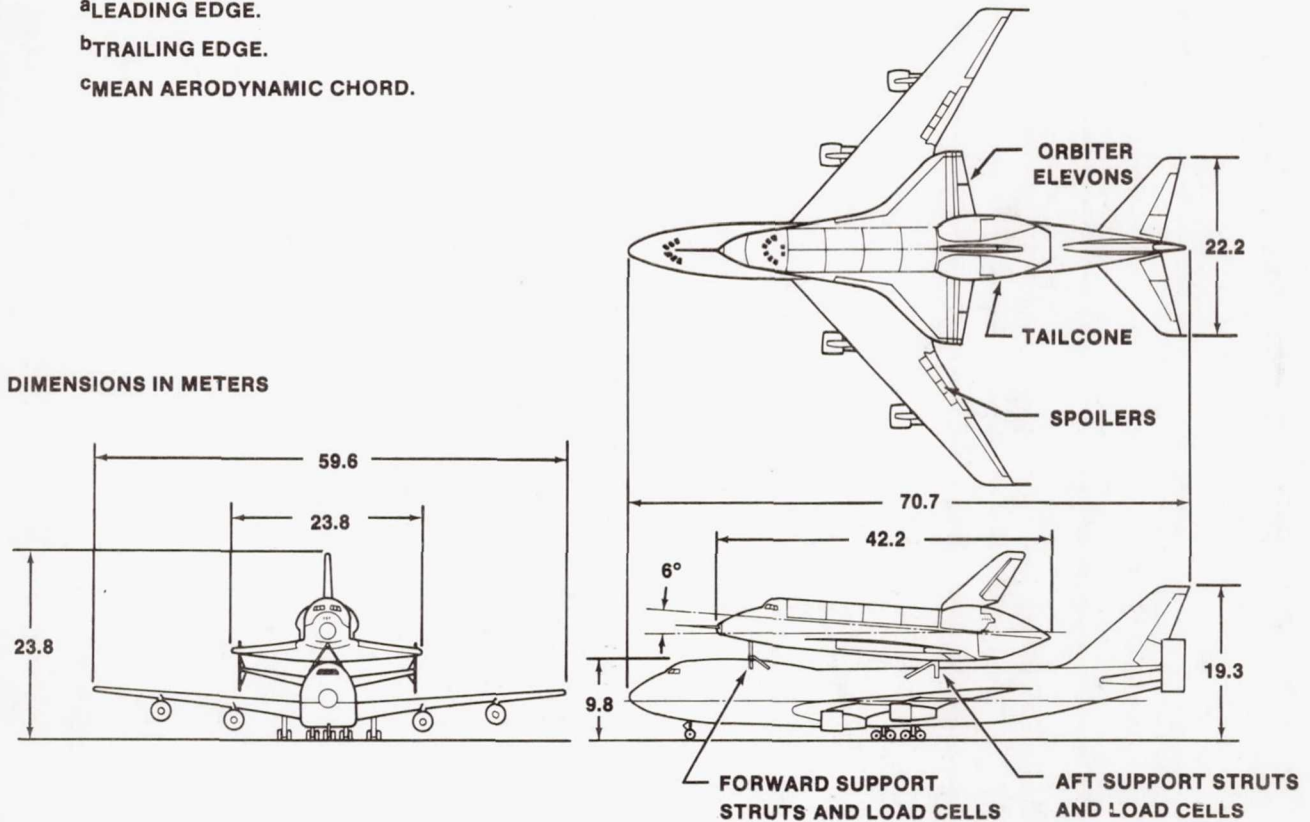

Figure 4. Mated Space Shuttle Orbiter/Carrier Aircraft Configuration.

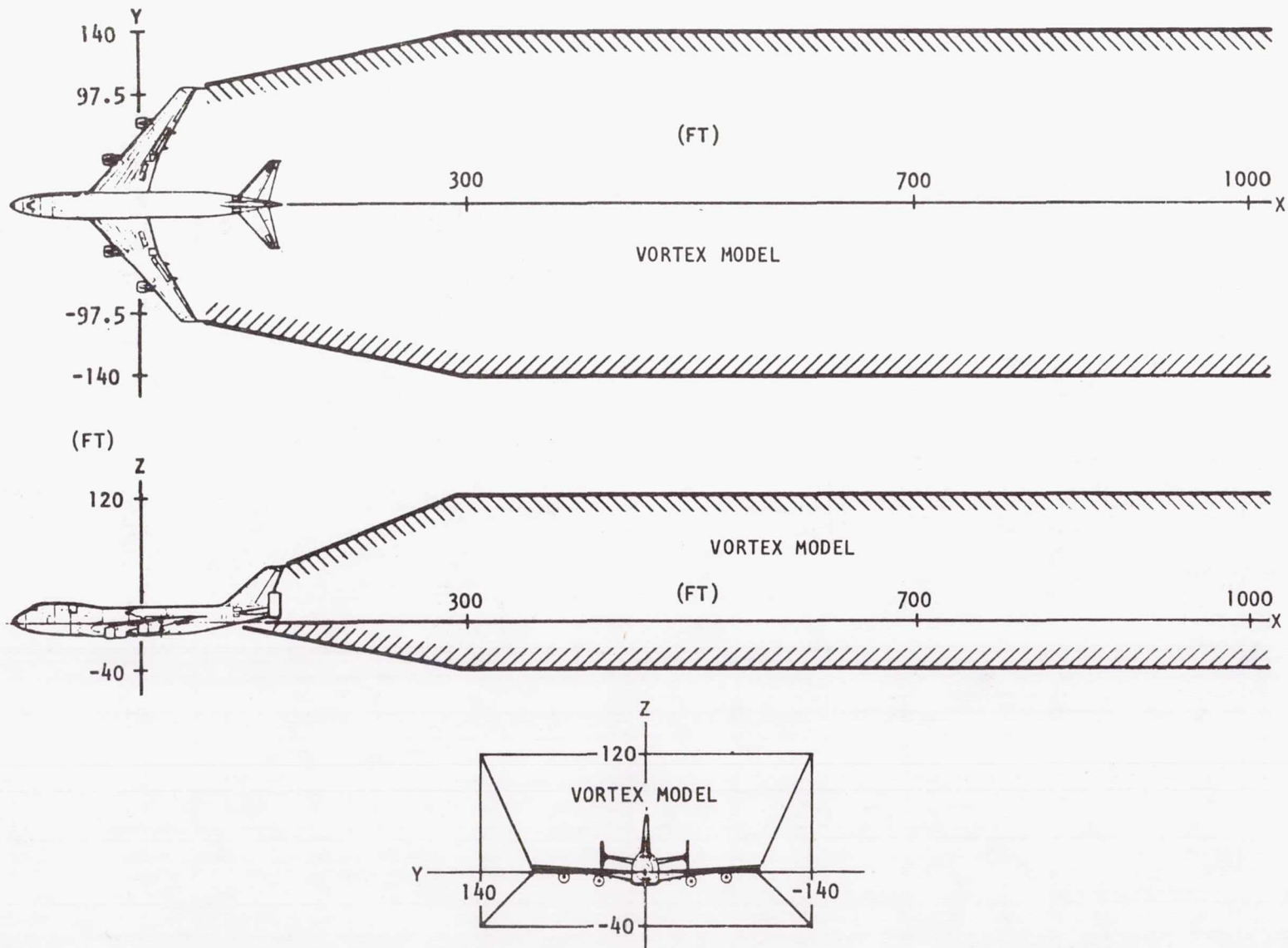
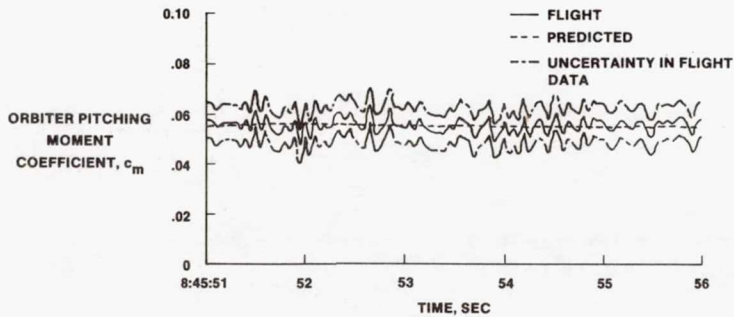
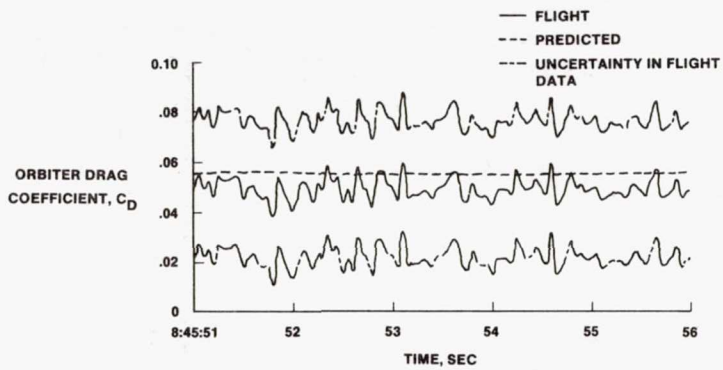
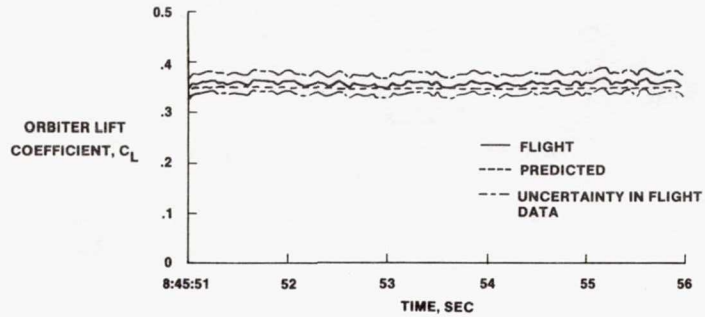
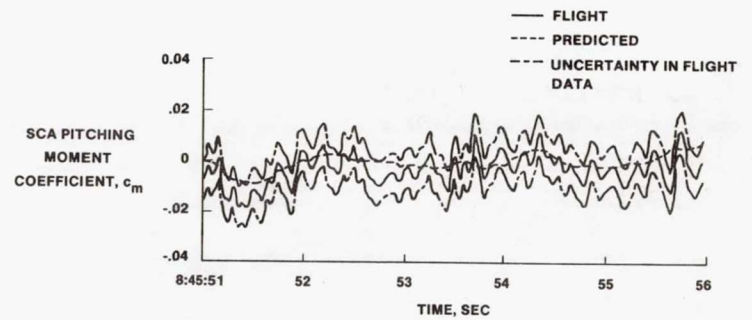
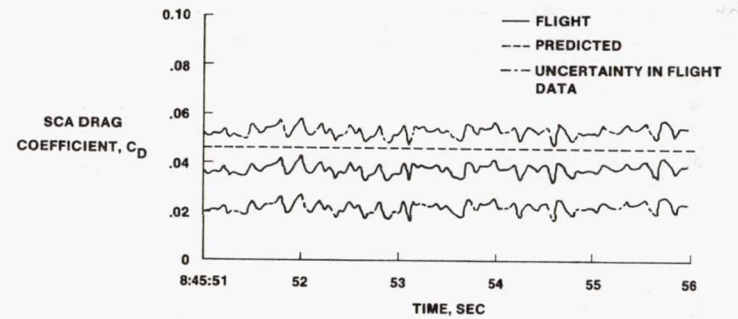
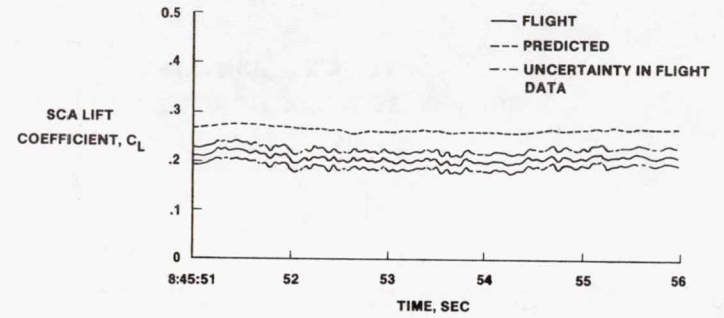

Figure 5. SCA Vortex Wake Definition.

FLIGHT 5 ORBITER AERODYNAMICS WHILE ATTACHED TO SCA



FLIGHT 5 SCA AERODYNAMICS WITH ORBITER ATTACHED



307

Figure 6. Inert Flight 5: Flight Test Data Compared to Off-Line Simulations.

TAILCONE ON

TAILCONE OFF

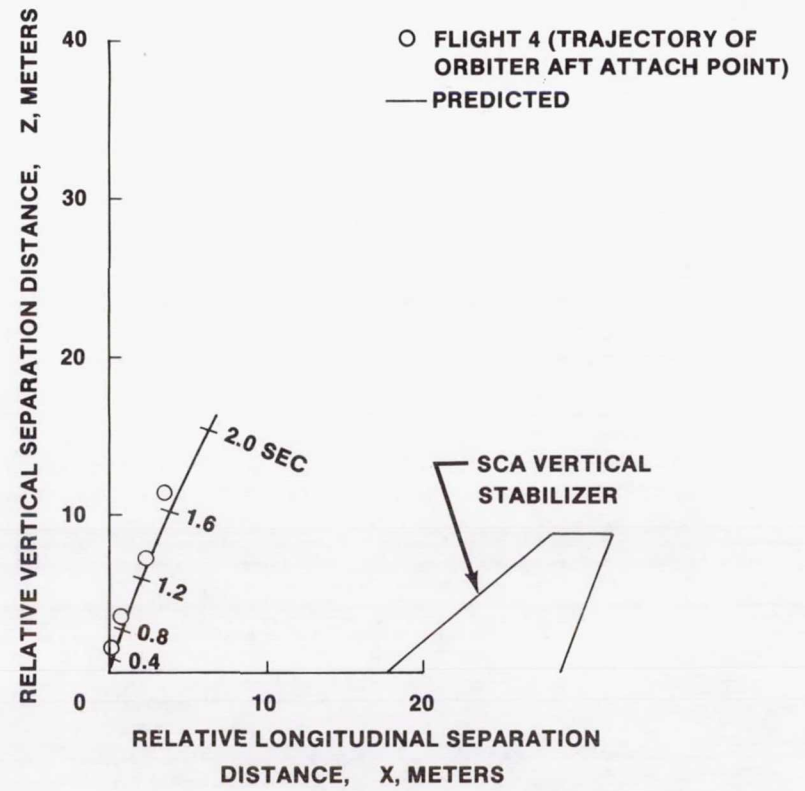
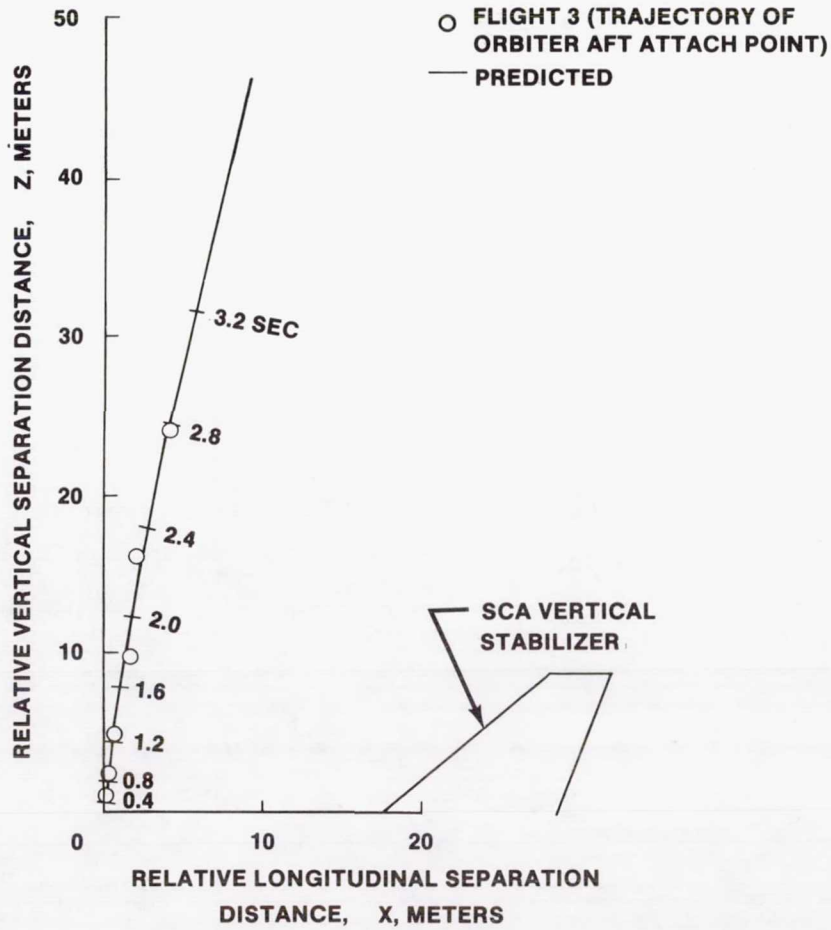

Figure 7. Comparison of Separation Clearances Between Flight Test and Predicted Data

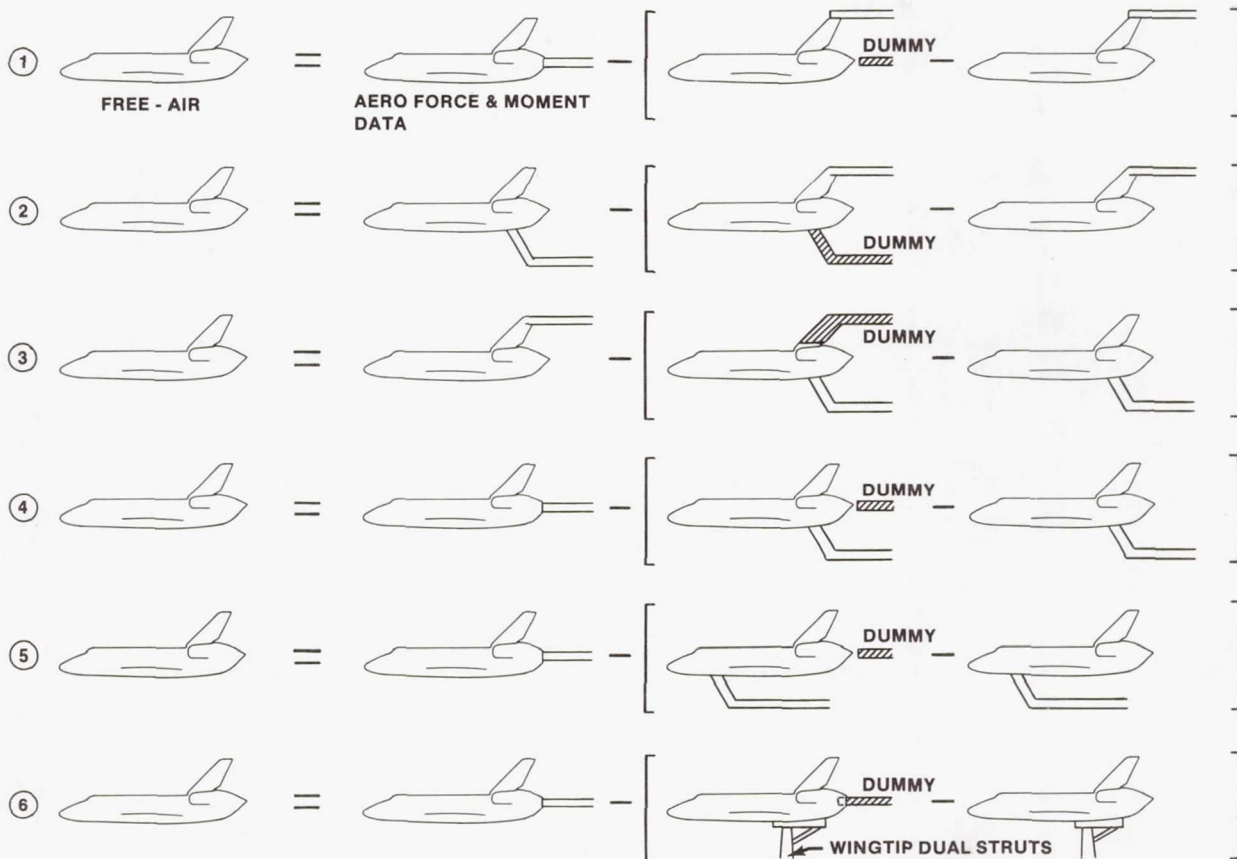

Figure 8. Model Support Systems Evaluated during Tailcone-on Wind Tunnel Testing.

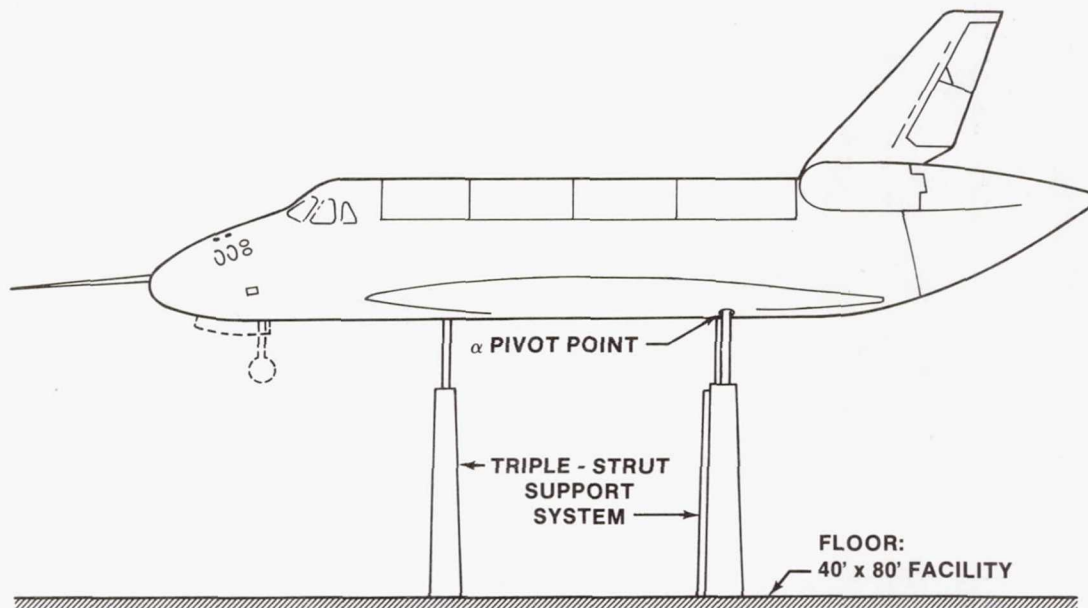

Figure 9. Triple-Strut Support System Utilized with the 0.36-scale Model Orbiter.

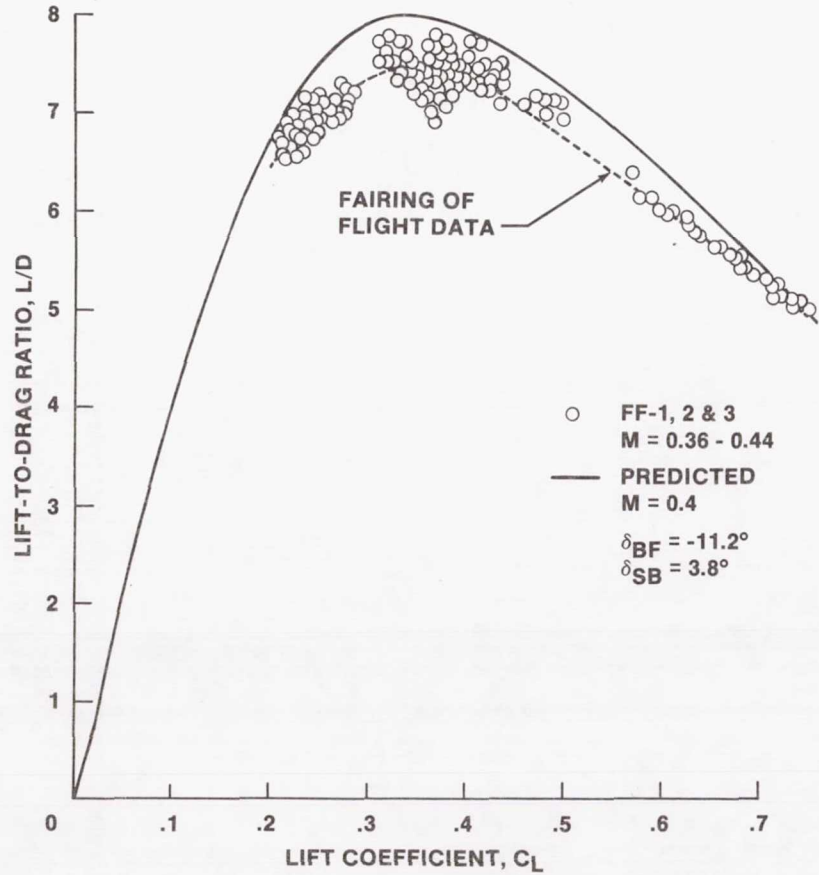

Figure 10. Tailcone-on Performance Comparisons of Flight Test and Predicted Data.

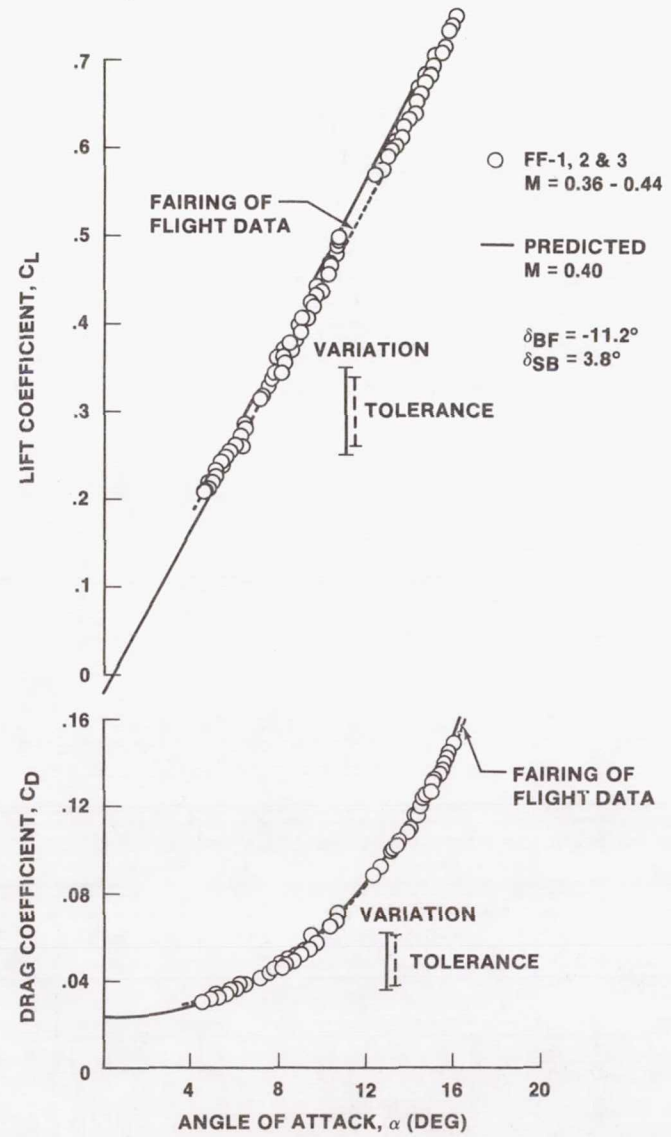

Figure 11. Tailcone-on Lift and Drag Coefficient Comparisons of Flight Test and Predicted Data.

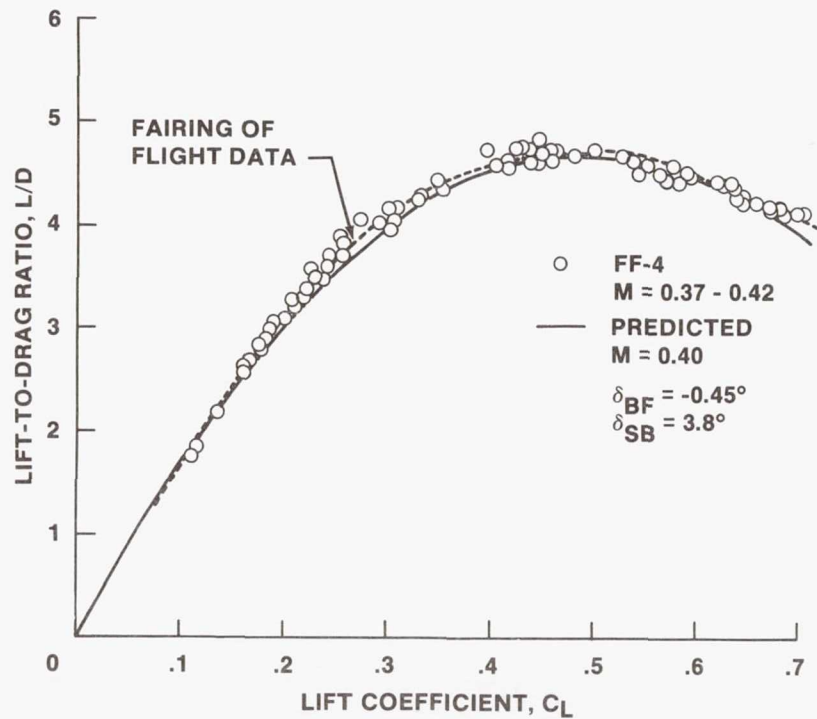

Figure 12. Tailcone-off Performance Comparisons of Flight Test and Predicted Data.

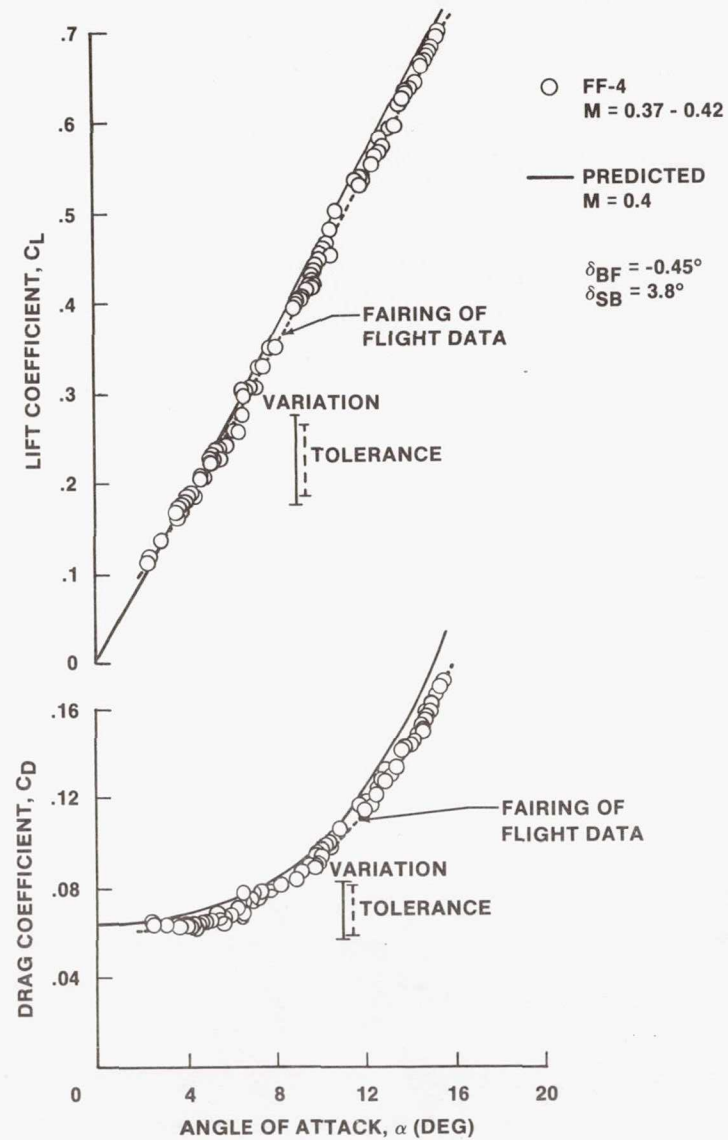

Figure 13. Tailcone-off Lift and Drag Coefficient Comparisons of Flight Test and Predicted Data.

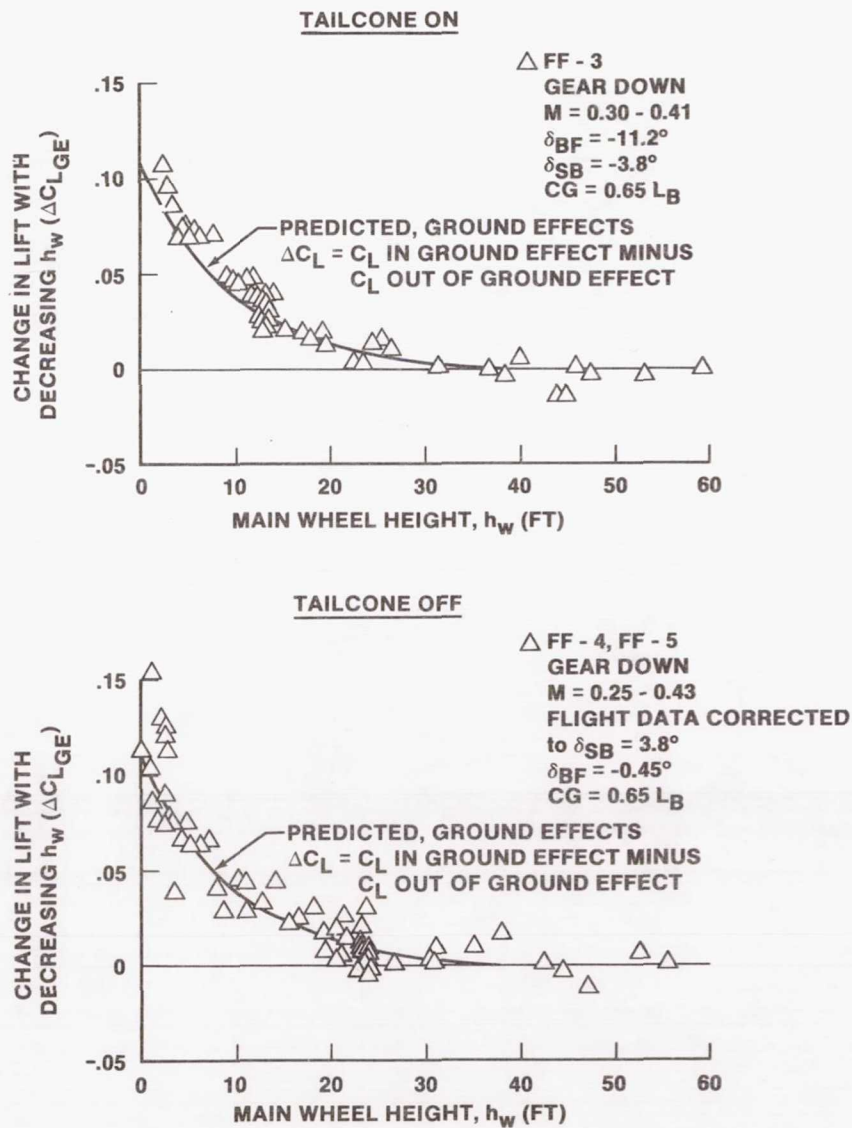

Figure 14. Incremental Lift Coefficient due to Ground Effect.

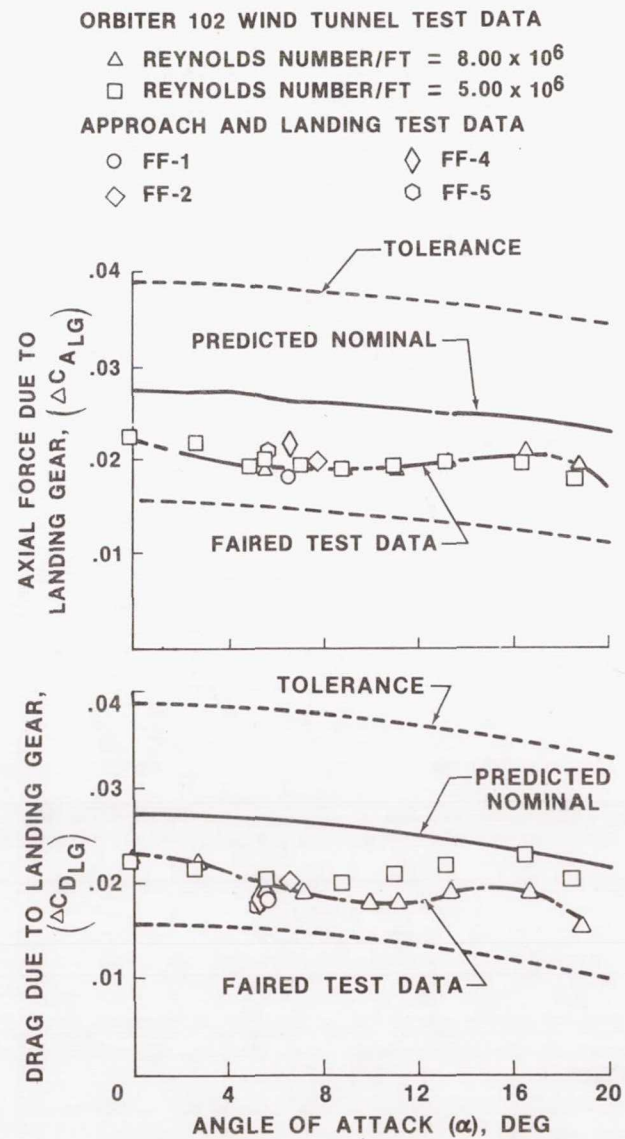

Figure 15. Incremental Axial Force and Drag Coefficients due to Landing Gear Deployed.