

NASA Technical Memorandum 86308

Detailed Pressure Distribution  
Measurements Obtained on Several  
Configurations of an Aspect-  
Ratio-7 Variable Twist Wing

G. Thomas Holbrook and Dana Morris Dunham  
*Langley Research Center*  
*Hampton, Virginia*

**NASA**  
National Aeronautics  
and Space Administration  
**Scientific and Technical  
Information Branch**

1985

## Summary

Detailed pressure distribution measurements were made for 11 configurations of a unique, multisegmented wing model operating at a lift coefficient of 0.6 and a wing-chord Reynolds number of  $1 \times 10^6$  in the Langley 4- by 7-Meter Tunnel. The untapered aspect-ratio-7 model generated a wide range of span-load distributions by the application of wing twist along the span to 72 independently rotatable wing segments. The tested configurations encompassed span loads ranging from that of an untwisted wing to simple flapped wings both with and without upper-surface spoilers attached.

For each of the wing twist configurations, electronic scanning pressure transducers were used to obtain 580 surface pressure measurements on the wing in about 0.1 sec. Integrated pressure distribution measurements compared favorably with force-balance measurements of lift on the model when the model centerbody lift was included. Complete plots and tabulations of the pressure distribution data for each model configuration are provided.

## Introduction

Wake vortex studies were conducted in a wind tunnel by using a unique, pressure-instrumented wing model that was capable of controlled variations in span load. Part of the test results included detailed wing load distribution measurements obtained for several model configurations at a nominal lift coefficient of 0.6 and wing-chord Reynolds number of  $1 \times 10^6$ . These data were required to correlate with wake vortex development and decay. As first noted by Betz in 1933 (ref. 1), the wing span-load distribution plays a major role in the reorganization of its bound circulation field into the downstream pair of counterrotating vortices that make up its wake. Later theoretical and experimental work (see refs. 2 and 3) highlighted this concept, but a lack of detailed load distribution measurements for a range of span loads inhibited the investigation of the transformation from wing flow to wake flow.

The untapered aspect-ratio-7 wing used in this investigation was capable of generating a wide range of span-load distributions via wing twist applied along the span of the wing to 72 independently rotatable wing segments. Detailed load distribution data were obtained from over 550 pressure-orifice measurements on a semi-span for each of 11 model configurations. These configurations represented span loads ranging from that of a simple untwisted wing through several twisted wings to part-span-flap wings. One of the part-span-flap configurations had upper-surface spoilers attached to evaluate a vortex-alleviation concept. The results are plotted and tabulated in this report as chordwise pressure coefficient distributions and spanwise section lift distribu-

tions. Integrated pressure distribution measurements are also compared with force-balance measurements of lift.

## Symbols

|                |  |
|----------------|--|
| $C_L$          | lift coefficient, $\frac{\text{Lift}}{q_\infty S}$   |
| $C_{L,CB}$     | centerbody lift coefficient, $\alpha \frac{dC_{L,CB}}{d\alpha}$  |
| $C_{L,p}$      | lift coefficient derived from integrated right-wing $c_p$ data, $\frac{1}{s} \int_0^s c_l dy$  |
| $c$            | wing chord, m  |
| $c_l$          | section lift coefficient, $c_n \cos(\alpha + \Delta\alpha)$  |
| $c_n$          | section normal-force coefficient integrated from chordwise $c_p$ data  |
| $c_p$          | static pressure coefficient, $\frac{p-p_\infty}{q_\infty}$   |
| $p$            | local static pressure, Pa  |
| $p_\infty$     | free-stream static pressure, Pa  |
| $q_\infty$     | free-stream dynamic pressure, Pa   |
| $S$            | wing reference area, $m^2$   |
| $s$            | wing semispan, m   |
| $X, Y, Z$      | right-hand Cartesian coordinate system originating at centerline of wing leading edge, with $X$ aligned to wind-tunnel longitudinal centerline, $Y$ aligned horizontally out the right wing and perpendicular to $X$ , and $Z$ aligned vertically upward |
| $x, y, z$      | longitudinal, lateral, and vertical dimensions along the $X, Y, Z$ Cartesian coordinate system, respectively, m  |
| $\alpha$       | geometric angle of attack of wing centerline chord, deg  |
| $\Delta\alpha$ | wing-segment twist angle relative to wing centerline chord (wing-segment leading edge up is positive), deg   |

Abbreviation:

VTW variable twist wing

## Model Description

The variable twist wing (VTW) model, shown in figure 1, was mounted atop a faired support strut that attached to the centerbody for installation in the wind-tunnel test section. The model, shown schematically in figure 2, had a metal wing with a taper ratio of 1, an aspect ratio of 7, a span of 2.489 m, and an NACA 0012 airfoil section. The wing consisted of

72 segments (each 2.96 cm wide and independently rotatable about its quarter chord), with 36 installed on each side of a wing center panel of 35.56-cm span fixed to the centerbody. A body-of-revolution wing-tip cap was fitted to each wing tip and twisted in unison with the final outboard wing segment. Spoilers or drag plates (shown in fig. 3) were added to two VTW configurations to alter the span-load distribution and/or the turbulence distribution shed into the wing wake. These devices were centered at  $y/s = \pm 0.607$  with the drag plates mounted aft of the trailing edge at about  $x/c = 1.43$ .

The VTW model had 580 pressure taps for the measurement of spanwise and chordwise pressure distributions. Pressure coefficient data were obtained along 19 spanwise locations on the right wing and 1 symmetrically matching location just left of the wing centerline. Each spanwise location and the corresponding chordwise locations of the pressure orifices are given in table I. Right-wing segments were hollowed to accept either pressure-orifice tubing or electronic scanning pressure transducers and associated wiring. Generally, alternate segments contained the pressure transducers that accepted the pressure-orifice inputs from the adjacent segment through openings in each side of the segment. These openings were sized and located to accommodate up to  $15^\circ$  twist between adjacent segments without unsealing the openings to the free stream. Pressure data were taken under computer control with all 580 orifices electronically scanned and recorded in 0.1 sec.

The VTW design thus allowed the span-load distribution to be tailored via wing-segment twist, and the pressure instrumentation permitted accurate monitoring of the pressure distribution over the wing. Eleven VTW configurations, differing in either wing twist distribution or wing-device installations, were tested for this investigation. The configurations, shown in figure 4, are categorized into three groups—continuous span-load distributions, part-span-flap span-load distributions, and alleviated wake vortex configurations. In terms of the wake vortex investigation, this grouping system differentiates between the configurations of group I, which produced one predominant vortex per semispan, and those of group II, which shed multiple semispan vortices; configurations of group III were tested to examine the mechanism of spoiler-produced wake vortex alleviation. The configurations are given designations and are described in table II. These groupings and configuration designations will be utilized throughout the remainder of this report. Details of the VTW twist distributions are given in table III.

### Test Conditions and Accuracy

The Langley 4-by 7-meter Tunnel was utilized for this investigation, the test section of which has a

height of 4.42 m, a width of 6.63 m, and a length of 15.24 m. The VTW was blade mounted atop a sting within the forward portion of the test section, near the entrance cone, and maintained at the test-section centerline during the test runs. The angle of attack was determined from an accelerometer mounted in the fuselage. A six-component strain-gauge balance was used to determine lift, drag, and pitching moment on the wing and centerbody combination. Blockage and jet-boundary corrections were applied to the wind-tunnel data according to the methods of references 4 and 5, respectively; however, these corrections were essentially negligible. The test was conducted at a Reynolds number of about  $1 \times 10^6$ , based on wing chord, requiring free-stream values of dynamic pressure and velocity of 1005 Pa and 40.52 m/sec, respectively. A high value of  $C_L$  was desirable for the downstream wake surveys that were performed as part of the wake vortex investigation, but  $C_L$  had to be sufficiently low to avoid wing stall over any twisted portion of the VTW. Local regions of separated flow would have introduced unwanted turbulence into the wake and invalidated comparisons with simple analytical span-load predictions. To meet these requirements, a value of  $C_L$  of about 0.6 (as determined with the internal force balance) was utilized for all VTW pressure distribution measurements.

Values of  $C_L$ , obtained with the force balance, are cited only for comparison with the values of  $C_{L,p}$ , obtained by integration of the pressure distribution measurements. Each  $C_L$  measurement corresponded to the average of 50 points, taken by sampling 10 points per second for 5 sec from a 0.1-Hz low-pass-filtered data signal. Maximum force-balance errors in normal and axial forces were 22 N and 11 N, respectively. At a Reynolds number of  $1 \times 10^6$  with the VTW set at  $\alpha = 12.5^\circ$ , these errors correspond to a possible  $\pm 0.027$  error in  $C_L$ , or about  $\pm 4.5$  percent of the nominal  $C_L = 0.6$ .

Pressure distribution measurements were taken on all VTW configurations in table II. As noted previously, electronic scanning pressure transducers were incorporated within VTW wing segments to allow a computer-controlled recording of all 580 pressure-orifice values in about 0.1 sec. The accuracy of the scanning pressure transducers was specified as  $\pm 96$  Pa, with about 80 percent of the transducers having an error of no more than  $\pm 46$  Pa. If the transducer errors were randomly distributed over the wing, the integrated  $c_n$  values should be correct within  $\pm 0.02$  and the integrated  $C_{L,p}$  should be correct within  $\pm 0.006$  ( $\pm 1$  percent of the nominal  $C_L = 0.6$ ). An additional source of  $c_n$  and  $C_{L,p}$  error was due to ignoring the local chordwise (or axial) forces in the integrations. Examination of the chordwise contribution to both high- and low-drag VTW

configurations at wing segments with small and large  $c_i$  values, and at wing segments with the spoilers installed, revealed a resultant error typically in the range of  $\pm 1$  percent, but not more than  $\pm 3$  percent. Thus, the overall error in the  $C_{L,p}$  values can be expected to be typically  $\pm 2$  percent, but not more than  $\pm 4$  percent. These error ranges are with respect to lift on the wing alone and do not account for neglecting the centerbody lift, which was a function of angle of attack and thus varied for each VTW configuration.

Each lift distribution was derived from the pressure distribution data by cosine transformation of each chordwise-integrated  $c_n$  through its local angle of attack ( $\alpha + \Delta\alpha$ ) to get local  $c_i$  values. Each chordwise  $c_n$  was arrived at by chordwise trapezoidal integration of the 29 measurements of  $c_p$  at that spanwise station by utilizing a trailing-edge  $c_p$  value assigned as the mean of the most aft upper- and lower-surface  $c_p$  measurements. The  $c_i$  values attained for the right wing were then integrated by using a cubic spline fit of the 19 spanwise  $c_i$  measurements, along with the centerline  $c_i$  set equal to the measured  $c_i$  at  $y/s = 0.0612$  and the wing-tip  $c_i$  set equal to 0. Thus, this integration of  $C_{L,p}$  assumed no lift on the body-of-revolution wing-tip caps, no modification due to the presence of the body, and equal lift on the right and left wings. The latter assumption was justified by the measurement of negligible rolling moment on the VTW during the test runs. Since no pressure distribution measurements were made on the centerbody or along the wing centerline, the effect of the centerbody was not included in the  $C_{L,p}$  integration. The  $c_i$  measured at  $y/s = -0.0612$  was ignored in the  $C_{L,p}$  integration since a small right-to-left wing lateral-flow angularity caused the centerbody to affect the left-wing lower-surface flow at this location, resulting in a locally reduced  $c_i$  left of the wing centerline.

Table IV compares the force-balance-measured and pressure-integrated lift for a nominal  $C_L = 0.6$  for all VTW configurations. Failure to incorporate the centerbody lift results in a significant negative error, as seen in the fourth column of table IV. Extrapolation of centerbody lift from experimental measurements of cylindrical bodies alone (refs. 6 and 7) cannot account for the lift deficit shown. To account for the influence of the wing on the centerbody, a potential flow, panel method code (ref. 8) was used to model the VTW wing and centerbody combination. Runs were made at  $\alpha = 0^\circ$  and  $8^\circ$ , and the predicted centerbody lift contribution at both angles of attack was used to determine  $dC_{L,CB}/d\alpha$  for VTW1 (the untwisted wing configuration), which was then applied to the proper  $\alpha$  for each VTW configuration to approximate  $C_{L,CB}$ . The resulting  $dC_{L,CB}/d\alpha$  (about 0.002 per degree based on the VTW reference area) is substantially above experimental body-alone measurements, and its inclusion into the comparison of

$C_{L,p}$  with  $C_L$  brings the errors well within the envelope of pressure instrumentation and force-balance accuracy.

## Presentation of Results

Results are plotted and tabulated for the wing twist configurations by group numbers I, II, and III. (See table II.) The applicable figure and table numbers are as follows:

| Measurement  | Plotted in figure— | Listed in table— |
|--|--------------------|------------------|
| Group I: VTW1, VTW2, VTW3, VTW4  |                    |                  |
| $C_L$ and $C_{L,p}$  |                    | IV, V            |
| $c_i$ versus $y/s$   | 5                  | V                |
| $c_n$ versus $y/s$   |                    | V                |
| $c_p$ versus $x/c$   | 6                  | V                |
| Group II: VTW5, VTW6, VTW7   |                    |                  |
| $C_L$ and $C_{L,p}$  |                    | IV, VI           |
| $c_i$ versus $y/s$   | 7                  | VI               |
| $c_n$ versus $y/s$   |                    | VI               |
| $c_p$ versus $x/c$   | 8                  | VI               |
| Group III: VTW7S <sub>0</sub> , VTW7S <sub>1</sub> ,<br>VTW7S <sub>3</sub> , VTW7S <sub>3P</sub> |                    |                  |
| $C_L$ and $C_{L,p}$  |                    | IV, VII          |
| $c_i$ versus $y/s$   | 9                  | VII              |
| $c_n$ versus $y/s$   |                    | VII              |
| $c_p$ versus $x/c$   | 10                 | VII              |

## Concluding Remarks

Detailed pressure distribution measurements were made for 11 configurations of a unique, multisegmented wing model operating at a lift coefficient of 0.6 and a wing-chord Reynolds number of  $1 \times 10^6$  in the Langley 4- by 7-Meter Tunnel. The untapered aspect-ratio-7 model generated a wide range of span-load distributions by the application of wing twist along the span to 72 independently rotatable wing segments. The tested configurations encompassed span loads ranging from that of an untwisted wing to simple flapped wings both with and without upper-surface spoilers attached.

For each of the wing twist configurations, electronic scanning pressure transducers were used to obtain 580 surface pressure measurements on the wing in about 0.1 sec. Pressure coefficient data were obtained along 19 spanwise locations on the right wing and 1 symmetrically matching location just left of the wing centerline; however, a small right-to-left wing lateral-flow angularity caused the model centerbody to affect the left-wing measurements. Integrated right-wing pressure distribution measurements compared favorably with force-balance measurements of lift when the model centerbody lift was included. Complete plots and tabulations

of the pressure distribution data for each model configuration are provided.

Langley Research Center  
National Aeronautics and Space Administration  
Hampton, VA 23665  
October 31, 1984

## References

1. Betz, A.: *Behavior of Vortex Systems*. NACA TM 713, 1933.
2. Donaldson, Coleman duP.; and Bilanin, Alan J.: *Vortex Wakes of Conventional Aircraft*. AGARD-AG-204, May 1975.
3. Rossow, Vernon J.: Inviscid Modeling of Aircraft Trailing Vortices. *Wake Vortex Minimization*, NASA SP-409, 1977, pp. 9-59.
4. Herriot, John G.: *Blockage Corrections for Three-Dimensional-Flow Closed-Throat Wind Tunnels, With Consideration of the Effect of Compressibility*. NACA Rep. 995, 1950. (Supersedes NACA RM A7B28.)
5. Gillis, Clarence L.; Polhamus, Edward C.; and Gray, Joseph L., Jr.: *Charts for Determining Jet-Boundary Corrections for Complete Models in 7- by 10-Foot Closed Rectangular Wind Tunnels*. NACA WR L-123, 1945. (Formerly NACA ARR L5G31.)
6. Peake, David J.; and Tobak, Murray: Three-Dimensional Flows About Simple Components at Angle of Attack. *High Angle-of-Attack Aerodynamics*, AGARD-LS-121, Dec. 1982, pp. 2-1-2-56.
7. Jorgensen, Leland Howard: *Prediction of Static Aerodynamic Characteristics for Slender Bodies Alone and With Lifting Surfaces to Very High Angles of Attack*. NASA TR R-474, 1977.
8. Hess, John L.: *Calculation of Potential Flow About Arbitrary Three-Dimensional Lifting Bodies*. Rep. No. MDC J5679-01 (Contract N00019-71-C-0524), McDonnell Douglas Corp., Oct. 1972. (Available from DTIC as AD 755 480.)

TABLE I. VTW PRESSURE-ORIFICE LOCATIONS

| Span location    |         |
|------------------|---------|
| Wing segment     | $y/s$   |
| 0-L <sup>a</sup> | -0.0612 |
| 0-R <sup>a</sup> | .0612   |
| 1                | .1560   |
| 3                | .2037   |
| 5                | .2513   |
| 7                | .2989   |
| 9                | .3465   |
| 13               | .4418   |
| 15               | .4894   |
| 17               | .5370   |
| 19               | .5846   |
| 21               | .6322   |
| 23               | .6798   |
| 25               | .7275   |
| 27               | .7751   |
| 29               | .8227   |
| 31               | .8703   |
| 33               | .9179   |
| 35               | .9656   |
| 36               | .9894   |

| Chord location |           |
|----------------|-----------|
| $x/c$          | $\pm z/c$ |
| 0              | 0         |
| .0125          | .01894    |
| .0250          | .02615    |
| .0500          | .03555    |
| .1000          | .04683    |
| .1500          | .05345    |
| .2000          | .05738    |
| .3000          | .06001    |
| .4000          | .05803    |
| .5000          | .05294    |
| .6000          | .04563    |
| .7000          | .03664    |
| .8000          | .02623    |
| .9000          | .01448    |
| .9800          | .00403    |

<sup>a</sup>Left (0-L) and right (0-R) side of wing center-panel section.

TABLE II. VTW CONFIGURATIONS

| Group | Wing twist configuration | Configuration description   |
|-------|--------------------------|---|
| I     | VTW1                     | Untwisted wing<br>Approximately rectangular loading<br>Maximum loading at midsemispan<br>Tapered loading, maximum at centerline   |
|       | VTW2                     |   |
|       | VTW3                     |   |
|       | VTW4                     |   |
| II    | VTW5                     | 40-percent flapped wing<br>60-percent flapped wing<br>80-percent flapped wing   |
|       | VTW6                     |   |
|       | VTW7                     |   |
| III   | VTW7S <sub>0</sub>       | 80-percent flapped wing with spoilers<br>Wing twisted to approximately match<br>span loading of VTW7S <sub>0</sub><br>Wing twisted to approximately match<br>span loading of VTW7S <sub>0</sub> (alternate of VTW7S <sub>1</sub> )<br>VTW7S <sub>3</sub> with drag plates |
|       | VTW7S <sub>1</sub>       |   |
|       | VTW7S <sub>3</sub>       |   |
|       | VTW7S <sub>3</sub> P     |   |

TABLE III. VTW TWIST DISTRIBUTIONS

[ $\Delta\alpha$  is given with respect to wing center panel; wing-segment leading edge up is positive]

| Wing segment  | Inboard edge y/s | $\Delta\alpha$ , deg, for wing configurations— |      |      |      |      |      |      |                    |                    |                    |                     |
|---------------|------------------|--|------|------|------|------|------|------|--------------------|--------------------|--------------------|---------------------|
|               |                  | VTW1   | VTW2 | VTW3 | VTW4 | VTW5 | VTW6 | VTW7 | VTW7S <sub>0</sub> | VTW7S <sub>1</sub> | VTW7S <sub>3</sub> | VTW7S <sub>3P</sub> |
| Centerline    | 0                | 0  | 0    | 0    | 0    | 0    | 0    | 0    | 0                  | 0                  | 0                  | 0                   |
| 1             | .1429            | ↓  | ↓    | 2    | -1   | ↓    | ↓    | ↓    | ↓                  | ↓                  | ↓                  | ↓                   |
| 2             | .1667            | ↓  | ↓    | ↓    | -1   | ↓    | ↓    | ↓    | ↓                  | ↓                  | ↓                  | ↓                   |
| 3             | .1905            | ↓  | ↓    | ↓    | -2   | ↓    | ↓    | ↓    | ↓                  | ↓                  | ↓                  | ↓                   |
| 4             | .2143            | ↓  | ↓    | ↓    | -2   | ↓    | ↓    | ↓    | ↓                  | ↓                  | ↓                  | ↓                   |
| 5             | .2381            | ↓  | ↓    | ↓    | -3   | ↓    | ↓    | ↓    | ↓                  | ↓                  | ↓                  | ↓                   |
| 6             | .2619            | ↓  | ↓    | ↓    | -3   | ↓    | ↓    | ↓    | ↓                  | ↓                  | ↓                  | ↓                   |
| 7             | .2857            | ↓  | ↓    | 4    | -4   | ↓    | ↓    | ↓    | ↓                  | ↓                  | ↓                  | ↓                   |
| 8             | .3095            | ↓  | ↓    | ↓    | -4   | ↓    | ↓    | ↓    | ↓                  | ↓                  | ↓                  | ↓                   |
| 9             | .3333            | ↓  | ↓    | ↓    | -5   | ↓    | ↓    | ↓    | ↓                  | ↓                  | ↓                  | ↓                   |
| 10            | .3571            | ↓  | .5   | ↓    | -5   | -2   | ↓    | ↓    | ↓                  | ↓                  | ↓                  | ↓                   |
| 11            | .3810            | ↓  | ↓    | ↓    | -5   | -4   | ↓    | ↓    | ↓                  | ↓                  | ↓                  | ↓                   |
| 12            | .4048            | ↓  | ↓    | ↓    | -6   | -6   | ↓    | ↓    | ↓                  | ↓                  | ↓                  | ↓                   |
| 13            | .4286            | ↓  | ↓    | ↓    | ↓    | ↓    | ↓    | ↓    | ↓                  | ↓                  | ↓                  | ↓                   |
| 14            | .4524            | ↓  | ↓    | 6    | ↓    | -7   | ↓    | ↓    | ↓                  | ↓                  | ↓                  | ↓                   |
| 15            | .4762            | ↓  | 1.0  | ↓    | ↓    | ↓    | ↓    | ↓    | ↓                  | ↓                  | ↓                  | ↓                   |
| 16            | .5000            | ↓  | ↓    | ↓    | ↓    | ↓    | ↓    | ↓    | ↓                  | ↓                  | ↓                  | ↓                   |
| 17            | .5238            | ↓  | ↓    | ↓    | ↓    | ↓    | ↓    | ↓    | ↓                  | -15                | -15.00             | -15.00              |
| 18            | .5476            | ↓  | ↓    | ↓    | ↓    | ↓    | ↓    | ↓    | ↓                  | ↓                  | ↓                  | ↓                   |
| 19            | .5714            | ↓  | ↓    | 4    | ↓    | ↓    | ↓    | ↓    | ↓                  | ↓                  | ↓                  | ↓                   |
| 20            | .5952            | ↓  | 1.5  | ↓    | -7   | ↓    | ↓    | ↓    | ↓                  | ↓                  | ↓                  | ↓                   |
| 21            | .6190            | ↓  | ↓    | ↓    | ↓    | -2.0 | ↓    | ↓    | ↓                  | ↓                  | ↓                  | ↓                   |
| 22            | .6429            | ↓  | ↓    | ↓    | ↓    | -4.0 | ↓    | ↓    | ↓                  | ↓                  | ↓                  | ↓                   |
| 23            | .6667            | ↓  | ↓    | ↓    | ↓    | -6.0 | ↓    | ↓    | ↓                  | ↓                  | ↓                  | ↓                   |
| 24            | .6905            | ↓  | ↓    | ↓    | ↓    | ↓    | ↓    | ↓    | ↓                  | 0                  | -11.25             | -11.25              |
| 25            | .7143            | ↓  | ↓    | ↓    | ↓    | ↓    | ↓    | ↓    | ↓                  | -7.50              | -7.50              | -7.50               |
| 26            | .7381            | ↓  | 2.0  | 2    | -8   | ↓    | ↓    | ↓    | ↓                  | ↓                  | -3.75              | -3.75               |
| 27            | .7619            | ↓  | ↓    | ↓    | ↓    | ↓    | ↓    | ↓    | ↓                  | 0                  | 0                  | 0                   |
| 28            | .7857            | ↓  | ↓    | ↓    | ↓    | ↓    | ↓    | ↓    | ↓                  | -3.00              | -3.00              | -3.00               |
| 29            | .8095            | ↓  | ↓    | ↓    | ↓    | ↓    | ↓    | -6   | -6                 | -6                 | -6.00              | -6.00               |
| 30            | .8333            | ↓  | 2.5  | ↓    | -9   | ↓    | ↓    | ↓    | ↓                  | ↓                  | ↓                  | ↓                   |
| 31            | .8571            | ↓  | ↓    | 0    | -9   | ↓    | ↓    | ↓    | ↓                  | ↓                  | ↓                  | ↓                   |
| 32            | .8810            | ↓  | ↓    | ↓    | -10  | ↓    | ↓    | ↓    | ↓                  | ↓                  | ↓                  | ↓                   |
| 33            | .9048            | ↓  | ↓    | ↓    | -11  | ↓    | ↓    | ↓    | ↓                  | ↓                  | ↓                  | ↓                   |
| 34            | .9286            | ↓  | ↓    | ↓    | -11  | -5.5 | ↓    | ↓    | ↓                  | ↓                  | ↓                  | ↓                   |
| 35            | .9524            | ↓  | 3.0  | ↓    | -12  | -5.0 | ↓    | ↓    | ↓                  | ↓                  | ↓                  | ↓                   |
| 36            | .9762            | ↓  | 3.0  | ↓    | -12  | -4.5 | ↓    | ↓    | ↓                  | ↓                  | ↓                  | ↓                   |
| Other devices |                  |  |      |      |      |      |      |      | Spoilers           |                    |                    | Drag plates         |



TABLE IV. COMPARISON OF FORCE-BALANCE-MEASURED AND PRESSURE-INTEGRATED LIFT FOR A NOMINAL  $C_L = 0.6$

| Wing twist configuration | $C_L$ | $C_{L,p}$ | $\frac{C_{L,p} - C_L}{C_L}$ | $\frac{(C_{L,p} + C_{L,CB}) - C_L}{C_L}$ |
|--------------------------|-------|-----------|-----------------------------|--|
| VTW1                     | 0.614 | 0.580     | -0.055                      | -0.030                                   |
| VTW2                     | .601  | .575      | -.043                       | -.021                                    |
| VTW3                     | .602  | .592      | -.017                       | .000                                     |
| VTW4                     | .628  | .577      | -.081                       | -.041                                    |
| VTW5                     | 0.615 | 0.597     | -0.029                      | +0.008                                   |
| VTW6                     | .620  | .591      | -.047                       | -.017                                    |
| VTW7                     | .596  | .571      | -.042                       | -.014                                    |
| VTW7S <sub>0</sub>       | 0.591 | 0.555     | -0.061                      | -0.023                                   |
| VTW7S <sub>1</sub>       | .607  | .575      | -.053                       | -.015                                    |
| VTW7S <sub>3</sub>       | .583  | .564      | -.033                       | +0.007                                   |
| VTW7S <sub>3</sub> P     | .606  | .591      | -.025                       | +0.015                                   |

TABLE V. PRESSURE DISTRIBUTION MEASUREMENTS FOR GROUP I VTW CONFIGURATIONS

(a) Wing twist configuration VTW1.  $\alpha = 7.50^\circ$ ;  $C_L = 0.614$ ;  $C_{L,p} = 0.580$

| x/c                             | z/c     | VALUES OF $c_p$ FOR $y/s =$ |          |          |          |          |          |          |          |          |          |
|---------------------------------|---------|-----------------------------|----------|----------|----------|----------|----------|----------|----------|----------|----------|
|                                 |         | -.06122                     | .06122   | .15604   | .20366   | .25128   | .29889   | .34651   | .41775   | .48917   | .53699   |
| 0.0000                          | 0.00000 | -.54376                     | -.91647  | -1.09351 | -1.02829 | -.97704  | -.95840  | -.85591  | -.70592  | -.6504   | -.58569  |
| .0125                           | .01894  | -2.37003                    | -2.66356 | -2.59834 | -2.71015 | -2.62163 | -2.55641 | -2.58902 | -2.43062 | -2.3840  | -2.30017 |
| .0250                           | .02615  | -2.00200                    | -2.36073 | -3.03627 | -2.49584 | -2.89133 | -2.03461 | -1.82496 | -1.2030  | -2.11381 | -2.01132 |
| .0500                           | .03555  | -1.37804                    | -1.63860 | -1.90416 | -1.85291 | -1.89737 | -1.82962 | -1.80632 | -1.75000 | -1.69111 | -1.65258 |
| .1000                           | .04683  | -1.10749                    | -1.26123 | -1.34043 | -1.33577 | -1.33577 | -1.30316 | -1.28453 | -1.25657 | -1.23400 | -1.18203 |
| .1500                           | .05345  | -.91182                     | -1.03761 | -1.11681 | -1.11215 | -1.10749 | -1.10749 | -1.08885 | -1.08419 | -1.04692 | -1.01431 |
| .2000                           | .05738  | -.77205                     | -.89784  | -.95375  | -.94909  | -.93977  | -.92579  | -.93049  | -.89784  | -.88366  | -.86989  |
| .3000                           | .06001  | -.58103                     | -.68819  | -.71148  | -.71614  | -.70216  | -.71148  | -.69751  | -.68819  | -.67421  | -.65558  |
| .4000                           | .05803  | -.42729                     | -.52979  | -.53444  | -.53308  | -.54376  | -.53910  | -.53444  | -.51115  | -.51581  | -.49717  |
| .5000                           | .05294  | -.30150                     | -.40400  | -.39002  | -.40865  | -.40865  | -.39468  | -.39934  | -.39468  | -.38536  | -.36672  |
| .6000                           | .04563  | -.18969                     | -.29218  | -.28286  | -.28752  | -.28286  | -.27820  | -.28286  | -.27355  | -.27355  | -.26423  |
| .7000                           | .03664  | -.09651                     | -.19900  | -.18037  | -.18903  | -.18037  | -.18037  | -.18037  | -.17571  | -.18037  | -.16173  |
| .8000                           | .02623  | .00133                      | -.09651  | -.08719  | -.09651  | -.07321  | -.06855  | -.06855  | -.07321  | -.06390  | -.05924  |
| .9000                           | .01448  | .11314                      | .00133   | .02462   | .03394   | .03860   | .05258   | .04326   | .04792   | .05258   | .05724   |
| .9800                           | .00403  | .22030                      | .10848   | .12246   | .12712   | .15041   | .15907   | .12712   | .15041   | .11314   | .15973   |
| .0125                           | -.01894 | .86323                      | .97504   | .97038   | .96572   | .90738   | .96572   | .96572   | .97504   | .98902   | .98902   |
| .0250                           | -.02615 | .97038                      | .96106   | .83061   | .90981   | .90916   | .90050   | .88652   | .86788   | .85391   | .83993   |
| .0500                           | -.03555 | .81684                      | .76073   | .65397   | .64426   | .64426   | .63028   | .62562   | .60238   | .59501   | .56506   |
| .1000                           | -.04683 | .55108                      | .49051   | .40194   | .38336   | .37870   | .36472   | .35541   | .29950   | .33677   | .34609   |
| .1500                           | -.05345 | .39734                      | .33211   | .25757   | .25291   | .24825   | .24359   | .23427   | .22030   | .21098   | .19700   |
| .2000                           | -.05738 | .29484                      | .22030   | .16905   | .16330   | .15864   | .15398   | .15007   | .14575   | .13178   | .13178   |
| .3000                           | -.06001 | .17371                      | .09451   | .09917   | .09519   | .07371   | .15907   | .07121   | .07567   | .04326   | .05724   |
| .4000                           | -.05803 | .12466                      | .04326   | .05724   | .05258   | .05258   | .04792   | .05258   | .05258   | .04326   | .02928   |
| .5000                           | -.05294 | .10382                      | .00599   | .03394   | .03860   | .03860   | .03860   | .03860   | .04326   | .02462   | .02462   |
| .6000                           | -.04563 | .06455                      | -.01731  | .02462   | .02928   | .03394   | .03860   | .04326   | .04326   | .03394   | .03394   |
| .7000                           | -.02664 | .04326                      | -.04992  | .02462   | .03394   | .04326   | .04792   | .04326   | .04326   | .04326   | .04326   |
| .8000                           | -.02623 | .07121                      | -.02197  | .03860   | .05724   | .06189   | .06655   | .06655   | .07121   | .06189   | .06655   |
| .9000                           | -.01448 | .13178                      | .02928   | .08053   | .09451   | .08919   | .09451   | .10382   | .09917   | .09917   | .09451   |
| .9800                           | -.00403 | .21098                      | .08519   | .10848   | .12712   | .13178   | .14110   | .14110   | .13644   | .14575   | .12712   |
| INTEGRATED $c_n$                |         | .6329                       | .6652    | .7036    | .7021    | .6892    | .6735    | .6700    | .6484    | .6406    | .6173    |
| $\Delta\alpha$ , (DEG)          |         | 0.000                       | 0.000    | 0.000    | 0.000    | 0.000    | 0.000    | 0.000    | 0.000    | 0.000    | 0.000    |
| $\alpha + \Delta\alpha$ , (DEG) |         | 7.500                       | 7.500    | 7.500    | 7.500    | 7.500    | 7.500    | 7.500    | 7.500    | 7.500    | 7.500    |
| RESULTANT $c_l$                 |         | .6275                       | .6595    | .6976    | .6941    | .6833    | .6678    | .6643    | .6429    | .6352    | .6120    |

| x/c                             | z/c     | VALUES OF $c_p$ FOR $y/s =$ |          |          |          |          |          |          |          |          |         |
|---------------------------------|---------|-----------------------------|----------|----------|----------|----------|----------|----------|----------|----------|---------|
|                                 |         | .58461                      | .63223   | .67985   | .72747   | .77509   | .82270   | .87032   | .91794   | .96556   | .98937  |
| 0.0000                          | 0.00000 | -.59902                     | -.51581  | -.39934  | -.35741  | -.20366  | -.11514  | -.00333  | .12712   | .02688   | .56040  |
| .0125                           | .01894  | -2.25824                    | -2.09052 | -2.10919 | -1.99268 | -1.95075 | -1.79701 | -1.68053 | -1.49418 | -1.20087 | -.93045 |
| .0250                           | .02615  | -2.06722                    | -1.93211 | -1.86273 | -1.79701 | -1.76439 | -1.58270 | -1.39168 | -1.13916 | -1.27987 | -.85591 |
| .0500                           | .03555  | -1.60599                    | -1.58736 | -1.55940 | -1.49952 | -1.43361 | -1.36839 | -1.27987 | -1.17737 | -.97238  | -.78137 |
| .1000                           | .04683  | -1.17271                    | -1.18203 | -1.14942 | -1.12612 | -1.10283 | -1.06556 | -.99569  | -.91182  | -.74409  | -.59967 |
| .1500                           | .05345  | -1.00033                    | -.98170  | -.96777  | -.93977  | -.89318  | -.84193  | -.79068  | -.74409  | -.68859  | -.49251 |
| .2000                           | .05738  | -.86057                     | -.83727  | -.84659  | -.80000  | -.76739  | -.72546  | -.67887  | -.60899  | -.54809  | -.40865 |
| .3000                           | .06001  | -.65092                     | -.63994  | -.63694  | -.60433  | -.57172  | -.54842  | -.51581  | -.45058  | -.38536  | -.40865 |
| .4000                           | .05803  | -.49251                     | -.48320  | -.48786  | -.46456  | -.44127  | -.41797  | -.37138  | -.31877  | -.25741  | -.31548 |
| .5000                           | .05294  | -.35741                     | -.35741  | -.35275  | -.33411  | -.32013  | -.29684  | -.28752  | -.24559  | -.27355  | -.23627 |
| .6000                           | .04563  | -.25025                     | -.25025  | -.25025  | -.24093  | -.22730  | -.20832  | -.20832  | -.20832  | -.20832  | -.17571 |
| .7000                           | .03664  | -.15707                     | -.14776  | -.13844  | -.14310  | -.13378  | -.11514  | -.11514  | -.18037  | -.14776  | -.16173 |
| .8000                           | .02623  | -.05924                     | -.04992  | -.06855  | -.04992  | -.03128  | -.03594  | -.02662  | -.02662  | -.16583  | -.18969 |
| .9000                           | .01448  | .05724                      | .05724   | .05258   | .06189   | .07121   | .06189   | .06189   | .03594   | -.04992  | -.35275 |
| .9800                           | .00403  | .15973                      | .16905   | .15041   | .15973   | .16005   | .17371   | .15973   | .15973   | -.00333  | -.57172 |
| .0125                           | -.01894 | .99833                      | .99833   | .98902   | .98902   | .97038   | .94106   | .93311   | .95077   | .09917   | -.48786 |
| .0250                           | -.02615 | .82130                      | .81198   | .80266   | .78868   | .76073   | .74209   | .74209   | .74209   | .80732   | .73278  |
| .0500                           | -.03555 | .56506                      | .54642   | .53244   | .50915   | .49051   | .45790   | .49051   | .45790   | .56971   | .46256  |
| .1000                           | -.04683 | .30887                      | .30416   | .27670   | .25757   | .23893   | .22962   | .18769   | .17837   | .29018   | .21098  |
| .1500                           | -.05345 | .19234                      | .17837   | .15507   | .14575   | .12712   | .12712   | .09917   | .09451   | .08053   | .03860  |
| .2000                           | -.05738 | .11314                      | .10848   | .09917   | .08053   | .06655   | .04326   | .04326   | .05724   | .01531   | -.02197 |
| .3000                           | -.06001 | .03860                      | .04326   | .02462   | .01996   | -.00333  | -.01265  | -.03860  | -.01265  | -.05458  | -.05924 |
| .4000                           | -.05803 | .01996                      | .01331   | -.00799  | .00133   | -.01265  | -.04526  | -.04526  | -.04526  | -.08253  | -.09651 |
| .5000                           | -.05294 | .01996                      | .00599   | -.03128  | .00133   | -.01731  | -.02662  | -.03594  | -.07321  | -.08719  | -.13844 |
| .6000                           | -.04563 | .01996                      | .00599   | -.00333  | .00133   | -.01131  | -.00799  | -.02662  | -.04526  | -.05924  | -.10117 |
| .7000                           | -.03664 | .04792                      | .02928   | .02928   | .02462   | .01065   | .00133   | -.02662  | -.03533  | -.04992  | -.08719 |
| .8000                           | -.02623 | .05258                      | .06655   | .05258   | .02462   | .03860   | .02928   | .07462   | .01065   | -.04992  | -.08719 |
| .9000                           | -.01448 | .10382                      | .09451   | .07547   | .08919   | .06655   | .08053   | .06189   | .06189   | -.01996  | -.07321 |
| .9800                           | -.00403 | .13178                      | .13178   | .14575   | .13178   | .14110   | .14110   | .14575   | .13178   | .09917   | -.04992 |
| INTEGRATED $c_n$                |         | .6036                       | .5838    | .5670    | .5445    | .5094    | .4720    | .4318    | .3733    | .2791    | .3183   |
| $\Delta\alpha$ , (DEG)          |         | 0.000                       | 0.000    | 0.000    | 0.000    | 0.000    | 0.000    | 0.000    | 0.000    | 0.000    | 0.000   |
| $\alpha + \Delta\alpha$ , (DEG) |         | 7.500                       | 7.500    | 7.500    | 7.500    | 7.500    | 7.500    | 7.500    | 7.500    | 7.500    | 7.500   |
| RESULTANT $c_l$                 |         | .5985                       | .5788    | .5622    | .5399    | .5041    | .4679    | .4281    | .3702    | .2767    | .3156   |

TABLE V. Continued

(b) Wing twist configuration VTW2.  $\alpha = 6.50^\circ$ ;  $C_L = 0.601$ ;  $C_{L,p} = 0.575$

| x/c                              | z/c     | VALUES OF $c_p$ FOR $y/s =$ |          |          |          |          |          |          |          |          |          |
|----------------------------------|---------|-----------------------------|----------|----------|----------|----------|----------|----------|----------|----------|----------|
|                                  |         | .06122                      | .06122   | .15604   | .20366   | .25128   | .29889   | .34651   | .44175   | .48937   | .53699   |
| 0.0000                           | 0.00000 | -.29349                     | -.47602  | -.62590  | -.57899  | -.54155  | -.54155  | -.48070  | -.48538  | -.56027  | -.53687  |
| .0125                            | .01894  | -2.17032                    | -2.27329 | -2.22191 | -2.33882 | -2.25925 | -2.25925 | -2.20309 | -2.29733 | -2.22649 | -2.24053 |
| .0250                            | .02615  | -1.85206                    | -3.26086 | -3.25618 | -2.43711 | -1.99715 | -1.80597 | -1.62740 | -1.91524 | -2.17969 | -2.43243 |
| .0500                            | .03555  | -1.51975                    | -1.59932 | -1.64144 | -1.65548 | -1.62272 | -1.58528 | -1.62272 | -1.60400 | -1.59932 | -1.59932 |
| .1000                            | .04683  | -1.07979                    | -1.13128 | -1.17808 | -1.19212 | -1.17340 | -1.16872 | -1.16404 | -1.16404 | -1.17808 | -1.13128 |
| .1500                            | .05345  | -.92066                     | -.94406  | -1.01895 | -1.01895 | -1.00990 | -.9.619  | -.99087  | -.98151  | -.99087  | -.97211  |
| .2000                            | .05738  | -.79429                     | -.81301  | -.86918  | -.86450  | -.85981  | -.84109  | -.89981  | -.85045  | -.85045  | -.83173  |
| .3000                            | .06001  | -.61175                     | -.63048  | -.65956  | -.64920  | -.64452  | -.63984  | -.64452  | -.63916  | -.64452  | -.63048  |
| .4000                            | .05803  | -.46198                     | -.49070  | -.49006  | -.52283  | -.49474  | -.48070  | -.50411  | -.48070  | -.48538  | -.46666  |
| .5000                            | .05294  | -.34965                     | -.36369  | -.36837  | -.37305  | -.35901  | -.34965  | -.36369  | -.31699  | -.35433  | -.34497  |
| .6000                            | .04563  | -.24688                     | -.26541  | -.26541  | -.26072  | -.25136  | -.24200  | -.25604  | -.23732  | -.24668  | -.22328  |
| .7000                            | .03664  | -.15309                     | -.17180  | -.16244  | -.16744  | -.15776  | -.14840  | -.25604  | -.23732  | -.24668  | -.22328  |
| .8000                            | .02623  | -.06415                     | -.07819  | -.06415  | -.04075  | -.05479  | -.13903  | -.14840  | -.12967  | -.12499  | -.12031  |
| .9000                            | .01448  | .03414                      | .03414   | .04818   | .02886   | .05754   | -.03607  | -.04074  | -.02671  | -.03139  | -.02202  |
| .9800                            | .00403  | .15583                      | .13711   | .14647   | .16051   | .17923   | .07626   | .07158   | .08562   | .07158   | .08094   |
| .0125                            | -.01894 | .92341                      | .94682   | .96554   | .96554   | .97490   | .97490   | .97490   | .97490   | .97490   | .97490   |
| .0250                            | -.02615 | .81108                      | .92809   | .79236   | .86257   | .85789   | .85789   | .85789   | .85789   | .85789   | .85789   |
| .0500                            | -.03555 | .69876                      | .70812   | .61451   | .59579   | .59579   | .59579   | .59579   | .59579   | .59579   | .59579   |
| .1000                            | -.04683 | .43197                      | .44133   | .35241   | .32000   | .33537   | .33537   | .33537   | .33537   | .33537   | .33537   |
| .1500                            | -.05345 | .28220                      | .27752   | .22136   | .21199   | .22136   | .21199   | .21199   | .21199   | .21199   | .21199   |
| .2000                            | -.05738 | .18391                      | .18391   | .16987   | .14179   | .13711   | .13711   | .13711   | .13711   | .13711   | .13711   |
| .3000                            | -.06001 | .08094                      | .07626   | .08094   | .08094   | .08094   | .08094   | .08094   | .08094   | .08094   | .08094   |
| .4000                            | -.05803 | .03414                      | .03414   | .04818   | .02946   | .04350   | .04350   | .04350   | .04350   | .04350   | .04350   |
| .5000                            | -.05294 | .01074                      | -.00798  | .03414   | .02478   | .04818   | .04818   | .04818   | .04818   | .04818   | .04818   |
| .6000                            | -.04563 | -.01266                     | -.00330  | .03414   | .03414   | .03754   | .03754   | .03754   | .03754   | .03754   | .03754   |
| .7000                            | -.03664 | -.03667                     | -.03139  | .04350   | .03882   | .04818   | .04818   | .04818   | .04818   | .04818   | .04818   |
| .8000                            | -.02623 | .00606                      | -.00330  | .06272   | .06272   | .06272   | .06272   | .06272   | .06272   | .06272   | .06272   |
| .9000                            | -.01448 | .00690                      | .05286   | .09498   | .09967   | .07626   | .07626   | .07626   | .07626   | .07626   | .07626   |
| .9800                            | -.00403 | .13711                      | .11839   | .14647   | .19115   | .12307   | .12307   | .12307   | .12307   | .12307   | .12307   |
| INTEGRATED $c_n$                 |         | .5800                       | .6260    | .6527    | .6724    | .6227    | .6103    | .6137    | .6103    | .6186    | .6170    |
| $\Delta \alpha$ , (DEG)          |         | 0.000                       | 0.000    | 0.000    | 0.000    | 0.000    | 0.000    | 0.000    | .500     | 1.000    | 1.000    |
| $\alpha + \Delta \alpha$ , (DEG) |         | 6.500                       | 6.500    | 6.500    | 6.500    | 6.500    | 6.500    | 6.500    | 7.000    | 7.500    | 7.500    |
| RESULTANT $c_l$                  |         | .5762                       | .6220    | .6481    | .6783    | .6187    | .6063    | .6097    | .6133    | .6133    | .6116    |

| x/c                              | z/c     | VALUES OF $c_p$ FOR $y/s =$ |          |          |          |          |          |          |          |          |          |
|----------------------------------|---------|-----------------------------|----------|----------|----------|----------|----------|----------|----------|----------|----------|
|                                  |         | .58461                      | .63223   | .67985   | .72747   | .77509   | .82270   | .87032   | .91794   | .96556   | .98937   |
| 0.0000                           | 0.00000 | -.60707                     | -.64452  | -.56963  | -.63984  | -.49942  | -.37773  | -.33093  | -.17190  | -.09030  | -.35241  |
| .0125                            | .01894  | -2.27797                    | -2.26861 | -2.24989 | -2.18905 | -2.17500 | -2.04395 | -1.95035 | -1.77249 | -1.49167 | -1.15468 |
| .0250                            | .02615  | -2.67581                    | -1.97843 | -1.90822 | -1.64144 | -1.41441 | -1.77015 | -1.67888 | -1.70697 | -1.60868 | -1.00257 |
| .0500                            | .03555  | -1.61804                    | -1.62740 | -1.61316 | -1.57591 | -1.53379 | -1.49635 | -1.41710 | -1.29977 | -1.06575 | -.85045  |
| .1000                            | .04683  | -1.14064                    | -1.15036 | -1.15468 | -1.12860 | -1.09851 | -1.06107 | -1.00023 | -.94974  | -.78961  | -.64452  |
| .1500                            | .05345  | -.99087                     | -.96746  | -.97214  | -.93470  | -.93470  | -.88322  | -.82705  | -.76153  | -.59303  | -.48538  |
| .2000                            | .05738  | -.83173                     | -.82705  | -.82705  | -.78493  | -.78961  | -.74281  | -.68664  | -.62580  | -.34497  | -.40582  |
| .3000                            | .06001  | -.63516                     | -.62580  | -.61643  | -.59303  | -.58367  | -.53091  | -.50411  | -.45267  | -.35433  | -.30285  |
| .4000                            | .05803  | -.47602                     | -.47134  | -.46198  | -.44326  | -.42494  | -.40382  | -.38437  | -.34029  | -.27009  | -.24668  |
| .5000                            | .05294  | -.34965                     | -.33093  | -.34497  | -.31689  | -.30285  | -.28413  | -.27604  | -.22796  | -.18116  | -.19520  |
| .6000                            | .04563  | -.22796                     | -.22328  | -.22796  | -.19988  | -.19988  | -.19052  | -.14372  | -.15308  | -.13903  | -.20458  |
| .7000                            | .03664  | -.13435                     | -.12031  | -.10627  | -.11095  | -.11095  | -.08755  | -.07819  | -.06883  | -.07351  | -.29817  |
| .8000                            | .02623  | -.02202                     | -.03139  | -.01266  | -.00798  | -.01734  | -.01734  | -.00606  | -.01266  | -.04543  | -.47602  |
| .9000                            | .01448  | .08562                      | .08562   | .08562   | .09967   | .08094   | .09030   | .11371   | .08094   | .00138   | -.86664  |
| .9800                            | .00403  | .18859                      | .18391   | .18859   | .19795   | .18859   | .19795   | .18391   | .17455   | .10435   | -.50411  |
| .0125                            | -.01894 | .98894                      | .97022   | .97022   | .96086   | .97490   | .98426   | .98894   | .97958   | .94214   | .85789   |
| .0250                            | -.02615 | .84385                      | .86257   | .85789   | .87661   | .89371   | .81577   | .82045   | .76428   | .70344   | .58643   |
| .0500                            | -.03555 | .59111                      | .61919   | .58643   | .59579   | .58643   | .56770   | .54430   | .49750   | .42720   | .32432   |
| .1000                            | -.04683 | .34335                      | .35709   | .34305   | .33837   | .32900   | .31964   | .30092   | .25412   | .22136   | .12307   |
| .1500                            | -.05345 | .22136                      | .23072   | .21668   | .21668   | .21199   | .18859   | .18391   | .13743   | .13743   | .07959   |
| .2000                            | -.05738 | .16919                      | .16051   | .14647   | .14179   | .12307   | .11371   | .10562   | .05754   | .10435   | -.03414  |
| .3000                            | -.06001 | .08562                      | .07158   | .07626   | .09498   | .06272   | .05286   | .04774   | .00606   | .01074   | -.05947  |
| .4000                            | -.05803 | .03882                      | .03882   | .03414   | .04350   | .03414   | .02946   | .21074   | -.00798  | -.02202  | -.07819  |
| .5000                            | -.05294 | .04350                      | .06690   | .02478   | .04350   | .0414    | .05286   | .01074   | -.00330  | -.01734  | -.10627  |
| .6000                            | -.04563 | .03754                      | .06272   | .03882   | .03414   | .03882   | .02010   | .07010   | -.00330  | -.02671  | -.08287  |
| .7000                            | -.03664 | .07158                      | .06490   | .05754   | .05754   | .06272   | .04350   | .03882   | .01542   | -.01734  | -.07819  |
| .8000                            | -.02623 | .10903                      | .09498   | .09498   | .08094   | .07626   | .07158   | .06690   | .03882   | .00606   | -.05947  |
| .9000                            | -.01448 | .12775                      | .12775   | .12307   | .11839   | .11371   | .10335   | .10435   | .08562   | .05754   | -.00330  |
| .9800                            | -.00403 | .15983                      | .19327   | .16987   | .17923   | .16051   | .18859   | .17923   | .16519   | .12307   | -.02671  |
| INTEGRATED $c_n$                 |         | .6278                       | .6143    | .5958    | .5740    | .5466    | .5335    | .4845    | .4765    | .3614    | .4055    |
| $\Delta \alpha$ , (DEG)          |         | 1.000                       | 1.500    | 1.500    | 2.000    | 2.000    | 2.000    | 2.500    | 2.500    | 3.000    | 3.000    |
| $\alpha + \Delta \alpha$ , (DEG) |         | 7.500                       | 8.000    | 8.000    | 8.500    | 8.500    | 8.500    | 9.000    | 9.000    | 9.500    | 9.500    |
| RESULTANT $c_l$                  |         | .6224                       | .6084    | .5900    | .5677    | .5584    | .5296    | .4775    | .4311    | .3985    | .3999    |

TABLE V. Continued

(c) Wing twist configuration VTW3.  $\alpha = 4.80^\circ$ ;  $C_L = 0.602$ ;  $C_{L,p} = 0.592$

| x/c                              | z/c     | VALUES OF $c_p$ FOR $y/s =$ |          |          |          |          |          |          |          |          |          |
|----------------------------------|---------|-----------------------------|----------|----------|----------|----------|----------|----------|----------|----------|----------|
|                                  |         | .06122                      | .06122   | .15604   | .20366   | .25128   | .29889   | .34651   | .44175   | .48937   | .53699   |
| 0.0000                           | 0.0000  | -.08850                     | -.24178  | -.78985  | -.77127  | -.79914  | -1.22645 | -1.17536 | -1.53765 | -1.51443 | -1.44940 |
| .0125                            | .0189   | -1.97890                    | -2.09037 | -2.30403 | -2.51758 | -2.50839 | -2.68954 | -2.84746 | -2.97751 | -3.04253 | -2.94035 |
| .0250                            | .02615  | -1.73273                    | -3.84607 | -3.06376 | -2.83357 | -2.19255 | -2.07644 | -2.39976 | -2.37692 | -2.81959 | -3.16794 |
| .0500                            | .03555  | -1.44475                    | -1.49120 | -1.69597 | -1.75131 | -1.80240 | -1.76524 | -1.87207 | -1.77453 | -1.83956 | -1.84420 |
| .1000                            | .04683  | -1.12891                    | -1.12427 | -1.22181 | -1.26826 | 30541    | -1.37399 | -1.36115 | -1.40295 | -1.41689 | -1.36115 |
| .1500                            | .05345  | -.91990                     | -.94777  | -1.05924 | -1.06853 | .09640   | -1.10569 | -1.11963 | -1.13356 | -1.13820 | -1.12427 |
| .2000                            | .05738  | -.81772                     | -.83630  | -.89668  | -.92455  | -.91940  | -.93848  | -.95706  | -.96171  | -.95242  | -.93848  |
| .3000                            | .06001  | -.65515                     | -.66444  | -.67838  | -.71089  | -.69696  | -.71554  | -.71089  | -.71089  | -.70180  | -.69231  |
| .4000                            | .05803  | -.50188                     | -.51117  | -.52510  | -.53504  | -.53439  | -.52975  | -.54368  | -.53439  | -.52510  | -.51581  |
| .5000                            | .05274  | -.39041                     | -.39970  | -.39970  | -.39970  | -.39970  | -.39505  | -.39505  | -.37647  | -.39041  | -.37647  |
| .6000                            | .04563  | -.29751                     | -.30216  | -.28358  | -.28358  | -.27893  | -.28358  | -.25107  | -.26500  | -.26500  | -.26035  |
| .7000                            | .03664  | -.20462                     | -.20462  | -.18604  | -.18139  | -.17211  | -.17675  | -.16746  | -.14424  | -.14424  | -.14888  |
| .8000                            | .02623  | -.11637                     | -.11637  | -.08386  | -.06992  | -.07921  | -.06528  | -.06063  | -.04205  | -.03741  | -.04205  |
| .9000                            | .01448  | .00439                      | -.01418  | .02297   | .03691   | .03691   | .05084   | .05084   | .06942   | .06013   | .06478   |
| .9800                            | .00403  | .11122                      | .11122   | .12516   | .13445   | .15302   | .13909   | .13445   | .13909   | .10193   | .15302   |
| .0125                            | -.01894 | .97978                      | .97978   | .97514   | .97414   | .96585   | .95191   | .95191   | .95656   | .93334   | .95191   |
| .0250                            | -.02615 | .66394                      | .65902   | .67939   | .67766   | .68224   | .69398   | .69427   | .69585   | .68443   | .65902   |
| .0500                            | -.03555 | .59427                      | .62214   | .61750   | .60821   | .61750   | .67788   | .69181   | .74290   | .73826   | .72432   |
| .1000                            | -.04683 | .33417                      | .35739   | .35275   | .34810   | .35739   | .38990   | .43635   | .40848   | .4647    | .45029   |
| .1500                            | -.05345 | .19947                      | .21805   | .21341   | .22270   | .23198   | .25985   | .27443   | .33881   | .32674   | .30166   |
| .2000                            | -.05738 | .11122                      | .12516   | .14374   | .14838   | .14374   | .13445   | .14838   | .22270   | .2270    | .20412   |
| .3000                            | -.06001 | .02297                      | .04155   | .05084   | .06013   | .08335   | .06942   | .09264   | .12051   | .07777   | .11587   |
| .4000                            | -.05803 | -.01418                     | -.00490  | .02762   | .02762   | .05549   | .05549   | .06478   | .08335   | .08335   | .08781   |
| .5000                            | -.05274 | -.03276                     | -.01418  | .00904   | .02297   | .02297   | .03226   | .04620   | .07406   | .06013   | .05549   |
| .6000                            | -.04563 | -.05134                     | -.03741  | .00439   | .01833   | .03691   | .04620   | .04620   | .05084   | .06478   | .05549   |
| .7000                            | -.03664 | -.06992                     | -.06063  | .01833   | .02762   | .02762   | .05549   | .06013   | .06478   | .06013   | .06478   |
| .8000                            | -.02623 | -.03741                     | -.02812  | .02762   | .05084   | .06013   | .06942   | .07406   | .07871   | .08335   | .08781   |
| .9000                            | -.01448 | .02297                      | .02297   | .06942   | .08800   | .08335   | .09729   | .09729   | .09729   | .11587   | .09729   |
| .9800                            | -.00403 | .10658                      | .10193   | .12516   | .12516   | .14374   | .13909   | .14838   | .15302   | .15302   | .13445   |
| INTEGRATED $c_n$                 |         | .5569                       | .6227    | .6541    | .6799    | .6696    | .6816    | .7076    | .7165    | .7306    | .7203    |
| $\Delta \alpha$ , (DEG)          |         | 0.000                       | 0.000    | 2.000    | 2.000    | 2.000    | 4.000    | 4.000    | 6.000    | 6.000    | 6.000    |
| $\alpha + \Delta \alpha$ , (DEG) |         | 4.800                       | 4.800    | 6.800    | 6.800    | 6.800    | 6.800    | 8.800    | 10.800   | 10.800   | 10.800   |
| RESULTANT $c_l$                  |         | .5550                       | .6205    | .6495    | .6662    | .6649    | .6736    | .6992    | .7038    | .7177    | .7075    |

| x/c                              | z/c     | VALUES OF $c_p$ FOR $y/s =$ |          |          |          |          |          |          |          |          |         |
|----------------------------------|---------|-----------------------------|----------|----------|----------|----------|----------|----------|----------|----------|---------|
|                                  |         | .58461                      | .63223   | .67985   | .72747   | .77509   | .82270   | .87032   | .91794   | .96556   | .98937  |
| 0.0000                           | 0.0000  | -1.05924                    | -.93848  | -.76198  | -.37434  | -1.13030 | .00904   | -.37597  | .49209   | -.69181  | .77542  |
| .0125                            | .01894  | -2.69883                    | -2.56413 | -2.41085 | -2.03463 | -1.98800 | -1.68164 | -1.34257 | -1.14749 | -.73346  | -.66444 |
| .0250                            | .02615  | -3.13078                    | -2.18926 | -1.89174 | -1.61196 | -1.60268 | -1.48888 | -1.23110 | -1.23110 | -1.14749 | -.65748 |
| .0500                            | .03555  | -1.89994                    | -1.80704 | -1.71413 | -1.94229 | -1.41224 | -1.29612 | -1.19214 | -.99846  | -.80379  | -.65051 |
| .1000                            | .04683  | -1.32864                    | -1.28683 | -1.22181 | -1.17936 | -1.09176 | -1.03138 | -.97919  | -.81367  | -.65051  | -.53439 |
| .1500                            | .05345  | -1.10569                    | -1.06389 | -1.02204 | -.96171  | -.89205  | -.80843  | -.79885  | -.70150  | -.54833  | -.44814 |
| .2000                            | .05738  | -.92919                     | -.90132  | -.88739  | -.82701  | -.77592  | -.72018  | -.65980  | -.59942  | -.52974  | -.28822 |
| .3000                            | .06001  | -.69231                     | -.66909  | -.65980  | -.62764  | -.58348  | -.56226  | -.51117  | -.45079  | -.34396  | -.28822 |
| .4000                            | .05803  | -.51581                     | -.50188  | -.50652  | -.48330  | -.45079  | -.42292  | -.34576  | -.33931  | -.26500  | -.25449 |
| .5000                            | .05274  | -.37647                     | -.36254  | -.36718  | -.35223  | -.32538  | -.31145  | -.28822  | -.25107  | -.18604  | -.16446 |
| .6000                            | .04563  | -.26035                     | -.26035  | -.25571  | -.25107  | -.22320  | -.22784  | -.21391  | -.17675  | -.13959  | -.13959 |
| .7000                            | .03664  | -.14424                     | -.14888  | -.14424  | -.13959  | -.13495  | -.13495  | -.13495  | -.10708  | -.08386  | -.13495 |
| .8000                            | .02623  | -.04205                     | -.05599  | -.07921  | -.05134  | -.04205  | -.04670  | -.04205  | -.04670  | -.04205  | -.16282 |
| .9000                            | .01448  | .06478                      | .06013   | .04620   | .05549   | .07406   | .06013   | .04155   | .05084   | .02762   | -.26964 |
| .9800                            | .00403  | .15302                      | .16231   | .13445   | .15302   | .17160   | .16231   | .14374   | .14302   | .12051   | -.21855 |
| .0125                            | -.01894 | .97978                      | .96120   | .97978   | .98443   | .97514   | .94262   | .87651   | .78096   | .69646   | .61285  |
| .0250                            | -.02615 | .91011                      | .89153   | .85902   | .78006   | .75884   | .71039   | .58963   | .52440   | .43171   | .34346  |
| .0500                            | -.03555 | .69930                      | .64072   | .61285   | .51996   | .47815   | .43171   | .32488   | .25985   | .18089   | .11587  |
| .1000                            | -.04683 | .43171                      | .37597   | .34346   | .28378   | .23663   | .19947   | .12051   | .07942   | .00904   | -.01883 |
| .1500                            | -.05345 | .26914                      | .24592   | .20876   | .15767   | .13445   | .08800   | .04155   | -.01418  | -.05599  | -.07457 |
| .2000                            | -.05738 | .18534                      | .15767   | .13909   | .07929   | .06013   | .02297   | -.02347  | -.06063  | -.09314  | -.09779 |
| .3000                            | -.06001 | .09264                      | .06942   | .05084   | .03691   | .01833   | -.01418  | -.05499  | -.08386  | -.08850  | -.11172 |
| .4000                            | -.05803 | .05549                      | .04620   | .04155   | .00439   | -.01833  | -.01418  | -.06063  | -.08386  | -.09314  | -.12101 |
| .5000                            | -.05274 | .03691                      | .13909   | -.00023  | -.00490  | -.00490  | .01833   | -.04670  | -.04388  | -.05134  | -.08850 |
| .6000                            | -.04563 | .06013                      | .02762   | .01368   | .01368   | .00904   | .01418   | -.03741  | -.05134  | -.06063  | -.08386 |
| .7000                            | -.03664 | .06013                      | .04620   | .03691   | .03691   | .02297   | .00439   | -.00954  | -.02347  | -.04205  | -.06992 |
| .8000                            | -.02623 | .08800                      | .07406   | .06478   | .05084   | .36013   | .03226   | .02297   | .00904   | -.00954  | -.04670 |
| .9000                            | -.01448 | .10658                      | .10193   | .08800   | .08800   | .08335   | .07871   | .07406   | .05084   | .06013   | -.02347 |
| .9800                            | -.00403 | .15767                      | .14838   | .13767   | .13302   | .15302   | .16696   | .14838   | .14374   | .11587   | -.00439 |
| INTEGRATED $c_n$                 |         | .7044                       | .6647    | .6228    | .5663    | .5163    | .4747    | .4004    | .3241    | .2350    | .2228   |
| $\Delta \alpha$ , (DEG)          |         | 4.000                       | 4.000    | 4.000    | 2.000    | 2.000    | 2.000    | 0.000    | 0.000    | 0.000    | 0.000   |
| $\alpha + \Delta \alpha$ , (DEG) |         | 8.800                       | 8.800    | 8.800    | 6.800    | 6.800    | 6.800    | 4.800    | 4.800    | 4.800    | 4.800   |
| RESULTANT $c_l$                  |         | .6961                       | .6569    | .6185    | .5623    | .5127    | .4713    | .3990    | .3269    | .2342    | .2220   |

TABLE V. Concluded

(d) Wing twist configuration VTW4.  $\alpha = 12.50^\circ$ ;  $C_L = 0.628$ ;  $C_{L,p} = 0.577$

| x/c                             | z/c     | VALUES OF $c_p$ FOR $y/s =$ |          |          |          |          |          |          |          |          |          |
|---------------------------------|---------|-----------------------------|----------|----------|----------|----------|----------|----------|----------|----------|----------|
|                                 |         | -.06122                     | .06122   | .15604   | .20366   | .25128   | .29889   | .34651   | .44175   | .48937   | .53699   |
| 0.0000                          | 0.00000 | -2.49102                    | -2.84879 | -2.84414 | -2.36558 | -1.92883 | -1.55248 | -1.11573 | -.60929  | -.49778  | -.37233  |
| .0125                           | .01894  | -3.97561                    | -4.08933 | -3.89884 | -3.67117 | -3.34593 | -3.02999 | -2.67091 | -2.33770 | -2.22154 | -2.09609 |
| .0250                           | .02615  | -2.89525                    | -2.94576 | -3.30417 | -3.26230 | -2.90454 | -2.61447 | -2.38416 | -2.02175 | -1.94277 | -1.84984 |
| .0500                           | .03555  | -2.14720                    | -2.17973 | -2.34699 | -2.19831 | -2.02175 | -1.93812 | -1.94741 | -1.67328 | -1.59430 | -1.51996 |
| .1000                           | .04683  | -1.52925                    | -1.55713 | -1.67793 | -1.61288 | -1.44319 | -1.44562 | -1.37592 | -1.21795 | -1.18078 | -1.11109 |
| .1500                           | .07345  | -1.20266                    | -1.22724 | -1.31088 | -1.29694 | -1.45983 | -1.18543 | -1.13897 | -1.03210 | -.98099  | -.94847  |
| .2000                           | .09738  | -1.00887                    | -1.02746 | -1.09250 | -1.06927 | -1.03210 | -.99029  | -.95776  | -.88342  | -.85554  | -.80908  |
| .3000                           | .06001  | -.73939                     | -.74868  | -.76727  | -.78120  | -.74868  | -.75333  | -.71614  | -.67434  | -.64182  | -.61394  |
| .4000                           | .05803  | -.59818                     | -.55354  | -.56748  | -.58606  | -.57212  | -.56748  | -.54425  | -.50243  | -.48384  | -.46061  |
| .5000                           | .05294  | -.40021                     | -.39547  | -.40950  | -.41880  | -.41880  | -.41880  | -.40021  | -.39557  | -.38163  | -.35400  |
| .6000                           | .04563  | -.27941                     | -.27941  | -.27012  | -.27941  | -.27941  | -.27476  | -.28406  | -.26082  | -.26082  | -.23759  |
| .7000                           | .03664  | -.16325                     | -.16325  | -.16325  | -.15861  | -.16325  | -.15861  | -.17255  | -.16325  | -.16325  | -.14931  |
| .8000                           | .02623  | -.05639                     | -.06104  | -.05174  | -.07497  | -.04710  | -.05512  | -.06104  | -.05977  | -.05977  | -.04641  |
| .9000                           | .01444  | .05512                      | .03189   | .05047   | .05047   | .05977   | .15734   | .14340   | .16663   | .11552   | .17128   |
| .9800                           | .00403  | .12017                      | .09694   | .12481   | .12481   | .14805   | .15734   | .15185   | .15185   | .15185   | .15185   |
| .0125                           | -.01894 | .86357                      | .82175   | .99831   | .98437   | .96114   | .95649   | .95185   | .97508   | 1.00296  | 1.00296  |
| .0250                           | -.02615 | .96114                      | .97508   | .95185   | .98437   | 1.00296  | .97043   | .93376   | .87206   | .84498   | .81246   |
| .0500                           | -.03555 | .96649                      | .97043   | .84963   | .83104   | .78458   | .73812   | .67772   | .60338   | .58015   | .54298   |
| .1000                           | -.04683 | .73347                      | .75206   | .61267   | .56156   | .51075   | .47328   | .41288   | .31066   | .32925   | .32925   |
| .1500                           | -.05345 | .59345                      | .56621   | .45470   | .40444   | .38036   | .33854   | .30137   | .21309   | .20380   | .19451   |
| .2000                           | -.05738 | .41753                      | .43611   | .34379   | .32925   | .29573   | .24097   | .21774   | .16663   | .14340   | .12481   |
| .3000                           | -.06001 | .24562                      | .26420   | .23168   | .20380   | .18986   | .16086   | .13411   | .09694   | .04118   | .03189   |
| .4000                           | -.05803 | .14805                      | .17128   | .16663   | .14340   | .12481   | .11088   | .08764   | .07371   | .04583   | .03654   |
| .5000                           | -.05294 | .09229                      | .11088   | .11552   | .11088   | .10158   | .08764   | .07371   | .05977   | .05512   | .04583   |
| .6000                           | -.04563 | .04118                      | .05977   | .08300   | .07835   | .06906   | .07371   | .06441   | .06441   | .06441   | .05047   |
| .7000                           | -.03664 | -.00993                     | .00866   | .05047   | .07371   | .08300   | .08764   | .08764   | .08764   | .08764   | .07835   |
| .8000                           | -.02623 | .00866                      | .01330   | .05977   | .07835   | .08300   | .08764   | .08764   | .08764   | .08764   | .08764   |
| .9000                           | -.01444 | .04583                      | .04118   | .08300   | .10158   | .09229   | .11088   | .12481   | .11552   | .09694   | .10623   |
| .9800                           | -.00403 | .08764                      | .09229   | .08764   | .12017   | .13411   | .13875   | .14805   | .14805   | .14805   | .13875   |
| INTEGRATED $c_n$                |         | .8245                       | .8498    | .8645    | .8527    | .8055    | .7689    | .7316    | .6472    | .6172    | .5933    |
| $\Delta\alpha$ , (DEG)          |         | 0.000                       | 0.000    | -1.000   | -2.000   | -3.000   | -4.000   | -5.000   | -6.000   | -6.000   | -6.000   |
| $\alpha + \Delta\alpha$ , (DEG) |         | 12.500                      | 12.500   | 11.500   | 10.500   | 9.500    | 8.500    | 7.500    | 6.500    | 6.500    | 6.500    |
| RESULTANT $c_l$                 |         | .8049                       | .8297    | .8471    | .8384    | .7945    | .7604    | .7253    | .6431    | .6132    | .5795    |

| x/c                             | z/c     | VALUES OF $c_p$ FOR $y/s =$ |          |          |          |          |          |         |         |         |         |
|---------------------------------|---------|-----------------------------|----------|----------|----------|----------|----------|---------|---------|---------|---------|
|                                 |         | -.58461                     | .63223   | .67985   | .72747   | .77509   | .82270   | .87032  | .91794  | .96556  | .98937  |
| 0.0000                          | 0.00000 | -.34010                     | -.08891  | .05047   | .25956   | .39430   | .49187   | .66843  | .86821  | .97043  | .99366  |
| .0125                           | .01894  | -1.98458                    | -1.75697 | -1.65955 | -1.40380 | -1.31088 | -.49187  | -.66843 | -.86821 | -.97043 | -.99366 |
| .0250                           | .02615  | -1.73369                    | -1.61793 | -1.51931 | -1.36663 | -1.23654 | -1.13432 | -.89271 | -.67434 | -.47920 | -.37233 |
| .0500                           | .03555  | -1.42703                    | -1.35734 | -1.32487 | -1.17614 | -1.07392 | -.97635  | -.84161 | -.70222 | -.53031 | -.42344 |
| .1000                           | .04683  | -1.08786                    | -1.07392 | -1.01816 | -.94847  | -.88342  | -.80444  | -.70866 | -.61394 | -.46384 | -.37233 |
| .1500                           | .05345  | -.91130                     | -.86484  | -.84161  | -.80444  | -.75333  | -.69293  | -.61394 | -.53031 | -.43738 | -.33901 |
| .2000                           | .05738  | -.78585                     | -.74868  | -.74868  | -.72566  | -.68949  | -.59071  | -.53960 | -.46991 | -.27012 | -.30266 |
| .3000                           | .06001  | -.59539                     | -.43738  | -.44203  | -.39557  | -.37698  | -.34910  | -.31193 | -.27476 | -.29799 | -.23275 |
| .4000                           | .05803  | -.45132                     | -.31658  | -.31193  | -.29335  | -.27941  | -.25418  | -.24224 | -.24224 | -.21436 | -.16325 |
| .5000                           | .05294  | -.33052                     | -.21901  | -.22830  | -.20042  | -.20042  | -.19113  | -.18184 | -.18184 | -.15861 | -.12144 |
| .6000                           | .04563  | -.24224                     | -.13073  | -.12144  | -.12144  | -.12144  | -.12144  | -.09821 | -.09821 | -.10750 | -.08427 |
| .7000                           | .03664  | -.14931                     | -.03116  | -.03174  | -.02387  | -.02387  | -.01922  | -.02387 | -.01922 | -.06568 | -.04710 |
| .8000                           | .02623  | -.05174                     | .07835   | .06441   | .07371   | .07835   | .06906   | .07835  | -.01922 | -.00528 | -.01922 |
| .9000                           | .01444  | .06906                      | .18472   | .17128   | .19451   | .18986   | .18057   | .17128  | .17128  | .05512  | .04118  |
| .9800                           | .00403  | .09366                      | .97043   | .91932   | .86821   | .81004   | .80781   | .71053  | .17128  | .14805  | .09229  |
| .0125                           | -.01894 | .79387                      | .73812   | .70395   | .64055   | .58944   | .54762   | .44076  | .30137  | .39894  | .36642  |
| .0250                           | -.02615 | .93110                      | .43147   | .43147   | .37571   | .32925   | .2814    | .18986  | .30137  | .17592  | .12481  |
| .0500                           | -.03555 | .24562                      | .19915   | .19915   | .14805   | .11088   | .07835   | .00866  | .08764  | -.01457 | -.04710 |
| .1000                           | -.04683 | .17734                      | .13411   | .08300   | .05047   | .02760   | -.00993  | -.05639 | -.05174 | -.12608 | -.12144 |
| .1500                           | -.05345 | .08764                      | .07835   | .06441   | .01330   | -.00993  | -.04710  | -.10750 | -.10750 | -.14002 | -.13338 |
| .2000                           | -.05738 | .01795                      | .01330   | -.01457  | -.01457  | -.01457  | -.05174  | -.07497 | -.08427 | -.12144 | -.13073 |
| .3000                           | -.06001 | .00866                      | -.00063  | -.04710  | -.02991  | -.04245  | -.05174  | -.08427 | -.08427 | -.12144 | -.11679 |
| .4000                           | -.05294 | .03189                      | .01330   | -.07033  | -.01457  | -.02851  | -.10750  | -.10750 | -.06568 | -.10285 | -.10285 |
| .5000                           | -.04563 | .01795                      | .00401   | -.01457  | -.00528  | -.00663  | -.12387  | -.06568 | -.09821 | -.07962 | -.03780 |
| .6000                           | -.03664 | .05047                      | .04118   | .01795   | .02260   | .00401   | -.00063  | -.03116 | -.04710 | -.05174 | -.04245 |
| .7000                           | -.02623 | .04118                      | .06906   | .05512   | .05512   | .04583   | .03189   | -.00063 | -.00993 | -.00993 | -.02387 |
| .8000                           | -.01444 | .10158                      | .10623   | .08300   | .10623   | .09229   | .09694   | .03189  | .03189  | .02724  | .00866  |
| .9000                           | -.00403 | .14805                      | .16198   | .17592   | .17128   | .18922   | .17128   | .09694  | .09229  | .05512  | .03654  |
| INTEGRATED $c_n$                |         | .5436                       | .5089    | .4741    | .4326    | .3897    | .3373    | .2861   | .2132   | .1330   | .1010   |
| $\Delta\alpha$ , (DEG)          |         | -6.000                      | -7.000   | -7.000   | -8.000   | -8.000   | -8.000   | -9.000  | -11.000 | -12.000 | -12.000 |
| $\alpha + \Delta\alpha$ , (DEG) |         | 6.500                       | 5.500    | 5.500    | 4.500    | 4.500    | 4.500    | 3.500   | 1.500   | .500    | .500    |
| RESULTANT $c_l$                 |         | .5401                       | .5065    | .4720    | .4312    | .3885    | .3363    | .2896   | .2132   | .1330   | .1010   |

TABLE VI. PRESSURE DISTRIBUTION MEASUREMENTS FOR GROUP II VTW CONFIGURATIONS

(a) Wing twist configuration VTW5.  $\alpha = 11.50^\circ$ ;  $C_L = 0.615$ ;  $C_{L,p} = 0.597$

| x/c                             | z/c     | VALUES OF $c_p$ FOR $y/s =$ |          |          |          |          |          |          |          |          |          |
|---------------------------------|---------|-----------------------------|----------|----------|----------|----------|----------|----------|----------|----------|----------|
|                                 |         | -.06122                     | .06122   | .15604   | .20366   | .25128   | .29889   | .34651   | .44175   | .48937   | .53699   |
| 0.0000                          | 0.00000 | -2.32428                    | -2.63607 | -2.89201 | -2.72914 | -2.50577 | -2.36151 | -2.00319 | -.72554  | -.09990  | .02109   |
| .0125                           | .01894  | -3.79945                    | -3.89717 | -3.94371 | -3.88786 | -3.71568 | -3.46439 | -3.21310 | -2.02140 | -1.89150 | -1.70536 |
| .0250                           | .02615  | -3.09676                    | -4.95817 | -4.10658 | -4.27876 | -3.30152 | -2.78498 | -2.60349 | -1.51922 | -1.83566 | -1.98923 |
| .0500                           | .03555  | -2.13349                    | -2.11487 | -2.31032 | -2.30101 | -2.13814 | -2.06368 | -1.91942 | -1.52853 | -1.52829 | -1.33308 |
| .1000                           | .04683  | -1.52387                    | -1.56110 | -1.62625 | -1.64021 | -1.59833 | -1.54714 | -1.38892 | -1.21674 | -1.10971 | -1.03525 |
| .1500                           | .05345  | -1.20743                    | -1.24001 | -1.37962 | -1.34239 | -1.28189 | -1.22605 | -1.04644 | -.97941  | -.90961  | -.87238  |
| .2000                           | .05738  | -1.02129                    | -1.03060 | -1.11902 | -1.08644 | -1.05952 | -1.03060 | -.97941  | -.86307  | -.82119  | -.77000  |
| .3000                           | .06001  | -.75139                     | -.76070  | -.82585  | -.77931  | -.79793  | -.65832  | -.71416  | -.64436  | -.61178  | -.59782  |
| .4000                           | .05803  | -.55129                     | -.55594  | -.61644  | -.58386  | -.53275  | -.41634  | -.56060  | -.52802  | -.50475  | -.46287  |
| .5000                           | .05294  | -.27203                     | -.41634  | -.42564  | -.43030  | -.29534  | -.38376  | -.40703  | -.25812  | -.36980  | -.35119  |
| .6000                           | .04563  | -.27078                     | -.27673  | -.32327  | -.29534  | -.29069  | -.28604  | -.25346  | -.25812  | -.25812  | -.25346  |
| .7000                           | .03664  | -.15574                     | -.17435  | -.22089  | -.17435  | -.18831  | -.16970  | -.15574  | -.15109  | -.06267  | -.11851  |
| .8000                           | .02623  | -.05802                     | -.08128  | -.09524  | -.03506  | -.07198  | -.05336  | -.05336  | -.03940  | -.00217  | -.00713  |
| .9000                           | .01448  | .04436                      | .06298   | .02575   | .03040   | .04436   | .06298   | .04436   | .04902   | .05832   | .08159   |
| .9800                           | .00403  | .14209                      | .10496   | .07694   | .14674   | .14209   | .14674   | .14674   | .10951   | .10951   | .17931   |
| .0125                           | -.01894 | .94249                      | .87734   | .97972   | .99368   | 1.00290  | .97972   | .95180   | .99368   | .93318   | .95645   |
| .0250                           | -.02615 | .96809                      | .97041   | .95645   | .90111   | .92707   | .98437   | .97041   | .97031   | .81219   | .75170   |
| .0500                           | -.03555 | .99368                      | .97507   | .94715   | .88665   | .86804   | .83081   | .82150   | .55625   | .51437   | .48645   |
| .1000                           | -.04683 | .75635                      | .74239   | .65397   | .59348   | .7952    | .63536   | .62605   | .27238   | .26308   | .30729   |
| .1500                           | -.05345 | .57952                      | .58882   | .44457   | .42595   | .734     | .37942   | .36546   | .27704   | .19327   | .12813   |
| .2000                           | -.05738 | .43526                      | .42130   | .41664   | .33753   | .30031   | .30496   | .28635   | .13278   | .09555   | .05832   |
| .3000                           | -.06001 | .27238                      | .25377   | .19793   | .26773   | .19793   | .20258   | .13278   | .05832   | -.00683  | .02575   |
| .4000                           | -.05803 | .17931                      | .17931   | .17001   | .12813   | .17001   | .14674   | .11882   | .08624   | .03971   | .03506   |
| .5000                           | -.05294 | .12813                      | .10951   | .10951   | .11882   | .10951   | .12347   | .09090   | .03040   | .02575   | .02109   |
| .6000                           | -.04563 | .07228                      | .07228   | .08159   | .11417   | .17347   | .13743   | .08159   | .08624   | .06298   | .03506   |
| .7000                           | -.05664 | .02575                      | .02575   | .16535   | .08624   | .07644   | .09090   | .11417   | .09090   | .04902   | .09555   |
| .8000                           | -.02623 | .03971                      | .04436   | .12347   | .09555   | .11882   | .15139   | .11882   | .09090   | .11417   | .09555   |
| .9000                           | -.01448 | .07228                      | .09367   | .10020   | .09090   | .14674   | .12813   | .11417   | .14209   | .15605   | .13743   |
| .9800                           | -.00403 | .12347                      | .11882   | .21654   | .15139   | .15605   | .19327   | .16535   | .17931   | .22120   | .17931   |
| INTEGRATED $c_n$                |         | .8576                       | .8964    | .9475    | .8946    | .9617    | .8141    | .7769    | .5976    | .5566    | .5320    |
| $\Delta\alpha$ , (DEG)          |         | 0.000                       | 0.000    | 0.000    | 0.000    | 0.000    | 0.000    | 0.000    | -7.000   | -7.000   | -7.000   |
| $\alpha + \Delta\alpha$ , (DEG) |         | 11.500                      | 11.500   | 11.500   | 11.500   | 11.500   | 11.500   | 11.500   | 4.500    | 4.500    | 4.500    |
| RESULTANT $c_l$                 |         | .8404                       | .8784    | .9285    | .8766    | .8444    | .7778    | .7613    | .5957    | .5549    | .5303    |

| x/c                             | z/c     | VALUES OF $c_p$ FOR $y/s =$ |          |          |          |          |          |          |          |         |         |
|---------------------------------|---------|-----------------------------|----------|----------|----------|----------|----------|----------|----------|---------|---------|
|                                 |         | .58461                      | .63223   | .67985   | .72747   | .77509   | .82270   | .87032   | .91794   | .96556  | .98937  |
| 0.0000                          | 0.00000 | .03971                      | .17931   | .20258   | .27635   | .39803   | .46783   | .46556   | .64467   | .79358  | .83081  |
| .0125                           | .01894  | -1.66813                    | -1.56576 | -1.52387 | -1.37031 | -1.26328 | -1.15625 | -1.03060 | -.96080  | -.73743 | -.55129 |
| .0250                           | .02615  | -1.97527                    | -1.41684 | -1.40754 | -1.19347 | -1.12367 | -.96080  | -1.08179 | -1.01664 | -.85842 | -.52337 |
| .0500                           | .03555  | -1.28654                    | -1.23070 | -1.26793 | -1.05387 | -1.05852 | -1.00733 | -.94684  | -.80723  | -.64436 | -.34138 |
| .1000                           | .04683  | -1.00268                    | -.97941  | -.98407  | -.91426  | -.81654  | -.81654  | -.76539  | -.67693  | -.54198 | -.47218 |
| .1500                           | .05345  | -.85842                     | -.81189  | -.85842  | -.72347  | -.75604  | -.71882  | -.64901  | -.59782  | -.43495 | -.37911 |
| .2000                           | .05738  | -.66763                     | -.68159  | -.74208  | -.63505  | -.63040  | -.60248  | -.54663  | -.47218  | -.22089 | -.35257 |
| .3000                           | .06001  | -.57921                     | -.56060  | -.56525  | -.50010  | -.48149  | -.47218  | -.39307  | -.36980  | -.29069 | -.23485 |
| .4000                           | .05803  | -.45822                     | -.41168  | -.46753  | -.38376  | -.36515  | -.36049  | -.31396  | -.28138  | -.23485 | -.21158 |
| .5000                           | .05294  | -.35584                     | -.29534  | -.32792  | -.30000  | -.23950  | -.25346  | -.13366  | -.19762  | -.10920 | -.15574 |
| .6000                           | .04563  | -.23485                     | -.20693  | -.23020  | -.17901  | -.15574  | -.16970  | -.04405  | -.10445  | -.08128 | -.12782 |
| .7000                           | .03664  | -.09524                     | -.11851  | -.13247  | -.10455  | -.06732  | -.09990  | -.04871  | -.03475  | -.01148 | -.07663 |
| .8000                           | .02623  | .02575                      | -.03940  | -.09524  | -.00683  | -.00683  | .05367   | .02575   | .03506   | .01179  | .01179  |
| .9000                           | .01448  | .11882                      | .10020   | .04436   | .08624   | .10020   | .12813   | .13743   | .10951   | .09555  | .02544  |
| .9800                           | .00403  | .25377                      | .21189   | .15605   | .20258   | .20258   | .19793   | .21050   | .18862   | .16070  | -.07663 |
| .0125                           | -.01894 | .90992                      | .93784   | .85873   | .87734   | .87724   | .82615   | .80754   | .74239   | .72843  | .60278  |
| .0250                           | -.02615 | .69586                      | .70051   | .64467   | .63536   | .62140   | .54229   | .59348   | .44318   | .40734  | .31892  |
| .0500                           | -.03555 | .43526                      | .48179   | .37011   | .37942   | .35615   | .30961   | .30961   | .22120   | .17931  | .16090  |
| .1000                           | -.04683 | .31892                      | .20724   | .16070   | .15605   | .18397   | .11882   | .11882   | .05367   | .01644  | -.00683 |
| .1500                           | -.05345 | .11417                      | .10486   | .05367   | .05832   | .08624   | .05367   | .05367   | -.02079  | -.02575 | -.09059 |
| .2000                           | -.05738 | .14674                      | .03971   | .02575   | .00713   | .02575   | -.01009  | -.07198  | -.07198  | -.08128 | -.09990 |
| .3000                           | -.06001 | .11417                      | .00713   | -.06732  | -.02544  | -.01613  | -.04405  | -.13009  | -.08128  | -.06732 | -.09059 |
| .4000                           | -.05803 | .01179                      | .01644   | -.07663  | -.02544  | -.03009  | -.03940  | -.04871  | -.06267  | -.05802 | -.07663 |
| .5000                           | -.05294 | .00713                      | .02575   | -.09524  | -.02544  | -.01148  | -.01148  | -.01148  | -.01144  | -.00713 | -.05802 |
| .6000                           | -.04563 | .07228                      | .09555   | -.02544  | .00713   | .00713   | -.01613  | -.00217  | -.03475  | -.00683 | -.07198 |
| .7000                           | -.03664 | .05832                      | .05832   | .01644   | .09371   | .07228   | .03040   | .02575   | .00248   | .01179  | -.03940 |
| .8000                           | -.02623 | .20724                      | .08159   | .09367   | .09367   | .10951   | .07694   | .06763   | .04436   | .02575  | -.01613 |
| .9000                           | -.01448 | .16070                      | .11882   | .08624   | .10486   | .18397   | .11882   | .12813   | .08159   | .15139  | .06763  |
| .9800                           | -.00403 | .24912                      | .25377   | .17931   | .21189   | .20258   | .18397   | .20724   | .20258   | .19793  | .08159  |
| INTEGRATED $c_n$                |         | .5294                       | .4777    | .4460    | .3991    | .3959    | .3499    | .2998    | .2556    | .1965   | .1653   |
| $\Delta\alpha$ , (DEG)          |         | -7.000                      | -7.000   | -7.000   | -7.000   | -7.000   | -7.000   | -7.000   | -7.000   | -7.000  | -7.000  |
| $\alpha + \Delta\alpha$ , (DEG) |         | 4.500                       | 4.500    | 4.500    | 4.500    | 4.500    | 4.500    | 4.500    | 4.500    | 4.500   | 4.500   |
| RESULTANT $c_l$                 |         | .5278                       | .4762    | .4446    | .3978    | .3947    | .3489    | .2989    | .2548    | .1959   | .1648   |

TABLE VI. Continued

(b) Wing twist configuration VTW6.  $\alpha = 9.10^\circ$ ;  $C_L = 0.620$ ;  $C_{L,p} = 0.591$

| x/c                             | z/c     | VALUES OF $c_p$ FOR $y/s =$ |          |          |          |          |          |          |          |          |          |
|---------------------------------|---------|-----------------------------|----------|----------|----------|----------|----------|----------|----------|----------|----------|
|                                 |         | -.06122                     | .06122   | .15604   | .20366   | .25128   | .29889   | -.34651  | .44175   | .48937   | .53699   |
| 0.0000                          | 0.00000 | -1.42899                    | -1.68841 | -1.95246 | -1.86907 | -1.75789 | -1.73010 | -1.56796 | -1.30392 | -1.17421 | -1.01671 |
| .0125                           | .01894  | -3.10130                    | -3.23564 | -3.23101 | -3.31439 | -3.22637 | -3.12909 | -3.13372 | -2.90674 | -2.80019 | -2.62416 |
| .0250                           | .02615  | -2.71217                    | -2.47129 | -4.06947 | -2.73997 | -2.73387 | -2.57320 | -2.41107 | -2.30452 | -2.16092 | -1.97562 |
| .0500                           | .03555  | -1.83201                    | -1.84591 | -1.95246 | -1.95709 | -1.90613 | -1.91540 | -1.91540 | -1.88760 | -1.87834 | -1.83201 |
| .1000                           | .04683  | -1.39193                    | -1.41973 | -1.52164 | -1.52627 | -1.50774 | -1.48458 | -1.44289 | -1.40583 | -1.34098 | -1.25296 |
| .1500                           | .05345  | -1.13713                    | -1.14641 | -1.26222 | -1.25296 | -1.22053 | -1.21590 | -1.16494 | -1.13715 | -1.09546 | -1.04913 |
| .2000                           | .05738  | -.96112                     | -.97965  | -1.04913 | -1.04450 | -1.01207 | -1.01671 | -1.00744 | -1.00744 | -.92406  | -.89163  |
| .3000                           | .06001  | -.73413                     | -.74803  | -.77119  | -.78049  | -.74339  | -.74339  | -.73413  | -.69707  | -.68780  | -.65538  |
| .4000                           | .05803  | -.56736                     | -.54883  | -.57199  | -.58129  | -.54419  | -.54419  | -.56736  | -.53493  | -.51177  | -.50251  |
| .5000                           | .05294  | -.41912                     | -.42376  | -.42376  | -.42839  | -.40523  | -.40986  | -.40059  | -.35890  | -.38206  | -.36353  |
| .6000                           | .04563  | -.30331                     | -.29868  | -.29405  | -.29268  | -.28478  | -.28941  | -.25699  | -.26625  | -.26625  | -.26162  |
| .7000                           | .03664  | -.19213                     | -.19677  | -.18287  | -.18287  | -.17360  | -.17824  | -.16434  | -.15044  | -.11802  | -.14581  |
| .8000                           | .02823  | -.09022                     | -.09485  | -.07632  | -.04853  | -.06706  | -.06243  | -.06243  | -.05779  | -.03000  | -.03463  |
| .9000                           | .01448  | .02559                      | .00706   | .03022   | .03949   | .04705   | .05802   | .04875   | .05802   | .06265   | .07655   |
| .9800                           | .00403  | .12287                      | .10897   | .11361   | .13677   | .15530   | .14140   | .14140   | .13677   | .11361   | .16456   |
| .0125                           | -.01894 | .98913                      | .91940   | .96134   | .95104   | .92208   | .94281   | .94281   | .93818   | .90112   | .94281   |
| .0250                           | -.02615 | .83626                      | .98450   | .92428   | .99840   | 1.00303  | .99840   | .99377   | .95208   | .90112   | .94281   |
| .0500                           | -.03555 | .85406                      | .87332   | .87332   | .78994   | .80808   | .75751   | .76678   | .72509   | .65597   | .92428   |
| .1000                           | -.04683 | .60464                      | .61391   | .53979   | .30736   | .49810   | .48420   | .51663   | .40082   | .71119   | .67413   |
| .1500                           | -.05345 | .43788                      | .44714   | .37302   | .35912   | .34986   | .34523   | .33133   | .35912   | .42398   | .39155   |
| .2000                           | -.05738 | .31280                      | .32207   | .31280   | .27574   | .24795   | .28037   | .24311   | .21552   | .29427   | .26184   |
| .3000                           | -.06001 | .16920                      | .17383   | .16456   | .15530   | .15067   | .13677   | .13677   | .11677   | .20162   | .16920   |
| .4000                           | -.05803 | .09508                      | .11361   | .11824   | .10897   | .12287   | .10897   | .10434   | .13214   | .06728   | .08581   |
| .5000                           | -.05294 | .05338                      | .05338   | .08118   | .08581   | .07655   | .08118   | .07655   | .11824   | .07655   | .07191   |
| .6000                           | -.04563 | .01633                      | .02096   | .06265   | .07191   | .09044   | .08581   | .07191   | .06265   | .06265   | .04875   |
| .7000                           | -.03664 | -.02073                     | -.01610  | .07655   | .06728   | .06728   | .08118   | .09044   | .07191   | .06728   | .04875   |
| .8000                           | -.02623 | .02443                      | .02443   | .07191   | .08581   | .09044   | .09044   | .09044   | .08118   | .06265   | .06728   |
| .9000                           | -.01448 | .04875                      | .04412   | .09508   | .10897   | .11824   | .12287   | .11824   | .09044   | .09044   | .08581   |
| .9800                           | -.00403 | .11361                      | .10434   | .15993   | .14603   | .15067   | .15530   | .14603   | .11824   | .12750   | .11361   |
| INTEGRATED $c_n$                |         | .7559                       | .7669    | .8334    | .8036    | .7850    | .7788    | .7647    | .7282    | .6946    | .6590    |
| $\Delta\alpha$ , (DEG)          |         | 0.000                       | 0.000    | 0.000    | 0.000    | 0.000    | 0.000    | 0.000    | 0.000    | 0.000    | 0.000    |
| $\alpha + \Delta\alpha$ , (DEG) |         | 9.100                       | 9.100    | 9.100    | 9.100    | 9.100    | 9.100    | 9.100    | 9.100    | 9.100    | 9.100    |
| RESULTANT $c_l$                 |         | .7464                       | .7572    | .8229    | .7935    | .7751    | .7690    | .7551    | .7190    | .6858    | .6507    |

| x/c                             | z/c     | VALUES OF $c_p$ FOR $y/s =$ |          |          |          |          |          |         |         |         |         |
|---------------------------------|---------|-----------------------------|----------|----------|----------|----------|----------|---------|---------|---------|---------|
|                                 |         | -.58461                     | -.63223  | -.67985  | -.72747  | -.77509  | -.82270  | -.87032 | -.91794 | -.96556 | -.98937 |
| 0.0000                          | 0.00000 | -.93799                     | -.04893  | -.33133  | -.42861  | -.54905  | -.61854  | -.68339 | -.72045 | -.80384 | -.81773 |
| .0125                           | .01894  | -2.40180                    | -1.66988 | -1.41046 | -1.24369 | -1.14178 | -1.00744 | -.88339 | -.72045 | -.58126 | -.58126 |
| .0250                           | .02615  | -2.04974                    | -1.62355 | -1.29928 | -1.37804 | -1.12788 | -.97038  | -.86384 | -.80825 | -.66001 | -.69317 |
| .0500                           | .03555  | -1.69767                    | -1.39656 | -1.16031 | -1.06766 | -1.00744 | -.94259  | -.88700 | -.81288 | -.68317 | -.53346 |
| .1000                           | .04683  | -1.16958                    | -1.13252 | -.99354  | -.90553  | -.82178  | -.78972  | -.74339 | -.67854 | -.56736 | -.47934 |
| .1500                           | .05345  | -.97965                     | -.91016  | -.84531  | -.74803  | -.73787  | -.67854  | -.64148 | -.59979 | -.44692 | -.37743 |
| .2000                           | .05738  | -.83141                     | -.79898  | -.70170  | -.67391  | -.64611  | -.60442  | -.56736 | -.51177 | -.25236 | -.32647 |
| .3000                           | .06001  | -.64148                     | -.62295  | -.53493  | -.52104  | -.48398  | -.47008  | -.42376 | -.37743 | -.28015 | -.22919 |
| .4000                           | .05803  | -.43324                     | -.47471  | -.43302  | -.42839  | -.42839  | -.35890  | -.37743 | -.37743 | -.28015 | -.18287 |
| .5000                           | .05294  | -.37743                     | -.35890  | -.34037  | -.31258  | -.26625  | -.26162  | -.22456 | -.19677 | -.11338 | -.11338 |
| .6000                           | .04563  | -.25699                     | -.25699  | -.23846  | -.21993  | -.18750  | -.18750  | -.13191 | -.13191 | -.09022 | -.06243 |
| .7000                           | .03664  | -.12728                     | -.15507  | -.13654  | -.12265  | -.10412  | -.10412  | -.08559 | -.06706 | -.02073 | -.04853 |
| .8000                           | .02623  | -.03000                     | -.06706  | -.05316  | -.03926  | -.02537  | -.02073  | -.06220 | -.01147 | .01169  | -.04300 |
| .9000                           | .01448  | .09118                      | .05338   | .06265   | .07191   | .09508   | .08581   | .08118  | .08581  | .08118  | -.13791 |
| .9800                           | .00403  | .17383                      | .15067   | .15993   | .18309   | .19236   | .19699   | .19236  | .18309  | .15993  | .13654  |
| .0125                           | -.01894 | .96597                      | .97987   | .85943   | .82700   | .81773   | .76677   | .70656  | .69266  | .69266  | .61854  |
| .0250                           | -.02615 | .90575                      | .72972   | .60928   | .58611   | .55369   | .49347   | .48420  | .42861  | .39618  | .34523  |
| .0500                           | -.03555 | .63707                      | .48883   | .36376   | .32670   | .29427   | .23868   | .21089  | .16920  | .15993  | .11824  |
| .1000                           | -.04683 | .43324                      | .23405   | .19067   | .14140   | .11824   | .06728   | .03949  | .02096  | -.00220 | -.01147 |
| .1500                           | -.05345 | .22478                      | .13677   | .07655   | .04875   | .08118   | -.00684  | -.03000 | -.03000 | -.03000 | -.08056 |
| .2000                           | -.05738 | .13993                      | .07191   | .01169   | -.07632  | -.00684  | -.05316  | -.06243 | -.02073 | -.12728 | -.08559 |
| .3000                           | -.06001 | .09508                      | .01169   | .01633   | -.05316  | -.02537  | -.05316  | -.11802 | -.10412 | -.08559 | -.09022 |
| .4000                           | -.05803 | .03485                      | -.00220  | .02559   | -.03000  | -.04853  | -.03000  | -.08096 | -.07632 | -.07169 | -.09022 |
| .5000                           | -.05294 | .01169                      | .01169   | .02559   | -.02537  | -.02537  | -.01610  | -.03926 | -.04853 | -.01610 | -.07169 |
| .6000                           | -.04563 | .09338                      | .01169   | .01633   | .00243   | .00706   | -.00684  | -.03000 | -.03926 | -.03000 | -.06243 |
| .7000                           | -.03664 | .03338                      | .02096   | .03022   | .03485   | .05338   | .02559   | .00706  | -.00684 | -.01610 | -.02537 |
| .8000                           | -.02623 | .11361                      | .06265   | .06265   | .07191   | .09508   | .06265   | .05338  | .03022  | .03022  | .00706  |
| .9000                           | -.01448 | .11361                      | .09044   | .10434   | .10434   | .12287   | .12287   | .10897  | .10897  | .12750  | .03485  |
| .9800                           | -.00403 | .17846                      | .15993   | .18773   | .20162   | .18309   | .19236   | .18773  | .18309  | .16456  | .07655  |
| INTEGRATED $c_n$                |         | .6311                       | .5364    | .4662    | .4129    | .3867    | .3471    | .2949   | .2558   | .1820   | .1740   |
| $\Delta\alpha$ , (DEG)          |         | 0.000                       | -4.000   | -6.000   | -6.000   | -6.000   | -6.000   | -6.000  | -5.500  | -4.500  | -4.000  |
| $\alpha + \Delta\alpha$ , (DEG) |         | 9.100                       | 5.100    | 3.100    | 3.100    | 3.100    | 3.100    | 3.100   | 3.600   | 4.600   | 5.100   |
| RESULTANT $c_l$                 |         | .6232                       | .5343    | .4656    | .4123    | .3861    | .3466    | .2943   | .2533   | .1814   | .1733   |

TABLE VI. Concluded

(c) Wing twist configuration VTW7.  $\alpha = 8.50^\circ$ ;  $C_L = 0.596$ ;  $C_{L,p} = 0.571$

| x/c                             | z/c     | VALUES OF $c_p$ FOR $y/s =$ |          |          |          |          |          |          |          |          |          |
|---------------------------------|---------|-----------------------------|----------|----------|----------|----------|----------|----------|----------|----------|----------|
|                                 |         | -.06122                     | .06122   | .15604   | .20366   | .25128   | .29889   | .34651   | .44175   | .48937   | .53699   |
| 0.0000                          | 0.00000 | -.73210                     | -1.13002 | -1.43539 | -1.33360 | -1.25494 | -1.22718 | -1.10226 | -.91718  | -.85703  | -.76912  |
| .0125                           | .01894  | -2.53047                    | -2.82346 | -2.86044 | -2.94376 | -2.85172 | -2.75406 | -2.79107 | -2.59674 | -2.55973 | -2.43943 |
| .0250                           | .02615  | -2.13405                    | -2.34226 | -2.44868 | -2.47644 | -2.44868 | -2.36540 | -2.43017 | -2.27286 | -2.15719 | -2.04152 |
| .0500                           | .03555  | -1.50017                    | -1.64360 | -1.94435 | -1.87495 | -1.87957 | -1.91196 | -1.90271 | -1.83793 | -1.78704 | -1.74539 |
| .1000                           | .04683  | -1.13002                    | -1.31047 | -1.39839 | -1.41226 | -1.39912 | -1.37062 | -1.33823 | -1.30584 | -1.30121 | -1.21793 |
| .1500                           | .05345  | -.89867                     | -1.07449 | -1.17166 | -1.16241 | -1.14390 | -1.13002 | -1.10226 | -1.07449 | -1.06987 | -1.03285 |
| .2000                           | .05738  | -.75061                     | -1.00046 | -.99121  | -.98196  | -.96808  | -.95420  | -.94957  | -.91255  | -.91255  | -.87554  |
| .3000                           | .06001  | -.54240                     | -.70434  | -.73673  | -.73673  | -.72285  | -.69972  | -.70434  | -.69509  | -.68584  | -.65807  |
| .4000                           | .05803  | -.36658                     | -.53315  | -.55628  | -.58404  | -.54703  | -.51464  | -.53778  | -.52389  | -.53315  | -.50076  |
| .5000                           | .05294  | -.29091                     | -.41285  | -.41285  | -.41748  | -.39434  | -.39897  | -.39434  | -.36658  | -.38509  | -.36658  |
| .6000                           | .04563  | -.14449                     | -.29255  | -.30180  | -.29255  | -.28792  | -.27404  | -.28330  | -.26479  | -.26479  | -.25553  |
| .7000                           | .03664  | -.04732                     | -.19076  | -.19539  | -.18613  | -.17688  | -.16762  | -.16762  | -.15374  | -.14912  | -.14449  |
| .8000                           | .02623  | .04984                      | -.09822  | -.08434  | -.06583  | -.07046  | -.06583  | -.06583  | -.04732  | -.05658  | -.04270  |
| .9000                           | .01448  | .17014                      | .01745   | .02208   | .03133   | .04059   | .04984   | .05909   | .05447   | .05447   | .07760   |
| .9800                           | .00403  | .28119                      | .11924   | .11924   | .14738   | .14238   | .14238   | .14238   | .15626   | .15626   | .17014   |
| .0125                           | -.01894 | .84042                      | .97059   | .96134   | .95671   | .95208   | .94746   | .94283   | .93820   | .91044   | .90582   |
| .0250                           | -.02615 | .87805                      | .99373   | .87343   | .97008   | .94746   | .94283   | .93820   | .91044   | .90582   | .88731   |
| .0500                           | -.03555 | .94283                      | .80865   | .72074   | .71611   | .68372   | .68372   | .66098   | .66098   | .63746   | .62358   |
| .1000                           | -.04683 | .66522                      | .56029   | .44775   | .43387   | .43387   | .42667   | .42667   | .34133   | .37372   | .42925   |
| .1500                           | -.05345 | .51253                      | .37372   | .29507   | .24581   | .21178   | .21178   | .19790   | .17939   | .15626   | .15626   |
| .2000                           | -.05738 | .39223                      | .25805   | .24417   | .21641   | .18112   | .18112   | .16551   | .16551   | .16637   | .16637   |
| .3000                           | -.06001 | .26730                      | .13312   | .11924   | .11924   | .10074   | .10074   | .10074   | .09611   | .09611   | .08223   |
| .4000                           | -.05803 | .20715                      | .08223   | .08223   | .08223   | .08686   | .08686   | .07297   | .07760   | .04984   | .05909   |
| .5000                           | -.05294 | .18865                      | .03133   | .04521   | .04521   | .06372   | .06372   | .06372   | .05447   | .05447   | .03596   |
| .6000                           | -.04563 | .14238                      | .00357   | .04059   | .04059   | .04984   | .06372   | .06372   | .05447   | .05447   | .04521   |
| .7000                           | -.03664 | .11924                      | -.02419  | .05447   | .05447   | .04984   | .06372   | .06372   | .07297   | .04984   | .06372   |
| .8000                           | -.02623 | .14701                      | -.00106  | .05909   | .06372   | .08223   | .08686   | .09148   | .08686   | .08223   | .08223   |
| .9000                           | -.01448 | .20253                      | .04059   | .07760   | .09148   | .12387   | .11462   | .11462   | .12387   | .11462   | .11462   |
| .9800                           | -.00403 | .27636                      | .10536   | .13775   | .13775   | .15163   | .15163   | .16089   | .15626   | .16089   | .13312   |
| INTEGRATED $c_n$                |         | .6761                       | .7084    | .7431    | .7389    | .7328    | .7242    | .7173    | .6813    | .6723    | .6444    |
| $\Delta\alpha$ , (DEG)          |         | 0.000                       | 0.000    | 0.000    | 0.000    | 0.000    | 0.000    | 0.000    | 0.000    | 0.000    | 0.000    |
| $\alpha + \Delta\alpha$ , (DEG) |         | 8.500                       | 8.500    | 8.500    | 8.500    | 8.500    | 8.500    | 8.500    | 8.500    | 8.500    | 8.500    |
| RESULTANT $c_l$                 |         | .6687                       | .7006    | .7349    | .7307    | .7248    | .7163    | .7094    | .6738    | .6649    | .6373    |

| x/c                             | z/c     | VALUES OF $c_p$ FOR $y/s =$ |          |          |          |          |          |         |         |         |         |
|---------------------------------|---------|-----------------------------|----------|----------|----------|----------|----------|---------|---------|---------|---------|
|                                 |         | .58461                      | .63223   | .67985   | .72747   | .77509   | .82270   | .87032  | .91794  | .96556  | .98937  |
| 0.0000                          | 0.00000 | -.77837                     | -.63957  | -.48225  | -.36195  | -.10747  | -.66984  | .77626  | .83641  | .92432  | .94283  |
| .0125                           | .01894  | -2.40241                    | -2.25435 | -2.17570 | -1.97211 | -1.67599 | -.95882  | -.90151 | -.67196 | -.49151 | -.36195 |
| .0250                           | .02615  | -2.01375                    | -1.98137 | -1.92584 | -1.77316 | -1.49893 | -1.11151 | -.89703 | -.71360 | -.57942 | -.54703 |
| .0500                           | .03555  | -1.68987                    | -1.63435 | -1.60859 | -1.41608 | -1.20405 | -.94957  | -.82927 | -.72748 | -.58867 | -.48688 |
| .1000                           | .04683  | -1.19479                    | -1.18091 | -1.14893 | -1.06987 | -.93106  | -.82464  | -.71967 | -.63494 | -.51927 | -.42210 |
| .1500                           | .05345  | -.82464                     | -.82464  | -.84778  | -.84778  | -.81539  | -.72748  | -.63494 | -.57016 | -.45449 | -.38046 |
| .2000                           | .05738  | -.85240                     | -.82464  | -.84778  | -.84778  | -.81539  | -.72748  | -.63494 | -.57016 | -.45449 | -.38046 |
| .3000                           | .06001  | -.64882                     | -.63031  | -.63494  | -.63494  | -.63494  | -.64882  | -.59451 | -.49151 | -.27867 | -.33419 |
| .4000                           | .05803  | -.49151                     | -.47300  | -.63494  | -.63494  | -.63494  | -.64882  | -.59451 | -.49151 | -.27867 | -.33419 |
| .5000                           | .05294  | -.37121                     | -.33882  | -.48225  | -.44524  | -.44524  | -.39434  | -.39434 | -.28792 | -.23703 | -.25553 |
| .6000                           | .04563  | -.25553                     | -.23703  | -.35270  | -.33419  | -.33419  | -.29255  | -.24628 | -.21852 | -.16762 | -.14912 |
| .7000                           | .03664  | -.13986                     | -.14449  | -.25091  | -.23119  | -.24628  | -.20927  | -.16762 | -.16762 | -.12135 | -.11210 |
| .8000                           | .02623  | -.04270                     | -.14449  | -.13524  | -.12135  | -.14912  | -.12398  | -.12398 | -.10897 | -.05658 | -.07500 |
| .9000                           | .01448  | .05909                      | -.09658  | -.07046  | -.03807  | -.06121  | -.04732  | -.02419 | -.02419 | -.00568 | -.02882 |
| .9800                           | .00403  | .17014                      | .06835   | .05447   | .05447   | .01745   | .05447   | .07760  | .07297  | .04984  | .08820  |
| .0125                           | -.01894 | .98910                      | .97939   | .95676   | .71014   | .12387   | .16551   | .17939  | .17014  | .14701  | .03596  |
| .0250                           | -.02615 | .89555                      | .85029   | .99835   | 1.00298  | .98910   | .70886   | .65506  | .48193  | .50328  | .44775  |
| .0500                           | -.03555 | .60044                      | .59119   | .54497   | .80402   | .75776   | .43387   | .39223  | .30495  | .32954  | .16551  |
| .1000                           | -.04683 | .35984                      | .33671   | .29507   | .27193   | .19790   | .20715   | .15626  | .08686  | .02671  | -.01956 |
| .1500                           | -.05345 | .22104                      | .19790   | .16889   | .14701   | .07297   | .04921   | -.00568 | -.05658 | -.10747 | -.10747 |
| .2000                           | -.05738 | .15163                      | .12387   | .10999   | .07797   | .01283   | -.03344  | -.07046 | -.11210 | -.13061 | -.13524 |
| .3000                           | -.06001 | .07297                      | .03909   | -.00568  | .00820   | -.02419  | -.06583  | -.11210 | -.12598 | -.12598 | -.14449 |
| .4000                           | -.05803 | .03133                      | .03133   | -.03344  | .00357   | -.04732  | -.08897  | -.11210 | -.09939 | -.11210 | -.12598 |
| .5000                           | -.05294 | .03133                      | .03133   | -.03344  | .00357   | -.04732  | -.08897  | -.11210 | -.09939 | -.11210 | -.12598 |
| .6000                           | -.04563 | .04059                      | .03133   | -.03344  | -.00106  | -.03807  | -.06583  | -.06583 | -.07046 | -.07046 | -.12135 |
| .7000                           | -.03664 | .04984                      | .04521   | -.01031  | -.00106  | -.02882  | -.04732  | -.04270 | -.06121 | -.06121 | -.07500 |
| .8000                           | -.02623 | .08686                      | .07297   | .06372   | .04984   | .00357   | -.02419  | -.01031 | -.03344 | -.03807 | -.04732 |
| .9000                           | -.01448 | .10899                      | .10536   | .08223   | .08223   | .07297   | .07760   | .09148  | .08223  | .01283  | -.01956 |
| .9800                           | -.00403 | .14238                      | .15626   | .13775   | .13163   | .14938   | .16089   | .17477  | .14551  | .14238  | .06835  |
| INTEGRATED $c_n$                |         | .6269                       | .6003    | .5658    | .5218    | .4669    | .3361    | .2868   | .2189   | .1467   | .1189   |
| $\Delta\alpha$ , (DEG)          |         | 0.000                       | 0.000    | 0.000    | 0.000    | 0.000    | -6.000   | -6.000  | -6.000  | -6.000  | -6.000  |
| $\alpha + \Delta\alpha$ , (DEG) |         | 8.500                       | 8.500    | 8.500    | 8.500    | 8.500    | 2.500    | 2.500   | 2.500   | 2.500   | 2.500   |
| RESULTANT $c_l$                 |         | .6200                       | .5937    | .5596    | .5160    | .4618    | .3358    | .2683   | .2187   | .1466   | .1188   |



TABLE VII. PRESSURE DISTRIBUTION MEASUREMENTS FOR GROUP III VTW CONFIGURATIONS

(a) Wing twist configuration VTW7S<sub>0</sub>.  $\alpha = 11.60^\circ$ ;  $C_L = 0.591$ ;  $C_{L,p} = 0.555$

| x/c                             | z/c      | VALUES OF $c_p$ FOR $y/s =$ |          |          |          |          |          |          |          |          |          |
|---------------------------------|----------|-----------------------------|----------|----------|----------|----------|----------|----------|----------|----------|----------|
|                                 |          | -.06122                     | .06122   | .15604   | .20366   | .29128   | .29889   | .34651   | .44175   | .48937   | .53699   |
| 0.0000                          | 0.00000  | -1.91706                    | -2.24605 | -2.57967 | -2.37579 | -2.16264 | -2.03290 | -1.70854 | -1.03203 | -1.65670 | -1.30454 |
| .0125                           | 0.01894  | -3.46934                    | -3.65005 | -3.67322 | -3.63615 | -3.46670 | -3.26082 | -3.13108 | -2.45920 | -2.04217 | -1.58343 |
| .0250                           | 0.02615  | -3.10791                    | -3.07084 | -2.81211 | -3.22839 | -3.03377 | -2.84379 | -2.76039 | -2.06997 | -1.71318 | -1.31932 |
| .0500                           | 0.03555  | -2.02827                    | -2.02827 | -2.19508 | -2.17191 | -2.01437 | -1.94486 | -1.85682 | -1.48613 | -1.21274 | -0.92082 |
| .1000                           | 0.04683  | -1.46296                    | -1.50003 | -1.60660 | -1.59270 | -1.52783 | -1.47686 | -1.35565 | -1.04593 | -0.73084 | -0.31844 |
| .1500                           | 0.05345  | -1.18031                    | -1.20347 | -1.30541 | -1.29151 | -1.23128 | -1.17567 | -1.08300 | -0.78181 | -0.42038 | -0.14029 |
| .2000                           | 0.05738  | -0.98569                    | -0.93472 | -1.06910 | -1.06446 | -1.01813 | -0.97179 | -0.93472 | -0.61500 | -0.21650 | 0.20053  |
| .3000                           | 0.06001  | -0.75864                    | -0.75864 | -0.79571 | -0.78181 | -0.74937 | -0.70304 | -0.66133 | -0.39259 | -0.37868 | 0.38988  |
| .4000                           | 0.05803  | -0.56866                    | -0.55476 | -0.42038 | -0.43428 | -0.39722 | -0.39258 | -0.37868 | -0.30941 | -0.30258 | -0.35551 |
| .5000                           | 0.05294  | -0.42502                    | -0.42905 | -0.29091 | -0.29991 | -0.29064 | -0.28137 | -0.28601 | -0.50379 | -0.45745 | -0.45745 |
| .6000                           | 0.04563  | -0.28601                    | -0.29527 | -0.19797 | -0.19943 | -0.18407 | -0.17480 | -0.19333 | -0.43892 | -0.44819 | -0.43428 |
| .7000                           | 0.03664  | -0.19333                    | -0.19333 | -0.06359 | -0.04047 | -0.07749 | -0.07286 | -0.11919 | -0.42502 | -0.50842 | -0.45745 |
| .8000                           | 0.02623  | -0.07749                    | -0.09139 | 0.01982  | 0.01518  | 0.02445  | 0.01918  | -0.04506 | -0.44819 | -0.51306 | -0.48062 |
| .9000                           | 0.01448  | 0.02908                     | 0.02445  | 0.09395  | 0.12176  | 0.13102  | 0.09395  | 0.03372  | -0.42502 | -0.50842 | -0.45745 |
| .9800                           | 0.00403  | 0.14029                     | 0.10785  | 0.09395  | 0.09395  | 0.09395  | 0.09395  | 0.09395  | -0.44819 | -0.51306 | -0.48062 |
| 0.0125                          | -0.01894 | 0.99289                     | 0.93265  | 0.88275  | 0.88275  | 0.95822  | 0.95822  | 0.93728  | -0.33234 | -0.38331 | -0.36478 |
| .0250                           | -0.02615 | 0.84461                     | 0.80045  | 0.78898  | 0.78898  | 0.86972  | 0.86972  | 0.87528  | -0.33234 | -0.38331 | -0.36478 |
| .0500                           | -0.03555 | 0.64192                     | 0.62895  | 0.62895  | 0.62895  | 0.69772  | 0.69772  | 0.70228  | -0.33234 | -0.38331 | -0.36478 |
| .1000                           | -0.04683 | 0.46704                     | 0.46704  | 0.46704  | 0.46704  | 0.46704  | 0.46704  | 0.46704  | -0.33234 | -0.38331 | -0.36478 |
| .1500                           | -0.05345 | 0.32025                     | 0.32025  | 0.32025  | 0.32025  | 0.32025  | 0.32025  | 0.32025  | -0.33234 | -0.38331 | -0.36478 |
| .2000                           | -0.05738 | 0.21443                     | 0.21443  | 0.21443  | 0.21443  | 0.21443  | 0.21443  | 0.21443  | -0.33234 | -0.38331 | -0.36478 |
| .3000                           | -0.06001 | 0.14029                     | 0.14029  | 0.14029  | 0.14029  | 0.14029  | 0.14029  | 0.14029  | -0.33234 | -0.38331 | -0.36478 |
| .4000                           | -0.05803 | 0.09395                     | 0.09395  | 0.09395  | 0.09395  | 0.09395  | 0.09395  | 0.09395  | -0.33234 | -0.38331 | -0.36478 |
| .5000                           | -0.05294 | 0.02908                     | 0.02908  | 0.02908  | 0.02908  | 0.02908  | 0.02908  | 0.02908  | -0.33234 | -0.38331 | -0.36478 |
| .6000                           | -0.04563 | -0.02908                    | -0.02908 | -0.02908 | -0.02908 | -0.02908 | -0.02908 | -0.02908 | -0.33234 | -0.38331 | -0.36478 |
| .7000                           | -0.03664 | -0.07749                    | -0.07749 | -0.07749 | -0.07749 | -0.07749 | -0.07749 | -0.07749 | -0.33234 | -0.38331 | -0.36478 |
| .8000                           | -0.02623 | 0.01982                     | 0.01982  | 0.01982  | 0.01982  | 0.01982  | 0.01982  | 0.01982  | -0.33234 | -0.38331 | -0.36478 |
| .9000                           | -0.01448 | 0.06132                     | 0.06132  | 0.06132  | 0.06132  | 0.06132  | 0.06132  | 0.06132  | -0.33234 | -0.38331 | -0.36478 |
| .9800                           | -0.00403 | 0.11249                     | 0.11249  | 0.11249  | 0.11249  | 0.11249  | 0.11249  | 0.11249  | -0.33234 | -0.38331 | -0.36478 |
| INTEGRATED $c_n$                |          | .8132                       | .8245    | .8630    | .8498    | .8262    | .7784    | .7504    | .6926    | .5826    | .3713    |
| $\Delta\alpha$ , (DEG)          |          | 0.000                       | 0.000    | 0.000    | 0.000    | 0.000    | 0.000    | 0.000    | 0.000    | 0.000    | 0.000    |
| $\alpha + \Delta\alpha$ , (DEG) |          | 11.600                      | 11.600   | 11.600   | 11.600   | 11.600   | 11.600   | 11.600   | 11.600   | 11.600   | 11.600   |
| RESULTANT $c_l$                 |          | .7666                       | .8077    | .8454    | .8324    | .8094    | .7626    | .7351    | .6784    | .5707    | .3637    |

| x/c                             | z/c      | VALUES OF $c_p$ FOR $y/s =$ |          |          |          |          |          |          |          |          |          |
|---------------------------------|----------|-----------------------------|----------|----------|----------|----------|----------|----------|----------|----------|----------|
|                                 |          | .58461                      | .63223   | .67985   | .72747   | .77509   | .82270   | .87032   | .91794   | .96556   | .98937   |
| 0.0000                          | 0.00000  | -1.16099                    | -0.66359 | -1.00666 | -1.23904 | -1.22577 | -1.49708 | -1.57732 | -1.62693 | -1.75657 | -1.82144 |
| .0125                           | 0.01894  | -1.34712                    | -1.27761 | -1.40277 | -1.58343 | -1.42514 | -1.12007 | -1.05056 | -0.95789 | -0.76791 | -0.58256 |
| .0250                           | 0.02615  | -1.11943                    | -1.00423 | -1.12470 | -1.32395 | -1.36102 | -1.24054 | -1.07373 | -0.84862 | -0.77718 | -0.80498 |
| .0500                           | 0.03555  | -0.76328                    | -0.77718 | -0.88338 | -1.09520 | -1.10612 | -0.97642 | -0.93935 | -0.90885 | -0.71230 | -0.59183 |
| .1000                           | 0.04683  | -0.42336                    | -0.43310 | -0.30914 | -0.50183 | -0.72157 | -0.79108 | -0.76328 | -0.60914 | -0.59183 | -0.75909 |
| .1500                           | 0.05345  | -0.26077                    | -0.27930 | -0.12639 | -0.34624 | -0.60110 | -0.67087 | -0.64280 | -0.60573 | -0.48989 | -0.40185 |
| .2000                           | 0.05738  | -0.13766                    | -0.13766 | -0.29320 | -0.15626 | -0.48949 | -0.57329 | -0.54476 | -0.49916 | -0.29064 | -0.34161 |
| .3000                           | 0.06001  | -0.03146                    | -0.03146 | -0.60829 | -0.33234 | -0.35088 | -0.43892 | -0.45602 | -0.38331 | -0.30918 | -0.25820 |
| .4000                           | 0.05803  | -0.37868                    | -0.43892 | -0.43892 | -0.53159 | -0.27674 | -0.36478 | -0.32771 | -0.29064 | -0.24894 | -0.19707 |
| .5000                           | 0.05294  | -0.40648                    | -0.44819 | -0.47509 | -0.45282 | -0.29527 | -0.29527 | -0.24430 | -0.21650 | -0.16090 | -0.14236 |
| .6000                           | 0.04563  | -0.46209                    | -0.49492 | -0.51306 | -0.49089 | -0.32304 | -0.23967 | -0.16090 | -0.16553 | -0.11919 | -0.11456 |
| .7000                           | 0.03664  | -0.51306                    | -0.53159 | -0.53159 | -0.50379 | -0.33698 | -0.20260 | -0.12846 | -0.09603 | -0.05432 | -0.08213 |
| .8000                           | 0.02623  | -0.50379                    | -0.58256 | -0.59646 | -0.53159 | -0.29527 | -0.14700 | -0.05432 | -0.07452 | -0.02189 | -0.04042 |
| .9000                           | 0.01448  | -0.46704                    | -0.50842 | -0.60110 | -0.47509 | -0.33504 | -0.03116 | 0.05225  | 0.06132  | 0.03372  | -0.04042 |
| .9800                           | 0.00403  | -0.34161                    | -0.43892 | -0.53159 | -0.35088 | -0.10993 | 0.0322   | 0.14410  | 0.15883  | 0.13102  | -0.05896 |
| 0.0125                          | -0.01894 | 1.00215                     | 0.99289  | 0.99752  | 0.88825  | 0.97898  | 0.82607  | 0.79364  | 0.74267  | 0.67316  | 0.60366  |
| .0250                           | -0.02615 | 0.82607                     | 0.81217  | 0.82607  | 0.83334  | 0.82607  | 0.61995  | 0.55269  | 0.48318  | 0.39978  | 0.32564  |
| .0500                           | -0.03555 | 0.59002                     | 0.58976  | 0.57122  | 0.56659  | 0.54805  | 0.33027  | 0.28393  | 0.22833  | 0.15863  | 0.08599  |
| .1000                           | -0.04683 | 0.36734                     | 0.33490  | 0.31637  | 0.31637  | 0.27467  | 0.13564  | 0.09395  | 0.03835  | 0.00128  | -0.04506 |
| .1500                           | -0.05345 | 0.22833                     | 0.20053  | 0.19589  | 0.19109  | 0.13102  | 0.03372  | 0.0128   | -0.04042 | -0.06822 | -0.08676 |
| .2000                           | -0.05738 | 0.17273                     | 0.12639  | 0.12639  | 0.10372  | 0.05225  | -0.01725 | -0.04506 | -0.07286 | -0.09139 | -0.10066 |
| .3000                           | -0.06001 | 0.07542                     | 0.04298  | 0.01982  | 0.00128  | 0.03579  | -0.05432 | -0.09603 | -0.13102 | -0.16090 | -0.19707 |
| .4000                           | -0.05803 | 0.00591                     | -0.00799 | -0.01262 | -0.00799 | -0.05432 | -0.10529 | -0.08676 | -0.09603 | -0.09603 | -0.09139 |
| .5000                           | -0.05294 | -0.02632                    | -0.01725 | -0.03116 | -0.03579 | -0.04822 | -0.13773 | -0.08676 | -0.08676 | -0.08676 | -0.08676 |
| .6000                           | -0.04563 | -0.02632                    | -0.04042 | -0.04969 | -0.04506 | -0.05996 | -0.08676 | -0.05432 | -0.05379 | -0.05379 | -0.05379 |
| .7000                           | -0.03664 | -0.02866                    | -0.02866 | -0.02119 | -0.02119 | -0.02119 | -0.02119 | -0.02119 | -0.02119 | -0.02119 | -0.02119 |
| .8000                           | -0.02623 | -0.06822                    | -0.11919 | -0.09603 | -0.05896 | -0.04969 | -0.04042 | -0.03335 | -0.00799 | -0.01725 | -0.03116 |
| .9000                           | -0.01448 | -0.14700                    | -0.17017 | -0.15676 | -0.10066 | -0.04042 | -0.00128 | 0.03835  | 0.03835  | 0.05225  | 0.00591  |
| .9800                           | -0.00403 | -0.25820                    | -0.24601 | -0.32308 | -0.17480 | -0.04969 | 0.09395  | 0.14029  | 0.14956  | 0.14956  | 0.04298  |
| INTEGRATED $c_n$                |          | .3101                       | .3327    | .3638    | .3317    | .4410    | .3543    | .3132    | .2645    | .1937    | .1637    |
| $\Delta\alpha$ , (DEG)          |          | 0.000                       | 0.000    | 0.000    | 0.000    | 0.000    | -6.000   | -6.000   | -6.000   | -6.000   | -6.000   |
| $\alpha + \Delta\alpha$ , (DEG) |          | 11.600                      | 11.600   | 11.600   | 11.600   | 11.600   | 5.600    | 5.600    | 5.600    | 5.600    | 5.600    |
| RESULTANT $c_l$                 |          | .3038                       | .3259    | .3564    | .3208    | .4320    | .3526    | .3118    | .2632    | .1927    | .1629    |

TABLE VII. Continued

(b) Wing twist configuration VTW7S<sub>1</sub>.  $\alpha = 11.40^\circ$ ;  $C_L = 0.607$ ;  $C_{L,p} = 0.575$

| x/c                             | z/c     | VALUES OF $c_p$ FOR $y/s =$ |          |          |          |          |          |          |          |          |          |
|---------------------------------|---------|-----------------------------|----------|----------|----------|----------|----------|----------|----------|----------|----------|
|                                 |         | -.06122                     | .06122   | .15604   | .20366   | .25128   | .29889   | .34651   | .44175   | .48937   | .53699   |
| 0.0000                          | 0.00000 | -2.18358                    | -2.45417 | -2.76675 | -2.58013 | -2.40285 | -2.32354 | -2.06695 | -1.52111 | -1.14321 | .94685   |
| .0125                           | .01894  | -3.69981                    | -3.83044 | -3.84444 | -3.80712 | -3.65782 | -3.50853 | -3.43389 | -3.01401 | -2.66411 | -.60204  |
| .0250                           | .02615  | -3.24261                    | -3.14464 | -3.27527 | -3.42922 | -3.25661 | -3.20468 | -2.57547 | -2.39597 | -2.23957 | -.89129  |
| .0500                           | .03555  | -2.12293                    | -2.11827 | -2.31421 | -2.27222 | -2.16959 | -2.09494 | -2.05295 | -1.79636 | -1.66573 | -1.15721 |
| .1000                           | .04683  | -1.54443                    | -1.54910 | -1.67973 | -1.67040 | -1.62374 | -1.58176 | -1.53510 | -1.39048 | -1.24119 | -1.00326 |
| .1500                           | .05345  | -1.23052                    | -1.24119 | -1.33916 | -1.33449 | -1.30650 | -1.27384 | -1.25052 | -1.12922 | -1.01259 | -.90528  |
| .2000                           | .05738  | -1.05457                    | -1.02192 | -1.11522 | -1.10589 | -1.08857 | -1.05457 | -1.03591 | -.93794  | -.87263  | -.83997  |
| .3000                           | .06001  | -.79332                     | -.77932  | -.80731  | -.80731  | -.77932  | -.78398  | -.75599  | -.70934  | -.70467  | -.69534  |
| .4000                           | .05803  | -.61137                     | -.57871  | -.59737  | -.61137  | -.59271  | -.56938  | -.56938  | -.53672  | -.56938  | -.51340  |
| .5000                           | .05294  | -.42942                     | -.43409  | -.43875  | -.42942  | -.42475  | -.41542  | -.41076  | -.41076  | -.44342  | -.39210  |
| .6000                           | .04563  | -.3145                      | -.30812  | -.32212  | -.30346  | -.28946  | -.29413  | -.30346  | -.29413  | -.33611  | -.28013  |
| .7000                           | .03664  | -.21482                     | -.19149  | -.20882  | -.18216  | -.17283  | -.17283  | -.17749  | -.18682  | -.23348  | -.17749  |
| .8000                           | .02623  | -.10751                     | -.08885  | -.08885  | -.09818  | -.09519  | -.06086  | -.06086  | -.08885  | -.14017  | -.09352  |
| .9000                           | .01448  | .00446                      | .00912   | .02778   | .03245   | .05111   | .04644   | .04644   | .02778   | -.04686  | -.00021  |
| .9800                           | .00403  | .00877                      | .09776   | .11176   | .11642   | .14908   | .13975   | .12575   | .13508   | .04178   | .09310   |
| .0125                           | -.01894 | .90486                      | .89553   | .99817   | .99817   | .98417   | .97484   | .96085   | .94685   | .96085   | .54563   |
| .0250                           | -.02615 | .97951                      | .96551   | .95618   | .97484   | .97951   | .98417   | .99350   | .97951   | .93752   | .34036   |
| .0500                           | -.03555 | .90953                      | .94685   | .83488   | .84421   | .83488   | .80689   | .78823   | .74624   | .68093   | .17241   |
| .1000                           | -.04683 | .67160                      | .70892   | .57829   | .57362   | .56896   | .54563   | .50831   | .40547   | .41034   | .08843   |
| .1500                           | -.05345 | .49898                      | .52977   | .42900   | .42433   | .41034   | .38235   | .37302   | .28904   | .30770   | -.00488  |
| .2000                           | -.05738 | .35902                      | .39168   | .32636   | .32170   | .31237   | .31237   | .31237   | .27971   | .21906   | -.05193  |
| .3000                           | -.06001 | .20040                      | .23306   | .20040   | .20040   | .19107   | .17241   | .15841   | .11176   | .00912   | -.12617  |
| .4000                           | -.05803 | .10709                      | .13975   | .14908   | .13508   | .13575   | .13042   | .11642   | .07443   | .00446   | -.15417  |
| .5000                           | -.05294 | .03111                      | .08377   | .10709   | .10243   | .11176   | .09776   | .09310   | .05111   | .00912   | -.15883  |
| .6000                           | -.04563 | .00446                      | .04178   | .06510   | .07910   | .09310   | .09310   | .06977   | .06044   | .00912   | -.15883  |
| .7000                           | -.03664 | -.03753                     | .00446   | .04178   | .06977   | .07910   | .08377   | .06977   | .05577   | .01845   | -.14950  |
| .8000                           | -.02623 | -.02354                     | .00446   | .05111   | .07443   | .09310   | .09310   | .08377   | .06977   | .03245   | -.11218  |
| .9000                           | -.01448 | .01379                      | .04178   | .07910   | .09310   | .11642   | .10709   | .11176   | .10709   | .06510   | -.03753  |
| .9800                           | -.00403 | .06510                      | .09310   | .08843   | .11176   | .14908   | .14441   | .14441   | .14441   | .11176   | .06977   |
| INTEGRATED $c_n$                |         | .8332                       | .8495    | .8774    | .8808    | .8983    | .8355    | .8118    | .7312    | .6816    | .3708    |
| $\Delta\alpha$ , (DEG)          |         | 0.000                       | 0.000    | 0.000    | 0.000    | 0.000    | 0.000    | 0.000    | 0.000    | 0.000    | -15.000  |
| $\alpha + \Delta\alpha$ , (DEG) |         | 11.400                      | 11.400   | 11.400   | 11.400   | 11.400   | 11.400   | 11.400   | 11.400   | 11.400   | -3.600   |
| RESULTANT $c_l$                 |         | .8168                       | .8327    | .8601    | .8634    | .8614    | .8191    | .7958    | .7168    | .6682    | .3701    |

| x/c                             | z/c     | VALUES OF $c_p$ FOR $y/s =$ |         |          |          |          |          |          |          |         |         |
|---------------------------------|---------|-----------------------------|---------|----------|----------|----------|----------|----------|----------|---------|---------|
|                                 |         | .58461                      | .63223  | .67985   | .72747   | .77509   | .82270   | .87032   | .91794   | .96556  | .98937  |
| 0.0000                          | 0.00000 | .91886                      | .94219  | .99817   | -.58338  | -.51340  | .32636   | .41967   | .50831   | .67160  | .76490  |
| .0125                           | .01894  | -.57405                     | -.49007 | -.39210  | -2.04829 | -1.97364 | -1.36715 | -1.24119 | -1.09656 | -.87263 | -.67202 |
| .0250                           | .02615  | -.71867                     | -.66269 | -.74666  | -1.76370 | -1.69640 | -1.31583 | -1.19920 | -1.06957 | -.89129 | -.73733 |
| .0500                           | .03555  | -.76999                     | -.72334 | -1.10123 | -1.44646 | -1.36715 | -1.14788 | -1.04991 | -.96127  | -.79332 | -.64869 |
| .1000                           | .04683  | -.75599                     | -.71400 | -.94727  | -.96593  | -.97060  | -.93328  | -.84463  | -.76066  | -.69336 | -.51340 |
| .1500                           | .05345  | -.71400                     | -.67668 | -.89129  | -.80731  | -.80265  | -.78865  | -.71400  | -.65336  | -.53672 | -.45275 |
| .2000                           | .05738  | -.66735                     | -.62070 | -.82073  | -.67202  | -.68135  | -.64869  | -.58804  | -.53672  | -.31745 | -.36411 |
| .3000                           | .06001  | -.55538                     | -.51806 | -.60204  | -.50873  | -.50573  | -.50407  | -.45741  | -.40143  | -.32212 | -.26613 |
| .4000                           | .05803  | -.42942                     | -.41542 | -.42942  | -.40609  | -.39676  | -.37810  | -.35944  | -.29879  | -.24281 | -.21482 |
| .5000                           | .05294  | -.33611                     | -.30346 | -.30346  | -.30346  | -.29413  | -.27546  | -.24747  | -.21482  | -.17283 | -.16390 |
| .6000                           | .04563  | -.25214                     | -.22415 | -.21482  | -.20082  | -.19615  | -.18682  | -.16350  | -.15883  | -.12151 | -.12617 |
| .7000                           | .03664  | -.18216                     | -.14484 | -.12151  | -.11218  | -.12151  | -.10285  | -.09352  | -.07019  | -.07019 | -.07952 |
| .8000                           | .02623  | -.09352                     | -.07486 | -.06552  | -.03287  | -.02354  | -.03287  | -.00954  | -.01421  | -.01887 | -.07019 |
| .9000                           | .01448  | .01845                      | .03245  | .02778   | .05111   | .06044   | .06510   | .08377   | .07910   | .02778  | -.08419 |
| .9800                           | .00403  | .13975                      | .16308  | .12575   | .15841   | .14908   | .18174   | .18174   | .17241   | .13508  | -.11684 |
| .0125                           | -.01894 | .47565                      | .46632  | .41034   | .98417   | .98417   | .85354   | .83488   | .78336   | .69492  | .62961  |
| .0250                           | -.02615 | .22373                      | .18640  | .23306   | .85354   | .85354   | .60628   | .57362   | .52231   | .43833  | .34502  |
| .0500                           | -.03555 | .04178                      | .00912  | .09310   | .55963   | .55963   | .34502   | .30770   | .26105   | .18174  | .12109  |
| .1000                           | -.04683 | -.08419                     | -.08419 | -.00488  | .27038   | .26371   | .13508   | .10709   | .06977   | .00446  | -.02820 |
| .1500                           | -.05345 | -.09818                     | -.11684 | -.07486  | .13042   | .12109   | .03245   | .01845   | -.01887  | -.05619 | -.07486 |
| .2000                           | -.05738 | -.11684                     | -.12151 | -.08843  | .05111   | .05111   | -.00954  | -.02820  | -.06532  | -.07486 | -.10285 |
| .3000                           | -.06001 | -.11218                     | -.11684 | -.20082  | -.01421  | -.01887  | -.05153  | -.05153  | -.07952  | -.09352 | -.10285 |
| .4000                           | -.05803 | -.11218                     | -.10751 | -.23614  | -.02820  | -.02820  | -.06552  | -.06552  | -.09352  | -.09818 | -.11218 |
| .5000                           | -.05294 | -.09352                     | -.11218 | -.21019  | -.01887  | -.01887  | -.06552  | -.05153  | -.05619  | -.07952 | -.10751 |
| .6000                           | -.04563 | -.08419                     | -.07486 | -.14950  | -.00954  | -.00954  | -.04220  | -.03287  | -.04686  | -.06086 | -.07952 |
| .7000                           | -.03664 | -.06086                     | -.04686 | -.09352  | .02312   | .00912   | -.01421  | -.00954  | -.02820  | -.03287 | -.06086 |
| .8000                           | -.02623 | -.03753                     | -.00021 | -.03287  | .05111   | .03711   | .01379   | .02778   | .00912   | -.00488 | -.03753 |
| .9000                           | -.01448 | .03245                      | .06977  | .01845   | .08377   | .06510   | .06510   | .06977   | .06044   | .03245  | -.00488 |
| .9800                           | -.00403 | .13042                      | .13375  | .12109   | .13975   | .13975   | .16774   | .17707   | .16308   | .13042  | .02778  |
| INTEGRATED $c_n$                |         | .3026                       | .2774   | .2932    | .4837    | .4708    | .3869    | .3495    | .2919    | .2135   | .1845   |
| $\Delta\alpha$ , (DEG)          |         | -15.000                     | -15.000 | -15.000  | 0.000    | 0.000    | -6.000   | -6.000   | -6.000   | -6.000  | -6.000  |
| $\alpha + \Delta\alpha$ , (DEG) |         | -3.600                      | -3.600  | -3.600   | 11.400   | 11.400   | 5.400    | 5.400    | 5.400    | 5.400   | 5.400   |
| RESULTANT $c_l$                 |         | .3020                       | .2769   | .2946    | .4741    | .4615    | .3852    | .3479    | .2906    | .2125   | .1837   |

TABLE VII. Continued

(c) Wing twist configuration VTW7S<sub>3</sub>.  $\alpha = 11.90^\circ$ ;  $C_L = 0.583$ ;  $C_{L,p} = 0.564$

| x/c                             | z/c     | VALUES OF $c_p$ FOR $y/s =$ |          |          |          |          |          |          |          |          |          |
|---------------------------------|---------|-----------------------------|----------|----------|----------|----------|----------|----------|----------|----------|----------|
|                                 |         | -.06122                     | .06122   | .15604   | .20366   | .25128   | .29889   | .34651   | .44175   | .48937   | .53699   |
| 0.0000                          | 0.00000 | -2.20565                    | -2.56889 | -2.88090 | -2.60666 | -2.51301 | -2.39659 | -2.12649 | -1.53040 | -1.12525 | .94241   |
| 0.0125                          | .01894  | -3.70517                    | -3.92405 | -3.95685 | -3.89145 | -3.74709 | -3.57478 | -3.48164 | -3.03458 | -2.64340 | -.60834  |
| 0.0250                          | .02615  | -3.22086                    | -3.10443 | -3.18360 | -3.53287 | -3.35591 | -3.18826 | -3.02992 | -2.62943 | -2.22894 | -.88775  |
| 0.0500                          | .03955  | -2.11717                    | -2.14977 | -2.36399 | -2.91276 | -2.22894 | -2.13114 | -2.07992 | -1.81447 | -1.66080 | -1.14854 |
| 0.1000                          | .04683  | -1.53040                    | -1.56766 | -1.69805 | -1.68408 | -1.66545 | -1.60491 | -1.54903 | -1.39555 | -1.37302 | -1.00418 |
| 0.1500                          | .05345  | -1.23236                    | -1.25565 | -1.36276 | -1.35344 | -1.39016 | -1.29290 | -1.25565 | -1.12991 | -1.01349 | -.89707  |
| 0.2000                          | .05738  | -1.04143                    | -1.06008 | -1.12991 | -1.12525 | -1.09266 | -1.07403 | -1.04143 | -.95295  | -.87644  | -.84118  |
| 0.3000                          | .06001  | -.77599                     | -.79462  | -.80859  | -.82256  | -.79927  | -.80392  | -.76202  | -.71079  | -.70148  | -.70148  |
| 0.4000                          | .05803  | -.58006                     | -.58040  | -.59903  | -.61300  | -.60368  | -.59437  | -.57574  | -.52917  | -.52917  | -.52452  |
| 0.5000                          | .05294  | -.44935                     | -.43603  | -.43138  | -.43138  | -.43138  | -.41741  | -.41275  | -.41741  | -.44069  | -.39878  |
| 0.6000                          | .04563  | -.31496                     | -.31030  | -.29633  | -.30564  | -.30098  | -.30098  | -.27770  | -.29633  | -.33350  | -.29167  |
| 0.7000                          | .03664  | -.20319                     | -.19853  | -.17991  | -.17991  | -.17991  | -.17525  | -.17059  | -.19388  | -.24510  | -.19853  |
| 0.8000                          | .02623  | -.09608                     | -.09142  | -.06814  | -.09608  | -.06348  | -.06348  | -.06348  | -.08677  | -.14731  | -.10540  |
| 0.9000                          | .01448  | .01103                      | .00637   | .02965   | .03897   | .04363   | .04828   | .05294   | .02965   | -.05417  | -.01226  |
| 0.9800                          | .00403  | .00951                      | .00919   | .10882   | .11814   | .13211   | .12745   | .12745   | .12279   | .04828   | .06554   |
| 0.0125                          | -.01894 | .91446                      | .87721   | .99363   | 1.00295  | .98897   | .98432   | .96569   | .94706   | .95638   | .93260   |
| 0.0250                          | -.02615 | .98897                      | .97500   | .96103   | .97035   | .97966   | .98897   | .98432   | .97966   | .93775   | .92304   |
| 0.0500                          | -.03955 | .92843                      | .94706   | .86324   | .85392   | .83995   | .82598   | .80736   | .74216   | .68162   | .15073   |
| 0.1000                          | -.04683 | .69093                      | .70956   | .60711   | .57451   | .56520   | .53726   | .52329   | .40221   | .40686   | .09088   |
| 0.1500                          | -.05345 | .51883                      | .53286   | .44877   | .43480   | .41152   | .39289   | .37892   | .30441   | .29510   | -.01691  |
| 0.2000                          | -.05738 | .37892                      | .40221   | .34632   | .33235   | .32304   | .33235   | .28113   | .22059   | .13676   | -.06814  |
| 0.3000                          | -.06001 | .22059                      | .23456   | .21593   | .18799   | .18333   | .16470   | .16936   | .10416   | .01103   | -.12868  |
| 0.4000                          | -.05803 | .12745                      | .14608   | .15073   | .13676   | .13676   | .12745   | .11348   | .04363   | .00171   | -.17991  |
| 0.5000                          | -.05294 | .06691                      | .08088   | .10882   | .10416   | .09951   | .09485   | .08554   | .02965   | .00171   | -.17525  |
| 0.6000                          | -.04563 | .02965                      | .04363   | .07622   | .07157   | .08088   | .08088   | .07157   | .04363   | .00637   | -.17059  |
| 0.7000                          | -.03664 | -.02157                     | -.00294  | .05760   | .06691   | .07157   | .08088   | .07157   | .04363   | .01103   | -.17059  |
| 0.8000                          | -.02623 | -.00760                     | -.00294  | .05294   | .07622   | .07622   | .08088   | .08088   | .06691   | .03431   | -.12402  |
| 0.9000                          | -.01448 | .02965                      | .03431   | .07622   | .09485   | .09019   | .10416   | .10416   | .09019   | .06225   | -.04951  |
| 0.9800                          | -.00403 | .08088                      | .09485   | .09951   | .10882   | .12745   | .14142   | .14142   | .13676   | .11348   | .05294   |
| INTEGRATED $c_n$                |         | .8413                       | .8603    | .8864    | .8907    | .8679    | .8482    | .8153    | .7264    | .6810    | .3450    |
| $\Delta\alpha$ , (DEG)          |         | 0.000                       | 0.000    | 0.000    | 0.000    | 0.000    | 0.000    | 0.000    | 0.000    | 0.000    | -15.000  |
| $\alpha + \Delta\alpha$ , (DEG) |         | 11.900                      | 11.900   | 11.900   | 11.900   | 11.900   | 11.900   | 11.900   | 11.900   | 11.900   | -3.100   |
| RESULTANT $c_l$                 |         | .8232                       | .8418    | .8673    | .8716    | .8493    | .8300    | .7978    | .7108    | .6663    | .3445    |

| x/c                             | z/c     | VALUES OF $c_p$ FOR $y/s =$ |         |         |          |          |          |          |          |         |         |
|---------------------------------|---------|-----------------------------|---------|---------|----------|----------|----------|----------|----------|---------|---------|
|                                 |         | -.58461                     | .63223  | .67985  | .72747   | .77509   | .82270   | .87032   | .91794   | .96556  | .98937  |
| 0.0000                          | 0.00000 | -.93775                     | -.97035 | -.99829 | -.09485  | -.04363  | -.40686  | -.47672  | -.54657  | -.70025 | -.78407 |
| 0.0125                          | .01894  | -.93849                     | -.42672 | -.46398 | -1.53506 | -1.63286 | -1.26962 | -1.18114 | -1.05074 | -.83187 | -.64559 |
| 0.0250                          | .02615  | -.66422                     | -.60834 | -.60834 | -1.43261 | -1.46055 | -1.24168 | -1.12525 | -1.03677 | -.86447 | -.68751 |
| 0.0500                          | .03955  | -.73873                     | -.67819 | -.79927 | -1.19045 | -1.20908 | -1.08800 | -1.01349 | -.93896  | -.78064 | -.63628 |
| 0.1000                          | .04683  | -.72942                     | -.67819 | -.77133 | -.90638  | -.94364  | -.88775  | -.81790  | -.81790  | -.62231 | -.51055 |
| 0.1500                          | .05345  | -.69682                     | -.63628 | -.72942 | -.75270  | -.74805  | -.74339  | -.69682  | -.63628  | -.52452 | -.43603 |
| 0.2000                          | .05738  | -.65025                     | -.59437 | -.67819 | -.64559  | -.64559  | -.61765  | -.58506  | -.54314  | -.31030 | -.36152 |
| 0.3000                          | .06001  | -.54780                     | -.49657 | -.54314 | -.50123  | -.48260  | -.48260  | -.45466  | -.39878  | -.31961 | -.26373 |
| 0.4000                          | .05803  | -.42672                     | -.39878 | -.41275 | -.38947  | -.38015  | -.36152  | -.31961  | -.29633  | -.24045 | -.20319 |
| 0.5000                          | .05294  | -.33824                     | -.30098 | -.29167 | -.28701  | -.26839  | -.26373  | -.24510  | -.21250  | -.17059 | -.14265 |
| 0.6000                          | .04563  | -.24976                     | -.22182 | -.21250 | -.20785  | -.19388  | -.18456  | -.17525  | -.15662  | -.11471 | -.10540 |
| 0.7000                          | .03664  | -.17059                     | -.14731 | -.11937 | -.11471  | -.10540  | -.09142  | -.08677  | -.07280  | -.06348 | -.07280 |
| 0.8000                          | .02623  | -.08677                     | -.07745 | -.07745 | -.03554  | -.00760  | -.02157  | -.01226  | -.01691  | -.01691 | -.05417 |
| 0.9000                          | .01448  | .01968                      | .02965  | .02034  | .05294   | .08088   | .06691   | .07622   | .08088   | .03897  | -.05883 |
| 0.9800                          | .00403  | .13676                      | .16005  | .11348  | .14608   | .16470   | .18333   | .17868   | .17402   | .14142  | -.07745 |
| 0.0125                          | -.01894 | .46275                      | .43015  | .36961  | .92378   | .93775   | .83064   | .80270   | .75613   | .67896  | .60711  |
| 0.0250                          | -.02615 | .20662                      | .15539  | .16936  | .69093   | .70956   | .56985   | .53726   | .50000   | .42083  | .33701  |
| 0.0500                          | -.03955 | .02965                      | -.02623 | .02965  | .40221   | .42549   | .30907   | .28113   | .22990   | .16936  | .10416  |
| 0.1000                          | -.04683 | -.08211                     | -.11005 | -.06348 | .14608   | .16470   | .11348   | .07157   | .04363   | -.00294 | -.03089 |
| 0.1500                          | -.05345 | -.10540                     | -.12868 | -.11005 | .02500   | .05294   | .00171   | -.00760  | -.04486  | -.08814 | -.07745 |
| 0.2000                          | -.05738 | -.12868                     | -.13799 | -.12868 | -.03354  | -.00294  | -.03089  | -.06348  | -.07745  | -.10540 | -.10540 |
| 0.3000                          | -.06001 | -.14265                     | -.11937 | -.14265 | -.09608  | -.03883  | -.07280  | -.07745  | -.09608  | -.11005 | -.11471 |
| 0.4000                          | -.05803 | -.11937                     | -.11005 | -.13799 | -.08877  | -.05883  | -.01226  | -.08211  | -.08211  | -.10074 | -.11005 |
| 0.5000                          | -.05294 | -.09608                     | -.10540 | -.14731 | -.07280  | -.04020  | -.07280  | -.05883  | -.09142  | -.07745 | -.08677 |
| 0.6000                          | -.04563 | -.08211                     | -.06814 | -.09142 | -.04486  | -.01691  | -.04486  | -.04486  | -.05417  | -.06348 | -.07745 |
| 0.7000                          | -.03664 | -.05883                     | -.02623 | -.04486 | -.01226  | -.01226  | -.01691  | -.01691  | -.03354  | -.04020 | -.05883 |
| 0.8000                          | -.02623 | -.03089                     | .02500  | -.00760 | .01968   | .03431   | .01968   | .02034   | .00171   | -.01691 | -.03554 |
| 0.9000                          | -.01448 | .05294                      | .07622  | .04828  | .07137   | .06225   | .08554   | .08088   | .06225   | .04828  | -.00294 |
| 0.9800                          | -.00403 | .13211                      | .16005  | .14142  | .15073   | .16005   | .16470   | .16470   | .15073   | .12745  | .04363  |
| INTEGRATED $c_n$                |         | .2756                       | .2516   | .2668   | .3884    | .4004    | .3573    | .3189    | .2709    | .1955   | .1672   |
| $\Delta\alpha$ , (DEG)          |         | -19.000                     | -19.000 | -11.250 | -3.750   | -3.000   | -6.000   | -6.000   | -6.000   | -6.000  | -6.000  |
| $\alpha + \Delta\alpha$ , (DEG) |         | -3.100                      | -3.100  | .650    | 8.150    | 8.900    | 9.900    | 9.900    | 9.900    | 9.900   | 9.900   |
| RESULTANT $c_l$                 |         | .2752                       | .2513   | .2667   | .3845    | .3956    | .3554    | .3173    | .2694    | .1944   | .1663   |

TABLE VII. Concluded

(d) Wing twist configuration VTW7S<sub>3</sub>P.  $\alpha = 12.20^\circ$ ;  $C_L = 0.606$ ;  $C_{L,p} = 0.591$

| x/c                             | z/c     | VALUES OF $c_p$ FOR $y/s =$ |          |          |          |          |          |          |          |          |          |
|---------------------------------|---------|-----------------------------|----------|----------|----------|----------|----------|----------|----------|----------|----------|
|                                 |         | -.06122                     | .06122   | .15604   | .20366   | .23128   | .24889   | .34651   | .44175   | .48937   | .53699   |
| 0.0000                          | 0.00000 | -2.54153                    | -2.90058 | -3.17570 | -3.05912 | -2.85861 | -2.76069 | -2.42962 | -1.78613 | -1.34315 | .89508   |
| .0125                           | .01894  | -3.97773                    | -4.15492 | -4.22486 | -4.11762 | -3.97773 | -3.77722 | -3.65598 | -3.17103 | -2.76535 | -.66702  |
| .0250                           | .02615  | -3.24098                    | -3.02223 | -2.97814 | -2.84533 | -2.61868 | -2.88659 | -2.91923 | -2.52754 | -2.36434 | -1.41309 |
| .0500                           | .03555  | -2.28040                    | -2.24776 | -2.46692 | -2.41563 | -2.32237 | -2.24776 | -2.18248 | -1.88405 | -1.59028 | -1.21725 |
| .1000                           | .04683  | -1.66489                    | -1.62759 | -1.75349 | -1.73950 | -1.70686 | -1.65557 | -1.58096 | -1.42242 | -1.23590 | -1.02140 |
| .1500                           | .05345  | -1.34781                    | -1.29185 | -1.41309 | -1.38978 | -1.35714 | -1.31983 | -1.23590 | -1.13331 | -1.01208 | -.92814  |
| .2000                           | .05736  | -1.14730                    | -1.08202 | -1.16129 | -1.14730 | -1.11000 | -1.09135 | -1.06337 | -.94213  | -.86752  | -.89550  |
| .3000                           | .06001  | -.87219                     | -.80690  | -.84421  | -.83488  | -.80690  | -.77893  | -.75561  | -.69033  | -.66702  | -.69033  |
| .4000                           | .05803  | -.68567                     | -.60173  | -.62039  | -.62971  | -.59241  | -.54578  | -.56443  | -.53179  | -.52713  | -.50381  |
| .5000                           | .05294  | -.52713                     | -.44786  | -.45252  | -.45252  | -.42920  | -.41055  | -.41055  | -.34927  | -.39656  | -.35926  |
| .6000                           | .04563  | -.39656                     | -.31263  | -.32194  | -.30330  | -.30330  | -.29864  | -.29864  | -.25667  | -.27999  | -.23802  |
| .7000                           | .03664  | -.27533                     | -.20538  | -.21004  | -.19139  | -.18673  | -.17274  | -.19875  | -.19875  | -.13544  | -.10280  |
| .8000                           | .02623  | -.17274                     | -.09813  | -.09347  | -.04218  | -.07948  | -.06549  | -.05150  | -.06083  | -.07482  | -.05108  |
| .9000                           | .01448  | -.06549                     | -.00021  | .00912   | .01844   | .02776   | .03708   | .04640   | .05572   | .06504   | .07436   |
| .9800                           | .00403  | .02310                      | .06973   | .07440   | .11170   | .12103   | .12103   | .13035   | .13967   | .14900   | .15832   |
| .0125                           | -.01894 | .80648                      | .81581   | .95104   | .96969   | .98834   | 1.00233  | .98368   | .96036   | .90441   | .59199   |
| .0250                           | -.02615 | .84146                      | .98368   | .95570   | .89042   | .87177   | .84379   | .85778   | .76918   | .72255   | .21429   |
| .0500                           | -.03555 | .87643                      | .96503   | .90441   | .89042   | .89042   | .97435   | .96969   | .97435   | .98368   | .57749   |
| .1000                           | -.04683 | .64794                      | .73654   | .63395   | .61064   | .59665   | .58732   | .61064   | .43811   | .42878   | .12569   |
| .1500                           | -.05345 | .47075                      | .56401   | .46142   | .45210   | .43811   | .43811   | .43811   | .39614   | .27957   | .01844   |
| .2000                           | -.05736 | .32620                      | .41946   | .37749   | .34951   | .32020   | .31687   | .31687   | .23294   | .16766   | -.03285  |
| .3000                           | -.06001 | .15367                      | .24693   | .21429   | .22924   | .19563   | .19097   | .15833   | .13502   | .02777   | -.10280  |
| .4000                           | -.05803 | .06041                      | .15367   | .16299   | .14434   | .16299   | .14900   | .13968   | .10238   | .05572   | -.13077  |
| .5000                           | -.05294 | -.00487                     | .08839   | .11170   | .10704   | .10704   | .10704   | .09771   | .08372   | .07440   | -.13544  |
| .6000                           | -.04563 | -.04684                     | .04642   | .07906   | .09305   | .10704   | .09771   | .08372   | .09305   | .07906   | -.09347  |
| .7000                           | -.03664 | -.10280                     | -.00954  | .08839   | .07906   | .07440   | .08372   | .09305   | .07906   | .05108   | -.03477  |
| .8000                           | -.02623 | -.09347                     | -.00954  | .05575   | .08372   | .08372   | .09771   | .10238   | .08372   | .08372   | -.00954  |
| .9000                           | -.01448 | -.04684                     | .01844   | .06507   | .07440   | .09771   | .10238   | .10704   | .10238   | .12103   | -.11170  |
| .9800                           | -.00403 | -.00021                     | .06973   | .10704   | .07440   | .12103   | .12569   | .15367   | .16299   | .16165   | -.24693  |
| INTEGRATED $c_n$                |         | .8614                       | .9189    | .9812    | .9349    | .8990    | .8578    | .8339    | .7408    | .6768    | .3659    |
| $\Delta\alpha$ , (DEG)          |         | 0.000                       | 0.000    | 0.000    | 0.000    | 0.000    | 0.000    | 0.000    | 0.000    | 0.000    | -15.000  |
| $\alpha + \Delta\alpha$ , (DEG) |         | 12.200                      | 12.200   | 12.200   | 12.200   | 12.200   | 12.200   | 12.200   | 12.200   | 12.200   | -2.800   |
| RESULTANT $c_l$                 |         | .8420                       | .8981    | .9591    | .9137    | .8787    | .8385    | .8131    | .7241    | .6615    | .3655    |

| x/c                             | z/c     | VALUES OF $c_p$ FOR $y/s =$ |         |         |          |          |          |          |          |          |         |
|---------------------------------|---------|-----------------------------|---------|---------|----------|----------|----------|----------|----------|----------|---------|
|                                 |         | .58461                      | .63223  | .67985  | .72747   | .77509   | .82270   | .87032   | .91794   | .96556   | .98937  |
| 0.0000                          | 0.00000 | .88575                      | .95570  | .95104  | -.01886  | -.07948  | .30755   | .37749   | .47541   | .65727   | .73188  |
| .0125                           | .01894  | -.62971                     | -.44319 | -.55044 | -1.61826 | -1.71132 | -1.35714 | -1.24989 | -1.14730 | -.91415  | -.70898 |
| .0250                           | .02615  | -1.31568                    | -.64836 | -.67634 | -1.27320 | -1.50169 | -1.24056 | -1.15663 | -1.33382 | -1.38045 | -.67401 |
| .0500                           | .03555  | -.77893                     | -.71831 | -.80224 | -1.17062 | -1.24989 | -1.06337 | -1.06337 | -.96078  | -1.78359 | -.63904 |
| .1000                           | .04683  | -.73696                     | -.69499 | -.77893 | -.89550  | -.88618  | -.90483  | -.84887  | -.76494  | -.62971  | -.51179 |
| .1500                           | .05345  | -.62971                     | -.63437 | -.69966 | -.70898  | -.76027  | -.71365  | -.69303  | -.51314  | -.42920  | -.42920 |
| .2000                           | .05736  | -.52971                     | -.58774 | -.61372 | -.62971  | -.64836  | -.62039  | -.58774  | -.54112  | -.27999  | -.36899 |
| .3000                           | .06001  | -.38724                     | -.47583 | -.48050 | -.47583  | -.46651  | -.47583  | -.43853  | -.41521  | -.31729  | -.27066 |
| .4000                           | .05803  | -.37325                     | -.36392 | -.36392 | -.36392  | -.34061  | -.34527  | -.35460  | -.29864  | -.24268  | -.21471 |
| .5000                           | .05294  | -.23667                     | -.26134 | -.25667 | -.26134  | -.25667  | -.21937  | -.24268  | -.21004  | -.14943  | -.15875 |
| .6000                           | .04563  | -.18673                     | -.16341 | -.16341 | -.14476  | -.14476  | -.14476  | -.15409  | -.11212  | -.13544  | -.11678 |
| .7000                           | .03664  | -.06549                     | -.06063 | -.06063 | -.06063  | -.03150  | -.07482  | -.07015  | -.06083  | -.05150  | -.09347 |
| .8000                           | .02623  | .06041                      | .03243  | .05575  | .03709   | .01378   | .01378   | -.00021  | -.00487  | -.00954  | -.05617 |
| .9000                           | .01448  | .20030                      | .18631  | .15833  | .11636   | .12103   | .10704   | .09771   | .08372   | .05572   | -.08881 |
| .9800                           | .00403  | .33592                      | .32620  | .30288  | .20446   | .18631   | .19097   | .20030   | .16766   | .13502   | -.11678 |
| .0125                           | -.01894 | .32204                      | .50329  | .45210  | .93705   | .99767   | .87177   | .83444   | .79716   | .75053   | .64328  |
| .0250                           | -.02615 | .27491                      | .22361  | .23760  | .72259   | .75985   | .61530   | .61530   | .53603   | .45676   | .37283  |
| .0500                           | -.03555 | .07906                      | .06041  | .06507  | .44744   | .44744   | .34951   | .32620   | .26658   | .20962   | .13035  |
| .1000                           | -.04683 | .04176                      | -.07015 | -.02353 | .19097   | .23760   | .14434   | .12103   | .07440   | .02777   | -.00954 |
| .1500                           | -.05345 | -.06549                     | -.09813 | -.07015 | -.06041  | .12569   | .05108   | .02310   | -.01420  | -.03285  | -.07482 |
| .2000                           | -.05736 | -.04684                     | -.10746 | -.08881 | -.00487  | .04642   | -.01420  | .00912   | -.05617  | -.07948  | -.09347 |
| .3000                           | -.06001 | -.03285                     | -.08881 | -.07482 | -.03751  | -.04218  | -.03751  | -.05617  | -.08414  | -.08414  | -.10746 |
| .4000                           | -.05803 | -.01844                     | -.06549 | -.06063 | -.03150  | -.04684  | -.00487  | -.07015  | -.08414  | -.07948  | -.09347 |
| .5000                           | -.05294 | -.05617                     | -.00487 | -.04218 | -.03751  | -.02819  | -.04684  | -.04218  | -.07948  | -.04218  | -.08414 |
| .6000                           | -.04563 | .00445                      | .02310  | -.01886 | -.00487  | -.00954  | -.02353  | -.03751  | -.05150  | -.06549  | -.08414 |
| .7000                           | -.03664 | .02310                      | .04176  | .01378  | .03243   | .04642   | .01378   | -.01420  | -.02353  | -.04218  | -.06063 |
| .8000                           | -.02623 | .14434                      | .12569  | .06041  | .05575   | .08839   | .04642   | .02777   | .00445   | -.00954  | -.04218 |
| .9000                           | -.01448 | .18148                      | .20446  | .18165  | .12103   | .14434   | .10238   | .07906   | .04176   | .07906   | -.00487 |
| .9800                           | -.00403 | .32620                      | .34465  | .29356  | .20462   | .17698   | .16766   | .16766   | .14900   | .13502   | .04642  |
| INTEGRATED $c_n$                |         | .3177                       | .2711   | .2740   | .3873    | .4103    | .3689    | .3298    | .2849    | .2174    | .1851   |
| $\Delta\alpha$ , (DEG)          |         | -15.000                     | -15.000 | -11.250 | -3.750   | -3.000   | -6.000   | -6.000   | -6.000   | -6.000   | -6.000  |
| $\alpha + \Delta\alpha$ , (DEG) |         | -2.800                      | -2.800  | .950    | 8.450    | 9.200    | 6.200    | 6.200    | 6.200    | 6.200    | 6.200   |
| RESULTANT $c_l$                 |         | .3174                       | .2708   | .2739   | .3831    | .4030    | .3667    | .3279    | .2833    | .2161    | .1840   |

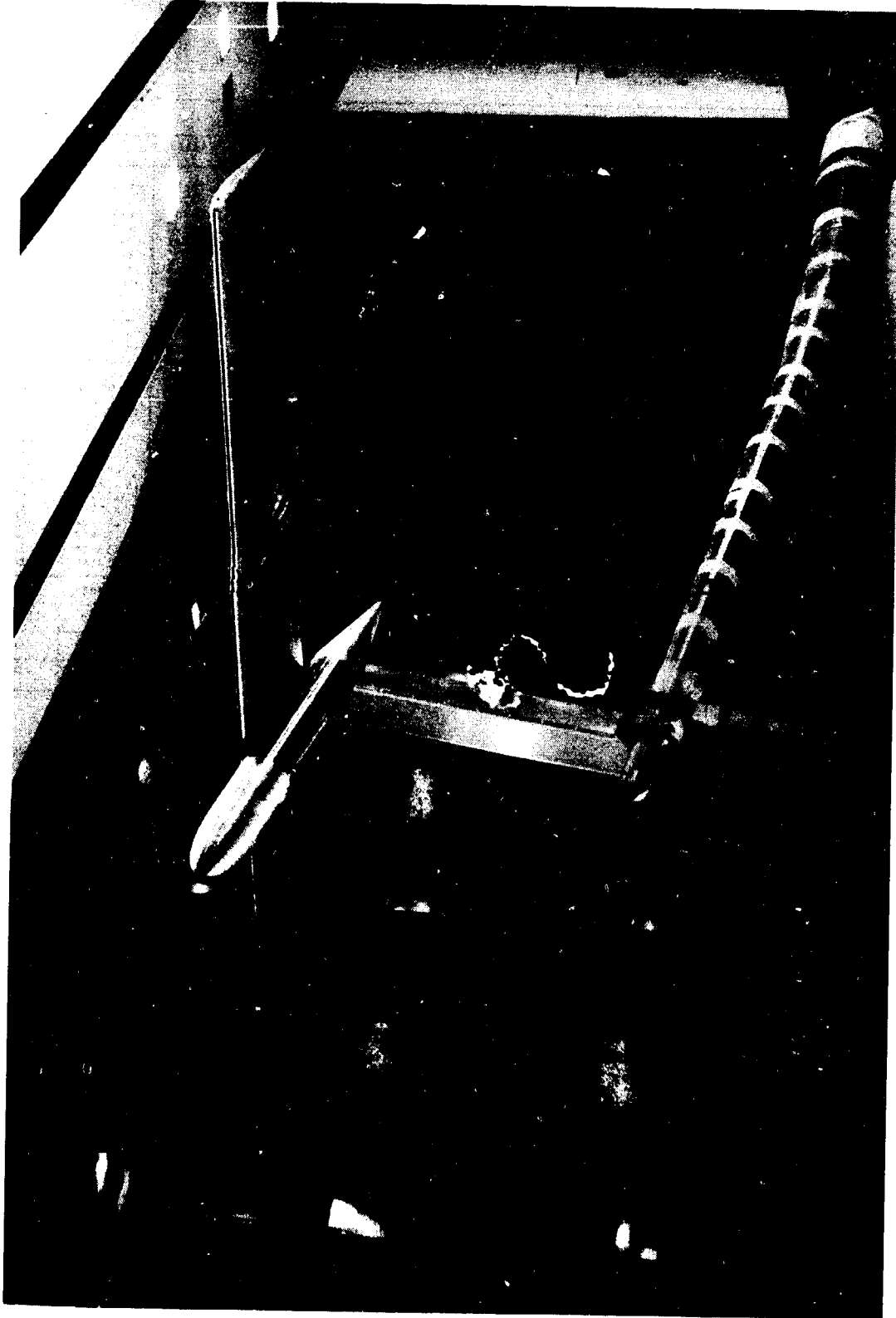

L-77-8375

Figure 1. Variable twist wing (VTW) model blade mounted in test section of the Langley 4 by 7-Meter Tunnel.

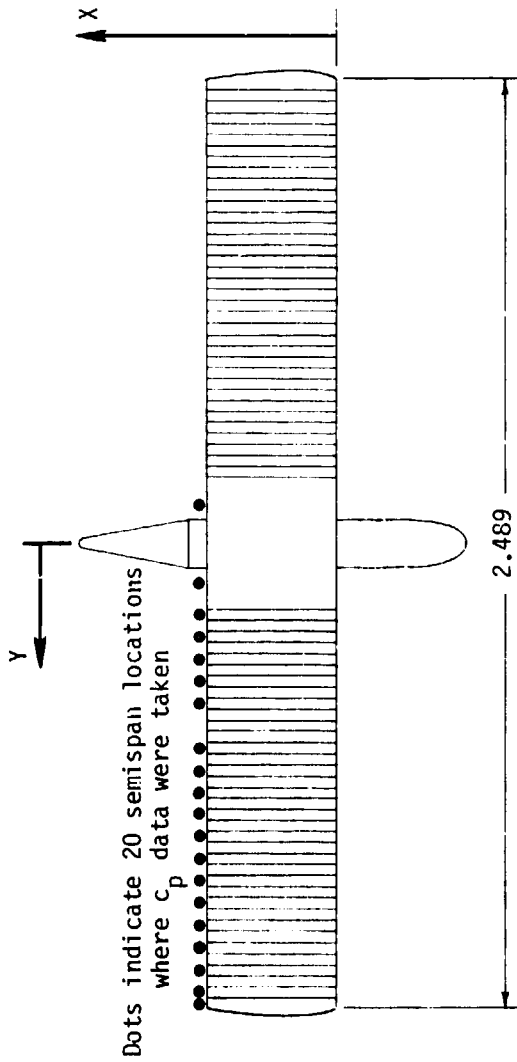

| Wing Characteristics |                       |
|----------------------|-----------------------|
| Area, S              | 0.8852 m <sup>2</sup> |
| Semispan, s          | 1.245 m               |
| Chord, c             | 0.3556 m              |
| Aspect ratio         | 7                     |
| Taper ratio          | 1                     |
| Airfoil section      | NACA 0012             |
| Segment width        | 0.02964 m             |

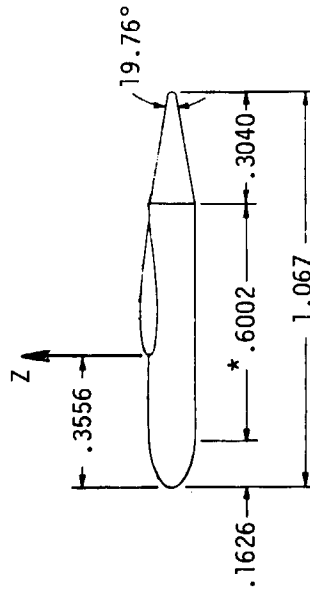
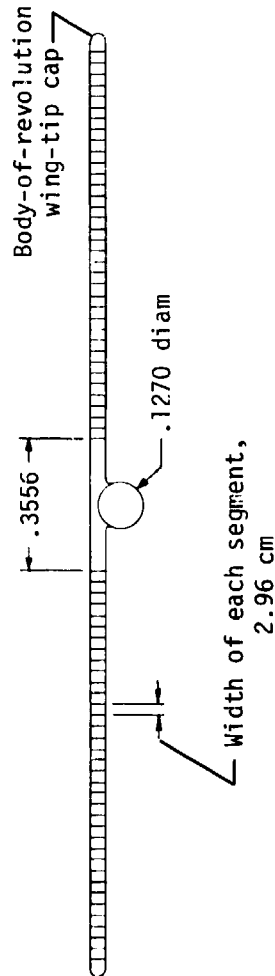

\* Cylindrical body length

Figure 2. Three-view sketch of VTW model with no wing twist applied. All dimensions are in meters unless otherwise specified.

| Device     | Front-face position, x/c |
|------------|--------------------------|
| Spoiler    | 0.30                     |
| Drag plate | 1.43                     |

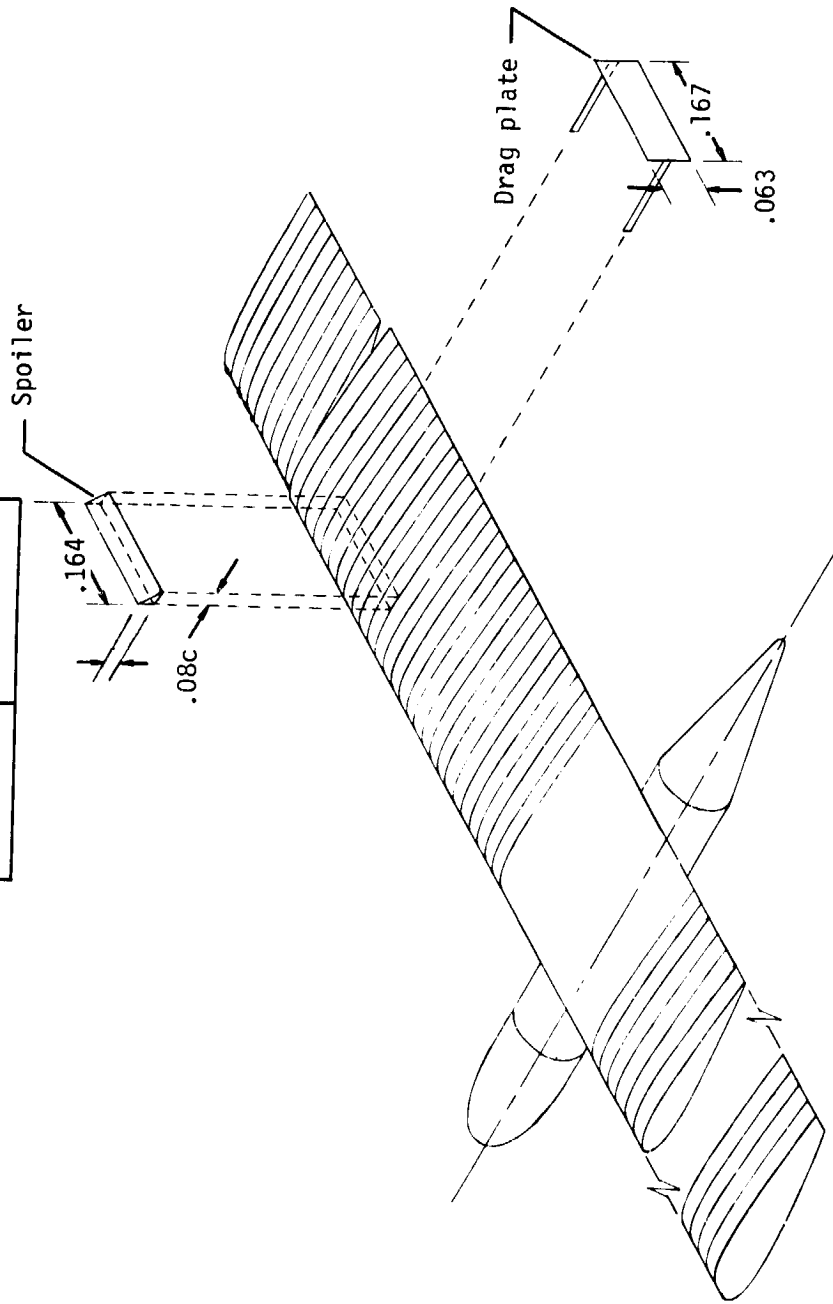

Figure 3. Installation of spoilers and drag plates on the VTW. Each device was centered at  $y/s = \pm 0.607$  and tested independently, with the spoilers installed on VTW7S<sub>0</sub> and the drag plates installed on VTW7S<sub>3P</sub>. Unless noted, all dimensions are normalized by the VTW semispan.

ORIGINAL PAGE IS  
OF POOR QUALITY

VTW1



VTW2

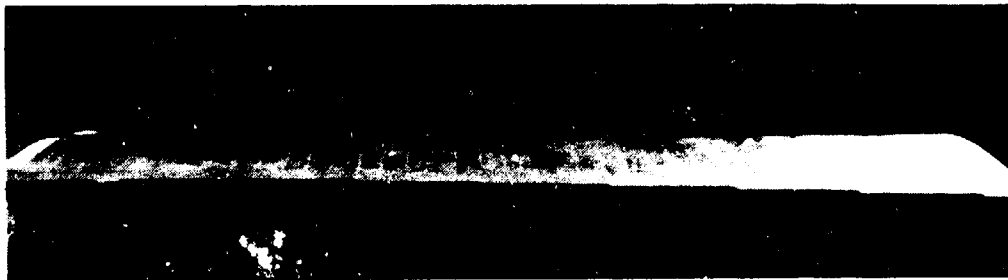

VTW3

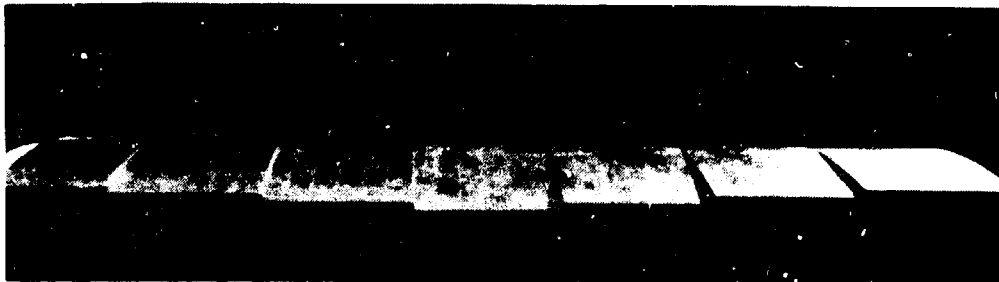

VTW4

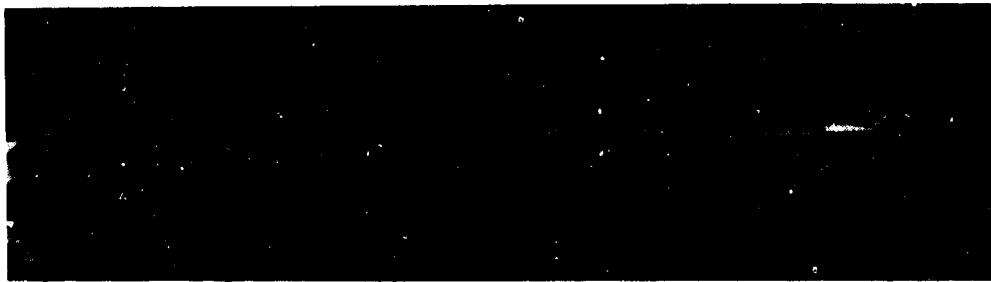

L-84-10,699

(a) Group I—continuous span-load distributions.

Figure 4. VTW group photographs.



ORIGINAL PAGE IS  
OF POOR QUALITY

VTW5



VTW6



VTW7

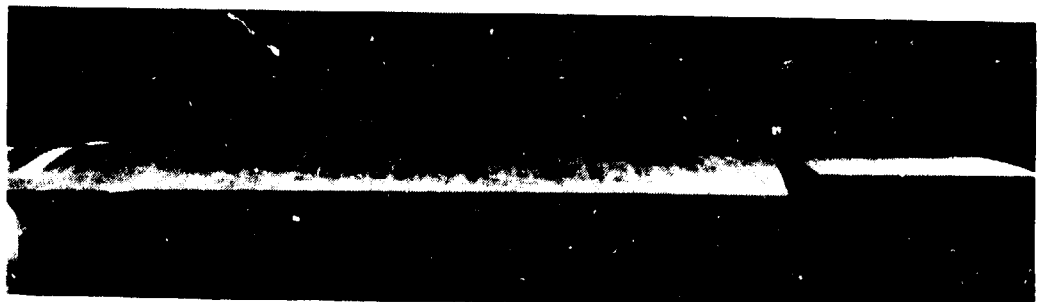

(b) Group II—part-span-flap span-load distributions.

L-84-10,700

Figure 4. Continued.

ORIGINAL PAGE IS  
OF POOR QUALITY

VTW7S<sub>0</sub>

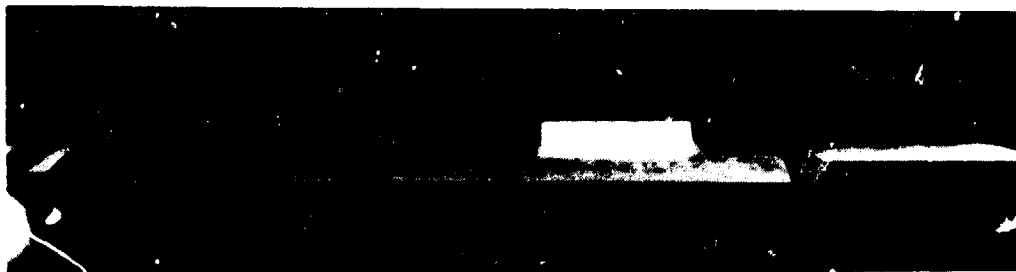

VTW7S<sub>1</sub>

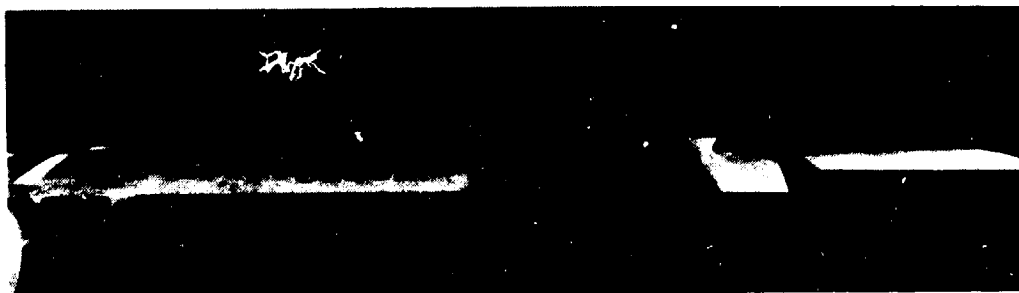

VTW7S<sub>3</sub>



VTW7S<sub>3</sub>P

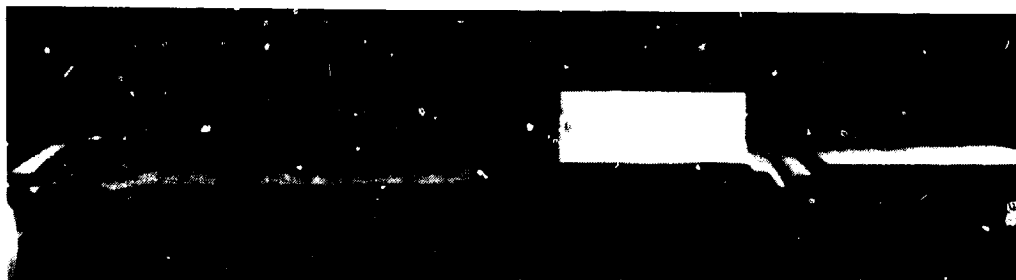

(c) Group III—alleviated wake vortex configurations.

L-84-12,901

Figure 4. Concluded.

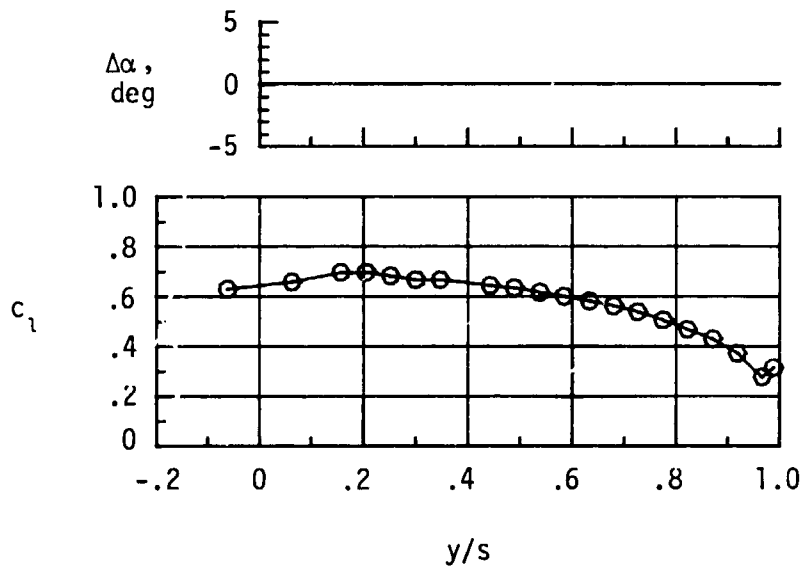

(a) VTW1 configuration.  $\alpha = 7.50^\circ$ .

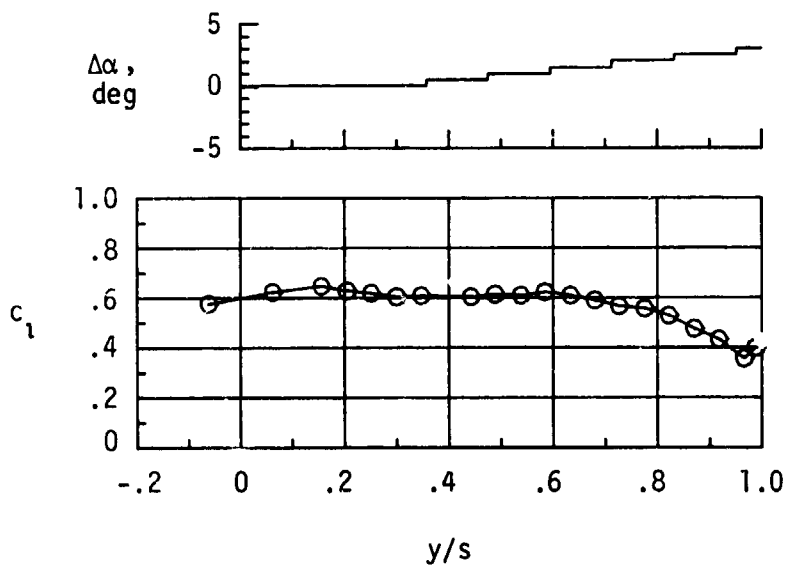

(b) VTW2 configuration.  $\alpha = 6.50^\circ$ .

Figure 5. Wing twist distributions and measured span-load distributions for group I VTW configurations at a nominal  $C_L = 0.6$ .

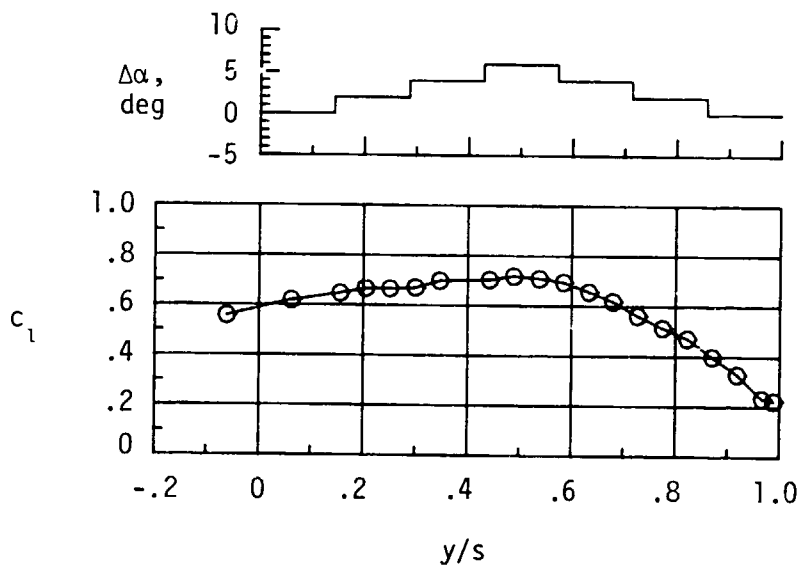

(c) VTW3 configuration.  $\alpha = 4.80^\circ$ .

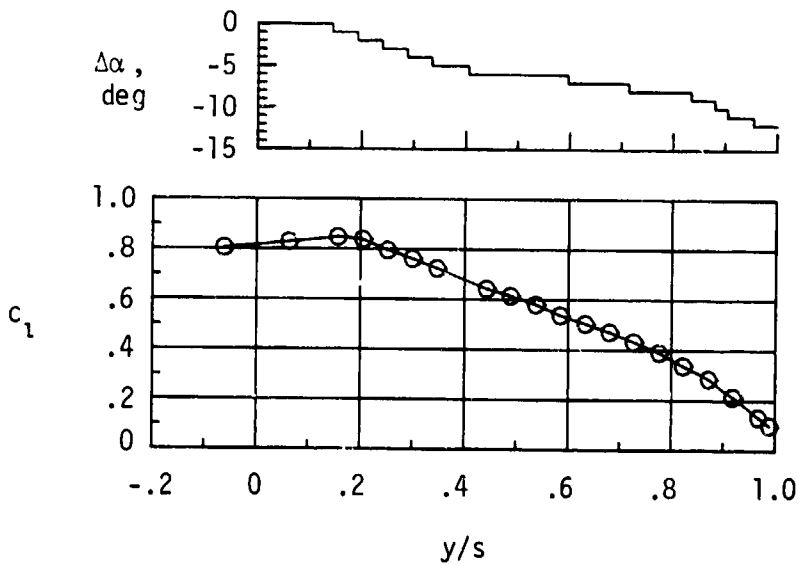

(d) VTW4 configuration.  $\alpha = 12.50^\circ$ .

Figure 5. Concluded.

- Measured, upper surface
- Measured, lower surface
- ◇ Interpolated, trailing edge

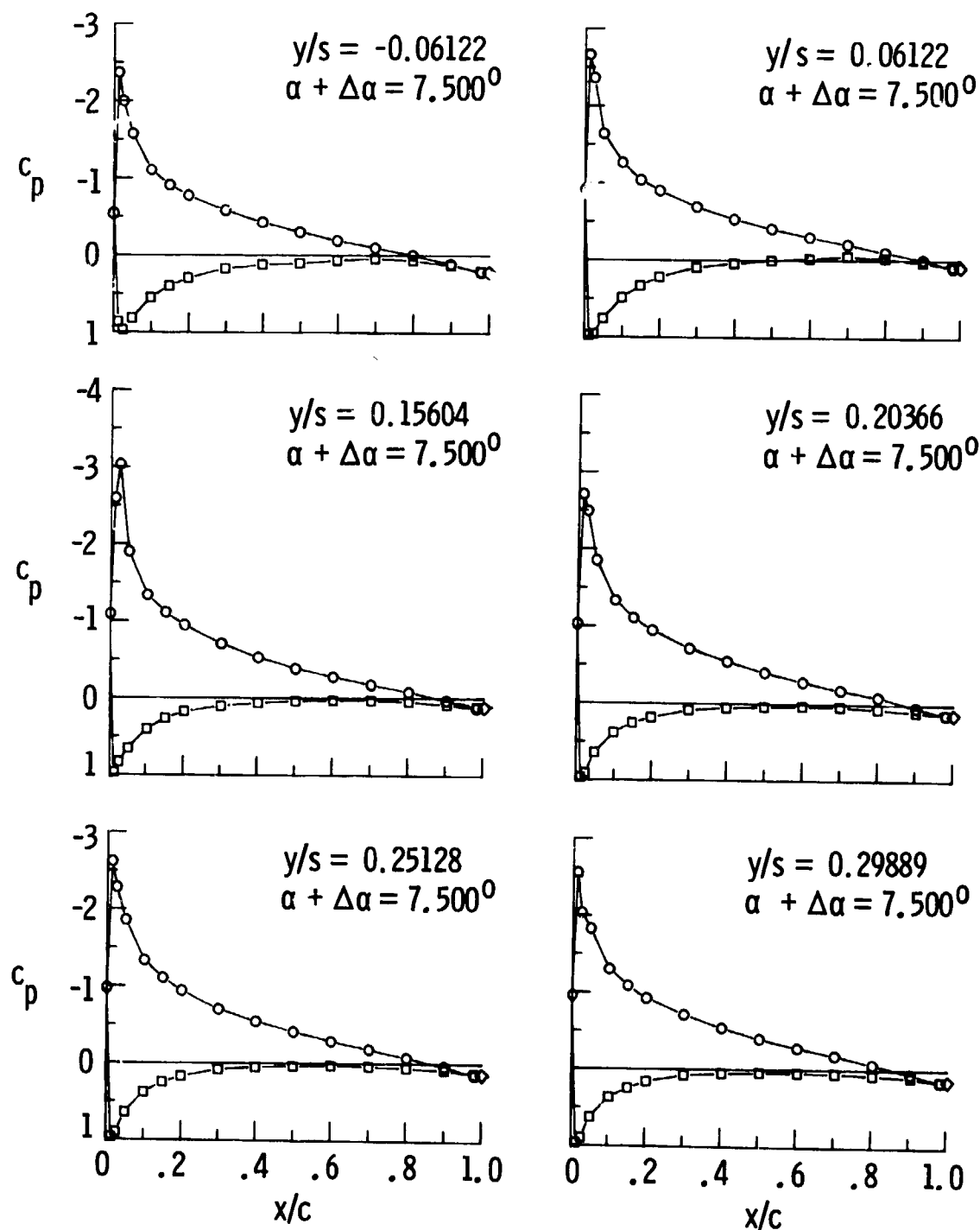

(a) VTW1 configuration.

Figure 6. Pressure distribution measurements for group I VTW configurations.

- Measured, upper surface
- Measured, lower surface
- ◇ Interpolated, trailing edge

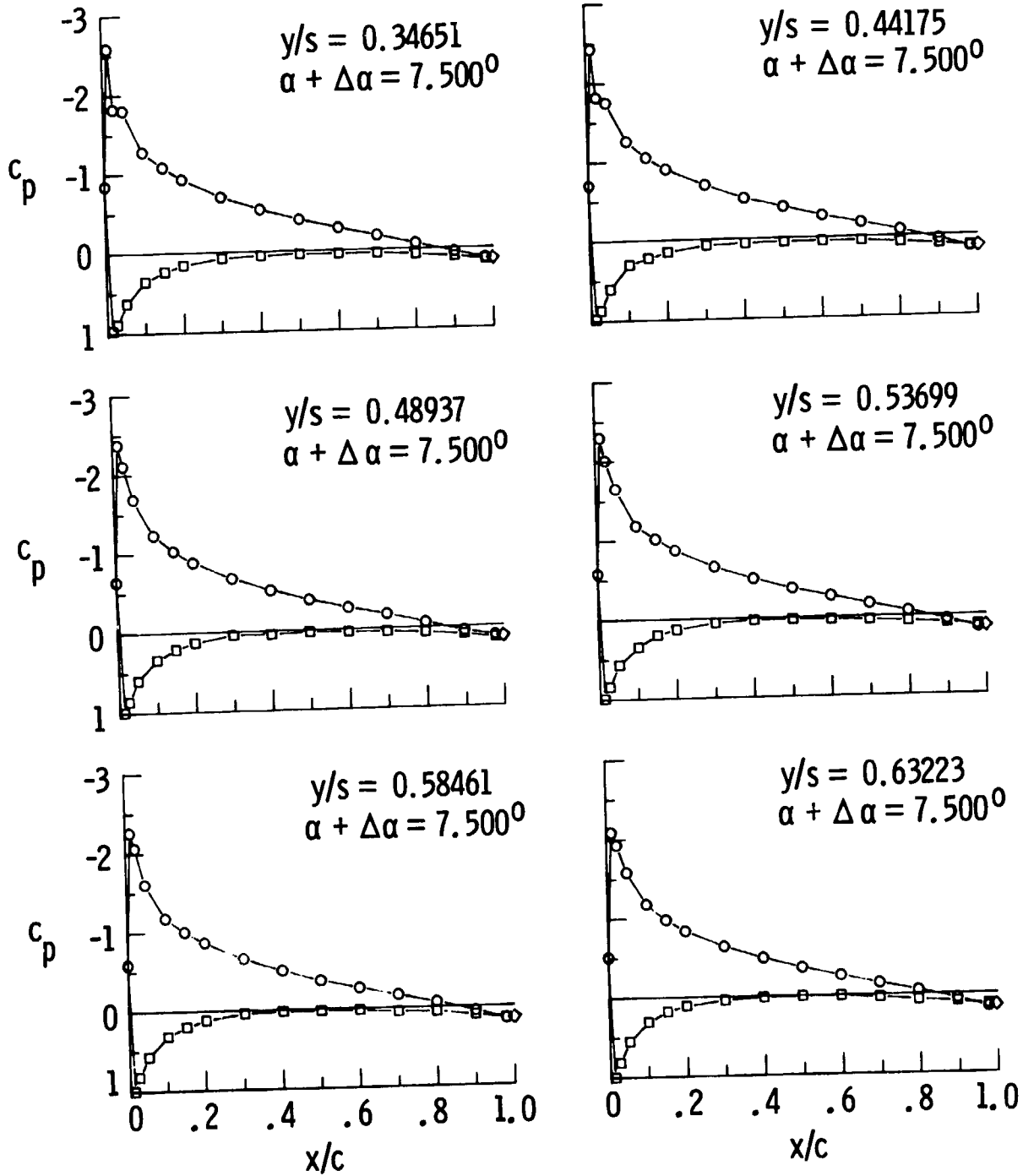

(a) Continued.

Figure 6. Continued.

- Measured, upper surface
- Measured, lower surface
- ◇ Interpolated, trailing edge

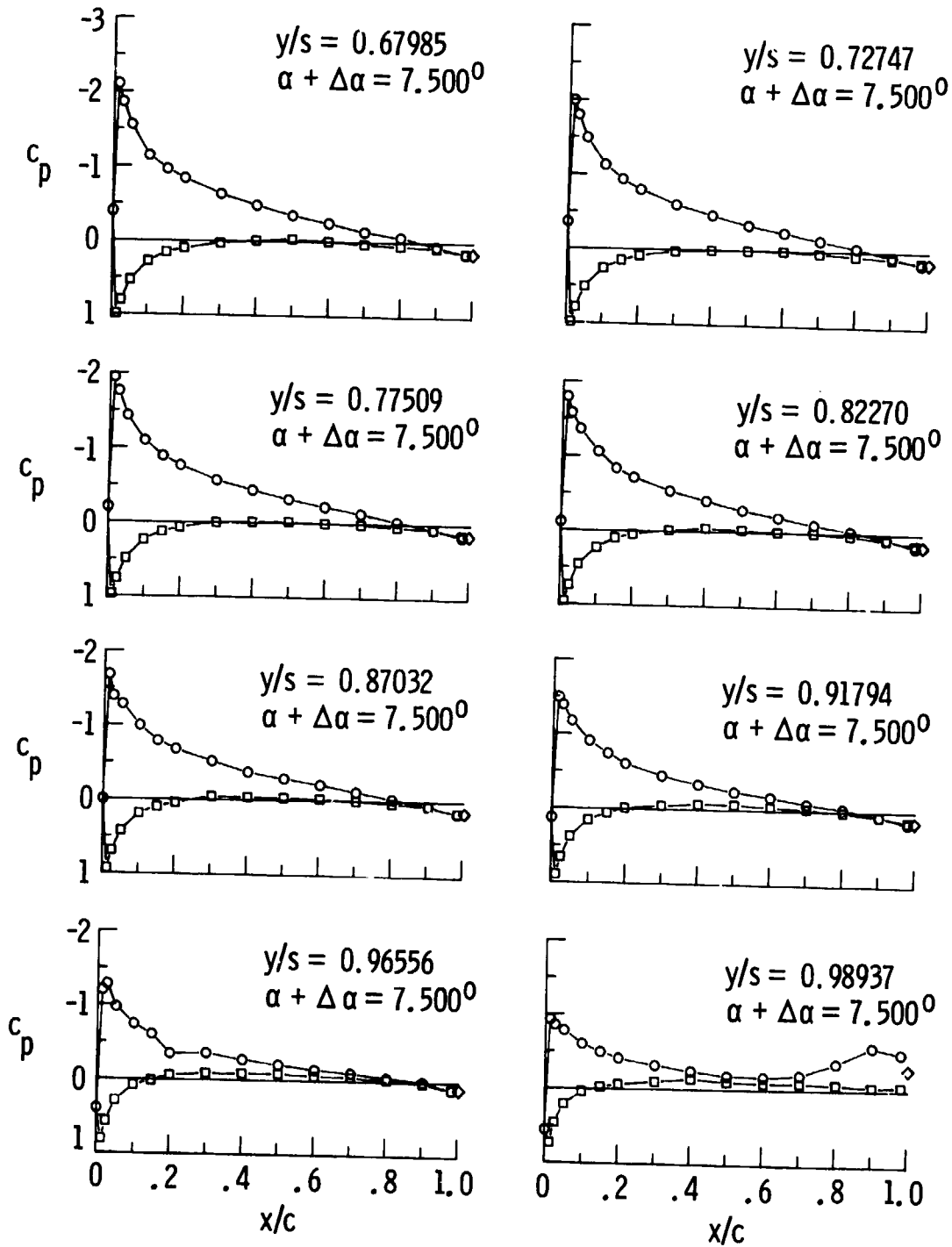

(a) Concluded.

Figure 6. Continued.

- Measured, upper surface
- Measured, lower surface
- ◇ Interpolated, trailing edge

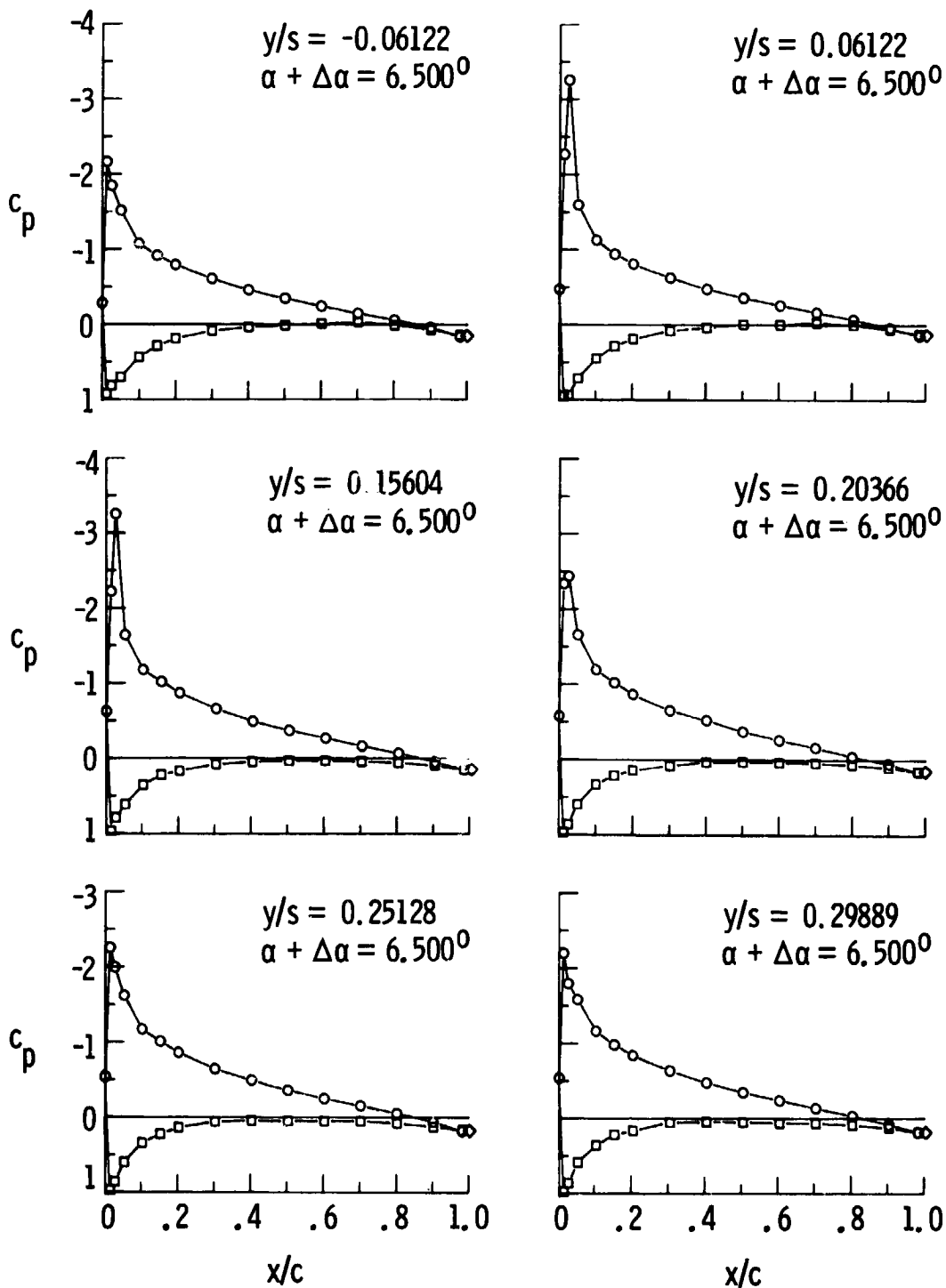

(b) VTW2 configuration.

Figure 6. Continued.



- Measured, upper surface
- Measured, lower surface
- ◇ Interpolated, trailing edge

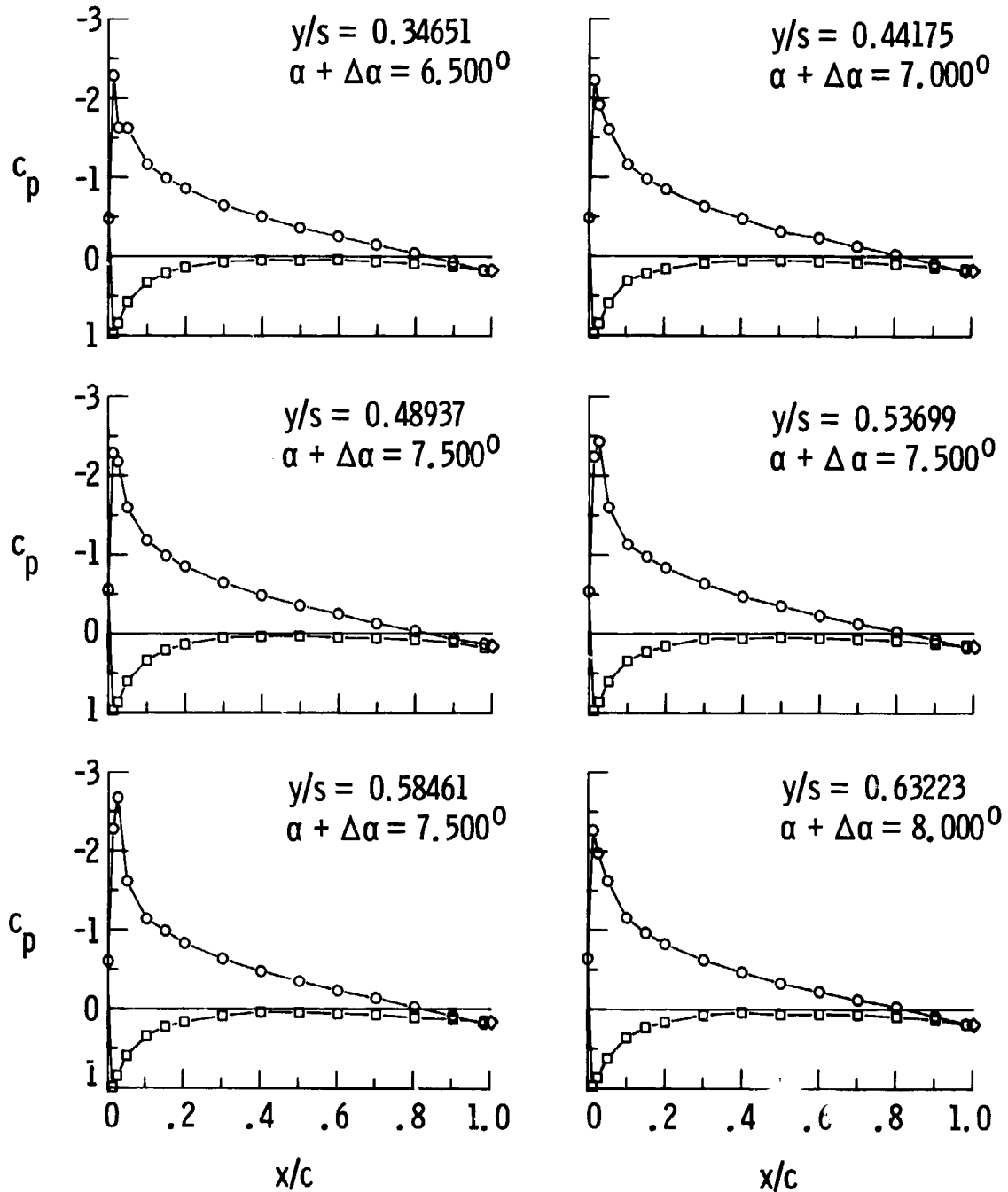

(b) Continued.

Figure 6. Continued.

- Measured, upper surface
- Measured, lower surface
- ◇ Interpolated, trailing edge

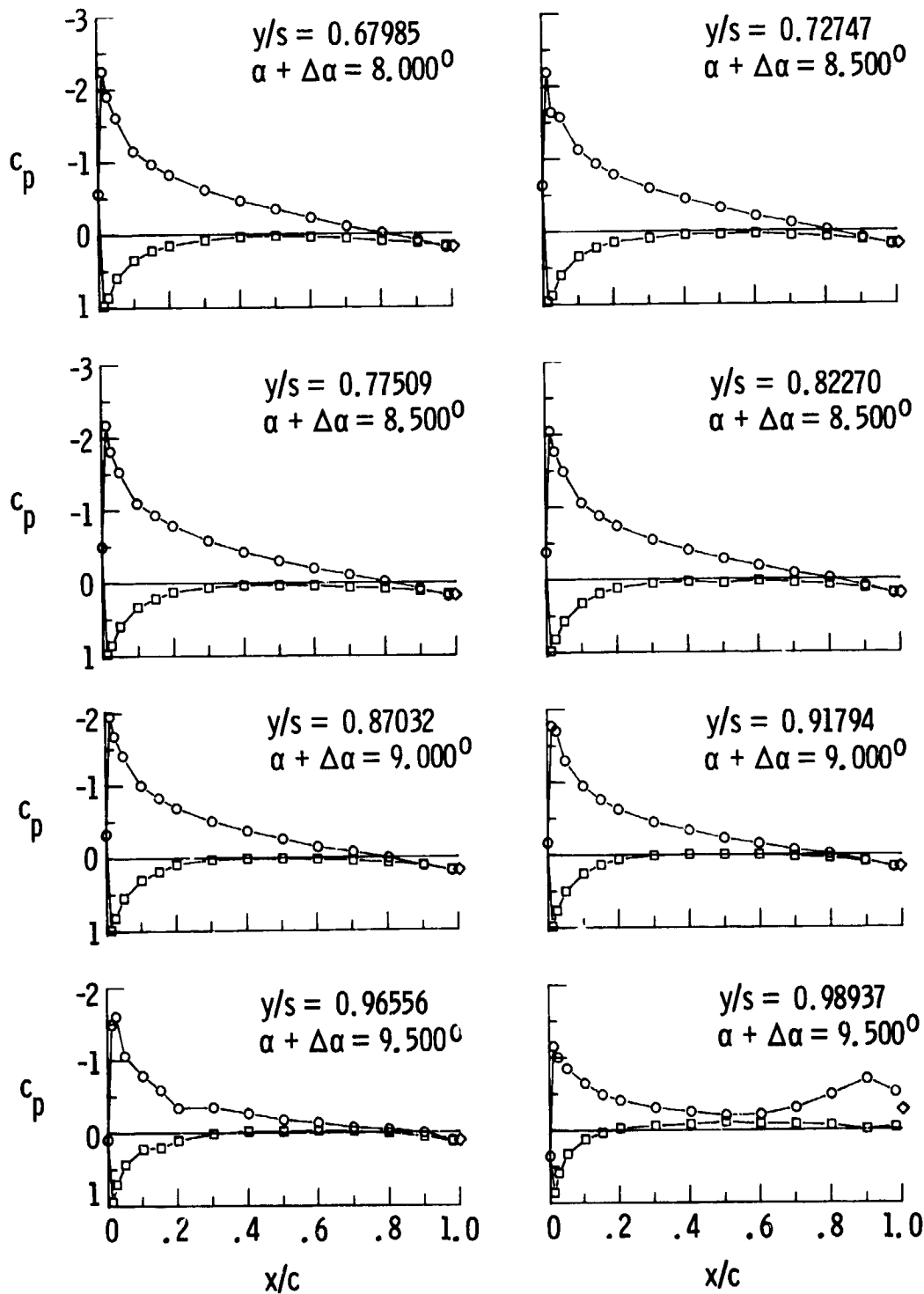

(b) Concluded.

Figure 6. Continued.

- Measured, upper surface
- Measured, lower surface
- ◇ Interpolated, trailing edge

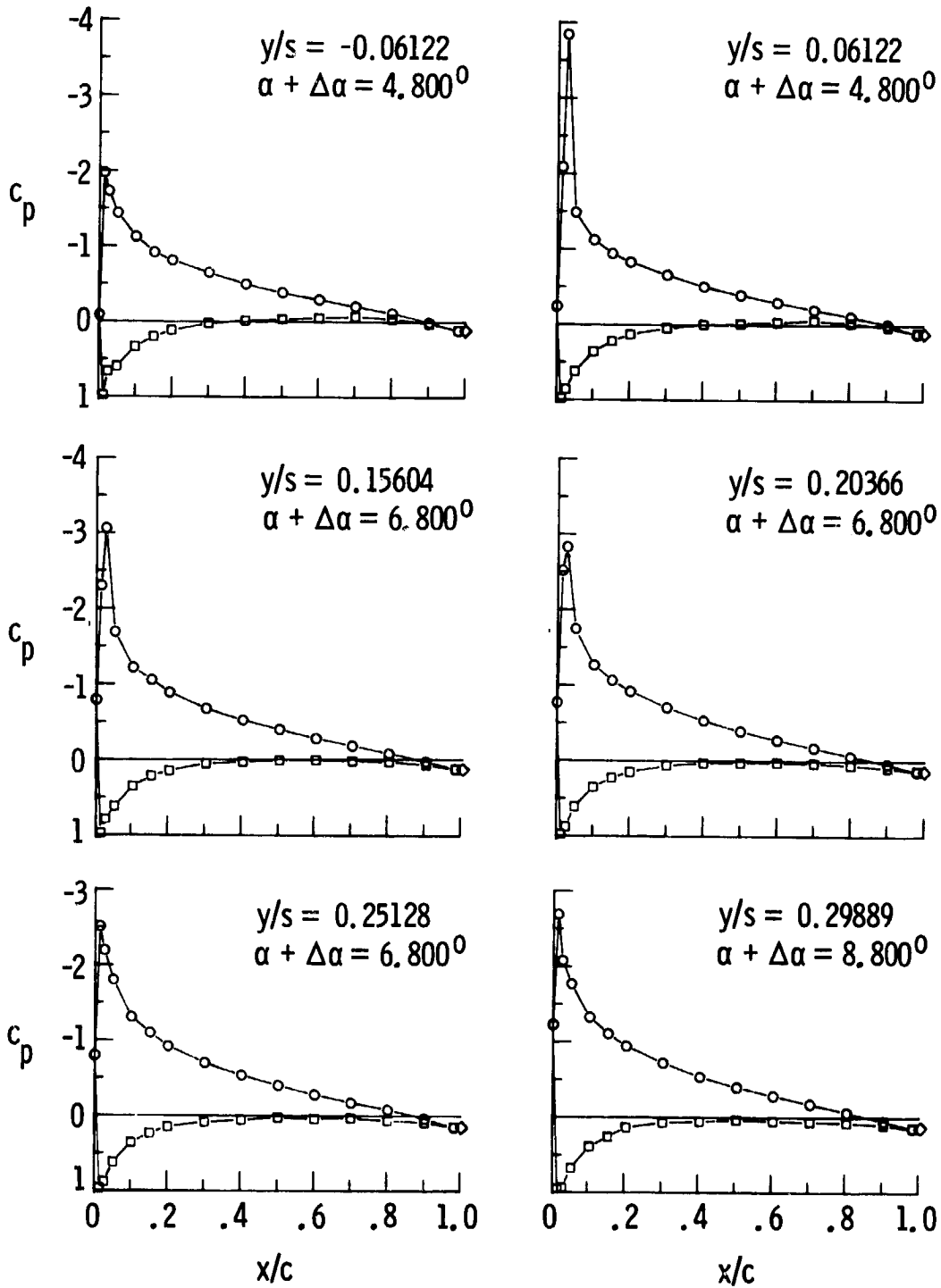

(c) VTW3 configuration.

Figure 6. Continued.

- Measured, upper surface
- Measured, lower surface
- ◇ Interpolated, trailing edge

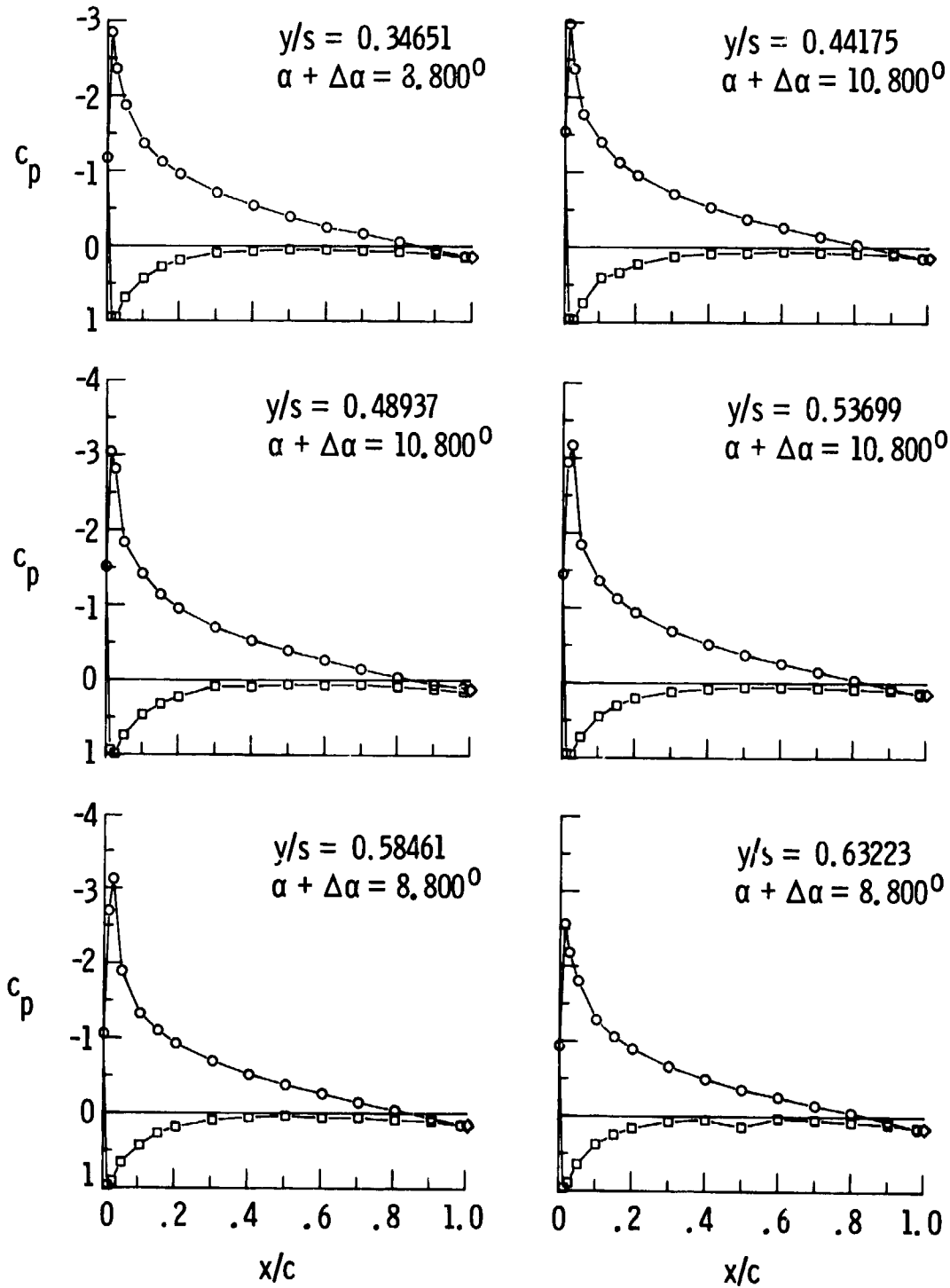

(c) Continued.

Figure 6. Continued.

- Measured, upper surface
- Measured, lower surface
- ◇ Interpolated, trailing edge

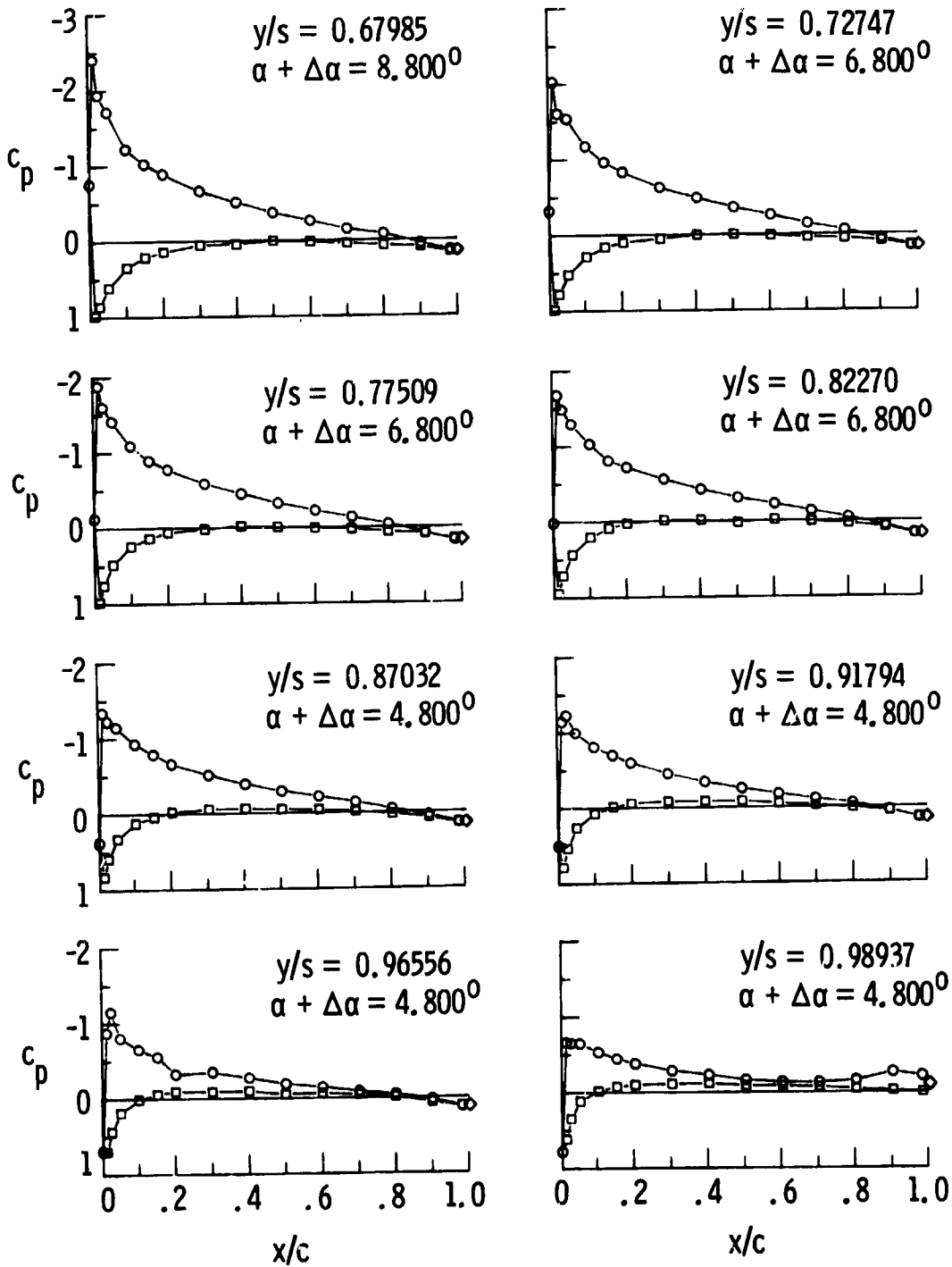

(c) Concluded.

Figure 6. Continued.

- Measured, upper surface
- Measured, lower surface
- ◇ Interpolated, trailing edge

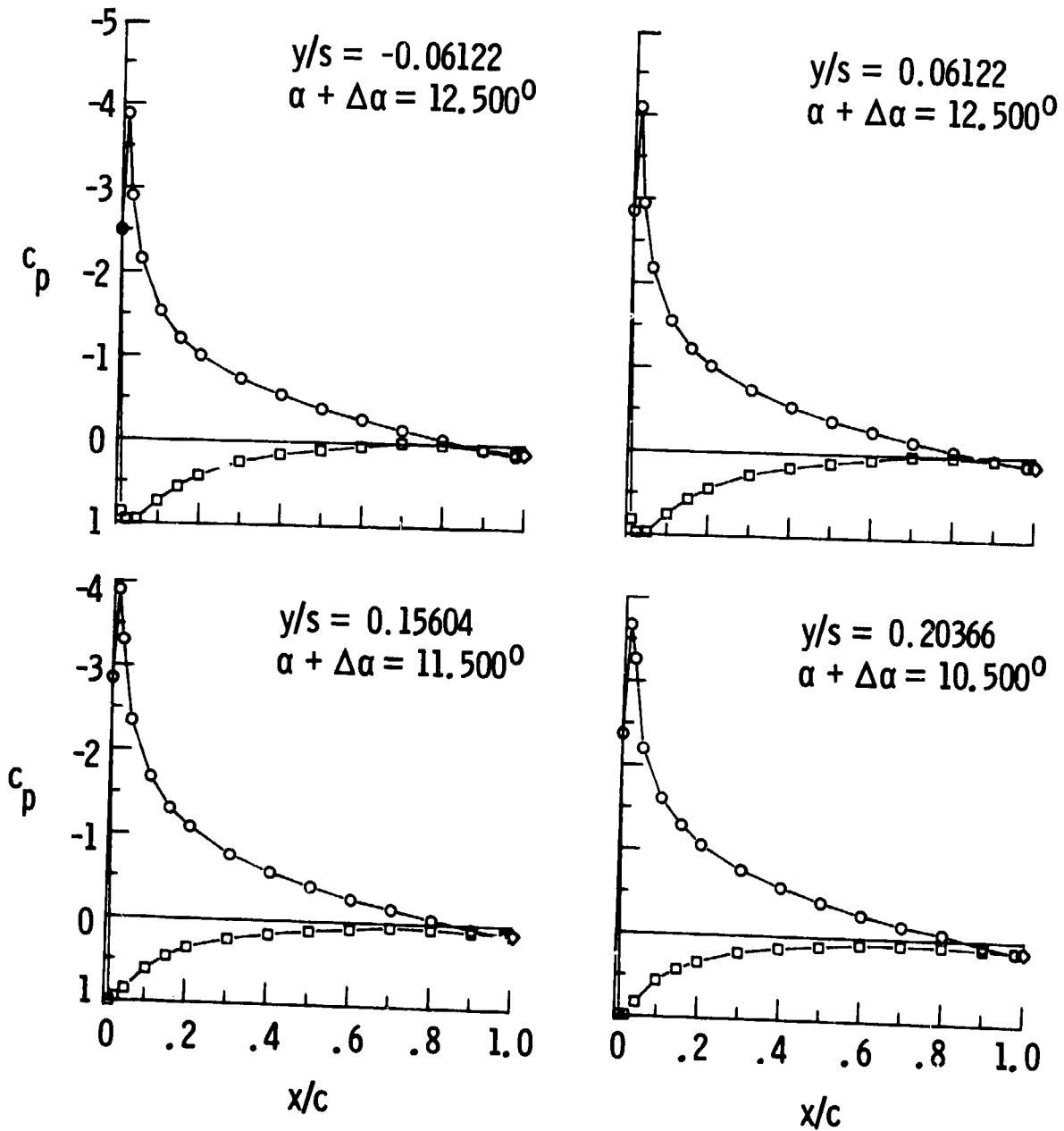

(d) VTW4 configuration.

Figure 6. Continued.

- Measured, upper surface
- Measured, lower surface
- ◇ Interpolated, trailing edge

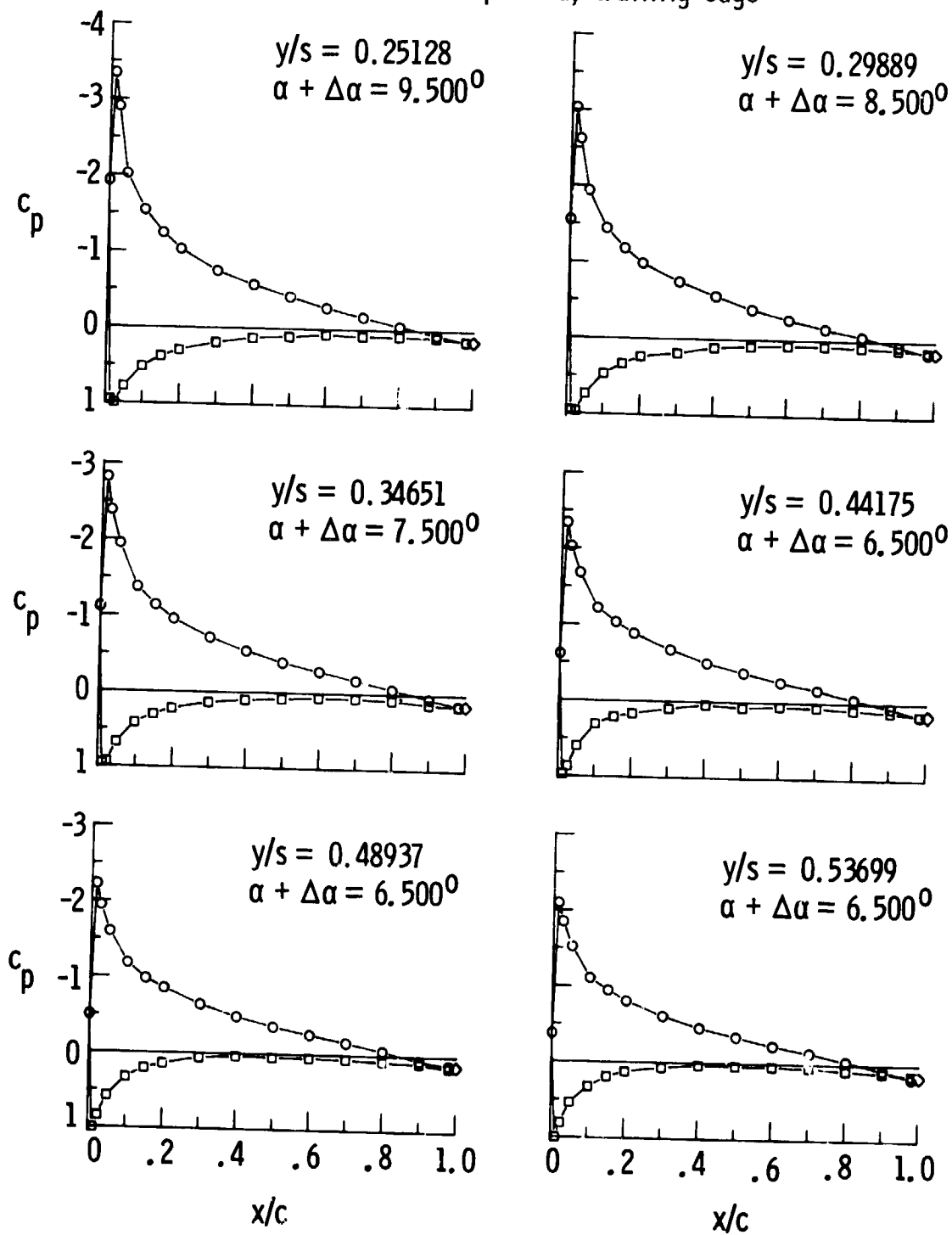

(d) Continued.

Figure 6. Continued.

- Measured, upper surface
- Measured, lower surface
- ◇ Interpolated, trailing edge

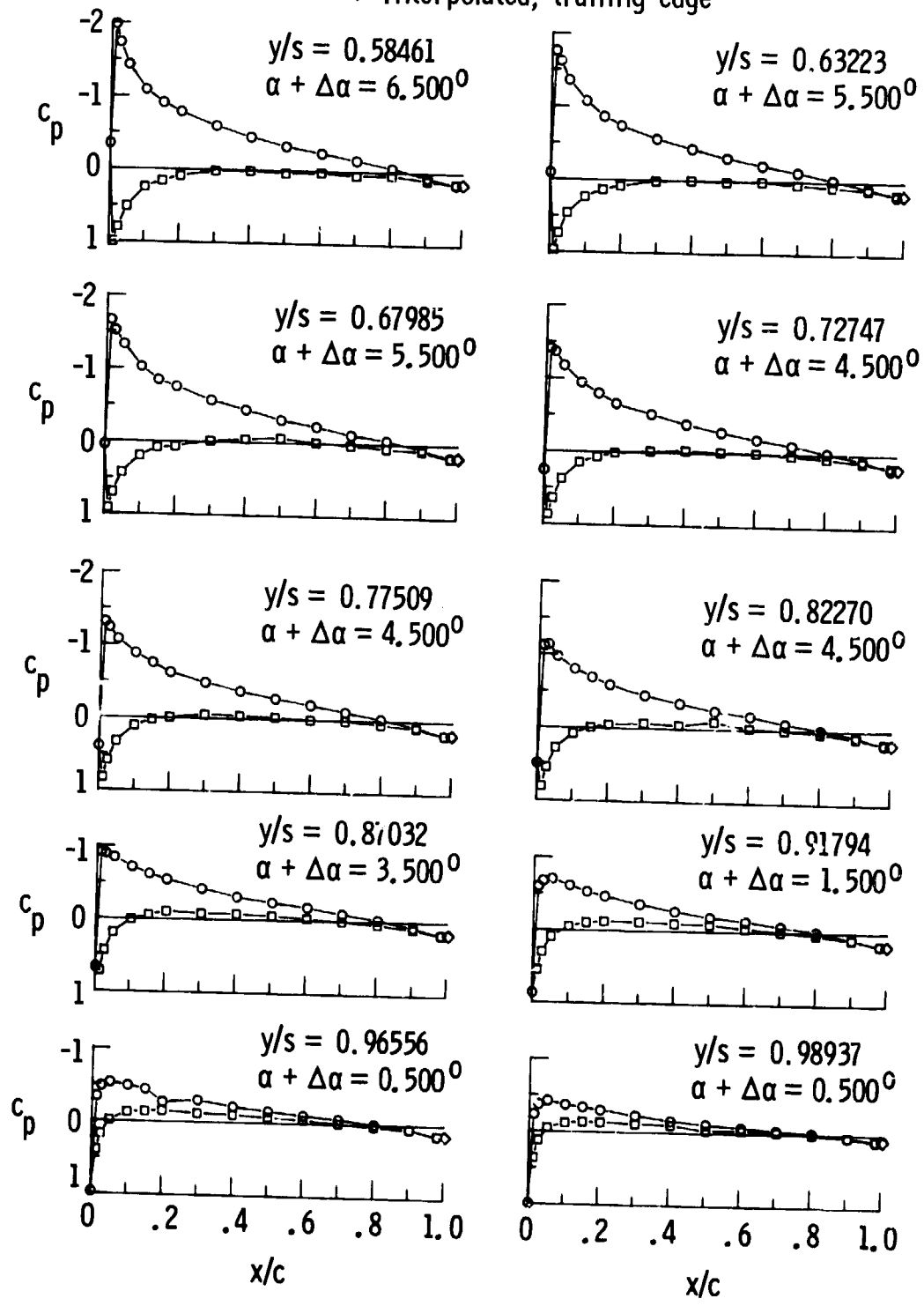

(d) Concluded.

Figure 6. Concluded.



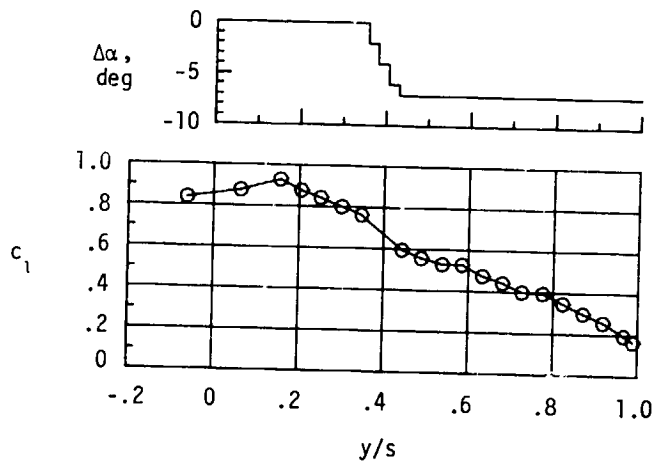

(a) VTW5 configuration.  $\alpha = 11.50^\circ$ .

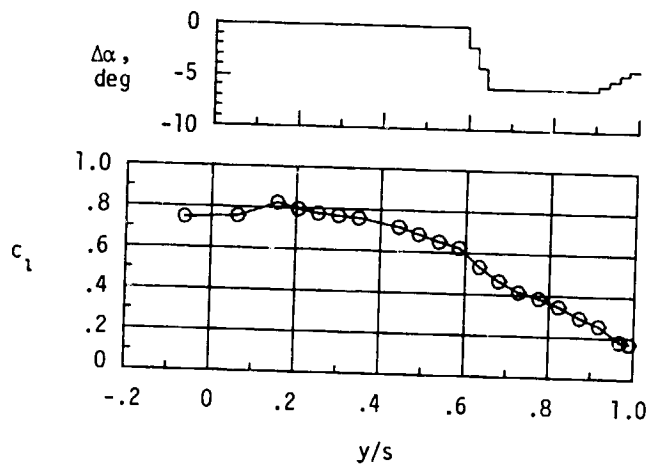

(b) VTW6 configuration.  $\alpha = 9.10^\circ$ .

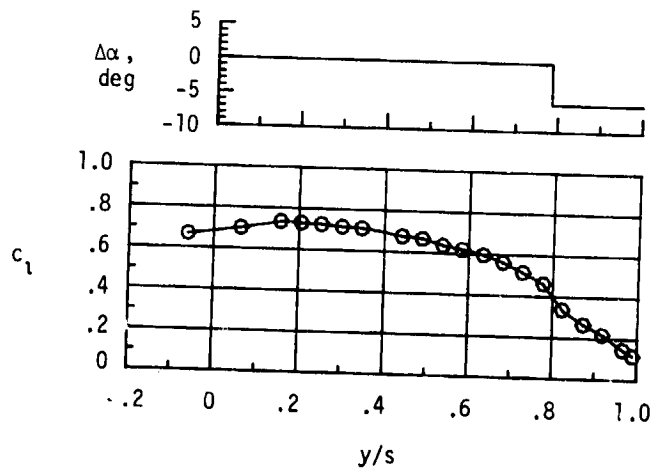

(c) VTW7 configuration.  $\alpha = 8.50^\circ$ .

Figure 7. Wing twist distributions and measured span-load distributions for group II VTW configurations at a nominal  $C_L = 0.6$ .

- Measured, upper surface
- Measured, lower surface
- ◇ Interpolated, trailing edge

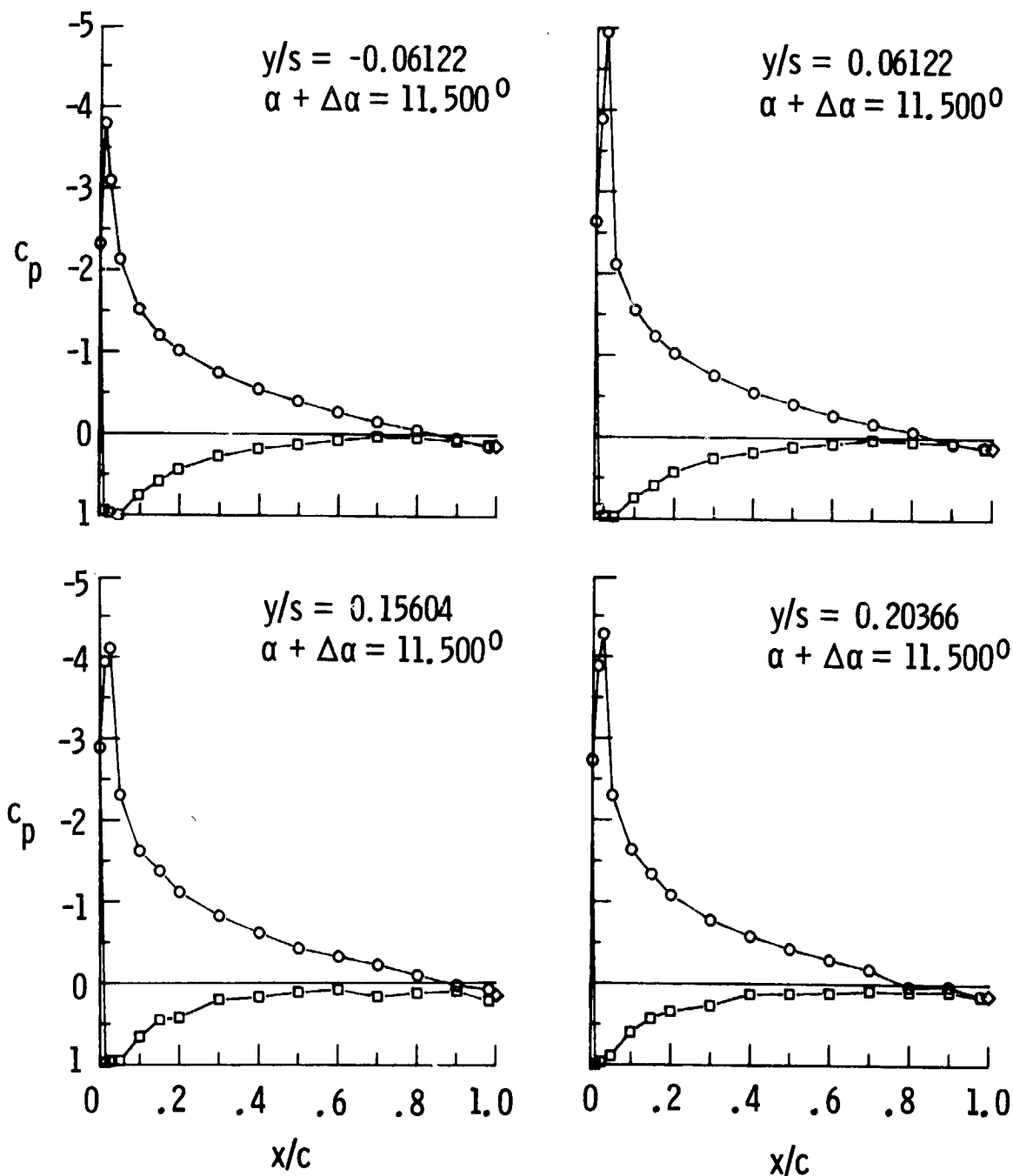

(a) VTW5 configuration.

Figure 8. Pressure distribution measurements for group II VTW configurations.

- Measured, upper surface
- Measured, lower surface
- ◇ Interpolated, trailing edge

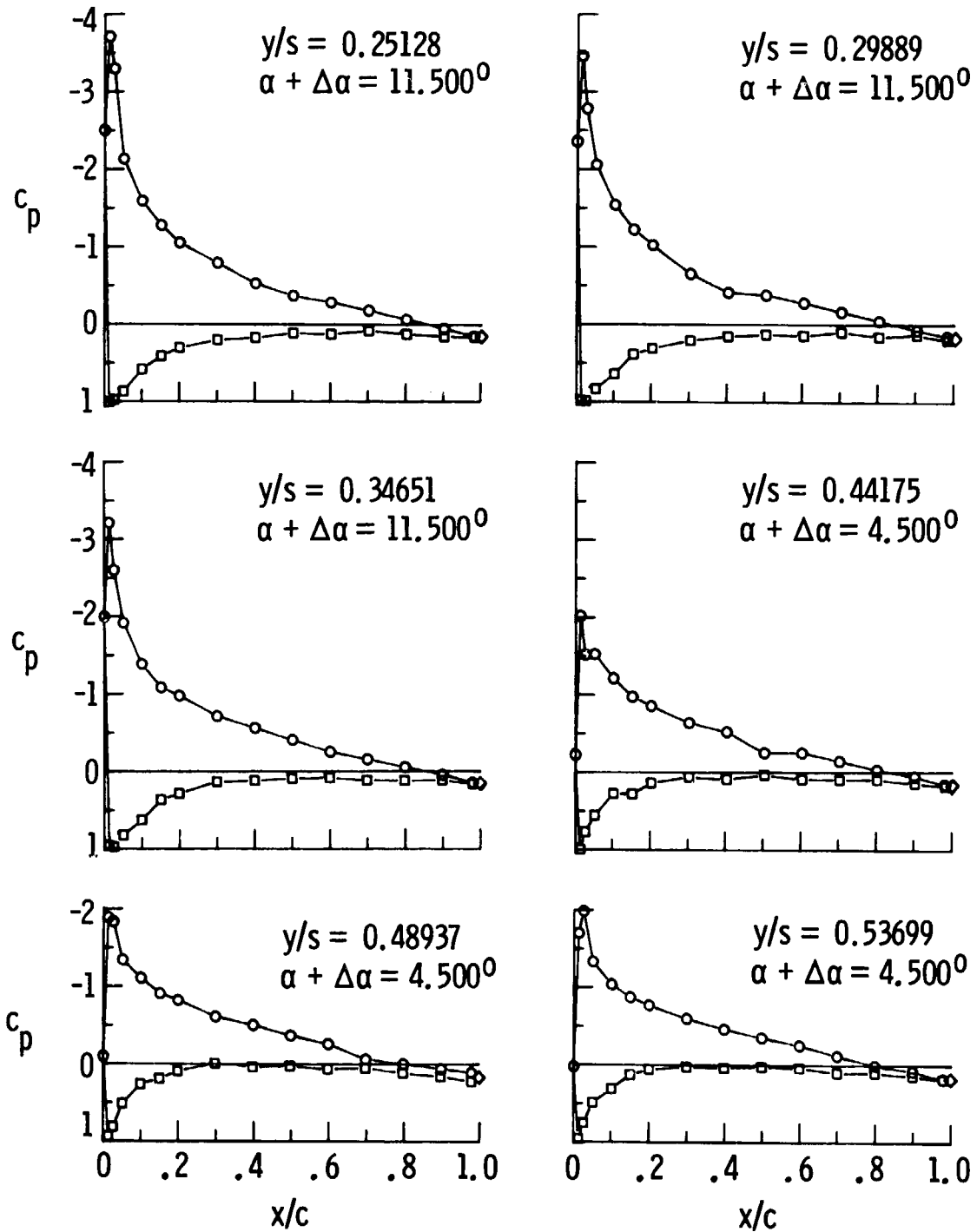

(a) Continued.

Figure 8. Continued.

- Measured, upper surface
- Measured, lower surface
- ◇ Interpolated, trailing edge

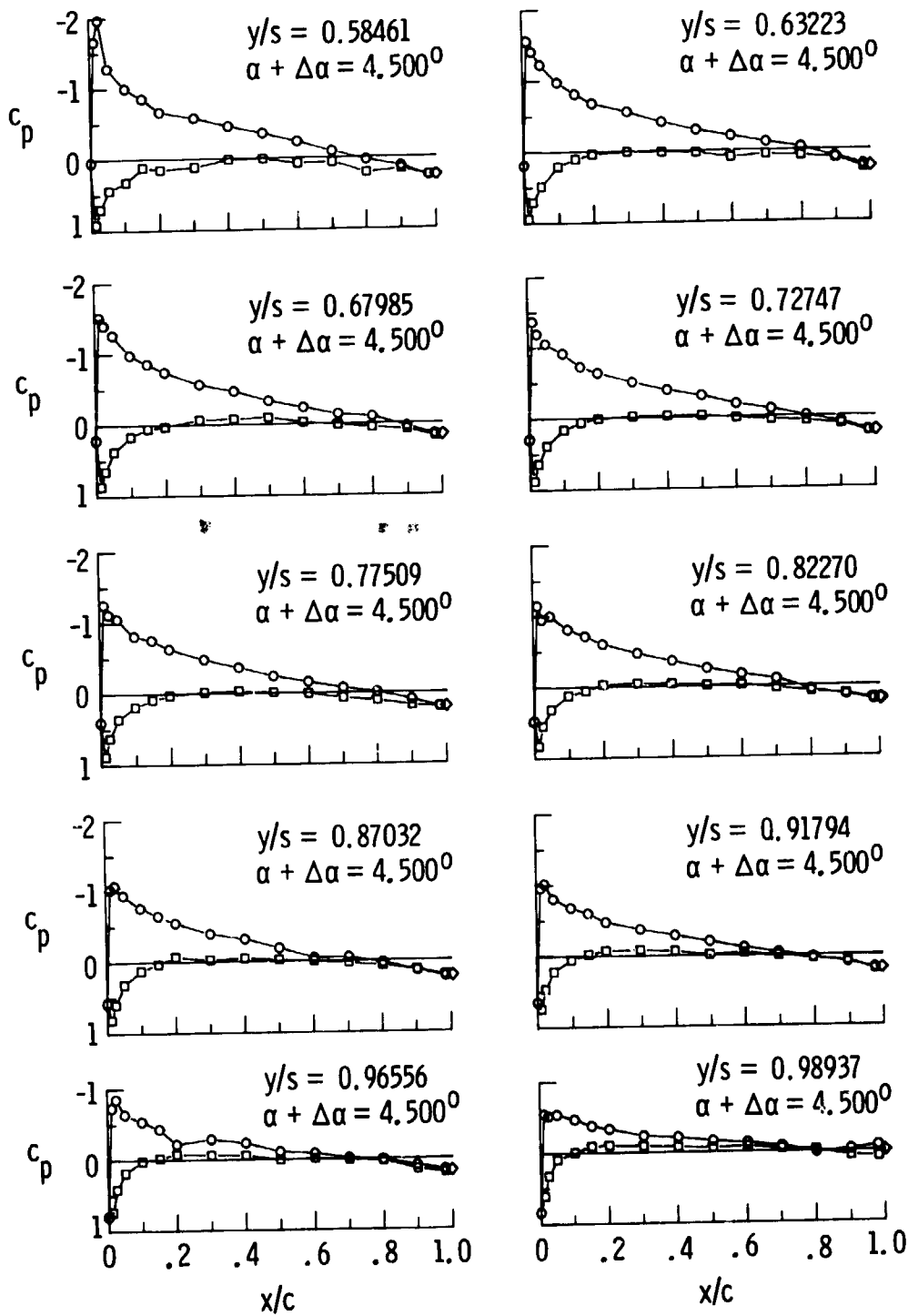

(a) Concluded.

Figure 8. Continued.

- Measured, upper surface
- Measured, lower surface
- ◇ Interpolated, trailing edge

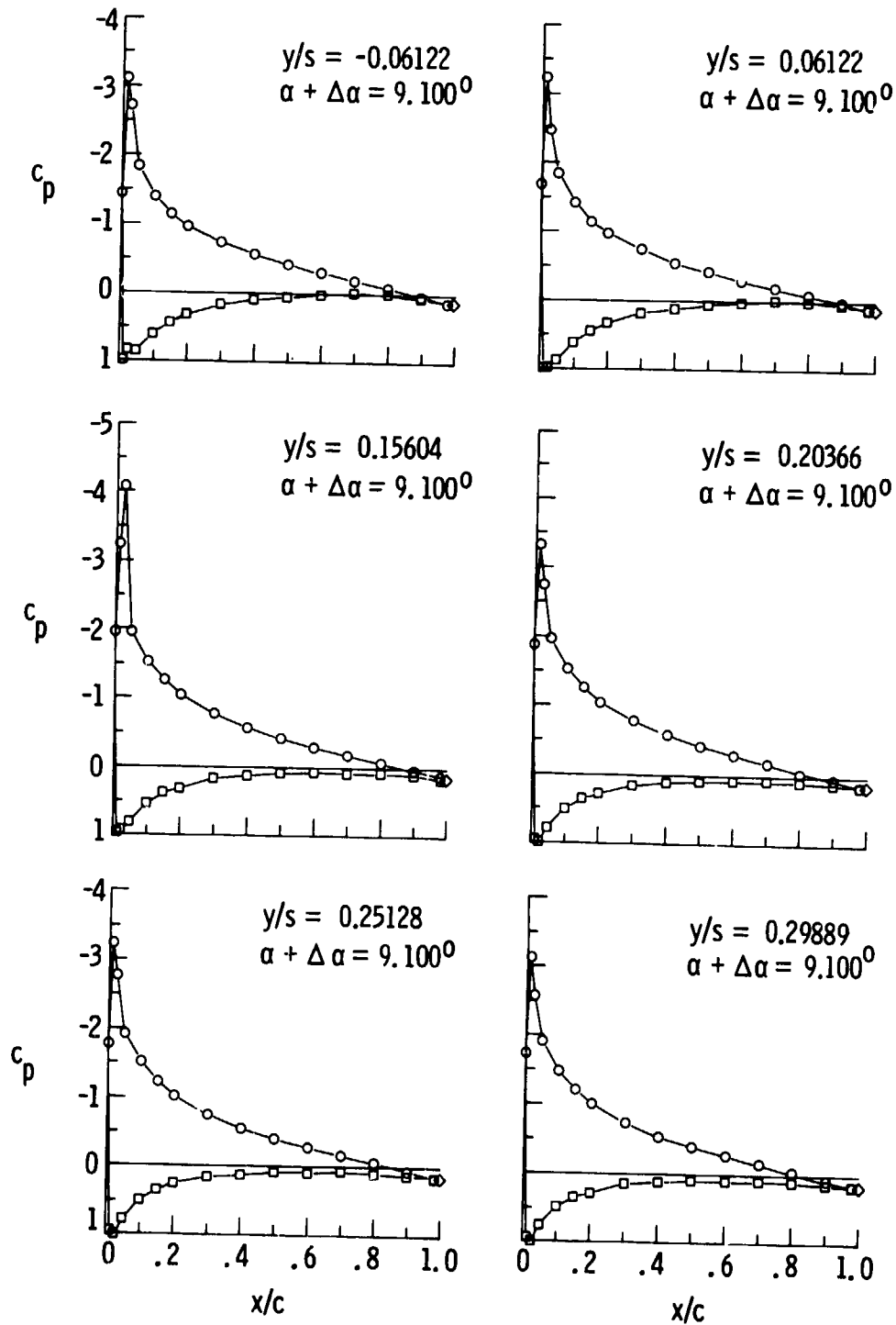

(b) VTW6 configuration.

Figure 8. Continued.

- Measured, upper surface
- Measured, lower surface
- ◇ Interpolated, trailing edge

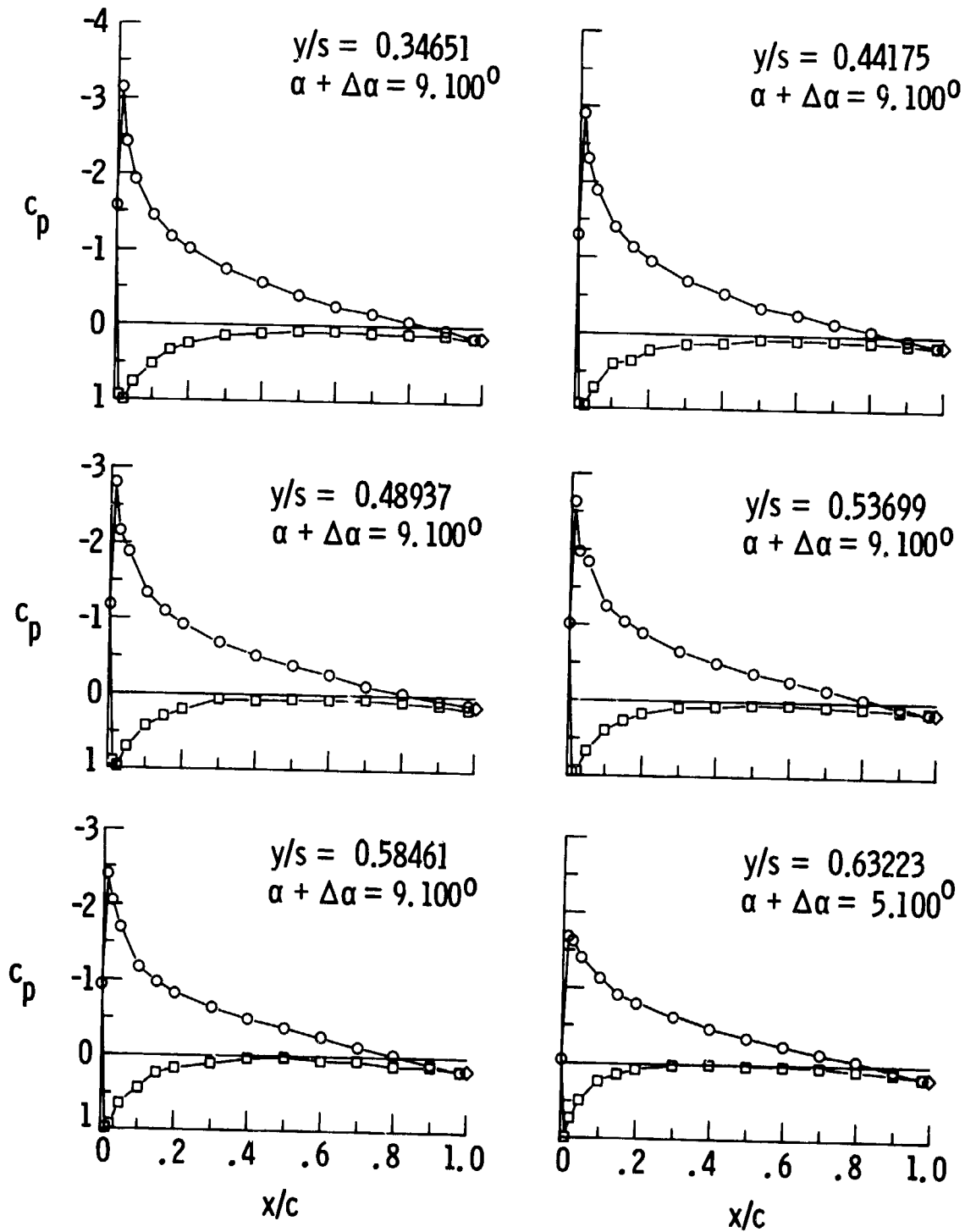

(b) Continued.

Figure 8. Continued.

- Measured, upper surface
- Measured, lower surface
- ◇ Interpolated, trailing edge

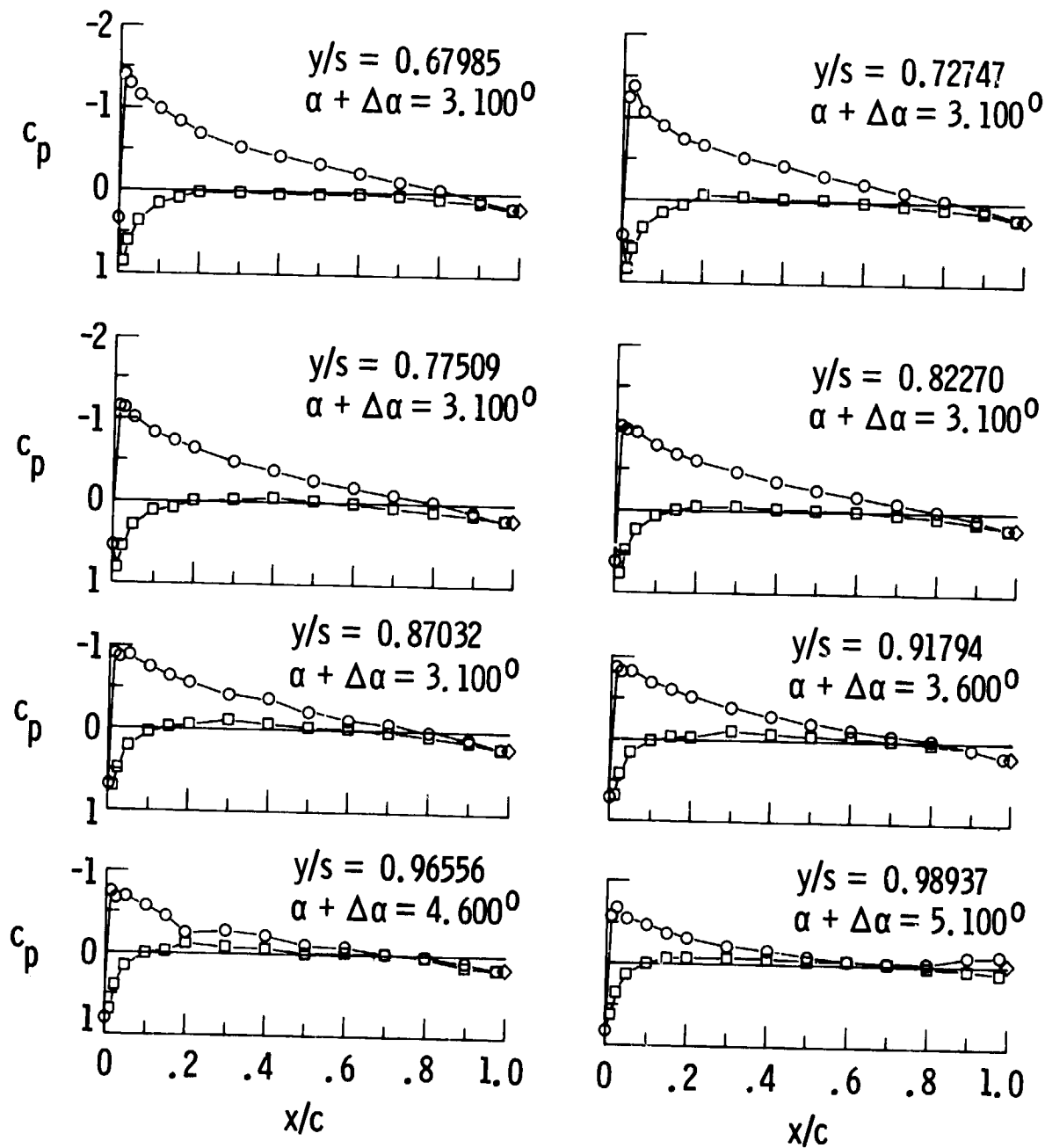

(b) Concluded.

Figure 8. Continued.

- Measured, upper surface
- Measured, lower surface
- ◇ Interpolated, trailing edge

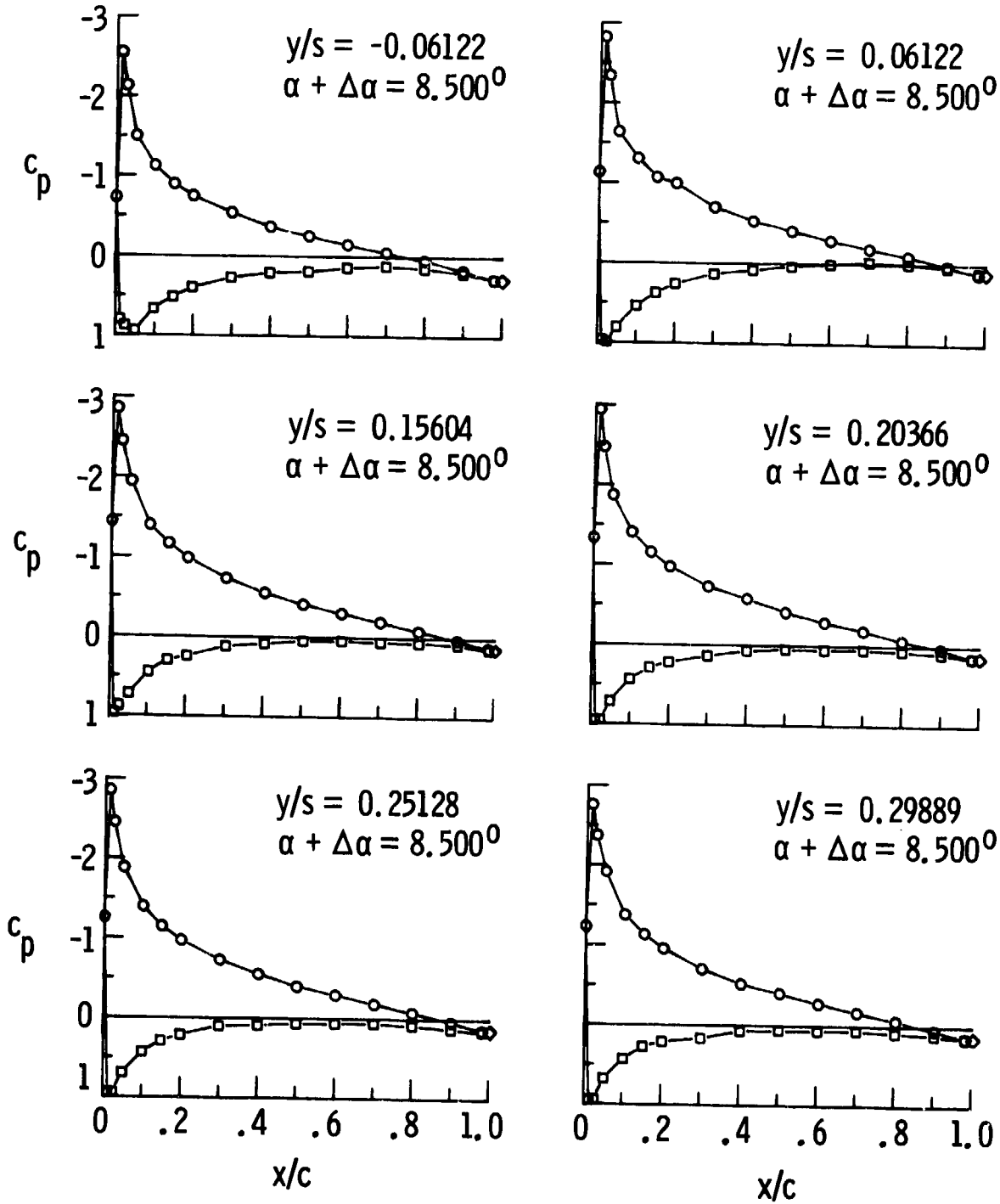

(c) VTW7 configuration.

Figure 8. Continued.



- Measured, upper surface
- Measured, lower surface
- ◇ Interpolated, trailing edge

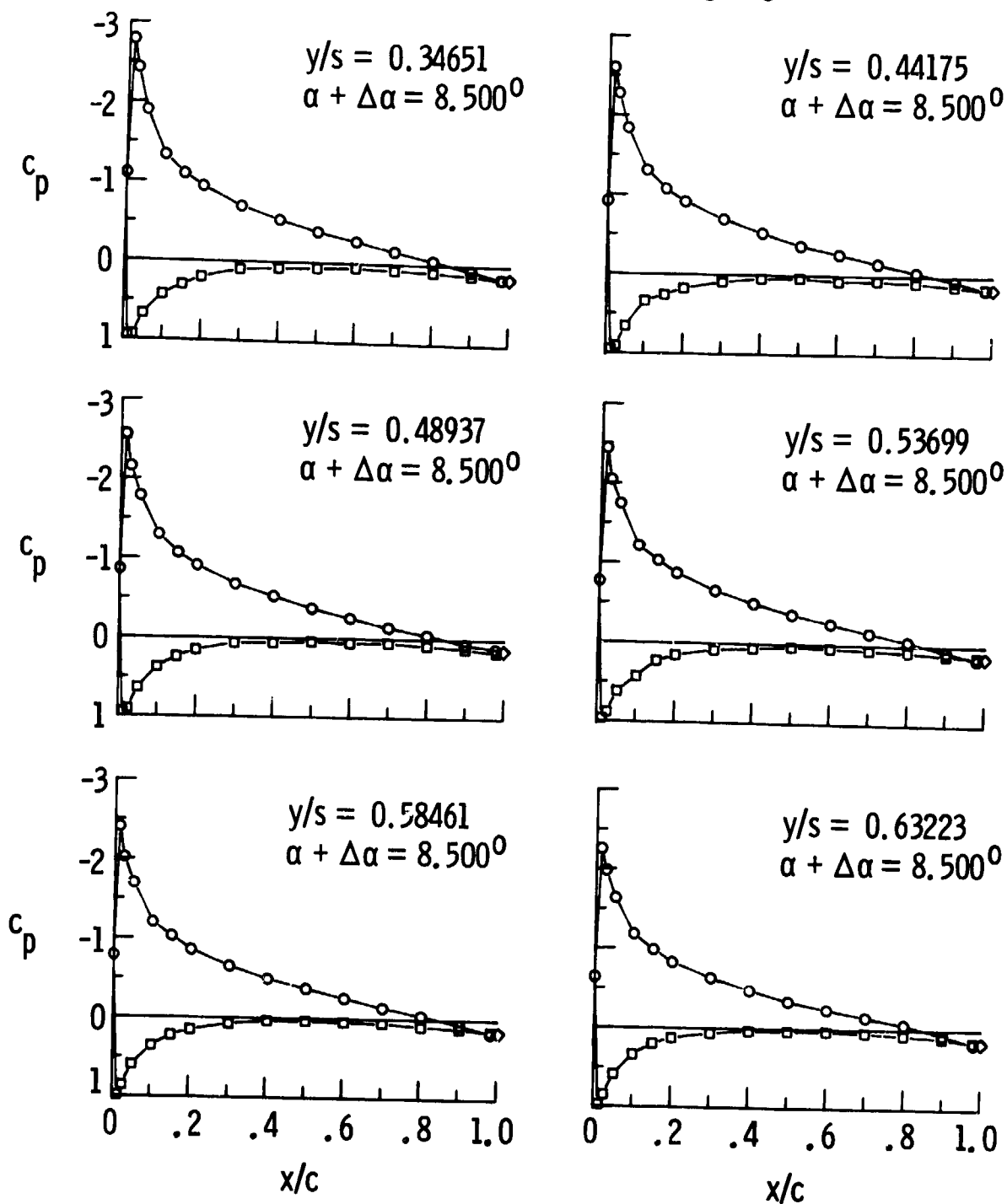

(c) Continued.

Figure 8. Continued.

- Measured, upper surface
- Measured, lower surface
- ◇ Interpolated, trailing edge

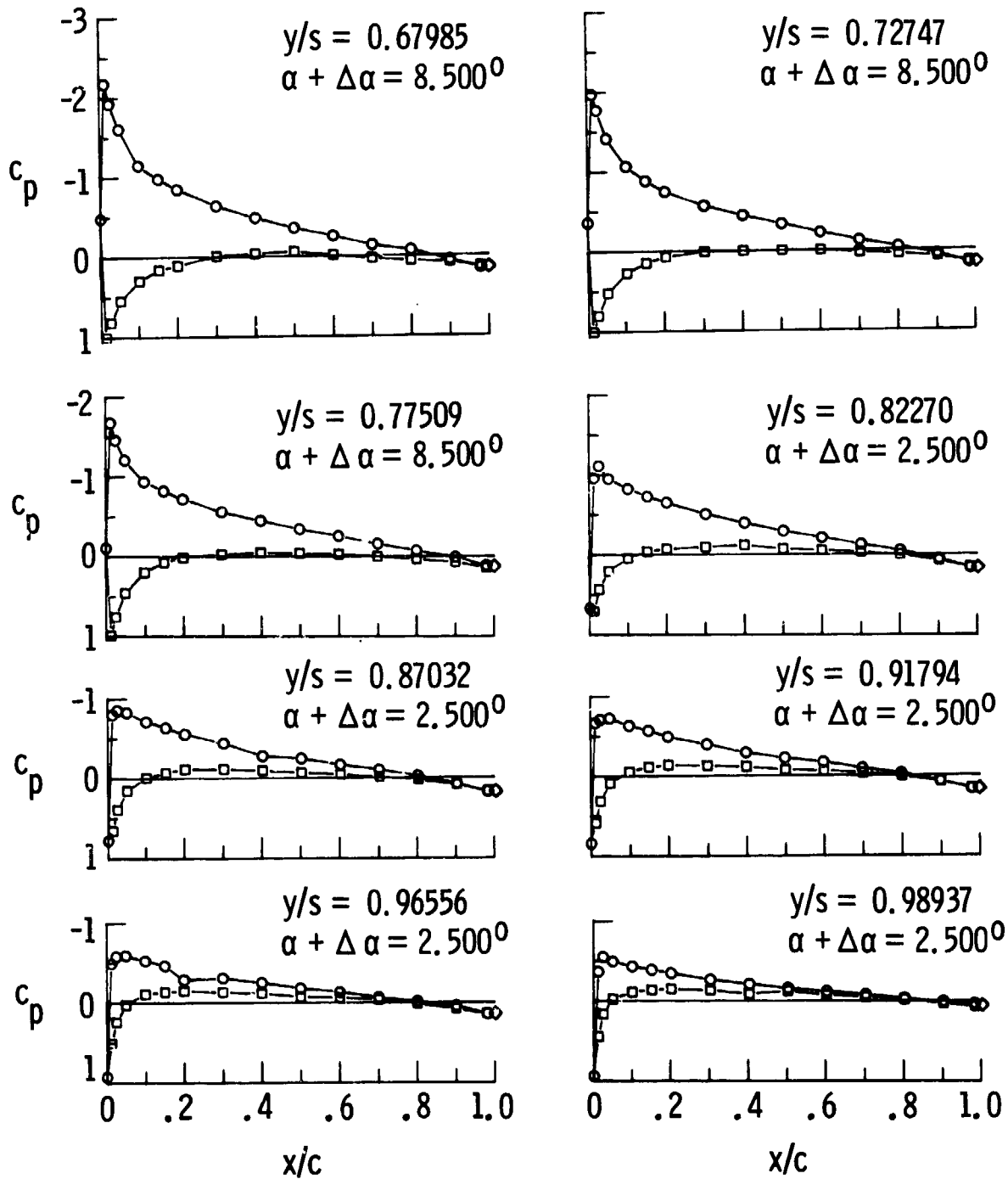

(c) Concluded.

Figure 8. Concluded.

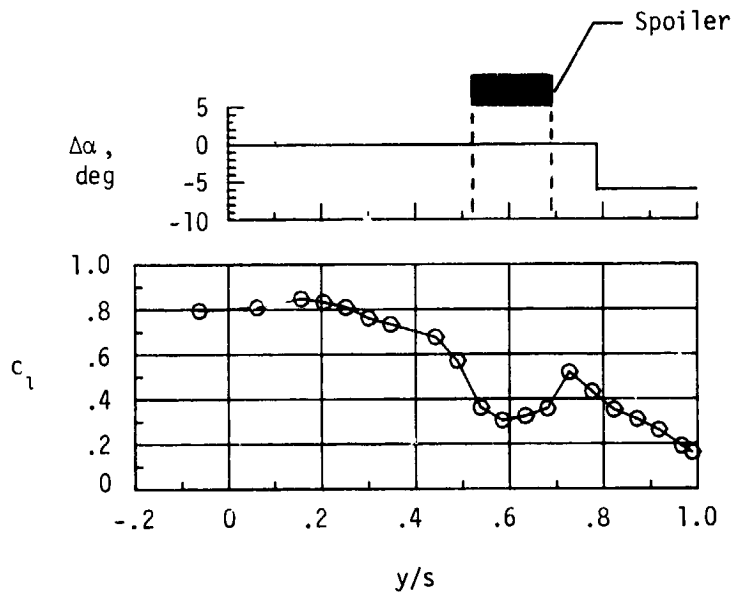

(a) VTW7S<sub>0</sub> configuration.  $\alpha = 11.60^\circ$ .

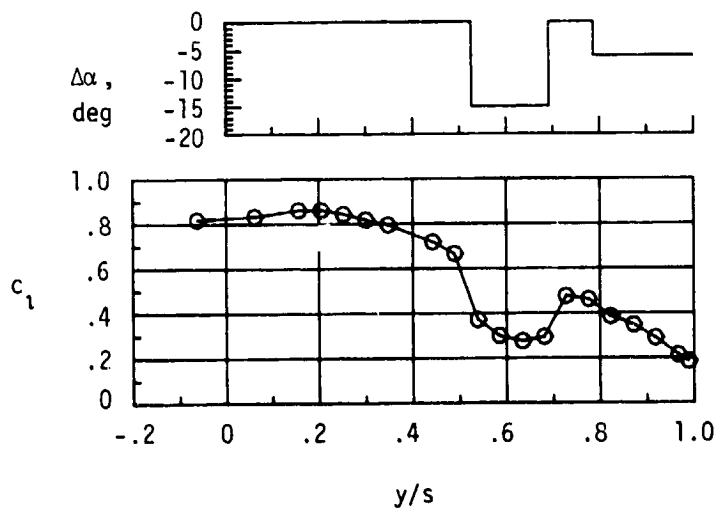

(b) VTW7S<sub>1</sub> configuration.  $\alpha = 11.40^\circ$ .

Figure 9. Wing twist distributions and measured span-load distributions for group III VTW configurations at a nominal  $C_L = 0.6$ .

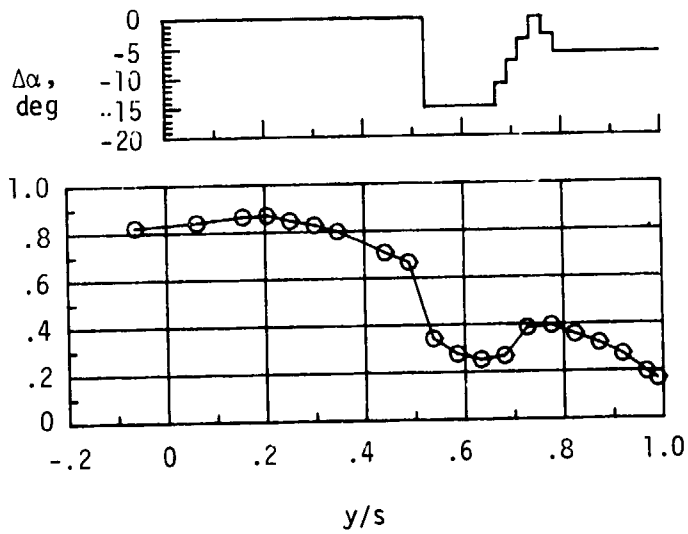

(c) VTW7S<sub>3</sub> configuration.  $\alpha = 11.90^\circ$ .

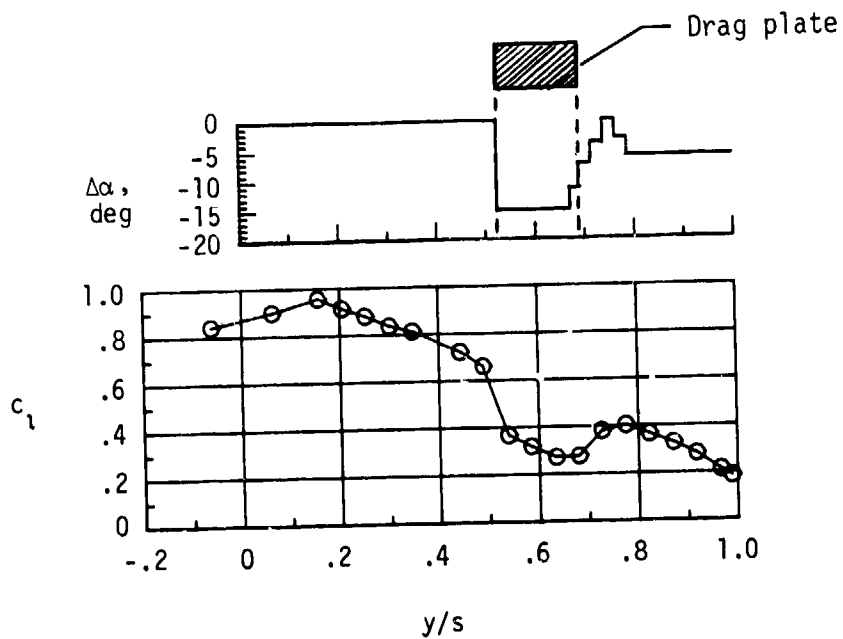

(d) VTW7S<sub>3</sub>P configuration.  $\alpha = 12.20^\circ$ .

Figure 9. Concluded.

- Measured, upper surface
- Measured, lower surface
- ◇ Interpolated, trailing edge

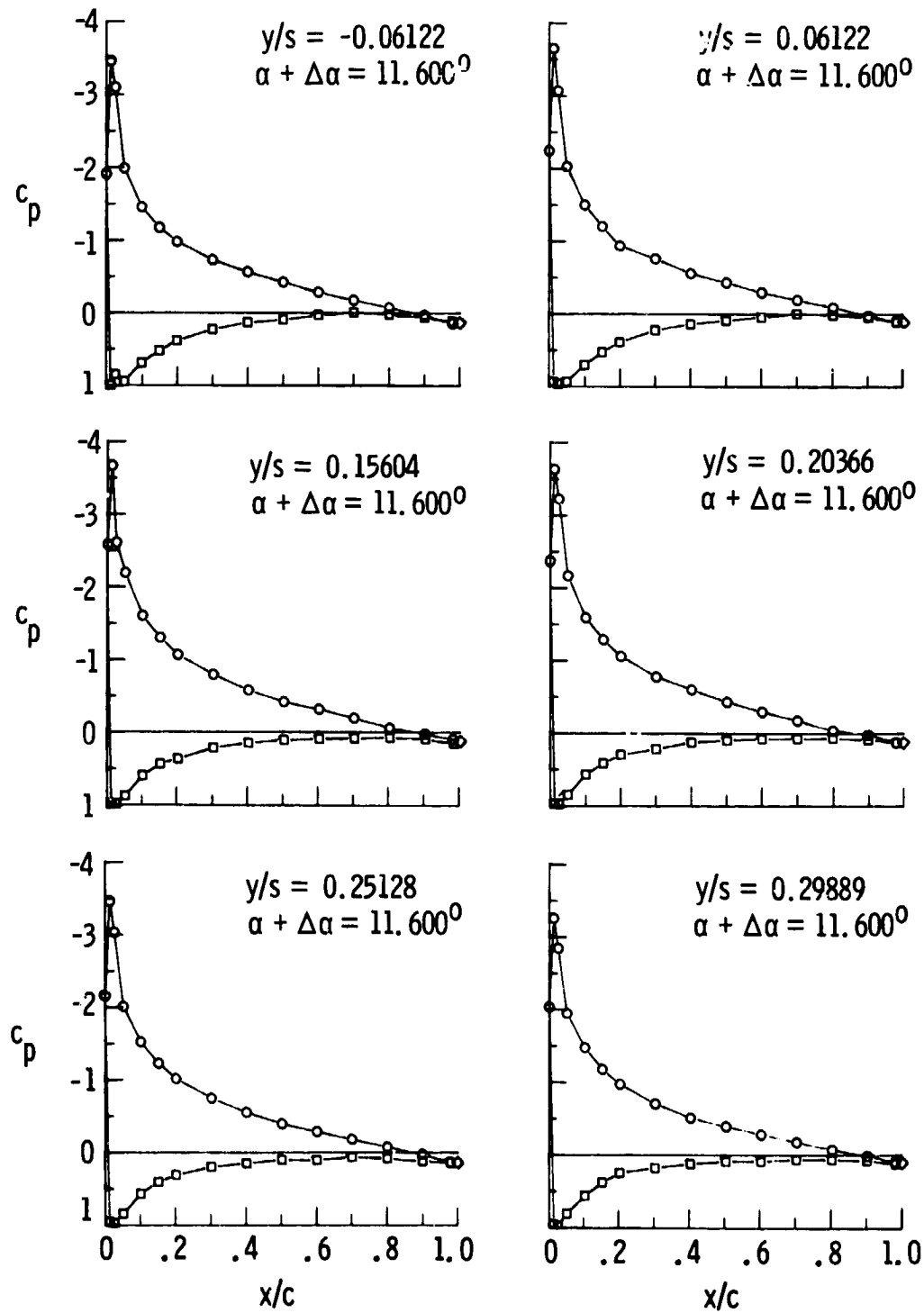

(a) VTW7S<sub>0</sub> configuration.

Figure 10. Pressure distribution measurements for group III VTW configurations.

- Measured, upper surface
- Measured, lower surface
- ◇ Interpolated, trailing edge

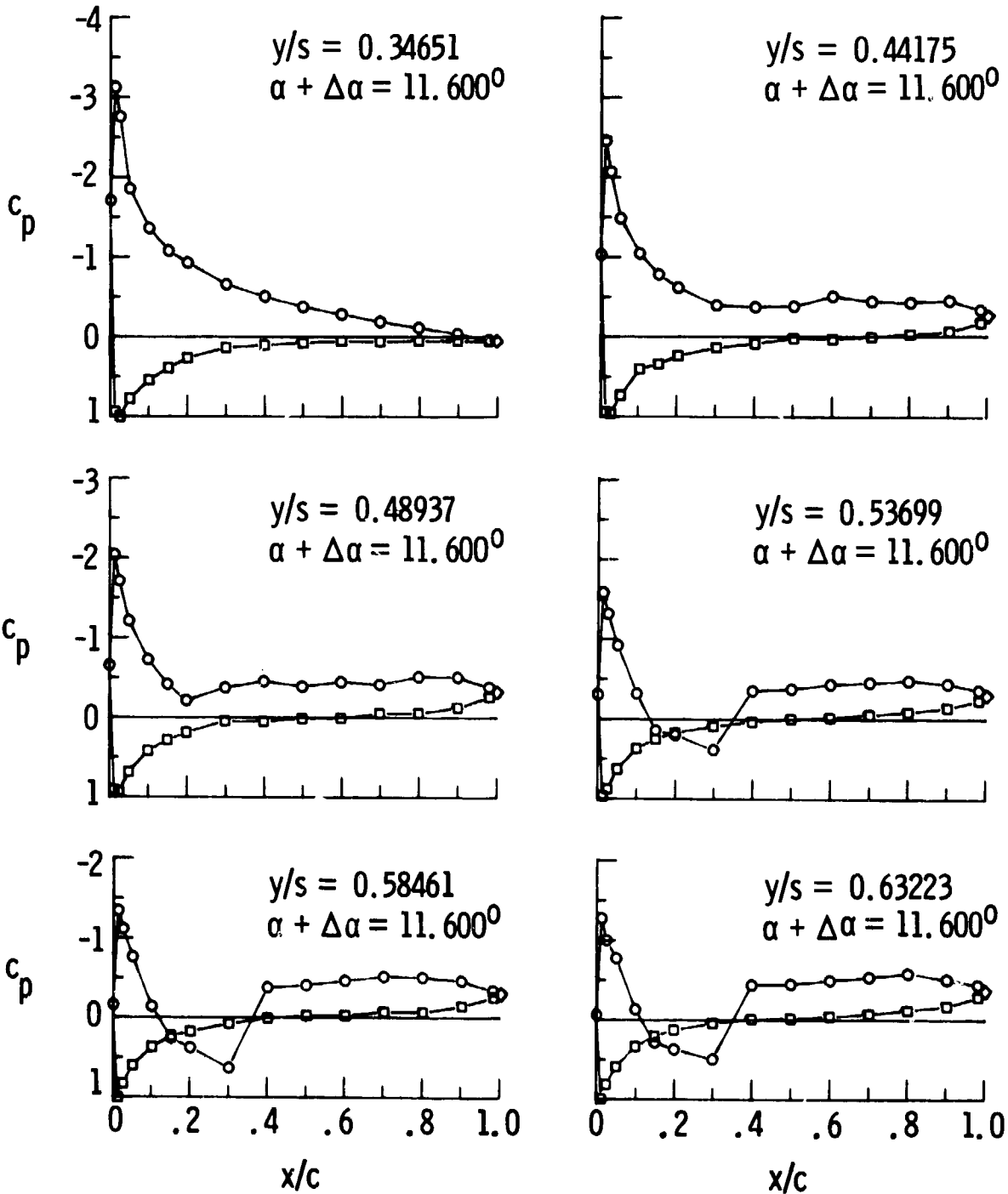

(a) Continued.

Figure 10. Continued.

- Measured, upper surface
- Measured, lower surface
- ◇ Interpolated, trailing edge

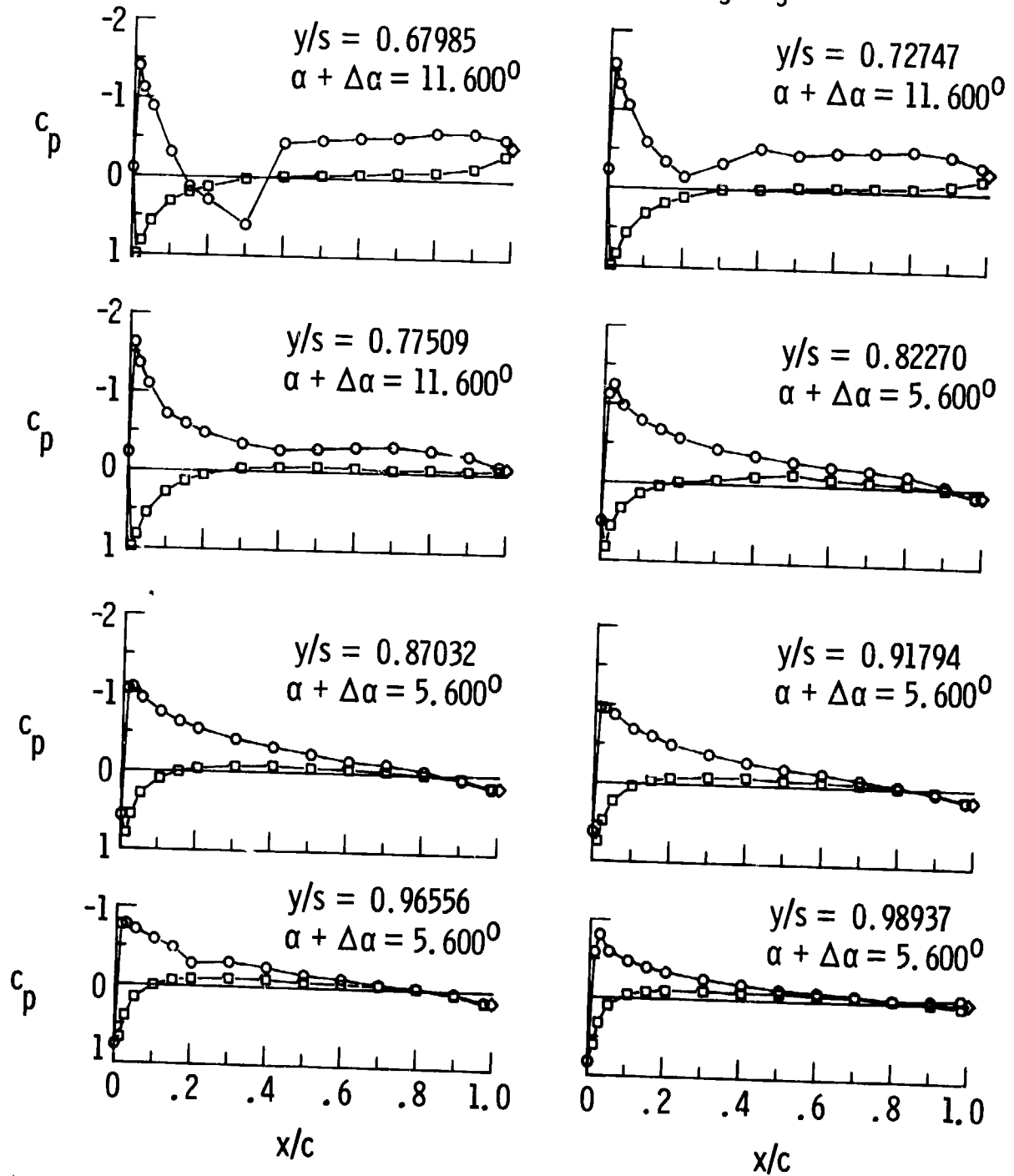

(a) Concluded.

Figure 10. Continued.

- Measured, upper surface
- Measured, lower surface
- ◇ Interpolated, trailing edge

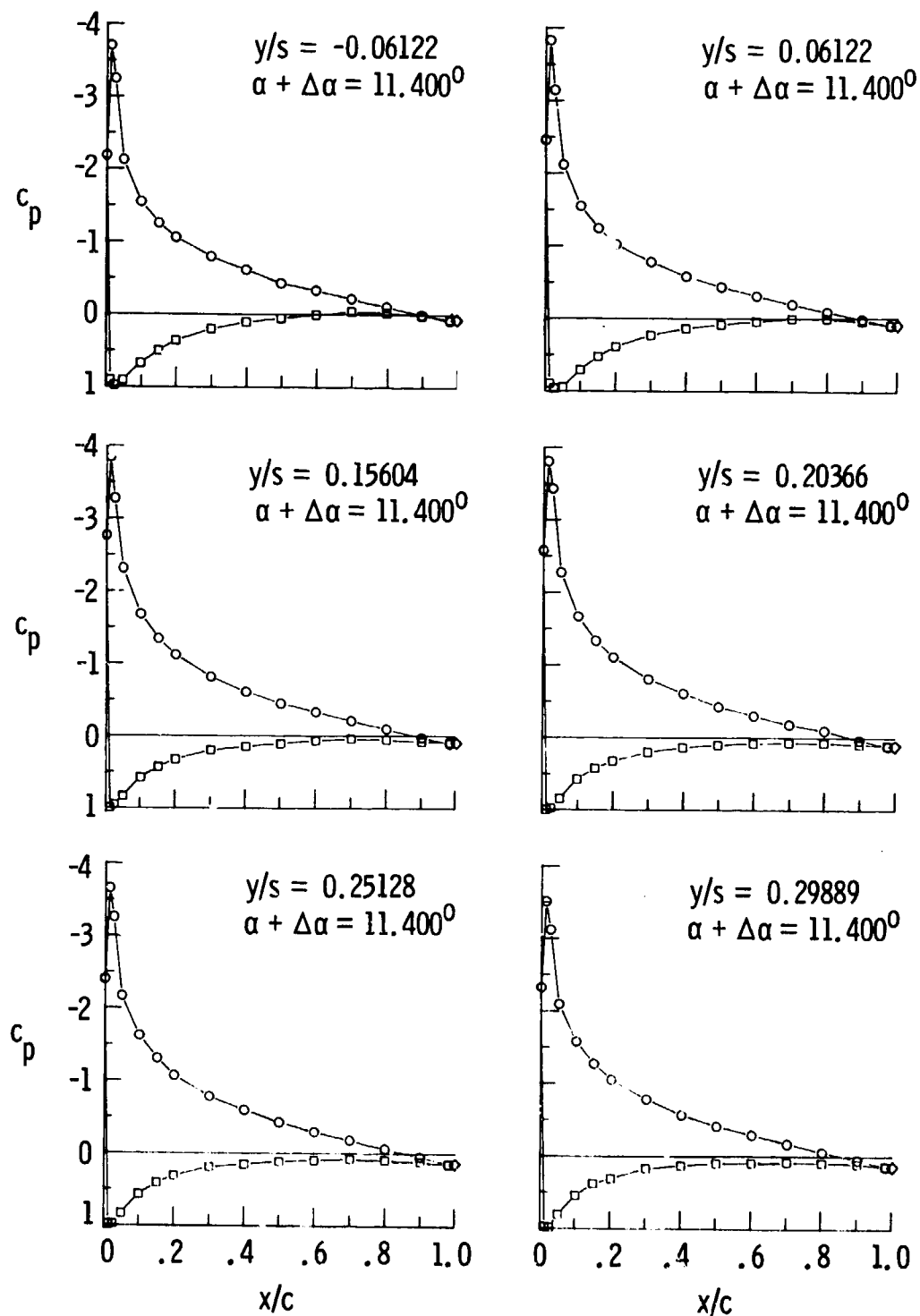

(b) VTW7S<sub>1</sub> configuration.

Figure 10. Continued.



- Measured, upper surface
- Measured, lower surface
- ◇ Interpolated, trailing edge

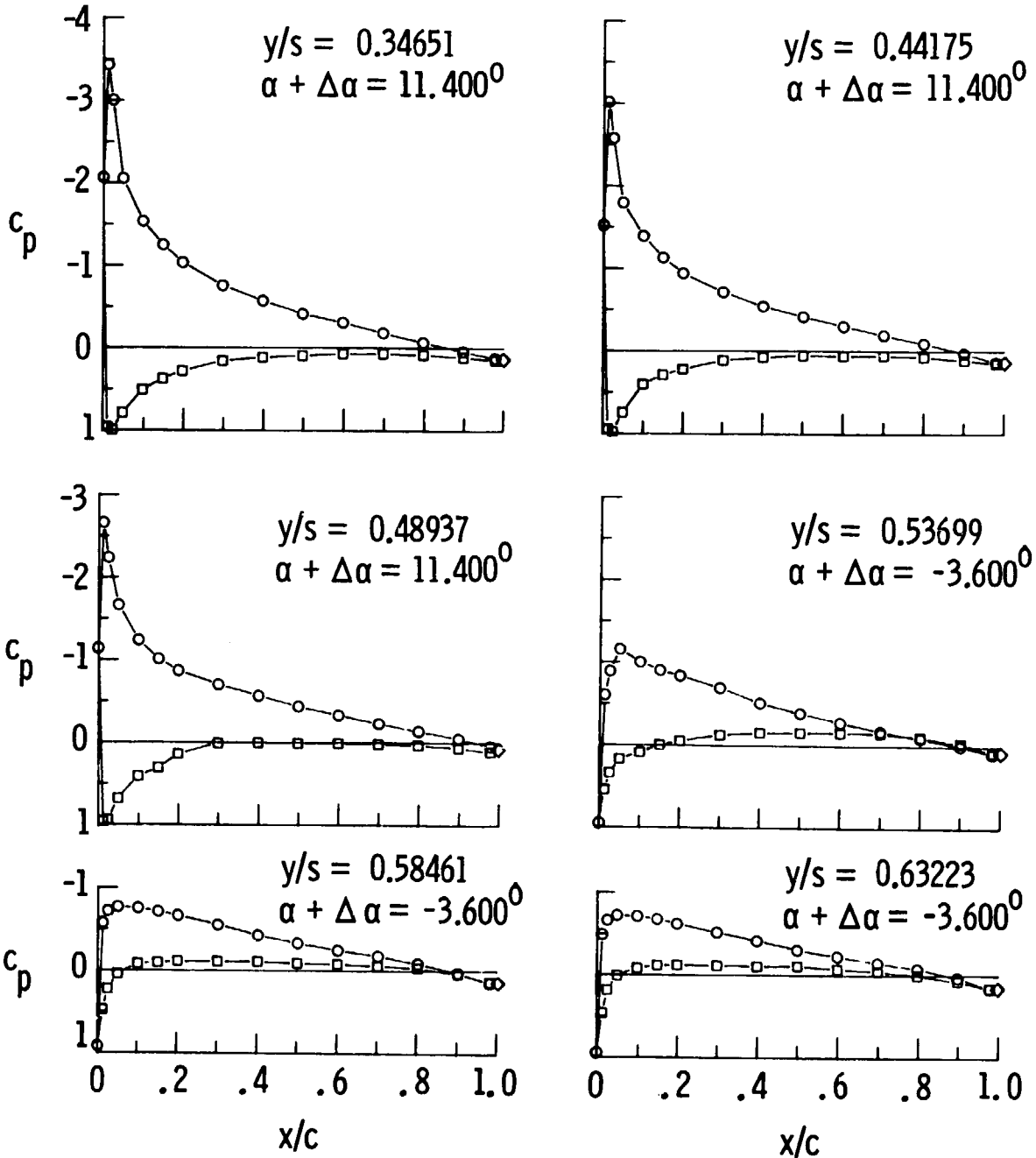

(b) Continued.

Figure 10. Continued.

- Measured, upper surface
- Measured, lower surface
- ◇ Interpolated, trailing edge

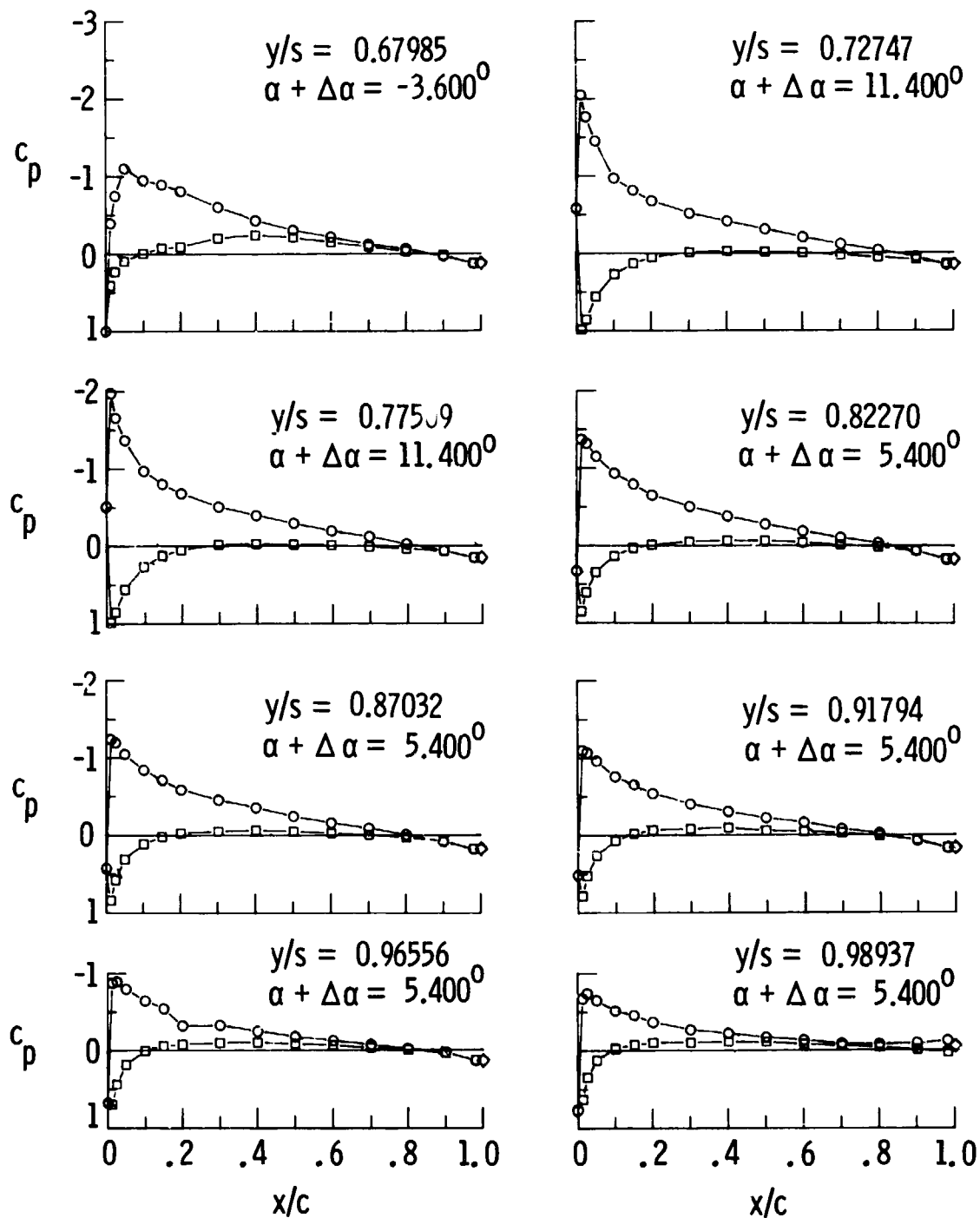

(b) Concluded.

Figure 10. Continued.

- Measured, upper surface
- Measured, lower surface
- ◇ Interpolated, trailing edge

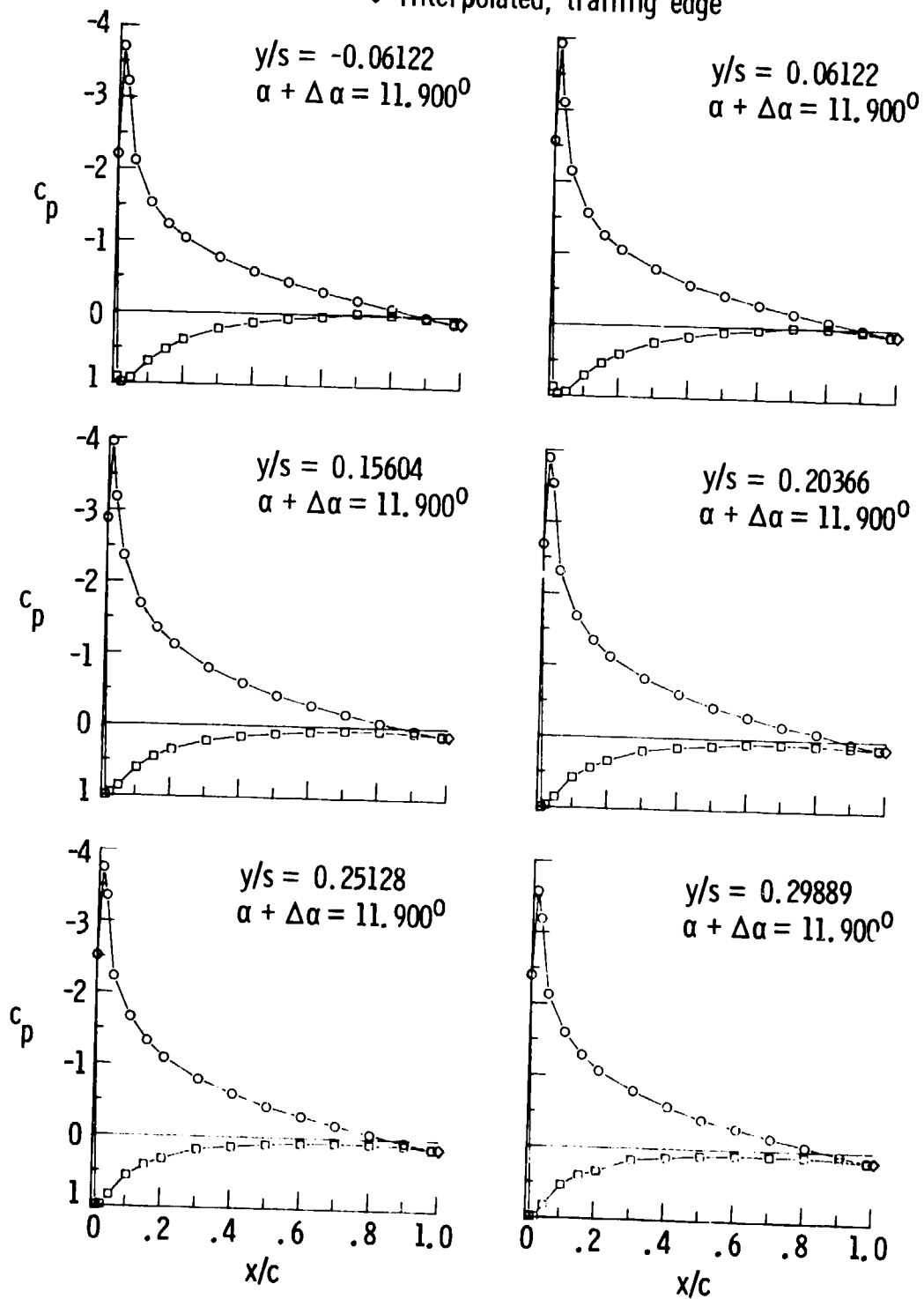

(c) VTW7S<sub>3</sub> configuration.

Figure 10. Continued.

- Measured, upper surface
- Measured, lower surface
- ◇ Interpolated, trailing edge

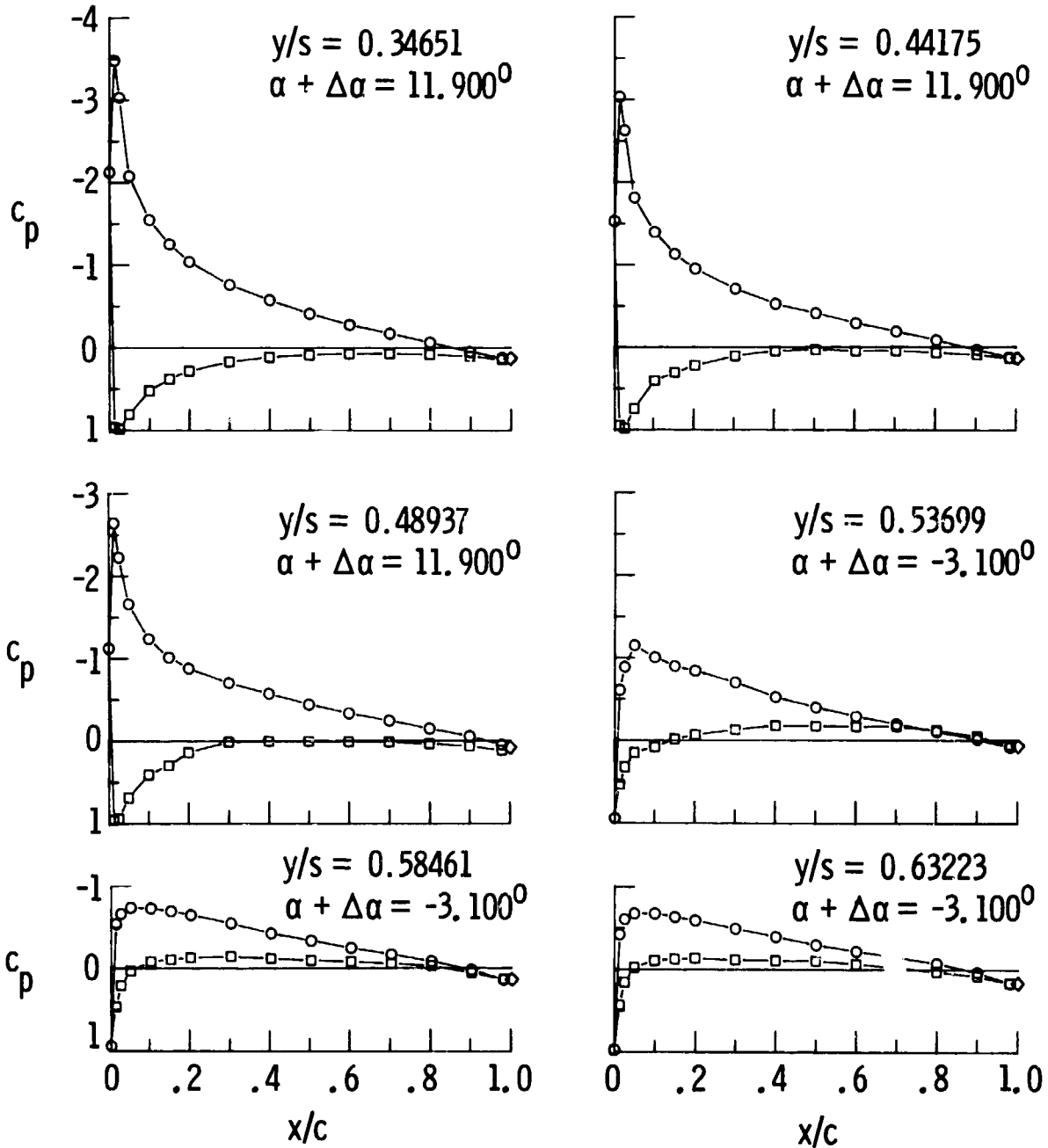

(c) Continued.

Figure 10. Continued.

- Measured, upper surface
- Measured, lower surface
- ◇ Interpolated, trailing edge

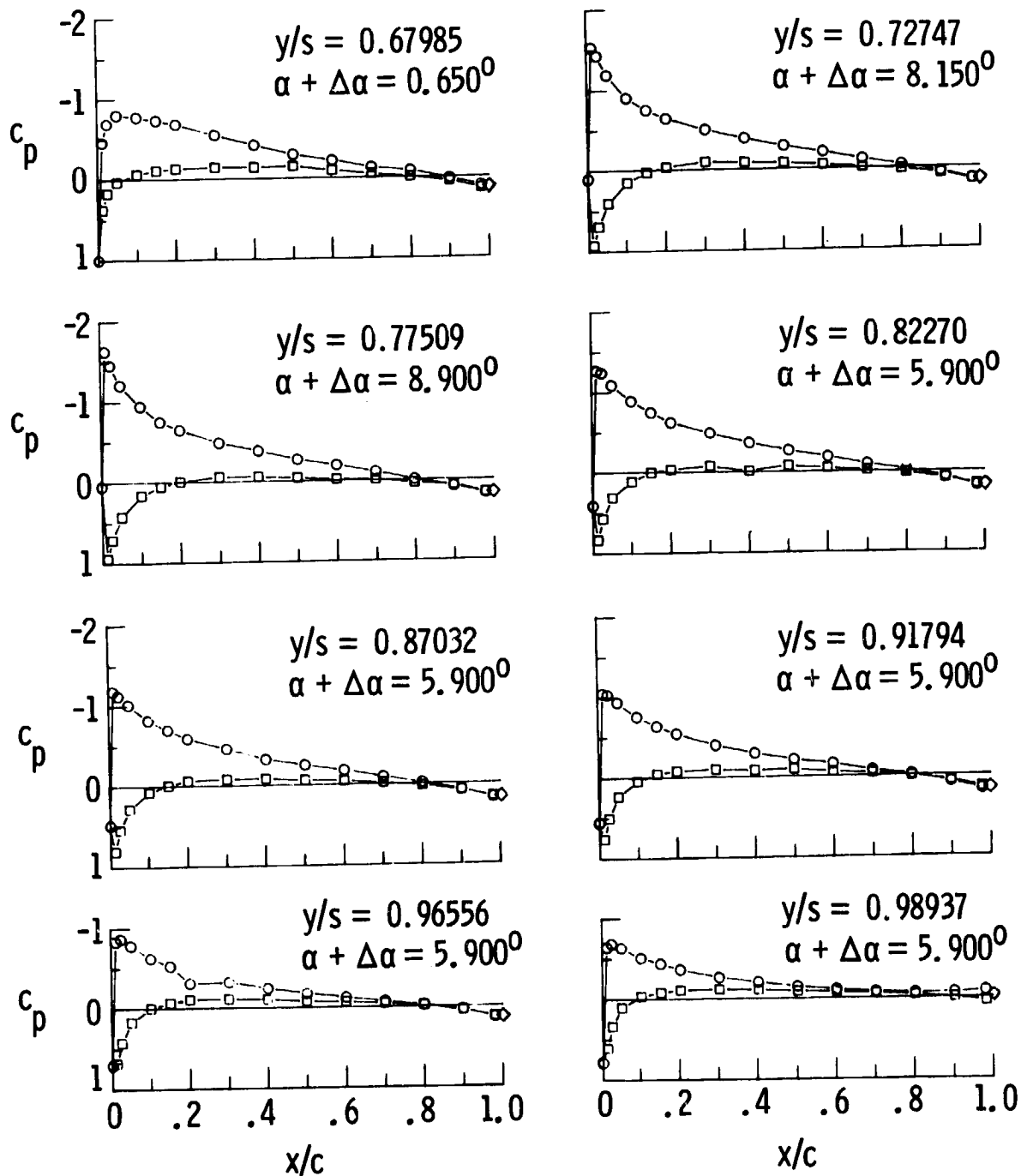

(c) Concluded.

Figure 10. Continued.

- Measured, upper surface
- Measured, lower surface
- ◇ Interpolated, trailing edge

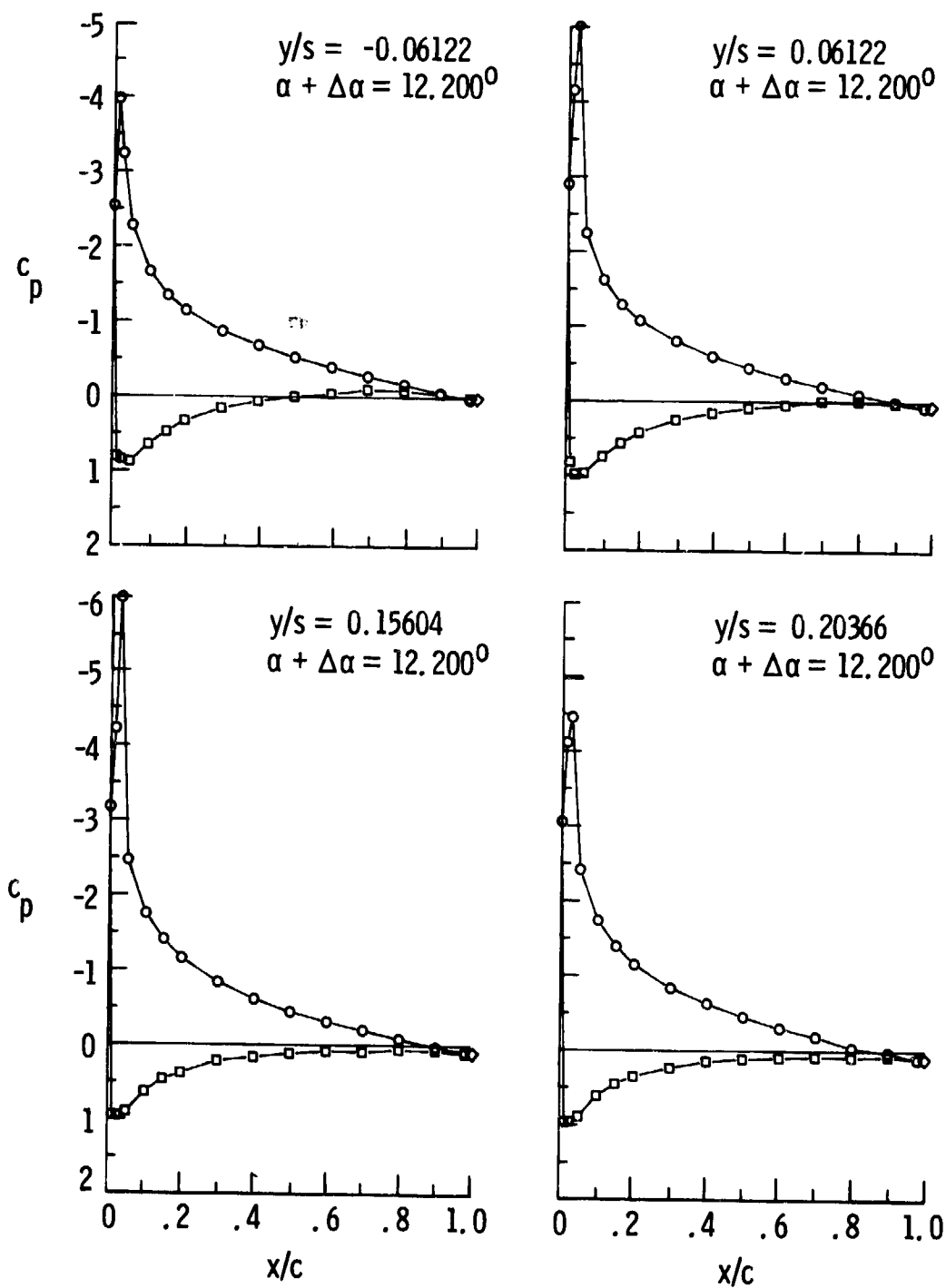

(d) VTW7S<sub>3</sub>P configuration.

Figure 10. Continued.

- Measured, upper surface
- Measured, lower surface
- ◇ Interpolated, trailing edge

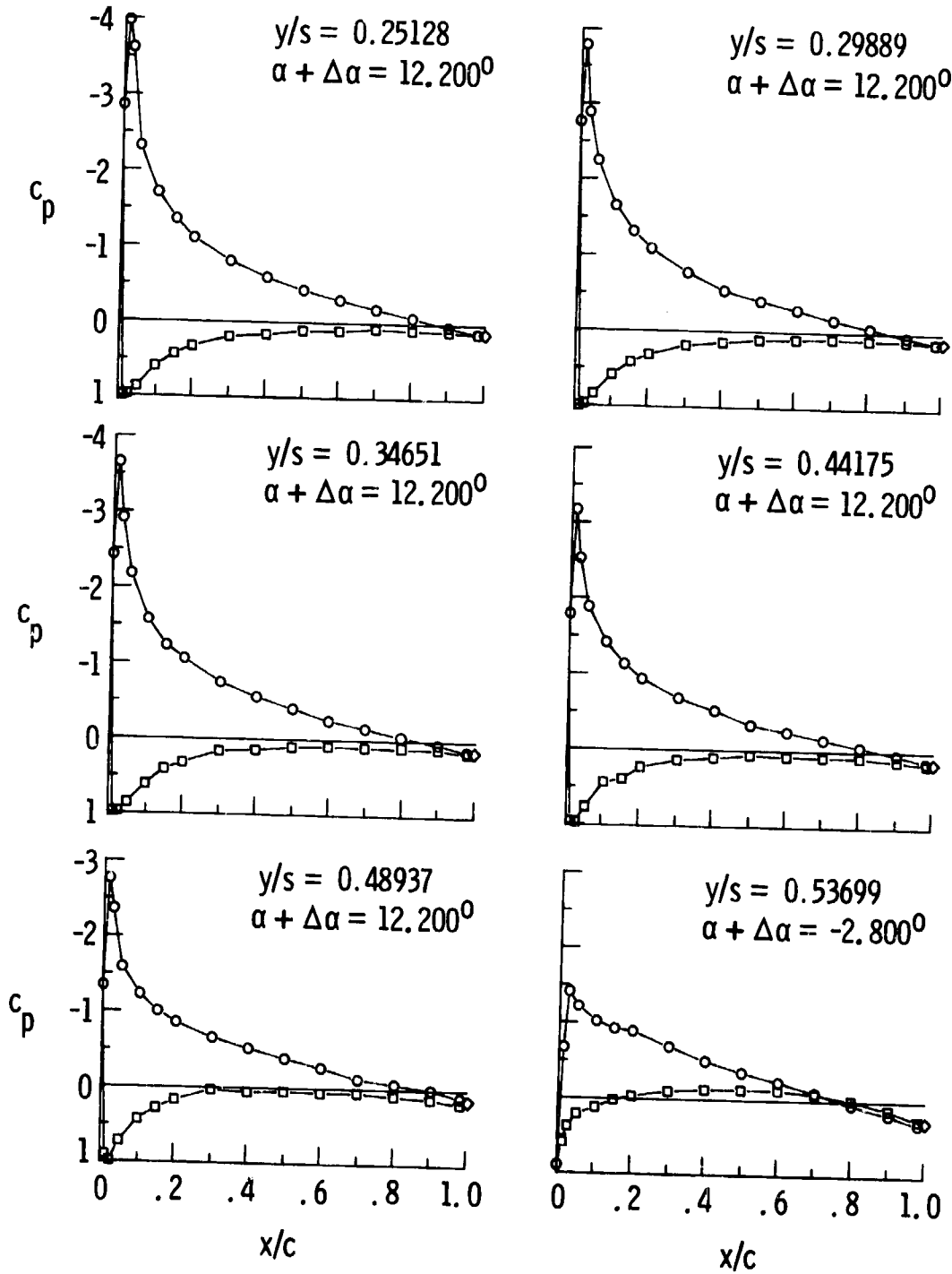

(d) Continued.

Figure 10. Continued.

- Measured, upper surface
- Measured, lower surface
- ◇ Interpolated, trailing edge

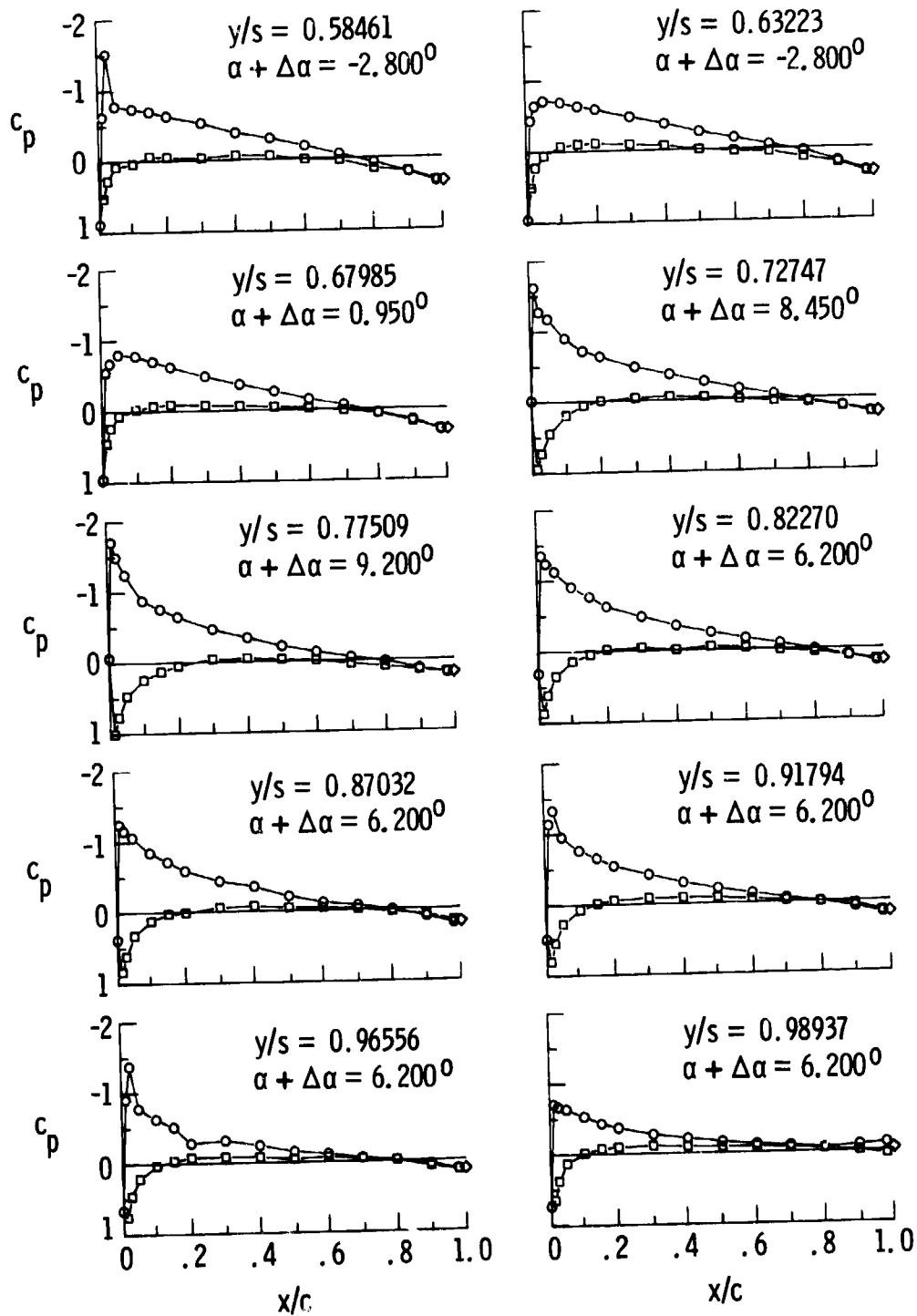

(d) Concluded.

Figure 10. Concluded.