

NASA TM-86417

NASA Technical Memorandum 86417

NASA-TM-86417 19850017584

STRUCTURES AND DYNAMICS DIVISION

RESEARCH AND TECHNOLOGY PLANS FOR FY 1985
AND ACCOMPLISHMENTS FOR FY 1984

Kay S. Bales

April 1985

NASA

National Aeronautics and
Space Administration

Langley Research Center
Hampton, Virginia 23665



STRUCTURES AND DYNAMICS DIVISION
RESEARCH AND TECHNOLOGY PLANS FOR FY 1985
AND ACCOMPLISHMENTS FOR FY 1984

BY

KAY S. BALES

SUMMARY

The purpose of this report is to present the Structures and Dynamics Division's research plans for FY 1985 and accomplishments for FY 1984. The work under each branch is shown by RTR Objectives, FY 1985 Plans, Approach, Milestones, and FY 1984 Accomplishments. Logic charts show elements of research and rough relationship to each other. This information is useful in program coordination with other government organizations in areas of mutual interest.

TABLE OF CONTENTS

I	STRUCTURES AND DYNAMICS DIVISION ORGANIZATION CHART	
II	FACILITIES	
III	IMPACT DYNAMICS BRANCH	
	RTOP 505-33-53	ADVANCED AIRCRAFT STRUCTURES AND DYNAMICS
	RTR 505-33-53-05	Transport Impact Dynamics Analysis
	RTR 505-33-53-09	Composite Crash Dynamics
	RTR 505-33-53-17	Flight Test of F-106B Active Control Landing Gears
	RTOP 505-42-23	ROTORCRAFT AIRFRAME SYSTEMS
	RTR 505-42-23-04	Composite Impact Dynamics
	RTOP 505-45-14	AIRCRAFT LANDING DYNAMICS
	RTR 505-45-14-01	Aircraft Landing Dynamics
	RTR 505-45-23-53	Joint FAA/NASA Aircraft/Ground Vehicle Runway Friction Program
	RTR 505-45-14-53	Joint FAA/NASA Runway Surface Traction Program
IV	STRUCTURAL CONCEPTS BRANCH	
	RTOP 506-53-43	ADVANCED SPACE STRUCTURES
	RTR 506-53-43-01	Advanced Space Structures Concepts
	RTR 506-53-43-14	ACCESS Flight Experiment Development
	RTOP 482-53-43	ADVANCED SPACE STRUCTURES/ ERECTABLE SPACE STRUCTURES
	RTR 482-53-43-21	Erectable Large Space Structures
V	STRUCTURAL DYNAMICS BRANCH	
	RTOP 506-53-43	ADVANCED SPACE STRUCTURES
	RTR 506-53-43-15	Vibration Control
	RTR 506-53-43-16	Advanced Spacecraft Dynamics Analysis
	RTR 506-53-43-17	Mast Project Ground Test Program
	RTOP 506-62-43	SPACECRAFT TECHNOLOGY EXPERIMENTS
	RTR 506-62-43-12	Dynamics of 15m Hoop-Column Antenna Structure

RTOP	482-53-53	ANALYSIS AND SYNTHESIS/SCALE MODEL STUDY
RTR	482-53-53-34	Space Station Structural Dynamic Analysis
RTR	482-53-53-38	Space Station Pathfinder Model

VI STRUCTURAL MECHANICS BRANCH

RTOP	505-33-33	COMPOSITES FOR AIRFRAME STRUCTURES
RTR	505-33-33-06	Composite Structures Design Technology
RTOP	534-06-23	COMPOSITE MATERIALS AND STRUCTURES
RTR	534-06-23-08	Failsafe Composite Structures
RTOP	505-33-53	ADVANCED AIRCRAFT STRUCTURES AND DYNAMICS
RTR	505-33-53-10	Structural Mechanics Analysis
RTR	505-33-53-15	Computational Structural Mechanics

VII ACCOMPLISHMENT HIGHLIGHTS

I STRUCTURES AND DYNAMICS DIVISION ORGANIZATION CHART

**STRUCTURES AND DYNAMICS
DIVISION**

M. F. CARD
H. G. McCOMB, JR.

**IMPACT
DYNAMICS
BRANCH**

R. G. THOMSON

**STRUCTURAL
MECHANICS
BRANCH**

J. H. STARNES, JR.

COMPUTATIONAL
STRUCTURAL MECHANICS
GROUP

**STRUCTURAL
DYNAMICS
BRANCH**

L. D. PINSON
B. R. HANKS

**STRUCTURAL
CONCEPTS
BRANCH**

M. M. MIKULAS, JR.
P. A. COOPER

CRASH
DYNAMICS

LANDING
DYNAMICS

COMPOSITE
STRUCTURES

NONLINEAR
MECHANICS

SPACE
VEHICLE
DYNAMICS

LARGE
SPACE
STRUCTURES

II FACILITIES

The Structures and Dynamics Division has four major facilities to support its research (shown in figure 1).

The Structures and Materials Laboratory equipment includes a 1,200,000 lbf capacity testing machine for tensile and compressive specimens up to 6 feet wide and 18 feet long; lower capacity testing machines of 300,000, 120,000, 100,000 and 10,000 lbf capacity; torsion machine of approximately 60,000 in.-lbf capacity; combined load testing machine; hydraulic and pneumatic pressurization equipment; and vertical abutment-type backstop for supporting and/or anchoring large structural test specimens.

The Impact Dynamics Research Facilities consist of the Aircraft Landing Dynamics Facility (ALDF) currently being upgraded under a \$15M CoF project, and the Impact Dynamics Research Facility. The ALDF will consist of a rail system 2,500 ft. long x 30 ft. wide, a 1.73 Mlbs. thrust propulsion system, a test carriage capable of approximately 220 knots, and an arrestment system. A wide variety of runway surface conditions, ranging from dry and flooded concrete or asphalt to solid ice, can be duplicated in the track test section. In addition, unprepared surfaces such as clay or sod can be installed for tests to provide data on aircraft off-runway operations.

The Impact Dynamics Research Facility is capable of testing full-scale general aviation aircraft and helicopters under controlled conditions. Simulation is accomplished by swinging the aircraft by cables, pendulum-style, into the ground from an A-frame structure approximately 400 ft. long x 240 ft. high. A Vertical Test Apparatus is attached to one leg of the A-frame for drop-testing structural components.

The Structural Dynamics Research Laboratory is designed for carrying out research on spacecraft and aircraft structures, equipment, and materials under various environmental conditions, including vibration, shock, acceleration, thermal and vacuum. Equipment in the laboratory includes a 55-ft. (inside diameter) thermal vacuum chamber with a removable 5-ton crane, a flat floor 70 feet from the dome peak, and whirl tables.

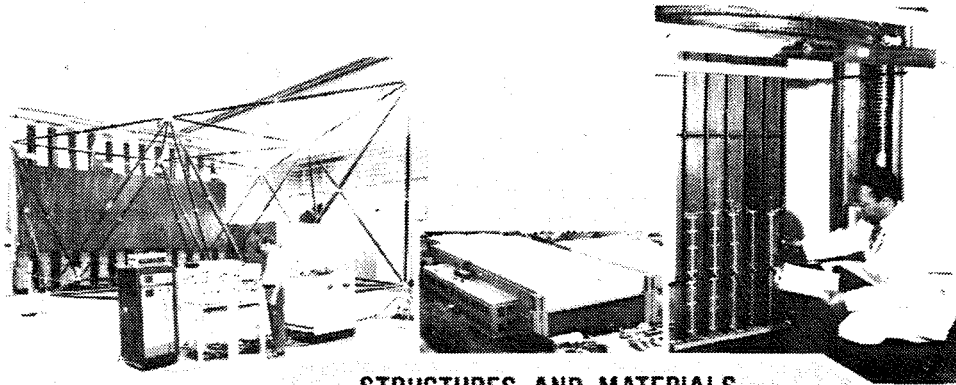

**STRUCTURES AND MATERIALS
RESEARCH LABORATORY**

STRUCTURES AND DYNAMICS

DIVISION

FACILITIES

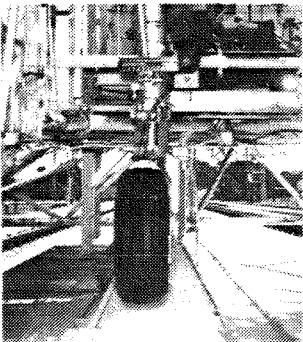

**IMPACT DYNAMICS
RESEARCH FACILITIES**

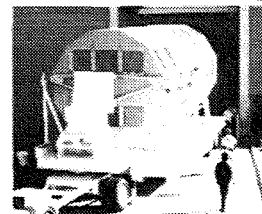
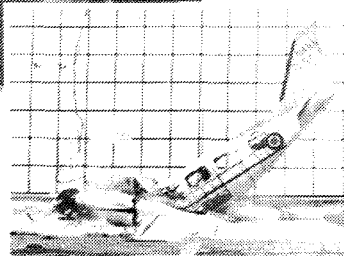
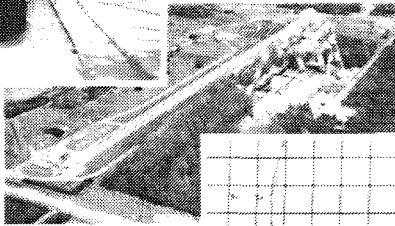

**STRUCTURAL DYNAMICS
RESEARCH LABORATORY**

Figure 1.

III IMPACT DYNAMICS BRANCH

IMPACT DYNAMICS BRANCH

DISCIPLINE	FY 84	FY 85	FY 86	FY 87	FY 88	GOAL	
LANDING DYNAMICS							
TIRE BEHAVIOR	THFRMAL STUDIES			HIGH-SPEED TIRE FAILURE		IMPROVED TIRE AND GEAR DESIGNS	
		TIRE MATERIAL STUDIES					
	TIRE CONTACT STUDIES	NATIONAL TIRE MODELING PROGRAM					
LANDING SYSTEMS	ALDF UPDATE / CHECKOUT / TESTING						
	F-106 ACTIVE GEAR FLIGHT TESTS					REDUCED RUNWAY AND AIRFRAME LOADINGS	
	LOW-SPEED TILT STEERING			HI-SPEED TILT STEERING			
		SHUTTLE HIGH-SPEED CORNERING AND BRAKING					
JOINT FAA/NASA AIRCRAFT RUNWAY FRICTION TESTS							
GROUND OPERATIONS	JOINT NASA/FAA RUNWAY SURFACE TRACTION TESTS						SAFE ALL-WEATHER OPERATIONS
CRASH DYNAMICS							
NONLINEAR STRUCTURAL ANALYSIS	G. A. FLOOR, PULSE		TRANSPORT			ACCURATE PREDICTIVE METHODS	
	METAL AND COMPOSITE GLOBAL/LOCAL COMPONENT RESPONSE						
COMPOSITE DYNAMIC RESPONSE CHARACTERISTICS	ABRASION, TEARING TESTS					DATA BASE	
	BEAMS, FRAMES						
	SUBFLOOR, CYLINDERS						
FULL-SCALE TESTING	METAL TRANS. SECT.					DEMONSTRATION AND VERIFICATION	
	△	COMPOSITE HELICOPTER					
	METAL TRANSPORT	△ B-720	△ OH-6				

III IMPACT DYNAMICS BRANCH

RTOP 505-33-53 ADVANCED AIRCRAFT STRUCTURES AND DYNAMICS

RTR 505-33-53-05 Transport Impact Dynamics Analysis

OBJECTIVE:

To enhance passenger safety through improvement of analysis methods, airframe structural concepts, and seat/restraint system concepts for future aircraft under crash conditions.

FY 1985 PLANS:

- o Predict global crash behavior of B-720 airplane using updated DYCAST finite element model
- o Conduct full-scale B-720 crash test

APPROACH:

Nonlinear analytical techniques, potentially suited to integration into design methods, will be used to predict crash dynamic response of fuselage sections, multi-seat/restraints/occupant systems, and complete airplanes. From studies of load-limiting structures the most promising seat and fuselage concepts will be selected and dynamically tested. A large-scale crash test will be performed to provide archival crash response data as metal baseline for future composite structures research. The analytical predictions will be compared to the measured quantities.

MILESTONES:

- o Refinement of B-720 crash model, October 1984
- o Preliminary report on B-720 crash data, December 1984
- o Initiate design study of composite transport data, December 1984
- o Final report on B-720 crash test experiments, August 1985

FY 1984 ACCOMPLISHMENTS:

- o A 352-channel Data Acquisition System for the B-720 Control Impact Demonstration (CID) Program was built, tested, and delivered on schedule to Dryden Flight Research Facility
- o A 10-camera Photographic System for the B-720 was also built, tested, and delivered on schedule to DFRF

- o Conducted three B-707 fuselage section drop tests in support of the CID Program

RTR 505-33-53-09 Composite Crash Dynamics

OBJECTIVE:

To establish a data base, develop a better understanding of the behavior, and generate or verify analytical and empirical tools to predict global response characteristics of composite structures under crash loading conditions.

FY 1985 PLANS:

- o Conduct abrasion tests on I-beam stiffened skin components on runway surface
- o Perform tests and predict impact behavior of metal and composite curved frames
- o Determine damage modes and dissipation energy of eccentrically loaded composite beams

APPROACH:

Develop in-house test methods, procedures and apparatus to conduct static and dynamic combined loading tests on representative composite components. Develop a data base to evaluate the effect of combined loadings on global response, stiffness and failure, and residual strength after failure. Analytical predictions using existing modified non-linear computer programs and newly developed analysis methods will be compared to the experimental results. Supportive contractual efforts will be used mainly to fabricate composite components requiring special tooling.

MILESTONES:

- o Complete runway abrasion tests of beams and panels, July 1984
- o Initiate tests and complete DYCAST analysis of composite fuselage frames, October 1984
- o Initiate analysis of composite fuselage frames with MSC/NASTRAN, December 1984
- o Continue design and fabrication of composite frame elements and initiate design of composite substructures, January 1985

- o Follow-on VPI&SU grant with additional tests and analysis of built-up composite beams under impact loads, February 1985
- o Complete analysis of composite fuselage frames with MSC/ NASTRAN, March 1985
- o Complete tests of composite fuselage frames, April 1985
- o Initiate design and fabrication of test apparatus for VPI&SU grant using built-up composite beams, June 1985
- o Complete design and fabrication of testing apparatus for Lockheed composite substructures specimens, September 1985

FY 1984 ACCOMPLISHMENTS:

- o Completed laboratory abrasion tests of composites and published NASA TP-2262 on wear and friction of metal and composite airplane skins
- o Completed design and fabrication of composite fuselage frames for crash loading
- o Designed and fabricated runway abrasion apparatus for full-scale wear tests of composite beams and panels on operational runway surfaces
- o Initiated analysis of composite fuselage frame with DYCAST
- o Initiated testing and analysis of simple composite beams under impact loads (VPI&SU grant)

RTR 505-33-53-17 Flight Test of F-106B
Active Control Landing Gears

OBJECTIVE:

To demonstrate the load alleviation characteristics of active control landing gears by flight tests.

FY 1985 PLANS:

- o Complete active gear modifications for full-scale landing dynamics demonstration

APPROACH:

To acquire and modify a set of F-106B landing gear for active controls using concepts developed under RTR 505-45-14-01 (Aircraft Landing Dynamics). Static drop test the modified gear using the landing dynamics facility. Test-ready gear

then will be delivered to the hangar for installation and flight tests on NASA F106B aircraft. Flight tests include touchdown and taxiing over various runway surfaces with and without active control operation.

MILESTONES:

- o Main and nose gear modified for active controls, January 1985
- o Complete static drop testing, July 1985
- o Initiate flight tests of F-106B active control landing gears, December 1985
- o Complete flight tests of F-106B active control landing gears, February 1986

FY 1984 ACCOMPLISHMENTS:

- o F-106B flight test program approved by LSAD, March 1984
- o Landing gear delivered to ALDF for study, March 1984
- o Initiated gear modification and controller design, March 1984
- o Held preliminary program safety review (ASRB), May 1984

RTOP 505-42-23 ROTORCRAFT AIRFRAME SYSTEMS

RTR 505-42-23-04 Composite Impact Dynamics

OBJECTIVE:

To understand better the response characteristics of generic composite components subjected to crash loading conditions.

FY 1985 PLANS:

- o Design and fabricate in-house a loading platform for use in full-scale testing of composite sections

APPROACH:

To develop in-house test methods, procedures, and apparatus to conduct static and dynamic combined loading tests on representative composite beam elements. To collect and assess the data, evaluate the effect of combined loading on global response, stiffness and failure, and define residual strength after failure. Analytical predictions using DYCAST

will be compared to the experimental results. Supportive contractual efforts will be used mainly to fabricate composite components requiring special tooling.

MILESTONES:

- o Complete DYCAST analysis of dynamically loaded composite frames, March 1985

FY 1984 ACCOMPLISHMENTS:

- o Initiated composite frame analysis using DYCAST

RTOP 505-45-14 AIRCRAFT LANDING DYNAMICS

RTR 505-45-14-01 Aircraft Landing Dynamics

OBJECTIVE:

Advance the technology for safe, economical all-weather aircraft ground operations including the development of new landing systems.

FY 1985 PLANS:

- o National Tire Modeling Program
 - Determine tire material properties
 - Develop 3-D large rotation finite element for tire analysis
- o Aircraft Landing Dynamics Facility (ALDF)
 - Check out facility
 - Initiate high-speed Shuttle nose gear tests
- o Continue Joint NASA/FAA Runway Surface Friction Program

APPROACH:

Coordinate in-house research, grants, and contracts with U.S. tire industry experimental effort to carry out National Tire Modeling Program. Conduct detailed studies of forces and moments in tire footprint for comparison with analytical tire predictions. Conduct spray ingestion tests and nose wheel spray pattern model studies. Develop analytical model to predict temperature gradients in yawed, rolling aircraft tire (asymmetric) and compare with measured temperatures. Obtain data to validate aircraft/ground vehicle friction correlation model.

MILESTONES:

- o Tire modeling session at GWU/NASA Symposium, October 1984
- o Conduct tests on P197/70 R14 tires for NTMP, October 1984
- o Conduct snow/ice airplane and ground vehicle runway friction tests, December 1984
- o Conduct checkout tests on updated track, April 1985
- o New track operational, June 1985
- o Publish experimental paper on footprint measurements, June 1985
- o Publish initial spray ingestion research paper, August 1985
- o Conduct in-house tests supporting friction theory, September 1985

FY 1984 ACCOMPLISHMENTS:

- o Tire modeling paper, NASA TP-2343, demonstrates computational efficiency of mixed mode and symmetry techniques
- o Spray ingestion tests indicate trajectory and volume of water displaced
- o Established unique towing techniques to study orbiter crosswind steering problems
- o Completed 54 FAA/NASA landing braking tests and over 400 ground vehicle braking tests
- o Footprint force and moment measurements give definitive force distributions
- o Completed spherical valve model studies
- o Tire modeling session of GWU/NASA Symposium focuses on National Tire Modeling Program need

IV STRUCTURAL CONCEPTS BRANCH

ADVANCED SPACE STRUCTURES

THRUSTS	FY 84	FY 85	FY 86	FY 87	FY 88	FY 89	RESULTS
DEPLOYABLE & SPACE CRANE CONCEPTS			1-g	deploy test			VERIFICATION OF CONCEPT FEASIBILITY
		BAT BEAM					
		SYNCHRONOUSLY DEPLOYABLE ANTENNA SURFACE					
	defin.	JOINT UT/NASA CONTROL.GEOM.BEAM					
ERECTABLE CONCEPTS	0-g	launch					VERIFICATION OF CONCEPT FEASIBILITY
	ACCESS						
	0-g	ANTENNA ASSEMBLY STUDIES					
	SABER	15 FOOT ERECTABLE BEAM EXPERIMENT					
SPACE STATION MOBILITY CONCEPTS		IN-HOUSE MRMS					FORMULATION & VERIFICATION OF CONCEPTS
	ATV	ADVANCED MRMS WITH ROBOTICS					
EVOLUTIONARY SPACE STATION CONFIGURATIONS		CONSTRUCTION SIMULATION STUDIES					FORMULATION OF SPACE STATION STRUCTURAL CONCEPTS
		STATION CONFIGURATION					
		EVOLUTIONARY STATION					
		ON-ORBIT CONSTRUCTION					

IV STRUCTURAL CONCEPTS BRANCH

RTOP 506-53-43 ADVANCED SPACE STRUCTURES

RTR 506-53-43-01 Advanced Space Structures Concepts

OBJECTIVE:

Develop deployable and erectable structural concepts and associated design technology for future large space structures with emphasis on space station.

FY 1985 PLANS:

- o Conduct on-orbit construction studies
- o Initiate fabrication of 15-meter deployable truss antenna test component
- o Design and fabricate 2nd generation BAT beam
- o Complete all ground simulations for ACCESS

APPROACH:

Construction of flight hardware and the flight test for the ACCESS program will be completed and an evaluation will be made of on-orbit construction of space structures using results from the test program. A computer-aided design capability will be established in-house to investigate structural configurations of the space station and to evaluate construction scenarios using both deployable and erectable concepts. Methods for structural modifications of, and extensions to, space station and scenarios for construction of earth resources and astrophysics spacecraft using the space station as a construction base will be investigated using the computer-aided design capabilities.

MILESTONES:

- o Establish in-house computer-aided design capability, to support space station design studies, February 1985
- o Development of concept to deploy BAT beam, March 1985
- o Preliminary design of 1-g and neutral buoyancy test components for ATV and large truss structure completed, March 1985
- o Complete fabrication of flight hardware and flight test of ACCESS, May 1985

- o Preliminary design of neutral buoyancy test model of 15m truss antenna completed and fabrication initiated, September 1985

FY 1984 ACCOMPLISHMENTS:

- o Conducted neutral buoyancy test of SABER
- o Designed, fabricated and tested ACCESS at 1-g and in the neutral buoyancy facility
- o Conceived an assembly transport vehicle and investigated applications for on-orbit construction of space station and spacecraft
- o Developed scenario for space flight test of construction of stiff beam structure
- o Conceived strongback support structure for deployable solar array approach for space station power production
- o Fabricated a deployable 36-element tetrahedral truss test model with lanyard development control system for antenna application
- o Designed and fabricated cluster joint for orthogonal tetrahedral truss (space station application)
- o Developed antenna surface analysis for synchronously deployed truss program
- o Redesigned both the side-latching thumb-release joint and slide/lock side-insertion joint for space assembly for small diameter struts
- o Completed test and analysis of geodesic deployable beam
- o Completed design and fabrication of BAT beam components

**RTOP 482-53-43 ADVANCES SPACE STRUCTURES/
ERECTABLE SPACE STRUCTURES**

RTR 482-53-43-21 Erectable Large Space Structures

OBJECTIVE:

Develop erectable truss structure construction procedures to a point where a rational assessment of their application to space station can be made. Evaluate candidate graphite/epoxy tube designs to determine their suitability for use as space station primary structure and to build a multi-bay component for use in testing a mobile remote manipulator system (MRMS)

FY 1985 PLANS:

- o Develop high stiffness, low coefficient thermal expansion, tough strut for space station
- o Develop 2nd generation erectable joint for space station
- o Establish design requirements and concepts for MRMS

APPROACH:

An erectable truss beam for keel structure of a gravity gradient space station configuration will be designed, fabricated, and ground tested. Included in the design is an associated mobile assembly machine required to assist the astronauts in the on-orbit erection process. Several different assembly concepts will be evaluated with an emphasis on versatility for use on different structures.

MILESTONES:

- o Complete beam strut and joint design, January 1985
- o Complete baseline definition of construction process, July 1985

FY 1984 ACCOMPLISHMENTS:

New RTR

V STRUCTURAL DYNAMICS BRANCH

STRUCTURAL DYNAMICS RESEARCH

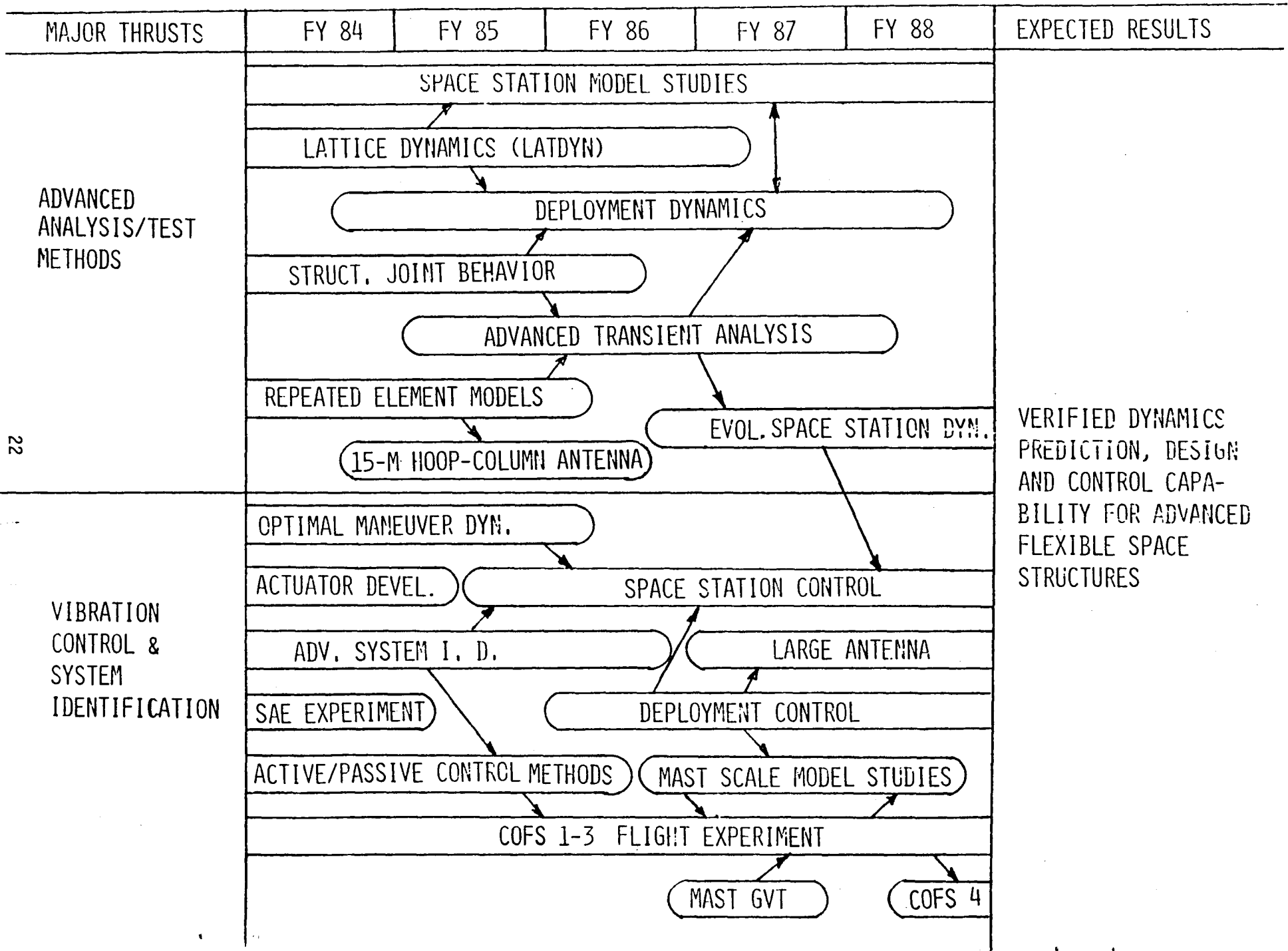

V STRUCTURAL DYNAMICS BRANCH

RTOP 506-53-43 ADVANCED SPACE STRUCTURES

RTR 506-53-43-15 Vibration Control

OBJECTIVE:

To develop and improve capability for identification of structural parameters and to control excessive vibrations of flexible structures using active and passive controllers.

FY 1985 PLANS:

- o Demonstrate slewing control on generic station model

APPROACH:

Techniques for identifying structural parameters will be developed with emphasis on methods which may be adapted to large space system requirements. Improvements to existing methods may significantly reduce computer requirements to make on-orbit identification feasible. New algorithm capability will be evaluated using laboratory models. Reduction of structural vibrations due to slewing maneuvers will be analyzed by tailoring the driving force in such a way as to minimize vibrations at the end of the maneuver. Also, active control methods will be evaluated by analyses and experiments. Actuators using state-of-the-art controller techniques will be incorporated with test models to verify slew rate algorithms, vibration suppression techniques, and identification algorithms.

MILESTONES:

- o Initiate telescoping member actuator concept development, October 1984
- o Initiate deployment control study, November 1984
- o Publish ERA Users Manual, April 1985
- o Complete nonlinear system identification overview study, May 1985
- o Initiate slewing control experiment, June 1985

FY 1984 ACCOMPLISHMENTS:

- o Demonstrated integrated-electronics linear actuator
- o Initiated nonlinear-to-linear transformation study

- o Demonstrated closed-form tracking problem solution
- o Developed improved time-domain system identification algorithm
- o Completed initial real-time simulation system installation
- o Completed Galileo system identification study
- o Completed complex modes model-improvement program

RTR 506-53-43-16 Advanced Spacecraft Dynamics Analysis

OBJECTIVE:

Develop and validate analytical methods for predicting the coupled structural dynamic and control of multibody space structures with flexible components, interfaces and dissipative mechanisms; and large amplitude responses.

FY 1985 PLANS:

- o Complete generic model dynamic tests
- o Initiate advanced transient analysis development contract

APPROACH:

Formulate new or improved analytical methods for predicting controlled transient and steady-state response of multibodies having a large number of flexible components and interfaces, accounting for coupled rigid body motions and flexible deformations, interface dissipative mechanisms and control forces. Develop or adapt modularized interdisciplinary computer based system as a framework for integrating new methods. Develop and verify realistic analytical models and procedures for joint and interface damping mechanisms. Perform tests of generic space station model and identify impact of measured results on new and future analysis methods.

MILESTONES:

- o Verify by test newly developed joint damping models, November 1984
- o Apply LATDYN to deployment of box and triangular beams, December 1984
- o Incorporate joint damping models into LATDYN, January 1985

- o Develop user friendly enhancement for LATDYN, February 1985
- o Conduct workshop on multibody dynamics analysis for government, academia, and industry, April 1985
- o Extend LATDYN to 3-D capability, September 1985

FY 1984 ACCOMPLISHMENTS:

- o Fabricated space station generic model and testing under way
- o Developed 2-D LATDYN for multibody maneuver and deployment, SDM paper
- o Established damping models for large class of joints
- o Identified fundamental characteristics of deployment dynamics in unfolding booms
- o Developed exact element for nonlinear prestress

RTR 506-53-43-17 Mast Project Ground Test Program

OBJECTIVE:

To provide for the ground test program for the LSS Structures/Controls Flight Experiment (Mast Flight Project).

FY 1985 PLANS:

- o Initiate COFS-1 development, lab beam tests

APPROACH:

Develop the plans, tools, devices, systems, and procedures required to implement and complete the LaRC ground test of the Mast Flight Project. The test program will include not only the testing of the full-scale flight system but also all precursor testing such as components, subassemblies, and the "mini-beam" program.

MILESTONES:

- o Start definition of total LaRC ground test program, October 1984
- o Begin prototype beam analysis, October 1984
- o Begin facility modification design, January 1985
- o Begin tests of prototype beam (Mini-Mast), June 1985

FY 1984 ACCOMPLISHMENTS:

- o Initiated prototype beam procurement (Mini-Mast)
- o Released Mini-Mast RFP
- o Awarded Mini-Mast contract

RTOP 506-62-43 SPACECRAFT TECHNOLOGY EXPERIMENTS

**RTR 506-62-43-12 Dynamics of 15m Hoop-Column
Antenna Structure**

OBJECTIVE:

To develop verified structural dynamics test and analysis methods applicable to large cable-stiffened antenna structures.

FY 1985 PLANS:

- o Initiate 15m hoop column antenna dynamic tests

APPROACH:

A 15m-diameter hoop-column antenna structure under construction by the Harris Corporation will be analyzed using the BUNVIS computer program with recently developed repeating element capability. The structure will be vibration tested in the LaRC 16m thermal vacuum chamber. Conduct of the test program will require special response measure methods and special handling of the test specimen. Comparisons of test and analysis results will be made to assess sensitivity to small cable tension variations due to various tolerances. Attempts to assess gravitational effects on vibration characteristics through model reorientation for similar tests or other appropriate means will be made.

MILESTONES:

- o Complete preliminary finite element model of full antenna, December 1984
- o Contract for QA inspection, March 1985
- o Contract for dynamic test support, March 1985
- o Install antenna in test facility, April 1985
- o Complete instrumentation and static verification tests, June 1985
- o Initiate modal vibration tests of antenna, July 1985

- o Initiate data reduction using state-of-the-art parameter identification algorithms, August 1985

FY 1984 ACCOMPLISHMENTS:

New RTR

RTOP 482-53-53 ANALYSIS AND SYNTHESIS/SCALE MODEL STUDY

RTR 482-53-53-34 Space Station Structural Dynamic Analysis

OBJECTIVE:

Develop, as soon as practical, a verified capability to analyze deployment of space station truss components and manipulation of flexible robotic arms on a relatively flexible station.

FY 1985 PLANS:

- o Complete 2-D LATDYN development, begin 3-D

APPROACH:

New analytical methods applicable to deployment, docking, maneuvering, and control will be investigated. Specifically, computer programs in flexible-body deployment, slewing, and vibration control will be improved and combined into a set of programs useful for general space station dynamic analysis.

MILESTONES:

- o Initiate contractual dynamic analysis development, March 1985

FY 1984 ACCOMPLISHMENTS:

New RTR

RTR 482-53-53-38 Space Station Pathfinder Model

OBJECTIVE:

Develop a space station pathfinder model and investigate, as far as possible under 1g, the testing of components, sub-structures, and complete models of space stations.

FY 1985 PLANS:

- o Prepare procurement package for IOC space station replica model

APPROACH:

- o A scaled structural dynamics model of a space station will be developed and the feasibility and limitations of testing such a model will be established. A feasibility study will be the first task, establishing limitations and benefits of the pathfinder model.

MILESTONES:

- o Initiate contractual feasibility study for a pathfinder model, March 1985

FY 1984 ACCOMPLISHMENTS:

New RTR

VI STRUCTURAL MECHANICS BRANCH

STRUCTURAL MECHANICS

MAJOR THRUSTS	FY 84	FY 85	FY 86	FY 87	FY 88	EXPECTED RESULTS	
COMPOSITE STRUCTURES	COMPOSITE STRUCTURES MECHANICS TECHNOLOGY					FAULT-TOLERANT COMPOSITE STRUCTURES DESIGN TECHNOLOGY FOR ADVANCED CONCEPTS	
	FAILURE MECHANISMS/ANALYSIS			←			
	CUTOUPS/IMPACT/DISCONTINUITIES			←			
	FAILSAFE CONCEPTS/DAMAGE TOLERANCE						
	FLAT/CURVED STIFFENED PANELS						
	POSTBUCKLING/NONLINEAR EFFECTS			←			
STRUCTURAL ANALYSIS AND COMPUTATIONAL STRUCTURAL MECHANICS	NONLINEAR STRUCTURAL ANALYSIS TECHNIQUES					NEW METHODS AND CODES FOR STRUCTURAL ANALYSIS AND SIZING	
	ANALYSIS/SIZING PROCEDURES FOR STIFFENED PANELS/SHELLS				←		
	ANALYSIS/SIZING PROCEDURES FOR DAMAGE/FAULT TOLERANCE						
	COMPUTATIONAL STRUCTURAL MECHANICS (CSM)						←
	COMPUTATIONAL METHODS						
TEST BED SYSTEMS							
PARALLEL PROCESSING (FEM/OTHERS)			←				

VI STRUCTURAL MECHANICS BRANCH

RTOP 505-33-33 COMPOSITES FOR AIRFRAME STRUCTURES

RTR 505-33-33-06 Composite Structures Design Technology

OBJECTIVE:

- o Develop mechanics technology required for the verified design of efficient, fault-tolerant advanced-composite aircraft structural components subject to combined loads, impact, postbuckling effects and local discontinuities.

FY 1985 PLANS:

- o Develop stiffener pull-off analysis
- o Study effects of cutouts on shear webs with postbuckling strength

MILESTONES:

- o Initiate study of effect of load transfer on composite panel performance, October 1984
- o Initiate study of effects of thickness discontinuities on composite panel performance, October 1984
- o Complete preliminary study of effects of impact damage and cutouts on shear webs with postbuckling strength, March 1985
- o Complete preliminary study of effect of lateral pressure on flat stiffened composite panels, March 1985
- o Complete preliminary study of curved composite stiffened compression panels and unstiffened panels with cutouts, June 1985
- o Complete preliminary study of cutout reinforcement concepts for flat composite panels, June 1985
- o Complete development of verified multi-layer-laminate compression failure analysis, June 1985
- o Complete development of stiffener pull off failure analysis, September 1985
- o Initiate preliminary study of combined load effects on stiffened composite cylinders, September 1985

FY 1984 ACCOMPLISHMENTS:

- o Tested modified graphite-epoxy stiffened shear panels with post-buckling strength. Modification reduces tendency of fastener heads from pulling through skins
- o Conducted Preliminary study of Z and channel graphite-epoxy stiffener crippling. Identified reentrant-corner and free-edge-delamination failure modes
- o Completed study of load-introduction and load-diffusion effects on compression strength of laminates with holes. Report on results being prepared
- o Formulated analytical model for predicting strength of multi-directional laminates loaded in compression. Verification and refinement of model under way
- o Developed analytical model for stress resultant distribution in skin-stringer interface region. Failure analysis for skin-stringer separation mode under development
- o Preliminary tests of composite panels with reinforced holes indicate that interlaminar shear stresses at reinforcement thickness discontinuities away from hole can cause failure. Scope of research being expanded to include effects of thickness discontinuities
- o Preliminary test results indicate that impact damage and cutouts can significantly degrade the postbuckling performance of graphite-epoxy shear webs
- o Conducted pure shear postbuckling test of curved composite stiffened panel. Panel failed due to complex phenomenon involving interaction of buckled skin and frames. Conducted combined compression-shear tests and results being analyzed
- o Developed prototype computer code that includes the effects of local stress intensity factors in design process of unstiffened and stiffened panels. Formulated approach to simultaneously perform nonlinear analysis and structural optimization

RTOP 534-06-23 COMPOSITE MATERIALS AND STRUCTURES

RTR 534-06-23-08 Failsafe Composite Structures

OBJECTIVE:

Develop verified analytical methods that reliably predict ultimate strength of composite structures with damage, local discontinuities and nonlinear effects, and develop structurally-efficient damage-tolerant structural concepts for heavily-loaded wing and fuselage primary structure.

FY 1985 PLANS:

- o Evaluate advanced damage-containment concepts for compression loading
- o Evaluate thin-walled filament-wound stiffened shell and other advanced shell-wall concepts

APPROACH:

Experiments will be conducted to identify the failure mechanisms that limit the performance of composite wing and fuselage structure and to verify analytical models. Compression, shear, tension, internal pressure and combined loads representative of aircraft primary structures will be considered. Analytical methods for reliably predicting ultimate strength of composite structures with local discontinuities, gradients and damage will be developed. Damage-tolerant structural concepts that resist and contain damage will be developed.

MILESTONES:

- o Conduct tests to evaluate three advanced heavily-loaded damage-containment wing panel concepts, October 1984
- o Compare moire-interferometry measurements with results of analysis for stiffened panel cross-section subjected to lateral bending, December 1984
- o Complete study of composite failure analysis deficiencies and conduct analytical study of one major deficiency, February 1985
- o Initiate tests to study damage-tolerance and load redistribution in remaining PRVT vertical fin specimens, March 1985
- o Conduct preliminary evaluation of a filament-wound stiffened cylinder subjected to compression loading, March 1985

- o Develop analysis for matrix-shearing failure mode in ± 45 -degree-dominated laminates, June 1985
- o Develop incremental deformation theory that describes fiber shear crippling in compression loaded laminates and conduct experiments to observe failure propagation, June 1985
- o Make precise displacement measurements in multispan beam shear specimen and correlate with theory, June 1985
- o Conduct preliminary evaluation of a honeycomb sandwich concept for fuselage applications, June 1985
- o Initiate structural efficiency study of orthogrid, hybrid and unbalanced-laminate wall concepts for fuselage applications, August 1985
- o Develop advanced theory for laminated plates that accurately accounts for interlaminar stresses, September 1985
- o Design multi-bay rib supported panel based on most promising damage-tolerant compression panel concept and generic load redistribution, September 1985
- o Initiate frame-skin interaction study for curved pressure-loaded composite panels, September 1985

FY 1984 ACCOMPLISHMENTS:

- o Completed residual strength test program on L-1011 composite covers and spars. Reported results at ACEE Symposium, August 1984
- o Reviewed proposals for contract to address composite failure analysis and to develop damage-tolerant structural concepts.
- o Demonstrated capability of bolted-skin splice to arrest damage propagation in stiffened compression panel concept
- o Identified role of microbuckling and associated shear crippling in compression laminate failure and damage propagation and developed unidirectional laminate compression failure theory
- o Demonstrated higher strain fiber to reduce size of impact damage and improve open-hole compression strength. However, the smaller diameter associated with most higher strain fibers was found to reduce microbuckling dominated compression strength
- o Identified matrix-shearing failure mode for compression-loaded ± 45 -degree laminates

- o Preliminary analytical studies show that a small amount of ± 45 -degree through-the-thickness stitching improves transverse shear stiffness and delamination resistance
- o Demonstrated use of transparent birefringent orthotropic fiberglass material for studying laminate failure modes
- o Completed study of effect of resin content impact damage tolerance
- o High-speed photography shows that sequency of failure events in stiffened compression panels and subsequent residual strength depends on boundary conditions provided by stiffeners following local failure
- o Published DOD/NASA Advanced Composite Design Guide

RTOP 505-33-53 ADVANCED AIRCRAFT STRUCTURES AND DYNAMICS

RTR 505-33-53-10 Structural Mechanics Analysis

OBJECTIVE:

Develop structural analysis and sizing methods for predicting and designing for the nonlinear behavior of aerospace structures including postbuckling phenomena and ultimate strength.

FY 1985 PLANS:

- o Implement in-house developed nonlinear analysis theory into general purpose analysis code

APPROACH:

Develop advanced structural analysis and sizing procedures for aerospace structures with nonlinear responses. Develop procedures that account for large deflections and rotations for analyzing flat and curved composite stiffened structural components. Procedures also will be developed for detailed 3-D stress analysis of composite components. Analytical procedures will be verified with available test data, and results will be compared with failure criteria that predict ultimate strength. New failure analyses will be developed as needed.

MILESTONES:

- o Document implementation of in-house developed equivalence transformation into STAGS code for improving efficiency of postbuckling calculations, March 1985

- o Document error analysis and correction procedure for finite element analysis of orthotropic composite plates, May 1985
- o Initiate analytical study to determine the influence of measured initial geometric imperfections on postbuckling response of composite panels and compare analytical results with tests, June 1985
- o Develop prototype computer program for carrying out structural optimization with constraints using nonlinear structural analysis, September 1985

FY 1984 ACCOMPLISHMENTS:

- o Completed pilot version of computer program for calculating buckling loads of flat composite panels with transverse stiffeners. Calculations with program are under way
- o Developed analysis for postbuckling response of long orthotropic plates subjected to combined transverse and longitudinal compression and combined transverse compression and shear
- o Preliminary documentation written for computer program VICON for predicting shear buckling loads of stiffened composite panels
- o Predicted postbuckling response of curved composite panels with circular hole correlate well with test results until local material failures occur
- o Documented modified modal method for nonlinear dynamic analysis of structures subjected to step loading
- o Signed contract to introduce into STAGS an advanced analysis procedure based on generalized Newton's method
- o Developed and coded an efficient algorithm for computing eigenvalues of $M\lambda^2 + C\lambda + K = 0$
- o Initiated analytical study to develop a higher-order nonlinear transverse shear theory for composite plates and shells

RTR 505-33-53-15 Computational Structural Mechanics

OBJECTIVE:

Develop advanced structural analysis and computational methods, and develop standard generic software system for structural analysis.

FY 1985 PLANS:

- o Acquire and evaluate initial test bed software system
- o Initiate research on local/global structural analysis methods
- o Initiate new research on nonlinear transient dynamics analysis methods

APPROACH:

Methods research will emphasize procedures that exploit computers having multiple processors and a concurrent processing capability. To aid in the methods development research, a test bed system will be created. It will consist of software for Langley's CYBER computers and a combination of software and hardware for concurrent processing. A standard generic software system that can accept applications modules will be developed. This software system will be aimed at the computers and aerospace structural analysis problems of the late 1980's and beyond.

MILESTONES:

- o Access results of workshop aimed at defining details of CSM activity and securing cooperation of industry, October 1984
- o Transient and nonlinear analysis algorithms operational on 16 processor FEM, December 1984
- o Award contracts and grants for methods research in nonlinear transient dynamics and 2D/3D stress analysis, January 1985
- o Acquire initial LaRC test bed software system, January 1985
- o Develop efficient finite difference technique for 3-D elasticity solutions of composite laminates, May 1985

FY 1984 ACCOMPLISHMENTS:

- o Highly efficient transient and nonlinear analysis algorithms have been developed and made operational on 8 processor FEM

VII ACCOMPLISHMENT HIGHLIGHTS

IMPACT DYNAMICS BRANCH

GENERAL AVIATION CRASH DATA PLAYING MAJOR ROLE
IN ACCIDENT ASSESSMENT AND TEST CRITERIA DEVELOPMENT

Huey D. Carden and Robert G. Thomson
Impact Dynamics Branch
Extension 3795
January 16, 1984
RTOP 505-53-33

Research Objective

In a recently concluded program, Langley conducted thirty-two (32) controlled, full-scale crash tests of general aviation airplanes and generated a substantial data base on crash behavior. The objective of this program was to determine dynamic response of airplane structure, seats, and occupants during a crash, and to determine the effect of flight parameters at impact on loads and structural damage.

Approach

A simplified analysis of the complicated crash scenario was developed based on impulse-momentum relationships. Typical comparison between this analysis and full-scale crash test data is shown in the upper right. The line is the analysis based on the assumption that the acceleration-time pulse is triangular in shape. The symbols are experimental data and include the general aviation tests, two transport tests, and fighter tests. Clustering of the experimental data about the line confirms the triangular shape as being representative of crash pulses.

Accomplishment Description

The National Transportation Safety Board (NTSB) has undertaken a special program of crash investigation to establish a range of accident scenarios for which design for passenger survivability is feasible. A crash assessment analysis methodology which stems from the Langley method is being developed, and the full-scale test data is used to validate the analysis. The crash visualization used in the NTSB accident assessment methodology is pictured in the lower-left-hand sketch.

A General Aviation Safety Panel (GASP) composed of industry and government personnel are working towards proposed recommendations to the FAA on modifications to FAA Part 23 to improve crashworthiness of GA airplanes. A major feature of the GASP efforts is to define dynamic test criteria for seats as illustrated in the lower-right-hand sketch. GASP is making extensive use of the NASA full-scale crash test data to define appropriate dynamic seat test pulses.

Plans

Continue to support NTSB, GASP, and FAA to aid development of technology for post-crash accident assessment and crashworthiness criteria for structural design and seat certification by use of Langley full-scale crash test data and simplified impulse-momentum analysis.

GENERAL AVIATION CRASH DATA PLAYING MAJOR ROLE IN ACCIDENT ASSESSMENT AND TEST CRITERIA DEVELOPMENT

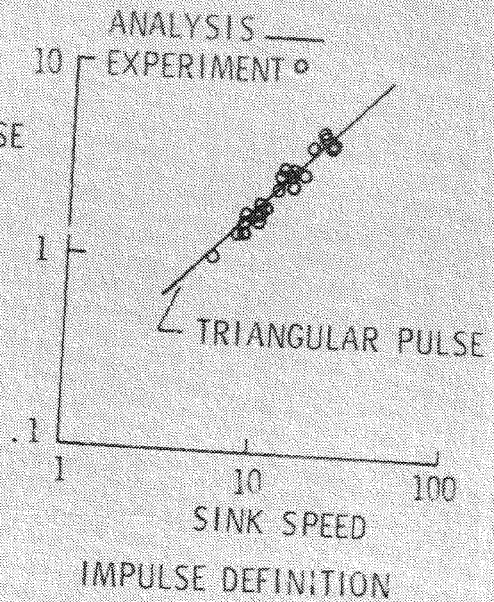
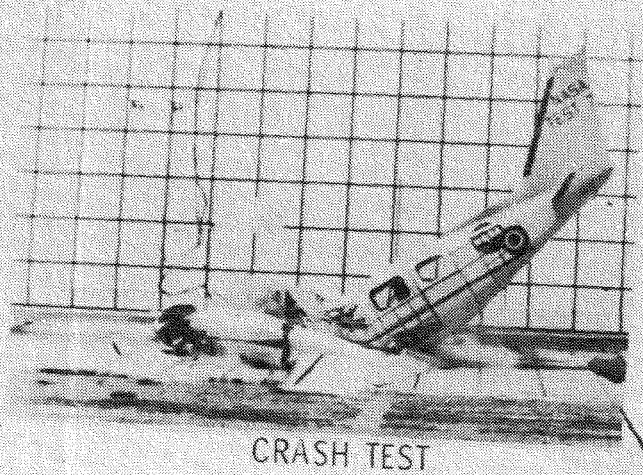

43

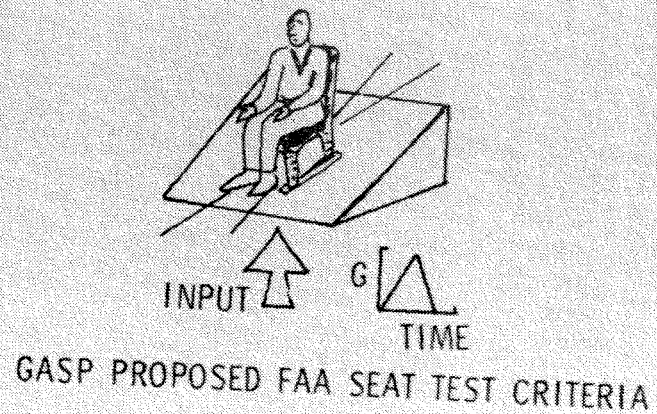
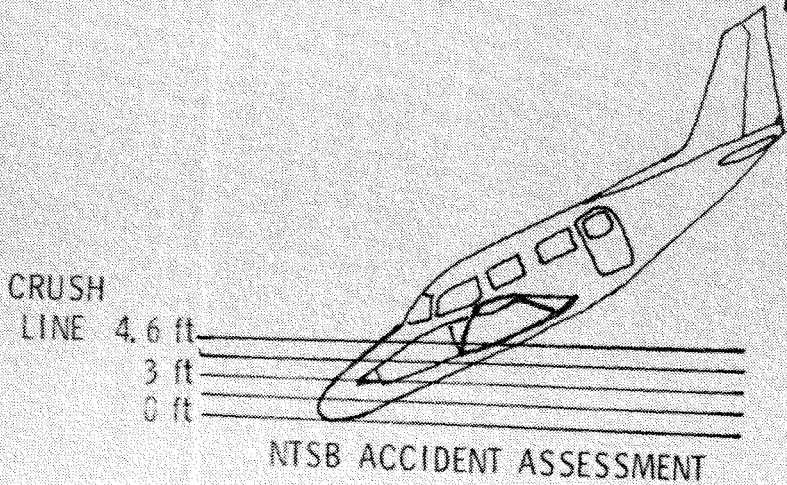

NEW AIRCRAFT TIRE MODELING ANALYSIS DEVELOPED WITH LARGE ROTATION, LIVE PRESSURE CAPABILITIES

Ahmed K. Noor, George Washington University; Carl M. Andersen,
College of William and Mary; and John A. Tanner, Impact
Dynamics Branch

Extension 2796
January 16, 1984
RTOP 505-45-14

Research Objective

The recently initiated National Tire Modeling Program is jointly sponsored by the National Aeronautics and Space Administration and the U.S. tire and rubber industry. The objective of this program is to develop the finite element technology for tire design.

Approach

The program has established a family of benchmark tire modeling problems and is in the process of developing the experimental data base necessary to characterize tire responses to these problems and producing a number of special purpose computer codes that will model these responses.

Accomplishment Description

A one dimensional shell code has been developed based on a mixed finite element formulation which has the ability to handle large rotations and live pressure loads. Large rotations are defined as angular displacements exceeding about 10 degrees requiring trigonometric representations. Live pressure is defined as pressure normal to the deformed shell surface and as such changes magnitude as the shell configuration changes, whereas standard pressure remains normal to the undeformed surface.

The figure shows the results from numerical studies of a 10-layer, orthotropic, incomplete torus (representing a tire) subjected to an internal pressure P_0 and a ring load P . The ring load represents a concentrated puncture load applied to a tire. The cross section deformations represent loading intensities typical for automobile and aircraft tires subjected to concentrated puncture loads. The plot in the figure shows the normalized ring load as a function of radial deflection for three different modeling strategies. These strategies include large rotation theory with and without live pressure capability and moderate rotation theory with live pressure capability. The shaded areas denote the range of deformations associated with normal automobile and airplane operations. These results indicate that any of the three strategies may be used for automotive tire design studies but only large rotation theory with live pressure capability is able to accurately predict the load-deflection responses of typical aircraft tires.

Plans

Work is currently underway to incorporate the large rotation theory with live pressure capability in a two dimension shell finite element code and to verify these numerical results with experimental load-deflection data.

NEW AIRCRAFT TIRE MODELING ANALYSIS DEVELOPED WITH
LARGE ROTATION, LIVE PRESSURE CAPABILITIES.

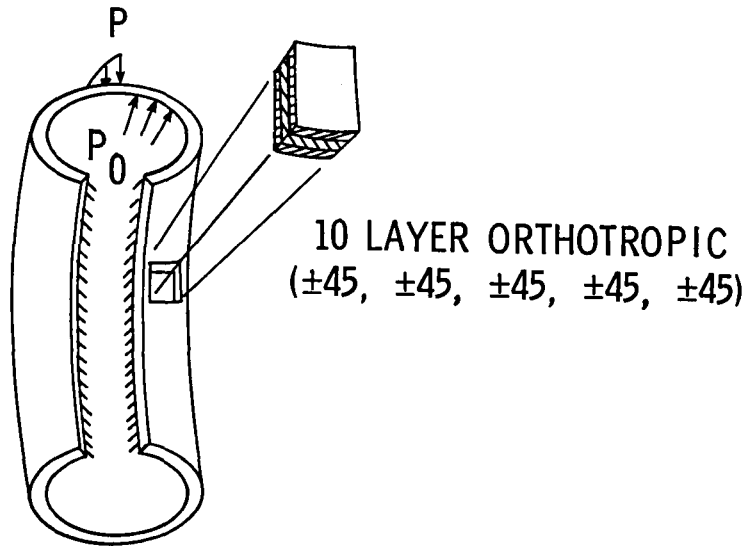

45

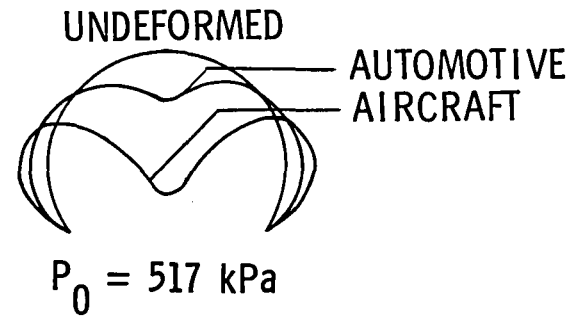

- LARGE ROTATION, LIVE PRESSURE
- - - - MODERATE ROTATION, LIVE PRESSURE
- - - - LARGE ROTATION, STANDARD PRESSURE

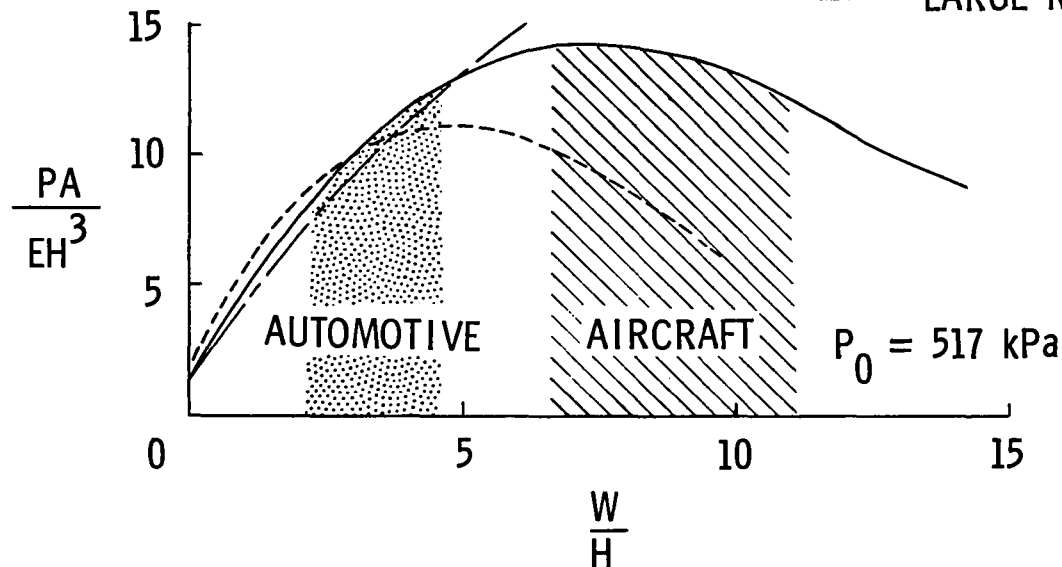

LOAD-LIMITING SUBFLOOR CONCEPTS REDUCE CRASH LOADS BY 50%
WHILE MAINTAINING SEAT/FLOOR INTEGRITY

Huey D. Carden
Impact Dynamics Branch
Extension 3795
February 22, 1984
RTOP 505-53-33

Research Objective

Three six-place, low wing, twin engine general aviation airplane test specimens were crash tested at the Langley Impact Dynamics Research Facility at 80 mph (sink speed = 30 fps), and -15 deg flight path. One unmodified airplane was the base-line airplane specimen for the test series. Each of the two other airplanes in the series were structurally modified to incorporate a different load-limiting (energy-absorbing) subfloor concept into the fuselage structure for full-scale crash test evaluation and comparison to the unmodified airplane test results.

Approach

On two of the three airplanes, the fuselage subfloor structure from the main wing carry-through spar at (fuselage station), FS 140 (in) to aft of the rear cabin door at FS 244 (in) was replaced with crashworthy subfloor structure. The modified area is illustrated in the attached figure. Of the existing structure, the upper floor panel was left in place. The keel beams, bulkheads, stringers, and lower contour skin were removed, and the corrugated-beam or notched-corner concepts installed. The crashworthy subfloor structure was designed to maintain lower skin contour, including the skin gage. Seat tracks were installed on the upper floor panel to provide seat attachment capability. Sketches on the bottom of the figure illustrate details of the construction of the corrugated beam and notched corners subfloor structures, respectively.

Accomplishment Description

The average peak normal crash pulse magnitudes measured on the airplane structure for the three test specimens are presented in the attached figure for three different fuselage stations. An analysis of the data indicate that ordering the tests in decreasing severity places the tests as follows; the unmodified structure, the notched corners structure, and the corrugated beams/notched corners structure. The magnitude of the normal accelerations for the unmodified airplane was approximately between -50 to -55 g's over the length of the airplane because of the flat impact attitude. In comparison, however, the normal accelerations for the notched corner structure, which allowed some crushing of the subfloor structure, were generally -35 to -40 g's. On the other hand, the magnitude of accelerations for the corrugated beams/notched corners structure, which allowed the most structural crush, were reduced to approximately -25 g's, about 50% of the acceleration magnitude of the unmodified airplane.

Plans

Publish NASA Technical Paper on the results of the test series for evaluating full-scale, subfloor load-limiting concepts.

LOAD-LIMITING SUBFLOOR CONCEPTS REDUCE CRASH LOADS BY 50%
WHILE MAINTAINING SEAT/FLOOR INTEGRITY

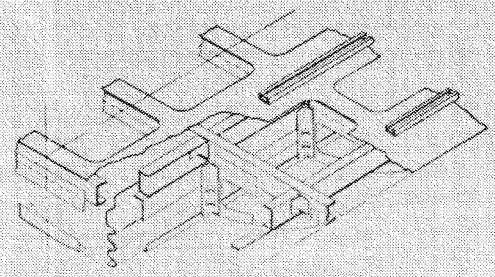
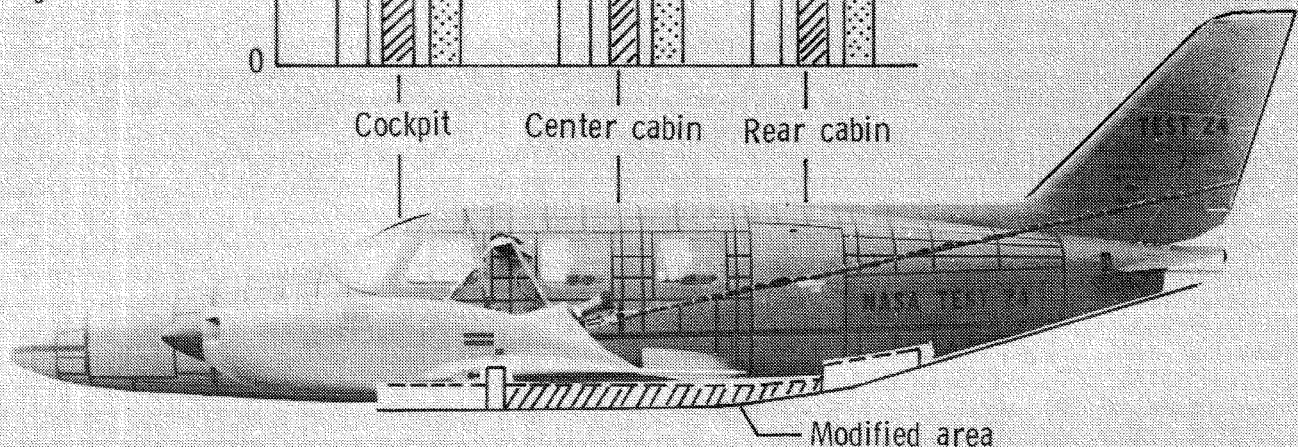
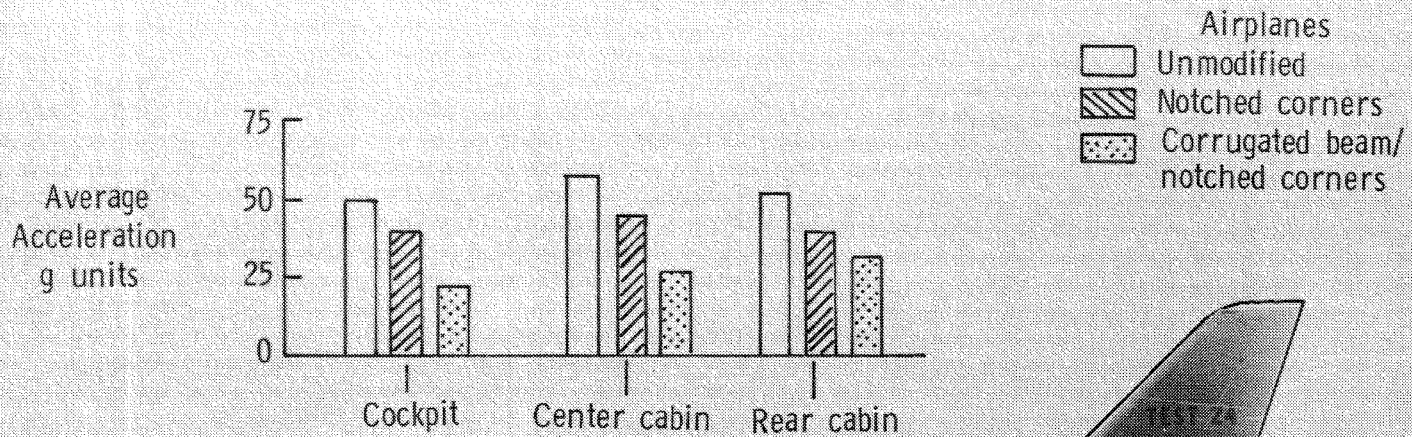

Corrugated beam/notched corner concept

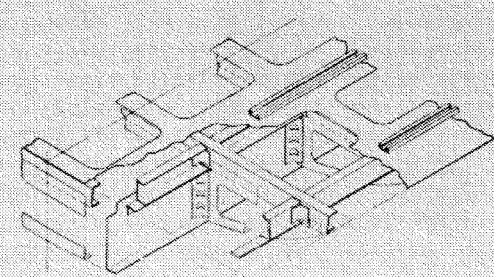

Notched corner concept

NATIONAL TIRE MODELING PROGRAM OFF TO A FAST START

John A. Tanner, Impact Dynamics Branch
Extension 2796
March 21, 1984
RTOP 505-45-14

Research Objective

A new research program has been formulated which is jointly sponsored by the National Aeronautics and Space Administration and the U.S. tire industry. The objective of this new program is to develop the technology necessary for analytical tire design.

Approach

NASA and six major U.S. tire manufacturers have established a six year research plan to conduct a three-phase analytical and experimental effort to develop accurate and efficient tire modeling codes, measure tire thermal and material properties, and conduct an investigation of various tire failure modes.

Accomplishment Description

The National Tire Modeling Program (NTMP) has been implemented and various research activities are underway. The steering committee for NTMP is composed of representatives from NASA and the six participating U.S. tire manufacturers - Goodrich, Goodyear, Firestone, General, Cooper, and Armstrong. The committee has established an initial set of benchmark problems which include the following loading cases: inflation only, inflated and statically loaded on a flat surface, and inflated and slowly rolling on a flat surface. The experimental data base necessary to characterize tire responses to these problems is in production and a number of special purpose finite element codes that will model these responses are under development. Additional participants in the NTMP program include researchers from George Washington University, the College of William and Mary, the University of Michigan, Akron University, and Computational Mechanics, Inc.

The photographs in the figure depict the major activities in the three-phase effort currently underway. Computer codes are being developed for tire modeling at Langley and several colleges and universities. These computer studies are looking at various aspects of the tire modeling problem such as tire contact, material characterization, and rolling dynamics. The tire manufacturers are currently producing P 195/70 R14 passenger car tires and 40 x 14 aircraft tires for the experimental studies. The manufacturers are also providing various test specimens of tire rubber and textile cords for material property measurements. The experimental studies are being conducted at both Langley and in the tire manufacturer laboratories. When the updated Aircraft Landing Dynamics Facility becomes operational in 1985, additional tests will be conducted to investigate tire failure modes.

Plans

The information from these various analytical and experimental studies will be used to define, validate, and demonstrate a family of analytical tools for tire design.

NATIONAL TIRE MODELING PROGRAM OFF TO A FAST START

PURPOSE:

DEVELOP FINITE ELEMENT TECHNOLOGY FOR TIRE DESIGN

PARTICIPANTS:

NASA

U. S. TIRE INDUSTRY (GOODYEAR, GOODRICH, FIRESTONE, GENERAL, ARMSTRONG, COOPER)

UNIVERSITIES (GWU, W & M, U of M, AKRON)

CONTRACTOR · COMPUTATIONAL MECHANICS, INC

APPROACH:

3-PHASE ANALYTICAL AND EXPERIMENTAL EFFORT

49

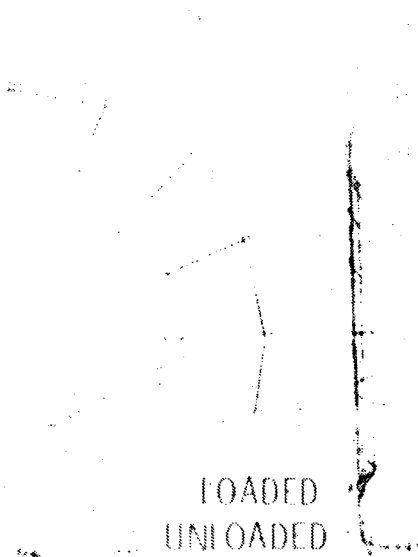

TIRE MODELING

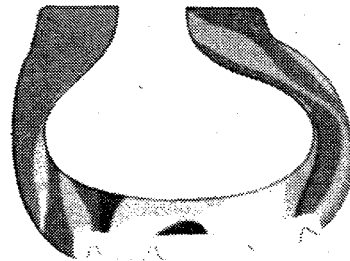
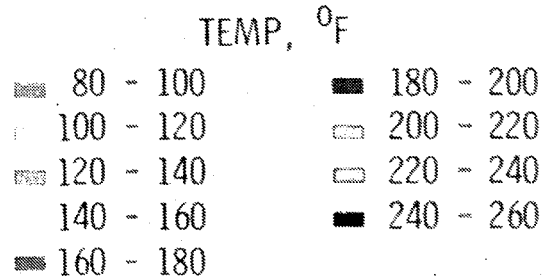

THERMAL AND MATERIAL PROPERTIES

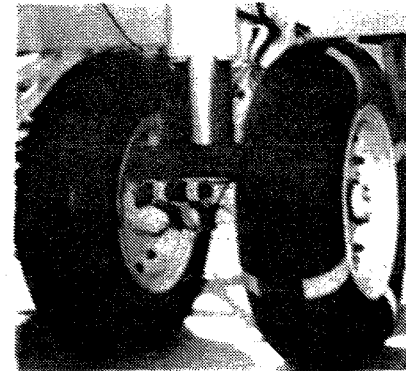

TIRE FAILURE MODES

SHAKER TESTS DEMONSTRATE EFFECTIVENESS OF ACTIVE CONTROL CONCEPT ON F-4 MAIN LANDING GEAR

Trafford J. W. Leland and John R. McGehee
Impact Dynamics Branch
Extension 2796
June 18, 1984
RTOP 533-02-93

Research Objective

The objective of this program is to explore the feasibility and potential of the series-hydraulic active-control landing gear concept, which previous analytical studies have shown to have great promise in reducing landing impact and taxi loads transmitted to the airframe, improving ride quality and extending the fatigue life of the structure.

Approach

The analytical studies established the necessary control laws and control philosophy to limit airframe loads based on certain critical landing gear and operational parameters. The results of an experimental test program, using a main landing gear from a light-twin general aviation aircraft and conducted at the Landing Loads Track, were so encouraging that the program was extended in scope to include the main landing gear from an F-4 fighter. Before the gear could be tested at the Track, however, an enforced shutdown of the facility mandated a change in planning, and the modified landing gear and controller were sent to the Air Force Wright Aeronautical Laboratories for testing on the large hydraulic shaker located there.

Accomplishment Description

The F-4 landing gear was modified, as shown in the simplified schematic of figure 1, to include a cylinder head adapter and an annular passage to the lower piston area to permit rapid extraction or addition of high-pressure hydraulic fluid. The electronic controller in this system positions a quick-reacting fluid-controlling servo valve to limit the airplane mass-center force to a minimum (the command limit force) compatible with the available shock-strut stroke and the airplane kinetic energy. As long as the mass-center force is greater than the limit force, the control system removes fluid from the strut at a rate which varies with the magnitude of the force difference. As the mass-center force decreases toward the limit force, the control system reduces the rate at which fluid is removed, and when the mass-center force becomes less than the limit force, fluid is added to the strut. This process is continued until a static value of shock strut extension and hydraulic pressure is reached at equilibrium.

The AFWAL shaker tests covered a broad range of vertical landing gear loads and simulated speeds and runway conditions. In the case shown in figure 2, the hydraulic shaker was raised 3.5 inches in a time equivalent to an aircraft encounter with a 3.5 inch step bump at 150 knots forward speed. Comparison of resulting active-control and passive (or conventional) upper mass accelerations show just how effective this system can be in reducing both positive and negative ground-induced airframe loads, and emphasizes the effect this could have on the fatigue life of the structure.

Plans

A flight test program has been initiated using the NASA F-106 aircraft, with all three landing gear under active control, to explore the operational effects of the system on overall ground handling performance.

FIGURE I. ACTIVE CONTROL LANDING GEAR SCHEMATIC

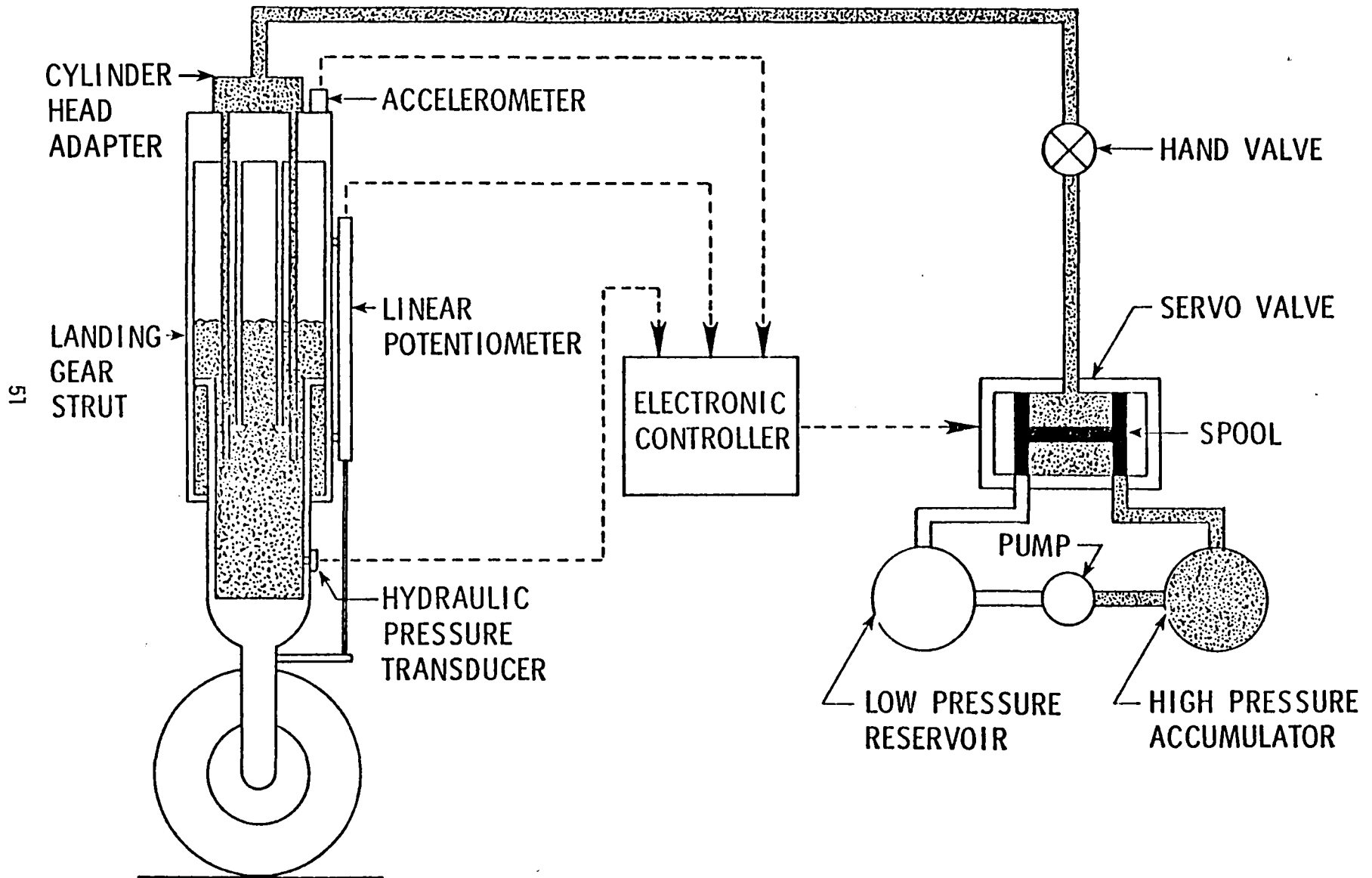
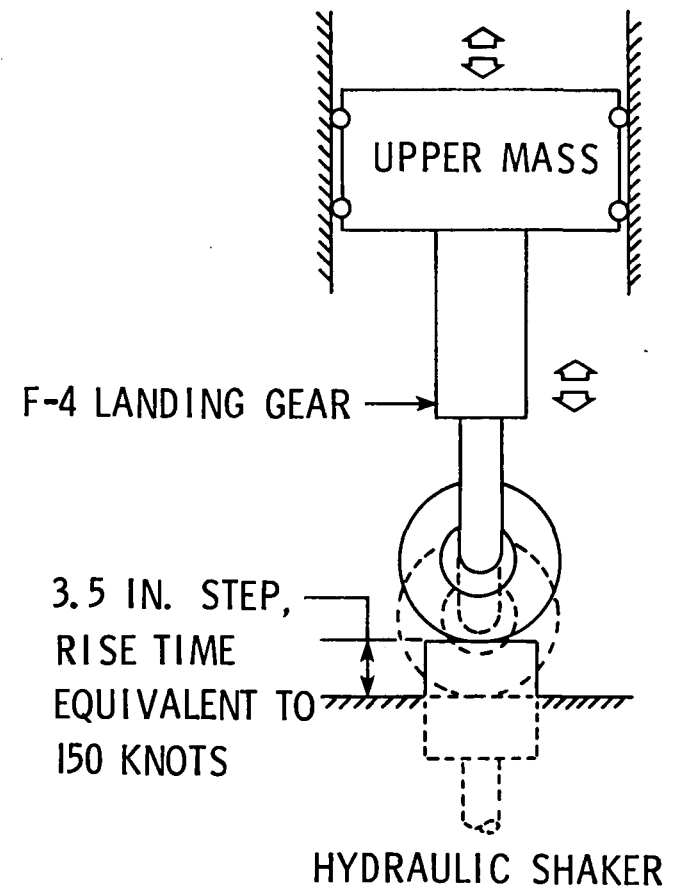
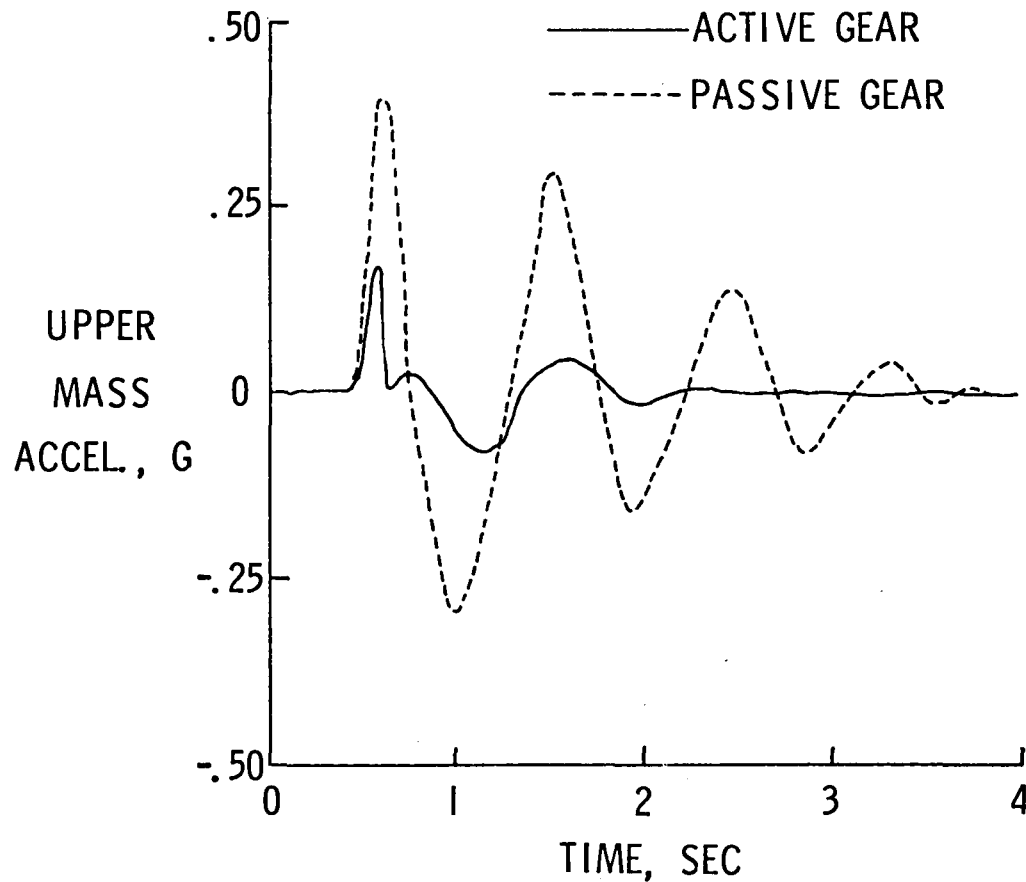

FIGURE 2. SHAKER TESTS DEMONSTRATE EFFECTIVENESS OF ACTIVE CONTROL CONCEPT ON F-4 MAIN LANDING GEAR

3.5 INCH STEP BUMP - SIMULATED ENCOUNTER SPEED 150 KNOTS



NEW HIGH "G" CARRIAGE ARRIVES AT
AIRCRAFT LANDING DYNAMICS FACILITY

Sandy M. Stubbs
Impact Dynamics Branch
Extension 2796
July 27, 1984

The new high "g" test carriage has been delivered to the Aircraft Landing Dynamics Facility at Langley Research Center after shipment by barge from Chicago Bridge and Iron Company in Memphis, Tennessee. The new carriage is designed to conduct research on tires, wheels, brakes, antiskid systems, landing gear systems, and runway surface treatments at speeds up to 250 miles per hour, doubling the speed capability of the old facility. The new carriage is a key part of a facility update taking place which also includes a larger propulsion system, a new higher energy arrestment system, and a test track extension and other supporting equipment.

The carriage is approximately 75 ft long, 40 ft wide, and 26 ft high. Its empty weight is about 95,000 lb and can accommodate test articles weighing up to 35,000 lb. Prominent features include a 10 ft high turning bucket at the rear of the carriage to catch and turn the 18 inch diameter stream of water used to propel the carriage to 250 miles per hour in 1.7 seconds. Water enters the bucket at 680 ft/sec and is turned approximately 180° creating a force on the carriage of 1,740,000 lb and producing an acceleration pulse that peaks near 17 g's. Another feature is a 20 by 40 ft open bay inside the carriage structure and the orange drop carriage that rides up and down on four vertical rails. Virtually every type of landing gear can be mounted on the drop carriage which can be dropped to produce vertical impact speeds up to 20 ft/sec. The hydraulic system will be able to simulate aircraft wing lift during the impact of the test article and can also be used to apply vertical loads on the test article up to 50,000 lb. With modifications, loadings up to 100,000 lb can be achieved. A nose block on the front of the carriage, not visible in the photograph, will engage 5 cables attached to 10 arresting gear engines which create a 5 to 6 g deceleration and will bring the carriage to a stop in 500 ft.

The hydraulic and electrical systems for the carriage are approximately 80% complete and work will continue at the test facility to finish and check out the carriage systems by November of this year.

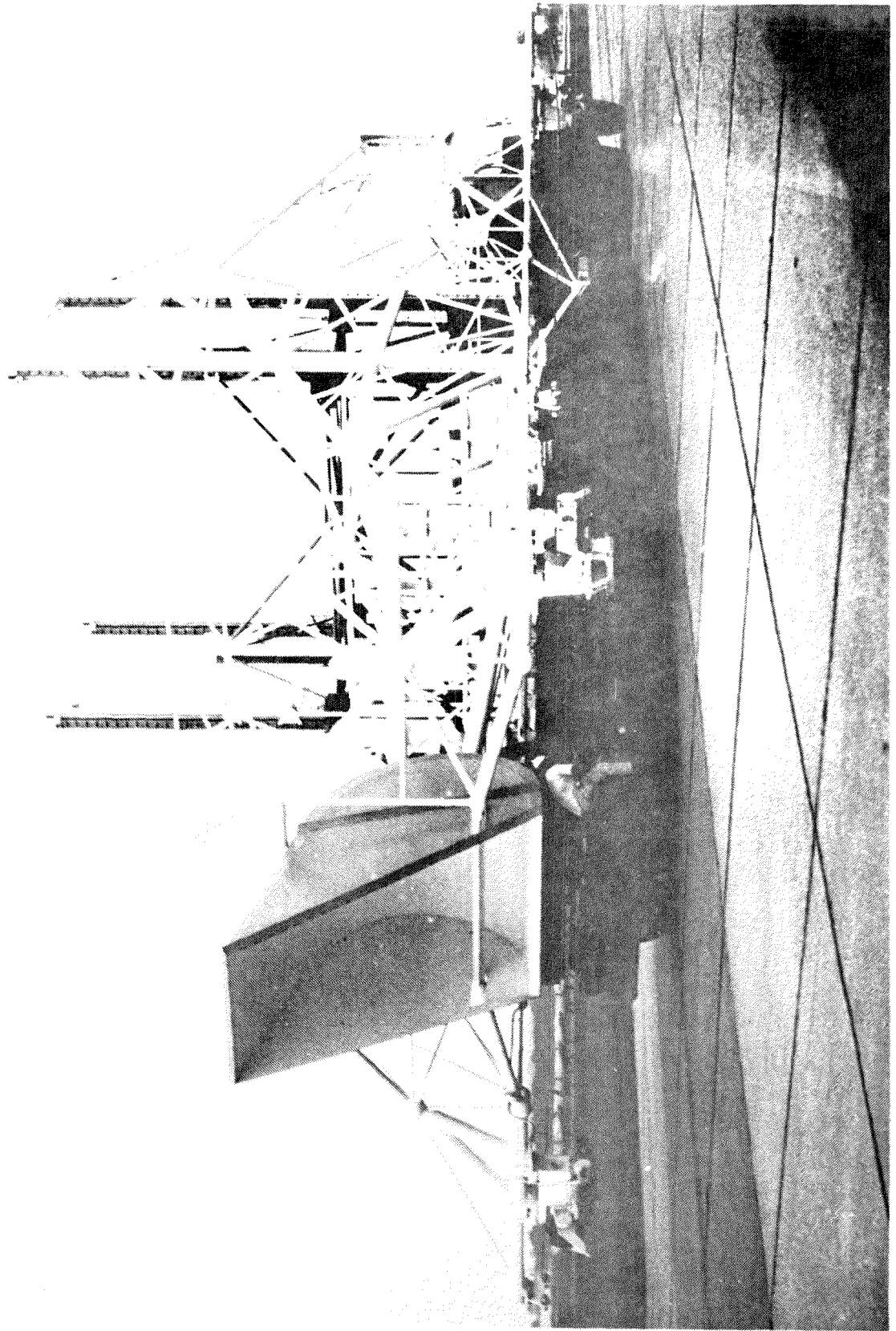

STRUCTURAL CONCEPTS BRANCH

CONTOURING MESH FACET HALVES ANTENNA PART COUNT

Harold G. Bush and W. B. Fichter
Structural Concepts Branch, SDD
Extension 2498 and 3596
October 17, 1983

(RTOP 506-53-43)

Research Objective

Due to their high stiffness and low mass, deployable tetrahedral trusses are being considered for the reflector support structure of large antennas. The deployment reliability of a truss structure decreases as the number of component parts (struts) increases. In addition, the fabrication cost of a truss structure increases with part count. Therefore, it is desirable, from a cost and operation reliability viewpoint, to decrease the number of parts (struts) required to build a given truss reflector.

Approach

An antenna reflector surface is formed by attaching a mesh (or membrane) surface to the truss surface. The reflector accuracy is determined by how closely the attached mesh approximates the desired surface. Stretching mesh between the truss hard points to create flat triangular facets is one potential attachment method. The rms-error of the resulting flat-faceted surface depends on the size of the facets. Hence, accuracy can be improved by reducing facet size (e.g., decreasing the distance between truss nodes), which increases truss part count, weight and cost. Analysis has shown that contouring the mesh facet edges appropriately decreases the deviation of the reflector from the perfect shape.

Accomplishment Description

The attached figure illustrates a newly devised method for contouring the facet edges using a forming membrane to which the mesh is sewn. The forming membrane can serve, if required, as the carrier for a tension network to react mesh pretension loads. Analytical results indicate that to achieve a specified surface accuracy, a facet with appropriately contoured edges can have twice the area at a flat facet. Consequently, the supporting structure for curved facets would require approximately one half as many hardpoints, or members, as are required using a flat-facet approach. Subdivision of the facet between structural nodes, also shown in the figure, would permit further increase in the facet size and reduction in part count.

Future Plans

Further detailed structural analysis of the mesh support system shown is being planned. An experimental investigation to compliment the analytical effort is under consideration.

CONTOURING MESH FACET HALVES ANTENNA PART COUNT

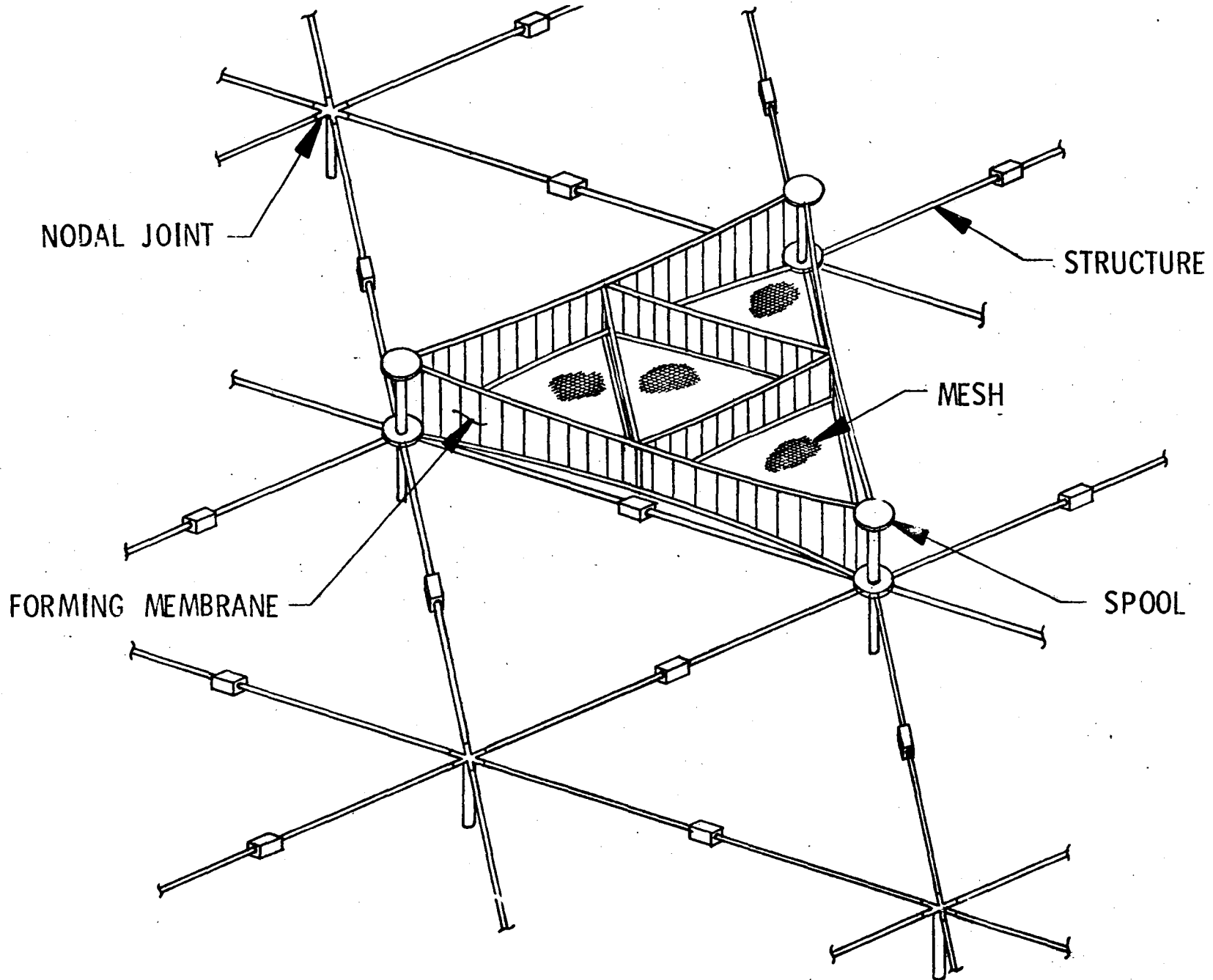

MOBILE WORK STATION CONCEPT CAN ERECT STIFF, MODULAR
SPACE STATION STRUCTURE

Martin M. Mikulas, Jr. and Harold G. Bush
Structural Concepts Branch
Extensions 2551, 2498
March 21, 1984
(RTOP 506-53-43)

Research Objective

Develop construction concept for space station structure which is erectable on-orbit, expandable in modular fashion, and stiff enough so that elaborate control systems are not required.

Approach

Use astronaut-assembled snap-together tubular struts to form a truss framework for space station structure.

Accomplishment Description

A box-truss array concept has been developed for the hardback framework of a space station (see chart). This truss framework is composed of 2" diameter graphite-epoxy tubular struts snapped together sideways at the joints. The basic module is a truss-cube 14' on an edge. By using this module a "peg-board" truss could be erected to support habitation and experiment chambers, and truss arms could be erected to support solar arrays for power supply or radiators for thermal control. This structure can be erected on-orbit by astronauts aided by a machine denoted "assembly and transport vehicle" (ATV). The ATV is located in the upper right-hand part of the picture. It is a movable platform powered by a push-pull drive mechanism which operates in "inch-worm" fashion to drive the platform one bay at a time. Pressure-suited astronauts are positioned within their work envelopes by movable manipulator arms attached to foot-restraint work stations. The ATV operates in either of two directions and may have a "space crane" attached for positioning payloads while the work-station astronauts attach equipment to the structure. A third astronaut may "drive" the ATV, operate the space crane and/or manually extract struts from a canister and pass them to the work station astronauts. The ATV is conceptually simple, and does not require advanced technology. It could be a low-risk development provided the detailed implementation retains the conceptual simplicity.

Plans

Continue developing this concept in cooperation with Johnson Space Center and Marshall Space Flight Center for potential application to space station structures.

MOBILE WORK STATION CONCEPT CAN ERECT STIFF, MODULAR SPACE STATION STRUCTURE

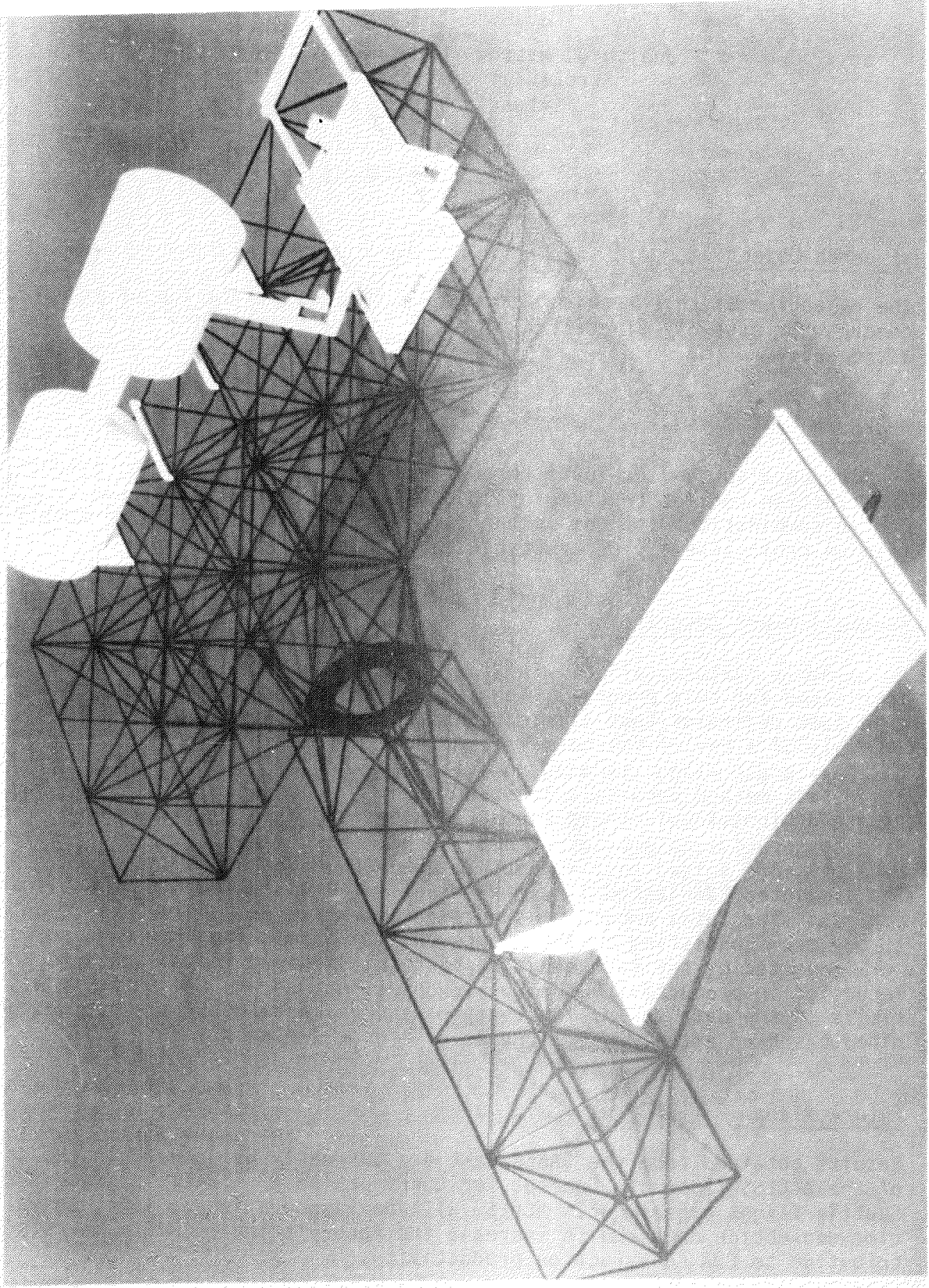

ONE-MAN STRUCTURAL ASSEMBLY CONCEPT PROVEN EFFECTIVE
FOR SPACE IN UNDERWATER NEUTRAL BUOYANCY TESTS

Judith J. Watson and Walter L. Heard, Jr.
Structural Concepts Branch, SDD
Extensions 3596 and 2608
May 22, 1984

(RTOP 506-53-43)

Research Objective

The objective of this research program is the identification of an effective concept for assembly of erectable beam-like space structure by a single astronaut.

Approach

Devise, develop, and evaluate through neutral buoyancy testing, a space construction concept that employs the intellect, versatility, and dexterity of man in combination with the mechanical advantage of a machine to enable effective on-orbit assembly of erectable space structure.

Accomplishment Description

An assembly fixture called Swing-Arm Beam Erector (SABER) was devised and fabricated for this program. The assembly fixture features a motorized moveable foot restraint that eliminates astronaut manual translation tasks. When assembly of a bay of the beam is completed, the beam is mechanically indexed one bay-length along its axis to clear the work site for assembly of the next bay. This method permits a constant assembly rate that depends only on the length of individual struts and not on the length of the beam being assembled. Five consecutive assemblies of a 3-bay beam in one simulated EVA were performed by a pressure suited test subject in the MSFC Neutral Buoyancy Simulator (NBS). The simulated EVA lasted 1-hour 44-minutes including four 10-minute rest periods. The total amount of structure assembled was equivalent to an 85-foot, 15 bay beam consisting of 150 struts and 48 nodes. The four rest periods were not requested by the test subject, but were required in the test procedure. Reduction in productivity due to astronaut fatigue was not a factor within the limits of the data taken. An average assembly rate of 26 s/strut was determined based on actual assembly time of 1-hour 4-minutes.

Future Plans

Results obtained from the SABER test are currently being used in the development of the ACCESS (Assembly Concept for Construction of Erectable Space Structure) Shuttle flight experiment. ACCESS will be launched in May 1985, to validate NBS time-and-motion data and to increase the Agency's insight into workstation contribution to EVA construction productivity.

ONE-MAN STRUCTURAL ASSEMBLY CONCEPT PROVEN EFFECTIVE FOR SPACE IN UNDERWATER NEUTRAL BUOYANCY TEST

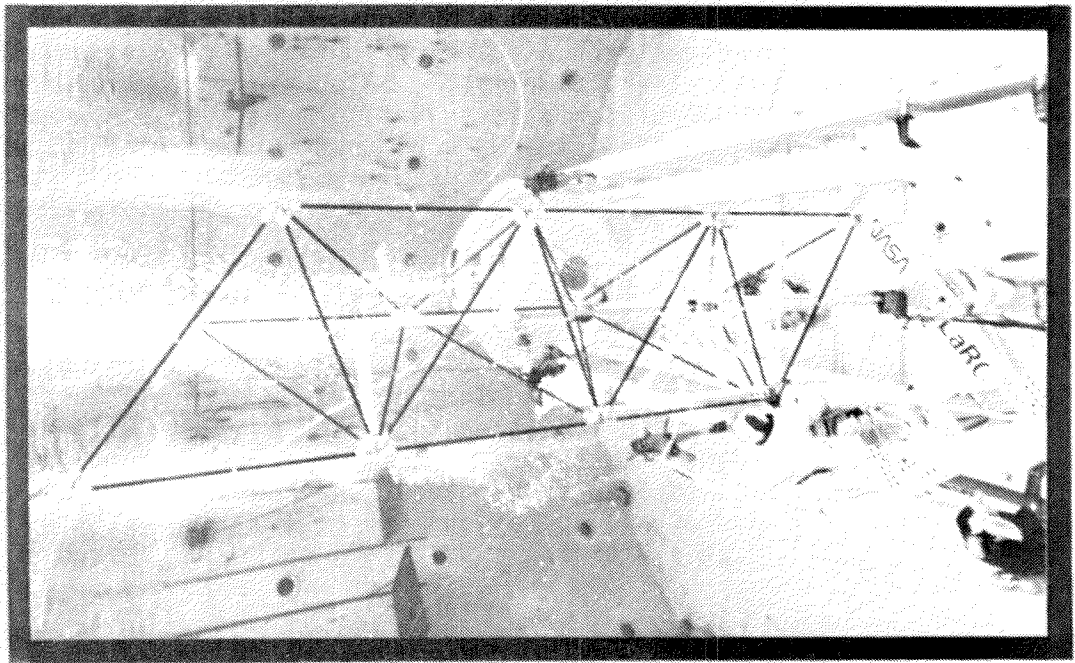

- 5 CONSECUTIVE ASSEMBLIES OF 3-BAY TRUSS EQUIVALENT TO CONSTRUCTION OF 85-FT. BEAM IN ONE SIMULATED EVA

- REDUCTION IN PRODUCTIVITY DUE TO ASTRONAUT FATIGUE NO FACTOR WITHIN LIMITS OF DATA TAKEN

- SUMMARY OF TEST RESULTS:

- ▶ EVA ELAPSED TIME = 1:44 (INCLUDES 4 10-MIN. REST PERIODS)
- ▶ ACTUAL ASSEMBLY TIME = 1:04
- ▶ ASSEMBLY RATE = 26 SEC./STRUT

SIMULATED ZERO-GRAVITY DEVELOPMENT TESTS OF THE ACCESS
SHUTTLE FLIGHT EXPERIMENT SUCCESSFULLY COMPLETED

Walter L. Heard, Jr. and Judith J. Watson
Structural Concepts Branch, SDD
Extensions 2608 and 2841
August 14, 1984

(RTOP 506-53-43)

Research Objective

The objectives of these simulated 0-g tests were to: (1) investigate EVA requirements and performance limits, (2) evaluate the assembly, disassembly, and contingency jettison procedures through test subject performance and comments, (3) determine assembly, disassembly, and contingency jettison timelines, (4) determine optimal camera locations and views for data recording.

Approach

Development hardware required to perform the ACCESS experiment was designed for neutral buoyancy (underwater) operation and fabricated at LaRC. Procedures for assembly and disassembly of a triangular cross-section beam-like truss were prepared, evaluated, and refined in 1-g tests at LaRC by both engineer and astronaut test subjects. The training hardware was then sent to MSFC and set up in a full scale mockup of the Shuttle cargo bay in the Neutral Buoyancy Simulator (NBS). Five pressure suit tests were conducted in the NBS with both engineer and astronaut test subjects. All possible EVA maneuvers anticipated for the ACCESS flight experiment, including contingency jettison alternatives were simulated and preliminary timelines were obtained for all maneuvers. A mockup of the Remote Manipulator System (RMS) arm with an elbow video camera and two forward bulkhead video cameras were used to determine optimal views for data recording.

Accomplishment Description

The tests showed that the ACCESS EVA construction concept is effective; all EVA requirements can be accomplished by the test subjects with relative ease and the hardware will function as designed. Some desirable modifications to the procedure were identified and minor adjustments to the hardware will be required. The time data taken suggest that a 45-foot long truss (10 bays) can be assembled, disassembled, and restowed on-orbit in about one hour and forty minutes. Adequate video coverage of all operations can be obtained with the RMS elbow camera used in combination with the two forward bulkhead cameras.

Future Plans

Modifications to the hardware will be made and additional NBS testing will be accomplished in October 1984. These tests will duplicate the anticipated flight test as closely as possible to generate data for comparison with flight data.

SIMULATED ZERO-GRAVITY DEVELOPMENT TESTS OF THE ACCESS SHUTTLE FLIGHT EXPERIMENT SUCCESSFULLY COMPLETED

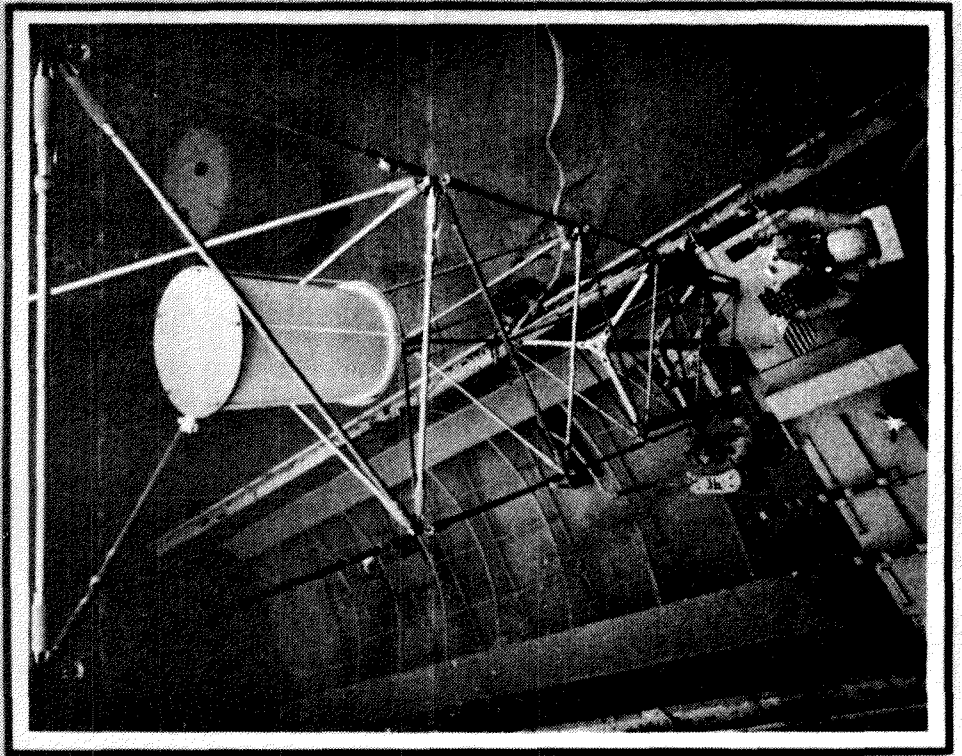

- PROCEDURES FOR ASSEMBLY AND DISASSEMBLY EVALUATED AND REFINED BY ASTRONAUT TEST SUBJECTS
- ALL EVA REQUIREMENTS CAN BE ACCOMPLISHED WITH RELATIVE EASE
- DATA INDICATES A 10-BAY, 45-FOOT LONG TRUSS CAN BE ASSEMBLED, DISASSEMBLED, AND RESTORED IN 1 HOUR AND 40 MINUTES

ACCESS EMERGENCY JETTISON PROCEDURE DEMONSTRATED
IN SIMULATED ZERO-GRAVITY TESTS

Walter L. Heard, Jr. and Judith J. Watson
Structural Concepts Branch, SDD
Extensions 2608 and 2841
September 25, 1984

(RTOP 506-53-43)

Research Objective

The assembly fixture and beam-like truss to be assembled during the ACCESS Shuttle flight experiment extends along the yaw axis beyond the moldline of the Shuttle cargo bay and, thus, must be stowed or jettisoned before the Shuttle can be configured for reentry. The objective of this test was to establish the effectiveness of the procedure for emergency jettison of the ACCESS hardware in event of a malfunction.

Approach

Design an assembly fixture with a separation plane within the moldline of the cargo bay. In event of a malfunction, a redundant latch, quick-release clamp is disengaged manually by one astronaut. A pin-puller lever is then manually depressed to release the protruding portion of the assembly fixture/truss system. Low energy springs provide initial acceleration along the yaw axis to jettison the structure.

Accomplishment Description

Both engineer and astronaut test subjects performed the jettison maneuvers during various stages of assembly. The emergency jettison operation was successfully accomplished in all tests. Tests results indicate this primary emergency jettison operation can be accomplished in less than ten seconds. Astronauts commented that jettison operation is clean and adequate.

Future Plans

Minor modifications to the hardware will be made to improve the operation. Additional simulated 0-g tests are planned for October 1984.

ACCESS EMERGENCY JETTISON PROCEDURE DEMONSTRATED
IN SIMULATED ZERO-GRAVITY TESTS

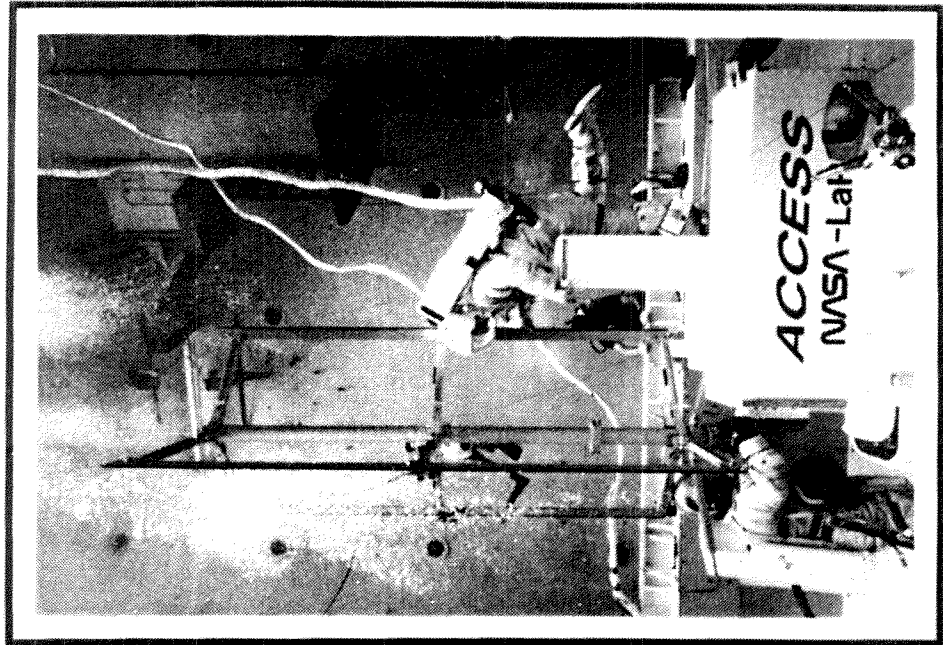

RELEASE OF ASSEMBLY FIXTURE

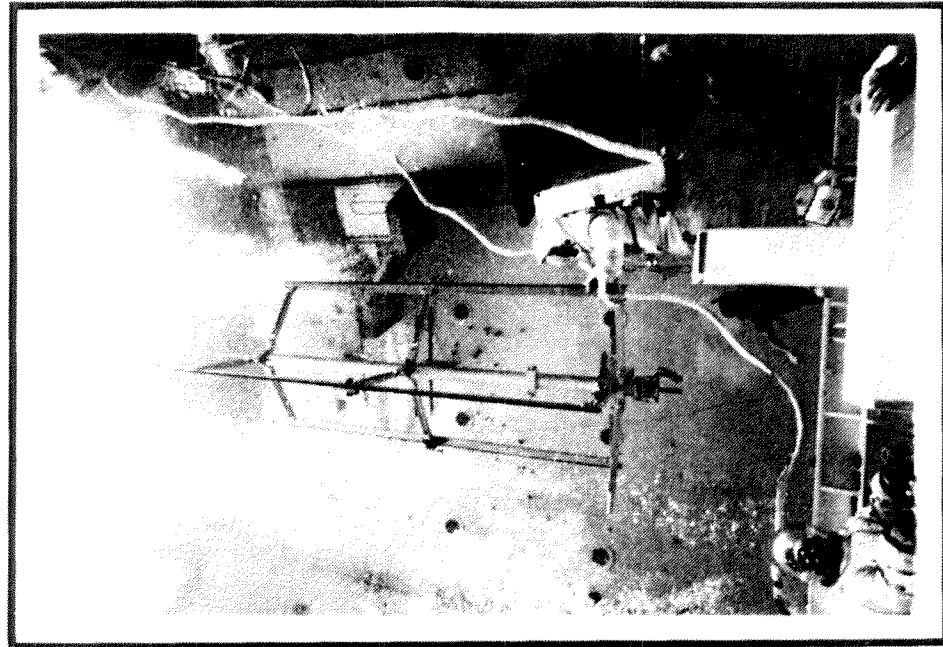

ASSEMBLY FIXTURE JETTISONED

STRUCTURAL DYNAMICS BRANCH

COUPLED HYDROELASTIC DYNAMIC ANALYSIS
CONFIRMS STRUCTURAL INTEGRITY OF ALDF L-VESSEL DESIGN

Jerrold Housner
Structural Dynamics Branch
Extension 2446
January 18, 1984
(RTOP 506-53-53)

Research Objective

Previous uncoupled dynamic analysis of FENG D on modified Aircraft Landing Loads Facility (ALDF) L-Vessel predicted possible excessive loads in structural support due to rapid valve opening and closing. Determine if coupled hydroelastic analysis predicts safe load levels by performing an independent analytical investigation.

Approach

Apply the NASTRAN structural analysis program using a structural analogy for water/air/structure dynamic interaction. Use time varying pressure loading at valve as supplied by FENG D to predict peak support reactions. Compare with design values to determine integrity.

Accomplishment Description

Previous uncoupled analysis had indicated a possible resonance phenomenon occurring between the water/air and structural portions of the system when the air column mode was "tuned" to a primary structural "racking mode." This resonance produced support loads exceeding design by up to a factor of ten. Redesigning to these values would have resulted in major system modifications and excessive delays. FENG D proposed and investigated possible fluid oriented fixes should this resonance occur. A team of researchers in SDD studied possible structural fixes and performed an independent coupled hydroelastic analysis on the L-Vessel using a structural analogy with the NASTRAN computer program. It was anticipated that a coupled analysis would yield more accurate and lower load values.

A range of practical damping values in the structure and fluids was considered and both "tuned" and "untuned" possibilities were examined. In addition uncoupled modal analyses of the structure and fluids was performed to fully understand the behavior of the total system. The slide displays the worst (lowest) predicted margins of safety and all values are seen to be positive indicating structural integrity. Furthermore the use of peak dynamic values in establishing integrity is considered to be quite conservative.

COUPLED HYDROELASTIC DYNAMIC ANALYSIS CONFIRMS STRUCTURAL INTEGRITY OF ALDF L-VESSEL DESIGN

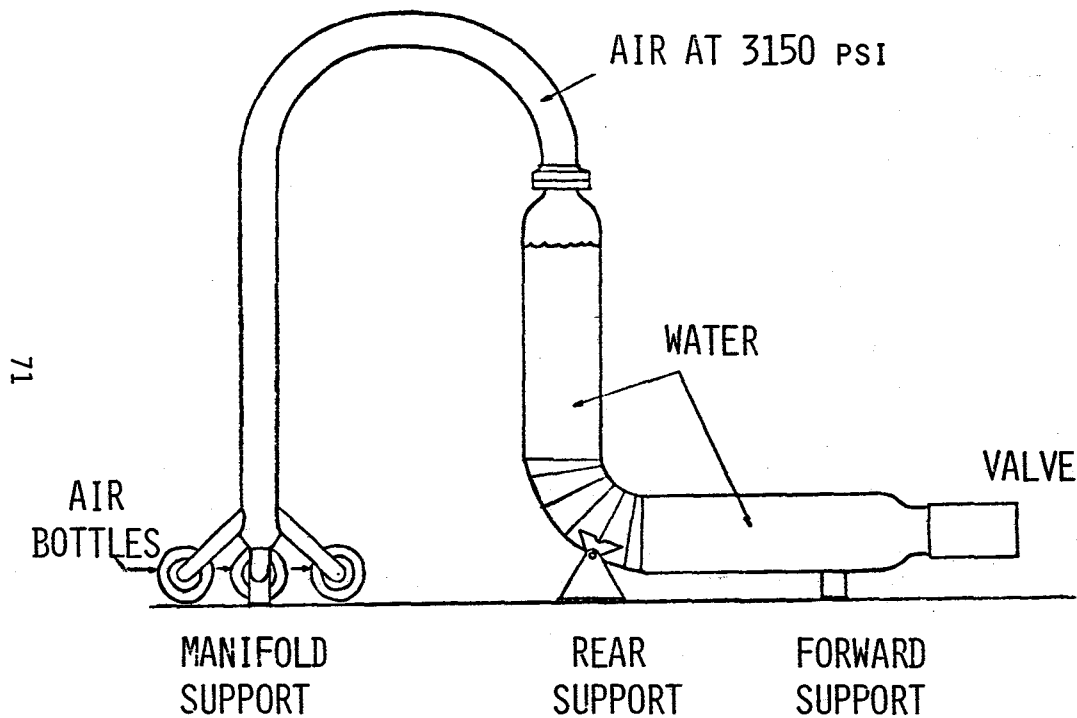

- WORST CASE: RAPID VALVE OPENING AND CLOSING

- INITIAL ANALYSIS INDICATED EXCESSIVE SUPPORT LOADS

MARGIN OF SAFETY $(1 - \frac{\text{PREDICTED VALUE}}{\text{ALLOWABLE VALUE}})$

MANIFOLD	L-VESSEL REAR	L-VESSEL FORWARD
0.23	0.04	0.17

- COUPLED HYDROELASTIC ANALYSIS INDICATED SAFE SUPPORT LOAD LEVELS

CLOSED-FORM SOLUTIONS DEVELOPED FOR APPLICATION TO CONTROL OF FLEXIBLE SPACECRAFT

Jer-Nan Juang
Structural Dynamics Branch, SDD
Extension 2881
April 13, 1984

RTOP 506-53-53-08

Research Objective

To derive solutions for an optimal, finite-time, tracking problem with terminal constraints for applications to spacecraft/aircraft slewing, tracking and intercept maneuvers.

Approach

The optimal control problem in this development is specified by defining a performance index which consists of an integral of quadratic forms in control amplitude and rate and the error between actual output states and desired output states with arbitrarily specified terminal constraints. The necessary conditions using the so-called sweep method, which results from the two-point boundary value problem minimizing the performance index, lead to several coupled nonlinear Riccati-like matrix differential equations. The number of equations depends on mission objectives such as pointing requirements. Closed-form solutions are developed for these equations based on matrix transformations which reconstruct coupled nonlinear equations into uncoupled linear matrix differential equations in terms of new variable matrices.

Accomplishment Description

Basic formulations of the command generation and feedback regulation for the terminal tracking problem are solved. Exact closed-form solutions expressed in recursive form are generated such that real-time computer implementation becomes feasible. These concepts have been validated via studies of several generic flexible spacecraft. Results generated using the recursive formulas produced a smooth control profile which reduces the excitation of both controlled and uncontrolled modes. Simulation results also show that the exact terminal tracker is insensitive to moderate system uncertainty such as 10% error in assumed natural frequencies.

Future Plans

Development of nonlinear-to-linear transformations for kinematics is currently in progress. The closed-form solutions for the linear regulator and tracking problem will be applied to the transformed nonlinear equations to generate control commands for kinematically nonlinear systems. Typical applications, both linear and nonlinear, will be addressed and implemented on experimental hardware.

MANEUVERING CONTROL ANALYSIS BREAKTHROUGHS

SETTLING

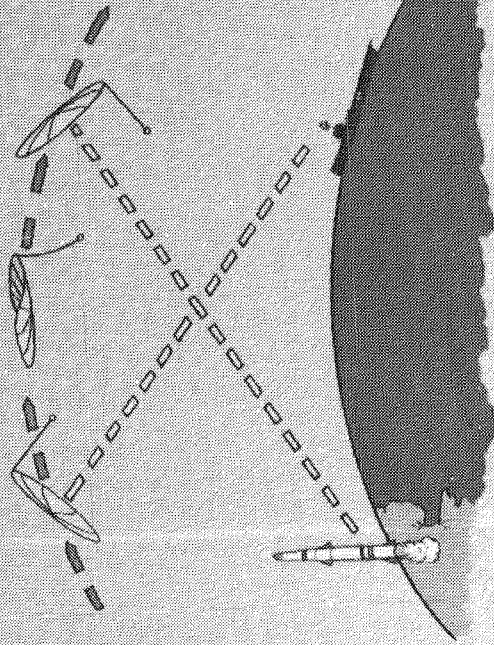

CHASE/INTERCEPT

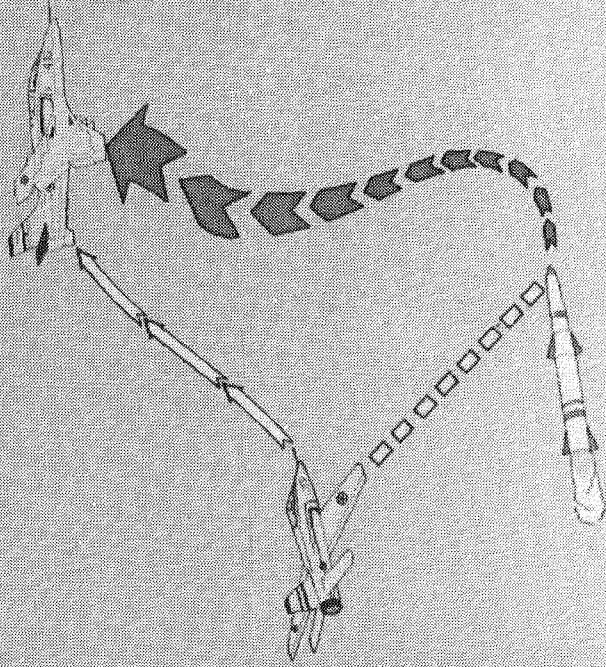

- Closed-form solutions to linear problems developed
- Nonlinear-to-linear transformation for kinematics in progress

**PHOTOGRAMMETRIC MEASUREMENT SYSTEM
MEETS SOLAR ARRAY EXPERIMENT REQUIREMENTS**

M. Larry Brumfield
Structural Dynamics Branch
Extension 3196

JUNE 18, 1984

RTOP 506-62-49

RESEARCH OBJECTIVES:

To develop a photogrammetric measurement system to measure dynamic responses of a large solar array during the MSFC/DAST-1 Solar Array Flight Experiment.

APPROACH:

The shuttle closed circuit television system will be used to record video images of the solar array during orbital tests. A ground based system has been designed to analyze this data by tracking the position change of specific targets from frame to frame. Data from four TV cameras will be merged in a triangulation program to determine a displacement time history of the solar array in shuttle coordinates. This motion history will be analyzed using appropriate system identification techniques to determine the modal and frequency characteristics of the array in response to input excitations.

ACCOMPLISHMENT DESCRIPTION:

A full-scale mock-up of the solar array extended to the 70% deployed position has been used in a series of static displacement tests to determine the resolution capability of the video analysis system. The development goal was to achieve a resolution capability of 2.5% of the displacement or less. This goal is a factor of two better than the experiment requirement of 5% of the displacement. The system surpassed the goal in six out of seven test cases. The graph at the right shows the results of the seven test cases compared to lines representing the experiment requirement and the development goal.

PLANS:

Dynamic tests will be conducted to evaluate the video system capability for analyzing dynamic data and to demonstrate the operational capability of the photogrammetric measurement system for measuring the response of low-frequency structures. Analysis of flight data from the Solar Array Flight Experiment, currently scheduled for launch on June 25, 1984, will then be conducted.

PHOTOGRAMMETRIC MEASUREMENT SYSTEM MEETS SOLAR ARRAY FLIGHT EXPERIMENT REQUIREMENTS

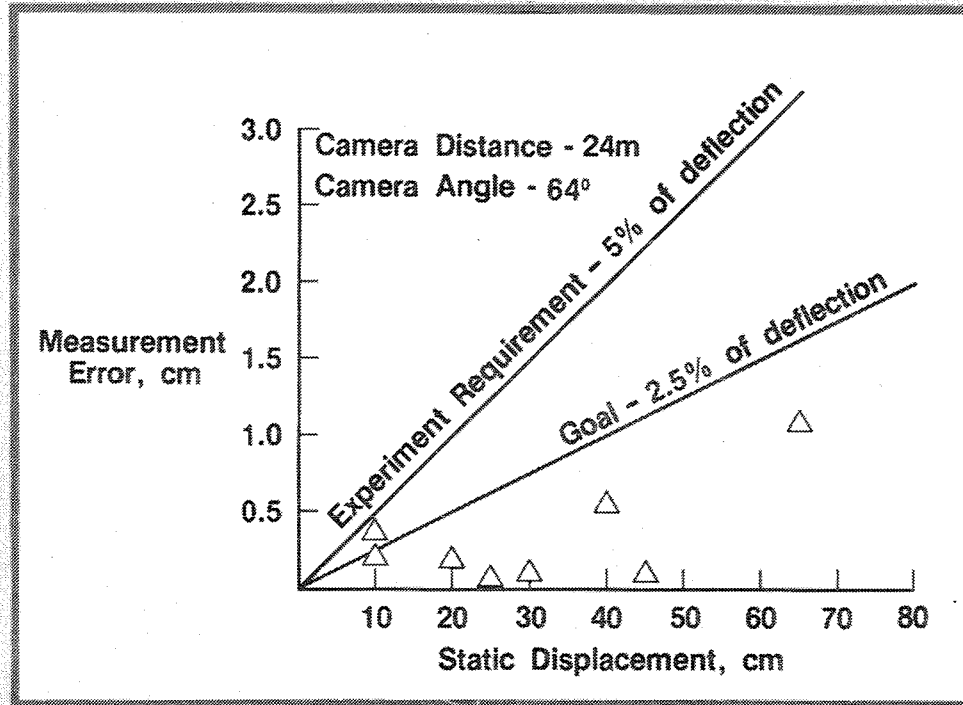
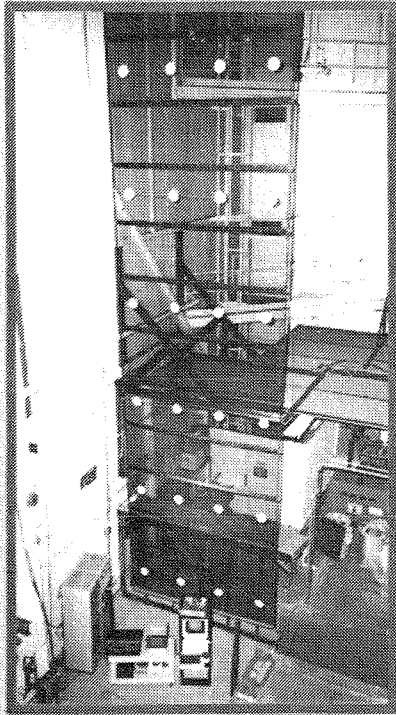

GENERIC SPACE STATION MODEL DYNAMIC TESTS

W. Keith Belvin
Structural Dynamics Branch, SDD
Extension 2446
August 24, 1984

(RTOP 506-53-53)

Research Objective

This research is intended to identify technology areas where better analytical and/or experimental methods are needed to adequately predict the dynamic characteristics of multibody space platforms such as the Space Station.

Approach

A multibody generic space station model is used to experimentally evaluate current dynamic analysis capabilities. The model is also used to evaluate ground test methods of space station components and sub-assemblies.

Accomplishment Description

The Generic Space Station Dynamics Model has been fabricated and is now undergoing ground vibration tests. Three areas of dynamic tests are anticipated as shown on the attached chart. Component modal vibration tests will be used to extract natural frequencies, mode shapes and damping information from each of the five components. These data will be used with analytical model synthesis procedures to predict the modal properties of the assembled model. In addition to modal tests, transient tests will be performed to validate analysis assumptions. The degree of damping coupling between modes and the level of modal participation for maneuvers such as solar array slewing and shuttle berthing will be determined. Active suppression of solar array vibrations will be performed using torque actuators at the root of each solar array. These active suppression tests will identify the hardware requirements and robustness of various control laws.

Future Plans

After completion of the three types of dynamic tests, extension of the model architecture to more closely resemble the space station reference configuration will be performed. This revised model will be used to study the role of scaled dynamic models in the space station program.

GENERIC SPACE STATION MODEL DYNAMIC TESTS

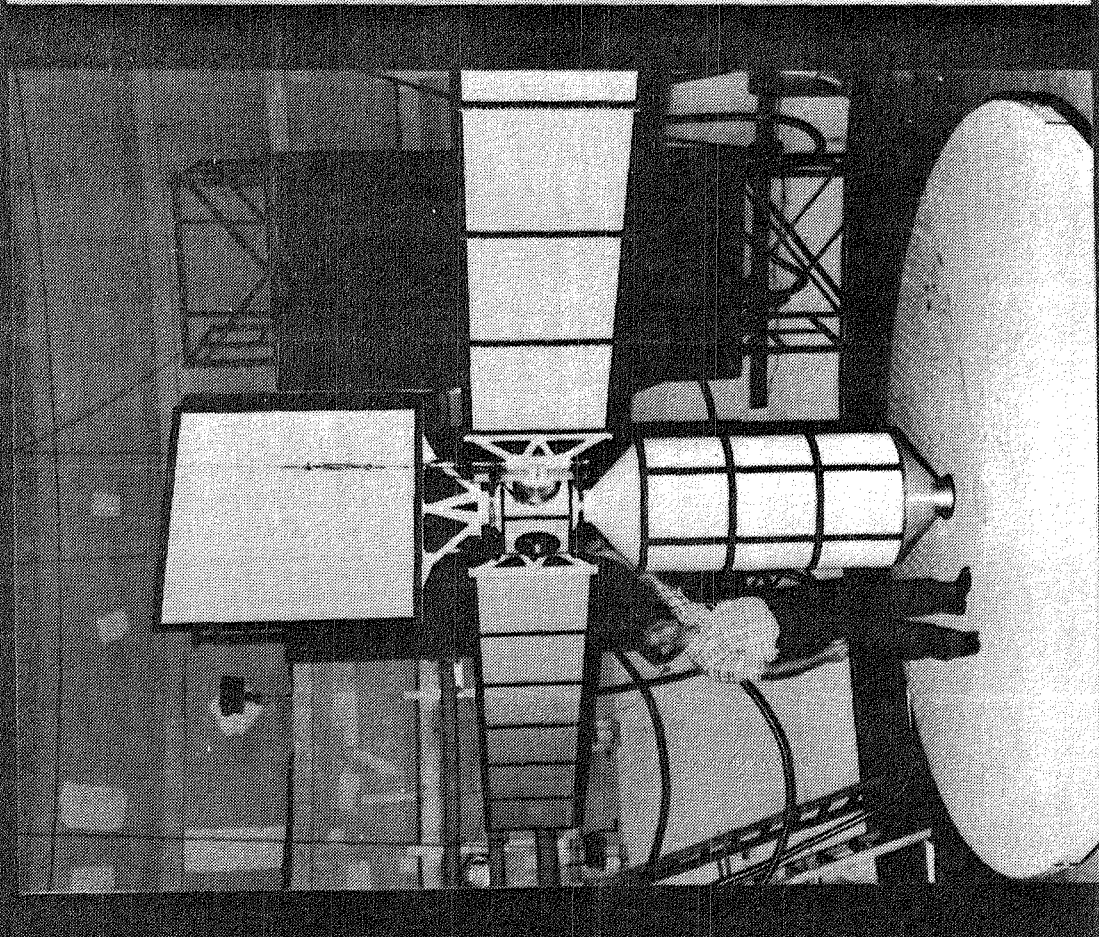

MULTIBODY SYNTHESIS

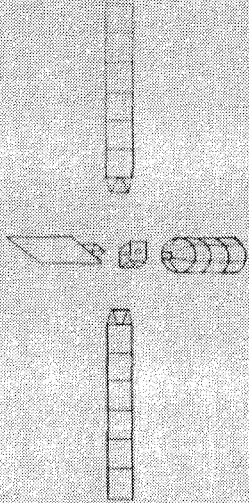

OPEN-LOOP MANEUVERS

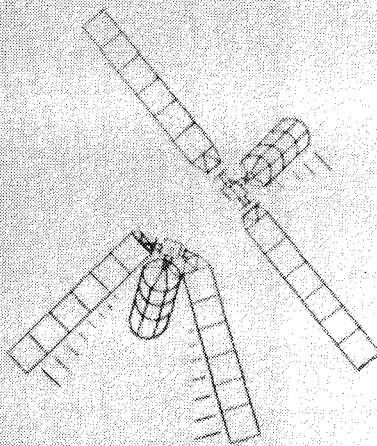

VIBRATION SUPPRESSION

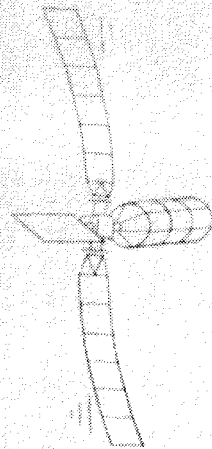

NEW EIGENSYSTEM REALIZATION ALGORITHM (ERA) SUCCESSFULLY USED
FOR GALILEO MODAL PARAMETER IDENTIFICATION

Richard S. Pappa and Jer-Nan Juang
Structural Dynamics Branch, SDD
Extensions 3196 & 2881
September 25, 1984

RTOP 506-53-53

Research Objective

To understand the advantages and limitations of a new modal parameter identification technique--the ERA method--when applied to complex structures.

Approach

The Eigensystem Realization Algorithm (ERA), developed at LaRC, is an extended version of the Ho-Kalman system realization algorithm (circa 1965) from the controls field. It is a procedure for constructing an analytical model, or realization, of a structure (or other dynamic system) from measurements. The resulting model consists of a set of three matrices, [A,B,C], for which the discrete-time state-space description of the system, namely

$$\begin{aligned}x(k+1) &= Ax(k) + Bu(k) \\y(k) &= Cx(k)\end{aligned}$$

is satisfied for sets of dynamic inputs, $u(k)$, and measured responses, $y(k)$. In these equations, k is an integer time index and $x(k)$ is a vector of states. Matrix A (the state-transition matrix) represents the structural properties, B the excitation locations and gains, and C the measurement locations and gains. The realization, [A,B,C], completely characterizes the linear dynamics of the system, relative to the selected excitation and measurement positions. From the realization the modal parameters of the structure can be calculated. If sufficient measurements are made, a dynamic model of the structure is obtained, based directly on test results, from which a vibration control system could also be designed.

Accomplishment Description

The ERA method is being applied to data from a variety of laboratory experiments to understand its advantages and limitations. One particularly challenging set of data was from the modal survey test of the Galileo spacecraft, conducted at the Jet Propulsion Laboratory (JPL) in 1983. The accompanying figure shows a photo of the test article and typical analysis results. This study contributed to a JPL-coordinated project to compare the performance of various contemporary modal identification techniques. The ERA results compared favorably with those of four other industry teams, but used considerably less test and data analysis time.

Future Plans

Though general agreement with the four other analyses was obtained, a closer comparison of the various results from the Galileo project is difficult. This is due to the effects of observed nonlinearities, since each technique, in general, acquired data under a different set of excitation conditions. Further experiments at LaRC will be used to help resolve the outstanding issues.

NEW EIGENSYSTEM REALIZATION ALGORITHM (ERA) SUCCESSFULLY USED FOR GALILEO MODAL PARAMETER IDENTIFICATION

Spacecraft

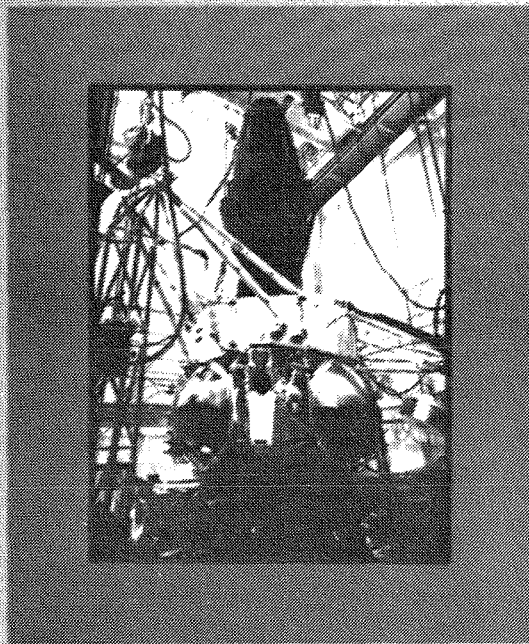

Typical Data Analysis Results*

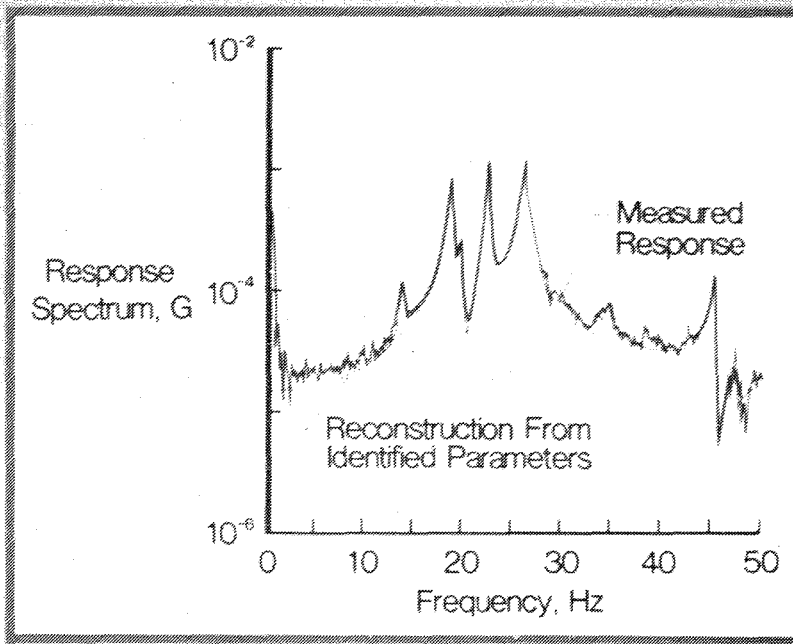

* Using 5 sec of free decay data

STRUCTURAL MECHANICS BRANCH

POSTBUCKLING RESPONSE AND FAILURE CHARACTERISTICS IDENTIFIED FOR
FLAT STIFFENED GRAPHITE-EPOXY COMPRESSION PANELS

James H. Starnes, Jr., Marshall Rouse and Norman F. Knight, Jr.
Structural Mechanics Branch, SDD
Extensions 2552, 4585, 3179
February 21, 1984

(RTOP 505-33-33)

Research Objective

To study the postbuckling response and failure characteristics of selected flat stiffened graphite-epoxy panels loaded in compression.

Approach

Six generic stiffened panel specimens were tested to failure in the laboratory to determine their postbuckling behavior and failure characteristics. A common stiffener design was used for all panels and the stiffener spacing and panel skin thickness were varied systematically to determine their effects on panel response.

Accomplishment Description

Flat stiffened graphite-epoxy panels (like the one shown in the upper left) were sized to allow their skins to buckle below ultimate load and were tested to failure. Panels with two skin thicknesses (24-ply and 16-ply) and three stiffener spacings (4.0, 5.5 and 7.0 inches) were tested.

The membrane strain ϵ distribution in the skin between stiffeners (normalized by the strain at buckling ϵ_{cr}) is shown in the upper right figure for 1.02, 2.0 and 2.96 times the buckling load P_{cr} of a panel. The results show the strains are higher at the stiffener than away from the stiffener. The lower left photograph is a moire-fringe pattern of the out-of-plane deflections of this buckled panel just before failure. This moire-fringe pattern indicates there are large bending gradients near the stiffeners (closely spaced fringes indicate large gradients). The high strains at the stiffeners (upper right figure) couple with these bending gradients to cause the stiffeners to separate from the skins and to fail the panel (lower right figures). All panels failed in this manner. This skin-stiffener separation failure mode is currently limiting the postbuckling strength of composite panels.

Future Plans

The effects of curvature, damage and cutouts on postbuckling response will be studied. An effort to find ways to suppress the skin-stiffener separation failure mode is underway.

POSTBUCKLING RESPONSE AND FAILURE CHARACTERISTICS IDENTIFIED FOR FLAT STIFFENED COMPRESSION PANELS

TYPICAL GRAPHITE-EPOXY SPECIMEN

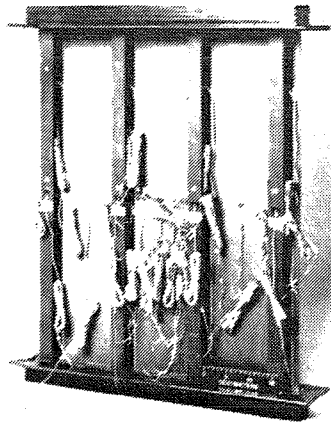

TYPICAL LONGITUDINAL MEMBRANE STRAIN DISTRIBUTION AS A FUNCTION OF LOAD

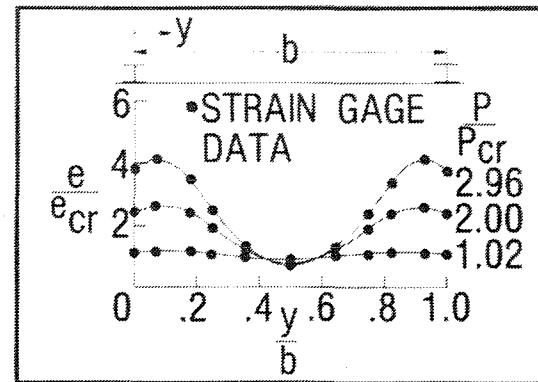

FAILURE MODE OF STIFFENED PANELS

FRONT VIEW

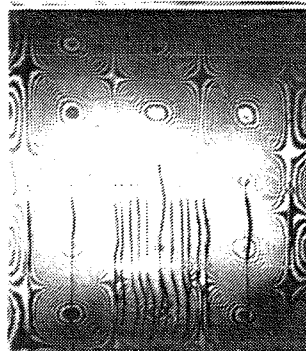

REAR VIEW OF FAILED PANEL

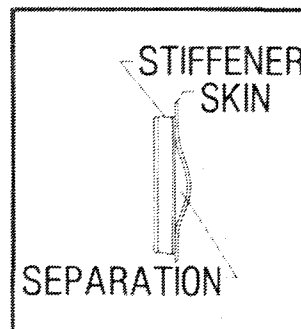
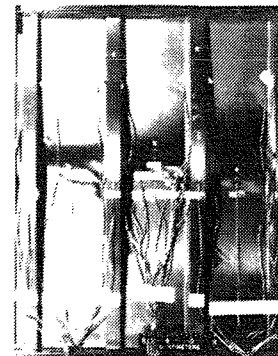

OFF-AXIS TENSILE COUPON REQUIRES HIGH ASPECT RATIO
TO MEASURE SHEAR MODULUS ACCURATELY

Michael P. Nemeth
Structural Mechanics Branch, SDD
Extension 3714
February 22, 1984

(RTOP 505-33-33)

Research Objective

To study the effect of specimen aspect ratio on the accuracy of elastic shear properties of graphite-epoxy laminates as determined from unidirectional off-axis tensile tests.

Approach

One way to measure the in-plane shear modulus of composite materials is by the "off-axis" tensile test. This test method is attractive in that it provides shear stress-strain data by a routine testing procedure. A finite element analysis was used to determine the pointwise stress and strain distributions in graphite-epoxy off-axis specimens having length-to-width ratios of 5, 10, 15, and 20 with 15° fiber orientation. A new optical method of high-sensitivity moire interferometry was used to verify the accuracy of the finite element results.

Accomplishment Description

This study indicated very good agreement between finite element results and experiment. Both experiment and analysis showed that the clamped end grips of the test machine introduce inplane bending and shear under tensile loading (see left figure). This loading state results in nonuniform stress distributions at the test section where the strain gages are located. The extent of the stress distribution nonuniformity was found to be significant for aspect ratios smaller than 15 (see center figure). This stress distribution nonuniformity causes errors in determining the shear modulus, G_{12} . The errors occur because the stresses at the strain gages cannot be determined exactly from the test data, but are calculated from the net load recorded by the testing machine. Hence, the presence of the stress distribution nonuniformity implies a difference in the actual stresses at the gages and the recorded values. The finite element results indicate that as the specimen aspect ratio increases to 15 and beyond (see right figure), the error in the shear stress (based on P/A calculations using test data) due to the nonuniformity of the shear stress distribution diminishes substantially and a more reliable determination of G_{12} can be obtained.

Status

Results of this study have recently been published in Composites Technology Review, and other researchers at LaRC are using the results to design test specimens.

OFF-AXIS TENSILE COUPON REQUIRES HIGH ASPECT RATIO TO MEASURE SHEAR MODULUS ACCURATELY

DEFORMATION MODES

SHEAR STRESS CONTOURS $\theta = 15^\circ$ OFF-AXIS COUPON

ERROR IN SHEAR STRESS AT STRAIN GAGE

UNCONSTRAINED
ENDS

CONSTRAINED
ENDS

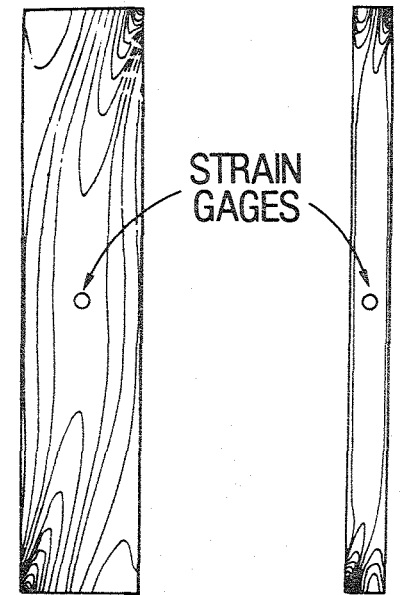
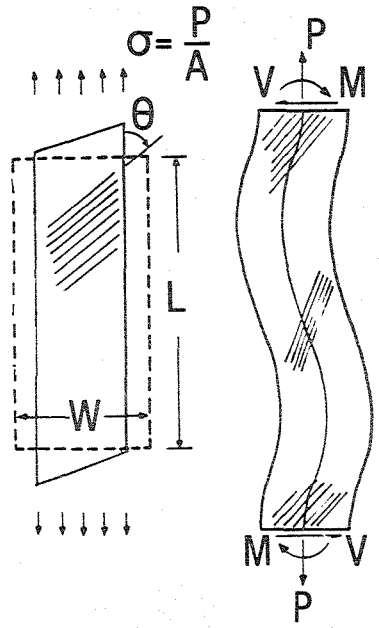

L/W=5

L/W=15

CONSTRAINED ENDS

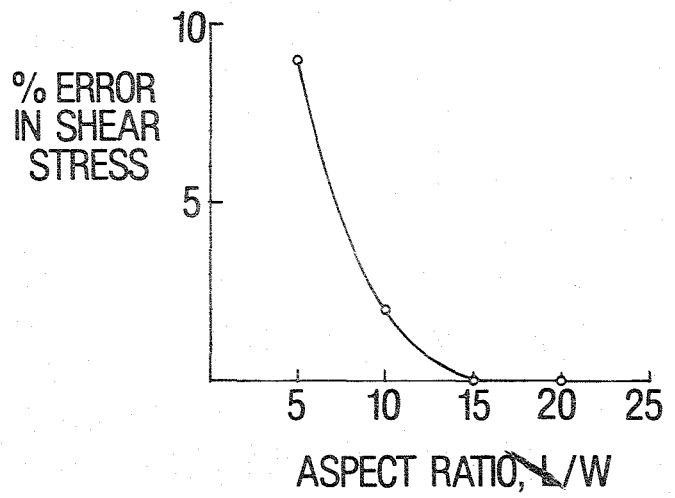

ANALYSIS NEEDS IDENTIFIED FOR BUCKLED COMPOSITE
CURVED PANELS WITH HOLES

Norman F. Knight, Jr. and James H. Starnes, Jr.
Structural Mechanics Branch, SDD
Extensions 3179 and 2552
May 22, 1984

(RTOP 505-33-53)

Research Objective

To understand and to predict accurately the postbuckling response of axially-compressed graphite-epoxy curved panels with holes.

Approach

The STAGSC-1 nonlinear finite element computer code was used to predict the postbuckling response of a curved graphite-epoxy panel with a hole. The Riks method, based on controlling an equilibrium-path-arc-length parameter instead of the traditional load parameter, was used to predict solutions along the unstable equilibrium path of the postbuckling response.

Accomplishment Description

The upper left figure compares test and analysis results for end shortening δ (normalized by panel length L) as a function of applied load P (normalized by panel initial prebuckling extensional stiffness EA). The correlation between test and analysis is good for the lowest values of the normalized applied load. The correlation deteriorates as the buckling load is approached and significant differences occur after buckling. Contour plots of the radial displacements and oblique views of the deformed geometry at three points on the analytical load-shortening curve (Points A, B, and C on upper left figure) are shown along the bottom of the chart. This sequence of contour plots shows the development of a local nodal line which intersects the hole boundary. This nodal line is associated with severe local bending and large local rotations of the panel skin. Following buckling, the local nodal line rotates around the hole axis and apparently causes local laminate failures to propagate and contribute to the overall failure of the panel. The significant difference in the test and analysis results after buckling is attributed to large local rotations of the panel skin, transverse shearing deformations that are associated with these large local bending deformations, and local delamination of the panel due to this severe local bending which are currently not accounted for in the analysis.

Future Plans

A refined analysis that accounts for large rotations associated with severe local bending gradients and for transverse shear effects is being developed. This refined analysis will be used in an attempt to predict local laminate failures and subsequent failure propagation.

ANALYSIS NEEDS IDENTIFIED FOR BUCKLED COMPOSITE CURVED PANELS WITH HOLES

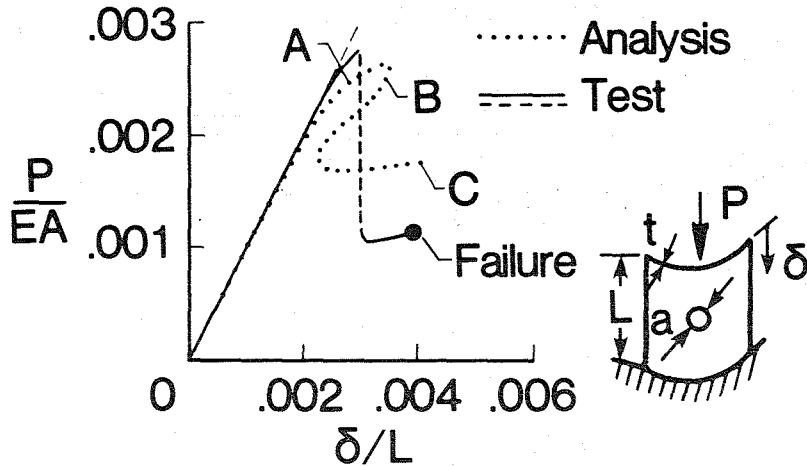

- Large rotations
- Transverse shear effects
- Unstable equilibrium path after buckling
- Local material failures near hole

87

Point A ($W_{max} = 1.0t$) Point B ($W_{max} = 2.4t$) Point C ($W_{max} = 4.5t$)

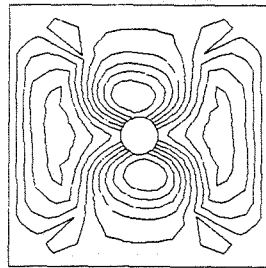
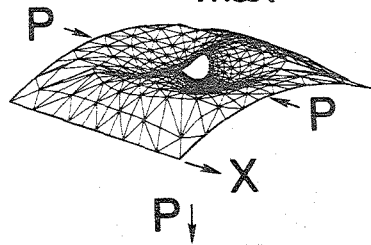

X ↓
P ↑

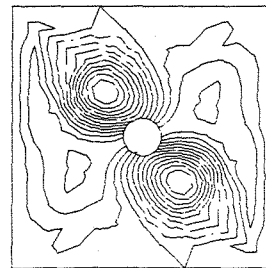
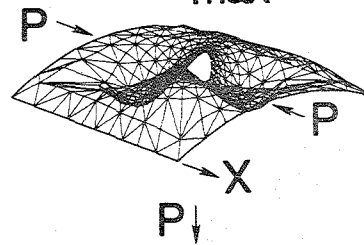

X ↓
P ↑

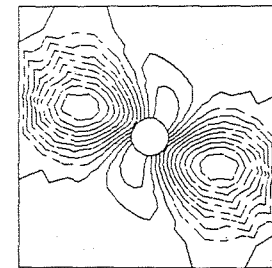
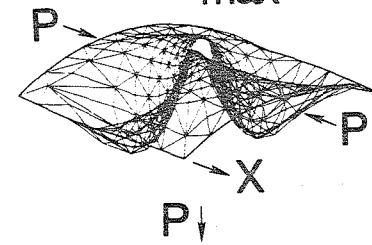

X ↓
P ↑

POSTBUCKLING CAPABILITY OF STIFFENED GRAPHITE/EPOXY
CURVED PANELS SUBJECTED TO COMBINED LOADS DEMONSTRATED

James H. Starnes, Jr. and John N. Dickson
Structural Mechanics Branch, SDD/Lockheed-Georgia Company
Extension 2552/(404) 425-4360
July 26, 1984

(RTOP 534-06-23 and 505-33-33)

Research Objective

To determine by testing the postbuckling capability of a stiffened graphite-epoxy curved fuselage panel design that is subjected to combined shear and compression loading.

Approach

A stiffened graphite-epoxy curved panel (upper left photograph) typical of a transport fuselage was designed to operate with buckled skins when subjected to combined shear and compression loads. Specimens were fabricated and tested to failure by Lockheed-Georgia Company under NASA Contract NAS1-15949* to demonstrate their postbuckling capability.

Accomplishment Description

Three 60-inch-long by 42-inch-wide stiffened panels were fabricated for testing in Lockheed-Georgia Company's combined load test machine. The specimens had 143 inch radii and were stiffened by five J stiffeners spaced approximately seven inches apart and three frame sections spaced 20 inches apart. The panels had failsafe straps in the skin and skin padding under the stiffeners to suppress the skin-stiffener separation failure mode common to postbuckled stiffened panels. The first panel was loaded in pure shear, the second panel was loaded with equal amounts of shear and compression, and the third panel was loaded with a three-to-one ratio of compression-to-shear loading. The results of the tests are shown in the lower left figure. All specimens buckled at loads slightly greater than their predicted buckling loads, all panels had substantial post-buckling capability, and all panels failed at loads slightly less than the predicted failure loads. A typical failed specimen is shown in the right photograph. Failure occurred along a diagonal of the panel and the stiffeners crippled at failure. The stiffeners did not separate from the skin at failure.

Future Plans

A fourth panel will be tested in pure compression in the future to complete this combined-load interaction study and detailed nonlinear analyses of the panel responses are being conducted.

POSTBUCKLING CAPABILITY OF STIFFENED GRAPHITE/EPOXY CURVED PANELS SUBJECTED TO COMBINED LOADS DEMONSTRATED

TYPICAL SPECIMEN

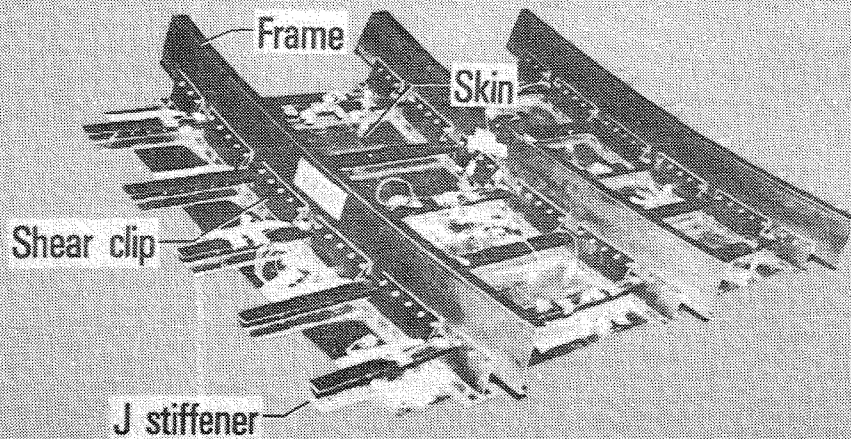

FAILED SPECIMEN

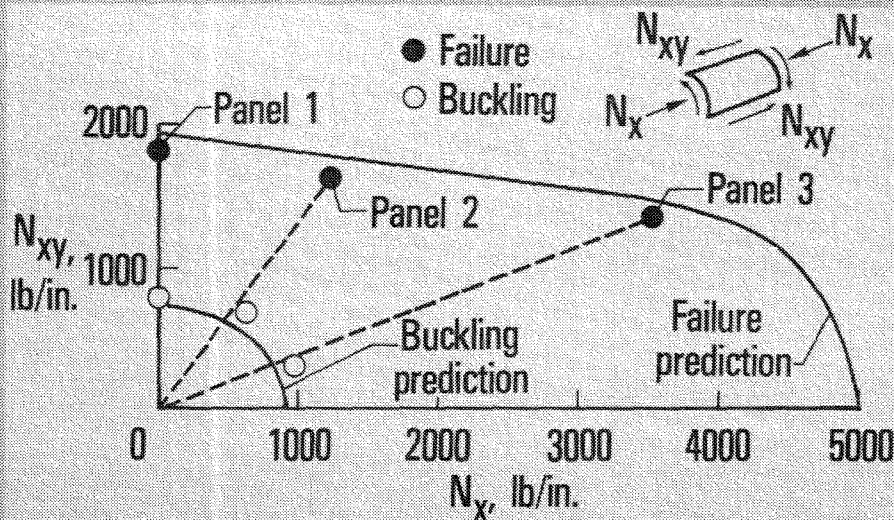
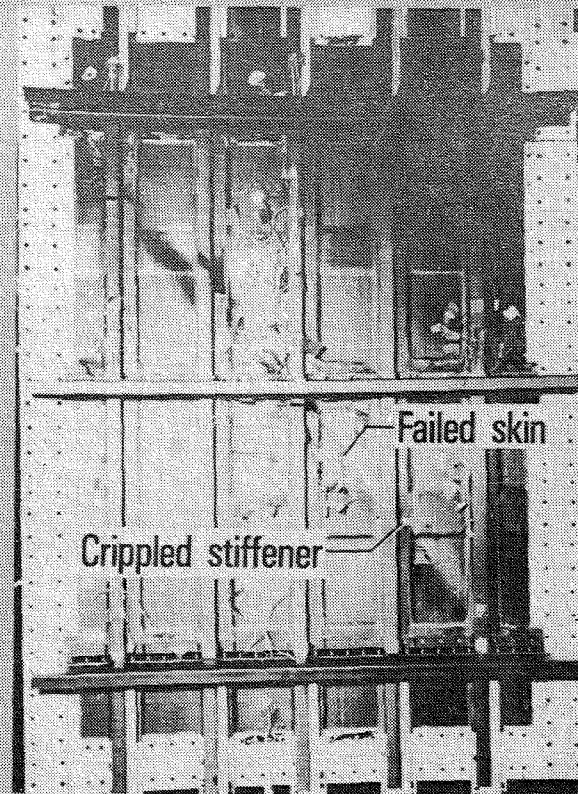

1. Report No. NASA TM-86417		2. Government Accession No.		3. Recipient's Catalog No.	
4. Title and Subtitle Structures and Dynamics Division Research and Technology Plans for FY 1985 and Accomplishments for FY 1984				5. Report Date April 1985	
				6. Performing Organization Code 506-53-43-15	
7. Author(s) Kay S. Bales				8. Performing Organization Report No.	
9. Performing Organization Name and Address NASA Langley Research Center Hampton, VA 23665				10. Work Unit No.	
				11. Contract or Grant No.	
12. Sponsoring Agency Name and Address National Aeronautics and Space Administration Washington, DC 20546				13. Type of Report and Period Covered Technical Memorandum	
				14. Sponsoring Agency Code	
15. Supplementary Notes					
16. Abstract This paper presents the Objectives, FY 1985 Plans, Approach, and FY 1985 Milestones for the Structures and Dynamics Division's research programs. FY 1984 Accomplishments are presented where applicable. This information is useful in program coordination with other government organizations in areas of mutual interest.					
17. Key Words (Suggested by Author(s)) Transport crash dynamics; Aircraft ground performance; Composite structures; Failure analysis; Space vehicle dynamics; Large space structures; Computational structural mechanics				18. Distribution Statement Unclassified - Unlimited Subject Category 39	
19. Security Classif. (of this report) Unclassified		20. Security Classif. (of this page) Unclassified		21. No. of Pages 94	22. Price A05

End of Document