

NASA Technical Memorandum 86370

Pressure Distributions From
High Reynolds Number Tests of
a NASA SC(3)-0712(B) Airfoil
in the Langley 0.3-Meter
Transonic Cryogenic Tunnel

William G. Johnson, Jr., Acquilla S. Hill,
and Otto Eichmann

*Langley Research Center
Hampton, Virginia*

NASA

National Aeronautics
and Space Administration

Scientific and Technical
Information Branch

1985

Use of trademarks or names of manufacturers in this report does not constitute an official endorsement of such products or manufacturers, either expressed or implied, by the National Aeronautics and Space Administration.

Contents

Summary	1
Introduction	1
Symbols	1
Wind Tunnel and Model	2
Test Apparatus and Procedures	4
Data Reduction and Quality	5
Concluding Remarks	6
Appendixes	8
References	390
Tables	391
Figures	393

Summary

In a cooperative effort with U.S. manufacturers of large transport aircraft, NASA is conducting a systematic study of well-known conventional and advanced-technology airfoil concepts over a wide range of Reynolds number. This study, referred to as the Advanced Technology Airfoil Tests (ATAT) program, is being conducted in the two-dimensional test section of the Langley 0.3-Meter Transonic Cryogenic Tunnel (0.3-m TCT).

The pressure distributions presented in this report are from the test of a NASA 12-percent-thick, supercritical, advanced-technology airfoil. This test was conducted as part of the ATAT program. Test temperature was varied from 220 K to 96 K at pressures ranging from about 122 kPa (1.2 atm) to 436 kPa (4.3 atm). Mach number was varied from 0.50 to 0.80. These variables provided a Reynolds number range (based on airfoil model chord) from 4.4×10^6 to 40.0×10^6 .

The pressure data are presented without analysis in tabulated format and as plots of pressure coefficient versus position on the airfoil. This report was prepared for use in conjunction with the aerodynamic coefficient data published in NASA TM-86371.

Introduction

The National Aeronautics and Space Administration (NASA) is conducting a systematic study of well-known conventional and advanced-technology airfoil concepts over a wide range of Reynolds number. This study, described in detail in reference 1, is referred to as the Advanced Technology Airfoil Tests (ATAT) program and is being conducted in the Langley 0.3-Meter Transonic Cryogenic Tunnel (0.3-m TCT). A significant portion of the advanced-technology airfoil phase of the ATAT program is being carried out in cooperation with U.S. industry. Three U.S. manufacturers of large commercial transport aircraft (Boeing, Douglas, and Lockheed) are participating individually in this phase of the program by providing technical personnel, airfoil design concepts, and airfoil models. The overall objectives of the ATAT program are (1) to provide the industry participants with the opportunity to test and compare their advanced airfoils with the latest NASA airfoils at flight design Reynolds numbers in the same facility, (2) to provide industry with experience in cryogenic wind-tunnel model design, construction, and testing techniques, (3) to expand the Reynolds number airfoil data base, and (4) to provide each participant with the opportunity to evaluate their current level of airfoil technology. As part of the first objective, it is necessary to test some of the latest NASA

designs in the same facility used by the industry participants.

The results presented in this report are from tests of a second model of the NASA SC(3)-0712 airfoil. The first model, designated NASA SC(3)-0712(A), distorted enough during its test to raise questions about the validity of the data. A second model, designated SC(3)-0712(B), was constructed with different material and fabrication procedures and is the subject model of this report. The tests were conducted in the Langley 0.3-m TCT with a two-dimensional, 20- by 60-cm (8- by 24-in.) test section installed. Reference 2 describes the operating envelope of this transonic cryogenic pressure tunnel. Test temperature was varied from 220 K to cryogenic temperatures (about 96 K) at pressures ranging from about 1.2 to 4.3 atm (1 atm = 101.3 kPa). Mach number was varied from 0.50 to 0.80. These variables provided a Reynolds number range (based on airfoil model chord) from 4.4×10^6 to 40.0×10^6 . The pressure data are presented herein in plotted and tabulated formats. (The aerodynamic coefficient data are published in ref. 3.) Included in this report are details of the model design and airfoil coordinates and details of the model fabrication techniques.

Symbols

The measurements and calculations were made in U.S. Customary Units; however, the measurements are presented in the International System of Units (SI) with the U.S. Customary Units in parentheses. Factors relating these two systems of units can be found in reference 4. The symbols in parentheses are those used on computer-generated plots and tables in the appendixes.

AOA		angle of attack
<i>b</i>	(B)	airfoil model span, cm (in.)
<i>c</i>	(C)	airfoil model chord, cm (in.)
	(CC)	section chord force coefficient from airfoil model pressures
<i>c_d</i>		section drag force co- efficient from wake measurements
	(CD1)	section drag force coeffi- cient from wake measure- ments for pitot tube at $y/(b/2) = 0.0$

	(CD2)	section drag coefficient from wake measurements for pitot tube at $y/(b/2) = -0.125$
	(CD3)	section drag coefficient from wake measurements for pitot tube at $y/(b/2) = -0.250$
	(CD4)	section drag coefficient from wake measurements for pitot tube at $y/(b/2) = -0.375$
	(CD5)	section drag coefficient from wake measurements for pitot tube at $y/(b/2) = -0.500$
	(CDCOR1 through CDCOR5)	corrected values for CD1 through CD5
c_m	(CM)	section pitching-moment coefficient about model quarter-chord point
c_n	(CN)	section normal-force coefficient from model pressures
C_p	(CP)	pressure coefficient
M	(MACH)	free-stream Mach number
	(MLOC)	local Mach number
	(P,L)	local static pressure, kPa (psi)
	(PT)	tunnel stagnation pressure, atm (1 atm = 101.3 kPa)
R	(RC)	free-stream Reynolds number based on model chord
	(TT)	tunnel stagnation temperature, K
x	(X)	chordwise distance from leading edge of model (positive measured aft), cm (in.)
y	(Y)	spanwise distance along model from centerline of tunnel and model (positive measured toward right-hand side), cm (in.)

z		vertical distance from model reference plane (positive measured up), cm (in.)
z_{design}		airfoil ordinate as designed, cm (in.)
z_{meas}		airfoil ordinate as measured, cm (in.)
α	(ALPHA)	uncorrected angle of attack (positive measured from tunnel centerline up to airfoil reference line), deg

Airfoil designation:

NASA SC(3)-0712(B) supercritical (phase 3), 0.7 design lift coefficient, 12 percent thick, model construction technique B

Wind Tunnel and Model

Wind Tunnel

The tests were made in the 20- by 60-cm (8- by 24-in.) two-dimensional test section of the 0.3-m TCT. A photograph of the tunnel is shown in figure 1(a). A schematic drawing showing some physical characteristics of the tunnel is shown in figure 1(b). A photograph and sketch of the two-dimensional test section are shown in figure 2. In the photograph, figure 2(a), the plenum lid and test-section ceiling have been removed to show model installation. The 0.3-m TCT is a continuous-flow, single-return, fan-driven transonic tunnel which uses nitrogen gas as the test medium. It is capable of operating at stagnation temperatures from about 80 K to about 327 K and stagnation pressures from slightly greater than 1 atm to 6 atm. Test-section Mach number can be varied from near zero to 0.9. The ability to operate at cryogenic temperatures and 6 atm pressure provides an extremely high Reynolds number capability at relatively low model loadings.

The two-dimensional test section, which features a slotted floor and ceiling, contains computer-driven angle-of-attack and wake survey rake systems. The angle-of-attack system is capable of varying the angle of attack over a range of about 40°. The wake survey rake, located just downstream of the model (see fig. 2(a)), provides up to nine total-pressure measurements across half the width of the tunnel. These pressures are converted to drag levels and provide a convenient mechanism for determining the

extent of two-dimensionality of the flow over the model. Additional design features and characteristics regarding the cryogenic concept in general and the 0.3-m TCT in particular are presented in references 5 and 6.

Model

The airfoil model used in this test is a 12-percent-thick, advanced-technology supercritical airfoil designed by NASA for a Reynolds number of 30×10^6 and is designated the NASA SC(3)-0712(B). The model has a chord of 15.24 cm (6.0 in.) and was fabricated in accordance with NASA aerodynamic and structural requirements for the ATAT program models. The aerodynamic specifications require airfoil contour accuracies of ± 0.0025 cm (± 0.001 in.), surface finishes of $0.254 \mu\text{m}$ (0.00001 in.) or better, and a sufficient coverage of pressure orifices with diameters of about 0.025 cm (0.010 in.). The structural specifications included tolerance requirements for the model chord and span dimensions, a selection of material suitable for use at cryogenic temperatures, a safety factor of at least 3 at all operating conditions, Charpy impact strengths of at least 20.34 J (15.0 ft-lb) at 77 K, and compatibility with existing 0.3-m TCT sidewall turntables. A photograph of the model installed in the 0.3-m TCT test section is shown in figure 3. The model was equipped with 64 static-pressure orifices, each having a diameter of 0.025 cm (0.010 in.). Figure 4 is a schematic drawing which indicates the general locations of the orifices and the general shape of the airfoil section. Table I lists the x/c and $y/(b/2)$ locations for each orifice.

Model stress analysis. The stress analysis used a design load of 6.4 kN (1440 lb) normal force. The analysis indicated a maximum bending stress level of $82\,740 \text{ kN/m}^2$ (12 000 psi) along the row of orifices. Along the bond surface, the maximum shear stress was found to be 2069 kN/m^2 (300 psi). These stress levels resulted in safety factors of 10 or better. Deflections along the model centerline, and the decambering effect of the trailing edge under load, were scaled-up calculations from a previously designed 6-percent supercritical airfoil model subjected to the same design loads. The scaled centerline deflection for the model as a simply supported beam under uniform loading was 0.010 cm (0.004 in.). The scaled trailing-edge deflection was 0.0003 to 0.0005 cm (0.0001 to 0.0002 in.).

Model fabrication. The model was fabricated from 18-percent Ni alloy, maraging, grade 200 steel (VascoMax C-200, manufactured by Teledyne Vasco). The contouring was done in stages, and the model was cryocycled (i.e., cooled to liquid-nitrogen tem-

perature and warmed to ambient temperature) during the contouring phase to allow for material stabilization and reduce the possibility of model distortion during cryogenic testing. A "cover plate" type of construction was used. For this model, the cover plate was basically the bottom half of the model block from about 3.2 percent chord to 90.7 percent chord. Trenches were cut from the parting line into both halves of the model block, which had been machined to a slightly oversize contour for the aerodynamic surface. Holes were then drilled in the bottoms of these trenches to within approximately 0.075 cm (0.030 in.) of the outside surface. Stainless-steel tubing with a 0.152-cm (0.060-in.) outside diameter (o.d.) and a 0.102-cm (0.040-in.) inside diameter (i.d.) was then soldered into all holes except for the orifices noted in table I, which had smaller diameter tubing in order to remain within the cambered contour at the model trailing edge. All undersized tubes were jumped to the largest size tube as soon as possible within the model. This procedure has been shown to improve the response time in measuring the model pressures. The pressure tubes were then routed along the trench and out a slot to the side of the model. The two halves of the model block were bonded together with a structural adhesive film, and the outside model surfaces were machined to the final contour. The static-pressure orifices, 0.025 cm (0.010 in.) in diameter, were then drilled into the model surface to meet the soldered tubes.

Pretest checks of the pressure tubes indicated that orifices 4, 21, 24, 40, 63, and 64 were completely lost due to blockage or severe leakage. Four of the six lost orifices were plumbed in such a way as to require joints in the tubing inside the model, and these joints were very likely the source of the problems. This experience highlights the fact that extreme care should be used to insure the integrity of the pressure-measuring tubes located within the model, since the area is no longer accessible once bonding is completed.

Model accuracy. Past experience has shown that many metals undergo drastic and irreversible changes in shape when exposed to a cryogenic environment. This has been very apparent in the current airfoil program. For example, the first version of this model, designated SC(3)-0712(A), was machined from Armco 15-5 PH stainless steel, and its posttest validation indicated about a 0.019-cm (0.008-in.) bow in the spanwise direction. Model construction procedures have since been established to alleviate this problem. It is now standard practice that all airfoil models intended for testing in the 0.3-m TCT be thermally cycled to cryogenic temperatures during the fabrication process so they can

stabilize before the final model contour validation and testing. Final contour and pressure-orifice locations on the model were checked with a Brown and Sharpe Validator 50 probe, which under ideal conditions has an accuracy of ± 0.0013 cm (± 0.0005 in.). The contour of the airfoil was checked at 50 chordwise stations at the centerline and at the ± 5.08 -cm (± 2.0 -in.) spanwise stations on both the upper and lower surfaces. Table II presents the design coordinates and the pretest measured coordinates for the centerline ($y = 0$) station. The differences between the design coordinates and measured coordinates are shown in figure 5 as a function of chordwise location. In general, the specified fabrication tolerance was maintained except on the high-curvature regions of the leading and trailing edges, which are recognized as the most difficult to manufacture as well as to machine.

Test Apparatus and Procedures

Test Instrumentation and Apparatus

A detailed discussion of the instrumentation and procedures selected for the calibration and control of the 0.3-m TCT can be found in reference 7. For two-dimensional airfoil tests, the 0.3-m TCT is equipped to obtain static-pressure measurements on the airfoil model surface, total-pressure measurements in the model wake, and static-pressure measurements on the test-section sidewalls, floor, and ceiling. The pressures are measured with individual transducers, except for the tunnel floor and ceiling pressures, which are measured with a scanning valve system capable of operating ten 48-port scanning valves. Because of the large changes in the pressure of the tunnel over its operational range, commercially available, high-precision, variable-capacitance pressure transducers are used instead of conventional strain gauge pressure transducers.

Airfoil model pressures. The pressures on the airfoil model are measured by individual transducers connected by tubing to each orifice on the model. The pressure transducers are located adjacent to the test section in order to reduce response time. To provide increased accuracy, the transducers are mounted on thermostatically controlled heater bases to maintain a constant temperature and on "shock" mounts to reduce possible vibration effects. The electrical outputs from the transducers are connected to individual signal conditioners located in the tunnel control room. The signal conditioners have autoranging capability and have seven ranges available. As a result of the autoranging capability, the analog electrical output to the data acquisition system is kept at a high level, even though the pressure transducer

may be operating at the low end of its range. The maximum range of these differential transducers is about ± 6.8 atm, with an accuracy of ± 0.25 percent of the reading from -25 percent to $+100$ percent of full scale.

Wake pressures. A vertically traversing survey mechanism is located on the left sidewall of the two-dimensional test section downstream of the turntables (fig. 2). The purpose of this mechanism is to move a total-pressure probe rake through the airfoil wake to survey the total pressures within the wake. Details of this survey rake are shown in figure 6. The survey mechanism has a total traversing range of 25.4 cm (10 in.). The rake support can be located with the measurement plane of the rake at either of two tunnel stations, 21.0 cm (8.3 in.) or 26.0 cm (10.2 in.). For this test, the wake survey measurements were made at the 26.0 cm (10.2 in.) station, which placed the measurement plane about 1.2 chord lengths downstream of the airfoil trailing edge. The survey mechanism is driven by an electric stepper motor and is designed to operate at speeds from about 0.25 to about 15 cm/sec (0.1 to 6 in/sec). The stroke (that portion of the total traversing range used in a given survey) and speed of the survey mechanism can be controlled from the operator's panel in the control room to suit the research requirements. The vertical position of the rake is recorded using the output from a digital shaft encoder geared to the survey mechanism. The wake survey mechanism is synchronized with the scanning valves so that the rake is moved to a different vertical location each time the scanning valves are advanced to a new port. This continues until the scanning valves complete their stepping, at which time the rake continues to step at a predetermined rate through the remaining portion of the wake. Nine total-pressure probes are located on the survey rake. However, only five were used in this test because of blockage or leaks in the remaining four tubes. The five were located at the following spanwise stations: $y(b/2) = 0.0, -0.125, -0.250, -0.375, \text{ and } -0.500$. Nine tunnel sidewall static-pressure taps are also provided in the measurement plane of the rake. Data from these are averaged for use in the determination of the momentum loss and, therefore, airfoil drag coefficient based on the method outlined in reference 8. The more sensitive individual differential pressure transducers, with a maximum range of ± 1.36 atm and of the type described previously, are used on each tube on the survey rake and for each of the sidewall taps.

Angle of attack. The angle-of-attack mechanism has a traversing range of $\pm 20^\circ$, which can be offset

from 0° in either direction at model installation. The mechanism is driven by an electric stepper motor, which is connected through a yoke to the perimeter of both turntables. This arrangement drives both ends of the model through the angle-of-attack range to eliminate possible model twisting. The angular position of the turntables, and therefore the angle of attack of the model, is recorded using the output from a digital shaft encoder geared to one of the turntables.

Test Program

Figure 7 shows the test program (R versus M) used in this investigation. The selection of test conditions was made in an effort to overlap experimental and theoretical work for some of the airfoils in the ATAT program. The extent of the effort to establish transition effects (fixed and free), Reynolds number effects, and Mach number effects can be seen in this figure.

Test Procedures

Pressure data. For the tests reported herein, 20 samples of the airfoil static-pressure data were taken only while the rake was at its first position. Since there were individual transducers for each orifice on the model, each sample of data consisted of simultaneous static-pressure readings from all orifices on the model. Likewise, 20 samples of total-pressure (wake-rake) data were taken at the first rake position and then at each succeeding step (vertical position) of the rake. As the rake was stepped to each new position, a 0.5-sec delay was followed by the 1-sec averaging period. For each angle of attack at each combination of test conditions, the rake was stepped in 50 increments through the wake. As a result, only about 75 sec per data point were required to determine the wake defect (drag condition) and airfoil pressures.

Use of wake rake. To provide maximum definition of the model wake, the stroke of the rake (lower to upper limits) and the number of steps within the stroke can be changed for each test condition, such as angle of attack or Mach number. For this test, the number of steps within the stroke was held constant at 50. However, the stroke was changed as required to scan the entire wake. An example of this stroke variation is shown in figure 8 for $M = 0.76$ and $M = 0.78$.

Transition. Transition strips located on both the upper and lower surfaces were used during a portion of the testing to evaluate their effect on the aerodynamic characteristics of the model. The transition strips were sized for a chord Reynolds number

of 4×10^6 and were located at the 5-percent chord line. The strips, which were approximately 1.6 mm (0.06 in.) wide, consisted of 0.041-mm (0.0016-in.) diameter glass beads that were applied using a clear acrylic spray. Figure 7 shows the test conditions for fixed transition.

Data Reduction and Quality

0.3-m TCT Data Acquisition System

Data were recorded on magnetic tape with a computer-controlled high-speed digital data acquisition system located in the control room of the 0.3-m TCT. This system has a total of 192 analog channels with five selectable ranges from 8.191 to 131 mV and a resolution of 1 part in 8191. All analog data were filtered with a 10-Hz low-pass filter. An operating and acquisition program is used by the computer to scan the data acquisition hardware and to write the raw data on tape.

Through the use of a separate "real-time" program, visual displays of Mach number, Reynolds number, stagnation pressure, and other flow and tunnel parameters are provided on LED readouts on the tunnel control panel and on a color CRT. This real-time program provides many on-line data reduction functions, such as correcting Mach number for real-gas effects and calculating the local pressure ratios and pressure coefficients, which are then integrated around the airfoil to determine values of c_n and c_m . Values of c_d are computed on-line by integrating the total head loss through the model wake. Local pressure coefficients, local pressure ratios, local Mach numbers, total head loss through the model wake, and model aerodynamic coefficients (c_n , c_d , and c_m) can be displayed graphically on an intelligent graphics terminal interfaced with the computer. This information can then be sent to a plotter/printer which produces hard copies.

Data Reduction

The test Mach number is based on an average of the Mach number distributions measured as a function of Reynolds number at several longitudinal stations during the calibration of the "empty" test section. As mentioned in the previous section, Mach number is corrected for real-gas effects. Real-gas effects are included in the data-reduction process through the use of the thermodynamic properties of nitrogen gas calculated from the Beattie-Bridgeman equation of state. This equation of state has been shown in reference 9 to give essentially the same thermodynamic properties and flow calculation results in the temperature-pressure regime of the 0.3-m TCT

as are given by the more complicated Jacobsen equation of state. Detailed discussions of real-gas effects when testing in cryogenic nitrogen are contained in references 10 and 11.

Section normal-force and pitching-moment coefficients are calculated from numerical integration (based on the trapezoidal method) of the local surface pressure coefficient measured at each crifice multiplied by an appropriate weighting factor (incremental area). Drag coefficient is obtained from the wake survey pressures by computing an incremental or point drag coefficient by the method of reference 8 for each rake tube pressure at each rake position. These point drag coefficients are then numerically integrated across the model wake according to the trapezoidal method. Specifically, the point drag coefficients are compared one by one with a "threshold" value of drag coefficient, which accounts for a nonzero pressure decrement outside the model wake. This threshold is determined from several wake profiles early in the test as well as from past experience with similar tests. For this test, the threshold value was 0.0002. If, in the integrating process, the individual coefficient is greater than or equal to the threshold, the weighting factor (incremental area) is applied and the incremental drag is included in the running sum of the total drag. If the individual coefficient is less than the threshold, the weighting factor is set equal to zero and the incremental drag is not included in the running sum of the total drag. The results of this integration are total drag coefficients for each of the five rake pitot tubes. The data reduction program then provides a correction which subtracts that summed portion of the individual incremental drag coefficients within the wake which is attributable to the threshold level. These corrected values of total drag coefficient are listed as CDCOR1 through CDCOR5 on the pages of tabulated data in the appendixes. All the plotted drag data are the corrected values from the rake tube at $y/(b/2) = -0.125$. Normally, the tunnel centerline tube is used, but the data from this off-centerline tube were inadvertently plotted for this report. Examination of the data shows little difference in the comparisons except for the high Mach number, high-normal-force conditions.

Data Quality

Mach number fluctuations. In all wind-tunnel testing, and especially in transonic testing, the steadiness of the tunnel flow conditions, such as Mach number, has direct bearing on the quality of the final aerodynamic data. With the use of individual pressure transducers on each of the model pressure ori-

fices, and with all model data recorded at the time of the first rake step, Mach number fluctuations in the model data for any given point were essentially nonexistent. The possibility of Mach number fluctuations during the time required for the rake to complete the survey of the wake was checked for several angles of attack for a single set of tunnel test conditions, $M = 0.76$ and $R = 30.0 \times 10^6$. The mean value of Mach number \bar{M} and the standard deviation σ for the selected angles of attack are as follows:

α , deg	\bar{M}	σ
-3	0.7616	0.0019
0	.7600	.0022
+3	.7633	.0025

This statistical sample of 102 values is based on 2 data points per α (from a hysteresis run) and 51 data frames per data point (50 rake steps plus step zero).

Repeatability of data. Two examples illustrating the degree of repeatability for the normal-force, pitching-moment, and axial-force coefficients at a Reynolds number of 30×10^6 are shown in figures 9 and 10. The repeatability shown in these figures is considered to be generally good.

Evaluation of hysteresis effects. An airfoil may exhibit substantially different aerodynamic characteristics at a given test condition, such as angle of attack, when the test condition is "approached" from different directions. A very brief attempt to develop hysteresis was made during this investigation, and the results obtained are plotted in figures 11 through 14. The hysteresis data points were obtained by increasing the model angle of attack until substantial separation occurred and then decreasing the angle of attack to the desired test condition before taking data. The data indicate an absence of hysteresis at the higher Reynolds number (30.0×10^6) for free transition and for all Reynolds numbers when transition is fixed. The effect of the transition location on hysteresis manifests itself in the low Reynolds number, free-transition drag data of figure 11 but is absent in the low Reynolds number, fixed-transition drag data of figure 13.

Concluding Remarks

A wind-tunnel investigation of a 12-percent-thick, advanced-technology, supercritical airfoil, designated NASA SC(3)-0712(B), was conducted in the Langley 0.3-Meter Transonic Cryogenic Tunnel (TCT). This investigation represents another in the series of NASA/U.S. industry two-dimensional airfoil

studies in the Advanced Technology Airfoil Tests program. This investigation was designed to (1) test a NASA advanced-technology airfoil from low to flight equivalent Reynolds numbers, (2) provide experience in cryogenic wind-tunnel model design and testing techniques, and (3) demonstrate the suitability of the 0.3-m TCT as an airfoil test facility.

All the objectives of this investigation were met. The pressure data from this investigation are pre-

sented without analysis in plotted and tabulated formats for each Mach number and Reynolds number combination.

NASA Langley Research Center
Hampton, VA 23665
February 27, 1985

Appendixes

Because of the uncertainty in lift-induced interference effects and solid and wake blockage effects (particularly in the presence of local supercritical flow), no corrections for wall effects have been applied to the basic experimental data.

The pressure data from this investigation are presented without analysis in plotted and tabulated formats in appendixes A through P to be used in conjunction with the aerodynamic coefficient data in reference 3. Each appendix contains data for a given Mach number through the Reynolds number range. For each combination of Mach number and Reynolds number, the data are plotted for each angle of attack with the associated tabulations immediately following. The pressure data from the upper surface of the airfoil are plotted as open symbols, and the lower-surface data are plotted as solid symbols. Since it is the intent of the authors to make these appendixes convenient for the user, similar angles of attack are always plotted at the same location on the page (e.g., $\alpha = 0$ is always at the page center). This arrangement should help the reader to follow a trend at a constant value of α , even if data were not taken at some angles of attack. The list below indicates the parameters plotted in each appendix.

Appendix	Mach number	Reynolds number ($\times 10^{-6}$)	Page
Free transition			
A	0.50	4.4, 7.0	9
B	0.60	7.0, 10.0, 15.0, 30.0	22
C	0.65	7.0, 30.0	47
D	0.70	4.4, 7.0, 10.0, 15.0, 30.0	60
E	0.72	7.0, 30.0	90
F	0.74	4.4, 7.0, 10.0, 15.0, 30.0, 40.0	103
G	0.75	10.0, 15.0, 30.0	136
H	0.76	^a 4.4, ^b 7.0, 10.0, 15.0, ^{a,b} 30.0, 40.0	155
I	0.77	10.0, 15.0, 30.0, 40.0	205
J	0.78	4.4, 7.0, 10.0, 15.0, 30.0, 40.0	226
K	0.79	10.0, 30.0	255
L	0.80	4.4, 7.0, 10.0, 15.0, 30.0	266
Fixed transition			
M	0.50	4.4, 7.0	290
N	0.65	7.0, 30.0	303
O	0.76	4.4, ^b 7.0, 10.0, 15.0, ^{a,b} 30.0, 40.0	315
P	0.78	4.4, 7.0, 10.0, 15.0, 30.0	364

^aConditions for "repeat data" runs.

^bConditions for "hysteresis data" runs.

Appendix A

Pressure Data for $M = 0.50$; $R = 4.4 \times 10^6$ and 7.0×10^6 ; Free Transition

The pressure measurements made on the NASA SC(3)-0712(B) airfoil are presented in coefficient form in graphs and tables in this appendix. The data are for a given Mach number through the Reynolds number range. The pressure data from the upper surface of the airfoil are plotted as open symbols, and the lower-surface data are plotted as solid symbols.

POOR QUALITY

TEST 167	PT 20.3839	PSI	CN	-0.0015	CD1	.00785	CDCOR1	.00737
RUN 17	TT 173.8574	K	CM	-1.1088	CD2	.00739	CDCOR2	.00697
POINT 1	RC 4.4211	MILLION	CC	.0036	CD3	.00788	CDCOR3	.00754
	MACH .5006				CD4	.00880	CDCOR4	.00845
	ALPHA -4.0169	DEG			CD5	.00793	CDCOR5	.00743

UPPER SURFACE				LOWER SURFACE				SPANWISE				
X/C	CP	P/L/PT	MLOC	X/C	CP	P/L/PT	MLOC	X/C	Y/(B/2)	CP	P/L/PT	MLOC
0.0000	.4952	.9157	.3567	0.0000	.4952	.9157	.3567	.1507	.7476	-.1439	.8211	.5380
.0132	.5448	.9231	.3399	.0126	-.8177	.7214	.6991	.1507	.4976	-.1582	.8190	.5416
.0259	.2314	.8767	.4375	.0255	-.7050	.7381	.6731	.1507	.2476	-.1574	.8191	.5414
.0759	-.0648	.8328	.5177	.0495	-.6687	.7435	.6645	.1507	-.2524	-.1552	.8195	.5408
.1003	-.1014	.8274	.5271	.0753	-.6018	.7533	.6490	.1507	-.5024	-.1595	.8188	.5419
.1507	-.1374	.8221	.5363	.1002	-.5750	.7573	.6427	.1507	-.7524	-.1549	.8195	.5407
.2003	-.1862	.8149	.5486	.1507	-.5266	.7645	.6313	.5002	.7476	-.2934	.7990	.5752
.2503	-.2169	.8103	.5563	.1976	-.5458	.7616	.6358	.5002	.4976	-.3098	.7966	.5792
.3001	-.2421	.8066	.5625	.2503	-.5298	.7646	.6321	.5002	.2476	-.3169	.7955	.5809
.3502	-.2576	.8043	.5684	.3001	-.5193	.7661	.6286	.5002	-.2524	-.3089	.7967	.5790
.4003	-.2746	.8016	.5705	.3507	-.4966	.7689	.6242	.5002	-.5024	-.2950	.7987	.5756
.4501	-.2946	.7988	.5755	.4001	-.4614	.7741	.6158	.5002	-.7524	-.2945	.7988	.5755
.5002	-.3122	.7962	.5798	.4501	-.4184	.7735	.6055	.8002	.7476	-.7996	.7246	.6950
.5502	-.3325	.7932	.5848	.5001	-.3495	.7907	.5889	.8002	.4976	-.2999	.7980	.5768
.6002	-.3488	.7908	.5887	.5497	-.2936	.8049	.5634	.8002	.2476	-.3114	.7953	.5796
.6500	-.3607	.7890	.5916	.6003	-.1491	.8204	.5393	.8002	-.5024	-.2896	.7996	.5743
.7000	-.3565	.7897	.5906	.6500	-.0962	.8341	.5155	.8002	-.7524	-.2719	.8022	.5699
.7500	-.3392	.7922	.5864	.7000	.0012	.8500	.4873					
.8002	-.3097	.7973	.5780	.7501	.1455	.8640	.4616					
.8502	-.1862	.8152	.5481	.8001	.2240	.8756	.4396					
.9501	-.0987	.8278	.5265	.8501	.2900	.8854	.4205					

TEST 167	PT 20.3892	PSI	CN	.1212	CD1	.00674	CDCOR1	.00653
RUN 17	TT 173.8472	K	CM	-1.1163	CD2	.00605	CDCOR2	.00584
POINT 2	RC -4.214	MILLION	CC	.0108	CD3	.00590	CDCOR3	.00573
	MACH .5005				CD4	.00698	CDCOR4	.00681
	ALPHA -3.0039	DEG			CD5	.00623	CDCOR5	.00608

UPPER SURFACE				LOWER SURFACE				SPANWISE				
X/C	CP	P/L/PT	MLOC	X/C	CP	P/L/PT	MLOC	X/C	Y/(B/2)	CP	P/L/PT	MLOC
0.0000	.7574	.9546	.2584	0.0000	.7574	.9546	.2584	.1507	.7476	-.2427	.8066	.5625
.0132	.3388	.8927	.4059	.0126	-.4541	.7753	.6139	.1507	.4976	-.2586	.8043	.5664
.0259	.0280	.8467	.4933	.0255	-.4395	.7775	.6104	.1507	.2476	-.2580	.8043	.5663
.0759	-.2057	.8121	.5533	.0495	-.4658	.7736	.6167	.1507	-.2524	-.2536	.8050	.5652
.1003	-.2239	.8094	.5579	.0753	-.4474	.7763	.6123	.1507	-.5024	-.2560	.8045	.5660
.1507	-.2373	.8074	.5612	.1002	-.4474	.7763	.6122	.1507	-.7524	-.2501	.8055	.5643
.2003	-.2791	.8012	.5715	.1503	-.4305	.7788	.6082	.5002	.7476	-.3368	.7927	.5856
.2503	-.2920	.7993	.5747	.1976	-.4594	.7745	.6151	.5002	.4976	-.3357	.7899	.5902
.3001	-.3097	.7967	.5790	.2503	-.4542	.7753	.6139	.5002	.2476	-.3637	.7887	.5921
.3502	-.3192	.7953	.5813	.3001	-.4465	.7766	.6121	.5002	-.2524	-.3545	.7901	.5899
.4003	-.3290	.7938	.5837	.3507	-.4335	.7784	.6089	.5002	-.5024	-.3393	.7923	.5862
.4501	-.3438	.7916	.5873	.4001	-.4055	.7825	.6022	.5002	-.7524	-.3387	.7924	.5860
.5002	-.3578	.7896	.5907	.4501	-.3700	.7878	.5937	.8002	.7476	-.8430	.7178	.6047
.5502	-.3744	.7871	.5947	.5001	-.3091	.7968	.5788	.8002	.4976	-.3199	.7952	.5815
.6002	-.3866	.7853	.5977	.5497	-.2200	.8100	.5569	.8002	.2476	-.3347	.7930	.5851
.6500	-.3946	.7841	.5996	.6003	-.1213	.8246	.5320	.8002	-.5024	-.3124	.7863	.5796
.7000	-.3868	.7853	.5977	.6500	-.0348	.8374	.5098	.8002	-.7524	-.2922	.7993	.5747
.7500	-.3657	.7884	.5926	.7000	.0717	.8531	.4816					
.8002	-.3252	.7944	.5878	.7501	.1682	.8674	.4552					
.8502	-.2027	.8125	.5524	.8001	.2514	.8797	.4316					
.9501	-.1137	.8257	.5304	.8501	.3267	.8909	.4095					

TEST 167	PT 20.3909	PSI	CN	.2216	CD1	.00741	CDCOR1	.00720
RUN 17	TT 173.8296	K	CM	-.1173	CD2	.00595	CDCOR2	.00576
POINT 3	RC 4.4205	MILLION	CC	.0144	CD3	.00623	CDCOR3	.00608
	MACH .5002				CD4	.00697	CDCOR4	.00680
	ALPHA -1.9763	DEG			CD5	.00712	CDCOR5	.00684

UPPER SURFACE				LOWER SURFACE				SPANWISE				
X/C	CP	P/L/PT	MLOC	X/C	CP	P/L/PT	MLOC	X/C	Y/(B/2)	CP	P/L/PT	MLOC
0.0000	.9365	.9812	.1649	0.0000	.9365	.9812	.1649	.1507	.7476	-.3344	.7936	.5840
.0132	.1699	.8592	.4705	.0126	-.1444	.8217	.5370	.1507	.4976	-.3549	.7906	.5890
.0259	-.1883	.8152	.5490	.0255	-.2061	.8126	.5525	.1507	.2476	-.3547	.7907	.5889
.0759	-.7459	.7919	.5866	.0495	-.2856	.8008	.5721	.1507	-.2524	-.3515	.7911	.5882
.1003	-.7431	.7924	.5861	.0753	-.3036	.7982	.5765	.1507	-.5024	-.3532	.7909	.5886
.1507	-.3291	.7944	.5827	.1002	-.1238	.7952	.5815	.1507	-.7524	-.3444	.7922	.5865
.2003	-.3445	.7922	.5865	.1503	-.3353	.7935	.5843	.5002	.7476	-.3767	.7874	.5943
.2503	-.3544	.7907	.5889	.1976	-.3778	.7872	.5945	.5002	.4976	-.3917	.7852	.5979
.3001	-.3639	.7893	.5912	.2503	-.3875	.7856	.5969	.5002	.2476	-.4006	.7839	.6000
.3502	-.3616	.7896	.5906	.3001	-.3898	.7855	.5974	.5002	-.2524	-.3935	.7849	.5983
.4003	-.3664	.7889	.5918	.3507	-.3843	.7863	.5951	.5002	-.5024	-.3821	.7866	.5956
.4501	-.3771	.7873	.5944	.4001	-.3630	.7894	.5910	.5002	-.7524	-.3790	.7871	.5948
.5002	-.3906	.7853	.5976	.4501	-.3318	.7940	.5834	.8002	.7476	-.8964	.7107	.6157
.5502	-.4053	.7832	.6012	.5001	-.2746	.8025	.5694	.8002	.4976	-.3319	.7940	.5834
.6002	-.4138	.7819	.6032	.5497	-.1893	.8151	.5483	.8002	.2476	-.3369	.7933	.5846
.6500	-.4181	.7813	.6042	.6003	-.0952	.8289	.5245	.8002	-.5024	-.3298	.7943	.5829
.7000	-.4063	.7830	.6014	.6500	-.0149	.8408	.5038	.8002	-.7524	-.3091	.7974	.5779
.7500	-.3802	.7869	.5991	.7000	.0891	.8551	.4761					
.8002	-.3358	.7934	.5844	.7501	.1841	.8702	.4500					
.8502	-.2065	.8125	.5526	.8011	.2671	.8824	.4264					
.9501	-.1076	.8271	.5277	.8501	.3449	.8939	.4034					

TEST	167	PT	20.3923	PSI	CM	.2768	CD1	.00792	CDCGR1	.00760
RUN	17	TT	173.9327	K	CM	-1.1174	CD2	.00624	CDCGR2	.00596
POINT	4	RC	4.4175	MILLION	CC	.0152	CD3	.00661	CDCGR3	.00669
		MACH	.5002				CD4	.00729	CDCGR4	.00705
		ALPHA	-1.4893	DEG			CD5	.00670	CDCGR5	.00637

UPPER SURFACE				LOWER SURFACE				SPANWISE				
X/C	CP	P _L /PT	MLOC	X/C	CP	P _L /PT	MLOC	X/C	Y/(B/2)	CP	P _L /PT	MLOC
0.0000	.9950	.9898	.1213	0.0000	.9950	.9898	.1213	.1507	.7476	-.3879	.7851	.5981
.0132	-.0244	.8389	.5071	.0126	-.0059	.8416	.5023	.1507	.4976	-.4073	.7822	.6027
.0259	-.3109	.7965	.5794	.0255	-.0989	.8278	.5264	.1507	.2476	-.4057	.7824	.6024
.0759	-.4237	.7798	.6067	.0495	-.1996	.8129	.5519	.1507	-.2524	-.4045	.7826	.6021
.1003	-.4093	.7819	.6032	.0753	-.2338	.8079	.5604	.1507	-.5024	-.4066	.7823	.6026
.1507	-.3785	.7865	.5958	.1002	-.2629	.8036	.5676	.1507	-.7524	-.3966	.7838	.6002
.2003	-.3816	.7860	.5965	.1503	-.2815	.8008	.5722	.5002	.7476	-.3993	.7834	.6008
.2503	-.3876	.7851	.5980	.1976	-.3281	.7939	.5836	.5002	-.4976	-.4075	.7822	.6028
.3001	-.3948	.7841	.5997	.2503	-.3417	.7919	.5859	.5002	.2476	-.4170	.7808	.6051
.3502	-.3912	.7846	.5989	.3001	-.3495	.7908	.5888	.5002	-.2524	-.4081	.7821	.6029
.4003	-.3945	.7841	.5997	.3507	-.3505	.7906	.5890	.5002	-.5024	-.4038	.7827	.6019
.4501	-.4034	.7828	.6018	.4001	-.3344	.7930	.5851	.5002	-.7524	-.3886	.7850	.5982
.5002	-.4139	.7812	.6043	.4501	-.3099	.7926	.5791	.8002	.7476	-.3313	.7934	.5843
.5502	-.4261	.7794	.6073	.5001	-.2586	.8042	.5665	.8002	-.4976	-.3424	.7918	.5870
.6002	-.4324	.7785	.6088	.5497	-.1762	.8164	.5480	.8002	.2476	-.3470	.7911	.5882
.6500	-.4345	.7782	.6093	.6003	-.0845	.8300	.5227	.8002	-.5024	-.3393	.7923	.5863
.7000	-.4202	.7803	.6058	.6500	-.0042	.8419	.5019	.8002	-.7524	-.3183	.7954	.5812
.7500	-.3917	.7845	.5990	.7000	.0963	.8567	.4750					
.8002	-.3650	.7914	.5877	.7501	.1886	.8704	.4496					
.9002	-.2096	.8115	.5544	.8001	.2690	.8823	.4286					
.9501	-.1076	.8266	.5286	.8501	.3425	.8932	.4048					

TEST	167	PT	20.3910	PSI	CM	.3261	CD1	.00830	CDCDR1	.00809
RUN	17	TT	174.0238	K	CM	-1.1178	CD2	.00756	CDCDR2	.00738
POINT	5	RC	4.4124	MILLION	CC	.0151	CD3	.00733	CDCDR3	.00708
		MACH	.5000				CD4	.00723	CDCDR4	.00696
		ALPHA	-.9877	DEG			CD5	.00675	CDCDR5	.00649

UPPER SURFACE				LOWER SURFACE				SPANWISE				
X/C	CP	P _L /PT	MLOC	X/C	CP	P _L /PT	MLOC	X/C	Y/(B/2)	CP	P _L /PT	MLOC
0.0000	1.0348	.9957	.0786	0.0000	1.0348	.9957	.0786	.1507	.7476	-.4309	.7792	.6075
.0132	-.1615	.8190	.5415	.0126	-.1184	.8603	.4684	.1507	.4976	-.4559	.7756	.6135
.0259	-.4335	.7789	.6082	.0255	-.0011	.8427	.5004	.1507	.2476	-.4407	.7778	.6099
.0759	-.4977	.7694	.6235	.0495	-.1206	.8251	.5312	.1507	-.2524	-.4532	.7759	.6129
.1003	-.4710	.7733	.6171	.0753	-.1699	.8178	.5437	.1507	-.5024	-.4554	.7756	.6134
.1507	-.4209	.7807	.6051	.1002	-.2070	.8123	.5530	.1507	-.7524	-.4444	.7772	.6108
.2003	-.4179	.7812	.6044	.1503	-.2404	.8074	.5612	.5002	.7476	-.4161	.7814	.6040
.2503	-.4211	.7807	.6052	.1976	-.2734	.7995	.5743	.5002	-.4976	-.4238	.7803	.6058
.3001	-.4247	.7802	.6061	.2503	-.3129	.7967	.5790	.5002	.2476	-.4344	.7787	.6084
.3502	-.4178	.7812	.6044	.3001	-.3227	.7952	.5814	.5002	-.2524	-.4263	.7799	.6064
.4003	-.4188	.7810	.6046	.3507	-.3254	.7948	.5821	.5002	-.5024	-.4228	.7804	.6056
.4501	-.4254	.7800	.6062	.4001	-.3118	.7968	.5788	.5002	-.7524	-.4103	.7823	.6026
.5002	-.4333	.7789	.6081	.4501	-.2899	.8001	.5734	.8002	.7476	-.3319	.7939	.5837
.5502	-.4431	.7774	.6105	.5001	-.2425	.8071	.5618	.8002	-.4976	-.3460	.7918	.5871
.6002	-.4473	.7768	.6115	.5497	-.1626	.8189	.5418	.8002	.2476	-.3512	.7910	.5884
.6500	-.4468	.7769	.6113	.6003	-.0729	.8321	.5190	.8002	-.5024	-.3451	.7919	.5869
.7000	-.4301	.7794	.6073	.6500	.0039	.8434	.4990	.8002	-.7524	-.3241	.7950	.5818
.7500	-.3990	.7840	.5999	.7000	.1031	.8581	.4720					
.8002	-.3498	.7812	.5880	.7501	.1943	.8716	.4474					
.9002	-.2096	.8119	.5536	.8001	.2744	.8834	.4244					
.9501	-.1074	.8270	.5278	.8501	.3491	.8944	.4023					

TEST	167	PT	20.3921	PSI	CM	.3786	CD1	.00815	CDCDR1	.00795
RUN	17	TT	174.0340	K	CM	-1.1190	CD2	.00773	CDCDR2	.00753
POINT	6	RC	4.4122	MILLION	CC	.0143	CD3	.00756	CDCDR3	.00739
		MACH	.5001				CD4	.00744	CDCDR4	.00723
		ALPHA	-.4948	DEG			CD5	.00742	CDCDR5	.00719

UPPER SURFACE				LOWER SURFACE				SPANWISE				
X/C	CP	P _L /PT	MLOC	X/C	CP	P _L /PT	MLOC	X/C	Y/(B/2)	CP	P _L /PT	MLOC
0.0000	1.0553	.9987	.0425	0.0000	1.0553	.9987	.0425	.1507	.7476	-.4800	.7724	.6186
.0132	-.3121	.7972	.5782	.0126	-.2331	.8775	.4359	.1507	.4976	-.5073	.7684	.6250
.0259	-.5661	.7597	.6389	.0255	-.0911	.8566	.4753	.1507	.2476	-.4877	.7713	.6204
.0759	-.5770	.7581	.6414	.0495	-.0451	.8365	.5113	.1507	-.2524	-.5048	.7688	.6244
.1003	-.5372	.7640	.6321	.0753	-.1077	.8273	.5274	.1507	-.5024	-.5065	.7685	.6248
.1507	-.4658	.7745	.6152	.1002	-.1523	.8207	.5387	.1507	-.7524	-.4953	.7702	.6222
.2003	-.4620	.7751	.6143	.1503	-.1971	.8141	.5499	.5002	.7476	-.44370	.7788	.6083
.2503	-.4568	.7755	.6135	.1976	-.2365	.8054	.5646	.5002	-.4976	-.4471	.7773	.6107
.3001	-.4575	.7757	.6132	.2503	-.2834	.8014	.5712	.5002	.2476	-.4559	.7760	.6128
.3502	-.4478	.7772	.6109	.3001	-.2976	.7993	.5747	.5002	-.2524	-.4481	.7771	.6110
.4003	-.4453	.7775	.6103	.3507	-.3030	.7985	.5760	.5002	-.5024	-.4456	.7775	.6104
.4501	-.4493	.7769	.6113	.4001	-.2919	.8001	.5733	.5002	-.7524	-.4330	.7773	.6074
.5002	-.4544	.7761	.6126	.4501	-.2729	.8029	.5686	.8002	.7476	-.3390	.7932	.5848
.5502	-.4624	.7750	.6144	.5001	-.2281	.8096	.5576	.8002	-.4976	-.3536	.7910	.5883
.6002	-.4644	.7747	.6149	.5497	-.1477	.8214	.5375	.8002	.2476	-.3595	.7902	.5897
.6500	-.4615	.7751	.6142	.6003	-.0604	.8343	.5193	.8002	-.5024	-.3528	.7912	.5881
.7000	-.4428	.7779	.6097	.6500	.0123	.8450	.4962	.8002	-.7524	-.3314	.7943	.5829
.7500	-.4095	.7828	.6018	.7000	.1105	.8594	.4700					
.8002	-.3581	.7904	.5894	.7501	.2006	.8727	.4451					
.9002	-.2140	.8116	.5541	.8001	.2800	.8844	.4223					
.9501	-.1108	.8269	.5281	.8501	.3555	.8956	.3999					

ORIENTED
OF POOR QUALITY

TEST 167 PT 20.3942 PSI CN .4325 CD1 .00825 CDCOR1 .00788
 RUN 17 TT 174.8559 K CM -.1191 CD2 .00809 CDCOR2 .00777
 POINT 7 RC 4.3848 MILLION CC .0128 CD3 .00790 CDCOR3 .00762
 MACH .5002 CD4 .00764 CDCOR4 .00734
 ALPHA .0132 DEG CD5 .00762 CDCOR5 .00716

UPPER SURFACE				LOWER SURFACE				SPANWISE				
X/C	CP	P/L/PT	MLOC	X/C	CP	P/L/PT	MLOC	X/C	Y/(B/2)	CP	P/L/PT	MLOC
0.0000	1.0626	.9998	.0177	0.0000	1.0626	.9998	.0177	.1507	.7476	-.3297	.7647	.6310
.0132	-.4761	.7726	.6183	.0126	.3460	.8940	.4032	.1507	.4976	-.5633	.7597	.6389
.0259	-.7093	.7381	.6729	.0255	-.1840	.8701	.4502	.1507	.2476	-.5412	.7630	.6337
.0759	-.6616	.7452	.6619	.0495	.0320	.8476	.4916	.1507	-.2524	-.5592	.7603	.6379
.1003	-.6034	.7538	.6483	.0753	-.0440	.8364	.5115	.1507	-.5024	-.5604	.7601	.6382
.1507	-.5179	.7664	.6282	.1002	-.0957	.8287	.5244	.1507	-.7524	-.5488	.7618	.6355
.2003	-.5040	.7685	.6249	.1503	-.1505	.8207	.5388	.5002	.7476	-.4983	.7752	.6140
.2503	-.4468	.7695	.6232	.1976	-.2153	.8111	.5550	.5002	.4976	-.4699	.7735	.6168
.3001	-.4920	.7702	.6221	.2503	-.2476	.8063	.5630	.5002	-.2476	-.4779	.7723	.6187
.3502	-.4768	.7725	.6185	.3001	-.2658	.8036	.5675	.5002	-.2524	-.4708	.7734	.6170
.4003	-.4715	.7733	.6172	.3507	-.2737	.8025	.5694	.5002	-.5024	-.4678	.7738	.6163
.4501	-.4729	.7730	.6175	.4001	-.2665	.8035	.5677	.5002	-.7524	-.4478	.7760	.6115
.5002	-.4754	.7727	.6181	.4501	-.2508	.8058	.5633	.8002	.7476	-.3461	.7918	.5871
.5502	-.4804	.7719	.6191	.5001	-.2104	.8118	.5538	.8002	.4976	-.3600	.7697	.5905
.6002	-.4799	.7725	.6192	.5497	-.1335	.8232	.5345	.8002	-.2476	-.3660	.7888	.5919
.6500	-.4750	.7727	.6180	.6003	-.0483	.8357	.5126	.8002	-.5024	-.3603	.7897	.5905
.7000	-.4537	.7759	.6130	.6500	.0225	.8462	.4941	.8002	-.7524	-.3386	.7929	.5853
.7500	-.4179	.7812	.6044	.7000	.1182	.8603	.4684					
.8002	-.3640	.7891	.5914	.7501	.2066	.8734	.4438					
.9002	-.2152	.8111	.5550	.8001	.2847	.8849	.4214					
.9501	-.1089	.8268	.5282	.8501	.3594	.8959	.3991					

TEST 167 PT 20.3932 PSI CN .4880 CD1 .00833 CDCOR1 .00803
 RUN 17 TT 174.9052 K CM -.1199 CD2 .00827 CDCOR2 .00800
 POINT 8 RC 4.3826 MILLION CC .0108 CD3 .00808 CDCOR3 .00787
 MACH .5001 CD4 .00778 CDCOR4 .00759
 ALPHA .5170 DEG CD5 .00777 CDCOR5 .00742

UPPER SURFACE				LOWER SURFACE				SPANWISE				
X/C	CP	P/L/PT	MLOC	X/C	CP	P/L/PT	MLOC	X/C	Y/(B/2)	CP	P/L/PT	MLOC
0.0000	1.0611	.9995	.0254	0.0000	1.0611	.9995	.0254	.1507	.7476	-.5727	.7581	.6414
.0132	-.6483	.7469	.6591	.0126	-.4488	.9091	.3714	.1507	.4976	-.6154	.7518	.6514
.0259	-.8580	.7159	.7076	.0255	-.2712	.8828	.4256	.1507	.2476	-.5913	.7553	.6458
.0759	-.7462	.7325	.6818	.0495	-.1073	.8586	.4716	.1507	-.2524	-.6083	.7528	.6498
.1003	-.6638	.7446	.6627	.0753	.0194	.8456	.4952	.1507	-.5024	-.6135	.7521	.6510
.1507	-.5717	.7582	.6412	.1002	-.0391	.8370	.5105	.1507	-.7524	-.5719	.7582	.6412
.2003	-.5473	.7618	.6355	.1503	-.1038	.8274	.5272	.5002	.7476	-.4784	.7720	.6192
.2503	-.5350	.7637	.6326	.1976	-.1734	.8171	.5448	.5002	.4976	-.4902	.7703	.6220
.3001	-.5259	.7656	.6304	.2503	-.2112	.8115	.5543	.5002	-.2476	-.4977	.7692	.6237
.3502	-.5061	.7679	.6257	.3001	-.2333	.8083	.5598	.5002	-.2524	-.4901	.7703	.6219
.4003	-.4975	.7692	.6237	.3507	-.2445	.8066	.5625	.5002	-.5024	-.4873	.7707	.6213
.4501	-.4965	.7694	.6235	.4001	-.2403	.8072	.5615	.5002	-.7524	-.4720	.7730	.6177
.5002	-.4959	.7694	.6233	.4501	-.2273	.8091	.5583	.8002	.7476	-.3527	.7906	.5890
.5502	-.4983	.7691	.6239	.5001	-.1906	.8146	.5491	.8002	.4976	-.3653	.7888	.5920
.6002	-.4955	.7695	.6232	.5497	-.1164	.8255	.5304	.8002	-.2476	-.3712	.7879	.5935
.6500	-.4882	.7706	.6215	.6003	-.0334	.8378	.5090	.8002	-.5024	-.3649	.7888	.5920
.7000	-.4646	.7741	.6159	.6500	.0348	.8479	.4911	.8002	-.7524	-.3431	.7920	.5867
.7500	-.4263	.7797	.6067	.7000	.1285	.8617	.4658					
.8002	-.3701	.7880	.5932	.7501	.2152	.8745	.4417					
.9002	-.2165	.8107	.5556	.8001	.2920	.8859	.4195					
.9501	-.1080	.8268	.5263	.8501	.3658	.8968	.3974					

TEST 167 PT 20.3938 PSI CN .5438 CD1 .00861 CDCOR1 .00825
 RUN 17 TT 174.9111 K CM -.1206 CD2 .00860 CDCOR2 .00830
 POINT 9 RC 4.3831 MILLION CC .0079 CD3 .00834 CDCOR3 .00809
 MACH .5002 CD4 .00807 CDCOR4 .00785
 ALPHA 1.0266 DEG CD5 .00810 CDCOR5 .00770

UPPER SURFACE				LOWER SURFACE				SPANWISE				
X/C	CP	P/L/PT	MLOC	X/C	CP	P/L/PT	MLOC	X/C	Y/(B/2)	CP	P/L/PT	MLOC
0.0000	1.0432	.9969	.0662	0.0000	1.0432	.9969	.0662	.1507	.7476	-.6261	.7507	.6532
.0132	-.8406	.7191	.7027	.0126	-.5424	.9231	.3400	.1507	.4976	-.6294	.7502	.6540
.0259	-.10212	.6924	.7439	.0255	-.3521	.8950	.4011	.1507	.2476	-.6414	.7484	.6567
.0759	-.8349	.7199	.7014	.0495	-.1775	.8692	.4518	.1507	-.2524	-.6382	.7489	.6580
.1003	-.7246	.7362	.6760	.0753	.0708	.8547	.4788	.1507	-.5024	-.6290	.7503	.6539
.1507	-.6257	.7508	.6531	.1002	.0141	.8451	.4940	.1507	-.7524	-.6205	.7515	.6519
.2003	-.5986	.7547	.6468	.1503	-.0596	.8343	.5152	.5002	.7476	-.4994	.7694	.6234
.2503	-.5753	.7582	.6413	.1976	-.1338	.8233	.5342	.5002	.4976	-.5117	.7676	.6263
.3001	-.5608	.7603	.6379	.2503	-.1767	.8170	.5490	.5002	-.2476	-.5105	.7665	.6281
.3502	-.5385	.7636	.6326	.3001	-.2022	.8132	.5514	.5002	-.2524	-.5105	.7677	.6261
.4003	-.5251	.7656	.6295	.3507	-.2167	.8111	.5550	.5002	-.5024	-.5080	.7681	.6255
.4501	-.5209	.7662	.6285	.4001	-.2153	.8113	.5547	.5002	-.7524	-.4980	.7703	.6219
.5002	-.5175	.7667	.6277	.4501	-.2053	.8128	.5522	.8002	.7476	-.3507	.7900	.5900
.5502	-.5175	.7667	.6277	.5001	-.1717	.8177	.5438	.8002	.4976	-.3724	.7881	.5931
.6002	-.5124	.7675	.6265	.5497	-.1012	.8261	.5259	.8002	-.2476	-.3781	.7875	.5945
.6500	-.45026	.7689	.6242	.6003	-.0201	.8401	.5050	.8002	-.5024	-.3715	.7883	.5929
.7000	-.4765	.7728	.6180	.6500	.0455	.8498	.4877	.8002	-.7524	-.3496	.7915	.5876
.7500	-.4358	.7788	.6083	.7000	.1372	.8633	.4629					
.8002	-.3771	.7874	.5942	.7501	.2221	.8738	.4392					
.9002	-.2187	.8104	.5555	.8001	.2975	.8869	.4174					
.9501	-.1092	.8269	.5280	.8501	.3705	.8977	.3955					

TEST 167 PT 20.4259 PSI CM .5978
 RUN 17 TT 175.1446 K CM -.1212
 POINT 10 RC 4.3800 MILLION CC .0045
 MACH .5000
 ALPHA 1.5100 DEG

CD1 .00879 CDCOR1 .00843
 CD2 .00877 CDCOR2 .00846
 CD3 .00854 CDCOR3 .00828
 CD4 .00829 CDCOR4 .00796
 CD5 .00625 CDCOR5 .00778

UPPER SURFACE				LOWER SURFACE			
X/C	CP	P _L /PT	MLOC	X/C	CP	P _L /PT	MLOC
0.0000	1.0112	.9922	.1056	0.0000	1.0112	.9922	.1056
.0132	-1.0330	.6908	.7465	.0126	.6251	.9353	.3105
.0259	-1.1818	.6688	.7902	.0255	.4268	.9060	.3779
.0759	-.9119	.7086	.7149	.0495	.2452	.8793	.4325
.1003	-.7874	.7270	.6904	.0753	.1372	.8633	.4628
.1507	-.6792	.7428	.6656	.1002	.0672	.8530	.4819
.2003	-.6461	.7478	.6577	.1503	-.0142	.8410	.5034
.2503	-.6110	.7530	.6496	.1976	-.0924	.8295	.5236
.3001	-.5917	.7558	.6450	.2503	-.1399	.8225	.5357
.3502	-.5658	.7597	.6390	.3001	-.1684	.8183	.5429
.4003	-.5491	.7621	.6350	.3507	-.1859	.8157	.5472
.4501	-.5422	.7631	.6334	.4001	-.1877	.8154	.5477
.5002	-.5359	.7641	.6320	.4501	-.1806	.8165	.5459
.5502	-.5234	.7644	.6314	.5001	-.1498	.8210	.5382
.6002	-.5261	.7652	.6296	.5497	-.0841	.8307	.5215
.6507	-.5139	.7673	.6266	.6003	-.0053	.8423	.5011
.7000	-.4855	.7715	.6200	.6500	.0584	.8517	.4842
.7500	-.4424	.7778	.6098	.7000	.1479	.8649	.4599
.8002	-.3816	.7868	.5952	.7501	.2309	.8771	.4366
.9002	-.2188	.8108	.5554	.8001	.3049	.8881	.4151
.9501	-.1072	.8273	.5274	.8501	.3766	.8986	.3936

SPANWISE				
X/C	Y/(B/2)	CP	P _L /PT	MLOC
.1507	.7476	-.6798	.7428	.6656
.1507	.4976	-.6916	.7411	.6683
.1507	.2476	-.6968	.7403	.6695
.1507	-.2524	-.6978	.7402	.6697
.1507	-.5024	-.6931	.7409	.6686
.1507	-.7524	-.6771	.7432	.6649
.5002	.7476	-.5170	.7669	.6275
.5002	.4976	-.5293	.7650	.6304
.5002	.2476	-.5367	.7639	.6321
.5002	-.2524	-.5272	.7653	.6299
.5002	-.5024	-.5248	.7657	.6293
.5002	-.7524	-.5114	.7677	.6262
.8002	.7476	-.3647	.7893	.5911
.8002	.4976	-.3761	.7876	.5939
.8002	.2476	-.3818	.7868	.5952
.8002	-.5024	-.3740	.7879	.5934
.8002	-.7524	-.3522	.7911	.5881

TEST 167 PT 20.4253 PSI CM .6510
 RUN 17 TT 175.1543 K CM -.1211
 POINT 11 RC 4.3786 MILLION CC .0002
 MACH .4998
 ALPHA 2.0243 DEG

CD1 .00901 CDCOR1 .00869
 CD2 .00897 CDCOR2 .00869
 CD3 .00878 CDCOR3 .00854
 CD4 .00851 CDCOR4 .00824
 CD5 .00834 CDCOR5 .00809

UPPER SURFACE				LOWER SURFACE			
X/C	CP	P _L /PT	MLOC	X/C	CP	P _L /PT	MLOC
0.0000	.9621	.9850	.1472	0.0000	.9621	.9850	.1472
.0132	-1.2503	.6583	.7963	.0126	.7030	.9467	.2807
.0259	-1.3645	.6415	.8222	.0255	.4995	.9167	.3546
.0759	-.9834	.6977	.7357	.0495	.3099	.8887	.4139
.1003	-.8592	.7161	.7074	.0753	.1929	.8714	.4477
.1507	-.7383	.7339	.6796	.1002	.1176	.8603	.4685
.2003	-.6865	.7416	.6676	.1503	.0284	.8471	.4925
.2503	-.6500	.7470	.6591	.1976	-.0541	.8349	.5141
.3001	-.6253	.7506	.6533	.2503	-.1065	.8272	.5275
.3502	-.5957	.7550	.6464	.3001	-.1387	.8224	.5357
.4003	-.5749	.7580	.6415	.3507	-.1595	.8194	.5410
.4501	-.5649	.7595	.6392	.4001	-.1645	.8186	.5422
.5002	-.5556	.7609	.6370	.4501	-.1602	.8193	.5411
.5502	-.5505	.7616	.6358	.5001	-.1325	.8234	.5341
.6002	-.5409	.7631	.6335	.5497	-.0706	.8325	.5183
.6500	-.5261	.7653	.6300	.6003	.0075	.8440	.4980
.7000	-.4953	.7698	.6228	.6500	.0687	.8531	.4817
.7500	-.4499	.7765	.6120	.7000	.1564	.8660	.4578
.8002	-.3863	.7859	.5967	.7501	.2377	.8780	.4350
.9002	-.2188	.8106	.5558	.8001	.3104	.8887	.4138
.9501	-.1057	.8273	.5273	.8501	.3811	.8992	.3924

SPANWISE				
X/C	Y/(B/2)	CP	P _L /PT	MLOC
.1507	.7476	-.7371	.7341	.6793
.1507	.4976	-.7532	.7317	.6830
.1507	.2476	-.7561	.7313	.6837
.1507	-.2524	-.7577	.7311	.6840
.1507	-.5024	-.7537	.7317	.6831
.1507	-.7524	-.7345	.7345	.6787
.5002	.7476	-.5532	.7639	.6322
.5002	.4976	-.5485	.7619	.6353
.5002	.2476	-.5562	.7608	.6371
.5002	-.2524	-.5473	.7621	.6351
.5002	-.5024	-.5452	.7624	.6346
.5002	-.7524	-.5314	.7645	.6313
.8002	.7476	-.3680	.7886	.5923
.8002	.4976	-.3802	.7868	.5953
.8002	.2476	-.3863	.7859	.5967
.8002	-.5024	-.3797	.7869	.5931
.8002	-.7524	-.3585	.7900	.5900

TEST 167 PT 20.4260 PSI CM .7000
 RUN 17 TT 175.1718 K CM -.1202
 POINT 12 RC 4.3777 MILLION CC -.0648
 MACH .4998
 ALPHA 2.5114 DEG

CD1 .00924 CDCOR1 .00891
 CD2 .00926 CDCOR2 .00897
 CD3 .00905 CDCOR3 .00881
 CD4 .00877 CDCOR4 .00848
 CD5 .00873 CDCOR5 .00842

UPPER SURFACE				LOWER SURFACE			
X/C	CP	P _L /PT	MLOC	X/C	CP	P _L /PT	MLOC
0.0000	.8924	.9748	.1910	0.0000	.8924	.9748	.1910
.0132	-1.4740	.6273	.8440	.0126	.7662	.9563	.2533
.0259	-1.5491	.6163	.8611	.0255	.5588	.9258	.3334
.0759	-1.0546	.6889	.7493	.0495	.3627	.8971	.3969
.1003	-.9382	.7060	.7230	.0753	.2385	.8788	.4334
.1507	-.7963	.7268	.6966	.1002	.1590	.8671	.4557
.2003	-.7357	.7357	.6767	.1503	.0640	.8532	.4815
.2503	-.6900	.7424	.6662	.1976	-.0222	.8405	.5042
.3001	-.6604	.7468	.6593	.2503	-.0780	.8323	.5186
.3502	-.6245	.7521	.6510	.3001	-.1132	.8272	.5276
.4003	-.6011	.7555	.6456	.3507	-.1370	.8237	.5336
.4501	-.5882	.7574	.6426	.4001	-.1451	.8225	.5357
.5002	-.5760	.7592	.6397	.4501	-.1459	.8227	.5353
.5502	-.5684	.7603	.6379	.5001	-.1188	.8263	.5290
.6002	-.5566	.7620	.6352	.5497	-.0614	.8348	.5144
.6500	-.5392	.7646	.6311	.6003	.0148	.8459	.4946
.7000	-.5061	.7694	.6233	.6500	.0741	.8547	.4788
.7500	-.4584	.7765	.6120	.7000	.1597	.8672	.4555
.8002	-.3926	.7861	.5963	.7501	.2391	.8789	.4332
.9002	-.2205	.8114	.5545	.8001	.3105	.8894	.4123
.9501	-.1063	.8262	.5258	.8501	.3800	.8996	.3916

SPANWISE				
X/C	Y/(B/2)	CP	P _L /PT	MLOC
.1507	.7476	-.7916	.7275	.6896
.1507	.4976	-.8123	.7245	.6943
.1507	.2476	-.8151	.7241	.6949
.1507	-.2524	-.8170	.7238	.6954
.1507	-.5024	-.8130	.7244	.6945
.1507	-.7524	-.7920	.7275	.6896
.5002	.7476	-.5557	.7622	.6310
.5002	.4976	-.5701	.7600	.6384
.5002	.2476	-.5781	.7589	.6402
.5002	-.2524	-.5698	.7601	.6383
.5002	-.5024	-.5679	.7604	.6378
.5002	-.7524	-.5561	.7621	.6351
.8002	.7476	-.3769	.7884	.5926
.8002	.4976	-.3885	.7867	.5954
.8002	.2476	-.3945	.7856	.5968
.8002	-.5024	-.3892	.7866	.5955
.8002	-.7524	-.3678	.7898	.5904

ORIGINAL PRINTING
OF POOR QUALITY

TEST	167	PT	20.4260	PSI		CN	.7568	CD1	.00947	CDCDR1	.00912
RUN	17	TT	175.1241	K		CM	-.1209	CD2	.00953	CDCDR2	.00925
POINT	13	RC	4.3800	MILLION		CC	-.0109	CD3	.00933	CDCDR3	.00905
		MACH	4.999					CD4	.00899	CDCDR4	.00874
		ALPHA	3.0141	DEG				CD5	.00899	CDCDR5	.00864

UPPER SURFACE				LOWER SURFACE				SPANWISE				
X/C	CP	P/L/PT	MLOC	X/C	CP	P/L/PT	MLOC	X/C	Y/(B/2)	CP	P/L/PT	MLOC
0.0000	.8140	.9632	.2320	0.0000	.8140	.9632	.2320	.1507	.7476	-.8457	.7187	.7033
.0132	-1.7216	.5896	.9024	.0126	.8299	.9655	.2243	.1507	.4976	-.8656	.7158	.7078
.0259	-1.7540	.5849	.9099	.0255	.6231	.9351	.3110	.1507	.2476	-.8679	.7154	.7084
.0759	-1.1448	.6746	.7713	.0495	.4245	.9058	.3784	.1507	-.2524	-.8684	.7153	.7085
.1003	-1.0121	.6942	.7412	.0753	.2938	.8866	.4182	.1507	-.5024	-.8637	.7160	.7074
.1507	-.8483	.7183	.7039	.1002	.2100	.8742	.4423	.1507	-.7524	-.8411	.7194	.7022
.2003	-.7794	.7285	.6881	.1503	.1077	.8591	.4706	.9002	.7476	-.5692	.7594	.6393
.2503	-.7236	.7367	.6753	.1976	.0186	.8460	.4945	.9002	.4976	-.5844	.7572	.6429
.3001	-.6892	.7419	.6671	.2503	-.0417	.8371	.5102	.9002	.2476	-.5920	.7561	.6447
.3502	-.6590	.7468	.6594	.3001	-.0800	.8315	.5201	.9002	-.2524	-.5819	.7575	.6423
.4003	-.6246	.7512	.6523	.3507	-.1065	.8276	.5269	.9002	-.5024	-.5800	.7578	.6419
.4501	-.6074	.7538	.6483	.4001	-.1170	.8260	.5295	.9002	-.7524	-.5618	.7605	.6376
.5002	-.5924	.7560	.6448	.4501	-.1179	.8259	.5298	.8002	.7476	-.3769	.7877	.5937
.5502	-.5829	.7574	.6426	.5001	-.0952	.8292	.5240	.8002	.4976	-.3883	.7861	.5964
.6002	-.5685	.7595	.6392	.5497	-.0418	.8371	.5102	.8002	.2476	-.3946	.7851	.5980
.6500	-.5482	.7625	.6344	.6003	.0341	.8483	.4904	.8002	-.5024	-.3871	.7862	.5962
.7000	-.5127	.7677	.6261	.6500	.0906	.8566	.4793	.8002	-.7524	-.3653	.7895	.5909
.7500	-.4629	.7751	.6143	.7000	.1745	.8690	.4523					
.8002	-.3945	.7851	.5979	.7501	.2520	.8804	.4303					
.9002	-.2183	.8111	.5550	.8001	.3219	.8907	.4098					
.9501	-.1098	.8277	.5267	.8501	.3906	.9008	.3890					

ORIGINAL PAGE IS
OF POOR QUALITY

TEST 167	PT 26.1798	PSI	CN -.0161	CD1 .00931	CDCOR1 .00908
RUN 19	TT 149.9933	K	CM -.1045	CD2 .00908	CDCOR2 .00886
POINT 28	RC 7.0016	MILLION	CC .0037	CD3 .00877	CDCOR3 .00865
	MACH .5012			CD4 .00883	CDCOR4 .00866
	ALPHA -4.0019	DEG		CD5 .00836	CDCOR5 .00798

UPPER SURFACE				LOWER SURFACE				SPANWISE				
X/C	CP	P/L/PT	MLOC	X/C	CP	P/L/PT	MLOC	X/C	Y/(B/2)	CP	P/L/PT	MLOC
0.0000	.4877	.9144	.3588	0.0000	-.4877	-.9144	-.3588	.1507	.7476	-.1373	.8225	.5358
.0132	-.5496	-.9240	-.3379	.0126	-.8227	-.7212	-.6995	.1507	.4976	-.1539	.8200	.5400
.0259	-.2367	-.8777	-.4356	.0255	-.6715	-.7435	-.6646	.1507	.2476	-.1338	.8230	.5349
.0759	-.0396	-.8369	-.5107	.0495	-.6334	-.7492	-.6557	.1507	-.2524	-.1506	.8209	.5391
.1003	-.0793	-.8311	-.5210	.0753	-.5781	-.7574	-.6428	.1507	-.5024	-.1425	.8217	.5371
.1507	-.1194	-.8251	-.5312	.1002	-.5781	-.7574	-.6428	.1507	-.7524	-.1564	.8197	.5406
.2003	-.1623	-.8188	-.5421	.1503	-.5307	-.7644	-.6316	.5002	.7476	-.2910	.7998	.5740
.2503	-.1995	-.8133	-.5514	.1976	-.5486	-.7617	-.6358	.5002	.49	-.2996	.7985	.5761
.3001	-.2278	-.8091	-.5584	.2503	-.5317	-.7644	-.6319	.5007	.2476	-.3027	.7981	.5769
.3502	-.2413	-.8071	-.5618	.3001	-.5169	-.7664	-.6284	.5002	-.2524	-.2942	.7993	.5748
.4003	-.2580	-.8047	-.5659	.3507	-.4962	-.7695	-.6235	.5002	-.5024	-.2935	.7994	.5746
.4501	-.2788	-.8016	-.5710	.4001	-.4596	-.7749	-.6148	.5002	-.7524	-.2859	.8005	.5728
.5002	-.3006	-.7984	-.5764	.4501	-.4193	-.7808	-.6051	.8002	.7476	-.2934	.7994	.5746
.5502	-.3239	-.7949	-.5821	.5001	-.3493	-.7912	-.5942	.8002	.4976	-.2929	.7995	.5745
.6002	-.3390	-.7927	-.5858	.5497	-.2537	-.8053	-.5849	.8002	.2476	-.2928	.7995	.5745
.6500	-.3447	-.7911	-.5883	.6003	-.1497	-.8206	-.5739	.8002	-.5024	-.2844	.8007	.5724
.7000	-.3442	-.7919	-.5870	.6500	-.0606	-.8338	-.5652	.8002	-.7524	-.2679	.8032	.5684
.7500	-.3262	-.7946	-.5826	.7000	-.0482	-.8499	-.4876					
.8002	-.2895	-.8000	-.5737	.7501	.1432	-.8639	-.4618					
.9002	-.1734	-.8171	-.5449	.8001	.2201	-.8753	-.4403					
.9501	-.0818	-.8307	-.5216	.8501	.2857	-.8850	-.4214					

TEST 167	PT 26.1826	PSI	CN .0965	CD1 .00902	CDCOR1 .00889
RUN 19	TT 149.9565	K	CM -.1077	CD2 .00845	CDCOR2 .00886
POINT 29	RC .6092	MILLION	CC .0107	CD3 .00885	CDCOR3 .00886
	MACH .5015			CD4 .00855	CDCOR4 .00849
	ALPHA -2.9836	DEG		CD5 .00802	CDCOR5 .00779

UPPER SURFACE				LOWER SURFACE				SPANWISE				
X/C	CP	P/L/PT	MLOC	X/C	CP	P/L/PT	MLOC	X/C	Y/(B/2)	CP	P/L/PT	MLOC
0.0000	.7497	.9532	.2625	0.0000	-.7497	-.9532	-.2625	.1507	.7476	-.2192	.8092	.5583
.0132	-.3562	-.8947	-.4018	.0126	-.4594	-.7735	-.6170	.1507	.4976	-.2471	.8050	.5653
.0259	-.0428	-.8481	-.4908	.0255	-.4156	-.7800	-.6065	.1507	.2476	-.2256	.8082	.5599
.0759	-.1684	-.8167	-.5456	.0495	-.4581	-.7737	-.6167	.1507	-.2524	-.2256	.8087	.5599
.1003	-.1921	-.8132	-.5515	.0753	-.4168	-.7798	-.6068	.1507	-.5024	-.2315	.8073	.5614
.1507	-.2118	-.8103	-.5565	.1002	-.4412	-.7762	-.6126	.1507	-.7524	-.2450	.8053	.5646
.2003	-.2433	-.8058	-.5643	.1503	-.4212	-.7792	-.6074	.5002	.7476	-.3261	.7933	.5848
.2503	-.2677	-.8020	-.5704	.1975	-.4531	-.7744	-.6155	.5002	.4976	-.3352	.7919	.5870
.3001	-.2883	-.7989	-.5753	.2503	-.4497	-.7749	-.6147	.5002	.2476	-.3414	.7910	.5885
.3502	-.2980	-.7975	-.5779	.3001	-.4446	-.7757	-.6135	.5002	-.2524	-.3335	.7922	.5866
.4003	-.3078	-.7960	-.5803	.3507	-.4326	-.7775	-.6106	.5002	-.5024	-.3320	.7924	.5862
.4501	-.3237	-.7936	-.5842	.4001	-.4037	-.7818	-.6036	.5002	-.7524	-.3197	.7942	.5832
.5002	-.3408	-.7911	-.5883	.4501	-.3711	-.7866	-.5957	.8002	.7476	-.2991	.7973	.5781
.5502	-.3408	-.7911	-.5883	.5001	-.3080	-.7960	-.5803	.8002	.4976	-.3037	.7960	.5793
.6002	-.33710	-.7882	-.5957	.5497	-.2190	-.8092	-.5583	.8002	.2476	-.3055	.7964	.5797
.6500	-.3372	-.7857	-.5972	.6003	-.1209	-.8238	-.5335	.8002	-.5024	-.2977	.7975	.5778
.7000	-.3452	-.7871	-.5949	.6500	-.0371	-.8362	-.5119	.8002	-.7524	-.2810	.8000	.5737
.7500	-.3452	-.7904	-.5994	.7000	-.0686	-.8520	-.4839					
.8002	-.3040	-.7966	-.5793	.7501	.1616	-.8658	-.4584					
.9002	-.1793	-.8151	-.5483	.8001	.2379	-.8771	-.4368					
.9501	-.0847	-.8292	-.5242	.8501	.3043	-.8870	-.4174					

TEST 167	PT 26.1846	PSI	CN .2066	CD1 .00882	CDCOR1 .00856
RUN 19	TT 149.9441	K	CM -.1111	CD2 .00876	CDCOR2 .00856
POINT 30	RC 7.0107	MILLION	CC .0145	CD3 .00871	CDCOR3 .00851
	MACH .5016			CD4 .00847	CDCOR4 .00825
	ALPHA -2.0009	DEG		CD5 .00729	CDCOR5 .00696

UPPER SURFACE				LOWER SURFACE				SPANWISE				
X/C	CP	P/L/PT	MLOC	X/C	CP	P/L/PT	MLOC	X/C	Y/(B/2)	CP	P/L/PT	MLOC
0.0000	.9254	.9794	.1725	0.0000	-.9254	-.9794	-.1725	.1507	.7476	-.3124	.7961	.5500
.0132	-.1256	-.8610	-.4673	.0126	-.1555	-.8194	-.5411	.1507	.4976	-.3460	.7912	.5387
.0259	-.1722	-.8169	-.5453	.0255	-.2031	-.8123	-.5530	.1507	.2476	-.3247	.7943	.5430
.0759	-.3089	-.7967	-.5792	.0495	-.2879	-.7998	-.5740	.1507	-.2524	-.3240	.7944	.5430
.1003	-.3139	-.7959	-.5804	.0753	-.2786	-.8012	-.5717	.1507	-.5024	-.3254	.7942	.5430
.1507	-.3110	-.7964	-.5797	.1002	-.3181	-.7993	-.5814	.1507	-.7524	-.3392	.7942	.5430
.2003	-.3306	-.7935	-.5845	.1503	-.3235	-.7945	-.5827	.5002	.7476	-.3698	.7876	.5940
.2503	-.3414	-.7919	-.5871	.1976	-.3683	-.7879	-.5936	.5002	.4976	-.3769	.7866	.5957
.3001	-.3545	-.7899	-.5903	.2503	-.3777	-.7865	-.5959	.5002	.2476	-.3857	.7853	.5978
.3502	-.3565	-.7896	-.5908	.3001	-.3811	-.7860	-.5967	.5002	-.2524	-.3772	.7865	.5958
.4003	-.3609	-.7900	-.5918	.3507	-.3768	-.7866	-.5957	.5002	-.5024	-.3754	.7868	.5954
.4501	-.3728	-.7872	-.5947	.4001	-.3553	-.7898	-.5905	.5002	-.7524	-.3540	.7892	.5914
.5002	-.3852	-.7854	-.5977	.4501	-.3294	-.7936	-.5842	.8002	.7476	-.3161	.7926	.5809
.5502	-.4002	-.7831	-.6013	.5001	-.2734	-.8019	-.5705	.8002	.4976	-.3229	.7946	.5826
.6002	-.4074	-.7821	-.6031	.5497	-.1901	-.8143	-.5499	.8002	.2476	-.3248	.7943	.5831
.6500	-.4099	-.7817	-.6037	.6003	-.0971	-.8280	-.5262	.8002	-.5024	-.3168	.7955	.5811
.7000	-.3962	-.7837	-.6004	.6500	-.0181	-.8397	-.5058	.8002	-.7524	-.2994	.7981	.5768
.7500	-.3693	-.7877	-.6049	.7000	-.0445	-.8549	-.4784					
.8002	-.3237	-.7945	-.5828	.7501	.1758	-.8684	-.4534					
.9002	-.1901	-.8142	-.5498	.8001	.2515	-.8796	-.4319					
.9501	-.0899	-.8291	-.5244	.8501	.3186	-.8896	-.4122					

TEST	167	PT	26.1844	PSI		CN	.2634	CD1	.00878	CDCOR1	.00849
RUN	19	TT	149.9495	K		CM	-.1129	CD2	.00879	CDCOR2	.00854
POINT	31	RC	7.0096	MILLION		CC	.0154	CD3	.00865	CDCOR3	.00847
		MACH	.5015					CD4	.00835	CDCOR4	.00816
		ALPHA	-1.5071	DEG				CD5	.00722	CDCOR5	.00699

UPPER SURFACE				LOWER SURFACE				SPANWISE				
X/C	CP	P/L/PT	MLOC	X/C	CP	P/L/PT	MLOC	X/C	Y/(B/2)	CP	P/L/PT	MLOC
0.0000	.9907	.9891	.1251	0.0000	.9907	.9891	.1251	.1507	.7476	-.3591	.7894	.5912
.0132	.0002	.8425	.5008	.0126	-.0148	.8403	.5047	.1507	.4976	-.3922	.7845	.5992
.0259	-.2490	.7997	.5741	.0255	-.1042	.8271	.5278	.1507	.2476	-.5737	.7872	.5947
.0759	-.3815	.7861	.5966	.0495	-.1995	.8130	.5519	.1507	-.2524	-.3733	.7873	.5946
.1003	-.3759	.7869	.5952	.0753	-.2093	.8016	.5543	.1507	-.5024	-.3739	.7872	.5948
.1507	-.3602	.7892	.5914	.1002	-.2538	.8150	.5654	.1507	-.7524	-.3882	.7851	.5982
.2003	-.3726	.7874	.5944	.1503	-.2710	.8024	.5696	.5002	.7476	-.3901	.7848	.5986
.2503	-.3768	.7868	.5954	.1976	-.3218	.7949	.5821	.5002	.4976	-.3985	.7835	.6007
.3001	-.3850	.7854	.5976	.2503	-.3374	.7926	.5859	.5002	.2476	-.4055	.7825	.6024
.3502	-.3634	.7858	.5970	.3001	-.3452	.7914	.5878	.5002	-.2524	-.3963	.7839	.6020
.4003	-.3853	.7855	.5975	.3507	-.3447	.7915	.5877	.5002	-.5024	-.3947	.7841	.5998
.4501	-.3952	.7840	.5999	.4001	-.3267	.7942	.5833	.5002	-.7524	-.3777	.7866	.5957
.5002	-.4050	.7826	.6022	.4501	-.3044	.7975	.5778	.8002	.7476	-.3240	.7946	.5826
.5502	-.4179	.7807	.6054	.5001	-.2515	.8093	.5648	.8002	.4976	-.3296	.7937	.5840
.6002	-.4230	.7799	.6066	.5497	-.1713	.8172	.5448	.8002	.2476	-.3314	.7935	.5844
.6500	-.4236	.7798	.6067	.6003	-.0811	.8305	.5219	.8002	-.5024	-.3230	.7947	.5824
.7000	-.4078	.7822	.6029	.6500	-.0046	.8418	.5020	.8002	-.7524	-.3048	.7974	.5779
.7500	-.3785	.7865	.5959	.7000	.0865	.8508	.4750					
.8002	-.3306	.7936	.5842	.7501	.1865	.8701	.4502					
.9002	-.1925	.8140	.5501	.8001	.2617	.8812	.4287					
.9501	-.0896	.8293	.5241	.8501	.3289	.8912	.4089					

TEST	167	PT	26.1841	PSI		CN	.3134	CD1	.00882	CDCOR1	.00859
RUN	19	TT	149.9262	K		CM	-.1131	CD2	.00879	CDCOR2	.00858
POINT	32	RC	7.0114	MILLION		CC	.0153	CD3	.00866	CDCOR3	.00852
		MACH	.5015					CD4	.00841	CDCOR4	.00823
		ALPHA	-1.0081	DEG				CD5	.00740	CDCOR5	.00717

UPPER SURFACE				LOWER SURFACE				SPANWISE				
X/C	CP	P/L/PT	MLOC	X/C	CP	P/L/PT	MLOC	X/C	Y/(B/2)	CP	P/L/PT	MLOC
0.0000	1.0298	.9948	.0859	0.0000	1.0298	.9948	.0859	.1507	.7476	-.4065	.7817	.6037
.0132	-.1367	.8217	.5371	.0126	-.1115	.8286	.4718	.1507	.4976	-.4323	.7779	.6099
.0259	-.4105	.7811	.6047	.0255	-.0069	.8410	.5035	.1507	.2476	-.4232	.7792	.6077
.0759	-.4552	.7745	.6154	.0495	-.1220	.8239	.5333	.1507	-.2524	-.4244	.7790	.6078
.1003	-.4384	.7770	.6114	.0753	-.1568	.8167	.5421	.1507	-.5024	-.4378	.7792	.6078
.1507	-.4089	.7813	.6043	.1002	-.1978	.8127	.5525	.1507	-.7524	-.4378	.7770	.6112
.2003	-.4081	.7814	.6041	.1503	-.2250	.8086	.5593	.5002	.7476	-.4075	.7815	.6040
.2503	-.4117	.7809	.6050	.1976	-.2812	.8003	.5732	.5002	.4976	-.4181	.7800	.6065
.3001	-.4166	.7802	.6061	.2503	-.3024	.7971	.5784	.5002	.2476	-.4246	.7790	.6081
.3502	-.4108	.7811	.6047	.3001	-.3144	.7954	.5813	.5002	-.2524	-.4171	.7801	.6063
.4003	-.4089	.7813	.6043	.3507	-.3177	.7949	.5822	.5002	-.5024	-.4155	.7805	.6059
.4501	-.4161	.7803	.6060	.4001	-.3031	.7970	.5786	.5002	-.7524	-.3993	.7827	.6020
.5002	-.4236	.7792	.6078	.4501	-.2842	.7998	.5739	.8002	.7476	-.3266	.7935	.5843
.5502	-.4342	.7776	.6104	.5001	-.2350	.8071	.5618	.8002	.4976	-.3347	.7923	.5843
.6002	-.4372	.7771	.6111	.5497	-.1578	.8186	.5424	.8002	.2476	-.3376	.7919	.5870
.6500	-.4335	.7774	.6107	.6003	-.0706	.8315	.5201	.8002	-.5024	-.3317	.7928	.5856
.7000	-.4176	.7800	.6064	.6500	.0031	.8425	.5009	.8002	-.7524	-.3130	.7956	.5816
.7500	-.3863	.7847	.5988	.7000	.1023	.8572	.4743					
.8002	-.3383	.7921	.5867	.7501	.1911	.8704	.4497					
.9002	-.1945	.8131	.5517	.8001	.2654	.8814	.4284					
.9501	-.0905	.8286	.5253	.8501	.3327	.8914	.4085					

TEST	167	PT	26.1841	PSI		CN	.3743	CD1	.00875	CDCOR1	.00847
RUN	19	TT	149.9392	K		CM	-.1151	CD2	.00970	CDCOR2	.00846
POINT	33	RC	7.0068	MILLION		CC	.0146	CD3	.00862	CDCOR3	.00843
		MACH	.5012					CD4	.00838	CDCOR4	.00818
		ALPHA	-.4888	DEG				CD5	.00739	CDCOR5	.00708

UPPER SURFACE				LOWER SURFACE				SPANWISE				
X/C	CP	P/L/PT	MLOC	X/C	CP	P/L/PT	MLOC	X/C	Y/(B/2)	CP	P/L/PT	MLOC
0.0000	1.0569	.9989	.0400	0.0000	1.0569	.9989	.0400	.1507	.7476	-.4614	.7736	.6167
.0132	-.3021	.7973	.5787	.0126	.2404	.8777	.4356	.1507	.4976	-.4778	.7712	.6206
.0259	-.5523	.7602	.6383	.0255	.0953	.8562	.4761	.1507	.2476	-.4807	.7708	.6213
.0759	-.5420	.7617	.6359	.0495	-.0388	.8363	.5117	.1507	-.2524	-.4819	.7706	.6216
.1003	-.5116	.7662	.6287	.0753	-.0936	.8279	.5264	.1507	-.5024	-.4794	.7710	.6210
.1507	-.4664	.7729	.6179	.1002	-.1385	.8215	.5374	.1507	-.7524	-.4895	.7695	.6234
.2003	-.4575	.7742	.6158	.1503	-.1976	.8160	.5465	.5002	.7476	-.4834	.7773	.6100
.2503	-.4538	.7748	.6149	.1976	-.2376	.8068	.5623	.5002	.4976	-.4443	.7763	.6124
.3001	-.4579	.7747	.6149	.2503	-.2652	.8027	.5691	.5002	.2476	-.4492	.7754	.6138
.3502	-.4452	.7760	.6129	.3001	-.2815	.8003	.5731	.5002	-.2524	-.4409	.7767	.6118
.4003	-.4398	.7768	.6115	.3507	-.2887	.7993	.5749	.5002	-.5024	-.4390	.7770	.6114
.4501	-.4442	.7762	.6126	.4001	-.2776	.8009	.5722	.5002	-.7524	-.4236	.7792	.6077
.5002	-.4489	.7755	.6137	.4501	-.2623	.8032	.5684	.8002	.7476	-.3393	.7918	.5873
.5502	-.4573	.7743	.6157	.5001	-.2162	.8100	.5569	.8002	.4976	-.3450	.7909	.5887
.6002	-.4579	.7742	.6159	.5497	-.1420	.8210	.5383	.8002	.2476	-.3479	.7905	.5894
.6500	-.4540	.7747	.6150	.6003	-.0574	.8336	.5186	.8002	-.5024	-.3410	.7915	.5877
.7000	-.4337	.7774	.6161	.6500	.0138	.8441	.4979	.8002	-.7524	-.3218	.7944	.5830
.7500	-.3999	.7828	.6020	.7000	.1116	.8586	.4716					
.8002	-.3473	.7906	.5892	.7501	.1994	.8717	.4473					
.9002	-.2004	.8124	.5930	.8001	.2733	.8826	.4260					
.9501	-.0943	.8281	.5261	.8501	.3410	.8927	.4059					

ORIGINAL PLAN OF POOR QUALITY

TEST	167	PT	26.1862	PSI	CN	.4251	CD1	.00883	CDCOR1	.00854
RUN	19	TT	150.0583	K	CM	-1.115	CD2	.00880	CDCOR2	.00855
POINT	34	RC	7.0013	MILLION	CC	.012	CD3	.00858	CDCOR3	.00840
		MACH	.5014				CD4	.00808	CDCOR4	.00786
		ALPHA	-.0102	DEG			CD5	.00730	CDCOR5	.00708

UPPER SURFACE				LOWER SURFACE				SPANWISE				
X/C	CP	P _L /PT	MLOC	X/C	CP	P _L /PT	MLOC	X/C	Y/(B/2)	CP	P _L /PT	MLOC
0.0000	1.0598	.9993	.0314	0.0000	1.0598	.9993	.0314	.1507	.7476	-.5122	.7663	.6286
.0132	-.4572	.7744	.6155	.0126	.3428	.8930	.4052	.1507	.4976	-.5308	.7635	.6330
.0259	-.6829	.7410	.6667	.0255	.1791	.8687	.4528	.1507	.2476	-.5352	.7629	.6340
.0759	-.6233	.7498	.6548	.0495	-.0306	.8467	.4933	.1507	-.2524	-.5366	.7627	.6343
.1003	-.5801	.7562	.6446	.0753	-.0385	.8365	.5115	.1507	-.5024	-.5332	.7632	.6335
.1507	-.5207	.7650	.6306	.1002	-.0883	.8291	.5243	.1507	-.7524	-.5069	.7671	.6273
.2003	-.5025	.7677	.6263	.1503	-.1355	.8221	.5364	.5002	.7476	-.4557	.7746	.6151
.2503	-.4933	.7691	.6241	.1976	-.2029	.8121	.5534	.5002	.4976	-.4662	.7731	.6176
.3001	-.4893	.7697	.6231	.2503	-.2355	.8073	.5615	.5002	.2476	-.4726	.7721	.6192
.3502	-.4735	.7720	.6194	.3001	-.2554	.8043	.5664	.5002	-.2524	-.4650	.7733	.6173
.4003	-.4662	.7731	.6176	.3507	-.2658	.8028	.5690	.5002	-.5024	-.4630	.7736	.6169
.4501	-.4688	.7727	.6182	.4001	-.2578	.8040	.5670	.5002	-.7524	-.4489	.7756	.6135
.5002	-.4709	.7724	.6187	.4501	-.2454	.8058	.5640	.8002	.7476	-.3487	.7905	.5893
.5502	-.4769	.7715	.6202	.5001	-.2024	.8122	.5533	.8002	.4976	-.3558	.7895	.5910
.6002	-.4755	.7717	.6198	.5497	-.1309	.8228	.5352	.8002	.2476	-.3585	.7891	.5917
.6500	-.4697	.7726	.6185	.6003	-.0488	.8350	.5141	.8002	-.5024	-.3528	.7899	.5903
.7000	-.4473	.7759	.6131	.6500	.0201	.8452	.4961	.8002	-.7524	-.3327	.7929	.5854
.7500	-.4112	.7812	.6044	.7000	.1161	.8594	.4702					
.8002	-.3567	.7893	.5913	.7501	.2026	.8722	.4462					
.9002	-.2054	.8117	.5540	.8001	.2756	.8831	.4252					
.9501	-.0962	.8279	.5264	.8501	.3428	.8930	.4052					

TEST	167	PT	26.1852	PSI	CN	.4855	CD1	.00892	CDCOR1	.00867
RUN	19	TT	150.0189	K	CM	-1.1178	CD2	.00880	CDCOR2	.00861
POINT	35	RC	7.0017	MILLION	CC	.0114	CD3	.00806	CDCOR3	.00784
		MACH	.5012				CD4	.00733	CDCOR4	.00730
		ALPHA	.5091	DEG			CD5	.00736	CDCOR5	.00700

UPPER SURFACE				LOWER SURFACE				SPANWISE				
X/C	CP	P _L /PT	MLOC	X/C	CP	P _L /PT	MLOC	X/C	Y/(B/2)	CP	P _L /PT	MLOC
0.0000	1.0626	.9997	.0197	0.0000	1.0626	.9997	.0197	.1507	.7476	-.5657	.7581	.6415
.0132	-.6332	.7481	.6574	.0126	.4524	.9092	.3712	.1507	.4976	-.5842	.7554	.6459
.0259	-.8233	.7199	.7016	.0255	.2720	.8824	.4264	.1507	.2476	-.5870	.7550	.6464
.0759	-.7065	.7372	.6745	.0495	.1103	.8594	.4720	.1507	-.2524	-.5879	.7548	.6468
.1003	-.6487	.7458	.6610	.0753	.0275	.8461	.4943	.1507	-.5024	-.5883	.7548	.6469
.1507	-.5724	.7571	.6431	.1002	-.0286	.8378	.5091	.1507	-.7524	-.5667	.7580	.6418
.2003	-.5468	.7609	.6371	.1503	-.0846	.8295	.5236	.5002	.7476	-.4713	.7721	.6191
.2503	-.5287	.7636	.6328	.1976	-.1552	.8190	.5416	.5002	.4976	-.4830	.7704	.6219
.3001	-.5197	.7650	.6307	.2503	-.1924	.8135	.5510	.5002	.2476	-.4896	.7694	.6235
.3502	-.5038	.7673	.6269	.3001	-.2165	.8099	.5570	.5002	-.2524	-.4808	.7707	.6214
.4003	-.4915	.7692	.6239	.3507	-.2296	.8090	.5603	.5002	-.5024	-.4795	.7709	.6211
.4501	-.4904	.7693	.6237	.4001	-.2253	.8086	.5592	.5002	-.7524	-.4617	.7736	.6168
.5002	-.4899	.7694	.6236	.4501	-.2162	.8100	.5570	.8002	.7476	-.3491	.7903	.5897
.5502	-.4939	.7684	.6245	.5001	-.1766	.8159	.5471	.8002	.4976	-.3579	.7890	.5918
.6002	-.4901	.7694	.6236	.5497	-.1083	.8260	.5297	.8002	.2476	-.3617	.7884	.5927
.6500	-.4818	.7706	.6216	.6003	-.0291	.8378	.5092	.8002	-.5024	-.3545	.7895	.5910
.7000	-.4571	.7743	.6157	.6500	.0375	.8476	.4917	.8002	-.7524	-.3343	.7925	.5861
.7500	-.4189	.7799	.6066	.7000	.1318	.8616	.4661					
.8002	-.3619	.7884	.5928	.7501	.2169	.8742	.4423					
.9002	-.2062	.8115	.5545	.8001	.2892	.8850	.4214					
.9501	-.0964	.8278	.5267	.8501	.3563	.8949	.4013					

TEST	167	PT	26.1876	PSI	CN	.5423	CD1	.00902	CDCOR1	.00871
RUN	19	TT	150.0499	K	CM	-1.1189	CD2	.00849	CDCOR2	.00822
POINT	36	RC	7.0048	MILLION	CC	.0085	CD3	.00792	CDCOR3	.00772
		MACH	.5016				CD4	.00767	CDCOR4	.00745
		ALPHA	1.0081	DEG			CD5	.00757	CDCOR5	.00723

UPPER SURFACE				LOWER SURFACE				SPANWISE				
X/C	CP	P _L /PT	MLOC	X/C	CP	P _L /PT	MLOC	X/C	Y/(B/2)	CP	P _L /PT	MLOC
0.0000	1.0415	.9966	.0697	0.0000	1.0415	.9966	.0697	.1507	.7476	-.6246	.7496	.6550
.0132	-.8285	.7194	.7023	.0126	.5426	.9227	.3410	.1507	.4976	-.6451	.7466	.6599
.0259	-.9836	.6964	.7379	.0255	.3516	.8943	.4025	.1507	.2476	-.6469	.7463	.6602
.0759	-.7977	.7240	.6853	.0495	.1792	.8688	.4527	.1507	-.2524	-.6480	.7462	.6605
.1003	-.7251	.7347	.6784	.0753	.0858	.8549	.4784	.1507	-.5024	-.6463	.7464	.6601
.1507	-.6320	.7485	.6567	.1002	.0224	.8455	.4954	.1507	-.7524	-.6280	.7491	.6598
.2003	-.5984	.7535	.6489	.1503	-.0434	.8358	.5127	.5002	.7476	-.4988	.7686	.6249
.2503	-.5711	.7576	.6424	.1976	-.1176	.8248	.5318	.5002	.4976	-.5080	.7669	.6275
.3001	-.5577	.7595	.6393	.2503	-.1802	.8185	.5426	.5002	.2476	-.5147	.7659	.6291
.3502	-.5345	.7630	.6339	.3001	-.1877	.8144	.5495	.5002	-.2524	-.5061	.7672	.6271
.4003	-.5199	.7652	.6303	.3507	-.2040	.8120	.5536	.5002	-.5024	-.5045	.7674	.6267
.4501	-.5168	.7656	.6296	.4001	-.2030	.8121	.5534	.5002	-.7524	-.4922	.7693	.6238
.5002	-.5135	.7661	.6284	.4501	-.1970	.8130	.5519	.8002	.7476	-.3623	.7885	.5926
.5502	-.5148	.7659	.6281	.5001	-.1608	.8184	.5428	.8002	.4976	-.3702	.7873	.5945
.6002	-.5090	.7668	.6278	.5497	-.0952	.8291	.5261	.8002	.2476	-.3735	.7869	.5933
.6500	-.4989	.7683	.6254	.6003	-.0185	.8395	.5082	.8002	-.5024	-.3667	.7879	.5936
.7000	-.4719	.7723	.6189	.6500	.0457	.8490	.4902	.8002	-.7524	-.3453	.7910	.5884
.7500	-.4315	.7783	.6093	.7000	.1381	.8627	.4641					
.8002	-.3726	.7870	.5951	.7501	.2222	.8752	.4406					
.9002	-.2128	.8107	.5598	.8001	.2942	.8858	.4197					
.9501	-.0992	.8275	.5271	.8501	.3616	.8958	.3945					

TEST 167	PT 26.1879	PSI	CM	.5994	CD1	.00904	CDCOR1	.00872
RUN 19	TT 150.0484	K	CM	-.1201	CD2	.00887	CDCOR2	.00830
POINT 37	RC 6.9990	MILLION	CC	.0049	CD3	.00897	CDCOR3	.00797
	MACH .5011				CD4	.00781	CDCOR4	.00760
	ALPHA 1.5071	DEG			CD5	.00775	CDCOR5	.00746

UPPER SURFACE				LOWER SURFACE				SPANWISE				
X/C	CP	P/L/PT	MLOC	X/C	CP	P/L/PT	MLOC	X/C	Y/(B/2)	CP	P/L/PT	MLOC
0.0000	1.0099	.9920	.1074	0.0000	1.0099	.9920	.1074	.1507	.7476	-.6796	.7421	.6659
.0132	-1.0316	.6900	.7477	.0126	.6290	.9356	.3097	.1507	.4976	-.7002	.7391	.6717
.0259	-1.1490	.6727	.7744	.0255	.4289	.9060	.3780	.1507	.2476	-.7022	.7388	.6721
.0759	-.8862	.7115	.7145	.0495	.7486	.8794	.4324	.1507	-.2524	-.7027	.7387	.6722
.1003	-.7577	.7246	.6942	.0753	.1443	.8640	.4618	.1507	-.5024	-.7011	.7389	.6719
.1507	-.6876	.7410	.6686	.1002	.0732	.8534	.4812	.1507	-.7524	-.6824	.7417	.6675
.2003	-.6468	.7470	.6592	.1503	-.0008	.8425	.5008	.5002	.7476	-.5157	.7653	.6284
.2503	-.6090	.7525	.6504	.1576	-.0760	.8314	.5204	.5002	.4976	-.5276	.7646	.6313
.3001	-.5905	.7553	.6461	.2503	-.1239	.8243	.5326	.5002	.2476	-.5344	.7636	.6328
.3502	-.5645	.7591	.6400	.3001	-.1547	.8147	.5405	.5002	-.2524	-.5247	.7650	.6306
.4003	-.5458	.7619	.6356	.3507	-.1742	.8169	.5494	.5002	-.5024	-.5231	.7652	.6302
.4501	-.5400	.7628	.6342	.4001	-.1763	.8165	.5459	.8002	-.7524	-.5076	.7675	.6265
.5002	-.5339	.7637	.6327	.4501	-.1735	.8170	.5432	.8002	.7476	-.3691	.7880	.5934
.5502	-.5230	.7638	.6325	.5001	-.1404	.8219	.5368	.8002	.4976	-.3761	.7870	.5951
.6002	-.5249	.7650	.6306	.5497	-.0775	.8312	.5208	.8002	.2476	-.3794	.7865	.5659
.6500	-.5123	.7668	.6276	.6003	-.0034	.8421	.5015	.8002	-.5024	-.3712	.7877	.5939
.7000	-.4432	.7712	.6207	.6500	.0584	.8513	.4851	.8002	-.7524	-.3498	.7900	.5887
.7500	-.4404	.7775	.6165	.7000	.1490	.8647	.4605					
.8002	-.3791	.7866	.6058	.7501	.2316	.8769	.4373					
.9002	-.2149	.8105	.5555	.8001	.3027	.8874	.4166					
.9501	-.1002	.8278	.5268	.8501	.3697	.8973	.3964					

TEST 167	PT 26.1871	PSI	CM	.6463	CD1	.00916	CDCOR1	.00893
RUN 19	TT 150.0716	K	CM	-.1192	CD2	.00875	CDCOR2	.00851
POINT 38	RC 6.4948	MILLION	CC	.0008	CD3	.00828	CDCOR3	.00805
	MACH .5008				CD4	.00801	CDCOR4	.00779
	ALPHA 2.0057	DEG			CD5	.00794	CDCOR5	.00759

UPPER SURFACE				LOWER SURFACE				SPANWISE				
X/C	CP	P/L/PT	MLOC	X/C	CP	P/L/PT	MLOC	X/C	Y/(B/2)	CP	P/L/PT	MLOC
0.0000	.9608	.9846	.1488	0.0000	.9608	.9846	.1488	.1507	.7476	-.7339	.7334	.6806
.0132	-1.2266	.6603	.7934	.0126	.6967	.9455	.2341	.1507	.4976	-.7577	.7298	.6861
.0259	-1.3221	.6462	.8152	.0255	.4914	.9150	.3583	.1507	.2476	-.7607	.7294	.6868
.0759	-.9773	.6973	.7366	.0495	.3014	.8869	.4176	.1507	-.2524	-.7639	.7289	.6875
.1003	-.8730	.7128	.7127	.0753	.1893	.8702	.4499	.1507	-.5024	-.7638	.7289	.6875
.1507	-.7445	.7318	.6830	.1002	.1132	.8590	.4710	.1507	-.7524	-.7436	.7319	.6828
.2003	-.6823	.7410	.6686	.1503	.0320	.8469	.4929	.5002	.7476	-.5370	.7626	.6345
.2503	-.6502	.7458	.6611	.1476	-.0478	.8351	.5139	.5002	.4976	-.5502	.7606	.6376
.3001	-.6269	.7492	.6536	.2503	-.0994	.8275	.5272	.5002	.2476	-.5576	.7595	.6393
.3502	-.5933	.7542	.6477	.3001	-.1333	.8224	.5359	.5002	-.2524	-.5509	.7605	.6378
.4003	-.5725	.7573	.6429	.3507	-.1558	.8191	.5416	.5002	-.5024	-.5494	.7607	.6374
.4501	-.5641	.7586	.6409	.4001	-.1605	.8184	.5427	.5002	-.7524	-.5335	.7631	.6337
.5002	-.5550	.7599	.6387	.4501	-.1605	.8184	.5427	.8002	.7476	-.3735	.7868	.5954
.5502	-.5515	.7604	.6379	.5001	-.1300	.8229	.5350	.8002	.4976	-.3841	.7852	.5979
.6002	-.5413	.7619	.6355	.5497	-.0697	.8319	.5196	.8002	.2476	-.3884	.7846	.5940
.6500	-.5264	.7641	.6320	.6003	.0020	.8425	.5009	.8002	-.5024	-.3847	.7851	.5981
.7000	-.4499	.7688	.6245	.6500	.0816	.8513	.4850	.8002	-.7524	-.3631	.7883	.5929
.7500	-.4499	.7755	.6138	.7000	.1506	.8645	.4607					
.8002	-.3862	.7849	.5984	.7501	.2319	.8768	.4378					
.9002	-.2177	.8099	.5571	.8001	.3022	.8870	.4174					
.9501	-.1011	.8272	.5276	.8501	.3688	.8969	.3973					

TEST 167	PT 26.1864	PSI	CM	.7074	CD1	.00929	CDCOR1	.00903
RUN 19	TT 150.0974	K	CM	-.1205	CD2	.00897	CDCOR2	.00873
POINT 39	RC 6.9957	MILLION	CC	-.0045	CD3	.00891	CDCOR3	.00830
	MACH .5011				CD4	.00818	CDCOR4	.00798
	ALPHA 2.5224	DEG			CD5	.00812	CDCOR5	.00787

UPPER SURFACE				LOWER SURFACE				SPANWISE				
X/C	CP	P/L/PT	MLOC	X/C	CP	P/L/PT	MLOC	X/C	Y/(B/2)	CP	P/L/PT	MLOC
0.0000	.8907	.9743	.1932	0.0000	.8907	.9743	.1932	.1507	.7476	-.7928	.7251	.6935
.0132	-1.4663	.6254	.8472	.0126	.7718	.9567	.2522	.1507	.4976	-.8139	.7219	.6964
.0259	-1.5118	.6106	.8576	.0255	.5638	.9259	.3334	.1507	.2476	-.8170	.7215	.6991
.0759	-1.0716	.6938	.7574	.0495	.3695	.8971	.3967	.1507	-.2524	-.8177	.7214	.6993
.1003	-.9487	.7020	.7293	.0753	.2491	.8793	.4325	.1507	-.5024	-.8171	.7215	.6991
.1507	-.8003	.7240	.6953	.1002	.1689	.8674	.4553	.1507	-.7524	-.7957	.7245	.6992
.2003	-.7352	.7336	.6902	.1503	.0801	.8543	.4796	.5002	.7476	-.5550	.7603	.6428
.2503	-.6872	.7407	.6891	.1476	-.0036	.8419	.5019	.5002	.4976	-.5678	.7584	.6412
.3001	-.6584	.7450	.6824	.2503	-.0590	.8337	.5163	.5002	.2476	-.5749	.7573	.6428
.3502	-.6243	.7500	.6744	.3001	-.0961	.8262	.5259	.5002	-.2524	-.5662	.7586	.6428
.4003	-.5991	.7539	.6683	.3507	-.1214	.8245	.5324	.5002	-.5024	-.5649	.7588	.6405
.4501	-.5863	.7556	.6635	.4001	-.1289	.8233	.5343	.5002	-.7524	-.5521	.7607	.6375
.5002	-.5743	.7574	.6627	.4501	-.1320	.8229	.5350	.8002	.7476	-.3799	.7862	.5964
.5502	-.5684	.7583	.6613	.5001	-.1046	.8269	.5281	.8002	.4976	-.3875	.7851	.5982
.6002	-.5558	.7602	.6583	.5497	-.0476	.8354	.5134	.8002	.2476	-.3916	.7845	.5992
.6500	-.5382	.7628	.6542	.6003	.0211	.8456	.4954	.8002	-.5024	-.3852	.7854	.5977
.7000	-.4504	.7678	.6262	.6500	.0781	.8540	.4801	.8002	-.7524	-.3639	.7886	.5925
.7500	-.4570	.7748	.6149	.7000	.1649	.8668	.4564					
.8002	-.3910	.7845	.5991	.7501	.2442	.8786	.4339					
.9002	-.2142	.8101	.5567	.8001	.3131	.8888	.4138					
.9501	-.1008	.8275	.5271	.8501	.3788	.8985	.3939					

CRITICAL
OF POOR QUALITY

TEST	167	PT	26.1862	PSI	CM	.7576	CD1	.00926	CDCOR1	.00898		
RUN	19	TT	156.0996	K	CM	-.1206	CD2	.00910	CDCOR2	.00888		
POINT	40	RC	6.9887	MILLION	CC	-.0100	CD3	.00867	CDCOR3	.00844		
		MACH	.5005				CD4	.00838	CDCOR4	.00818		
		ALPHA	2.9938	DEG			CD5	.00824	CDCOR5	.00792		
UPPER SURFACE				LOWER SURFACE				SPANWISE				
X/C	CP	P/L/P/T	MLOC	X/C	CP	P/L/P/T	MLOC	X/C	Y/(B/2)	CP	P/L/P/T	MLOC
0.0000	.8116	.9625	.2341	0.0000	.8116	.9625	.2341	.1507	.7476	-.8490	.7164	.7070
.0132	-1.6920	.5915	.8998	.0126	.8271	.9648	.2266	.1507	.4976	-.8722	.7130	.7123
.0259	-1.7619	.5900	.9021	.0255	.8183	.9339	.3140	.1507	.2476	-.8754	.7125	.7130
.0759	-1.1652	.6696	.7793	.0495	.4192	.9044	.3816	.1507	-.2524	-.6765	.7123	.7133
.1003	-1.0252	.6703	.7473	.0753	.2918	.8855	.4204	.1507	-.5024	-.8750	.7126	.7130
.1507	-.8580	.7151	.7090	.1002	.2079	.8731	.4446	.1507	-.7324	-.8527	.7159	.7078
.2003	-.7750	.7274	.6899	.1503	.1126	.8589	.4711	.5002	.7476	-.5769	.7568	.6437
.2503	-.7274	.7344	.6779	.1976	.0253	.8460	.4946	.5002	.4976	-.5904	.7548	.6469
.3001	-.6938	.7394	.6711	.2503	-.0334	.8373	.5100	.5002	.2476	-.5974	.7537	.6486
.3502	-.6536	.7454	.6617	.3001	-.0731	.8314	.5203	.5002	-.2524	-.5875	.7549	.6467
.4003	-.6252	.7496	.6551	.3507	-.1013	.8272	.5276	.5002	-.5024	-.5882	.7551	.6464
.4501	-.6102	.7516	.6516	.4001	-.1112	.8258	.5301	.5002	-.7324	-.5771	.7567	.6438
.5002	-.5955	.7540	.6481	.4501	-.1167	.8250	.5315	.8002	.7476	-.3881	.7847	.5987
.5502	-.5874	.7552	.6462	.5001	-.0918	.8286	.5251	.8002	.4976	-.3964	.7835	.6008
.6002	-.5727	.7574	.6428	.5497	-.0371	.8368	.5110	.8002	.2476	-.4010	.7828	.6019
.6500	-.5526	.7604	.6380	.6003	.0294	.8466	.4935	.8002	-.5024	-.3958	.7836	.6006
.7000	-.5165	.7657	.6295	.6500	.0442	.8547	.4788	.8002	-.7324	-.3745	.7867	.5955
.7500	-.4669	.7730	.6177	.7000	.1695	.8674	.4554					
.8002	-.3987	.7832	.6013	.7501	.2475	.8799	.4333					
.9007	-.2718	.8094	.5590	.8001	.3157	.8890	.4133					
.9501	-.1649	.8267	.5263	.8501	.3814	.8988	.3934					

TEST	167	PT	26.1864	PSI	CM	.8192	CD1	.00937	CDCOR1	.00913		
RUN	19	TT	150.1162	K	CM	-.1202	CD2	.00933	CDCOR2	.00913		
POINT	41	RC	6.9921	MILLION	CC	-.0180	CD3	.00897	CDCOR3	.00884		
		MACH	.5009				CD4	.00865	CDCOR4	.00852		
		ALPHA	3.5029	DEG			CD5	.00858	CDCOR5	.00828		
UPPER SURFACE				LOWER SURFACE				SPANWISE				
X/C	CP	P/L/P/T	MLOC	X/C	CP	P/L/P/T	MLOC	X/C	Y/(B/2)	CP	P/L/P/T	MLOC
0.0000	.6977	.9459	.2828	0.0000	.6977	.9459	.2828	.1507	.7476	-.9077	.7090	.7185
.0132	-1.4478	.5481	.9682	.0126	.8864	.9738	.1951	.1507	.4976	-.9334	.7052	.7243
.0259	-1.4421	.5763	.9351	.0255	.8644	.9440	.2881	.1507	.2476	-.9367	.7047	.7251
.0759	-1.2658	.6556	.8037	.0495	.4658	.9147	.3591	.1507	-.2524	-.9375	.7046	.7253
.1003	-1.1105	.6794	.7542	.0753	.3527	.8950	.4011	.1507	-.5024	-.9347	.7050	.7246
.1507	-.9192	.7073	.7211	.1002	.2621	.8817	.4279	.1507	-.7324	-.9113	.7083	.7193
.2003	-.8304	.7204	.7068	.1503	.1598	.8665	.4569	.5002	.7476	-.6958	.7550	.6465
.2503	-.7862	.7299	.6860	.1976	.0675	.8329	.4821	.5002	.4976	-.6894	.7530	.6496
.3001	-.7265	.7358	.6769	.2503	.0047	.8437	.4988	.5002	.2476	-.6166	.7520	.6513
.3502	-.6806	.7425	.6662	.3001	-.0368	.8375	.5096	.5002	-.2524	-.6072	.7533	.6491
.4003	-.6490	.7472	.6589	.3507	-.0675	.8330	.5176	.5002	-.5024	-.6056	.7536	.6487
.4501	-.6315	.7498	.6548	.4001	-.0806	.8311	.5209	.5002	-.7324	-.5893	.7560	.6449
.5002	-.6133	.7525	.6505	.4501	-.0892	.8298	.5231	.8002	.7476	-.3948	.7847	.5988
.5502	-.6021	.7541	.6479	.5001	-.0678	.8330	.5176	.8002	.4976	-.4015	.7837	.6004
.6002	-.5850	.7568	.6434	.5497	-.0162	.8506	.5043	.8002	.2476	-.4046	.7833	.6012
.6500	-.5625	.7599	.6387	.6002	.0476	.8500	.4874	.8002	-.5024	-.3979	.7842	.5986
.7000	-.5234	.7656	.6296	.6500	.0991	.8576	.4736					
.7500	-.4718	.7734	.6172	.7000	.1823	.8699	.4507					
.8002	-.4611	.7834	.6003	.7501	.2583	.8811	.4291					
.9007	-.2200	.8105	.5561	.8001	.3252	.8910	.4091					
.9501	-.1048	.8282	.5258	.8501	.3903	.9006	.3896					

Appendix B

Pressure Data for $M = 0.60$; $R = 7.0 \times 10^6$, 10.0×10^6 , 15.0×10^6 , and 30.0×10^6 ; Free Transition

The pressure measurements made on the NASA SC(3)-0712(B) airfoil are presented in coefficient form in graphs and tables in this appendix. The data are for a given Mach number through the Reynolds number range. The pressure data from the upper surface of the airfoil are plotted as open symbols, and the lower-surface data are plotted as solid symbols.

TEST 167	PT 26.1105	PSI	CN	-0.0265	CD1	.00923	CDCOR1	.00905
RUN 18	TT 165.0557	K	CM	-1.098	CD2	.00854	CDCOR2	.00843
POINT 14	RC 7.0013	MILLION	CC	.0038	CD3	.00813	CDCOR3	.00807
	MACH .6010				CD4	.00846	CDCOR4	.00840
	ALPHA -3.9917	DEG			CD5	.00605	CDCOR5	.00785

UPPER SURFACE				LOWER SURFACE				SPANWISE				
X/C	CP	P/L/PT	MLOC	X/C	CP	P/L/PT	MLOC	X/C	Y/(B/2)	CP	P/L/PT	MLOC
0.0000	.5567	.8937	.4038	0.0000	-.5567	.8937	.4038	.1507	.7476	-.1420	.7553	.6459
.0132	.5810	.8986	.3936	.0126	-.8592	.6132	.8658	.1507	.4976	-.1616	.7514	.6521
.0259	.2584	.8346	.5147	.0255	-.7175	.6413	.8225	.1507	.2476	-.1439	.7549	.6465
.0759	-.0374	.7760	.6128	.0495	-.6955	.6457	.8158	.1507	-.2524	-.1608	.7515	.6510
.1003	-.0900	.7676	.6264	.0753	-.6355	.6575	.7976	.1507	-.5024	-.1507	.7536	.6487
.1507	-.1313	.7574	.6426	.1002	-.6370	.6972	.7980	.1507	-.7524	-.1619	.7513	.6522
.2003	-.1764	.7485	.6567	.1503	-.5895	.6666	.7836	.5002	.7476	-.3176	.7205	.7005
.2503	-.2155	.7407	.6689	.1976	-.5131	.6620	.7907	.5002	.4976	-.3269	.7187	.7034
.3001	-.2461	.7347	.6784	.2503	-.5952	.6655	.7853	.5002	.2476	-.3306	.7179	.7045
.3502	-.2583	.7322	.6822	.3001	-.5775	.6690	.7799	.5002	-.2524	-.3255	.7189	.7029
.4003	-.2799	.7280	.6889	.3507	-.5553	.6734	.7732	.5002	-.5024	-.3206	.7199	.7014
.4501	-.3031	.7234	.6960	.4001	-.5125	.6819	.7601	.5002	-.7524	-.3069	.7226	.6972
.5002	-.3265	.7187	.7033	.4501	-.4619	.6919	.7447	.8002	.7476	-.3138	.7213	.6995
.5502	-.3514	.7138	.7109	.5001	-.3821	.7077	.7203	.8002	.4976	-.3164	.7207	.7001
.6002	-.3691	.7103	.7163	.5497	-.2742	.7291	.6871	.8002	.2476	-.3172	.7206	.7004
.6500	-.3810	.7078	.7202	.6003	-.1594	.7518	.6514	.8002	-.5024	-.3092	.7222	.6979
.7000	-.3761	.7069	.7185	.6500	-.0601	.7715	.6200	.8002	-.7524	-.2920	.7256	.6926
.7500	-.3545	.7132	.7119	.7000	.0522	.7937	.5839					
.8002	-.3121	.7216	.6988	.7501	.1489	.8129	.5519					
.8002	-.1801	.7477	.6579	.8001	.2266	.8283	.5256					
.9501	-.0764	.7683	.6252	.8501	.2913	.8411	.5032					

TEST 167	PT 26.1114	PSI	CN	.0970	CD1	.00901	CDCOR1	.00883
RUN 18	TT 165.0782	K	CM	-1.145	CD2	.00880	CDCOR2	.00867
POINT 15	RC 6.9974	MILLION	CC	.0133	CD3	.00849	CDCOR3	.00840
	MACH .6007				CD4	.00788	CDCOR4	.00778
	ALPHA -3.0039	DEG			CD5	.00735	CDCOR5	.00714

UPPER SURFACE				LOWER SURFACE				SPANWISE				
X/C	CP	P/L/PT	MLOC	X/C	CP	P/L/PT	MLOC	X/C	Y/(B/2)	CP	P/L/PT	MLOC
0.0000	.7667	.9394	.3001	0.0000	-.7667	.9394	.3001	.1507	.7476	-.2397	.7364	.6756
.0132	.3911	.8612	.4669	.0126	-.4708	.6907	.7465	.1507	.4976	-.2608	.7323	.6822
.0259	.0651	.7967	.5790	.0255	-.4385	.6969	.7370	.1507	.2476	-.2399	.7364	.6757
.0759	-.1720	.7498	.6546	.0495	-.4463	.6877	.7512	.1507	-.2524	-.2466	.7351	.6778
.1003	-.1978	.7447	.6626	.0753	-.4567	.6935	.7422	.1507	-.5024	-.2449	.7354	.6772
.1507	-.2246	.7386	.6722	.1002	-.4815	.6886	.7499	.1507	-.7524	-.2368	.7331	.6809
.2003	-.2625	.7319	.6827	.1503	-.4648	.6919	.7447	.5002	.7476	-.3604	.7126	.7128
.2503	-.2893	.7266	.6910	.1976	-.5024	.6845	.7561	.5002	.4976	-.3712	.7104	.7161
.3001	-.3124	.7221	.6981	.2503	-.4998	.6850	.7553	.5002	.2476	-.3740	.7099	.7170
.3502	-.3214	.7203	.7008	.3001	-.4943	.6861	.7537	.5002	-.2524	-.3651	.7117	.7142
.4003	-.3354	.7175	.7051	.3507	-.4802	.6889	.7494	.5002	-.5024	-.3624	.7122	.7134
.4501	-.3536	.7139	.7107	.4001	-.4482	.6952	.7396	.5002	-.7524	-.3506	.7145	.7098
.5002	-.3719	.7103	.7163	.4501	-.4068	.7034	.7270	.8002	.7476	-.3276	.7191	.7027
.5502	-.3925	.7062	.7226	.5001	-.3358	.7174	.7053	.8002	.4976	-.3313	.7183	.7039
.6002	-.4055	.7037	.7246	.5497	-.2357	.7337	.6744	.8002	.2476	-.3325	.7181	.7042
.6500	-.4135	.7021	.7290	.6003	-.1275	.7586	.6406	.8002	-.5024	-.3230	.7200	.7013
.7000	-.4C30	.7042	.7258	.6500	-.0338	.7771	.6109	.8002	-.7524	-.3054	.7234	.6959
.7500	-.3763	.7094	.7177	.7000	.0756	.7988	.5755					
.8002	-.3287	.7188	.7031	.7501	.1712	.8177	.5438					
.8002	-.1863	.7470	.6590	.8001	.2495	.8332	.5172					
.9501	-.0792	.7682	.6254	.8501	.3138	.8463	.4940					

TEST 167	PT 26.1240	PSI	CN	.2130	CD1	.00897	CDCOR1	.00874
RUN 18	TT 145.0833	K	CM	-1.178	CD2	.00887	CDCOR2	.00867
POINT 16	RC 7.0006	MILLION	CC	.0153	CD3	.00864	CDCOR3	.00851
	MACH .6006				CD4	.00782	CDCOR4	.00765
	ALPHA -1.9958	DEG			CD5	.00671	CDCOR5	.00649

UPPER SURFACE				LOWER SURFACE				SPANWISE				
X/C	CP	P/L/PT	MLOC	X/C	CP	P/L/PT	MLOC	X/C	Y/(B/2)	CP	P/L/PT	MLOC
0.0000	.9549	.9725	.1998	0.0000	-.9549	.9725	.1998	.1507	.7476	-.3343	.7171	.7058
.0132	.1583	.8167	.5455	.0126	-.1547	.7527	.6201	.1507	.4976	-.3687	.7103	.7164
.0259	-.1546	.7527	.6560	.0255	-.2174	.7403	.6896	.1507	.2476	-.3475	.7145	.7098
.0759	-.3236	.7107	.7025	.0495	-.3116	.7216	.6983	.1507	-.2524	-.3488	.7142	.7102
.1003	-.3302	.7179	.7045	.0753	-.3162	.7207	.7002	.1507	-.5024	-.3497	.7140	.7105
.1507	-.3372	.7165	.7067	.1002	-.3484	.7145	.7101	.1507	-.7524	-.3613	.7117	.7141
.2003	-.3513	.7137	.7110	.1503	-.3587	.7123	.7133	.5002	.7476	-.4065	.7028	.7279
.2503	-.3705	.7099	.7169	.1976	-.4100	.7021	.7290	.5002	.4976	-.4149	.7011	.7305
.3001	-.3852	.7070	.7214	.2503	-.4215	.6998	.7325	.5002	.2476	-.4225	.6996	.7328
.3502	-.3867	.7067	.7210	.3001	-.4260	.6989	.7319	.5002	-.2524	-.4147	.7012	.7304
.4003	-.3947	.7052	.7242	.3507	-.4212	.6994	.7324	.5002	-.5024	-.4172	.7017	.7297
.4501	-.4073	.7026	.7282	.4001	-.3975	.7046	.7252	.5002	-.7524	-.3967	.7047	.7249
.5002	-.4203	.7000	.7322	.4501	-.3843	.7111	.7130	.8002	.7476	-.3398	.7160	.7075
.5502	-.4366	.6966	.7371	.5001	-.3010	.7237	.6955	.8002	.4976	-.3487	.7142	.7102
.6002	-.4453	.6951	.7398	.5497	-.2077	.7422	.6666	.8002	.2476	-.3514	.7137	.7110
.6500	-.4485	.6945	.7408	.6003	-.1052	.7625	.6345	.8002	-.5024	-.3445	.7151	.7069
.7000	-.4330	.6975	.7360	.6500	-.0166	.7800	.6063	.8002	-.7524	-.3262	.7187	.7033
.7500	-.4011	.7039	.7263	.7000	.0902	.8012	.5715					
.8002	-.3442	.7143	.7161	.7501	.1844	.8199	.5401					
.8002	-.1958	.7445	.6629	.8001	.2628	.8354	.5133					
.9501	-.0847	.7665	.6280	.8501	.3305	.8488	.4894					

ORIGINAL PAGE IS
OF POOR QUALITY

TEST	167	PT	26.1529	PSI		CN	.2779	CD1	.00993	CDCOR1	.00883
RUN	18	TT	165.0607	K		CM	-.1200	CD2	.00887	CDCOR2	.00867
POINT	17	RC	7.0090	MILLION		CC	.0162	CD3	.00844	CDCOR3	.00828
		MACH	.6006					CD4	.00778	CDCOR4	.00760
		ALPHA	-1.4867	DEG				CD5	.00677	CDCOR5	.00654

UPPER SURFACE				LOWER SURFACE				SPANWISE				
X/C	CP	P/L/PT	MLOC	X/C	CP	P/L/PT	MLOC	X/C	Y/(B/2)	CP	P/L/PT	MLOC
0.0000	1.0175	.9850	.1471	0.0000	1.0175	.9850	.1471	.1507	.7476	-.3867	.7071	.7213
.0132	-.0360	.7907	.5888	.0126	-.0054	.7826	.6021	.1507	.4976	-.4240	.6997	.7327
.0259	-.2803	.7281	.6886	.0255	-.1057	.7627	.6341	.1507	.2476	-.4030	.7039	.7263
.0759	-.4049	.7035	.7268	.0495	-.2137	.7613	.6679	.1507	-.2524	-.4042	.7036	.7266
.1003	-.4001	.7045	.7254	.0753	-.2412	.7359	.6765	.1507	-.5024	-.4042	.7036	.7266
.1507	-.3928	.7059	.7231	.1002	-.2764	.7284	.6874	.1507	-.7524	-.4163	.7012	.7303
.2003	-.4042	.7036	.7266	.1503	-.2988	.7245	.6943	.5002	.7476	-.4301	.6985	.7345
.2503	-.4107	.7023	.7286	.1976	-.3558	.7132	.7116	.5002	.4976	-.4359	.6974	.7363
.3001	-.4208	.7003	.7317	.2503	-.3740	.7096	.7174	.5002	.2476	-.4452	.6955	.7391
.3502	-.4196	.7006	.7313	.3001	-.3932	.7078	.7202	.5002	-.2524	-.4359	.6974	.7363
.4003	-.4234	.6998	.7325	.3507	-.3830	.7078	.7201	.5002	-.5024	-.4333	.6979	.7355
.4501	-.4337	.6978	.7356	.4001	-.3637	.7116	.7142	.5002	-.7524	-.4168	.7012	.7303
.5002	-.4436	.6958	.7387	.4501	-.3349	.7174	.7054	.8002	.7476	-.3488	.7146	.7097
.5502	-.4574	.6931	.7429	.5001	-.2758	.7290	.6872	.8002	.4976	-.3557	.7132	.7118
.6002	-.4630	.6919	.7448	.5497	-.1864	.7467	.6594	.8002	.2476	-.3581	.7128	.7125
.6500	-.4643	.6918	.7450	.6003	-.0875	.7663	.6284	.8002	-.5024	-.3501	.7144	.7100
.7000	-.4462	.6953	.7394	.6500	-.0020	.7862	.6011	.8002	-.7524	-.3312	.7181	.7043
.7500	-.4116	.7022	.7289	.7000	.1031	.8040	.5668					
.8002	-.3560	.7132	.7119	.7501	.1961	.8224	.5357					
.9002	-.1985	.7444	.6632	.8001	.2742	.8379	.5089					
.9501	-.0855	.7667	.6277	.8501	.3422	.8513	.4849					

TEST	167	PT	26.1523	PSI		CN	.3342	CD1	.00898	CDCOR1	.00885
RUN	18	TT	165.0894	K		CM	-.1209	CD2	.00864	CDCOR2	.00853
POINT	18	RC	7.0057	MILLION		CC	.0162	CD3	.00826	CDCOR3	.00820
		MACH	.6004					CD4	.00786	CDCOR4	.00776
		ALPHA	-.9877	DEG				CD5	.00690	CDCOR5	.00668

UPPER SURFACE				LOWER SURFACE				SPANWISE				
X/C	CP	P/L/PT	MLOC	X/C	CP	P/L/PT	MLOC	X/C	Y/(B/2)	CP	P/L/PT	MLOC
0.0000	1.0564	.9927	.1023	0.0000	1.0564	.9927	.1023	.1507	.7476	-.4407	.6966	.7374
.0132	-.0982	.7644	.6315	.0126	-.1214	.8078	.5605	.1507	.4976	-.4807	.6887	.7496
.0259	-.4097	.7028	.7280	.0255	-.0044	.7829	.6016	.1507	.2476	-.4594	.6929	.7431
.0759	-.4879	.6873	.7518	.0495	-.1310	.7579	.6418	.1507	-.2524	-.4609	.6926	.7436
.1003	-.4702	.6906	.7464	.0753	-.1760	.7490	.6539	.1507	-.5024	-.4591	.6930	.7430
.1507	-.4486	.6951	.7398	.1002	-.2161	.7411	.6684	.1507	-.7524	-.4712	.6906	.7467
.2003	-.4444	.6951	.7398	.1503	-.2496	.7344	.6787	.5002	.7476	-.4518	.6945	.7408
.2503	-.4512	.6946	.7406	.1976	-.3120	.7221	.6980	.5002	.4976	-.4597	.6929	.7432
.3001	-.4467	.6935	.7423	.2503	-.3449	.7173	.7054	.5002	.2476	-.4680	.6913	.7457
.3502	-.4514	.6945	.7407	.3001	-.3385	.7166	.7096	.5002	-.2524	-.4592	.6930	.7431
.4003	-.4514	.6945	.7407	.3507	-.3385	.7166	.7096	.5002	-.5024	-.4567	.6935	.7423
.4501	-.4558	.6931	.7429	.4001	-.3385	.7166	.7096	.5002	-.7524	-.4413	.6965	.7376
.5002	-.4666	.6916	.7451	.4501	-.3136	.7218	.6985	.8002	.7476	-.3335	.7159	.7108
.5502	-.4774	.6894	.7486	.5001	-.2593	.7327	.6815	.8002	.4976	-.3624	.7121	.7135
.6002	-.4812	.6886	.7498	.5497	-.1725	.7497	.6548	.8002	.2476	-.3659	.7114	.7146
.6500	-.4794	.6890	.7492	.6003	-.0766	.7657	.6246	.8002	-.5024	-.3589	.7128	.7124
.7000	-.4558	.6931	.7429	.6500	.0001	.7850	.5986	.8002	-.7524	-.3396	.7166	.7065
.7500	-.4216	.7064	.7316	.7000	.1046	.8035	.5644					
.8002	-.3636	.7119	.7138	.7501	.2019	.8237	.5335					
.9002	-.2017	.7439	.6639	.8001	.2797	.8391	.5067					
.9501	-.0870	.7666	.6279	.8501	.3484	.8527	.4824					

TEST	167	PT	26.1527	PSI		CN	.3966	CD1	.00885	CDCOR1	.00870
RUN	18	TT	165.0862	K		CM	-.1228	CD2	.00807	CDCOR2	.00797
POINT	19	RC	7.0063	MILLION		CC	.0157	CD3	.00770	CDCOR3	.00765
		MACH	.6004					CD4	.00786	CDCOR4	.00777
		ALPHA	-.4866	DEG				CD5	.00707	CDCOR5	.00687

UPPER SURFACE				LOWER SURFACE				SPANWISE				
X/C	CP	P/L/PT	MLOC	X/C	CP	P/L/PT	MLOC	X/C	Y/(B/2)	CP	P/L/PT	MLOC
0.0000	1.0828	.9940	.0539	0.0000	1.0828	.9980	.0539	.1507	.7476	-.4984	.6853	.7542
.0132	-.2504	.7347	.6783	.0126	-.2457	.8327	.5180	.1507	.4976	-.5418	.6772	.7674
.0259	-.5548	.6746	.7713	.0255	-.0966	.8032	.5681	.1507	.2476	-.5209	.6813	.7610
.0759	-.5787	.6549	.7786	.0495	-.0462	.7750	.6143	.1507	-.2524	-.5236	.6808	.7618
.1003	-.5477	.6740	.7691	.0753	-.1073	.7630	.6337	.1507	-.5024	-.5194	.6816	.7606
.1507	-.5101	.6835	.7577	.1002	-.1543	.7537	.6484	.1507	-.7524	-.5314	.6792	.7642
.2003	-.4994	.6856	.7545	.1503	-.1981	.7450	.6621	.5002	.7476	-.4779	.6898	.7479
.2503	-.4956	.6863	.7533	.1976	-.2660	.7317	.6831	.5002	.4976	-.4861	.6882	.7505
.3001	-.4964	.6862	.7536	.2503	-.2965	.7256	.6925	.5002	.2476	-.4938	.6867	.7528
.3502	-.4857	.6883	.7507	.3001	-.3146	.7221	.6981	.5002	-.2524	-.4852	.6884	.7502
.4003	-.4425	.6949	.7493	.3507	-.3226	.7205	.7005	.5002	-.5024	-.4825	.6889	.7494
.4501	-.4474	.6979	.7509	.4001	-.3113	.7227	.6971	.5002	-.7524	-.4684	.6917	.7451
.5002	-.4915	.6871	.7521	.4501	-.2904	.7268	.6906	.8002	.7476	-.3646	.7122	.7134
.5512	-.5002	.6854	.7547	.5001	-.2392	.7369	.6749	.8002	.4976	-.3724	.7106	.7158
.6002	-.5017	.6851	.7552	.5497	-.1566	.7533	.6491	.8002	.2476	-.3757	.7100	.7168
.6500	-.4975	.6859	.7539	.6003	-.0637	.7716	.6199	.8002	-.5024	-.3691	.7113	.7148
.7000	-.4743	.6905	.7449	.6500	.0160	.7873	.5944	.8002	-.7524	-.3480	.7151	.7086
.7500	-.4344	.6984	.7347	.7000	.1179	.8074	.5611					
.8002	-.3731	.7104	.7162	.7501	.2095	.8255	.5304					
.9002	-.2071	.7433	.6649	.8001	.2877	.8410	.5034					
.9501	-.0891	.7666	.6279	.8501	.3579	.8548	.4785					

TEST	167	PT	26.1723	PSI	CN	.4543	CD1	.00890	CDCDR1	.00878
RUN	18	TT	165.0906	K	CM	-.1237	CD2	.00818	CDCDR2	.00808
POINT	20	RC	7.0100	MILLION	CC	.0141	CD3	.00780	CDCDR3	.00775
		MACH	.6603				CD4	.00778	CDCDR4	.00765
		ALPHA	.0102	DEG			CD5	.00721	CDCDR5	.00700

UPPER SURFACE				LOWER SURFACE				SPANWISE				
X/C	CP	P _L /PT	MLOC	X/C	CP	P _L /PT	MLOC	X/C	Y/(B/2)	CP	P _L /PT	MLOC
0.0000	1.0942	1.0002	0.0060	0.0000	1.0942	1.0002	0.0000	.1507	.7476	-.5474	.6756	.7698
.0132	-.4054	.7037	.7266	.0126	.3557	.8542	.4797	.1507	.4976	-.5942	.6663	.7840
.0259	-.7004	.6453	.8163	.0255	-.1904	.8215	.5374	.1507	.2476	-.5749	.6701	.7182
.0759	-.6650	.6523	.8055	.0495	.0334	.7904	.5893	.1507	-.2524	-.5772	.6697	.7789
.1003	-.6191	.6614	.7916	.0753	-.0404	.7758	.6131	.1507	-.5024	-.5722	.6707	.7773
.1507	-.5635	.6724	.7747	.1002	-.0938	.7653	.6300	.1507	-.7524	-.5519	.6747	.7712
.2003	-.5428	.6765	.7684	.1503	-.1463	.7548	.6467	.5002	.7476	-.4956	.6858	.7561
.2503	-.5327	.6785	.7654	.1976	-.2123	.7405	.6693	.5002	.4976	-.5051	.6840	.7570
.3001	-.5284	.6793	.7640	.2503	-.2551	.7334	.6804	.5002	.2476	-.5121	.6826	.7591
.3502	-.5144	.6821	.7598	.3001	-.2771	.7290	.6872	.5002	-.2524	-.5031	.6843	.7564
.4003	-.5074	.6835	.7577	.3507	-.2888	.7267	.6908	.5002	-.5024	-.5006	.6848	.7556
.4501	-.5088	.6832	.7581	.4001	-.2811	.7282	.6884	.5002	-.7524	-.4859	.6877	.7511
.5002	-.5099	.6830	.7584	.4501	-.2637	.7317	.6831	.8002	.7476	-.3663	.6914	.7146
.5502	-.5162	.6818	.7603	.5001	-.2160	.7411	.6883	.8002	.4976	-.3754	.7026	.7174
.6002	-.5193	.6819	.7601	.5497	-.1368	.7568	.6436	.8002	.2476	-.3793	.7088	.7186
.6500	-.5063	.6833	.7579	.6003	-.0469	.7745	.6151	.8002	-.5024	-.3725	.7102	.7165
.7000	-.4826	.6884	.7501	.6500	.0302	.7898	.5903	.8002	-.7524	-.3517	.7143	.7102
.7500	-.4401	.6968	.7372	.7000	.1303	.8096	.575					
.8002	-.3771	.7093	.7179	.7501	.2206	.8275	.5271					
.9002	-.2058	.7431	.6651	.8001	.2981	.8428	.5002					
.9501	-.0670	.7566	.6279	.8501	-.680	.8566	.4753					

TEST	167	PT	26.1705	PSI	CN	.5139	CD1	.00882	CDCDR1	.00864
RUN	18	TT	165.0720	K	CM	-.1248	CD2	.00814	CDCDR2	.00802
POINT	21	RC	7.0119	MILLION	CC	.0118	CD3	.00759	CDCDR3	.00749
		MACH	.5004				CD4	.00726	CDCDR4	.00715
		ALPHA	.5144	DEG			CD5	.00715	CDCDR5	.00694

UPPER SURFACE				LOWER SURFACE				SPANWISE				
X/C	CP	P _L /PT	MLOC	X/C	CP	P _L /PT	MLOC	X/C	Y/(B/2)	CP	P _L /PT	MLOC
0.0000	1.0887	.9990	.0375	0.0000	1.0887	.9990	.0375	.1507	.7476	-.6125	.6617	.7911
.0132	-.5774	.6687	.7804	.0126	.4512	.8726	.4453	.1507	.4976	-.6308	.6581	.7967
.0259	-.8684	.5109	.8693	.0255	.2722	.8371	.5102	.1507	.2476	-.6425	.6558	.8003
.0759	-.7676	.6310	.8384	.0495	.1031	.8036	.5675	.1507	-.2524	-.6454	.6552	.8011
.1003	-.7052	.6433	.8194	.0753	.0170	.7865	.5957	.1507	-.5024	-.6323	.6578	.7971
.1507	-.6309	.6581	.7967	.1002	-.0443	.7744	.6154	.1507	-.7524	-.6118	.6619	.7909
.2003	-.5974	.6647	.7865	.1503	-.1063	.7621	.6351	.5002	.7476	-.5230	.6795	.7638
.2503	-.5809	.6680	.7815	.1976	-.1811	.7473	.6586	.5002	.4976	-.5339	.6773	.7672
.3001	-.5709	.6700	.7784	.2503	-.2222	.7391	.6715	.5002	.2476	-.5410	.6759	.7694
.3502	-.5529	.6735	.7730	.3001	-.2484	.7339	.6794	.5002	-.2524	-.5329	.6775	.7689
.4003	-.5423	.6756	.7698	.3507	-.2641	.7308	.6844	.5002	-.5024	-.5303	.6780	.7681
.4501	-.5407	.6760	.7692	.4001	-.2600	.7315	.6832	.5002	-.7524	-.5136	.6813	.7610
.5002	-.5387	.6764	.7686	.4501	-.2463	.7343	.6789	.8002	.7476	-.3761	.7086	.7190
.5502	-.5423	.6756	.7697	.5001	-.2022	.7431	.6652	.8002	.4976	-.3872	.7084	.7224
.6002	-.5389	.6763	.7687	.5497	-.1260	.7582	.6413	.8002	.2476	-.3822	.7054	.7239
.6500	-.5292	.6782	.7657	.6003	-.0388	.7759	.6136	.8002	-.5024	-.3870	.7064	.7223
.7000	-.5008	.6839	.7571	.6500	.0357	.7902	.5896	.8002	-.7524	-.3656	.7107	.7157
.7500	-.4556	.6928	.7433	.7000	.1342	.8098	.5572					
.8002	-.3898	.7059	.7232	.7501	.2234	.8275	.5271					
.9002	-.2134	.7408	.6687	.8001	.3002	.8427	.5004					
.9501	-.0925	.7648	.6307	.8501	.3700	.8565	.4754					

TEST	167	PT	26.1838	PSI	CN	.5773	CD1	.00904	CDCDR1	.00883
RUN	18	TT	165.1038	K	CM	-.1259	CD2	.00846	CDCDR2	.00824
POINT	22	RC	7.0090	MILLION	CC	.0088	CD3	.00795	CDCDR3	.00781
		MACH	.5999				CD4	.00763	CDCDR4	.00744
		ALPHA	1.0126	DEG			CD5	.00754	CDCDR5	.00726

UPPER SURFACE				LOWER SURFACE				SPANWISE				
X/C	CP	P _L /PT	MLOC	X/C	CP	P _L /PT	MLOC	X/C	Y/(B/2)	CP	P _L /PT	MLOC
0.0000	1.0818	.9977	.0567	0.0000	1.0818	.9977	.0567	.1507	.7476	-.6783	.6500	.8091
.0132	-.7657	.6326	.8356	.0126	.5487	.8924	.4063	.1507	.4976	-.6997	.6458	.8156
.0259	-1.0538	.5759	.9240	.0255	.3568	.8545	.4791	.1507	.2476	-.7069	.6444	.8177
.0759	-.8717	.6118	.8679	.0495	.1782	.8193	.5412	.1507	-.2524	-.7087	.6441	.8183
.1003	-.7900	.6280	.8430	.0753	.0811	.8001	.5734	.1507	-.5024	-.7008	.6456	.8159
.1507	-.6948	.6468	.8141	.1002	-.0146	.7869	.5950	.1507	-.7524	-.6798	.6498	.8095
.2003	-.6525	.6551	.8012	.1503	-.0568	.7728	.6179	.5002	.7476	-.5480	.6758	.7695
.2503	-.6257	.6605	.7929	.1976	-.1358	.7572	.6429	.5002	.4976	-.5579	.6738	.7725
.3001	-.6095	.6636	.7882	.2503	-.1818	.7481	.6572	.5002	.2476	-.5646	.6725	.7746
.3502	-.5860	.6683	.7810	.3001	-.2116	.7423	.6665	.5002	-.2524	-.5547	.6745	.7715
.4003	-.5718	.6711	.7767	.3507	-.2309	.7344	.6725	.5002	-.5024	-.5525	.6749	.7709
.4501	-.5654	.6723	.7748	.4001	-.2301	.7366	.6723	.5002	-.7524	-.5411	.6771	.7675
.5002	-.5619	.6731	.7737	.4501	-.2200	.7406	.6691	.8002	.7476	-.3863	.7077	.7203
.5502	-.5631	.6728	.7741	.5001	-.1795	.7486	.6565	.8002	.4976	-.3946	.7061	.7228
.6002	-.5571	.6740	.7723	.5497	-.1067	.7630	.6337	.8002	.2476	-.3991	.7052	.7242
.6500	-.5442	.6765	.7684	.6003	-.0227	.7796	.6070	.8002	-.5024	-.3919	.7066	.7220
.7000	-.5130	.6827	.7589	.6500	.0491	.7938	.5838	.8002	-.7524	-.3705	.7109	.7155
.7500	-.4650	.6922	.7443	.7000	.1455	.8128	.5521					
.8002	-.3963	.7058	.7234	.7501	.2330	.8301	.5225					
.9002	-.2147	.7416	.6675	.8001	.3088	.8451	.4962					
.9501	-.0932	.7656	.6294	.8501	.3784	.8588	.4712					

ORIGINAL DATA
OF POOL QUALITY

TEST 167	PT 26.1847	PSI	CN .6357	CD1 .00910	CDCOR1 .00888
RUN 1P	TT 165.1184	K	CM -.1262	CD2 .00860	CDCOR2 .00839
POINT 23	PC 7.0047	MILLION	CC .0050	CD3 .00817	CDCOR3 .00796
	MACH .5495			CD4 .00780	CDCOR4 .00760
	ALPHA 1.5293	DEG		CD5 .00769	CDCOR5 .00745

UPPER SURFACE				LOWER SURFACE				SPANWISE				
X/C	CP	P/L/PT	MLOC	X/C	CP	P/L/PT	MLOC	X/C	Y/(B/2)	CP	P/L/PT	MLOC
0.0000	1.0586	.4932	.0986	0.0000	1.0586	.4932	.0986	.1507	.7476	-.7386	.6384	.8269
.0132	-.0550	.5957	.8929	.0126	.6317	.9089	.3717	.1507	.4976	-.7597	.6343	.8333
.0259	-1.2513	.5372	.9855	.0255	.4325	.8696	.4510	.1507	.2476	-.7666	.6329	.8354
.0759	-.9724	.5423	.8983	.0495	.2467	.8329	.5176	.1507	-.2524	-.7672	.6328	.8356
.1003	-.8702	.6125	.8670	.0753	.1404	.8120	.5535	.1507	-.5024	-.7605	.6341	.8335
.1507	-.7537	.6355	.8315	.1002	.0682	.7977	.5773	.1507	-.7524	-.7374	.6387	.8265
.2003	-.6985	.6464	.9147	.1503	-.0111	.7821	.6030	.5002	.7476	-.5643	.6728	.7740
.2503	-.6649	.6530	.8045	.1976	-.0933	.7658	.6291	.5002	.4976	-.5760	.6705	.7776
.3001	-.6435	.6572	.7980	.2503	-.1438	.7559	.6450	.5002	.2476	-.5831	.6691	.7797
.3502	-.6177	.6623	.7902	.3001	-.1768	.7493	.6553	.5002	-.2524	-.5131	.6711	.7767
.4003	-.5986	.6661	.7844	.3507	-.1989	.7450	.6622	.5002	-.5024	-.5711	.6715	.7761
.4501	-.5890	.6660	.7815	.4001	-.2017	.7444	.6631	.5002	-.7524	-.5556	.6746	.7714
.5002	-.5816	.6694	.7793	.4501	-.1948	.7458	.6609	.5002	.7476	-.3871	.7078	.7201
.5502	-.5800	.6697	.7788	.5001	-.1583	.7530	.6495	.5002	.4976	-.3969	.7059	.7231
.6002	-.5714	.6715	.7762	.5497	-.0890	.7667	.6278	.5002	.2476	-.4025	.7048	.7249
.6500	-.5559	.6745	.7715	.6003	-.0081	.7826	.6020	.5002	-.5024	-.3949	.7063	.7225
.7000	-.5223	.6812	.7613	.6500	.0613	.7963	.5796	.5002	-.7524	-.3740	.7104	.7161
.7500	-.4717	.6911	.7459	.7000	.1534	.8149	.5485					
.8002	-.4607	.7051	.7243	.7501	.2412	.8318	.5195					
.9002	-.2152	.7418	.6673	.8001	.3159	.8466	.4934					
.9501	-.0932	.7658	.6291	.8501	.3848	.8602	.4687					

TEST 167	PT 26.1829	PSI	CN .6953	CD1 .00925	CDCOR1 .00904
RUN 1P	TT 165.1754	K	CM -.1261	CD2 .00883	CDCOR2 .00863
POINT 24	PC 7.0065	MILLION	CC .0003	CD3 .00841	CDCOR3 .00823
	MACH .6001			CD4 .00607	CDCOR4 .00785
	ALPHA 2.0087	DEG		CD5 .00802	CDCOR5 .00779

UPPER SURFACE				LOWER SURFACE				SPANWISE				
X/C	CP	P/L/PT	MLOC	X/C	CP	P/L/PT	MLOC	X/C	Y/(B/2)	CP	P/L/PT	MLOC
0.0000	1.0238	.9255	.1396	0.0000	1.0238	.9255	.1396	.1507	.7476	-.8009	.6274	.8439
.0132	-1.1501	.5587	.9511	.0126	.7056	.9239	.3381	.1507	.4976	-.8247	.6228	.8511
.0259	-1.4841	.4930	1.0582	.0255	.5026	.8839	.4234	.1507	.2476	-.8302	.6217	.8528
.0759	-1.0776	.5730	.9286	.0495	.3107	.8461	.4492	.1507	-.2524	-.8312	.6215	.8530
.1003	-.9545	.5972	.8907	.0753	.1958	.8235	.5338	.1507	-.5024	-.8243	.6228	.8510
.1507	-.8173	.6242	.8488	.1002	.1192	.8083	.5597	.1507	-.7524	-.8002	.6276	.8437
.2003	-.7567	.6357	.8311	.1503	.0314	.7912	.5881	.5002	.7476	-.5874	.6694	.7793
.2503	-.7082	.6457	.8158	.1976	-.0541	.7744	.6154	.5002	.4976	-.5991	.6671	.7828
.3001	-.6818	.6509	.8078	.2503	-.1095	.7635	.6329	.5002	.2476	-.6065	.6657	.7850
.3502	-.6481	.6575	.7976	.3001	-.1456	.7564	.6442	.5002	-.2524	-.5967	.6676	.7821
.4003	-.6264	.6618	.7911	.3507	-.1705	.7515	.6520	.5002	-.5024	-.5946	.6680	.7814
.4501	-.6143	.6642	.7874	.4001	-.1767	.7503	.6539	.5002	-.7524	-.5800	.6709	.7770
.5002	-.6030	.6662	.7842	.4501	-.1731	.7510	.6528	.5002	.7476	-.3962	.7071	.7213
.5502	-.5995	.6671	.7829	.5001	-.1402	.7574	.6425	.5002	.4976	-.4053	.7044	.7251
.6002	-.5884	.6692	.7796	.5497	-.0738	.7705	.6216	.5002	.2476	-.4099	.7044	.7251
.6500	-.5698	.6729	.7740	.6003	.0044	.7859	.5967	.5002	-.5024	-.4021	.7059	.7231
.7000	-.5340	.6799	.7631	.6500	.0714	.7991	.5751	.5002	-.7524	-.3807	.7101	.7166
.7500	-.4804	.6905	.7469	.7000	.1636	.8172	.5446					
.8002	-.4669	.7049	.7246	.7501	.2481	.8338	.5160					
.9002	-.2165	.7424	.6662	.8001	.3222	.8484	.4902					
.9501	-.0916	.7670	.6273	.8501	.3909	.8619	.4654					

TEST 167	PT 26.1834	PSI	CN .7596	CD1 .00942	CDCOR1 .00917
RUN 1P	TT 165.2476	K	CM -.1274	CD2 .00909	CDCOR2 .00884
POINT 26	PC 7.0078	MILLION	CC -.0046	CD3 .00873	CDCOR3 .00853
	MACH .6008			CD4 .00833	CDCOR4 .00807
	ALPHA 2.5248	DEG		CD5 .00829	CDCOR5 .00806

UPPER SURFACE				LOWER SURFACE				SPANWISE				
X/C	CP	P/L/PT	MLOC	X/C	CP	P/L/PT	MLOC	X/C	Y/(B/2)	CP	P/L/PT	MLOC
0.0000	.9813	.9774	.1810	0.0000	.9813	.9774	.1810	.1507	.7476	-.8663	.6082	.8736
.0132	-1.3252	.5163	1.0195	.0126	.7775	.9366	.3070	.1507	.4976	-.8865	.6042	.8798
.0259	-1.7245	.4357	1.1574	.0255	.5732	.8958	.3994	.1507	.2476	-.8919	.6031	.8815
.0759	-1.1751	.5465	.9766	.0495	.3796	.8571	.4743	.1507	-.2524	-.8891	.6036	.8806
.1003	-1.0368	.5741	.9268	.0753	.2573	.8327	.5170	.1507	-.5024	-.8825	.6050	.8786
.1507	-.8785	.6054	.8773	.1002	.1734	.8159	.5468	.1507	-.7524	-.8566	.6101	.8706
.2003	-.8017	.6211	.8536	.1503	.0788	.7970	.5784	.5002	.7476	-.6058	.6602	.7934
.2503	-.7491	.6316	.8374	.1976	-.0086	.7800	.6064	.5002	.4976	-.6181	.6578	.7971
.3001	-.7162	.6382	.8273	.2503	-.0857	.7682	.6254	.5002	.2476	-.6247	.6565	.7992
.3502	-.6836	.6447	.8173	.3001	-.1051	.7603	.6380	.5002	-.2524	-.6117	.6591	.7952
.4003	-.6556	.6503	.8087	.3507	-.1334	.7546	.6469	.5002	-.5024	-.6098	.6625	.7946
.4501	-.6385	.6537	.8034	.4001	-.1426	.7528	.6499	.5002	-.7524	-.5952	.6624	.7901
.5002	-.6247	.6566	.7990	.4501	-.1423	.7529	.6497	.5002	.7476	-.3941	.7026	.7283
.5502	-.6172	.6580	.7969	.5001	-.1125	.7588	.6403	.5002	.4976	-.4029	.7008	.7310
.6002	-.6031	.6604	.7925	.5497	-.0493	.7714	.6201	.5002	.2476	-.4068	.6996	.7328
.6500	-.5807	.6653	.7857	.6003	.0259	.7865	.5958	.5002	-.5024	-.3980	.7018	.7295
.7000	-.5417	.6731	.7737	.6500	.0906	.7994	.5745	.5002	-.7524	-.3769	.7060	.7230
.7500	-.4850	.6844	.7563	.7000	.1807	.8174	.5443					
.8002	-.4679	.6908	.7326	.7501	.2634	.8339	.5158					
.9002	-.2116	.7390	.6716	.8001	.3314	.8485	.4900					
.9501	-.0893	.7637	.6326	.8501	.4045	.8621	.4651					

TEST	167	PT	26.1817	PSI		CN	.8018
RUN	18	TT	165.2359	K		CM	-.1274
POINT	27	PC	7.0026	MILLION		CC	-.0083
		MACH	.6001				
		ALPHA	3.0204	DEG			

CD1	.00980	CDCDR1	.00958
CD2	.00958	CDCDR2	.00930
CD3	.00929	CDCDR3	.00904
CD4	.00892	CDCDR4	.00871
CD5	.00900	CDCDR5	.00879

UPPER SURFACE				LOWER SURFACE				SPANWISE				
X/C	CP	P _o L/PT	MLOC	X/C	CP	P _o L/PT	MLOC	X/C	Y/(B/2)	CP	P _o L/PT	MLOC
0.0000	.9138	.9639	.2296	0.0000	.9138	.9639	.2296	.1507	.7476	-.9218	.5973	.8905
.0132	-1.5051	.4808	1.0788	.0126	.8209	.9454	.2843	.1507	.4976	-.9377	.5941	.8955
.0259	-1.9039	.4011	1.2212	.0255	.6185	.9049	.3803	.1507	.2476	-.9450	.5927	.8978
.0759	-1.1818	.5434	.9725	.0495	.4240	.8661	.4577	.1507	-.2524	-.9421	.5932	.8969
.1003	-1.0783	.5660	.9399	.0753	.2964	.8406	.5041	.1507	-.5024	-.9334	.5950	.8941
.1507	-.9318	.5953	.8936	.1002	.2092	.8232	.5344	.1507	-.7524	-.9097	.5997	.8868
.2003	-.8555	.6105	.8700	.1503	.1093	.8032	.5682	.5002	.7476	-.6293	.6557	.8003
.2503	-.7904	.6233	.8499	.1976	-.0192	.7852	.5978	.5002	.4976	-.6418	.6532	.8042
.3001	-.7527	.6311	.8383	.2503	-.0416	.7731	.6175	.5002	.2476	-.6480	.6520	.8061
.3502	-.7185	.6379	.8277	.3001	-.0827	.7649	.6306	.5002	-.2524	-.6339	.6548	.8018
.4003	-.6858	.6444	.8177	.3507	-.1134	.7588	.6404	.5002	-.5024	-.6325	.6551	.8013
.4501	-.6647	.6486	.8112	.4001	-.1251	.7564	.6441	.5002	-.7524	-.6188	.6578	.7971
.5002	-.6473	.6521	.8059	.4501	-.1277	.7559	.6450	.8002	.7476	-.4037	.7008	.7311
.5502	-.6376	.6541	.8029	.5001	-.1012	.7612	.6386	.8002	.4976	-.4105	.6994	.7331
.6002	-.6270	.6574	.7978	.5497	-.0415	.7731	.6175	.8002	.2476	-.4165	.6982	.7350
.6500	-.5934	.6625	.7899	.6003	.0305	.7875	.5941	.8002	-.5024	-.4054	.7004	.7316
.7000	-.5538	.6708	.7772	.6500	.0922	.7998	.5738	.8002	-.7524	-.3846	.7046	.7252
.7500	-.5152	.6826	.7591	.7000	.1799	.8173	.5444					
.8002	-.4755	.6984	.7347	.7501	.2607	.8335	.5167					
.8502	-.4363	.7182	.6729	.8001	.3321	.8477	.4914					
.9001	-.3993	.7626	.6344	.8501	.3993	.8612	.4669					

ORIGINAL PAGES
OF POOR QUALITY

TEST 167	PT 27.9993	PSI	CN	-.0261	C01	.00876	CDC01	.00855
RUN 20	TT 135.3580	K	CM	-.1121	C02	.00869	CDC02	.00850
POINT 42	RC 9.9891	MILLION	CC	.0037	C03	.00862	CDC03	.00844
	MACH .6016				C04	.00861	CDC04	.00843
	ALPHA -4.0120	DEG			C05	.00822	CDC05	.00800

UPPER SURFACE				LOWER SURFACE				SPANWISE				
X/C	CP	P/L/PT	MLOC	X/C	CP	P/L/PT	MLOC	X/C	Y/(B/2)	CP	P/L/PT	MLOC
0.0000	.5415	.8908	.4099	0.0000	.5415	.8908	.4099	1.507	.7476	-.1242	.7591	.6402
.0132	.5883	.9001	.3908	.0126	-.8569	.6141	.8648	1.507	.4976	-.1540	.7532	.6496
.0259	.2684	.8368	.5112	.0255	-.7163	.6419	.8219	1.507	.2476	-.1334	.7573	.6431
.0759	-.0269	.7783	.6093	.0495	-.6990	.6454	.8167	1.507	-.2524	-.1351	.7569	.6437
.1003	-.0727	.7693	.6239	.0753	-.6379	.6575	.7981	1.507	-.5024	-.1363	.7567	.6441
.1507	-.1236	.7592	.6400	.1002	-.6387	.6573	.7983	1.507	-.7524	-.1442	.7551	.6465
.2003	-.1719	.7496	.6552	.1503	-.5868	.6676	.7826	1.507	-.7476	-.3110	.7221	.6984
.2503	-.2076	.7426	.6663	.1976	-.6092	.6631	.7894	1.507	.4976	-.3164	.7211	.7000
.3001	-.2386	.7365	.6760	.2503	-.5893	.6671	.7833	1.507	.2476	-.3230	.7198	.7020
.3502	-.2569	.7328	.6816	.3001	-.5714	.6706	.7779	1.507	-.2524	-.3144	.7215	.6994
.4003	-.2757	.7291	.6874	.3507	-.5490	.6750	.7711	1.507	-.5024	-.3121	.7219	.6987
.4501	-.2982	.7247	.6944	.4001	-.5053	.6837	.7578	1.507	-.7524	-.2994	.7244	.6948
.5032	-.3221	.7199	.7018	.4501	-.4556	.6935	.7426	1.507	.4976	-.3082	.7227	.6975
.5502	-.3482	.7148	.7098	.5001	-.3753	.7094	.7181	1.507	.4976	-.3100	.7223	.6980
.6002	-.3654	.7114	.7151	.5497	-.2677	.7307	.6850	1.507	.2476	-.3116	.7220	.6985
.6500	-.3775	.7090	.7187	.6003	-.1529	.7334	.6492	1.507	-.5024	-.2990	.7245	.6946
.7000	-.3720	.7101	.7171	.6500	-.0598	.7276	.6186	1.507	-.7524	-.2836	.7275	.6899
.7500	-.3512	.7142	.7107	.7000	.0586	.7053	.5817					
.8032	-.3092	.7225	.6978	.7501	.1573	.8148	.5491					
.9002	-.1789	.7483	.6574	.8001	.2372	.8306	.5220					
.9501	-.0794	.7880	.6261	.8501	.3049	.8440	.4984					

TEST 167	PT 28.0060	PSI	CN	.0972	C01	.00855	CDC01	.00833
RUN 20	TT 135.1038	K	CM	-.1159	C02	.00852	CDC02	.00833
POINT 42	RC 10.0214	MILLION	CC	.0115	C03	.00848	CDC03	.00830
	MACH .6018				C04	.00840	CDC04	.00823
	ALPHA -2.9836	DEG			C05	.00787	CDC05	.00766

UPPER SURFACE				LOWER SURFACE				SPANWISE				
X/C	CP	P/L/PT	MLOC	X/C	CP	P/L/PT	MLOC	X/C	Y/(B/2)	CP	P/L/PT	MLOC
0.0000	.7829	.9382	.3034	0.0000	.7829	.9382	.3034	1.507	.7476	-.2199	.7368	.6723
.0132	.3972	.8615	.4665	.0126	-.4741	.6883	.7507	1.507	.4976	-.2408	.7347	.6788
.0259	.0739	.7972	.5785	.0255	-.4368	.6957	.7392	1.507	.2476	-.2368	.7355	.6775
.0759	-.1678	.7492	.6559	.0495	-.4780	.6875	.7519	1.507	-.2524	-.2394	.7350	.6783
.1003	-.1944	.7435	.6649	.0753	-.4633	.6905	.7473	1.507	-.5024	-.2387	.7351	.6781
.1507	-.2263	.7376	.6742	.1002	-.4659	.6858	.7546	1.507	-.7524	-.2408	.7347	.6788
.2003	-.2565	.7316	.6837	.1503	-.4670	.6897	.7485	1.507	-.7476	-.3601	.7110	.7157
.2503	-.2863	.7258	.6929	.1976	-.5049	.6822	.7601	1.507	.4976	-.3665	.7097	.7176
.3001	-.3100	.7209	.7002	.2503	-.5012	.6829	.7590	1.507	.2476	-.3723	.7085	.7194
.3502	-.3211	.7187	.7037	.3001	-.4953	.6841	.7572	1.507	-.2524	-.3636	.7103	.7188
.4003	-.3340	.7162	.7076	.3507	-.4813	.6869	.7529	1.507	-.5024	-.3611	.7108	.7180
.4501	-.3518	.7126	.7131	.4001	-.4480	.6933	.7427	1.507	-.7524	-.3474	.7135	.7118
.5032	-.3710	.7088	.7190	.4501	-.4072	.7016	.7302	1.507	.4976	-.3280	.7173	.7058
.5502	-.3927	.7045	.7257	.5001	-.3353	.7159	.7080	1.507	.4976	-.3292	.7171	.7061
.6002	-.4056	.7019	.7297	.5497	-.2349	.7359	.6769	1.507	.2476	-.3310	.7167	.7067
.6500	-.4133	.7004	.7320	.6003	-.1263	.7574	.6429	1.507	-.5024	-.3196	.7190	.7032
.7000	-.4029	.7025	.7288	.6500	-.0347	.7596	.6137	1.507	-.7524	-.3035	.7222	.6982
.7500	-.3766	.7077	.7208	.7000	.0769	.7978	.5775					
.8002	-.3291	.7171	.7061	.7501	.1741	.8172	.5450					
.9002	-.1880	.7452	.6623	.8001	.2540	.8330	.5177					
.9501	-.0832	.7660	.6292	.8501	.3229	.8467	.4935					

TEST 167	PT 28.0072	PSI	CN	.2132	C01	.00854	CDC01	.00834
RUN 20	TT 135.0947	K	CM	-.1182	C02	.00851	CDC02	.00832
POINT 44	RC 10.0202	MILLION	CC	.0198	C03	.00847	CDC03	.00830
	MACH .6016				C04	.00835	CDC04	.00815
	ALPHA -1.9958	DEG			C05	.00780	CDC05	.00753

UPPER SURFACE				LOWER SURFACE				SPANWISE				
X/C	CP	P/L/PT	MLOC	X/C	CP	P/L/PT	MLOC	X/C	Y/(B/2)	CP	P/L/PT	MLOC
0.0000	.9335	.9721	.2013	0.0000	.9335	.9721	.2013	1.507	.7476	-.3232	.7188	.7034
.0132	.1770	.8181	.5435	.0126	-.1563	.7520	.6516	1.507	.4976	-.3405	.7154	.7088
.0259	-.1449	.7542	.6480	.0255	-.2006	.7432	.6634	1.507	.2476	-.3426	.7150	.7094
.0759	-.3174	.7200	.7017	.0495	-.2849	.7264	.6916	1.507	-.2524	-.3453	.7145	.7103
.1003	-.3258	.7183	.7043	.0753	-.3077	.7219	.6987	1.507	-.5024	-.3439	.7147	.7098
.1507	-.3314	.7172	.7060	.1002	-.3497	.7136	.6987	1.507	-.7524	-.3392	.7157	.7084
.2003	-.3461	.7143	.7105	.1503	-.3572	.7121	.7139	1.507	.4976	-.4051	.7026	.7286
.2503	-.3647	.7106	.7162	.1976	-.4082	.7020	.7296	1.507	.2476	-.4117	.7011	.7310
.3001	-.3805	.7075	.7211	.2503	-.4188	.6999	.7328	1.507	.2476	-.4118	.6999	.7328
.3502	-.3817	.7072	.7214	.3001	-.4230	.6990	.7341	1.507	-.2524	-.4118	.7015	.7303
.4003	-.3893	.7057	.7238	.3507	-.4183	.7000	.7327	1.507	-.5024	-.4082	.7020	.7296
.4501	-.4023	.7032	.7278	.4001	-.3938	.7048	.7231	1.507	-.7524	-.3913	.7033	.7244
.5032	-.4162	.7004	.7320	.4501	-.3614	.7113	.7152	1.507	.4976	-.3418	.7132	.7092
.5502	-.4331	.6970	.7372	.5001	-.2978	.7239	.6956	1.507	.4976	-.3459	.7144	.7104
.6002	-.4415	.6953	.7399	.5497	-.2048	.7423	.6667	1.507	.2476	-.3488	.7138	.7113
.6500	-.4449	.6947	.7408	.6003	-.1023	.7627	.6345	1.507	-.5024	-.3390	.7157	.7083
.7000	-.4291	.6977	.7361	.6500	-.0102	.7798	.6070	1.507	-.7524	-.3219	.7191	.7030
.7500	-.3917	.7040	.7265	.7000	.0922	.8013	.5718					
.8002	-.3458	.7144	.7104	.7501	.1875	.8202	.5349					
.9002	-.1957	.7442	.6638	.8001	.2667	.8359	.5127					
.9501	-.0855	.7660	.6242	.8501	.3364	.8497	.4881					

TEST 167	PT 28.0120	PSI	CM .2712	CD1 .00850	CDCOR1 .00829
RUN 20	TT 135.1501	K	CM -.1192	CD2 .00848	CDCOR2 .00832
POINT 45	RC 10.0187	MILLION	CC .0168	CD3 .00844	CDCOR3 .00832
	MACH .6018			CD4 .00834	CDCOR4 .00820
	ALPHA -1.4969	DEG		CD5 .00780	CDCOR5 .00762

UPPER SURFACE				LOWER SURFACE				SPANWISE				
X/C	CP	P/L/PT	MLOC	X/C	CP	P/L/PT	MLOC	X/C	Y/(B/2)	CP	P/L/PT	MLOC
0.0000	1.0106	.9835	.1546	0.0000	1.0106	.9835	.1546	.1507	.7476	-.3790	.7076	.7210
.0132	-.0512	.7930	.5855	.0126	-.0161	.7796	.6073	.1507	.4976	-.3994	.7035	.7272
.0259	-.2669	.7298	.6864	.0255	-.0946	.7640	.6324	.1507	.2476	-.4012	.7031	.7278
.0759	-.4007	.7033	.7276	.0495	-.1973	.7436	.6647	.1507	-.2524	-.4048	.7024	.7289
.1003	-.3977	.7038	.7267	.0753	-.2362	.7359	.6768	.1507	-.5024	-.4049	.7024	.7289
.1507	-.3898	.7054	.7243	.1002	-.2859	.7261	.6922	.1507	-.7524	-.3942	.7045	.7256
.2003	-.3911	.7052	.7247	.1503	-.3060	.7220	.6985	.5002	.7476	-.4308	.6973	.7368
.2503	-.4081	.7018	.7299	.1976	-.3633	.7107	.7161	.5002	.4976	-.4389	.6957	.7393
.3001	-.4197	.6995	.7334	.2503	-.3807	.7072	.7215	.5002	.2476	-.4450	.6944	.7412
.3502	-.4144	.7005	.7318	.3001	-.3896	.7055	.7242	.5002	-.2524	-.4378	.6959	.7390
.4003	-.4196	.6995	.7334	.3507	-.3893	.7055	.7241	.5002	-.5024	-.4359	.6963	.7384
.4501	-.4305	.6973	.7368	.4001	-.3690	.7095	.7179	.5002	-.7524	-.4219	.6990	.7341
.5002	-.4415	.6952	.7401	.4501	-.3407	.7152	.7092	.8002	.7476	-.3503	.7133	.7121
.5502	-.4557	.6923	.7445	.5001	-.2812	.7270	.6908	.8002	.4976	-.3561	.7121	.7139
.6002	-.4622	.6910	.7464	.5497	-.1917	.7448	.6829	.8002	.2476	-.3593	.7115	.7149
.6500	-.4631	.6909	.7467	.6003	-.0922	.7645	.6316	.8002	-.5024	-.3914	.7130	.7125
.7000	-.4493	.6944	.7413	.6500	-.0088	.7811	.6049	.8002	-.7524	-.3340	.7165	.7071
.7500	-.4310	.7012	.7308	.7000	.0977	.8022	.5702					
.8002	-.3561	.7121	.7139	.7501	.1919	.8209	.5386					
.8002	-.2006	.7430	.6657	.8001	.2706	.8365	.5115					
.9501	-.0876	.7654	.6301	.8501	.3403	.8504	.4869					

TEST 167	PT 28.0108	PSI	CM -.3343	CD1 .00851	CDCOR1 .00832
RUN 20	TT 135.0128	K	CM -.1213	CD2 .00851	CDCOR2 .00834
POINT 46	PC 10.0358	MILLION	CC .0169	CD3 .00845	CDCOR3 .00833
	MACH .6021			CD4 .00835	CDCOR4 .00819
	ALPHA -1.0014	DEG		CD5 .00785	CDCOR5 .00766

UPPER SURFACE				LOWER SURFACE				SPANWISE				
X/C	CP	P/L/PT	MLOC	X/C	CP	P/L/PT	MLOC	X/C	Y/(B/2)	CP	P/L/PT	MLOC
0.0000	1.0561	.9925	.1037	0.0000	1.0561	.9925	.1037	.1507	.7476	-.4334	.6968	.7376
.0132	-.0864	.7657	.6297	.0126	-.1201	.8067	.5627	.1507	.4976	-.4533	.6928	.7437
.0259	-.3948	.7045	.7258	.0255	.0084	.7945	.5993	.1507	.2476	-.4557	.6924	.7444
.0759	-.4844	.6867	.7532	.0495	-.1058	.7618	.6359	.1507	-.2524	-.4587	.6918	.7453
.1003	-.4680	.6899	.7482	.0753	-.1596	.7911	.6529	.1507	-.5024	-.4582	.6919	.7452
.1507	-.4443	.6946	.7409	.1002	-.2179	.7396	.6711	.1507	-.7524	-.4425	.6950	.7404
.2003	-.4419	.6951	.7402	.1503	-.2491	.7334	.6808	.5002	.7476	-.44515	.6932	.7432
.2503	-.4470	.6941	.7418	.1976	-.3118	.7209	.7002	.5002	.4976	-.4598	.6916	.7457
.3001	-.4536	.6928	.7438	.2503	-.3351	.7163	.7074	.5002	.2476	-.4658	.6904	.7475
.3502	-.4478	.6939	.7420	.3001	-.3485	.7136	.7115	.5002	-.2524	-.4567	.6922	.7447
.4003	-.4442	.6939	.7421	.3507	-.3525	.7128	.7128	.5002	-.5024	-.4590	.6925	.7442
.4501	-.4553	.6924	.7443	.4001	-.3261	.7161	.7077	.5002	-.7524	-.4449	.6945	.7411
.5002	-.4634	.6908	.7464	.4501	-.3118	.7209	.7002	.8002	.7476	-.3364	.7121	.7140
.5502	-.4756	.6884	.7505	.5001	-.2560	.7320	.6829	.8002	.4976	-.3616	.7110	.7156
.6002	-.4795	.6876	.7517	.5497	-.1701	.7491	.6562	.8002	.2476	-.3693	.7103	.7167
.6500	-.4775	.6880	.7511	.6003	-.0741	.7681	.6258	.8002	-.5024	-.3945	.7124	.7134
.7000	-.4571	.6921	.7449	.6500	.0066	.7841	.5999	.8002	-.7524	-.3367	.7160	.7079
.7500	-.4204	.6994	.7336	.7000	.1111	.8049	.5657					
.8002	-.3626	.7108	.7159	.7501	.2038	.8233	.5346					
.9002	-.2021	.7427	.6602	.8001	.2818	.8388	.5076					
.9501	-.0887	.7652	.6305	.8501	.3514	.8526	.4829					

TEST 167	PT 28.0083	PSI	CM .3941	CD1 .00862	CDCOR1 .00844
RUN 20	TT 135.0792	K	CM -.1228	CD2 .00857	CDCOR2 .00840
POINT 47	RC 10.0238	MILLION	CC .0162	CD3 .00852	CDCOR3 .00838
	MACH .6017			CD4 .00840	CDCOR4 .00822
	ALPHA -1.4990	DEG		CD5 .00765	CDCOR5 .00742

UPPER SURFACE				LOWER SURFACE				SPANWISE				
X/C	CP	P/L/PT	MLOC	X/C	CP	P/L/PT	MLOC	X/C	Y/(B/2)	CP	P/L/PT	MLOC
0.0000	1.0824	.9977	.0566	0.0000	1.0824	.9977	.0566	.1507	.7476	-.4940	.6851	.7555
.0132	-.2340	.7367	.6756	.0126	.2392	.8305	.5220	.1507	.4976	-.5150	.6810	.7619
.0259	-.5314	.6777	.7669	.0255	.0945	.8019	.5708	.1507	.2476	-.5166	.6807	.7624
.0759	-.5736	.6694	.7798	.0495	-.0287	.7774	.6108	.1507	-.2524	-.5195	.6801	.7633
.1003	-.5438	.6753	.7707	.0753	-.0924	.7648	.6312	.1507	-.5024	-.5197	.6800	.7634
.1507	-.5051	.6829	.7589	.1002	-.1565	.7521	.6514	.1507	-.7524	-.4934	.6853	.7594
.2003	-.4936	.6892	.7554	.1503	-.1989	.7437	.6647	.5002	.7476	-.4765	.6886	.7502
.2503	-.4931	.6897	.7547	.1976	-.2671	.7301	.6859	.5002	.4976	-.4849	.6869	.7528
.3001	-.4931	.6893	.7553	.2503	-.2968	.7243	.6950	.5002	.2476	-.4912	.6857	.7547
.3502	-.4812	.6871	.7516	.3001	-.3145	.7207	.7005	.5002	-.2524	-.4824	.6874	.7520
.4003	-.4786	.6882	.7508	.3507	-.3224	.7192	.7030	.5002	-.5024	-.4805	.6878	.7514
.4501	-.4436	.6872	.7524	.4001	-.3101	.7216	.6991	.5002	-.7524	-.4656	.6906	.7469
.5002	-.4486	.6862	.7539	.4501	-.2895	.7257	.6928	.8002	.7476	-.3648	.7108	.7160
.5502	-.4480	.6863	.7568	.5001	-.2376	.7360	.6767	.8002	.4976	-.3707	.7096	.7178
.6002	-.4494	.6860	.7572	.5497	-.1590	.7524	.6509	.8002	.2476	-.3747	.7088	.7190
.6500	-.4453	.6869	.7559	.6003	-.0618	.7708	.6214	.8002	-.5024	-.3649	.7107	.7160
.7000	-.4723	.6894	.7489	.6500	.0161	.7863	.5964	.8002	-.7524	-.3465	.7144	.7104
.7500	-.4327	.6973	.7369	.7000	.1191	.8067	.5627					
.8002	-.3723	.7693	.7183	.7501	.2107	.8249	.5318					
.8002	-.2064	.7421	.6671	.8001	.2882	.8402	.5050					
.9501	-.0899	.7653	.6304	.8501	.3579	.8541	.4802					

TEST	167	PT	28.0086	PSI	CM	.4532	CD1	.00859	CDCOR1	.00838		
RUN	20	TT	135.0886	K	CM	-.1236	CD2	.00859	CDCOR2	.00841		
POINT	48	RC	10.0203	MILLION	CC	.0146	CD3	.00848	CDCOR3	.00834		
		MACH	.6019				CD4	.00836	CDCOR4	.00818		
		ALPHA	.0000	DEG			CD5	.00756	CDCOR5	.00729		
UPPER SURFACE				LOWER SURFACE				SPANWISE				
X/C	CP	P/L/PT	MLOC	X/C	CP	P/L/PT	MLOC	X/C	Y/(B/2)	CP	P/L/PT	MLOC
0.0000	1.0916	.9997	.0219	0.0000	1.0916	.9997	.0219	.1507	.7476	-.5498	.6754	.7706
.0132	-.3929	.7064	.7228	.0126	.3534	.8338	.4806	.1507	.4976	-.5722	.6709	.7774
.0259	-.6909	.6475	.8134	.0255	-.1859	.8207	.5390	.1507	.2476	-.5750	.6704	.7782
.0759	-.6654	.6525	.8057	.0495	-.0456	.7930	.5854	.1507	-.2524	-.5780	.6698	.7791
.1003	-.6197	.6616	.7948	.0753	-.0270	.7787	.6088	.1507	-.5024	-.5781	.6698	.7792
.1507	-.5632	.6727	.7746	.1002	-.0971	.7648	.6311	.1507	-.7524	-.5752	.6747	.7716
.2003	-.5445	.6764	.7690	.1503	-.1493	.7545	.6475	.5002	.7476	-.4975	.6857	.7547
.2503	-.5314	.6790	.7650	.1976	-.2222	.7401	.6703	.5002	.4976	-.5064	.6839	.7574
.3001	-.5277	.6797	.7639	.2503	-.2574	.7331	.6812	.5002	.2476	-.5129	.6827	.7594
.3502	-.5135	.6825	.7595	.3001	-.2790	.7289	.6879	.5002	-.2524	-.5041	.6844	.7567
.4003	-.5068	.6839	.7575	.3507	-.2906	.7266	.6914	.5002	-.5024	-.5023	.6848	.7561
.4501	-.5086	.6835	.7580	.4001	-.2819	.7283	.6887	.5002	-.7524	-.4865	.6879	.7513
.5002	-.5108	.6831	.7587	.4501	-.2651	.7316	.6836	.8002	.7476	-.3697	.7110	.7157
.5502	-.5175	.6818	.7607	.5001	-.2170	.7411	.6687	.8002	.4976	-.3767	.7096	.7178
.6002	-.5166	.6819	.7605	.5497	-.1381	.7567	.6440	.8002	.2476	-.3810	.7087	.7192
.6500	-.5098	.6833	.7584	.6003	-.0481	.7745	.6136	.8002	-.5024	-.3718	.7105	.7163
.7000	-.4843	.6883	.7507	.6500	.0268	.7893	.5915	.8002	-.7524	-.3531	.7142	.7106
.7500	-.4421	.6966	.7378	.7000	.1278	.8092	.5584					
.8002	-.3793	.7051	.7186	.7501	.2180	.8271	.5281					
.9002	-.2092	.7427	.6662	.8001	.2945	.8422	.5016					
.9501	-.0908	.7661	.6291	.8501	.3640	.8559	.4768					

TEST	167	PT	28.0077	PSI	CM	.5147	CD1	.00870	CDCOR1	.00852		
RUN	20	TT	135.1009	K	CM	-.1246	CD2	.00863	CDCOR2	.00848		
POINT	49	RC	10.0165	MILLION	CC	.0123	CD3	.00855	CDCOR3	.00845		
		MACH	.6013				CD4	.00835	CDCOR4	.00820		
		ALPHA	.5120	DEG			CD5	.00764	CDCOR5	.00737		
UPPER SURFACE				LOWER SURFACE				SPANWISE				
X/C	CP	P/L/PT	MLOC	X/C	CP	P/L/PT	MLOC	X/C	Y/(B/2)	CP	P/L/PT	MLOC
0.0000	1.0899	.9993	.0326	0.0000	1.0899	.9993	.0326	.1507	.7476	-.6153	.6614	.7920
.0132	-.3644	.6715	.7765	.0126	.4352	.8735	.4439	.1507	.4976	-.6376	.6570	.7988
.0259	-.8526	.6132	.8663	.0255	-.2734	.8375	.5179	.1507	.2476	-.6405	.6564	.7997
.0759	-.7672	.6313	.8383	.0495	-.1124	.8036	.5709	.1507	-.2524	-.6436	.6558	.8006
.1003	-.7040	.6438	.8190	.0753	-.0376	.7908	.5944	.1507	-.5024	-.6433	.6559	.8005
.1507	-.6276	.6590	.7958	.1002	-.0382	.7797	.6135	.1507	-.7524	-.6200	.6605	.7935
.2003	-.5955	.6653	.7860	.1503	-.1001	.7681	.6377	.5002	.7476	-.5227	.6788	.7638
.2503	-.5770	.6690	.7804	.1976	-.1788	.7481	.6577	.5002	.4976	-.5318	.6790	.7666
.3001	-.5679	.6768	.7776	.2503	-.2104	.7400	.6703	.5002	.2476	-.5384	.6767	.7686
.3502	-.5482	.6747	.7716	.3001	-.2441	.7350	.6783	.5002	-.2524	-.5288	.6785	.7657
.4003	-.5380	.6767	.7685	.3507	-.2595	.7319	.6931	.5002	-.5024	-.5273	.6788	.7652
.4501	-.5347	.6774	.7675	.4001	-.2544	.7329	.6815	.5002	-.7524	-.5152	.6812	.7616
.5002	-.5355	.6772	.7677	.4501	-.2413	.7355	.6774	.8002	.7476	-.3794	.7081	.7201
.5502	-.5399	.6764	.7691	.5001	-.1969	.7443	.6636	.8002	.4976	-.3856	.7069	.7219
.6002	-.5362	.6771	.7679	.5497	-.1215	.7592	.6400	.8002	.2476	-.3900	.7061	.7233
.6500	-.5265	.6790	.7650	.6003	-.0348	.7784	.6125	.8002	-.5024	-.3806	.7079	.7204
.7000	-.4986	.6845	.7565	.6500	.0373	.7907	.5892	.8002	-.7524	-.3622	.7116	.7148
.7500	-.4537	.6934	.7428	.7000	.1362	.8103	.5566					
.8002	-.3880	.7005	.7227	.7501	.2249	.8279	.5267					
.9002	-.2126	.7412	.6685	.8001	.3004	.8428	.5004					
.9501	-.0926	.7650	.6308	.8501	.3693	.8565	.4757					

TEST	167	PT	28.0127	PSI	CM	.5773	CD1	.00881	CDCOR1	.00861		
RUN	20	TT	134.9725	K	CM	-.1258	CD2	.00882	CDCOR2	.00867		
POINT	50	RC	10.0312	MILLION	CC	.0093	CD3	.00866	CDCOR3	.00857		
		MACH	.6013				CD4	.00843	CDCOR4	.00828		
		ALPHA	1.0083	DEG			CD5	.00781	CDCOR5	.00755		
UPPER SURFACE				LOWER SURFACE				SPANWISE				
X/C	CP	P/L/PT	MLOC	X/C	CP	P/L/PT	MLOC	X/C	Y/(B/2)	CP	P/L/PT	MLOC
0.0000	1.0816	.9978	.0367	0.0000	1.0816	.9978	.0367	.1507	.7476	-.6773	.6509	.8081
.0132	-.7471	.6772	.8293	.0126	.5513	.8932	.4051	.1507	.4976	-.6989	.6485	.8148
.0259	-.6348	.5804	.9174	.0255	-.3389	.8552	.4781	.1507	.2476	-.7028	.6499	.8159
.0759	-.8697	.6130	.8666	.0495	-.1826	.8205	.5394	.1507	-.2524	-.7049	.6495	.8165
.1003	-.7870	.6293	.8414	.0753	-.0969	.8036	.5679	.1507	-.5024	-.7024	.6460	.8158
.1507	-.6901	.6484	.8120	.1002	-.0202	.7884	.5929	.1507	-.7524	-.6786	.6507	.8085
.2003	-.6516	.6560	.8004	.1503	-.0502	.7746	.6194	.5002	.7476	-.5447	.6771	.7680
.2503	-.6200	.6622	.7908	.1976	-.1315	.7503	.6411	.5002	.4976	-.5539	.6752	.7708
.3001	-.6093	.6651	.7863	.2503	-.1774	.7495	.6535	.5002	.2476	-.5602	.6740	.7727
.3502	-.5822	.6697	.7793	.3001	-.2068	.7437	.6646	.5002	-.2524	-.5497	.6761	.7695
.4003	-.5673	.6726	.7748	.3507	-.2259	.7399	.6705	.5002	-.5024	-.5483	.6763	.7691
.4501	-.5609	.6739	.7729	.4001	-.2244	.7402	.6701	.5002	-.7524	-.5340	.6792	.7647
.5002	-.5585	.6743	.7722	.4501	-.2149	.7421	.6671	.8002	.7476	-.3875	.7081	.7202
.5502	-.5601	.6740	.7726	.5001	-.1743	.7501	.6545	.8002	.4976	-.3925	.7071	.7217
.6002	-.5577	.6753	.7707	.5497	-.1024	.7643	.6320	.8002	.2476	-.3964	.7063	.7229
.6500	-.5412	.6777	.7669	.6003	-.0189	.7807	.6035	.8002	-.5024	-.3853	.7095	.7195
.7000	-.5106	.6838	.7576	.6500	.0504	.7944	.5831	.8002	-.7524	-.3663	.7122	.7137
.7500	-.4630	.6932	.7432	.7000	.1473	.8135	.5512					
.8002	-.3947	.7066	.7224	.7501	.2345	.8307	.5218					
.9002	-.2146	.7422	.6670	.8001	.3092	.8456	.4958					
.9501	-.0931	.7661	.6290	.8501	.3779	.8590	.4712					

ORIGINAL
OF POC

TEST 167 PT 28.0104 PSI CN .6371 CD1 .00891 CDCOR1 .00891
 RUN 20 TT 135.1952 K CM -.1270 CD2 .00887 CDCOR2 .00891
 POINT 51 RC 9.9984 MILLION CC .0057 CD3 .00864 CDCOR3 .00871
 MACH .6006 CD4 .00845 CDCOR4 .00846
 ALPHA 1.4969 DEG CD5 .00791 CDCOR5 .00777

UPPER SURFACE				LOWER SURFACE				SPANWISE				
X/C	CP	P/L/PT	MLOC	X/C	CP	P/L/PT	MLOC	X/C	Y/(B/2)	CP	P/L/PT	MLOC
0.0000	1.0587	.9933	.0979	0.0000	1.0587	.9933	.0979	.1507	.7476	-.7438	.6388	.8268
.0132	-.9326	.6016	.8843	.0126	.6276	.9085	.3728	.1507	.4976	-.7652	.6346	.8333
.0259	-1.2339	.5424	.9777	.0255	.4277	.8692	.4521	.1507	.2476	-.7686	.6339	.8343
.0759	-.9767	.5929	.8977	.0495	.2436	.8330	.5178	.1507	-.2524	-.7703	.6335	.8349
.1003	-.8733	.6133	.8661	.0753	.1488	.8143	.5498	.1507	-.5024	-.7678	.6340	.8341
.1507	-.7536	.6364	.8304	.1002	.0649	.7982	.5768	.1507	-.7524	-.7436	.6388	.8268
.2003	-.7042	.6466	.8148	.1507	-.0098	.7831	.6015	.5002	.7476	-.5707	.6728	.7745
.2503	-.6664	.6540	.8034	.1976	-.0952	.7663	.6287	.5002	.4976	-.5804	.6709	.7774
.3001	-.6463	.6579	.7973	.2503	-.1437	.7564	.6445	.5002	.2476	-.5868	.6696	.7794
.3502	-.6212	.6629	.7898	.3001	-.1785	.7498	.6547	.5002	-.2524	-.5753	.6719	.7759
.4003	-.6013	.6668	.7838	.3507	-.2006	.7456	.6616	.5002	-.5024	-.5737	.6722	.7754
.4501	-.5912	.6688	.7807	.4001	-.2023	.7453	.6621	.5002	-.7524	-.5612	.6747	.7716
.5002	-.5857	.6699	.7790	.4501	-.1957	.7456	.6621	.8002	.7476	-.3964	.7071	.7217
.5502	-.5847	.6701	.7787	.5001	-.1887	.7459	.6601	.8002	.4976	-.4021	.7060	.7234
.6002	-.5759	.6718	.7761	.5497	-.0898	.7674	.6270	.8002	.2476	-.4070	.7050	.7249
.6500	-.5601	.6749	.7713	.6003	-.0091	.7833	.6013	.8002	-.5024	-.3954	.7073	.7214
.7000	-.5271	.6814	.7613	.6500	.0580	.7965	.5797	.8002	-.7524	-.3763	.7110	.7156
.7500	-.4769	.6913	.7461	.7000	.1531	.8152	.5484					
.8002	-.4060	.7052	.7246	.7501	.2388	.8320	.5194					
.9002	-.2211	.7416	.6679	.8001	.3129	.8466	.4937					
.9501	-.0984	.7657	.6297	.8501	.3813	.8601	.4692					

TEST 167 PT 28.0104 PSI CN .6967 CD1 .00908 CDCOR1 .00885
 RUN 20 TT 135.2964 K CM -.1261 CD2 .00909 CDCOR2 .00888
 POINT 52 RC 9.9985 MILLION CC .0007 CD3 .00893 CDCOR3 .00864
 MACH .6012 CD4 .00860 CDCOR4 .00838
 ALPHA 2.0061 DEG CD5 .00811 CDCOR5 .00788

UPPER SURFACE				LOWER SURFACE				SPANWISE				
X/C	CP	P/L/PT	MLOC	X/C	CP	P/L/PT	MLOC	X/C	Y/(B/2)	CP	P/L/PT	MLOC
0.0000	1.0206	.9856	.1440	0.0000	1.0206	.9856	.1440	.1507	.7476	-.8023	.6252	.8477
.0132	-1.1313	.5602	.9493	.0126	.7112	.9244	.3369	.1507	.4976	-.8245	.6208	.8545
.0259	-1.4682	.4936	1.0577	.0255	.5072	.8841	.4233	.1507	.2476	-.8287	.6200	.8558
.0759	-1.0837	.5696	.9344	.0495	.3150	.8461	.4946	.1507	-.2524	-.8291	.6199	.8559
.1003	-.9565	.5947	.8949	.0753	.2108	.8255	.5307	.1507	-.5024	-.8244	.6209	.8544
.1507	-.8146	.6228	.8515	.1002	.1244	.8084	.5994	.1507	-.7524	-.7986	.6260	.8466
.2003	-.7488	.6358	.8314	.1503	.0405	.7919	.5873	.5002	.7476	-.5866	.6679	.7821
.2503	-.7043	.6446	.8178	.1976	-.0483	.7743	.6159	.5002	.4976	-.5913	.6659	.7851
.3001	-.6782	.6494	.8099	.2503	-.1032	.7634	.6333	.5002	.2476	-.6028	.6647	.7870
.3502	-.6472	.6559	.8003	.3001	-.1394	.7563	.6447	.5002	-.2524	-.5913	.6689	.7835
.4003	-.6245	.6604	.7936	.3507	-.1647	.7513	.6526	.5002	-.5024	-.5700	.6672	.7831
.4501	-.6099	.6633	.7892	.4001	-.1697	.7503	.6542	.5002	-.7524	-.5745	.6703	.7784
.5002	-.6006	.6651	.7863	.4501	-.1665	.7509	.6532	.8002	.7476	-.3969	.7054	.7243
.5502	-.5971	.6658	.7853	.5001	-.1332	.7575	.6428	.8002	.4976	-.4020	.7044	.7259
.6002	-.5859	.6680	.7819	.5497	-.0680	.7704	.6222	.8002	.2476	-.4070	.7034	.7274
.6500	-.5664	.6719	.7760	.6003	.0093	.7857	.5974	.8002	-.5024	-.3954	.7057	.7239
.7000	-.5308	.6749	.7651	.6500	.0738	.7984	.5764	.8002	-.7524	-.3769	.7093	.7182
.7500	-.4779	.6894	.7490	.7000	.1664	.8167	.5458					
.8002	-.4043	.7039	.7266	.7501	.2502	.8333	.5172					
.9002	-.2145	.7414	.6682	.8001	.3228	.8477	.4918					
.9501	-.0970	.7656	.6298	.8501	.3905	.8610	.4674					

TEST 167 PT 26.5132 PSI CN .7533 CD1 .00922 CDCOR1 .00900
 RUN 20 TT 130.1067 K CM -.1252 CD2 .00918 CDCOR2 .00898
 POINT 51 RC 9.9805 MILLION CC -.0047 CD3 .00897 CDCOR3 .00875
 MACH .5982 CD4 .00873 CDCOR4 .00851
 ALPHA 2.5152 DEG CD5 .00826 CDCOR5 .00797

UPPER SURFACE				LOWER SURFACE				SPANWISE				
X/C	CP	P/L/PT	MLOC	X/C	CP	P/L/PT	MLOC	X/C	Y/(B/2)	CP	P/L/PT	MLOC
0.0000	.9641	.9746	.1920	0.0000	.9641	.9746	.1920	.1507	.7476	-.8737	.6125	.8674
.0132	-1.3298	.5227	1.0097	.0126	.7644	.9353	.3109	.1507	.4976	-.8984	.6077	.8749
.0259	-1.7398	.4419	1.1469	.0255	.5601	.8950	.4013	.1507	.2476	-.9032	.6067	.8764
.0759	-1.1989	.5485	.9640	.0495	.3638	.8563	.4761	.1507	-.2524	-.9052	.6063	.8770
.1003	-1.0507	.5777	.9218	.0753	.2503	.8340	.5161	.1507	-.5024	-.8993	.6075	.8752
.1507	-.8881	.6097	.8718	.1002	.1623	.8166	.5460	.1507	-.7524	-.8737	.6125	.8674
.2003	-.8046	.6262	.8464	.1503	.0707	.7986	.5763	.5002	.7476	-.6182	.6629	.7899
.2503	-.7580	.6353	.8322	.1976	-.0212	.7805	.6059	.5002	.4976	-.6292	.6607	.7932
.3001	-.7264	.6416	.8226	.2503	-.0906	.7689	.6244	.5002	.2476	-.6359	.6594	.7952
.3502	-.6875	.6482	.8108	.3001	-.1198	.7611	.6372	.5002	-.2524	-.6260	.6613	.7922
.4003	-.64617	.6543	.8030	.3507	-.1483	.7555	.6461	.5002	-.5024	-.6251	.6615	.7919
.4501	-.6447	.6577	.7979	.4001	-.1567	.7538	.6487	.5002	-.7524	-.6106	.6644	.7875
.5002	-.6319	.6602	.7940	.4501	-.1564	.7539	.6486	.8002	.7476	-.4126	.7034	.7275
.5502	-.6251	.6615	.7919	.5001	-.1268	.7597	.6394	.8002	.4976	-.4186	.7022	.7293
.6002	-.6118	.6641	.7879	.5497	-.0646	.7719	.6197	.8002	.2476	-.4234	.7013	.7308
.6500	-.5884	.6685	.7812	.6003	.0100	.7866	.5959	.8002	-.5024	-.4143	.7030	.7280
.7000	-.5515	.6760	.7697	.6500	.0723	.7989	.5757	.8002	-.7524	-.3954	.7068	.7222
.7500	-.4956	.6870	.7527	.7000	.1625	.8167	.5459					
.8002	-.4194	.7020	.7296	.7501	.2448	.8329	.5180					
.9002	-.2254	.7403	.6701	.8001	.3165	.8470	.4933					
.9501	-.0991	.7651	.6307	.8501	.3836	.8602	.4689					

TEST 167	PT 26.9270	PSI	CM .8013	CD1 .00977	CDCOR1 .00955
AUN 20	TT 130.2245	K	CM -.1259	CD2 .00970	CDCOR2 .00949
POINT 54	RC 9.9972	MILLION	CC -.0082	CD3 .00950	CDCOR3 .00932
	MACH .6002			CD4 .00921	CDCOR4 .00898
	ALPHA 3.0141	DEG		CD5 .00885	CDCOR5 .00858

UPPER SURFACE				LOWER SURFACE				SPANWISE				
X/C	CP	P/L/PT	MLOC	X/C	CP	P/L/PT	MLOC	X/C	Y/(B/2)	CP	P/L/PT	MLOC
0.0000	.9073	.9631	.2324	0.0000	.9073	.9631	.2324	.1507	.7476	-.9286	.3996	.8875
.0132	-1.4903	.4883	1.0866	.0126	.8228	.9464	.2818	.1507	.4976	-.9509	.3952	.8944
.0259	-1.9057	.4081	1.2125	.0255	.6197	.9062	.3779	.1507	.2476	-.9566	.3940	.8962
.0759	-1.2220	.3415	.9792	.0495	.4204	.8667	.4569	.1507	-.2524	-.9593	.3935	.8970
.1003	-1.1527	.3651	.9416	.0753	.3004	.8429	.5003	.1507	-.5024	-.9514	.3951	.8945
.1507	-.9419	.5969	.8915	.1002	.2080	.8246	.5323	.1507	-.7524	-.9265	.6000	.8869
.2003	-.8435	.6164	.8614	.1503	.1111	.8054	.5649	.5002	.7476	-.8400	.6567	.7993
.2533	-.7977	.6255	.8474	.1976	.0167	.7868	.5957	.5002	.4976	-.8499	.6548	.8023
.3001	-.7611	.6327	.8362	.2503	-.0463	.7743	.6160	.5002	.2476	-.8561	.6535	.8042
.3502	-.7152	.6418	.8222	.3001	-.0885	.7659	.6294	.5002	-.2524	-.8636	.6556	.8010
.4003	-.6878	.6473	.8158	.3507	-.1202	.7596	.6394	.5002	-.5024	-.8647	.6558	.8007
.4501	-.6678	.6512	.8078	.4001	-.1312	.7579	.6429	.5002	-.7524	-.8295	.6588	.7961
.5002	-.6510	.6545	.8027	.4501	-.1335	.7571	.6436	.8002	.7476	-.8171	.7009	.7314
.5502	-.6417	.6564	.7998	.5001	-.1069	.7623	.6353	.8002	.4976	-.8209	.7001	.7326
.6002	-.6254	.6596	.7949	.5497	-.0479	.7740	.6165	.8002	.2476	-.8257	.6992	.7340
.6500	-.5999	.6647	.7871	.6003	.0238	.7882	.5934	.8002	-.5024	-.8160	.7011	.7311
.7000	-.5586	.6728	.7746	.6500	.0842	.8001	.5737	.8002	-.7524	-.8365	.7049	.7251
.7500	-.4996	.6845	.7566	.7000	.1723	.8176	.5444					
.8002	-.4402	.7002	.7324	.7501	.2530	.8335	.5169					
.8002	-.2205	.7398	.6708	.8001	.3238	.8476	.4720					
.9501	-.0960	.7644	.6318	.8501	.3903	.8607	.4480					

TEST 167	PT 26.5237	PSI	CM .8766	CD1 .01111	CDCOR1 .01084
AUN 20	TT 130.2314	K	CM -.1239	CD2 .01110	CDCOR2 .01082
POINT 55	RC 10.0017	MILLION	CC -.0177	CD3 .01083	CDCOR3 .01058
	MACH .6008			CD4 .01040	CDCOR4 .01009
	ALPHA 3.5029	DEG		CD5 .01038	CDCOR5 .01002

UPPER SURFACE				LOWER SURFACE				SPANWISE				
X/C	CP	P/L/PT	MLOC	X/C	CP	P/L/PT	MLOC	X/C	Y/(B/2)	CP	P/L/PT	MLOC
0.0000	.9488	.9514	.2678	0.0000	.8488	.9514	.2678	.1507	.7476	-.9614	.3924	.8886
.0132	-1.6645	.6530	1.1273	.0126	.8830	.9582	.2478	.1507	.4976	-.9666	.3914	.8903
.0259	-2.0373	.3791	1.2644	.0255	.6832	.9186	.3505	.1507	.2476	-.9718	.3904	.8918
.0759	-1.9425	.3979	1.2280	.0495	.4871	.8797	.4320	.1507	-.2524	-.9687	.3910	.8909
.1003	-1.1098	.5630	.9449	.0753	.3611	.8567	.4791	.1507	-.5024	-.9603	.3926	.8934
.1507	-.9561	.5935	.8970	.1002	.2666	.8358	.5129	.1507	-.7524	-.9444	.6558	.8883
.2003	-.8849	.6076	.8750	.1503	.1646	.8157	.5475	.5002	.7476	-.8634	.6554	.8012
.2533	-.8184	.6208	.8566	.1976	.0683	.7966	.5795	.5002	.4976	-.8634	.6534	.8044
.3001	-.7779	.6288	.8422	.2503	.0017	.7834	.6012	.5002	.2476	-.8699	.6522	.8062
.3502	-.7446	.6354	.8320	.3001	-.0430	.7746	.6155	.5002	-.2524	-.8649	.6552	.8017
.4003	-.7069	.6429	.8206	.3507	-.0773	.7677	.6285	.5002	-.5024	-.8640	.6554	.8014
.4501	-.6802	.6482	.8124	.4001	-.0913	.7650	.6309	.5002	-.7524	-.8264	.6588	.7960
.5002	-.6608	.6520	.8065	.4501	-.0967	.7639	.6326	.8002	.7476	-.8024	.7033	.7276
.5502	-.6490	.6544	.8029	.5001	-.0734	.7685	.6252	.8002	.4976	-.8065	.7025	.7289
.6002	-.6297	.6582	.7970	.5497	-.0178	.7796	.6074	.8002	.2476	-.8130	.7012	.7309
.6500	-.5996	.6642	.7878	.6003	.0510	.7932	.5852	.8002	-.5024	-.8379	.7042	.7263
.7000	-.5557	.6729	.7745	.6500	.1088	.8047	.5662	.8002	-.7524	-.8387	.7080	.7204
.7500	-.4943	.6851	.7557	.7000	.1946	.8217	.5374					
.8002	-.4126	.7013	.7308	.7501	.2733	.8373	.5103					
.8002	-.2102	.7414	.6683	.8001	.3428	.8511	.4857					
.9501	-.0903	.7652	.6306	.8501	.4084	.8641	.4618					

TEST	167	PT	33.1507	PSI	CM	-.0160	CD1	.00622	CDCOR1	.00803
RUN	21	TT	115.2706	K	CM	-.1147	CD2	.00813	CDCOR2	.00796
POINT	56	RC	14.9529	MILLION	CC	.0048	CD3	.00807	CDCOR3	.00793
		MACH	.8013				CD4	.00813	CDCOR4	.00794
		ALPHA	-3.9815	DEG			CD5	.00790	CDCOR5	.00765

UPPER SURFACE				LOWER SURFACE				SPANWISE				
X/C	CP	P.L./PT	MLOC	X/C	CP	P.L./PT	MLOC	X/C	Y/(B/2)	CP	P.L./PT	MLOC
0.0000	.5645	.8949	.4020	0.0000	.5645	.8949	.4020	.1507	.7476	-.1294	.7579	.6427
.0132	.5850	.8999	.3936	.0126	-.8108	.6219	.8531	.1507	.4976	-.1352	.7560	.6458
.0259	.2672	.8358	.5133	.0255	-.7077	.6423	.9221	.1507	.2476	-.1348	.7560	.6457
.0759	-.0311	.7766	.6127	.0495	-.6872	.6464	.9158	.1507	-.2524	-.1384	.7553	.6466
.1003	-.0756	.7678	.6269	.0753	-.6274	.6583	.7976	.1507	-.5024	-.1419	.7546	.6480
.1507	-.1268	.7576	.6432	.1002	-.8308	.6576	.7986	.1507	-.7524	-.1334	.7563	.6453
.2003	-.1698	.7491	.6567	.1503	-.5790	.6679	.7829	.5002	.7476	-.3136	.7206	.7015
.2503	-.2083	.7415	.6688	.1976	-.6018	.6633	.7899	.5002	.4976	-.3187	.7195	.7030
.3001	-.2397	.7352	.6784	.2503	-.5821	.6673	.7433	.5002	.2476	-.3238	.7185	.7046
.3502	-.2585	.7315	.6844	.3001	-.5643	.6708	.7783	.5002	-.2524	-.3149	.7203	.7019
.4003	-.2762	.7280	.6899	.3507	-.5419	.6752	.7715	.5002	-.5024	-.3129	.7207	.7012
.4501	-.2975	.7238	.6965	.4021	-.5178	.6839	.7582	.5002	-.7524	-.2992	.7234	.6970
.5002	-.3230	.7187	.7044	.4501	-.4502	.6934	.7434	.8002	.7476	-.2132	.7206	.7013
.5502	-.3494	.7134	.7125	.5001	-.3692	.7095	.7186	.8002	.4976	-.3110	.7211	.7007
.6002	-.3864	.7101	.7178	.5497	-.2820	.7308	.6455	.8002	.2476	-.3120	.7209	.7010
.6500	-.3789	.7076	.7214	.6003	-.1449	.7537	.6495	.8002	-.5024	-.2972	.7238	.6964
.7000	-.3728	.7088	.7197	.6500	-.0527	.7723	.6196	.8002	-.7524	-.2840	.7264	.6923
.7500	-.3523	.7129	.7134	.7000	.0647	.7956	.5816					
.8002	-.3103	.7212	.7003	.7501	.1658	.8157	.5480					
.9002	-.1895	.7470	.6601	.8001	.2480	.8320	.5200					
.9501	-.0821	.7665	.6290	.8501	.3185	.8460	.4952					

TEST	167	PT	33.1467	PSI	CM	-.0978	CD1	.00808	CDCOR1	.00789
RUN	21	TT	115.2557	K	CM	-.1172	CD2	.00803	CDCOR2	.00787
POINT	57	RC	14.9548	MILLION	CC	.0119	CD3	.00795	CDCOR3	.00785
		MACH	.8013				CD4	.00802	CDCOR4	.00785
		ALPHA	-2.9938	DEG			CD5	.00790	CDCOR5	.00754

UPPER SURFACE				LOWER SURFACE				SPANWISE				
X/C	CP	P.L./PT	MLOC	X/C	CP	P.L./PT	MLOC	X/C	Y/(B/2)	CP	P.L./PT	MLOC
0.0000	.7786	.9376	.3051	0.0000	.7786	.9376	.3051	.1507	.7476	-.2220	.7396	.6717
.0132	.4624	.8632	.4639	.0126	-.4522	.6941	.7425	.1507	.4976	-.2365	.7367	.6762
.0259	.0825	.7999	.5747	.0255	-.4437	.6957	.7399	.1507	.2476	-.2364	.7368	.6762
.0759	-.1671	.7905	.6546	.0495	-.4832	.6879	.7520	.1507	-.2524	-.2414	.7358	.6777
.1003	-.1960	.7848	.6636	.0753	-.4676	.6910	.7472	.1507	-.5024	-.2446	.7351	.6787
.1507	-.2275	.7785	.6734	.1002	-.4896	.6866	.7539	.1507	-.7524	-.2311	.7378	.6745
.2003	-.2542	.7732	.6817	.1503	-.4688	.6908	.7476	.5002	.7476	-.3612	.7121	.7147
.2503	-.2830	.7270	.6814	.1976	-.5065	.6833	.7591	.5002	.4976	-.3676	.7108	.7166
.3001	-.3105	.7221	.6991	.2503	-.5025	.6841	.7579	.5002	.2476	-.3731	.7097	.7183
.3502	-.3189	.7204	.7017	.3001	-.4956	.6855	.7558	.5002	-.2524	-.3658	.7112	.7160
.4003	-.3322	.7178	.7058	.3507	-.4826	.6880	.7518	.5002	-.5024	-.3638	.7116	.7154
.4501	-.3494	.7144	.7111	.4001	-.4485	.6948	.7414	.5002	-.7524	-.3591	.7135	.7125
.5002	-.3704	.7102	.7175	.4501	-.4086	.7027	.7292	.8002	.7476	-.3315	.7179	.7055
.5502	-.3923	.7059	.7242	.5001	-.3359	.7171	.7069	.8002	.4976	-.3322	.7178	.7057
.6002	-.4055	.7033	.7282	.5497	-.2358	.7369	.6760	.8002	.2476	-.3339	.7175	.7063
.6500	-.4140	.7016	.7308	.6003	-.1265	.7585	.6418	.8002	-.5024	-.3211	.7200	.7024
.7000	-.4033	.7017	.7276	.6500	-.0377	.7761	.6136	.8002	-.7524	-.3075	.7227	.6981
.7500	-.3778	.7088	.7197	.7000	.0767	.7967	.5765					
.8002	-.3310	.7180	.7054	.7501	.1761	.8144	.5435					
.9002	-.1918	.7456	.6622	.8001	.2581	.8346	.5154					
.9501	-.0874	.7662	.6294	.8501	.3295	.8467	.4903					

TEST	167	PT	33.1491	PSI	CM	.2209	CD1	.00796	CDCOR1	.00781
RUN	21	TT	115.2010	K	CM	-.1205	CD2	.00796	CDCOR2	.00783
POINT	58	RC	14.9619	MILLION	CC	.0164	CD3	.00789	CDCOR3	.00782
		MACH	.8012				CD4	.00792	CDCOR4	.00779
		ALPHA	-1.0958	DEG			CD5	.00774	CDCOR5	.00753

UPPER SURFACE				LOWER SURFACE				SPANWISE				
X/C	CP	P.L./PT	MLOC	X/C	CP	P.L./PT	MLOC	X/C	Y/(B/2)	CP	P.L./PT	MLOC
0.0000	.9539	.9724	.2007	0.0000	.9539	.9724	.2007	.1507	.7476	-.3325	.7181	.7053
.0132	.1719	.8178	.5445	.0126	-.1315	.7578	.6429	.1507	.4976	-.3489	.7148	.7104
.0259	-.1421	.7557	.6463	.0255	-.1946	.7453	.6627	.1507	.2476	-.3441	.7150	.7101
.0759	-.3254	.7195	.7032	.0495	-.2833	.7278	.6902	.1507	-.2524	-.3532	.7140	.7117
.1003	-.3326	.7160	.7054	.0753	-.3049	.7231	.6975	.1507	-.5024	-.3545	.7137	.7121
.1507	-.3387	.7160	.7072	.1002	-.3405	.7149	.7103	.1507	-.7524	-.3380	.7170	.7070
.2003	-.3466	.7153	.7097	.1503	-.3556	.7135	.7124	.5002	.7476	-.4117	.7024	.7296
.2503	-.3691	.7108	.7166	.1976	-.4069	.7033	.7282	.5002	.4976	-.4102	.7011	.7316
.3001	-.3856	.7076	.7216	.2503	-.4173	.7013	.7313	.5002	.2476	-.4236	.7000	.7333
.3502	-.3865	.7074	.7219	.3001	-.4216	.7005	.7326	.5002	-.2524	-.4160	.7015	.7309
.4003	-.3931	.7061	.7239	.3507	-.4164	.7015	.7311	.5002	-.5024	-.4140	.7019	.7303
.4501	-.4055	.7036	.7277	.4001	-.3916	.7064	.7235	.5002	-.7524	-.3998	.7048	.7260
.5002	-.4211	.7003	.7325	.4501	-.3609	.7125	.7141	.8002	.7476	-.3511	.7144	.7111
.5502	-.4384	.6971	.7378	.5001	-.2966	.7252	.6943	.8002	.4976	-.3527	.7141	.7115
.6002	-.4468	.6955	.7403	.5497	-.2040	.7455	.6656	.8002	.2476	-.3547	.7137	.7122
.6500	-.4504	.6948	.7414	.6003	-.1012	.7638	.6334	.8002	-.5024	-.3417	.7162	.7082
.7000	-.4350	.6978	.7367	.6500	-.0182	.7802	.6069	.8002	-.7524	-.3276	.7170	.7038
.7500	-.4041	.7039	.7273	.7000	.0920	.8021	.5709					
.8002	-.3520	.7142	.7113	.7501	.1899	.8213	.5384					
.9002	-.2024	.7408	.6631	.8001	.2707	.8373	.5107					
.9501	-.0935	.7633	.6309	.8501	.3425	.8515	.4855					

ORIGINAL DESIGN
OF POOR QUALITY.

TEST 167	PT	33.1506	PSI	CM	.2833	CD1	.06800	CDCOR1	.00783
PUN 21	TT	115.2859	K	CM	-.1225	CD2	.05796	CDCOR2	.00780
POINT 59	RC	14.9521	MILLION	CC	.0174	CD3	.00785	CDCOR3	.00782
	MACH	.6014				CD4	.00772	CDCOR4	.00777
	ALPHA	-1.4867	DEG			CD5	.00775	CDCOR5	.00759

UPPER SURFACE				LOWER SURFACE				SPANWISE				
X/C	CP	P/L/P/T	MLOC	X/C	CP	P/L/P/T	MLOC	X/C	Y/(B/2)	CP	P/L/P/T	MLOC
0.0000	1.0221	.9840	.1521	0.0000	1.0121	.9840	.1521	.1507	.7476	-.3893	.7083	.7201
.0132	.0446	.7933	.5855	.0126	.0067	.7858	.5978	.1507	.4976	-.4016	.7053	.7231
.0259	-.2561	.7340	.6805	.0255	-.0829	.7681	.6264	.1507	.2476	-.4813	.7054	.7250
.0759	-.4043	.7048	.7259	.0495	-.1875	.7475	.6592	.1507	-.2524	-.4050	.7046	.7262
.1003	-.3997	.7057	.7245	.0753	-.2275	.7396	.6716	.1507	-.5024	-.4066	.7041	.7266
.1507	-.3916	.7073	.7221	.1002	-.2778	.7297	.6872	.1507	-.7524	-.3928	.7070	.7224
.2003	-.4016	.7053	.7251	.1503	-.2967	.7260	.6930	.1502	.7476	-.4315	.6994	.7342
.2503	-.4074	.7042	.7269	.1976	-.3538	.7147	.7105	.1502	.4976	-.4385	.6980	.7353
.3001	-.4194	.7018	.7305	.2503	-.3707	.7114	.7157	.1502	.2476	-.4441	.6969	.7360
.3502	-.4184	.7020	.7302	.3001	-.3797	.7096	.7184	.1502	-.2524	-.4346	.6988	.7352
.4003	-.4207	.7015	.7300	.3507	-.3789	.7098	.7182	.1502	-.5024	-.4328	.6992	.7346
.4501	-.4301	.6997	.7338	.4001	-.3583	.7138	.7119	.1502	-.7524	-.4209	.7015	.7310
.5002	-.4428	.6972	.7377	.4501	-.3319	.7191	.7039	.1502	.7476	-.4269	.7145	.7109
.5502	-.4577	.6943	.7422	.5001	-.2716	.7309	.6853	.1502	.4976	-.3578	.7139	.7117
.6002	-.4635	.6931	.7440	.5497	-.1830	.7484	.6578	.1502	.2476	-.3606	.7134	.7126
.6500	-.4647	.6929	.7443	.6003	-.0835	.7680	.6266	.1502	-.5024	-.3454	.7164	.7079
.7000	-.4469	.6964	.7389	.6500	-.0036	.7838	.6011	.1502	-.7524	-.3106	.7193	.7034
.7500	-.4136	.7029	.7288	.7000	.1052	.8052	.5657					
.8002	-.3591	.7137	.7121	.7501	.2007	.8241	.5338					
.8502	-.2051	.7440	.6647	.8001	.2807	.8398	.5063					
.9001	-.0945	.7658	.6301	.8501	.3523	.8539	.4809					

TEST 167	PT	33.1475	PSI	CM	.3418	CD1	.06800	CDCOR1	.00786
PUN 21	TT	115.2411	K	CM	-.1240	CD2	.06800	CDCOR2	.00800
POINT 40	RC	14.9461	MILLION	CC	.0176	CD3	.00793	CDCOR3	.00787
	MACH	.6008				CD4	.00791	CDCOR4	.00791
	ALPHA	-.9979	DEG			CD5	.00772	CDCOR5	.00758

UPPER SURFACE				LOWER SURFACE				SPANWISE				
X/C	CP	P/L/P/T	MLOC	X/C	CP	P/L/P/T	MLOC	X/C	Y/(B/2)	CP	P/L/P/T	MLOC
0.0000	1.0558	.9924	.1030	0.0000	1.0558	.9924	.1030	.1507	.7476	-.4394	.6980	.7365
.0132	-.0471	.7674	.6276	.0126	-.1344	.8110	.5960	.1507	.4976	-.4567	.6945	.7418
.0259	-.3769	.7103	.7175	.0255	-.0107	.7884	.5935	.1507	.2476	-.4570	.6945	.7419
.0759	-.4768	.6884	.7509	.0495	-.1003	.7647	.6319	.1507	-.2524	-.4596	.6938	.7427
.1003	-.4696	.6920	.7457	.0753	-.1554	.7539	.6491	.1507	-.5024	-.4607	.6938	.7430
.1507	-.4467	.6965	.7387	.1002	-.2137	.7424	.6672	.1507	-.7524	-.4425	.6938	.7437
.2003	-.4393	.6980	.7365	.1503	-.2438	.7365	.6766	.1502	.7476	-.4531	.6938	.7429
.2503	-.4446	.6945	.7387	.1976	-.3064	.7242	.6959	.1502	.4976	-.4605	.6938	.7429
.3001	-.4537	.6951	.7400	.2503	-.3294	.7196	.7029	.1502	.2476	-.4661	.6927	.7446
.3502	-.4493	.6960	.7395	.3001	-.3428	.7170	.7070	.1502	-.2524	-.4537	.6927	.7415
.4003	-.4480	.6982	.7391	.3507	-.3462	.7163	.7081	.1502	-.5024	-.4544	.6959	.7411
.4501	-.4537	.6951	.7408	.4001	-.3294	.7196	.7029	.1502	-.7524	-.4409	.6977	.7369
.5002	-.4448	.6929	.7442	.4501	-.3068	.7241	.6960	.1502	.7476	-.3600	.7136	.7123
.5502	-.4774	.6904	.7481	.5001	-.2505	.7352	.6786	.1502	.4976	-.3643	.7126	.7146
.6002	-.4811	.6897	.7492	.5497	-.1851	.7520	.6521	.1502	.2476	-.3677	.7121	.7156
.6500	-.4787	.6900	.7484	.6003	-.0849	.7710	.6218	.1502	-.5024	-.3518	.7132	.7098
.7000	-.4595	.6940	.7424	.6500	.0087	.7863	.5971	.1502	-.7524	-.3169	.7181	.7052
.7500	-.4235	.7011	.7317	.7000	.1158	.8074	.5621					
.8002	-.3684	.7123	.7142	.7501	.2099	.8255	.5300					
.8502	-.2076	.7437	.6653	.8001	.2892	.8415	.5032					
.9001	-.0947	.7659	.6300	.8501	.3607	.8556	.4778					

TEST 167	PT	33.1462	PSI	CM	.4023	CD1	.06805	CDCOR1	.00788
PUN 21	TT	115.1401	K	CM	-.1256	CD2	.06806	CDCOR2	.00789
POINT 61	RC	14.9707	MILLION	CC	.0170	CD3	.00797	CDCOR3	.00785
	MACH	.6009				CD4	.00796	CDCOR4	.00779
	ALPHA	-.9990	DEG			CD5	.00780	CDCOR5	.00759

UPPER SURFACE				LOWER SURFACE				SPANWISE				
X/C	CP	P/L/P/T	MLOC	X/C	CP	P/L/P/T	MLOC	X/C	Y/(B/2)	CP	P/L/P/T	MLOC
0.0000	1.0849	.9982	.0508	0.0000	1.0849	.9982	.0508	.1507	.7476	-.4691	.6940	.7579
.0132	-.2324	.7369	.6759	.0126	.2540	.8336	.5173	.1507	.4976	-.5103	.6906	.7632
.0259	-.5154	.6808	.7629	.0255	-.0173	.8003	.5639	.1507	.2476	-.5175	.6904	.7636
.0759	-.5775	.6645	.7819	.0495	-.0189	.7793	.6084	.1507	-.2524	-.5215	.6796	.7640
.1003	-.5683	.6747	.7724	.0753	-.0877	.7656	.6304	.1507	-.5024	-.5218	.6793	.7649
.1507	-.5071	.6824	.7604	.1002	-.1537	.7525	.6513	.1507	-.7524	-.5024	.6934	.7590
.2003	-.4897	.6859	.7551	.1503	-.1946	.7444	.6641	.1502	.7476	-.4784	.6901	.7516
.2503	-.4904	.6854	.7553	.1976	-.2624	.7318	.6852	.1502	.4976	-.4806	.6906	.7539
.3001	-.4927	.6873	.7560	.2503	-.2915	.7252	.6942	.1502	.2476	-.4917	.6855	.7557
.3502	-.4839	.6870	.7533	.3001	-.3091	.7217	.6997	.1502	-.2524	-.4827	.6874	.7528
.4003	-.4797	.6879	.7520	.3507	-.3167	.7202	.7020	.1502	-.5024	-.4806	.6877	.7523
.4501	-.4823	.6874	.7528	.4001	-.3034	.7228	.6979	.1502	-.7524	-.4683	.6901	.7485
.5002	-.4806	.6857	.7554	.4501	-.2845	.7266	.6920	.1502	.7476	-.3787	.7095	.7186
.5502	-.4768	.6837	.7583	.5001	-.2519	.7371	.6756	.1502	.4976	-.3739	.7089	.7196
.6002	-.4608	.6834	.7588	.5497	-.1694	.7534	.6499	.1502	.2476	-.3771	.7082	.7206
.6500	-.4453	.6842	.7577	.6003	-.0557	.7720	.6202	.1502	-.5024	-.3619	.7112	.7159
.7000	-.4253	.6908	.7507	.6500	.0198	.7894	.5962	.1502	-.7524	-.3466	.7143	.7112
.7500	-.4363	.6945	.7388	.7000	.1246	.8077	.5615					
.8002	-.3761	.7084	.7203	.7501	.2176	.8262	.5301					
.8502	-.2112	.7411	.6693	.8001	.2961	.8417	.5029					
.9001	-.0949	.7640	.6350	.8501	.3674	.8556	.4773					

TEST 167	PT 33.1504	PSI	CN	.4611	CD1	.00811	CDCOR1	.00801
RUN 21	TT 115.2035	K	CM	-.1263	CD2	.00810	CDCOR2	.00802
POINT 62	RC 14.9367	MILLION	CC	.0134	CD3	.00802	CDCOR3	.00800
	MACH .0008				CD4	.00798	CDCOR4	.00788
	ALPHA .0004	DEG			CD5	.00783	CDCOR5	.00761

UPPER SURFACE				LOWER SURFACE				SPANWISE				
X/C	CP	P/L/PT	MLOC	X/C	CP	P/L/PT	MLOC	X/C	Y/(B/2)	CP	P/L/PT	MLOC
0.0000	1.0902	.9995	.0279	0.0000	1.0902	.9995	.0279	.1507	.7476	-.5652	.6739	.7735
.0132	-.3963	.7071	.7223	.0126	.3563	.8555	.4780	.1507	.4976	-.5843	.6701	.7793
.0259	-.6734	.6526	.8063	.0255	.2024	.8249	.5324	.1507	.2476	-.5852	.6700	.7796
.0759	-.6775	.6518	.8075	.0495	-.0420	.7933	.5855	.1507	-.2524	-.5899	.6690	.7810
.1003	-.6309	.6610	.7734	.0753	-.0276	.7796	.6079	.1507	-.5024	-.5903	.6690	.7811
.1507	-.5742	.6721	.7753	.1002	-.0990	.7656	.6305	.1507	-.7524	-.5735	.6723	.7861
.2003	-.5486	.6772	.7685	.1503	-.1505	.7555	.6466	.5002	.7476	-.5979	.6852	.7562
.2503	-.5396	.6789	.7658	.1976	-.2236	.7411	.6694	.5002	.4976	-.5156	.6837	.7585
.3001	-.5371	.6794	.7650	.2503	-.2588	.7342	.6802	.5002	.2476	-.5215	.6825	.7603
.3502	-.5213	.6825	.7603	.3001	-.2806	.7299	.6949	.5002	-.2524	-.5128	.6842	.7577
.4003	-.5141	.6840	.7581	.3502	-.2918	.7277	.6904	.5002	-.5024	-.5112	.6845	.7572
.4501	-.5141	.6840	.7581	.4001	-.2827	.7295	.6876	.5002	-.7524	-.4973	.6873	.7530
.5002	-.5193	.6829	.7597	.4501	-.2674	.7325	.6829	.5002	.7476	-.3835	.7092	.7184
.5502	-.5269	.6814	.7619	.5001	-.2185	.7421	.6678	.5002	.4976	-.3879	.7088	.7198
.6002	-.5257	.6817	.7614	.5497	-.1399	.7576	.6433	.8002	.2476	-.3910	.7081	.7209
.6500	-.5194	.6829	.7597	.6003	-.0493	.7754	.6148	.8002	-.5024	-.3768	.7110	.7164
.7000	-.4939	.6879	.7510	.6500	.0227	.7895	.5917	.8002	-.7524	-.3613	.7140	.7116
.7500	-.4522	.6961	.7393	.7000	.1264	.8099	.5578					
.8002	-.3896	.7084	.7203	.7501	.2180	.8279	.5271					
.9002	-.2199	.7418	.6682	.8001	.2957	.8432	.5003					
.9501	-.1017	.7651	.6313	.8501	.3666	.8572	.4750					

TEST 167	PT 33.1537	PSI	CN	.5199	CD1	.00821	CDCOR1	.00803
RUN 21	TT 115.3575	K	CM	-.1268	CD2	.00822	CDCOR2	.00807
POINT 33	RC 14.9281	MILLION	CC	.0130	CD3	.00814	CDCOR3	.00805
	MACH .0008				CD4	.00805	CDCOR4	.00790
	ALPHA .4990	DEG			CD5	.00787	CDCOR5	.00766

UPPER SURFACE				LOWER SURFACE				SPANWISE				
X/C	CP	P/L/PT	MLOC	X/C	CP	P/L/PT	MLOC	X/C	Y/(B/2)	CP	P/L/PT	MLOC
0.0000	1.0901	.9994	.0304	0.0000	1.0901	.9994	.0304	.1507	.7476	-.6222	.6616	.7925
.0132	-.5606	.6737	.7738	.0126	.4626	.8756	.4404	.1507	.4976	-.6425	.6576	.7987
.0259	-.8339	.6198	.8568	.0255	.2859	.8407	.5047	.1507	.2476	-.6443	.6572	.7992
.0759	-.7729	.6318	.8383	.0495	.1108	.8082	.5641	.1507	-.2524	-.6489	.6563	.8006
.1003	-.7066	.6445	.8187	.0753	-.0374	.7921	.5875	.1507	-.5024	-.6483	.6564	.8004
.1507	-.6330	.6594	.7958	.1002	-.0987	.7768	.6123	.1507	-.7524	-.6297	.6601	.7948
.2003	-.5928	.6674	.7836	.1503	-.1764	.7658	.6317	.5002	.7476	-.5277	.6802	.7638
.2503	-.5798	.6699	.7796	.1976	-.2169	.7415	.6561	.5002	.4976	-.5356	.6786	.7662
.3001	-.5716	.6715	.7772	.2503	-.2429	.7365	.6766	.5002	.2476	-.5414	.6775	.7680
.3502	-.5515	.6755	.7710	.3001	-.2520	.7335	.6812	.5002	-.2524	-.5325	.6793	.7653
.4003	-.5401	.6778	.7676	.3502	-.2574	.7346	.6795	.5002	-.5024	-.5308	.6796	.7648
.4501	-.5366	.6785	.7665	.4001	-.2403	.7369	.6759	.5002	-.7524	-.5164	.6824	.7604
.5002	-.5399	.6780	.7672	.4501	-.1951	.7458	.6619	.8002	.7476	-.3877	.7078	.7212
.5502	-.5436	.6771	.7687	.5001	-.1201	.7606	.6384	.8002	.4976	-.3922	.7069	.7226
.6002	-.5398	.6778	.7675	.6003	-.0329	.7778	.6108	.8002	.2476	-.3957	.7062	.7237
.6500	-.5310	.6796	.7648	.6500	.0363	.7915	.5885	.8002	-.5024	-.3806	.7092	.7191
.7000	-.5027	.6851	.7562	.7000	.1377	.8115	.5552	.8002	-.7524	-.3650	.7123	.7143
.7500	-.4590	.6940	.7426	.7501	.2275	.8292	.5249					
.8002	-.3931	.7068	.7229	.8001	.3040	.8443	.4983					
.9002	-.2169	.7411	.6693	.8501	.3743	.8591	.4732					
.9501	-.0987	.7648	.6317									

TEST 167	PT 33.2118	PSI	CN	.5813	CD1	.00934	CDCOR1	.00813
RUN 21	TT 115.3474	K	CM	-.1279	CD2	.00930	CDCOR2	.00811
POINT 64	RC 14.9482	MILLION	CC	.0101	CD3	.00822	CDCOR3	.00805
	MACH .0003				CD4	.00816	CDCOR4	.00798
	ALPHA 1.0081	DEG			CD5	.00801	CDCOR5	.00777

UPPER SURFACE				LOWER SURFACE				SPANWISE				
X/C	CP	P/L/PT	MLOC	X/C	CP	P/L/PT	MLOC	X/C	Y/(B/2)	CP	P/L/PT	MLOC
0.0000	1.0837	.9981	.0515	0.0000	1.0837	.9981	.0515	.1507	.7476	-.6822	.6505	.8096
.0132	-.7378	.6396	.8263	.0126	.5565	.8944	.4030	.1507	.4976	-.7034	.6464	.8159
.0259	-1.0103	.5860	.9094	.0255	.3623	.8561	.4769	.1507	.2476	-.7055	.6459	.8165
.0759	-.8737	.6128	.8676	.0495	.1844	.8211	.5388	.1507	-.2524	-.7099	.6451	.8179
.1003	-.7901	.6293	.8422	.0753	.1022	.8050	.5662	.1507	-.5024	-.7084	.6434	.8174
.1507	-.6944	.6481	.8131	.1002	.0200	.7888	.5930	.1507	-.7524	-.6879	.6494	.8112
.2003	-.6457	.6577	.7984	.1503	-.0497	.7790	.6133	.5002	.7476	-.5486	.6768	.7690
.2503	-.6216	.6625	.7911	.1976	-.1316	.7589	.6411	.5002	.4976	-.5572	.6792	.7716
.3001	-.6082	.6651	.7871	.2503	-.1772	.7499	.6594	.5002	.2476	-.5633	.6739	.7735
.3502	-.5844	.6698	.7799	.3001	-.2064	.7442	.6643	.5002	-.2524	-.5532	.6799	.7704
.4003	-.5669	.6728	.7752	.3502	-.2249	.7406	.6702	.5002	-.5024	-.5516	.6762	.7699
.4501	-.5620	.6742	.7731	.4001	-.2228	.7410	.6695	.5002	-.7524	-.5369	.6791	.7655
.5002	-.5613	.6743	.7729	.4501	-.2146	.7426	.6670	.8002	.7476	-.3934	.7074	.7219
.5502	-.5634	.6739	.7735	.5001	-.1729	.7508	.6540	.8002	.4976	-.3981	.7065	.7233
.6002	-.5573	.6751	.7717	.5497	-.1013	.7649	.6316	.8002	.2476	-.3916	.7058	.7244
.6500	-.5456	.6774	.7681	.6003	-.0170	.7815	.6048	.8002	-.5024	-.3849	.7091	.7193
.7000	-.5146	.6835	.7587	.6500	.0445	.7946	.5834	.8002	-.7524	-.3690	.7122	.7145
.7500	-.4672	.6929	.7443	.7000	.1490	.8142	.5507					
.8002	-.3997	.7062	.7238	.7501	.2372	.8315	.5209					
.9002	-.2707	.7414	.6689	.8001	.3127	.8464	.4946					
.9501	-.0984	.7655	.6307	.8501	.3823	.8601	.4696					

ORIGINAL PRINTING
OF POOR QUALITY

TEST 167 PT 33.2118 PSI CM .6408
 RUN 21 TT 115.3979 K CM -.1286
 POINT 65 RC 14.9372 MILLION CC .0065
 MACH .6003
 ALPHA 1.4969 DEG

UPPER SURFACE				LOWER SURFACE				SPANWISE				
X/C	CP	P/L/PT	MLOC	X/C	CP	P/L/PT	MLOC	X/C	Y/(B/2)	CP	P/L/PT	MLOC
0.0000	1.0618	.9938	.0940	0.0000	1.0618	.9938	.0940	.1507	.7476	-.7403	.6385	.6279
.0132	-.9185	.6041	.8812	.0126	.5374	.9103	.3693	.1507	.4976	-.7640	.6345	.6342
.0259	-1.2024	.5482	.9692	.0255	.4377	.3710	.4491	.1507	.2476	-.7662	.6340	.6349
.0759	-.9770	.5925	.8992	.0495	.2529	.8346	.5154	.1507	-.2524	-.7698	.6333	.6360
.1003	-.8722	.6132	.8671	.0753	.1604	.8165	.5467	.1507	-.5024	-.7671	.6338	.6351
.1507	-.7546	.6363	.8314	.1002	.0730	.7992	.5757	.1507	-.7524	-.7452	.6302	.6285
.2003	-.6947	.6481	.8132	.1503	-.0040	.7840	.6007	.5002	.7476	-.5680	.6730	.7749
.2503	-.6626	.6544	.8035	.1976	-.0890	.7673	.6277	.5002	.4976	-.5774	.6712	.7777
.3001	-.6434	.6582	.7977	.2503	-.1391	.7575	.6434	.5002	.2476	-.5836	.6700	.7796
.3502	-.6176	.6633	.7899	.3001	-.1716	.7511	.6536	.5002	-.2524	-.5727	.6721	.7763
.4003	-.5971	.6673	.7837	.3507	-.1933	.7468	.6604	.5002	-.5024	-.5713	.6724	.7759
.4501	-.5857	.6695	.7802	.4001	-.1944	.7466	.6607	.5002	-.7524	-.5566	.6753	.7714
.5002	-.5826	.6702	.7793	.4501	-.1894	.7476	.6591	.8002	.7476	-.3952	.7071	.7224
.5502	-.5821	.6703	.7791	.5001	-.1913	.7551	.6472	.8002	.4976	-.4012	.7059	.7242
.6002	-.5734	.6720	.7765	.5497	-.0828	.7685	.6257	.8002	.2476	-.4058	.7050	.7257
.6500	-.5585	.6749	.7720	.6003	-.0017	.7845	.5999	.8002	-.5024	-.3891	.7083	.7206
.7000	-.5250	.6815	.7618	.6500	.0624	.7971	.5792	.8002	-.7524	-.3731	.7114	.7157
.7500	-.4749	.6914	.7467	.7000	.1597	.8163	.5471					
.8002	-.4608	.7052	.7253	.7501	.2463	.8335	.5177					
.9002	-.2211	.7413	.6690	.8001	.3207	.8480	.4917					
.9501	-.0981	.7655	.6306	.8501	.3897	.8616	.4669					

TEST 167 PT 33.2126 PSI CM .7017
 RUN 21 TT 115.6894 K CM -.1282
 POINT 66 RC 14.8737 MILLION CC .0016
 MACH .5997
 ALPHA 2.0072 DEG

UPPER SURFACE				LOWER SURFACE				SPANWISE				
X/C	CP	P/L/PT	MLOC	X/C	CP	P/L/PT	MLOC	X/C	Y/(B/2)	CP	P/L/PT	MLOC
0.0000	1.0159	.9849	.1475	0.0000	1.0159	.9849	.1475	.1507	.7476	-.8116	.6263	.6468
.012	-1.1206	.5656	.9414	.0126	.7114	.9252	.3356	.1507	.4976	-.8330	.6221	.6533
.0259	-1.4415	.5027	1.0433	.0255	.5090	.8855	.4210	.1507	.2476	-.8360	.6215	.6542
.0759	-1.0926	.5711	.9327	.0495	.3167	.8477	.4922	.1507	-.2524	-.8394	.6208	.6552
.1003	-.9642	.5963	.8932	.0753	.2153	.8278	.5273	.1507	-.5024	-.8359	.6215	.6542
.1507	-.8232	.6240	.8503	.1002	.1226	.8096	.5583	.1507	-.7524	-.8120	.6262	.6469
.2003	-.7511	.6382	.8285	.1503	.0381	.7930	.5859	.5002	.7476	-.5952	.6688	.7814
.2503	-.7099	.6463	.8160	.1976	-.0502	.7757	.6142	.5002	.4976	-.6041	.6670	.7841
.3001	-.6853	.6511	.8086	.2503	-.1051	.7649	.6315	.5002	.2476	-.6101	.6658	.7859
.3502	-.6524	.6575	.7997	.3001	-.1410	.7579	.6428	.5002	-.2524	-.5990	.6680	.7826
.4003	-.6296	.6620	.7918	.3507	-.1658	.7530	.6505	.5002	-.5024	-.5978	.6682	.7822
.4501	-.6141	.6651	.7871	.4001	-.1704	.7521	.6519	.5002	-.7524	-.5827	.6712	.7777
.5002	-.6073	.6664	.7851	.4501	-.1684	.7525	.6513	.8002	.7476	-.4079	.7055	.7248
.5502	-.6045	.6669	.7842	.5001	-.1345	.7592	.6407	.8002	.4976	-.4119	.7047	.7260
.6002	-.5934	.6691	.7809	.5497	-.0697	.7719	.6204	.8002	.2476	-.4165	.7038	.7274
.6500	-.5750	.6727	.7753	.6003	.0081	.7871	.5956	.8002	-.5024	-.3980	.7073	.7221
.7000	-.5389	.6798	.7645	.6500	.0697	.7993	.5757	.8002	-.7524	-.3834	.7103	.7174
.7500	-.4860	.6902	.7485	.7000	.1644	.8178	.5444					
.8002	-.4134	.7044	.7265	.7501	.2490	.8344	.5158					
.9002	-.2249	.7414	.6888	.8001	.3223	.8488	.4902					
.9501	-.1011	.7657	.6303	.8501	.3903	.8622	.4657					

TEST 167 PT 33.2134 PSI CM .7594
 RUN 21 TT 115.3567 K CM -.1279
 POINT 67 RC 14.9526 MILLION CC -.0033
 MACH .6006
 ALPHA 2.4948 DEG

UPPER SURFACE				LOWER SURFACE				SPANWISE				
X/C	CP	P/L/PT	MLOC	X/C	CP	P/L/PT	MLOC	X/C	Y/(B/2)	CP	P/L/PT	MLOC
0.0000	.9729	.9763	.1357	0.0000	.9729	.9763	.1357	.1507	.7476	-.8712	.6128	.6677
.0132	-1.2840	.5114	.9962	.0126	.7753	.9373	.3058	.1507	.4976	-.8947	.6081	.6749
.0259	-1.6881	.4502	1.1331	.0255	.5711	.8971	.3974	.1507	.2476	-.8984	.6074	.6760
.0759	-1.1949	.5490	.9880	.0495	.3759	.8586	.4724	.1507	-.2524	-.9012	.6068	.6769
.1003	-1.0460	.5783	.9215	.0753	.2656	.8368	.5115	.1507	-.5024	-.8958	.6079	.6752
.1507	-.8893	.6100	.8721	.1002	.1718	.8194	.5437	.1507	-.7524	-.8704	.6128	.6876
.2003	-.8060	.6256	.8479	.1503	.0803	.8003	.5739	.5002	.7476	-.6158	.6631	.7902
.2503	-.7519	.6363	.8314	.1976	-.0121	.7821	.6038	.5002	.4976	-.6254	.6612	.7931
.3001	-.7223	.6421	.8224	.2503	-.0714	.7704	.6228	.5002	.2476	-.6318	.6600	.7950
.3502	-.6828	.6499	.8105	.3001	-.1105	.7627	.6351	.5002	-.2524	-.6209	.6621	.7917
.4003	-.6362	.6552	.8024	.3507	-.1380	.7573	.6437	.5002	-.5024	-.6195	.6624	.7913
.4501	-.6381	.6587	.7969	.4001	-.1458	.7558	.6462	.5002	-.7524	-.6012	.6660	.7857
.5002	-.6281	.6607	.7939	.4501	-.1469	.7555	.6465	.8002	.7476	-.4118	.7033	.7282
.5502	-.6221	.6619	.7921	.5001	-.1161	.7616	.6268	.8002	.4976	-.4173	.7022	.7299
.6002	-.6087	.6645	.7880	.5497	-.0539	.7739	.6172	.8002	.2476	-.4215	.7014	.7312
.6500	-.5880	.6686	.7817	.6003	.0215	.7887	.5930	.8002	-.5024	-.4044	.7048	.7259
.7000	-.5491	.6763	.7699	.6500	.0808	.8004	.5737	.8002	-.7524	-.3885	.7079	.7211
.7500	-.4932	.6873	.7530	.7000	.1738	.8187	.5429					
.8002	-.4179	.7021	.7301	.7501	.2570	.8352	.5145					
.9002	-.2245	.7403	.6707	.8001	.3293	.8494	.4891					
.9501	-.0970	.7654	.6308	.8501	.3969	.8627	.4647					

TEST 167	PT 33.2135	PSI	CN .8104	CD1 .00931	CDCDR1 .00911
RUN 21	TT 115.4422	K	CM -.1288	CD2 .00933	CDCDR2 .00916
POINT 68	RC 14.9342	MILLION	CC -.0073	CD3 .00920	CDCDR3 .00902
	MACH .6005			CD4 .00898	CDCDR4 .00880
	ALPHA 2.9938	DEG		CD5 .00882	CDCDR5 .00860

UPPER SURFACE				LOWER SURFACE				SPANWISE				
X/C	CP	P _L /PT	MLOC	X/C	CP	P _L /PT	MLOC	X/C	Y/(B/2)	CP	P _L /PT	MLOC
0.0000	.9153	.9651	.2280	0.0000	.9153	.9651	.2260	.1507	.7476	-.9157	.6055	.8790
.0132	-1.4498	.9006	1.0468	.0126	.8391	.9502	.2713	.1507	.4976	-.9341	.6019	.8844
.0259	-1.8901	.4160	1.1946	.0255	.6372	.9105	.3688	.1507	.2476	-.9381	.6011	.8859
.0759	-1.2117	.5473	.9705	.0495	.4418	.8721	.4470	.1507	-.2524	-.9387	.6010	.8860
.1003	-1.0904	.5712	.9327	.0753	.3261	.8494	.4891	.1507	-.5024	-.9322	.6022	.8840
.1507	-.9246	.6037	.8817	.1002	.2286	.8302	.5231	.1507	-.7524	-.9069	.6072	.8763
.2003	-.8427	.6198	.8568	.1503	.1323	.8113	.5594	.5002	.7476	-.9225	.6631	.7902
.2503	-.7773	.6327	.8370	.1976	.0381	.7928	.5863	.5002	.4976	-.8320	.6612	.7930
.3001	-.7423	.6395	.8264	.2503	-.0247	.7805	.6084	.5002	.2476	-.8378	.6601	.7948
.3502	-.7070	.6465	.8157	.3001	-.0663	.7723	.6197	.5002	-.2524	-.8241	.6628	.7907
.4003	-.6732	.6531	.8055	.3507	-.0966	.7664	.6282	.5002	-.5024	-.8229	.6630	.7903
.4501	-.6497	.6577	.7984	.4001	-.1070	.7643	.6325	.5002	-.7524	-.8046	.6666	.7846
.5002	-.6368	.6603	.7945	.4501	-.1111	.7635	.6338	.8002	.7476	-.4403	.7060	.7241
.5502	-.6285	.6619	.7920	.5001	-.0836	.7689	.6251	.8002	.4976	-.4079	.7052	.7252
.6002	-.6122	.6651	.7871	.5497	-.0251	.7804	.6066	.8002	.2476	-.4125	.7043	.7266
.6500	-.5880	.6699	.7798	.6003	.0468	.7945	.5835	.8002	-.5024	-.3925	.7082	.7206
.7000	-.5466	.6779	.7673	.6500	.1032	.8056	.5651	.8002	-.7524	-.3759	.7115	.7155
.7500	-.4886	.6894	.7497	.7000	.1934	.8233	.5350					
.8002	-.4111	.7046	.7262	.7501	.2744	.8393	.5073					
.9002	-.2142	.7433	.6659	.8001	.3450	.8531	.4824					
.9501	-.0889	.7679	.6268	.8501	.4114	.8662	.4583					

TEST 167	PT 33.2133	PSI	CN .8720	CD1 .01052	CDCDR1 .01029
RUN 21	TT 115.3872	K	CM -.1247	CD2 .01057	CDCDR2 .01033
POINT 69	RC 14.9450	MILLION	CC -.0163	CD3 .01043	CDCDR3 .01026
	MACH .6005			CD4 .01019	CDCDR4 .00999
	ALPHA 3.5131	DEG		CD5 .01014	CDCDR5 .00992

UPPER SURFACE				LOWER SURFACE				SPANWISE				
X/C	CP	P _L /PT	MLOC	X/C	CP	P _L /PT	MLOC	X/C	Y/(B/2)	CP	P _L /PT	MLOC
0.0000	.8480	.9515	.2676	0.0000	.8480	.9515	.2676	.1507	.7476	-.9671	.5941	.8967
.0132	-1.6301	.4622	1.1120	.0126	.8780	.9575	.2502	.1507	.4976	-.9704	.5925	.8992
.0259	-2.0041	.2884	1.2470	.0255	.6795	.9183	.3515	.1507	.2476	-.9748	.5916	.9006
.0759	-1.9016	.4086	1.2085	.0495	.4826	.8794	.4330	.1507	-.2524	-.9758	.5914	.9009
.1003	-1.1146	.5640	.9440	.0753	.3617	.8595	.4780	.1507	-.5024	-.9682	.5929	.8986
.1507	-.9598	.5946	.8960	.1002	.2629	.8366	.5130	.1507	-.7524	-.9544	.5956	.8943
.2003	-.8763	.6111	.8704	.1503	.1611	.8159	.5477	.5002	.7476	-.8496	.6558	.8013
.2503	-.8195	.6273	.8530	.1976	.0610	.7967	.5798	.5002	.4976	-.8589	.6540	.8042
.3001	-.7818	.6247	.8415	.2503	-.0026	.7836	.6014	.5002	.2476	-.8651	.6528	.8060
.3502	-.7384	.6383	.8283	.3001	-.0471	.7748	.6157	.5002	-.2524	-.8526	.6552	.8022
.4003	-.7036	.6452	.8177	.3507	-.0803	.7682	.6242	.5002	-.5024	-.8511	.6555	.8019
.4501	-.6781	.6502	.8100	.4001	-.0935	.7656	.6304	.5002	-.7524	-.8326	.6592	.7962
.5002	-.6620	.6534	.8051	.4501	-.1004	.7643	.6326	.8002	.7476	-.4141	.7023	.7297
.5502	-.6508	.6556	.8017	.5001	-.0761	.7691	.6249	.8002	.4976	-.4170	.7017	.7306
.6002	-.6315	.6594	.7958	.5497	-.0205	.7800	.6072	.8602	.2476	-.4214	.7009	.7320
.6500	-.6039	.6649	.7874	.6003	.0488	.7937	.5848	.8002	-.5024	-.4032	.7045	.7264
.7000	-.5598	.6736	.7741	.6500	.1031	.8044	.5670	.8002	-.7524	-.3859	.7079	.7211
.7500	-.4982	.6857	.7554	.7000	.1913	.8219	.5375					
.8002	-.4182	.7015	.7310	.7501	.2709	.8376	.5102					
.9002	-.2172	.7412	.6692	.8001	.3403	.8513	.4857					
.9501	-.0713	.7661	.6297	.8501	.4061	.8643	.4618					

TEST	167	PT	66.4402	PSI	CM	-.0143	CD1	.00748	CDCOR1	.00741
RUN	22	TT	115.3295	K	CM	-.1175	CD2	.00746	CDCOR2	.00743
POINT	70	RC	29.8710	MILLION	CC	.0048	CD3	.00733	CDCOR3	.00738
		MACH	.6012				CD4	.00742	CDCOR4	.00742
		ALPHA	-4.0019	DEG			CD5	.00735	CDCOR5	.00716

UPPER SURFACE				LOWER SURFACE				SPANWISE				
X/C	CP	P.L/PT	MLOC	X/C	CP	P.L/PT	MLOC	X/C	Y/(B/2)	CP	P.L/PT	MLOC
0.0000	.5505	.8930	.4063	0.0000	.5505	.8930	.4063	.1507	.7476	-.1304	.7588	.6422
.0132	.5851	.8998	.3922	.0126	-.8291	.6210	.8561	.1507	.4976	-.1409	.7567	.6455
.0259	.2775	.8392	.5080	.0255	-.7195	.6426	.8227	.1507	.2476	-.1376	.7573	.6444
.0759	-.0324	.7781	.6111	.0495	-.6996	.6466	.8166	.1507	-.2524	-.1437	.7561	.6464
.1003	-.0782	.7691	.6257	.0753	-.6365	.6590	.7975	.1507	-.5024	-.1486	.7552	.6479
.1507	-.1338	.7581	.6432	.1002	-.6404	.6582	.7987	.1507	-.7524	-.1440	.7561	.6464
.2003	-.1720	.7506	.6552	.1503	-.5856	.6690	.7821	.5002	.7476	-.3203	.7213	.7011
.2503	-.2111	.7428	.6674	.1976	-.6092	.6644	.7892	.5002	.4976	-.3256	.7203	.7028
.3001	-.2441	.7363	.6777	.2503	-.5893	.6683	.7832	.5002	.2476	-.3298	.7195	.7041
.3502	-.2609	.7330	.6828	.3001	-.5726	.6716	.7781	.5002	-.2524	-.3219	.7210	.7016
.4003	-.2783	.7256	.6882	.3507	-.5472	.6766	.7704	.5002	-.5024	-.3200	.7214	.7010
.4501	-.2946	.7264	.6932	.4001	-.5016	.6836	.7565	.5002	-.7524	-.3067	.7240	.6970
.5002	-.3283	.7198	.7036	.4501	-.4582	.6942	.7433	.8002	.7476	-.8991	.6072	.8775
.5502	-.3562	.7142	.7122	.5001	-.3739	.7108	.7176	.8002	.4976	-.3217	.7211	.7016
.6002	-.3721	.7111	.7170	.5497	-.2667	.7319	.6846	.8002	.2476	-.3211	.7212	.7014
.6500	-.3859	.7084	.7213	.6003	-.1494	.7550	.6481	.8002	-.5024	-.2971	.7259	.6940
.7000	-.3801	.7095	.7195	.6500	-.0620	.7723	.6205	.8002	-.7524	-.2944	.7264	.6932
.7500	-.3600	.7135	.7133	.7000	.0629	.7969	.5803					
.8002	-.3192	.7216	.7008	.7501	.1674	.8175	.5457					
.8002	-.1905	.7469	.6610	.8001	.2528	.8343	.5166					
.9501	-.0922	.7643	.6301	.8501	.3262	.8488	.4908					

TEST	167	PT	66.5724	PSI	CM	.1091	CD1	.00730	CDCOR1	.00715
RUN	22	TT	115.3049	K	CM	-.1208	CD2	.00731	CDCOR2	.00721
POINT	71	RC	29.9395	MILLION	CC	.0126	CD3	.00724	CDCOR3	.00722
		MACH	.6012				CD4	.00728	CDCOR4	.00721
		ALPHA	-2.9976	DEG			CD5	.00721	CDCOR5	.00703

UPPER SURFACE				LOWER SURFACE				SPANWISE				
X/C	CP	P.L/PT	MLOC	X/C	CP	P.L/PT	MLOC	X/C	Y/(B/2)	CP	P.L/PT	MLOC
0.0000	.7736	.9386	.3029	0.0000	.7836	.9386	.3029	.1507	.7476	-.2312	.7378	.6754
.0132	.3959	.8619	.4668	.0126	-.4412	.6962	.7401	.1507	.4976	-.2433	.7354	.6792
.0259	.0820	.7998	.5755	.0255	-.4342	.6976	.7380	.1507	.2476	-.2409	.7359	.6784
.0759	-.1737	.7452	.6574	.0495	-.4746	.6896	.7503	.1507	-.2524	-.2476	.7345	.6805
.1003	-.2030	.7434	.6666	.0753	-.4606	.6924	.7460	.1507	-.5024	-.2518	.7337	.6818
.1507	-.2367	.7367	.6771	.1002	-.4865	.6873	.7539	.1507	-.7524	-.2450	.7350	.6797
.2003	-.2565	.7328	.6833	.1503	-.4640	.6917	.7471	.5002	.7476	-.3688	.7106	.7179
.2503	-.2889	.7264	.6933	.1976	-.5032	.6840	.7591	.5002	.4976	-.3742	.7095	.7196
.3001	-.3151	.7212	.7014	.2503	-.4996	.6847	.7580	.5002	.2476	-.3786	.7086	.7209
.3502	-.3239	.7194	.7041	.3001	-.4941	.6858	.7563	.5002	-.2524	-.3709	.7101	.7186
.4003	-.3359	.7171	.7078	.3507	-.4790	.6887	.7517	.5002	-.5024	-.3689	.7105	.7180
.4501	-.3472	.7148	.7113	.4001	-.4428	.6959	.7406	.5002	-.7524	-.3547	.7133	.7146
.5002	-.3764	.7091	.7203	.4501	-.4082	.7028	.7300	.8002	.7476	-.9608	.5934	.8990
.5502	-.3998	.7044	.7274	.5001	-.3325	.7177	.7067	.8002	.4976	-.3418	.7159	.7096
.6002	-.4216	.7021	.7310	.5497	-.2327	.7375	.6759	.8002	.2476	-.3414	.7160	.7095
.6500	-.4213	.7002	.7340	.6003	-.1219	.7594	.6411	.8002	-.5024	-.3167	.7209	.7019
.7000	-.4106	.7023	.7307	.6500	-.0403	.7756	.6152	.8002	-.7524	-.3144	.7213	.7012
.7500	-.3850	.7074	.7229	.7000	.0812	.7996	.5758					
.8002	-.3188	.7165	.7087	.7501	.1831	.8198	.5418					
.8002	-.1998	.7440	.6656	.8001	.2676	.8365	.5129					
.9501	-.0958	.7646	.6329	.8501	.3416	.8511	.4866					

TEST	167	PT	66.6219	PSI	CM	.2351	CD1	.00724	CDCOR1	.00715
RUN	22	TT	115.4335	K	CM	-.1247	CD2	.00730	CDCOR2	.00726
POINT	72	RC	29.9132	MILLION	CC	.0172	CD3	.00723	CDCOR3	.00725
		MACH	.6012				CD4	.00722	CDCOR4	.00720
		ALPHA	-1.9921	DEG			CD5	.00718	CDCOR5	.00700

UPPER SURFACE				LOWER SURFACE				SPANWISE				
X/C	CP	P.L/PT	MLOC	X/C	CP	P.L/PT	MLOC	X/C	Y/(B/2)	CP	P.L/PT	MLOC
0.0000	.9558	.9728	.1992	0.0000	.9558	.9728	.1992	.1507	.7476	-.3456	.7160	.7694
.0132	.1692	.8176	.5454	.0126	-.1184	.7609	.6388	.1507	.4976	-.3574	.7137	.7130
.0259	-.1469	.7553	.6478	.0255	-.1874	.7473	.6604	.1507	.2476	-.3547	.7143	.7122
.0759	-.3331	.7185	.7055	.0495	-.2737	.7302	.6872	.1507	-.2524	-.3613	.7130	.7142
.1003	-.3421	.7167	.7083	.0753	-.2987	.7253	.6949	.1507	-.5024	-.3643	.7124	.7151
.1507	-.3495	.7153	.7166	.1002	-.3438	.7164	.7088	.1507	-.7524	-.3546	.7143	.7121
.2003	-.3543	.7143	.7120	.1503	-.3489	.7154	.7104	.5002	.7476	-.4206	.7013	.7323
.2503	-.3741	.7104	.7141	.1976	-.4016	.7050	.7265	.5002	.4976	-.4262	.7002	.7340
.3001	-.3921	.7069	.7236	.2503	-.4125	.7029	.7299	.5002	.2476	-.4308	.6992	.7354
.3502	-.3947	.7064	.7244	.3001	-.4175	.7019	.7314	.5002	-.2524	-.4216	.7011	.7326
.4003	-.3991	.7055	.7258	.3507	-.4121	.7029	.7297	.5002	-.5024	-.4198	.7014	.7321
.4501	-.4047	.7044	.7275	.4001	-.3848	.7083	.7214	.5002	-.7524	-.4049	.7044	.7275
.5002	-.4280	.6996	.7349	.4501	-.3590	.7134	.7135	.8002	.7476	-.40178	.5834	.9147
.5502	-.4479	.6959	.7407	.5001	-.2915	.7267	.6927	.8002	.4976	-.3631	.7126	.7147
.6002	-.4550	.6945	.7428	.5497	-.1996	.7448	.6643	.8002	.2476	-.3635	.7125	.7149
.6500	-.4599	.6935	.7443	.6003	-.0954	.7654	.6315	.8002	-.5024	-.3370	.7178	.7067
.7000	-.4441	.6966	.7395	.6500	-.0200	.7803	.6075	.8002	-.7524	-.3347	.7182	.7060
.7500	-.4132	.7027	.7301	.7000	.0980	.8036	.5691					
.8002	-.3617	.7129	.7143	.7501	.1970	.8231	.5360					
.8002	-.2123	.7423	.6682	.8001	.2800	.8395	.5074					
.9501	-.1036	.7638	.6341	.8501	.3539	.8541	.4812					

ORIGINAL PAGE IS
OF POOR QUALITY

TEST 167	PT	66.6776	PSI	CM	.2976	CD1	.00726	CDCOR1	.00721
RUN 22	TT	115.4314	K	CM	-.1262	CD2	.00732	CDCOR2	.00731
POINT 73	RC	29.9304	MILLION	CC	.0181	CD3	.00724	CDCOR3	.00731
	MACH	.6009				CD4	.00721	CDCOR4	.00724
	ALPHA	-1.4867	DEG			CD5	.00717	CDCOR5	.00703

UPPER SURFACE				LOWER SURFACE				SPANWISE				
X/C	CP	P/L/PT	MLOC	X/C	CP	P/L/PT	MLOC	X/C	Y/(B/2)	CP	P/L/PT	MLOC
0.0000	1.0167	.9849	.1478	0.0000	1.0167	.9849	.1478	.1507	.7476	-.4020	.7057	.7254
.0132	.0380	.7923	.5878	.0126	.0262	.7900	.5917	.1507	.4976	-.4145	.7032	.7292
.0259	-.2748	.7307	.6864	.0255	-.0743	.7702	.6239	.1507	.2476	-.4125	.7036	.7286
.0759	-.4183	.7025	.7304	.0495	-.1800	.7494	.6571	.1507	-.2524	-.4191	.7023	.7307
.10J3	-.4148	.7032	.7293	.0753	-.2218	.7412	.6701	.1507	-.5024	-.4216	.7018	.7314
.1507	-.4072	.7047	.7270	.1002	-.2756	.7306	.6867	.1507	-.7524	-.4107	.7040	.7281
.2003	-.4055	.7050	.7265	.1503	-.2931	.7271	.6921	.5002	.7476	-.4450	.6972	.7385
.2503	-.4162	.7029	.7298	.1976	-.3517	.7156	.7101	.5002	.4976	-.4505	.6962	.7402
.3001	-.4297	.7002	.7339	.2503	-.3694	.7121	.7155	.5002	.2476	-.4551	.6953	.7416
.3502	-.4287	.7004	.7336	.3001	-.3792	.7102	.7185	.5002	-.2524	-.4456	.6971	.7387
.4003	-.4293	.7003	.7338	.3507	-.3784	.7103	.7182	.5002	-.5024	-.4436	.6975	.7381
.4501	-.4322	.6998	.7347	.4001	-.3594	.7149	.7112	.5002	-.7524	-.4284	.7005	.7335
.5002	-.4535	.6956	.7411	.4501	-.3336	.7192	.7045	.8002	.7476	-1.0456	.5790	.9216
.5502	-.4702	.6923	.7462	.5001	-.2701	.7317	.6850	.8002	.4976	-.3723	.7116	.7164
.6002	-.4747	.6914	.7476	.5497	-.1820	.7490	.6577	.8002	.2476	-.3727	.7115	.7165
.6500	-.4772	.6909	.7483	.6003	-.0810	.7689	.6260	.8002	-.5024	-.3448	.7170	.7080
.7000	-.4584	.6945	.7427	.6500	-.0085	.7832	.6028	.8002	-.7524	-.3426	.7174	.7073
.7500	-.4293	.7011	.7325	.7000	.1075	.8060	.5651					
.8002	-.3711	.7118	.7160	.7501	.2090	.8252	.5325					
.9002	-.2164	.7422	.6694	.8001	.2870	.8413	.5042					
.9501	-.1054	.7641	.6337	.8501	.3607	.8558	.4780					

TEST 167	PT	66.6512	PSI	CM	.3562	CD1	.00725	CDCOR1	.00718
RUN 22	TT	115.3497	K	CM	-.1274	CD2	.00733	CDCOR2	.00730
POINT 74	RC	29.9489	MILLION	CC	.0181	CD3	.00725	CDCOR3	.00728
	MACH	.6009				CD4	.00723	CDCOR4	.00721
	ALPHA	-.9979	DEG			CD5	.00721	CDCOR5	.00704

UPPER SURFACE				LOWER SURFACE				SPANWISE				
X/C	CP	P/L/PT	MLOC	X/C	CP	P/L/PT	MLOC	X/C	Y/(B/2)	CP	P/L/PT	MLOC
0.0000	1.0576	.9929	.1009	0.0000	1.0576	.9929	.1009	.1507	.7476	-.4553	.6948	.7424
.0132	-.0939	.7660	.6306	.0126	.1550	.8150	.5498	.1507	.4976	-.4692	.6920	.7466
.0259	-.4006	.7055	.7257	.0255	.0286	.7901	.5914	.1507	.2476	-.4671	.6924	.7460
.0759	-.5007	.6858	.7562	.0495	-.0934	.7661	.6305	.1507	-.2524	-.4740	.6911	.7481
.1003	-.4843	.6891	.7512	.0753	-.1497	.7550	.6482	.1507	-.5024	-.4759	.6907	.7486
.1507	-.4616	.6935	.7443	.1002	-.2103	.7430	.6671	.1507	-.7524	-.4644	.6930	.7451
.2003	-.4515	.6955	.7412	.1503	-.2393	.7373	.6761	.5002	.7476	-.4649	.6929	.7453
.2503	-.4550	.6944	.7423	.1976	-.3033	.7247	.6959	.5002	.4976	-.4712	.6916	.7472
.3001	-.4641	.6930	.7450	.2503	-.3272	.7200	.7032	.5002	.2476	-.4761	.6907	.7487
.3502	-.4594	.6940	.7436	.3001	-.3413	.7172	.7075	.5002	-.2524	-.4662	.6926	.7457
.4003	-.4561	.6946	.7426	.3507	-.3447	.7166	.7086	.5002	-.5024	-.4644	.6930	.7451
.4501	-.4558	.6947	.7425	.4001	-.3256	.7203	.7027	.5002	-.7524	-.4489	.6966	.7404
.5002	-.4744	.6910	.7482	.4501	-.3076	.7239	.6972	.8002	.7476	-1.0554	.5765	.9256
.5502	-.4886	.6882	.7525	.5001	-.2400	.7356	.6786	.8002	.4976	-.3771	.7102	.7185
.6002	-.4908	.6878	.7532	.5497	-.1633	.7523	.6525	.8002	.2476	-.3786	.7099	.7190
.6500	-.4909	.6877	.7532	.6003	-.0655	.7716	.6216	.8002	-.5024	-.3502	.7155	.7103
.7000	-.4699	.6919	.7468	.6500	.0042	.7853	.5993	.8002	-.7524	-.3481	.7159	.7096
.7500	-.4338	.6990	.7358	.7000	.1183	.8078	.5620					
.8002	-.3771	.7102	.7185	.7501	.2142	.8267	.5298					
.9002	-.2178	.7416	.6694	.8001	.2932	.8427	.5018					
.9501	-.1045	.7639	.6340	.8501	.3685	.8571	.4756					

TEST 167	PT	66.6590	PSI	CM	.4169	CD1	.00729	CDCOR1	.00718
RUN 22	TT	115.3154	K	CM	-.1285	CD2	.00739	CDCOR2	.00733
POINT 75	RC	29.9693	MILLION	CC	.0173	CD3	.00730	CDCOR3	.00731
	MACH	.6010				CD4	.00725	CDCOR4	.00721
	ALPHA	-.4899	DEG			CD5	.00721	CDCOR5	.00704

UPPER SURFACE				LOWER SURFACE				SPANWISE				
X/C	CP	P/L/PT	MLOC	X/C	CP	P/L/PT	MLOC	X/C	Y/(B/2)	CP	P/L/PT	MLOC
0.0000	1.0821	.9977	.0575	0.0000	1.0821	.9977	.0575	.1507	.7476	-.5151	.6823	.7615
.0132	-.2447	.7357	.6786	.0126	.2744	.8382	.5097	.1507	.4976	-.5297	.6795	.7660
.0259	-.5468	.6761	.7712	.0255	.1265	.8090	.5600	.1507	.2476	-.5283	.6797	.7656
.0759	-.5943	.6667	.7856	.0495	-.0115	.7818	.6051	.1507	-.2524	-.5358	.6782	.7679
.1003	-.5630	.6729	.7761	.0753	-.0818	.7679	.6275	.1507	-.5024	-.5366	.6781	.7681
.1507	-.5231	.6808	.7640	.1002	-.1482	.7548	.6485	.1507	-.7524	-.5226	.6809	.7638
.2003	-.4979	.6857	.7563	.1503	-.1886	.7468	.6612	.5002	.7476	-.4908	.6871	.7541
.2503	-.4993	.6855	.7567	.1976	-.2581	.7331	.6828	.5002	.4976	-.4969	.6859	.7560
.3001	-.5034	.6847	.7580	.2503	-.2881	.7272	.6920	.5002	.2476	-.5017	.6850	.7575
.3502	-.4940	.6865	.7551	.3001	-.3066	.7235	.6978	.5002	-.2524	-.4918	.6869	.7545
.4003	-.4871	.6879	.7530	.3507	-.3140	.7221	.7000	.5002	-.5024	-.4896	.6874	.7538
.4501	-.4839	.6885	.7521	.4001	-.2988	.7256	.6954	.5002	-.7524	-.4737	.6905	.7489
.5002	-.4998	.6854	.7569	.4501	-.2846	.7279	.6910	.8002	.7476	-1.0835	.5701	.9356
.5502	-.5115	.6831	.7504	.5001	-.2287	.7389	.6737	.8002	.4976	-.3870	.7076	.7224
.6002	-.5111	.6831	.7503	.5497	-.1476	.7549	.6483	.8002	.2476	-.3882	.7074	.7229
.6500	-.5086	.6836	.7506	.6003	-.0528	.7736	.6183	.8002	-.5024	-.3586	.7132	.7137
.7000	-.4849	.6883	.7523	.6500	.0141	.7868	.5964	.8002	-.7524	-.3563	.7137	.7130
.7500	-.4459	.6960	.7405	.7000	.1263	.8090	.5601					
.8002	-.3864	.7078	.7223	.7501	.2205	.8276	.5283					
.9002	-.2219	.7402	.6715	.8001	.3006	.8434	.5005					
.9501	-.1064	.7630	.6353	.8501	.3733	.8578	.4744					

TEST 167	PT	66.6562	PSI	CN	.4793	CD1	.00732	CDCOR1	.00725
RUN 22	TT	115.3168	K	CM	-.1296	CD2	.00742	CDCOR2	.00739
POINT 76	RC	29.9644	MILLION	CC	.0156	CD3	.00736	CDCOR3	.00741
	MACH	.6009				CD4	.00727	CDCOR4	.00727
	ALPHA	.0102	DEG			CD5	.00724	CDCOR5	.00707

UPPER SURFACE				LOWER SURFACE				SPANWISE				
X/C	CP	P _z L/PT	MLOC	X/C	CP	P _z L/PT	MLOC	X/C	Y/(B/2)	CP	P _z L/PT	MLOC
0.0000	1.0881	.9991	.0363	0.0000	1.0881	.9991	.0363	.1507	.7476	-.5768	.6727	.7763
.0132	-.4101	.7054	.7259	.0126	.3854	.8613	.4678	.1507	.4976	-.5919	.6698	.7809
.0254	-.7042	.6478	.8148	.0255	.2196	.8288	.5261	.1507	.2476	-.5908	.6700	.7805
.0759	-.6914	.6503	.8109	.0495	.0680	.7991	.5765	.1507	-.2524	-.5989	.6684	.7830
.1003	-.6436	.6397	.7965	.0753	-.0144	.7830	.6031	.1507	-.5024	-.5994	.6683	.7832
.1507	-.5854	.6772	.7789	.1002	-.0867	.7688	.6261	.1507	-.7524	-.5860	.6709	.7791
.2003	-.5541	.6772	.7695	.1303	-.1373	.7589	.6420	.5002	.7476	-.5158	.6847	.7579
.2503	-.5433	.6793	.7662	.1976	-.2114	.7444	.6650	.5002	.4976	-.5216	.6836	.7596
.3001	-.5424	.6795	.7659	.2503	-.2470	.7374	.6760	.5002	.2476	-.5263	.6826	.7611
.3502	-.5280	.6823	.7616	.3001	-.2695	.7330	.6829	.5002	-.2524	-.5163	.6846	.7581
.4003	-.5173	.6844	.7584	.3507	-.2807	.7308	.6864	.5002	-.5024	-.5142	.6850	.7574
.4501	-.5114	.6856	.7566	.4001	-.2695	.7330	.6829	.5002	-.7524	-.4977	.6882	.7524
.5002	-.5243	.6830	.7505	.4501	-.2591	.7330	.6797	.8002	.7476	-1.1133	.6876	.9396
.5502	-.5332	.6813	.7462	.5001	-.2072	.7452	.6637	.8002	.4976	-.3965	.7081	.7217
.6002	-.5304	.6819	.7423	.5497	-.1299	.7604	.6396	.8002	.2476	-.3973	.7079	.7220
.6500	-.5255	.6828	.7408	.6003	-.0387	.7782	.6109	.8002	-.5024	-.3667	.7139	.7127
.7000	-.4990	.6880	.7328	.6500	.0252	.7907	.5904	.8002	-.7524	-.3649	.7143	.7121
.7500	-.4575	.6941	.7402	.7000	.1352	.8123	.5544					
.8002	-.3954	.7083	.7214	.7501	.2277	.8304	.5233					
.9002	-.2260	.7415	.6695	.8001	.3065	.8459	.4960					
.9501	-.1078	.7647	.6327	.8501	.3786	.8600	.4702					

TEST 167	PT	66.6534	PSI	CN	.5388	CD1	.00740	CDCOR1	.00730
RUN 22	TT	115.2766	K	CM	-.1306	CD2	.00753	CDCOR2	.00746
POINT 77	RC	29.9674	MILLION	CC	.0134	CD3	.00745	CDCOR3	.00745
	MACH	.6006				CD4	.00734	CDCOR4	.00728
	ALPHA	.5091	DEG			CD5	.00736	CDCOR5	.00718

UPPER SURFACE				LOWER SURFACE				SPANWISE				
X/C	CP	P _z L/PT	MLOC	X/C	CP	P _z L/PT	MLOC	X/C	Y/(B/2)	CP	P _z L/PT	MLOC
0.0000	1.0904	.9994	.0304	0.0000	1.0904	.9994	.0304	.1507	.7476	-.6377	.6583	.7987
.0132	-.5738	.6709	.7793	.0126	.4829	.8794	.4333	.1507	.4976	-.6541	.6550	.8037
.0254	-.8663	.6131	.8683	.0255	.3057	.8445	.4986	.1507	.2476	-.6531	.6552	.8033
.0759	-.7909	.6280	.8453	.0495	.1417	.8121	.5548	.1507	-.2524	-.6613	.6536	.8059
.1003	-.7252	.6410	.8253	.0753	.0487	.7937	.5855	.1507	-.5024	-.6599	.6539	.8054
.1507	-.6474	.6563	.8016	.1002	-.0293	.7783	.6107	.1507	-.7524	-.6432	.6572	.8003
.2003	-.5942	.6668	.7855	.1303	-.0893	.7665	.6298	.5002	.7476	-.5379	.6780	.7683
.2503	-.5865	.6664	.7831	.1976	-.1686	.7510	.6546	.5002	.4976	-.5444	.6767	.7703
.3001	-.5804	.6696	.7812	.2503	-.2089	.7429	.6674	.5002	.2476	-.5494	.6757	.7710
.3502	-.5616	.6733	.7755	.3001	-.2356	.7376	.6757	.5002	-.2524	-.5394	.6777	.7688
.4003	-.5473	.6761	.7712	.3507	-.2502	.7347	.6802	.5002	-.5024	-.5375	.6780	.7682
.4501	-.5378	.6780	.7683	.4001	-.2424	.7363	.6778	.5002	-.7524	-.5200	.6815	.7629
.5002	-.5476	.6760	.7714	.4501	-.2393	.7377	.6756	.8002	.7476	-1.1231	.6825	.9478
.5502	-.5541	.6747	.7733	.5001	-.1869	.7472	.6605	.8002	.4976	-.4016	.7049	.7268
.6002	-.5487	.6758	.7716	.5497	-.1127	.7619	.6372	.8002	.2476	-.4035	.7045	.7274
.6500	-.5407	.6774	.7692	.6003	-.0243	.7793	.6091	.8002	-.5024	-.3730	.7105	.7180
.7000	-.5115	.6832	.7603	.6500	.0372	.7915	.5892	.8002	-.7524	-.3716	.7108	.7176
.7500	-.4670	.6920	.7467	.7000	.1484	.8128	.5536					
.8002	-.4619	.7048	.7269	.7501	.2364	.8308	.5227					
.9002	-.2272	.7393	.6730	.8001	.3142	.8461	.4956					
.9501	-.1069	.7630	.6354	.8501	.3859	.8603	.4697					

TEST 167	PT	66.6575	PSI	CN	.5991	CD1	.00750	CDCOR1	.00741
RUN 22	TT	115.2884	K	CM	-.1314	CD2	.00766	CDCOR2	.00761
POINT 78	RC	29.9569	MILLION	CC	.0102	CD3	.00754	CDCOR3	.00756
	MACH	.6004				CD4	.00737	CDCOR4	.00734
	ALPHA	1.0091	DEG			CD5	.00742	CDCOR5	.00722

UPPER SURFACE				LOWER SURFACE				SPANWISE				
X/C	CP	P _z L/PT	MLOC	X/C	CP	P _z L/PT	MLOC	X/C	Y/(B/2)	CP	P _z L/PT	MLOC
0.0000	1.0773	.9968	.0677	0.0000	1.0773	.9968	.0677	.1507	.7476	-.6994	.6467	.8164
.0132	-.7574	.6353	.8341	.0126	.5667	.8962	.3997	.1507	.4976	-.7169	.6433	.8218
.0254	-.10476	.5781	.9231	.0255	.3819	.8598	.4707	.1507	.2476	-.7166	.6433	.8217
.0759	-.8943	.6083	.8758	.0495	.2089	.8257	.5316	.1507	-.2524	-.7232	.6420	.8237
.1003	-.8084	.6252	.8496	.0753	.1073	.8057	.5856	.1507	-.5024	-.7212	.6424	.8231
.1507	-.7099	.6447	.8196	.1002	-.0239	.7892	.5929	.1507	-.7524	-.7030	.6460	.8176
.2003	-.6529	.6559	.8023	.1303	-.0440	.7759	.6147	.5002	.7476	-.6999	.6742	.7741
.2503	-.6300	.6604	.7954	.1976	-.1263	.7597	.6408	.5002	.4976	-.6977	.6727	.7765
.3001	-.6187	.6627	.7919	.2503	-.1720	.7506	.6551	.5002	.2476	-.6970	.6716	.7781
.3502	-.5981	.6667	.7857	.3001	-.2021	.7447	.6645	.5002	-.2524	-.6914	.6739	.7746
.4003	-.5782	.6706	.7797	.3507	-.2198	.7412	.6700	.5002	-.5024	-.6997	.6742	.7741
.4501	-.5646	.6733	.7755	.4001	-.2156	.7420	.6687	.5002	-.7524	-.6432	.6775	.7690
.5002	-.5715	.6719	.7776	.4501	-.2120	.7428	.6676	.8002	.7476	-1.1325	.6814	.9495
.5502	-.5752	.6712	.7788	.5001	-.1672	.7516	.6536	.8002	.4976	-.4089	.7040	.7282
.6002	-.5674	.6727	.7744	.5497	-.0945	.7655	.6314	.8002	.2476	-.4120	.7033	.7291
.6500	-.5564	.6749	.7731	.6003	-.0113	.7823	.6043	.8002	-.5024	-.3794	.7098	.7192
.7000	-.5244	.6811	.7635	.6500	.0475	.7939	.5833	.8002	-.7524	-.3778	.7101	.7187
.7500	-.4776	.6904	.7491	.7000	.1933	.8147	.5504					
.8002	-.4103	.7037	.7286	.7501	.2425	.8323	.5201					
.9002	-.2313	.7390	.6736	.8001	.3191	.8474	.4933					
.9501	-.1097	.7679	.6356	.8501	.3901	.8614	.4677					

ORIGINAL PAGE IS
OF POOR QUALITY

TEST	167	PT	66.6331	PSI	CM	-6564	CD1	.00759	CDCOR1	.00747			
RUN	22	TT	115.3837	K	CM	-1311	CD2	.00767	CDCOR2	.00761			
POINT	79	RC	29.9458	MILLION	CC	.0063	CD3	.00759	CDCOR3	.00759			
		MACH	.6012				CD4	.00748	CDCOR4	.00744			
		ALPHA	1.5172	DEG			CD5	.00739	CDCOR5	.00721			
		UPPER SURFACE				LOWER SURFACE				SPANWISE			
X/C	CP	P/L/PT	MLOC	X/C	CP	P/L/PT	MLOC	X/C	Y/(B/2)	CP	P/L/PT	MLOC	
0.0000	1.0541	.9921	.1066	0.0000	1.0541	.9921	.1066	.1507	.7476	-.7585	.6236	.8366	
.0132	-.9365	.5984	.8912	.0126	.6474	.9117	.3666	.1507	.4976	-.7782	.6297	.8427	
.0259	-1.2437	.5376	.9875	.0255	.4569	.8740	.4439	.1507	.2476	-.7791	.6295	.8429	
.0759	-1.0001	.5858	.9109	.0495	.2743	.8379	.5103	.1507	-.2524	-.7867	.6280	.8453	
.1003	-.8914	.6073	.8774	.0753	.1644	.8162	.5479	.1507	-.5024	-.7633	.6287	.8443	
.1507	-.7916	.6310	.8407	.1002	.0786	.7992	.5765	.1507	-.7924	-.7645	.6324	.8385	
.2003	-.7007	.6450	.8196	.1503	.0022	.7841	.6013	.5002	.7476	-.5805	.6688	.7824	
.2503	-.6713	.6509	.8100	.1976	-.0844	.7669	.6291	.5002	.4976	-.5889	.6672	.7850	
.3001	-.6548	.6541	.8030	.2503	-.1352	.7569	.6452	.5002	.2476	-.5943	.6661	.7866	
.3502	-.6263	.6598	.7963	.3001	-.1688	.7502	.6557	.5002	-.2524	-.5841	.6681	.7835	
.4003	-.6039	.6642	.7895	.3507	-.1896	.7461	.6622	.5002	-.5024	-.5825	.6684	.7830	
.4501	-.5880	.6673	.7847	.4001	-.1889	.7463	.6620	.5002	-.7924	-.5844	.6721	.7774	
.5002	-.5913	.6667	.7857	.4501	-.1883	.7464	.6618	.8002	.7476	-1.1507	.5560	.9380	
.5502	-.5822	.6665	.7860	.5001	-.1473	.7545	.6490	.8002	.4976	-.4141	.7017	.7316	
.6002	-.5820	.6685	.7829	.5497	-.0797	.7679	.6276	.8002	.2476	-.4170	.7012	.7325	
.6500	-.5886	.6712	.7788	.6003	.0025	.7841	.6013	.8002	-.5024	-.3849	.7075	.7226	
.7000	-.5342	.6780	.7683	.7000	.1626	.8158	.5486	.8002	-.7924	-.3841	.7077	.7224	
.7500	-.4841	.6879	.7530	.8501	.2500	.8331	.5187						
.8002	-.4141	.7017	.7316	.8001	.3256	.8480	.4922						
.9002	-.2302	.7381	.6749	.8501	.3955	.8619	.4668						
.9501	-.1055	.7628	.6358										

TEST	167	PT	66.6667	PSI	CM	.7213	CD1	.00778	CDCOR1	.00760			
RUN	22	TT	115.2430	K	CM	-1313	CD2	.00781	CDCOR2	.00766			
POINT	80	RC	29.9912	MILLION	CC	.0012	CD3	.00776	CDCOR3	.00768			
		MACH	.6008				CD4	.00761	CDCOR4	.00746			
		ALPHA	2.0235	DEG			CD5	.00759	CDCOR5	.00739			
		UPPER SURFACE				LOWER SURFACE				SPANWISE			
X/C	CP	P/L/PT	MLOC	X/C	CP	P/L/PT	MLOC	X/C	Y/(B/2)	CP	P/L/PT	MLOC	
0.0000	1.0160	.9848	.1482	0.0000	1.0160	.9848	.1482	.1507	.7476	-.8156	.6248	.8503	
.0132	-1.1339	.5622	.9482	.0126	.7334	.9293	.3261	.1507	.4976	-.8340	.6211	.8559	
.0259	-1.4932	.4016	1.0634	.0255	.5365	.8906	.4112	.1507	.2476	-.8357	.6208	.8564	
.0759	-1.1053	.5678	.9393	.0495	.3499	.8539	.4815	.1507	-.2524	-.8418	.6196	.8583	
.1003	-.9710	.5982	.8978	.0753	.2326	.8308	.5227	.1507	-.5024	-.8375	.6205	.8570	
.1507	-.8275	.6224	.8539	.1002	-.1411	.8128	.5536	.1507	-.7924	-.8176	.6244	.8509	
.2003	-.7541	.6388	.8317	.1503	-.0580	.7965	.5809	.5002	.7476	-.5957	.6680	.7837	
.2503	-.7061	.6463	.8171	.1976	-.0314	.7789	.6097	.5002	.4976	-.6033	.6665	.7860	
.3001	-.6839	.6507	.8104	.2503	-.0867	.7681	.6273	.5002	.2476	-.6079	.6656	.7874	
.3502	-.6540	.6565	.8013	.3001	-.1234	.7608	.6389	.5002	-.2524	-.5954	.6680	.7836	
.4003	-.6259	.6621	.7928	.3507	-.1476	.7561	.6464	.5002	-.5024	-.5941	.6683	.7832	
.4501	-.6055	.6661	.7866	.4001	-.1501	.7556	.6472	.5002	-.7924	-.5953	.6720	.7775	
.5002	-.6053	.6661	.7866	.4501	-.1528	.7551	.6480	.8002	.7476	-1.1667	.5557	.9384	
.5502	-.6037	.6664	.7861	.5001	-.1158	.7623	.6365	.8002	.4976	-.4126	.7040	.7281	
.6002	-.5910	.6689	.7822	.5497	-.0520	.7749	.6163	.8002	.2476	-.4152	.7035	.7289	
.6500	-.5737	.6723	.7770	.6003	.0265	.7903	.5911	.8002	-.5024	-.3811	.7102	.7185	
.7000	-.5371	.6795	.7659	.7000	.0807	.8010	.5735	.8002	-.7924	-.3796	.7105	.7180	
.7500	-.4843	.6899	.7499	.8501	.1812	.8207	.5401						
.8002	-.4119	.7041	.7279	.7501	.2666	.8375	.5109						
.9002	-.2236	.7411	.6701	.8001	.3406	.8521	.4849						
.9501	-.0988	.7657	.6311	.8501	.4094	.8656	.4599						

TEST	167	PT	66.6799	PSI	CM	.7807	CD1	.00806	CDCOR1	.00813			
RUN	22	TT	115.2655	K	CM	-1318	CD2	.00813	CDCOR2	.00824			
POINT	81	RC	29.9946	MILLION	CC	-.0035	CD3	.00804	CDCOR3	.00819			
		MACH	.6010				CD4	.00787	CDCOR4	.00800			
		ALPHA	2.5263	DEG			CD5	.00781	CDCOR5	.00778			
		UPPER SURFACE				LOWER SURFACE				SPANWISE			
X/C	CP	P/L/PT	MLOC	X/C	CP	P/L/PT	MLOC	X/C	Y/(B/2)	CP	P/L/PT	MLOC	
0.0000	.9614	.9740	.1949	0.0000	.9614	.9740	.1949	.1507	.7476	-.8827	.6105	.8725	
.0132	-1.3001	.5282	1.0028	.0126	.7933	.9408	.2971	.1507	.4976	-.9010	.6069	.8760	
.0259	-1.7371	.4421	1.1489	.0255	.5944	.9016	.3883	.1507	.2476	-.9033	.6064	.8788	
.0759	-1.2063	.5467	.9729	.0495	.4660	.8645	.4619	.1507	-.2524	-.9085	.6054	.8803	
.1003	-1.0572	.5761	.9262	.0753	.2823	.8401	.5063	.1507	-.5024	-.9026	.6066	.8785	
.1507	-.8945	.6082	.8761	.1002	.1865	.8212	.5393	.1507	-.7924	-.8821	.6108	.8723	
.2003	-.8059	.6256	.8490	.1503	.0973	.8037	.5690	.5002	.7476	-.8214	.6620	.7929	
.2503	-.7528	.6361	.8328	.1976	.0048	.7854	.5992	.5002	.4976	-.8296	.6604	.7954	
.3001	-.7249	.6416	.8244	.2503	-.0546	.7737	.6182	.5002	.2476	-.8343	.6594	.7969	
.3502	-.6935	.6478	.8148	.3001	-.0944	.7659	.6308	.5002	-.2524	-.8210	.6621	.7928	
.4003	-.6605	.6543	.8048	.3507	-.1216	.7605	.6394	.5002	-.5024	-.8195	.6624	.7924	
.4501	-.6359	.6591	.7973	.4001	-.1272	.7594	.6412	.5002	-.7924	-.8194	.6643	.7862	
.5002	-.6320	.6599	.7961	.4501	-.1327	.7583	.6429	.8002	.7476	-1.1789	.5319	.9646	
.5502	-.6278	.6607	.7949	.5001	-.0991	.7643	.6323	.8002	.4976	-.4207	.7016	.7349	
.6002	-.6124	.6638	.7902	.5497	-.0384	.7769	.6130	.8002	.2476	-.4241	.7009	.7329	
.6500	-.5918	.6674	.7839	.6003	.0372	.7918	.5887	.8002	-.5024	-.3895	.7077	.7224	
.7000	-.5521	.6757	.7719	.7000	.0887	.8019	.5719	.8002	-.7924	-.3869	.7082	.7216	
.7500	-.4965	.6866	.7550	.8501	.1872	.8214	.5390						
.8002	-.4215	.7016	.7321	.7501	.2707	.8378	.5104						
.9002	-.2280	.7389	.6727	.8001	.3435	.8522	.4847						
.9501	-.1619	.7644	.6332	.8501	.4115	.8656	.4599						

TFST	167	PT	66.6745	PSI	CN	.8289	CD1	.00871	CDCOR1	.00863
RUN	22	TT	119.1592	K	CM	-.1327	CD2	.00883	CDCOR2	.00880
PCINT	82	RC	30.0373	MILLION	CC	-.0074	CD3	.00869	CDCOR3	.00875
		MACH	.8010				CD4	.00853	CDCOR4	.00852
		ALPHA	3.0345	DEG			CD5	.00854	CDCOR5	.00834

UPPER SURFACE				LOWER SURFACE				SPANWISE				
X/C	CP	P ₂ L/PT	MLOC	X/C	CP	P ₂ L/PT	MLOC	X/C	Y/(B/2)	CP	P ₂ L/PT	MLOC
0.0000	.9009	.9618	.2372	0.0000	.9009	.9618	.2372	.1507	.7476	-.9424	.5967	.8939
.0132	-1.4672	.4928	1.0613	.0126	.8413	.9499	.2724	.1507	.4976	-.9539	.5945	.8974
.0259	-1.9004	.4069	1.2132	.0255	.6426	.9106	.3690	.1507	.2476	-.9561	.5940	.8981
.0759	-1.3101	.5239	1.0098	.0495	.4538	.8732	.4454	.1507	-.2524	-.9610	.5930	.8996
.1003	-1.0810	.5693	.9370	.0753	.3253	.8478	.4927	.1507	-.5024	-.9531	.5946	.8971
.1507	-.9461	.5960	.8950	.1002	.2251	.8279	.5277	.1507	-.7524	-.9353	.5981	.8917
.2003	-.8382	.6174	.8618	.1503	.1309	.8093	.5596	.5002	.7476	-.6457	.6555	.8029
.2503	-.7966	.6256	.8490	.1976	.0358	.7904	.5909	.5002	.4976	-.6544	.6538	.8056
.3001	-.7639	.6321	.8390	.2503	-.0271	.7780	.6113	.5002	.2476	-.6595	.6528	.8071
.3502	-.7280	.6392	.8240	.3001	-.0697	.7695	.6249	.5002	-.2524	-.6458	.6555	.8030
.4003	-.6937	.6460	.8176	.3507	-.1000	.7635	.6345	.5002	-.5024	-.6444	.6557	.8025
.4501	-.6653	.6516	.8089	.4001	-.1080	.7620	.6371	.5002	-.7524	-.6243	.6597	.7964
.5002	-.6585	.6530	.8068	.4501	-.1165	.7603	.6398	.8002	.7476	-1.1841	.5489	.9695
.5502	-.6514	.6543	.8048	.5001	-.0860	.7663	.6301	.8002	.4976	-.4276	.5987	.7363
.6002	-.6332	.6580	.7991	.5497	-.0284	.7777	.6117	.8002	.2476	-.4314	.6979	.7375
.6500	-.6089	.6624	.7917	.6003	.0446	.7922	.5881	.8002	-.5024	-.3977	.7046	.7272
.7000	-.5665	.6712	.7788	.6500	.0943	.8020	.5717	.8002	-.7524	-.3930	.7055	.7257
.7500	-.5079	.6828	.7609	.7000	.1407	.8211	.5395					
.8002	-.4300	.6982	.7371	.7501	.2728	.8374	.5112					
.9002	-.2312	.7376	.6757	.8001	.3445	.8516	.4858					
.9501	-.1057	.7624	.6363	.8501	.4127	.8649	.4612					

TFST	167	PT	66.6686	PSI	CN	.8926	CD1	.00966	CDCOR1	.00958
RUN	22	TT	119.2692	K	CM	-.1285	CD2	.00978	CDCOR2	.00973
PCINT	83	RC	29.9743	MILLION	CC	-.0165	CD3	.00971	CDCOR3	.00978
		MACH	.8005				CD4	.00950	CDCOR4	.00948
		ALPHA	3.4216	DEG			CD5	.00954	CDCOR5	.00936

UPPER SURFACE				LOWER SURFACE				SPANWISE				
X/C	CP	P ₂ L/PT	MLOC	X/C	CP	P ₂ L/PT	MLOC	X/C	Y/(B/2)	CP	P ₂ L/PT	MLOC
0.0000	.8531	.9523	.2657	0.0000	.8531	.9523	.2657	.1507	.7476	-.9664	.5920	.9012
.0132	-1.6106	.4645	1.1095	.0126	.8868	.9590	.2459	.1507	.4976	-.9630	.5923	.9007
.0259	-2.0005	.3873	1.2507	.0255	.6889	.9198	.3485	.1507	.2476	-.9664	.5920	.9012
.0759	-2.0631	.3749	1.2750	.0495	.4996	.8823	.4277	.1507	-.2524	-.9695	.5914	.9021
.1003	-1.1735	.5510	.9660	.0753	.3658	.8558	.4780	.1507	-.5024	-.9608	.5931	.8995
.1507	-.9557	.5942	.8979	.1002	.2641	.8357	.5142	.1507	-.7524	-.9576	.5938	.8984
.2003	-.8579	.6135	.8677	.1503	.1636	.8158	.5486	.5002	.7476	-.6672	.6513	.8094
.2503	-.8268	.6197	.8592	.1976	.0655	.7964	.5812	.5002	.4976	-.6743	.6499	.8116
.3001	-.7929	.6264	.8478	.2503	-.0014	.7831	.6029	.5002	.2476	-.6789	.6490	.8130
.3502	-.7508	.6347	.8349	.3001	-.0468	.7741	.6175	.5002	-.2524	-.6636	.6516	.8089
.4003	-.7145	.6419	.8238	.3507	-.0796	.7676	.6280	.5002	-.5024	-.6636	.6520	.8083
.4501	-.6849	.6478	.8148	.4001	-.0906	.7655	.6315	.5002	-.7524	-.6405	.6566	.8013
.5002	-.6758	.6446	.8120	.4501	-.1011	.7634	.6348	.8002	.7476	-1.2079	.5442	.9769
.5502	-.6660	.6515	.8091	.5001	-.0733	.7689	.6260	.8002	.4976	-.4326	.6977	.7378
.6002	-.6453	.6556	.8027	.5497	-.0176	.7799	.6082	.8002	.2476	-.4349	.6973	.7385
.6500	-.6190	.6608	.7947	.6003	.0535	.7940	.5851	.8002	-.5024	-.4004	.7041	.7279
.7000	-.5737	.6698	.7804	.6500	.1015	.8035	.5693	.8002	-.7524	-.3946	.7033	.7261
.7500	-.5119	.6820	.7620	.7000	.1969	.8224	.5373					
.8002	-.4314	.6980	.7374	.7501	.2782	.8385	.5092					
.9002	-.2283	.7382	.6748	.8001	.3495	.8526	.4839					
.9501	-.1007	.7634	.6347	.8501	.4165	.8658	.4594					

Appendix C

Pressure Data for $M = 0.65$; $R = 7.0 \times 10^6$ and 30.0×10^6 ; Free Transition

The pressure measurements made on the NASA SC(3)-0712(B) airfoil are presented in coefficient form in graphs and tables in this appendix. The data are for a given Mach number through the Reynolds number range. The pressure data from the upper surface of the airfoil are plotted as open symbols, and the lower-surface data are plotted as solid symbols.

ORIGINAL PAGE IS
OF POOR QUALITY

TEST 167	PT 21.9673	PSI	CN	-.0270	CD1 .00935	CDCDR1 .00914
RUN 26	TT 152.1246	K	CM	-.1148	CD2 .00860	CDCDR2 .00837
POINT 31	RC 6.9891	MILLION	CC	.0040	CD3 .00809	CDCDR3 .00791
	MACH .6492				CD4 .00854	CDCDR4 .00833
	ALPHA -3.9510	DEG			CD5 .00813	CDCDR5 .00794

UPPER SURFACE				LOWER SURFACE				SPANWISE				
X/C	CP	P/L/PT	MLOC	X/C	CP	P/L/PT	MLOC	X/C	Y/(B/2)	CP	P/L/PT	MLOC
0.0000	.6114	.8890	.4134	0.0000	.6114	.8890	.4134	.1507	.7476	-.1484	.7198	.7017
.0132	.9885	.8839	.4235	.0126	-.8428	.5652	.9409	.1507	.4476	-.1658	.7160	.7077
.0259	.2658	.8120	.5535	.0255	-.7220	.5921	.8987	.1507	.2476	-.1575	.7178	.7048
.0759	-.0376	.7445	.6831	.0495	-.7261	.5912	.9001	.1507	-.7524	-.1646	.7162	.7073
.1003	-.0813	.7348	.6784	.0753	-.6582	.6063	.8786	.1507	-.5024	-.1541	.7186	.7037
.1507	-.1428	.7211	.6997	.1002	-.6663	.6045	.8794	.1507	-.7524	-.1612	.7170	.7061
.2003	-.1823	.7123	.7134	.1503	-.6183	.6152	.8828	.5002	.7476	-.3336	.6786	.7653
.2503	-.2224	.7034	.7272	.1976	-.6493	.6083	.8735	.5002	.4476	-.3417	.6768	.7641
.3001	-.2551	.6961	.7384	.2503	-.6305	.6125	.8671	.5002	.2476	-.3449	.6761	.7692
.3502	-.2758	.6815	.7455	.3001	-.6110	.6188	.8603	.5002	-.2524	-.3409	.6770	.7678
.4003	-.2966	.6688	.7526	.3507	-.5867	.6222	.8520	.5002	-.5024	-.3351	.6783	.7658
.4501	-.3185	.6820	.7601	.4001	-.5386	.6310	.8451	.5002	-.7524	-.3245	.6806	.7622
.4902	-.3437	.6754	.7644	.4501	-.4791	.6462	.8151	.8002	.7476	-.3203	.6816	.7608
.5502	-.3672	.6711	.7708	.5001	-.3911	.6518	.7850	.8002	.4476	-.3239	.6808	.7620
.6002	-.3901	.6660	.7846	.5497	-.2750	.6617	.7432	.8002	.2476	-.3274	.6800	.7632
.6500	-.4032	.6631	.7891	.6003	-.1540	.7186	.7036	.8002	-.5024	-.3174	.6821	.7599
.7000	-.3964	.6646	.7864	.6500	-.0488	.7420	.6670	.8002	-.7524	-.3023	.6856	.7546
.7500	-.3712	.6702	.7742	.7000	.0647	.7673	.6269					
.8002	-.3230	.6810	.7617	.7501	.1615	.7888	.5921					
.9002	-.1794	.7129	.7124	.8001	.2396	.8062	.5633					
.9501	-.0689	.7373	.6744	.8501	.3036	.8205	.5392					

TEST 167	PT 21.9704	PSI	CN	.0957	CD1 .00944	CDCDR1 .00919
RUN 26	TT 152.3050	K	CM	-.1195	CD2 .00911	CDCDR2 .00887
POINT 32	RC 6.9761	MILLION	CC	.0113	CD3 .00815	CDCDR3 .00795
	MACH .6490				CD4 .00834	CDCDR4 .00813
	ALPHA -3.0141	DEG			CD5 .00773	CDCDR5 .00751

UPPER SURFACE				LOWER SURFACE				SPANWISE				
X/C	CP	P/L/PT	MLOC	X/C	CP	P/L/PT	MLOC	X/C	Y/(B/2)	CP	P/L/PT	MLOC
0.0000	.8052	.9325	.3174	0.0000	.4052	.9325	.3174	.1507	.7476	-.2456	.6495	.7332
.0132	.4170	.8466	.7935	.0126	-.4774	.6481	.8122	.1507	.4476	-.2636	.6455	.7393
.0259	.0861	.7730	.6177	.0255	-.4557	.6529	.8048	.1507	.2476	-.2412	.7005	.7317
.0759	-.1683	.7186	.7066	.0495	-.5076	.6414	.8225	.1507	-.2524	-.2619	.6959	.7387
.1003	-.1976	.7101	.7167	.0753	-.4493	.6439	.8187	.1507	-.5024	-.2461	.6944	.7384
.1507	-.2403	.7007	.7313	.1002	-.5111	.6406	.8237	.1507	-.7524	-.2550	.6974	.7384
.2003	-.2725	.6935	.7424	.1503	-.4495	.6441	.8184	.5002	.7476	-.3795	.6898	.7749
.2503	-.2977	.6879	.7510	.1976	-.5395	.6343	.8334	.5002	.4476	-.3870	.6881	.7814
.3001	-.3236	.6822	.7596	.2503	-.5361	.6350	.8323	.4002	.2476	-.3920	.6870	.7831
.3502	-.3397	.6780	.7653	.3001	-.5301	.6364	.8302	.5002	-.2524	-.3913	.6894	.7795
.4003	-.3541	.6754	.7702	.3507	-.5146	.6398	.8249	.5002	-.5024	-.3802	.6896	.7791
.4501	-.3711	.6717	.7760	.4001	-.4784	.6478	.8126	.5002	-.7524	-.3671	.6725	.7747
.5002	-.3914	.6672	.7829	.4501	-.4292	.6588	.7958	.8002	.7476	-.3385	.6789	.7649
.5502	-.4105	.6629	.7894	.5001	-.3508	.6761	.7691	.8002	.4476	-.3421	.6781	.7661
.6002	-.4292	.6588	.7958	.5497	-.2424	.7001	.7321	.8002	.2476	-.3455	.6773	.7673
.6500	-.4371	.6570	.7945	.6003	-.1278	.7255	.6927	.8002	-.5024	-.3348	.6797	.7636
.7000	-.4234	.6596	.7945	.6500	-.0279	.7473	.6580	.8002	-.7524	-.3187	.6833	.7581
.7500	-.3948	.6664	.7841	.7000	.0837	.7725	.6185					
.8002	-.3413	.6783	.7659	.7501	.1804	.7940	.5436					
.9002	-.1876	.7123	.7133	.8001	.2603	.8117	.5541					
.9501	-.0749	.7373	.6743	.8501	.3267	.8264	.5290					

TEST 167	PT 21.9713	PSI	CN	.2229	CD1 .00913	CDCDR1 .00887
RUN 26	TT 152.2727	K	CM	-.1223	CD2 .00859	CDCDR2 .00846
POINT 33	RC 6.9896	MILLION	CC	.0159	CD3 .00837	CDCDR3 .00816
	MACH .6505				CD4 .00840	CDCDR4 .00819
	ALPHA -1.9958	DEG			CD5 .00734	CDCDR5 .00710

UPPER SURFACE				LOWER SURFACE				SPANWISE				
X/C	CP	P/L/PT	MLOC	X/C	CP	P/L/PT	MLOC	X/C	Y/(B/2)	CP	P/L/PT	MLOC
0.0000	.4707	.9491	.2121	0.0000	.9707	.9491	.2121	.1507	.7476	-.3483	.6762	.7691
.0132	.1815	.7961	.5902	.0126	-.4182	.7206	.7004	.1507	.4476	-.3827	.6687	.7804
.0259	-.1411	.7222	.6946	.0255	-.2205	.7044	.7253	.1507	.2476	-.3608	.6734	.7733
.0759	-.3312	.6800	.7832	.0495	-.3008	.6867	.7524	.1507	-.2524	-.3810	.6649	.7702
.1003	-.3407	.6779	.7844	.0753	-.3348	.6792	.7645	.1507	-.5024	-.3622	.6731	.7718
.1507	-.3597	.6738	.7864	.1002	-.3433	.6728	.7742	.1507	-.7524	-.3710	.6711	.7749
.2003	-.3710	.6711	.7748	.1503	-.3375	.6697	.7790	.5002	.7476	-.4431	.6569	.7947
.2503	-.3892	.6671	.7830	.1976	-.4345	.6570	.7985	.5002	.4476	-.4409	.6556	.8006
.3001	-.4064	.6633	.7903	.2503	-.4473	.6542	.8028	.5002	.2476	-.4443	.6540	.8032
.3502	-.4104	.6624	.7933	.3001	-.4528	.6530	.8047	.5002	-.2524	-.4399	.6558	.8033
.4003	-.4195	.6604	.7974	.3507	-.4480	.6540	.8031	.5002	-.5024	-.4372	.6564	.7994
.4501	-.4326	.6578	.7974	.4001	-.4221	.6598	.7942	.5002	.7476	-.4241	.6593	.7949
.5002	-.4467	.6543	.8024	.4501	-.3827	.6685	.7604	.8002	.4476	-.4161	.6733	.7733
.5502	-.4607	.6512	.8074	.5001	-.3139	.6738	.7573	.8002	.2476	-.4153	.6724	.7749
.6002	-.4742	.6447	.8120	.5497	-.2137	.7061	.7230	.8002	-.5024	-.4161	.6717	.7729
.6500	-.4790	.6474	.8133	.6003	-.1052	.7302	.6854	.8002	.2476	-.4142	.6716	.7726
.7000	-.4603	.6513	.8073	.6500	-.0112	.7511	.6528	.8002	-.7524	-.4149	.6776	.7669
.7500	-.4234	.6595	.7947	.7000	.0974	.7752	.6143					
.8002	-.3637	.6727	.7743	.7501	.1930	.7964	.5796					
.9002	-.1977	.7098	.7175	.8001	.2729	.8141	.5500					
.9501	-.0797	.7360	.6744	.8501	.3409	.8242	.5241					

TEST	167	PT	21.9700	PSI		CN	-2856	CD1	.00906	CDCOR1	.00884
RUN	26	TT	157.2431	K		CM	-1244	CD2	.00885	CDCOR2	.00870
POINT	34	RC	6.9922	MILLION		CC	.0169	CD3	.00842	CDCOR3	.00835
		MACH	.6506					CD4	.00837	CDCOR4	.00826
		ALPHA	-1.4969	DEG				CD5	.00739	CDCOR5	.00717

UPPER SURFACE				LOWER SURFACE				SPANWISE				
X/C	CP	P _L /PT	MLOC	X/C	CP	P _L /PT	MLOC	X/C	Y/(B/2)	CP	P _L /PT	MLOC
0.0000	1.0275	.9818	.1623	0.0000	1.0275	.9818	.1623	.1507	.7476	-.4029	.6641	.7876
.0132	-.6712	.7694	.6236	.0126	-.0059	.7523	.6509	.1507	.4976	-.4414	.6555	.6007
.0259	-.2639	.6950	.7401	.0259	-.1102	.7291	.6872	.1507	.2476	-.4183	.6606	.7929
.0759	-.4156	.6613	.7915	.0495	-.2066	.7077	.7205	.1507	-.2524	-.4395	.6590	.6001
.1003	-.4124	.6670	.7909	.0753	-.2581	.6962	.7382	.1507	-.5024	-.4172	.6609	.7925
.1507	-.4173	.6609	.7925	.1002	-.2945	.6882	.7506	.1507	-.7524	-.4269	.6588	.7958
.2003	-.4267	.6589	.7925	.1503	-.3189	.6828	.7589	.5002	.7476	-.4577	.6519	.6063
.2503	-.4315	.6577	.7974	.1976	-.3824	.6686	.7606	.5002	.4976	-.4637	.6506	.6083
.3001	-.4440	.6550	.8016	.2503	-.4021	.6643	.7873	.5002	.2476	-.4714	.6489	.6110
.3502	-.4462	.6545	.8024	.3001	-.4126	.6619	.7909	.5002	-.2524	-.4629	.6508	.6081
.4003	-.4507	.6535	.8039	.3507	-.4127	.6619	.7909	.5002	-.5024	-.4600	.6514	.6071
.4501	-.4589	.6517	.8067	.4001	-.4115	.6666	.7837	.5002	-.7524	-.4474	.6542	.6028
.5002	-.4699	.6492	.8105	.4501	-.4367	.6744	.7718	.8002	.7476	-.3640	.6727	.7743
.5502	-.4817	.6466	.8145	.5001	-.4217	.6888	.7496	.8002	.4976	-.3701	.6734	.7764
.6002	-.4933	.6440	.8184	.5497	-.4193	.7102	.7166	.8002	.2476	-.3750	.6703	.7781
.6500	-.4930	.6441	.8184	.6003	-.4010	.7334	.6806	.8002	-.5024	-.3651	.6725	.7747
.7000	-.4729	.6496	.8115	.6500	-.4003	.7535	.6489	.8002	-.7524	-.3479	.6743	.7688
.7500	-.4334	.6573	.7940	.7000	-.4066	.7772	.6109					
.8002	-.3713	.6711	.7768	.7501	-.2011	.7982	.5766					
.8502	-.2003	.7091	.7183	.8001	-.2809	.8160	.5449					
.9001	-.0802	.7358	.6768	.8501	-.3497	.8312	.5206					

TEST	167	PT	21.9695	PSI		CN	-3476	CD1	.00904	CDCOR1	.00883
RUN	26	TT	152.2321	K		CM	-1258	CD2	.00893	CDCOR2	.00872
POINT	35	RC	6.9939	MILLION		CC	.0171	CD3	.00850	CDCOR3	.00833
		MACH	.6508					CD4	.00840	CDCOR4	.00821
		ALPHA	-.9979	DEG				CD5	.00745	CDCOR5	.00724

UPPER SURFACE				LOWER SURFACE				SPANWISE				
X/C	CP	P _L /PT	MLOC	X/C	CP	P _L /PT	MLOC	X/C	Y/(B/2)	CP	P _L /PT	MLOC
0.0000	1.0096	.9910	.1134	0.0000	1.0096	.9910	.1134	.1507	.7476	-.4607	.6506	.6083
.0132	-.0600	.7398	.6705	.0126	-.1256	.7811	.6047	.1507	.4976	-.5026	.6413	.6226
.0259	-.3946	.6654	.7857	.0259	-.0032	.7524	.6506	.1507	.2476	-.4792	.6465	.6146
.0759	-.5047	.6409	.8233	.0495	-.1171	.7271	.6904	.1507	-.2524	-.5016	.6415	.6222
.1003	-.4880	.6446	.8176	.0753	-.1842	.7121	.7136	.1507	-.5024	-.4797	.6444	.6147
.1507	-.4779	.6468	.8141	.1002	-.2283	.7023	.7288	.1507	-.7524	-.4876	.6447	.6174
.2003	-.4720	.6481	.8121	.1503	-.2635	.6945	.7408	.5002	.7476	-.4839	.6455	.6162
.2503	-.4756	.6473	.8133	.1976	-.3320	.6793	.7643	.5002	.4976	-.4888	.6462	.6182
.3001	-.4832	.6457	.8159	.2503	-.3584	.6734	.7733	.5002	.2476	-.4970	.6426	.6207
.3502	-.4808	.6462	.8151	.3001	-.3736	.6700	.7785	.5002	-.2524	-.4881	.6446	.6176
.4003	-.4819	.6459	.8155	.3507	-.3784	.6690	.7801	.5002	-.5024	-.4851	.6452	.6166
.4501	-.4871	.6448	.8173	.4001	-.4116	.6727	.7744	.5002	-.7524	-.4729	.6479	.6124
.5002	-.4944	.6431	.8199	.4501	-.4333	.6794	.7641	.8002	.7476	-.3739	.6699	.7786
.5502	-.5047	.6410	.8231	.5001	-.4231	.6928	.7435	.8002	.4976	-.3787	.6689	.7803
.6002	-.5132	.6390	.8262	.5497	-.4189	.7133	.7117	.8002	.2476	-.3832	.6679	.7818
.6500	-.5105	.6396	.8253	.6003	-.4074	.7359	.6766	.8002	-.5024	-.3731	.6701	.7793
.7000	-.4871	.6448	.8173	.6500	-.4105	.7535	.6458	.8002	-.7524	-.3554	.6741	.7723
.7500	-.4445	.6543	.8027	.7000	-.4158	.7789	.6082					
.8002	-.3789	.6888	.7803	.7501	-.2096	.7986	.5743					
.8502	-.2024	.7081	.7198	.8001	-.2884	.8173	.5447					
.9001	-.0804	.7352	.6776	.8501	-.3569	.8325	.5186					

TEST	167	PT	21.9734	PSI		CN	-4099	CD1	.00894	CDCOR1	.00867
RUN	26	TT	152.0644	K		CM	-1262	CD2	.00896	CDCOR2	.00873
POINT	36	RC	7.0105	MILLION		CC	.0186	CD3	.00850	CDCOR3	.00834
		MACH	.6514					CD4	.00835	CDCOR4	.00811
		ALPHA	-.4888	DEG				CD5	.00759	CDCOR5	.00732

UPPER SURFACE				LOWER SURFACE				SPANWISE				
X/C	CP	P _L /PT	MLOC	X/C	CP	P _L /PT	MLOC	X/C	Y/(B/2)	CP	P _L /PT	MLOC
0.0000	1.0096	.9965	.0703	0.0000	1.0096	.9965	.0703	.1507	.7476	-.5187	.6346	.6329
.0132	-.2000	.7059	.7233	.0126	-.2516	.8073	.5615	.1507	.4976	-.5629	.6247	.6482
.0259	-.3945	.6310	.8384	.0259	-.1011	.7730	.6169	.1507	.2476	-.5416	.6295	.6409
.0759	-.5045	.6171	.8608	.0495	-.0121	.7482	.6573	.1507	-.2524	-.5645	.6243	.6488
.1003	-.4867	.6243	.8489	.0753	-.0949	.7296	.6864	.1507	-.5024	-.5348	.6265	.6454
.1507	-.4791	.6300	.8400	.1002	-.1620	.7144	.7098	.1507	-.7524	-.5468	.6283	.6426
.2003	-.4746	.6333	.8350	.1503	-.2083	.7042	.7259	.5002	.7476	-.5853	.6376	.6283
.2503	-.4815	.6346	.8329	.1976	-.2812	.6878	.7511	.5002	.4976	-.5134	.6358	.6311
.3001	-.4912	.6340	.8338	.2503	-.3133	.6804	.7622	.5002	.2476	-.5401	.6343	.6334
.3502	-.4930	.6337	.8313	.3001	-.3333	.6762	.7691	.5002	-.2524	-.5112	.6363	.6303
.4003	-.4912	.6363	.8304	.3507	-.3429	.6740	.7724	.5002	-.5024	-.5081	.6370	.6293
.4501	-.4935	.6358	.8312	.4001	-.3307	.6768	.7682	.5002	-.7524	-.4969	.6395	.6254
.5002	-.4982	.6347	.8328	.4501	-.3048	.6825	.7593	.8002	.7476	-.3727	.6673	.7827
.5502	-.5040	.6334	.8348	.5001	-.2494	.6950	.7481	.8002	.4976	-.3812	.6634	.7856
.6002	-.5102	.6320	.8369	.5497	-.1610	.7146	.7095	.8002	.2476	-.3867	.6642	.7874
.6500	-.5044	.6333	.8349	.6003	-.0629	.7388	.6752	.8002	-.5024	-.3784	.6661	.7846
.7000	-.4575	.6493	.8256	.6500	-.0222	.7599	.6451	.8002	-.7524	-.3596	.6705	.7781
.7500	-.4111	.6697	.8097	.7000	-.1254	.7790	.6081					
.8002	-.3825	.6891	.7888	.7501	-.2177	.7997	.5742					
.8502	-.2003	.7059	.7232	.8001	-.2965	.8174	.5445					
.9001	-.0773	.7336	.6803	.8501	-.3656	.8328	.5178					

ORIGINAL PARTS
OF POOR QUALITY

TEST 167	PT 21.9743	PSI	CN	.4744	CD1	.00964	CDCOR1	.00882
RUN 26	TT 152.0677	K	CM	-.1285	CD2	.00901	CDCOR2	.00879
POINT 37	RC 7.0041	MILLION	CC	.0150	CD3	.00865	CDCOR3	.00849
	MACH .6505				CD4	.00841	CDCOR4	.00821
	ALPHA .0102	DEG			CD5	.00792	CDCOR5	.00761

UPPER SURFACE				LOWER SURFACE				SPANWISE				
X/C	CP	P/L/P/T	MLOC	X/C	CP	P/L/P/T	MLOC	X/C	Y/(B/2)	CP	P/L/P/T	MLOC
0.0000	1.1083	.9997	.0208	0.0000	1.1083	.9997	.0208	.1507	.7476	-.5810	.6245	.0485
.0132	-.3359	.6745	.7716	-.0176	.3606	.9335	.5147	.1507	.4976	-.6202	.6145	.0643
.0259	-.6936	.5965	.4872	-.0255	.1924	.7963	.5798	.1507	.2476	-.6071	.6187	.0574
.0759	-.6991	.5983	.8981	-.0495	.0519	.7631	.6305	.1507	-.2524	-.6316	.6133	.0658
.1003	-.6499	.6092	.8721	-.0753	-.0400	.7447	.6629	.1507	-.5024	-.6244	.6149	.0634
.1507	-.6046	.6193	.8506	-.1002	-.1019	.7309	.6844	.1507	-.7524	-.5922	.6220	.6523
.2003	-.5750	.6257	.8467	-.1503	-.1591	.7184	.7038	.5002	.7476	-.5324	.6353	.8319
.2503	-.5459	.6279	.8433	-.1976	-.2344	.7015	.7301	.5002	.4976	-.5407	.6335	.8347
.3001	-.5631	.6285	.8424	-.2503	-.2712	.6932	.7427	.5002	.2476	-.5405	.6322	.8367
.3502	-.5525	.6308	.8387	-.3001	-.2949	.6881	.7508	.5002	-.2524	-.5370	.6343	.8334
.4003	-.5454	.6324	.8363	-.3507	-.3087	.6850	.7555	.5002	-.5024	-.5339	.6350	.8324
.4501	-.5438	.6328	.8358	-.4001	-.3207	.6858	.7528	.5002	-.7524	-.5229	.6374	.8286
.5002	-.5452	.6325	.8363	.4501	-.2792	.6915	.7454	.8002	.7476	-.5841	.6602	.7512
.5507	-.5462	.6318	.8373	.5002	-.2231	.7028	.7279	.8002	.4976	-.3907	.6668	.7835
.6002	-.5517	.6310	.8364	.5497	-.1438	.7216	.6989	.8002	.2476	-.3940	.6656	.7853
.6500	-.5427	.6330	.8354	.6003	-.0492	.7426	.6660	.8002	-.5024	-.3866	.6677	.7421
.7000	-.5130	.6396	.8252	.6500	.0328	.7608	.6372	.8002	-.7524	-.3680	.6710	.7757
.7500	-.4679	.6505	.8045	.7000	.1246	.7834	.6008					
.8002	-.3923	.6664	.7841	.7501	.2261	.8030	.5674					
.8502	-.2057	.7079	.7202	.8001	.3048	.8232	.5379					
.9501	-.0224	.7353	.6776	.8501	.3745	.8367	.5110					

TEST 167	PT 21.9743	PSI	CN	.5339	CD1	.00910	CDCOR1	.00894
RUN 26	TT 152.1113	K	CM	-.1291	CD2	.00904	CDCOR2	.00891
POINT 38	RC 6.9976	MILLION	CC	.0126	CD3	.00834	CDCOR3	.00831
	MACH .6500				CD4	.00813	CDCOR4	.00802
	ALPHA .4990	DEG			CD5	.00790	CDCOR5	.00768

UPPER SURFACE				LOWER SURFACE				SPANWISE				
X/C	CP	P/L/P/T	MLOC	X/C	CP	P/L/P/T	MLOC	X/C	Y/(B/2)	CP	P/L/P/T	MLOC
0.0000	1.1062	.9997	.0301	0.0000	1.1062	.9994	.0301	.1507	.7476	-.6396	.6132	.8659
.0132	-.3171	.6473	.8242	.0126	.4534	.8550	.4784	.1507	.4976	-.6618	.6083	.8736
.0259	-.6816	.5941	.9427	.0255	.2744	.8155	.5479	.1507	.2476	-.6703	.6064	.8765
.0759	-.6833	.5770	.9224	.0495	.1222	.7817	.6037	.1507	-.2524	-.6703	.6064	.8765
.1003	-.7351	.5921	.8986	.0753	.0173	.7545	.6409	.1507	-.5024	-.6550	.6098	.8712
.1507	-.6886	.6088	.8759	-.1002	-.0471	.7443	.6635	.1507	-.7524	-.6282	.6157	.8621
.2003	-.6372	.6137	.8652	-.1503	-.1255	.7298	.6862	.5002	.7476	-.5558	.6317	.8373
.2503	-.6099	.6198	.8558	-.1976	-.1927	.7121	.7137	.5002	.4976	-.5649	.6297	.8404
.3001	-.6012	.6217	.8528	-.2503	-.2344	.7028	.7280	.5002	.2476	-.5709	.6284	.8422
.3502	-.5876	.6247	.8482	-.3001	-.2616	.6968	.7373	.5002	-.2524	-.5604	.6307	.8389
.4003	-.5761	.6273	.8443	-.3507	-.2790	.6930	.7412	.5002	-.5024	-.5577	.6313	.8380
.4501	-.5712	.6243	.8426	-.4001	-.2750	.6939	.7418	.8002	.7476	-.3883	.6330	.8341
.5002	-.5689	.6288	.8418	.4501	-.2574	.6977	.7359	.8002	.4976	-.3979	.6667	.7805
.5502	-.5690	.6288	.8419	.5002	-.2106	.7081	.7199	.8002	.2476	-.3979	.6667	.7805
.6002	-.5700	.6284	.8422	.5497	-.1299	.7259	.6921	.8002	-.2476	-.3945	.6674	.7825
.6500	-.5583	.6312	.8382	.6007	-.0384	.7442	.6604	.8002	-.5024	-.3945	.6674	.7825
.7000	-.5259	.6383	.8272	.6500	.0407	.7637	.6327					
.7500	-.4742	.6498	.8096	.7000	.1407	.7858	.5970					
.8002	-.4004	.6661	.7845	.7501	.2312	.8058	.5639					
.8502	-.2099	.7082	.7196	.8001	.3095	.8231	.5346					
.9501	-.0853	.7358	.6767	.8501	.3794	.8366	.5077					

TEST 167	PT 21.9718	PSI	CN	.5984	CD1	.00915	CDCOR1	.00892
RUN 26	TT 151.9811	K	CM	-.1301	CD2	.00907	CDCOR2	.00887
POINT 39	RC 7.0074	MILLION	CC	.0098	CD3	.00844	CDCOR3	.00847
	MACH .6504				CD4	.00810	CDCOR4	.00790
	ALPHA 1.0634	DEG			CD5	.00788	CDCOR5	.00766

UPPER SURFACE				LOWER SURFACE				SPANWISE				
X/C	CP	P/L/P/T	MLOC	X/C	CP	P/L/P/T	MLOC	X/C	Y/(B/2)	CP	P/L/P/T	MLOC
0.0000	1.1050	.9999	.0347	0.0000	1.1050	.9989	.0397	.1507	.7476	-.7077	.5756	.6933
.0132	-.6711	.6031	.8417	.0126	.5517	.8758	.4393	.1507	.4976	-.7213	.5826	.6980
.0259	-.6430	.6210	.8102	.0255	.3810	.8334	.5169	.1507	.2476	-.7304	.5814	.6934
.0759	-.6168	.6491	.8667	.0495	.1983	.7972	.5783	.1507	-.2524	-.7206	.5914	.6999
.1003	-.7247	.5696	.9341	.0753	.0832	.7714	.6201	.1507	-.5024	-.7230	.5827	.6986
.1507	-.7330	.5695	.9328	-.1002	.0121	.7557	.6453	.1507	-.7524	-.7000	.5873	.6986
.2003	-.6891	.6060	.8865	-.1503	-.0621	.7392	.6716	.5002	.7476	-.5775	.6246	.8006
.2503	-.6554	.6272	.8752	-.1976	-.1451	.7268	.7002	.5002	.4976	-.5671	.6246	.8006
.3001	-.6403	.6106	.8700	-.2503	-.1911	.7105	.7141	.5002	.2476	-.5629	.6241	.8017
.3502	-.6207	.6150	.8632	-.3001	-.2209	.7039	.7243	.5002	-.2524	-.5617	.6236	.8017
.4003	-.6059	.6182	.8582	-.3507	-.2417	.6993	.7334	.5002	-.5024	-.5679	.6241	.8017
.4501	-.6058	.6205	.8547	-.4001	-.2415	.6993	.7334	.8002	.7476	-.5684	.6236	.8017
.5002	-.5913	.6215	.8531	.4501	-.2280	.7023	.7249	.8002	.4976	-.3892	.6601	.7875
.5502	-.5984	.6221	.8521	.5002	-.1852	.7116	.7141	.8002	.2476	-.3896	.6601	.7875
.6002	-.5867	.6225	.8516	.5497	-.1082	.7290	.6874	.8002	.2476	-.3864	.6606	.7896
.6500	-.5707	.6261	.8461	.6003	-.0200	.7480	.6586	.8002	-.5024	-.3871	.6647	.7847
.7000	-.5350	.6340	.8338	.6500	.0566	.7657	.6295					
.7500	-.4799	.6443	.8150	.7000	.1547	.7879	.5943					
.8002	-.4027	.6605	.7866	.7501	.2437	.8073	.5615					
.8502	-.2063	.7072	.7213	.8001	.3213	.8245	.5322					
.9501	-.0816	.7349	.6782	.8501	.3913	.8401	.5051					

TEST	167	PT	21.9755	PSI		CM	.0644	CD1	.00926	CDCOR1	.00903
RUN	26	TT	152.0755	K		CM	-.1317	CD2	.00935	CDCOR2	.00914
POINT	40	RC	7.0024	MILLION		CC	.0014	CD3	.00880	CDCOR3	.00863
		MACH	.6503					CD4	.00826	CDCOR4	.00803
		ALPHA	1.5137	DEG				CD5	.00816	CDCOR5	.00791

UPPER SURFACE				LOWER SURFACE				SPANWISE				
X/C	CP	P/L/PT	MLOC	X/C	CP	P/L/PT	MLOC	X/C	Y/(B/2)	CP	P/L/PT	MLOC
0.0000	1.0892	.9955	.0804	0.0000	1.0892	.9955	.0804	.1507	.7476	-.7779	.5812	.9158
.0132	-.8413	.5671	.9380	.0126	.6372	.8952	.4008	.1507	.4976	-.7911	.5782	.9204
.0259	-1.2474	.4770	1.0854	.0255	.4403	.8515	.4847	.1507	.2476	-.8017	.5759	.9241
.0759	-1.0212	.5272	1.0019	.0495	.2716	.8141	.5501	.1507	-.2524	-.7932	.5778	.9211
.1003	-.9035	.5522	.9616	.0753	.1480	.7866	.5956	.1507	-.5024	-.7683	.5789	.9195
.1507	-.7973	.5769	.9226	.1002	.0723	.7698	.6228	.1507	-.7524	-.7619	.5847	.9103
.2003	-.7474	.5880	.9052	.1503	-.0090	.7518	.6516	.5002	.7476	-.5968	.6214	.8534
.2503	-.6970	.5991	.8878	.1976	-.0956	.7326	.6818	.5002	.4976	-.6072	.6191	.8569
.3001	-.6754	.6039	.8804	.2503	-.1466	.7213	.6994	.5002	.2476	-.6124	.6179	.8587
.3502	-.6606	.6072	.8753	.3001	-.1801	.7138	.7110	.5002	-.2524	-.5986	.6210	.8540
.4003	-.6369	.6125	.8671	.3507	-.2036	.7086	.7190	.5002	-.5024	-.5968	.6214	.8533
.4501	-.6208	.6160	.8616	.4001	-.2067	.7079	.7201	.5002	-.7524	-.5845	.6241	.8491
.5002	-.6128	.6178	.8588	.4501	-.1966	.7102	.7166	.8002	.7476	-.3941	.6664	.7841
.5502	-.6065	.6191	.8568	.5001	-.1582	.7187	.7034	.8002	.4976	-.4019	.6646	.7868
.6002	-.6025	.6201	.8553	.5497	-.0851	.7349	.6782	.8002	.2476	-.4391	.6630	.7893
.6500	-.5835	.6243	.8468	.6003	-.0005	.7537	.6486	.8002	-.5024	-.3960	.6659	.7848
.7000	-.5448	.6329	.8355	.6500	.0732	.7700	.6225	.8002	-.7524	-.3768	.6702	.7782
.7500	-.4870	.6457	.8158	.7001	.1688	.7913	.5681					
.8002	-.4071	.6635	.7866	.7501	.2559	.8106	.5559					
.9002	-.2068	.7079	.7202	.8001	.3326	.8276	.5270					
.9501	-.0837	.7352	.6776	.8501	.4021	.8430	.4999					

TEST	167	PT	21.9708	PSI		CM	.7225	CD1	.00975	CDCOR1	.00948
RUN	26	TT	151.9653	K		CM	-.1295	CD2	.00971	CDCOR2	.00942
POINT	42	RC	7.0135	MILLION		CC	.0011	CD3	.00924	CDCOR3	.00896
		MACH	.6510					CD4	.00879	CDCOR4	.00850
		ALPHA	2.0214	DEG				CD5	.00860	CDCOR5	.00820

UPPER SURFACE				LOWER SURFACE				SPANWISE				
X/C	CP	P/L/PT	MLOC	X/C	CP	P/L/PT	MLOC	X/C	Y/(B/2)	CP	P/L/PT	MLOC
0.0000	1.0564	.9879	.1322	0.0000	1.0564	.9879	.1322	.1507	.7476	-.8407	.5638	.9432
.0132	-.9820	.5322	.9936	.0126	.7000	.9082	.3734	.1507	.4976	-.8460	.5626	.9431
.0259	-1.4004	.4387	1.1523	.0255	.5001	.8635	.4626	.1507	.2476	-.8606	.5594	.9503
.0759	-1.4121	.4360	1.1570	.0495	.3242	.8242	.5328	.1507	-.2524	-.8524	.5612	.9474
.1003	-.9381	.5470	.9780	.0753	.1944	.7952	.5816	.1507	-.5024	-.8465	.5625	.9453
.1507	-.8573	.5601	.9491	.1002	.1132	.7770	.6113	.1507	-.7524	-.8297	.5663	.9393
.2003	-.8017	.5725	.9294	.1503	.0245	.7572	.6430	.1507	-.7524	-.8297	.5663	.9393
.2503	-.7483	.5844	.9107	.1976	-.0661	.7369	.6750	.5002	.4976	-.8374	.6092	.9271
.3001	-.7222	.5903	.9016	.2503	-.1219	.7245	.6945	.5002	.2476	-.8432	.6079	.9271
.3502	-.6932	.5968	.8915	.3001	-.1584	.7163	.7071	.5002	-.2524	-.8321	.6104	.9271
.4003	-.6701	.6019	.8835	.3507	-.1845	.7105	.7162	.5002	-.5024	-.8306	.6107	.9271
.4501	-.6519	.6060	.8771	.4001	-.1911	.7090	.7185	.5002	-.7524	-.8189	.6134	.9266
.5002	-.6399	.6087	.8730	.4501	-.1843	.7105	.7161	.8002	.7476	-.4037	.6615	.7916
.5502	-.6312	.6106	.8700	.5001	-.1497	.7182	.7041	.8002	.4976	-.4124	.6595	.7946
.6002	-.6237	.6123	.8674	.5497	-.0796	.7339	.6797	.8002	.2476	-.4203	.6578	.7973
.6500	-.6009	.6174	.8595	.6003	.0024	.7522	.6509	.8002	-.5024	-.4098	.6601	.7937
.7000	-.5591	.6267	.8451	.6500	.0740	.7683	.6234	.8002	-.7524	-.3905	.6644	.7871
.7500	-.4976	.6405	.8239	.7000	.1677	.7892	.5914					
.8002	-.4147	.6590	.7954	.7501	.2536	.8084	.5596					
.9002	-.2096	.7049	.7249	.8001	.3294	.8253	.5308					
.9501	-.0858	.7325	.6819	.8501	.3985	.8408	.5039					

TEST	167	PT	21.9701	PSI		CM	.7905	CD1	.01072	CDCOR1	.01036
RUN	26	TT	151.9444	K		CM	-.1275	CD2	.01055	CDCOR2	.01020
POINT	43	RC	7.0090	MILLION		CC	-.0050	CD3	.01010	CDCOR3	.00977
		MACH	.6502					CD4	.00990	CDCOR4	.00953
		ALPHA	2.5048	DEG				CD5	.01000	CDCOR5	.00945

UPPER SURFACE				LOWER SURFACE				SPANWISE				
X/C	CP	P/L/PT	MLOC	X/C	CP	P/L/PT	MLOC	X/C	Y/(B/2)	CP	P/L/PT	MLOC
0.0000	1.0199	.9804	.1084	0.0000	1.0199	.9804	.1084	.1507	.7476	-.8672	.5638	.9433
.0132	-1.1331	.5051	1.0382	.0126	.7616	.9234	.3394	.1507	.4976	-.8924	.5714	.9311
.0259	-1.5110	.4128	1.1994	.0255	.5618	.8792	.4327	.1507	.2476	-.8923	.5671	.9380
.0759	-1.6450	.3921	1.2381	.0495	.3934	.8399	.5055	.1507	-.2524	-.8812	.5695	.9342
.1003	-1.3870	.4490	1.1339	.0753	.2469	.8097	.5574	.1507	-.5024	-.8585	.5701	.9332
.1507	-.8566	.5661	.9396	.1002	.1622	.7910	.5884	.1507	-.7524	-.8358	.5663	.9393
.2003	-.8376	.5703	.9329	.1503	.0672	.7701	.6223	.1507	-.7524	-.8358	.5663	.9393
.2503	-.7769	.5837	.9119	.1976	-.0253	.7496	.6550	.5002	.4976	-.8401	.6139	.9249
.3001	-.7484	.5900	.9020	.2503	-.0841	.7367	.6754	.5002	.2476	-.8374	.6115	.9267
.3502	-.7241	.5954	.8937	.3001	-.1232	.7280	.6889	.5002	.4976	-.8374	.6115	.9267
.4003	-.6936	.6021	.8832	.3507	-.1522	.7216	.6989	.5002	-.2524	-.8438	.6131	.9266
.4501	-.6712	.6070	.8755	.4001	-.1619	.7195	.7022	.5002	-.5024	-.8432	.6132	.9269
.5002	-.6565	.6103	.8705	.4501	-.1587	.7202	.7011	.5002	-.7524	-.8305	.6160	.9216
.5502	-.6430	.6128	.8665	.5001	-.1276	.7270	.7011	.8002	.7476	-.4025	.6664	.7841
.6002	-.6346	.6191	.8630	.5497	-.0611	.7417	.6675	.8002	.4976	-.4115	.6644	.7872
.6500	-.6089	.6208	.8542	.6003	.0177	.7591	.6400	.8002	.2476	-.4193	.6627	.7898
.7000	-.5646	.6306	.8391	.6500	.0860	.7742	.6138	.8002	-.5024	-.4068	.6654	.7856
.7500	-.5010	.6446	.8175	.7000	.1777	.7945	.5828	.8002	-.7524	-.3880	.6696	.7792
.8002	-.4164	.6633	.7888	.7501	.2622	.8131	.5517					
.9002	-.2092	.7090	.7184	.8001	.3369	.8296	.5235					
.9501	-.0867	.7361	.6763	.8501	.4055	.8447	.4968					

ORIGINAL PAGE IS
OF POOR QUALITY

TEST 167	PT 21.9755	PSI	CN .8475	CD1 .01232	CDCOR1 .01196
RUN 26	TT 151.9748	K	CM -.1274	CD2 .01202	CDCOR2 .01158
POINT 44	RC 7.0085	MILLION	CC -.0093	CD3 .01186	CDCOR3 .01147
	MACH .6502			CD4 .01170	CDCOR4 .01131
	ALPHA 3.0141	DEG		CD5 .01180	CDCOR5 .01140

UPPER SURFACE				LOWER SURFACE				SPANWISE				
X/C	CP	P _L /PT	MLOC	X/C	CP	P _L /PT	MLOC	X/C	Y/(B/2)	CP	P _L /PT	MLOC
0.0000	.9783	.9711	.2052	0.0000	.9783	.9711	.2052	.1507	.7476	-.7906	.5795	.9184
.0132	-1.2620	.4752	1.0884	.0126	.8145	.9348	.3118	.1507	.4976	-.8490	.5666	.9388
.0259	-1.6567	.3878	1.2468	.0255	.6152	.8907	.4100	.1507	.2476	-.9212	.5560	.9642
.0759	-1.7422	.3579	1.3065	.0495	.4365	.8511	.4854	.1507	-.2524	-.8516	.5660	.9397
.1003	-1.7455	.3682	1.2856	.0753	.2953	.8199	.5402	.1507	-.5024	-.7714	.5838	.9118
.1507	-.9119	.5527	.9608	.1002	.2065	.8002	.5733	.1507	-.7524	-.7855	.5807	.9167
.2003	-.7991	.5777	.9214	.1503	.1054	.7778	.6099	.5002	.7476	-.6613	.6081	.8738
.2503	-.7874	.5803	.9173	.1976	.0110	.7570	.6434	.5002	.4976	-.6718	.6038	.8774
.3001	-.7713	.5838	.9117	.2503	-.0507	.7433	.6650	.5002	.2476	-.6778	.6045	.8795
.3507	-.7506	.5884	.9045	.3001	-.0925	.7340	.6795	.5002	-.2524	-.6630	.6078	.8744
.4003	-.7191	.5954	.8937	.3507	-.1245	.7270	.6906	.5002	-.5024	-.6628	.6078	.8743
.4501	-.6954	.6006	.8855	.4001	-.1371	.7242	.6949	.5002	-.7524	-.6500	.6107	.8699
.5002	-.6784	.6044	.8797	.4501	-.1369	.7242	.6948	.5002	.7476	-.6494	.6639	.7879
.5502	-.6645	.6075	.8749	.5001	-.1092	.7303	.6853	.8002	.4976	-.6169	.6622	.7904
.6002	-.6516	.6103	.8705	.5497	-.0458	.7444	.6633	.8002	.2476	-.6244	.6606	.7930
.6500	-.6229	.6167	.8606	.6003	.0303	.7612	.6366	.8002	-.5024	-.6106	.6636	.7883
.7000	-.5741	.6270	.8446	.6500	.0961	.7758	.6132	.8002	-.7524	-.5917	.6678	.7819
.7500	-.5095	.6418	.8219	.7000	.1860	.7957	.5808					
.8002	-.4226	.6610	.7924	.7501	.2690	.8141	.51					
.9002	-.2125	.7075	.7208	.8001	.3427	.8304	.5222					
.9501	-.0892	.7348	.6784	.8501	.4108	.8454	.4956					

TEST 167	PT 21.9736	PSI	CN .9227	CD1 .01477	CDCOR1 .01429
RUN 26	TT 151.9465	K	CM -.1232	CD2 .01450	CDCOR2 .01407
POINT 45	RC 7.0068	MILLION	CC -.0158	CD3 .01449	CDCOR3 .01411
	MACH .6498			CD4 .01456	CDCOR4 .01405
	ALPHA 3.5029	DEG		CD5 .01443	CDCOR5 .01402

UPPER SURFACE				LOWER SURFACE				SPANWISE				
X/C	CP	P _L /PT	MLOC	X/C	CP	P _L /PT	MLOC	X/C	Y/(B/2)	CP	P _L /PT	MLOC
0.0000	.9377	.9619	.2363	0.0000	.9377	.9619	.2363	.1507	.7476	-1.4184	.4390	1.1516
.0132	-1.3845	.4501	1.1320	.0126	.8605	.9447	.2860	.1507	.4976	-1.7912	.3563	1.3097
.0259	-1.7363	.3695	1.2850	.0255	.6635	.9010	.3887	.1507	.2476	-1.7601	.3632	1.2956
.0759	-1.6984	.3325	1.3599	.0495	.4820	.8608	.4677	.1507	-.2524	-1.7620	.3628	1.2964
.1003	-1.8596	.3411	1.3414	.0753	.3368	.8285	.5253	.1507	-.5024	-1.7615	.3629	1.2962
.1507	-1.7494	.3656	1.2908	.1002	.2464	.8085	.5595	.1507	-.7524	-1.2126	.4847	1.0722
.2003	-.8935	.5644	.9423	.1503	.1410	.7851	.5982	.5002	.7476	-.6778	.6034	.8812
.2503	-.7366	.5903	.9015	.1976	.0442	.7636	.6328	.5002	.4976	-.6864	.6015	.8842
.3001	-.7555	.5861	.9081	.2503	-.0213	.7491	.6559	.5002	.2476	-.6928	.6001	.8864
.3507	-.7465	.5882	.9049	.3001	-.0660	.7392	.6715	.5002	-.2524	-.6823	.6024	.8828
.4003	-.7266	.5926	.8980	.3507	-.1007	.7314	.6856	.5002	-.5024	-.6820	.6025	.8826
.4501	-.7071	.5969	.8913	.4001	-.1161	.7280	.6889	.5002	-.7524	-.6708	.6049	.8788
.5002	-.6907	.6005	.8856	.4501	-.1187	.7275	.6898	.8002	.7476	-.6160	.6615	.7916
.5502	-.6760	.6038	.8806	.5001	-.0940	.7329	.6813	.8002	.4976	-.6237	.6598	.7943
.6002	-.6611	.6071	.8755	.5497	-.0332	.7464	.6601	.8002	.2476	-.6297	.6584	.7963
.6500	-.6314	.6137	.8652	.6003	.0406	.7628	.6341	.8002	-.5024	-.6194	.6607	.7928
.7000	-.5823	.6246	.8484	.6500	.1041	.7759	.6115	.8002	-.7524	-.5994	.6652	.7860
.7500	-.5135	.6398	.8249	.7000	.1924	.7965	.5795					
.8002	-.4253	.6594	.7948	.7501	.2743	.8147	.5491					
.9002	-.2135	.7064	.7225	.8001	.3471	.8308	.5214					
.9501	-.0873	.7344	.6789	.8501	.4149	.8458	.4449					

ORIGIN OF POINTS

TEST	167	PT	62.8618	PSI	CM	-.0154	CD1	.00752	CDCOR1	.00743
RUN	23	TT	115.4291	K	CM	-.1223	CD2	.00745	CDCOR2	.00740
POINT	85	PC	29.8538	MILLION	CC	.0054	CD3	.00737	CDCOR3	.00738
		MACH	.6500				CD4	.00744	CDCOR4	.00741
		ALPHA	-4.0120	DEG			CD5	.00731	CDCOR5	.00714

UPPER SURFACE				LOWER SURFACE				SPANWISE				
X/C	CP	P _z L/PT	MLOC	X/C	CP	P _z L/PT	MLOC	X/C	Y/(B/2)	CP	P _z L/PT	MLOC
0.0000	.6093	.8885	.4153	0.0000	.6093	.8885	.4153	.1507	.7476	-.1300	.7241	.6968
.0132	.5966	.8857	.4210	.0126	-.8169	.5713	.9337	.1507	.4976	-.1407	.7217	.7005
.0259	.2877	.8170	.5465	.0255	-.7228	.5922	.9008	.1507	.2476	-.1380	.7223	.6996
.0759	-.0278	.7468	.6611	.0445	-.7200	.5928	.8998	.1507	-.2524	-.1444	.7209	.7018
.1003	-.0760	.7361	.6780	.0753	-.6600	.6062	.8790	.1507	-.5024	-.1490	.7198	.7034
.1507	-.1345	.7231	.6944	.1002	-.6711	.6037	.8829	.1507	-.7524	-.1419	.7214	.7009
.2003	-.1738	.7143	.7120	.1503	-.6156	.6161	.8637	.5002	.7476	-.3353	.6784	.7675
.2503	-.2164	.7048	.7267	.1976	-.6451	.6095	.8739	.5002	.4976	-.3403	.6773	.7693
.3001	-.2516	.6970	.7388	.2503	-.6258	.6138	.8672	.5002	.2476	-.3443	.6764	.7706
.3502	-.2717	.6925	.7457	.3001	-.6058	.6182	.8603	.5002	-.2524	-.3347	.6785	.7673
.4003	-.2911	.6882	.7524	.3507	-.5782	.6244	.8508	.5002	-.5024	-.3328	.6790	.7667
.4501	-.3084	.6844	.7583	.4001	-.5276	.6356	.8334	.5002	-.7524	-.3188	.6821	.7619
.5002	-.3426	.6788	.7700	.4501	-.4752	.6473	.8155	.8002	.7476	-.9335	.5453	.9749
.5502	-.3725	.6701	.7803	.5001	-.3849	.6674	.7845	.8002	.4976	-.9318	.6792	.7663
.6002	-.4006	.6661	.7865	.5497	-.2687	.6932	.7447	.8002	.2476	-.9326	.6790	.7666
.6500	-.4053	.6628	.7915	.6003	-.1492	.7207	.7021	.8002	-.5024	-.9041	.6853	.7568
.7000	-.3986	.6643	.7892	.6500	-.0512	.7416	.6693	.8002	-.7524	-.9023	.6857	.7562
.7500	-.3752	.6695	.7812	.7000	.0749	.7696	.6247					
.8002	-.3294	.6797	.7655	.7501	.1800	.7930	.5866					
.9002	-.1903	.7106	.7177	.8001	.2660	.8121	.5547					
.9501	-.0857	.7339	.6814	.8501	.3392	.8284	.5268					

TEST	167	PT	62.8716	PSI	CM	.1141	CD1	.00739	CDCOR1	.00728
RUN	23	TT	115.1375	K	CM	-.1260	CD2	.00736	CDCOR2	.00730
POINT	86	PC	29.9837	MILLION	CC	.0131	CD3	.00731	CDCOR3	.00730
		MACH	.6504				CD4	.00738	CDCOR4	.00732
		ALPHA	-2.9836	DEG			CD5	.00724	CDCOR5	.00704

UPPER SURFACE				LOWER SURFACE				SPANWISE				
X/C	CP	P _z L/PT	MLOC	X/C	CP	P _z L/PT	MLOC	X/C	Y/(B/2)	CP	P _z L/PT	MLOC
0.0000	.8112	.9340	.3144	0.0000	.8112	.9340	.3144	.1507	.7476	-.2364	.7025	.7303
.0132	.4137	.8462	.4954	.0126	-.4332	.6590	.7974	.1507	.4976	-.2484	.6990	.7344
.0259	.0962	.7760	.6144	.0255	-.4362	.6584	.7984	.1507	.2476	-.2457	.7005	.7335
.0759	-.1724	.7167	.7083	.0445	-.4875	.6470	.8159	.1507	-.2524	-.2507	.6994	.7352
.1003	-.2043	.7096	.7193	.0753	-.4741	.6500	.8113	.1507	-.5024	-.2546	.6985	.7365
.1507	-.2412	.7015	.7319	.1002	-.5072	.6427	.8226	.1507	-.7524	-.2451	.7006	.7333
.2003	-.2757	.6938	.7437	.1503	-.4856	.6474	.8152	.5002	.7476	-.3857	.6645	.7812
.2503	-.2989	.6887	.7516	.1976	-.5295	.6377	.8301	.5002	.4976	-.3918	.6682	.7833
.3001	-.3271	.6825	.7613	.2503	-.5270	.6383	.8293	.5002	.2476	-.3960	.6673	.7847
.3502	-.3408	.6795	.7659	.3001	-.5211	.6396	.8273	.5002	-.2524	-.3854	.6696	.7811
.4003	-.3533	.6767	.7702	.3507	-.5044	.6433	.8216	.5002	-.5024	-.3837	.6700	.7805
.4501	-.3653	.6740	.7743	.4001	-.4651	.6520	.8082	.5002	-.7524	-.3711	.6728	.7762
.5002	-.3945	.6676	.7842	.4501	-.4237	.6611	.7941	.8002	.7476	-.9845	.3372	.9881
.5502	-.4199	.6620	.7929	.5001	-.3430	.6789	.7667	.8002	.4976	-.9515	.6771	.7696
.6002	-.4334	.6590	.7974	.5497	-.2357	.7027	.7300	.8002	.2476	-.9532	.6767	.7702
.6500	-.4433	.6560	.8008	.6003	-.1191	.7284	.6900	.8002	-.5024	-.9247	.6830	.7604
.7000	-.4313	.6594	.7967	.6500	-.0315	.7478	.6595	.8002	-.7524	-.9225	.6835	.7597
.7500	-.4023	.6659	.7868	.7000	.0916	.7750	.6160					
.8002	-.3506	.6772	.7693	.7501	.1945	.7978	.5788					
.9002	-.2013	.7103	.7183	.8001	.2798	.8166	.5471					
.9501	-.0910	.7344	.6806	.8501	.3538	.8330	.5189					

TEST	167	PT	62.9288	PSI	CM	.2404	CD1	.00743	CDCOR1	.00730
RUN	23	TT	115.2702	K	CM	-.1295	CD2	.00742	CDCOR2	.00732
POINT	87	PC	29.9469	MILLION	CC	.0179	CD3	.00733	CDCOR3	.00730
		MACH	.6500				CD4	.00737	CDCOR4	.00729
		ALPHA	-1.9857	DEG			CD5	.00726	CDCOR5	.00707

UPPER SURFACE				LOWER SURFACE				SPANWISE				
X/C	CP	P _z L/PT	MLOC	X/C	CP	P _z L/PT	MLOC	X/C	Y/(B/2)	CP	P _z L/PT	MLOC
0.0000	.9735	.9698	.2101	0.0000	.9735	.9698	.2101	.1507	.7476	-.3527	.6763	.7707
.0132	.2607	.7988	.5770	.0126	-.1149	.7289	.6892	.1507	.4976	-.3666	.6732	.7755
.0259	-.1263	.7264	.6931	.0255	-.1887	.7126	.7146	.1507	.2476	-.3644	.6737	.7747
.0759	-.3364	.6799	.7652	.0445	-.2853	.6912	.7477	.1507	-.2524	-.3720	.6720	.7773
.1003	-.3477	.6774	.7690	.0753	-.3117	.6854	.7567	.1507	-.5024	-.3742	.6716	.7781
.1507	-.3593	.6749	.7730	.1002	-.3612	.6744	.7736	.1507	-.7524	-.3624	.6742	.7740
.2003	-.3707	.6723	.7769	.1503	-.3694	.6726	.7764	.5002	.7476	-.4438	.6562	.8018
.2503	-.3895	.6682	.7833	.1976	-.4273	.6598	.7962	.5002	.4976	-.4496	.6549	.8038
.3001	-.4098	.6637	.7902	.2503	-.4405	.6569	.8006	.5002	.2476	-.4538	.6539	.8052
.3502	-.4137	.6628	.7915	.3001	-.4458	.6557	.8024	.5002	-.2524	-.4439	.6561	.8018
.4003	-.4204	.6613	.7938	.3507	-.4397	.6571	.8004	.5002	-.5024	-.4421	.6565	.8012
.4501	-.4274	.6598	.7962	.4001	-.4103	.6635	.7904	.5002	-.7524	-.4264	.6600	.7958
.5002	-.4515	.6545	.8044	.4501	-.3786	.6706	.7796	.8002	.7476	-1.0515	.3217	1.0133
.5502	-.4718	.6500	.8113	.5001	-.3069	.6865	.7551	.8002	.4976	-.9762	.6711	.7787
.6002	-.4806	.6480	.8143	.5497	-.2072	.7085	.7210	.8002	.2476	-.9782	.6707	.7794
.6500	-.4836	.6469	.8160	.6003	-.0970	.7329	.6830	.8002	-.5024	-.9490	.6771	.7695
.7000	-.4679	.6508	.8100	.6500	-.0151	.7510	.6544	.8002	-.7524	-.9467	.6776	.7687
.7500	-.4327	.6586	.7980	.7000	.1049	.7776	.6118					
.8002	-.3751	.6714	.7784	.7501	.2056	.7999	.5752					
.9002	-.2138	.7071	.7232	.8001	.2901	.8186	.5437					
.9501	-.0984	.7326	.6934	.8501	.3644	.8350	.5152					

TEST 167	PT	62.9295	PSI	CN	.3039	CD1	.00742	CDCOR1	.00736
RUN 23	TI	115.2065	K	CM	-.1311	CD2	.60743	CDCOR2	.00741
POINT R8	RC	29.9762	MILLION	CC	.0189	CD3	.00736	CDCOR3	.00740
	MACH	.6502				CD4	.00739	CDCOR4	.00737
	ALPHA	-1.4867	DEG			CD5	.00729	CDCOR5	.00707

UPPER SURFACE				LOWER SURFACE				SPANWISE				
X/C	CP	P ₂ L/PT	MLOC	X/C	CP	P ₂ L/PT	MLOC	X/C	Y/(B/2)	CP	P ₂ L/PT	MLOC
0.0000	1.0313	.4826	.1590	0.0000	1.0313	.9826	.1590	.1507	.7476	-.4111	.6630	.7912
.0132	.0415	.7722	.6206	.0126	.0267	.7600	.6401	.1507	.4976	-.4259	.6598	.7962
.0259	-.2478	.6992	.7354	.0255	-.0746	.7376	.6756	.1507	.2476	-.4241	.6602	.7956
.0759	-.4232	.6604	.7953	.0495	-.1891	.7122	.7152	.1507	-.2524	-.4335	.6581	.7988
.1003	-.4221	.6606	.7949	.0753	-.2328	.7025	.7302	.1507	-.5024	-.4348	.6578	.7993
.1507	-.4194	.6612	.7940	.1002	-.2893	.6900	.7496	.1507	-.7524	-.4230	.6604	.7952
.2003	-.4171	.6617	.7932	.1503	-.3107	.6853	.7569	.5002	.7476	-.4696	.6501	.8111
.2501	-.4339	.6580	.7989	.1976	-.3748	.6711	.7788	.5002	.4976	-.4754	.6488	.8131
.3001	-.4496	.6545	.8043	.2503	-.3950	.6666	.7857	.5002	.2476	-.4799	.6478	.8146
.3502	-.4482	.6548	.8038	.3001	-.4054	.6643	.7892	.5002	-.2524	-.4698	.6500	.8112
.4003	-.4518	.6540	.8051	.3507	-.4044	.6645	.7889	.5002	-.5024	-.4668	.6504	.8107
.4501	-.4557	.6532	.8064	.4001	-.3798	.6700	.7805	.5002	-.7524	-.4512	.6542	.8048
.5002	-.4767	.6485	.8136	.4501	-.3524	.6760	.7712	.8002	.7476	-1.0777	.5154	1.0236
.5502	-.4949	.6445	.8198	.5001	-.2849	.6910	.7441	.8002	.4976	-.3840	.6690	.7820
.6002	-.5013	.6431	.8220	.5497	-.1890	.7122	.7152	.8002	.2476	-.3866	.6685	.7828
.6500	-.5035	.6426	.8227	.6003	-.0822	.7354	.6783	.8002	-.5024	-.3570	.6750	.7727
.7000	-.4828	.6472	.8156	.6500	-.0030	.7539	.6506	.8002	-.7524	-.3553	.6754	.7721
.7500	-.4445	.6557	.8026	.7000	.1151	.7796	.6055					
.8002	-.3837	.6691	.7818	.7501	.2143	.8016	.5724					
.9002	-.2163	.7062	.7246	.8001	.2980	.8201	.5411					
.9501	-.0980	.7324	.6837	.8501	.3722	.8366	.5125					

TEST 167	PT	62.9381	PSI	CN	.3659	CD1	.00745	CDCOR1	.00740
RUN 23	TI	115.2044	K	CM	-.1323	CD2	.00747	CDCOR2	.00745
POINT R9	RC	29.9746	MILLION	CC	.0190	CD3	.00740	CDCOR3	.00744
	MACH	.6500				CD4	.00738	CDCOR4	.00738
	ALPHA	.9979	DEG			CD5	.00724	CDCOR5	.00707

UPPER SURFACE				LOWER SURFACE				SPANWISE				
X/C	CP	P ₂ L/PT	MLOC	X/C	CP	P ₂ L/PT	MLOC	X/C	Y/(B/2)	CP	P ₂ L/PT	MLOC
0.0000	1.0692	.9910	.1139	0.0000	1.0692	.9910	.1139	.1507	.7476	-.4706	.6500	.8112
.0132	-.0497	.7432	.6668	.0126	.1533	.7882	.5946	.1507	.4976	-.4865	.6465	.8167
.0259	-.3788	.6704	.7799	.0255	.0282	.7605	.6394	.1507	.2476	-.4854	.6467	.8163
.0759	-.5143	.6403	.8261	.0495	-.1005	.7320	.6844	.1507	-.2524	-.4941	.6448	.8193
.1003	-.4991	.6437	.8210	.0753	-.1590	.7190	.7047	.1507	-.5024	-.4942	.6448	.8193
.1507	-.4800	.6479	.8144	.1002	-.2229	.7049	.7266	.1507	-.7524	-.4806	.6478	.8146
.2003	-.4688	.6504	.8106	.1503	-.2553	.6977	.7378	.5002	.7476	-.4943	.6448	.8193
.2501	-.4775	.6485	.8136	.1976	-.3247	.6823	.7615	.5002	.4976	-.5004	.6434	.8214
.3001	-.4883	.6461	.8173	.2503	-.3510	.6765	.7705	.5002	.2476	-.5047	.6425	.8229
.3502	-.4843	.6470	.8159	.3001	-.3661	.6732	.7756	.5002	-.2524	-.4934	.6450	.8190
.4003	-.4834	.6472	.8156	.3507	-.3698	.6723	.7769	.5002	-.5024	-.4920	.6453	.8185
.4501	-.4856	.6471	.8157	.4001	-.3498	.6768	.7701	.5002	-.7524	-.4970	.6489	.8130
.5002	-.5014	.6432	.8218	.4501	-.3269	.6818	.7622	.8002	.7476	-1.0970	.5113	1.0303
.5502	-.5172	.6397	.8271	.5001	-.2639	.6958	.7407	.8002	.4976	-.3921	.6674	.7845
.6002	-.5211	.6388	.8285	.5497	-.1723	.7161	.7093	.8002	.2476	-.3950	.6667	.7855
.6500	-.5203	.6390	.8282	.6003	-.0690	.7389	.6735	.8002	-.5024	-.3643	.6736	.7750
.7000	-.4967	.6442	.8201	.6500	.0071	.7599	.6468					
.7500	-.4553	.6534	.8060	.7000	.1231	.7815	.6055					
.8002	-.3919	.6674	.7844	.7501	.2206	.8031	.5699					
.9002	-.2700	.7055	.7256	.8001	.3034	.8214	.5389					
.9501	-.1001	.7321	.6843	.8501	.3772	.8377	.5105					

TEST 167	PT	63.0889	PSI	CN	.4285	CD1	.00748	CDCOR1	.00744
RUN 23	TI	115.2311	K	CM	-.1337	CD2	.00748	CDCOR2	.00747
POINT R9	RC	30.0379	MILLION	CC	.0183	CD3	.00742	CDCOR3	.00740
	MACH	.6500				CD4	.00739	CDCOR4	.00740
	ALPHA	-.4990	DEG			CD5	.00724	CDCOR5	.00711

UPPER SURFACE				LOWER SURFACE				SPANWISE				
X/C	CP	P ₂ L/PT	MLOC	X/C	CP	P ₂ L/PT	MLOC	X/C	Y/(B/2)	CP	P ₂ L/PT	MLOC
0.0000	1.0955	.9968	.0680	0.0000	1.0955	.9968	.0680	.1507	.7476	-.5330	.6360	.8329
.0132	-.1902	.7119	.7157	.0126	.2694	.8137	.5520	.1507	.4976	-.5507	.6320	.8390
.0259	-.5194	.6390	.8282	.0255	.1235	.7814	.6056	.1507	.2476	-.5496	.6323	.8386
.0759	-.6114	.6186	.8598	.0495	-.0183	.7500	.6560	.1507	-.2524	-.5569	.6307	.8411
.1003	-.5803	.6255	.8491	.0753	-.0896	.7342	.6809	.1507	-.5024	-.5554	.6310	.8406
.1507	-.5435	.6336	.8365	.1002	-.1601	.7186	.7054	.1507	-.7524	-.5393	.6346	.8351
.2003	-.5232	.6381	.8296	.1503	-.2025	.7092	.7200	.5002	.7476	-.5192	.6390	.8282
.2501	-.5233	.6381	.8296	.1976	-.2770	.6927	.7455	.5002	.4976	-.5257	.6376	.8304
.3001	-.5291	.6368	.8316	.2503	-.3094	.6855	.7566	.5002	.2476	-.5303	.6366	.8320
.3502	-.5215	.6385	.8290	.3001	-.3289	.6812	.7633	.5002	-.2524	-.5184	.6392	.8279
.4003	-.5162	.6397	.8272	.3507	-.3368	.6794	.7660	.5002	-.5024	-.5170	.6395	.8274
.4501	-.5125	.6405	.8259	.4001	-.3210	.6829	.7605	.5002	-.7524	-.4985	.6436	.8211
.5002	-.5273	.6372	.8310	.4501	-.3020	.6871	.7540	.8002	.7476	-1.1109	.5079	1.0359
.5502	-.5403	.6343	.8354	.5001	-.2432	.7002	.7339	.8002	.4976	-.3991	.6656	.7872
.6002	-.5417	.6340	.8359	.5497	-.1555	.7196	.7038	.8002	.2476	-.4032	.6647	.7866
.6500	-.5379	.6349	.8346	.6003	-.0554	.7418	.6690	.8002	-.5024	-.3716	.6717	.7778
.7000	-.5111	.6408	.8254	.6500	.0179	.7580	.6433	.8002	-.7524	-.3698	.6721	.7772
.7500	-.4664	.6507	.8102	.7000	.1322	.7833	.6025					
.8002	-.4003	.6654	.7876	.7501	.2282	.8046	.5673					
.9002	-.2731	.7046	.7270	.8001	.3102	.8228	.5365					
.9501	-.1011	.7317	.6849	.8501	.3837	.8391	.5081					

ORIGINAL PAGE IS
OF POOR QUALITY

TEST RUN POINT	167 27 46	PT TT RC MACH ALPHA	62.7122 115.1438 29.9295 .6512 .0204	PSI K MILLION DEG	CN CM CC	.5602 -1.1350 .0165	CD1 CD2 CD3 CD4 CD5	.00757 .00752 .00752 .00748 .00738	CDCOR1 CDCOR2 CDCOR3 CDCOR4 CDCOR5	.00752 .00750 .00757 .00747 .00724		
UPPER SURFACE												
X/C	CP	P/L/PT	MLOC	X/C	CP	P/L/PT	MLOC	SPANWISE				
0.0000	1.1088	.9997	.0222	0.0000	1.1088	.9997	.0222	X/C	Y/(B/2)	CP	P/L/PT	MLOC
.0132	-.3568	.6741	.7741	.0126	.3918	.8404	.5057	.1507	.7476	-.6042	.6192	.8588
.0259	-.6876	.6007	.8876	.0255	.2262	.8036	.5690	.1507	.4976	-.6172	.6163	.8633
.0759	-.7242	.5926	.9002	.0495	.0792	.7710	.6225	.1507	.2476	-.6202	.6157	.8643
.1003	-.6725	.6040	.8823	.0753	-.0116	.7508	.6547	.1507	-.2524	-.6227	.6151	.8652
.1507	-.6167	.6164	.8631	.1002	-.0901	.7334	.6822	.1507	-.5024	-.6255	.6145	.8661
.2003	-.5902	.6223	.8540	.1503	-.1439	.7214	.7009	.1507	-.7524	-.6067	.6186	.8597
.2503	-.5726	.6262	.8479	.1976	-.2222	.7040	.7279	.5002	.7476	-.5458	.6322	.8387
.3001	-.5735	.6260	.8482	.2503	-.2605	.6955	.7411	.5002	.4976	-.5526	.6307	.8411
.3502	-.5649	.6279	.8453	.3001	-.2848	.6901	.7494	.5002	.2476	-.5567	.6298	.8425
.4003	-.5534	.6305	.8414	.3507	-.2980	.6872	.7539	.5002	-.2524	-.5443	.6325	.8382
.4501	-.5425	.6329	.8376	.4001	-.2863	.6898	.7499	.5002	-.5024	-.5419	.6330	.8374
.5002	-.5549	.6302	.8418	.4501	-.2718	.6930	.7450	.5002	-.7524	-.5284	.6360	.8328
.5502	-.5603	.6290	.8437	.5001	-.2163	.7053	.7259	.8002	.7476	-.11320	.5020	1.0457
.6002	-.5628	.6284	.8446	.5497	-.1323	.7240	.6960	.8002	.4976	-.4036	.6638	.7901
.6500	-.5546	.6302	.8418	.6003	-.0362	.7454	.6634	.8002	.2476	-.4086	.6626	.7918
.7000	-.5248	.6366	.8316	.6500	.0322	.7605	.6393	.8002	-.5024	-.3795	.6691	.7818
.7500	-.4755	.6478	.8147	.7000	.1463	.7859	.5983	.8002	-.7524	-.3753	.6701	.7804
.8002	-.4060	.6632	.7909	.7501	.2401	.8067	.5638					
.9002	-.2222	.7040	.7279	.8001	.3210	.8247	.5332					
.9501	-.0981	.7316	.6850	.8501	.3943	.8410	.5048					

TEST RUN POINT	167 27 47	PT TT RC MACH ALPHA	62.8638 115.2166 29.9511 .6505 .5193	PSI K MILLION DEG	CN CM CC	.5576 -1.1355 .0144	CD1 CD2 CD3 CD4 CD5	.00768 .00761 .00758 .00751 .00746	CDCOR1 CDCOR2 CDCOR3 CDCOR4 CDCOR5	.00758 .00755 .00760 .00749 .00728
----------------	-----------------	---------------------------------	--	----------------------------	----------------	---------------------------	---------------------------------	--	--	--

UPPER SURFACE												
X/C	CP	P/L/PT	MLOC	X/C	CP	P/L/PT	MLOC	SPANWISE				
0.0000	1.1055	.9990	.0377	0.0000	1.1055	.9990	.0377	X/C	Y/(B/2)	CP	P/L/PT	MLOC
.0132	-.5085	.6414	.8245	.0126	.4784	.8601	.4701	.1507	.7476	-.6734	.6049	.8610
.0259	-.8499	.5658	.9423	.0255	.3009	.8208	.5400	.1507	.4976	-.6880	.6017	.8660
.0759	-.8341	.5693	.9368	.0495	.1419	.7855	.5989	.1507	.2476	-.6913	.6009	.8672
.1003	-.7630	.5850	.9120	.0753	.0417	.7633	.6348	.1507	-.2524	-.6949	.6001	.8684
.1507	-.6876	.6018	.8959	.1002	-.0404	.7451	.6637	.1507	-.5024	-.6965	.5998	.8690
.2003	-.6366	.6130	.8683	.1503	-.1033	.7312	.6756	.1507	-.7524	-.6766	.6042	.8621
.2503	-.6228	.6161	.8636	.1976	-.1858	.7129	.7142	.5002	.7476	-.5763	.6264	.8477
.3001	-.6188	.6170	.8622	.2503	-.2292	.7033	.7291	.5002	.4976	-.5828	.6250	.8499
.3502	-.6009	.6210	.8561	.3001	-.2566	.6972	.7385	.5002	.2476	-.5872	.6240	.8514
.4003	-.5882	.6238	.8517	.3507	-.2733	.6935	.7442	.5002	-.2524	-.5764	.6264	.8477
.4501	-.5750	.6267	.8472	.4001	-.2656	.6953	.7415	.5002	-.5024	-.5735	.6270	.8467
.5002	-.5845	.6246	.8504	.4501	-.2550	.6976	.7379	.5002	-.7524	-.5598	.6301	.8420
.5502	-.5874	.6239	.8515	.5001	-.2040	.7089	.7204	.8002	.7476	-.11626	.4965	1.0549
.6002	-.5870	.6241	.8513	.5497	-.1238	.7267	.6927	.8002	.4976	-.4176	.6616	.7934
.6500	-.5766	.6263	.8477	.6003	-.0307	.7473	.6603	.8002	.2476	-.4220	.6606	.7949
.7000	-.5438	.6336	.8365	.6500	.0351	.7619	.6372	.8002	-.5024	-.3926	.6671	.7849
.7500	-.4913	.6452	.8186	.7000	.1472	.7867	.5970	.8002	-.7524	-.3897	.6678	.7839
.8002	-.4187	.6613	.7938	.7501	.2398	.8072	.5630					
.9002	-.2299	.7032	.7293	.8001	.3200	.8250	.5327					
.9501	-.1028	.7313	.6855	.8501	.3927	.8411	.5045					

TEST RUN POINT	167 27 48	PT TT RC MACH ALPHA	62.8669 115.2762 29.9272 .6504 1.0181	PSI K MILLION DEG	CN CM CC	.6194 -1.1360 .0114	CD1 CD2 CD3 CD4 CD5	.00782 .00774 .00774 .00761 .00758	CDCOR1 CDCOR2 CDCOR3 CDCOR4 CDCOR5	.00771 .00769 .00775 .00757 .00738
----------------	-----------------	---------------------------------	---	----------------------------	----------------	---------------------------	---------------------------------	--	--	--

UPPER SURFACE												
X/C	CP	P/L/PT	MLOC	X/C	CP	P/L/PT	MLOC	SPANWISE				
0.0000	1.1011	.9979	.0550	0.0000	1.1011	.9979	.0550	X/C	Y/(B/2)	CP	P/L/PT	MLOC
.0132	-.6605	.6060	.8792	.0126	.5658	.8788	.4345	.1507	.7476	-.734	.5896	.9049
.0259	-.6230	.5252	1.0075	.0255	.3806	.8376	.5107	.1507	.4976	-.750	.5860	.9125
.0759	-.9503	.5416	.9810	.0495	.2139	.8005	.5741	.1507	.2476	-.7550	.5850	.9121
.1003	-.8493	.5640	.9451	.0753	.1059	.7765	.6136	.1507	-.2524	-.7574	.5845	.9129
.1507	-.7498	.5862	.9102	.1002	-.0186	.7571	.6448	.1507	-.5024	-.7504	.5847	.9126
.2003	-.6898	.5495	.8805	.1503	-.0516	.7415	.6695	.1507	-.7524	-.7337	.5898	.9046
.2503	-.6642	.6052	.8805	.1976	-.1373	.7224	.6994	.5002	.7476	-.5936	.6209	.8561
.3001	-.6540	.6075	.8770	.2503	-.1855	.7117	.7161	.5002	.4976	-.6012	.6192	.8588
.3502	-.6349	.6117	.8704	.3001	-.2170	.7047	.7267	.5002	.2476	-.6061	.6181	.8604
.4003	-.6184	.6158	.8640	.3507	-.2369	.7003	.7338	.5002	-.2524	-.5936	.6209	.8561
.4501	-.5982	.6199	.8577	.4001	-.2525	.7012	.7523	.5002	-.5024	-.5908	.6215	.8552
.5002	-.6042	.6186	.8598	.4501	-.2248	.7029	.7296	.5002	-.7524	-.5767	.6247	.8503
.5502	-.6044	.6185	.8599	.5001	-.1783	.7133	.7136	.8002	.7476	-.11571	.4956	1.0565
.6002	-.6012	.6192	.8588	.5497	-.1020	.7303	.6671	.8002	.4976	-.4172	.6601	.7956
.6500	-.5866	.6225	.8537	.6003	-.0126	.7502	.6558	.8002	.2476	-.4229	.6589	.7976
.7000	-.5510	.6304	.8415	.6500	.0505	.7642	.6334	.8002	-.5024	-.3922	.6657	.7871
.7500	-.4954	.6428	.8224	.7000	.1602	.7886	.5939	.8002	-.7524	-.3886	.6665	.7898
.8002	-.4201	.6595	.7966	.7501	.2510	.8088	.5604					
.9002	-.2267	.7025	.7303	.8001	.3299	.8263	.5304					
.9501	-.0997	.7304	.6863	.8501	.4017	.8423	.5024					

TEST 167 PT 62.8586 PSI CN .6782
 RUN 27 TT 115.1070 K CM -.1359 CD1 .00787 C0C0R1 .00781
 POINT 49 RC 29.9834 MILLION CC .0081 CD2 .00784 C0C0R2 .00783
 MACH .6502 CD3 .00785 C0C0R3 .00791
 ALPHA 1.5172 DEG CD4 .00772 C0C0R4 .00772
 CD5 .00768 C0C0R5 .00753

UPPER SURFACE				LOWER SURFACE				SPANWISE				
X/C	CP	P/L/PT	MLOC	X/C	CP	P/L/PT	MLOC	X/C	Y/(B/2)	CP	P/L/PT	MLOC
0.0000	1.0882	.9952	.0833	0.0000	1.0882	.9952	.0833	.1507	.7476	-.7947	.5778	.9233
.0132	-.8119	.5740	.9293	.0126	.6518	.8984	.3920	.1507	.4976	-.8111	.5742	.9291
.0259	-1.7066	.4865	1.0716	.0255	.4620	.8564	.4769	.1507	.2476	-.8158	.5732	.9307
.0759	-1.0596	.5191	1.0175	.0495	.2864	.8174	.5457	.1507	-.2524	-.8188	.5725	.9317
.1507	-.9279	.5483	.9702	.0733	.1702	.7917	.5888	.1507	-.5024	-.8159	.5731	.9307
.2003	-.8096	.5745	.9285	.1002	.0798	.7717	.6214	.1507	-.7524	-.7921	.5784	.9224
.2503	-.7287	.5925	.9004	.1503	.0017	.7543	.6804	.9002	.7476	-.6114	.6185	.9599
.3001	-.6852	.6019	.8857	.1976	-.0877	.7345	.6987	.9002	.4976	-.6186	.6169	.9624
.3502	-.6597	.6078	.8765	.2503	-.1754	.7151	.7108	.9002	.2476	-.6234	.6158	.9641
.4003	-.6385	.6125	.8693	.3001	-.2507	.6922	.7186	.9002	-.2524	-.6120	.6167	.9601
.4501	-.6177	.6171	.8621	.3502	-.3307	.6700	.7184	.9002	-.5024	-.6095	.6189	.9593
.5002	-.6204	.6165	.8630	.4001	-.4102	.6483	.7172	.9002	-.7524	-.5940	.6223	.9540
.5502	-.6176	.6171	.8621	.4501	-.4902	.6267	.7026	.8002	.7476	-1.1732	.4939	1.0592
.6002	-.6112	.6185	.8599	.5001	-.5702	.6051	.6875	.8002	.4976	-.4181	.6613	.7938
.6500	-.5939	.6223	.8539	.5497	-.6497	.5836	.6779	.8002	.2476	-.4226	.6603	.7954
.7000	-.5953	.6309	.8407	.6003	-.7297	.5621	.6613	.8002	-.5024	-.3923	.6670	.7850
.7500	-.4968	.6439	.8207	.6500	-.8097	.5406	.6473	.8002	-.7524	-.3883	.6679	.7837
.8002	-.4191	.6611	.7942	.7000	-.8897	.5191	.6325					
.9002	-.2211	.7050	.7265	.7501	-.9697	.4976	.6240					
.9501	-.0915	.7337	.6917	.8001	-1.0497	.4761	.6155					
				.8501	-1.1297	.4546	.6070					
				.9001	-1.2097	.4331	.5985					
				.9501	-1.2897	.4116	.5900					

TEST 167 PT 62.8586 PSI CN .7901
 RUN 27 TT 115.0816 K CM -.1357 CD1 .00838 C0C0R1 .00838
 POINT 50 RC 30.0229 MILLION CC .0026 CD2 .00837 C0C0R2 .00842
 MACH .6512 CD3 .00834 C0C0R3 .00845
 ALPHA 2.0164 DEG CD4 .00819 C0C0R4 .00824
 CD5 .00827 C0C0R5 .00814

UPPER SURFACE				LOWER SURFACE				SPANWISE				
X/C	CP	P/L/PT	MLOC	X/C	CP	P/L/PT	MLOC	X/C	Y/(B/2)	CP	P/L/PT	MLOC
0.0000	1.0616	.9893	.1245	0.0000	1.0616	.9893	.1245	.1507	.7476	-.8612	.5632	.9465
.0132	-.9454	.5445	.9763	.0126	.7240	.9145	.3604	.1507	.4976	-.8656	.5622	.9481
.0259	-1.3774	.4488	1.1369	.0255	.5298	.8714	.4488	.1507	.2476	-.8707	.5611	.9498
.0759	-1.4790	.4272	1.1756	.0495	.3478	.8311	.5221	.1507	-.2524	-.8697	.5613	.9495
.1507	-1.0128	.5296	1.0004	.0733	.2249	.8039	.5886	.1507	-.5024	-.8646	.5624	.9477
.2003	-.8632	.5627	.9472	.1002	.1304	.7829	.6032	.1507	-.7524	-.8499	.5657	.9425
.2503	-.7877	.5795	.9208	.1503	.0452	.7640	.6337	.9002	.7476	-.6399	.6122	.9696
.3001	-.7515	.5875	.9082	.1976	-.0478	.7434	.6664	.9002	.4976	-.6479	.6104	.9724
.3502	-.7024	.5964	.8912	.2503	-.1054	.7307	.6865	.9002	.2476	-.6524	.6095	.9739
.4003	-.6761	.6042	.8821	.3001	-.1438	.7222	.6989	.9002	-.2524	-.6393	.6123	.9694
.4501	-.6505	.6099	.8733	.3502	-.1702	.7163	.7089	.9002	-.5024	-.6371	.6128	.9687
.5002	-.6498	.6100	.8730	.4001	-.1732	.7156	.7099	.9002	-.7524	-.6201	.6166	.9628
.5502	-.6439	.6113	.8710	.4501	-.1730	.7157	.7098	.8002	.7476	-1.1902	.4903	1.0654
.6002	-.6346	.6134	.8678	.5001	-.1339	.7243	.6964	.8002	.4976	-.4263	.6596	.7965
.6500	-.6134	.6181	.8605	.5497	-.0647	.7397	.6723	.8002	.2476	-.4313	.6584	.7983
.7000	-.5711	.6275	.8460	.6003	.0188	.7582	.6430	.8002	-.5024	-.3989	.6656	.7872
.7500	-.5090	.6412	.8248	.6500	.0764	.7710	.6226	.8002	-.7524	-.3941	.6667	.7856
.8002	-.4279	.6592	.7971	.7000	.1823	.7944	.5843					
.9002	-.2234	.7045	.7272	.7501	.2700	.8139	.5518					
.9501	-.0926	.7335	.6921	.8001	.3470	.8309	.5225					
				.8501	.4177	.8466	.4947					

TEST 167 PT 62.8582 PSI CN .8131
 RUN 27 TT 115.1383 K CM -.1325 CD1 .00956 C0C0R1 .00936
 POINT 51 RC 29.9830 MILLION CC -.0032 CD2 .00954 C0C0R2 .00939
 MACH .6507 CD3 .00954 C0C0R3 .00953
 ALPHA 2.9355 DEG CD4 .00940 C0C0R4 .00928
 CD5 .00955 C0C0R5 .00928

UPPER SURFACE				LOWER SURFACE				SPANWISE				
X/C	CP	P/L/PT	MLOC	X/C	CP	P/L/PT	MLOC	X/C	Y/(B/2)	CP	P/L/PT	MLOC
0.0000	1.0136	.9786	.1763	0.0000	1.0136	.9786	.1763	.1507	.7476	-.8693	.5612	.9496
.0132	-1.0763	.5153	1.0237	.0126	.7766	.9261	.3337	.1507	.4976	-.8386	.5640	.9388
.0259	-1.9107	.4190	1.1905	.0255	.5818	.8829	.4265	.1507	.2476	-.8485	.5658	.9423
.0759	-1.0651	.3848	1.2353	.0495	.3565	.8418	.5032	.1507	-.2524	-.8460	.5664	.9414
.1507	-1.6131	.3963	1.2331	.0733	.2684	.8134	.5825	.1507	-.5024	-.8359	.5686	.9379
.2003	-.8437	.5669	.9406	.1002	.1717	.7920	.5983	.1507	-.7524	-.8324	.5650	.9437
.2503	-.8075	.5749	.9279	.1503	.0806	.7718	.6212	.9002	.7476	-.6675	.6060	.9794
.3001	-.7840	.5801	.9197	.1976	-.0131	.7506	.6531	.9002	.4976	-.6745	.6044	.9818
.3502	-.7670	.5839	.9138	.2503	-.0767	.7369	.6767	.9002	.2476	-.6790	.6034	.9833
.4003	-.7359	.5908	.9030	.3001	-.1181	.7277	.6911	.9002	-.2524	-.6663	.6062	.9790
.4501	-.7054	.5975	.8921	.3502	-.1474	.7212	.7012	.9002	-.5024	-.6643	.6067	.9783
.5002	-.6786	.6035	.8832	.4001	-.1536	.7199	.7034	.9002	-.7524	-.6465	.6106	.9721
.5502	-.6754	.6042	.8821	.4501	-.1566	.7192	.7044	.8002	.7476	-1.2052	.4868	1.0713
.6002	-.6666	.6061	.8791	.5001	-.1215	.7270	.6922	.8002	.4976	-.4362	.6572	.8002
.6500	-.6542	.6089	.8748	.5497	-.0560	.7415	.6694	.8002	.2476	-.4405	.6563	.8016
.7000	-.6302	.6142	.8665	.6003	.0241	.7593	.6413	.8002	-.5024	-.4084	.6634	.7907
.7500	-.5847	.6243	.8509	.6500	.0787	.7714	.6219					
.8002	-.5194	.6388	.8286	.7000	.1819	.7942	.5846					
.9002	-.4361	.6573	.8001	.7501	.2677	.8133	.5526					
.9501	-.2285	.7033	.7291	.8001	.3433	.8300	.5240					
				.8501	.4129	.8455	.4968					

ORIGINAL
OF POOR QUALITY

TEST	167	PT	62.8533	PSI	CN	.8823	CD1	.01130	CDCOR1	.01102
RUN	27	TT	115.0924	K	CM	-1.1300	CD2	.01136	CDCOR2	.01107
POINT	52	RC	29.9919	MILLION	CC	-.0090	CD3	.01134	CDCOR3	.01104
		MACH	.6504				CD4	.01123	CDCOR4	.01094
		ALPHA	3.0141	DEG			CD5	.01150	CDCOR5	.01121

UPPER SURFACE				LOWER SURFACE				SPANWISE				
X/C	CP	P/L/PT	MLOC	X/C	CP	P/L/PT	MLOC	X/C	Y/(B/2)	CP	P/L/PT	MLOC
0.0000	.9730	.4694	.2117	0.0000	.9730	.9694	.2117	.1507	.7476	-.9496	.5416	.9809
.0132	-1.2028	.4853	1.0738	.0126	.8231	.9360	.3094	.1507	.4976	-1.3224	.4587	1.1195
.0259	-1.6116	.3943	1.2369	.0255	.6291	.8929	.4065	.1507	.2476	-1.4680	.4263	1.1772
.0759	-1.7828	.3563	1.3124	.0495	.4436	.8516	.4857	.1507	-.2524	-1.4421	.4321	1.1668
.1003	-1.7481	.3640	1.2967	.0753	.3112	.8221	.5376	.1507	-.5024	-1.2500	.4726	1.0955
.1507	-1.4583	.4284	1.1733	.1002	.2125	.8002	.5748	.1507	-.7524	-.9297	.3461	.9738
.2003	-.7595	.5839	.9138	.1503	.1164	.7788	.6099	.5002	.7476	-.6835	.6008	.8873
.2503	-.7625	.5832	.9148	.1976	.0187	.7571	.6448	.5002	.4976	-.6907	.5992	.8898
.3001	-.7726	.5810	.9184	.2503	-.0462	.7426	.6677	.5002	.2476	-.6952	.5992	.8914
.3502	-.7522	.5855	.9112	.3001	-.0902	.7328	.6831	.5002	-.2524	-.6825	.6010	.8870
.4003	-.7247	.5917	.9017	.3507	-.1225	.7257	.6943	.5002	-.5024	-.6811	.6033	.8804
.4501	-.6937	.5966	.8909	.4001	-.1313	.7237	.6974	.5002	-.7524	-.6825	.6010	.8865
.5002	-.6920	.5989	.8903	.4501	-.1373	.7224	.6995	.8002	.7476	-1.2032	.4892	1.0739
.5502	-.6819	.6012	.8868	.5001	-.1052	.7295	.6883	.8002	.4976	-.4387	.6593	.8031
.6007	-.6675	.6044	.8818	.5497	-.0426	.7434	.6664	.8002	.2476	-.4435	.6542	.8048
.6500	-.6400	.6105	.8723	.6003	.0348	.7607	.6391	.8002	-.5024	-.4107	.6615	.7935
.7000	-.5921	.6212	.8558	.6500	.0874	.7724	.6203	.8002	-.7524	-.4053	.6627	.7917
.7500	-.5246	.6362	.8326	.7000	.1890	.7949	.5834					
.8002	-.4396	.6551	.8034	.7501	.2733	.8137	.5521					
.9002	-.2296	.7618	.7314	.8001	.3478	.8303	.5236					
.9501	-.0995	.7308	.6863	.8501	.4168	.8456	.4964					

TEST	167	PT	62.8534	PSI	CN	.9497	CD1	.01459	CDCOR1	.01419
RUN	27	TT	115.0330	K	CM	-.1268	CD2	.01465	CDCOR2	.01399
POINT	54	RC	30.0356	MILLION	CC	-.0148	CD3	.01479	CDCOR3	.01442
		MACH	.6511				CD4	.01476	CDCOR4	.01439
		ALPHA	3.5336	DEG			CD5	.01521	CDCOR5	.01478

UPPER SURFACE				LOWER SURFACE				SPANWISE				
X/C	CP	P/L/PT	MLOC	X/C	CP	P/L/PT	MLOC	X/C	Y/(B/2)	CP	P/L/PT	MLOC
0.0000	.9242	.9584	.2476	0.0000	.9242	.9584	.2476	.1507	.7476	-1.6914	.3756	1.2734
.0132	-1.3193	.4585	1.1198	.0126	.8770	.9479	.2781	.1507	.4976	-1.8075	.3497	1.3259
.0259	-1.7007	.3735	1.2775	.0255	.6855	.9052	.3807	.1507	.2476	-1.7853	.3547	1.3157
.0759	-1.8833	.3329	1.3618	.0495	.5018	.8643	.4623	.1507	-.2524	-1.7828	.3552	1.3145
.1003	-1.8631	.3374	1.3521	.0753	.3861	.8341	.5170	.1507	-.5024	-1.7974	.3520	1.3212
.1507	-1.7647	.3593	1.3062	.1002	.2650	.8115	.5557	.1507	-.7524	-1.6460	.3857	1.2595
.2003	-1.1485	.4966	1.0548	.1503	.1647	.7892	.5929	.5002	.7476	-.6870	.5994	.8895
.2503	-.7231	.5914	.9021	.1976	.0653	.7670	.6289	.5002	.4976	-.6922	.5983	.8914
.3001	-.7184	.5924	.9036	.2503	-.0030	.7518	.6532	.5002	.2476	-.6949	.5976	.8923
.3502	-.7274	.5904	.9036	.3001	-.0494	.7415	.6695	.5002	-.2524	-.6821	.6005	.8878
.4003	-.7154	.5931	.8994	.3507	-.0841	.7337	.6817	.5002	-.5024	-.6835	.6002	.8883
.4501	-.6911	.5965	.8910	.4001	-.0962	.7310	.6859	.5002	-.7524	-.6654	.6042	.8821
.5002	-.6920	.5983	.8913	.4501	-.1049	.7291	.6889	.8002	.7476	-1.2038	.4843	1.0755
.5502	-.6818	.6006	.8878	.5001	-.0770	.7353	.6792	.8002	.4976	-.4327	.6561	.8019
.6002	-.6658	.6041	.8822	.5497	-.0180	.7485	.6584	.8002	.2476	-.4361	.6593	.8031
.6500	-.6364	.6107	.8720	.6003	.0560	.7650	.6322	.8002	-.5024	-.4017	.6630	.7913
.7000	-.5872	.6216	.8550	.6500	.1060	.7761	.6142	.8002	-.7524	-.3970	.6640	.7897
.7500	-.5179	.6371	.8312	.7000	.2045	.7980	.5783					
.8002	-.4321	.6562	.8017	.7501	.2869	.8164	.5474					
.9002	-.2221	.7030	.7296	.8001	.3599	.8327	.5194					
.9501	-.0934	.7317	.6849	.8501	.4276	.8478	.4926					

Appendix D

Pressure Data for $M = 0.70$; $R = 4.4 \times 10^6$, 7.0×10^6 , 10.0×10^6 , 15.0×10^6 , and 30.0×10^6 ; Free Transition

The pressure measurements made on the NASA SC(3)-0712(B) airfoil are presented in coefficient form in graphs and tables in this appendix. The data are for a given Mach number through the Reynolds number range. The pressure data from the upper surface of the airfoil are plotted as open symbols, and the lower-surface data are plotted as solid symbols.

ORIGINAL FILE OF POOR QUALITY

TEST 167	PT 20.5755	PSI	CM	-0.0370	CD1	.00816	CDCOR1	.00790
RUN 24	TT 208.7017	K	CM	-1.1298	CD2	.00794	CDCOR2	.00771
POINT 1	RC 4.4128	MILLION	CC	.0027	CD3	.00750	CDCOR3	.00735
	MACH .7011				CD4	.00649	CDCOR4	.00626
	ALPHA -4.0017	DEG			CD5	.00669	CDCOR5	.00648

UPPER SURFACE				LOWER SURFACE				SPANWISE				
X/C	CP	P.L./PT	MLOC	X/C	CP	P.L./PT	MLOC	X/C	Y/(B/2)	CP	P.L./PT	MLOC
0.0000	.6530	.8821	.4270	0.0000	.6530	.8821	.4270	.1507	.7476	-.1482	.6835	.7575
.0132	.6114	.8718	.4468	.0126	-.8508	.5094	1.0307	.1507	.4976	-.1628	.6799	.7630
.0259	.2901	.7922	.3864	.0255	-.7823	.5264	1.0029	.1507	.2476	-.1631	.6798	.7631
.0759	-.0450	.7091	.7180	.0495	-.8263	.5159	1.0207	.1507	-.2524	-.1624	.6800	.7629
.1003	-.0897	.6980	.7352	.0753	-.7751	.5214	1.0000	.1507	-.5024	-.1633	.6798	.7632
.1507	-.1571	.6813	.7609	.1002	-.7619	.5381	.9947	.1507	-.7524	-.1524	.6825	.7591
.2003	-.2006	.6705	.7774	.1503	-.6966	.5476	.9886	.5002	.7476	-.3603	.6309	.8363
.2503	-.2391	.6610	.7921	.1976	-.7394	.5370	.9837	.5002	.4976	-.3717	.6281	.8426
.3001	-.2720	.6528	.8046	.2503	-.7188	.5421	.9775	.5002	.2476	-.3765	.6249	.8445
.3502	-.2926	.6477	.8124	.3001	-.6889	.5495	.9656	.5002	-.2524	-.3691	.6286	.8416
.4003	-.3176	.6415	.8220	.3507	-.6496	.5593	.9501	.5002	-.5024	-.3643	.6300	.8398
.4501	-.3422	.6354	.8313	.4001	-.5897	.5741	.9266	.5002	-.7524	-.3488	.6339	.8339
.5002	-.3677	.6291	.8411	.4501	-.5166	.5922	.8983	.8002	.7476	-.3405	.6359	.8307
.5502	-.3944	.6225	.8513	.5001	-.4190	.6174	.8592	.8002	.4976	-.3485	.6339	.8337
.6002	-.4230	.6154	.8622	.5497	-.2850	.6496	.8096	.8002	.2476	-.3559	.6320	.8366
.6500	-.4401	.6112	.8688	.6003	-.1544	.6820	.7594	.8002	-.5024	-.3477	.6341	.8334
.7000	-.4539	.6127	.8664	.6500	-.0412	.7100	.7186	.8002	-.7524	-.3243	.6399	.8245
.7500	-.4059	.6197	.8557	.7000	.0766	.7392	.6711					
.8002	-.3520	.6330	.8351	.7501	.1772	.7642	.6317					
.8502	-.1952	.6719	.7754	.8001	.2595	.7846	.5918					
.9501	-.0798	.7005	.7314	.8501	.3263	.8011	.5716					

TEST 167	PT 20.5762	PSI	CM	-1.091	CD1	.00737	CDCOR1	.00711
RUN 24	TT 208.6416	K	CM	-1.1330	CD2	.00737	CDCOR2	.00715
POINT 2	RC 4.4143	MILLION	CC	.0117	CD3	.00695	CDCOR3	.00674
	MACH .7010				CD4	.00584	CDCOR4	.00563
	ALPHA -2.9938	DEG			CD5	.00594	CDCOR5	.00573

UPPER SURFACE				LOWER SURFACE				SPANWISE				
X/C	CP	P.L./PT	MLOC	X/C	CP	P.L./PT	MLOC	X/C	Y/(B/2)	CP	P.L./PT	MLOC
0.0000	.8376	.9279	.3286	0.0000	.8376	.9279	.3286	.1507	.7476	-.2594	.6561	.7996
.0132	.4330	.8281	.5258	.0126	-.4582	.6068	.8755	.1507	.4976	-.2776	.6516	.8066
.0259	.1026	.7458	.6608	.0255	-.4779	.6019	.8831	.1507	.2476	-.2784	.6514	.8068
.0759	-.1049	.6721	.7751	.0495	-.5518	.5836	.9116	.1507	-.2524	-.2763	.6519	.8060
.1003	-.2232	.6650	.7859	.0753	-.5509	.5839	.9113	.1507	-.5024	-.2758	.6520	.8058
.1507	-.2701	.6534	.8037	.1002	-.5662	.5801	.9173	.1507	-.7524	-.2618	.6559	.8005
.2003	-.2978	.6486	.8142	.1503	-.5552	.5828	.9130	.5002	.7476	-.4146	.6176	.8588
.2503	-.3278	.6391	.8257	.1976	-.6091	.5704	.9324	.5002	.4976	-.4294	.6140	.8643
.3001	-.3530	.6329	.8353	.2503	-.6034	.5709	.9317	.5002	.2476	-.4357	.6124	.8669
.3502	-.3689	.6289	.8414	.3001	-.5906	.5740	.9268	.5002	-.2524	-.4277	.6144	.8638
.4003	-.3865	.6246	.8481	.3507	-.5726	.5785	.9197	.5002	-.5024	-.4229	.6156	.8620
.4501	-.4055	.6199	.8553	.4001	-.5276	.5896	.9024	.5002	-.7524	-.4076	.6194	.8561
.5002	-.4258	.6149	.8631	.4501	-.4644	.6053	.8779	.8002	.7476	-.3559	.6322	.8364
.5502	-.4485	.6092	.8718	.5001	-.3713	.6284	.8423	.8002	.4976	-.3694	.6288	.8416
.6002	-.4731	.6031	.8813	.5497	-.2503	.6583	.7962	.8002	.2476	-.3795	.6263	.8454
.6500	-.4848	.6002	.8858	.6003	-.1259	.6889	.7492	.8002	-.5024	-.3722	.6281	.8426
.7000	-.4724	.6033	.8810	.6500	-.0202	.7153	.7084	.8002	-.7524	-.3436	.6352	.8317
.7500	-.4379	.6119	.8677	.7000	.0973	.7445	.6629					
.8002	-.3766	.6270	.8443	.7501	.2004	.7700	.6223					
.8502	-.2093	.6695	.7906	.8001	.2872	.7915	.5874					
.9501	-.0912	.6977	.7356	.8501	.3603	.8096	.5574					

TEST 167	PT 20.5783	PSI	CM	-2.443	CD1	.00747	CDCOR1	.00721
RUN 24	TT 208.5939	K	CM	-1.1364	CD2	.00734	CDCOR2	.00711
POINT 3	RC 4.4150	MILLION	CC	.0168	CD3	.00669	CDCOR3	.00647
	MACH .7507				CD4	.00599	CDCOR4	.00577
	ALPHA -1.9958	DEG			CD5	.00642	CDCOR5	.00615

UPPER SURFACE				LOWER SURFACE				SPANWISE				
X/C	CP	P.L./PT	MLOC	X/C	CP	P.L./PT	MLOC	X/C	Y/(B/2)	CP	P.L./PT	MLOC
0.0000	.9900	.9656	.2240	0.0000	.9900	.9656	.2240	.1507	.7476	-.3798	.6261	.8457
.0132	.7251	.7760	.6126	.0126	-.1380	.6860	.7536	.1507	.4976	-.3999	.6211	.8534
.0259	-.1164	.6914	.7454	.0255	-.2212	.6654	.7893	.1507	.2476	-.4022	.6206	.8543
.0759	-.3635	.6302	.8395	.0495	-.3292	.6387	.8264	.1507	-.2524	-.4003	.6210	.8535
.1003	-.3717	.6281	.8426	.0753	-.3660	.6295	.8404	.1507	-.5024	-.3984	.6215	.8528
.1507	-.3931	.6229	.8508	.1002	-.4009	.6209	.8538	.1507	-.7524	-.3803	.6260	.8459
.2003	-.4201	.6211	.8535	.1503	-.4226	.6159	.8621	.5002	.7476	-.4719	.6033	.8810
.2503	-.4215	.6158	.8617	.1976	-.4836	.6064	.8855	.5002	.4976	-.4861	.5998	.8865
.3001	-.4375	.6114	.8674	.2503	-.4988	.5967	.8913	.5002	.2476	-.4935	.5979	.8893
.3502	-.4458	.6098	.8710	.3001	-.4998	.5964	.8917	.5002	-.2524	-.4847	.6001	.8859
.4003	-.4562	.6072	.8750	.3507	-.4915	.5984	.8886	.5002	-.5024	-.4758	.6023	.8825
.4501	-.4692	.6040	.8800	.4001	-.4616	.6059	.8770	.5002	-.7524	-.4637	.6053	.8779
.5002	-.4829	.6006	.8859	.4501	-.4148	.6175	.8591	.8002	.7476	-.3724	.6279	.8429
.5502	-.5003	.5962	.8920	.5001	-.3325	.6378	.8274	.8002	.4976	-.3879	.6241	.8488
.6002	-.5295	.5913	.8998	.5497	-.2179	.6663	.7840	.8002	.2476	-.3988	.6214	.8530
.6500	-.5255	.5900	.9017	.6003	-.1814	.6951	.7396	.8002	-.5024	-.3874	.6242	.8486
.7000	-.5063	.5948	.8943	.6500	-.0802	.7202	.7008	.8002	-.7524	-.3605	.6309	.8383
.7500	-.4840	.6052	.8780	.7000	.1138	.7485	.6566					
.8002	-.3959	.6271	.8518	.7501	.2146	.7734	.6168					
.8502	-.2179	.6662	.7840	.8001	.3004	.7947	.5822					
.9501	-.0974	.6961	.7391	.8501	.3731	.8127	.5521					

ORIGINAL PAGE
OF POOR QUALITY

TEST 167	PT	20.5791	PSI	CM	.3106	CD1	.00751	CDCDR1	.00726
RUN 24	TT	208.5853	K	CM	-.1372	CD2	.00675	CDCDR2	.00651
POINT 4	RC	4.4150	MILLION	CC	.0180	CD3	.00682	CDCDR3	.00673
	MACH	.7006				CD4	.00725	CDCDR4	.00702
	ALPHA	-1.4867	DEG			CD5	.00680	CDCDR5	.00650

UPPER SURFACE				LOWER SURFACE				SPANWISE				
X/C	CP	P/L/P/T	MLOC	X/C	CP	P/L/P/T	MLOC	X/C	Y/(B/2)	CP	P/L/P/T	MLOC
0.0000	1.0456	.9796	.1715	0.0000	1.0456	.9796	.1715	.1507	.7476	-.4469	.6112	.8688
.0132	-.1038	.7471	.6597	.0126	-.0055	.7229	.6967	.1507	.4976	-.4250	.6060	.8769
.0259	-.2423	.6617	.7910	.0255	-.1042	.6958	.7386	.1507	.2476	-.4708	.6053	.8720
.0759	-.4592	.6081	.8735	.0495	-.2271	.6654	.7852	.1507	-.2524	-.4483	.6050	.8770
.1003	-.4552	.6091	.8720	.0753	-.2807	.6522	.8056	.1507	-.5024	-.4645	.6067	.8757
.1507	-.4595	.6081	.8736	.1002	-.3239	.6416	.8219	.1507	-.7524	-.4548	.6117	.8680
.2003	-.4583	.6084	.8732	.1503	-.3589	.6329	.8353	.5002	.7476	-.5016	.5977	.8697
.2503	-.4694	.6056	.8774	.1976	-.4254	.6165	.8606	.5002	.4976	-.5136	.5947	.8644
.3001	-.4700	.6030	.8815	.2503	-.4480	.6109	.8692	.5002	.2476	-.5211	.5929	.8972
.3502	-.4823	.6024	.8824	.3001	-.4561	.6089	.8723	.5002	-.2524	-.5116	.5952	.8936
.4003	-.4893	.6007	.8851	.3507	-.4533	.6096	.8713	.5002	-.5024	-.5032	.5973	.8904
.4501	-.5000	.5981	.8892	.4001	-.4295	.6155	.8622	.5002	-.7524	-.4913	.6002	.8858
.5002	-.5106	.5954	.8932	.4501	-.3898	.6253	.8470	.8002	.7476	-.3841	.6267	.8849
.5502	-.5254	.5918	.8969	.5001	-.3159	.6435	.8189	.8002	.4976	-.3978	.6233	.8501
.6002	-.5426	.5876	.9055	.5497	-.2043	.6711	.7766	.8002	.2476	-.4077	.6208	.8537
.6500	-.5444	.5871	.9062	.6003	-.0905	.6992	.7334	.8002	-.5024	-.3951	.6240	.8490
.7000	-.5215	.5928	.8974	.6500	.0076	.7234	.6959	.8002	-.7524	-.3699	.6302	.8394
.7500	-.4750	.6042	.8796	.7000	.1198	.7511	.6524					
.8002	-.4035	.6219	.8522	.7501	.2201	.7758	.6129					
.9002	-.2208	.6670	.7829	.8001	.3062	.7971	.5782					
.9501	-.0960	.6976	.7358	.8501	.3799	.8153	.5478					

TEST 167	PT	20.5813	PSI	CM	.3133	CD1	.00756	CDCDR1	.00730
RUN 24	TT	208.6297	K	CM	-.1376	CD2	.00681	CDCDR2	.00658
POINT 5	RC	4.4126	MILLION	CC	.0181	CD3	.00721	CDCDR3	.00701
	MACH	.7002				CD4	.00737	CDCDR4	.00713
	ALPHA	-.9797	DEG			CD5	.00671	CDCDR5	.00638

UPPER SURFACE				LOWER SURFACE				SPANWISE				
X/C	CP	P/L/P/T	MLOC	X/C	CP	P/L/P/T	MLOC	X/C	Y/(B/2)	CP	P/L/P/T	MLOC
0.0000	1.0844	.9892	.1247	0.0000	1.0844	.9892	.1247	.1507	.7476	-.5107	.5952	.8936
.0132	-.0206	.7182	.7070	.0126	.1328	.7541	.6476	.1507	.4976	-.5359	.5890	.9033
.0259	-.3710	.6297	.8402	.0255	.0007	.7215	.6988	.1507	.2476	-.5398	.5880	.9048
.0759	-.5580	.5835	.9119	.0495	-.1355	.6879	.7508	.1507	-.2524	-.364	.5868	.9035
.1003	-.5401	.5879	.9050	.0753	-.2041	.6709	.7768	.1507	-.5024	-.5312	.5901	.9015
.1507	-.5264	.5913	.8997	.1002	-.2546	.6584	.7960	.1507	-.7524	-.5079	.5959	.8925
.2003	-.5094	.5955	.8931	.1503	-.3012	.6469	.8137	.5002	.7476	-.5247	.5917	.8990
.2503	-.5161	.5939	.8957	.1976	-.3727	.6293	.8409	.5002	.4976	-.5358	.5890	.9033
.3001	-.5215	.5925	.8978	.2503	-.4021	.6220	.8527	.5002	.2476	-.5444	.5868	.9066
.3502	-.5297	.5930	.8971	.3001	-.4159	.6186	.8573	.5002	-.2524	-.5346	.5893	.9028
.4003	-.5320	.5922	.8983	.3507	-.4178	.6181	.8580	.5002	-.5024	-.5290	.5907	.9007
.4501	-.5303	.5903	.9012	.4001	-.3987	.6228	.8507	.5002	-.7524	-.5138	.5944	.8948
.5002	-.5326	.5889	.9035	.4501	-.3642	.6314	.8376	.8002	.7476	-.5261	.5894	.8960
.5502	-.5485	.5859	.9081	.5001	-.2968	.6480	.8120	.8002	.4976	-.4021	.6220	.8521
.6002	-.5625	.5824	.9136	.5497	-.1897	.6745	.7714	.8002	.2476	-.4136	.6192	.8564
.6500	-.5606	.5825	.9129	.6003	-.0791	.7018	.7293	.8002	-.5024	-.4022	.6220	.8521
.7000	-.5338	.5899	.8834	.6500	.0161	.7253	.6929	.8002	-.7524	-.3768	.6283	.8424
.7500	-.4846	.6018	.8834	.7000	.1265	.7526	.6501					
.8002	-.4095	.6202	.8549	.7501	.2251	.7769	.6111					
.9002	-.2212	.6667	.7433	.8001	.3108	.7981	.5786					
.9501	-.0954	.6977	.7357	.8501	.3848	.8164	.5460					

TEST 167	PT	20.5824	PSI	CM	.4367	CD1	.00791	CDCDR1	.00769
RUN 24	TT	208.6736	K	CM	-.1373	CD2	.00757	CDCDR2	.00737
POINT 6	RC	4.4083	MILLION	CC	.0172	CD3	.00753	CDCDR3	.00730
	MACH	.6993				CD4	.00751	CDCDR4	.00728
	ALPHA	-.4888	DEG			CD5	.00695	CDCDR5	.00672

UPPER SURFACE				LOWER SURFACE				SPANWISE				
X/C	CP	P/L/P/T	MLOC	X/C	CP	P/L/P/T	MLOC	X/C	Y/(B/2)	CP	P/L/P/T	MLOC
0.0000	1.1086	.9953	.0817	0.0000	1.1086	.9953	.0817	.1507	.7476	-.5801	.5795	.9181
.0132	-.1537	.6845	.7560	.0126	.2455	.7828	.6818	.1507	.4976	-.6061	.5731	.9282
.0259	-.5100	.5948	.8912	.0255	.0896	.7459	.8006	.1507	.2476	-.6106	.5720	.9299
.0759	-.6846	.5587	.9510	.0495	-.0509	.7098	.7189	.1507	-.2524	-.6072	.5724	.9286
.1003	-.6308	.5670	.9378	.0753	-.1332	.6896	.7482	.1507	-.5024	-.6011	.5743	.9263
.1507	-.5938	.5761	.9235	.1002	-.1901	.6755	.7694	.1507	-.7524	-.5738	.5811	.9157
.2003	-.5648	.5833	.9122	.1503	-.2468	.6616	.7912	.5002	.7476	-.5498	.5870	.9065
.2503	-.5619	.5840	.9111	.1976	-.3222	.6430	.8197	.5002	.4976	-.5590	.5847	.9100
.3001	-.5630	.5835	.9118	.2503	-.3574	.6343	.8330	.5002	.2476	-.5667	.5828	.9130
.3502	-.5579	.5850	.9096	.3001	-.3760	.6298	.8401	.5002	-.2524	-.5538	.5859	.9080
.4003	-.5560	.5854	.9088	.3507	-.3827	.6281	.8426	.5002	-.5024	-.5512	.5886	.9070
.4501	-.5592	.5846	.9101	.4001	-.3688	.6315	.8373	.5002	-.7524	-.5389	.5898	.9020
.5002	-.5616	.5842	.9108	.4501	-.3392	.6388	.8261	.8002	.7476	-.3919	.6259	.8960
.5502	-.5710	.5817	.9144	.5001	-.2776	.6540	.8028	.8002	.4976	-.4075	.6220	.8520
.6002	-.5825	.5789	.9191	.5497	-.1758	.6791	.7643	.8002	.2476	-.4189	.6192	.8564
.6500	-.5770	.5803	.9170	.6003	-.0684	.7055	.7236	.8002	-.5024	-.4087	.6217	.8525
.7000	-.5463	.5878	.9051	.6500	.0236	.7282	.6884	.8002	-.7524	-.3855	.6279	.8430
.7500	-.4925	.6011	.8845	.7000	.1319	.7548	.6445					
.8002	-.4144	.6202	.8544	.7501	.2280	.7787	.6081					
.9002	-.2197	.6682	.7810	.8001	.3137	.7996	.5741					
.9501	-.0934	.6983	.7331	.8501	.3875	.8178	.5436					

TEST RUN POINT	167 24 7	PT TT RC MACH ALPHA	20.6010 208.8238 4.4106 .7000 .0159	PSI K MILLION DEG	CN CM CC	.4969 -1.169 .0157	CD1 CD2 CD3 CD4 CD5	.00827 .00811 .00792 .00767 .00760	CDCUR1 CDCUR2 CDCUR3 CDCUR4 CDCUR5	.00805 .00791 .00776 .00746 .00736		
		UPPER SURFACE		LOWER SURFACE		SPANWISE						
X/C	CP	P/L/PT	MLOC	X/C	CP	P/L/PT	MLOC	X/C	Y/(B/2)	CP	P/L/PT	MLOC
0.0000	1.1246	.9991	.0349	0.0000	1.1246	.9991	.0349	.1507	.7476	-.6500	.5611	.9472
.0132	-.2618	.8520	.8060	.0126	.3545	.6090	.5583	.1507	.4976	-.6764	.5546	.9576
.0259	-.4482	.5615	.9465	.0255	.1896	.7683	.6250	.1507	.2476	-.6818	.5532	.9597
.0759	-.7790	.5292	.9983	.0495	.0347	.7301	.6854	.1507	-.2524	-.6760	.5544	.9578
.1003	-.7235	.5429	.9762	.0753	-.0596	.7068	.7216	.1507	-.5024	-.6687	.5564	.9566
.1507	-.6597	.5587	.9510	.1002	-.1230	.6912	.7457	.1507	-.7524	-.6382	.5640	.9428
.2003	-.6204	.5684	.9357	.1503	-.1887	.6749	.7707	.5002	.7476	-.5749	.5796	.9180
.2503	-.6059	.5720	.9360	.2503	-.2686	.6552	.8009	.5002	.4976	-.5847	.5772	.9210
.3001	-.6004	.5733	.9279	.3001	-.3096	.6451	.8165	.5002	.2476	-.5906	.5769	.9241
.3502	-.5984	.5763	.9232	.3507	-.3447	.6344	.8298	.5002	-.2524	-.5777	.5789	.9191
.4003	-.5983	.5773	.9216	.4001	-.3348	.6389	.8260	.5002	-.5024	-.5759	.5796	.9164
.4501	-.5860	.5769	.9223	.4501	-.3099	.6450	.8166	.5002	-.7524	-.5635	.5824	.9136
.5002	-.5871	.5766	.9227	.5001	-.2541	.6588	.7954	.8002	.7476	-.3921	.6247	.8478
.5502	-.5850	.5751	.9250	.5501	-.1571	.6827	.7587	.8002	.4976	-.4088	.6211	.8535
.6002	-.5801	.5734	.9277	.6003	-.0524	.7086	.7188	.8002	.2476	-.4173	.6185	.8574
.6500	-.5531	.5849	.9096	.6500	.0372	.7307	.6845	.8002	-.5024	-.4070	.6211	.8535
.7000	-.4911	.5994	.8871	.7000	.1431	.7568	.6433	.8002	-.7524	-.3835	.6269	.8446
.7500	-.4178	.6196	.8557	.7501	.2383	.7803	.6056					
.8002	-.2112	.6694	.7792	.8001	.3220	.8010	.5717					
.8501	-.0846	.7006	.7311	.8501	.3956	.8192	.5412					

TEST RUN POINT	167 24 8	PT TT RC MACH ALPHA	20.5991 208.8759 4.4097 .7003 .5193	PSI K MILLION DEG	CN CM CC	.5592 -1.162 .0132	CD1 CD2 CD3 CD4 CD5	.00873 .00866 .00851 .00805 .00823	CDCUR1 CDCUR2 CDCUR3 CDCUR4 CDCUR5	.00850 .00843 .00829 .00783 .00796		
		UPPER SURFACE		LOWER SURFACE		SPANWISE						
X/C	CP	P/L/PT	MLOC	X/C	CP	P/L/PT	MLOC	X/C	Y/(B/2)	CP	P/L/PT	MLOC
0.0000	1.1282	.9999	.0135	0.0000	1.1282	.9999	.0135	.1507	.7476	-.7194	.5423	.9772
.0132	-.4154	.8174	.8589	.0126	.4517	.6323	.5189	.1507	.4976	-.7522	.5341	.9903
.0259	-.7958	.5233	1.0078	.0255	.2747	.7885	.5924	.1507	.2476	-.7803	.5321	.9935
.0759	-.9227	.4919	1.0398	.0495	.1109	.7479	.6575	.1507	-.2524	-.7542	.5336	.9911
.1003	-.8336	.5135	1.0230	.0753	.0060	.7219	.6981	.1507	-.5024	-.7430	.5364	.9886
.1507	-.7284	.5405	.9800	.1002	-.0831	.7048	.7246	.1507	-.7524	-.7119	.5441	.9742
.2003	-.6720	.5540	.9584	.1503	-.1375	.6864	.7531	.5002	.7476	-.5995	.5520	.9300
.2503	-.6496	.5596	.9496	.2503	-.2214	.6656	.7850	.5002	.4976	-.6112	.5691	.9346
.3001	-.6430	.5612	.9470	.3001	-.2980	.6471	.8134	.5002	.2476	-.6176	.5675	.9371
.3502	-.6314	.5641	.9425	.3507	-.3118	.6432	.8194	.5002	-.2524	-.6053	.5705	.9323
.4003	-.6248	.5669	.9399	.4001	-.3081	.6446	.8172	.5002	-.5024	-.6031	.5711	.9314
.4501	-.6199	.5681	.9360	.4501	-.2850	.6499	.8092	.5002	-.7524	-.5903	.5742	.9264
.5002	-.6150	.5679	.9364	.5001	-.2336	.6626	.7894	.8002	.7476	-.3920	.6234	.8500
.5502	-.6185	.5672	.9374	.5501	-.1415	.6854	.7546	.8002	.4976	-.4080	.6199	.8553
.6002	-.6019	.5714	.9309	.6003	-.0399	.7106	.7159	.8002	.2476	-.4162	.6174	.8592
.6500	-.5819	.5815	.9150	.6500	.0473	.7322	.6822	.8002	-.5024	-.4073	.6196	.8558
.7000	-.4978	.5972	.8908	.7000	.1512	.7579	.6617	.8002	-.7524	-.3854	.6250	.8474
.7500	-.4119	.6184	.8576	.7501	.2447	.7811	.6045					
.8002	-.2037	.6700	.7782	.8001	.3276	.8016	.5708					
.8501	-.0799	.7007	.7311	.8501	.4008	.8197	.5403					

TEST RUN POINT	167 24 9	PT TT RC MACH ALPHA	20.6016 209.3189 4.3977 .7004 1.0221	PSI K MILLION DEG	CN CM CC	.6215 -1.161 .0100	CD1 CD2 CD3 CD4 CD5	.00918 .00919 .00914 .00884 .00878	CDCUR1 CDCUR2 CDCUR3 CDCUR4 CDCUR5	.00894 .00893 .00887 .00838 .06843		
		UPPER SURFACE		LOWER SURFACE		SPANWISE						
X/C	CP	P/L/PT	MLOC	X/C	CP	P/L/PT	MLOC	X/C	Y/(B/2)	CP	P/L/PT	MLOC
0.0000	1.1266	.9993	.0317	0.0000	1.1266	.9993	.0317	.1507	.7476	-.7321	.5372	.9854
.0132	-.5323	.9369	.9066	.0126	.9331	.8517	.4841	.1507	.4976	-.8255	.5144	1.0224
.0259	-.9287	.4883	1.0658	.0255	.3475	.8036	.5641	.1507	.2476	-.8706	.5027	1.0417
.0759	-1.1198	.4404	1.1431	.0495	.1767	.7631	.6333	.1507	-.2524	-.8629	.5047	1.0385
.1003	-1.0594	.4591	1.1177	.0753	.0626	.7340	.6781	.1507	-.5024	-.7921	.5223	1.0096
.1507	-.7826	.5248	1.0055	.1002	-.0112	.7164	.7067	.1507	-.7524	-.7020	.5447	.9734
.2003	-.7122	.5421	.9774	.1503	-.0926	.6942	.7380	.5002	.7476	-.6317	.5622	.9455
.2503	-.7093	.5429	.9763	.2503	-.1809	.6742	.7717	.5002	.4976	-.6438	.5591	.9363
.3001	-.7002	.5451	.9726	.3001	-.2329	.6613	.7916	.5002	.2476	-.6498	.5576	.9327
.3502	-.6879	.5517	.9622	.3507	-.2852	.6483	.8116	.5002	-.2524	-.6394	.5602	.9485
.4003	-.6829	.5545	.9576	.4001	-.2841	.6488	.8112	.5002	-.5024	-.6374	.5607	.9478
.4501	-.6748	.5564	.9546	.4501	-.2689	.6528	.8046	.5002	-.7524	-.6246	.5639	.9427
.5002	-.6646	.5589	.9506	.5001	-.2200	.6645	.7867	.8002	.7476	-.3988	.6201	.8951
.5502	-.6413	.5598	.9493	.5501	-.1324	.6863	.7532	.8002	.4976	-.4180	.6170	.8997
.6002	-.6393	.5602	.9485	.6003	-.0331	.7110	.7191	.8002	.2476	-.4190	.6150	.8928
.6500	-.6181	.5655	.9401	.6500	.0577	.7320	.6824	.8002	-.5024	-.4134	.6164	.8907
.7000	-.5720	.5770	.9221	.7000	.1536	.7574	.6425	.8002	-.7524	-.3934	.6214	.8930
.7500	-.5033	.5941	.8954	.7501	.2459	.7803	.6057					
.8002	-.4136	.6164	.8607	.8001	.3276	.8007	.5723					
.8501	-.1892	.6697	.7788	.8501	.4003	.8167	.5420					

ORIGINAL PAGE IS
OF POOR QUALITY

TEST	167	PT	ZC.5992	PSI	CM	.6835	CD1	.00961	CDCDR1	.00960
RUN	24	TT	Z09.5096	K	CM	-.1314	CD2	.00967	CDCDR2	.00959
POINT	10	RC	4.3915	MILLION	CC	.0061	CD3	.00963	CDCDR3	.00934
		MACH	.7003				CD4	.00965	CDCDR4	.00882
		ALPHA	1.5020	DEG			CD5	.00916	CDCDR5	.00892

UPPER SURFACE				LOWER SURFACE				SPANWISE				
X/C	CP	P.L./PT	MLOC	X/C	CP	P.L./PT	MLOC	X/C	Y/(B/2)	CP	P.L./PT	MLOC
0.0000	1.1175	.9971	.0646	0.0000	1.1175	.9971	.0646	.1507	.7476	-.8363	.5119	1.0266
.0132	-.5441	.5591	.9503	.0126	.6047	.8697	.4507	.1507	.4976	-1.1281	.4394	1.1506
.0259	-1.0492	.4592	1.1160	.0255	.4142	.8224	.5356	.1507	.2476	-1.1227	.4408	1.1482
.0759	-1.2364	.4076	1.2089	.0495	.2383	.7787	.6082	.1507	-.2524	-1.1077	.4445	1.1416
.1003	-1.2411	.4113	1.2018	.0753	.1168	.7486	.6584	.1507	-.5024	-1.1014	.4440	1.1388
.1507	-1.1053	.4451	1.1405	.1002	.0396	.7294	.6885	.1507	-.7524	-.7626	.5302	.9947
.2003	-.8837	.5498	.9652	.1503	-.0482	.7076	.7204	.5002	.7476	-.6534	.5573	.9532
.2503	-.7038	.5448	.9732	.1976	-.1393	.6850	.7553	.5002	.4976	-.6643	.5546	.9575
.3001	-.4837	.5393	.9820	.2503	-.2458	.6710	.7748	.5002	.2476	-.6707	.5530	.9600
.3502	-.2693	.5459	.9714	.3001	-.2313	.6621	.7903	.5002	-.2524	-.6618	.5552	.9585
.4001	-.0475	.5488	.9667	.3507	-.2550	.6562	.7994	.5002	-.5024	-.6602	.5556	.9559
.4501	-.6782	.5511	.9630	.4001	-.2576	.6556	.8004	.5002	-.7524	-.6483	.5586	.9512
.5002	-.8646	.5545	.9576	.4501	-.2439	.6590	.7951	.8002	.7476	-.6501	.6195	.9560
.5502	-.6578	.5582	.9549	.5001	-.2014	.6695	.7789	.8002	.4976	-.6131	.6170	.9598
.6002	-.4523	.5576	.9524	.5497	-.1187	.6901	.7474	.8002	.2476	-.6204	.6152	.9626
.6500	-.2727	.5637	.9431	.6003	-.0230	.7139	.7107	.8002	-.5024	-.6173	.6159	.9614
.7000	-.0742	.5760	.9257	.6500	.0588	.7342	.6791	.8002	-.7524	-.3981	.6207	.9540
.7500	-.3062	.5939	.8957	.7000	.1583	.7589	.6401					
.8002	-.4139	.6168	.8601	.7501	.2490	.7814	.6039					
.8502	-.1965	.6728	.7771	.8001	.3295	.8014	.5711					
.9501	-.0732	.7014	.7249	.8501	.4015	.8193	.5410					

TEST	167	PT	ZC.5955	PSI	CM	.7695	CD1	.01035	CDCDR1	.01006
RUN	24	TT	Z09.5262	K	CM	-.1322	CD2	.01066	CDCDR2	.01027
POINT	12	RC	4.3404	MILLION	CC	.0017	CD3	.01034	CDCDR3	.00999
		MACH	.7003				CD4	.00995	CDCDR4	.00965
		ALPHA	2.0287	DEG			CD5	.00975	CDCDR5	.00939

UPPER SURFACE				LOWER SURFACE				SPANWISE				
X/C	CP	P.L./PT	MLOC	X/C	CP	P.L./PT	MLOC	X/C	Y/(B/2)	CP	P.L./PT	MLOC
0.0000	1.0945	.9915	.1102	0.0000	1.0945	.9915	.1102	.1507	.7476	-1.2628	.4077	1.2086
.0132	-.7642	.5312	.9951	.0126	.6748	.8875	.4162	.1507	.4976	-1.3459	.3871	1.2480
.0259	-1.1689	.4309	1.1459	.0255	.4807	.8395	.5000	.1507	.76	-1.3359	.3896	1.2430
.0759	-1.3802	.3786	1.264	.0495	.3050	.7940	.5801	.1507	-.2524	-1.3201	.3934	1.2256
.1003	-1.3765	.3795	1.2624	.0753	.1758	.7640	.6320	.1507	-.5024	-1.3214	.3931	1.2363
.1507	-1.3259	.3920	1.2384	.1002	.0950	.7439	.6637	.1507	-.7524	-1.2299	.4008	1.1936
.2003	-1.2320	.4154	1.1945	.1503	.0000	.7204	.7005	.5002	.7476	-.6720	.5540	.9585
.2503	-.8678	.5501	.9647	.1976	-.0979	.6974	.7361	.5002	.4976	-.6838	.5510	.9611
.3001	-.6426	.5613	.9669	.2503	-.1527	.6826	.7589	.5002	.2476	-.6889	.5498	.9651
.3502	-.4607	.5494	.9659	.3001	-.1912	.6731	.7735	.5002	-.2524	-.6753	.5532	.9598
.4003	-.2733	.5462	.9708	.3507	-.2173	.6666	.7814	.5002	-.5024	-.6748	.5553	.9596
.4501	-.0490	.5473	.9691	.4001	-.2232	.6651	.7857	.5002	-.7524	-.6430	.5586	.9549
.5002	-.8663	.5504	.9641	.4501	-.2133	.6676	.7819	.8002	.7476	-.6451	.6201	.9550
.5502	-.6783	.5574	.9616	.5001	-.1757	.6769	.7676	.8002	.4976	-.6168	.6172	.9595
.6002	-.4723	.5539	.9576	.5497	-.0984	.6961	.7382	.8002	.2476	-.6273	.6146	.9635
.6500	-.2620	.5614	.9467	.6003	-.0047	.7193	.7023	.8002	-.5024	-.6188	.6167	.9602
.7000	-.0503	.5742	.9264	.6500	.0733	.7386	.6721	.8002	-.7524	-.3984	.6218	.9524
.7500	-.3173	.5923	.8981	.7000	.1763	.7627	.6341					
.8002	-.4234	.6155	.8620	.7501	.2598	.7848	.5984					
.8502	-.2055	.6695	.7796	.8001	.3400	.8047	.5657					
.9501	-.0844	.6995	.7328	.8501	.4138	.8229	.5349					

TEST	167	PT	ZC.5998	PSI	CM	.8442	CD1	.01277	CDCDR1	.01219
RUN	24	TT	Z09.4029	K	CM	-.1389	CD2	.01297	CDCDR2	.01240
POINT	13	RC	4.3429	MILLION	CC	-.0021	CD3	.01236	CDCDR3	.01190
		MACH	.7002				CD4	.01143	CDCDR4	.01097
		ALPHA	2.5038	DEG			CD5	.01166	CDCDR5	.01069

UPPER SURFACE				LOWER SURFACE				SPANWISE				
X/C	CP	P.L./PT	MLOC	X/C	CP	P.L./PT	MLOC	X/C	Y/(B/2)	CP	P.L./PT	MLOC
0.0000	1.0811	.9882	.1300	0.0000	1.0811	.9882	.1300	.1507	.7476	-1.4214	.3667	1.2842
.0132	-.8555	.5088	1.0317	.0126	.7418	.9043	.3817	.1507	.4976	-1.4815	.3538	1.3149
.0259	-1.2523	.4106	1.2032	.0255	.5469	.8560	.4763	.1507	.2476	-1.4455	.3627	1.2962
.0759	-1.4644	.3576	1.3068	.0495	.3688	.8119	.5535	.1507	-.2524	-1.4356	.3652	1.2913
.1003	-1.4632	.3584	1.3052	.0753	.2340	.7785	.6086	.1507	-.5024	-1.4685	.3590	1.3034
.1507	-1.4243	.3580	1.2856	.1002	.1506	.7579	.6417	.1507	-.7524	-1.3799	.3700	1.2638
.2003	-1.3722	.3809	1.2600	.1503	.0506	.7331	.6807	.5002	.7476	-.6680	.5552	.9565
.2503	-1.2925	.4006	1.2220	.1976	-.0449	.7295	.7175	.5002	.4976	-.6735	.5539	.9587
.3001	-.9733	.5381	.9840	.2503	-.1087	.6937	.7415	.5002	.2476	-.6742	.5537	.9580
.3502	-.7570	.5773	.9216	.3001	-.1501	.6834	.7576	.5002	-.2524	-.6644	.5561	.9551
.4003	-.5235	.5462	.9390	.3507	-.1789	.6704	.7694	.5002	-.5024	-.6706	.5546	.9575
.4501	-.2609	.5570	.9537	.4001	-.1876	.6742	.7719	.5002	-.7524	-.6656	.5556	.9555
.5002	-.8703	.5547	.9574	.4501	-.1807	.6759	.7692	.8002	.7476	-.6435	.6207	.9540
.5502	-.6711	.5545	.9577	.5001	-.1468	.6852	.7566	.8002	.4976	-.6167	.6174	.9591
.6002	-.4680	.5552	.9565	.5497	-.0736	.7024	.7284	.8002	.2476	-.6262	.6151	.9627
.6500	-.2606	.5620	.9457	.6003	.0170	.7248	.6937	.8002	-.5024	-.6199	.6167	.9603
.7000	-.0508	.5748	.9255	.6500	.0925	.7415	.6644	.8002	-.7524	-.3983	.6224	.9514
.7500	-.3155	.5930	.8970	.7000	.1876	.7670	.6271					
.8002	-.4222	.6161	.8612	.7501	.2755	.7888	.5919					
.8502	-.2048	.6649	.7744	.8001	.3547	.8084	.5594					
.9501	-.0784	.7012	.7303	.8501	.4278	.8265	.5246					

TEST 167	PT 20.5934	PSI	CN .9421	CD1 .01775	CDCDR1 .01706
RUN 24	TT 210.0439	K	CM -.1320	CD2 .01800	CDCDR2 .01739
POINT 14	RC 4.3767	MILLION	CC -.0065	CD3 .01636	CDCDR3 .01580
	MACH .7008			CD4 .01419	CDCDR4 .01356
	ALPHA 3.0246	DEG		CD5 .01312	CDCDR5 .01230

UPPER SURFACE				LOWER SURFACE				SPANWISE				
X/C	CP	P ₂ L/PT	MLOC	X/C	CP	P ₂ L/PT	MLOC	X/C	Y/(B/2)	CP	P ₂ L/PT	MLOC
0.0000	1.0466	.9795	.1720	0.0000	1.0466	.9795	.1720	.1507	.7476	-1.5390	.3377	1.3484
.0132	-.9518	.4834	1.0740	.0126	.7899	.9158	.3565	.1507	.4976	-1.5713	.3297	1.3657
.0259	-1.3329	.3889	1.2445	.0255	.5962	.8677	.4546	.1507	.2476	-1.5361	.3284	1.3469
.0759	-1.5515	.3346	1.3551	.0495	.4184	.8236	.5337	.1507	-.2524	-1.5260	.3409	1.3416
.1003	-1.5491	.3352	1.3538	.0753	.2799	.7891	.5914	.1507	-.5024	-1.5522	.3344	1.3555
.1507	-1.5204	.3423	1.3386	.1002	.1939	.7677	.6260	.1507	-.7524	-1.5007	.3472	1.3283
.2003	-1.4913	.3495	1.3234	.1503	.0888	.7418	.6671	.5002	.7476	-.6431	.5601	.9488
.2503	-1.4484	.3557	1.3110	.1976	-.0082	.7177	.7047	.5002	.4976	-.6230	.5651	.9409
.3001	-1.4333	.3639	1.2938	.2503	-.0751	.7011	.7304	.9002	.2476	-.6006	.5706	.9321
.3502	-1.0884	.4495	1.1376	.3001	-.1191	.6901	.7473	.5002	-.2524	-.5976	.5714	.9309
.4063	-.5777	.5763	.9232	.3507	-.1503	.6824	.7592	.5002	-.5024	-.6314	.5630	.9442
.4501	-.5483	.5836	.9117	.4001	-.1624	.6794	.7638	.5002	-.7524	-.6512	.5581	.9520
.5002	-.5918	.5728	.9286	.4501	-.1587	.6803	.7624	.8002	.7476	-.6049	.6192	.8563
.5502	-.6294	.5635	.9434	.5001	-.1283	.6879	.7508	.8002	.4976	-.6224	.6149	.8631
.6002	-.6480	.5589	.9507	.5497	-.0595	.7050	.7244	.8002	.2476	-.6324	.6124	.8669
.6500	-.6327	.5627	.9447	.6003	.0288	.7149	.6904	.8002	-.5024	-.6231	.6147	.8634
.7000	-.5882	.5717	.9272	.6500	.1017	.7450	.6521	.8002	-.7524	-.3942	.6219	.8523
.7500	-.5195	.5908	.9005	.7000	.1948	.7681	.6254					
.8002	-.4291	.6132	.8656	.7501	.2811	.7895	.5907					
.9002	-.2172	.6658	.7847	.8001	.3592	.8089	.5586					
.9501	-.0928	.6967	.7372	.8501	.4318	.8269	.5279					

TEST 167	PT 20.5664	PSI	CN 1.0281	CG1 .02458	CDCDR1 .02395
RUN 24	TT 210.0462	K	CM -.1336	CG2 .02443	CDCDR2 .02370
POINT 15	RC 4.3743	MILLION	CC -.0106	CG3 .02137	CDCDR3 .02073
	MACH .7000			CG4 .01820	CDCDR4 .01743
	ALPHA 3.5188	DEG		CG5 .01644	CDCDR5 .01568

UPPER SURFACE				LOWER SURFACE				SPANWISE				
X/C	CP	P ₂ L/PT	MLOC	X/C	CP	P ₂ L/PT	MLOC	X/C	Y/(B/2)	CP	P ₂ L/PT	MLOC
0.0000	1.0108	.9711	.2051	0.0000	1.0108	.9711	.2051	.1507	.7476	-1.6544	.3132	1.4024
.0132	-1.0615	.4595	1.1151	.0126	.8315	.9268	.3311	.1507	.4976	-1.6628	.3111	1.4071
.0259	-1.4211	.3708	1.2800	.0255	.6282	.8791	.4328	.1507	.2476	-1.6268	.3200	1.3870
.0759	-1.6401	.3167	1.3944	.0495	.4610	.8356	.5132	.1507	-.2524	-1.6144	.3230	1.3804
.1003	-1.6378	.3173	1.3931	.0753	.3177	.8000	.5735	.1507	-.5024	-1.6382	.3172	1.3934
.1507	-1.6117	.3237	1.3788	.1002	.2298	.7763	.6090	.1507	-.7524	-1.6016	.3262	1.3733
.2003	-1.5746	.3329	1.3588	.1503	.1209	.7514	.6519	.5002	.7476	-.6108	.5708	.9319
.2503	-1.5704	.3339	1.3565	.1976	.0220	.7270	.6902	.5002	.4976	-.6013	.5830	.9126
.3001	-1.5715	.3337	1.3571	.2503	-.0479	.7097	.7171	.5002	.2476	-.6179	.5937	.8959
.3502	-1.5316	.3439	1.3361	.3001	-.0943	.6983	.7347	.5002	-.2524	-.6139	.5947	.8944
.4003	-1.1174	.4457	1.1393	.3507	-.1279	.6900	.7475	.5002	-.5024	-.6769	.5782	.9187
.4501	-.5906	.5856	.9085	.4001	-.1429	.6863	.7532	.5002	-.7524	-.6308	.5639	.9396
.5002	-.5312	.5954	.8933	.4501	-.1421	.6865	.7529	.8002	.7476	-.6056	.6214	.8529
.5502	-.5607	.5831	.9124	.5001	-.1148	.6932	.7423	.8002	.4976	-.6248	.6167	.8602
.6002	-.6033	.5726	.9289	.5497	-.0589	.7095	.7174	.8002	.2476	-.6339	.6145	.8637
.6500	-.6065	.5718	.9302	.6003	.0356	.7304	.6850	.8002	-.5024	-.6241	.6189	.8600
.7000	-.5763	.5793	.9185	.6500	.1063	.7478	.6576	.8002	-.7524	-.3872	.6260	.8459
.7500	-.5164	.5941	.8953	.7000	.1976	.7703	.6218					
.8002	-.4313	.6151	.8627	.7501	.2823	.7913	.5879					
.9002	-.2271	.6655	.7851	.8001	.3594	.8103	.5563					
.9501	-.1041	.6959	.7385	.8501	.4312	.8280	.5260					

TEST 167	PT 21.9641	PSI	CM	-0524	CD1	.00953	CDCOR1	.00929
RUN 25	TT 158.1004	K	CM	-1194	CD2	.00935	CDCOR2	.00910
POINT 16	RC 6.9560	MILLION	CC	.0029	CD3	.00862	CDCOR3	.00844
	MACH .7013				CD4	.00889	CDCOR4	.00870
	ALPHA -3.9829	DEG			CD5	.00836	CDCOR5	.00813

UPPER SURFACE				LOWER SURFACE				SPANWISE				
X/C	CP	P _L /PT	MLOC	X/C	CP	P _L /PT	MLOC	X/C	Y/(B/2)	CP	P _L /PT	MLOC
0.0000	.6519	.8816	.4279	0.0000	.6519	.8816	.4279	.1507	.7476	-.1440	.6842	.7566
.0132	.6170	.8730	.4447	.0126	-.8623	.5061	1.0365	.1507	.4976	-.1595	.6804	.7625
.0259	.2944	.7930	.5852	.0255	-.7527	.5332	.9920	.1507	.2476	-.1540	.6817	.7605
.0759	-.0215	.7146	.7097	.0495	-.8046	.5204	1.0129	.1507	-.2524	-.1579	.6808	.7619
.1003	-.0687	.7029	.7278	.0753	-.7356	.5375	.9852	.1507	-.5024	-.1555	.6814	.7610
.1507	-.1369	.6860	.7539	.1002	-.7466	.5348	.9896	.1507	-.7524	-.1523	.6822	.7598
.2003	-.1842	.6743	.7720	.1503	-.6874	.5495	.9660	.5002	.7476	-.3532	.6323	.8364
.2503	-.2253	.6641	.7876	.1976	-.7417	.5360	.9876	.5002	.4976	-.3611	.6304	.8394
.3001	-.2620	.6550	.8016	.2503	-.7308	.5387	.9832	.5002	.2476	-.3565	.6295	.8408
.3502	-.2855	.6491	.8106	.3001	-.6938	.5479	.9685	.5002	-.2524	-.3523	.6326	.8360
.4003	-.3108	.6429	.8202	.3507	-.6558	.5573	.9535	.5002	-.5024	-.3414	.6353	.8319
.4501	-.3356	.6367	.8296	.4001	-.5937	.5727	.9291	.8002	.7476	-.3371	.6363	.8302
.5002	-.3620	.6302	.8397	.4501	-.5169	.5917	.8993	.8002	.4976	-.3406	.6355	.8316
.5502	-.3893	.6234	.8502	.5001	-.4133	.6174	.8594	.8002	.2476	-.3447	.6344	.8331
.6002	-.4175	.6164	.8610	.5497	-.2841	.6495	.8100	.8002	-.5024	-.3350	.6369	.8294
.6500	-.4317	.6129	.8664	.6003	-.1547	.6816	.7607	.8002	-.7524	-.3178	.6411	.8229
.7000	-.4241	.6147	.8635	.6500	-.0433	.7092	.7181					
.7500	-.3948	.6220	.8523	.7000	.0714	.7377	.6738					
.8002	-.3388	.6359	.8309	.7501	.1672	.7614	.6363					
.9002	-.1777	.6759	.7695	.8001	.2443	.7805	.6055					
.9501	-.0594	.7052	.7243	.8501	.3070	.7961	.5801					

TEST 157	PT 21.9678	PSI	CM	.0866	CD1	.00943	CDCOR1	.00913
RUN 25	TT 158.0228	K	CM	-.1237	CD2	.00708	CDCOR2	.00883
POINT 17	RC 6.9609	MILLION	CC	.0115	CD3	.00878	CDCOR3	.00858
	MACH .7011				CD4	.00888	CDCOR4	.00866
	ALPHA -2.9938	DEG			CD5	.00793	CDCOR5	.00763

UPPER SURFACE				LOWER SURFACE				SPANWISE				
X/C	CP	P _L /PT	MLOC	X/C	CP	P _L /PT	MLOC	X/C	Y/(B/2)	CP	P _L /PT	MLOC
0.0000	.8321	.9263	.3324	0.0000	.8321	.9263	.3324	.1507	.7476	-.2556	.6564	.7993
.0132	.4454	.8303	.5222	.0126	-.4747	.6021	.8832	.1507	.4976	-.2733	.6520	.8061
.0259	.1085	.7468	.6595	.0255	-.4681	.6037	.8807	.1507	.2476	-.2623	.6548	.8019
.0759	-.1669	.6784	.7655	.0495	-.5407	.5857	.9087	.1507	-.2524	-.2591	.6555	.8007
.1003	-.1987	.6705	.7777	.0753	-.5239	.5898	.9022	.1507	-.5024	-.2604	.6552	.8012
.1507	-.2484	.6582	.7966	.1002	-.5580	.5814	.9154	.1507	-.7524	-.2619	.6549	.8017
.2003	-.2813	.6500	.8091	.1503	-.5450	.5846	.9104	.5002	.7476	-.4111	.6178	.8587
.2503	-.3145	.6418	.8218	.1976	-.6038	.5700	.9333	.5002	.4976	-.4187	.6160	.8617
.3001	-.3442	.6344	.8331	.2503	-.6117	.5681	.9364	.5002	.2476	-.4250	.6144	.8641
.3502	-.3620	.6300	.8400	.3001	-.5969	.5717	.9306	.5002	-.2524	-.4153	.6168	.8603
.4003	-.3811	.6253	.8472	.3507	-.5778	.5765	.9232	.5002	-.5024	-.4115	.6177	.8589
.4501	-.4004	.6203	.8546	.4001	-.5315	.5880	.9052	.5002	-.7524	-.3975	.6212	.8535
.5002	-.4222	.6151	.8630	.4501	-.4685	.6036	.8808	.8002	.7476	-.3573	.6312	.8381
.5502	-.4443	.6096	.8715	.5001	-.3768	.6264	.8456	.8002	.4976	-.3622	.6300	.8400
.6002	-.4677	.6038	.8805	.5497	-.2557	.6564	.7994	.8002	.2476	-.3668	.6288	.8418
.6500	-.4769	.6015	.8840	.6003	-.1325	.6870	.7524	.8002	-.5024	-.3572	.6312	.8381
.7000	-.4618	.6053	.8782	.6500	-.0259	.7134	.7116	.8002	-.7524	-.3393	.6357	.8313
.7500	-.4248	.6144	.8640	.7000	.0871	.7415	.6678					
.8002	-.3611	.6302	.8396	.7501	.1831	.7653	.6301					
.9002	-.1876	.6733	.7734	.8001	.2616	.7848	.5987					
.9501	-.0647	.7038	.7265	.8501	.3261	.8007	.5724					

TEST 167	PT 21.9691	PSI	CM	.2220	CD1	.00948	CDCOR1	.00923
RUN 25	TT 158.0400	K	CM	-.1276	CD2	.00917	CDCOR2	.00894
POINT 18	RC 6.9586	MILLION	CC	.0165	CD3	.00838	CDCOR3	.00821
	MACH .7008				CD4	.00869	CDCOR4	.00848
	ALPHA -1.9979	DEG			CD5	.00791	CDCOR5	.00762

UPPER SURFACE				LOWER SURFACE				SPANWISE				
X/C	CP	P _L /PT	MLOC	X/C	CP	P _L /PT	MLOC	X/C	Y/(B/2)	CP	P _L /PT	MLOC
0.0000	.9466	.9648	.2266	0.0000	.9466	.9648	.2266	.1507	.7476	-.3688	.6294	.8409
.0132	.2382	.7796	.6070	.0126	-.1480	.6840	.7569	.1507	.4976	-.3926	.6235	.8500
.0259	-.1066	.6943	.7412	.0255	-.2268	.6645	.7889	.1507	.2476	-.3696	.6292	.8412
.0759	-.3322	.6384	.8270	.0495	-.3189	.6417	.8210	.1507	-.2524	-.3909	.6239	.8494
.1003	-.3403	.6364	.8301	.0753	-.3428	.6358	.8310	.1507	-.5024	-.3768	.6274	.8440
.1507	-.3676	.6297	.8405	.1002	-.3927	.6235	.8501	.1507	-.7524	-.3760	.6276	.8437
.2003	-.3859	.6251	.8475	.1503	-.4109	.6189	.8570	.5002	.7476	-.4640	.6058	.8774
.2503	-.4058	.6202	.8551	.1976	-.4782	.6023	.8828	.5002	.4976	-.4717	.6039	.8803
.3001	-.4266	.6151	.8630	.2503	-.5002	.5968	.8913	.5002	.2476	-.4791	.6021	.8832
.3502	-.4371	.6125	.8671	.3001	-.5016	.5965	.8918	.5002	-.2524	-.4684	.6047	.8791
.4003	-.4485	.6096	.8714	.3507	-.4951	.5981	.8893	.5002	-.5024	-.4652	.6055	.8778
.4501	-.4620	.6063	.8766	.4001	-.4636	.6039	.8772	.5002	-.7524	-.4511	.6090	.8724
.5002	-.4771	.6026	.8824	.4501	-.4146	.6180	.8584	.8002	.7476	-.3702	.6290	.8415
.5502	-.4941	.5984	.8890	.5001	-.3352	.6377	.8282	.8002	.4976	-.3771	.6273	.8441
.6002	-.5119	.5939	.8958	.5497	-.2238	.6653	.7858	.8002	.2476	-.3827	.6259	.8463
.6500	-.5142	.5934	.8967	.6003	-.1071	.6941	.7414	.8002	-.5024	-.3732	.6283	.8426
.7000	-.4923	.5988	.8882	.6500	-.0059	.7192	.7026	.9002	-.7524	-.3545	.6329	.8355
.7500	-.4471	.6100	.8709	.7000	.1652	.7467	.6596					
.8002	-.3774	.6272	.8442	.7501	.2012	.7705	.6218					
.9002	-.1920	.6731	.7737	.8001	.2811	.7902	.5897					
.9501	-.0669	.7041	.7260	.8501	.3475	.8067	.5625					

ORIGINAL PAGE IS
OF POOR QUALITY

TEST	167	PT	21.9709	PSI	CM	.2904	CD1	.00943	CDCOR1	.00918
RUN	25	TT	157.9261	K	CM	-.1294	CD2	.00926	CDCOR2	.00903
POINT	19	RC	6.9680	MILLION	CC	.0177	CD3	.00888	CDCOR3	.00870
		MACH	.7011				CD4	.00862	CDCOR4	.00841
		ALPHA	-1.4867	DEG			CD5	.00761	CDCOR5	.00732

UPPER SURFACE				LOWER SURFACE				SPANWISE				
X/C	CP	P/L/PT	MLOC	X/C	CP	P/L/PT	MLOC	X/C	Y/(B/2)	CP	P/L/PT	MLOC
0.0000	1.0402	.9779	-.1787	0.0000	1.0402	.9779	-.1787	.1507	.7476	-.4255	.6143	.8843
.0132	-.1211	.7499	.6546	.0126	-.0051	.7186	-.7036	.1507	.4976	-.4592	.6059	.8773
.0259	-.2282	.6632	.7889	.0255	-.1119	.6921	-.7446	.1507	.2476	-.4354	.6118	.8681
.0759	-.4211	.6133	.8626	.0495	-.2199	.6653	-.7858	.1507	-.2524	-.4587	.6060	.8770
.1003	-.4222	.6151	.8630	.0753	-.2622	.6548	-.8019	.1507	-.5024	-.4535	.6073	.8751
.1907	-.4330	.6124	.8672	.1002	-.3179	.6410	-.8231	.1507	-.7524	-.4417	.6102	.8705
.2603	-.4432	.6099	.8711	.1503	-.3464	.6339	-.8340	.5002	.4976	-.4936	.5973	.8905
.2903	-.4557	.6068	.8759	.1976	-.4193	.6198	-.8619	.5002	.4976	-.5012	.5955	.8935
.3001	-.4708	.6030	.8817	.2503	-.4486	.6085	-.8732	.5002	.2476	-.5091	.5935	.8965
.3502	-.4786	.6011	.8847	.3001	-.4558	.6067	-.8758	.5002	-.2524	-.4974	.5964	.8920
.4003	-.4857	.5993	.8875	.3507	-.4554	.6068	-.8758	.5002	-.5024	-.4941	.5972	.8907
.4501	-.4952	.5970	.8911	.4001	-.4302	.6131	-.8661	.5002	-.7524	-.4813	.6004	.8858
.5002	-.5067	.5941	.8956	.4501	-.3875	.6237	-.8497	.8002	.7476	-.3761	.6265	.8454
.5502	-.5209	.5906	.9011	.5001	-.3139	.6419	-.8216	.8002	.4976	-.3845	.6244	.8486
.6002	-.5356	.5869	.9088	.5497	-.2070	.6685	-.7808	.8002	.2476	-.3909	.6228	.8510
.6500	-.5505	.5873	.9061	.6003	-.0941	.6965	-.7377	.8002	-.5024	-.3820	.6250	.8476
.7000	-.5685	.5937	.8963	.6500	.0037	.7208	-.7002	.8002	-.7524	-.3628	.6298	.8403
.7500	-.5891	.6039	.8772	.7000	.1135	.7480	-.6576					
.8002	-.6384	.6242	.8489	.7501	.2088	.7716	-.6199					
.9002	-.1945	.6716	.7761	.8001	.2887	.7915	-.5877					
.9501	-.0681	.7029	.7278	.8501	.3599	.8081	-.5600					

TEST	167	PT	21.9703	PSI	CM	.3528	CD1	.00937	CDCOR1	.00915
RUN	25	TT	156.0327	K	CM	-.1300	CD2	.00927	CDCOR2	.00909
POINT	20	RC	6.9560	MILLION	CC	.0179	CD3	.00903	CDCOR3	.00890
		MACH	.7003				CD4	.00861	CDCOR4	.00847
		ALPHA	-.9979	DEG			CD5	.00764	CDCOR5	.00736

UPPER SURFACE				LOWER SURFACE				SPANWISE				
X/C	CP	P/L/PT	MLOC	X/C	CP	P/L/PT	MLOC	X/C	Y/(B/2)	CP	P/L/PT	MLOC
0.0000	1.0825	.9888	-.1257	0.0000	1.0825	.9888	-.1267	.1507	.7476	-.4823	.6033	.8813
.0132	-.0006	.7220	.6983	.0126	-.1219	.7522	-.6739	.1507	.4976	-.5232	.5932	.8969
.0259	-.3531	.6351	.8321	.0255	-.0072	.7204	-.7008	.1507	.2476	-.4984	.5993	.8874
.0759	-.5136	.5956	.8932	.0495	-.1293	.6903	-.7473	.1507	-.2524	-.5221	.5935	.8965
.1003	-.5014	.5986	.8886	.0753	-.1983	.6733	-.7734	.1507	-.5024	-.5197	.5941	.8956
.1507	-.4962	.5999	.8866	.1002	-.2472	.6612	-.7919	.1507	-.7524	-.5009	.5987	.8884
.2003	-.5012	.5986	.8885	.1503	-.2863	.6516	-.8068	.5002	.7476	-.5166	.5949	.8944
.2503	-.5013	.5986	.8885	.1976	-.3627	.6328	-.8357	.5002	.4976	-.5237	.5931	.8971
.3001	-.5113	.5962	.8924	.2503	-.3968	.6244	-.8486	.5002	.2476	-.5323	.5910	.9004
.3502	-.5120	.5960	.8926	.3001	-.4114	.6208	-.8542	.5002	-.2524	-.5208	.5938	.8960
.4003	-.5154	.5952	.8939	.3507	-.4162	.6196	-.8560	.5002	-.5024	-.5169	.5948	.8945
.4501	-.5217	.5936	.8963	.4001	-.3970	.6243	-.8487	.5002	-.7524	-.5051	.5977	.8900
.5002	-.5290	.5918	.8992	.4501	-.3602	.6334	-.8348	.8002	.7476	-.3788	.6288	.8418
.5502	-.5403	.5890	.9035	.5001	-.2924	.6501	-.8091	.8002	.4976	-.3888	.6263	.8456
.6002	-.5514	.5863	.9078	.5497	-.1902	.6753	-.7704	.8002	.2476	-.3950	.6248	.8479
.6500	-.5677	.5874	.9060	.6003	-.0809	.7022	-.7289	.8002	-.5024	-.3860	.6270	.8445
.7000	-.5891	.5945	.8949	.6500	.0136	.7255	-.6928	.8002	-.7524	-.3666	.6318	.8372
.7500	-.6056	.6074	.8749	.7000	.1216	.7521	-.6511					
.8002	-.6385	.6262	.8459	.7501	.2161	.7754	-.6139					
.9002	-.1945	.6742	.7720	.8001	.2958	.7950	-.5818					
.9501	-.0668	.7057	.7235	.8501	.3636	.8117	-.5540					

TEST	167	PT	21.9723	PSI	CM	.4234	CD1	.00938	CDCOR1	.00917
RUN	25	TT	157.9779	K	CM	-.1321	CD2	.00925	CDCOR2	.00902
POINT	21	RC	6.9593	MILLION	CC	.0174	CD3	.00911	CDCOR3	.00892
		MACH	.6995				CD4	.00862	CDCOR4	.00842
		ALPHA	-.4749	DEG			CD5	.00776	CDCOR5	.00750

UPPER SURFACE				LOWER SURFACE				SPANWISE				
X/C	CP	P/L/PT	MLOC	X/C	CP	P/L/PT	MLOC	X/C	Y/(B/2)	CP	P/L/PT	MLOC
0.0000	1.1111	.9958	-.0777	0.0000	1.1111	.9958	-.0777	.1507	.7476	-.5532	.5848	.9101
.0132	-.1385	.6872	.7520	.0126	-.2473	.7825	-.6024	.1507	.4976	-.5985	.5736	.9277
.0259	-.4988	.5982	.8892	.0255	-.0965	.7452	-.6819	.1507	.2476	-.5742	.5796	.9182
.0759	-.6247	.5671	.9379	.0495	-.0396	.7116	-.7144	.1507	-.2524	-.5993	.5734	.9280
.1003	-.5932	.5749	.9256	.0753	-.1231	.6910	-.7462	.1507	-.5024	-.5970	.5740	.9271
.1507	-.5892	.5808	.9163	.1002	-.1784	.6773	-.7672	.1507	-.7524	-.5979	.5747	.9181
.2003	-.5540	.5846	.9104	.1503	-.2285	.6650	-.7862	.5002	.7476	-.5947	.5857	.9088
.2503	-.5541	.5846	.9105	.1976	-.3077	.6454	-.8163	.5002	.4976	-.5967	.5839	.9115
.3001	-.5581	.5836	.9120	.2503	-.3477	.6355	-.8314	.5002	.2476	-.5960	.5821	.9143
.3502	-.5591	.5843	.9108	.3001	-.3668	.6308	-.8387	.5002	-.2524	-.5911	.5853	.9093
.4003	-.5542	.5845	.9105	.3507	-.3769	.6283	-.8426	.5002	-.5024	-.5943	.5860	.9082
.4501	-.5556	.5842	.9110	.4001	-.3632	.6317	-.8373	.5002	-.7524	-.5931	.5888	.9039
.5002	-.5605	.5830	.9129	.4501	-.3320	.6394	-.8255	.8002	.7476	-.3892	.6253	.8472
.5502	-.5688	.5809	.9161	.5001	-.2695	.6549	-.8017	.8002	.4976	-.3975	.6232	.8504
.6002	-.5769	.5789	.9193	.5497	-.1721	.6789	-.7648	.8002	.2476	-.4036	.6217	.8527
.6500	-.5672	.5913	.9155	.6003	-.0670	.7049	-.7248	.8002	-.5024	-.3938	.6241	.8490
.7000	-.5348	.5893	.9030	.6500	.0246	.7275	-.6897	.8002	-.7524	-.3742	.6290	.8415
.7500	-.4784	.6033	.8813	.7000	.1307	.7537	-.6485					
.8002	-.3983	.6230	.8507	.7501	.2242	.7768	-.6116					
.9002	-.1974	.6726	.7744	.8001	.3040	.7965	-.5794					
.9501	-.0700	.7041	.7260	.8501	.3724	.8134	-.5512					

TEST	167	PT	21.9697	PSI	CM	.4896	CD1	.00962	CDCOR1	.00940
RUN	25	TT	158.0356	K	CM	-.1332	CD2	.00934	CDCOR2	.00915
POINT	22	RC	6.9561	MILLION	CC	.0160	CD3	.00894	CDCOR3	.00875
		MACH	.7004				CD4	.00845	CDCOR4	.00825
		ALPHA	.0235	DEG			CD5	.00795	CDCOR5	.00772

UPPER SURFACE				LOWER SURFACE				SPANWISE				
X/C	CP	P _L /PT	MLOC	X/C	CP	P _L /PT	MLOC	X/C	Y/(B/2)	CP	P _L /PT	MLOC
0.0000	1.1287	1.0000	.0080	0.0000	1.1287	1.0000	.0080	.1507	.7476	-.6236	.5638	.9400
.0132	-.2673	.6541	.8029	.0126	.3592	.8093	.3581	.1507	.4976	-.6730	.5536	.9594
.0259	-.6410	.5615	.9468	.0255	.1923	.7679	.6258	.1507	.2476	-.6456	.5603	.9486
.0759	-.7423	.3364	.9869	.0495	.0436	.7311	.6841	.1507	-.2524	-.6732	.5535	.9595
.1003	-.6865	.3502	.9648	.0753	-.0516	.7075	.7207	.1507	-.5024	-.6685	.5547	.9577
.1507	-.6413	.3614	.9469	.1002	-.1136	.6922	.7444	.1507	-.7524	-.6399	.5617	.9464
.2003	-.6105	.3690	.9349	.1503	-.1732	.6774	.7671	.1507	-.5024	-.6752	.5578	.9211
.2503	-.6052	.3703	.9328	.1976	-.2562	.6568	.7987	.5002	.4976	-.5833	.5758	.9243
.3001	-.6030	.3709	.9319	.2503	-.3021	.6455	.8162	.5002	.2476	-.5901	.5741	.9269
.3502	-.5946	.3731	.9284	.3001	-.3249	.6398	.8249	.5002	-.2524	-.5773	.5773	.9219
.4003	-.5894	.3743	.9266	.3507	-.3397	.6361	.8305	.5002	-.5024	-.5748	.5779	.9210
.4501	-.5863	.3750	.9254	.4001	-.3304	.6384	.8270	.5002	-.7524	-.5636	.5807	.9166
.5002	-.5867	.3749	.9256	.4501	-.3041	.6449	.8170	.8002	.7476	-.3890	.6239	.8493
.5502	-.5911	.3738	.9275	.5001	-.2468	.6592	.7951	.8002	.4976	-.3985	.6216	.8530
.6002	-.5963	.3726	.9293	.5497	-.1535	.6823	.7596	.8002	.2476	-.4055	.6198	.8557
.6500	-.5827	.3759	.9240	.6003	-.0516	.7075	.7207	.8002	-.5024	-.3971	.6219	.8524
.7000	-.5450	.3653	.9094	.6500	.0076	.7296	.6864	.8002	-.7524	-.3776	.6267	.8450
.7500	-.4845	.3603	.8860	.7000	.1422	.7555	.6436					
.8002	-.4010	.3620	.8539	.7501	.2347	.7785	.6089					
.9002	-.1944	.6721	.7752	.8001	.3143	.7982	.5766					
.9501	-.6668	.7038	.7265	.8501	.3831	.8152	.5481					

TEST	167	PT	21.9732	PSI	CM	.5936	CD1	.00954	CDCOR1	.00934
RUN	25	TT	158.0067	K	CM	-.1331	CD2	.00926	CDCOR2	.00910
POINT	23	RC	6.9606	MILLION	CC	.0136	CD3	.00864	CDCOR3	.00851
		MACH	.7006				CD4	.00828	CDCOR4	.00809
		ALPHA	.5091	DEG			CD5	.00816	CDCOR5	.00789

UPPER SURFACE				LOWER SURFACE				SPANWISE				
X/C	CP	P _L /PT	MLOC	X/C	CP	P _L /PT	MLOC	X/C	Y/(B/2)	CP	P _L /PT	MLOC
0.0000	1.1281	1.0001	0.0000	0.0000	1.1281	1.0001	0.0000	.1507	.7476	-.6814	.5550	.9571
.0132	-.4077	.6223	.8518	.0126	.4556	.8347	.5145	.1507	.4976	-.7203	.5454	.9724
.0259	-.7970	.5266	1.0029	.0255	.2773	.7908	.5887	.1507	.2476	-.7132	.5472	.9696
.0759	-.8801	.5061	1.0364	.0495	.1198	.7521	.6510	.1507	-.2524	-.7332	.5423	.9775
.1003	-.7819	.5303	.9968	.0753	.0156	.7265	.6913	.1507	-.5024	-.7191	.5457	.9719
.1507	-.7108	.5478	.9686	.1002	-.0520	.7098	.7171	.1507	-.7524	-.6636	.5504	.9502
.2003	-.6824	.5547	.9575	.1503	-.1207	.6929	.7432	.5002	.7476	-.5986	.5754	.9249
.2503	-.6536	.5618	.9463	.1976	-.2068	.6717	.7758	.5002	.4976	-.6075	.5732	.9284
.3001	-.6454	.5638	.9431	.2503	-.2561	.6596	.7944	.5002	.2476	-.6132	.5718	.9306
.3502	-.6275	.5682	.9361	.3001	-.2839	.6528	.8049	.5002	-.2524	-.6009	.5748	.9258
.4003	-.6182	.5705	.9325	.3507	-.3027	.6482	.8120	.5002	-.5024	-.5989	.5753	.9250
.4501	-.6123	.5720	.9302	.4001	-.2979	.6493	.8102	.5002	-.7524	-.5876	.5781	.9206
.5002	-.6085	.5729	.9287	.4501	-.2765	.6546	.8021	.8002	.7476	-.3958	.6253	.8473
.5502	-.6093	.5727	.9290	.5001	-.2246	.6674	.7825	.8002	.4976	-.4047	.6231	.8507
.6002	-.6107	.5724	.9296	.5497	-.1361	.6891	.7491	.8002	.2476	-.4107	.6216	.8529
.6500	-.5941	.5765	.9232	.6003	-.0381	.7133	.7118	.8002	-.5024	-.4029	.6235	.8500
.7000	-.5537	.5864	.9076	.6500	.0476	.7343	.6790	.8002	-.7524	-.3834	.6283	.8426
.7500	-.4904	.6020	.8833	.7000	.1501	.7596	.6392					
.8002	-.4051	.6230	.8508	.7501	.2415	.7820	.6031					
.9002	-.1952	.6746	.7714	.8001	.3205	.8015	.5711					
.9501	-.6656	.7065	.7223	.8501	.3892	.8184	.5427					

TEST	167	PT	21.9736	PSI	CM	.6266	CD1	.00970	CDCOR1	.00946
RUN	25	TT	158.0050	K	CM	-.1342	CD2	.00932	CDCOR2	.00909
POINT	24	RC	6.9582	MILLION	CC	.0103	CD3	.00878	CDCOR3	.00857
		MACH	.7002				CD4	.00818	CDCOR4	.00796
		ALPHA	1.0081	DEG			CD5	.00823	CDCOR5	.00790

UPPER SURFACE				LOWER SURFACE				SPANWISE				
X/C	CP	P _L /PT	MLOC	X/C	CP	P _L /PT	MLOC	X/C	Y/(B/2)	CP	P _L /PT	MLOC
0.0000	1.1260	.9995	.0258	0.0000	1.1260	.9995	.0258	.1507	.7476	-.7475	.5376	.9850
.0132	-.5356	.5900	.9020	.0126	.5394	.8549	.4785	.1507	.4976	-.7019	.5488	.9670
.0259	-.9430	.4894	1.0643	.0255	.3526	.8088	.5589	.1507	.2476	-.7627	.5338	.9911
.0759	-1.0944	.4520	1.1285	.0495	.1881	.7683	.6253	.1507	-.2524	-.7173	.5450	.9731
.1003	-.9961	.4763	1.0865	.0753	.0750	.7404	.6695	.1507	-.5024	-.7245	.5433	.9759
.1507	-.7676	.5326	.9930	.1002	.0017	.7223	.6978	.1507	-.7524	-.7371	.5401	.9809
.2003	-.7440	.5384	.9836	.1503	-.0747	.7035	.7269	.5002	.7476	-.6282	.5670	.9381
.2503	-.7097	.5469	.9700	.1976	-.1632	.6816	.7606	.5002	.4976	-.6382	.5645	.9420
.3001	-.6957	.5504	.9645	.2503	-.2170	.6684	.7810	.5002	.2476	-.6436	.5632	.9441
.3502	-.6749	.5555	.9563	.3001	-.2473	.6609	.7924	.5002	-.2524	-.6305	.5664	.9390
.4003	-.6597	.5592	.9504	.3507	-.2702	.6553	.8011	.5002	-.5024	-.6294	.5667	.9386
.4501	-.6490	.5619	.9462	.4001	-.2696	.6554	.8009	.5002	-.7524	-.6175	.5696	.9339
.5002	-.6403	.5640	.9428	.4501	-.2524	.6597	.7944	.8002	.7476	-.4071	.6228	.8511
.5502	-.6372	.5648	.9416	.5001	-.2048	.6714	.7764	.8002	.4976	-.4106	.6207	.8544
.6002	-.6356	.5652	.9410	.5497	-.1204	.6922	.7443	.8002	.2476	-.4174	.6190	.8570
.6500	-.6140	.5705	.9326	.6003	-.0257	.7156	.7082	.8002	-.5024	-.4090	.6210	.8538
.7000	-.5693	.5815	.9152	.6500	.0575	.7361	.6763	.8002	-.7524	-.3898	.6258	.8465
.7500	-.5021	.5981	.8894	.7000	.1585	.7610	.6370					
.8002	-.4133	.6200	.8554	.7501	.2489	.7833	.6011					
.9002	-.1983	.6730	.7739	.8001	.3279	.8027	.5691					
.9501	-.6700	.7046	.7252	.8501	.3971	.8198	.5403					

ORIGINAL PRICE
OF POOR QUALITY

TEST 167	PT 21.9744	PSI	CM	.6967	CD1	.01005	CDCOR1	.00979
RUN 25	TT 157.9508	K	CM	-.1336	CD2	.00953	CDCOR2	.00931
POINT 25	RC 6.9627	MILLION	CC	.0065	CD3	.00950	CDCOR3	.00924
	MACH .7003				CD4	.00900	CDCOR4	.00874
	ALPHA 1.5172	DEG			CD5	.00897	CDCOR5	.00867

UPPER SURFACE				LOWER SURFACE				SPANWISE				
X/C	CP	P/L/PT	MLOC	X/C	CP	P/L/PT	MLOC	X/C	Y/(B/2)	CP	P/L/PT	MLOC
0.0000	1.1135	.9962	.0734	0.0000	1.1135	.9962	.0734	.1507	.7476	-.7713	.9297	.9978
.0132	-.6523	.5592	.9505	.0126	.6128	.8723	.4460	.1507	.4976	-1.1027	.4477	1.1362
.0259	-1.0664	.4567	1.1204	.0255	.4212	.8249	.5316	.1507	.2476	-1.0541	.4597	1.1151
.0759	-1.2436	.4128	1.1994	.0495	.2509	.7827	.6020	.1507	-.2524	-1.1150	.4446	1.1416
.1003	-1.2290	.4164	1.1927	.0753	.1305	.7529	.6497	.1507	-.5024	-1.0720	.4593	1.1228
.1507	-1.0395	.4633	1.1088	.1002	.0523	.7336	.6802	.1507	-.7524	-.7060	.3459	.9717
.2003	-.7238	.5415	.9788	.1503	-.0313	.7129	.7124	.5002	.7476	-.6534	.3589	.9509
.2503	-.7322	.5394	.9821	.1976	-.1219	.6904	.7471	.5002	.4976	-.6841	.3562	.9551
.3001	-.7323	.5393	.9822	.2503	-.1791	.6763	.7688	.5002	.2476	-.6699	.3548	.9574
.3502	-.7135	.5446	.9747	.3001	-.2116	.6682	.7812	.5002	-.2524	-.6560	.3582	.9520
.4003	-.6948	.5486	.9673	.3507	-.2382	.6617	.7913	.5002	-.5024	-.6532	.3584	.9517
.4501	-.6795	.5524	.9612	.4001	-.2417	.6608	.7926	.5002	-.7524	-.6438	.3613	.9472
.5002	-.6675	.5554	.9565	.4501	-.2287	.6640	.7877	.8002	.7476	-.6437	.6207	.8543
.5502	-.6607	.5571	.9538	.5001	-.1856	.6747	.7713	.8002	.4976	-.6139	.6182	.8582
.6002	-.6561	.5582	.9520	.5497	-.1050	.5946	.7406	.8002	.2476	-.4221	.6161	.8614
.6500	-.6593	.5649	.9415	.6003	-.0138	.7172	.7057	.8002	-.5024	-.4137	.6182	.8582
.7000	-.5802	.5770	.9223	.6500	.0662	.7370	.6748	.8002	-.7524	-.3945	.6230	.8508
.7500	-.5097	.5945	.8950	.7000	.1651	.7615	.6361					
.8002	-.4181	.6171	.8598	.7501	.2543	.7836	.6006					
.9002	-.2003	.6710	.7769	.8001	.3326	.8030	.5687					
.9501	-.0731	.7025	.7284	.8501	.4021	.8202	.5397					

TEST 167	PT 21.9624	PSI	CM	.7720	CD1	.01120	CDCOR1	.01085
RUN 25	TT 157.9584	K	CM	-.1323	CD2	.01073	CDCOR2	.01043
POINT 26	RC 6.9607	MILLION	CC	.0023	CD3	.01039	CDCOR3	.01028
	MACH .7007				CD4	.00991	CDCOR4	.00963
	ALPHA 2.0121	DEG			CD5	.00942	CDCOR5	.00902

UPPER SURFACE				LOWER SURFACE				SPANWISE				
X/C	CP	P/L/PT	MLOC	X/C	CP	P/L/PT	MLOC	X/C	Y/(B/2)	CP	P/L/PT	MLOC
0.0000	1.0986	.9926	.1027	0.0000	1.0986	.9926	.1027	.1507	.7476	-1.2736	.4665	1.2111
.0132	-.7636	.5325	.9732	.0126	.6831	.8900	.4413	.1507	.4976	-1.3723	.3821	1.2579
.0259	-1.1741	.4311	1.1058	.0255	.4876	.8417	.5023	.1507	.2476	-1.3169	.3958	1.2314
.0759	-1.3527	.3859	1.2505	.0495	.3124	.7984	.5762	.1507	-.2524	-1.3166	.3959	1.2313
.1003	-1.3529	.3870	1.2484	.0753	.1852	.7670	.6274	.1507	-.5024	-1.3493	.3878	1.2468
.1507	-1.2993	.4002	1.2231	.1002	.1049	.7470	.6591	.1507	-.7524	-1.2434	.4140	1.1972
.2003	-1.1875	.4277	1.1719	.1503	.0145	.7248	.6939	.5002	.7476	-.6775	.5538	.9590
.2503	-.6835	.5323	.9614	.1976	-.0799	.7016	.7299	.5002	.4976	-.6848	.5520	.9619
.3001	-.6823	.5326	.9609	.2503	-.1404	.6865	.7531	.5002	.2476	-.6907	.5505	.9642
.3502	-.7047	.5471	.9697	.3001	-.1769	.6775	.7670	.5002	-.2524	-.6780	.5537	.9592
.4003	-.7060	.5468	.9703	.3507	-.2064	.6702	.7782	.5002	-.5024	-.6768	.5540	.9588
.4501	-.6978	.5488	.9670	.4001	-.2132	.6685	.7808	.5002	-.7524	-.6761	.5564	.9550
.5002	-.6859	.5517	.9623	.4501	-.2042	.6707	.7774	.8002	.7476	-.6413	.6191	.8567
.5502	-.6780	.5537	.9592	.5001	-.1657	.6803	.7627	.8002	.4976	-.64225	.6168	.8603
.6002	-.6712	.5554	.9566	.5497	-.0888	.6993	.7335	.8002	.2476	-.4289	.6152	.8628
.6500	-.6416	.5627	.9450	.6003	-.0005	.7211	.6997	.8002	-.5024	-.4199	.6174	.8593
.7000	-.5902	.5754	.9249	.6500	.0767	.7402	.6699	.8002	-.7524	-.4011	.6221	.8522
.7500	-.5165	.5936	.8964	.7000	.1739	.7642	.6319					
.8002	-.4227	.6167	.8604	.7501	.2624	.7860	.6006					
.9002	-.2017	.6714	.7764	.8001	.3406	.8054	.5647					
.9501	-.0730	.7032	.7274	.8501	.4110	.8228	.5353					

TEST 167	PT 21.9718	PSI	CM	.8505	CD1	.01402	CDCOR1	.01362
RUN 25	TT 157.9662	K	CM	-.1312	CD2	.01373	CDCOR2	.01335
POINT 27	RC 6.9597	MILLION	CC	-.0018	CD3	.01360	CDCOR3	.01319
	MACH .7001				CD4	.01196	CDCOR4	.01153
	ALPHA 2.5050	DEG			CD5	.01108	CDCOR5	.01052

UPPER SURFACE				LOWER SURFACE				SPANWISE				
X/C	CP	P/L/PT	MLOC	X/C	CP	P/L/PT	MLOC	X/C	Y/(B/2)	CP	P/L/PT	MLOC
0.0000	1.0809	.9883	.1296	0.0000	1.0809	.9883	.1296	.1507	.7476	-1.4243	.3697	1.2025
.0132	-.8594	.5092	1.0314	.0126	.7430	.9049	.3805	.1507	.4976	-1.4830	.3552	1.3120
.0259	-1.2612	.4099	1.2047	.0255	.5467	.8564	.4757	.1507	.2476	-1.4261	.3692	1.2835
.0759	-1.4543	.3623	1.2975	.0495	.3690	.8125	.5527	.1507	-.2524	-1.4263	.3692	1.2835
.1003	-1.4470	.3641	1.2938	.0753	.2371	.7799	.6069	.1507	-.5024	-1.4684	.3588	1.3046
.1507	-1.4084	.3736	1.2747	.1002	.1537	.7593	.6396	.1507	-.7524	-1.4025	.3750	1.2718
.2003	-1.3608	.3853	1.2516	.1503	.0584	.7358	.6767	.5002	.7476	-.6798	.5535	.9595
.2503	-1.3020	.3999	1.2237	.1976	-.0383	.7119	.7139	.5002	.4976	-.6820	.5530	.9604
.3001	-.7963	.5244	1.0058	.2503	-.1019	.6962	.7381	.5002	.2476	-.6827	.5528	.9606
.3502	-.6183	.5687	.9354	.3001	-.1428	.6861	.7537	.5002	-.2524	-.6737	.5550	.9571
.4003	-.6371	.5661	.9428	.3507	-.1745	.6783	.7657	.5002	-.5024	-.6776	.5541	.9586
.4501	-.6643	.5574	.9534	.4001	-.1845	.6758	.7695	.5002	-.7524	-.6755	.5546	.9578
.5002	-.6791	.5547	.9576	.4501	-.1787	.6772	.7673	.8002	.7476	-.6165	.6185	.8577
.5502	-.6769	.5542	.9584	.5001	-.1442	.6858	.7542	.8002	.4976	-.6268	.6160	.8616
.6002	-.6737	.5550	.9571	.5497	-.0706	.7040	.7262	.8002	.2476	-.4326	.6146	.8638
.6500	-.6459	.5619	.9462	.6003	.0150	.7251	.6934	.8002	-.5024	-.4253	.6164	.8610
.7000	-.5942	.5747	.9260	.6500	.0895	.7435	.6646	.8002	-.7524	-.4042	.6216	.8530
.7500	-.5199	.5930	.8973	.7000	.1851	.7671	.6272					
.8002	-.4260	.6162	.8613	.7501	.2723	.7886	.5923					
.9002	-.2067	.6705	.7778	.8001	.3501	.8078	.5605					
.9501	-.0758	.7077	.7282	.8501	.4204	.8252	.5310					

TEST 167	PT 21.9724	PSI	CN .9327	CD1 .01862	CDCDR1 .01804
RUN 25	TT 158.1265	K	CM -.1303	CD2 .01835	CDCDR2 .01784
POINT 28	RC 6.9503	MILLION	CC -.0062	CD3 .01763	CDCDR3 .01705
	MACH .7002			CD4 .01429	CDCDR4 .01379
	ALPHA 3.0046	DEG		CD5 .01309	CDCDR5 .01260

UPPER SURFACE				LOWER SURFACE				SPANWISE				
X/C	CP	P _L /PT	MLOC	X/C	CP	P _L /PT	MLOC	X/C	Y/(B/2)	CP	P _L /PT	MLOC
0.0000	1.0509	.9808	.1666	0.0000	1.0509	.9808	.1666	.1507	.7476	-1.5350	.3412	1.3413
.0132	-.9570	.4842	1.0731	.0126	.7920	.9167	.3545	.1507	.4976	-1.5716	.3321	1.3607
.0259	-1.3406	.3893	1.2440	.0255	.5961	.8683	.4536	.1507	.2476	-1.5141	.3463	1.3304
.0759	-1.5555	.3361	1.3521	.0495	.4166	.8239	.5333	.1507	-.2524	-1.5144	.3463	1.3305
.1003	-1.5446	.3388	1.3463	.0753	.2806	.7903	.5897	.1507	-.5024	-1.5534	.3368	1.3210
.1507	-1.4973	.3505	1.3217	.1002	.1939	.7688	.6244	.1507	-.7524	-1.5124	.3468	1.3295
.2003	-1.4561	.3607	1.3007	.1503	.0941	.7441	.6636	.5002	.7476	-.6525	.5595	.9500
.2503	-1.4452	.3634	1.2952	.1976	-.0042	.7198	.7016	.5002	.4976	-.6364	.5634	.9437
.3001	-1.4357	.3657	1.2904	.2503	-.0719	.7031	.7276	.5002	.2476	-.6175	.5681	.9363
.3502	-.9006	.4981	1.0497	.3001	-.1124	.6930	.7430	.5002	-.2524	-.6166	.5684	.9359
.4003	-.6320	.5645	.9420	.3507	-1.1470	.6845	.7562	.5002	-.5024	-.6425	.5619	.9461
.4501	-.5829	.5767	.9228	.4001	-1.601	.6813	.7612	.5002	-.7524	-.6612	.5573	.9534
.5002	-.6074	.5706	.9324	.4501	-1.578	.6818	.7603	.8002	.7476	-.4131	.6187	.8574
.5502	-.6351	.5638	.9432	.5001	-.1267	.6895	.7485	.8002	.4976	-.4268	.6153	.8627
.6002	-.6499	.5601	.9490	.5497	-.0568	.7068	.7218	.8002	.2476	-.4338	.6136	.8653
.6500	-.6328	.5643	.9423	.6003	.0257	.7272	.6901	.8002	-.5024	-.4269	.6153	.8627
.7000	-.5881	.5754	.9249	.6500	.0978	.7450	.6622	.8002	-.7524	-.4018	.6215	.8531
.7500	-.5182	.5927	.8978	.7000	.1914	.7682	.6254					
.8002	-.4273	.6152	.8629	.7501	.2774	.7895	.5910					
.9002	-.2126	.6683	.7811	.8001	.3542	.8085	.5595					
.9501	-.0849	.6999	.7325	.8501	.4242	.8258	.5300					

TEST 167	PT 21.9688	PSI	CN 1.0352	CD1 .02710	CDCDR1 .02614
RUN 25	TT 158.1464	K	CM -.1323	CD2 .02652	CDCDR2 .02565
POINT 30	RC 6.9527	MILLION	CC -.0111	CD3 .02336	CDCDR3 .02259
	MACH .7010			CD4 .01914	CDCDR4 .01830
	ALPHA 3.5946	DEG		CD5 .01727	CDCDR5 .01620

UPPER SURFACE				LOWER SURFACE				SPANWISE				
X/C	CP	P _L /PT	MLOC	X/C	CP	P _L /PT	MLOC	X/C	Y/(B/2)	CP	P _L /PT	MLOC
0.0000	1.0087	.9707	.2066	0.0000	1.0087	.9707	.2066	.1507	.7476	-1.6576	.3138	1.4012
.0132	-1.0762	.4571	1.1197	.0126	.8438	.9301	.3234	.1507	.4976	-1.6674	.3114	1.4067
.0259	-1.4343	.3689	1.2842	.0255	.6505	.8824	.4264	.1507	.2476	-1.6137	.3247	1.3770
.0759	-1.6514	.3154	1.3977	.0495	.4723	.8385	.5078	.1507	-.2524	-1.6097	.3250	1.3749
.1003	-1.6384	.3186	1.3905	.0753	.3322	.8040	.5669	.1507	-.5024	-1.6436	.3173	1.3934
.1507	-1.5924	.3299	1.3655	.1002	.2420	.7818	.6035	.1507	-.7524	-1.6218	.3227	1.3814
.2003	-1.5707	.3353	1.3539	.1503	.1369	.7559	.6450	.5002	.7476	-.6075	.5725	.9294
.2503	-1.5494	.3405	1.3479	.1976	.0371	.7313	.6837	.5002	.4976	-.5863	.5622	.9142
.3001	-1.5593	.3381	1.3479	.2503	-.0314	.7145	.7099	.5002	.2476	-.5793	.5795	.9185
.3502	-1.5266	.3461	1.3308	.3001	-.0762	.7034	.7270	.5002	-.2524	-.5789	.5796	.9183
.4003	-1.0132	.4726	1.0928	.3507	-1.1134	.6943	.7412	.5002	-.5024	-.5900	.5769	.9226
.4501	-.7184	.5452	.9272	.4001	-1.2299	.6902	.7475	.5002	-.7524	-.6297	.5671	.9367
.5002	-.5982	.5748	.9258	.4501	-.1311	.6899	.7479	.8002	.7476	-.4038	.6227	.8512
.5502	-.5693	.5819	.9146	.5001	-.1045	.6965	.7378	.8002	.4976	-.4203	.6186	.8575
.6002	-.5838	.5784	.9202	.5497	-.0386	.7127	.7127	.8002	.2476	-.4247	.6176	.8592
.6500	-.5852	.5780	.9207	.6003	.0402	.7321	.6825	.8002	-.5024	-.4153	.6199	.8556
.7000	-.5586	.5846	.9104	.6500	.1092	.7491	.6558	.8002	-.7524	-.3815	.6282	.8427
.7500	-.5006	.5989	.8881	.7000	.2002	.7715	.6201					
.8002	-.4180	.6192	.8566	.7501	.2843	.7922	.5864					
.9002	-.2138	.6695	.7792	.8001	.3599	.8108	.5555					
.9501	-.0896	.7001	.7321	.8501	.4291	.8279	.5264					

TFST	167	PT	26.5855	PSI	CM	-.0409	CD1	.00900	CDCOR1	.00875
RUN	53	TT	140.0219	K	CM	-.1227	CD2	.00887	CDCOR2	.00863
POINT	29	RC	10.0204	MILLION	CC	.0037	CD3	.00865	CDCOR3	.00848
		MACH	.7014				CD4	.00849	CDCOR4	.00831
		ALPHA	-3.9917	DEG			CD5	.00814	CDCOR5	.00795

UPPER SURFACE				LOWER SURFACE				SPANWISE				
X/C	CP	P,L/PT	MLOC	X/C	CP	P,L/PT	MLOC	X/C	Y/(B/2)	CP	P,L/PT	MLOC
0.0000	.6577	.8818	.4277	0.0000	.6577	.8818	.4277	.1507	.7476	-.1244	.6864	.7535
.0132	.6217	.8728	.4452	.0126	-.8443	.5065	1.0361	.1507	.4976	-.1245	.6803	.7536
.0259	.3058	.7939	.5839	.0255	-.7246	.5364	.9873	.1507	.2476	-.1226	.6868	.7529
.0759	-.0085	.7153	.7088	.0495	-.7794	.5227	1.0095	.1507	-.2524	-.1448	.6813	.7614
.1003	-.0565	.7033	.7274	.0753	-.7144	.5389	.9831	.1507	-.5024	-.1284	.6854	.7551
.1507	-.1256	.6861	.7540	.1002	-.7308	.5348	.9898	.1507	-.7524	-.1314	.6846	.7562
.2003	-.1745	.6739	.7720	.1503	-.6715	.5496	.9659	.5002	.7476	-.3401	.6325	.8364
.2503	-.2136	.6641	.7878	.1976	-.7239	.5365	.9870	.5002	.4976	-.3473	.6307	.8392
.3001	-.2496	.6551	.8016	.2503	-.7024	.5419	.9783	.5002	.2476	-.3513	.6257	.8407
.3502	-.2825	.6469	.8143	.3001	-.6746	.5489	.9672	.5002	-.2524	-.3401	.6325	.8364
.4003	-.3042	.6414	.8226	.3507	-.6357	.5586	.9517	.5002	-.5024	-.3369	.6333	.8352
.4501	-.3272	.6357	.8315	.4001	-.5735	.5741	.9271	.5002	-.7524	-.3237	.6366	.8301
.5002	-.3541	.6290	.8418	.4501	-.4988	.5928	.8979	.8002	.7476	-.3249	.6363	.8306
.5502	-.3813	.6222	.8523	.5001	-.3959	.6185	.8580	.8002	.4976	-.3283	.6354	.8319
.6002	-.4093	.6152	.8631	.5497	-.2675	.6506	.8085	.8002	.2476	-.3327	.6343	.8336
.6500	-.4237	.6116	.8687	.6003	-.1388	.6828	.7591	.8002	-.5024	-.3133	.6392	.8261
.7000	-.4164	.6134	.8659	.6500	-.0292	.7102	.7168	.8002	-.7524	-.2984	.6429	.8204
.7500	-.3872	.6207	.8546	.7000	.0868	.7392	.6717					
.8002	-.3316	.6346	.8332	.7501	.1547	.7636	.6329					
.9002	-.1736	.6741	.7724	.8001	.2631	.7832	.6014					
.9501	-.0623	.7019	.7296	.8501	.3280	.7994	.5748					

TEST	167	PT	26.5824	PSI	CM	.0907	CD1	.00879	CDCOR1	.00864
RUN	53	TT	140.0038	K	CM	-.1249	CD2	.00868	CDCOR2	.00856
POINT	30	RC	10.0305	MILLION	CC	.0116	CD3	.00851	CDCOR3	.00842
		MACH	.7015				CD4	.00823	CDCOR4	.00806
		ALPHA	-3.0650	DEG			CD5	.00796	CDCOR5	.00777

UPPER SURFACE				LOWER SURFACE				SPANWISE				
X/C	CP	P,L/PT	MLOC	X/C	CP	P,L/PT	MLOC	X/C	Y/(B/2)	CP	P,L/PT	MLOC
0.0000	.8188	.9233	.3396	0.0000	.8138	.9233	.3396	.1507	.7476	-.2172	.6669	.7835
.0132	.6645	.8356	.5131	.0126	-.4925	.5987	.8886	.1507	.4976	-.2285	.6641	.7878
.0259	.1344	.7539	.6484	.0255	-.4718	.6039	.8807	.1507	.2476	-.2283	.6641	.7878
.0759	-.1439	.6850	.7557	.0495	-.5466	.5853	.9095	.1507	-.2524	-.2542	.6577	.7976
.1003	-.1787	.6764	.7689	.0753	-.5276	.5900	.9022	.1507	-.5024	-.2367	.6620	.7909
.1507	-.2319	.6632	.7891	.1002	-.5612	.5817	.9152	.1507	-.7524	-.2358	.6623	.7906
.2003	-.2645	.6552	.8015	.1503	-.5435	.5861	.9083	.5002	.7476	-.3971	.6224	.8520
.2503	-.2982	.6468	.8143	.1976	-.5992	.5723	.9300	.5002	.4976	-.4037	.6207	.8546
.3001	-.3280	.6394	.8257	.2503	-.5989	.5724	.9299	.5002	.2476	-.4084	.6196	.8563
.3502	-.3471	.6347	.8329	.3001	-.5889	.5749	.9259	.5002	-.2524	-.3997	.6217	.8530
.4003	-.3660	.6300	.8402	.3507	-.5689	.5798	.9182	.5002	-.5024	-.3969	.6224	.8520
.4501	-.3861	.6251	.8478	.4001	-.5221	.5914	.9001	.5002	-.7524	-.3844	.6235	.8472
.5002	-.4077	.6197	.8561	.4501	-.4611	.6065	.8765	.8002	.7476	-.3508	.6338	.8343
.5502	-.4301	.6142	.8647	.5001	-.3700	.6291	.8417	.8002	.4976	-.3542	.6330	.8357
.6002	-.4537	.6083	.8737	.5497	-.2497	.6588	.7959	.8002	.2476	-.3577	.6321	.8370
.6500	-.4635	.6039	.8775	.6003	-.1268	.6892	.7491	.8002	-.5024	-.3421	.6360	.8310
.7000	-.4509	.6040	.8726	.6500	-.0222	.7131	.7091	.8002	-.7524	-.3254	.6401	.8247
.7500	-.4190	.6179	.8589	.7000	.0927	.7436	.6647					
.8002	-.3536	.6331	.8354	.7501	.1913	.7680	.6259					
.9002	-.1856	.6747	.7715	.8001	.2713	.7878	.5939					
.9501	-.0689	.7036	.7270	.8501	.3387	.8044	.5664					

TEST	167	PT	26.5834	PSI	CM	.2181	CD1	.00868	CDCOR1	.00865
RUN	53	TT	140.2630	K	CM	-.1286	CD2	.00848	CDCOR2	.00847
POINT	31	RC	10.0093	MILLION	CC	.0172	CD3	.00844	CDCOR3	.00844
		MACH	.7016				CD4	.00830	CDCOR4	.00828
		ALPHA	-2.0366	DEG			CD5	.00796	CDCOR5	.00785

UPPER SURFACE				LOWER SURFACE				SPANWISE				
X/C	CP	P,L/PT	MLOC	X/C	CP	P,L/PT	MLOC	X/C	Y/(B/2)	CP	P,L/PT	MLOC
0.0000	.9778	.9627	.2337	0.0000	.9778	.9627	.2337	.1507	.7476	-.3328	.6385	.8272
.0132	.2598	.7851	.5983	.0126	-.1558	.6623	.7598	.1507	.4976	-.3499	.6342	.8337
.0259	-.0775	.7016	.7300	.0255	-.2119	.6684	.7812	.1507	.2476	-.3518	.6338	.8344
.0759	-.3073	.6448	.8175	.0495	-.3201	.6416	.8223	.1507	-.2524	-.3741	.6283	.8429
.1003	-.3232	.6408	.8235	.0753	-.3444	.6366	.8301	.1507	-.5024	-.3557	.6328	.8359
.1507	-.3534	.6333	.8392	.1002	-.3901	.6243	.8490	.1507	-.7524	-.3477	.6348	.8328
.2003	-.3712	.6290	.8418	.1503	-.4045	.6207	.8545	.5002	.7476	-.4535	.6086	.8733
.2503	-.3916	.6239	.8496	.1976	-.4495	.6047	.8794	.5002	.4976	-.4610	.6086	.8761
.3001	-.4129	.6187	.8577	.2503	-.4887	.6004	.8860	.5002	.2476	-.4664	.6054	.8782
.3502	-.4217	.6165	.8661	.3001	-.4918	.5991	.8880	.5002	-.2524	-.4560	.6080	.8742
.4003	-.4345	.6133	.8660	.3507	-.4863	.6005	.8859	.5002	-.5024	-.4534	.6086	.8732
.4501	-.4460	.6105	.8704	.4001	-.4539	.6085	.8734	.5002	-.7524	-.4408	.6118	.8684
.5002	-.4640	.6060	.8773	.4501	-.4066	.6202	.8553	.8002	.7476	-.3662	.6302	.8399
.5502	-.4816	.6017	.8840	.5001	-.3279	.6397	.8253	.8002	.4976	-.3722	.6297	.8422
.6002	-.4991	.5973	.8908	.5497	-.2170	.6671	.7831	.8002	.2476	-.3764	.6277	.8438
.6500	-.5028	.5964	.8922	.6003	-.1009	.6958	.7389	.8002	-.5024	-.3599	.6318	.8375
.7000	-.4829	.6013	.8845	.6500	-.0024	.7202	.7613	.8002	-.7524	-.3417	.6363	.8306
.7500	-.4393	.6121	.8678	.7000	.1100	.7480	.6577					
.8002	-.3717	.6289	.8420	.7501	.2077	.7722	.6192					
.9002	-.1921	.6733	.7737	.8001	.2885	.7922	.5867					
.9501	-.0703	.7034	.7273	.8501	.3577	.8093	.5583					

ORIGINAL FACE IS OF POOR QUALITY

TEST 167	PT 26.5848	PSI	CM	.2890	CD1 .00868	CDCOR1 .00860
RUN 53	TT 140.5092	K	CM	-.1303	CD2 .00849	CDCOR2 .00845
POINT 32	RC 9.9746	MILLION	CC	.0185	CD3 .00851	CDCOR3 .00848
	MACH .7010				CD4 .00834	CDCOR4 .00827
	ALPHA -1.4969	DEG			CD5 .00793	CDCOR5 .00777

UPPER SURFACE				LOWER SURFACE				SPANWISE				
X/C	CP	P _z L/PT	MLOC	X/C	CP	P _z L/PT	MLOC	X/C	Y/(B/2)	CP	P _z L/PT	MLOC
0.0000	1.0401	.9781	.1782	0.0000	1.0401	.9781	.1782	.1507	.7476	-.3995	.6219	.8528
.0132	.1361	.7544	.6476	.0126	-.0020	.7202	.7012	.1507	.4976	-.4195	.6169	.8604
.0259	-.2053	.6699	.7788	.0255	-.0917	.6980	.7356	.1507	.2476	-.4222	.6163	.8614
.0759	-.4047	.6206	.8547	.0495	-.2170	.6670	.7833	.1507	-.2524	-.4254	.6155	.8627
.1003	-.4081	.6197	.8561	.0753	-.2530	.6581	.7969	.1507	-.5024	-.4248	.6156	.8624
.1507	-.4241	.6158	.8622	.1002	-.3110	.6438	.8190	.1507	-.7524	-.4127	.6186	.8578
.2003	-.4270	.6151	.8633	.1503	-.3394	.6367	.8298	.5002	.7476	-.4847	.6008	.8854
.2503	-.4449	.6106	.8701	.1976	-.4097	.6193	.8566	.5002	.4976	-.4927	.5988	.8885
.3001	-.4596	.6070	.8758	.2503	-.4341	.6133	.8660	.5002	.2476	-.4976	.5976	.8904
.3502	-.4630	.6062	.8771	.3001	-.4456	.6105	.8704	.5002	-.2524	-.4884	.5999	.8888
.4003	-.4723	.6039	.8806	.3507	-.4465	.6102	.8707	.5002	-.5024	-.4849	.6007	.8855
.4501	-.4811	.6017	.8840	.4001	-.4202	.6168	.8607	.5002	-.7524	-.4727	.6038	.8808
.5002	-.4953	.5982	.8895	.4501	-.3795	.6268	.8451	.8002	.7476	-.3736	.6283	.8429
.5502	-.5099	.5946	.8951	.5001	-.3065	.6449	.8173	.8002	.4976	-.3803	.6266	.8454
.6002	-.5242	.5910	.9006	.5497	-.2006	.6711	.7770	.8002	.2476	-.3850	.6255	.8472
.6500	-.5244	.5910	.9007	.6003	-.0880	.6990	.7341	.8602	-.5024	-.3706	.6290	.8417
.7000	-.5004	.5969	.8914	.6500	.0074	.7226	.6976	.8002	-.7524	-.3512	.6338	.8343
.7500	-.4518	.6089	.8728	.7000	-.1185	.7500	.6545					
.8002	-.3805	.6264	.8455	.7501	-.2154	.7740	.6162					
.9002	-.1947	.6726	.7748	.8001	.2961	.7940	.5837					
.9501	-.0710	.7032	.7277	.8501	.3661	.8113	.5548					

TEST 167	PT 26.5862	PSI	CM	.3459	CD1 .00872	CDCOR1 .00866
RUN 53	TT 140.5123	K	CM	-.1314	CD2 .00855	CDCOR2 .00851
POINT 33	RC 9.9735	MILLION	CC	.0188	CD3 .00853	CDCOR3 .00851
	MACH .7008				CD4 .00834	CDCOR4 .00829
	ALPHA -1.0488	DEG			CD5 .00796	CDCOR5 .00780

UPPER SURFACE				LOWER SURFACE				SPANWISE				
X/C	CP	P _z L/PT	MLOC	X/C	CP	P _z L/PT	MLOC	X/C	Y/(B/2)	CP	P _z L/PT	MLOC
0.0000	1.0747	.9871	.1363	0.0000	1.0747	.9871	.1363	.1507	.7476	-.4555	.6077	.8747
.0132	.0280	.7274	.6900	.0126	-.1080	.7472	.6589	.1507	.4976	-.4772	.6023	.8830
.0259	-.3135	.6429	.8204	.0255	-.0030	.7188	.7019	.1507	.2476	-.4806	.6015	.8843
.0759	-.4872	.5899	.8869	.0495	-.1403	.6857	.7545	.1507	-.2524	-.4829	.6009	.8852
.1003	-.4793	.6014	.8838	.0753	-.1857	.6745	.7718	.1507	-.5024	-.4822	.6011	.8840
.1507	-.4821	.6011	.8849	.1002	-.2491	.6588	.7959	.1507	-.7524	-.4656	.6052	.8785
.2003	-.4779	.6022	.8833	.1503	-.2875	.6493	.8105	.5002	.7476	-.5091	.5944	.8953
.2503	-.4871	.5999	.8868	.1976	-.3617	.6309	.8388	.5002	.4976	-.5172	.5924	.8984
.3001	-.4981	.5972	.8910	.2503	-.3920	.6234	.8503	.5002	.2476	-.5218	.5913	.9002
.3502	-.4975	.5973	.8908	.3001	-.4088	.6193	.8568	.5002	-.2524	-.5123	.5936	.8965
.4003	-.5027	.5960	.8922	.3507	-.4125	.6184	.8562	.5002	-.5024	-.5092	.5944	.8953
.4501	-.5090	.5945	.8953	.4001	-.3924	.6233	.8505	.5002	-.7524	-.4967	.5975	.8905
.5002	-.5189	.5920	.8991	.4501	-.3584	.6323	.8367	.8002	.7476	-.3785	.6288	.8452
.5502	-.5316	.5889	.9040	.5001	-.2879	.6492	.8106	.8002	.4976	-.3856	.6250	.8479
.6002	-.5432	.5860	.9085	.5497	-.1880	.6744	.7719	.8002	.2476	-.3912	.6236	.8500
.6500	-.5401	.5868	.9073	.6003	-.0769	.7015	.7303	.8002	-.5024	-.3766	.6272	.8445
.7000	-.5127	.5935	.8967	.6500	.0157	.7244	.6947	.8002	-.7524	-.3567	.6322	.8369
.7500	-.4668	.6064	.8767	.7000	.1250	.7515	.6523					
.8002	-.3886	.6248	.8483	.7501	.2213	.7753	.6142					
.9002	-.1964	.6719	.7758	.8001	.3018	.7952	.5817					
.9501	-.0714	.7027	.7282	.8501	.3714	.8124	.5529					

TEST 167	PT 26.5848	PSI	CM	.4230	CD1 .00869	CDCOR1 .00861
RUN 53	TT 140.5134	K	CM	-.1334	CD2 .00851	CDCOR2 .00846
POINT 34	RC 9.9742	MILLION	CC	.0192	CD3 .00843	CDCOR3 .00840
	MACH .7010				CD4 .00829	CDCOR4 .00821
	ALPHA -1.4988	DEG			CD5 .00794	CDCOR5 .00778

UPPER SURFACE				LOWER SURFACE				SPANWISE				
X/C	CP	P _z L/PT	MLOC	X/C	CP	P _z L/PT	MLOC	X/C	Y/(B/2)	CP	P _z L/PT	MLOC
0.0000	1.1095	.9953	.0419	0.0000	1.1095	.9953	.0419	.1507	.7476	-.5297	.5902	.9019
.0132	-.1187	.6914	.7452	.0126	.2450	.7617	.5039	.1507	.4976	-.5518	.5848	.9104
.0259	-.4679	.6055	.8781	.0255	.1051	.7471	.6591	.1507	.2476	-.5569	.5835	.9124
.0759	-.6037	.5720	.9305	.0495	-.0428	.7106	.7162	.1507	-.2524	-.5583	.5832	.9129
.1003	-.5763	.5787	.9199	.0753	-.0990	.6967	.7377	.1507	-.5024	-.5552	.5839	.9117
.1507	-.5581	.5832	.9124	.1002	-.1704	.6790	.7648	.1507	-.7524	-.5259	.5912	.9004
.2003	-.5505	.5851	.9099	.1503	-.2199	.6668	.7816	.5002	.7476	-.5369	.5895	.9046
.2503	-.5407	.5875	.9061	.1976	-.2982	.6474	.8134	.5002	.4976	-.5451	.5864	.9078
.3001	-.5451	.5864	.9078	.2503	-.3347	.6384	.8273	.5002	.2476	-.5495	.5853	.9095
.3502	-.5451	.5864	.9078	.3001	-.3566	.6330	.8356	.5002	-.2524	-.5376	.5883	.9048
.4003	-.5429	.5870	.9070	.3507	-.3660	.6307	.8391	.5002	-.5024	-.5350	.5889	.9039
.4501	-.5434	.5868	.9072	.4001	-.3517	.6342	.8337	.5002	-.7524	-.5221	.5921	.8999
.5002	-.5483	.5856	.9041	.4501	-.3220	.6416	.8224	.8002	.7476	-.3815	.6269	.8450
.5502	-.5571	.5835	.9125	.5001	-.2598	.6569	.7989	.8002	.4976	-.3898	.6248	.8482
.6002	-.5658	.5813	.9198	.5497	-.1633	.6808	.7621	.8002	.2476	-.3962	.6232	.8507
.6500	-.5574	.5834	.9126	.6003	-.0589	.7066	.7223	.8002	-.5024	-.3794	.6274	.8443
.7000	-.5260	.5911	.9004	.6500	.0303	.7286	.6881	.8002	-.7524	-.3591	.6324	.8363
.7500	-.4708	.6048	.8742	.7000	.1375	.7551	.6464					
.8002	-.3935	.6239	.8496	.7501	.2322	.7785	.6090					
.9002	-.1982	.6722	.7754	.8001	.3121	.7983	.5766					
.9501	-.0717	.7029	.7280	.8501	.3819	.8155	.5478					

TEST 167	PT 26.5840	PSI	CM	.4871	CD1	.00876	CDCOR1	.00864
RUN 53	TY 140.5317	K	CM	-.1340	CD2	.00857	CDCOR2	.00848
POINT 35	MC 9.9666	MILLION	CC	.0169	CD3	.00857	CDCOR3	.00849
	MACH .7004				CD4	.00842	CDCOR4	.00828
	ALPHA .0102	DEG			CD5	.00810	CDCOR5	.00791

UPPER SURFACE				LOWER SURFACE				SPANWISE				
X/C	CP	P/L/P/T	MLOC	X/C	CP	P/L/P/T	MLOC	X/C	Y/(B/2)	CP	P/L/P/T	MLOC
0.0000	1.1261	.9994	.0291	0.0000	1.1261	.9994	.0291	.1507	.7476	-.5947	.5742	.9270
.0132	-.2483	.6598	.7944	.0126	.3548	.8088	.5590	.1507	.4976	-.6243	.5669	.9385
.0259	-.6079	.5709	.9321	.0255	.1926	.7687	.6247	.1507	.2476	-.6308	.5653	.9411
.0759	-.7182	.5437	.9755	.0495	.0301	.7286	.6882	.1507	-.2524	-.6328	.5648	.9418
.1003	-.6694	.5557	.9562	.0753	-.0291	.7140	.7109	.1507	-.5024	-.6267	.5663	.9295
.1507	-.6320	.5650	.9416	.1002	-.1059	.6950	.7403	.1507	-.7524	-.5944	.5713	.9269
.2003	-.6066	.5713	.9316	.1503	-.1645	.6805	.7626	.5002	.7476	-.5650	.5815	.9155
.2503	-.5926	.5747	.9262	.1976	-.2473	.6600	.7943	.5002	.4976	-.5729	.5796	.9185
.3001	-.5910	.5751	.9255	.2503	-.2899	.6495	.8102	.5002	.2476	-.5775	.5785	.9203
.3502	-.5819	.5774	.9220	.3001	-.3165	.6429	.8203	.5002	-.2324	-.5659	.5813	.9158
.4003	-.5766	.5787	.9200	.3502	-.3303	.6395	.8255	.5002	-.5024	-.5635	.5819	.9149
.4501	-.5741	.5793	.9190	.4001	-.3206	.6419	.8218	.8002	-.7524	-.5508	.5850	.9100
.5002	-.5746	.5792	.9192	.4501	-.2958	.6481	.8124	.8002	.7476	-.5379	.6253	.8474
.5502	-.5798	.5779	.9212	.5001	-.2388	.6672	.7909	.8002	.4976	-.3956	.6234	.8504
.6002	-.5851	.5766	.9232	.5497	-.1466	.6849	.7559	.8002	-.2476	-.4013	.6220	.8526
.6500	-.5728	.5796	.9185	.6003	-.0484	.7099	.7172	.8002	-.5024	-.3852	.6260	.8466
.7000	-.5375	.5893	.9048	.6500	.0407	.7312	.6841	.8002	-.7524	-.3650	.6310	.8387
.7500	-.4755	.6029	.8821	.7000	.1461	.7573	.6431					
.8002	-.3978	.6229	.8512	.7501	.2397	.7804	.6059					
.9002	-.1972	.6724	.7750	.8001	.3191	.8000	.5737					
.9501	-.0706	.7037	.7268	.8501	.3890	.8173	.5447					

TEST 167	PT 26.5900	PSI	CM	.5498	CD1	.00897	CDCOR1	.00883
RUN 53	TY 40.3594	K	CM	-.1345	CD2	.00879	CDCOR2	.00867
POINT 36	MC 9.9823	MILLION	CC	.0147	CD3	.00871	CDCOR3	.00861
	MACH .7004				CD4	.00850	CDCOR4	.00832
	ALPHA .5193	DEG			CD5	.00823	CDCOR5	.00804

UPPER SURFACE				LOWER SURFACE				SPANWISE				
X/C	CP	P/L/P/T	MLOC	X/C	CP	P/L/P/T	MLOC	X/C	Y/(B/2)	CP	P/L/P/T	MLOC
0.0000	1.1281	.9999	.0105	0.0000	1.1281	.9999	.0105	.1507	.7476	-.6700	.5557	.9563
.0132	-.3812	.6270	.8448	.0126	.4483	.8320	.5195	.1507	.4976	-.7009	.5480	.9685
.0259	-.7563	.5343	.9905	.0255	.2722	.7885	.5928	.1507	.2476	-.7102	.5457	.9722
.0759	-.8606	.5086	1.0326	.0495	.0965	.7451	.6624	.1507	-.2524	-.7102	.5457	.9722
.1003	-.7675	.5316	.9950	.0753	.0268	.7278	.6894	.1507	-.5024	-.7009	.5480	.9685
.1507	-.7110	.5456	.9725	.1002	-.0515	.7085	.7194	.1507	-.7524	-.7009	.5480	.9685
.2003	-.6857	.5567	.9546	.1503	-.1177	.6921	.7447	.5002	.7476	-.5922	.5748	.9294
.2503	-.6477	.5612	.9476	.1976	-.2046	.6707	.7777	.5002	.4976	-.6012	.5727	.9259
.3001	-.6397	.5631	.9444	.2503	-.2525	.6588	.7959	.5002	.2476	-.6063	.5714	.9314
.3502	-.6229	.5673	.9379	.3001	-.2831	.6513	.8075	.5002	-.2524	-.5955	.5741	.9272
.4003	-.6136	.5696	.9342	.3502	-.3010	.6468	.8143	.5002	-.5024	-.5934	.5746	.9264
.4501	-.6074	.5711	.9318	.4001	-.2958	.6481	.8123	.5002	-.7524	-.5813	.5776	.9264
.5002	-.6034	.5721	.9303	.4501	-.2751	.6532	.8045	.8002	.7476	-.3912	.6245	.9217
.5502	-.6048	.5718	.9308	.5001	-.2228	.6662	.7846	.8002	.4976	-.4077	.6220	.8586
.6002	-.6069	.5713	.9316	.5497	-.1347	.6879	.7511	.8002	.2476	-.3946	.6237	.8494
.6500	-.5906	.5753	.9253	.6003	-.0367	.7121	.7138	.8002	-.5024	-.4068	.6237	.8494
.7000	-.5518	.5849	.9103	.6500	.0469	.7328	.6816	.8002	-.7524	-.3742	.6288	.8421
.7500	-.4889	.6004	.8860	.7000	.1507	.7584	.6412					
.8002	-.4055	.6210	.8541	.7501	.2433	.7813	.6044					
.9002	-.2003	.6717	.7760	.8001	.3223	.8008	.5724					
.9501	-.0729	.7032	.7276	.8501	.3928	.8183	.5431					

TEST 167	PT 26.5876	PSI	CM	.6129	CD1	.00910	CDCOR1	.00898
RUN 53	TY 140.3773	K	CM	-.1337	CD2	.00896	CDCOR2	.00886
POINT 37	MC 9.9820	MILLION	CC	.0115	CD3	.00887	CDCOR3	.00879
	MACH .7002				CD4	.00867	CDCOR4	.00853
	ALPHA 1.6033	DEG			CD5	.00847	CDCOR5	.00824

UPPER SURFACE				LOWER SURFACE				SPANWISE				
X/C	CP	P/L/P/T	MLOC	X/C	CP	P/L/P/T	MLOC	X/C	Y/(B/2)	CP	P/L/P/T	MLOC
0.0000	1.1255	.9993	.0316	0.0000	1.1255	.9993	.0316	.1507	.7476	-.7435	.5378	.9849
.0132	-.5100	.5955	.8937	.0126	.5347	.8534	.4813	.1507	.4976	-.7672	.5320	.9943
.0259	-.9026	.4985	1.0493	.0255	.3493	.8076	.5610	.1507	.2476	-.7757	.5299	.9977
.0759	-1.0509	.4619	1.1115	.0495	.1860	.7624	.6349	.1507	-.2524	-.7746	.5302	.9973
.1003	-.9065	.4976	1.0509	.0753	.0836	.7421	.6671	.1507	-.5024	-.7636	.5319	.9929
.1507	-.7760	.5298	.9979	.1002	.0037	.7223	.6979	.1507	-.7524	-.7387	.5360	.9929
.2003	-.7219	.5432	.9763	.1503	-.0699	.7041	.7261	.5002	.7476	-.6146	.5687	.9830
.2503	-.6954	.5497	.9658	.1976	-.1590	.6822	.7600	.5002	.4976	-.6243	.5673	.9341
.3001	-.6814	.5532	.9603	.2503	-.2112	.6663	.7798	.5002	.2476	-.6295	.5680	.9400
.3502	-.6569	.5592	.9507	.3001	-.2452	.6609	.7927	.5002	-.2524	-.6195	.5685	.9361
.4003	-.6434	.5626	.9454	.3502	-.2671	.6555	.8011	.5002	-.5024	-.6175	.5688	.9361
.4501	-.6335	.5650	.9415	.4001	-.2658	.6558	.8006	.5002	-.7524	-.6054	.5718	.9306
.5002	-.6256	.5670	.9384	.4501	-.2495	.6598	.7944	.8002	.7476	-.3942	.6241	.8594
.5502	-.6232	.5675	.9375	.5001	-.2017	.6716	.7762	.8002	.4976	-.4047	.6213	.8534
.6002	-.6219	.5678	.9370	.5497	-.1178	.6923	.7444	.8002	.2476	-.4120	.6197	.8561
.6500	-.6016	.5719	.9291	.6007	-.0236	.7156	.7084	.8002	-.5024	-.3991	.6229	.8512
.7000	-.5593	.5813	.9127	.6500	.0567	.7354	.6775	.8002	-.7524	-.3782	.6280	.8432
.7500	-.4935	.5996	.8873	.7000	.1585	.7605	.6378					
.8002	-.4075	.6208	.8544	.7501	.2495	.7830	.6017					
.9002	-.1983	.6724	.7750	.8001	.3277	.8023	.5699					
.9501	-.0711	.7039	.7268	.8501	.3978	.8196	.5408					

ORIGINAL PAGE IS
OF POOR QUALITY

TEST	167	PT	26.3896	PSI	CM	.0013	CD1	.00953	CDCOR1	.00938			
RUN	53	TT	140.3963	K	CM	-.1335	CD2	.00941	CDCOR2	.00929			
POINT	38	RC	9.9765	MILLION	CC	.0079	CD3	.00930	CDCOR3	.00921			
		MACH	.0997				CD4	.00911	CDCOR4	.00894			
		ALPHA	1.5172	DEG			CD5	.00888	CDCOR5	.00865			
		UPPER SURFACE				LOWER SURFACE				SPANWISE			
X/C	CP	P/L/PT	MLOC	X/C	CP	P/L/PT	MLOC	X/C	Y/(B/2)	CP	P/L/PT	MLOC	
0.0000	1.1168	.9972	.0627	0.0000	1.1166	.9972	.0627	.1507	.7476	-.7649	.9334	.9921	
.0132	-.6399	.5642	.9428	.0126	-.6148	.6735	.4438	.1507	.4976	-.7537	.5362	.9876	
.0259	-1.0377	.4061	1.1042	.0255	-.4234	.8263	.5293	.1507	.2476	-.8451	.5136	1.0243	
.0759	-1.2182	.4216	1.1834	.0495	-.2356	.7798	.6070	.1507	-.2524	-.8275	.5180	1.0172	
.1003	-1.1966	.4270	1.1736	.0753	-.1427	.7571	.6433	.1507	-.5024	-.7421	.5300	.9830	
.1507	-.8537	.5115	1.0278	.1002	-.0585	.7384	.6760	.1507	-.7524	-.7611	.5343	.9966	
.2003	-.7431	.5387	.9834	.1503	-.0224	.7184	.7071	.3002	.7476	-.6385	.5645	.9422	
.2503	-.7232	.5212	.9794	.1976	-.1136	.6939	.7419	.3002	.4976	-.6481	.5622	.9460	
.3001	-.7211	.5442	.9747	.2503	-.1697	.6801	.7632	.3002	.2476	-.6535	.5608	.9481	
.3502	-.6935	.5510	.9638	.3001	-.2069	.6709	.7775	.3002	-.2524	-.6425	.5636	.9438	
.4003	-.6762	.5552	.9570	.3507	-.2326	.6646	.7870	.3002	-.5024	-.6410	.5639	.9432	
.4501	-.6627	.5586	.9517	.4001	-.2353	.6639	.7880	.3002	-.7524	-.6285	.5670	.9383	
.5002	-.6505	.5616	.9469	.4501	-.2233	.6639	.7835	.3002	.7476	-.3999	.6234	.8504	
.5502	-.6447	.5630	.9447	.5001	-.1788	.6776	.7870	.3002	.4976	-.6166	.6210	.8541	
.6002	-.6400	.5642	.9428	.5497	-.1002	.6972	.7369	.3002	.2476	-.6163	.6193	.8567	
.6500	-.6158	.5701	.9334	.6003	-.0097	.7196	.7022	.3002	-.5024	-.6027	.6227	.8515	
.7000	-.5697	.5815	.9155	.6500	.0675	.7386	.6725	.3002	-.7524	-.3816	.6279	.8435	
.7500	-.5009	.5985	.8890	.7000	.1674	.7632	.6336						
.8002	-.4419	.6204	.8550	.7501	.2571	.7853	.5979						
.8502	-.1985	.6730	.7741	.8001	.3348	.8044	.5664						
.9501	-.0721	.7047	.7261	.8501	.4046	.8217	.5372						

TEST	167	PT	26.5683	PSI	CM	-.7558	CD1	.01067	CDCOR1	.01032			
RUN	53	TT	140.3922	K	CM	-.1325	CD2	.01061	CDCOR2	.01030			
POINT	38	RC	9.9787	MILLION	CC	.0036	CD3	.01038	CDCOR3	.01007			
		MACH	.7001				CD4	.01016	CDCOR4	.00984			
		ALPHA	2.0162	DEG			CD5	.00973	CDCOR5	.00943			
		UPPER SURFACE				LOWER SURFACE				SPANWISE			
X/C	CP	P/L/PT	MLOC	X/C	CP	P/L/PT	MLOC	X/C	Y/(B/2)	CP	P/L/PT	MLOC	
0.0000	1.0955	.9920	.1372	0.0000	1.0955	.9920	.1072	.1507	.7476	-.6032	.4549	1.1238	
.0132	-.7531	.5363	.9874	.0126	-.6784	.8892	.6131	.1507	.4976	-1.3110	.3985	1.2265	
.0259	-1.1936	.4375	1.1545	.0255	-.4840	.8412	.5032	.1507	.2476	-1.2886	.4043	1.2157	
.0759	-1.3406	.3914	1.2401	.0495	-.2932	.7942	.5833	.1507	-.2524	-1.2833	.4056	1.2132	
.1003	-1.3351	.3928	1.2375	.0753	-.1935	.7696	.6233	.1507	-.5024	-1.3081	.3995	1.2248	
.1507	-1.2779	.4069	1.2107	.1002	-.1057	.7480	.6578	.1507	-.7524	-1.0381	.4060	1.1644	
.2003	-.9208	.4949	1.0553	.1503	.0185	.7265	.6915	.3002	.7476	-.6647	.5581	.9525	
.2503	-.6847	.5531	.9803	.1976	-.0744	.7036	.7270	.3002	.4976	-.6733	.5560	.9559	
.3001	-.7114	.5486	.9700	.2503	-.1333	.6891	.7494	.3002	.2476	-.6701	.5548	.9578	
.3502	-.7140	.5459	.9719	.3001	-.1718	.6796	.7640	.3002	-.2524	-.6650	.5583	.9526	
.4003	-.7031	.5486	.9676	.3507	-.2023	.6720	.7756	.3002	-.5024	-.6639	.5583	.9522	
.4501	-.6896	.5519	.9623	.4001	-.2084	.6705	.7779	.3002	-.7524	-.6516	.5613	.9474	
.5002	-.6756	.5554	.9568	.4501	-.2003	.6726	.7748	.3002	.7476	-.6070	.6216	.8552	
.5502	-.6676	.5574	.9536	.5001	-.1612	.6827	.7600	.3002	.4976	-.6169	.6191	.8570	
.6002	-.6606	.5591	.9506	.5497	-.0857	.7008	.7313	.3002	.2476	-.6240	.6174	.8596	
.6500	-.6321	.5661	.9398	.6003	.0013	.7223	.6981	.3002	-.5024	-.6088	.6211	.8539	
.7000	-.5429	.5782	.9206	.6500	.0757	.7406	.6694	.3002	-.7524	-.3874	.6264	.8457	
.7500	-.5108	.5960	.8929	.7000	.1735	.7647	.6312						
.8002	-.4198	.6184	.8581	.7501	.2616	.7864	.5961						
.8502	-.2036	.6717	.7761	.8001	.3383	.8053	.5649						
.9501	-.0786	.7026	.7286	.8501	.4078	.8225	.5359						

TEST	167	PT	26.5878	PSI	CM	.8336	CD1	.01312	CDCOR1	.01259			
RUN	53	TT	140.3259	K	CM	-.1304	CD2	.01302	CDCOR2	.01253			
POINT	40	RC	9.9920	MILLION	CC	-.0008	CD3	.01269	CDCOR3	.01214			
		MACH	.7007				CD4	.01190	CDCOR4	.01131			
		ALPHA	2.5050	DEG			CD5	.01076	CDCOR5	.01014			
		UPPER SURFACE				LOWER SURFACE				SPANWISE			
X/C	CP	P/L/PT	MLOC	X/C	CP	P/L/PT	MLOC	X/C	Y/(B/2)	CP	P/L/PT	MLOC	
0.0000	1.0756	.9868	.1381	0.0000	1.0756	.9868	.1381	.1507	.7476	-1.1450	.3866	1.2406	
.0132	-.8377	.5126	1.0260	.0126	-.7415	.9039	.3826	.1507	.4976	-1.4321	.3692	1.3019	
.0259	-1.2330	.4144	1.1968	.0255	-.5437	.8534	.4776	.1507	.2476	-1.3976	.3738	1.2746	
.0759	-1.4255	.3669	1.2885	.0495	-.3526	.8076	.5611	.1507	-.2524	-1.3944	.3746	1.2730	
.1003	-1.4279	.3675	1.2871	.0753	-.2473	.7815	.6042	.1507	-.5024	-1.4255	.3669	1.2894	
.1507	-1.3882	.3761	1.2700	.1002	-.1562	.7599	.6405	.1507	-.7524	-1.2704	.4031	1.2179	
.2003	-1.3275	.3912	1.2406	.1503	.0645	.7362	.6763	.3002	.7476	-.6673	.5548	.9577	
.2503	-1.1613	.4324	1.1639	.1976	-.0302	.7127	.7129	.3002	.4976	-.6727	.5535	.9598	
.3001	-.8491	.5487	.9674	.2503	-.0923	.6973	.7367	.3002	.2476	-.6739	.5532	.9602	
.3502	-.8347	.5629	.9449	.3001	-.1332	.6867	.7531	.3002	-.2524	-.6624	.5560	.9558	
.4003	-.8547	.5579	.9527	.3507	-.1665	.6799	.7650	.3002	-.5024	-.6650	.5552	.9571	
.4501	-.8691	.5543	.9584	.4001	-.1761	.6765	.7667	.3002	-.7524	-.6571	.5575	.9537	
.5002	-.8702	.5541	.9589	.4501	-.1712	.6777	.7668	.3002	.7476	-.6481	.6260	.8556	
.5502	-.8673	.5548	.9577	.5001	-.1363	.6864	.7535	.3002	.4976	-.6163	.6175	.8595	
.6002	-.8619	.5561	.9556	.5497	-.0645	.7042	.7260	.3002	.2476	-.6211	.6150	.8621	
.6500	-.8323	.5635	.9440	.6002	.0193	.7250	.6938	.3002	-.5024	-.6082	.6195	.8564	
.7000	-.5822	.5759	.9243	.6500	.0909	.7427	.6660	.3002	-.7524	-.3843	.6249	.8480	
.7500	-.5092	.5940	.8960	.7000	.1867	.7664	.6284						
.8002	-.4173	.6168	.8607	.7501	.2732	.7879	.5957						
.8502	-.2012	.6763	.7782	.8001	.3488	.8066	.5627						
.9501	-.0772	.7010	.7309	.8501	.4179	.8238	.5357						

TEST 167	PT 26.9845	PSI	CM	.9054	CD1 .01741	COCOR1 .01694
RUN 53	TT 140.3545	K	CM	-.1271	CD2 .01725	COCOR2 .01618
POINT 41	PC 9.9891	MILLION	CC	-.0051	CD3 .01857	COCOR3 .01602
	MACH				CD4 .01428	COCOR4 .01345
	ALPHA 3.0141	DEG			CD5 .01297	COCOR5 .01242

UPPER SURFACE				LOWER SURFACE				SPANWISE				
X/C	CP	P.L./PT	MLOC	X/C	CP	P.L./PT	MLOC	X/C	Y/(B/2)	CP	P.L./PT	MLOC
0.0000	1.0550	.9818	.1621	0.0000	1.0550	.9818	.1621	.1507	.7476	-1.4660	.3384	1.3056
.0132	-.9274	.4918	1.0405	.0126	.7927	.9172	.3533	.1507	.4976	-1.5237	.3444	1.3148
.0259	-1.3151	.3960	1.2314	.0255	.5988	.8691	.4523	.1507	.2476	-1.4901	.3527	1.3174
.0759	-1.5131	.3470	1.3292	.0495	.4019	.8204	.5395	.1507	-.2524	-1.4882	.3532	1.3164
.1003	-1.5091	.3480	1.3272	.0753	.2906	.7929	.5855	.1507	-.5024	-1.5167	.3461	1.3111
.1507	-1.4790	.3555	1.3117	.1002	.1984	.7701	.6229	.1507	-.7524	-1.5157	.3464	1.3306
.2003	-1.4255	.3687	1.2844	.1503	.1011	.7460	.6608	.0002	.7476	-.6509	.5601	.9492
.2503	-1.4197	.3701	1.2819	.1976	.0033	.7219	.6987	.0002	.4976	-.6399	.5629	.9449
.3001	-1.2911	.4017	1.2201	.2503	-.0830	.7055	.7241	.0002	.2476	-.6252	.5665	.9301
.3502	-.7324	.5400	.9814	.3001	-.1087	.6942	.7413	.0002	-.2524	-.6222	.5673	.9380
.4003	-.6047	.5712	.9317	.3502	-.1426	.6858	.7544	.0002	-.5024	-.6437	.5619	.9464
.4501	-.5996	.5753	.9253	.4001	-.1555	.6824	.7593	.0002	-.7524	-.6531	.5596	.9501
.5002	-.6116	.5699	.9338	.4501	-.1539	.6830	.7587	.0002	.7476	-.64057	.6208	.8545
.5502	-.6319	.5649	.9417	.5001	-.1229	.6977	.7469	.0002	.4976	-.6174	.6179	.8589
.6002	-.6400	.5629	.9448	.5497	-.0539	.7077	.7204	.0002	.2476	-.6226	.6166	.8609
.6500	-.6200	.5678	.9431	.6003	.0277	.7279	.6893	.0002	-.5024	-.6137	.6188	.8575
.7000	-.5749	.5789	.9196	.6500	.0969	.7450	.6624	.0002	-.7524	-.6373	.6253	.8474
.7500	-.5045	.5963	.8424	.7000	.1911	.7683	.6254					
.8002	-.4152	.6184	.8581	.7501	.2773	.7896	.5909					
.8502	-.2226	.6710	.7772	.8001	.3524	.8052	.5602					
.9001	-.0749	.7025	.7286	.8501	.4211	.8232	.5312					

TEST 167	PT 26.9890	PSI	CM	.9982	CD1 .02395	COCOR1 .02330
RUN 53	TT 140.3823	K	CM	-.1239	CD2 .02363	COCOR2 .02301
POINT 42	PC 9.9841	MILLION	CC	-.0092	CD3 .02153	COCOR3 .02091
	MACH				CD4 .01857	COCOR4 .01790
	ALPHA 3.3116	DEG			CD5 .01598	COCOR5 .01524

UPPER SURFACE				LOWER SURFACE				SPANWISE				
X/C	CP	P.L./PT	MLOC	X/C	CP	P.L./PT	MLOC	X/C	Y/(B/2)	CP	P.L./PT	MLOC
0.0000	1.0186	.9729	.1985	0.0000	1.0186	.9729	.1985	.1507	.7476	-1.5077	.3291	1.3676
.0132	-1.0235	.4885	1.1002	.0126	.8432	.9249	.3247	.1507	.4976	-1.6006	.3250	1.3746
.0259	-1.3912	.3777	1.2670	.0255	.6503	.8819	.4275	.1507	.2476	-1.5675	.3341	1.3567
.0759	-1.5901	.3285	1.3689	.0495	.4566	.8341	.5159	.1507	-.2524	-1.5643	.3349	1.3551
.1003	-1.5878	.3291	1.3676	.0753	.3413	.8056	.5647	.1507	-.5024	-1.5911	.3282	1.3694
.1507	-1.5578	.3365	1.3517	.1002	.2464	.7822	.6031	.1507	-.7524	-1.6089	.3238	1.3791
.2003	-1.5125	.3477	1.3279	.1503	.1450	.7572	.6431	.0002	.7476	-.6121	.5701	.9335
.2503	-1.5038	.3498	1.3234	.1976	.0483	.7332	.6810	.0002	.4976	-.5929	.5773	.9421
.3001	-1.5128	.3478	1.3281	.2503	-.0209	.7191	.7076	.0002	.2476	-.5834	.5821	.9144
.3502	-1.3730	.3821	1.2582	.3001	-.0488	.7043	.7239	.0002	-.2524	-.5902	.5829	.9133
.4003	-.7808	.5284	1.0001	.3502	-.1051	.6933	.7199	.0002	-.5024	-.5917	.5791	.8255
.4501	-.6041	.5721	.9304	.4001	-.1205	.6915	.7436	.0002	-.7524	-.6221	.5876	.9374
.5002	-.5617	.5825	.9139	.4501	-.1220	.6911	.7482	.0002	.7476	-.63919	.6245	.8687
.5502	-.5775	.5786	.9200	.5002	-.0943	.6980	.7354	.0002	.4976	-.6055	.6211	.8529
.6032	-.5694	.5732	.9285	.5497	-.0293	.6911	.7140	.0002	.2476	-.6111	.6197	.8561
.6500	-.5916	.5751	.9255	.6033	.0486	.6933	.6808	.0002	-.5024	-.6371	.6232	.8507
.7000	-.5565	.5830	.9119	.6500	.1153	.7486	.6549	.0002	-.7524	-.6631	.6316	.8378
.7500	-.4629	.5995	.8874	.7000	.2071	.7724	.6188					
.8002	-.4078	.6205	.8548	.7501	.2910	.7932	.5891					
.8502	-.2023	.6713	.7767	.8001	.3644	.8113	.5548					
.9001	-.0410	.7013	.7306	.8501	.4329	.8292	.5246					

TFST	167	PT	36.1387	PSI	CM	-.0345	CD1	.00841	CDCOR1	.00838
RUN	47	TT	131.5365	K	CM	-.1233	CD2	.00829	CDCOR2	.00829
POINT	52	PC	14.9234	MILLION	CC	.0047	CD3	.00822	CDCOR3	.00826
		MACH	.7015				CD4	.00828	CDCOR4	.00830
		ALPHA	-3.9815	DEG			CD5	.00784	CDCOR5	.00773

UPPER SURFACE				LOWER SURFACE				SPANWISE				
X/C	CP	P/L/PT	MLOC	X/C	CP	P/L/PT	MLOC	X/C	Y/(B/2)	CP	P/L/PT	MLOC
0.0000	.6599	.8832	.4250	0.0000	.6589	.8832	.4250	.1507	.7476	-.1241	.6889	.7499
.0132	.6136	.8720	.4469	.0126	-.8123	.5182	1.0172	.1507	.4976	-.1378	.6855	.7551
.0259	.2963	.7933	.5851	.0255	-.7104	.5434	.9762	.1507	.2476	-.1371	.6857	.7548
.0759	-.0202	.7147	.7100	.0495	-.7464	.5345	.9906	.1507	-.2524	-.1430	.6843	.7571
.1003	-.0699	.7024	.7291	.0753	-.7148	.5424	.9780	.1507	-.5024	-.1451	.6837	.7579
.1507	-.1384	.6854	.7553	.1002	-.7291	.5388	.9837	.1507	-.7524	-.1413	.6847	.7565
.2001	-.1799	.6751	.7712	.1507	-.6732	.5527	.9614	.5002	.7476	-.3548	.5317	.6379
.2503	-.2247	.6640	.7882	.1976	-.7237	.5401	.9815	.5002	.4976	-.3602	.6304	.6400
.3001	-.2620	.6547	.8025	.2503	-.7041	.5450	.9737	.5002	.2476	-.3639	.6294	.6414
.3502	-.2834	.6494	.8107	.3001	-.6766	.5518	.9628	.5002	-.2524	-.3578	.6309	.6391
.4003	-.3085	.6432	.8202	.3507	-.6389	.5612	.9479	.5002	-.5024	-.3558	.6314	.6383
.4501	-.3331	.6377	.8296	.4001	-.5773	.5765	.9238	.5002	-.7524	-.3438	.6344	.6337
.5002	-.3614	.6300	.8405	.4501	-.5051	.5944	.8957	.8002	.7476	-.9499	.4841	1.0739
.5502	-.3894	.6231	.8512	.5001	-.4036	.6196	.8566	.8002	.4976	-.3422	.6348	.6331
.6002	-.4168	.6163	.8617	.5497	-.2760	.6512	.8078	.8002	.2476	-.3448	.6342	.6341
.6500	-.4319	.6126	.8675	.6003	-.1469	.6833	.7586	.8002	-.5024	-.3288	.6381	.6280
.7000	-.4246	.6144	.8647	.6500	-.0416	.7044	.7182	.8002	-.7524	-.3225	.6397	.6256
.7500	-.3943	.6219	.8530	.7000	.0776	.7395	.6714					
.8002	-.3392	.6356	.8320	.7501	.1810	.7646	.6315					
.8502	-.2817	.6476	.8119	.8001	.2628	.7849	.5987					
.9001	-.0668	.7032	.7279	.8501	.3303	.8017	.5711					

TEST	167	PT	36.1414	PSI	CN	.0091	CD1	.00821	CDCOR1	.00817
RUN	47	TT	131.5029	K	CM	-.1275	CD2	.00813	CDCOR2	.00813
POINT	53	RC	14.9348	MILLION	CC	.0128	CD3	.00808	CDCOR3	.00811
		MACH	.7018				CD4	.00810	CDCOR4	.00809
		ALPHA	-3.0046	DEG			CD5	.00782	CDCOR5	.00768

UPPER SURFACE				LOWER SURFACE				SPANWISE				
X/C	CP	P/L/PT	MLOC	X/C	CP	P/L/PT	MLOC	X/C	Y/(B/2)	CP	P/L/PT	MLOC
0.0000	.8340	.9268	.3314	0.0000	.8340	.9268	.3314	.1507	.7476	-.2274	.6636	.7888
.0132	.4490	.8314	.5207	.0126	-.4446	.6098	.8718	.1507	.4976	-.2439	.6596	.7950
.0259	-.1243	.7509	.6534	.0255	-.4408	.6107	.8703	.1507	.2476	-.2430	.6598	.7947
.0759	-.1530	.6806	.7627	.0495	-.5033	.5932	.8944	.1507	-.2524	-.2479	.6586	.7966
.1003	-.1939	.6720	.7760	.0753	-.5100	.5936	.8970	.1507	-.5024	-.2504	.6579	.7975
.1507	-.2447	.6594	.7793	.1002	-.5483	.5541	.9118	.1507	-.7524	-.2400	.6605	.7936
.2003	-.2801	.6506	.8088	.1503	-.5322	.5881	.9051	.5002	.7476	-.4084	.6188	.8579
.2503	-.3647	.6435	.8197	.1976	-.5889	.5740	.9276	.5002	.4976	-.4144	.6173	.8601
.3001	-.3390	.6380	.8313	.2503	-.5904	.5737	.9282	.5002	.2476	-.4191	.6161	.8620
.3502	-.3749	.6320	.8374	.3001	-.5614	.5759	.9247	.5002	-.2524	-.4108	.6182	.8588
.4003	-.4051	.6274	.8445	.3507	-.5612	.5809	.9168	.5002	-.5024	-.4091	.6186	.8581
.4501	-.4321	.6228	.8516	.4001	-.5146	.5925	.8987	.5002	-.7524	-.3952	.6220	.8528
.5002	-.4467	.6187	.8611	.4501	-.4547	.6073	.8757	.8002	.7476	-1.0030	.4714	1.0957
.5502	-.4401	.6109	.8700	.5001	-.3638	.6256	.8408	.8002	.4976	-.3598	.6308	.8392
.6002	-.4630	.6032	.8788	.5497	-.2448	.6593	.7954	.8002	.2476	-.3633	.6300	.8406
.6500	-.4775	.6029	.8825	.6003	-.1225	.6897	.7487	.8002	-.5024	-.3458	.6343	.8339
.7000	-.4590	.6062	.8773	.6500	-.0225	.7144	.7104	.8002	-.7524	-.3401	.6357	.8317
.7500	-.4205	.6157	.8626	.7000	.0967	.7440	.6642					
.8002	-.3585	.6311	.8388	.7501	.1975	.7690	.6245					
.8502	-.1704	.6728	.7747	.8001	.2802	.7895	.5913					
.9001	-.0711	.7024	.7291	.8501	.3497	.8067	.5627					

TEST	167	PT	36.2197	PSI	CN	.2372	CD1	.00820	CDCOR1	.00812
RUN	47	TT	131.4659	K	CM	-.1317	CD2	.00813	CDCOR2	.00808
POINT	54	RC	14.9445	MILLION	CC	.0181	CD3	.00808	CDCOR3	.00807
		MACH	.6997				CD4	.00806	CDCOR4	.00802
		ALPHA	-1.9958	DEG			CD5	.00781	CDCOR5	.00764

UPPER SURFACE				LOWER SURFACE				SPANWISE				
X/C	CP	P/L/PT	MLOC	X/C	CP	P/L/PT	MLOC	X/C	Y/(B/2)	CP	P/L/PT	MLOC
0.0000	.9870	.9691	.2258	0.0000	.9870	.9691	.2258	.1507	.7476	-.3498	.6353	.8324
.0132	.7409	.7811	.6051	.0126	-.1234	.6912	.7464	.1507	.4976	-.3677	.6309	.8392
.0259	-.0984	.6998	.7331	.0255	-.1870	.6755	.7706	.1507	.2476	-.3670	.6311	.8389
.0759	-.3264	.6411	.8235	.0495	-.2870	.6508	.8085	.1507	-.2524	-.3715	.6299	.8406
.1003	-.3407	.6375	.8289	.0753	-.3255	.6413	.8231	.1507	-.5024	-.3735	.6295	.8414
.1507	-.3675	.6309	.8391	.1002	-.3805	.6277	.8440	.1507	-.7524	-.3784	.6332	.8396
.2003	-.3882	.6263	.8462	.1503	-.3933	.6241	.8497	.5002	.7476	-.4112	.6068	.8764
.2503	-.4030	.6222	.8526	.1976	-.4506	.6080	.8746	.5002	.4976	-.4226	.6050	.8792
.3001	-.4249	.6168	.8610	.2503	-.4785	.6035	.8819	.5002	.2476	-.4279	.6037	.8812
.3502	-.4343	.6144	.8646	.3001	-.4839	.6022	.8835	.5002	-.2524	-.4678	.6062	.8774
.4003	-.4452	.6118	.8687	.3507	-.4779	.6037	.8811	.5002	-.5024	-.4663	.6085	.8768
.4501	-.4561	.6091	.8729	.4001	-.4458	.6116	.8688	.5002	-.7524	-.4534	.6097	.8719
.5002	-.4753	.6043	.8803	.4501	-.4011	.6226	.8519	.8002	.7476	-1.0454	.4637	1.1089
.5502	-.4934	.5999	.8872	.5001	-.3725	.6420	.8220	.8002	.4976	-.3778	.6284	.8430
.6002	-.5107	.5956	.8938	.5497	-.2128	.6691	.7804	.8002	.2476	-.3831	.6271	.8450
.6500	-.5134	.5919	.8949	.6003	-.0969	.6977	.7364	.8002	-.5024	-.3659	.6313	.8385
.7000	-.4927	.6000	.8860	.6500	-.0030	.7209	.7005	.8002	-.7524	-.3584	.6332	.8356
.7500	-.4474	.6112	.8695	.7000	.1133	.7496	.6554					
.8002	-.3793	.6290	.8436	.7501	.2128	.7741	.6163					
.8502	-.1991	.6725	.7752	.8001	.2954	.7945	.5831					
.9001	-.0767	.7027	.7286	.8501	.3660	.8119	.5540					

ORIGINAL PAGE IS
OF POOR QUALITY

TEST 167	PT 36.2163	PSI	CN	.341	CD1 .00819	CDCOR1 .00812
RUN 47	TT 131.4714	K	CM	-1349	CD2 .00810	CDCOR2 .00806
POINT 55	RC 14.9458	MILLION	CC	.0191	CD3 .00809	CDCOR3 .00808
	MACH .7000				CD4 .00833	CDCOR4 .00860
	ALPHA -1.5066	DEG			CD5 .00760	CDCOR5 .00766

UPPER SURFACE				LOWER SURFACE				SPANWISE				
X/C	CP	P/L/PT	MLOC	X/C	CP	P/L/PT	MLOC	X/C	Y/(B/2)	CP	P/L/PT	MLOC
0.0000	1.0414	.9783	.1771	0.0000	1.0414	.9783	.1771	.1507	.7476	-.4111	.6177	.8580
.0132	.1261	.7518	.6519	.0126	.0164	.7247	.6946	.1507	.4976	-.4311	.6139	.8654
.0259	-.2031	.6703	.7785	.0255	-.0745	.7022	.7294	.1507	.2476	-.4312	.6139	.8655
.0759	-.4156	.6177	.8595	.0495	-.2125	.6680	.7821	.1507	-.2524	-.4371	.6124	.8677
.1003	-.4188	.5169	.4607	.0753	-.2422	.6607	.7934	.1507	-.5024	-.4378	.6122	.8680
.1507	-.4320	.6177	.8657	.1002	-.3066	.6447	.8179	.1507	-.7524	-.4170	.6174	.8600
.2003	-.4372	.6124	.8677	.1503	-.3343	.6379	.8284	.5002	.7476	-.4942	.5963	.8896
.2503	-.4514	.6089	.8712	.1976	-.4046	.6204	.8553	.5002	.4976	-.5016	.5965	.8925
.3001	-.4684	.6047	.8797	.2503	-.4294	.6143	.8648	.5002	.2476	-.5066	.5952	.8948
.3502	-.4720	.6038	.8811	.3001	-.4406	.6115	.8691	.5002	-.2524	-.4972	.5975	.8908
.4003	-.4801	.6018	.8842	.3507	-.4409	.6115	.8692	.2002	-.5024	-.4959	.5979	.8903
.4501	-.4879	.5999	.8872	.4001	-.4115	.6180	.8590	.5002	.7476	-.4828	.6011	.8853
.5002	-.5031	.5961	.8931	.4501	-.3753	.6277	.8441	.8002	.4976	-1.0668	.4566	1.1213
.5502	-.5190	.5922	.8992	.5001	-.3017	.6459	.8160	.8002	-.4976	-.3858	.6251	.8481
.6002	-.5325	.5886	.9047	.5497	-.1965	.6720	.7760	.8002	.2476	-.3911	.6238	.8501
.6500	-.5325	.5888	.9044	.6003	-.0843	.6997	.7332	.8002	-.5024	-.3748	.6278	.8439
.7000	-.5080	.5949	.8950	.6500	.0065	.7222	.6984	.8002	-.7524	-.3671	.6297	.8409
.7500	-.4585	.6071	.8759	.7000	.1212	.7506	.6538					
.8002	-.3867	.6249	.8484	.7500	.2195	.7749	.6150					
.9002	-.2008	.6709	.7776	.8001	.3017	.7954	.5818					
.9501	-.0765	.7017	.7302	.8501	.3727	.8128	.5525					

TEST 167	PT 36.2259	PSI	CN	.3683	CD1 .00820	CDCOR1 .00811
RUN 47	TT 131.4730	K	CM	-1349	CD2 .00815	CDCOR2 .00810
POINT 56	RC 14.9676	MILLION	CC	.0194	CD3 .00814	CDCOR3 .00813
	MACH .7013				CD4 .00808	CDCOR4 .00802
	ALPHA -.9979	DEG			CD5 .00781	CDCOR5 .00755

UPPER SURFACE				LOWER SURFACE				SPANWISE				
X/C	CP	P/L/PT	MLOC	X/C	CP	P/L/PT	MLOC	X/C	Y/(B/2)	CP	P/L/PT	MLOC
0.0000	1.0850	.9891	.1254	0.0000	1.0850	.9891	.1254	.1507	.7476	-.4780	.6617	.8843
.0132	.0042	.7212	.6999	.0126	.1424	.7555	.6461	.1507	.4976	-.4993	.5964	.8925
.0259	-.3263	.6393	.8262	.0255	-.0286	.7273	.6905	.1507	.2476	-.5001	.5928	.8928
.0759	-.5132	.5930	.8979	.0495	-.1263	.6889	.7500	.1507	-.2524	-.5060	.5948	.8951
.1003	-.5026	.5956	.8938	.0753	-.1670	.6788	.7655	.1507	-.5024	-.5047	.5951	.8946
.1507	-.5008	.5961	.8931	.1002	-.2366	.6615	.7920	.1507	-.7524	-.4747	.6014	.8848
.2003	-.4970	.5970	.8917	.1503	-.2764	.6517	.8072	.5002	.7476	-.5235	.5944	.9019
.2503	-.5027	.5956	.8938	.1976	-.3515	.6331	.8358	.5002	.4976	-.5310	.5886	.9048
.3001	-.5147	.5926	.8985	.2503	-.3831	.6252	.8479	.5002	.2476	-.5366	.5872	.9069
.3502	-.5129	.5931	.8978	.3001	-.3996	.6212	.8542	.5002	-.2524	-.5269	.5896	.9032
.4003	-.5169	.5921	.8993	.3507	-.4048	.6199	.8562	.5002	-.5024	-.5262	.5898	.9029
.4501	-.5217	.5909	.9012	.4001	-.3843	.6249	.8483	.5002	.7476	-.5128	.5931	.8977
.5002	-.5329	.5881	.9055	.4501	-.3507	.6333	.8355	.8002	-.4976	-1.0829	.4518	1.1296
.5502	-.5459	.5849	.9106	.5001	-.2817	.6504	.8092	.8002	.4976	-.3939	.6220	.8520
.6002	-.5573	.5821	.9150	.5497	-.1804	.6755	.7705	.8002	.2476	-.3997	.6211	.8542
.6500	-.5532	.5831	.9134	.6003	-.0713	.7025	.7287	.8002	-.5024	-.3830	.6253	.8478
.7000	-.5245	.5902	.9023	.6500	.0168	.7243	.6951	.8002	-.7524	-.3744	.6254	.8445
.7500	-.4709	.6035	.8816	.7000	.1302	.7524	.6509					
.8002	-.3935	.6222	.8526	.7500	.2274	.7765	.6124					
.9002	-.2028	.6699	.7791	.8001	.3091	.7966	.5793					
.9501	-.0761	.7013	.7303	.8501	.3805	.8145	.5497					

TEST 167	PT 36.2269	PSI	CN	.4317	CD1 .00824	CDCOR1 .00819
RUN 47	TT 131.4533	K	CM	-1358	CD2 .00822	CDCOR2 .00820
POINT 57	RC 14.9640	MILLION	CC	.0197	CD3 .00819	CDCOR3 .00821
	MACH .7008				CD4 .00813	CDCOR4 .00811
	ALPHA -.4993	DEG			CD5 .00789	CDCOR5 .00777

UPPER SURFACE				LOWER SURFACE				SPANWISE				
X/C	CP	P/L/PT	MLOC	X/C	CP	P/L/PT	MLOC	X/C	Y/(B/2)	CP	P/L/PT	MLOC
0.0000	1.1090	.9953	.0820	0.0000	1.1090	.9953	.0820	.1507	.7476	-.5467	.5873	.9088
.0132	-.1245	.6914	.7461	.0126	.2956	.7850	.5946	.1507	.4976	-.5695	.5817	.9155
.0259	-.4627	.6080	.8745	.0255	-.1209	.7518	.6519	.1507	.2476	-.5706	.5815	.9160
.0759	-.6189	.5695	.9347	.0495	-.1048	.7102	.7170	.1507	-.2524	-.5765	.5800	.9183
.1003	-.5908	.5765	.9216	.0753	-.0975	.6980	.7359	.1507	-.5024	-.5735	.5807	.9171
.1507	-.5712	.5813	.9162	.1002	-.1733	.6673	.7646	.1507	-.7524	-.5929	.5858	.9091
.2003	-.5493	.5867	.9078	.1503	-.2223	.6673	.7832	.5002	.7476	-.5498	.5866	.9079
.2503	-.5526	.5859	.9090	.1976	-.3010	.6479	.8130	.5002	.4976	-.5574	.5847	.9109
.3001	-.5587	.5844	.9114	.2503	-.3378	.6388	.8270	.5002	.2476	-.5630	.5833	.9136
.3502	-.5523	.5866	.9089	.3001	-.3579	.6313	.8346	.5002	-.2524	-.5532	.5857	.9092
.4003	-.5519	.5861	.9087	.3507	-.3645	.6313	.8386	.5002	-.5024	-.5525	.5859	.9090
.4501	-.5525	.5859	.9090	.4001	-.3528	.6351	.8320	.5002	.7476	-.5389	.5893	.9037
.5002	-.5596	.5842	.9117	.4501	-.3247	.6420	.8270	.8002	.4976	-1.0664	.4519	1.1295
.5502	-.5694	.5817	.9155	.5001	-.2613	.6577	.7940	.8002	-.4976	-.4006	.6233	.8508
.6002	-.5776	.5797	.9187	.5497	-.1650	.6814	.7615	.8002	.2476	-.4051	.6220	.8524
.6500	-.5694	.5817	.9159	.6003	-.0601	.7072	.7216	.8002	-.5024	-.3892	.6262	.8465
.7000	-.5374	.5896	.9031	.6500	.0291	.7257	.6849	.8002	-.7524	-.3818	.6260	.8437
.7500	-.4805	.6037	.8813	.7000	.1365	.7557	.6458					
.8002	-.4026	.6228	.8516	.7500	.2323	.7793	.6079					
.9002	-.2063	.6712	.7771	.8001	.3135	.7993	.5751					
.9501	-.0791	.7025	.7289	.8501	.3847	.8168	.5457					

TEST 167	PT 36.2260	PSI	CN .4990	CD1 .00832	CDCDR1 .00821
RUN 47	TT 131.4703	K	CM -.1366	CD2 .00829	CDCDR2 .00822
POINT 58	RC 14.9167	MILLION	CC .0172	CD3 .00825	CDCDR3 .00821
	MACH .6576			CD4 .00817	CDCDR4 .00809
	ALPHA .0000	DEG		CD5 .00793	CDCDR5 .00776

UPPER SURFACE				LOWER SURFACE				SPANWISE				
X/C	CP	P ₂ L/PT	MLOC	X/C	CP	P ₂ L/PT	MLOC	X/C	Y/(B/2)	CP	P ₂ L/PT	MLOC
0.0000	1.1239	.9093	.324	0.0000	1.1239	.9993	.0324	.1507	.7476	-.6160	.5731	.9292
.0132	-.2607	.6601	.7942	.0126	.3666	.8138	.5509	.1507	.4976	-.6399	.5672	.9384
.0259	-.6101	.5745	.9269	.0255	.2120	.7759	.6134	.1507	.2476	-.6423	.5666	.9393
.0759	-.7347	.5440	.9754	.0495	.0343	.7324	.6823	.1507	-.2524	-.6462	.5657	.9408
.1003	-.6834	.5565	.9553	.0753	-.0249	.7179	.7051	.1507	-.5024	-.6408	.5670	.9387
.1507	-.6424	.5666	.9394	.1002	-.1056	.6981	.7358	.1507	-.7524	-.6173	.5727	.9296
.2003	-.6215	.5717	.9313	.1503	-.1635	.6839	.7576	.5002	.7476	-.5730	.5836	.9126
.2503	-.6013	.5767	.9235	.1976	-.2461	.6637	.7888	.5002	.4976	-.5814	.5815	.9158
.3001	-.6012	.5767	.9234	.2503	-.2886	.6533	.8047	.5002	.2476	-.5871	.5801	.9150
.3502	-.5913	.5791	.9196	.3001	-.3143	.6470	.8144	.5002	-.2524	-.5755	.5830	.9135
.4003	-.5841	.5809	.9169	.3507	-.3274	.6437	.8194	.5002	-.5024	-.5748	.5831	.9133
.4501	-.5804	.5818	.9155	.4001	-.3170	.6463	.8155	.5002	-.7524	-.5609	.5866	.9080
.5002	-.5837	.5810	.9167	.4501	-.2943	.6519	.8069	.8002	.7476	-1.1059	.5530	1.1275
.5502	-.5856	.5795	.9190	.5001	-.2366	.6660	.7851	.8002	.4976	-.6043	.6249	.8484
.6002	-.5944	.5783	.9208	.5497	-.1452	.6884	.7507	.8002	.2476	-.6107	.6233	.8508
.6500	-.5822	.5813	.9161	.6003	-.0440	.7132	.7124	.8002	-.5024	-.3927	.6278	.8440
.7000	-.5870	.5900	.9026	.6500	.0377	.7332	.6812	.8002	-.7524	-.3845	.6298	.8409
.7500	-.4874	.6046	.8799	.7000	.1469	.7599	.6399					
.8002	-.4072	.6242	.8495	.7501	.2413	.7831	.6018					
.9002	-.2066	.6733	.7739	.8001	.3217	.8028	.5494					
.9501	-.0779	.7049	.7253	.8501	.3928	.8202	.5400					

TEST 167	PT 36.2263	PSI	CN .5640	CD1 .00850	CDCDR1 .00850
RUN 47	TT 31.3379	K	CM -.1363	CD2 .00848	CDCDR2 .00853
POINT 59	PC 14.9544	MILLION	CC .0148	CD3 .00841	CDCDR3 .00947
	MACH .5986			CD4 .00831	CDCDR4 .00839
	ALPHA .4990	DEG		CD5 .00809	CDCDR5 .00800

UPPER SURFACE				LOWER SURFACE				SPANWISE				
X/C	CP	P ₂ L/PT	MLOC	X/C	CP	P ₂ L/PT	MLOC	X/C	Y/(B/2)	CP	P ₂ L/PT	MLOC
0.0000	1.1158	.9971	.0640	0.0000	1.1158	.9971	.0640	.1507	.7476	-.6960	.5520	.9625
.0132	-.3562	.6257	.8472	.0126	.4600	.8360	.5125	.1507	.4976	-.7215	.5458	.9725
.0259	-.7654	.5350	.9898	.0255	.2909	.7945	.5831	.1507	.2476	-.7252	.5449	.9739
.0759	-.8865	.5052	1.0385	.0495	.1054	.7489	.6565	.1507	-.2524	-.7282	.5441	.9751
.1003	-.7649	.5302	.9976	.0753	.0368	.7321	.6830	.1507	-.5024	-.7201	.5461	.9719
.1507	-.7244	.5450	.9737	.1002	-.0400	.7112	.7154	.1507	-.7524	-.6953	.5522	.9622
.2003	-.6924	.5529	.9611	.1503	-.1142	.6930	.7406	.5002	.7476	-.6058	.5742	.9274
.2503	-.6586	.5612	.9479	.1976	-.2004	.6738	.7732	.5002	.4976	-.6133	.5724	.9303
.3001	-.6523	.5628	.9454	.2503	-.2483	.6620	.7913	.5002	.2476	-.6192	.5709	.9325
.3502	-.6337	.5673	.9382	.3001	-.2778	.6548	.8024	.5002	-.2524	-.6084	.5736	.9284
.4003	-.6224	.5701	.9338	.3507	-.2953	.6505	.8090	.5002	-.5024	-.6079	.5737	.9282
.4501	-.6150	.5719	.9309	.4001	-.2897	.6518	.8069	.5002	-.7524	-.5941	.5771	.9228
.5002	-.6136	.5723	.9304	.4501	-.2714	.6564	.8000	.8002	.7476	-1.1298	.4455	1.1408
.5502	-.6158	.5717	.9312	.5001	-.2193	.6692	.7803	.8002	.4976	-.6144	.6212	.8541
.6002	-.6174	.5713	.9319	.5497	-.1326	.6905	.7475	.8002	.2476	-.6203	.6198	.8563
.6500	-.6015	.5753	.9237	.6003	-.0354	.7143	.7106	.8002	-.5024	-.6034	.6239	.8499
.7000	-.5823	.5849	.9106	.6500	.0429	.7336	.6807	.8002	-.7524	-.3953	.6259	.8468
.7500	-.4987	.6005	.8862	.7000	.1492	.7597	.6394					
.8002	-.4155	.6210	.8545	.7501	.2417	.7824	.6029					
.9002	-.2101	.6714	.7768	.8001	.3211	.8019	.5708					
.9501	-.0791	.7036	.7273	.8501	.3914	.8192	.5417					

TEST 167	PT 36.2204	PSI	CN .6373	CD1 .00875	CDCDR1 .00856
RUN 47	TT 131.3436	K	CM -.1373	CD2 .00873	CDCDR2 .00861
POINT 60	RC 14.9623	MILLION	CC .0116	CD3 .00869	CDCDR3 .00860
	MACH .5995			CD4 .00855	CDCDR4 .00840
	ALPHA 1.0081	DEG		CD5 .00840	CDCDR5 .00817

UPPER SURFACE				LOWER SURFACE				SPANWISE				
X/C	CP	P ₂ L/PT	MLOC	X/C	CP	P ₂ L/PT	MLOC	X/C	Y/(B/2)	CP	P ₂ L/PT	MLOC
0.0000	1.1231	.9987	.0435	0.0000	1.1231	.9987	.0435	.1507	.7476	-.7737	.5302	.9975
.0132	-.5193	.5931	.8978	.0126	.5517	.8576	.4739	.1507	.4976	-.7843	.5276	1.0018
.0259	-.9004	.4990	1.0490	.0255	.3677	.8121	.5537	.1507	.2476	-.7829	.5280	1.0012
.0759	-1.0460	.4521	1.1291	.0495	.1780	.7653	.6305	.1507	-.2524	-.7819	.5282	1.0008
.1003	-1.0081	.4724	1.0939	.0753	.1020	.7465	.6603	.1507	-.5024	-.7754	.5298	.9982
.1507	-.7816	.5283	1.0007	.1002	.0115	.7242	.6954	.1507	-.7524	-.7562	.5346	.9905
.2003	-.7432	.5373	.9862	.1503	-.0620	.7060	.7235	.5002	.7476	-.6288	.5600	.9402
.2503	-.7096	.5461	.9720	.1976	-.1517	.6839	.7577	.5002	.4976	-.6385	.5636	.9440
.3001	-.6974	.5491	.9672	.2503	-.2050	.6709	.7776	.5002	.2476	-.6443	.5622	.9463
.3502	-.6765	.5543	.9590	.3001	-.2375	.6627	.7903	.5002	-.2524	-.6321	.5652	.9415
.4003	-.6600	.5582	.9527	.3507	-.2591	.6573	.7985	.5002	-.5024	-.6323	.5652	.9416
.4501	-.6470	.5615	.9474	.4001	-.2572	.6578	.7978	.5002	-.7524	-.6188	.5685	.9363
.5002	-.6414	.5629	.9452	.4501	-.2428	.6614	.7923	.8002	.7476	-1.1199	.4447	1.1421
.5502	-.6397	.5633	.9445	.5001	-.1944	.6733	.7739	.8002	.4976	-.6131	.6193	.8571
.6002	-.6383	.5637	.9439	.5497	-.1113	.6938	.7423	.8002	.2476	-.6208	.6174	.8600
.6500	-.6184	.5691	.9354	.6003	-.0174	.7170	.7064	.8002	-.5024	-.6033	.6217	.8533
.7000	-.5726	.5799	.9184	.6500	.0559	.7359	.6771	.8002	-.7524	-.3954	.6237	.8503
.7500	-.5050	.5966	.8923	.7000	.1638	.7618	.6361					
.8002	-.4179	.6181	.8589	.7501	.2550	.7843	.5998					
.9002	-.2064	.6703	.7785	.8001	.3339	.8034	.5677					
.9501	-.0776	.7022	.7295	.8501	.4043	.8212	.5383					

ORIGINAL PAGE IS
OF POOR QUALITY

TEST 167	PT 36.2290	PSI	CN	.7089	CD1 .00920	CDCOR1 .00900
RUN 47	TT 131.4407	K	CM	-.1374	CD2 .00917	CDCOR2 .00897
POINT 61	RC 14.9483	MILLION	CC	.0093	CD3 .00916	CDCOR3 .00902
	MACH .6994				CD4 .00900	CDCOR4 .00879
	ALPHA 1.5071	DEG			CD5 .00883	CDCOR5 .00857

UPPER SURFACE				LOWER SURFACE				SPANWISE				
X/C	CP	P/L/PT	MLOC	X/C	CP	P/L/PT	MLOC	X/C	Y/(B/2)	CP	P/L/PT	MLOC
0.0000	1.1210	.9981	.0524	0.0000	1.1210	.9981	.0524	.1507	.7476	-.8308	.5138	1.0244
.0132	-.6289	.5652	.9415	.0126	.6311	.8769	.4375	.1507	.4976	-.9548	.4846	1.0730
.0259	-1.0011	.4732	1.0925	.0255	.4383	.8292	.5245	.1507	.2476	-1.0720	.4556	1.1229
.0759	-1.2265	.4174	1.1915	.0495	.2458	.7816	.6042	.1507	-.2524	-1.0664	.4570	1.1205
.1003	-1.2143	.4205	1.1860	.0753	.1624	.7610	.6374	.1507	-.5024	-.9278	.4913	1.0618
.1507	-1.0702	.4561	1.1211	.1002	.0676	.7375	.6744	.1507	-.7524	-.7667	.5312	.9960
.2003	-.7327	.5396	.9425	.1503	-.0122	.7178	.7053	.5002	.4976	-.6536	.5591	.9512
.2503	-.7257	.5413	.9797	.1976	-.1052	.6948	.7409	.5002	.7476	-.6633	.5267	.9550
.3001	-.7322	.5397	.9823	.2503	-.1619	.6808	.7625	.5002	.2476	-.6689	.5553	.9572
.3502	-.7125	.5446	.9744	.3001	-.1989	.6716	.7765	.5002	-.2524	-.6564	.5584	.9523
.4003	-.4931	.5494	.9668	.3507	-.2243	.6653	.7862	.5002	-.5024	-.6506	.5584	.9524
.4501	-.6674	.5535	.9602	.4001	-.2260	.6649	.7869	.5002	-.7524	-.6428	.5618	.9470
.5002	-.6670	.5558	.9565	.4501	-.2153	.6675	.7828	.8002	.7476	-1.1267	.4421	1.1468
.5502	-.6616	.5572	.9543	.5001	-.1711	.6785	.7660	.8002	.4976	-.6151	.6181	.8589
.6002	-.6569	.5583	.9525	.5497	-.0917	.6981	.7357	.8002	.2476	-.4225	.6163	.8617
.6500	-.6302	.5649	.9420	.6003	-.0009	.7206	.7009	.8002	-.5024	-.4042	.6208	.8547
.7000	-.5827	.5768	.9233	.6500	.0732	.7389	.6723	.8002	-.7524	-.3963	.6228	.8517
.7500	-.5108	.5945	.8956	.7000	.1764	.7644	.6319					
.8002	-.4202	.6169	.8608	.7501	.2663	.7867	.5759					
.9002	-.2033	.6705	.7782	.8001	.3446	.8060	.5639					
.9501	-.0749	.7023	.7293	.8501	.4148	.8234	.5345					

TEST 167	PT 36.2317	PSI	CN	.7780	CD1 .01051	CDCOR1 .01026
RUN 48	TT 131.2375	K	CM	-.1350	CD2 .01052	CDCOR2 .01023
POINT 62	RC 15.0137	MILLION	CC	.0040	CD3 .01051	CDCOR3 .01018
	MACH .7016				CD4 .01019	CDCOR4 .00979
	ALPHA 2.0060	DEG			CD5 .00986	CDCOR5 .00939

UPPER SURFACE				LOWER SURFACE				SPANWISE				
X/C	CP	P/L/PT	MLOC	X/C	CP	P/L/PT	MLOC	X/C	Y/(B/2)	CP	P/L/PT	MLOC
0.0000	1.1020	.9934	.0972	0.0000	1.1020	.9934	.0972	.1507	.7476	-1.1669	.4327	1.1637
.0132	-.7360	.5392	.9831	.0126	.6953	.8929	.4056	.1507	.4976	-1.3285	.3928	1.2380
.0259	-1.1225	.4437	1.1440	.0255	.4989	.8444	.4977	.1507	.2476	-1.3024	.3992	1.2257
.0759	-1.3380	.3904	1.2423	.0495	.3030	.7960	.5807	.1507	-.2524	-1.3026	.3992	1.2258
.1003	-1.3369	.3907	1.2420	.0759	.2134	.7738	.6168	.1507	-.5024	-1.3296	.3925	1.2385
.1507	-1.2892	.4025	1.2195	.1002	.1173	.7501	.6547	.1507	-.7524	-1.1901	.4270	1.1741
.2003	-1.1547	.4357	1.1592	.1503	.0311	.7288	.6882	.5002	.7476	-.6749	.5543	.9589
.2503	-.7202	.5431	.9768	.1975	-.0647	.7051	.7249	.5002	.4976	-.6826	.5524	.9638
.3001	-.6736	.5546	.9584	.2503	-.1254	.6901	.7481	.5002	.2476	-.6874	.5512	.9619
.3502	-.6968	.5484	.9683	.3001	-.1653	.6802	.7633	.5002	-.2524	-.6755	.5541	.9591
.4003	-.7019	.5476	.9696	.3507	-.1940	.6731	.7742	.5002	-.5024	-.6773	.5537	.9599
.4501	-.6924	.5500	.9658	.4001	-.1993	.6718	.7762	.5002	-.7524	-.6640	.5570	.9546
.5002	-.6840	.5520	.9625	.4501	-.1924	.6735	.7736	.8002	.7476	-1.1398	.4394	1.1517
.5502	-.6772	.5537	.9598	.5001	-.1525	.6834	.7584	.8002	.4976	-.6203	.6172	.8603
.6002	-.6705	.5554	.9572	.5497	-.0772	.7020	.7297	.8002	.2476	-.4273	.6155	.8630
.6500	-.6405	.5628	.9454	.6003	.0103	.7236	.6962	.8002	-.5024	-.4094	.6199	.8561
.7000	-.5899	.5793	.9256	.6500	.0814	.7412	.5687	.8002	-.7524	-.4018	.6218	.8532
.7500	-.5157	.5936	.8969	.7000	.1823	.7661	.6291					
.8002	-.4236	.6164	.8615	.7501	.2708	.7880	.5935					
.9002	-.2046	.6705	.7782	.8001	.3479	.807	.5622					
.9501	-.0758	.7024	.7292	.8501	.4177	.8243	.5329					

TEST 167	PT 36.2267	PSI	CN	.8595	CD1 .01339	CDCOR1 .01301
RUN 48	TT 131.1944	K	CM	-.1322	CD2 .01344	CDCOR2 .01310
POINT 63	RC 15.0280	MILLION	CC	-.0006	CD3 .01315	CDCOR3 .01260
	MACH .7023				CD4 .01186	CDCOR4 .01148
	ALPHA 2.5152	DEG			CD5 .01113	CDCOR5 .01059

UPPER SURFACE				LOWER SURFACE				SPANWISE				
X/C	CP	P/L/PT	MLOC	X/C	CP	P/L/PT	MLOC	X/C	Y/(B/2)	CP	P/L/PT	MLOC
0.0000	1.0806	.9881	.1306	0.0000	1.0806	.9881	.1306	.1507	.7476	-1.2936	.4016	1.2212
.0132	-.8286	.5165	1.0200	.0126	.7550	.9077	.3746	.1507	.4976	-1.4432	.3646	1.2934
.0259	-1.2139	.4213	1.1445	.0255	.5588	.8592	.4708	.1507	.2476	-1.4132	.3720	1.2786
.0759	-1.4353	.3666	1.2095	.0495	.3588	.8098	.5575	.1507	-.2524	-1.4101	.3728	1.2770
.1003	-1.4348	.3666	1.2095	.0753	.2629	.7861	.5968	.1507	-.5024	-1.4359	.3664	1.2898
.1507	-1.4413	.3730	1.2727	.1002	.1637	.7621	.6355	.1507	-.7524	-1.2894	.4026	1.2192
.2003	-1.3539	.3867	1.2497	.1503	.0735	.7393	.6716	.5002	.7476	-.6733	.5548	.9580
.2503	-.9379	.3957	1.2324	.1976	-.0251	.7150	.7096	.5002	.4976	-.6745	.5545	.9585
.3001	-.9379	.3957	1.2324	.2503	-.0699	.6990	.7344	.5002	.2476	-.6724	.5551	.9577
.3502	-.6320	.5651	.9418	.3001	-.1328	.6884	.7507	.5002	-.2524	-.6654	.5568	.9549
.4003	-.6212	.5677	.9477	.3507	-.1641	.6806	.7627	.5002	-.5024	-.6757	.5542	.9540
.4501	-.6469	.5614	.9477	.4001	-.1730	.6784	.7660	.5002	-.7524	-.6702	.5556	.9568
.5002	-.6691	.5569	.9448	.4501	-.1698	.6792	.7648	.8002	.7476	-1.1436	.4387	1.1930
.5502	-.6713	.5553	.9472	.5001	-.1340	.6881	.7512	.8002	.4976	-.4226	.6168	.8609
.6002	-.6690	.5559	.9463	.5497	-.0622	.7058	.7238	.8002	.2476	-.4290	.6152	.8634
.6500	-.6413	.5627	.9455	.6003	.0224	.7267	.6913	.8002	-.5024	-.4133	.6191	.8574
.7000	-.5909	.5792	.9258	.6500	.0906	.7436	.6650	.8002	-.7524	-.4034	.6213	.8536
.7500	-.5162	.5936	.8969	.7000	.1497	.7689	.6261					
.8002	-.4240	.6164	.8615	.7501	.2770	.7896	.5911					
.9002	-.2062	.6702	.7782	.8001	.3534	.8085	.5598					
.9501	-.0759	.7024	.7292	.8501	.4227	.8256	.5307					

TEST 167	PT 36.2273	PSI	CN	.9464	CD1	.01862	CDCOR1	.01813
RUN 48	TT 131.2440	K	CM	-.1323	CD2	.01838	CDCOR2	.01787
POINT 64	RC 15.0216	MILLION	CC	-.0051	CD3	.01676	CDCOR3	.01622
	MACH .7024				CD4	.01500	CDCOR4	.01408
	ALPHA 3.0141	DEG			CD5	.01361	CDCOR5	.01291

UPPER SURFACE				LOWER SURFACE				SPANWISE				
X/C	CP	P/L/PT	MLOC	X/C	CP	P/L/PT	MLOC	X/C	Y/(B/2)	CP	P/L/PT	MLOC
0.0000	1.0440	.9788	.1752	0.0000	1.0440	.9788	.1752	.1507	.7476	-1.4364	.3633	1.2962
.0132	-.9230	.4907	1.0628	.0126	-.7982	.9178	.3523	.1507	.4976	-1.5252	.3413	1.3419
.0259	-1.2943	.3985	1.2269	.0255	-.6039	.8696	.4514	.1507	.2476	-1.4979	.3480	1.3276
.0759	-1.5171	.3433	1.3376	.0495	-.4041	.8200	.5403	.1507	-.2524	-1.4943	.3489	1.3257
.1003	-1.5159	.3436	1.3370	.0753	-.3045	.7753	.5818	.1507	-.5024	-1.5176	.3431	1.3378
.1507	-1.4857	.3511	1.3215	.1002	-.2048	.7706	.6220	.1507	-.7524	-1.3792	.3775	1.2678
.2003	-1.4449	.3612	1.3004	.1503	-.1094	.7469	.6597	.5002	.7476	-.6389	.5612	.9479
.2503	-1.4325	.3643	1.2942	.1976	-.0096	.7221	.6985	.5002	.4976	-.6177	.5665	.9396
.3001	-1.4410	.3621	1.2985	.2503	-.0577	.7054	.7244	.5002	.2476	-.6002	.5708	.9327
.3502	-1.1752	.4281	1.1720	.3001	-.1028	.6942	.7417	.5002	-.2524	-.5972	.5715	.9315
.4003	-.6816	.5306	.9648	.3507	-.1367	.6858	.7547	.5002	-.5024	-.6283	.5638	.9437
.4501	-.5814	.5755	.9254	.4001	-.1484	.6829	.7592	.5002	-.7524	-.6484	.5588	.9517
.5002	-.5916	.5731	.9291	.4501	-.1482	.6829	.7591	.8002	.7476	-1.1204	.4417	1.1475
.5502	-.6205	.5658	.9407	.5001	-.1160	.6910	.7468	.8002	.4976	-.4203	.6154	.8630
.6002	-.6390	.5612	.9480	.5497	-.0479	.7078	.7207	.8002	.2476	-.4273	.6137	.8657
.6500	-.6235	.5650	.9418	.6005	.0331	.7280	.6894	.8002	-.5024	-.4101	.6180	.8591
.7000	-.5818	.5754	.9255	.6500	.0987	.7442	.6639	.8002	-.7524	-.3969	.6212	.8541
.7500	-.5123	.5926	.8985	.7000	.1956	.7683	.6257					
.8002	-.4235	.6146	.8643	.7501	.2808	.7894	.5914					
.9002	-.2109	.6674	.7830	.8001	.3560	.8081	.5605					
.9501	-.0849	.6987	.7349	.8501	.4245	.8251	.5316					

TEST 167	PT 36.2223	PSI	CN	1.0216	CD1	.02557	CDCOR1	.02388
RUN 48	TT 131.1970	K	CM	-.1321	CD2	.02497	CDCOR2	.02343
POINT 65	RC 15.0241	MILLION	CC	-.0089	CD3	.02188	CDCOR3	.02110
	MACH .7622				CD4	.01957	CDCOR4	.01869
	ALPHA 3.5169	DEG			CD5	.01739	CDCOR5	.01626

UPPER SURFACE				LOWER SURFACE				SPANWISE				
X/C	CP	P/L/PT	MLOC	X/C	CP	P/L/PT	MLOC	X/C	Y/(B/2)	CP	P/L/PT	MLOC
0.0000	1.0140	.9715	.2036	0.0000	1.0140	.9715	.2036	.1507	.7476	-1.5409	.3387	1.3474
.0132	-1.0219	.4672	1.1028	.0126	-.8375	.9278	.3290	.1507	.4976	-1.5979	.3245	1.3780
.0259	-1.3662	.3819	1.2590	.0255	-.6456	.8802	.4309	.1507	.2476	-1.5720	.3310	1.3640
.0759	-1.5898	.3265	1.3736	.0495	-.4422	.8299	.5233	.1507	-.2524	-1.5719	.3310	1.3639
.1003	-1.5902	.3264	1.3738	.0753	-.3384	.8042	.5671	.1507	-.5024	-1.5921	.3260	1.3748
.1507	-1.5611	.3336	1.3581	.1002	-.2387	.7795	.6077	.1507	-.7524	-1.4916	.3509	1.3217
.2003	-1.5235	.3430	1.3382	.1503	-.1388	.7547	.6473	.5002	.7476	-.6137	.5683	.9366
.2503	-1.5114	.3460	1.3319	.1976	-.0368	.7295	.6871	.5002	.4976	-.5959	.5727	.9297
.3001	-1.5251	.3423	1.3396	.2503	-.0340	.7119	.7144	.5002	.2476	-.6002	.5717	.9314
.3502	-1.5103	.3462	1.3313	.3001	-.0815	.7001	.7326	.5002	-.2524	-.5933	.5734	.9287
.4003	-1.1690	.4308	1.1672	.3507	-.1179	.6911	.7465	.5002	-.5024	-.6018	.5713	.9320
.4501	-.7616	.5317	.9952	.4001	-.1326	.6875	.7521	.5002	-.7524	-.6303	.5642	.9431
.5002	-.8672	.5699	.9341	.4501	-.1358	.6867	.7533	.8002	.7476	-1.0840	.4518	1.1296
.5502	-.7616	.5812	.9163	.5001	-.1069	.6939	.7423	.8002	.4976	-.4127	.6181	.9589
.6002	-.5846	.5795	.9190	.5497	-.0417	.7100	.7173	.8002	.2476	-.4178	.6169	.8608
.6500	-.5701	.5791	.9196	.6003	.0371	.7295	.6870	.8002	-.5024	-.4053	.6200	.8561
.7000	-.5473	.5848	.9107	.6500	.1002	.7452	.6625	.8002	-.7524	-.3611	.6259	.8468
.7500	-.4908	.5981	.8889	.7000	.1956	.7688	.6249					
.8002	-.4105	.6187	.8581	.7501	.2801	.7897	.5904					
.9002	-.2682	.6683	.7809	.8001	.3548	.8082	.5602					
.9501	-.0843	.6995	.7337	.8501	.4231	.8251	.5315					

TEST	167	PT	47.0159	PSI	CN	-.0220	CD1	.00771	CDCOR1	.00764
RUN	41	TY	98.0797	K	CM	-.1288	CD2	.00759	CDCOR2	.00756
POINT	54	RC	29.9649	MILLION	CC	.0058	CD3	.00762	CDCOR3	.00763
		MACH	.7017				CD4	.00761	CDCOR4	.00758
		ALPHA	-3.9917	DEG			CD5	.00754	CDCOR5	.00740

UPPER SURFACE				LOWER SURFACE				SPANWISE				
X/C	CP	P/L/PT	MLOC	X/C	CP	P/L/PT	MLOC	X/C	Y/(B/2)	CP	P/L/PT	MLOC
0.0000	.6676	.8860	.4211	0.0000	.6676	.8860	.4211	.1507	.7476	-.1330	.6885	.7530
.0132	.6112	.8721	.4483	.0126	-.7797	.5290	1.0024	.1507	.4976	-.1400	.6868	.7557
.0259	.3002	.7954	.5837	.0255	-.7173	.5444	.9776	.1507	.2476	-.1414	.6864	.7562
.0759	-.0234	.7156	.7111	.0495	-.7484	.5367	.9899	.1507	-.2524	-.1467	.6851	.7583
.1003	-.0745	.7029	.7307	.0753	-.7128	.5455	.9758	.1507	-.5024	-.1533	.6835	.7607
.1507	-.1413	.6865	.7562	.1002	-.7296	.5413	.9824	.1507	-.7524	-.1456	.6819	.7578
.2003	-.1934	.6761	.7722	.1503	-.6726	.5554	.9999	.5002	.7476	-.3624	.6319	.8402
.2503	-.2279	.6651	.7891	.1976	-.7246	.5426	.9801	.5002	.4976	-.3672	.6307	.8421
.3001	-.2672	.6554	.8040	.2503	-.7025	.5480	.9717	.5002	.2476	-.3715	.6297	.8437
.3502	-.2895	.6499	.8125	.3001	-.6756	.5546	.9611	.5002	-.2524	-.3653	.6317	.8406
.4003	-.3133	.6440	.8216	.3507	-.6373	.5641	.9461	.5002	-.5024	-.3613	.6322	.8398
.4501	-.3332	.6391	.8291	.4001	-.5749	.5795	.9218	.5002	-.7524	-.3496	.6351	.8333
.5002	-.3691	.6303	.8428	.4501	-.5052	.5967	.8949	.8002	.7476	-.9812	.4793	1.0850
.5502	-.3988	.6230	.8541	.5001	-.4026	.6220	.8555	.8002	.4976	-.9319	.6345	.8362
.6002	-.4250	.6165	.8641	.5497	-.2742	.6537	.8067	.8002	.2476	-.9359	.6340	.8370
.6500	-.4419	.6123	.8706	.6003	-.1433	.6860	.7569	.8002	-.5024	-.9300	.6399	.8279
.7000	-.4343	.6142	.8677	.6500	-.0425	.7108	.7185	.8002	-.7524	-.9260	.6409	.8264
.7500	-.4044	.6215	.8563	.7000	.0855	.7424	.6491					
.8002	-.3496	.6351	.8354	.7501	.1907	.7644	.6277					
.9002	-.1944	.6734	.7764	.8001	.2767	.7896	.5932					
.9501	-.0813	.7013	.7333	.8501	.3481	.8072	.5639					

TFST	167	PT	47.0157	PSI	CN	.1145	CD1	.00759	CDCOR1	.00746
RUN	41	TT	98.1426	K	CM	-.1331	CD2	.00747	CDCOR2	.00738
POINT	55	RC	29.9435	MILLION	CC	.0140	CD3	.00752	CDCOR3	.00749
		MACH	.7020				CD4	.00747	CDCOR4	.00741
		ALPHA	-2.9938	DEG			CD5	.00744	CDCOR5	.00726

UPPER SURFACE				LOWER SURFACE				SPANWISE				
X/C	CP	P/L/PT	MLOC	X/C	CP	P/L/PT	MLOC	X/C	Y/(B/2)	CP	P/L/PT	MLOC
0.0000	.8432	.9294	.3263	0.0000	.8432	.9294	.3263	.1507	.7476	-.2413	.6620	.7938
.0132	.4443	.8311	.5231	.0126	-.4162	.6180	.8603	.1507	.4976	-.2491	.6601	.7968
.0259	.1216	.7515	.6547	.0255	-.4376	.6136	.8685	.1507	.2476	-.2510	.6596	.7975
.0759	-.1665	.6805	.7654	.0495	-.5004	.5981	.8926	.1507	-.2524	-.2571	.6581	.7998
.1003	-.2023	.6717	.7790	.0753	-.5032	.5970	.8944	.1507	-.5024	-.2621	.6565	.8017
.1507	-.2506	.6597	.7973	.1002	-.5446	.5873	.9096	.1507	-.7524	-.2532	.6551	.7984
.2003	-.2809	.6523	.8089	.1503	-.5287	.5912	.9035	.5002	.7476	-.4196	.6181	.8616
.2503	-.3139	.6441	.8214	.1976	-.5889	.5768	.9260	.5002	.4976	-.4250	.6167	.8637
.3001	-.3475	.6358	.8342	.2503	-.5867	.5769	.9259	.5002	.2476	-.4294	.6137	.8654
.3502	-.3631	.6320	.8401	.3001	-.5776	.5791	.9224	.5002	-.2524	-.4197	.6180	.8617
.4003	-.3811	.6276	.8469	.3507	-.5581	.5839	.9148	.5002	-.5024	-.4182	.6184	.8611
.4501	-.3952	.6241	.8523	.4001	-.5105	.5956	.8965	.5002	-.7524	-.4052	.6216	.8562
.5002	-.4269	.6163	.8644	.4501	-.4539	.6096	.8747	.8002	.7476	-1.0470	.4634	1.1122
.5502	-.4521	.6101	.8741	.5001	-.3825	.6322	.8399	.8002	.4976	-.9375	.6299	.8449
.6002	-.4734	.6048	.8822	.5497	-.2428	.6617	.7944	.8002	.2476	-.9357	.6354	.8348
.6500	-.4848	.6020	.8866	.6003	-.1186	.6923	.7472	.8002	-.5024	-.9492	.6362	.8336
.7000	-.4709	.6054	.8813	.6500	-.0241	.7156	.7111					
.7500	-.4333	.6147	.8669	.7000	.1019	.7466	.6824					
.8002	-.3714	.6300	.8432	.7501	.2060	.7723	.6214					
.9002	-.2042	.6712	.7797	.8001	.2922	.7936	.5867					
.9501	-.0863	.7002	.7349	.8501	.3654	.8116	.5565					

TFST	167	PT	47.0143	PSI	CN	.2542	CD1	.00751	CDCOR1	.00746
RUN	41	TT	98.1065	K	CM	-.1374	CD2	.00740	CDCOR2	.00738
POINT	56	RC	29.9426	MILLION	CC	.0192	CD3	.00749	CDCOR3	.00753
		MACH	.7014				CD4	.00739	CDCOR4	.00739
		ALPHA	-1.9958	DEG			CD5	.00736	CDCOR5	.00724

UPPER SURFACE				LOWER SURFACE				SPANWISE				
X/C	CP	P/L/PT	MLOC	X/C	CP	P/L/PT	MLOC	X/C	Y/(B/2)	CP	P/L/PT	MLOC
0.0000	.9953	.9671	.2201	0.0000	.9953	.9671	.2201	.1507	.7476	-.3639	.6324	.8394
.0132	.2384	.7807	.6078	.0126	-.0966	.6982	.7380	.1507	.4976	-.3739	.6300	.8432
.0259	-.0984	.6976	.7391	.0255	-.1800	.5777	.7697	.1507	.2476	-.3778	.6290	.8447
.0759	-.3397	.6384	.8302	.0495	-.2548	.6519	.8094	.1507	-.2524	-.3844	.6274	.8472
.1003	-.3535	.6350	.8355	.0753	-.3213	.6429	.8233	.1507	-.5024	-.3879	.6265	.8485
.1507	-.3771	.6292	.8445	.1002	-.3785	.6288	.8450	.1507	-.7524	-.3764	.6294	.8442
.2003	-.3898	.6281	.8493	.1503	-.3942	.6250	.8510	.5002	.7476	-.4817	.6034	.8844
.2503	-.4125	.6205	.8579	.1976	-.4614	.6084	.8766	.5002	.4976	-.4875	.6020	.8866
.3001	-.4370	.6144	.8673	.2503	-.4782	.6043	.8830	.5002	.2476	-.4919	.6009	.8883
.3502	-.4448	.6125	.8702	.3001	-.4838	.6029	.8831	.5002	-.2524	-.4804	.6038	.8839
.4003	-.4558	.6098	.8745	.3507	-.4778	.6044	.8829	.5002	-.5024	-.4796	.6040	.8835
.4501	-.4635	.6079	.8774	.4001	-.4443	.6127	.8700	.5002	-.7524	-.4656	.6074	.8782
.5002	-.4884	.6018	.8869	.4501	-.4018	.6231	.8538	.8002	.7476	-1.1032	.4504	1.1349
.5502	-.5073	.5966	.8949	.5001	-.3216	.6429	.8234	.8002	.4976	-.9349	.6248	.8512
.6002	-.5257	.5926	.9012	.5497	-.2112	.6700	.7815	.8002	.2476	-.9381	.6240	.8524
.6500	-.5287	.5916	.9028	.6003	-.0935	.6990	.7368	.8002	-.5024	-.9695	.6311	.8416
.7000	-.5083	.5969	.8946	.6500	-.0047	.7209	.7029	.8002	-.7524	-.9659	.6319	.8402
.7500	-.4623	.6082	.8769	.7000	.1186	.7512	.6591					
.8002	-.3937	.6251	.8508	.7501	.2203	.7763	.6130					
.9002	-.2139	.6694	.7825	.8001	.3060	.7974	.5804					
.9501	-.0916	.6995	.7361	.8501	.3801	.8156	.5498					

ORIGINAL
OF FILE

TEST 167	PT 47.0138	PSI	CM	.3212	CD1	.00748	CDCDR1	.00741
RUN 41	TT 98.1060	K	CM	-.1392	CD2	.00740	CDCDR2	.00736
POINT 58	RC 29.9470	MILLION	CC	.0202	CD3	.00747	CDCDR3	.00748
	MACH .7016				CD4	.00738	CDCDR4	.00735
	ALPHA -1.5071	DEG			CD5	.00731	CDCDR5	.00716

UPPER SURFACE				LOWER SURFACE				SPANWISE				
X/C	CP	P/L/P/T	MLOC	X/C	CP	P/L/P/T	MLOC	X/C	Y/(B/2)	CP	P/L/P/T	MLOC
0.0000	1.0465	.9746	.1727	0.0000	1.0465	.9796	.1727	.1507	.7476	-.4275	.6161	.8647
.0132	.1272	.7529	.6525	.0126	.0386	.7310	.6870	.1507	.4976	-.4384	.6134	.8688
.0259	-.2158	.6683	.7841	.0255	-.0680	.7047	.7279	.1507	.2476	-.4426	.6124	.8704
.0759	-.4310	.6152	.8660	.0795	-.1907	.6749	.7746	.1507	-.2524	-.4496	.6107	.8731
.1003	-.4318	.6151	.8663	.0753	-.2399	.6624	.7933	.1507	-.5024	-.4528	.6099	.8744
.1507	-.4415	.6127	.8706	.1002	-.3034	.6467	.8174	.1507	-.7524	-.4409	.6128	.8698
.2003	-.4437	.6121	.8709	.1503	-.3315	.6398	.8281	.5002	.4976	-.5110	.5955	.8967
.2503	-.44608	.6079	.8774	.1976	-.4033	.6221	.8555	.5002	.4976	-.5153	.5942	.8987
.3001	-.44808	.6030	.8851	.2503	-.4267	.6163	.8644	.5002	.2476	-.5207	.5931	.9004
.3502	-.44844	.6021	.8865	.3001	-.4384	.6134	.8688	.5002	-.2524	-.5084	.5952	.8957
.4003	-.44912	.6004	.8891	.3507	-.4384	.6134	.8688	.5002	-.5024	-.5076	.5964	.8954
.4501	-.44956	.5993	.8908	.4001	-.4104	.6203	.8582	.5002	-.7524	-.4928	.6000	.8897
.5002	-.45170	.5940	.8990	.4501	-.3733	.6295	.8440	.8002	.4976	-1.1249	.4442	1.1460
.5502	-.45349	.5896	.9059	.5001	-.2985	.6479	.8156	.8002	.4976	-.4020	.6224	.8549
.6002	-.45488	.5862	.9113	.5497	-.1928	.6740	.7754	.8002	.2476	-.4058	.6215	.8564
.6500	-.45491	.5861	.9114	.6003	-.0789	.7021	.7321	.8002	-.5024	-.3758	.6289	.8450
.7000	-.45240	.5923	.9017	.6500	.0065	.7231	.6993	.8002	-.7524	-.3725	.6297	.8437
.7500	-.4743	.6046	.8826	.7000	.1279	.7531	.6522					
.8002	-.4019	.6224	.8549	.7501	.2283	.7778	.6125					
.9002	-.2159	.6683	.7342	.8001	.3133	.7988	.5781					
.9501	-.0911	.6991	.7367	.8501	.3872	.8170	.5474					

TEST 167	PT 47.0171	PSI	CM	.3901	CD1	.00754	CDCDR1	.00744
RUN 41	Ti 98.6786	K	CM	-.1407	CD2	.00746	CDCDR2	.00739
POINT 59	RC 29.9544	MILLION	CC	.0204	CD3	.00751	CDCDR3	.00750
	MACH .7013				CD4	.00738	CDCDR4	.00731
	ALPHA -.9979	DEG			CD5	.00739	CDCDR5	.00721

UPPER SURFACE				LOWER SURFACE				SPANWISE				
X/C	CP	P/L/P/T	MLOC	X/C	CP	P/L/P/T	MLOC	X/C	Y/(B/2)	CP	P/L/P/T	MLOC
0.0000	1.0862	.9895	.1236	0.0000	1.0862	.9895	.1236	.1507	.7476	-.4959	.6001	.8895
.0132	.0023	.7227	.7000	.0126	.1666	.7631	.6361	.1507	.4976	-.5071	.5975	.8938
.0259	-.3464	.6369	.8325	.0255	-.0387	.7317	.6860	.1507	.2476	-.5122	.5961	.8958
.0759	-.5525	.5911	.9036	.0495	-.0982	.6980	.7384	.1507	-.2524	-.5185	.5946	.8982
.1003	-.5179	.5947	.8780	.0753	-.1599	.6828	.7618	.1507	-.5024	-.5201	.5941	.8988
.1507	-.5112	.5963	.8954	.1002	-.2299	.6656	.7884	.1507	-.7524	-.5052	.5976	.8931
.2003	-.5002	.5990	.8912	.1503	-.2690	.6559	.8032	.5002	.4976	-.5387	.5896	.9060
.2503	-.5111	.5964	.8954	.1976	-.3450	.6373	.8320	.5002	.4976	-.5443	.5882	.9081
.3001	-.5260	.5927	.9011	.2503	-.3746	.6300	.8432	.5002	.2476	-.5488	.5871	.9098
.3502	-.5258	.5928	.9010	.3001	-.3911	.6259	.8495	.5002	-.2524	-.5349	.5905	.9045
.4003	-.5275	.5923	.9017	.3507	-.3963	.6246	.8515	.5002	-.5024	-.5348	.5905	.9045
.4501	-.5279	.5922	.9018	.4001	-.3745	.6300	.8432	.5002	-.7524	-.5190	.5944	.8984
.5002	-.5455	.5879	.9086	.4501	-.3438	.6375	.8316	.8002	.4976	-1.1415	.4412	1.1512
.5502	-.5600	.5843	.9142	.5001	-.2744	.6546	.8052	.8002	.4976	-.4088	.6215	.8563
.6002	-.5705	.5818	.9182	.5497	-.1737	.6794	.7671	.8002	.2476	-.4132	.6205	.8579
.6500	-.5668	.5827	.9168	.6003	-.0641	.7064	.7254	.8002	-.5024	-.3820	.6281	.8461
.7000	-.5380	.5897	.9057	.6500	.0179	.7266	.6940	.8002	-.7524	-.3781	.6291	.8446
.7500	-.4850	.6028	.8854	.7000	.1372	.7559	.6477					
.8002	-.4096	.6214	.8566	.7501	.2361	.7803	.6085					
.9002	-.2183	.6684	.7840	.8001	.3202	.8010	.5744					
.9501	-.0924	.6994	.7362	.8501	.3942	.8192	.5437					

TEST 167	PT 47.0147	PSI	CM	.4572	CD1	.00758	CDCDR1	.00745
RUN 41	TT 98.0669	K	CM	-.1416	CD2	.00755	CDCDR2	.00746
POINT 60	RC 29.9359	MILLION	CC	.0197	CD3	.00761	CDCDR3	.00756
	MACH .7005				CD4	.00743	CDCDR4	.00734
	ALPHA -.4888	DEG			CD5	.00744	CDCDR5	.00725

UPPER SURFACE				LOWER SURFACE				SPANWISE				
X/C	CP	P/L/P/T	MLOC	X/C	CP	P/L/P/T	MLOC	X/C	Y/(B/2)	CP	P/L/P/T	MLOC
0.0000	1.1119	.9959	.0767	0.0000	1.1119	.9959	.0767	.1507	.7476	-.5666	.5839	.9148
.0132	-.1296	.6712	.7489	.0126	.2836	.7922	.5883	.1507	.4976	-.5797	.5807	.9199
.0259	-.4462	.6037	.8840	.0255	-.1379	.7568	.6442	.1507	.2476	-.5861	.5792	.9223
.0759	-.6430	.5652	.9444	.0495	-.0121	.7200	.7641	.1507	-.2524	-.5929	.5775	.9249
.1003	-.6099	.5733	.9315	.0753	-.0848	.7022	.7319	.1507	-.5024	-.5931	.5774	.9250
.1507	-.5847	.5795	.9218	.1002	-.1613	.6834	.7639	.1507	-.7524	-.5758	.5817	.9183
.2003	-.5597	.5856	.9122	.1503	-.2099	.6715	.7793	.5002	.4976	-.5671	.5838	.9150
.2503	-.5631	.5848	.9135	.1976	-.2905	.6517	.8097	.5002	.4976	-.5727	.5825	.9171
.3001	-.5723	.5825	.9170	.2503	-.3264	.6429	.8233	.5002	.2476	-.5771	.5814	.9189
.3502	-.5659	.5841	.9145	.3001	-.3477	.6377	.8314	.5002	-.2524	-.5633	.5847	.9136
.4003	-.5632	.5848	.9135	.3507	-.3582	.6351	.8394	.5002	-.5024	-.5629	.5849	.9134
.4501	-.5599	.5856	.9122	.4001	-.3414	.6392	.8290	.5002	-.7524	-.5470	.5886	.9073
.5002	-.5729	.5824	.9172	.4501	-.3152	.6437	.8191	.9002	.4976	-1.1592	.4385	1.1561
.5502	-.5639	.5797	.9215	.5001	-.2518	.6612	.7991	.8002	.4976	-.4144	.6213	.8507
.6002	-.5914	.5778	.9244	.5497	-.1561	.6847	.7591	.8002	.2476	-.4187	.6202	.8583
.6500	-.5835	.5798	.9213	.6003	-.0505	.7106	.7188	.8002	-.5024	-.3871	.6280	.8463
.7000	-.5510	.5878	.9048	.6500	.0288	.7311	.6885	.8002	-.7524	-.3851	.6285	.8455
.7500	-.4939	.6018	.8869	.7000	.1457	.7588	.6431					
.8002	-.4154	.6210	.8570	.7501	.2429	.7826	.6046					
.9002	-.2195	.6691	.7829	.8001	.3263	.8031	.5709					
.9501	-.0918	.7005	.7345	.8501	.3799	.8212	.5403					

TEST	167	PT	47.0132	PSI	CN	.5204	CD1	.00768	CDCOR1	.00751
RUN	41	TT	98.1236	K	CM	-1.1416	CD2	.00763	CDCOR2	.00750
POINT	61	RC	29.9139	MILLION	CC	.0180	CD3	.00769	CDCOR3	.00761
		MACH	.7007				CD4	.00753	CDCOR4	.00739
		ALPHA	.0102	DEG			CD5	.00752	CDCOR5	.00734

UPPER SURFACE				LOWER SURFACE				SPANWISE				
X/C	CP	P ₂ L/PT	MLOC	X/C	CP	P ₂ L/PT	MLOC	X/C	Y/(B/2)	CP	P ₂ L/PT	MLOC
0.0000	1.1239	.9989	.0395	0.0000	1.1239	.9989	.0395	.1507	.7476	-.6369	.5671	.9413
.0132	-.2651	.6583	.7995	.0126	.3894	.8188	.5443	.1507	.4976	-.6521	.5634	.9471
.0259	-.6309	.5686	.9389	.0255	.2285	.7794	.6100	.1507	.2476	-.6599	.5616	.9500
.0759	-.7612	.5367	.9899	.0495	.0670	.7398	.6732	.1507	-.2524	-.6652	.5602	.9523
.1003	-.7033	.5509	.9671	.0753	-.0158	.7195	.7050	.1507	-.5024	-.6628	.5608	.9513
.1507	-.6570	.5622	.9491	.1002	-.0961	.6998	.7356	.1507	-.7524	-.6428	.5657	.9435
.2003	-.6138	.5728	.9323	.1507	-.1540	.6356	.7575	.5002	.7476	-.5916	.5783	.9237
.2503	-.6121	.5732	.9316	.1976	-.2384	.6649	.7895	.5002	.4976	-.5968	.5770	.9257
.3001	-.6152	.5725	.9328	.2503	-.2799	.6547	.8051	.5002	.2476	-.6012	.5759	.9274
.3502	-.6000	.5767	.9270	.3001	-.3057	.6484	.8148	.5002	-.2524	-.5890	.5789	.9227
.4003	-.5942	.5776	.9247	.3507	-.3204	.6448	.8204	.5002	-.5024	-.5891	.5789	.9228
.4501	-.5874	.5793	.9222	.4001	-.33084	.6477	.8159	.5002	-.7524	-.5720	.5831	.9162
.5002	-.5965	.5770	.9256	.4501	-.2872	.6529	.8079	.8002	.7476	-1.1671	.4371	1.1585
.5502	-.6040	.5752	.9285	.5001	-.2288	.6672	.7858	.8002	.4976	-.4177	.6209	.8573
.6002	-.6080	.5742	.9300	.5497	-.1380	.6895	.7515	.8002	.2476	-.4227	.6197	.8592
.6500	-.5963	.5771	.9255	.6003	-.0364	.7144	.7129	.8002	-.5024	-.3923	.6271	.8476
.7000	-.5601	.5860	.9116	.6500	.0393	.7330	.6839	.8002	-.7524	-.3898	.6277	.8467
.7500	-.4998	.6008	.8885	.7000	.7000	.7611	.6394					
.8002	-.4187	.6207	.8576	.7501	.2497	.7846	.6015					
.9002	-.2162	.6698	.7818	.8001	.3321	.8048	.5681					
.9501	-.0889	.7015	.7329	.8501	.4053	.8227	.5376					

TEST	167	PT	47.0094	PSI	CN	.5906	CD1	.00783	CDCOR1	.00773
RUN	41	TT	98.0494	K	CM	-1.1430	CD2	.00779	CDCOR2	.00773
POINT	62	RC	29.9433	MILLION	CC	.0157	CD3	.00781	CDCOR3	.00780
		MACH	.7007				CD4	.00762	CDCOR4	.00756
		ALPHA	.5091	DEG			CD5	.00760	CDCOR5	.00741

UPPER SURFACE				LOWER SURFACE				SPANWISE				
X/C	CP	P ₂ L/PT	MLOC	X/C	CP	P ₂ L/PT	MLOC	X/C	Y/(B/2)	CP	P ₂ L/PT	MLOC
0.0000	1.1264	.9997	.0205	0.0000	1.1264	.9997	.0205	.1507	.7476	-.7168	.5494	.9695
.0132	-.3997	.6769	.8480	.0126	.4835	.8426	.5027	.1507	.4976	-.7326	.5455	.9757
.0259	-.7808	.5338	.9947	.0255	.3102	.8003	.5755	.1507	.2476	-.7418	.5433	.9793
.0759	-.9197	.4998	1.0503	.0495	.1409	.7590	.6428	.1507	-.2524	-.7443	.5427	.9803
.1003	-.8011	.5288	1.0027	.0753	.0495	.7366	.6782	.1507	-.5024	-.7390	.5440	.9777
.1507	-.7342	.5442	.9779	.1002	-.0363	.7157	.7110	.1507	-.7524	-.7187	.5489	.9703
.2003	-.6884	.5563	.9584	.1503	-.1019	.6996	.7358	.5002	.7476	-.6217	.5726	.9326
.2503	-.6683	.5612	.9506	.1976	-.1902	.6781	.7691	.5002	.4976	-.6275	.5712	.9348
.3001	-.6651	.5620	.9494	.2503	-.2367	.6667	.7867	.5002	.2476	-.6321	.5701	.9366
.3502	-.6474	.5664	.9425	.3001	-.2669	.6593	.7980	.5002	-.2524	-.6171	.5737	.9308
.4003	-.6344	.5695	.9375	.3507	-.2853	.6548	.8049	.5002	-.5024	-.6181	.5735	.9312
.4501	-.6224	.5725	.9329	.4001	-.2780	.6566	.8022	.5002	-.7524	-.6007	.5778	.9245
.5002	-.6271	.5713	.9347	.4501	-.2613	.6607	.7959	.8002	.7476	-1.1788	.4365	1.1596
.5502	-.6307	.5704	.9361	.5001	-.2075	.6738	.7757	.8002	.4976	-.4250	.6207	.8576
.6002	-.6316	.5702	.9364	.5497	-.1277	.6950	.7430	.8002	.2476	-.4306	.6193	.8597
.6500	-.6154	.5742	.9302	.6003	-.0225	.7190	.7057	.8002	-.5024	-.3986	.6271	.8476
.7000	-.5754	.5839	.9148	.6500	.0503	.7368	.6779	.8002	-.7524	-.3969	.6276	.8470
.7500	-.5113	.5996	.8903	.7000	.1631	.7644	.6342					
.8002	-.4270	.6202	.8584	.7501	.2574	.7874	.5968					
.9002	-.2713	.6705	.7808	.8001	.3391	.8074	.5637					
.9501	-.0900	.7025	.7313	.8501	.4121	.8252	.5333					

TEST	167	PT	47.0062	PSI	CN	.6562	CD1	.00800	CDCOR1	.00783
RUN	41	TT	98.0299	K	CM	-1.1427	CD2	.00798	CDCOR2	.00786
POINT	63	RC	29.9423	MILLION	CC	.0126	CD3	.00803	CDCOR3	.00798
		MACH	.7003				CD4	.00783	CDCOR4	.00770
		ALPHA	.9979	DEG			CD5	.00785	CDCOR5	.00769

UPPER SURFACE				LOWER SURFACE				SPANWISE				
X/C	CP	P ₂ L/PT	MLOC	X/C	CP	P ₂ L/PT	MLOC	X/C	Y/(B/2)	CP	P ₂ L/PT	MLOC
0.0000	1.1200	.9978	.0559	0.0000	1.1200	.9978	.0559	.1507	.7476	-.7912	.5279	1.0041
.0132	-.5145	.5960	.8960	.0126	.5572	.8595	.4721	.1507	.4976	-.7781	.5311	.9949
.0259	-.9088	.4990	1.0517	.0255	.3763	.8130	.5508	.1507	.2476	-.7814	.5304	.9904
.0759	-1.1154	.4482	1.1388	.0495	.1997	.7715	.6228	.1507	-.2524	-.7764	.5316	.9982
.1003	-1.0666	.4597	1.1186	.0753	.1015	.7474	.6612	.1507	-.5024	-.7567	.5340	.9943
.1507	-.7767	.5315	.9983	.1002	.0116	.7293	.6959	.1507	-.7524	-.7822	.5301	1.0005
.2003	-.7327	.5423	.9909	.1503	-.0609	.7075	.7237	.5002	.7476	-.6540	.5617	.9499
.2503	-.7237	.5445	.9773	.1976	-.1525	.6890	.7585	.5002	.4976	-.6609	.5600	.9527
.3001	-.7173	.5461	.9748	.2503	-.2037	.6724	.7779	.5002	.2476	-.6655	.5518	.9545
.3502	-.6914	.5525	.9646	.3001	-.2373	.6641	.7906	.5002	-.2524	-.6516	.5622	.9490
.4003	-.6759	.5563	.9585	.3507	-.2590	.6588	.7989	.5002	-.5024	-.6526	.5620	.9454
.4501	-.6600	.5602	.9523	.4001	-.2558	.6596	.7976	.5002	-.7524	-.6351	.5663	.9426
.5002	-.6609	.5600	.9527	.4501	-.2434	.6626	.7929	.8002	.7476	-1.1855	.4310	1.1796
.5502	-.6607	.5600	.9526	.5001	-.1938	.6748	.7742	.8002	.4976	-.4334	.6199	.8596
.6002	-.6581	.5626	.9516	.5497	-.1106	.6933	.7420	.8002	.2476	-.4398	.6143	.8675
.6500	-.6370	.5658	.9433	.6003	-.0160	.7185	.7065	.8002	-.5024	-.4090	.6219	.8557
.7000	-.5924	.5768	.9260	.6500	.0547	.7359	.6793	.8002	-.7524	-.4073	.6223	.8551
.7500	-.5742	.5936	.8997	.7000	.1653	.7631	.6362					
.8002	-.4365	.6151	.8662	.7501	.2579	.7859	.5994					
.9002	-.2752	.6671	.7861	.8001	.3388	.8058	.5664					
.9501	-.0936	.6994	.7361	.8501	.4112	.8236	.5361					

CR
OF

TEST 167	PT 47.0093	PSI	CM .7272	CD1 .00860	CDCOR1 .00839
RUN 41	TT 97.9985	K	CM -.1414	CD2 .00864	CDCOR2 .00842
POINT 64	RC 29.9618	MILLION	CC .0085	CD3 .00872	CDCOR3 .00850
	MACH .7004			CD4 .00851	CDCOR4 .00829
	ALPHA 1.5071	DEG		CD5 .00847	CDCOR5 .00823

UPPER SURFACE				LOWER SURFACE				SPANWISE				
X/C	CP	P _L /PT	MLOC	X/C	CP	P _L /PT	MLOC	X/C	Y/(B/2)	CP	P _L /PT	MLOC
0.0000	1.1167	.9973	.0620	0.0000	1.1167	.9973	.0620	.1507	.7476	-.8340	.5206	1.0161
.0132	-.6272	.5711	.9350	.0126	.6389	.8805	.4320	.1507	.4976	-1.0092	.4778	1.0875
.0259	-1.0443	.4692	1.1022	.0255	.4527	.8350	.5162	.1507	.2476	-1.1142	.4521	1.1319
.0759	-1.2446	.4193	1.1909	.0495	.2703	.7905	.5918	.1507	-.2524	-1.1207	.4505	1.1347
.1003	-1.2375	.4220	1.1860	.0753	.1663	.7650	.6331	.1507	-.5024	-1.0218	.4747	1.0928
.1507	-1.1076	.4537	1.1291	.1002	.0732	.7423	.6693	.1507	-.7524	-.8220	.5235	1.0113
.2003	-.7271	.5467	.9738	.1503	-.0057	.7230	.6995	.5002	.7476	-.6676	.5612	.9506
.2503	-.7224	.5479	.9720	.1976	-1.0000	.7000	.7353	.5002	.4976	-.6751	.5594	.9535
.3001	-.7389	.5438	.9784	.2503	-.1552	.6865	.7562	.5002	.2476	-.6796	.5583	.9553
.3502	-.7166	.5443	.9697	.3001	-.1921	.6775	.7701	.5002	-.2524	-.6649	.5619	.9496
.4003	-.6976	.5519	.9623	.3507	-.2173	.6713	.7796	.5002	-.5024	-.6658	.5617	.9499
.4501	-.6783	.5586	.9547	.4001	-.2177	.6712	.7797	.5002	-.7524	-.6479	.5661	.9430
.5002	-.6751	.5594	.9535	.4501	-.2089	.6733	.7764	.8002	.7476	-1.1846	.4349	1.1625
.5502	-.6716	.5603	.9522	.5001	-.1641	.6843	.7595	.8002	.4976	-.4302	.6193	.8598
.6002	-.6660	.5616	.9500	.5497	-.0853	.7036	.7298	.8002	.2476	-.4362	.6178	.8620
.6500	-.6611	.5677	.9403	.6003	.0056	.7258	.6952	.8002	-.5024	-.4043	.6256	.8500
.7000	-.5935	.5794	.9120	.6500	.0732	.7423	.6692	.8002	-.7524	-.4077	.6260	.8494
.7500	-.5226	.5967	.8949	.7000	.1813	.7687	.6272					
.8002	-.4328	.6186	.8698	.7501	.2724	.7910	.5909					
.9002	-.2181	.6711	.7799	.8001	.3520	.8104	.5585					
.9501	-.0963	.7033	.7301	.8501	.4238	.8260	.5285					

TEST 167	PT 46.9994	PSI	CM .6791	CD1 .01322	CDCOR1 .01277
RUN 41	TT 97.9749	K	CM -.1368	CD2 .01321	CDCOR2 .01283
POINT 65	RC 29.9641	MILLION	CC -.0003	CD3 .01287	CDCOR3 .01252
	MACH .7003			CD4 .01157	CDCOR4 .01121
	ALPHA 2.5233	DEG		CD5 .01104	CDCOR5 .01053

UPPER SURFACE				LOWER SURFACE				SPANWISE				
X/C	CP	P _L /PT	MLOC	X/C	CP	P _L /PT	MLOC	X/C	Y/(B/2)	CP	P _L /PT	MLOC
0.0000	1.0593	.9829	.1578	0.0000	1.0593	.9829	.1578	.1507	.7476	-1.4074	.3765	1.2725
.0132	-.8220	.5204	1.0164	.0126	.7518	.9073	.3769	.1507	.4976	-1.4537	.3651	1.2952
.0259	-1.2458	.4162	1.1966	.0255	.5618	.8606	.4700	.1507	.2476	-1.4337	.3700	1.2853
.0759	-1.4994	.3637	1.2980	.0495	.3735	.8143	.5520	.1507	-.2524	-1.4321	.3704	1.2845
.1003	-1.4563	.3649	1.2964	.0753	.2604	.7865	.5983	.1507	-.5024	-1.4556	.3646	1.2961
.1507	-1.4169	.3741	1.2771	.1002	.1624	.7624	.6374	.1507	-.7524	-1.3473	.3913	1.2436
.2003	-1.3461	.3915	1.2431	.1503	.0735	.7406	.6720	.5002	.7476	-.6871	.5536	.9629
.2503	-1.3384	.3934	1.2395	.1976	-.0248	.7164	.7099	.5002	.4976	-.6857	.5539	.9623
.3001	-1.0119	.4737	1.0945	.2503	-.0873	.7010	.7337	.5002	.2476	-.6815	.5549	.9607
.3502	-.6617	.5599	.9529	.3001	-.1294	.6907	.7497	.5002	-.2524	-.6701	.5577	.9622
.4003	-.6210	.5698	.9371	.3507	-.1611	.6829	.7617	.5002	-.5024	-.6814	.5550	.9606
.4501	-.6476	.5633	.9474	.4001	-.1683	.6811	.7645	.5002	-.7524	-.6718	.5573	.9569
.5002	-.6751	.5565	.95A2	.4501	-.1675	.6813	.7642	.8002	.7476	-1.1853	.4311	1.1694
.5502	-.6854	.5540	.9622	.5001	-.1302	.6905	.7500	.8002	.4976	-.4399	.6143	.8674
.6002	-.6841	.5543	.9617	.5497	-.0604	.7076	.7235	.8002	.2476	-.4469	.6128	.8698
.6500	-.6377	.5668	.9514	.6003	.0238	.7283	.6912	.8002	-.5024	-.4153	.6204	.8581
.7000	-.6077	.5731	.9319	.6500	.0854	.7435	.6674	.8002	-.7524	-.4112	.6214	.8565
.7500	-.5341	.5912	.9035	.7000	.1849	.7689	.6269					
.8002	-.4428	.6136	.8686	.7501	.2765	.7905	.5918					
.9002	-.2270	.6667	.7767	.8001	.3534	.8034	.5604					
.9501	-.0979	.6984	.7378	.8501	.4235	.8266	.5309					

Appendix E

Pressure Data for $M = 0.72$; $R = 7.0 \times 10^6$ and 30.0×10^6 ; Free Transition

The pressure measurements made on the NASA SC(3)-0712(B) airfoil are presented in coefficient form in graphs and tables in this appendix. The data are for a given Mach number through the Reynolds number range. The pressure data from the upper surface of the airfoil are plotted as open symbols, and the lower-surface data are plotted as solid symbols.

TEST	167	PT	22.2467	PSI	CM	-0.0523	CD1	.00953	CDCOR1	.00939
RUN	54	TY	160.1956	K	CM	-1.1225	CD2	.00874	CDCOL2	.00865
POINT	43	RC	7.0354	MILLION	CC	.0032	CD3	.00784	CDCOR3	.00778
		MACH	.7212				CD4	.00730	CDCOR4	.00720
		ALPHA	-3.9815	DEG			CD5	.00779	CDCOR5	.00763

UPPER SURFACE				LOWER SURFACE				SPANWISE				
X/C	CP	P _z /PT	MLOC	X/C	CP	P _z /PT	MLOC	X/C	V/(B/2)	CP	P _z /PT	MLOC
0.0000	.6781	.8821	.4271	0.0000	.6781	.8821	.4271	.1507	.7476	-1.332	.6734	.7732
.013	.6230	.8679	.4543	.0126	-.8199	.4967	1.0519	.1507	.4976	-1.320	.6737	.7728
.0259	.3037	.7838	.5970	.0255	-.7333	.5190	1.0131	.1567	.2476	-1.327	.6735	.7730
.0759	-.0170	.7033	.7272	.0495	-.9338	.4932	1.0579	.1507	-.2524	-1.550	.6678	.7819
.1003	-.0610	.6920	.7447	.0753	-.7536	.5138	1.0237	.1507	-.5024	-1.396	.6717	.7758
.1507	-.1222	.6736	.7729	.1002	-.7618	.5117	1.0271	.1507	-.7524	-1.513	.6687	.7804
.2003	-.1717	.6630	.7893	.1503	-.6880	.5307	.9961	.5002	.7476	-1.338	.6166	.8604
.2503	-.2219	.6506	.8083	.1976	-.7594	.5123	1.0261	.5002	.4976	-1.3613	.6147	.8636
.3001	-.2585	.6412	.8228	.2503	-.7518	.5143	1.0229	.5002	.2476	-1.3667	.6133	.8657
.3502	-.2842	.6344	.8329	.3001	-.7141	.5240	1.0070	.5002	-.2524	-1.3599	.6151	.8630
.4003	-.3112	.6276	.8437	.3507	-.6665	.5362	.9872	.5002	-.5024	-1.3554	.6162	.8612
.4501	-.3370	.6210	.8539	.4001	-.5977	.5539	.9588	.5002	-.7524	-1.3420	.6197	.8559
.5002	-.3643	.6140	.8647	.4501	-.5164	.5748	.9257	.8002	.7476	-1.3326	.6221	.8521
.5502	-.3932	.6065	.8762	.5001	-.4092	.6024	.8827	.8002	.4976	-1.3383	.6206	.8545
.6002	-.4226	.5989	.8880	.5497	-.2761	.6366	.8298	.8002	.2476	-1.3439	.6192	.8566
.6500	-.4385	.5949	.8944	.6003	-.1447	.6704	.7778	.8002	-.5024	-1.3315	.6224	.8517
.7000	-.4306	.5969	.8912	.6500	-.0319	.6994	.7332	.8002	-.7524	-1.3134	.6271	.8445
.7500	-.3988	.6051	.8785	.7000	.0825	.7289	.6875					
.8002	-.3402	.6201	.8552	.7501	.1792	.7537	.6484					
.8502	-.1736	.6630	.7892	.8001	.2561	.7735	.6168					
.9501	-.0546	.6936	.7421	.8501	.3198	.7899	.5902					

TEST	167	PT	22.2461	PSI	CM	.0836	CD1	.00918	CDCOR1	.00914
RUN	54	TY	160.2105	K	CM	-1.1268	CD2	.00837	CDCOR2	.00833
POINT	44	RC	7.0348	MILLION	CC	.0112	CD3	.00819	CDCOR3	.00818
		MACH	.7213				CD4	.00751	CDCOR4	.00748
		ALPHA	-2.9938	DEG			CD5	.00694	CDCOR5	.00681

UPPER SURFACE				LOWER SURFACE				SPANWISE				
X/C	CP	P _z /PT	MLOC	X/C	CP	P _z /PT	MLOC	X/C	V/(B/2)	CP	P _z /PT	MLOC
0.0000	.6420	.9240	.3378	0.0000	.6420	.9240	.3378	.1507	.7476	-1.2348	.6466	.8144
.0132	.4680	.8277	.5268	.0126	-.4684	.5869	.9068	.1507	.4976	-1.2376	.6459	.8136
.0259	.1329	.7413	.6690	.0255	-.4732	.5852	.9095	.1507	.2476	-1.2364	.6462	.8151
.0759	-.1712	.6630	.7893	.0495	-.5657	.5613	.9470	.1507	-.2524	-1.2617	.6397	.8251
.1003	-.1959	.6566	.7990	.0753	-.5499	.5654	.9406	.1507	-.5024	-1.2443	.6441	.8182
.1507	-.2376	.6459	.8155	.1002	-.5745	.5591	.9506	.1507	-.7524	-1.2539	.6417	.8220
.2003	-.2708	.6373	.8287	.1503	-.5532	.5645	.9419	.5002	.7476	-1.4093	.6016	.8838
.2503	-.3070	.6280	.8431	.1976	-.6187	.5477	.9688	.5002	.4976	-1.4180	.5994	.8873
.3001	-.3378	.6201	.8553	.2503	-.6225	.5467	.9703	.5002	.2476	-1.4237	.5979	.8896
.3502	-.3572	.6151	.8630	.3001	-.6138	.5489	.9688	.5002	-.2524	-1.4131	.6006	.8854
.4003	-.3785	.6094	.8715	.3507	-.5908	.5549	.9573	.5002	-.5024	-1.4127	.6008	.8852
.4501	-.3997	.6041	.8800	.4001	-.5394	.5681	.9363	.5002	-.7524	-1.3997	.6041	.8800
.5002	-.4212	.5986	.8886	.4501	-.4712	.5857	.9087	.8002	.7476	-1.3486	.6173	.8594
.5502	-.4455	.5923	.8944	.5001	-.3753	.6104	.8702	.8002	.4976	-1.3569	.6151	.8629
.6002	-.4715	.5859	.9000	.5497	-.2494	.6428	.8202	.8002	.2476	-1.3636	.6134	.8656
.6500	-.4814	.5831	.9128	.6003	-.1230	.6754	.7782	.8002	-.5024	-1.3528	.6162	.8613
.7000	-.4669	.5869	.9068	.6500	-.0144	.7033	.7272	.8002	-.7524	-1.3341	.6210	.8538
.7500	-.4268	.5971	.8909	.7000	.0992	.7326	.6816					
.8002	-.3600	.6143	.8642	.7501	.1968	.7578	.6420					
.8502	-.1889	.6606	.7929	.8001	.2759	.7782	.6093					
.9501	-.0570	.6924	.7440	.8501	.3422	.7953	.5814					

TEST	167	PT	22.2432	PSI	CM	-.2249	CD1	.00917	CDCOR1	.00909
RUN	54	TY	160.2338	K	CM	-1.1310	CD2	.00868	CDCOR2	.00864
POINT	45	RC	7.0316	MILLION	CC	.0168	CD3	.00766	CDCOR3	.00763
		MACH	.7211				CD4	.00705	CDCOR4	.00699
		ALPHA	-1.9857	DEG			CD5	.00690	CDCOR5	.00676

UPPER SURFACE				LOWER SURFACE				SPANWISE				
X/C	CP	P _z /PT	MLOC	X/C	CP	P _z /PT	MLOC	X/C	V/(B/2)	CP	P _z /PT	MLOC
0.0000	.6920	.9627	.2337	0.0000	.6920	.9627	.2337	.1507	.7476	-1.3576	.6149	.8632
.0132	.2844	.8752	.6141	.0126	-.1411	.6707	.7774	.1507	.4976	-1.3768	.6160	.8709
.0259	-.0812	.8062	.7336	.0255	-.2213	.6501	.8091	.1507	.2476	-1.3821	.6138	.8630
.0759	-.3294	.6222	.8520	.0495	-.3351	.6289	.8542	.1507	-.2524	-1.3877	.6072	.8752
.1003	-.3363	.6204	.8547	.0753	-.3586	.6147	.8636	.1507	-.5024	-1.3678	.6123	.8672
.1507	-.3629	.6136	.8651	.1002	-.3972	.6048	.8790	.1507	-.7524	-1.3743	.6106	.8696
.2003	-.3773	.6099	.8711	.1503	-.4133	.6006	.8854	.5002	.7476	-1.4731	.5652	.9095
.2503	-.4049	.6028	.8820	.1976	-.4830	.5825	.9135	.5002	.4976	-1.476	.5633	.9125
.3001	-.4275	.5949	.8924	.2503	-.5034	.5774	.9217	.5002	.2476	-1.4869	.5616	.9151
.3502	-.4382	.5942	.8954	.3001	-.5096	.5758	.9242	.5002	-.2524	-1.4761	.5644	.9187
.4003	-.4526	.5965	.9012	.3507	-.5047	.5771	.9222	.5002	-.5024	-1.4738	.5650	.9090
.4501	-.4690	.5862	.9078	.4001	-.4694	.5861	.9080	.5002	-.7524	-1.4603	.5683	.9043
.5002	-.4836	.5824	.9138	.4501	-.4171	.5996	.8849	.8002	.7476	-1.3695	.6119	.8600
.5502	-.5027	.5776	.9214	.5001	-.3338	.6211	.8537	.8002	.4976	-1.3768	.6100	.8708
.6002	-.5223	.5725	.9294	.5497	-.2177	.6510	.8077	.8002	.2476	-1.3823	.6086	.8730
.6500	-.5252	.5718	.9306	.6003	-.0982	.6818	.7604	.8002	-.5024	-1.3711	.6115	.8686
.7000	-.5017	.5778	.9210	.6500	.0044	.7062	.7196	.8002	-.7524	-1.3569	.6167	.8603
.7500	-.4525	.5963	.9012	.7000	.1158	.7369	.6749					
.8002	-.3775	.6098	.8711	.7501	.2133	.7620	.6333					
.8502	-.1855	.6593	.7949	.8001	.2932	.7826	.6021					
.9501	-.0547	.6920	.7447	.8501	.3411	.8001	.5744					

ORIGINAL PRICE IS
OF POOR QUALITY

ORIGINAL PAGE(S)
OF POOR QUALITY

TEST	167	PT	22.2348	PSI	CM	.2921	CD1	.00914	CDCOR1	.00895
RUN	54	TT	160.4245	K	CM	-.1336	CD2	.00880	CDCOR2	.00858
POINT	48	RC	7.0160	MILLION	CC	.0183	CD3	.00835	CDCOR3	.00313
		MACH	.7210				CD4	.00754	CDCOR4	.00736
		ALPHA	-1.4867	DEG			CD5	.00698	CDCOR5	.00677

UPPER SURFACE				LOWER SURFACE				SPANWISE				
X/C	CP	P/L/PT	MLOC	X/C	CP	P/L/PT	MLOC	X/C	Y/(R/2)	CP	P/L/PT	MLOC
0.0000	1.0492	.9770	.1826	0.0000	1.0492	.9770	.1826	1.507	.7476	-.4199	.5484	.8920
.0137	1.1586	.7463	.8602	.0126	-.0058	.7037	.7265	1.507	.4978	-.4525	.5880	.9051
.0259	-.1930	.6552	.8012	.0255	-.1108	.6765	.7685	1.507	.2478	-.4707	.5936	.8983
.0759	-.6107	.5988	.8882	.0495	-.2410	.6428	.8203	1.507	-.2524	-.4585	.5984	.9075
.1003	-.6115	.5986	.8886	.0753	-.2812	.6323	.8384	1.507	-.5024	-.4372	.5919	.8988
.1307	-.6316	.5934	.8967	.1002	-.3279	.6202	.8550	1.507	-.7524	-.4424	.5908	.9010
.2003	-.2274	.5045	.8950	.1503	-.3575	.6126	.8668	5.002	.7476	-.5088	.5754	.9286
.2503	-.4592	.5062	.9078	.1976	-.4306	.5936	.8963	5.002	.4978	-.5137	.5721	.9300
.3001	-.4771	.5816	.9151	.2503	-.4564	.5870	.9067	5.002	.2478	-.5212	.5702	.9331
.3502	-.4409	.5806	.9166	.3001	-.4702	.5834	.9123	5.002	-.2524	-.5119	.5724	.9293
.4003	-.4937	.5773	.9218	.3502	-.4702	.5834	.9123	5.002	-.5024	-.5100	.5731	.9285
.4501	-.4799	.5679	.9366	.4001	-.4424	.5908	.9010	5.002	-.7524	-.4968	.5765	.9230
.5002	-.5182	.5710	.9318	.4501	-.5058	.6027	.8622	8.002	.7476	-.3758	.6078	.8742
.5502	-.5345	.5668	.9383	.5001	-.3175	.6229	.8508	8.002	.4978	-.3844	.6056	.8777
.6002	-.5515	.5623	.9455	.5497	-.2051	.6521	.8040	8.002	.2478	-.3909	.6035	.8803
.6500	-.5501	.5627	.9449	.6003	-.0884	.6823	.7596	8.002	-.5024	-.3523	.6062	.8788
.7000	-.5211	.5702	.9330	.6500	.0126	.7085	.7192	8.002	-.7524	-.3611	.6116	.8883
.7500	-.4684	.5844	.9107	.7000	.1235	.7372	.6745					
.8002	-.3881	.6052	.8783	.7501	.2207	.7624	.6347					
.9002	-.1864	.6569	.7986	.8001	.3013	.7832	.6011					
.9501	-.0598	.6997	.7482	.8501	.3704	.8014	.5717					

TEST	167	PT	22.2318	PSI	CM	.3520	CD1	.00912	CDCOR1	.00904
RUN	54	TT	160.5750	K	CM	-.1328	CD2	.00888	CDCOR2	.00882
POINT	47	RC	7.0041	MILLION	CC	.0186	CD3	.00847	CDCOR3	.00844
		MACH	.7207				CD4	.00751	CDCOR4	.00744
		ALPHA	-.4979	DEG			CD5	.00697	CDCOR5	.00683

UPPER SURFACE				LOWER SURFACE				SPANWISE				
X/C	CP	P/L/PT	MLOC	X/C	CP	P/L/PT	MLOC	X/C	Y/(R/2)	CP	P/L/PT	MLOC
0.0000	1.0835	.9867	.1386	0.0000	1.0835	.9867	.1386	1.507	.7476	-.4837	.5853	.8927
.0132	-.0364	.7185	.7036	.0126	-.1106	.7389	.6718	1.507	.4978	-.5227	.5754	.9249
.0259	-.3202	.6272	.8443	.0255	-.0100	.7024	.7220	1.507	.2478	-.5008	.5810	.9180
.0759	-.5000	.5789	.9194	.0495	-.1433	.6700	.7789	1.507	-.2524	-.5302	.5735	.9279
.1003	-.4944	.5821	.9143	.0753	-.2038	.6585	.7992	1.507	-.5024	-.5087	.5793	.9184
.1507	-.5009	.5810	.9161	.1002	-.2585	.6430	.8199	1.507	-.7524	-.5110	.5784	.9262
.2003	-.4904	.5838	.9119	.1503	-.2983	.6378	.8356	5.002	.7476	-.5340	.5725	.9286
.2503	-.2274	.5739	.9193	.1976	-.3748	.6132	.8654	5.002	.4978	-.5398	.5710	.9318
.3001	-.204	.5759	.9241	.2503	-.4068	.6050	.8785	5.002	.2478	-.5443	.5688	.9352
.3502	-.5134	.5775	.9211	.3001	-.4254	.6003	.8859	5.002	-.2524	-.5447	.5707	.9321
.4003	-.5234	.5752	.9252	.3502	-.4305	.5990	.8880	5.002	-.5024	-.5385	.5713	.9313
.4501	-.5431	.5727	.9291	.4001	-.4103	.6041	.8799	5.002	-.7524	-.5280	.5745	.9282
.5002	-.5420	.5704	.9327	.4501	-.3717	.6146	.8646	8.002	.7476	-.3849	.6107	.8698
.5502	-.5547	.5672	.9378	.5001	-.3014	.6320	.8368	8.002	.4978	-.3946	.6082	.8737
.6002	-.5678	.5638	.9431	.5497	-.1951	.6592	.7950	8.002	.2478	-.4004	.6067	.8780
.6500	-.5640	.5648	.9416	.6003	-.0627	.6840	.7507	8.002	-.5024	-.3948	.6082	.8750
.7000	-.5322	.5729	.9287	.6500	.0142	.7128	.7124	8.002	-.7524	-.3727	.6138	.8830
.7500	-.4748	.5876	.9057	.7000	.1232	.7409	.6809					
.8002	-.3936	.6094	.8733	.7501	.2201	.7656	.6296					
.9002	-.1925	.6599	.7739	.8001	.3008	.7862	.5962					
.9501	-.0624	.6931	.7429	.8501	.3704	.8042	.5667					

TEST	167	PT	22.2312	PSI	CM	.4202	CD1	.00920	CDCOR1	.00910
RUN	54	TT	160.5023	K	CM	-.1343	CD2	.00900	CDCOR2	.00895
POINT	48	RC	7.0018	MILLION	CC	.0181	CD3	.00870	CDCOR3	.00865
		MACH	.7198				CD4	.00778	CDCOR4	.00765
		ALPHA	-.4990	DEG			CD5	.00718	CDCOR5	.00701

UPPER SURFACE				LOWER SURFACE				SPANWISE				
X/C	CP	P/L/PT	MLOC	X/C	CP	P/L/PT	MLOC	X/C	Y/(R/2)	CP	P/L/PT	MLOC
0.0000	1.1116	.9941	.0921	0.0000	1.1116	.9941	.0921	1.507	.7476	-.5410	.5722	.9299
.0132	-.0954	.6886	.7484	.0126	-.2340	.7792	.6222	1.507	.4978	-.5872	.5807	.9481
.0259	-.4491	.5959	.8926	.0255	-.0899	.7334	.6884	1.507	.2478	-.5639	.5886	.9387
.0759	-.4066	.5959	.9357	.0495	-.0616	.6946	.7404	1.507	-.2524	-.5908	.5997	.9496
.1003	-.4773	.5829	.9445	.0753	-.1271	.6740	.7661	1.507	-.5024	-.5645	.5845	.9389
.1507	-.4838	.5864	.9387	.1002	-.1817	.6641	.7875	1.507	-.7524	-.5673	.5857	.9501
.2003	-.4536	.5887	.9343	.1503	-.2314	.6514	.8070	5.002	.7476	-.5521	.5896	.9339
.2503	-.4513	.5804	.9340	.1976	-.3121	.6388	.8387	5.002	.4978	-.5597	.5877	.9370
.3001	-.4578	.5881	.9363	.2503	-.3498	.6212	.8533	5.002	.2478	-.5672	.5858	.9400
.3502	-.4532	.5893	.9344	.3001	-.3730	.6153	.8620	5.002	-.2524	-.5556	.5867	.9333
.4003	-.5543	.5891	.9348	.3502	-.3823	.6129	.8664	5.002	-.5024	-.5536	.5892	.9345
.4501	-.5577	.5887	.9387	.4001	-.3678	.6166	.8686	5.002	-.7524	-.5487	.5725	.9293
.5002	-.5627	.5868	.9438	.4501	-.3353	.6249	.8478	8.002	.7476	-.3780	.6136	.8653
.5502	-.5715	.5847	.9424	.5001	-.2707	.6414	.8224	8.002	.4978	-.3914	.6106	.8700
.6002	-.5813	.5822	.9457	.5497	-.1499	.6671	.7878	8.002	.2478	-.3992	.6086	.8730
.6500	-.5724	.5844	.9421	.6003	-.0620	.6947	.7405	8.002	-.5024	-.3893	.6111	.8691
.7000	-.5371	.5735	.9279	.6500	.0313	.716	.7037	8.002	-.7524	-.3873	.6188	.8804
.7500	-.4472	.5887	.9038	.7000	.1381	.7437	.6611					
.8002	-.3939	.6103	.8794	.7501	.2335	.7700	.6274					
.9002	-.1900	.6620	.7748	.8001	.3137	.7905	.5982					
.9501	-.0621	.6946	.7408	.8501	.3838	.8083	.5697					

ORIGINAL SOURCE
OF POOR QUALITY

TEST 167	PT 22.2374	PSI	CN .4645	CD1 .00914	CDCOR1 .00900
RUN 54	TT 160.5989	K	CM -.1346	CD2 .00904	CDCOR2 .00892
POINT 49	RC 7.0006	MILLION	CC .0168	CD3 .00875	CDCOR3 .00864
	MACH .7201			CD4 .00796	CDCOR4 .00781
	ALPHA .0102	DEG		CD5 .00746	CDCOR5 .00726

UPPER SURFACE				LOWER SURFACE				SPANWISE				
X/C	CP	P _L /PT	MLOC	X/C	CP	P _L /PT	MLOC	X/C	Y/(B/2)	CP	P _L /PT	MLOC
0.0000	1.1275	.9977	.0567	0.0000	1.1275	.9977	.0567	.1507	.7476	-.6235	.5478	.9685
.0132	-.2109	.6538	.8033	.0126	-.3399	.7954	.5813	.1507	.4976	-.6757	.5344	.9901
.0259	-.5878	.5570	.9539	.0259	.1790	.7540	.6480	.1507	.2476	-.6916	.5406	.9801
.0759	-.7402	.5178	1.0170	.0495	.0127	.7113	.7148	.1507	-.2524	-.6520	.5405	.9803
.1003	-.5836	.5324	.9934	.0753	-.0644	.6915	.7454	.1507	-.5024	-.6485	.5414	.9788
.1507	-.6509	.5406	.9748	.1002	-.1261	.6756	.7698	.1507	-.7524	-.6426	.5429	.9764
.2003	-.6098	.5514	.9629	.1503	-.1839	.6603	.7934	.5002	.7476	-.5895	.5566	.9546
.2503	-.6167	.5476	.9658	.1976	-.2709	.6384	.8270	.5002	.4976	-.5984	.5543	.9582
.3001	-.165	.5496	.9657	.2503	-.3149	.6271	.8444	.5002	.2476	-.6057	.5524	.9612
.3502	-.6012	.5536	.9574	.3001	-.3429	.6199	.8555	.5002	-.2524	-.5976	.5545	.9579
.4003	-.6007	.5537	.9592	.3507	-.3576	.6161	.8613	.5002	-.5024	-.5953	.5551	.9570
.4501	-.6014	.5535	.9595	.4001	-.3477	.6187	.8574	.5002	-.7524	-.5832	.5582	.9520
.5002	-.6004	.5538	.9590	.4501	-.3198	.6259	.8463	.8002	.7476	-.3863	.6088	.8727
.5502	-.6052	.5525	.9610	.5001	-.2601	.6412	.8227	.8002	.4976	-.3996	.6054	.8780
.6002	-.6116	.5509	.9636	.5497	-.1628	.6662	.7843	.8002	.2476	-.4078	.6033	.8813
.6500	-.5966	.5547	.9575	.6003	-.0578	.6932	.7428	.8002	-.5024	-.4617	.6048	.8789
.7000	-.5553	.5654	.9407	.6500	.0335	.7166	.7066	.8002	-.7524	-.3802	.6103	.8703
.7500	-.4497	.5822	.9141	.7000	.1390	.7437	.6642					
.8002	-.4018	.6048	.8789	.7501	.2337	.7681	.6256					
.9002	-.1913	.6549	.7955	.8001	.3138	.7887	.5922					
.9501	-.0641	.6916	.7453	.8501	.3843	.8068	.5623					

TEST 167	PT 22.2444	PSI	CN .5598	CD1 .00924	CDCOR1 .00909
RUN 54	TT 160.6362	K	CM -.1370	CD2 .00909	CDCOR2 .00898
POINT 50	RC 6.9991	MILLION	CC .0146	CD3 .00863	CDCOR3 .00852
	MACH .7198			CD4 .00791	CDCOR4 .00775
	ALPHA .5054	DEG		CD5 .00768	CDCOR5 .00744

UPPER SURFACE				LOWER SURFACE				SPANWISE				
X/C	CP	P _L /PT	MLOC	X/C	CP	P _L /PT	MLOC	X/C	Y/(B/2)	CP	P _L /PT	MLOC
0.0000	1.1307	.9989	.0397	0.0000	1.1307	.9989	.0397	.1507	.7476	-.6912	.5337	.9913
.0132	-.3458	.6219	.8525	.0126	-.4404	.6226	.5355	.1507	.4976	-.7252	.5250	1.0054
.0259	-.7358	.5223	1.0096	.0259	.2638	.7780	.6095	.1507	.2476	-.7198	.5264	1.0031
.0759	-.8986	.4807	1.0790	.0495	.0933	.7340	.6795	.1507	-.2524	-.7429	.5205	1.0128
.1003	-.8156	.5019	1.0433	.0753	.0056	.7116	.7143	.1507	-.5024	-.7018	.5310	.9957
.1507	-.7227	.5236	1.0044	.1002	-.0622	.6943	.7411	.1507	-.7524	-.6634	.5408	.9799
.2003	-.6870	.5347	.9896	.1503	-.1303	.6769	.7679	.5002	.7476	-.6131	.5531	.9601
.2503	-.6701	.5391	.9826	.1976	-.2176	.6546	.8021	.5002	.4976	-.6256	.5504	.9644
.3001	-.6636	.5407	.9799	.2503	-.2651	.6425	.8207	.5002	.2476	-.6318	.5488	.9669
.3502	-.6479	.5447	.9735	.3001	-.2960	.6346	.8329	.5002	-.2524	-.6194	.5520	.9619
.4003	-.6390	.5470	.9699	.3507	-.3148	.6298	.8403	.5002	-.5024	-.6171	.5576	.9609
.4501	-.6340	.5483	.9678	.4001	-.3098	.6311	.8383	.5002	-.7524	-.6042	.5559	.9557
.5002	-.6284	.5497	.9655	.4501	-.2872	.6368	.8294	.8002	.7476	-.3919	.6101	.8707
.5502	-.6289	.5496	.9657	.5001	-.2332	.6506	.8082	.8002	.4976	-.4041	.6070	.8755
.6002	-.6320	.5468	.9670	.5497	-.1412	.6741	.7721	.8002	.2476	-.4128	.6048	.8790
.6500	-.6120	.5539	.9589	.6003	-.0403	.6999	.7325	.8002	-.5024	-.4019	.6076	.8746
.7000	-.5672	.5653	.9407	.6500	.0479	.7224	.6976	.8002	-.7524	-.3793	.6133	.8657
.7500	-.4492	.5827	.9134	.7000	.1516	.7489	.6561					
.8002	-.4091	.6057	.8775	.7501	.2453	.7728	.6180					
.9002	-.1955	.6663	.7934	.8001	.3256	.7933	.5846					
.9501	-.0699	.6923	.7441	.8501	.3972	.8116	.5542					

TEST 167	PT 22.2465	PSI	CN .6288	CD1 .00921	CDCOR1 .00908
RUN 54	TT 160.4988	K	CM -.1375	CD2 .00922	CDCOR2 .00913
POINT 51	RC 7.0087	MILLION	CC .0119	CD3 .00877	CDCOR3 .00868
	MACH .7199			CD4 .00834	CDCOR4 .00819
	ALPHA 1.0081	DEG		CD5 .00795	CDCOR5 .00771

UPPER SURFACE				LOWER SURFACE				SPANWISE				
X/C	CP	P _L /PT	MLOC	X/C	CP	P _L /PT	MLOC	X/C	Y/(B/2)	CP	P _L /PT	MLOC
0.0000	1.1301	.9984	.0413	0.0000	1.1301	.9988	.0413	.1507	.7476	-.7392	.5218	1.0105
.0132	-.4463	.5917	.8992	.0126	-.5279	.6451	.4962	.1507	.4976	-.8627	.4903	1.0627
.0259	-.8688	.4888	1.0653	.0259	.3446	.7984	.5761	.1507	.2476	-.8094	.5039	1.0400
.0759	-1.0422	.4394	1.1508	.0495	.1658	.7528	.6500	.1507	-.2524	-.8249	.4745	1.0896
.1003	-1.0471	.4433	1.1440	.0753	.0703	.7284	.6883	.1507	-.5024	-.7325	.5236	1.0077
.1507	-.7966	.5072	1.0346	.1002	-.0029	.7097	.7173	.1507	-.7524	-.6871	.5351	.9889
.2003	-.7160	.5278	1.0009	.1503	-.0784	.6905	.7470	.5002	.7476	-.6410	.5469	.9700
.2503	-.7150	.5280	1.0005	.1976	-.1685	.6675	.7824	.5002	.4976	-.6512	.5443	.9742
.3001	-.7102	.5293	.9985	.2503	-.2213	.6540	.8030	.5002	.2476	-.6571	.5428	.9766
.3502	-.6880	.5354	.9887	.3001	-.2553	.6433	.8164	.5002	-.2524	-.6442	.5461	.9713
.4003	-.6719	.5390	.9827	.3507	-.2775	.6396	.8251	.5002	-.5024	-.6426	.5465	.9707
.4501	-.6637	.5411	.9793	.4001	-.2771	.6398	.8249	.5002	-.7524	-.6299	.5497	.9659
.5002	-.6534	.5437	.9751	.4501	-.2895	.6442	.8180	.8002	.7476	-.3967	.6092	.8720
.5502	-.6499	.5446	.9737	.5001	-.2108	.6567	.7989	.8002	.4976	-.4083	.6063	.8766
.6002	-.6490	.5449	.9733	.5497	-.1230	.6791	.7645	.8002	.2476	-.4161	.6043	.8797
.6500	-.6249	.5510	.9635	.6003	-.0256	.7039	.7262	.8002	-.5024	-.4045	.6072	.8751
.7000	-.5758	.5635	.9435	.6500	.0591	.7255	.6927	.8002	-.7524	-.3812	.6132	.8659
.7500	-.5044	.5818	.9148	.7000	.1612	.7516	.6518					
.8002	-.4125	.6052	.8783	.7501	.2541	.7753	.6140					
.9002	-.1969	.6602	.7935	.8001	.3347	.7938	.5805					
.9501	-.0716	.6972	.7443	.8501	.4073	.8144	.5495					

C-2

ORIGINAL PLAN OF
OF POOR QUALITY

TEST 167	PT 22.2459	PSI	CN	.7033	CD1 .00983	CDCDR1 .00955
RUN 54	TT 160.4563	K	CM	-1370	CD2 .00965	CDCDR2 .00960
POINT 52	RC 7.0174	MILLION	CC	.0055	CD3 .00930	CDCDR3 .00905
	MACH .7209				CD4 .00848	CDCDR4 .00815
	ALPHA 1.4969	DEG			CD5 .00823	CDCDR5 .00789

UPPER SURFACE				LOWER SURFACE				SPANWISE				
X/C	CP	P/L/PT	MLOC	X/C	CP	P/L/PT	MLOC	X/C	Y/(B/2)	CP	P/L/PT	MLOC
0.0000	1.1270	.9973	.0620	0.0000	1.1270	.9973	.0620	.1507	.7476	-1.0511	.4346	1.1594
.0132	-.5470	.5649	.9414	.0126	.5980	.8606	.4679	.1507	.4976	-1.1804	.4012	1.2210
.0259	-.9528	.4600	1.1145	.0255	.4104	.8122	.5532	.1507	.2476	-1.1384	.4121	1.2007
.0759	-1.1554	.4077	1.2089	.0495	.2260	.7645	.6312	.1507	-.2324	-1.1580	.4070	1.2102
.1003	-1.1377	.4071	1.2100	.0753	.1228	.7379	.6734	.1507	-.5024	-1.1594	.4067	1.2108
.1507	-1.1249	.4156	1.1942	.1002	.0455	.7179	.7045	.1507	-.7524	-1.0677	.4304	1.1872
.2003	-1.0296	.4402	1.1495	.1503	-.0371	.6964	.7376	.5002	.7476	-.6700	.5331	.9922
.2503	-.7565	.5107	1.0297	.1976	-.1291	.6728	.7741	.5002	.4976	-.6803	.5304	.9965
.3001	-.6522	.5377	.9848	.2503	-.1949	.6584	.7963	.5002	.2476	-.6875	.5286	.9996
.3502	-.6814	.5301	.9970	.3001	-.2222	.6488	.8111	.5002	-.2524	-.6739	.5321	.9934
.4003	-.6942	.5268	1.0324	.3502	-.2477	.6422	.8212	.5002	-.5024	-.6727	.5324	.9880
.4501	-.6944	.5268	1.0025	.4001	-.2503	.6415	.8222	.5002	-.7524	-.6598	.5357	.9808
.5002	-.6838	.5295	.9980	.4501	-.2364	.6451	.8167	.8002	.7476	-.3972	.6036	.8861
.5502	-.6762	.5315	.9948	.5001	-.1914	.6567	.7988	.8002	.4976	-.4102	.6002	.8895
.6002	-.6727	.5324	.9934	.5497	-.1066	.6786	.7652	.8002	.2476	-.4185	.5980	.8895
.6500	-.6417	.5404	.9804	.6003	-.0122	.7030	.7276	.8002	-.5024	-.4070	.6010	.8846
.7000	-.5856	.5549	.9573	.6500	.0700	.7242	.6947	.8002	-.7524	-.3828	.6073	.8751
.7500	-.5096	.5745	.9262	.7000	.1706	.7502	.6540					
.8002	-.4137	.5993	.8975	.7501	.2625	.7740	.6161					
.9002	-.1940	.6560	.7999	.8001	.3426	.7947	.5824					
.9501	-.0727	.6874	.7517	.8501	.4156	.8135	.5509					

TEST 167	PT 22.2502	PSI	CN	.7881	CD1 .01190	CDCDR1 .01141
RUN 54	TT 160.4084	K	CM	-1353	CD2 .01153	CDCDR2 .01108
POINT 52	RC 7.0179	MILLION	CC	.0045	CD3 .01060	CDCDR3 .01018
	MACH .7203				CD4 .00929	CDCDR4 .00878
	ALPHA 2.0060	DEG			CD5 .00873	CDCDR5 .00822

UPPER SURFACE				LOWER SURFACE				SPANWISE				
X/C	CP	P/L/PT	MLOC	X/C	CP	P/L/PT	MLOC	X/C	Y/(B/2)	CP	P/L/PT	MLOC
0.0000	1.1203	.9957	.0786	0.0000	1.1203	.9957	.0786	.1507	.7476	-1.2171	.3931	1.2365
.0132	-.6482	.5398	.9814	.0126	.6722	.8802	.4308	.1507	.4976	-1.3038	.3708	1.2803
.0259	-1.0519	.4357	1.1575	.0255	.4812	.8309	.5211	.1507	.2476	-1.2482	.3851	1.2520
.0759	-1.2547	.3836	1.2550	.0495	.2922	.7822	.6028	.1507	-.2524	-1.2668	.3803	1.2614
.1003	-1.2567	.3829	1.2563	.0753	.1826	.7540	.6480	.1507	-.5024	-1.2760	.3780	1.2660
.1507	-1.2358	.3883	1.2458	.1002	.1022	.7332	.6807	.1507	-.7524	-1.2169	.3932	1.2364
.2003	-1.1839	.4017	1.2222	.1503	.0127	.7102	.7166	.5002	.7476	-.6682	.5346	.9898
.2503	-1.1937	.3992	1.2250	.1976	-.0824	.6856	.7544	.5002	.4976	-.6683	.5346	.9885
.3001	-1.0927	.4252	1.1765	.2503	-.1429	.6701	.7784	.5002	.2476	-.6653	.5354	.9856
.3502	-.6393	.5421	.9778	.3001	-.1831	.6597	.7943	.5002	-.2524	-.6581	.5372	.9905
.4003	-.5854	.5560	.9555	.3502	-.2115	.6524	.8055	.5002	-.5024	-.6700	.5342	.9856
.4501	-.6249	.5458	.9718	.4001	-.2178	.6508	.8080	.5002	-.7524	-.6652	.5354	.9885
.5002	-.6560	.5378	.9847	.4501	-.2077	.6534	.8040	.8002	.7476	-.3991	.6040	.8801
.5502	-.6695	.5343	.9903	.5001	-.1675	.6637	.7881	.8002	.4976	-.4135	.6003	.8859
.6002	-.6725	.5335	.9916	.5497	-.0867	.6845	.7561	.8002	.2476	-.4214	.5983	.8891
.6500	-.6443	.5408	.9798	.6003	.0047	.7081	.7198	.8002	-.5024	-.4111	.6009	.8850
.7000	-.5881	.5553	.9566	.6500	.0838	.7285	.6881	.8002	-.7524	-.3841	.6079	.8741
.7500	-.5110	.5752	.9252	.7000	.1822	.7539	.6482					
.8002	-.4150	.5999	.8865	.7501	.2729	.7773	.6108					
.9002	-.1956	.6565	.7992	.8001	.3523	.7977	.5774					
.9501	-.0710	.6886	.7495	.8501	.4250	.8165	.5460					

TEST 167	PT 22.2218	PSI	CN	.6852	CD1 .01594	CDCDR1 .01552
RUN 54	TT 160.4820	K	CM	-1379	CD2 .01469	CDCDR2 .01427
POINT 54	RC 7.0023	MILLION	CC	.0008	CD3 .01282	CDCDR3 .01240
	MACH .7200				CD4 .01120	CDCDR4 .01074
	ALPHA 2.5050	DEG			CD5 .01039	CDCDR5 .00982

UPPER SURFACE				LOWER SURFACE				SPANWISE				
X/C	CP	P/L/PT	MLOC	X/C	CP	P/L/PT	MLOC	X/C	Y/(B/2)	CP	P/L/PT	MLOC
0.0000	1.1023	.9913	.1116	0.0000	1.1023	.9913	.1116	.1507	.7476	-1.3466	.3626	1.2968
.0132	-.7450	.5171	1.0183	.0126	.7395	.8982	.3944	.1507	.4976	-1.3983	.3493	1.3241
.0259	-1.1425	.4150	1.1993	.0255	.5460	.8485	.4901	.1507	.2476	-1.3410	.3641	1.2938
.0759	-1.3464	.3627	1.2968	.0495	.3563	.7998	.5739	.1507	-.2524	-1.3572	.3607	1.3007
.1003	-1.3472	.3625	1.2970	.0753	.2409	.7702	.6222	.1507	-.5024	-1.3643	.3581	1.3060
.1507	-1.3277	.3675	1.2870	.1002	.1577	.7488	.6562	.1507	-.7524	-1.3205	.3693	1.2833
.2003	-1.2407	.3770	1.2680	.1503	.0637	.7247	.6941	.5002	.7476	-.6219	.5486	.9672
.2503	-1.2941	.3761	1.2698	.1976	-.0329	.6999	.7325	.5002	.4976	-.5916	.5564	.9548
.3001	-1.3077	.3726	1.2767	.2503	-.0962	.6836	.7575	.5002	.2476	-.5772	.5599	.9494
.3502	-1.2698	.3823	1.2574	.3001	-.1391	.6726	.7744	.5002	-.2524	-.5783	.5513	.9630
.4003	-.7848	.5068	1.0352	.3502	-.1697	.6647	.7865	.5002	-.5024	-.6115	.5458	.9718
.4501	-.5716	.5616	.9466	.4001	-.1791	.6623	.7902	.5002	-.7524	-.6351	.5458	.9718
.5002	-.5717	.5617	.9465	.4501	-.1726	.6640	.7877	.8002	.7476	-.3926	.6034	.8811
.5502	-.6032	.5535	.9596	.5001	-.1365	.6733	.7734	.8002	.4976	-.4087	.6011	.8847
.6002	-.6313	.5462	.9711	.5497	-.0604	.6928	.7434	.8002	.2476	-.4178	.6051	.8784
.6500	-.6211	.5489	.9669	.6003	.0275	.7154	.7085	.8002	-.5024	-.4019	.6051	.8784
.7000	-.5772	.5601	.9489	.6500	.1042	.7351	.6778	.8002	-.7524	-.3694	.6135	.8655
.7500	-.5062	.5784	.9202	.7000	.2005	.7598	.6388					
.8002	-.4135	.6022	.8630	.7501	.2894	.7826	.6021					
.9002	-.1487	.6573	.7979	.8001	.3678	.8028	.5690					
.9501	-.0769	.6886	.7499	.8501	.4400	.8213	.5377					

ORIGINAL PAGE IS
OF POOR QUALITY

TEST 167	PT 22.2327	PSI	CN	.9564	C01	.02221	CDC0R1	.02157
RUN 54	TT 160.4266	K	CM	-.1379	C02	.01937	CDC0R2	.01855
POINT 55	PC 7.0132	MILLION	CC	-.0025	C03	.01681	CDC0R3	.01599
	MACH .7206				C04	.01464	CDC0R4	.01377
	ALPHA 2.9957	DEG			C05	.01432	CDC0R5	.01372

UPPER SURFACE				LOWER SURFACE				SPANWISE				
X/C	CP	P/L/PT	MLOC	X/C	CP	P/L/PT	MLOC	X/C	Y/(B/2)	CP	P/L/PT	MLOC
0.0000	1.0720	.9837	.1534	0.0000	1.0720	.9837	.1534	-1.507	.7476	-1.4269	.3434	1.3365
.0132	-.8394	.4940	1.0566	.0126	.7736	.9072	.3754	-1.507	.4976	-1.4809	.3296	1.3662
.0259	-1.2257	.3950	1.2330	.0255	.5807	.8578	.4731	-1.507	.2476	-1.4251	.3439	1.3355
.0759	-1.4324	.3420	1.3395	.0495	.3895	.8088	.5589	-1.507	-.2524	-1.4387	.3404	1.3429
.1003	-1.4311	.3423	1.3388	.0753	.2705	.7783	.6091	-1.507	-.5024	-1.4474	.3382	1.3477
.1507	-1.4113	.3474	1.3291	.1002	.1852	.7565	.6441	-1.507	-.7524	-1.4213	.3449	1.3335
.2003	-1.3836	.3545	1.3133	.1503	.0869	.7313	.6837	.5002	.7476	-.6037	.5543	.9582
.2503	-1.3823	.3549	1.3126	.1976	-.0122	.7059	.7232	.5002	.4976	-.5561	.5665	.9388
.3001	-1.3999	.3503	1.3220	.2503	-.0794	.6897	.7498	.5002	.2476	-.5858	.5589	.9508
.3502	-1.3991	.3505	1.3216	.3001	-.1247	.6771	.7676	.5002	-.2524	-.5707	.5628	.9447
.4003	-1.3375	.3663	1.2893	.3507	-.1584	.6694	.7809	.5002	-.5024	-.5847	.5592	.9504
.4501	-.8071	.5022	1.0428	.4001	-.1715	.6651	.7860	.5002	-.7524	-.6216	.5497	.9655
.5002	-.6021	.5548	.9575	.4501	-.1684	.6659	.7848	.8002	.7476	-.3916	.6087	.8729
.5502	-.5469	.5689	.9351	.5001	-.1362	.6741	.7721	.8002	.4976	-.4124	.6034	.8811
.6002	-.5593	.5657	.9401	.5497	-.0631	.6929	.7433	.8002	.2476	-.4206	.6012	.8845
.6500	-.5705	.5629	.9446	.6003	.0228	.7148	.7093	.8002	-.5024	-.4098	.6040	.8801
.7000	-.5516	.5677	.9370	.6500	.0972	.7339	.6796	.8002	-.7524	-.3669	.6150	.8631
.7500	-.4967	.5818	.9148	.7000	.1919	.7582	.6414					
.8002	-.4144	.6028	.8819	.7501	.2801	.7808	.6051					
.9002	-.2109	.6550	.8015	.8001	.3580	.8007	.5724					
.9501	-.0874	.6867	.7529	.8501	.4298	.8191	.5414					

TEST 167	PT 22.2397	PSI	CN	1.0368	C01	.02966	CDC0R1	.02897
RUN 54	TT 160.4147	K	CM	-.1440	C02	.02526	CDC0R2	.02447
POINT 56	PC 7.0150	MILLION	CC	-.0046	C03	.02140	CDC0R3	.02038
	MACH .7204				C04	.01864	CDC0R4	.01747
	ALPHA 3.5029	DEG			C05	.01895	CDC0R5	.01820

UPPER SURFACE				LOWER SURFACE				SPANWISE				
X/C	CP	P/L/PT	MLOC	X/C	CP	P/L/PT	MLOC	X/C	Y/(B/2)	CP	P/L/PT	MLOC
0.0000	1.0458	.9771	.1821	0.0000	1.0458	.9771	.1821	-1.507	.7476	-1.5278	.3189	1.3898
.0132	-.9186	.4747	1.0892	.0126	.8194	.9192	.3489	-1.507	.4976	-1.5438	.3148	1.3990
.0259	-1.2914	.3793	1.2633	.0255	.6269	.8700	.4504	-1.507	.2476	-1.4906	.3284	1.3688
.0759	-1.4984	.3264	1.3732	.0495	.4367	.8213	.5377	-1.507	-.2524	-1.5006	.3293	1.3744
.1003	-1.4981	.3265	1.3730	.0753	.3141	.7900	.5901	-1.507	-.5024	-1.5067	.3243	1.3778
.1507	-1.4790	.3314	1.3623	.1002	.2249	.7671	.6271	-1.507	-.7524	-1.4880	.3291	1.3674
.2003	-1.4516	.3384	1.3473	.1503	.1222	.7409	.6687	.5002	.7476	-.6803	.3356	.9881
.2503	-1.4498	.3388	1.3463	.1976	.0210	.7152	.7088	.5002	.4976	-.7215	.5231	1.0052
.3001	-1.4672	.3344	1.3358	.2503	-.0476	.6975	.7362	.5002	.2476	-.6795	.5150	1.0216
.3502	-1.4735	.3328	1.3359	.3001	-.0949	.6853	.7549	.5002	-.2524	-.6795	.5358	.9878
.4003	-1.4691	.3339	1.3366	.3507	-.1305	.6762	.7689	.5002	-.5024	-.6260	.5495	.9658
.4501	-1.2796	.3824	1.2374	.4001	-.1454	.6724	.7747	.5002	-.7524	-.6271	.5505	.9642
.5002	-.7709	.5125	1.0259	.4501	-.1451	.6725	.7746	.8002	.7476	-.3766	.6133	.8657
.5502	-.6011	.5559	.9557	.5001	-.1163	.6799	.7633	.8002	.4976	-.3976	.6079	.8740
.6002	-.5287	.5744	.9264	.5497	-.0470	.6976	.7360	.8002	.2476	-.4038	.6064	.8765
.6500	-.5161	.5776	.9213	.6003	.0364	.7189	.7030	.8002	-.5024	-.3970	.6081	.8738
.7000	-.5091	.5794	.9185	.6500	.1088	.7375	.6741	.8002	-.7524	-.3432	.6219	.8525
.7500	-.4714	.5891	.9034	.7000	.2020	.7613	.6364					
.8002	-.4015	.6069	.8756	.7501	.2890	.7835	.6006					
.9002	-.2120	.6554	.8009	.8001	.3664	.8033	.5680					
.9501	-.0967	.6849	.7556	.8501	.4389	.8219	.5367					

TEST	167	PT	46.0736	PSI	CM	-.0271	CD1	.00787	CDCOR1	.00776
RUN	40	TT	98.0682	K	CM	-.1314	CD2	.00771	CDCOR2	.00765
POINT	38	RC	29.8727	MILLION	CC	.0059	CD3	.00775	CDCOR3	.00773
		MACH	.7207				CD4	.00772	CDCOR4	.00765
		ALPHA	-3.9917	DEG			CD5	.00764	CDCOR5	.00746

UPPER SURFACE				LOWER SURFACE				SPANWISE				
X/C	CP	P _o L/PT	MLOC	X/C	CP	P _o L/PT	MLOC	X/C	Y/(B/2)	CP	P _o L/PT	MLOC
0.0000	-.937	.8868	.4196	0.0000	.6937	.8868	.4196	.1507	.7476	-.1333	.6754	.7732
.0132	.6174	.8673	.4575	.0126	-.7515	.5174	1.0212	.1507	.4976	-.1406	.6735	.7761
.0259	.3061	.7877	.5963	.0259	-.6951	.5318	.9977	.1507	.2476	-.1423	.6731	.7767
.0759	-.0209	.7041	.7288	.0495	-.7624	.5146	1.0258	.1507	-.2524	-.1480	.6716	.7790
.1003	-.0729	.6908	.7494	.0753	-.7345	.5217	1.0141	.1507	-.5024	-.1533	.6703	.7811
.1507	-.1419	.6732	.7766	.1002	-.7632	.5144	1.0261	.1507	-.7524	-.1462	.6721	.7783
.2003	-.1861	.6619	.7940	.1503	-.6931	.5323	.9969	.5002	.7476	-.3740	.6139	.8681
.2503	-.2320	.6502	.8120	.1976	-.7680	.5132	1.0282	.5002	.4976	-.3790	.6126	.8700
.3001	-.2729	.6397	.8281	.2503	-.7614	.5148	1.0254	.5002	.2476	-.3828	.6116	.8716
.3502	-.2963	.6337	.8374	.3001	-.7173	.5261	1.0070	.5002	-.2524	-.3732	.6141	.8678
.4003	-.3221	.6271	.8475	.3507	-.6635	.5399	.9847	.5002	-.5024	-.3718	.6144	.8672
.4501	-.3429	.6218	.8558	.4001	-.5927	.5580	.9557	.5002	-.7524	-.3592	.6175	.8622
.5002	-.3797	.6124	.8703	.4501	-.5159	.5776	.9247	.8002	.7476	-.9994	.4540	1.1285
.5502	-.4120	.6042	.8831	.5001	-.4076	.6053	.8814	.8002	.4976	-.3590	.6177	.8621
.6002	-.4403	.5969	.8944	.5497	-.2740	.6394	.8286	.8002	.2476	-.3623	.6169	.8634
.6500	-.4573	.5926	.9012	.6003	-.1403	.6736	.7760	.8002	-.5024	-.3325	.6245	.8517
.7000	-.4492	.5946	.8980	.6500	-.0373	.6999	.7353	.8002	-.7524	-.3311	.6248	.8511
.7500	-.4162	.6031	.8848	.7000	.0906	.7326	.6844					
.8002	-.3580	.6179	.8618	.7500	.1955	.7594	.6420					
.9002	-.1933	.6600	.7968	.8001	.2810	.7813	.6068					
.9501	-.0763	.6900	.7507	.8501	.3517	.7994	.5771					

TEST	167	PT	46.0761	PSI	CM	.1106	CD1	.00761	CDCOR1	.00755
RUN	40	TT	98.1080	K	CM	-.1359	CD2	.00751	CDCOR2	.00748
POINT	39	RC	29.8594	MILLION	CC	.0142	CD3	.00759	CDCOR3	.00760
		MACH	.7208				CD4	.00756	CDCOR4	.00753
		ALPHA	-3.0141	DEG			CD5	.00746	CDCOR5	.00731

UPPER SURFACE				LOWER SURFACE				SPANWISE				
X/C	CP	P _o L/PT	MLOC	X/C	CP	P _o L/PT	MLOC	X/C	Y/(B/2)	CP	P _o L/PT	MLOC
0.0000	.8548	.9278	.3302	0.0000	.8548	.9278	.3302	.1507	.7476	-.2398	.6478	.8157
.0132	.4607	.8270	.5301	.0126	-.4109	.6040	.8834	.1507	.4976	-.2480	.6457	.8189
.0259	.1358	.7439	.6667	.0259	-.4370	.5973	.8938	.1507	.2476	-.2502	.6451	.8198
.0759	-.1603	.6661	.7843	.0495	-.5108	.5785	.9233	.1507	-.2524	-.2598	.6437	.8219
.1003	-.1974	.6587	.7989	.0753	-.5215	.5757	.9276	.1507	-.5024	-.2598	.6427	.8236
.1507	-.2491	.6454	.8193	.1002	-.5631	.5651	.9444	.1507	-.7524	-.2503	.6451	.8198
.2003	-.2810	.6373	.8319	.1503	-.5499	.5685	.9391	.5002	.7476	-.4327	.5985	.8920
.2503	-.3182	.6277	.8466	.1976	-.6194	.5507	.9673	.5002	.4976	-.4379	.5971	.8941
.3001	-.3532	.6188	.8604	.2503	-.6222	.5500	.9685	.5002	.2476	-.4421	.5960	.8958
.3502	-.3712	.6142	.8676	.3001	-.6122	.5525	.9644	.5002	-.2524	-.4309	.5989	.8913
.4003	-.3909	.6092	.8754	.3507	-.5860	.5592	.9537	.5002	-.5024	-.4302	.5991	.8910
.4501	-.4068	.6091	.8817	.4001	-.5325	.5729	.9320	.5002	-.7524	-.4163	.6027	.8855
.5002	-.4388	.5969	.8945	.4501	-.4683	.5894	.9062	.8002	.7476	-1.0606	.4378	1.1571
.5502	-.4667	.5898	.9056	.5001	-.3703	.6144	.8672	.8002	.4976	-.3791	.6122	.8707
.6002	-.4912	.5835	.9154	.5497	-.2445	.6466	.8175	.8002	.2476	-.3831	.6112	.8723
.6500	-.5021	.5807	.9198	.6003	-.1167	.6793	.7672	.8002	-.5024	-.3517	.6192	.8598
.7000	-.4868	.5846	.9137	.6500	-.0186	.7044	.7284	.8002	-.7524	-.3501	.6198	.8592
.7500	-.4456	.5952	.8972	.7000	.1074	.7366	.6781					
.8002	-.3791	.6122	.8707	.7501	.2113	.7633	.6359					
.9002	-.2617	.6576	.8006	.8001	.2976	.7853	.6003					
.9501	-.0806	.6885	.7529	.8501	.3702	.8039	.5695					

TEST	167	PT	46.0740	PSI	CM	.2562	CD1	.00756	CDCOR1	.00747
RUN	40	TT	98.1136	K	CM	-.1401	CD2	.00747	CDCOR2	.00742
POINT	41	RC	29.8517	MILLION	CC	.0195	CD3	.00757	CDCOR3	.00755
		MACH	.7207				CD4	.00746	CDCOR4	.00742
		ALPHA	-2.0060	DEG			CD5	.00740	CDCOR5	.00722

UPPER SURFACE				LOWER SURFACE				SPANWISE				
X/C	CP	P _o L/PT	MLOC	X/C	CP	P _o L/PT	MLOC	X/C	Y/(B/2)	CP	P _o L/PT	MLOC
0.0000	.9986	.9648	.2277	0.0000	-.9986	.9648	.2277	.1507	.7476	-.3666	.6164	.8642
.0132	.2602	.7764	.6148	.0126	-.0965	.6833	.7579	.1507	.4976	-.3767	.6138	.8682
.0259	-.0862	.6895	.7514	.0259	-.1820	.6635	.7915	.1507	.2476	-.3804	.6129	.8697
.0759	-.3355	.6243	.8519	.0495	-.2886	.6363	.8534	.1507	-.2524	-.3869	.6112	.8722
.1003	-.3509	.6204	.8580	.0753	-.3279	.6263	.8619	.1507	-.5024	-.3905	.6103	.8737
.1507	-.3797	.6130	.8694	.1002	-.3876	.6110	.8725	.1507	-.7524	-.3786	.6133	.8689
.2003	-.3971	.6086	.8763	.1503	-.4096	.6064	.8796	.5002	.7476	-.4983	.5828	.9166
.2503	-.4201	.6027	.8834	.1976	-.4789	.5877	.9088	.5002	.4976	-.5034	.5815	.9186
.3001	-.4467	.5959	.8960	.2503	-.4979	.5829	.9164	.5002	.2476	-.5078	.5804	.9204
.3502	-.4574	.5932	.9002	.3001	-.5044	.5812	.9190	.5002	-.2524	-.4951	.5836	.9153
.4003	-.4691	.5902	.9049	.3507	-.4971	.5831	.9161	.5002	-.5024	-.4939	.5839	.9148
.4501	-.4783	.5879	.9086	.4001	-.4602	.5925	.9013	.5002	-.7524	-.4786	.5878	.9087
.5002	-.5042	.5813	.9189	.4501	-.4121	.6046	.8822	.8002	.7476	-1.1179	.4246	1.1810
.5502	-.5260	.5757	.9277	.5001	-.3274	.6264	.8487	.8002	.4976	-.3992	.6081	.8771
.6002	-.5453	.5706	.9355	.5497	-.2119	.6559	.8033	.8002	.2476	-.4034	.6070	.8787
.6500	-.5489	.5699	.9369	.6003	-.0914	.6866	.7559	.8002	-.5024	-.3704	.6154	.8657
.7000	-.5242	.5762	.9270	.6500	.0000	.7100	.7198	.8002	-.7524	-.3684	.6159	.8649
.7500	-.4728	.5893	.9064	.7000	.1233	.7414	.6706					
.8002	-.3986	.6082	.8768	.7501	.2255	.7673	.6291					
.9002	-.2105	.6362	.8027	.8001	.3113	.7894	.5935					
.9501	-.0650	.6882	.7534	.8501	.3847	.8082	.5623					

ORIGINAL RECORD
OF POOR QUALITY

TEST 167	PT 46.0737	PSI	CN .3261	CD1 .00754	CDCDR1 .00743
RUN 40	TT 98.2088	K	CM -.1421	CD2 .00750	CDCDR2 .00742
POINT 42	RC 29.8024	MILLION	CC .0207	CD3 .00758	CDCDR3 .00755
	MACH .7205			CD4 .00745	CDCDR4 .00737
	ALPHA -1.5071	DEG		CD5 .00742	CDCDR5 .00723

UPPER SURFACE				LOWER SURFACE				SPANWISE				
X/C	CP	P/L/PT	MLOC	X/C	CP	P/L/PT	MLOC	X/C	Y/(B/2)	CP	P/L/PT	MLOC
0.0000	1.0516	.9783	.1779	0.0000	1.0516	.9783	.1779	.1507	.7476	-.4347	.5988	.8914
.0132	.1496	.7480	.6601	.0126	.0391	.7198	.7044	.1507	.4976	-.4460	.5960	.8959
.0259	-.1467	.6596	.7975	.0255	-.0691	.6922	.7473	.1507	.2476	-.4504	.5948	.8977
.0759	-.4312	.5997	.8900	.0495	-.1931	.6605	.7961	.1507	-.2524	-.4572	.5931	.9004
.1003	-.4340	.5990	.8912	.0753	-.2448	.6473	.8164	.1507	-.5024	-.4595	.5927	.9013
.1507	-.4496	.5950	.8974	.1002	-.3107	.6305	.8423	.1507	-.7524	-.4450	.5962	.8955
.2003	-.4522	.5944	.8984	.1503	-.3413	.6227	.8544	.5002	.7476	-.5314	.5741	.9301
.2503	-.4735	.5889	.9069	.1976	-.4177	.5032	.8847	.5002	.4976	-.5365	.5728	.9322
.3001	-.4953	.5833	.9156	.2503	-.4437	.5965	.8950	.5002	.2476	-.5409	.5717	.9340
.3502	-.5005	.5820	.9177	.3001	-.4570	.5931	.9003	.5002	-.2524	-.5280	.5750	.9287
.4003	-.5087	.5799	.9210	.3507	-.4560	.5934	.8999	.5002	-.5024	-.5267	.5753	.9282
.4501	-.5147	.5784	.9234	.4001	-.4262	.6010	.8881	.5002	-.7524	-.5109	.5794	.9219
.5002	-.5368	.5728	.9323	.4501	-.3851	.6115	.8717	.8002	.7476	-1.1387	.4191	1.1912
.5502	-.5556	.5680	.9399	.5001	-.3061	.6317	.8405	.8002	.4976	-.4072	.6058	.8805
.6002	-.5719	.5638	.9465	.5497	-.1954	.6599	.7970	.8002	.2476	-.4118	.6047	.8823
.6500	-.5709	.5641	.9460	.6003	-.0783	.6824	.7509	.8002	-.5024	-.3789	.6131	.8693
.7000	-.5416	.5715	.9342	.6500	.0102	.7124	.7159	.8002	-.7524	-.3768	.6136	.8685
.7500	-.4859	.5858	.9119	.7000	.1320	.7435	.6672					
.8002	-.4071	.6059	.8805	.7501	.2330	.7693	.6262					
.9002	-.2127	.6555	.8038	.8001	.3182	.7911	.5908					
.9501	-.0853	.6880	.7537	.8501	.3919	.8099	.5594					

TEST 167	PT 46.2213	PSI	CN .3942	CD1 .00761	CDCDR1 .00754
RUN 40	TT 98.1444	K	CM -.1434	CD2 .00752	CDCDR2 .00748
POINT 43	RC 29.9100	MILLION	CC .0210	CD3 .00761	CDCDR3 .00761
	MACH .7198			CD4 .00750	CDCDR4 .00746
	ALPHA -1.0081	DEG		CD5 .00745	CDCDR5 .00728

UPPER SURFACE				LOWER SURFACE				SPANWISE				
X/C	CP	P/L/PT	MLOC	X/C	CP	P/L/PT	MLOC	X/C	Y/(B/2)	CP	P/L/PT	MLOC
0.0000	1.0911	.9884	.1297	0.0000	1.0911	.9884	.1297	.1507	.7476	-.5037	.5812	.9190
.0132	.0333	.7183	.7668	.0126	.1656	.7521	.6537	.1507	.4976	-.5166	.5779	.9242
.0259	-.3212	.6278	.8465	.0255	.0367	.7192	.7054	.1507	.2476	-.5221	.5765	.9264
.0759	-.5332	.5737	.9308	.0495	-.1031	.6835	.7607	.1507	-.2524	-.5295	.5746	.9294
.1003	-.5212	.5767	.9260	.0753	-.1658	.6675	.7853	.1507	-.5024	-.5303	.5744	.9297
.1507	-.5217	.5766	.9267	.1002	-.2377	.6491	.8136	.1507	-.7524	-.5142	.5786	.9232
.2003	-.5089	.5799	.9211	.1503	-.2795	.6385	.8301	.5002	.7476	-.5619	.5664	.9424
.2503	-.5265	.5754	.9282	.1976	-.3594	.6181	.8616	.5002	.4976	-.5671	.5650	.9445
.3001	-.5433	.5711	.9349	.2503	-.3920	.6097	.8745	.5002	.2476	-.5715	.5639	.9463
.3502	-.5419	.5715	.9344	.3001	-.4105	.6050	.8818	.5002	-.2524	-.5587	.5672	.9411
.4003	-.5465	.5703	.9362	.3507	-.4155	.6037	.8838	.5002	-.5024	-.5584	.5673	.9410
.4501	-.5489	.5697	.9372	.4001	-.3923	.6097	.8746	.5002	-.7524	-.5421	.5714	.9345
.5002	-.5670	.5651	.9445	.4501	-.3576	.6185	.8609	.8002	.7476	-1.1545	.4151	1.1986
.5502	-.5826	.5611	.9508	.5001	-.2842	.6373	.8319	.8002	.4976	-.4136	.6042	.8831
.6002	-.5958	.5577	.9562	.5497	-.1790	.6641	.7906	.8002	.2476	-.4185	.6030	.8850
.6500	-.5903	.5591	.9539	.6003	-.0659	.6930	.7460	.8002	-.5024	-.3861	.6112	.8722
.7000	-.5560	.5679	.9400	.6500	.0195	.7148	.7123	.8002	-.7524	-.3838	.6118	.8712
.7500	-.4958	.5832	.9158	.7000	.1396	.7455	.6642					
.8002	-.4143	.6041	.8833	.7501	.2395	.7710	.6235					
.9002	-.2140	.6552	.8043	.8001	.3243	.7926	.5482					
.9501	-.0851	.6881	.7536	.8501	.3982	.8115	.5567					

TEST 167	PT 46.2189	PSI	CN .4628	CD1 .00768	CDCDR1 .00754
RUN 40	TT 98.0729	K	CM -.1444	CD2 .00762	CDCDR2 .00752
POINT 44	RC 29.9104	MILLION	CC .0202	CD3 .00771	CDCDR3 .00767
	MACH .7186			CD4 .00758	CDCDR4 .00748
	ALPHA -.4990	DEG		CD5 .00757	CDCDR5 .00736

UPPER SURFACE				LOWER SURFACE				SPANWISE				
X/C	CP	P/L/PT	MLOC	X/C	CP	P/L/PT	MLOC	X/C	Y/(B/2)	CP	P/L/PT	MLOC
0.0000	1.1121	.9941	.0920	0.0000	1.1121	.9941	.0920	.1507	.7476	-.5779	.5654	.9440
.0132	-.0964	.6876	.7544	.0126	.2749	.7818	.6060	.1507	.4976	-.5916	.5619	.9495
.0259	-.4577	.5959	.8960	.0255	.1292	.7448	.6653	.1507	.2476	-.5984	.5602	.9522
.0759	-.6464	.5480	.9716	.0495	-.0202	.7069	.7246	.1507	-.2524	-.6038	.5588	.9544
.1003	-.6153	.5359	.9550	.0753	-.0929	.6884	.7531	.1507	-.5024	-.6032	.5590	.9541
.1507	-.5969	.5606	.9516	.1002	-.1710	.6686	.7836	.1507	-.7524	-.5843	.5638	.9465
.2003	-.5781	.5654	.9440	.1503	-.2207	.6560	.8030	.5002	.7476	-.5901	.5610	.9489
.2503	-.5803	.5648	.9449	.1976	-.3031	.6351	.8352	.5002	.4976	-.5954	.5610	.9510
.3001	-.5911	.5621	.9493	.2503	-.3409	.6255	.8501	.5002	.2476	-.5996	.5599	.9527
.3502	-.5865	.5632	.9474	.3001	-.3637	.6198	.8590	.5002	-.2524	-.5846	.5637	.9466
.4003	-.5849	.5637	.9468	.3507	-.3740	.6171	.8630	.5002	-.5024	-.5844	.5638	.9466
.4501	-.5821	.5643	.9456	.4001	-.3565	.6216	.8562	.5002	-.7524	-.5678	.5680	.9399
.5002	-.5957	.5609	.9511	.4501	-.3280	.6288	.8450	.8002	.7476	-1.1655	.4163	1.1963
.5502	-.6075	.5579	.9559	.5001	-.2616	.6457	.8190	.8002	.4976	-.4204	.6034	.8813
.6002	-.6170	.5555	.9597	.5497	-.1618	.6710	.7800	.8002	.2476	-.4260	.6040	.8835
.6500	-.6065	.5581	.9555	.6003	-.0533	.6985	.7376	.8002	-.5024	-.3918	.6126	.8700
.7000	-.5686	.5678	.9402	.6500	.0286	.7193	.7053	.8002	-.7524	-.3891	.6133	.8690
.7500	-.5059	.5837	.9152	.7000	.1461	.7491	.6585					
.8002	-.4223	.6049	.8820	.7501	.2442	.7740	.6187					
.9002	-.2185	.6566	.8022	.8001	.3280	.7952	.5839					
.9501	-.0893	.6894	.7517	.8501	.4014	.8138	.5527					

TEST	167	PT	46.1985	PSI	CN	.5384	CD1	.00777	CDCOR1	.00759
RUN	40	TT	98.0049	K	CM	-.1469	CD2	.00771	CDCOR2	.00755
POINT	46	RC	29.9763	MILLION	CC	.0189	CD3	.00779	CDCOR3	.00767
		MACH	.7205				CD4	.00764	CDCOR4	.00747
		ALPHA	.0204	DEG			CD5	.00762	CDCOR5	.00740

UPPER SURFACE				LOWER SURFACE				SPANWISE				
X/C	CP	P ₂ L/PT	MLOC	X/C	CP	P ₂ L/PT	MLOC	X/C	Y/(B/2)	CP	P ₂ L/PT	MLOC
0.0000	1.1316	.9984	.0473	0.0000	1.1316	.9984	.0473	1.507	.7476	-.6633	.5378	.9881
.0132	-.2104	.6540	.8061	.0126	.3832	.8064	.5654	1.507	.4976	-.6796	.5336	.9949
.0259	-.5831	.5584	.9551	.0255	.2232	.7653	.6327	1.507	.2476	-.6881	.5314	.9984
.0759	-.7954	.5039	1.0435	.0495	.0634	.7245	.6975	1.507	-.2524	-.689A	.5310	.9990
.1003	-.7153	.5244	1.0097	.0753	-.0192	.7031	.7304	1.507	-.5024	-.6884	.5324	.9969
.1507	-.6844	.5324	.9968	.1002	-.1036	.6814	.7639	1.507	-.7524	-.6605	.5385	.9869
.2003	-.6459	.5423	.9809	.1503	-.1625	.6613	.7872	1.507	-.5002	.7475	-.6282	.5468
.2503	-.6438	.5428	.9800	.1976	-.2498	.6419	.8217	1.507	.4976	-.6344	.5452	.9762
.3001	-.6504	.5411	.9828	.2503	-.2938	.6326	.8391	1.507	.5002	.2476	-.6389	.5441
.3502	-.6394	.5439	.9782	.3001	-.3215	.6255	.8501	1.507	-.2524	-.6222	.5483	.9711
.4003	-.6328	.5456	.9755	.3507	-.3370	.6215	.8562	1.507	-.5024	-.6230	.5481	.9715
.4501	-.6268	.5472	.9730	.4001	-.3243	.6248	.8512	1.507	-.7524	-.6052	.5527	.9642
.5002	-.6353	.5450	.9765	.4501	-.2998	.6311	.8415	1.507	.4976	-.6216	.5411	1.2079
.5502	-.6427	.5431	.9796	.5001	-.2382	.6469	.8171	1.507	.4976	-.6213	.5999	.8898
.6002	-.6491	.5414	.9822	.5497	-.1419	.6716	.7791	1.507	.2476	-.6286	.5980	.8927
.6500	-.6316	.5459	.9750	.6003	-.0362	.6987	.7372	1.507	-.5024	-.3937	.6070	.8788
.7000	-.5844	.5590	.9557	.6500	.0439	.7193	.7053	1.507	-.7524	-.3919	.6074	.8781
.7500	-.5146	.5759	.9273	.7000	.1596	.7490	.6587					
.8002	-.4258	.5988	.8916	.7501	.2566	.7739	.6188					
.9002	-.2145	.6530	.8078	.8001	.3401	.7953	.5838					
.9501	-.0851	.6862	.7566	.8501	.4136	.8142	.5522					

TEST	167	PT	46.2027	PSI	CN	.6040	CD1	.00796	CDCOR1	.00778
RUN	40	TT	98.0289	K	CM	-.1463	CD2	.00790	CDCOR2	.00778
POINT	47	RC	29.9372	MILLION	CC	.0164	CD3	.00798	CDCOR3	.00792
		MACH	.7193				CD4	.00781	CDCOR4	.00767
		ALPHA	.5193	DEG			CD5	.00780	CDCOR5	.00757

UPPER SURFACE				LOWER SURFACE				SPANWISE				
X/C	CP	P ₂ L/PT	MLOC	X/C	CP	P ₂ L/PT	MLOC	X/C	Y/(B/2)	CP	P ₂ L/PT	MLOC
0.0000	1.1349	.9995	.0256	0.0000	1.1349	.9995	.0256	1.507	.7476	-.7364	.5214	1.0146
.0132	-.3323	.6247	.8513	.0126	.4808	.8324	.5207	1.507	.4976	-.7401	.5205	1.0182
.0259	-.7143	.5271	1.0054	.0255	.3095	.7887	.5947	1.507	.2476	-.7368	.5213	1.0148
.0759	-.9323	.4714	1.0984	.0495	.1412	.7457	.6639	1.507	-.2524	-.7338	.5221	1.0136
.1003	-.9088	.4774	1.0881	.0753	.0508	.7226	.7002	1.507	-.5024	-.7332	.5223	1.0133
.1507	-.7323	.5225	1.0129	.1002	-.0377	.7000	.7353	1.507	-.7524	-.7276	.5237	1.0110
.2003	-.6889	.5336	.9949	.1503	-.1035	.6831	.7613	1.507	.4976	-.6457	.5446	.9771
.2503	-.6882	.5338	.9946	.1976	-.1934	.6602	.7966	1.507	.4976	-.6518	.5431	.9796
.3001	-.6920	.5328	.9962	.2503	-.2414	.6479	.8155	1.507	.5002	.2476	-.6561	.5420
.3502	-.6695	.5385	.9869	.3001	-.2725	.6400	.8278	1.507	-.2524	-.6402	.5460	.9749
.4003	-.6595	.5411	.9828	.3507	-.2924	.6349	.8356	1.507	-.5024	-.6413	.5458	.9753
.4501	-.6495	.5436	.9787	.4001	-.2843	.6370	.8324	1.507	-.7524	-.6233	.5503	.9680
.5002	-.6529	.5428	.9801	.4501	-.2615	.6428	.8235	1.507	.4976	-.6159	.5435	1.2016
.5502	-.6559	.5420	.9813	.5001	-.2093	.6561	.8029	1.507	.4976	-.6187	.6026	.8856
.6002	-.6582	.5414	.9822	.5497	-.1188	.6792	.7673	1.507	.2476	-.6261	.6007	.8885
.6500	-.6361	.5471	.9732	.6003	-.0175	.7051	.7273	1.507	-.5024	-.3932	.6091	.8755
.7000	-.5859	.5599	.9527	.6500	.0587	.7246	.6970	1.507	-.7524	-.3914	.6096	.8748
.7500	-.5139	.5783	.9236	.7000	.1721	.7536	.6514					
.8002	-.4234	.6014	.8875	.7501	.2673	.7779	.6123					
.9002	-.2093	.6561	.8029	.8001	.3494	.7989	.5779					
.9501	-.0797	.6892	.7519	.8501	.4223	.8175	.5465					

TEST	167	PT	46.2060	PSI	CN	.6758	CD1	.00835	CDCOR1	.00815
RUN	40	TT	98.0324	K	CM	-.1450	CD2	.00834	CDCOR2	.00814
POINT	48	RC	29.9453	MILLION	CC	.0130	CD3	.00837	CDCOR3	.00820
		MACH	.7196				CD4	.00816	CDCOR4	.00796
		ALPHA	1.0081	DEG			CD5	.00806	CDCOR5	.00783

UPPER SURFACE				LOWER SURFACE				SPANWISE				
X/C	CP	P ₂ L/PT	MLOC	X/C	CP	P ₂ L/PT	MLOC	X/C	Y/(B/2)	CP	P ₂ L/PT	MLOC
0.0000	1.1275	.9980	.0536	0.0000	1.1275	.9980	.0536	1.507	.7476	-.8227	.5027	1.0455
.0132	-.4569	.5956	.8965	.0126	.5547	.8525	.4848	1.507	.4976	-.9657	.4864	1.1069
.0259	-.8476	.4964	1.0960	.0255	.3751	.8069	.5644	1.507	.2476	-1.0248	.4914	1.1331
.0759	-1.0880	.4354	1.1616	.0495	.1993	.7623	.6375	1.507	-.2524	-1.0306	.4499	1.1357
.1003	-1.0830	.4366	1.1594	.0753	.1016	.7375	.6768	1.507	-.5024	-.9922	.4597	1.1186
.1507	-1.0135	.4543	1.1281	.1002	.0105	.7143	.7130	1.507	-.7524	-.8166	.5043	1.0429
.2003	-.7740	.5151	1.0250	.1503	-.0628	.6957	.7419	1.507	.4976	-.6823	.5384	.9872
.2503	-.7041	.5328	.9961	.1976	-.1559	.6721	.7783	1.507	.4976	-.6888	.5367	.9898
.3001	-.7418	.5233	1.0116	.2503	-.2090	.6586	.7991	1.507	.2476	-.6934	.5356	.9917
.3502	-.7209	.5286	1.0030	.3001	-.2438	.6497	.8127	1.507	-.2524	-.6773	.5397	.9851
.4003	-.7006	.5337	.9947	.3507	-.2661	.6441	.8214	1.507	-.5024	-.6790	.5392	.9858
.4501	-.6879	.5370	.9894	.4001	-.2632	.6448	.8203	1.507	-.7524	-.6607	.5439	.9783
.5002	-.6882	.5369	.9896	.4501	-.2493	.6483	.8149	1.507	.4976	-1.1868	.4103	1.2076
.5502	-.6862	.5374	.9887	.5001	-.1985	.6613	.7930	1.507	.4976	-.4342	.6014	.8875
.6002	-.6843	.5379	.9880	.5497	-.1123	.6831	.7613	1.507	.2476	-.4403	.5998	.8897
.6500	-.6583	.5445	.9773	.6003	-.0149	.7070	.7230	1.507	-.5024	-.4085	.6079	.8773
.7000	-.6041	.5582	.9554	.6500	.0580	.7264	.6942	1.507	-.7524	-.4086	.6084	.8766
.7500	-.5288	.5774	.9251	.7000	.1693	.7547	.6497					
.8002	-.4363	.6009	.8883	.7501	.2634	.7785	.6113					
.9002	-.2188	.6561	.8029	.8001	.3444	.7991	.5774					
.9501	-.0667	.6896	.7513	.8501	.4171	.8176	.5464					

ORIGINAL PARTIAL
OF POOR QUALITY

TEST 167	PT	46.0841	PSI	CM	.7467	CD1	.00940	CDCOR1	.00913
RUN 40	TT	98.0452	K	CM	-.1432	CD2	.00929	CDCOR2	.00903
POINT 49	RC	29.8673	MILLION	CC	.0094	CD3	.00918	CDCOR3	.00883
	MACH	.7198				CD4	.00857	CDCOR4	.00835
	ALPHA	1.5072	DEG			CD5	.00840	CDCOR5	.00815

UPPER SURFACE				LOWER SURFACE				SPANWISE				
X/C	CP	P/L/PT	MLOC	X/C	CP	P/L/PT	MLOC	X/C	Y/(B/2)	CP	P/L/PT	MLOC
0.0000	1.1242	.9971	.0645	0.0000	1.1242	.9971	.0645	.1507	.7476	-1.1039	.4309	1.1697
.0132	-.5509	.5714	.9345	.0126	.6274	.8709	.4506	.1507	.4976	-1.1901	.4080	1.2100
.0259	-.9623	.4669	1.1062	.0255	.4442	.8243	.5348	.1507	.2476	-1.1721	.4135	1.2015
.0759	-1.1876	.4096	1.2088	.0495	.2633	.7783	.6116	.1507	-.2524	-1.1706	.4139	1.2008
.1003	-1.1930	.4082	1.2114	.0753	.1601	.7521	.6537	.1507	-.5024	-1.1943	.4079	1.2120
.1507	-1.1935	.4183	1.1927	.1002	.0664	.7283	.6912	.1507	-.7524	-1.1221	.4262	1.1761
.2003	-1.0965	.4327	1.1663	.1503	-.0128	.7082	.7226	.5002	.7476	-1.0969	.5343	.9937
.2503	-.9504	.4699	1.1010	.1976	-.1086	.6838	.7602	.5002	.4976	-1.7047	.5323	.9969
.3001	-.6571	.5444	.9774	.2503	-.1654	.6694	.7825	.5002	.2476	-1.7093	.5312	.9988
.3502	-.6616	.5433	.9792	.3001	-.2034	.6597	.7973	.5002	-.2524	-1.6927	.5354	.9920
.4003	-.6934	.5352	.9923	.3507	-.2291	.6532	.8074	.5002	-.5024	-1.6954	.5347	.9931
.4501	-.6993	.5337	.9947	.4001	-.2301	.6529	.8078	.5002	-.7524	-1.6766	.5394	.9854
.5002	-.7038	.5325	.9966	.4501	-.2202	.6584	.8039	.8002	.7476	-1.1785	.4119	1.2045
.5502	-.6992	.5337	.9947	.5001	-.1740	.6672	.7858	.8002	.4976	-1.4319	.6017	.8871
.6002	-.6954	.5347	.9931	.5497	-.0919	.6880	.7537	.8002	.2476	-1.4384	.6000	.8896
.6500	-.6635	.5428	.9800	.6003	.6021	.7119	.7167	.8002	-.5024	-1.4060	.6082	.8769
.7000	-.6057	.5575	.9565	.6500	.0722	.7298	.6889	.8002	-.7524	-1.4046	.6086	.8763
.7500	-.5278	.5773	.9252	.7000	.1813	.7575	.6451					
.8002	-.4340	.6011	.8879	.7501	.2739	.8014	.6073					
.8502	-.2148	.6568	.8018	.8001	.3539	.8810	.5737					
.9501	-.0836	.6902	.7504	.8501	.4260	.8197	.5428					

TFST 167	PT	46.0937	PSI	CM	.8396	CD1	.01194	CDCOR1	.01133
RUN 40	TT	98.1242	K	CM	-.1431	CD2	.01142	CDCOR2	.01109
POINT 50	RC	29.8311	MILLION	CC	.0097	CD3	.01070	CDCOR3	.00987
	MACH	.7196				CD4	.00977	CDCOR4	.00946
	ALPHA	2.0060	DEG			CD5	.00931	CDCOR5	.00891

UPPER SURFACE				LOWER SURFACE				SPANWISE				
X/C	CP	P/L/PT	MLOC	X/C	CP	P/L/PT	MLOC	X/C	Y/(B/2)	CP	P/L/PT	MLOC
0.0000	1.1138	.9942	.0919	0.0000	1.1138	.9942	.0919	.1507	.7476	-1.2612	.3873	1.2512
.0132	-.6264	.5495	.9693	.0126	.6905	.8860	.4212	.1507	.4976	-1.2858	.3810	1.2635
.0259	-1.0394	.4439	1.1463	.0255	.5048	.8385	.5009	.1507	.2476	-1.2627	.3869	1.2520
.0759	-1.2661	.3860	1.2537	.0495	.3205	.7914	.5902	.1507	-.2524	-1.2614	.3872	1.2514
.1003	-1.2734	.3841	1.2573	.0753	.2127	.7639	.6349	.1507	-.5024	-1.2866	.3808	1.2639
.1507	-1.2469	.3909	1.2442	.1002	.1170	.7394	.6775	.1507	-.7524	-1.2026	.4022	1.2226
.2003	-1.1935	.4046	1.2187	.1503	.0324	.7178	.7045	.5002	.7476	-1.6652	.5396	.9852
.2503	-1.2098	.4604	1.2261	.1976	-.0655	.6928	.7464	.5002	.4976	-1.6495	.5436	.9788
.3001	-1.2257	.3963	1.2338	.2503	-.1251	.6776	.7682	.5002	.2476	-1.6345	.5474	.9726
.3502	-1.1080	.4264	1.1778	.3001	-.1668	.6669	.7898	.5002	-.2524	-1.6294	.5487	.9705
.4003	-.6428	.5453	.9760	.3507	-.1959	.6595	.7977	.5002	-.5024	-1.6557	.5420	.9813
.4501	-.5742	.5628	.9481	.4001	-.1999	.6585	.7993	.5002	-.7524	-1.6601	.5409	.9831
.5002	-.6239	.5501	.9683	.4501	-.1934	.6601	.7967	.8002	.7476	-1.1631	.4123	1.2037
.5502	-.6654	.5395	.9853	.5001	-.1512	.6709	.7801	.8002	.4976	-1.4289	.5999	.8897
.6002	-.6830	.5350	.9926	.5497	-.0732	.6908	.7494	.8002	.2476	-1.4360	.5981	.8925
.6500	-.6609	.5406	.9835	.6003	.0193	.7145	.7177	.8002	-.5024	-1.4039	.6063	.8798
.7000	-.6050	.5549	.9606	.6500	.0893	.7313	.6864	.8002	-.7524	-1.3995	.6075	.8780
.7500	-.5271	.5748	.9290	.7000	.1926	.7587	.6431					
.8002	-.4327	.5990	.8913	.7501	.2833	.7819	.6057					
.8502	-.2136	.6350	.8046	.8001	.3627	.8022	.5723					
.9501	-.0836	.6682	.7533	.8501	.4344	.8205	.5413					

TEST 167	PT	46.3092	PSI	CM	.9222	CD1	.01718	CDCOR1	.01683
RUN 40	TT	98.6222	K	CM	-.1426	CD2	.01986	CDCOR2	.01963
POINT 51	RC	29.7480	MILLION	CC	.0019	CD3	.01430	CDCOR3	.01430
	MACH	.7197				CD4	.01241	CDCOR4	.01226
	ALPHA	2.5152	DEG			CD5	.01249	CDCOR5	.01185

UPPER SURFACE				LOWER SURFACE				SPANWISE				
X/C	CP	P/L/PT	MLOC	X/C	CP	P/L/PT	MLOC	X/C	Y/(B/2)	CP	P/L/PT	MLOC
0.0000	1.0892	.9882	.1310	0.0000	1.0892	.9882	.1310	.1507	.7476	-1.3378	.3708	1.2836
.0132	-.7230	.5272	1.0052	.0126	.7433	.9002	.1920	.1507	.4976	-1.3779	.3606	1.3042
.0259	-1.1377	.4217	1.1864	.0255	.5567	.8527	.4845	.1507	.2476	-1.3605	.3650	1.2952
.0759	-1.3633	.3643	1.2966	.0495	.3690	.8050	.5676	.1507	-.2524	-1.3585	.3655	1.2942
.1003	-1.3679	.3631	1.2990	.0753	.2565	.7784	.6147	.1507	-.5024	-1.3818	.3596	1.3062
.1507	-1.3444	.3691	1.2870	.1002	.1600	.7518	.6541	.1507	-.7524	-1.2823	.3849	1.2558
.2003	-1.2915	.3826	1.2604	.1503	.0701	.7289	.6902	.5002	.7476	-1.6109	.5557	.9593
.2503	-1.3068	.3786	1.2680	.1976	-.0300	.7035	.7298	.5002	.4976	-1.5831	.5626	.9481
.3001	-1.3312	.3724	1.2803	.2503	-.0937	.6872	.7549	.5002	.2476	-1.5700	.5661	.9428
.3502	-1.3324	.3721	1.2809	.3001	-.1372	.6762	.7719	.5002	-.2524	-1.5630	.5679	.9400
.4003	-1.2650	.3893	1.2473	.3507	-.1692	.6681	.7845	.5002	-.5024	-1.5930	.5602	.9321
.4501	-.7193	.5281	1.0037	.4001	-.1769	.6661	.7875	.5002	-.7524	-1.6193	.5535	.9628
.5002	-.5597	.5687	.9387	.4501	-.1750	.6686	.7867	.8002	.7476	-1.1432	.4198	1.1899
.5502	-.5663	.5670	.9413	.5001	-.1167	.6763	.7717	.8002	.4976	-1.4270	.6025	.8857
.6002	-.6073	.5566	.9579	.5497	-.0627	.6931	.7427	.8002	.2476	-1.4332	.6009	.8882
.6500	-.6159	.5545	.9612	.6003	.0246	.7173	.7082	.8002	-.5024	-1.4017	.6089	.8757
.7000	-.5838	.5676	.9484	.6500	.0889	.7337	.6827	.8002	-.7524	-1.3918	.6114	.8718
.7500	-.5174	.5795	.9217	.7000	.1941	.7605	.6403					
.8002	-.4287	.6020	.8844	.7501	.2833	.7832	.6037					
.8502	-.2165	.6540	.8030	.8001	.3617	.8031	.5708					
.9501	-.0876	.6888	.7525	.8501	.4328	.8212	.5401					

TEST 167	PT	46.3063	PSI	CM	1.0190	CD1	.02268	CDCOR1	.02177
RUN 40	TT	98.0414	K	CM	-.1497	CD2	.02156	CDCOR2	.02083
POINT 52	RC	30.0373	MILLION	CC	-.0006	CD3	.01908	CDCOR3	.01723
	MACH	.7208				CD4	.01719	CDCOR4	.01661
	ALPHA	3.0141	DEG			CD5	.01828	CDCOR5	.01761

UPPER SURFACE				LOWER SURFACE				SPANWISE				
X/C	CP	P.L./PT	MLOC	X/C	CP	P.L./PT	MLOC	X/C	Y/(B/2)	CP	P.L./PT	MLOC
0.0000	1.0683	.9829	.1577	0.0000	1.0683	.9829	.1577	.1507	.7476	-1.3957	.3568	1.3120
.0132	-.7996	.5083	1.0363	.0126	-.7958	.9137	.3629	.1507	.4976	-1.4518	.3425	1.3416
.0259	-1.2095	.4041	1.2191	.0255	-.6057	.8654	.4610	.1507	-.2476	-1.4303	.3480	1.3302
.0759	-1.4371	.3463	1.3338	.0495	-.4224	.8188	.5443	.1507	-.2524	-1.4234	.3498	1.3265
.1003	-1.4390	.3458	1.3348	.0753	-.3073	.7896	.5933	.1507	-.5024	-1.4407	.3454	1.3357
.1507	-1.4144	.3520	1.3218	.1002	-.2071	.7641	.6346	.1507	-.7524	-1.3356	.3721	1.2311
.2003	-1.3619	.3654	1.2945	.1503	-.1147	.7406	.6719	.5002	.7476	-.8576	.4935	1.0608
.2503	-1.3789	.3611	1.3032	.1976	-.0130	.7149	.7123	.5002	.4976	-.9938	.4589	1.1200
.3001	-1.4056	.3543	1.3172	.2503	-.0934	.6979	.7385	.5002	.2476	-.9789	.4627	1.1134
.3502	-1.4151	.3519	1.3221	.3001	-.0993	.6862	.7565	.5002	-.2524	-.8581	.4934	1.0610
.4003	-1.4062	.3541	1.3174	.3507	-.1338	.6775	.7700	.5002	-.5024	-.8346	.4994	1.0510
.4501	-1.3508	.3682	1.2888	.4001	-.1443	.6748	.7741	.5002	-.7524	-.7063	.5320	.9975
.5002	-.9223	.4771	1.0886	.4501	-.1454	.6745	.7746	.8002	.7476	-1.0805	.4369	1.1585
.5502	-.5694	.5668	.9418	.5001	-.1110	.6832	.7611	.8002	.4976	-.4053	.6085	.8765
.6002	-.5313	.5764	.9265	.5497	-.0407	.7011	.7335	.8002	.2476	-.4095	.6074	.8781
.6500	-.5363	.5752	.9285	.6003	-.0436	.7225	.7002	.8002	-.5024	-.5777	.6155	.8656
.7000	-.5280	.5773	.9252	.6500	-.1056	.7383	.6755	.8002	-.7524	-.3579	.6205	.8578
.7500	-.4826	.5888	.9071	.7000	-.2088	.7645	.6339					
.8002	-.4077	.6079	.8774	.7501	-.2967	.7868	.5977					
.9002	-.2087	.6584	.7993	.8001	-.3740	.8065	.5651					
.9501	-.0862	.6895	.7514	.8501	-.4447	.8245	.5346					

TEST 167	PT	46.3094	PSI	CM	1.0696	CD1	.03036	CDCOR1	.02946
RUN 40	TT	97.9625	K	CM	-.1512	CD2	.02844	CDCOR2	.02771
POINT 53	RC	30.0607	MILLION	CC	-.0024	CD3	.02488	CDCOR3	.02423
	MACH	.7202				CD4	.02254	CDCOR4	.02166
	ALPHA	3.5029	DEG			CD5	.02372	CDCOR5	.02277

UPPER SURFACE				LOWER SURFACE				SPANWISE				
X/C	CP	P.L./PT	MLOC	X/C	CP	P.L./PT	MLOC	X/C	Y/(B/2)	CP	P.L./PT	MLOC
0.0000	1.0485	.9776	.1808	0.0000	1.0485	.9776	.1808	.1507	.7476	-1.4370	.3439	1.3388
.0132	-.8761	.4869	1.0720	.0126	-.8299	.9219	.3442	.1507	.4976	-1.4986	.3282	1.3725
.0259	-1.2538	.3906	1.2448	.0255	-.6396	.8734	.4458	.1507	-.2476	-1.4769	.3337	1.3605
.0759	-1.4428	.3322	1.3637	.0495	-.4514	.8254	.5329	.1507	-.2524	-1.4726	.3348	1.3581
.1003	-1.4854	.3316	1.3651	.0753	-.3338	.7954	.5836	.1507	-.5024	-1.4873	.3311	1.3662
.1507	-1.4596	.3381	1.3510	.1002	-.2335	.7698	.6254	.1507	-.7524	-1.3930	.3551	1.3134
.2003	-1.4015	.3529	1.3199	.1503	-.1363	.7451	.6649	.5002	.7476	-1.2619	.3889	1.2488
.2503	-1.4247	.3470	1.3322	.1976	-.0325	.7186	.7064	.5002	.4976	-1.3343	.3701	1.2831
.3001	-1.4523	.3400	1.3470	.2503	-.0372	.7008	.7340	.5002	.2476	-1.3242	.3727	1.2799
.3502	-1.4583	.3385	1.3503	.3001	-.0858	.6884	.7531	.5002	-.2524	-1.2640	.3880	1.2498
.4003	-1.4335	.3397	1.3477	.3507	-.1233	.6789	.7679	.5002	-.5024	-1.1902	.4068	1.2140
.4501	-1.4632	.3372	1.3529	.4001	-.1369	.6754	.7732	.5002	-.7524	-.9487	.4484	1.1035
.5002	-1.3266	.3721	1.2811	.4501	-.1412	.6743	.7749	.8002	.7476	-.9990	.4556	1.1258
.5502	-.7630	.5158	1.0239	.5001	-.1096	.6824	.7625	.8002	.4976	-.3780	.6139	.8680
.6002	-.5690	.5652	.9443	.5497	-.0417	.6997	.7358	.8002	.2476	-.3795	.6135	.8687
.6500	-.4894	.5859	.9123	.6003	-.0408	.7207	.7031	.8002	-.5024	-.3474	.6166	.8639
.7000	-.4636	.5921	.9020	.6500	-.1007	.7360	.6792	.8002	-.7524	-.3338	.6252	.8506
.7500	-.4330	.5999	.8898	.7000	-.2034	.7622	.6377					
.8002	-.3748	.6147	.8668	.7501	-.2908	.7844	.6016					
.9002	-.1973	.6600	.7969	.8001	-.3679	.8041	.5692					
.9501	-.0811	.6896	.7513	.8501	-.4386	.8221	.5386					

Appendix F

Pressure Data for $M = 0.74$; $R = 4.4 \times 10^6$, 7.0×10^6 , 10.0×10^6 , 15.0×10^6 , 30.0×10^6 , and 40.0×10^6 ; Free Transition

The pressure measurements made on the NASA SC(3)-0712(B) airfoil are presented in coefficient form in graphs and tables in this appendix. The data are for a given Mach number through the Reynolds number range. The pressure data from the upper surface of the airfoil are plotted as open symbols, and the lower-surface data are plotted as solid symbols.

ORIGINAL PAGE IS
OF POOR QUALITY

TEST	167	PT	20.3409	PSI	CN	-0.0374	CD1	.00752	CDCOR1	.00747
RUN	11	TT	213.3171	K	CM	-0.1363	CD2	.00680	CDCOR2	.00675
POINT	2	RC	4.3880	MILLION	CC	.0035	CD3	.00780	CDCOR3	.00781
		MACH	.7412				CD4	.00643	CDCOR4	.00640
		ALPHA	-3.9956	DEG			CD5	.00644	CDCOR5	.00632

UPPER SURFACE				LOWER SURFACE				SPANWISE				
X/C	CP	P/L/PT	MLOC	X/C	CP	P/L/PT	MLOC	X/C	Y/(B/2)	CP	P/L/PT	MLOC
0.0000	.7189	.8665	.4183	0.0000	.7189	.8665	.4183	.1507	.7476	-.1542	.8936	.8035
.0132	.6183	.8596	.4696	.0126	-.7635	.4911	1.0612	.1507	.4976	-.1699	.6494	.8099
.0259	.2033	.7729	.6176	.0259	-.7188	.5030	1.0413	.1507	.2476	-.1710	.6491	.8104
.0759	-.6464	.0823	.7993	.0499	-.8261	.4743	1.0896	.1507	-.2524	-.1714	.6490	.8105
.1003	-.0932	.6698	.7785	.0753	-.8186	.4763	1.0861	.1507	-.5024	-.1720	.6488	.8107
.1507	-.1661	.6504	.8083	.1002	-.8190	.4745	1.0859	.1507	-.7524	-.1594	.6522	.8056
.2003	-.2115	.6383	.8270	.1503	-.7570	.4928	1.0583	.5002	.7476	-.3955	.5892	.9030
.2502	-.2568	.6262	.8456	.1976	-.7905	.4838	1.0734	.5002	.4976	-.4060	.5864	.9073
.3001	-.2926	.6167	.8603	.2503	-.8753	.4612	1.1122	.5002	.2476	-.4116	.5049	.9096
.3502	-.3127	.6113	.8646	.3001	-.9110	.4517	1.1288	.5002	-.2524	-.4047	.5868	.9068
.4003	-.3421	.6034	.8608	.3507	-.7661	.4903	1.0624	.5002	-.5024	-.3997	.5881	.9047
.4501	-.3722	.5954	.8633	.4001	-.5764	.5410	.9793	.5002	-.7524	-.3835	.5924	.8980
.5002	-.3994	.5883	.8644	.4501	-.5081	.5992	.9502	.8002	.7476	-.3647	.5974	.8901
.5502	-.4327	.5793	.8185	.5001	-.5119	.5848	.9098	.8002	.4976	-.3828	.5926	.8976
.6002	-.4649	.5707	.8170	.5497	-.2772	.6248	.8540	.8002	.2476	-.3899	.5907	.9004
.6500	-.4840	.5656	.8400	.6003	-.1431	.6565	.7989	.8002	-.5024	-.3737	.5950	.8939
.7000	-.4777	.5673	.8374	.6500	-.0285	.6871	.7520	.8002	-.7524	-.3641	.6029	.8816
.7500	-.4414	.5769	.8223	.7000	.0915	.7191	.7025					
.8002	-.3773	.5941	.8954	.7501	.1957	.7469	.6590					
.9002	-.2009	.6411	.8226	.8001	.2808	.7696	.6229					
.9501	-.0779	.6739	.7722	.8501	.3540	.7891	.5913					

TEST	167	PT	20.3915	PSI	CN	.1148	CD1	.00677	CDCOR1	.00665
RUN	11	TT	213.5033	K	CM	-.1416	CD2	.00586	CDCOR2	.00577
POINT	3	RC	4.3830	MILLION	CC	.0126	CD3	.00704	CDCOR3	.00696
		MACH	.7412				CD4	.00558	CDCOR4	.00548
		ALPHA	-3.0059	DEG			CD5	.00612	CDCOR5	.00593

UPPER SURFACE				LOWER SURFACE				SPANWISE				
X/C	CP	P/L/PT	MLOC	X/C	CP	P/L/PT	MLOC	X/C	Y/(B/2)	CP	P/L/PT	MLOC
0.0000	.8746	.9279	.3286	0.0000	.8746	.9279	.3286	.1507	.7476	-.2664	.6232	.8902
.0132	.4563	.8162	.5463	.0126	-.4227	.5815	.9150	.1507	.4976	-.2836	.6187	.8572
.0259	.1185	.7280	.6918	.0259	-.4561	.5726	.9290	.1507	.2476	-.2848	.6183	.8577
.0759	-.1925	.6430	.8197	.0499	-.5465	.5485	.9673	.1507	-.2524	-.2837	.6186	.8572
.1003	-.2249	.6343	.8330	.0753	-.5719	.5417	.9871	.1507	-.5024	-.2824	.6190	.8567
.1507	-.2808	.6194	.8561	.1002	-.5928	.5361	.9873	.1507	-.7524	-.2653	.6235	.8497
.2003	-.3156	.6101	.8704	.1503	-.5933	.5360	.9873	.5002	.7476	-.4534	.5728	.9287
.2502	-.3511	.6006	.8851	.1976	-.6720	.5150	1.0215	.5002	.4976	-.4684	.5691	.9346
.3001	-.3799	.5929	.8971	.2503	-.7061	.5059	1.0365	.5002	.2476	-.4684	.5693	.9341
.3502	-.3740	.5886	.9038	.3001	-.8828	.5121	1.0262	.5002	-.2524	-.4670	.5697	.9338
.4003	-.4174	.5829	.9127	.3507	-.8414	.5232	1.0081	.5002	-.5024	-.4601	.5715	.9306
.4501	-.4429	.5761	.9234	.4001	-.5690	.5425	.9769	.5002	-.7524	-.4443	.5758	.9240
.5002	-.4837	.5706	.9322	.4501	-.4782	.5667	.9343	.8002	.7476	-.3791	.5942	.8951
.5502	-.4923	.5629	.9442	.5001	-.3796	.5930	.8970	.8002	.4976	-.4010	.5973	.9059
.6002	-.5203	.5555	.9561	.5497	-.2500	.6276	.8434	.8002	.2476	-.4029	.5868	.9067
.6500	-.5329	.5521	.9615	.6003	-.1203	.6623	.7901	.8002	-.5024	-.3894	.5904	.9010
.7000	-.5176	.5562	.9549	.6500	-.0102	.6916	.7450	.8002	-.7524	-.3588	.5986	.8883
.7500	-.4716	.5645	.9355	.7000	.1093	.7236	.6956					
.8002	-.3962	.5886	.9039	.7501	.2146	.7517	.6515					
.9002	-.2092	.6385	.8266	.8001	.3023	.7791	.6141					
.9501	-.0839	.6720	.7752	.8501	.3798	.7958	.5804					

TEST	167	PT	20.3914	PSI	CN	.2551	CD1	.00689	CDCOR1	.00676
RUN	11	TT	213.8117	K	CM	-.1438	CD2	.00570	CDCOR2	.00560
POINT	4	RC	4.3780	MILLION	CC	.0179	CD3	.00663	CDCOR3	.00654
		MACH	.7406				CD4	.00543	CDCOR4	.00533
		ALPHA	-1.9958	DEG			CD5	.00742	CDCOR5	.00724

UPPER SURFACE				LOWER SURFACE				SPANWISE				
X/C	CP	P/L/PT	MLOC	X/C	CP	P/L/PT	MLOC	X/C	Y/(B/2)	CP	P/L/PT	MLOC
0.0000	1.0081	.9637	.2104	0.0000	1.0081	.9637	.2104	.1507	.7476	-.3892	.5911	.9000
.0132	.2625	.7644	.6306	.0126	-.1252	.6615	.7914	.1507	.4976	-.4095	.5857	.9085
.0259	-.0493	.5718	.7754	.0259	-.2128	.6381	.8272	.1507	.2476	-.4109	.5853	.9091
.0759	-.3804	.5447	.8841	.0499	-.3205	.6070	.8753	.1507	-.2524	-.4117	.5851	.9094
.1003	-.3745	.5450	.8934	.0753	-.3744	.5937	.8940	.1507	-.5024	-.4079	.5861	.9079
.1507	-.4073	.5362	.9076	.1002	-.4173	.5836	.9118	.1507	-.7524	-.3886	.5917	.8990
.2003	-.4170	.5336	.9116	.1503	-.4497	.5749	.9253	.5002	.7476	-.5172	.5569	.9538
.2502	-.4503	.5247	.9257	.1976	-.5255	.5547	.9573	.5002	.4976	-.5338	.5525	.9609
.3001	-.4706	.5164	.9341	.2503	-.5442	.5484	.9674	.5002	.2476	-.5289	.5538	.9587
.3502	-.4769	.5177	.9388	.3001	-.5503	.5481	.9678	.5002	-.2524	-.5308	.5533	.9595
.4003	-.4416	.5239	.9424	.3507	-.5398	.5509	.9634	.5002	-.5024	-.5113	.5585	.9515
.4501	-.4124	.5282	.9517	.4001	-.5015	.5611	.9471	.5002	-.7524	-.5066	.5598	.9493
.5002	-.3264	.5545	.9377	.4501	-.4419	.5770	.9220	.8002	.7476	-.3862	.5919	.8988
.5502	-.3485	.5486	.9471	.5001	-.3453	.6024	.8818	.8002	.4976	-.4084	.5864	.9073
.6002	-.3706	.5427	.9565	.5497	-.2225	.6355	.8312	.8002	.2476	-.4157	.5840	.9111
.6500	-.3767	.5411	.9641	.6003	-.0996	.6683	.7809	.8002	-.5024	-.3960	.5893	.9029
.7000	-.3500	.5482	.9677	.6500	.0064	.6986	.7373	.8002	-.7524	-.3707	.5960	.8923
.7500	-.4936	.5632	.9434	.7000	.1225	.7275	.6894					
.8002	-.4094	.5457	.9065	.7501	.2255	.7550	.6493					
.9002	-.2130	.6340	.8271	.8001	.3122	.7791	.6093					
.9501	-.0849	.6722	.7749	.8501	.3896	.7947	.5755					

TEST 167 PT 20.3935 PSI CM -3234 CD1 .00717 CDCOR1 .00706
 RUN 11 TT 213.4260 K CM -1441 CD2 .00585 CDCOR2 .00578
 POINT 5 RC 4.3840 MILLION CC .0191 CD3 .00669 CDCOR3 .00662
 MACH .7407 CD4 .00547 CDCOR4 .00536
 ALPHA -1.4923 DEG CD5 .00749 CDCOR5 .00730

UPPER SURFACE				LOWER SURFACE				SPANWISE				
X/C	CP	P/L/PT	MLOC	X/C	CP	P/L/PT	MLOC	X/C	Y/(B/2)	CP	P/L/PT	MLOC
0.0000	1.0601	.9774	.1400	0.0000	1.0601	.9774	.1400	1.507	.7476	-.4573	.5722	.9296
.0132	-.1574	.7363	.6756	.0126	-.0104	.6971	.7366	1.507	.4976	-.4803	.5660	.9393
.0259	-.1970	.6417	.8217	.0255	-.1006	.6674	.7822	1.507	.2476	-.4791	.5666	.9388
.0759	-.4545	.5729	.9284	.0495	-.2319	.6324	.8361	1.507	-.2524	-.4835	.5652	.9407
.1003	-.4581	.5720	.9300	.0753	-.2927	.6161	.8611	1.507	-.5024	-.4786	.5665	.9386
.1507	-.4773	.5668	.9381	.1002	-.3386	.6039	.8801	1.507	-.7524	-.4540	.5731	.9283
.2003	-.4848	.5648	.9412	.1503	-.3813	.5925	.8978	1.507	-.5024	-.4540	.5731	.9283
.2503	-.5021	.5594	.9495	.1976	-.4589	.5717	.9303	1.507	.4976	-.4578	.5678	.9427
.3001	-.5207	.5553	.9566	.2503	-.4872	.5642	.9422	1.507	.2476	-.4521	.5642	.9471
.3502	-.5187	.5558	.9556	.3001	-.4996	.5609	.9475	1.507	-.2524	-.4531	.5637	.9474
.4003	-.5300	.5528	.9604	.3507	-.4974	.5615	.9466	1.507	-.5024	-.4548	.5683	.9476
.4501	-.5437	.5486	.9671	.4001	-.4681	.5693	.9342	1.507	-.7524	-.4510	.5498	.9651
.5002	-.5578	.5454	.9722	.4501	-.4176	.5828	.9130	1.507	.4976	-.4060	.5859	.9087
.5502	-.5782	.5399	.9810	.5001	-.3289	.6065	.8741	1.507	.2476	-.4203	.5830	.9126
.6002	-.5974	.5348	.9893	.5507	-.2088	.6388	.8265	1.507	-.5024	-.4035	.5866	.9071
.6500	-.6007	.5339	.9907	.6003	-.0389	.6700	.7774	1.507	-.7524	-.3789	.5931	.8968
.7000	-.5851	.5434	.9754	.6500	.0152	.6584	.7346					
.7500	-.5619	.5603	.9485	.7000	.1291	.7288	.6875					
.8002	-.5134	.5839	.9112	.7501	.2307	.7559	.6448					
.8502	-.4213	.6379	.8276	.8001	.3164	.7788	.6082					
.9001	-.0796	.6730	.7736	.8501	.3927	.7992	.5748					

TEST 167 PT 20.3967 PSI CM .3910 CD1 .00731 CDCOR1 .00725
 RUN 11 TT 213.3802 K CM -1444 CD2 .00597 CDCOR2 .00594
 POINT A RC 4.3842 MILLION CC .0194 CD3 .00687 CDCOR3 .00684
 MACH .7402 CD4 .00555 CDCOR4 .00549
 ALPHA -.9540 DEG CD5 .00752 CDCOR5 .00740

UPPER SURFACE				LOWER SURFACE				SPANWISE				
X/C	CP	P/L/PT	MLOC	X/C	CP	P/L/PT	MLOC	X/C	Y/(B/2)	CP	P/L/PT	MLOC
0.0000	1.0993	.9881	.1305	0.0000	1.0993	.9881	.1305	1.507	.7476	-.5283	.5552	.9566
.0132	-.0422	.7069	.7214	.0126	-.1362	.7320	.6825	1.507	.4976	-.5327	.5487	.9669
.0259	-.3190	.6109	.8692	.0255	-.0047	.6970	.7348	1.507	.2476	-.5498	.5495	.9636
.0759	-.5579	.5473	.9681	.0495	-.1409	.6592	.7963	1.507	-.2524	-.5571	.5475	.9698
.1003	-.5482	.5499	.9650	.0753	-.2108	.6396	.8249	1.507	-.5024	-.5506	.5493	.9640
.1507	-.5502	.5494	.9658	.1002	-.2641	.6255	.8467	1.507	-.7524	-.5223	.5568	.9540
.2003	-.5434	.5512	.9630	.1503	-.3164	.6116	.8682	1.507	.4976	-.5799	.5415	.9785
.2503	-.5582	.5472	.9682	.1976	-.3954	.5905	.9009	1.507	.4976	-.5974	.5368	.9860
.3001	-.5669	.5449	.9729	.2503	-.4289	.5816	.9148	1.507	.2476	-.5923	.5382	.9836
.3502	-.5804	.5406	.9762	.3001	-.4477	.5766	.9226	1.507	-.2524	-.5944	.5376	.9847
.4003	-.5859	.5453	.9723	.3507	-.4531	.5752	.9249	1.507	-.5024	-.5773	.5422	.9774
.4501	-.5779	.5420	.9776	.4001	-.4311	.5810	.9157	1.507	-.7524	-.5705	.5440	.9745
.5002	-.5863	.5388	.9812	.4501	-.3887	.5923	.8981	1.507	.4976	-.5928	.5312	.9898
.5502	-.6034	.5311	.9886	.5001	-.3095	.6134	.8654	1.507	.4976	-.6087	.5870	.9064
.6002	-.6173	.5310	.9955	.5497	-.1933	.6443	.8177	1.507	.2476	-.6236	.5830	.9126
.6500	-.6173	.5315	.9945	.6003	-.0767	.6753	.7701	1.507	-.5024	-.6083	.5871	.9062
.7000	-.5755	.5426	.9766	.6500	.0247	.7023	.7286	1.507	-.7524	-.5839	.5936	.8961
.7500	-.5642	.5611	.9472	.7000	.1364	.7320	.6824					
.8002	-.4167	.5849	.9097	.7501	.2307	.7587	.6404					
.8502	-.2102	.6398	.8246	.8001	.3217	.7813	.6041					
.9001	-.0778	.6730	.7705	.8501	.3975	.8015	.5710					

TEST 167 PT 20.4181 PSI CM .4539 CD1 .00752 CDCOR1 .00738
 RUN 11 TT 213.3881 K CM -1447 CD2 .00629 CDCOR2 .00619
 POINT 7 RC 4.3807 MILLION CC .0188 CD3 .00726 CDCOR3 .00715
 MACH .7401 CD4 .00587 CDCOR4 .00574
 ALPHA -.4903 DEG CD5 .00726 CDCOR5 .00706

UPPER SURFACE				LOWER SURFACE				SPANWISE				
X/C	CP	P/L/PT	MLOC	X/C	CP	P/L/PT	MLOC	X/C	Y/(B/2)	CP	P/L/PT	MLOC
0.0000	1.1289	.9960	.0754	0.0000	1.1289	.9960	.0754	1.507	.7476	-.5990	.5364	.9667
.0132	-.0691	.6773	.7670	.0126	-.2526	.7629	.6337	1.507	.4976	-.6260	.5290	.9887
.0259	-.4371	.5794	.9182	.0255	.1043	.7236	.6956	1.507	.2476	-.6236	.5298	.9973
.0759	-.6685	.5179	1.0168	.0495	-.0922	.6818	.7601	1.507	-.2524	-.6306	.5208	1.0003
.1003	-.6427	.5247	1.0055	.0753	-.1383	.6610	.7920	1.507	-.5024	-.6210	.5305	.9962
.1507	-.6242	.5287	.9975	.1002	-.1894	.6433	.8161	1.507	-.7524	-.6174	.5394	.9817
.2003	-.6055	.5366	.9895	.1503	-.2507	.6298	.8412	1.507	.4976	-.6007	.5399	.9874
.2503	-.6083	.5358	.9907	.1976	-.3319	.6074	.8746	1.507	.4976	-.6185	.5317	.9942
.3001	-.6096	.5356	.9912	.2503	-.3698	.5973	.8905	1.507	.2476	-.6124	.5327	.9927
.3502	-.5945	.5370	.9956	.3001	-.3940	.5909	.9005	1.507	-.5024	-.6048	.5366	.9892
.4003	-.5966	.5370	.9956	.3507	-.4048	.5860	.9048	1.507	-.7524	-.6087	.5386	.9828
.4501	-.6065	.5344	.9989	.4001	-.3891	.5922	.8983	1.507	.4976	-.6096	.5375	.9857
.5002	-.6103	.5334	.9995	.4501	-.3531	.6018	.8833	1.507	.2476	-.6203	.5839	.9112
.5502	-.6232	.5298	.9971	.5001	-.2828	.6205	.8544	1.507	-.5024	-.6072	.5874	.9056
.6002	-.6354	.5267	1.0024	.5497	-.1717	.6500	.8089	1.507	-.7524	-.5829	.5938	.8957
.6500	-.6286	.5285	.9994	.6003	-.0585	.6801	.7626					
.7000	-.5791	.5416	.9782	.6500	.0399	.7063	.7225					
.7500	-.5656	.5612	.9476	.7000	.1494	.7334	.6771					
.8002	-.4148	.5854	.9089	.7501	.2481	.7617	.6356					
.8502	-.2032	.6417	.8218	.8001	.3323	.7841	.5995					
.9001	-.0763	.6770	.7675	.8501	.4081	.8043	.5663					

ORIGINAL PAGE IS
OF POOR QUALITY

TEST 167	PT 20.4190	PSI	CM .5305	CD1 .00743	CDCOR1 .00781
RUN 11	TT 213.3868	K	CM -.1451	CD2 .00735	CDCOR2 .00725
POINT 8	RC 4.3889	MILLION	CC .0170	CD3 .00774	CDCOR3 .00765
	MACH .7402			CD4 .00688	CDCOR4 .00675
	ALPHA .0281	DEG		CD5 .00741	CDCOR5 .00722

UPPER SURFACE				LOWER SURFACE				SPANWISE				
X/C	CP	P/L/PT	MLOC	X/C	CP	P/L/PT	MLOC	X/C	Y/(B/2)	CP	P/L/PT	MLOC
0.0000	1.1368	.9981	.0525	0.0000	1.1368	.9981	.0525	.1507	.7476	-.6891	.5120	1.0263
.0132	-.1937	.6439	.8183	.0126	.3513	.7890	.5916	.1507	.4976	-.7160	.5049	1.0382
.0259	-.5701	.5437	.9749	.0255	.1892	.7458	.6608	.1507	.2476	-.7150	.5051	1.0377
.0759	-.8156	.4784	1.0827	.0495	.0217	.7012	.7302	.1507	-.2324	-.7214	.5034	1.0406
.1003	-.7870	.4860	1.0698	.0753	-.0641	.6784	.7653	.1507	-.5024	-.7079	.5070	1.0346
.1507	-.7181	.5043	1.0391	.1002	-.1293	.6610	.7920	.1507	-.7524	-.6709	.5169	1.0184
.2003	-.6874	.5125	1.0256	.1503	-.1999	.6423	.8209	.5002	.7476	-.6319	.5273	1.0014
.2503	-.6689	.5174	1.0175	.1976	-.2838	.6199	.8552	.5002	.4976	-.6423	.5245	1.0060
.3001	-.6678	.5177	1.0170	.2503	-.3255	.6088	.8724	.5002	.2476	-.6506	.5223	1.0096
.3502	-.6559	.5209	1.0119	.3001	-.3543	.6011	.8843	.5002	-.2324	-.6359	.5262	1.0032
.4003	-.6436	.5241	1.0065	.3507	-.3701	.5969	.8909	.5002	-.5024	-.6319	.5273	1.0014
.4501	-.6473	.5232	1.0081	.4001	-.3600	.5996	.8867	.5002	-.7524	-.6167	.5313	.9949
.5002	-.6472	.5232	1.0081	.4501	-.3300	.6076	.8743	.8002	.7476	-.3939	.5906	.9908
.5502	-.6565	.5207	1.0121	.5001	-.2664	.6245	.8481	.8002	.4976	-.4113	.5860	.9900
.6002	-.6675	.5178	1.0168	.5497	-.1608	.6527	.8049	.8002	.2476	-.4250	.5823	.9137
.6500	-.6522	.5219	1.0102	.6003	-.0509	.6819	.7599	.8002	-.5024	-.4113	.5860	.9900
.7000	-.5937	.5374	.9850	.6500	.6449	.7074	.7207	.8002	-.7524	-.3883	.5921	.8984
.7500	-.5156	.5582	.9517	.7000	.1325	.7360	.6761					
.8002	-.4213	.5833	.9121	.7501	.2494	.7619	.6333					
.9022	-.2040	.6412	.8225	.8001	.3327	.7840	.5996					
.9501	-.0757	.6753	.7701	.8501	.4084	.8042	.5665					

TEST 167	PT 20.4190	PSI	CM .5892	CD1 .00865	CDCOR1 .00849
RUN 11	TT 213.3492	K	CM -.1415	CD2 .00887	CDCOR2 .00875
POINT 9	RC 4.3908	MILLION	CC .0144	CD3 .00856	CDCOR3 .00844
	MACH .7405			CD4 .00831	CDCOR4 .00818
	ALPHA .5254	DEG		CD5 .00830	CDCOR5 .00808

UPPER SURFACE				LOWER SURFACE				SPANWISE				
X/C	CP	P/L/PT	MLOC	X/C	CP	P/L/PT	MLOC	X/C	Y/(B/2)	CP	P/L/PT	MLOC
0.0000	1.1457	1.0005	0.0000	0.0000	1.1452	1.0005	0.0000	.1507	.7476	-.7817	.4894	1.0640
.0132	-.2959	.6183	.8578	.0126	.4428	.8142	.5496	.1507	.4976	-.8451	.4726	1.0926
.0259	-.6818	.5159	1.0200	.0255	.2703	.7684	.6248	.1507	.2476	-.8744	.4648	1.1059
.0759	-.9328	.4493	1.1330	.0495	.0930	.7214	.6589	.1507	-.2524	-.8648	.4674	1.1015
.1003	-.9355	.4486	1.1343	.0753	.0004	.6969	.7369	.1507	-.5024	-.8233	.4784	1.0827
.1507	-.8730	.4652	1.1053	.1002	-.0693	.6784	.7654	.1507	-.7524	-.7580	.4957	1.0534
.2003	-.7731	.4917	1.0602	.1503	-.1474	.6577	.7972	.5002	.7476	-.6629	.5209	1.0118
.2503	-.6767	.5172	1.0178	.1976	-.2347	.6345	.8328	.5002	.4976	-.6777	.5170	1.0182
.3001	-.6815	.5160	1.0198	.2503	-.2816	.6221	.8520	.5002	.2476	-.6863	.5147	1.0220
.3502	-.6900	.5137	1.0235	.3001	-.3145	.6133	.8655	.5002	-.24	-.6679	.5196	1.0140
.4003	-.6784	.5168	1.0185	.3507	-.3347	.6080	.8718	.4002	-.5024	-.6662	.5200	1.0132
.4501	-.6838	.5154	1.0208	.4001	-.3299	.6093	.8718	.5002	-.7524	-.6478	.5249	1.0053
.5002	-.6822	.5158	1.0201	.4501	-.3052	.6158	.8616	.8002	.7476	-.3908	.5931	.8969
.5502	-.6798	.5164	1.0191	.5001	-.2482	.6309	.8383	.8002	.4976	-.4039	.5896	.9023
.6002	-.6530	.5235	1.0193	.5497	-.1461	.6575	.7975	.8002	.2476	-.4151	.5866	.9069
.6500	-.5986	.5406	.9798	.6003	-.0408	.6859	.7538	.8002	-.5024	-.4052	.5893	.9028
.7000	-.5074	.5622	.9455	.6500	.0519	.7105	.7158	.8002	-.7524	-.3861	.5943	.8949
.7500	-.4105	.5879	.9050	.7000	.1574	.7385	.6723					
.8002	-.1891	.6486	.8147	.7501	.2531	.7639	.6321					
.9002	-.0643	.6797	.7633	.8001	.3354	.7857	.5969					
.9501				.8501	.4107	.8057	.5639					

TEST 167	PT 20.4222	PSI	CM .6622	CD1 .00895	CDCOR1 .00871
RUN 11	TT 213.4618	K	CM -.1400	CD2 .00915	CDCOR2 .00901
POINT 10	RC 4.3884	MILLION	CC .0114	CD3 .00867	CDCOR3 .00855
	MACH .7405			CD4 .00842	CDCOR4 .00831
	ALPHA 1.0156	DEG		CD5 .00856	CDCOR5 .00833

UPPER SURFACE				LOWER SURFACE				SPANWISE				
X/C	CP	P/L/PT	MLOC	X/C	CP	P/L/PT	MLOC	X/C	Y/(B/2)	CP	P/L/PT	MLOC
0.0000	1.1433	1.0002	0.0000	0.0000	1.1433	1.0002	0.0000	.1507	.7476	-.9606	.4442	1.1421
.0132	-.4047	.5911	.9000	.0126	.5221	.8361	.5120	.1507	.4976	-1.0630	.4471	1.1911
.0259	-.7970	.4874	1.0673	.0255	.3407	.7881	.5930	.1507	.2476	-1.0459	.4426	1.1828
.0759	-1.0479	.4211	1.1837	.0495	.1574	.7397	.6704	.1507	-.2524	-1.0420	.4427	1.1809
.1003	-1.0527	.4199	1.1861	.0753	.0590	.7137	.7109	.1507	-.5024	-1.0405	.4431	1.1801
.1507	-1.0363	.4242	1.1781	.1002	-.0150	.6941	.7412	.1507	-.7524	-.9182	.4454	1.1223
.2003	-1.0133	.4303	1.1671	.1503	-.0987	.6720	.7752	.5002	.7476	-.8886	.5161	1.0197
.2503	-.9279	.4528	1.1268	.1976	-.1893	.6480	.8120	.5002	.4976	-.7048	.5118	1.0267
.3001	-.8910	.5154	1.0207	.2503	-.2764	.6345	.8328	.5002	.2476	-.7151	.5091	1.0312
.3502	-.8139	.5358	.9876	.3001	-.3004	.6250	.8474	.5002	-.2524	-.6459	.5141	1.0229
.4003	-.8642	.5225	1.0091	.3507	-.3004	.6187	.8571	.5002	-.5024	-.6458	.5142	1.0228
.4501	-.7007	.5129	1.0249	.4001	-.3002	.6187	.8571	.5002	-.7524	-.6764	.5193	1.0144
.5002	-.7093	.5106	1.0287	.4501	-.2804	.6240	.8490	.8002	.7476	-.3999	.5924	.8980
.5502	-.7053	.5117	1.0269	.5001	-.2295	.6374	.8283	.8002	.4976	-.4121	.5892	.9030
.6002	-.6991	.5133	1.0242	.5497	-.1331	.6624	.7900	.8002	.2476	-.4216	.5866	.9070
.6500	-.6676	.5216	1.0106	.6003	-.0309	.6899	.7476	.8002	-.5024	-.4109	.5895	.9025
.7000	-.5985	.5399	.9810	.6500	.0590	.7137	.7110	.8002	-.7524	-.3918	.5945	.8946
.7500	-.5137	.5623	.9452	.7000	.1622	.7409	.6685					
.8002	-.4161	.5881	.9047	.7501	.2565	.7659	.6289					
.9002	-.1932	.6470	.8136	.8001	.3380	.7874	.5942					
.9501	-.0665	.6805	.7621	.8501	.4128	.8072	.5615					

TEST 167	PT	20.3259	PSI	CM	.7673	CD1	.00896	CDCOR1	.00868
RUN 11	TY	213.4600	K	CM	-1436	CD2	.00919	CDCOR2	.00887
POINT 11	RC	4.3580	MILLION	CC	.0088	CD3	.00396	CDCOR3	.00870
	MACH	.7406				CD4	.00832	CDCOR4	.00799
	ALPHA	1.5152	DEG			CD5	.00899	CDCOR5	.00864

UPPER SURFACE				LOWER SURFACE				SPANWISE				
X/C	CP	P _z L/PT	MLOC	X/C	CP	P _z L/PT	MLOC	X/C	Y/(B/2)	CP	P _z L/PT	MLOC
0.0000	1.1427	.9994	.0298	0.0000	1.1427	.9994	.0298	.1507	.7476	-1.0952	.4011	1.2210
.0132	-.4803	.5655	.9401	.0126	-.5925	.8523	.4830	.1507	.4976	-1.1708	.3809	1.2599
.0259	-.8708	.4611	1.1123	.0255	-.4073	.8028	.5688	.1507	.2476	-1.1315	.3914	1.2395
.0759	-1.1166	.3954	1.2318	.0495	-.2173	.7520	.6510	.1507	-.2524	-1.1309	.3916	1.2392
.1003	-1.1277	.3925	1.2375	.0753	-.1150	.7247	.6939	.1507	-.5024	-1.1560	.3849	1.2521
.1507	-1.1223	.3939	1.2347	.1002	-.0381	.7041	.7258	.1507	-.7524	-1.0613	.4102	1.2039
.2053	-1.1142	.3961	1.2306	.1503	-.0913	.6802	.7626	.5002	.7476	-.6286	.5259	1.0037
.2503	-1.1252	.3931	1.2362	.1976	-.1442	.6556	.8007	.5002	.4976	-.5832	.5380	.9840
.3001	-1.1397	.3892	1.2437	.2503	-.1990	.6407	.8232	.5002	.2476	-.5780	.5394	.9818
.3502	-1.1085	.3976	1.2277	.3001	-.2378	.6304	.8392	.5002	-.2524	-.5617	.5438	.9748
.4003	-1.0102	.4239	1.1787	.3502	-.2652	.6230	.8505	.5002	-.5024	-.6039	.5325	.9930
.4501	-.6441	.5217	1.0164	.4001	-.2685	.6221	.8518	.5002	-.7524	-.6426	.5221	1.0098
.5002	-.5351	.5509	.9634	.4501	-.2526	.6264	.8453	.8002	.7476	-.3982	.5875	.9056
.5502	-.5978	.5341	.9903	.5001	-.2054	.6390	.8258	.8002	.4976	-.4169	.5825	.9135
.6002	-.6630	.5167	1.0187	.5497	-.1154	.6631	.7889	.8002	.2476	-.4298	.5790	.9189
.6500	-.6778	.5127	1.0252	.6003	-.0141	.6901	.7473	.8002	-.5024	-.4176	.5823	.9138
.7000	-.6118	.5304	.9964	.6500	.0737	.7136	.7110	.8002	-.7524	-.3918	.5892	.9030
.7500	-.5209	.5547	.9574	.7000	.1754	.7408	.6687					
.8002	-.4240	.5806	.9165	.7501	.2683	.7656	.6293					
.9002	-.2052	.6391	.8258	.8001	.3490	.7872	.5945					
.9501	-.0751	.6738	.7723	.8501	.4239	.8072	.5613					

TEST 167	PT	20.4175	PSI	CM	.8691	CD1	.01041	CDCOR1	.00977
RUN 11	TY	213.4264	K	CM	-1499	CD2	.01121	CDCOR2	.01060
POINT 12	RC	4.3878	MILLION	CC	.0064	CD3	.01159	CDCOR3	.01061
	MACH	.7403				CD4	.01107	CDCOR4	.01062
	ALPHA	2.0147	DEG			CD5	.01152	CDCOR5	.01106

UPPER SURFACE				LOWER SURFACE				SPANWISE				
X/C	CP	P _z L/PT	MLOC	X/C	CP	P _z L/PT	MLOC	X/C	Y/(B/2)	CP	P _z L/PT	MLOC
0.0000	1.1298	.9963	.0725	0.0000	1.1298	.9963	.0725	.1507	.7476	-1.2198	.3722	1.2773
.0132	-.5772	.5429	.9762	.0126	-.6585	.8711	.4480	.1507	.4976	-1.2665	.3598	1.3023
.0259	-.9698	.4396	1.1521	.0255	-.4701	.8211	.5379	.1507	.2476	-1.2254	.3707	1.2802
.0759	-1.2096	.3749	1.2718	.0495	-.2768	.7697	.6227	.1507	-.2524	-1.2206	.3720	1.2777
.1003	-1.2209	.3719	1.2778	.0753	-.1705	.7415	.6675	.1507	-.5024	-1.2485	.3646	1.2925
.1507	-1.2160	.3730	1.2756	.1002	-.0901	.7201	.7009	.1507	-.7524	-1.1697	.3855	1.2510
.2003	-1.2114	.3744	1.2728	.1503	-.0047	.6949	.7399	.5002	.7476	-.7780	.4895	1.0637
.2503	-1.2174	.3728	1.2760	.1976	-.1009	.6694	.7791	.5002	.4976	-.6777	.4631	1.1090
.3001	-1.2371	.3676	1.2665	.2503	-.1642	.6526	.8050	.5002	.2476	-.6218	.4646	1.1063
.3502	-1.2408	.3645	1.2927	.3001	-.2035	.6421	.8210	.5002	-.2524	-.6264	.4761	1.0865
.4003	-1.2315	.3691	1.2834	.3502	-.2302	.6351	.8319	.5002	-.5024	-.6476	.4710	1.0952
.4501	-1.1779	.3833	1.2553	.4001	-.2352	.6337	.8340	.5002	-.7524	-.6476	.4981	1.0495
.5002	-.8608	.4676	1.1012	.4501	-.2227	.6370	.8289	.8002	.7476	-.3925	.5919	.8987
.5502	-.9033	.5625	.9449	.5001	-.1814	.6480	.8120	.8002	.4976	-.4149	.5840	.9079
.6002	-.9345	.5542	.9581	.5497	-.0972	.6704	.7776	.8002	.2476	-.4293	.5822	.9139
.6500	-.9677	.5406	.9799	.6003	.0026	.6949	.7369	.8002	-.5024	-.4109	.5871	.9063
.7000	-.9762	.5432	.9758	.6500	.0859	.7189	.7028	.8002	-.7524	-.3790	.5955	.8931
.7500	-.9144	.5596	.9496	.7000	.1853	.7454	.6614					
.8002	-.8254	.5832	.9133	.7501	.2771	.7698	.6226					
.9002	-.2155	.6390	.8259	.8001	.3575	.7912	.5880					
.9501	-.0885	.6727	.7741	.8501	.4344	.8116	.5540					

TEST 167	PT	20.4158	PSI	CM	.9502	CD1	.01156	CDCOR1	.01169
RUN 11	TY	213.4879	K	CM	-1569	CD2	.01330	CDCOR2	.01303
POINT 13	RC	4.3886	MILLION	CC	.0054	CD3	.01407	CDCOR3	.01381
	MACH	.7412				CD4	.01370	CDCOR4	.01339
	ALPHA	2.5152	DEG			CD5	.01328	CDCOR5	.01290

UPPER SURFACE				LOWER SURFACE				SPANWISE				
X/C	CP	P _z L/PT	MLOC	X/C	CP	P _z L/PT	MLOC	X/C	Y/(B/2)	CP	P _z L/PT	MLOC
0.0000	1.1217	.9939	.0938	0.0000	1.1217	.9939	.0938	.1507	.7476	-1.2928	.3493	1.3239
.0132	-.6407	.5234	1.0078	.0126	-.7059	.8828	.4254	.1507	.4976	-1.3230	.3412	1.3409
.0259	-1.0262	.4204	1.1850	.0255	-.5163	.8322	.5187	.1507	.2476	-1.2807	.3523	1.3173
.0759	-1.2623	.3574	1.3071	.0495	-.3187	.7795	.6070	.1507	-.2524	-1.2741	.3543	1.3136
.1003	-1.2714	.3550	1.3121	.0753	-.2098	.7504	.6535	.1507	-.5024	-1.3003	.3473	1.3281
.1507	-1.2701	.3553	1.3114	.1002	-.1275	.7284	.6880	.1507	-.7524	-1.2361	.3644	1.2928
.2003	-1.2698	.3554	1.3112	.1503	-.0288	.7021	.7289	.5002	.7476	-1.2058	.3725	1.2766
.2503	-1.2736	.3544	1.3133	.1976	-.0701	.6757	.7695	.5002	.4976	-1.2335	.3651	1.2914
.3001	-1.2948	.3487	1.3251	.2503	-.1376	.6577	.7972	.5002	.2476	-.12316	.3603	1.3013
.3502	-1.3063	.3457	1.3315	.3001	-.1809	.6451	.8149	.5002	-.2524	-1.2332	.3652	1.2913
.4003	-1.3193	.3433	1.3366	.3502	-.2106	.6382	.8271	.5002	-.5024	-1.2177	.3693	1.2829
.4501	-1.3280	.3390	1.3438	.4001	-.2195	.6359	.8308	.5002	-.7524	-1.1487	.3877	1.2466
.5002	-1.2804	.3518	1.3187	.4501	-.2101	.6383	.8269	.8002	.7476	-.3842	.5972	.8905
.5502	-1.1301	.3427	1.2371	.5001	-.1724	.6484	.8114	.8002	.4976	-.3837	.5920	.8986
.6002	-.5722	.5416	.9762	.5497	-.0915	.6700	.7783	.8002	.2476	-.3914	.5899	.9019
.6500	-.4420	.5764	.9230	.6003	.0071	.6943	.7378	.8002	-.5024	-.3859	.5914	.8995
.7000	-.4356	.5727	.9288	.6500	.0885	.7180	.7042	.8002	-.7524	-.3528	.6002	.8898
.7500	-.4440	.5753	.9247	.7000	.1869	.7443	.6631					
.8002	-.3890	.5906	.9008	.7501	.2781	.7686	.6245					
.9002	-.2095	.6385	.8267	.8001	.3582	.7900	.5899					
.9501	-.0876	.6710	.7767	.8501	.4350	.8105	.5558					

TEST	167	PT	22.5949	PSI	CN	-.0733	CD1	.01071	CDCOR1	.01047
RUN	12	TT	164.5927	K	CM	-.1253	CD2	.01058	CDCOR2	.01039
POINT	14	RC	6.9922	MILLION	CC	.0025	CD3	.01002	CDCOR3	.00990
		MACH	.7419				CD4	.00799	CDCOR4	.00781
		ALPHA	-3.9917	DEG			CD5	.00752	CDCOR5	.00727

UPPER SURFACE				LOWER SURFACE				SPANWISE				
X/C	CP	P/L/PT	MLOC	X/C	CP	P/L/PT	MLOC	X/C	Y/(B/2)	CP	P/L/PT	MLOC
0.0000	.7118	.8839	.4235	0.0000	.7118	.8839	.4235	.1507	.7476	-.1419	.6553	.8010
.0132	.6315	.8624	.4667	.0126	-.7859	.4829	1.0752	.1507	.4976	-.1577	.6511	.8075
.0259	.3073	.7756	.6135	.0255	-.7004	.5058	1.0369	.1507	.2476	-.1479	.6537	.8035
.0759	-.0282	.6857	.7543	.0495	-.8325	.4701	1.0970	.1507	-.2524	-.1428	.6550	.8014
.1003	-.0679	.6751	.7706	.0753	-.8372	.4691	1.0987	.1507	-.5024	-.1599	.6505	.8084
.1507	-.1361	.6568	.7986	.1002	-.8156	.4749	1.0888	.1507	-.7524	-.1499	.6532	.8043
.2003	-.1881	.6429	.8200	.1503	-.7604	.4897	1.0638	.5002	.4976	-.3804	.5914	.8997
.2503	-.2339	.6307	.8389	.1976	-.7593	.4900	1.0632	.5002	.4976	-.3846	.5903	.9014
.3001	-.2741	.6199	.8555	.2503	-.8798	.4577	1.1185	.5002	.2476	-.3922	.5883	.9046
.3502	-.2993	.6132	.8659	.3001	-.9506	.4388	1.1520	.5002	-.2524	-.3807	.5914	.8998
.4003	-.3294	.6091	.8764	.3507	-.8963	.4533	1.1262	.5002	-.5024	-.3774	.5923	.8984
.4501	-.3597	.5970	.8910	.4001	-.5773	.5387	.9831	.5002	-.7524	-.3629	.5961	.8923
.5002	-.3881	.5894	.9029	.4501	-.3102	.5567	.9544	.8002	.4976	-.3541	.5985	.8887
.5502	-.4233	.5799	.9177	.5001	-.4099	.5835	.9120	.8002	.4976	-.3582	.5974	.8904
.6002	-.4543	.5716	.9307	.5497	-.2782	.6188	.8572	.8002	.2476	-.3639	.5959	.8928
.6500	-.4696	.5676	.9372	.6003	-.1458	.6545	.8026	.8002	-.5024	-.3498	.5996	.8869
.7000	-.4618	.5697	.9358	.6500	-.0320	.6847	.7558	.8002	-.7524	-.3310	.6047	.8791
.7500	-.4220	.5803	.9171	.7000	.0818	.7152	.7088					
.8002	-.3560	.5960	.8895	.7501	.1772	.7407	.6689					
.9002	-.1749	.6465	.8146	.8001	.2538	.7612	.6365					
.9501	-.0502	.6799	.7633	.8501	.3179	.7784	.6089					

TEST	167	PT	22.6199	PSI	CN	-.0785	CD1	.00998	CDCOR1	.00996
RUN	12	TT	164.6131	K	CM	-.1292	CD2	.00995	CDCOR2	.00995
POINT	15	RC	6.9990	MILLION	CC	.0114	CD3	.00959	CDCOR3	.00962
		MACH	.7424				CD4	.00761	CDCOR4	.00761
		ALPHA	-2.9938	DEG			CD5	.00676	CDCOR5	.00668

UPPER SURFACE				LOWER SURFACE				SPANWISE				
X/C	CP	P/L/PT	MLOC	X/C	CP	P/L/PT	MLOC	X/C	Y/(B/2)	CP	P/L/PT	MLOC
0.0000	.8656	.9250	.3353	0.0000	.8656	.9250	.3353	.1507	.7476	-.2544	.6252	.8474
.0132	.4750	.8204	.5392	.0126	-.4470	.5736	.9277	.1507	.4976	-.2731	.6201	.8551
.0259	.1341	.7292	.6870	.0255	-.4574	.5709	.9320	.1507	.2476	-.2586	.6240	.8491
.0759	-.1790	.6453	.8163	.0495	-.5640	.5422	.9775	.1507	-.2524	-.2568	.6245	.8484
.1003	-.2076	.6377	.8281	.0753	-.5786	.5383	.9837	.1507	-.5024	-.2714	.6206	.8544
.1507	-.2526	.6256	.8466	.1002	-.5967	.5335	.9916	.1507	-.7524	-.2586	.6240	.8491
.2003	-.2685	.6160	.8615	.1503	-.5855	.5365	.9867	.5002	.4976	-.4443	.5743	.9265
.2503	-.3281	.6034	.8779	.1976	-.6808	.5110	1.0283	.5002	.4976	-.4505	.5727	.9291
.3001	-.3621	.5963	.8921	.2503	-.7203	.5004	1.0498	.5002	.2476	-.4580	.5706	.9323
.3502	-.3800	.5915	.9096	.3001	-.6988	.5062	1.0363	.5002	-.2524	-.4468	.5736	.9276
.4003	-.4041	.5875	.9209	.3507	-.6535	.5183	1.0163	.5002	-.5024	-.4428	.5747	.9259
.4501	-.4308	.5778	.9305	.4001	-.5775	.5386	.9832	.5002	-.7524	-.4287	.5785	.9199
.5002	-.4539	.5717	.9305	.4501	-.4497	.5601	.9489	.8002	.4976	-.3712	.5939	.8958
.5502	-.4845	.5635	.9435	.5001	-.3912	.5885	.9042	.8002	.4976	-.3766	.5924	.8981
.6002	-.5107	.5565	.9546	.5497	-.2891	.6239	.8493	.8002	.2476	-.3433	.5906	.9009
.6500	-.5210	.5538	.9590	.6003	-.1283	.6589	.7955	.8002	-.5024	-.3717	.5937	.8961
.7000	-.5014	.5590	.9507	.6500	-.0166	.6888	.7495	.8002	-.7524	-.3526	.5989	.8881
.7500	-.4515	.5724	.9296	.7000	.0971	.7193	.7024					
.8002	-.3750	.5928	.8875	.7501	.1930	.7449	.6623					
.9002	-.1802	.6450	.8168	.8001	.2697	.7655	.6297					
.9501	-.0518	.6794	.7640	.8501	.3347	.7829	.6016					

TEST	167	PT	22.6162	PSI	CN	.2278	CD1	.00945	CDCOR1	.00933
RUN	12	TT	164.8826	K	CM	-.1344	CD2	.00956	CDCOR2	.00947
POINT	16	RC	6.9819	MILLION	CC	.0170	CD3	.00929	CDCOR3	.00923
		MACH	.7420				CD4	.00725	CDCOR4	.00714
		ALPHA	-1.9958	DEG			CD5	.00669	CDCOR5	.00651

UPPER SURFACE				LOWER SURFACE				SPANWISE				
X/C	CP	P/L/PT	MLOC	X/C	CP	P/L/PT	MLOC	X/C	Y/(B/2)	CP	P/L/PT	MLOC
0.0000	1.0019	.9619	.2360	0.0000	1.0019	.9619	.2360	.1507	.7476	-.3797	.5935	.8965
.0132	.2805	.7696	.6232	.0126	-.1432	.6565	.7991	.1507	.4976	-.4003	.5880	.9051
.0259	-.0723	.6754	.7702	.0255	-.2269	.6342	.8334	.1507	.2476	-.3824	.5927	.8977
.0759	-.3484	.6018	.8837	.0495	-.3419	.6036	.8808	.1507	-.2524	-.3849	.5921	.8967
.1003	-.3984	.5991	.8877	.0753	-.3837	.5924	.8982	.1507	-.5024	-.4026	.5874	.9060
.1507	-.3768	.5937	.8961	.1002	-.4487	.5836	.9119	.1507	-.7524	-.3811	.5931	.8971
.2003	-.4000	.5886	.9050	.1503	-.4409	.5771	.9220	.5002	.4976	-.5088	.5901	.9506
.2503	-.4291	.5803	.9171	.1976	-.3257	.5545	.9578	.5002	.4976	-.5142	.5876	.9529
.3001	-.4450	.5734	.9280	.2503	-.5542	.5469	.9700	.5002	.2476	-.5221	.5859	.9563
.3502	-.4664	.5703	.9328	.3001	-.5623	.5448	.9734	.5002	-.2524	-.5090	.5890	.9507
.4003	-.4828	.5660	.9396	.3507	-.5908	.5478	.9689	.5002	-.5024	-.5043	.5902	.9487
.4501	-.5014	.5610	.9475	.4001	-.5080	.5592	.9503	.5002	-.7524	-.4917	.5936	.9434
.5002	-.5190	.5563	.9550	.4501	-.4467	.5756	.9245	.8002	.4976	-.3862	.5917	.8992
.5502	-.5444	.5495	.9658	.5001	-.3539	.6004	.8858	.8002	.4976	-.3921	.5902	.9016
.6002	-.5650	.5440	.9746	.5497	-.2305	.6332	.8349	.8002	.2476	-.3996	.5882	.9048
.6500	-.5670	.5433	.9754	.6003	-.1060	.6665	.7838	.8002	-.5024	-.3874	.5914	.8997
.7000	-.5363	.5517	.9623	.6500	.0006	.6944	.7401	.8002	-.7524	-.3686	.5964	.8919
.7500	-.4762	.5677	.9369	.7000	.1139	.7251	.6934					
.8002	-.3923	.5901	.9017	.7501	.2106	.7509	.6529					
.9002	-.1866	.6450	.8169	.8001	.2896	.7720	.6193					
.9501	-.0573	.6795	.7639	.8501	.3577	.7901	.5894					

ORIGINAL PAGE IS
OF POOR QUALITY

TEST 167	PT 22.6162	PSI	CN	.2934	CD1 .00941	CDCDR1 .00929
RUN 12	TT 164.9135	K	CM	-.1349	CD2 .00955	CDCDR2 .00946
POINT 17	RC 6.9768	MILLION	CC	.0183	CD3 .00942	CDCDR3 .00936
	MACH .7414				CD4 .00749	CDCDR4 .00741
	ALPHA -1.4896	DEG			CD5 .00668	CDCDR5 .00650

UPPER SURFACE				LOWER SURFACE				SPANWISE				
X/C	CP	P _L /PT	MLOC	X/C	CP	P _L /PT	MLOC	X/C	Y/(B/2)	CP	P _L /PT	MLOC
0.0000	1.0547	.9759	.1869	0.0000	1.0547	.9759	.1869	.1507	.7476	-.4440	.5736	.9244
.0132	.1787	.7419	.6670	.0126	-.0075	.6922	.7443	.1507	.4976	-.4692	.5689	.9350
.0259	-.1801	.6461	.8151	.0255	-.1153	.6634	.7885	.1507	.2476	-.4494	.5742	.9267
.0759	-.4390	.5770	.9223	.0495	-.2445	.6289	.8416	.1507	-.2524	-.4530	.5732	.9282
.1003	-.4375	.5774	.9217	.0753	-.2969	.6149	.8632	.1507	-.5024	-.4704	.5686	.9355
.1507	-.4452	.5753	.9249	.1002	-.3392	.6036	.8807	.1507	-.7524	-.4434	.5758	.9242
.2003	-.4531	.5732	.9282	.1502	-.3752	.5940	.8957	.5002	.7476	-.5389	.5503	.9646
.2503	-.4622	.5654	.9405	.1976	-.4614	.5710	.9317	.5002	.4976	-.5457	.5485	.9675
.3001	-.5028	.5599	.9492	.2503	-.4964	.5616	.9465	.5002	.2476	-.5543	.5462	.9711
.3502	-.5646	.5595	.9500	.3001	-.5113	.5577	.9528	.5002	-.2524	-.5426	.5493	.9661
.4003	-.5187	.5557	.9560	.3501	-.5094	.5582	.9520	.5002	-.5024	-.5376	.5506	.9640
.4501	-.5364	.5510	.9635	.4001	-.4767	.5669	.9382	.5002	-.7524	-.5249	.5540	.9586
.5002	-.5498	.5474	.9692	.4501	-.4229	.5813	.9156	.8002	.7476	-.3862	.5911	.9002
.5502	-.5712	.5417	.9784	.5001	-.3363	.6044	.8795	.8002	.4976	-.3953	.5886	.9040
.6002	-.5883	.5371	.9857	.5497	-.2172	.6362	.8304	.8002	.2476	-.4021	.5868	.9069
.6500	-.5857	.5378	.9846	.6003	-.0959	.6686	.7806	.8002	-.5024	-.3939	.5890	.9035
.7000	-.5480	.5479	.9684	.6500	-.0077	.6963	.7380	.8002	-.7524	-.3755	.5939	.8958
.7500	-.4822	.5654	.9475	.7000	.1199	.7262	.6916					
.8002	-.3947	.5888	.9034	.7501	.2169	.7522	.6509					
.9002	-.1837	.6452	.8166	.8001	.2964	.7734	.6170					
.9501	-.0521	.6803	.7628	.8501	.3654	.7918	.5871					

TEST 167	PT 22.6181	PSI	CN	.3699	CD1 .00940	CDCDR1 .00935
RUN 12	TT 164.9887	K	CM	-.1379	CD2 .00939	CDCDR2 .00935
POINT 18	RC 6.9719	MILLION	CC	.0189	CD3 .00926	CDCDR3 .00928
	MACH .7412				CD4 .00738	CDCDR4 .00739
	ALPHA -.9979	DEG			CD5 .00679	CDCDR5 .00672

UPPER SURFACE				LOWER SURFACE				SPANWISE				
X/C	CP	P _L /PT	MLOC	X/C	CP	P _L /PT	MLOC	X/C	Y/(B/2)	CP	P _L /PT	MLOC
0.0000	1.0970	.9862	.1409	0.0000	1.0920	.9862	.1409	.1507	.7476	-.5180	.5582	.9520
.0132	.1575	.7112	.7130	.0126	-.1196	.7277	.6894	.1507	.4976	-.5429	.5515	.9626
.0259	-.3081	.6140	.8647	.0255	-.0100	.6932	.7427	.1507	.2476	-.5242	.5565	.9547
.0759	-.5420	.5518	.9622	.0495	-.1517	.6555	.8006	.1507	-.2524	-.5261	.5560	.9555
.1003	-.5139	.5593	.9503	.0753	-.2138	.6390	.8260	.1507	-.5024	-.5445	.5511	.9633
.1507	-.5196	.5577	.9527	.1002	-.2647	.6255	.8469	.1507	-.7524	-.5110	.5600	.9491
.2003	-.5281	.5555	.9563	.1502	-.3096	.6136	.8653	.5002	.7476	-.5725	.5437	.9752
.2503	-.5400	.5523	.9614	.1976	-.3951	.5908	.9006	.5002	.4976	-.5793	.5418	.9781
.3001	-.5543	.5485	.9674	.2503	-.4341	.5805	.9168	.5002	.2476	-.5876	.5396	.9816
.3502	-.5576	.5478	.9686	.3001	-.4844	.5751	.9253	.5002	-.2524	-.5714	.5440	.9747
.4003	-.5640	.5459	.9715	.3501	-.4590	.5738	.9272	.5002	-.5024	-.5669	.5451	.9728
.4501	-.5757	.5428	.9766	.4001	-.4352	.5802	.9173	.5002	-.7524	-.5543	.5485	.9674
.5002	-.5840	.5406	.9801	.4501	-.3902	.5921	.8986	.8002	.7476	-.3942	.5911	.9002
.5502	-.6023	.5357	.9879	.5001	-.3119	.6129	.8663	.8002	.4976	-.4029	.5888	.9038
.6002	-.6158	.5322	.9937	.5497	-.1993	.6429	.8201	.8002	.2476	-.4099	.5869	.9068
.6500	-.6058	.5348	.9894	.6003	-.0825	.6739	.7724	.8002	-.5024	-.3980	.5901	.9018
.7000	-.5624	.5463	.9709	.6500	.0181	.7007	.7312	.8002	-.7524	-.3800	.5949	.8943
.7500	-.4522	.5650	.9412	.7000	.1290	.7302	.6855					
.8002	-.4030	.5887	.9039	.7501	.2256	.7559	.6450					
.9002	-.1883	.6458	.8156	.8001	.3056	.7771	.6110					
.9501	-.0596	.6800	.7630	.8501	.3760	.7958	.5804					

TEST 167	PT 22.6117	PSI	CN	.4413	CD1 .00939	CDCDR1 .00922
RUN 12	TT 164.9688	K	CM	-.1389	CD2 .00945	CDCDR2 .00932
POINT 19	RC 6.9750	MILLION	CC	.0185	CD3 .00931	CDCDR3 .00920
	MACH .7419				CD4 .00753	CDCDR4 .00737
	ALPHA -1.4751	DEG			CD5 .00713	CDCDR5 .00692

UPPER SURFACE				LOWER SURFACE				SPANWISE				
X/C	CP	P _L /PT	MLOC	X/C	CP	P _L /PT	MLOC	X/C	Y/(B/2)	CP	P _L /PT	MLOC
0.0000	1.1248	.9944	.0894	0.0000	1.1248	.9944	.0894	.1507	.7476	-.5909	.5348	.9895
.0132	-.0506	.6795	.7638	.0126	.2427	.7581	.6415	.1507	.4976	-.6214	.5266	.10027
.0259	-.4254	.5791	.9189	.0255	.0948	.7185	.7037	.1507	.2476	-.6047	.5311	.9955
.0759	-.6562	.5173	1.0179	.0495	-.0609	.6768	.7680	.1507	-.2524	-.6064	.5306	.9962
.1003	-.6027	.5316	.9946	.0753	-.1332	.6574	.7978	.1507	-.5024	-.6210	.5267	1.0025
.1507	-.5998	.5324	.9943	.1002	-.1706	.6420	.8214	.1507	-.7524	-.5819	.5372	.9856
.2003	-.5922	.5344	.9900	.1503	-.2460	.6272	.8443	.5002	.7476	-.6062	.5307	.9961
.2503	-.6010	.5321	.9939	.1976	-.3247	.6034	.8610	.5002	.4976	-.6134	.5287	.9992
.3001	-.6113	.5293	.9993	.2503	-.3795	.5914	.8997	.5002	.2476	-.6230	.5262	1.0034
.3502	-.6022	.5318	.9944	.3001	-.4054	.5845	.9105	.5002	-.2524	-.6076	.5303	.9967
.4003	-.6058	.5308	.9959	.3502	-.4165	.5815	.9152	.5002	-.5024	-.6024	.5377	.9945
.4501	-.6161	.5280	1.0004	.4001	-.4165	.5863	.9077	.5002	-.7524	-.5902	.5350	.9892
.5002	-.6198	.5271	1.0020	.4501	-.3988	.5966	.8916	.8002	.7476	-.3904	.5885	.9043
.5502	-.6327	.5236	1.0076	.5001	-.3602	.6159	.8616	.8002	.4976	-.3990	.5862	.9079
.6002	-.6427	.5209	1.0120	.5497	-.2879	.6450	.8168	.8002	.2476	-.4063	.5842	.9109
.6500	-.6270	.5251	1.0052	.6003	-.1795	.6754	.7702	.8002	-.5024	-.3973	.5866	.9071
.7000	-.5714	.5400	.9811	.6500	-.0661	.7016	.7297	.8002	-.7524	-.3798	.5913	.8998
.7500	-.4930	.5610	.9475	.7000	.0320	.7309	.6843					
.8002	-.3995	.5861	.9081	.7501	.1412	.7565	.6441					
.9002	-.1797	.6450	.8169	.8001	.2368	.7778	.6100					
.9501	-.0519	.6792	.7643	.8501	.3161	.7966	.5792					

TEST 167	PT 22.6157	PSI	CN	.5149	CD1	.00943	CDCDR1	.00924
RUN 12	TT 165.1807	K	CM	-.1395	CD2	.00959	CDCDR2	.00941
POINT 20	RC 6.9633	MILLION	CC	.0170	CD3	.00925	CDCDR3	.00914
	MACH .7419				CD4	.00825	CDCDR4	.00808
	ALPHA .0243	DEG			CD5	.00788	CDCDR5	.00767

UPPER SURFACE				LOWER SURFACE				SPANWISE				
X/C	CP	P,L/PT	MLOC	X/C	CP	P,L/PT	MLOC	X/C	Y/(B/2)	CP	P,L/PT	MLOC
0.0000	1.1407	.9989	.0401	0.0000	1.1407	.9989	.0401	.1507	.7476	-.6830	.5118	1.0269
.0132	-.1699	.6489	.8109	.0126	.3493	.7875	.5941	.1507	.4976	-.7073	.5053	1.0376
.0259	-.5546	.5461	.9712	.0255	.1863	.7440	.6638	.1507	.2476	-.6906	.5098	1.0302
.0759	-.7959	.4817	1.0773	.0495	.0183	.6991	.7336	.1507	-.2524	-.6915	.5096	1.0306
.1003	-.7583	.4917	1.0603	.0753	-.0622	.6776	.7667	.1507	-.5024	-.7034	.5064	1.0359
.1507	-.6845	.5114	1.0276	.1002	-.1264	.6605	.7930	.1507	-.7524	-.6604	.5179	1.0170
.2003	-.6726	.5146	1.0223	.1503	-.1908	.6433	.8195	.5002	.7476	-.6470	.5214	1.0111
.2503	-.6646	.5167	1.0188	.1976	-.2816	.6190	.8568	.5002	.4976	-.6552	.5193	1.0147
.3001	-.6773	.5134	1.0244	.2503	-.3306	.6059	.8771	.5002	.2476	-.6639	.5169	1.0185
.3502	-.6502	.5206	1.0125	.3001	-.3600	.5981	.8893	.5002	-.2524	-.6486	.5210	1.0118
.4003	-.6463	.5216	1.0108	.3507	-.3763	.5937	.8961	.5002	-.5024	-.6447	.5220	1.0101
.4501	-.6569	.5188	1.0154	.4001	-.3647	.5968	.8913	.5002	-.7524	-.6289	.5263	1.0032
.5002	-.6582	.5185	1.0160	.4501	-.3335	.6052	.8783	.8002	.7476	-.4000	.5874	.9060
.5502	-.6630	.5172	1.0181	.5001	-.2683	.6226	.8514	.8002	.4976	-.4068	.5856	.9088
.6002	-.6676	.5159	1.0201	.5497	-.1653	.6501	.8090	.8002	.2476	-.4124	.5841	.9111
.6500	-.6466	.5215	1.0110	.6003	-.0556	.6794	.7640	.8002	-.5024	-.4025	.5867	.9070
.7000	-.5829	.5386	.9834	.6500	.0393	.7047	.7250	.8002	-.7524	-.3853	.5913	.8998
.7500	-.4991	.5609	.9476	.7000	.1468	.7334	.6403					
.8002	-.4035	.5865	.9074	.7501	.2418	.7588	.6404					
.9002	-.1804	.6461	.8152	.8001	.3215	.7801	.6062					
.9501	-.0520	.6803	.7625	.8501	.3928	.7991	.5750					

TEST 167	PT 22.6677	PSI	CN	.5836	CD1	.00960	CDCDR1	.00941
RUN 12	TT 165.1745	K	CM	-.1398	CD2	.00977	CDCDR2	.00962
POINT 21	RC 6.9778	MILLION	CC	.0149	CD3	.00932	CDCDR3	.00920
	MACH .7416				CD4	.00871	CDCDR4	.00853
	ALPHA .3167	DEG			CD5	.00834	CDCDR5	.00809

UPPER SURFACE				LOWER SURFACE				SPANWISE				
X/C	CP	P,L/PT	MLOC	X/C	CP	P,L/PT	MLOC	X/C	Y/(B/2)	CP	P,L/PT	MLOC
0.0000	1.1446	.9999	.0115	0.0000	1.1446	.9999	.0115	.1507	.7476	-.7732	.4876	1.0672
.0132	-.2766	.6203	.8549	.0126	.4408	.8119	.5536	.1507	.4976	-.8497	.4672	1.1021
.0259	-.6685	.5156	1.0207	.0255	.2669	.7654	.6298	.1507	.2476	-.8531	.4663	1.1036
.0759	-.9122	.4505	1.1312	.0495	.0905	.7183	.7039	.1507	-.2524	-.8465	.4680	1.1006
.1003	-.8998	.4538	1.1253	.0753	.0035	.6951	.7398	.1507	-.5024	-.8352	.4711	1.0954
.1507	-.8355	.4710	1.0956	.1002	-.0650	.6768	.7680	.1507	-.7524	-.7333	.4983	1.0493
.2003	-.7305	.4990	1.0481	.1503	-.1364	.6577	.7973	.5002	.7476	-.6707	.5150	1.0217
.2503	-.6761	.5136	1.0241	.1976	-.2281	.6332	.8349	.5002	.4976	-.6820	.5120	1.0266
.3001	-.7263	.5002	1.0462	.2503	-.2801	.6193	.8564	.5002	.2476	-.6896	.5099	1.0300
.3502	-.7205	.5017	1.0436	.3001	-.3132	.6105	.8700	.5002	-.2524	-.6719	.5147	1.0222
.4003	-.6816	.5121	1.0265	.3507	-.3330	.6052	.8782	.5002	-.5024	-.6699	.5152	1.0213
.4501	-.6814	.5121	1.0264	.4001	-.3271	.6068	.8758	.8002	.7476	-.6525	.5199	1.0137
.5002	-.6840	.5114	1.0275	.4501	-.3015	.6136	.8652	.8002	.4976	-.6393	.5891	.9033
.5502	-.6828	.5118	1.0270	.5001	-.2425	.6294	.8408	.8002	.2476	-.4019	.5868	.9069
.6002	-.6809	.5123	1.0261	.5497	-.1452	.6554	.8009	.8002	-.5024	-.4093	.5848	.9100
.6500	-.6512	.5202	1.0131	.6003	-.0400	.6835	.7577	.8002	-.7524	-.3988	.5876	.9056
.7000	-.5834	.5383	.9838	.6500	.0516	.7079	.7200	.8002	-.5024	-.3825	.5920	.8988
.7500	-.4984	.5610	.9475	.7000	.1572	.7361	.6761					
.8002	-.4019	.5868	.9069	.7501	.2510	.7612	.6365					
.9002	-.1783	.6465	.8145	.8001	.3304	.7824	.6024					
.9501	-.0552	.6799	.7632	.8501	.4027	.8017	.5707					

TEST 167	PT 22.6662	PSI	CN	.6653	CD1	.00977	CDCDR1	.00953
RUN 12	TT 165.1301	K	CM	-.1396	CD2	.01012	CDCDR2	.00989
POINT 22	RC 6.9782	MILLION	CC	.0119	CD3	.00948	CDCDR3	.00920
	MACH .7412				CD4	.00857	CDCDR4	.00836
	ALPHA 1.0221	DEG			CD5	.00839	CDCDR5	.00814

UPPER SURFACE				LOWER SURFACE				SPANWISE				
X/C	CP	P,L/PT	MLOC	X/C	CP	P,L/PT	MLOC	X/C	Y/(B/2)	CP	P,L/PT	MLOC
0.0000	1.1414	.9990	.0382	0.0000	1.1414	.9990	.0382	.1507	.7476	-.9653	.4356	1.1576
.0132	-.3766	.5930	.8971	.0126	.5154	.8316	.5199	.1507	.4976	-1.0615	.4099	1.2048
.0259	-.7771	.4860	1.0700	.0255	.3339	.7830	.6014	.1507	.2476	-1.0160	.4221	1.1822
.0759	-1.0295	.4184	1.1889	.0495	.1491	.7336	.6801	.1507	-.2524	-1.0110	.4234	1.1798
.1003	-1.0358	.4168	1.1920	.0753	.0562	.7088	.7187	.1507	-.5024	-1.0557	.4114	1.2019
.1507	-1.0140	.4226	1.1813	.1002	-.0173	.6891	.7490	.1507	-.7524	-.9403	.4423	1.1457
.2003	-.9761	.4327	1.1628	.1503	-.0960	.6681	.7814	.5002	.7476	-.7065	.5048	1.0385
.2503	-.9693	.4346	1.1595	.1976	-.1909	.6427	.8204	.5002	.4976	-.7174	.5009	1.0433
.3001	-.8630	.4624	1.1103	.2503	-.2480	.6274	.8439	.5002	.2476	-.7259	.5000	1.0471
.3502	-.6586	.5176	1.0174	.3001	-.2846	.6176	.8590	.5002	-.2524	-.7118	.5000	1.0413
.4003	-.6561	.5183	1.0163	.3507	-.3086	.6112	.8689	.5002	-.5024	-.6976	.5071	1.0348
.4501	-.6915	.5088	1.0318	.4001	-.3078	.6114	.8686	.8002	.7476	-.6077	.5847	.9101
.5002	-.7188	.5016	1.0439	.4501	-.2870	.6170	.8600	.8002	.4976	-.6161	.5825	.9137
.5502	-.7286	.4989	1.0483	.5001	-.2335	.6313	.8379	.8002	.2476	-.4216	.5810	.9160
.6002	-.7195	.5013	1.0442	.5497	-.1397	.6564	.7993	.8002	.2476	-.4216	.5810	.9160
.6500	-.6832	.5111	1.0282	.6003	-.0371	.6838	.7572	.8002	-.5024	-.4144	.5829	.9129
.7000	-.6038	.5323	.9935	.6500	.0518	.7076	.7205	.8002	-.7524	-.3974	.5875	.9056
.7500	-.5107	.5573	.9534	.7000	.1561	.7335	.6771					
.8002	-.4122	.5835	.9120	.7501	.2500	.7606	.6375					
.9002	-.1872	.6437	.8188	.8001	.3299	.7820	.6031					
.9501	-.0606	.6775	.7668	.8501	.4039	.8018	.5706					

ORIGINAL PAGE IS
OF POOR QUALITY

TEST 167	PT 22.6658	PSI	CM .7644	CD1 .01015	CDCOR1 .00991
RUN 12	TT 165.1800	K	CM -.1421	CD2 .01062	CDCOR2 .01036
POINT 23	RC 6.9774	MILLION	CC .0089	CD3 .01003	CDCOR3 .00978
	MACH .7416			CD4 .00918	CDCOR4 .00883
	ALPHA 1.5321	DEG		CD5 .00913	CDCOR5 .00878

UPPER SURFACE				LOWER SURFACE				SPANWISE				
X/C	CP	P/L/PT	MLOC	X/C	CP	P/L/PT	MLOC	X/C	Y/(B/2)	CP	P/L/PT	MLOC
0.0000	1.1443	.9998	.0181	0.0000	1.1443	.9998	.0181	.1507	.7476	-1.0884	.4027	1.2182
.0132	-.4679	.5687	.9354	.0126	.6008	.8544	.4793	.1507	.4976	-1.1572	.3843	1.2335
.0259	-.8682	.4616	1.1117	.0255	.4143	.8046	.5659	.1507	.2476	-1.1034	.3987	1.2258
.0759	-1.1129	.3962	1.2306	.0495	.2244	.7538	.6483	.1507	-.2524	-1.0983	.4001	1.2232
.1003	-1.1225	.3936	1.2356	.0753	.1265	.7276	.6895	.1507	-.5024	-1.1495	.3864	1.2495
.1507	-1.1055	.3982	1.2268	.1002	.0483	.7067	.7219	.1507	-.7524	-1.0515	.4126	1.1997
.2003	-1.0799	.4050	1.2139	.1503	-.0361	.6841	.7567	.5002	.7476	-1.6407	.5227	1.0095
.2503	-1.0845	.4038	1.2162	.1976	-.1317	.6585	.7960	.5002	.4976	-1.6084	.5311	.9955
.3001	-1.1102	.3969	1.2292	.2503	-.1908	.6428	.8203	.5002	.2476	-1.6079	.5312	.9952
.3502	-1.1100	.3970	1.2291	.3001	-.2296	.6324	.8362	.5002	-.2524	-1.6076	.5313	.9951
.4003	-.9673	.4351	1.1585	.3507	-.2565	.6252	.8473	.5002	-.5024	-1.6218	.5275	1.0013
.4501	-.6447	.5214	1.0112	.4001	-.2595	.6244	.8486	.5002	-.7524	-1.6491	.5202	1.0131
.5002	-.6036	.5324	.9933	.4501	-.2436	.6286	.8420	.8002	.7476	-1.3961	.5879	.9058
.5502	-.6374	.5233	1.0081	.5001	-.1957	.6414	.8223	.8002	.4976	-1.4071	.5849	.9098
.6002	-.6696	.5147	1.0221	.5497	-.1069	.6652	.7855	.8002	.2476	-1.4149	.5828	.9131
.6500	-.6621	.5167	1.0186	.6003	-.0091	.6914	.7456	.8002	-.5024	-1.4021	.5863	.9077
.7000	-.5959	.5344	.9900	.6500	.0762	.7142	.7104	.8002	-.7524	-1.3819	.5917	.8993
.7500	-.5061	.5585	.9516	.7000	.1783	.7415	.6678					
.8002	-.4079	.5847	.9102	.7501	.2703	.7661	.6288					
.9002	-.1844	.6445	.8176	.8001	.3496	.7873	.5945					
.9501	-.0603	.6777	.7666	.8501	.4242	.8072	.5615					

TEST 167	PT 22.6673	PSI	CM .8503	CD1 .01141	CDCUR1 .01108
RUN 12	TT 165.2921	K	CM -.1457	CD2 .01212	CDCOR2 .01184
POINT 24	RC 6.9686	MILLION	CC .0066	CD3 .01180	CDCOR3 .01129
	MACH .7412			CD4 .01119	CDCOR4 .01091
	ALPHA 2.0122	DEG		CD5 .01090	CDCOR5 .01062

UPPER SURFACE				LOWER SURFACE				SPANWISE				
X/C	CP	P/L/PT	MLOC	X/C	CP	P/L/PT	MLOC	X/C	Y/(B/2)	CP	P/L/PT	MLOC
0.0000	1.1334	.9969	.0671	0.0000	1.1334	.9969	.0671	.1507	.7476	-1.1865	.3766	1.2686
.0132	-.5554	.5454	.9724	.0126	.6501	.8677	.4548	.1507	.4976	-1.2419	.3618	1.2983
.0259	-.9525	.4392	1.1512	.0255	.4615	.8172	.5446	.1507	.2476	-1.1852	.3770	1.2679
.0759	-1.1902	.3757	1.2705	.0495	.2667	.7651	.6302	.1507	-.2524	-1.1820	.3778	1.2662
.1003	-1.2010	.3728	1.2763	.0753	.1653	.7381	.6731	.1507	-.5024	-1.2331	.3642	1.2495
.1507	-1.1899	.3757	1.2704	.1002	.0843	.7164	.7069	.1507	-.7524	-1.1502	.3864	1.2495
.2003	-1.1656	.3823	1.2576	.1503	-.0053	.6924	.7439	.5002	.7476	-1.9267	.4461	1.1389
.2503	-1.1662	.3821	1.2579	.1976	-.1028	.6664	.7840	.5002	.4976	-1.9924	.4285	1.1704
.3001	-1.1975	.3737	1.2744	.2503	-.1654	.6496	.8097	.5002	.2476	-1.9893	.4294	1.1689
.3502	-1.2064	.3712	1.2794	.3001	-.2065	.6386	.8266	.5002	-.2524	-1.9561	.4383	1.1529
.4003	-1.2102	.3703	1.2812	.3507	-.2363	.6307	.8389	.5002	-.5024	-1.9964	.4275	1.1724
.4501	-1.1823	.3778	1.2664	.4001	-.2427	.6290	.8415	.5002	-.7524	-1.8835	.4577	1.1186
.5002	-.9095	.4507	1.1308	.4501	-.2308	.6322	.8366	.8002	.7476	-1.3870	.5904	.9013
.5502	-.6500	.5201	1.0134	.5001	-.1877	.6437	.8189	.8002	.4976	-1.4026	.5862	.9178
.6002	-.5713	.5411	.9793	.5497	-.1021	.6666	.7837	.8002	.2476	-1.4106	.5841	.9112
.6500	-.5599	.5442	.9744	.6003	-.0067	.6921	.7445	.8002	-.5024	-1.4020	.5864	.9175
.7000	-.5428	.5487	.9671	.6500	.0762	.7142	.7102	.8002	-.7524	-1.3748	.5937	.8962
.7500	-.4859	.5640	.9428	.7000	.1766	.7411	.6684					
.8002	-.4618	.5664	.9075	.7501	.2680	.7655	.6297					
.9002	-.1902	.6430	.8199	.8001	.3469	.7866	.5956					
.9501	-.0670	.6759	.7693	.8501	.4216	.8066	.5626					

TEST 167	PT 22.6631	PSI	CM .9333	CD1 .01644	CDCOR1 .01571
RUN 12	TT 165.2381	K	CM -.1524	CD2 .01771	CDCOR2 .01723
POINT 25	RC 6.9731	MILLION	CC .0050	CD3 .01757	CDCOR3 .01648
	MACH .7416			CD4 .01695	CDCOR4 .01633
	ALPHA 2.5229	DEG		CD5 .01581	CDCOR5 .01524

UPPER SURFACE				LOWER SURFACE				SPANWISE				
X/C	CP	P/L/PT	MLOC	X/C	CP	P/L/PT	MLOC	X/C	Y/(B/2)	CP	P/L/PT	MLOC
0.0000	1.1130	.9914	.1111	0.0000	1.1130	.9914	.1111	.1507	.7476	-1.2754	.3528	1.3169
.0132	-.6398	.9227	1.0091	.0126	.7042	.8821	.4271	.1507	.4976	-1.3125	.3428	1.3377
.0259	-1.0307	.4182	1.1894	.0255	.5137	.8311	.5207	.1507	.2476	-1.2561	.3579	1.3063
.0759	-1.2641	.3558	1.3107	.0495	.3163	.7784	.6090	.1507	-.2524	-1.2518	.3590	1.3040
.1003	-1.2722	.3536	1.3152	.0753	.2118	.7504	.6536	.1507	-.5024	-1.3000	.3462	1.3307
.1507	-1.2622	.3563	1.3097	.1002	.1271	.7278	.6892	.1507	-.7524	-1.2324	.3642	1.2934
.2003	-1.2416	.3618	1.2984	.1503	.0335	.7027	.7280	.5002	.7476	-1.1932	.3747	1.2724
.2503	-1.2358	.3633	1.2952	.1976	-.0654	.6763	.7687	.5002	.4976	-1.2272	.3656	1.2906
.3001	-1.2664	.3552	1.3120	.2503	-.1307	.6585	.7956	.5002	.2476	-1.2358	.3633	1.2952
.3502	-1.2796	.3516	1.3193	.3001	-.1744	.6472	.8135	.5002	-.2524	-1.2065	.3712	1.2795
.4003	-1.2872	.3496	1.3235	.3507	-.2063	.6386	.8266	.5002	-.5024	-1.2012	.3726	1.2767
.4501	-1.3069	.3443	1.3345	.4001	-.2159	.6361	.8306	.5002	-.7524	-1.1141	.3959	1.2312
.5002	-1.2613	.3565	1.3092	.4501	-.2079	.6382	.8273	.8002	.7476	-1.3672	.5956	.8932
.5502	-.9096	.4505	1.1311	.5001	-.1696	.6484	.8116	.8002	.4976	-1.3800	.5922	.8985
.6002	-.6200	.5280	1.0005	.5497	-.0887	.6701	.7783	.8002	.2476	-1.3841	.5911	.9002
.6500	-.5284	.5525	.9611	.6003	.0032	.6946	.7405	.8002	-.5024	-1.3830	.5914	.8997
.7000	-.4928	.5620	.9459	.6500	.0838	.7162	.7072	.8002	-.7524	-1.3523	.5996	.8870
.7500	-.4479	.5740	.9270	.7000	.1819	.7424	.6663					
.8002	-.3790	.5924	.8981	.7501	.2718	.7665	.6282					
.9002	-.1888	.6433	.8194	.8001	.3499	.7873	.5944					
.9501	-.0732	.6742	.7720	.8501	.4243	.8072	.5615					

TEST	167	PT	22.6653	PSI	CM	.9914	CD1	.02328	CDCOR1	.02263
RUN	12	TT	165.2326	K	CM	-.1583	CD2	.02435	CDCOR2	.02376
POINT	26	RC	6.9730	MILLION	CC	.0047	CD3	.02237	CDCOR3	.02179
		MACH	.7414				CD4	.02208	CDCOR4	.02143
		ALPHA	3.0195	DEG			CD5	.01945	CDCOR5	.01883

UPPER SURFACE				LOWER SURFACE				SPANWISE				
X/C	CP	P _o L/P _T	MLOC	X/C	CP	P _o L/P _T	MLOC	X/C	V/(B/2)	CP	P _o L/P _T	MLOC
0.0000	1.1007	.9878	.1323	0.0000	1.1007	.9878	.1323	.1507	.7476	-1.3440	.3317	1.3615
.0132	-.6943	.5061	1.0363	.0126	.7448	.8923	.4066	.1507	.4976	-1.3587	.3285	1.3686
.0259	-1.0765	.4035	1.2167	.0255	.5530	.8411	.5033	.1507	.2476	-1.2995	.3437	1.3360
.0759	-1.3082	.3413	1.3409	.0495	.354	.7877	.5939	.1507	-.2524	-1.2935	.3453	1.3325
.1003	-1.3149	.3395	1.3447	.0753	.2479	.7590	.6401	.1507	-.5024	-1.3410	.3325	1.3598
.1507	-1.3052	.3422	1.3392	.1002	.1616	.7358	.6767	.1507	-.7524	-1.2934	.3453	1.3325
.2003	-1.2847	.3476	1.3276	.1503	.0645	.7097	.7172	.5002	.7476	-1.2711	.3513	1.3200
.2503	-1.2786	.3493	1.3242	.1976	-.0358	.6828	.7587	.5002	.4976	-1.2828	.3482	1.3264
.3001	-1.3093	.3410	1.3415	.2503	-.1036	.6646	.7867	.5002	.2476	-1.2962	.3446	1.3341
.3502	-1.3242	.3370	1.3501	.3001	-.1500	.6522	.8056	.5002	-.2524	-1.2724	.3510	1.3207
.4003	-1.3336	.3345	1.3554	.3507	-.1846	.6429	.8201	.5002	-.5024	-1.2414	.3593	1.3036
.4501	-1.3605	.3273	1.3711	.4001	-.1971	.6395	.8233	.5002	-.7524	-1.1298	.3892	1.2441
.5002	-1.3760	.3231	1.3803	.4501	-.1923	.6408	.8233	.8002	.7476	-1.3450	.5998	.8866
.5502	-1.1588	.3814	1.2592	.5001	-.1572	.6502	.8088	.8002	.4976	-1.3527	.5978	.8898
.6002	-.7413	.4935	1.0574	.5497	-.0795	.6711	.7768	.8002	.2476	-1.3532	.5976	.8900
.6500	-.5702	.5394	.9820	.6003	.0103	.6952	.7397	.8002	-.5024	-1.3681	.5956	.8962
.7000	-.4803	.5635	.9435	.6500	.0894	.7164	.7068	.8002	-.7524	-1.3518	.5980	.8894
.7500	-.4169	.5806	.9167	.7000	.1865	.7425	.6662					
.8002	-.3500	.5985	.8887	.7501	.2754	.7663	.6284					
.9002	-.1786	.6445	.8176	.8001	.3533	.7872	.5945					
.9501	-.0726	.6729	.7739	.8501	.4281	.8073	.5613					

TEST 167	PT 26.9534	PSI	CM	-0.0740	CD1 .01013	CDCOR1 .01002
RUN 13	TT 144.8035	K	CM	-.1257	CD2 .00988	CDCOR2 .00780
POINT 27	RC 10.0237	MILLION	CC	.0028	CD3 .00985	CDCOR3 .00983
	MACH .7417				CD4 .00963	CDCOR4 .00957
	ALPHA -4.0324	DEG			CD5 .00839	CDCOR5 .00821

UPPER SURFACE				LOWER SURFACE				SPANWISE				
X/C	CP	P _L /PT	MLOC	X/C	CP	P _L /PT	MLOC	X/C	Y/(B/2)	CP	P _L /PT	MLOC
0.0000	.7018	.8816	.4281	0.0000	-.7018	.8816	.4281	.1507	.7476	-.1279	.6500	.7941
.0132	.6354	.8639	.4620	.0126	-.7959	.4815	1.0778	.1507	.4976	-.1530	.6533	.8043
.0259	.3193	.7784	.6092	.0255	-.6898	.5099	1.0304	.1507	.2476	-.1310	.6591	.7953
.0759	-.0043	.6930	.7435	.0495	-.8278	.4730	1.0024	.1507	-.2524	-.1438	.6557	.8006
.1003	-.0347	.6793	.7640	.0753	-.8077	.4784	1.0832	.1507	-.5024	-.1356	.6579	.7972
.1307	-.1294	.6596	.7947	.1002	-.8104	.4776	1.0844	.1507	-.7524	-.1412	.6564	.7995
.2003	-.1838	.6450	.8170	.1503	-.7550	.4925	1.0594	.5002	.7476	-.3732	.5944	.8952
.2503	-.2276	.6333	.8330	.1976	-.7686	.4888	1.0655	.5002	.4976	-.3789	.5929	.8976
.3001	-.2682	.6223	.8517	.2503	-.8854	.4582	1.1180	.5002	.2476	-.3859	.5911	.9005
.3502	-.2961	.6150	.8633	.3001	-.9505	.4402	1.1497	.5002	-.2524	-.3749	.5940	.8959
.4003	-.3247	.6074	.8731	.3507	-.8586	.4648	1.1065	.5002	-.5024	-.3722	.5947	.8948
.4501	-.3539	.5996	.8872	.4001	-.5720	.5413	.9792	.5002	-.7524	-.3576	.5986	.8886
.5002	-.3828	.5919	.8992	.4501	-.5110	.5576	.9532	.8002	.7476	-.3499	.6007	.8855
.5502	-.4184	.5823	.9141	.5001	-.4080	.5851	.9097	.8002	.4976	-.3525	.6000	.8866
.6002	-.4474	.5743	.9265	.5497	-.2762	.6204	.8550	.8002	.2476	-.3591	.5982	.8894
.6500	-.4633	.5704	.9330	.6003	-.1439	.6557	.8006	.8002	-.5024	-.3419	.6028	.8822
.7000	-.4954	.5725	.9296	.6500	-.0321	.6855	.7547	.8002	-.7524	-.3265	.6069	.8758
.7500	-.4158	.5831	.9130	.7000	.0838	.7165	.7069					
.8002	-.3524	.6000	.8866	.7501	.1809	.7425	.6864					
.9002	-.1750	.6474	.8134	.8001	.2580	.7630	.6338					
.9501	-.0521	.6802	.7630	.8501	.3237	.7806	.6055					

TEST 167	PT 26.9626	PSI	CM	.0818	CD1 .00923	CDCOR1 .00911
RUN 13	TT 144.8327	K	CM	-.1305	CD2 .00907	CDCOR2 .00899
POINT 27	RC 10.0217	MILLION	CC	.0121	CD3 .00909	CDCOR3 .00904
	MACH .7414				CD4 .00896	CDCOR4 .00888
	ALPHA -3.0141	DEG			CD5 .00742	CDCOR5 .00725

UPPER SURFACE				LOWER SURFACE				SPANWISE				
X/C	CP	P _L /PT	MLOC	X/C	CP	P _L /PT	MLOC	X/C	Y/(B/2)	CP	P _L /PT	MLOC
0.0000	.8597	.9241	.3376	0.0000	-.8597	.9241	.3376	.1507	.7476	-.2347	.6326	.8362
.0132	.4763	.8220	.5366	.0126	-.4448	.5766	.9232	.1507	.4976	-.2663	.6241	.8492
.0259	.1405	.7323	.6820	.0255	-.4490	.5755	.9249	.1507	.2476	-.2452	.6298	.8403
.0759	-.1485	.6555	.8009	.0495	-.3586	.5463	.9713	.1507	-.2524	-.2498	.6286	.8424
.1003	-.1859	.6456	.8162	.0753	-.3457	.5497	.9658	.1507	-.5024	-.2482	.6290	.8417
.1307	-.2449	.6299	.8404	.1002	-.3921	.5374	.9856	.1507	-.7524	-.2488	.6288	.8420
.2003	-.2891	.6181	.8585	.1503	-.3819	.5401	.9812	.5002	.7476	-.4372	.5786	.9200
.2503	-.3222	.6093	.8722	.1976	-.6722	.5160	1.0203	.5002	.4976	-.4432	.5770	.9225
.3001	-.3560	.6002	.8862	.2503	-.6973	.5093	1.0313	.5002	.2476	-.4497	.5733	.9252
.3502	-.3773	.5946	.8950	.3001	-.6820	.5134	1.0246	.5002	-.2524	-.4374	.5786	.9201
.4003	-.3995	.5887	.9042	.3507	-.6357	.5257	1.0044	.5002	-.5024	-.4349	.5792	.9190
.4501	-.4224	.5826	.9138	.4001	-.5668	.5441	.9748	.5002	-.7524	-.4201	.5832	.9128
.5002	-.4467	.5761	.9240	.4501	-.4892	.5648	.9418	.8002	.7476	-.3691	.5968	.9116
.5502	-.4785	.5676	.9373	.5001	-.3847	.5926	.8981	.8002	.4976	-.3706	.5964	.9122
.6002	-.5036	.5609	.9479	.5497	-.2539	.6275	.8440	.8002	.2476	-.3781	.5944	.9154
.6500	-.5128	.5585	.9518	.6003	-.1239	.6621	.7908	.8002	-.5024	-.3623	.5986	.8868
.7000	-.4944	.5634	.9440	.6500	-.0148	.6912	.7461	.8002	-.7524	-.3468	.6027	.8824
.7500	-.4449	.5766	.9232	.7000	.1011	.7220	.6983					
.8002	-.3722	.5959	.8929	.7501	.1987	.7480	.6576					
.9002	-.1812	.6468	.8143	.8001	.2772	.7690	.6243					
.9501	-.0541	.6807	.7622	.8501	.3448	.7869	.5952					

TEST 167	PT 26.9632	PSI	CM	.7260	CD1 .00888	CDCOR1 .00887
RUN 13	TT 144.8236	K	CM	-.1343	CD2 .00887	CDCOR2 .00878
POINT 29	RC 10.0232	MILLION	CC	.0177	CD3 .00894	CDCOR3 .00889
	MACH .7414				CD4 .00881	CDCOR4 .00872
	ALPHA -1.9958	DEG			CD5 .00768	CDCOR5 .00751

UPPER SURFACE				LOWER SURFACE				SPANWISE				
X/C	CP	P _L /PT	MLOC	X/C	CP	P _L /PT	MLOC	X/C	Y/(B/2)	CP	P _L /PT	MLOC
0.0000	1.0000	.9613	.2376	0.0000	1.0000	.9613	.2376	.1507	.7476	-.3569	.5987	.8871
.0132	.7839	.7705	.6214	.0126	-.1367	.6584	.7965	.1507	.4976	-.3902	.5908	.9009
.0259	-.0661	.6772	.7675	.0255	-.2056	.6400	.8247	.1507	.2476	-.3763	.5945	.8951
.0759	-.3172	.6103	.8706	.0495	-.3387	.6045	.8795	.1507	-.2524	-.3806	.5934	.9049
.1003	-.3362	.6052	.8783	.0753	-.3563	.5998	.8868	.1507	-.5024	-.3786	.5939	.8961
.1307	-.3759	.5946	.8949	.1002	-.4146	.5863	.9111	.1507	-.7524	-.3724	.5956	.8935
.2003	-.4010	.5879	.9054	.1503	-.4403	.5775	.9218	.5002	.7476	-.5068	.5987	.9498
.2503	-.4273	.5809	.9184	.1976	-.5252	.5548	.9576	.5002	.4976	-.5129	.5981	.9524
.3001	-.4531	.5741	.9272	.2503	-.5559	.5472	.9698	.5002	.2476	-.5207	.5960	.9557
.3502	-.4624	.5714	.9313	.3001	-.5609	.5453	.9728	.5002	-.2524	-.5087	.5992	.9506
.4003	-.4798	.5669	.9384	.3507	-.5488	.5485	.9676	.5002	-.5024	-.5045	.5988	.9497
.4501	-.4986	.5619	.9463	.4001	-.5055	.5601	.9492	.5002	-.7524	-.4918	.5637	.9435
.5002	-.5170	.5570	.9541	.4501	-.4444	.5764	.9235	.8002	.7476	-.3846	.5923	.8985
.5502	-.5424	.5502	.9649	.5001	-.3521	.6010	.8851	.8002	.4976	-.3884	.5913	.9001
.6002	-.5620	.5430	.9733	.5497	-.2293	.6337	.8344	.8002	.2476	-.3963	.5892	.9034
.6500	-.5630	.5448	.9737	.6003	-.1051	.6668	.7835	.8002	-.5024	-.3836	.5926	.8981
.7000	-.5327	.5528	.9608	.6500	-.0089	.6946	.7408	.8002	-.7524	-.3682	.5967	.8917
.7500	-.4712	.5692	.9348	.7000	.1136	.7251	.6935					
.8072	-.3987	.5910	.9007	.7501	.2114	.7512	.6528					
.9002	-.1863	.6452	.8168	.8001	.2910	.7724	.6187					
.9501	-.0582	.6799	.7635	.8501	.3604	.7909	.5887					

ORIGINAL FACTS
OF POOR QUALITY

TEST	167	PT	26.9649	PSI		CN	.3010		CD1	.00899	CDCOR1	.00892
RUN	13	TT	144.8382	K		CM	-.1369		CD2	.00887	CDCOR2	.00883
POINT	30	RC	10.0199	MILLION		CC	.0192		CD3	.00891	CDCOR3	.00890
		MACH	.7411						CD4	.00874	CDCOR4	.00869
		ALPHA	-1.4896	DEG					CD5	.00768	CDCOR5	.00756
UPPER SURFACE				LOWER SURFACE				SPANWISE				
X/C	CP	P _L /PT	MLOC	X/C	CP	P _L /PT	MLOC	X/C	Y/(B/2)	CP	P _L /PT	MLOC
0.0000	1.0542	.9760	.1867	0.0000	1.0542	.9760	.1867	.1507	.7476	-.4231	.5824	.9141
.0132	-.1761	.7420	.6671	.0126	.0031	.6939	.7387	.1507	.4976	-.4503	.5752	.9234
.0259	-.1794	.6473	.8135	.0255	-.0945	.6700	.7787	.1507	.2476	-.4459	.5763	.9236
.0759	-.4096	.5860	.9084	.0495	-.2372	.6319	.8372	.1507	-.2524	-.4510	.5750	.9245
.1003	-.4173	.5840	.9116	.0753	-.2663	.6242	.8491	.1507	-.5024	-.4481	.5757	.9257
.1507	-.4448	.5766	.9231	.1002	-.3323	.6066	.8763	.1507	-.7524	-.4366	.5788	.9197
.2003	-.4616	.5722	.9302	.1503	-.3695	.5967	.8918	.5002	.7476	-.5414	.5509	.9639
.2503	-.4819	.5667	.9387	.1976	-.4535	.5743	.9268	.5002	.4976	-.5474	.5493	.9684
.3001	-.5029	.5611	.9475	.2503	-.4875	.5652	.9411	.5002	.2476	-.5548	.5473	.9686
.3502	-.5087	.5596	.9500	.3001	-.5015	.5615	.9470	.5002	-.2524	-.5413	.5509	.9638
.4003	-.5211	.5563	.9533	.3507	-.4989	.5622	.9459	.5002	-.5024	-.5398	.5513	.9632
.4501	-.5369	.5521	.9620	.4001	-.4656	.5711	.9318	.5002	-.7524	-.5247	.5533	.9568
.5002	-.5512	.5483	.9680	.4501	-.4133	.5850	.9099	.8002	.7476	-.3913	.5900	.9008
.5502	-.5735	.5423	.9776	.5001	-.3283	.6077	.8747	.8002	.4976	-.3948	.5899	.9023
.6002	-.5899	.5380	.9846	.5497	-.2107	.6390	.8263	.8002	.2476	-.4019	.5881	.9052
.6500	-.5857	.5391	.9828	.6003	-.0905	.6710	.7771	.8002	-.2476	-.3884	.5916	.8996
.7000	-.5483	.5491	.9668	.6500	.0108	.6980	.7356	.8002	.7524	-.3742	.5954	.8937
.7500	-.4820	.5667	.9387	.7000	.1240	.7282	.6888					
.8002	-.3959	.5966	.9027	.7501	.2214	.7541	.6480					
.9002	-.1865	.6434	.8164	.8001	.3012	.7754	.6140					
.9501	-.0559	.6802	.7629	.8501	.3716	.7941	.5834					

TEST	167	PT	26.9670	PSI		CN	.3685		CD1	.00905	CDCOR1	.00895
RUN	14	TT	144.8675	K		CM	-.1376		CD2	.00892	CDCOR2	.00885
POINT	31	RC	10.0140	MILLION		CC	.0195		CD3	.00893	CDCOR3	.00890
		MACH	.7407						CD4	.00876	CDCOR4	.00870
		ALPHA	-.9988	DEG					CD5	.00772	CDCOR5	.00757
UPPER SURFACE				LOWER SURFACE				SPANWISE				
X/C	CP	P _L /PT	MLOC	X/C	CP	P _L /PT	MLOC	X/C	Y/(B/2)	CP	P _L /PT	MLOC
0.0000	1.0902	.9855	.1444	0.0000	1.0902	.9855	.1444	.1507	.7476	-.4940	.5633	.9442
.0132	-.0617	.7114	.7148	.0126	.1248	.7282	.6887	.1507	.4976	-.5163	.5573	.9536
.0259	-.3006	.6149	.8635	.0255	.0018	.6954	.7395	.1507	.2476	-.5222	.5598	.9561
.0759	-.5109	.5588	.9513	.0495	-.1496	.6551	.8016	.1507	-.2524	-.5262	.5647	.9578
.1003	-.5075	.5602	.9490	.0753	-.1905	.6442	.8183	.1507	-.5024	-.5206	.5662	.9594
.1507	-.5204	.5563	.9553	.1002	-.2612	.6253	.8473	.1507	-.7524	-.5050	.5604	.9488
.2003	-.5238	.5554	.9567	.1503	-.3087	.6127	.8669	.5002	.7476	-.5757	.5415	.9789
.2503	-.5397	.5511	.9535	.1976	-.3950	.5897	.9027	.5002	.4976	-.5821	.5399	.9816
.3001	-.5557	.5469	.9703	.2503	-.4338	.5793	.9188	.5002	.2476	-.5888	.5380	.9845
.3502	-.5538	.5474	.9695	.3001	-.4532	.5742	.9270	.5002	-.2524	-.5753	.5416	.9787
.4003	-.5626	.5450	.9733	.3507	-.4586	.5727	.9293	.5002	-.5024	-.5738	.5420	.9781
.4501	-.5752	.5416	.9787	.4001	-.4331	.5795	.9185	.5002	-.7524	-.5587	.5461	.9716
.5002	-.5846	.5362	.9827	.4501	-.3891	.5913	.9002	.8002	.7476	-.3964	.5893	.9032
.5502	-.6032	.5342	.9907	.5001	-.3105	.6122	.8676	.8002	.4976	-.4012	.5880	.9053
.6002	-.6157	.5309	.9961	.5497	-.1984	.6421	.8216	.8002	.2476	-.4077	.5863	.9079
.6500	-.6062	.5334	.9920	.6003	-.0819	.6731	.7738	.8002	-.5024	-.3949	.5897	.9026
.7000	-.5613	.5454	.9727	.6500	.0164	.6993	.7335	.8002	-.7524	-.3810	.5934	.8968
.7500	-.4899	.5644	.9424	.7000	.1281	.7291	.6873					
.8002	-.4014	.5880	.9053	.7501	.2249	.7549	.6467					
.9002	-.1880	.6448	.8173	.8001	.3046	.7761	.6127					
.9501	-.0571	.6797	.7637	.8501	.3732	.7950	.5821					

TEST	167	PT	26.9425	PSI		CN	.4449		CD1	.00915	CDCOR1	.00911
RUN	14	TT	144.4562	K		CM	-.1398		CD2	.00905	CDCOR2	.00905
POINT	32	RC	10.0572	MILLION		CC	.0192		CD3	.00901	CDCOR3	.00903
		MACH	.7420						CD4	.00885	CDCOR4	.00886
		ALPHA	-.4786	DEG					CD5	.00787	CDCOR5	.00778
UPPER SURFACE				LOWER SURFACE				SPANWISE				
X/C	CP	P _L /PT	MLOC	X/C	CP	P _L /PT	MLOC	X/C	Y/(B/2)	CP	P _L /PT	MLOC
0.0000	1.1243	.9941	.0916	0.0000	1.1243	.9941	.0916	.1507	.7476	-.5709	.5595	.9422
.0132	-.0445	.6806	.7624	.0126	.2443	.7581	.6416	.1507	.4976	-.5977	.5522	.9539
.0259	-.4181	.5804	.9172	.0255	.1039	.7204	.7009	.1507	.2476	-.6061	.5299	.9676
.0759	-.6269	.5243	1.0067	.0495	-.0571	.6772	.7676	.1507	-.2524	-.6047	.5292	.9687
.1003	-.5997	.5316	.9948	.0753	-.1099	.6631	.7803	.1507	-.5024	-.5976	.5322	.9639
.1507	-.6041	.5304	.9968	.1002	-.1863	.6425	.8208	.1507	-.7524	-.5756	.5381	.9484
.2003	-.6014	.5312	.9956	.1503	-.2437	.6273	.8444	.5002	.7476	-.6155	.5274	1.0017
.2503	-.6037	.5306	.9966	.1976	-.3335	.6030	.8819	.5002	.4976	-.6233	.5253	1.0051
.3001	-.6164	.5272	1.0021	.2503	-.3791	.5908	.9009	.5002	.2476	-.6306	.5233	1.0083
.3502	-.6062	.5294	.9988	.3001	-.4037	.5842	.9112	.5002	-.2524	-.6141	.5278	1.0011
.4003	-.6089	.5282	.9988	.3507	-.4158	.5810	.9163	.5002	-.5024	-.6124	.5262	1.0003
.4501	-.6197	.5263	1.0035	.4001	-.3972	.5860	.9085	.5002	-.7524	-.5963	.5325	.9934
.5002	-.6258	.5246	1.0062	.4501	-.3589	.5962	.8924	.8002	.7476	-.3938	.5869	.9070
.5502	-.6383	.5213	1.0117	.5001	-.2862	.6157	.8622	.8002	.4976	-.3993	.5854	.9094
.6002	-.6483	.5169	1.0161	.5497	-.1779	.6448	.8174	.8002	.2476	-.4055	.5837	.9120
.6500	-.6327	.5220	1.0092	.6003	-.0645	.6732	.7706	.8002	-.5024	-.3925	.5872	.9065
.7000	-.5737	.5386	.9436	.6500	.0315	.7010	.7310	.8002	-.7524	-.3797	.5907	.9011
.7500	-.4926	.5604	.9484	.7000	.1416	.7305	.6851					
.8002	-.3987	.5853	.9095	.7501	.2376	.7563	.6446					
.9002	-.1814	.6439	.8198	.8001	.3178	.7778	.6101					
.9501	-.0505	.6790	.7649	.8501	.3885	.7968	.5791					

TEST 167	PT 26.9685	PSI	CM .5113	CD1 .00924	CDCOR1 .00916
RUN 14	TT 144.8102	K	CM -1.190	CD2 .00918	CDCOR2 .00912
POINT 33	RC 10.0293	MILLION	CC .0179	CD3 .00907	CDCOR3 .00905
	MACH .7413			CD4 .00885	CDCOR4 .00878
	ALPHA .0204	DEG		CD5 .00805	CDCOR5 .00788

UPPER SURFACE				LOWER SURFACE				SPANWISE				
X/C	CP	P.L/P.T	MLOC	X/C	CP	P.L/P.T	MLOC	X/C	Y/(B/2)	CP	P.L/P.T	MLOC
0.0000	1.1389	.9983	.0486	0.0000	1.1389	.9983	.0486	.1507	.7476	-.6471	.5213	1.0116
.0132	-.1676	.6494	.8103	.0126	.3515	.7880	.5934	.1507	.4976	-.6028	.5118	1.0273
.0259	-.5510	.5470	.9701	.0255	-.1906	.7450	.6623	.1507	.2476	-.6943	.5087	1.0323
.0759	-.7612	.4908	1.0621	.0495	.0210	.6998	.7328	.1507	-.2524	-.6924	.5092	1.0315
.1003	-.7284	.4906	1.0475	.0753	-.0414	.6831	.7585	.1507	-.5024	-.6741	.5141	1.0234
.1507	-.6918	.5093	1.0313	.1002	-.1213	.6617	.7913	.1507	-.7524	-.6306	.5257	1.0044
.2003	-.6598	.5179	1.0172	.1503	-.1856	.6448	.8177	.5002	.7476	-.6394	.5234	1.0083
.2503	-.6590	.5181	1.0169	.1976	-.2767	.6202	.8552	.5002	.4976	-.6475	.5212	1.0118
.3001	-.6710	.5149	1.0221	.2503	-.3260	.6071	.8756	.5002	.2476	-.6552	.5191	1.0152
.3502	-.6437	.5222	1.0102	.3001	-.3559	.5991	.8880	.5002	-.2524	-.6411	.5229	1.0090
.4003	-.6413	.5229	1.0091	.3507	-.3717	.5949	.8946	.5002	-.5024	-.6400	.5232	1.0085
.4501	-.6496	.5206	1.0127	.4001	-.3988	.5980	.8896	.5002	-.7524	-.6231	.5277	1.0012
.5002	-.6504	.5204	1.0131	.4501	-.4289	.6063	.8768	.8002	.7476	-.6394	.5091	.9036
.5502	-.6553	.5191	1.0152	.5001	-.4638	.6217	.8499	.8002	.4976	-.6401	.5073	.9064
.6002	-.6587	.5182	1.0167	.5497	-.5020	.6509	.8080	.8002	.2476	-.6406	.5055	.9091
.6500	-.6376	.5238	1.0075	.6003	-.5533	.6799	.7634	.8002	-.5024	-.6367	.5082	.9050
.7000	-.6766	.5401	.9811	.6500	-.6193	.7046	.7253	.8002	-.7524	-.6362	.5018	.8994
.7500	-.4945	.5621	.9461	.7000	-.6974	.7335	.6804					
.8002	-.4006	.5871	.9066	.7501	-.2424	.7589	.6404					
.9002	-.1806	.6459	.8157	.8001	.3216	.7801	.6084					
.9501	-.0512	.6803	.7626	.8501	.3933	.7992	.5750					

TEST 167	PT 26.9745	PSI	CM .5797	CD1 .00947	CDCOR1 .00930
RUN 14	TT 145.1114	K	CM -1.192	CD2 .00941	CDCOR2 .00928
POINT 34	RC 9.9978	MILLION	CC .0156	CD3 .00928	CDCOR3 .00921
	MACH .7414			CD4 .00900	CDCOR4 .00886
	ALPHA .5088	DEG		CD5 .00834	CDCOR5 .00814

UPPER SURFACE				LOWER SURFACE				SPANWISE				
X/C	CP	P.L/P.T	MLOC	X/C	CP	P.L/P.T	MLOC	X/C	Y/(B/2)	CP	P.L/P.T	MLOC
0.0000	1.1465	1.0003	0.0000	0.0000	1.1465	1.0003	0.0000	.1507	.7476	-.7330	.4975	1.0509
.0132	-.2686	.8218	.8529	.0126	.4448	.8126	.5526	.1507	.4976	-.8044	.4784	1.0432
.0259	-.6615	.5167	1.0192	.0255	.2716	.7663	.6286	.1507	.2476	-.8504	.4661	1.1042
.0759	-.8759	.4593	1.1161	.0495	-.0930	.7187	.7035	.1507	-.2524	-.8515	.4658	1.1047
.1003	-.8823	.4576	1.1190	.0753	.0185	.6986	.7347	.1507	-.5024	-.7944	.4811	1.0789
.1507	-.8412	.4686	1.1000	.1002	-.0599	.6776	.7670	.1507	-.7524	-.6950	.5077	1.0340
.2003	-.7084	.5041	1.0399	.1503	-.1316	.6584	.7965	.5002	.7476	-.6758	.5128	1.0255
.2503	-.6701	.5144	1.0230	.1976	-.2252	.6334	.8350	.5002	.4976	-.6843	.5105	1.0293
.3001	-.7326	.4976	1.0507	.2503	-.2793	.6189	.8573	.5002	.2476	-.6910	.5087	1.0322
.3502	-.7145	.5025	1.0426	.3001	-.3133	.6098	.8714	.5002	-.2524	-.6776	.5123	1.0265
.4003	-.6784	.5121	1.0267	.3507	-.3334	.6044	.8797	.5002	-.5024	-.6779	.5169	1.0187
.4501	-.6778	.5123	1.0264	.4001	-.3266	.6062	.8769	.8002	.7476	-.6939	.5082	.9049
.5002	-.6846	.5165	1.0294	.4501	-.3014	.6130	.8664	.8002	.4976	-.6993	.5067	.9073
.5502	-.6841	.5166	1.0292	.5001	-.2417	.6289	.8418	.8002	.2476	-.6956	.5051	.9098
.6002	-.6796	.5118	1.0272	.5497	-.1445	.6549	.8018	.8002	-.5024	-.6982	.5071	.9067
.6500	-.6523	.5191	1.0152	.6003	-.0393	.6831	.7585	.8002	-.7524	-.6948	.5007	.9011
.7000	-.3825	.5377	.9850	.6500	.0503	.7071	.7215					
.7500	-.4947	.5613	.9474	.7000	.1568	.7335	.6772					
.8002	-.3987	.5849	.9049	.7501	.2507	.7606	.6376					
.9002	-.1760	.6465	.8147	.8001	.3300	.7819	.6034					
.9501	-.0469	.6810	.7617	.8501	.4013	.8010	.5721					

TEST 167	PT 26.9689	PSI	CM .6617	CD1 .00996	CDCOR1 .00965
RUN 14	TT 145.0668	K	CM -1.190	CD2 .00979	CDCOR2 .00949
POINT 35	RC 10.0007	MILLION	CC .0124	CD3 .00956	CDCOR3 .00942
	MACH .7414			CD4 .00914	CDCOR4 .00901
	ALPHA 1.0091	DEG		CD5 .00861	CDCOR5 .00838

UPPER SURFACE				LOWER SURFACE				SPANWISE				
X/C	CP	P.L/P.T	MLOC	X/C	CP	P.L/P.T	MLOC	X/C	Y/(B/2)	CP	P.L/P.T	MLOC
0.0000	1.1450	1.0003	0.0000	0.0000	1.1450	1.0003	0.0000	.1507	.7476	-.9202	.4914	1.1298
.0132	-.3835	.5941	.8958	.0126	.5284	.8364	.5116	.1507	.4976	-1.0173	.4256	1.1768
.0259	-.7854	.4873	1.0681	.0255	.3443	.7880	.5934	.1507	.2476	-1.0602	.4288	1.1702
.0759	-1.0011	.4299	1.1685	.0495	-.1421	.7391	.6717	.1507	-.2524	-1.0671	.4283	1.1711
.1003	-1.0065	.4285	1.1708	.0753	-.0450	.7186	.7037	.1507	-.5024	-1.0213	.4246	1.1779
.1507	-.9498	.4329	1.1827	.1002	-.0031	.6992	.7399	.1507	-.7524	-.9164	.4924	1.1281
.2003	-.9742	.4371	1.1553	.1503	-.0806	.6746	.7716	.5002	.7476	-.7018	.5095	1.0310
.2503	-.9344	.4477	1.1345	.1976	-.1757	.6493	.8104	.5002	.4976	-.7155	.5059	1.0371
.3001	-.7410	.4991	1.0483	.2503	-.2335	.6339	.8341	.5002	.2476	-.7234	.5037	1.0405
.3502	-.5546	.5220	1.0105	.3001	-.2706	.6241	.8493	.5002	-.2524	-.7064	.5083	1.0331
.4003	-.6824	.5166	1.0226	.3507	-.2942	.6178	.8590	.5002	-.5024	-.7057	.5084	1.0328
.4501	-.7078	.5079	1.0337	.4001	-.2926	.6182	.8583	.5002	-.7524	-.6863	.5136	1.0243
.5002	-.7169	.5055	1.0377	.4501	-.2729	.6235	.8502	.8002	.7476	-.6813	.5093	.9032
.5502	-.7125	.5066	1.0357	.5001	-.2195	.6377	.8283	.8002	.4976	-.6867	.5079	.9054
.6002	-.7003	.5099	1.0304	.5497	-.1277	.6621	.7904	.8002	.2476	-.6821	.5063	.9077
.6500	-.6656	.5191	1.0152	.6003	-.0247	.6889	.7496	.8002	-.5024	-.6822	.5091	.9055
.7000	-.3915	.5388	.9833	.6500	.0596	.7118	.7142	.8002	-.7524	-.6883	.5028	.8978
.7500	-.5027	.5624	.9453	.7000	.1640	.7396	.6709					
.8002	-.4059	.5881	.9051	.7501	.2566	.7642	.6320					
.9002	-.1815	.6478	.8128	.8001	.3334	.7851	.5982					
.9501	-.0524	.6821	.7601	.8501	.4067	.8061	.5689					

ORIGINAL RECORDING
OF POOR QUALITY

TEST 167	PT 26.9648	PS1	CM .7576	CD1 .01050	CDCOR1 .01014
RUN 14	TY 145.0074	X	CM -.1402	CD2 .01044	CDCOR2 .01011
POINT 37	RC 10.0114	MILLION	CC .0093	CD3 .01024	CDCOR3 .00995
	MACH .7422			C4 .00999	CDCOR4 .00970
	ALPHA 1.9317	DE6		CD5 .00950	CDCOR5 .00926

UPPER SURFACE				LOWER SURFACE				SPANWISE				
X/C	CP	P/L/PT	MLOC	X/C	CP	P/L/PT	MLOC	X/C	Y/(B/2)	CP	P/L/PT	MLOC
0.0000	1.1410	.9992	.0343	0.0000	1.1410	.9992	.0343	.1507	.7476	-1.0626	.4105	1.2039
.0132	-.4736	.5678	.9371	.0126	-.0001	.8545	.4793	.1507	.4976	-1.1265	.3934	1.2362
.0259	-.8731	.4611	1.1129	.0255	.4126	.8044	.5663	.1507	.2476	-1.0973	.4012	1.2213
.0759	-1.0847	.4046	1.2150	.0495	.2232	.7538	.6484	.1507	-.2524	-1.1017	.4001	1.2235
.1003	-1.0964	.4015	1.2109	.0753	.1373	.7309	.6845	.1507	-.5024	-1.1204	.3935	1.2361
.1507	-1.0828	.4051	1.2140	.1002	.0493	.7074	.7210	.1507	-.7524	-1.0461	.4149	1.1957
.2003	-1.0794	.4060	1.2123	.1503	-.0335	.6853	.7551	.5002	.7476	-.6369	.5242	1.0049
.2503	-1.0879	.4037	1.2166	.1976	-.1309	.6593	.7951	.5002	.4976	-.6100	.5314	.9953
.3001	-1.1103	.3978	1.2279	.2503	-.1923	.6429	.8203	.5002	.2476	-.6041	.5329	.9927
.3502	-1.1030	.3997	1.2242	.3001	-.2324	.6321	.8369	.5002	-.2524	-.6071	.5321	.9940
.4003	-.9673	.4366	1.1973	.3507	-.2602	.6248	.8482	.5002	-.5024	-.6268	.5269	1.0026
.4501	-.8678	.4159	1.0204	.4001	-.2627	.6241	.8492	.5002	-.7524	-.6451	.5220	1.0105
.5002	-.8017	.3336	.9917	.4501	-.2474	.6282	.8429	.8002	.7476	-.4001	.5874	.9062
.5502	-.8320	.3255	1.0048	.5001	-.1987	.6412	.8229	.8002	.4976	-.4079	.5833	.9095
.6002	-.8693	.3155	1.0211	.5497	-.1111	.6646	.7869	.8002	.2476	-.4144	.5836	.9122
.6500	-.8830	.3172	1.0183	.6003	-.0136	.6806	.7469	.8002	-.5024	-.4024	.5868	.9071
.7000	-.8971	.3148	.9987	.6500	.0703	.7130	.7123	.8002	-.7524	-.3852	.5914	.9060
.7500	-.9092	.3193	.9504	.7000	.1727	.7404	.6697					
.8002	-.9076	.3851	.9093	.7501	.2641	.7648	.6310					
.8502	-.8940	.4621	.8169	.8001	.3418	.7855	.5975					
.9001	-.8955	.6794	.7641	.8501	.4132	.8046	.5641					

TEST 167	PT 26.9720	PS1	CM .8523	CD1 .01240	CDCOR1 .01190
RUN 14	TY 145.1049	X	CM -.1455	CD2 .01264	CDCOR2 .01221
POINT 38	RC 9.9968	MILLION	CC .0067	CD3 .01287	CDCOR3 .01229
	MACH .7412			CD4 .01278	CDCOR4 .01204
	ALPHA 2.0162	DE6		CD5 .01200	CDCOR5 .01119

UPPER SURFACE				LOWER SURFACE				SPANWISE				
X/C	CP	P/L/PT	MLOC	X/C	CP	P/L/PT	MLOC	X/C	Y/(B/2)	CP	P/L/PT	MLOC
0.0000	1.1290	.9960	.0761	0.0000	1.1290	.9960	.0761	.1507	.7476	-1.1733	.3831	1.2562
.0132	-.5679	.5463	.9745	.0126	-.8669	.8735	.4438	.1507	.4976	-1.2147	.3721	1.2779
.0259	-.9608	.4373	1.1349	.0255	.4777	.8226	.5356	.1507	.2476	-1.1831	.3805	1.2613
.0759	-1.1720	.3834	1.2555	.0495	.2867	.7717	.6198	.1507	-.2524	-1.1815	.3809	1.2664
.1002	-1.1818	.3808	1.2606	.0753	.1967	.7478	.6588	.1507	-.5024	-1.2090	.3736	1.2749
.1507	-1.1759	.3839	1.2549	.1002	.1036	.7230	.6968	.1507	-.7524	-1.1531	.3883	1.2497
.2003	-1.1658	.3851	1.2523	.1503	.0193	.7006	.7316	.5002	.7476	-.7710	.4960	1.0635
.2503	-1.1702	.3839	1.2546	.1976	-.0779	.6747	.7714	.5002	.4976	-.8318	.4740	1.0906
.3001	-1.1952	.3733	1.2676	.2503	-.1408	.6579	.7672	.5002	.2476	-.8170	.4779	1.0839
.3502	-1.2104	.3732	1.2736	.3001	-.1831	.6467	.8145	.5002	-.2524	-.7504	.4957	1.0540
.4003	-1.1987	.3761	1.2700	.3507	-.2132	.6387	.8268	.5002	-.5024	-.7895	.4853	1.0714
.4501	-1.0817	.4075	1.2095	.4001	-.2188	.6372	.8291	.5002	-.7524	-.7209	.5035	1.0409
.5002	-.8704	.5012	1.0647	.4501	-.2077	.6401	.8245	.8002	.7476	-.3852	.5929	.8976
.5502	-.8912	.5581	.9844	.5001	-.1642	.6517	.8067	.8002	.4976	-.3955	.5901	.9019
.6002	-.9043	.5388	.9832	.5497	-.0823	.6735	.7733	.8002	.2476	-.4041	.5870	.9055
.6500	-.9030	.5276	.9832	.6003	.0181	.6981	.7354	.8002	-.5024	-.3862	.5926	.8961
.7000	-.9134	.5455	.9452	.6500	.0911	.7197	.7020	.8002	-.7524	-.3841	.5983	.8869
.7500	-.9236	.5640	.9430	.7000	.1909	.7462	.6604					
.8002	-.9030	.6459	.9030	.7501	.2799	.7699	.6227					
.8502	-.8859	.7456	.8156	.8001	.3565	.7903	.5897					
.9001	-.8629	.6787	.7653	.8501	.4277	.8093	.5583					

TEST 167	PT 26.9236	PS1	CM .9302	CD1 .01693	CDCOR1 .01566
RUN 14	TY 145.1030	X	CM -.1525	CD2 .01737	CDCOR2 .01682
POINT 39	RC 9.9648	MILLION	CC .0061	CD3 .01817	CDCOR3 .01737
	MACH .7418			CD4 .01816	CDCOR4 .01721
	ALPHA 2.5254	DE6		CD5 .01653	CDCOR5 .01550

UPPER SURFACE				LOWER SURFACE				SPANWISE				
X/C	CP	P/L/PT	MLOC	X/C	CP	P/L/PT	MLOC	X/C	Y/(B/2)	CP	P/L/PT	MLOC
0.0000	1.1265	.9949	.0837	0.0000	1.1265	.9949	.0837	.1507	.7476	-1.2329	.3630	1.2963
.0132	-.6229	.5263	1.0834	.0126	.7161	.8850	.4215	.1507	.4976	-1.2659	.3542	1.3143
.0259	-.9161	.4205	1.1894	.0255	.5243	.8336	.5166	.1507	.2476	-1.2347	.3626	1.2976
.0759	-1.2201	.3664	1.2893	.0495	.3270	.7888	.6033	.1507	-.2524	-1.2332	.3629	1.2964
.1002	-1.2281	.3643	1.2936	.0753	.2308	.7550	.6466	.1507	-.5024	-1.2568	.3566	1.3093
.1507	-1.2204	.3663	1.2893	.1002	.1378	.7301	.6856	.1507	-.7524	-1.2283	.3642	1.2939
.2003	-1.2131	.3683	1.2855	.1503	.0489	.7063	.7228	.5002	.7476	-1.1938	.3737	1.2748
.2503	-1.2250	.3659	1.2893	.1976	-.0510	.6795	.7646	.5002	.4976	-1.2183	.3660	1.2895
.3001	-1.2500	.3584	1.3056	.2503	-.1183	.6615	.7917	.5002	.2476	-1.2260	.3640	1.2930
.3502	-1.2626	.3550	1.3125	.3001	-.1639	.6493	.8189	.5002	-.2524	-1.2045	.3706	1.2809
.4003	-1.2669	.3532	1.3160	.3507	-.1976	.6403	.8245	.5002	-.5024	-1.1932	.3730	1.2749
.4501	-1.2835	.3494	1.3261	.4001	-.2071	.6377	.8282	.5002	-.7524	-1.1296	.5007	1.2415
.5002	-1.2515	.3580	1.3064	.4501	-.1906	.6399	.8249	.8002	.7476	-.3523	.5988	.8885
.5502	-1.0511	.4251	1.1770	.5001	-.1592	.6585	.8086	.8002	.4976	-.3593	.5966	.8914
.6002	-.8651	.5177	1.0175	.5497	-.0790	.6720	.7755	.8002	.2476	-.3638	.5958	.8937
.6500	-.8710	.5334	.9598	.6003	.0120	.6964	.7380	.8002	-.5024	-.3634	.5959	.8936
.7000	-.8761	.5637	.9694	.6500	.0918	.7178	.7030	.8002	-.7524	-.3390	.6024	.8828
.7500	-.8822	.5782	.9286	.7000	.1907	.7442	.6636					
.8002	-.8614	.5964	.8922	.7501	.2796	.7688	.6258					
.8502	-.8407	.6475	.8153	.8001	.3562	.7886	.5925					
.9001	-.8153	.6784	.7658	.8501	.4277	.8077	.5686					

TEST	167	PT	26.9561	PSI	CM	.9711
RUM	14	TY	145.1136	K	CM	-.1932
POINT	50	RC	9.9811	MILLION	CC	.0053
		WACH	.7414			
		ALPHA	3.0163	DEG		

CD1	.02307	CDCOR1	.02237
CD2	.02424	CDCOR2	.02365
CD3	.02379	CDCOR3	.02298
CD4	.02338	CDCOR4	.02274
CD5	.02019	CDCOR5	.01910

UPPER SURFACE				LOWER SURFACE				SPANWISE				
X/C	CP	P _L /PT	MLOC	X/C	CP	P _L /PT	MLOC	X/C	V/(B/2)	CP	P _L /PT	MLOC
0.0000	1.1082	.9901	.1191	0.0000	1.1082	.9901	.1171	.1507	.7476	-1.3039	.3456	1.3322
.0132	-.6879	.5115	1.0277	.0128	.7433	.8928	.4061	.1507	.4976	-1.3236	.3403	1.3436
.0258	-1.0730	.4673	1.2100	.0255	.5918	.8414	.3028	.1507	.2476	-1.3432	.3404	1.3263
.0759	-1.2777	.3528	1.3176	.0495	.3492	.7873	.3946	.1507	-.2324	-1.2925	.3486	1.3258
.1003	-1.2844	.3508	1.3213	.0753	.2492	.7606	.6377	.1507	-.5024	-1.2319	.3423	1.3390
.1507	-1.2767	.3528	1.3171	.1002	.1581	.7362	.8762	.1507	-.7524	-1.2982	.3471	1.3291
.2003	-1.2456	.3558	1.3110	.1503	-.0434	.7109	.7159	.5002	.7476	-1.2737	.3536	1.3154
.2503	-1.2770	.3528	1.3172	.1976	-.0398	.6834	.7581	.5002	.4976	-1.2880	.3498	1.3233
.3001	-1.3047	.3454	1.3327	.2503	-.1113	.6642	.7875	.5002	.2476	-1.2916	.3488	1.3256
.3502	-1.3089	.3442	1.3350	.3001	-.1595	.6514	.8073	.5002	-.2324	-1.2788	.3523	1.3182
.4003	-1.3172	.3427	1.3398	.3502	-.1961	.6416	.8223	.7502	-.5024	-1.2497	.3602	1.3022
.4501	-1.3398	.3360	1.3527	.4001	-.2094	.6380	.8278	.5002	-.7524	-1.1431	.3680	1.2467
.5002	-1.3584	.3314	1.3624	.4501	-.2053	.6391	.8251	.8002	.7476	-1.3443	.6020	.8835
.5502	-1.1727	.3806	1.2810	.5001	-.1496	.6487	.8111	.8002	.4976	-1.3463	.6014	.8843
.6002	-.7839	.4899	1.0637	.5497	-.0916	.6693	.7794	.8002	.2476	-1.3481	.6010	.8851
.6500	-.5791	.5392	.9825	.6003	-.0019	.6935	.7425	.8002	-.5024	-1.3706	.5949	.8944
.7000	-.4845	.5645	.9427	.6500	.0750	.7140	.7107	.8002	-.7524	-1.3628	.5970	.8912
.7500	-.4126	.5837	.9119	.7000	.1751	.7402	.6699					
.8002	-.3425	.6025	.8827	.7501	.2623	.7641	.6321					
.8032	-.1570	.6494	.9103	.8001	.3390	.7846	.5991					
.9501	-.0541	.6795	.7640	.8501	.4104	.8037	.5676					

TEST	167	PT	34.4779	PSI	CM	-0.0663	CD1	.00944	CDCOR1	.00920
RUN	15	TT	129.9395	K	CM	-0.1297	CD2	.00929	CDCOR2	.00909
POINT	41	RC	15.0231	MILLION	CC	.0037	CD3	.00915	CDCOR3	.00902
		MACH	.7430				CD4	.00895	CDCOR4	.00878
		ALPHA	-4.0394	DEG			CD5	.00854	CDCOR5	.00831

UPPER SURFACE				LOWER SURFACE				SPANWISE				
X/C	CP	P _L /PT	MLOC	X/C	CP	P _L /PT	MLOC	X/C	Y/(B/2)	CP	P _L /PT	MLOC
0.0000	.7072	.8822	.4272	0.0000	.7072	.8822	.4272	.1507	.7476	-1.165	.6612	.7926
.0132	.6353	.8629	.4640	.0126	-.7679	.4864	1.0700	.1507	.4976	-1.290	.6578	.7977
.0259	.3211	.7786	.6091	.0255	-.6504	.5179	1.0176	.1507	.2476	-1.287	.6579	.7976
.0759	-.0023	.6918	.7454	.0495	-.8041	.4767	1.0865	.1507	-.2524	-1.337	.6566	.7997
.1003	-.0544	.6778	.7670	.0753	-.8087	.4755	1.0886	.1507	-.5024	-1.366	.6558	.8009
.1507	-.1280	.6581	.7973	.1002	-.8141	.4740	1.0911	.1507	-.7524	-1.295	.6577	.7979
.2003	-.1772	.6449	.8176	.1503	-.7732	.4890	1.0724	.5002	.7476	-1.376	.5915	.9003
.2503	-.2260	.6318	.8378	.1976	-.7491	.4914	1.0615	.5002	.4976	-1.3819	.5900	.9026
.3001	-.2677	.6206	.8550	.2503	-.8683	.4595	1.1162	.5002	.2476	-1.388	.5686	.9047
.3502	-.2998	.6123	.8679	.3001	-.9507	.4374	1.1553	.5062	-.2524	-1.371	.5921	.8994
.4003	-.3268	.6048	.8796	.3507	-.9412	.4399	1.1507	.5002	-.5024	-1.376	.5925	.8987
.4501	-.3537	.5975	.8908	.4001	-.5587	.5425	.9777	.5002	-.7524	-1.353	.5963	.8927
.5002	-.3857	.5890	.9042	.4501	-.4965	.5592	.9510	.8002	.7476	-1.984	.4282	1.1717
.5502	-.4233	.5789	.9200	.5001	-.3995	.5853	.9100	.8002	.4976	-1.354	.5974	.8910
.6002	-.4533	.5708	.9327	.5497	-.2680	.6203	.8555	.8002	.2476	-1.3609	.5956	.8938
.6500	-.4889	.5666	.9393	.6003	-.1364	.6598	.8008	.8002	-.5024	-1.3383	.6017	.8844
.7000	-.4810	.5687	.9360	.6500	-.0266	.6892	.7556	.8002	-.7524	-1.3257	.6050	.8791
.7500	-.4210	.5795	.9191	.7000	.0927	.7173	.7060					
.8002	-.3560	.5969	.8918	.7501	.1927	.7441	.6641					
.9002	-.1793	.6443	.8185	.8001	.2726	.7656	.6301					
.9501	-.0585	.6767	.7686	.8501	.3402	.7837	.6008					

TEST	167	PT	34.4801	PSI	CM	.0901	CD1	.00858	CDCOR1	.00852
RUN	15	TT	130.1910	K	CM	-.1334	CD2	.00851	CDCOR2	.00848
POINT	42	RC	14.9679	MILLION	CC	.0129	CD3	.00851	CDCOR3	.00851
		MACH	.7419				CD4	.00845	CDCOR4	.00843
		ALPHA	-2.9938	DEG			CD5	.00815	CDCOR5	.00803

UPPER SURFACE				LOWER SURFACE				SPANWISE				
X/C	CP	P _L /PT	MLOC	X/C	CP	P _L /PT	MLOC	X/C	Y/(B/2)	CP	P _L /PT	MLOC
0.0000	.8620	.9247	.3364	0.0000	.8620	.9247	.3364	.1507	.7476	-2.238	.6333	.8354
.0132	.4752	.8217	.5375	.0126	-.4314	.5802	.9180	.1507	.4976	-2.2476	.6291	.8419
.0259	.1427	.7331	.6814	.0255	-.4356	.5790	.9197	.1507	.2476	-2.2480	.6290	.8421
.0759	-.1517	.6547	.8026	.0495	-.5259	.5550	.9378	.1507	-.2524	-2.2551	.6271	.8450
.1003	-.1897	.6446	.8181	.0753	-.5489	.5489	.9676	.1507	-.5024	-2.2583	.6263	.8463
.1507	-.2476	.6291	.8419	.1002	-.5916	.5375	.9858	.1507	-.7524	-2.2453	.6297	.8410
.2003	-.2879	.6184	.8585	.1503	-.5798	.5406	.9808	.5002	.7476	-1.4439	.5768	.9232
.2503	-.3243	.6087	.8735	.1976	-.6697	.5167	1.0196	.5002	.4976	-1.4496	.5753	.9256
.3001	-.3591	.5994	.8879	.2503	-.6966	.5095	1.0315	.5002	.2476	-1.4552	.5738	.9279
.3502	-.3789	.5941	.8961	.3001	-.6835	.5150	1.0257	.5002	-.2524	-1.4432	.5770	.9229
.4003	-.4018	.5880	.9056	.3507	-.6347	.5260	1.0045	.5002	-.5024	-1.4418	.5774	.9224
.4501	-.4253	.5818	.9155	.4001	-.5650	.5446	.9744	.5002	-.7524	-1.4274	.5812	.9163
.5002	-.4514	.5748	.9264	.4501	-.4882	.5650	.9419	.8002	.7476	-1.0542	.4143	1.1974
.5502	-.4840	.5662	.9401	.5001	-.3835	.5929	.8980	.8002	.4976	-1.3768	.5947	.8952
.6002	-.5094	.5594	.9508	.5497	-.2530	.6277	.8441	.8002	.2476	-1.3838	.5928	.8981
.6500	-.5193	.5567	.9550	.6003	-.1225	.6625	.7906	.8002	-.5024	-1.3624	.5985	.8893
.7000	-.5010	.5616	.9472	.6500	-.0159	.6908	.7470	.8002	-.7524	-1.3499	.6019	.8841
.7500	-.4510	.5749	.9262	.7000	.1035	.7226	.6977					
.8002	-.3772	.5946	.8954	.7501	.2043	.7495	.6556					
.9002	-.1879	.6450	.8174	.8001	.2855	.7711	.6211					
.9501	-.0609	.6788	.7654	.8501	.3554	.7897	.5909					

TEST	167	PT	34.4786	PSI	CM	.2378	CD1	.00847	CDCOR1	.00834
RUN	15	TT	140.1557	K	CM	-.1375	CD2	.00840	CDCOR2	.00830
POINT	43	RC	14.9613	MILLION	CC	.0185	CD3	.00839	CDCOR3	.00833
		MACH	.7409				CD4	.00835	CDCOR4	.00826
		ALPHA	-1.9755	DEG			CD5	.00811	CDCOR5	.00794

UPPER SURFACE				LOWER SURFACE				SPANWISE				
X/C	CP	P _L /PT	MLOC	X/C	CP	P _L /PT	MLOC	X/C	Y/(B/2)	CP	P _L /PT	MLOC
0.0000	1.0021	.9620	.2358	0.0000	1.0021	.9620	.2358	.1507	.7476	-3.576	.5999	.8372
.0132	.2799	.7497	.6235	.0126	-.1216	.6627	.7902	.1507	.4976	-3.768	.5947	.8952
.0259	-.0634	.6782	.7664	.0255	-.1968	.6443	.8185	.1507	.2476	-3.785	.5943	.8929
.0759	-.3216	.6095	.8723	.0495	-.3042	.6141	.8651	.1507	-.2524	-3.847	.5926	.8985
.1003	-.3404	.6045	.8801	.0753	-.3515	.6015	.8847	.1507	-.5024	-3.863	.5922	.8991
.1507	-.3768	.5947	.8952	.1002	-.4091	.5861	.9086	.1507	-.7524	-3.856	.5977	.8905
.2003	-.4017	.5881	.9055	.1503	-.4329	.5798	.9186	.5002	.7476	-1.5104	.5592	.9511
.2503	-.4278	.5812	.9164	.1976	-.5166	.5575	.9538	.5002	.4976	-1.5164	.5576	.9537
.3001	-.4545	.5741	.9276	.2503	-.5446	.5501	.9657	.5002	.2476	-1.5222	.5560	.9561
.3502	-.4660	.5710	.9324	.3001	-.5531	.5478	.9693	.5002	-.2524	-1.5088	.5596	.9505
.4003	-.4819	.5668	.9391	.3507	-.5397	.5514	.9635	.5002	-.5024	-1.5079	.5598	.9501
.4501	-.4995	.5621	.9465	.4001	-.4967	.5628	.9453	.5002	-.7524	-1.4928	.5639	.9437
.5002	-.5190	.5569	.9548	.4501	-.4370	.5787	.9202	.8002	.7476	-1.0851	.4061	1.2126
.5502	-.5452	.5499	.9659	.5001	-.3453	.6032	.8821	.8002	.4976	-1.3904	.5911	.9008
.6002	-.5652	.5446	.9744	.5497	-.2233	.6356	.8319	.8002	.2476	-1.3986	.5989	.9042
.6500	-.5661	.5443	.9749	.6003	-.0993	.6687	.7811	.8002	-.5024	-1.3783	.5944	.8938
.7000	-.5357	.5524	.9619	.6500	.0020	.6957	.7395	.8002	-.7524	-1.3657	.5977	.8906
.7500	-.4746	.5687	.9360	.7000	.1195	.7270	.6910					
.8002	-.3928	.5905	.9018	.7501	.2196	.7536	.6491					
.9002	-.1920	.6440	.8190	.8001	.3014	.7754	.6143					
.9501	-.0627	.6764	.7661	.8501	.3729	.7944	.5832					

ORIGINAL PAGE IS
OF POOR QUALITY

TEST	167	PT	34.4793	PSI	CN	.3069	CD1	.00849	CDCOR1	.00840
RUN	15	TT	130.1609	K	CM	-.1393	CD2	.00840	CDCOR2	.00835
POINT	44	RC	14.9363	MILLION	CC	.0199	CD3	.00840	CDCOR3	.00839
		MACH	.7405				CD4	.00833	CDCOR4	.00829
		ALPHA	-1.4969	DEG			CD5	.00809	CDCOR5	.00794

UPPER SURFACE				LOWER SURFACE				SPANWISE				
X/C	CP	P/L/PT	MLOC	X/C	CP	P/L/PT	MLOC	X/C	Y/(B/2)	CP	P/L/PT	MLOC
0.0000	1.0500	.9748	.1914	0.0000	1.0500	.9748	.1914	.1507	.7476	-.4236	.5821	.9149
.0132	.1777	.7223	.6669	.0126	.0081	.6971	.7372	.1507	.4976	-.4442	.5766	.9236
.0259	-.1703	.6496	.8104	.0255	-.0860	.6721	.7759	.1507	.2476	-.4465	.5760	.9245
.0759	-.4109	.5855	.9097	.0495	-.2118	.6386	.8274	.1507	-.2524	-.4535	.5741	.9275
.1003	-.4189	.5834	.9130	.0753	-.2691	.6233	.8509	.1507	-.5024	-.4535	.5741	.9275
.1507	-.4443	.5766	.9236	.1002	-.3329	.6063	.8772	.1507	-.7524	-.4297	.5805	.9175
.2003	-.4595	.5725	.9300	.1503	-.3679	.5970	.8917	.5002	.7476	-.5450	.5498	.9661
.2503	-.4812	.5668	.9391	.1976	-.4518	.5746	.9266	.5002	.4976	-.5508	.5482	.9686
.3001	-.5038	.5607	.9486	.2503	-.4852	.5657	.9408	.5002	.2476	-.5567	.5466	.9711
.3502	-.5094	.5592	.9510	.3001	-.4999	.5618	.9470	.5002	-.2524	-.5428	.5503	.9652
.4003	-.5217	.5560	.9562	.3507	-.4959	.5628	.9453	.5002	-.5024	-.5425	.5504	.9651
.4501	-.5370	.5519	.9627	.4001	-.4617	.5719	.9309	.5002	-.7524	-.5271	.5545	.9585
.5002	-.5532	.5476	.9696	.4501	-.4107	.5855	.9096	.8002	.7476	-1.1033	.4010	1.2223
.5502	-.5761	.5415	.9794	.5001	-.3253	.6083	.8741	.8002	.4976	-.3972	.5874	.9039
.6002	-.5929	.5370	.9866	.5497	-.2085	.6394	.8260	.8002	.2476	-.4050	.5871	.9072
.6500	-.5894	.5379	.9851	.6003	-.0882	.6715	.7768	.8002	-.5024	-.3861	.5921	.8993
.7000	-.5514	.5480	.9689	.6500	.0103	.7177	.7363	.8002	-.7524	-.3741	.5953	.8943
.7500	-.4852	.5657	.9468	.7000	.1261	.7286	.6885					
.8002	-.3996	.5885	.9049	.7501	.2255	.7551	.6468					
.9002	-.1935	.6434	.8199	.8001	.3071	.7768	.6120					
.9501	-.0632	.6781	.7665	.8501	.3792	.7960	.5806					

TEST	167	PT	34.4787	PSI	CN	.3741	CD1	.00848	CDCOR1	.00837
RUN	15	TT	130.1367	K	CM	-.1401	CD2	.00841	CDCOR2	.00833
POINT	45	RC	14.9581	MILLION	CC	.0203	CD3	.00843	CDCOR3	.00839
		MACH	.7403				CD4	.00836	CDCOR4	.00829
		ALPHA	-.9979	DEG			CD5	.00811	CDCOR5	.00796

UPPER SURFACE				LOWER SURFACE				SPANWISE				
X/C	CP	P/L/PT	MLOC	X/C	CP	P/L/PT	MLOC	X/C	Y/(B/2)	CP	P/L/PT	MLOC
0.0000	1.0911	.9857	.1436	0.0000	1.0911	.9857	.1436	.1507	.7476	-.4949	.5630	.9450
.0132	.0687	.7132	.7124	.0126	.1269	.7288	.6882	.1507	.4976	-.5203	.5563	.9557
.0259	-.2835	.6194	.8569	.0255	.0148	.6989	.7346	.1507	.2476	-.5239	.5533	.9573
.0759	-.5127	.5583	.9525	.0495	-.1258	.6614	.7922	.1507	-.2524	-.5327	.5530	.9610
.1003	-.5079	.5596	.9505	.0753	-.1922	.6437	.8194	.1507	-.5024	-.5308	.5535	.9602
.1507	-.5219	.5560	.9563	.1002	-.2616	.6252	.8479	.1507	-.7524	-.5024	.5610	.9482
.2003	-.5193	.5565	.9553	.1503	-.3078	.6129	.8670	.5002	.7476	-.5816	.5399	.9819
.2503	-.5411	.5507	.9646	.1976	-.3938	.5900	.9026	.5002	.4976	-.5874	.5384	.9844
.3001	-.5594	.5458	.9724	.2503	-.4335	.5794	.9192	.5002	.2476	-.5938	.5367	.9871
.3502	-.5531	.5475	.9697	.3001	-.4538	.5740	.9277	.5002	-.2524	-.5818	.5399	.9820
.4003	-.5633	.5448	.9741	.3507	-.4574	.5730	.9292	.5002	-.5024	-.5818	.5399	.9820
.4501	-.5773	.5411	.9800	.4001	-.4316	.5799	.9184	.5002	-.7524	-.5659	.5441	.9751
.5002	-.5885	.5381	.9844	.4501	-.3883	.5915	.9003	.8002	.7476	-1.1165	.3974	1.2291
.5502	-.6072	.5331	.9929	.5001	-.3092	.6125	.8675	.8002	.4976	-.4044	.5872	.9070
.6002	-.6202	.5297	.9985	.5497	-.1967	.6425	.8213	.8002	.2476	-.4110	.5854	.9098
.6500	-.6127	.5316	.9953	.6003	-.0794	.6738	.7732	.8002	-.5024	-.3953	.5896	.9032
.7000	-.5660	.5441	.9752	.6500	.0162	.6992	.7340	.8002	-.7524	-.3838	.5926	.8985
.7500	-.4936	.5634	.9444	.7000	.1310	.7298	.6865					
.8002	-.4045	.5871	.9071	.7501	.2299	.7562	.6450					
.9002	-.1936	.6433	.8200	.8001	.3113	.7779	.6102					
.9501	-.0609	.6787	.7657	.8501	.3838	.7972	.5736					

TEST	167	PT	34.4746	PSI	CN	.4493	CD1	.00867	CDCOR1	.00857
RUN	15	TT	130.1523	K	CM	-.1428	CD2	.00856	CDCOR2	.00849
POINT	46	RC	14.9630	MILLION	CC	.0201	CD3	.00855	CDCOR3	.00853
		MACH	.7411				CD4	.00843	CDCOR4	.00839
		ALPHA	-.5397	DEG			CD5	.00824	CDCOR5	.00809

UPPER SURFACE				LOWER SURFACE				SPANWISE				
X/C	CP	P/L/PT	MLOC	X/C	CP	P/L/PT	MLOC	X/C	Y/(B/2)	CP	P/L/PT	MLOC
0.0000	1.1192	.9928	.1014	0.0000	1.1192	.9928	.1014	.1507	.7476	-.5763	.5387	.9839
.0132	-.0412	.6820	.7605	.0126	.2440	.7384	.6415	.1507	.4976	-.6030	.5315	.9954
.0259	-.3918	.5841	.9055	.0255	.1124	.7232	.6969	.1507	.2476	-.6082	.5301	.9977
.0759	-.6293	.5245	1.0069	.0495	-.0397	.6824	.7599	.1507	-.2524	-.6132	.5283	1.0007
.1003	-.6042	.5312	.9959	.0753	-.1131	.6622	.7909	.1507	-.5024	-.6088	.5300	.9979
.1507	-.6057	.5308	.9966	.1002	-.1926	.6415	.8229	.1507	-.7524	-.5688	.5407	.9807
.2003	-.5920	.5345	.9907	.1503	-.2473	.6268	.8455	.5002	.7476	-.6217	.5265	1.0036
.2503	-.6057	.5308	.9966	.1976	-.3360	.6031	.8822	.5002	.4976	-.6285	.5247	1.0065
.3001	-.6202	.5269	1.0029	.2503	-.3806	.5911	.9009	.5002	.2476	-.6351	.5230	1.0094
.3502	-.6064	.5306	.9969	.3001	-.4061	.5843	.9115	.5002	-.2524	-.6198	.5270	1.0027
.4003	-.6117	.5292	.9992	.3507	-.4163	.5815	.9156	.5002	-.5024	-.6187	.5271	1.0027
.4501	-.6230	.5267	1.0041	.4001	-.3966	.5868	.9076	.5002	-.7524	-.6029	.5316	.9954
.5002	-.6307	.5241	1.0075	.4501	-.3594	.5968	.8920	.8002	.7476	-1.1199	.3931	1.2374
.5502	-.6439	.5206	1.0133	.5001	-.2865	.6163	.8617	.8002	.4976	-.4036	.5842	.9117
.6002	-.6541	.5179	1.0177	.5497	-.1785	.6452	.8171	.8002	.2476	-.4138	.5822	.9148
.6500	-.6408	.5214	1.0119	.6003	-.0648	.6757	.7703	.8002	-.5024	-.3973	.5866	.9078
.7000	-.5619	.5372	.9863	.6500	.0285	.7007	.7314	.8002	-.7524	-.3876	.5892	.9038
.7500	-.5008	.5589	.9515	.7000	.1414	.7109	.6844					
.8002	-.4085	.5836	.9125	.7501	.2393	.7372	.6435					
.9002	-.1926	.6433	.8229	.8001	.3204	.7789	.6086					
.9501	-.0611	.6787	.7687	.8501	.3931	.7984	.5767					

TEST	167	PT	34.4744	PSI	CN	.5301	CD1	.00884	CDCOR1	.00865		
RUN	15	TY	130.0757	K	CM	-1.450	CD2	.00872	CDCOR2	.00852		
POINT	47	RC	14.9763	MILLION	CC	.0188	CD3	.00874	CDCOR3	.00858		
		MACH	.7412				CD4	.00859	CDCOR4	.00841		
		ALPHA	-.0305	DEG			CD5	.00839	CDCOR5	.00810		
UPPER SURFACE		LOWER SURFACE		SPANWISE								
X/C	CP	P/L/PT	MLOC	X/C	CP	P/L/PT	MLOC	X/C	Y/(B/2)	CP	P/L/PT	MLOC
0.0000	1.1388	.9981	.0516	0.0000	1.1388	.9981	.0516	.1507	.7476	-.6619	.5161	1.0205
.0132	-.1508	.6529	.8052	.0126	.3560	.7886	.5928	.1507	.4976	-.6914	.5083	1.0335
.0259	-.5106	.5566	.9552	.0255	.2056	.7484	.6574	.1507	.2476	-.6982	.5064	1.0365
.0759	-.7656	.4884	1.0667	.0495	.0373	.7033	.7277	.1507	-.2524	-.6975	.5066	1.0362
.1003	-.7509	.4923	1.0600	.0753	-.0343	.6842	.7573	.1507	-.5024	-.6877	.5093	1.0319
.1507	-.6947	.5074	1.0350	.1002	-.1194	.6614	.7923	.1507	-.7524	-.6464	.5203	1.0137
.2003	-.6737	.5130	1.0257	.1503	-.1815	.6448	.8178	.1507	.7476	-.6556	.5178	1.0177
.2503	-.6650	.5153	1.0219	.1976	-.2720	.6205	.8552	.1507	.4976	-.6650	.5153	1.0219
.3001	-.6853	.5099	1.0300	.2503	-.3207	.6075	.8754	.1507	.2476	-.6721	.5134	1.0250
.3502	-.6648	.5154	1.0218	.3001	-.3504	.5995	.8877	.1507	-.2524	-.6520	.5188	1.0162
.4003	-.6518	.5189	1.0161	.3507	-.3660	.5954	.8942	.1507	-.5024	-.6512	.5190	1.0158
.4501	-.6615	.5163	1.0204	.4001	-.3526	.5989	.8886	.1507	-.7524	-.6318	.5242	1.0074
.5002	-.6693	.5142	1.0238	.4501	-.3218	.6072	.8758	.1507	.7476	-.6118	.3940	1.2357
.5502	-.6729	.5132	1.0254	.5001	-.2560	.6248	.8486	.1507	.4976	-.6408	.5847	.9109
.6002	-.6777	.5119	1.0275	.5497	-.1537	.6522	.8064	.1507	-.5024	-.6329	.5882	.9054
.6500	-.6574	.5174	1.0185	.6003	-.0442	.6815	.7614	.1507	-.7524	-.3829	.5908	.9013
.7000	-.5997	.5355	.9891	.6500	.0457	.7056	.7242					
.7500	-.5036	.5585	.9522	.7000	.1566	.7353	.6780					
.8002	-.4093	.5838	.9123	.7501	.2529	.7610	.6373					
.8501	-.1903	.6424	.8215	.8001	.3334	.7826	.6026					
.9002	-.4093	.5838	.9123	.8501	.4064	.8021	.5705					
.9501	-.0600	.6773	.7678									

TEST	167	PT	34.4707	PSI	CN	.5980	CD1	.00910	CDCOR1	.00917		
RUN	15	TY	130.0280	K	CM	-1.436	CD2	.00899	CDCOR2	.00909		
POINT	48	RC	14.9682	MILLION	CC	.0164	CD3	.00898	CDCOR3	.00912		
		MACH	.7400				CD4	.00873	CDCOR4	.00885		
		ALPHA	.5193	DEG			CD5	.00856	CDCOR5	.00857		
UPPER SURFACE		LOWER SURFACE		SPANWISE								
X/C	CP	P/L/PT	MLOC	X/C	CP	P/L/PT	MLOC	X/C	Y/(B/2)	CP	P/L/PT	MLOC
0.0000	1.1427	.9997	.0210	0.0000	1.1427	.9997	.0210	.1507	.7476	-.7479	.4977	1.0511
.0132	-.2713	.6243	.8494	.0126	.4493	.8156	.5479	.1507	.4976	-.8266	.4768	1.0864
.0259	-.6372	.5271	1.0027	.0255	.2826	.7713	.6209	.1507	.2476	-.8745	.4641	1.1082
.0759	-.8950	.4586	1.1177	.0495	.0988	.7225	.6979	.1507	-.2524	-.8787	.4630	1.1101
.1003	-.9030	.4565	1.1214	.0753	.0277	.7036	.7272	.1507	-.5024	-.8333	.4750	1.0894
.1507	-.8634	.4670	1.1031	.1002	-.0599	.6804	.7631	.1507	-.7524	-.6925	.5124	1.0267
.2003	-.7550	.4958	1.0542	.1503	-.1308	.6616	.7920	.1507	.7476	-.6903	.5130	1.0237
.2503	-.6826	.5150	1.0224	.1976	-.2238	.6368	.8300	.1507	.4976	-.7002	.5104	1.0300
.3001	-.7425	.4991	1.0487	.2503	-.2775	.6226	.8520	.1507	.2476	-.7065	.5087	1.0328
.3502	-.7392	.5000	1.0472	.3001	-.3116	.6135	.8660	.1507	-.2524	-.6879	.5136	1.0247
.4003	-.6972	.5112	1.0287	.3507	-.3303	.6086	.8737	.1507	-.5024	-.6895	.5132	1.0254
.4501	-.6897	.5131	1.0255	.4001	-.3234	.6104	.8709	.1507	-.7524	-.6701	.5183	1.0169
.5002	-.6991	.5107	1.0296	.4501	-.2996	.6167	.8610	.1507	.7476	-.6133	.3954	1.2330
.5502	-.6992	.5106	1.0296	.5001	-.2404	.6325	.8368	.1507	.4976	-.6131	.5866	.9079
.6002	-.6940	.5120	1.0274	.5497	-.1435	.6582	.7972	.1507	-.5024	-.6197	.5848	.9107
.6500	-.6678	.5190	1.0159	.6003	.0484	.6862	.7541	.1507	-.7524	-.4031	.5892	.9038
.7000	-.5973	.5377	.9855	.6500	.0474	.7091	.7187					
.7500	-.5086	.5612	.9479	.7000	.1375	.7381	.6736					
.8002	-.4134	.5865	.9080	.7501	.2530	.7635	.6334					
.8501	-.1922	.6453	.8171	.8001	.3332	.7847	.5991					
.9002	-.4094	.5839	.9124	.8501	.4062	.8041	.5671					
.9501	-.0594	.6805	.7629									

TEST	167	PT	34.4703	PSI	CN	.6744	CD1	.00958	CDCOR1	.00927		
RUN	15	TY	130.0827	K	CM	-1.439	CD2	.00937	CDCOR2	.00912		
POINT	49	RC	14.9568	MILLION	CC	.0136	CD3	.00926	CDCOR3	.00905		
		MACH	.7398				CD4	.00895	CDCOR4	.00872		
		ALPHA	1.0081	DEG			CD5	.00887	CDCOR5	.00867		
UPPER SURFACE		LOWER SURFACE		SPANWISE								
X/C	CP	P/L/PT	MLOC	X/C	CP	P/L/PT	MLOC	X/C	Y/(B/2)	CP	P/L/PT	MLOC
0.0000	1.1504	1.0015	0.0000	0.0000	1.1504	1.0015	0.0000	.1507	.7476	-.9118	.4519	1.1295
.0132	-.3688	.5966	.8923	.0126	.5384	.8384	.5084	.1507	.4976	-1.0099	.4257	1.1763
.0259	-.7350	.4990	1.0489	.0255	.3595	.7907	.5893	.1507	.2476	-.9980	.4289	1.1705
.0759	-.9917	.4306	1.1675	.0495	.1709	.7405	.6699	.1507	-.2524	-1.0007	.4282	1.1719
.1003	-1.0009	.4281	1.1719	.0753	.0959	.7204	.7011	.1507	-.5024	-1.0191	.4233	1.1808
.1507	-.9830	.4329	1.1633	.1002	.0020	.6954	.7399	.1507	-.7524	-.9003	.4549	1.1241
.2003	-.9549	.4404	1.1499	.1503	-.0731	.6754	.7707	.1507	.7476	-.9003	.5083	1.0335
.2503	-.9379	.4449	1.1418	.1976	-.1674	.6503	.8093	.1507	.4976	-.9003	.5046	1.0396
.3001	-.9095	.4492	1.0823	.2503	-.2238	.6352	.8325	.1507	.2476	-.9003	.5023	1.0434
.3502	-.8614	.4586	1.0165	.3001	-.2611	.6253	.8478	.1507	-.2524	-.9003	.5067	1.0361
.4003	-.8672	.4571	1.0190	.3507	-.2841	.6192	.8573	.1507	-.5024	-.9003	.5064	1.0365
.4501	-.8985	.4507	1.0328	.4001	-.2611	.6200	.8560	.1507	.7476	-.8858	.5121	1.0272
.5002	-.8720	.4529	1.0425	.4501	-.2613	.6252	.8479	.1507	.4976	-1.1063	.4000	1.2241
.5502	-.8718	.4525	1.0430	.5001	-.2076	.6396	.8258	.1507	.4976	-.9025	.5876	.9063
.6002	-.8070	.4665	1.0365	.5497	-.1159	.6640	.7882	.1507	-.5024	-.9003	.5955	.9097
.6500	-.6713	.5160	1.0200	.6003	-.0148	.6909	.7468	.1507	-.7524	-.8928	.5902	.9022
.7000	-.5948	.5364	.9876	.6500	.0895	.7134	.7120					
.7500	-.5033	.5608	.9486	.7000	.1766	.7420	.6675					
.8002	-.4070	.5864	.9082	.7501	.2704	.7670	.6278					
.8501	-.1839	.6459	.8161	.8001	.3496	.7881	.5937					
.9002	-.4094	.5839	.9124	.8501	.4228	.8076	.5613					
.9501	-.0597	.6798	.7640									

ORIGINAL RECORDS
OF POOR QUALITY

TEST 167	PT 34.4642	PSI	CM	.7598	CD1	.01018	CDCOR1	.00991
RUN 15	TT 130.0844	K	CM	-1.426	CD2	.00998	CDCOR2	.00998
POINT 50	RC 14.9517	MILLION	CC	.00999	CD3	.00991	CDCOR3	.00995
	MACH .7396				CD4	.00960	CDCOR4	.00925
	ALPHA 1.5172	DEG			CD5	.00961	CDCOR5	.00936

UPPER SURFACE				LOWER SURFACE				SPANWISE				
X/C	CP	P/L/PT	MLOC	X/C	CP	P/L/PT	MLOC	X/C	Y/(B/2)	CP	P/L/PT	MLOC
0.0000	1.1287	.9961	.0745	0.0000	1.1287	.9961	.0745	.1507	.7476	-1.0501	.4191	1.1885
.0132	-.4812	.5697	.9344	.0126	.6002	.8561	.4765	.1507	.4976	-1.1397	.3953	1.2331
.0259	-.8519	.4716	1.0953	.0255	.4147	.8070	.5623	.1507	.2476	-1.1114	.4028	1.2188
.0750	-1.0994	.4060	1.2128	.0495	.2253	.7568	.6440	.1507	-.2524	-1.1101	.4031	1.2182
.1003	-1.1113	.4028	1.2188	.0753	.1444	.7354	.6778	.1507	-.5024	-1.1339	.3968	1.2302
.1507	-1.0953	.4071	1.2108	.1002	.0495	.7103	.7169	.1507	-.7524	-1.0409	.4215	1.1841
.2003	-1.0870	.4090	1.2071	.1503	-.0310	.6890	.7498	.5002	.7476	-.6692	.5199	1.0143
.2503	-1.0888	.4088	1.2076	.1976	-.1273	.6635	.7891	.5002	.4976	-.6542	.5239	1.0078
.3001	-1.1054	.4044	1.2158	.2503	-.1872	.6476	.8135	.5002	.2476	-.6474	.5257	1.0049
.3502	-1.0720	.4132	1.1993	.3001	-.2269	.6371	.8296	.5002	-.2524	-.6432	.5268	1.0031
.4003	-.7970	.4861	1.0706	.3507	-.2530	.6302	.8403	.5002	-.5024	-.6605	.5222	1.0106
.4501	-.6258	.5314	.9954	.4001	-.2546	.6297	.8410	.5002	-.7524	-.6627	.5216	1.0115
.5002	-.6451	.5263	1.0039	.4501	-.2404	.6335	.8352	.8002	.7476	-1.1230	.3997	1.2247
.5502	-.6771	.5178	1.0178	.5001	-.1928	.6461	.8157	.8002	.4976	-.6457	.5671	.9072
.6002	-.6956	.5129	1.0258	.5497	-.1067	.6689	.7807	.8002	.2476	-.6432	.5851	.9163
.6500	-.6722	.5191	1.0156	.6003	-.0102	.6945	.7414	.8002	-.5024	-.64024	.5906	.9017
.7000	-.6030	.5375	.9859	.6500	.0696	.7156	.7087	.8002	-.7524	-.3894	.5940	.8963
.7500	-.5140	.5610	.9482	.7000	.1736	.7432	.6656					
.8002	-.4179	.5865	.9081	.7501	.2654	.7675	.6270					
.8502	-.1965	.6451	.8172	.8001	.3433	.7881	.5936					
.9001	-.0668	.6795	.7644	.8501	.4154	.8072	.5620					

TEST 167	PT 34.4645	PSI	CM	-.8462	CD1	.01201	CDCOR1	.01136
RUN 15	TT 130.1960	K	CM	-1.440	CD2	.01212	CDCOR2	.01157
POINT 51	RC 14.9362	MILLION	CC	.0069	CD3	.01247	CDCOR3	.01160
	MACH .7394				CD4	.01255	CDCOR4	.01152
	ALPHA 2.0182	DEG			CD5	.01227	CDCOR5	.01106

UPPER SURFACE				LOWER SURFACE				SPANWISE				
X/C	CP	P/L/PT	MLOC	X/C	CP	P/L/PT	MLOC	X/C	Y/(B/2)	CP	P/L/PT	MLOC
0.0000	1.1234	.9950	.0847	0.0000	1.1234	.9950	.0847	.1507	.7476	-1.1593	.3929	1.2377
.0132	-.5713	.5480	.9689	.0126	.6647	.8740	.4430	.1507	.4976	-1.2302	.3742	1.2742
.0259	-.9488	.4484	1.1356	.0255	.4757	.8242	.5332	.1507	.2476	-1.1992	.3824	1.2581
.0750	-1.1840	.3864	1.2503	.0495	.2825	.7732	.6178	.1507	-.2524	-1.1977	.3828	1.2573
.1003	-1.1974	.3829	1.2572	.0753	.1962	.7504	.6541	.1507	-.5024	-1.2239	.3759	1.2709
.1507	-1.1843	.3863	1.2504	.1002	.1004	.7242	.6938	.1507	-.7524	-1.1437	.3970	1.2298
.2003	-1.1738	.3891	1.2451	.1503	.0145	.7025	.7290	.5002	.7476	-.7357	.5046	1.0395
.2503	-1.1788	.3878	1.2476	.1976	-.0842	.6785	.7691	.5002	.4976	-.6986	.4893	1.0652
.3001	-1.2048	.3809	1.2610	.2503	-.1478	.6597	.7948	.5002	.2476	-.7742	.4945	1.0564
.3502	-1.2123	.3789	1.2654	.3001	-.1898	.6486	.8119	.5002	-.2524	-.6986	.5144	1.0234
.4003	-1.1940	.3838	1.2554	.3507	-.2186	.6410	.8235	.5002	-.5024	-.7421	.5030	1.0423
.4501	-1.0363	.4253	1.1770	.4001	-.2242	.6395	.8258	.5002	-.7524	-.6941	.5156	1.0214
.5002	-.6800	.5193	1.0153	.4501	-.2148	.6420	.8220	.8002	.7476	-1.0885	.4116	1.2024
.5502	-.7884	.5435	.9762	.5001	-.1724	.6532	.8048	.8002	.4976	-.64086	.5909	.9011
.6002	-.5949	.5418	.9789	.5497	-.0906	.6748	.7716	.8002	.2476	-.64167	.5888	.9045
.6500	-.6020	.5399	.9819	.6003	.0026	.6994	.7338	.8002	-.5024	-.3960	.5942	.8960
.7000	-.5720	.5478	.9692	.6500	.0794	.7196	.7024	.8002	-.7524	-.3768	.5993	.8881
.7500	-.5014	.5665	.9396	.7000	.1815	.7486	.6603					
.8002	-.4111	.5902	.9022	.7501	.2723	.7705	.6221					
.8502	-.1936	.6471	.8142	.8001	.3495	.7909	.5891					
.9001	-.0658	.6813	.7616	.8501	.4214	.8098	.5576					

TEST 167	PT 34.4710	PSI	CM	.9333	CD1	.01632	CDCOR1	.01514
RUN 15	TT 130.1383	K	CM	-1.493	CD2	.01679	CDCOR2	.01570
POINT 52	RC 14.9465	MILLION	CC	.0047	CD3	.01776	CDCOR3	.01586
	MACH .7397				CD4	.01789	CDCOR4	.01638
	ALPHA 2.5254	DEG			CD5	.01676	CDCOR5	.01506

UPPER SURFACE				LOWER SURFACE				SPANWISE				
X/C	CP	P/L/PT	MLOC	X/C	CP	P/L/PT	MLOC	X/C	Y/(B/2)	CP	P/L/PT	MLOC
0.0000	1.1060	.9905	.1170	0.0000	1.1060	.9905	.1170	.1507	.7476	-1.2453	.3709	1.2808
.0132	-.6518	.5273	1.0023	.0126	.7735	.8897	.4122	.1507	.4976	-1.3084	.3543	1.3145
.0259	-1.0293	.4278	1.1725	.0255	.5315	.8391	.5077	.1507	.2476	-1.2749	.3631	1.2965
.0750	-1.2608	.3668	1.2890	.0495	.3367	.8078	.5942	.1507	-.2524	-1.2707	.3642	1.2942
.1003	-1.2712	.3641	1.2945	.0753	.2470	.7841	.6324	.1507	-.5024	-1.2933	.3583	1.3063
.1507	-1.2597	.3671	1.2884	.1002	.1482	.7381	.6736	.1507	-.7524	-1.2245	.3764	1.2699
.2003	-1.2489	.3700	1.2827	.1503	.0986	.7145	.7104	.5002	.7476	-1.1115	.4062	1.2125
.2503	-1.2521	.3691	1.2844	.1976	-.0416	.6881	.7512	.5002	.4976	-1.1755	.3893	1.2447
.3001	-1.2795	.3619	1.2989	.2503	-.1080	.6708	.7781	.5002	.2476	-1.1773	.3888	1.2456
.3502	-1.2900	.3591	1.3046	.3001	-.1526	.6588	.7962	.5002	-.2524	-1.1319	.4008	1.2227
.4003	-1.2923	.3585	1.3059	.3507	-.1850	.6503	.8093	.5002	-.5024	-1.1272	.4020	1.2203
.4501	-1.3007	.3563	1.3103	.4001	-.1941	.6479	.8130	.8002	-.7524	-.9983	.4359	1.1578
.5002	-1.1535	.3951	1.2335	.4501	-.1883	.6494	.8106	.8002	.7476	-1.0342	.4266	1.1748
.5502	-.7100	.5120	1.0274	.5001	-.1901	.6395	.7932	.8002	.4976	-.3889	.5967	.9222
.6002	-.5496	.5342	.9590	.5497	-.0724	.6800	.7637	.8002	.2476	-.3934	.5954	.8942
.6500	-.5210	.5618	.9470	.6003	.0169	.7035	.7274	.8002	-.5024	-.3764	.5999	.8872
.7000	-.5083	.5651	.9417	.6500	.0912	.7231	.6970	.8002	-.7524	-.3494	.6070	.8761
.7500	-.4432	.5770	.9230	.7000	.1913	.7495	.6597					
.8002	-.3895	.5964	.8926	.7501	.2802	.7729	.6183					
.8502	-.1901	.6490	.8114	.8001	.3586	.7930	.5855					
.9001	-.0658	.6817	.7610	.8501	.4283	.8119	.5541					

TEST 167	PT 34.4765	PSI	CN	.9895	CD1 .02271	CDCOR1 .02209
RUN 15	TT 130.1025	K	CM	-.1972	CD2 .02381	CDCOR2 .02294
POINT 53	RC 14.9609	MILLION	CC	.0058	CD3 .02358	CDCOR3 .02272
	MACH .7402				CD4 .02356	CDCOR4 .02263
	ALPHA 3.0264	DEG			CD5 .02062	CDCOR5 .01989

UPPER SURFACE				LOWER SURFACE				SPANWISE				
X/C	CP	P/L/PT	MLOC	X/C	CP	P/L/PT	MLOC	X/C	Y/(B/2)	CP	P/L/PT	MLOC
0.0000	1.1067	.9900	.1201	0.0000	1.1067	.9900	.1201	.1507	.7476	-1.2786	.3553	1.3125
.0132	-.8826	.5139	1.0243	.0126	.7561	.8967	.3979	.1507	.4976	-1.3302	.3416	1.3412
.0259	-1.0535	.4152	1.1957	.0255	.5637	.8455	.4958	.1507	.2476	-1.3007	.3494	1.3246
.0759	-1.2954	.3535	1.3162	.0495	.3628	.7920	.5871	.1507	-.2524	-1.2984	.3500	1.3234
.1003	-1.2952	.3509	1.3216	.0753	.2699	.7673	.6272	.1507	-.5024	-1.3194	.3445	1.3351
.1507	-1.2853	.3535	1.3161	.1002	.1709	.7410	.6690	.1507	-.7524	-1.2594	.3604	1.3020
.2003	-1.2737	.3566	1.3098	.1503	.0767	.7159	.7082	.5002	.7476	-1.2826	.3552	1.3147
.2503	-1.2807	.3547	1.3136	.1976	-.0268	.6884	.7508	.5002	.4976	-1.2911	.3520	1.3193
.3001	-1.3096	.3471	1.3296	.2503	-.0974	.6696	.7796	.5002	.2476	-1.2984	.3500	1.3234
.3502	-1.3184	.3447	1.3345	.3001	-.1454	.6568	.7993	.5002	-.2524	-1.2804	.3548	1.3135
.4003	-1.3232	.3434	1.3372	.3502	-.1810	.6474	.8138	.5002	-.5024	-1.2498	.3630	1.2968
.4501	-1.3440	.3375	1.3490	.4001	-.1935	.6440	.8189	.5002	-.7524	-1.1508	.3893	1.2447
.5002	-1.3636	.3327	1.3602	.4501	-.1908	.6447	.8179	.8002	.7476	-.9153	.4520	1.1294
.5502	-1.2289	.3685	1.2856	.5001	-.1556	.6541	.8034	.8002	.4976	-.9434	.6041	.8806
.6002	-.7772	.4887	1.0662	.5497	-.0766	.6746	.7720	.8002	.2476	-.9453	.6036	.8813
.6500	-.5652	.5451	.9735	.6003	.0105	.6983	.7354	.8002	-.5024	-1.3560	.6008	.8858
.7000	-.4714	.5701	.9339	.7000	.0842	.7179	.7051	.8002	-.7524	-.3521	.6018	.8842
.7500	-.4068	.5873	.9069	.7501	.2743	.7685	.6253					
.8002	-.3425	.6044	.8802	.8001	.3513	.7890	.5921					
.9002	-.1706	.6501	.8096	.8501	.4239	.8083	.5601					
.9501	-.0581	.6801	.7636									

TEST 167	PT 34.4754	PSI	CN	1.0341	CD1 .03220	CDCOR1 .03135
RUN 15	TT 130.1350	K	CM	-.1610	CD2 .03195	CDCOR2 .02945
POINT 54	RC 14.9537	MILLION	CC	.0056	CD3 .02910	CDCOR3 .02638
	MACH .7401				CD4 .02830	CDCOR4 .02640
	ALPHA 3.5120	DEG			CD5 .02363	CDCOR5 .02102

UPPER SURFACE				LOWER SURFACE				SPANWISE				
X/C	CP	P/L/PT	MLOC	X/C	CP	P/L/PT	MLOC	X/C	Y/(B/2)	CP	P/L/PT	MLOC
0.0000	1.0862	.9843	.1508	0.0000	1.0862	.9843	.1508	.1507	.7476	-1.3421	.3358	1.3534
.0132	-.7362	.4976	1.0512	.0126	.7910	.9054	.3796	.1507	.4976	-1.3727	.3276	1.3712
.0259	-1.0987	.4008	1.2226	.0255	.5990	.8541	.4802	.1507	.2476	-1.3416	.3360	1.3532
.0759	-1.3285	.3395	1.3457	.0495	.3968	.8002	.5737	.1507	-.2524	-1.3382	.3369	1.3512
.1003	-1.3369	.3372	1.3505	.0753	.3032	.7752	.6146	.1507	-.5024	-1.3560	.3321	1.3615
.1507	-1.3267	.3399	1.3446	.1002	.1993	.7474	.6589	.1507	-.7524	-1.3065	.3453	1.3332
.2003	-1.3193	.3430	1.3382	.1503	.1026	.7216	.6993	.5002	.7476	-1.3327	.3383	1.3481
.2503	-1.3224	.3411	1.3422	.1976	-.0022	.6936	.7427	.5002	.4976	-1.3365	.3373	1.3502
.3001	-1.3502	.3337	1.3581	.2503	-.0749	.6742	.7726	.5002	.2476	-1.3427	.3357	1.3538
.3502	-1.3614	.3307	1.3646	.3001	-.1258	.6606	.7935	.5002	-.2524	-1.3230	.3409	1.3426
.4003	-1.3668	.3292	1.3677	.3502	-.1651	.6501	.8096	.5002	-.5024	-1.2796	.3525	1.3182
.4501	-1.3887	.3234	1.3806	.4001	-.1803	.6461	.8155	.5002	-.7524	-1.0598	.4112	1.2031
.5002	-1.4207	.3148	1.3997	.4501	-.1804	.6460	.8159	.8002	.7476	-.8793	.4594	1.1163
.5502	-1.3240	.3407	1.3431	.5001	-.1469	.6550	.8021	.8002	.4976	-.8326	.6054	.8786
.6002	-.8194	.4754	1.0887	.5497	-.0746	.6745	.7722	.8002	.2476	-.8360	.6045	.8800
.6500	-.6207	.5285	1.0004	.6003	.0125	.6975	.7366	.8002	-.5024	-1.3528	.6000	.8876
.7000	-.5002	.5606	.9488	.7000	.0851	.7169	.7066	.8002	-.7524	-.3821	.5922	.8992
.7500	-.4091	.5849	.9105	.7501	.1843	.7434	.6632					
.8002	-.3338	.6051	.8791	.8001	.2730	.7871	.6276					
.9002	-.1675	.6495	.8106	.8001	.3495	.7875	.5945					
.9501	-.0659	.6766	.7689	.8501	.4223	.8070	.5624					

TEST 167	PT 44.3245	PSI	CN	-.0399	CD1 .00842	CDCDR1 .00840
RUN 10	TT 96.2827	K	CM	-.1356	CD2 .00831	CDCDR2 .00832
POINT 54	RC 30.0822	MILLION	CC	.0051	CD3 .00821	CDCDR3 .00826
	MACH .7418				CD4 .00820	CDCDR4 .00822
	ALPHA -3.9917	DEG			CD5 .00791	CDCDR5 .00780

UPPER SURFACE				LOWER SURFACE				SPANWISE				
X/C	CP	P _L /PT	MLOC	X/C	CP	P _L /PT	MLOC	X/C	Y/(B/2)	CP	P _L /PT	MLOC
0.0000	.7146	.8856	.4220	0.0000	.7146	.8856	.4220	.1507	.7476	-.1317	.6608	.7957
.0132	.6296	.8630	.4655	.0126	-.7165	.9055	1.0409	.1507	.4976	-.1461	.6570	.8017
.0259	.3179	.7802	.6086	.0255	-.6638	.5195	1.0179	.1507	.2476	-.1405	.6585	.7994
.0759	-.0159	.6916	.7484	.0495	-.7888	.4863	1.0331	.1507	-.2524	-.1486	.6563	.8027
.1003	-.0682	.6777	.7698	.0753	-.7811	.4883	1.0696	.1507	-.5024	-.1562	.6543	.8058
.1507	-.1420	.6581	.8000	.1002	-.7960	.4844	1.0763	.1507	-.7524	-.1493	.6561	.8029
.2003	-.1908	.6451	.8199	.1503	-.7356	.5004	1.0494	.5002	.7476	-.3933	.5913	.9033
.2503	-.2395	.6322	.8395	.1976	-.7648	.4927	1.0623	.5002	.4976	-.3979	.5901	.9052
.3001	-.2821	.6209	.8574	.2503	-.8738	.4637	1.1117	.5002	.2476	-.4019	.5890	.9068
.3502	-.3070	.6143	.8676	.3001	-.9395	.4463	1.1422	.5002	-.2524	-.3922	.5916	.9028
.4003	-.3365	.6064	.8797	.3507	-.8279	.4760	1.0906	.5002	-.5024	-.3906	.5921	.9021
.4501	-.3579	.6007	.8886	.4001	-.5533	.5488	.9704	.5002	-.7524	-.3759	.5960	.8960
.5002	-.3982	.5900	.9053	.4501	-.4999	.5630	.9478	.8002	.7476	-1.0614	.4139	1.2009
.5502	-.4380	.5795	.9219	.5001	-.3982	.5900	.9053	.8002	.4976	-.3734	.5966	.8950
.6002	-.4668	.5718	.9339	.5497	-.2846	.6255	.8502	.8002	.2476	-.3757	.5960	.8960
.6500	-.4868	.5665	.9423	.6003	-.1304	.6611	.7952	.8002	-.5024	-.3417	.6050	.8819
.7000	-.4767	.5692	.9381	.6500	-.0297	.6890	.7524	.8002	-.7524	-.3489	.6031	.8849
.7500	-.4363	.5799	.9212	.7000	.1001	.7224	.7006					
.8002	-.3700	.5975	.8936	.7501	.2039	.7500	.6572					
.9002	-.1902	.6453	.8197	.8001	.2980	.7723	.6215					
.9501	-.0639	.6788	.7680	.8501	.3571	.7906	.5916					

TEST 167	PT 44.1894	PSI	CN	.1111	CD1 .00782	CDCDR1 .00784
RUN 10	TT 96.2800	K	CM	-.1402	CD2 .00776	CDCDR2 .00779
POINT 55	RC 29.9645	MILLION	CC	.0140	CD3 .00771	CDCDR3 .00779
	MACH .7415				CD4 .00776	CDCDR4 .00781
	ALPHA -2.9938	DEG			CD5 .00754	CDCDR5 .00748

UPPER SURFACE				LOWER SURFACE				SPANWISE				
X/C	CP	P _L /PT	MLOC	X/C	CP	P _L /PT	MLOC	X/C	Y/(B/2)	CP	P _L /PT	MLOC
0.0000	.8655	.9259	.3349	0.0000	.8655	.9259	.3349	.1507	.7476	-.2427	.6320	.8401
.0132	.4734	.8219	.5390	.0126	-.4006	.5902	.9051	.1507	.4976	-.2580	.6280	.8463
.0259	.1487	.7356	.6795	.0255	-.4326	.5817	.9184	.1507	.2476	-.2529	.6293	.8443
.0759	-.1591	.6542	.8059	.0495	-.5176	.5591	.9540	.1507	-.2524	-.2609	.6272	.8476
.1003	-.1968	.6442	.8213	.0753	-.5396	.5533	.9633	.1507	-.5024	-.2676	.6254	.8503
.1507	-.2544	.6289	.8449	.1002	-.5857	.5411	.9829	.1507	-.7524	-.2578	.6280	.8463
.2003	-.2893	.6197	.8592	.1503	-.5752	.5439	.9784	.5002	.7476	-.4575	.5751	.9288
.2503	-.3321	.6083	.8768	.1976	-.6626	.5207	1.0159	.5002	.4976	-.4624	.5738	.9308
.3001	-.3683	.5987	.8917	.2503	-.6852	.5147	1.0258	.5002	.2476	-.4670	.5726	.9327
.3502	-.3882	.5934	.8999	.3001	-.6714	.5183	1.0198	.5002	-.2524	-.4560	.5755	.9281
.4003	-.4114	.5873	.9096	.3507	-.6232	.5306	.9998	.5002	-.5024	-.4543	.5759	.9274
.4501	-.4282	.5828	.9165	.4001	-.5541	.5495	.9694	.5002	-.7524	-.4386	.5801	.9209
.5002	-.4639	.5734	.9314	.4501	-.4805	.5690	.9384	.8002	.7476	-1.1168	.4002	1.2264
.5502	-.4995	.5639	.9464	.5001	-.3750	.5969	.8945	.8002	.4976	-.3924	.5923	.9017
.6002	-.5242	.5574	.9588	.5497	-.2435	.6318	.8404	.8002	.2476	-.3950	.5916	.9028
.6500	-.5381	.5537	.9626	.6003	-.1125	.6666	.7869	.8002	-.5024	-.3609	.6007	.8887
.7000	-.5169	.5593	.9537	.6500	-.0112	.6934	.7455	.8002	-.7524	-.3678	.5989	.8915
.7500	-.4659	.5728	.9323	.7000	.1143	.7267	.6938					
.8002	-.3899	.5930	.9006	.7501	.2185	.7543	.6504					
.9002	-.1976	.6440	.8216	.8001	.3034	.7768	.6141					
.9501	-.0676	.6785	.7686	.8501	.3746	.7957	.5832					

TEST 167	PT 44.1884	PSI	CN	.2562	CD1 .00773	CDCDR1 .00766
RUN 10	TT 96.5022	K	CM	-.1442	CD2 .00767	CDCDR2 .00761
POINT 56	RC 29.8519	MILLION	CC	.0197	CD3 .00762	CDCDR3 .00762
	MACH .7411				CD4 .00766	CDCDR4 .00761
	ALPHA -2.0060	DEG			CD5 .00752	CDCDR5 .00737

UPPER SURFACE				LOWER SURFACE				SPANWISE				
X/C	CP	P _L /PT	MLOC	X/C	CP	P _L /PT	MLOC	X/C	Y/(B/2)	CP	P _L /PT	MLOC
0.0000	1.0031	.9621	.2367	0.0000	1.0031	.9621	.2367	.1507	.7476	-.3709	.5466	.8950
.0132	.2841	.7708	.6238	.0126	-.1030	.6679	.7849	.1507	.4976	-.3908	.5913	.9033
.0259	-.0532	.6811	.7645	.0255	-.1894	.6449	.8202	.1507	.2476	-.3868	.5924	.9016
.0759	-.3296	.6076	.8779	.0495	-.3029	.6147	.8669	.1507	-.2524	-.3962	.5899	.9055
.1003	-.3489	.6024	.8859	.0753	-.3491	.6024	.8860	.1507	-.5024	-.4016	.5884	.9078
.1507	-.3878	.5921	.9020	.1002	-.4093	.5864	.9110	.1507	-.7524	-.3885	.5919	.9023
.2003	-.4012	.5885	.9076	.1503	-.4347	.5796	.9216	.5002	.7476	-.5342	.5532	.9635
.2503	-.4407	.5780	.9241	.1976	-.5179	.5575	.9566	.5002	.4976	-.5388	.5519	.9654
.3001	-.4700	.5702	.9364	.2503	-.5451	.5503	.9681	.5002	.2476	-.5436	.5507	.9675
.3502	-.4778	.5682	.9397	.3001	-.5528	.5482	.9714	.5002	-.2524	-.5327	.5536	.9628
.4003	-.4964	.5632	.9475	.3507	-.5406	.5514	.9662	.5002	-.5024	-.5315	.5539	.9623
.4501	-.5092	.5598	.9529	.4001	-.4944	.5638	.9466	.5002	-.7524	-.5138	.5586	.9548
.5002	-.5391	.5519	.9636	.4501	-.4367	.5791	.9224	.8002	.7476	-1.1666	.3849	1.2598
.5502	-.5696	.5437	.9786	.5001	-.3425	.6041	.8873	.8002	.4976	-.4116	.5836	.9120
.6002	-.5898	.5384	.9872	.5497	-.2191	.6370	.8124	.8002	.2476	-.4147	.5849	.9132
.6500	-.5973	.5364	.9904	.6003	-.0940	.6703	.7812	.8002	-.5024	-.3831	.5933	.9001
.7000	-.5594	.5464	.9742	.6500	.0023	.6959	.7417	.8002	-.7524	-.3906	.5914	.9032
.7500	-.4942	.5638	.9466	.7000	.1254	.7287	.6907					
.8002	-.4092	.5864	.9109	.7501	.2284	.7560	.6476					
.9002	-.2038	.6410	.8262	.8001	.3138	.7787	.6111					
.9501	-.0693	.6768	.7711	.8501	.3864	.7980	.5793					

ORIGINAL PAGE IS
OF POOR QUALITY

TEST 167	PT	44.3268	PSI	CN	.3314	CD1	.00771	CDCOR1	.00767
RUN 10	TT	96.3583	K	CM	-.1462	CD2	.00766	CDCOR2	.00764
POINT 57	RC	30.0130	MILLION	CC	.0210	CD3	.00766	CDCOR3	.00769
	MACH	.7411				CD4	.00765	CDCOR4	.00764
	ALPHA	-1.5071	DEG			CD5	.00750	CDCOR5	.00738

UPPER SURFACE				LOWER SURFACE				SPANWISE				
X/C	CP	P/L/PT	MLOC	X/C	CP	P/L/PT	MLOC	X/C	Y/(B/2)	CP	P/L/PT	MLOC
0.0000	1.0564	.9766	.1851	0.0000	1.0564	.9766	.1851	.1507	.7476	-.4411	.5799	.9212
.0132	-.1789	.7441	.6664	.0126	.0325	.7033	.7270	.1507	.4976	-.4624	.5742	.9301
.0259	-.1688	.6520	.8093	.0255	-.0753	.6768	.7711	.1507	.2476	-.4594	.5750	.9289
.0759	-.4260	.5839	.9149	.0495	-.2032	.6429	.8233	.1507	-.2524	-.4690	.5725	.9328
.1003	-.4335	.5819	.9180	.0753	-.2591	.6281	.8462	.1507	-.5024	-.4730	.5714	.9345
.1507	-.4601	.5748	.9291	.1002	-.3268	.6101	.8739	.1507	-.7524	-.4575	.5755	.9280
.2003	-.4643	.5737	.9309	.1503	-.3641	.6003	.8893	.5002	.7476	-.5697	.5458	.9753
.2503	-.4973	.5650	.9447	.1976	-.4447	.5789	.9227	.5002	.4976	-.5738	.5447	.9770
.3001	-.5219	.5585	.9550	.2503	-.4767	.5704	.9361	.5002	.2476	-.5783	.5435	.9789
.3502	-.5236	.5580	.9558	.3001	-.4910	.5686	.9421	.5002	-.2524	-.5663	.5467	.9738
.4003	-.5381	.5542	.9619	.3507	-.4891	.5671	.9413	.5002	-.5024	-.5655	.5469	.9735
.4501	-.5479	.5516	.9660	.4001	-.4525	.5768	.9260	.5002	-.7524	-.5470	.5518	.9656
.5002	-.5735	.5448	.9769	.4501	-.4051	.5894	.9063	.8002	.7476	-1.1887	.3818	1.2619
.5502	-.6006	.5376	.9884	.5001	-.3184	.6124	.8709	.8002	.4976	-.4185	.5859	.9118
.6002	-.6173	.5332	.9956	.5497	-.2010	.6435	.8224	.8002	.2476	-.4210	.5852	.9128
.6500	-.6198	.5325	.9966	.6003	-.0801	.6755	.7731	.8002	-.5024	-.3889	.5937	.8996
.7000	-.5741	.5446	.9771	.6500	.0127	.7001	.7351	.8002	-.7524	-.3968	.5916	.9028
.7500	-.5034	.5634	.9473	.7000	.1342	.7323	.6850					
.8002	-.4151	.5867	.9104	.7501	.2363	.7593	.6423					
.9002	-.2052	.6424	.8241	.8001	.3212	.7818	.6060					
.9501	-.0692	.6784	.7686	.8501	.3942	.8012	.5741					

TEST 167	PT	44.2834	PSI	CN	.4040	CD1	.00777	CDCOR1	.00774
RUN 10	TT	96.2961	K	CM	-.1481	CD2	.00777	CDCOR2	.00777
POINT 58	RC	29.9988	MILLION	CC	.0214	CD3	.00774	CDCOR3	.00778
	MACH	.7406				CD4	.00773	CDCOR4	.00772
	ALPHA	-1.9979	DEG			CD5	.00761	CDCOR5	.00749

UPPER SURFACE				LOWER SURFACE				SPANWISE				
X/C	CP	P/L/PT	MLOC	X/C	CP	P/L/PT	MLOC	X/C	Y/(B/2)	CP	P/L/PT	MLOC
0.0000	1.0994	.9870	.1375	0.0000	1.0994	.9870	.1375	.1507	.7476	-.5134	.5612	.9508
.0132	-.0693	.7154	.7114	.0126	.1556	.7382	.6757	.1507	.4976	-.5361	.5591	.9603
.0259	-.2863	.6213	.8567	.0255	.0289	.7047	.7280	.1507	.2476	-.5346	.5593	.9597
.0759	-.5287	.5571	.9572	.0495	-.1123	.6673	.7857	.1507	-.2524	-.5431	.5533	.9633
.1003	-.5215	.5590	.9542	.0753	-.1773	.6501	.8122	.1507	-.5024	-.5457	.5526	.9644
.1507	-.5351	.5554	.9599	.1002	-.2511	.6306	.8423	.1507	-.7524	-.5266	.5577	.9563
.2003	-.5277	.5574	.9568	.1503	-.2990	.6179	.8619	.5002	.7476	-.6023	.5376	.9884
.2503	-.5541	.5504	.9680	.1976	-.3811	.5962	.8957	.5002	.4976	-.6068	.5364	.9904
.3001	-.5736	.5452	.9782	.2503	-.4180	.5864	.9110	.5002	.2476	-.6113	.5352	.9923
.3502	-.5714	.5458	.9753	.3001	-.4373	.5813	.9190	.5002	-.2524	-.5974	.5389	.9884
.4003	-.5803	.5434	.9791	.3507	-.4433	.5797	.9215	.5002	-.5024	-.5969	.5390	.9861
.4501	-.5864	.5418	.9816	.4001	-.4143	.5874	.9094	.5002	-.7524	-.5776	.5442	.9779
.5002	-.6075	.5362	.9906	.4501	-.3743	.5980	.8929	.8002	.7476	-1.1862	.3831	1.2594
.5502	-.6308	.5301	1.0006	.5001	-.2941	.6192	.8599	.8002	.4976	-.4194	.5860	.9116
.6002	-.6438	.5266	1.0062	.5497	-.1822	.6488	.8142	.8002	.2476	-.4231	.5851	.9131
.6500	-.6406	.5275	1.0049	.6003	-.0652	.6798	.7665	.8002	-.5024	-.3906	.5937	.8996
.7000	-.5861	.5419	.9815	.6500	.0248	.7036	.7297	.8002	-.7524	-.3991	.5914	.9032
.7500	-.5094	.5622	.9491	.7000	.1446	.7333	.6803					
.8002	-.4187	.5862	.9113	.7501	.2454	.7620	.6380					
.9002	-.2048	.6428	.8234	.8001	.3299	.7844	.6018					
.9501	-.0693	.6787	.7682	.8501	.4030	.8037	.5699					

TEST 167	PT	44.2833	PSI	CN	.4785	CD1	.00787	CDCOR1	.00781
RUN 10	TT	96.4089	K	CM	-.1497	CD2	.00786	CDCOR2	.00784
POINT 59	RC	29.9442	MILLION	CC	.0209	CD3	.00786	CDCOR3	.00787
	MACH	.7405				CD4	.00781	CDCOR4	.00779
	ALPHA	-1.4990	DEG			CD5	.00765	CDCOR5	.00754

UPPER SURFACE				LOWER SURFACE				SPANWISE				
X/C	CP	P/L/PT	MLOC	X/C	CP	P/L/PT	MLOC	X/C	Y/(B/2)	CP	P/L/PT	MLOC
0.0000	1.1199	.9933	.0988	0.0000	1.1199	.9933	.0988	.1507	.7476	-.5988	.5369	.9896
.0132	-.0454	.6839	.7602	.0126	.2677	.7670	.6309	.1507	.4976	-.6256	.5298	1.0011
.0259	-.4111	.5867	.9104	.0255	.1247	.7290	.6902	.1507	.2476	-.6261	.5297	1.0013
.0759	-.6544	.5221	1.0135	.0495	-.0296	.6881	.7538	.1507	-.2524	-.6325	.5279	1.0041
.1003	-.6232	.5304	1.0001	.0753	-.1033	.6685	.7839	.1507	-.5024	-.6306	.5285	1.0032
.1507	-.6255	.5298	1.0011	.1002	-.1829	.6473	.8165	.1507	-.7524	-.6050	.5353	.9922
.2003	-.5993	.5368	.9988	.1503	-.2506	.6320	.8401	.5002	.7476	-.6478	.5239	1.0107
.2503	-.6238	.5303	1.0003	.1976	-.3249	.6096	.8747	.5002	.4976	-.6540	.5222	1.0134
.3001	-.6414	.5256	1.0079	.2503	-.3674	.5984	.8923	.5002	.2476	-.6594	.5208	1.0157
.3502	-.6253	.5299	1.0010	.3001	-.3922	.5918	.9024	.5002	-.2524	-.6438	.5250	1.0089
.4003	-.6301	.5286	1.0030	.3507	-.4043	.5886	.9074	.5002	-.5024	-.6422	.5254	1.0083
.4501	-.6348	.5273	1.0051	.4001	-.3820	.5943	.8986	.5002	-.7524	-.6197	.5313	.9986
.5002	-.6548	.5220	1.0137	.4501	-.3495	.6031	.8849	.8002	.7476	-1.1944	.3788	1.2679
.5502	-.6687	.5183	1.0198	.5001	-.2754	.6228	.8544	.8002	.4976	-.4259	.5828	.9166
.6002	-.6790	.5156	1.0242	.5497	-.1689	.6511	.8106	.8002	.2476	-.4292	.5819	.9180
.6500	-.6722	.5174	1.0213	.6003	-.0552	.6813	.7642	.8002	-.5024	-.3973	.5904	.9047
.7000	-.6051	.5352	.9923	.6500	.0318	.7044	.7286	.8002	-.7524	-.4067	.5879	.9086
.7500	-.5174	.5585	.9550	.7000	.1495	.7359	.6798					
.8002	-.4243	.5832	.9159	.7501	.2492	.7621	.6379					
.9002	-.2063	.6411	.8261	.8001	.3331	.7843	.6019					
.9501	-.0696	.6774	.7701	.8501	.4060	.8037	.5699					

TEST	167	PT	44.2812	FSI	CM	.5489	CD1	.00802	CDCOR1	.00792
RUN	10	TT	96.3212	K	CM	-.1489	CD2	.00799	CDCOR2	.00793
POINT	60	RC	29.9624	MILLION	CC	.0189	CD3	.00796	CDCOR3	.00796
		MACH	.7396				CD4	.00791	CDCOR4	.00787
		ALPHA	.0102	DEG			CD5	.00786	CDCOR5	.00764

UPPER SURFACE				LOWER SURFACE				SPANWISE				
X/C	CP	P _L /PT	MLOC	X/C	CP	P _L /PT	MLOC	X/C	Y/(B/2)	CP	P _L /PT	MLOC
0.0000	1.1311	.9968	.0679	0.0000	1.1311	.9968	.0679	.1507	.7476	-.6846	.5190	1.0187
.0132	-.1739	.6534	.8072	.0126	.3679	.7960	.5828	.1507	.4976	-.7156	.5108	1.0322
.0259	-.5485	.5548	.9609	.0255	.2127	.7551	.6490	.1507	.2476	-.7158	.5107	1.0322
.0759	-.7952	.4899	1.0670	.0495	.0479	.7117	.7171	.1507	-.2524	-.7144	.5111	1.0317
.1003	-.7724	.4958	1.0570	.0753	-.0336	.6902	.7504	.1507	-.5024	-.7103	.5122	1.0299
.1507	-.7127	.5115	1.0309	.1002	-.1175	.6682	.7843	.1507	-.7524	-.6823	.5196	1.0178
.2003	-.6861	.5186	1.0194	.1503	-.1825	.6511	.8107	.5002	.7476	-.6735	.5219	1.0140
.2503	-.6805	.5200	1.0170	.1976	-.2682	.6285	.8455	.5002	.4976	-.6816	.5197	1.0175
.3001	-.7009	.5147	1.0258	.2503	-.3152	.6162	.8646	.5002	.2476	-.6874	.5182	1.0200
.3502	-.6730	.5220	1.0138	.3001	-.3441	.6086	.8764	.5002	-.2524	-.6711	.5225	1.0130
.4003	-.6644	.5243	1.0161	.3507	-.3608	.6042	.8832	.5002	-.5024	-.6702	.5228	1.0122
.4501	-.6655	.5240	1.0105	.4001	-.3457	.6082	.8770	.5002	-.7524	-.6461	.5291	1.0022
.5002	-.6818	.5197	1.0176	.4501	-.3194	.6151	.8663	.8002	.7476	-1.1938	.5849	1.2558
.5502	-.6895	.5177	1.0209	.5001	-.2530	.6325	.8393	.8002	.4976	-.4298	.5860	.9116
.6002	-.6921	.5170	1.0220	.5497	-.1526	.6590	.7986	.8002	.2476	-.4338	.5849	.9132
.7000	-.6771	.5209	1.0155	.6003	-.0441	.6875	.7546	.8002	-.5024	-.4019	.5934	.9001
.7500	-.6080	.5391	.9860	.6500	.0394	.7095	.7206	.8002	-.7524	-.4119	.5907	.9042
.8002	-.5223	.5617	.9500	.7000	.1546	.7398	.6732					
.8502	-.4283	.5864	.9109	.7501	.2527	.7656	.6322					
.9002	-.2084	.6443	.8212	.8001	.3359	.7875	.5967					
.9501	-.0716	.6803	.7657	.8501	.4087	.8067	.5649					

TEST	167	PT	44.3282	PSI	CM	.6314	CD1	.00832	CDCOR1	.00816
RUN	10	TT	96.2506	K	CM	-.1518	CD2	.00830	CDCOR2	.00819
POINT	61	RC	30.0686	MILLION	CC	.0173	CD3	.00822	CDCOR3	.00820
		MACH	.7413				CD4	.00807	CDCOR4	.00800
		ALPHA	.5193	DEG			CD5	.00798	CDCOR5	.00783

UPPER SURFACE				LOWER SURFACE				SPANWISE				
X/C	CP	P _L /PT	MLOC	X/C	CP	P _L /PT	MLOC	X/C	Y/(B/2)	CP	P _L /PT	MLOC
0.0000	1.1449	.9996	.0235	0.0000	1.1449	.9996	.0235	.1507	.7476	-.8025	.4803	1.0833
.0132	-.2606	.6248	.8513	.0126	.4628	.8177	.5463	.1507	.4976	-.8992	.4545	1.1278
.0259	-.6417	.5231	1.0119	.0255	.2955	.7731	.6202	.1507	.2476	-.9017	.4538	1.1289
.0759	-.9049	.4530	1.1304	.0495	.1220	.7268	.6936	.1507	-.2524	-.9033	.4534	1.1297
.1003	-.9096	.4517	1.1327	.0753	.0331	.7031	.7305	.1507	-.5024	-.9085	.4520	1.1321
.1507	-.8899	.4570	1.1234	.1002	-.0562	.6793	.7673	.1507	-.7524	-.7828	.4855	1.0744
.2003	-.8112	.4780	1.0872	.1503	-.1298	.6597	.7975	.5002	.7476	-.7390	.4972	1.0548
.2503	-.7804	.4662	1.0733	.1976	-.2189	.6359	.8341	.5002	.4976	-.7509	.4940	1.0600
.3001	-.6907	.5101	1.0334	.2503	-.2711	.6220	.8556	.5002	.2476	-.7511	.4940	1.0601
.3502	-.7384	.4974	1.0545	.3001	-.3050	.6130	.8696	.5002	-.2524	-.7290	.4999	1.0503
.4003	-.7467	.4952	1.0582	.3507	-.3288	.6071	.8786	.5002	-.5024	-.7392	.4971	1.0548
.4501	-.7263	.5006	1.0491	.4001	-.3162	.6100	.8743	.5002	-.7524	-.7126	.5052	1.0430
.5002	-.7376	.4976	1.0541	.4501	-.2945	.6157	.8653	.8002	.7476	-1.1755	.5808	1.2639
.5502	-.7526	.4936	1.0608	.5001	-.2320	.6324	.8395	.8002	.4976	-.4242	.5812	.9192
.6002	-.7450	.4956	1.0574	.5497	-.1345	.6584	.7994	.8002	.2476	-.4278	.5802	.9207
.6500	-.7106	.5048	1.0422	.6003	-.0281	.6868	.7557	.8002	-.5024	-.3987	.5879	.9086
.7000	-.6264	.5272	1.0053	.6500	.0537	.7086	.7220	.8002	-.7524	-.4096	.5851	.9131
.7500	-.5190	.5559	.9592	.7000	.1678	.7390	.6745					
.8002	-.4229	.5815	.9187	.7501	.2651	.7650	.6332					
.8502	-.2005	.6408	.8265	.8001	.3477	.7870	.5975					
.9002	-.0658	.6767	.7712	.8501	.4208	.8065	.5652					

TEST	167	PT	44.3274	PSI	CM	.7129	CD1	.00865	CDCOR1	.00839
RUN	10	TT	96.3981	K	CM	-.1508	CD2	.00859	CDCOR2	.00837
POINT	62	RC	29.9917	MILLION	CC	.0140	CD3	.00854	CDCOR3	.00846
		MACH	.7402				CD4	.00837	CDCOR4	.00823
		ALPHA	1.0081	DEG			CD5	.00834	CDCOR5	.00811

UPPER SURFACE				LOWER SURFACE				SPANWISE				
X/C	CP	P _L /PT	MLOC	X/C	CP	P _L /PT	MLOC	X/C	Y/(B/2)	CP	P _L /PT	MLOC
0.0000	1.1432	.9997	.0222	0.0000	1.1432	.9997	.0222	.1507	.7476	-.9500	.4458	1.1431
.0132	-.3693	.5994	.8906	.0126	.5493	.8425	.5030	.1507	.4976	-1.0388	.4223	1.1854
.0259	-.7555	.4972	1.0547	.0255	.3741	.7961	.5825	.1507	.2476	-1.0204	.4271	1.1765
.0759	-1.0156	.4284	1.1743	.0495	.1972	.7493	.6562	.1507	-.2524	-1.0200	.4272	1.1764
.1003	-1.0225	.4266	1.1775	.0753	.1028	.7244	.6975	.1507	-.5024	-1.0439	.4269	1.1791
.1507	-1.0077	.4305	1.1705	.1002	-.0059	.6995	.7361	.1507	-.7524	-.9648	.4418	1.1561
.2003	-.9737	.4395	1.1543	.1503	-.0709	.6784	.7687	.5002	.7476	-.7697	.5093	1.0346
.2503	-.9640	.4362	1.1401	.1976	-.1593	.6550	.8047	.5002	.4976	-.7127	.5086	1.0393
.3001	-.9555	.4443	1.1457	.2503	-.2144	.6404	.8272	.5002	.2476	-.7182	.5071	1.0383
.3502	-.7917	.4877	1.0708	.3001	-.2512	.6307	.8422	.5002	-.2524	-.7065	.5102	1.0331
.4003	-.6627	.5218	1.0141	.3507	-.2763	.6240	.8525	.5002	-.5024	-.7064	.5102	1.0331
.4501	-.6735	.5189	1.0188	.4001	-.2676	.6263	.8489	.5002	-.7524	-.6886	.5149	1.0253
.5002	-.7201	.5066	1.0391	.4501	-.2542	.6299	.8434	.8002	.7476	-1.1772	.5836	1.2543
.5502	-.7496	.4988	1.0521	.5001	-.1985	.6446	.8207	.8002	.4976	-.4225	.5833	.9126
.6002	-.7475	.4993	1.0512	.5497	-.1075	.6687	.7836	.8002	.2476	-.4269	.5842	.9144
.6500	-.7104	.5092	1.0349	.6003	-.0066	.6954	.7424	.8002	-.5024	-.3934	.5930	.9086
.7000	-.6234	.5321	.9973	.6500	.0716	.7161	.7104	.8002	-.7524	-.4041	.5902	.9050
.7500	-.5193	.5597	.9530	.7000	.1824	.7454	.6644					
.8002	-.4232	.5852	.9129	.7501	.2779	.7707	.6241					
.8502	-.1996	.6443	.8211	.8001	.3590	.7922	.5891					
.9002	-.0663	.6795	.7669	.8501	.4316	.8114	.5570					

ORIGINAL PAGE IS
OF POOR QUALITY.

TEST RUN POINT	167 36 5	PT TT RC MACH ALPHA	44.3525 96.6327 29.8723 .7398 1.5387	PSI K MILLION DEG	CM CM CC	-7895 -1478 .0108	CD1 CD2 CD3 CD4 CD5	.00953 .00950 .00942 .00923 .00920	CDCOR1 CDCOR2 CDCOR3 CDCOR4 CDCOR5	.00930 .00922 .00913 .00894 .00883					
UPPER SURFACE			X/C	CP	P/L/PT	MLOC	X/C	CP	P/L/PT	MLOC	X/C	Y/(8/2)	CP	P/L/PT	MLOC
0.0000	1.1371	.9982	.0511	0.0000	1.1371	.9982	.0511	.1507	.7476	-1.0936	.4091	1.2094			
.0132	-.4576	.5771	.9255	.0126	.6132	.8598	.4714	.1507	.4976	-1.1415	.3965	1.2335			
.0259	-.8684	.4686	1.1032	.0255	.4342	.8126	.5949	.1507	.2476	-1.1167	.4030	1.2211			
.0759	-1.1002	.4074	1.2129	.0495	.2545	.7651	.6330	.1507	-.2524	-1.1142	.4037	1.2198			
.1003	-1.1165	.4031	1.2210	.0753	.1526	.7382	.6757	.1507	-.5024	-1.1363	.3979	1.2309			
.1507	-1.0991	.4077	1.2124	.1002	.0592	.7136	.7142	.1507	-.7524	-1.0799	.4138	1.2069			
.2003	-1.0758	.4155	1.2009	.1503	-.0210	.6924	.7470	.5002	.7476	-.6560	.5247	1.0093			
.2503	-1.0884	.4105	1.2071	.1976	-.1187	.6666	.7868	.5002	.4976	-.5521	.5310	.9991			
.3001	-1.1175	.4028	1.2215	.2503	-.1774	.6511	.8107	.5002	.2476	-.6129	.5361	.9909			
.3502	-1.1182	.4027	1.2218	.3001	-.2177	.6404	.8271	.5002	-.2524	-.6062	.5378	.9880			
.4003	-1.0334	.4250	1.1803	.3507	-.2449	.6333	.8381	.5002	-.5024	-.6350	.5302	1.0003			
.4501	-.7038	.5121	1.0300	.4001	-.2455	.6331	.8384	.5002	-.7524	-.6540	.5252	1.0084			
.5002	-.6020	.5390	.9862	.4501	-.2324	.6365	.8331	.8002	.7476	-1.1504	.3941	1.2311			
.5502	-.6217	.5337	.9946	.5001	-.1837	.6494	.8132	.8002	.4976	-.6233	.5861	.9113			
.6002	-.6628	.5229	1.0123	.5497	-.0975	.6722	.7782	.8002	.2476	-.6214	.5845	.9138			
.6500	-.6695	.5211	1.0152	.6003	-.0002	.6990	.7384	.8002	-.5024	-.6096	.5919	.9024			
.7000	-.6096	.5369	.9895	.6500	.0733	.7173	.7084	.8002	-.7524	-.3910	.5947	.8980			
.7500	-.5196	.5607	.9514	.7000	.1640	.7465	.6626								
.8002	-.4251	.5857	.9120	.7501	.2777	.7713	.6231								
.9002	-.2061	.6435	.8223	.8001	.3592	.7928	.5880								
.9501	-.0744	.6783	.7688	.8501	.4320	.8120	.5559								

TEST RUN POINT	167 36 6	PT TT RC MACH ALPHA	44.3437 96.1569 30.1037 .7406 2.0386	PSI K MILLION DEG	CM CM CC	-.8715 -1504 .0082	CD1 CD2 CD3 CD4 CD5	.01199 .01214 .01249 .01294 .01255	CDCOR1 CDCOR2 CDCOR3 CDCOR4 CDCOR5	.01163 .01191 .01241 .01233 .01193					
UPPER SURFACE			X/C	CP	P/L/PT	MLOC	X/C	CP	P/L/PT	MLOC	X/C	Y/(8/2)	CP	P/L/PT	MLOC
0.0000	1.1305	.9968	.0684	0.0000	1.1305	.9968	.0684	.1507	.7476	-1.2013	.3841	1.2575			
.0132	-.5447	.5566	.9580	.0126	.6744	.8769	.4391	.1507	.4976	-1.2319	.3760	1.2733			
.0259	-.9305	.4500	1.1357	.0255	.4913	.8288	.5271	.1507	.2476	-1.2041	.3833	1.2589			
.0759	-1.1984	.3875	1.2509	.0495	.3061	.7801	.6088	.1507	-.2524	-1.2033	.3826	1.2583			
.1003	-1.2026	.3837	1.2582	.0753	.1992	.7520	.6539	.1507	-.5024	-1.2253	.3778	1.2698			
.1507	-1.1879	.3876	1.2506	.1002	.1048	.7273	.6929	.1507	-.7524	-1.1480	.3981	1.1428			
.2003	-1.1591	.3952	1.2361	.1503	.0186	.7046	.7282	.5002	.7476	-.9659	.4459	1.2306			
.2503	-1.1730	.3915	1.2431	.1976	-.0817	.6783	.7689	.5002	.4976	-1.0456	.4459	1.1428			
.3001	-1.2088	.3826	1.2603	.2503	-.1439	.6619	.7941	.5002	.2476	-1.0392	.4267	1.1674			
.3502	-1.2150	.3805	1.2645	.3001	-.1868	.6506	.8114	.5002	-.2524	-.9648	.4462	1.1423			
.4003	-1.2117	.3813	1.2629	.3507	-.2166	.6428	.8235	.5002	-.5024	-1.0075	.4350	1.1623			
.4501	-1.1757	.3908	1.2445	.4001	-.2210	.6416	.8253	.5002	-.7524	-.8816	.4361	1.1041			
.5002	-.9434	.4518	1.1324	.4501	-.2133	.6437	.8221	.8002	.7476	-1.1027	.4300	1.2091			
.5502	-.6254	.5354	.9920	.5001	-.1685	.6554	.8040	.8002	.4976	-.6124	.5914	.9032			
.6002	-.5556	.5537	.9626	.5497	-.0864	.6770	.7708	.8002	.2476	-.6186	.5897	.9058			
.6500	-.5505	.5524	.9647	.6003	.0084	.7019	.7323	.8002	-.5024	-.3949	.5960	.8960			
.7000	-.5522	.5546	.9612	.6500	.0789	.7204	.7036	.8002	-.7524	-.3798	.5999	.8899			
.7500	-.4977	.5689	.9385	.7000	.1882	.7492	.6585								
.8002	-.4141	.5909	.9039	.7501	.2811	.7736	.6194								
.9002	-.2033	.6463	.8181	.8001	.3620	.7948	.5847								
.9501	-.0744	.6802	.7660	.8501	.4347	.8139	.5527								

TEST RUN POINT	167 36 7	PT TT RC MACH ALPHA	44.3440 96.2474 30.0403 .7397 2.5316	PSI K MILLION DEG	CM CM CC	.9440 -1579 .0077	CD1 CD2 CD3 CD4 CD5	.01685 .01681 .01825 .01812 .01703	CDCOR1 CDCOR2 CDCOR3 CDCOR4 CDCOR5	.01680 .01680 .01734 .01721 .01658					
UPPER SURFACE			X/C	CP	P/L/PT	MLOC	X/C	CP	P/L/PT	MLOC	X/C	Y/(8/2)	CP	P/L/PT	MLOC
0.0000	1.1142	.9920	.1074	0.0000	1.1142	.9920	.1074	.1507	.7476	-1.2346	.3710	1.2832			
.0132	-.6025	.5381	.9476	.0126	.7107	.8854	.4225	.1507	.4976	-1.2871	.3571	1.3113			
.0259	-1.0060	.4315	1.1687	.0255	.5271	.8368	.5131	.1507	.2476	-1.2506	.3642	1.2970			
.0759	-1.2447	.3683	1.2886	.0495	.3385	.7869	.5976	.1507	-.2524	-1.2568	.3652	1.2950			
.1003	-1.2537	.3660	1.2934	.0753	.2285	.7579	.6446	.1507	-.5024	-1.2745	.3605	1.3045			
.1507	-1.2436	.3666	1.2880	.1002	.1333	.7327	.6844	.1507	-.7524	-1.1867	.3837	1.2583			
.2003	-1.2113	.3772	1.2710	.1503	.0427	.7087	.7210	.5002	.7476	-1.2334	.3713	1.2826			
.2503	-1.2285	.3726	1.2800	.1976	-.0480	.6816	.7638	.5002	.4976	-1.2455	.3681	1.2890			
.3001	-1.2630	.3635	1.2983	.2503	-.1762	.6641	.7987	.5002	.2476	-1.2498	.3670	1.2913			
.3502	-1.2719	.3611	1.3031	.3001	-.1722	.6519	.8095	.5002	-.2524	-1.2415	.3692	1.2899			
.4003	-1.2761	.3600	1.3054	.3507	-.2056	.6431	.8231	.5002	-.5024	-1.2190	.3751	1.2751			
.4501	-1.2840	.3580	1.3096	.4001	-.2137	.6409	.8244	.5002	-.7524	-1.1583	.3817	1.2427			
.5002	-1.2788	.3593	1.3068	.4501	-.2095	.6421	.8246	.8002	.7476	-1.0105	.4303	1.1708			
.5502	-1.1353	.3973	1.2321	.5001	-.1478	.6531	.8077	.8002	.4976	-1.3779	.3876	.9936			
.6002	-.7476	.4998	1.0504	.5497	-.0782	.6741	.7752	.8002	.2476	-1.3800	.3870	.9945			
.6500	-.5350	.5560	.9590	.6003	.0037	.6984	.7377	.8002	-.5024	-1.3750	.3983	.8924			
.7000	-.4727	.5725	.9329	.6500	.0732	.7168	.7093	.8002	-.7524	-.3594	.4024	.8860			
.7500	-.4341	.5827	.9168	.7000	.1816	.7455	.6643								
.8002	-.3753	.5982	.8925	.7501	.2737	.7698	.6255								
.9002	-.1944	.6460	.8185	.8001	.3542	.7911	.5908								
.9501	-.0746	.6777	.7697	.8501	.4271	.8104	.5587								

T-ST	167	PT	44.3432	PSI	CM	.9971	CD1	-.02386	CDCOR1	.02320
RUN	36	TT	96.2209	K	CM	-.1967	CD2	-.02343	CDCOR2	.02284
POINT	8	MC	29.9882	MILLION	CC	.0052	CD3	-.02169	CDCOR3	.01893
		MACH	.7371				CD4	-.02199	CDCOR4	.01950
		ALPHA	3.0331	DEG			CD5	-.01951	CDCOR5	.01890

UPPER SURFACE				LOWER SURFACE				SPANWISE				
X/C	CP	P,L/PT	MLOC	X/C	CP	P,L/PT	MLOC	X/C	Y/(B/2)	CP	P,L/PT	MLOC
0.0000	1.0994	.9887	.1280	0.0000	1.0994	.9887	-.1280	.1507	.7478	-1.2970	.3402	1.3051
.0132	-.7415	.5216	1.0144	.0126	.7437	.9007	-.3912	.1507	.4976	-1.3538	.3453	1.3359
.0759	-1.0911	.4142	1.7003	.0259	.5792	.8523	-.4854	.1507	-.2476	-1.3322	.3309	1.3241
.0759	-1.3222	.3536	1.3186	.0495	.3890	.8024	-.5721	.1507	-.2524	-1.3271	.3323	1.3213
.1003	-1.3310	.3513	1.3234	.0753	.2757	.7727	-.6207	.1507	-.5024	-1.3443	.3478	1.3307
.1507	-1.3167	.3550	1.3157	.1002	.1780	.7470	-.6618	.1507	-.7524	-1.2479	.3731	1.2762
.2003	-1.2783	.3651	1.2951	.1503	.0840	.7224	-.7006	.5002	.7478	-1.2972	.3601	1.3052
.2503	-1.2947	.3608	1.3038	.1976	-.0203	.6950	-.7410	.5002	.4976	-1.3107	.3566	1.3124
.3001	-1.3270	.3523	1.3212	.2503	-.0893	.6749	-.7709	.5002	-.2476	-1.3099	.3426	1.3023
.3502	-1.3345	.3504	1.3253	.3001	-.1374	.6643	-.7904	.5002	-.2524	-1.2917	.3426	1.3120
.4003	-1.3348	.3503	1.3255	.3507	-.1731	.6550	-.8047	.5002	-.5024	-1.2495	.3727	1.2900
.4501	-1.3441	.3478	1.3305	.4001	-.1845	.6520	-.8094	.5002	-.7524	-1.0622	.4218	1.1963
.5002	-1.3618	.3432	1.3403	.4501	-.1845	.6520	-.8094	.8002	.7478	-1.3087	.4463	1.1422
.5502	-1.1193	.4068	1.7141	.5001	-.1477	.6616	-.7945	.8002	.4976	-.3834	.6050	.8919
.6032	-.6722	.5241	1.0104	.5437	-.0726	.6813	-.7642	.8002	.2476	-.3874	.6050	.5935
.6500	-.5162	.5650	.9447	.6003	.0166	.7047	-.7280	.8002	-.5024	-.3732	.6023	.8859
.7000	-.4598	.5798	.9214	.6500	.0822	.7219	-.7013	.8002	-.7524	-.3537	.6076	.8779
.7500	-.4217	.5898	.9057	.7000	.1887	.7498	-.6574					
.8002	-.3662	.6043	.8830	.7501	.2798	.7737	-.6191					
.8002	-.1932	.6497	.8129	.8001	.3595	.7947	-.5849					
.8501	-.0751	.6807	.7652	.8501	.4323	.8137	-.5530					

TEST 167
 RUN 34
 MACH .740
 R 40.0×10^6

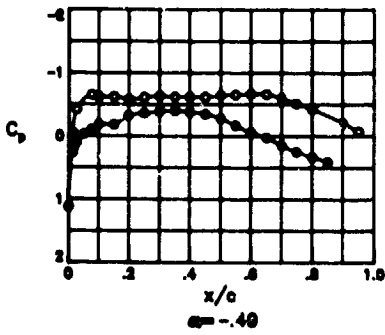
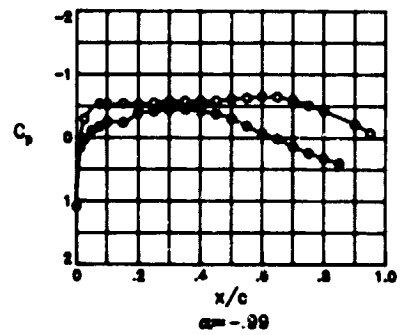
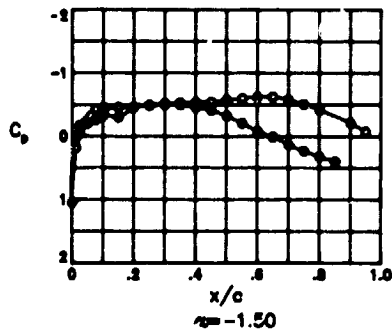
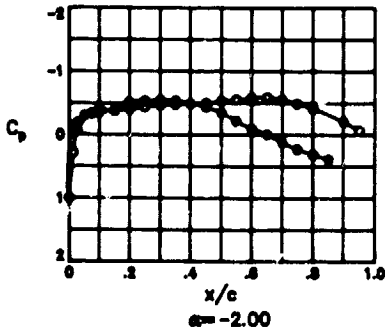
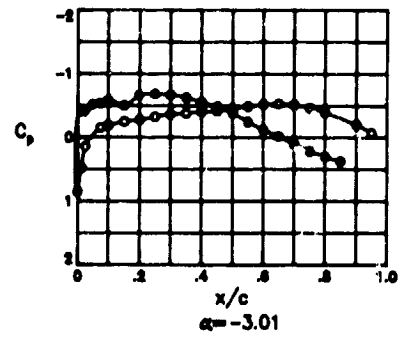
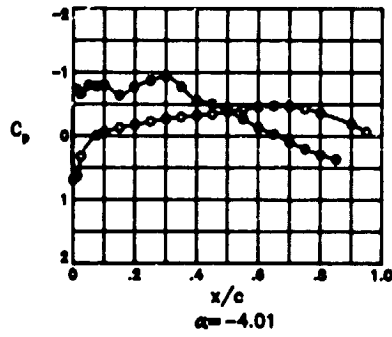

ORIGINAL
 OF POOR QUALITY

TEST 167	PT 63.0077	PSI	CM -.0394	CD1 .00804	CDCOR1 .00795
RUN 34	TT 101.1680	K	CM -.1352	CD2 .00785	CDCOR2 .00781
POINT 63	RC 40.0564	MILLION	CC .0054	CD3 .00773	CDCOR3 .00776
	MACH .7390			CD4 .00771	CDCOR4 .00776
	ALPHA -4.0120	DEG		CD5 .00744	CDCOR5 .70729

UPPER SURFACE				LOWER SURFACE				SPANWISE				
X/C	CP	P/L/PT	MLOC	X/C	CP	P/L/PT	MLOC	X/C	Y/(B/2)	CP	P/L/PT	MLOC
0.0000	.6921	.8804	.4325	0.0000	.6921	.8804	.4325	.1507	.7476	-.1255	.6643	.7910
.0132	.6320	.8642	.4630	.0126	-.7308	.9043	1.0438	.1507	.4976	-.1383	.6609	.7962
.0259	.3191	.7815	.6064	.0255	-.6653	.9216	1.0133	.1507	.2476	-.1327	.6624	.7939
.0759	-.0081	.6953	.7431	.0495	-.7965	.4869	1.0729	.1507	-.2524	-.1412	.6602	.7974
.1003	-.0628	.6809	.7654	.0751	-.7831	.4909	1.0669	.1507	-.5024	-.1474	.6585	.7999
.1507	-.1341	.6620	.7945	.1002	-.7974	.4867	1.0732	.1507	-.7524	-.1400	.6605	.7969
.2003	-.1805	.6498	.8134	.1503	-.6430	.9275	1.0037	.5002	.7476	-.3845	.5958	.8970
.2503	-.2292	.6369	.8332	.1976	-.7719	.4935	1.0619	.5002	-.976	-.3892	.5946	.8989
.3001	-.2738	.6251	.8515	.2503	-.8730	.4667	1.1074	.5002	.2476	-.3934	.5935	.9006
.3502	-.3008	.6180	.8625	.3004	-.9359	.4502	1.1362	.5002	-.2524	-.3818	.5966	.8958
.4003	-.3274	.6107	.8735	.3507	-.7739	.4929	1.0628	.5002	-.5024	-.3601	.5970	.8951
.4501	-.3449	.6063	.8806	.4001	-.5592	.5497	.9999	.5002	-.7524	-.3643	.6012	.8886
.5002	-.3903	.5943	.8993	.4501	-.5961	.5637	.9475	.5002	.7476	-1.0251	.4265	1.1786
.5502	-.4259	.5849	.9141	.5001	-.4614	.5914	.9040	.8002	.4976	-.3869	.6006	.8895
.6002	-.4579	.5765	.9274	.5497	-.2459	.6272	.8482	.8002	.2476	-.3708	.5995	.8912
.6500	-.4776	.5712	.9356	.6003	-.1307	.6629	.7931	.8002	-.5024	-.3271	.6110	.8733
.7000	-.4884	.5737	.9318	.6500	-.0293	.6897	.7518	.8002	-.7524	-.3330	.6093	.8761
.7500	-.4299	.5839	.9157	.7000	.1010	.7242	.6983					
.8002	-.3657	.6008	.8892	.7501	.2062	.7520	.6544					
.8502	-.1909	.6470	.8177	.8001	.2919	.7746	.6181					
.9501	-.0685	.6794	.7678	.8501	.3628	.7934	.5875					

TEST 167	PT 63.6709	PSI	CM -1.089	CD1 .00750	CDCOR1 .00745
RUN 34	TT 101.0813	K	CM -1.1390	CD2 .00743	CDCOR2 .00741
POINT 64	RC 40.2290	MILLION	CC .0146	CD3 .00739	CDCOR3 .00741
	MACH .7425			CD4 .00741	CDCOR4 .00740
	ALPHA -3.0058	DEG		CD5 .00721	CDCOR5 .00710

UPPER SURFACE				LOWER SURFACE				SPANWISE				
X/C	CP	P/L/PT	MLOC	X/C	CP	P/L/PT	MLOC	X/C	Y/(B/2)	CP	P/L/PT	MLOC
0.0000	.8530	.9229	.3421	0.0000	.8530	.9229	.3421	.1507	.7476	-.2415	.6335	.8385
.0132	.4779	.8237	.5363	.0126	-.4083	.9894	.9070	.1507	.4976	-.2560	.6297	.8444
.0259	.1453	.7358	.6801	.0255	-.4337	.9826	.8177	.1507	.2476	-.2502	.6312	.8420
.0759	-.1594	.6563	.8034	.0495	-.5224	.5593	.9546	.1507	-.2524	-.2609	.6284	.8464
.1003	-.1953	.6457	.8196	.0751	-.5408	.5544	.9624	.1507	-.5024	-.2659	.6271	.8485
.1507	-.2510	.6310	.8424	.1002	-.5862	.5424	.9814	.1507	-.7524	-.2560	.6297	.8444
.2003	-.2796	.6235	.8541	.1503	-.5018	.5647	.9400	.5002	.7476	-.4547	.5771	.9263
.2503	-.3256	.6113	.8729	.1976	-.6430	.5221	1.0149	.5002	.4976	-.4593	.5759	.9282
.3001	-.3691	.6008	.8892	.2503	-.6823	.5170	1.0229	.5002	.2476	-.4637	.5748	.9300
.3502	-.3807	.5967	.8956	.3001	-.6700	.5202	1.0176	.5002	-.2524	-.4533	.5775	.9258
.4003	-.4039	.5906	.9052	.3507	-.6277	.5314	.9993	.5002	-.5024	-.4518	.5779	.9251
.4501	-.4185	.5867	.9113	.4001	-.5578	.5499	.9689	.5002	-.7524	-.4440	.5826	.9177
.5002	-.4589	.5760	.9280	.4501	-.4852	.5691	.9390	.8002	.7476	-1.0930	.4084	1.2121
.5502	-.4904	.5677	.9412	.5001	-.3807	.5967	.8956	.8002	.4976	-.3907	.5941	.8997
.6002	-.5183	.5603	.9529	.5497	-.2489	.6316	.8415	.8002	.2476	-.3948	.5950	.9014
.6500	-.5320	.5565	.9590	.6003	-.1170	.6664	.7877	.8002	-.5024	-.3937	.6039	.8845
.7000	-.5128	.5618	.9506	.6500	-.0196	.6921	.7401	.8002	-.7524	-.3602	.6021	.8871
.7500	-.4634	.5749	.9299	.7000	.1099	.7264	.6948					
.8002	-.3891	.5945	.8991	.7501	.2133	.7543	.6508					
.8502	-.2610	.6442	.8220	.8001	.3000	.7772	.6140					
.9501	-.0726	.6782	.7696	.8501	.3751	.7966	.5822					

TEST 167	PT 63.6746	PSI	CM .2599	CD1 .00738	CDCOR1 .00736
RUN 34	TT 101.1834	K	CM -1.442	CD2 .00735	CDCOR2 .00735
POINT 65	RC 40.1679	MILLION	CC .0204	CD3 .00736	CDCOR3 .00741
	MACH .7425			CD4 .00733	CDCOR4 .00735
	ALPHA -1.9959	DEG		CD5 .00719	CDCOR5 .00712

UPPER SURFACE				LOWER SURFACE				SPANWISE				
X/C	CP	P/L/PT	MLOC	X/C	CP	P/L/PT	MLOC	X/C	Y/(B/2)	CP	P/L/PT	MLOC
0.0000	.9999	.9615	.2387	0.0000	.9999	.9615	.2387	.1507	.7476	-.3711	.5986	.8927
.0132	.2472	.7729	.6210	.0126	-.1029	.6696	.7827	.1507	.4976	-.3892	.5938	.9002
.0259	-.0593	.6811	.7650	.0255	-.1862	.6476	.8163	.1507	.2476	-.3845	.5950	.8982
.0759	-.3295	.6096	.8756	.0495	-.2997	.6175	.8633	.1507	-.2524	-.3949	.5923	.9026
.1003	-.3649	.6045	.8835	.0751	-.3437	.6058	.8814	.1507	-.5024	-.3986	.5913	.9041
.1507	-.3849	.5949	.8944	.1002	-.4060	.5893	.9071	.1507	-.7524	-.3851	.5949	.8985
.2003	-.3484	.5944	.9040	.1503	-.3628	.6088	.8897	.5002	.7476	-.5299	.5569	.9380
.2503	-.4339	.5819	.9187	.1976	-.5126	.5611	.9517	.5002	.4976	-.5346	.5593	.9409
.3001	-.4668	.5732	.9325	.2503	-.5384	.5543	.9625	.5002	.2476	-.5343	.5540	.9420
.3502	-.4749	.5711	.9358	.3001	-.5469	.5520	.9661	.5002	-.2524	-.5254	.5574	.9376
.4003	-.4401	.5671	.9422	.3507	-.5371	.5546	.9620	.5002	-.5024	-.5259	.5570	.9373
.4501	-.4491	.5647	.9460	.4001	-.4912	.5668	.9426	.5002	-.7524	-.5059	.5629	.9409
.5002	-.5344	.5533	.9608	.4501	-.4351	.5816	.9192	.8002	.7476	-1.1411	.3947	1.2380
.5502	-.6339	.5484	.9719	.5001	-.3620	.6063	.8807	.8002	.4976	-.6092	.5885	.9084
.6002	-.6835	.5423	.9817	.5497	-.2188	.6389	.8302	.8002	.2476	-.6141	.5872	.9185
.6500	-.6908	.5404	.9848	.6003	-.0938	.6722	.7788	.8002	-.5024	-.6371	.5904	.8938
.7000	-.6549	.5499	.9645	.6500	-.0013	.6965	.7413	.8002	-.7524	-.6390	.5885	.8959
.7500	-.6023	.5665	.9431	.7000	.1263	.7303	.6987					
.8002	-.4687	.6086	.8983	.7501	.2303	.7576	.6452					
.8502	-.2674	.6619	.8255	.8001	.3170	.7598	.6081					
.9501	-.0756	.6770	.7714	.8501	.3914	.7805	.5757					

ORIGINAL PAGE IS
OF POOR QUALITY

TEST	167	PT	63.4860	PSI	CN	.3365	CD1	.00743	CDCOR1	.00737			
RUN	34	TT	101.0260	K	CM	-.1473	CD2	.00736	CDCOR2	.00734			
POINT	66	RC	40.1424	MILLION	CC	.0218	CD3	.00734	CDCOR3	.00737			
		MACH	.7423				CD4	.00732	CDCOR4	.00731			
		ALPHA	-1.4969	DEG			CD5	.00717	CDCOR5	.00706			
		UPPER SURFACE				LOWER SURFACE				SPANWISE			
X/C	CP	P/L/PT	MLOC	X/C	CP	P/L/PT	MLOC	X/C	Y/(B/2)	CP	P/L/PT	MLOC	
0.0000	1.0496	.9743	.1942	0.0000	1.0496	.9743	.1942	.1507	.7476	-.4436	.5767	.9270	
.0132	.1809	.7430	.6688	.0126	.0312	.7031	.7311	.1507	.4976	-.4618	.5719	.9346	
.0759	-.4270	.6488	.8149	.0255	-.0740	.6751	.7744	.1507	.2476	-.4584	.5728	.9332	
.1003	-.4342	.5792	.9231	.0495	-.2016	.6412	.8267	.1507	-.2524	-.4682	.5702	.9373	
.1507	-.4587	.5727	.9333	.1002	-.3268	.6078	.8784	.1507	-.5024	-.4707	.5695	.9384	
.2003	-.4589	.5726	.9334	.1503	-.2988	.6153	.8668	.1507	-.7524	-.4544	.5738	.9315	
.2503	-.4934	.5635	.9480	.1976	-.4460	.5761	.9280	.5002	.7476	-.5726	.5424	.9816	
.3001	-.5227	.5557	.9604	.2503	-.4776	.5677	.9413	.5002	.4976	-.5772	.5411	.9836	
.3502	-.5276	.5544	.9625	.3001	-.4940	.5633	.9482	.5002	.2476	-.5814	.5400	.9854	
.4003	-.5387	.5514	.9672	.3507	-.4915	.5640	.9472	.5002	-.2524	-.5858	.5442	.9788	
.4501	-.5447	.5498	.9697	.4001	-.4552	.5736	.9319	.5002	-.5024	-.5853	.5443	.9786	
.5002	-.5770	.5412	.9836	.4501	-.4066	.5866	.9115	.5002	-.7524	-.5443	.5499	.9696	
.5502	-.6009	.5349	.9938	.5001	-.3199	.6097	.8755	.8002	.7476	-1.1616	.3856	1.2557	
.6002	-.6214	.5294	1.0027	.5497	-.2016	.6411	.8267	.8002	.4976	-.4172	.5838	.9159	
.6500	-.6249	.5285	1.0042	.6003	-.0798	.6736	.7767	.8002	.2476	-.4219	.5825	.9179	
.7000	-.5765	.5413	.9833	.6500	.0090	.6972	.7403	.8002	-.5024	-.3785	.5940	.8998	
.7500	-.5049	.5604	.9528	.7000	-.1347	.7307	.6881	.8002	-.7524	-.3862	.5970	.9030	
.8002	-.4173	.5837	.9160	.7501	-.2374	.7580	.6449						
.9002	-.2099	.6389	.8302	.8001	-.3235	.7809	.6079						
.9501	-.0770	.6743	.7756	.8501	.3982	.8008	.5751						

TEST	167	PT	63.6818	PSI	CM	-.4102	CD1	.00743	CDCOR1	.00738			
RUN	34	TT	101.0717	K	CM	-.1489	CD2	.00739	CDCOR2	.00738			
POINT	67	RC	40.2355	MILLION	CC	.0220	CD3	.00739	CDCOR3	.00742			
		MACH	.7423				CD4	.00732	CDCOR4	.00733			
		ALPHA	-.9877	DEG			CD5	.00721	CDCOR5	.00713			
		UPPER SURFACE				LOWER SURFACE				SPANWISE			
X/C	CP	P/L/PT	MLOC	X/C	CP	P/L/PT	MLOC	X/C	Y/(B/2)	CP	P/L/PT	MLOC	
0.0000	1.0889	.9849	.1481	0.0000	1.0889	.9849	.1481	.1507	.7476	-.5207	.5575	.9575	
.0132	.0665	.7134	.7151	.0126	-.1535	.7365	.6789	.1507	.4976	-.5405	.5522	.9658	
.0259	-.2950	.6174	.8634	.0255	-.0290	.7035	.7305	.1507	.2476	-.5389	.5527	.9651	
.0759	-.5349	.5537	.9635	.0495	-.1113	.6662	.7881	.1507	-.2524	-.5467	.5506	.9685	
.1003	-.5271	.5558	.9602	.0753	-.1756	.6491	.8144	.1507	-.5024	-.5472	.5505	.9687	
.1507	-.5380	.5529	.9648	.1002	-.2524	.6287	.8459	.1507	-.7524	-.5280	.5555	.9605	
.2003	-.5293	.5552	.9611	.1503	-.2371	.6328	.8396	.5002	.7476	-.6087	.5341	.9950	
.2503	-.5542	.5486	.9716	.1976	-.3818	.5944	.8993	.5002	.4976	-.6135	.5328	.9970	
.3001	-.5776	.5424	.9817	.2503	-.4183	.5847	.9144	.5002	.2476	-.6171	.5319	.9986	
.3502	-.5745	.5419	.9824	.3001	-.4398	.5776	.9234	.5002	-.2524	-.5998	.5366	.9911	
.4003	-.5826	.5410	.9838	.3507	-.4431	.5770	.9257	.5002	-.5024	-.6002	.5364	.9913	
.4501	-.5833	.5409	.9841	.4001	-.4169	.5851	.9139	.5002	-.7524	-.5778	.5423	.9817	
.5002	-.6133	.5329	.9949	.4501	-.3767	.5957	.8971	.8002	.7476	-1.1687	.3854	1.2559	
.5502	-.6323	.5279	1.0051	.5001	-.2973	.6168	.8644	.8002	.4976	-.4217	.5838	.9159	
.6002	-.6498	.5232	1.0127	.5497	-.1848	.6467	.8182	.8002	.2476	-.4269	.5824	.9181	
.6500	-.6476	.5238	1.0118	.6003	.0183	.6779	.7700	.8002	-.5024	-.3829	.5941	.8997	
.7000	-.5906	.5389	.9872	.7000	.0183	.7007	.7349	.8002	-.7524	-.3909	.5920	.9031	
.7500	-.5126	.5596	.9540	.7501	.2437	.7335	.6836						
.8002	-.4229	.5835	.9164	.8001	.3292	.7582	.6409						
.9002	-.2116	.6396	.8292	.8501	.4039	.8030	.5714						
.9501	-.0786	.6749	.7747										

TEST	167	PT	64.6685	PSI	CN	-.4776	CD1	.00754	CDCOR1	.00745			
RUN	34	TT	104.4155	K	CM	-.1490	CD2	.00748	CDCOR2	.00744			
POINT	68	RC	38.7541	MILLION	CC	.0214	CD3	.00749	CDCOR3	.00751			
		MACH	.7374				CD4	.00741	CDCOR4	.00738			
		ALPHA	-.4888	DEG			CD5	.00733	CDCOR5	.00718			
		UPPER SURFACE				LOWER SURFACE				SPANWISE			
X/C	CP	P/L/PT	MLOC	X/C	CP	P/L/PT	MLOC	X/C	Y/(B/2)	CP	P/L/PT	MLOC	
0.0000	1.1194	.9934	.0976	0.0000	1.1194	.9934	.0976	.1507	.7476	-.5968	.5400	.9853	
.0132	-.0486	.6848	.7592	.0126	.2672	.7683	.6283	.1507	.4976	-.6218	.5334	.9959	
.0259	-.4.39	.9867	.9110	.0255	-.1249	.7307	.6879	.1507	.2476	-.6228	.5331	.9964	
.0759	-.6549	.5246	1.0101	.0495	-.0283	.6902	.7509	.1507	-.2524	-.6309	.5310	.9998	
.1003	-.62.4	.9327	.9970	.0753	-.1019	.6708	.7809	.1507	-.5024	-.6276	.5319	.9984	
.1507	-.6215	.5335	.9958	.1002	-.1826	.6494	.8137	.1507	-.7524	-.6039	.5381	.9883	
.2003	-.5806	.5443	.9784	.1503	-.1782	.6506	.8120	.5002	.7476	-.6405	.5284	1.0039	
.2503	-.6136	.5396	.9924	.1976	-.3228	.6124	.8710	.5002	.4976	-.6468	.5288	1.0066	
.3001	-.6340	.5302	1.0011	.2503	-.3638	.6013	.8879	.5002	.2476	-.6514	.5256	1.0086	
.3502	-.6194	.5340	.9949	.3001	-.3900	.5946	.8967	.5002	-.2524	-.6337	.5302	1.0010	
.4003	-.6204	.5377	.9954	.3507	-.4010	.5917	.9032	.5002	-.5024	-.6339	.5302	1.0011	
.4501	-.6185	.5343	.9945	.4001	-.3802	.5972	.8946	.5002	-.7524	-.6084	.5369	.9902	
.5002	-.6453	.5272	1.0066	.4501	-.3480	.6057	.8814	.8002	.7476	-1.1764	.3869	1.2529	
.5502	-.6563	.5243	1.0107	.5001	-.2754	.6249	.8514	.8002	.4976	-.4259	.5851	.9135	
.6002	-.6685	.5210	1.0160	.5497	-.1689	.6530	.8082	.8002	.2476	-.4306	.5839	.9155	
.6500	-.6617	.5230	1.0128	.6003	-.0553	.6831	.7619	.8002	-.5024	-.3880	.5952	.8978	
.7000	-.5986	.5395	.9860	.6500	.0268	.7048	.7283	.8002	-.7524	-.3968	.5928	.9015	
.7500	-.5164	.5612	.9513	.7000	-.1488	.7370	.6780						
.8002	-.4249	.5894	.9131	.7501	.2491	.7635	.6359						
.9002	-.2107	.6420	.8252	.8001	.3341	.7859	.5995						
.9501	-.0756	.6777	.7702	.8501	.4086	.8056	.5669						

Appendix G

Pressure Data for $M = 0.75$; $R = 10.0 \times 10^6$, 15.0×10^6 , and 30.0×10^6 ; Free Transition

The pressure measurements made on the NASA SC(3)-0712(B) airfoil are presented in coefficient form in graphs and tables in this appendix. The data are for a given Mach number through the Reynolds number range. The pressure data from the upper surface of the airfoil are plotted as open symbols, and the lower-surface data are plotted as solid symbols.

ORIGINAL PAGE IS
OF POOR QUALITY

TEST 167	PT 25.3840	PSI	CN -.0691	CD1 .01057	CDCOR1 .01049
RUN 52	TT 140.3261	K	CM -.1261	CD2 .01027	CDCOR2 .01023
POINT 15	RC 9.9652	MILLION	CC .0039	CD3 .00988	CDCOR3 .00986
	MACH .7523			CD4 .00934	CDCOR4 .00927
	ALPHA -3.9815	DEG		CD5 .00850	CDCOR5 .00931

UPPER SURFACE				LOWER SURFACE				SPANWISE				
X/C	CP	P ₂ L/PT	MLOC	X/C	CP	P ₂ L/PT	MLOC	X/C	Y/(B/2)	CP	P ₂ L/PT	MLOC
0.0000	.7198	.8835	.4244	0.0000	.7199	.8835	.4244	.1507	.7476	-.1273	.6535	.9040
.0132	.6331	.8600	.4693	.0176	-.7502	.4844	1.0729	.1507	.4976	-.1317	.6523	.8058
.0259	.3123	.7729	.6181	.0255	-.6375	.5150	1.0219	.1507	.2476	-.1316	.6524	.8056
.0759	-.0073	.6861	.7739	.0495	-.8038	.4699	1.0977	.1507	-.2524	-.1522	.6468	.8144
.1003	-.0575	.6725	.7749	.0753	-.7844	.4752	1.0887	.1507	-.5024	-.1381	.6506	.8085
.1507	-.1332	.6519	.8064	.1002	-.7965	.4719	1.0943	.1507	-.7524	-.1498	.6474	.8134
.2003	-.1865	.6375	.8287	.1503	-.7753	.4776	1.0845	.5002	.7476	-.3776	.5836	.9091
.2503	-.2294	.6258	.8466	.1976	-.7486	.4849	1.0722	.5002	.4976	-.3841	.5838	.9119
.3001	-.2694	.6150	.8634	.2503	-.8376	.4607	1.1136	.5002	.2476	-.3890	.5827	.9135
.3502	-.2974	.6074	.8752	.3001	-.9296	.4357	1.1577	.5002	-.2524	-.3773	.5827	.9090
.4003	-.3264	.5995	.8874	.3507	-.9948	.4180	1.1900	.5002	-.5024	-.3732	.5868	.9072
.4501	-.3556	.5916	.8998	.4001	-.6056	.5237	1.0078	.5002	-.7524	-.3588	.5907	.9011
.5002	-.3859	.5834	.9126	.4501	-.4803	.5577	.9531	.8002	.7476	-.3511	.5928	.8976
.5502	-.4186	.5745	.9266	.5001	-.3929	.5814	.9155	.8002	.4976	-.3537	.5921	.8989
.6002	-.4531	.5651	.9414	.5497	-.2665	.6158	.8622	.8002	.2476	-.3582	.5909	.9009
.6500	-.4714	.5601	.9492	.6003	-.1373	.6508	.8082	.8002	-.5024	-.3383	.5963	.8925
.7000	-.4610	.5629	.9448	.6500	-.0265	.6809	.7619	.8002	-.7524	-.3173	.6020	.8836
.7500	-.4203	.5740	.9273	.7000	.0877	.7119	.7141					
.8002	-.3524	.5924	.8984	.7501	.1849	.7393	.6730					
.9002	-.1720	.6414	.8226	.8001	.2631	.7595	.6395					
.9501	-.0495	.6747	.7716	.8501	.3280	.7771	.6112					

TEST 167	PT 25.3812	PSI	CN .0644	CD1 .00935	CDCOR1 .00923
RUN 52	TT 140.3310	K	CM -.1302	CD2 .00918	CDCOR2 .00910
POINT 16	RC 9.9645	MILLION	CC .0118	CD3 .00911	CDCOR3 .00905
	MACH .7524			CD4 .00880	CDCOR4 .00870
	ALPHA -3.0591	DEG		CD5 .00814	CDCOR5 .00794

UPPER SURFACE				LOWER SURFACE				SPANWISE				
X/C	CP	P ₂ L/PT	MLOC	X/C	CP	P ₂ L/PT	MLOC	X/C	Y/(B/2)	CP	P ₂ L/PT	MLOC
0.0000	.8547	.9198	.3476	0.0000	.8547	.9198	.3476	.1507	.7476	-.2208	.6272	.8445
.0132	.4968	.8224	.5359	.0126	-.4512	.5645	.9422	.1507	.4976	-.2324	.6241	.8493
.0259	.1628	.7316	.6835	.0255	-.4481	.5654	.9409	.1507	.2476	-.2333	.6238	.8498
.0759	-.1329	.6511	.8077	.0495	-.5641	.5338	.9913	.1507	-.2524	-.2540	.6182	.8584
.1003	-.1719	.6405	.8240	.0753	-.5620	.5344	.9904	.1507	-.5024	-.2392	.6222	.8522
.1507	-.2350	.6234	.8504	.1002	-.6083	.5218	1.0109	.1507	-.7524	-.2374	.6227	.8515
.2003	-.2728	.6131	.8663	.1503	-.5894	.5269	1.0025	.5002	.7476	-.4375	.5683	.9364
.2503	-.3141	.6018	.8838	.1976	-.6864	.5005	1.0459	.5002	.4976	-.4445	.5664	.9393
.3001	-.3491	.5923	.8986	.2503	-.7677	.4799	1.0806	.5002	.2476	-.4490	.5651	.9413
.3502	-.3695	.5868	.9073	.3001	-.7620	.4800	1.0905	.5002	-.2524	-.4386	.5680	.9368
.4003	-.3942	.5800	.9178	.3507	-.6651	.5063	1.1363	.5002	-.5024	-.4345	.5691	.9350
.4501	-.4209	.5728	.9292	.4001	-.5831	.5286	.9947	.5002	-.7524	-.4214	.5727	.9294
.5002	-.4442	.5659	.9401	.4501	-.4924	.5533	.9600	.8002	.7476	-.3676	.5873	.9064
.5502	-.4750	.5581	.9525	.5001	-.3867	.5821	.9146	.8002	.4976	-.3702	.5866	.9076
.6002	-.5063	.5496	.9661	.5497	-.2533	.6184	.8581	.8002	.2476	-.3751	.5852	.9097
.6500	-.5193	.5460	.9717	.6003	-.1227	.6539	.8034	.8002	-.5024	-.3576	.5900	.9022
.7000	-.4981	.5518	.9625	.6500	-.0126	.6839	.7574	.8002	-.7524	-.3367	.5957	.8933
.7500	-.4469	.5657	.9404	.7000	.1021	.7151	.7092					
.8002	-.3686	.5870	.9069	.7501	.1995	.7416	.6679					
.9002	-.1793	.6396	.8254	.8001	.2782	.7630	.6340					
.9501	-.0491	.6739	.7727	.8501	.3439	.7808	.6052					

TEST 167	PT 25.3835	PSI	CN .2156	CD1 .00921	CDCOR1 .00907
RUN 52	TT 140.3690	K	CM -.1349	CD2 .00904	CDCOR2 .00893
POINT 17	RC 9.9577	MILLION	CC .0179	CD3 .00896	CDCOR3 .00888
	MACH .7519			CD4 .00869	CDCOR4 .00858
	ALPHA -2.0468	DEG		CD5 .00815	CDCOR5 .00794

UPPER SURFACE				LOWER SURFACE				SPANWISE				
X/C	CP	P ₂ L/PT	MLOC	X/C	CP	P ₂ L/PT	MLOC	X/C	Y/(B/2)	CP	P ₂ L/PT	MLOC
0.0000	.9940	.9579	.2485	0.0000	.9940	.9579	.2445	.1507	.7476	-.3408	.5956	.8934
.0132	.3115	.7727	.6184	.0126	-.1469	.6483	.8121	.1507	.4976	-.3580	.5910	.9007
.0259	-.0351	.6786	.7655	.0255	-.2098	.6312	.8384	.1507	.2476	-.3606	.5903	.9014
.0759	-.2962	.6077	.8746	.0495	-.3377	.5965	.8921	.1507	-.2524	-.3658	.5888	.9046
.1003	-.3181	.6018	.8839	.0753	-.3651	.5890	.9637	.1507	-.5024	-.3637	.5894	.9031
.1507	-.3621	.5898	.9025	.1002	-.4219	.5736	.9279	.1507	-.7524	-.3528	.5924	.8985
.2003	-.3849	.5836	.9121	.1503	-.4456	.5672	.9380	.5002	.7476	-.5049	.5511	.9636
.2503	-.4160	.5752	.9254	.1976	-.5371	.5423	.9776	.5002	.4976	-.5120	.5492	.9667
.3001	-.4427	.5680	.9368	.2503	-.5695	.5335	.9918	.5002	.2476	-.5167	.5479	.9687
.3502	-.4560	.5644	.9425	.3001	-.5810	.5304	.9968	.5002	-.2524	-.5045	.5512	.9634
.4003	-.4737	.5596	.9501	.3507	-.5663	.5344	.9904	.5002	-.5024	-.5012	.5521	.9620
.4501	-.4934	.5542	.9586	.4001	-.5162	.5480	.9685	.5002	-.7524	-.4880	.5537	.9563
.5002	-.5144	.5485	.9677	.4501	-.4473	.5667	.9388	.8002	.7476	-.3807	.5848	.9104
.5502	-.5375	.5423	.9778	.5001	-.3518	.5926	.8941	.8002	.4976	-.3839	.5839	.9117
.6002	-.5633	.5352	.9890	.5497	-.2255	.6269	.8449	.8002	.2476	-.3842	.5825	.9140
.6500	-.5680	.5340	.9911	.6003	-.1001	.6610	.7926	.8002	-.5024	-.3723	.5871	.9088
.7000	-.5325	.5436	.9756	.6500	.0054	.6896	.7486	.8002	-.7524	-.3522	.5925	.8982
.7500	-.4694	.5607	.9483	.7000	.1192	.7205	.7008					
.8002	-.3835	.5840	.9116	.7501	.2169	.7470	.6593					
.9002	-.1789	.6396	.8255	.8001	.2969	.7687	.6247					
.9501	-.0511	.6743	.7721	.8501	.3644	.7870	.5951					

ORIGINAL PAGE IS
OF POOR QUALITY

TEST 167	PT 25.3854	PSI	CN	.2956	CD1	.00914	CDCOR1	.00900
RUN 52	TT 140.3457	K	CM	-.1372	CD2	.00899	CDCOR2	.00888
POINT 18	RC 9.9561	MILLION	CC	.0196	CD3	.00880	CDCOR3	.00871
	MACH .7513				CD4	.00854	CDCOR4	.00841
	ALPHA -1.4908	DEG			CD5	.00815	CDCOR5	.00796

UPPER SURFACE				LOWER SURFACE				SPANWISE				
X/C	CP	P/L/PT	MLOC	X/C	CP	P/L/PT	MLOC	X/C	Y/(B/2)	CP	P/L/PT	MLOC
0.0000	1.0515	.9736	.1959	0.0000	1.0515	.9736	.1959	.1507	.7476	-.4157	.5754	.9250
.0132	-.1967	.7416	.6678	.0126	-.0010	.6880	.7511	.1507	.4976	-.4376	.5685	.9344
.0259	-.1550	.6462	.8153	.0255	-.0936	.6625	.7897	.1507	.2476	-.4418	.5684	.9362
.0759	-.3996	.5798	.9182	.0495	-.2311	.6255	.8471	.1507	-.2524	-.4446	.5676	.9374
.1003	-.4103	.5769	.9227	.0753	-.2730	.6142	.8647	.1507	-.5024	-.4435	.5679	.9370
.1507	-.4429	.5680	.9267	.1002	-.3364	.5970	.8914	.1507	-.7524	-.4283	.5720	.9304
.2003	-.4563	.5644	.9424	.1503	-.3734	.5869	.9070	.5002	.7476	-.5479	.5396	.9821
.2503	-.4803	.5579	.9528	.1976	-.4633	.5625	.9455	.5002	.4976	-.5544	.5378	.9849
.3001	-.5030	.5517	.9626	.2503	-.5008	.5523	.9616	.5002	.2476	-.5594	.5364	.9871
.3502	-.5079	.5504	.9647	.3001	-.5188	.5475	.9694	.5002	.5024	-.5476	.5366	.9820
.4003	-.5224	.5465	.9647	.4001	-.5188	.5475	.9694	.5002	.7524	-.5442	.5406	.9805
.4501	-.5398	.5418	.9766	.4501	-.4758	.5380	.9526	.5002	.5024	-.5312	.5441	.9748
.5002	-.5563	.5373	.9858	.5001	-.3329	.5979	.9274	.8002	.7476	-.3899	.5824	.9141
.5502	-.5759	.5319	.9944	.5497	-.2119	.6307	.8391	.8002	.2476	-.3979	.5815	.9156
.6022	-.5983	.5259	1.0062	.6003	-.0901	.6608	.7882	.8002	-.5024	-.3826	.5844	.9175
.6500	-.5988	.5257	1.0045	.6500	.0125	.6916	.7455	.8002	.2476	-.3826	.5844	.9109
.7000	-.5528	.5382	.9862	.7000	.1253	.7222	.6981	.8002	-.7524	-.3629	.5898	.9026
.7500	-.4622	.5574	.9536	.7501	.2230	.7488	.6565					
.8002	-.3926	.5817	.9152	.8001	.3034	.7706	.6218					
.9002	-.1818	.6389	.8265	.8501	.3719	.7891	.5917					
.9501	-.0526	.6740	.7726									

TEST 167	PT 25.3879	PSI	CN	.3590	CD1	.00919	CDCOR1	.00902
RUN 52	TT 140.3593	K	CM	-.1385	CD2	.00907	CDCOR2	.00894
POINT 19	RC 9.9556	MILLION	CC	.0200	CD3	.00889	CDCOR3	.00879
	MACH .7513				CD4	.00866	CDCOR4	.00851
	ALPHA -1.0285	DEG			CD5	.00823	CDCOR5	.00805

UPPER SURFACE				LOWER SURFACE				SPANWISE				
X/C	CP	P/L/PT	MLOC	X/C	CP	P/L/PT	MLOC	X/C	Y/(B/2)	CP	P/L/PT	MLOC
0.0000	1.0904	.9840	.1521	0.0000	1.0904	.9840	.1521	.1507	.7476	-.4805	.5568	.9545
.0132	-.0997	.7166	.7160	.0126	-.1121	.7180	.7047	.1507	.4976	-.5025	.5508	.9640
.0259	-.2542	.6183	.8582	.0255	-.0018	.6870	.7526	.1507	.2476	-.5075	.5495	.9662
.0759	-.4869	.5551	.9573	.0495	-.1459	.6478	.8128	.1507	-.2524	-.5097	.5469	.9672
.1003	-.4957	.5554	.9567	.0753	-.1981	.6336	.8347	.1507	-.5024	-.5060	.5499	.9655
.1507	-.5083	.5492	.9666	.1002	-.2676	.6147	.8638	.1507	-.7524	-.4858	.5554	.9568
.2003	-.5073	.5495	.9661	.1503	-.3134	.6022	.8832	.5002	.7476	-.5748	.5312	.9957
.2503	-.5307	.5432	.9763	.1976	-.4037	.5777	.9215	.5002	.4976	-.5826	.5290	.9991
.3001	-.5468	.5382	.9842	.2503	-.4452	.5664	.9393	.5002	.2476	-.5880	.5276	1.0014
.3502	-.5485	.5383	.9841	.3001	-.4679	.5602	.9491	.5002	-.2524	-.5756	.5310	.9960
.4003	-.5586	.5356	.9885	.3502	-.4731	.5588	.9513	.5002	-.5024	-.5726	.5318	.9947
.4501	-.5731	.5316	.9949	.4001	-.4452	.5664	.9393	.5002	.7524	-.5597	.5353	.9890
.5002	-.5851	.5284	1.0002	.4501	-.3941	.5803	.9174	.8002	.7476	-.5832	.5383	.9128
.5502	-.6003	.5242	1.0069	.5001	-.3121	.6026	.8826	.8002	.4976	-.5908	.5312	.9160
.6002	-.6199	.5199	1.0156	.5497	-.1957	.6343	.8336	.8002	.2476	-.5965	.5297	.9184
.6500	-.6146	.5203	1.0133	.6003	-.0772	.6665	.7841	.8002	-.5024	-.5839	.5311	.9131
.7000	-.5604	.5351	.9893	.6500	.0231	.6937	.7422	.8002	-.7524	-.5647	.5383	.9049
.7500	-.4835	.5560	.9598	.7000	.1348	.7241	.6951					
.8002	-.3917	.5809	.9164	.7501	.2321	.7506	.6536					
.9002	-.1781	.6346	.8263	.8001	.3126	.7725	.6187					
.9501	-.0505	.6737	.7730	.8501	.3817	.7913	.5882					

TEST 167	PT 25.3857	PSI	CN	.4323	CD1	.00933	CDCOR1	.00914
RUN 52	TT 140.2427	K	CM	-.1385	CD2	.00921	CDCOR2	.00906
POINT 20	RC 9.9638	MILLION	CC	.0195	CD3	.00906	CDCOR3	.00892
	MACH .7510				CD4	.00881	CDCOR4	.00864
	ALPHA -1.4888	DEG			CD5	.00842	CDCOR5	.00819

UPPER SURFACE				LOWER SURFACE				SPANWISE				
X/C	CP	P/L/PT	MLOC	X/C	CP	P/L/PT	MLOC	X/C	Y/(B/2)	CP	P/L/PT	MLOC
0.0000	1.1213	.9929	.1009	0.0000	1.1213	.9929	.1009	.1507	.7476	-.5599	.5394	.9823
.0132	-.0226	.6647	.7569	.0126	.2320	.7529	.6500	.1507	.4976	-.5873	.5318	.9947
.0259	-.3883	.5855	.9093	.0255	.0952	.7160	.7078	.1507	.2476	-.5958	.5295	.9984
.0759	-.6113	.5253	1.0057	.0495	-.0591	.6743	.7721	.1507	-.2524	-.5964	.5293	.9987
.1003	-.5885	.5314	.9952	.0753	-.1177	.6585	.7964	.1507	-.5024	-.5883	.5315	.9951
.1507	-.5963	.5293	.9986	.1002	-.1920	.6384	.8272	.1507	-.7524	-.5639	.5381	.9845
.2003	-.5992	.5315	.9951	.1503	-.2472	.6236	.8501	.5002	.7476	-.6064	.5266	1.0031
.2503	-.5937	.5300	.9975	.1976	-.3383	.5990	.9483	.5002	.4976	-.6155	.5241	1.0070
.3001	-.6067	.5265	1.0032	.2503	-.3847	.5864	.9078	.5002	.2476	-.6215	.5225	1.0097
.3502	-.5943	.5299	.9978	.3001	-.4121	.5790	.9194	.5002	-.2524	-.6091	.5259	1.0042
.4003	-.5990	.5286	.9998	.3502	-.4230	.5761	.9240	.5002	.5024	-.6056	.5268	1.0027
.4501	-.6098	.5257	1.0046	.4001	-.4047	.5810	.9162	.5002	.7524	-.5913	.5307	.9965
.5002	-.6169	.5238	1.0077	.4501	-.3638	.5921	.8990	.8002	.7476	-.5862	.5360	.9084
.5502	-.6246	.5217	1.0111	.5001	-.2908	.6118	.8684	.8002	.4976	-.5950	.5337	.9121
.6002	-.6382	.5180	1.0171	.5497	-.1808	.6415	.8226	.8002	.2476	-.6010	.5320	.9147
.6500	-.6266	.5211	1.0120	.6003	-.0665	.6723	.7751	.8002	-.5024	-.5892	.5352	.9077
.7000	-.5682	.5369	.9763	.6500	.0299	.6983	.7351	.8002	-.7524	-.5699	.5396	.9015
.7500	-.4882	.5565	.9518	.7000	.1398	.7280	.6891					
.8002	-.3656	.5835	.9124	.7501	.2363	.7541	.6481					
.9002	-.1801	.6417	.8223	.8001	.3169	.7758	.6134					
.9501	-.0508	.6765	.7665	.8501	.3866	.7946	.5827					

TFST	167	PT	25.3863	PSI	CK	.5077	CD1	.00947	CDCOR1	.00925
RUN	52	TY	140.2271	K	CM	-.1399	CD2	.00930	CDCOR2	.00910
POINT	21	RC	9.9615	MILLION	CC	.0162	CD3	.00915	CDCOR3	.00895
		MACH	.7504				CD4	.00888	CDCOR4	.00864
		ALPHA	.0138	DEG			CD5	.00855	CDCOR5	.00831

UPPER SURFACE				LOWER SURFACE				SPANWISE				
X/C	CP	P/L/P/T	MLOC	X/C	CP	P/L/P/T	MLOC	X/C	Y/(B/2)	CP	P/L/P/T	MLOC
0.0000	1.1403	.9978	.0555	0.0030	1.1403	.9978	.0555	1.507	.7476	-.6393	.5163	1.0199
.0132	-.1353	.6927	.8053	.0126	.3405	.7814	.6043	1.507	.4976	-.6713	.5076	1.0342
.0259	-.5092	.5915	.9630	.0255	.1838	.7390	.6719	1.507	.2476	-.6820	.5047	1.0390
.0759	-.7442	.4879	1.0871	.0495	-.0255	.6962	.7384	1.507	-.2524	-.6807	.5051	1.0383
.1003	-.7326	.4911	1.0618	.0753	-.0448	.6772	.7577	1.507	-.5024	-.6657	.5091	1.0316
.1507	-.6848	.5040	1.0402	.1002	-.1250	.6575	.8010	1.507	-.7524	-.6433	.5233	1.0084
.2003	-.6578	.5113	1.0281	.1503	-.1883	.6383	.8274	1.507	-.9024	-.6246	.5149	1.0222
.2503	-.6530	.5126	1.0240	.1976	-.2811	.6132	.8661	1.507	-.9776	-.6065	.5116	1.0275
.3001	-.6768	.5061	1.0366	.2503	-.3316	.5905	.8873	1.507	-.9276	-.6030	.5099	1.0304
.3502	-.6493	.5136	1.0243	.3001	-.3635	.5909	.9009	1.507	-.8524	-.6010	.5134	1.0247
.4003	-.6387	.5164	1.0196	.3507	-.3800	.5865	.9078	1.507	-.8024	-.6043	.5144	1.0230
.4501	-.6503	.5133	1.0248	.4001	-.3678	.5898	.9026	1.507	-.7524	-.6293	.5190	1.0154
.5002	-.6590	.5110	1.0286	.4501	-.3338	.5990	.8882	1.507	-.7476	-.3888	.5841	.9115
.5502	-.6568	.5116	1.0277	.5001	-.2668	.6171	.8601	1.507	-.4976	-.3957	.5822	.9144
.6002	-.6638	.5097	1.0230	.5497	-.1821	.6454	.8165	1.507	-.2476	-.4014	.5807	.9168
.6500	-.6483	.5144	1.0300	.6003	-.0519	.6752	.7706	1.507	-.5024	-.3905	.5836	.9122
.7000	-.5766	.5333	.9422	.6500	.0417	.7006	.7310	1.507	-.7524	-.3713	.5688	.9041
.7500	-.4913	.5563	.9552	.7000	.1501	.7299	.6841					
.8002	-.3960	.5821	.9145	.7501	.2456	.7538	.6454					
.9002	-.1770	.6414	.8227	.8001	.3261	.7775	.6106					
.9501	-.0504	.6757	.7700	.8501	.3962	.7965	.5796					

TFST	167	PT	25.3889	PSI	CK	.5807	CD1	.00965	CDCOR1	.00941
RUN	52	TY	140.1942	K	CM	-.1403	CD2	.00947	CDCOR2	.00924
POINT	22	RC	9.9680	MILLION	CC	.0162	CD3	.00924	CDCOR3	.00904
		MACH	.7507				CD4	.00895	CDCOR4	.00871
		ALPHA	.5193	DEG			CD5	.00869	CDCOR5	.00843

UPPER SURFACE				LOWER SURFACE				SPANWISE				
X/C	CP	P/L/P/T	MLOC	X/C	CP	P/L/P/T	MLOC	X/C	Y/(B/2)	CP	P/L/P/T	MLOC
0.0000	1.1473	.9997	.0203	0.0000	1.1473	.9997	.0203	1.507	.7476	-.7409	.4883	1.0663
.0132	-.2392	.6242	.8491	.0126	.4353	.8049	.5623	1.507	.4976	-.8228	.4662	1.1042
.0259	-.6210	.5208	1.0125	.0255	.2657	.7609	.6372	1.507	.2476	-.8520	.4583	1.1179
.0759	-.8429	.4579	1.1186	.0495	.0898	.7133	.7119	1.507	-.2524	-.8523	.4582	1.1180
.1003	-.8684	.4438	1.1257	.0753	.0230	.6992	.7399	1.507	-.5024	-.8313	.4639	1.1082
.1507	-.8429	.4607	1.1136	.1002	-.0615	.6723	.7751	1.507	-.7524	-.7351	.4899	1.0637
.2003	-.7820	.4772	1.0852	.1503	-.1321	.6525	.8045	1.507	-.9024	-.6831	.5046	1.0402
.2503	-.6698	.5076	1.0342	.1976	-.2271	.6275	.8441	1.507	-.9776	-.6647	.5009	1.0454
.3001	-.6989	.4987	1.0473	.2503	-.2823	.6125	.8672	1.507	-.9276	-.6491	.5002	1.0465
.3502	-.7250	.4927	1.0591	.3001	-.3181	.6028	.8822	1.507	-.8524	-.6432	.5040	1.0402
.4003	-.6987	.4988	1.0472	.3507	-.3391	.5972	.8910	1.507	-.8024	-.6454	.5034	1.0412
.4501	-.6835	.5039	1.0404	.4001	-.3327	.5989	.8884	1.507	-.7524	-.6671	.5083	1.0330
.5002	-.6894	.5023	1.0430	.4501	-.3049	.6064	.8767	1.507	-.7476	-.3893	.5836	.9123
.5502	-.6842	.5023	1.0429	.5001	-.2445	.6228	.8513	1.507	-.4976	-.3954	.5819	.9149
.6002	-.6885	.5025	1.0426	.5497	-.1448	.6498	.8098	1.507	-.2476	-.4002	.5806	.9169
.6500	-.6614	.5099	1.0325	.6003	-.0382	.6787	.7654	1.507	-.5024	-.3905	.5833	.9128
.7000	-.5828	.5311	.9957	.6500	.0535	.7032	.7264	1.507	-.7524	-.3712	.5885	.9046
.7500	-.4902	.5562	.9534	.7000	.1588	.7320	.6828					
.8002	-.3944	.5822	.9144	.7501	.2533	.7576	.6425					
.9002	-.1746	.6417	.8222	.8001	.3333	.7792	.6078					
.9501	-.0483	.6759	.7696	.8501	.4035	.7983	.5766					

TEST	167	PT	25.3880	PSI	CK	.6560	CD1	.00998	CDCOR1	.00970
RUN	52	TY	140.1866	K	CM	-.1403	CD2	.00977	CDCOR2	.00950
POINT	23	RC	9.9668	MILLION	CC	.0136	CD3	.00950	CDCOR3	.00926
		MACH	.7504				CD4	.00917	CDCOR4	.00890
		ALPHA	.9946	DEG			CD5	.00893	CDCOR5	.00868

UPPER SURFACE				LOWER SURFACE				SPANWISE				
X/C	CP	P/L/P/T	MLOC	X/C	CP	P/L/P/T	MLOC	X/C	Y/(B/2)	CP	P/L/P/T	MLOC
0.0000	1.1476	.9999	.0146	0.0000	1.1476	.9999	.0146	1.507	.7476	-.8887	.4489	1.1344
.0132	-.3315	.5996	.8872	.0126	.5135	.8283	.5259	1.507	.4976	-.9882	.4219	1.1820
.0259	-.7206	.4943	1.0563	.0255	.3356	.7801	.6063	1.507	.2476	-.9696	.4270	1.1736
.0759	-.9527	.4315	1.1653	.0495	.1531	.7308	.6846	1.507	-.2524	-.9652	.4282	1.1714
.1003	-.9660	.4279	1.1719	.0753	.0791	.7107	.7159	1.507	-.5024	-.9856	.4226	1.1815
.1507	-.9379	.4301	1.1679	.1002	-.0083	.6871	.7524	1.507	-.7524	-.9332	.4368	1.1558
.2003	-.9419	.4345	1.1600	.1503	-.0840	.6666	.7839	1.507	-.9024	-.8829	.5046	1.0392
.2503	-.9409	.4347	1.1596	.1976	-.1801	.6406	.8239	1.507	-.9776	-.8638	.5016	1.0441
.3001	-.9834	.4503	1.1319	.2503	-.2384	.6248	.8482	1.507	-.9276	-.7014	.4995	1.0476
.3502	-.7108	.4970	1.0518	.3001	-.2772	.6143	.8644	1.507	-.8524	-.6913	.5023	1.0430
.4003	-.6897	.5135	1.0244	.3507	-.3020	.6076	.8748	1.507	-.8024	-.6897	.5027	1.0423
.4501	-.6732	.5072	1.0349	.4001	-.2989	.6082	.8740	1.507	-.7524	-.6774	.5060	1.0368
.5002	-.7001	.4989	1.0470	.4501	-.2773	.6143	.8645	1.507	-.7476	-.3911	.5835	.9124
.5502	-.7089	.4975	1.0510	.5001	-.2222	.6292	.8415	1.507	-.4976	-.3978	.5817	.9152
.6002	-.7103	.4971	1.0516	.5497	-.1274	.6549	.8020	1.507	-.2476	-.4021	.5805	.9170
.6500	-.6796	.5079	1.0338	.6003	-.0243	.6827	.7592	1.507	-.5024	-.3915	.5834	.9125
.7000	-.5877	.5303	.9965	.6500	.0635	.7065	.7227	1.507	-.7524	-.3710	.5889	.9039
.7500	-.4936	.5558	.9561	.7000	.1681	.7348	.6784					
.8002	-.3965	.5820	.9147	.7501	.2614	.7601	.6386					
.9002	-.1753	.6419	.8219	.8001	.3411	.7816	.6038					
.9501	-.0505	.6757	.7700	.8501	.4114	.8006	.5727					

ORIGINAL PRINTING
OF POOR QUALITY

TEST 167	PT 25.3886	PSI	CM .7458	CD1 .01050	CDCOR1 .01019
RUN 52	TT 140.2022	K	CM -.1408	CD2 .01047	CDCOR2 .01005
POINT 24	RC 9.9668	MILLION	CC .0107	CD3 .01054	CDCOR3 .01026
	MACH .7506			CD4 .01048	CDCOR4 .01015
	ALPHA 1.5172	DEG		CD5 .01001	CDCOR5 .00964

UPPER SURFACE				LOWER SURFACE				SPANWISE				
X/C	CP	P/L/PT	MLOC	X/C	CP	P/L/PT	MLOC	X/C	Y/(B/2)	CP	P/L/PT	MLOC
0.0000	1.1475	.9997	.0211	0.0000	1.1475	.9997	.0211	.1507	.7476	-1.0122	.4142	1.1971
.0132	-.4230	.3739	.9275	.0176	-.5894	.6484	.4904	.1507	.4976	-1.0894	.3932	1.2367
.0259	-.8104	.4689	1.0495	.0255	-.4058	.7986	.5761	.1507	.2476	-1.0584	.4016	1.2206
.0759	-1.6360	.4077	1.2092	.0495	-.2143	.7467	.6598	.1507	-.2524	-1.0548	.4026	1.2188
.1003	-1.0527	.4632	1.2177	.0753	.1312	.7241	.6951	.1507	-.5024	-1.0819	.3952	1.2328
.1507	-1.0473	.4046	1.2150	.1002	.0463	.7011	.7308	.1507	-.7524	-1.0375	.4073	1.2100
.2003	-1.0349	.4080	1.2086	.1503	-.0347	.6792	.7646	.5002	.7476	-.7095	.4962	1.0531
.2503	-1.0522	.4033	1.2175	.1876	-.1326	.6526	.8054	.5002	.4976	-.6953	.5001	1.0467
.3001	-1.0760	.3968	1.2297	.2503	-.1945	.6358	.8312	.5002	.2476	-.6762	.5032	1.0381
.3502	-1.0753	.3970	1.2294	.3001	-.2361	.6246	.8486	.5002	-.2524	-.6772	.5050	1.0386
.4003	-1.0143	.4136	1.1982	.3507	-.2643	.6169	.8604	.5002	-.5024	-.7126	.4954	1.0545
.4501	-.8049	.4704	1.0969	.4001	-.2670	.6162	.8615	.5002	-.7524	-.7128	.4953	1.0546
.5002	-.6591	.5099	1.0304	.4501	-.2495	.6209	.8542	.8002	.7476	-.3848	.5843	.9112
.5502	-.6111	.5229	1.0091	.5001	-.2004	.6343	.8337	.8002	.4976	-.3955	.5813	.9158
.6002	-.6254	.5190	1.0154	.5497	-.1103	.6597	.7961	.8002	.2476	-.4013	.5798	.9182
.6500	-.6279	.5183	1.0165	.6003	-.0113	.6855	.7548	.8002	-.5024	-.3904	.5827	.9136
.7000	-.5762	.5324	.9937	.6500	.0737	.7086	.7193	.8002	-.7524	-.3654	.5895	.9030
.7500	-.4906	.5556	.9565	.7000	.1763	.7364	.6760					
.8002	-.3943	.5817	.9153	.7501	.2683	.7613	.6366					
.9002	-.1748	.6412	.8230	.8001	.3472	.7827	.6022					
.9501	-.0498	.6751	.7709	.8501	.4174	.8018	.5709					

TEST 167	PT 25.3894	PSI	CM .6416	CD1 .01298	CDCOR1 .01251
RUN 52	TT 140.2077	K	CM -.1480	CD2 .01304	CDCOR2 .01260
POINT 25	RC 9.9698	MILLION	CC .0090	CD3 .01418	CDCOR3 .01349
	MACH .7510			CD4 .01389	CDCOR4 .01312
	ALPHA 2.0060	DEG		CD5 .01293	CDCOR5 .01240

UPPER SURFACE				LOWER SURFACE				SPANWISE				
X/C	CP	P/L/PT	MLOC	X/C	CP	P/L/PT	MLOC	X/C	Y/(B/2)	CP	P/L/PT	MLOC
0.0000	1.1367	.9969	.0665	0.0000	1.1367	.9969	.0665	.1507	.7476	-1.1115	.3887	1.2453
.0132	-.4512	.5505	.9645	.0126	-.6474	.8645	.4608	.1507	.4976	-1.1762	.3712	1.2797
.0259	-.9013	.4456	1.1402	.0255	-.4598	.8138	.5507	.1507	.2476	-1.1400	.3810	1.2604
.0759	-1.1193	.3866	1.2575	.0495	-.2663	.7614	.6364	.1507	-.2524	-1.1364	.3820	1.2585
.1003	-1.1367	.3819	1.2386	.0753	-.1760	.7370	.6750	.1507	-.5024	-1.1635	.3746	1.2720
.1507	-1.1326	.3830	1.2564	.1002	-.0890	.7135	.7117	.1507	-.7524	-1.1160	.3875	1.2477
.2003	-1.1208	.3862	1.2502	.1503	-.0026	.6901	.7478	.5002	.7476	-1.0622	.4020	1.2198
.2503	-1.1345	.3825	1.2575	.1976	-.0962	.6634	.7889	.5002	.4976	-1.1088	.3894	1.2439
.3001	-1.1622	.3750	1.2722	.2503	-.1610	.6458	.8158	.5002	.2476	-1.1122	.3885	1.2457
.3502	-1.1734	.3719	1.2763	.3001	-.2053	.6338	.8343	.5002	-.2524	-1.0539	.4043	1.2156
.4003	-1.1763	.3712	1.2798	.3507	-.2368	.6253	.8474	.5002	-.5024	-1.0980	.3924	1.2383
.4501	-1.1518	.3778	1.2567	.4001	-.2431	.6236	.8500	.5002	-.7524	-.9992	.4191	1.1880
.5002	-1.0466	.4062	1.2119	.4501	-.2300	.6272	.8446	.8002	.7476	-.3740	.5882	.9050
.5502	-.8694	.4704	1.0968	.5001	-.1854	.6392	.8260	.8002	.4976	-.3855	.5851	.9099
.6002	-.8858	.5309	.9960	.5497	-.0996	.6624	.7903	.8002	.2476	-.3909	.5836	.9122
.6500	-.8387	.5437	.9755	.6003	-.0038	.6884	.7505	.8002	-.5024	-.3848	.5853	.9096
.7000	-.7180	.5493	.9645	.6500	.0782	.7106	.7162	.8002	-.7524	-.3605	.5919	.8993
.7500	-.6479	.5628	.9450	.7000	.1795	.7379	.6735					
.8002	-.4875	.5846	.9107	.7501	.2706	.7626	.6345					
.9002	-.1806	.6405	.8240	.8001	.3491	.7838	.6003					
.9501	-.0594	.6733	.7736	.8501	.4197	.8029	.5689					

TEST 167	PT 25.3866	PSI	CM .9166	CD1 .01757	CDCOR1 .01713
RUN 52	TT 140.1899	K	CM -.1561	CD2 .01772	CDCOR2 .01641
POINT 26	RC 9.9696	MILLION	CC .0090	CD3 .02053	CDCOR3 .02006
	MACH .7509			CD4 .01883	CDCOR4 .01835
	ALPHA 2.9218	DEG		CD5 .01669	CDCOR5 .01585

UPPER SURFACE				LOWER SURFACE				SPANWISE				
X/C	CP	P/L/PT	MLOC	X/C	CP	P/L/PT	MLOC	X/C	Y/(B/2)	CP	P/L/PT	MLOC
0.0000	1.1327	.9956	.0792	0.0000	1.1327	.9956	.0792	.1507	.7476	-1.2021	.3621	1.2980
.0132	-.5199	.5337	.9916	.0126	-.6969	.8774	.4363	.1507	.4976	-1.2313	.3542	1.3142
.0259	-.9559	.4289	1.1700	.0255	-.5082	.8262	.5295	.1507	.2476	-1.1946	.3642	1.2938
.0759	-1.1710	.3766	1.2810	.0495	-.3129	.7732	.6176	.1507	-.2524	-1.1897	.3655	1.2912
.1003	-1.1659	.3665	1.2891	.0753	-.2176	.7473	.6588	.1507	-.5024	-1.2144	.3588	1.3048
.1507	-1.1860	.3663	1.2892	.1002	-.1289	.7233	.6984	.1507	-.7524	-1.1725	.3702	1.2818
.2003	-1.1716	.3704	1.2413	.1503	-.0359	.6980	.7356	.5002	.7476	-1.1876	.3661	1.2900
.2503	-1.1464	.3664	1.2894	.1976	-.0645	.6708	.7775	.5002	.4976	-1.2000	.3627	1.2988
.3001	-1.1255	.3585	1.3054	.2503	-.1324	.6524	.8058	.5002	.2476	-1.2087	.3604	1.3016
.3502	-1.1265	.3555	1.3116	.3001	-.1796	.6396	.8255	.5002	-.2524	-1.1943	.3643	1.2937
.4003	-1.2362	.3529	1.3170	.3507	-.2145	.6301	.8400	.5002	-.5024	-1.1834	.3672	1.2877
.4501	-1.2573	.3472	1.3289	.4001	-.2247	.6273	.8443	.5002	-.7524	-1.1252	.3830	1.2584
.5002	-1.2314	.3542	1.3143	.4501	-.2160	.6297	.8407	.8002	.7476	-.3485	.5937	.9864
.5502	-1.1513	.3759	1.2703	.5001	-.1751	.6408	.8236	.8002	.4976	-.3480	.5939	.9861
.6002	-.8357	.4616	1.1122	.5497	-.0922	.6633	.7890	.8002	.2476	-.3493	.5935	.9867
.6500	-.7723	.5330	.9926	.6003	.0016	.6887	.7499	.8002	-.5024	-.3676	.5886	.9045
.7000	-.4784	.5585	.9518	.6500	.0813	.7103	.7165	.8002	-.7524	-.3565	.5916	.8997
.7500	-.4156	.5755	.9249	.7000	.1819	.7376	.6740					
.8002	-.3471	.5941	.8958	.7501	.2728	.7623	.6350					
.9002	-.1864	.6432	.8240	.8001	.3512	.7836	.6007					
.9501	-.0543	.6736	.7732	.8501	.4222	.8028	.5690					

TEST 167 PT 25.3861 PSI CM .9621
 RUN 52 TT 140.1041 K CM -.1608
 POINT 27 RC 9.9803 MILLION CC .0095
 MACH .7512
 ALPHA 3.0233 DEG

CD1 .02445 CDCOR1 .02262
 CD2 .02465 CDCOR2 .02312
 CD3 .02596 CDCOR3 .02427
 CD4 .02325 CDCOR4 .02184
 CD5 .01819 CDCOR5 .01752

UPPER SURFACE				LOWER SURFACE				SPANWISE				
X/C	CP	P _L /PT	MLOC	X/C	CP	P _L /PT	MLOC	X/C	Y/(B/2)	CP	P _L /PT	MLOC
0.0000	1.1198	.9919	.1080	0.0000	1.1198	.9919	.1080	.1507	.7476	-1.2510	.3464	1.3305
.0132	-.6218	.5177	1.0176	.0126	.7319	.8862	.4190	.1507	.4976	-1.2713	.3409	1.3422
.0259	-1.0019	.4142	1.1971	.0235	-.5427	.8347	.5146	.1507	.2476	-1.2370	.3502	1.3226
.0759	-1.2154	.3561	1.3104	.0495	.3443	.7807	.6054	.1507	-.2524	-1.2341	.3510	1.3209
.1003	-1.2298	.3522	1.3189	.0753	.2455	.7538	.6485	.1507	-.5024	-1.2562	.3450	1.3335
.1507	-1.2293	.3523	1.3182	.1002	.1534	.7288	.6879	.1507	-.7524	-1.2254	.3534	1.3160
.2003	-1.2139	.3565	1.3096	.1503	.0567	.7024	.7288	.5002	.7476	-1.2427	.3488	1.3255
.2503	-1.2281	.3526	.3175	.1976	-.0437	.6745	.7717	.5002	.4976	-1.2499	.3467	1.3299
.3001	-1.2573	.3447	1.3342	.2503	-.1159	.6534	.8011	.5002	.2476	-1.2375	.3446	1.3343
.3502	-1.2694	.3414	1.3411	.3001	-.1658	.6418	.8379	.5002	-.2524	-1.2463	.3471	1.3290
.4003	-1.2790	.3388	1.3467	.3507	-.2037	.6315	.8739	.5002	-.5024	-1.2124	.3569	1.3087
.4501	-1.3041	.3319	1.3614	.4001	-.2176	.6278	.8437	.5002	-.7524	-1.1047	.3882	1.2501
.5002	-1.3149	.3290	1.3678	.4501	-.2123	.6292	.8414	.8002	.7476	-.3381	.5949	.8945
.5502	-1.2354	.3506	1.3217	.5001	-.1746	.6395	.8256	.8002	.4976	-.3399	.5944	.8953
.6002	-.9549	.427C	1.1735	.5497	-.0943	.6613	.7920	.8002	.2476	-.3435	.5935	.8968
.6500	-.6281	.5160	1.0204	.6003	-.0025	.6863	.7536	.8002	-.5024	-.3740	.5852	.9098
.7000	-.5110	.5479	.9688	.6500	.0758	.7076	.7207	.8002	-.7524	-.3706	.5861	.9083
.7500	-.4240	.5716	.9312	.7000	.1755	.7348	.6785					
.8002	-.3436	.5934	.8969	.7501	.2659	.7594	.6397					
.9002	-.1668	.6416	.8224	.8001	.3441	.7807	.6055					
.9501	-.0644	.6895	.7795	.8501	.4156	.8002	.5735					

TEST 167 PT 25.3836 PSI CM .9988
 RUN 52 TT 140.1475 K CM -.1588
 POINT 28 RC 9.9813 MILLION CC .0077
 MACH .7520
 ALPHA 3.4425 DEG

CD1 .03376 CDCOR1 .03289
 CD2 .03237 CDCOR2 .02850
 CD3 .02940 CDCOR3 .02583
 CD4 .02585 CDCOR4 .02293
 CD5 .01829 CDCOR5 .01744

UPPER SURFACE				LOWER SURFACE				SPANWISE				
X/C	CP	P _L /PT	MLOC	X/C	CP	P _L /PT	MLOC	X/C	Y/(B/2)	CP	P _L /PT	MLOC
0.0000	1.1026	.9876	.1339	0.0000	1.1026	.9876	.1339	.1507	.7476	-1.3141	.3328	1.3596
.0132	-.6874	.5026	1.0426	.0126	.7726	.8982	.3947	.1507	.4976	-1.3311	.3281	1.3696
.0259	-1.0658	.4000	1.2236	.0259	.5813	.8463	.4941	.1507	.2476	-1.2976	.3372	1.3499
.0759	-1.2790	.3423	1.3392	.0495	.3836	.7927	.5858	.1507	-.2524	-1.2920	.3388	1.3467
.1003	-1.2906	.3391	1.3459	.0753	.2804	.7648	.6310	.1507	-.5024	-1.3115	.3335	1.3581
.1507	-1.2880	.3398	1.3444	.1002	.1882	.7398	.6706	.1507	-.7524	-1.2921	.3387	1.3468
.2003	-1.2689	.3450	1.3334	.1503	.0904	.7133	.7120	.5002	.7476	-1.2982	.3371	1.3503
.2503	-1.2833	.3411	1.3417	.1976	-.0151	.6847	.7561	.5002	.4976	-1.3018	.3361	1.3524
.3001	-1.3116	.3334	1.3381	.2503	-.0891	.6647	.7869	.5002	.2476	-1.3100	.3339	1.3572
.3502	-1.3219	.3307	1.3642	.3001	-.1419	.6504	.8088	.5002	-.2524	-1.2973	.3373	1.3498
.4003	-1.3305	.3283	1.3692	.3507	-.1824	.6394	.8257	.5002	-.5024	-1.2440	.3518	1.3194
.4501	-1.3504	.3229	1.3811	.4001	-.1995	.6347	.8329	.5002	-.7524	-.9536	.4304	1.1673
.5002	-1.3796	.3150	1.3988	.4501	-.1976	.6333	.8321	.8002	.7476	-.3332	.5985	.8889
.5502	-1.2490	.3504	1.3222	.5001	-.1639	.6444	.8180	.8002	.4976	-.3368	.5976	.8904
.6002	-.7851	.4761	1.0871	.5497	-.0871	.6852	.7861	.8002	.2476	-.3423	.5961	.8928
.6500	-.6239	.5198	1.0142	.6003	.0020	.6894	.7489	.8002	-.5024	-.3850	.5845	.9108
.7000	-.5144	.5494	.9663	.6500	.0780	.7099	.7172	.8002	-.7524	-.3859	.5842	.9112
.7500	-.4233	.5741	.9272	.7000	.1765	.7366	.6796					
.8002	-.3430	.5959	.8931	.7501	.2662	.7609	.6372					
.9002	-.1721	.6422	.8214	.8001	.3443	.7821	.6032					
.9501	-.0721	.6893	.7798	.8501	.4159	.8015	.5713					

ORIGINAL PAGE IS
 OF POOR QUALITY

TEST 167	PT 32.1452	PSI	CM	-.0547	CD1 .00986	CDCOR1 .00967
RUN 46	TT 124.9570	K	CM	-.1306	CD2 .00964	CDCOR2 .00950
POINT 38	RC 14.9484	MILLION	CC	.0050	CD3 .00936	CDCOR3 .00929
	MACH .7521				CD4 .00906	CDCOR4 .00895
	ALPHA -3.9713	DEG			CD5 .00887	CDCOR5 .00825

UPPER SURFACE				LOWER SURFACE				SPANWISE				
X/C	CP	P/L/PT	MLOC	X/C	CP	P/L/PT	MLOC	X/C	Y/(B/2)	CP	P/L/PT	MLOC
0.0000	.7260	.8850	.4217	0.0000	.7260	.8850	.4217	.1507	.7476	-.1248	.6538	.8040
.0132	.6247	.8575	.4742	.0126	-.7208	.4919	1.0609	.1507	.4976	-.1389	.6500	.8098
.0259	.3098	.7719	.6200	.0255	-.6229	.5185	1.0168	.1507	.2476	-.1387	.6501	.8098
.0759	-.0138	.6840	.7576	.0495	-.7679	.4791	1.0825	.1507	-.2524	-.1443	.6485	.8121
.1003	-.0653	.6700	.7791	.0753	-.7792	.4763	1.0073	.1507	-.5024	-.1455	.6482	.8126
.1507	-.1403	.6496	.8105	.1002	-.7926	.4724	1.0939	.1507	-.7524	-.1394	.6499	.8101
.2003	-.1884	.6366	.8306	.1503	-.7735	.4776	1.0851	.5002	.7476	-.3893	.5820	.9153
.2503	-.2371	.6233	.8510	.1976	-.7532	.4831	1.0757	.5002	.4976	-.3952	.5804	.9178
.3001	-.2747	.6120	.8685	.2503	-.8358	.4607	1.1142	.5002	.2476	-.3997	.5742	.9197
.3502	-.3055	.6048	.8747	.3001	-.9283	.4356	1.1586	.5002	-.2524	-.3411	.5815	.9160
.4003	-.3352	.5967	.8923	.3507	-.9978	.4127	1.1930	.5002	-.5024	-.3887	.5821	.9150
.4501	-.3634	.5890	.9042	.4001	-.6319	.5161	1.0208	.5002	-.7524	-.3762	.5855	.9097
.5002	-.3967	.5800	.9184	.4501	-.4707	.5599	.9501	.8002	.7476	-.4991	.4163	1.1937
.5502	-.4312	.5706	.9331	.5001	-.3870	.5826	.9143	.8002	.4976	-.3630	.5891	.9041
.6002	-.4670	.5609	.9485	.5497	-.2524	.6165	.8616	.8002	.2476	-.3684	.5877	.9064
.6500	-.4857	.5558	.9566	.6003	-.1332	.6516	.8075	.8002	-.5024	-.3476	.5933	.8975
.7000	-.4790	.5587	.9520	.6500	-.0255	.6808	.7625	.8002	-.7524	-.3401	.5953	.8944
.7500	-.4320	.5704	.9335	.7000	.0935	.7131	.7126					
.8002	-.3623	.5893	.9038	.7501	.1934	.7403	.6703					
.9002	-.1804	.6387	.8272	.8001	.2746	.7624	.6353					
.9501	-.0570	.6723	.7757	.8501	.3417	.7806	.6060					

TEST 167	PT 32.1471	PSI	CM	.0884	CD1 .00878	CDCOR1 .00874
RUN 46	TT 124.9244	K	CM	-.1348	CD2 .00863	CDCOR2 .00864
POINT 39	RC 14.9549	MILLION	CC	.0132	CD3 .00857	CDCOR3 .00860
	MACH .7523				CD4 .00852	CDCOR4 .00855
	ALPHA -3.0243	DEG			CD5 .00803	CDCOR5 .00794

UPPER SURFACE				LOWER SURFACE				SPANWISE				
X/C	CP	P/L/PT	MLOC	X/C	CP	P/L/PT	MLOC	X/C	Y/(B/2)	CP	P/L/PT	MLOC
0.0000	.8644		.3410	0.0000	.8644	.9228	.3410	.1507	.7476	-.2275	.6265	.8461
.0132	.8446		.5409	.0126	-.4179	.5749	.9265	.1507	.4976	-.2449	.6218	.8534
.0259	.1566	.7307	.6852	.0255	-.4249	.5730	.9294	.1507	.2476	-.2450	.6218	.8534
.0759	-.1456	.6487	.8118	.0495	-.5189	.5475	.9699	.1507	-.2524	-.2510	.6201	.8559
.1003	-.1847	.6381	.8282	.0753	-.5459	.5401	.9817	.1507	-.5024	-.2531	.6196	.8568
.1507	-.2462	.6214	.8339	.1002	-.5949	.5268	1.0032	.1507	-.7524	-.2406	.6230	.8515
.2003	-.2832	.6109	.8703	.1503	-.5794	.5310	.9964	.5002	.7476	-.4524	.5655	.9412
.2503	-.3247	.6001	.8869	.1976	-.6761	.5048	1.0394	.5002	.4976	-.4581	.5639	.9437
.3001	-.3606	.5904	.9021	.2503	-.7402	.4874	1.0685	.5002	.2476	-.4630	.5626	.9458
.3502	-.3790	.5854	.9099	.3001	-.7199	.4929	1.0592	.5002	-.2524	-.4535	.5632	.9417
.4003	-.4041	.5786	.9206	.3507	-.6569	.5100	1.0307	.5002	-.5024	-.4513	.5658	.9408
.4501	-.4291	.5718	.9312	.4001	-.5714	.5332	.9929	.5002	-.7524	-.4384	.5693	.9352
.5002	-.4589	.5637	.9440	.4501	-.4849	.5567	.9552	.8002	.7476	-1.0605	.4005	1.2233
.5502	-.4886	.5557	.9568	.5001	-.3804	.5850	.9105	.8002	.4976	-.3801	.5851	.9104
.6002	-.5209	.5469	.9708	.5497	-.2479	.6210	.8546	.8002	.2476	-.3851	.5837	.9123
.6500	-.5370	.5411	.9769	.6003	-.1174	.6564	.8001	.8002	-.5024	-.3659	.5890	.9043
.7000	-.5120	.5493	.9669	.6500	-.0110	.6853	.7557	.8002	-.7524	-.3586	.5909	.9012
.7500	-.4577	.5641	.9435	.7000	.1082	.7176	.7057					
.8002	-.3777	.5858	.9093	.7501	.2085	.7448	.6632					
.9002	-.1833	.6385	.8275	.8001	.2902	.7670	.6279					
.9501	-.0549	.6734	.7740	.8501	.3578	.7853	.5983					

TEST 167	PT 32.3510	PSI	CM	.2396	CD1 .00894	CDCOR1 .00844
RUN 46	TT 124.7740	K	CM	-.1397	CD2 .00846	CDCOR2 .00840
POINT 40	RC 15.0359	MILLION	CC	.0190	CD3 .00846	CDCOR3 .00842
	MACH .7519				CD4 .00843	CDCOR4 .00837
	ALPHA -2.0060	DEG			CD5 .00806	CDCOR5 .00789

UPPER SURFACE				LOWER SURFACE				SPANWISE				
X/C	CP	P/L/PT	MLOC	X/C	CP	P/L/PT	MLOC	X/C	Y/(B/2)	CP	P/L/PT	MLOC
0.0000	1.0011	.9594	.2428	0.0000	1.0011	.9598	.2428	.1507	.7476	-.3539	.5922	.8993
.0132	.7984	.7692	.6244	.0126	-.1183	.6561	.8005	.1507	.4976	-.3735	.5868	.9077
.0259	-.0346	.6777	.7673	.0255	-.1873	.6374	.8293	.1507	.2476	-.3742	.5867	.9079
.0759	-.3114	.6037	.8814	.0495	-.3048	.6055	.8786	.1507	-.2524	-.3797	.5852	.9103
.1003	-.3333	.5977	.8906	.0753	-.3488	.5936	.8872	.1507	-.5024	-.3788	.5854	.9099
.1507	-.3751	.5864	.9083	.1002	-.4105	.5768	.9234	.1507	-.7524	-.3613	.5902	.9025
.2003	-.4060	.5780	.9215	.1503	-.4348	.5702	.9336	.5002	.7476	-.5210	.5468	.9710
.2503	-.4283	.5720	.9310	.1976	-.5249	.5458	.9727	.5002	.4976	-.5278	.5450	.9739
.3001	-.4571	.5642	.9433	.2503	-.5571	.5370	.9867	.5002	.2476	-.5333	.5435	.9763
.3502	-.4694	.5608	.9486	.3001	-.5681	.5340	.9915	.5002	-.2524	-.5216	.5467	.9712
.4003	-.4868	.5561	.9561	.3507	-.5543	.5378	.9853	.5002	-.5024	-.5196	.5472	.9703
.4501	-.5066	.5507	.9647	.4001	-.5053	.5511	.9641	.5002	-.7524	-.5058	.5509	.9644
.5002	-.5301	.5443	.9749	.4501	-.4386	.5692	.9354	.8002	.7476	-1.0887	.3941	1.2354
.5502	-.5549	.5376	.9857	.5001	-.3445	.5947	.8953	.8002	.4976	-.3912	.5820	.9152
.6002	-.5817	.5303	.9975	.5497	-.2193	.6287	.8427	.8002	.2476	-.3977	.5803	.9179
.6500	-.5972	.5289	.9999	.6003	-.0941	.6627	.7904	.8002	-.5024	-.3790	.5853	.9100
.7000	-.5476	.5396	.9825	.6500	.0080	.6904	.7478	.8002	-.7524	-.3724	.5871	.9072
.7500	-.4860	.5579	.9532	.7000	.1255	.7222	.6985					
.8002	-.3920	.5816	.9159	.7501	.2252	.7493	.6561					
.9002	-.1867	.6375	.8291	.8001	.3075	.7716	.6204					
.9501	-.0571	.6727	.7750	.8501	.3770	.7905	.5898					

ORIGINAL RECORDS
OF POOR QUALITY

TEST	167	PT	32.3456	PSI	CN	.3141	CD1	.00854	CDCR1	.00848
RUN	46	TT	124.9426	K	CM	-.1420	CD2	.00849	CDCR2	.00846
POINT	41	RC	15.0335	MILLION	CC	.0205	CD3	.00847	CDCR3	.00847
		MACH	.7514				CD4	.00841	CDCR4	.00838
		ALPHA	-1.5172	DEG			CD5	.00804	CDCR5	.00792

UPPER SURFACE				LOWER SURFACE				SPANWISE				
X/C	CP	P/L/PT	MLOC	X/C	CP	P/L/PT	MLOC	X/C	Y/(B/2)	CP	P/L/PT	MLOC
0.0000	1.0555	.9749	.1911	0.0000	1.0555	.9749	.1911	.1507	.7476	-.4248	.5744	.9272
.0132	.1902	.7408	.6695	.0126	.0156	.6935	.7430	.1507	.4976	-.4456	.5657	.9361
.0259	-.1477	.6493	.8109	.0255	-.0770	.6664	.7815	.1507	-.2476	-.4471	.5683	.9368
.0759	-.4064	.5793	.9194	.0495	-.2099	.6325	.8364	.1507	-.2524	-.4537	.5655	.9368
.1003	-.4170	.5765	.9239	.0753	-.2617	.6185	.8584	.1507	-.5024	-.4512	.5672	.9385
.1507	-.4482	.5680	.9372	.1002	-.3295	.6001	.8869	.1507	-.7524	-.4303	.5729	.9296
.2003	-.4627	.5641	.9434	.1503	-.3660	.5903	.9023	.5002	.7476	-.5613	.5376	.9860
.2503	-.4864	.5577	.9536	.1976	-.4542	.5664	.9398	.5002	.4976	-.5669	.5359	.9855
.3001	-.5113	.5510	.9643	.2503	-.4900	.5567	.9592	.5002	.2476	-.5717	.5346	.9916
.3502	-.5167	.5495	.9667	.3001	-.5073	.5520	.9626	.5002	-.5024	-.5582	.5383	.9847
.4003	-.5307	.5457	.9728	.3507	-.5043	.5529	.9613	.5002	-.7524	-.5444	.5420	.9787
.4501	-.5484	.5409	.9804	.4001	-.4681	.5626	.9458	.8002	.7476	-1.1161	.5873	1.2486
.5002	-.5676	.5357	.9888	.4501	-.4114	.5780	.9215	.8002	.4976	-.4001	.5810	.9167
.5502	-.5891	.5299	.9982	.5001	-.3246	.6015	.8848	.8002	.2476	-.4053	.5796	.9189
.6002	-.6132	.5234	1.0088	.5497	-.2042	.6340	.8345	.8002	-.5024	-.3868	.5846	.9111
.6500	-.6153	.5228	1.0097	.6003	-.0828	.6669	.7839	.8002	-.7524	-.3292	.5864	.9083
.7000	-.5652	.5364	.9878	.6400	.0161	.6937	.7427					
.7500	-.4903	.5566	.9553	.7000	.1327	.7252	.6939					
.8002	-.4000	.5811	.9167	.7501	.2321	.7521	.6516					
.9002	-.1887	.6382	.8280	.8001	.3147	.7744	.6159					
.9501	-.0573	.6738	.7733	.8501	.3851	.7939	.5949					

TEST	167	PT	32.3486	PSI	CN	.3853	CD1	.00863	CDCR1	.00844
RUN	46	TT	124.8999	K	CM	-.1444	CD2	.00857	CDCR2	.00840
POINT	42	RC	15.0337	MILLION	CC	.0211	CD3	.00852	CDCR3	.00835
		MACH	.7507				CD4	.00845	CDCR4	.00827
		ALPHA	-1.0081	DEG			CD5	.00816	CDCR5	.00796

UPPER SURFACE				LOWER SURFACE				SPANWISE				
X/C	CP	P/L/PT	MLOC	X/C	CP	P/L/PT	MLOC	X/C	Y/(B/2)	CP	P/L/PT	MLOC
0.0000	1.0989	.9862	.1413	0.0000	1.0989	.9862	.1413	.1507	.7476	-.5010	.5509	.9645
.0132	.0865	.7107	.7164	.0126	.1382	.7248	.6945	.1507	.4976	-.5235	.5447	.9743
.0259	-.2587	.6168	.8611	.0255	.0227	.6933	.7432	.1507	.2476	-.5261	.5440	.9754
.0759	-.5094	.5486	.9681	.0495	-.1359	.6502	.8096	.1507	-.2524	-.5345	.5418	.9791
.1003	-.5067	.5493	.9669	.0753	-.1842	.6371	.8298	.1507	-.5024	-.5288	.5433	.9766
.1507	-.5274	.5436	.9761	.1002	-.2599	.6165	.8616	.1507	-.7524	-.5020	.5506	.9649
.2003	-.5180	.5462	.9719	.1503	-.3069	.6037	.8814	.5002	.7476	-.5041	.5228	1.0098
.2503	-.5509	.5373	.9863	.1976	-.3969	.5792	.9196	.5002	.4976	-.6105	.5211	1.0176
.3001	-.5730	.5313	.9960	.2503	-.4391	.5677	.9377	.5002	.2476	-.6163	.5195	1.0157
.3502	-.5666	.5330	.9932	.3001	-.4616	.5616	.9474	.5002	-.2524	-.6065	.5222	1.0108
.4003	-.5789	.5287	.9986	.3507	-.4669	.5601	.9497	.5002	-.5024	-.6046	.5227	1.0100
.4501	-.5966	.5249	1.0064	.4001	-.4389	.5678	.9377	.5002	-.7524	-.5888	.5270	1.0030
.5002	-.6141	.5201	1.0142	.4501	-.3897	.5812	.9166	.8002	.7476	-1.1149	.5838	1.2554
.5522	-.6290	.5160	1.0208	.5001	-.3079	.6034	.8818	.8002	.4976	-.4030	.5775	.9222
.6002	-.6491	.5106	1.0298	.5497	-.1917	.6350	.8330	.8002	.2476	-.4084	.5761	.9246
.6500	-.6495	.5105	1.0300	.6003	-.0731	.6673	.7833	.8002	-.5024	-.3932	.5802	.9181
.7000	-.5873	.5274	1.0023	.6500	.0241	.6937	.7426	.8002	-.7524	-.3879	.5816	.9158
.7500	-.4970	.5520	.9627	.7000	.1395	.7251	.6940					
.8002	-.4035	.5774	.9225	.7501	.2383	.7520	.6517					
.9002	-.1874	.6362	.8311	.8001	.3212	.7746	.6157					
.9501	-.0576	.6715	.7768	.8501	.3922	.7939	.5842					

TEST	167	PT	32.3534	PSI	CN	.4489	CD1	.00877	CDCR1	.00827
RUN	46	TT	124.8491	K	CM	-.1429	CD2	.00869	CDCR2	.00856
POINT	43	RC	15.0412	MILLION	CC	.0203	CD3	.00865	CDCR3	.00857
		MACH	.7504				CD4	.00852	CDCR4	.00841
		ALPHA	-.5091	DEG			CD5	.00828	CDCR5	.00807

UPPER SURFACE				LOWER SURFACE				SPANWISE				
X/C	CP	P/L/PT	MLOC	X/C	CP	P/L/PT	MLOC	X/C	Y/(B/2)	CP	P/L/PT	MLOC
0.0000	1.1189	.9921	.1063	0.0000	1.1189	.9921	.1063	.1507	.7476	-.5731	.5351	.9849
.0132	-.0279	.6923	.7402	.0126	.2458	.7563	.6450	.1507	.4976	-.6030	.5270	1.0030
.0259	-.3804	.5971	.9072	.0255	-.1136	.7206	.7011	.1507	.2476	-.6077	.5257	1.0050
.0759	-.6247	.5211	1.0125	.0495	-.0570	.6742	.7727	.1507	-.2524	-.6133	.5242	1.0075
.1003	-.6009	.5276	1.0020	.0753	-.1116	.6597	.7949	.1507	-.5024	-.6025	.5271	1.0027
.1507	-.6045	.5255	1.0054	.1002	-.1908	.6383	.8278	.1507	-.7524	-.5866	.5265	.9870
.2003	-.5939	.5294	.9940	.1503	-.2561	.6234	.8509	.5002	.7476	-.6273	.5264	1.0137
.2503	-.6069	.5259	1.0047	.1976	-.3363	.5990	.8966	.5002	.4976	-.6364	.5180	1.0177
.3001	-.6254	.5209	1.0128	.2503	-.3821	.5867	.9074	.5002	.2476	-.6434	.5161	1.0204
.3502	-.6053	.5264	1.0040	.3001	-.4082	.5796	.9190	.5002	-.2524	-.6328	.5184	1.0161
.4003	-.6120	.5245	1.0069	.3507	-.4262	.5764	.9241	.5002	-.5024	-.6307	.5195	1.0152
.4501	-.6274	.5209	1.0128	.4001	-.4006	.5817	.9154	.5002	-.7524	-.6136	.5241	1.0076
.5002	-.6386	.5174	1.0186	.4501	-.3609	.5924	.8990	.8002	.7476	-1.1078	.5306	1.2422
.5502	-.6446	.5157	1.0213	.5001	-.2875	.6122	.8652	.8002	.4976	-.4054	.5804	.9178
.6002	-.6598	.5116	1.0281	.5497	-.1782	.6417	.8226	.8002	.2476	-.4110	.5788	.9202
.6500	-.6919	.5138	1.0245	.6003	-.0641	.6724	.7752	.8002	-.5024	-.3966	.5827	.9141
.7000	-.5856	.5317	.9953	.6500	.0247	.6976	.7366	.8002	-.7524	-.3913	.5842	.9115
.7500	-.4983	.5543	.9575	.7003	.1420	.7242	.6991					
.8002	-.4049	.5805	.9176	.7501	.2397	.7546	.6476					
.9002	-.1889	.6399	.8270	.8001	.3219	.7764	.6121					
.9501	-.0571	.6745	.7723	.8501	.3928	.7960	.5809					

TFST	167	PT	32.3546	PSI	CM	.9273	CD1	.00893	CDCDR1	.00880
RUN	46	TT	124.8288	K	CM	-.1443	CD2	.00886	CDCDR2	.00880
POINT	44	RC	19.0423	MILLION	CC	.0189	CD3	.00886	CDCDR3	.00884
		MACH	.7501	DEG			CD4	.00862	CDCDR4	.00856
		ALPHA	.0000				CD5	.00833	CDCDR5	.00815

UPPER SURFACE				LOWER SURFACE				SPANWISE				
X/C	CP	P/L/PT	MLOC	X/C	CP	P/L/PT	MLOC	X/C	Y/(B/2)	CP	P/L/PT	MLOC
0.0000	1.1370	.9974	.0603	0.0000	1.1370	.9974	.0603	.1507	.7476	-.6700	.9123	1.0270
.0132	-.1490	.4522	.8066	.0126	.4503	.7862	.5968	.1507	.4976	-.6963	.5052	1.0387
.0259	-.5146	.5540	.9505	.0255	.1986	.7457	.6617	.1507	.2476	-.6989	.5045	1.0398
.0759	-.7868	.4863	1.0703	.0495	-.0188	.6972	.7373	.1507	-.2524	-.6971	.5050	1.0390
.1003	-.7675	.4861	1.0703	.0753	-.0433	.6805	.7629	.1507	-.5024	-.6919	.5064	1.0367
.1507	-.6972	.5050	1.0391	.1002	-.1276	.6579	.7977	.1507	-.7524	-.6864	.5159	1.0210
.2003	-.6872	.5077	1.0346	.1503	-.1915	.6407	.8241	.5002	.7476	-.6756	.5108	1.0295
.2503	-.6722	.5117	1.0280	.1976	-.2839	.6159	.8624	.5002	.4976	-.6865	.5078	1.0343
.3001	-.7040	.5032	1.0421	.2503	-.3244	.6024	.8834	.5002	.2476	-.6934	.5060	1.0374
.3502	-.6745	.5111	1.0290	.3001	-.3647	.5947	.8961	.5002	-.2524	-.6826	.5089	1.0326
.4003	-.6575	.5111	.0215	.3507	-.3822	.5885	.9034	.5002	-.5024	-.6810	.5093	1.0319
.4501	-.6712	.5120	1.0275	.4001	-.3693	.5930	.8980	.5002	-.7524	-.6808	.5148	1.0229
.5002	-.6874	.5076	1.0347	.4501	-.3368	.6017	.8844	.8002	.7476	-1.1307	.3886	1.2461
.5502	-.6855	.5081	1.0339	.5001	-.2706	.6195	.8569	.8002	.4976	-.4158	.5805	.9175
.6002	-.6912	.5066	1.0364	.5597	-.1865	.6475	.8138	.8002	.2476	-.4206	.5792	.9196
.6500	-.6763	.5166	1.0298	.6003	-.0586	.6771	.7682	.8002	-.5024	-.4066	.5830	.9137
.7000	-.6042	.5199	.9982	.6500	.0340	.7013	.7310	.8002	-.7524	-.4009	.5845	.9113
.7500	-.5092	.5555	.9572	.7000	.1458	.7313	.6843					
.8002	-.4137	.5811	.9167	.7501	.2428	.7574	.6433					
.9002	-.1938	.6401	.8251	.8001	.3249	.7794	.6079					
.9501	-.0617	.6756	.7705	.8501	.3963	.7986	.5765					

TEST	167	PT	32.3433	PSI	CM	.6095	CD1	.00925	CDCDR1	.00903
RUN	46	TT	124.9152	K	CM	-.1469	CD2	.00916	CDCDR2	.00890
POINT	45	RC	19.0338	MILLION	CC	.0171	CD3	.00910	CDCDR3	.00889
		MACH	.7511	DEG			CD4	.00886	CDCDR4	.00884
		ALPHA	.4990				CD5	.00865	CDCDR5	.00843

UPPER SURFACE				LOWER SURFACE				SPANWISE				
X/C	CP	P/L/PT	MLOC	X/C	CP	P/L/PT	MLOC	X/C	Y/(B/2)	CP	P/L/PT	MLOC
0.0000	1.1499	1.0002	0.0000	0.0000	1.1499	1.0002	0.0000	.1507	.7476	-.6876	.4694	1.0992
.0132	-.2377	.6239	.8500	.0126	.4500	.8104	.5567	.1507	.4976	-.6585	.4556	1.1232
.0259	-.6157	.5214	1.0120	.0255	.2874	.7663	.6290	.1507	.2476	-.6721	.4519	1.1296
.0759	-.8643	.4540	1.1259	.0495	.0999	.7155	.7090	.1507	-.2524	-.6725	.4518	1.1298
.1003	-.8786	.4501	1.1327	.0753	-.0316	.6970	.7376	.1507	-.5024	-.6638	.4541	1.1257
.1507	-.8664	.4540	1.1259	.1002	-.0587	.6725	.7753	.1507	-.7524	-.6725	.4627	1.0595
.2003	-.8215	.4656	1.1057	.1503	-.1291	.6534	.8047	.5002	.7476	-.7171	.4939	1.0575
.2503	-.7640	.4812	1.0790	.1976	-.2234	.6278	.8441	.5002	.4976	-.7296	.4905	1.0632
.3001	-.6834	.5030	1.0423	.2503	-.2774	.6132	.8667	.5002	.2476	-.7300	.4904	1.0634
.3502	-.7225	.4924	1.0600	.3001	-.3124	.6037	.8814	.5002	-.2524	-.7116	.4954	1.0550
.4003	-.7320	.4899	1.0643	.3507	-.3333	.5980	.8902	.5002	-.5024	-.7203	.4937	1.0590
.4501	-.7210	.4928	1.0593	.4001	-.3257	.6000	.8870	.5002	-.7524	-.7027	.4978	1.0510
.5002	-.7218	.4926	1.0596	.4501	-.2986	.6074	.8756	.8002	.7476	-1.0929	.3920	1.2396
.5502	-.7268	.4813	1.0619	.5001	-.2373	.6240	.8499	.8002	.4976	-.4014	.5795	.9191
.6002	-.7284	.4908	1.0627	.5497	-.1378	.6510	.8083	.8002	.2476	-.4076	.5779	.9217
.6500	-.6911	.5009	1.0458	.6003	-.0313	.6799	.7630	.8002	-.5024	-.3916	.5821	.9150
.7000	-.6043	.5240	1.0079	.6500	.0586	.7037	.7272	.8002	-.7524	-.3867	.5835	.9129
.7500	-.5006	.5526	.9617	.7000	.1663	.7235	.6809					
.8002	-.4031	.5791	.9194	.7501	.2614	.7593	.6402					
.9002	-.1823	.6389	.8269	.8001	.3430	.7814	.6046					
.9501	-.0561	.6732	.7743	.8501	.4142	.8007	.5729					

TFST	167	PT	32.3540	PSI	CM	.9867	CD1	.00961	CDCDR1	.00939
RUN	46	TT	124.9425	K	CM	-.1447	CD2	.00954	CDCDR2	.00940
POINT	46	RC	19.0262	MILLION	CC	.0140	CD3	.00949	CDCDR3	.00941
		MACH	.7589	DEG			CD4	.00922	CDCDR4	.00909
		ALPHA	1.0081				CD5	.00914	CDCDR5	.00890

UPPER SURFACE				LOWER SURFACE				SPANWISE				
X/C	CP	P/L/PT	MLOC	X/C	CP	P/L/PT	MLOC	X/C	Y/(B/2)	CP	P/L/PT	MLOC
0.0000	1.1448	.9991	.0367	0.0000	1.1448	.9991	.0367	.1507	.7476	-.9378	.4360	1.1579
.0132	-.3380	.5961	.8900	.0126	.5385	.8330	.5180	.1507	.4976	-.9475	.4198	1.1872
.0259	-.7086	.4979	1.0508	.0255	.3354	.7856	.5978	.1507	.2476	-.9877	.4223	1.1824
.0759	-.9675	.4279	1.1724	.0495	.1658	.7344	.6795	.1507	-.2524	-.9901	.4218	1.1836
.1003	-.9822	.4240	1.1796	.0753	-.0905	.7140	.7113	.1507	-.5024	-1.0866	.4174	1.1918
.1507	-.9757	.4257	1.1764	.1002	-.0017	.6891	.7490	.1507	-.7524	-.9254	.4303	1.1519
.2003	-.9614	.4295	1.1695	.1503	-.0787	.6683	.7814	.5002	.7476	-.6758	.5060	1.0360
.2503	-.9675	.4279	1.1724	.1976	-.1743	.6424	.8216	.5002	.4976	-.6649	.5099	1.0311
.3001	-.9747	.4260	1.1759	.2503	-.2324	.6267	.8497	.5002	.2476	-.6748	.5071	1.0356
.3502	-.9870	.4497	1.1334	.3001	-.2703	.6169	.8616	.5002	-.2524	-.6793	.5059	1.0376
.4001	-.9764	.4931	1.0585	.3507	-.2947	.6099	.8718	.5002	-.5024	-.6748	.5071	1.0356
.4501	-.6655	.5096	1.0314	.4001	-.2922	.6105	.8708	.5002	-.7524	-.6797	.5050	1.0376
.5002	-.6816	.5053	1.0386	.4501	-.2712	.6162	.8619	.8002	.7476	-1.1020	.3916	1.2403
.5502	-.7625	.4996	1.0480	.5001	-.2163	.6310	.8390	.8002	.4976	-.4051	.5800	.9164
.6002	-.7249	.4935	1.0581	.5497	-.1228	.6564	.8001	.8002	.2476	-.4100	.5787	.9204
.6500	-.7025	.4996	1.0480	.6003	-.0204	.6846	.7576	.8002	-.5024	-.3962	.5824	.9146
.7000	-.6099	.5246	1.0368	.6500	.0636	.7067	.7225	.8002	-.7524	-.3897	.5842	.9118
.7500	-.5013	.5540	.9595	.7000	.1711	.7350	.6773					
.8002	-.4037	.5804	.9178	.7501	.2646	.7611	.6373					
.9002	-.1826	.6402	.8250	.8001	.3493	.7829	.6022					
.9501	-.0549	.6747	.7719	.8501	.4163	.8021	.5766					

ORIGINAL PAGE IS
OF POOR QUALITY

TEST	167	PT	32.3499	PSI	CM	.7725	CD1	.01051	CDCOR1	.01017
RUN	46	TT	125.1483	K	CC	-1.456	CD2	.01069	CDCOR2	.01039
POINT	47	HC	14.9863	MILLION	CC	.0114	CD3	.01087	CDCOR3	.01047
		MACH	.7504				CD4	.01091	CDCOR4	.01019
		ALPHA	1.5172	DEG			CD5	.01086	CDCOR5	.01052

UPPER SURFACE				LOWER SURFACE				SPANWISE				
X/C	CP	P/L/PT	MLOC	X/C	CP	P/L/PT	MLOC	X/C	Y/(R/2)	CP	P/L/PT	MLOC
0.0000	1.1502	1.0009	0.0000	0.0000	1.1502	1.0008	0.0000	.1507	.7476	-1.9934	.4233	1.1409
.0132	-.4281	.5756	.9254	.0126	.6031	.8534	.4817	.1507	.4976	-1.1008	.1343	1.2350
.0259	-.7868	.4789	1.0828	.0255	.4185	.7037	.5680	.1507	.2476	-1.0751	.4013	1.2219
.0759	-1.0507	.4078	1.2095	.0495	.2282	.7524	.6512	.1507	-.2524	-1.0745	.4014	1.2215
.1003	-1.0687	.4030	1.2186	.0753	.1460	.7302	.6880	.1507	-.5024	-1.0959	.3957	1.2325
.1507	-1.0619	.4048	1.2151	.1002	.0531	.7052	.7249	.1507	-.7524	-1.0081	.4193	1.1882
.2003	-1.0518	.4075	1.2101	.1503	-.0302	.6826	.7595	.5002	.7476	-.8281	.4678	1.1019
.2503	-1.0646	.4041	1.2165	.1976	-.1284	.6563	.8002	.5002	.4476	-.8543	.4607	1.1141
.3001	-1.0912	.3969	1.2301	.2503	-.1904	.6396	.8259	.5002	.2476	-.8334	.4664	1.1043
.3562	-1.0903	.3972	1.2296	.3001	-.2310	.6287	.8427	.5002	-.2524	-.8266	.4682	1.1012
.4003	-1.0435	.4098	1.2059	.3507	-.2587	.6212	.8543	.5002	-.5024	-.8853	.4524	1.1287
.4501	-.9436	.4367	1.1566	.4001	-.2607	.6207	.8551	.5002	-.7524	-.8410	.4643	1.1079
.5002	-.7988	.4757	1.0883	.4501	-.2430	.6249	.8486	.8002	.7476	-1.0731	.4018	1.2208
.5502	-.6739	.5093	1.0316	.5001	-.1955	.6382	.8280	.8002	.4976	-.9992	.5834	.9131
.6002	-.6233	.5230	1.0095	.5497	-.1061	.6623	.7910	.8002	.2476	-.4054	.5817	.9157
.6500	-.5982	.5498	.9985	.6003	-.0069	.6890	.7499	.8002	-.5024	-.3909	.5856	.9086
.7000	-.5644	.5388	.9838	.6500	.0742	.7109	.7161	.8002	-.7524	-.3791	.5888	.9046
.7500	-.4884	.5590	.9515	.7000	.1801	.7394	.6716					
.8002	-.3973	.5839	.9123	.7501	.2730	.7644	.6320					
.9002	-.1788	.6427	.8211	.8001	.3530	.7860	.5971					
.9501	-.0505	.6773	.7679	.8501	.4242	.8052	.5655					

TEST	167	PT	32.3556	PSI	CM	.8707	CD1	.01356	CDCOR1	.01288
RUN	46	TT	125.1685	K	CC	-1.554	CD2	.01421	CDCOR2	.01331
POINT	43	HC	14.9877	MILLION	CC	.0104	CD3	.01475	CDCOR3	.01433
		MACH	.7505				CD4	.01507	CDCOR4	.01442
		ALPHA	2.0060	DEG			CD5	.01525	CDCOR5	.01466

UPPER SURFACE				LOWER SURFACE				SPANWISE				
X/C	CP	P/L/PT	MLOC	X/C	CP	P/L/PT	MLOC	X/C	Y/(R/2)	CP	P/L/PT	MLOC
0.0000	1.1370	.9970	.0650	0.0000	1.1370	.9970	.0650	.1507	.7476	-1.0573	.4044	1.2160
.0132	-.5096	.5523	.9622	.0126	.6598	.8682	.4543	.1507	.4976	-1.1767	.3721	1.2784
.0259	-.8765	.4532	1.1273	.0255	.4711	.8172	.5452	.1507	.2476	-1.1486	.3787	1.2634
.0759	-1.1227	.3867	1.2498	.0495	.2774	.7649	.6313	.1507	-.2524	-1.1478	.3799	1.2630
.1003	-1.1417	.3816	1.2598	.0753	.1910	.7415	.6683	.1507	-.5024	-1.1683	.3744	1.2739
.1507	-1.1383	.3825	1.2580	.1002	.0944	.7154	.7490	.1507	-.7524	-1.0624	.4030	1.2186
.2003	-1.1253	.3860	1.2511	.1503	.0069	.6918	.7456	.5002	.7476	-1.1275	.3854	1.2523
.2503	-1.1365	.3830	1.2570	.1976	-.0930	.6648	.7871	.5002	.4976	-1.1473	.3801	1.2627
.3001	-1.1671	.3747	1.2733	.2503	-.1576	.6474	.8134	.5002	.2476	-1.1561	.3777	1.2674
.3562	-1.1781	.3718	1.2792	.3001	-.2008	.6357	.8319	.5002	-.2524	-1.1189	.3877	1.2478
.4003	-1.1760	.3723	1.2791	.3507	-.2320	.6273	.8444	.5002	-.5024	-1.1402	.3820	1.2590
.4501	-1.1410	.3818	1.2594	.4001	-.2575	.6258	.8471	.5002	-.7524	-1.0923	.3949	1.2339
.5002	-1.1216	.3870	1.2492	.4501	-.2259	.6289	.8423	.8002	.7476	-.9704	.4278	1.1726
.5502	-1.0790	.3985	1.2270	.5001	-.1408	.6411	.8235	.8002	.4976	-.9688	.5403	.9622
.6002	-.8058	.4723	1.0941	.5497	-.0958	.6641	.7843	.8002	.2476	-.9776	.5890	.9042
.6500	-.5634	.5376	.9857	.6003	-.0002	.6899	.7485	.8002	-.5024	-.3647	.5914	.9005
.7000	-.4920	.5571	.9546	.6500	.0783	.7111	.7158	.8002	-.7524	-.3545	.5942	.8961
.7500	-.4197	.5712	.9322	.7000	.1822	.7392	.6720					
.8002	-.3686	.5904	.9021	.7501	.2737	.7639	.6329					
.9002	-.1735	.6431	.8205	.8001	.3531	.7853	.5983					
.9501	-.0591	.6751	.7713	.8501	.4240	.8045	.5667					

TEST	167	PT	32.3446	PSI	CM	.9471	CD1	.01447	CDCOR1	.01445
RUN	46	TT	125.0421	K	CC	-1.654	CD2	.02035	CDCOR2	.01481
POINT	49	HC	15.0045	MILLION	CC	.0107	CD3	.02219	CDCOR3	.02138
		MACH	.7511				CD4	.02267	CDCOR4	.02185
		ALPHA	2.5050	DEG			CD5	.02223	CDCOR5	.02134

UPPER SURFACE				LOWER SURFACE				SPANWISE				
X/C	CP	P/L/PT	MLOC	X/C	CP	P/L/PT	MLOC	X/C	Y/(R/2)	CP	P/L/PT	MLOC
0.0000	1.1274	.9944	.0499	0.0000	1.1274	.9944	.0499	.1507	.7476	-1.1224	.3448	1.2536
.0132	-.5684	.5350	.9499	.0126	.7061	.8841	.4312	.1507	.4976	-1.2316	.3553	1.3126
.0259	-.9370	.4171	1.1595	.0255	.5162	.8287	.5255	.1507	.2476	-1.2019	.3633	1.2961
.0759	-1.1783	.3762	1.2422	.0495	.3214	.7759	.6135	.1507	-.2524	-1.1945	.3683	1.2943
.1003	-1.1922	.3654	1.2408	.0753	.2314	.7515	.6525	.1507	-.5024	-1.2188	.3548	1.3053
.1507	-1.1914	.3682	1.2404	.1002	.1330	.7249	.6943	.1507	-.7524	-1.1078	.3802	1.2431
.2003	-1.1775	.3684	1.2428	.1503	.0418	.7002	.7327	.5002	.7476	-1.2040	.3622	1.2584
.2503	-1.1481	.3871	1.2488	.1976	-.0599	.6727	.7750	.5002	.4976	-1.2155	.3596	1.3036
.3001	-1.2188	.3586	1.3054	.2503	-.1275	.6543	.8032	.5002	.2476	-1.2271	.3585	1.3101
.3562	-1.2309	.3555	1.3122	.3001	-.1737	.6416	.8225	.5002	-.2524	-1.2045	.3626	1.2476
.4003	-1.2364	.3539	1.3154	.3507	-.2081	.6325	.8368	.5002	-.5024	-1.1854	.3679	1.2671
.4501	-1.2482	.3504	1.3219	.4001	-.2171	.6301	.8405	.5002	-.7524	-1.1725	.3715	1.2831
.5002	-1.2174	.3591	1.3048	.4501	-.2093	.6322	.8373	.8002	.7476	-.9017	.4446	1.1424
.5502	-1.2208	.3543	1.3165	.5001	-.1680	.6434	.8201	.8002	.4976	-.9384	.5072	.8915
.6002	-1.1644	.3734	1.2758	.5497	-.0844	.6655	.7961	.8002	.2476	-.9393	.5470	.9115
.6500	-.8940	.5064	1.0467	.6003	.0069	.6896	.7474	.8002	-.5024	-.3346	.5389	.9220
.7000	-.5043	.5523	.9622	.6500	.0833	.7114	.7151	.8002	-.7524	-.3346	.5442	.8946
.7500	-.4148	.5765	.9238	.7000	.1857	.7394	.6723					
.8002	-.3376	.5976	.8408	.7501	.2760	.7636	.6331					
.9002	-.1568	.6444	.8154	.8001	.3549	.7850	.5989					
.9501	-.0448	.6774	.7709	.8501	.4256	.8041	.5672					

TEST 167 PT 32.3441 PSI CN .9999
 RUN 46 TT 125.0919 K CM -.1708
 POINT 90 PC 15.0037 MILLION CC .0112
 MACH .7512
 ALPHA 3.0007 DEG

C01 .02879 CDCR1 .02784
 C02 .02714 CDCR2 .02643
 C03 .03250 CDCR3 .03131
 C04 .03143 CDCR4 .03009
 C05 .02925 CDCR5 .02843

UPPER SURFACE				LOWER SURFACE				SPANWISE				
X/C	CP	P.L./PT	MLOC	X/C	CP	P.L./PT	MLOC	X/C	Y/(B/2)	CP	P.L./PT	MLOC
0.0000	1.1116	.9899	1.225	0.0000	1.1116	.9899	1.205	.1507	.7476	-1.2125	.3599	1.3030
.0132	-.6267	.5187	1.0164	.0126	-.7451	.8906	.8104	.1507	.4976	-1.2814	.3413	1.3419
.0259	-.9918	.4198	1.1873	.0255	-.9537	.8387	.9080	.1507	.2476	-1.2534	.3489	1.3259
.0759	-1.2307	.3550	1.3131	.0495	-.9882	.7857	.9974	.1507	-.2524	-1.2466	.3502	1.3232
.1003	-1.2454	.3509	1.3216	.0753	-.2638	.7601	.6384	.1507	-.5024	-1.2080	.3449	1.3342
.1507	-1.2431	.3517	1.3201	.1002	.1818	.7324	.6825	.1507	-.7524	-1.1985	.3746	1.2736
.2003	-1.2289	.3555	1.3122	.1503	.0875	.7069	.7223	.5002	.7476	-1.2644	.3459	1.3322
.2503	-1.2382	.3530	1.3173	.1976	-.0362	.6798	.7656	.5002	.4976	-1.2707	.3442	1.3357
.3001	-1.2645	.3448	1.3384	.2503	-.1070	.6596	.7951	.5002	.2476	-1.3073	.3342	1.3569
.3502	-1.2822	.3411	1.3423	.3001	-.1582	.6463	.8156	.5002	-.2524	-1.2559	.3482	1.3273
.4003	-1.2844	.3394	1.3439	.3507	-.1942	.6360	.8315	.5002	-.5024	-1.2223	.3573	1.3084
.4501	-1.3634	.3344	1.3567	.4001	-.2067	.6326	.8367	.5002	-.7524	-1.2293	.3554	1.3123
.5002	-1.3215	.3304	1.3632	.4501	-.2022	.6338	.8348	.8002	.7476	-.8939	.6463	1.1394
.5502	-1.2720	.3438	1.3385	.5001	-.1847	.6439	.8192	.8002	.4976	-1.3440	.5953	.8944
.6002	-1.2655	.3456	1.3328	.5497	-.0883	.6652	.7865	.8002	.2476	-1.3910	.5934	.8973
.6500	-.7188	.4943	1.0589	.6003	.0041	.6897	.7488	.8002	-.5024	-1.3452	.5950	.8944
.7000	-.5934	.5386	.9641	.6500	.0793	.7101	.7173	.8002	-.7524	-1.3421	.5959	.8935
.7500	-.4432	.5885	.9365	.7000	.1805	.7375	.6746					
.8002	-.3461	.5948	.8952	.7501	.2699	.7618	.6363					
.8002	-.1949	.6453	.8172	.8001	.3484	.7930	.6020					
.8501	-.0889	.6705	.7784	.8501	.4193	.8022	.5704					

TEST 167 PT 32.3467 PSI CN 1.0123
 RUN 46 TT 125.1022 K CP -.1664
 POINT 51 PC 15.0073 MILLION CC .0109
 MACH .7516
 ALPHA 3.9230 DEG

C01 .04053 CDCR1 .03955
 C02 .03805 CDCR2 .03723
 C03 .03767 CDCR3 .03651
 C04 .03684 CDCR4 .03568
 C05 .03341 CDCR5 .03242

UPPER SURFACE				LOWER SURFACE				SPANWISE				
X/C	CP	P.L./PT	MLOC	X/C	CP	P.L./PT	MLOC	X/C	Y/(B/2)	CP	P.L./PT	MLOC
0.0000	1.1045	.9874	1.327	0.0000	1.1045	.9878	1.327	.1507	.7476	-1.2923	.3365	1.3520
.0132	-.6697	.5057	1.0379	.0126	-.7848	.9009	.8092	.1507	.4976	-1.3170	.3298	1.3665
.0259	-1.0306	.4076	1.2099	.0255	-.9418	.8490	.8895	.1507	.2476	-1.2868	.3380	1.3488
.0759	-1.2676	.3433	1.3377	.0495	-.9979	.7958	.9810	.1507	-.2524	-1.2807	.3397	1.3453
.1003	-1.2792	.3401	1.3444	.0753	-.3009	.7694	.6240	.1507	-.5024	-1.2984	.3349	1.3555
.1507	-1.2765	.3408	1.3428	.1002	-.1975	.7413	.6686	.1507	-.7524	-1.2885	.3593	1.3043
.2003	-1.2610	.3450	1.3339	.1503	-.1000	.7148	.7100	.5002	.7476	-1.2979	.3350	1.3553
.2503	-1.2702	.3425	1.3392	.1976	-.0058	.6861	.7544	.5002	.4976	-1.3008	.3342	1.3570
.3001	-1.2994	.3346	1.3561	.2503	-.0797	.6660	.7852	.5002	.2476	-1.3297	.3264	1.3741
.3502	-1.3125	.3310	1.3639	.3001	-.1319	.6518	.8071	.5002	-.2524	-1.2959	.3355	1.3541
.4003	-1.3198	.3291	1.3667	.3507	-.1733	.6406	.8243	.5002	-.5024	-1.2425	.3501	1.3234
.4501	-1.3404	.3233	1.3804	.4001	-.1895	.6362	.8311	.5002	-.7524	-1.2455	.3493	1.3231
.5002	-1.3431	.3171	1.3944	.4501	-.1889	.6363	.8309	.8002	.7476	-.9046	.6460	1.1492
.5502	-1.2784	.3560	1.3099	.5001	-.1545	.6457	.8165	.8002	.4976	-1.3509	.5923	.8991
.6002	-.8972	.4548	1.1245	.5497	-.0797	.6660	.7853	.8002	.2476	-1.3686	.5875	.9006
.6500	-.6743	.5099	1.0309	.6003	.0084	.6900	.7484	.8002	-.5024	-1.3474	.5933	.8976
.7000	-.5585	.5559	.9485	.6500	.0815	.7098	.7177					
.7500	-.4408	.5625	.9480	.7000	.1814	.7370	.6755					
.8002	-.3439	.5688	.9046	.7501	.2700	.7610	.6374					
.8002	-.1833	.6379	.8285	.8001	.3478	.7822	.6034					
.8501	-.0817	.6576	.7902	.8501	.4183	.8013	.5710					

TEST 167	PT 43.7996	PSI	CN	-0.0465	CD1 .00910	CDCDR1 .00892
RUN 38	TT 96.6272	K	CM	-1.1358	CD2 .00882	CDCDR2 .00870
POINT 21	PC 29.7754	MILLION	CC	.0062	CD3 .00866	CDCDR3 .00859
	MACH .7512				CD4 .00842	CDCDR4 .00830
	ALPHA -3.9917	DEG			CD5 .00813	CDCDR5 .00787

UPPER SURFACE				LOWER SURFACE				SPANWISE				
X/C	CP	P/L/PT	MLOC	X/C	CP	P/L/PT	MLOC	X/C	Y/(B/2)	CP	P/L/PT	MLOC
0.0000	.7347	.8876	.4180	0.0000	.7347	.8876	.4180	.1507	.7476	-.1306	.6534	.8072
.0132	.6295	.8591	.4728	.0126	-.6778	.5052	1.0413	.1507	.4976	-.1372	.6516	.8099
.0259	.3198	.7753	.6166	.0255	-.6272	.5189	1.0188	.1507	.2476	-.1388	.6511	.8106
.0759	-.0119	.6855	.7577	.0495	-.7698	.4803	1.0831	.1507	-.2524	-.1458	.6492	.8135
.1003	-.0649	.6711	.7798	.0753	-.7765	.4785	1.0862	.1507	-.5024	-.1517	.6476	.8160
.1507	-.1388	.6511	.8106	.1002	-.7919	.4743	1.0933	.1507	-.7524	-.1448	.6495	.8131
.2003	-.1864	.6382	.8305	.1503	-.7735	.4793	1.0848	.5002	.4776	-.3958	.5816	.9185
.2503	-.2365	.6247	.8514	.1976	-.7698	.4803	1.0831	.5002	.4976	-.4005	.5803	.9205
.3001	-.2803	.6128	.8697	.2503	-.8295	.4641	1.1109	.5002	.2476	-.4047	.5791	.9223
.3502	-.3067	.6057	.8809	.3001	-.9184	.4401	1.1531	.5002	-.2524	-.3948	.5818	.9181
.4003	-.3362	.5977	.8933	.3507	-.9962	.4190	1.1913	.5002	-.5024	-.3925	.5825	.9171
.4501	-.3612	.5909	.9038	.4001	-.6958	.5003	1.0454	.8002	.7476	-1.0353	.4084	1.2110
.5002	-.4016	.5800	.9210	.4501	-.4538	.5659	.9432	.8002	.4976	-.3709	.5883	.9079
.5502	-.4374	.5703	.9362	.5001	-.3789	.5862	.9112	.8002	.2476	-.3759	.5869	.9101
.6002	-.4735	.5605	.9517	.5497	-.2557	.6195	.8594	.8002	-.5024	-.3433	.5958	.8963
.6500	-.4945	.5548	.9607	.6003	-.1258	.6546	.8052	.8002	-.7524	-.3386	.5970	.8943
.7000	-.4828	.5580	.9557	.6500	-.0230	.6825	.7623					
.7500	-.4395	.5697	.9372	.7000	.1022	.7164	.7099					
.8000	-.3700	.5885	.9076	.7501	.2059	.7443	.6660					
.9002	-.1903	.6372	.8321	.8001	.2902	.7673	.6295					
.9501	-.0683	.6702	.7812	.8501	.3602	.7862	.5988					

TEST 167	PT 43.8583	PSI	CN	.1038	CD1 .00796	CDCDR1 .00795
RUN 38	TT 96.3387	K	CM	-1.1412	CD2 .00783	CDCDR2 .00777
POINT 22	PC 29.9409	MILLION	CC	.0144	CD3 .00787	CDCDR3 .00787
	MACH .7510				CD4 .00775	CDCDR4 .00770
	ALPHA -3.0141	DEG			CD5 .00769	CDCDR5 .00750

UPPER SURFACE				LOWER SURFACE				SPANWISE				
X/C	CP	P/L/PT	MLOC	X/C	CP	P/L/PT	MLOC	X/C	Y/(B/2)	CP	P/L/PT	MLOC
0.0000	.8717	.9249	.3372	0.0000	.8717	.9249	.3372	.1507	.7476	-.2397	.6245	.8517
.0132	.4638	.8201	.5422	.0126	-.3931	.5830	.9162	.1507	.4976	-.2477	.6223	.8556
.0259	.1582	.7320	.6854	.0255	-.4249	.5744	.9297	.1507	.2476	-.2500	.6217	.8560
.0759	-.1513	.6484	.8148	.0495	-.5199	.5488	.9705	.1507	-.2524	-.2570	.6198	.8589
.1003	-.1904	.6378	.8311	.0753	-.5421	.5425	.9806	.1507	-.5024	-.2618	.6185	.8609
.1507	-.2496	.6218	.8559	.1002	-.5930	.5290	1.0023	.1507	-.7524	-.2519	.6212	.8628
.2003	-.2853	.6122	.8708	.1503	-.5768	.5334	.9953	.5002	.7476	-.4628	.5642	.9459
.2503	-.3282	.6006	.8888	.1976	-.6750	.5058	1.0387	.5002	.4976	-.4676	.5629	.9480
.3001	-.3672	.5900	.9052	.2503	-.7425	.4886	1.0691	.5002	.2476	-.4724	.5616	.9500
.3502	-.3875	.5845	.9138	.3001	-.7232	.4938	1.0604	.5002	-.2524	-.4607	.5647	.9450
.4003	-.4117	.5780	.9241	.3507	-.6485	.5140	1.0269	.5002	-.5024	-.4586	.5653	.9441
.4501	-.4325	.5724	.9330	.4001	-.5677	.5358	.9913	.5002	-.7524	-.4450	.5690	.9385
.5002	-.4692	.5624	.9487	.4501	-.4621	.5590	.9542	.8002	.7476	-1.0925	.3940	1.2383
.5502	-.5017	.5537	.9626	.5001	-.3781	.5871	.9098	.8002	.4976	-.3908	.5836	.9153
.6002	-.5334	.5451	.9763	.5497	-.2447	.6231	.8538	.8002	.2476	-.3961	.5822	.9175
.6500	-.5497	.5407	.9834	.6003	-.1127	.6588	.7988	.8002	-.5024	-.3634	.5911	.9036
.7000	-.5249	.5474	.9727	.6500	-.0107	.6864	.7563	.8002	-.7524	-.3585	.5924	.9016
.7500	-.4498	.5623	.9489	.7000	.1151	.7204	.7036					
.8002	-.3900	.5839	.9149	.7501	.2190	.7485	.6595					
.9002	-.1979	.6358	.8342	.8001	.3046	.7716	.6225					
.9501	-.0715	.6700	.7810	.8501	.3761	.7909	.5910					

TEST 167	PT 43.8403	PSI	CN	.2589	CD1 .00784	CDCDR1 .00775
RUN 38	TT 96.4148	K	CM	-1.1457	CD2 .00772	CDCDR2 .00767
POINT 23	PC 29.8857	MILLION	CC	.0203	CD3 .00777	CDCDR3 .00777
	MACH .7506				CD4 .00766	CDCDR4 .00761
	ALPHA -1.9958	DEG			CD5 .00764	CDCDR5 .00745

UPPER SURFACE				LOWER SURFACE				SPANWISE				
X/C	CP	P/L/PT	MLOC	X/C	CP	P/L/PT	MLOC	X/C	Y/(B/2)	CP	P/L/PT	MLOC
0.0000	1.0098	.9626	.2348	0.0000	1.0098	.9726	.2348	.1507	.7476	-.3689	.5915	.9029
.0132	.2964	.7706	.6241	.0126	-.0911	.6063	.7872	.1507	.4976	-.3803	.5885	.9077
.0259	-.0476	.6780	.7692	.0255	-.1796	.6425	.8239	.1507	.2476	-.3849	.5872	.9096
.0759	-.3263	.6030	.8850	.0495	-.2961	.6111	.8724	.1507	-.2524	-.3927	.5891	.9129
.1003	-.3457	.5978	.8931	.0753	-.3422	.5987	.8917	.1507	-.5024	-.3962	.5842	.9144
.1507	-.3846	.5873	.9095	.1002	-.4051	.5818	.9181	.1507	-.7524	-.3826	.5878	.9087
.2003	-.4023	.5825	.9169	.1503	-.4293	.5753	.9204	.5002	.7476	-.5377	.5461	.9747
.2503	-.4367	.5733	.9315	.1976	-.5193	.5510	.9664	.5002	.4976	-.5420	.5449	.9766
.3001	-.4687	.5647	.9451	.2503	-.5489	.5431	.9796	.5002	.2476	-.5466	.5437	.97
.3502	-.4776	.5623	.9489	.3001	-.5595	.5402	.9842	.5002	-.2524	-.5343	.5470	.9733
.4003	-.4956	.5574	.9566	.3507	-.5459	.5439	.9783	.5002	-.5024	-.5327	.5474	.9726
.4501	-.5128	.5528	.9640	.4001	-.4978	.5568	.9576	.5002	-.7524	-.5176	.5515	.9660
.5002	-.5426	.5448	.9768	.4501	-.4345	.5739	.9306	.8002	.7476	-1.1459	.3824	1.2607
.5502	-.5692	.5376	.9884	.5001	-.3412	.5990	.8912	.8002	.4976	-.4068	.5813	.9188
.6002	-.5936	.5305	.9999	.5497	-.2161	.6327	.8390	.8002	.2476	-.4114	.5801	.9208
.6500	-.6054	.5279	1.0041	.6003	-.0897	.6667	.7866	.8002	-.5024	-.3803	.5885	.9077
.7000	-.5628	.5393	.9856	.6500	.0067	.6926	.7466	.8002	-.7524	-.3765	.5895	.9061
.7500	-.4928	.5582	.9554	.7000	.1308	.7260	.6948					
.8002	-.4059	.5816	.9185	.7501	.2338	.7538	.6511					
.9002	-.2021	.6364	.8332	.8001	.3197	.7769	.6139					
.9501	-.0717	.6719	.7791	.8501	.3928	.7966	.5817					

ORIGINAL PAGE IS
OF POOR QUALITY

ORIGINAL PRINTING
OF POOR QUALITY

TEST	167	PT	43.8699	PSI		CN	.3315	CD1	.00784	CDCOR1	.00771
RUN	38	TT	96.3849	K		CM	-.1476	CD2	.00774	CDCOR2	.00764
POINT	24	RC	29.9041	MILLION		CC	.0216	CD3	.00778	CDCOR3	.00773
		MACH	.7500					CD4	.00764	CDCOR4	.00756
		ALPHA	-1.4994	DEG				CD5	.00760	CDCOR5	.00741

UPPER SURFACE				LOWER SURFACE				SPANWISE				
X/C	CP	P _L /PT	MLOC	X/C	CP	P _L /PT	MLOC	X/C	Y/(B/2)	CP	P _L /PT	MLOC
0.0000	1.0561	.9753	.1903	0.0000	1.0561	.9753	.1903	.1507	.7476	-.4403	.5730	.9319
.0132	-.1930	.7433	.5677	.0126	-.0353	.7009	.7339	.1507	.4976	-.4526	.5697	.9372
.0259	-.1581	.6489	.8140	.0255	-.0735	.6716	.7790	.1507	.2476	-.4581	.5683	.9395
.0759	-.4213	.5781	.9239	.0495	-.2020	.6371	.9322	.1507	-.2524	-.4653	.5663	.9425
.1003	-.4294	.5760	.9273	.0753	-.2580	.6220	.8555	.1507	-.5024	-.4674	.5657	.9434
.1507	-.4974	.5684	.9392	.1002	-.3274	.6034	.8844	.1507	-.7524	-.4514	.5700	.9366
.2003	-.4671	.5658	.9433	.1503	-.3623	.5940	.8990	.5002	.7476	-.5753	.5368	.9898
.2503	-.4944	.5585	.9549	.1976	-.4506	.5703	.9363	.5002	.4976	-.5794	.5357	.9915
.3001	-.5223	.5510	.9669	.2503	-.4847	.5611	.9508	.5002	.2476	-.5837	.5345	.9934
.3502	-.5256	.5501	.9683	.3001	-.5016	.5566	.9580	.5002	-.2524	-.5706	.5380	.9877
.4003	-.5388	.5465	.9740	.3507	-.4983	.5575	.9566	.5002	-.5024	-.5696	.5383	.9873
.4501	-.5536	.5426	.9804	.4001	-.4617	.5673	.9410	.5002	-.7524	-.5535	.5426	.9303
.5002	-.5794	.5356	.9916	.4501	-.4083	.5816	.9184	.8002	.7476	-1.1576	.3802	1.2649
.5502	-.6025	.5294	1.0016	.5001	-.3218	.6049	.8821	.8002	.4976	-.4138	.5602	.9207
.6002	-.6260	.5231	1.0119	.5497	-.2022	.6370	.8323	.8002	.2476	-.4185	.5789	.9227
.6500	-.6314	.5217	1.0142	.6003	-.0798	.6699	.7816	.8002	-.5024	-.3870	.5874	.9094
.7000	-.5804	.5354	.9920	.6500	.0136	.6950	.7429	.8002	-.7524	-.3846	.5880	.9084
.7500	-.5024	.5563	.9584	.7000	.1360	.7279	.6918					
.8002	-.4137	.5802	.9207	.7501	.2382	.7554	.6485					
.9002	-.2061	.6360	.8339	.8001	.3238	.7784	.6115					
.9501	-.0749	.6712	.7796	.8501	.3971	.7981	.5792					

TEST	167	PT	43.8547	PSI		CN	.4050	CD1	.00790	CDCOR1	.00777
RUN	38	TT	96.3125	K		CM	-.1491	CD2	.00782	CDCOR2	.00774
POINT	25	RC	29.9133	MILLION		CC	.0220	CD3	.00784	CDCOR3	.00782
		MACH	.7494					CD4	.00772	CDCOR4	.00766
		ALPHA	-1.0081	DEG				CD5	.00764	CDCOR5	.00746

UPPER SURFACE				LOWER SURFACE				SPANWISE				
X/C	CP	P _L /PT	MLOC	X/C	CP	P _L /PT	MLOC	X/C	Y/(B/2)	CP	P _L /PT	MLOC
0.0000	1.0944	.9856	.1446	0.0000	1.0944	.9856	.1446	.1507	.7476	-.5141	.5938	.9625
.0132	-.0802	.7133	.7146	.0126	-.1609	.7350	.6808	.1507	.4976	-.5280	.5900	.9685
.0259	-.2784	.6170	.8632	.0255	-.0351	.7007	.7342	.1507	.2476	-.5356	.5480	.9717
.0759	-.5270	.5503	.9681	.0495	-.1096	.6624	.7933	.1507	-.2524	-.5430	.5460	.9749
.1003	-.5201	.5521	.9651	.0753	-.1753	.6447	.8205	.1507	-.5024	-.5428	.5460	.9748
.1507	-.5351	.5481	.9715	.1002	-.2508	.6244	.8518	.1507	-.7524	-.5239	.5511	.9667
.2003	-.5281	.5500	.9685	.1503	-.2961	.6123	.8706	.5002	.7476	-.6103	.5279	1.0041
.2503	-.5539	.5431	.9796	.1976	-.3846	.5885	.9076	.5002	.4976	-.6148	.5267	1.0061
.3001	-.5774	.5368	.9898	.2503	-.4231	.5782	.9238	.5002	.2476	-.6194	.5255	1.0081
.3502	-.5729	.5380	.9879	.3001	-.4445	.5724	.9329	.5002	-.2524	-.6047	.5294	1.0016
.4003	-.5820	.5355	.9916	.3507	-.4497	.5710	.9351	.5002	-.5024	-.6038	.5297	1.0012
.4501	-.5936	.5324	.9968	.4001	-.4221	.5785	.9234	.5002	-.7524	-.5862	.5344	.9936
.5002	-.6158	.5265	1.0065	.4501	-.3780	.5903	.9048	.8002	.7476	-1.1660	.3787	1.2679
.5502	-.6332	.5218	1.0141	.5001	-.2980	.6118	.8714	.8002	.4976	-.4177	.5796	.9216
.6002	-.6530	.5165	1.0228	.5497	-.1844	.6423	.8242	.8002	.2476	-.4219	.5785	.9233
.6500	-.6527	.5165	1.0227	.6003	-.0661	.6740	.7753	.8002	-.5024	-.3898	.5871	.9098
.7000	-.5933	.5325	.9967	.6500	.0237	.6981	.7382	.8002	-.7524	-.3877	.5877	.9089
.7500	-.5078	.5554	.9598	.7000	.1444	.7306	.6877					
.8002	-.4172	.5798	.9213	.7501	.2452	.7576	.6450					
.9002	-.2062	.6364	.8333	.8001	.3302	.7805	.6042					
.9501	-.0750	.6717	.7790	.8501	.4039	.8002	.5757					

TEST	167	PT	43.8473	PSI		CN	.4754	CD1	.00804	CDCOR1	.00806
RUN	38	TT	96.3343	K		CM	-.1495	CD2	.00798	CDCOR2	.00804
POINT	26	RC	29.8992	MILLION		CC	.0215	CD3	.00801	CDCOR3	.00812
		MACH	.7494					CD4	.00782	CDCOR4	.00791
		ALPHA	-1.4990	DEG				CD5	.00774	CDCOR5	.00771

UPPER SURFACE				LOWER SURFACE				SPANWISE				
X/C	CP	P _L /PT	MLOC	X/C	CP	P _L /PT	MLOC	X/C	Y/(B/2)	CP	P _L /PT	MLOC
0.0000	1.1236	.9937	.0954	0.0000	1.1236	.9937	.0954	.1507	.7476	-.5933	.5344	.9936
.0132	-.0300	.6851	.7583	.0126	-.2726	.7661	.6315	.1507	.4976	-.6129	.5292	1.0021
.0259	-.3970	.5869	.9101	.0255	-.1292	.7277	.6922	.1507	.2476	-.6223	.5266	1.0062
.0759	-.6465	.5202	1.0167	.0495	-.0262	.6861	.7567	.1507	-.2524	-.6291	.5248	1.0091
.1003	-.6162	.5283	1.0035	.0753	-.1007	.6662	.7874	.1507	-.5024	-.6250	.5259	1.0073
.1507	-.6207	.5271	1.0034	.1002	-.1799	.6450	.8201	.1507	-.7524	-.6016	.5322	.9971
.2003	-.5982	.5331	.9957	.1503	-.2345	.6304	.8426	.5002	.7476	-.6489	.5195	1.0178
.2503	-.6165	.5202	1.0036	.1976	-.3247	.6063	.8799	.5002	.4976	-.6563	.5176	1.0210
.3001	-.6410	.5217	1.0143	.2503	-.3682	.5946	.8981	.5002	.2476	-.6619	.5161	1.0235
.3502	-.6162	.5283	1.0035	.3001	-.3939	.5878	.9088	.5002	-.2524	-.6478	.5198	1.0173
.4003	-.6220	.5267	1.0060	.3507	-.4058	.5846	.9138	.5002	-.5024	-.6459	.5204	1.0164
.4501	-.6325	.5239	1.0106	.4001	-.3858	.5899	.9054	.5002	-.7524	-.6244	.5261	1.0071
.5002	-.6556	.5178	1.0207	.4501	-.3496	.5956	.8903	.8002	.7476	-1.1721	.3796	1.2663
.5502	-.6607	.5164	1.0230	.5001	-.2770	.6190	.8601	.8002	.4976	-.4207	.5806	.9200
.6002	-.6752	.5125	1.0293	.5497	-.1689	.6480	.8155	.8002	.2476	-.4247	.5795	.9217
.6500	-.6706	.5137	1.0273	.6003	-.0343	.6786	.7683	.8002	-.5024	-.3944	.5876	.9090
.7000	-.6045	.5314	.9984	.6500	.0322	.7016	.7325	.8002	-.7524	-.3936	.5878	.9087
.7500	-.5107	.5565	.9581	.7000	.1513	.7336	.6829					
.8002	-.4182	.5813	.9190	.7501	.2512	.7603	.6406					
.9002	-.2042	.6385	.8301	.8001	.3360	.7830	.6040					
.9501	-.0708	.6742	.7751	.8501	.4096	.8027	.5715					

TEST 167	PT 44.0600	PSI	CN .5512	CD1 .00824	CDCOR1 .00802
RUN 38	TT 96.7864	K	CM -.1514	CD2 .00820	CDCOR2 .00797
POINT 27	RC 29.8521	MILLION	CC .0202	CD3 .00819	CDCOR3 .00805
	MACH .7499			CD4 .00798	CDCOR4 .00779
	ALPHA .0000	DEG		CD5 .00786	CDCOR5 .00763

UPPER SURFACE				LOWER SURFACE				SPANWISE				
X/C	CP	P/L/PT	MLOC	X/C	CP	P/L/PT	MLOC	X/C	Y/(B/2)	CP	P/L/PT	MLOC
0.0000	1.1408	.9977	.0573	0.0000	1.1408	.9977	.0573	.1507	.7476	-.6757	.5073	1.0370
.0132	-.1272	.6554	.8040	.0126	.3722	.7902	.5922	.1507	.4976	-.6740	.5077	1.0371
.0259	-.5006	.3546	.9612	.0255	.2175	.7484	.6595	.1507	.2476	-.6811	.5058	1.0403
.0759	-.7591	.4848	1.0756	.0495	.0520	.7040	.7291	.1507	-.2524	-.6909	.5032	1.0447
.1003	-.7754	.4804	1.0830	.0753	-.0297	.6817	.7635	.1507	-.5024	-.6678	.5094	1.0344
.1507	-.6896	.5035	1.0441	.1002	-.1141	.6589	.7986	.1507	-.7524	-.6700	.5088	1.0353
.2003	-.6737	.5078	1.0370	.1503	-.1767	.6420	.8246	.5002	.7476	-.6930	.5026	1.0456
.2503	-.6822	.5055	1.0408	.1976	-.2693	.6170	.8632	.5002	.4976	-.7021	.5001	1.0497
.3001	-.6986	.5011	1.0481	.2503	-.3176	.6040	.8835	.5002	.2476	-.7057	.4992	1.0513
.3502	-.7072	.4988	1.0520	.3001	-.3462	.5957	.8963	.5002	-.2524	-.6927	.5027	1.0455
.4003	-.6764	.5071	1.0382	.3507	-.3650	.5912	.9034	.5002	-.5024	-.6962	.5018	1.0470
.4501	-.6606	.5113	1.0312	.4001	-.3508	.5950	.8974	.5002	-.7524	-.6731	.5080	1.0367
.5002	-.6983	.5012	1.0480	.4501	-.3199	.6033	.8844	.8002	.7476	-1.1473	.3799	1.2655
.5502	-.7170	.4961	1.0564	.5001	-.2527	.6215	.8563	.8002	.4976	-.4125	.5784	.9235
.6002	-.7152	.766	1.0556	.5497	-.1487	.6496	.8130	.8002	.2476	-.4169	.5772	.9254
.6500	-.6942	.5023	1.0462	.6003	-.0376	.6796	.7668	.8002	-.5024	-.3898	.5845	.9139
.7000	-.6175	.5230	1.0121	.6500	.0470	.7024	.7315	.8002	-.7524	-.3901	.5844	.9140
.7500	-.5058	.5532	.9634	.7000	.1637	.7319	.6824					
.8002	-.4114	.5786	.9231	.7501	.2622	.7605	.6403					
.9002	-.1961	.6368	.8327	.8001	.3462	.7832	.6037					
.9501	-.0654	.6721	.7783	.8501	.4196	.8030	.5710					

TEST 167	PT 44.1077	PSI	CN .6323	CD1 .00854	CDCOR1 .00827
RUN 38	TT 97.0066	K	CM -.1529	CD2 .00846	CDCOR2 .00823
POINT 29	RC 29.8018	MILLION	CC .0182	CD3 .00845	CDCOR3 .00834
	MACH .7509			CD4 .00819	CDCOR4 .00802
	ALPHA .4990	DEG		CD5 .00814	CDCOR5 .00786

UPPER SURFACE				LOWER SURFACE				SPANWISE				
X/C	CP	P/L/PT	MLOC	X/C	CP	P/L/PT	MLOC	X/C	Y/(B/2)	CP	P/L/PT	MLOC
0.0000	1.1455	.9989	.0398	0.0000	1.1455	.9989	.0398	.1507	.7476	-.7914	.4754	1.0913
.0132	-.2290	.6274	.8471	.0126	.4592	.8134	.5534	.1507	.4976	-.8767	.4323	1.1315
.0259	-.6072	.5251	1.0085	.0255	.2940	.7687	.6271	.1507	.2476	-.8840	.4503	1.1350
.0759	-.8721	.4535	1.1293	.0495	.1231	.7225	.7002	.1507	-.2524	-.8886	.4491	1.1372
.1003	-.8835	.4505	1.1347	.0753	-.0327	.6981	.7361	.1507	-.5024	-.9008	.4428	1.1430
.1507	-.8712	.4538	1.1289	.1002	-.0557	.6742	.7750	.1507	-.7524	-.8122	.4697	1.1012
.2003	-.8310	.4646	1.1100	.1503	-.1258	.6553	.8042	.5002	.7476	-.7261	.4930	1.0617
.2503	-.8292	.4651	1.1091	.1976	-.2208	.6296	.8430	.5002	.4976	-.7382	.4897	1.0671
.3001	-.7468	.4874	1.0711	.2503	-.2733	.6154	.8657	.5002	.2476	-.7499	.4866	1.0725
.3502	-.7092	.4976	1.0540	.3001	-.3080	.6060	.8802	.5002	-.2524	-.7381	.4898	1.0671
.4003	-.7281	.4925	1.0625	.3507	-.3294	.6002	.8893	.5002	-.5024	-.7401	.4892	1.0680
.4501	-.7319	.4914	1.0643	.4001	-.3206	.6026	.8855	.5002	-.7524	-.7163	.4956	1.0572
.5002	-.7931	.4857	1.0739	.4501	-.2956	.6094	.8751	.8002	.7476	-1.1427	.3804	1.2646
.5502	-.7565	.4848	1.0755	.5001	-.2338	.6261	.8492	.8002	.4976	-.4148	.5771	.9254
.6002	-.7579	.4844	1.0761	.5497	-.1345	.6529	.8078	.8002	.2476	-.4185	.5761	.9270
.6500	-.7258	.4931	1.0615	.6003	-.0268	.6820	.7629	.8002	-.5024	-.3922	.5833	.9158
.7000	-.6280	.5195	1.0177	.6500	.0552	.7042	.7287	.8002	-.7524	-.3935	.5829	.9163
.7500	-.5074	.5521	.9650	.7000	.1702	.7353	.6803					
.8002	-.4130	.5776	.9245	.7501	.2676	.7616	.6385					
.9002	-.1969	.6361	.8338	.8001	.3510	.7842	.6021					
.9501	-.0672	.6711	.7798	.8501	.4243	.8040	.5694					

TEST 167	PT 44.1765	PSI	CN .7094	CD1 .00881	CDCOR1 .00853
RUN 38	TT 96.9211	K	CM -.1505	CD2 .00882	CDCOR2 .00854
POINT 30	RC 29.8620	MILLION	CC .0131	CD3 .00879	CDCOR3 .00850
	MACH .7498			CD4 .00850	CDCOR4 .00816
	ALPHA .9979	DEG		CD5 .00854	CDCOR5 .00804

UPPER SURFACE				LOWER SURFACE				SPANWISE				
X/C	CP	P/L/PT	MLOC	X/C	CP	P/L/PT	MLOC	X/C	Y/(B/2)	CP	P/L/PT	MLOC
0.0000	1.1439	.9985	.0464	0.0000	1.1439	.9985	.0464	.1507	.7476	-.9232	.4400	1.1532
.0132	-.3199	.6030	.8849	.0126	.5331	.8335	.5189	.1507	.4976	-.9945	.4208	1.1881
.0259	-.7035	.4984	1.0510	.0255	.3615	.7871	.5973	.1507	.2476	-.9877	.4226	1.1847
.0759	-.9670	.4282	1.1745	.0495	.1834	.7390	.6744	.1507	-.2524	-.9913	.4216	1.1865
.1003	-.9826	.4260	1.1822	.0753	-.0866	.7128	.7153	.1507	-.5024	-1.0123	.4160	1.1949
.1507	-.9713	.4270	1.1766	.1002	-.0016	.6870	.7522	.1507	-.7524	-.9642	.4289	1.1732
.2003	-.9419	.4350	1.1623	.1503	-.0790	.6681	.7844	.5002	.7476	-.7849	.4774	1.0880
.2503	-.9674	.4281	1.1747	.1976	-.1763	.6418	.8249	.5002	.4976	-.7985	.4737	1.0943
.3001	-.9912	.4216	1.1865	.2503	-.2330	.6265	.8485	.5002	.2476	-.7540	.4857	1.0739
.3502	-.9622	.4295	1.1721	.3001	-.2712	.6162	.8645	.5002	-.2524	-.7715	.4810	1.0819
.4003	-.8451	.4611	1.1180	.3507	-.2957	.6096	.8747	.5002	-.5024	-.8120	.4701	1.1006
.4501	-.7925	.4753	1.0916	.4001	-.2920	.6106	.8732	.5002	-.7524	-.8173	.4687	1.1030
.5002	-.7548	.4856	1.0742	.4501	-.2730	.6137	.8653	.8002	.7476	-1.1368	.3823	1.2408
.5502	-.7290	.4925	1.0625	.5001	-.2169	.6309	.8418	.8002	.4976	-.4168	.5768	.9259
.6002	-.7083	.4901	1.0532	.5497	-.1224	.6564	.8025	.8002	.2476	-.4203	.5759	.9274
.6500	-.6741	.5073	1.0378	.6003	-.0185	.6845	.7592	.8002	-.5024	-.3973	.5821	.9176
.7000	-.6119	.5341	1.0102	.6500	.0596	.7056	.7266	.8002	-.7524	-.3943	.5829	.9163
.7500	-.5066	.5526	.9643	.7000	.1729	.7352	.6789					
.8002	-.4121	.5781	.9239	.7501	.2691	.7622	.6377					
.9002	-.1951	.6367	.8327	.8001	.3516	.7844	.6016					
.9501	-.0632	.6724	.7778	.8501	.4247	.8042	.5690					

ORIGINAL PRINT IS
OF POOR QUALITY

TEST 167	PT 44.3629	PSI	CN .8076	C01 .01051	CDCOR1 .01000
RUN 39	TT 96.9603	K	CM -.1557	C02 .01081	CDCOR2 .01034
POINT 33	RC 29.9957	MILLION	CC .0131	C03 .01088	CDCOR3 .01033
	MACH .7508			C04 .01078	CDCOR4 .01012
	ALPHA 1.5172	DEG		C05 .01132	CDCOR5 .01104

UPPER SURFACE				LOWER SURFACE				SPANWISE				
X/C	CP	P,L/P,T	MLOC	X/C	CP	P,L/P,T	MLOC	X/C	Y/(B/2)	CP	P,L/P,T	MLOC
0.0000	1.1502	1.0004	0.0000	0.0000	1.1502	1.0004	0.0000	.1507	.7476	-1.0406	.4104	1.2073
.0132	-.4027	.5822	.9175	.0126	.6072	.8542	.4818	.1507	.4976	-1.0974	.3951	1.2362
.0259	-.8013	.4748	1.0925	.0255	.4291	.8662	.5656	.1507	.2476	-1.0732	.4016	1.2238
.0759	-1.0470	.4086	1.2105	.0495	-.2480	.7574	.6452	.1507	-.2524	-1.0725	.4018	1.2234
.1003	-1.0653	.4037	1.2198	.0753	.1458	.7299	.6887	.1507	-.5024	-1.0934	.3962	1.2341
.1507	-1.0595	.4064	1.2148	.1002	.0548	.7054	.7269	.1507	-.7524	-1.0353	.4118	1.2046
.2003	-1.0314	.4129	1.2027	.1503	-.0280	.6831	.7613	.5002	.7476	-1.0279	.4138	1.2009
.2503	-1.0577	.4058	1.2159	.1976	-.1279	.6582	.8027	.5002	.4976	-1.0562	.4062	1.2152
.3001	-1.0936	.3961	1.2342	.2503	-.1860	.6400	.8277	.5002	.2476	-1.0555	.4064	1.2148
.3502	-1.1607	.3942	1.2379	.3001	-.2293	.6289	.8448	.5002	-.2524	-1.0052	.4199	1.1897
.4003	-1.0821	.3992	1.2283	.3507	-.2572	.6214	.865	.5002	-.5024	-1.0611	.4049	1.2176
.4501	-1.0060	.4197	1.1900	.4001	-.2541	.6211	.8968	.5002	-.7524	-0.9790	.4270	1.1767
.5002	-.9939	.4230	1.1841	.4501	-.2447	.6247	.8913	.8002	.7476	-1.0567	.4061	1.2194
.5502	-.9183	.4433	1.1473	.5001	-.1934	.6385	.8299	.8002	.4976	-0.9923	.5850	.9131
.6002	-.7854	.4791	1.0851	.5497	-.1036	.6627	.7927	.8002	.2476	-0.9975	.5836	.9153
.6500	-.8037	.5280	1.0038	.6003	-.0028	.6899	.7509	.8002	-.5024	-0.9737	.5900	.9053
.7000	-.5145	.5921	.9651	.6500	.0722	.7101	.7196	.8002	-.7524	-0.9677	.5916	.9027
.7500	-.4620	.5862	.9427	.7000	.1844	.7403	.6724					
.8002	-.3869	.5864	.9108	.7501	.2795	.7859	.6317					
.9002	-.1839	.6411	.8260	.8001	.3617	.7880	.5958					
.9501	-.0582	.6750	.7739	.8501	.4350	.8078	.5630					

TEST 167	PT 43.7450	PSI	CN .9018	C01 .01267	CDCOR1 .01250
RUN 39	TT 95.8600	K	CM -.1654	C02 .01308	CDCOR2 .01273
POINT 34	RC 29.9949	MILLION	CC .0121	C03 .01440	CDCOR3 .01372
	MACH .7472			C04 .01478	CDCOR4 .01438
	ALPHA 2.0061	DEG		C05 .01482	CDCOR5 .01431

UPPER SURFACE				LOWER SURFACE				SPANWISE				
X/C	CP	P,L/P,T	MLOC	X/C	CP	P,L/P,T	MLOC	X/C	Y/(B/2)	CP	P,L/P,T	MLOC
0.0000	1.1344	.9962	.0742	0.0000	1.1344	.9962	.0742	.1507	.7476	-1.1514	.3808	1.2639
.0132	-.4866	.5998	.9529	.0126	.6688	.8708	.4508	.1507	.4976	-1.1750	.3745	1.2764
.0259	-.8896	.4524	1.1315	.0255	.4865	.8218	.5393	.1507	.2476	-1.1487	.3816	1.2624
.0759	-1.1253	.3879	1.2502	.0495	.3056	.7730	.6203	.1507	-.2524	-1.1443	.3827	1.2601
.1003	-1.1414	.3835	1.2586	.0753	.2003	.7447	.6655	.1507	-.5024	-1.1663	.3768	1.2710
.1507	-1.1337	.3856	1.2546	.1002	.1027	.7184	.7067	.1507	-.7524	-1.0935	.3964	1.2337
.2003	-1.1023	.3940	1.2382	.1503	.0187	.6958	.7418	.5002	.7476	-1.1360	.3850	1.2558
.2503	-1.1292	.3868	1.2522	.1976	-.0813	.6689	.7833	.5002	.4976	-1.1498	.3813	1.2630
.3001	-1.1650	.3772	1.2710	.2503	-.1432	.6522	.8090	.5002	.2476	-1.1595	.3786	1.2602
.3502	-1.1819	.3726	1.2801	.3001	-.1865	.6406	.8269	.5002	-.2524	-1.1292	.3868	1.2522
.4003	-1.1825	.3724	1.2804	.3507	-.2179	.6321	.8400	.5002	-.5024	-1.1346	.3854	1.2590
.4501	-1.1717	.3754	1.2746	.4001	-.2215	.6311	.8415	.5002	-.7524	-1.0760	.4011	1.2248
.5002	-1.1260	.3877	1.2506	.4501	-.2117	.6338	.8374	.8002	.7476	-.9852	.4256	1.1794
.5502	-1.1192	.3895	1.2470	.5001	-.1660	.6461	.8184	.8002	.4976	-0.9637	.5929	.9008
.6002	-1.0366	.4117	1.2049	.5497	-.0819	.6687	.7835	.8002	.2476	-0.9458	.5923	.9017
.6500	-.6251	.5225	1.0130	.6003	.0146	.6947	.7435	.8002	-.5024	-0.9687	.5969	.8946
.7000	-.4803	.5615	.9503	.6500	.0867	.7141	.7134	.8002	-.7524	-0.9444	.5981	.8928
.7500	-.4288	.5754	.9283	.7000	.1958	.7435	.6675					
.8002	-.3659	.5923	.9018	.7501	.2883	.7684	.6278					
.9002	-.1800	.6423	.8242	.8001	.3691	.7901	.5924					
.9501	-.0621	.6741	.7753	.8501	.4415	.8096	.5599					

TEST 167	PT 46.7639	PSI	CN .9713	C01 .02006	CDCOR1 .01922
RUN 39	TT 100.8878	K	CM -.1715	C02 .02079	CDCOR2 .02004
POINT 35	RC 29.8200	MILLION	CC .0118	C03 .02391	CDCOR3 .02266
	MACH .7513			C04 .02385	CDCOR4 .02267
	ALPHA 2.5254	DEG		C05 .02355	CDCOR5 .02281

UPPER SURFACE				LOWER SURFACE				SPANWISE				
X/C	CP	P,L/P,T	MLOC	X/C	CP	P,L/P,T	MLOC	X/C	Y/(B/2)	CP	P,L/P,T	MLOC
0.0000	1.1242	.9938	.0949	0.0000	1.1242	.9938	.0949	.1507	.7476	-1.2037	.3693	1.2864
.0132	-.5575	.5426	.9800	.0126	.7114	.8830	.4269	.1507	.4976	-1.2391	.3598	1.3056
.0259	-.9487	.4350	1.1620	.0255	.5299	.8343	.5171	.1507	.2476	-1.2196	.3650	1.2950
.0759	-1.1981	.3708	1.2834	.0495	.3456	.7849	.6007	.1507	-.2524	-1.2146	.3663	1.2923
.1003	-1.2106	.3674	1.2901	.0753	.2357	.7554	.6482	.1507	-.5024	-1.2349	.3609	1.3033
.1507	-1.2044	.3691	1.2868	.1002	.1404	.7298	.6885	.1507	-.7524	-1.1477	.3843	1.2567
.2003	-1.1692	.3785	1.2680	.1503	.0502	.7056	.7262	.5002	.7476	-1.2253	.3635	1.2981
.2503	-1.1950	.3716	1.2818	.1976	-.0527	.6780	.7688	.5002	.4976	-1.2326	.3619	1.3020
.3001	-1.2295	.3623	1.3004	.2503	-.1217	.6595	.7973	.5002	.2476	-1.2396	.3596	1.3059
.3502	-1.2414	.3592	1.3069	.3001	-.1658	.6477	.8155	.5002	-.2524	-1.2172	.3657	1.2937
.4003	-1.2435	.3586	1.3080	.3507	-.1993	.6387	.8294	.5002	-.5024	-1.1901	.3729	1.2791
.4501	-1.2541	.3557	1.3138	.4001	-.2077	.6364	.8329	.5002	-.7524	-1.1693	.3785	1.2681
.5002	-1.2608	.3540	1.3175	.4501	-.2035	.6376	.8311	.8002	.7476	-.9240	.4443	1.1494
.5502	-1.2244	.3637	1.2976	.5001	-.1619	.6487	.8140	.8002	.4976	-0.9416	.6005	.8885
.6002	-1.2199	.3649	1.2952	.5497	-.0812	.6704	.7806	.8002	.2476	-0.9404	.6009	.8880
.6500	-.8257	.4707	1.0993	.6003	.0116	.6953	.7422	.8002	-.5024	-0.9374	.6017	.8868
.7000	-.8187	.4730	.9633	.6500	.0808	.7138	.7139	.8002	-.7524	-0.9373	.6017	.8867
.7500	-.8140	.4811	.9189	.7000	.1889	.7428	.6681					
.8002	-.8372	.4817	.8867	.7501	.2810	.7675	.6288					
.9002	-.6641	.4882	.8148	.8001	.3610	.7890	.5934					
.9501	-.0542	.4676	.7695	.8501	.4333	.8084	.5617					

TEST	167	PT	46.7665	PSI	CN	1.0216	CD1	.02615	CDCDR1	.02537
RUN	39	TT	100.9005	K	CM	-.1740	CD2	.02614	CDCDR2	.02548
POINT	36	RC	29.7793	MILLION	CC	.0109	CD3	.03133	CDCDR3	.02953
		MACH	.7498				CD4	.02905	CDCDR4	.02747
		ALPHA	3.0141	DEG			CD5	.02668	CDCDR5	.02583

UPPER SURFACE				LOWER SURFACE				SPANWISE				
X/C	CP	P _z L/PT	MLOC	X/C	CP	P _z L/PT	MLOC	X/C	Y/(B/2)	CP	P _z L/PT	MLOC
0.0000	1.1103	.9901	.1196	0.0000	1.1103	.9901	.1196	.1507	.7476	-1.2442	.3592	1.3067
.0132	-.6109	.5289	1.0021	.0126	.7583	.8958	.4011	.1507	.4976	-1.2948	.3457	1.3348
.0259	-1.0152	.4206	1.1882	.0255	.5745	.8465	.4954	.1507	.2476	-1.2697	.3524	1.3208
.0759	-1.2502	.3576	1.3101	.0495	.3892	.7969	.5809	.1507	-.2524	-1.2631	.3541	1.3171
.1003	-1.2631	.3542	1.3171	.0753	.2767	.7667	.6301	.1507	-.5024	-1.2809	.3494	1.3270
.1507	-1.2542	.3565	1.3122	.1002	.1780	.7403	.6721	.1507	-.7524	-1.1900	.3737	1.2775
.2003	-1.2156	.3669	1.2912	.1503	.0852	.7154	.7110	.5002	.7476	-1.2755	.3508	1.3240
.2503	-1.2427	.3596	1.3059	.1976	-.0191	.6875	.7542	.5002	.4976	-1.2777	.3502	1.3253
.3001	-1.2776	.3503	1.3252	.2503	-.0881	.6690	.7827	.5002	.2476	-1.2787	.3499	1.3258
.3502	-1.2920	.3464	1.3332	.3001	-.1366	.6560	.8028	.5002	-.2524	-1.2684	.3527	1.3200
.4003	-1.2968	.3451	1.3360	.3507	-.1733	.6462	.8179	.5002	-.5024	-1.2223	.3651	1.2948
.4501	-1.3141	.3405	1.3457	.4001	-.1842	.6432	.8224	.5002	-.7524	-1.2117	.3679	1.2891
.5002	-1.3468	.3317	1.3645	.4501	-.1832	.6435	.8220	.8002	.7476	-.9136	.4478	1.1392
.5502	-1.3112	.3412	1.3441	.5001	-.1456	.6536	.8065	.8002	.4976	-.3338	.6032	.8844
.6002	-1.2676	.3529	1.3196	.5497	-.0686	.6742	.7747	.8002	.2476	-.3335	.6032	.8843
.6500	-.7579	.4895	1.0672	.6003	.0218	.6984	.7373	.8002	-.5024	-.3348	.6029	.8848
.7000	-.5211	.5530	.9634	.6500	.0888	.7164	.7095	.8002	-.7524	-.3421	.6009	.8879
.7500	-.4145	.5815	.9182	.7000	.1955	.7450	.6647					
.8002	-.3315	.6038	.8835	.7501	.2864	.7693	.6259					
.9002	-.1596	.6498	.8123	.8001	.3659	.7906	.5912					
.9501	-.0559	.6776	.7695	.8501	.4381	.8100	.5590					

Appendix H

Pressure Data for $M = 0.76$; $R = 4.4 \times 10^6$, 7.0×10^6 , 10.0×10^6 , 15.0×10^6 , 30.0×10^6 , and 40.0×10^6 ; Free Transition

The pressure measurements made on the NASA SC(3)-0712(B) airfoil are presented in coefficient form in graphs and tables in this appendix. The data are for a given Mach number through the Reynolds number range. The pressure data from the upper surface of the airfoil are plotted as open symbols, and the lower-surface data are plotted as solid symbols.

ORIGINALLY PRINTED
OF THE AIR FORCE

TEST 167 PT 20.2836 PSI CM -.0356 CD1 .00735 CDCOR1 .00738
 RUN 1 TT 215.2322 K CM -.1447 CD2 .00668 CDCOR2 .00672
 POINT 2 PC 4.3763 MILLION CC .0052 CD3 .00698 CDCOR3 .00704
 MACH .7607 CD4 .00616 CDCOR4 .00618
 ALPHA -4.0120 DEG CD5 .00588 CDCOR5 .00580

UPPER SURFACE				LOWER SURFACE				SPANWISE				
X/C	CP	P _L /PT	MLOC	X/C	CP	P _L /PT	MLOC	X/C	Y/(B/2)	CP	P _L /PT	MLOC
0.0000	.7517	.8891	.4129	0.0000	.7517	.8891	.4129	.1507	.7476	-.1582	.6378	.8278
.0132	.6212	.8531	.4416	.0126	-.7028	.4873	1.0675	.1507	.4976	-.1721	.6339	.8337
.0259	.2973	.7636	.6326	.0255	-.6702	.4963	1.0524	.1507	.2476	-.1728	.6337	.8340
.0759	-.0449	.6691	.7797	.0495	-.7812	.4657	1.1045	.1507	-.2524	-.1714	.6341	.8334
.1003	-.0931	.6557	.8001	.0753	-.8112	.4574	1.1189	.1507	-.5024	-.1722	.6339	.8337
.1507	-.1702	.6344	.8329	.1002	-.8226	.4542	1.1244	.1507	-.7524	-.1583	.6377	.8278
.2003	-.2195	.6208	.8539	.1503	-.8255	.4534	1.1258	.5002	.7476	-.4212	.5651	.9408
.2503	-.2677	.6075	.8745	.1976	-.8460	.4478	1.1358	.5002	.4976	-.4327	.5619	.9458
.3001	-.3060	.5969	.8909	.2503	-.8728	.4403	1.1489	.5002	.2476	-.4374	.5606	.9479
.3502	-.3305	.5902	.9014	.3001	-.9318	.4241	1.1783	.5002	-.2524	-.4286	.5631	.9440
.4003	-.3626	.5813	.9153	.3507	-.9789	.4110	1.2024	.5002	-.5024	-.4216	.5650	.9410
.4501	-.3958	.5721	.9297	.4001	-.9141	.4289	1.1694	.5002	-.7524	-.4069	.5690	.9346
.5002	-.4265	.5636	.9431	.4501	-.4718	.5503	.9643	.8002	.7476	-.3888	.5741	.9267
.5502	-.4635	.5534	.9593	.5001	-.3110	.5892	.9029	.8002	.4976	-.3993	.5712	.9312
.6002	-.5006	.5432	.9757	.5497	-.2419	.6146	.8634	.8002	.2476	-.4210	.5652	.9407
.6500	-.5304	.5349	.9890	.6003	-.1231	.6475	.8128	.8002	-.5024	-.3982	.5715	.9308
.7000	-.5202	.5378	.9844	.6500	-.0178	.6766	.7682	.8002	-.7524	-.3529	.5840	.9111
.7500	-.4776	.5495	.9656	.7000	.1029	.7099	.7168					
.8002	-.3998	.5710	.9315	.7501	.2103	.7396	.6706					
.9002	-.2090	.6237	.8494	.8001	.2993	.7642	.6317					
.9501	-.0831	.6585	.7959	.8501	.3773	.7857	.5969					

TEST 167 PT 20.2917 PSI CM -.1223 CD1 .00647 CDCOR1 .00648
 RUN 1 TT 215.1866 K CM -.1491 CD2 .00559 CDCOR2 .00562
 POINT 3 PC 4.3787 MILLION CC .0137 CD3 .00577 CDCOR3 .00581
 MACH .7605 CD4 .00541 CDCOR4 .00543
 ALPHA -2.9836 DEG CD5 .00539 CDCOR5 .00533

UPPER SURFACE				LOWER SURFACE				SPANWISE				
X/C	CP	P _L /PT	MLOC	X/C	CP	P _L /PT	MLOC	X/C	Y/(B/2)	CP	P _L /PT	MLOC
0.0000	.8933	.9282	.3277	0.0000	.8933	.9282	.3277	.1507	.7476	-.2719	.6064	.8762
.0132	.4644	.8098	.5571	.0126	-.3909	.5735	.9276	.1507	.4976	-.2891	.6016	.8836
.0259	.1259	.7162	.7070	.0255	-.4324	.5620	.9457	.1507	.2476	-.2908	.6011	.8844
.0759	-.1916	.6285	.8420	.0495	-.5369	.5331	.9919	.1507	-.2524	-.2881	.6019	.8832
.1003	-.2267	.6198	.8569	.0753	-.5721	.5234	1.0077	.1507	-.5024	-.2873	.6021	.8829
.1507	-.2883	.6018	.8833	.1002	-.6031	.5149	1.0217	.1507	-.7524	-.2688	.6072	.8749
.2003	-.3236	.5921	.8985	.1503	-.6004	.5156	1.0205	.5002	.7476	-.4854	.5474	.9690
.2503	-.3661	.5803	.9158	.1976	-.6842	.4925	1.0589	.5002	.4976	-.5017	.5429	.9762
.3001	-.3991	.5715	.9307	.2503	-.7738	.4677	1.1009	.5002	.2476	-.5070	.5414	.9786
.3502	-.4182	.5665	.9386	.3001	-.8071	.4565	1.1169	.5002	-.2524	-.4978	.5440	.9745
.4003	-.4420	.5594	.9499	.3507	-.7508	.4740	1.0900	.5002	-.5024	-.4906	.5439	.9713
.4501	-.4720	.5511	.9631	.4001	-.6267	.5083	1.0324	.5002	-.7524	-.4748	.5503	.9643
.5002	-.4972	.5441	.9742	.4501	-.4590	.5547	.9574	.8002	.7476	-.3950	.5723	.9294
.5502	-.5283	.5355	.9880	.5001	-.3711	.5789	.9190	.8002	.4976	-.4060	.5693	.9342
.6002	-.5606	.5266	1.0025	.5497	-.2433	.6142	.8640	.8002	.2476	-.4346	.5614	.9467
.6500	-.5871	.5193	1.0145	.6003	-.1135	.6501	.8088	.8002	-.5024	-.4149	.5669	.9380
.7000	-.5646	.5254	1.0044	.6500	-.0036	.6805	.7622	.8002	-.7524	-.3610	.5817	.9146
.7500	-.5071	.5414	.9786	.7000	.1179	.7140	.7104					
.8002	-.4122	.5676	.9369	.7501	.2258	.7438	.6639					
.9002	-.2122	.6228	.8507	.8001	.3150	.7685	.6248					
.9501	-.0835	.6584	.7960	.8501	.3927	.7900	.5900					

TEST 167 PT 20.2946 PSI CM .2747 CD1 .00623 CDCOR1 .00619
 RUN 1 TT 215.2450 K CM -.1534 CD2 .00534 CDCOR2 .00532
 POINT 4 PC 4.3770 MILLION CC .0193 CD3 .00535 CDCOR3 .00534
 MACH .7603 CD4 .00513 CDCOR4 .00509
 ALPHA -1.9936 DEG CD5 .00508 CDCOR5 .00497

UPPER SURFACE				LOWER SURFACE				SPANWISE				
X/C	CP	P _L /PT	MLOC	X/C	CP	P _L /PT	MLOC	X/C	Y/(B/2)	CP	P _L /PT	MLOC
0.0000	1.0177	.9629	.2330	0.0000	1.0177	.9629	.2330	.1507	.7476	-.4011	.5718	.9302
.0132	.2775	.7348	.6801	.0126	-.1097	.6921	.8057	.1507	.4976	-.4228	.5658	.9397
.0259	-.0737	.6621	.7904	.0255	-.2019	.6267	.8448	.1507	.2476	-.4255	.5651	.9408
.0759	-.3618	.5827	.9132	.0495	-.3254	.5927	.8975	.1507	-.2524	-.4219	.5661	.9392
.1003	-.3801	.5776	.9211	.0753	-.3815	.5772	.9217	.1507	-.5024	-.4179	.5672	.9375
.1507	-.4222	.5660	.9394	.1002	-.4240	.5655	.9402	.1507	-.7524	-.3930	.5741	.9267
.2003	-.4407	.5609	.9474	.1503	-.4463	.5555	.9560	.5002	.7476	-.5384	.5285	.9995
.2503	-.4754	.5513	.9627	.1976	-.5382	.5305	.9962	.5002	.4976	-.5383	.5230	1.0084
.3001	-.5004	.5443	.9737	.2503	-.5482	.5175	.9843	.5002	.2476	-.5380	.5214	1.0110
.3502	-.5063	.5428	.9763	.3001	-.6081	.5146	1.0218	.5002	-.2524	-.5350	.5239	1.0069
.4003	-.5256	.5375	.9848	.3507	-.5887	.5146	1.0131	.5002	-.5024	-.5361	.5258	1.0038
.4501	-.5502	.5307	.9958	.4001	-.5385	.5339	.9909	.5002	-.7524	-.5308	.5306	.9961
.5002	-.5722	.5247	1.0056	.4501	-.4613	.5552	.9365	.8002	.7476	-.4061	.5304	.9324
.5502	-.5543	.5180	1.0165	.5001	-.3468	.5868	.9067	.8002	.4976	-.4077	.5300	.9331
.6002	-.6226	.5104	1.0284	.5497	-.2196	.6218	.8523	.8002	.2476	-.4293	.5640	.9425
.6500	-.6461	.5043	1.0391	.6003	-.0947	.6563	.7993	.8002	-.5024	-.4132	.5685	.9355
.7000	-.6155	.5127	1.0252	.6500	.0116	.6855	.7543	.8002	-.7524	-.3721	.5798	.9176
.7500	-.4323	.5357	.9878	.7000	.1304	.7183	.7038					
.8002	-.4206	.5665	.9387	.7501	.2371	.7477	.6578					
.9002	-.2185	.6221	.8518	.8001	.3265	.7724	.6185					
.9501	-.0872	.6583	.7961	.8501	.4058	.7942	.5830					

TEST	167	PT	20.2934	PSI	CM	.3984	CD1	.00640	CDCOR1	.00635
RUN	1	TT	219.4361	K	CM	-1.1580	CD2	.00541	CDCOR2	.00538
POINT	6	RC	4.3759	MILLION	CC	.0210	CD3	.00531	CDCOR3	.00529
		MACH	.7616				CD4	.00510	CDCOR4	.00505
		ALPHA	-1.4867	DEG			CD5	.00503	CDCOR5	.00491

UPPER SURFACE					LOWER SURFACE					SPANWISE				
X/C	CP	P/L/PT	MLOC		X/C	CP	P/L/PT	MLOC		X/C	Y/(B/2)	CP	P/L/PT	MLOC
0.0000	1.0709	.9770	.1823		0.0000	1.0709	.9770	.1823		.1507	.7476	-.4723	.5493	.9660
.0132	-.1788	.7297	.6860		.0126	-.0292	.6883	.7502		.1507	.4976	-.4955	.5428	.9763
.0259	-.1788	.6306	.8387		.0255	-.0851	.6566	.7988		.1507	.2476	-.4996	.5417	.9781
.0759	-.4559	.5538	.9588		.0495	-.2216	.6187	.8571		.1507	-.2524	-.4943	.5432	.9758
.1003	-.4645	.5514	.9626		.0753	-.2880	.6004	.8556		.1507	-.5024	-.4879	.5450	.9729
.1507	-.4958	.5427	.9784		.1002	-.3377	.5866	.9071		.1507	-.7524	-.4586	.5331	.9599
.2003	-.5085	.5392	.9821		.1503	-.3878	.5727	.9289		.5002	.7476	-.6016	.5134	1.0240
.2503	-.5362	.5316	.9945		.1976	-.4786	.5475	.9688		.5002	.4976	-.6269	.5064	1.0256
.3001	-.5587	.5253	1.0046		.2503	-.5433	.5296	.9901		.5002	.2476	-.6331	.5047	1.0284
.3502	-.5588	.5253	1.0046		.3001	-.5433	.5296	.9977		.5002	-.2524	-.6245	.5071	1.0345
.4003	-.5741	.5210	1.0115		.3507	-.5347	.5320	.9938		.5002	-.5024	-.6170	.5092	1.0311
.4501	-.5985	.5143	1.0225		.4001	-.4945	.5432	.9757		.5002	-.7524	-.5988	.5142	1.0228
.5002	-.6242	.5072	1.0344		.4501	-.4354	.5595	.9497		.8002	.7476	-.4063	.5676	.9369
.5502	-.6412	.5024	1.0422		.5001	-.3267	.5896	.9023		.8002	.4976	-.3979	.5699	.9332
.6002	-.6644	.4960	1.0529		.5497	-.1973	.6235	.8467		.8002	.2476	-.4111	.5662	.9390
.6500	-.6876	.4896	1.0637		.6003	-.0760	.6591	.7950		.8002	-.5024	-.4003	.5692	.9343
.7000	-.6598	.4973	1.0508		.6500	.0276	.6878	.7509		.8002	-.7524	-.3737	.5766	.9227
.7500	-.5487	.5281	1.0001		.7000	.1447	.7203	.7007						
.8002	-.4153	.5651	.9409		.7507	.2506	.7496	.6548						
.9002	-.2165	.6202	.8549		.8001	.3397	.7743	.6154						
.9501	-.0848	.6567	.7987		.8501	.4197	.7965	.5732						

TEST	167	PT	20.2953	PSI	CM	.4225	CD1	.00650	CDCOR1	.00643
RUN	1	TT	219.3597	K	CM	-1.1564	CD2	.00544	CDCOR2	.00539
POINT	7	RC	4.3744	MILLION	CC	.0210	CD3	.00539	CDCOR3	.00537
		MACH	.7605				CD4	.00515	CDCOR4	.00507
		ALPHA	-1.0008	DEG			CD5	.00514	CDCOR5	.00501

UPPER SURFACE					LOWER SURFACE					SPANWISE				
X/C	CP	P/L/PT	MLOC		X/C	CP	P/L/PT	MLOC		X/C	Y/(B/2)	CP	P/L/PT	MLOC
0.0000	1.1037	.9866	.1388		0.0000	1.1037	.9866	.1388		.1507	.7476	-.5467	.5319	.9939
.0132	-.0696	.7017	.7294		.0126	-.1422	.7217	.6984		.1507	.4976	-.5741	.5244	1.0041
.0259	-.2947	.6014	.8840		.0255	-.0096	.6852	.7549		.1507	.2476	-.5800	.5228	1.0087
.0759	-.5612	.5280	1.0003		.0495	-.1384	.6444	.8175		.1507	-.2524	-.5739	.5246	1.0058
.1003	-.5583	.5287	.9990		.0753	-.2126	.6240	.8490		.1507	-.5024	-.5646	.5270	1.0018
.1507	-.5742	.5244	1.0062		.1002	-.2684	.6086	.8728		.1507	-.7524	-.5303	.5364	.9866
.2003	-.5698	.5256	1.0042		.1503	-.3263	.5926	.8976		.5002	.7476	-.6363	.5072	1.0342
.2503	-.5951	.5186	1.0155		.1976	-.4163	.5679	.9364		.5002	.4976	-.6637	.4997	1.0447
.3001	-.6151	.5131	1.0246		.2503	-.4640	.5547	.9573		.5002	.2476	-.6705	.4978	1.0499
.3502	-.6035	.5163	1.0193		.3001	-.4891	.5489	.9665		.5002	-.2524	-.6634	.4998	1.0466
.4003	-.6114	.5141	1.0229		.3507	-.4846	.5490	.9663		.5002	-.5024	-.6565	.5017	1.0434
.4501	-.6312	.5087	1.0319		.4001	-.4559	.5570	.9537		.5002	-.7524	-.6370	.5071	1.0345
.5002	-.6562	.5018	1.0433		.4501	-.4083	.5701	.9330		.8002	.7476	-.4116	.5681	.9344
.5502	-.6708	.4978	1.0500		.5001	-.3187	.5947	.8943		.8002	.4976	-.4073	.5703	.9325
.6002	-.6863	.4935	1.0571		.5497	-.1890	.6305	.8390		.8002	.2476	-.4145	.5684	.9357
.6500	-.7012	.4894	1.0640		.6003	-.0701	.6632	.7886		.8002	-.5024	-.4066	.5705	.9322
.7000	-.6638	.4997	1.0468		.6500	.0311	.6911	.7458		.8002	-.7524	-.3798	.5770	.9206
.7500	-.5367	.5347	.9894		.7000	.1458	.7227	.6969						
.8002	-.4200	.5668	.9381		.7501	.2502	.7515	.6518						
.9002	-.2168	.6228	.8508		.8001	.3381	.7757	.6132						
.9501	-.0821	.6599	.7937		.8501	.4170	.7974	.5777						

TEST	167	PT	20.2972	PSI	CM	.4972	CD1	.00694	CDCOR1	.00686
RUN	1	TT	215.5513	K	CM	-1.1573	CD2	.00552	CDCOR2	.00546
POINT	8	RC	4.3702	MILLION	CC	.0204	CD3	.00552	CDCOR3	.00548
		MACH	.7607				CD4	.00525	CDCOR4	.00514
		ALPHA	-1.4888	DEG			CD5	.00534	CDCOR5	.00515

UPPER SURFACE					LOWER SURFACE					SPANWISE				
X/C	CP	P/L/PT	MLOC		X/C	CP	P/L/PT	MLOC		X/C	Y/(B/2)	CP	P/L/PT	MLOC
0.0000	1.1290	.9932	.0984		0.0000	1.1290	.9932	.0984		.1507	.7476	-.6273	.5073	1.0341
.0132	-.0337	.6715	.7759		.0126	.2511	.7503	.6537		.1507	.4976	-.6589	.4986	1.0487
.0259	-.4040	.5691	.9345		.0255	.1041	.7097	.7172		.1507	.2476	-.6677	.4961	1.0527
.0759	-.6784	.4932	1.0577		.0495	-.0543	.6658	.7844		.1507	-.2524	-.6590	.4989	1.0487
.1003	-.6667	.4964	1.0522		.0753	-.1364	.6431	.8195		.1507	-.5024	-.6457	.5022	1.0426
.1507	-.6616	.4978	1.0499		.1002	-.1970	.6263	.8453		.1507	-.7524	-.6060	.5132	1.0244
.2003	-.6596	.5011	1.0444		.1503	-.2638	.6081	.8735		.5002	.7476	-.6790	.4930	1.0579
.2503	-.6579	.4988	1.0482		.1976	-.3550	.5826	.9132		.5002	.4976	-.7045	.4859	1.0698
.3001	-.6813	.4924	1.0590		.2503	-.4058	.5686	.9353		.5002	.2476	-.7098	.4845	1.0723
.3502	-.6747	.4942	1.0560		.3001	-.4316	.5615	.9466		.5002	-.2524	-.7051	.4858	1.0701
.4003	-.6592	.4987	1.0483		.3507	-.4381	.5597	.9494		.5002	-.5024	-.7029	.4864	1.0691
.4501	-.6634	.4973	1.0507		.4001	-.4172	.5634	.9403		.5002	-.7524	-.6849	.4913	1.0607
.5002	-.6915	.4895	1.0637		.4501	-.3767	.5766	.9226		.8002	.7476	-.4063	.5684	.9355
.5502	-.7154	.4829	1.0749		.5001	-.2997	.5980	.8893		.8002	.4976	-.4074	.5681	.9360
.6002	-.7257	.4801	1.0798		.5497	-.1724	.6331	.8349		.8002	.2476	-.4147	.5661	.9392
.6500	-.7285	.4793	1.0811		.6003	-.0559	.6634	.7833		.8002	-.5024	-.4074	.5681	.9360
.7000	-.6774	.4934	1.0572		.6500	.0425	.6926	.7435		.8002	-.7524	-.3778	.5763	.9231
.7500	-.5265	.5352	.9886		.7000	.1591	.7238	.6953						
.8002	-.4160	.5654	.9398		.7501	.2580	.7522	.6506						
.9002	-.2170	.6222	.8517		.8001	.3450	.7763	.6121						
.9501	-.0757	.6599	.7937		.8501	.4239	.7981	.5765						

TEST 167	PT	20.2932	PSI	CM	.5695	CD1	.00731	CDCOP1	.00725
RUN 1	TT	215.5932	K	CM	-.1569	CD2	.00597	CDCUM2	.00593
POINT 9	RC	4.3707	MILLION	CC	.0188	CD3	.00635	CDCOR3	.00631
	MACH	.7615				CD4	.00583	CDCOR4	.00575
	ALPHA	.0204	DEG			CD5	.00600	CDCOR5	.00578

UPPER SURFACE				LOWER SURFACE				SPANWISE				
X/C	CP	P _L /PT	MLOC	X/C	CP	P _L /PT	MLOC	X/C	Y/(B/2)	CP	P _L /PT	MLOC
0.0000	1.1438	.9973	.0625	0.0000	1.1438	.9973	.0625	.1507	.7476	-.7137	.4828	1.0751
.0132	-.1332	.6434	.8188	.0126	.3491	.7772	.6108	.1507	.4976	-.7633	.4691	1.0985
.0259	-.5089	.5396	.9819	.0253	.1895	.7330	.6609	.1507	.2476	-.7887	.4621	1.1107
.0759	-.7802	.5644	1.1066	.0495	-.0229	.6868	.7524	.1507	-.2524	-.7721	.4667	1.1027
.1003	-.8001	.4589	1.1161	.0753	-.0656	.6623	.7900	.1507	-.5024	-.7322	.4777	1.0838
.1507	-.7808	.4643	1.1069	.1002	-.1314	.6441	.8180	.1507	-.7524	-.6836	.4912	1.0610
.2003	-.7592	.4702	1.0966	.1503	-.2067	.6232	.8501	.5002	.7476	-.7108	.4820	1.0765
.2503	-.7228	.4803	1.0793	.1976	-.2984	.5979	.8895	.5002	.4976	-.7330	.4775	1.0841
.3001	-.7238	.4800	1.0798	.2503	-.3523	.5829	.9129	.5002	.2476	-.7367	.4765	1.0859
.3502	-.7255	.4796	1.0806	.3001	-.3823	.5746	.9258	.5002	-.2524	-.7327	.4776	1.0840
.4003	-.7286	.4787	1.0821	.3507	-.3943	.5713	.9310	.5002	-.5024	-.7364	.4765	1.0858
.4501	-.7233	.4802	1.0796	.4001	-.3796	.5754	.9246	.5002	-.7524	-.7198	.4811	1.0780
.5002	-.7218	.4806	1.0789	.4501	-.3449	.5850	.9096	.8002	.7476	-.4037	.5687	.9351
.5502	-.7374	.4763	1.0862	.5001	-.2700	.6035	.8807	.8002	.4976	-.4112	.5686	.9384
.6002	-.7505	.4726	1.0924	.5497	-.1570	.6370	.8289	.8002	.2476	-.4199	.5642	.9422
.6500	-.7421	.4750	1.0885	.6003	-.0423	.6688	.7801	.8002	-.5024	-.4103	.5669	.9380
.7000	-.6652	.4963	1.0524	.6500	.0534	.6952	.7394	.8002	-.7524	-.3730	.5772	.9217
.7500	-.5189	.5368	.9860	.7000	.1636	.7258	.6921					
.8002	-.4149	.5656	.9400	.7501	.2646	.7538	.6482					
.9002	-.2055	.6236	.8496	.8001	.3506	.7776	.6101					
.9501	-.0708	.6609	.7922	.8501	.4291	.7993	.5745					

TEST 167	PT	20.2932	PSI	CM	.6408	CD1	.00770	CDCOR1	.00763
RUN 1	TT	215.4854	K	CM	-.1551	CD2	.00668	CDCOR2	.00662
POINT 10	RC	4.3746	MILLION	CC	.0166	CD3	.00692	CDCOR3	.00689
	MACH	.7618				CD4	.00682	CDCOR4	.00671
	ALPHA	.5193	DEG			CD5	.00691	CDCOR5	.00670

UPPER SURFACE				LOWER SURFACE				SPANWISE				
X/C	CP	P _L /PT	MLOC	X/C	CP	P _L /PT	MLOC	X/C	Y/(B/2)	CP	P _L /PT	MLOC
0.0000	1.1543	1.0002	0.0000	0.0000	1.1543	1.0002	0.0000	.1507	.7476	-.8321	.4500	1.1318
.0132	-.2206	.6793	.8561	.0126	.4346	.8008	.5721	.1507	.4976	-.9203	.4256	1.1756
.0259	-.6008	.5140	1.0230	.0253	.2662	.7542	.6476	.1507	.2476	-.9074	.4291	1.1691
.0759	-.8707	.4393	1.1508	.0495	.0916	.7058	.7231	.1507	-.2524	-.8944	.4327	1.1626
.1003	-.8883	.4344	1.1596	.0753	-.0027	.6797	.7633	.1507	-.5024	-.8930	.4331	1.1619
.1507	-.8647	.4326	1.1627	.1002	-.0722	.6605	.7929	.1507	-.7524	-.7890	.4619	1.1109
.2003	-.8880	.4345	1.1594	.1503	-.1543	.6377	.8275	.5002	.7476	-.7322	.4777	1.0839
.2503	-.8953	.4325	1.1631	.1976	-.2478	.6118	.8678	.5002	.4976	-.7353	.4768	1.0853
.3001	-.8697	.4396	1.1503	.2503	-.3054	.5959	.8926	.5002	.2476	-.7321	.4721	1.0933
.3502	-.8031	.4580	1.1177	.3001	-.3394	.5865	.9072	.5002	-.2524	-.7403	.4754	1.0877
.4003	-.7536	.4717	1.0940	.3507	-.3562	.5810	.9145	.5002	-.5024	-.7366	.4764	1.0860
.4501	-.7523	.4721	1.0934	.4001	-.3467	.5844	.9104	.5002	-.7524	-.7370	.4763	1.0862
.5002	-.7509	.4725	1.0927	.4501	-.3173	.5926	.8977	.8002	.7476	-.3948	.5711	.9313
.5502	-.7451	.4741	1.0900	.5001	-.2576	.6091	.8720	.8002	.4976	-.4047	.5684	.9356
.6002	-.7437	.4745	1.0893	.5497	-.1434	.6407	.8232	.8002	.2476	-.4126	.5662	.9391
.6500	-.7334	.4773	1.0844	.6003	-.0293	.6723	.7747	.8002	-.5024	-.4042	.5685	.9355
.7000	-.6582	.4981	1.0493	.6500	.0634	.6980	.7352	.8002	-.7524	-.3669	.5788	.9192
.7500	-.5129	.5384	.9834	.7000	.1719	.7281	.6886					
.8002	-.4069	.5677	.9366	.7501	.2717	.7557	.6451					
.9002	-.1942	.6267	.8449	.8001	.3569	.7793	.6073					
.9501	-.0636	.6628	.7893	.8501	.4350	.8009	.5719					

TEST 167	PT	19.8991	PSI	CM	.7469	CD1	.00783	CDCOR1	.00745
RUN 1	TT	217.5736	K	CM	-.1609	CD2	.00711	CDCOR2	.00675
POINT 11	RC	4.3569	MILLION	CC	.0146	CD3	.00726	CDCOR3	.00683
	MACH	.7613				CD4	.00748	CDCOR4	.00698
	ALPHA	1.0464	DEG			CD5	.00788	CDCOR5	.00743

UPPER SURFACE				LOWER SURFACE				SPANWISE				
X/C	CP	P _L /PT	MLOC	X/C	CP	P _L /PT	MLOC	X/C	Y/(B/2)	CP	P _L /PT	MLOC
0.0000	1.1537	1.0001	0.0000	0.0000	1.1537	1.0001	0.0000	.1507	.7476	-.8544	.4173	1.1907
.0132	-.3188	.5930	.8970	.0126	.5179	.8243	.5323	.1507	.4976	-1.0355	.3949	1.2329
.0259	-.7047	.4865	1.0889	.0253	.3418	.7757	.6132	.1507	.2476	-1.0062	.4030	1.2174
.0759	-.9685	.4140	1.1969	.0495	.1606	.7256	.6925	.1507	-.2524	-.8946	.4062	1.2114
.1003	-.9841	.4081	1.2060	.0753	-.0609	.6980	.7352	.1507	-.5024	-1.0127	.4012	1.2209
.1507	-.9925	.4068	1.2103	.1002	-.0120	.6778	.7662	.1507	-.7524	-.8193	.4270	1.1729
.2003	-.9959	.4059	1.2121	.1503	-.1002	.6535	.8036	.5002	.7476	-.8443	.4201	1.1856
.2503	-1.0127	.4012	1.2209	.1976	-.1952	.6272	.8440	.5002	.4976	-.8679	.4136	1.1977
.3001	-1.0325	.3958	1.2312	.2503	-.2563	.6103	.8701	.5002	.2476	-.8510	.4182	1.1890
.3502	-1.0285	.3968	1.2292	.3001	-.2292	.6000	.8862	.5002	-.2524	-.8419	.4208	1.1844
.4003	-.9759	.4114	1.2018	.3507	-.3147	.5842	.8935	.5002	-.5024	-.8562	.4188	1.1916
.4501	-.9276	.4247	1.1771	.4001	-.3108	.5952	.8935	.5002	-.7524	-.8430	.4205	1.1849
.5002	-.9028	.4317	1.1645	.4501	-.2865	.6020	.8831	.8002	.7476	-.3900	.5734	.9278
.5502	-.8937	.4341	1.1601	.5001	-.2336	.6166	.8604	.8002	.4976	-.4059	.5689	.9347
.6002	-.8419	.4484	1.1346	.5497	-.1288	.6436	.8158	.8002	.2476	-.4149	.5665	.9387
.6500	-.6481	.5023	1.0420	.6003	-.0153	.6769	.7676	.8002	-.5024	-.4018	.5701	.9330
.7000	-.5429	.5311	.9953	.6500	.0746	.7018	.7291	.8002	-.7524	-.3615	.5812	.9154
.7500	-.4487	.5621	.9711	.7000	.1808	.7311	.6838					
.8002	-.4082	.5883	.9357	.7501	.2790	.7583	.6410					
.9002	-.2056	.6243	.8445	.8001	.3633	.7816	.6036					
.9501	-.0727	.6612	.7918	.8501	.4410	.8031	.5683					

TEST 167 PT 19.5846 PSI CM .8288
 RUN 1 TT 209.6698 K CM -.1652
 POINT 12 RC 4.3733 MILLION CC .0131
 MACH .7585
 ALPHA 1.5281 DEG

CD1 .00914 CDCOR1 .00878
 CD2 .00904 CDCOR2 .00878
 CD3 .00914 CDCOR3 .00847
 CD4 .01024 CDCOR4 .00946
 CD5 .01102 CDCOR5 .01062

UPPER SURFACE				LOWER SURFACE			
X/C	CP	P/L/P/T	MLOC	X/C	CP	P/L/P/T	MLOC
0.0000	1.1495	.9992	.0336	0.0000	1.1495	.9992	.0336
.0132	-.4086	.9700	.9331	.0126	.5809	.8426	.5005
.0259	-.7943	.4637	1.1078	.0255	.4000	.7927	.5854
.0759	-1.0458	.3944	1.2338	.0495	.2137	.7414	.6677
.1003	-1.0644	.3893	1.2436	.0753	.1104	.7129	.7121
.1507	-1.0713	.3874	1.2473	.1002	.0344	.6920	.7444
.2003	-1.0678	.3884	1.2454	.1503	-.0570	.6668	.7831
.2503	-1.0916	.3818	1.2582	.1976	-.1538	.6402	.8241
.3001	-1.1145	.3755	1.2706	.2503	-.2170	.6228	.8509
.3502	-1.1276	.3719	1.2778	.3001	-.2572	.6117	.8680
.4003	-1.1239	.3729	1.2758	.3507	-.2818	.6049	.8785
.4501	-1.0816	.3846	1.2528	.4001	-.2823	.6048	.8787
.5002	-1.0395	.3962	1.2304	.4501	-.2623	.6103	.8702
.5502	-1.0133	.4034	1.2168	.5001	-.2146	.6234	.8499
.6002	-.9626	.4174	1.1906	.5497	-.1182	.6500	.8090
.6500	-.9173	.4849	1.0716	.6003	-.0065	.6808	.7617
.7000	-.4954	.5461	.9711	.6500	.0810	.7648	.7246
.7500	-.4327	.5633	.9436	.7000	.1847	.7334	.6802
.8002	-.3776	.5785	.9197	.7501	.2814	.7601	.6382
.9002	-.2036	.6265	.8452	.8001	.3866	.7827	.6014
.9501	-.0773	.6612	.7917	.8501	.4414	.8041	.5666

SPANWISE				
X/C	Y/(B/2)	CP	P/L/P/T	MLOC
.1507	.7476	-1.0557	.3917	1.2390
.1507	.4976	-1.1215	.3736	1.2744
.1507	.7476	-1.0850	.3936	1.2546
.1507	-.2524	-1.0737	.3869	1.2483
.1507	-.5024	-1.0939	.3803	1.2611
.1507	-.7524	-1.0611	.4040	1.2156
.5002	.7476	-1.0470	.3935	1.2355
.5002	.4976	-1.0701	.3877	1.2467
.5002	.2476	-1.0856	.3835	1.2549
.5002	-.2524	-1.0698	.3878	1.2465
.5002	-.5024	-1.0667	.3887	1.2449
.5002	-.7524	-1.0367	.3969	1.2290
.8002	.7476	-1.3695	.5808	.9162
.8002	.4976	-1.3802	.5778	.9208
.8002	.2476	-1.3867	.5760	.9236
.8002	-.2524	-1.3775	.5785	.9177
.8002	-.7524	-1.3505	.5860	.9080

TEST 167 PT 18.9263 PSI CM -.9167
 RUN 1 TT 204.3948 K CM -.1800
 POINT 13 RC 4.3839 MILLION CC .0147
 MACH .7604
 ALPHA 2.0264 DEG

CD1 .01246 CDCOR1 .01210
 CD2 .01301 CDCOR2 .01272
 CD3 .01274 CDCOR3 .01212
 CD4 .01546 CDCOR4 .01505
 CD5 .01519 CDCOR5 .01491

UPPER SURFACE				LOWER SURFACE			
X/C	CP	P/L/P/T	MLOC	X/C	CP	P/L/P/T	MLOC
0.0000	1.1444	.9976	.0539	0.0000	1.1444	.9976	.0539
.0132	-.4692	.5516	.9624	.0126	.6283	.8549	.4783
.0259	-.8535	.4453	1.1401	.0255	.4449	.8042	.5665
.0759	-1.0991	.3774	1.2668	.0495	.2544	.7516	.6517
.1003	-1.1182	.3721	1.2773	.0753	.1475	.7220	.6980
.1507	-1.1273	.3696	1.2823	.1002	.0691	.7003	.7316
.2003	-1.1284	.3693	1.2829	.1503	-.0273	.6737	.7726
.2503	-1.1475	.3641	1.2936	.1976	-.1261	.6464	.8146
.3001	-1.1714	.3574	1.3071	.2503	-.1929	.6279	.8430
.3502	-1.1887	.3527	1.3169	.3001	-.2370	.6157	.8618
.4003	-1.2050	.3482	1.3253	.3507	-.2654	.6079	.8739
.4501	-1.2079	.3474	1.3280	.4001	-.2697	.6067	.8758
.5002	-1.1695	.3580	1.3080	.4501	-.2729	.6113	.8686
.5502	-1.1440	.3650	1.2914	.5001	-.2082	.6237	.8495
.6002	-1.1494	.3639	1.2947	.5497	-.1188	.6489	.8105
.6500	-1.1333	.3680	1.2857	.6003	-.0044	.6800	.7629
.7000	-.6889	.4930	1.0579	.6500	.0816	.7038	.7263
.7500	-.3905	.5733	.9279	.7000	.1847	.7323	.6820
.8002	-.3146	.5943	.8931	.7501	.2806	.7588	.6403
.9002	-.1868	.6296	.8404	.8001	.3837	.7818	.6033
.9501	-.0761	.6602	.7933	.8501	.4420	.8034	.5678

SPANWISE				
X/C	Y/(B/2)	CP	P/L/P/T	MLOC
.1507	.7476	-1.1377	.3668	1.2881
.1507	.4976	-1.1791	.3553	1.3114
.1507	.2476	-1.1401	.3661	1.2895
.1507	-.2524	-1.1282	.3694	1.2828
.1507	-.5024	-1.1536	.3624	1.2970
.1507	-.7524	-1.0742	.3843	1.2533
.5002	.7476	-1.1370	.3670	1.2877
.5002	.4976	-1.1460	.3645	1.2928
.5002	.2476	-1.1701	.3578	1.3063
.5002	-.2524	-1.1549	.3620	1.2977
.5002	-.5024	-1.1250	.3703	1.2811
.5002	-.7524	-1.1226	.3709	1.2790
.8002	.7476	-1.3940	.5834	.9121
.8002	.4976	-1.3417	.5868	.9068
.8002	.2476	-1.3178	.5934	.8964
.8002	-.2524	-1.3450	.5859	.9082
.8002	-.7524	-1.3654	.5802	.9170

TEST 167 PT 18.6716 PSI CM -.9508
 RUN 1 TT 202.4041 K CM -.1815
 POINT 14 RC 4.3851 MILLION CC .0144
 MACH .7608
 ALPHA 2.3217 DEG

CD1 .01587 CDCOR1 .01501
 CD2 .01632 CDCOR2 .01552
 CD3 .01690 CDCOR3 .01649
 CD4 .01967 CDCOR4 .01897
 CD5 .01978 CDCOR5 .01838

UPPER SURFACE				LOWER SURFACE			
X/C	CP	P/L/P/T	MLOC	X/C	CP	P/L/P/T	MLOC
0.0000	1.1494	.9991	.0361	0.0000	1.1494	.9991	.0361
.0132	-.5010	.5437	.9749	.0126	.6669	.8660	.4579
.0259	-.8849	.4378	1.1533	.0255	.4818	.8149	.5485
.0759	-1.1278	.3708	1.2800	.0495	.2914	.7624	.6346
.1003	-1.1459	.3658	1.2900	.0753	.1826	.7324	.6819
.1507	-1.1550	.3633	1.2951	.1002	.1026	.7103	.7132
.2003	-1.1518	.3642	1.2933	.1503	.0027	.6827	.7588
.2503	-1.1721	.3586	1.3047	.1976	-.0958	.6555	.8005
.3001	-1.1947	.3524	1.3175	.2503	-.1844	.6366	.8296
.3502	-1.2128	.3474	1.3279	.3001	-.2098	.6241	.8489
.4003	-1.2299	.3427	1.3379	.3507	-.2402	.6137	.8618
.4501	-1.2431	.3390	1.3456	.4001	-.2469	.6139	.8647
.5002	-1.2154	.3467	1.3294	.4501	-.2321	.6179	.8584
.5502	-1.1839	.3554	1.3113	.5001	-.1903	.6295	.8406
.6002	-1.1783	.3569	1.3082	.5497	-.1029	.6536	.8035
.6500	-1.1534	.3638	1.2942	.6003	.0078	.6841	.7566
.7000	-.6890	.4974	1.0506	.6500	.0926	.7075	.7205
.7500	-.3768	.5780	.9205	.7000	.1942	.7336	.6769
.8002	-.2988	.6001	.8860	.7501	.2895	.7618	.6354
.9002	-.1747	.6338	.8339	.8001	.3720	.7846	.5908
.9501	-.0674	.6634	.7885	.8501	.4496	.8060	.5635

SPANWISE				
X/C	Y/(B/2)	CP	P/L/P/T	MLOC
.1507	.7476	-1.1646	.3607	1.3004
.1507	.4976	-1.2061	.3492	1.3240
.1507	.2476	-1.1679	.3598	1.3023
.1507	-.2524	-1.1530	.3639	1.2940
.1507	-.5024	-1.1778	.3570	1.3079
.1507	-.7524	-1.1016	.3781	1.2656
.5002	.7476	-1.1643	.3608	1.3003
.5002	.4976	-1.1723	.3586	1.3048
.5002	.2476	-1.1960	.3520	1.3183
.5002	-.2524	-1.1787	.3568	1.3084
.5002	-.5024	-1.1369	.3683	1.2850
.5002	-.7524	-1.1488	.3631	1.2915
.8002	.7476	-1.3627	.5874	.9058
.8002	.4976	-1.3293	.5911	.9000
.8002	.2476	-1.2995	.5994	.8872
.8002	-.2524	-1.3357	.5894	.9027
.8002	-.7524	-1.3674	.5806	.9164

TEST 167
 RUN 55
 MACH .760
 R 4.4×10^6

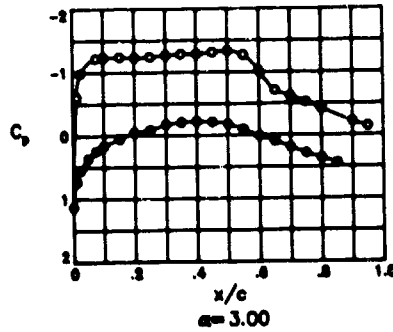
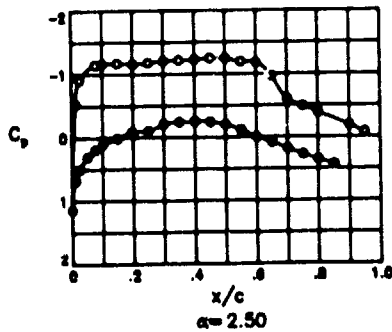
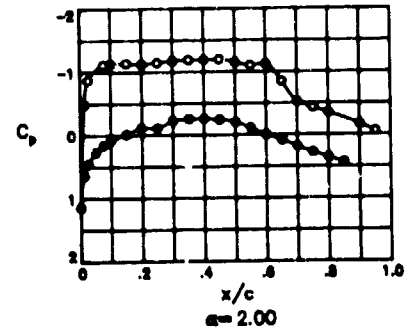
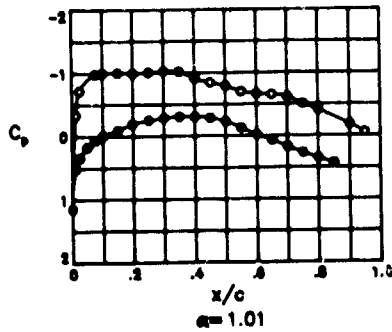
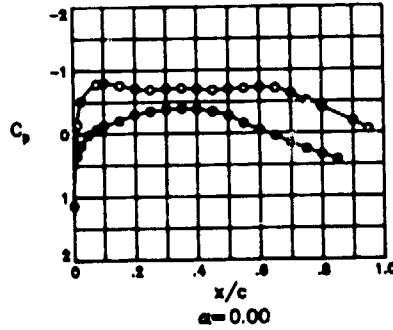
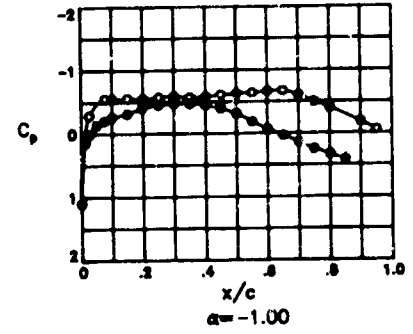
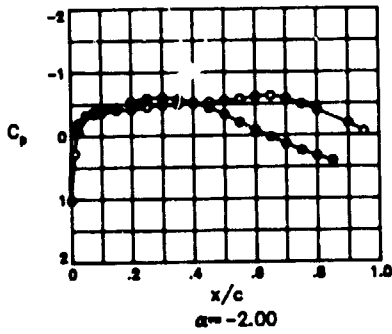
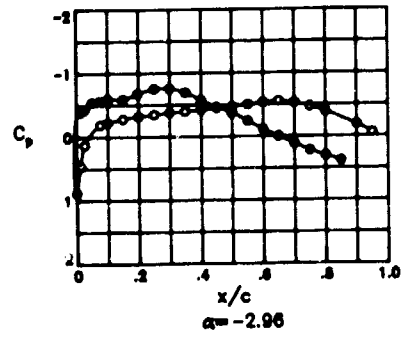
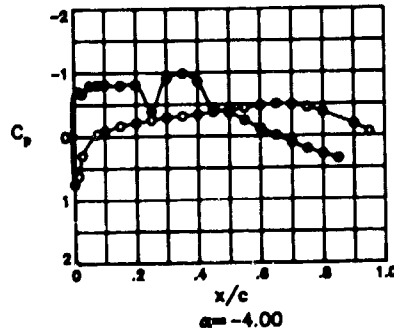

TFST	.67	PT	20.5049	PSI	CM	-.0269	CD1	.01041	CDCOR1	.01028
RUN	55	TT	216.2941	K	CM	-.1355	CD2	.00876	CDCOR2	.00867
POINT	57	RC	4.3920	MILLION	CC	.0054	CD3	.00795	CDCOR3	.00789
		MACH	.7601	DEG			CD4	.00780	CDCOR4	.00767
		ALPHA	-4.0019	DEG			CD5	.00733	CDCOR5	.00711

UPPER SURFACE				LOWER SURFACE				SPANWISE				
X/C	CP	P/L/PT	MLOC	X/C	CP	P/L/PT	MLOC	X/C	Y/(B/2)	CP	P/L/PT	MLOC
0.0000	.7472	.8881	.4150	0.0000	.7472	.8881	.4150	.1507	.7476	-.1429	.8425	.4204
.0132	.6226	.8537	.4804	.0126	-.7045	.4876	1.0670	.1507	.4976	-.1612	.6375	.8282
.0259	.3021	.7653	.6299	.0255	-.6684	.4975	1.0504	.1507	.2476	-.1623	.8372	.8287
.0759	-.0378	.6715	.7759	.0495	-.7479	.4610	1.1110	.1507	-.2524	-.1645	.6366	.8296
.1003	-.0857	.6583	.7962	.0753	-.8056	.4497	1.1148	.1507	-.5024	-.1665	.6360	.8304
.1507	-.1617	.6373	.8284	.1002	-.8110	.4582	1.1174	.1507	-.7524	-.1685	.6360	.8304
.2003	-.2104	.6239	.8491	.1503	-.7978	.4618	1.1111	.5002	.7476	-.3966	.5725	.9261
.2503	-.2542	.6118	.8678	.1976	-.8118	.4580	1.1178	.5002	.4976	-.4123	.5682	.9339
.3001	-.2922	.6013	.8841	.2503	-.8447	.5756	.9239	.5002	.2476	-.4081	.5694	.9341
.3502	-.3125	.5957	.8929	.3001	-.8081	.4314	1.1650	.5002	-.2524	-.4135	.5679	.9364
.4003	-.3407	.5879	.9049	.3507	-.9829	.4108	1.2029	.5002	-.5024	-.4082	.5693	.9411
.4501	-.3734	.5789	.9190	.4001	-.8560	.4458	1.1392	.5002	-.7524	-.3934	.5734	.9277
.5002	-.4047	.5703	.9326	.4501	-.4454	.5591	.9503	.8002	.7476	-.3565	.5836	.9117
.5502	-.4398	.5606	.9479	.5001	-.3804	.5825	.9134	.8002	.4976	-.3637	.5810	.9157
.6002	-.4796	.5496	.9654	.5477	-.2443	.6145	.8636	.8002	.2476	-.3744	.5786	.9195
.6500	-.5037	.5430	.9760	.6003	-.1189	.6492	.8102	.8002	-.5024	-.3808	.5789	.9222
.7000	-.4913	.5464	.9706	.6500	-.0071	.6800	.7629	.8002	-.7524	-.3497	.5855	.9088
.7500	-.4471	.5586	.9511	.7000	.1062	.7123	.7147					
.8002	-.3713	.5791	.9181	.7501	.2042	.7388	.6717					
.8002	-.1802	.6322	.8363	.8001	.2884	.7615	.6359					
.9501	-.0526	.6674	.7823	.8501	.3541	.7807	.6050					

TEST	167	PT	20.5504	PSI	CM	.1101	CD1	.00859	CDCOR1	.00878
RUN	55	TT	216.6565	K	CM	-.1410	CD2	.00803	CDCOR2	.00828
POINT	58	RC	4.3919	MILLION	CC	.0120	CD3	.00698	CDCOR3	.00719
		MACH	.7601	DEG			CD4	.00680	CDCOR4	.00711
		ALPHA	-2.9632	DEG			CD5	.00594	CDCOR5	.00605

UPPER SURFACE				LOWER SURFACE				SPANWISE				
X/C	CP	P/L/PT	MLOC	X/C	CP	P/L/PT	MLOC	X/C	Y/(B/2)	CP	P/L/PT	MLOC
0.0000	.8805	.9257	.3337	0.0000	.8805	.9257	.3337	.1507	.7476	-.2609	.6125	.8667
.0132	.4667	.8116	.5540	.0126	-.3948	.5758	.9239	.1507	.4976	-.2815	.6069	.8734
.0259	.1271	.7190	.7027	.0255	-.4334	.5632	.9406	.1507	.2476	-.2831	.6064	.8761
.0759	-.1872	.6328	.8359	.0495	-.5458	.5364	.9898	.1507	-.2524	-.2833	.6064	.8762
.1003	-.2217	.6233	.8500	.0753	-.5636	.5295	.9978	.1507	-.5024	-.2845	.6061	.8767
.1507	-.2791	.6077	.8744	.1002	-.5916	.5218	1.0103	.1507	-.7524	-.2707	.6098	.8708
.2003	-.3215	.5959	.8925	.1503	-.5992	.5225	1.0092	.5002	.7476	-.4637	.5569	.9339
.2503	-.3482	.5826	.9039	.1976	-.6284	.4989	1.0481	.5002	.4976	-.4813	.5521	.9615
.3001	-.3797	.5799	.9175	.2503	-.7527	.4741	1.0831	.5002	.2476	-.4764	.5533	.9595
.3502	-.3961	.5754	.9245	.3001	-.7527	.4776	1.0840	.5002	-.2524	-.4808	.5522	.9613
.4003	-.4186	.5643	.9342	.3507	-.6929	.4940	1.0562	.5002	-.5024	-.4753	.5536	.9590
.4501	-.4474	.5614	.9467	.4001	-.5718	.5272	1.0015	.5002	-.7524	-.4606	.5577	.9525
.5002	-.4723	.5545	.9576	.4501	-.4634	.5570	.9537	.8002	.7476	-.3705	.5625	.9135
.5502	-.5026	.5462	.9708	.5001	-.3715	.5922	.9139	.8002	.4976	-.3825	.5792	.9187
.6002	-.5375	.5366	.9863	.5477	-.2460	.6183	.8578	.8002	.2476	-.3927	.5764	.9230
.6500	-.5544	.5320	.9937	.6003	-.1101	.6539	.8029	.8002	-.5024	-.3990	.5746	.9258
.7000	-.4726	.5391	.9823	.6500	-.0009	.6839	.7569	.8002	-.7524	-.3672	.5834	.9121
.7500	-.4719	.5546	.9574	.7000	.1188	.7161	.7071					
.8002	-.4779	.5777	.9210	.7501	.2213	.7448	.6625					
.8002	-.1861	.6330	.8350	.8001	.3076	.7685	.6247					
.9501	-.0570	.6605	.7806	.8501	.3925	.7891	.5914					

TFST	167	PT	20.5582	PSI	CM	.2612	CD1	.00857	CDCOR1	.00839
RUN	55	TT	216.6826	K	CM	-.1477	CD2	.00779	CDCOR2	.00756
POINT	59	RC	4.3910	MILLION	CC	.0177	CD3	.00634	CDCOR3	.00663
		MACH	.7596	DEG			CD4	.00640	CDCOR4	.00626
		ALPHA	-1.9997	DEG			CD5	.00629	CDCOR5	.00611

UPPER SURFACE				LOWER SURFACE				SPANWISE				
X/C	CP	P/L/PT	MLOC	X/C	CP	P/L/PT	MLOC	X/C	Y/(B/2)	CP	P/L/PT	MLOC
0.0000	1.0197	.9629	.2329	0.0000	1.0197	.9629	.2329	.1507	.7476	-.3848	.5739	.9269
.0132	.2827	.7588	.6402	.0126	-.1078	.6506	.8380	.1507	.4976	-.4029	.5689	.9347
.0259	-.0606	.6637	.7879	.0255	-.1978	.6257	.8463	.1507	.2476	-.4048	.5684	.9356
.0759	-.3471	.5844	.9105	.0495	-.3247	.5906	.9028	.1507	-.2524	-.4049	.5684	.9356
.1003	-.3668	.5795	.9182	.0753	-.3706	.5779	.9067	.1507	-.5024	-.4039	.5680	.9332
.1507	-.4081	.5680	.9361	.1002	-.4132	.5661	.9393	.1507	-.7524	-.3838	.5742	.9264
.2003	-.4153	.5655	.9402	.1503	-.4492	.5561	.9551	.5002	.7476	-.5390	.5312	.9930
.2503	-.4550	.5545	.9576	.1976	-.5403	.5360	.9955	.5002	.4976	-.5576	.5261	1.0033
.3001	-.4882	.5475	.9689	.2503	-.5877	.5177	1.0169	.5002	.2476	-.5504	.5281	1.0001
.3502	-.4899	.5448	.9731	.3001	-.5994	.5145	1.0222	.5002	-.2524	-.5556	.5266	1.0024
.4003	-.5039	.5409	.9794	.3507	-.5762	.5209	1.0117	.5002	-.5024	-.5403	.5309	.9936
.4501	-.5286	.5341	.9903	.4001	-.5231	.5356	.9876	.5002	-.7524	-.5304	.5336	.9911
.5002	-.5510	.5279	1.0009	.4501	-.4381	.5592	.9502	.8002	.7476	-.3760	.5764	.9230
.5502	-.5781	.5204	1.0126	.5001	-.3314	.5887	.9037	.8002	.4976	-.3862	.5735	.9275
.6002	-.6108	.5113	1.0275	.5477	-.2067	.6233	.8501	.8002	.2476	-.3977	.5704	.9325
.6500	-.6272	.5089	1.0369	.6003	-.0919	.6578	.7970	.8002	-.5024	-.3994	.5727	.9289
.7000	-.5773	.5286	1.0122	.6500	.0248	.6871	.7519	.8002	-.7524	-.3772	.5774	.9216
.7500	-.4933	.5439	.9746	.7000	.1484	.7194	.7021					
.8002	-.3877	.5795	.9325	.7501	.2439	.7480	.6572					
.8002	-.1819	.6382	.8395	.8001	.3308	.7721	.6189					
.9501	-.0549	.6653	.7894	.8501	.4076	.7934	.5844					

ORIGINAL RECORD
OF POOR QUALITY

TEST 167 PT 20.4936 PSI CN .4014 CD1 .00863 CDCOR1 .00843
 RUN 55 TT 216.8979 K CM -.1478 CD2 .00846 CDCOR2 .00826
 POINT 60 RC 4.3695 MILLION CC .0195 CD3 .00667 CDCOR3 .00646
 MACH .7590 CD4 .00635 CDCOR4 .00613
 ALPHA -.9979 DEG CD5 .00762 CDCOR5 .00740

UPPER SURFACE				LOWER SURFACE				SPANWISE				
X/C	CP	P _s L/PT	MLOC	X/C	CP	P _s L/PT	MLOC	X/C	Y/(B/2)	CP	P _s L/PT	MLOC
0.0000	1.1043	.9869	.1372	0.0000	1.1043	.9869	.1372	.1507	.7476	-.5309	.5373	.9852
.0132	-.0718	.7030	.7275	.0126	-.1452	.7232	.6962	.1507	.4976	-.5585	.5297	.9975
.0259	-.2898	.6036	.8806	.0255	-.0141	.6871	.7519	.1507	.2476	-.5635	.5283	.9997
.0759	-.5516	.5315	.9945	.0495	-.1365	.6457	.8156	.1507	-.2524	-.5646	.5280	1.0003
.1103	-.5474	.5377	.9926	.0753	-.2061	.6266	.8430	.1507	-.5024	-.5588	.5296	.9977
.1507	-.5597	.5293	.9981	.1002	-.2612	.6114	.8684	.1507	-.7524	-.5283	.5380	.9841
.2003	-.5528	.5312	.9950	.1503	-.3172	.5960	.8923	.5002	.7476	-.6201	.5127	1.0252
.2503	-.5731	.5256	1.0041	.1976	-.4069	.5713	.9310	.5002	.4976	-.6375	.5079	1.0331
.3001	-.5909	.5207	1.0120	.2503	-.4525	.5588	.9508	.5002	.2476	-.6332	.5091	1.0311
.3502	-.5713	.5261	1.0032	.3001	-.4723	.5534	.9594	.5002	-.2524	-.6424	.5066	1.0353
.4003	-.5844	.5225	1.0091	.3507	-.4718	.5535	.9592	.5002	-.5024	-.6167	.5137	1.0236
.4501	-.6087	.5159	1.0200	.4001	-.4446	.5610	.9473	.5002	-.7524	-.6083	.5160	1.0199
.5002	-.6262	.5105	1.0288	.4501	-.3979	.5738	.9271	.8002	.7476	-.3902	.5759	.9237
.5502	-.6394	.5074	1.0339	.5001	-.3109	.5979	.8896	.8002	.4976	-.4005	.5731	.9282
.6002	-.6636	.5007	1.0450	.5497	-.1849	.6324	.8360	.8002	.2476	-.4076	.5712	.9312
.6500	-.6721	.4984	1.0489	.6003	-.0671	.6648	.7862	.8002	-.5024	-.4055	.5717	.9304
.7000	-.6032	.5174	1.0176	.6500	.0334	.6924	.7438	.8002	-.7524	-.3896	.5761	.9234
.7500	-.5005	.5456	.9718	.7000	1.1460	.7234	.6999					
.8002	-.4018	.5728	.9287	.7501	.2483	.7515	.6517					
.9002	-.1811	.6334	.8344	.8001	.3354	.7755	.6135					
.9501	-.0530	.6687	.7803	.8501	.4134	.7969	.5785					

TEST 167 PT 20.5382 PSI CN .5454 CD1 .00917 CDCOR1 .00894
 RUN 55 TT 216.7459 K CM -.1491 CD2 .00862 CDCOR2 .00840
 POINT 61 RC 4.3834 MILLION CC .0175 CD3 .00723 CDCOR3 .00702
 MACH .7591 CD4 .00696 CDCOR4 .00670
 ALPHA .0000 DEG CD5 .00849 CDCOR5 .00822

UPPER SURFACE				LOWER SURFACE				SPANWISE				
X/C	CP	P _s L/PT	MLOC	X/C	CP	P _s L/PT	MLOC	X/C	Y/(B/2)	CP	P _s L/PT	MLOC
0.0000	1.1415	.9972	.0633	0.0000	1.1415	.9972	.0633	.1507	.7476	-.7048	.4899	1.0631
.0132	-.1449	.6438	.8185	.0126	-.3461	.7787	.6083	.1507	.4976	-.7375	.4809	1.0783
.0259	-.5200	.5407	.9797	.0255	-.1861	.7347	.6782	.1507	.2476	-.7657	.4732	1.0915
.0759	-.7868	.4674	1.1014	.0495	-.0191	.6888	.7493	.1507	-.2524	-.7621	.4742	1.0898
.1003	-.8029	.4630	1.1091	.0753	-.0683	.6648	.7862	.1507	-.5024	-.7273	.4837	1.0735
.1507	-.7635	.4733	1.0905	.1002	-.1340	.6468	.8139	.1507	-.7524	-.6843	.4956	1.0536
.2003	-.7112	.4882	1.0660	.1503	-.2065	.6268	.8446	.5002	.7476	-.6914	.4936	1.0569
.2503	-.6932	.4931	1.0577	.1976	-.2789	.6015	.8838	.5002	.4976	-.7033	.4903	1.0624
.3001	-.7098	.4885	1.0654	.2503	-.3517	.5870	.9065	.5002	.2476	-.7087	.4889	1.0649
.3502	-.7152	.4871	1.0679	.3001	-.3810	.5789	.9191	.5002	-.2524	-.7000	.4912	1.0609
.4003	-.6992	.4915	1.0605	.3507	-.3928	.5757	.9242	.5002	-.5024	-.6969	.4921	1.0595
.4501	-.6843	.4936	1.0537	.4001	-.3791	.5794	.9182	.5002	-.7524	-.6837	.4957	1.0534
.5002	-.7004	.4911	1.0611	.4501	-.3454	.5867	.9037	.8002	.7476	-.3942	.5753	.9248
.5502	-.7140	.4874	1.0674	.5001	-.2797	.6067	.8756	.8002	.4976	-.4054	.5722	.9296
.6002	-.7248	.4844	1.0723	.5497	-.1415	.6392	.8255	.8002	.2476	-.4096	.5710	.9314
.6500	-.7111	.4882	1.0660	.6003	-.0481	.6703	.7777	.8002	-.5024	-.4117	.5705	.9323
.7000	-.6282	.5110	1.0281	.6500	.0467	.6964	.7376	.8002	-.7524	-.3973	.5744	.9261
.7500	-.5062	.5445	.9736	.7000	1.1552	.7262	.6914					
.8002	-.4043	.5725	.9292	.7501	.2548	.7536	.6485					
.9002	-.1812	.6334	.8339	.8001	.3403	.7771	.6109					
.9501	-.0587	.6674	.7822	.8501	.4182	.7985	.5759					

TFS 167 PT 19.6163 PSI CN .7186 CD1 .00928 CDCOR1 .00897
 RUN 55 TT 209.7289 K CM -.1502 CD2 .00868 CDCOR2 .00838
 POINT 62 RC 4.3767 MILLION CC .0127 CD3 .00800 CDCOR3 .00769
 MACH .7579 CD4 .00320 CDCOR4 .00781
 ALPHA 1.0081 DEG CD5 .00929 CDCOR5 .00896

UPPER SURFACE				LOWER SURFACE				SPANWISE				
X/C	CP	P _s L/PT	MLOC	X/C	CP	P _s L/PT	MLOC	X/C	Y/(B/2)	CP	P _s L/PT	MLOC
0.0000	1.1522	1.0003	0.0000	0.0000	1.1522	1.0003	0.0000	.1507	.7476	-.9619	.4206	1.1847
.0132	-.3362	.5922	.8983	.0126	-.5227	.8275	.9269	.1507	.4976	-.10387	.3995	1.2240
.0259	-.7220	.4864	1.0691	.0255	-.3446	.7788	.6081	.1507	.2476	-.10130	.4066	1.2107
.0759	-.9815	.4152	1.1946	.0495	-.1673	.7302	.6852	.1507	-.2524	-.10070	.4082	1.2076
.1003	-.9970	.4110	1.2025	.0753	-.0651	.7022	.7287	.1507	-.5024	-.10282	.4024	1.2186
.1507	-1.0016	.4097	1.2049	.1002	-.0085	.6320	.7598	.1507	-.7524	-.9299	.4294	1.1887
.2003	-.9925	.4122	1.2002	.1503	-.0946	.6584	.7961	.5002	.7476	-.8030	.4642	1.1071
.2503	-1.0074	.4081	1.2078	.1976	-.1902	.6322	.8364	.5002	.4976	-.8302	.4567	1.1200
.3001	-1.0273	.4027	1.2181	.2503	-.2498	.6156	.8616	.5002	.2476	-.7793	.4707	1.0958
.3502	-1.0713	.4043	1.2150	.3001	-.2862	.6059	.8770	.5002	-.2524	-.7935	.4668	1.1025
.4003	-.8087	.4352	1.1982	.3507	-.3072	.6001	.8859	.5002	-.5024	-.8482	.4518	1.1287
.4501	-.8407	.4538	1.1251	.4001	-.3041	.6010	.8846	.5002	-.7524	-.8194	.4597	1.1149
.5002	-.7921	.4672	1.1019	.4501	-.2808	.6074	.8747	.8002	.7476	-.3902	.5774	.9215
.5502	-.6997	.4927	1.0585	.5001	-.2284	.6217	.8525	.8002	.4976	-.4048	.5733	.9278
.6002	-.6644	.5019	1.0431	.5497	-.1242	.6497	.8094	.8002	.2476	-.4100	.5719	.9300
.6500	-.6176	.5051	1.0378	.6003	-.0164	.6798	.7631	.8002	-.5024	-.4066	.5728	.9286
.7000	-.6129	.5163	1.0193	.6500	.0731	.7044	.7253					
.7500	-.5067	.5454	.9722	.7000	1.1769	.7329	.6811					
.8002	-.4039	.5736	.9274	.7501	.2733	.7593	.6395					
.9002	-.1785	.6354	.8314	.8001	.3570	.7822	.6026					
.9501	-.0565	.6688	.7800	.8501	.4341	.8034	.5678					

TEST 167	PT 18.6881	PSI	CN	.9030	CD1 .01635	CDCOR1 .01598
RUN 55	TT 201.7903	K	CM	-.1694	CD2 .01345	CDCOR2 .01475
POINT 63	RC 4.4025	MILLION	CC	.0124	CD3 .01497	CDCOR3 .01437
	MACH .7593				CD4 .01646	CDCOR4 .01600
	ALPHA 1.9958	DEG			CD5 .01890	CDCOR5 .01832

UPPER SURFACE				LOWER SURFACE				SPANWISE				
X/C	CP	P _L /PT	MLOC	X/C	CP	P _L /PT	MLOC	X/C	Y/(B/2)	CP	P _L /PT	MLOC
0.0000	1.1424	.9973	.0617	0.0000	1.1424	.9973	.0617	.1507	.7476	-1.1281	.3725	1.2767
.0132	-.4891	.5483	.9676	.0126	.6387	.8587	.4714	.1507	.4976	-1.1870	.3562	1.3095
.0259	-.8724	.4420	1.1446	.0255	.4544	.8080	.5602	.1507	.2476	-1.1485	.3668	1.2880
.0759	-1.1142	.3763	1.2691	.0495	.2710	.7575	.6423	.1507	-.2524	-1.1404	.3691	1.2835
.1003	-1.1315	.3715	1.2786	.0753	.1593	.7268	.6907	.1507	-.5024	-1.1673	.3617	1.2984
.1507	-1.1386	.3696	1.2825	.1002	.0811	.7052	.7241	.1507	-.7524	-1.1012	.3799	1.2621
.2003	-1.1218	.3742	1.2733	.1503	-.0139	.6791	.7643	.5002	.7476	-1.1327	.3712	1.2793
.2503	-1.1462	.3675	1.2867	.1976	-.1129	.6519	.8062	.5002	.4976	-1.1424	.3685	1.2846
.3001	-1.1722	.3603	1.3012	.2503	-.1106	.6255	.8052	.5002	.2476	-1.1385	.3640	1.2936
.3502	-1.1862	.3565	1.3091	.3001	-.2221	.6218	.8524	.5002	-.2524	-1.1540	.3653	1.2910
.4003	-1.1897	.3555	1.3111	.3507	-.2500	.6141	.8643	.5002	-.5024	-1.1346	.3707	1.2803
.4501	-1.1958	.3538	1.3146	.4001	-.2552	.6127	.8665	.5002	-.7524	-1.1117	.3770	1.2678
.5002	-1.1448	.3679	1.2859	.4501	-.2395	.6170	.8598	.8002	.7476	-1.3475	.5873	.9060
.5502	-1.1008	.3800	1.2619	.5001	-.1962	.6289	.8414	.8002	.4976	-1.3508	.5864	.9074
.6002	-1.1213	.3743	1.2730	.5497	-.1063	.6537	.8034	.8002	.2476	-1.3529	.5858	.9083
.6500	-.8642	.4506	1.1308	.6003	.0014	.6833	.7578	.8002	-.5024	-1.3487	.5869	.9065
.7000	-.5258	.5382	.9838	.6500	.0864	.7067	.7218	.8002	-.7524	-1.3480	.5871	.9062
.7500	-.4290	.5649	.9413	.7000	.1865	.7342	.6790					
.8002	-.3491	.5868	.9067	.7501	.2801	.7600	.6383					
.9002	-.1863	.6372	.8237	.8001	.3623	.7826	.6020					
.9501	-.0580	.6670	.7830	.8501	.4387	.8037	.5674					

TEST 167	PT 18.4315	PSI	CN	.9563	CD1 .02442	CDCOR1 .02188
RUN 55	TT 199.8991	K	CM	-.1799	CD2 .02151	CDCOR2 .01969
POINT 64	RC 4.4026	MILLION	CC	.0155	CD3 .02736	CDCOR3 .02125
	MACH .7603				CD4 .02510	CDCOR4 .02256
	ALPHA 2.5050	DEG			CD5 .02786	CDCOR5 .02464

UPPER SURFACE				LOWER SURFACE				SPANWISE				
X/C	CP	P _L /PT	MLOC	X/C	CP	P _L /PT	MLOC	X/C	Y/(B/2)	CP	P _L /PT	MLOC
0.0000	1.1448	.9976	.0582	0.0000	1.1448	.9976	.0582	.1507	.7476	-1.1686	.3579	1.3061
.0132	-.5290	.5348	.9893	.0126	.6824	.8698	.4507	.1507	.4976	-1.2189	.3440	1.3351
.0259	-.9087	.4298	1.1680	.0255	.4963	.8183	.5427	.1507	.2476	-1.1821	.3542	1.3138
.0759	-1.1472	.3638	1.2941	.0495	.3082	.7663	.6283	.1507	-.2524	-1.1746	.3562	1.3095
.1003	-1.1629	.3595	1.3029	.0753	.1927	.7344	.6788	.1507	-.5024	-1.2000	.3492	1.3241
.1507	-1.1720	.3570	1.3081	.1002	.1119	.7120	.7136	.1507	-.7524	-1.1439	.3647	1.2922
.2003	-1.1592	.3605	1.3008	.1503	.0131	.6847	.7557	.5002	.7476	-1.1829	.3539	1.3143
.2503	-1.1788	.3551	1.3120	.1976	-.0895	.6563	.7993	.5002	.4976	-1.1864	.3530	1.3163
.3001	-1.2044	.3480	1.3267	.2503	-.1026	.6527	.8049	.5002	.2476	-1.2014	.3488	1.3249
.3502	-1.2167	.3446	1.3338	.3001	-.2081	.6235	.8498	.5002	-.2524	-1.1969	.3501	1.3223
.4003	-1.2232	.3428	1.3376	.3507	-.2403	.6146	.8635	.5002	-.5024	-1.1563	.3613	1.2992
.4501	-1.2438	.3371	1.3497	.4001	-.2497	.6120	.8675	.5002	-.7524	-1.1689	.3578	1.3063
.5002	-1.2442	.3370	1.3500	.4501	-.2371	.6155	.8622	.8002	.7476	-1.3597	.5816	.9149
.5502	-1.1892	.3522	1.3179	.5001	-.1973	.6265	.8452	.8002	.4976	-1.3631	.5806	.9164
.6002	-1.1769	.3556	1.3109	.5497	-.1109	.6504	.8084	.8002	.2476	-1.3885	.5736	.9274
.6500	-.9824	.4149	1.1952	.6003	-.0015	.6806	.7620	.8002	-.5024	-1.3839	.5749	.9254
.7000	-.5969	.5160	1.0199	.6500	.0830	.7040	.7260	.8002	-.7524	-1.3687	.5791	.9188
.7500	-.4907	.5454	.9723	.7000	.1824	.7315	.6833					
.8002	-.3962	.5743	.9264	.7501	.2760	.7574	.6425					
.9002	-.1818	.6368	.8386	.8001	.3581	.7801	.6061					
.9501	-.0776	.6596	.7943	.8501	.4345	.8012	.5715					

TEST 167	PT 18.4387	PSI	CN	1.0099	CD1 .03604	CDCOR1 .03540
RUN 55	TT 199.8934	K	CM	-.1825	CD2 .02832	CDCOR2 .02757
POINT 65	RC 4.4035	MILLION	CC	.0147	CD3 .03022	CDCOR3 .02963
	MACH .7600				CD4 .03218	CDCOR4 .03145
	ALPHA 3.0039	DEG			CD5 .03428	CDCOR5 .03351

UPPER SURFACE				LOWER SURFACE				SPANWISE				
X/C	CP	P _L /PT	MLOC	X/C	CP	P _L /PT	MLOC	X/C	Y/(B/2)	CP	P _L /PT	MLOC
0.0000	1.1319	.9946	.0875	0.0000	1.1319	.9946	.0875	.1507	.7476	-1.2554	.3396	1.3443
.0132	-.6029	.5187	1.0155	.0126	.7371	.8863	.4186	.1507	.4976	-1.2842	.3318	1.3613
.0259	-.9819	.4147	1.1956	.0255	.5493	.8348	.5143	.1507	.2476	-1.2483	.3416	1.3401
.0759	-1.2190	.3497	1.3232	.0495	.3631	.7837	.6002	.1507	-.2524	-1.2379	.3445	1.3341
.1003	-1.2328	.3458	1.3312	.0753	.2435	.7509	.6528	.1507	-.5024	-1.2621	.3378	1.3482
.1507	-1.2398	.3439	1.3352	.1002	.1591	.7278	.6891	.1507	-.7524	-1.2190	.3496	1.3232
.2003	-1.2284	.3471	1.3286	.1503	.0553	.6993	.7332	.5002	.7476	-1.2419	.3434	1.3364
.2503	-1.2420	.3433	1.3365	.1976	-.0473	.6711	.7766	.5002	.4976	-1.2420	.3433	1.3365
.3001	-1.2653	.3369	1.3501	.2503	-.0880	.6600	.7937	.5002	.2476	-1.2583	.3389	1.3460
.3502	-1.2818	.3324	1.3598	.3001	-.1702	.6374	.8284	.5002	-.2524	-1.2476	.3418	1.3397
.4003	-1.2468	.3310	1.3628	.3507	-.2042	.6281	.8427	.5002	-.5024	-1.1978	.3555	1.3111
.4501	-1.3099	.3247	1.3767	.4001	-.2172	.6245	.8482	.5002	-.7524	-1.2272	.3474	1.3279
.5002	-1.3318	.3187	1.3900	.4501	-.2077	.6271	.8442	.8002	.7476	-1.3575	.5860	.9080
.5502	-1.2670	.3365	1.3510	.5001	-.1722	.6369	.8292	.8002	.4976	-1.3682	.5831	.9126
.6002	-1.0115	.4066	1.2108	.5497	-.0935	.6585	.7960	.8002	.2476	-1.4318	.5656	.9400
.6500	-.7079	.4899	1.0632	.6003	.0144	.6880	.7506	.8002	-.5024	-1.3588	.5857	.9089
.7000	-.6161	.5151	1.0214	.6500	.0956	.7103	.7162	.8002	-.7524	-1.3559	.5864	.9073
.7500	-.5229	.5406	.9799	.7000	.1927	.7370	.6747					
.8002	-.4162	.5699	.9333	.7501	.2842	.7621	.6350					
.9002	-.2079	.6271	.8443	.8001	.3650	.7843	.5993					
.9501	-.1377	.6463	.8146	.8501	.4407	.8050	.5651					

TEST 167	PT 21.2605	PSI	CN	-.0725	CD1 .01093	CDCOR1	.01071
RUN 2	TT 159.2190	K	CM	-.1351	CD2 .00870	CDCOR2	.00867
POINT 15	RC 7.0140	MILLION	CC	.0043	CD3 .00851	CDCOR3	.00853
	MACH .7631				CD4 .00810	CDCOR4	.00805
	ALPHA -4.0631	DEG			CD5 .00791	CDCOR5	.00779

UPPER SURFACE				LOWER SURFACE				SPANWISE				
X/C	CP	P _L /PT	MLOC	X/C	CP	P _L /PT	MLOC	X/C	Y/(B/2)	CP	P _L /PT	MLOC
0.0000	.7413	.8856	.4202	0.0000	.7413	.8856	.4202	.1507	.7476	-.1427	.6405	.8238
.0132	.639A	.8574	.4738	.0126	-.7261	.4788	1.0822	.1507	.4976	-.1559	.6369	.8294
.0259	.3150	.7674	.6267	.0255	-.6819	.4910	1.0615	.1507	.2476	-.1568	.6366	.8298
.0759	-.0279	.6723	.7749	.0495	-.7696	.4667	1.1029	.1507	-.2524	-.1567	.6366	.8297
.1063	-.0735	.6597	.7943	.0753	-.8044	.4571	1.1197	.1507	-.5024	-.1590	.6360	.8307
.1507	-.1466	.6394	.8254	.1002	-.8376	.4479	1.1358	.1507	-.7524	-.1474	.6392	.8258
.2003	-.1843	.6290	.8415	.1503	-.8285	.4504	1.1314	.5002	.7476	-.4003	.5691	.9348
.2503	-.2373	.6143	.8642	.1976	-.8582	.4422	1.1459	.5002	.4976	-.4123	.5658	.9400
.3001	-.2800	.6024	.8826	.2503	-.8926	.4326	1.1630	.5002	.2476	-.4179	.5642	.9425
.3502	-.3089	.5944	.8950	.3001	-.9203	.4250	1.1770	.5002	-.2524	-.4068	.5673	.9376
.4003	-.3415	.5854	.9091	.3507	-.9910	.4054	1.2133	.5002	-.5024	-.4022	.5686	.9356
.4501	-.3739	.5764	.9232	.4001	-1.0305	.3944	1.2341	.5002	-.7524	-.3885	.5724	.9296
.5002	-.4076	.5671	.9380	.4501	-.4797	.5471	.9697	.8002	.7476	-.3766	.5757	.9244
.5502	-.4488	.5573	.9560	.5001	-.3548	.5817	.9149	.8002	.4976	-.3783	.5752	.9252
.6002	-.4865	.5452	.9727	.5497	-.2459	.6119	.8679	.8002	.2476	-.3853	.5733	.9282
.6500	-.5135	.5377	.9848	.6003	-.1250	.6454	.8162	.8002	-.5024	-.3647	.5790	.9192
.7000	-.5017	.5410	.9795	.6500	-.0159	.6757	.7698	.8002	-.7524	-.3392	.5860	.9081
.7500	-.4561	.5536	.9593	.7000	.0985	.7074	.7209					
.8002	-.3746	.5748	.9257	.7501	.1995	.7354	.6471					
.9002	-.1877	.6280	.8430	.8001	.2824	.7584	.6411					
.9501	-.0565	.6644	.7871	.8501	.3535	.7761	.6095					

TEST 167	PT 21.2611	PSI	CN	.0881	CD1 .00907	CDCOR1	.00901
RUN 2	TT 160.1070	K	CM	-.1377	CD2 .00842	CDCOR2	.00838
POINT 16	RC 6.9393	MILLION	CC	.0123	CD3 .00825	CDCOR3	.00824
	MACH .7594				CD4 .00729	CDCOR4	.00725
	ALPHA -3.0141	DEG			CD5 .00661	CDCOR5	.00650

UPPER SURFACE				LOWER SURFACE				SPANWISE				
X/C	CP	P _L /PT	MLOC	X/C	CP	P _L /PT	MLOC	X/C	Y/(B/2)	CP	P _L /PT	MLOC
0.0000	.8804	.9249	.3358	0.0000	.8804	.9249	.3358	.1507	.7476	-.2524	.6124	.8671
.0132	.4854	.8159	.5469	.0126	-.4205	.5661	.9396	.1507	.4976	-.2730	.6067	.8759
.0259	.1455	.7222	.6980	.0255	-.4558	.5563	.9550	.1507	.2476	-.2745	.6063	.8766
.0759	-.1738	.6341	.8336	.0495	-.5333	.5349	.9893	.1507	-.2524	-.2720	.6070	.8755
.1003	-.2069	.6250	.8477	.0753	-.5603	.5275	1.0013	.1507	-.5024	-.2739	.6065	.8763
.1507	-.2638	.6093	.8720	.1002	-.6117	.5133	1.0244	.1507	-.7524	-.2590	.6106	.8699
.2003	-.2934	.6011	.8846	.1503	-.5866	.5202	1.0131	.5002	.7476	-.4616	.5447	.9576
.2503	-.3315	.5906	.9010	.1976	-.6787	.4948	1.0551	.5002	.4976	-.4763	.5507	.9640
.3001	-.3686	.5804	.9170	.2503	-.7693	.4699	1.0975	.5002	.2476	-.4838	.5486	.9673
.3502	-.3912	.5742	.9268	.3001	-.8211	.4542	1.1247	.5002	-.2524	-.4619	.5546	.9577
.4003	-.4174	.5669	.9382	.3507	-.7822	.4663	1.1036	.5002	-.5024	-.4678	.5530	.9603
.4501	-.4455	.5592	.9505	.4001	-.5557	.5288	.9993	.5002	-.7524	-.4537	.5569	.9541
.5002	-.4731	.5516	.9626	.4501	-.4823	.5490	.9667	.8002	.7476	-.3840	.5761	.9237
.5502	-.5091	.5416	.9785	.5001	-.3830	.5764	.9233	.8002	.4976	-.3872	.5752	.9251
.6002	-.5415	.5327	.9929	.5497	-.2501	.6131	.8661	.8002	.2476	-.3937	.5734	.9279
.6500	-.5608	.5274	1.0015	.6003	-.1187	.6493	.8103	.8002	-.5024	-.3723	.5794	.9186
.7000	-.5329	.5351	.9890	.6500	-.0065	.6802	.7627	.8002	-.7524	-.3488	.5858	.9085
.7500	-.4732	.5515	.9626	.7000	.1102	.7124	.7131					
.8002	-.3879	.5751	.9254	.7501	.2118	.7405	.6694					
.9002	-.1834	.6315	.8377	.8001	.2941	.7632	.6335					
.9501	-.0521	.6677	.7820	.8501	.3644	.7826	.6022					

TEST 167	PT 21.2777	PSI	CN	.2413	CD1 .00890	CDCOR1	.00887
RUN 2	TT 160.1897	K	CM	-.1413	CD2 .00844	CDCOR2	.00843
POINT 17	RC 6.9465	MILLION	CC	.0181	CD3 .00828	CDCOR3	.00830
	MACH .7608				CD4 .00723	CDCOR4	.00723
	ALPHA -1.9847	DEG			CD5 .00633	CDCOR5	.00626

UPPER SURFACE				LOWER SURFACE				SPANWISE				
X/C	CP	P _L /PT	MLOC	X/C	CP	P _L /PT	MLOC	X/C	Y/(B/2)	CP	P _L /PT	MLOC
0.0000	1.0121	.9613	.2379	0.0000	1.0121	.9613	.2379	.1507	.7476	-.3823	.5772	.9219
.0132	.2972	.7644	.6315	.0126	-.1251	.6481	.8121	.1507	.4976	-.4070	.5704	.9326
.0259	-.0589	.6663	.7841	.0255	-.2156	.6232	.8505	.1507	.2476	-.4033	.5713	.9310
.0759	-.3466	.5871	.9065	.0495	-.3183	.5949	.8944	.1507	-.2524	-.4072	.5704	.9317
.1003	-.3625	.5827	.9133	.0753	-.3650	.5820	.9145	.1507	-.5024	-.4071	.5704	.9327
.1507	-.4077	.5730	.9236	.1002	-.4233	.5660	.9397	.1507	-.7524	-.3865	.5761	.9237
.2003	-.4405	.5709	.9319	.1503	-.4515	.5582	.9520	.5002	.7476	-.5375	.5345	.9900
.2503	-.4413	.5610	.9476	.1976	-.5469	.5319	.9942	.5002	.4976	-.5448	.5325	.9932
.3001	-.4713	.5527	.9605	.2503	-.5885	.5204	1.0128	.5002	.2476	-.5521	.5305	.9965
.3502	-.4821	.5498	.9655	.3001	-.6087	.5149	1.0219	.5002	-.2524	-.5372	.5346	.9899
.4003	-.5027	.5441	.9745	.3507	-.5899	.5201	1.0134	.5002	-.5024	-.5463	.5321	.9939
.4501	-.5254	.5378	.9846	.4001	-.5314	.5362	.9873	.5002	-.7524	-.5307	.5364	.9870
.5002	-.5482	.5316	.9947	.4501	-.4563	.5569	.9541	.8002	.7476	-.3974	.5731	.9285
.5502	-.5790	.5231	1.0085	.5001	-.3585	.5830	.9116	.8002	.4976	-.4003	.5723	.9297
.6002	-.6064	.5155	1.0209	.5497	-.2293	.6194	.8563	.8002	.2476	-.4066	.5706	.9324
.6500	-.6210	.5115	1.0275	.6003	-.1018	.6545	.8022	.8002	-.5024	-.3887	.5755	.9247
.7000	-.5716	.5251	1.0052	.6500	.0068	.6844	.7563	.8002	-.7524	-.3638	.5823	.9139
.7500	-.4918	.5471	.9697	.7000	.1223	.7162	.7072					
.8002	-.3988	.5727	.9291	.7501	.2239	.7442	.6635					
.9002	-.1846	.6317	.8373	.8001	.3076	.7677	.6271					
.9501	-.0578	.6680	.7815	.8501	.3785	.7868	.5953					

ORIGINAL PAGE IS
OF POOR QUALITY

TEST	167	PT	21.3162	PSI	CN	.3201	CD1	.00898	CDCOR1	.00881
RUN	2	TT	160.1885	K	CM	-1.1440	CD2	.00850	CDCOR2	.00831
POINT	18	RC	6.9613	MILLION	CC	.0197	CD3	.00825	CDCOR3	.00819
		MACH	.7612				CD4	.00720	CDCOR4	.00712
		ALPHA	-1.4754	DEG			CD5	.00620	CDCOR5	.00609

UPPER SURFACE				LOWER SURFACE				SPANWISE				
X/C	CP	P ₂ L/PT	MLOC	X/C	CP	P ₂ L/PT	MLOC	X/C	Y/(B/2)	CP	P ₂ L/PT	MLOC
0.0000	1.0683	.9768	.1834	0.0000	1.0683	.9768	.1834	.1507	.7476	-.4558	.5569	.9541
.0132	.1956	.7364	.6758	.0125	.0156	.6868	.7527	.1507	.4976	-.4790	.5505	.9643
.0259	-.1667	.6365	.8299	.0255	-.0982	.6554	.8009	.1507	.2476	-.4622	.5531	.9569
.0759	-.4414	.5608	.9478	.0495	-.2176	.6225	.8519	.1507	-.2524	-.4805	.5501	.9649
.1003	-.4466	.5594	.9501	.0753	-.2720	.6075	.8747	.1507	-.5024	-.4790	.5505	.9643
.1507	-.4690	.5532	.9599	.1002	-.3374	.5895	.9027	.1507	-.7524	-.4546	.5572	.9536
.2003	-.4628	.5549	.9572	.1503	-.3806	.5776	.9214	.5002	.7476	-.5796	.5228	1.0090
.2503	-.5003	.5446	.9737	.1976	-.4718	.5525	.9611	.5002	.4976	-.5863	.5209	1.0120
.3001	-.5266	.5374	.9853	.2503	-.5143	.5408	.9799	.5002	.2476	-.5937	.5189	1.0153
.3502	-.5293	.5366	.9865	.3001	-.5354	.5350	.9892	.5002	-.2524	-.5783	.5231	1.0084
.4003	-.5475	.5316	.9946	.3507	-.5324	.5358	.9879	.5002	-.5024	-.5890	.5202	1.0132
.4501	-.5703	.5253	1.0048	.4001	-.4905	.5473	.9694	.5002	-.7524	-.5707	.5252	1.0050
.5002	-.5906	.5197	1.0139	.4501	-.4261	.5631	.9411	.8002	.7476	-.4019	.5717	.9306
.5502	-.6159	.5128	1.0254	.5001	-.3547	.5902	.9016	.8002	.4976	-.4019	.5717	.9306
.6002	-.6405	.5060	1.0365	.5497	-.2101	.6246	.8483	.8002	.2476	-.4062	.5705	.9325
.6500	-.6521	.5028	1.0418	.6003	-.0859	.6586	.7957	.8002	-.5024	-.3918	.5745	.9262
.7000	-.6917	.5194	1.0145	.6500	.0203	.6881	.7507	.8002	-.7524	-.3663	.5816	.9152
.7500	-.4957	.5459	.9717	.7000	.1346	.7195	.7020					
.8002	-.3990	.5725	.9293	.7501	.2357	.7474	.6584					
.9002	-.1800	.6329	.8355	.8001	.3187	.7703	.6221					
.9501	-.0484	.6691	.7798	.8501	.3910	.7902	.5898					

TEST	167	PT	21.3160	PSI	CN	.3910	CD1	.00926	CDCOR1	.00905
RUN	2	TT	160.1531	K	CM	-1.1455	CD2	.00870	CDCOR2	.00857
POINT	19	RC	6.9704	MILLION	CC	.0202	CD3	.00828	CDCOR3	.00824
		MACH	.7625				CD4	.00701	CDCOR4	.00695
		ALPHA	-.9688	DEG			CD5	.00611	CDCOR5	.00601

UPPER SURFACE				LOWER SURFACE				SPANWISE				
X/C	CP	P ₂ L/PT	MLOC	X/C	CP	P ₂ L/PT	MLOC	X/C	Y/(B/2)	CP	P ₂ L/PT	MLOC
0.0000	1.1063	.9870	.1366	0.0000	1.1063	.9870	.1366	.1507	.7476	-.5266	.5359	.9877
.0132	.0920	.7068	.7218	.0126	.1368	.7192	.7026	.1507	.4976	-.5576	.5273	1.0016
.0259	-.2776	.6047	.8791	.0255	.0051	.6828	.7588	.1507	.2476	-.5392	.5324	.9934
.0759	-.5396	.5323	.9935	.0495	-.1320	.6449	.8170	.1507	-.2524	-.5572	.5274	1.0014
.1003	-.5196	.5378	.9846	.0753	-.1946	.6276	.8436	.1507	-.5024	-.5527	.5287	.9994
.1507	-.5355	.5334	.9917	.1002	-.2634	.6086	.8730	.1507	-.7524	-.5218	.5372	.9856
.2003	-.5359	.5333	.9918	.1503	-.3162	.5940	.8957	.5002	.7476	-.6235	.5091	1.0314
.2503	-.5652	.5252	1.0050	.1976	-.4091	.5684	.9359	.5002	.4976	-.6350	.5059	1.0367
.3001	-.5903	.5183	1.0163	.2503	-.4356	.5555	.9563	.5002	.2476	-.6449	.5032	1.0412
.3502	-.5769	.5220	1.0103	.3001	-.4820	.5482	.9679	.5002	-.2524	-.6303	.5072	1.0345
.4003	-.5914	.5180	1.0168	.3507	-.4869	.5469	.9701	.5002	-.5024	-.6403	.5045	1.0391
.4501	-.6129	.5121	1.0265	.4001	-.4565	.5553	.9567	.5002	-.7524	-.6153	.5114	1.0277
.5002	-.6402	.5045	1.0390	.4501	-.4022	.5703	.9329	.8002	.7476	-.3991	.5717	.9315
.5502	-.6531	.5010	1.0449	.5001	-.3169	.5938	.8960	.8002	.4976	-.4006	.5707	.9322
.6002	-.6698	.4963	1.0527	.5497	-.1964	.6271	.8444	.8002	.2476	-.4047	.5696	.9340
.6500	-.6789	.4938	1.0569	.6003	-.0751	.6606	.7929	.8002	-.5024	-.3952	.5722	.9298
.7000	-.6108	.5126	1.0256	.6500	.0283	.6892	.7489	.8002	-.7524	-.3686	.5796	.9183
.7500	-.4955	.5445	.9739	.7000	.1416	.7205	.7006					
.8002	-.3966	.5718	.9305	.7501	.2424	.7484	.6570					
.9002	-.1759	.6328	.8357	.8001	.3257	.7714	.6203					
.9501	-.0453	.6689	.7802	.8501	.3984	.7915	.5877					

TEST	167	PT	21.3166	PSI	CN	.4650	CD1	.00928	CDCOR1	.00908
RUN	2	TT	160.1824	K	CM	-1.1475	CD2	.00860	CDCOR2	.00840
POINT	20	RC	6.9692	MILLION	CC	.0197	CD3	.00790	CDCOR3	.00779
		MACH	.7626				CD4	.00659	CDCOR4	.00648
		ALPHA	-.4711	DEG			CD5	.00625	CDCOR5	.00612

UPPER SURFACE				LOWER SURFACE				SPANWISE				
X/C	CP	P ₂ L/PT	MLOC	X/C	CP	P ₂ L/PT	MLOC	X/C	Y/(B/2)	CP	P ₂ L/PT	MLOC
0.0000	1.1260	.9920	.1068	0.0000	1.1260	.9920	.1068	.1507	.7476	-.6087	.5102	1.0297
.0132	-.0112	.6762	.7690	.0126	.2405	.7461	.6606	.1507	.4976	-.6447	.5002	1.0462
.0259	-.3885	.5713	.8412	.0255	.0940	.7094	.7240	.1507	.2476	-.6284	.5047	1.0387
.0759	-.6629	.4951	1.0547	.0495	-.0635	.6616	.7913	.1507	-.2524	-.6469	.4995	1.0473
.1003	-.6392	.5017	1.0437	.0753	-.1379	.6410	.8231	.1507	-.5024	-.6394	.5016	1.0438
.1507	-.6284	.5047	1.0387	.1002	-.2008	.6235	.8500	.1507	-.7524	-.6040	.5115	1.0275
.2003	-.5996	.5127	1.0255	.1503	-.2617	.6065	.8762	.5002	.7476	-.6740	.4920	1.0599
.2503	-.6266	.5052	1.0379	.1976	-.3562	.5803	.9171	.5002	.4976	-.6800	.4903	1.0627
.3001	-.6660	.4942	1.0561	.2503	-.4061	.5664	.9390	.5002	.2476	-.6911	.4873	1.0679
.3502	-.6619	.4954	1.0542	.3001	-.4370	.5578	.9526	.5002	-.2524	-.6799	.4904	1.0626
.4003	-.6407	.5013	1.0444	.3507	-.4485	.5547	.9576	.5002	-.5024	-.6869	.4884	1.0659
.4501	-.6461	.4998	1.0469	.4001	-.4278	.5504	.9485	.5002	-.7524	-.6666	.4941	1.0564
.5002	-.6842	.4892	1.0647	.4501	-.3817	.5732	.9283	.8002	.7476	-.4034	.5672	.9378
.5502	-.7160	.4804	1.0796	.5001	-.3020	.5993	.8936	.8002	.4976	-.4028	.5673	.9375
.6002	-.7255	.4777	1.0841	.5497	-.1857	.6277	.8435	.8002	.2476	-.4055	.5666	.9387
.6500	-.7154	.4805	1.0793	.6003	-.0681	.6603	.7933	.8002	-.5024	-.4026	.5674	.9374
.7000	-.6314	.5038	1.0401	.6500	.0325	.6883	.7504	.8002	-.7524	-.3746	.5752	.9252
.7500	-.4985	.5408	.9799	.7000	.1443	.7193	.7024					
.8002	-.3969	.5690	.9349	.7501	.2446	.7472	.6588					
.9002	-.1764	.6307	.8396	.8001	.3280	.7704	.6219					
.9501	-.0478	.6660	.7847	.8501	.4016	.7908	.5887					

ORIGINAL PAGE IS
OF POOR QUALITY

TFST	167	PT	21.3157	PSI	CM	.5442	CD1	.00909	CDCOR1	.00869
RUN	2	TT	160.2079	K	CM	-.1482	CD2	.00864	CDCOR2	.00845
POINT	21	RC	6.9670	MILLION	CC	.0181	CD3	.00809	CDCOR3	.00789
		MACH	.7625				CD4	.00690	CDCOR4	.00677
		ALPHA	.0363	DEG			CD5	.00704	CDCOR5	.00690

UPPER SURFACE				LOWER SURFACE				SPANWISE				
X/C	CP	P _L /PT	MLOC	X/C	CP	P _L /PT	MLOC	X/C	Y/(B/2)	CP	P _L /PT	MLOC
0.0000	1.1463	.9983	.0500	0.0000	1.1463	.9983	.0500	.1507	.7476	-.6965	.4904	1.0627
.0132	-.1239	.6482	.8120	.0126	.3469	.7779	.6097	.1507	.4976	-.7413	.4780	1.0835
.0259	-.5097	.5418	.9782	.0255	.1863	.7337	.6600	.1507	.2476	-.7622	.4722	1.0934
.0759	-.7783	.4678	1.1010	.0495	.0198	.6878	.7511	.1507	-.2524	-.7613	.4725	1.0930
.1003	-.7976	.4625	1.1103	.0753	-.0640	.6647	.7866	.1507	-.5024	-.7261	.4622	1.0764
.1507	-.7569	.4737	1.0969	.1002	-.1286	.6469	.8140	.1507	-.7524	-.6833	.4940	1.0565
.2003	-.7054	.4879	1.0668	.1503	-.1978	.6278	.8434	.5002	.7476	-.7054	.4879	1.0668
.2503	-.6690	.4979	1.0500	.1976	-.2911	.6021	.8831	.5002	.4976	-.7110	.4864	1.0694
.3001	-.7068	.4875	1.0674	.2503	-.3439	.5875	.9058	.5002	.2476	-.7119	.4861	1.0698
.3502	-.7162	.4849	1.0718	.3001	-.3776	.5783	.9203	.5002	-.2524	-.7035	.4884	1.0659
.4003	-.7166	.4848	1.0720	.3507	-.3445	.5736	.9277	.5002	-.5024	-.7094	.4868	1.0686
.4501	-.7032	.4885	1.0658	.4001	-.3819	.5771	.9222	.5002	-.7524	-.6982	.4899	1.0634
.5002	-.7028	.4886	1.0656	.4501	-.3452	.5872	.9064	.8002	.7476	-.4041	.5709	.9319
.5502	-.7257	.4823	1.0763	.5001	-.2750	.6065	.8763	.8002	.4976	-.4038	.5710	.9317
.6002	-.7387	.4787	1.0824	.5497	-.1651	.6368	.8294	.8002	.2476	-.4067	.5702	.9330
.6500	-.7198	.4839	1.0735	.6003	-.0518	.6680	.8815	.8002	-.5024	-.3998	.5721	.9300
.7000	-.6291	.5089	1.0317	.6500	.0454	.6948	.7403	.8002	-.7524	-.3715	.5799	.9177
.7500	-.4994	.5447	.9736	.7000	.1553	.7251	.6934					
.8002	-.3979	.5727	.9291	.7501	.2546	.7525	.6504					
.9002	-.1768	.6336	.8344	.8001	.3378	.7754	.6138					
.9501	-.0482	.6690	.7799	.8501	.4120	.7959	.5804					

TEST	167	PT	21.3159	PSI	CM	.6164	CD1	.00966	CDCOR1	.00935
RUN	2	TT	160.1798	K	CM	-.1479	CD2	.00891	CDCOR2	.00868
POINT	22	RC	6.9664	MILLION	CC	.0163	CD3	.00819	CDCOR3	.00796
		MACH	.7621				CD4	.00749	CDCOR4	.00722
		ALPHA	.5223	DEG			CD5	.00768	CDCOR5	.00747

UPPER SURFACE				LOWER SURFACE				SPANWISE				
X/C	CP	P _L /PT	MLOC	X/C	CP	P _L /PT	MLOC	X/C	Y/(B/2)	CP	P _L /PT	MLOC
0.0000	1.1515	.9998	.0189	0.0000	1.1515	.9998	.0189	.1507	.7476	-.8218	.4564	1.1209
.0132	-.2201	.6221	.8522	.0126	.4299	.8010	.5719	.1507	.4976	-.9192	.4296	1.1686
.0259	-.6115	.5143	1.0229	.0255	.2593	.7541	.6479	.1507	.2476	-.8907	.4374	1.1545
.0759	-.8722	.4425	1.1454	.0495	.0841	.7058	.7233	.1507	-.2524	-.8989	.4351	1.1585
.1003	-.8749	.4417	1.1467	.0753	-.0060	.6810	.7616	.1507	-.5024	-.9017	.4344	1.1599
.1507	-.8725	.4424	1.1455	.1002	-.0741	.6723	.7903	.1507	-.7524	-.7964	.4634	1.1087
.2003	-.8517	.4481	1.1353	.1503	-.1492	.6416	.8221	.5002	.7476	-.7237	.4834	1.0744
.2503	-.8657	.4443	1.1422	.1976	-.2440	.6155	.8624	.5002	.4976	-.7267	.4826	1.0738
.3001	-.8406	.4512	1.1300	.2503	-.3013	.5997	.8868	.5002	.2476	-.7403	.4788	1.0822
.3502	-.7339	.4806	1.0792	.3001	-.3387	.5894	.9029	.5002	-.2524	-.7371	.4797	1.0807
.4003	-.7273	.4824	1.0761	.3507	-.3605	.5834	.9123	.5002	-.5024	-.7297	.4817	1.0772
.4501	-.7273	.4824	1.0761	.4001	-.3539	.5852	.9094	.5002	-.7524	-.7227	.4837	1.0739
.5002	-.7429	.4781	1.0833	.4501	-.3234	.5956	.8963	.8002	.7476	-.4047	.5712	.9314
.5502	-.7586	.4738	1.0908	.5001	-.2599	.6111	.8692	.8002	.4976	-.4049	.5712	.9315
.6002	-.7689	.4709	1.0956	.5497	-.1547	.6401	.8244	.8002	.2476	-.4071	.5705	.9324
.6500	-.7397	.4790	1.0819	.6003	-.0445	.6704	.7778	.8002	-.5024	-.4016	.5721	.9301
.7000	-.6316	.5087	1.0320	.6500	.0501	.6965	.7377	.8002	-.7524	-.3733	.5799	.9178
.7500	-.4999	.5450	.9731	.7000	.1581	.7262	.6917					
.8002	-.3980	.5731	.9285	.7501	.2563	.7532	.6492					
.9002	-.1759	.6340	.8339	.8001	.3386	.7759	.6130					
.9501	-.0495	.6691	.7799	.8501	.4121	.7962	.5800					

TEST	167	PT	21.3165	PSI	CM	.7119	CD1	.01005	CDCOR1	.00963
RUN	2	TT	160.2482	K	CM	-.1510	CD2	.00939	CDCOR2	.00916
POINT	23	RC	6.9645	MILLION	CC	.0140	CD3	.00904	CDCOR3	.00867
		MACH	.7625				CD4	.00807	CDCOR4	.00777
		ALPHA	1.0345	DEG			CD5	.00820	CDCOR5	.00797

UPPER SURFACE				LOWER SURFACE				SPANWISE				
X/C	CP	P _L /PT	MLOC	X/C	CP	P _L /PT	MLOC	X/C	Y/(B/2)	CP	P _L /PT	MLOC
0.0000	1.1509	.9995	.0257	0.0000	1.1509	.9995	.0257	.1507	.7476	-.9452	.4219	1.1825
.0132	-.3110	.5967	.8919	.0126	.5085	.8225	.5356	.1507	.4976	-1.0292	.3988	1.2257
.0259	-.7065	.4877	1.0671	.0255	.3312	.7737	.6166	.1507	.2476	-.9800	.4123	1.2003
.0759	-.9615	.4174	1.1908	.0495	.1503	.7238	.6934	.1507	-.2524	-.9946	.4083	1.2077
.1003	-.9653	.4164	1.1927	.0753	.0550	.6975	.7361	.1507	-.5024	-1.0152	.4026	1.2184
.1507	-.9669	.4159	1.1936	.1002	-.0165	.6778	.7664	.1507	-.7524	-.9227	.4261	1.1712
.2003	-.9810	.4176	1.1905	.1503	-.0981	.6554	.8009	.5002	.7476	-.8932	.4363	1.1565
.2503	-.9810	.4121	1.2008	.1976	-.1950	.6287	.8420	.5002	.4976	-.9185	.4293	1.1691
.3001	-1.0047	.4055	1.2130	.2503	-.2545	.6122	.8674	.5002	.2476	-.8750	.4413	1.1476
.3502	-1.0008	.4066	1.2110	.3001	-.2940	.6014	.8842	.5002	-.2524	-.8609	.4452	1.1406
.4003	-.9140	.4305	1.1669	.3507	-.3194	.5944	.8951	.5002	-.5024	-.9203	.4288	1.1700
.4501	-.8724	.4420	1.1463	.4001	-.3178	.5948	.8944	.5002	-.7524	-.8937	.4361	1.1568
.5002	-.8675	.4433	1.1439	.4501	-.2937	.6015	.8841	.8002	.7476	-.3998	.5722	.9298
.5502	-.8196	.4568	1.1201	.5001	-.2368	.6171	.8599	.8002	.4976	-.4037	.5712	.9315
.6002	-.7536	.4747	1.0892	.5497	-.1365	.6448	.8172	.8002	.2476	-.4064	.5704	.9327
.6500	-.6712	.4974	1.0508	.6003	-.0239	.6742	.7721	.8002	-.5024	-.3990	.5724	.9295
.7000	-.5751	.5239	1.0071	.6500	.0616	.6994	.7333	.8002	-.7524	-.3665	.5814	.9154
.7500	-.4492	.5476	.9689	.7000	.1676	.7286	.6880					
.8002	-.3059	.5733	.9281	.7501	.2647	.7553	.6459					
.9002	-.1798	.6331	.8352	.8001	.3466	.7779	.6098					
.9501	-.0525	.6679	.7817	.8501	.4202	.7982	.5766					

TEST	167	PT	21.3160	PSI	CM	.8144	CD1	.01187	CDCOR1	.01137
RUN	2	TT	160.1792	K	CM	-.1644	CD2	.01151	CDCOR2	.01116
POINT	24	RC	6.9689	MILLION	CC	.0146	CD3	.00998	CDCOR3	.00962
		MACH	.7625				CD4	.01024	CDCOR4	.00998
		ALPHA	1.5342	DEG			CD5	.01116	CDCOR5	.01095

UPPER SURFACE				LOWER SURFACE				SPANWISE				
X/C	CP	P/L/PT	MLOC	X/C	CP	P/L/PT	MLOC	X/C	Y/(B/2)	CP	P/L/PT	MLOC
0.0000	1.1539	1.0001	0.0000	0.0000	1.1539	1.0001	0.0000	.1507	.7476	-1.0290	.3962	1.2307
.0132	-.3923	.5751	.9253	.0126	.5758	.8402	.5049	.1507	.4976	-1.0998	.3766	1.2687
.0259	-.7756	.4653	1.1037	.0255	.3941	.7899	.5903	.1507	.2476	-1.0449	.3918	1.2391
.0759	-1.0207	.3985	1.2263	.0495	.2074	.7382	.6729	.1507	-.2524	-1.0573	.3883	1.2457
.1003	-1.0207	.3966	1.2299	.0753	.1079	.7107	.7158	.1507	-.5024	-1.0817	.3816	1.2589
.1507	-1.0298	.3560	1.2311	.1002	.0333	.6901	.7476	.1507	-.7524	-.9997	.4043	1.2153
.2003	-1.0268	.3968	1.2295	.1503	-.0528	.6663	.7842	.5002	.7476	-1.0505	.3902	1.2421
.2503	-1.0509	.3901	1.2423	.1976	-.1523	.6387	.8265	.5002	.4976	-1.0616	.3872	1.2480
.3001	-1.0790	.3823	1.2574	.2503	-.2148	.6214	.8532	.5002	.2476	-1.0712	.3845	1.2532
.3502	-1.0895	.3794	1.2631	.3001	-.2571	.6097	.8713	.5002	-.2524	-1.0368	.3940	1.2348
.4003	-1.0948	.3780	1.2660	.3507	-.2858	.6018	.8836	.5002	-.5024	-1.0646	.3863	1.2496
.4501	-1.0456	.3916	1.2395	.4001	-.2880	.6012	.8845	.5002	-.7524	-1.0332	.3950	1.2329
.5002	-.9985	.4046	1.2146	.4501	-.2689	.6065	.8763	.8002	.7476	-.3610	.5810	.9160
.5502	-1.0278	.3965	1.2300	.5001	-.2722	.6208	.8542	.8002	.4976	-.3609	.5810	.9160
.6002	-1.0335	.3949	1.2330	.5497	-.1201	.6476	.8128	.8002	.2476	-.3636	.5803	.9172
.6500	-.8920	.4341	1.1604	.6003	-.0158	.6765	.7685	.8002	-.5024	-.3614	.5809	.9162
.7000	-.5481	.5292	.9285	.6500	.0732	.7011	.7306	.8002	-.7524	-.3482	.5845	.9105
.7500	-.4335	.5609	.9477	.7000	.1776	.7300	.6856					
.8002	-.3549	.5827	.9134	.7501	.2738	.7556	.6439					
.9002	-.1667	.6347	.8327	.8001	.3556	.7792	.6076					
.9501	-.0494	.6672	.7828	.8501	.4300	.7998	.5739					

TEST	167	PT	21.3165	PSI	CM	.8831	CD1	.01637	CDCOR1	.01597
RUN	2	TT	160.2471	K	CM	-.1739	CD2	.01582	CDCOR2	.01536
POINT	25	RC	6.9679	MILLION	CC	.0159	CD3	.01427	CDCOR3	.01334
		MACH	.7631				CD4	.01594	CDCOR4	.01492
		ALPHA	2.0264	DEG			CD5	.01589	CDCOR5	.01549

UPPER SURFACE				LOWER SURFACE				SPANWISE				
X/C	CP	P/L/PT	MLOC	X/C	CP	P/L/PT	MLOC	X/C	Y/(B/2)	CP	P/L/PT	MLOC
0.0000	1.1522	.9994	.0294	0.0000	1.1522	.9994	.0294	.1507	.7476	-1.0916	.3766	1.2687
.0132	-.4387	.5578	.9526	.0126	.5263	.8534	.4811	.1507	.4976	-1.1514	.3600	1.3020
.0259	-.8295	.4494	1.1332	.0255	.4426	.8024	.5696	.1507	.2476	-1.1161	.3698	1.2822
.0759	-1.0681	.3831	1.2559	.0495	.2521	.7496	.6550	.1507	-.2524	-1.1042	.3731	1.2756
.1003	-1.0738	.3814	1.2592	.0753	.1498	.7212	.6995	.1507	-.5024	-1.1294	.3661	1.2897
.1507	-1.0799	.3799	1.2623	.1002	.0714	.6994	.7332	.1507	-.7524	-1.0543	.3870	1.2484
.2003	-1.0795	.3800	1.2621	.1503	-.0184	.6745	.7716	.5002	.7476	-1.1164	.3697	1.2824
.2503	-1.1005	.3741	1.2736	.1976	-.1210	.6460	.8133	.5002	.4976	-1.1244	.3675	1.2869
.3001	-1.1291	.3662	1.2895	.2503	-.1876	.6275	.8438	.5002	.2476	-1.1432	.3623	1.2974
.3502	-1.1427	.3624	1.2971	.3001	-.2326	.6150	.8631	.5002	-.2524	-1.1054	.3728	1.2745
.4003	-1.1573	.3584	1.3054	.3507	-.2645	.6062	.8768	.5002	-.5024	-1.1022	.3737	1.2745
.4501	-1.1641	.3565	1.3093	.4001	-.2706	.6045	.8794	.5002	-.7524	-1.0922	.3765	1.2690
.5002	-1.1112	.3712	1.2795	.4501	-.2553	.6007	.8729	.8002	.7476	-.3486	.5828	.9131
.5502	-1.0948	.3757	1.2704	.5001	-.2087	.6217	.8528	.8002	.4976	-.3394	.5854	.9092
.6002	-1.1212	.3684	1.2851	.5497	-.1143	.6479	.8124	.8002	.2476	-.3389	.5855	.9089
.6500	-1.0541	.3870	1.2483	.6003	-.0111	.6765	.7685	.8002	-.5024	-.3488	.5828	.9132
.7000	-.6136	.5093	1.0311	.6500	.0756	.7006	.7314	.8002	-.7524	-.3759	.5753	.9250
.7500	-.4620	.5314	.9829	.7000	.1788	.7292	.6870					
.8002	-.3589	.5800	.9176	.7501	.2747	.7558	.6451					
.9002	-.1615	.6348	.8326	.8001	.3561	.7784	.6089					
.9501	-.0493	.6659	.7847	.8501	.4305	.7991	.5751					

TEST	167	PT	21.3620	PSI	CM	.8932	CD1	.01343	CDCOR1	.01291
RUN	3	TT	160.1200	K	CM	-.1721	CD2	.01421	CDCOR2	.01307
POINT	28	RC	6.9739	MILLION	CC	.0137	CD3	.01304	CDCOR3	.01228
		MACH	.7599				CD4	.01481	CDCOR4	.01449
		ALPHA	1.9398	DEG			CD5	.01496	CDCOR5	.01462

UPPER SURFACE				LOWER SURFACE				SPANWISE				
X/C	CP	P/L/PT	MLOC	X/C	CP	P/L/PT	MLOC	X/C	Y/(B/2)	CP	P/L/PT	MLOC
0.0000	1.1500	.9992	.0337	0.0000	1.1500	.9992	.0337	.1507	.7476	-1.1054	.3770	1.2679
.0132	-.4547	.5565	.9547	.0126	.6355	.8573	.4741	.1507	.4976	-1.1614	.3615	1.2989
.0259	-.8463	.4485	1.1348	.0255	.5011	.8061	.5634	.1507	.2476	-1.1269	.3710	1.2798
.0759	-1.0911	.3809	1.2602	.0495	.2603	.7538	.6484	.1507	-.2524	-1.1173	.3737	1.2745
.1003	-1.1103	.3756	1.2708	.0753	.1568	.7252	.6932	.1507	-.5024	-1.1433	.3665	1.2888
.1507	-1.1132	.3748	1.2722	.1002	.0788	.7037	.7266	.1507	-.7524	-1.0666	.3877	1.2470
.2003	-1.1112	.3754	1.2711	.1503	-.0147	.6779	.7663	.5002	.7476	-1.1155	.3742	1.2735
.2503	-1.1216	.3725	1.2768	.1976	-.1107	.6514	.8070	.5002	.4976	-1.1267	.3711	1.2796
.3001	-1.1432	.3666	1.2888	.2503	-.1740	.6339	.8339	.5002	.2476	-1.1345	.3690	1.2839
.3502	-1.1521	.3681	1.2937	.3001	-.2180	.6218	.8526	.5002	-.2524	-1.1002	.3784	1.2631
.4003	-1.1642	.3608	1.3005	.3507	-.2478	.6136	.8653	.5002	-.5024	-1.1078	.3763	1.2692
.4501	-1.1680	.3597	1.3026	.4001	-.2526	.6123	.8673	.5002	-.7524	-1.0914	.3809	1.2603
.5002	-1.1031	.3771	1.2678	.4501	-.2378	.6163	.8610	.8002	.7476	-.3459	.5865	.9074
.5502	-1.0862	.3823	1.2575	.5001	-.1908	.6293	.8410	.8002	.4976	-.3443	.5870	.9077
.6002	-1.1049	.3766	1.2688	.5497	-.0987	.6547	.8019	.8002	.2476	-.3467	.5863	.9077
.6500	-.9609	.4169	1.1918	.6003	.0024	.6826	.7591	.8002	-.5024	-.3451	.5867	.9070
.7000	-.5388	.5333	.9919	.6500	.0886	.7064	.7224	.8002	-.7524	-.3484	.5858	.9065
.7500	-.4239	.5650	.9412	.7000	.1914	.7347	.6783					
.8002	-.3472	.5862	.9080	.7501	.2864	.7610	.6370					
.9002	-.1708	.6348	.8325	.8001	.3677	.7834	.6009					
.9501	-.0559	.6665	.7838	.8501	.4427	.8041	.5668					

ORIGINAL PAGE IS
OF POOR QUALITY

TEST 167	PT	21.3405	PSI	CN	.8141	CD1	.00995	CDCOR1	.00946
RUN 3	TT	160.1716	K	CM	-.1638	CD2	.01029	CDCOR2	.01001
POINT 29	RC	6.9726	MILLION	CC	.0139	CD3	.00916	CDCOR3	.00885
	MACH	.7604				CD4	.00958	CDCOR4	.00930
	ALPHA	1.4860	DEG			CD5	.01058	CDCOR5	.01037

UPPER SURFACE				LOWER SURFACE				SPANWISE				
X/C	CP	P/L/PT	MLOC	X/C	CP	P/L/PT	MLOC	X/C	Y/(B/2)	CP	P/L/PT	MLOC
0.0000	1.1499	.9991	.0360	0.0000	1.1499	.9991	.0360	.1507	.7476	-1.0253	.3982	1.2268
.0132	-.3851	.5750	.9254	.0126	.5723	.8395	.5060	.1507	.4976	-1.1037	.3766	1.2688
.0259	-.7789	.4663	1.1037	.0255	.3912	.7895	.5909	.1507	.2476	-1.0695	.3860	1.2503
.0759	-1.0317	.3964	1.2302	.0495	.2052	.7381	.6730	.1507	-.2524	-1.0585	.3890	1.2444
.1003	-1.0506	.3912	1.2402	.0753	.1061	.7107	.7157	.1507	-.5024	-1.0822	.3825	1.2571
.1507	-1.0535	.3904	1.2417	.1002	.0315	.6901	.7475	.1507	-.7524	-1.0990	.4055	1.2131
.2003	-1.0931	.3905	1.2415	.1503	-.0555	.6661	.7845	.5002	.7476	-1.0434	.3932	1.2363
.2503	-1.0660	.3870	1.2484	.1976	-.1525	.6393	.8256	.5002	.4976	-1.0604	.3885	1.2454
.3001	-1.0881	.3809	1.2603	.2503	-.2138	.6224	.8517	.5002	.2476	-1.0608	.3884	1.2456
.3502	-1.0923	.3797	1.2626	.3001	-.2556	.6108	.8696	.5002	-.2524	-1.0293	.3971	1.2289
.4003	-1.0934	.3794	1.2632	.3507	-.2836	.6031	.8815	.5002	-.5024	-1.0599	.3886	1.2452
.4501	-1.0335	.3959	1.2311	.4001	-.2854	.6026	.8823	.5002	-.7524	-1.0257	.3901	1.2270
.5002	-.9867	.4089	1.2067	.4501	-.2662	.6079	.8741	.8002	.7476	-1.3692	.5794	.9185
.5502	-1.0094	.4026	1.2185	.5001	-.2146	.6222	.8520	.8002	.4976	-1.3731	.5784	.9201
.6002	-.9992	.4054	1.2132	.5497	-.1178	.6489	.8109	.8002	.2476	-1.3768	.5774	.9217
.6500	-.8233	.4540	1.1250	.6003	-.0139	.6776	.7668	.8002	-.5024	-1.3694	.5794	.9215
.7000	-.5310	.5348	.9895	.6500	.0749	.7021	.7290	.8002	-.7524	-1.3492	.5850	.9098
.7500	-.4416	.5595	.9500	.7000	.1792	.7309	.6843					
.8002	-.3705	.5791	.9190	.7501	.2754	.7575	.6425					
.8502	-.1827	.6310	.8385	.8001	.3571	.7801	.6062					
.9501	-.0593	.6651	.7860	.8501	.4320	.8008	.5723					

TEST 167	PT	21.3598	PSI	CN	.7259	CD1	.00821	CDCOR1	.00802
RUN 3	TT	160.1353	K	CM	-.1550	CD2	.00712	CDCOR2	.00690
POINT 30	RC	6.9742	MILLION	CC	.0143	CD3	.00709	CDCOR3	.00658
	MACH	.7603				CD4	.00740	CDCOR4	.00680
	ALPHA	.9877	DEG			CD5	.00821	CDCOR5	.00782

UPPER SURFACE				LOWER SURFACE				SPANWISE				
X/C	CP	P/L/PT	MLOC	X/C	CP	P/L/PT	MLOC	X/C	Y/(B/2)	CP	P/L/PT	MLOC
0.0000	1.1512	.9996	.0247	0.0000	1.1512	.9996	.0247	.1507	.7476	-.9377	.4235	1.1796
.0132	-.3100	.5966	.8916	.0126	.5132	.8236	.5338	.1507	.4976	-1.0292	.3983	1.2267
.0259	-.7042	.4879	1.0868	.0255	.3348	.7744	.6154	.1507	.2476	-1.0009	.4061	1.2119
.0759	-.9658	.4158	1.1939	.0495	.1549	.7248	.6939	.1507	-.2524	-1.0898	.4091	1.2062
.1003	-.9823	.4112	1.2023	.0753	.0599	.6986	.7345	.1507	-.5024	-1.0083	.4040	1.2158
.1507	-.9831	.4110	1.2027	.1002	-.0123	.6787	.7651	.1507	-.7524	-1.0150	.4298	1.1682
.2003	-.9831	.4110	1.2028	.1503	-.0957	.6557	.8004	.5002	.7476	-1.0965	.4349	1.1590
.2503	-.9886	.4095	1.2056	.1976	-.1496	.6298	.8402	.5002	.4976	-1.0228	.4276	1.1722
.3001	-1.0073	.4043	1.2153	.2503	-.2478	.6138	.8650	.5002	.2476	-1.0653	.4435	1.1436
.3502	-1.0033	.4054	1.2132	.3001	-.2867	.6030	.8817	.5002	-.2524	-1.0921	.4471	1.1372
.4003	-.9207	.4282	1.1711	.3507	-.3111	.5963	.8921	.5002	-.5024	-1.0179	.4490	1.1697
.4501	-.8670	.4430	1.1445	.4001	-.3089	.5969	.8912	.5002	-.7524	-1.0977	.4345	1.1596
.5002	-.8614	.4445	1.1417	.4501	-.2847	.6036	.8808	.8002	.7476	-1.4003	.5717	.9306
.5502	-.8150	.4573	1.1192	.5001	-.2276	.6193	.8564	.8002	.4976	-1.4063	.5701	.9332
.6002	-.7597	.4726	1.0928	.5497	-.1276	.6469	.8139	.8002	.2476	-1.4123	.5684	.9359
.6500	-.6625	.4994	1.0475	.6003	-.0215	.6762	.7690	.8002	-.5024	-1.3975	.5725	.9294
.7000	-.5903	.5193	1.0147	.6500	.0699	.7014	.7302	.8002	-.7524	-1.3617	.5823	.9139
.7500	-.5046	.5429	.9764	.7000	.1759	.7306	.6848					
.8002	-.4075	.5697	.9338	.7501	.2727	.7574	.6427					
.8502	-.1918	.6292	.8412	.8001	.3550	.7800	.6064					
.9501	-.0579	.6661	.7844	.8501	.4296	.8006	.5726					

TEST 167	PT	21.3603	PSI	CN	.6305	CD1	.00868	CDCOR1	.00845
RUN 3	TT	160.1158	K	CM	-.1511	CD2	.00744	CDCOR2	.00719
POINT 31	RC	6.9761	MILLION	CC	.0165	CD3	.00712	CDCOR3	.00690
	MACH	.7604				CD4	.00720	CDCOR4	.00700
	ALPHA	.4991	DEG			CD5	.00740	CDCOR5	.00762

UPPER SURFACE				LOWER SURFACE				SPANWISE				
X/C	CP	P/L/PT	MLOC	X/C	CP	P/L/PT	MLOC	X/C	Y/(B/2)	CP	P/L/PT	MLOC
0.0000	1.1521	.9995	.0257	0.0000	1.1521	.9995	.0257	.1507	.7476	-.8046	.4578	1.1184
.0132	-.2142	.6212	.8535	.0126	.4764	.8014	.5713	.1507	.4976	-.9105	.4285	1.1706
.0259	-.6041	.5133	1.0245	.0255	.2654	.7540	.6480	.1507	.2476	-.9033	.4303	1.1670
.0759	-.8720	.4391	1.1514	.0495	.0907	.7057	.6725	.1507	-.2524	-1.0847	.4329	1.1627
.1003	-.8889	.4364	1.1598	.0753	.0006	.6807	.7620	.1507	-.5024	-1.0891	.4319	1.1644
.1507	-.8843	.4357	1.1575	.1002	-.0677	.6618	.7910	.1507	-.7524	-1.0922	.4312	1.1644
.2003	-.8635	.4415	1.1472	.1503	-.1452	.6404	.8240	.5002	.7476	-1.3728	.4777	1.0841
.2503	-.8632	.4416	1.1470	.1976	-.2378	.6147	.8636	.5002	.4976	-1.3715	.4780	1.0835
.3001	-.8462	.4463	1.1386	.2503	-.2931	.5994	.8873	.5002	.2476	-1.3452	.4762	1.0900
.3502	-.7575	.4708	1.0958	.3001	-.3300	.5892	.9032	.5002	-.2524	-1.3726	.4777	1.0840
.4003	-.7459	.4740	1.0903	.3507	-.3507	.5834	.9122	.5002	-.5024	-1.3710	.4782	1.0833
.4501	-.7337	.4774	1.0846	.4001	-.3435	.5835	.9090	.5002	-.7524	-1.3352	.4770	1.0853
.5002	-.7431	.4748	1.0890	.4501	-.3127	.5940	.8958	.8002	.7476	-1.3993	.5700	.9333
.5502	-.7607	.4699	1.0973	.5001	-.2490	.6116	.8684	.8002	.4976	-1.4006	.5697	.9339
.6002	-.7684	.4678	1.1010	.5497	-.1442	.6406	.8236	.8002	.2476	-1.4050	.5684	.9358
.6500	-.7475	.4736	1.0911	.6003	-.0348	.6709	.7770	.8002	-.5024	-1.3960	.5709	.9319
.7000	-.6450	.5020	1.0432	.6500	.0598	.6971	.7366					
.7500	-.5032	.5412	.9791	.7000	.1675	.7269	.6905					
.8002	-.3987	.5707	.9331	.7501	.2654	.7540	.6480					
.8502	-.1790	.6310	.8344	.8001	.3477	.7768	.6115					
.9501	-.0479	.6673	.7826	.8501	.4217	.7973	.5780					

TEST	167	PT	21.3607	PSI	CM	.5519	CD1	.00865	CDCOR1	.00843
RUN	3	TT	160.0716	K	CM	-.1511	CD2	.00783	CDCOR2	.00765
POINT	32	RC	6.9793	MILLION	CC	.0184	CD3	.00667	CDCOR3	.00671
		MACH	.7604				CD4	.00621	CDCOR4	.00606
		ALPHA	.0015	DEG			CD5	.00701	CDCOR5	.00687

UPPER SURFACE				LOWER SURFACE				SPANWISE				
X/C	CP	P _L /PT	MLOC	X/C	CP	P _L /PT	MLOC	X/C	Y/(B/2)	CP	P _L /PT	MLOC
0.0000	1.1487	.9987	.0430	0.0000	1.1487	.9987	.0430	.1507	.7476	-.6815	.4927	1.0588
.0132	-.1167	.6458	.8110	.0126	.3512	.7782	.6093	.1507	.4976	-.7301	.4792	1.0814
.0259	-.5015	.5425	.9772	.0255	.1895	.7335	.6803	.1507	.2476	-.7627	.4702	1.0969
.0759	-.7705	.4681	1.1006	.0495	.0239	.6877	.7512	.1507	-.2524	-.7516	.4733	1.0916
.1003	-.7900	.4627	1.1099	.0753	-.0610	.6642	.7873	.1507	-.5024	-.7141	.4837	1.0739
.1507	-.7482	.4742	1.0900	.1002	-.1236	.6469	.8139	.1507	-.7524	-.6735	.4949	1.0551
.2003	-.7134	.4839	1.0736	.1503	-.1957	.6270	.8446	.5002	.7476	-.6960	.4887	1.0655
.2503	-.6760	.4942	1.0562	.1976	-.2845	.6024	.8826	.5002	.4976	-.6995	.4877	1.0671
.3001	-.7025	.4869	1.0685	.2503	-.3353	.5884	.9044	.5002	.2476	-.6988	.4879	1.0668
.3502	-.7172	.4828	1.0754	.3001	-.3688	.5791	.9190	.5002	-.2524	-.6870	.4912	1.0613
.4003	-.7129	.4840	1.0734	.3507	-.3850	.5747	.9260	.5002	-.5024	-.6960	.4887	1.0655
.4501	-.6904	.4902	1.0629	.4001	-.3719	.5783	.9203	.5002	-.7524	-.6879	.4909	1.0517
.5002	-.6938	.4893	1.0645	.4501	-.3348	.5885	.9042	.8002	.7476	-.3984	.5710	.9318
.5502	-.7238	.4810	1.0785	.5001	-.2644	.6080	.8739	.8002	.4976	-.3998	.5706	.9324
.6002	-.7439	.4754	1.0879	.5497	-.1547	.6383	.8271	.8002	.2476	-.4045	.5693	.9345
.6500	-.7305	.4791	1.0817	.6003	-.0419	.6695	.7792	.8002	-.5024	-.3929	.5725	.9294
.7000	-.6374	.5049	1.0384	.6500	.0552	.6964	.7379	.8002	-.7524	-.3640	.5805	.9169
.7500	-.5021	.5423	.9774	.7000	.1650	.7267	.6909					
.8002	-.3994	.5707	.9323	.7501	.2640	.7541	.6479					
.9002	-.1776	.6320	.8369	.8001	.3471	.7771	.6111					
.9501	-.0469	.6681	.7813	.8501	.4215	.7976	.5775					

TEST	167	PT	21.3598	PSI	CM	.4785	CD1	.00860	CDCOR1	.00837
RUN	3	TT	160.2059	K	CM	-.1502	CD2	.00755	CDCOR2	.00735
POINT	33	RC	6.9730	MILLION	CC	.0198	CD3	.00642	CDCOR3	.00631
		MACH	.7609				CD4	.00609	CDCOR4	.00595
		ALPHA	-.4982	DEG			CD5	.00632	CDCOR5	.00616

UPPER SURFACE				LOWER SURFACE				SPANWISE				
X/C	CP	P _L /PT	MLOC	X/C	CP	P _L /PT	MLOC	X/C	Y/(B/2)	CP	P _L /PT	MLOC
0.0000	1.1311	.9936	.0960	0.0000	1.1311	.9936	.0960	.1507	.7476	-.6023	.5127	1.0256
.0132	-.0148	.6757	.7698	.0126	.2497	.7480	.6559	.1507	.4976	-.6457	.5066	1.0455
.0259	-.3921	.5710	.9318	.0255	.1019	.7080	.7199	.1507	.2476	-.6940	.4983	1.0493
.0759	-.6066	.4948	1.0552	.0495	-.0534	.6649	.7863	.1507	-.2524	-.6474	.5001	1.0463
.1003	-.6508	.4992	1.0479	.0753	-.1268	.6446	.8175	.1507	-.5024	-.6372	.5030	1.0416
.1507	-.6355	.5034	1.0408	.1002	-.1908	.6268	.8449	.1507	-.7524	-.6011	.5130	1.0221
.2003	-.6265	.5059	1.0367	.1503	-.2524	.6097	.8714	.5002	.7476	-.6713	.4935	1.0574
.2503	-.6262	.5060	1.0365	.1976	-.3450	.5840	.9113	.5002	.4976	-.6844	.4899	1.0635
.3001	-.6622	.4960	1.0532	.2503	-.3938	.5705	.9326	.5002	.2476	-.6889	.4887	1.0654
.3502	-.6626	.4959	1.0533	.3001	-.4236	.5622	.9456	.5002	-.2524	-.6736	.4929	1.0584
.4003	-.6401	.5022	1.0429	.3507	-.4346	.5592	.9505	.5002	-.5024	-.6800	.4911	1.0614
.4501	-.6435	.5012	1.0445	.4001	-.4142	.5648	.9415	.5002	-.7524	-.6608	.4964	1.0525
.5002	-.6800	.4911	1.0614	.4501	-.3687	.5775	.9216	.8002	.7476	-.4041	.5876	.9370
.5502	-.7095	.4829	1.0752	.5001	-.2906	.5991	.8877	.8002	.4976	-.4052	.5873	.9376
.6002	-.7220	.4794	1.0811	.5497	-.1754	.6311	.8383	.8002	.2476	-.4096	.5861	.9395
.6500	-.7201	.4800	1.0802	.6003	-.0584	.6636	.7884	.8002	-.5024	-.4001	.5887	.9393
.7000	-.6467	.5003	1.0460	.6500	.0421	.6914	.7455					
.7500	-.5065	.5392	.9823	.7000	.1355	.7223	.6977					
.8002	-.4023	.5681	.9363	.7501	.2335	.7501	.6542					
.9002	-.1802	.6298	.8403	.8001	.3365	.7731	.6175					
.9501	-.0444	.6674	.7824	.8501	.4100	.7935	.5843					

TEST	167	PT	21.3597	PSI	CM	-.4030	CD1	.00849	CDCOR1	.00838
RUN	3	TT	160.2768	K	CM	-.1482	CD2	.00788	CDCOR2	.00782
POINT	34	RC	6.9618	MILLION	CC	.0200	CD3	.00693	CDCOR3	.00692
		MACH	.7596				CD4	.00596	CDCOR4	.00592
		ALPHA	-.9877	DEG			CD5	.00537	CDCOR5	.00530

UPPER SURFACE				LOWER SURFACE				SPANWISE				
X/C	CP	P _L /PT	MLOC	X/C	CP	P _L /PT	MLOC	X/C	Y/(B/2)	CP	P _L /PT	MLOC
0.0000	1.1010	.9856	.1441	0.0000	1.1010	.9856	.1441	.1507	.7476	-.5258	.5362	.9873
.0132	.0825	.7642	.7238	.0126	.1371	.7193	.7024	.1507	.4976	-.5650	.5253	1.0048
.0259	-.7869	.6022	.8830	.0255	.0050	.6828	.7588	.1507	.2476	-.5710	.5237	1.0075
.0759	-.5536	.5285	.9997	.0495	-.1389	.6431	.8199	.1507	-.2524	-.5660	.5231	1.0053
.1003	-.5467	.5304	.9966	.0753	-.2049	.6248	.8480	.1507	-.5024	-.5607	.5265	1.0029
.1507	-.5552	.5281	1.0004	.1002	-.2622	.6090	.8724	.1507	-.7524	-.5299	.5350	.9881
.2003	-.5681	.5300	.9972	.1503	-.3150	.5944	.8951	.5002	.7476	-.6311	.5071	1.0348
.2503	-.5694	.5241	1.0068	.1976	-.4061	.5692	.9345	.5002	.4976	-.6544	.5006	1.0455
.3001	-.5966	.5166	1.0191	.2503	-.4508	.5569	.9540	.5002	.2476	-.6612	.4988	1.0486
.3502	-.5842	.5200	1.0135	.3001	-.4761	.5499	.9652	.5002	-.2524	-.6348	.5061	1.0365
.4003	-.5953	.5170	1.0185	.3507	-.4803	.5487	.9671	.5002	-.5024	-.6431	.5038	1.0403
.4501	-.6157	.5113	1.0278	.4001	-.4520	.5566	.9546	.5002	-.7524	-.6186	.5105	1.0291
.5002	-.6447	.4933	1.0410	.4501	-.3985	.5713	.9312	.8002	.7476	-.4068	.5890	.9349
.5502	-.6600	.4991	1.0490	.5001	-.3131	.5949	.8942	.8002	.4976	-.4087	.5865	.9357
.6002	-.6764	.4946	1.0556	.5497	-.1932	.6281	.8429	.8002	.2476	-.4145	.5869	.9382
.6500	-.6908	.4906	1.0623	.6003	-.0728	.6613	.7918	.8002	-.5024	-.4029	.5701	.9311
.7000	-.6289	.5077	1.0338	.6500	.0303	.6898	.7480					
.7500	-.5090	.5408	.9798	.7000	.1432	.7210	.6998					
.8002	-.4091	.5686	.9358	.7501	.2439	.7488	.6563					
.9002	-.1872	.6297	.8404	.8001	.3267	.7717	.6198					
.9501	-.0491	.6678	.7818	.8501	.3993	.7917	.5872					

TEST 167	PT	21.3572	PSI	CM	.3276	CD1	.00839	CDCDR1	.00818
RUN 3	TT	160.3240	K	CM	-.1458	CD2	.00812	CDCDR2	.00800
POINT 35	RC	6.9601	MILLION	CC	.0196	CD3	.00798	CDCDR3	.00792
	MACH	.7600				CD4	.00609	CDCDR4	.00602
	ALPHA	-1.4867	DEG			CD5	.00925	CDCDR5	.00913

UPPER SURFACE				LOWER SURFACE				SPANWISE				
X/C	CP	P/L/PT	MLOC	X/C	CP	P/L/PT	MLOC	X/C	Y/(B/2)	CP	P/L/PT	MLOC
0.0000	1.0661	.9750	.1874	0.0000	1.0661	.9750	.1874	.1507	.7476	-.4478	.5569	.9540
.0132	.1925	.7341	.6794	.0126	.0197	.0863	.7535	.1507	.4976	-.4810	.5475	.9691
.0259	-.1684	.6342	.8334	.0255	-.0944	.6547	.8019	.1507	.2476	-.4862	.5463	.9710
.0759	-.4434	.5582	.9521	.0495	-.2265	.6182	.8582	.1507	-.2524	-.4819	.5475	.9691
.1003	-.4492	.5565	.9547	.0753	-.2847	.6020	.8632	.1507	-.5024	-.4793	.5482	.9679
.1507	-.4727	.5500	.9650	.1002	-.3324	.5889	.9037	.1507	-.7524	-.4533	.5557	.9564
.2003	-.4783	.5485	.9675	.1503	-.3746	.5772	.9220	.5002	.7476	-.5836	.5171	1.0166
.2503	-.5032	.5416	.9785	.1975	-.4667	.5517	.9624	.5002	.4976	-.6051	.5134	1.0243
.3001	-.5296	.5342	.9904	.2503	-.5083	.5402	.9808	.5002	.2476	-.6110	.5118	1.0270
.3502	-.5318	.5337	.9913	.3001	-.5288	.5345	.9899	.5002	-.2524	-.5807	.5202	1.0132
.4003	-.5483	.5291	.9947	.3507	-.5256	.5354	.9885	.5002	-.5024	-.5915	.5172	1.0182
.4501	-.5704	.5230	1.0086	.4001	-.4650	.5466	.9704	.5002	-.7524	-.5727	.5224	1.0097
.5002	-.5929	.5158	1.0188	.4501	-.4207	.5644	.9421	.8002	.7476	-.4022	.5695	.9340
.5502	-.6174	.5100	1.0299	.5001	-.3292	.5898	.9023	.8002	.4976	-.4021	.5696	.9340
.6002	-.6446	.5027	1.0421	.5497	-.2045	.6242	.8488	.8002	.2476	-.4072	.5681	.9363
.6500	-.6625	.4975	1.0506	.6003	-.0806	.6585	.7961	.8002	-.5024	-.3928	.5722	.9299
.7000	-.6869	.5129	1.0251	.6500	.0249	.6877	.7512	.8002	-.7524	-.3673	.5792	.9189
.7500	-.7010	.5422	.9775	.7000	.1387	.7192	.7026					
.8002	-.4030	.5693	.9344	.7501	.2392	.7470	.6591					
.9002	-.1834	.6301	.8398	.8001	.3211	.7697	.6230					
.9501	-.0451	.6884	.7810	.8501	.3921	.7863	.5912					

TEST 167	PT	21.4565	PSI	CM	.2462	CD1	.00897	CDCDR1	.00875
RUN 3	TT	160.3439	K	CM	-.1421	CD2	.00728	CDCDR2	.00706
POINT 36	RC	6.9871	MILLION	CC	.0181	CD3	.00657	CDCDR3	.00643
	MACH	.7592				CD4	.00623	CDCDR4	.00608
	AL	-2.0030	DEG			CD5	.00942	CDCDR5	.00927

UPPER SURFACE				LOWER SURFACE				SPANWISE				
X/C	CP	P/L/PT	MLOC	X/C	CP	P/L/PT	MLOC	X/C	Y/(B/2)	CP	P/L/PT	MLOC
0.0000	1.0180	.9627	.2337	0.0000	1.0180	.9627	.2337	.1507	.7476	-.3785	.5769	.9224
.0132	.2947	.7829	.6337	.0126	-.1159	.6495	.8100	.1507	.4976	-.4085	.5687	.9354
.0259	-.0602	.6848	.7864	.0255	-.2072	.6242	.8484	.1507	.2476	-.4117	.5678	.9369
.0759	-.3477	.5854	.9091	.0495	-.3267	.5912	.9000	.1507	-.2524	-.4137	.5672	.9377
.1003	-.3638	.5810	.9160	.0753	-.3695	.5794	.9185	.1507	-.5024	-.4124	.5676	.9371
.1507	-.3991	.5712	.9314	.1002	-.4179	.5660	.9296	.1507	-.7524	-.3916	.5733	.9281
.2003	-.3980	.5715	.9309	.1503	-.4443	.5588	.9511	.5002	.7476	-.5408	.5321	.9938
.2503	-.4444	.5587	.9511	.1976	-.5417	.5318	.9943	.5002	.4976	-.5585	.5272	1.0018
.3001	-.4745	.5504	.9644	.2503	-.5819	.5208	1.0123	.5002	.2476	-.5648	.5255	1.0046
.3502	-.4801	.5489	.9669	.3001	-.6001	.5157	1.0205	.5002	-.2524	-.5583	.5273	1.0017
.4003	-.5024	.5427	.9767	.3507	-.5821	.5207	1.0124	.5002	-.5024	-.5528	.5286	.9992
.4501	-.5257	.5363	.9871	.4001	-.5267	.5360	.9875	.5102	-.7524	-.5383	.5328	.9927
.5002	-.5493	.5298	.9976	.4501	-.4508	.5570	.9540	.8002	.7476	-.3985	.5714	.9311
.5502	-.5797	.5214	1.0113	.5001	-.3519	.5843	.9109	.8002	.4976	-.4012	.5707	.9323
.6002	-.6079	.5136	1.0241	.5497	-.2229	.6199	.8555	.8002	.2476	-.4067	.5691	.9347
.6500	-.6281	.5080	1.0333	.6003	-.0956	.6551	.8014	.8002	-.5024	-.3952	.5723	.9297
.7000	-.6531	.5204	1.0129	.6500	.0132	.6851	.7552	.8002	.7524	-.3700	.5793	.9187
.7500	-.6461	.5445	.9739	.7000	.1278	.7168	.7063					
.8002	-.4014	.5705	.9326	.7501	.2276	.7444	.6633					
.9002	-.1844	.6305	.8391	.8001	.3081	.7666	.6280					
.9501	-.0444	.6892	.7797	.8501	.3769	.7856	.5973					

TEST 167	PT	21.3607	PSI	CM	.0994	CD1	.00923	CDCDR1	.00917
RUN 3	TT	160.3355	K	CM	-.1382	CD2	.00744	CDCDR2	.00740
POINT 37	RC	6.9542	MILLION	CC	.0126	CD3	.00678	CDCDR3	.00677
	MACH	.7588				CD4	.00631	CDCDR4	.00627
	ALPHA	-2.0942	DEG			CD5	.00961	CDCDR5	.00950

UPPER SURFACE				LOWER SURFACE				SPANWISE				
X/C	CP	P/L/PT	MLOC	X/C	CP	P/L/PT	MLOC	X/C	Y/(B/2)	CP	P/L/PT	MLOC
0.0000	.9878	.9270	.3308	0.0000	.9878	.9270	.3308	.1507	.7476	-.2569	.6113	.8688
.0132	.4773	.8140	.5501	.0126	-.4041	.5707	.8322	.1507	.4976	-.2771	.6057	.8774
.0259	.1382	.7202	.7010	.0255	-.4422	.5602	.8488	.1507	.2476	-.2786	.6053	.8781
.0759	-.1789	.6328	.8356	.0495	-.5300	.5360	.9876	.1507	-.2524	-.2764	.6059	.8772
.1003	-.2112	.6239	.8493	.0753	-.5477	.5311	.9954	.1507	-.5024	-.2768	.6058	.8773
.1507	-.2671	.6085	.8732	.1002	-.5945	.5182	1.0164	.1507	-.7524	-.2607	.6103	.8704
.2003	-.2962	.6005	.8856	.1503	-.5741	.5239	1.0072	.5002	.7476	-.4633	.5344	.9580
.2503	-.3351	.5898	.9023	.1976	-.6683	.4976	1.0506	.5002	.4976	-.4789	.5501	.9649
.3001	-.3717	.5797	.9181	.2503	-.7574	.4733	1.0916	.5002	.2476	-.4851	.5494	.9676
.3502	-.3915	.5742	.9287	.3001	-.8000	.4614	1.1118	.5002	-.2524	-.4737	.5515	.9626
.4003	-.4178	.5669	.9382	.3507	-.7029	.4883	1.0641	.5002	-.5024	-.4686	.5529	.9604
.4501	-.4461	.5591	.9505	.4001	-.5657	.5262	1.0035	.5002	-.7524	-.4548	.5567	.9543
.5002	-.4732	.5517	.9624	.4501	-.4788	.5501	.9649	.8002	.7476	-.3851	.5760	.9239
.5502	-.5008	.5418	.9781	.5001	-.3759	.5785	.9200	.8002	.4976	-.3887	.5750	.9255
.6002	-.5216	.5328	.9927	.5497	-.2427	.6152	.8628	.8002	.2476	-.3943	.5734	.9278
.6500	-.5621	.5271	1.0019	.6003	-.1115	.6514	.8071	.8002	-.5024	-.3744	.5789	.9193
.7000	-.5351	.5346	.9898	.6500	.0005	.6823	.7596	.8002	-.7524	-.3510	.5854	.9092
.7500	-.4747	.5512	.9631	.7000	.1182	.7142	.7104					
.8002	-.3894	.5748	.9258	.7501	.2183	.7418	.6873					
.9002	-.1738	.6315	.8377	.8001	.2982	.7638	.6324					
.9501	-.0458	.6893	.7792	.8501	.3638	.7825	.6024					

TEST	167	PT	21.3636	PSI	CM	-0.0601	CD1	.01074	CDCOR1	.01057
RUN	3	TT	160.3294	K	CM	-1.1333	CD2	.00872	CDCOR2	.00871
PJINT	34	RC	6.9566	MILLION	CC	.0043	CD3	.00770	CDCOR3	.00773
		MACH	.7590				CD4	.00713	CDCOR4	.00713
		ALPHA	-4.0120	DEG			CD5	.00610	CDCOR5	.00600

UPPER SURFACE				LOWER SURFACE				SPANWISE				
X/C	CP	P/L/PT	MLOC	X/C	CP	P/L/PT	MLOC	X/C	Y/(B/2)	CP	P/L/PT	MLOC
0.0000	.7437	.8872	.4169	0.0000	.7437	.8872	.4169	.1507	.7476	-.1433	.6426	.0205
.0132	.6311	.8562	.4761	.0128	-.7175	.4843	1.0729	.1507	.4976	-.1609	.6378	.0280
.0259	.3059	.7665	.6281	.0255	-.6677	.4980	1.0498	.1507	.2476	-.1620	.6375	.0284
.0759	-.0347	.6726	.7745	.0495	-.7671	.4706	1.0962	.1507	-.2524	-.1612	.6377	.0281
.1003	-.0796	.6602	.7935	.0753	-.7913	.4640	1.1077	.1507	-.5024	-.1634	.6371	.0291
.1507	-.1507	.6406	.8236	.1002	-.8167	.4569	1.1199	.1507	-.7524	-.1524	.6401	.0244
.2003	-.1907	.6296	.8406	.1503	-.8020	.4610	1.1128	.5002	.7476	-.3970	.5727	.9291
.2503	-.2400	.6140	.8616	.1976	-.8190	.4563	1.1210	.5002	.4976	-.4084	.5695	.9341
.3001	-.2821	.6044	.8746	.2503	-.8350	.4519	1.1267	.5002	.2476	-.4144	.5679	.9367
.3502	-.3081	.5972	.8907	.3001	-.9083	.4317	1.1648	.5002	-.2524	-.4043	.5706	.9324
.4003	-.3399	.5884	.9044	.3507	-.9858	.4103	1.2040	.5002	-.5024	-.3984	.5721	.9299
.4501	-.3714	.5797	.9180	.4001	-.9133	.4303	1.1672	.5002	-.7524	-.3864	.5756	.9245
.5002	-.4041	.5707	.9322	.4501	-.4572	.5561	.9554	.8002	.7476	-.3711	.5798	.9179
.5502	-.4436	.5598	.9494	.5001	-.3646	.5816	.9151	.8002	.4976	-.3738	.5791	.9191
.6002	-.4792	.5500	.9650	.5497	-.2492	.6134	.8656	.8002	.2476	-.3801	.5773	.9218
.6500	-.5035	.5433	.9758	.6003	-.1241	.6479	.8124	.8002	-.5024	-.3595	.5830	.9129
.7000	-.4920	.5465	.9707	.6500	-.0128	.6786	.7652	.8002	-.7524	-.3374	.5891	.9034
.7500	-.4487	.5584	.9516	.7000	.1014	.7101	.7167					
.8002	-.3738	.5791	.9191	.7501	.2011	.7376	.6739					
.9002	-.1832	.6316	.8374	.8001	.2813	.7597	.6390					
.9501	-.0497	.6684	.7809	.8501	.3487	.7783	.6091					

TEST 167	PT 25.1599	PSI	CM -.0791	CD1 .01183	CDCR1 -.01173
RUN 6	TT 140.3252	K	CM -.1301	CD2 .01160	CDCR2 -.01192
POINT 10	RC 9.9291	MILLION	CC .0042	CD3 .01114	CDCR3 -.01113
	MACH .7590			CD4 .01082	CDCR4 -.01075
	ALPHA -4.0120	DEG		CD5 .01029	CDCR5 -.01080

UPPER SURFACE				LOWER SURFACE				SPANWISE				
X/C	CP	P.L./PT	MLOC	X/C	CP	P.L./PT	MLOC	X/C	Y/(B/2)	CP	P.L./PT	MLOC
0.0000	.7395	.8862	.4191	0.0000	.7395	.8862	.4191	.1507	.7476	-.1277	.4473	.8136
.0112	.6310	.8563	.4761	.0126	-.7221	.4833	1.0745	.1507	.4976	-.1515	.6407	.8237
.0259	.3100	.7679	.6261	.0255	-.6792	.4953	1.0546	.1507	.2476	-.1407	.4437	.8191
.0759	-.0130	.6789	.7651	.0495	-.7898	.4648	1.1064	.1507	-.2524	-.1442	.6427	.8206
.1003	-.0627	.6652	.7861	.0753	-.7915	.4644	1.1073	.1507	-.5024	-.1442	.6427	.8206
.1507	-.1402	.6415	.8189	.1002	-.8248	.4552	1.1232	.1507	-.7524	-.1580	.4389	.8265
.2003	-.1951	.6267	.8422	.1503	-.8112	.4589	1.1167	.5002	.7476	-.4008	.5720	.9304
.2503	-.2429	.6155	.8626	.1976	-.8393	.4512	1.1302	.5002	.4976	-.4070	.5703	.9331
.3001	-.2855	.6030	.8808	.2503	-.8645	.4443	1.1425	.5002	.2476	-.4111	.5687	.9356
.3502	-.3131	.5962	.8926	.3001	-.9240	.4279	1.1720	.5002	-.2524	-.4033	.5713	.9315
.4003	-.3454	.5873	.9065	.3502	-1.0033	.4060	1.2123	.5002	-.5024	-.4001	.5722	.9301
.4501	-.3772	.5795	.9202	.4001	-1.0503	.3931	1.2369	.5002	-.7524	-.3871	.5759	.9245
.5002	-.4106	.5693	.9347	.4501	-.4983	.3951	.9731	.8002	.7476	-.3735	.5795	.9186
.5502	-.4512	.5581	.9524	.5001	-.3620	.3827	.9136	.8002	.4976	-.3750	.5767	.9184
.6002	-.4854	.5487	.9674	.5497	-.2483	.6140	.7948	.8002	.2476	-.3778	.5786	.9204
.6500	-.5089	.5423	.9775	.6003	-.1264	.6476	.6131	.8002	-.5024	-.3619	.5827	.9136
.7000	-.4938	.5464	.9711	.6500	-.0186	.6773	.7674	.8002	-.7524	-.3525	.5553	.9093
.7500	-.4461	.5595	.9501	.7000	.0337	.7083	.7198					
.8042	-.3704	.5804	.9172	.7501	.1903	.7349	.6784					
.8502	-.1778	.6334	.8349	.8001	.2693	.7566	.6441					
.9001	-.0466	.6888	.7806	.8501	.3349	.7747	.6151					

TEST 167	PT 25.1634	PSI	CM .0775	CD1 .0067	CDCR1 -.00937
RUN 6	TT 140.2105	K	CM -.1352	CD2 .0011	CDCR2 .03924
POINT 11	RC 9.9418	MILLION	CC .0121	CD3 .00889	CDCR3 .00890
	MACH .7589			CD4 .00885	CDCR4 .00883
	ALPHA -2.9938	DEG		CD5 .00878	CDCR5 .00886

UPPER SURFACE				LOWER SURFACE				SPANWISE				
X/C	CP	P.L./PT	MLOC	X/C	CP	P.L./PT	MLOC	X/C	Y/(B/2)	CP	P.L./PT	MLOC
0.0000	.3776	.9242	.3374	0.0000	.3776	.9242	.3374	.1507	.7476	-.2375	.6170	.8603
.0132	.4839	.8157	.5474	.0124	-.4165	.6677	.9373	.1507	.4976	-.2501	.6118	.8683
.0259	.1463	.7227	.6973	.0255	-.4624	.6550	.9574	.1507	.2476	-.2509	.6133	.8640
.0759	-.1485	.6415	.8225	.0495	-.5607	.6279	1.0009	.1507	-.2524	-.2551	.6121	.8678
.1003	-.1879	.6306	.8392	.0753	-.5521	.6303	.9971	.1507	-.5024	-.2532	.6126	.8670
.1507	-.2514	.6131	.8662	.1002	-.6126	.6136	1.0243	.1507	-.7524	-.2532	.6126	.8670
.2003	-.2931	.6017	.8841	.1503	-.5905	.6197	1.0143	.5002	.7476	-.4683	.5533	.9600
.2503	-.3363	.5897	.9026	.1976	-.6773	.6030	1.0585	.5002	.4976	-.4750	.5515	.9624
.3001	-.3731	.5796	.9185	.2503	-.7193	.6877	1.1015	.5002	.2476	-.4805	.5500	.9633
.3502	-.3946	.5727	.9278	.3001	-.8411	.4507	1.1312	.5002	-.2524	-.4692	.5531	.9604
.4003	-.4217	.5662	.9396	.3502	-.8327	.4530	1.1271	.5002	-.5024	-.4683	.5539	.9591
.4501	-.4484	.5589	.9512	.4001	-.5558	.6291	.9987	.5002	-.7524	-.4531	.5576	.9533
.5002	-.4780	.5507	.9642	.4501	-.4914	.6498	.9657	.8002	.7476	-.3879	.5755	.9249
.5502	-.5121	.5405	.9806	.5001	-.3817	.6772	.9222	.8002	.4976	-.3880	.5761	.9241
.6002	-.5459	.5320	.9943	.5497	-.2501	.6135	.6657	.8002	-.5024	-.3903	.5749	.9259
.6500	-.5636	.5271	1.0022	.6003	-.1196	.6495	.6103	.8001	-.7524	-.3763	.5787	.9199
.7000	-.5223	.5357	.9883	.6500	-.0097	.6767	.7637	.8002	-.5024	-.3673	.5812	.9160
.7500	-.4894	.5531	.9603	.7000	.1058	.7115	.7147					
.8002	-.3837	.5748	.9229	.7501	.2639	.7386	.6724					
.8502	-.1776	.6335	.8349	.8001	.2837	.7608	.6378					
.9001	-.0467	.6894	.7794	.8501	.3499	.7788	.6085					

TEST 167	PT 25.1849	PSI	CM .2340	CD1 .00910	CDCR1 .00960
RUN 6	TT 140.3352	K	CM -.1396	CD2 .00910	CDCR2 .00902
POINT 12	RC 9.9329	MILLION	CC .0180	CD3 .00879	CDCR3 .00877
	MACH .7594			CD4 .00878	CDCR4 .00871
	ALPHA -1.9958	DEG		CD5 .00866	CDCR5 .00850

UPPER SURFACE				LOWER SURFACE				SPANWISE				
X/C	CP	P.L./PT	MLOC	X/C	CP	P.L./PT	MLOC	X/C	Y/(B/2)	CP	P.L./PT	MLOC
0.0000	1.0059	.9599	.2426	0.0000	1.0059	.9599	.2426	.1507	.7476	-.3656	.5830	.9132
.0132	.3003	.7659	.6292	.0126	-.1303	.6476	.6131	.1507	.4976	-.3887	.5766	.9232
.0259	-.0537	.6887	.7807	.0255	-.2261	.6223	.6536	.1507	.2476	-.3756	.5775	.9219
.0759	-.3144	.5975	.8913	.0495	-.3423	.5893	.9032	.1507	-.2524	-.3883	.5767	.9230
.1003	-.3587	.5903	.9218	.0753	-.3630	.5837	.9121	.1507	-.5024	-.3845	.5770	.9214
.1507	-.3254	.5775	.9218	.1002	-.4254	.5655	.9391	.1507	-.7524	-.3930	.5759	.9231
.2003	-.4146	.5695	.9345	.1503	-.4559	.5581	.9524	.5002	.7476	-.3427	.5343	.9906
.2503	-.4659	.5609	.9490	.1976	-.5523	.5316	.9949	.5002	.4976	-.3484	.5327	.9931
.3001	-.4743	.5531	.9604	.2503	-.5936	.5113	1.0133	.5002	.2476	-.3545	.5310	.9958
.3502	-.4848	.5502	.9650	.3001	-.6135	.5148	1.0223	.5002	-.2524	-.3433	.5341	.9989
.4003	-.5058	.5444	.9743	.3502	-.5915	.5209	1.0124	.5002	-.5024	-.3406	.5349	.9979
.4501	-.5289	.5381	.9845	.4001	-.5373	.5372	.9880	.5002	-.7524	-.3263	.5388	.9833
.5002	-.5519	.5318	.9947	.4501	-.4562	.5581	.9525	.8002	.7476	-.3020	.5729	.9290
.5502	-.5837	.5230	1.0089	.5001	-.3568	.5854	.9097	.8002	.4976	-.3010	.5732	.9285
.6002	-.5100	.5158	1.0207	.5497	-.2287	.6206	.8547	.8002	.2476	-.3048	.5722	.9282
.6500	-.4820	.5122	1.0266	.6003	-.1519	.6554	.8011	.8002	-.5024	-.3016	.5758	.9245
.7000	-.4712	.5264	1.0033	.6500	.0043	.6846	.7562	.8002	-.7524	-.3030	.5762	.9287
.7500	-.4894	.5489	.9871	.7000	.1186	.7160	.7077					
.8002	-.3967	.5746	.9264	.7501	.2168	.7430	.6656					
.8502	-.1807	.6338	.8364	.8001	.2974	.7651	.6305					
.9001	-.0480	.6902	.7784	.8501	.3651	.7838	.6005					

ORIGINAL PAGE IS
OF POOR QUALITY

TEST	167	PT	25.1695	PSI	CN	.3117	CD1	.00926	CDCOR1	.00892
RUN	6	TY	140.3277	K	CM	-.1417	CD2	.00919	CDCOR2	.00880
POINT	13	RC	9.9396	MILLION	CC	.0196	CD3	.00895	CDCOR3	.00878
		MACH	.7599				CD4	.00885	CDCOR4	.00867
		ALPHA	-1.4862	DEG			CD5	.00870	CDCOR5	.00852

UPPER SURFACE				LOWER SURFACE				SPANWISE				
X/C	CP	P/L/PT	MLOC	X/C	CP	P/L/PT	MLOC	X/C	Y/(B/2)	CP	P/L/PT	MLOC
0.0000	1.0599	.9742	.1935	0.0000	1.0599	.9742	.1935	.1507	.7476	-.4367	.5609	.9479
.0132	.1941	.7351	.6774	.0126	.0118	.6848	.7560	.1507	.4976	-.4825	.5483	.9681
.0259	-.1647	.6360	.8309	.0255	-.1068	.6520	.8063	.1507	.2476	-.4615	.5541	.9588
.0759	-.4104	.5682	.9365	.0495	-.2384	.6157	.8623	.1507	-.2524	-.4659	.5529	.9608
.1003	-.4245	.5643	.9426	.0753	-.2742	.6058	.8776	.1507	-.5024	-.4799	.5490	.9669
.1507	-.4620	.5540	.9590	.1002	-.3405	.5875	.9061	.1507	-.7524	-.4653	.5530	.9605
.2003	-.4732	.5508	.9640	.1503	-.3832	.5757	.9246	.5002	.7476	-.5894	.5188	1.0196
.2500	-.5084	.5411	.9796	.1976	-.4788	.5493	.9665	.5002	.4976	-.5971	.5166	1.0193
.3001	-.5343	.5340	.9911	.2503	-.5235	.5370	.9863	.5002	.2476	-.6024	.5152	1.0217
.3502	-.5320	.5346	.9901	.3001	-.5446	.5311	.9957	.5002	-.2524	-.5917	.5181	1.0169
.4003	-.5517	.5292	.9989	.3507	-.5402	.5323	.9937	.5002	-.5024	-.5878	.5192	1.0151
.4501	-.5755	.5226	1.0096	.4001	-.4973	.5442	.9746	.5002	-.7524	-.5724	.5234	1.0082
.5002	-.5979	.5164	1.0197	.4501	-.4315	.5624	.9457	.8002	.7476	-.4068	.5692	.9349
.5502	-.6228	.5095	1.0310	.5001	-.3386	.5880	.9053	.8002	.4976	-.4037	.5700	.9336
.6002	-.6478	.5026	1.0434	.5497	-.2147	.6223	.8522	.8002	.2476	-.4068	.5692	.9349
.6500	-.6626	.4985	1.0492	.6003	-.0908	.6565	.7995	.8002	-.5024	-.3974	.5718	.9308
.7000	-.5990	.5161	1.0202	.6500	.0131	.6851	.7554	.8002	-.7524	-.3904	.5737	.9277
.7500	-.4936	.5452	.9730	.7000	.1263	.7164	.7071					
.8002	-.3966	.5720	.9304	.7501	.2243	.7435	.6649					
.9002	-.1769	.6327	.8361	.8001	.3052	.7658	.6294					
.9501	-.0441	.6694	.7797	.8501	.3735	.7847	.5990					

TEST	167	PT	25.1684	PSI	CN	.3842	CD1	.00936	CDCOR1	.00912
RUN	6	TY	140.3401	K	CM	-.1430	CD2	.00934	CDCOR2	.00916
POINT	14	RC	9.9391	MILLION	CC	.0202	CD3	.00919	CDCOR3	.00907
		MACH	.7401				CD4	.00901	CDCOR4	.00889
		ALPHA	-.9921	DEG			CD5	.00886	CDCOR5	.00867

UPPER SURFACE				LOWER SURFACE				SPANWISE				
X/C	CP	P/L/PT	MLOC	X/C	CP	P/L/PT	MLOC	X/C	Y/(B/2)	CP	P/L/PT	MLOC
0.0000	1.0990	.9852	.1459	0.0000	1.0990	.9852	.1459	.1507	.7476	-.5089	.5423	.9777
.0132	.0943	.7085	.7194	.0126	.1315	.7187	.7035	.1507	.4976	-.5550	.5296	.9682
.0259	-.2759	.6065	.8766	.0255	-.0049	.6811	.7616	.1507	.2476	-.5381	.5343	.9906
.0759	-.5102	.5419	.9783	.0495	-.1475	.6419	.8219	.1507	-.2524	-.5405	.5336	.9917
.1003	-.5106	.5419	.9784	.0753	-.1947	.6289	.8420	.1507	-.5024	-.5426	.5363	.9971
.1507	-.5387	.5341	.9909	.1002	-.2646	.6096	.8718	.1507	-.7524	-.5316	.5360	.9878
.2003	-.5403	.5336	.9916	.1503	-.3183	.5948	.8947	.5002	.7476	-.6281	.5095	1.0311
.2503	-.5683	.5259	1.0041	.1976	-.4113	.5692	.9249	.5002	.4976	-.6388	.5065	1.0360
.3001	-.5934	.5190	1.0194	.2503	-.4585	.5562	.9555	.5002	.2476	-.6473	.5042	1.0399
.3502	-.5805	.5226	1.0096	.3001	-.4840	.5492	.9667	.5002	-.2524	-.6354	.5074	1.0345
.4003	-.5945	.5187	1.0159	.3507	-.4888	.5478	.9648	.5002	-.5024	-.6314	.5086	1.0326
.4501	-.6159	.5128	1.0256	.4001	-.4585	.5562	.9555	.5002	-.7524	-.6125	.5138	1.0240
.5002	-.6425	.5055	1.0377	.4501	-.4035	.5713	.9316	.8002	.7476	-.4027	.5719	.9312
.5502	-.6563	.5017	1.0440	.5001	-.3183	.5948	.8947	.8002	.4976	-.4021	.5717	.9309
.6002	-.6726	.4972	1.0515	.5497	-.1993	.6276	.8439	.8002	.2476	-.4050	.5709	.9321
.6500	-.6814	.4948	1.0555	.6003	-.0738	.6608	.7828	.8002	-.5024	-.3962	.5734	.9283
.7000	-.6479	.5150	1.0219	.6500	.0224	.6887	.7500	.8002	-.7524	-.3896	.5752	.9255
.7500	-.4941	.5464	.9711	.7000	.1344	.7195	.7023					
.8002	-.3958	.5735	.9282	.7501	.2321	.7464	.6602					
.9002	-.1751	.6343	.8336	.8001	.3131	.7687	.6247					
.9501	-.0428	.6707	.7776	.8501	.3821	.7877	.5940					

TEST	167	PT	25.1690	PSI	CN	.4633	CD1	.00975	CDCOR1	.00950
RUN	6	TY	140.2722	K	CM	-.1430	CD2	.00966	CDCOR2	.00945
POINT	15	RC	9.9453	MILLION	CC	.0197	CD3	.00931	CDCOR3	.00917
		MACH	.7600				CD4	.00909	CDCOR4	.00895
		ALPHA	-.4888	DEG			CD5	.00901	CDCOR5	.00874

UPPER SURFACE				LOWER SURFACE				SPANWISE				
X/C	CP	P/L/PT	MLOC	X/C	CP	P/L/PT	MLOC	X/C	Y/(B/2)	CP	P/L/PT	MLOC
0.0000	1.1261	.9931	.0995	0.0000	1.1261	.9931	.0995	.1507	.7476	-.5948	.5215	1.0114
.0132	-.0225	.6784	.7459	.0126	.2457	.7514	.6517	.1507	.4976	-.6313	.5115	1.0277
.0259	-.4018	.5744	.9267	.0255	.0943	.7104	.7165	.1507	.2476	-.6288	.5122	1.0266
.0759	-.6594	.5093	1.0314	.0495	-.0602	.6680	.7819	.1507	-.2524	-.6270	.5127	1.0258
.1003	-.6076	.5180	1.0171	.0753	-.1171	.6524	.8057	.1507	-.5024	-.6201	.5146	1.0227
.1507	-.6291	.5121	1.0267	.1002	-.1925	.6317	.8375	.1507	-.7524	-.6129	.5165	1.0195
.2003	-.6218	.5141	1.0235	.1503	-.2561	.6143	.8640	.5002	.7476	-.6679	.5015	1.0443
.2503	-.6313	.5115	1.0277	.1976	-.3451	.5899	.9023	.5002	.4976	-.6806	.4980	1.0502
.3001	-.6609	.5034	1.0412	.2503	-.3946	.5764	.9235	.5002	.2476	-.6888	.4963	1.0530
.3502	-.6500	.5064	1.0362	.3001	-.4239	.5683	.9362	.5002	-.2524	-.6725	.5002	1.0465
.4003	-.6349	.5105	1.0294	.3507	-.4361	.5650	.9415	.5002	-.5024	-.6710	.5006	1.0458
.4501	-.6522	.5058	1.0372	.4001	-.4149	.5708	.9523	.5002	-.7524	-.6530	.5035	1.0376
.5002	-.6813	.4978	1.0504	.4501	-.3705	.5830	.9132	.8002	.7476	-.4087	.5725	.9266
.5502	-.7000	.4927	1.0590	.5001	-.2938	.6040	.8804	.8002	.4976	-.4066	.5731	.9287
.6002	-.7040	.4916	1.0609	.5497	-.1814	.6348	.8328	.8002	.2476	-.4087	.5725	.9297
.6500	-.6959	.4938	1.0572	.6003	-.0654	.6666	.7839	.8002	-.5024	-.3972	.5757	.9247
.7000	-.6166	.5155	1.0211	.6500	.0327	.6935	.7426	.8002	-.7524	-.3918	.5771	.9223
.7500	-.4998	.5476	.9642	.7000	.1427	.7236	.6959					
.8002	-.3995	.5750	.9257	.7501	.2393	.7501	.6544					
.9002	-.1770	.6360	.8309	.8001	.3202	.7723	.6191					
.9501	-.0473	.6716	.7763	.8501	.3892	.7912	.5884					

TEST	167	PT	25.1654	PSI	CN	.5380	CD1	.00984	CDCDR1	.00955
RUN	6	TT	140.2449	K	CM	-.1454	CD2	.00980	CDCDR2	.00954
POINT	16	RC	9.9557	MILLION	CC	.0185	CD3	.00952	CDCDR3	.00933
		MACH	.7612				CD4	.00917	CDCDR4	.00900
		ALPHA	.0196	DEG			CD5	.00910	CDCDR5	.00887

UPPER SURFACE				LOWER SURFACE				SPANWISE				
X/C	CP	P/L/PT	MLOC	X/C	CP	P/L/PT	MLOC	X/C	Y/(B/2)	CP	P/L/PT	MLOC
0.0000	1.1462	.9985	.0460	0.0000	1.1462	.9985	.0460	.1507	.7476	-.9152	.4788	1.0488
.0132	-.1242	.6500	.8095	.0126	.3501	.7801	.6064	.1507	.497	-.61	.4975	1.0509
.0259	-.5117	.5437	.9755	.0255	-.1673	.7354	.6775	.1507	.2476	-.711	.4872	1.0682
.0759	-.7441	.4799	1.0806	.0495	-.0224	.6902	.7476	.1507	-.2524	-.7161	.4875	1.0678
.1003	-.7648	.4742	1.0903	.0753	-.0450	.6717	.7761	.1507	-.5024	-.6852	.4961	1.0534
.1507	-.7172	.4673	1.0681	.1002	-.1223	.6505	.8086	.1507	-.7524	-.6873	.4955	1.0543
.2003	-.6970	.4928	1.0588	.1503	-.1928	.6312	.8384	.5002	.7476	-.7017	.4915	1.0610
.2503	-.6862	.4958	1.0538	.1976	-.2850	.6059	.8775	.5002	.4976	-.7074	.4900	1.0636
.3001	-.7160	.4876	1.0676	.2503	-.3386	.5912	.9004	.5002	.2476	-.7078	.4899	1.0638
.3502	-.7240	.4854	1.0713	.3001	-.3718	.5820	.9147	.5002	-.2524	-.6961	.4931	1.0584
.4003	-.7216	.4861	1.0702	.3507	-.3886	.5774	.9219	.5002	-.5024	-.7036	.4910	1.0618
.4501	-.7023	.4914	1.0612	.4001	-.3758	.5809	.9164	.5002	-.7524	-.6926	.4940	1.0568
.5002	-.6987	.4924	1.0596	.4501	-.3395	.5909	.9008	.8002	.7476	-.4040	.5732	.9285
.5502	-.7190	.4868	1.0689	.5001	-.2699	.6100	.8711	.8002	.4976	-.3997	.5744	.9267
.6002	-.7322	.4832	1.0751	.5497	-.1628	.6394	.8257	.8002	.2476	-.4010	.5740	.9272
.6500	-.7159	.4876	1.0675	.6003	-.0505	.6702	.7784	.8002	-.5024	-.3933	.5761	.9239
.7000	-.6210	.5137	1.0242	.6500	.0444	.6962	.7383	.8002	-.7524	-.3880	.5776	.9216
.7500	-.4922	.5490	.9669	.7000	.1529	.7260	.6922					
.8002	-.3918	.5766	.9233	.7501	.2487	.7523	.6509					
.9002	-.1696	.6375	.8286	.8001	.3293	.7744	.6156					
.9501	-.0409	.6728	.7743	.8501	.3985	.7934	.5847					

TEST	167	PT	25.1666	PSI	CN	.6211	CD1	.01013	CDCDR1	.00987
RUN	6	TT	140.2259	K	CM	-.1464	CD2	.01010	CDCDR2	.00992
POINT	17	RC	9.9634	MILLION	CC	.0163	CD3	.00992	CDCDR3	.00965
		MACH	.7618				CD4	.00956	CDCDR4	.00931
		ALPHA	.5193	DEG			CD5	.00939	CDCDR5	.00915

UPPER SURFACE				LOWER SURFACE				SPANWISE				
X/C	CP	P/L/PT	MLOC	X/C	CP	P/L/PT	MLOC	X/C	Y/(B/2)	CP	P/L/PT	MLOC
0.0000	1.1449	.9978	.0565	0.0000	1.1449	.9978	.0565	.1507	.7476	-.7997	.4613	1.1126
.0132	-.2241	.6201	.8555	.0126	.4341	.8017	.5710	.1507	.4976	-.8903	.4363	1.1567
.0259	-.6163	.5119	1.0271	.0255	.2615	.7540	.6481	.1507	.2476	-.7756	.4404	1.1495
.0759	-.8515	.4470	1.1377	.0495	.0873	.7060	.7233	.1507	-.2524	-.8740	.4408	1.1487
.1003	-.8625	.4440	1.1430	.0753	.0125	.6854	.7551	.1507	-.5024	-.8879	.4370	1.1556
.1507	-.8668	.4428	1.1452	.1002	-.0678	.6632	.7891	.1507	-.7524	-.8219	.4552	1.1233
.2003	-.8560	.4458	1.1399	.1503	-.1451	.6419	.8219	.5002	.7476	-.7446	.4765	1.0864
.2503	-.8691	.4421	1.1463	.1976	-.2388	.6160	.8618	.5002	.4976	-.7513	.4746	1.0896
.3001	-.8574	.4454	1.1406	.2503	-.2961	.6007	.8883	.5002	.2476	-.7784	.4672	1.1024
.3502	-.7510	.4747	1.0895	.3001	-.3333	.5900	.9023	.5002	-.2524	-.7822	.4661	1.1043
.4003	-.7472	.4758	1.0876	.3507	-.3549	.5840	.9116	.5002	-.5024	-.7538	.4740	1.0908
.4501	-.7670	.4703	1.0970	.4001	-.3477	.5860	.9085	.5002	-.7524	-.7446	.4751	1.0888
.5002	-.7873	.4647	1.1067	.4501	-.3176	.5943	.8935	.8002	.7476	-.4046	.5703	.9331
.5502	-.7911	.4637	1.1085	.5001	-.2537	.6119	.8681	.8002	.4976	-.3999	.5716	.9311
.6002	-.7744	.4683	1.1005	.5497	-.1516	.6401	.8247	.8002	.2476	-.4008	.5713	.9315
.6500	-.7241	.4821	1.0768	.6003	-.0432	.6700	.7787	.8002	-.5024	-.3935	.5728	.9292
.7000	-.6166	.5118	1.0272	.6500	.0491	.6954	.7395	.8002	-.7524	-.3917	.5739	.9275
.7500	-.4928	.5460	.9718	.7000	.1556	.7248	.6940					
.8002	-.3910	.5741	.9272	.7501	.2501	.7509	.6531					
.9002	-.1695	.6352	.8323	.8001	.3300	.7730	.6179					
.9501	-.0449	.6695	.7794	.8501	.3993	.7921	.5869					

TEST	167	PT	25.1670	PSI	CN	.7157	CD1	.01110	CDCDR1	.01086
RUN	6	TT	140.3294	K	CM	-.1500	CD2	.01110	CDCDR2	.01047
POINT	18	RC	9.9454	MILLION	CC	.0144	CD3	.01094	CDCDR3	.01044
		MACH	.7609				CD4	.01062	CDCDR4	.01026
		ALPHA	1.0285	DEG			CD5	.01043	CDCDR5	.01018

UPPER SURFACE				LOWER SURFACE				SPANWISE				
X/C	CP	P/L/PT	MLOC	X/C	CP	P/L/PT	MLOC	X/C	Y/(B/2)	CP	P/L/PT	MLOC
0.0000	1.1514	.9998	.0173	0.0000	1.1514	.9998	.0173	.1507	.7476	-.9152	.4314	1.1656
.0132	-.3136	.5964	.8915	.0126	.5140	.8245	.5324	.1507	.4976	-1.0000	.4081	1.2085
.0259	-.7088	.4882	1.0666	.0255	.3357	.7754	.6140	.1507	.2476	-.9696	.4164	1.1929
.0759	-.9383	.4250	1.1771	.0495	.1538	.7254	.6931	.1507	-.2524	-.9670	.4172	1.1916
.1003	-.9543	.4207	1.1851	.0753	.0711	.7027	.7284	.1507	-.5024	-.9892	.4111	1.2029
.1507	-.9582	.4196	1.1872	.1002	-.0107	.6802	.7631	.1507	-.7524	-.9423	.4239	1.1778
.2003	-.9581	.4196	1.1871	.1503	-.0933	.6574	.7980	.5002	.7476	-.9397	.4247	1.1778
.2503	-.9780	.4141	1.1972	.1976	-.1901	.6308	.8389	.5002	.4976	-.9597	.4192	1.1879
.3001	-1.0031	.4072	1.2101	.2503	-.2513	.6140	.8649	.5002	.2476	-.9160	.4312	1.1660
.3502	-.9988	.4084	1.2078	.3001	-.2914	.6030	.8820	.5002	-.2524	-.8936	.4373	1.1549
.4003	-.9313	.4270	1.1736	.3507	-.3169	.5960	.8929	.5002	-.5024	-.8597	.4192	1.1879
.4501	-.8875	.4390	1.1519	.4001	-.3154	.5964	.8923	.5002	-.7524	-.9310	.4271	1.1734
.5002	-.8985	.4360	1.1574	.4501	-.2913	.6030	.8820	.8002	.7476	-.3947	.5746	.9264
.5502	-.8880	.4389	1.1521	.5001	-.2339	.6188	.8575	.8002	.4976	-.3933	.5749	.9258
.6002	-.8493	.4495	1.1332	.5497	-.1362	.6436	.8161	.8002	.2476	-.3925	.5732	.9235
.6500	-.7051	.4892	1.0649	.6003	-.0310	.6746	.7717	.8002	-.5024	-.3870	.5767	.9231
.7000	-.5460	.5330	.9927	.6500	.0582	.6991	.7339	.8002	-.7524	-.3836	.5776	.9216
.7500	-.4662	.5549	.9576	.7000	.1632	.7280	.6891					
.8002	-.3794	.5788	.9198	.7501	.2571	.7538	.6485					
.9002	-.1659	.6375	.8287	.8001	.3368	.7757	.6135					
.9501	-.0420	.6715	.7763	.8501	.4062	.7948	.5823					

ORIGINAL DATA IS
OF POOR QUALITY

TEST	167	PT	25.1659	PSI		CN	.8012	CD1	.01409	COCOR1	.01352
RUN	6	TT	140.2642	K		CM	-.1620	CD2	.01438	COCOR2	.01382
POINT	19	RC	9.9571	MILLION		CC	.0150	CD3	.01388	COCOR3	.01351
		MACH	.7616					CD4	.01353	COCOR4	.01321
		ALPHA	1.5172	DEG				CD5	.01433	COCOR5	.01396

UPPER SURFACE				LOWER SURFACE				SPANWISE				
X/C	CP	P/L/PT	MLOC	X/C	CP	P/L/PT	MLOC	X/C	Y/(B/2)	CP	P/L/PT	MLOC
0.0000	1.1542	1.0001	0.0000	0.0000	1.1542	1.0001	0.0000	.1507	.7476	-.9935	.4060	1.2124
.0132	-.3774	.5764	.9235	.0126	.5831	.8421	.5016	.1507	.4976	-1.0628	.3868	1.2491
.0259	-.7682	.4683	1.1005	.0255	.3995	.7913	.5881	.1507	.2476	-1.0266	.3968	1.2298
.0759	-.9928	.4062	1.2121	.0495	.2120	.7397	.6708	.1507	-.2524	-1.0226	.3979	1.2277
.1003	-1.0122	.4008	1.2222	.0753	.1248	.7154	.7088	.1507	-.5024	-1.0491	.3906	1.2417
.1507	-1.0146	.4001	1.2235	.1002	.0419	.6924	.7443	.1507	-.7524	-1.0007	.4040	1.2162
.2003	-1.0167	.3995	1.2246	.1503	-.0457	.6682	.7815	.5002	.7476	-1.0442	.3919	1.2391
.2503	-1.0384	.3935	1.2360	.1976	-.1425	.6414	.8227	.5002	.4976	-1.0610	.3873	1.2481
.3001	-1.0678	.3854	1.2518	.2503	-.2061	.6238	.8498	.5002	.2476	-1.0677	.3854	1.2517
.3502	-1.0794	.3822	1.2580	.3001	-.2493	.6118	.8603	.5002	-.2524	-1.0441	.3919	1.2391
.4003	-1.0833	.3811	1.2601	.3507	-.2784	.6038	.8807	.5002	-.5024	-1.0640	.3864	1.2497
.4501	-1.0409	.3928	1.2374	.4001	-.2805	.6031	.8818	.5002	-.7524	-1.0228	.3978	1.2278
.5002	-1.0001	.4041	1.2159	.4501	-.2614	.6095	.8734	.8002	.7476	-.3536	.5830	.9132
.5502	-1.0057	.3970	1.2293	.5001	-.2085	.6231	.8508	.8002	.4976	-.3472	.5848	.9104
.6002	-1.0520	.3898	1.2433	.5497	-.1153	.6489	.8111	.8002	.2476	-.3465	.5849	.9101
.6500	-.9473	.4187	1.1887	.6003	-.0136	.6770	.7679	.8002	-.5024	-.3450	.5854	.9094
.7000	-.9570	.5267	1.0029	.6500	.0730	.7010	.7310	.8002	-.7524	-.3472	.5848	.9104
.7500	-.9428	.5633	.9442	.7000	.1762	.7296	.6867					
.8002	-.3385	.5872	.9067	.7501	.2688	.7552	.6463					
.9002	-.1462	.6404	.8242	.8001	.3474	.7769	.6115					
.9501	-.0361	.6708	.7774	.8501	.4168	.7961	.5802					

TEST	167	PT	25.1670	PSI		CN	.8873	CD1	.01816	COCOR1	.01753
RUN	6	TT	140.2359	K		CM	-.1676	CD2	.01885	COCOR2	.01823
POINT	20	RC	9.9570	MILLION		CC	.0140	CD3	.01848	COCOR3	.01816
		MACH	.7611					CD4	.01907	COCOR4	.01870
		ALPHA	2.0172	DEG				CD5	.01995	COCOR5	.01955

UPPER SURFACE				LOWER SURFACE				SPANWISE				
X/C	CP	P/L/PT	MLOC	X/C	CP	P/L/PT	MLOC	X/C	Y/(B/2)	CP	P/L/PT	MLOC
0.0000	1.1484	.9991	.0350	0.0000	1.1484	.9991	.0350	.1507	.7476	-1.0779	.3884	1.2460
.0132	-.4742	.5540	.9590	.0126	.6411	.8600	.4693	.1507	.4976	-1.1515	.3682	1.2856
.0259	-.8680	.4459	1.1395	.0255	.4535	.8085	.5596	.1507	.2476	-1.1110	.3793	1.2637
.0759	-1.0796	.3879	1.2469	.0495	.2627	.7562	.6448	.1507	-.2524	-1.1036	.3813	1.2597
.1003	-1.0964	.3833	1.2559	.0753	.1701	.7308	.6848	.1507	-.5024	-1.1299	.3741	1.2739
.1507	-1.0996	.3824	1.2575	.1002	.0835	.7070	.7217	.1507	-.7524	-1.0783	.3883	1.2462
.2003	-1.0954	.3835	1.2554	.1503	-.0079	.6819	.7604	.5002	.7476	-1.1311	.3738	1.2746
.2503	-1.1161	.3779	1.2665	.1976	-.1057	.6551	.8016	.5002	.4976	-1.1438	.3703	1.2815
.3001	-1.1453	.3699	1.2824	.2503	-.1726	.6367	.8298	.5002	.2476	-1.1524	.3679	1.2863
.3502	-1.1592	.3661	1.2901	.3001	-.2179	.6243	.8490	.5002	-.2524	-1.1361	.3724	1.2773
.4003	-1.1736	.3621	1.2980	.3507	-.2503	.6154	.8627	.5002	-.5024	-1.1266	.3750	1.2722
.4501	-1.1806	.3602	1.3020	.4001	-.2371	.6135	.8656	.5002	-.7524	-1.1048	.3810	1.2604
.5002	-1.1209	.3766	1.2691	.4501	-.2429	.6175	.8596	.8002	.7476	-.3463	.5882	.9030
.5502	-1.1076	.3802	1.2619	.5001	-.1961	.6303	.8398	.8002	.4976	-.3466	.5850	.9038
.6002	-1.1326	.3734	1.2754	.5497	-.1015	.6546	.8024	.8002	.2476	-.3484	.5885	.9045
.6500	-.9618	.4202	1.1859	.6003	-.0093	.6815	.7610	.8002	-.5024	-.3497	.5881	.9031
.7000	-.9638	.5289	.9994	.6500	.0744	.7045	.7256	.8002	-.7524	-.3462	.5891	.9036
.7500	-.9440	.5633	.9442	.7000	.1758	.7323	.6823					
.8002	-.3461	.5891	.9036	.7501	.2675	.7575	.6427					
.9002	-.1525	.6422	.8214	.8001	.3457	.7789	.6083					
.9501	-.0457	.6715	.7763	.8501	.4151	.7980	.5771					

TEST	167	PT	25.1634	PSI		CN	.9191	CD1	.02506	COCOP1	.02434
RUN	6	TT	140.2454	K		CM	-.1705	CD2	.02560	COCOP2	.02501
POINT	21	RC	9.9624	MILLION		CC	.0157	CD3	.02955	COCOP3	.02802
		MACH	.7621					CD4	.03033	COCOP4	.02801
		ALPHA	2.5180	DEG				CD5	.02848	COCOP5	.02720

UPPER SURFACE				LOWER SURFACE				SPANWISE				
X/C	CP	P/L/PT	MLOC	X/C	CP	P/L/PT	MLOC	X/C	Y/(B/2)	CP	P/L/PT	MLOC
0.0000	1.1432	.9971	.0648	0.0000	1.1432	.9971	.0648	.1507	.7476	-1.1237	.3697	1.2828
.0132	-.5087	.5399	.9815	.0126	.6782	.8684	.4536	.1507	.4976	-1.1790	.3544	1.3139
.0259	-.8984	.4321	1.1644	.0255	.4900	.8163	.5464	.1507	.2476	-1.1396	.3653	1.2916
.0759	-1.1095	.3736	1.2749	.0495	.2962	.7627	.6345	.1507	-.2524	-1.1352	.3665	1.2891
.1003	-1.1242	.3695	1.2831	.0753	.2009	.7363	.6761	.1507	-.5024	-1.1616	.3592	1.3040
.1507	-1.1304	.3678	1.2865	.1002	.1108	.7113	.7150	.1507	-.7524	-1.1213	.3704	1.2814
.2003	-1.1287	.3683	1.2856	.1503	.0156	.6848	.7559	.5002	.7476	-1.1718	.3564	1.3098
.2503	-1.1460	.3635	1.2952	.1976	-.0836	.6576	.7978	.5002	.4976	-1.1823	.3535	1.3158
.3001	-1.1741	.3558	1.3111	.2503	-.1537	.6381	.8277	.5002	.2476	-1.1873	.3521	1.3187
.3502	-1.1890	.3516	1.3196	.3001	-.2028	.6246	.8486	.5002	-.2524	-1.1744	.3557	1.3113
.4003	-1.2053	.3471	1.3290	.3507	-.2394	.6144	.8643	.5002	-.5024	-1.1480	.3630	1.2963
.4501	-1.2280	.3408	1.3423	.4001	-.2501	.6112	.8688	.5002	-.7524	-1.1483	.3629	1.2965
.5002	-1.2257	.3415	1.3410	.4501	-.2395	.6144	.8643	.8002	.7476	-.3556	.5823	.9143
.5502	-1.1718	.3564	1.3098	.5001	-.1963	.6264	.8458	.8002	.4976	-.3709	.5780	.9209
.6002	-1.1743	.3557	1.3112	.5497	-.1103	.6502	.8092	.8002	.2476	-.3707	.5781	.9209
.6500	-.8214	.4532	1.1267	.6003	-.0141	.6768	.7683	.8002	-.5024	-.3739	.5772	.9223
.7000	-.9632	.5248	1.0060	.6500	.0683	.6996	.7332	.8002	-.7524	-.3531	.5830	.9132
.7500	-.9457	.5537	.9594	.7000	.1686	.7273	.6901					
.8002	-.3435	.5801	.9177	.7501	.2594	.7525	.6507					
.9002	-.1830	.6300	.8402	.8001	.3370	.7740	.6163					
.9501	-.0913	.6554	.8011	.8501	.4062	.7931	.5851					

QUALITY CONTROL
OF POOR QUALITY

TEST 167 PT 34.0702 PSI CM -.0621
 RUN 7 TT 130.4755 K CM -.1331
 POINT 22 RC 14.9639 MILLION CC .0054
 MACH .7607
 ALPHA -3.9611 DEG

UPPER SURFACE				LOWER SURFACE				SPANWISE				
X/C	CP	P _L /PT	MLOC	X/C	CP	P _L /PT	MLOC	X/C	Y/(B/2)	CP	P _L /PT	MLOC
0.0000	.7459	.8876	.4164	0.0000	.7459	.8876	.4164	.1507	.7476	-.1307	.6457	.8163
.0132	.6265	.8547	.4792	.0126	-.7012	.4883	1.0668	.1507	.4976	-.1460	.6415	.8228
.0259	.3071	.7665	.6285	.0255	-.6381	.9057	1.0377	.1507	.2476	-.1441	.6420	.8220
.0759	-.0153	.6776	.7673	.0495	-.7502	.4740	1.0899	.1507	-.2524	-.1486	.6408	.8239
.1003	-.0673	.6532	.7894	.0753	-.7671	.4701	1.0977	.1507	-.5024	-.1496	.6405	.8243
.1507	-.1437	.6421	.8218	.1002	-.8047	.4598	1.1157	.1507	-.7524	-.1604	.6359	.8315
.2003	-.1937	.6283	.8431	.1503	-.7940	.4627	1.1106	.5002	.7476	-.4065	.5696	.9345
.2503	-.2453	.6141	.8651	.1976	-.8179	.4561	1.1221	.5002	.4976	-.4120	.5681	.9370
.3001	-.2889	.6021	.8839	.2503	-.8448	.4487	1.1351	.5002	.2476	-.4169	.5668	.9391
.3502	-.3155	.5947	.8952	.3001	-.9115	.4303	1.1680	.5002	-.2524	-.4072	.5694	.9349
.4003	-.3472	.5860	.9088	.3507	-.9952	.4072	1.2106	.5002	-.5024	-.4046	.5702	.9337
.4501	-.3778	.5775	.9221	.4001	-1.0399	.3948	1.2340	.5002	-.7524	-.3925	.5735	.9285
.5002	-.4140	.5676	.9378	.4501	-.4791	.3496	.9664	.8002	.7476	-1.0568	.6202	1.2429
.5502	-.4556	.5561	.9560	.5001	-.3517	.5848	.9108	.8002	.4976	-.3746	.5784	.9207
.6002	-.4900	.5466	.9712	.5497	-.2399	.6156	.8628	.8002	.2476	-.3785	.5774	.9224
.6500	-.5136	.5401	.9816	.6003	-.1178	.6493	.8108	.8002	-.5024	-.3596	.5826	.9142
.7000	-.4979	.5444	.9747	.6500	-.0127	.6783	.7663	.8002	-.7524	-.3537	.5842	.9117
.7500	-.4484	.5581	.9529	.7000	.1026	.7161	.7172					
.8002	-.3716	.5793	.9194	.7501	.2013	.7374	.6747					
.8002	-.1803	.6321	.8374	.8001	.2813	.7594	.6399					
.9501	-.0517	.6675	.7828	.8501	.3478	.7778	.6104					

TEST 167 PT 34.0678 PSI CM .0915
 RUN 7 TT 130.4240 K CM -.1381
 POINT 23 RC 14.9726 MILLION CC .0130
 MACH .7608
 ALPHA -2.9938 DEG

UPPER SURFACE				LOWER SURFACE				SPANWISE				
X/C	CP	P _L /PT	MLOC	X/C	CP	P _L /PT	MLOC	X/C	Y/(B/2)	CP	P _L /PT	MLOC
0.0000	.8794	.9247	.3363	0.0000	.8794	.9247	.3363	.1507	.7476	-.2378	.6171	.8605
.0132	.4847	.8160	.5471	.0126	-.4006	.5722	.9304	.1507	.4976	-.2557	.6121	.8681
.0259	.1482	.7234	.6966	.0255	-.4524	.5580	.9530	.1507	.2476	-.2544	.6125	.8676
.0759	-.1510	.6410	.8236	.0495	-.5199	.5394	.9828	.1507	-.2524	-.2600	.6109	.8700
.1003	-.1910	.6300	.8406	.0753	-.5446	.5326	.9938	.1507	-.5024	-.2626	.6102	.8711
.1507	-.2542	.6125	.8675	.1002	-.6032	.5164	1.0201	.1507	-.7524	-.2721	.6076	.8752
.2003	-.2933	.6018	.8842	.1503	-.5829	.5220	1.0109	.5002	.7476	-.4741	.5520	.9625
.2503	-.3380	.5895	.9034	.1976	-.6796	.4954	1.0549	.5002	.4976	-.4794	.5505	.9649
.3001	-.3798	.5790	.9197	.2503	-.7690	.4708	1.0967	.5002	.2476	-.4844	.5491	.9671
.3502	-.4217	.5742	.9274	.3001	-.8254	.4552	1.1236	.5002	-.2524	-.4743	.5519	.9626
.4003	-.4493	.5664	.9396	.3507	-.7645	.4720	1.0945	.5002	-.5024	-.4720	.5526	.9616
.4501	-.4401	.5588	.9517	.4001	-.5540	.5300	.9979	.5002	-.7524	-.4593	.5561	.9360
.5002	-.4801	.5503	.9652	.4501	-.4778	.5510	.9642	.8002	.7476	-1.1085	.3773	1.2581
.5502	-.5181	.5399	.9820	.5001	-.3764	.5789	.9199	.8002	.4976	-.3903	.5751	.9266
.6002	-.5492	.5313	.9958	.5497	-.2449	.6151	.8635	.8002	.2476	-.3936	.5741	.9274
.6500	-.5693	.5258	1.0048	.6003	-.1143	.6511	.8081	.8002	-.5024	-.3766	.5788	.9200
.7000	-.5373	.5346	.9905	.6500	-.0075	.6805	.7629	.8002	-.7524	-.3717	.5802	.9179
.7500	-.4727	.5526	.9615	.7000	.1109	.7131	.7125					
.8002	-.3861	.5762	.9242	.7501	.2117	.7408	.6693					
.8002	-.1625	.6323	.8370	.8001	.2930	.7632	.6338					
.9501	-.0501	.6687	.7809	.8501	.3608	.7819	.6037					

TEST 167 PT 34.0706 PSI CM .2444
 RUN 7 TT 130.4361 K CM -.1427
 POINT 24 RC 14.9667 MILLION CC .0187
 MACH .7604
 ALPHA -1.9958 DEG

UPPER SURFACE				LOWER SURFACE				SPANWISE				
X/C	CP	P _L /PT	MLOC	X/C	CP	P _L /PT	MLOC	X/C	Y/(B/2)	CP	P _L /PT	MLOC
0.0000	1.0064	.9599	.2426	0.0000	1.0064	.9599	.2426	.1507	.7476	-.3634	.5932	.9132
.0132	.3023	.7663	.6289	.0126	-.1149	.4517	.8072	.1507	.4976	-.3848	.5773	.9224
.0259	-.0484	.6698	.7793	.0255	-.2178	.6213	.8509	.1507	.2476	-.3843	.5775	.9222
.0759	-.3156	.5964	.8927	.0495	-.3217	.5947	.8933	.1507	-.2524	-.3882	.5764	.9239
.1003	-.3386	.5900	.9025	.0753	-.3555	.5854	.9098	.1507	-.5024	-.3891	.5761	.9243
.1507	-.3937	.5776	.9220	.1002	-.4192	.5679	.9373	.1507	-.7524	-.3985	.5733	.9284
.2003	-.4112	.5701	.9339	.1503	-.4485	.5598	.9501	.5002	.7476	-.5462	.5330	.9931
.2503	-.4443	.5610	.9483	.1976	-.5431	.5338	.9918	.5002	.4976	-.5519	.5314	.9957
.3001	-.4750	.5525	.9617	.2503	-.5864	.5219	1.0111	.5002	.2476	-.5573	.5299	.9981
.3502	-.4849	.5498	.9664	.3001	-.6019	.5176	1.0181	.5002	-.2524	-.5454	.5332	.9928
.4003	-.5058	.5441	.9752	.3507	-.5805	.5235	1.0085	.5002	-.5024	-.5435	.5337	.9920
.4501	-.5292	.5376	.9856	.4001	-.5212	.5398	.9821	.8002	.7476	-1.1298	.3725	1.2776
.5002	-.5537	.5309	.9963	.4501	-.4476	.5601	.9497	.8002	-.7524	-.3994	.5733	.9287
.5502	-.5865	.5219	1.0112	.5001	-.3492	.5871	.9071	.8002	.2476	-.4037	.5721	.9306
.6002	-.6129	.5146	1.0230	.5497	-.2217	.6222	.8526	.8002	.4976	-.3877	.5765	.9237
.6500	-.6283	.5104	1.0300	.6003	-.0930	.6570	.7990	.8002	-.5024	-.3842	.5775	.9222
.7000	-.5771	.5245	1.0069	.6500	.0082	.6854	.7553					
.7500	-.4692	.5486	.9679	.7000	.1255	.7176	.7055					
.8002	-.3972	.5739	.9278	.7501	.2258	.7452	.6623					
.8002	-.1848	.6323	.8369	.8001	.3079	.7678	.6265					
.9501	-.0515	.6690	.7806	.8501	.3771	.7868	.5957					

TEST 167 PT 34.0732 PSI CN .3203
 RUN 7 TT 130.5116 K CM -.1454
 POINT 25 RC 14.9669 MILLION CC .0202
 MACH .7614
 ALPHA -1.4867 DEG

CD1 .00874 CDCOR1 .00862
 CD2 .00871 CDCOR2 .00863
 CD3 .00865 CDCOR3 .00863
 CD4 .00859 CDCOR4 .00854
 CD5 .00833 CDCOR5 .00819

UPPER SURFACE				LOWER SURFACE				SPANWISE				
X/C	CP	P/L/PT	MLOC	X/C	CP	P/L/PT	MLOC	X/C	Y/(B/2)	CP	P/L/PT	MLOC
0.0000	1.0582	.9738	.1953	0.0000	1.0582	.9738	.1953	.1507	.7476	-.4325	.5623	.9461
.0132	.2017	.7374	.6747	.0126	.0189	.6869	.7530	.1507	.4976	-.4558	.5559	.9563
.0259	-.1549	.6389	.8268	.0255	-.1046	.6528	.8054	.1507	.2476	-.4574	.5555	.9570
.0759	-.4083	.5690	.9355	.0495	-.2307	.6180	.8590	.1507	-.2524	-.4630	.5539	.9595
.1003	-.4216	.5655	.9411	.0753	-.2688	.6075	.8753	.1507	-.5024	-.4627	.5540	.9593
.1507	-.4571	.5555	.9569	.1002	-.3387	.5882	.9054	.1507	-.7524	-.4691	.5522	.9622
.2003	-.4695	.5521	.9624	.1503	-.3810	.5765	.9237	.5002	.7476	-.5925	.5181	1.0172
.2503	-.5055	.5422	.9783	.1976	-.4744	.5508	.9645	.5002	.4976	-.5996	.5162	1.0204
.3001	-.5338	.5344	.9909	.2503	-.5205	.5380	.9849	.5002	.2476	-.6058	.5145	1.0233
.3502	-.5345	.5291	.9912	.3001	-.5383	.5331	.9928	.5002	-.2524	-.5937	.5170	1.0178
.4003	-.5529	.5291	.9994	.3507	-.5325	.5347	.9903	.5002	-.5024	-.5910	.5186	1.0165
.4501	-.5770	.5224	1.0102	.4001	-.4586	.5468	.9708	.5002	-.7524	-.5756	.5228	1.0096
.5002	-.6022	.5155	1.0216	.4501	-.4240	.5647	.9424	.8002	.7476	-1.1436	.3661	1.2905
.5502	-.6263	.5088	1.0326	.5001	-.3315	.5902	.9023	.8002	.4976	-.4033	.5704	.9334
.6002	-.6525	.5016	1.0446	.5497	-.2077	.6244	.8492	.8002	.2476	-.4061	.5696	.9346
.6500	-.6701	.4967	1.0527	.6003	-.0838	.6586	.7966	.8002	-.5024	-.3925	.5734	.9287
.7000	-.6861	.5144	1.0234	.6500	.0174	.6865	.7536	.8002	-.7524	-.3904	.5739	.9279
.7500	-.4946	.5452	.9734	.7000	.1335	.7185	.7041					
.8002	-.3990	.5716	.9315	.7501	.2333	.7461	.6610					
.9002	-.1825	.6313	.8385	.8001	.3154	.7687	.6250					
.9501	-.0493	.6681	.7819	.8501	.3853	.7880	.5937					

TEST 167 PT 34.0758 PSI CN -.3990
 RUN 7 TT 130.4339 K CM -.1477
 POINT 26 RC 14.9795 MILLION CC .0208
 MACH .7612
 ALPHA -.9966 DEG

CD1 .00885 CDCOR1 .00871
 CD2 .00881 CDCOR2 .00869
 CD3 .00877 CDCOR3 .00873
 CD4 .00868 CDCOR4 .00861
 CD5 .00847 CDCOR5 .00832

UPPER SURFACE				LOWER SURFACE				SPANWISE				
X/C	CP	P/L/PT	MLOC	X/C	CP	P/L/PT	MLOC	X/C	Y/(B/2)	CP	P/L/PT	MLOC
0.0000	1.1000	.9856	.1439	0.0000	1.1000	.9856	.1439	.1507	.7476	-.5070	.5440	.9754
.0132	.0962	.7098	.7177	.0126	.1457	.7234	.6966	.1507	.4976	-.5311	.5373	.9861
.0259	-.2698	.6091	.8728	.0255	.0044	.6845	.7567	.1507	.2476	-.5330	.5368	.9869
.0759	-.5114	.5427	.9774	.0495	-.1356	.6460	.8158	.1507	-.2524	-.5354	.5361	.9880
.1003	-.5089	.5434	.9762	.0753	-.1796	.6340	.8344	.1507	-.5024	-.5333	.5367	.9870
.1507	-.5326	.5369	.9867	.1002	-.2568	.6127	.8672	.1507	-.7524	-.5312	.5373	.9861
.2003	-.5396	.5350	.9898	.1503	-.3106	.5979	.8902	.5002	.7476	-.6278	.5107	1.0294
.2503	-.5623	.5288	.9999	.1976	-.3973	.5741	.9275	.5002	.4976	-.6381	.5079	1.0341
.3001	-.5884	.5216	1.0116	.2503	-.4453	.5609	.9484	.5002	.2476	-.6444	.5062	1.0369
.3502	-.5833	.5230	1.0093	.3001	-.4659	.5553	.9573	.5002	-.2524	-.6277	.5108	1.0294
.4003	-.5947	.5198	1.0145	.3507	-.4694	.5543	.9580	.5002	-.5024	-.6245	.5117	1.0279
.4501	-.6132	.5148	1.0228	.4001	-.4390	.5626	.9458	.5002	-.7524	-.6066	.5166	1.0198
.5002	-.6411	.5071	1.0354	.4501	-.3866	.5770	.9229	.8002	.7476	-1.1420	.3694	1.2837
.5502	-.6584	.5023	1.0433	.5001	-.3028	.6001	.8869	.8002	.4976	-.4017	.5729	.9294
.6002	-.6751	.4978	1.0509	.5497	-.1854	.6324	.8369	.8002	.2476	-.4046	.5721	.9306
.6500	-.6850	.4950	1.0555	.6003	-.0659	.6652	.7864	.8002	-.5024	-.3890	.5764	.9234
.7000	-.6148	.5143	1.0235	.6500	.0319	.6921	.7491	.8002	-.7524	-.3876	.5768	.9233
.7500	-.4957	.5471	.9704	.7000	.1462	.7235	.6964					
.8002	-.3991	.5736	.9283	.7501	.2450	.7566	.6538					
.9002	-.1809	.6336	.8350	.8001	.3271	.7732	.6177					
.9501	-.0491	.6698	.7793	.8501	.3975	.7926	.5863					

TEST 167 PT 34.0735 PSI CN .4718
 RUN 7 TT 130.3358 K CM -.1485
 POINT 27 RC 14.9936 MILLION CC .0204
 MACH .7614
 ALPHA -.4888 DEG

CD1 .00906 CDCOR1 .00879
 CD2 .00900 CDCOR2 .00879
 CD3 .00895 CDCOR3 .00877
 CD4 .00884 CDCOR4 .00864
 CD5 .00863 CDCOR5 .00842

UPPER SURFACE				LOWER SURFACE				SPANWISE				
X/C	CP	P/L/PT	MLOC	X/C	CP	P/L/PT	MLOC	X/C	Y/(B/2)	CP	P/L/PT	MLOC
0.0000	1.1271	.9931	.0993	0.0000	1.1271	.9931	.0993	.1507	.7476	-.5893	.5215	1.0117
.0132	-.0098	.6807	.7625	.0126	.2330	.7529	.6501	.1507	.4976	-.6213	.5127	1.0261
.0259	-.3866	.5772	.9226	.0255	.0978	.7103	.7169	.1507	.2476	-.6252	.5117	1.0279
.0759	-.6350	.5090	1.0323	.0495	-.0564	.6680	.7822	.1507	-.2524	-.6267	.5112	1.0286
.1003	-.6026	.5179	1.0177	.0753	-.1097	.6533	.8047	.1507	-.5024	-.6202	.5130	1.0256
.1507	-.6247	.5118	1.0277	.1002	-.1905	.6311	.8388	.1507	-.7524	-.5879	.5219	1.0111
.2003	-.6206	.5124	1.0258	.1503	-.2521	.6142	.8650	.5002	.7476	-.6783	.4871	1.0521
.2503	-.6295	.5105	1.0298	.1976	-.3422	.5894	.9035	.5002	.4976	-.6893	.4940	1.0572
.3001	-.6666	.5003	1.0468	.2503	-.3939	.5752	.9258	.5002	.2476	-.6964	.4921	1.0604
.3502	-.6609	.5018	1.0441	.3001	-.4202	.5680	.9372	.5002	-.2524	-.6888	.4953	1.0591
.4003	-.6318	.5098	1.0309	.3507	-.4311	.5650	.9419	.5002	-.5024	-.6840	.4935	1.0547
.4501	-.6497	.5049	1.0390	.4001	-.4094	.5709	.9325	.5002	-.7524	-.6691	.5007	1.0460
.5002	-.6816	.4934	1.0582	.4501	-.3661	.5829	.9137	.8002	.7476	-1.1424	.3695	1.2835
.5502	-.7175	.4863	1.0702	.5001	-.2889	.6041	.8807	.8002	.4976	-.4047	.5722	.9304
.6002	-.7195	.4857	1.0711	.5497	-.1759	.6351	.8327	.8002	.2476	-.4082	.5718	.9311
.6500	-.7068	.4892	1.0652	.6003	-.0594	.6671	.7834	.8002	-.5024	-.3947	.5750	.9261
.7000	-.6287	.5107	1.0295	.6500	.0356	.6932	.7433	.8002	-.7524	-.3943	.5751	.9259
.7500	-.4974	.5468	.9709	.7000	.1488	.7243	.6951					
.8002	-.3990	.5737	.9280	.7501	.2473	.7514	.6526					
.9002	-.1801	.6340	.8344	.8001	.3295	.7740	.6165					
.9501	-.0475	.6704	.7784	.8501	.4005	.7935	.5848					

ORIGINAL COPY
OF FOOT COPY

TEST 167 PT 34.0740 PSI CN .5570 CD1 .00927 CDCOR1 .00899
 RUN 7 TT 130.3143 K CM -.1519 CD2 .00930 CDCOR2 .00906
 POINT 28 RC 15.0000 MILLION CC .0195 CD3 .00923 CDCOR3 .00899
 MACH .7613 CD4 .00904 CDCOR4 .00880
 ALPHA .0204 DEG CD5 .00888 CDCOR5 .00866

UPPER SURFACE				LOWER SURFACE				SPANWISE				
X/C	CP	P _z L/PT	MLOC	X/C	CP	P _z L/PT	MLOC	X/C	Y/(B/2)	CP	P _z L/PT	MLOC
0.0000	1.1468	.9983	.0488	0.0000	1.1468	.9983	.0488	.1507	.7476	-.6781	.4955	1.0548
.0132	-.1123	.6514	.8076	.0126	.3573	.7806	.6055	.1507	.4976	-.6921	.4916	1.0613
.0259	-.4973	.5453	.9733	.0255	.1918	.7352	.6782	.1507	.2476	-.7310	.4809	1.0794
.0759	-.7369	.4793	1.0821	.0495	.0253	.6893	.7493	.1507	-.2524	-.7359	.4795	1.0816
.1003	-.7636	.4719	1.0947	.0753	-.0354	.6726	.7751	.1507	-.5024	-.6862	.4932	1.0585
.1507	-.7281	.4817	1.0780	.1002	-.1225	.6486	.8120	.1507	-.7524	-.6522	.5026	1.0429
.2003	-.6997	.4895	1.0648	.1503	-.1931	.6291	.8419	.5002	.7476	-.7302	.4811	1.0790
.2503	-.6857	.4934	1.0583	.1976	-.2837	.6042	.8805	.5002	.4976	-.7378	.4790	1.0825
.3001	-.7284	.4816	1.0782	.2503	-.3398	.5887	.9046	.5002	.2476	-.7431	.4775	1.0850
.3502	-.7369	.4793	1.0821	.3001	-.3700	.5804	.9177	.5002	-.2524	-.7285	.4816	1.0782
.4003	-.7406	.4782	1.0639	.3507	-.3873	.5756	.9251	.5002	-.5024	-.7322	.4806	1.0799
.4501	-.7424	.4778	1.0847	.4001	-.3725	.5797	.9187	.5002	-.7524	-.7271	.4820	1.0775
.5002	-.7424	.4777	1.0847	.4501	-.3360	.5897	.9030	.8002	.7476	-1.1321	.3704	1.2819
.5502	-.7535	.4747	1.0900	.5001	-.2649	.6093	.8725	.8002	.4976	-.3997	.5722	.9305
.6002	-.7647	.4716	1.0952	.5497	-.1569	.6391	.8265	.8002	.2476	-.4003	.5720	.9308
.6500	-.7545	.4744	1.0904	.6003	-.0439	.6702	.7787	.8002	-.5024	-.3896	.5750	.9262
.7000	-.6422	.5054	1.0383	.6500	.0487	.6957	.7394	.8002	-.7524	-.3906	.5747	.9266
.7500	-.4937	.5463	.9717	.7000	.1603	.7265	.6917					
.8002	-.3937	.5758	.9280	.7501	.2576	.7533	.6496					
.9002	-.1754	.6340	.8344	.8001	.3394	.7758	.6135					
.9501	-.0467	.6695	.7797	.8501	.4106	.7955	.5815					

TEST 167 PT 34.0746 PSI CN .6300 CD1 .00969 CDCOR1 .00940
 RUN 7 TT 130.4125 K CM -.1506 CD2 .00975 CDCOR2 .00947
 POINT 29 RC 14.9799 MILLION CC .0172 CD3 .00972 CDCOR3 .00950
 MACH .7610 CD4 .00939 CDCOR4 .00912
 ALPHA .5130 DEG CD5 .00920 CDCOR5 .00893

UPPER SURFACE				LOWER SURFACE				SPANWISE				
X/C	CP	P _z L/PT	MLOC	X/C	CP	P _z L/PT	MLOC	X/C	Y/(B/2)	CP	P _z L/PT	MLOC
0.0000	1.1517	.9996	.0248	0.0000	1.1517	.9996	.0248	.1507	.7476	-.7800	.4664	1.1042
.0132	-.2090	.6240	.8498	.0126	.4403	.8032	.5686	.1507	.4976	-.8715	.4412	1.1485
.0259	-.5981	.5166	1.0197	.0255	.2675	.7555	.6460	.1507	.2476	-.8642	.4432	1.1449
.0759	-.8382	.4504	1.1321	.0495	.0917	.7070	.7220	.1507	-.2524	-.8630	.4435	1.1443
.1003	-.8510	.4468	1.1384	.0753	.0242	.6884	.7508	.1507	-.5024	-.8751	.4402	1.1502
.1507	-.8545	.4459	1.1401	.1002	-.0640	.6640	.7882	.1507	-.7524	-.7673	.4699	1.0981
.2003	-.8428	.4491	1.1344	.1503	-.1389	.6434	.8199	.5002	.7476	-.7655	.4704	1.0972
.2503	-.8547	.4458	1.1402	.1976	-.2333	.6173	.8601	.5002	.4976	-.7738	.4681	1.1012
.3001	-.8465	.4481	1.1362	.2503	-.2918	.6012	.8852	.5002	.2476	-.8040	.4598	1.1156
.3502	-.7493	.4749	1.0896	.3001	-.3262	.5917	.8999	.5002	-.2524	-.8064	.4591	1.1168
.4003	-.7618	.4714	1.0955	.3507	-.3473	.5858	.9091	.5002	-.5024	-.7773	.4670	1.1031
.4501	-.7838	.4654	1.1060	.4001	-.3389	.5882	.9054	.5002	-.7524	-.7742	.4680	1.1014
.5002	-.8038	.4599	1.1155	.4501	-.3095	.5963	.8928	.8002	.7476	-1.1112	.3750	1.2726
.5502	-.8135	.4572	1.1202	.5001	-.2454	.6140	.8653	.8002	.4976	-.3995	.5725	.9300
.6002	-.7986	.4613	1.1130	.5497	-.1429	.6423	.8217	.8002	.2476	-.3967	.5722	.9305
.6500	-.7364	.4785	1.0835	.6003	-.0339	.6723	.7754	.8002	-.5024	-.3890	.5743	.9271
.7000	-.6093	.5138	1.0244	.6500	.0554	.6970	.7375	.8002	-.7524	-.3904	.5740	.9277
.7500	-.4865	.5474	.9698	.7000	.1652	.7273	.6905					
.8002	-.3884	.5745	.9269	.7501	.2614	.7538	.6487					
.9002	-.1707	.6346	.8335	.8001	.3423	.7762	.6130					
.9501	-.0424	.6700	.7790	.8501	.4135	.7958	.5809					

TEST 167 PT 34.0767 PSI CN .7321 CD1 .01103 CDCOR1 .01063
 RUN 7 TT 130.3887 K CM -.1546 CD2 .01095 CDCOR2 .01056
 POINT 30 RC 14.9828 MILLION CC .0154 CD3 .01089 CDCOR3 .01046
 MACH .7608 CD4 .01058 CDCOR4 .01019
 ALPHA 1.0285 DEG CD5 .01034 CDCOR5 .01005

UPPER SURFACE				LOWER SURFACE				SPANWISE				
X/C	CP	P _z L/PT	MLOC	X/C	CP	P _z L/PT	MLOC	X/C	Y/(B/2)	CP	P _z L/PT	MLOC
0.0000	1.1476	.9987	.0432	0.0000	1.1476	.9987	.0432	.1507	.7476	-.9027	.4349	1.1597
.0132	-.3118	.5974	.8910	.0126	.5260	.8278	.5270	.1507	.4976	-.9925	.4102	1.2049
.0259	-.7029	.4898	1.0642	.0255	.3461	.7783	.6095	.1507	.2476	-.9690	.4167	1.1929
.0759	-.9379	.4252	1.1772	.0495	.1648	.7284	.6887	.1507	-.2524	-.9637	.4181	1.1902
.1003	-.9539	.4208	1.1893	.0753	.0925	.7086	.7196	.1507	-.5024	-.9857	.4121	1.2014
.1507	-.9358	.4203	1.1862	.1002	-.0015	.6827	.7594	.1507	-.7524	-.9074	.4336	1.1620
.2003	-.9353	.4204	1.1860	.1503	-.0258	.6760	.7697	.5002	.7476	-.9190	.4304	1.1578
.2503	-.9704	.4163	1.1936	.1976	-.1742	.6352	.8325	.5002	.4976	-.9416	.4242	1.1791
.3001	-.9947	.4096	1.2061	.2503	-.2362	.6182	.8588	.5002	.2476	-.8887	.4388	1.1527
.3502	-.9964	.4091	1.2069	.3001	-.2723	.6082	.8742	.5002	-.2524	-.8572	.4474	1.1374
.4003	-.9124	.4322	1.1645	.3507	-.2968	.6015	.8846	.5002	-.5024	-.9292	.4276	1.1729
.4501	-.8652	.4452	1.1417	.4001	-.2934	.6025	.8832	.5002	-.7524	-.9022	.4350	1.1594
.5002	-.8778	.4417	1.1474	.4501	-.2707	.6087	.8735	.8002	.7476	-1.0870	.3842	1.2545
.5502	-.8689	.4442	1.1430	.5001	-.2139	.6243	.8493	.8002	.4976	-.3936	.5749	.9262
.6002	-.8404	.4520	1.1292	.5497	-.1181	.6506	.8088	.8002	.2476	-.3941	.5748	.9264
.6500	-.6926	.4927	1.0595	.6003	-.0146	.6791	.7650	.8002	-.5024	-.3812	.5783	.9209
.7000	-.5719	.5259	1.0046	.6500	.0710	.7026	.7287	.8002	-.7524	-.3806	.5785	.9206
.7500	-.4006	.5510	.9642	.7000	.1780	.7321	.6830					
.8002	-.3899	.5759	.9247	.7501	.2721	.7579	.6422					
.9002	-.1741	.6353	.8324	.8001	.3521	.7800	.6069					
.9501	-.0484	.6698	.7793	.8501	.4229	.7994	.5749					

TEST	167	PT	34.0728	PSI	CN	.8228	CD1	.01461	CDCOR1	.01428
RUN	7	TT	130.3870	K	CM	-.1643	CD2	.01482	CDCOR2	.01449
POINT	31	RC	14.9910	MILLION	CC	.0156	CD3	.01444	CDCOR3	.01400
		MACH	.7617				CD4	.01404	CDCOR4	.01371
		ALPHA	1.5071	DEG			CD5	.01436	CDCOR5	.01393

UPPER SURFACE				LOWER SURFACE				SPANWISE				
X/C	CP	P _L /PT	MLOC	X/C	CP	P _L /PT	MLOC	X/C	Y/(B/2)	CP	P _L /PT	MLOC
0.0000	1.1466	.9782	.0507	0.0000	1.1466	.9982	.0507	.1507	.7476	-.9879	.4094	1.2065
.0132	-.3897	.5744	.9270	.0126	.5841	.8430	.5002	.1507	.4976	-1.0626	.3087	1.2457
.0259	-.7751	.4681	1.1013	.0255	.4011	.7925	.5603	-.1507	.2476	-1.0333	.3968	1.2302
.0759	-.9995	.4062	1.2125	.0495	.2145	.7411	.6689	.1507	-.2524	-1.0280	.3983	1.2274
.1003	-1.0205	.4004	1.2234	.0753	.1364	.7195	.7026	.1507	-.2024	-1.0532	.3914	1.2407
.1507	-1.0200	.4005	1.2232	.1002	.0413	.6933	.7432	.1507	-.7524	-.9802	.4115	1.2025
.2003	-1.0193	.4007	1.2228	.1503	.0342	.6913	.7462	.5002	.7476	-1.0497	.3923	1.2388
.2503	-1.0396	.3951	1.2335	.1976	-.1392	.6435	.8198	.5002	.4976	-1.0638	.3884	1.2463
.3001	-1.0700	.3867	1.2497	.2503	-.2025	.6260	.8467	.5002	.2476	-1.0696	.3868	1.2424
.3502	-1.0845	.3827	1.2575	.3001	-.2445	.6144	.8646	.5002	-.2524	-1.0383	.3955	1.2328
.4003	-1.0809	.3837	1.2555	.3507	-.2725	.6067	.8765	.5002	-.5024	-1.0636	.3885	1.2462
.4501	-1.0272	.3985	1.2269	.4001	-.2737	.6064	.8771	.5002	-.7524	-1.0186	.4009	1.2225
.5002	-.9971	.4068	1.2112	.4501	-.2560	.6113	.8695	.8002	.7476	-.9700	.4143	1.1973
.5502	-1.0319	.3972	1.2294	.5001	-.2037	.6257	.8472	.8002	.4976	-.9538	.5843	.9115
.6002	-1.0512	.3919	1.2396	.5497	-.1114	.6512	.8080	.8002	.2476	-.9524	.5847	.9109
.6500	-.9727	.4135	1.1987	.6003	-.0103	.6740	.7651	.8002	-.5024	-.9464	.5863	.9083
.7000	-.5475	.5253	1.0055	.6500	.0728	.7020	.7298	.8002	-.7524	-.9523	.5847	.9109
.7500	-.4281	.5638	.9438	.7000	.1786	.7312	.6844					
.8002	-.3465	.5863	.9084	.7501	.2719	.7569	.6439					
.9002	-.1563	.6368	.8270	.8001	.3514	.7788	.6087					
.9501	-.0419	.6703	.7785	.8501	.4220	.7983	.5768					

TEST	167	PT	34.0671	PSI	CN	.8857	CD1	.01918	CDCOR1	.01824
RUN	7	TT	130.4587	K	CM	-.1732	CD2	.02015	CDCOR2	.01923
POINT	32	RC	14.9779	MILLION	CC	.0175	CD3	.01957	CDCOR3	.01837
		MACH	.7618				CD4	.01959	CDCOR4	.01810
		ALPHA	1.9839	DEG			CD5	.02132	CDCOR5	.02088

UPPER SURFACE				LOWER SURFACE				SPANWISE				
X/C	CP	P _L /PT	MLOC	X/C	CP	P _L /PT	MLOC	X/C	Y/(B/2)	CP	P _L /PT	MLOC
0.0000	1.1520	.9996	.0236	0.0000	1.1520	.9996	.0236	.1507	.7476	-1.0422	.3936	1.2364
.0132	-.4353	.5612	.9479	.0126	.6348	.8568	.4754	.1507	.4976	-1.1124	.3742	1.2743
.0259	-.8280	.4527	1.1280	.0255	.4486	.8053	.5651	.1507	.2476	-1.0808	.3829	1.2571
.0759	-1.0452	.3928	1.2380	.0495	.2552	.7519	.6518	.1507	-.2524	-1.0754	.3844	1.2541
.1003	-1.0660	.3870	1.2491	.0753	.1721	.7290	.6879	.1507	-.5024	-1.1015	.3772	1.2643
.1507	-1.0669	.3867	1.2496	.1002	.0766	.7026	.7288	.1507	-.7524	-1.0262	.3980	1.2279
.2003	-1.0639	.3876	1.2480	.1503	.0660	.6996	.7334	.5002	.7476	-1.1146	.3736	1.2755
.2503	-1.0891	.3817	1.2594	.1976	-.1131	.6502	.8095	.5002	.4976	-1.1233	.3712	1.2803
.3001	-1.1168	.3730	1.2767	.2503	-.1804	.6316	.8381	.5002	.2476	-1.1350	.3679	1.2867
.3502	-1.1315	.3689	1.2846	.3001	-.2259	.6190	.8575	.5002	-.2524	-1.1157	.3733	1.2740
.4003	-1.1425	.3659	1.2909	.3507	-.2578	.6102	.8711	.5002	-.5024	-1.1060	.3759	1.2708
.4501	-1.1400	.3666	1.2895	.4001	-.2633	.6087	.8755	.5002	-.7524	-1.0826	.3824	1.2580
.5002	-1.0977	.3783	1.2662	.4501	-.2497	.6125	.8676	.8002	.7476	-.9349	.4232	1.1809
.5502	-1.0946	.3791	1.2645	.5001	-.2010	.6259	.8469	.8002	.4976	-.9502	.5847	.9108
.6002	-1.1269	.3702	1.2822	.5497	-.1109	.6508	.8085	.8002	.2476	-.9483	.5832	.9100
.6500	-1.1578	.3616	1.3094	.6003	-.0112	.6783	.7662	.8002	-.5024	-.9518	.5843	.9115
.7000	-.8609	.4989	1.0490	.6500	.0732	.7008	.7316	.8002	-.7524	-.9474	.5855	.9096
.7500	-.4566	.5533	.9572	.7000	.1753	.7298	.6865					
.8002	-.3462	.5858	.9091	.7501	.2684	.7556	.6460					
.9002	-.1488	.6403	.8246	.8001	.3478	.7775	.6109					
.9501	-.0456	.6708	.7608	.8501	.4136	.7970	.5789					

ORIGINAL PAGE IS
OF POOR QUALITY.

TEST	167	PT	61.8964	PSI	CM	-0.0589	CD1	.01113	CDCOR1	.01111			
RUN	8	TT	122.0418	K	CM	-0.1382	CD2	.01091	CDCOR2	.01093			
POINT	34	RC	30.0145	MILLION	CC	.0063	CD3	.01069	CDCOR3	.01082			
		MACH	.7634				CD4	.01061	CDCOR4	.01067			
		ALPHA	-4.0222	DEG			CD5	.01008	CDCOR5	.00997			
		UPPER SURFACE				LOWER SURFACE				SPANWISE			
X/C	CP	P/L/PT	MLOC	X/C	CP	P/L/PT	MLOC	X/C	Y/(B/2)	CP	P/L/PT	MLOC	
0.0000	.7426	.8862	.4196	0.0000	.7426	.8862	.4196	.1507	.7476	-1.258	.6460	.8168	
.0132	.6373	.8571	.4753	.0126	-.0650	.4969	1.0336	.1507	.4976	-1.1399	.6421	.8228	
.0259	.3280	.7715	.6212	.0255	-.6191	.3096	1.0325	.1507	.2476	-1.1348	.6435	.8206	
.0759	-.0071	.6789	.7663	.0495	-.7522	.4728	1.0944	.1507	-.2524	-1.432	.6412	.8242	
.1003	-.0603	.6641	.7889	.0753	-.7834	.4642	1.1093	.1507	-.5024	-1.506	.6392	.8273	
.1507	-.1366	.6430	.8214	.1002	-.8148	.4555	1.1244	.1507	-.7524	-1.450	.6407	.8250	
.2003	-.1872	.6290	.8430	.1503	-.8058	.4480	1.1201	.5002	.7476	-1.4103	.5674	.9392	
.2503	-.2396	.6146	.8654	.1976	-.8404	.4484	1.1389	.5002	.4976	-1.4148	.5661	.9412	
.3001	-.2857	.6018	.8852	.2503	-.8800	.4374	1.1564	.5002	.2476	-1.4195	.5648	.9433	
.3502	-.3123	.5944	.8967	.3001	-.8777	.4381	1.1553	.5002	-.2524	-1.4102	.5674	.9392	
.4003	-.3449	.5854	.9108	.3507	-.9930	.4062	1.2138	.5002	-.5024	-1.4074	.5682	.9380	
.4501	-.3733	.5776	.9231	.4001	-1.0555	.3889	1.2467	.5002	-.7524	-1.3944	.5717	.9323	
.5002	-.4167	.5656	.9421	.4501	-.9325	.5336	.9933	.8002	.7476	-1.0897	.3795	1.2652	
.5507	-.4616	.5532	.9618	.5001	-.9331	.5887	.9057	.8002	.4976	-1.3838	.5747	.9277	
.6002	-.4976	.5432	.9777	.5497	-.9224	.189	.8587	.8002	.2476	-1.3866	.5739	.9289	
.6500	-.5269	.5351	.9908	.6003	-1.053	.6517	.8081	.8002	-.5024	-1.3535	.5830	.9145	
.7000	-.5103	.5397	.9834	.6500	-.0072	.6788	.7663	.8002	-.7524	-1.3603	.5812	.9174	
.7500	-.4579	.5542	.9602	.7000	.1122	.7116	.7153						
.8002	-.3795	.5759	.9258	.7501	.2124	.7395	.6720						
.9002	-.1882	.6288	.8434	.8001	.2946	.7623	.6360						
.9501	-.0598	.6643	.7887	.8501	.3629	.7812	.6055						

TEST	167	PT	61.7637	PSI	CM	.1052	CD1	.00836	CDCOR1	.00831			
RUN	8	TT	122.0282	K	CM	-.1446	CD2	.00826	CDCOR2	.00825			
POINT	35	RC	29.9500	MILLION	CC	.0142	CD3	.00814	CDCOR3	.00819			
		MACH	.7632				CD4	.00816	CDCOR4	.00816			
		ALPHA	-2.9938	DEG			CD5	.00794	CDCOR5	.00784			
		UPPER SURFACE				LOWER SURFACE				SPANWISE			
X/C	CP	P/L/PT	MLOC	X/C	CP	P/L/PT	MLOC	X/C	Y/(B/2)	CP	P/L/PT	MLOC	
0.0000	.8808	.9244	.3375	0.0000	.8808	.9244	.3375	.1507	.7476	-1.2400	.5144	.8657	
.0132	.4877	.8156	.5483	.0126	-.3795	.5758	.9259	.1507	.4976	-1.2567	.6098	.8728	
.0259	.1628	.7258	.6936	.0255	-.4170	.5654	.9423	.1507	.2476	-1.2119	.6111	.8708	
.0759	-.1514	.6389	.8278	.0495	-.5150	.5383	.9856	.1507	-.2524	-1.2607	.6086	.8746	
.1003	-.1914	.6278	.8449	.0753	-.5460	.5297	.9995	.1507	-.5024	-1.2672	.6068	.8774	
.1507	-.2538	.6106	.8716	.1002	-.6064	.5130	1.0268	.1507	-.7524	-1.2981	.6094	.8734	
.2003	-.2929	.5997	.8884	.1503	-.5782	.5208	1.0140	.5002	.7476	-1.481	.5465	.9724	
.2503	-.3384	.5872	.9081	.1976	-.6738	.4944	1.0578	.5002	.4976	-1.489	.5454	.9742	
.3001	-.3795	.5758	.9259	.2503	-.7865	.4687	1.1014	.5002	.2476	-1.4940	.5441	.9763	
.3502	-.3982	.5706	.9341	.3001	-.8082	.4572	1.1214	.5002	-.2524	-1.4640	.5469	.9718	
.4003	-.4259	.5630	.9462	.3507	-.8519	.4451	1.1427	.5002	-.5024	-1.4810	.5477	.9705	
.4501	-.4519	.5558	.9576	.4001	-.9518	.5281	1.0022	.5002	-.7524	-1.4665	.5517	.9641	
.5002	-.4909	.5430	.9749	.4501	-.9560	.5546	.9595	.8002	.7476	-1.1416	.3650	1.2940	
.5507	-.5321	.5336	.9933	.5001	-.9647	.5799	.9195	.8002	.4976	-1.3989	.5704	.9144	
.6002	-.5651	.5244	1.0081	.5497	-.9352	.6157	.8636	.8002	.2476	-1.4014	.5697	.9155	
.6500	-.5962	.5138	1.0222	.6003	-.1041	.6520	.8077	.8002	-.5024	-1.3711	.5781	.9223	
.7000	-.5617	.5254	1.0066	.6500	-.0031	.6799	.7646	.8002	-.7524	-1.3789	.5760	.9257	
.7500	-.4817	.5475	.9708	.7000	.1219	.7145	.7112						
.8002	-.3946	.5716	.9325	.7501	.2254	.7431	.6664						
.9002	-.1907	.6280	.8446	.8001	.3097	.7664	.6294						
.9501	-.0581	.6647	.7881	.8501	.3800	.7859	.5979						

TEST	167	PT	62.0132	PSI	CM	.2647	CD1	.00794	CDCOR1	.00788			
RUN	8	TT	122.0502	K	CM	-.1495	CD2	.00790	CDCOR2	.00786			
POINT	36	RC	30.0197	MILLION	CC	.0203	CD3	.00786	CDCOR3	.00789			
		MACH	.7613				CD4	.00789	CDCOR4	.00789			
		ALPHA	-1.9903	DEG			CD5	.00771	CDCOR5	.00761			
		UPPER SURFACE				LOWER SURFACE				SPANWISE			
X/C	CP	P/L/PT	MLOC	X/C	CP	P/L/PT	MLOC	X/C	Y/(B/2)	CP	P/L/PT	MLOC	
0.0000	1.0091	.9603	.2416	0.0000	1.0091	.9603	.2416	.1507	.7476	-1.3721	.5797	.9198	
.0132	.3065	.7667	.6289	.0126	-.0935	.6565	.8007	.1507	.4976	-1.3915	.5744	.9282	
.0259	-.0357	.6724	.7762	.0255	-.1834	.6317	.8389	.1507	.2476	-1.3878	.5784	.9266	
.0759	-.3222	.5935	.8952	.0495	-.3004	.5995	.8858	.1507	-.2524	-1.3968	.5728	.9305	
.1003	-.3443	.5874	.9077	.0753	-.3512	.5855	.9107	.1507	-.5024	-1.4019	.5715	.9327	
.1507	-.3893	.5750	.9272	.1002	-.4149	.5680	.9382	.1507	-.7524	-1.3889	.5731	.9270	
.2003	-.4136	.5683	.9378	.1503	-.4430	.5602	.9506	.5002	.7476	-1.5662	.5262	1.0059	
.2503	-.4508	.5580	.9540	.1976	-.5405	.5333	.9937	.5002	.4976	-1.5700	.5252	1.0059	
.3001	-.4857	.5484	.9694	.2503	-.5811	.5221	1.0119	.5002	.2476	-1.5750	.5238	1.0092	
.3502	-.4938	.5462	.9730	.3001	-.6017	.5144	1.0212	.5002	-.2524	-1.5637	.5269	1.0081	
.4003	-.5148	.5404	.9823	.3507	-.5801	.5222	1.0114	.5002	-.5024	-1.5608	.5277	1.0028	
.4501	-.5384	.5339	.9928	.4001	-.5154	.5402	.9777	.5002	-.7524	-1.5449	.5321	.9957	
.5002	-.5718	.5247	1.0077	.4501	-.4432	.5601	.9507	.8002	.7476	-1.1760	.3582	1.3078	
.5507	-.6078	.5144	1.0240	.5001	-.3444	.5873	.9078	.8002	.4976	-1.4100	.3693	.9362	
.6002	-.6356	.5071	1.0366	.5497	-.2159	.6227	.8527	.8002	.2476	-1.4119	.3688	.9370	
.6500	-.6653	.4989	1.0502	.6003	-.0877	.6501	.7982	.8002	-.5024	-1.3839	.3765	.9249	
.7000	-.6172	.5122	1.0282	.6500	.0093	.6848	.7571	.8002	-.7524	-1.3936	.3738	.9291	
.7500	-.4983	.5449	.9750	.7000	.1333	.7190	.7042						
.8002	-.4053	.5706	.9342	.7501	.2365	.7474	.6596						
.9002	-.1944	.6287	.8436	.8001	.3216	.7706	.6223						
.9501	-.0597	.6658	.7864	.8501	.3934	.7906	.5901						

TEST 167 PT 62.0079 PSI CM .3425
 RUN 8 TT 121.9227 K CM -.1511
 POINT 37 RC 30.0093 MILLION CC .0217
 MACH .7590
 ALPHA -1.4867 DEG

CD1 .00792 CDCOR1 .00780
 CD2 .00789 CDCOR2 .00781
 CD3 .00788 CDCOR3 .00787
 CD4 .00782 CDCOR4 .00779
 CD5 .00769 CDCOR5 .00776

UPPER SURFACE				LOWER SURFACE				SPANWISE				
X/C	CP	P,L/PT	MLOC	X/C	CP	P,L/PT	MLOC	X/C	Y/(B/2)	CP	P,L/PT	MLOC
0.0000	1.0582	.9743	.1934	0.0000	1.0582	.9743	.1934	.1507	.7476	-.4475	.5610	.9483
.0132	-.1990	.7388	.6732	.0126	-.0374	.6945	.7421	.1507	.4976	-.4691	.5557	.9577
.0259	-.1518	.6427	.8220	.0255	-.0731	.6642	.7888	.1507	.2476	-.4686	.5564	.9566
.0759	-.4231	.5683	.9377	.0495	-.2033	.6286	.8437	.1507	-.2524	-.4780	.5538	.9608
.1003	-.4338	.5654	.9424	.0753	-.2629	.6122	.8690	.1507	-.5024	-.4798	.5528	.9624
.1507	-.4679	.5560	.9572	.1002	-.3323	.5932	.8986	.1507	-.7524	-.4643	.5570	.9557
.2003	-.4810	.5524	.9630	.1503	-.3737	.5819	.9164	.5002	.7476	-.8099	.5171	1.0201
.2503	-.5141	.5434	.9775	.1976	-.4649	.5568	.9559	.5002	.4976	-.8166	.5153	1.0231
.3001	-.5456	.5347	.9914	.2503	-.5053	.5458	.9736	.5002	.2476	-.8222	.5137	1.0257
.3502	-.5445	.5350	.9909	.3001	-.5234	.5408	.9816	.5002	-.2524	-.8100	.5171	1.0202
.4003	-.5614	.5304	.9984	.3507	-.5187	.5421	.9795	.5002	-.5024	-.8059	.5182	1.0183
.4501	-.5808	.5251	1.0071	.4001	-.4758	.5539	.9607	.5002	-.7524	-.8588	.5237	1.0093
.5002	-.6185	.5148	1.0240	.4501	-.4180	.5697	.9355	.8002	.7476	-1.1901	.5381	1.3080
.5502	-.6408	.5087	1.0341	.5001	-.3261	.5949	.8960	.8002	.4976	-.4170	.5700	.9351
.6002	-.6675	.5013	1.0462	.5497	-.2033	.6286	.8437	.8002	.2476	-.4181	.5697	.9356
.6500	-.6925	.4945	1.0577	.6003	-.0789	.6627	.7912	.8002	-.5024	-.3902	.5773	.9235
.7000	-.8316	.5112	1.0299	.6500	.0150	.6884	.7516	.8002	-.7524	-.4013	.5743	.9283
.7500	-.5068	.5454	.9743	.7000	.1378	.7220	.6994					
.8002	-.4108	.5717	.9324	.7501	.2405	.7502	.6532					
.9002	-.1976	.6301	.8413	.8001	.3255	.7735	.6180					
.9501	-.0621	.6673	.7841	.8501	.3978	.7933	.5837					

TEST 167 PT 62.0002 PSI CM .4233
 RUN 8 TT 121.9153 K CM -.1554
 POINT 3A RC 30.0174 MILLION CC .0223
 MACH .7594
 ALPHA -.9979 DEG

CD1 .00811 CDCOR1 .00790
 CD2 .00807 CDCOR2 .00790
 CD3 .00801 CDCOR3 .00794
 CD4 .00797 CDCOR4 .00789
 CD5 .00781 CDCOR5 .00763

UPPER SURFACE				LOWER SURFACE				SPANWISE				
X/C	CP	P,L/PT	MLOC	X/C	CP	P,L/PT	MLOC	X/C	Y/(B/2)	CP	P,L/PT	MLOC
0.0000	1.0941	.9838	.1929	0.0000	1.0941	.9838	.1929	.1507	.7476	-.5218	.5393	.9840
.0132	.0935	.7091	.7195	.0126	.1558	.7257	.6937	.1507	.4976	-.5426	.5336	.9932
.0259	-.2584	.6118	.8697	.0255	-.0266	.6902	.7488	.1507	.2476	-.5418	.5338	.9929
.0759	-.5225	.5391	.9843	.0495	-.1115	.6522	.8073	.1507	-.2524	-.5465	.5325	.9950
.1003	-.5183	.5403	.9824	.0753	-.1781	.6339	.8355	.1507	-.5024	-.5490	.5319	.9961
.1507	-.5422	.5337	.9930	.1002	-.2575	.6121	.8693	.1507	-.7524	-.5287	.5374	.9970
.2003	-.5524	.5309	.9976	.1503	-.3091	.5979	.8914	.5002	.7476	-.6349	.5027	1.0439
.2503	-.5732	.5252	1.0069	.1976	-.3955	.5741	.9287	.5002	.4976	-.6653	.4999	1.0487
.3001	-.6072	.5159	1.0222	.2503	-.4388	.5622	.9474	.5002	.2476	-.6706	.4984	1.0511
.3502	-.6023	.5172	1.0200	.3001	-.4631	.5555	.9581	.5002	-.2524	-.6525	.5034	1.0428
.4003	-.6068	.5159	1.0220	.3507	-.4656	.5548	.9592	.5002	-.5024	-.6505	.5039	1.0419
.4501	-.6238	.5113	1.0297	.4001	-.4329	.5638	.9449	.5002	-.7524	-.6281	.5101	1.0317
.5002	-.6678	.4992	1.0498	.4501	-.3833	.5774	.9233	.8002	.7476	-1.1801	.5383	1.3078
.5502	-.6963	.4913	1.0630	.5001	-.2982	.6000	.8867	.8002	.4976	-.4132	.5692	.9363
.6002	-.7063	.4886	1.0676	.5497	-.1804	.6332	.8366	.8002	.2476	-.4148	.5688	.9370
.6500	-.7220	.4843	1.0749	.6003	-.0602	.6663	.7856	.8002	-.5024	-.3839	.5773	.9236
.7000	-.6597	.5014	1.0461	.6500	.0315	.6915	.7467	.8002	-.7524	-.3962	.5739	.9289
.7500	-.5089	.5429	.9783	.7000	.1522	.7247	.6952					
.8002	-.4099	.5701	.9349	.7501	.2534	.7526	.6515					
.9002	-.1957	.6291	.8430	.8001	.3378	.7758	.6142					
.9501	-.0636	.6654	.7870	.8501	.4102	.7957	.5817					

TEST 167 PT 62.0069 PSI CM .4917
 RUN 8 TT 121.9679 K CM -.1549
 POINT 39 RC 29.9742 MILLION CC .0219
 MACH .7592
 ALPHA -.4488 DEG

CD1 .00822 CDCOR1 .00802
 CD2 .00817 CDCOR2 .00797
 CD3 .00818 CDCOR3 .00803
 CD4 .00808 CDCOR4 .00791
 CD5 .00795 CDCOR5 .00775

UPPER SURFACE				LOWER SURFACE				SPANWISE				
X/C	CP	P,L/PT	MLOC	X/C	CP	P,L/PT	MLOC	X/C	Y/(B/2)	CP	P,L/PT	MLOC
0.0000	1.1254	.9925	.1038	0.0000	1.1254	.9925	.1038	.1507	.7476	-.6014	.5179	1.0188
.0132	-.0053	.6817	.7618	.0126	.2658	.7562	.6456	.1507	.4976	-.6284	.5105	1.0311
.0259	-.3695	.5816	.9167	.0255	-.1233	.7171	.7072	.1507	.2476	-.6300	.5100	1.0318
.0759	-.6414	.5069	1.0370	.0495	-.0312	.6746	.7728	.1507	-.2524	-.6358	.5084	1.0344
.1003	-.6806	.5184	1.0213	.0753	-.1064	.6539	.8046	.1507	-.5024	-.6340	.5089	1.0336
.1507	-.6298	.5101	1.0317	.1002	-.1868	.6318	.8387	.1507	-.7524	-.6078	.5161	1.0218
.2003	-.6205	.5126	1.0275	.1503	-.2463	.6155	.8639	.5002	.7476	-.6875	.4942	1.0581
.2503	-.6278	.5106	1.0308	.1976	-.3362	.5908	.9024	.5002	.4976	-.6955	.4920	1.0618
.3001	-.6748	.4977	1.0522	.2503	-.3888	.5777	.9229	.5002	-.2524	-.6984	.4912	1.0631
.3502	-.6793	.4965	1.0543	.3001	-.4122	.5699	.9352	.5002	-.5024	-.6888	.4939	1.0587
.4003	-.6556	.5030	1.0434	.3507	-.4219	.5672	.9394	.5002	-.7524	-.6944	.4923	1.0612
.4501	-.6417	.5068	1.0371	.4001	-.3988	.5736	.9274	.5002	-.5024	-.6739	.4979	1.0518
.5002	-.6931	.4927	1.0607	.4501	-.3591	.5845	.9123	.8002	.7476	-1.1623	.5387	1.2968
.5502	-.7369	.4806	1.0810	.5001	-.2811	.6059	.8788	.8002	.4976	-.4088	.5708	.9338
.6002	-.7523	.4764	1.0883	.5497	-.1666	.6368	.8310	.8002	.2476	-.4099	.5705	.9342
.6500	-.7474	.4777	1.0860	.6003	-.0517	.6690	.7815	.8002	-.5024	-.3874	.5767	.9245
.7000	-.6616	.5013	1.0462	.6500	.0370	.6934	.7439	.8002	-.7524	-.4018	.5728	.9307
.7500	-.5016	.5453	.9744	.7000	.1562	.7261	.6930					
.8002	-.4041	.5721	.9317	.7501	.2567	.7537	.6496					
.9002	-.1906	.6308	.8403	.8001	.3410	.7769	.6124					
.9501	-.0578	.6673	.7841	.8501	.4139	.7969	.5796					

TEST 167 PT 62.0155 PSI CM .5724
 RUN 8 TT 121.8257 K CM -.1554
 POINT 40 RC 30.0258 MILLION CC .0202
 MACH .7580
 ALPHA .0407 DEG

CD1 .00860 CDCOR1 .00838
 CD2 .00856 CDCOR2 .00833
 CD3 .00848 CDCOR3 .00828
 CD4 .00835 CDCOR4 .00815
 CD5 .00824 CDCOR5 .00801

UPPER SURFACE				LOWER SURFACE				SPANWISE				
X/C	CP	P _z /PT	MLOC	X/C	CP	P _z /PT	MLOC	X/C	Y/(B/2)	CP	P _z /PT	MLOC
0.0000	1.1416	.9974	.0611	0.0000	1.1416	.9974	.0611	.1507	.7476	-.6903	.4968	1.0537
.0132	-.1198	.6527	.8065	.0126	-.3685	.7861	.5974	.1507	.4976	-.7060	.4926	1.0609
.0259	-.4611	.5513	.9648	.0255	-.2126	.7436	.2657	.1507	.2476	-.7448	.4819	1.0780
.0759	-.7548	.4792	1.0834	.0495	-.0491	.6889	.7354	.1507	-.2524	-.7543	.4794	1.0332
.1003	-.7793	.4725	1.0949	.0753	-.0333	.6765	.7701	.1507	-.5024	-.7195	.4789	1.0671
.1507	-.7459	.4850	1.0770	.1002	-.1176	.6533	.8056	.1507	-.7524	-.6785	.5001	1.0483
.2003	-.7269	.4869	1.0705	.1503	-.1853	.6348	.8341	.5002	.7476	-.7327	.4853	1.0732
.2503	-.6800	.4997	1.0490	.1976	-.2752	.6103	.8720	.5002	.4976	-.7399	.4833	1.0765
.3001	-.7367	.4842	1.0750	.2503	-.3263	.5947	.8938	.5002	.2476	-.7416	.4828	1.0773
.3502	-.7433	.4824	1.0781	.3001	-.3583	.5676	.9074	.5002	-.2524	-.7248	.4874	1.0695
.4003	-.7426	.4826	1.0778	.3507	-.3741	.5533	.9142	.5002	-.5024	-.7316	.4856	1.0727
.4501	-.7322	.4854	1.0729	.4001	-.3546	.5875	.9076	.5002	-.7524	-.7181	.4893	1.0864
.5002	-.7378	.4834	1.0755	.4501	-.3279	.5960	.8943	.8002	.7476	-1.1615	.3681	1.2877
.5502	-.7500	.4805	1.0822	.5001	-.2572	.6132	.8644	.8002	.4976	-.4102	.5734	.9297
.6002	-.7623	.4772	1.0989	.5497	-.1510	.6442	.8196	.8002	.2476	-.4108	.5732	.9300
.6500	-.7560	.4789	1.0840	.6003	-.0384	.6750	.7722	.8002	-.5024	-.3874	.5796	.9199
.7000	-.6806	.5050	1.0402	.6500	-.1487	.6982	.7364	.8002	-.7524	-.4016	.5757	.9260
.7500	-.5062	.5472	.9714	.7000	-.1641	.7303	.6865					
.8002	-.4036	.5752	.9269	.7501	-.2634	.7574	.6437					
.9002	-.1895	.6337	.8358	.8001	-.3470	.7803	.6070					
.9501	-.0566	.6700	.7799	.8501	-.4197	.8001	.5743					

TEST 167 PT 62.1987 PSI CM .6512
 RUN 8 TT 122.4302 K CM -.1532
 POINT 41 RC 26.3635 MILLION CC .0142
 MACH .7575
 ALPHA .5284 DEG

CD1 .00887 CDCOR1 .00854
 CD2 .00890 CDCOR2 .00860
 CD3 .00891 CDCOR3 .00866
 CD4 .00865 CDCOR4 .00842
 CD5 .00854 CDCOR5 .00824

UPPER SURFACE				LOWER SURFACE				SPANWISE				
X/C	CP	P _z /PT	MLOC	X/C	CP	P _z /PT	MLOC	X/C	Y/(B/2)	CP	P _z /PT	MLOC
0.0000	1.1549	1.0009	0.0000	0.0000	1.1549	1.0009	0.0000	.1507	.7476	-.7093	.4862	1.1058
.0132	-.2082	.6279	.8447	.0126	-.4623	.8114	.5554	.1507	.4976	-.8021	.4408	1.1504
.0259	-.5822	.5256	1.0062	.0255	-.2971	.7662	.6297	.1507	.2476	-.8760	.4452	1.1425
.0759	-.8537	.4513	1.1317	.0495	-.1240	.7188	.7044	.1507	-.2524	-.8763	.4451	1.1427
.1003	-.8694	.4481	1.1374	.0753	-.0345	.6944	.7423	.1507	-.5024	-.8018	.4409	1.1503
.1507	-.8637	.4486	1.1368	.1002	-.0518	.6707	.7787	.1507	-.7524	-.8007	.4842	1.1093
.2003	-.8526	.4516	1.1312	.1503	-.1260	.6504	.8100	.5002	.7476	-.7780	.4720	1.0957
.2503	-.8617	.4491	1.1356	.1976	-.2195	.6249	.8494	.5002	.4976	-.7781	.4725	1.0944
.3001	-.8681	.4474	1.1387	.2503	-.2748	.6098	.8728	.5002	.2476	-.8011	.4637	1.1066
.3502	-.7700	.4742	1.0920	.3001	-.3103	.6000	.8880	.5002	-.2524	-.8071	.4640	1.1093
.4003	-.7576	.4776	1.0882	.3507	-.3307	.5944	.8947	.5002	-.5024	-.7813	.4711	1.0973
.4501	-.7715	.4738	1.0927	.4001	-.3211	.5970	.9026	.5002	-.7524	-.7698	.4743	1.0919
.5002	-.8024	.4653	1.1073	.4501	-.2967	.6037	.8822	.8002	.7476	-1.1447	.3717	1.2805
.5502	-.8176	.4612	1.1144	.5001	-.2321	.6214	.8546	.8002	.4976	-.4010	.5752	.9268
.6002	-.8089	.4636	1.1103	.5497	-.1309	.6491	.8120	.8002	.2476	-.4001	.5754	.9265
.6500	-.7630	.4761	1.0887	.6003	-.0218	.6789	.7661	.8002	-.5024	-.3809	.5807	.9182
.7000	-.6233	.5144	1.0246	.6500	.0600	.7013	.7315					
.7500	-.4840	.5525	.9629	.7000	.1746	.7331	.6822					
.8002	-.3905	.5780	.9224	.7501	.2741	.7589	.6397					
.9002	-.1778	.6362	.8318	.8001	.3570	.7826	.6032					
.9501	-.0455	.6725	.7761	.8501	.4296	.8025	.5705					

TEST 167 PT 53.0033 PSI CM .7946
 RUN 8 TT 110.2344 K CM -.1670
 POINT 42 RC 29.8261 MILLION CC .0185
 MACH .7600
 ALPHA 1.0183 DEG

CD1 .01097 CDCOR1 .01053
 CD2 .01093 CDCOR2 .01047
 CD3 .01084 CDCOR3 .01049
 CD4 .01064 CDCOR4 .00992
 CD5 .01037 CDCOR5 .01003

UPPER SURFACE				LOWER SURFACE				SPANWISE				
X/C	CP	P _z /PT	MLOC	X/C	CP	P _z /PT	MLOC	X/C	Y/(B/2)	CP	P _z /PT	MLOC
0.0000	1.1533	.9996	.0226	0.0000	1.1533	.9996	.0226	.1507	.7476	-.8904	.4346	1.1622
.0132	-.2709	.6059	.8796	.0126	-.5305	.8274	.5287	.1507	.4976	-.9693	.4127	1.2021
.0259	-.6483	.5019	1.0406	.0255	-.3885	.7864	.6074	.1507	.2476	-.9447	.4193	1.1893
.0759	-.9130	.4281	1.1739	.0495	-.1841	.7317	.6850	.1507	-.2524	-.9445	.4196	1.1894
.1003	-.9304	.4233	1.1823	.0753	-.0903	.7057	.7255	.1507	-.5024	-.9051	.4139	1.1990
.1507	-.9307	.4234	1.1824	.1002	-.0813	.6904	.7646	.1507	-.7524	-.9033	.4310	1.1684
.2003	-.9245	.4251	1.1793	.1503	-.0813	.6583	.8394	.5002	.7476	-.9099	.4099	1.2075
.2503	-.9479	.4187	1.1912	.1976	-.1769	.6318	.8786	.5002	.4976	-.9095	.4168	1.1945
.3001	-.9797	.4099	1.2074	.2503	-.2348	.6159	.9081	.5002	-.2524	-.9158	.4275	1.1749
.3502	-.9841	.4097	1.2097	.3001	-.2742	.6049	.9211	.5002	-.5024	-.9199	.4098	1.2075
.4003	-.9374	.4216	1.1850	.3507	-.2499	.5978	.9297	.5002	-.7524	-.9256	.4248	1.1799
.4501	-.8885	.4351	1.1613	.4001	-.2944	.5904	.9388	.8002	.7476	-1.0000	.4020	1.2222
.5002	-.9278	.4242	1.1810	.4501	-.2737	.6051	.9350	.8002	.4976	-.9356	.3824	.9162
.5502	-.9395	.4194	1.1971	.5001	-.2135	.6217	.9133	.8002	.2476	-.9304	.3839	.9139
.6002	-.9721	.4120	1.2035	.5497	-.1150	.6487	.7681	.8002	-.5024	-.9446	.3866	.9097
.6500	-.9904	.4069	1.2130	.6003	-.0096	.6761	.7681					
.7000	-.7182	.4822	1.0791	.6500	.0706	.7003	.7339					
.7500	-.4303	.5618	.9488	.7000	.1846	.7318	.6844					
.8002	-.3433	.5858	.9169	.7501	.413	.7585	.6426					
.9002	-.1581	.6370	.8313	.8001	.3633	.7812	.6060					
.9501	-.0378	.6703	.7801	.8501	.4363	.8014	.5729					

ORIGINAL FILE
OF POOR QUALITY

TEST	167	PT	53.0073	PSI	CM	-0.8411	CD1	.01921	CDCOR1	.01492
RUN	A	TT	110.1622	K	CM	-1.1757	CD2	.01331	CDCOR2	.01502
POINT	43	AC	29.9038	MILLION	CC	.0185	CD3	.01307	CDCOR3	.01470
		MACH	.7620				CD4	.01482	CDCOR4	.01422
		ALPHA	1.5172	DEG			CD5	.01487	CDCOR5	.01459

UPPER SURFACE				LOWER SURFACE				SPANWISE				
X/C	CP	P/L/PT	MLOC	X/C	CP	P/L/PT	MLOC	X/C	Y/(B/2)	CP	P/L/PT	MLOC
0.0000	1.1508	.9994	.0287	0.0000	1.1508	.9994	.0287	.1507	.7476	-.9872	.4122	1.2032
.0132	-.3583	.5849	.9123	.0126	.5902	.8454	.4970	.1507	.4976	-1.0578	.3928	1.2398
.0259	-.7353	.4814	1.0804	.0255	.4148	.7973	.3757	.1507	.2476	-1.0280	.4010	1.2242
.0759	-.9975	.4094	1.2084	.0495	-.2331	.7474	.8403	.1507	-.2524	-1.0208	.4013	1.2230
.1003	-1.0168	.4040	1.2184	.0753	-.1339	.7201	.7031	.1507	-.5024	-1.0489	.3952	1.2351
.1507	-1.0140	.4048	1.2169	.1002	.0406	.6945	.7429	.1507	-.7524	-.9842	.4130	1.2014
.2003	-1.0050	.4073	1.2123	.1503	-.0447	.6711	.7790	.5002	.7476	-1.0617	.3917	1.2419
.2503	-1.0301	.4004	1.2253	.1976	-.1417	.6444	.8200	.5002	.4976	-1.0717	.3890	1.2472
.3001	-1.0648	.3909	1.2435	.2503	-.2034	.6275	.8461	.5002	.2476	-1.0790	.3870	1.2511
.3502	-1.0794	.3869	1.2513	.3001	-.2455	.6159	.8461	.5002	-.2524	-1.0521	.3943	1.2368
.4003	-1.0756	.3879	1.2492	.3502	-.2741	.6081	.8762	.5002	-.5024	-1.0646	.3909	1.2434
.4501	-1.0345	.3992	1.2276	.4001	-.2734	.6082	.8759	.5002	-.7524	-1.0102	.4059	1.2130
.5002	-1.0187	.4035	1.2194	.4501	-.2587	.6123	.8694	.8002	.7476	-.4378	.4258	1.1782
.5502	-1.0440	.3960	1.2334	.5001	-.2041	.6273	.8464	.8002	.4976	-.3413	.5094	.9050
.6002	-1.0782	.3872	1.2500	.5497	-.1168	.6529	.8069	.8002	.2476	-.3393	.5001	.9041
.6500	-1.1152	.3770	1.2709	.6003	-.0078	.6812	.7633	.8002	-.5024	-.3300	.5927	.9001
.7000	-.8338	.4543	1.1271	.6500	.0491	.7023	.7308	.8002	-.7524	-.3451	.5886	.9066
.7500	-.4444	.5613	.9496	.7000	-.1819	.7333	.6825					
.8002	-.3364	.5909	.9028	.7501	-.2778	.7594	.6409					
.9002	-.1510	.6418	.8239	.8001	-.3346	.7821	.6047					
.9501	-.0393	.6723	.7767	.8501	-.4322	.8020	.5718					

TEST	167	PT	53.0073	PSI	CM	-0.8913	CD1	.02102	CDCOR1	.02061
RUN	A	TT	110.0366	K	CM	-1.1819	CD2	.02191	CDCOR2	.02156
POINT	44	AC	29.9089	MILLION	CC	.0201	CD3	.02105	CDCOR3	.02052
		MACH	.7424				CD4	.02101	CDCOR4	.02059
		ALPHA	1.9898	DEG			CD5	.02232	CDCOR5	.02201

UPPER SURFACE				LOWER SURFACE				SPANWISE				
X/C	CP	P/L/PT	MLOC	X/C	CP	P/L/PT	MLOC	X/C	Y/(B/2)	CP	P/L/PT	MLOC
0.0000	1.1464	.9978	.0554	0.0000	1.1464	.9978	.0554	.1507	.7476	-1.0351	.3934	1.2349
.0132	-.4478	.5896	.9386	.0124	.6308	.8534	.4789	.1507	.4976	-1.1033	.3765	1.2715
.0259	-.7903	.4630	1.1120	.0255	.4529	.8065	.3647	.1507	.2476	-1.0725	.3850	1.2546
.0759	-1.0394	.3942	1.2371	.0495	-.2683	.7533	.6474	.1507	-.2524	-1.0646	.3859	1.2532
.1003	-1.0401	.3885	1.2482	.0753	-.1657	.7270	.6924	.1507	-.5024	-1.0916	.3798	1.2451
.1507	-1.0384	.3889	1.2473	.1002	.0697	.7005	.7336	.1507	-.7524	-1.0363	.3950	1.2359
.2003	-1.0469	.3921	1.2411	.1503	-.0107	.6761	.7713	.5002	.7476	-1.1171	.3727	1.2790
.2503	-1.0718	.3853	1.2544	.1976	-.1192	.6483	.8148	.5002	.4976	-1.1243	.3707	1.2831
.3001	-1.1049	.3756	1.2734	.2503	-.1848	.6302	.8419	.5002	.2476	-1.1344	.3680	1.2886
.3502	-1.1220	.3712	1.2822	.3001	-.2305	.6176	.8615	.5002	-.2524	-1.1129	.3759	1.2768
.4003	-1.1280	.3695	1.2855	.3502	-.2629	.6088	.8753	.5002	-.5024	-1.0974	.3782	1.2683
.4501	-1.1211	.3716	1.2812	.4001	-.2669	.6076	.8770	.5002	-.7524	-1.0626	.3878	1.2495
.5002	-1.1030	.3764	1.2718	.4501	-.2354	.6187	.8721	.8002	.7476	-.9629	.4153	1.1973
.5502	-1.1092	.3749	1.2747	.5001	-.2051	.6246	.8506	.8002	.4976	-.3638	.5086	.9188
.6002	-1.1319	.3667	1.2472	.5497	-.1147	.6496	.8121	.8002	.2476	-.3590	.5018	.9172
.6500	-1.1844	.3541	1.3168	.6003	-.0133	.6776	.7690	.8002	-.5024	-.3540	.5829	.9154
.7000	-.5849	.4368	1.1581	.6500	.0621	.6984	.7369	.8002	-.7524	-.3535	.5836	.9144
.7500	-.4888	.5463	.9716	.7000	-.1733	.7291	.6891					
.8002	-.3821	.5812	.9181	.7501	-.2884	.7554	.6477					
.9002	-.1594	.6372	.8311	.8001	-.3494	.7777	.6118					
.9501	-.0543	.6682	.7864	.8501	-.4216	.7977	.5791					

ORIGINAL PAGE IS
OF POOR QUALITY

TEST 167
RUN 16
MACH .760
R 30.0×10^6

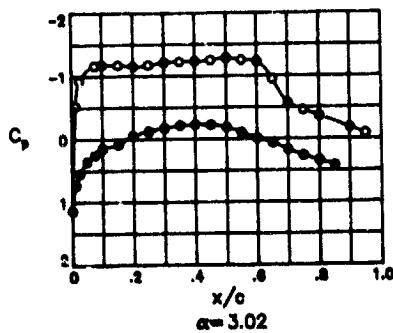
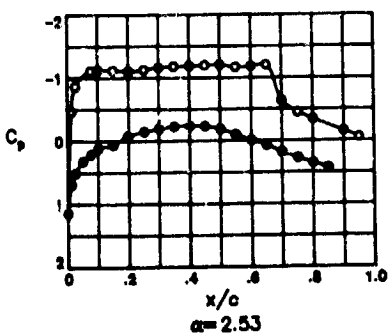
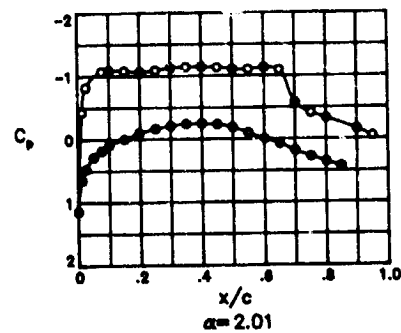
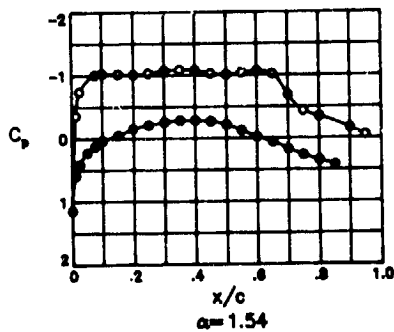
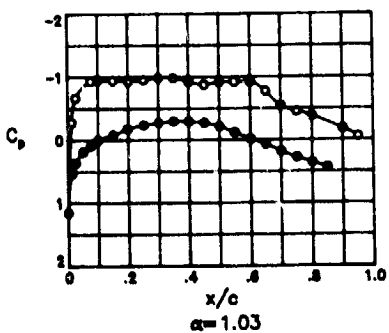
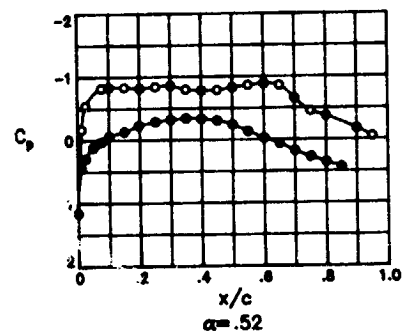
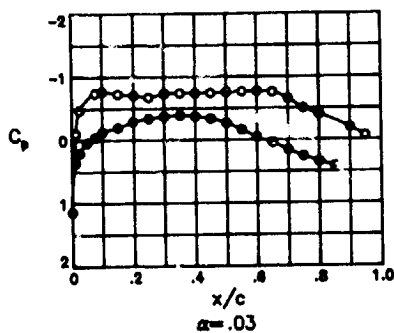
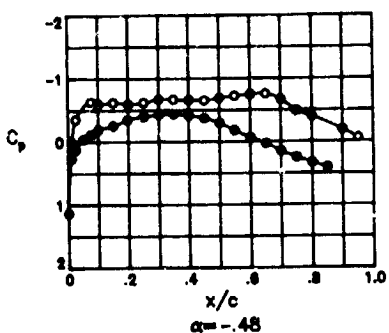
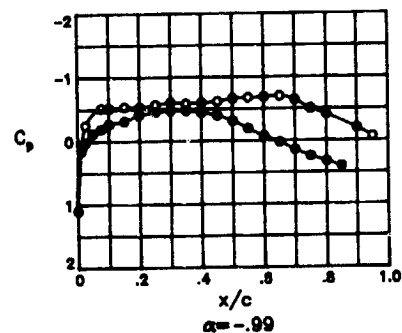
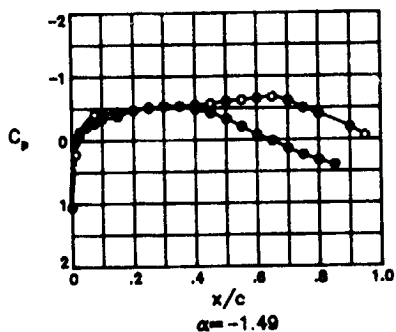
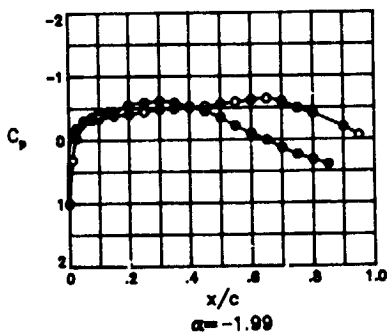
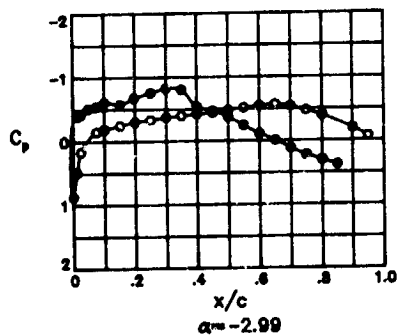
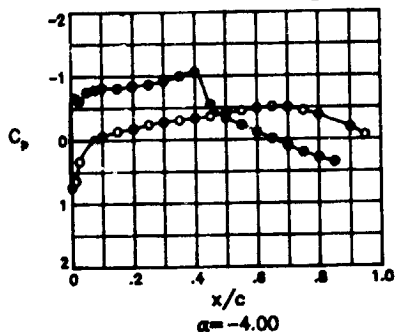

c-3

TFST 167	PT 43.9375	PSI	CM -.0702	CD1 .01108	CDCOR1 .01087
RUN 16	TT 96.2601	K	CM -.1354	CD2 .01080	CDCOR2 .01063
POINT 55	RC 30.0314	MILLION	CC .0066	CD3 .01039	CDCOR3 .01030
	MACH .7627			CD4 .01000	CDCOR4 .00983
	ALPHA -4.0007	DEG		CD5 .00929	CDCOR5 .00902

UPPER SURFACE				LOWER SURFACE				SPANWISE				
X/C	CP	P _L /PT	MLOC	X/C	CP	P _L /PT	MLOC	X/C	Y/(B/2)	CP	P _L /PT	MLOC
0.0000	.7408	.8858	.4216	0.0000	.7408	.8858	.4216	.1507	.7476	-.1236	.6473	.8165
.0132	.6416	.8584	.4741	.0126	-.6636	.4982	1.0529	.1507	.4976	-.1368	.6436	.8222
.0259	.3314	.7728	.6206	.0255	-.6073	.5137	1.0272	.1507	.2476	-.1332	.6446	.8206
.0759	-.0039	.6803	.7657	.0495	-.7549	.4730	1.0955	.1507	-.2524	-.1449	.6414	.8256
.1003	-.0574	.6655	.7884	.0753	-.7875	.4640	1.1110	.1507	-.5024	-.1488	.6403	.8273
.1507	-.1331	.6446	.8206	.1002	-.8155	.4563	1.1245	.1507	-.7524	-.1410	.6424	.8240
.2003	-.1758	.6328	.8388	.1503	-.8087	.4582	1.1212	.5002	.7476	-.4052	.5695	.9374
.2503	-.2362	.6162	.8645	.1976	-.8430	.4487	1.1378	.5002	.4976	-.4089	.5685	.9390
.3001	-.2820	.6035	.8841	.2503	-.8662	.4423	1.1491	.5002	.2476	-.4141	.5671	.9413
.3502	-.3071	.5966	.8949	.3001	-.9209	.4272	1.1763	.5002	-.2524	-.4045	.5697	.9371
.4003	-.3397	.5876	.9090	.3507	-.9967	.4063	1.2149	.5002	-.5024	-.4026	.5703	.9363
.4501	-.3675	.5799	.9210	.4001	-1.0577	.3895	1.2469	.5002	-.7524	-.3877	.5744	.9298
.5002	-.4109	.5679	.9399	.4501	-1.5558	.5280	1.0040	.8002	.7476	-1.0485	.3920	1.2421
.5502	-.4532	.5563	.9584	.5001	-.3387	.5879	.9086	.8002	.4976	-.3769	.5773	.9251
.6002	-.4891	.5464	.9742	.5497	-.2320	.6173	.8627	.8002	.2476	-.3826	.5758	.9276
.6500	-.5150	.5392	.9858	.6003	-.1142	.6498	.8126	.8002	-.5024	-.3508	.5845	.9138
.7000	-.5021	.5428	.9800	.6500	-.0154	.6771	.7706	.8002	-.7524	-.3436	.5865	.9107
.7500	-.4510	.5569	.9575	.7000	.1039	.7100	.7197					
.8002	-.3762	.5775	.9248	.7501	.2048	.7379	.6762					
.9002	-.1894	.6291	.8445	.8001	.2872	.7606	.6402					
.9501	-.0636	.6638	.7910	.8501	.3584	.7802	.6085					

TEST 167	PT 43.5413	PSI	CM .0989	CD1 .00830	CDCOR1 .00926
RUN 16	TT 96.2128	K	CM -.1429	CD2 .00817	CDCOR2 .00817
POINT 56	RC 30.0117	MILLION	CC .0139	CD3 .00808	CDCOR3 .00813
	MACH .7625			CD4 .00802	CDCOR4 .00804
	ALPHA -2.9938	DEG		CD5 .00775	CDCOR5 .00764

UPPER SURFACE				LOWER SURFACE				SPANWISE				
X/C	CP	P _L /PT	MLOC	X/C	CP	P _L /PT	MLOC	X/C	Y/(B/2)	CP	P _L /PT	MLOC
0.0000	.8742	.9236	.3402	0.0000	.8742	.9236	.3402	.1507	.7476	-.2380	.6189	.8603
.0132	.4895	.8182	.5453	.0126	-.3898	.5774	.9252	.1507	.4976	-.2517	.6192	.8661
.0259	.1638	.7290	.6902	.0255	-.4228	.5683	.9394	.1507	.2476	-.2480	.6162	.8645
.0759	-.1491	.6433	.8227	.0495	-.5188	.5420	.9813	.1507	-.2524	-.2562	.6139	.8640
.1003	-.2080	.6326	.8391	.0753	-.5492	.5337	.9948	.1507	-.5024	-.2587	.6133	.8691
.1507	-.2480	.6162	.8645	.1002	-.6078	.5176	1.0209	.1507	-.7524	-.2485	.6161	.8647
.2003	-.3005	.6018	.8869	.1503	-.5798	.5253	1.0084	.5002	.7476	-.4725	.5547	.9610
.2503	-.3311	.5934	.8999	.1976	-.6764	.4988	1.0520	.5002	.4976	-.4766	.5536	.9628
.3001	-.3715	.5824	.9173	.2503	-.7557	.4771	1.0886	.5002	.2476	-.4821	.5521	.9652
.3502	-.3948	.5760	.9273	.3001	-.8250	.4581	1.1214	.5002	-.2524	-.4665	.5544	.9584
.4003	-.4187	.5694	.9376	.3507	-.8054	.4635	1.1120	.5002	-.5024	-.4453	.5577	.9579
.4501	-.4410	.5633	.9473	.4001	-.5385	.5368	.9900	.5002	-.7524	-.4493	.5610	.9509
.5002	-.4796	.5527	.9641	.4501	-.4716	.5549	.9606	.8002	.7476	-1.0866	.3865	1.2528
.5502	-.5180	.5422	.9810	.5001	-.3725	.5821	.9177	.8002	.4976	-.3894	.5775	.9250
.6002	-.5495	.5336	.9949	.5497	-.2408	.6182	.8615	.8002	.2476	-.3972	.5793	.9283
.6500	-.5691	.5282	1.0036	.6003	-.1085	.6544	.8098	.8002	-.5024	-.3821	.5849	.9133
.7000	-.5399	.5362	.9906	.6500	-.0055	.6826	.7621	.8002	-.7524	-.3582	.5860	.9116
.7500	-.4744	.5542	.9618	.7000	.1194	.7169	.7091					
.8002	-.3918	.5768	.9260	.7501	.2236	.7434	.6644					
.9002	-.1937	.6311	.8415	.8001	.3079	.7685	.6276					
.9501	-.0646	.6664	.7870	.8501	.3807	.7885	.5952					

TEST 167	PT 43.9134	PSI	CM .2541	CD1 .00789	CDCOR1 .00782
RUN 16	TT 96.1277	K	CM -.1477	CD2 .00781	CDCOR2 .00778
POINT 57	RC 30.0591	MILLION	CC .0202	CD3 .00778	CDCOR3 .00779
	MACH .7619			CD4 .00772	CDCOR4 .00771
	ALPHA -1.9857	DEG		CD5 .00755	CDCOR5 .00744

UPPER SURFACE				LOWER SURFACE				SPANWISE				
X/C	CP	P _L /PT	MLOC	X/C	CP	P _L /PT	MLOC	X/C	Y/(B/2)	CP	P _L /PT	MLOC
0.0000	1.0063	.9597	.2442	0.0000	1.0063	.9597	.2442	.1507	.7476	-.3671	.5828	.9165
.0132	.3149	.7700	.6252	.0126	-.0992	.6563	.8026	.1507	.4976	-.3837	.5783	.9237
.0259	-.0300	.6753	.7733	.0255	-.1865	.6324	.8395	.1507	.2476	-.3829	.5785	.9233
.0759	-.3179	.5963	.8954	.0495	-.3046	.6000	.8897	.1507	-.2524	-.3953	.5731	.9287
.1003	-.3390	.5905	.9045	.0753	-.3356	.5860	.9116	.1507	-.5024	-.3767	.5747	.9293
.1507	-.3823	.5787	.9231	.1002	-.4183	.5688	.9297	.1507	-.7524	-.3826	.5786	.9232
.2003	-.4054	.5723	.9331	.1503	-.4451	.5614	.9503	.5002	.7476	-.5572	.5307	.9996
.2503	-.4436	.5618	.9496	.1976	-.5459	.5338	.9946	.5002	.4976	-.5597	.5300	1.0007
.3001	-.4789	.5521	.9651	.2503	-.5892	.5219	1.0139	.5002	.2476	-.5656	.5284	1.0034
.3502	-.4867	.5500	.9685	.3001	-.6093	.5164	1.0229	.5002	-.2524	-.5529	.5319	.9977
.4003	-.5068	.5445	.9773	.3507	-.5847	.5231	1.0119	.5002	-.5024	-.5524	.5320	.9975
.4501	-.5291	.5384	.9871	.4001	-.5208	.5407	.9835	.5002	-.7524	-.5343	.5370	.9894
.5002	-.5622	.5293	1.0018	.4501	-.4488	.5604	.9519	.8002	.7476	-1.1396	.3709	1.2834
.5502	-.5951	.5203	1.0165	.5001	-.3493	.5877	.9089	.8002	.4976	-.4047	.5725	.9327
.6002	-.6227	.5127	1.0290	.5497	-.2208	.6230	.8540	.8002	.2476	-.4098	.5711	.9349
.6500	-.6440	.5069	1.0386	.6003	-.0921	.6583	.7996	.8002	-.5024	-.3813	.5789	.9226
.7000	-.5981	.5194	1.0179	.6500	.0069	.6855	.7577	.8002	-.7524	-.3796	.5794	.9219
.7500	-.4939	.5480	.9716	.7000	.1308	.7194	.7051					
.8002	-.4040	.5727	.9324	.7501	.2346	.7479	.6604					
.9002	-.1960	.6298	.8435	.8001	.3192	.7712	.6233					
.9501	-.0630	.6663	.7873	.8501	.3937	.7916	.5900					

UPPER SURFACE

TEST RUN POINT	167 16 5R	PT TT RC MACH ALPHA	43.4907 96.0991 30.0412 .7613 -1.4879	PSI K MILLION DEG	CN CM CC	.3281 -.1499 .0217	CD1 CD2 CD3 CD4 CD5	.00787 .00778 .00779 .00773 .00753	CDCOR1 CDCOR2 CDCOR3 CDCOR4 CDCOR5	.00776 .00771 .00778 .00768 .00740		
UPPER SURFACE												
X/C	CP	P/L/PT	MLOC	X/C	CP	P/L/PT	MLOC	X/C	Y/(B/2)	CP	P/L/PT	MLOC
0.0000	1.0555	.9733	.1978	0.0000	1.0555	.9733	.1978	.1507	.7476	-.4354	.5647	.9450
.0132	.2184	.7439	.6667	.0126	.0256	.6911	.7491	.1507	.4976	-.4540	.5596	.9331
.0259	-.1326	.6477	.8159	.0255	-.0821	.6615	.7946	.1507	.2476	-.4541	.5596	.9532
.0759	-.4085	.5721	.9334	.0495	-.2123	.6098	.8496	.1507	-.2524	-.4661	.5563	.9584
.1003	-.1192	.5692	.9380	.0753	-.2711	.5912	.8745	.1507	-.5024	-.4660	.5563	.9584
.1507	-.4529	.5599	.9527	.1002	-.3389	.5720	.9035	.1507	-.7524	-.4492	.5609	.9511
.2003	-.4663	.5563	.9585	.1507	-.3775	.5806	.9200	.5002	.7476	-.5977	.5202	1.0166
.2503	-.5009	.5468	.9737	.1976	-.4742	.5421	.9620	.5002	.4976	-.6026	.5189	1.0188
.3001	-.5337	.5378	.9881	.2503	-.5179	.5211	.9811	.5002	.2476	-.6095	.5170	1.0219
.3502	-.5339	.5377	.9882	.3001	-.5356	.5373	.9889	.5002	-.2524	-.5946	.5211	1.0152
.4003	-.5501	.5333	.9954	.3507	-.5282	.5393	.9857	.5002	-.5024	-.5931	.5215	1.0145
.4501	-.5710	.5276	1.0046	.4001	-.4838	.5515	.9662	.5002	-.7524	-.5717	.5274	1.0050
.5002	-.6059	.5180	1.0203	.4501	-.4228	.5682	.9396	.8002	.7476	-1.1444	.3704	1.2843
.5502	-.6275	.5121	1.0300	.5001	-.3293	.5938	.8993	.8002	.4976	-.4076	.5724	.9330
.6002	-.6552	.5045	1.0425	.5497	-.2058	.6277	.8468	.8002	.2476	-.4120	.5711	.9349
.6500	-.6736	.4995	1.0509	.6003	-.0804	.6620	.7939	.8002	-.5024	-.3845	.5787	.9230
.7000	-.6152	.5154	1.0245	.6500	.0161	.6885	.7531	.8002	-.7524	-.3844	.5787	.9230
.7500	-.4988	.5473	.9727	.7000	.1385	.7220	.7011					
.8002	-.4065	.5726	.9325	.7501	.2416	.7502	.6567					
.9002	-.1960	.6303	.8427	.8001	.3261	.7734	.6197					
.9501	-.4624	.6669	.7863	.8501	.4008	.7939	.5862					

TEST RUN POINT	167 16 5R	PT TT RC MACH ALPHA	43.4882 96.0398 30.0585 .7609 -.9905	PSI K MILLION DEG	CN CM CC	.4054 -.1517 .0223	CD1 CD2 CD3 CD4 CD5	.00803 .00790 .00790 .00785 .00768	CDCOR1 CDCOR2 CDCOR3 CDCOR4 CDCOR5	.00783 .00772 .00779 .00769 .00750
----------------	-----------------	---------------------------------	--	----------------------------	----------------	--------------------------	---------------------------------	--	--	--

UPPER SURFACE												
X/C	CP	P/L/PT	MLOC	X/C	CP	P/L/PT	MLOC	X/C	Y/(B/2)	CP	P/L/PT	MLOC
0.0000	1.0988	.9853	.1460	0.0000	1.0988	.9853	.1460	.1507	.7476	-.5175	.5433	.9792
.0132	.1070	.7141	.7134	.0126	-.1491	.7256	.6954	.1507	.4976	-.5381	.5377	.9883
.0259	-.2524	.6158	.8651	.0255	-.0228	.6911	.7490	.1507	.2476	-.5394	.5373	.9888
.0759	-.5179	.5432	.9794	.0495	-.1220	.6515	.9100	.1507	-.2524	-.5506	.5343	.9938
.1003	-.5142	.5442	.9777	.0753	-.1897	.6330	.8386	.1507	-.5024	-.5467	.5353	.9921
.1507	-.5373	.5379	.9879	.1002	-.2636	.6128	.8698	.1507	-.7524	-.5242	.5415	.9822
.2003	-.5321	.5393	.9856	.1503	-.3119	.5995	.8904	.5002	.7476	-.6477	.5077	1.0372
.2503	-.5676	.5296	1.0013	.2503	-.4530	.5609	.9510	.5002	.4976	-.6564	.5053	1.0411
.3001	-.6028	.5200	1.0170	.3001	-.4747	.5543	.9605	.5002	.2476	-.6640	.5033	1.0446
.3502	-.5853	.5248	1.0092	.3507	-.4773	.5543	.9605	.5002	-.2524	-.6509	.5068	1.0386
.4003	-.5983	.5212	1.0150	.4001	-.4457	.5629	.9479	.5002	-.5024	-.6494	.5072	1.0380
.4501	-.6177	.5159	1.0237	.4501	-.3962	.5765	.9265	.5002	-.7524	-.6217	.5148	1.0255
.5002	-.6599	.5044	1.0427	.5001	-.3101	.6000	.8896	.8002	.7476	-1.1451	.3717	1.2818
.5502	-.6749	.5003	1.0495	.5497	-.1921	.6323	.8396	.8002	.4976	-.4108	.5725	.9328
.6002	-.6847	.4976	1.0546	.6003	-.0705	.6655	.7884	.8002	.2476	-.4153	.5713	.9347
.6500	-.6981	.4939	1.0601	.6500	.0233	.6912	.7488	.8002	-.5024	-.3892	.5784	.9235
.7000	-.6373	.5106	1.0325	.7000	.1441	.7242	.6976	.8002	-.7524	-.3913	.5778	.9244
.7500	-.5037	.5471	.9731	.7501	.2463	.7522	.6536					
.8002	-.4092	.5729	.9321	.8001	.3308	.7733	.6166					
.9002	-.1964	.6311	.8414	.8501	.4060	.7939	.5829					
.9501	-.4032	.6676	.7853									

TEST RUN POINT	167 16 60	PT TT PC MACH ALPHA	43.4764 96.0310 30.0541 .7609 -.4764	PSI K MILLION DEG	CN CM CC	.4781 -.1528 .0223	CD1 CD2 CD3 CD4 CD5	.00827 .00810 .00812 .00796 .00778	CDCOR1 CDCOR2 CDCOR3 CDCOR4 CDCOR5	.00802 .00791 .00801 .00785 .00762
----------------	-----------------	---------------------------------	--	----------------------------	----------------	--------------------------	---------------------------------	--	--	--

UPPER SURFACE												
X/C	CP	P/L/PT	MLOC	X/C	CP	P/L/PT	MLOC	X/C	Y/(B/2)	CP	P/L/PT	MLOC
0.0000	1.1317	.9940	.0930	0.0000	1.1317	.9940	.0930	.1507	.7476	-.5958	.5198	1.0174
.0132	.0121	.6866	.7559	.0126	.2627	.7554	.6484	.1507	.4976	-.6235	.5121	1.0299
.0259	-.3546	.5860	.9116	.0255	.1209	.7165	.7096	.1507	.2476	-.6268	.5112	1.0314
.0759	-.6326	.5096	1.0340	.0495	-.0391	.6726	.7775	.1507	-.2524	-.6395	.5077	1.0372
.1003	-.6019	.5181	1.0202	.0753	-.1157	.6516	.8099	.1507	-.5024	-.6329	.5095	1.0342
.1507	-.6235	.5121	1.0299	.1032	-.1933	.6303	.8428	.1507	-.7524	-.6003	.5168	1.0222
.2003	-.5975	.5193	1.0182	.1503	-.2520	.6141	.8677	.5002	.7476	-.6919	.4934	1.0611
.2503	-.6227	.5124	1.0295	.1976	-.3481	.5877	.9088	.5002	.4976	-.6976	.4918	1.0637
.3001	-.6701	.4994	1.0511	.2503	-.3994	.5737	.9310	.5002	.2476	-.7005	.4910	1.0651
.3502	-.6695	.4995	1.0508	.3001	-.4274	.5680	.9431	.5002	-.2524	-.6917	.4934	1.0610
.4003	-.6590	.5024	1.0464	.3507	-.4375	.5632	.9475	.5002	-.5024	-.6988	.4915	1.0643
.4501	-.6563	.5031	1.0448	.4001	-.4151	.5693	.9378	.5002	-.7524	-.6789	.4969	1.0551
.5002	-.6888	.4942	1.0597	.4501	-.3732	.5809	.9196	.8002	.7476	-1.1340	.3720	1.2813
.5502	-.7238	.4846	1.0759	.5001	-.2934	.6028	.8854	.8002	.4976	-.4040	.5724	.9329
.6002	-.7458	.4785	1.0861	.5497	-.1796	.6340	.8370	.8002	.2476	-.4037	.5719	.9337
.6500	-.7537	.4758	1.0908	.6003	-.0609	.6666	.7868	.8002	-.5024	-.3909	.5760	.9272
.7000	-.6715	.4989	1.0518	.6500	.0302	.6916	.7482	.8002	-.7524	-.3960	.5746	.9295
.7500	-.4892	.5400	.9701	.7000	.1497	.7244	.6973					
.8002	-.3963	.5745	.9296	.7501	.2513	.7523	.6534					
.9002	-.1876	.6318	.8464	.8001	.3395	.7754	.6164					
.9501	-.4037	.6686	.7837	.8501	.4110	.7962	.5824					

TEST 167	PT 43.4775	PSI	CN .5628	CD1 .00856	CDCDR1 .00832
RUN 16	TT 95.9841	K	CM -1.1558	CD2 .00845	CDCDR2 .00821
POINT 61	RC 30.0867	MILLION	CC .0208	CD3 .00841	CDCDR3 .00830
	MACH .7613			CD4 .00814	CDCDR4 .00801
	ALPHA .0275	DEG		CD5 .00802	CDCDR5 .00783

UPPER SURFACE				LOWER SURFACE				SPANWISE				
X/C	CP	P _L /PT	MLOC	X/C	CP	P _L /PT	MLOC	X/C	Y/(B/2)	CP	P _L /PT	MLOC
0.0000	1.1408	.9966	.0699	0.0000	1.1408	.9966	.0699	.1507	.7476	-.8842	.4961	1.0566
.0132	-.1021	.6557	.8036	.0126	.3594	.7823	.6053	.1507	.4976	-.7004	.4916	1.0641
.0259	-.4731	.5539	.4622	.0255	.2052	.7400	.6729	.1507	.2476	-.7347	.4822	1.0800
.0759	-.7428	.4800	1.0837	.0495	.0402	.6947	.7434	.1507	-.2524	-.7417	.4803	1.0832
.1003	-.7673	.7333	1.0952	.0753	-.0416	.6723	.7780	.1507	-.5024	-.6911	.4942	1.0598
.1507	-.7272	.4843	1.0765	.1002	-.1272	.6488	.8142	.1507	-.7524	-.6697	.5000	1.0500
.2003	-.7037	.4707	1.0656	.1503	-.1991	.6291	.8446	.5002	.7476	-.7359	.4819	1.0805
.2503	-.6757	.4984	1.0527	.1976	-.2869	.6050	.8819	.5002	.4976	-.7424	.4801	1.0835
.3001	-.7338	.4824	1.0796	.2503	-.3421	.5899	.9055	.5002	.2476	-.7504	.4779	1.0873
.3502	-.7390	.4810	1.0819	.3001	-.3713	.5819	.9181	.5002	-.2524	-.7364	.4817	1.0807
.4003	-.7399	.4808	1.0824	.3507	-.3877	.5774	.9251	.5002	-.5024	-.7358	.4819	1.0805
.4501	-.7409	.4805	1.0829	.4001	-.3719	.5817	.9183	.5002	-.7524	-.7214	.4858	1.0738
.5002	-.7543	.4768	1.0891	.4501	-.3378	.5911	.9037	.8002	.7476	-1.1165	.3775	1.2704
.5502	-.7597	.4753	1.0916	.5001	-.2663	.6107	.8731	.8002	.4976	-.4063	.5723	.9332
.6002	-.7668	.4729	1.0959	.5497	-.1584	.6403	.8274	.8002	.2476	-.4097	.5713	.9346
.6500	-.7534	.4771	1.0887	.6003	-.0445	.6715	.7793	.8002	-.5024	-.3854	.5780	.9241
.7000	-.6505	.5053	1.0412	.6500	.0439	.6958	.7419	.8002	-.7524	-.3887	.5771	.9255
.7500	-.5003	.5465	.9742	.7000	.1609	.7278	.6920					
.8002	-.4054	.5725	.9328	.7501	.2606	.7552	.6489					
.9002	-.1932	.6307	.8421	.8001	.3438	.7780	.6122					
.9501	-.0629	.6865	.7870	.8501	.4193	.7987	.5782					

TEST 167	PT 43.4745	PSI	CN .6525	CD1 .00996	CDCDR1 .00847
RUN 16	TT 96.0688	K	CM -1.1605	CD2 .00886	CDCDR2 .00843
POINT 62	RC 30.0429	MILLION	CC .0200	CD3 .00891	CDCDR3 .00865
	MACH .7612			CD4 .00854	CDCDR4 .00827
	ALPHA .5193	DEG		CD5 .00842	CDCDR5 .00819

UPPER SURFACE				LOWER SURFACE				SPANWISE				
X/C	CP	P _L /PT	MLOC	X/C	CP	P _L /PT	MLOC	X/C	Y/(B/2)	CP	P _L /PT	MLOC
0.0000	1.1554	.9999	.0109	0.0000	1.1554	.9999	.0109	.1507	.7476	-.7852	.4625	1.1137
.0132	-.1719	.6324	.8395	.0126	.4514	.8050	.5678	.1507	.4976	-.8563	.4428	1.1483
.0259	-.5436	.5294	1.0017	.0255	.2883	.7598	.6415	.1507	.2476	-.8488	.4449	1.1446
.0759	-.8175	.4536	1.1293	.0475	.1162	.7121	.7165	.1507	-.2524	-.8525	.4439	1.1464
.1003	-.8348	.4488	1.1378	.0753	.0290	.6880	.7539	.1507	-.5024	-.8622	.4412	1.1512
.1507	-.8347	.4488	1.1377	.1002	-.0613	.6630	.7924	.1507	-.7524	-.7728	.4459	1.1078
.2003	-.8191	.4531	1.1301	.1503	-.1310	.6437	.8221	.5002	.7476	-.8425	.4465	1.1415
.2503	-.8420	.4468	1.1413	.1976	-.2291	.6165	.8641	.5002	.4976	-.8192	.4531	1.1302
.3001	-.8597	.4419	1.1500	.2503	-.2881	.6002	.8894	.5002	.2476	-.8347	.4488	1.1377
.3502	-.7975	.4591	1.1197	.3001	-.3211	.5910	.9037	.5002	-.2524	-.8294	.4503	1.1351
.4003	-.7778	.4646	1.1102	.3507	-.3429	.5850	.9131	.5002	-.5024	-.8248	.4515	1.1324
.4501	-.7847	.4626	1.1135	.4001	-.3324	.5879	.9086	.5002	-.7524	-.8207	.4527	1.1369
.5002	-.8274	.4508	1.1342	.4501	-.3039	.5958	.8963	.8002	.7476	-1.0637	.3854	1.2549
.5502	-.8644	.4406	1.1523	.5001	-.2378	.6141	.8678	.8002	.4976	-.3778	.5753	.9278
.6002	-.8884	.4339	1.1642	.5497	-.1341	.6428	.8234	.8002	.2476	-.3765	.5757	.9276
.6500	-.8593	.4420	1.1498	.6003	-.0235	.6735	.7762	.8002	-.5024	-.3629	.5795	.9219
.7000	-.6509	.4997	1.0505	.6500	.0626	.6973	.7395	.8002	-.7524	-.3697	.5776	.9248
.7500	-.4524	.5547	.9611	.7000	.1780	.7292	.6898					
.8002	-.3725	.5768	.9260	.7501	.2760	.7564	.6469					
.9002	-.1744	.6316	.8407	.8001	.3585	.7793	.6102					
.9501	-.0487	.6865	.7870	.8501	.4340	.8001	.5758					

TEST 167	PT 43.4771	PSI	CN .7382	CD1 .01072	CDCDR1 .01004
RUN 16	TT 96.2176	K	CM -1.1598	CD2 .01052	CDCDR2 .00991
POINT 63	RC 29.9796	MILLION	CC .0169	CD3 .01041	CDCDR3 .01014
	MACH .7614			CD4 .01006	CDCDR4 .00974
	ALPHA 1.0329	DEG		CD5 .00980	CDCDR5 .00938

UPPER SURFACE				LOWER SURFACE				SPANWISE				
X/C	CP	P _L /PT	MLOC	X/C	CP	P _L /PT	MLOC	X/C	Y/(B/2)	CP	P _L /PT	MLOC
0.0000	1.1515	.9997	.0212	0.0000	1.1515	.9997	.0212	.1507	.7476	-.9124	.4348	1.1627
.0132	-.2849	.6065	.8795	.0126	.5339	.8036	.5239	.1507	.4976	-.9757	.4174	1.1942
.0259	-.6678	.5017	1.0472	.0255	.3628	.7838	.6028	.1507	.2476	-.9599	.4218	1.1863
.0759	-.9329	.4291	1.1728	.0495	.1851	.7352	.6805	.1507	-.2524	-.9630	.4209	1.1878
.1003	-.9500	.4245	1.1813	.0753	.0910	.7094	.7207	.1507	-.5024	-.9768	.4171	1.1948
.1507	-.9437	.4262	1.1782	.1002	-.0016	.6841	.7599	.1507	-.7524	-.9034	.4372	1.1583
.2003	-.9344	.4287	1.1736	.1503	-.0780	.6631	.7921	.5002	.7476	-.9572	.4225	1.1850
.2503	-.9551	.4231	1.1839	.1976	-.1736	.6364	.8333	.5002	.4976	-.9672	.4198	1.1900
.3001	-.9849	.4149	1.1989	.2503	-.2369	.6196	.8592	.5002	.2476	-.9262	.4310	1.1695
.3502	-.9842	.4151	1.1985	.3001	-.2722	.6100	.8741	.5002	-.2524	-.8924	.4442	1.1529
.4003	-.9229	.4319	1.1679	.3507	-.2978	.6030	.8850	.5002	-.5024	-.9626	.4210	1.1876
.4501	-.8758	.4448	1.1448	.4001	-.2933	.6042	.8831	.5002	-.7524	-.9065	.4364	1.1598
.5002	-.9160	.4338	1.1644	.4501	-.2730	.6098	.8745	.8002	.7476	-1.0553	.3957	1.2351
.5502	-.9196	.4328	1.1662	.5001	-.2149	.6257	.8498	.8002	.4976	-.3866	.5787	.9230
.6002	-.9214	.4323	1.1671	.5497	-.1185	.6521	.8092	.8002	.2476	-.3883	.5782	.9238
.6500	-.7743	.4726	1.0964	.6003	-.0132	.6809	.7648	.8002	-.5024	-.3663	.5843	.9143
.7000	-.5401	.5367	.9899	.6500	.0684	.7032	.7303	.8002	-.7524	-.3673	.5840	.9147
.7500	-.4525	.5606	.9515	.7000	.1815	.7342	.6820					
.8002	-.3806	.5803	.9205	.7501	.2780	.7606	.6402					
.9002	-.1791	.6355	.8347	.8001	.3596	.7829	.6042					
.9501	-.0525	.6701	.7814	.8501	.4347	.8035	.5702					

STANDARD SPECIFICATIONS
OF POOR QUALITY

TEST 167	PT	47.2368	PSI	CN	.8217	CD1	.01354	CDCDR1	.01300
RUN 16	TT	101.9378	K	CM	-1.6886	CD2	.01359	CDCDR2	.01315
POINT 64	RC	29.8605	MILLION	CC	.0.72	CD3	.01321	CDCDR3	.01230
	MACH	.7598				CD4	.01278	CDCDR4	.01244
	ALPHA	1.5376	DEG			CD5	.01340	CDCDR5	.01305

UPPER SURFACE				LOWER SURFACE				SPANWISE				
X/C	CP	P/L/PT	MLOC	X/C	CP	P/L/PT	MLOC	X/C	Y/(B/2)	CP	P/L/PT	MLOC
0.0000	1.1459	.9982	.0513	0.0000	1.1459	.9982	.0513	.1507	.7476	-1.0038	.4093	1.2089
.0132	-.3621	.5851	.9125	.0126	.5840	.8443	.4995	.1507	.4976	-1.0663	.3922	1.2414
.0259	-.7430	.4808	1.0820	.0255	.4089	.7963	.5818	.1507	.2476	-1.0372	.4002	1.2261
.0759	-1.0667	.0885	1.2104	.0495	.2238	.7456	.6637	.1507	-.2524	-1.0404	.3993	1.2278
.1003	-1.0250	.4035	1.2198	.0753	.1251	.7186	.7061	.1507	-.5024	-1.0562	.3950	1.2361
.1507	-1.6196	.4050	1.2170	.1002	.0329	.6933	.7452	.1507	-.7524	-.9934	.4122	1.2036
.2063	-1.0090	.4079	1.2116	.1503	-.0500	.6706	.7802	.5002	.7476	-1.0616	.3935	1.2389
.2503	-1.0345	.4009	1.2247	.1976	-.1501	.6432	.8224	.5002	.4976	-1.0704	.3911	1.2435
.3001	-1.0719	.3907	1.2443	.2503	-.2142	.6256	.8495	.5002	.2476	-1.0762	.3895	1.2466
.3502	-1.0830	.3876	1.2502	.3001	-.2552	.6144	.8669	.5002	-.2524	-1.0474	.3974	1.2315
.4003	-1.0774	.3897	1.2472	.3507	-.2832	.6067	.8788	.5002	-.5024	-1.0745	.3900	1.2457
.4501	-1.0284	.4026	1.2216	.4001	-.2837	.6066	.8790	.5002	-.7524	-1.0024	.4057	1.2082
.5002	-1.0085	.4060	1.2113	.4501	-.2692	.6105	.8729	.8002	.7476	-.9583	.4218	1.1859
.5502	-1.0411	.3991	1.2282	.5001	-.2152	.6253	.8499	.8002	.4976	-1.0524	.4278	.9084
.6002	-1.0656	.3924	1.2410	.5497	-.1223	.6508	.8107	.8002	.2476	-1.3514	.5880	.9079
.6500	-1.0162	.4059	1.2153	.6003	-.0192	.6790	.7672	.8002	-.5024	-1.3446	.5899	.9050
.7000	-.6848	.4967	1.0551	.6500	.0593	.7005	.7340	.8002	-.7524	-1.3541	.5873	.9091
.7500	-.4317	.5660	.9426	.7000	.1717	.7311	.6861					
.8002	-.3434	.5902	.9045	.7501	.2677	.7576	.6446					
.9002	-.1644	.6393	.8285	.8001	.3489	.7799	.6088					
.9501	-.0501	.6706	.7802	.8501	.4242	.8005	.5749					

TEST 167	PT	47.4599	PSI	CN	.8897	CD1	.01748	CDCDR1	.01684
RUN 16	TT	101.9402	K	CM	-1.1720	CD2	.01819	CDCDR2	.01764
POINT 65	RC	29.9732	MILLION	CC	.0158	CD3	.01771	CDCDR3	.01666
	MACH	.7586				CD4	.01807	CDCDR4	.01676
	ALPHA	2.0060	DEG			CD5	.01867	CDCDR5	.01774

UPPER SURFACE				LOWER SURFACE				SPANWISE				
X/C	CP	P/L/PT	MLOC	X/C	CP	P/L/PT	MLOC	X/C	Y/(B/2)	CP	P/L/PT	MLOC
0.0000	1.1429	.9975	.0597	0.0000	1.1429	.9975	.0597	.1507	.7476	-1.0735	.3920	1.2417
.0132	-.4338	.5669	.9413	.0126	.5489	.8626	.4660	.1507	.4976	-1.1259	.3777	1.2696
.0259	-.8233	.4604	1.1170	.0255	.4694	.8136	.5529	.1507	.2476	-1.0980	.3854	1.2546
.0759	-1.0720	.3925	1.2409	.0495	.2836	.7628	.6363	.1507	-.2524	-1.1002	.3847	1.2558
.1003	-1.0903	.3875	1.2505	.0753	.1817	.7349	.6804	.1507	-.5024	-1.1178	.3799	1.2652
.1507	-1.0821	.3897	1.2462	.1002	.0856	.7087	.7214	.1507	-.7524	-1.0557	.3969	1.2324
.2003	-1.0672	.3938	1.2484	.1503	-.0007	.6851	.7578	.5002	.7476	-1.1243	.3782	1.2687
.2503	-1.0898	.3876	1.2503	.1976	-.1010	.6577	.8000	.5002	.4976	-1.1307	.3764	1.2721
.3001	-1.1266	.3775	1.2699	.2503	-.1676	.6395	.8280	.5002	.2476	-1.1410	.3736	1.2777
.3502	-1.1417	.3734	1.2781	.3001	-.2097	.6280	.8458	.5002	-.2524	-1.1154	.3806	1.2639
.4003	-1.1435	.3729	1.2791	.3507	-.2404	.6196	.8588	.5002	-.5024	-1.1109	.3818	1.2615
.4501	-1.1330	.3758	1.2734	.4001	-.2443	.6186	.8604	.5002	-.7524	-1.0569	.3966	1.2330
.5002	-1.1052	.3834	1.2585	.4501	-.2339	.6214	.8560	.8002	.7476	-1.0973	.4375	1.1575
.5502	-1.1033	.3839	1.2574	.5001	-.1859	.6345	.8358	.8002	.4976	-1.3319	.5946	.8576
.6002	-1.1301	.3766	1.2718	.5497	-.0985	.6584	.7990	.8002	.2476	-1.3331	.5943	.8981
.6500	-1.0908	.3873	1.2508	.6003	.0001	.6853	.7575	.8002	-.5024	-1.3269	.5960	.8955
.7000	-.5792	.5271	1.0050	.6500	.0754	.7059	.7257	.8002	-.7524	-1.3355	.5937	.8991
.7500	-.4098	.5734	.9310	.7000	.1856	.7360	.6787					
.8002	-.3296	.5953	.8966	.7501	.2797	.7617	.6380					
.9002	-.1552	.6429	.8228	.8001	.3598	.7836	.6027					
.9501	-.0449	.6730	.7765	.8501	.4346	.8040	.5689					

TEST 167	PT	47.3377	PSI	CN	.9401	CD1	.02447	CDCDR1	.02365
RUN 16	TT	102.0117	K	CM	-1.1784	CD2	.02594	CDCDR2	.02527
POINT 67	RC	29.9274	MILLION	CC	.0178	CD3	.02787	CDCDR3	.02667
	MACH	.7613				CD4	.02734	CDCDR4	.02634
	ALPHA	2.5254	DEG			CD5	.02981	CDCDR5	.02509

UPPER SURFACE				LOWER SURFACE				SPANWISE				
X/C	CP	P/L/PT	MLOC	X/C	CP	P/L/PT	MLOC	X/C	Y/(B/2)	CP	P/L/PT	MLOC
0.0000	1.1403	.9964	.0725	0.0000	1.1403	.9964	.0725	.1507	.7476	-1.1173	.3756	1.2737
.0132	-.44721	.5510	.9633	.0126	.6906	.8727	.4498	.1507	.4976	-1.1642	.3627	1.2996
.0259	-.8760	.4436	1.1465	.0255	.5082	.8225	.5376	.1507	.2476	-1.1363	.3703	1.2842
.0759	-1.1098	.3776	1.2697	.0495	.3198	.7707	.6235	.1507	-.2524	-1.1370	.3702	1.2845
.1003	-1.1246	.3736	1.2777	.0753	.2151	.7420	.6694	.1507	-.5024	-1.1531	.3657	1.2934
.1507	-1.1208	.3746	1.2757	.1002	.1157	.7146	.7122	.1507	-.7524	-1.0917	.3826	1.2599
.2003	-1.1027	.3796	1.2658	.1503	.0620	.6998	.7351	.5002	.7476	-1.1717	.3606	1.3038
.2503	-1.1271	.3729	1.2791	.1976	-.0781	.6613	.7944	.5002	.4976	-1.1764	.3593	1.3064
.3001	-1.1632	.3630	1.2990	.2503	-.1479	.6421	.8240	.5002	.2476	-1.1842	.3572	1.3108
.3502	-1.1795	.3585	1.3081	.3001	-.1939	.6295	.8435	.5002	-.2524	-1.1629	.3630	1.2989
.4003	-1.1858	.3567	1.3117	.3507	-.2295	.6197	.8587	.5002	-.5024	-1.1381	.3699	1.2852
.4501	-1.1968	.3537	1.3180	.4001	-.2377	.6175	.8621	.5002	-.7524	-1.1015	.3799	1.2652
.5002	-1.2037	.3518	1.3214	.4501	-.2310	.6193	.8593	.8002	.7476	-1.0201	.4298	1.1712
.5502	-1.1474	.3618	1.3014	.5001	-.1865	.6315	.8404	.8002	.4976	-1.3496	.5867	.9101
.6002	-1.1795	.3545	1.3042	.5497	-.1011	.6550	.8042	.8002	.2476	-1.3483	.5870	.9095
.6500	-1.2017	.3524	1.3208	.6003	-.0040	.6817	.7631	.8002	-.5024	-1.3324	.5914	.9027
.7000	-.6356	.5080	1.0362	.6500	.0706	.7022	.7314					
.7500	-.4497	.5542	.9535	.7000	.1799	.7323	.6846					
.8002	-.3422	.5487	.9068	.7501	.2738	.7581	.6438					
.9002	-.1535	.6406	.8264	.8001	.3539	.7801	.6084					
.9501	-.0548	.6677	.7846	.8501	.4288	.8007	.5745					

TEST 167	PT 47.3334	PSI	CN .9734	CD1 .03144	CDCOR1 .02904
RUN 16	TT 101.4549	K	CM -1.768	CD2 .03169	CDCOR2 .02980
POINT 68	RC 29.9887	MILLION	CC .0171	CD3 .03777	CDCOR3 .03335
	MACH .7630			CD4 .03538	CDCOR4 .03134
	ALPHA 3.0215	DEG		CD5 .03146	CDCOR5 .02957

UPPER SURFACE				LOWER SURFACE				SPANWISE				
X/C	CP	P/L/PT	MLOC	X/C	CP	P/L/PT	MLOC	X/C	Y/(B/2)	CP	P/L/PT	MLOC
0.0000	1.1352	.9953	.0824	0.0000	1.1352	.9953	.0824	.1507	.7476	-1.1825	.3608	1.3035
.0132	-.5293	.5396	.9848	.0126	.7313	.8847	.4234	.1507	.4976	-1.2185	.3509	1.3237
.0259	-.9278	.4305	1.1700	.0255	.5469	.8342	.5172	.1507	.2476	-1.1908	.3585	1.3081
.0759	-1.1662	.3652	1.2944	.0495	.3555	.7818	.6055	.1507	-.2524	-1.1907	.3585	1.3081
.1003	-1.1787	.3618	1.3014	.0753	.2477	.7523	.6530	.1507	-.5024	-1.2046	.3547	1.3159
.1507	-1.1745	.3630	1.2990	.1002	.1464	.7246	.6966	.1507	-.7524	-1.1448	.3711	1.2827
.2003	-1.1541	.3685	1.2878	.1503	.0879	.7086	.7215	.5002	.7476	-1.2232	.3496	1.3264
.2503	-1.1772	.3622	1.3006	.1976	-.0538	.6698	.7814	.5002	.4976	-1.2252	.3491	1.3276
.3001	-1.2138	.3522	1.3211	.2503	-.1272	.6497	.8124	.5002	.2476	-1.2287	.3481	1.3295
.3502	-1.2289	.3481	1.3297	.3001	-.1765	.6362	.8331	.5002	-.2524	-1.2089	.3535	1.3183
.4003	-1.2354	.3463	1.3334	.3507	-.2155	.6255	.8497	.5002	-.5024	-1.1759	.3626	1.2998
.4501	-1.2511	.3420	1.3424	.4001	-.2280	.6221	.8550	.5002	-.7524	-1.1358	.3736	1.2778
.5002	-1.2863	.3323	1.3631	.4501	-.2253	.6228	.8538	.8002	.7476	-1.2232	.3496	1.3264
.5502	-1.2515	.3419	1.3427	.5001	-.1850	.6336	.8368	.8002	.4976	-1.2232	.3491	1.3276
.6002	-1.2289	.3481	1.3297	.5497	-.1024	.6565	.8019	.8002	.2476	-1.2287	.3481	1.3295
.6500	-.9469	.4252	1.1795	.6003	-.0071	.6825	.7618	.8002	-.5024	-1.3429	.5906	.9039
.7000	-.5717	.5280	1.0033	.6500	.0661	.7026	.7308	.8002	-.7524	-1.3895	.5779	.9239
.7500	-.4554	.5598	.9524	.7000	.1744	.7322	.6846					
.8002	-.3617	.5855	.9119	.7501	.2679	.7578	.6442					
.9002	-.1804	.6351	.8348	.8001	.3479	.7797	.6090					
.9501	-.0866	.6608	.7953	.8501	.4229	.8003	.5752					

TEST 167	PT 47.3410	PSI	CN .9484	CD1 .03241	CDCOR1 .03052
RUN 16	TT 101.9831	K	CM -1.765	CD2 .03236	CDCOR2 .03090
POINT 69	RC 29.9927	MILLION	CC .0194	CD3 .03830	CDCOR3 .03563
	MACH .7635			CD4 .03618	CDCOR4 .03406
	ALPHA 3.0243	DEG		CD5 .03221	CDCOR5 .03129

UPPER SURFACE				LOWER SURFACE				SPANWISE				
X/C	CP	P/L/PT	MLOC	X/C	CP	P/L/PT	MLOC	X/C	Y/(B/2)	CP	P/L/PT	MLOC
0.0000	1.1295	.9929	.1009	0.0000	1.1295	.9929	.1009	.1507	.7476	-1.1532	.3616	1.3018
.0132	-.5050	.5409	.9827	.0126	.7123	.8775	.4375	.1507	.4976	-1.1965	.3496	1.3264
.0259	-.9008	.4314	1.1684	.0255	.5289	.8268	.5302	.1507	.2476	-1.1682	.3575	1.3103
.0759	-1.1396	.3654	1.2942	.0495	.3384	.7741	.6181	.1507	-.2524	-1.1683	.3574	1.3104
.1003	-1.1540	.3614	1.3023	.0753	.2310	.7444	.6655	.1507	-.5024	-1.1812	.3538	1.3177
.1507	-1.1519	.3620	1.3011	.1002	.1310	.7168	.7088	.1507	-.7524	-1.1227	.3700	1.2848
.2003	-1.1336	.3670	1.2909	.1503	.0723	.7005	.7340	.5002	.7476	-1.2090	.3462	1.3337
.2503	-1.1573	.3605	1.3041	.1976	-.0711	.6609	.7952	.5002	.4976	-1.2113	.3455	1.3351
.3001	-1.1939	.3503	1.3250	.2503	-.1451	.6404	.8267	.5002	.2476	-1.2133	.3450	1.3362
.3502	-1.2100	.3459	1.3343	.3001	-.1955	.6265	.8482	.5002	-.2524	-1.1946	.3501	1.3254
.4003	-1.2171	.3439	1.3384	.3507	-.2357	.6154	.8654	.5002	-.5024	-1.1620	.3591	1.3068
.4501	-1.2327	.3396	1.3475	.4001	-.2486	.6118	.8709	.5002	-.7524	-1.1310	.3677	1.2894
.5002	-1.2657	.3305	1.3672	.4501	-.2460	.6125	.8698	.8002	.7476	-1.0089	.4015	1.2236
.5502	-1.2297	.3404	1.3457	.5001	-.2042	.6241	.8519	.8002	.4976	-1.0038	.3688	.9381
.6002	-1.2066	.3468	1.3323	.5497	-.1199	.6574	.8159	.8002	.2476	-1.0094	.3573	.9405
.6500	-.8736	.4389	1.1548	.6003	-.0234	.6741	.7748	.8002	-.5024	-1.3363	.5820	.9174
.7000	-.5661	.5240	1.0101	.6500	.0902	.6944	.7434	.8002	-.7524	-1.3937	.5716	.9337
.7500	-.4488	.5509	.9666	.7000	.1591	.7245	.6967					
.8002	-.3854	.5739	.9301	.7501	.2527	.7504	.6560					
.9002	-.2179	.6203	.8578	.8001	.3323	.7725	.6208					
.9501	-.1402	.6418	.8246	.8501	.4069	.7931	.5871					

TEST 167	PT 47.3393	PSI	CN .9457	CD1 .02505	CDCOR1 .02414
RUN 16	TT 101.9618	K	CM -1.802	CD2 .02665	CDCOR2 .02588
POINT 71	RC 30.0019	MILLION	CC .0177	CD3 .02863	CDCOR3 .02694
	MACH .7636			CD4 .02827	CDCOR4 .02693
	ALPHA 2.5152	DEG		CD5 .02685	CDCOR5 .02628

UPPER SURFACE				LOWER SURFACE				SPANWISE				
X/C	CP	P/L/PT	MLOC	X/C	CP	P/L/PT	MLOC	X/C	Y/(B/2)	CP	P/L/PT	MLOC
0.0000	1.1449	.9976	.0594	0.0000	1.1449	.9976	.0594	.1507	.7476	-1.1146	.3756	1.2737
.0132	-.4460	.5558	.9589	.0126	.7001	.8751	.4422	.1507	.4976	-1.1592	.3633	1.2983
.0259	-.8578	.4463	1.1417	.0255	.5171	.8247	.5338	.1507	.2476	-1.1276	.3720	1.2808
.0759	-1.0984	.3798	1.2654	.0495	.3323	.7739	.6185	.1507	-.2524	-1.1250	.3727	1.2797
.1003	-1.1159	.3753	1.2744	.0753	.2283	.7453	.6642	.1507	-.5024	-1.1418	.3681	1.2886
.1507	-1.1127	.3761	1.2727	.1002	.1265	.7172	.7081	.1507	-.7524	-1.0820	.3846	1.2561
.2003	-1.0935	.3814	1.2623	.1503	.0536	.6972	.7397	.5002	.7476	-1.1626	.3624	1.3002
.2503	-1.1194	.3743	1.2763	.1976	-.0647	.6646	.7895	.5002	.4976	-1.1681	.3609	1.3033
.3001	-1.1582	.3642	1.2966	.2503	-.1357	.6451	.8195	.5002	.2476	-1.1756	.3588	1.3074
.3502	-1.1768	.3585	1.3082	.3001	-.1796	.6330	.8382	.5002	-.2524	-1.1505	.3657	1.2934
.4003	-1.1838	.3566	1.3121	.3507	-.2193	.6232	.8533	.5002	-.5024	-1.1269	.3722	1.2805
.4501	-1.1957	.3533	1.3189	.4001	-.2226	.6211	.8565	.5002	-.7524	-1.0903	.3823	1.2605
.5002	-1.2024	.3515	1.3226	.4501	-.2193	.6232	.8533	.8002	.7476	-1.0007	.4372	1.1579
.5502	-1.1831	.3623	1.3009	.5001	-.1710	.6354	.8345	.8002	.4976	-1.0339	.5905	.9041
.6002	-1.1740	.3593	1.3066	.5497	-.0860	.6588	.7984	.8002	.2476	-1.0367	.5897	.9053
.6500	-1.1981	.3526	1.3202	.6003	.0108	.6854	.7574	.8002	-.5024	-1.3169	.5952	.8968
.7000	-.6174	.5125	1.0290	.6500	.0857	.7060	.7253	.8002	-.7524	-1.3412	.5885	.9072
.7500	-.4342	.5629	.9475	.7000	.1948	.7360	.6787					
.8002	-.3306	.5914	.9027	.7501	.2883	.7618	.6379					
.9002	-.1437	.6423	.8238	.8001	.3681	.7837	.6025					
.9501	-.0509	.6684	.7836	.8501	.4429	.8043	.5684					

ORIGINAL SOURCE
OF POOR QUALITY

TEST 167	PT 47.3343	PSI	CN .8827	CD1 .02017	CDCOR1 .01869
RUN 16	TT 102.0314	K	CM -1.1786	CD2 .02081	CDCOR2 .01952
POINT 72	RC 29.9756	MILLION	CC .0195	CD3 .01998	CDCOR3 .01794
	MACH .7639			CD4 .02024	CDCOR4 .01807
	ALPHA 2.0060	DEG		CD5 .02063	CDCOR5 .01911

UPPER SURFACE				LOWER SURFACE				SPANWISE				
X/C	CP	P _L /PT	MLOC	X/C	CP	P _L /PT	MLOC	X/C	Y/(B/2)	CP	P _L /PT	MLOC
0.0000	1.1465	.9975	.0596	0.0000	1.1465	.9975	.0596	.1507	.7476	-1.0465	.3901	1.2455
.0132	-.3925	.5712	.9343	.0126	.6338	.8555	.4791	.1507	.4976	-1.0998	.3753	1.2743
.0259	-.7790	.4642	1.1104	.0255	.4552	.8066	.5656	.1507	.2476	-1.0650	.3849	1.2554
.0759	-1.0324	.3940	1.2379	.0495	.2697	.7547	.6493	.1507	-.2524	-1.0659	.3847	1.2559
.1003	-1.0523	.3885	1.2485	.0753	.1686	.7266	.6934	.1507	-.5024	-1.0829	.3800	1.2651
.1507	-1.0483	.3896	1.2464	.1002	.0721	.6999	.7349	.1507	-.7524	-1.0200	.3974	1.2314
.2003	-1.0346	.3934	1.2391	.1503	.0052	.6814	.7636	.5002	.7476	-1.1055	.3737	1.2774
.2503	-1.0628	.3855	1.2542	.1976	-.1165	.6477	.8155	.5002	.4976	-1.1113	.3721	1.2806
.3001	-1.1016	.3748	1.2753	.2503	-.1839	.6290	.8442	.5002	.2476	-1.1192	.3699	1.2850
.3502	-1.1204	.3696	1.2856	.3001	-.2271	.6170	.8628	.5002	-.2524	-1.1033	.3743	1.2762
.4003	-1.1270	.3678	1.2893	.3507	-.2595	.6081	.8767	.5002	-.5024	-1.0932	.3771	1.2707
.4501	-1.1237	.3687	1.2975	.4001	-.2636	.6069	.8784	.5002	-.7524	-1.0411	.3916	1.2426
.5002	-1.0928	.3772	1.2705	.4501	-.2520	.6101	.8734	.8002	.7476	-.9147	.4266	1.1771
.5502	-1.0862	.3791	1.2679	.5001	-.2019	.6240	.8520	.8002	.4976	-.9340	.4587	.9115
.6002	-1.1169	.3706	1.2837	.5497	-.1115	.6491	.8133	.8002	.2476	-.9349	.5852	.9123
.6500	-1.1645	.3574	1.3104	.6003	-.0106	.6770	.7703	.8002	-.5024	-.9330	.5877	.9084
.7000	-.8315	.4496	1.1358	.6500	.0669	.6985	.7372	.8002	-.7524	-.9345	.5842	.9139
.7500	-.4627	.5518	.9652	.7000	.1780	.7293	.6893					
.8002	-.3412	.5854	.9120	.7501	.2728	.7555	.6479					
.9002	-.1484	.6388	.8291	.8001	.3532	.7778	.6121					
.9501	-.0471	.6669	.7859	.8501	.4281	.7985	.5781					

TFST 167	PT 47.3333	PSI	CN .8053	CD1 .01337	CDCOR1 .01295
PUN 16	TT 101.9792	K	CM -1.1694	CD2 .01320	CDCOR2 .01287
POINT 73	RC 29.9294	MILLION	CC .0185	CD3 .01294	CDCOR3 .01259
	MACH .7609			CD4 .01251	CDCOR4 .01201
	ALPHA 1.4256	DEG		CD5 .01287	CDCOR5 .01237

UPPER SURFACE				LOWER SURFACE				SPANWISE				
X/C	CP	P _L /PT	MLOC	X/C	CP	P _L /PT	MLOC	X/C	Y/(B/2)	CP	P _L /PT	MLOC
0.0000	1.1464	.9977	.0577	0.0000	1.1464	.9977	.0577	.1507	.7476	-.9561	.4139	1.2004
.0132	-.3271	.5905	.9041	.0126	.5737	.8394	.5081	.1507	.4976	-1.0308	.3960	1.2340
.0259	-.7062	.4857	1.0735	.0255	.3996	.7913	.5901	.1507	.2476	-1.0037	.4035	1.2198
.0759	-.9722	.4122	1.2035	.0495	.2166	.7407	.6713	.1507	-.2524	-1.0076	.4024	1.2219
.1003	-.9911	.4070	1.2133	.0753	.1193	.7138	.7134	.1507	-.5024	-1.0234	.3981	1.2301
.1507	-.9847	.4082	1.2110	.1002	.0260	.6881	.7533	.1507	-.7524	-1.0609	.4154	1.1977
.2003	-.9761	.4111	1.2055	.1503	-.0348	.6712	.7792	.5002	.7476	-1.0328	.3955	1.2351
.2503	-1.0038	.4035	1.2199	.1976	-.1551	.6380	.8304	.5002	.4976	-1.0412	.3931	1.2395
.3001	-1.0402	.3934	1.2390	.2503	-.2185	.6205	.8574	.5002	.2476	-1.0447	.3922	1.2414
.3502	-1.0528	.3899	1.2457	.3001	-.2587	.6094	.8746	.5002	-.2524	-1.0147	.4005	1.2256
.4003	-1.0423	.3929	1.2401	.3507	-.2861	.6018	.8864	.5002	-.5024	-1.0476	.3914	1.2429
.4501	-.9849	.4087	1.2100	.4001	-.2854	.6020	.8861	.5002	-.7524	-.9740	.4117	1.2044
.5002	-.9799	.4101	1.2075	.4501	-.2685	.6067	.8788	.8002	.7476	-.9444	.4199	1.1893
.5502	-1.0153	.4003	1.2259	.5001	-.2137	.6218	.8553	.8002	.4976	-.9343	.5857	.9115
.6002	-1.0397	.3936	1.2388	.5497	-.1197	.6478	.8153	.8002	.2476	-.9349	.5858	.9114
.6500	-1.0306	.3961	1.2339	.6003	-.0138	.6765	.7711	.8002	-.5024	-.9356	.5881	.9078
.7000	-.7477	.4743	1.0930	.6500	.0638	.6985	.7371	.8002	-.7524	-.9346	.5852	.9123
.7500	-.4350	.5607	.9511	.7000	.1760	.7295	.6889					
.8002	-.3379	.5875	.9087	.7501	.2719	.7560	.6471					
.9002	-.1576	.6373	.8314	.8001	.3529	.7784	.6112					
.9501	-.0453	.6684	.7836	.8501	.4277	.7991	.5772					

TEST 167	PT 43.5212	PSI	CN .7131	CD1 .00935	CDCOR1 .00907
RUN 16	TT 96.1293	K	CM -1.1549	CD2 .00922	CDCOR2 .00888
POINT 75	RC 29.9309	MILLION	CC .0165	CD3 .00920	CDCOR3 .00895
	MACH .7562			CD4 .00888	CDCOR4 .00856
	ALPHA .9470	DEG		CD5 .00886	CDCOR5 .00841

UPPER SURFACE				LOWER SURFACE				SPANWISE				
X/C	CP	P _L /PT	MLOC	X/C	CP	P _L /PT	MLOC	X/C	Y/(B/2)	CP	P _L /PT	MLOC
0.0000	1.1475	.9989	.0403	0.0000	1.1475	.9989	.0403	.1507	.7476	-.9008	.4404	1.1526
.0132	-.2814	.6093	.8753	.0126	.5139	.8261	.5318	.1507	.4976	-.9795	.4189	1.1915
.0259	-.6671	.5041	1.0432	.0255	.3475	.7807	.6078	.1507	.2476	-.9600	.4243	1.1817
.0759	-.9330	.4316	1.1684	.0495	.1690	.7321	.6854	.1507	-.2524	-.9623	.4236	1.1829
.1003	-.9484	.4274	1.1760	.0753	.0745	.7063	.7255	.1507	-.5024	-.9763	.4198	1.1899
.1507	-.9415	.4293	1.1726	.1002	-.0160	.6816	.7636	.1507	-.7524	-.8978	.4412	1.1511
.2003	-.9288	.4327	1.1663	.1503	-.0720	.6663	.7872	.5002	.7476	-.8987	.4410	1.1516
.2503	-.9514	.4266	1.1775	.1976	-.1903	.6341	.8368	.5002	.4976	-.9135	.4369	1.1588
.3001	-.9790	.4191	1.1912	.2503	-.2494	.6180	.8617	.5002	.2476	-.9690	.4470	1.1373
.3502	-.9653	.4228	1.1844	.3001	-.2451	.6082	.8768	.5002	-.2524	-.8529	.4534	1.1295
.4003	-.8724	.4481	1.1389	.3507	-.3100	.6015	.8874	.5002	-.5024	-.9141	.4368	1.1591
.4501	-.8441	.4538	1.1253	.4001	-.3050	.6028	.8853	.5002	-.7524	-.8641	.4504	1.1349
.5002	-.8602	.4514	1.1330	.4501	-.2846	.6084	.8766	.8002	.7476	-1.1020	.3855	1.2546
.5502	-.8526	.4535	1.1294	.5001	-.2257	.6244	.8518	.8002	.4976	-.9030	.5761	.9271
.6002	-.8241	.4602	1.1177	.5497	-.1287	.6509	.8109	.8002	.2476	-.9046	.5757	.9278
.6500	-.7244	.4885	1.0693	.6003	-.0229	.6798	.7665	.8002	-.5024	-.9799	.5824	.9172
.7000	-.5694	.5307	.9995	.6500	.0592	.7021	.7320	.8002	-.7524	-.9806	.5814	.9174
.7500	-.4750	.5565	.9581	.7000	.1725	.7330	.6839					
.8002	-.3941	.5785	.9233	.7501	.2692	.7594	.6421					
.9002	-.1864	.6352	.8352	.8001	.3507	.7816	.6063					
.9501	-.0571	.6704	.7809	.8501	.4258	.8021	.5726					

TEST 167	PT 43.3191	PSI	CM	.6633	CD1	.00915	CDCOR1	.00880
RUN 16	TT 96.1314	K	CM	-.1608	CD2	.00911	CDCOR2	.00880
POINT 76	RC 30.0551	MILLION	CC	.0203	CD3	.00910	CDCOR3	.00870
	MACH .7618				CD4	.00873	CDCOR4	.00844
	ALPHA .5499	DEG			CD5	.00858	CDCOR5	.00833

UPPER SURFACE				LOWER SURFACE				SPANWISE				
X/C	CP	P/L/PT	MLOC	X/C	CP	P/L/PT	MLOC	X/C	Y/(B/2)	CP	P/L/PT	MLOC
0.0000	1.1479	.9978	.0562	0.0000	1.1479	.9978	.0562	.1507	.7476	-.7981	.4587	1.1203
.0132	-.1808	.6297	.8436	.0126	.4454	.8032	.5707	.1507	.4976	-.8725	.4381	1.1567
.0259	-.5548	.5261	1.0070	.0255	.2852	.7588	.6431	.1507	.2476	-.8634	.4406	1.1522
.0759	-.8301	.4498	1.1359	.0495	.1115	.7107	.7187	.1507	-.2524	-.8661	.4399	1.1535
.1003	-.8469	.4452	1.1441	.0753	.0225	.6860	.7568	.1507	-.5024	-.8731	.4379	1.1570
.1507	-.8481	.4449	1.1447	.1002	-.0658	.6616	.7945	.1507	-.7524	-.8764	.4420	1.1147
.2003	-.8368	.4480	1.1392	.1503	-.1170	.6474	.8164	.1507	-.9924	-.8840	.4404	1.1525
.2503	-.8561	.4426	1.1486	.1976	-.2364	.6143	.8675	.1507	-.9976	-.8842	.4465	1.1418
.3001	-.8771	.4368	1.1590	.2303	-.2944	.5982	.8924	.1507	-.9976	-.8846	.4447	1.1449
.3502	-.8238	.4516	1.1328	.3001	-.2387	.6137	.8684	.1507	-.2524	-.8405	.4470	1.1410
.4003	-.7883	.4614	1.1156	.3507	-.3511	.5825	.9170	.1507	-.5024	-.8527	.4436	1.1470
.4501	-.7985	.4586	1.1205	.4001	-.3414	.5852	.9128	.1507	-.7524	-.8396	.4472	1.1405
.5002	-.8390	.4474	1.1402	.4501	-.3138	.5929	.9008	.1507	-.9924	-.8396	.4472	1.1405
.5502	-.8773	.4368	1.1591	.5001	-.2472	.6113	.8721	.8002	.4976	-1.0681	.3839	1.2578
.6002	-.9072	.4285	1.1741	.5497	-.1434	.6401	.8277	.8002	.4976	-1.3806	.5744	.9298
.6500	-.8968	.4314	1.1689	.6003	-.0330	.6707	.7805	.8002	.2476	-.3770	.5754	.9283
.7000	-.6999	.4859	1.0737	.6500	.0527	.6944	.7439	.8002	-.5024	-.3694	.5786	.9232
.7500	-.4554	.5537	.9627	.7000	.1680	.7264	.6943	.8002	-.7524	-.3763	.5756	.9280
.8002	-.3696	.5774	.9250	.7501	.2659	.7535	.6516					
.9002	-.1772	.6307	.8421	.8001	.3481	.7763	.6150					
.9501	-.0522	.6653	.7487	.8501	.4232	.7971	.5810					

TEST 167	PT 43.6194	PSI	CM	.5692	CD1	.00842	CDCOR1	.00806
RUN 16	TT 96.1200	K	CM	-.1566	CD2	.00830	CDCOR2	.00799
POINT 77	RC 30.0585	MILLION	CC	.0211	CD3	.00831	CDCOR3	.00812
	MACH .7586				CD4	.00812	CDCOR4	.00792
	ALPHA .0000	DEG			CD5	.00801	CDCOR5	.00779

UPPER SURFACE				LOWER SURFACE				SPANWISE				
X/C	CP	P/L/PT	MLOC	X/C	CP	P/L/PT	MLOC	X/C	Y/(B/2)	CP	P/L/PT	MLOC
0.0000	1.1423	.9970	.0653	0.0000	1.1423	.9970	.0653	.1507	.7476	-.8799	.4975	1.0542
.0132	-.1006	.6563	.8026	.0126	.3610	.7829	.6043	.1507	.4976	-.8856	.4959	1.0568
.0259	-.4720	.5545	.9613	.0255	.2088	.7411	.6711	.1507	.2476	-.7259	.4849	1.0754
.0759	-.7411	.4807	1.0824	.0495	.0438	.6965	.7408	.1507	-.2524	-.7310	.4835	1.0777
.1003	-.7641	.4744	1.0932	.0753	-.0361	.6740	.7754	.1507	-.5024	-.6803	.4974	1.0544
.1507	-.7191	.4868	1.0722	.1002	-.1233	.6501	.8122	.1507	-.7524	-.6815	.5026	1.0458
.2003	-.7002	.4919	1.0635	.1503	-.1856	.6330	.8385	.1507	-.9924	-.7258	.4849	1.0753
.2503	-.6760	.4986	1.0524	.1976	-.2809	.6069	.8790	.1507	-.9976	-.7338	.4827	1.0791
.3001	-.7249	.4852	1.0749	.2303	-.3358	.5918	.9025	.1507	-.9976	-.7391	.4813	1.0815
.3502	-.7368	.4819	1.0804	.3001	-.2748	.6086	.8764	.1507	-.2524	-.7204	.4864	1.0728
.4003	-.7340	.4827	1.0792	.3507	-.3812	.5794	.9219	.1507	-.5024	-.7224	.4859	1.0737
.4501	-.7284	.4842	1.0765	.4001	-.3649	.5839	.9149	.1507	-.7524	-.7068	.4901	1.0665
.5002	-.7398	.4811	1.0818	.4501	-.3312	.5931	.9005	.1507	-.9924	-.7116	.4778	1.2697
.5502	-.7539	.4772	1.0884	.5001	-.2596	.6127	.8699	.8002	.4976	-1.4034	.5733	.9315
.6002	-.7644	.4743	1.0934	.5497	-.1520	.6422	.8244	.8002	.2476	-.4072	.5723	.9332
.6500	-.7526	.4776	1.0878	.6003	-.0387	.6733	.7765	.8002	.2476	-.3774	.5804	.9203
.7000	-.6503	.5056	1.0407	.6500	.0527	.6975	.7391	.8002	-.5024	-.3833	.5788	.9228
.7500	-.5007	.5466	.9739	.7000	.1663	.7295	.6894					
.8002	-.4035	.5733	.9316	.7501	.2654	.7566	.6465					
.9002	-.1913	.6315	.8409	.8001	.3483	.7794	.6100					
.9501	-.0622	.6668	.7864	.8501	.4236	.8000	.5760					

TEST 167	PT 43.5216	PSI	CM	.4845	CD1	.00818	CDCOR1	.00798
RUN 16	TT 96.1175	K	CM	-.1532	CD2	.00811	CDCOR2	.00789
POINT 78	RC 29.9764	MILLION	CC	.0223	CD3	.00811	CDCOR3	.00797
	MACH .7579				CD4	.00795	CDCOR4	.00779
	ALPHA -.4888	DEG			CD5	.00780	CDCOR5	.00758

UPPER SURFACE				LOWER SURFACE				SPANWISE				
X/C	CP	P/L/PT	MLOC	X/C	CP	P/L/PT	MLOC	X/C	Y/(B/2)	CP	P/L/PT	MLOC
0.0000	1.1293	.9934	.0975	0.0000	1.1293	.9934	.0975	.1507	.7476	-.5909	.5214	1.0147
.0132	-.0103	.6863	.7564	.0126	.2617	.7553	.6486	.1507	.4976	-.6188	.5137	1.0273
.0259	-.3541	.5864	.9110	.0255	.1232	.7173	.7084	.1507	.2476	-.6222	.5128	1.0288
.0759	-.6330	.5098	1.0337	.0495	-.0336	.6743	.7749	.1507	-.2524	-.6314	.5103	1.0330
.1003	-.5981	.5194	1.0180	.0753	-.1098	.6534	.8071	.1507	-.5024	-.6236	.5124	1.0295
.1507	-.6197	.5135	1.0277	.1002	-.1884	.6318	.8404	.1507	-.7524	-.6354	.5201	1.0168
.2003	-.6022	.5183	1.0198	.1503	-.2458	.6161	.8647	.1507	-.9924	-.6481	.4963	1.0561
.2503	-.6186	.5138	1.0272	.1976	-.3409	.5900	.9033	.1507	-.9976	-.6590	.4945	1.0593
.3001	-.6671	.5005	1.0482	.2303	-.3913	.5761	.9270	.1507	-.9976	-.6695	.4930	1.0618
.3502	-.6705	.4995	1.0508	.3001	-.3245	.5945	.8983	.1507	-.2524	-.6810	.4967	1.0556
.4003	-.6451	.5065	1.0392	.3507	-.4291	.5658	.9434	.1507	-.5024	-.6871	.4950	1.0584
.4501	-.6354	.5092	1.0348	.4001	-.4062	.5721	.9335	.1507	-.7524	-.6833	.5015	1.0475
.5002	-.6854	.4954	1.0576	.4501	-.3649	.5834	.9157	.1507	-.9924	-.6871	.4950	1.0584
.5502	-.7253	.4845	1.0761	.5001	-.2853	.6032	.8815	.8002	.4976	-1.1226	.3755	1.2743
.6002	-.7381	.4810	1.0820	.5497	-.1721	.6363	.8335	.8002	.4976	-1.4022	.5732	.9317
.6500	-.7319	.4827	1.0791	.6003	-.0543	.6686	.7837	.8002	.2476	-.4058	.5722	.9333
.7000	-.6436	.5069	1.0385	.6500	.0369	.6937	.7451	.8002	-.5024	-.3811	.5789	.9226
.7500	-.4931	.5462	.9714	.7000	.1553	.7262	.6945	.8002	-.7524	-.3877	.5771	.9255
.8002	-.3992	.5740	.9305	.7501	.2564	.7539	.6509					
.9002	-.1879	.6320	.8402	.8001	.3401	.7768	.6141					
.9501	-.0555	.6683	.7842	.8501	.4152	.7975	.5803					

GENERAL STATEMENT
OF POOR QUALITY

TEST 167	PT	43.5181	PSI	CM	.4120	CD1	.00802	CDCOR1	.00788
RUN 16	TT	96.2094	K	CM	-.1513	CD2	.00794	CDCOR2	.00785
POINT 79	RC	29.9608	MILLION	CC	.0225	CD3	.00792	CDCOR3	.00791
	MACH	.7592				CD4	.00784	CDCOR4	.00783
	ALPHA	-1.0081	DEG			CD5	.00771	CDCOR5	.00760

UPPER SURFACE				LOWER SURFACE				SPANWISE				
X/C	CP	P/L/PT	MLOC	X/C	CP	P/L/PT	MLOC	X/C	Y/(B/2)	CP	P/L/PT	MLOC
0.0000	1.0975	.9851	.1472	0.0000	1.0975	.9851	.1472	.1507	.7476	-.5159	.5444	.9775
.0132	.1039	.7137	.7140	.0126	.1926	.7270	.6933	.1507	.4976	-.5397	.5379	.9879
.0259	-.2550	.6157	.8654	.0255	-.0273	.6928	.7464	.1507	.2476	-.5418	.5373	.9889
.0759	-.5212	.5430	.9798	.0495	-.1177	.6932	.8075	.1507	-.2524	-.5554	.5336	.9948
.1003	-.5173	.5440	.9781	.0753	-.1865	.6344	.8364	.1507	-.5024	-.5518	.5346	.9933
.1507	-.5403	.5377	.9882	.1002	-.2604	.6142	.8677	.1507	-.7524	-.5296	.5406	.9835
.2003	-.5429	.5370	.9893	.1503	-.3086	.6010	.8881	.5002	.7476	-.6488	.5081	1.0366
.2503	-.5694	.5298	1.0011	.1976	-.4029	.5753	.9284	.5002	.4976	-.6572	.5058	1.0404
.3001	-.6045	.5202	1.0167	.2503	-.4489	.5627	.9483	.5002	.2476	-.6651	.5037	1.0439
.3502	-.5844	.5257	1.0077	.3001	-.3756	.5827	.9167	.5002	-.2524	-.6528	.5070	1.0384
.4003	-.5975	.5221	1.0135	.3507	-.4749	.5556	.9595	.5002	-.5024	-.6523	.5071	1.0382
.4501	-.6174	.5167	1.0225	.4001	-.4438	.5641	.9481	.5002	-.7524	-.6225	.5153	1.0247
.5002	-.6589	.5053	1.0411	.4501	-.3952	.5774	.9251	.8002	.7476	-1.1593	.3687	1.2879
.5502	-.6757	.5008	1.0487	.5001	-.3099	.6007	.8886	.8002	.4976	-.4145	.5721	.9334
.6002	-.6865	.4978	1.0537	.5497	-.1923	.6328	.8389	.8002	.2476	-.4177	.5712	.9348
.6500	-.7007	.4939	1.0602	.6003	-.0713	.6658	.7879	.8002	-.5024	-.3890	.5791	.9224
.7000	-.6352	.5114	1.0305	.6500	.0220	.6913	.7479	.8002	-.7524	-.3943	.5776	.9247
.7500	-.5041	.5476	.9723	.7000	.1422	.7241	.6977					
.8002	-.4099	.5734	.9314	.7501	.2441	.7520	.6539					
.9002	-.1973	.6314	.8410	.8001	.3280	.7749	.6172					
.9501	-.0623	.6683	.7842	.8501	.4029	.7954	.5838					

TEST 167	PT	43.5202	PSI	CM	.3448	CD1	.00792	CDCOR1	.00791
RUN 16	TT	96.1559	K	CM	-.1505	CD2	.00782	CDCOR2	.00785
POINT 80	RC	29.9859	MILLION	CC	.0219	CD3	.00779	CDCOR3	.00786
	MACH	.7593				CD4	.00775	CDCOR4	.00783
	ALPHA	-1.4867	DEG			CD5	.00759	CDCOR5	.00753

UPPER SURFACE				LOWER SURFACE				SPANWISE				
X/C	CP	P/L/PT	MLOC	X/C	CP	P/L/PT	MLOC	X/C	Y/(B/2)	CP	P/L/PT	MLOC
0.0000	1.0584	.9743	.1941	0.0000	1.0584	.9743	.1941	.1507	.7476	-.4424	.5640	.9463
.0132	.2023	.7402	.6725	.0126	.0408	.6961	.7413	.1507	.4976	-.4614	.5588	.9545
.0259	-.1478	.6445	.8208	.0255	-.0685	.6662	.7874	.1507	.2476	-.4620	.5586	.9548
.0759	-.4211	.5698	.9371	.0495	-.1972	.6310	.8416	.1507	-.2524	-.4721	.5558	.9592
.1003	-.4296	.5675	.9407	.0753	-.2575	.6145	.8671	.1507	-.5024	-.4710	.5561	.9587
.1507	-.4608	.5589	.9543	.1002	-.3277	.5993	.8970	.1507	-.7524	-.4516	.5615	.9503
.2003	-.4868	.5518	.9656	.1503	-.3656	.5890	.9132	.5002	.7476	-.5982	.5214	1.0148
.2503	-.5058	.5466	.9739	.1976	-.4604	.5590	.9341	.5002	.4976	-.6033	.5200	1.0171
.3001	-.5371	.5381	.9877	.2503	-.5035	.5473	.9729	.5002	.2476	-.6102	.5181	1.0201
.3502	-.5412	.5369	.9895	.3001	-.4227	.5694	.9377	.5002	-.2524	-.6017	.5231	1.0119
.4003	-.5539	.5335	.9951	.3507	-.5149	.5442	.9779	.5002	-.5024	-.5910	.5233	1.0116
.4501	-.5727	.5283	1.0034	.4001	-.4725	.5557	.9593	.5002	-.7524	-.5684	.5295	1.0015
.5002	-.6063	.5191	1.0184	.4501	-.4144	.5716	.9342	.8002	.7476	-1.1450	.3719	1.2815
.5502	-.6301	.5127	1.0291	.5001	-.3221	.5949	.8946	.8002	.4976	-.4084	.5733	.9316
.6002	-.6558	.5056	1.0407	.5497	-.2001	.6302	.8428	.8002	.2476	-.4131	.5720	.9336
.6500	-.6706	.5016	1.0474	.6003	-.0760	.6641	.7906	.8002	-.5024	-.3783	.5815	.9186
.7000	-.6139	.5171	1.0218	.6500	.0198	.6903	.7503	.8002	-.7524	-.3823	.5804	.9204
.7500	-.4996	.5483	.9712	.7000	.1412	.7235	.6987					
.8002	-.4079	.5734	.9314	.7501	.2435	.7515	.6547					
.9002	-.1972	.6310	.8416	.8001	.3274	.7744	.6180					
.9501	-.0640	.6674	.7855	.8501	.4017	.7947	.5848					

TEST 167	PT	43.5207	PSI	CM	.2687	CD1	.00783	CDCOR1	.00779
RUN 16	TT	96.4688	K	CM	-.1478	CD2	.00777	CDCOR2	.00774
POINT 81	RC	29.8232	MILLION	CC	.0205	CD3	.00774	CDCOR3	.00779
	MACH	.7583				CD4	.00774	CDCOR4	.00773
	ALPHA	-1.9859	DEG			CD5	.00755	CDCOR5	.00744

UPPER SURFACE				LOWER SURFACE				SPANWISE				
X/C	CP	P/L/PT	MLOC	X/C	CP	P/L/PT	MLOC	X/C	Y/(B/2)	CP	P/L/PT	MLOC
0.0000	1.0126	.9620	.2368	0.0000	1.0126	.9620	.2368	.1507	.7476	-.3736	.5838	.9149
.0132	.2989	.7673	.6294	.0126	-.0869	.6621	.7937	.1507	.4976	-.3899	.5794	.9219
.0259	-.0427	.6741	.7752	.0255	-.1753	.6380	.8309	.1507	.2476	-.3887	.5797	.9214
.0759	-.3277	.5964	.8953	.0495	-.2928	.6059	.8805	.1507	-.2524	-.4004	.5765	.9264
.1003	-.3473	.5910	.9036	.0753	-.3438	.5920	.9022	.1507	-.5024	-.4008	.5764	.9265
.1507	-.3841	.5799	.9211	.1002	-.4071	.5747	.9292	.1507	-.7524	-.3846	.5809	.9196
.2003	-.4110	.5736	.9309	.1503	-.4336	.5675	.9407	.5002	.7476	-.5531	.5349	.9517
.2503	-.4461	.5641	.9461	.1976	-.5302	.5411	.9827	.5002	.4976	-.5562	.5340	.9541
.3001	-.4797	.5549	.9606	.2503	-.5692	.5305	.9998	.5002	.2476	-.5621	.5324	.9567
.3502	-.4892	.5523	.9648	.3001	-.4728	.5568	.9576	.5002	-.2524	-.5480	.5363	.9505
.4003	-.5071	.5474	.9726	.3507	-.5636	.5320	.9974	.5002	-.5024	-.5477	.5364	.9504
.4501	-.5267	.5421	.9812	.4001	-.5082	.5471	.9730	.5002	-.7524	-.5272	.5420	.9514
.5002	-.5590	.5333	.9954	.4501	-.4400	.5657	.9434	.8002	.7476	-1.1375	.3755	1.2743
.5502	-.5912	.5245	1.0096	.5001	-.3425	.5923	.9016	.8002	.4976	-.4050	.5753	.9283
.6002	-.6168	.5175	1.0210	.5497	-.2159	.6269	.8480	.8002	.2476	-.4108	.5737	.9308
.6500	-.6325	.5132	1.0281	.6003	-.0885	.6616	.7944	.8002	-.5024	-.3756	.5833	.9157
.7000	-.5850	.5262	1.0069	.6500	.0099	.6885	.7530	.8002	-.7524	-.3741	.5826	.9168
.7500	-.4941	.5510	.9669	.7000	.1330	.7221	.7010					
.8002	-.4056	.5751	.9286	.7501	.2360	.7502	.6568					
.9002	-.1973	.6320	.8401	.8001	.3203	.7732	.6200					
.9501	-.0650	.6680	.7845	.8501	.3945	.7934	.5870					

TEST 167	PT	43.5248	PSI	CM	.1159	CD1	.00814	CDCOR1	.00807
RUN 16	TT	96.1412	K	CM	-.1434	CD2	.00802	CDCOR2	.00799
POINT 82	RC	30.0305	MILLION	CC	.0149	CD3	.00794	CDCOR3	.00795
	MACH	.7606				CD4	.00791	CDCOR4	.00789
	ALPHA	-2.9836	DEG			CD5	.00769	CDCOR5	.00757

UPPER SURFACE				LOWER SURFACE				SPANWISE				
X/C	CP	P/L/PT	MLOC	X/C	CP	P/L/PT	MLOC	X/C	Y/(B/2)	CP	P/L/PT	MLOC
0.0000	.8868	.9270	.3322	0.0000	.8868	.9270	.3322	.1507	.7476	-.2418	.6176	.8623
.0132	.4809	.8157	.5496	.0128	-.3836	.5842	.9144	.1507	.4976	-.2553	.6139	.8681
.0259	.1564	.7268	.6936	.0255	-.4008	.5740	.9304	.1507	.2476	-.2528	.6146	.8670
.0759	-.1561	.6411	.8260	.0495	-.5003	.5467	.9737	.1507	-.2524	-.2635	.6117	.8716
.1003	-.1941	.6307	.8421	.0753	-.5333	.5377	.9883	.1507	-.5024	-.2657	.6110	.8725
.1507	-.2531	.6145	.8672	.1002	-.5668	.5220	1.0121	.1507	-.7524	-.2530	.6145	.8671
.2003	-.2916	.6039	.8835	.1503	-.5687	.5280	1.0260	.5002	.4976	-.4753	.5536	.9628
.2503	-.3346	.5922	.9019	.1976	-.6679	.5008	1.0487	.5002	.4976	-.4790	.5526	.9644
.3001	-.3747	.5812	.9191	.2503	-.7557	.4767	1.0893	.5002	.2476	-.4847	.5510	.9649
.3502	-.3961	.5753	.9284	.3001	-.8833	.5020	1.0488	.5002	-.2324	-.4710	.5548	.9609
.4003	-.4205	.5686	.9389	.3507	-.7400	.4810	1.0819	.5002	-.5024	-.4609	.5551	.9604
.4501	-.4430	.5624	.9487	.4001	-.9430	.5350	.9926	.5002	-.7524	-.4517	.5600	.9525
.5002	-.4817	.5518	.9656	.4501	-.4717	.5546	.9612	.8002	.7476	-1.0982	.3828	1.2599
.5502	-.5200	.5413	.9824	.5001	-.3690	.5827	.9167	.8002	.4976	-.3894	.3771	.9254
.6002	-.5515	.5327	.9963	.5497	-.2368	.6190	.8602	.8002	.2476	-.3957	.3754	.9282
.6500	-.5714	.5272	1.0052	.6003	-.1048	.6551	.8044	.8002	-.5024	-.3379	.3858	.9119
.7000	-.5410	.5356	.9917	.6500	-.0020	.6833	.7610	.8002	-.7524	-.3593	.3854	.9125
.7500	-.4736	.5541	.9620	.7000	.1226	.7175	.7081					
.8002	-.3900	.5770	.9257	.7501	.2265	.7460	.6635					
.9002	-.1906	.6316	.8406	.8001	.3103	.7690	.6288					
.9501	-.0609	.6672	.7859	.8501	.3829	.7889	.5944					

TEST 167	PT	43.4351	PSI	CM	-.0514	CD1	.01045	CDCOR1	.01038
RUN 16	TT	96.3928	K	CM	-.1365	CD2	.01024	CDCOR2	.01022
POINT 83	RC	29.8688	MILLION	CC	.0067	CD3	.00974	CDCOR3	.00996
	MACH	.7613				CD4	.00963	CDCOR4	.00963
	ALPHA	-3.9917	DEG			CD5	.00904	CDCOR5	.00886

UPPER SURFACE				LOWER SURFACE				SPANWISE				
X/C	CP	P/L/PT	MLOC	X/C	CP	P/L/PT	MLOC	X/C	Y/(B/2)	CP	P/L/PT	MLOC
0.0000	.7391	.8866	.4200	0.0000	.7391	.8866	.4200	.1507	.7476	-.1303	.6482	.8150
.0132	.6319	.8572	.4764	.0128	-.8847	.5018	1.0470	.1507	.4976	-.1434	.6446	.8256
.0259	.3221	.7722	.6215	.0255	-.6096	.5169	1.0221	.1507	.2476	-.1398	.6456	.8190
.0759	-.0121	.6806	.7651	.0495	-.7591	.4759	1.0906	.1507	-.2524	-.1503	.6428	.8235
.1003	-.0650	.6661	.7875	.0753	-.7817	.4697	1.1013	.1507	-.5024	-.1537	.6418	.8249
.1507	-.1388	.6456	.8190	.1002	-.8099	.4620	1.1146	.1507	-.7524	-.1451	.6442	.8213
.2003	-.1906	.6317	.8405	.1503	-.7961	.4637	1.1081	.5002	.7476	-.4066	.5725	.9327
.2503	-.2409	.6179	.8618	.1976	-.8182	.4597	1.1186	.5002	.4976	-.4103	.5715	.9343
.3001	-.2862	.6055	.8811	.2503	-.8416	.4533	1.1298	.5002	.2476	-.4157	.5700	.9367
.3502	-.3117	.5985	.8919	.3001	-.7648	.4743	1.0933	.5002	-.2324	-.4041	.5732	.9327
.4003	-.3424	.5901	.9051	.3507	-.9944	.4114	1.2054	.5002	-.5024	-.4026	.5736	.9310
.4501	-.3691	.5828	.9165	.4001	-1.0391	.3991	1.2284	.5002	-.7524	-.3863	.5781	.9240
.5002	-.4120	.5710	.9351	.4501	-.4461	.5562	.9586	.8002	.7476	-1.0490	.3964	1.2336
.5502	-.4532	.5597	.9530	.5001	-.3462	.5891	.9067	.8002	.4976	-.3776	.3805	.9202
.6002	-.4877	.5503	.9680	.5497	-.2396	.6183	.8613	.8002	.2476	-.3830	.3790	.9225
.6500	-.5110	.5439	.9783	.6003	-.1175	.6518	.8096	.8002	-.5024	-.3451	.3894	.9062
.7000	-.4990	.5472	.9730	.6500	-.0165	.6794	.7670	.8002	-.7524	-.3457	.3892	.9065
.7500	-.4502	.5605	.9517	.7000	.1046	.7126	.7137					
.8002	-.3764	.5808	.9197	.7501	.2065	.7405	.6720					
.9002	-.1903	.6317	.8404	.8001	.2888	.7631	.6362					
.9501	-.0644	.6663	.7872	.8501	.3600	.7826	.6046					

TEST 167
 RUN 9
 MACH .760
 R 40.0×10^6

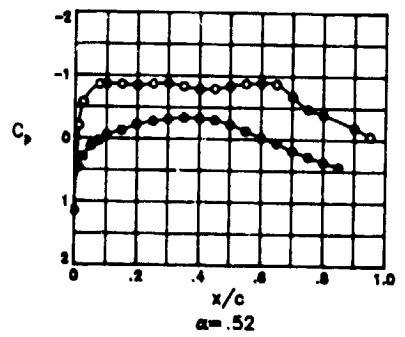
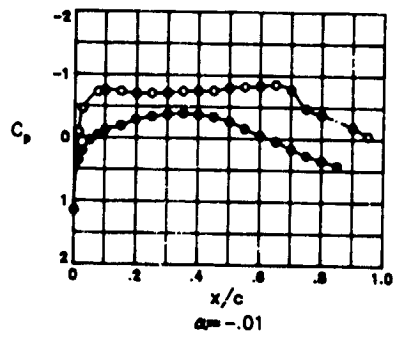
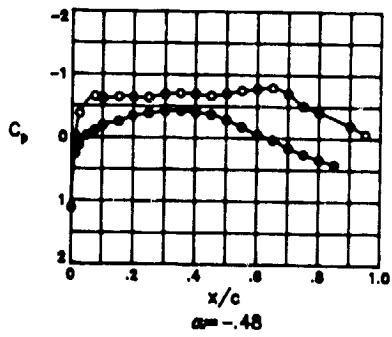
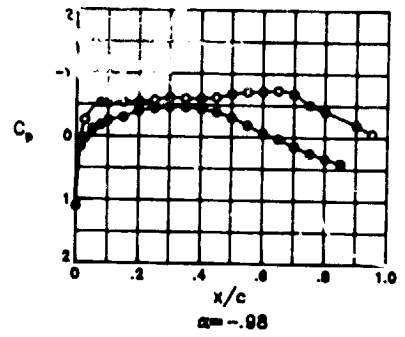
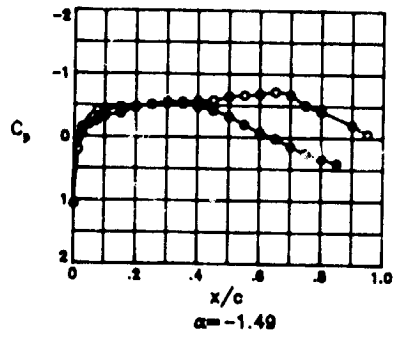
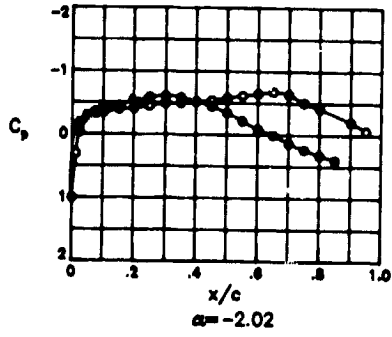
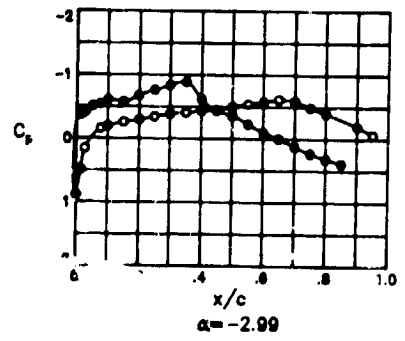
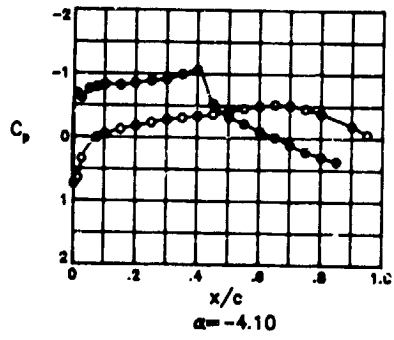

ORIGINAL PLOT
 OF POOR QUALITY

TEST 167	PT 63.3847	PSI	CM	-0.0657	CD1	.01088	CDCOR1	.01085
RUN 9	TT 102.4781	K	CM	-0.1395	CD2	.01067	CDCOR2	.01067
POINT 45	RC 39.8693	MILLION	CC	.0058	CD3	.01049	CDCOR3	.01056
	MACH .7627				CD4	.01049	CDCOR4	.01053
	ALPHA -4.1037	DEG			CD5	.00994	CDCOR5	.00980

UPPER SURFACE				LOWER SURFACE				SPANWISE				
X/C	CP	P/L/PT	M/OC	X/C	CP	P/L/PT	M/OC	X/C	Y/(B/2)	CP	P/L/PT	M/OC
0.0000	.7304	.8834	.4245	0.0000	.7304	.8834	.4245	.1507	.7476	-.1217	.6489	.8145
.0132	.6444	.8597	.4718	.0126	-.6824	.4946	1.0597	.1507	.4976	-.1353	.6452	.8203
.0259	.3350	.7746	.6180	.0255	-.6231	.5109	1.0326	.1507	.2476	-.1289	.6469	.8176
.0759	-.0007	.6826	.7626	.0495	-.7594	.4734	1.0956	.1507	-.2524	-.1373	.6446	.8211
.1003	-.0542	.6675	.7859	.0753	-.7958	.4634	1.1129	.1507	-.5024	-.1446	.6426	.8243
.1507	-.1305	.6445	.8182	.1002	-.8297	.4541	1.1292	.1507	-.7524	-.1596	.6440	.8221
.2003	-.1819	.6322	.8401	.1503	-.8210	.4565	1.1250	.5002	.7476	-.4089	.5699	.9375
.2503	-.2248	.6178	.8626	.1976	-.8550	.4471	1.1414	.5002	.4976	-.4127	.5688	.9392
.3001	-.2619	.6048	.8827	.2503	-.8936	.4365	1.1604	.5002	.2476	-.4173	.5676	.9412
.3502	-.3103	.5970	.8949	.3001	-.9216	.4288	1.1743	.5002	-.2524	-.4063	.5706	.9384
.4003	-.3420	.5883	.9085	.3507	-.9966	.4082	1.2123	.5002	-.5024	-.4041	.5712	.9354
.4501	-.3656	.5816	.9187	.4001	-1.0594	.3909	1.2451	.5002	-.7524	-.3887	.5754	.9288
.5002	-.4144	.5683	.9400	.4501	-.9353	.5351	.9931	.8002	.7476	-1.0973	.3804	1.2654
.5502	-.4600	.5557	.9601	.5001	-.9273	.5293	.9922	.8002	.4976	-.3852	.5764	.9272
.6002	-.4962	.5459	.9758	.5497	-.9218	.6214	.8571	.8002	.2476	-.3863	.5756	.9286
.6500	-.5257	.5377	.9879	.6003	-1.037	.6539	.8069	.8002	-.5024	-.3471	.5869	.9107
.7000	-.5101	.5420	.9919	.6506	-.0081	.6602	.7663	.8002	-.7524	-.3590	.5836	.9159
.7500	-.4590	.5561	.9594	.7000	.2137	.7137	.7145					
.8002	-.3815	.5774	.9256	.7501	.2148	.7415	.6709					
.8502	-.1918	.6256	.8443	.8001	.2978	.7643	.6346					
.9001	-.0621	.6653	.7892	.8501	.3672	.7834	.6036					

TEST 167	PT 63.4779	PSI	CM	-1.192	CD1	.00798	CDCOR1	.00789
RUN 9	TT 102.4888	K	CM	-.1474	CD2	.00790	CDCOR2	.00784
POINT 46	RC 39.9133	MILLION	CC	.0146	CD3	.00782	CDCOR3	.00783
	MACH .7624				CD4	.00778	CDCOR4	.00775
	ALPHA -2.9938	DEG			CD5	.00763	CDCOR5	.00749

UPPER SURFACE				LOWER SURFACE				SPANWISE				
X/C	CP	P/L/PT	M/OC	X/C	CP	P/L/PT	M/OC	X/C	Y/(B/2)	CP	P/L/PT	M/OC
0.0000	.8835	.9247	.3377	0.0000	.8835	.9247	.3377	.1507	.7476	-.2481	.6117	.8720
.0132	.4876	.7152	.3507	.0126	-.3735	.5770	.9262	.1507	.4976	-.2630	.6076	.8784
.0259	.1581	.7241	.6982	.0255	-.4111	.5566	.9427	.1507	.2476	-.2566	.6094	.8757
.0759	-.1959	.6373	.8324	.0495	-.5094	.5394	.9861	.1507	-.2524	-.2663	.6067	.8799
.1003	-.1960	.6261	.8497	.0753	-.5423	.5303	1.0098	.1507	-.5024	-.2732	.6048	.8828
.1507	-.2586	.6088	.8765	.1002	-.6113	.5113	1.0321	.1507	-.7524	-.2647	.6071	.8792
.2003	-.2958	.5985	.8926	.1503	-.5769	.4944	1.0165	.5002	.7476	-.4980	.5426	.9810
.2503	-.3446	.5850	.9137	.1976	-.6723	.4944	1.0601	.5002	.4976	-.5010	.5418	.9824
.3001	-.3874	.5732	.9323	.2503	-.7867	.4693	1.1045	.5002	.2476	-.5047	.5405	.9845
.3502	-.4072	.5677	.9408	.3001	-.8372	.4488	1.1385	.5002	-.2524	-.4938	.5437	.9792
.4003	-.4343	.5602	.9578	.3507	-.8906	.4340	1.1649	.5002	-.5024	-.4917	.5443	.9782
.4501	-.4568	.5540	.9628	.4001	-.6186	.5092	1.0354	.5002	-.7524	-.4734	.5494	.9701
.5002	-.5024	.5414	.9830	.4501	-.5362	.5597	.9537	.5002	.7476	-1.1388	.3598	1.3067
.5502	-.5456	.5294	1.0024	.5001	-.5071	.5373	.9815	.8002	.4976	-.4038	.5687	.9359
.6002	-.5791	.5202	1.0174	.5497	-.5234	.6163	.8648	.8002	.2476	-.4056	.5682	.9403
.6500	-.6165	.5098	1.0344	.6003	-.5111	.6524	.8042	.8002	-.5024	-.3473	.5788	.9235
.7000	-.5872	.5179	1.0211	.6500	-.0030	.5795	.7673	.8602	-.7524	-.3824	.5746	.9301
.7500	-.4891	.5451	.9771	.7000	.1242	.7147	.7128					
.8002	-.3988	.5700	.9373	.7501	.2286	.7436	.6676					
.8502	-.1959	.6263	.8485	.8001	.3140	.7672	.6300					
.9001	-.0607	.6635	.7920	.8501	.3855	.7870	.6076					

TEST 167	PT 64.9008	PSI	CM	.2695	CD1	.00763	CDCOR1	.00760
RUN 9	TT 103.1772	K	CM	-.1519	CD2	.00759	CDCOR2	.00759
POINT 47	RC 40.0453	MILLION	CC	.0206	CD3	.00755	CDCOR3	.00761
	MACH .7628				CD4	.00752	CDCOR4	.00754
	ALPHA -2.9162	DEG			CD5	.00739	CDCOR5	.00732

UPPER SURFACE				LOWER SURFACE				SPANWISE				
X/C	CP	P/L/PT	M/OC	X/C	CP	P/L/PT	M/OC	X/C	Y/(B/2)	CP	P/L/PT	M/OC
0.0000	1.0092	.9602	.2425	0.0000	1.0092	.9602	.2425	.1507	.7476	-.3774	.5790	.9230
.0132	.3080	.7674	.6295	.0126	-.0962	.6563	.8040	.1507	.4976	-.3954	.5740	.9308
.0259	-.0367	.6727	.7778	.0255	-.1831	.6319	.8407	.1507	.2476	-.3898	.5756	.9284
.0759	-.3239	.5937	.9000	.0495	-.3020	.5997	.8906	.1507	-.2524	-.4007	.5726	.9331
.1003	-.3468	.5874	.9098	.0753	-.3527	.5836	.9124	.1507	-.5024	-.4066	.5711	.9354
.1507	-.3919	.5750	.9243	.1002	-.4179	.5679	.9406	.1507	-.7524	-.3937	.5745	.9301
.2003	-.4117	.5696	.9379	.1503	-.4493	.5603	.9526	.5002	.7476	-.5755	.5245	1.0102
.2503	-.4543	.5578	.9565	.1976	-.5442	.5331	.9962	.5002	.4976	-.5793	.5235	1.0119
.3001	-.4911	.5477	.9727	.2503	-.6360	.5219	1.0145	.5002	.2476	-.5843	.5221	1.0141
.3502	-.4992	.5455	.9763	.3001	-.6077	.5157	1.0247	.5002	-.2524	-.5714	.5256	1.0085
.4003	-.5200	.5398	.9854	.3507	-.6857	.5217	1.0148	.5002	-.5024	-.5698	.5241	1.0076
.4501	-.5375	.5349	.9934	.4001	-.9174	.5405	.9843	.5002	-.7524	-.5472	.5323	.9075
.5002	-.5813	.5229	1.0128	.4501	-.4443	.5806	.9521	.8002	.7476	-1.1011	.3593	1.3154
.5502	-.6167	.5132	1.0287	.5001	-.3449	.5879	.9090	.8002	.4976	-.4142	.5688	.9380
.6002	-.6440	.5051	1.0421	.5497	-.2161	.6233	.8339	.8002	.2476	-.4151	.5682	.9394
.6500	-.6798	.4959	1.0575	.6003	-.0873	.6587	.7993	.8002	-.5024	-.3789	.5784	.9237
.7000	-.6344	.5082	1.0369	.6500	.0076	.6848	.7590					
.7500	-.5647	.5440	.9787	.7000	.1343	.7197	.7050					
.8002	-.4684	.5705	.9365	.7501	.2386	.7484	.6599					
.8502	-.1982	.6260	.8467	.8001	.3248	.7720	.6220					
.9001	-.0627	.6655	.7884	.8501	.3976	.7921	.5893					

ORIGINAL PAGE IS
OF POOR QUALITY

TEST 167	PT 64.4771	PSI	CM	.3539	CD1 .00770	CDCOR1 .00756
RUN 9	TT 103.3568	K	CM	-1.1554	CD2 .00766	CDCOR2 .00755
POINT 48	RC 40.0069	MILLION	CC	.0223	CD3 .00762	CDCOR3 .00760
	RACH .7616				CD4 .00756	CDCOR4 .00751
	ALPHA -1.4867	DEG			CD5 .00743	CDCOR5 .00730

UPPER SURFACE				LOWER SURFACE				SPANWISE				
X/C	CP	P/L/PT	MLOC	X/C	CP	P/L/PT	MLOC	X/C	Y/(B/2)	CP	P/L/PT	MLOC
0.0000	1.0614	.9746	.1929	0.0000	1.0614	.9746	.1929	.1507	.7476	-.4509	.5580	.9547
.0132	-.2046	.7392	.6745	.0126	-.0405	.6961	.7448	.1507	.4976	-.4706	.5536	.9613
.0259	-.1462	.6428	.6739	.0255	-.0695	.6638	.7914	.1507	.2476	-.4468	.5547	.9616
.0759	-.4217	.5671	.9419	.0495	-.1983	.6285	.8460	.1507	-.2524	-.4768	.5519	.9660
.1003	-.4330	.5640	.9468	.0753	-.2575	.6122	.8712	.1507	-.5024	-.4489	.5508	.9678
.1537	-.4684	.5542	.9623	.1002	-.3307	.5921	.9026	.1507	-.7524	-.4657	.5550	.9611
.2003	-.4774	.5518	.9663	.1503	-.3722	.5807	.9204	.5002	.7476	-.6267	.5107	1.0329
.2503	-.5174	.5408	.9839	.1976	-.4653	.5551	.9609	.5002	.4976	-.6358	.5082	1.0370
.3001	-.5527	.5311	.9986	.2503	-.5060	.5439	.9789	.5002	.2476	-.6418	.5066	1.0397
.3502	-.5532	.5309	.9998	.3001	-.5265	.5383	.9879	.5002	-.2524	-.6276	.5105	1.0333
.4003	-.5689	.5266	1.0068	.3502	-.5216	.5396	.9858	.5002	-.5024	-.6250	.5112	1.0321
.4501	-.5837	.5225	1.0135	.4001	-.4747	.5525	.9651	.5002	-.7524	-.5956	.5193	1.0188
.5002	-.6385	.5075	1.0382	.4501	-.4150	.5689	.9390	.8002	.7476	-1.1898	.3560	1.1144
.5502	-.6622	.5010	1.0491	.5001	-.3212	.5947	.8985	.8002	.4976	-.6410	.5692	.9386
.6002	-.6803	.4960	1.0574	.5497	-.1975	.6287	.8457	.8002	.2476	-.6147	.5690	.9389
.6500	-.7149	.4854	1.0752	.6003	-.0722	.6631	.7926	.8002	-.5024	-.5787	.5789	.9233
.7000	-.6711	.4985	1.0531	.6500	.0201	.6885	.7555	.8002	-.7524	-.3974	.5737	.9314
.7500	-.5062	.5439	.9789	.7000	.1454	.7229	.7000					
.8002	-.4090	.5706	.9364	.7501	.2467	.7513	.6553					
.8002	-.1980	.6285	.8459	.8001	.3347	.7749	.6174					
.9501	-.0617	.6860	.7881	.8501	.4081	.7951	.5844					

TEST 167	PT 64.5774	PSI	CM	.4254	CD1 .00786	CDCOR1 .00762
RUN 9	TT 103.4616	K	CM	-1.1558	CD2 .00782	CDCOR2 .00761
POINT 48	RC 40.0101	MILLION	CC	.0227	CD3 .00778	CDCOR3 .00764
	RACH .7617				CD4 .00769	CDCOR4 .00756
	ALPHA -.9776	DEG			CD5 .00757	CDCOR5 .00742

UPPER SURFACE				LOWER SURFACE				SPANWISE				
X/C	CP	P/L/PT	MLOC	X/C	CP	P/L/PT	MLOC	X/C	Y/(B/2)	CP	P/L/PT	MLOC
0.0000	1.1008	.9856	.1447	0.0000	1.1008	.9856	.1447	.1507	.7476	-.5249	.5397	.9856
.0132	-.1007	.7113	.7180	.0126	-.1400	.7274	.6927	.1507	.4976	-.5493	.5320	.9964
.0259	-.2561	.6135	.842	.0255	-.0335	.6929	.7466	.1507	.2476	-.5470	.5337	.9954
.0759	-.5236	.5401	.9850	.0495	-.1087	.6536	.8072	.1507	-.2524	-.5365	.5311	.9996
.1003	-.5205	.5404	.9836	.0753	-.1776	.6350	.8359	.1507	-.5024	-.5576	.5306	1.0000
.1537	-.5448	.5337	.9953	.1002	-.2544	.6139	.8685	.1507	-.7524	-.5381	.5361	.9914
.2003	-.5447	.5343	.9943	.1503	-.3054	.5999	.8903	.5002	.7476	-.6662	.5010	1.0490
.2503	-.5773	.5254	1.0099	.1976	-.3974	.5747	.9298	.5002	.4976	-.6762	.4983	1.0534
.3001	-.6183	.5139	1.0277	.2503	-.4408	.5624	.9487	.5002	.2476	-.6825	.4965	1.0545
.3502	-.6028	.5184	1.0203	.3001	-.4659	.5559	.9536	.5002	-.2524	-.6716	.4997	1.0512
.4003	-.6024	.5185	1.0201	.3502	-.4690	.5551	.9610	.5002	-.5024	-.6711	.4996	1.0513
.4501	-.6227	.5129	1.0293	.4001	-.4384	.5640	.9467	.5002	-.7524	-.6400	.5082	1.0411
.5002	-.6773	.4979	1.0541	.4501	-.3887	.5771	.9260	.8002	.7476	-1.1799	.3601	1.1360
.5502	-.7104	.4889	1.0693	.5001	-.3021	.6008	.8889	.8002	.4976	-.6417	.5708	.9350
.6002	-.7193	.4864	1.0735	.5497	-.1837	.6333	.8385	.8002	.2476	-.6419	.5707	.9361
.6500	-.7361	.4813	1.0813	.6003	-.0622	.6666	.7871	.8002	-.5024	-.6303	.5794	.9224
.7000	-.6781	.4977	1.0544	.6500	.0270	.6911	.7494	.8002	-.7524	-.6408	.5738	.9313
.7500	-.5063	.5449	.9773	.7000	.1506	.7250	.6967					
.8002	-.4044	.5728	.9329	.7501	.2533	.7532	.6523					
.8002	-.1945	.6204	.8431	.8001	.3389	.7766	.6146					
.9501	-.0576	.6679	.7852	.8501	.4128	.7969	.5814					

TEST 167	PT 64.3433	PSI	CM	.5049	CD1 .00809	CDCOR1 .00786
RUN 9	TT 103.3057	K	CM	-1.1588	CD2 .00808	CDCOR2 .00789
POINT 50	RC 39.8959	MILLION	CC	.0242	CD3 .00800	CDCOR3 .00792
	RACH .7618				CD4 .00792	CDCOR4 .00783
	ALPHA -.4832	DEG			CD5 .00760	CDCOR5 .00763

UPPER SURFACE				LOWER SURFACE				SPANWISE				
X/C	CP	P/L/PT	MLOC	X/C	CP	P/L/PT	MLOC	X/C	Y/(B/2)	CP	P/L/PT	MLOC
0.0000	1.1207	.9913	.1121	0.0000	1.1207	.9913	.1121	.1507	.7476	-.6184	.5166	1.0232
.0132	-.0119	.6618	.7638	.0126	-.2592	.7529	.6480	.1507	.4976	-.6454	.5087	1.0363
.0259	-.3767	.5621	.9142	.0255	-.1176	.7172	.7089	.1507	.2476	-.6445	.5089	1.0359
.0759	-.6541	.5063	1.0402	.0495	-.0358	.6753	.7734	.1507	-.2524	-.6501	.5074	1.0384
.1003	-.6217	.5153	1.0254	.0753	-.1107	.6544	.8054	.1507	-.5024	-.6498	.5075	1.0383
.1537	-.6431	.5093	1.0333	.1002	-.1937	.6321	.8404	.1507	-.7524	-.6237	.5146	1.0265
.2003	-.6394	.5103	1.0316	.1503	-.2536	.6157	.8657	.5002	.4976	-.6700	.4910	1.0458
.2503	-.6838	.5104	1.0331	.1976	-.3438	.5911	.9041	.5002	.2476	-.6756	.4925	1.0443
.3001	-.6870	.4973	1.0552	.2503	-.3404	.5783	.9241	.5002	.2476	-.6746	.4947	1.0474
.3502	-.7042	.4920	1.0640	.3001	-.4196	.5704	.9467	.5002	-.2524	-.6707	.4955	1.0465
.4003	-.6961	.4944	1.0593	.3502	-.4299	.5675	.9411	.5002	-.5024	-.6701	.4910	1.0458
.4501	-.6661	.5035	1.0448	.4001	-.4058	.5742	.9307	.5002	-.7524	-.6887	.4968	1.0560
.5002	-.7042	.4926	1.0631	.4501	-.3861	.5649	.9137	.8002	.7476	-1.1408	.3623	1.1015
.5502	-.7502	.4400	1.0643	.5001	-.2886	.6067	.8797	.8002	.4976	-.6418	.5707	.9361
.6002	-.7777	.4322	1.0476	.5497	-.1737	.6376	.8419	.8002	.2476	-.6477	.5704	.9359
.6500	-.7941	.4269	1.1066	.6003	-.0559	.6690	.7923	.8002	-.5024	-.6371	.5792	.9227
.7000	-.7049	.4914	1.0643	.6500	.0304	.6933	.7454	.8002	-.7524	-.6404	.5734	.9314
.7500	-.5047	.5469	.9746	.7000	.1526	.7268	.6940					
.8002	-.4115	.572	.9332	.7501	.2540	.7545	.6502					
.8002	-.2010	.6101	.8434	.8001	.3342	.7777	.6124					
.9501	-.0651	.6672	.7842	.8501	.4132	.7960	.5746					

TEST	167	PT	61.4778	PSI	CM	.5788	CD1	.00839	CDCOR1	.00817
RUN	9	TT	100.1456	K	CM	-1.613	CD2	.00836	CDCOR2	.00815
POINT	52	RC	39.9706	MILLION	CC	.0219	CD3	.00831	CDCOR3	.00809
		MACH	.7610				CD4	.00814	CDCOR4	.00795
		ALPHA	-.0102	DEG			CD5	.00805	CDCOR5	.00784

UPPER SURFACE				LOWER SURFACE				SPANWISE				
X/C	CP	P _L /PT	MLOC	X/C	CP	P _L /PT	MLOC	X/C	Y/(B/2)	CP	P _L /PT	MLOC
0.0000	1.1449	.9973	.6625	0.0000	1.1449	.9973	.6625	.1507	.7476	-.6790	.4948	1.0597
.0132	-.0865	.6580	.8007	.0126	.3567	.7801	.6093	.1507	.4976	-.7194	.4837	1.0785
.0259	-.4575	.5558	.9602	.0255	.2048	.7383	.6762	.1507	.2476	-.7394	.4781	1.0879
.0759	-.7265	.4817	1.01	.0495	.0395	.6927	.7472	.1507	-.2524	-.7533	.4743	1.0944
.1003	-.7549	.4739	1.0751	.0753	-.0426	.6701	.7821	.1507	-.5024	-.7449	.4766	1.0904
.1507	-.7337	.4797	1.0852	.1002	-.1263	.6471	.8176	.1507	-.7524	-.6752	.4958	1.0579
.2003	-.7013	.4886	1.0701	.1503	-.1932	.6286	.8461	.5002	.7476	-.7695	.4698	1.1021
.2503	-.7084	.4867	1.0733	.1976	-.2889	.6023	.8870	.5002	.4976	-.7882	.4647	1.1109
.3001	-.7147	.4849	1.0763	.2503	-.3410	.5879	.9094	.5002	.2476	-.7984	.4619	1.1158
.3502	-.7431	.4771	1.0896	.3001	-.3747	.5786	.9240	.5002	-.2524	-.7957	.4626	1.1145
.4003	-.7484	.4757	1.0921	.3507	-.3913	.5741	.9312	.5002	-.5024	-.7827	.4662	1.1083
.4501	-.7547	.4739	1.0951	.4001	-.3735	.5790	.9235	.5002	-.7524	-.7576	.4731	1.0964
.5002	-.7996	.4616	1.1164	.4501	-.3407	.5880	.9093	.8002	.7476	-1.1216	.3728	1.2806
.5502	-.8206	.4558	1.1265	.5001	-.2657	.6066	.8771	.8002	.4976	-.3885	.5748	.9300
.6002	-.8291	.4534	1.1306	.5497	-.1562	.6388	.8303	.8002	.2476	-.3863	.5754	.9291
.6500	-.8555	.4462	1.1434	.6003	-.0409	.6706	.7813	.8002	-.5024	-.3684	.5804	.9213
.7000	-.7727	.4690	1.1036	.6500	.0433	.6938	.7455	.8002	-.7524	-.3940	.5733	.9324
.7500	-.4785	.5300	.9694	.7000	.1642	.7271	.6938					
.8002	-.3773	.5779	.9251	.7501	.2648	.7548	.6500					
.9002	-.1805	.6321	.8407	.8001	.3495	.7781	.6125					
.9501	-.0488	.6664	.7847	.8501	.4236	.7986	.5789					

TEST	167	PT	61.4769	PSI	CM	.6743	CD1	.00884	CDCOR1	.00848
RUN	9	TT	99.9132	K	CM	-1.637	CD2	.00892	CDCOR2	.00856
POINT	53	RC	40.0478	MILLION	CC	.0194	CD3	.00889	CDCOR3	.00867
		MACH	.7590				CD4	.00862	CDCOR4	.00842
		ALPHA	.5193	DEG			CD5	.00849	CDCOR5	.00824

UPPER SURFACE				LOWER SURFACE				SPANWISE				
X/C	CP	P _L /PT	MLOC	X/C	CP	P _L /PT	MLOC	X/C	Y/(B/2)	CP	P _L /PT	MLOC
0.0000	1.1454	.9977	.6573	0.0000	1.1454	.9977	.6573	.1507	.7476	-.8067	.4621	1.1154
.0132	-.2016	.6282	.8648	.0126	.4551	.8083	.5626	.1507	.4976	-.8872	.4400	1.1543
.0259	-.5756	.5255	1.0089	.0255	.2911	.7633	.6364	.1507	.2476	-.8745	.4435	1.1481
.0759	-.8900	.4502	1.1362	.0495	.1217	.7169	.7097	.1507	-.2524	-.8727	.4440	1.1472
.1003	-.8621	.4469	1.1420	.0753	.0346	.6930	.7468	.1507	-.5024	-.8879	.4398	1.1546
.1507	-.8618	.4470	1.1419	.1002	-.0567	.6879	.7855	.1507	-.7524	-.8104	.4611	1.1172
.2003	-.8422	.4524	1.1324	.1503	-.1312	.6475	.8170	.5002	.7476	-.8482	.4507	1.1353
.2503	-.8646	.4462	1.1432	.1976	-.2222	.6225	.8596	.5002	.4976	-.8327	.4550	1.1279
.3001	-.8782	.4425	1.1499	.2503	-.2754	.6079	.8782	.5002	.2476	-.8419	.4525	1.1323
.3502	-.8291	.4560	1.1261	.3001	-.3117	.5979	.8937	.5002	-.2524	-.8731	.4549	1.1280
.4003	-.7876	.4674	1.1063	.3507	-.3334	.5920	.9031	.5002	-.5024	-.8199	.4585	1.1217
.4501	-.7914	.4663	1.1081	.4001	-.3218	.5952	.8981	.5002	-.7524	-.8135	.4603	1.1186
.5002	-.6385	.4534	1.1306	.4501	-.2970	.6020	.8875	.8002	.7476	-1.1234	.3752	1.2759
.5502	-.8750	.4434	1.1483	.5001	-.2307	.6202	.8592	.8002	.4976	-.3952	.5750	.9297
.6002	-.8893	.4395	1.1553	.5497	-.1291	.6480	.8161	.8002	.2476	-.3921	.5759	.9283
.6500	-.8716	.4443	1.1467	.6003	-.0197	.6781	.7699	.8002	-.5024	-.3653	.5832	.9168
.7000	-.6816	.4964	1.0569	.6500	.0609	.7002	.7357	.8002	-.7524	-.3862	.5775	.9258
.7500	-.4758	.5529	.9648	.7000	.1785	.7324	.6854					
.8002	-.3898	.5765	.9273	.7501	.2767	.7594	.6427					
.9002	-.1856	.6325	.8401	.8001	.3600	.7822	.6058					
.9501	-.0551	.6683	.7848	.8501	.4336	.8024	.5725					

Appendix I

Pressure Data for $M = 0.77$; $R = 10.0 \times 10^6$, 15.0×10^6 , 30.0×10^6 , and 40.0×10^6 ; Free Transition

The pressure measurements made on the NASA SC(3)-0712(B) airfoil are presented in coefficient form in graphs and tables in this appendix. The data are for a given Mach number through the Reynolds number range. The pressure data from the upper surface of the airfoil are plotted as open symbols, and the lower-surface data are plotted as solid symbols.

ORIGINAL PAGE IS
OF POOR QUALITY

TEST 167	PT 24.9743	PSI	CN	-.0899	CD1 .01404	CDCOR1	.01377
RUN 51	TT 139.5004	K	CM	-.1260	CD2 .01337	CDCOR2	.01315
POINT 1	RC 10.0226	MILLION	CC	.0065	CD3 .01268	CDCOR3	.01250
	MACH .7699				CD4 .01135	CDCOR4	.01109
	ALPHA -3.9950	DEG			CD5 .00920	CDCOR5	.00883

UPPER SURFACE				LOWER SURFACE				SPANWISE				
X/C	CP	P/L/PT	MLOC	X/C	CP	P/L/PT	MLOC	X/C	Y/(B/2)	CP	P/L/PT	MLOC
0.0000	.7452	.8846	.4222	0.0000	.7452	.8846	.4222	.1507	.7476	-.1279	.6399	.8250
.0132	.6335	.8533	.4815	.0126	-.6960	.4807	1.0793	.1507	.4976	-.1358	.6377	.8284
.0259	-.3163	.7644	.6317	.0255	-.5896	.5105	1.0294	.1507	.2476	-.1356	.6377	.8283
.0759	-.0085	.6734	.7736	.0495	-.7649	.4614	1.1125	.1507	-.2524	-.1422	.6359	.8311
.1003	-.0595	.6591	.7955	.0753	-.7703	.4599	1.1151	.1507	-.5024	-.1449	.6351	.8323
.1507	-.1387	.6369	.8296	.1002	-.8064	.4499	1.1328	.1507	-.7524	-.1520	.6332	.8354
.2003	-.1907	.6223	.8521	.1503	-.8060	.4499	1.1326	.5002	.7476	-.4043	.5624	.9456
.2503	-.2407	.6083	.8738	.1976	-.8471	.4383	1.1531	.5002	.4976	-.4103	.5608	.9482
.3001	-.2836	.5963	.8925	.2503	-.8945	.4251	1.1771	.5002	.2476	-.4142	.5597	.9499
.3502	-.3111	.5886	.9045	.3001	-.9316	.4147	1.1962	.5002	-.2524	-.4051	.5622	.9459
.4003	-.3439	.5794	.9189	.3507	-.9983	.3960	1.2314	.5002	-.5024	-.4000	.5636	.9437
.4501	-.3778	.5699	.9338	.4001	-1.0624	.3780	1.2662	.5002	-.7524	-.3865	.5674	.9376
.5002	-.4121	.5603	.9490	.4501	-.6287	.4996	1.0475	.8002	.7476	-.3692	.5723	.9300
.5502	-.4493	.5498	.9656	.5001	-.3821	.5687	.9357	.8002	.4976	-.3716	.5716	.9311
.6002	-.4893	.5383	.9841	.5497	-.2550	.6043	.8800	.8002	.2476	-.3770	.5701	.9334
.6500	-.5183	.5305	.9967	.6003	-.1336	.6383	.8274	.8002	-.5024	-.3589	.5752	.9255
.7000	-.5020	.5351	.9894	.6500	-.0261	.6624	.7811	.8002	-.7524	-.3354	.5818	.9151
.7500	-.4492	.5499	.9656	.7000	.0830	.6990	.7341					
.8002	-.3711	.5717	.9309	.7501	.1776	.7255	.6930					
.9002	-.1760	.6259	.8466	.8001	.2561	.7475	.6585					
.9501	-.0526	.6610	.7925	.8501	.3220	.7660	.6291					

TEST 167	PT 24.9984	PSI	CN	.0528	CD1 .01072	CDCOR1	.01059
RUN 51	TT 139.5457	K	CM	-.1321	CD2 .01047	CDCOR2	.01038
POINT 2	RC 10.0267	MILLION	CC	.0131	CD3 .00998	CDCOR3	.00991
	MACH .7698				CD4 .00951	CDCOR4	.00937
	ALPHA -2.9854	DEG			CD5 .00852	CDCOR5	.00822

UPPER SURFACE				LOWER SURFACE				SPANWISE				
X/C	CP	P/L/PT	MLOC	X/C	CP	P/L/PT	MLOC	X/C	Y/(B/2)	CP	P/L/PT	MLOC
0.0000	.8722	.9201	.3470	0.0000	.8722	.9201	.3470	.1507	.7476	-.2281	.6115	.8688
.0132	.4976	.8151	.5485	.0126	-.4175	.5584	.9520	.1507	.4976	-.2420	.6076	.8748
.0259	.1701	.7232	.6966	.0255	-.4211	.5574	.9536	.1507	.2476	-.2430	.6073	.8753
.0759	-.1375	.6369	.8296	.0495	-.5516	.5208	1.0125	.1507	-.2524	-.2476	.6060	.8772
.1003	-.1776	.6257	.8469	.0753	-.5601	.5184	1.0164	.1507	-.5024	-.2493	.6056	.8780
.1507	-.2447	.6069	.8760	.1002	-.6345	.4976	1.0509	.1507	-.7524	-.2447	.6069	.8760
.2003	-.2863	.5952	.8941	.1503	-.5867	.5109	1.0287	.5002	.7476	-.4697	.5438	.9754
.2503	-.3299	.5830	.9132	.1976	-.6822	.4842	1.0734	.5002	.4976	-.4762	.5419	.9783
.3001	-.3679	.5723	.9300	.2503	-.7803	.4567	1.1207	.5002	.2476	-.4803	.5408	.9801
.3502	-.3899	.5661	.9397	.3001	-.8581	.4348	1.1594	.5002	-.2524	-.4690	.5440	.9750
.4003	-.4174	.5584	.9519	.3507	-.9257	.4159	1.1940	.5002	-.5024	-.4641	.5453	.9728
.4501	-.4458	.5505	.9646	.4001	-.9022	.4225	1.1818	.5002	-.7524	-.4504	.5492	.9667
.5002	-.4777	.5415	.9789	.4501	-.4533	.5484	.9680	.8002	.7476	-.3795	.5691	.9351
.5502	-.5114	.5321	.9942	.5001	-.3612	.5742	.9270	.8002	-.976	-.3814	.5685	.9359
.6002	-.5493	.5214	1.0115	.5497	-.2457	.6086	.8764	.8002	.2476	-.3864	.5671	.9381
.6500	-.5791	.5142	1.0233	.6003	-.1217	.6414	.8227	.8002	-.5024	-.3706	.5716	.9312
.7000	-.5401	.5240	1.0073	.6500	-.0134	.6717	.7761	.8002	-.7524	-.3483	.5778	.9213
.7500	-.4677	.5443	.9744	.7000	.1002	.7036	.7270					
.8002	-.3865	.5688	.9356	.7501	.1979	.7310	.6844					
.9002	-.1759	.6261	.8462	.8001	.2779	.7534	.6492					
.9501	-.0483	.6619	.7911	.8501	.3449	.7722	.6192					

TEST 167	PT 24.9855	PSI	CN	-.2149	CD1 .00975	CDCOR1	.00951
RUN 51	TT 139.5384	K	CM	-.1372	CD2 .00954	CDCOR2	.00936
POINT 3	RC 10.0107	MILLION	CC	.0183	CD3 .00940	CDCOR3	.00925
	MACH .7682				CD4 .00907	CDCOR4	.00885
	ALPHA -1.9742	DEG			CD5 .00847	CDCOR5	.00820

UPPER SURFACE				LOWER SURFACE				SPANWISE				
X/C	CP	P/L/PT	MLOC	X/C	CP	P/L/PT	MLOC	X/C	Y/(B/2)	CP	P/L/PT	MLOC
0.0000	1.0011	.9567	.2524	0.0000	1.0011	.9567	.2524	.1507	.7476	-.3557	.5776	.9214
.0132	.3169	.7655	.6299	.0126	-.1362	.6389	.8265	.1507	.4976	-.3742	.5724	.9298
.0259	-.0232	.6705	.7779	.0255	-.2026	.6204	.8551	.1507	.2476	-.3778	.5714	.9313
.0759	-.3052	.5917	.8995	.0495	-.3407	.5818	.9151	.1507	-.2524	-.3828	.5700	.9335
.1003	-.3287	.5852	.9098	.0753	-.3742	.5725	.9297	.1507	-.5024	-.3812	.5705	.9329
.1507	-.3790	.5711	.9319	.1002	-.4358	.5552	.9570	.1507	-.7524	-.3690	.5739	.9275
.2003	-.3497	.5653	.9410	.1503	-.4639	.5474	.9695	.5002	.7476	-.5460	.5245	1.0065
.2503	-.4401	.5540	.9589	.1976	-.5710	.5175	1.0180	.5002	.4976	-.5524	.5227	1.0095
.3001	-.4712	.5453	.9728	.2503	-.6357	.4994	1.0478	.5002	.2476	-.5571	.5213	1.0116
.3502	-.4807	.5427	.9771	.3001	-.6626	.4919	1.0804	.5002	-.2524	-.5463	.5244	1.0067
.4003	-.5026	.5366	.9869	.3507	-.6449	.4988	1.0521	.5002	-.5024	-.5425	.5254	1.0050
.4501	-.5292	.5292	.9989	.4001	-.5646	.5192	1.0151	.5002	-.7524	-.5284	.5291	.9990
.5002	-.5535	.5223	1.0100	.4501	-.4706	.5455	.9725	.8002	.7476	-.3887	.5684	.9362
.5502	-.5802	.5149	1.0222	.5001	-.3677	.5742	.9269	.8002	.4976	-.3902	.5680	.9368
.6002	-.6125	.5059	1.0371	.5497	-.2366	.6109	.8697	.8002	.2476	-.3939	.5669	.9384
.6500	-.6325	.5003	1.0463	.6003	-.1083	.6467	.8145	.8002	-.5024	-.3853	.5693	.9347
.7000	-.5815	.5145	1.0228	.6500	-.0004	.6789	.7682	.8002	-.7524	-.3665	.5746	.9264
.7500	-.4613	.5425	.9773	.7000	.1135	.7087	.7191					
.8002	-.3877	.5687	.9357	.7501	.2112	.7360	.6766					
.9002	-.1752	.6281	.8432	.8001	.2909	.7583	.6415					
.9501	-.0466	.6640	.7880	.8501	.3579	.7770	.6115					

TEST 167	PT	24.9870	PSI	CN	.2898	CD1	.00969	CDCOR1	.00946
RUN 51	TT	139.6220	K	CM	-1.1390	CD2	.00992	CDCOR2	.00992
POINT 4	RC	9.9957	MILLION	CC	.0201	CD3	.00935	CDCOR3	.00919
	MACH	.7673				CD4	.00905	CDCOR4	.00889
	ALPHA	-1.4851	DEG			CD5	.00853	CDCOR5	.00830

UPPER SURFACE				LOWER SURFACE				SPANWISE				
X/C	CP	P _L /PT	MLOC	X/C	CP	P _L /PT	MLOC	X/C	Y/(B/2)	CP	P _L /PT	MLOC
0.0000	1.0550	.9718	.2027	0.0000	1.0550	.9718	.2027	.1507	.7476	-.4206	.5597	.9500
.0132	.2235	.7395	.6710	.0126	-.0009	.6759	.7681	.1507	.4976	-.4432	.5533	.9600
.0259	-.1214	.6432	.8199	.0255	-.0953	.6505	.8086	.1507	.2476	-.4471	.5523	.9618
.0759	-.3925	.5675	.9376	.0495	-.2406	.6099	.8712	.1507	-.2524	-.4520	.5509	.9639
.1003	-.4063	.5636	.9437	.0753	-.2860	.5973	.8909	.1507	-.5024	-.4487	.5518	.9625
.1507	-.4476	.5521	.9620	.1002	-.3518	.5789	.9196	.1507	-.7524	-.4318	.5565	.9549
.2003	-.4574	.5494	.9684	.1503	-.3943	.5670	.9384	.9002	.7476	-.5859	.5135	1.0245
.2503	-.4959	.5386	.9836	.1976	-.4476	.5382	.9843	.9002	.4976	-.5956	.5108	1.0289
.3001	-.5245	.5305	.9967	.2503	-.5483	.5240	1.0073	.9002	.2476	-.6005	.5094	1.0312
.3502	-.5242	.5307	.9964	.3001	-.5794	.5193	1.0219	.9002	-.2524	-.5904	.5122	1.0266
.4003	-.5432	.5254	1.0050	.3507	-.5742	.5168	1.0191	.9002	-.5024	-.5852	.5137	1.0242
.4501	-.5687	.5183	1.0186	.4001	-.5225	.5312	.9956	.9002	-.7524	-.5690	.5182	1.0167
.5002	-.5965	.5105	1.0293	.4501	-.4475	.5521	.9619	.8002	.7476	-.3886	.5686	.9358
.5502	-.6117	.5063	1.0364	.5001	-.3499	.5794	.9188	.8002	.4976	-.3898	.5683	.9363
.6002	-.6411	.4981	1.0500	.6497	-.2221	.6151	.8632	.8002	.2476	-.3927	.5674	.9376
.6500	-.6588	.4931	1.0583	.6003	-.0962	.6503	.8090	.8002	-.5024	-.3878	.5688	.9355
.7000	-.5974	.5103	1.0298	.6500	.0091	.6797	.7638	.8002	-.7524	-.3694	.5740	.9274
.7500	-.4773	.5427	.9771	.7000	.1226	.7114	.7150					
.8002	-.3858	.5694	.9346	.7501	.2204	.7387	.6724					
.9002	-.1711	.6293	.8412	.8001	.3007	.7611	.6369					
.9501	-.0426	.6652	.7861	.8501	.3688	.7801	.6064					

TEST 167	PT	24.9861	PSI	CN	.3693	CD1	.00986	CDCOR1	.00962
RUN 51	TT	139.8505	K	CM	-1.1413	CD2	.00968	CDCOR2	.00949
POINT 5	RC	9.9849	MILLION	CC	.0206	CD3	.00952	CDCOR3	.00938
	MACH	.7691				CD4	.00916	CDCOR4	.00900
	ALPHA	-.9755	DEG			CD5	.00874	CDCOR5	.00852

UPPER SURFACE				LOWER SURFACE				SPANWISE				
X/C	CP	P _L /PT	MLOC	X/C	CP	P _L /PT	MLOC	X/C	Y/(B/2)	CP	P _L /PT	MLOC
0.0000	1.0980	.9841	.1515	0.0000	1.0980	.9841	.1515	.1507	.7476	-.4958	.5407	.9802
.0132	.1144	.7105	.7163	.0126	.1234	.7130	.7124	.1507	.4976	-.5234	.5331	.9926
.0259	-.2374	.6126	.8671	.0255	.0049	.6800	.7633	.1507	.2476	-.5285	.5316	.9949
.0759	-.4972	.5403	.9808	.0495	-.1594	.6343	.8335	.1507	-.2524	-.5318	.5307	.9964
.1003	-.4976	.5402	.9810	.0753	-.1993	.6232	.8507	.1507	-.5024	-.5251	.5326	.9934
.1507	-.5291	.5315	.9952	.1002	-.2717	.6031	.8819	.1507	-.7524	-.5013	.5392	.9827
.2003	-.5379	.5290	.9991	.1503	-.3243	.5884	.9047	.9002	.7476	-.6290	.5037	1.0407
.2503	-.5590	.5232	1.0087	.1976	-.4246	.5605	.9486	.9002	.4976	-.6414	.5002	1.0464
.3001	-.5905	.5144	1.0230	.2503	-.4763	.5462	.9715	.9002	.2476	-.6466	.4988	1.0488
.3502	-.5765	.5183	1.0166	.3001	-.5064	.5378	.9849	.9002	-.2524	-.6363	.5016	1.0441
.4003	-.5871	.5153	1.0215	.3507	-.5133	.5359	.9880	.9002	-.5024	-.6329	.5026	1.0425
.4501	-.6120	.5084	1.0329	.4001	-.4792	.5454	.9728	.9002	-.7524	-.6121	.5084	1.0329
.5002	-.6423	.5000	1.0468	.4501	-.4183	.5623	.9458	.8002	.7476	-.3899	.5702	.9333
.5502	-.6569	.4959	1.0536	.5001	-.3291	.5871	.9067	.8002	.4976	-.3909	.5699	.9337
.6002	-.6715	.4919	1.0604	.6497	-.2061	.6213	.8536	.8002	.2476	-.3930	.5693	.9347
.6500	-.6754	.4908	1.0622	.6003	-.0835	.6554	.8011	.8002	-.5024	-.3886	.5705	.9328
.7000	-.6121	.5084	1.0329	.6500	.0190	.6840	.7572	.8002	-.7524	-.3712	.5754	.9251
.7500	-.4843	.5439	.9751	.7000	.1315	.7153	.7089					
.8002	-.3865	.5712	.9318	.7501	.2293	.7425	.6665					
.9002	-.1711	.6311	.8386	.8001	.3101	.7649	.6309					
.9501	-.0425	.6668	.7836	.8501	.3790	.7841	.5999					

TEST 167	PT	24.9854	PSI	CN	.4422	CD1	.01001	CDCOR1	.00974
RUN 51	TT	139.8207	K	CM	-1.1422	CD2	.00982	CDCOR2	.00955
POINT 6	RC	9.9831	MILLION	CC	.0202	CD3	.00967	CDCOR3	.00945
	MACH	.7685				CD4	.00919	CDCOR4	.00895
	ALPHA	-.4429	DEG			CD5	.00869	CDCOR5	.00843

UPPER SURFACE				LOWER SURFACE				SPANWISE				
X/C	CP	P _L /PT	MLOC	X/C	CP	P _L /PT	MLOC	X/C	Y/(B/2)	CP	P _L /PT	MLOC
0.0000	1.1270	.9921	1.063	0.0000	1.1270	.9921	1.063	.1507	.7476	-.5715	.5193	1.0290
.0132	.0127	.6819	.7604	.0126	-.2364	.7442	.6638	.1507	.4976	-.6021	.5107	1.0290
.0259	-.3476	.5816	.9154	.0255	-.0967	.7053	.7244	.1507	.2476	-.6111	.5083	1.0331
.0759	-.6121	.5080	1.0336	.0495	-.0785	.6565	.7994	.1507	-.2524	-.6112	.5082	1.0332
.1003	-.5837	.5199	1.0206	.0753	-.1208	.6447	.8175	.1507	-.5024	-.6004	.5112	1.0282
.1507	-.6113	.5082	1.0332	.1002	-.1981	.6232	.8507	.1507	-.7524	-.5711	.5194	1.0148
.2003	-.6113	.5082	1.0332	.1503	-.2386	.6064	.8767	.9002	.7476	-.6593	.4948	1.0355
.2503	-.6115	.5081	1.0333	.1976	-.3373	.5789	.9196	.9002	.4976	-.6709	.4916	1.0609
.3001	-.6499	.4974	1.0511	.2503	-.4104	.5641	.9429	.9002	.2476	-.6744	.4906	1.0625
.3502	-.6492	.4976	1.0508	.3001	-.4428	.5551	.9572	.9002	-.2524	-.6648	.4933	1.0580
.4003	-.6290	.5033	1.0414	.3507	-.4566	.5513	.9633	.9002	-.5024	-.6665	.4928	1.0588
.4501	-.6345	.5017	1.0439	.4001	-.4341	.5575	.9534	.9002	-.7524	-.6485	.4978	1.0504
.5002	-.6683	.4922	1.0596	.4501	-.3846	.5713	.9316	.8002	.7476	-.3856	.5710	.9320
.5502	-.6908	.4861	1.0702	.5001	-.3038	.5938	.8963	.8002	.4976	-.3869	.5707	.9326
.6002	-.7032	.4826	1.0760	.6497	-.1871	.6263	.8459	.8002	.2476	-.3888	.5701	.9334
.6500	-.6866	.4872	1.0682	.6003	-.0686	.6593	.7932	.8002	-.5024	-.3853	.5711	.9319
.7000	-.6086	.5089	1.0320	.6500	.0308	.6870	.7526	.8002	-.7524	-.3689	.5757	.9247
.7500	-.4803	.5447	.9739	.7000	.1418	.7178	.7049					
.8002	-.3816	.5721	.9302	.7501	.2388	.7449	.6627					
.9002	-.1659	.6322	.8368	.8001	.3198	.7674	.6269					
.9501	-.0403	.6672	.7831	.8501	.3892	.7867	.5956					

ORIGINAL PAGE IS
OF POOR QUALITY

TEST 167	PT	24.9830	PSI	CM	.5306	CD1	.01042	CDCOR1	.01004
RUN 51	TT	139.9049	K	CM	-.1456	CD2	.01024	CDCOR2	.00992
POINT 8	RC	9.9845	MILLION	CC	.0193	CD3	.01001	CDCOR3	.00972
	MACH	.7700				CD4	.00960	CDCOR4	.00928
	ALPHA	.0460	DEG			CD5	.00915	CDCOR5	.00881

UPPER SURFACE				LOWER SURFACE				SPANWISE				
X/C	CP	P _L /PT	MLOC	X/C	CP	P _L /PT	MLOC	X/C	Y/(B/2)	CP	P _L /PT	MLOC
0.0000	1.1485	.9977	.0574	0.0000	1.1485	.9977	.0574	.1507	.7476	-.6573	.4922	1.0598
.0132	-.0835	.6528	.8051	.0126	.3436	.7724	.6189	.1507	.4976	-.6865	.4840	1.0736
.0259	-.4518	.5467	.9658	.0255	.1885	.7290	.6876	.1507	.2.76	-.7197	.4747	1.0895
.0759	-.7097	.4775	1.0846	.0495	.0101	.6790	.7648	.1507	-.2524	-.7233	.4737	1.0912
.1003	-.7372	.4698	1.0979	.0753	-.0439	.6639	.7881	.1507	-.5024	-.6914	.4826	1.0760
.1507	-.7162	.4757	1.0878	.1002	-.1247	.6413	.8228	.1507	-.7524	-.6590	.4917	1.0607
.2003	-.7156	.4759	1.0875	.1503	-.1922	.6224	.8519	.5002	.7476	-.7188	.4750	1.0890
.2503	-.6755	.4871	1.0685	.1976	-.2921	.5944	.8953	.5002	.4976	-.7296	.4770	1.0942
.3001	-.7020	.4797	1.0810	.2503	-.3488	.5786	.9201	.5002	.2476	-.7384	.4695	1.0984
.3502	-.7124	.4768	1.0860	.3001	-.3860	.5681	.9365	.5002	-.2524	-.7313	.4715	1.0950
.4003	-.7198	.4747	1.0895	.3507	-.4046	.5629	.9448	.5002	-.5024	-.7238	.4736	1.0914
.4501	-.7341	.4707	1.0583	.4001	-.3905	.5669	.9385	.5002	-.7524	-.7237	.4736	1.0914
.5002	-.7462	.4673	1.1022	.4501	-.3440	.5783	.9206	.8002	.7476	-.3780	.5704	.9330
.5502	-.7445	.4678	1.1014	.5001	-.2761	.5989	.8883	.8002	.4976	-.3771	.5706	.9326
.6002	-.7462	.4673	1.1022	.5497	-.1645	.6302	.8400	.8002	.2476	-.3783	.5703	.9332
.6500	-.7170	.4755	1.0881	.6003	-.0499	.6622	.7906	.8002	-.5024	-.3767	.5707	.9324
.7000	-.6009	.5080	1.0336	.6500	.0469	.6893	.7490	.8002	-.7524	-.3615	.5750	.9257
.7500	-.4721	.5440	.9749	.7000	.1563	.7199	.7016					
.8002	-.3733	.5717	.9309	.7501	.2522	.7468	.6596					
.9002	-.1584	.6319	.8373	.8001	.3328	.7693	.6238					
.9501	-.0362	.6661	.7848	.8501	.4025	.7869	.5921					

TEST 167	PT	24.9865	PSI	CM	.6077	CD1	.01100	CDCOR1	.01063
RUN 51	TT	139.9078	K	CM	-.1465	CD2	.01080	CDCOR2	.01053
POINT 9	RC	9.9852	MILLION	CC	.0175	CD3	.01055	CDCOR3	.01033
	MACH	.7699				CD4	.00999	CDCOR4	.00972
	ALPHA	.5235	DEG			CD5	.00953	CDCOR5	.00909

UPPER SURFACE				LOWER SURFACE				SPANWISE				
X/C	CP	P _L /PT	MLOC	X/C	CP	P _L /PT	MLOC	X/C	Y/(B/2)	CP	P _L /PT	MLOC
0.0000	1.1539	.9995	.0269	0.0000	1.1539	.9995	.0269	.1507	.7476	-.7731	.4622	1.1109
.0132	-.1822	.6270	.8448	.0126	.4264	.7967	.5793	.1507	.4976	-.8500	.4408	1.1487
.0259	-.5933	.5235	1.0080	.0255	.2577	.7496	.6551	.1507	.2476	-.8471	.4416	1.1472
.0759	-.8109	.4517	1.1294	.0495	.0762	.6990	.7340	.1507	-.2524	-.8414	.4432	1.1444
.1003	-.8316	.4459	1.1395	.0753	.0106	.6807	.7622	.1507	-.5024	-.8504	.4407	1.1489
.1507	-.8366	.4445	1.1420	.1002	-.0703	.6582	.7969	.1507	-.7524	-.7757	.4615	1.1122
.2003	-.8371	.4444	1.1423	.1503	-.1436	.6378	.8283	.5002	.7476	-.7712	.4628	1.1100
.2503	-.8419	.4431	1.1446	.1976	-.2438	.6098	.8714	.5002	.4976	-.7703	.4630	1.1096
.3001	-.8413	.4432	1.1444	.2503	-.3033	.5932	.8972	.5002	.2476	-.7874	.4583	1.1179
.3502	-.7803	.4602	1.1144	.3001	-.3423	.5824	.9142	.5002	-.2524	-.7992	.4590	1.1236
.4003	-.7515	.4683	1.1065	.3507	-.3655	.5759	.9243	.5002	-.5024	-.7683	.4636	1.1087
.4501	-.7596	.4660	1.1044	.4001	-.3580	.5780	.9211	.5002	-.7524	-.7764	.4613	1.1125
.5002	-.7895	.4577	1.1189	.4501	-.3253	.5871	.9068	.8002	.7476	-.3796	.5720	.9305
.5502	-.8064	.4530	1.1272	.5001	-.2590	.6056	.8780	.8002	.4976	-.3817	.5714	.9314
.6002	-.7980	.4553	1.1231	.5497	-.1529	.6351	.8323	.8002	.2476	-.3829	.5710	.9320
.6500	-.6991	.4829	1.0756	.6003	-.0420	.6661	.7847	.8002	-.5024	-.3805	.5717	.9309
.7000	-.5794	.5162	1.0200	.6500	.0516	.6922	.7446	.8002	-.7524	-.3649	.5760	.9241
.7500	-.4740	.5456	.9723	.7000	.1596	.7223	.6980					
.8002	-.3787	.5722	.9301	.7501	.2548	.7498	.6564					
.9002	-.1638	.6321	.8369	.8001	.3352	.7712	.6207					
.9501	-.0426	.6659	.7850	.8501	.4054	.7908	.5889					

TEST 167	PT	24.9872	PSI	CM	.6949	CD1	.01269	CDCOR1	.01243
RUN 51	TT	139.9449	K	CM	-.1501	CD2	.01249	CDCOR2	.01207
POINT 10	RC	9.9783	MILLION	CC	.0158	CD3	.01219	CDCOR3	.01181
	MACH	.7695				CD4	.01168	CDCOR4	.01122
	ALPHA	1.0242	DEG			CD5	.01110	CDCOR5	.01063

UPPER SURFACE				LOWER SURFACE				SPANWISE				
X/C	CP	P _L /PT	MLOC	X/C	CP	P _L /PT	MLOC	X/C	Y/(B/2)	CP	P _L /PT	MLOC
0.0000	1.1520	.9989	.0389	0.0000	1.1520	.9989	.0389	.1507	.7476	-.8869	.4303	1.1676
.0132	-.2719	.6018	.8838	.0126	.4988	.8168	.5456	.1507	.4976	-.9576	.4106	1.2039
.0259	-.6528	.4956	1.0542	.0255	.3237	.7679	.6261	.1507	.2476	-.9383	.4159	1.1938
.0759	-.8991	.4269	1.1738	.0495	.1364	.7157	.7083	.1507	-.2524	-.9321	.4177	1.1907
.1003	-.9194	.4212	1.1841	.0753	.0612	.6947	.7407	.1507	-.5024	-.9513	.4123	1.2006
.1507	-.9267	.4196	1.1871	.1002	-.0204	.6719	.7757	.1507	-.7524	-.8917	.4289	1.1701
.2003	-.9267	.4192	1.1879	.1503	-.0990	.6500	.8094	.5002	.7476	-.9361	.4166	1.1927
.2503	-.9453	.4146	1.1975	.1976	-.1999	.6219	.8527	.5002	.4976	-.9518	.4122	1.2008
.3001	-.9730	.4063	1.2119	.2503	-.2623	.6045	.8797	.5002	.2476	-.9128	.4230	1.1808
.3502	-.9716	.4066	1.2112	.3001	-.3046	.5927	.8980	.5002	-.2524	-.8847	.4309	1.1665
.4003	-.9083	.4243	1.1784	.3507	-.3315	.5852	.9098	.5002	-.5024	-.9485	.4131	1.1991
.4501	-.8835	.4312	1.1659	.4001	-.3296	.5857	.9089	.5002	-.7524	-.9256	.4195	1.1873
.5002	-.8917	.4289	1.1700	.4501	-.3033	.5931	.8975	.8002	.7476	-.734	.5755	.9281
.5502	-.8798	.4323	1.1640	.5001	-.2432	.6098	.8714	.8002	.4976	-.771	.5724	.9297
.6002	-.8943	.4282	1.1713	.5497	-.1423	.6380	.8280	.8002	.2476	-.3762	.5727	.9293
.6500	-.7241	.4757	1.0878	.6003	-.0350	.6679	.7820	.8002	-.5024	-.3777	.5723	.9300
.7000	-.5203	.5325	.9935	.6500	.0557	.6932	.7431	.8002	-.7524	-.3627	.5765	.9234
.7500	-.4483	.5526	.9612	.7000	.1625	.7230	.6970					
.8002	-.3689	.5747	.9261	.7501	.2569	.7493	.6557					
.9002	-.1636	.6320	.8371	.8001	.3371	.7717	.6200					
.9501	-.0455	.6649	.7865	.8501	.4080	.7914	.5879					

TEST 167	PT 25.0803	PSI	CM .7783	CD1 .01811	CDCOR1 .01775
RUN 51	TT 140.1844	K	CM -.1601	CD2 .01769	CDCOR2 .01741
POINT 11	RC 10.0054	MILLION	CC .0167	CD3 .01682	CDCOR3 .01632
	MACH .7715			CD4 .01626	CDCOR4 .01586
	ALPHA 1.5212	DEG		CD5 .01632	CDCOR5 .01565

UPPER SURFACE				LOWER SURFACE				SPANWISE				
X/C	CP	P/L/PT	MLOC	X/C	CP	P/L/PT	MLOC	X/C	Y/(B/2)	CP	P/L/PT	MLOC
0.0000	1.1545	.9995	.0278	0.0000	1.1545	.9995	.0278	.1507	.7476	-.9547	.4096	1.2056
.0132	-.3348	.5830	.9132	.0126	-.5609	.8335	.5169	.1507	.4976	-1.0215	.3909	1.2411
.0259	-.7218	.4747	1.0895	.0255	-.3811	.7832	.6014	.1507	.2476	-.9941	.3986	1.2264
.0759	-.9536	.4099	1.2051	.0495	-.1911	.7300	.6859	.1507	-.2524	-.9897	.3998	1.2241
.1003	-.9772	.4033	1.2174	.0753	-.1084	.7069	.7219	.1507	-.5024	-1.0122	.3935	1.2361
.1507	-.9826	.4018	1.2203	.1002	-.0250	.6836	.7578	.1507	-.7524	-.9718	.4048	1.2146
.2003	-.9897	.3998	1.2241	.1503	-.0588	.6601	.7937	.5002	.7476	-1.0269	.3894	1.2440
.2503	-1.0062	.3952	1.2329	.1976	-.1620	.6313	.8382	.5002	.4976	-1.0418	.3853	1.2520
.3001	-1.0382	.3862	1.2501	.2503	-.2267	.6126	.8670	.5002	.2476	-1.0452	.3843	1.2539
.3502	-1.0504	.3824	1.2567	.3001	-.2743	.5999	.8868	.5002	-.2524	-.9948	.3984	1.2268
.4003	-1.0489	.3833	1.2559	.3507	-.3052	.5912	.9003	.5002	-.5024	-1.0522	.3823	1.2577
.4501	-1.0056	.3954	1.2325	.4001	-.3081	.5904	.9015	.5002	-.7524	-1.0001	.3969	1.2296
.5002	-.9953	.3982	1.2270	.4501	-.2872	.5963	.8924	.8002	.7476	-.3433	.5806	.9169
.5502	-1.0129	.3933	1.2364	.5001	-.2321	.6117	.8685	.8002	.4976	-.3408	.5813	.9159
.6002	-1.0158	.3925	1.2380	.5497	-.1341	.6391	.8262	.8002	.2476	-.3409	.5813	.9159
.6500	-.9717	.4049	1.2145	.6003	-.0290	.6685	.7810	.8002	-.5024	-.3534	.5778	.9214
.7000	-.9777	.5150	1.0220	.6500	.0593	.6932	.7431	.8002	-.7524	-.3557	.5771	.9224
.7500	-.4293	.5577	.9532	.7000	.1647	.7227	.6974					
.8002	-.3377	.5821	.9145	.7501	.2588	.7490	.6562					
.9002	-.1503	.6346	.8332	.8001	.3388	.7713	.6206					
.9501	-.0432	.6645	.7872	.8501	.4099	.7912	.5883					

TEST 167	PT 25.0772	PSI	CM .8422	CD1 .02245	CDCOR1 .02147
RUN 51	TT 140.1762	K	CM -.1653	CD2 .02355	CDCOR2 .02266
POINT 12	RC 10.0047	MILLION	CC .0168	CD3 .02217	CDCOR3 .02130
	MACH .7714			CD4 .02224	CDCOR4 .02136
	ALPHA 2.0225	DEG		CD5 .02085	CDCOR5 .02010

UPPER SURFACE				LOWER SURFACE				SPANWISE				
X/C	CP	P/L/PT	MLOC	X/C	CP	P/L/PT	MLOC	X/C	Y/(B/2)	CP	P/L/PT	MLOC
0.0000	1.1584	1.0005	0.0300	0.0000	1.1584	1.0005	0.0300	.1507	.7476	-1.0178	.3917	1.2396
.0132	-.3975	.5652	.9411	.0126	-.6248	.8512	.4853	.1507	.4976	-1.0762	.3753	1.2715
.0259	-.7862	.4565	1.1210	.0255	-.4402	.7996	.5745	.1507	.2476	-1.0443	.3843	1.2340
.0759	-1.0055	.3951	1.2330	.0495	-.2476	.7457	.6614	.1507	-.2524	-1.0390	.3858	1.2511
.1003	-1.0316	.3878	1.2476	.0753	-.1589	.7209	.7002	.1507	-.5024	-1.0633	.3790	1.2644
.1507	-1.0358	.3866	1.2493	.1002	-.0734	.6970	.7372	.1507	-.7524	-1.0177	.3917	1.2396
.2003	-1.0343	.3871	1.2485	.1503	-.0144	.6724	.7750	.5002	.7476	-1.0837	.3732	1.2757
.2503	-1.0522	.3818	1.2589	.1976	-.1190	.6431	.8200	.5002	.4976	-1.0957	.3699	1.2824
.3001	-1.0867	.3724	1.2774	.2503	-.1879	.6239	.8497	.5002	.2476	-1.1049	.3673	1.2876
.3502	-1.1037	.3677	1.2869	.3001	-.2358	.6105	.8704	.5002	-.2524	-1.0743	.3759	1.2704
.4003	-1.1127	.3651	1.2920	.3507	-.2701	.6009	.8853	.5002	-.5024	-1.0884	.3719	1.2783
.4501	-1.1114	.3655	1.2912	.4001	-.2770	.5989	.8883	.5002	-.7524	-1.0495	.3828	1.2568
.5002	-1.0677	.3777	1.2668	.4501	-.2612	.6034	.8814	.8002	.7476	-.3270	.5850	.9101
.5502	-1.0802	.3742	1.2737	.5001	-.2107	.6175	.8595	.8002	.4976	-.3275	.5841	.9103
.6002	-1.1034	.3677	1.2867	.5497	-.1172	.6436	.8192	.8002	.2476	-.3298	.5841	.9114
.6500	-1.0106	.3937	1.2357	.6003	-.0155	.6721	.7755	.8002	-.5024	-.3428	.5805	.9170
.7000	-.5351	.5211	1.0120	.6500	.0707	.6962	.7384	.8002	-.7524	-.3522	.5779	.9212
.7500	-.4207	.5587	.9515	.7000	.1746	.7253	.6934					
.8002	-.3295	.5843	.9112	.7501	.2674	.7512	.6526					
.9002	-.1449	.6359	.8311	.8001	.3467	.7734	.6172					
.9501	-.0464	.6634	.7888	.8501	.4176	.7932	.5849					

TEST 167	PT 25.0785	PSI	CM .8905	CD1 .02667	CDCOR1 .02499
RUN 51	TT 140.2493	K	CM -.1673	CD2 .02801	CDCOR2 .02654
POINT 13	RC 9.9979	MILLION	CC .0164	CD3 .02956	CDCOR3 .02792
	MACH .7715			CD4 .02765	CDCOR4 .02611
	ALPHA 2.5262	DEG		CD5 .02316	CDCOR5 .02237

UPPER SURFACE				LOWER SURFACE				SPANWISE				
X/C	CP	P/L/PT	MLOC	X/C	CP	P/L/PT	MLOC	X/C	Y/(B/2)	CP	P/L/PT	MLOC
0.0000	1.1425	.9960	.0755	0.0000	1.1425	.9960	.0755	.1507	.7476	-1.1124	.3648	1.2926
.0132	-.4664	.5456	.9723	.0126	-.6677	.8631	.4635	.1507	.4976	-1.1386	.3573	1.3076
.0259	-.8567	.4364	1.1566	.0255	-.4809	.8108	.5557	.1507	.2476	-1.1031	.3674	1.2874
.0759	-1.0693	.3769	1.2685	.0495	-.2896	.7573	.6430	.1507	-.2524	-1.0985	.3687	1.2847
.1003	-1.0905	.3709	1.2803	.0753	-.1963	.7317	.6833	.1507	-.5024	-1.1210	.3624	1.2975
.1507	-1.0978	.3689	1.2844	.1002	-.1023	.7048	.7250	.1507	-.7524	-1.0749	.3753	1.2716
.2003	-1.0938	.3700	1.2821	.1503	.0128	.6798	.7637	.5002	.7476	-1.1432	.3556	1.3113
.2503	-1.1102	.3654	1.2914	.1976	-.0921	.6504	.8088	.5002	.4976	-1.1529	.3535	1.3158
.3001	-1.1422	.3565	1.3096	.2503	-.1636	.6304	.8396	.5002	.2476	-1.1603	.3514	1.3201
.3502	-1.1615	.3511	1.3208	.3001	-.2146	.6161	.8616	.5002	-.2524	-1.1488	.3546	1.3134
.4003	-1.1742	.3475	1.3282	.3507	-.2529	.6054	.8782	.5002	-.5024	-1.1284	.3609	1.3006
.4501	-1.1967	.3412	1.3415	.4001	-.2636	.6024	.8829	.5002	-.7524	-1.0956	.3695	1.2831
.5002	-1.1813	.3455	1.3324	.4501	-.2522	.6056	.8779	.8002	.7476	-.3425	.5803	.9174
.5502	-1.1524	.3536	1.3155	.5001	-.2064	.6184	.8581	.8002	.4976	-.3529	.5774	.9219
.6002	-1.1662	.3497	1.3235	.5497	-.1171	.6434	.8195	.8002	.2476	-.3557	.5769	.9227
.6500	-.8221	.4461	1.1393	.6003	-.0186	.6710	.7772	.8002	-.5024	-.3558	.5766	.9232
.7000	-.5502	.5222	1.0103	.6500	.0677	.6952	.7400	.8002	-.7524	-.3716	.5722	.9302
.7500	-.4421	.5524	.9614	.7000	.1685	.7234	.6963					
.8002	-.3486	.5786	.9201	.7501	.2603	.7491	.6560					
.9002	-.1641	.6303	.8398	.8001	.3396	.7713	.6207					
.9501	-.0846	.6525	.8056	.8501	.4109	.7912	.5883					

ORIGINAL PAGE IS
OF POOR QUALITY

TEST 167 PT 25.0800 PSI CM .9194
 RUN 51 TT 140.2010 K CM -.1666
 POINT 14 RC 10.0041 MILLION CC .0168
 MACH .7716
 ALPHA 3.0173 DEG

CD1 .03504 CDCOR1 .03404
 CD2 .03264 CDCOR2 .03124
 CD3 .03732 CDCOR3 .03574
 CD4 .03382 CDCOR4 .03255
 CD5 .02840 CDCOR5 .02732

UPPER SURFACE				LOWER SURFACE				SPANWISE				
X/C	CP	P,L/PT	MLOC	X/C	CP	P,L/PT	MLOC	X/C	Y/(B/2)	CP	P,L/PT	MLOC
0.0000	1.1433	.9964	.0714	0.0000	1.1433	.9964	.0714	.1507	.7476	-1.1620	.3528	1.3172
.0132	-.5172	.5328	.9930	.0126	-.7128	.8762	.4386	.1507	.4976	-1.1641	.3466	1.3301
.0259	-.9070	.4240	1.1791	.0255	-.5246	.8237	.5338	.1507	.2476	-1.1497	.3562	1.3102
.0759	-1.1168	.3654	1.2914	.0495	-.3290	.7491	.6242	.1507	-.2524	-1.1450	.3575	1.3075
.1003	-1.1360	.3600	1.3023	.0753	-.2330	.7423	.6667	.1507	-.5024	-1.1663	.3516	1.3197
.1507	-1.1430	.3581	1.3063	.1002	-.1377	.7157	.7083	.1507	-.7524	-1.1267	.3626	1.2970
.2003	-1.1348	.3604	1.3016	.1503	-.0426	.6891	.7493	.5002	.7476	-1.1881	.3455	1.3324
.2503	-1.1517	.3556	1.3113	.1976	-.0626	.6597	.7949	.5002	.4976	-1.1936	.3440	1.3357
.3001	-1.1836	.3467	1.3298	.2503	-.1375	.6388	.8266	.5002	.2476	-1.1996	.3423	1.3392
.3502	-1.2000	.3421	1.3395	.3001	-.1911	.6238	.8497	.5002	-.2524	-1.1919	.3444	1.3347
.4003	-1.2120	.3388	1.3466	.3507	-.2327	.6122	.8676	.5002	-.5024	-1.1515	.3557	1.3112
.4501	-1.2390	.3313	1.3628	.4001	-.2480	.6080	.8743	.5002	-.7524	-1.1193	.3647	1.2928
.5002	-1.2527	.3274	1.3712	.4501	-.2411	.6099	.8713	.8002	.7476	-.3513	.5791	.9192
.5502	-1.1926	.3442	1.3351	.5001	-.2003	.6213	.8537	.8002	.4976	-.3742	.5727	.9293
.6002	-1.0057	.3964	1.2305	.5497	-.1142	.6453	.8166	.8002	.2476	-.3821	.5705	.9328
.6500	-.6404	.4984	1.0495	.6003	-.0178	.6722	.7753	.8002	-.5024	-.3595	.5768	.9228
.7000	-.5372	.5272	1.0021	.6500	-.0706	.6969	.7373	.8002	-.7524	-.3725	.5732	.9285
.7500	-.4539	.5505	.9646	.7000	-.1655	.7234	.6963					
.8002	-.3707	.5737	.9277	.7501	-.2569	.7489	.6562					
.8002	-.2039	.6203	.8552	.8001	-.3356	.7709	.6212					
.8501	-.1380	.6387	.8269	.8501	-.4085	.7907	.5891					

OP FOOT QUALITY

TEST 167 PT 31.8462 PSI CN -.0704 CD1 .01272 CDCOR1 .01256
 RUN 44 TT 129.5045 K CM -.1310 CD2 .01226 CDCOR2 .01214
 POINT 25 RC 14.9171 MILLION CC .0070 CD3 .01182 CDCOR3 .01177
 MACH .7701 CD4 .01114 CDCOR4 .01103
 ALPHA -4.6019 DEG CD5 .01029 CDCOR5 .00998

UPPER SURFACE				LOWER SURFACE				SPANWISE				
X/C	CP	P/L/PT	MLOC	X/C	CP	P/L/PT	MLOC	X/C	Y/(B/2)	CP	P/L/PT	MLOC
0.0000	.7519	.8862	.4192	0.0000	.7519	.8862	.4192	.1507	.7476	-.1187	.6420	.8221
.0132	.6339	.8531	.4821	.0126	-.6653	.4886	1.0663	.1507	.4976	-.1337	.6378	.8286
.0259	.3204	.7653	.6305	.0255	-.5736	.5144	1.0235	.1507	.2476	-.1323	.6382	.8260
.0759	-.0044	.6741	.7728	.0495	-.7280	.4711	1.0962	.1507	-.2524	-.1375	.6367	.8303
.1003	-.0561	.6596	.7951	.0753	-.7558	.4633	1.1096	.1507	-.5024	-.1389	.6364	.8308
.1507	-.1340	.6377	.8287	.1002	-.7921	.4531	1.1273	.1507	-.7524	-.1322	.6382	.8279
.2003	-.1881	.6231	.8513	.1503	-.7860	.4548	1.1244	.5002	.7476	-.4012	.6628	.9455
.2503	-.2396	.6092	.8727	.1976	-.8250	.4439	1.1436	.5002	.4976	-.4068	.6612	.9480
.3001	-.2796	.5969	.8919	.2503	-.8651	.4327	1.1638	.5002	.2476	-.4119	.6598	.9503
.3502	-.3180	.5889	.9044	.3001	-.9100	.4201	1.1867	.5002	-.2524	-.4016	.6627	.9457
.4003	-.3590	.5862	.9180	.3507	-.9475	.3983	1.2274	.5002	-.5024	-.3986	.6635	.9443
.4501	-.3715	.5711	.9323	.4001	-1.0497	.3809	1.2611	.5002	-.7524	-.3854	.6672	.9385
.5002	-.4091	.5606	.9490	.4501	-.9880	.5104	1.0301	.8002	.7476	-1.0100	.3920	1.2395
.5502	-.4478	.5497	.9683	.5001	-.9507	.5769	.9231	.8002	.4976	-.3659	.5727	.9299
.6002	-.4895	.5380	.9851	.5502	-.9230	.6108	.8703	.8002	.2476	-.3730	.5707	.9330
.6500	-.5175	.5302	.9978	.6003	-.8855	.6441	.8189	.8002	-.5024	-.3472	.5779	.9216
.7000	-.5004	.5330	.9900	.6500	-.8085	.6729	.7746	.8002	-.7524	-.3408	.5797	.9188
.7500	-.4460	.5502	.9655	.7000	.1038	.7044	.7261					
.8002	-.3672	.5723	.9304	.7501	.1999	.7314	.6842					
.9002	-.1750	.6262	.8465	.8001	.2799	.7538	.6489					
.9501	-.0499	.6613	.7924	.8501	.3465	.7725	.6190					

TEST 167 PT 31.8447 PSI CN .0834 CD1 .00956 CDCOR1 .00946
 RUN 44 TT 125.5093 K CM -.1301 CD2 .00937 CDCOR2 .00930
 POINT 26 RC 14.9128 MILLION CC .0138 CD3 .00918 CDCOR3 .00914
 MACH .7699 CD4 .00908 CDCOR4 .00900
 ALPHA -3.0042 DEG CD5 .00867 CDCOR5 .00842

UPPER SURFACE				LOWER SURFACE				SPANWISE				
X/C	CP	P/L/PT	MLOC	X/C	CP	P/L/PT	MLOC	X/C	Y/(B/2)	CP	P/L/PT	MLOC
0.0000	.8817	.9229	.3406	0.0000	.8817	.9229	.3406	.1507	.7476	-.2287	.6121	.8482
.0132	.4927	.8140	.5505	.0126	-.3873	.5677	.9376	.1507	.4976	-.2454	.6074	.8755
.0259	.1669	.7229	.6975	.0255	-.4000	.5642	.9433	.1507	.2476	-.2444	.6077	.8751
.0759	-.1410	.6367	.8303	.0495	-.5123	.5327	.9936	.1507	-.2524	-.2503	.6061	.8776
.1003	-.1811	.6254	.8477	.0753	-.5378	.5256	1.0052	.1507	-.5024	-.2525	.6055	.8786
.1507	-.2462	.6072	.8758	.1002	-.6096	.5055	1.0381	.1507	-.7524	-.2349	.6104	.8710
.2003	-.2868	.5959	.8935	.1503	-.5740	.5155	1.0217	.5002	.7476	-.4735	.6436	.9761
.2503	-.3304	.5836	.9126	.1976	-.6684	.4890	1.0657	.5002	.4976	-.4790	.6421	.9785
.3001	-.3692	.5728	.9297	.2503	-.7635	.4624	1.1111	.5002	.2476	-.4840	.6407	.9808
.3502	-.3905	.5688	.9391	.3001	-.8358	.4422	1.1467	.5002	-.2524	-.4731	.6437	.9759
.4003	-.4176	.5593	.9511	.3507	-.8943	.4258	1.1762	.5002	-.5024	-.4706	.6444	.9748
.4501	-.4478	.5508	.9646	.4001	-.8740	.4875	1.0683	.5002	-.7524	-.4572	.6482	.9688
.5002	-.4811	.5415	.9795	.4501	-.8410	.5527	.9615	.8002	.7476	-1.0608	.3792	1.2644
.5502	-.5163	.5316	.9954	.5001	-.8383	.5759	.9248	.8002	.4976	-.3811	.6695	.9349
.6002	-.5548	.5209	1.0129	.5502	-.8245	.6105	.8708	.8002	.2476	-.3862	.6680	.9372
.6500	-.5928	.5130	1.0258	.6003	-.8071	.6462	.8158	.8002	-.5024	-.3650	.6740	.9278
.7000	-.5476	.5230	1.0093	.6500	-.8013	.6758	.7702	.8002	-.7524	-.3616	.6749	.9263
.7500	-.4688	.5449	.9740	.7000	.1165	.7087	.7194					
.8002	-.3809	.5696	.9348	.7501	.2160	.7366	.6760					
.9002	-.1764	.6268	.8456	.8001	.2976	.7595	.6399					
.9501	-.0473	.6629	.7900	.8501	.3655	.7784	.6094					

TEST 167 PT 31.8447 PSI CN .2428 CD1 .00893 CDCOR1 .00881
 RUN 44 TT 125.5237 K CM -.1433 CD2 .00886 CDCOR2 .00878
 POINT 27 RC 14.9078 MILLION CC .0195 CD3 .00880 CDCOR3 .00876
 MACH .7697 CD4 .00874 CDCOR4 .00867
 ALPHA -2.0060 DEG CD5 .00844 CDCOR5 .00822

UPPER SURFACE				LOWER SURFACE				SPANWISE				
X/C	CP	P/L/PT	MLOC	X/C	CP	P/L/PT	MLOC	X/C	Y/(B/2)	CP	P/L/PT	MLOC
0.0000	1.0105	.9543	.2445	0.0000	1.0105	.9593	.2445	.1507	.7476	-.3569	.5776	.9222
.0132	.3137	.7646	.6314	.0126	-.1070	.6473	.8140	.1507	.4976	-.3772	.5719	.9311
.0259	-.0232	.6707	.7780	.0255	-.1782	.6275	.8446	.1507	.2476	-.3782	.5716	.9315
.0759	-.3066	.5916	.9002	.0495	-.3164	.5889	.9045	.1507	-.2524	-.3854	.5696	.9347
.1003	-.3311	.5848	.9109	.0753	-.3510	.5792	.9196	.1507	-.5024	-.3859	.5693	.9349
.1507	-.3794	.5713	.9371	.1002	-.4154	.5612	.9480	.1507	-.7524	-.3846	.5754	.9255
.2003	-.4030	.5647	.9625	.1503	-.4432	.5535	.9603	.5002	.7476	-.5546	.6224	1.0104
.2503	-.4410	.5541	.9593	.1976	-.5466	.5246	1.0058	.5002	.4976	-.5597	.6210	1.0127
.3001	-.4745	.5447	.9743	.2503	-.5961	.5108	1.0295	.5002	.2476	-.5651	.6194	1.0152
.3502	-.4824	.5425	.9778	.3001	-.6225	.5034	1.0417	.5002	-.2524	-.5551	.6222	1.0107
.4003	-.5043	.5364	.9877	.3507	-.6057	.5081	1.0339	.5002	-.5024	-.5528	.6229	1.0096
.4501	-.5333	.5283	1.0007	.4001	-.6324	.5286	1.0003	.5002	-.7524	-.5379	.6270	1.0028
.5002	-.5618	.5264	1.0137	.4501	-.6472	.5524	.9621	.8002	.7476	-1.0962	.3712	1.2803
.5502	-.5907	.5123	1.0270	.5001	-.6483	.5800	.9184	.8002	.4976	-.3920	.6678	.9376
.6002	-.6245	.5029	1.0425	.5502	-.6160	.6160	.8623	.8002	.2476	-.3956	.6688	.9392
.6500	-.6519	.4952	1.0553	.6003	-.6023	.6514	.8077	.8002	-.5024	-.3796	.6712	.9322
.7000	-.6967	.5106	1.0297	.6500	.0112	.6803	.7633	.8002	-.7524	-.3770	.6719	.9310
.7500	-.6436	.5422	.9783	.7000	.1289	.7131	.7127					
.8002	-.3894	.5685	.9365	.7501	.2281	.7409	.6693					
.9002	-.1772	.6277	.8441	.8001	.3102	.7638	.6330					
.9501	-.0465	.6647	.7880	.8501	.3794	.7831	.6018					

TEST 167	PT	31.8472	PSI	CM	.3141	CD1	.00893	CDCOR1	.00873
RUN 44	TT	125.5146	K	CM	-1.1450	CD2	.00888	CDCOR2	.00873
POINT 28	RC	14.9100	MILLION	CC	.0209	CD3	.00883	CDCOR3	.00874
	MACH	.7696				CD4	.00872	CDCOR4	.00861
	ALPHA	-1.5071	DEG			CD5	.00844	CDCOR5	.00823

UPPER SURFACE				LOWER SURFACE				SPANWISE				
X/C	CP	P _L /PT	MLOC	X/C	CP	P _L /PT	MLOC	X/C	Y/(B/2)	CP	P _L /PT	MLOC
0.0000	1.0571	.9722	.2012	0.0000	1.0571	.9722	.2012	.1507	.7476	-.4247	.5580	.9531
.0132	.2200	.7382	.6735	.0126	.0171	.6815	.7614	.1507	.4976	-.4483	.5514	.9636
.0257	-.1211	.6429	.8208	.0255	-.0769	.6552	.8018	.1507	.2476	-.4495	.5511	.9641
.0759	-.3954	.5662	.9401	.0495	-.2283	.6129	.8671	.1507	-.2324	-.4558	.5493	.9669
.1003	-.4099	.5621	.9465	.0702	-.2695	.6014	.8849	.1507	-.5024	-.4546	.5496	.9664
.1307	-.4501	.5509	.9644	.1003	-.3390	.5620	.9153	.1507	-.7524	-.4276	.5572	.9544
.2003	-.4650	.5467	.9710	.1503	-.3793	.5707	.9330	.5002	.7476	-.5986	.5094	1.0317
.2503	-.4994	.5371	.9865	.1976	-.4800	.5426	.9778	.5002	.4976	-.6094	.5064	1.0367
.3001	-.5314	.5282	1.0010	.2503	-.5277	.5292	.9993	.5002	.2476	-.6164	.5044	1.0400
.3502	-.5307	.5284	1.0006	.3001	-.5548	.5216	1.0116	.5002	-.2524	-.6064	.5072	1.0353
.4003	-.5484	.5234	1.0087	.3502	-.5488	.5233	1.0089	.5002	-.5024	-.6026	.5083	1.0336
.4501	-.5759	.5158	1.0213	.4001	-.4998	.5370	.9867	.5002	-.7524	-.5828	.5138	1.0245
.5002	-.6125	.5055	1.0382	.4501	-.4290	.5568	.9550	.8002	.7476	-1.0845	.3736	1.2755
.5502	-.6262	.5017	1.0445	.5001	-.3344	.5833	.9132	.8002	.4976	-.3911	.5674	.9382
.6002	-.6552	.4936	1.0581	.5497	-.2083	.6185	.8584	.8002	.2476	-.3951	.5663	.9399
.6500	-.6832	.4858	1.0712	.6003	-.0836	.6533	.8047	.8002	-.5024	-.3828	.5697	.9345
.7000	-.6213	.5031	1.0422	.6500	.0177	.6817	.7612	.8002	-.7524	-.3819	.5700	.9341
.7500	-.4851	.5411	.9801	.7000	.1342	.7142	.7109					
.8002	-.3888	.5680	.9372	.7501	.2335	.7420	.6676					
.8502	-.1759	.6276	.8444	.8001	.3157	.7650	.6311					
.9001	-.0452	.6641	.7882	.8501	.3854	.7844	.5997					

TEST 167	PT	31.8442	PSI	CM	.3866	CD1	.00912	CDCOR1	.00893
RUN 44	TT	125.5344	K	CM	-1.1462	CD2	.00903	CDCOR2	.00888
POINT 29	RC	14.8913	MILLION	CC	.0214	CD3	.00897	CDCOR3	.00889
	MACH	.7684				CD4	.00887	CDCOR4	.00875
	ALPHA	-1.0081	DEG			CD5	.00855	CDCOR5	.00831

UPPER SURFACE				LOWER SURFACE				SPANWISE				
X/C	CP	P _L /PT	MLOC	X/C	CP	P _L /PT	MLOC	X/C	Y/(B/2)	CP	P _L /PT	MLOC
0.0000	1.0989	.9842	.1510	0.0000	1.0989	.9842	.1510	.1507	.7476	-.4954	.5403	.9814
.0132	.1186	.7113	.7125	.0126	.1362	.7162	.7079	.1507	.4976	-.5228	.5327	.9937
.0257	-.2289	.6145	.8666	.0255	-.0227	.6866	.7567	.1507	.2476	-.5252	.5320	.9948
.0759	-.4947	.5405	.9811	.0495	-.1398	.6393	.8263	.1507	-.2324	-.5295	.5308	.9967
.1003	-.4953	.5403	.9813	.0702	-.1878	.6260	.8469	.1507	-.5024	-.5246	.5322	.9945
.1307	-.5254	.5320	.9949	.1003	-.2625	.6051	.8791	.1507	-.7524	-.4921	.5412	.9799
.2003	-.5297	.5307	.9968	.1503	-.3126	.5912	.9008	.5002	.7476	-.6462	.4983	1.0443
.2503	-.5563	.5233	1.0089	.1976	-.4098	.5641	.9433	.5002	.4976	-.6462	.4983	1.0501
.3001	-.5613	.5136	1.0248	.2503	-.4984	.5506	.9649	.5002	.7476	-.6330	.4964	1.0533
.3502	-.5754	.5180	1.0175	.3001	-.4854	.5431	.9769	.5002	-.2324	-.6435	.4991	1.0489
.4003	-.5860	.5151	1.0224	.3502	-.4907	.5416	.9793	.5002	-.5024	-.6427	.4993	1.0485
.4501	-.6124	.5077	1.0343	.4001	-.4573	.5509	.9644	.5002	-.7524	-.6216	.5052	1.0387
.5002	-.6483	.5077	1.0511	.4501	-.3997	.5669	.9389	.8002	.7476	-1.0836	.3765	1.2697
.5502	-.6676	.4923	1.0601	.5001	-.3129	.5911	.9009	.8002	.4976	-.3905	.5695	.9349
.6002	-.6810	.4886	1.0684	.5497	-.1920	.6288	.8687	.8002	.2476	-.3942	.5685	.9365
.6500	-.6924	.4854	1.0717	.6003	-.0706	.6586	.8267	.8002	-.5024	-.3823	.5718	.9313
.7000	-.6235	.5046	1.0396	.6500	.0282	.6861	.7844	.8002	-.7524	-.3814	.5720	.9309
.7500	-.4850	.5432	.9747	.7000	.1434	.7182	.7048					
.8002	-.3875	.5703	.9336	.7501	.2423	.7457	.6617					
.8502	-.1734	.6300	.8407	.8001	.3247	.7686	.6252					
.9001	-.0433	.6662	.7850	.8501	.3949	.7882	.5935					

TEST 167	PT	31.9352	PSI	CM	-.4676	CD1	.00937	CDCOR1	.00914
RUN 44	TT	125.3480	K	CM	-1.1490	CD2	.00927	CDCOR2	.00909
POINT 30	RC	14.9635	MILLION	CC	.0214	CD3	.00922	CDCOR3	.00911
	MACH	.7687				CD4	.00902	CDCOR4	.00889
	ALPHA	-.5091	DEG			CD5	.00873	CDCOR5	.00848

UPPER SURFACE				LOWER SURFACE				SPANWISE				
X/C	CP	P _L /PT	MLOC	X/C	CP	P _L /PT	MLOC	X/C	Y/(B/2)	CP	P _L /PT	MLOC
0.0000	1.1282	.9925	.1038	0.0000	1.1282	.9925	.1038	.1507	.7476	-.5627	.5169	1.0194
.0132	.0099	.6816	.7612	.0126	.2486	.7480	.6581	.1507	.4976	-.6122	.5087	1.0329
.0257	-.3417	.5839	.9122	.0255	-.1172	.7115	.7152	.1507	.2476	-.6160	.5076	1.0346
.0759	-.5897	.5079	1.0357	.0495	-.0564	.6832	.7696	.1507	-.2324	-.6195	.5067	1.0362
.1003	-.6165	.5049	1.0226	.0702	-.1110	.6490	.8129	.1507	-.5024	-.6117	.5080	1.0326
.1307	-.6165	.5079	1.0348	.1003	-.1922	.6235	.8476	.1507	-.7524	-.5765	.5203	1.0138
.2003	-.6161	.5077	1.0346	.1503	-.2305	.6092	.8727	.5002	.7476	-.6800	.4899	1.0643
.2503	-.6159	.5077	1.0346	.1976	-.3472	.5824	.9146	.5002	.4976	-.6878	.4877	1.0679
.3001	-.6602	.4954	1.0550	.2503	-.3986	.5681	.9371	.5002	.2476	-.6896	.4872	1.0699
.3502	-.6686	.4930	1.0589	.3001	-.4292	.5596	.9406	.5002	-.2324	-.6806	.4897	1.0645
.4003	-.6936	.4872	1.0520	.3502	-.4416	.5581	.9560	.5002	-.5024	-.6870	.4879	1.0675
.4501	-.6451	.4890	1.0490	.4001	-.4187	.5625	.9550	.5002	-.7524	-.6748	.4912	1.0619
.5002	-.6810	.4886	1.0647	.4501	-.3717	.5736	.9253	.8002	.7476	-1.0995	.3731	1.2764
.5502	-.7171	.4786	1.0817	.5001	-.2927	.5975	.8909	.8002	.4976	-.3925	.5697	.9345
.6002	-.7426	.4734	1.0939	.5497	-.1773	.6296	.8413	.8002	.2476	-.3941	.5691	.9351
.6500	-.7682	.4691	1.1022	.6003	-.0597	.6623	.7909	.8002	-.5024	-.3894	.5714	.9313
.7000	-.6867	.4921	1.0588	.6500	.0361	.6884	.7500					
.7500	-.4861	.5438	.9798	.7000	.1499	.7204	.7011					
.8002	-.3867	.5714	.9319	.7501	.2479	.7479	.6584					
.8502	-.1724	.6309	.8393	.8001	.3301	.7707	.6220					
.9001	-.0446	.6666	.7843	.8501	.4009	.7903	.5900					

GENERAL REPORT
OF POOR QUALITY

TEST 167	PT 31.9385	PSI	CM .5441	CD1 .00972	CDCOR1 .00948
RUN 44	TT 125.3670	K	CM -.1501	CD2 .00967	CDCOR2 .00948
POINT 31	RC 14.9685	MILLION	CC .0202	CD3 .00938	CDCOR3 .00945
	MACH .7687			CD4 .00933	CDCOR4 .00915
	ALPHA -.0102	DEG		CD5 .00913	CDCOR5 .00879

UPPER SURFACE				LOWER SURFACE				SPANWISE				
X/C	CP	P/L/PT	MLOC	X/C	CP	P/L/PT	MLOC	X/C	Y/(B/2)	CP	P/L/PT	MLOC
0.0000	1.1465	.9977	.0578	0.0000	1.1465	.9977	.0578	.1507	.7476	-.6555	.4973	1.0519
.0132	-.0876	.6551	.8020	.0126	-.3520	.7770	.6117	.1507	.4976	-.6779	.4910	1.0623
.0259	-.6495	.5545	.9587	.0255	-.2055	.7364	.6764	.1507	.2476	-.7072	.4829	1.0760
.0759	-.7424	.4807	1.0798	.0495	-.0259	.6865	.7539	.1507	-.2524	-.7100	.4821	1.0774
.1003	-.7424	.4731	1.0927	.0753	-.0362	.6692	.7803	.1507	-.5024	-.6629	.4952	1.0553
.1507	-.7064	.4831	1.0757	.1002	-.1218	.6455	.8169	.1507	-.7524	-.6291	.5046	1.0397
.2003	-.6976	.4856	1.0715	.1503	-.1871	.6273	.8448	.5002	.7476	-.7164	.4804	1.0804
.2503	-.6706	.4931	1.0589	.1976	-.2836	.6005	.8863	.5002	.4976	-.7260	.4777	1.0849
.3001	-.7123	.4815	1.0704	.2503	-.3370	.5857	.9094	.5002	-.2476	-.7326	.4759	1.0880
.3502	-.7200	.4794	1.0821	.3001	-.3704	.5784	.9240	.5002	-.2524	-.7198	.4794	1.0820
.4003	-.7216	.4789	1.0828	.3507	-.3885	.5714	.9319	.5002	-.5024	-.7239	.4783	1.0839
.4501	-.7269	.4774	1.0854	.4001	-.3734	.5756	.9253	.5002	-.7524	-.7197	.4794	1.0819
.5002	-.7350	.4752	1.0892	.4501	-.3357	.5861	.9088	.8002	.7476	-1.0765	.3803	1.2622
.5502	-.7377	.4744	1.0904	.5001	-.2640	.6080	.8778	.8002	.4976	-.3870	.5718	.9312
.6002	-.7528	.4702	1.0977	.5497	-.1550	.6362	.8310	.8002	-.2476	-.3890	.5713	.9321
.6500	-.7337	.4755	1.0886	.6003	-.0418	.6677	.7827	.8002	-.5024	-.3783	.5742	.9274
.7000	-.6257	.5055	1.0381	.6500	.0508	.6934	.7431	.8002	-.7524	-.3768	.5747	.9268
.7500	-.4842	.5448	.9741	.7000	.1627	.7243	.6950					
.8002	-.3838	.5727	.9294	.7500	.2593	.7513	.6529					
.8502	-.1691	.6323	.8370	.8001	.3413	.7741	.6165					
.9501	-.0425	.6675	.7830	.8501	.4120	.7937	.5843					

TEST 167	PT 31.9316	PSI	CM .6301	CD1 .01077	CDCOR1 .01043
RUN 45	TT 125.678	K	CM -.1594	CD2 .01096	CDCOR2 .01044
POINT 32	RC 14.9806	MILLION	CC .0196	CD3 .01069	CDCOR3 .01054
	MACH .7701			CD4 .01017	CDCOR4 .00996
	ALPHA .4888	DEG		CD5 .00981	CDCOR5 .00944

UPPER SURFACE				LOWER SURFACE				SPANWISE				
X/C	CP	P/L/PT	MLOC	X/C	CP	P/L/PT	MLOC	X/C	Y/(B/2)	CP	P/L/PT	MLOC
0.0000	1.1518	.9983	.0495	0.0000	1.1518	.9983	.0495	.1507	.7476	-.7944	.4516	1.1302
.0132	-.1574	.6304	.8400	.0126	-.4311	.7958	.5810	.1507	.4976	-.8324	.4409	1.1490
.0259	-.5290	.5201	1.0043	.0255	-.2733	.7519	.6526	.1507	.2476	-.8297	.4416	1.1477
.0759	-.7935	.4518	1.1297	.0495	-.0877	.6994	.7339	.1507	-.2524	-.8310	.4413	1.1484
.1003	-.8152	.4457	1.1405	.0753	-.0193	.6801	.7639	.1507	-.5024	-.8387	.4391	1.1522
.1507	-.8229	.4435	1.1443	.1002	-.0702	.6550	.8022	.1507	-.7524	-.7442	.4451	1.1066
.2003	-.8192	.4446	1.1429	.1503	-.1410	.6351	.8266	.5002	.7476	-.8320	.4410	1.1489
.2503	-.8295	.4417	1.1476	.1976	-.2413	.6069	.8763	.5002	.4976	-.8171	.4452	1.1414
.3001	-.8386	.4391	1.1522	.2503	-.2955	.5906	.9018	.5002	-.2476	-.8281	.4421	1.1469
.3502	-.7962	.4510	1.1311	.3001	-.3379	.5798	.9107	.5002	-.2524	-.8227	.4436	1.1442
.4003	-.7693	.4586	1.1178	.3507	-.3612	.5733	.9289	.5002	-.5024	-.8232	.4435	1.1445
.4501	-.7844	.4544	1.1252	.4001	-.3514	.5760	.9246	.8002	-.7524	-.8359	.4399	1.1508
.5002	-.8183	.4448	1.1420	.4501	-.3186	.5852	.9102	.8002	.7476	-1.0207	.3880	1.2472
.5502	-.8521	.4354	1.1590	.5001	-.2513	.6041	.8807	.8002	.4976	-.3863	.5718	.9312
.6002	-.8850	.4261	1.1757	.5497	-.1452	.6339	.8346	.8002	-.2476	-.3833	.5727	.9299
.6500	-.8750	.4289	1.1706	.6003	-.0366	.6650	.7867	.8002	-.5024	-.3618	.5731	.9292
.7000	-.6616	.4889	1.0660	.6500	.0365	.6908	.7475	.8002	-.7524	-.3647	.5723	.9305
.7500	-.4469	.5492	.9972	.7000	.1672	.7217	.6993					
.8002	-.3573	.5743	.9272	.7501	.2629	.7484	.6572					
.8502	-.1583	.6302	.8403	.8001	.3444	.7715	.6207					
.9501	-.0393	.6637	.7889	.8501	.4157	.7915	.5881					

TEST 167	PT 31.9397	PSI	CM .7214	CD1 .01324	CDCOR1 .01285
RUN 45	TT 125.3067	K	CM -.1597	CD2 .01320	CDCOR2 .01277
POINT 33	RC 14.9430	MILLION	CC .0180	CD3 .01298	CDCOR3 .01250
	MACH .7699			CD4 .01263	CDCOR4 .01212
	ALPHA .9877	DEG		CD5 .01230	CDCOR5 .01187

UPPER SURFACE				LOWER SURFACE				SPANWISE				
X/C	CP	P/L/PT	MLOC	X/C	CP	P/L/PT	MLOC	X/C	Y/(B/2)	CP	P/L/PT	MLOC
0.0000	1.1500	.9999	.0098	0.0000	1.1500	.9999	.0098	.1507	.7476	-.6885	.4293	1.1499
.0132	-.2576	.6054	.8787	.0126	-.9120	.8202	.5401	.1507	.4976	-.9406	.4131	1.1997
.0259	-.8346	.5002	1.0471	.0255	-.3430	.7730	.6162	.1507	.2476	-.9093	.4179	1.1908
.0759	-.8935	.4279	1.1725	.0495	-.1540	.7283	.7016	.1507	-.2524	-.9281	.4182	1.1901
.1003	-.9144	.4221	1.1831	.0753	-.0788	.6993	.7340	.1507	-.5024	-.9437	.4139	1.1982
.1507	-.9183	.4210	1.1851	.1002	-.0192	.6730	.7745	.1507	-.7524	-.8752	.4330	1.1632
.2003	-.9202	.4204	1.1861	.1503	-.0924	.6515	.8076	.5002	.7476	-.9491	.4124	1.2010
.2503	-.9347	.4164	1.1936	.1976	-.1920	.6237	.8504	.5002	.4976	-.9604	.4092	1.2064
.3001	-.9421	.4085	1.2083	.2503	-.2530	.6066	.8768	.5002	-.2476	-.9214	.4281	1.1867
.3502	-.9619	.4088	1.2077	.3001	-.2937	.5953	.8944	.5002	-.2524	-.8953	.4274	1.1734
.4003	-.9623	.4254	1.1770	.3507	-.3199	.5880	.9059	.5002	-.5024	-.9330	.4113	1.2030
.4501	-.9603	.4260	1.1759	.4001	-.3166	.5889	.9045	.8002	.7476	-.9801	.4037	1.2172
.5002	-.9654	.4246	1.1785	.4501	-.2912	.5960	.8933	.8002	.4976	-.9588	.4071	.9229
.5502	-.9197	.4204	1.1858	.5001	-.2314	.6127	.8674	.8002	-.2476	-.9569	.4070	.9219
.6002	-.9452	.4134	1.1990	.5497	-.1311	.6407	.8242	.8002	-.5024	-.9368	.4094	.9194
.6500	-.9395	.4150	1.1960	.6003	-.0242	.6755	.7783	.8002	-.7524	-.9340	.4089	.9208
.7000	-.6208	.5040	1.0407	.6500	.0637	.6985	.7406					
.7500	-.4341	.5561	.9561	.7000	.1728	.7255	.6934					
.8002	-.3488	.5799	.9165	.7501	.2677	.7520	.6518					
.8502	-.1575	.6331	.8356	.8001	.3490	.7747	.6155					
.9501	-.0437	.6651	.7867	.8501	.4206	.7947	.5829					

TEST	167	PT	31.9332	PSI	LN	.7926	CD1	.01816	CDCOR1	.01792		
RUN	45	TT	125.3579	K	CM	-.1624	CD2	.01777	CDCOR2	.01767		
POINT	34	RC	14.9867	MILLION	CC	.0168	CD3	.01736	CDCOR3	.01722		
		MACH	.7704				CD4	.01799	CDCOR4	.01808		
		ALPHA	1.4867	DEG			CD5	.01719	CDCOR5	.01652		
UPPER SURFACE				LOWER SURFACE				SPANWISE				
X/C	CP	P/L/PT	MLOC	X/C	CP	P/L/PT	MLOC	X/C	Y/(B/2)	CP	P/L/PT	MLOC
0.0000	1.1468	.9977	.0577	0.0000	1.1468	.9977	.0577	.1507	.7476	-.9291	.4206	1.1858
.0132	-.3373	.5851	.9103	.0126	.5764	.8391	.5072	.1507	.4976	-1.0258	.3937	1.2362
.0259	-.6093	.4873	1.0686	.0255	.3981	.7966	.5913	.1507	.2476	-1.0024	.4002	1.2238
.0759	-.9667	.4102	1.2051	.0495	-.2111	.7376	.6745	.1507	-.2524	-.9995	.4010	1.2223
.1003	-.9879	.4043	1.2162	.0753	.1304	.7151	.7095	.1507	-.5024	-1.0189	.3956	1.2326
.1507	-.9903	.4036	1.2174	.1022	.0382	.6895	.7491	.1507	-.7524	-.9451	.4101	1.1940
.2003	-.9900	.4037	1.2173	.1503	-.0450	.6664	.7847	.5002	.7476	-1.0301	.3925	1.2385
.2503	-1.0088	.3990	1.2261	.1976	-.1455	.6384	.8277	.5002	.4976	-1.0411	.3895	1.2444
.3001	-1.0395	.3899	1.2435	.2503	-.2095	.6206	.8551	.5002	.2476	-1.0424	.3891	1.2451
.3502	-1.0450	.3881	1.2470	.3001	-.2524	.6087	.8735	.5002	-.2524	-.9994	.4011	1.2222
.4003	-1.0326	.3918	1.2398	.3507	-.2813	.6007	.8860	.5002	-.5024	-1.0453	.3883	1.2466
.4501	-.9883	.4042	1.2164	.4001	-.2831	.6002	.8868	.5002	-.7524	-.9960	.4020	1.2204
.5002	-1.0077	.3988	1.2266	.4501	-.2646	.6053	.8788	.8002	.7476	-.9266	.4213	1.1845
.5502	-1.0020	.4003	1.2236	.5001	-.2111	.6202	.8558	.8002	.4976	-.9406	.3842	.9118
.6002	-1.0247	.3940	1.2356	.5497	-.1168	.6464	.8154	.8002	.2476	-.9394	.3845	.9112
.6500	-.9855	.4049	1.2149	.6003	-.0141	.6750	.7715	.8002	-.5024	-.9370	.3852	.9102
.7000	-.9839	.5166	1.0199	.6500	.0494	.6982	.7357	.8002	-.7524	-.9374	.3851	.9133
.7500	-.4170	.5630	.9452	.7000	.1759	.7278	.6888					
.8002	-.3329	.5863	.9084	.7501	.2495	.7538	.6489					
.8502	-.1477	.6378	.8286	.8001	.3495	.7760	.6133					
.9501	-.0349	.6692	.7804	.8501	.4202	.7957	.5812					

TEST	167	PT	32.0312	PSI	CM	.8908	CD1	.02355	CDCOR1	.02219		
RUN	45	TT	125.4584	K	CM	-.1719	CD2	.02447	CDCOR2	.02339		
POINT	35	RC	15.0124	MILLION	CC	.0194	CD3	.02511	CDCOR3	.02354		
		MACH	.7702				CD4	.02357	CDCOR4	.02183		
		ALPHA	1.9958	DEG			CD5	.02516	CDCOR5	.02443		
UPPER SURFACE				LOWER SURFACE				SPANWISE				
X/C	CP	P/L/PT	MLOC	X/C	CP	P/L/PT	MLOC	X/C	Y/(B/2)	CP	P/L/PT	MLOC
0.0000	1.1800	1.0008	0.0000	0.0000	1.1800	1.0008	0.0000	.1507	.7476	-.9340	.4089	1.2081
.0132	-.3764	.5704	.9335	.0126	.6291	.8521	.4840	.1507	.4976	-1.0628	.3781	1.2666
.0259	-.7314	.4709	1.0965	.0255	.4442	.8008	.5727	.1507	.2476	-1.0339	.3872	1.2508
.0759	-.9946	.3972	1.2296	.0495	-.2557	.7474	.6590	.1507	-.2524	-1.0329	.3864	1.2503
.1003	-1.0183	.3905	1.2423	.0753	-.1711	.7237	.6961	.1507	-.5024	-1.0532	.3888	1.2614
.1507	-1.0227	.3893	1.2447	.1002	.0745	.6967	.7380	.1507	-.7524	-.9683	.4040	1.2156
.2003	-1.0241	.3889	1.2455	.1503	-.0127	.6723	.7756	.5002	.7476	-1.0802	.3732	1.2763
.2503	-1.0387	.3848	1.2534	.1976	-.1161	.6433	.8202	.5002	.4976	-1.0894	.3706	1.2814
.3001	-1.0729	.3752	1.2722	.2503	-.1843	.6242	.8496	.5002	.2476	-1.0967	.3686	1.2895
.3502	-1.0889	.3708	1.2812	.3001	-.2315	.6110	.8701	.5002	-.2524	-1.0749	.3747	1.2733
.4003	-1.0953	.3690	1.2847	.3507	-.2655	.6014	.8849	.5002	-.5024	-1.0769	.3741	1.2744
.4501	-1.0843	.3720	1.2786	.4001	-.2718	.5997	.8876	.5002	-.7524	-1.0472	.3825	1.2580
.5002	-1.0649	.3775	1.2878	.4501	-.2566	.6039	.8810	.8002	.7476	-.9904	.4236	1.1803
.5502	-1.0982	.3682	1.2864	.5001	-.2042	.6180	.8591	.8002	.4976	-.9360	.3817	.9157
.6002	-1.0924	.3688	1.2831	.5497	-.1133	.6441	.8190	.8002	.2476	-.9375	.3813	.9143
.6500	-1.1284	.3597	1.3035	.6003	-.0117	.6725	.7752	.8002	-.5024	-.9393	.3803	.9171
.7000	-.6583	.4913	1.0518	.6500	.0718	.6959	.7392	.8002	-.7524	-.9265	.3844	.9115
.7500	-.4433	.5516	.9632	.7000	.1778	.7256	.6932					
.8002	-.3352	.5819	.9153	.7501	.2710	.7517	.6522					
.8502	-.1432	.6357	.8319	.8001	.3514	.7743	.6162					
.9501	-.0482	.6623	.7909	.8501	.4226	.7942	.5837					

TEST	167	PT	32.0249	PSI	CM	.8963	CD1	.02833	CDCOR1	.02536		
RUN	45	TT	125.4804	K	CM	-.1723	CD2	.03154	CDCOR2	.02845		
POINT	36	RC	15.0140	MILLION	CC	.0188	CD3	.03341	CDCOR3	.02813		
		MACH	.7708				CD4	.03383	CDCOR4	.03220		
		ALPHA	2.4948	DEG			CD5	.03346	CDCOR5	.03266		
UPPER SURFACE				LOWER SURFACE				SPANWISE				
X/C	CP	P/L/PT	MLOC	X/C	CP	P/L/PT	MLOC	X/C	Y/(B/2)	CP	P/L/PT	MLOC
0.0000	1.1537	.9994	.0298	0.0000	1.1537	.9994	.0298	.1507	.7476	-1.0170	.3943	1.2351
.0132	-.4516	.5519	.9628	.0126	.6737	.8656	.4591	.1507	.4976	-1.1292	.3630	1.2967
.0259	-.8136	.4510	1.1311	.0255	.4864	.8135	.5513	.1507	.2476	-1.1001	.3712	1.2804
.0759	-1.0645	.3811	1.2607	.0495	-.2935	.7596	.6390	.1507	-.2524	-1.0968	.3721	1.2785
.1003	-1.0890	.3754	1.2720	.0753	-.2050	.7349	.6780	.1507	-.5024	-1.1165	.3666	1.2895
.1507	-1.0897	.3741	1.2744	.1002	.1083	.7040	.7203	.1507	-.7524	-1.0199	.3933	1.2366
.2003	-1.0822	.3762	1.2704	.1503	.0194	.6822	.7604	.5002	.7476	-1.1434	.3591	1.3048
.2503	-1.0991	.3714	1.2798	.1976	-.0902	.6527	.8058	.5002	.4976	-1.1586	.3571	1.3080
.3001	-1.1325	.3621	1.2985	.2503	-.1628	.6327	.8366	.5002	.2476	-1.1594	.3546	1.3139
.3502	-1.1478	.3579	1.3073	.3001	-.2120	.6147	.8581	.5002	-.2524	-1.1374	.3608	1.3013
.4003	-1.1364	.3555	1.3122	.3507	-.2494	.6083	.8742	.5002	-.5024	-1.1190	.3659	1.2909
.4501	-1.1188	.3517	1.3199	.4001	-.2601	.6053	.8784	.5002	-.7524	-1.1189	.3681	1.2844
.5002	-1.1422	.3594	1.3041	.4501	-.2505	.6080	.8747	.8002	.7476	-.9442	.4141	1.1979
.5502	-1.1412	.3591	1.3150	.5001	-.2049	.6207	.8550	.8002	.4976	-.9359	.3758	.9249
.6002	-1.1725	.3516	1.3215	.5497	-.1157	.6456	.8167	.8002	.2476	-.9322	.3769	.9233
.6500	-1.0055	.3475	1.2289	.6003	-.0166	.6742	.7742	.8002	-.5024	-.9388	.3778	.9218
.7000	-.5694	.5191	1.0158	.6500	.0635	.6955	.7399	.8002	-.7524	-.9387	.3834	.9130
.7500	-.4447	.5527	.9615	.7000	.1687	.7246	.6944					
.8002	-.3535	.5793	.9145	.7501	.2613	.7506	.6539					
.8502	-.1755	.6289	.8424	.8001	.3411	.7729	.6184					
.9501	-.0873	.6535	.8045	.8501	.4122	.7927	.5861					

ORIGINAL PAGE IS
OF POOR QUALITY

TEST	167	PT	32.0272	PSI	CM	.0995	CD1	.03886	CDCOR1	.03697
RUN	42	TT	125.4252	K	CM	-.1674	CD2	.03598	CDCOR2	.03457
POINT	37	RC	15.0224	MILLION	CC	.0196	CD3	.03980	CDCOR3	.03777
		MACH	.7707				CD4	.04140	CDCOR4	.03852
		ALPHA	2.9938	DEG			CD5	.03920	CDCOR5	.03705

UPPER SURFACE				LOWER SURFACE				SPANWISE				
X/C	CP	P/L/PT	MLOC	X/C	CP	P/L/PT	MLOC	X/C	Y/(B/2)	CP	P/L/PT	MLOC
0.0000	1.1436	.9962	.0735	0.0000	1.1436	.9962	.0735	.1507	.7476	-1.0756	.3744	1.2729
.0132	-.4983	.5365	.9874	.0126	.7012	.8724	.4462	.1507	.4976	-1.1865	.3494	1.3247
.0259	-.8589	.4356	1.1926	.0255	.5137	.8199	.5406	.1507	.2476	-1.1384	.3573	1.3084
.0759	-1.1028	.3073	1.2891	.0475	.3176	.7650	.6311	.1507	-.2524	-1.1391	.3582	1.3065
.1003	-1.1219	.3019	1.2790	.0751	.2255	.7392	.6720	.1507	-.5024	-1.1548	.3528	1.3178
.1507	-1.1274	.3004	1.3021	.1002	.1279	.7118	.7146	.1507	-.7524	-1.0509	.3818	1.2593
.2003	-1.1213	.3021	1.2980	.1503	.0310	.6847	.7565	.5002	.7476	-1.1815	.3452	1.3335
.2503	-1.1350	.3983	1.3064	.1976	-.0775	.6544	.8032	.5002	.4976	-1.1871	.3437	1.3368
.3001	-1.1680	.3490	1.3256	.2503	-.1529	.6332	.8357	.5002	.2476	-1.2148	.3359	1.3353
.3502	-1.1820	.3451	1.3338	.3001	-.2064	.6181	.8590	.5002	-.2524	-1.1753	.3470	1.3328
.4003	-1.1921	.3423	1.3397	.3507	-.2486	.6064	.8771	.5002	-.5024	-1.1440	.3358	1.3318
.4501	-1.2135	.3363	1.3325	.4001	-.2638	.6022	.8837	.5002	-.7524	-1.1516	.3336	1.3310
.5002	-1.2244	.3332	1.3591	.4501	-.2580	.6036	.8814	.8002	.7476	-1.0113	.3929	1.2378
.5502	-1.1754	.3469	1.3299	.5001	-.2166	.6154	.8632	.8002	.4976	-.4057	.5625	.9460
.6002	-.9898	.3989	1.2263	.5497	-.1297	.6397	.8257	.8002	.2476	-.4013	.5637	.9441
.6500	-.6117	.5048	1.0394	.6003	-.0324	.6670	.7838	.8002	-.5024	-.3831	.5688	.9360
.7000	-.5209	.5302	.9977	.6500	.0463	.6890	.7499	.8002	-.7524	-.3616	.5748	.9265
.7500	-.4555	.5485	.9682	.7000	.1505	.7187	.7048					
.8002	-.3897	.5669	.9389	.7501	.2422	.7439	.6646					
.8002	-.2563	.6043	.8804	.8001	.3212	.7660	.6295					
.8501	-.1906	.6227	.8520	.8501	.3917	.7857	.5976					

ORIGINAL PAGE IS
OF POOR QUALITY

TEST 167	PT 44.5351	PSI	CN	-.0562	CD1 .01194	CDCOR1 .01167
RUN 37	TT 98.3087	K	CM	-.1362	CD2 .01140	CDCOR2 .01123
POINT 9	RC 29.9495	MILLION	CC	.0087	CD3 .01095	CDCOR3 .01086
	MACH .7703				CD4 .01027	CDCOR4 .01011
	ALPHA -3.9815	DEG			CD5 .00964	CDCOR5 .00928

UPPER SURFACE				LOWER SURFACE				SPANWISE				
X/C	CP	P _L /PT	MLOC	X/C	CP	P _L /PT	MLOC	X/C	Y/(B/2)	CP	P _L /PT	MLOC
0.0000	.7730	.9929	.4070	0.0000	.7730	.8929	.4070	.1507	.7476	-.1331	.6405	.8268
.0132	.6268	.8522	.4853	.0126	-.6222	.5042	1.0429	.1507	.4976	-.1405	.6384	.8300
.0259	.3169	.7659	.6316	.0255	-.5798	.5160	1.0234	.1507	.2476	-.1427	.6378	.8310
.0759	-.0142	.6736	.7758	.0495	-.7283	.4746	1.0927	.1507	-.2524	-.1504	.6356	.8343
.1003	-.0675	.6567	.7987	.0753	-.7511	.4682	1.1036	.1507	-.5024	-.1562	.6340	.8368
.1507	-.1434	.6376	.8313	.1002	-.7888	.4577	1.1218	.1507	-.7524	-.1495	.6399	.8339
.2003	-.1936	.6236	.8529	.1503	-.7817	.4597	1.1184	.5002	.7476	-.4175	.5612	.9304
.2503	-.2451	.6093	.8751	.1976	-.8202	.4490	1.1372	.5002	.4976	-.4211	.5602	.9320
.3001	-.2910	.5965	.8950	.2503	-.8648	.4366	1.1593	.5002	.2476	-.4255	.5590	.9340
.3502	-.3172	.5892	.9064	.3001	-.9174	.4219	1.1858	.5002	-.2524	-.4144	.5621	.9491
.4003	-.3488	.5804	.9202	.3507	-.9877	.4023	1.2223	.5002	-.5024	-.4117	.5628	.9479
.4501	-.3781	.5722	.9330	.4001	-1.0536	.3840	1.2575	.5002	-.7524	-.3980	.5666	.9418
.5002	-.4222	.5599	.9525	.4501	-.1034	.3608	1.0485	.8002	.7476	-1.0653	.3807	1.2639
.5502	-.4625	.5487	.9704	.5001	-.3374	.3835	.9152	.8002	.4976	-.3829	.5708	.9352
.6002	-.5037	.5372	.9889	.5497	-.2253	.6148	.8665	.8002	.2476	-.3872	.5696	.9371
.6500	-.5353	.5284	1.0031	.6003	-.1102	.6468	.8170	.8002	-.5024	-.3500	.5800	.9208
.7000	-.5181	.5332	.9954	.6500	-.0140	.6736	.7757	.8002	-.7524	-.3433	.5819	.9178
.7500	-.4606	.5492	.9696	.7000	.1047	.7067	.7247					
.8002	-.3819	.5711	.9348	.7501	.2048	.7346	.6811					
.9002	-.1922	.6240	.8523	.8001	.2883	.7579	.6443					
.9501	-.0674	.6588	.7987	.8501	.3588	.7775	.6128					

TEST 167	PT 44.5315	PSI	CN	.0957	CD1 .00894	CDCOR1 .00871
RUN 37	TT 98.2557	K	CM	-.1438	CD2 .00868	CDCOR2 .00852
POINT 10	RC 29.9754	MILLION	CC	.0153	CD3 .00850	CDCOR3 .00840
	MACH .7705				CD4 .00828	CDCOR4 .00814
	ALPHA -2.9902	DEG			CD5 .00813	CDCOR5 .00782

UPPER SURFACE				LOWER SURFACE				SPANWISE				
X/C	CP	P _L /PT	MLOC	X/C	CP	P _L /PT	MLOC	X/C	Y/(B/2)	CP	P _L /PT	MLOC
0.0000	.8973	.9273	.3313	0.0000	.8973	.9273	.3313	.1507	.7476	-.2403	.6098	.8743
.0132	.4923	.8143	.5519	.0126	-.3599	.5764	.9265	.1507	.4976	-.2488	.6074	.8780
.0259	.1661	.7232	.6990	.0255	-.3977	.5658	.9431	.1507	.2476	-.2514	.6067	.8791
.0759	-.1479	.6356	.8344	.0495	-.5049	.5359	.9909	.1507	-.2524	-.2591	.6045	.8824
.1003	-.1882	.6243	.8518	.0753	-.5366	.5271	1.0093	.1507	-.5024	-.2644	.6030	.8847
.1507	-.2518	.6066	.8793	.1002	-.6092	.5068	1.0385	.1507	-.7524	-.2545	.6058	.8804
.2003	-.2912	.5956	.8964	.1503	-.5698	.5178	1.0204	.5002	.7476	-.4887	.5405	.9836
.2503	-.3364	.5830	.9161	.1976	-.6656	.4910	1.0648	.5002	.4976	-.4923	.5394	.9853
.3001	-.3787	.5711	.9347	.2503	-.7614	.4643	1.1104	.5002	.2476	-.4968	.5382	.9873
.3502	-.3983	.5657	.9434	.3001	-.8348	.4438	1.1463	.5002	-.2524	-.4849	.5415	.9820
.4003	-.4253	.5581	.9553	.3507	-.8996	.4257	1.1789	.5002	-.5024	-.4626	.5421	.9809
.4501	-.4450	.5504	.9676	.4001	-.7846	.4578	1.1216	.5002	-.7524	-.4681	.5462	.9744
.5002	-.4494	.5391	.9858	.4501	-.44231	.5587	.9544	.8002	.7476	-1.1068	.3679	1.2892
.5502	-.5307	.5287	1.0026	.5001	-.3500	.5791	.9221	.8002	.4976	-.3935	.5670	.9412
.6002	-.5694	.5179	1.0202	.5497	-.2302	.6126	.8699	.8002	.2476	-.3967	.5661	.9427
.6500	-.6055	.5078	1.0368	.6003	-.1025	.6482	.8149	.8002	-.5024	-.3653	.5749	.9288
.7000	-.5755	.5162	1.0230	.6500	-.0019	.6763	.7716	.8002	-.7524	-.3611	.5761	.9270
.7500	-.4804	.5428	.9789	.7000	.1220	.7109	.7182					
.8002	-.3911	.5677	.9402	.7501	.2250	.7397	.6732					
.9002	-.1907	.6236	.8529	.8001	.3102	.7634	.6355					
.9501	-.0619	.6596	.7974	.8501	.3815	.7834	.6033					

TEST 167	PT 44.5327	PSI	CN	.2603	CD1 .00817	CDCOR1 .00797
RUN 37	TT 98.3312	K	CM	-.1501	CD2 .00866	CDCOR2 .00792
POINT 11	RC 29.9243	MILLION	CC	.0209	CD3 .00802	CDCOR3 .00795
	MACH .7697				CD4 .00784	CDCOR4 .00773
	ALPHA -1.9958	DEG			CD5 .00776	CDCOR5 .00752

UPPER SURFACE				LOWER SURFACE				SPANWISE				
X/C	CP	P _L /PT	MLOC	X/C	CP	P _L /PT	MLOC	X/C	Y/(B/2)	CP	P _L /PT	MLOC
0.0000	1.0183	.9615	.2383	0.0000	1.0183	.9615	.2383	.1507	.7476	-.3683	.5759	.9272
.0132	.3204	.7674	.6291	.0126	-.0869	.6542	.8057	.1507	.4976	-.3796	.5728	.9321
.0259	-.0243	.6716	.7789	.0255	-.1767	.6292	.8442	.1507	.2476	-.3842	.5715	.9341
.0759	-.3148	.5908	.9039	.0495	-.2983	.5954	.8967	.1507	-.2524	-.3910	.5696	.9371
.1003	-.3377	.5844	.9138	.0753	-.3491	.5812	.9188	.1507	-.5024	-.3936	.5689	.9383
.1507	-.3880	.5715	.9341	.1002	-.4145	.5631	.9475	.1507	-.7524	-.3784	.5731	.9316
.2003	-.4061	.5654	.9438	.1503	-.4414	.5556	.9594	.5002	.7476	-.5702	.5190	1.0172
.2503	-.4459	.5543	.9543	.1976	-.5471	.5262	1.0067	.5002	.4976	-.5754	.5183	1.0196
.3001	-.4833	.5439	.9780	.2503	-.5986	.5119	1.0302	.5002	.2476	-.5810	.5168	1.0221
.3502	-.4912	.5417	.9815	.3001	-.6232	.5050	1.0415	.5002	-.2524	-.5679	.5204	1.0161
.4003	-.5119	.5360	.9908	.3507	-.6052	.5100	1.0332	.5002	-.5024	-.5649	.5212	1.0148
.4501	-.5380	.5287	1.0026	.4001	-.5313	.5306	.9995	.5002	-.7524	-.5472	.5262	1.0067
.5002	-.5780	.5176	1.0207	.4501	-.4438	.5549	.9605	.8002	.7476	-1.1383	.3618	1.3016
.5502	-.6030	.5106	1.0322	.5001	-.3457	.5822	.9173	.8002	.4976	-.4015	.5667	.9418
.6002	-.6401	.5003	1.0493	.5497	-.2161	.6182	.8611	.8002	.2476	-.4030	.5663	.9424
.6500	-.6758	.4904	1.0659	.6003	-.0872	.6541	.8058	.8002	-.5024	-.3768	.5736	.9309
.7000	-.6346	.5019	1.0467	.6500	.0113	.6815	.7637	.8002	-.7524	-.3755	.5739	.9304
.7500	-.4946	.5410	.9828	.7000	.1356	.7161	.7102					
.8002	-.3974	.5678	.9400	.7501	.2389	.7448	.6652					
.9002	-.1919	.6250	.8507	.8001	.3246	.7686	.6272					
.9501	-.0612	.6613	.7947	.8501	.3972	.7888	.5944					

TEST 167 PT 44.5312 PSI CN .3440
 RUN 37 TT 98.3239 K CM -.1928
 POINT 12 RC 29.9188 MILLION CC .0224
 MACH .7694
 ALPHA -1.4765 DEG

CD1 .00826 CDCOR1 .00802
 CD2 .00814 CDCOR2 .00796
 CD3 .00809 CDCOR3 .00800
 CD4 .00790 CDCOR4 .00777
 CD5 .00782 CDCOR5 .00758

UPPER SURFACE				LOWER SURFACE				SPANWISE				
X/C	CP	P _L /PT	MLOC	X/C	CP	P _L /PT	MLOC	X/C	Y/(B/2)	CP	P _L /PT	MLOC
0.0000	1.0683	.9757	.1883	0.0000	1.0683	.9757	.1883	.1507	.7476	-.4418	-.5572	.9569
.0132	-.2162	.7395	.6734	.0126	-.0479	.6929	.7460	.1507	.4976	-.4546	.5536	.9625
.0259	-.1366	.6418	.8248	.0255	-.0634	.6620	.7936	.1507	.2476	-.4613	.5518	.9655
.0759	-.4147	.5647	.9449	.0495	-.1947	.6256	.8497	.1507	-.2524	-.4680	.5499	.9685
.1003	-.4253	.5617	.9496	.0753	-.2546	.6091	.8754	.1507	-.5024	-.4701	.5493	.9694
.1507	-.4612	.5518	.9655	.1002	-.3272	.5889	.9068	.1507	-.7524	-.4530	.5541	.9618
.2003	-.4790	.5469	.9733	.1503	-.3665	.5780	.9239	.5002	.7476	-.6180	.5083	1.0360
.2503	-.5080	.5388	.9863	.1976	-.4667	.5503	.9679	.5002	.4976	-.6272	.5058	1.0402
.3001	-.5438	.5289	1.0023	.2503	-.5110	.5380	.9876	.5002	.2476	-.6333	.5041	1.0430
.3502	-.5439	.5289	1.0024	.3001	-.5366	.5309	.9990	.5002	-.2524	-.6189	.5081	1.0364
.4003	-.5591	.5247	1.0092	.3507	-.5309	.5325	.9965	.5002	-.5024	-.6165	.5047	1.0353
.4501	-.5817	.5184	1.0194	.4001	-.4838	.5455	.9755	.5002	-.7524	-.5944	.5149	1.0252
.5002	-.6294	.5052	1.0412	.4501	-.4184	.5636	.9466	.8002	.7476	-1.1462	.3619	1.3013
.5502	-.6683	.4999	1.0499	.5001	-.3246	.5897	.9056	.8002	.4976	-.4037	.5677	.9401
.6002	-.6703	.4938	1.0601	.5497	-.1990	.6245	.8515	.8002	.2476	-.4049	.5674	.9406
.6500	-.7041	.4845	1.0759	.6003	-.0733	.6593	.7978	.8002	-.5024	-.3777	.5749	.9287
.7000	-.7544	.4982	1.0526	.6500	.0226	.6859	.7569	.8002	-.7524	-.3770	.5751	.9284
.7500	-.8069	.5419	.9813	.7000	.1455	.7199	.7041					
.8002	-.8995	.5689	.9383	.7501	.2478	.7483	.6596					
.9002	-.1917	.6265	.8484	.8001	.3335	.7721	.6216					
.9501	-.0608	.6628	.7925	.8501	.4064	.7923	.5887					

TEST 167 PT 44.5297 PSI CN .4170
 RUN 37 TT 98.2802 K CM -.1549
 POINT 13 RC 29.9351 MILLION CC .0231
 MACH .7693
 ALPHA -.9979 DEG

CD1 .00849 CDCOR1 .00825
 CD2 .00835 CDCOR2 .00812
 CD3 .00826 CDCOR3 .00808
 CD4 .00805 CDCOR4 .00783
 CD5 .00787 CDCOR5 .00760

UPPER SURFACE				LOWER SURFACE				SPANWISE				
X/C	CP	P _L /PT	MLOC	X/C	CP	P _L /PT	MLOC	X/C	Y/(B/2)	CP	P _L /PT	MLOC
0.0000	1.1035	.9853	.1460	0.0000	1.1035	.9853	.1460	.1507	.7476	-.5139	.5361	.9908
.0132	-.1185	.7118	.7169	.0126	-.1613	.7237	.6983	.1507	.4976	-.5300	.5316	.9979
.0259	-.2407	.6120	.8708	.0255	-.0335	.6881	.7534	.1507	.2476	-.5388	.5292	1.0018
.0759	-.5127	.5365	.9901	.0495	-.1109	.6481	.8151	.1507	-.2524	-.5464	.5271	1.0052
.1003	-.5098	.5373	.9888	.0753	-.1794	.6290	.8445	.1507	-.5024	-.5459	.5272	1.0050
.1507	-.5384	.5293	1.0016	.1002	-.2559	.6078	.8774	.1507	-.7524	-.5255	.5329	.9958
.2003	-.5379	.5295	1.0014	.1503	-.3058	.5939	.8990	.5002	.7476	-.6613	.4952	1.0578
.2503	-.5680	.5211	1.0150	.1976	-.4040	.5666	.9418	.5002	.4976	-.6715	.4923	1.0626
.3001	-.6129	.5086	1.0355	.2503	-.4512	.5535	.9627	.5002	.2476	-.6791	.4902	1.0662
.3502	-.6079	.5100	1.0332	.3001	-.4787	.5459	.9749	.5002	-.2524	-.6674	.4935	1.0607
.4003	-.5899	.5150	1.0250	.3507	-.4831	.5447	.9768	.5002	-.5024	-.6674	.4935	1.0607
.4501	-.6205	.5065	1.0390	.4001	-.4495	.5540	.9619	.5002	-.7524	-.6486	.4987	1.0520
.5002	-.6742	.4916	1.0639	.4501	-.3951	.5691	.9379	.8002	.7476	-1.1393	.3624	1.3003
.5502	-.7082	.4821	1.0798	.5001	-.3075	.5934	.8997	.8002	.4976	-.4008	.5675	.9404
.6002	-.7325	.4754	1.0913	.5497	-.1868	.6270	.8476	.8002	.2476	-.4008	.5675	.9404
.6500	-.7496	.4707	1.0994	.6003	-.0643	.6610	.7952	.8002	-.5024	-.3805	.5732	.9315
.7000	-.6792	.4902	1.0662	.6500	.0288	.6869	.7554	.8002	-.7524	-.3821	.5727	.9322
.7500	-.6902	.5427	.9800	.7000	.1504	.7206	.7030					
.8002	-.3932	.5691	.9380	.7501	.2522	.7489	.6587					
.9002	-.1891	.6263	.8486	.8001	.3376	.7726	.6207					
.9501	-.0587	.6625	.7928	.8501	.4109	.7930	.5875					

TEST 167 PT 44.5240 PSI CN .4893
 RUN 37 TT 98.2433 K CM -.1559
 POINT 14 RC 29.9333 MILLION CC .0228
 MACH .7686
 ALPHA -.4990 DEG

CD1 .00872 CDCOR1 .00846
 CD2 .00861 CDCOR2 .00838
 CD3 .00851 CDCOR3 .00840
 CD4 .00823 CDCOR4 .00812
 CD5 .00803 CDCOR5 .00781

UPPER SURFACE				LOWER SURFACE				SPANWISE				
X/C	CP	P _L /PT	MLOC	X/C	CP	P _L /PT	MLOC	X/C	Y/(B/2)	CP	P _L /PT	MLOC
0.0000	1.1310	.9931	.0996	0.0000	1.1310	.9931	.0996	.1507	.7476	-.5947	.5149	1.0251
.0132	-.0226	.6860	.7567	.0126	-.2846	.7531	.6521	.1507	.4976	-.6178	.5085	1.0357
.0259	-.3464	.5837	.9149	.0255	-.1236	.7140	.7134	.1507	.2476	-.6277	.5058	1.0402
.0759	-.6294	.5053	1.0410	.0495	-.0339	.6703	.7808	.1507	-.2524	-.6349	.5038	1.0435
.1003	-.6067	.5116	1.0306	.0753	-.1105	.6491	.8135	.1507	-.5024	-.6327	.5044	1.0425
.1507	-.6251	.5065	1.0390	.1002	-.1895	.6272	.8473	.1507	-.7524	-.6066	.5116	1.0305
.2003	-.6172	.5087	1.0354	.1503	-.2488	.6108	.8727	.5002	.7476	-.7037	.4847	1.0755
.2503	-.6241	.5068	1.0386	.1976	-.3467	.5836	.9150	.5002	.4976	-.7104	.4828	1.0786
.3001	-.6624	.4961	1.0562	.2503	-.3971	.5697	.9370	.5002	.2476	-.7108	.4828	1.0786
.3502	-.6805	.4911	1.0647	.3001	-.4280	.5611	.9506	.5002	-.2524	-.7029	.4849	1.0751
.4003	-.6860	.4896	1.0672	.3507	-.4394	.5580	.9556	.5002	-.5024	-.7107	.4828	1.0788
.4501	-.6820	.4907	1.0653	.4001	-.4164	.5643	.9459	.5002	-.7524	-.7012	.4854	1.0743
.5002	-.7032	.4849	1.0752	.4501	-.3723	.5766	.9262	.8002	.7476	-1.1268	.3675	1.2901
.5502	-.7278	.4780	1.0868	.5001	-.2917	.5989	.8912	.8002	.4976	-.3964	.5699	.9367
.6002	-.7652	.4677	1.1046	.5497	-.1758	.6310	.8414	.8002	.2476	-.3964	.5704	.9359
.6500	-.7932	.4599	1.1180	.6003	-.0564	.6641	.7905	.8002	-.5024	-.3827	.5737	.9307
.7000	-.7202	.4801	1.0833	.6500	.0336	.6890	.7520	.8002	-.7524	-.3863	.5727	.9323
.7500	-.8833	.5458	.9750	.7000	.1541	.7224	.7002					
.8002	-.3861	.5727	.9322	.7501	.2531	.7504	.6582					
.9002	-.1649	.6265	.8453	.8001	.3403	.7740	.6184					
.9501	-.0548	.6645	.7898	.8501	.4142	.7945	.5850					

ORIGINAL PAGE IS
OF POOR QUALITY.

TEST 167	PT 44.5283	PSI	CN .65731	CD1 .00943	CDCOR1 .00912
RUN 37	TT 98.2438	K	CM -1.184	CD2 .00945	CDCOR2 .00914
POINT 15	RC 29.9478	MILLION	CC .0215	CD3 .00927	CDCOR3 .00905
	MACH .7691			CD4 .00888	CDCOR4 .00862
	ALPHA .0189	DEG		CD5 .00862	CDCOR5 .00817

UPPER SURFACE				LOWER SURFACE				SPANWISE				
X/C	CP	P/L/PT	MLOC	X/C	CP	P/L/PT	MLOC	X/C	Y/(B/2)	CP	P/L/PT	MLOC
0.0000	1.1476	.9979	.0552	0.0000	1.1476	.9979	.0552	.1507	.7476	-.6744	.4938	1.0602
.0132	-.0841	.6571	.8012	.0126	.3672	.7820	.8096	.1507	.4976	-.7078	.4846	1.0757
.0259	-.4556	.5543	.9614	.0255	.2138	.7395	.6735	.1507	.2476	-.7371	.4765	1.0895
.0759	-.7252	.4797	1.0839	.0495	.0508	.6944	.7437	.1507	-.2524	-.7447	.4743	1.0931
.1003	-.7541	.4717	1.0976	.0753	-.0317	.6716	.7789	.1507	-.5024	-.7295	.4785	1.0860
.1507	-.7307	.4782	1.0865	.1002	-.1172	.6479	.8153	.1507	-.7524	-.6683	.4955	1.0573
.2003	-.7153	.4825	1.0793	.1503	-.1819	.6301	.8429	.5002	.7476	-.7486	.4733	1.0950
.2503	-.6911	.4892	1.0680	.1976	-.2790	.6032	.8845	.5002	.4976	-.7612	.4698	1.1010
.3001	-.7095	.4841	1.0766	.2503	-.3313	.5887	.9071	.5002	.2476	-.7716	.4669	1.1059
.3502	-.7358	.4768	1.0889	.3001	-.3653	.5793	.9218	.5002	-.2524	-.7655	.4686	1.1030
.4003	-.7338	.4773	1.0880	.3507	-.3828	.5745	.9395	.5002	-.5024	-.7613	.4697	1.1010
.4501	-.7453	.4742	1.0934	.4001	-.3671	.5788	.9226	.5002	-.7524	-.7541	.4738	1.0976
.5002	-.7772	.4653	1.1086	.4501	-.3317	.5886	.9073	.8002	.7476	-1.0997	.3761	1.2728
.5502	-.7932	.4609	1.1163	.5001	-.2591	.6087	.8760	.8002	.4976	-.3903	.3724	.9327
.6002	-.7999	.4591	1.1195	.5497	-.1498	.6389	.8292	.8002	.2476	-.3905	.3723	.9328
.6500	-.7997	.4591	1.1194	.6003	-.0351	.6707	.7893	.8002	-.5024	-.3732	.3771	.9253
.7000	-.6684	.4955	1.0574	.6500	.0520	.6947	.7452	.8002	-.7524	-.3751	.3766	.9261
.7500	-.4780	.5481	.9713	.7000	.1701	.7274	.6924					
.8002	-.3868	.5733	.9312	.7501	.2695	.7549	.6491					
.9002	-.1824	.6299	.8431	.8001	.3539	.7783	.6119					
.9501	-.0546	.6653	.7887	.8501	.4276	.7987	.5781					

TEST 167	PT 43.9201	PSI	CN .6573	CD1 .01077	CDCOR1 .01026
RUN 37	TT 97.0796	K	CM -1.1632	CD2 .01670	CDCOR2 .01024
POINT 16	RC 30.0551	MILLION	CC .0211	CD3 .01074	CDCOR3 .01039
	MACH .7687			CD4 .01001	CDCOR4 .00965
	ALPHA .5193	DEG		CD5 .00955	CDCOR5 .00905

UPPER SURFACE				LOWER SURFACE				SPANWISE				
X/C	CP	P/L/PT	MLOC	X/C	CP	P/L/PT	MLOC	X/C	Y/(B/2)	CP	P/L/PT	MLOC
0.0000	1.1539	.9988	.0408	0.0000	1.1539	.9988	.0408	.1507	.7476	-.7680	.4616	1.1151
.0132	-.1557	.6328	.8384	.0126	.4483	.8016	.5735	.1507	.4976	-.8449	.4402	1.1528
.0259	-.5220	.5287	1.0027	.0255	.2874	.7566	.6464	.1507	.2476	-.8411	.4412	1.1511
.0759	-.8024	.4520	1.1320	.0495	.1161	.7087	.7216	.1507	-.2524	-.8413	.4411	1.1512
.1003	-.8213	.4467	1.1413	.0753	-.0269	.6838	.7602	.1507	-.5024	-.8541	.4376	1.1576
.1507	-.8269	.4452	1.1441	.1002	-.0606	.6594	.7978	.1507	-.7524	-.7924	.4488	1.1271
.2003	-.8144	.4487	1.1379	.1503	-.1328	.6392	.8289	.5002	.7476	-.8689	.4334	1.1650
.2503	-.8369	.4424	1.1490	.1976	-.2324	.6113	.8720	.5002	.4976	-.8620	.4354	1.1619
.3001	-.8641	.4348	1.1626	.2503	-.2892	.5955	.8967	.5002	.2476	-.8408	.4413	1.1509
.3502	-.8221	.4465	1.1417	.3001	-.3273	.5848	.9133	.5002	-.2524	-.8321	.4437	1.1466
.4003	-.7880	.4560	1.1249	.3507	-.3502	.5784	.9234	.5002	-.5024	-.8313	.4439	1.1562
.4501	-.7942	.4543	1.1279	.4001	-.3406	.5811	.9192	.8002	-.7524	-.8455	.4400	1.1533
.5002	-.8262	.4454	1.1437	.4501	-.3109	.5894	.9061	.8002	.7476	-1.0340	.3873	1.2511
.5502	-.8631	.4350	1.1621	.5001	-.2436	.6082	.8768	.8002	.4976	-.3590	.3759	.9273
.6002	-.9109	.4217	1.1863	.5497	-.1380	.6377	.8312	.8002	.2476	-.3506	.3783	.9235
.6500	-.9467	.4117	1.2048	.6003	-.0261	.6690	.7830	.8002	-.5024	-.3471	.3749	.9220
.7000	-.8001	.4527	1.1308	.6500	.0585	.6927	.7465					
.7500	-.4412	.5330	.9637	.7000	.1750	.7252	.6960					
.8002	-.3419	.5807	.9197	.7501	.2734	.7527	.6527					
.9002	-.1621	.6310	.8416	.8001	.3572	.7761	.6151					
.9501	-.0422	.6645	.7899	.8501	.4308	.7967	.5814					

TEST 167	PT 47.1279	PSI	CN .7494	CD1 .01530	CDCOR1 .01472
RUN 37	TT 102.2138	K	CM -1.1737	CD2 .01530	CDCOR2 .01462
POINT 17	RC 29.9619	MILLION	CC .0219	CD3 .01497	CDCOR3 .01435
	MACH .7725			CD4 .01431	CDCOR4 .01385
	ALPHA 1.0285	DEG		CD5 .01340	CDCOR5 .01277

UPPER SURFACE				LOWER SURFACE				SPANWISE				
X/C	CP	P/L/PT	MLOC	X/C	CP	P/L/PT	MLOC	X/C	Y/(B/2)	CP	P/L/PT	MLOC
0.0000	1.1553	.9991	.0350	0.0000	1.1553	.9991	.0350	.1507	.7476	-.8680	.4323	1.1667
.0132	-.7299	.6111	.8720	.0126	.5173	.8204	.5412	.1507	.4976	-.9336	.4139	1.2003
.0259	-.6072	.5054	1.0406	.0255	.3487	.7732	.6196	.1507	.2476	-.9177	.4184	1.1921
.0759	-.8792	.4292	1.1724	.0495	.1725	.7238	.6978	.1507	-.2524	-.9164	.4187	1.1914
.1003	-.9000	.4233	1.1830	.0753	.0777	.6972	.7391	.1507	-.5024	-.9325	.4142	1.1997
.1507	-.9014	.4229	1.1837	.1002	-.0132	.6718	.7783	.1507	-.7524	-.8866	.4271	1.1761
.2003	-.8902	.4261	1.1779	.1503	-.0910	.6500	.8119	.9002	.7476	-.9683	.4042	1.2185
.2503	-.9209	.4175	1.1937	.1976	-.1924	.6216	.8557	.9002	.4976	-.9760	.4020	1.2225
.3001	-.9583	.4070	1.2132	.2503	-.2529	.6046	.8820	.9002	.2476	-.9948	.4080	1.2114
.3502	-.9647	.4052	1.2166	.3001	-.2943	.5930	.9001	.9002	-.2524	-.9203	.4176	1.1934
.4003	-.9315	.4145	1.1992	.3507	-.3214	.5854	.9119	.9002	-.5024	-.9810	.4006	1.2252
.4501	-.8883	.4266	1.1770	.4001	-.3175	.5865	.9102	.9002	-.7524	-.9189	.4181	1.1927
.5002	-.9272	.4157	1.1970	.4501	-.2936	.5932	.8997	.8002	.7476	-.9375	.4128	1.2024
.5502	-.9556	.4077	1.2118	.5001	-.2317	.6106	.8727	.8002	.4976	-.9335	.4221	.9172
.6002	-.9721	.4031	1.2205	.5497	-.1302	.6390	.8288	.8002	.2476	-.3309	.3828	.9161
.6500	-1.0322	.3863	1.2527	.6003	-.0212	.6695	.7818	.8002	-.5024	-.3250	.3844	.9135
.7000	-1.0398	.3842	1.2568	.6500	.0613	.6926	.7461	.8002	-.7524	-.3375	.3809	.9190
.7500	-.4808	.5408	.9928	.7000	.1765	.7249	.6961					
.8002	-.3245	.5834	.9151	.7501	.2740	.7522	.6531					
.9002	-.1460	.6346	.8356	.8001	.3574	.7756	.6156					
.9501	-.0382	.6648	.7891	.8501	.4310	.7962	.5819					

TEST 167	PT 47.1067	PSI	CM .8198	CD1 .01588	CDCOR1 .01513
RUN 37	TT 102.1519	K	CM -1.756	CD2 .01574	CDCOR2 .01509
POINT 18	RC 29.7721	MILLION	CC .0203	CD3 .01548	CDCOR3 .01479
	MACH .7636			CD4 .01494	CDCOR4 .01397
	ALPHA 1.5172	DEG		CD5 .01593	CDCOR5 .01931

UPPER SURFACE				LOWER SURFACE				SPANWISE				
X/C	CP	P _L /PT	MLOC	X/C	CP	P _L /PT	MLOC	X/C	Y/(B/2)	CP	P _L /PT	MLOC
0.0000	1.1526	.9988	.0409	0.0000	1.1526	.9988	.0409	.1507	.7476	-1.0748	.4065	1.2142
.0132	-.3175	.5895	.9056	.0126	-.5829	.8402	.5067	.1507	.4976	-1.0177	.3945	1.2369
.0259	-.6977	.4836	1.0770	.0255	-.4092	.7918	.5891	.1507	.2476	-1.0991	.4008	1.2249
.0759	-.9582	.4111	1.2056	.0495	-.2302	.7420	.6693	.1507	-.2524	-1.0927	.4015	1.2236
1.003	-.9791	.4053	1.2165	.0753	-.1306	.7143	.7127	.1507	-.9024	-1.0115	.3963	1.2335
1.507	-.9782	.4055	1.2160	.1002	-.0371	.6882	.7530	.1507	-.7524	-1.0951	.4108	1.2060
2.003	-.9659	.4090	1.2096	.1503	-.0446	.6655	.7880	.5002	.7476	-1.0349	.3897	1.2460
2.503	-.9937	.4012	1.2241	.1976	-.1463	.6372	.8316	.5002	.4976	-1.0453	.3868	1.2516
3.001	-1.0330	.3903	1.2450	.2503	-.2090	.6197	.8586	.5002	.2476	-1.0488	.3859	1.2536
3.502	-1.0474	.3863	1.2528	.3001	-.2537	.6073	.8779	.5002	-.2524	-1.0175	.3946	1.2367
4.003	-1.0432	.3874	1.2505	.3507	-.2828	.5992	.8905	.5002	-.5024	-1.0469	.3864	1.2525
4.501	-1.0052	.3980	1.2302	.4001	-.2832	.5990	.8907	.5002	-.7524	-1.0842	.4039	1.2191
5.002	-1.0020	.3989	1.2285	.4501	-.2663	.6038	.8833	.8002	.7476	-1.0914	.4224	1.1846
5.502	-1.0203	.3938	1.2382	.5001	-.2111	.6191	.8595	.8002	.4976	-1.3323	.5854	.9120
6.002	-1.0476	.3862	1.2529	.5497	-.1155	.6457	.8184	.8002	.2476	-1.3322	.5854	.9120
6.500	-1.0798	.3783	1.2682	.6003	-.0110	.6748	.7736	.8002	-.5024	-1.3244	.5876	.9086
7.000	-.9128	.4237	1.1923	.6500	.0681	.6969	.7396	.8002	-.7524	-1.3299	.5860	.9110
7.500	-.4598	.5499	.9662	.7000	.1811	.7283	.6907					
8.002	-.3326	.5853	.9121	.7501	.2772	.7551	.6485					
9.002	-.1476	.6373	.8314	.8001	.3599	.7781	.6115					
9.501	-.0398	.6668	.7460	.8501	.4333	.7986	.5780					

TEST 167	PT 47.0214	PSI	CM .8649	CD1 .02630	CDCOR1 .02539
RUN 37	TT 102.1129	K	CM -1.804	CD2 .02720	CDCOR2 .02626
POINT 19	RC 29.9379	MILLION	CC .0215	CD3 .02593	CDCOR3 .02501
	MACH .7725			CD4 .02580	CDCOR4 .02486
	ALPHA 2.0060	DEG		CD5 .02655	CDCOR5 .02564

UPPER SURFACE				LOWER SURFACE				SPANWISE				
X/C	CP	P _L /PT	MLOC	X/C	CP	P _L /PT	MLOC	X/C	Y/(B/2)	CP	P _L /PT	MLOC
0.0000	1.1574	.9999	.0104	0.0000	1.1574	.9999	.0104	.1507	.7476	-1.0342	.3875	1.2504
.0132	-.3618	.5754	.9277	.0126	-.6337	.8536	.4826	.1507	.4976	-1.0592	.3806	1.2640
.0259	-.7571	.4649	1.1091	.0255	-.4565	.8041	.5689	.1507	.2476	-1.0359	.3871	1.2513
.0759	-.9990	.3974	1.2315	.0495	-.2756	.7535	.6511	.1507	-.2524	-1.0333	.3878	1.2499
1.003	-1.0199	.3915	1.2427	.0753	-.1717	.7245	.6968	.1507	-.5024	-1.0528	.3823	1.2605
1.507	-1.0202	.3914	1.2428	.1002	-.0768	.6980	.7380	.1507	-.7524	-1.0868	.4008	1.2250
2.003	-1.0007	.3969	1.2324	.1503	-.0098	.6738	.7753	.5002	.7476	-1.0858	.3731	1.2787
2.503	-1.0316	.3882	1.2490	.1976	-.1146	.6445	.8204	.5002	.4976	-1.0927	.3712	1.2825
3.001	-1.0714	.3771	1.2707	.2503	-.1814	.6258	.8492	.5002	.2476	-1.1005	.3690	1.2868
3.502	-1.0880	.3725	1.2799	.3001	-.2290	.6125	.8698	.5002	-.2524	-1.0796	.3749	1.2752
4.003	-1.0935	.3710	1.2829	.3507	-.2630	.6030	.8845	.5002	-.5024	-1.0734	.3766	1.2718
4.501	-1.0901	.3719	1.2811	.4001	-.2681	.6016	.8868	.5002	-.7524	-1.0355	.3872	1.2511
5.002	-1.0681	.3781	1.2689	.4501	-.2588	.6042	.8827	.8002	.7476	-1.0933	.4157	1.1970
5.502	-1.0819	.3742	1.2765	.5001	-.2043	.6194	.8591	.8002	.4976	-1.3479	.5793	.9216
6.002	-1.1011	.3688	1.2872	.5497	-.1114	.6454	.8190	.8002	.2476	-1.3477	.5793	.9215
6.500	-1.1481	.3557	1.3138	.6003	-.0086	.6741	.7748	.8002	-.5024	-1.3582	.5820	.9174
7.000	-.9036	.4240	1.1818	.6500	.0685	.6956	.7416	.8002	-.7524	-1.3304	.5842	.9140
7.500	-.4715	.5448	.9765	.7000	.1806	.7270	.6929					
8.002	-.3463	.5797	.9209	.7501	.2760	.7536	.6509					
9.002	-.1495	.6347	.8354	.8001	.3583	.7786	.6140					
9.501	-.0448	.6676	.7925	.8501	.4314	.7971	.5805					

TEST 167	PT 47.6242	PSI	CM .9086	CD1 .02799	CDCOR1 .02718
RUN 37	TT 104.1497	K	CM -1.806	CD2 .03071	CDCOR2 .02970
POINT 20	RC 29.3415	MILLION	CC .0214	CD3 .03295	CDCOR3 .03218
	MACH .7678			CD4 .03341	CDCOR4 .03256
	ALPHA 2.5319	DEG		CD5 .03291	CDCOR5 .03193

UPPER SURFACE				LOWER SURFACE				SPANWISE				
X/C	CP	P _L /PT	MLOC	X/C	CP	P _L /PT	MLOC	X/C	Y/(B/2)	CP	P _L /PT	MLOC
0.0000	1.1437	.9960	.0761	0.0000	1.1437	.9960	.0761	.1507	.7476	-1.0930	.3700	1.2848
.0132	-.4238	.5573	.9563	.0126	-.6735	.8644	.4626	.1507	.4976	-1.1141	.3640	1.2967
.0259	-.8130	.4483	1.1380	.0255	-.4930	.8139	.5523	.1507	.2476	-1.0908	.3706	1.2836
.0759	-1.0574	.3799	1.2651	.0495	-.3103	.7627	.6363	.1507	-.2524	-1.0887	.3712	1.2824
1.003	-1.0771	.3744	1.2760	.0753	-.2034	.7328	.6837	.1507	-.5024	-1.1058	.3664	1.2920
1.507	-1.0782	.3741	1.2766	.1002	-.1043	.7051	.7269	.1507	-.7524	-1.0306	.3874	1.2504
2.003	-1.0579	.3798	1.2654	.1503	-.0142	.6798	.7658	.5002	.7476	-1.1420	.3563	1.3126
2.503	-1.0844	.3724	1.2800	.1976	-.0924	.6500	.8117	.5002	.4976	-1.1465	.3550	1.3152
3.001	-1.1221	.3618	1.3013	.2503	-.1618	.6306	.8417	.5002	.2476	-1.1512	.3537	1.3179
3.502	-1.1413	.3565	1.3122	.3001	-.2127	.6164	.8637	.5002	-.2524	-1.1338	.3586	1.3079
4.003	-1.1480	.3548	1.3161	.3507	-.2507	.6057	.8802	.5002	-.5024	-1.1067	.3661	1.2925
4.501	-1.1601	.3517	1.3231	.4001	-.2600	.6031	.8843	.5002	-.7524	-1.0903	.3707	1.2833
5.002	-1.1657	.3496	1.3284	.4501	-.2495	.6060	.8797	.8002	.7476	-1.0702	.4043	1.2181
5.502	-1.1456	.3552	1.3167	.5001	-.2051	.6185	.8604	.8002	.4976	-1.3803	.5694	.9371
6.002	-1.1678	.3490	1.3275	.5497	-.1158	.6435	.8219	.8002	.2476	-1.3789	.5698	.9364
6.500	-1.1749	.3470	1.3317	.6003	-.0159	.6714	.7788	.8002	-.5024	-1.3584	.5756	.9274
7.000	-.8240	.5017	1.0474	.6500	.0596	.6926	.7462	.8002	-.7524	-1.3446	.5794	.9213
7.500	-.4818	.5466	.9734	.7000	.1704	.7236	.6981					
8.002	-.3646	.5738	.9301	.7501	.2647	.7500	.6566					
9.002	-.1879	.6233	.8530	.8001	.3463	.7728	.6201					
9.501	-.1154	.6436	.8217	.8501	.4193	.7932	.5868					

TEST 167
 RUN 33
 MACH .770
 R 40.0×10^6

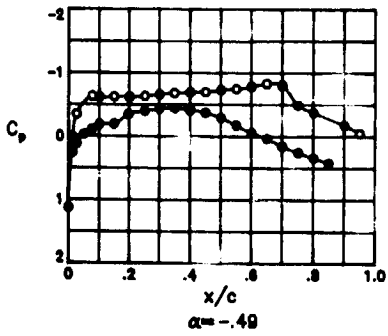
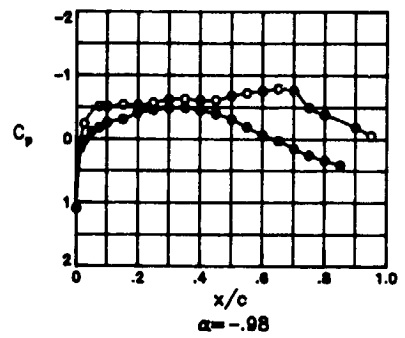
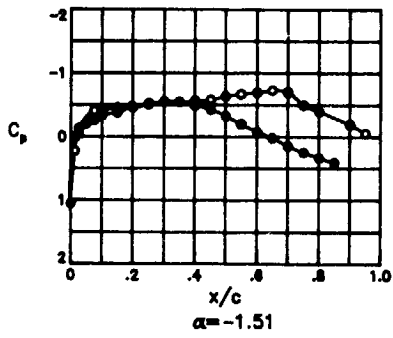
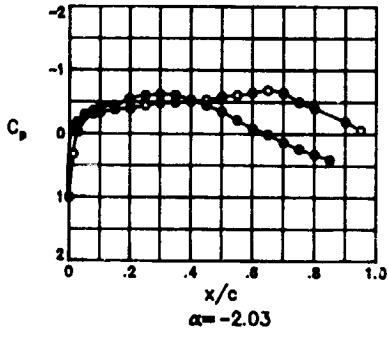
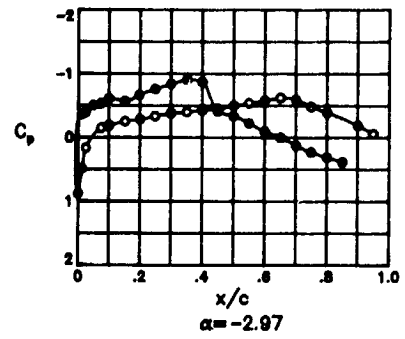
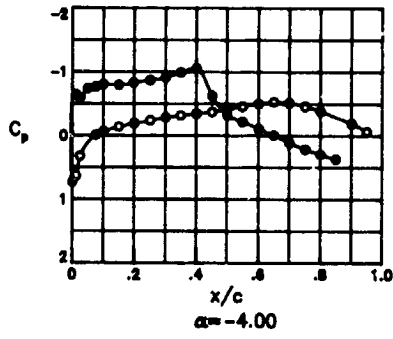

ORIGINAL PAGE IS
 OF POOR QUALITY

TEST 167	PT	62.0803	PSI	CM	-.0573	CD1	.01167	CDCOR1	.01158
RUN 33	TT	101.1816	K	CM	-.1384	CD2	.01120	CDCOR2	.01116
POINT 57	RC	39.9669	MILLION	CC	.0071	CD3	.01082	CDCOR3	.01089
	MACH	.7682				CD4	.01045	CDCOR4	.01043
	ALPHA	-4.0019	DEG			CD5	.00968	CDCOR5	.00945

UPPER SURFACE				LOWER SURFACE				SPANWISE				
X/C	CP	P/L/PT	MLOC	X/C	CP	P/L/PT	MLOC	X/C	Y/(B/2)	CP	P/L/PT	MLOC
0.0000	.7318	.8822	.4289	0.0000	-.7318	.8822	.4289	.1507	.7476	-.1290	.6434	.8231
.0132	.6317	.8544	.4817	.0126	-.6457	.5001	1.0508	.1507	.4976	-.1412	.6400	.8284
.0259	.3216	.7684	.6281	.0255	-.5912	.5152	1.0257	.1507	.2476	-.1354	.6416	.8259
.0759	-.0078	.6770	.7713	.0495	-.7409	.4737	1.0953	.1507	-.2524	-.1426	.6396	.8290
.1003	-.0622	.6620	.7946	.0753	-.7664	.4666	1.1075	.1507	-.5024	-.1485	.6380	.8315
.1507	-.1370	.6412	.8266	.1002	-.8014	.4569	1.1244	.1507	-.7524	-.1403	.6403	.8279
.2003	-.1931	.6256	.8506	.1503	-.7939	.4590	1.1208	.5002	.7476	-.4130	.5646	.9670
.2503	-.2383	.6131	.8700	.1976	-.8308	.4487	1.1387	.5002	.4976	-.4169	.5635	.9477
.3001	-.2862	.5998	.8907	.2503	-.8688	.4382	1.1575	.5002	.2476	-.4215	.5623	.9497
.3502	-.3166	.5914	.9039	.3001	-.9142	.4256	1.1802	.5002	-.2524	-.4076	.5661	.9436
.4003	-.3457	.5833	.9165	.3507	-.9931	.4037	1.2208	.5002	-.5024	-.4034	.5668	.9426
.4501	-.3690	.5768	.9267	.4001	-1.0544	.3867	1.2533	.5002	-.7524	-.3890	.5713	.9354
.5002	-.4192	.5629	.9487	.4501	-.6217	.5067	1.0397	.8002	.7476	-1.0601	.3851	1.2564
.5502	-.4607	.5514	.9670	.5001	-.3250	.5890	.9075	.8002	.4976	-.3822	.5732	.9325
.6002	-.5013	.5401	.9851	.5497	-.2176	.6188	.8611	.8002	.2476	-.3870	.5719	.9346
.6500	-.5325	.5315	.9991	.6003	-.1025	.6508	.8118	.8002	-.5024	-.3389	.5852	.9136
.7000	-.5148	.5364	.9912	.6500	-.0081	.6770	.7714	.8002	-.7524	-.3428	.5841	.9153
.7500	-.4603	.5315	.9669	.7000	.1126	.7104	.7196					
.8002	-.3820	.5732	.9324	.7501	.2131	.7383	.6760					
.9002	-.1919	.6260	.8501	.8001	.2968	.7615	.6392					
.9501	-.0668	.6607	.7965	.8501	.3672	.7811	.6076					

TEST 167	PT	62.0748	PSI	CM	.0975	CD1	.00881	CDCOR1	.00876
RUN 33	TT	101.0696	K	CM	-.1455	CD2	.00860	CDCOR2	.00858
POINT 58	RC	40.1177	MILLION	CC	.0152	CD3	.00839	CDCOR3	.00845
	MACH	.7715				CD4	.00827	CDCOR4	.00826
	ALPHA	-2.9734	DEG			CD5	.00793	CDCOR5	.00779

UPPER SURFACE				LOWER SURFACE				SPANWISE				
X/C	CP	P/L/PT	MLOC	X/C	CP	P/L/PT	MLOC	X/C	Y/(B/2)	CP	P/L/PT	MLOC
0.0000	.8807	.9223	.3425	0.0000	-.8807	.9223	.3425	.1507	.7476	-.2398	.6097	.8752
.0132	.4949	.8148	.5515	.0126	-.3816	.5757	.9285	.1507	.4976	-.2558	.6052	.8822
.0259	.1648	.7227	.7005	.0255	-.3951	.5863	.9432	.1507	.2476	-.2501	.6068	.8797
.0759	-.1476	.6354	.8354	.0495	-.5034	.5361	.9916	.1507	-.2524	-.2607	.6039	.8843
.1003	-.1882	.6241	.8529	.0753	-.5355	.5271	1.0062	.1507	-.5024	-.2662	.6023	.8867
.1507	-.2515	.6065	.8803	.1002	-.6102	.5063	1.0404	.1507	-.7524	-.2555	.6033	.8821
.2003	-.2851	.5971	.8949	.1503	-.5667	.5184	1.0203	.5002	.7476	-.4948	.5385	.9877
.2503	-.3369	.5826	.9176	.1976	-.6643	.4912	1.0656	.5002	.4976	-.4983	.5375	.9893
.3001	-.3821	.5700	.9375	.2503	-.7608	.4642	1.1116	.5002	.2476	-.5030	.5362	.9914
.3502	-.4006	.5648	.9457	.3001	-.8373	.4429	1.1491	.5002	-.2524	-.4920	.5393	.9864
.4003	-.4279	.5572	.9578	.3507	-.9045	.4241	1.1829	.5002	-.5024	-.4903	.5398	.9857
.4501	-.4518	.5505	.9684	.4001	-.9899	.4338	1.1653	.5002	-.7524	-.4721	.5449	.9775
.5002	-.4995	.5372	.9898	.4501	-.4135	.5612	.9514	.8002	.7476	-1.1073	.3675	1.2912
.5502	-.5391	.5261	1.0078	.5001	-.3379	.5823	.9180	.8002	.4976	-.3946	.5665	.9430
.6002	-.5777	.5154	1.0254	.5497	-.2239	.6141	.8884	.8002	.2476	-.3972	.5657	.9442
.6500	-.6213	.5032	1.0455	.6003	-.1079	.6493	.8140	.8002	-.5024	-.3598	.5762	.9277
.7000	-.5935	.5109	1.0327	.6500	-.0008	.6764	.7722	.8002	-.7524	-.3681	.5739	.9313
.7500	-.4847	.5413	.9832	.7000	.1251	.7116	.7178					
.8002	-.3914	.5674	.9416	.7501	.2288	.7405	.6725					
.9002	-.1905	.6233	.8539	.8001	.3145	.7645	.6344					
.9501	-.0593	.6601	.7974	.8501	.3868	.7847	.6017					

TEST 167	PT	62.0781	PSI	CM	.2605	CD1	.00774	CDCOR1	.00760
RUN 33	TT	101.1386	K	CM	-.1518	CD2	.00764	CDCOR2	.00755
POINT 59	RC	39.9435	MILLION	CC	.0206	CD3	.00762	CDCOR3	.00759
	MACH	.7666				CD4	.00755	CDCOR4	.00749
	ALPHA	-2.0264	DEG			CD5	.00739	CDCOR5	.00720

UPPER SURFACE				LOWER SURFACE				SPANWISE				
X/C	CP	P/L/PT	MLOC	X/C	CP	P/L/PT	MLOC	X/C	Y/(B/2)	CP	P/L/PT	MLOC
0.0000	1.0033	.9577	.2505	0.0000	1.0033	.9577	.2505	.1507	.7476	-.3666	.5780	.9247
.0132	.3221	.7689	.6273	.0126	-.1016	.6515	.8107	.1507	.4976	-.3838	.5733	.9323
.0259	-.0234	.6731	.7773	.0255	-.1868	.6279	.8471	.1507	.2476	-.3801	.5743	.9306
.0759	-.3113	.5934	.9007	.0495	-.3093	.5950	.8981	.1507	-.2524	-.3902	.5715	.9351
.1003	-.3348	.5869	.9109	.0753	-.3549	.5813	.9196	.1507	-.5024	-.3941	.5704	.9368
.1507	-.3810	.5741	.9310	.1002	-.4215	.5628	.9488	.1507	-.7524	-.3793	.5745	.9303
.2003	-.3984	.5692	.9387	.1503	-.4469	.5558	.9600	.5002	.7476	-.5743	.5205	1.0170
.2503	-.4440	.5566	.9587	.1976	-.5317	.5267	1.0068	.5002	.4976	-.5799	.5189	1.0195
.3001	-.4842	.5455	.9769	.2503	-.6031	.5125	1.0301	.5002	.2476	-.5831	.5175	1.0219
.3502	-.4932	.5430	.9806	.3001	-.6239	.5067	1.0396	.5002	-.2524	-.5713	.5213	1.0156
.4003	-.5133	.5374	.9895	.3507	-.6084	.5113	1.0325	.5002	-.5024	-.5690	.5219	1.0146
.4501	-.5343	.5316	.9989	.4001	-.5314	.5324	.9976	.5002	-.7524	-.5458	.5284	1.0041
.5002	-.5823	.5183	1.0206	.4501	-.4445	.5565	.9589	.8002	.7476	-1.1470	.3618	1.3027
.5502	-.6083	.5111	1.0324	.5001	-.3461	.5837	.9158	.8002	.4976	-.6056	.5672	.9418
.6002	-.6460	.5006	1.0498	.5497	-.2162	.6197	.8597	.8002	.2476	-.6071	.5668	.9425
.6500	-.6866	.4894	1.0686	.6003	-.0888	.6556	.8043	.8002	-.5024	-.3708	.5769	.9266
.7000	-.6433	.5008	1.0494	.6500	.0087	.6820	.7635	.8002	-.7524	-.3816	.5739	.9313
.7500	-.4980	.5416	.9827	.7000	.1358	.7173	.7090					
.8002	-.4014	.5684	.9400	.7501	.2399	.7461	.6637					
.9002	-.1948	.6257	.8505	.8001	.3263	.7700	.6255					
.9501	-.0619	.6625	.7937	.8501	.3997	.7904	.5923					

ORIGINAL PAGE IS
OF POOR QUALITY

TEST 167	PT 62.0881	PSI	CN .3431	CD1 .00789	CDCOR1 .00769
RUN 33	TT 101.0958	K	CM -1.550	CD2 .00781	CDCOR2 .00767
POINT 60	RC 40.0605	MILLION	CC .0225	CD3 .00777	CDCOR3 .00770
	MACH .7694			CD4 .00768	CDCOR4 .00759
	ALPHA -1.5070	DEG		CD5 .00749	CDCOR5 .00729

UPPER SURFACE				LOWER SURFACE				SPANWISE				
X/C	CP	P/L/PT	MLOC	X/C	CP	P/L/PT	MLOC	X/C	Y/(B/2)	CP	P/L/PT	MLOC
0.0000	1.0551	.9717	.2040	0.0000	1.0551	.9717	.2040	.1507	.7476	-.4394	.5562	.9594
.0132	.2244	.7407	.6722	.0126	.0315	.6871	.7558	.1507	.4976	-.4598	.5505	.9684
.0259	-.1289	.6425	.8245	.0255	-.0739	.6578	.8009	.1507	.2476	-.4575	.5512	.9674
.0759	-.4071	.5652	.9451	.0495	-.2050	.6213	.8572	.1507	-.2524	-.4673	.5484	.9718
.1003	-.4199	.5616	.9508	.0753	-.2642	.6049	.8828	.1507	-.5024	-.4696	.5478	.9728
.1507	-.4576	.5511	.9675	.1002	-.3370	.5847	.9144	.1507	-.7524	-.4521	.5527	.9650
.2003	-.4655	.5489	.9710	.1503	-.3760	.5738	.9315	.5002	.7476	-.6290	.5035	1.0451
.2503	-.5080	.5371	.9900	.1976	-.4776	.5456	.9764	.5002	.4976	-.6381	.5010	1.0493
.3001	-.5499	.5255	1.0089	.2503	-.5228	.5330	.9967	.5002	.2476	-.6435	.4995	1.0518
.3502	-.5640	.5265	1.0071	.3001	-.5514	.5250	1.0096	.5002	-.2524	-.6315	.5028	1.0462
.4003	-.5622	.5220	1.0145	.3507	-.5446	.5269	1.0065	.5002	-.5024	-.6327	.5024	1.0468
.4501	-.5790	.5174	1.0221	.4001	-.4914	.5417	.9825	.5002	-.7524	-.6050	.5101	1.0340
.5002	-.6391	.5007	1.0497	.4501	-.4236	.5606	.9524	.8002	.7476	-1.1396	.3615	1.3032
.5502	-.6729	.4913	1.0655	.5001	-.3285	.5870	.9107	.8002	.4976	-.4027	.5664	.9432
.6002	-.6936	.4855	1.0752	.5497	-.2019	.6222	.8559	.8002	.2476	-.4029	.5663	.9433
.6500	-.7308	.4752	1.0928	.6003	-.0753	.6574	.8015	.8002	-.5024	-.3717	.5570	.9295
.7000	-.7618	.4632	1.0790	.6500	.0178	.6833	.7616	.8002	-.7524	-.3849	.5713	.9353
.7500	-.4969	.5402	.9850	.7000	.1434	.7182	.7075					
.8002	-.3965	.5681	.9405	.7501	.2466	.7469	.6625					
.9002	-.1917	.6251	.8515	.8001	.3327	.7708	.6242					
.9501	-.0588	.6620	.7945	.8501	.4062	.7913	.5909					

TEST 167	PT 62.0919	PSI	CN .4243	CD1 .00819	CDCOR1 .00792
RUN 33	TT 101.0925	K	CM -1.580	CD2 .00806	CDCOR2 .00783
POINT 61	RC 40.0623	MILLION	CC .0234	CD3 .00798	CDCOR3 .00786
	MACH .7693			CD4 .00785	CDCOR4 .00773
	ALPHA -.9776	DEG		CD5 .00768	CDCOR5 .00744

UPPER SURFACE				LOWER SURFACE				SPANWISE				
X/C	CP	P/L/PT	MLOC	X/C	CP	P/L/PT	MLOC	X/C	Y/(B/2)	CP	P/L/PT	MLOC
0.0000	1.0966	.9832	.1565	0.0000	1.0966	.9832	.1565	.1507	.7476	-.5198	.5336	.9956
.0132	.1195	.7114	.7181	.0126	.1538	.7210	.7032	.1507	.4976	-.5423	.5274	1.0058
.0259	-.2411	.6111	.8730	.0255	.0300	.6866	.7566	.1507	.2476	-.5420	.5275	1.0057
.0759	-.5144	.5351	.9932	.0495	-.1134	.6467	.8181	.1507	-.2524	-.5516	.5248	1.0100
.1003	-.5120	.5358	.9921	.0753	-.1816	.6277	.8474	.1507	-.5024	-.5509	.5250	1.0097
.1507	-.5414	.5276	1.0054	.1002	-.2598	.6099	.8811	.1507	-.7524	-.5292	.5310	.9999
.2003	-.5343	.5296	1.0022	.1503	-.3096	.5921	.9027	.5002	.7476	-.6699	.4919	1.0645
.2503	-.5713	.5193	1.0189	.1976	-.4088	.5645	.9462	.5002	.4976	-.6789	.4894	1.0687
.3001	-.6203	.5057	1.0414	.2503	-.4563	.5513	.9672	.5002	.2476	-.6835	.4881	1.0708
.3502	-.6273	.5037	1.0446	.3001	-.4854	.5432	.9802	.5002	-.2524	-.6728	.4911	1.0658
.4003	-.6676	.5092	1.0355	.3507	-.4897	.5420	.9821	.5002	-.5024	-.6753	.4904	1.0670
.4501	-.6102	.5085	1.0368	.4001	-.4534	.5521	.9659	.5002	-.7524	-.6520	.4969	1.0561
.5002	-.6781	.4996	1.0683	.4501	-.3987	.5673	.9417	.8002	.7476	-1.1239	.3656	1.2950
.5502	-.7222	.4773	1.0891	.5001	-.3096	.5921	.9028	.8002	.4976	-.3935	.5688	.9394
.6002	-.7559	.4680	1.1051	.5497	-.1878	.6260	.8501	.8002	.2476	-.3913	.5694	.9385
.6500	-.7904	.4584	1.1218	.6003	-.0648	.6602	.7973	.8002	-.5024	-.3697	.5574	.9290
.7000	-.7573	.4676	1.1058	.6500	.0260	.6894	.7583	.8002	-.7524	-.3862	.5708	.9362
.7500	-.4991	.5394	.9863	.7000	.1501	.7199	.7048					
.8002	-.3856	.5710	.9360	.7501	.2523	.7484	.6601					
.9002	-.1860	.6259	.8502	.8001	.3384	.7723	.6218					
.9501	-.0571	.6623	.7940	.8501	.4123	.7929	.5862					

TEST 167	PT 62.0885	PSI	CN .5048	CD1 .00855	CDCOR1 .00827
RUN 33	TT 101.6809	K	CM -1.599	CD2 .00844	CDCOR2 .00821
POINT 62	RC 39.6900	MILLION	CC .0236	CD3 .00832	CDCOR3 .00822
	MACH .7686			CD4 .00814	CDCOR4 .00803
	ALPHA -.4888	DEG		CD5 .00792	CDCOR5 .00768

UPPER SURFACE				LOWER SURFACE				SPANWISE				
X/C	CP	P/L/PT	MLOC	X/C	CP	P/L/PT	MLOC	X/C	Y/(B/2)	CP	P/L/PT	MLOC
0.0000	1.1278	.9919	.1085	0.0000	1.1278	.9919	.1085	.1507	.7476	-.5973	.5120	1.0309
.0132	.0225	.6844	.7599	.0126	.2611	.7508	.8562	.1507	.4976	-.6247	.5044	1.0434
.0259	-.3446	.5823	.9180	.0255	.1226	.7123	.7167	.1507	.2476	-.6264	.5040	1.0442
.0759	-.6267	.5039	1.0444	.0495	-.0319	.6693	.7832	.1507	-.2524	-.6312	.5026	1.0465
.1003	-.6166	.5067	1.0397	.0753	-.1081	.6481	.8158	.1507	-.5024	-.6293	.5031	1.0456
.1507	-.6232	.5048	1.0427	.1002	-.1897	.6254	.8509	.1507	-.7524	-.6013	.5109	1.0327
.2003	-.6184	.5062	1.0406	.1503	-.1927	.6246	.8522	.5002	.7476	-.7196	.4780	1.0879
.2503	-.6326	.5022	1.0471	.1976	-.3460	.5819	.9186	.5002	.4976	-.7299	.4732	1.0927
.3001	-.6592	.4948	1.0595	.2503	-.3963	.5679	.9407	.5002	.2476	-.7332	.4742	1.0943
.3502	-.6815	.4886	1.0639	.3001	-.4227	.5589	.9550	.5002	-.2524	-.7185	.4783	1.0873
.4003	-.6953	.4848	1.0764	.3507	-.4407	.5556	.9603	.5002	-.5024	-.7277	.4758	1.0917
.4501	-.6975	.4842	1.0774	.4001	-.4150	.5627	.9489	.5002	-.7524	-.7082	.4812	1.0824
.5002	-.7310	.4749	1.0933	.4501	-.3708	.5740	.9295	.8002	.7476	-1.1030	.3714	1.2834
.5502	-.7478	.4702	1.1013	.5001	-.2884	.5980	.8935	.8002	.4976	-.3838	.5714	.9351
.6002	-.7838	.4602	1.1186	.5497	-.1718	.6304	.8432	.8002	.2476	-.3789	.5728	.9330
.6500	-.8317	.4469	1.1420	.6003	-.0720	.6637	.7918	.8002	-.5024	-.3653	.5766	.9271
.7000	-.8108	.4527	1.1318	.6500	.0357	.6881	.7542	.8002	-.7524	-.3834	.5715	.9350
.7500	-.4887	.5422	.9817	.7000	.1586	.7223	.7011					
.8002	-.3727	.5745	.9303	.7501	.2400	.7505	.6547					
.9002	-.1806	.6280	.8449	.8001	.3456	.7743	.6186					
.9501	-.0511	.6640	.7914	.8501	.4199	.7950	.5848					

Appendix J

Pressure Data for $M = 0.78$; $R = 4.4 \times 10^6$, 7.0×10^6 , 10.0×10^6 , 15.0×10^6 , 30.0×10^6 , and 40.0×10^6 ; Free Transition

The pressure measurements made on the NASA SC(3)-0712(B) airfoil are presented in coefficient form in graphs and tables in this appendix. The data are for a given Mach number through the Reynolds number range. The pressure data from the upper surface of the airfoil are plotted as open symbols, and the lower-surface data are plotted as solid symbols.

TEST 167
 RUN 56
 MACH .780
 R 4.4×10^6

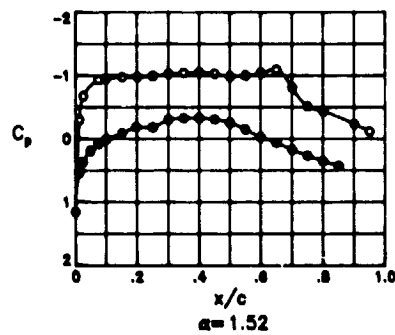
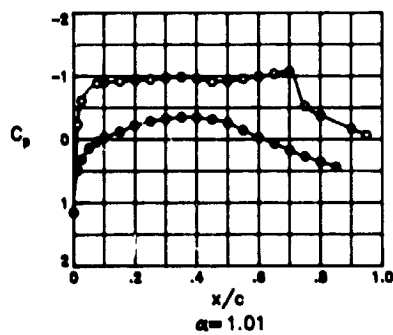
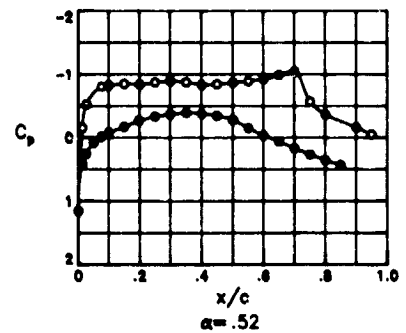
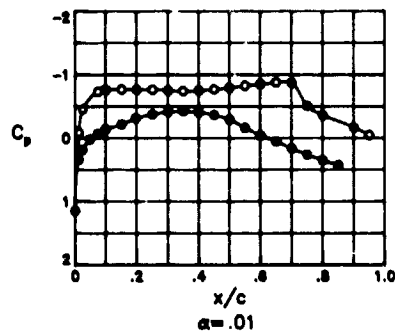
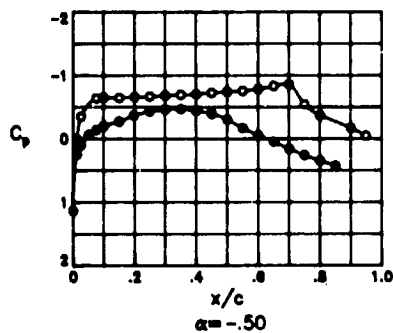
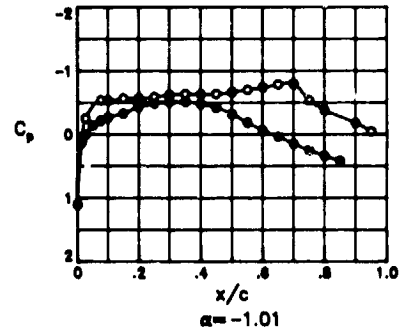
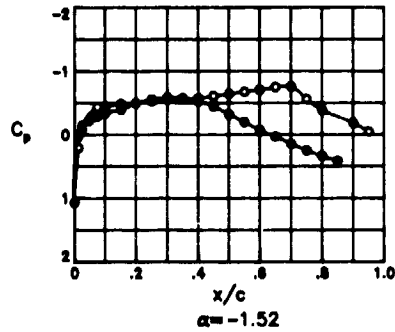
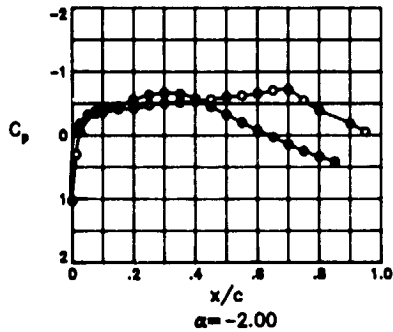
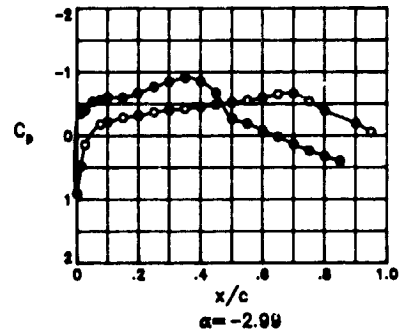
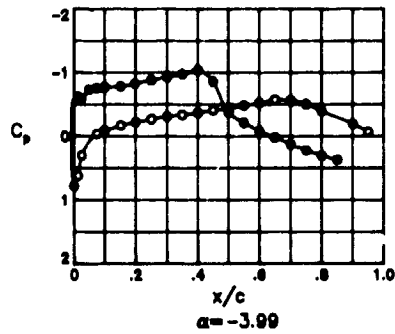

TEST 167	PT 20.7579	PSI	CM -.0394	CD1 .01229	CDCOR1 .01218
RUN 56	TT 220.4336	K	CM -.1427	CD2 .01118	CDCOR2 .01118
POINT 66	RC 4.3959	MILLION	CC .0087	CD3 .01129	CDCOR3 .01126
	MACH .7705			CD4 .01111	CDCOR4 .01110
	ALPHA -3.9913	DEG		CD5 .01111	CDCOR5 .01079

UPPER SURFACE				LOWER SURFACE				SPANWISE				
X/C	CP	P/L/PT	MLOC	X/C	CP	P/L/PT	MLOC	X/C	Y/(B/2)	CP	P/L/PT	MLOC
0.0000	.7833	.8923	.4065	0.0000	.7833	.8923	.4065	.1507	.7476	-.1503	.6263	.8434
.0132	.6193	.8456	.4951	.0126	-.6214	.4921	1.0594	.1507	.4976	-.1670	.6216	.8527
.0259	.2986	.7542	.6475	.0255	-.6017	.4977	1.0501	.1507	.2476	-.1691	.6209	.8537
.0759	-.0418	.6572	.7978	.0495	-.7349	.4597	1.1147	.1507	-.2524	-.1704	.6206	.8542
.1003	-.0904	.6434	.8191	.0753	-.7592	.4528	1.1208	.1507	-.5024	-.1727	.6199	.8552
.1307	-.1692	.6209	.8437	.1302	-.7757	.4481	1.1351	.1507	-.7524	-.1625	.6228	.8507
.2063	-.2238	.6054	.8777	.1503	-.7843	.4457	1.1394	.5002	.7476	-.4316	.5462	.9709
.2503	-.2686	.5926	.8976	.1976	-.8307	.4324	1.1631	.5002	.4976	-.4433	.5428	.9763
.3001	-.3109	.5806	.9164	.2503	-.8838	.4173	1.1907	.5002	.2476	-.4443	.5411	.9790
.3502	-.3374	.5730	.9283	.3001	-.9289	.4045	1.2147	.5002	-.2524	-.4433	.5428	.9763
.4003	-.3700	.5637	.9430	.3502	-.9801	.3899	1.2425	.5002	-.5024	-.4376	.5444	.9737
.4501	-.4093	.5525	.9608	.4001	-1.0409	.3725	1.2765	.5002	-.7524	-.4235	.5485	.9672
.5002	-.4427	.5430	.9760	.4501	-.8598	.3241	1.1782	.8002	.7476	-.3782	.5614	.9467
.5502	-.4805	.5322	.9934	.5001	-.3753	.5622	.9434	.8002	.4976	-.3853	.5593	.9499
.6002	-.5252	.5195	1.0141	.5497	-.2094	.8695	.8714	.8002	.2476	-.3948	.5587	.9542
.6500	-.5738	.5057	1.0368	.6003	-.0826	.6436	.8157	.8002	-.5024	-.4183	.5499	.9649
.7000	-.5670	.5076	1.0336	.6500	.0222	.6755	.7698	.8002	-.7524	-.3692	.5640	.9426
.7500	-.5017	.5262	1.0032	.7000	1.2600	.7050	.7243					
.8002	-.3956	.5564	.9546	.7501	.2214	.7322	.6821					
.9002	-.1956	.6134	.8653	.8001	.3025	.7553	.6457					
.9501	-.0726	.6485	.8113	.8501	.3734	.7755	.6134					

TEST 167	PT 20.8438	PSI	CM .1159	CD1 .00778	CDCOR1 .00741
RUN 56	TT 220.5616	K	CM -.1916	CD2 .00762	CDCOR2 .00732
POINT 67	RC 4.4112	MILLION	CC .0146	CD3 .00709	CDCOR3 .00682
	MACH .7807			CD4 .00785	CDCOR4 .00748
	ALPHA -2.9904	DEG		CD5 .00747	CDCOR5 .00702

UPPER SURFACE				LOWER SURFACE				SPANWISE				
X/C	CP	P/L/PT	MLOC	X/C	CP	P/L/PT	MLOC	X/C	Y/(B/2)	CP	P/L/PT	MLOC
0.0000	.9060	.9239	.5310	0.0000	.9560	.9269	.3310	.1507	.7476	-.2620	.5931	.8988
.0132	.4764	.8041	.5665	.0126	-.3574	.5659	.9396	.1507	.4976	-.2816	.5875	.9055
.0259	.1410	.7083	.7193	.0255	-.4023	.5530	.9599	.1507	.2476	-.2843	.5868	.9067
.0759	-.1807	.6164	.8608	.0495	-.5317	.5161	1.0197	.1507	-.2524	-.2870	.5860	.9079
.1003	-.2181	.6057	.8773	.0753	-.5603	.5079	1.0331	.1507	-.5024	-.2881	.5957	.9084
.1307	-.2847	.5867	.9069	.1002	-.6043	.4953	1.0540	.1507	-.7524	-.2738	.5898	.9020
.2063	-.3180	.5777	.9209	.1503	-.5964	.4976	1.0502	.5002	.7476	-.5081	.5227	1.0089
.2503	-.3676	.5630	.9442	.1976	-.6471	.4774	1.0843	.5002	.4976	-.5220	.5188	1.0131
.3001	-.4059	.5520	.9616	.2503	-.7081	.4485	1.1344	.5002	.2476	-.5193	.5196	1.0139
.3502	-.4233	.5470	.9695	.3001	-.8502	.4251	1.1765	.5002	-.2524	-.5247	.5181	1.0164
.4003	-.4521	.5388	.9827	.3502	-.9121	.4074	1.2092	.5002	-.5024	-.5193	.5196	1.0139
.4501	-.4917	.5275	1.0010	.4001	-.8580	.4228	1.1805	.5002	-.7524	-.5046	.5238	1.0070
.5002	-.5220	.5189	1.0151	.4501	-.6713	.4762	1.0864	.8002	.7476	-.3835	.5584	.9514
.5502	-.5559	.5092	1.0310	.5001	-.2655	.5921	.8983	.8002	.4976	-.3876	.5572	.9533
.6002	-.5980	.4971	1.0510	.5497	-.1885	.6141	.8642	.8002	.2476	-.3994	.5539	.9586
.6500	-.6526	.4815	1.0773	.6003	-.0806	.6450	.8167	.8002	-.5024	-.4258	.5463	.9706
.7000	-.6405	.4793	1.0811	.6500	.0196	.6736	.7727	.8002	-.7524	-.3892	.5579	.9521
.7500	-.5385	.5141	1.0228	.7000	.1344	.7064	.7222					
.8002	-.3927	.5558	.9554	.7501	.2373	.7358	.6765					
.9002	-.1918	.6132	.8657	.8001	.3235	.7604	.6376					
.9501	-.0567	.6518	.8062	.8501	.3990	.7820	.6029					

TEST 167	PT 20.7431	PSI	CM .2800	CD1 .00723	CDCOR1 .00694
RUN 56	TT 220.6772	K	CM -.1581	CD2 .00628	CDCOR2 .00604
POINT 68	RC 4.3837	MILLION	CC .0196	CD3 .00656	CDCOR3 .00625
	MACH .7797			CD4 .00696	CDCOR4 .00672
	ALPHA -1.9958	DEG		CD5 .00656	CDCOR5 .00628

UPPER SURFACE				LOWER SURFACE				SPANWISE				
X/C	CP	P/L/PT	MLOC	X/C	CP	P/L/PT	MLOC	X/C	Y/(B/2)	CP	P/L/PT	MLOC
0.0000	1.0274	.9821	.2353	0.0000	1.0274	.9821	.2353	.1507	.7476	-.3885	.5595	.9496
.0132	.3029	.7961	.6445	.0126	-.0938	.6434	.8191	.1507	.4976	-.4088	.5555	.9593
.0259	-.0446	.6573	.7977	.0255	-.1862	.6171	.8597	.1507	.2476	-.4137	.5524	.9618
.0759	-.3433	.5724	.9293	.0495	-.3215	.5786	.9195	.1507	-.2524	-.4144	.5522	.9613
.1003	-.3847	.5663	.9389	.0753	-.3725	.5641	.9424	.1507	-.5024	-.4128	.5526	.9606
.1307	-.4145	.5521	.9614	.1002	-.4184	.5510	.9631	.1507	-.7524	-.3914	.5587	.9509
.2063	-.4240	.5494	.9657	.1503	-.4561	.5403	.9803	.5002	.7476	-.5860	.5034	1.0406
.2503	-.4745	.5351	.9887	.1976	-.5573	.5115	1.0271	.5002	.4976	-.6053	.4979	1.0497
.3001	-.5072	.5258	1.0038	.2503	-.6371	.4888	1.0649	.5002	.2476	-.6087	.4969	1.0514
.3502	-.5175	.5229	1.0086	.3001	-.6860	.4801	1.0794	.5002	-.2524	-.6050	.4980	1.0496
.4003	-.5380	.5176	1.0172	.3502	-.8531	.4483	1.0726	.5002	-.5024	-.5954	.5007	1.0451
.4501	-.5700	.5079	1.0331	.4001	-.5821	.5045	1.0388	.5002	-.7524	-.5889	.5044	1.0382
.5002	-.6060	.4977	1.0501	.4501	-.4507	.5419	.9773	.8002	.7476	-.3803	.5619	.9459
.5502	-.6292	.4911	1.0611	.5001	-.3246	.5777	.9264	.8002	.4976	-.3830	.5611	.9471
.6002	-.6598	.4824	1.0758	.5497	-.2018	.6126	.8665	.8002	.2476	-.3954	.5576	.9528
.6500	-.7083	.4686	1.0994	.6003	-.0774	.6480	.8120	.8002	-.5024	-.3976	.5581	.9519
.7000	-.7224	.4646	1.1063	.6500	.0289	.6782	.7656	.8002	-.7524	-.3840	.5608	.9476
.7500	-.5503	.5135	1.0239	.7000	.1462	.7116	.7142					
.8002	-.3910	.5588	.9507	.7501	.2514	.7415	.6676					
.9002	-.1884	.6164	.8606	.8001	.3400	.7687	.6274					
.9501	-.0517	.6547	.8017	.8501	.4181	.7889	.5917					

ORIGINAL PAGE IS
OF POOR QUALITY

TFST	167	PT	20.8397	PSI	CN	.3546	CD1	.00736	CDCOR1	.00737
RUN	56	TT	221.1607	K	CM	-.1593	CD2	.00631	CDCOR2	.00605
POINT	69	RC	4.3913	MILLION	CC	.0211	CD3	.00646	CDCOR3	.00620
		MACH	.7798				CD4	.00677	CDCOR4	.00649
		ALPHA	-1.5172	DEG			CD5	.00787	CDCOR5	.00757

UPPER SURFACE				LOWER SURFACE				SPANWISE				
X/C	CP	P _L /PT	MLOC	X/C	CP	P _L /PT	MLOC	X/C	Y/(B/2)	CP	P _L /PT	MLOC
0.0000	1.0713	.9746	.1920	0.0000	1.0713	.9746	.1920	.1507	.7476	-.4593	.5193	.9819
.0132	.7094	.7295	.6864	.0126	.0296	.6783	.7654	.1507	.4976	-.4629	.5326	.9927
.0259	-.1458	.6285	.8420	.0255	-.0837	.6461	.8149	.1507	.2476	-.4674	.5313	.9948
.0759	-.4352	.5462	.9709	.0495	-.2281	.6051	.8782	.1507	-.2524	-.4684	.5311	.9953
.1003	-.4478	.5426	.9766	.0753	-.2900	.5874	.9057	.1507	-.5024	-.4642	.5322	.9933
.1507	-.4874	.5313	.9949	.1002	-.3418	.5727	.9288	.1507	-.7524	-.4581	.5396	.9814
.2003	-.4986	.5282	1.0000	.1503	-.3927	.5583	.9516	.5002	.7476	-.6324	.4901	1.0020
.2503	-.5325	.5185	1.0157	.1976	-.4439	.5295	.9978	.5002	.4976	-.6478	.4857	1.0702
.3001	-.5687	.5082	1.0326	.2503	-.5574	.5114	1.0273	.5002	.2476	-.6669	.4860	1.0698
.3502	-.5678	.5085	1.0322	.3001	-.5680	.5027	1.0417	.5002	-.2524	-.6486	.4859	1.0706
.4003	-.5764	.5066	1.0362	.3507	-.5776	.5097	1.0364	.5002	-.5024	-.6359	.4882	1.0643
.4501	-.6093	.4967	1.0518	.4001	-.5258	.5204	1.0126	.5002	-.7524	-.6290	.4911	1.0612
.5002	-.6445	.4866	1.0686	.4501	-.4614	.5446	.9737	.8002	.7476	-.3828	.5611	.9472
.5502	-.6758	.4778	1.0837	.5001	-.3206	.5788	.9193	.8002	.4976	-.3802	.5618	.9460
.6002	-.7089	.4683	1.0999	.5497	-.1933	.6150	.8629	.8002	.2476	-.3901	.5590	.9505
.6500	-.7492	.4569	1.1147	.6003	-.0709	.6498	.8093	.8002	-.5024	-.3943	.5578	.9423
.7000	-.7596	.4542	1.1244	.6500	.0338	.6799	.7636	.8002	-.7524	-.3870	.5599	.9491
.7500	-.5602	.5106	1.0286	.7000	1.495	.7124	.7128					
.8002	-.3849	.5605	.9481	.7501	.2539	.7621	.6666					
.8502	-.1822	.6181	.8580	.8001	.3423	.7673	.6267					
.9501	-.0478	.6563	.7992	.8501	.4208	.7696	.5905					

TEST	167	PT	20.8418	PSI	CN	.4242	CD1	.00784	CDCOR1	.00757
RUN	56	TT	221.1026	K	CM	-.1585	CD2	.00721	CDCOR2	.00700
POINT	70	RC	4.3910	MILLION	CC	.0214	CD3	.00679	CDCOR3	.00660
		MACH	.7790				CD4	.00699	CDCOR4	.00679
		ALPHA	-1.0081	DEG			CD5	.00848	CDCOR5	.00819

UPPER SURFACE				LOWER SURFACE				SPANWISE				
X/C	CP	P _L /PT	MLOC	X/C	CP	P _L /PT	MLOC	X/C	Y/(B/2)	CP	P _L /PT	MLOC
0.0000	1.1054	.9845	.1494	0.0000	1.1054	.9845	.1494	.1507	.7476	-.5328	.5198	1.0135
.0132	.1087	.7018	.7293	.0126	.1422	.7113	.7146	.1507	.4976	-.5626	.5114	1.0274
.0259	-.2528	.5983	.8872	.0255	.0121	.6744	.7715	.1507	.2476	-.5686	.5097	1.0302
.0759	-.5376	.5185	1.0157	.0495	-.1411	.6309	.8383	.1507	-.2524	-.5688	.5096	1.0303
.1003	-.5396	.5179	1.0167	.0753	-.2132	.6105	.8698	.1507	-.5024	-.5620	.5116	1.0271
.1507	-.5678	.5100	1.0297	.1002	-.2700	.5944	.8949	.1507	-.7524	-.5298	.5207	1.0121
.2003	-.5700	.5093	1.0308	.1503	-.3296	.5775	.9213	.5002	.7476	-.6672	.4817	1.0769
.2503	-.5922	.5030	1.0412	.1976	-.4293	.5492	.9661	.5002	.4976	-.6795	.4782	1.0829
.3001	-.6292	.4925	1.0588	.2503	-.4880	.5326	.9928	.5002	.2476	-.6738	.4798	1.0801
.3502	-.6364	.4905	1.0622	.3001	-.5160	.5246	1.0057	.5002	-.2524	-.6794	.4783	1.0828
.4003	-.6344	.4910	1.0612	.3507	-.5156	.5247	1.0055	.5002	-.5024	-.6693	.4811	1.0780
.4501	-.6397	.4895	1.0638	.4001	-.4798	.5349	.9891	.8002	-.7524	-.6699	.4810	1.0782
.5002	-.6659	.4821	1.0763	.4501	-.4215	.5514	.9625	.8002	.7476	-.3823	.5625	.9449
.5502	-.7024	.4717	1.0940	.5001	-.3170	.5811	.9157	.8002	.4976	-.3794	.5634	.9436
.6002	-.7433	.4601	1.1140	.5497	-.1852	.6184	.8575	.8002	.2476	-.3862	.5614	.9466
.6500	-.7874	.4476	1.1360	.6003	-.0652	.6525	.8051	.8002	-.5024	-.3925	.5596	.9495
.7000	-.7951	.4454	1.1399	.6500	.0373	.6816	.7605	.8002	-.7524	-.3887	.5607	.9478
.7500	-.5346	.5193	1.0143	.7000	1.511	.7134	.7107					
.8002	-.3766	.5641	.9423	.7501	.2544	.7431	.6649					
.8502	-.1776	.6206	.8542	.8001	.3423	.7681	.6234					
.9501	-.0450	.6582	.7963	.8501	.4202	.7902	.5896					

TFST	167	PT	19.7169	PSI	CN	.5071	CD1	.00891	CDCOR1	.00852
RUN	56	TT	211.2150	K	CM	-.1630	CD2	.00880	CDCOR2	.00846
POINT	71	RC	4.4260	MILLION	CC	.0217	CD3	.00739	CDCOR3	.00704
		MACH	.7790				CD4	.00740	CDCOR4	.00703
		ALPHA	-.4990	DEG			CD5	.00924	CDCOR5	.00879

UPPER SURFACE				LOWER SURFACE				SPANWISE				
X/C	CP	P _L /PT	MLOC	X/C	CP	P _L /PT	MLOC	X/C	Y/(B/2)	CP	P _L /PT	MLOC
0.0000	1.1339	.9923	.1053	0.0000	1.1339	.9923	.1053	.1507	.7476	-.6120	.4951	1.0544
.0132	.0172	.6743	.7717	.0126	.2644	.7399	.6706	.1507	.4976	-.6361	.4882	1.0639
.0259	-.3493	.5699	.9332	.0255	.1013	.6982	.7348	.1507	.2476	-.6439	.4860	1.0697
.0759	-.6398	.4872	1.0677	.0495	-.0572	.6531	.8042	.1507	-.2524	-.6402	.4871	1.0679
.1003	-.6507	.4841	1.0729	.0753	-.1381	.6301	.8396	.1507	-.5024	-.6285	.4904	1.0623
.1507	-.6442	.4880	1.0698	.1002	-.2000	.6124	.8649	.1507	-.7524	-.5927	.5006	1.0452
.2003	-.6597	.4818	1.0768	.1503	-.2693	.5927	.8975	.5002	.7476	-.7233	.4634	1.1084
.2503	-.6664	.4794	1.0806	.1976	-.3689	.5643	.9420	.5002	.4976	-.7373	.4594	1.1153
.3001	-.6822	.4751	1.0882	.2503	-.4292	.5472	.9694	.5002	.2476	-.7342	.4603	1.1138
.3502	-.6931	.4720	1.0935	.3001	-.4624	.5377	.9846	.5002	-.2524	-.7447	.4573	1.1169
.4003	-.7031	.4690	1.0988	.3507	-.4681	.5361	.9872	.5002	-.5024	-.7199	.4644	1.1067
.4501	-.7248	.4630	1.1091	.4001	-.4417	.5436	.9751	.8002	-.7524	-.7264	.4625	1.1099
.5002	-.7421	.4581	1.1176	.4501	-.3935	.5573	.9532	.8002	.7476	-.3730	.5632	.9439
.5502	-.7542	.4546	1.1237	.5001	-.3026	.5832	.9123	.8002	.4976	-.3658	.5632	.9466
.6002	-.7727	.4485	1.1380	.5497	-.1679	.6216	.8527	.8002	.2476	-.3722	.5634	.9435
.6500	-.8317	.4326	1.1629	.6003	-.0508	.6549	.8014	.8002	-.5024	-.3787	.5616	.9464
.7000	-.8570	.4254	1.1760	.6500	.0492	.6834	.7577	.8002	-.7524	-.3793	.5616	.9467
.7500	-.5417	.5191	1.0213	.7000	1.613	.7193	.7034					
.8002	-.3869	.5650	.9409	.7501	.2630	.7444	.6630					
.8502	-.1889	.6214	.8536	.8001	.3512	.7694	.6233					
.9501	-.0499	.6584	.7981	.8501	.4300	.7918	.5869					

TEST 167 PT 19.7229 PSI CM .5826
 RUN 56 TT 211.0908 K CM -.1638
 POINT 72 RC 4.4257 MILLION CC .0209
 MACH .7782
 ALPHA .0102 DEG

C01 .00964 CDCOR1 .00939
 C02 .00955 CDCOR2 .00931
 C03 .00787 CDCOR3 .00772
 C04 .00832 CDCOR4 .00801
 C05 .01007 CDCOR5 .00959

UPPER SURFACE				LOWER SURFACE				SPANWISE				
X/C	CP	P.L./PT	MLOC	X/C	CP	P.L./PT	MLOC	X/C	Y/(B/2)	CP	P.L./PT	MLOC
0.0000	1.1492	.9968	.0676	0.0000	1.1492	.9968	.0676	.1507	.7476	-.7032	.4706	1.0960
.0132	-.0819	.6471	.8134	.0126	-.3421	.7675	.6263	.1507	.4976	-.7408	.4562	1.1244
.0259	-.4531	.3416	.9782	.0255	-.1848	.7229	.6967	.1507	.2476	-.7664	.4526	1.1272
.0759	-.7330	.4621	1.1106	.0495	-.0178	.6754	.7699	.1507	-.2524	-.7896	.4520	1.1283
.1003	-.7595	.4546	1.1237	.0753	-.0707	.6503	.8085	.1507	-.5024	-.7534	.4563	1.1207
.1507	-.7649	.4531	1.1264	.1002	-.1375	.6313	.8378	.1507	-.7524	-.6764	.4486	1.1324
.2003	-.7603	.4544	1.1242	.1503	-.2130	.6098	.8709	.5002	.7476	-.7769	.4441	1.1423
.2503	-.7631	.4536	1.1255	.1976	-.3123	.5816	.9148	.5002	.4976	-.7965	.4426	1.1450
.3001	-.7464	.4583	1.1173	.2503	-.3729	.5644	.9419	.5002	.2476	-.8018	.4395	1.1504
.3502	-.7417	.4596	1.1149	.3001	-.4086	.5543	.9580	.5002	-.2524	-.8125	.4471	1.1369
.4003	-.7489	.4578	1.1185	.3502	-.4212	.5507	.9637	.5002	-.5024	-.7851	.4470	1.1371
.4501	-.7685	.4526	1.1272	.4001	-.4041	.5556	.9560	.8002	.7476	-.3683	.5657	.9398
.5002	-.7965	.4447	1.1413	.4501	-.3638	.5670	.9378	.8002	.4976	-.3601	.5681	.9362
.5502	-.8226	.4367	1.1555	.5001	-.2898	.5880	.9048	.8002	.2476	-.3666	.5662	.9391
.6002	-.8517	.4284	1.1705	.5497	-.1582	.6254	.8468	.8002	-.5024	-.3739	.5641	.9424
.6500	-.8771	.4212	1.1836	.6003	-.0427	.6582	.7963	.8002	-.7524	-.3759	.5636	.9432
.7000	-.8724	.4225	1.1812	.6500	.0547	.6859	.7538					
.7500	-.9032	.4268	1.0022	.7000	.1649	.7172	.7055					
.8002	-.9300	.4681	.9361	.7501	.2656	.7458	.6608					
.9002	-.1640	.6238	.8493	.8001	.3524	.7705	.6216					
.9501	-.0460	.6573	.7978	.8501	.4309	.7928	.5854					

TEST 167 PT 18.5699 PSI CM .6770
 RUN 56 TT 203.2386 K CM -.1752
 POINT 73 RC 4.3980 MILLION CC .0225
 MACH .7804
 ALPHA .5193 DEG

C01 .01247 CDCOR1 .01201
 C02 .01242 CDCOR2 .01183
 C03 .01138 CDCOR3 .01073
 C04 .01088 CDCOR4 .01031
 C05 .01263 CDCOR5 .01206

UPPER SURFACE				LOWER SURFACE				SPANWISE				
X/C	CP	P.L./PT	MLOC	X/C	CP	P.L./PT	MLOC	X/C	Y/(B/2)	CP	P.L./PT	MLOC
0.0000	1.1567	.9984	.0481	0.0000	1.1567	.9984	.0481	.1507	.7476	-.8003	.4385	1.1522
.0132	-.1521	.6240	.8490	.0126	-.4188	.7873	.5943	.1507	.4976	-.8098	.4187	1.1883
.0259	-.5253	.3172	1.0179	.0255	-.2542	.7402	.6696	.1507	.2476	-.8353	.4228	1.1806
.0759	-.8027	.4379	1.1534	.0495	-.0819	.6909	.7461	.1507	-.2524	-.8500	.4243	1.1779
.1003	-.8259	.4312	1.1653	.0753	-.0135	.6436	.7881	.1507	-.5024	-.8621	.4209	1.1842
.1507	-.8454	.4257	1.1755	.1002	-.0830	.6437	.8186	.1507	-.7524	-.7663	.4483	1.1349
.2003	-.8361	.4283	1.1706	.1503	-.1655	.6201	.8550	.5002	.7476	-.8941	.4117	1.2011
.2503	-.8702	.4186	1.1485	.1976	-.2663	.5913	.8997	.5002	.4976	-.9024	.4093	1.2056
.3001	-.8938	.4118	1.2010	.2503	-.3308	.5728	.9286	.5002	.2476	-.9667	.4195	1.1867
.3502	-.8725	.4179	1.1897	.3001	-.3711	.5613	.9468	.5002	-.2524	-.8730	.4177	1.1900
.4003	-.8329	.4292	1.1690	.3502	-.3894	.5561	.9551	.5002	-.5024	-.9007	.4098	1.2047
.4501	-.8434	.4262	1.1744	.4001	-.3786	.5592	.9503	.5002	-.7524	-.8824	.4151	1.1949
.5002	-.8650	.4200	1.1658	.4501	-.3432	.5693	.9342	.8002	.7476	-.3543	.5661	.9393
.5502	-.8875	.4136	1.1976	.5001	-.2778	.5880	.9048	.8002	.4976	-.3492	.5676	.9369
.6002	-.9242	.4031	1.2173	.5497	-.1490	.6249	.8477	.8002	.2476	-.3616	.5640	.9425
.6500	-.9889	.3846	1.2528	.6003	-.0334	.6579	.7968	.8002	-.5024	-.3618	.5640	.9426
.7000	-1.0460	.3683	1.2851	.6500	.0614	.6891	.7552	.8002	-.7524	-.3602	.5644	.9419
.7500	-.9677	.4051	1.0378	.7000	.1698	.7161	.7073					
.8002	-.9623	.4639	.9428	.7501	.2697	.7448	.6627					
.9002	-.1574	.6225	.8514	.8001	.3560	.7693	.6234					
.9501	-.0467	.6536	.8035	.8501	.4352	.7920	.5867					

TEST 167 PT 18.2342 PSI CM .7593
 RUN 56 TT 200.1242 K CM -.1811
 POINT 74 RC 4.4677 MILLION CC .0221
 MACH .7740
 ALPHA 1.0081 DEG

C01 .01676 CDCOR1 .01633
 C02 .01478 CDCOR2 .01445
 C03 .01460 CDCOR3 .01435
 C04 .01390 CDCOR4 .01358
 C05 .01588 CDCOR5 .01500

UPPER SURFACE				LOWER SURFACE				SPANWISE				
X/C	CP	P.L./PT	MLOC	X/C	CP	P.L./PT	MLOC	X/C	Y/(B/2)	CP	P.L./PT	MLOC
0.0000	1.1568	.9988	.0417	0.0000	1.1568	.9988	.0417	.1507	.7476	-.8098	.4161	1.1930
.0132	-.2359	.6023	.8826	.0126	-.4899	.8089	.5586	.1507	.4976	-.8947	.3971	1.2280
.0259	-.6130	.4949	1.0548	.0255	-.3153	.7601	.6383	.1507	.2476	-.9315	.4042	1.2152
.0759	-.8834	.4179	1.1896	.0495	-.1431	.7102	.7164	.1507	-.2524	-.9448	.4085	1.2223
.1003	-.9042	.4120	1.2006	.0753	-.0422	.6615	.7687	.1507	-.5024	-.8593	.4248	1.1771
.1507	-.9209	.4072	1.2045	.1002	-.0304	.6608	.7924	.1507	-.7524	-.8652	.3946	1.2334
.2003	-.9381	.4023	1.2187	.1503	-.1173	.6360	.8303	.5002	.7476	-.9652	.3899	1.2426
.2503	-.9466	.3999	1.2233	.1976	-.2164	.6073	.8749	.5002	.4976	-.9818	.3943	1.2361
.3001	-.9753	.3918	1.2389	.2503	-.2839	.5886	.9039	.5002	.2476	-.9592	.3943	1.2361
.3502	-.9668	.3891	1.2441	.3001	-.3262	.5766	.9320	.5002	-.2524	-.9634	.3951	1.2325
.4003	-.9598	.3962	1.2385	.3502	-.3488	.5701	.9320	.5002	-.5024	-.9416	.4013	1.2207
.4501	-.9130	.4095	1.2053	.4001	-.3443	.5714	.9306	.8002	.7476	-.3458	.5716	.9316
.5002	-.9253	.4080	1.2119	.4501	-.3151	.5797	.9179	.8002	.4976	-.3466	.5707	.9320
.5502	-.9595	.3962	1.2303	.5001	-.2575	.5961	.8922	.8002	.2476	-.3482	.5643	.9421
.6002	-.9919	.3870	1.2481	.5497	-.1404	.6294	.8406	.8002	-.5024	-.3614	.5665	.9386
.6500	-1.0375	.3740	1.2739	.6003	-.0231	.6629	.7893	.8002	-.7524	-.3525	.5691	.9346
.7000	-1.0720	.3662	1.2933	.6500	.0696	.6993	.7437					
.7500	-.9523	.4199	1.0135	.7000	.1759	.7195	.7019					
.8002	-.9744	.4628	.9444	.7501	.2746	.7476	.6580					
.9002	-.1645	.6226	.8512	.8001	.3602	.7720	.6192					
.9501	-.0625	.6517	.8065	.8501	.4389	.7944	.5827					

C:\...
 C:\...

TEST 167	PT 17.7215	PSI	CM .0130	CO1 .02214	COCOR1 .02113
RUN 56	TT 190.1402	K	CM -.1853	CO2 .01887	COCOR2 .01908
POINT 75	RC 4.4065	MILLION	CC .0240	CO3 .01891	COCOR3 .01827
	RACH .7784			CO4 .01977	COCOR4 .01879
	ALPHA 1.5172	DEG		CO5 .02309	COCOR5 .02238

UPPER SURFACE				LOWER SURFACE				SPANWISE				
X/C	CP	P/L/PT	MLOC	X/C	CP	P/L/PT	MLOC	X/C	Y/(B/2)	CP	P/L/PT	MLOC
0.0000	1.1596	.9993	.C309	0.0000	1.1596	.9993	.0309	.1507	.7476	-.9522	.3962	1.2305
.0132	-.2959	.5836	.9114	.0126	-.5448	.8235	.3339	.1507	.4976	-1.0100	.3774	1.2670
.0259	-.6736	.4757	1.0872	.0235	-.3689	.7735	.6168	.1507	.2476	-.9828	.3874	1.2473
.0759	-.9336	.4015	1.2204	.0495	-.1898	.7223	.6976	.1507	-.2327	-.9745	.3898	1.2427
.1003	-.9553	.3953	1.2322	.0793	-.0842	.6922	.7642	.1507	-.5024	-.9668	.3834	1.2551
.1507	-.9706	.3909	1.2406	.1027	-.0097	.6709	.7769	.1507	-.7524	-.9205	.4052	1.2133
.2003	-.9812	.3879	1.2465	.1503	-.0813	.6449	.8109	.3002	.7476	-1.0102	.3773	1.2671
.2503	-.9969	.3834	1.2552	.1976	-.1848	.6153	.8624	.3002	.4976	-1.0308	.3767	1.2742
.3001	-1.0279	.3745	1.2726	.2503	-.1815	.6163	.8609	.3002	.2476	-1.0363	.3721	1.2773
.3502	-1.0433	.3701	1.2813	.3001	-.3001	.5824	.9137	.3002	-.2924	-1.0428	.3703	1.2811
.4003	-1.0501	.3682	1.2893	.3507	-.3278	.5745	.9261	.3002	-.5024	-1.0330	.3731	1.2755
.4501	-1.0308	.3737	1.2742	.4001	-.3297	.5740	.9269	.3002	-.7524	-.9953	.3839	1.2542
.5002	-.9859	.3865	1.2490	.4501	-.3057	.5808	.9162	.8002	.7476	-.3591	.3655	.9402
.5504	-1.0003	.3824	1.2570	.5001	-.2530	.5959	.8926	.8002	.4976	-.3696	.3626	.9449
.6002	-1.0422	.3709	1.2807	.5497	-.1431	.6273	.8440	.8002	.2476	-.4152	.3495	.9656
.6500	-1.0916	.3563	1.3094	.6003	-.0246	.6811	.7920	.8002	-.5024	-.4127	.3503	.9645
.7000	-.8133	.4354	1.1571	.6500	.0668	.6872	.7519	.8002	-.7524	-.3743	.3612	.9471
.7500	-.5112	.5221	1.0099	.7000	.1714	.7171	.7057					
.8002	-.4309	.5450	.9728	.7501	.2490	.7450	.6622					
.9002	-.2316	.6019	.8832	.8001	.3536	.7691	.6238					
.9501	-.1143	.6355	.8314	.8501	.4314	.7913	.5878					



TEST 167
 RUN 28
 MACH .780
 R 7.0×10^6

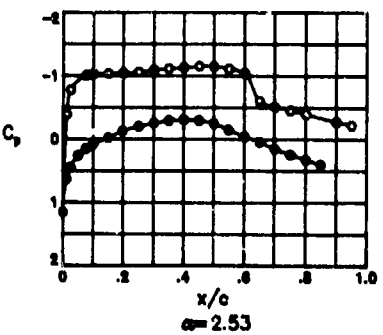
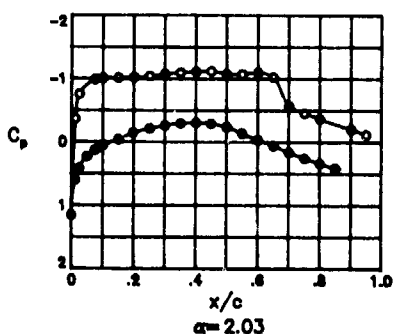
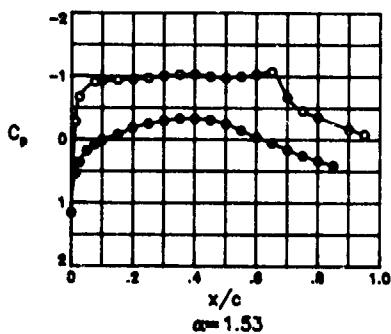
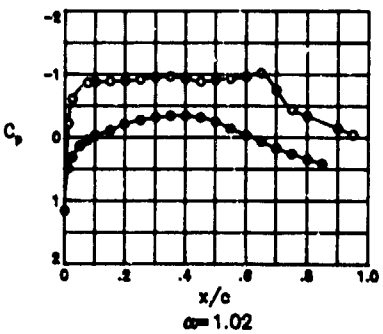
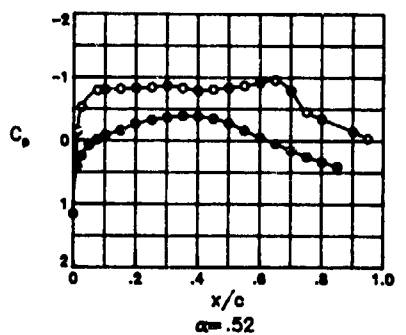
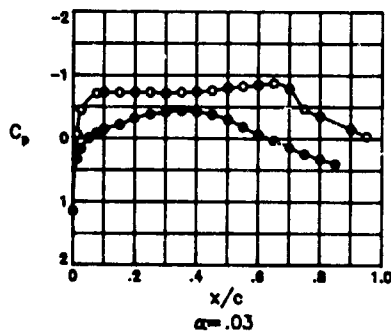
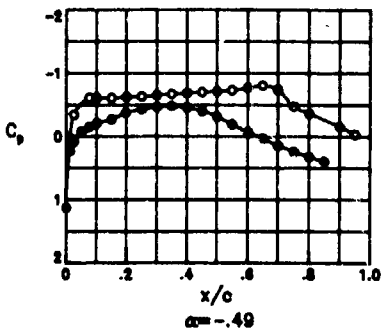
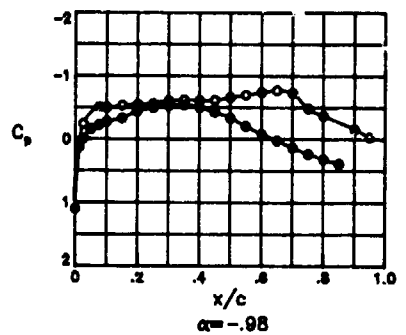
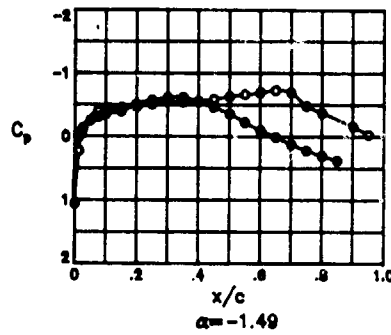
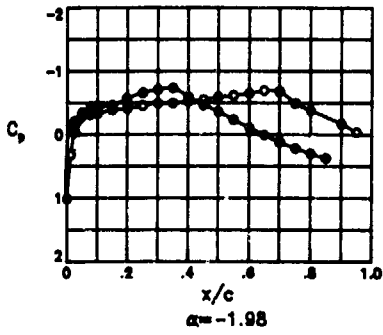
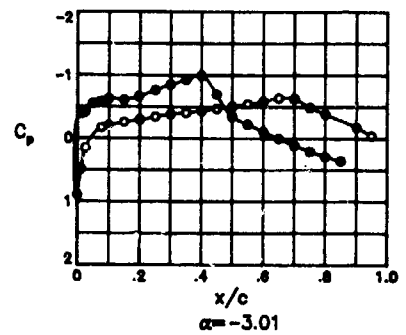
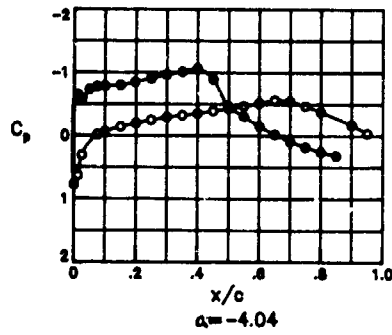

ORIGINAL PAGE IS
OF POOR QUALITY

TEST 167	PT	21.9674	PSI	CN	-0.1016	CD1	-0.0866	CDCOR1	-0.01838
RUN 28	TY	164.8649	K	CM	-0.1230	CD2	-0.0591	CDCOR2	-0.01567
POINT 3	RC	6.7852	MILLION	CC	0.0092	CD3	-0.01398	CDCOR3	-0.01381
	MACH	.7811				CD4	-0.01325	CDCOR4	-0.01299
	ALPHA	-4.0426	DEG			CD5	-0.01146	CDCOR5	-0.01110

UPPER SURFACE				LOWER SURFACE				SPANWISE				
X/C	CP	P/L/PT	MLOC	X/C	CP	P/L/PT	MLOC	X/C	Y/(B/2)	CP	P/L/PT	MLOC
0.0000	.7761	.8899	.4115	0.0000	.7761	.8899	.4115	.1507	.7476	-1.453	.6269	.8447
.0132	.6319	.8466	.4698	.0126	-.6450	.4843	1.0728	.1507	.4976	-1.600	.6227	.8511
.0259	.3088	.7565	.6440	.0255	-.5889	.5003	1.0459	.1507	.2476	-1.550	.6242	.8489
.0759	-.0139	.6644	.7870	.0495	-.7338	.4590	1.1163	.1507	-.2524	-1.1623	.6221	.8521
.1003	-.0639	.6502	.8089	.0753	-.7780	.4464	1.1385	.1507	-.5024	-1.1644	.6215	.8531
.1507	-.1419	.6279	.8432	.1002	-.7882	.4434	1.1436	.1507	-.7524	-1.1533	.6247	.8482
.2003	-.1939	.6131	.8661	.1503	-.7994	.4402	1.1494	.5002	.7476	-1.4228	.5477	.8687
.2503	-.2458	.5982	.8891	.1976	-.8481	.4263	1.1744	.5002	.4976	-1.4346	.5443	.9741
.3001	-.2908	.5854	.9091	.2503	-.9066	.4097	1.2032	.5002	.2476	-1.4203	.5436	.9721
.3502	-.3197	.5771	.9220	.3001	-.9670	.3924	1.2379	.5002	-.2524	-1.4278	.5463	.9709
.4003	-.3538	.5674	.9374	.3507	-1.0141	.3790	1.2640	.5002	-.5024	-1.4172	.5493	.9661
.4501	-.3910	.5564	.9542	.4001	-1.0633	.3649	1.2920	.5002	-.7524	-1.4059	.5526	.9610
.5002	-.4289	.5460	.9715	.4501	-.8952	.4129	1.1992	.8002	.7476	-1.3752	.5613	.9478
.5502	-.4703	.5342	.9905	.5001	-.8632	.5362	.9872	.8002	.4976	-1.3768	.5609	.9478
.6002	-.5172	.5208	1.0122	.5497	-.8063	.6810	.9160	.8002	.2476	-1.3840	.5588	.9510
.6500	-.5621	.5080	1.0335	.6003	-.7521	.8230	.8476	.8002	-.5024	-1.3711	.5625	.9452
.7000	-.5448	.5129	1.0251	.6500	-.0215	.6623	.7903	.8002	-.7524	-1.3479	.5691	.9347
.7500	-.4683	.5347	.9895	.7000	-.0894	.6939	.7417					
.8002	-.3775	.5607	.9480	.7501	.1797	.7197	.7018					
.9002	-.1719	.6194	.8563	.8001	.2550	.7412	.6682					
.9501	-.0372	.6578	.7972	.8501	.3171	.7589	.6402					

TEST 167	PT	21.9610	PSI	CN	-0.0653	CD1	-0.01259	CDCOR1	-0.01250
RUN 28	TY	165.0223	K	CM	-0.1369	CD2	-0.01145	CDCOR2	-0.01141
POINT 4	RC	6.9715	MILLION	CC	0.0141	CD3	-0.01032	CDCOR3	-0.01033
	MACH	.7807				CD4	-0.01052	CDCOR4	-0.01048
	ALPHA	-3.0071	DEG			CD5	-0.00936	CDCOR5	-0.00912

UPPER SURFACE				LOWER SURFACE				SPANWISE				
X/C	CP	P/L/PT	MLOC	X/C	CP	P/L/PT	MLOC	X/C	Y/(B/2)	CP	P/L/PT	MLOC
0.0000	.8935	.9233	.3394	0.0000	.8935	.9233	.3394	.1507	.7476	-1.2567	.5947	.8945
.0132	.4920	.8086	.5592	.0126	-.3878	.5573	.9534	.1507	.4976	-1.2743	.5897	.9023
.0259	.1590	.7123	.7132	.0255	-.4133	.5500	.9650	.1507	.2476	-1.2569	.5947	.8946
.0759	-.1676	.6202	.8550	.0495	-.5498	.5110	1.0282	.1507	-.2524	-1.2748	.5896	.9026
.1003	-.2006	.6106	.8696	.0753	-.5819	.5019	1.0434	.1507	-.5024	-1.2742	.5898	.9023
.1507	-.2583	.5943	.8952	.1002	-.6243	.4897	1.0636	.1507	-.7524	-1.2596	.5939	.8958
.2003	-.2990	.5838	.9116	.1503	-.6105	.4937	1.0570	.5002	.7476	-1.5001	.5252	1.0050
.2503	-.3417	.5705	.9326	.1976	-.6609	.4793	1.0813	.5002	.4976	-1.5117	.5219	1.0104
.3001	-.3835	.5585	.9514	.2503	-.7620	.4504	1.1313	.5002	.2476	-1.5084	.5228	1.0088
.3502	-.4044	.5525	.9610	.3001	-.8513	.4249	1.1770	.5002	-.2524	-1.4945	.5268	1.0023
.4003	-.4345	.5440	.9747	.3507	-.9313	.4021	1.2195	.5002	-.5024	-1.4912	.5278	1.0008
.4501	-.4694	.5340	.9907	.4001	-.9944	.3840	1.2541	.5002	-.7524	-1.4782	.5214	.9948
.5002	-.5050	.5238	1.0073	.4501	-.8953	.4695	1.0982	.8002	.7476	-1.3862	.5578	.9927
.5502	-.5435	.5128	1.0252	.5001	-.8462	.5692	.9346	.8002	.4976	-1.3844	.5583	.9519
.6002	-.5878	.5002	1.0462	.5497	-.7211	.6049	.8787	.8002	.2476	-1.3902	.5566	.9545
.6500	-.6383	.4857	1.0704	.6003	-.1036	.6385	.8269	.8002	-.5024	-1.3843	.5583	.9518
.7000	-.6280	.4887	1.0654	.6500	.0015	.6685	.7807	.8002	-.7524	-1.3662	.5635	.9436
.7500	-.4863	.5292	.9986	.7000	-.1110	.6998	.7326					
.8002	-.3832	.5586	.9513	.7501	.2075	.7273	.6899					
.9002	-.1730	.6187	.8574	.8001	.2868	.7506	.6534					
.9501	-.0399	.6567	.7989	.8501	.3572	.7701	.6223					

TEST 167	PT	21.9755	PSI	CN	-0.2291	CD1	-0.00997	CDCOR1	-0.00971
RUN 28	TY	164.9935	K	CM	-0.1435	CD2	-0.00949	CDCOR2	-0.00927
POINT 5	RC	6.9711	MILLION	CC	0.0165	CD3	-0.00893	CDCOR3	-0.00876
	MACH	.7793				CD4	-0.00957	CDCOR4	-0.00937
	ALPHA	-1.9781	DEG			CD5	-0.00849	CDCOR5	-0.00822

UPPER SURFACE				LOWER SURFACE				SPANWISE				
X/C	CP	P/L/PT	MLOC	X/C	CP	P/L/PT	MLOC	X/C	Y/(B/2)	CP	P/L/PT	MLOC
0.0000	1.0135	.9562	.2478	0.0000	1.0135	.9582	.2478	.1507	.7476	-1.3858	.5604	.9484
.0132	.3175	.7603	.6379	.0126	-.1213	.6356	.8317	.1507	.4976	-1.4070	.5544	.9581
.0259	-.0356	.6600	.7938	.0255	-.2106	.6102	.8705	.1507	.2476	-1.3968	.5573	.9534
.0759	-.3134	.5810	.9160	.0495	-.3422	.5728	.9289	.1507	-.2524	-1.4069	.5544	.9580
.1003	-.3346	.5750	.9255	.0753	-.3936	.5582	.9520	.1507	-.5024	-1.4036	.5554	.9565
.1507	-.3872	.5600	.9491	.1002	-.4334	.5469	.9700	.1507	-.7524	-1.3829	.5612	.9472
.2003	-.4113	.5532	.9600	.1503	-.4615	.5389	.9829	.5002	.7476	-1.5837	.5042	1.0396
.2503	-.4532	.5412	.9791	.1976	-.5707	.5079	1.0334	.5002	.4976	-1.5995	.4997	1.0470
.3001	-.4893	.5310	.9956	.2503	-.6584	.4829	1.0752	.5002	.2476	-1.5973	.5003	1.0460
.3502	-.4950	.5294	.9982	.3001	-.7115	.4678	1.1009	.5002	-.2524	-1.5849	.5038	1.0401
.4003	-.5185	.5227	1.0091	.3507	-.7344	.4613	1.1122	.5002	-.5024	-1.5816	.5047	1.0386
.4501	-.5511	.5134	1.0243	.4001	-.5944	.5011	1.0446	.5002	-.7524	-1.5637	.5089	1.0302
.5002	-.5931	.5015	1.0440	.4501	-.4605	.5392	.9824	.8002	.7476	-1.3901	.5592	.9504
.5502	-.6172	.4946	1.0594	.5001	-.3612	.5674	.9374	.8002	.4976	-1.3852	.5606	.9482
.6002	-.6502	.4853	1.0712	.5497	-.2317	.6042	.8798	.8002	.2476	-1.3892	.5595	.9500
.6500	-.6965	.4721	1.0936	.6003	-.1037	.6406	.8236	.8002	-.5024	-1.3908	.5590	.9507
.7000	-.6809	.4765	1.0860	.6500	.0054	.6716	.7759	.8002	-.7524	-1.3770	.5629	.9445
.7500	-.4923	.5302	.9970	.7000	-.1197	.7041	.7259					
.8002	-.3812	.5617	.9464	.7501	.2192	.7324	.6820					
.9002	-.1674	.6225	.8515	.8001	.3021	.7559	.6449					
.9501	-.0363	.6598	.7942	.8501	.3724	.7759	.6129					

TEST	167	PT	21.9825	PSI	CM	.3023	CD1	.01001	CDCOR1	.00974
RUN	28	TT	165.0767	K	CM	-.1441	CD2	.01012	CDCOR2	.00988
POINT	F	PC	6.9687	MILLION	CC	.0201	CD3	.00965	CDCOR3	.00948
		MACH	.7794				CD4	.00914	CDCOR4	.00894
		ALPHA	-1.4851	DEG			CD5	.00811	CDCOR5	.00783

UPPER SURFACE				LOWER SURFACE				SPANWISE				
X/C	CP	P/L/PT	MLOC	X/C	CP	P/L/PT	MLOC	X/C	Y/(B/2)	CP	P/L/PT	MLOC
0.0000	1.0623	.9721	.2013	0.0000	1.0623	.9721	.2013	.1507	.7476	-.4505	.5425	.9771
.0132	-.2263	.7347	.6784	.0126	.0051	.6719	.7755	.1507	.4976	-.4769	.5350	.9892
.0259	-.1332	.6326	.8359	.0255	-.1058	.6404	.8239	.1507	.2476	-.4592	.5400	.9811
.0759	-.4044	.5555	.9562	.0495	-.2476	.6001	.8862	.1507	-.2524	-.4760	.5352	.9888
.1003	-.4123	.5533	.9597	.0753	-.3079	.5830	.9129	.1507	-.5024	-.4733	.5360	.9875
.1507	-.4555	.5410	.9794	.1002	-.3548	.5690	.9338	.1507	-.7524	-.4474	.5434	.9757
.2003	-.4702	.5369	.9861	.1503	-.3974	.5575	.9530	.5002	.7476	-.6225	.4936	1.0571
.2503	-.5076	.5262	1.0033	.1976	-.5081	.5261	1.0035	.5002	.4976	-.6369	.4895	1.0640
.3001	-.5490	.5145	1.0225	.2503	-.5732	.5076	1.0338	.5002	.2476	-.6276	.4892	1.0646
.3502	-.5375	.5178	1.0172	.3001	-.6169	.4952	1.0545	.5002	-.2524	-.6303	.4914	1.0609
.4003	-.5575	.5121	1.0265	.3507	-.6193	.4945	1.0556	.5002	-.5024	-.6274	.4922	1.0595
.4501	-.5901	.5028	1.0418	.4001	-.5485	.5146	1.0223	.5002	-.7524	-.6148	.4958	1.0535
.5002	-.6317	.4910	1.0615	.4501	-.4533	.5617	.9784	.8002	.7476	-.3871	.5605	.9484
.5502	-.6645	.4817	1.0773	.5001	-.3533	.5701	.9332	.8002	.4976	-.3805	.5623	.9454
.6002	-.6951	.4730	1.0921	.5497	-.2236	.6069	.8756	.8002	.2476	-.3827	.5617	.9464
.6500	-.7293	.4633	1.1088	.6003	-.0967	.6430	.8200	.8002	-.5024	-.3902	.5596	.9498
.7000	-.6963	.4727	1.0927	.6500	.0106	.6734	.7732	.8002	-.7524	-.3799	.5625	.9451
.7500	-.4827	.5333	.9918	.7000	.1244	.7057	.7234					
.8002	-.3725	.5646	.9418	.7501	.2236	.7339	.6796					
.9002	-.1601	.6250	.8477	.8001	.3066	.7575	.6425					
.9501	-.0321	.6613	.7918	.8501	.3770	.7775	.6104					

TEST	167	PT	21.9890	PSI	CM	.3857	CD1	.01031	CDCOR1	.00989
RUN	28	TT	164.9879	K	CM	-.1479	CD2	.00969	CDCOR2	.00932
POINT	7	PC	6.9742	MILLION	CC	.0210	CD3	.00935	CDCOR3	.00907
		MACH	.7790				CD4	.00922	CDCOR4	.00894
		ALPHA	-.9837	DEG			CD5	.00833	CDCOR5	.00801

UPPER SURFACE				LOWER SURFACE				SPANWISE				
X/C	CP	P/L/PT	MLOC	X/C	CP	P/L/PT	MLOC	X/C	Y/(B/2)	CP	P/L/PT	MLOC
0.0000	1.1002	.9829	.1589	0.0000	1.1002	.9829	.1589	.1507	.7476	-.5242	.5218	1.0105
.0132	.1257	.7663	.7226	.0126	.1219	.7052	.7242	.1507	.4976	-.5539	.5134	1.0244
.0259	-.2401	.6024	.8825	.0255	-.0072	.6886	.7806	.1507	.2476	-.5356	.5186	1.0158
.0759	-.5017	.5282	1.0001	.0495	-.1958	.6264	.8455	.1507	-.2524	-.5525	.5138	1.0237
.1003	-.4989	.5290	.9989	.0753	-.2246	.6068	.8757	.1507	-.5024	-.5457	.5157	1.0206
.1507	-.5339	.5191	1.0150	.1002	-.2776	.5918	.8991	.1507	-.7524	-.5145	.5245	1.0061
.2003	-.5455	.5158	1.0204	.1503	-.3509	.5787	.9228	.5002	.7476	-.6545	.4840	1.0720
.2503	-.5653	.5101	1.0297	.1976	-.4365	.5467	.9703	.5002	.4976	-.6650	.4818	1.0770
.3001	-.6099	.4975	1.0507	.2503	-.4936	.5305	.9964	.5002	.2476	-.6659	.4816	1.0775
.3502	-.6234	.4936	1.0571	.3001	-.5313	.5198	1.0139	.5002	-.2524	-.6584	.4837	1.0738
.4003	-.6127	.4967	1.0520	.3507	-.5404	.5172	1.0181	.5002	-.5024	-.6574	.4840	1.0734
.4501	-.6179	.4952	1.0545	.4001	-.4990	.5289	.9989	.5002	-.7524	-.6531	.4852	1.0713
.5002	-.6605	.4831	1.0748	.4501	-.4257	.5498	.9654	.8002	.7476	-.3810	.5625	.9452
.5502	-.7023	.4712	1.0931	.5001	-.3323	.5763	.9234	.8002	.4976	-.3740	.5644	.9421
.6002	-.7425	.4598	1.1148	.5497	-.2061	.6121	.8676	.8002	.2476	-.3750	.5641	.9425
.6500	-.7745	.4508	1.1307	.6003	-.0820	.6473	.8122	.8002	-.5024	-.3840	.5616	.9466
.7000	-.7300	.4634	1.1086	.6500	.0231	.6772	.7674	.8002	-.7524	-.3762	.5638	.9431
.7500	-.4840	.5332	.9920	.7000	.1357	.7091	.7181					
.8002	-.3689	.5659	.9398	.7501	.2343	.7371	.6746					
.9002	-.1598	.6255	.8468	.8001	.3171	.7606	.6375					
.9501	-.0344	.6608	.7925	.8501	.3879	.7807	.6052					

TEST	167	PT	21.9899	PSI	CM	.4630	CD1	.01084	CDCOR1	.01035
RUN	28	TT	165.3047	K	CM	-.1499	CD2	.01029	CDCOR2	.01006
POINT	8	PC	6.9533	MILLION	CC	.0209	CD3	.01007	CDCOR3	.00990
		MACH	.7790				CD4	.00950	CDCOR4	.00929
		ALPHA	-.4910	DEG			CD5	.00860	CDCOR5	.00822

UPPER SURFACE				LOWER SURFACE				SPANWISE				
X/C	CP	P/L/PT	MLOC	X/C	CP	P/L/PT	MLOC	X/C	Y/(B/2)	CP	P/L/PT	MLOC
0.0000	1.1302	.9916	.1100	0.0000	1.1302	.9916	.1100	.1507	.7476	-.6019	.5007	1.0454
.0132	.0320	.6803	.7626	.0126	.2300	.7365	.6756	.1507	.4976	-.6276	.4934	1.0375
.0259	-.3417	.5744	.9264	.0255	.0861	.6957	.7390	.1507	.2476	-.6110	.4981	1.0497
.0759	-.6048	.4987	1.0486	.0495	-.0726	.6507	.8081	.1507	-.2524	-.6264	.4937	1.0570
.1003	-.6088	.4987	1.0486	.0753	-.1484	.6292	.8412	.1507	-.5024	-.6193	.4957	1.0536
.1507	-.6093	.4986	1.0489	.1002	-.2080	.6123	.8672	.1507	-.7524	-.5875	.5047	1.0386
.2003	-.6272	.4935	1.0373	.1503	-.2702	.5947	.8946	.5002	.7476	-.7028	.4721	1.0937
.2503	-.6315	.4923	1.0594	.1976	-.3726	.5657	.9401	.5002	.4976	-.7162	.4683	1.1002
.3001	-.6540	.4859	1.0701	.2503	-.4291	.5496	.9656	.5002	.2476	-.7182	.4677	1.1012
.3502	-.6724	.4806	1.0791	.3001	-.4648	.5395	.9818	.5002	-.2524	-.7094	.4713	1.0949
.4003	-.6873	.4764	1.0862	.3507	-.4811	.5349	.9893	.5002	-.5024	-.7081	.4705	1.0963
.4501	-.7010	.4726	1.0928	.4001	-.4546	.5424	.9772	.5002	-.7524	-.7098	.4701	1.0971
.5002	-.7158	.4684	1.1000	.4501	-.3973	.5587	.9512	.8002	.7476	-.3792	.5638	.9431
.5502	-.7314	.4638	1.1079	.5001	-.3112	.5830	.9128	.8002	.4976	-.3698	.5664	.9389
.6002	-.7700	.4530	1.1267	.5497	-.1900	.6174	.8593	.8002	.2476	-.3695	.5665	.9386
.6500	-.8063	.4427	1.1449	.6003	-.0693	.6516	.8067	.8002	-.5024	-.3814	.5632	.9441
.7000	-.7405	.4614	1.1121	.6500	.0332	.6807	.7620	.8002	-.7524	-.3739	.5653	.9408
.7500	-.4735	.5370	.9858	.7000	.1447	.7123	.7133					
.8002	-.3628	.5684	.9358	.7501	.2426	.7400	.6701					
.9002	-.1532	.6276	.8433	.8001	.3233	.7635	.6329					
.9501	-.0325	.6621	.7906	.8501	.3966	.7837	.6004					

ORIGINAL PAGE IS
OF POOR QUALITY

TEST 167	PT	21.9892	PSI	CM	.5461	CD1	.01212	CDCOR1	.01191
RUN 28	TT	165.2891	K	CM	-.1536	CD2	.01154	CDCOR2	.01138
POINT 9	RC	6.9619	MILLION	CC	.0206	CD3	.01137	CDCOR3	.01126
	MACH	.7802				CD4	.01073	CDCOR4	.01057
	ALPHA	.0271	DEG			CD5	.00967	CDCOR5	.00931

UPPER SURFACE				LOWER SURFACE				SPANWISE				
X/C	CP	P/L/PT	MLOC	X/C	CP	P/L/PT	MLOC	X/C	Y/(B/2)	CP	P/L/PT	MLOC
0.0000	1.1489	.9969	.0666	0.0000	1.1489	.9969	.0666	.1507	.7476	-.6887	.4762	1.0666
.0132	-.0620	.6537	.8034	.0126	-.1328	.7637	.6326	.1507	.4976	-.7536	.4578	1.1184
.0259	-.4421	.5461	.9713	.0255	-.1685	.7191	.7027	.1507	.2476	-.7355	.4629	1.1095
.0759	-.7085	.4706	1.0963	.0495	-.0018	.6718	.7756	.1507	-.2524	-.7512	.4584	1.1172
.1003	-.7280	.4650	1.1058	.0753	-.0816	.6482	.8119	.1507	-.5024	-.7359	.4628	1.1097
.1507	-.7258	.4656	1.1047	.1002	-.1456	.6301	.8398	.1507	-.7524	-.6710	.4812	1.0781
.2003	-.7272	.4652	1.1054	.1503	-.2165	.6100	.8708	.5002	.7476	-.7663	.4542	1.1247
.2503	-.7273	.4652	1.1055	.1976	-.3186	.5810	.9159	.5002	.4976	-.7866	.4484	1.1348
.3001	-.7127	.4694	1.0983	.2503	-.4378	.5643	.9424	.5002	.2476	-.7976	.4453	1.1404
.3502	-.7282	.4650	1.1059	.3001	-.4458	.5535	.9594	.5002	-.2524	-.7956	.4459	1.1394
.4003	-.7390	.4619	1.1112	.3507	-.4456	.5479	.9684	.5002	-.5024	-.7851	.4488	1.1341
.4501	-.7598	.4560	1.1215	.4001	-.4405	.5522	.9816	.5002	-.7524	-.7823	.4496	1.1327
.5002	-.7974	.4454	1.1402	.4501	-.3749	.5651	.9411	.8002	.7476	-.3713	.5661	.9394
.5502	-.8252	.4375	1.1543	.5001	-.2962	.5874	.9060	.8002	.4976	-.3582	.5698	.9336
.6002	-.8459	.4316	1.1649	.5497	-.1794	.6205	.8546	.8002	.2476	-.3578	.5699	.9334
.6500	-.8706	.4246	1.1776	.6003	-.0617	.6538	.8032	.8002	-.5024	-.3723	.5658	.9399
.7000	-.7889	.4478	1.1360	.6500	.0380	.6821	.7598	.8002	-.7524	-.3708	.5663	.9392
.7500	-.4638	.5399	.9812	.7000	.1483	.7133	.7116					
.8002	-.3513	.5718	.9305	.7501	.2458	.7410	.6685					
.9002	-.1490	.6291	.8413	.8001	.3285	.7644	.6314					
.9501	-.0347	.6615	.7915	.8501	.3998	.7846	.5989					

TEST 167	PT	21.9877	PSI	CM	.6296	CD1	.01367	CDCOR1	.01311
RUN 28	TT	165.2545	K	CM	-.1577	CD2	.01298	CDCOR2	.01248
POINT 10	RC	6.9626	MILLION	CC	.0199	CD3	.01311	CDCOR3	.01266
	MACH	.7800				CD4	.01177	CDCOR4	.01130
	ALPHA	.5221	DEG			CD5	.01054	CDCOR5	.01010

UPPER SURFACE				LOWER SURFACE				SPANWISE				
X/C	CP	P/L/PT	MLOC	X/C	CP	P/L/PT	MLOC	X/C	Y/(B/2)	CP	P/L/PT	MLOC
0.0000	1.1561	.9988	.15	0.0000	1.1561	.9988	.0415	.1507	.7476	-.7937	.4451	1.1406
.0132	-.1476	.6286	.8221	.0126	-.4089	.7866	.5955	.1507	.4976	-.6735	.4225	1.1814
.0259	-.5306	.5199	1.0137	.0255	.2428	.7395	.6709	.1507	.2476	-.8334	.4339	1.1608
.0759	-.7932	.4453	1.1404	.0495	.0705	.6905	.7469	.1507	-.2524	-.8460	.4303	1.1672
.1003	-.8067	.4415	1.1472	.0753	-.0184	.6653	.7856	.1507	-.5024	-.8550	.4278	1.1718
.1507	-.8198	.4378	1.1538	.1002	-.0856	.6462	.8150	.1507	-.7524	-.7741	.4507	1.1307
.2003	-.8263	.4359	1.1571	.1503	-.1625	.6244	.8486	.5002	.7476	-.8655	.4248	1.1773
.2503	-.8426	.4313	1.1655	.1976	-.2643	.5955	.8933	.5002	.4976	-.8628	.4255	1.1759
.3001	-.8688	.4238	1.1790	.2503	-.3254	.5761	.9205	.5002	.2476	-.8449	.4306	1.1666
.3502	-.8320	.4343	1.1600	.3001	-.3659	.5666	.9386	.5002	-.2524	-.8395	.4322	1.1638
.4003	-.7944	.4450	1.1409	.3507	-.2903	.5597	.9496	.5002	-.5024	-.8640	.4252	1.1765
.4501	-.8100	.4405	1.1488	.4001	-.2677	.5618	.9462	.5002	-.7524	-.8675	.4242	1.1783
.5002	-.8333	.4339	1.1607	.4501	-.3462	.5722	.9298	.8002	.7476	-.3633	.5674	.9375
.5502	-.8701	.4235	1.1797	.5001	-.2748	.5922	.8980	.8002	.4976	-.3506	.5718	.9318
.6002	-.9185	.4097	1.2051	.5497	-.1636	.6241	.8490	.8002	.2476	-.3476	.5718	.9304
.6500	-.9587	.3983	1.2266	.6003	-.0497	.6564	.7993	.8002	-.5024	-.3667	.5681	.9363
.7000	-.7896	.4463	1.1385	.6500	.0473	.6839	.7570	.8002	-.7524	-.3631	.5674	.9373
.7500	-.4535	.5417	.9782	.7000	.1559	.7148	.7094					
.8002	-.3426	.5732	.9282	.7501	.2524	.7422	.6667					
.9002	-.1456	.6292	.8412	.8001	.3345	.7655	.6297					
.9501	-.0368	.6601	.7937	.8501	.4059	.7858	.5970					

TEST 167	PT	21.9904	PSI	CM	.7121	CD1	.01864	CDCOR1	.01805
RUN 28	TT	165.3638	K	CM	-.1634	CD2	.01770	CDCOR2	.01712
POINT 11	RC	6.9582	MILLION	CC	.0194	CD3	.01707	CDCOR3	.01650
	MACH	.7803				CD4	.01634	CDCOR4	.01564
	ALPHA	1.0243	DEG			CD5	.01452	CDCOR5	.01370

UPPER SURFACE				LOWER SURFACE				SPANWISE				
X/C	CP	P/L/PT	MLOC	X/C	CP	P/L/PT	MLOC	X/C	Y/(B/2)	CP	P/L/PT	MLOC
0.0000	1.1589	.9996	.0227	0.0000	1.1589	.9996	.0227	.1507	.7476	-.8863	.4193	1.1873
.0132	-.2228	.6075	.8746	.0126	-.4880	.8093	.5581	.1507	.4976	-.9509	.3993	1.2248
.0259	-.6097	.4978	1.0502	.0255	.3137	.7598	.6388	.1507	.2476	-.9036	.4144	1.1964
.0759	-.8648	.4254	1.1762	.0495	.1362	.7094	.7177	.1507	-.2524	-.9171	.4105	1.2036
.1003	-.8788	.4214	1.1834	.0753	.0430	.6830	.7585	.1507	-.5024	-.9363	.4051	1.2137
.1507	-.8908	.4180	1.1897	.1002	-.0290	.6625	.7899	.1507	-.7524	-.8651	.4253	1.1763
.2003	-.8986	.4158	1.1938	.1503	-.1111	.6393	.8257	.5002	.7476	-.9452	.4026	1.2185
.2503	-.9194	.4099	1.2048	.1976	-.2116	.6107	.8697	.5002	.4976	-.9604	.3982	1.2267
.3001	-.9538	.4001	1.2231	.2503	-.2739	.5931	.8971	.5002	.2476	-.9351	.4054	1.2131
.3502	-.9656	.3968	1.2295	.3001	-.3158	.5812	.9157	.5002	-.2524	-.9236	.4087	1.2070
.4003	-.9298	.4069	1.2103	.3507	-.3435	.5733	.9281	.5002	-.5024	-.9576	.3990	1.2252
.4501	-.8825	.4204	1.1854	.4001	-.3416	.5738	.9272	.8002	-.7524	-.9271	.4077	1.2088
.5002	-.9096	.4127	1.1996	.4501	-.3128	.5820	.9144	.8002	.7476	-.3457	.5727	.9291
.5502	-.9331	.4060	1.2120	.5001	-.2479	.6004	.8857	.8002	.4976	-.3385	.5747	.9258
.6002	-.9653	.3949	1.2243	.5497	-.1422	.6304	.8393	.8002	.2476	-.3376	.5750	.9254
.6500	-1.0191	.3816	1.2588	.6003	-.0325	.6615	.7914	.8002	-.5024	-.3455	.5727	.9290
.7000	-.7564	.4567	1.1212	.6500	.0619	.6884	.7502					
.7500	-.4405	.5428	.9718	.7000	.1687	.7187	.7034					
.8002	-.3354	.5756	.9244	.7501	.2638	.7456	.6612					
.9002	-.1435	.6291	.8399	.8001	.3453	.7688	.6245					
.9501	-.0436	.6584	.7962	.8501	.4162	.7889	.5919					

TEST	167	PT	21.9868	PSI		CM	.7660	CD1	.02417	CDCOR1	.02315
RUN	28	TT	165.4827	K		CM	-.1682	CD2	.02266	CDCOR2	.02195
POINT	12	RC	6.9500	MILLION		CC	.0206	CD3	.02173	CDCOR3	.02051
		MACH	.7803					CD4	.02094	CDCOR4	.02021
		ALPHA	1.5288	DEG				CD5	.02048	CDCOR5	.01983

UPPER SURFACE				LOWER SURFACE				SPANWISE				
X/C	CP	P _o L/PT	MLOC	X/C	CP	P _o L/PT	MLOC	X/C	Y/(B/2)	CP	P _o L/PT	MLOC
0.0000	1.1598	.9995	.0265	0.0000	1.1598	.9995	.0265	.1507	.7476	-.9504	.3978	1.2275
.0132	-.2807	.5887	.9039	.0126	.5409	.8230	.5348	.1507	.4976	-1.0125	.3801	1.2618
.0259	-.6683	.4782	1.0831	.0255	.3621	.7720	.6192	.1507	.2476	-.9551	.3965	1.2301
.0759	-.9086	.4097	1.2050	.0495	.1804	.7202	.7009	.1507	-.2524	-.9654	.3935	1.2357
.1003	-.9294	.4038	1.2162	.0753	.0824	.6923	.7441	.1507	-.5024	-.9860	.3876	1.2471
.1507	-.9412	.4004	1.2226	.1002	.0085	.6712	.7765	.1507	-.7524	-.9190	.4068	1.2106
.2003	-.9520	.3974	1.2284	.1503	-.0790	.6463	.8149	.5002	.7476	-1.0060	.3820	1.2521
.2503	-.9709	.3920	1.2387	.1976	-.1828	.6167	.8605	.5002	.4976	-1.0211	.3776	1.2666
.3001	-1.0060	.3820	1.2581	.2503	-.2491	.5978	.8898	.5002	.2476	-1.0240	.3768	1.2683
.3502	-1.0255	.3764	1.2691	.3001	-.2954	.5846	.9104	.5002	-.2524	-.9990	.3840	1.2542
.4003	-1.0308	.3749	1.2721	.3507	-.3273	.5759	.9247	.5002	-.5024	-1.0234	.3770	1.2679
.4501	-.9957	.3849	1.2524	.4001	-.3308	.5745	.9262	.8002	-.7524	-.9840	.3882	1.2460
.5002	-.9726	.3915	1.2397	.4501	-.3076	.5811	.9198	.8002	.7476	-.3409	.5716	.9308
.5502	-.9953	.3850	1.2522	.5001	-.2468	.5984	.8888	.8002	.4976	-.3411	.5715	.9309
.6002	-1.0268	.3760	1.2698	.5497	-.1432	.6280	.8430	.8002	.2476	-.3477	.5697	.9338
.6500	-1.0716	.3632	1.2954	.6003	-.0349	.6588	.7956	.8002	-.5024	-.3503	.5689	.9350
.7000	-.6640	.4795	1.0810	.6500	.0578	.6893	.7549	.8002	-.7524	-.3424	.5712	.9315
.7500	-.4524	.5398	.9814	.7000	.1639	.7195	.7082					
.8002	-.3497	.5691	.9347	.7501	.2987	.7426	.6641					
.9002	-.1663	.6214	.8532	.8001	.3401	.7658	.6292					
.9501	-.0824	.6453	.8164	.8501	.4115	.7861	.5964					

TEST	167	PT	21.9869	PSI		CM	.8352	CD1	.03023	CDCOR1	.02937
RUN	28	TT	165.3457	K		CM	-.1731	CD2	.02892	CDCOR2	.02773
POINT	13	RC	6.9598	MILLION		CC	.0202	CD3	.02749	CDCOR3	.02662
		MACH	.7806					CD4	.02767	CDCOR4	.02650
		ALPHA	2.0263	DEG				CD5	.02798	CDCOR5	.02682

UPPER SURFACE				LOWER SURFACE				SPANWISE				
X/C	CP	P _o L/PT	MLOC	X/C	CP	P _o L/PT	MLOC	X/C	Y/(B/2)	CP	P _o L/PT	MLOC
0.0000	1.1574	.9995	.0262	0.0000	1.1574	.9995	.0262	.1507	.7476	-1.0489	.3761	1.2697
.0132	-.3656	.5692	.9346	.0126	.6011	.8423	.5011	.1507	.4976	-1.0925	.3638	1.2944
.0259	-.7541	.4594	1.1156	.0255	.4176	.7905	.5893	.1507	.2476	-1.0322	.3808	1.2604
.0759	-.9879	.3933	1.2361	.0495	.2329	.7383	.6728	.1507	-.2524	-1.0397	.3787	1.2646
.1003	-1.0092	.3873	1.2477	.0753	.1308	.7094	.7177	.1507	-.5024	-1.0615	.3725	1.2767
.1507	-1.0173	.3850	1.2521	.1002	.0526	.6873	.7518	.1507	-.7524	-.9934	.3918	1.2391
.2003	-1.0217	.3838	1.2546	.1503	-.0399	.6612	.7919	.5002	.7476	-1.0781	.3678	1.2861
.2503	-1.0419	.3781	1.2658	.1976	-.1440	.6318	.8371	.5002	.4976	-1.0903	.3644	1.2931
.3001	-1.0770	.3682	1.2855	.2503	-.2128	.6123	.8672	.5002	.2476	-1.0970	.3625	1.2970
.3502	-1.0981	.3622	1.2975	.3001	-.2605	.5989	.8861	.5002	-.2524	-1.0793	.3686	1.2845
.4003	-1.1112	.3585	1.3051	.3507	-.2947	.5892	.9032	.5002	-.5024	-1.0747	.3688	1.2842
.4501	-1.1198	.3561	1.3101	.4001	-.3028	.5869	.9067	.8002	-.7524	-1.0540	.3747	1.2725
.5002	-1.0765	.3683	1.2852	.4501	-.2866	.5915	.8996	.8002	.7476	-.3531	.5727	.9290
.5502	-1.0714	.3697	1.2823	.5001	-.2343	.6063	.8766	.8002	.4976	-.3628	.5702	.9330
.6002	-1.0964	.3627	1.2966	.5497	-.1349	.6344	.8332	.8002	.2476	-.3667	.5659	.9351
.6500	-1.0252	.3828	1.2965	.6003	-.0293	.6642	.7873	.8002	-.5024	-.3694	.5681	.9363
.7000	-.5733	.5105	1.0291	.6500	.0599	.6894	.7486	.8002	-.7524	-.3532	.5727	.9291
.7500	-.4553	.5438	.9749	.7000	.1645	.7189	.7029					
.8002	-.3653	.5693	.9345	.7501	.2591	.7457	.6611					
.9002	-.1968	.6169	.8602	.8001	.3412	.7689	.6242					
.9501	-.1169	.6395	.8254	.8501	.4140	.7895	.5909					

TEST	167	PT	21.9880	PSI		CM	.8348	CD1	.03584	CDCOR1	.03318
RUN	28	TT	165.3322	K		CM	-.1696	CD2	.03203	CDCOR2	.02974
POINT	14	RC	6.9620	MILLION		CC	.0222	CD3	.03345	CDCOR3	.03254
		MACH	.7808					CD4	.03616	CDCOR4	.03495
		ALPHA	2.5302	DEG				CD5	.03504	CDCOR5	.03391

UPPER SURFACE				LOWER SURFACE				SPANWISE				
X/C	CP	P _o L/PT	MLOC	X/C	CP	P _o L/PT	MLOC	X/C	Y/(B/2)	CP	P _o L/PT	MLOC
0.0000	1.1568	.9985	.0464	0.0000	1.1568	.9985	.0464	.1507	.7476	-1.0680	.3628	1.2963
.0132	-.3932	.5536	.9561	.0126	.6319	.8485	.4900	.1507	.4976	-1.1053	.3522	1.3181
.0259	-.7779	.4457	1.1396	.0255	.4475	.7958	.5803	.1507	.2476	-1.0490	.3682	1.2853
.0759	-1.0053	.3808	1.2603	.0495	.2588	.7419	.6671	.1507	-.2524	-1.0585	.3656	1.2908
.1003	-1.0267	.3746	1.2726	.0753	.1535	.7118	.7140	.1507	-.5024	-1.0853	.3579	1.3066
.1507	-1.0368	.3718	1.2783	.1002	.0742	.6892	.7489	.1507	-.7524	-1.0171	.3774	1.2672
.2003	-1.0444	.3696	1.2827	.1503	-.0227	.6615	.7915	.5002	.7476	-1.1024	.3530	1.3166
.2503	-1.0588	.3655	1.2909	.1976	-.1305	.6307	.8388	.5002	.4976	-1.1129	.3500	1.3227
.3001	-1.0927	.3558	1.3107	.2503	-.2038	.6097	.8712	.5002	.2476	-1.1200	.3480	1.3269
.3502	-1.1126	.3501	1.3225	.3001	-.2562	.5948	.8945	.5002	-.2524	-1.1012	.3533	1.3157
.4003	-1.1282	.3456	1.3318	.3507	-.2958	.5835	.9121	.5002	-.5024	-1.0807	.3592	1.3037
.4501	-1.1504	.3393	1.3453	.4001	-.3086	.5797	.9180	.8002	-.7524	-1.0855	.3578	1.3065
.5002	-1.1455	.3407	1.3423	.4501	-.2970	.5831	.9127	.8002	.7476	-.3773	.5602	.9448
.5502	-1.1081	.3514	1.3198	.5001	-.2472	.5974	.8904	.8002	.4976	-.4094	.5510	.9634
.6002	-1.0413	.3705	1.2809	.5497	-.1463	.6256	.8467	.8002	.2476	-.4022	.5531	.9602
.6500	-.6060	.4948	1.0551	.6003	-.0430	.6557	.8004	.8002	-.5024	-.3896	.5567	.9544
.7000	-.5070	.5231	1.0084	.6500	.0455	.6810	.7616	.8002	-.7524	-.3667	.5632	.9440
.7500	-.4519	.5388	.9829	.7000	.1498	.7108	.7156					
.8002	-.3949	.5551	.9568	.7501	.2437	.7376	.6738					
.9002	-.2746	.5895	.9027	.8001	.3254	.7609	.6373					
.9501	-.2191	.6054	.8780	.8501	.3983	.7818	.6035					

TEST 167 PT 26.0484 PSI CM -.1081
 RUN 29 TT 145.1136 K CM -.1180
 POINT 15 RC 9.9465 MILLION CC .0091
 MACH .7805
 ALPHA -4.0222 DEG

CD1 .01822 CDCOR1 .01798
 CD2 .01693 CDCOR2 .01675
 CD3 .01612 CDCOR3 .01600
 CD4 .01488 CDCOR4 .01469
 CD5 .01235 CDCOR5 .01198

UPPER SURFACE				LOWER SURFACE				SPANWISE				
X/C	CP	P _L /PT	MLOC	X/C	CP	P _L /PT	MLOC	X/C	Y/(B/2)	CP	P _L /PT	MLOC
0.0000	.7670	.8875	.4163	0.0000	.7670	.8875	.4163	.1507	.7476	-.1298	.6319	.6372
.0132	.6374	.8506	.4864	.0126	-.6556	.4820	1.0770	.1507	.4976	-.1321	.6312	.6382
.0259	.3181	.7596	.6393	.0255	-.5726	.5057	1.0373	.1507	.2476	-.1327	.6311	.6385
.0759	-.0016	.6684	.7811	.0495	-.7078	.4671	1.1024	.1507	-.2524	-.1412	.6286	.6422
.1003	-.0542	.6534	.8041	.0753	-.7501	.4551	1.1234	.1507	-.5024	-.1374	.6297	.6406
.1507	-.1339	.6307	.8390	.1002	-.7865	.4447	1.1417	.1507	-.7524	-.1401	.6290	.6417
.2003	-.1867	.6157	.8622	.1503	-.7929	.4429	1.1450	.5002	.7476	-.4121	.5514	.9630
.2503	-.2393	.6007	.8855	.1976	-.8444	.4282	1.1713	.5002	.4976	-.4172	.5500	.9653
.3001	-.2847	.5877	.9057	.2503	-.9035	.4113	1.2023	.5002	.2476	-.4227	.5484	.9679
.3502	-.3126	.5798	.9182	.3001	-.9611	.3949	1.2333	.5002	-.2524	-.4134	.5510	.9636
.4003	-.3462	.5701	.9332	.3502	-1.0039	.3827	1.2569	.5002	-.5024	-.4092	.5522	.9617
.4501	-.3826	.5598	.9496	.4001	-1.0507	.3671	1.2879	.5002	-.7524	-.3968	.5558	.9561
.5002	-.4200	.5492	.9666	.4501	-.8046	.4395	1.1509	.8002	.7476	-1.0222	.3775	1.2672
.5502	-.4606	.5376	.9852	.5001	-.4363	.5445	.9741	.8002	.4976	-.3697	.5635	.9438
.6002	-.5059	.5247	1.0061	.5497	-.2936	.5852	.9097	.8002	.2476	-.3740	.5623	.9458
.6500	-.5437	.5139	1.0237	.6003	-.1562	.6244	.8488	.8002	-.5024	-.3581	.5668	.9386
.7000	-.5246	.5193	1.0148	.6500	-.0355	.6588	.7959	.8002	-.7524	-.3392	.5722	.9301
.7500	-.4542	.5394	.9823	.7000	.0737	.6899	.7481					
.8002	-.3669	.5643	.9425	.7501	.1631	.7154	.7086					
.9002	-.1691	.6218	.8528	.8001	.2367	.7364	.6759					
.9501	-.0339	.6592	.7952	.8501	.2976	.7537	.6486					

TEST 167 PT 26.0534 PSI CM .0653
 RUN 29 TT 145.1532 K CM -.1349
 POINT 16 RC 9.9445 MILLION CC .0142
 MACH .7805
 ALPHA -2.9980 DEG

CD1 .01247 CDCOR1 .01228
 CD2 .01207 CDCOR2 .01193
 CD3 .01175 CDCOR3 .01168
 CD4 .01127 CDCOR4 .01113
 CD5 .00998 CDCOR5 .00965

UPPER SURFACE				LOWER SURFACE				SPANWISE				
X/C	CP	P _L /PT	MLOC	X/C	CP	P _L /PT	MLOC	X/C	Y/(B/2)	CP	P _L /PT	MLOC
0.0000	.8920	.9235	.3389	0.0000	.8920	.9235	.3389	.1507	.7476	-.2360	.6029	.8821
.0132	.4968	.8112	.5550	.0126	-.3834	.5609	.9479	.1507	.4976	-.2478	.5995	.8874
.0259	.1600	.7154	.7086	.0255	-.3981	.5568	.9545	.1507	.2476	-.2480	.5994	.8874
.0759	-.1395	.6303	.8397	.0495	-.5272	.5201	1.0136	.1507	-.2524	-.2555	.5973	.8908
.1003	-.1864	.6186	.8577	.0753	-.5413	.5161	1.0202	.1507	-.5024	-.2516	.5984	.8890
.1507	-.2485	.5993	.8877	.1002	-.6185	.4941	1.0566	.1507	-.7524	-.2487	.5992	.8877
.2003	-.2930	.5866	.9074	.1503	-.6628	.4815	1.0778	.5002	.7476	-.4868	.5316	.9949
.2503	-.3374	.5740	.9272	.1976	-.7685	.4514	1.1298	.5002	.4976	-.4927	.5299	.9977
.3001	-.3783	.5624	.9455	.2503	-.8530	.4274	1.1727	.5002	-.2524	-.4873	.5314	.9932
.3502	-.3990	.5565	.9549	.3001	-.9286	.4059	1.2124	.5002	-.5024	-.4840	.5323	.9937
.4003	-.4272	.5485	.9677	.3502	-.9836	.3803	1.2422	.5002	-.7524	-.4716	.5359	.9880
.4501	-.4606	.5390	.9829	.4001	-.5383	.5169	1.0188	.8002	.7476	-1.0592	.3688	1.2845
.5002	-.4952	.5292	.9988	.4501	-.3369	.5742	.9270	.8002	.4976	-.3799	.5619	.9463
.5502	-.5319	.5187	1.0158	.5001	-.3369	.5742	.9270	.8002	.2476	-.3836	.5609	.9479
.6002	-.5739	.5068	1.0355	.5497	-.2231	.6065	.8764	.8002	-.5024	-.3715	.5643	.9425
.6500	-.6137	.4955	1.0543	.6003	-.1052	.6400	.8247	.8002	-.7524	-.3565	.5686	.9358
.7000	-.5853	.5035	1.0409	.6500	-.0007	.6698	.7790					
.7500	-.4730	.5355	.9886	.7000	.1106	.7014	.7303					
.8002	-.3763	.5630	.9446	.7501	.2070	.7288	.6878					
.9002	-.1684	.6221	.8524	.8001	.2869	.7515	.6521					
.9501	-.0385	.6590	.7955	.8501	.3538	.7705	.6218					

TEST 167 PT 26.0569 PSI CM .2215
 RUN 29 TT 145.1062 K CM -.1408
 POINT 17 RC 9.9465 MILLION CC .0188
 MACH .7799
 ALPHA -1.9958 DEG

CD1 .01005 CDCOR1 .00976
 CD2 .00982 CDCOR2 .00956
 CD3 .00967 CDCOR3 .00951
 CD4 .00950 CDCOR4 .00927
 CD5 .00876 CDCOR5 .00848

UPPER SURFACE				LOWER SURFACE				SPANWISE				
X/C	CP	P _L /PT	MLOC	X/C	CP	P _L /PT	MLOC	X/C	Y/(B/2)	CP	P _L /PT	MLOC
0.0000	1.0118	.9573	.2504	0.0000	1.0118	.9573	.2504	.1507	.7476	-.3562	.5673	.9377
.0132	.3296	.7628	.6341	.0126	-.1167	.6356	.8315	.1507	.4976	-.3747	.5621	.9461
.0259	-.0224	.6625	.7901	.0255	-.1890	.6150	.8633	.1507	.2476	-.3769	.5614	.9471
.0759	-.2972	.5842	.9112	.0495	-.3306	.5746	.9262	.1507	-.2524	-.3791	.5608	.9481
.1003	-.3230	.5768	.9228	.0753	-.3671	.5642	.9426	.1507	-.5024	-.3794	.5607	.9482
.1507	-.3773	.5613	.9473	.1002	-.4302	.5463	.9713	.1507	-.7524	-.3668	.5643	.9425
.2003	-.4036	.5538	.9592	.1503	-.4570	.5386	.9835	.5002	.7476	-.3770	.5644	1.0394
.2503	-.4484	.5416	.9787	.1976	-.5692	.5068	1.0357	.5002	.4976	-.3876	.5614	1.0444
.3001	-.4834	.5311	.9957	.2503	-.6588	.4811	1.0785	.5002	.2476	-.3935	.5497	1.0472
.3502	-.4894	.5294	.9985	.3001	-.7172	.4644	1.1071	.5002	-.2524	-.3842	.5623	1.0428
.4003	-.5132	.5226	1.0095	.3502	-.7505	.4550	1.1236	.5002	-.5024	-.3809	.5633	1.0413
.4501	-.5562	.5132	1.0249	.4001	-.6011	.4975	1.0508	.5002	-.7524	-.3647	.5679	1.0336
.5002	-.5896	.5008	1.0454	.4501	-.4535	.5396	.9819	.8002	.7476	-1.0693	.3641	1.2940
.5502	-.6151	.4936	1.0575	.5001	-.3561	.5874	.9377	.8002	.4976	-.3794	.5607	.9482
.6002	-.6461	.4847	1.0724	.5497	-.2273	.6041	.8802	.8002	.2476	-.3758	.5606	.9484
.6500	-.6921	.4716	1.0947	.6003	-.0999	.6404	.8241	.8002	-.5024	-.3777	.5612	.9474
.7000	-.6661	.4790	1.0821	.6500	.0069	.6708	.7773	.8002	-.7524	-.3688	.5638	.9434
.7500	-.4795	.5322	.9939	.7000	.1209	.7034	.7273					
.8002	-.3712	.5631	.9443	.7501	.2184	.7311	.6841					
.9002	-.1602	.6232	.8506	.8001	.2984	.7539	.6483					
.9501	-.0312	.6600	.7940	.8501	.3653	.7730	.6178					

ORIGINAL PAGE IS
OF POOR QUALITY

TEST 167	PT 26.0568	PSI	CM .3093	CD1 .01003	CDCOR1 .00975
RUN 29	TT 145.2948	K	CM -.1440	CD2 .00985	CDCOR2 .00962
POINT 18	RC 9.9220	MILLION	CC .0206	CD3 .00872	CDCOR3 .00952
	MACH .7791			CD4 .00945	CDCOR4 .00922
	ALPHA -1.4667	DEG		CD5 .00878	CDCOR5 .00892

UPPER SURFACE				LOWER SURFACE				SPANWISE				
X/C	CP	P _L /PT	MLOC	X/C	CP	P _L /PT	MLOC	X/C	Y/(B/2)	CP	P _L /PT	MLOC
0.0000	1.0615	.9716	.2033	0.0000	1.0615	.9716	.2033	.1507	.7476	-.4248	.5484	.9678
.0132	.2327	.7356	.6771	.0126	.0131	.6731	.7739	.1507	.4976	-.4451	.5426	.9771
.0259	-.1258	.6336	.8347	.0255	-.0850	.6452	.8168	.1507	.2476	-.4484	.5417	.9765
.0759	-.3672	.5591	.9507	.0495	-.2345	.6026	.8825	.1507	-.2524	-.4302	.5412	.9794
.1003	-.4027	.5547	.9578	.0753	-.2778	.5903	.9017	.1507	-.5024	-.4480	.5418	.9784
.1507	-.4481	.5418	.9785	.1002	-.3469	.5706	.9326	.1507	-.7524	-.4315	.5465	.9709
.2003	-.4687	.5359	.9879	.1503	-.3900	.5583	.9520	.5002	.7476	-.8166	.4938	1.0571
.2503	-.5039	.5259	1.0041	.1976	-.5011	.5267	1.0028	.5002	.4976	-.6271	.4908	1.0621
.3001	-.5436	.5146	1.0226	.2503	-.5635	.5089	1.0319	.5002	.2476	-.6332	.4891	1.0650
.3502	-.5938	.5161	1.0201	.3001	-.6104	.4956	1.0542	.5002	-.2524	-.6238	.4917	1.0605
.4003	-.6467	.5110	1.0284	.3507	-.6667	.4966	1.0524	.5002	-.5024	-.6243	.4916	1.0607
.4501	-.6967	.5023	1.0429	.4001	-.7403	.5155	1.0211	.5002	-.7524	-.6112	.4933	1.0745
.5002	-.7498	.4901	1.0634	.4501	-.8431	.5432	.9762	.8002	.7476	-1.0844	.3663	1.2895
.5502	-.8042	.4602	1.0800	.5001	-.9425	.5719	.9306	.8002	.4976	-.3752	.5625	.9453
.6002	-.8692	.4714	1.0950	.5497	-.1237	.6085	.8733	.8002	.2476	-.3749	.5626	.9452
.6500	-.9386	.4628	1.1100	.6003	-.0877	.6444	.8180	.8002	-.5024	-.3758	.5624	.9456
.7000	-.1089	.4746	1.0895	.6500	.0176	.6744	.7719	.8002	-.7524	-.3692	.5643	.9426
.7500	-.4742	.5338	.9913	.7000	.1311	.7067	.7221					
.8002	-.3683	.5645	.9422	.7501	.2283	.7344	.6791					
.8002	-.1573	.6246	.8485	.8001	.3097	.7572	.6430					
.9501	-.0309	.6606	.7931	.8501	.3758	.7764	.6124					

TEST 167	PT 26.0579	PSI	CM .3821	CD1 .01034	CDCOR1 .01003
RUN 29	TT 145.1867	K	CM -.1462	CD2 .01018	CDCOR2 .00987
POINT 10	RC 9.9325	MILLION	CC .0214	CD3 .00992	CDCOR3 .00967
	MACH .7790			CD4 .00960	CDCOR4 .00932
	ALPHA -.9975	DEG		CD5 .00893	CDCOR5 .00861

UPPER SURFACE				LOWER SURFACE				SPANWISE				
X/C	CP	P _L /PT	MLOC	X/C	CP	P _L /PT	MLOC	X/C	Y/(B/2)	CP	P _L /PT	MLOC
0.0000	1.1012	.9833	.1554	0.0000	1.1012	.9833	.1554	.1507	.7476	-.4965	.5301	.9973
.0132	.1348	.7092	.7183	.0126	.1303	.7079	.7203	.1507	.4976	-.5217	.5230	1.0089
.0259	-.2300	.6057	.8777	.0255	-.0089	.6735	.7733	.1507	.2476	-.5264	.5217	1.0110
.0759	-.4845	.5335	.9917	.0495	-.1467	.6293	.8412	.1507	-.2524	-.5248	.5221	1.0103
.1003	-.4863	.5330	.9926	.0753	-.1978	.6149	.8635	.1507	-.5024	-.5165	.5245	1.0064
.1507	-.5246	.5221	1.0102	.1002	-.2712	.5940	.8959	.1507	-.7524	-.4977	.5298	.9978
.2003	-.5344	.5194	1.0147	.1503	-.3251	.5787	.9198	.5002	.7476	-.6501	.4866	1.0693
.2503	-.5607	.5119	1.0270	.1976	-.4314	.5486	.9675	.5002	.4976	-.6584	.4842	1.0732
.3001	-.6044	.4995	1.0475	.2503	-.4885	.5324	.9936	.5002	.2476	-.6620	.4832	1.0749
.3502	-.6154	.4964	1.0527	.3001	-.5262	.5217	1.0109	.5002	-.2524	-.6545	.4853	1.0714
.4003	-.6054	.4992	1.0480	.3507	-.5327	.5199	1.0140	.5002	-.5024	-.6584	.4842	1.0732
.4501	-.6124	.4973	1.0513	.4001	-.4913	.5316	.9948	.5002	-.7524	-.6525	.4859	1.0704
.5002	-.6568	.4847	1.0725	.4501	-.4207	.5516	.9627	.8002	.7476	-1.0546	.3718	1.2784
.5502	-.6991	.4727	1.0929	.5001	-.3267	.5783	.9205	.8002	.4976	-.3705	.5659	.9401
.6002	-.7386	.4615	1.1122	.5497	-.2009	.6140	.8649	.8002	.2476	-.3692	.5662	.9395
.6500	-.7708	.4523	1.1282	.6003	-.0772	.6491	.8108	.8002	-.5024	-.3734	.5650	.9414
.7000	-.7000	.4698	1.0977	.6500	.0259	.6783	.7659	.8002	-.7524	-.3686	.5664	.9392
.7500	-.4690	.5379	.9847	.7000	.1387	.7103	.7145					
.8002	-.3625	.5681	.9365	.7501	.2360	.7379	.6736					
.8002	-.1542	.6272	.8444	.8001	.3185	.7607	.6375					
.9501	-.0291	.6627	.7898	.8501	.3849	.7801	.6063					

TEST 167	PT 26.0563	PSI	CM .4639	CD1 .01087	CDCOR1 .01054
RUN 29	TT 145.2025	K	CM -.1488	CD2 .01066	CDCOR2 .01040
POINT 20	RC 9.9303	MILLION	CC .0212	CD3 .01041	CDCOR3 .01022
	MACH .7790			CD4 .00997	CDCOR4 .00975
	ALPHA -.4785	DEG		CD5 .00926	CDCOR5 .00891

UPPER SURFACE				LOWER SURFACE				SPANWISE				
X/C	CP	P _L /PT	MLOC	X/C	CP	P _L /PT	MLOC	X/C	Y/(B/2)	CP	P _L /PT	MLOC
0.0000	1.1267	.9905	.1170	0.0000	1.1267	.9905	.1170	.1507	.7476	-.5777	.5049	1.0352
.0132	.0325	.6801	.7632	.0126	.0325	.6737	.7383	.1507	.4976	-.6052	.4992	1.0481
.0259	-.3428	.5736	.9279	.0255	-.0969	.6483	.7350	.1507	.2476	-.6141	.4966	1.0524
.0759	-.6017	.5001	1.0465	.0495	-.4663	.6520	.8062	.1507	-.2524	-.6122	.4972	1.0515
.1003	-.5959	.5018	1.0437	.0753	-.5241	.6356	.8314	.1507	-.5024	-.5963	.5017	1.0439
.1507	-.6126	.4971	1.0516	.1002	-.6201	.6135	.8656	.1507	-.7524	-.5732	.5082	1.0331
.2003	-.6337	.4911	1.0607	.1503	-.6246	.5958	.8931	.5002	.7476	-.7051	.4708	1.0961
.2503	-.6311	.4918	1.0604	.1976	-.6380	.5864	.9391	.5002	.4976	-.7171	.4674	1.1020
.3001	-.6515	.4860	1.0702	.2503	-.6257	.5901	.9632	.5002	.2476	-.7229	.4658	1.1048
.3502	-.6699	.4808	1.0790	.3001	-.6424	.5397	.9818	.5002	-.2524	-.7098	.4695	1.0984
.4003	-.6877	.4758	1.0876	.3507	-.6773	.5354	.9887	.5002	-.5024	-.7142	.4682	1.1005
.4501	-.7049	.4709	1.0960	.4001	-.6506	.5430	.9765	.5002	-.7524	-.7157	.4678	1.1013
.5002	-.7214	.4662	1.1040	.4501	-.6346	.5589	.9511	.8002	.7476	-1.0493	.3732	1.2758
.5502	-.7347	.4624	1.1106	.5001	-.6088	.5632	.9127	.8002	.4976	-.3701	.5659	.9401
.6002	-.7722	.4518	1.1292	.5497	-.5082	.6174	.8395	.8002	.2476	-.3669	.5667	.9387
.6500	-.8124	.4404	1.1494	.6003	-.3680	.6515	.8070	.8002	-.5024	-.3746	.5646	.9421
.7000	-.7363	.4620	1.1114	.6500	.0321	.6800	.7633	.8002	-.7524	-.3707	.5657	.9404
.7500	-.4641	.5392	.9826	.7000	.1438	.7116	.7145					
.8002	-.3598	.5688	.9355	.7501	.2406	.7391	.6717					
.8002	-.1535	.6273	.8443	.8001	.3212	.7620	.6395					
.9501	-.0314	.6619	.7910	.8501	.3903	.7816	.6039					

TEST 167 PT 26.0390 PSI CM .9445
 RUN 29 TT 145.1409 K CM -.1529
 POINT 21 RC 9.9370 MILLION CC .0212
 MACH .7790
 ALPHA .0285 DEG

CD1 .01187 CDCOR1 .01190
 CD2 .01178 CDCOR2 .01143
 CD3 .01149 CDCOR3 .01119
 CD4 .01084 CDCOR4 .01052
 CD5 .01001 CDCOR5 .00963

UPPER SURFACE				LOWER SURFACE				SPANWISE				
X/C	CP	P/L/PT	MLOC	X/C	CP	P/L/PT	MLOC	X/C	Y/(B/2)	CP	P/L/PT	MLOC
0.0000	1.1492	.9968	.0676	0.0000	1.1492	.9968	.0676	.1507	.7476	-.6480	.4866	1.0693
.0132	-.0346	.6550	.8016	.0126	.3326	.7650	.6307	.1507	.4976	-.7065	.4699	1.0976
.0259	-.4367	.5465	.9708	.0259	.1786	.7212	.6996	.1507	.2476	-.7189	.4664	1.1036
.0759	-.6819	.4769	1.0856	.0495	.0100	.6734	.7735	.1507	-.2524	-.7168	.4670	1.1026
.1003	-.7196	.4674	1.1020	.0753	-.0555	.6548	.8020	.1507	-.5024	-.6985	.4722	1.0937
.1507	-.7104	.4688	1.0995	.1002	-.1365	.6318	.8374	.1507	-.7524	-.6823	.4882	1.0665
.2003	-.7104	.4687	1.0998	.1503	-.2067	.6118	.8682	.5002	.7476	-.7663	.4530	1.1271
.2503	-.7159	.4673	1.1022	.1976	-.3099	.5825	.9138	.5002	.4976	-.7887	.4466	1.1430
.3001	-.7038	.4670	1.0963	.2503	-.3702	.5654	.9408	.5002	.2476	-.7981	.4439	1.1432
.3502	-.7241	.4649	1.1062	.3001	-.4093	.5543	.9584	.5002	-.2524	-.7984	.4439	1.1432
.4003	-.7345	.4620	1.1113	.3507	-.4303	.5484	.9679	.5002	-.5024	-.7907	.4461	1.1393
.4501	-.7565	.4598	1.1222	.4001	-.4135	.5531	.9603	.5002	-.7524	-.7865	.4472	1.1258
.5002	-.7953	.4447	1.1416	.4501	-.3678	.5661	.9397	.8002	.7476	-1.0080	.3843	1.2536
.5502	-.8259	.4360	1.1571	.5001	-.2894	.5883	.9048	.8002	.4976	-.3500	.5712	.9317
.6002	-.8490	.4295	1.1690	.5497	-.1738	.6212	.8537	.8002	.2476	-.3482	.5717	.9309
.6500	-.8742	.4223	1.1820	.6003	-.0568	.6544	.8026	.8002	-.5024	-.3606	.5682	.9364
.7000	-.8010	.4431	1.1445	.6500	.0410	.6822	.7599	.8002	-.7524	-.3634	.5674	.9377
.7500	-.4929	.5420	.9782	.7000	.1514	.7135	.7116					
.8002	-.3401	.5740	.9273	.7501	.2477	.7409	.6689					
.9002	-.1422	.6302	.8399	.8001	.3283	.7637	.6327					
.9501	-.0262	.6631	.7893	.8501	.3979	.7835	.6008					

TEST 167 PT 26.0711 PSI CM .6282
 RUN 29 TT 145.1601 K CM -.1578
 POINT 22 RC 9.9420 MILLION CC .0207
 MACH .7793
 ALPHA .5198 DEG

CD1 .01385 CDCOR1 .01340
 CD2 .01373 CDCOR2 .01317
 CD3 .01376 CDCOR3 .01327
 CD4 .01286 CDCOR4 .01213
 CD5 .01199 CDCOR5 .01096

UPPER SURFACE				LOWER SURFACE				SPANWISE				
X/C	CP	P/L/PT	MLOC	X/C	CP	P/L/PT	MLOC	X/C	Y/(B/2)	CP	P/L/PT	MLOC
0.0000	1.1525	.9976	.0588	0.0000	1.1525	.9976	.0588	.1507	.7476	-.7578	.4542	1.1250
.0132	-.1414	.6295	.8409	.0126	.4127	.7871	.5949	.1507	.4976	-.8333	.4327	1.1631
.0259	-.5290	.5193	1.0149	.0259	.2463	.7398	.6705	.1507	.2476	-.8183	.4370	1.1555
.0759	-.7712	.4504	1.1317	.0495	.0732	.6906	.7470	.1507	-.2524	-.8092	.4356	1.1508
.1003	-.7949	.4436	1.1436	.0753	.0019	.6703	.7782	.1507	-.5024	-.8198	.4365	1.1562
.1507	-.8079	.4399	1.1591	.1002	-.0819	.6464	.8148	.1507	-.7524	-.8198	.4355	1.1227
.2003	-.8198	.4377	1.1542	.1503	-.1579	.6248	.8481	.5002	.7476	-.8678	.4229	1.1810
.2503	-.8323	.4330	1.1626	.1976	-.2605	.5956	.8933	.5002	.4976	-.8588	.4255	1.1763
.3001	-.8581	.4257	1.1759	.2503	-.3219	.5782	.9207	.5002	.2476	-.8421	.4302	1.1677
.3502	-.8164	.4375	1.1545	.3001	-.3639	.5662	.9395	.5002	-.2524	-.8426	.4301	1.1676
.4003	-.8092	.4460	1.1394	.3507	-.3878	.5594	.9303	.5002	-.5024	-.8634	.4242	1.1787
.4501	-.8317	.4407	1.1488	.4001	-.3791	.5619	.9463	.5002	-.7524	-.8673	.4230	1.1807
.5002	-.8317	.4332	1.1823	.4501	-.3429	.5722	.9300	.8002	.7476	-.9843	.3898	1.2432
.5502	-.8740	.4211	1.1842	.5001	-.2716	.5925	.8983	.8002	.4976	-.3457	.5714	.9313
.6002	-.9231	.4072	1.2101	.5497	-.1812	.6239	.8495	.8002	.2476	-.3410	.5727	.9282
.6500	-.9726	.3951	1.2388	.6003	-.0480	.6561	.8000	.8002	-.5024	-.3520	.5696	.9342
.7000	-.8455	.4292	1.1694	.6500	.0471	.6831	.7584	.8002	-.7524	-.3583	.5678	.9370
.7500	-.4501	.5417	.9786	.7000	.1556	.7140	.7108					
.8002	-.3354	.5743	.9267	.7501	.2507	.7410	.6686					
.9002	-.1417	.6294	.8410	.8001	.3306	.7638	.6326					
.9501	-.0327	.6604	.7933	.8501	.4002	.7836	.6007					

TEST 167 PT 26.0671 PSI CM .7107
 RUN 29 TT 145.2220 K CM -.1619
 POINT 23 RC 9.9294 MILLION CC .0197
 MACH .7786
 ALPHA 1.0285 DEG

CD1 .01718 CDCOR1 .01687
 CD2 .01703 CDCOR2 .01645
 CD3 .01657 CDCOR3 .01599
 CD4 .01572 CDCOR4 .01514
 CD5 .01442 CDCOR5 .01359

UPPER SURFACE				LOWER SURFACE				SPANWISE				
X/C	CP	P/L/PT	MLOC	X/C	CP	P/L/PT	MLOC	X/C	Y/(B/2)	CP	P/L/PT	MLOC
0.0000	1.1603	1.0004	0.0000	0.0000	1.1608	1.0004	0.0000	.1507	.7476	-.8578	.4295	1.1690
.0132	-.2222	.6052	.8722	.0126	.4482	.8124	.5329	.1507	.4976	-.9236	.4109	1.2032
.0259	-.6165	.4977	1.0506	.0259	.3215	.7630	.6339	.1507	.2476	-.9002	.4175	1.1909
.0759	-.8959	.4300	1.1680	.0495	.1435	.7127	.7129	.1507	-.2524	-.8892	.4208	1.1852
.1003	-.8754	.4245	1.1781	.0753	.0636	.6901	.7477	.1507	-.5024	-.8998	.4148	1.1960
.1507	-.8860	.4215	1.1835	.1002	-.0219	.6659	.7850	.1507	-.7524	-.8554	.4302	1.1677
.2003	-.8971	.4183	1.1893	.1503	-.1020	.6432	.8198	.5002	.7476	-.9473	.4042	1.2158
.2503	-.9158	.4131	1.1941	.1976	-.2036	.6145	.8641	.5002	.4976	-.9570	.4014	1.2209
.3001	-.9484	.4038	1.2164	.2503	-.2677	.5964	.8922	.5002	.2476	-.9280	.4096	1.2055
.3502	-.9571	.4014	1.2210	.3001	-.3116	.5840	.9116	.5002	-.2524	-.9130	.4139	1.1976
.4003	-.9134	.4137	1.1979	.3507	-.3394	.5761	.9239	.5002	-.5024	-.9508	.4032	1.2176
.4501	-.8768	.4241	1.1788	.4001	-.3372	.5767	.9230	.5002	-.7524	-.9255	.4103	1.2042
.5002	-.9072	.4155	1.1946	.4501	-.3088	.5847	.9104	.8002	.7476	-.3451	.5745	.9265
.5502	-.9261	.4102	1.2045	.5001	-.2457	.6026	.8825	.8002	.4976	-.3383	.5764	.9234
.6002	-.9625	.3999	1.2239	.5497	-.1412	.6322	.8368	.8002	.2476	-.3388	.5768	.9228
.6500	-1.0062	.3875	1.2476	.6003	-.0320	.630	.7893	.8002	-.5024	-.3408	.5757	.9246
.7000	-.7758	.4527	1.1276	.6500	.0694	.706	.7470	.8002	-.7524	-.3422	.5753	.9252
.7500	-.4436	.5461	.9716	.7000	.1666	.7192	.7027					
.8002	-.3350	.5773	.9220	.7501	.2609	.7459	.6610					
.9002	-.1399	.6325	.8362	.8001	.3407	.7684	.6252					
.9501	-.0356	.6620	.7909	.8501	.4108	.7882	.5931					

ORIGINAL PAGE IS
OF POOR QUALITY

TEST 167	PT 26.0679	PSI	CN	.7626	CD1	.02377	CDCOR1	.02297
RUN 29	TT 145.1139	K	CM	-.1664	CD2	.02290	CDCOR2	.02220
POINT 24	RC 9.9457	MILLION	CC	.0208	CD3	.02194	CDCOR3	.02113
	MACH				CD4	.02078	CDCOR4	.02011
	ALPHA 1.5172	DEG			CD5	.02046	CDCOR5	.01967

UPPER SURFACE				LOWER SURFACE				SPANWISE				
X/C	CP	P _L /PT	MLOC	X/C	CP	P _L /PT	MLOC	X/C	Y/(B/2)	CP	P _L /PT	MLOC
0.0000	1.1571	.9987	.0438	0.0000	1.1571	.9987	.0438	.1507	.7476	-1.0172	.4070	1.2105
.0132	-.2708	.3914	1.9000	.0126	.5477	.8248	.5318	.1507	.4976	-.9729	.3911	1.2407
.0259	-.6633	.4794	1.0814	.0255	.3694	.7740	.6163	.1507	.2476	-.9422	.3998	1.2240
.0759	-.8978	.4123	1.2002	.0495	.1864	.7218	.6987	.1507	-.2524	-.9339	.4022	1.2195
.1003	-.9186	.4066	1.2112	.0753	.0995	.6970	.7371	.1507	-.5024	-.9558	.3960	1.2313
.1507	-.9283	.4038	1.2164	.1002	.0150	.6729	.7742	.1507	-.7524	-.9066	.4100	1.2048
.2003	-.9397	.4006	1.2226	.1503	-.0694	.6488	.8112	.5002	.7476	-1.0002	.3833	1.2558
.2503	-.9602	.3947	1.2337	.2503	-.1723	.6195	.8564	.5002	.4976	-1.0120	.3790	1.2624
.3001	-.9970	.3842	1.2340	.3507	-.2390	.6004	.8859	.5002	.2476	-1.0179	.3783	1.2657
.3502	-1.0147	.3792	1.2639	.4001	-.2867	.5868	.9071	.5002	-.2524	-.9869	.3871	1.2484
.4003	-1.0163	.3787	1.2648	.4501	-.3197	.5774	.9219	.5002	-.5024	-1.0196	.3789	1.2644
.4501	-.9762	.3902	1.2425	.5001	-.3221	.5767	.9230	.5002	-.7524	-.9767	.3700	1.2428
.5002	-.9650	.3933	1.2364	.5501	-.2990	.5833	.9126	.8002	.7476	-.3333	.5735	.9280
.5502	-.9927	.3854	1.2516	.6003	-.2393	.6003	.8860	.8002	.4976	-.3339	.5734	.9282
.6002	-1.0205	.3775	1.2672	.6500	-.1379	.6293	.8413	.8002	.2476	-.3371	.5725	.9297
.6500	-1.0689	.3637	1.2948	.7000	-.0312	.6597	.7945	.8002	-.5024	-.3377	.5723	.9299
.7000	-.7126	.4653	1.1055	.7501	-.1649	.6854	.7549	.8002	-.7524	-.3332	.5736	.9279
.7500	-.4479	.3408	.9800	.8001	.2581	.7422	.6667					
.8002	-.3380	.5722	.9301	.8501	.3376	.7649	.6308					
.9002	-.1499	.6258	.8466	.8501	.4074	.7848	.5987					
.9501	-.0663	.6496	.8099									

TEST 167	PT 26.0674	PSI	CN	.8233	CD1	.02946	CDCOR1	.02855
RUN 29	TT 145.1459	K	CM	-.1690	CD2	.02955	CDCOR2	.02866
POINT 25	RC 9.9447	MILLION	CC	.0205	CD3	.02638	CDCOR3	.02734
	MACH				CD4	.02806	CDCOR4	.02728
	ALPHA 2.0264	DEG			CD5	.02890	CDCOR5	.02795

UPPER SURFACE				LOWER SURFACE				SPANWISE				
X/C	CP	P _L /PT	MLOC	X/C	CP	P _L /PT	MLOC	X/C	Y/(B/2)	CP	P _L /PT	MLOC
0.0000	1.1611	.9984	0.0000	0.0000	1.1611	1.0004	0.0000	.1507	.7476	-1.0037	.3875	1.2476
.0132	-.2719	.3719	.9305	.0126	.6082	.8439	.4984	.1507	.4976	-1.0468	.3753	1.2715
.0259	-.6604	.4604	1.1141	.0255	.4241	.7917	.5873	.1507	.2476	-1.0121	.3852	1.2522
.0759	-.8910	.3968	1.2298	.0495	.2388	.7393	.6714	.1507	-.2524	-1.0033	.3876	1.2473
.1003	-.9929	.3906	1.2417	.0753	.1455	.7129	.7125	.1507	-.5024	-1.0264	.3811	1.2601
.1507	-.9987	.3889	1.2448	.1002	-.0596	.6885	.7501	.1507	-.7524	-.9817	.3938	1.2355
.2003	-1.0055	.3870	1.2485	.1503	-.0304	.6631	.7893	.5002	.7476	-1.0671	.3696	1.2829
.2503	-1.0247	.3816	1.2592	.1976	-.1351	.6334	.8349	.5002	.4976	-1.0789	.3682	1.2896
.3001	-1.0605	.3714	1.2792	.2503	-.2050	.6136	.8634	.5002	.2476	-1.0880	.3637	1.2948
.3502	-1.0786	.3663	1.2895	.3001	-.2549	.5995	.8873	.5002	-.2524	-1.0604	.3715	1.2791
.4003	-1.0908	.3629	1.2965	.3507	-.2913	.5892	.9034	.5002	-.5024	-1.0822	.3710	1.2802
.4501	-1.0949	.3617	1.2988	.4001	-.2991	.5870	.9068	.5002	-.7524	-1.0407	.3771	1.2681
.5002	-1.0513	.3740	1.2740	.4501	-.2824	.5917	.8995	.8002	.7476	-.3462	.5737	.9278
.5502	-1.0589	.3719	1.2783	.5001	-.2294	.6067	.8761	.8002	.4976	-.3366	.5707	.9324
.6002	-1.0871	.3639	1.2944	.5501	-.1325	.6342	.8337	.8002	.2476	-.3524	.5719	.9305
.6500	-1.0640	.3704	1.2812	.6003	-.0287	.6636	.7855	.8002	-.5024	-.3561	.5709	.9322
.7000	-.5763	.3083	1.0326	.6500	.0586	.6883	.7505	.8002	-.7524	-.3424	.5747	.9261
.7500	-.4410	.3468	.9704	.7000	.1632	.7179	.7048					
.8002	-.3488	.5729	.9289	.7501	.2561	.7442	.6637					
.9002	-.1778	.6211	.8535	.8001	.3352	.7666	.6281					
.9501	-.0980	.6439	.8187	.8501	.4052	.7864	.5961					

TEST 167	PT 26.0650	PSI	CN	.8412	CD1	.03212	CDCOR1	.02996
RUN 29	TT 145.1485	K	CM	-.1668	CD2	.03218	CDCOR2	.03005
POINT 26	RC 9.9448	MILLION	CC	.0215	CD3	.03548	CDCOR3	.03438
	MACH				CD4	.03747	CDCOR4	.03572
	ALPHA 2.5291	DEG			CD5	.03588	CDCOR5	.03470

UPPER SURFACE				LOWER SURFACE				SPANWISE				
X/C	CP	P _L /PT	MLOC	X/C	CP	P _L /PT	MLOC	X/C	Y/(B/2)	CP	P _L /PT	MLOC
0.0000	1.1626	1.0006	0.0000	0.0000	1.1626	1.0006	0.0000	.1507	.7476	-1.0520	.3714	1.2792
.0132	-.3905	.5594	.9503	.0126	.6472	.8542	.4799	.1507	.4976	-1.0811	.3632	1.2958
.0259	-.7850	.4473	1.1371	.0255	.4612	.8013	.5716	.1507	.2476	-1.0452	.3734	1.2753
.0759	-1.0043	.3850	1.2525	.0495	.2734	.7480	.6577	.1507	-.2524	-1.0362	.3759	1.2703
.1003	-1.0751	.3791	1.2640	.0753	.1764	.7204	.7009	.1507	-.5024	-1.0632	.3683	1.2859
.1507	-1.0333	.3768	1.2686	.1002	.0895	.6957	.7391	.1507	-.7524	-1.0165	.3815	1.2592
.2003	-1.0410	.3746	1.2729	.1503	-.0053	.6688	.7805	.1507	-.7524	-1.0129	.3570	1.3085
.2503	-1.0575	.3746	1.2729	.1976	-.1126	.6333	.8273	.5002	.7476	-1.1065	.3537	1.3153
.3001	-1.0925	.3600	1.3024	.2503	-.1860	.6175	.8595	.5002	.4976	-1.1145	.3518	1.3192
.3502	-1.1110	.3547	1.3132	.3001	-.2397	.6022	.8831	.5002	-.2524	-1.1212	.3577	1.3070
.4003	-1.1259	.3505	1.3220	.3507	-.2804	.5906	.9011	.5002	-.5024	-1.0870	.3629	1.2963
.4501	-1.1475	.3443	1.3348	.4001	-.2931	.5870	.9068	.5002	-.7524	-1.0808	.3633	1.2956
.5002	-1.1368	.3474	1.3284	.4501	-.2815	.5903	.9016	.8002	.7476	-.3664	.5662	.9345
.5502	-1.1035	.3568	1.3088	.5001	-.2319	.6044	.8797	.8002	.4976	-.3920	.5589	.9510
.6002	-1.1035	.3563	1.3100	.5501	-.1371	.6313	.8381	.8002	.2476	-.3803	.5623	.9458
.6500	-.6760	.4783	1.0833	.6003	-.0348	.6604	.7934	.8002	-.5024	-.3749	.5638	.9433
.7000	-.5090	.3257	1.0045	.6500	.0509	.6848	.7539	.8002	-.7524	-.3508	.5706	.9325
.7500	-.4360	.3464	.9713	.7000	.1549	.7143	.7103					
.8002	-.3680	.5657	.9402	.7501	.2472	.7405	.6694					
.9002	-.2336	.6839	.8805	.8001	.3258	.7629	.6341					
.9501	-.1787	.6195	.8563	.8501	.3959	.7828	.6020					

ORIGINAL PAGE IS
OF POOR QUALITY

TEST 167	PT	31.5264	PSI	CM	-0.986	CD1	.01763	CDCOR1	.01677
RUN 30	TT	24.9763	K	CM	.1219	CD2	.01594	CDCOR2	.01578
POINT 27	RC	14.9763	MILLION	CC	.0103	CD3	.01516	CDCOR3	.01508
	MACH	.7808				CD4	.01415	CDCOR4	.01397
	ALPHA	-3.9815	DEG			CD5	.01223	CDCOR5	.01183

UPPER SURFACE				LOWER SURFACE				SPANWISE				
X/C	CP	P,L/PT	MLOC	X/C	CP	P,L/PT	MLOC	X/C	Y/(B/2)	CP	P,L/PT	MLOC
0.0000	.7698	.8884	.4150	0.0000	.7698	.8884	.4150	.1507	.7476	-.1206	.6347	.8334
.0132	.6364	.8504	.4871	.0126	-.6292	.4898	1.0844	.1507	.4976	-.1360	.6303	.8402
.0259	.3209	.7605	.6383	.0255	-.5393	.5134	1.0218	.1507	.2476	-.1356	.6304	.8400
.0759	-.0045	.6678	.7825	.0495	-.7020	.4691	1.0497	.1507	-.2524	-.1397	.6293	.8418
.1003	-.0572	.6528	.8056	.0753	-.7396	.4584	1.1182	.1507	-.5024	-.1442	.6280	.8438
.1507	-.1362	.6303	.8403	.1002	-.7790	.4471	1.1380	.1507	-.7524	-.1344	.6278	.8435
.2003	-.1881	.6155	.8631	.1503	-.7860	.4451	1.1415	.5002	.7476	-.4162	.5505	.9650
.2503	-.2404	.6006	.8862	.1976	-.8329	.4318	1.1654	.5002	.4976	-.4211	.5491	.9673
.3001	-.2870	.5873	.9069	.2503	-.8882	.4160	1.1942	.5002	.2476	-.4262	.5477	.9696
.3502	-.3133	.5798	.9186	.3001	-.9453	.3998	1.2247	.5002	-.2524	-.4163	.5505	.9651
.4001	-.3466	.5703	.9336	.3507	-.9945	.3858	1.2516	.5002	-.5024	-.4134	.5513	.9638
.4501	-.3828	.5601	.9478	.4001	-1.0547	.3686	1.2855	.5002	-.7524	-.4014	.5547	.9583
.5002	-.4228	.5486	.9680	.4501	-.9350	.4027	1.2191	.8002	.7476	-1.0306	.3755	1.2718
.5502	-.4644	.5368	.9871	.5001	-.6434	.5428	.9774	.8002	.4976	-.3722	.5630	.9451
.6002	-.5099	.5238	1.0081	.5497	-.2839	.5882	.9055	.8002	.2476	-.3769	.5617	.9472
.6500	-.5512	.5120	1.0274	.6003	-.1392	.6294	.8416	.8002	-.5024	-.3577	.5672	.9386
.7000	-.5344	.5168	1.0195	.6500	-.0204	.6633	.7895	.8002	-.7524	-.3425	.5715	.9317
.7500	-.4578	.5386	.9841	.7000	.0894	.6945	.7414					
.8002	-.3700	.5637	.9441	.7501	.1803	.7204	.7013					
.8502	-.1716	.6202	.8558	.8001	.2548	.7416	.6681					
.9501	-.0422	.6571	.7990	.8501	.3170	.7594	.6401					

TEST 167	PT	31.5278	PSI	CM	.0751	CD1	.01190	CDCOR1	.01167
RUN 30	TT	125.0378	K	CM	-.1388	CD2	.01157	CDCOR2	.01141
POINT 28	RC	14.9699	MILLION	CC	.0193	CD3	.01116	CDCOR3	.01107
	MACH	.7811				CD4	.01068	CDCOR4	.01053
	ALPHA	-2.9938	DEG			CD5	.00993	CDCOR5	.00958

UPPER SURFACE				LOWER SURFACE				SPANWISE				
X/C	CP	P,L/PT	MLOC	X/C	CP	P,L/PT	MLOC	X/C	Y/(B/2)	CP	P,L/PT	MLOC
0.0000	.8927	.9235	.3393	0.0000	.8927	.9235	.3393	.1507	.7476	-.2301	.6039	.8818
.0132	.4964	.8107	.5561	.0126	-.3688	.5645	.9427	.1507	.4976	-.2483	.5988	.8890
.0259	.1706	.7180	.7051	.0255	-.3852	.5598	.9502	.1507	.2476	-.2477	.5989	.8887
.0759	-.1397	.6297	.8411	.0495	-.5005	.5270	1.0029	.1507	-.2524	-.2522	.5977	.8907
.1003	-.1810	.6179	.8593	.0753	-.5381	.5163	1.0204	.1507	-.5024	-.2576	.5963	.8929
.1507	-.2483	.5988	.8890	.1002	-.6163	.4940	1.0573	.1507	-.7524	-.2417	.6007	.8861
.2003	-.2923	.5861	.9085	.1503	-.5819	.5038	1.0410	.5002	.7476	-.4443	.5288	1.0001
.2503	-.3374	.5734	.9287	.1976	-.6523	.4826	1.0785	.5002	.4976	-.4489	.5275	1.0022
.3001	-.3765	.5614	.9477	.2503	-.7814	.4527	1.1281	.5002	.2476	-.4506	.5261	1.0043
.3502	-.3996	.5557	.9567	.3001	-.8470	.4284	1.1718	.5002	-.2524	-.4427	.5292	.9993
.4001	-.4288	.5474	.9700	.3507	-.9238	.4065	1.2119	.5002	-.5024	-.4400	.5300	.9980
.4501	-.4637	.5375	.9859	.4001	-.9823	.3899	1.2436	.5002	-.7524	-.4377	.5335	.9924
.5002	-.5007	.5269	1.0030	.4501	-.8520	.5038	1.0410	.8002	.7476	-1.0752	.3634	1.2959
.5502	-.5396	.5159	1.0211	.5001	-.3304	.5754	.9256	.8002	.4976	-.3832	.5604	.9493
.6002	-.5823	.5037	1.0411	.5497	-.2143	.6084	.8740	.8002	.2476	-.3858	.5596	.9505
.6500	-.6309	.4899	1.0643	.6003	-.0970	.6418	.8224	.8002	-.5024	-.3708	.5639	.9437
.7000	-.6113	.4954	1.0549	.6500	.0046	.6708	.7780	.8002	-.7524	-.3598	.5670	.9384
.7500	-.4785	.5333	.9928	.7000	.1181	.7031	.7282					
.8002	-.3700	.5616	.9474	.7501	.2162	.7310	.6949					
.8502	-.1743	.6198	.8564	.8001	.2971	.7540	.6486					
.9501	-.0438	.6570	.7991	.8501	.3698	.7735	.6174					

TEST 167	PT	31.5458	PSI	CM	.2322	CD1	.00953	CDCOR1	.00931
RUN 30	TT	125.0303	K	CM	-.1450	CD2	.00923	CDCOR2	.00918
POINT 28	RC	14.9700	MILLION	CC	.0196	CD3	.00892	CDCOR3	.00894
	MACH	.7802				CD4	.00863	CDCOR4	.00860
	ALPHA	-1.9958	DEG			CD5	.00885	CDCOR5	.00838

UPPER SURFACE				LOWER SURFACE				SPANWISE				
X/C	CP	P,L/PT	MLOC	X/C	CP	P,L/PT	MLOC	X/C	Y/(B/2)	CP	P,L/PT	MLOC
0.0000	1.0104	.9571	.2512	0.0000	1.0104	.9571	.2512	.1507	.7476	-.3506	.5700	.9341
.0132	.3311	.7639	.6329	.0126	-.1104	.6383	.8279	.1507	.4976	-.3736	.5634	.9445
.0259	-.0112	.6665	.7845	.0255	-.1825	.6178	.8595	.1507	.2476	-.3740	.5633	.9446
.0759	-.2959	.5856	.9096	.0495	-.3862	.5828	.9143	.1507	-.2524	-.3795	.5617	.9471
.1003	-.3770	.5781	.9213	.0753	-.3855	.5657	.9408	.1507	-.5024	-.3814	.5612	.9450
.1507	-.3747	.5633	.9448	.1002	-.4282	.5479	.9613	.1507	-.7524	-.3772	.5681	.9371
.2003	-.4062	.5547	.9588	.1503	-.4547	.5304	.9813	.5002	.7476	-.5776	.5094	1.0183
.2503	-.4430	.5437	.9759	.1976	-.5647	.5091	1.0322	.5002	.4976	-.5874	.5026	1.0429
.3001	-.4819	.5326	.9937	.2503	-.6520	.4842	1.0738	.5002	.2476	-.5936	.5009	1.0459
.3502	-.4884	.5308	.9967	.3001	-.7073	.4685	1.1006	.5002	-.2524	-.5837	.5037	1.0412
.4001	-.5116	.5242	1.0079	.3507	-.7335	.4611	1.1135	.5002	-.5024	-.5809	.5045	1.3399
.4501	-.5440	.5150	1.0226	.4001	-.5795	.5049	1.0382	.5002	-.7524	-.5846	.5091	1.0322
.5002	-.5898	.5019	1.0441	.4501	-.4498	.5418	.9780	.8002	.7476	-1.0775	.3632	1.2983
.5502	-.6170	.4942	1.0570	.5001	-.3517	.5697	.9346	.8002	.4976	-.3801	.5616	.9474
.6002	-.6478	.4834	1.0718	.5497	-.2222	.6065	.8770	.8002	.2476	-.3803	.5615	.9475
.6500	-.6940	.4723	1.0941	.6003	-.0940	.6430	.8207	.8002	-.5024	-.3757	.5626	.9454
.7000	-.6877	.4741	1.0911	.6500	.0110	.6728	.7748	.8002	-.7524	-.3706	.5643	.9431
.7500	-.4849	.5318	.9952	.7000	.1283	.7062	.7234					
.8002	-.3727	.5637	.9441	.7501	.2283	.7346	.6781					
.8502	-.1673	.6221	.8529	.8001	.3102	.7579	.6424					
.9501	-.0373	.6591	.7959	.8501	.3793	.7746	.6108					

TEST 167	PT 31.5460	PSI	CN	.3136	CD1	.00945	CDCOR1	.00923
RUN 30	TT 124.9855	K	CM	-.1482	CD2	.00930	CDCOR2	.00913
POINT 30	RC 14.9678	MILLION	CC	.0214	CD3	.00920	CDCOR3	.00912
	MACH .7793				CD4	.00898	CDCOR4	.00888
	ALPHA -1.4969	DEG			CD5	.00865	CDCOR5	.00842

UPPER SURFACE				LOWER SURFACE				SPANWISE				
X/C	CP	P/L/P/T	MLOC	X/C	CP	P/L/P/T	MLOC	X/C	Y/(B/2)	CP	P/L/P/T	MLOC
0.0000	1.0001	.9714	.2041	0.0000	1.0001	.9714	.2041	.1507	.7476	-.4189	.5315	.9635
.0132	.2357	.7373	.6749	.0126	.0139	.6744	.7724	.1507	.4976	-.4444	.5442	.9751
.0259	-.1113	.6388	.8271	.0255	-.0807	.6475	.8137	.1507	.2476	-.4441	.5437	.9759
.0739	-.3862	.5607	.9487	.0495	-.2148	.6094	.8725	.1507	-.2524	-.4520	.5420	.9786
.1003	-.44025	.5561	.9561	.0753	-.2803	.5908	.9014	.1507	-.5024	-.4531	.5418	.9791
.1507	-.4463	.5437	.9760	.1002	-.3488	.5713	.9320	.1507	-.7524	-.4263	.5403	.9869
.2003	-.4661	.5381	.9850	.1303	-.3910	.5594	.9509	.5002	.7476	-.0214	.4990	1.0374
.2503	-.5024	.5277	1.0017	.1976	-.5008	.5282	1.0010	.5002	.4976	-.0309	.4913	1.0619
.3001	-.5448	.5157	1.0214	.2503	-.5626	.5106	1.0297	.5002	.2476	-.4368	.4896	1.0648
.3532	-.5378	.5177	1.0191	.3001	-.6086	.4976	1.0514	.5002	-.2524	-.6276	.4922	1.0604
.4003	-.5554	.5127	1.0263	.3507	-.6025	.4993	1.0485	.5002	-.5024	-.6287	.4919	1.0509
.4501	-.5874	.5038	1.0413	.4001	-.6357	.5183	1.0171	.5002	-.7524	-.6135	.4916	1.0546
.5002	-.6324	.4908	1.0627	.4501	-.6399	.5455	.9731	.8002	.7476	-1.0766	.5647	1.2933
.5502	-.6682	.4804	1.0803	.5001	-.6407	.5737	.9283	.8002	.4976	-.3785	.5629	.9453
.6002	-.7027	.4709	1.0966	.5497	-.6103	.6103	.8711	.8002	.2476	-.3778	.5631	.9450
.6500	-.7403	.4602	1.1150	.6003	-.6048	.6463	.8156	.8002	-.5024	-.3761	.5636	.9442
.7000	-.7189	.4663	1.1045	.6500	.0184	.6756	.7705	.8002	-.7524	-.3737	.5643	.9431
.7500	-.4815	.5337	.9921	.7000	.1352	.7088	.7193					
.8002	-.3705	.5852	.9417	.7501	.2350	.7371	.6752					
.8500	-.1856	.6234	.8509	.8001	.1171	.7604	.6384					
.9501	-.0366	.6600	.7945	.8501	.3868	.7802	.6065					

TEST 167	PT 31.5470	PSI	CN	.3925	CD1	.00976	CDCOR1	.00946
RUN 30	TT 124.9373	K	CM	-.1508	CD2	.00961	CDCOR2	.00937
POINT 31	RC 14.9709	MILLION	CC	.0223	CD3	.00948	CDCOR3	.00932
	MACH .7787				CD4	.00921	CDCOR4	.00903
	ALPHA -1.9979	DEG			CD5	.00880	CDCOR5	.00851

UPPER SURFACE				LOWER SURFACE				SPANWISE				
X/C	CP	P/L/P/T	MLOC	X/C	CP	P/L/P/T	MLOC	X/C	Y/(B/2)	CP	P/L/P/T	MLOC
0.0000	1.0969	.9819	.1619	0.0000	1.0969	.9819	.1619	.1507	.7476	-.4940	.5302	.9977
.0132	.1373	.7094	.7183	.0126	.1322	.7080	.7270	.1507	.4976	-.5209	.5226	1.0101
.0259	-.2131	.6100	.8716	.0255	.0177	.6755	.7777	.1507	.2476	-.5235	.5218	1.0113
.0739	-.4893	.5327	.9917	.0495	-.1302	.6335	.8352	.1507	-.2524	-.5266	.5209	1.0129
.1003	-.4872	.5322	.9946	.0753	-.1972	.6145	.8646	.1507	-.5024	-.5238	.5218	1.0114
.1507	-.5228	.5220	1.0110	.1002	-.2723	.5932	.8978	.1507	-.7524	-.4909	.5211	.9962
.2003	-.5301	.5200	1.0143	.1503	-.3249	.5782	.9211	.5002	.7476	-.6355	.4848	1.0726
.2503	-.5593	.5117	1.0280	.1976	-.4280	.5487	.9679	.5002	.4976	-.6613	.4827	1.0763
.3001	-.6097	.4988	1.0493	.2503	-.4846	.5329	.9933	.5002	.2476	-.6635	.4821	1.0774
.3502	-.6188	.4948	1.0560	.3001	-.5218	.5223	1.0105	.5002	-.2524	-.6557	.4843	1.0736
.4003	-.6102	.4972	1.0519	.3507	-.5276	.5207	1.0132	.5002	-.5024	-.6698	.4832	1.0756
.4501	-.6120	.4967	1.0528	.4001	-.4849	.5328	.9935	.5002	-.7524	-.6541	.4848	1.0729
.5002	-.6387	.4835	1.0751	.4501	-.4149	.5527	.9615	.8002	.7476	-1.0601	.5695	1.2838
.5507	-.7039	.4708	1.0970	.5001	-.3216	.5792	.9196	.8002	.4976	-.3715	.5650	.9420
.6002	-.7453	.4599	1.1173	.5497	-.1962	.6148	.8642	.8002	.2476	-.3694	.5636	.9411
.6500	-.7844	.4478	1.1368	.6003	-.0726	.6499	.8101	.8002	-.5024	-.3719	.5649	.9422
.7000	-.7507	.4574	1.1200	.6500	.0282	.6785	.7661	.8002	-.7524	-.3708	.5652	.9417
.7500	-.4772	.5350	.9900	.7000	.1436	.7112	.7155					
.8002	-.3650	.5868	.9391	.7501	.2427	.7394	.6717					
.8500	-.1630	.6242	.8496	.8001	.3248	.7627	.6348					
.9501	-.0370	.6600	.7945	.8501	.3951	.7826	.6026					

TEST 167	PT 31.5447	PSI	CN	.4742	CD1	-.01038	CDCOR1	-.01013
RUN 30	TT 125.0146	K	CM	-.1533	CD2	.01010	CDCOR2	.01001
POINT 32	RC 14.9586	MILLION	CC	.0224	CD3	.01003	CDCOR3	.00993
	MACH .7790				CD4	.00962	CDCOR4	.00950
	ALPHA -1.788	DEG			CD5	.00921	CDCOR5	.00889

UPPER SURFACE				LOWER SURFACE				SPANWISE				
X/C	CP	P/L/P/T	MLOC	X/C	CP	P/L/P/T	MLOC	X/C	Y/(B/2)	CP	P/L/P/T	MLOC
0.0000	1.1300	.9916	.1102	0.0000	1.1300	.9916	.1102	.1507	.7476	-.3753	.5090	1.0324
.0132	.0361	.8820	.7607	.0126	.2445	.7410	.6692	.1507	.4976	-.6854	.5085	1.0465
.0259	-.3118	.7836	.9127	.0255	.1130	.7036	.7271	.1507	.2476	-.6891	.4994	1.0483
.0739	-.5903	.5822	1.0437	.0495	-.0492	.6576	.7978	.1507	-.2524	-.6887	.4995	1.0481
.1003	-.6081	.5848	1.0394	.0753	-.1169	.6387	.8272	.1507	-.5024	-.6824	.4913	1.0451
.1507	-.6081	.5883	1.0488	.1002	-.1970	.6161	.8622	.1507	-.7524	-.5804	.5132	1.0255
.2003	-.6233	.4954	1.0599	.1503	-.2584	.5987	.8892	.5002	.7476	-.7055	.4722	1.0944
.2503	-.6234	.4954	1.0598	.1976	-.3598	.5700	.9341	.5002	.4976	-.7166	.4690	1.0988
.3001	-.6478	.4885	1.0666	.2503	-.4161	.5541	.9594	.5002	.2476	-.7216	.4676	1.1022
.3532	-.6663	.4827	1.0764	.3001	-.4519	.5439	.9756	.5002	-.2524	-.7071	.4717	1.0951
.4003	-.6844	.4781	1.0892	.3507	-.4655	.5401	.9818	.5002	-.5024	-.7131	.4700	1.0981
.4501	-.6999	.4737	1.0917	.4001	-.4386	.5477	.9695	.5002	-.7524	-.7127	.4701	1.0979
.5002	-.7203	.4680	1.1016	.4501	-.3843	.5631	.9451	.8002	.7476	-1.0561	.5728	1.2768
.5502	-.7355	.4637	1.1098	.5001	-.2909	.5869	.9075	.8002	.4976	-.3669	.5680	.9373
.6002	-.7729	.4531	1.1275	.5497	-.1799	.6289	.8547	.8002	.2476	-.3633	.5690	.9357
.6500	-.8169	.4408	1.1493	.6003	-.0597	.6659	.8023	.8002	-.5024	-.3688	.5676	.9378
.7000	-.7635	.4501	1.1327	.6500	.0382	.6926	.7597	.8002	-.7524	-.3686	.5677	.9378
.7500	-.4715	.5384	.9845	.7000	.1524	.7149	.7096					
.8002	-.3575	.5786	.9331	.7501	.2518	.7428	.6663					
.8500	-.1570	.6271	.8451	.8001	.3333	.7661	.6293					
.9501	-.0334	.6623	.7989	.8501	.4043	.7862	.5968					

OF POOR QUALITY

TEST 167	PT 31.5682	PSI	CM	.9226	CD1 .01195	CDCOR1 .01153
RUN 30	TT 125.1773	K	CM	-.1606	CD2 .01196	CDCOR2 .01157
POINT 33	RC 14.9573	MILLION	CC	.0259	CD3 .01169	CDCOR3 .01139
	MACH .7805				CD4 .01114	CDCOR4 .01077
	ALPHA .0101	DEG			CD5 .01053	CDCOR5 .01008

UPPER SURFACE				LOWER SURFACE				SPANWISE				
X/C	CP	P/L/PT	MLOC	X/C	CP	P/L/PT	MLOC	X/C	Y/(R/2)	CP	P/L/PT	MLOC
0.0000	1.1484	.9967	.0692	0.0000	1.1484	.9967	.0692	.1507	.7476	-.6450	.4886	1.0044
.0132	-.0490	.6275	.7984	.0126	-.3397	.7476	.6270	.1507	.4976	-.1966	.4734	1.0041
.0259	-.4060	.5963	.9557	.0255	-.1930	.7240	.6921	.1507	.2476	-.7129	.4601	1.0096
.0759	-.6831	.4778	1.0866	.0495	-.0201	.6770	.7683	.1507	-.2524	-.7159	.4686	1.0094
.1003	-.7155	.4486	1.1004	.0753	-.0509	.6569	.7892	.1507	-.5024	-.6895	.4735	1.0021
.1507	-.0666	.6525	.8061	.1002	-.1345	.6332	.8356	.1507	-.7524	-.6290	.4931	1.0588
.2003	-.7025	.4723	1.0941	.1503	-.2035	.6137	.8659	.3002	.7476	-.7689	.4535	1.1267
.2503	-.7651	.4716	1.0953	.1976	-.3047	.5850	.9105	.3002	.4976	-.7912	.4472	1.1370
.3001	-.6967	.4734	1.0922	.2503	-.3630	.5685	.9364	.3002	.2476	-.7968	.4455	1.1406
.3502	-.7302	.4645	1.1074	.3001	-.4014	.5576	.9537	.3002	-.2524	-.7955	.4460	1.1400
.4003	-.7347	.4632	1.1098	.3507	-.4213	.5520	.9627	.3002	-.5024	-.7898	.4474	1.1371
.4501	-.7543	.4577	1.1195	.4001	-.4400	.5569	.9548	.3002	-.7524	-.7818	.4409	1.1331
.5002	-.7962	.4458	1.1403	.4501	-.3595	.5695	.9344	.8002	.7476	-1.0113	.3849	1.2533
.5502	-.8275	.4369	1.1561	.5001	-.2819	.5915	.9004	.8002	.4976	-.1303	.5720	.9309
.6002	-.8517	.4301	1.1685	.5497	-.1668	.6241	.8498	.8002	.2476	-.1460	.5728	.9297
.6500	-.8788	.4224	1.1825	.6003	-.0498	.6572	.7987	.8002	-.5024	-.1362	.5710	.9325
.7000	-.8505	.4304	1.1679	.6500	.0454	.6842	.7573	.8002	-.7524	-.1302	.5693	.9352
.7500	-.8610	.4307	.9107	.7000	-.1583	.7162	.7079					
.8002	-.3418	.5745	.9107	.7501	.2559	.7438	.6646					
.9002	-.1495	.8290	.8622	.8001	.3382	.7471	.6276					
.9501	-.0308	.6676	.7905	.8501	.4095	.7873	.5950					

TEST 167	PT 31.5525	PSI	CM	.8659	CD1 .01422	CDCOR1 .01378
RUN 30	TT 125.1553	K	CM	-.1679	CD2 .01415	CDCOR2 .01361
POINT 34	RC 14.9526	MILLION	CC	.0262	CD3 .01414	CDCOR3 .01373
	MACH .7804				CD4 .01312	CDCOR4 .01266
	ALPHA .5272	DEG			CD5 .01226	CDCOR5 .01176

UPPER SURFACE				LOWER SURFACE				SPANWISE				
X/C	CP	P/L/PT	MLOC	X/C	CP	P/L/PT	MLOC	X/C	Y/(R/2)	CP	P/L/PT	MLOC
0.0000	1.1477	.9996	.0241	0.0000	1.1597	.9996	.0241	.1507	.7476	-.7377	.4603	1.1149
.0132	-.1245	.6345	.8336	.0126	-.4241	.7905	.5898	.1507	.4976	-.8223	.4362	1.1579
.0259	-.4820	.5327	.9937	.0255	-.2652	.7453	.6623	.1507	.2476	-.8083	.4402	1.1533
.0759	-.7604	.4538	1.1262	.0495	-.0885	.6951	.7405	.1507	-.2524	-.8037	.4415	1.1480
.1003	-.7858	.4466	1.1389	.0753	-.0134	.6730	.7734	.1507	-.5024	-.8126	.4390	1.1525
.1507	-.0877	.6450	.8176	.1002	-.0743	.6488	.8117	.1507	-.7524	-.7251	.4639	1.1687
.2003	-.8024	.4419	1.1473	.1503	-.1495	.6274	.8444	.3002	.7476	-.8693	.4228	1.1817
.2503	-.8189	.4372	1.1557	.1976	-.2515	.5985	.8895	.3002	.4976	-.8635	.4247	1.1786
.3001	-.8464	.4294	1.1668	.2503	-.3133	.5809	.9170	.3002	.2476	-.8474	.4291	1.1703
.3502	-.8070	.4405	1.1497	.3001	-.3549	.5691	.9355	.3002	-.2524	-.8361	.4293	1.1645
.4003	-.7854	.4467	1.1388	.3507	-.3802	.5619	.9470	.3002	-.5024	-.8368	.4264	1.1752
.4501	-.8075	.4404	1.1499	.4001	-.3702	.5647	.9424	.3002	-.7524	-.8574	.4262	1.1755
.5002	-.8359	.4323	1.1644	.4501	-.3337	.5751	.9261	.8002	.7476	-.8647	.3957	1.2324
.5502	-.8729	.4218	1.1836	.5001	-.2626	.5953	.8944	.8002	.4976	-.1353	.5746	.9138
.6002	-.9231	.4075	1.2100	.5497	-.1517	.6268	.8456	.8002	.2476	-.1329	.5753	.9157
.6500	-.9801	.3913	1.2408	.6003	-.0377	.6592	.7957	.8002	-.5024	-.1344	.5749	.9264
.7000	-.9700	.3942	1.2352	.6500	.0551	.6856	.7551	.8002	-.7524	-.1459	.5716	.9315
.7500	-.8826	.5328	.9176	.7000	-.1667	.7173	.7061					
.8002	-.3294	.5763	.9241	.7501	.2636	.7449	.6617					
.9002	-.1367	.8311	.8390	.8001	.3456	.7682	.6260					
.9501	-.0274	.6622	.7912	.8501	.4173	.7886	.5930					

TEST 167	PT 31.6006	PSI	CM	.7212	CD1 .01856	CDCOR1 .01764
RUN 30	TT 125.2814	K	CM	-.1710	CD2 .01850	CDCOR2 .01765
POINT 35	RC 14.9660	MILLION	CC	.0231	CD3 .01806	CDCOR3 .01750
	MACH .7817				CD4 .01708	CDCOR4 .01628
	ALPHA 1.0285	DEG			CD5 .01581	CDCOR5 .01513

UPPER SURFACE				LOWER SURFACE				SPANWISE				
X/C	CP	P/L/PT	MLOC	X/C	CP	P/L/PT	MLOC	X/C	Y/(R/2)	CP	P/L/PT	MLOC
0.0000	1.1667	1.0015	0.0000	0.0000	1.1667	1.0016	0.0000	.1507	.7476	-.8265	.4350	1.1596
.0132	-.1977	.6137	.8658	.0126	-.5002	.8121	.5538	.1507	.4976	-.8093	.4343	1.1674
.0259	-.5572	.5115	1.0282	.0255	-.3330	.7646	.6317	.1507	.2476	-.8772	.4206	1.1850
.0759	-.8320	.4334	1.1624	.0495	-.1513	.7130	.7129	.1507	-.2524	-.8742	.4213	1.1842
.1003	-.8550	.4269	1.1743	.0753	-.0710	.6904	.7478	.1507	-.5024	-.8800	.4189	1.1925
.1507	-.8642	.4243	1.1790	.1002	-.0184	.6647	.7877	.1507	-.7524	-.8192	.4371	1.1559
.2003	-.8726	.4219	1.1834	.1503	-.0988	.6418	.8224	.3002	.7476	-.8645	.4013	1.2215
.2503	-.8926	.4162	1.1938	.1976	-.2015	.6127	.8674	.3002	.4976	-.8518	.3994	1.2254
.3001	-.9275	.4063	1.2123	.2503	-.2601	.5943	.8960	.3002	.2476	-.8280	.4061	1.2126
.3502	-.9348	.4042	1.2162	.3001	-.3109	.5816	.9159	.3002	-.2524	-.8078	.4121	1.2014
.4003	-.9478	.4017	1.1960	.3507	-.3496	.5734	.9287	.3002	-.5024	-.8506	.3999	1.2244
.4501	-.9716	.4222	1.1820	.4001	-.3362	.5744	.9272	.3002	-.7524	-.8161	.4095	1.2063
.5002	-.9105	.4111	1.2033	.4501	-.3079	.5824	.9145	.8002	.7476	-.8179	.4090	1.2072
.5502	-.9337	.4049	1.2157	.5001	-.2730	.6009	.8850	.8002	.4976	-.1297	.5762	.9263
.6002	-.9634	.3955	1.2327	.5497	-.1370	.6310	.8391	.8002	.2476	-.1314	.5757	.9250
.6500	-.1.0293	.3777	1.2674	.6003	-.0245	.6624	.7980	.8002	-.5024	-.1262	.5772	.9227
.7000	-.1.0407	.3741	1.2745	.6500	.0631	.6879	.7516	.8002	-.7524	-.1301	.5761	.9243
.7500	-.8484	.5308	.9197	.7000	-.1732	.7192	.7032					
.8002	-.3397	.5759	.9247	.7501	.2693	.7465	.6605					
.9002	-.1325	.8123	.8371	.8001	.3505	.7696	.6237					
.9501	-.0300	.6614	.7923	.8501	.4220	.7899	.5908					

TEST 167 PT 31.6071 PSI CN .7749
 RUN 30 TT 125.2383 K CM -.1719
 POINT 36 RC 14.9715 MILLION CC .0224
 MACH .7811
 ALPHA 1.5274 DEG

CD1 .02518 CDCOR1 .02437
 CD2 .02422 CDCOR2 .02345
 CD3 .02313 CDCOR3 .02228
 CD4 .02221 CDCOR4 .02110
 CD5 .02124 CDCOR5 .02029

UPPER SURFACE				LOWER SURFACE				SPANWISE				
X/C	CP	P/L/PT	MLOC	X/C	CP	P/L/PT	MLOC	X/C	Y/(B/2)	CP	P/L/PT	MLOC
0.0000	1.1613	1.0002	0.0000	0.0000	1.1613	1.0002	0.0000	.1507	.7476	-.9037	.4143	1.1973
.0132	-.2743	.5929	.8981	.0126	.55	.8279	.5267	.1507	.4976	-.9786	.3931	1.2374
.0259	-.6357	.4904	1.0634	.0255	.3796	.7784	.6094	.1507	.2476	-.9473	.4020	1.2205
.0759	-.9026	.4147	1.1967	.0495	.1939	.7257	.6930	.1507	-.2524	-.9430	.4032	1.2182
.1003	-.9249	.4083	1.2085	.0753	.1101	.7020	.7299	.1507	-.5024	-.9633	.3974	1.2291
.1507	-.9319	.4063	1.2123	.1002	.0183	.6759	.7700	.1507	-.7524	-.8905	.4181	1.1904
.2003	-.9392	.4043	1.2162	.1503	-.0669	.6518	.8072	.5002	.7476	-1.0082	.3847	1.2537
.2503	-.9605	.3982	1.2276	.1976	-.1709	.6222	.8526	.5002	.4976	-1.0183	.3818	1.2593
.3001	-.9984	.3875	.2482	.2503	-.2386	.6030	.8824	.5002	.2476	-1.0211	.3810	1.2608
.3502	-1.0135	.3832	1.2566	.3001	-.2859	.5896	.9033	.5002	-.2524	-.9907	.3897	1.2440
.4003	-1.0127	.3834	1.2562	.3507	.3181	.5805	.9176	.5002	-.5024	-1.0191	.3816	1.2597
.4501	-.9713	.3952	1.2334	.4001	-.3206	.5798	.9187	.5002	-.7524	-.9813	.3923	1.2389
.5002	-.9682	.3960	1.2318	.4501	-.2988	.5860	.9090	.8002	.7476	-.9392	.4043	1.2161
.5502	-.9980	.3876	1.2480	.5001	-.2402	.6026	.8831	.8002	.4976	-.9441	.3731	.9292
.6002	-1.0248	.3800	1.2629	.5497	-.1385	.6314	.8385	.8002	.2476	-.9442	.3731	.9292
.6500	-1.0739	.3661	1.2906	.6003	-.0307	.6620	.7915	.8002	-.5024	-.9417	.3738	.9281
.7000	-.8865	.4192	1.1883	.6500	.0565	.6867	.7534	.8002	-.7524	-.9353	.3756	.9253
.7500	-.4714	.5370	.9867	.7000	.1649	.7175	.7058					
.8002	-.3477	.5721	.9308	.7501	.2601	.7445	.6636					
.9002	-.1532	.6273	.8449	.8001	.3419	.7674	.6271					
.9501	-.0533	.6556	.8012	.8501	.4123	.7877	.5943					

TEST 167 PT 31.6060 PSI CM .8069
 RUN 30 TT 125.2217 K CM -.1705
 POINT 37 RC 14.9759 MILLION CC .0227
 MACH .7811
 ALPHA 2.0060 DEG

CD1 .03013 CDCOR1 .02923
 CD2 .03074 CDCOR2 .02984
 CD3 .02928 CDCOR3 .02824
 CD4 .02827 CDCOR4 .02698
 CD5 .02935 CDCOR5 .02848

UPPER SURFACE				LOWER SURFACE				SPANWISE				
X/C	CP	P/L/PT	MLOC	X/C	CP	P/L/PT	MLOC	X/C	Y/(B/2)	CP	P/L/PT	MLOC
0.0000	1.1641	1.0008	0.0000	0.0000	1.1641	1.0008	0.0000	.1507	.7476	-.9565	.3981	1.2279
.0132	-.3234	.5781	.9214	.0126	.6005	.8406	.5045	.1507	.4976	-1.0204	.3799	1.2630
.0259	-.6848	.4753	1.0989	.0255	.4214	.7897	.5910	.1507	.2476	-.9888	.3889	1.2455
.0759	-.9432	.4019	1.2207	.0495	.2326	.7361	.6768	.1507	-.2524	-.9839	.3903	1.2428
.1003	-.9675	.3950	1.2338	.0753	.1462	.7115	.7151	.1507	-.5024	-1.0050	.3843	1.2544
.1507	-.9738	.3932	1.2373	.1002	.0522	.6848	.7563	.1507	-.7524	-.9269	.4065	1.2119
.2003	-.9794	.3916	1.2403	.1503	-.0371	.6594	.7954	.5002	.7476	-1.0533	.3706	1.2515
.2503	-.9996	.3859	1.2514	.1976	-.1435	.6292	.8419	.5002	.4976	-1.0625	.3680	1.2667
.3001	-1.0376	.3750	1.2727	.2503	-.2146	.6090	.8732	.5002	.2476	-1.0694	.3660	1.2907
.3502	-1.0535	.3705	1.2816	.3001	-.2656	.5945	.8957	.5002	-.2524	-1.0429	.3735	1.2756
.4003	-1.0624	.3680	1.2867	.3507	-.3022	.5841	.9119	.5002	-.5024	-1.0460	.3727	1.2774
.4501	-1.0573	.3694	1.2838	.4001	-.3096	.5820	.9153	.5002	-.7524	-1.0265	.3782	1.2664
.5002	-1.0276	.3779	1.2670	.4501	-.2929	.5867	.9078	.8002	.7476	-.9710	.3940	1.2357
.5502	-1.0457	.3727	1.2772	.5001	-.2382	.6023	.8836	.8002	.4976	-.9603	.3675	.9380
.6002	-1.0740	.3647	1.2933	.5497	-.1391	.6304	.8400	.8002	.2476	-.9553	.3696	.9348
.6500	-1.0992	.3575	1.3079	.6003	-.0333	.6605	.7937	.8002	-.5024	-.9589	.3680	.9373
.7000	-.6193	.4939	1.0574	.6500	.0522	.6848	.7563	.8002	-.7524	-.9413	.3730	.9294
.7500	-.4399	.5449	.9740	.7000	.1599	.7154	.7091					
.8002	-.3484	.5709	.9326	.7501	.2542	.7422	.6672					
.9002	-.1872	.6148	.8611	.8001	.3347	.7651	.6309					
.9501	-.1085	.6391	.8266	.8501	.4061	.7854	.5981					

TEST 167 PT 31.6036 PSI CM .8481
 RUN 30 TT 125.2481 K CM -.1707
 POINT 38 RC 14.9720 MILLION CC .0225
 MACH .7814
 ALPHA 2.5132 DEG

CD1 .03172 CDCOR1 .03078
 CD2 .03371 CDCOR2 .03199
 CD3 .03764 CDCOR3 .03642
 CD4 .03998 CDCOR4 .03884
 CD5 .03808 CDCOR5 .03691

UPPER SURFACE				LOWER SURFACE				SPANWISE				
X/C	CP	P/L/PT	MLOC	X/C	CP	P/L/PT	MLOC	X/C	Y/(B/2)	CP	P/L/PT	MLOC
0.0000	1.1519	.9972	.0630	0.0000	1.1519	.9972	.0630	.1507	.7476	-1.0252	.3772	1.2684
.0132	-.3876	.5588	.9518	.0126	.6502	.8543	.4799	.1507	.4976	-1.0751	.3630	1.2968
.0259	-.7502	.4555	1.1232	.0255	.4654	.8017	.5712	.1507	.2476	-1.0423	.3723	1.2780
.0759	-.9994	.3845	1.2539	.0495	.2766	.7480	.6582	.1507	-.2524	-1.0365	.3740	1.2743
.1003	-1.0231	.3778	1.2672	.0753	.1873	.7225	.6980	.1507	-.5024	-1.0597	.3674	1.2879
.1507	-1.0300	.3758	1.2711	.1002	.0865	.6938	.7425	.1507	-.7524	-.9739	.3918	1.2399
.2003	-1.0324	.3752	1.2724	.1503	-.0054	.6676	.7828	.5002	.7476	-1.1044	.3564	1.3139
.2503	-1.0495	.3703	1.2821	.1976	-.1110	.6376	.8290	.5002	.4976	-1.1111	.3527	1.3178
.3001	-1.0860	.3599	1.3031	.2503	-.1837	.6169	.8609	.5002	.2476	-1.1194	.3504	1.3227
.3502	-1.1069	.3539	1.3154	.3001	-.2374	.6016	.8847	.5002	-.2524	-1.0962	.3570	1.3091
.4003	-1.1189	.3505	1.3224	.3507	-.2784	.5899	.9029	.5002	-.5024	-1.0787	.3620	1.2989
.4501	-1.1345	.3461	1.3317	.4001	-.2897	.5867	.9079	.5002	-.7524	-1.0778	.3622	1.2983
.5002	-1.1258	.3485	1.3266	.4501	-.2777	.5901	.9026	.8002	.7476	-.9861	.3883	1.2466
.5502	-1.1065	.3540	1.3151	.5001	-.2287	.6040	.8808	.8002	.4976	-.9832	.3595	.9508
.6002	-1.1308	.3471	1.3295	.5497	-.1347	.6308	.8394	.8002	.2476	-.9796	.3611	.9482
.6500	-.8230	.4348	1.1600	.6003	-.0330	.6598	.7948	.8002	-.5024	-.9695	.3638	.9439
.7000	-.5280	.5188	1.0163	.6500	.0514	.6838	.7579	.8002	-.7524	-.9480	.3700	.9340
.7500	-.4381	.5444	.9748	.7000	.1571	.7139	.7114					
.8002	-.3635	.5656	.9410	.7501	.2496	.7403	.6703					
.9002	-.2225	.6058	.8781	.8001	.3296	.7630	.6342					
.9501	-.1779	.6185	.8584	.8501	.4009	.7833	.6015					

TEST 167	PT	57.3967	PSI	CN	-0.0874	CD1	.01553	CDCOR1	.01538
RUN 31	TT	117.1481	K	CM	-.1297	CD2	.01474	CDCOR2	.01466
POINT 39	RC	29.9588	MILLION	CC	.0107	CD3	.01390	CDCOR3	.01394
	MACH	.7804				CD4	.01303	CDCOR4	.01295
	ALPHA	-3.9815	DEG			CD5	.01153	CDCOR5	.01122

UPPER SURFACE				LOWER SURFACE				SPANWISE				
X/C	CP	P _L /PT	MLOC	X/C	CP	P _L /PT	MLOC	X/C	Y/(B/2)	CP	P _L /PT	MLOC
0.0000	.7450	.8817	.4284	0.0000	.7450	.8817	.4286	.1507	.7476	-.1220	.6356	.8332
.0132	.6384	.9515	.4857	.0126	-.5916	.5022	1.0449	.1507	.4976	-.1366	.6314	.8395
.0259	.3314	.7643	.6330	.0255	-.5560	.9123	1.0282	.1507	.2476	-.1318	.6328	.8375
.0759	-.0015	.6698	.7805	.0495	-.7063	.4697	1.1000	.1507	-.2524	-.1397	.6305	.8409
.1003	-.0556	.6544	.8041	.0753	-.7425	.4594	1.1179	.1507	-.5024	-.1462	.6287	.8438
.1507	-.1335	.6323	.8382	.1002	-.7819	.4482	1.1375	.1507	-.7524	-.1386	.6308	.8468
.2003	-.1874	.6170	.8619	.1503	-.7867	.4468	1.1399	.5002	.7476	-.4204	.5508	.9658
.2503	-.2379	.6026	.8841	.1976	-.8315	.4341	1.1626	.5002	.4976	-.4243	.5497	.9675
.3001	-.2866	.5888	.9057	.2503	-.8844	.4191	1.1900	.5002	.2476	-.4288	.5484	.9696
.3502	-.3143	.5809	.9181	.3001	-.9353	.4046	1.2169	.5002	-.2524	-.4184	.5514	.9649
.4003	-.3471	.5717	.9327	.3507	-.9912	.3887	1.2473	.5002	-.5024	-.4160	.5521	.9638
.4501	-.3789	.5626	.9470	.4001	-1.0514	.3716	1.2808	.5002	-.7524	-.4032	.5557	.9580
.5002	-.4257	.5493	.9682	.4501	-1.0903	.3606	1.3031	.8002	.7476	-1.0580	.3704	1.2834
.5502	-.4696	.5369	.9882	.5007	-.4184	.3514	.9648	.8002	.4976	-.3800	.5623	.9475
.6002	-.5147	.5240	1.0090	.5497	-.2438	.6010	.8867	.8002	.2476	-.3837	.5612	.9492
.6500	-.5602	.5111	1.0302	.6003	-.1082	.6395	.8271	.8002	-.5024	-.3524	.5701	.9351
.7000	-.5498	.5141	1.0253	.6500	-.0038	.6691	.7815	.8002	-.7524	-.3482	.5713	.9332
.7500	-.4683	.5372	.9876	.7000	.1069	.7006	.7330					
.8002	-.3776	.5630	.9464	.7501	.2004	.7271	.6918					
.9002	-.1851	.6176	.8609	.8001	.2793	.7495	.6565					
.9501	-.0577	.6538	.8050	.8501	.3459	.7684	.6264					

TEST 167	PT	57.3811	PSI	CN	.0819	CD1	.01172	CDCOR1	.01163
RUN 31	TT	117.1545	K	CM	-.1438	CD2	.01130	CDCOR2	.01127
POINT 40	RC	30.0365	MILLION	CC	.0167	CD3	.01077	CDCOR3	.01083
	MACH	.7844				CD4	.01029	CDCOR4	.01023
	ALPHA	-2.9947	DEG			CD5	.00960	CDCOR5	.00936

UPPER SURFACE				LOWER SURFACE				SPANWISE				
X/C	CP	P _L /PT	MLOC	X/C	CP	P _L /PT	MLOC	X/C	Y/(B/2)	CP	P _L /PT	MLOC
0.0000	.8800	.9191	.3498	0.0000	.8800	.9191	.3498	.1507	.7476	-.2303	.6019	.8853
.0132	.5060	.8123	.5543	.0126	-.3528	.5669	.9402	.1507	.4976	-.2462	.5974	.8923
.0259	.1817	.7196	.7034	.0255	-.3847	.5578	.9545	.1507	.2476	-.2422	.5985	.8906
.0759	-.1359	.6289	.8435	.0495	-.4988	.5252	1.0071	.1507	-.2524	-.2311	.5960	.8945
.1003	-.1775	.6170	.8618	.0753	-.5301	.5163	1.0218	.1507	-.5024	-.2568	.5943	.8971
.1507	-.2442	.5979	.8915	.1002	-.6111	.4931	1.0601	.1507	-.7524	-.2455	.5976	.8920
.2003	-.2873	.5856	.9107	.1503	-.5879	.4997	1.0491	.5002	.7476	-.5025	.5242	1.0088
.2503	-.3341	.5723	.9317	.1976	-.6432	.4840	1.0756	.5002	.4976	-.5054	.5223	1.0102
.3001	-.3801	.5591	.9526	.2503	-.7493	.4536	1.1279	.5002	.2476	-.5099	.5230	1.0123
.3502	-.3999	.5535	.9615	.3001	-.8376	.4284	1.1729	.5002	-.2524	-.4996	.5250	1.0075
.4003	-.4291	.5451	.9749	.3507	-.9191	.4051	1.2159	.5002	-.5074	-.4978	.5255	1.0067
.4501	-.4620	.5357	.9901	.4001	-.9784	.3882	1.2483	.5002	-.7524	-.4860	.5294	1.0002
.5002	-.5073	.5228	1.0111	.4501	-.7612	.4503	1.1338	.8002	.7476	-1.0922	.3557	1.3132
.5502	-.5492	.5108	1.0307	.5001	-.3151	.5777	.9232	.8002	.4976	-.3827	.5584	.9537
.6002	-.5935	.4982	1.0517	.5497	-.1961	.6117	.8701	.8002	.2476	-.3823	.5585	.9536
.6500	-.6533	.4811	1.0805	.6003	-.0829	.6440	.8201	.8002	-.5024	-.3606	.5547	.9437
.7000	-.6780	.4740	1.0926	.6500	.0110	.6708	.7788	.8002	-.7524	-.3627	.5641	.9446
.7500	-.4958	.5260	1.0057	.7000	.1281	.7043	.7272					
.8002	-.3752	.5605	.9503	.7501	.2275	.7327	.6830					
.9002	-.1807	.6161	.8633	.8001	.3104	.7554	.6456					
.9501	-.0518	.6529	.8064	.8501	.3810	.7766	.6133					

TEST 167	PT	57.3830	PSI	CN	.2505	CD1	.00866	CDCOR1	.00854
RUN 31	TT	117.1772	K	CM	-.1523	CD2	.00850	CDCOR2	.00844
POINT 41	RC	29.9226	MILLION	CC	.0208	CD3	.00836	CDCOR3	.00838
	MACH	.7796				CD4	.00824	CDCOR4	.00821
	ALPHA	-1.9865	DEG			CD5	.00802	CDCOR5	.00785

UPPER SURFACE				LOWER SURFACE				SPANWISE				
X/C	CP	P _L /PT	MLOC	X/C	CP	P _L /PT	MLOC	X/C	Y/(B/2)	CP	P _L /PT	MLOC
0.0000	1.0052	.9557	.2557	0.0000	1.0052	.9557	.2557	.1507	.7476	-.3587	.5685	.9377
.0132	.3408	.7671	.6286	.0126	-.0997	.6420	.8233	.1507	.4976	-.3784	.5629	.9466
.0259	-.0011	.6700	.7802	.0255	-.1826	.6185	.8596	.1507	.2476	-.3752	.5638	.9451
.0759	-.2979	.5857	.9106	.0495	-.3059	.5835	.9141	.1507	-.2524	-.3830	.5616	.9487
.1003	-.3240	.5783	.9222	.0753	-.3603	.5680	.9384	.1507	-.5024	-.3865	.5606	.9502
.1507	-.3756	.5637	.9453	.1002	-.4256	.5495	.9680	.1507	-.7524	-.3701	.5652	.9428
.2003	-.4036	.5557	.9580	.1503	-.4508	.5423	.9794	.5002	.7476	-.5902	.5027	1.0441
.2503	-.4447	.5440	.9766	.1976	-.5602	.5113	1.0300	.5002	.4976	-.5989	.5003	1.0482
.3001	-.4879	.5318	.9964	.2503	-.6469	.4867	1.0710	.5002	.2476	-.6036	.4989	1.0504
.3502	-.4938	.5301	.9992	.3001	-.7010	.4713	1.0973	.5002	-.2524	-.5945	.5015	1.0461
.4003	-.5158	.5239	1.0093	.3507	-.7239	.4646	1.1084	.5002	-.5024	-.5946	.5015	1.0462
.4501	-.5445	.5157	1.0226	.4001	-.5684	.5089	1.0338	.5002	-.7524	-.5763	.5067	1.0375
.5002	-.5999	.5000	1.0487	.4501	-.4449	.5440	.9767	.8002	.7476	-1.0918	.3603	1.3037
.5502	-.6376	.4893	1.0666	.5001	-.3451	.5723	.9316	.8002	.4976	-.3819	.5619	.9482
.6002	-.6662	.4812	1.0803	.5497	-.2100	.6090	.8743	.8002	.2476	-.3797	.5625	.9472
.6500	-.7159	.4671	1.1045	.6003	-.0868	.6457	.8176	.8002	-.5024	-.3674	.5660	.9416
.7000	-.7474	.4581	1.1200	.6500	.0124	.6738	.7743	.8002	-.7524	-.3762	.5635	.9456
.7500	-.5075	.5262	1.0055	.7000	.1362	.7090	.7200					
.8002	-.3726	.5645	.9441	.7501	.2393	.7382	.6743					
.9002	-.1781	.6197	.8576	.8001	.3243	.7624	.6361					
.9501	-.0480	.6567	.8006	.8501	.3962	.7828	.6031					

ORIGINAL PAGE IS
OF POOR QUALITY

TEST	167	PT	57.3736	PSI	CN	.3286	CD1	.00886	CDCOR1	.00857
RUN	31	TT	117.2064	K	CM	-1.1555	CD2	.00872	CDCOR2	.00846
POINT	42	RC	29.9028	MILLION	CC	.0229	CD3	.00857	CDCOR3	.00845
		MACH	.7795				CD4	.00840	CDCOR4	.00829
		ALPHA	-1.4969	DEG			CD5	.00812	CDCOR5	.00785

UPPER SURFACE				LOWER SURFACE				SPANWISE				
X/C	CP	P/L/PT	MLOC	X/C	CP	P/L/PT	MLOC	X/C	Y/(B/2)	CP	P/L/PT	MLOC
0.0000	1.0578	.9705	.2076	0.0000	1.0578	.9705	.2076	.1507	.7476	-.4243	.5492	.9683
.0132	.2547	.7422	.6680	.0126	.0223	.6762	.7706	.1507	.4976	-.4479	.5425	.9790
.0259	-.0961	.6425	.8224	.0255	-.0811	.6488	.8138	.1507	.2476	-.4459	.5431	.9781
.0759	-.3849	.5604	.9504	.0495	-.2157	.6085	.8750	.1507	-.2524	-.4548	.5406	.9822
.1003	-.4016	.5557	.9580	.0753	-.2788	.5906	.9029	.1507	-.5024	-.4560	.5402	.9828
.1507	-.4458	.5431	.9781	.1002	-.3480	.5709	.9338	.1507	-.7524	-.4360	.5459	.9736
.2003	-.4600	.5391	.9846	.1503	-.3897	.5591	.9526	.5002	.7476	-.6327	.4900	1.0654
.2503	-.5018	.5277	1.0038	.1976	-.5003	.5276	1.0031	.5002	.4976	-.6418	.4874	1.0697
.3001	-.5527	.5128	1.0275	.2503	-.5653	.5092	1.0334	.5002	.2476	-.6474	.4858	1.0724
.3502	-.5484	.5140	1.0255	.3001	-.6098	.4965	1.0544	.5002	-.2524	-.6392	.4881	1.0685
.4003	-.5487	.5139	1.0256	.3507	-.6089	.4968	1.0540	.5002	-.5024	-.6404	.4878	1.0691
.4501	-.5846	.5037	1.0425	.4001	-.5337	.5181	1.0186	.5002	-.7524	-.6259	.4919	1.0621
.5002	-.6415	.4875	1.0696	.4501	-.4365	.5458	.9738	.8002	.7476	-1.0674	.3665	1.2912
.55	-.6835	.4756	1.0899	.5001	-.3360	.5743	.9284	.8002	.4976	-.3656	.5659	.9417
.60	-.7230	.4643	1.1092	.5497	-.2072	.6109	.8712	.8002	.2476	-.3606	.5673	.9395
.6500	-.7741	.4498	1.1346	.6003	-.0795	.6472	.8151	.8002	-.5024	-.3611	.5672	.9397
.7000	-.8131	.4387	1.1543	.6500	.0178	.6749	.7726	.8002	-.7524	-.3766	.5628	.9467
.7500	-.8547	.5142	1.0252	.7000	.1409	.7099	.7186					
.8002	-.3536	.5693	.9363	.7501	.2437	.7391	.6729					
.8002	-.1690	.6218	.8544	.8001	.3288	.7633	.6346					
.9501	-.0414	.6581	.7985	.8501	.4010	.7838	.6014					

TEST	167	PT	57.3670	PSI	CN	.4151	CD1	.00937	CDCOR1	.00903
RUN	31	TT	117.725	K	CM	-1.1586	CD2	.00921	CDCOR2	.00886
POINT	43	RC	29.9112	MILLION	CC	.0237	CD3	.00909	CDCOR3	.00882
		MACH	.7794				CD4	.00879	CDCOR4	.00852
		ALPHA	-.9889	DEG			CD5	.00839	CDCOR5	.00810

UPPER SURFACE				LOWER SURFACE				SPANWISE				
X/C	CP	P/L/PT	MLOC	X/C	CP	P/L/PT	MLOC	X/C	Y/(B/2)	CP	P/L/PT	MLOC
0.0000	1.0986	.9825	.1591	0.0000	1.0986	.9825	.1591	.1507	.7476	-.5078	.5283	1.0021
.0132	.1424	.7121	.7151	.0126	.1424	.7122	.7150	.1507	.4976	-.5307	.5218	1.0127
.0259	-.2152	.6110	.8711	.0255	-.0211	.6778	.7681	.1507	.2476	-.5307	.5218	1.0127
.0759	-.44954	.5318	.9964	.0495	-.1221	.6373	.8304	.1507	-.2524	-.5369	.5200	1.0156
.1003	-.4962	.5315	.9968	.0753	-.1926	.6174	.8612	.1507	-.5024	-.5356	.5204	1.0149
.1507	-.5305	.5218	1.0126	.1002	-.2698	.5956	.8952	.1507	-.7524	-.5107	.5275	1.0035
.2003	-.5329	.5212	1.0137	.1503	-.3212	.5810	.9179	.5002	.7476	-.6682	.4829	1.0774
.2503	-.5639	.5124	1.0281	.1976	-.4244	.5518	.9641	.5002	.4976	-.6755	.4808	1.0809
.3001	-.6134	.4984	1.0513	.2503	-.4784	.5366	.9887	.5002	.2476	-.6743	.4812	1.0803
.3502	-.6204	.4936	1.0593	.3001	-.5141	.5265	1.0050	.5002	-.2524	-.6664	.4834	1.0765
.4003	-.6295	.4939	1.0589	.3507	-.5177	.5255	1.0067	.5002	-.5024	-.6735	.4814	1.0799
.4501	-.6229	.4957	1.0598	.4001	-.4759	.5373	.9875	.5002	-.7524	-.6649	.4838	1.0758
.5002	-.6660	.4835	1.0763	.4501	-.4098	.5560	.9575	.8002	.7476	-1.0717	.3688	1.2865
.5502	-.7133	.4702	1.0992	.5001	-.3172	.5822	.9161	.8002	.4976	-.3693	.5674	.9393
.6002	-.7587	.4573	1.1215	.5497	-.1921	.6175	.8610	.8002	.2476	-.3651	.5686	.9374
.6500	-.8110	.4425	1.1475	.6003	-.0675	.6528	.8066	.8002	-.5024	-.3626	.5693	.9364
.7000	-.8354	.4356	1.1599	.6500	.0275	.6796	.7653	.8002	-.7524	-.3777	.5651	.9431
.7500	-.8550	.5206	1.0147	.7000	.1495	.7141	.7120					
.8002	-.3608	.5698	.9355	.7501	.2514	.7430	.6669					
.8002	-.1732	.6229	.8527	.8001	.3366	.7671	.6286					
.9501	-.0477	.6584	.7980	.8501	.4097	.7877	.5950					

TEST	167	PT	57.3713	PSI	CN	.4956	CD1	.01055	CDCOR1	.01019
RUN	31	TT	117.1170	K	CM	-1.1620	CD2	.01036	CDCOR2	.01001
POINT	44	RC	29.9569	MILLION	CC	.0242	CD3	.01017	CDCOR3	.00997
		MACH	.7804				CD4	.00972	CDCOR4	.00948
		ALPHA	-.4888	DEG			CD5	.00926	CDCOR5	.00893

UPPER SURFACE				LOWER SURFACE				SPANWISE				
X/C	CP	P/L/PT	MLOC	X/C	CP	P/L/PT	MLOC	X/C	Y/(B/2)	CP	P/L/PT	MLOC
0.0000	1.1297	.9912	.1127	0.0000	1.1297	.9912	.1127	.1507	.7476	-.5773	.5077	1.0359
.0132	-.0568	.6873	.7535	.0126	.2504	.7421	.6682	.1507	.4976	-.6047	.4999	1.0488
.0259	-.3075	.5841	.9131	.0255	.1151	.7038	.7280	.1507	.2476	-.6022	.5006	1.0476
.0759	-.5966	.5022	1.0450	.0495	-.0391	.6601	.7954	.1507	-.2524	-.6048	.4999	1.0489
.1003	-.5489	.5015	1.0461	.0753	-.1176	.6379	.8296	.1507	-.5024	-.6035	.5002	1.0483
.1507	-.6006	.5011	1.0469	.1002	-.1980	.6151	.8648	.1507	-.7524	-.5728	.5089	1.0338
.2003	-.6210	.4953	1.0566	.1503	-.2589	.5978	.8916	.5002	.7476	-.7233	.4663	1.1058
.2503	-.6310	.4975	1.0613	.1976	-.3615	.5688	.9372	.5002	.4976	-.7352	.4629	1.1117
.3001	-.6526	.4863	1.0716	.2503	-.4180	.5528	.9627	.5002	.2476	-.7450	.4602	1.1165
.3502	-.6663	.4825	1.0782	.3001	-.4548	.5424	.9794	.5002	-.2524	-.7297	.4645	1.1090
.4003	-.6829	.4778	1.0862	.3507	-.4667	.5390	.9848	.5002	-.5024	-.7318	.4639	1.1100
.4501	-.7027	.4721	1.0958	.4001	-.4375	.5473	.9715	.5002	-.7524	-.7261	.4655	1.1072
.5002	-.7450	.4602	1.1165	.4501	-.3841	.5624	.9474	.8002	.7476	-1.0235	.3813	1.2618
.5502	-.7668	.4546	1.1273	.5001	-.2977	.5869	.9088	.8002	.4976	-.3498	.5721	.9320
.6002	-.7922	.4488	1.1400	.5497	-.1766	.6212	.8554	.8002	.2476	-.3472	.5728	.9308
.6500	-.8510	.4301	1.1698	.6003	-.0547	.6537	.8022	.8002	-.5024	-.3455	.5733	.9301
.7000	-.8908	.4189	1.1904	.6500	.0374	.6818	.7620	.8002	-.7524	-.3651	.5678	.9389
.7500	-.9307	.5067	1.0375	.7000	.1583	.7160	.7090					
.8002	-.3427	.5743	.9286	.7501	.2597	.7447	.6641					
.8002	-.1569	.6267	.8468	.8001	.3446	.7688	.6258					
.9501	-.0359	.6610	.7940	.8501	.4181	.7896	.5920					

TEST 167	PT	57.3822	PSI	CN	.9717	CD1	.01234	CDCOR1	.01195
RUN 31	TT	117.0629	K	CM	-.1648	CD2	.01241	CDCOR2	.01203
POINT 45	RC	30.0026	MILLION	CC	.0238	CD3	.01209	CDCOR3	.01183
	MACH	.7813				CD4	.01140	CDCOR4	.01108
	ALPHA	.0102	DEG			CD5	.01086	CDCOR5	.01040

UPPER SURFACE				LOWER SURFACE				SPANWISE				
X/C	CP	P _o L/PT	MLOC	X/C	CP	P _o L/PT	MLOC	X/C	Y/(B/2)	CP	P _o L/PT	MLOC
0.0000	1.1439	.9953	.0824	0.0000	1.1439	.9953	.0824	.1507	.7476	-.6540	.4863	1.0717
.0132	-.0394	.6602	.7951	.0126	.3421	.7683	.6266	.1507	.4976	-.7064	.4714	1.0970
.0259	-.4077	.5560	.9575	.0255	.1943	.7264	.6928	.1507	.2476	-.7161	.4686	1.1018
.0759	-.6837	.4778	1.0860	.0495	-.0324	.6806	.7638	.1507	-.2524	-.7177	.4662	1.1025
.1003	-.7172	.4684	1.1023	.0753	-.0518	.6567	.8006	.1507	-.5024	-.7068	.4713	1.0972
.1507	-.7072	.4712	1.0974	.1002	-.1361	.6329	.8373	.1507	-.7524	-.6472	.4882	1.0685
.2003	-.7057	.4716	1.0967	.1503	-.2035	.6138	.8668	.5002	.7476	-.7825	.4499	1.1345
.2503	-.7094	.4706	1.0985	.1976	-.3039	.5854	.9111	.5002	.4976	-.8014	.4445	1.1440
.3001	-.7053	.4717	1.0965	.2503	-.3616	.5690	.9368	.5002	.2476	-.8048	.4435	1.1457
.3502	-.7321	.4641	1.1096	.3001	-.3999	.5582	.9540	.5002	-.2524	-.8016	.4444	1.1441
.4003	-.7372	.4627	1.1121	.3507	-.4181	.5530	.9622	.5002	-.5024	-.7959	.4461	1.1412
.4501	-.7490	.4593	1.1179	.4001	-.3990	.5584	.9536	.5002	-.7524	-.7815	.4501	1.1340
.5002	-.8021	.4443	1.1444	.4501	-.3572	.5703	.9349	.8002	.7476	-.9979	.3889	1.2470
.5502	-.8397	.4337	1.1634	.5001	-.2787	.5925	.9000	.8002	.4976	-.9438	.5741	.9289
.6002	-.8686	.4255	1.1783	.5497	-.1637	.6251	.8494	.8002	.2476	-.9424	.5745	.9282
.6500	-.8991	.4168	1.1941	.6003	-.0457	.6585	.7979	.8002	-.5024	-.9368	.5760	.9258
.7000	-.9344	.4069	1.2127	.6500	.0436	.6838	.7590	.8002	-.7524	-.9373	.5703	.9349
.7500	-.9518	.3952	1.2235	.7000	.1627	.7175	.7068					
.8002	-.9390	.3757	1.2263	.7501	.2629	.7458	.6624					
.9002	-.1536	.5279	.8450	.8001	.3474	.7698	.6242					
.9501	-.0366	.6611	.7939	.8501	.4207	.7905	.5905					

TEST 167	PT	57.3905	PSI	CN	.6598	CD1	.01490	CDCOR1	.01444
RUN 31	TT	117.5011	K	CM	-.1694	CD2	.01475	CDCOR2	.01435
POINT 46	RC	29.8175	MILLION	CC	.0233	CD3	.01487	CDCOR3	.01466
	MACH	.7802				CD4	.01383	CDCOR4	.01353
	ALPHA	.9100	DEG			CD5	.01294	CDCOR5	.01246

UPPER SURFACE				LOWER SURFACE				SPANWISE				
X/C	CP	P _o L/PT	MLOC	X/C	CP	P _o L/PT	MLOC	X/C	Y/(B/2)	CP	P _o L/PT	MLOC
0.0000	1.1641	1.0014	0.0000	0.0000	1.1641	1.0014	0.0000	.1507	.7476	-.7491	.4627	1.1120
.0132	-.1753	.6384	.8288	.0126	.4377	.7969	.5800	.1507	.4976	-.8306	.4398	1.1524
.0259	-.4964	.5339	.9930	.0255	.2790	.7522	.6523	.1507	.2476	-.8159	.4439	1.1451
.0759	-.7733	.4559	1.1239	.0495	.1104	.7047	.7266	.1507	-.2524	-.8143	.4443	1.1443
.1003	-.7965	.4494	1.1354	.0753	.0199	.6792	.7659	.1507	-.5024	-.8249	.4414	1.1496
.1507	-.8034	.4474	1.1388	.1002	-.0677	.6546	.8039	.1507	-.7524	-.7552	.4610	1.1150
.2003	-.8027	.4476	1.1385	.1503	-.1413	.6339	.8358	.5002	.7476	-.8752	.4272	1.1751
.2503	-.8208	.4425	1.1475	.1976	-.2416	.6056	.8795	.5002	.4976	-.8711	.4284	1.1730
.3001	-.8512	.4339	1.1629	.2503	-.3017	.5887	.9059	.5002	.2476	-.8492	.4345	1.1619
.3502	-.8190	.4430	1.1466	.3001	-.3419	.5773	.9237	.5002	-.2524	-.8373	.4379	1.1559
.4003	-.7879	.4518	1.1311	.3507	-.3648	.5709	.9338	.5002	-.5024	-.8586	.4319	1.1666
.4501	-.8012	.4480	1.1377	.4001	-.3939	.5740	.9290	.5002	-.7524	-.8503	.4342	1.1624
.5002	-.8374	.4378	1.1559	.4501	-.3216	.5831	.9147	.8002	.7476	-.9768	.3966	1.2283
.5502	-.8750	.4272	1.1750	.5001	-.2911	.6029	.8837	.8002	.4976	-.9364	.5789	.9212
.6002	-.9237	.4135	1.2002	.5497	-.1415	.6338	.8359	.8002	.2476	-.9330	.5799	.9197
.6500	-.9413	.3973	1.2307	.6003	-.0272	.6660	.7863	.8002	-.5024	-.9255	.5820	.9164
.7000	-.9921	.3943	1.2365	.6500	.0591	.6903	.7489	.8002	-.7524	-.9448	.5765	.9250
.7500	-.9287	.5248	1.0078	.7000	.1764	.7233	.6977					
.8002	-.9300	.5807	.9184	.7501	.2757	.7512	.6538					
.9002	-.1396	.6343	.8351	.8001	.3599	.7750	.6159					
.9501	-.0266	.6661	.7860	.8501	.4334	.7957	.5820					

TEST 167	PT	49.5811	PSI	CN	.7254	CD1	.01935	CDCOR1	.01850
RUN 31	TT	106.2166	K	CM	-.1760	CD2	.01926	CDCOR2	.01850
POINT 47	RC	29.9699	MILLION	CC	.0246	CD3	.01908	CDCOR3	.01816
	MACH	.7816				CD4	.01772	CDCOR4	.01680
	ALPHA	.9979	DEG			CD5	.01651	CDCOR5	.01531

UPPER SURFACE				LOWER SURFACE				SPANWISE				
X/C	CP	P _o L/PT	MLOC	X/C	CP	P _o L/PT	MLOC	X/C	Y/(B/2)	CP	P _o L/PT	MLOC
0.0000	1.1655	1.0011	0.0000	0.0000	1.1655	1.0011	0.0000	.1507	.7476	-.8141	.4393	1.1539
.0132	-.1800	.6193	.8590	.0126	.5017	.8127	.5540	.1507	.4976	-.8941	.4166	1.1951
.0259	-.5930	.5134	1.0271	.0255	.3358	.7656	.6315	.1507	.2476	-.8699	.4235	1.1825
.0759	-.8253	.4361	1.1596	.0495	.1624	.7164	.7091	.1507	-.2524	-.8685	.4239	1.1818
.1003	-.8493	.4293	1.1719	.0753	.0668	.6893	.7511	.1507	-.5024	-.8815	.4202	1.1885
.1507	-.8555	.4276	1.1750	.1002	-.0220	.6641	.7899	.1507	-.7524	-.8292	.4350	1.1616
.2003	-.8519	.4286	1.1732	.1503	-.1021	.6414	.8249	.5002	.7476	-.9410	.4033	1.2200
.2503	-.8798	.4206	1.1877	.1976	-.2052	.6121	.8701	.5002	.4976	-.9470	.4016	1.2232
.3001	-.9179	.4099	1.2076	.2503	-.2688	.5941	.8982	.5002	.2476	-.9267	.4073	1.2123
.3502	-.9291	.4078	1.2115	.3001	-.3131	.5815	.9179	.5002	-.2524	-.9020	.4144	1.1953
.4003	-.8844	.4194	1.1900	.3507	-.3413	.5735	.9305	.5002	-.5024	-.8979	.4013	1.2237
.4501	-.8595	.4264	1.1771	.4001	-.3361	.5749	.9282	.5002	.7476	-.8997	.4150	1.1981
.5002	-.9071	.4129	1.2020	.4501	-.3099	.5824	.9164	.8002	.4976	-.9167	.4102	1.2070
.5502	-.9354	.4049	1.2170	.5001	-.2449	.6014	.8887	.8002	.2476	-.9342	.3755	.9273
.6002	-.9611	.3976	1.2308	.5497	-.1363	.6316	.8399	.8002	.4976	-.9406	.3737	.9302
.6500	-.10237	.3793	1.2662	.6003	-.0242	.6635	.7909	.8002	-.5024	-.9208	.3793	.9213
.7000	-.10908	.3608	1.3032	.6500	.0599	.6873	.7541	.8002	-.7524	-.9264	.3777	.9238
.7500	-.5906	.5027	1.0447	.7000	.1763	.7203	.7029					
.8002	-.3465	.5720	.9328	.7501	.2747	.7483	.6591					
.9002	-.1284	.6339	.8364	.8001	.3582	.7720	.6212					
.9501	-.0239	.6636	.7907	.8501	.4319	.7929	.5871					

ORIGINAL
OF POOR

TEST 167	PT 49.5852	PSI	CN	.7969	CD1 .02576	CDCOR1 .02498
RUN 31	TT 106.2382	K	CM	-.1813	CD2 .02459	CDCOR2 .02396
POINT 48	RC 29.9471	MILLION	CC	.0246	CD3 .02329	CDCOR3 .02153
	MACH .7808				CD4 .02251	CDCOR4 .02069
	ALPHA 1.5141	DEG			CD5 .02133	CDCOR5 .02066

UPPER SURFACE				LOWER SURFACE				SPANWISE				
X/C	CP	P, L/PT	MLOC	X/C	CP	P, L/PT	MLOC	X/C	Y/(B/2)	CP	P, L/PT	MLOC
0.0000	1.1563	.9987	.0432	0.0000	1.1563	.9997	.0432	.1507	.7476	-.9104	.4139	1.2002
.0132	-.2597	.5980	.8920	.0126	.5583	.8295	.5253	.1507	.4976	-.9773	.3950	1.2358
.0259	-.6362	.4915	1.0635	.0255	.3865	.7809	.6068	.1507	.2476	-.9453	.4040	1.2186
.0759	-.9036	.4158	1.1966	.0495	-.2116	.7314	.6857	.1507	-.2524	-.9396	.4056	1.2136
.1063	-.9269	.4092	1.2088	.0753	.1121	.7032	.7295	.1507	-.5024	-.9360	.4010	1.2243
.1507	-.9305	.4082	1.2108	.1002	.0171	.6763	.7710	.1507	-.7524	-.9033	.4159	1.1984
.2003	-.9243	.4100	1.2074	.1503	-.0657	.6529	.8071	.5002	.7476	-1.0110	.3854	1.2542
.2503	-.9534	.4017	1.2230	.1976	-.1686	.6238	.8520	.5002	.4976	-1.0194	.3831	1.2588
.3001	-.9944	.3901	1.2451	.2503	-.2344	.6052	.8809	.5002	.2476	-1.0222	.3823	1.2604
.3502	-1.0128	.3849	1.2552	.3001	-.2812	.5919	.9015	.5002	-.2524	-.9932	.3905	1.2444
.4003	-1.0103	.3856	1.2538	.3507	-.3141	.5826	.9161	.5002	-.5024	-1.0154	.3842	1.2566
.4501	-.9646	.3985	1.2290	.4001	-.3139	.5827	.9160	.5002	-.7524	-.9645	.3986	1.2289
.5002	-.9791	.3945	1.2368	.4501	-.2939	.5883	.9071	.8002	.7476	-.9317	.4079	1.2114
.5502	-1.0075	.3864	1.2523	.5001	-.2339	.6053	.8807	.8002	.4976	-.9480	.3730	.9312
.6002	-1.0371	.3780	1.2687	.5497	-.1325	.6340	.8362	.8002	.2476	-.9330	.3716	.9334
.6500	-1.0817	.3654	1.2938	.6003	-.0241	.6647	.7890	.8002	-.5024	-.9347	.3768	.9253
.7000	-1.1255	.3530	1.3192	.6500	.0575	.6876	.7534	.8002	-.7524	-.9290	.3784	.9227
.7500	-.93190	.5246	1.0087	.7000	.1718	.7201	.7033					
.8002	-.3587	.8700	.9360	.7501	.2687	.7475	.6603					
.9002	-.1521	.6285	.8448	.8001	.3513	.7709	.6230					
.9501	-.0576	.6552	.8036	.8501	.4247	.7917	.5892					

TEST 167	PT 49.5834	PSI	CN	.8131	CD1 .03147	CDCOR1 .03046
RUN 31	TT 106.1809	K	CM	-.1758	CD2 .03237	CDCOR2 .03115
POINT 49	RC 29.9853	MILLION	CC	.0248	CD3 .03080	CDCOR3 .02930
	MACH .7815				CD4 .02940	CDCOR4 .02767
	ALPHA 2.0162	DEG			CD5 .03032	CDCOR5 .02945

UPPER SURFACE				LOWER SURFACE				SPANWISE				
X/C	CP	P, L/PT	MLOC	X/C	CP	P, L/PT	MLOC	X/C	Y/(B/2)	CP	P, L/PT	MLOC
0.0000	1.1578	.9990	.0381	0.0000	1.1578	.9990	.0381	.1507	.7476	-.9673	.3966	1.2327
.0132	-.3109	.5827	.9160	.0126	.5955	.8396	.5076	.1507	.4976	-1.0199	.3817	1.2615
.0259	-.6481	.4757	1.0902	.0255	.4214	.7902	.5915	.1507	.2476	-.9902	.3901	1.2452
.0759	-.9471	.4023	1.2216	.0495	.2400	.7388	.6740	.1507	-.2524	-.9899	.3902	1.2450
.1063	-.9737	.3943	1.2362	.0753	.1362	.7094	.7200	.1507	-.5024	-1.0059	.3856	1.2538
.1507	-.9755	.3943	1.2372	.1002	.0448	.6835	.7600	.1507	-.7524	-.9456	.4027	1.2210
.2003	-.9656	.3971	1.2318	.1503	-.0450	.6580	.7992	.5002	.7476	-1.0609	.3700	1.2845
.2503	-.9845	.3880	1.2475	.1976	-.1524	.6276	.8462	.5002	.4976	-1.0672	.3683	1.2881
.3001	-1.0356	.3772	1.2703	.2503	-.2238	.6073	.8775	.5002	.2476	-1.0737	.3664	1.2918
.3502	-1.0518	.3726	1.2794	.3001	-.2750	.5928	.9001	.5002	-.2524	-1.0536	.3721	1.2804
.4003	-1.0582	.3708	1.2830	.3507	-.3122	.5823	.9166	.5002	-.5024	-1.0452	.3745	1.2757
.4501	-1.0529	.3723	1.2800	.4001	-.3188	.5804	.9195	.5002	-.7524	-1.0148	.3831	1.2587
.5002	-1.0366	.3769	1.2706	.4501	-.3051	.5843	.9135	.8002	.7476	-1.0241	.3805	1.2639
.5502	-1.0564	.3713	1.2820	.5001	-.2546	.5986	.8911	.8002	.4976	-.9796	.3632	.9468
.6002	-1.0825	.3639	1.2968	.5497	-.1490	.6286	.8447	.8002	.2476	-.9700	.3659	.9424
.6500	-1.1193	.3507	1.3240	.6003	-.0415	.6590	.7977	.8002	-.5024	-.9735	.3649	.9440
.7000	-.7682	.4530	1.1296	.6500	.0273	.6813	.7633	.8002	-.7524	-.9499	.3716	.9335
.7500	-.4563	.5414	.9815	.7000	.1515	.7137	.7133					
.8002	-.3648	.5674	.9401	.7501	.2483	.7412	.6703					
.9002	-.2091	.6115	.8710	.8001	.3303	.7644	.6334					
.9501	-.1211	.6365	.8325	.8501	.4033	.7851	.5999					

TEST 167	PT 49.5860	PSI	CN	.8617	CD1 .03316	CDCOR1 .03104
RUN 31	TT 106.2706	K	CM	-.1776	CD2 .03561	CDCOR2 .03337
POINT 50	RC 29.9447	MILLION	CC	.0246	CD3 .03981	CDCOR3 .03816
	MACH .7813				CD4 .04157	CDCOR4 .03947
	ALPHA 2.5152	DEG			CD5 .03994	CDCOR5 .03893

UPPER SURFACE				LOWER SURFACE				SPANWISE				
X/C	CP	P, L/PT	MLOC	X/C	CP	P, L/PT	MLOC	X/C	Y/(B/2)	CP	P, L/PT	MLOC
0.0000	1.1568	.9998	.0419	0.0000	1.1568	.9988	.0419	.1507	.7476	-1.0271	.3804	1.2641
.0132	-.3676	.5671	.9406	.0126	.6526	.8580	.4779	.1507	.4976	-1.0726	.3675	1.2896
.0259	-.7567	.4569	1.1227	.0255	.4736	.8053	.5665	.1507	.2476	-1.0405	.3766	1.2715
.0759	-1.0006	.3879	1.2494	.0495	.2919	.7539	.6502	.1507	-.2524	-1.0379	.3773	1.2701
.1063	-1.0753	.3809	1.2630	.0753	.1848	.7236	.6979	.1507	-.5024	-1.0350	.3725	1.2797
.1507	-1.0280	.3801	1.2645	.1002	.0870	.6959	.7409	.1507	-.7524	-.9850	.3923	1.2409
.2003	-1.0137	.3842	1.2366	.1503	-.0057	.6646	.7814	.5002	.7476	-1.1074	.3575	1.3096
.2503	-1.0418	.3762	1.2722	.1976	-.1133	.6391	.8283	.5002	.4976	-1.1123	.3562	1.3125
.3001	-1.0816	.3649	1.2948	.2503	-.1861	.6185	.8502	.5002	.2476	-1.1181	.3546	1.3158
.3502	-1.1612	.3594	1.3060	.3001	-.2401	.6032	.8834	.5002	-.2524	-1.0988	.3601	1.3046
.4003	-1.1091	.3572	1.3106	.3507	-.2812	.5916	.9020	.5002	-.5024	-1.0733	.3673	1.2900
.4501	-1.1175	.3548	1.3155	.4001	-.2912	.5888	.9064	.5002	-.7524	-1.0590	.3713	1.2819
.5002	-1.1206	.3539	1.3173	.4501	-.2826	.5912	.9026	.8002	.7476	-1.0275	.3803	1.2643
.5502	-1.1079	.3575	1.3099	.5001	-.2316	.6036	.8801	.8002	.4976	-.9352	.3593	.9529
.6002	-1.1320	.3507	1.3240	.5497	-.1368	.6325	.8386	.8002	.2476	-.9389	.3625	.9478
.6500	-1.0955	.3610	1.3027	.6003	-.0329	.6619	.7933	.8002	-.5024	-.9348	.3651	.9437
.7000	-.5836	.5118	1.0300	.6500	.0444	.6838	.7596	.8002	-.7524	-.9499	.3721	.9326
.7500	-.4432	.5457	.9746	.7000	.1571	.7137	.7102					
.8002	-.3694	.5686	.9413	.7501	.2526	.7428	.6678					
.9002	-.2309	.6058	.8738	.8001	.3342	.7658	.6311					
.9501	-.1735	.6221	.8546	.8501	.4073	.7866	.5976					

TEST 167
 RUN 32
 MACH .780
 R 40.0×10^6

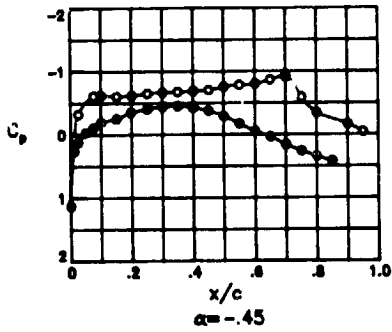
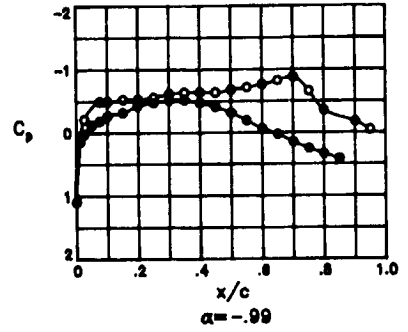
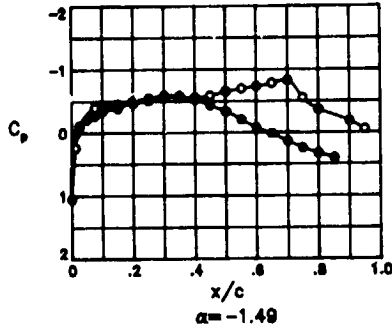
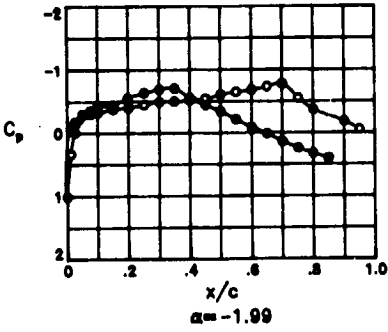
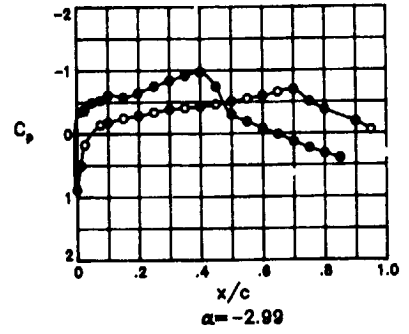
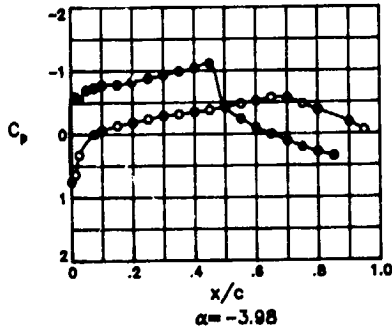

ORIGIN
OF FOOT

TEST 167	PT 61.5845	PSI	CN	-0806	CD1	.01557	CDCOR1	.01542
RUN 32	TT 101.1289	K	CM	-1321	CD2	.01473	CDCOR2	.01467
POINT 51	RC 40.0761	MILLION	CC	.0112	CD3	.01405	CDCOR3	.01409
	MACH .7815				CD4	.01316	CDCOR4	.01309
	ALPHA -3.9815	DEG			CD5	.01163	CDCOR5	.01133

UPPER SURFACE				LOWER SURFACE				SPANWISE				
X/C	CP	P _L /PT	MLOC	X/C	CP	P _L /PT	MLOC	X/C	Y/(B/2)	CP	P _L /PT	MLOC
0.0000	.7545	.8845	.4243	0.0000	.7545	.8845	.4243	.1507	.7476	-1.251	.6353	.8356
.0132	.6394	.8519	.4863	.0126	-.5963	.5018	1.0478	.1507	.4976	-1.384	.6315	.8414
.0259	.3279	.7637	.6397	.0255	-.5505	.5148	1.0263	.1507	.2776	-1.327	.6332	.8389
.0759	-.0028	.6700	.7921	.0495	-.7003	.4723	1.0976	.1507	-.2524	-1.430	.6303	.8434
.1003	-.0576	.6544	.8061	.0753	-.7361	.4622	1.1151	.1507	-.5024	-1.495	.6284	.8463
.1507	-.1349	.6324	.8398	.1002	-.7766	.4507	1.1351	.1507	-.7524	-1.419	.6306	.8429
.2003	-.1866	.6179	.8625	.1503	-.7817	.4493	1.1377	.5002	.7476	-1.4274	.5497	.9698
.2503	-.2396	.6029	.8859	.1976	-.8271	.4364	1.1606	.5002	.4976	-1.4303	.5469	.9711
.3001	-.2899	.5886	.9081	.2503	-.8801	.4214	1.1878	.5002	.2476	-1.4348	.5476	.9731
.3502	-.3167	.5810	.9200	.3001	-.9350	.4059	1.2167	.5002	-.2524	-1.4241	.5506	.9683
.4003	-.3497	.5717	.9348	.3507	-.9929	.3894	1.2479	.5002	-.5024	-1.4218	.5512	.9672
.4501	-.3778	.5637	.9474	.4001	-1.0463	.3743	1.2775	.5002	-.7524	-1.4060	.5557	.9601
.5002	-.4314	.5485	.9716	.4501	-1.1170	.3543	1.3180	.8002	.7476	-1.0757	.3660	1.2292
.5502	-.4768	.5357	.9923	.5001	-.4227	.5510	.9676	.8002	.4976	-1.3833	.5622	.9498
.6002	-.5220	.5229	1.0131	.5497	-.2381	.6033	.8852	.8002	.2776	-1.3857	.5615	.9509
.6500	-.5750	.5079	1.0378	.6003	-.1014	.6420	.8252	.8002	-.5024	-1.3461	.5727	.9331
.7000	-.5668	.5102	1.0340	.6500	.0009	.6710	.7806	.8002	-.7524	-1.3501	.5716	.9350
.7500	-.4753	.5361	.9916	.7000	.1121	.7025	.7318					
.8002	-.3793	.5633	.9480	.7501	.2063	.7292	.6903					
.9002	-.1871	.6177	.8628	.8001	.2857	.7517	.6548					
.9501	-.0588	.6541	.8066	.8501	.3531	.7708	.6242					

TEST 167	PT 61.5802	PSI	CN	.0911	CD1	.01070	CDCOR1	.01054
RUN 32	TT 101.0645	K	CM	-1467	CD2	.01037	CDCOR2	.01029
POINT 52	RC 40.1230	MILLION	CC	.0169	CD3	.00998	CDCOR3	.00998
	MACH .7819				CD4	.00963	CDCOR4	.00953
	ALPHA -2.9938	DEG			CD5	.00907	CDCOR5	.00878

UPPER SURFACE				LOWER SURFACE				SPANWISE				
X/C	CP	P _L /PT	MLOC	X/C	CP	P _L /PT	MLOC	X/C	Y/(B/2)	CP	P _L /PT	MLOC
0.0000	.8841	.9207	.3473	0.0000	.8841	.9207	.3473	.1507	.7476	-1.2559	.6022	.8870
.0132	.5036	.8125	.5555	.0126	-.3500	.5697	.9379	.1507	.4976	-1.2503	.5981	.8933
.0259	.1753	.7191	.7061	.0255	-.3843	.5600	.9533	.1507	.2476	-1.2452	.5995	.8911
.0759	-.1401	.6294	.8447	.0495	-.4966	.5280	1.0047	.1507	-.2524	-1.2548	.5968	.8954
.1003	-.1812	.6177	.8628	.0753	-.5281	.5191	1.0193	.1507	-.5024	-1.2608	.5951	.8980
.1507	-.2463	.4992	.8916	.1002	-.6101	.4958	1.0579	.1507	-.7524	-1.2499	.5982	.8932
.2003	-.2864	.5878	.9094	.1503	-.5611	.5040	1.0442	.5002	.7476	-1.5079	.5248	1.0099
.2503	-.3364	.5736	.9318	.1976	-.6440	.4861	1.0741	.5002	.4976	-1.5107	.5240	1.0112
.3001	-.3839	.5601	.9532	.2503	-.7493	.4562	1.1256	.5002	.2476	-1.5155	.5227	1.0134
.3502	-.4048	.5541	.9626	.3001	-.8370	.4312	1.1699	.5002	-.2524	-1.5032	.5261	1.0078
.4003	-.4330	.5461	.9754	.3507	-.9175	.4083	1.2120	.5002	-.5024	-1.5017	.5266	1.0071
.4501	-.4608	.5382	.9882	.4001	-.9751	.3920	1.2431	.5002	-.7524	-1.4842	.5316	.9989
.5002	-.5129	.5234	1.0122	.4501	-.7426	.4581	1.1223	.8002	.7476	-1.1005	.3563	1.3139
.5502	-.5548	.5115	1.0318	.5001	-.3005	.5638	.9157	.8002	.4976	-1.3842	.5600	.9533
.6002	-.5949	.4989	1.0526	.5497	-.1916	.6148	.8674	.8002	.2476	-1.3834	.5602	.9529
.6500	-.6598	.4816	1.0817	.6003	-.0795	.6467	.8181	.8002	-.5024	-1.3536	.5687	.9395
.7000	-.6945	.4718	1.0986	.6500	.0118	.6726	.7781	.8002	-.7524	-1.3639	.5688	.9441
.7500	-.6502	.5250	1.0096	.7000	.1320	.7068	.7252					
.8002	-.3767	.5621	.9499	.7501	.2325	.7354	.6806					
.9002	-.1843	.6168	.8642	.8001	.3163	.7592	.6429					
.9501	-.0551	.6536	.8074	.8501	.3878	.7795	.6101					

TEST 167	PT 61.5910	PSI	CN	.2655	CD1	.00848	CDCOR1	.00836
RUN 32	TT 101.1428	K	CM	-1566	CD2	.00832	CDCOR2	.00826
POINT 53	RC 40.0497	MILLION	CC	.0215	CD3	.00819	CDCOR3	.00822
	MACH .7808				CD4	.00809	CDCOR4	.00806
	ALPHA -1.9878	DEG			CD5	.00778	CDCOR5	.00763

UPPER SURFACE				LOWER SURFACE				SPANWISE				
X/C	CP	P _L /PT	MLOC	X/C	CP	P _L /PT	MLOC	X/C	Y/(B/2)	CP	P _L /PT	MLOC
0.0000	1.0083	.9566	.2937	0.0000	1.0083	.9566	.2937	.1507	.7476	-1.3645	.5681	.9404
.0132	.3358	.7663	.6315	.0126	-.0909	.6455	.8198	.1507	.4976	-1.3821	.5631	.9483
.0259	-.0085	.6688	.7839	.0255	-.1771	.6211	.8975	.1507	.2476	-1.3787	.5641	.9468
.0759	-.3036	.5453	.9133	.0495	-.2991	.5866	.9112	.1507	-.2524	-1.3884	.5613	.9511
.1003	-.3286	.5783	.9244	.0753	-.3521	.5716	.9348	.1507	-.5024	-1.3926	.5602	.9530
.1507	-.3793	.5639	.9470	.1002	-.4207	.5522	.9657	.1507	-.7524	-1.3777	.5644	.9463
.2003	-.4403	.5577	.9569	.1503	-.4456	.5451	.9770	.5002	.7476	-1.5997	.5016	1.0482
.2503	-.4484	.5444	.9782	.1976	-.5559	.5139	1.0277	.5002	.4976	-1.6070	.4995	1.0517
.3001	-.4493	.5314	.9992	.2503	-.6405	.4900	1.0675	.5002	.2476	-1.6115	.4982	1.0538
.3502	-.5007	.5296	1.0022	.3001	-.6927	.4732	1.0926	.5002	-.2524	-1.6006	.5013	1.0486
.4003	-.5218	.5236	1.0119	.3507	-.7103	.4703	1.1011	.5002	-.5024	-1.6022	.5008	1.0494
.4501	-.5450	.5170	1.0226	.4001	-.7536	.5146	1.0266	.5002	-.7524	-1.5791	.5074	1.0385
.5002	-.6040	.4992	1.0521	.4501	-.4418	.5462	.9752	.8002	.7476	-1.1002	.3599	1.3065
.5502	-.6499	.4873	1.0720	.5001	-.3403	.5750	.9296	.8002	.4976	-1.3777	.5644	.9463
.6002	-.6814	.4784	1.0872	.5497	-.2110	.6115	.8724	.8002	.2476	-1.3740	.5634	.9447
.6500	-.7329	.4639	1.1122	.6003	-.0815	.6482	.8157	.8002	-.5024	-1.3563	.5704	.9367
.7000	-.7790	.4508	1.1350	.6500	.0153	.6756	.7735	.8002	-.7524	-1.3757	.5649	.9454
.7500	-.6496	.5157	1.0748	.7000	.1415	.7113	.7182					
.8002	-.3676	.5672	.9418	.7501	.2452	.7406	.6723					
.9002	-.1801	.6203	.8586	.8001	.3313	.7630	.6335					
.9501	-.0507	.6569	.8023	.8501	.4042	.7856	.6001					

TEST 167	PT 61.5998	PSI	CM .3453	CD1 .00866	CDCOR1 .00835
RUN 32	TT 101.1967	K	CM -.1589	CD2 .00853	CDCOR2 .00829
POINT 54	RC 39.9835	MILLION	CC .0232	CD3 .00841	CDCOR3 .00829
	MACH .7794			CD4 .00824	CDCOR4 .00809
	ALPHA -1.4867	DEG		CD5 .00793	CDCOR5 .00765

UPPER SURFACE				LOWER SURFACE				SPANWISE				
X/C	CP	P ₂ L/PT	MLOC	X/C	CP	P ₂ L/PT	MLOC	X/C	Y/(B/2)	CP	P ₂ L/PT	MLOC
0.0000	1.0577	.9692	.2127	0.0000	1.0522	.9692	.2127	.1507	.7476	-.4382	.5485	.9717
.0132	.2383	.7395	.6742	.0126	.0266	.6797	.7672	.1507	.4976	-.4585	.5427	.9809
.0259	-.1130	.6403	.8280	.0235	-.0788	.6499	.8131	.1507	.2476	-.4565	.5433	.9800
.0759	-.3994	.5594	.9542	.0495	-.2111	.6126	.8708	.1507	-.2324	-.4669	.5403	.9848
.1003	-.4142	.5552	.9609	.0753	-.2718	.5954	.8975	.1507	-.5024	-.4692	.5397	.9858
.1507	-.4567	.5432	.9801	.1002	-.3450	.5748	.9299	.1507	-.7524	-.4510	.5448	.9775
.2003	-.4679	.5401	.9852	.1503	-.3858	.5632	.9481	.5002	.7476	-.6435	.4905	1.0668
.2503	-.5110	.5279	1.0049	.1976	-.4948	.5325	.9975	.5002	.4976	-.6521	.4881	1.0708
.3001	-.5636	.5132	1.0289	.2503	-.5503	.5168	1.0230	.5002	.2476	-.6581	.4864	1.0737
.3502	-.5626	.5133	1.0287	.3001	-.5932	.5047	1.0430	.5002	-.2324	-.6468	.4895	1.0683
.4003	-.5587	.5144	1.0269	.3507	-.5863	.5066	1.0398	.5002	-.5024	-.6476	.4893	1.0687
.4501	-.5880	.5062	1.0406	.4001	-.5208	.5251	1.0094	.5002	-.7524	-.6258	.4955	1.0584
.5002	-.6539	.4876	1.0717	.4501	-.4321	.5502	.9690	.8002	.7476	-1.0880	.3650	1.2262
.5502	-.6961	.4756	1.0919	.5001	-.3341	.5778	.9251	.8002	.4976	-.3745	.3664	.9431
.6002	-.7338	.4650	1.1103	.5497	-.2055	.6141	.8684	.8002	.2476	-.3693	.3679	.9408
.6500	-.7843	.4507	1.1351	.6003	-.0777	.6502	.8125	.8002	-.5024	-.3588	.3709	.9360
.7000	-.8254	.4391	1.1557	.6500	.0168	.6769	.7715	.8002	-.7524	-.3807	.3647	.9458
.7500	-.8529	.4361	1.0242	.7000	.1426	.7124	.7165					
.8002	-.8648	.3692	.9387	.7501	.2459	.7416	.6708					
.9002	-.1811	.6210	.8577	.8001	.3320	.7659	.6321					
.9501	-.0527	.6573	.8017	.8501	.4054	.7866	.5985					

TEST 167	PT 61.5945	PSI	CM .4280	CD1 .00947	CDCOR1 .00901
RUN 32	TT 101.3246	K	CM -.1637	CD2 .00931	CDCOR2 .00891
POINT 55	RC 39.9368	MILLION	CC .0247	CD3 .00920	CDCOR3 .00894
	MACH .7805			CD4 .00887	CDCOR4 .00865
	ALPHA -.9870	DEG		CD5 .00845	CDCOR5 .00816

UPPER SURFACE				LOWER SURFACE				SPANWISE				
X/C	CP	P ₂ L/PT	MLOC	X/C	CP	P ₂ L/PT	MLOC	X/C	Y/(B/2)	CP	P ₂ L/PT	MLOC
0.0000	1.0930	.9806	.1685	0.0000	1.0930	.9806	.1685	.1507	.7476	-.5089	.5272	1.0060
.0132	.1453	.7123	.7166	.0126	.1442	.7120	.7171	.1507	.4976	-.5324	.5205	1.0169
.0259	-.2130	.6109	.8733	.0235	.0223	.6775	.7705	.1507	.2476	-.5326	.5205	1.0170
.0759	-.4955	.5310	.9999	.0495	-.1208	.6370	.8329	.1507	-.2524	-.5404	.5183	1.0206
.1003	-.4955	.5310	.9999	.0753	-.1897	.6175	.8631	.1507	-.5024	-.5398	.5184	1.0203
.1507	-.5314	.5208	1.0164	.1002	-.2687	.5952	.8978	.1507	-.7524	-.5174	.5248	1.0100
.2003	-.5329	.5204	1.0171	.1503	-.3197	.5807	.9205	.5002	.7476	-.6830	.4779	1.0880
.2503	-.5635	.5117	1.0313	.1976	-.4242	.5511	.9674	.5002	.4976	-.6889	.4763	1.0908
.3001	-.6160	.4969	1.0560	.2503	-.4776	.5360	.9916	.5002	.2476	-.6878	.4766	1.0903
.3502	-.6378	.4907	1.0664	.3001	-.5155	.5253	1.0091	.5002	-.2524	-.6757	.4800	1.0845
.4003	-.6421	.4895	1.0684	.3507	-.5201	.5240	1.0112	.5002	-.5024	-.6839	.4777	1.0884
.4501	-.6374	.4907	1.0663	.4001	-.4754	.5367	.9906	.5002	-.7524	-.6702	.4815	1.0818
.5002	-.6799	.4788	1.0865	.4501	-.4076	.5559	.9598	.8002	.7476	-1.0522	.3734	1.2793
.5502	-.7180	.4680	1.1050	.5001	-.3146	.5822	.9132	.8002	.4976	-.3384	.3698	.9377
.6002	-.7644	.4548	1.1280	.5497	-.1896	.6175	.8630	.8002	.2476	-.3342	.3710	.9359
.6500	-.8247	.4378	1.1580	.6003	-.0647	.6529	.8084	.8002	-.5024	-.3463	.3732	.9323
.7000	-.8792	.4224	1.1860	.6500	.0274	.6790	.7682	.8002	-.7524	-.3739	.3654	.9447
.7500	-.8596	.4845	1.0767	.7000	.1917	.7141	.7138					
.8002	-.3514	.5718	.9344	.7501	.2541	.7431	.6684					
.9002	-.1699	.6231	.8544	.8001	.3400	.7674	.6296					
.9501	-.0463	.6581	.8004	.8501	.4137	.7883	.5957					

TEST 167	PT 61.5902	PSI	CM .5103	CD1 .00961	CDCOR1 .00920
RUN 32	TT 101.8675	K	CM -.1648	CD2 .00946	CDCOR2 .00913
POINT 56	RC 39.4762	MILLION	CC .0244	CD3 .00933	CDCOR3 .00910
	MACH .7758			CD4 .00893	CDCOR4 .00867
	ALPHA -.4480	DEG		CD5 .00854	CDCOR5 .00821

UPPER SURFACE				LOWER SURFACE				SPANWISE				
X/C	CP	P ₂ L/PT	MLOC	X/C	CP	P ₂ L/PT	MLOC	X/C	Y/(B/2)	CP	P ₂ L/PT	MLOC
0.0000	1.1286	.9910	.1142	0.0000	1.1286	.9910	.1142	.1507	.7476	-.5880	.5072	1.0388
.0132	.0426	.6849	.7590	.0126	.2620	.7468	.6626	.1507	.4976	-.6087	.5014	1.0485
.0259	-.3232	.5818	.9187	.0235	.1240	.7079	.7236	.1507	.2476	-.6039	.5027	1.0462
.0759	-.6106	.5008	1.0494	.0495	-.0295	.6846	.7904	.1507	-.2524	-.6046	.5025	1.0466
.1003	-.6201	.4982	1.0538	.0753	-.1083	.6430	.8237	.1507	-.5024	-.6063	.5020	1.0474
.1507	-.6652	.5023	1.0469	.1002	-.1900	.6194	.8602	.1507	-.7524	-.5958	.5078	1.0378
.2003	-.6186	.4986	1.0531	.1503	-.2302	.6024	.8866	.5002	.7476	-.7329	.4864	1.1078
.2503	-.6489	.4900	1.0675	.1976	-.3512	.5739	.9312	.5002	.4976	-.7441	.4632	1.1133
.3001	-.6681	.4846	1.0766	.2503	-.4091	.5587	.9552	.5002	.2476	-.7552	.4601	1.1187
.3502	-.6757	.4825	1.0802	.3001	-.4411	.5486	.9714	.5002	-.2524	-.7401	.4643	1.1114
.4003	-.6883	.4789	1.0862	.3507	-.4540	.5450	.9773	.5002	-.5024	-.7398	.4644	1.1112
.4501	-.7034	.4747	1.0935	.4001	-.4232	.5531	.9843	.5002	-.7524	-.7242	.4688	1.1036
.5002	-.7545	.4597	1.1194	.4501	-.3760	.5669	.9422	.8002	.7476	-1.0342	.3815	1.2634
.5502	-.7804	.4530	1.1311	.5001	-.2905	.5911	.9043	.8002	.4976	-.3513	.3739	.9312
.6002	-.8014	.4471	1.1416	.5497	-.1708	.6248	.8518	.8002	.2476	-.3466	.3752	.9291
.6500	-.8624	.4299	1.1724	.6003	-.0496	.6589	.7991	.8002	-.5024	-.3376	.3778	.9251
.7000	-.9144	.4152	1.1942	.6500	.0392	.6840	.7605	.8002	-.7524	-.3648	.3701	.9372
.7500	-.9855	.5079	1.0376	.7000	.1623	.7186	.7068					
.8002	-.3428	.5763	.9274	.7501	.2637	.7472	.6619					
.9002	-.1624	.6271	.8482	.8001	.3492	.7713	.6233					
.9501	-.0404	.6415	.7951	.8501	.4235	.7923	.5892					

ORIGINAL FILE
OF POOR QUALITY

Appendix K

Pressure Data for $M = 0.79$; $R = 10.0 \times 10^6$ and 30.0×10^6 ; Free Transition

The pressure measurements made on the NASA SC(3)-0712(B) airfoil are presented in coefficient form in graphs and tables in this appendix. The data are for a given Mach number through the Reynolds number range. The pressure data from the upper surface of the airfoil are plotted as open symbols, and the lower-surface data are plotted as solid symbols.

ORIGINAL
OF FOUR

TEST 167	PT 24.7866	PSI	CN	-.1178	CD1 .02260	CDCOR1 .02231
RUN 50	TT 140.6041	K	CM	-.1030	CD2 .02004	CDCOR2 .01983
POINT 70	RC 9.9685	MILLION	CC	.0112	CD3 .01821	CDCOR3 .01808
	RACH .75				CD4 .01591	CDCOR4 .01572
	ALPHA -3.9917	DEG			CD5 .01287	CDCOR5 .01242

UPPER SURFACE				LOWER SURFACE				SPANWISE				
X/C	CP	P/L/PT	MLOC	X/C	CP	P/L/PT	MLOC	X/C	Y/(B/2)	CP	P/L/PT	MLOC
0.0000	.7863	.8902	.4110	0.0000	-.7863	.8902	.4110	.1507	.7476	-.1264	.6262	.8481
.0132	-.6341	.8462	.4944	.0126	-.6110	.4865	1.0703	.1507	.4976	-.1317	.6247	.8484
.0259	-.3161	.7542	.6479	.0255	-.5380	.5071	1.0350	.1507	.2476	-.1311	.6248	.8482
.0759	-.0020	.6622	.7907	.0495	-.6087	.4608	1.1137	.1507	-.2524	-.1545	.6181	.8586
.1003	-.0535	.6473	.8136	.0753	-.7104	.4573	1.1196	.1507	-.5024	-.1368	.6232	.8507
.1507	-.1332	.6242	.8491	.1002	-.7526	.4450	1.1411	.1507	-.7524	-.1384	.6227	.8514
.2003	-.1951	.6092	.8723	.1503	-.7638	.4418	1.1469	.5002	.7476	-.4266	.5423	.9777
.2503	-.2389	.5936	.9065	.1976	-.8180	.4261	1.1751	.5002	.4976	-.4218	.5407	.9802
.3001	-.2842	.5806	.9170	.2503	-.8800	.4082	1.2082	.5002	.2476	-.4273	.5392	.9827
.3502	-.3130	.5722	.9301	.3001	-.9408	.3906	1.2417	.5002	-.2524	-.4177	.5419	.9783
.4003	-.3472	.5623	.9457	.3507	-.9938	.3753	1.2716	.5002	-.5024	-.4154	.5426	.9772
.4501	-.3857	.5512	.9635	.4001	-1.0436	.3609	1.3006	.5002	-.7524	-.4028	.5462	.9714
.5002	-.4251	.5398	.9817	.4501	-.6318	.4794	1.0815	.8002	.7476	-.9981	.3740	1.2741
.5502	-.4678	.5274	1.0017	.5001	-.4152	.5427	.9771	.8002	.4976	-.9993	.3588	.9513
.6002	-.5162	.5134	1.0245	.5497	-.3094	.5733	.9284	.8002	.2476	-.9616	.3582	.9523
.6500	-.5680	.4984	1.0494	.6003	-.1979	.6055	.8780	.8002	-.5024	-.9333	.3605	.9486
.7000	-.6260	.5019	1.0436	.6500	-.0891	.6370	.8295	.8002	-.7524	-.9475	.3622	.9459
.7500	-.6938	.5315	.9951	.7070	.0115	.6661	.7847					
.8002	-.7654	.5600	.9495	.7501	.0935	.6898	.7482					
.8502	-.8451	.6208	.8544	.8001	.1628	.7099	.7173					
.9501	-.0092	.6601	.7939	.8501	.2217	.7269	.6909					

TEST 167	PT 24.7879	PSI	CN	.0633	CD1 .01403	CDCOR1 .01377
RUN 50	TT 140.5168	K	CM	-.1352	CD2 .01353	CDCOR2 .01336
POINT 80	RC 9.9775	MILLION	CC	.0167	CD3 .01273	CDCOR3 .01262
	RACH .7887				CD4 .01199	CDCOR4 .01181
	ALPHA -3.0141	DEG			CD5 .01052	CDCOR5 .01014

UPPER SURFACE				LOWER SURFACE				SPANWISE				
X/C	CP	P/L/PT	MLOC	X/C	CP	P/L/PT	MLOC	X/C	Y/(B/2)	CP	P/L/PT	MLOC
0.0000	.9036	.9242	.3374	0.0000	-.9036	.9242	.3374	.1507	.7476	-.2279	.5970	.8913
.0132	.5035	.8085	.5595	.0126	-.3562	.5599	.9496	.1507	.4976	-.2393	.5937	.8964
.0259	.1685	.7116	.7145	.0255	-.3746	.5546	.9580	.1507	.2476	-.2401	.5935	.8968
.0759	-.1312	.6250	.8479	.0495	-.5230	.5117	1.0275	.1507	-.2524	-.2844	.5865	.9077
.1003	-.1725	.6130	.8664	.0753	-.5174	.5131	1.0250	.1507	-.5024	-.2450	.5921	.8990
.1507	-.2425	.5928	.8979	.1002	-.6000	.4894	1.0645	.1507	-.7524	-.2430	.5926	.8981
.2003	-.2867	.5800	.9179	.1503	-.5921	.4917	1.0607	.5002	.7476	-.4473	.5191	1.0153
.2503	-.3349	.5661	.9398	.1976	-.6416	.4774	1.0849	.5002	.4976	-.5025	.5176	1.0178
.3001	-.3774	.5538	.9593	.2503	-.7403	.4489	1.1344	.5002	.2476	-.5081	.5160	1.0204
.3502	-.4251	.5430	.9685	.3001	-.8304	.4226	1.1815	.5002	-.2524	-.4989	.5186	1.0160
.4003	-.4779	.5392	.9827	.3507	-.9148	.3984	1.2269	.5002	-.5024	-.4977	.5191	1.0153
.4501	-.4665	.5280	1.0007	.4001	-.9798	.3796	1.2632	.5002	-.7524	-.4866	.5228	1.0093
.5002	-.5056	.5167	1.0192	.4501	-.8345	.4216	1.1834	.8002	.7476	-1.0476	.3600	1.3024
.5502	-.5439	.5056	1.0375	.5001	-.3691	.5562	.9555	.8002	.4976	-.9393	.3561	.9536
.6002	-.5920	.4917	1.0607	.5497	-.2214	.5987	.8886	.8002	.2476	-.9397	.3560	.9538
.6500	-.6525	.4747	1.0903	.6003	-.0952	.6354	.8319	.8002	-.5024	-.9369	.3577	.9531
.7000	-.6838	.4652	1.1059	.6500	.0126	.6665	.7840	.8002	-.7524	-.9329	.3580	.9527
.7500	-.6483	.5220	1.0106	.7000	.1205	.6977	.7560					
.8002	-.3616	.5583	.9521	.7501	.2133	.7246	.6944					
.8502	-.1575	.6174	.8597	.8001	.2914	.7472	.6590					
.9501	-.0294	.6544	.8026	.8501	.3566	.7660	.6291					

TEST 167	PT 24.7916	PSI	CN	.2311	CD1 .01099	CDCOR1 .01088
RUN 50	TT 140.1794	K	CM	-.1457	CD2 .01080	CDCOR2 .01075
POINT 81	RC 10.0210	MILLION	CC	.0199	CD3 .01044	CDCOR3 .01044
	RACH .7897				CD4 .01006	CDCOR4 .01001
	ALPHA -1.9958	DEG			CD5 .00883	CDCOR5 .00862

UPPER SURFACE				LOWER SURFACE				SPANWISE				
X/C	CP	P/L/PT	MLOC	X/C	CP	P/L/PT	MLOC	X/C	Y/(B/2)	CP	P/L/PT	MLOC
0.0000	1.0161	.9571	.4511	0.0000	-1.0161	.9571	.4511	.1507	.7476	-.3447	.5635	.9439
.0132	.3413	.7625	.6348	.0126	-.1056	.6336	.8347	.1507	.4976	-.3653	.5587	.9415
.0259	-.0077	.6618	.7913	.0255	-.1775	.6128	.8667	.1507	.2476	-.3671	.5512	.9523
.0759	-.2459	.5816	.9154	.0495	-.3282	.5694	.9346	.1507	-.2524	-.3917	.5511	.9636
.1003	-.3126	.5719	.9275	.0753	-.3541	.5619	.9464	.1507	-.5024	-.3698	.5574	.9536
.1507	-.3694	.5575	.9334	.1002	-.4203	.5425	.9769	.1507	-.7524	-.3618	.5597	.9499
.2003	-.3997	.5488	.9673	.1503	-.4458	.5355	.9887	.5002	.7476	-.5936	.4957	1.0330
.2503	-.4418	.5366	.9868	.1976	-.5374	.5033	1.0414	.5002	.4976	-.5924	.4932	1.0582
.3001	-.4819	.5251	1.0055	.2503	-.6521	.4763	1.0908	.5002	.2476	-.5975	.4917	1.0607
.3502	-.4899	.5228	1.0093	.3001	-.7181	.4570	1.1202	.5002	-.2524	-.5900	.4939	1.0570
.4003	-.5131	.5161	1.0203	.3507	-.7701	.4419	1.1466	.5002	-.5024	-.5907	.4937	1.0574
.4501	-.5472	.5062	1.0365	.4001	-.7031	.4613	1.1126	.5002	-.7524	-.5764	.4978	1.0505
.5002	-.5946	.4926	1.0592	.4501	-.4264	.5411	.9797	.8002	.7476	-1.0410	.3638	1.2946
.5502	-.6342	.4811	1.0785	.5001	-.3348	.5675	.9376	.8002	.4976	-.9314	.3598	.9497
.6002	-.6716	.4703	1.0970	.5497	-.2118	.6029	.8821	.8002	.2476	-.9398	.3603	.9490
.6500	-.7212	.4560	1.1219	.6003	-.0970	.6389	.8264	.8002	-.5024	-.9323	.3596	.9501
.7000	-.7627	.4442	1.1426	.6500	.0192	.6696	.7793	.8002	-.7524	-.9362	.3578	.9533
.7500	-.8058	.5182	1.0168	.7000	.1323	.7022	.7291					
.8002	-.3535	.5621	.9461	.7501	.2288	.7300	.6859					
.8502	-.1499	.6208	.8544	.8001	.3089	.7531	.6496					
.9501	-.0248	.6569	.7988	.8501	.3753	.7723	.6190					

TEST 167	PT 24.7847	PSI	CM	-3106	CD1	.01194	CDCOR1	.01109
RUN 50	TT 140.1479	K	CM	-1508	CD2	.01129	CDCOR2	.01092
POINT 82	RC 10.0341	MILLION	CC	.0227	CD3	.01096	CDCOR3	.01056
	MACH .7915				CD4	.01048	CDCOR4	.01007
	ALPHA -1.5172	DEG			CD5	.00938	CDCOR5	.00897

UPPER SURFACE				LOWER SURFACE				SPANWISE				
X/C	CP	P/L/P/T	MLOC	X/C	CP	P/L/P/T	MLOC	X/C	Y/(B/2)	CP	P/L/P/T	MLOC
0.0000	1.0660	.9707	.2065	0.0000	1.0660	.9707	.2065	.1507	.7476	-.4119	.5416	.9788
.0132	.7503	.7339	.6799	.0126	.0180	.6664	.7842	.1507	.4976	-.4366	.5344	.9903
.0259	-.1003	.6321	.8369	.0255	-.0783	.6385	.8271	.1507	.2476	-.4386	.5339	.9913
.0759	-.3716	.5533	.9800	.0495	-.2363	.5926	.8781	.1507	-.2524	-.4476	.5313	.9955
.1003	-.3890	.5483	.9881	.0753	-.2755	.5812	.9160	.1507	-.5024	-.4375	.5342	.9908
.1507	-.4405	.5333	.9921	.1002	-.3443	.5613	.9474	.1507	-.7524	-.4244	.5380	.9846
.2003	-.4627	.5269	1.0026	.1503	-.3888	.5483	.9880	.5002	.7476	-.6282	.4788	1.0024
.2503	-.5002	.5160	1.0204	.1976	-.5042	.5148	1.0223	.5002	.4976	-.6345	.4770	1.0056
.3001	-.5484	.5020	1.0435	.2503	-.5903	.4898	1.0638	.5002	-.2476	-.6377	.4761	1.0071
.3502	-.5931	.5006	1.0458	.3001	-.6456	.4738	1.0911	.5002	-.2524	-.6336	.4773	1.0051
.4003	-.5996	.4988	1.0489	.3507	-.6835	.4628	1.1100	.5002	-.5024	-.6370	.4763	1.0088
.4501	-.5829	.4920	1.0602	.4001	-.6282	.4788	1.0825	.5002	-.7524	-.6325	.4776	1.0046
.5002	-.6283	.4788	1.0825	.4501	-.6400	.5339	.9910	.8002	.7476	-.3682	.5543	.9584
.5502	-.6738	.4656	1.1052	.5001	-.3327	.5646	.9421	.8002	.4976	-.3499	.5596	.9500
.6002	-.7217	.4517	1.1294	.5497	-.2095	.6004	.8860	.8002	.2476	-.3527	.5588	.9513
.6500	-.7822	.4341	1.1606	.6003	-.0850	.6365	.8301	.8002	-.5024	-.3525	.5589	.9512
.7000	-.8364	.4184	1.1893	.6500	.0201	.6670	.7832	.8002	-.7524	-.3678	.5544	.9583
.7500	-.8929	.4017	1.0947	.7000	.1329	.6998	.7228					
.8002	-.9496	.3597	.9496	.7501	.2299	.7280	.6881					
.8502	-.1327	.6227	.8515	.8001	.3103	.7513	.6525					
.9501	-.0171	.6562	.7998	.8501	.3779	.7708	.6212					

TEST 167	PT 24.7913	PSI	CM	-3948	CD1	.01182	CDCOR1	.01149
RUN 50	TT 140.0731	K	CM	-1928	CD2	.01154	CDCOR2	.01129
POINT 83	RC 10.0318	MILLION	CC	.0228	CD3	.01117	CDCOR3	.01098
	MACH .7887				CD4	.01058	CDCOR4	.01033
	ALPHA -.9978	DEG			CD5	.00960	CDCOR5	.00920

UPPER SURFACE				LOWER SURFACE				SPANWISE				
X/C	CP	P/L/P/T	MLOC	X/C	CP	P/L/P/T	MLOC	X/C	Y/(B/2)	CP	P/L/P/T	MLOC
0.0000	1.1035	.9825	.1588	0.0000	1.1035	.9825	.1588	.1507	.7476	-.4876	.5248	1.0060
.0132	.1560	.7100	.6717	.0126	.1324	.7032	.7278	.1507	.4976	-.5092	.5186	1.0162
.0259	-.2073	.6054	.8782	.0255	.0160	.6697	.7792	.1507	.2476	-.5129	.5175	1.0179
.0759	-.4681	.5304	.9969	.0495	-.1471	.6228	.8914	.1507	-.2524	-.5148	.5170	1.0188
.1003	-.4711	.5295	.9983	.0753	-.1932	.6095	.8719	.1507	-.5024	-.5031	.5198	1.0142
.1507	-.5151	.5169	1.0189	.1002	-.2671	.5882	.9050	.1507	-.7524	-.4873	.5249	1.0059
.2003	-.5331	.5117	1.0274	.1503	-.3207	.5728	.9292	.5002	.7476	-.6597	.4753	1.0085
.2503	-.5523	.5062	1.0365	.1976	-.4308	.5411	.9796	.5002	.4976	-.6675	.4730	1.0223
.3001	-.5728	.4931	1.0584	.2503	-.4918	.5236	1.0080	.5002	-.2476	-.6685	.4727	1.0028
.3502	-.5925	.4863	1.0698	.3001	-.5389	.5100	1.0302	.5002	-.2524	-.6684	.4757	1.0078
.4003	-.6291	.4841	1.0735	.3507	-.5481	.5074	1.0348	.5002	-.5024	-.6669	.4738	1.0011
.4501	-.6676	.4817	1.0776	.4001	-.5016	.5208	1.0126	.5002	-.7524	-.6669	.4738	1.0010
.5002	-.6631	.4743	1.0901	.4501	-.4139	.5440	.9718	.8002	.7476	-.3633	.5606	.9486
.5502	-.6488	.4640	1.1079	.5001	-.4139	.5440	.9718	.8002	.4976	-.3462	.5655	.9406
.6002	-.7475	.4500	1.1323	.5497	-.3170	.5739	.9275	.8002	.2476	-.3449	.5688	.9402
.6500	-.8050	.4335	1.1618	.6003	-.1911	.6101	.8710	.8002	-.5024	-.3495	.5655	.9423
.7000	-.8502	.4205	1.1855	.6500	-.0675	.6456	.8161	.8002	-.7524	-.3610	.5612	.9475
.7500	-.9345	.3513	1.0281	.7000	.1484	.7078	.7205					
.8002	-.9421	.3667	.9389	.7501	.2447	.7355	.6774					
.8502	-.1404	.6247	.8464	.8001	.3251	.7586	.6409					
.9501	-.0733	.6584	.7966	.8501	.3929	.7781	.6096					

TEST 167	PT 24.7954	PSI	CM	-4458	CD1	.01102	CDCOR1	.01275
RUN 50	TT 140.0290	K	CM	-1591	CD2	.01277	CDCOR2	.01257
POINT 84	RC 10.0349	MILLION	CC	.0235	CD3	.01237	CDCOR3	.01223
	MACH .7892				CD4	.01170	CDCOR4	.01153
	ALPHA -.5075	DEG			CD5	.01098	CDCOR5	.01015

UPPER SURFACE				LOWER SURFACE				SPANWISE				
X/C	CP	P/L/P/T	MLOC	X/C	CP	P/L/P/T	MLOC	X/C	Y/(B/2)	CP	P/L/P/T	MLOC
0.0000	1.1254	.9898	.1211	0.0000	1.1254	.9898	.1211	.1507	.7476	-.5355	.5046	1.0392
.0132	.0663	.6833	.7583	.0126	.2307	.7307	.6859	.1507	.4976	-.5753	.4983	1.0497
.0259	-.2985	.5778	.9214	.0255	.0973	.6922	.7646	.1507	.2476	-.5844	.4956	1.0541
.0759	-.5678	.5005	1.0459	.0495	-.0710	.6437	.8191	.1507	-.2524	-.5803	.4968	1.0521
.1003	-.5748	.4986	1.0495	.0753	-.1284	.6271	.8446	.1507	-.5024	-.5866	.5008	1.0455
.1507	-.5967	.4950	1.0552	.1002	-.2043	.6052	.8783	.1507	-.7524	-.5895	.5037	1.0373
.2003	-.6080	.4888	1.0655	.1503	-.2675	.5870	.9069	.5002	.7476	-.7180	.4971	1.1199
.2503	-.6273	.4833	1.0749	.1976	-.3763	.5556	.9563	.5002	.4976	-.7262	.4963	1.1249
.3001	-.6487	.4771	1.0854	.2503	-.4394	.5374	.9856	.5002	-.2476	-.7389	.4911	1.1304
.3502	-.6646	.4754	1.0893	.3001	-.4825	.5250	1.0098	.5002	-.2524	-.7348	.4923	1.1283
.4003	-.6730	.4701	1.0974	.3507	-.5005	.5199	1.0141	.5002	-.5024	-.7292	.4939	1.1255
.4501	-.7012	.4620	1.1114	.4001	-.4692	.5286	.9981	.5002	-.7524	-.7336	.4926	1.1277
.5002	-.7379	.4514	1.1298	.4501	-.4012	.5485	.9678	.8002	.7476	-.3588	.5613	.9474
.5502	-.7656	.4434	1.1440	.5001	-.3109	.5745	.9263	.8002	.4976	-.3413	.5638	.9403
.6002	-.7935	.4354	1.1584	.5497	-.2876	.6101	.8710	.8002	.2476	-.3432	.5652	.9412
.6500	-.8474	.4198	1.1867	.6003	-.0859	.6451	.8169	.8002	-.5024	-.3444	.5649	.9417
.7000	-.8945	.4051	1.2141	.6500	.0355	.6744	.7720	.8002	-.7524	-.3378	.5610	.9479
.7500	-.9378	.3905	1.0460	.7000	.1470	.7065	.7224					
.8002	-.9386	.3865	.9391	.7501	.2435	.7343	.6792					
.8502	-.1310	.6264	.8458	.8001	.3241	.7576	.6425					
.9501	-.0202	.6583	.7966	.8501	.3926	.7773	.6109					

CRACKS OF POOR QUALITY

TEST 167	PT 24.7891	PSI	CN .5455	CD1 .01455	CDCOR1 .01458
RUN 50	TT 140.7191	K	CM -.1584	CD2 .01452	CDCOR2 .01465
POINT R5	RC 0.9590	MILLION	CC .0232	CD3 .01408	CDCOR3 .01423
	MACH .7890			CD4 .01333	CDCOR4 .01349
	ALPHA .0000	DEG		CD5 .01222	CDCOR5 .01202

UPPER SURFACE				LOWER SURFACE				SPANWISE				
X/C	CP	P/L/P/T	MLOC	X/C	CP	P/L/P/T	MLOC	X/C	Y/(B/2)	CP	P/L/P/T	MLOC
0.0000	1.1450	.9946	.0877	0.0000	1.1450	.9944	.0877	.1507	.7476	-.8608	.4760	1.0872
.0132	-.0294	.6576	.7377	.0126	.3244	.7584	.6413	.1507	.4976	-.8650	.4695	1.0985
.0259	-.4025	.5502	.9850	.0255	.1719	.7152	.7091	.1507	.2476	-.8931	.4667	1.1032
.0759	-.6560	.4774	1.0840	.0495	.0026	.6665	.7840	.1507	-.2524	-.8948	.4662	1.1040
.1003	-.6898	.4677	1.1015	.0753	-.0630	.6477	.8129	.1507	-.5024	-.8826	.4698	1.0980
.1507	-.6917	.4671	1.1025	.1002	-.1413	.6252	.8476	.1507	-.7524	-.8245	.4884	1.0695
.2003	-.6940	.4665	1.1038	.1503	-.2113	.6051	.8787	.5002	.7476	-.7761	.4429	1.1449
.2503	-.7035	.4637	1.1083	.1976	-.3163	.5749	.9259	.5002	.4976	-.7923	.4383	1.1532
.3001	-.7036	.4637	1.1084	.2503	-.3786	.5571	.9541	.5002	.2476	-.7989	.4364	1.1565
.3502	-.7135	.4609	1.1133	.3001	-.4196	.5453	.9729	.5002	-.2524	-.7983	.4365	1.1563
.4003	-.7267	.4571	1.1199	.3507	-.4619	.5389	.9932	.5002	-.5024	-.7907	.4387	1.1524
.4501	-.7510	.4501	1.1322	.4001	-.4230	.5443	.9745	.5002	-.7524	-.7922	.4383	1.1532
.5002	-.7805	.4388	1.1523	.4501	-.3726	.5588	.9514	.8002	.7476	-.3534	.5643	.9426
.5502	-.8273	.4282	1.1714	.5001	-.2917	.5820	.9147	.5002	.4976	-.3385	.5681	.9350
.6002	-.8443	.4184	1.1930	.5497	-.1742	.6158	.8622	.8002	.2476	-.3397	.5682	.9364
.6500	-.8053	.4058	1.2127	.6003	-.0564	.6496	.8101	.8002	-.5024	-.3419	.5676	.9374
.7000	-.7422	.3952	1.2328	.6500	.0421	.6779	.7666	.8002	-.7524	-.3544	.5640	.9431
.7500	-.5226	.5157	1.2509	.7000	.1520	.7095	.7179					
.8002	-.3357	.5694	.9346	.7501	.2477	.7369	.6751					
.8002	-.1328	.6277	.8438	.8001	.3282	.7601	.6386					
.9501	-.0245	.6588	.7960	.9501	.3971	.7798	.6068					

TEST 167	PT 24.7896	PSI	CN .6315	CD1 .01417	CDCOR1 .01758
RUN 50	TT 140.1140	K	CM -.1663	CD2 .01794	CDCOR2 .01741
POINT R6	RC 10.0249	MILLION	CC .0241	CD3 .01778	CDCOR3 .01750
	MACH .7894			CD4 .01622	CDCOR4 .01598
	ALPHA .5091	DEG		CD5 .01466	CDCOR5 .01390

UPPER SURFACE				LOWER SURFACE				SPANWISE				
X/C	CP	P/L/P/T	MLOC	X/C	CP	P/L/P/T	MLOC	X/C	Y/(B/2)	CP	P/L/P/T	MLOC
0.0000	1.1672	1.0007	0.0000	0.0000	1.1672	1.0007	0.0000	.1507	.7476	-.7670	.4434	1.1441
.0132	-.0971	.6164	.8303	.0126	.4163	.7844	.5985	.1507	.4976	-.7852	.4379	1.1539
.0259	-.4742	.5278	1.0012	.0255	.2517	.7369	.6751	.1507	.2476	-.7754	.4410	1.1484
.0759	-.7244	.4557	1.1224	.0495	.0791	.6772	.7523	.1507	-.2524	-.7721	.4419	1.1467
.1003	-.7508	.4481	1.1358	.0753	-.0072	.6665	.7441	.1507	-.5024	-.7789	.4400	1.1502
.1507	-.7708	.4423	1.1460	.1002	-.0759	.6426	.8209	.1507	-.7524	-.7085	.4603	1.1144
.2003	-.7772	.4405	1.1493	.1503	-.1500	.6212	.8538	.5002	.7476	-.8559	.4178	1.1904
.2503	-.7948	.4348	1.1594	.1976	-.2554	.5908	.9009	.5002	.4976	-.8316	.4190	1.1892
.3001	-.8222	.4275	1.1727	.2503	-.3198	.5723	.9300	.5002	.2476	-.8307	.4250	1.1771
.3502	-.8035	.4329	1.1674	.3001	-.3651	.5572	.9507	.5002	-.2524	-.8325	.4245	1.1790
.4003	-.7895	.4369	1.1556	.3507	-.3888	.5524	.9515	.5002	-.5024	-.8486	.4199	1.1865
.4501	-.7934	.4358	1.1576	.4001	-.3407	.5547	.9578	.5002	-.7524	-.8474	.4202	1.1859
.5002	-.8269	.4261	1.1751	.4501	-.3395	.5666	.9390	.8002	.7476	-.3337	.5683	.9364
.5502	-.8597	.4167	1.1925	.5001	-.2641	.5883	.9049	.8002	.4976	-.3257	.5703	.9332
.6002	-.9075	.4029	1.2182	.5497	-.1499	.6212	.8538	.8002	.2476	-.3325	.5685	.9358
.6500	-.9750	.3435	1.2555	.6003	-.0361	.6540	.8033	.8002	-.5024	-.3247	.5709	.9322
.7000	-1.0204	.3704	1.2814	.6500	.0606	.6779	.7604	.8002	-.7524	-.3306	.5691	.9350
.7500	-.9043	.5179	1.0172	.7000	-.1697	.7179	.7119					
.8002	-.3341	.5681	.9365	.7501	.2655	.7406	.6893					
.8002	-.1275	.6277	.8438	.8001	.3449	.7618	.6326					
.9501	-.0358	.6541	.8031	.9501	.4147	.7839	.6002					

TEST 167	PT 24.7922	PSI	CN .6924	CD1 .02251	CDCOR1 .02321
RUN 50	TT 140.3543	K	CM -.1661	CD2 .02257	CDCOR2 .02237
POINT 47	RC 10.0332	MILLION	CC .0238	CD3 .02143	CDCOR3 .02128
	MACH .7896			CD4 .02018	CDCOR4 .02000
	ALPHA 1.0741	DEG		CD5 .01894	CDCOR5 .01828

UPPER SURFACE				LOWER SURFACE				SPANWISE				
X/C	CP	P/L/P/T	MLOC	X/C	CP	P/L/P/T	MLOC	X/C	Y/(B/2)	CP	P/L/P/T	MLOC
0.0000	1.1603	.9987	.0430	0.0000	1.1603	.9987	.0430	.1507	.7476	-.8254	.4262	1.1750
.0132	-.1745	.6139	.8651	.0126	.4757	.8013	.5716	.1507	.4976	-.8722	.4127	1.1990
.0259	-.5569	.5036	1.0404	.0255	.3043	.7519	.6515	.1507	.2476	-.8505	.4190	1.1883
.0759	-.8019	.4330	1.1627	.0495	.1264	.7037	.7314	.1507	-.2524	-.8440	.4197	1.1866
.1003	-.8247	.4264	1.1780	.0753	-.0434	.6767	.7685	.1507	-.5024	-.8444	.4149	1.1957
.1507	-.8414	.4209	1.1886	.1002	-.0358	.6539	.8035	.1507	-.7524	-.8123	.4300	1.1682
.2003	-.8532	.4182	1.1897	.1503	-.1180	.6307	.8391	.5002	.7476	-.9275	.3968	1.2299
.2503	-.8750	.4119	1.2014	.1976	-.2217	.6002	.8862	.5002	.4976	-.9361	.3943	1.2146
.3001	-.9077	.4025	1.2190	.2503	-.2865	.5910	.9163	.5002	.2476	-.9125	.4011	1.2217
.3502	-.9164	.3998	1.2241	.3001	-.3357	.5674	.9377	.5002	-.2524	-.8968	.4062	1.2116
.4003	-.9417	.4100	1.2050	.3507	-.3861	.5586	.9516	.5002	-.5024	-.8901	.3934	1.2263
.4501	-.9614	.4099	1.2051	.4001	-.3628	.5596	.9501	.5002	-.7524	-.9076	.4025	1.2190
.5002	-.9927	.4088	1.2109	.4501	-.3303	.5669	.9353	.8002	.7476	-.3332	.4081	.9366
.5502	-.9262	.3971	1.2294	.5001	-.2613	.5888	.9041	.8002	.4976	-.3345	.4077	.9372
.6002	-.9554	.3887	1.2494	.5497	-.1526	.6202	.8554	.8002	.2476	-.3400	.4062	.9367
.6500	-1.0136	.3719	1.2793	.6003	-.0411	.6523	.8059	.8002	-.5024	-.3374	.4069	.9357
.7000	-.9883	.3649	1.2528	.6500	.0530	.6774	.7642					
.7500	-.9433	.3576	1.0048	.7000	.1606	.7105	.7163					
.8002	-.3650	.5657	.9420	.7501	.2544	.7375	.6742					
.8002	-.1479	.6214	.8931	.8001	.3343	.7606	.6374					
.9501	-.0666	.6496	.8172	.9501	.4037	.7806	.6057					

TEST	167	PT	24.7894	PSI	CN	.7408	CD1	.03034	CDCOR1	.02947
RUN	50	TT	139.9810	K	CM	-.1662	CD2	.02940	CDCOR2	.02861
POINT	88	PC	10.0408	MILLION	CC	.0229	CD3	.02691	CDCOR3	.02606
		MACH	.7897				CD4	.02566	CDCOR4	.02434
		ALPHA	1.5071	DEG			CD5	.02403	CDCOR5	.02323

UPPER SURFACE				LOWER SURFACE				SPANWISE				
X/C	CP	P _L /PT	MLOC	X/C	CP	P _L /PT	MLOC	X/C	Y/(B/2)	CP	P _L /PT	MLOC
0.0000	1.1636	1.0000	0.0000	0.0000	1.1636	1.0000	0.0000	.1507	.7476	-.8682	.4169	1.1921
.0132	-.2443	.5959	.8930	.0126	.5359	.8198	.5404	.1507	.4976	-.9473	.3941	1.2349
.0259	-.6251	.4866	1.0697	.0255	.3606	.7695	.6234	.1507	.2476	-.9155	.4033	1.2175
.0759	-.8640	.4169	1.1921	.0495	.1781	.7172	.7060	.1507	-.2524	-.9115	.4044	1.2154
.1003	-.8919	.4101	1.2048	.0753	.0898	.6918	.7452	.1507	-.5024	-.9301	.3991	1.2255
.1507	-.9064	.4058	1.2128	.1002	.0084	.6685	.7811	.1507	-.7524	-.8930	.4097	1.2054
.2003	-.9122	.4042	1.2157	.1503	-.0770	.6440	.8187	.5002	.7476	-.9848	.3834	1.2557
.2503	-.9379	.3968	1.2297	.1976	-.1840	.6132	.8661	.5002	.4976	-.9978	.3797	1.2630
.3001	-.9741	.3865	1.2497	.2303	-.2541	.5931	.8974	.5002	.2476	-.9988	.3794	1.2636
.3502	-.9894	.3821	1.2593	.3001	-.3036	.5789	.9196	.5002	-.2524	-.9976	.3858	1.2509
.4003	-.9967	.3828	1.2568	.3507	-.3380	.5690	.9351	.5002	-.5024	-1.0011	.3787	1.2649
.4501	-.9956	.3929	1.2372	.4001	-.3413	.5581	.9366	.5002	-.7524	-.9600	.3905	1.2419
.5002	-.9702	.3876	1.2475	.4501	-.3162	.5753	.9253	.8002	.7476	-.3378	.5691	.9351
.5502	-.9736	.3866	1.2494	.5001	-.2540	.5931	.8973	.8002	.4976	-.3427	.5677	.9373
.6002	-1.0124	.3755	1.2713	.5497	-.1493	.6232	.8507	.8002	.2476	-.3455	.5669	.9385
.6500	-1.0555	.3631	1.2961	.6003	-.0403	.6545	.8025	.8002	-.5024	-.3516	.5651	.9413
.7000	-.6809	.4705	1.0965	.6500	.0509	.6806	.7624	.8002	-.7524	-.3342	.5701	.9334
.7500	-.3428	.5389	.9831	.7000	.1571	.7111	.7153					
.8002	-.3468	.5665	.9391	.7501	.2507	.7380	.6735					
.9002	-.1783	.6149	.8636	.8001	.3300	.7608	.6375					
.9501	-.0979	.6379	.8280	.8501	.3993	.7807	.6055					

TEST	167	PT	24.7918	PSI	CN	.7668	CD1	.03415	CDCOR1	.03214
RUN	50	TT	139.9126	K	CM	-.1651	CD2	.03555	CDCOR2	.03332
POINT	89	PC	10.0500	MILLION	CC	.0238	CD3	.03555	CDCOR3	.03466
		MACH	.7898				CD4	.03330	CDCOR4	.03246
		ALPHA	2.0227	DEG			CD5	.03304	CDCOR5	.03213

UPPER SURFACE				LOWER SURFACE				SPANWISE				
X/C	CP	P _L /PT	MLOC	X/C	CP	P _L /PT	MLOC	X/C	Y/(B/2)	CP	P _L /PT	MLOC
0.0000	1.1609	.9987	.0429	0.0000	1.1609	.9987	.0429	.1507	.7476	-.8971	.4042	1.2158
.0132	-.2954	.5780	.9210	.0126	.5756	.8296	.5235	.1507	.4976	-.9915	.3769	1.2684
.0259	-.6701	.4698	1.0980	.0255	.3970	.7780	.6098	.1507	.2476	-.9576	.3867	1.2492
.0759	-.9086	.4007	1.2220	.0495	.2112	.7243	.6948	.1507	-.2524	-.9514	.3885	1.2457
.1003	-.9340	.3935	1.2360	.0753	.1144	.6978	.7359	.1507	-.5024	-.9727	.3824	1.2577
.1507	-.9484	.3894	1.2440	.1002	.0357	.6737	.7731	.1507	-.7524	-.9311	.3944	1.2344
.2003	-.9556	.3873	1.2481	.1503	-.0540	.6477	.8129	.5002	.7476	-1.0293	.3660	1.2902
.2503	-.9770	.3811	1.2601	.1976	-.1634	.6151	.8616	.5002	.4976	-1.0414	.3625	1.2972
.3001	-1.0124	.3709	1.2803	.2503	-.2372	.5948	.8947	.5002	.2476	-1.0460	.3612	1.2999
.3502	-1.0305	.3657	1.2909	.3001	-.2911	.5793	.9190	.5002	-.2524	-1.0299	.3658	1.2905
.4003	-1.0404	.3628	1.2967	.3507	-.3309	.5678	.9371	.5002	-.5024	-1.0286	.3662	1.2897
.4501	-1.0322	.3652	1.2919	.4001	-.3398	.5652	.9412	.5002	-.7524	-1.0043	.3733	1.2757
.5002	-1.0207	.3685	1.2851	.4501	-.3205	.5708	.9324	.8002	.7476	-.3607	.5591	.9408
.5502	-1.0401	.3629	1.2965	.5001	-.2620	.5877	.9059	.8002	.4976	-.3729	.5556	.9564
.6002	-1.0523	.3594	1.3036	.5497	-.1594	.6173	.8598	.8002	.2476	-.3618	.5589	.9512
.6500	-.9510	.3886	1.2455	.6003	-.0519	.6483	.8120	.8002	-.5024	-.3766	.5546	.9580
.7000	-.5157	.5144	1.0230	.6500	.0378	.6743	.7722	.8002	-.7524	-.3557	.5606	.9485
.7500	-.4205	.5418	.9784	.7000	.1436	.7048	.7251					
.8002	-.3540	.5611	.9477	.7501	.2367	.7317	.6833					
.9002	-.2296	.5970	.8912	.8001	.3161	.7547	.6472					
.9501	-.1697	.6143	.8644	.8501	.3855	.7747	.6151					

TFST 167	PT	55.3536	PSI						
RUN 43	TT	115.1783	K	CN	-0.970	CD1	.02057	CDCOR1	.02041
POINT 13	RC	29.8799	MILLION	CM	-0.163	CD2	.01833	CDCOR2	.01824
	MACH	.7920		CC	.0149	CD3	.01685	CDCOR3	.01689
	ALPHA	-3.9871	DEG			CD4	.01492	CDCOR4	.01485
						CD5	.01281	CDCOR5	.01247

UPPER SURFACE				LOWER SURFACE				SPANWISE				
X/C	CP	P/L/PT	MLOC	X/C	CP	P/L/PT	MLOC	X/C	Y/(B/2)	CP	P/L/PT	MLOC
0.0000	.7900	.8908	.4105	0.0000	.7900	.8908	.4105	.1507	.7476	-.1241	.6262	.8477
.0132	.6355	.8461	.4954	.0126	-.5483	.5034	1.0431	.1507	.4976	-.1380	.6222	.8539
.0259	.3285	.7572	.6444	.0255	-.5138	.5134	1.0266	.1507	.2476	-.1323	.623C	.8514
.0759	-.0030	.6613	.7937	.0495	-.6635	.4700	1.0995	.1507	-.2524	-.1413	.6212	.8554
.1003	-.0563	.6458	.8174	.0753	-.6992	.4597	1.1173	.1507	-.5024	-.1463	.6198	.8577
.1507	-.1351	.6230	.8526	.1002	-.7431	.4470	1.1397	.1507	-.7524	-.1374	.6224	.8536
.2003	-.1873	.6079	.8760	.1503	-.7546	.4437	1.1456	.5002	.7476	-.4332	.5367	.9885
.2503	-.2413	.5923	.9004	.1976	-.8040	.4293	1.1713	.5002	.4976	-.4359	.5359	.9898
.3001	-.2906	.5780	.9228	.2503	-.8645	.4118	1.2034	.5002	.5024	-.4404	.5346	.9919
.3502	-.3181	.5700	.9393	.3001	-.9262	.3940	1.2372	.5002	-.2524	-.4317	.5371	.9878
.4003	-.3525	.5601	.9511	.3507	-.9835	.3774	1.2695	.5002	-.5024	-.4295	.5378	.9868
.4501	-.3885	.5497	.9677	.4001	-1.0372	.3619	1.3006	.5002	-.7524	-.4168	.5415	.9809
.5002	-.4378	.5354	.9907	.4501	-1.0267	.3649	1.2945	.8002	.7476	-1.0437	.3600	1.3044
.5502	-.4845	.5219	1.0127	.5001	-.4489	.5322	.9959	.8002	.4976	-.3676	.5557	.9581
.6002	-.5335	.5077	1.0360	.5497	-.3078	.5730	.9306	.8002	.2476	-.3667	.5560	.9577
.6500	-.5983	.4889	1.0673	.6003	-.1741	.6117	.8701	.8002	-.5024	-.3488	.5611	.9494
.7000	-.6621	.4762	1.0888	.7000	-.0552	.6462	.8169	.8002	-.7524	-.3559	.5591	.9527
.7500	-.7210	.4611	1.1088	.7501	.1455	.7043	.7274					
.8002	-.7610	.4576	.9550	.8001	.2186	.7254	.6945					
.9002	-.1866	.6139	.8667	.8501	.2796	.7431	.6668					
.9501	-.0335	.6524	.8072									

TEST 167	PT	55.3502	PSI						
RUN 43	TT	115.2132	K	CN	.0860	CD1	.01471	CDCOR1	.01449
POINT 14	RC	29.9365	MILLION	CM	-.1453	CD2	.01397	CDCOR2	.01386
	MACH	.7954		CC	.0208	CD3	.01302	CDCOR3	.01302
	ALPHA	-3.0039	DEG			CD4	.01207	CDCOR4	.01200
						CD5	.01089	CDCOR5	.01056

UPPER SURFACE				LOWER SURFACE				SPANWISE				
X/C	CP	P/L/PT	MLOC	X/C	CP	P/L/PT	MLOC	X/C	Y/(B/2)	CP	P/L/PT	MLOC
0.0000	.9084	.9243	.3379	0.0000	.9084	.9243	.3379	.1507	.7476	-.2304	.5928	.8996
.0132	.5091	.8080	.5615	.0126	-.3110	.5693	.9365	.1507	.4976	-.2458	.5883	.9066
.0259	.1859	.7139	.7124	.0255	-.3521	.5573	.9555	.1507	.2476	-.2405	.5898	.9042
.0759	-.1320	.6214	.8551	.0495	-.4720	.5224	1.0117	.1507	-.2524	-.2493	.5873	.9082
.1003	-.1739	.6092	.8740	.0753	-.5110	.5111	1.0303	.1507	-.5024	-.2535	.5860	.9102
.1507	-.2427	.5892	.9052	.1002	-.5887	.4895	1.0681	.1507	-.7524	-.2409	.5897	.9044
.2003	-.2861	.5766	.9250	.1503	-.5861	.4892	1.0668	.5002	.7476	-.5189	.5088	1.0341
.2503	-.3356	.5621	.9478	.1976	-.6296	.4766	1.0893	.5002	.4976	-.5258	.5068	1.0374
.3001	-.3832	.5483	.9699	.2503	-.7197	.4593	1.1338	.5002	.2476	-.5310	.5053	1.0400
.3502	-.4625	.5427	.9789	.3001	-.8093	.4242	1.1806	.5002	-.2524	-.5230	.5076	1.0361
.4001	-.4326	.5339	.9931	.3507	-.8967	.3988	1.2280	.5002	-.5024	-.5210	.5082	1.0351
.4501	-.4682	.5235	1.0099	.4001	-.9656	.3788	1.2668	.8002	.7476	-1.0378	.3577	1.3090
.5002	-.5281	.5061	1.0386	.4501	-1.0376	.3578	1.3089	.8002	.4976	-.3503	.5132	1.0268
.5502	-.5855	.4952	1.0567	.5001	-.4059	.5417	.9805	.8002	.2476	-1.0378	.3577	1.3090
.6000	-.6053	.4836	1.0762	.5497	-.2120	.5981	.8913	.8002	.4976	-.3503	.5132	1.0268
.6500	-.6702	.4647	1.1086	.6003	-.0771	.6374	.8304	.8002	.2476	-.3495	.5581	.9546
.7000	-.7416	.4440	1.1450	.6500	.0232	.6666	.7855	.8002	-.5024	-.3370	.5617	.9485
.7500	-.7733	.4452	1.1428	.7000	.1338	.6988	.7358	.8002	-.7524	-.3557	.5563	.9571
.8002	-.3455	.5593	.9524	.7501	.2282	.7263	.6931					
.9002	-.1625	.6125	.8689	.8001	.3082	.7496	.6566					
.9501	-.0400	.6482	.8138	.8501	.3765	.7694	.6248					

TEST 167	PT	55.4696	PSI						
RUN 43	TT	115.2363	K	CN	.2614	CD1	.00983	CDCOR1	.00950
POINT 15	RC	29.8639	MILLION	CM	-.1593	CD2	.00961	CDCOR2	.00936
	MACH	.7894		CC	.0232	CD3	.00937	CDCOR3	.00925
	ALPHA	-1.9958	DEG			CD4	.00917	CDCOR4	.00899
						CD5	.00873	CDCOR5	.00837

UPPER SURFACE				LOWER SURFACE				SPANWISE				
X/C	CP	P/L/PT	MLOC	X/C	CP	P/L/PT	MLOC	X/C	Y/(B/2)	CP	P/L/PT	MLOC
0.0000	1.0169	.9569	.2521	0.0000	1.0169	.9569	.2521	.1507	.7476	-.3532	.5613	.9491
.0132	.3508	.7646	.6326	.0126	-.0773	.6410	.8249	.1507	.4976	-.3721	.5559	.9578
.0259	.0096	.6661	.7863	.0255	-.1656	.6155	.8643	.1507	.2476	-.3679	.5568	.9563
.0759	-.2885	.5800	.9196	.0495	-.2926	.5788	.9715	.1507	-.2524	-.3788	.5539	.9609
.1003	-.3150	.5721	.9320	.0753	-.3477	.5629	.9466	.1507	-.5024	-.3818	.5531	.9622
.1507	-.3708	.5563	.9572	.1002	-.4160	.5432	.9781	.1507	-.7524	-.3656	.5577	.9548
.2003	-.3998	.5479	.9706	.1503	-.4393	.5365	.9889	.5002	.7476	-.5985	.4905	1.0646
.2503	-.4431	.5354	.9907	.1976	-.5483	.5050	1.0404	.5002	.4976	-.6044	.4888	1.0675
.3001	-.4922	.5212	1.0138	.2503	-.6432	.4776	1.0865	.5002	.2476	-.6093	.4874	1.0699
.3502	-.4939	.5207	1.0145	.3001	-.7132	.4574	1.1214	.5002	-.2524	-.6003	.4900	1.0655
.4003	-.5155	.5145	1.0248	.3507	-.7731	.4401	1.1519	.5002	-.5024	-.6021	.4895	1.0684
.4501	-.5476	.5052	1.0401	.4001	-.7809	.4378	1.1560	.8002	-.7524	-.5902	.4929	1.0606
.5002	-.6048	.4887	1.0677	.4501	-.4067	.5459	.9738	.8002	.7476	-1.0287	.3663	1.2916
.5502	-.6493	.4759	1.0895	.5001	-.3172	.5717	.9327	.8002	.4976	-.3438	.5640	.9448
.6002	-.6931	.4632	1.1113	.5497	-.2006	.6054	.8800	.8002	.2476	-.3430	.5643	.9473
.6500	-.7521	.4462	1.1411	.6003	-.0756	.6415	.8242	.8002	-.5024	-.3371	.5660	.9473
.7000	-.8120	.4289	1.1721	.6500	.0225	.6698	.7805	.8002	-.7524	-.3625	.5587	.9534
.7500	-.7706	.4408	1.1507	.7000	.1449	.7051	.7260					
.8002	-.3408	.5649	.9434	.7501	.2469	.7346	.6801					
.9002	-.1560	.6183	.8600	.8001	.3316	.7590	.6415					
.9501	-.0347	.6533	.8059	.8501	.4033	.7797	.6082					

ORIGINAL PAGE IS
OF POOR QUALITY

TEST	167	PT	55.4763	PSI		CN	.3430	CD1	.01133	CDCOR1	.01076		
RUN	43	TT	115.1873	K		CM	-.1649	CD2	.01110	CDCOR2	.01061		
POINT	16	RC	29.9850	MILLION		CC	.0259	CD3	.01081	CDCOR3	.01041		
		MACH	.7940					CD4	.01035	CDCOR4	.00999		
		ALPHA	-1.4867	DEG				CD5	.00962	CDCOR5	.00911		
UPPER SURFACE													
X/C	1.0631	P/L/PT	.9700	MLOC	X/C	1.0631	P/L/PT	MLOC	SPANWISE				
CP	.2689	.7402	.6713	.2095	CP	.2689	.7402	.6713	X/C	Y/(B/2)	CP	P/L/PT	MLOC
.0132	.2689	.7402	.6713	.2095	.0126	.0392	.6737	.7745	.1507	.7476	-.4178	.5415	.9808
.0259	-.0808	.6390	.8280	.0255	-.0684	.6426	.8224	.0259	.4976	-.4405	.5349	.9914	
.0759	-.3728	.5545	.9600	.0495	-.2058	.6028	.8840	.0759	.2476	-.4387	.5354	.9906	
.1003	-.3909	.5492	.9684	.0753	-.2698	.5843	.9129	.1003	-.2524	-.4496	.5323	.9957	
.1507	-.4398	.5351	.9911	.1002	-.3416	.5635	.9457	.1507	-.5024	-.4503	.5321	.9960	
.2003	-.4612	.5289	1.0012	.1503	-.3832	.5515	.9648	.2003	-.7524	-.4301	.5379	.9866	
.2503	-.4973	.5185	1.0182	.1976	-.4972	.5285	1.0182	.2503	.7476	-.6396	.4773	1.0870	
.3001	-.5507	.5030	1.0437	.2503	-.5824	.4939	1.0590	.3001	.4976	-.6431	.4763	1.0887	
.3502	-.5674	.4982	1.0518	.3001	-.6375	.4779	1.0860	.3502	.2476	-.6424	.4765	1.0884	
.4003	-.5753	.4959	1.0556	.3507	-.6843	.4644	1.1093	.4003	-.2324	-.6358	.4784	1.0852	
.4501	-.5855	.4930	1.0605	.4001	-.6152	.4844	1.0750	.4501	-.5024	-.6407	.4770	1.0876	
.5002	-.6317	.4796	1.0831	.4501	-.4237	.5398	.9836	.5002	-.7524	-.6383	.4777	1.0864	
.5502	-.6789	.4659	1.1066	.5001	-.3234	.5688	.9373	.5502	.7476	-1.0165	.3682	1.2877	
.6002	-.7283	.4516	1.1315	.5497	-.1997	.6046	.8812	.6002	.4976	-.3599	.3582	.9541	
.6500	-.7936	.4327	1.1652	.6003	-.0734	.6411	.8247	.6500	.2476	-.3752	.3538	.9611	
.7000	-.8637	.4124	1.2023	.6500	.0239	.6893	.7813	.7000	-.5024	-.3408	.3638	.9453	
.7500	-.8926	.4041	1.2180	.7000	.1463	.7047	.7267	.8002	-.7524	-.3611	.3579	.9546	
.8002	-.3792	.5527	.9629	.7501	.2486	.7343	.6806						
.8002	-.1391	.6221	.8540	.8001	.3335	.7589	.6417						
.9501	-.0244	.6553	.8028	.8501	.4057	.7798	.6081						

TEST	167	PT	55.4804	PSI		CN	.4274	CD1	.01246	CDCOR1	.05		
RUN	43	TT	115.1695	K		CM	-.1693	CD2	.01216	CDCOR2	.01175		
POINT	17	RC	29.9782	MILLION		CC	.0270	CD3	.01181	CDCOR3	.01135		
		MACH	.7933					CD4	.01121	CDCOR4	.01083		
		ALPHA	-.9979	DEG				CD5	.01045	CDCOR5	.01002		
UPPER SURFACE													
X/C	1.0983	P/L/PT	.9802	MLOC	X/C	1.0983	P/L/PT	MLOC	SPANWISE				
CP	.1744	.7129	.7140	.1695	CP	.1744	.7129	.7140	X/C	Y/(B/2)	CP	P/L/PT	MLOC
.0132	.1744	.7129	.7140	.1695	.0126	.1482	.7054	.7257	.1507	.7476	-.4946	.5194	1.0167
.0259	-.1812	.6101	.3727	.0255	-.0238	.6694	.7812	.0259	.4976	-.5148	.5135	1.0263	
.0759	-.4691	.5268	1.0046	.0495	-.1206	.6276	.8436	.0759	.2476	-.5142	.5137	1.0260	
.1003	-.4725	.5258	1.0063	.0753	-.1908	.6073	.8770	.1003	-.2524	-.5211	.5117	1.0293	
.1507	-.5149	.5135	1.0263	.1002	-.2707	.5842	.9131	.1507	-.5024	-.5180	.5126	1.0278	
.2003	-.5300	.5092	1.0335	.1503	-.3215	.5695	.9362	.2003	-.7524	-.4923	.5201	1.0156	
.2503	-.5481	.5039	1.0422	.1976	-.4329	.5372	.9877	.2503	.7476	-.6892	.4631	1.1115	
.3001	-.5981	.4894	1.0664	.2503	-.4967	.5188	1.0177	.3001	.4976	-.6934	.4619	1.1135	
.3502	-.6243	.4819	1.0792	.3001	-.5921	.5028	1.0441	.3502	.2476	-.6961	.4611	1.1149	
.4003	-.6386	.4777	1.0863	.3507	-.5681	.4981	1.0519	.4003	-.2524	-.6834	.4648	1.1085	
.4501	-.6543	.4732	1.0940	.4001	-.5139	.5138	1.0259	.4501	-.5024	-.6878	.4635	1.1107	
.5002	-.6973	.4607	1.1155	.4501	-.4143	.5426	.9790	.5002	-.7524	-.6884	.4633	1.1111	
.5502	-.7269	.4522	1.1305	.5001	-.3141	.5716	.9329	.5502	.7476	-.9989	.3735	1.2772	
.6002	-.7636	.4416	1.1493	.5497	-.1882	.6080	.8759	.6002	.4976	-.3559	.3595	.9520	
.6500	-.8282	.4229	1.1831	.6003	-.0630	.6442	.8199	.6500	.2476	-.3755	.3544	.9601	
.7000	-.8962	.4032	1.2196	.6500	.0333	.6721	.7770	.7000	-.5024	-.3358	.3633	.9428	
.7500	-.8982	.4026	1.2267	.7000	.1348	.7073	.7227	.8002	-.7524	-.3552	.3597	.9517	
.8002	-.3734	.5545	.9601	.7501	.2564	.7366	.6769						
.8002	-.1406	.6218	.8545	.8001	.3414	.7612	.6380						
.9501	-.0287	.6542	.8046	.8501	.4141	.7823	.6040						

TEST	167	PT	55.5829	PSI		CN	.5039	CD1	.01431	CDCOR1	.01385		
RUN	43	TT	115.2739	K		CM	-.1743	CD2	.01416	CDCOR2	.01371		
POINT	18	RC	29.9939	MILLION		CC	.0284	CD3	.01371	CDCOR3	.01337		
		MACH	.7933					CD4	.01288	CDCOR4	.01251		
		ALPHA	-.4888	DEG				CD5	.01199	CDCOR5	.01150		
UPPER SURFACE													
X/C	1.1276	P/L/PT	.9885	MLOC	X/C	1.1276	P/L/PT	MLOC	SPANWISE				
CP	.0951	.6893	.7304	.1287	CP	.0951	.6893	.7304	X/C	Y/(B/2)	CP	P/L/PT	MLOC
.0132	.0951	.6893	.7304	.1287	.0126	.2471	.7334	.6820	.1507	.7476	-.5544	.5011	1.0469
.0259	-.2668	.5844	.9127	.0255	-.0435	.6491	.8123	.0259	.4976	-.5689	.4969	1.0539	
.0759	-.5599	.4995	1.0495	.0495	-.1208	.6267	.8469	.0759	.2476	-.5692	.4968	1.0540	
.1003	-.5775	.4944	1.0581	.0753	-.1208	.6267	.8469	.1003	-.2524	-.5711	.4963	1.0549	
.1507	-.5709	.4963	1.0549	.1002	-.2044	.6025	.8844	.1507	-.5024	-.5631	.4986	1.0511	
.2003	-.5982	.4884	1.0682	.1503	-.2644	.5831	.9116	.2003	-.7524	-.5481	.5029	1.0439	
.2503	-.6264	.4802	1.0820	.1976	-.3746	.5532	.9621	.2503	.7476	-.7429	.4465	1.1406	
.3001	-.6585	.4709	1.0979	.2503	-.4387	.5346	.9919	.3001	.4976	-.7462	.4455	1.1423	
.3502	-.6661	.4687	1.1017	.3001	-.4898	.5198	1.0160	.3502	.2476	-.7508	.4442	1.1446	
.4003	-.6736	.4666	1.1055	.3507	-.5087	.5144	1.0250	.4003	-.2524	-.7477	.4451	1.1431	
.4501	-.6952	.4603	1.1163	.4001	-.4745	.5242	1.0088	.4501	-.5024	-.7390	.4476	1.1386	
.5002	-.7485	.4440	1.1435	.4501	-.3957	.5471	.9718	.5002	-.7524	-.7379	.4479	1.1380	
.5502	-.7887	.4332	1.1643	.5001	-.3022	.5742	.9288	.5502	.7476	-.9819	.3772	1.2698	
.6002	-.8268	.4222	1.1844	.5497	-.1781	.6101	.8726	.6002	.4976	-.3636	.3589	.9570	
.6500	-.8707	.4095	1.2079	.6003	-.0545	.6460	.8172	.6500	.2476	-.3894	.3549	.9689	
.7000	-.9344	.3898	1.2452	.6500	.0399	.6733	.7751	.7000	-.5024	-.3343	.3649	.9435	
.7500	-.9637	.3825	1.2594	.7000	.1606	.7083	.7211	.8002	-.7524	-.3427	.3624	.9473	
.8002	-.3874	.5495	.9680	.7501	.2617	.7376	.6754						
.8002	-.1297	.6242	.8508	.8001	.3469	.7623	.6363						
.9501	-.0225	.6552	.8030	.8501	.4900	.7835	.6021						

TEST 167	PT	55.5716	PSI	CN	.5812	CD1	.01740	CDCOR1	.01683
RUN 43	TT	115.2056	K	CM	-.1768	CD2	.01750	CDCOR2	.01679
POINT 19	RC	30.0201	MILLION	CC	.0286	CD3	.01696	CDCOR3	.01647
	MACH	.7936				CD4	.01573	CDCOR4	.01516
	ALPHA	.0355	DEG			CD5	.01446	CDCOR5	.01390

UPPER SURFACE				LOWER SURFACE				SPANWISE				
X/C	CP	P/L/PT	MLOC	X/C	CP	P/L/PT	MLOC	X/C	Y/(B/2)	CP	P/L/PT	MLOC
0.0000	1.1476	.9947	.0872	0.0000	1.1476	.9947	.0872	.1507	.7476	-.6594	.4734	1.0937
.0132	.0023	.6643	.7890	.0126	.3400	.7617	.6372	.1507	.4976	-.6911	.4642	1.1095
.0259	-.3674	.5576	.9550	.0255	.1921	.7191	.7044	.1507	.2476	-.6915	.4641	1.1097
.0759	-.6445	.4777	1.0864	.0495	.0289	.6720	.7772	.1507	-.2524	-.6944	.4633	1.1111
.1003	-.6811	.4671	1.1045	.0753	-.0548	.6478	.8144	.1507	-.5024	-.6866	.4656	1.1072
.1507	-.6847	.4661	1.1063	.1002	-.1392	.6235	.8519	.1507	-.7524	-.6224	.4841	1.0755
.2003	-.6858	.4658	1.1068	.1503	-.2076	.6037	.8825	.5002	.7476	-.8034	.4319	1.1668
.2503	-.7058	.4600	1.1168	.1976	-.3152	.5727	.9311	.5002	.4976	-.7966	.4338	1.1632
.3001	-.7192	.4561	1.1236	.2503	-.3794	.5542	.9605	.5002	-.2476	-.8097	.4312	1.1680
.3502	-.7171	.4567	1.1225	.3001	-.4249	.5410	.9816	.5002	-.2524	-.7962	.4339	1.1630
.4003	-.7283	.4535	1.1282	.3507	-.4472	.5346	.9919	.5002	-.5024	-.7947	.4344	1.1622
.4501	-.7446	.4488	1.1365	.4001	-.4262	.5407	.9822	.5002	-.7524	-.7884	.4362	1.1590
.5002	-.7923	.4351	1.1610	.4501	-.3749	.5555	.9584	.8002	.7476	-.9717	.3833	1.2579
.5502	-.8328	.4234	1.1822	.5001	-.2901	.5799	.9197	.8002	.4976	-.9356	.5581	.9542
.6002	-.8783	.4102	1.2065	.5497	-.1700	.6146	.8657	.8002	.2476	-.8399	.5541	.9607
.6500	-.9409	.3922	1.2407	.6003	-.0492	.6494	.8119	.8002	-.5024	-.3394	.5657	.9422
.7000	-.9911	.3777	1.2689	.6500	.0417	.6757	.7715	.8002	-.7524	-.3414	.5651	.9431
.7500	-.9527	.3888	1.2472	.7000	.1615	.7102	.7181					
.8002	-.8835	.5530	.9624	.7501	.2622	.7393	.6728					
.9002	-.1312	.6258	.8484	.8001	.3469	.7637	.6340					
.9501	-.0241	.6567	.8008	.8501	.4201	.7848	.5990					

TEST 167	PT	55.5591	PSI	CN	-.6083	CD1	.02058	CDCOR1	.01972
RUN 43	TT	115.0376	K	CM	-.1743	CD2	.02031	CDCOR2	.01962
POINT 20	RC	30.0881	MILLION	CC	.0295	CD3	.02045	CDCOR3	.01954
	MACH	.7940				CD4	.01863	CDCOR4	.01767
	ALPHA	.5061	DEG			CD5	.01693	CDCOR5	.01581

UPPER SURFACE				LOWER SURFACE				SPANWISE				
X/C	CP	P/L/PT	MLOC	X/C	CP	P/L/PT	MLOC	X/C	Y/(B/2)	CP	P/L/PT	MLOC
0.0000	1.1593	.9970	.0660	0.0000	1.1593	.9970	.0660	.1507	.7476	-.7112	.4505	1.1335
.0132	-.0330	.6486	.8132	.0126	.3978	.7745	.6167	.1507	.4976	-.7400	.4403	1.1516
.0259	-.4007	.5412	.9813	.0255	.2449	.7298	.6877	.1507	.2476	-.7327	.4442	1.1447
.0759	-.6736	.4669	1.1153	.0495	-.0756	.6804	.7643	.1507	-.2524	-.7343	.4437	1.1455
.1003	-.7073	.4516	1.1315	.0753	-.0130	.6545	.8042	.1507	-.5024	-.7406	.4419	1.1488
.1507	-.7237	.4468	1.1400	.1002	-.0998	.6291	.8433	.1507	-.7524	-.6702	.4625	1.1126
.2003	-.7336	.4439	1.1451	.1503	-.1751	.6071	.8773	.5002	.7476	-.8472	.4108	1.2055
.2503	-.7545	.4378	1.1560	.1976	-.2866	.5746	.9283	.5002	.4976	-.8470	.4108	1.2054
.3001	-.7900	.4275	1.1748	.2503	-.3573	.5539	.9610	.5002	.2476	-.8275	.4165	1.1948
.3502	-.7761	.4315	1.1674	.3001	-.4109	.5382	.9861	.5002	-.2524	-.8172	.4195	1.1893
.4003	-.7675	.4341	1.1628	.3507	-.4436	.5287	.9861	.5002	-.5024	-.8421	.4122	1.2028
.4501	-.7728	.4325	1.1656	.4001	-.4307	.5325	.9955	.5002	-.7524	-.8179	.4193	1.1897
.5002	-.8221	.4181	1.1919	.4501	-.3795	.5474	.9714	.8002	.7476	-.9544	.3795	1.2655
.5502	-.8516	.4094	1.2080	.5001	-.2943	.5723	.9315	.8002	.4976	-.9359	.5485	.9697
.6002	-.8904	.3981	1.2293	.5497	-.1736	.6076	.8766	.8002	.2476	-.8324	.5543	.9683
.6500	-.9576	.3785	1.2674	.6003	-.0532	.6427	.8222	.8002	-.5024	-.3564	.5542	.9606
.7000	-.10331	.3565	1.3117	.6500	.0369	.6691	.7817	.8002	-.7524	-.3330	.5610	.9497
.7500	-.7292	.4453	1.1428	.7000	.1563	.7039	.7279					
.8002	-.3711	.5499	.9675	.7501	.2565	.7332	.6823					
.9002	-.1616	.6111	.8712	.8001	.3407	.7378	.6435					
.9501	-.0716	.6374	.8305	.8501	.4139	.7792	.6091					

TEST 167	PT	55.5731	PSI	CN	.6892	CD1	.02644	CDCOR1	.02560
RUN 43	TT	115.1895	K	CM	-.1766	CD2	.02481	CDCOR2	.02365
POINT 21	RC	30.0232	MILLION	CC	.0280	CD3	.02405	CDCOR3	.02246
	MACH	.7934				CD4	.02257	CDCOR4	.02192
	ALPHA	1.0081	DEG			CD5	.02105	CDCOR5	.02021

UPPER SURFACE				LOWER SURFACE				SPANWISE				
X/C	CP	P/L/PT	MLOC	X/C	CP	P/L/PT	MLOC	X/C	Y/(B/2)	CP	P/L/PT	MLOC
0.0000	1.1658	.9997	.0195	0.0000	1.1658	.9997	.0195	.1507	.7476	-.7926	.4332	1.1644
.0132	-.1261	.6260	.8480	.0126	.4771	.8005	.5741	.1507	.4976	-.8393	.4197	1.1890
.0259	-.5106	.5147	1.0243	.0255	.3153	.7537	.6500	.1507	.2476	-.8213	.4249	1.1795
.0759	-.7724	.4390	1.1538	.0495	.1422	.7036	.7284	.1507	-.2524	-.8213	.4249	1.1794
.1003	-.7974	.4318	1.1669	.0753	.0487	.6786	.7701	.1507	-.5024	-.8347	.4210	1.1865
.1507	-.8102	.4281	1.1736	.1002	-.0421	.6503	.8106	.1507	-.7524	-.7820	.4362	1.1589
.2003	-.8159	.4264	1.1766	.1503	-.1209	.6275	.8457	.5002	.7476	-.9178	.3969	1.2315
.2503	-.8396	.4196	1.1892	.1976	-.2296	.5960	.8945	.5002	.4976	-.9234	.3953	1.2346
.3001	-.8780	.4085	1.2098	.2503	-.2986	.5761	.9258	.5002	.2476	-.9065	.4002	1.2253
.3502	-.8671	.4058	1.2147	.3001	-.3491	.5615	.9489	.5002	-.2524	-.8823	.4072	1.2121
.4003	-.8595	.4138	1.1998	.3507	-.3823	.5519	.9642	.5002	-.5024	-.9237	.3953	1.2348
.4501	-.8633	.4127	1.2019	.4001	-.3774	.5533	.9619	.5002	-.7524	-.8763	.4089	1.2089
.5002	-.8834	.4065	1.2217	.4501	-.3452	.5626	.9471	.8002	.7476	-.9366	.3915	1.2410
.5502	-.9180	.3969	1.2316	.5001	-.2711	.5840	.9133	.8002	.4976	-.9395	.5585	.9537
.6002	-.9475	.3884	1.2480	.5497	-.1578	.6168	.8622	.8002	.2476	-.8391	.5586	.9535
.6500	-.10033	.3722	1.2797	.6003	-.0418	.6504	.8104	.8002	-.5024	-.3457	.5624	.9474
.7000	-.10731	.3520	1.3208	.6500	.0447	.6754	.7719	.8002	-.7524	-.3265	.5680	.9385
.7500	-.5502	.5033	1.0432	.7000	.1626	.7095	.7192					
.8002	-.3648	.5569	.9561	.7501	.2617	.7382	.6745					
.9002	-.1741	.6121	.8695	.8001	.3455	.7624	.6361					
.9501	-.0865	.6369	.8312	.8501	.4188	.7836	.6019					

ORIGINAL PAGE IS
OF POOR QUALITY

TEST 167	PT 55.5795	PSI	CN .7406	CD1 .03325	CDCOR1 .03222
RUN 43	TT 115.5683	K	CM -.1763	CD2 .03181	CDCOR2 .03094
POINT 22	RC 29.8635	MILLION	CC .0278	CD3 .02887	CDCOR3 .02781
	MACH .7926			CD4 .02793	CDCOR4 .02655
	ALPHA 1.5042	DEG		CD5 .02631	CDCOR5 .02511

UPPER SURFACE				LOWER SURFACE				SPANWISE				
X/C	CP	P _L /PT	MLOC	X/C	CP	P _L /PT	MLOC	X/C	Y/(B/2)	CP	P _L /PT	MLOC
0.0000	1.1692	1.0011	0.0000	0.0000	1.1692	1.0011	0.0000	.1507	.7476	-.8326	.4267	1.1798
.0132	-.1963	.6079	.8760	.0126	.5384	.8195	.5421	.1507	.4976	-.9114	.4020	1.2219
.0259	-.5704	.5002	1.0484	.0255	.3713	.7714	.6217	.1507	.2476	-.8849	.4096	1.2076
.0759	-.8380	.4231	1.1826	.0495	.0935	.7202	.7027	.1507	-.2524	-.8845	.4098	1.2074
.1003	-.8640	.4157	1.1964	.0753	.0948	.6917	.7468	.1507	-.5024	-.8992	.4055	1.2153
.1507	-.8724	.4132	1.2009	.1002	.0044	.6657	.7868	.1507	-.7524	-.8471	.4205	1.1874
.2003	-.8748	.4125	1.2022	.1503	-.0801	.6414	.8243	.5002	.7476	-.9703	.3850	1.2545
.2503	-.8992	.4055	1.2153	.1976	-.1892	.6100	.8729	.5002	.4976	-.9776	.3829	1.2586
.3001	-.9395	.3939	1.2373	.2503	-.2604	.5895	.9048	.5002	.2476	-.9769	.3832	1.2582
.3502	-.9536	.3898	1.2452	.3001	-.3118	.5747	.9280	.5002	-.2524	-.9553	.3894	1.2561
.4003	-.9474	.3915	1.2420	.3507	-.3476	.5644	.9443	.5002	-.5024	-.9732	.3842	1.2501
.4501	-.9137	.4013	1.2232	.4001	-.3500	.5637	.9454	.5002	-.7524	-.9267	.3976	1.2303
.5002	-.9602	.3880	1.2488	.4501	-.3277	.5701	.9352	.8002	.7476	-.9538	.3898	1.2452
.5502	-.9614	.3876	1.2495	.5001	-.2615	.5891	.9053	.8002	.4976	-.9551	.3622	.9477
.6002	-.9974	.3772	1.2698	.5497	-.1534	.6203	.8569	.8002	.2476	-.9532	.3627	.9469
.6500	-1.0445	.3637	1.2969	.6003	-.0407	.6527	.8068	.8002	-.5024	-.9511	.5633	.9459
.7000	-.9767	.3832	1.2580	.6500	.0420	.6765	.7702	.8002	-.7524	-.9276	.5701	.9352
.7500	-.4545	.5336	.9936	.7000	.1586	.7101	.7183					
.8002	-.3548	.5623	.9476	.7501	.2568	.7384	.6742					
.9002	-.2098	.6046	.8821	.8001	.3397	.7623	.6363					
.9501	-.1126	.6320	.8387	.8501	.4127	.7833	.6024					

TEST 167	PT 55.5520	PSI	CN .7621	CD1 .03416	CDCOR1 .03254
RUN 43	TT 115.0180	K	CM -.1733	CD2 .03769	CDCOR2 .03554
POINT 23	RC 30.0748	MILLION	CC .0283	CD3 .03917	CDCOR3 .03820
	MACH .7932			CD4 .03571	CDCOR4 .03194
	ALPHA 2.0162	DEG		CD5 .03399	CDCOR5 .03094

UPPER SURFACE				LOWER SURFACE				SPANWISE				
X/C	CP	P _L /PT	MLOC	X/C	CP	P _L /PT	MLOC	X/C	Y/(B/2)	CP	P _L /PT	MLOC
0.0000	1.1651	.9994	.0288	0.0000	1.1651	.9994	.0288	.1507	.7476	-.8643	.4116	1.2040
.0132	-.2402	.5924	.9003	.0126	.5776	.8292	.5252	.1507	.4976	-.9548	.3854	1.2538
.0259	-.5876	.4917	1.0626	.0255	.4066	.7797	.6083	.1507	.2476	-.9246	.3941	1.2369
.0759	-.8778	.4077	1.2112	.0495	.2271	.7277	.6909	.1507	-.2524	-.9226	.3947	1.2358
.1003	-.9042	.4001	1.2256	.0753	.1255	.6983	.7366	.1507	-.5024	-.9388	.3900	1.2449
.1507	-.9131	.3975	1.2306	.1002	.0315	.6711	.7786	.1507	-.7524	-.8824	.4064	1.2137
.2003	-.9136	.3973	1.2308	.1503	-.0573	.6453	.8182	.5002	.7476	-1.0123	.3687	1.2867
.2503	-.9381	.3902	1.2445	.1976	-.1689	.6130	.8681	.5002	.4976	-1.0191	.3668	1.2907
.3001	-.9799	.3781	1.2680	.2503	-.2437	.5914	.9019	.5002	.2476	-1.0226	.3658	1.2927
.3502	-.9984	.3728	1.2787	.3001	-.3003	.5750	.9276	.5002	-.2524	-1.0085	.3698	1.2845
.4003	-1.0053	.3708	1.2827	.3507	-.3424	.5628	.9460	.5002	-.5024	-.9985	.3727	1.2787
.4501	-.9930	.3743	1.2756	.4001	-.3904	.5605	.9505	.5002	-.7524	-.9666	.3819	1.2606
.5002	-.9982	.3728	1.2786	.4501	-.3331	.5655	.9426	.8002	.7476	-1.0173	.3687	1.2867
.5502	-1.0316	.3632	1.2986	.5001	-.2701	.5837	.9138	.8002	.4976	-.9739	.5537	.9614
.6002	-1.0370	.3616	1.3012	.5497	-.1633	.6146	.8656	.8002	.2476	-.9615	.5572	.9557
.6500	-1.0884	.3467	1.3319	.6003	-.0518	.6469	.8158	.8002	-.5024	-.9742	.5536	.9615
.7000	-.6412	.4762	1.0489	.6500	.0307	.6708	.7790	.8002	-.7524	-.9475	.5613	.9492
.7500	-.4238	.5392	.9846	.7000	.1465	.7044	.7272					
.8002	-.3574	.5584	.9538	.7501	.2442	.7327	.6832					
.9002	-.2411	.5921	.9007	.8001	.3269	.7566	.6453					
.9501	-.1647	.6084	.8752	.8501	.4001	.7779	.6113					

TFST 167	PT 55.5767	PSI	CN .8002	CD1 .03561	CDCOR1 .03458
RUN 43	TT 115.3020	K	CM -.1740	CD2 .04074	CDCOR2 .03965
POINT 24	RC 29.9762	MILLION	CC .0288	CD3 .04898	CDCOR3 .04649
	MACH .7931			CD4 .04941	CDCOR4 .04840
	ALPHA 2.5261	DEG		CD5 .04520	CDCOR5 .04391

UPPER SURFACE				LOWER SURFACE				SPANWISE				
X/C	CP	P _L /PT	MLOC	X/C	CP	P _L /PT	MLOC	X/C	Y/(B/2)	CP	P _L /PT	MLOC
0.0000	1.1640	.9992	.0342	0.0000	1.1640	.9992	.0342	.1507	.7476	-.9093	.3992	1.2272
.0132	-.2960	.5767	.9248	.0126	.6231	.8427	.5016	.1507	.4976	-1.0052	.3715	1.2612
.0259	-.6521	.4736	1.0933	.0255	.4492	.7923	.5876	.1507	.2476	-.9738	.3805	1.2633
.0759	-.9280	.3938	1.2375	.0495	.2561	.7393	.6727	.1507	-.2524	-.9742	.3804	1.2635
.1003	-.9551	.3860	1.2527	.0753	.1603	.7087	.7204	.1507	-.5024	-.9898	.3759	1.2724
.1507	-.9635	.3835	1.2574	.1002	.0646	.6810	.7632	.1507	-.7524	-.9236	.3951	1.2351
.2003	-.9625	.3838	1.2568	.1503	-.0292	.6539	.8050	.5002	.7476	-1.0594	.3558	1.3130
.2503	-.9835	.3777	1.2688	.1976	-.1424	.6211	.8555	.5002	.4976	-1.0645	.3543	1.3161
.3001	-1.0237	.3661	1.2920	.2503	-.2199	.5987	.8904	.5002	.2476	-1.0679	.3533	1.3181
.3502	-1.0438	.3603	1.3038	.3001	-.2794	.5815	.9173	.5002	-.2524	-1.0522	.3579	1.3087
.4003	-1.0733	.3575	1.3094	.3507	-.3258	.5681	.9384	.5002	-.5024	-1.0291	.3646	1.2951
.4501	-1.0615	.3552	1.3142	.4001	-.3391	.5642	.9445	.5002	-.7524	-1.0123	.3694	1.2854
.5002	-1.0484	.3590	1.3065	.4501	-.3289	.5672	.9398	.8002	.7476	-1.0798	.3499	1.3252
.5502	-1.0869	.3478	1.3295	.5001	-.2704	.5841	.9132	.8002	.4976	-.9412	.5431	.9782
.6002	-1.0973	.3454	1.3346	.5497	-.1671	.6140	.8666	.8002	.2476	-.9393	.5485	.9695
.6500	-1.0541	.3573	1.3099	.6003	-.0578	.6456	.8177	.8002	-.5024	-.9405	.5459	.9738
.7000	-.5131	.5139	1.0254	.6500	.0222	.6688	.7821	.8002	-.7524	-.9825	.5517	.9645
.7500	-.4214	.5404	.9826	.7000	.1379	.7022	.7305					
.8002	-.3711	.5550	.9593	.7501	.2351	.7304	.6867					
.9002	-.2742	.5830	.9149	.8001	.3175	.7542	.6492					
.9501	-.2316	.5953	.8956	.8501	.3900	.7755	.6151					

Appendix L

Pressure Data for $M = 0.80$; $R = 4.4 \times 10^6$, 7.0×10^6 , 10.0×10^6 , 15.0×10^6 , and 30.0×10^6 ; Free Transition

The pressure measurements made on the NASA SC(3)-0712(B) airfoil are presented in coefficient form in graphs and tables in this appendix. The data are for a given Mach number through the Reynolds number range. The pressure data from the upper surface of the airfoil are plotted as open symbols, and the lower-surface data are plotted as solid symbols.

TEST 167
 RUN 5
 MACH .800
 R 4.4×10^6

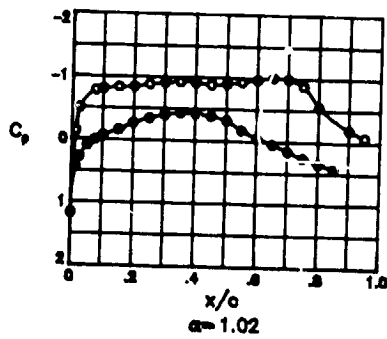
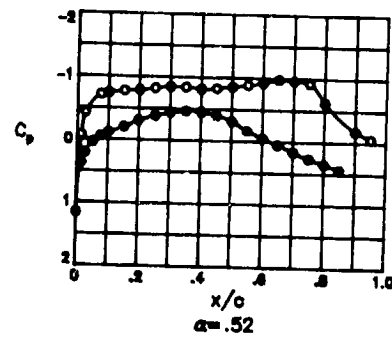
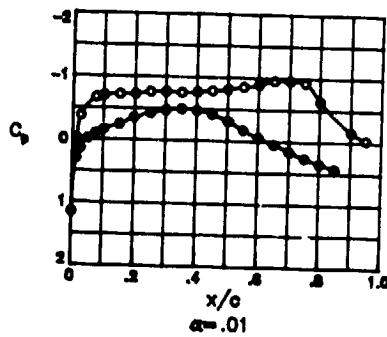
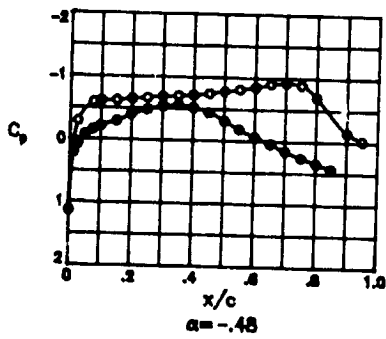
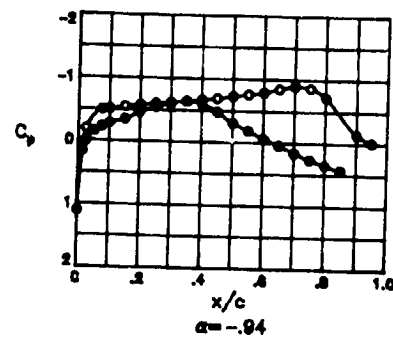
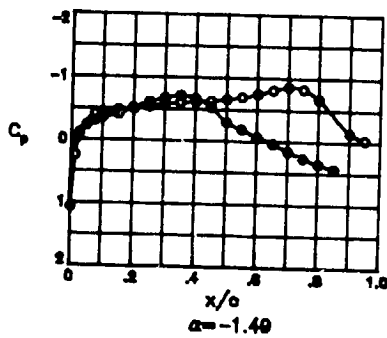
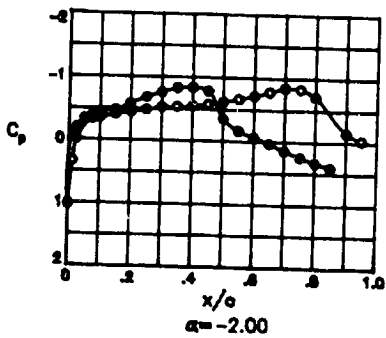
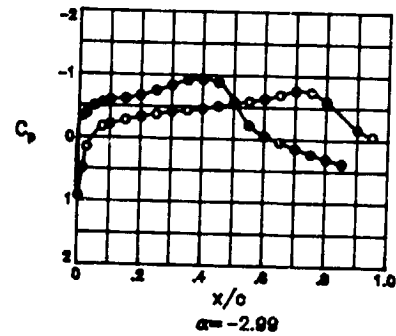

TEST 167	PT 17.9473	PSI	CM	-.1237	CD1	.01379	CDCOR1	.01371
RUN 5	TY 200.1855	K	CM	-.1608	CD2	.01325	CDCOR2	.01330
POINT 2	RC 4.3944	MILLION	CC	.0218	CD3	.01306	CDCOR3	.01785
	MACH .7986				CD4	.01259	CDCOR4	.01229
	ALPHA -2.9938	DEG			CD5	.01144	CDCOR5	.01094

UPPER SURFACE				LOWER SURFACE				SPANWISE				
X/C	CP	P ₂ L/PT	MLOC	X/C	CP	P ₂ L/PT	MLOC	X/C	Y/(B/2)	CP	P ₂ L/PT	MLOC
0.0000	.9257	.9287	.3265	0.0000	.9257	.9287	.3265	.1507	.7476	-.2672	.5795	.9183
.0132	.4863	.8001	.5733	.0126	-.3328	.5603	.9486	.1507	.4976	-.2832	.5748	.9256
.0259	.1518	.7021	.7288	.0259	-.3827	.5457	.9718	.1507	.2476	-.2858	.5740	.9268
.0759	-.1756	.6063	.8764	.0495	-.3076	.5091	1.0313	.1507	-.5524	-.2832	.5748	.9256
.1003	-.2128	.5954	.8934	.0753	-.5526	.4959	1.0532	.1507	-.5024	-.2809	.5754	.9246
.1507	-.2833	.5748	.9256	.1002	-.6010	.4817	1.0770	.1507	-.7524	-.2622	.5809	.9160
.2003	-.3308	.5608	.9476	.1500	-.6257	.4745	1.0894	.5002	.7476	-.5411	.4993	1.0475
.2503	-.3757	.5477	.9685	.1976	-.6717	.4610	1.1126	.5002	.4976	-.5429	.4987	1.0484
.3001	-.4167	.5357	.9879	.2503	-.7546	.4367	1.1554	.5002	.2476	-.5583	.4942	1.0559
.3502	-.4377	.5295	.9978	.3001	-.8399	.4118	1.2010	.5002	-.2524	-.5519	.4961	1.0528
.4003	-.4692	.5203	1.0128	.3507	-.9219	.3878	1.2466	.5002	-.5024	-.5463	.4977	1.0541
.4501	-.5105	.5082	1.0327	.4001	-.9333	.3844	1.2531	.5002	-.7524	-.5353	.5010	1.0447
.5002	-.5549	.4952	1.0543	.4501	-.8924	.3964	1.2300	.8002	.7476	-.3865	.5445	.9736
.5502	-.5998	.4832	1.0744	.5001	-.9886	.4854	1.0709	.8002	.4976	-.3902	.5429	.9762
.6002	-.6372	.4711	1.0951	.5497	-.2156	.5946	.8946	.8002	.2476	-.6311	.4729	1.0920
.6500	-.7022	.4521	1.1281	.6003	-.0489	.6434	.8192	.8002	-.5024	-.4908	.5140	1.0232
.7000	-.7668	.4332	1.1618	.6500	.0477	.6704	.7758	.8002	-.7524	-.3846	.5451	.9728
.7500	-.7441	.4398	1.1499	.7000	.1458	.7004	.7315					
.8002	-.6022	.4814	1.0776	.7501	.2345	.7263	.6913					
.9002	-.1613	.8105	.8699	.8001	.3113	.7488	.6561					
.9501	-.0563	.6412	.8225	.8501	.3776	.7683	.6252					

TEST 167	PT 17.9488	PSI	CM	.2777	CD1	.01011	CDCOR1	.00964
RUN 5	TY 201.0469	K	CM	-.1738	CD2	.01041	CDCOR2	.01006
POINT 3	RC 4.3718	MILLION	CC	.0263	CD3	.00991	CDCOR3	.00930
	MACH .7997				CD4	.01149	CDCOR4	.01163
	ALPHA -1.9958	DEG			CD5	.00972	CDCOR5	.00970

UPPER SURFACE				LOWER SURFACE				SPANWISE				
X/C	CP	P ₂ L/PT	MLOC	X/C	CP	P ₂ L/PT	MLOC	X/C	Y/(B/2)	CP	P ₂ L/PT	MLOC
0.0000	1.0218	.9562	.2537	0.0000	1.0218	.9562	.2537	.1507	.7476	-.3835	.5424	.9770
.0132	.3388	.7551	.8462	.0126	-.1015	.6254	.8468	.1507	.4976	-.4086	.5350	.9889
.0259	-.0094	.6525	.8051	.0259	-.1948	.5980	.8893	.1507	.2476	-.4116	.5341	.9903
.0759	-.3486	.5603	.9486	.0495	-.3298	.5582	.9518	.1507	-.2524	-.4077	.5353	.9885
.1003	-.3886	.5527	.9606	.0753	-.3927	.5397	.9814	.1507	-.5024	-.4025	.5368	.9860
.1507	-.4463	.5357	.9878	.1002	-.4435	.5247	1.0056	.1507	-.7524	-.3777	.5411	.9743
.2003	-.4442	.5245	1.0059	.1503	-.4748	.5155	1.0208	.5002	.7476	-.6216	.4723	1.0931
.2503	-.4799	.5140	1.0231	.1976	-.5730	.4866	1.0688	.5002	.4976	-.6199	.4728	1.0922
.3001	-.5249	.5008	1.0450	.2503	-.6792	.4554	1.1224	.5002	.2476	-.6319	.4693	1.0983
.3502	-.5355	.4977	1.0502	.3001	-.7605	.4314	1.1650	.5002	-.2524	-.6276	.4705	1.0961
.4003	-.5495	.4935	1.0571	.3507	-.8327	.4101	1.2041	.5002	-.5024	-.6170	.4737	1.0908
.4501	-.5777	.4852	1.0711	.4001	-.8400	.4080	1.2081	.5002	-.7524	-.6224	.4721	1.0935
.5002	-.6213	.4724	1.0929	.4501	-.7867	.4237	1.1791	.8002	.7476	-.4191	.5319	.9939
.5502	-.6670	.4589	1.1162	.5001	-.3499	.5523	.9612	.8002	.4976	-.4601	.5199	1.0135
.6002	-.7158	.4446	1.1415	.5497	-.1612	.6079	.8740	.8002	.2476	-.7280	.4410	1.1478
.6500	-.7817	.4252	1.1764	.6003	-.0583	.6381	.8272	.8002	-.5024	-.4575	.5206	1.0123
.7000	-.8456	.4064	1.2112	.6500	.0343	.6654	.7854	.8002	-.7524	-.4036	.5365	.9866
.7500	-.8310	.4106	1.2031	.7000	.1430	.6974	.7361					
.8002	-.7097	.4464	1.1382	.7501	.2427	.7268	.6907					
.9002	-.1408	.8139	.8647	.8001	.3280	.7519	.6512					
.9501	-.0286	.6469	.8138	.8501	.4025	.7738	.6163					

TEST 167	PT 17.9556	PSI	CM	-.3747	CD1	.01027	CDCOR1	.00985
RUN 5	TY 201.0714	K	CM	-.1904	CD2	.01024	CDCOR2	.00987
POINT 4	RC 4.3700	MILLION	CC	.0270	CD3	.00948	CDCOR3	.00909
	MACH .7987				CD4	.01171	CDCOR4	.01131
	ALPHA -1.4867	DEG			CD5	.00970	CDCOR5	.00933

UPPER SURFACE				LOWER SURFACE				SPANWISE				
X/C	CP	P ₂ L/PT	MLOC	X/C	CP	P ₂ L/PT	MLOC	X/C	Y/(B/2)	CP	P ₂ L/PT	MLOC
0.0000	1.0735	.9723	.2007	0.0000	1.0735	.9723	.2007	.1507	.7476	-.4540	.5259	1.0037
.0132	.2456	.7303	.8891	.0126	.0203	.6645	.7867	.1507	.4976	-.4772	.5192	1.0147
.0259	-.1073	.6272	.8440	.0259	-.0918	.6318	.8370	.1507	.2476	-.4813	.5180	1.0166
.0759	-.4121	.5382	.9838	.0495	-.2329	.5905	.9009	.1507	-.2524	-.4733	.5203	1.0129
.1003	-.4278	.5336	.9912	.0753	-.3022	.5703	.9327	.1507	-.5024	-.4652	.5227	1.0090
.1507	-.4764	.5194	1.0143	.1002	-.3357	.5547	.9574	.1507	-.7524	-.4359	.5312	.9991
.2003	-.4979	.5131	1.0246	.1503	-.4082	.5393	.9920	.5002	.7476	-.6537	.4676	1.1012
.2503	-.5331	.5028	1.0416	.1976	-.5144	.5083	1.0326	.5002	.4976	-.6538	.4675	1.1013
.3001	-.5742	.4908	1.0617	.2503	-.6104	.4802	1.0795	.5002	.2476	-.6640	.4646	1.1044
.3502	-.5985	.4837	1.0737	.3001	-.6749	.4614	1.1119	.5002	-.2524	-.6593	.4659	1.1040
.4003	-.6140	.4792	1.0813	.3507	-.7126	.4504	1.1312	.5002	-.5024	-.6501	.4686	1.0994
.4501	-.6306	.4743	1.0896	.4001	-.6860	.4440	1.1074	.5002	-.7524	-.6578	.4664	1.1033
.5002	-.6589	.4661	1.1038	.4501	-.5342	.5025	1.0422	.8002	.7476	-.3798	.4476	.9687
.5502	-.6980	.4546	1.1237	.5001	-.2915	.5734	.9278	.8002	.4976	-.4109	.5385	.9833
.6002	-.7455	.4408	1.1482	.5497	-.1821	.6054	.8778	.8002	.2476	-.6078	.4576	1.1185
.6500	-.8107	.4217	1.1827	.6003	-.0648	.6396	.8249	.8002	-.5024	-.4132	.5379	.9843
.7000	-.8624	.4066	1.2107	.6500	.0388	.6699	.7784	.8002	-.7524	-.3767	.5485	.9672
.7500	-.8301	.4160	1.1931	.7000	.1352	.7039	.7211					
.8002	-.6712	.4625	1.1101	.7501	.2601	.7346	.6784					
.9002	-.1382	.8182	.8580	.8001	.3501	.7609	.6369					
.9501	-.0341	.6486	.8111	.8501	.4289	.7839	.5999					

TEST 167 PT 17.9511 PSI CN .4539
 RUN 5 TT 200.9522 K CM -1846
 POINT 5 RC 4.3745 MILLION CC .0290
 MACH .7994
 ALPHA -.9431 DEG

CD1 .01247 CDCOR1 .01223
 CD2 .01220 CDCOR2 .01201
 CD3 .01118 CDCOR3 .01102
 CD4 .01384 CDCOR4 .01364
 CD5 .01118 CDCOR5 .01078

UPPER SURFACE				LOWER SURFACE				SPANWISE				
X/C	CP	P/L/PT	MLOC	X/C	CP	P/L/PT	MLOC	X/C	Y/(B/2)	CP	P/L/PT	MLOC
0.0000	1.1090	.9819	.1616	0.0000	1.1090	.9819	.1616	.1507	.7476	-.5198	.5027	1.0418
.0132	.1649	.7041	.7258	.0126	.1296	.6938	.7418	.1507	.4976	-.5462	.4949	1.0548
.0259	-.1921	.5991	.8876	.0255	.0024	.6563	.7993	.1507	.2476	-.5516	.4933	1.0575
.0759	-.4991	.5088	1.0318	.0495	-.1480	.6121	.8675	.1507	-.2524	-.5428	.4959	1.0531
.1003	-.5079	.5062	1.0360	.0753	-.2247	.5895	.9026	.1507	-.5024	-.5330	.4988	1.0463
.1507	-.5461	.4950	1.0547	.1002	-.2826	.5725	.9293	.1507	-.7524	-.4995	.5087	1.0319
.2003	-.5767	.4859	1.0899	.1503	-.3459	.5538	.9587	.5002	.7476	-.7056	.4480	1.1354
.2503	-.5959	.4803	1.0795	.1976	-.4566	.5213	1.0112	.5002	.4976	-.7101	.4467	1.1377
.3001	-.6211	.4729	1.0921	.2503	-.5435	.4957	1.0535	.5002	.2476	-.7281	.4414	1.1471
.3502	-.6409	.4671	1.1021	.3001	-.6041	.4779	1.0836	.5002	-.2524	-.7056	.4480	1.1353
.4003	-.6642	.4602	1.1140	.3507	-.6419	.4667	1.1027	.5002	-.5024	-.7153	.4452	1.1404
.4501	-.6926	.4518	1.1286	.4001	-.6993	.4493	1.0811	.8002	.7476	-.3837	.5427	.9765
.5002	-.7259	.4421	1.1459	.4501	-.7772	.5152	1.0212	.8002	.4976	-.4342	.5270	1.0005
.5502	-.7589	.4323	1.1633	.5001	-.8012	.5670	.9379	.8002	.2476	-.7260	.4420	1.1460
.6002	-.7921	.4226	1.1811	.5497	-.8186	.6022	.8828	.8002	-.5024	-.4437	.5251	1.0051
.6500	-.8488	.4059	1.2121	.6003	-.8608	.6377	.8279	.8002	-.7524	-.3801	.5438	.9748
.7000	-.8973	.3916	1.2392	.6500	-.9041	.6683	.7809					
.7500	-.8634	.4016	1.2202	.7000	.1588	.7023	.7286					
.8002	-.7217	.4433	1.1438	.7501	.2624	.7328	.6912					
.9002	-.1333	.6164	.8608	.8001	.3506	.7588	.6403					
.9501	-.0135	.6516	.8065	.8501	.4283	.7816	.6036					

TEST 167 PT 17.9511 PSI CN .5281
 RUN 5 TT 199.9007 K CM -1869
 POINT 6 RC 4.4035 MILLION CC .0294
 MACH .7984
 ALPHA -.4783 DEG

CD1 .01417 CDCOR1 .01365
 CD2 .01398 CDCOR2 .01345
 CD3 .01288 CDCOR3 .01239
 CD4 .01613 CDCOR4 .01586
 CD5 .01259 CDCOR5 .01202

UPPER SURFACE				LOWER SURFACE				SPANWISE				
X/C	CP	P/L/PT	MLOC	X/C	CP	P/L/PT	MLOC	X/C	Y/(B/2)	CP	P/L/PT	MLOC
0.0000	1.1323	.9892	.1245	0.0000	1.1323	.9892	.1245	.1507	.7476	-.5859	.4861	1.0697
.0132	-.0758	.6798	.7632	.0126	-.2202	.7221	.6979	.1507	.4976	-.6123	.4783	1.0828
.0259	-.2859	.5739	.9270	.0255	-.0798	.6810	.7614	.1507	.2476	-.6287	.4755	1.0910
.0759	-.5903	.4846	1.0719	.0495	-.0786	.6146	.8327	.1507	-.2524	-.6149	.4775	1.0841
.1003	-.6120	.4784	1.0827	.0753	-.1509	.6105	.8699	.1507	-.5024	-.5968	.4829	1.0751
.1507	-.6202	.4760	1.0867	.1002	-.2228	.5924	.8980	.1507	-.7524	-.5839	.4823	1.0589
.2003	-.6457	.4685	1.0996	.1503	-.2934	.5717	.9305	.5002	.7476	-.7561	.4362	1.1544
.2503	-.6637	.4633	1.1087	.1976	-.4032	.5396	.9816	.5002	.4976	-.7620	.4345	1.1595
.3001	-.6883	.4560	1.1212	.2503	-.4799	.5171	1.0181	.5002	.2476	-.7788	.4296	1.1684
.3502	-.6984	.4531	1.1264	.3001	-.5360	.5006	1.0452	.5002	-.2524	-.7752	.4306	1.1665
.4003	-.7136	.4487	1.1342	.3507	-.5931	.4856	1.0536	.5002	-.5024	-.7600	.4351	1.1584
.4501	-.7389	.4412	1.1474	.4001	-.6163	.5064	1.0356	.5002	-.7524	-.7691	.4324	1.1632
.5002	-.7731	.4312	1.1654	.4501	-.6410	.5285	.9999	.8002	.7476	-.3861	.5445	.9759
.5502	-.8099	.4204	1.1850	.5001	-.6140	.5657	.9400	.8002	.4976	-.4334	.5307	.9936
.6002	-.8494	.4089	1.2065	.5497	-.6802	.6049	.8786	.8002	.2476	-.6985	.4531	1.1265
.6500	-.9007	.3939	1.2349	.6003	-.6990	.6404	.8238	.8002	-.5024	-.4398	.5288	.9990
.7000	-.9228	.3874	1.2474	.6500	.0440	.6705	.7775					
.7500	-.8886	.3974	1.2282	.7000	.1583	.7040	.7260					
.8002	-.6959	.4538	1.1251	.7501	.2613	.7342	.6791					
.9002	-.1399	.6167	.8604	.8001	.3492	.7599	.6355					
.9501	-.0166	.6528	.8048	.8501	.4268	.7826	.6020					

TEST 167 PT 17.3562 PSI CN .5993
 RUN 5 TT 193.9999 K CM -1834
 POINT 7 RC 4.4439 MILLION CC .0296
 MACH .8000
 ALPHA .0102 DEG

CD1 .01753 CDCOR1 .01711
 CD2 .01735 CDCOR2 .01698
 CD3 .01620 CDCOR3 .01585
 CD4 .02098 CDCOR4 .02061
 CD5 .01557 CDCOR5 .01490

UPPER SURFACE				LOWER SURFACE				SPANWISE				
X/C	CP	P/L/PT	MLOC	X/C	CP	P/L/PT	MLOC	X/C	Y/(B/2)	CP	P/L/PT	MLOC
0.0000	1.1568	.9949	.0854	0.0000	1.1508	.9949	.0854	.1507	.7476	-.6668	.4842	1.1070
.0132	-.0036	.6590	.7967	.0126	.3044	.7678	.6577	.1507	.4976	-.7378	.4435	1.1434
.0259	-.1691	.5912	.9631	.0255	.1532	.7036	.7266	.1507	.2476	-.7303	.4457	1.1345
.0759	-.6640	.4651	1.1056	.0495	-.0113	.6556	.8004	.1507	-.2524	-.7138	.4505	1.1309
.1003	-.6955	.4559	1.1213	.0753	-.0985	.6302	.8395	.1507	-.5024	-.7036	.4535	1.1257
.1507	-.7151	.4501	1.1317	.1002	-.1640	.6110	.8691	.1507	-.7524	-.6335	.4570	1.0903
.2003	-.7221	.4441	1.1352	.1503	-.2439	.5877	.9054	.5002	.7476	-.8116	.4220	1.1823
.2503	-.7565	.4381	1.1531	.1976	-.3496	.5599	.9540	.5002	.4976	-.8079	.4230	1.1803
.3001	-.7629	.4362	1.1565	.2503	-.4235	.5353	.9886	.5002	.2476	-.8228	.4187	1.1883
.3502	-.7510	.4397	1.1502	.3001	-.4747	.5203	1.0128	.5002	-.2524	-.8143	.4212	1.1837
.4003	-.7630	.4361	1.1565	.3507	-.4948	.5144	1.0224	.5002	-.5024	-.8101	.4224	1.1815
.4501	-.7845	.4299	1.1678	.4001	-.4674	.5213	1.0112	.5002	-.7524	-.8245	.4182	1.1892
.5002	-.8152	.4209	1.1842	.4501	-.4136	.5382	.9839	.8002	.7476	-.3846	.5466	.9703
.5502	-.8524	.4100	1.2043	.5001	-.3125	.5677	.9368	.8002	.4976	-.4276	.5341	.9905
.6002	-.8943	.3978	1.2273	.5497	-.1712	.6089	.8723	.8002	.2476	-.6827	.4654	1.1050
.6500	-.9534	.3806	1.2607	.6003	-.0518	.6438	.8186	.8002	-.5024	-.4355	.5318	.9942
.7000	-.9547	.3802	1.2614	.6500	.0491	.6733	.7737					
.7500	-.9246	.3890	1.2443	.7000	.1618	.7062	.7227					
.8002	-.6386	.4725	1.0928	.7501	.2640	.7360	.6763					
.9002	-.1552	.6136	.8651	.8001	.3518	.7616	.6359					
.9501	-.0258	.6514	.8069	.8501	.4288	.7841	.5996					

TFST	167	PT	16.9884	PSI	CN	.6560	CD1	.02136	COCOR1	.02112
RUN	5	TT	189.1645	K	CM	-1.1928	CD2	.02020	COCOR2	.01997
POINT	8	RC	4.4824	MILLION	CC	.0306	CD3	.02090	COCOR3	.02067
		MACH	.8009				CD4	.02814	COCOR4	.02777
		ALPHA	.5191	DEG			CD5	.02043	COCOR5	.01947

UPPER SURFACE				LOWER SURFACE				SPANWISE				
X/C	CP	P _L /PT	MLOC	X/C	CP	P _L /PT	MLOC	X/C	Y/(B/2)	CP	P _L /PT	MLOC
0.0000	1.1612	.9972	.0627	0.0000	1.1612	.9972	.0627	.1507	.7476	-.7323	.4402	1.1493
.0132	-.0995	.6381	.8273	.0126	.3733	.7655	.6297	.1507	.4976	-.8050	.4188	1.1881
.0259	-.4256	.9304	.0964	.0255	.2150	.7189	.7030	.1507	.2476	-.7849	.4247	1.1772
.0759	-.7138	.4456	1.1396	.0495	.0449	.6688	.7801	.1507	-.2524	-.7719	.4285	1.1703
.1003	-.7428	.4371	1.1549	.0753	-.0469	.6420	.8214	.1507	-.5024	-.7796	.4263	1.1744
.1507	-.7703	.4290	1.1694	.1002	-.1154	.6217	.8527	.1507	-.7524	-.6967	.4307	1.1307
.2003	-.7890	.4235	1.1794	.1503	-.2024	.5961	.8923	.5002	.7476	-.8658	.4009	1.2215
.2503	-.8175	.4151	1.1949	.1976	-.3080	.5650	.9411	.5002	.4976	-.8721	.3990	1.2250
.3001	-.8456	.4069	1.2103	.2503	-.3834	.5428	.9764	.5002	.2476	-.8611	.4023	1.2189
.3502	-.8714	.4081	1.2080	.3001	-.4384	.5266	1.0025	.5002	-.2524	-.8555	.4039	1.2158
.4003	-.8951	.4158	1.1936	.3507	-.4658	.5186	1.0157	.5002	-.5024	-.8766	.3977	1.2275
.4501	-.8268	.4124	1.2000	.4001	-.4512	.5229	1.0086	.5002	-.7524	-.8665	.4007	1.2219
.5002	-.8564	.4037	1.2163	.4501	-.4003	.5379	.9844	.8002	.7476	-.3819	.5433	.9757
.5502	-.8175	.3944	1.2339	.5001	-.3143	.5631	.9440	.8002	.4976	-.4281	.5297	.9976
.6002	-.80	.3832	1.2556	.5497	-.1625	.6078	.8741	.8002	.2476	-.8166	.4742	1.0899
.6500	-.8789	.3676	1.2864	.6003	-.0469	.6420	.8214	.8002	-.5024	-.4444	.5249	1.0054
.7000	-.8514	.3728	1.2761	.6500	.0521	.6710	.7769	.8002	-.7524	-.3706	.5466	.9704
.7500	-.8250	.3835	1.2550	.7000	.1644	.7040	.7260					
.8002	-.8159	.4744	1.0895	.7501	.2497	.7338	.6797					
.9002	-.1740	.6044	.8793	.8001	.3533	.7596	.6391					
.9501	-.0525	.6402	.8241	.8501	.4319	.7827	.6019					

TEST	167	PT	16.4963	PSI	CN	.7096	CD1	.02516	COCOR1	.02434
RUN	5	TT	185.3464	K	CM	-1.1918	CD2	.02138	COCOR2	.02034
POINT	9	RC	4.5049	MILLION	CC	.0304	CD3	.02768	COCOR3	.02658
		MACH	.8013				CD4	.03743	COCOR4	.03665
		ALPHA	1.0183	DEG			CD5	.02791	COCOR5	.02648

UPPER SURFACE				LOWER SURFACE				SPANWISE				
X/C	CP	P _L /PT	MLOC	X/C	CP	P _L /PT	MLOC	X/C	Y/(B/2)	CP	P _L /PT	MLOC
0.0000	1.1663	.9992	.0347	0.0000	1.1663	.9992	.0347	.1507	.7476	-.8071	.4211	1.1838
.0132	-.1320	.6189	.8570	.0126	.4376	.7857	.5970	.1507	.4976	-.8784	.4003	1.2227
.0259	-.5010	.9108	1.0285	.0255	.2731	.7375	.6739	.1507	.2476	-.8512	.4082	1.2077
.0759	-.7840	.4279	1.1714	.0495	.0982	.6863	.7533	.1507	-.2524	-.8361	.4128	1.1995
.1003	-.8080	.4209	1.1843	.0753	.0022	.6582	.7965	.1507	-.5024	-.8516	.4081	1.2079
.1507	-.8344	.4131	1.1985	.1002	-.0669	.6374	.8285	.1507	-.7524	-.7726	.4312	1.1854
.2003	-.8439	.4103	1.2038	.1503	-.1579	.6115	.8687	.5002	.7476	-.9228	.3872	1.2477
.2503	-.8820	.3992	1.2248	.1976	-.2673	.5792	.9187	.5002	.4976	-.9334	.3841	1.2337
.3001	-.9129	.3901	1.2421	.2503	-.3444	.5567	.9543	.5002	.2476	-.9326	.3844	1.2333
.3502	-.9283	.3856	1.2508	.3001	-.3987	.5408	.9797	.5002	-.2524	-.9313	.3848	1.2325
.4003	-.9159	.3893	1.2438	.3507	-.4300	.5316	.9945	.5002	-.5024	-.9340	.3840	1.2341
.4501	-.8893	.3971	1.2288	.4001	-.4253	.5330	.9923	.5002	-.7524	-.9112	.3907	1.2411
.5002	-.9037	.3929	1.2369	.4501	-.3860	.5445	.9738	.8002	.7476	-.4015	.5399	.9811
.5502	-.9359	.3834	1.2551	.5001	-.3174	.5646	.9418	.8002	.4976	-.4447	.5273	1.0015
.6002	-.9710	.3731	1.2754	.5497	-.1702	.6077	.8743	.8002	.2476	-.4705	.5197	1.0138
.6500	-.10107	.3615	1.2988	.6003	-.0493	.6431	.8197	.8002	-.5024	-.4552	.5242	1.0065
.7000	-.9867	.3685	1.2846	.6500	.0465	.6712	.7788	.8002	-.7524	-.3783	.5467	.9702
.7500	-.8823	.3991	1.2249	.7000	.1563	.7033	.7271					
.8002	-.5501	.4964	1.0524	.7501	.2574	.7329	.6811					
.9002	-.1905	.6017	.8835	.8001	.3450	.7586	.6407					
.9501	-.0766	.6351	.8320	.8501	.4235	.7816	.6038					

TEST 167
 RUN 4
 MACH .800
 R 7.0×10^6

ORIGINAL PLOT
 OF POOR QUALITY

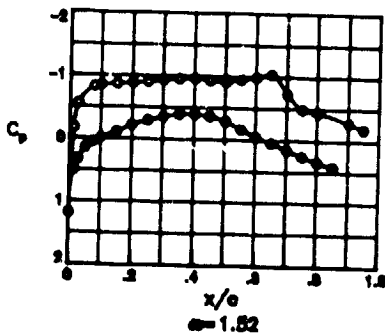
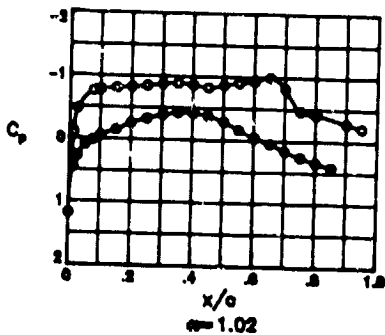
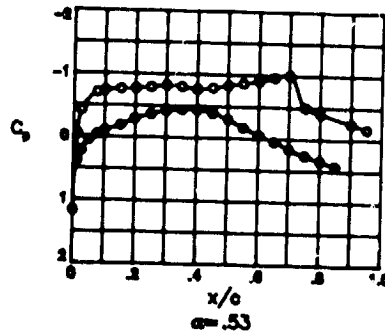
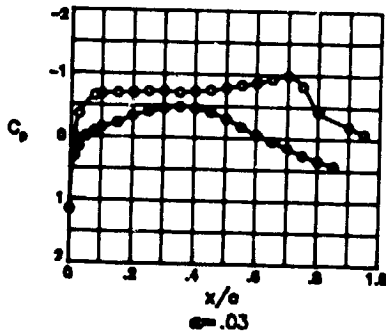
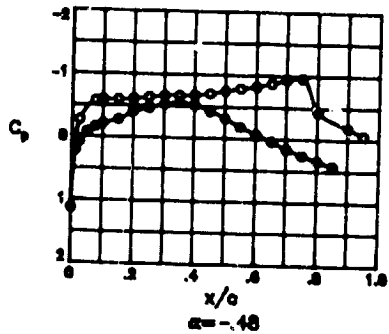
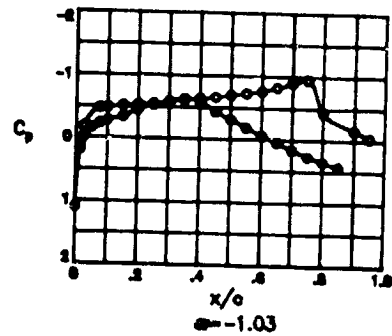
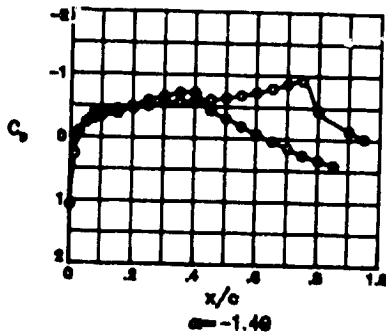
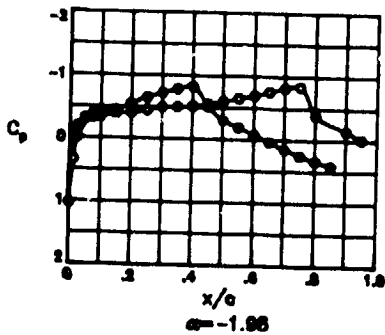
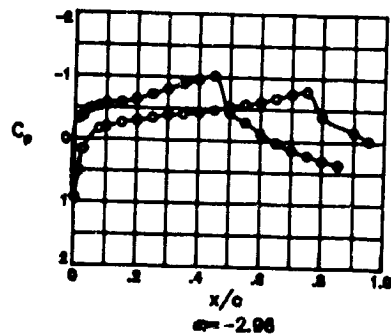

TEST 167	PT 21.8781	PSI	CN	.0877	CD1	.01853	CDCOR1	.01851
RUN 4	TT 186.0707	K	CM	-1.441	CD2	.01364	CDCOR2	.01364
POINT 39	RC 6.9824	MILLION	CC	.0207	CD3	.01142	CDCOR3	.01149
	MACH .8017				CD4	.01149	CDCOR4	.01143
	ALPHA -2.9632	DEG			CD5	.00890	CDCOR5	.00868

UPPER SURFACE				LOWER SURFACE				SPANWISE				
X/C	CP	P/L/PT	MLOC	X/C	CP	P/L/PT	MLOC	X/C	Y/(B/2)	CP	P/L/PT	MLOC
0.0000	.9256	.9277	.3291	0.0000	.9256	.9277	.3291	.1507	.7476	-.2518	.5807	.0164
.0132	.9005	.8024	.5095	.0126	-.3262	.5588	.9510	.1507	.4976	-.2711	.5790	.0254
.0259	.1624	.7028	.7280	.0255	-.3720	.5453	.6725	.1507	.2476	-.2731	.5744	.0263
.0753	-.1630	.6069	.8756	.0495	-.4922	.5099	1.0301	.1507	-.2524	-.2724	.5747	.0260
.1003	-.1899	.5980	.8925	.0753	-.5254	.5001	1.0463	.1507	-.5024	-.2730	.5745	.0262
.1507	-.2644	.5769	.9225	.1002	-.5829	.4831	1.0748	.1507	-.7524	-.2956	.5796	.0182
.2003	-.2988	.5689	.9382	.1503	-.5948	.4796	1.0807	.5002	.7476	-.5227	.5009	1.0450
.2503	-.3455	.5531	.9601	.1976	-.6435	.4653	1.1053	.5002	.4976	-.5407	.4956	1.0238
.3001	-.3907	.5308	.9814	.2503	-.7238	.4416	1.1468	.5002	.2476	-.5452	.4943	1.0560
.3502	-.4084	.5344	.9898	.3001	-.8091	.4165	1.1924	.5002	-.2524	-.5372	.4966	1.0521
.4003	-.4404	.5252	1.0051	.3507	-.8934	.3917	1.2393	.5002	-.5024	-.5353	.4972	1.0512
.4501	-.4780	.5138	1.0237	.4001	-.9633	.3710	1.2797	.5002	-.7524	-.5240	.5005	1.0456
.5002	-.5311	.4984	1.0491	.4501	-1.0195	.3545	1.3133	.8002	.7476	-.5827	.5421	.9776
.5502	-.5760	.4852	1.0713	.5001	-.4377	.5259	1.0038	.8002	.4976	-.5851	.5473	.9693
.6002	-.6182	.4734	1.0915	.5497	-.2848	.5710	.9317	.8002	.2476	-.4501	.5356	.9882
.6500	-.6787	.4549	1.1234	.6003	-.1153	.6209	.8539	.8002	-.5024	-.3504	.5517	.9824
.7000	-.7466	.4348	1.1589	.6500	.0276	.6631	.7891	.8002	-.7524	-.3525	.5511	.9633
.7500	-.7841	.4239	1.1789	.7000	.1577	.6955	.7392					
.8002	-.8886	.5404	.9804	.7501	.2274	.7219	.6983					
.8002	-.8886	.5404	.9804	.8001	.3019	.7439	.6640					
.9002	-.1489	.6110	.3692	.8501	.3664	.7629	.6338					
.9501	-.0218	.6485	.8114									

TEST 167	PT 21.8898	PSI	CN	.2637	CD1	.01309	CDCOR1	.01297
RUN 4	TT 185.8373	K	CM	-1.617	CD2	.00983	CDCOR2	.00973
POINT 40	RC 6.9968	MILLION	CC	.0225	CD3	.00911	CDCOR3	.00908
	MACH .8009				CD4	.00903	CDCOR4	.00887
	ALPHA -1.9791	DEG			CD5	.00692	CDCOR5	.00656

UPPER SURFACE				LOWER SURFACE				SPANWISE				
X/C	CP	P/L/PT	MLOC	X/C	CP	P/L/PT	MLOC	X/C	Y/(B/2)	CP	P/L/PT	MLOC
0.0000	1.0318	.9599	.2422	0.0000	1.0318	.9599	.2422	.1507	.7476	-.3679	.5506	.9641
.0132	.3475	.7599	.6386	.0126	-.0941	.6307	.8388	.1507	.4976	-.3938	.5430	.9762
.0259	-.0052	.6567	.7989	.0255	-.1845	.6042	.8797	.1507	.2476	-.3963	.5423	.9774
.0753	-.3136	.5865	.9388	.0495	-.3173	.5654	.9406	.1507	-.2524	-.3927	.5434	.9756
.1003	-.3368	.5597	.9496	.0753	-.3782	.5476	.9689	.1507	-.5024	-.3901	.5441	.9744
.1507	-.4172	.5450	.9731	.1002	-.4184	.5358	.9878	.1507	-.7524	-.3855	.5513	.9620
.2003	-.4618	.5308	.9798	.1503	-.4424	.5288	.9991	.5002	.7476	-.5955	.4841	1.0732
.2503	-.4457	.5279	1.0007	.1976	-.5470	.4982	1.0494	.5002	.4976	-.6129	.4790	1.0819
.3001	-.4844	.5136	1.0238	.2503	-.6472	.4689	1.0491	.5002	.2476	-.6169	.4778	1.0830
.3502	-.5027	.5112	1.0280	.3001	-.7229	.4468	1.1377	.5002	-.2524	-.6069	.4807	1.0789
.4003	-.5188	.5071	1.0347	.3507	-.7887	.4275	1.1722	.5002	-.5024	-.6079	.4804	1.0794
.4501	-.5510	.4971	1.0514	.4001	-.8249	.4170	1.1916	.5002	-.7524	-.60	.4818	1.0771
.5002	-.6009	.4825	1.0799	.4501	-.5095	.5092	1.0312	.5002	.7476	-.3777	.5478	.9686
.5502	-.6489	.4684	1.0999	.5001	-.7981	.5710	.9317	.8002	.4976	-.354	.5530	.9802
.6002	-.6950	.4549	1.1233	.5497	-.1851	.6041	.8800	.8002	.2476	-.4070	.5392	.9824
.6500	-.7560	.4371	1.1550	.6003	-.0675	.6385	.8249	.8002	-.5024	-.3422	.5581	.9521
.7000	-.8188	.4187	1.1883	.6500	.0379	.6693	.7795	.8002	-.7524	-.3487	.5562	.9531
.7500	-.8354	.4139	1.1973	.7000	.1505	.7023	.7287					
.8002	-.8907	.5439	.9747	.7501	.2522	.7319	.6827					
.8002	-.8907	.5439	.9747	.8001	.3356	.7563	.6443					
.9002	-.1398	.6173	.8595	.8501	.4079	.7775	.6104					
.9501	-.0152	.6538	.8034									

TEST 167	PT 21.8332	PSI	CN	.3454	CD1	.01424	CDCOR1	.01484
RUN 4	TT 185.7489	K	CM	-1.680	CD2	.01017	CDCOR2	.01080
POINT 41	RC 6.9261	MILLION	CC	.0253	CD3	.00954	CDCOR3	.00946
	MACH .8022				CD4	.00963	CDCOR4	.00942
	ALPHA -1.4867	DEG			CD5	.00695	CDCOR5	.00645

UPPER SURFACE				LOWER SURFACE				SPANWISE				
X/C	CP	P/L/PT	MLOC	X/C	CP	P/L/PT	MLOC	X/C	Y/(B/2)	CP	P/L/PT	MLOC
0.0000	1.0743	.9717	.2026	0.0000	1.0743	.9717	.2026	.1507	.7476	-.4304	.5274	1.0015
.0132	.7840	.7334	.6805	.0126	.0231	.6625	.7899	.1507	.4976	-.4617	.5199	1.0136
.0259	-.0836	.6282	.8427	.0255	-.0884	.6297	.8403	.1507	.2476	-.4646	.5191	1.0150
.0753	-.3963	.5392	.9824	.0495	-.2296	.5882	.9047	.1507	-.2524	-.4591	.5207	1.0124
.1003	-.4114	.5367	.9896	.0753	-.2982	.5680	.9365	.1507	-.5024	-.4533	.5224	1.0096
.1507	-.4940	.5277	1.0077	.1002	-.3637	.5546	.9576	.1507	-.7524	-.4434	.5312	.9953
.2003	-.4622	.5144	1.0139	.1503	-.3855	.5423	.9773	.5002	.7476	-.6397	.4675	1.1014
.2503	-.4981	.5092	1.0312	.1976	-.4962	.5097	1.0304	.5002	.4976	-.6543	.4633	1.1089
.3001	-.5471	.4948	1.0552	.2503	-.5910	.4819	1.0769	.5002	.2476	-.6526	.4638	1.1060
.3502	-.5701	.4890	1.0665	.3001	-.6569	.4625	1.1102	.5002	-.2524	-.6471	.4654	1.1052
.4003	-.5958	.4834	1.0743	.3507	-.7136	.4458	1.1394	.5002	-.5024	-.6498	.4646	1.1045
.4501	-.6020	.4786	1.0824	.4001	-.7154	.4453	1.1404	.5002	-.7524	-.6528	.4637	1.1081
.5002	-.6358	.4687	1.0995	.4501	-.6377	.5270	1.0021	.8002	.7476	-.3903	.5409	.9796
.5502	-.6794	.4559	1.1217	.5001	-.3082	.5651	.9411	.8002	.4976	-.4657	.5187	1.0156
.6002	-.7275	.4417	1.1467	.5497	-.1988	.6002	.8861	.8002	.2476	-.5237	.5017	1.0437
.6500	-.7919	.4228	1.1809	.6003	-.0603	.6362	.8303	.8002	-.5024	-.3825	.5432	.9759
.7000	-.8436	.4017	1.2202	.6500	.0408	.6677	.7819	.8002	-.7524	-.3474	.5355	.9594
.7500	-.9199	.3851	1.2519	.7000	.1543	.7011	.7306					
.8002	-.4394	.5265	1.0030	.7501	.2530	.7307	.6846					
.8002	-.4394	.5265	1.0030	.8001	.3376	.7550	.6464					
.9002	-.1342	.6182	.8612	.8501	.4088	.7760	.6129					
.9501	-.0146	.6514	.9070									

OPTICAL FINISHING OF POOR QUALITY

TEST 167	PT 21.7607	PSI	CM	-4219	CD1	-01477	CDCD1	-01483
RUN 4	TT 165.7497	K	CM	-1747	CD2	-01136	CDCD2	-01144
POINT 42	RC 6.9634	MILLION	CC	.0270	CD3	-01029	CDCD3	-01040
	MACH				CD4	-01011	CDCD4	-01011
	ALPHA	-1.0269	DEG		CD5	-00729	CDCD5	-00709

UPPER SURFACE				LOWER SURFACE				SPANWISE				
X/C	CP	P/L/P/T	MLOC	X/C	CP	P/L/P/T	MLOC	X/C	Y/(B/2)	CP	P/L/P/T	MLOC
0.0000	1.1043	.9805	.1677	0.0000	1.1043	.9805	.1677	.1507	.7476	-4.981	.5093	1.0310
.0132	-.1866	.7107	.7158	.0126	-.1162	.6900	.7477	.1507	.4976	-5.259	.5011	1.0446
.0259	-.1763	.6039	.8802	.0255	-.0098	.6329	.8047	.1507	.2476	-5.303	.4998	1.0467
.0759	-.4763	.5151	1.0214	.0435	-.1570	.6036	.8714	.1507	-.2924	-5.230	.5020	1.0432
.1307	-.5194	.5031	1.0414	.0753	-.2310	.5879	.9053	.1507	-.5074	-5.167	.5019	1.0401
.2003	-.5315	.4985	1.0473	.1002	-.2823	.5728	.9289	.1507	-.7524	-4.830	.5138	1.0237
.2503	-.5491	.4943	1.0559	.1276	-.3374	.5565	.9545	.5002	.7476	-6.865	.4539	1.1251
.3001	-.5878	.4830	1.0751	.1576	-.4497	.5255	1.0077	.5002	.4976	-7.042	.4487	1.1343
.3502	-.6140	.4752	1.0882	.2503	-.5303	.4999	1.0457	.5002	.2476	-7.170	.4470	1.1373
.4003	-.633	.4690	1.0990	.3001	-.5890	.4826	1.0757	.5002	-.7524	-6.978	.4506	1.1310
.4501	-.6297	.4618	1.1114	.3507	-.6322	.4699	1.0974	.5002	-.5024	-6.966	.4509	1.1304
.5002	-.6084	.4510	1.1303	.4001	-.6882	.4528	1.0753	.5002	-.7524	-7.003	.4498	1.1323
.5502	-.7287	.4415	1.1471	.4501	-.7436	.4280	1.0504	.8001	.7476	-6.391	.5478	.9788
.6002	-.7634	.4313	1.1634	.5001	-.8113	.3642	.9424	.8002	.378	-6.890	.5121	1.0266
.6500	-.8268	.4127	1.1936	.5497	-.1854	.8013	.8843	.8002	.2476	-5.230	.5020	1.0432
.7000	-.8872	.3919	1.2388	.6003	-.0618	.6376	.8242	.8002	-.5024	-3.924	.5474	.9804
.7500	-.9492	.3767	1.2895	.6500	-.0448	.6690	.7800	.8002	-.7524	-3.397	.5559	.9556
.8002	-.4328	.5285	.8896	.7000	.1593	.7026	.7282					
.8002	-.1480	.6123	.8673	.7501	.2620	.7328	.6813					
.9501	-.0359	.6452	.8145	.8001	.3471	.7579	.6419					
				.8501	.4217	.7798	.6068					

TEST 167	PT 21.7630	PSI	CM	-5010	CD1	.01666	CDCD1	.01675
RUN 4	TT 165.7480	K	CM	-1794	CD2	.01421	CDCD2	.01431
POINT 43	RC 6.9660	MILLION	CC	.0288	CD3	.01266	CDCD3	.01242
	MACH	.8019			CD4	.01213	CDCD4	.01219
	ALPHA	-.4840	DEG		CD5	.00852	CDCD5	.00830

UPPER SURFACE				LOWER SURFACE				SPANWISE				
X/C	CP	P/L/P/T	MLOC	X/C	CP	P/L/P/T	MLOC	X/C	Y/(B/2)	CP	P/L/P/T	MLOC
0.0000	1.1310	.9883	.1296	0.0000	1.1310	.9883	.1296	.1507	.7476	-5.630	.4897	1.0437
.0132	-.6988	.8845	.7581	.0126	-.2258	.7190	.7029	.1507	.4976	-5.902	.4917	1.0772
.0259	-.2702	.5759	.9240	.0255	-.0774	.6782	.7658	.1507	.2476	-6.052	.4773	1.0847
.0759	-.5728	.4568	1.0686	.0435	-.0791	.6320	.8368	.1507	-.2524	-5.934	.4905	1.0788
.1307	-.5549	.4803	1.0796	.0753	-.1590	.6086	.8729	.1507	-.5024	-5.807	.4845	1.0725
.2003	-.5931	.4809	1.0786	.1002	-.2170	.5916	.8994	.1507	-.7524	-5.476	.4943	1.0360
.2503	-.6585	.4763	1.0867	.1276	-.2807	.5728	.9289	.5002	.7476	-7.424	.4369	1.1553
.3001	-.6330	.4689	1.0990	.1576	-.3449	.5392	.9623	.5002	.4976	-7.529	.4338	1.1609
.3502	-.6804	.4611	1.1127	.2503	-.4472	.5179	1.0189	.5002	.2476	-7.641	.4305	1.1668
.4003	-.6839	.4600	1.1145	.3001	-.5266	.5004	1.0457	.5002	-.2524	-7.571	.4326	1.1630
.4501	-.6765	.4583	1.1209	.3507	-.5533	.4926	1.0589	.5002	-.5024	-7.559	.4329	1.1624
.5002	-.7020	.4488	1.1341	.4001	-.5179	.5030	1.0415	.5002	-.7524	-7.565	.4320	1.1627
.5502	-.7454	.4360	1.1569	.4501	-.4272	.5297	.9977	.4002	.7476	-6.011	.5374	.9853
.6002	-.7859	.4241	1.1785	.5001	-.3134	.6832	.9441	.8002	.4976	-6.554	.5214	1.0112
.6500	-.8233	.4131	1.1987	.5497	-.1844	.8011	.8845	.8002	.2476	-6.444	.5246	1.0059
.7000	-.722	.3897	1.2258	.6003	-.0811	.6375	.8284	.8002	-.5024	-4.420	.5253	1.0068
.7500	-.9363	.3798	1.2623	.6500	-.0439	.6683	.7810	.8002	-.7524	-3.391	.5356	.9561
.8002	-.4583	.5274	1.2751	.7000	.1579	.7024	.7293					
.8002	-.4344	.5276	1.2011	.7501	.2608	.7321	.6824					
.9501	-.1788	.6029	.8519	.8001	.3458	.7572	.6424					
	-.0567	.6348	.4264	.8501	.4211	.7794	.6074					

TEST 167	PT 21.8122	PSI	CM	.5757	CD1	.02014	CDCD1	.02026
RUN 4	TT 165.7607	K	CM	-1821	CD2	.01919	CDCD2	.01929
POINT 44	RC 6.9836	MILLION	CC	.0269	CD3	.01632	CDCD3	.01646
	MACH	.8025			CD4	.01452	CDCD4	.01452
	ALPHA	.0305	DEG		CD5	.01100	CDCD5	.01086

UPPER SURFACE				LOWER SURFACE				SPANWISE				
X/C	CP	P/L/P/T	MLOC	X/C	CP	P/L/P/T	MLOC	X/C	Y/(B/2)	CP	P/L/P/T	MLOC
0.0000	1.1532	.9950	.0843	0.0000	1.1532	.9950	.0843	.1507	.7476	-6.384	.4889	1.0042
.0132	-.0175	.8815	.7915	.0126	-.3109	.7477	.6540	.1507	.4976	-6.707	.4990	1.1345
.0259	-.3541	.5518	.9627	.0255	-.1588	.7030	.7276	.1507	.2476	-6.703	.4940	1.1219
.0759	-.6669	.4664	1.1035	.0435	-.0054	.6548	.8038	.1507	-.2524	-6.677	.4919	1.1247
.1307	-.6804	.4565	1.1206	.0753	-.0911	.6236	.8405	.1507	-.5024	-6.650	.4930	1.1233
.2003	-.6933	.4529	1.1272	.1002	-.1538	.6112	.8699	.1507	-.7524	-6.156	.4927	1.0977
.2503	-.7008	.4506	1.1310	.1276	-.2278	.5895	.9027	.5002	.7476	-7.456	.4327	1.1910
.3001	-.7226	.4441	1.1424	.1576	-.3359	.5577	.9524	.5002	.4976	-7.676	.4301	1.1765
.3502	-.7081	.4400	1.1444	.2503	-.4054	.5373	.9854	.5002	.2476	-7.659	.4317	1.1826
.4003	-.7251	.4387	1.1555	.3001	-.4574	.5220	1.0102	.5002	-.2524	-7.591	.4321	1.1802
.4501	-.7453	.4333	1.1639	.3507	-.4839	.5142	1.0229	.5002	-.5024	-7.581	.4320	1.1787
.5002	-.7688	.4371	1.1550	.4001	-.4622	.5206	1.0125	.5002	-.7524	-7.581	.4320	1.1814
.5502	-.7855	.4257	1.1757	.4501	-.3396	.6190	.9427	.4002	.7476	-6.382	.5441	.9745
.6002	-.8294	.4124	1.1944	.5001	-.2392	.6685	.8757	.8002	.4976	-6.137	.5340	.9893
.6500	-.8704	.4007	1.2220	.5497	-.1705	.8063	.8766	.8002	.2476	-6.009	.5346	.9833
.7000	-.9222	.3834	1.2546	.6003	-.0495	.6418	.8217	.8002	-.5024	-4.900	.5418	.9782
.7500	-.9892	.3661	1.2936	.6500	-.0530	.6719	.7755	.8002	-.7524	-3.332	.5515	.9315
.8002	-.4134	.4157	1.1934	.7000	.1465	.7032	.7242					
.8002	-.4244	.5316	.9466	.7501	.2684	.7312	.6776					
.9501	-.1912	.6002	.9840	.8001	.3537	.7603	.6361					
	-.0827	.6321	.9367	.8501	.4299	.7826	.6021					

TEST 167	PT	21.8066	PSI	CN	.6235	CD1	.02446	CDCOR1	.02414
RUN 4	TT	165.8955	K	CM	-.1803	CD2	.02158	CDCOR2	.02127
POINT 45	RC	6.9758	MILLION	CC	.0294	CD3	.01865	CDCOR3	.01844
	MACH	.8029				CD4	.01729	CDCOR4	.01688
	ALPHA	.5295	DEG			CD5	.01367	CDCOR5	.01288

UPPER SURFACE				LOWER SURFACE				SPANWISE				
X/C	CP	P _L /PT	MLOC	X/C	CP	P _L /PT	MLOC	X/C	Y/(B/2)	CP	P _L /PT	MLOC
0.0000	1.1666	.9988	.0422	0.0000	1.1666	.9988	.0422	.1507	.7476	-.7132	.4453	1.1403
.0132	-.0439	.6424	.8208	.0126	.3839	.7683	.6232	.1507	.4976	-.7880	.4233	1.1800
.0259	-.4199	.5317	.9945	.0255	.2239	.7212	.6994	.1507	.2476	-.7720	.4280	1.1714
.0759	-.7052	.4477	1.1361	.0495	.0536	.6711	.7768	.1507	-.2524	-.7597	.4316	1.1648
.1003	-.7351	.4389	1.1518	.0753	-.0355	.6448	.6171	.1507	-.5024	-.7674	.4294	1.1689
.1507	-.7552	.4327	1.1630	.1002	-.1034	.6248	.8478	.1507	-.7524	-.6791	.4554	1.1226
.2003	-.7685	.4290	1.1695	.1503	-.1832	.6014	.8842	.5002	.7476	-.8538	.4039	1.2159
.2503	-.7908	.4225	1.1815	.1976	-.2920	.5693	.9344	.5002	.4976	-.8600	.4021	1.2194
.3001	-.8180	.4145	1.1962	.2503	-.3642	.5481	.9681	.5002	.2476	-.8456	.4063	1.2114
.3502	-.8025	.4190	1.1878	.3001	-.4178	.5323	.9935	.5002	-.2524	-.8304	.4108	1.2030
.4003	-.7853	.4300	1.1678	.3507	-.4405	.5256	1.0044	.5002	-.5024	-.8462	.4062	1.2117
.4501	-.7884	.4231	1.1803	.4001	-.4391	.5260	1.0037	.5002	-.7524	-.8377	.4087	1.2070
.5002	-.8274	.4117	1.2014	.4501	-.3886	.5409	.9796	.8002	.7476	-.3906	.5403	.9806
.5502	-.8636	.4010	1.2214	.5001	-.2970	.5679	.9367	.8002	.4976	-.4200	.5316	.9945
.6002	-.9043	.3893	1.2438	.5497	-.1687	.6056	.8776	.8002	.2476	-.4037	.5364	.9868
.6500	-.9616	.3722	1.2774	.6003	-.0490	.6409	.8232	.8002	-.5024	-.3676	.5471	.9697
.7000	-1.0030	.3600	1.3021	.6500	.0514	.6704	.7778	.8002	-.7524	-.3446	.5539	.9580
.7500	-.9007	.3079	1.0334	.7000	.1626	.7052	.7273					
.8002	-.4603	.5377	.9852	.7501	.2635	.7329	.6812					
.9002	-.2485	.5821	.9142	.8001	.3474	.7576	.6423					
.9501	-.1619	.6076	.8745	.8501	.4218	.7795	.6072					

TEST 167	PT	21.8050	PSI	CN	.6732	CD1	.02829	CDCOR1	.02746
RUN 4	TT	165.8849	K	CM	-.1814	CD2	.02472	CDCOR2	.02392
POINT 46	RC	6.9773	MILLION	CC	.0298	CD3	.02156	CDCOR3	.02041
	MACH	.8032				CD4	.02071	CDCOR4	.01990
	ALPHA	1.0183	DEG			CD5	.01711	CDCOR5	.01635

UPPER SURFACE				LOWER SURFACE				SPANWISE				
X/C	CP	P _L /PT	MLOC	X/C	CP	P _L /PT	MLOC	X/C	Y/(B/2)	CP	P _L /PT	MLOC
0.0000	1.1759	1.0013	0.0000	0.0000	1.1759	1.0013	0.0000	.1507	.7476	-.7829	.4434	1.1799
.0132	-.1004	.6247	.8480	.0126	.4449	.7856	.5972	.1507	.4976	-.8494	.4038	.2163
.0259	-.4770	.5136	1.0237	.0255	.2772	.7362	.6761	.1507	.2476	-.8225	.4117	1.2014
.0759	-.7584	.4306	1.1667	.0495	.1049	.6853	.7549	.1507	-.2524	-.8082	.4159	1.1936
.1003	-.7846	.4229	1.1807	.0753	.0231	.6612	.7920	.1507	-.5024	-.8227	.4116	1.2015
.1507	-.8065	.4104	1.1926	.1002	-.0587	.6370	.8291	.1507	-.7524	-.7382	.4366	1.1559
.2003	-.8258	.4167	1.2032	.1503	-.1476	.6114	.8686	.5002	.7476	-.8970	.3897	1.2431
.2503	-.8470	.4045	1.2149	.1976	-.2520	.5800	.9175	.5002	.4976	-.9052	.3873	1.2478
.3001	-.8775	.3954	1.2321	.2503	-.3257	.5583	.9519	.5002	.2476	-.8997	.3889	1.2446
.3502	-.8843	.3920	1.2387	.3001	-.3827	.5414	.9787	.5002	-.2524	-.8984	.3893	1.2439
.4003	-.8667	.3996	1.2259	.3507	-.4183	.5309	.9957	.5002	-.5024	-.8975	.3896	1.2433
.4501	-.8285	.4099	1.2047	.4001	-.4142	.5322	.9937	.5002	-.7524	-.8766	.3957	1.2315
.5002	-.8671	.3985	1.2262	.4501	-.3710	.5449	.9732	.8002	.7476	-.3962	.5375	.9851
.5502	-.9057	.3871	1.2481	.5001	-.2866	.5698	.9336	.8002	.4976	-.3986	.5368	.9863
.6002	-.9412	.3767	1.2666	.5497	-.1628	.6063	.8765	.8002	.2476	-.4124	.5327	.9929
.6500	-.9975	.3600	1.3020	.6003	-.0441	.6414	.8224	.8002	-.5024	-.3533	.5501	.9648
.7000	-.8230	.4115	1.2017	.6500	.0563	.6710	.7769	.8002	-.7524	-.3615	.5477	.9687
.7500	-.4659	.5169	1.0186	.7000	.1664	.7035	.7269					
.8002	-.4126	.5326	.9930	.7501	.2645	.7324	.6820					
.9002	-.2758	.5730	.9286	.8001	.3458	.7564	.6442					
.9501	-.2031	.5938	.8959	.8501	.4168	.7773	.6106					

TEST 167	PT	21.8118	PSI	CN	.7257	CD1	.03052	CDCOR1	.02913
RUN 4	TT	165.9081	K	CM	-.1818	CD2	.02592	CDCOR2	.02452
POINT 47	RC	6.9739	MILLION	CC	.0292	CD3	.02467	CDCOR3	.02348
	MACH	.8023				CD4	.02245	CDCOR4	.02154
	ALPHA	1.5172	DEG			CD5	.02021	CDCOR5	.01936

UPPER SURFACE				LOWER SURFACE				SPANWISE				
X/C	CP	P _L /PT	MLOC	X/C	CP	P _L /PT	MLOC	X/C	Y/(B/2)	CP	P _L /PT	MLOC
0.0000	1.1760	1.0018	0.0000	0.0000	1.1760	1.0018	0.0000	.1507	.7476	-.8474	.4079	1.2084
.0132	-.1726	.6040	.8770	.0126	.5024	.8041	.5667	.1507	.4976	-.9153	.3880	1.2464
.0259	-.5537	.4941	1.0563	.0255	.3299	.7534	.6489	.1507	.2476	-.8866	.3964	1.2302
.0759	-.8270	.4139	1.1973	.0495	.1509	.7009	.7309	.1507	-.2324	-.8761	.3995	1.2244
.1003	-.8525	.4064	1.2113	.0753	.0530	.6722	.7751	.1507	-.5024	-.8970	.3934	1.2360
.1507	-.8712	.4009	1.2216	.1002	-.0184	.6512	.8072	.1507	-.7524	-.8170	.4168	1.1918
.2003	-.8832	.3974	1.2283	.1503	-.1090	.6246	.8482	.5002	.7476	-.9335	.3767	1.2685
.2503	-.9040	.3913	1.2400	.1976	-.2177	.5927	.8976	.5002	.4976	-.9605	.3747	1.2724
.3001	-.9341	.3825	1.2572	.2503	-.2939	.5707	.9322	.5002	.2476	-.9791	.3693	1.2833
.3502	-.9517	.3773	1.2673	.3001	-.3496	.5540	.9586	.5002	-.2524	-.9985	.3753	1.2713
.4003	-.9600	.3749	1.2721	.3507	-.3838	.5425	.9770	.5002	-.5024	-.9489	.3781	1.2697
.4501	-.9329	.3828	1.2564	.4001	-.3973	.5415	.9787	.8002	-.7524	-.9271	.3845	1.2731
.5002	-.9125	.3888	1.2448	.4501	-.3621	.5503	.9645	.8002	.7476	-.4264	.5315	.9948
.5502	-.8905	.3777	1.2661	.5001	-.2890	.5718	.9304	.8002	.4976	-.4054	.5377	.9848
.6002	-.9966	.3671	1.2877	.5497	-.1639	.6079	.8740	.8002	.2476	-.4187	.5339	.9909
.6500	-1.0345	.3530	1.3165	.6003	-.0484	.6424	.8208	.8002	-.5024	-.3656	.5493	.9661
.7000	-.7284	.4427	1.1449	.6500	.0485	.6709	.7771	.8002	-.7524	-.3492	.5595	.9819
.7500	-.4873	.5136	1.0240	.7000	.1586	.7032	.7274					
.8002	-.4369	.5284	.9998	.7501	.2589	.7326	.6818					
.9002	-.2800	.5749	.9263	.8001	.3429	.7573	.6428					
.9501	-.2070	.6018	.8836	.8501	.4184	.7794	.6072					

TEST	167	PT	24.7318	PSI		CN		CD1	.03404	CDCOR1	.03352
RUN	49	TT	141.1656	K		CM	-.1341	CD2	.02882	CDCOR2	.02847
POINT	66	RC	9.9650	MILLION		CC	-.0824	CD3	.02498	CDCOR3	.02472
		MACH	.7999				.0148	CD4	.01912	CDCOR4	.01880
		ALPHA	-3.9917	DEG				CD5	.01449	CDCOR5	.01391

UPPER SURFACE				LOWER SURFACE				SPANWISE				
X/C	CP	P/L/PT	MLOC	X/C	CP	P/L/PT	MLOC	X/C	Y/(B/2)	CP	P/L/PT	MLOC
0.0000	.8050	.8927	.4060	0.0000	.8050	.8927	.4060	.1507	.7476	-.1283	.6185	.8579
.0132	.6319	.8418	.5021	.0126	-.5689	.4891	1.0650	.1507	.4976	-.1327	.6173	.8598
.0259	.3148	.7487	.6566	.0255	-.5067	.5074	1.0345	.1507	.2476	-.1321	.6174	.8596
.0759	-.0023	.6556	.8009	.0495	-.6444	.4670	1.1028	.1507	-.2524	-.1321	.6116	.8687
.1003	-.0535	.6405	.8240	.0753	-.6867	.4545	1.1244	.1507	-.5024	-.1365	.6162	.8616
.1507	-.1336	.6170	.8603	.1002	-.7260	.4430	1.1448	.1507	-.7524	-.1404	.6150	.8633
.2003	-.1869	.6013	.8845	.1503	-.7426	.4381	1.1535	.5002	.7476	-.4277	.5306	.9965
.2503	-.2411	.5894	.9094	.1976	-.7970	.4221	1.1824	.5002	.4976	-.4317	.5294	.9984
.3001	-.2876	.5718	.9308	.2503	-.8636	.4026	1.2188	.5002	.2476	-.4366	.5280	1.0008
.3502	-.3164	.5633	.9442	.3001	-.9309	.3828	1.2568	.5002	-.2524	-.4282	.5304	.9968
.4003	-.3516	.5530	.9606	.3507	-.9858	.3667	1.2888	.5002	-.5024	-.4258	.5312	.9956
.4501	-.3930	.5408	.9801	.4001	-.9463	.3783	1.2657	.8002	-.7524	-.4133	.5348	.9897
.5002	-.4344	.5286	.9997	.4501	-.9743	.3169	1.0188	.8002	.7476	-.4995	.5326	1.2970
.5502	-.4798	.5153	1.0215	.5001	-.9374	.5462	.9715	.8002	.4976	-.3541	.5522	.9618
.6002	-.5307	.5004	1.0462	.5497	-.9381	.5657	.9403	.8002	.2476	-.3926	.5527	.9611
.6500	-.5968	.4809	1.0788	.6003	-.9239	.5867	.9074	.8002	-.5024	-.3493	.5536	.9593
.7000	-.6412	.4679	1.1012	.6500	-.9164	.6078	.8745	.8002	-.7524	-.3513	.5530	.9605
.7500	-.6786	.4556	1.0209	.7000	-.9302	.6289	.8416					
.8002	-.7349	.4549	.9575	.7501	-.9319	.6469	.8142					
.9002	-.8359	.6163	.8613	.8001	-.9306	.6652	.7860					
.9501	-.9033	.6553	.8013	.8501	-.9887	.6823	.7598					

TEST	167	PT	24.7271	PSI		CN	.0507	CD1	.01948	CDCOR1	.01908
RUN	49	TT	141.2164	K		CM	-.1296	CD2	.01803	CDCOR2	.01778
POINT	67	RC	9.9599	MILLION		CC	.0197	CD3	.01661	CDCOR3	.01585
		MACH	.8002					CD4	.01445	CDCOR4	.01426
		ALPHA	-3.0141	DEG				CD5	.01199	CDCOR5	.01153

UPPER SURFACE				LOWER SURFACE				SPANWISE				
X/C	CP	P/L/PT	MLOC	X/C	CP	P/L/PT	MLOC	X/C	Y/(B/2)	CP	P/L/PT	MLOC
0.0000	.9142	.9247	.3363	0.0000	.9142	.9247	.3363	.1507	.7476	-.2228	.5904	.9015
.0132	.5118	.8064	.5631	.0126	-.3331	.5580	.9526	.1507	.4976	-.2333	.5874	.9063
.0259	.1779	.7082	.7198	.0255	-.3540	.5519	.9623	.1507	.2476	-.2335	.5873	.9064
.0759	-.1222	.6200	.8556	.0495	-.4985	.5094	1.0312	.1507	-.2524	-.2573	.5862	.9081
.1003	-.1640	.6077	.8746	.0753	-.5169	.5040	1.0401	.1507	-.5024	-.2363	.5865	.9077
.1507	-.2352	.5868	.9072	.1002	-.5837	.4844	1.0730	.1507	-.7524	-.2331	.5874	.9062
.2003	-.2824	.5729	.9290	.1503	-.5931	.4816	1.0777	.5002	.7476	-.5057	.5073	1.0347
.2503	-.3305	.5588	.9514	.1976	-.6394	.4680	1.1010	.5002	.4976	-.5145	.5047	1.0390
.3001	-.3746	.5456	.9720	.2503	-.7211	.4440	1.1430	.5002	.2476	-.5195	.5032	1.0414
.3502	-.3966	.5393	.9824	.3001	-.8067	.4188	1.1885	.5002	-.2524	-.5107	.5058	1.0371
.4003	-.4266	.5305	.9966	.3507	-.8931	.3934	1.2362	.5002	-.5024	-.5081	.5066	1.0358
.4501	-.4670	.5187	1.0160	.4001	-.9654	.3722	1.2778	.5002	-.7524	-.4921	.5113	1.0281
.5002	-.5171	.5039	1.0403	.4501	-.9978	.3626	1.2970	.8002	.7476	-.4977	.5132	1.2969
.5502	-.5521	.4936	1.0574	.5001	-.9421	.5320	.9943	.8002	.4976	-.3427	.5552	.9570
.6002	-.5964	.4806	1.0794	.5497	-.9258	.5749	.9259	.8002	.2476	-.3428	.5552	.9571
.6500	-.6616	.4615	1.1123	.6003	-.9130	.6166	.8609	.8002	-.5024	-.3420	.5554	.9567
.7000	-.7290	.4417	1.1471	.6500	-.9059	.6542	.8029	.8002	-.7524	-.3517	.5526	.9612
.7500	-.6343	.4695	1.0984	.7000	-.9173	.6875	.7518					
.8002	-.7380	.5966	.9548	.7501	.9176	.7140	.7108					
.9002	-.8361	.6159	.8619	.8001	.9218	.7356	.6768					
.9501	-.9109	.6527	.8032	.8501	.9321	.7536	.6489					

TEST	167	PT	24.7287	PSI		CN	.2340	CD1	.01309	CDCOR1	.01263
RUN	49	TT	141.2487	K		CM	-.1913	CD2	.01278	CDCOR2	.01239
POINT	68	RC	9.9498	MILLION		CC	.0222	CD3	.01223	CDCOR3	.01196
		MACH	.7991					CD4	.01171	CDCOR4	.01143
		ALPHA	-1.9958	DEG				CD5	.01023	CDCOR5	.00982

UPPER SURFACE				LOWER SURFACE				SPANWISE				
X/C	CP	P/L/PT	MLOC	X/C	CP	P/L/PT	MLOC	X/C	Y/(B/2)	CP	P/L/PT	MLOC
0.0000	1.0185	.9557	.2553	0.0000	1.0185	.9557	.2553	.1507	.7476	-.3458	.5557	.9563
.0132	.3530	.7605	.6378	.0126	-.0993	.6279	.8434	.1507	.4976	-.3599	.5515	.9629
.0259	.0642	.6583	.7947	.0255	-.1724	.6065	.8765	.1507	.2476	-.3604	.5514	.9631
.0759	-.2753	.5763	.9236	.0495	-.3243	.5620	.9463	.1507	-.2524	-.3676	.5504	.9646
.1003	-.3034	.5681	.9366	.0753	-.3519	.5339	.9591	.1507	-.5024	-.3625	.5508	.9641
.1507	-.3629	.5507	.9643	.1002	-.4191	.5342	.9907	.1507	-.7524	-.3528	.5536	.9595
.2003	-.3931	.5414	.9785	.1503	-.4410	.5278	1.0012	.5002	.7476	-.5892	.4643	1.0731
.2503	-.4392	.5283	1.0003	.1976	-.5306	.4956	1.0541	.5002	.4976	-.5967	.4621	1.0768
.3001	-.4857	.5146	1.0226	.2503	-.6508	.4663	1.1040	.5002	.2476	-.6016	.4607	1.0793
.3502	-.4914	.5130	1.0253	.3001	-.7281	.4436	1.1437	.5002	-.2524	-.5939	.4629	1.0755
.4003	-.5105	.5074	1.0345	.3507	-.7985	.4230	1.1809	.5002	-.5024	-.5955	.4625	1.0762
.4501	-.5488	.4962	1.0532	.4001	-.8461	.4060	1.2067	.5002	-.7524	-.5862	.4652	1.0716
.5002	-.5982	.4817	1.0776	.4501	-.9432	.4978	1.0505	.8002	.7476	-.4958	.5680	1.2860
.5502	-.6419	.4689	1.0995	.5001	-.9041	.5679	.9369	.8002	.4976	-.3379	.5580	.9576
.6002	-.6891	.4550	1.1235	.5497	-.8945	.6000	.8845	.8002	.2476	-.3432	.5564	.9551
.6500	-.7503	.4371	1.1553	.6003	-.8778	.6343	.8336	.8002	-.5024	-.3408	.5571	.9539
.7000	-.8099	.4196	1.1871	.6500	-.9255	.6645	.7871	.8002	-.7524	-.3374	.5523	.9617
.7500	-.7420	.4305	1.1509	.7000	-.9363	.6970	.7371					
.8002	-.7412	.5570	.9541	.7501	-.9232	.7251	.6935					
.9002	-.8323	.6183	.8583	.8001	-.9125	.7487	.6566					
.9501	-.9163	.6523	.8059	.8501	-.9795	.7683	.6254					

OF POOR QUALITY

TEST RUN POINT	167 49 70	PT TT RC MACH ALPHA	24.7251 141.1432 9.9684 .8005 -1.5071	PSI K MILLION DEG	CN CM CC	.3141 -1.1567 .0243	CD1 CD2 CD3 CD4 CD5	.01357 .01328 .01285 .01209 .01058	CDCOR1 CDCOR2 CDCOR3 CDCOR4 CDCOR5	.01302 .01283 .01249 .01164 .01010		
UPPER SURFACE												
X/C	CP	P/L/PT	MLOC	X/C	CP	P/L/PT	MLOC	X/C	Y/(B/2)	SPANWISE CP	P/L/PT	MLOC
0.0000	1.0682	.9701	.2085	0.0000	1.0682	.9701	.2085	1.507	.7476	-.4039	.5382	.9842
.0132	.2710	.7362	.6762	.0126	.0189	.6623	.7906	1.507	.4976	-.4225	.5327	.9931
.0259	-.0809	.6330	.8356	.0255	-.0768	.6342	.8338	1.507	.2476	-.4244	.5322	.9939
.0759	-.3545	.5527	.9610	.0495	-.2350	.5878	.9057	1.507	-.2524	-.4317	.5301	.9974
.1003	-.3728	.5473	.9696	.0753	-.2727	.5767	.9230	1.507	-.5024	-.4198	.5335	.9918
.1507	-.4264	.5316	.9949	.1002	-.3432	.5560	.9557	1.507	-.7524	-.4056	.5377	.9851
.2003	-.4524	.5240	1.0073	.1503	-.3835	.5442	.9746	1.507	.7476	-.6227	.4740	1.0907
.2503	-.4878	.5136	1.0243	.1976	-.4497	.5104	1.0295	1.507	.4976	-.6278	.4725	1.0932
.3001	-.5365	.4993	1.0479	.2503	-.5922	.4830	1.0754	1.507	.2476	-.6281	.4724	1.0933
.3502	-.5593	.4926	1.0591	.3001	-.6586	.4635	1.1088	1.507	-.2524	-.6211	.4724	1.0899
.4003	-.5685	.4899	1.0636	.3507	-.7171	.4463	1.1389	1.507	-.5024	-.6264	.4729	1.0925
.4501	-.5831	.4856	1.0709	.4001	-.7250	.4440	1.1430	1.507	-.7524	-.6246	.4735	1.0916
.5002	-.6220	.4742	1.0903	.4501	-.7398	.4277	1.1603	1.507	.7476	-.6211	.4724	1.0933
.5502	-.6683	.4606	1.1137	.5001	-.7327	.4250	1.1603	1.507	.4976	-.6278	.4725	1.0932
.6002	-.7194	.4456	1.1401	.5497	-.7194	.4250	1.1603	1.507	.2476	-.6281	.4724	1.0933
.6500	-.7843	.4266	1.1742	.6003	-.7029	.4353	.8873	1.507	-.2524	-.6211	.4724	1.0899
.7000	-.8534	.4063	1.2117	.6500	-.6320	.4661	.7846	1.507	-.5024	-.6264	.4729	1.0925
.7500	-.8147	.4177	1.1906	.7000	-.5024	.4661	.7846	1.507	.7476	-.6211	.4724	1.0933
.8002	-.8523	.4534	.9600	.7501	-.2402	.7272	.6903	1.507	.4976	-.6278	.4725	1.0932
.9002	-.1222	.6209	.8543	.8001	.3206	.7508	.6533	1.507	.2476	-.6281	.4724	1.0933
.9501	-.0131	.6529	.8050	.8501	.3881	.7706	.6217	1.507	-.2524	-.6211	.4724	1.0899

TEST RUN POINT	167 49 71	PT TT RC MACH ALPHA	24.7320 141.1580 9.9591 .7989 -.9979	PSI K MILLION DEG	CN CM CC	-.3884 -1.1586 .0242	CD1 CD2 CD3 CD4 CD5	.01441 .01406 .01368 .01277 .01134	CDCOR1 CDCOR2 CDCOR3 CDCOR4 CDCOR5	.01401 .01374 .01341 .01243 .01087		
UPPER SURFACE												
X/C	CP	P/L/PT	MLOC	X/C	CP	P/L/PT	MLOC	X/C	Y/(B/2)	SPANWISE CP	P/L/PT	MLOC
0.0000	1.1021	.9803	.1687	0.0000	1.1021	.9803	.1687	1.507	.7476	-.4767	.5182	1.0168
.0132	.1868	.7106	.7161	.0126	.1217	.6934	.7428	1.507	.4976	-.4963	.5124	1.0262
.0259	-.1749	.6065	.8765	.0255	-.0666	.6596	.7946	1.507	.2476	-.4987	.5117	1.0273
.0759	-.4477	.5266	1.0030	.0495	-.1560	.6120	.8679	1.507	-.2524	-.4961	.5125	1.0261
.1003	-.4519	.5254	1.0049	.0753	-.2039	.5980	.8897	1.507	-.5024	-.4884	.5147	1.0224
.1507	-.5008	.5111	1.0284	.1002	-.2766	.5767	.9230	1.507	-.7524	-.4719	.5196	1.0145
.2003	-.5192	.5057	1.0373	.1503	-.3309	.5608	.9481	1.507	.7476	-.6735	.4606	1.1139
.2503	-.5388	.5000	1.0468	.1976	-.4473	.5268	1.0027	1.507	.4976	-.6810	.4583	1.1177
.3001	-.5850	.4864	1.0695	.2503	-.5246	.5042	1.0399	1.507	.2476	-.6862	.4568	1.1203
.3502	-.6100	.4791	1.0819	.3001	-.5853	.4864	1.0697	1.507	-.2524	-.6768	.4596	1.1155
.4003	-.6281	.4738	1.0910	.3507	-.6298	.4733	1.0918	1.507	-.5024	-.6789	.4590	1.1166
.4501	-.6522	.4668	1.1031	.4001	-.6716	.4404	1.0629	1.507	-.7524	-.6824	.4579	1.1164
.5002	-.6864	.4568	1.1204	.4501	-.7299	.4319	.9945	1.507	.7476	-.6789	.4590	1.1166
.5502	-.7132	.4489	1.1342	.5001	-.7328	.4255	.9943	1.507	.4976	-.6768	.4596	1.1155
.6002	-.7532	.4372	1.1551	.5497	-.7193	.4250	.9943	1.507	.2476	-.6789	.4590	1.1166
.6500	-.8171	.4185	1.1891	.6003	-.7023	.4365	.8301	1.507	-.2524	-.6768	.4596	1.1155
.7000	-.8838	.3990	1.2256	.6500	-.6320	.4661	.7832	1.507	-.5024	-.6768	.4596	1.1155
.7500	-.7926	.4257	1.1759	.7000	-.5024	.4661	.7832	1.507	.7476	-.6768	.4596	1.1155
.8002	-.8516	.4548	.9577	.7501	-.2404	.7281	.6889	1.507	.4976	-.6768	.4596	1.1155
.9002	-.1217	.6221	.8524	.8001	.3210	.7517	.6519	1.507	.2476	-.6768	.4596	1.1155
.9501	-.0158	.6531	.8047	.8501	.3888	.7715	.6202	1.507	-.2524	-.6768	.4596	1.1155

TEST RUN POINT	167 49 72	PT TT RC MACH ALPHA	24.7412 141.1498 9.9637 .7989 -.4993	PSI K MILLION DEG	CN CM CC	.4627 -1.1622 .0261	CD1 CD2 CD3 CD4 CD5	.01636 .01610 .01561 .01455 .01314	CDCOR1 CDCOR2 CDCOR3 CDCOR4 CDCOR5	.01585 .01567 .01525 .01413 .01259		
UPPER SURFACE												
X/C	CP	P/L/PT	MLOC	X/C	CP	P/L/PT	MLOC	X/C	Y/(B/2)	SPANWISE CP	P/L/PT	MLOC
0.0000	1.1282	.9878	.1324	0.0000	1.1282	.9878	.1324	1.507	.7476	-.5378	.4993	1.0479
.0132	.1005	.6865	.7533	.0126	.2201	.7216	.6991	1.507	.4976	-.5527	.4950	1.0552
.0259	-.2625	.5800	.9178	.0255	-.0876	.6827	.7591	1.507	.2476	-.5542	.4945	1.0560
.0759	-.5402	.4986	1.0491	.0495	-.0810	.6333	.8351	1.507	-.2524	-.5519	.4952	1.0548
.1003	-.5529	.4949	1.0553	.0753	-.1371	.6168	.8605	1.507	-.5024	-.5395	.4988	1.0487
.1507	-.5610	.4925	1.0593	.1002	-.2134	.5944	.8953	1.507	-.7524	-.5292	.5019	1.0437
.2003	-.5886	.4844	1.0729	.1503	-.2760	.5761	.9240	1.507	.7476	-.7245	.4446	1.1419
.2503	-.6161	.4764	1.0866	.1976	-.3899	.5427	.9770	1.507	.4976	-.7311	.4426	1.1454
.3001	-.6427	.4666	1.1000	.2503	-.4589	.5225	1.0098	1.507	.2476	-.7390	.4403	1.1495
.3502	-.6518	.4659	1.1046	.3001	-.5195	.5047	1.0390	1.507	-.2524	-.7373	.4408	1.1486
.4003	-.6645	.4622	1.1110	.3507	-.5478	.4964	1.0528	1.507	-.5024	-.7303	.4429	1.1450
.4501	-.6939	.4536	1.1261	.4001	-.5998	.5075	1.0343	1.507	-.7524	-.7367	.4416	1.1473
.5002	-.7371	.4409	1.1485	.4501	-.6148	.5354	.9888	1.507	.7476	-.7343	.4426	1.1454
.5502	-.7750	.4298	1.1685	.5001	-.6139	.5630	.9415	1.507	.4976	-.7367	.4426	1.1454
.6002	-.8124	.4188	1.1889	.5497	-.5986	.6017	.8839	1.507	.2476	-.7367	.4426	1.1454
.6500	-.8579	.4055	1.2133	.6003	-.5659	.6377	.8283	1.507	-.2524	-.7367	.4426	1.1454
.7000	-.9242	.3860	1.2505	.6500	-.4369	.6679	.7820	1.507	-.5024	-.7367	.4426	1.1454
.7500	-.8709	.4339	1.1610	.7000	-.3666	.7006	.7316	1.507	.7476	-.7367	.4426	1.1454
.8002	-.8548	.455	.9506	.7501	-.2447	.7288	.6879	1.507	.4976	-.7367	.4426	1.1454
.9002	-.1247	.6204	.8549	.8001	.3254	.7524	.6507	1.507	.2476	-.7367	.4426	1.1454
.9501	-.0271	.6491	.8108	.8501	.3941	.7726	.6186	1.507	-.2524	-.7367	.4426	1.1454

TEST 167	PT 24.7234	PSI	CM	.5204	CD1 .01965	CDCOR1 .01936
RUN 49	TT 141.2219	K	CM	-1.1626	CD2 .01942	CDCOR2 .01922
POINT 73	RC 9.9546	MILLION	CC	.0264	CD3 .01877	CDCOR3 .01861
	MACH .7997				CD4 .01733	CDCOR4 .01709
	ALPHA .0000	DEG			CD5 .01554	CDCOR5 .01492

UPPER SURFACE				LOWER SURFACE				SPANWISE				
X/C	CP	P _L /PT	MLOC	X/C	CP	P _L /PT	MLOC	X/C	Y/(B/2)	CP	P _L /PT	MLOC
0.0000	1.1459	.9927	.1026	0.0000	1.1459	.9927	.1026	.1507	.7476	-.6211	.4726	1.0931
.0132	.0283	.6637	.7883	.0126	.3017	.7442	.6637	.1507	.4976	-.6451	.4655	1.1053
.0259	-.3389	.5556	.9563	.0255	.1574	.7017	.7298	.1507	.2476	-.6512	.4637	1.1084
.0759	-.6015	.4783	1.0832	.0495	-.0150	.6510	.8079	.1507	-.2524	-.6469	.4650	1.1062
.1003	-.6369	.4679	1.1011	.0753	-.0792	.6321	.8370	.1507	-.5024	-.6342	.4687	1.0997
.1507	-.6473	.4649	1.1064	.1002	-.1576	.6090	.8726	.1507	-.7524	-.5837	.4836	1.0743
.2003	-.6606	.4610	1.1132	.1503	-.2280	.5883	.9049	.5002	.7476	-.7721	.4281	1.1715
.2503	-.6751	.4567	1.1206	.1976	-.3409	.5551	.9573	.5002	.4976	-.7756	.4271	1.1733
.3001	-.6841	.4540	1.1252	.2503	-.4113	.5343	.9905	.5002	.2476	-.7820	.4252	1.1768
.3502	-.6968	.4503	1.1318	.3001	-.4671	.5179	1.0172	.5002	-.2524	-.7777	.4265	1.1745
.4003	-.7105	.4463	1.1389	.3507	-.4989	.5085	1.0326	.5002	-.5024	-.7762	.4269	1.1736
.4501	-.7232	.4396	1.1508	.4001	-.4773	.5149	1.0221	.5002	-.7524	-.7773	.4266	1.1743
.5002	-.7741	.4276	1.1725	.4501	-.4008	.5374	.9855	.8002	.7476	-.3397	.5534	.9567
.5502	-.8134	.4160	1.1937	.5001	-.3059	.5654	.9409	.8002	.4976	-.3484	.5527	.9608
.6002	-.8605	.4021	1.2196	.5497	-.1827	.6016	.8841	.8002	.2476	-.3520	.5518	.9625
.6500	-.9196	.3847	1.2530	.6003	-.0621	.6371	.8293	.8002	-.5024	-.3426	.5545	.9581
.7000	-.9726	.3691	1.2839	.6500	.0391	.6669	.7835	.8002	-.7524	-.3387	.5556	.9563
.7500	-.8052	.4772	1.0891	.7000	.1497	.6994	.7334					
.8002	-.3488	.5527	.7610	.7501	.2449	.7275	.6899					
.9002	-.1366	.6152	.8631	.8001	.3254	.7511	.6527					
.9501	-.0547	.6393	.8259	.8501	.3941	.7714	.6205					

TEST 167	PT 24.7301	PSI	CM	.5792	CD1 .02376	CDCOR1 .02332
RUN 49	TT 141.1206	K	CM	-1.1637	CD2 .02272	CDCOR2 .02233
POINT 74	RC 9.9667	MILLION	CC	.0271	CD3 .02209	CDCOR3 .02179
	MACH .7996				CD4 .02017	CDCOR4 .01974
	ALPHA .5091	DEG			CD5 .01828	CDCOR5 .01744

UPPER SURFACE				LOWER SURFACE				SPANWISE				
X/C	CP	P _L /PT	MLOC	X/C	CP	P _L /PT	MLOC	X/C	Y/(B/2)	CP	P _L /PT	MLOC
0.0000	1.1587	.9962	.0737	0.0000	1.1587	.9962	.0737	.1507	.7476	-.7124	.4443	1.1425
.0132	-.0430	.6417	.8221	.0126	.3784	.7609	.6290	.1507	.4976	-.7362	.4372	1.1350
.0259	-.4122	.5328	.9929	.0255	.2236	.7204	.7010	.1507	.2476	-.7270	.4399	1.1302
.0759	-.6687	.4571	1.1196	.0495	.0475	.6684	.7811	.1507	-.2524	-.7256	.4404	1.1494
.1003	-.6998	.4480	1.1359	.0753	-.0237	.6474	.8134	.1507	-.5024	-.7315	.4386	1.1525
.1507	-.7218	.4415	1.1474	.1002	-.1060	.6231	.8508	.1507	-.7524	-.6761	.4590	1.1236
.2003	-.7395	.4363	1.1568	.1503	-.1823	.6006	.8856	.5002	.7476	-.8370	.4075	1.2095
.2503	-.7581	.4308	1.1667	.1976	-.2953	.5673	.9378	.5002	.4976	-.8367	.4076	1.2094
.3001	-.7852	.4228	1.1812	.2503	-.3682	.5458	.9720	.5002	.2476	-.8179	.4131	1.1990
.3502	-.7705	.4271	1.1733	.3001	-.4238	.5294	.9985	.5002	-.2524	-.8154	.4139	1.1976
.4003	-.7622	.4296	1.1689	.3507	-.4613	.5183	1.0165	.5002	-.5024	-.8330	.4087	1.2073
.4501	-.7761	.4255	1.1763	.4001	-.4490	.5220	1.0106	.5002	-.7524	-.8268	.4105	1.2039
.5002	-.8128	.4146	1.1967	.4501	-.3597	.5394	.9823	.8002	.7476	-.3366	.5531	.9572
.5502	-.8436	.4055	1.2132	.5001	-.3018	.5654	.9409	.8002	.4976	-.3467	.5522	.9619
.6002	-.8872	.3927	1.2376	.5497	-.1807	.6011	.8849	.8002	.2476	-.3435	.5531	.9604
.6500	-.9541	.3730	1.2762	.6003	-.0619	.6361	.8307	.8002	-.5024	-.3445	.5528	.9609
.7000	-.9616	.3619	1.2985	.6500	.0374	.6654	.7857	.8002	-.7524	-.3329	.5562	.9554
.7500	-.4710	.5159	1.0212	.7000	.1472	.6978	.7358					
.8002	-.3387	.5545	.9582	.7501	.2420	.7258	.6925					
.9002	-.1707	.6041	.8803	.8001	.3224	.7495	.6533					
.9501	-.1051	.6234	.8504	.8501	.3912	.7698	.6230					

TEST 167	PT 24.7317	PSI	CM	.6567	CD1 .03023	CDCOR1 .02966
RUN 49	TT 141.1584	K	CM	-1.1644	CD2 .02811	CDCOR2 .02769
POINT 75	RC 9.960	MILLION	CC	.0261	CD3 .02517	CDCOR3 .02477
	MACH .8000				CD4 .02367	CDCOR4 .02342
	ALPHA 1.0081	DEG			CD5 .02219	CDCOR5 .02137

UPPER SURFACE				LOWER SURFACE				SPANWISE				
X/C	CP	P _L /PT	MLOC	X/C	CP	P _L /PT	MLOC	X/C	Y/(B/2)	CP	P _L /PT	MLOC
0.0000	1.1641	.9987	.0435	0.0000	1.1641	.9987	.0435	.1507	.7476	-.7904	.4277	1.1722
.0132	-.1244	.6223	.8521	.0126	.4381	.7924	.5863	.1507	.4976	-.8295	.4163	1.1932
.0259	-.5033	.5116	1.0276	.0255	.2894	.7431	.6654	.1507	.2476	-.8096	.4221	1.1825
.0759	-.7556	.4379	1.1539	.0495	.1191	.6922	.7445	.1507	-.2524	-.7992	.4251	1.1769
.1003	-.7803	.4307	1.1669	.0753	.0349	.6688	.7705	.1507	-.5024	-.8167	.4200	1.1863
.1507	-.8010	.4246	1.1779	.1002	-.0483	.6451	.8170	.1507	-.7524	-.7740	.4325	1.1635
.2003	-.8157	.4203	1.1858	.1503	-.1266	.6216	.8531	.5002	.7476	-.9025	.3950	1.2333
.2503	-.8402	.4132	1.1990	.1976	-.2365	.5895	.9029	.5002	.4976	-.9106	.3926	1.2378
.3001	-.8724	.4036	1.2169	.2503	-.3074	.5688	.9355	.5002	.2476	-.8901	.3986	1.2264
.3502	-.8835	.4005	1.2227	.3001	-.3604	.5533	.9600	.5002	-.2524	-.8710	.4042	1.2198
.4003	-.8532	.4094	1.2060	.3507	-.3951	.5432	.9763	.5002	-.5024	-.9103	.3927	1.2376
.4501	-.8577	.4087	1.2085	.4001	-.3916	.5442	.9746	.5002	-.7524	-.8600	.4015	1.2204
.5002	-.8737	.4034	1.2173	.4501	-.3535	.5555	.9566	.8002	.7476	-.3342	.5610	.9478
.5502	-.9087	.3932	1.2367	.5001	-.2774	.5776	.9217	.8002	.4976	-.3398	.5593	.9505
.6002	-.9406	.3838	1.2548	.5497	-.1631	.6110	.8696	.8002	.2476	-.3401	.5593	.9506
.6500	-.9974	.373	1.2577	.6003	-.0483	.6445	.8179	.8002	-.5024	-.3405	.5591	.9508
.7000	-.7919	.4273	1.1730	.6500	.0472	.6724	.7750	.8002	-.7524	-.3249	.5637	.9439
.7500	-.4421	.5295	.9984	.7000	.1556	.7041	.7262					
.8002	-.3447	.5579	.9527	.7501	.2499	.7316	.6834					
.9002	-.1481	.6037	.8800	.8001	.3298	.7550	.6467					
.9501	-.1320	.6200	.8556	.8501	.3991	.7752	.6143					

TEST 167	PT 24.7324	PSI	CN	.7065	CD1	.03544	CDCOR1	.03535
RUN 49	TT 141.1595	K	CM	-.1648	CD2	.03435	CDCOR2	.03443
POINT 76	RC 9.9671	MILLION	CC	.0234	CD3	.03164	CDCOR3	.03174
	MACH .8001				CD4	.02947	CDCOR4	.02999
	ALPHA 1.5071	DEG			CD5	.02760	CDCOR5	.02733

UPPER SURFACE				LOWER SURFACE				SPANWISE				
X/C	CP	P/L/PT	MLOC	X/C	CP	P/L/PT	MLOC	X/C	Y/(B/2)	CP	P/L/PT	MLOC
0.0000	1.1633	.9990	.6376	0.0000	1.1633	.9990	.0376	.1507	.7476	-.8365	.4185	1.1890
.0132	-.1961	.6044	.8797	.0126	.5145	.8107	.5559	.1507	.4976	-.9093	.3974	1.2286
.0259	-.5790	.4933	1.0580	.0255	.3423	.7607	.6376	.1507	.2476	-.8791	.4062	1.2120
.0759	-.8243	.4221	1.1825	.0495	.1640	.7089	.7187	.1507	-.2524	-.8733	.4079	1.2089
.1003	-.8515	.4142	1.1970	.0753	.0760	.6834	.7581	.1507	-.5024	-.8898	.4031	1.2179
.1507	-.8702	.4087	1.2072	.1002	-.0045	.6600	.7940	.1507	-.7524	-.8480	.4152	1.1952
.2003	-.8776	.4066	1.2112	.1503	-.0906	.6351	.8818	.5002	.7476	-.9623	.3820	1.2583
.2503	-.9067	.3982	1.2272	.1976	-.2008	.6031	.8324	.5002	.4976	-.9749	.3784	1.2655
.3001	-.9432	.3876	1.2475	.2573	-.2743	.5817	.9151	.5002	.2476	-.9758	.3781	1.2660
.3502	-.9586	.3831	1.2562	.3001	-.3277	.5602	.9396	.5002	-.2524	-.9523	.3849	1.2527
.4003	-.9585	.3831	1.2562	.3507	-.3650	.5534	.9367	.5002	-.5024	-.9727	.3790	1.2643
.4501	-.9279	.3920	1.2390	.4001	-.3689	.5543	.9385	.5002	-.7524	-.9361	.3896	1.2435
.5002	-.9479	.3862	1.2501	.4501	-.3409	.5624	.9456	.8002	.7476	-.3499	.5598	.9497
.5502	-.9553	.3841	1.2543	.5001	-.2739	.5819	.9149	.8002	.4976	-.3526	.5590	.9510
.6002	-.9661	.3722	1.2777	.5497	-.1674	.6127	.8668	.8002	.2476	-.3497	.5599	.9496
.6500	-1.0364	.3605	1.3013	.6003	-.0519	.6463	.8151	.8002	-.5024	-.3558	.5581	.9525
.7000	-.9580	.4930	1.0585	.6500	.0403	.6730	.7740	.8002	-.7524	-.3386	.5631	.9445
.7500	-.4191	.5397	.9818	.7000	.1473	.7041	.7262					
.8002	-.3485	.5602	.9491	.7501	.2414	.7314	.6838					
.9002	-.2177	.5982	.8895	.8001	.3207	.7544	.6475					
.9501	-.1553	.6163	.8614	.8501	.3896	.7744	.6156					

TEST 167	PT 24.7279	PSI	CN	.7125	CD1	.03747	CDCOR1	.03639
RUN 49	TT 141.2145	K	CM	-.1607	CD2	.03828	CDCOR2	.03719
POINT 78	RC 9.9544	MILLION	CC	.0267	CD3	.03923	CDCOR3	.03740
	MACH .7993				CD4	.03762	CDCOR4	.03589
	ALPHA 2.0162	DEG			CD5	.03637	CDCOR5	.03431

UPPER SURFACE				LOWER SURFACE				SPANWISE				
X/C	CP	P/L/PT	MLOC	X/C	CP	P/L/PT	MLOC	X/C	Y/(B/2)	CP	P/L/PT	MLOC
0.0000	1.1763	1.0015	0.0000	0.0000	1.1763	1.0015	0.0000	.1507	.7476	-.8447	.4063	1.2118
.0132	-.2235	.5893	.9033	.0126	.5591	.8198	.5405	.1507	.4976	-.9275	.3819	1.2585
.0259	-.6004	.4783	1.0834	.0255	.3830	.7679	.6260	.1507	.2476	-.8959	.3912	1.2405
.0759	-.8416	.4072	1.2101	.0495	.1976	.7133	.7120	.1507	-.2524	-.8922	.3923	1.2383
.1003	-.8690	.3992	1.2253	.0753	.1078	.6869	.7528	.1507	-.5024	-.9122	.3864	1.2497
.1507	-.8873	.3938	1.2356	.1002	.0223	.6616	.7915	.1507	-.7524	-.8738	.3977	1.2280
.2003	-.8974	.3908	1.2413	.1503	-.0675	.6352	.8321	.5002	.7476	-.9833	.3655	1.2912
.2503	-.9216	.3837	1.2551	.1976	-.1812	.6017	.8839	.5002	.4976	-.9948	.3621	1.2980
.3001	-.9592	.3726	1.2770	.2503	-.2595	.5787	.9199	.5002	.2476	-.9999	.3606	1.3011
.3502	-.9795	.3666	1.2899	.3001	-.3200	.5608	.9481	.5002	-.2524	-.9859	.3647	1.2928
.4003	-.9906	.3633	1.2955	.3507	-.3664	.5472	.9698	.5002	-.5024	-.9820	.3659	1.2904
.4501	-.9824	.3659	1.2965	.4001	-.3778	.5438	.9752	.5002	-.7524	-.9602	.3723	1.2776
.5002	-.9783	.3670	1.2882	.4501	-.3532	.5511	.9636	.8002	.7476	-.3723	.5454	.9726
.5502	-.9923	.3620	1.2966	.5001	-.2853	.5711	.9319	.8002	.4976	-.3717	.5457	.9723
.6002	-1.0129	.3568	1.3090	.5497	-.1743	.6036	.8808	.8002	.2476	-.3511	.5508	.9641
.6500	-.8100	.4165	1.1927	.6003	-.0621	.6368	.8297	.8002	-.5024	-.3759	.5444	.9743
.7000	-.4627	.5188	1.0157	.6500	.0315	.6644	.7873	.8002	-.7524	-.3714	.5457	.9722
.7500	-.3931	.5393	.9825	.7000	.1392	.6961	.7386					
.8002	-.3447	.5536	.9596	.7501	.2329	.7237	.6958					
.9002	-.2556	.5798	.9181	.8001	.3130	.7473	.6589					
.9501	-.2186	.5907	.9011	.8501	.3828	.7678	.6261					

ORIGINAL PAGE IS
OF POOR QUALITY

TEST 167	PT 36.7542	PSI	CN -.1335	CD1 .03206	CDCDR1 .03185
RUN 35	TT 140.3700	K	CM -.0809	CD2 .02760	CDCDR2 .02747
POINT 69	RC 14.9284	MILLION	CC .0169	CD3 .02532	CDCDR3 .02532
	MACH .8003			CD4 .02205	CDCDR4 .02199
	ALPHA -4.0019	DEG		CD5 .01792	CDCDR5 .01759

UPPER SURFACE				LOWER SURFACE				SPANWISE				
X/C	CP	P ₂ L/PT	MLOC	X/C	CP	P ₂ L/PT	MLOC	X/C	Y/(B/2)	CP	P ₂ L/PT	MLOC
0.0000	.7952	.8496	.4123	0.0000	.7952	.8896	.4123	.1507	.7476	-.1122	.6226	.8517
.0132	.6370	.8430	.5000	.0126	-.5553	.4923	1.0598	.1507	.4976	-.1297	.6175	.8596
.0259	.3230	.7506	.6536	.0255	-.4869	.5124	1.0264	.1507	.2476	-.1296	.6175	.8595
.0759	.0013	.6560	.8002	.0495	-.6369	.4683	1.1007	.1507	-.2524	-.1346	.6161	.8618
.1003	-.0506	.6408	.8002	.0753	-.6821	.4550	1.1238	.1507	-.5024	-.1388	.6148	.8637
.1507	-.1312	.6170	.8603	.1002	-.7282	.4414	1.1477	.1507	-.7524	-.1279	.6180	.8588
.2003	-.1781	.6032	.8817	.1503	-.6690	.4589	1.1170	.5002	.7476	-.4297	.5293	.9989
.2503	-.2385	.5855	.9094	.1976	-.7962	.4215	1.1839	.5002	.4976	-.4336	.5281	1.0008
.3001	-.2871	.5712	.9318	.2503	-.8615	.4022	1.2197	.5002	.2476	-.4382	.5266	1.0029
.3502	-.3129	.5636	.9438	.3001	-.9269	.3830	1.2566	.5002	-.2524	-.4301	.5291	.9991
.4003	-.3489	.5530	.9607	.3507	-.9820	.3668	1.2888	.5002	-.5024	-.4281	.5297	.9981
.4501	-.3906	.5408	.9803	.4001	-.9575	.3740	1.2744	.5002	-.7524	-.4163	.5332	.9925
.5002	-.4353	.5276	1.0016	.4501	-.8817	.3140	1.0239	.8002	.7476	-.9981	.3621	1.2984
.5502	-.4820	.5139	1.0240	.5001	-.8753	.3453	.9731	.8002	.4976	-.9514	.5523	.9618
.6002	-.5332	.4968	1.0490	.5497	-.8101	.3644	.9425	.8002	.2476	-.9498	.5527	.9611
.6500	-.6008	.4789	1.0825	.6003	-.2414	.5846	.9107	.8002	-.5024	-.9428	.5568	.9578
.7000	-.6592	.4618	1.1120	.6500	-.1740	.6045	.8798	.8002	-.7524	-.9478	.5533	.9601
.7500	-.5264	.5008	-.0456	.7000	-.1061	.6244	.8489					
.8002	-.3420	.5550	.9574	.7501	-.0472	.6418	.8222					
.9002	-.1461	.6127	.8671	.8001	.0104	.6587	.7961					
.9501	-.0176	.6505	.8088	.8501	.0071	.6754	.7705					

TEST 167	PT 36.7362	PSI	CN .0508	CD1 .02006	CDCDR1 .01977
RUN 35	TT 140.5011	K	CM -.1290	CD2 .01847	CDCDR2 .01828
POINT 70	RC 14.9051	MILLION	CC .0215	CD3 .01673	CDCDR3 .01670
	MACH .8012			CD4 .01508	CDCDR4 .01498
	ALPHA -3.0141	DEG		CD5 .01317	CDCDR5 .01282

UPPER SURFACE				LOWER SURFACE				SPANWISE				
X/C	CP	P ₂ L/PT	MLOC	X/C	CP	P ₂ L/PT	MLOC	X/C	Y/(B/2)	CP	P ₂ L/PT	MLOC
0.0000	.9025	.9209	.3451	0.0000	.9025	.9209	.3451	.1507	.7476	-.2143	.5921	.8991
.0132	.5178	.8076	.5610	.0126	-.3316	.5575	.9535	.1507	.4976	-.2336	.5864	.9080
.0259	.1867	.7102	.7169	.0255	-.3507	.5519	.9624	.1507	.2476	-.2332	.5865	.9078
.0759	-.1202	.6198	.8561	.0495	-.4703	.5167	1.0194	.1507	-.2524	-.2376	.5052	.9098
.1003	-.1631	.6071	.8756	.0753	-.5277	.4998	1.0473	.1507	-.5024	-.2429	.5837	.9122
.1507	-.2344	.5861	.9084	.1002	-.5894	.4816	1.0779	.1507	-.7524	-.2270	.5883	.9049
.2003	-.2777	.5734	.9283	.1503	-.5334	.4981	1.0501	.5002	.7476	-.5188	.5048	1.0391
.2503	-.3294	.5582	.9524	.1976	-.6489	.4641	1.1079	.5002	.4976	-.5189	.5024	1.0430
.3001	-.3756	.5446	.9742	.2503	-.7239	.4420	1.1467	.5002	.2476	-.5237	.5010	1.0454
.3502	-.3956	.5387	.9837	.3001	-.8062	.4178	1.1906	.5002	-.2524	-.5155	.5034	1.0413
.4003	-.4266	.5296	.9984	.3507	-.8944	.3918	1.2396	.5002	-.5024	-.5142	.5038	1.0407
.4501	-.4671	.5176	1.0178	.4001	-.9662	.3707	1.2810	.5002	-.7524	-.4993	.5081	1.0335
.5002	-.5208	.5018	1.0440	.4501	-.9144	.3565	1.3098	.8002	.7476	-.9925	.3629	1.2967
.5502	-.5603	.4902	1.0634	.5001	-.4405	.5255	1.0051	.8002	.4976	-.9427	.5543	.9587
.6002	-.6024	.4778	1.0844	.5497	-.2932	.5688	.9356	.8002	.2476	-.9437	.5540	.9591
.6500	-.6667	.4588	1.1170	.6003	-.1505	.6109	.8699	.8002	-.5024	-.9366	.5561	.9558
.7000	-.7360	.4385	1.1531	.6500	-.0196	.6494	.8104	.8002	-.7524	-.9484	.5526	.9614
.7500	-.7220	.4426	1.1457	.7000	.0966	.6836	.7578					
.8002	-.3393	.5593	.9571	.7501	.1872	.7103	.7166					
.9002	-.1377	.6146	.8640	.8001	.2605	.7319	.6831					
.9501	-.0119	.6517	.8069	.8501	.3204	.7495	.6554					

TEST 167	PT 36.7465	PSI	CN .2416	CD1 .01352	CDCDR1 .01304
RUN 35	TT 140.4056	K	CM -.1552	CD2 .01315	CDCDR2 .01256
POINT 72	RC 14.9152	MILLION	CC .0244	CD3 .01278	CDCDR3 .01239
	MACH .8003			CD4 .01225	CDCDR4 .01183
	ALPHA -1.9792	DEG		CD5 .01121	CDCDR5 .01071

UPPER SURFACE				LOWER SURFACE				SPANWISE				
X/C	CP	P ₂ L/PT	MLOC	X/C	CP	P ₂ L/PT	MLOC	X/C	Y/(B/2)	CP	P ₂ L/PT	MLOC
0.0000	1.0194	.9556	.2556	0.0000	1.0194	.9556	.2556	.1507	.7476	-.3322	.5583	.9523
.0132	.3611	.7621	.6355	.0126	-.0878	.6301	.8402	.1507	.4976	-.3549	.5516	.9630
.0259	.0163	.6607	.7931	.0255	-.1610	.6086	.8734	.1507	.2476	-.3562	.5512	.9636
.0759	-.2706	.5763	.9237	.0495	-.2919	.5701	.9336	.1507	-.2524	-.3603	.9500	.9655
.1003	-.2993	.5679	.9370	.0753	-.3463	.5541	.9590	.1507	-.5024	-.3631	.9492	.9668
.1507	-.3572	.5509	.9641	.1002	-.4165	.5334	.9921	.1507	-.7524	-.3406	.9558	.9563
.2003	-.3897	.5413	.9794	.1503	-.3788	.5445	.9742	.5002	.7476	-.5886	.4829	1.0758
.2503	-.4332	.5285	1.0000	.1976	-.5447	.4958	1.0540	.5002	.4976	-.5954	.4809	1.0792
.3001	-.4835	.5138	1.0242	.2503	-.6458	.4660	1.1046	.5002	.2476	-.6001	.4795	1.0815
.3502	-.4924	.5112	1.0285	.3001	-.7251	.4427	1.1454	.5002	-.2524	-.5909	.4822	1.0767
.4003	-.5022	.5083	1.0332	.3507	-.7994	.4209	1.1849	.5002	-.5024	-.5914	.4821	1.0771
.4501	-.5429	.4963	1.0532	.4001	-.8513	.4057	1.2132	.5002	-.7524	-.5834	.4844	1.0732
.5002	-.5962	.4806	1.0795	.4501	-.8811	.4557	1.1276	.8002	.7476	-.9842	.3666	1.2893
.5502	-.6416	.4673	1.1024	.5001	-.2984	.5682	.9366	.8002	.4976	-.9481	.5536	.9595
.6002	-.6898	.4531	1.1271	.5497	-.1825	.6023	.8832	.8002	.2476	-.9609	.5498	.9658
.6500	-.7531	.4345	1.1602	.6003	-.0373	.6361	.8309	.8002	-.5024	-.9339	.5577	.9531
.7000	-.8182	.4154	1.1951	.6500	.0333	.6657	.7854	.8002	-.7524	-.9373	.5578	.9594
.7500	-.8444	.4077	1.2095	.7000	1.454	.6986	.7347					
.8002	-.3598	.5501	.9653	.7501	.2474	.7271	.6905					
.9002	-.1280	.6183	.8584	.8001	.3235	.7510	.6520					
.9501	-.0132	.6570	.8064	.8501	.3919	.7711	.6209					

TEST 167	PT 36.7486	PSI	CN	.3262	CD1	.01313	CDCOR1	.01286
RUN 35	TT 140.3653	K	CM	-.1590	CD2	.01281	CDCOR2	.01262
POINT 73	RC 14.9137	MILLION	CC	.0231	CD3	.01255	CDCOR3	.01248
	MACH .7995				CD4	.01191	CDCOR4	.01176
	ALPHA -1.4765	DEG			CD5	.01096	CDCOR5	.01055

UPPER SURFACE				LOWER SURFACE				SPANWISE				
X/C	CP	P/L/PT	MLOC	X/C	CP	P/L/PT	MLOC	X/C	Y/(B/2)	CP	P/L/PT	MLOC
0.0000	1.0668	.9701	.2087	0.0000	1.0668	.9701	.2087	.1507	.7476	-.3970	.5419	.9785
.0132	.2739	.7382	.6732	.0126	.0275	.6661	.7848	.1507	.4976	-.4226	.5344	.9906
.0259	-.0787	.6350	.8326	.0255	-.0652	.6390	.8265	.1507	.2476	-.4242	.5339	.9913
.0759	-.3552	.5541	.9589	.0495	-.2102	.5965	.8921	.1507	-.1524	-.4282	.5328	.9932
.1003	-.3741	.5486	.9678	.0753	-.2660	.5802	.9176	.1507	-.5024	-.4278	.5329	.9930
.1507	-.4247	.5338	.9916	.1002	-.3387	.5590	.9312	.1507	-.7524	-.4005	.5409	.9801
.2003	-.4469	.5273	1.0021	.1503	-.3229	.5636	.9439	.5002	.7476	-.6233	.4757	1.0880
.2503	-.4482	.5161	1.0204	.1976	-.4937	.5136	1.0245	.5002	.4976	-.6279	.4744	1.0902
.3001	-.5380	.5012	1.0449	.2503	-.5851	.4869	1.0690	.5002	.2476	-.6270	.4746	1.0898
.3502	-.5555	.4955	1.0544	.3001	-.6485	.4683	1.1006	.5002	-.2524	-.6199	.4767	1.0863
.4003	-.5636	.4932	1.0584	.3507	-.7032	.4523	1.1285	.5002	-.5024	-.6253	.4751	1.0890
.4501	-.5775	.4891	1.0652	.4001	-.6781	.4597	1.1196	.5002	-.7524	-.6218	.4761	1.0872
.5002	-.6188	.4770	1.0857	.4501	-.4237	.5341	.9911	.8002	.7476	-.6825	.3706	1.2812
.5502	-.6666	.4630	1.1098	.5001	-.3122	.5667	.9389	.8002	.4976	-.6340	.3574	.9537
.6002	-.7179	.4480	1.1361	.5497	-.1913	.6021	.8835	.8002	.2476	-.6340	.3545	.9583
.6500	-.7817	.4294	1.1695	.6003	-.0679	.6382	.8277	.8002	-.5024	-.6324	.3568	.9483
.7000	-.8497	.4095	1.2061	.6500	.0351	.6683	.7814	.8002	-.7524	-.3471	.5565	.9551
.7500	-.8403	.4122	1.2010	.7000	.1500	.7019	.7297					
.8002	-.8528	.3548	.9578	.7501	.2482	.7306	.6850					
.9002	-.1236	.6219	.8528	.8001	.3300	.7546	.6474					
.9501	-.0098	.6552	.8016	.8501	.3990	.7747	.6151					

TEST 167	PT 36.7470	PSI	CN	.3963	CD1	.01469	CDCOR1	.01439
RUN 35	TT 140.3609	K	CM	-.1636	CD2	.01437	CDCOR2	.01416
POINT 74	RC 14.9214	MILLION	CC	.0274	CD3	.01401	CDCOR3	.01394
	MACH .8002				CD4	.01318	CDCOR4	.01307
	ALPHA -.9877	DEG			CD5	.01218	CDCOR5	.01176

UPPER SURFACE				LOWER SURFACE				SPANWISE				
X/C	CP	P/L/PT	MLOC	X/C	CP	P/L/PT	MLOC	X/C	Y/(B/2)	CP	P/L/PT	MLOC
0.0000	1.0988	.9791	.1737	0.0000	1.0988	.9791	.1737	.1507	.7476	-.4629	.5210	1.0123
.0132	.1936	.7136	.7115	.0126	.1234	.6930	.7434	.1507	.4976	-.4936	.5120	1.0270
.0259	-.1647	.6085	.8735	.0255	-.0132	.6607	.7931	.1507	.2476	-.4959	.5114	1.0282
.0759	-.4413	.5274	1.0019	.0495	-.1398	.6158	.8622	.1507	-.2524	-.4977	.5108	1.0290
.1003	-.4482	.5254	1.0052	.0753	-.2062	.5963	.8924	.1507	-.5024	-.4745	.5118	1.0275
.1507	-.4951	.5116	1.0278	.1002	-.2811	.5744	.9268	.1507	-.7524	-.4440	.5207	1.0128
.2003	-.5169	.5052	1.0383	.1503	-.2783	.5752	.9255	.5002	.7476	-.6819	.4968	1.1206
.2503	-.5366	.4997	1.0479	.1976	-.4516	.5244	1.0068	.5002	.4976	-.6879	.4950	1.1237
.3001	-.5822	.4860	1.0704	.2503	-.5340	.5002	1.0467	.5002	.2476	-.6930	.4535	1.1263
.3502	-.6059	.4791	1.0822	.3001	-.5954	.4822	1.0769	.5002	-.2524	-.6825	.4566	1.1209
.4003	-.6258	.4733	1.0922	.3507	-.6469	.4671	1.1028	.5002	-.5024	-.6855	.4537	1.1225
.4501	-.6525	.4654	1.1056	.4001	-.6112	.4775	1.0848	.5002	-.7524	-.6842	.4561	1.1218
.5002	-.6907	.4542	1.1252	.4501	-.4344	.5294	.9987	.8002	.7476	-.9826	.3686	1.2852
.5502	-.7198	.4457	1.1402	.5001	-.3203	.5629	.9450	.8002	.4976	-.6373	.3549	.9670
.6002	-.7558	.4351	1.1591	.5497	-.1973	.5990	.8884	.8002	.2476	-.6384	.3549	.9752
.6500	-.80216	.4158	1.1943	.6003	-.0734	.6351	.8321	.8002	-.5024	-.6301	.3541	.9589
.7000	-.8909	.3955	1.2325	.6500	.0285	.6652	.7862	.8002	-.7524	-.3490	.5545	.9564
.7500	-.9131	.3890	1.2450	.7000	.1438	.6990	.7341					
.8002	-.9366	.3434	.9766	.7501	.2426	.7280	.6891					
.9002	-.1231	.6207	.8546	.8001	.3250	.7522	.6512					
.9501	-.0143	.6526	.8053	.8501	.3950	.7727	.6184					

TEST 167	PT 36.7490	PSI	CN	.4787	CD1	.01702	CDCOR1	.01674
RUN 35	TT 140.3678	K	CM	-.1669	CD2	.01677	CDCOR2	.01656
POINT 75	RC 14.9201	MILLION	CC	.0277	CD3	.01619	CDCOR3	.01611
	MACH .8002				CD4	.01521	CDCOR4	.01503
	ALPHA -.4888	DEG			CD5	.01404	CDCOR5	.01354

UPPER SURFACE				LOWER SURFACE				SPANWISE				
X/C	CP	P/L/PT	MLOC	X/C	CP	P/L/PT	MLOC	X/C	Y/(B/2)	CP	P/L/PT	MLOC
0.0000	1.1285	.9883	.1297	0.0000	1.1285	.9883	.1297	.1507	.7476	-.5350	.5023	1.0431
.0132	.0948	.6876	.7517	.0126	.2231	.7239	.6959	.1507	.4976	-.5596	.4954	1.0547
.0259	-.2666	.5809	.9165	.0255	-.0976	.6873	.7522	.1507	.2476	-.622	.4946	1.0560
.0759	-.5437	.4915	1.0479	.0495	-.0675	.6391	.8263	.1507	-.2924	-.5599	.4953	1.0548
.1003	-.5600	.4933	1.0549	.0753	-.1337	.6198	.8561	.1507	-.5024	-.5578	.4959	1.0538
.1507	-.5639	.4941	1.0568	.1002	-.2142	.5963	.8926	.1507	-.7524	-.5301	.5040	1.0403
.2003	-.5927	.4837	1.0709	.1503	-.2237	.5935	.8969	.5002	.7476	-.7362	.4452	1.1435
.2503	-.6226	.4770	1.0858	.1976	-.3906	.5447	.9739	.5002	.4976	-.7404	.4426	1.1457
.3001	-.6513	.4686	1.1001	.2503	-.4406	.5243	1.0070	.5002	.2476	-.7472	.4404	1.1492
.3502	-.6563	.4671	1.1027	.3001	-.5192	.5072	1.0350	.5002	-.2524	-.7410	.4424	1.1460
.4003	-.6682	.4637	1.1086	.3507	-.5409	.5008	1.0456	.5002	-.5024	-.7363	.4438	1.1435
.4501	-.6988	.4548	1.1242	.4001	-.5075	.5108	1.0294	.5002	-.7524	-.7361	.4438	1.1435
.5002	-.7447	.4413	1.1479	.4501	-.4163	.5372	.9860	.8002	.7476	-.9764	.3737	1.2750
.5502	-.7822	.4304	1.1676	.5001	-.3151	.5686	.9388	.8002	.4976	-.6366	.3520	.9622
.6002	-.8197	.4194	1.1876	.5497	-.1893	.6034	.8815	.8002	.2476	-.6353	.3492	.9668
.6500	-.8642	.4064	1.2118	.6003	-.0666	.6393	.8259	.8002	-.5024	-.6347	.3578	.9530
.7000	-.9316	.3867	1.2494	.6500	.0335	.6686	.7810	.8002	-.7524	-.3444	.5582	.9524
.7500	-.9797	.4019	1.2703	.7000	.1444	.7021	.7293					
.8002	-.9769	.3487	.9675	.7501	.2469	.7309	.6847					
.9002	-.1280	.6214	.8535	.8001	.3291	.7549	.6488					
.9501	-.0228	.6521	.8062	.8501	.3995	.7754	.6140					

ORIGINAL RECORDS
OF FOOD QUALITY

TEST 167 PT 36.7453 PSI CM .5326 CD1 .01953 CDCOR1 .01947
 RUN 35 TT 140.3410 K CM -.1669 CD2 .01940 CDCOR2 .01940
 POINT 76 RC 14.9259 MILLION CC .0283 CD3 .01871 CDCOR3 .01888
 MACH .8005 CD4 .01750 CDCOR4 .01757
 ALPHA .0102 DEG CD5 .01609 CDCOR5 .01580

UPPER SURFACE				LOWER SURFACE				SPANWISE				
X/C	CP	P _L /PT	MLOC	X/C	CP	P _L /PT	MLOC	X/C	Y/(B/2)	CP	P _L /PT	MLOC
0.0000	1.1439	.9921	.1068	0.0000	1.1439	.9921	.1068	.1507	.7476	-.5916	.4813	1.0785
.0132	-.0317	.6647	.7869	.0126	.3082	.7461	.6608	.1507	.4976	-.6452	.4655	1.1055
.0259	-.3367	.5563	.9555	.0255	.1694	.7052	.7245	.1507	.2476	-.6501	.4641	1.1080
.0759	-.6032	.4778	1.0843	.0495	-.0068	.6534	.8043	.1507	-.2524	-.6511	.4637	1.1085
.1003	-.6396	.4671	1.1027	.0753	-.0735	.6337	.8345	.1507	-.5024	-.6447	.4656	1.1053
.1507	-.6440	.4658	1.1049	.1002	-.1588	.6086	.8733	.1507	-.7524	-.5829	.4638	1.0742
.2003	-.6562	.4622	1.1112	.1503	-.1763	.6035	.8813	.0002	.7476	-.7828	.4250	1.1775
.2503	-.6755	.4566	1.1211	.1976	-.3408	.5551	.9574	.0002	.4976	-.7801	.4258	1.1760
.3001	-.6858	.4535	1.1264	.2503	-.4125	.5340	.9913	.5002	.2476	-.7865	.4239	1.1794
.3502	-.6984	.4498	1.1329	.3001	-.4689	.5174	1.0183	.5002	-.2524	-.7809	.4256	1.1764
.4003	-.7156	.4448	1.1418	.3507	-.5005	.5081	1.0336	.5002	-.5024	-.7736	.4277	1.1725
.4501	-.7368	.4385	1.1530	.4001	-.4790	.5144	1.0232	.5002	-.7524	-.7728	.4279	1.1721
.5002	-.7772	.4266	1.1745	.4501	-.4032	.5367	.9868	.8002	.7476	-.9645	.3715	1.2794
.5502	-.8185	.4145	1.1968	.5001	-.3087	.5645	.9424	.8002	.4976	-.9653	.5478	.9689
.6002	-.8640	.4011	1.2219	.5597	-.1848	.6010	.8852	.8002	.2476	-.9670	.5474	.9697
.6500	-.9227	.3838	1.2551	.6003	-.0634	.6367	.8300	.8002	-.5024	-.9496	.5525	.9615
.7000	-.9758	.3682	1.2860	.6500	.0351	.6657	.7854	.8002	-.7524	-.9358	.5566	.9550
.7500	-.9730	.4385	1.1531	.7000	.1489	.6992	.7338					
.8002	-.9667	.5475	.9695	.7501	.2465	.7279	.6892					
.9002	-.1397	.6143	.8646	.8001	.3286	.7521	.6513					
.9501	-.0487	.6410	.8233	.8501	.3991	.7729	.6181					

TEST 167 PT 36.7484 PSI CM .5945 CD1 .02425 CDCOR1 .02353
 RUN 35 TT 140.2692 K CM -.1664 CD2 .02338 CDCOR2 .02278
 POINT 77 RC 14.9368 MILLION CC .0279 CD3 .02282 CDCOR3 .02230
 MACH .8003 CD4 .02098 CDCOR4 .02037
 ALPHA .5193 DEG CD5 .01930 CDCOR5 .01858

UPPER SURFACE				LOWER SURFACE				SPANWISE				
X/C	CP	P _L /PT	MLOC	X/C	CP	P _L /PT	MLOC	X/C	Y/(B/2)	CP	P _L /PT	MLOC
0.0000	1.1628	.9940	.0531	0.0000	1.1628	.9980	.0531	.1507	.7476	-.6666	.4620	1.1115
.0132	-.0424	.6449	.8173	.0126	.3893	.7714	.6205	.1507	.4976	-.7458	.4388	1.1524
.0259	-.4181	.5343	.9898	.0255	.2406	.7278	.6894	.1507	.2476	-.7343	.4422	1.1464
.0759	-.6747	.4597	1.1156	.0495	.0575	.6742	.7723	.1507	-.2524	-.7319	.4429	1.1451
.1003	-.7072	.4502	1.1323	.0753	-.0127	.6536	.8039	.1507	-.5024	-.7384	.4410	1.1485
.1507	-.7232	.4449	1.1417	.1002	-.1001	.6280	.8434	.1507	-.7524	-.6665	.4621	1.1115
.2003	-.7344	.4422	1.1464	.1503	-.1260	.6204	.8551	.5002	.7476	-.8456	.4096	1.2059
.2503	-.7596	.4348	1.1597	.1976	-.2886	.5728	.9293	.5002	.4976	-.8452	.4097	1.2056
.3001	-.7912	.4255	1.1784	.2503	-.3614	.5515	.9632	.5002	.2476	-.8276	.4149	1.1960
.3502	-.7706	.4316	1.1655	.3001	-.4148	.5338	.9983	.5002	-.2524	-.8126	.4193	1.1879
.4003	-.7556	.4360	1.1575	.3507	-.4485	.5260	1.0043	.5002	-.5024	-.8353	.4126	1.2002
.4501	-.7847	.4274	1.1730	.4001	-.4371	.5293	.9988	.5002	-.7524	-.8261	.4193	1.1952
.5002	-.8212	.4168	1.1926	.4501	-.3835	.5450	.9735	.8002	.7476	-.9466	.3800	1.2625
.5502	-.8512	.4080	1.2089	.5001	-.2991	.5697	.9342	.8002	.4976	-.9347	.5534	.9600
.6002	-.8959	.3949	1.2337	.5497	-.1778	.6053	.8786	.8002	.2476	-.9358	.5546	.9582
.6500	-.9597	.3762	1.2701	.6003	-.0582	.6403	.8244	.8002	-.5024	-.9458	.5560	.9559
.7000	-1.0254	.3569	1.3089	.6500	.0379	.6684	.7812	.8002	-.7524	-.9284	.5611	.9478
.7500	-.9377	.4648	1.0473	.7000	.1509	.7016	.7302					
.8002	-.9480	.5554	.9569	.7501	.2484	.7301	.6858					
.9002	-.1615	.6100	.8712	.8001	.3303	.7541	.6441					
.9501	-.0773	.6347	.8331	.8501	.4012	.7749	.6149					

TEST 167 PT 36.7289 PSI CM .6463 CD1 .03018 CDCOR1 .02929
 RUN 35 TT 140.1528 K CM -.1665 CD2 .02791 CDCOR2 .02702
 POINT 78 RC 14.9130 MILLION CC .0281 CD3 .02589 CDCOR3 .02524
 MACH .8000 CD4 .02455 CDCOR4 .02378
 ALPHA 1.0285 DEG CD5 .02284 CDCOR5 .02192

UPPER SURFACE				LOWER SURFACE				SPANWISE				
X/C	CP	P _L /PT	MLOC	X/C	CP	P _L /PT	MLOC	X/C	Y/(B/2)	CP	P _L /PT	MLOC
0.0000	1.1703	1.0002	0.0000	0.0000	1.1703	1.0002	0.0000	.1507	.7476	-.7426	.4394	1.1515
.0132	-.1023	.6771	.8448	.0126	.4576	.7912	.5883	.1507	.4976	-.8137	.4185	1.1893
.0259	-.4853	.5148	1.0225	.0255	.2978	.7444	.6635	.1507	.2476	-.7957	.4238	1.1796
.0759	-.7390	.4404	1.1456	.0495	.1205	.6924	.7443	.1507	-.2524	-.7928	.4247	1.1780
.1003	-.7660	.4325	1.1638	.0753	.0359	.6676	.7825	.1507	-.5024	-.8079	.4202	1.1802
.1507	-.7843	.4271	1.1736	.1002	-.0534	.6414	.8227	.1507	-.7524	-.7453	.4386	1.1526
.2003	-.7964	.4236	1.1800	.1503	-.0866	.6317	.8377	.5002	.7476	-.8979	.3938	1.2357
.2503	-.8224	.4160	1.1940	.1976	-.2470	.5847	.9107	.5002	.4976	-.9054	.3916	1.2400
.3001	-.8589	.4053	1.2140	.2503	-.3210	.5630	.9449	.5002	.2476	-.8566	.3971	1.2295
.3502	-.8676	.4027	1.2188	.3001	-.3761	.5468	.9706	.5002	-.2524	-.8690	.4023	1.2196
.4003	-.8382	.4113	1.2026	.3507	-.4141	.5357	.9885	.5002	-.5024	-.9032	.3923	1.2387
.4501	-.8297	.4138	1.1990	.4001	.4104	.5368	.9868	.5002	-.7524	-.8739	.4010	1.2221
.5002	-.8697	.4021	1.2200	.4501	-.3511	.5488	.9673	.8002	.7476	-.9468	.3795	1.2636
.5502	-.9025	.3927	1.2383	.5001	-.2911	.5717	.9310	.8002	.4976	-.9345	.5563	.9594
.6002	-.9347	.3836	1.2566	.5497	-.1732	.6063	.8770	.8002	.2476	-.9383	.5579	.9529
.6500	-.9957	.3651	1.2922	.6003	-.0561	.6406	.8240	.8002	-.5024	-.9424	.5567	.9548
.7000	-.8737	.4009	1.2222	.6500	.0379	.6682	.7816	.8002	-.7524	-.9219	.5628	.9491
.7500	-.4751	.5295	.9985	.7000	.1499	.7010	.7310					
.8002	-.3389	.5577	.9532	.7501	.2466	.7294	.6870					
.9002	-.1973	.5542	.8879	.8001	.3280	.7532	.6492					
.9501	-.1341	.6177	.8592	.8501	.3987	.7740	.6164					

TEST 167	PT 36.7159	PSI	CM .6827	C01 .03613	COCOR1 .03523
RUN 35	TT 140.3390	K	CM -.1626	C02 .03491	COCOR2 .03289
POINT 79	RC 14.9102	MILLION	CC .0272	C03 .03147	COCOR3 .02943
	MACH .8001			C04 .02859	COCOR4 .02760
	ALPHA 1.5071	DEG		C05 .02686	COCOR5 .02590

UPPER SURFACE				LOWER SURFACE				SPANWISE				
X/C	CP	P/L/PT	MLOC	X/C	CP	P/L/PT	MLOC	X/C	Y/(B/2)	CP	P/L/PT	MLOC
0.0000	1.1683	.9999	.0124	0.0000	1.1683	.9999	.0124	.1507	.7476	-.8147	.4207	1.1853
.0132	-.1720	.8084	.8737	.0126	.5045	.8061	.5636	.1507	.4976	-.8829	.4608	1.2225
.0259	-.3583	.4956	1.0544	.0255	.3383	.7575	.6427	.1507	.2476	-.8594	.4076	1.2095
.0759	-.8067	.4230	1.1810	.0495	.1502	.7025	.7287	.1507	-.2524	-.8547	.4090	1.2070
.1003	-.8216	.4158	1.1944	.0753	.0716	.6796	.7641	.1507	-.5024	-.8751	.4031	1.2181
.1507	-.8461	.4115	1.2023	.1002	-.0186	.6532	.8045	.1507	-.7524	-.8113	.4217	1.1835
.2003	-.8572	.4083	1.2083	.1503	-.0563	.6422	.8215	.5002	.7476	-.9528	.3803	1.2619
.2503	-.8829	.4008	1.2225	.1976	-.2192	.5946	.8491	.5002	.4976	-.9621	.3777	1.2672
.3001	-.9207	.3897	1.2436	.2503	-.2961	.5722	.9303	.5002	.2476	-.9630	.3774	1.2677
.3502	-.9361	.3852	1.2523	.3001	-.3522	.5558	.9563	.5002	-.2524	-.9385	.3849	1.2537
.4003	-.9331	.3861	1.2506	.3507	-.3929	.5439	.9793	.5002	-.5024	-.9569	.3792	1.2642
.4501	-.9015	.3953	1.2328	.4001	-.3974	.5427	.9772	.5002	-.7524	-.9282	.3875	1.2478
.5002	-.9173	.3907	1.2417	.4501	-.3674	.5413	.9633	.8002	.7476	-1.0067	.3646	1.2932
.5502	-.9502	.3811	1.2603	.5001	-.3082	.5687	.9359	.5002	.4976	-.9588	.3530	.9593
.6002	-.9854	.3708	1.2807	.5497	-.1814	.6057	.8779	.8002	.2476	-.9487	.3568	.9546
.6500	-1.0343	.3565	1.3097	.6003	-.0662	.6393	.8259	.8002	-.5024	-.9585	.3539	.9592
.7000	-.9879	.4869	1.0689	.6500	.0250	.6660	.7850	.8002	-.7524	-.9376	.3600	.9495
.7500	-.4074	.5397	.9821	.7000	.1369	.6985	.7349					
.8002	-.3449	.5579	.9529	.7501	.2333	.7248	.6910					
.9002	-.2349	.5900	.9023	.8001	.3149	.7505	.6538					
.9501	-.1706	.6088	.8730	.8501	.3855	.7713	.6207					

TEST 167	PT 36.7412	PSI	CM .7247	C01 .03779	COCOR1 .03488
RUN 35	TT 140.3594	K	CM -.1641	C02 .03825	COCOR2 .03532
POINT 80	RC 14.9247	MILLION	CC .0277	C03 .03738	COCOR3 .03627
	MACH .8008			C04 .03661	COCOR4 .03457
	ALPHA 2.0060	DEG		C05 .03696	COCOR5 .03596

UPPER SURFACE				LOWER SURFACE				SPANWISE				
X/C	CP	P/L/PT	MLOC	X/C	CP	P/L/PT	MLOC	X/C	Y/(B/2)	CP	P/L/PT	MLOC
0.0000	1.1688	.9998	.0179	0.0000	1.1688	.9998	.0179	.1507	.7476	-.8871	.4031	1.2180
.0132	-.2229	.5919	.8993	.0126	.5609	.8216	.5373	.1507	.4976	-.9292	.3849	1.2529
.0259	-.6035	.4804	1.0807	.0255	.3868	.7706	.6238	.1507	.2476	-.9003	.3934	1.2365
.0759	-.8466	.4091	1.2067	.0495	.1966	.7148	.7056	.1507	-.2524	-.8948	.3950	1.2335
.1003	-.8729	.4014	1.2213	.0753	.1159	.6912	.7462	.1507	-.5024	-.9154	.3890	1.2451
.1507	-.8870	.3973	1.2291	.1002	.0215	.6635	.7887	.1507	-.7524	-.8479	.4087	1.2075
.2003	-.8975	.3942	1.2350	.1503	-.0220	.6508	.8083	.5002	.7476	-.9898	.3672	1.2881
.2503	-.9214	.3872	1.2485	.1976	-.1826	.6037	.8809	.5002	.4976	-.9986	.3646	1.2933
.3001	-.9602	.3758	1.2708	.2503	-.2611	.5807	.9169	.5002	.2476	-1.0050	.3627	1.2971
.3502	-.9800	.3700	1.2823	.3001	-.3202	.5634	.9442	.5002	-.2524	-.9835	.3690	1.2844
.4003	-.9847	.3675	1.2874	.3507	-.3663	.5499	.9657	.5002	-.5024	-.9816	.3696	1.2833
.4501	-.9821	.3694	1.2835	.4001	-.3762	.5470	.9703	.5002	-.7524	-.9649	.3745	1.2735
.5002	-.9674	.3737	1.2750	.4501	-.3537	.5536	.9599	.8002	.7476	-1.0322	.3547	1.3134
.5502	-.9877	.3678	1.2868	.5001	-.2876	.5730	.9291	.8002	.4976	-.9682	.3543	.9566
.6002	-1.0203	.3562	1.3062	.5497	-.1764	.6095	.8781	.8002	.2476	-.9502	.3546	.9582
.6500	-1.0058	.3625	1.2976	.6003	-.0636	.6386	.8270	.8002	-.5024	-.9704	.3487	.9676
.7000	-.4910	.5133	1.0249	.6500	.0262	.6649	.7866					
.7500	-.3965	.5410	.9799	.7000	.1367	.6973	.7367					
.8002	-.3439	.5564	.9552	.7501	.2328	.7254	.6931					
.9002	-.2513	.5836	.9124	.8001	.3136	.7491	.6559					
.9501	-.2092	.5982	.8926	.8501	.3850	.7701	.6226					

TEST 167	PT 36.7283	PSI	CM .7535	C01 .03644	COCOR1 .03311
RUN 35	TT 140.2841	K	CM -.1642	C02 .03969	COCOR2 .03843
POINT 41	RC 14.9286	MILLION	CC .0286	C03 .04792	COCOR3 .04448
	MACH .8005			C04 .05161	COCOR4 .04992
	ALPHA 2.5050	DEG		C05 .04748	COCOR5 .04598

UPPER SURFACE				LOWER SURFACE				SPANWISE				
X/C	CP	P/L/PT	MLOC	X/C	CP	P/L/PT	MLOC	X/C	Y/(B/2)	CP	P/L/PT	MLOC
0.0000	1.1664	.9988	.0419	0.0000	1.1664	.9988	.0419	.1507	.7476	-.9124	.3877	1.2476
.0132	-.2680	.5771	.9223	.0126	.6022	.8329	.5178	.1507	.4976	-.9705	.3706	1.2812
.0259	-.7478	.4855	1.1056	.0255	.4285	.7814	.6044	.1507	.2476	-.9390	.3798	1.2629
.0759	-.8859	.3955	1.2326	.0495	.2320	.7241	.6952	.1507	-.2524	-.9348	.3811	1.2604
.1003	-.9136	.3873	1.2483	.0753	.1495	.6998	.7428	.1507	-.5024	-.9555	.3750	1.2725
.1507	-.9250	.3831	1.2563	.1002	.0512	.6709	.7773	.1507	-.7524	-.8830	.3963	1.2310
.2003	-.9356	.3809	1.2609	.1503	.0022	.6565	.7995	.5002	.7476	-1.0281	.3537	1.3157
.2503	-.9588	.3740	1.2743	.1976	-.1574	.6096	.8718	.5002	.4976	-1.0355	.3515	1.3202
.3001	-.9982	.3624	1.2977	.2503	-.2385	.5836	.9089	.5002	.2476	-1.0433	.3492	1.3250
.3502	-1.0205	.3559	1.3110	.3001	-.3013	.5673	.9380	.5002	-.2524	-1.0238	.3551	1.3126
.4003	-1.0332	.3521	1.3188	.3507	-.3527	.5522	.9620	.5002	-.5024	-1.0080	.3596	1.3033
.4501	-1.0459	.3484	1.3265	.4001	-.3686	.5475	.9694	.5002	-.7524	-1.0042	.3607	1.3013
.5002	-1.0339	.3519	1.3192	.4501	-.3524	.5522	.9619	.8002	.7476	-1.1060	.3308	1.3642
.5502	-1.0347	.3517	1.3197	.5001	-.2895	.5708	.9325	.8002	.4976	-.9470	.3562	.9876
.6002	-1.0612	.3439	1.3360	.5497	-.1805	.6028	.8823	.8002	.2476	-.9311	.3409	.9801
.6500	-.7213	.4438	1.1435	.6003	-.0692	.6356	.8317	.8002	-.5024	-.9486	.3572	.9860
.7000	-.4786	.5175	1.0180	.6500	.0197	.6617	.7816					
.7500	-.4121	.5347	.9900	.7000	.1301	.6941	.7417					
.8002	-.3689	.5474	.9496	.7501	.2258	.7223	.6981					
.9002	-.2875	.5714	.9316	.8001	.3066	.7460	.6609					
.9501	-.2634	.5785	.9204	.8501	.3784	.7671	.6273					

TEST 167	PT	51.3976	PSI						
RUN 42	TT	110.0307	K	CN	-0.1115	CD1	.03067	CDCOR1	.03003
POINT 1	RC	Z .620	MILLION	CC	-.0888	CD2	.02614	CDCOR2	.02563
	MACH	047			.0208	CD3	.02383	CDCOR3	.02358
	ALPHA	-3.9445	DEG			CD4	.02035	CDCOR4	.02006
						CD5	.01672	CDCOR5	.01610

UPPER SURFACE				LOWER SURFACE				SPANWISE				
X/C	CP	P/L/PT	MLOC	X/C	CP	P/L/PT	MLOC	X/C	Y/(B/2)	CP	P/L/PT	MLOC
0.0000	.8153	.8947	.4029	0.0000	.8153	.8947	.4029	.1507	.7476	-.1389	.7134	.8678
.0132	-.8246	.8385	.5093	.0126	-.4943	.5086	1.0247	.1507	.4976	-.1516	.6097	.8736
.0259	-.3164	.7476	.8599	.0255	-.4777	.5148	1.0245	.1507	.2476	-.1450	.8116	.8706
.0759	-.0151	.6499	.9115	.0495	-.6242	.4703	1.0992	.1507	-.2524	-.1135	.6091	.8745
.1003	-.0673	.8345	.9332	.0753	-.6622	.4591	1.1186	.1507	-.5024	-.1590	.6075	.8770
.1507	-.1471	.8110	.8716	.1002	-.7066	.4461	1.1416	.1507	-.7524	-.1497	.6102	.8728
.2003	-.2201	.5954	.8959	.1507	-.7247	.4407	1.1511	.5002	.7476	-.4548	.5203	1.0155
.2503	-.2522	.5791	.9213	.1976	-.7786	.4248	1.1798	.5002	.4976	-.4579	.5194	1.0170
.3001	-.3381	.5541	.9578	.2503	-.8433	.4058	1.2151	.5002	.2476	-.4632	.5178	1.0196
.3502	-.3335	.5541	.9578	.3001	-.9101	.3861	1.2527	.5002	-.2524	-.4553	.5201	1.0158
.4003	-.3686	.5457	.9744	.3507	-.9689	.3658	1.2869	.5002	-.5024	-.4532	.5207	1.0140
.4501	-.4075	.5342	.9928	.4001	-1.0195	.3430	1.3172	.8002	-.7524	-.4440	.5235	1.0103
.5002	-.4619	.5182	1.0189	.4501	-.9857	.3190	1.3490	.8002	.7476	-1.0000	.5369	1.3110
.5502	-.5057	.5053	1.0462	.5001	-.9312	.3390	1.3850	.8002	.4976	-.3460	.5524	.9637
.6002	-.5587	.4897	1.0663	.5497	-.8255	.3584	.9541	.8002	.2476	-.3553	.5496	.9681
.6500	-.6291	.4689	1.1017	.6003	-.7574	.3785	.9223	.8002	-.5024	-.3465	.5522	.9639
.7000	-.7016	.4475	1.1390	.6500	-.6895	.3985	.8910	.8002	-.7524	-.3636	.5472	.9720
.7500	-.7763	.4344	1.1525	.7000	-.6156	.4203	.8572					
.8002	-.8530	.5503	.9670	.7501	-.5524	.4389	.8244					
.8502	-.9349	.6087	.8751	.8001	-.5132	.4582	.7986					
.9002	-.9524	.6448	.8193	.8501	-.4765	.4769	.7699					

TEST 167	PT	52.6615	PSI						
RUN 42	TT	111.9597	K	CN	-.0701	CD1	.02070	CDCOR1	.02013
POINT 2	RC	Z 9.9076	MILLION	CC	-.1355	CD2	.01857	CDCOR2	.01799
	MACH	.8044			.0243	CD3	.01646	CDCOR3	.01622
	ALPHA	-7.9700	DEG			CD4	.01487	CDCOR4	.01462
						CD5	.01272	CDCOR5	.01230

UPPER SURFACE				LOWER SURFACE				SPANWISE				
X/C	CP	P/L/PT	MLOC	X/C	CP	P/L/PT	MLOC	X/C	Y/(B/2)	CP	P/L/PT	MLOC
0.0000	.9219	.9257	.3347	0.0000	.7210	.9257	.3347	.1507	.7476	-.2326	.5853	.9115
.0132	-.5101	.8044	.5676	.0126	-.2863	.5495	.9384	.1507	.4976	-.2468	.5811	.9181
.0259	-.1870	.7091	.7200	.0255	-.3308	.5283	.9573	.1507	.2476	-.2418	.5826	.9158
.0759	-.1322	.6149	.8653	.0495	-.4535	.5201	1.0157	.1507	-.2524	-.2520	.5796	.9205
.1003	-.1740	.6026	.8845	.0753	-.5056	.5047	1.0740	.1507	-.5024	-.2575	.5780	.9230
.1507	-.2443	.5818	.9169	.1002	-.5728	.4849	1.1391	.1507	-.7524	-.2463	.5813	.9178
.2003	-.2892	.5686	.9378	.1503	-.5866	.4814	1.0801	.8002	.7476	-.5274	.4983	1.0517
.2503	-.3393	.5538	.9613	.1976	-.6354	.4684	1.1458	.8002	.4976	-.5324	.4968	1.0542
.3001	-.3840	.5391	.9848	.2503	-.7119	.4439	1.2193	.8002	.2476	-.5370	.4955	1.0564
.3502	-.4064	.5340	.9931	.3001	-.7957	.4191	1.1901	.8002	-.2524	-.5302	.4975	1.0531
.4003	-.4365	.5251	1.0075	.3507	-.8836	.3932	1.2348	.8002	-.5024	-.5314	.4971	1.0537
.4501	-.4717	.5148	1.0245	.4001	-.9555	.3720	1.2803	.8002	-.7524	-.5218	.5000	1.0489
.5002	-.5337	.4964	1.0548	.4501	-1.0342	.3488	1.3277	.8002	.7476	-1.0000	.5372	1.3102
.5502	-.5807	.4826	1.0782	.5001	-.9424	.3516	1.0297	.8002	.4976	-.3704	.5446	.9759
.6002	-.6253	.4694	1.1007	.5497	-.8047	.3640	.9650	.8002	.2476	-.4024	.5532	.9911
.6500	-.6873	.4511	1.1325	.6003	-.7057	.3877	.8745	.8002	-.5024	-.3370	.5543	.9805
.7000	-.7561	.4308	1.1687	.6500	-.6224	.4073	.8133	.8002	-.7524	-.3446	.5508	.9661
.7500	-.8149	.4135	1.2006	.7000	-.5573	.4284	.7608					
.8002	-.8400	.5359	.9900	.7501	-.4908	.4502	.7183					
.8502	-.9354	.6140	.8668	.8001	-.4262	.4725	.6836					
.9002	-.9165	.6491	.8126	.8501	-.3277	.4906	.6550					

TEST 167	PT	53.0174	PSI						
RUN 42	TT	112.0074	K	CN	-.2440	CD1	.01262	CDCOR1	.01212
POINT 3	RC	Z 9.9718	MILLION	CC	-.1593	CD2	.01221	CDCOR2	.01162
	MACH	.7936			.0254	CD3	.01170	CDCOR3	.01135
	ALPHA	-1.9896	DEG			CD4	.01103	CDCOR4	.01070
						CD5	.00997	CDCOR5	.00953

UPPER SURFACE				LOWER SURFACE				SPANWISE				
X/C	CP	P/L/PT	MLOC	X/C	CP	P/L/PT	MLOC	X/C	Y/(B/2)	CP	P/L/PT	MLOC
0.0000	1.0204	.9563	.2540	0.0000	1.0206	.9563	.2540	.1507	.7476	-.3492	.3558	.9582
.0132	.3666	.7631	.6320	.0126	-.0750	.6359	.8329	.1507	.4976	-.3468	.3506	.9664
.0259	-.0271	.6638	.7869	.0255	-.1632	.6102	.8727	.1507	.2476	-.3424	.3519	.9643
.0759	-.2764	.5770	.9244	.0495	-.2926	.5723	.9319	.1507	-.2524	-.3713	.3453	.9684
.1003	-.3051	.5687	.9377	.0753	-.3499	.5559	.9904	.1507	-.5024	-.3737	.3486	.9696
.1507	-.3633	.5517	.9467	.1002	-.4192	.5393	.9910	.1507	-.7524	-.3566	.3536	.9616
.2003	-.3945	.5425	.9703	.1503	-.4394	.5294	1.0006	.8002	.7476	-.3970	.3483	1.0749
.2503	-.4380	.5298	.9999	.1976	-.4668	.4980	1.0527	.8002	.4976	-.4015	.3420	1.0782
.3001	-.4827	.5138	1.0260	.2503	-.4674	.4684	1.1022	.8002	.2476	-.4062	.3406	1.0815
.3502	-.5435	.5107	1.0312	.3001	-.4724	.4455	1.1425	.8002	-.2524	-.3994	.3426	1.0782
.4003	-.5659	.5100	1.0324	.3507	-.4829	.4231	1.1828	.8002	-.5024	-.3985	.3426	1.0782
.4501	-.5383	.5005	1.0591	.4001	-.4952	.4078	1.2111	.8002	-.7524	-.4000	.3446	1.0784
.5002	-.6018	.4814	1.0743	.4501	-.4808	.4294	1.1711	.8002	.7476	-1.0000	.3646	1.2932
.5502	-.6644	.4640	1.1032	.5001	-.4294	.4527	.9314	.8002	.4976	-.3616	.3521	.9640
.6002	-.6956	.4545	1.1266	.5497	-.3790	.4655	.8799	.8002	.2476	-.3873	.3446	.9759
.6500	-.7611	.4353	1.1607	.6003	-.3068	.4883	.8291	.8002	-.5024	-.3356	.3597	.9518
.7000	-.8306	.4150	1.1977	.6500	-.2245	.5056	.7871	.8002	-.7524	-.3549	.3541	.9608
.7500	-.8776	.4013	1.2235	.7000	-.1451	.5284	.7336					
.8002	-.9386	.5444	.9755	.7501	-.2458	.5004	.6876					
.8502	-.9354	.6163	.8401	.8001	-.3299	.5243	.6491					
.9002	-.9524	.6513	.8092	.8501	-.4018	.5454	.6154					

OF POOR QUALITY

TEST 167	PT 53.0197	PSI	CN	.3280	CD1	.01325	CDCOR1	.01273
RUN 42	TT 111.9665	K	CM	-1.6659	CD2	.01291	CDCOR2	.01241
POINT 4	RC 30.0300	MILLION	CC	.0276	CD3	.01234	CDCOR3	.01206
	ACH .8096				CD4	.01152	CDCOR4	.01123
	ALPHA -1.4757	UEG			CD5	.01028	CDCOR5	.00982

UPPER SURFACE				LOWER SURFACE				SPANWISE				
X/C	CP	P/L/P/T	MLOC	X/C	CP	P/L/P/T	MLOC	X/C	V/(B/2)	CP	P/L/P/T	MLOC
0.0000	1.0627	.9681	.2161	0.0000	1.0627	.9681	.2161	.1507	.7476	-.4132	.5348	.0019
.0132	.2866	.7402	.6714	.0126	.0334	.8667	.7866	.1507	.4976	-.4327	.5290	1.0011
.0259	-.0617	.6379	.8298	.0255	-.0732	.8366	.8349	.1507	.2476	-.4299	.5299	.9988
.0759	-.3587	.3508	.9661	.0495	-.2104	.5966	.8974	.1507	-.2524	-.4393	.5271	1.0043
.1003	-.3784	.5450	.9754	.0793	-.2753	.5752	.9273	.1507	-.5024	-.4396	.5270	1.0044
.1507	-.4308	.5296	1.0002	.1002	-.3466	.5537	.9615	.1507	-.7524	-.4187	.5331	.9949
.2003	-.4514	.5235	1.0101	.1503	-.3876	.5423	.9797	.5002	.7476	-.4649	-.670	1.1048
.2503	-.4897	.5123	1.0285	.1976	-.5018	.5087	1.0344	.5002	.4976	-.4657	.9665	1.1050
.3001	-.5440	.4963	1.0550	.2501	-.5973	.4807	1.0814	.5002	.2476	-.4642	.9663	1.1068
.3502	-.5622	.4898	1.0659	.3001	-.6688	.4597	1.1175	.5002	-.2524	-.4637	.9688	1.1017
.4003	-.5917	.4853	1.0736	.3507	-.7353	.4402	1.1520	.5002	-.5024	-.4638	.9670	1.1048
.4501	-.5989	.4802	1.0822	.4001	-.7735	.4290	1.1722	.5002	-.7524	-.4636	.9650	1.1083
.5002	-.6425	.4674	1.1041	.4501	-.8370	.4078	1.2069	.8002	.7476	-1.0399	.3507	1.3236
.5502	-.6788	.4568	1.1228	.5001	-.8952	.3894	.9365	.8002	.4976	-.4621	.3322	.9960
.6002	-.7268	.4427	1.1475	.5497	-.1073	.3691	.8858	.8002	.2476	-.4612	.3106	1.0182
.6500	-.7949	.4227	1.1836	.6003	-.1893	.3501	.8352	.8002	-.5024	-.3568	.3513	.9632
.7000	-.8655	.4019	1.2222	.7000	-.2640	.3327	.7901	.8002	-.7524	-.3597	.3505	.9666
.7500	-.9278	.3836	1.2673	.7501	-.3481	.3179	.7355					
.8002	-.9691	.3683	1.0186	.8001	-.4329	.3038	.6892					
.9002	-.1260	.6191	.8269	.9001	-.5329	.2891	.6499					
.9501	-.0171	.6511	.8096	.9501	-.6053	.2751	.6159					

TEST 167	PT 53.0274	PSI	CN	.4102	CD1	.01373	CDCOR1	.01524
RUN 42	TT 111.9092	K	CM	-1.1730	CD2	.01328	CDCOR2	.01491
POINT 5	RC 30.1108	MILLION	CC	.0293	CD3	.01463	CDCOR3	.01449
	MACH .8031				CD4	.01346	CDCOR4	.01327
	ALPHA -.4970	UEG			CD5	.01206	CDCOR5	.01163

UPPER SURFACE				LOWER SURFACE				SPANWISE				
X/C	CP	P/L/P/T	MLOC	X/C	CP	P/L/P/T	MLOC	X/C	V/(B/2)	CP	P/L/P/T	MLOC
0.0000	1.1027	.9798	.1713	0.0000	1.1027	.9798	.1713	.1507	.7476	-.4745	.5165	1.0217
.0132	.2123	.7182	.7059	.0126	.1403	.8671	.7387	.1507	.4976	-.4994	.5107	1.0312
.0259	-.1411	.6641	.8641	.0255	-.0187	.8612	.7910	.1507	.2476	-.4994	.5115	1.0298
.0759	-.4373	.5274	1.0038	.0495	-.1240	.6194	.8584	.1507	-.2524	-.4994	.5106	1.0313
.1003	-.4435	.5256	1.0068	.0793	-.1955	.5986	.8910	.1507	-.5024	-.4992	.5113	1.0302
.1507	-.4907	.5117	1.0294	.1002	-.2754	.5749	.9278	.1507	-.7524	-.4666	.5188	1.0179
.2003	-.5212	.5027	1.0521	.1503	-.3253	.5630	.9514	.5002	.7476	-.4684	.5336	1.1262
.2503	-.5369	.4981	1.0520	.1976	-.4438	.5253	1.0069	.5002	.4976	-.4691	.9526	1.1269
.3001	-.5753	.4868	1.0710	.2501	-.5296	.5003	1.0494	.5002	.2476	-.4692	.9508	1.1332
.3502	-.6023	.4783	1.0944	.3001	-.5918	.4820	1.0792	.5002	-.2524	-.4696	.9533	1.1288
.4003	-.6223	.4730	1.0945	.3507	-.6566	.4630	1.0494	.5002	-.5024	-.4686	.9547	1.1262
.4501	-.6452	.4663	1.1061	.4001	-.6849	.4607	1.1159	.5002	-.7524	-.4680	.9537	1.1280
.5002	-.6670	.4511	1.1326	.4501	-.7379	.4272	1.0041	.8002	.7476	-1.0332	.3517	1.3215
.5502	-.7347	.4400	1.1522	.5001	-.8025	.4070	.9403	.8002	.4976	-.4657	.3106	.9981
.6002	-.7667	.4324	1.1192	.5497	-.1041	.3818	.8858	.8002	.2476	-.4647	.3164	1.0218
.6500	-.8995	.4134	1.2034	.6003	-.1600	.3632	.8293	.8002	-.5024	-.3559	.3513	.9653
.7000	-.9995	.3916	1.2719	.7000	-.2365	.3466	.7857	.8002	-.7524	-.3463	.3547	.9548
.7500	-.9622	.3732	1.2779	.7501	-.3183	.3244	.7305					
.8002	-.9463	.3580	1.0192	.8001	-.4003	.3033	.6839					
.9002	-.1204	.6205	.8567	.9001	-.4854	.2873	.6444					
.9501	-.0133	.6514	.8092	.9501	-.5182	.2787	.6100					

TEST 167	PT 53.0267	PSI	CN	.4922	CD1	.01763	CDCOR1	.01712
RUN 42	TT 112.0943	K	CM	-1.1732	CD2	.01750	CDCOR2	.01710
POINT A	RC 30.0070	MILLION	CC	.0288	CD3	.01669	CDCOR3	.01645
	MACH .8017				CD4	.01536	CDCOR4	.01511
	ALPHA -.4976	UEG			CD5	.01478	CDCOR5	.01323

UPPER SURFACE				LOWER SURFACE				SPANWISE				
X/C	CP	P/L/P/T	MLOC	X/C	CP	P/L/P/T	MLOC	X/C	V/(B/2)	CP	P/L/P/T	MLOC
0.0000	1.1244	.9872	.1360	0.0000	1.1244	.9872	.1360	.1507	.7476	-.5357	.4986	1.0512
.0132	.1033	.6903	.7492	.0126	.2386	.7296	.6881	.1507	.4976	-.5139	.4947	1.0501
.0259	-.2567	.5856	.9113	.0255	-.1024	.6900	.7494	.1507	.2476	-.5081	.4950	1.0572
.0759	-.5521	.4997	1.0444	.0495	-.3524	.6450	.8189	.1507	-.2524	-.5041	.4947	1.0577
.1003	-.5719	.4939	1.0591	.0793	-.4306	.6223	.8560	.1507	-.5024	-.5001	.4973	1.0533
.1507	-.5670	.4953	1.0567	.1002	-.5118	.5973	.8905	.1507	-.7524	-.5072	.5017	1.0461
.2003	-.596	.4889	1.0708	.1503	-.5742	.5805	.9190	.5002	.7476	-.5157	.6634	1.1462
.2503	-.6235	.4789	1.0844	.1976	-.6383	.5676	.9712	.5002	.4976	-.5180	.6627	1.1474
.3001	-.6614	.4679	1.1053	.2501	-.6952	.5279	1.0030	.5002	.2476	-.5171	.6616	1.1494
.3502	-.6824	.4676	1.1038	.3001	-.7517	.5109	1.0307	.5002	-.2524	-.5156	.6617	1.1493
.4003	-.7074	.4553	1.1178	.3507	-.8154	.5045	1.0414	.5002	-.5024	-.5139	.6639	1.1492
.4501	-.7417	.4431	1.1106	.4001	-.8493	.4950	1.0240	.5002	-.7524	-.5167	.6631	1.1467
.5002	-.7642	.4432	1.1125	.4501	-.8424	.4803	.9829	.8002	.7476	-.5013	.3749	1.2746
.5502	-.7874	.4315	1.1680	.5001	-.9117	.4690	.9371	.8002	.4976	-.4768	.3507	.9663
.6002	-.8277	.4145	1.2494	.5497	-.1084	.4654	.8880	.8002	.2476	-.4634	.3429	.9787
.6500	-.8743	.4060	1.2145	.6003	-.1638	.4617	.8240	.8002	-.5024	-.3439	.3602	.9511
.7000	-.9374	.3875	1.2448	.7000	-.2300	.4491	.7618	.8002	-.7524	-.3467	.3588	.9533
.7500	-.9834	.3743	1.2748	.7501	-.3122	.4343	.7272					
.8002	-.9457	.3623	.9798	.8001	-.3941	.4241	.6810					
.9002	-.1290	.6230	.8574	.9001	-.4793	.4089	.6419					
.9501	-.0201	.6544	.8044	.9501	-.5127	.4003	.6075					

ORIGINAL DATA
OF POOR QUALITY

TEST 167	PT 53.0216	PSI	CM	.5486	CD1 .02044	CDCDR1 .01980
RUN 42	TT 112.0454	K	CM	-.1774	CD2 .02041	CDCDR2 .01982
POINT 7	RC 30.0361	MILLION	CC	.0307	CD3 .01956	CDCDR3 .01916
	MACH .8024				CD4 .01796	CDCDR4 .01754
	ALPHA -.0039	DEG			CD5 .01605	CDCDR5 .01543

UPPER SURFACE				LOWER SURFACE				SPANWISE				
K/C	CP	P _z L/PT	MLOC	K/C	CP	P _z L/PT	MLOC	K/C	Y/(B/2)	CP	P _z L/PT	MLOC
0.0000	1.1491	.9939	.0940	0.0000	1.1491	.9939	.0940	.1507	.7476	-.6414	.4703	1.0991
.0132	-.6478	.6718	.7776	.0126	-.3180	.7508	.6547	.1507	.4976	-.6439	.4696	1.1004
.0259	-.3144	.5659	.9420	.0255	-.1731	.7085	.7210	.1507	.2476	-.6469	.4687	1.1019
.0759	-.5997	.4825	1.0763	.0495	-.0118	.6613	.7938	.1507	-.2524	-.6503	.4677	1.1036
.1003	-.6366	.4717	1.0967	.0753	-.0720	.6368	.8315	.1507	-.5024	-.6445	.4694	1.1007
.1507	-.6407	.4705	1.0968	.1002	-.1572	.6119	.8700	.1507	-.7524	-.5865	.4684	1.0716
.2003	-.6504	.4677	1.1037	.1503	-.2264	.5917	.9015	.5002	.7476	-.7862	.4280	1.1739
.2503	-.6703	.4619	1.1137	.1976	-.3405	.5583	.9541	.5002	.4976	-.7789	.4301	1.1701
.3001	-.936	.4551	1.1256	.2503	-.4119	.5374	.9876	.5002	.2476	-.7864	.4279	1.1740
.3502	-.7049	.4517	1.1315	.3001	-.4706	.5202	1.0155	.5002	-.2524	-.7699	.4327	1.1653
.4003	-.7048	.4518	1.1314	.3507	-.5022	.5110	1.0306	.5002	-.5024	-.7792	.4300	1.1702
.4501	-.7229	.4465	1.1408	.4001	-.4791	.5178	1.0395	.5002	-.7524	-.7712	.4323	1.1660
.5002	-.7719	.4322	1.1663	.4501	-.4022	.5403	.9830	.8002	.7476	-1.0036	.3644	1.2956
.5502	-.8131	.4201	1.1883	.5001	-.3058	.6085	.9280	.8002	.4976	-.9391	.5427	.9796
.6002	-.8587	.4066	1.2131	.5497	-.1812	.6649	.8709	.8002	.2476	-.4033	.5399	.9835
.6500	-.9251	.3874	1.2501	.6003	-.0575	.6410	.8251	.8002	-.5024	-.3602	.5525	.9633
.7000	-.9826	.3705	1.2832	.6500	.0354	.6682	.7832	.8002	-.7524	-.3412	.5581	.9544
.7500	-1.0094	.3627	1.2990	.7000	.1561	.7035	.7287					
.8002	-.4002	.5408	.9821	.7501	.2574	.7331	.6826					
.9002	-.1407	.6167	.8626	.8001	.3425	.7580	.6433					
.9501	-.0369	.6471	.8157	.8501	.4160	.7795	.6037					

TEST 167	PT 53.0167	PSI	CM	.5827	CD1 .02525	CDCDR1 .02444
RUN 42	TT 111.9801	K	CM	-.1710	CD2 .02387	CDCDR2 .02303
POINT 8	RC 30.0705	MILLION	CC	.0302	CD3 .02372	CDCDR3 .02298
	MACH .8028				CD4 .02185	CDCDR4 .02079
	ALPHA .5279	DEG			CD5 .01921	CDCDR5 .01836

UPPER SURFACE				LOWER SURFACE				SPANWISE				
K/C	CP	P _z L/PT	MLOC	K/C	CP	P _z L/PT	MLOC	K/C	Y/(B/2)	CP	P _z L/PT	MLOC
0.0000	1.1599	.9964	.0715	0.0000	1.1599	.9964	.0715	.1507	.7476	-.7056	.4473	1.1392
.0132	-.0132	.6511	.8095	.0126	-.3869	.7689	.6259	.1507	.4976	-.7246	.4417	1.1492
.0259	-.3777	.5438	.9772	.0255	-.2348	.7241	.6967	.1507	.2476	-.7148	.4446	1.1441
.0759	-.6556	.4620	1.1135	.0495	-.0653	.6742	.7739	.1507	-.2524	-.7157	.4441	1.1531
.1003	-.6880	.4525	1.1301	.0753	-.0237	.6480	.8142	.1507	-.5024	-.7214	.4427	1.1675
.1507	-.7081	.4472	1.1395	.1002	-.1099	.6227	.8534	.1507	-.7524	-.6922	.4630	1.1117
.2003	-.7157	.4443	1.1445	.1503	-.1873	.5999	.8887	.5002	.7476	-.8390	.4081	1.2105
.2503	-.7291	.4375	1.1568	.1976	-.3025	.5660	.9419	.5002	.4976	-.8386	.4082	1.2105
.3001	-.7749	.4269	1.1759	.2503	-.3776	.5439	.9772	.5002	.2476	-.8202	.4136	1.2004
.3502	-.7649	.4299	1.1795	.3001	-.4381	.5261	1.0060	.5002	-.2524	-.8154	.4150	1.1978
.4003	-.7678	.4290	1.1720	.3507	-.4775	.5145	1.0250	.5002	-.5024	-.8134	.4097	1.2076
.4501	-.7747	.4270	1.1757	.4001	-.4680	.5173	1.0204	.5002	-.7524	-.8116	.4161	1.1957
.5002	-.8039	.4166	1.1948	.4501	-.4026	.5375	.9890	.8002	.7476	-.9707	.3693	1.2857
.5502	-.8426	.4070	1.2127	.5001	-.3090	.5841	.9450	.8002	.4976	-.9779	.5438	.9774
.6002	-.8813	.3958	1.2343	.5497	-.1855	.6004	.8879	.8002	.2476	-.9634	.5480	.9705
.6500	-.9479	.3760	1.2724	.6003	-.0634	.6363	.8322	.8002	-.5024	-.9596	.5492	.9687
.7000	-1.0232	.3558	1.3172	.6500	.0272	.6632	.7909	.8002	-.7524	-.9336	.5568	.9565
.7500	-.6182	.4730	1.0945	.7000	.1479	.6985	.7364					
.8002	-.3556	.5503	.9688	.7501	.2485	.7282	.6904					
.9002	-.1871	.5999	.8686	.8001	.3328	.7530	.6513					
.9501	-.1658	.6239	.8515	.8501	.4060	.7745	.6168					

TEST 167	PT 53.0266	PSI	CM	-.6611	CD1 .03302	CDCDR1 .03221
RUN 42	TT 111.9311	K	CM	-.1744	CD2 .02957	CDCDR2 .02853
POINT 9	RC 30.0830	MILLION	CC	.0294	CD3 .02700	CDCDR3 .02622
	MACH .8023				CD4 .02547	CDCDR4 .02472
	ALPHA 1.0226	DEG			CD5 .02370	CDCDR5 .02284

UPPER SURFACE				LOWER SURFACE				SPANWISE				
K/C	CP	P _z L/PT	MLOC	K/C	CP	P _z L/PT	MLOC	K/C	Y/(B/2)	CP	P _z L/PT	MLOC
0.0000	1.1651	.9985	.0459	0.0000	1.1651	.9985	.0459	.1507	.7476	-.7696	.4326	1.1656
.0132	-.1007	.6283	.8447	.0126	-.4663	.7911	.5848	.1507	.4976	-.8124	.4201	1.1884
.0259	-.4790	.5176	1.0198	.0255	-.3051	.7470	.6608	.1507	.2476	-.7952	.4251	1.1791
.0759	-.7438	.4402	1.1320	.0495	-.1317	.6962	.7400	.1507	-.2524	-.7959	.4249	1.1795
.1003	-.7649	.4325	1.1657	.0753	-.0397	.6690	.7819	.1507	-.5024	-.8055	.4221	1.1847
.1507	-.7845	.4262	1.1736	.1002	-.0535	.6421	.8234	.1507	-.7524	-.7900	.4303	1.1552
.2003	-.7921	.4260	1.1775	.1503	-.1334	.6187	.8595	.5002	.7476	-.9010	.3942	1.2370
.2503	-.8157	.4191	1.1902	.1976	-.2424	.5860	.9105	.5002	.4976	-.9034	.3929	1.2395
.3001	-.8542	.4079	1.2110	.2503	-.3181	.5647	.9440	.5002	.2476	-.8881	.3979	1.2298
.3502	-.8648	.4048	1.2169	.3001	-.3739	.5484	.9700	.5002	-.2524	-.8667	.4042	1.2160
.4003	-.8365	.4130	1.2014	.3507	-.4118	.5373	.9878	.5002	-.5024	-.9062	.3926	1.2399
.4501	-.8465	.4101	1.2068	.4001	-.4071	.5386	.9856	.5002	-.7524	-.8663	.4052	1.2161
.5002	-.8707	.4030	1.2201	.4501	-.3678	.5501	.9672	.8002	.7476	-.9473	.3806	1.2632
.5502	-.9031	.3930	1.2493	.5001	-.2883	.5734	.9302	.8002	.4976	-.9398	.5525	.9634
.6002	-.9345	.3844	1.2559	.5497	-.1706	.6078	.8764	.8002	.2476	-.9341	.5562	.9607
.6500	-.9903	.3680	1.2882	.6003	-.0524	.6484	.8229	.8002	-.5024	-.9346	.5537	.9582
.7000	-1.0457	.3519	1.3213	.6500	.0365	.6684	.7829					
.7500	-.4839	.5162	1.0221	.7000	.1547	.7030	.7296					
.8002	-.3553	.5538	.9613	.7501	.2540	.7320	.6843					
.9002	-.2008	.5990	.8901	.8001	.3341	.7566	.6455					
.9501	-.1298	.6198	.8579	.8501	.4114	.7780	.6111					

C-4

ORIGINAL RECORD
OF POOR QUALITY

TEST 167	PT 53.0156	PSI	CN	.7000	CD1	.03710	CDCOR1	.03632
RUN 42	TT 111.9474	K	CM	-.1733	CD2	.03571	CDCOR2	.03420
POINT 10	RC 30.0671	MILLION	CC	.0297	CD3	.03230	CDCOR3	.03051
	MACH .8021				CD4	.03078	CDCOR4	.02847
	ALPHA 1.5383	DEG			CD5	.02903	CDCOR5	.02811

UPPER SURFACE				LOWER SURFACE				SPANWISE				
X/C	CP	P/L/PT	MLOC	X/C	CP	P/L/PT	MLOC	X/C	Y/(B/2)	CP	P/L/PT	MLOC
0.0000	1.1734	1.0011	0.0000	0.0000	1.1734	1.0011	0.0000	.1507	.7476	-.8034	.4237	1.1818
.0132	-.1491	.6151	.8651	.0126	.5187	.8099	.5585	.1507	.4976	-.8712	.4039	1.2185
.0259	-.5291	.5038	1.0426	.0255	.3532	.7615	.6377	.1507	.2476	-.8447	.4116	1.2040
.0759	-.7899	.4276	1.1746	.0495	.1775	.7102	.7183	.1507	-.2524	-.8428	.4122	1.2030
.1003	-.8206	.4186	1.1910	.0753	.0804	.6818	.7622	.1507	-.5024	-.8584	.4076	1.2115
.1507	-.8330	.4150	1.1977	.1002	-.0170	.6548	.8037	.1507	-.7524	-.8072	.4226	1.1838
.2003	-.8383	.4135	1.2006	.1503	-.0975	.6299	.8422	.5002	.7476	-.9452	.3823	1.2601
.2503	-.8651	.4057	1.2152	.1976	-.2111	.5967	.8937	.5002	.4976	-.9522	.3802	1.2640
.3001	-.9072	.3934	1.2385	.2503	-.2865	.5747	.9282	.5002	.2476	-.9530	.3800	1.2645
.3502	-.9255	.3880	1.2488	.3001	-.3452	.5575	.9554	.5002	-.2524	-.9294	.3869	1.2511
.4003	-.9223	.3889	1.2470	.3507	-.3580	.5450	.9753	.5002	-.5024	-.9443	.3825	1.2595
.4501	-.8932	.3975	1.2307	.4001	-.3907	.5442	.9766	.5002	-.7524	-.9032	.3945	1.2363
.5002	-.9389	.3841	1.2564	.4501	-.3613	.5528	.9628	.8002	.7476	-.9776	.3728	1.2787
.5502	-.9438	.3827	1.2592	.5001	-.2863	.5747	.9281	.8002	.4976	-.9564	.5542	.9606
.6002	-.9801	.3721	1.2801	.5497	-.1707	.6085	.8753	.8002	.2476	-.9477	.5568	.9565
.6500	-1.0288	.3579	1.3089	.6003	-.0539	.6426	.8226	.8002	-.5024	-.9334	.5551	.9592
.7000	-.8373	.4138	1.2000	.6500	.0320	.6677	.7839	.8002	-.7524	-.9275	.5627	.9472
.7500	-.4210	.9354	.9909	.7000	.1503	.7023	.7307					
.8002	-.3494	.9563	.9573	.7501	.2496	.7312	.6856					
.9002	-.2332	.9502	.9038	.8001	.3330	.7556	.6471					
.9501	-.1742	.6075	.8769	.8501	.4063	.7770	.6127					

TEST 167	PT 53.0262	PSI	CN	-.7444	CD1	.03751	CDCOR1	.03510
RUN 42	TT 111.8893	K	CM	-.1732	CD2	.04041	CDCOR2	.03955
POINT 11	RC 30.1046	MILLION	CC	.0294	CD3	.04212	CDCOR3	.04060
	MACH .8025				CD4	.03366	CDCOR4	.03734
	ALPHA 2.0146	DEG			CD5	.03619	CDCOR5	.03523

UPPER SURFACE				LOWER SURFACE				SPANWISE				
X/C	CP	P/L/PT	MLOC	X/C	CP	P/L/PT	MLOC	X/C	Y/(B/2)	CP	P/L/PT	MLOC
0.0000	1.1673	.9993	.0319	0.0000	1.1673	.9993	.0319	.1507	.7476	-.8417	.4124	1.2026
.0132	-.109	.9567	.8937	.0126	.5710	.8251	.3326	.1507	.4976	-.9272	.3874	1.2500
.0259	-.75	.4939	1.0591	.0255	.4012	.7755	.6151	.1507	.2476	-.8973	.3961	1.2332
.0759	-.6437	.4100	1.2070	.0495	.2237	.7236	.6975	.1507	-.2524	-.8953	.3967	1.2321
.1003	-.8753	.4026	1.2210	.0753	.1224	.6940	.7434	.1507	-.5024	-.9117	.3919	1.2413
.1507	-.8864	.3997	1.2272	.1002	-.0261	.6659	.7867	.1507	-.7524	-.8580	.4082	1.2104
.2003	-.8895	.3984	1.2289	.1503	-.0622	.6401	.8264	.5002	.7476	-.9920	.3685	1.2874
.2503	-.9142	.3912	1.2427	.1976	-.1752	.6071	.8775	.5002	.4976	-.9086	.3665	1.2913
.3001	-.9568	.3787	1.2669	.2503	-.2513	.5848	.9122	.5002	.2476	-1.0027	.3693	1.2937
.3502	-.9785	.3724	1.2795	.3001	-.3109	.5674	.9396	.5002	-.2524	-.9858	.3703	1.2837
.4003	-.9867	.3700	1.2943	.3507	-.3568	.5540	.9609	.5002	-.5024	-.9773	.3728	1.2788
.4501	-.9733	.3739	1.2765	.4001	-.3648	.5517	.9646	.5002	-.7524	-.9468	.3817	1.2612
.5002	-.9824	.3713	1.2818	.4501	-.3443	.5577	.9551	.8002	.7476	-1.0066	.3642	1.2960
.5502	-1.0122	.3626	1.2993	.5001	-.2764	.5775	.9237	.8002	.4976	-.9369	.5502	.9670
.6002	-1.0217	.3598	1.3049	.5497	-.1660	.6098	.8733	.8002	.2476	-.9564	.5541	.9607
.6500	-1.0742	.3444	1.3367	.6003	-.0524	.6429	.8220	.8002	-.5024	-.9364	.5512	.9654
.7000	-.6284	.4747	1.0917	.6500	.0314	.6674	.7843	.8002	-.7524	-.9393	.5591	.9528
.7500	-.4141	.9373	.9978	.7000	.1489	.7016	.7316					
.8002	-.3506	.9558	.9580	.7501	.2467	.7303	.6870					
.9002	-.2441	.9669	.9089	.8001	.3296	.7546	.6488					
.9501	-.2064	.5983	.8917	.8501	.4030	.7760	.6144					

TEST 167	PT 53.0209	PSI	CN	.7565	CD1	.03799	CDCOR1	.03686
RUN 42	TT 112.3625	K	CM	-.1715	CD2	.04375	CDCOR2	.04220
POINT 12	RC 29.9017	MILLION	CC	.0313	CD3	.05154	CDCOR3	.05023
	MACH .8020				CD4	.05148	CDCOR4	.05028
	ALPHA 2.5130	DEG			CD5	.04664	CDCOR5	.04525

UPPER SURFACE				LOWER SURFACE				SPANWISE				
X/C	CP	P/L/PT	MLOC	X/C	CP	P/L/PT	MLOC	X/C	Y/(B/2)	CP	P/L/PT	MLOC
0.0000	1.1667	.9986	.0452	0.0000	1.1667	.9986	.0452	.1507	.7476	-.8632	.4020	1.2221
.0132	-.2465	.5826	.9157	.0126	.6024	.8327	.3193	.1507	.4976	-.9559	.3747	1.2749
.0259	-.4925	.4815	1.0800	.0255	.4305	.7822	.6043	.1507	.2476	-.9271	.3832	1.2582
.0759	-.6771	.3979	1.2299	.0495	.2480	.7286	.6897	.1507	-.2524	-.9283	.3828	1.2589
.1003	-.9056	.3895	1.2460	.0753	.1433	.6978	.7375	.1507	-.5024	-.9425	.3787	1.2671
.1507	-.9164	.3863	1.2521	.1002	.0488	.6700	.7804	.1507	-.7524	-.8812	.3967	1.2322
.2003	-.9194	.3854	1.2538	.1503	-.0462	.6421	.8234	.5002	.7476	-1.0226	.3551	1.3145
.2503	-.9406	.3792	1.2660	.1976	-.1626	.6079	.8763	.5002	.4976	-1.0277	.3536	1.3176
.3001	-.9818	.3671	1.2901	.2503	-.2441	.5839	.9136	.5002	.2476	-1.0309	.3527	1.3195
.3502	-1.0016	.3613	1.3019	.3001	-.3089	.5649	.9436	.5002	-.2524	-1.0165	.3569	1.3108
.4003	-1.0119	.3583	1.3081	.3507	-.3611	.5495	.9681	.5002	-.5024	-.9955	.3631	1.2982
.4501	-1.0173	.3567	1.3113	.4001	-.3760	.5446	.9760	.5002	-.7524	-.9791	.3679	1.2885
.5002	-1.0069	.3597	1.3050	.4501	-.3640	.5487	.9694	.8002	.7476	-1.1199	.3265	1.3753
.5502	-1.0526	.3463	1.3329	.5001	-.2979	.5681	.9385	.8002	.4976	-.9451	.5337	.9936
.6002	-1.0544	.3458	1.3340	.5497	-.1867	.6008	.8872	.8002	.2476	-.9350	.5396	.9841
.6500	-1.0377	.3507	1.3237	.6003	-.0729	.6342	.8355	.8002	-.5024	-.94071	.5360	.9898
.7000	-.4493	.5101	1.0321	.6500	.0100	.6586	.7979	.8002	-.7524	-.9315	.5406	.9824
.7500	-.4117	.5347	.9920	.7003	.1275	.6931	.7447					
.8002	-.3719	.5463	.9732	.7501	.2259	.7221	.6999					
.9002	-.2975	.5682	.9364	.8001	.3090	.7465	.6615					
.9501	-.2646	.5779	.9231	.8501	.3831	.7683	.6269					

Appendix M

Pressure Data for $M = 0.50$; $R = 4.4 \times 10^6$ and 7.0×10^6 ; Fixed Transition

The pressure measurements made on the NASA SC(3)-0712(B) airfoil are presented in coefficient form in graphs and tables in this appendix. The data are for a given Mach number through the Reynolds number range. The pressure data from the upper surface of the airfoil are plotted as open symbols, and the lower-surface data are plotted as solid symbols.

TEST 167	PT 20.4097	PSI	CN -0.332	CD1 .01058	CDCDR1 .01043
RUN 59	TT 174.4476	K	CM -0.092	CD2 .01029	CDCDR2 .01022
POINT 25	RC 4.4075	MILLION	CC .0023	CD3 .01024	CDCDR3 .01027
	MACH .5009			CD4 .01056	CDCDR4 .01061
	ALPHA -4.0019	DEG		CD5 .01007	CDCDR5 .01077

UPPER SURFACE				LOWER SURFACE				SPANWISE				
X/C	CP	P _L /PT	MLOC	X/C	CP	P _L /PT	MLOC	X/C	Y/(B/2)	CP	P _L /PT	MLOC
0.0000	.4644	.9114	.3663	0.0000	.4644	.9114	.3663	.1507	.7476	-.1216	.8248	.5516
.0132	.5677	.9267	.3315	.0126	-.8447	.7180	.7043	.1507	.4976	-.1330	.8232	.5345
.0259	.2567	.8807	.4296	.0255	-.7200	.7364	.6756	.1507	.2476	-.1302	.8236	.5338
.0759	-.0279	.8387	.5075	.0495	-.6486	.7470	.6590	.1507	-.2524	-.1296	.9237	.5336
.1003	-.0718	.8322	.5168	.0753	-.5733	.7581	.6414	.1507	-.5024	-.1381	.8224	.5358
.1507	-.1292	.8237	.5335	.1002	-.5840	.7565	.6439	.1507	-.7524	-.1244	.8244	.5323
.2003	-.1665	.8182	.5429	.1503	-.5424	.7627	.6341	.5002	.7476	-.1820	.8012	.5716
.2503	-.1961	.8138	.5503	.1976	-.5900	.7602	.6380	.5002	.4976	-.2915	.7997	.5739
.3001	-.2243	.8097	.5574	.2503	-.5400	.7630	.6336	.5002	.2476	-.2965	.7990	.5752
.3502	-.2393	.8075	.5611	.3001	-.5257	.7652	.6302	.5002	-.2524	-.2921	.7997	.5741
.4003	-.2551	.8051	.5650	.3507	-.5047	.7683	.6252	.5002	-.5024	-.2875	.8003	.5730
.4501	-.2749	.8022	.5699	.4001	-.4686	.7736	.6167	.5002	-.7524	-.2777	.8018	.5705
.5002	-.2937	.7994	.5745	.4501	-.4244	.7801	.6061	.8002	.7476	-.7502	.7320	.6826
.5502	-.3134	.7965	.5793	.5001	-.3543	.7905	.5892	.8002	.4976	-.2776	.8018	.5705
.6002	-.3297	.7941	.5833	.5497	-.2581	.8047	.5657	.8002	.2476	-.2806	.8014	.5713
.6500	-.3462	.7917	.5873	.6003	-.1535	.8201	.5397	.8002	-.5024	-.2754	.8021	.5700
.7000	-.3359	.7932	.5848	.6500	-.0610	.8338	.5160	.8002	-.7524	-.2605	.8043	.5663
.7500	-.3157	.7962	.5798	.7000	.0431	.8492	.4888					
.8002	-.2817	.8012	.5715	.7501	.1338	.8626	.4642					
.9002	-.1602	.8192	.5413	.8001	.2058	.8732	.4442					
.9501	-.0677	.8328	.5178	.8501	.2657	.8821	.4271					

TEST 167	PT 20.4304	PSI	CN .0819	CD1 .01038	CDCDR1 .00994
RUN 59	TT 174.8299	K	CM -.1034	CD2 .01022	CDCDR2 .00985
POINT 27	RC 4.3994	MILLION	CC .0099	CD3 .01011	CDCDR3 .00971
	MACH .5010			CD4 .01040	CDCDR4 .01001
	ALPHA -2.9938	DEG		CD5 .01048	CDCDR5 .01004

UPPER SURFACE				LOWER SURFACE				SPANWISE				
X/C	CP	P _L /PT	MLOC	X/C	CP	P _L /PT	MLOC	X/C	Y/(B/2)	CP	P _L /PT	MLOC
0.0000	.7365	.9515	.2674	0.0000	.7365	.9515	.2674	.1507	.7476	-.2182	.8101	.5567
.0132	.3675	.8968	.3974	.0126	-.4806	.7712	.6205	.1507	.4976	-.2281	.8086	.5592
.0259	.0599	.8513	.4850	.0255	-.4555	.7749	.6145	.1507	.2476	-.2255	.8090	.5585
.0759	-.1636	.8181	.5430	.0495	-.4525	.7754	.6138	.1507	-.2524	-.2251	.8090	.5584
.1003	-.1886	.8144	.5493	.0753	-.4185	.7804	.6057	.1507	-.5024	-.2331	.8079	.5604
.1507	-.2250	.8090	.5584	.1002	-.4507	.7756	.6134	.1507	-.7524	-.2170	.8102	.5564
.2003	-.2408	.8067	.5623	.1503	-.4366	.7777	.6101	.5002	.7476	-.3247	.7943	.5830
.2503	-.2684	.8026	.5692	.1976	-.4674	.7732	.6174	.5002	.4976	-.3348	.7928	.5894
.3001	-.2893	.7995	.5743	.2503	-.4626	.7739	.6162	.5002	.2476	-.3400	.7920	.5867
.3502	-.3018	.7977	.5774	.3001	-.4583	.7745	.6152	.5002	-.2524	-.3351	.7927	.5895
.4003	-.3102	.7964	.5794	.3507	-.4456	.7764	.6121	.5002	-.5024	-.3310	.7933	.5845
.4501	-.3254	.7942	.5831	.4001	-.4173	.7806	.6054	.5002	-.7524	-.3210	.7948	.5820
.5002	-.3395	.7921	.5866	.4501	-.3807	.7860	.5966	.8002	.7476	-.7973	.7243	.6946
.5502	-.3550	.7898	.5903	.5001	-.3176	.7953	.5812	.8002	.4976	-.2950	.7987	.5757
.6002	-.3676	.7879	.5934	.5497	-.2278	.8086	.5591	.8002	.2476	-.2990	.7981	.5767
.6500	-.3804	.7860	.5965	.6003	-.1288	.8233	.5342	.8002	-.5024	-.2930	.7990	.5752
.7000	-.3653	.7883	.5928	.6500	-.0410	.8363	.5117	.8002	-.7524	-.2774	.8013	.5714
.7500	-.3406	.7919	.5868	.7000	.0608	.8514	.4848					
.8002	-.3020	.7976	.5774	.7501	.1506	.8647	.4603					
.9002	-.1709	.8171	.5449	.8001	.2232	.8754	.4399					
.9501	-.0759	.8311	.5207	.8501	.2849	.8846	.4221					

TEST 167	PT 20.4320	PSI	CN .1945	CD1 .01001	CDCDR1 .00978
RUN 59	TT 174.7886	K	CM -1.061	CD2 .00990	CDCDR2 .00971
POINT 28	RC 4.3992	MILLION	CC .0140	CD3 .00993	CDCDR3 .00974
	MACH .5007			CD4 .01010	CDCDR4 .00989
	ALPHA -1.9857	DEG		CD5 .00998	CDCDR5 .00968

UPPER SURFACE				LOWER SURFACE				SPANWISE				
X/C	CP	P _L /PT	MLOC	X/C	CP	P _L /PT	MLOC	X/C	Y/(B/2)	CP	P _L /PT	MLOC
0.0000	.9247	.9794	.1727	0.0000	.9247	.9794	.1727	.1507	.7476	-.3141	.7963	.5796
.0132	.1338	.8625	.4644	.0126	-.1620	.8188	.5420	.1507	.4976	-.3248	.7947	.5823
.0259	-.1602	.8191	.5413	.0255	-.2161	.8108	.5555	.1507	.2476	-.3233	.7949	.5819
.0759	-.3071	.7973	.5779	.0495	-.2692	.8029	.5686	.1507	-.2524	-.3238	.7949	.5820
.1003	-.3104	.7969	.5787	.0753	-.2721	.8025	.5694	.1507	-.5024	-.3321	.7936	.5840
.1507	-.3234	.7949	.5819	.1002	-.3207	.7953	.5812	.1507	-.7524	-.3146	.7962	.5798
.2003	-.3303	.7939	.5836	.1503	-.3326	.7916	.5841	.5002	.7476	-.3638	.7887	.5798
.2503	-.3400	.7925	.5859	.1976	-.3757	.7872	.5941	.5002	.4976	-.3759	.7872	.5946
.3001	-.3531	.7905	.5891	.2503	-.3840	.7860	.5966	.5002	.2476	-.3815	.7863	.5960
.3502	-.3576	.7899	.5902	.3001	-.3888	.7853	.5978	.5002	-.2524	-.3765	.7871	.5948
.4003	-.3605	.7894	.5909	.3507	-.3845	.7859	.5967	.5002	-.5024	-.3724	.7877	.5938
.4501	-.3703	.7880	.5933	.4001	-.3639	.7889	.5917	.5002	-.7524	-.3618	.7893	.5912
.5002	-.3809	.7864	.5958	.4501	-.3346	.7933	.5846	.8002	.7476	-.8448	.7179	.5906
.5502	-.3921	.7848	.5986	.5001	-.2789	.8015	.5710	.8002	.4976	-.3103	.7969	.5787
.6002	-.4004	.7835	.6005	.5497	-.1954	.8139	.5503	.8002	.2476	-.3145	.7962	.5797
.6500	-.4091	.7823	.6026	.6003	-.1023	.8276	.5268	.8002	-.5024	-.3082	.7972	.5782
.7000	-.3898	.7851	.5980	.6500	-.0199	.8398	.5055	.8002	-.7524	-.2915	.7996	.5741
.7500	-.3606	.7894	.5909	.7000	.0786	.8543	.4794					
.8002	-.3175	.7958	.5805	.7501	.1665	.8673	.4554					
.9002	-.1777	.8165	.5459	.8001	.2389	.8780	.4349					
.9501	-.0781	.8312	.5206	.8501	.3014	.8873	.4167					

ORIGINAL PARTS
OF POOR QUALITY

TEST 167	PT 20.4315	PSI	CN	.2478	CD1 .01004	CDCOR1 .00971
RUN 59	TT 174.8342	K	CM	-.1066	CD2 .00997	CDCOR2 .00966
POINT 29	RC 4.3972	MILLION	CC	.0148	CD3 .01002	CDCOR3 .00979
	MACH .5007				CD4 .01017	CDCOR4 .00995
	ALPHA -1.4863	DEG			CD5 .01003	CDCOR5 .00970

UPPER SURFACE				LOWER SURFACE				SPANWISE				
X/C	CP	P/L/PT	MLOC	X/C	CP	P/L/PT	MLOC	X/C	Y/(B/2)	CP	P/L/PT	MLOC
0.0000	.9854	.9882	.1301	0.0000	.9854	.9882	.1301	.1507	.7476	-.3646	.7875	.5941
.0132	.0009	.8419	.5019	.0126	-.0214	.8385	.5077	.1507	.4976	-.3779	.7855	.5973
.0259	-.2825	.7997	.5740	.0255	-.1081	.8236	.5302	.1507	.2476	-.3767	.7857	.5970
.0759	-.3853	.7844	.5991	.0495	-.1874	.8139	.5503	.1507	-.2524	-.3777	.7856	.5973
.1003	-.3760	.7858	.5969	.0753	-.2070	.8109	.5552	.1507	-.5024	-.3852	.7844	.5991
.1507	-.3763	.7858	.5969	.1002	-.2629	.8026	.5691	.1507	-.7524	-.3659	.7873	.5944
.2003	-.3703	.7867	.5995	.1503	-.2865	.7991	.5740	.5002	.7476	-.3882	.7840	.5998
.2503	-.3792	.7853	.5976	.1976	-.3357	.7918	.5707	.5002	.4976	-.3990	.7824	.6024
.3001	-.3879	.7841	.5997	.2503	-.3503	.7896	.5900	.5002	.2476	-.4049	.7815	.6038
.3502	-.3874	.7841	.5996	.3001	-.3594	.7863	.5928	.5002	-.2524	-.4005	.7822	.6028
.4003	-.3876	.7841	.5996	.3507	-.3589	.7884	.5927	.5002	-.5024	-.3965	.7828	.6018
.4501	-.3945	.7831	.6013	.4001	-.3418	.7909	.5885	.5002	-.7524	-.3862	.7843	.5993
.5002	-.4029	.7818	.6034	.4501	-.3159	.7947	.5822	.8002	.7476	-.8646	.7132	.7119
.5502	-.4119	.7805	.6055	.5001	-.2637	.8025	.5693	.8002	.4976	-.3194	.7942	.5831
.6002	-.4181	.7796	.6070	.5497	-.1832	.8145	.5493	.8002	.2476	-.3242	.7935	.5842
.6500	-.4246	.7786	.6086	.6003	-.0928	.8279	.5263	.8002	-.5024	-.3196	.7942	.5831
.7000	-.4029	.7818	.6034	.6500	-.0130	.8398	.5055	.8002	-.7524	-.3025	.7967	.5789
.7500	-.3715	.7865	.5958	.7000	.0938	.8542	.4797					
.8002	-.3257	.7933	.5846	.7501	.1708	.8671	.4558					
.9002	-.1814	.8148	.5488	.8001	.2428	.8778	.4353					
.9501	-.0790	.8298	.5230	.8501	.3056	.8872	.4170					

TEST 167	PT 20.4308	PSI	CN	.3050	CD1 .01009	CDCOR1 .00988
RUN 59	TT 174.8081	K	CM	-.1091	CD2 .01005	CDCOR2 .00984
POINT 30	RC 4.3974	MILLION	CC	.0150	CD3 .01004	CDCOR3 .00984
	MACH .5006				CD4 .01015	CDCOR4 .00992
	ALPHA -.6979	DEG			CD5 .01006	CDCOR5 .00973

UPPER SURFACE				LOWER SURFACE				SPANWISE				
X/C	CP	P/L/PT	MLOC	X/C	CP	P/L/PT	MLOC	X/C	Y/(B/2)	CP	P/L/PT	MLOC
0.0000	1.0303	.9950	.0849	0.0000	1.0303	.9950	.0849	.1507	.7476	-.4128	.7811	.6045
.0132	-.1325	.8226	.5354	.0126	-.1048	.8578	.4731	.1507	.4976	-.4236	.7795	.6071
.0259	-.4003	.7829	.6015	.0255	-.0093	.8409	.5036	.1507	.2476	-.4223	.7797	.6068
.0759	-.4560	.7747	.6149	.0495	-.1068	.8264	.5288	.1507	-.2524	-.4214	.7798	.6066
.1003	-.4348	.7778	.6098	.0753	-.1349	.8217	.5370	.1507	-.5024	-.4288	.7787	.6084
.1507	-.4225	.7797	.6068	.1002	-.2026	.8122	.5530	.1507	-.7524	-.4081	.7818	.6034
.2003	-.4184	.7803	.6059	.1503	-.2361	.8073	.5614	.5002	.7476	-.4034	.7825	.6023
.2503	-.4118	.7812	.6043	.1976	-.2900	.7993	.5767	.5002	.4976	-.4152	.7807	.6051
.3001	-.4164	.7806	.6054	.2503	-.3100	.7963	.5796	.5002	.2476	-.4214	.7798	.6066
.3502	-.4173	.7804	.6056	.3001	-.3232	.7944	.5828	.5002	-.2524	-.4148	.7808	.6050
.4003	-.4124	.7812	.6044	.3507	-.3262	.7939	.5836	.5002	-.5024	-.4111	.7813	.6041
.4501	-.4167	.7805	.6055	.4001	-.3125	.7960	.5802	.5002	-.7524	-.3999	.7830	.6014
.5002	-.4225	.7797	.6068	.4501	-.2899	.7993	.5747	.8002	.7476	-.8675	.7137	.7110
.5502	-.4294	.7786	.6085	.5001	-.2407	.8066	.5625	.8002	.4976	-.3226	.7945	.5827
.6002	-.4335	.7780	.6095	.5497	-.1633	.8181	.5432	.8002	.2476	-.3285	.7936	.5841
.6500	-.4387	.7773	.6106	.6003	-.0759	.8310	.5209	.8002	-.5024	-.3210	.7947	.5823
.7000	-.4141	.7809	.6048	.6500	.0018	.8425	.5007	.8002	-.7524	-.3033	.7973	.5779
.7500	-.3804	.7858	.5968	.7000	.0970	.8566	.4752					
.8002	-.3329	.7929	.5852	.7501	.1828	.8694	.4515					
.9002	-.1845	.8149	.5485	.8001	.2544	.8800	.4311					
.9501	-.0829	.8300	.5227	.8501	.3174	.8893	.4126					

TEST 167	PT 20.4324	PSI	CN	.3507	CD1 .00984	CDCOR1 .00986
RUN 59	TT 174.9133	K	CM	-.1079	CD2 .00979	CDCOR2 .00960
POINT 31	RC 4.3955	MILLION	CC	.0142	CD3 .00978	CDCOR3 .00965
	MACH .5008				CD4 .00991	CDCOR4 .00977
	ALPHA -.4888	DEG			CD5 .00977	CDCOR5 .00957

UPPER SURFACE				LOWER SURFACE				SPANWISE				
X/C	CP	P/L/PT	MLOC	X/C	CP	P/L/PT	MLOC	X/C	Y/(B/2)	CP	P/L/PT	MLOC
0.0000	1.0531	.9984	.0483	0.0000	1.0531	.9984	.0483	.1507	.7476	-.4620	.7744	.6153
.0132	-.2780	.8016	.5708	.0126	-.2189	.8751	.4406	.1507	.4976	-.4788	.7719	.6193
.0259	-.5302	.7643	.6315	.0255	-.0827	.8549	.4783	.1507	.2476	-.4776	.7721	.6190
.0759	-.5377	.7632	.6333	.0495	-.0377	.8371	.5102	.1507	-.2524	-.4800	.7717	.6196
.1003	-.5027	.7684	.6250	.0753	-.0853	.8301	.5225	.1507	-.5024	-.4874	.7707	.6214
.1507	-.4773	.7721	.6190	.1002	-.1530	.8201	.5397	.1507	-.7524	-.4666	.7737	.6164
.2003	-.4531	.7757	.6132	.1503	-.1973	.8135	.5509	.5002	.7476	-.4265	.7797	.6069
.2503	-.4521	.7759	.6130	.1976	-.2576	.8046	.5658	.5002	.4976	-.4391	.7778	.6099
.3001	-.4528	.7758	.6131	.2503	-.2835	.8008	.5722	.5002	.2476	-.4458	.7768	.6115
.3502	-.4416	.7774	.6165	.3001	-.3002	.7983	.5763	.5002	-.2524	-.4431	.7772	.6108
.4003	-.4385	.7782	.6093	.3507	-.3069	.7973	.5779	.5002	-.5024	-.4392	.7778	.6099
.4501	-.4392	.7777	.6099	.4001	-.2964	.7989	.5754	.5002	-.7524	-.4287	.7793	.6074
.5002	-.4427	.7773	.6097	.4501	-.2769	.8014	.5706	.8002	.7476	-.8973	.7101	.7166
.5502	-.4474	.7766	.6118	.5001	-.2317	.8084	.5594	.8002	.4976	-.3337	.7934	.5845
.6002	-.4491	.7763	.6123	.5497	-.1570	.8195	.5407	.8002	.2476	-.3392	.7926	.5858
.6500	-.4457	.7759	.6129	.6003	-.0720	.8321	.5191	.8002	-.5024	-.3372	.7929	.5853
.7000	-.4158	.7798	.6067	.6500	.0034	.8432	.4995	.8002	-.7524	-.3191	.7955	.5809
.7500	-.3900	.7851	.5981	.7000	.0968	.8570	.4745					
.8002	-.3400	.7924	.5860	.7501	.1818	.8696	.4511					
.9002	-.1877	.8156	.5485	.8001	.2532	.8801	.4308					
.9501	-.0809	.8307	.5214	.8501	.3166	.8899	.4123					

TEST 167	PT	20.4484	PSI	CN	.4089	CD1	.00995	CDCOR1	.00974
RUN 59	TT	175.0401	K	CM	-.1090	CD2	.00995	CDCOR2	.00974
POINT 32	RC	4.3938	MILLION	CC	.0127	CD3	.00995	CDCOR3	.00979
	MACH	.5007				CD4	.01000	CDCOR4	.00985
	ALPHA	.0204	DEG			CD5	.00997	CDCOR5	.00974

UPPER SURFACE				LOWER SURFACE				SPANWISE				
X/C	CP	P/L/PT	MLOC	X/C	CP	P/L/PT	MLOC	X/C	Y/(B/2)	CP	P/L/PT	MLOC
0.0000	1.0582	.9991	.0353	0.0000	1.0582	.9991	.0353	.1507	.7476	-.5156	.7666	.6279
.0132	-.4459	.7769	.6113	.0126	.3351	.8923	.4066	.1507	.4976	-.5326	.7641	.6319
.0259	-.6766	.7428	.6656	.0255	.1773	.8690	.4323	.1507	.2476	-.5320	.7642	.6318
.0759	-.6230	.7507	.6531	.0495	-.0401	.8487	.4896	.1507	-.2524	-.5335	.7639	.6321
.1003	-.5728	.7581	.6414	.0753	-.0195	.8399	.5053	.1507	-.5124	-.5400	.7630	.6337
.1507	-.5320	.7642	.6318	.1002	-.0939	.8289	.5246	.1507	-.7524	-.5171	.7664	.6283
.2003	-.5055	.7681	.6255	.1503	-.1482	.8209	.5384	.5002	.7476	-.4472	.7767	.6117
.2503	-.4706	.7703	.6220	.1976	-.2134	.8112	.5547	.5002	.4976	-.4599	.7748	.6147
.3001	-.4865	.7709	.6210	.2503	-.2447	.8066	.5625	.5002	.2476	-.4667	.7738	.6163
.3502	-.4722	.7730	.6176	.3001	-.2660	.8035	.5678	.5002	-.2524	-.4626	.7744	.6153
.4003	-.4633	.7743	.6155	.3507	-.2753	.8021	.5700	.5002	-.5024	-.4586	.7750	.6144
.4501	-.4635	.7743	.6155	.4001	-.2869	.8030	.5685	.5002	-.7524	-.4478	.7766	.6118
.5002	-.4639	.7742	.6156	.4501	-.2929	.8054	.5645	.8002	.7476	-.3303	.7920	.5835
.5502	-.4662	.7739	.6162	.5002	-.2910	.8116	.5541	.8002	.4976	-.3405	.7925	.5860
.6002	-.4656	.7740	.6160	.5497	-.2396	.8221	.5362	.8002	.2476	-.3465	.7916	.5874
.6500	-.4659	.7739	.6161	.6003	-.0576	.8343	.5132	.8002	-.5024	-.3425	.7922	.5865
.7000	-.4376	.7781	.6094	.6500	.0149	.8430	.4963	.8002	-.7524	-.3240	.7949	.5820
.7500	-.3995	.7837	.6002	.7000	.1064	.8585	.4718					
.8002	-.3472	.7915	.5876	.7501	.1899	.8708	.4487					
.9002	-.1904	.8146	.5490	.8001	.2602	.8812	.4287					
.9501	-.0826	.8306	.5217	.8501	.3235	.8906	.4101					

TEST 167	PT	20.4459	PSI	CN	.4618	CD1	-.01012	CDCOR1	.00994
RUN 59	TT	175.0390	K	CM	-.1095	CD2	.01014	CDCOR2	.01001
POINT 33	RC	4.3930	MILLION	CC	.0107	CD3	.01013	CDCOR3	.01005
	MACH	.5007				CD4	.01020	CDCOR4	.01016
	ALPHA	.5081	DEG			CD5	.01010	CDCOR5	.00992

UPPER SURFACE				LOWER SURFACE				SPANWISE				
X/C	CP	P/L/PT	MLOC	X/C	CP	P/L/PT	MLOC	X/C	Y/(B/2)	CP	P/L/PT	MLOC
0.0000	1.0592	.9993	.0316	0.0000	1.0592	.9993	.0316	.1507	.7476	-.5692	.7592	.6397
.0132	-.6137	.7526	.6501	.0126	.4369	.9075	.3747	.1507	.4976	-.5866	.7566	.6438
.0259	-.8221	.7219	.6983	.0255	.2632	.8819	.4273	.1507	.2476	-.5863	.7567	.6437
.0759	-.7078	.7388	.6720	.0495	.1098	.8593	.4703	.1507	-.2524	-.5890	.7563	.6443
.1003	-.6424	.7484	.6568	.0753	-.0381	.8487	.4896	.1507	-.5024	-.5952	.7554	.6450
.1507	-.5837	.7567	.6437	.1002	-.0408	.8371	.5103	.1507	-.7524	-.5710	.7589	.6401
.2003	-.5437	.7630	.6337	.1503	-.1043	.8277	.5266	.5002	.7476	-.4695	.7739	.6162
.2503	-.5290	.7651	.6302	.1976	-.1747	.8174	.5444	.5002	.4976	-.4817	.7721	.6190
.3001	-.5206	.7664	.6283	.2503	-.2135	.8119	.5536	.5002	.2476	-.4885	.7711	.6207
.3502	-.4993	.7695	.6232	.3001	-.2364	.8083	.5597	.5002	-.2524	-.4852	.7716	.6199
.4003	-.4886	.7711	.6207	.3507	-.2488	.8084	.5628	.5002	-.5024	-.4811	.7722	.6189
.4501	-.4868	.7714	.6203	.4001	-.2498	.8069	.5621	.5002	-.7524	-.4701	.7738	.6163
.5002	-.4844	.7717	.6197	.4501	-.2329	.8088	.5589	.8002	.7476	-.3408	.7929	.5853
.5502	-.4844	.7717	.6197	.5001	-.1944	.8145	.5493	.8002	.4976	-.3494	.7916	.5874
.6002	-.4814	.7721	.6190	.5497	-.1296	.8246	.5320	.8002	.2476	-.3542	.7909	.5885
.6500	-.4795	.7724	.6185	.6003	-.0460	.8363	.5116	.8002	-.5024	-.3518	.7913	.5879
.7000	-.4492	.7769	.6113	.6500	.0241	.8467	.4933	.8002	-.7524	-.3326	.7941	.5833
.7500	-.4086	.7829	.6016	.7000	.1139	.8599	.4692					
.8002	-.3539	.7910	.5884	.7501	.1963	.8721	.4464					
.9002	-.1925	.8147	.5488	.8001	.2660	.8823	.4265					
.9501	-.0813	.8311	.5207	.8501	.3292	.8917	.4079					

TEST 167	PT	20.4462	PSI	CN	.5213	CD1	.01028	CDCOR1	.01003
RUN 59	TT	174.9963	K	CM	-.1119	CD2	.01032	CDCOR2	.01010
POINT 34	RC	4.3930	MILLION	CC	.0082	CD3	.01030	CDCOR3	.01003
	MACH	.5005				CD4	.01033	CDCOR4	.01005
	ALPHA	1.0081	DEG			CD5	.01032	CDCOR5	.01001

UPPER SURFACE				LOWER SURFACE				SPANWISE				
X/C	CP	P/L/PT	MLOC	X/C	CP	P/L/PT	MLOC	X/C	Y/(B/2)	CP	P/L/PT	MLOC
0.0000	1.0522	.9982	.0505	0.0000	1.0522	.9982	.0505	.1507	.7476	-.6215	.7504	.6536
.0132	-.7957	.7246	.6941	.0126	.5332	.9214	.3439	.1507	.4976	-.6366	.7482	.6572
.0259	-.9763	.6979	.7355	.0255	.3463	.8937	.4037	.1507	.2476	-.6367	.7481	.6572
.0759	-.7916	.7252	.6931	.0495	.1815	.8693	.4517	.1507	-.2524	-.6382	.7479	.6576
.1003	-.7097	.7373	.6742	.0753	.1018	.8575	.4736	.1507	-.5024	-.6444	.7470	.6590
.1507	-.6375	.7480	.6574	.1002	-.0157	.8447	.4967	.1507	-.7524	-.6190	.7508	.6590
.2003	-.5884	.7533	.6459	.1503	-.0959	.8341	.5135	.5002	.7476	-.4847	.7706	.6531
.2503	-.5641	.7589	.6402	.1976	-.1301	.8232	.5345	.5002	.4976	-.4976	.7687	.6214
.3001	-.5505	.7609	.6370	.2503	-.1712	.8171	.5449	.5002	.2476	-.5046	.7677	.6245
.3502	-.5313	.7638	.6324	.3001	-.1999	.8128	.5521	.5002	-.2524	-.4996	.7685	.6261
.4003	-.5145	.7662	.6285	.3507	-.2156	.8105	.5560	.5002	-.5024	-.4938	.7690	.6249
.4501	-.5088	.7671	.6271	.4001	-.2154	.8105	.5560	.5002	-.7524	-.4842	.7707	.6240
.5002	-.5040	.7678	.6260	.4501	-.2057	.8120	.5533	.8002	.7476	-.3400	.7921	.6213
.5502	-.5017	.7681	.6254	.5001	-.1697	.8173	.5445	.8002	.4976	-.3502	.7906	.5886
.6002	-.4967	.7689	.6242	.5497	-.1038	.8271	.5278	.8002	.2476	-.3565	.7896	.5901
.6500	-.4924	.7695	.6232	.6003	-.0268	.8385	.5079	.8002	-.5024	-.3513	.7904	.5896
.7000	-.4594	.7744	.6153	.6500	.0410	.8485	.4900	.8002	-.7524	-.3325	.7932	.5848
.7500	-.4165	.7808	.6051	.7000	.1296	.8616	.4661					
.8002	-.3591	.7893	.5912	.7501	.2106	.8736	.4435					
.9002	-.1927	.8139	.5503	.8001	.2798	.8838	.4235					
.9501	-.0830	.8301	.5224	.8501	.3430	.8932	.4047					

CRITICAL POINTS
OF POOR QUALITY

TEST 167	PT 20.4478	PSI	CN .5745	CD1 .01031	CDCDR1 .01006
RUN 59	TT 175.0490	K	CM -.1118	CD2 .01035	CDCDR2 .01013
POINT 35	RC 4.3928	MILLION	CC .0046	CD3 .01030	CDCDR3 .01015
	MACH .5006			CD4 .01034	CDCDR4 .01018
	ALPHA 1.5160	DEG		CD5 .01035	CDCDR5 .01006

UPPER SURFACE				LOWER SURFACE				SPANWISE				
X/C	CP	P _z L/PT	MLOC	X/C	CP	P _z L/PT	MLOC	X/C	Y/(B/2)	CP	P _z L/PT	MLOC
0.0000	1.0149	.9927	.1022	0.0000	1.0149	.9927	.1022	.1507	.7476	-.6766	.7427	.6657
.0132	-.9972	.6954	.7394	.0126	.6152	.9336	.3146	.1507	.4976	-.6933	.7403	.6696
.0259	-1.1454	.6735	.7731	.0255	.4195	.9047	.3807	.1507	.2476	-.6942	.7401	.6698
.0759	-.8833	.7122	.7134	.0495	.2433	.8787	.4336	.1507	-.2524	-.6962	.7398	.6703
.1003	-.7839	.7269	.6905	.0753	.1539	.8655	.4988	.1507	-.8024	-.7020	.7390	.6716
.1507	-.6946	.7401	.6699	.1002	.0642	.8522	.4833	.1507	-.7524	-.6795	.7429	.6655
.2003	-.6379	.7485	.6567	.1503	-.0157	.8404	.5044	.5002	.7476	-.5064	.7679	.6258
.2503	-.6043	.7534	.6488	.1976	-.0941	.8288	.5244	.5002	.4976	-.5199	.7659	.6290
.3001	-.5859	.7561	.6445	.2503	-.1401	.8220	.5364	.5002	.2476	-.5273	.7648	.6308
.3502	-.5617	.7597	.6389	.3001	-.1721	.8173	.5445	.5002	-.2524	-.5225	.7655	.6296
.4003	-.5417	.7627	.6342	.3507	-.1909	.8145	.5492	.5002	-.5024	-.5187	.7661	.6287
.4501	-.5335	.7639	.6322	.4001	-.1939	.8141	.5499	.5002	-.7524	-.5471	.7678	.6260
.5002	-.5259	.7650	.6304	.4501	-.1872	.8151	.5483	.8002	.7476	-.5489	.7912	.5881
.5502	-.5213	.7657	.6293	.5001	-.1846	.8199	.5401	.8002	.4976	-.5593	.7896	.5906
.6002	-.5138	.7668	.6276	.5497	-.0916	.8292	.5241	.8002	.2476	-.5651	.7888	.5920
.6500	-.5071	.7678	.6260	.6003	-.0175	.8402	.5049	.8002	-.5024	-.5603	.7895	.5909
.7000	-.4919	.7730	.6176	.6500	.0477	.8498	.4877	.8002	-.7524	-.5412	.7923	.5862
.7500	-.4266	.7797	.6058	.7000	.1341	.8626	.4643					
.8002	-.3672	.7885	.5925	.7501	.2136	.8743	.4425					
.9002	-.1967	.8137	.5506	.8001	.2817	.8844	.4225					
.9501	-.0849	.8302	.5223	.8501	.3445	.8937	.4038					

TEST 167	PT 20.4479	PSI	CN .6221	CD1 .01058	CDCDR1 .01036
RUN 59	TT 175.0812	K	CM -.1106	CD2 .01057	CDCDR2 .01049
POINT 36	RC 4.3875	MILLION	CC .0003	CD3 .01056	CDCDR3 .01044
	MACH .5001			CD4 .01055	CDCDR4 .01041
	ALPHA 2.0121	DEG		CD5 .01070	CDCDR5 .01044

UPPER SURFACE				LOWER SURFACE				SPANWISE				
X/C	CP	P _z L/PT	MLOC	X/C	CP	P _z L/PT	MLOC	X/C	Y/(B/2)	CP	P _z L/PT	MLOC
0.0000	.9669	.9858	.1432	0.0000	.9669	.9858	.1432	.1507	.7476	-.7330	.7358	.6766
.0132	-1.2007	.6670	.7830	.0126	.6878	.9447	.2861	.1507	.4976	-.7542	.7327	.6815
.0259	-1.3176	.6498	.8094	.0255	.4897	.9150	.3583	.1507	.2476	-.7549	.7326	.6817
.0759	-.9791	.6996	.7328	.0495	.2970	.8873	.4168	.1507	-.2524	-.7603	.7318	.6829
.1003	-.8616	.7169	.7061	.0753	.1986	.8728	.4450	.1507	-.5024	-.7659	.7310	.6842
.1507	-.7553	.7325	.6817	.1002	.1058	.8591	.4706	.1507	-.7524	-.7383	.7350	.6779
.2003	-.6730	.7443	.6632	.1503	.0186	.8463	.4939	.5002	.7476	-.5305	.7656	.6295
.2503	-.6472	.7494	.6568	.1976	-.0643	.8341	.5155	.5002	.4976	-.5446	.7635	.6328
.3001	-.6243	.7518	.6515	.2503	-.1152	.8266	.5285	.5002	.2476	-.5522	.7624	.6346
.3502	-.5885	.7570	.6431	.3001	-.1503	.8215	.5374	.5002	-.2524	-.5511	.7625	.6344
.4003	-.5681	.7600	.6384	.3507	-.1724	.8182	.5429	.5002	-.5024	-.5473	.7631	.6335
.4501	-.5581	.7615	.6360	.4001	-.1785	.8173	.5444	.5002	-.7524	-.5359	.7648	.6308
.5002	-.5472	.7631	.6335	.4501	-.1746	.8179	.5435	.8002	.7476	-.5359	.7907	.5888
.5502	-.5401	.7642	.6318	.5001	-.1452	.8222	.5361	.8002	.4976	-.5368	.7892	.5913
.6002	-.5302	.7656	.6295	.5497	-.0848	.8311	.5207	.8002	.2476	-.5373	.7883	.5927
.6500	-.5211	.7670	.6273	.6003	-.0131	.8417	.5022	.8002	-.5024	-.5376	.7883	.5927
.7000	-.4839	.7724	.6185	.6500	.0500	.8509	.4856	.8002	-.7524	-.5360	.7912	.5880
.7500	-.4361	.7795	.6072	.7000	.1348	.8634	.4627					
.8002	-.3742	.7885	.5924	.7501	.2133	.8750	.4409					
.9002	-.1995	.8142	.5497	.8001	.2809	.8849	.4215					
.9501	-.0837	.8313	.5205	.8501	.3438	.8941	.4028					

TEST 167	PT 20.4504	PSI	CN .6807	CD1 .01078	CDCDR1 .01045
RUN 59	TT 175.0809	K	CM -.1117	CD2 .01085	CDCDR2 .01054
POINT 37	RC 4.3577	MILLION	CC -.0048	CD3 .01074	CDCDR3 .01046
	MACH .5000			CD4 .01076	CDCDR4 .01053
	ALPHA 2.5219	DEG		CD5 .01090	CDCDR5 .01048

UPPER SURFACE				LOWER SURFACE				SPANWISE				
X/C	CP	P _z L/PT	MLOC	X/C	CP	P _z L/PT	MLOC	X/C	Y/(B/2)	CP	P _z L/PT	MLOC
0.0000	.9024	.9764	.1847	0.0000	.9024	.9764	.1847	.1507	.7476	-.7897	.7289	.6874
.0132	-1.4346	.6345	.8324	.0126	.7610	.9558	.2549	.1507	.4976	-.8094	.7260	.6920
.0259	-1.5060	.6241	.8490	.0255	.5545	.9255	.3341	.1507	.2476	-.8108	.7258	.6923
.0759	-1.0748	.6872	.7520	.0495	.3592	.8970	.3970	.1507	-.2524	-.8155	.7251	.6933
.1003	-.9362	.7074	.7207	.0753	.2544	.8816	.4279	.1507	-.5024	-.8204	.7244	.6944
.1507	-.8119	.7256	.6925	.1002	.1571	.8674	.4552	.1507	-.7524	-.7917	.7286	.6879
.2003	-.7279	.7379	.6733	.1333	.0627	.8536	.4808	.5002	.7476	-.5480	.7642	.6317
.2503	-.6852	.7441	.6635	.1976	-.0239	.8409	.5035	.5002	.4976	-.5627	.7621	.6351
.3001	-.6572	.7483	.6570	.2503	-.0791	.8328	.5177	.5002	.2476	-.5708	.7609	.6370
.3502	-.6194	.7538	.6483	.3001	-.1176	.8272	.5275	.5002	-.2524	-.5682	.7613	.6364
.4003	-.5948	.7574	.6426	.3507	-.1427	.8235	.5338	.5002	-.5024	-.5646	.7618	.6355
.4501	-.5816	.7593	.6395	.4001	-.1516	.8222	.5361	.5002	-.7524	-.5522	.7636	.6327
.5002	-.5676	.7614	.6363	.4501	-.1507	.8224	.5358	.8002	.7476	-.5636	.7912	.5880
.5502	-.5579	.7628	.6340	.5001	-.1241	.8262	.5292	.8002	.4976	-.5741	.7897	.5905
.6002	-.5459	.7645	.6312	.5497	-.0665	.8347	.5145	.8002	.2476	-.5798	.7888	.5919
.6500	-.5342	.7662	.6285	.6003	.0027	.8448	.4966	.8002	-.5024	-.5778	.7891	.5914
.7000	-.4944	.7721	.6191	.6500	.0634	.8537	.4806	.8002	-.7524	-.5582	.7920	.5867
.7500	-.4444	.7794	.6073	.7000	.1466	.8659	.4581					
.8002	-.3800	.7888	.5920	.7501	.2237	.8771	.4366					
.9002	-.2007	.8150	.5483	.8001	.2904	.8869	.4175					
.9501	-.0848	.8330	.5142	.8501	.3528	.8960	.3989					

TEST 167	PT 20.4498	PSI	CN .7318	CD1 .01120	CDCOR1 .01083
RUN 59	TT 175.0997	K	CM -.1112	CD2 .01135	CDCOR2 .01101
POINT 38	RC 4.3864	MILLION	CC -.0107	CD3 .01122	CDCOR3 .01095
	MACH .4999			CD4 .01122	CDCOR4 .01093
	ALPHA 3.0141	DEG		CD5 .01139	CDCOR5 .01107

UPPER SURFACE				LOWER SURFACE				SPANWISE				
X/C	CP	P _L /PT	MLOC	X/C	CP	P _L /PT	MLOC	X/C	Y/(B/2)	CP	P _L /PT	MLOC
0.0000	.8189	.9638	.2301	0.0000	.8189	.9638	.2301	.1507	.7476	-.8436	.7182	.7041
.0132	-1.6645	.5969	.8911	.0126	.8204	.9640	.2293	.1507	.4976	-.2634	.7152	.7087
.0259	-1.7002	.5916	.8994	.0255	.6144	.9336	.3148	.1507	.2476	-.8653	.7150	.7091
.0759	-1.1715	.6697	.7788	.0495	.4131	.9038	.3827	.1507	.2524	-.8691	.7144	.7100
.1003	-1.0105	.6935	.7423	.0733	.3026	.8875	.4163	.1507	-.5024	-.8725	.7139	.7107
.1507	-.8654	.7149	.7091	.1002	.2024	.8727	.4452	.1507	-.7524	-.8425	.7103	.7039
.2003	-.7621	.7302	.6854	.1503	.1017	.8578	.4731	.5002	.7476	-.5646	.7594	.6394
.2503	-.7209	.7363	.6759	.1976	.0122	.8446	.4970	.5002	.4976	-.5799	.7571	.6430
.3001	-.6874	.7412	.6681	.2503	-.0466	.8359	.5124	.5002	.2476	-.5878	.7559	.6449
.3502	-.6476	.7471	.6588	.3001	-.0882	.8298	.5231	.5002	-.2524	-.5852	.7563	.6442
.4003	-.6181	.7515	.6520	.3507	-.1160	.8256	.5302	.5002	-.5024	-.5816	.7569	.6434
.4501	-.6012	.7540	.6480	.4001	-.1275	.8240	.5331	.5002	-.7524	-.5692	.7587	.6405
.5002	-.5845	.7564	.6441	.4501	-.1294	.8237	.5336	.8002	.7476	-.3666	.7886	.5923
.5502	-.5723	.7582	.6412	.5001	-.1055	.8272	.5275	.8002	.4976	-.3766	.7871	.5947
.6002	-.5581	.7603	.6379	.5497	-.0508	.8353	.5135	.8002	.2476	-.3827	.7862	.5962
.6500	-.5438	.7625	.6345	.6003	.0154	.8451	.4961	.8002	-.5024	-.3808	.7865	.5957
.7000	-.5014	.7687	.6245	.6500	.0737	.8537	.4806	.8002	-.7524	-.3617	.7894	.5911
.7500	-.4490	.7764	.6120	.7000	.1549	.8657	.4585					
.8002	-.3822	.7863	.5960	.7501	.2302	.8768	.4373					
.9002	-.1986	.8134	.5510	.8001	.2957	.8865	.4183					
.9501	-.0840	.8304	.5220	.8501	.3574	.8956	.3999					

TEST 167	PT 20.4710	PSI	CN .7928	CD1 .01145	CDCOR1 .01111
RUN 59	TT 175.0716	K	CM -.1111	CD2 .01166	CDCOR2 .01137
POINT 39	RC 4.3943	MILLION	CC -.0183	CD3 .01154	CDCOR3 .01126
	MACH .5003			CD4 .01197	CDCOR4 .01127
	ALPHA 3.5538	DEG		CD5 .01172	CDCOR5 .01132

UPPER SURFACE				LOWER SURFACE				SPANWISE				
X/C	CP	P _L /PT	MLOC	X/C	CP	P _L /PT	MLOC	X/C	Y/(B/2)	CP	P _L /PT	MLOC
0.0000	.7135	.9481	.2769	0.0000	.7135	.9481	.2769	.1507	.7476	-.9062	.7087	.7188
.0132	-1.9524	.5535	.9594	.0126	.8780	.9724	.2001	.1507	.4976	-.9247	.7096	.7235
.0259	-1.9333	.5563	.9549	.0255	.6768	.9427	.2915	.1507	.2476	-.9275	.7092	.7242
.0759	-1.2827	.6526	.8050	.0495	.4728	.9125	.3640	.1507	-.2524	-.9306	.7048	.7258
.1003	-1.0954	.6804	.7625	.0733	.3562	.8952	.4004	.1507	-.5024	-.9348	.7041	.7259
.1507	-.9275	.7052	.7242	.1002	.2533	.8800	.4311	.1507	-.7524	-.9026	.7089	.7185
.2003	-.8185	.7213	.6992	.1503	.1463	.8641	.4613	.5002	.7476	-.5838	.7561	.6447
.2503	-.7627	.7296	.6863	.1976	.0532	.8504	.4866	.5002	.4976	-.5999	.7537	.6484
.3001	-.7234	.7354	.6772	.2503	-.0100	.8410	.5034	.5002	.2476	-.6082	.7525	.6504
.3502	-.6778	.7422	.6666	.3001	-.0547	.8344	.5150	.5002	-.2524	-.6044	.7530	.6495
.4003	-.6449	.7470	.6590	.3507	-.0855	.8298	.5230	.5002	-.5024	-.6006	.7536	.6486
.4501	-.6254	.7499	.6544	.4001	-.1000	.8277	.5267	.5002	-.7524	-.5877	.7535	.6456
.5002	-.6050	.7529	.6496	.4501	-.1051	.8269	.5280	.8002	.7476	-.3712	.7875	.5940
.5502	-.5899	.7552	.6461	.5001	-.0842	.8300	.5226	.8002	.4976	-.3812	.7861	.5946
.6002	-.5730	.7577	.6421	.5497	-.0325	.8377	.5092	.8002	.2476	-.3862	.7853	.5976
.6500	-.5557	.7602	.6380	.6003	.0310	.8471	.4926	.8002	-.5024	-.3832	.7858	.5969
.7000	-.5107	.7669	.6274	.6500	.0868	.8553	.4776	.8002	-.7524	-.3646	.7883	.5924
.7500	-.4554	.7751	.6143	.7000	.1660	.8671	.4559					
.8002	-.3857	.7854	.5975	.7501	.2398	.8780	.4350					
.9002	-.1977	.8132	.5514	.8001	.3042	.8875	.4163					
.9501	-.0820	.8303	.5221	.8501	.3652	.8965	.3979					

TEST 167	PT 26.2337	PSI	CM	-0.0094	CD1	.00936	CDCOR1	.00913
RUN 67	TT 149.7566	K	CM	-1.036	CD2	.00929	CDCOR2	.00909
POINT 58	RC 7.0280	MILLION	CC	.0034	CD3	.00919	CDCOR3	.00902
	MACH .5008	DEG			CD4	.00930	CDCOR4	.00912
	ALPHA -3.9815				CD5	.00926	CDCOR5	.00915

UPPER SURFACE				LOWER SURFACE				SPANWISE				
X/C	CP	P/L/PT	MLOC	X/C	CP	P/L/PT	MLOC	X/C	Y/(B/2)	CP	P/L/PT	MLOC
0.0000	.4928	.9157	.3569	0.0000	.4928	.9157	.3569	.1507	.7476	-.1232	.8247	.5319
.0132	.5911	.9243	.3372	.0126	-.8261	.7239	.4954	.1507	.4976	-.1337	.8232	.5346
.0259	.2431	.8788	.4335	.0235	-.6900	.7410	.6688	.1507	.2476	-.1323	.8234	.5343
.0759	-.0484	.8358	.5128	.0495	-.5947	.7551	.4464	.1507	-.2524	-.1299	.8237	.5336
.1003	-.0811	.8309	.5212	.0793	-.5671	.7592	.6399	.1507	-.5024	-.1377	.8226	.5356
.1507	-.1362	.8228	.5352	.1002	-.5636	.7597	.6391	.1507	-.7524	-.1411	.8214	.5342
.2003	-.1778	.8166	.5457	.1503	-.5193	.7662	.6288	.5002	.7476	-.1481	.8181	.5318
.2503	-.1975	.8137	.5506	.1976	-.5358	.7638	.6325	.5002	.4976	-.1572	.8161	.5271
.3001	-.2262	.8095	.5578	.2503	-.5191	.7663	.6296	.5002	.2476	-.1667	.7991	.5252
.3502	-.2414	.8073	.5616	.3001	-.5055	.7683	.6254	.5002	-.2524	-.1767	.7903	.5212
.4003	-.2551	.8052	.5649	.3507	-.4845	.7714	.6204	.5002	-.5024	-.1857	.8021	.5201
.4501	-.2754	.8022	.5699	.4001	-.4480	.7788	.6117	.5002	-.7524	-.1952	.8007	.5174
.5002	-.2961	.7992	.5750	.4501	-.4084	.7826	.6022	.5002	.7476	-.2047	.8014	.5172
.5502	-.3154	.7963	.5797	.5001	-.3833	.7930	.5953	.8002	.4976	-.2143	.8014	.5171
.6002	-.3323	.7938	.5838	.5497	-.2430	.8070	.5820	.8002	-.5024	-.2243	.8014	.5171
.6500	-.3437	.7922	.5866	.6003	-.1399	.8223	.5662	.8002	.2476	-.2343	.8014	.5171
.7000	-.3375	.7931	.5851	.6500	-.0513	.8393	.5535	.8002	-.7524	-.2443	.8014	.5171
.7500	-.3181	.7959	.5804	.7000	.0563	.8592	.4952	.8002	-.5024	-.2543	.8014	.5171
.8002	-.2808	.8014	.5713	.7501	.1494	.8850	.4599	.8002	-.7524	-.2643	.8014	.5171
.9002	-.1644	.8186	.5424	.8001	.2253	.9162	.4386	.8002	-.5024	-.2743	.8014	.5171
.9501	-.0722	.8322	.5189	.8501	.2894	.9596	.4201					

TEST 167	PT 26.2314	PSI	CM	.0958	CD1	.00918	CDCOR1	.00897
RUN 67	TT 149.7725	K	CM	-1.065	CD2	.00908	CDCOR2	.00890
POINT 59	RC 7.0271	MILLION	CC	.0102	CD3	.00901	CDCOR3	.00893
	MACH .5008	DEG			CD4	.00912	CDCOR4	.00892
	ALPHA -3.0141				CD5	.00916	CDCOR5	.00899

UPPER SURFACE				LOWER SURFACE				SPANWISE				
X/C	CP	P/L/PT	MLOC	X/C	CP	P/L/PT	MLOC	X/C	Y/(B/2)	CP	P/L/PT	MLOC
0.0000	.7388	.9520	.2661	0.0000	.7388	.9520	.2661	.1507	.7476	-.2150	.8111	.5551
.0132	.3648	.8967	.3976	.0126	-.4710	.7733	.6173	.1507	.4976	-.2260	.8094	.5580
.0259	.0554	.8510	.4855	.0255	-.4476	.7788	.6117	.1507	.2476	-.2256	.8095	.5577
.0759	-.1790	.8164	.5461	.0495	-.4239	.7803	.6040	.1507	-.2524	-.2247	.8097	.5575
.1003	-.1940	.8142	.5498	.0793	-.4219	.7806	.6035	.1507	-.5024	-.2318	.8086	.5592
.1507	-.2298	.8089	.5588	.1002	-.4416	.7777	.6103	.1507	-.7524	-.2333	.8099	.5571
.2003	-.2546	.8053	.5649	.1503	-.4237	.7803	.6080	.5002	.7476	-.2370	.7946	.5626
.2503	-.2682	.8033	.5682	.1976	-.4537	.7759	.6131	.5002	.4976	-.2464	.7932	.5644
.3001	-.2900	.8000	.5736	.2503	-.4500	.7764	.6123	.5002	.2476	-.2512	.7925	.5661
.3502	-.2994	.7987	.5759	.3001	-.4454	.7771	.6122	.5002	-.2524	-.2539	.7936	.5643
.4003	-.3079	.7974	.5780	.3507	-.4328	.7790	.6081	.5002	-.5024	-.2539	.7940	.5636
.4501	-.3240	.7950	.5819	.4001	-.4034	.7833	.6011	.5002	.7476	-.2612	.7954	.5612
.5002	-.3402	.7926	.5858	.4501	-.3708	.7881	.5933	.5002	.4976	-.2681	.7968	.5576
.5502	-.3558	.7903	.5896	.5001	-.3076	.7974	.5779	.8002	.2476	-.2767	.7982	.5562
.6002	-.3690	.7884	.5928	.5497	-.2183	.8106	.5559	.8002	-.5024	-.2832	.7996	.5544
.6500	-.3767	.7872	.5947	.6003	-.1204	.8251	.5313	.8002	-.7524	-.2932	.8017	.5508
.7000	-.3665	.7867	.5922	.6500	-.0367	.8374	.5098					
.7500	-.3431	.7922	.5855	.7000	.0680	.8529	.4821					
.8002	-.3015	.7983	.5764	.7501	.1595	.8664	.4572					
.9002	-.1766	.8168	.5455	.8001	.2352	.8776	.4359					
.9501	-.0803	.8310	.5210	.8501	.3005	.8877	.4169					

TEST 167	PT 26.2364	PSI	CM	.2119	CD1	.00908	CDCOR1	.00890
RUN 67	TT 149.7805	K	CM	-1.100	CD2	.00901	CDCOR2	.00882
POINT 60	RC 7.0273	MILLION	CC	.0143	CD3	.00898	CDCOR3	.00881
	MACH .5008	DEG			CD4	.00903	CDCOR4	.00883
	ALPHA -1.9958				CD5	.00901	CDCOR5	.00881

UPPER SURFACE				LOWER SURFACE				SPANWISE				
X/C	CP	P/L/PT	MLOC	X/C	CP	P/L/PT	MLOC	X/C	Y/(B/2)	CP	P/L/PT	MLOC
0.0000	.9314	.9804	.1685	0.0000	.9314	.9804	.1685	.1507	.7476	-.3134	.7963	.5798
.0132	.1250	.8611	.4671	.0126	-.1440	.8210	.5382	.1507	.4976	-.3243	.7947	.5825
.0259	-.1680	.8178	.5438	.0255	-.2049	.8123	.5530	.1507	.2476	-.3239	.7947	.5824
.0759	-.3244	.7647	.5825	.0495	-.2447	.8065	.5629	.1507	-.2524	-.3236	.7948	.5823
.1003	-.3172	.7657	.5807	.0793	-.2473	.8031	.5685	.1507	-.5024	-.3304	.7938	.5840
.1507	-.3291	.7640	.5836	.1002	-.3091	.7969	.5788	.1507	-.7524	-.3200	.7953	.5814
.2003	-.3380	.7627	.5858	.1503	-.3169	.7958	.5807	.5002	.7476	-.3284	.7882	.5932
.2503	-.3408	.7622	.5863	.1976	-.3402	.7894	.5912	.5002	.4976	-.3378	.7868	.5954
.3001	-.3547	.7602	.5899	.2503	-.3496	.7880	.5935	.5002	.2476	-.3472	.7860	.5966
.3502	-.3577	.7607	.5906	.3001	-.3744	.7873	.5946	.5002	-.2524	-.3578	.7872	.5947
.4003	-.3598	.7604	.5911	.3507	-.3698	.7879	.5935	.5002	-.5024	-.3678	.7876	.5940
.4501	-.3711	.7578	.5938	.4001	-.3481	.7912	.5883	.5002	.7476	-.3620	.7891	.5916
.5002	-.3827	.7560	.5966	.4501	-.3229	.7949	.5821	.8002	.4976	-.3725	.7904	.5796
.5502	-.3939	.7544	.5993	.5001	-.2664	.8032	.5683	.8002	.2476	-.3818	.7919	.5784
.6002	-.4029	.7531	.6015	.5497	-.1834	.8195	.5477	.8002	-.5024	-.3911	.7936	.5809
.6500	-.4066	.7525	.6024	.6003	-.0912	.8292	.5243	.8002	.2476	-.4001	.7971	.5784
.7000	-.3919	.7547	.5988	.6500	-.0124	.8408	.5039	.8002	-.7524	-.4093	.7994	.5746
.7500	-.3638	.7688	.5921	.7000	.0892	.8558	.4788					
.8002	-.3176	.7937	.5808	.7501	.1787	.8691	.4572					
.9002	-.1931	.8156	.5476	.8001	.2540	.8882	.4388					
.9501	-.0829	.8304	.5221	.8501	.3200	.8900	.4114					

ORIGINAL PAGE IS
OF POOR QUALITY

TFST 167	PT 26.2321	PSI	CM	.2029	CD1 .00914	CDCOR1 .00891
RUN A7	TT 149.7597	K	CM	-.1104	CD2 .00907	CDCOR2 .00887
POINT A1	RC 7.0274	MILLION	CC	.0151	CD3 .00902	CDCOR3 .00880
	NACH .5008				CD4 .00911	CDCOR4 .00890
	ALPMA -1.4969	DEG			CD5 .00909	CDCOR5 .00882

UPPER SURFACE				LOWER SURFACE				SPANWISE				
X/C	CP	P/L/PT	MLOC	X/C	CP	P/L/PT	MLOC	X/C	Y/(B/2)	CP	P/L/PT	MLOC
0.0000	.9920	.9893	.1240	0.0000	.9920	.9893	.1240	.1507	.7476	-.3867	.7885	.5927
.0132	-.0064	.8415	.5926	.0126	-.0093	.8411	.5934	.1507	.4976	-.3779	.7865	.5958
.0259	-.2909	.7994	.5747	.0259	-.0994	.8277	.5247	.1507	.2476	-.3778	.7865	.5984
.0739	-.4030	.7628	.6019	.0495	-.1705	.8172	.5448	.1507	-.2524	-.3802	.7862	.5984
.1003	-.3838	.7896	.5973	.0753	-.2040	.8123	.5531	.1507	-.5024	-.3886	.7852	.5980
.1507	-.3829	.7858	.5971	.1002	-.2540	.8049	.5656	.1507	-.7524	-.3743	.7870	.5950
.2003	-.3696	.7877	.5938	.1503	-.2738	.8019	.5705	.9002	.7476	-.3913	.7845	.5991
.2503	-.3805	.7861	.5965	.1976	-.3233	.7946	.5824	.9002	.4976	-.4016	.7830	.6016
.3001	-.3905	.7846	.5989	.2503	-.3389	.7923	.5864	.9002	.2476	-.4088	.7822	.6028
.3502	-.3886	.7849	.5984	.3001	-.3479	.7909	.5884	.9001	-.2524	-.4016	.7830	.6016
.4003	-.3877	.7851	.5982	.3507	-.3471	.7911	.5884	.9002	-.5024	-.3988	.7834	.6009
.4501	-.3969	.7837	.6004	.4001	-.3291	.7937	.5840	.9002	-.7524	-.3993	.7848	.5986
.5002	-.4059	.7824	.6026	.4501	-.3070	.7970	.5786	.8002	.7476	-.3204	.7950	.5819
.5502	-.4149	.7810	.6048	.5001	-.2541	.8048	.5656	.8002	.4976	-.3255	.7943	.5831
.6002	-.4219	.7800	.6064	.5497	-.1739	.8147	.5456	.8002	.2476	-.3287	.7938	.5839
.6500	-.4235	.7798	.6068	.6003	-.0843	.8306	.5238	.8002	-.5024	-.3219	.7948	.5823
.7000	-.4065	.7823	.6027	.6500	-.0078	.8413	.5030	.8002	-.7524	-.3063	.7971	.5784
.7500	-.3761	.7868	.5954	.7000	.0923	.8561	.4743					
.8002	-.3275	.7940	.5836	.7501	.1807	.8692	.4519					
.9002	-.1884	.8146	.5492	.8001	.2559	.8803	.4306					
.9501	-.0856	.8298	.5232	.8501	.3216	.8901	.4112					

TEST 167	PT 26.2332	PSI	CM	.3167	CD1 .00914	CDCOR1 .00892
RUN 67	TT 149.7630	K	CM	-.1111	CD2 .00909	CDCOR2 .00889
POINT 62	RC 7.0283	MILLION	CC	.0151	CD3 .00901	CDCOR3 .00885
	NACH .5009				CD4 .00912	CDCOR4 .00894
	ALPMA -1.0082	DEG			CD5 .00906	CDCOR5 .00886

UPPER SURFACE				LOWER SURFACE				SPANWISE				
X/C	CP	P/L/PT	MLOC	X/C	CP	P/L/PT	MLOC	X/C	Y/(B/2)	CP	P/L/PT	MLOC
0.0000	1.0326	.9953	.0820	0.0000	1.0326	.9953	.0820	.1507	.7476	-.4124	.7814	.6042
.0132	-.1426	.8213	.5374	.0126	-.1202	.8602	.4687	.1507	.4976	-.4266	.7793	.6076
.0259	-.4131	.7813	.6044	.0259	-.0022	.8627	.5004	.1507	.2476	-.4268	.7792	.6077
.0739	-.4779	.7717	.6199	.0495	-.0943	.8285	.5255	.1507	-.2524	-.4298	.7788	.6084
.1003	-.4462	.7764	.6123	.0753	-.1380	.8223	.5361	.1507	-.5024	-.4355	.7779	.6109
.1507	-.4321	.7784	.6090	.1002	-.1941	.8137	.5507	.1507	-.7524	-.4216	.7800	.6064
.2003	-.4170	.7807	.6053	.1503	-.2298	.8091	.5584	.9002	.7476	-.4105	.7816	.6038
.2503	-.4156	.7808	.6050	.1976	-.2798	.8010	.5720	.9002	.4976	-.4206	.7801	.6062
.3001	-.4214	.7800	.6064	.2503	-.3110	.7978	.5772	.9002	.2476	-.4260	.7794	.6075
.3502	-.4168	.7810	.6048	.3001	-.3146	.7959	.5804	.9002	-.2524	-.4204	.7802	.6062
.4003	-.4111	.7816	.6039	.3507	-.3170	.7955	.5811	.9002	-.5024	-.4176	.7806	.6055
.4501	-.4178	.7804	.6055	.4001	-.3023	.7977	.5775	.9002	-.7524	-.4080	.7820	.6032
.5002	-.4244	.7794	.6071	.4501	-.2836	.8004	.5729	.8002	.7476	-.3271	.7940	.5836
.5502	-.4312	.7786	.6087	.5001	-.2340	.8078	.5607	.8002	.4976	-.3320	.7933	.5848
.6002	-.4359	.7779	.6098	.5497	-.1970	.8192	.5414	.8002	.2476	-.3350	.7928	.5855
.6500	-.4356	.7779	.6098	.6003	-.0702	.8320	.5193	.8002	-.5024	-.3288	.7939	.5839
.7000	-.4168	.7808	.6052	.6500	.0034	.8429	.5001	.8002	-.7524	-.3119	.7963	.5799
.7500	-.3839	.7856	.5974	.7000	.1015	.8574	.4738					
.8002	-.3332	.7931	.5851	.7501	.1884	.8703	.4498					
.9002	-.1400	.8143	.5497	.8001	.2624	.8813	.4287					
.9501	-.0851	.8298	.5231	.8501	.3283	.8910	.4092					

TEST 167	PT 26.2339	PSI	CM	.3712	CD1 .00916	CDCOR1 .00892
RUN 67	TT 149.7679	K	CM	-.1120	CD2 .00911	CDCOR2 .00889
POINT 63	RC 7.0243	MILLION	CC	.0143	CD3 .00907	CDCOR3 .00894
	NACH .5007				CD4 .00916	CDCOR4 .00899
	ALPMA -1.4980	DEG			CD5 .00911	CDCOR5 .00890

UPPER SURFACE				LOWER SURFACE				SPANWISE				
X/C	CP	P/L/PT	MLOC	X/C	CP	P/L/PT	MLOC	X/C	Y/(B/2)	CP	P/L/PT	MLOC
0.0000	1.0349	.9987	.0439	0.0000	1.0349	.9987	.0439	.1507	.7476	-.4479	.7740	.6162
.0132	-.3813	.7985	.5761	.0126	-.2387	.8702	.4346	.1507	.4976	-.4634	.7717	.6199
.0259	-.5905	.7618	.6358	.0259	-.0964	.8372	.4742	.1507	.2476	-.4631	.7717	.6198
.0739	-.5622	.7600	.6389	.0495	-.0317	.8383	.5082	.1507	-.2524	-.4682	.7713	.6206
.1003	-.5169	.7667	.6274	.0753	-.0677	.8330	.5175	.1507	-.5024	-.4910	.7705	.6217
.1507	-.4896	.7709	.6211	.1002	-.1399	.8224	.5360	.1507	-.7524	-.4759	.7728	.6181
.2003	-.4646	.7744	.6154	.1503	-.1816	.8162	.5465	.9002	.7476	-.4341	.7789	.6082
.2503	-.4568	.7756	.6136	.1976	-.2421	.8073	.5615	.9002	.4976	-.4450	.7773	.6108
.3001	-.4583	.7754	.6139	.2503	-.2691	.8033	.5682	.9002	.2476	-.4506	.7765	.6121
.3502	-.4462	.7772	.6110	.3001	-.2862	.8008	.5724	.9002	-.2524	-.4453	.7773	.6104
.4003	-.4400	.7741	.6094	.3507	-.2926	.7998	.5740	.9002	-.5024	-.4426	.7777	.6102
.4501	-.4443	.7774	.6106	.4001	-.2814	.8015	.5712	.9002	-.7524	-.4320	.7791	.6079
.5002	-.4482	.7760	.6115	.4501	-.2461	.8037	.5675	.8002	.7476	-.3363	.7934	.5846
.5502	-.4528	.7762	.6126	.5001	-.2200	.8105	.5563	.8002	.4976	-.3424	.7925	.5861
.6002	-.4553	.7758	.6132	.5497	-.1458	.8215	.5375	.8002	.2476	-.3462	.7919	.5870
.6500	-.4528	.7762	.6126	.6003	-.0616	.8339	.5160	.8002	-.5024	-.3397	.7929	.5854
.7000	-.4315	.7793	.6075	.6500	.0097	.8444	.4974	.8002	-.7524	-.3230	.7953	.5814
.7500	-.3967	.7845	.5992	.7000	.1062	.8597	.4716					
.8002	-.3437	.7923	.5864	.7501	.1920	.8713	.4479					
.9002	-.1461	.8141	.5501	.8001	.2654	.8822	.4269					
.9501	-.0859	.8299	.5230	.8501	.3314	.8919	.4075					

TEST 167	PT 26.2318	PSI	CN .4276	CD1 .00923	CDCOR1 .00903
RUN 67	TT 149.7787	K	CM -.1130	CD2 .00919	CDCOR2 .00900
POINT 64	RC 7.0261	MILLION	CC .0127	CD3 .00913	CDCOR3 .00898
	MACH .5009			CD4 .00922	CDCOR4 .00905
	ALPHA .0102	DEG		CD5 .00918	CDCOR5 .00889

UPPER SURFACE				LOWER SURFACE				SPANWISE				
X/C	CP	P/L/P/T	MLOC	X/C	CP	P/L/P/T	MLOC	X/C	Y/(B/2)	CP	P/L/P/T	MLOC
0.0000	1.0826	.9999	.0179	0.0000	1.0826	.9999	.0179	.1507	.7476	-.5191	.7661	.8288
.0132	-.4866	.7742	.6159	.0126	.4541	.8951	.4009	.1507	.4976	-.5350	.7638	.8326
.0259	-.5939	.7403	.6697	.0255	-.1906	.8710	.4486	.1507	.2476	-.5357	.7637	.8327
.0759	-.6856	.7474	.6585	.0495	-.0441	.8493	.4886	.1507	-.2524	-.5385	.7632	.8334
.1003	-.5857	.7563	.6444	.0753	-.0023	.8425	.5009	.1507	-.5024	-.5434	.7625	.8345
.1507	-.5414	.7628	.6341	.1002	-.0819	.8307	.5216	.1507	-.7524	-.5274	.7649	.8308
.2003	-.5082	.7677	.6262	.1503	-.1334	.8231	.5347	.5002	.7476	-.4933	.7758	.8132
.2503	-.4938	.7699	.6228	.1976	-.1990	.8134	.5512	.5002	.4976	-.4843	.7742	.8159
.3001	-.4906	.7703	.6221	.2503	-.2310	.8087	.5592	.5002	.2476	-.4702	.7733	.8172
.3502	-.4754	.7726	.6185	.3001	-.2522	.8055	.5644	.5002	-.2524	-.4645	.7742	.8158
.4003	-.4654	.7740	.6161	.3507	-.2622	.8041	.5669	.5002	-.5024	-.4617	.7746	.8152
.4501	-.4668	.7738	.6164	.4001	-.2542	.8033	.5649	.5002	.7524	-.4518	.7761	.8128
.5002	-.4680	.7737	.6167	.4501	-.2422	.8070	.5620	.8002	.7476	-.3420	.7923	.5864
.5502	-.4703	.7733	.6172	.5001	-.1991	.8134	.5512	.8002	.4976	-.3476	.7914	.5878
.6002	-.4708	.7733	.6173	.5497	-.1279	.8239	.5333	.8002	.2476	-.3517	.7918	.5872
.6500	-.4658	.7740	.6162	.6003	-.0463	.8359	.5124	.8002	-.5024	-.3451	.7918	.5872
.7000	-.4422	.7775	.6105	.6500	.0222	.8461	.4944	.8002	-.7524	-.3279	.7944	.5830
.7500	-.4049	.7830	.6016	.7000	.1170	.8601	.4690					
.8002	-.3495	.7912	.5882	.7501	.2014	.8725	.4456					
.8502	-.1971	.8137	.5507	.8001	.2740	.8833	.4248					
.9501	-.0883	.8298	.5232	.8501	.3399	.8930	.4052					

TEST 167	PT 26.2343	PSI	CN .4793	CD1 .00925	CDCOR1 .00899
RUN 67	TT 149.7883	K	CM -.1137	CD2 .00924	CDCOR2 .00902
POINT 65	RC 7.0272	MILLION	CC .0107	CD3 .00920	CDCOR3 .00907
	MACH .5009			CD4 .00928	CDCOR4 .00911
	ALPHA .4990	DEG		CD5 .00919	CDCOR5 .00888

UPPER SURFACE				LOWER SURFACE				SPANWISE				
X/C	CP	P/L/P/T	MLOC	X/C	CP	P/L/P/T	MLOC	X/C	Y/(B/2)	CP	P/L/P/T	MLOC
0.0000	1.0609	.9995	.0282	0.0000	1.0609	.9995	.0282	.1507	.7476	-.5681	.7587	.8406
.0132	-.6797	.7496	.6550	.0126	.4494	.9091	.3713	.1507	.4976	-.5852	.7582	.8446
.0259	-.8350	.7193	.7025	.0255	-.2723	.8830	.4254	.1507	.2476	-.5858	.7561	.8448
.0759	-.7252	.7355	.6772	.0495	-.1124	.8593	.4704	.1507	-.2524	-.5899	.7557	.8455
.1003	-.6504	.7466	.6599	.0753	.0543	.8507	.4801	.1507	-.5024	-.5930	.7550	.8465
.1507	-.5919	.7552	.6462	.1002	-.0298	.8383	.5083	.1507	-.7524	-.5754	.7576	.8424
.2003	-.5509	.7613	.6365	.1503	-.0900	.8294	.5238	.5002	.7476	-.4688	.7734	.8171
.2503	-.5288	.7645	.6313	.1976	-.1601	.8190	.5417	.5002	.4976	-.4617	.7719	.8207
.3001	-.5210	.7657	.6296	.2503	-.1949	.8136	.5509	.8002	.2476	-.4683	.7705	.8217
.3502	-.5029	.7684	.6252	.3001	-.2220	.8099	.5571	.5002	-.2524	-.4627	.7714	.8204
.4003	-.4894	.7704	.6270	.3507	-.2342	.8081	.5602	.5002	-.5024	-.4696	.7718	.8197
.4501	-.4882	.7705	.6217	.4001	-.2297	.8087	.5591	.5002	.7524	-.4699	.7732	.8174
.5002	-.4867	.7708	.6214	.4501	-.2206	.8101	.5568	.8002	.7476	-.3422	.7920	.5869
.5502	-.4865	.7708	.6213	.5001	-.1810	.8159	.5469	.8002	.4976	-.3420	.7907	.5890
.6002	-.4850	.7710	.6210	.5497	-.1125	.8261	.5266	.8002	.2476	-.3569	.7899	.5902
.6500	-.4790	.7720	.6193	.6003	-.0338	.8377	.5093	.8002	-.5024	-.3500	.7910	.5886
.7000	-.4522	.7759	.6131	.6500	.0326	.8475	.4919					
.7500	-.4128	.7817	.6037	.7000	.1255	.8612	.4668					
.8002	-.3552	.7902	.5898	.7501	.2085	.8735	.4437					
.8502	-.1991	.8133	.5514	.8001	.2803	.8841	.4231					
.9501	-.0885	.8298	.5234	.8501	.3457	.8938	.4036					

TEST 167	PT 26.2361	PSI	CN .5376	CD1 .00946	CDCOR1 .00921
RUN 67	TT 149.7772	K	CM -.1148	CD2 .00949	CDCOR2 .00927
POINT 66	RC 7.0280	MILLION	CC .0079	CD3 .00940	CDCOR3 .00928
	MACH .5009			CD4 .00932	CDCOR4 .00935
	ALPHA 1.0091	DEG		CD5 .00946	CDCOR5 .00911

UPPER SURFACE				LOWER SURFACE				SPANWISE				
X/C	CP	P/L/P/T	MLOC	X/C	CP	P/L/P/T	MLOC	X/C	Y/(B/2)	CP	P/L/P/T	MLOC
0.0000	1.0443	.9971	.0648	0.0000	1.0443	.9971	.0648	.1507	.7476	-.6285	.7497	.8549
.0132	-.8244	.7208	.7022	.0126	.5457	.9233	.3394	.1507	.4976	-.6446	.7474	.8586
.0259	-.9109	.6945	.7408	.0255	-.3352	.8952	.4009	.1507	.2476	-.6455	.7472	.8588
.0759	-.8199	.7214	.6992	.0495	-.1914	.8695	.4514	.1507	-.2524	-.6498	.7467	.8596
.1003	-.7274	.7351	.6778	.0753	.1131	.8594	.4703	.1507	-.5024	-.6523	.7462	.8604
.1507	-.6517	.7463	.6603	.1002	-.0222	.8461	.4944	.1507	-.7524	-.6341	.7489	.8562
.2003	-.5946	.7549	.6469	.1503	-.0459	.8390	.5125	.5002	.7476	-.4942	.7606	.8232
.2503	-.5713	.7582	.6414	.1976	-.1206	.8240	.5317	.5002	.4976	-.4900	.7608	.8240
.3001	-.5587	.7601	.6385	.2503	-.1623	.8187	.5423	.5002	.2476	-.4813	.7609	.8275
.3502	-.5369	.7633	.6333	.3001	-.1913	.8144	.5466	.5002	-.2524	-.4803	.7608	.8261
.4003	-.5199	.7659	.6292	.3507	-.2069	.8121	.5535	.5002	-.5024	-.4836	.7602	.8255
.4501	-.5153	.7665	.6282	.4001	-.2059	.8131	.5531	.5002	.7524	-.4835	.7607	.8231
.5002	-.5111	.7671	.6272	.4501	-.1966	.8131	.5516	.8002	.7476	-.3552	.7901	.5899
.5502	-.5089	.7675	.6266	.5001	-.1638	.8166	.5425	.8002	.4976	-.3619	.7892	.5915
.6002	-.5044	.7681	.6257	.5497	-.0974	.8282	.5259	.8002	.2476	-.3664	.7895	.5924
.6500	-.4992	.7687	.6255	.6003	-.0216	.8395	.5062	.8002	-.5024	-.3592	.7896	.5909
.7000	-.4869	.7716	.6167	.6500	.0424	.8489	.4893					
.7500	-.4249	.7798	.6067	.7000	.1335	.8624	.4647					
.8002	-.3648	.7887	.5922	.7501	.2151	.8745	.4419					
.8502	-.2035	.8126	.5526	.8001	.2899	.8849	.4215					
.9501	-.0913	.8292	.5242	.8501	.3509	.8945	.4021					

ORIGINAL PAGE IS
OF POOR QUALITY

ORIGINAL PAGE
OF POOR QUALITY

TEST 167	PT 26.2348	P	CN .5926	CD1 .00963	CDCOR1 .00940
RUN 67	TT 149.7920	K	CM -.1155	CD2 .00961	CDCOR2 .00932
POINT 67	RC 7.0251	MILLION	CC .0043	CD3 .00952	CDCOR3 .00936
	MACH .5007			CD4 .00971	CDCOR4 .00950
	ALPHA 1.4969	DEG		CD5 .00959	CDCOR5 .00926

UPPER SURFACE				LOWER SURFACE				SPANWISE				
X/C	CP	P/L/PT	MLOC	X/C	CP	P/L/PT	MLOC	X/C	Y/(B/2)	CP	P/L/PT	MLOC
0.0000	1.0100	.9921	.1067	0.0000	1.0100	.9921	.1067	.1507	.7476	-.6825	.7427	.6659
.0132	-1.0240	.6924	.7441	.0126	.6248	.9353	.3105	.1507	.4976	-.6992	.7403	.6698
.0259	-1.1685	.6711	.7768	.0255	.4269	.9062	.3778	.1507	.2476	-.7007	.7400	.6701
.0759	-.9084	.7094	.7178	.0495	.2447	.8793	.4325	.1507	-.2524	-.7040	.7396	.6709
.1003	-.7996	.7255	.6929	.0753	.1659	.8677	.4548	.1507	-.5024	-.7078	.7390	.6718
.1507	-.7071	.7391	.6716	.1002	.0732	.8540	.4901	.1507	-.7524	-.6896	.7417	.6676
.2003	-.6494	.7476	.6582	.1503	-.0042	.8426	.5006	.3002	.7476	-.5141	.7675	.6265
.2503	-.6099	.7534	.6490	.1976	-.0831	.8310	.5210	.3002	.4976	-.5265	.7657	.6295
.3001	-.5928	.7559	.6450	.2503	-.1294	.8242	.5328	.3002	.2476	-.5332	.7647	.6311
.3502	-.5667	.7590	.6389	.3001	-.1619	.8194	.5410	.3002	-.2524	-.5268	.7657	.6296
.4003	-.5457	.7629	.6340	.3507	-.1804	.8167	.5457	.3002	-.5024	-.5240	.7661	.6289
.4501	-.5394	.7628	.6325	.4001	-.1821	.8164	.5461	.3002	-.7524	-.5138	.7676	.6265
.5002	-.5324	.7648	.6309	.4501	-.1791	.8169	.5453	.6002	.7476	-.3620	.7899	.5903
.5502	-.5274	.7656	.6297	.5001	-.1457	.8218	.5369	.6002	.4976	-.3694	.7889	.5920
.6002	-.5211	.7665	.6282	.5497	-.0830	.8310	.5210	.8002	.2476	-.3738	.7882	.5931
.6500	-.5096	.7682	.6255	.6003	-.0066	.8418	.5020	.8002	-.5024	-.3657	.7894	.5911
.7000	-.4792	.7727	.6183	.6500	.0519	.8509	.4858	.8002	-.7524	-.3480	.7920	.5869
.7500	-.4350	.7792	.6078	.7000	.1412	.8641	.4616					
.8002	-.3728	.7883	.5929	.7501	.2212	.8759	.4392					
.8502	-.2074	.8127	.5524	.8001	.2911	.8861	.4191					
.9501	-.0929	.8296	.5235	.8501	.3556	.8957	.3998					

TEST 167	PT 26.2371	PSI	CN .6457	CD1 .00974	CDCOR1 .00951
RUN 67	TT 149.8890	K	CM -.1154	CD2 .00981	CDCOR2 .00956
POINT 68	RC 7.0142	MILLION	CC -.0002	CD3 .00972	CDCOR3 .00955
	MACH .5003			CD4 .00985	CDCOR4 .00964
	ALPHA 1.9958	DEG		CD5 .00980	CDCOR5 .00956

UPPER SURFACE				LOWER SURFACE				SPANWISE				
X/C	CP	P/L/PT	MLOC	X/C	CP	P/L/PT	MLOC	X/C	Y/(B/2)	CP	P/L/PT	MLOC
0.0000	.9588	.9845	.1495	0.0000	.9588	.9845	.1495	.1507	.7476	-.7383	.7344	.6789
.0132	-1.2322	.6616	.7914	.0126	.7025	.9467	.2806	.1507	.4976	-.7556	.7319	.6830
.0259	-1.3471	.6447	.8174	.0255	.4989	.9167	.3545	.1507	.2476	-.7577	.7316	.6834
.0759	-1.0027	.6954	.7394	.0495	.3065	.8884	.4146	.1507	-.2524	-.7614	.7310	.6843
.1003	-.8750	.7143	.7103	.0753	.2192	.8755	.4399	.1507	-.5024	-.7652	.7304	.6852
.1507	-.7639	.7306	.6848	.1002	.1224	.8613	.4668	.1507	-.7524	-.7441	.7336	.6803
.2003	-.6860	.7421	.6669	.1503	.0373	.8487	.4897	.3002	.7476	-.5339	.7645	.6313
.2503	-.6486	.7476	.6582	.1976	-.0456	.8365	.5115	.3002	.4976	-.5464	.7627	.6343
.3001	-.6265	.7509	.6530	.2503	-.0963	.8290	.5245	.3002	.2476	-.5533	.7617	.6359
.3502	-.5942	.7556	.6455	.3001	-.1323	.8237	.5336	.3002	-.2524	-.5477	.7625	.6346
.4003	-.5705	.7591	.6399	.3507	-.1538	.8205	.5391	.3002	-.5024	-.5449	.7629	.6339
.4501	-.5614	.7605	.6378	.4001	-.1584	.8199	.5402	.3002	-.7524	-.5346	.7644	.6315
.5002	-.5514	.7620	.6355	.4501	-.1583	.8199	.5402	.8002	.7476	-.3677	.7890	.5910
.5502	-.5440	.7630	.6337	.5001	-.1279	.8244	.5325	.8002	.4976	-.3743	.7881	.5933
.6002	-.5353	.7643	.6317	.5497	-.0680	.8332	.5172	.8002	.2476	-.3701	.7873	.5945
.6500	-.5214	.7664	.6284	.6003	.0029	.8436	.4986	.8002	-.5024	-.3723	.7883	.5928
.7000	-.4885	.7712	.6206	.6500	.0821	.8524	.4831	.8002	-.7524	-.3544	.7910	.5885
.7500	-.4417	.7781	.6095	.7000	.1496	.8653	.4594					
.8002	-.3773	.7877	.5940	.7501	.2281	.8768	.4373					
.8502	-.2069	.8127	.5524	.8001	.2970	.8870	.4174					
.9501	-.0909	.8298	.5231	.8501	.3610	.8964	.3983					

TEST 167	PT 26.2347	PSI	CN .6984	CD1 .01003	CDCOR1 .00975
RUN 67	TT 149.9188	K	CM -.1156	CD2 .01007	CDCOR2 .00982
POINT 69	RC .0102	MILLION	CC -.0052	CD3 .01001	CDCOR3 .00982
	MACH .5002			CD4 .01004	CDCOR4 .00980
	ALPHA 2.4948	DEG		CD5 .01004	CDCOR5 .00977

UPPER SURFACE				LOWER SURFACE				SPANWISE				
X/C	CP	P/L/PT	MLOC	X/C	CP	P/L/PT	MLOC	X/C	Y/(B/2)	CP	P/L/PT	MLOC
0.0000	.8889	.9741	.1940	0.0000	.8889	.9741	.1940	.1507	.7476	-.7917	.7257	.6926
.0132	-1.4513	.6282	.8428	.0126	.7690	.9564	.2531	.1507	.4976	-.7092	.7231	.6966
.0259	-1.5181	.6183	.8581	.0255	.5625	.9258	.3335	.1507	.2476	-.8115	.7228	.6971
.0759	-1.0939	.6810	.7616	.0495	.3633	.8964	.3983	.1507	-.2524	-.8147	.7223	.6978
.1003	-.9470	.7028	.7281	.0753	.2693	.8825	.4262	.1507	-.5024	-.8184	.7218	.6987
.1507	-.8169	.7220	.6983	.1002	.1689	.8677	.4548	.1507	-.7524	-.7955	.7251	.6934
.2003	-.7315	.7346	.6787	.1503	.0776	.8542	.4798	.3002	.7476	-.5504	.7614	.6364
.2503	-.6848	.7415	.6678	.1976	-.0084	.8415	.5026	.3002	.4976	-.5639	.7594	.6396
.3001	-.6573	.7456	.6614	.2503	-.0627	.8335	.5160	.3002	.2476	-.5711	.7583	.6413
.3502	-.6231	.7506	.6535	.3001	-.1017	.8277	.5260	.3002	-.2524	-.5646	.7593	.6397
.4003	-.5949	.7548	.6468	.3507	-.1261	.8241	.5330	.3002	-.5024	-.5621	.7596	.6391
.4501	-.5823	.7567	.6439	.4001	-.1333	.8230	.5349	.3002	-.7524	-.5510	.7613	.6365
.5002	-.5696	.7585	.6409	.4501	-.1302	.8226	.5336	.8002	.7476	-.3711	.7879	.5936
.5502	-.5598	.7600	.6386	.5001	-.1085	.8267	.5285	.8002	.4976	-.3782	.7868	.5953
.6002	-.5448	.7616	.6360	.5497	-.0516	.8351	.5139	.8002	.2476	-.3834	.7860	.5966
.6500	-.5325	.7640	.6322	.6003	.0163	.8451	.4961	.8002	-.5024	-.3759	.7872	.5948
.7000	-.4972	.7692	.6238	.6500	.0730	.8535	.4810	.8002	-.7524	-.3579	.7898	.5904
.7500	-.4484	.7764	.6122	.7000	.1564	.8661	.4577					
.8002	-.3815	.7863	.5962	.7501	.2352	.8775	.4361					
.8502	-.2074	.8121	.5535	.8001	.3030	.8875	.4164					
.9501	-.0915	.8292	.5242	.8501	.3681	.8968	.3974					

TEST 167 PT 26.2339 PSI CM .7540
 RUN 67 TT 149.8391 K CM -.1163
 POINT 71 RC 7.0200 MILLION CC -.0110
 MACH .5006
 ALPHA 2.9938 DEG

CD1 .01034 CDCOR1 .01005
 CD2 .01036 CDCOR2 .01011
 CD3 .01031 CDCOR3 .01019
 CD4 .01033 CDCOR4 .01013
 CD5 .01043 CDCOR5 .01009

UPPER SURFACE				LOWER SURFACE				SPANWISE				
X/C	CP	P _L /PT	MLOC	X/C	CP	P _L /PT	MLOC	X/C	Y/(B/2)	CP	P _L /PT	MLOC
0.0000	.8005	.9609	.2392	0.0000	.8005	.9609	.2392	.1507	.7476	-.8915	.7164	.7070
.0132	-1.7004	.5907	.9009	.0126	.8281	.9650	.2260	.1507	.4976	-.8690	.7138	.7110
.0259	-1.6956	.5914	.8998	.0255	.8204	.9343	.3130	.1507	.2476	-.8714	.7135	.7116
.0759	-1.1965	.6653	.7857	.0495	.4172	.9042	.3819	.1507	-.2524	-.8741	.7131	.7122
.1003	-1.0283	.6902	.7475	.0733	.3164	.8893	.4128	.1507	-.5024	-.8766	.7127	.7128
.1507	-.8776	.7125	.7130	.1002	.2125	.8739	.4430	.1507	-.7524	-.8927	.7162	.7073
.2003	-.7876	.7259	.6923	.1503	.1149	.8595	.4701	.5002	.7476	-.5722	.7577	.6422
.2503	-.7255	.7350	.6780	.1976	-.0255	.8462	.4942	.5002	.4976	-.5863	.7557	.6455
.3001	-.6940	.7397	.6706	.2503	-.0330	.8376	.5096	.5002	.2476	-.5936	.7546	.6472
.3502	-.6578	.7451	.6622	.3001	-.0749	.8314	.5204	.5002	-.2524	-.5864	.7556	.6455
.4003	-.6252	.7499	.6546	.3507	-.1023	.8273	.5275	.5002	-.5024	-.5842	.7560	.6450
.4501	-.6090	.7523	.6508	.4001	-.1123	.8258	.5300	.5002	-.7524	-.5727	.7577	.6423
.5002	-.5933	.7546	.6471	.4501	-.1180	.8250	.5315	.8002	.7476	-.3780	.7865	.5959
.5502	-.5810	.7564	.6442	.5001	-.0930	.8287	.5251	.8002	.4976	-.3862	.7853	.5979
.6002	-.5690	.7584	.6412	.5497	-.0388	.8367	.5111	.8002	.2476	-.3916	.7845	.5992
.6500	-.5488	.7612	.6366	.6003	.0264	.8464	.4939	.8002	-.5024	-.3832	.7857	.5971
.7000	-.5112	.7668	.6278	.6500	.0811	.8545	.4793	.8002	-.7524	-.3653	.7884	.5928
.7500	-.4599	.7744	.6155	.7000	.1648	.8666	.4554					
.8002	-.3904	.7847	.5989	.7501	.2400	.8760	.4351					
.9002	-.2119	.8111	.5551	.8001	.3068	.8879	.4156					
.9501	-.0953	.8283	.5257	.8501	.3695	.8971	.3967					

TEST 167 PT 26.2333 PSI CM .8106
 RUN 67 TT 149.8784 K CM -.1155
 POINT 72 RC 7.0134 MILLION CC -.0183
 MACH .5002
 ALPHA 3.3335 DEG

CD1 .01053 CDCOR1 .01024
 CD2 .01061 CDCOR2 .01032
 CD3 .01056 CDCOR3 .01031
 CD4 .01056 CDCOR4 .01032
 CD5 .01064 CDCOR5 .01033

UPPER SURFACE				LOWER SURFACE				SPANWISE				
X/C	CP	P _L /PT	MLOC	X/C	CP	P _L /PT	MLOC	X/C	Y/(B/2)	CP	P _L /PT	MLOC
0.0000	.7046	.9467	.2807	0.0000	.7046	.9467	.2807	.1507	.7476	-.9068	.7080	.7200
.0132	-1.9751	.5498	.9165	.0126	.8886	.9740	.1944	.1507	.4976	-.9270	.7051	.7246
.0259	-1.9204	.5579	.926	.0255	.8859	.9439	.2882	.1507	.2476	-.9298	.7046	.7252
.0759	-1.2993	.6499	.8094	.0495	.4790	.9133	.3622	.1507	-.2524	-.9342	.7040	.7262
.1003	-1.1080	.6782	.7659	.0733	.3712	.8973	.3964	.1507	-.5024	-.9357	.7038	.7266
.1507	-.9358	.7038	.7266	.1002	.2650	.8816	.4280	.1507	-.7524	-.9111	.7074	.7209
.2003	-.8207	.7206	.7002	.1503	.1609	.8662	.4578	.5002	.7476	-.9882	.7552	.6461
.2503	-.7626	.7294	.6868	.1976	.0677	.8524	.4831	.5002	.4976	-.6028	.7531	.6446
.3001	-.7261	.7348	.6783	.2503	.0049	.8431	.4998	.5002	.2476	-.6105	.7519	.6514
.3502	-.6797	.7417	.6675	.3001	-.0403	.8364	.5116	.5002	-.2524	-.6043	.7528	.6499
.4003	-.6436	.7467	.6576	.3507	-.0705	.8319	.5195	.5002	-.5024	-.6018	.7532	.6493
.4501	-.6276	.7494	.6554	.4001	-.0834	.8300	.5228	.5002	-.7524	-.5900	.7550	.6466
.5002	-.6081	.7523	.6508	.4501	-.0920	.8287	.5250	.8002	.7476	-.3791	.7862	.5964
.5502	-.5930	.7545	.6473	.5001	-.0701	.8320	.5194	.8002	.4976	-.3871	.7850	.5983
.6002	-.5774	.7568	.6436	.5497	-.0184	.8396	.5059	.8002	.2476	-.3922	.7843	.5995
.6500	-.5557	.7600	.6385	.6003	.0444	.8489	.4893	.8002	-.5024	-.3851	.7853	.5978
.7000	-.5155	.7660	.6290	.6500	.0968	.8567	.4754	.8002	-.7524	-.3666	.7880	.5934
.7500	-.4614	.7740	.6161	.7000	.1786	.8688	.4527					
.8002	-.3844	.7847	.5988	.7501	.2525	.8798	.4317					
.9002	-.2057	.8119	.5538	.8001	.3182	.8895	.4124					
.9501	-.0861	.8296	.5235	.8501	.3804	.8987	.3935					

Appendix N

Pressure Data for $M = 0.65$; $R = 7.0 \times 10^6$ and 30.0×10^6 ; Fixed Transition

The pressure measurements made on the NASA SC(3)-0712(B) airfoil are presented in coefficient form in graphs and tables in this appendix. The data are for a given Mach number through the Reynolds number range. The pressure data from the upper surface of the airfoil are plotted as open symbols, and the lower-surface data are plotted as solid symbols.

ORIGINAL PAGE IS
OF POOR QUALITY

TEST 167	PT 21.9373	PSI	CN -.0485	CD1 .01011	CDCOR1 .00987
RUN 62	TT 151.7124	K	CM -.1088	CD2 .00976	CDCOR2 .00957
POINT 80	RC 7.0167	MILLION	CC .0029	CD3 .00964	CDCOR3 .00954
	MACH .6506			CD4 .01000	CDCOR4 .00989
	ALPHA -4.0019	DEG		CD5 .01001	CDCOR5 .00976

UPPER SURFACE				LOWER SURFACE				SPANWISE				
X/C	CP	P/L/PT	MLOC	X/C	CP	P/L/PT	MLOC	X/C	Y/(B/2)	CP	P/L/PT	MLOC
0.0000	.5961	.8852	.4210	0.0000	.5961	.8852	.4210	.1507	.7476	-.1229	.7247	.6942
.0132	.6065	.8975	.4184	.0126	-.8763	.5565	.9549	.1507	.4976	-.1368	.7215	.6990
.0259	.2873	.8162	.5464	.0255	-.7395	.5870	.9067	.1507	.2476	-.1359	.7217	.6987
.0759	-.0297	.7455	.6816	.0495	-.6774	.6009	.8851	.1507	-.2524	-.1375	.7214	.6992
.1003	-.0702	.7364	.6758	.0753	-.7232	.5906	.9010	.1507	-.5024	-.1435	.7201	.7013
.1507	-.1352	.7219	.6985	.1002	-.6833	.5995	.8872	.1507	-.7524	-.1308	.7229	.6969
.2003	-.1756	.7129	.7124	.1503	-.6339	.6106	.8700	.5002	.7476	-.3235	.6799	.7634
.2503	-.2147	.7041	.7260	.1976	-.6621	.6043	.8798	.5002	.4976	-.3318	.6780	.7662
.3001	-.2484	.6966	.7376	.2503	-.6418	.6088	.8728	.5002	.2476	-.3374	.6768	.7681
.3502	-.2674	.6924	.7441	.3001	-.6204	.6136	.8654	.5002	-.2524	-.3308	.6782	.7659
.4003	-.2883	.6877	.7513	.3507	-.5944	.6194	.8564	.5002	-.5024	-.3276	.6790	.7648
.4501	-.3108	.6827	.7590	.4001	-.5442	.6306	.8391	.8002	.7476	-.3071	.6811	.7615
.5002	-.3341	.6775	.7670	.4501	-.4831	.6442	.8181	.8002	.4976	-.3096	.6830	.7586
.5502	-.3572	.6723	.7749	.5001	-.3938	.6642	.7875	.8002	.2476	-.3150	.6818	.7605
.6000	-.3792	.6674	.7825	.5497	-.2773	.6922	.7475	.8002	-.5024	-.3058	.6838	.7573
.6500	-.3976	.6633	.7888	.6003	-.1567	.7171	.7059	.8002	-.7524	-.2914	.6870	.7524
.7000	-.3846	.6662	.7843	.6500	-.0512	.7407	.6692					
.7500	-.3583	.6721	.7753	.7000	.0585	.7651	.6304					
.8002	-.3134	.6821	.7599	.7501	.1502	.7856	.5973					
.8002	-.1653	.7152	.7089	.8001	.2217	.8016	.5710					
.9002	-.0968	.7394	.6711	.8501	.2808	.8148	.5489					

TEST 167	PT 21.9361	PSI	CN .0776	CD1 .00978	CDCOR1 .00966
RUN 62	TT 151.8122	K	CM -.1127	CD2 .00951	CDCOR2 .00942
POINT R1	RC 7.0077	MILLION	CC .0108	CD3 .00947	CDCOR3 .00943
	MACH .6503			CD4 .00974	CDCOR4 .00968
	ALPHA -2.9836	DEG		CD5 .00968	CDCOR5 .00946

UPPER SURFACE				LOWER SURFACE				SPANWISE				
X/C	CP	P/L/PT	MLOC	X/C	CP	P/L/PT	MLOC	X/C	Y/(B/2)	CP	P/L/PT	MLOC
0.0000	.7988	.9306	.3220	0.0000	.7988	.9306	.3220	.1507	.7476	-.2272	.7021	.7292
.0132	.4265	.8477	.4915	.0126	-.4846	.6447	.8174	.1507	.4976	-.2431	.6985	.7346
.0259	.0990	.7747	.6149	.0255	-.4656	.6490	.8109	.1507	.2476	-.2425	.6987	.7345
.0759	-.1750	.7137	.7112	.0495	-.4659	.6489	.8109	.1507	-.2524	-.2460	.6979	.7357
.1003	-.1968	.7089	.7187	.0753	-.5178	.6373	.8288	.1507	-.5024	-.2525	.6964	.7379
.1507	-.2422	.6987	.7343	.1002	-.5222	.6364	.8303	.1507	-.7524	-.2370	.6997	.7328
.2003	-.2573	.6954	.7395	.1503	-.5082	.6395	.8255	.5002	.7476	-.3755	.6690	.7800
.2503	-.2980	.6863	.7535	.1976	-.5503	.6301	.8399	.5002	.4976	-.3840	.6671	.7829
.3001	-.3243	.6804	.7625	.2503	-.5477	.6307	.8390	.5002	.2476	-.3900	.6658	.7850
.3502	-.3350	.6781	.7662	.3001	-.5408	.6322	.8366	.5002	-.2524	-.3842	.6671	.7830
.4003	-.3504	.6746	.7714	.3507	-.5246	.6358	.8311	.5002	-.5024	-.3807	.6679	.7818
.4501	-.3685	.6706	.7776	.4001	-.4980	.6440	.8185	.5002	-.7524	-.3714	.6699	.7786
.5002	-.3859	.6667	.7836	.4501	-.4380	.6551	.8014	.8002	.7476	-.3261	.6800	.7631
.5502	-.4043	.6626	.7899	.5001	-.3584	.6728	.7742	.8002	.4976	-.3296	.6793	.7643
.6002	-.4219	.6587	.7959	.5497	-.2198	.6970	.7370	.8002	.2476	-.3362	.6778	.7666
.6500	-.4350	.6558	.8004	.6003	-.1357	.7224	.6976	.8002	-.5024	-.3285	.6795	.7639
.7000	-.4166	.6599	.7941	.6500	-.0358	.7447	.6628	.8002	-.7524	-.3131	.6829	.7587
.7500	-.3843	.6671	.7830	.7000	.0724	.7688	.6245					
.8002	-.3341	.6783	.7658	.7501	.1651	.7895	.5910					
.8002	-.1798	.7135	.7115	.8001	.2391	.8059	.5637					
.9002	-.1334	.6733	.6722	.8501	.3011	.8198	.5404					

TEST 167	PT 21.9576	PSI	CN .2055	CD1 .00968	CDCOR1 .00949
RUN 62	TT 151.8659	K	CM -.1172	CD2 .00946	CDCOR2 .00930
POINT R2	RC 7.0088	MILLION	CC .0154	CD3 .00944	CDCOR3 .00934
	MACH .6500			CD4 .00965	CDCOR4 .00949
	ALPHA -1.9958	DEG		CD5 .00952	CDCOR5 .00930

UPPER SURFACE				LOWER SURFACE				SPANWISE				
X/C	CP	P/L/PT	MLOC	X/C	CP	P/L/PT	MLOC	X/C	Y/(B/2)	CP	P/L/PT	MLOC
0.0000	.9656	.9679	.2163	0.0000	.9656	.9679	.2163	.1507	.7476	-.3369	.6782	.7659
.0132	.2127	.8604	.5730	.0126	-.1611	.7173	.7036	.1507	.4976	-.3516	.6750	.7709
.0259	-.1147	.7276	.6895	.0255	-.2285	.7023	.7288	.1507	.2476	-.3509	.6751	.7707
.0759	-.3318	.6794	.7842	.0495	-.2754	.6919	.7449	.1507	-.2524	-.3536	.6745	.7716
.1003	-.3293	.6799	.7833	.0753	-.3363	.6784	.7637	.1507	-.5024	-.3587	.6734	.7734
.1507	-.3506	.6752	.7768	.1002	-.3715	.6705	.7777	.1507	-.7524	-.3404	.6774	.7671
.2003	-.3613	.6728	.7743	.1503	-.3855	.6674	.7825	.5002	.7476	-.4217	.6594	.7949
.2503	-.3795	.6687	.7805	.1976	-.4401	.6553	.8012	.5002	.4976	-.4308	.6573	.7980
.3001	-.3973	.6648	.7866	.2503	-.4525	.6525	.8054	.5002	.2476	-.4370	.6560	.8001
.3502	-.4030	.6635	.7895	.3001	-.4573	.6514	.8071	.5002	-.2524	-.4297	.6576	.7976
.4003	-.4107	.6618	.7911	.3507	-.4519	.6527	.8052	.5002	-.5024	-.4266	.6583	.7966
.4501	-.4231	.6590	.7954	.4001	-.4250	.6586	.7960	.5002	-.7524	-.4166	.6605	.7932
.5002	-.4349	.6564	.7994	.4501	-.3851	.6675	.7824	.8002	.7476	-.3380	.6780	.7663
.5502	-.4485	.6534	.8040	.5001	-.3151	.6831	.7584	.8002	.4976	-.3439	.6767	.7683
.6002	-.4611	.6506	.8084	.5497	-.2149	.7054	.7241	.8002	.2476	-.3509	.6751	.7707
.6500	-.4693	.6484	.8112	.6003	-.1072	.7293	.6869	.8002	-.5024	-.3421	.6771	.7677
.7000	-.4453	.6542	.8029	.6500	-.0126	.7503	.6539	.8002	-.7524	-.3255	.6808	.7620
.7500	-.4070	.6626	.7899	.7000	.0935	.7739	.6162					
.8002	-.3507	.6752	.7706	.7501	.1858	.7945	.5828					
.8002	-.1814	.7126	.7126	.8001	.2610	.8112	.5549					
.9002	-.0862	.7384	.6727	.8501	.3253	.8255	.5106					

TEST	167	PT	21.9629	PSI	CN	.2777	CD1	.00965	CDCOR1	.00947
RUN	62	TT	152.1676	K	CM	-.1214	CD2	.00951	CDCOR2	.00931
POINT	84	RC	6.9937	MILLION	CC	.0166	CD3	.00948	CDCOR3	.00929
		MACH	.6505				CD4	.00968	CDCOR4	.00948
		ALPHA	-1.4969	DEG			CD5	.00953	CDCOR5	.00933

UPPER SURFACE				LOWER SURFACE				SPANWISE				
X/C	CP	P ₂ L/PT	MLOC	X/C	CP	P ₂ L/PT	MLOC	X/C	Y/(B/2)	CP	P ₂ L/PT	MLOC
0.0000	1.0280	.9817	.1627	0.0000	1.0280	.9817	.1627	.1507	.7476	-.3952	.6645	.7870
.0132	.0879	.7721	.6191	.0126	-.0116	.7500	.6545	.1507	.4976	-.4054	.6622	.7905
.0259	-.2384	.6994	.7332	.0255	-.1105	.7279	.6891	.1507	.2476	-.4064	.6620	.7908
.0759	-.4180	.6594	.7948	.0495	-.1815	.7121	.7136	.1507	-.2524	-.4037	.6626	.7899
.1003	-.3998	.6635	.7886	.0753	-.2467	.6976	.7301	.1507	-.5024	-.4087	.6615	.7916
.1507	-.4068	.6619	.7910	.1002	-.2953	.6867	.7528	.1507	-.7524	-.3887	.6659	.7848
.2003	-.4244	.6580	.7970	.1503	-.3208	.6811	.7615	.5002	.7476	-.4425	.6539	.8032
.2503	-.4198	.6590	.7954	.1976	-.3807	.6677	.7821	.5002	.4976	-.4523	.6518	.8066
.3001	-.4324	.6562	.7997	.2503	-.3995	.6635	.7885	.5002	.2476	-.4579	.6505	.8085
.3502	-.4452	.6533	.8041	.3001	-.4096	.6613	.7919	.5002	-.2524	-.4463	.6531	.8045
.4003	-.4449	.6534	.8040	.3507	-.4091	.6614	.7918	.5002	-.5024	-.4434	.6537	.8035
.4501	-.4522	.6518	.8065	.4001	-.3867	.6664	.7841	.5002	-.7524	-.4322	.6562	.7997
.5002	-.4606	.6499	.8094	.4501	-.3515	.6742	.7721	.8002	.7476	-.3409	.6766	.7766
.5502	-.4717	.6474	.8132	.5001	-.2857	.6889	.7495	.8002	.4976	-.3472	.6752	.7704
.6002	-.4824	.6451	.8169	.5497	-.1894	.7103	.7164	.8002	.2476	-.3559	.6732	.7736
.6500	-.4873	.6440	.8185	.6003	-.0855	.7335	.6804	.8002	-.5024	-.3410	.6766	.7684
.7000	-.4998	.6501	.8091	.6500	.0062	.7540	.6482	.8002	-.7524	-.3244	.6803	.7628
.7500	-.4195	.6591	.7953	.7000	.1109	.7773	.6108					
.8002	-.3603	.6723	.7751	.7501	.2024	.7977	.5775					
.9002	-.1846	.7114	.7147	.8001	.2777	.8145	.5494					
.9501	-.0709	.7368	.6753	.8501	.3427	.8289	.5246					

TEST	167	PT	21.9707	PSI	CN	.3244	CD1	.00966	CDCOR1	.00970
RUN	62	TT	152.1537	K	CM	-.1183	CD2	.00957	CDCOR2	.00963
POINT	85	RC	6.9946	MILLION	CC	.0164	CD3	.00955	CDCOR3	.00966
		MACH	.6501				CD4	.00968	CDCOR4	.00978
		ALPHA	-.9979	DEG			CD5	.00953	CDCOR5	.00952

UPPER SURFACE				LOWER SURFACE				SPANWISE				
X/C	CP	P ₂ L/PT	MLOC	X/C	CP	P ₂ L/PT	MLOC	X/C	Y/(B/2)	CP	P ₂ L/PT	MLOC
0.0000	1.0626	.9898	.1213	0.0000	1.0626	.9898	.1213	.1507	.7476	-.4532	.6547	.8020
.0132	-.0420	.7456	.6614	.0126	.1091	.7790	.6080	.1507	.4976	-.4756	.6498	.8096
.0259	-.3699	.6731	.7738	.0255	-.0120	.7522	.6509	.1507	.2476	-.4772	.6494	.8102
.0759	-.5194	.6401	.8245	.0495	-.1153	.7294	.6868	.1507	-.2524	-.4813	.6485	.8116
.1003	-.4843	.6478	.8126	.0753	-.1888	.7132	.7120	.1507	-.5024	-.4862	.6474	.8132
.1507	-.4777	.6493	.8104	.1002	-.2417	.7015	.7301	.1507	-.7524	-.4655	.6520	.8062
.2003	-.4704	.6509	.8079	.1503	-.2805	.6929	.7433	.5002	.7476	-.4762	.6496	.8098
.2503	-.4732	.6503	.8088	.1976	-.3470	.6782	.7660	.5002	.4976	-.4858	.6475	.8131
.3001	-.4817	.6484	.8117	.2503	-.3734	.6724	.7749	.5002	.2476	-.4926	.6460	.8154
.3502	-.4690	.6512	.8074	.3001	-.3883	.6691	.7800	.5002	-.2524	-.4883	.6470	.8139
.4003	-.4727	.6504	.8087	.3507	-.3924	.6682	.7814	.5002	-.5024	-.4852	.6476	.8129
.4501	-.4805	.6487	.8113	.4001	-.3751	.6720	.7755	.5002	-.7524	-.4757	.6497	.8097
.5002	-.4859	.6475	.8131	.4501	-.3446	.6787	.7651	.8002	.7476	-.3573	.6759	.7695
.5502	-.4941	.6457	.8159	.5001	-.2842	.6921	.7446	.8002	.4976	-.3657	.6740	.7723
.6002	-.5013	.6441	.8184	.5497	-.1918	.7125	.7130	.8002	.2476	-.3729	.6725	.7748
.6500	-.5042	.6434	.8193	.6003	-.0906	.7349	.6782	.8002	-.5024	-.3680	.6735	.7731
.7000	-.4748	.6499	.8094	.6500	-.0020	.7544	.6474	.8002	-.7524	-.3507	.6774	.7672
.7500	-.4312	.6596	.7946	.7000	.1012	.7773	.6109					
.8002	-.3696	.6732	.7736	.7501	.1926	.7975	.5779					
.9002	-.1903	.7128	.7125	.8001	.2679	.8141	.5500					
.9501	-.0687	.7397	.6706	.8501	.3335	.8286	.5252					

TFST	167	PT	21.9634	PSI	CN	.3879	CD1	.00971	CDCOR1	.00958
RUN	62	TT	151.8081	K	CM	-.1204	CD2	.00963	CDCOR2	.00953
POINT	86	RC	7.0223	MILLION	CC	.0158	CD3	.00964	CDCOR3	.00960
		MACH	.6497				CD4	.00975	CDCOR4	.00969
		ALPHA	-.4990	DEG			CD5	.00960	CDCOR5	.00942

UPPER SURFACE				LOWER SURFACE				SPANWISE				
X/C	CP	P ₂ L/PT	MLOC	X/C	CP	P ₂ L/PT	MLOC	X/C	Y/(B/2)	CP	P ₂ L/PT	MLOC
0.0000	1.0908	.9958	.0777	0.0000	1.0908	.9958	.0777	.1507	.7476	-.5157	.6388	.8265
.0132	-.1840	.7123	.7130	.0126	.2296	.8044	.5663	.1507	.4976	-.5353	.6345	.8332
.0259	-.3073	.6407	.8236	.0255	.0859	.7723	.6186	.1507	.2476	-.5376	.6339	.8340
.0759	-.6166	.6164	.8610	.0495	-.0416	.7442	.6636	.1507	-.2524	-.5409	.6332	.8331
.1003	-.5616	.6286	.8422	.0753	-.1118	.7285	.6881	.1507	-.5024	-.5449	.6323	.8365
.1507	-.5383	.6338	.8342	.1002	-.1782	.7138	.7110	.1507	-.7524	-.5223	.6373	.8287
.2003	-.5148	.6390	.8262	.1503	-.2268	.7030	.7278	.5002	.7476	-.4996	.6424	.8210
.2503	-.5167	.6386	.8268	.1976	-.2979	.6872	.7521	.5002	.4976	-.5097	.6401	.8244
.3001	-.5199	.6379	.8279	.2503	-.3303	.6800	.7632	.5002	.2476	-.5158	.6388	.8265
.3502	-.5088	.6403	.8241	.3001	-.3498	.6757	.7698	.5002	-.2524	-.5103	.6400	.8246
.4003	-.5067	.6408	.8234	.3507	-.3581	.6738	.7727	.5002	-.5024	-.5064	.6409	.8233
.4501	-.5102	.6400	.8246	.4001	-.3447	.6768	.7681	.5002	-.7524	-.4972	.6429	.8202
.5002	-.5115	.6397	.8250	.4501	-.3182	.6827	.7590	.8002	.7476	-.4970	.6730	.7740
.5502	-.5174	.6384	.8270	.5001	-.2618	.6952	.7398	.8002	.4976	-.3709	.6710	.7770
.6002	-.5223	.6373	.8287	.5497	-.1735	.7148	.7094	.8002	.2476	-.3787	.6692	.7797
.6500	-.5219	.6375	.8286	.6003	-.0757	.7366	.6755	.8002	-.5024	-.3719	.6707	.7774
.7000	-.4891	.6447	.8174	.6500	.0102	.7557	.6455	.8002	-.7524	-.3544	.6747	.7714
.7500	-.4422	.6551	.8014	.7000	.1118	.7782	.6093					
.8002	-.3776	.6695	.7793	.7501	.2020	.7983	.5765					
.9002	-.1927	.7106	.7160	.8001	.2772	.8130	.5485					
.9501	-.0715	.7375	.6741	.8501	.3432	.8297	.5234					

ORIGINAL PAGE IS
OF POOR QUALITY

TEST 167	PT 21.9676	PSI	CN .4524	CD1 .00980	CDCOR1 .00973
RUN 62	TT 151.8833	K	CM -.1222	CD2 .00972	CDCOR2 .00967
POINT 87	RC 7.0094	MILLION	CC .0145	CD3 .00977	CDCOR3 .00977
	MACH .6498			CD4 .00982	CDCOR4 .00975
	ALPHA -.0102	DEG		CD5 .00975	CDCOR5 .00959

UPPER SURFACE				LOWER SURFACE				SPANWISE				
X/C	CP	P/L/PT	MLOC	X/C	CP	P/L/PT	MLOC	X/C	Y/(B/2)	CP	P/L/PT	MLOC
0.0000	1.1101	1.0001	0.0000	0.0000	1.1101	1.0001	0.0000	.1507	.7476	-.5759	.6252	.8473
.0132	-.3264	.6806	.7522	.0126	.3448	-.8299	.5230	.1507	.4976	-.5941	.6211	.8538
.0259	-.6519	.6083	.8736	.0255	.1827	.7938	.5838	.1507	.2476	-.5905	.6205	.8547
.0759	-.7175	.5937	.8963	.0495	-.0404	.7622	.6351	.1507	-.2524	-.5972	.6204	.8548
.1003	-.6380	.6113	.8688	.0753	-.0356	.7453	.6618	.1507	-.5024	-.6012	.6195	.8562
.1507	-.5965	.6206	.8546	.1002	-.1110	.7285	.6881	.1507	-.7524	-.5744	.6255	.8470
.2003	-.5653	.6275	.8439	.1503	-.1692	.7156	.7083	.5002	.7476	-.5172	.6382	.8274
.2503	-.5566	.6295	.8409	.1976	-.2447	.6988	.7342	.5002	.4976	-.5278	.6358	.8310
.3001	-.5541	.6300	.8400	.2503	-.2823	.6904	.7471	.5002	.2476	-.5347	.634	.8334
.3502	-.5423	.6326	.8360	.3001	-.3061	.6851	.7553	.5002	-.2524	-.5271	.6360	.8308
.4003	-.5345	.6344	.8333	.3507	-.3188	.6823	.7596	.5002	-.5024	-.5235	.6368	.8295
.4501	-.5345	.6344	.8333	.4001	-.3096	.6844	.7564	.5002	-.7524	-.5138	.6390	.8262
.5002	-.5325	.6348	.8326	.4501	-.2872	.6893	.7488	.8002	.7476	-.3610	.6730	.7740
.5502	-.5351	.6342	.8335	.5001	-.2347	.7010	.7308	.8002	.4976	-.3705	.6708	.7773
.6002	-.5373	.6337	.8343	.5497	-.1500	.7199	.7016	.8002	.2476	-.3791	.6689	.7802
.6500	-.5338	.6345	.8331	.6003	-.0555	.7409	.6688	.8002	-.5024	-.3704	.6708	.7772
.7000	-.4978	.6425	.8207	.6500	.0274	.7593	.6396	.8002	-.7524	-.3525	.6748	.7711
.7500	-.4478	.6536	.8037	.7000	.1275	.7816	.6039					
.8002	-.3798	.6688	.7805	.7501	.2167	.8014	.5713					
.9002	-.1899	.7110	.7154	.8001	.2915	.8180	.5433					
.9501	-.0689	.7379	.6735	.8501	.3578	.8328	.5180					

TEST 167	PT 21.9683	PSI	CN .5155	CD1 .00997	CDCOR1 .00978
RUN 62	TT 151.9479	K	CM -.1226	CD2 .00990	CDCOR2 .00971
POINT 86	RC 7.0022	MILLION	CC .0122	CD3 .00988	CDCOR3 .00974
	MACH .6494			CD4 .00994	CDCOR4 .00977
	ALPHA .4990	DEG		CD5 .00992	CDCOR5 .00970

UPPER SURFACE				LOWER SURFACE				SPANWISE				
X/C	CP	P/L/PT	MLOC	X/C	CP	P/L/PT	MLOC	X/C	Y/(B/2)	CP	P/L/PT	MLOC
0.0000	1.1084	.9997	.0214	0.0000	1.1084	.9997	.0214	.1507	.7476	-.6428	.6103	.8704
.0132	-.4887	.6446	.8176	.0126	.4465	.8525	.4828	.1507	.4976	-.6625	.6060	.8772
.0259	-.8217	.5706	.9325	.0255	.2706	.8134	.5512	.1507	.2476	-.6664	.6051	.8785
.0759	-.8440	.5656	.9403	.0495	.1142	.7786	.6087	.1507	-.2524	-.6671	.6049	.8788
.1003	-.7795	.5911	.9004	.0753	.0296	.7598	.6388	.1507	-.5024	-.6707	.6041	.8800
.1507	-.6664	.6051	.8785	.1002	-.0521	.7417	.6676	.1507	-.7524	-.6417	.6106	.8700
.2003	-.6222	.6149	.8633	.1503	-.1200	.7266	.6912	.5002	.7476	-.5446	.6322	.8367
.2503	-.6065	.6189	.8577	.1976	-.1999	.7088	.7188	.5002	.4976	-.5550	.6299	.8403
.3001	-.5957	.6208	.8542	.2503	-.2431	.6992	.7336	.5002	.2476	-.5621	.6283	.8427
.3502	-.5787	.6246	.8484	.3001	-.2709	.6930	.7431	.5002	-.2524	-.5540	.6301	.8399
.4003	-.5676	.6270	.8446	.3507	-.2876	.6893	.7489	.5002	-.5024	-.5512	.6307	.8390
.4501	-.5649	.6277	.8436	.4001	-.2829	.6904	.7472	.5002	-.7524	-.5409	.6330	.8354
.5002	-.5595	.6289	.8418	.4501	-.2648	.6944	.7411	.8002	.7476	-.3720	.6705	.7777
.5502	-.5589	.6290	.8416	.5001	-.2169	.7050	.7246	.8002	.4976	-.3804	.6687	.7806
.6002	-.5580	.6292	.8413	.5497	-.1358	.7231	.6966	.8002	.2476	-.3877	.6671	.7831
.6500	-.5515	.6306	.8390	.6003	-.0445	.7434	.6649	.8002	-.5024	-.3792	.6690	.7801
.7000	-.5125	.6393	.8257	.6500	.0355	.7612	.6367	.8002	-.7524	-.3608	.6730	.7739
.7500	-.4591	.6512	.8074	.7000	.1334	.7829	.6017					
.8002	-.3880	.6670	.7832	.7501	.2215	.8025	.5695					
.9002	-.1928	.7104	.7163	.8001	.2957	.8190	.5417					
.9501	-.0701	.7377	.6739	.8501	.3620	.8337	.5163					

TEST 167	PT 21.9675	PSI	CN .5763	CD1 .01019	CDCOR1 .00999
RUN 62	TT 151.9310	K	CM -.1227	CD2 .01012	CDCOR2 .00991
POINT 89	RC 7.0024	MILLION	CC .0091	CD3 .01013	CDCOR3 .00994
	MACH .6493			CD4 .01022	CDCOR4 .01001
	ALPHA .9979	DEG		CD5 .01031	CDCOR5 .01010

UPPER SURFACE				LOWER SURFACE				SPANWISE				
X/C	CP	P/L/PT	MLOC	X/C	CP	P/L/PT	MLOC	X/C	Y/(B/2)	CP	P/L/PT	MLOC
0.0000	1.1044	.9989	.0399	0.0000	1.1044	.9989	.0399	.1507	.7476	-.7131	.5959	.8928
.0132	-.6539	.6090	.8725	.0126	.3300	.8715	.4475	.1507	.4976	-.7363	.5907	.9009
.0259	-1.0058	.5310	.9957	.0255	.3449	.8305	.5220	.1507	.2476	-.7408	.5897	.9024
.0759	-.9916	.5341	.9907	.0495	.1759	.7930	.5652	.1507	-.2524	-.7409	.5897	.9025
.1003	-.8257	.5709	.9320	.0753	.0830	.7724	.6187	.1507	-.5024	-.7425	.5894	.9030
.1507	-.7397	.5960	.9021	.1002	-.0035	.7532	.6493	.1507	-.7524	-.7096	.5966	.8917
.2003	-.6796	.6033	.8813	.1503	-.0798	.7363	.6760	.5002	.7476	-.5726	.6270	.8446
.2503	-.6563	.6085	.8733	.1976	-.1642	.7176	.7052	.5002	.4976	-.5844	.6244	.8486
.3001	-.6417	.6117	.8683	.2503	-.2130	.7068	.7219	.5002	.2476	-.5917	.6228	.8511
.3502	-.6180	.6170	.8601	.3001	-.2446	.6998	.7327	.5002	-.2524	-.5848	.6243	.8488
.4003	-.6030	.6203	.8550	.3507	-.2650	.6952	.7397	.5002	-.5024	-.5825	.6248	.8490
.4501	-.6164	.6173	.8596	.4001	-.2642	.6954	.7394	.5002	-.7524	-.5718	.6272	.8443
.5002	-.5882	.6236	.8499	.4501	-.2498	.6986	.7345	.8002	.7476	-.3807	.6696	.7792
.5502	-.5847	.6244	.8487	.5001	-.2061	.7083	.7196	.8002	.4976	-.3908	.6673	.7826
.6002	-.5809	.6252	.8474	.5497	-.1281	.7256	.6927	.8002	.2476	-.3990	.6655	.7854
.6500	-.5712	.6273	.8441	.6003	-.0394	.7453	.6619	.8002	-.5024	-.3918	.6671	.7829
.7000	-.5291	.6367	.8298	.6500	.0382	.7625	.6346	.8002	-.7524	-.3731	.6713	.7766
.7500	-.4725	.6492	.8105	.7000	.1347	.7839	.6002					
.8002	-.3986	.6640	.7853	.7501	.2220	.8032	.5683					
.9002	-.1987	.7099	.7170	.8001	.2962	.8197	.5406					
.9501	-.0742	.7376	.6740	.8501	.3629	.8345	.5150					

TEST	167	PT	21.9657	PSI		CN	.6464	CD1	.01048	CDCOR1	.01021
RUN	62	TT	152.0247	K		CM	-.1236	CD2	.01042	CDCOR2	.01017
POINT	91	RC	7.0028	MILLION		CC	.0047	CD3	.01039	CDCOR3	.01019
		MACH	.6503					CD4	.01053	CDCOR4	.01032
		ALPHA	1.9070	DEG				CD5	.01076	CDCOR5	.01050

UPPER SURFACE				LOWER SURFACE				SPANWISE				
X/C	CP	P _L /PT	MLOC	X/C	CP	P _L /PT	MLOC	X/C	Y/(B/2)	CP	P _L /PT	MLOC
0.0000	1.0889	.9954	.0813	0.0000	1.0889	.9954	.0813	.1507	.7476	-.7802	.5803	.9173
.0132	-.8181	.9719	.9305	.0125	.6183	.8909	.4096	.1507	.4976	-.7980	.5763	.9234
.0259	-1.2085	.4851	1.0715	.0259	.4242	.8476	.4914	.1507	.2476	-.8029	.5752	.9252
.0759	-1.2038	.4862	1.0697	.0495	.2470	.8084	.5596	.1507	-.2524	-.7991	.5761	.9239
.1003	-.9079	.5519	.9621	.0753	.1497	.7868	.5954	.1507	-.5024	-.7975	.5764	.9233
.1507	-.8018	.5755	.9248	.1002	.0567	.7661	.6288	.1507	.7524	-.7625	.5642	.9111
.2003	-.7475	.5875	.9059	.1503	-.0261	.7478	.6580	.5002	.7476	-.5988	.6226	.8515
.2503	-.6977	.5986	.8886	.1976	-.1131	.7284	.6883	.5002	.4976	-.6021	.6198	.8557
.3001	-.6573	.6034	.8812	.2503	-.1660	.7167	.7066	.5002	.2476	-.6091	.6183	.8581
.3502	-.6574	.6076	.8747	.3001	-.2012	.7089	.7187	.5002	-.2524	-.5986	.6206	.8545
.4003	-.6338	.6128	.8666	.3507	-.2251	.7036	.7269	.5002	-.5024	-.5967	.6210	.8539
.4501	-.6199	.6159	.8618	.4001	-.2276	.7030	.7277	.5002	-.7524	-.5647	.6237	.8498
.5002	-.6094	.6182	.8582	.4501	-.2171	.7053	.7241	.8002	.7476	-.3798	.6692	.7798
.5502	-.6030	.6196	.8560	.5001	-.1772	.7142	.7104	.8002	.4976	-.3897	.6670	.7831
.6002	-.5962	.6211	.8537	.5497	-.1034	.7306	.6849	.8002	.2476	-.3990	.6649	.7863
.6500	-.5832	.6240	.8492	.6003	-.0185	.7494	.6553	.8002	-.5024	-.3866	.6677	.7821
.7000	-.5735	.6342	.8336	.6500	.0561	.7660	.6289	.8002	-.7524	-.3678	.6719	.7757
.7500	-.4781	.6474	.8133	.7000	.1504	.7870	.5951					
.8002	-.4014	.6644	.7871	.7501	.2358	.8059	.5638					
.9002	-.1970	.7098	.7172	.8001	.3090	.8222	.5363					
.9501	-.0762	.7366	.6755	.8501	.3754	.8369	.5107					

TEST	167	PT	21.9676	PSI		CN	.7024	CD1	.01079	CDCOR1	.01054
RUN	62	TT	152.0608	K		CM	-.1225	CD2	.01066	CDCOR2	.01044
POINT	92	RC	6.9933	MILLION		CC	.0005	CD3	.01069	CDCOR3	.01054
		MACH	.6492					CD4	.01084	CDCOR4	.01059
		ALPHA	2.0032	DEG				CD5	.01112	CDCOR5	.01085

UPPER SURFACE				LOWER SURFACE				SPANWISE				
X/C	CP	P _L /PT	MLOC	X/C	CP	P _L /PT	MLOC	X/C	Y/(B/2)	CP	P _L /PT	MLOC
0.0000	1.0632	.9898	.1211	0.0000	1.0632	.9898	.1211	.1507	.7476	-.8361	.5691	.9349
.0132	-.9715	.5391	.9827	.0126	.6919	.9076	.3748	.1507	.4976	-.8533	.5653	.9409
.0259	-1.3874	.4470	1.1375	.0259	.4943	.8638	.4621	.1507	.2476	-.8591	.5640	.9429
.0759	-1.3841	.4477	1.1363	.0495	.3096	.8229	.5351	.1507	-.2524	-.8554	.5648	.9416
.1003	-.9785	.5375	.9852	.0753	.2053	.7998	.5740	.1507	-.5024	-.8529	.5653	.9408
.1507	-.8584	.5641	.9427	.1002	.1095	.7785	.6088	.1507	-.7524	-.8218	.5722	.9299
.2003	-.7869	.5800	.9177	.1503	.0201	.7587	.6406	.5002	.7476	-.6069	.6198	.8557
.2503	-.7368	.5911	.9004	.1976	-.0702	.7387	.6722	.5002	.4976	-.6193	.6171	.8600
.3001	-.7098	.5970	.8910	.2503	-.1274	.7261	.6920	.5002	.2476	-.6266	.6155	.8625
.3502	-.6828	.6030	.8818	.3001	-.1657	.7176	.7052	.5002	-.2524	-.6172	.6176	.8592
.4003	-.6568	.6088	.8728	.3507	-.1924	.7116	.7144	.5002	-.5024	-.6152	.6180	.8585
.4501	-.6390	.6127	.8667	.4001	-.1986	.7103	.7165	.5002	-.7524	-.6035	.6206	.8545
.5002	-.6250	.6158	.8619	.4501	-.1916	.7118	.7141	.8002	.7476	-.3806	.6700	.7786
.5502	-.6156	.6179	.8587	.5001	-.1560	.7197	.7018	.6002	.4976	-.3914	.6676	.7822
.6002	-.6064	.6199	.8555	.5497	-.0858	.7353	.6776	.8002	.2476	-.4007	.6655	.7854
.6500	-.5903	.6235	.8500	.6003	-.0043	.7533	.6491	.8002	-.5024	-.3391	.6681	.7815
.7000	-.5420	.6342	.8333	.6500	.0675	.7692	.6238	.8002	-.7524	-.3696	.6724	.7749
.7500	-.4801	.6479	.8124	.7000	.1597	.7897	.5907					
.8002	-.4012	.6654	.7856	.7501	.2436	.8082	.5599					
.9002	-.1935	.7114	.7147	.8001	.3158	.8242	.5327					
.9501	-.0720	.7383	.6728	.8501	.3819	.8389	.5072					

TEST	167	PT	21.9647	PSI		CN	.7684	CD1	.01156	CDCOR1	.01129
RUN	62	TT	152.1435	K		CM	-.1208	CD2	.01152	CDCOR2	.01125
POINT	93	RC	6.9887	MILLION		CC	-.0049	CD3	.01147	CDCOR3	.01122
		MACH	.6495					CD4	.01154	CDCOR4	.01128
		ALPHA	2.4948	DEG				CD5	.01177	CDCOR5	.01148

UPPER SURFACE				LOWER SURFACE				SPANWISE				
X/C	CP	P _L /PT	MLOC	X/C	CP	P _L /PT	MLOC	X/C	Y/(B/2)	CP	P _L /PT	MLOC
0.0000	1.0270	.9816	.1628	0.0000	1.0270	.9816	.1628	.1507	.7476	-.8873	.5566	.9547
.0132	-1.1089	.5074	1.0343	.0126	.7510	.9204	.3463	.1507	.4976	-.8810	.5580	.9524
.0259	-1.5267	.4146	1.1961	.0259	.5528	.8763	.4383	.1507	.2476	-.8854	.5570	.9540
.0759	-1.6224	.3934	1.2362	.0495	.3619	.8340	.5159	.1507	-.2524	-.8814	.5579	.9526
.1003	-1.3606	.4515	1.1295	.0753	.2522	.8096	.5576	.1507	-.5024	-.8816	.5579	.9526
.1507	-.8856	.5570	.9541	.1002	.1535	.7877	.5939	.1507	-.7524	-.8774	.5588	.9512
.2003	-.8260	.5702	.9331	.1503	.0581	.7665	.6282	.5002	.7476	-.6331	.6130	.8662
.2503	-.7803	.5804	.9171	.1976	-.0354	.7457	.6611	.5002	.4976	-.6455	.6103	.8705
.3001	-.7503	.5870	.9067	.2503	-.0969	.7321	.6826	.5002	.2476	-.6532	.6086	.8732
.3502	-.7164	.5945	.8949	.3001	-.1384	.7229	.6969	.5002	-.2524	-.6444	.6105	.8701
.4003	-.6880	.6008	.8851	.3507	-.1683	.7162	.7073	.5002	-.5024	-.6427	.6109	.8695
.4501	-.6680	.6053	.8782	.4001	-.1777	.7142	.7105	.5002	-.7524	-.6310	.6135	.8655
.5002	-.6511	.6090	.8724	.4501	-.1740	.7150	.7092	.8002	.7476	-.3893	.6672	.7829
.5502	-.6384	.6118	.8681	.5001	-.1419	.7221	.6981	.8002	.4976	-.3994	.6649	.7863
.6002	-.6299	.6146	.8637	.5497	-.0749	.7370	.6749	.8002	.2476	-.4080	.6630	.7893
.6500	-.6063	.6190	.8570	.6003	.0039	.7545	.6473	.8002	-.5024	-.3983	.6652	.7860
.7000	-.5591	.6303	.8395	.6500	.0733	.7699	.6228	.8002	-.7524	-.3792	.6694	.7795
.7500	-.4897	.6449	.8171	.7000	.1637	.7900	.5902					
.8002	-.4078	.6631	.7892	.7501	.2463	.8083	.5598					
.9002	-.1959	.7101	.7168	.8001	.3179	.8242	.5328					
.9501	-.0744	.7371	.6748	.8501	.3838	.8388	.5074					

ORIGINAL DESIGN
OF POOR QUALITY

TEST 167	PT 21.9654	PSI	CM .8231	CD1 .01293	CDCOR1 .01261
RUN 62	TT 152.0598	K	CM -.1187	CD2 .01303	CDCOR2 .01273
POINT 94	RC 6.9932	MILLION	CC -.0097	CD3 .01300	CDCOR3 .01275
	MACH .6496			CD4 .01319	CDCOR4 .01286
	ALPHA 3.0039	DEG		CD5 .01336	CDCOR5 .01319

UPPER SURFACE				LOWER SURFACE				SPANWISE				
X/C	CP	P/L/P/T	MLOC	X/C	CP	P/L/P/T	MLOC	X/C	Y/(B/2)	CP	P/L/P/T	MLOC
0.0000	.9847	.9723	.2008	0.0000	.9847	.9723	.2008	.1507	.7476	-.9063	.5523	.9615
.0132	-1.2369	.4789	1.0821	.0126	.8023	.9317	.3193	.1507	.4976	-.9090	.5517	.9624
.0259	-1.6392	.3895	1.2435	.0255	.6051	.8879	.4155	.1507	.2476	-.9430	.5442	.9745
.0759	-1.7796	.3584	1.3055	.0495	.4114	.8449	.4965	.1507	-.2524	-.9402	.5448	.9735
.1003	-1.7131	.3731	1.2757	.0753	.2966	.8194	.5410	.1507	-.5024	-.9202	.5492	.9664
.1507	-.9540	.5417	.9784	.1002	.1969	.7973	.5781	.1507	-.7524	-.8986	.5540	.9587
.2003	-.8253	.5703	.9329	.1503	.0958	.7749	.6148	.5002	.7476	-.6528	.6086	.8731
.2503	-.7963	.5767	.9228	.1976	-.0007	.7534	.6490	.5002	.4976	-.6644	.6060	.8771
.3001	-.7741	.5817	.9151	.2503	-.0662	.7389	.6719	.5002	.2476	-.6723	.6043	.8798
.3502	-.7355	.5902	.9017	.3001	-.1104	.7291	.6873	.5002	-.2524	-.6656	.6058	.8775
.4003	-.7077	.5964	.8920	.3507	-.1429	.7218	.6985	.5002	-.5024	-.6641	.6061	.8770
.4501	-.6876	.6009	.8851	.4001	-.1956	.7190	.7029	.5002	-.7524	-.6529	.6086	.8731
.5002	-.6681	.6052	.8764	.4501	-.2511	.7191	.7028	.8002	.7476	-.3934	.6662	.7843
.5502	-.6535	.6084	.8733	.5001	-.3267	.7254	.6929	.8002	.4976	-.4044	.6638	.7881
.6002	-.6379	.6119	.8690	.5497	-.4028	.7395	.6708	.8002	.2476	-.4120	.6621	.7907
.6500	-.6161	.6168	.8605	.6003	-.0133	.7565	.6441	.8002	-.5024	-.4049	.6637	.7883
.7000	-.5625	.6287	.8421	.6500	.0797	.7713	.6205	.8002	-.7524	-.3853	.6680	.7816
.7500	-.4944	.6438	.8188	.7000	.1682	.7909	.5886					
.8002	-.4108	.6623	.7903	.7501	.2498	.8090	.5506					
.9002	-.1975	.7097	.7174	.8001	.3204	.8247	.5319					
.9501	-.0733	.7373	.6744	.8501	.3862	.8393	.5064					

TEST 167	PT 21.9676	PSI	CM .9001	CD1 .01550	CDCOR1 .01518
RUN 62	TT 152.0738	K	CM -.1172	CD2 .01561	CDCOR2 .01533
POINT 95	RC 6.9947	MILLION	CC -.0161	CD3 .01563	CDCOR3 .01541
	MACH .6495			CD4 .01590	CDCOR4 .01559
	ALPHA 3.5029	DEG		CD5 .01628	CDCOR5 .01578

UPPER SURFACE				LOWER SURFACE				SPANWISE				
X/C	CP	P/L/P/T	MLOC	X/C	CP	P/L/P/T	MLOC	X/C	Y/(B/2)	CP	P/L/P/T	MLOC
0.0000	.9407	.9627	.2337	0.0000	.9407	.9627	.2337	.1507	.7476	-1.0450	.5228	1.0090
.0132	-1.3697	.4509	1.1305	.0126	.8590	.9446	.2865	.1507	.4976	-1.4200	.4398	1.1503
.0259	-1.7339	.3702	1.2815	.0255	.6639	.9013	.3480	.1507	.2476	-1.5771	.4050	1.2141
.0759	-1.8961	.3343	1.3561	.0495	.4691	.8582	.4724	.1507	-.2524	-1.5378	.4137	1.1970
.1003	-1.8462	.3454	1.3325	.0753	.3520	.8323	.5188	.1507	-.5024	-1.3353	.4585	1.1172
.1507	-1.5712	.4063	1.2117	.1002	.2497	.8096	.5576	.1507	-.7524	-1.0003	.5327	.9929
.2003	-.8439	.5674	.9376	.1503	.1446	.7863	.5961	.5002	.7476	-.6555	.6091	.8723
.2503	-.7706	.5836	.9120	.1976	.0466	.7644	.6312	.5002	.4976	-.6678	.6064	.8765
.3001	-.7445	.5849	.9099	.2503	-.0216	.7499	.6532	.5002	.2476	-.6751	.6048	.8791
.3502	-.7441	.5895	.9028	.3001	-.0681	.7392	.6714	.5002	-.2524	-.6657	.6069	.8758
.4003	-.7165	.5956	.8933	.3507	-.1033	.7314	.6836	.5002	-.5024	-.6650	.6070	.8756
.4501	-.6940	.6006	.8855	.4001	-.1183	.7281	.6898	.5002	-.7524	-.6552	.6092	.8722
.5002	-.6735	.6051	.8785	.4501	-.1209	.7275	.6897	.8002	.7476	-.3862	.6688	.7804
.5502	-.6574	.6087	.8730	.5001	-.0953	.7332	.6809	.8002	.4976	-.3968	.6664	.7841
.6002	-.6406	.6124	.8672	.5497	-.0350	.7465	.6599	.8002	.2476	-.4060	.6644	.7872
.6500	-.6160	.6179	.8598	.6003	.0377	.7626	.6343	.8002	-.5024	-.3951	.6688	.7835
.7000	-.5601	.6302	.8397	.6500	.1016	.7748	.6116	.8002	-.7524	-.3756	.6711	.7768
.7500	-.4911	.6455	.8161	.7000	.1881	.7960	.5803					
.8002	-.4066	.6642	.7874	.7501	.2677	.8136	.5509					
.9002	-.1929	.7116	.7145	.8001	.3374	.8290	.5245					
.9501	-.0729	.7381	.6731	.8501	.4022	.8434	.4992					

TEST 167
 RUN 72
 MACH .650
 R 30.0×10^6

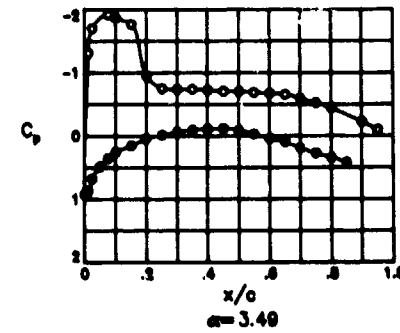
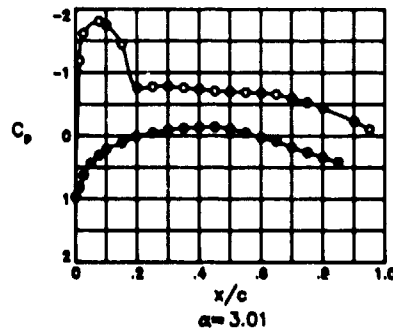
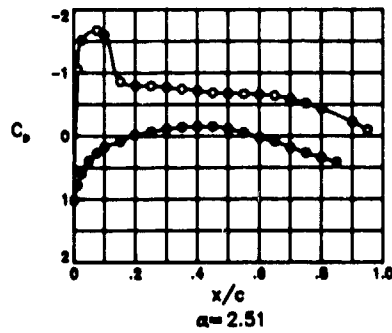
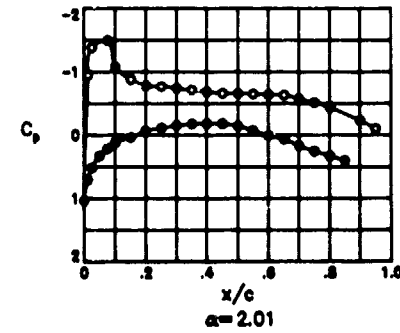
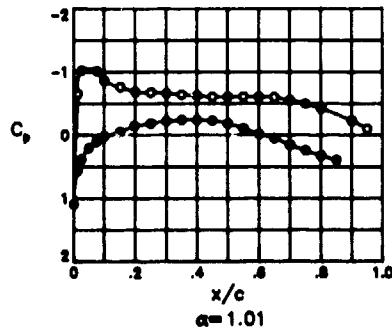
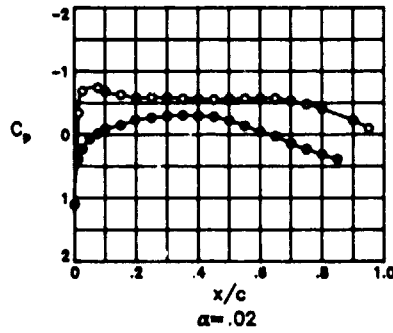
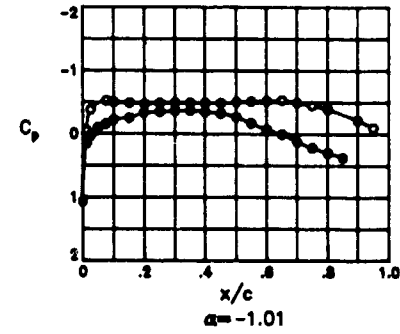
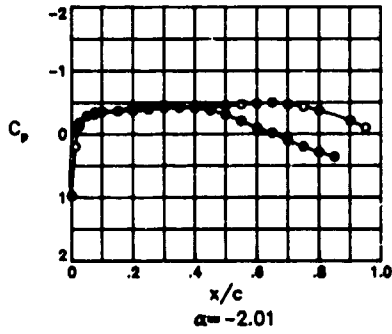
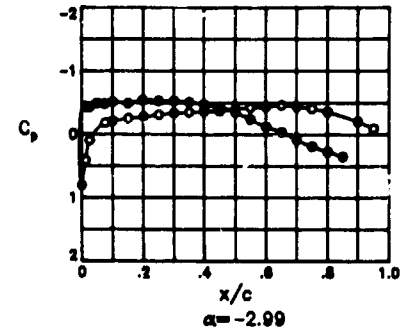
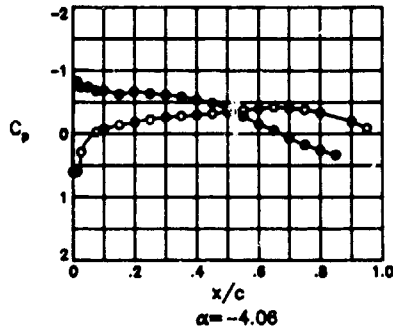

ORIGINAL PAGE IS
OF POOR QUALITY

TEST 167	PT 54.9961	PSI	CN -.0200	CD1 -.00763	CDCOR1 -.00754
RUN 72	TT 105.2925	K	CM -.1222	CD2 -.00763	CDCOR2 -.00757
POINT 16	RC 30.0373	MILLION	CC .0047	CD3 -.00762	CDCOR3 -.00763
	MACH .6526			CD4 -.00769	CDCOR4 -.00765
	ALPHA -4.0613	DEG		CD5 -.00778	CDCOR5 -.00751

UPPER SURFACE				LOWER SURFACE				SPANWISE				
X/C	CP	P/L/PT	MLOC	X/C	CP	P/L/PT	MLOC	X/C	Y/(B/2)	CP	P/L/PT	MLOC
0.0000	.6007	.8857	.4214	0.0000	.6007	.8857	.4214	.1507	.7476	-.1297	.7224	.7001
.0132	.6016	.8859	.4210	.0126	-.8285	.5661	.9425	.1507	.4976	-.1401	.7201	.7037
.0259	.2935	.8170	.3470	.0255	-.7333	.5874	.9090	.1507	.2476	-.1342	.7210	.7023
.0759	-.0309	.7445	.6654	.0495	-.7368	.5867	.9102	.1507	-.2524	-.1406	.7200	.7039
.1003	-.0737	.7349	.6805	.0753	-.6785	.5997	.8898	.1507	-.5024	-.1509	.7197	.7053
.1507	-.1392	.7203	.7034	.1002	-.6833	.5986	.8915	.1507	-.7524	-.1417	.7197	.7053
.2003	-.1783	.7115	.7170	.1503	-.6268	.6113	.8718	.5002	.7476	-.3364	.6762	.7718
.2503	-.2238	.7014	.7328	.1976	-.6631	.6031	.8845	.5002	.4976	-.3422	.6749	.7737
.3001	-.2540	.6946	.7437	.2500	-.6349	.6094	.8747	.5002	.2476	-.3472	.6738	.7754
.3502	-.2753	.6899	.7506	.3001	-.6157	.6137	.8680	.5002	-.2524	-.3394	.6755	.7727
.4003	-.2956	.6853	.7576	.3507	-.5866	.6202	.8579	.5002	-.5024	-.3368	.6781	.7718
.4501	-.3110	.6819	.7629	.4001	-.5352	.6317	.8401	.5002	-.7524	-.3271	.6783	.7684
.5002	-.3444	.6744	.7744	.4501	-.4808	.6439	.8214	.8002	.7476	-.9239	.5448	.9765
.5502	-.3723	.6682	.7840	.5001	-.3889	.6644	.7897	.8002	.4976	-.9316	.6772	.7700
.6002	-.3930	.6635	.7912	.5497	-.2720	.6906	.7494	.8002	.2476	-.9337	.6769	.7706
.6500	-.4200	.6575	.8005	.6003	-.1481	.7183	.7065	.8002	-.5024	-.9137	.6813	.7638
.7000	-.4014	.6616	.7941	.6500	-.0540	.7393	.6736	.8002	-.7524	-.9091	.6823	.7623
.7500	-.3768	.6672	.7856	.7000	.0728	.7607	-.285					
.8002	-.3305	.6775	.7696	.7501	.1757	.7907	.5911					
.9002	-.1893	.7091	.7208	.8001	.2632	.8102	.5595					
.9501	-.0843	.7326	.6842	.8501	.3356	.8265	.5308					

TEST 167	PT 55.0068	PSI	CM .1139	CD1 -.00753	CDCOR1 .00748
RUN 72	TT 105.4232	K	CM -.1258	CD2 -.00751	CDCOR2 .00749
POINT 17	RC 29.8817	MILLION	CC .0129	CD3 -.00755	CDCOR3 .00759
	MACH .6493			CD4 -.00770	CDCOR4 .00768
	ALPHA -2.9938	DEG		CD5 .00774	CDCOR5 .00748

UPPER SURFACE				LOWER SURFACE				SPANWISE				
X/C	CP	P/L/PT	MLOC	X/C	CP	P/L/PT	MLOC	X/C	Y/(B/2)	CP	P/L/PT	MLOC
0.0000	.8098	.9335	.3161	0.0000	.8098	.9335	.3161	.1507	.7476	-.2407	.7010	.7334
.0132	.4144	.8460	.4964	.0126	-.4306	.6589	.7982	.1507	.4976	-.2519	.6985	.7372
.0259	.0972	.7758	.6154	.0255	-.4347	.6590	.7996	.1507	.2476	-.2473	.6995	.7356
.0759	-.1811	.7142	.7129	.0495	-.4953	.6446	.8203	.1507	-.2524	-.2514	.6986	.7370
.1003	-.2062	.7086	.7215	.0753	-.4833	.6473	.8162	.1507	-.5024	-.2610	.6965	.7403
.1507	-.2505	.6988	.7367	.1002	-.5109	.6411	.8256	.1507	-.7524	-.2498	.6989	.7365
.2003	-.2748	.6934	.7450	.1503	-.4904	.6457	.8186	.5002	.7476	-.3884	.6681	.7638
.2503	-.3092	.6858	.7568	.1976	-.5417	.6343	.8361	.5002	.4976	-.3950	.6668	.7661
.3001	-.3318	.6808	.7645	.2503	-.5314	.6366	.8326	.5002	.2476	-.4005	.6656	.7679
.3502	-.3463	.6776	.7694	.3001	-.5254	.6379	.8305	.5002	-.2524	-.3928	.6673	.7653
.4003	-.3596	.6746	.7740	.3507	-.5092	.6415	.8250	.5002	-.5024	-.3901	.6679	.7644
.4501	-.3703	.6723	.7777	.4001	-.4700	.6502	.8116	.5002	-.7524	-.3795	.6702	.7608
.5002	-.3982	.6661	.7872	.4501	-.4275	.6596	.7971	.8002	.7476	-.9754	.5383	.9869
.5502	-.4211	.6616	.7950	.5001	-.3461	.6776	.7694	.8002	.4976	-.9515	.6764	.7712
.6002	-.4368	.6576	.8003	.5497	-.2383	.7015	.7325	.8002	.2476	-.9543	.6758	.7722
.6500	-.4591	.6526	.8079	.6003	-.1218	.7273	.6924	.8002	-.5024	-.9337	.6804	.7652
.7000	-.4348	.6580	.7996	.6500	-.0344	.7466	.6620	.8002	-.7524	-.9295	.6813	.7637
.7500	-.4042	.6648	.7892	.7000	.0893	.7740	.6183					
.8002	-.3521	.6763	.7714	.7501	.1900	.7963	.5918					
.9002	-.2003	.7099	.7195	.8001	.2772	.8156	.5494					
.9501	-.0906	.7342	.6816	.8501	.3509	.8319	.5212					

TEST 167	PT 55.0078	PSI	CM .2422	CD1 -.00749	CDCOR1 .00742
RUN 72	TT 105.3058	K	CM -.1293	CD2 -.00754	CDCOR2 .00750
POINT 18	RC 29.9379	MILLION	CC .0177	CD3 -.00762	CDCOR3 .00763
	MACH .6507			CD4 -.00771	CDCOR4 .00769
	ALPHA -2.0060	DEG		CD5 .00767	CDCOR5 .00748

UPPER SURFACE				LOWER SURFACE				SPANWISE				
X/C	CP	P/L/PT	MLOC	X/C	CP	P/L/PT	MLOC	X/C	Y/(B/2)	CP	P/L/PT	MLOC
0.0000	.9743	.9699	.2102	0.0000	.9743	.9699	.2102	.1507	.7476	-.3549	.6754	.7729
.0132	.2008	.7985	.5782	.0126	-.1082	.7300	.6881	.1507	.4976	-.3677	.6729	.7773
.0259	-.1247	.7264	.6939	.0255	-.1822	.7136	.7137	.1507	.2476	-.3635	.6735	.7758
.0759	-.3442	.6777	.7692	.0495	-.2866	.6905	.7695	.1507	-.2524	-.3687	.6723	.7776
.1003	-.3473	.6770	.7703	.0753	-.3135	.6849	.7588	.1507	-.5024	-.3772	.6704	.7805
.1507	-.3667	.6727	.7769	.1002	-.3595	.6744	.7744	.1507	-.7524	-.3624	.6736	.7756
.2003	-.3678	.6725	.7773	.1503	-.3681	.6724	.7774	.5002	.7476	-.4423	.6560	.8027
.2503	-.3976	.6659	.7874	.1976	-.4329	.6581	.7995	.5002	.4976	-.4491	.6545	.8050
.3001	-.4116	.6628	.7922	.2503	-.4387	.6568	.8015	.5002	.2476	-.4549	.6532	.8070
.3502	-.4182	.6613	.7945	.3001	-.4441	.6556	.8033	.5002	-.2524	-.4469	.6550	.8043
.4003	-.4246	.6599	.7967	.3507	-.4387	.6568	.8015	.5002	-.5024	-.4443	.6536	.8034
.4501	-.4296	.6588	.7984	.4001	-.4098	.6632	.7916	.5002	-.7524	-.4331	.6588	.7996
.5002	-.4521	.6538	.8061	.4501	-.3771	.6705	.7804	.8002	.7476	-1.0322	.5233	1.0080
.5502	-.4701	.6498	.8122	.5001	-.3051	.6864	.7559	.8002	.4976	-.9715	.6717	.7785
.6002	-.4811	.6474	.8160	.5497	-.2055	.7085	.7217	.8002	.2476	-.9750	.6709	.7797
.6500	-.4980	.6437	.8217	.6003	-.0957	.7328	.6838	.8002	-.5024	-.9538	.6736	.7725
.7000	-.4679	.6503	.8114	.6500	-.0143	.7508	.6554	.8002	-.7524	-.9492	.6766	.7769
.7500	-.4309	.6580	.7998	.7000	.1060	.7775	.6126					
.8002	-.3726	.6714	.7789	.7501	.2041	.7992	.5770					
.9002	-.2094	.7076	.7231	.8001	.2905	.8184	.5447					
.9501	-.0944	.7331	.6834	.8501	.3646	.8348	.5163					

TEST	167	PT	55.3113	PSI	CN	-3701	CD1	.00761	CDCOR1	.00753
RUN	72	TT	105.2591	K	CM	-1323	CD2	.00764	CDCOR2	.00760
POINT	19	RC	29.9778	MILLION	CC	.0189	CD3	.00776	CDCOR3	.00778
		MACH	.6500				CD4	.00787	CDCOR4	.00784
		ALPHA	-1.00*1	DEG			CD5	.00775	CDCOR5	.00759

UPPER SURFACE				LOWER SURFACE				SPANWISE				
X/C	CP	P/L/PT	MLOC	X/C	CP	P/L/PT	MLOC	X/C	Y/(B/2)	CP	P/L/PT	MLOC
0.0000	1.0715	.9914	.1117	0.0000	1.0715	.9914	.1117	.1507	.7476	-.4750	.6484	.8144
.0132	-.0499	.7427	.6682	.0126	.1819	.7897	.5927	.1507	.4976	-.4898	.6452	.8193
.0259	-.3826	.6689	.7828	.0255	.0358	.7617	.6381	.1507	.2476	-.4883	.6459	.8182
.0759	-.5272	.6369	.8322	.0495	-.1003	.7315	.6858	.1507	-.2524	-.4930	.6444	.8205
.1003	-.5012	.6426	.8233	.0753	-.1582	.7187	.7059	.1507	-.5024	-.5001	.6429	.8233
.1507	-.4902	.6451	.8196	.1002	-.2209	.7048	.7274	.1507	-.7524	-.4833	.6466	.8172
.2003	-.4698	.6496	.8126	.1503	-.2531	.6977	.7385	.5002	.7476	-.4950	.6440	.8212
.2503	-.4880	.6456	.8188	.1976	-.4293	.6806	.7646	.5002	.4976	-.5014	.6426	.8234
.3001	-.4924	.6466	.8203	.2503	-.3485	.6765	.7712	.5002	.2476	-.5073	.6413	.8254
.3502	-.4914	.6448	.8200	.3001	-.3638	.6731	.7764	.5002	-.2524	-.4981	.6433	.8223
.4003	-.4900	.6451	.8195	.3507	-.3681	.6721	.7779	.5002	-.5024	-.4962	.6437	.8216
.4501	-.4879	.6456	.8188	.4001	-.3485	.6765	.7712	.5002	-.7524	-.4843	.6464	.8175
.5002	-.5042	.6420	.8243	.4501	-.3249	.6817	.7631	.8002	.7476	-1.0809	.5141	1.0264
.5502	-.5171	.6391	.8288	.5001	-.2618	.6957	.7415	.8002	.4976	-.3889	.6475	.7849
.6002	-.5231	.6378	.8308	.5497	-.1705	.7160	.7101	.8002	.2476	-.3927	.6467	.7863
.6500	-.5341	.6353	.8346	.6003	-.0676	.7388	.6744	.8002	-.5024	-.3699	.6717	.7785
.7000	-.4981	.6433	.8223	.6500	.0076	.7555	.6480	.8002	-.7524	-.3654	.6727	.7769
.7500	-.4549	.6529	.8075	.7000	.1241	.7813	.6065					
.8002	-.3905	.6672	.7855	.7501	.2188	.8023	.5718					
.9002	-.2163	.7058	.7259	.8001	.3035	.8211	.5400					
.9501	-.0968	.7323	.6846	.8501	.3774	.8374	.5116					

TEST	167	PT	55.0042	PSI	CN	.4974	CD1	.00779	CDCOR1	.00773
RUN	72	TT	105.4211	K	CM	-1340	CD2	.00787	CDCOR2	.00783
POINT	20	RC	29.9709	MILLION	CC	.0165	CD3	.00799	CDCOR3	.00802
		MACH	.6521				CD4	.00808	CDCOR4	.00806
		ALPHA	.0204	DEG			CD5	.00802	CDCOR5	.00784

UPPER SURFACE				LOWER SURFACE				SPANWISE				
X/C	CP	P/L/PT	MLOC	X/C	CP	P/L/PT	MLOC	X/C	Y/(B/2)	CP	P/L/PT	MLOC
0.0000	1.1081	.9993	.0310	0.0000	1.1081	.9993	.0310	.1507	.7476	-.6074	.6173	.8824
.0132	-.3402	.6768	.7707	.0126	.3916	.8398	.5073	.1507	.4976	-.6253	.6133	.8886
.0259	-.6835	.6004	.8887	.0255	.2273	.8032	.5703	.1507	.2476	-.6231	.6138	.8876
.0759	-.7417	.5974	.9090	.0495	-.0659	.7673	.6292	.1507	-.2524	-.6305	.6122	.8704
.1003	-.6796	.6021	.8880	.0753	-.0178	.7486	.7589	.1507	-.5024	-.6344	.6112	.8719
.1507	-.6267	.6130	.8691	.1002	-.0919	.7321	.7749	.1507	-.7524	-.6136	.6159	.8646
.2003	-.5761	.6243	.8514	.1503	-.1461	.7200	.7837	.5002	.7476	-.5481	.6305	.8420
.2503	-.5953	.6222	.8548	.1976	-.2322	.7009	.7335	.5002	.4976	-.5558	.6289	.8446
.3001	-.5788	.6237	.8526	.2503	-.2642	.6937	.7446	.5002	.2476	-.5618	.6275	.8466
.3502	-.5655	.6267	.8480	.3001	-.2886	.6883	.7530	.5002	-.2524	-.5538	.6293	.8440
.4003	-.5568	.6286	.8450	.3507	-.3017	.6854	.7574	.5002	-.5024	-.5517	.6297	.8432
.4501	-.5484	.6305	.8421	.4001	-.2910	.6878	.7538	.5002	-.7524	-.5388	.6326	.8387
.5002	-.5578	.6283	.8454	.4501	-.2759	.6911	.7486	.8002	.7476	-1.1157	.5046	1.0421
.5502	-.5644	.6269	.8476	.5001	-.2215	.7033	.7298	.8002	.4976	-.4033	.6627	.7924
.6002	-.5648	.6269	.8477	.5497	-.1377	.7219	.7008	.8002	.2476	-.4088	.6616	.7941
.6500	-.5696	.6257	.8494	.6003	-.0414	.7433	.6672	.8002	-.5024	-.3651	.6644	.7861
.7000	-.5269	.6352	.8347	.6500	.0280	.7598	.6427	.8002	-.7524	-.3812	.6677	.7847
.7500	-.4765	.6465	.8174	.7000	.1408	.7839	.6022					
.8002	-.4057	.6622	.7931	.7501	.2327	.8064	.5683					
.9002	-.2203	.7035	.7294	.8001	.3157	.8229	.5370					
.9501	-.0958	.7312	.6882	.8501	.3889	.8392	.5085					

TEST	167	PT	55.0017	PSI	CN	.6213	CD1	.00807	CDCOR1	.00800
RUN	72	TT	105.6273	K	CM	-1350	CD2	.00816	CDCOR2	.00813
POINT	21	RC	29.8624	MILLION	CC	.0109	CD3	.00837	CDCOR3	.00839
		MACH	.6515				CD4	.00849	CDCOR4	.00847
		ALPHA	1.0081	DEG			CD5	.00852	CDCOR5	.00834

UPPER SURFACE				LOWER SURFACE				SPANWISE				
X/C	CP	P/L/PT	MLOC	X/C	CP	P/L/PT	MLOC	X/C	Y/(B/2)	CP	P/L/PT	MLOC
0.0000	1.0995	.9973	.0618	0.0000	1.0995	.9973	.0619	.1507	.7476	-.7409	.5867	.9101
.0132	-.6507	.6048	.8787	.0126	.5891	.8790	.4347	.1507	.4976	-.7617	.5820	.9174
.0259	-1.0225	.5238	1.0104	.0255	.3842	.8377	.5111	.1507	.2476	-.7617	.5820	.9174
.0759	-1.0137	.5294	1.0072	.0495	.2854	.7974	.5792	.1507	-.2524	-.7651	.5813	.9166
.1003	-.8549	.5613	.9501	.0753	.1841	.7752	.6163	.1507	-.5024	-.7657	.5811	.9188
.1507	-.7616	.5821	.9174	.1002	.0183	.7581	.6470	.1507	-.7524	-.7384	.5872	.9092
.2003	-.6829	.5994	.8498	.1503	-.0514	.7405	.6716	.5002	.7476	-.5979	.6187	.8403
.2503	-.6777	.6008	.8881	.1976	-.1447	.7197	.7043	.5002	.4976	-.6056	.6169	.8631
.3001	-.6608	.6045	.8822	.2503	-.1869	.7103	.7189	.5002	.2476	-.6120	.6134	.8653
.3502	-.6410	.6090	.8754	.3001	-.2189	.7032	.7300	.5002	-.2524	-.6022	.6176	.8619
.4003	-.6229	.6130	.8691	.3507	-.2385	.6988	.7367	.5002	-.5024	-.6007	.6210	.8613
.4501	-.6057	.6188	.8632	.4001	-.2553	.6945	.7357	.5002	-.7524	-.5868	.6211	.8564
.5002	-.6074	.6186	.8639	.4501	-.2275	.7012	.7328	.8002	.7476	-1.1413	.5973	1.0542
.5502	-.6086	.6182	.8642	.5001	-.1816	.7115	.7171	.8002	.4976	-.6166	.6598	.7988
.6002	-.6040	.6172	.8626	.5497	-.1054	.7285	.6906	.8002	.2476	-.6224	.6577	.8008
.6500	-.6011	.6179	.8615	.6003	-.0158	.7485	.6591	.8002	-.5024	-.5949	.6634	.7912
.7000	-.5526	.6297	.8448	.6500	.0485	.7628	.6362	.8002	-.7524	-.5933	.6662	.7880
.7500	-.4856	.6414	.8252	.7000	.1566	.7869	.5972					
.8002	-.4190	.6595	.7988	.7501	.2448	.8086	.5645					
.9002	-.2234	.7021	.7315	.8001	.3260	.8247	.5337					
.9501	-.0970	.7303	.6876	.8501	.3977	.8408	.5057					

ORIGINAL OF RECORD

TEST 167 PT 35.0071 PSI CM .7501 CD1 .00868 CDCOR1 .00868
 RUN 72 TT 105.5335 K CM -.1345 CD2 .00876 CDCOR2 .00857
 POINT 72 RC 24.4302 MILLION CC .0020 CD3 .00901 CDCOR3 .00892
 MACH .8494 CD4 .00908 CDCOR4 .00891
 ALPHA 2.0127 DEG CD5 .00915 CDCOR5 .00890

UPPER SURFACE				LOWER SURFACE				SPANWISE				
X/C	CP	P/L/PT	MLOC	X/C	CP	P/L/PT	MLOC	X/C	Y/(B/2)	CP	P/L/PT	MLOC
0.0000	1.0428	.9849	.2479	0.0000	1.0428	.9849	.1479	.1907	.7476	-.8662	.5610	.9507
.0132	-.9440	.5437	.9743	.0126	.7107	.9112	.3652	.1907	.4976	-.8773	.5585	.9546
.0259	-1.3807	.4467	1.1411	.0255	.5188	.8826	.4547	.1907	.2476	-.8795	.5580	.9553
.0759	-1.4931	.4218	1.1861	.0495	.3301	.8267	.5324	.1907	-.2524	-.8756	.5589	.9540
.1003	-1.0714	.5154	1.0242	.0753	.2147	.8010	.5739	.1907	-.5024	-.8704	.5601	.9521
.1507	-.8749	.5582	.9551	.1002	.1203	.7897	.6084	.1907	-.7524	-.8656	.5631	.9473
.2003	-.7776	.5406	.9196	.1503	.0378	.7617	.6380	.9002	.7476	-.8435	.6104	.8731
.2503	-.7695	.5843	.9168	.1975	-.0613	.7397	.6729	.9002	.4976	-.8526	.6084	.8762
.3001	-.7407	.5899	.9067	.2503	-.1121	.7285	.6906	.9002	.2476	-.8593	.6069	.8785
.3502	-.7153	.5945	.8974	.3031	-.1503	.7200	.7038	.9002	-.2524	-.8482	.6094	.8747
.4003	-.6873	.6007	.8882	.4031	-.1748	.7141	.7130	.9002	-.5024	-.8475	.6098	.8744
.4501	-.6616	.6064	.8793	.4501	-.1904	.7135	.7142	.9002	-.7524	-.8321	.6130	.8691
.5002	-.6365	.6076	.8775	.5001	-.1995	.7135	.7139	.8002	.7476	-1.1591	.6959	1.0569
.5502	-.6113	.6087	.8754	.5501	-.1918	.7135	.7009	.8002	.4976	-.8286	.6582	.7994
.6002	-.6411	.6110	.8723	.5997	-.0733	.7371	.6771	.8002	.2476	-.8451	.6567	.8016
.6500	-.6311	.6132	.8688	.6003	.0093	.7554	.6481	.8002	-.5024	-.8088	.6626	.7926
.7000	-.5768	.6252	.8501	.6500	.0683	.7685	.6271	.8002	-.7524	-.8050	.6634	.7913
.7500	-.5143	.6391	.8287	.7000	.1712	.7914	.5899					
.8002	-.4327	.6573	.8008	.7501	.2955	.8101	.5587					
.8502	-.2781	.7027	.7307	.8001	.3342	.8276	.5288					
.9001	-.1010	.7309	.6467	.8501	.4041	.8431	.5015					

TEST 167 PT 54.9944 PSI CM .8195 CD1 .00968 CDCOR1 .00944
 RUN 72 TT 105.5359 K CM -.1335 CD2 .00987 CDCOR2 .00965
 POINT 23 RC 28.8142 MILLION CC -.0032 CD3 .01006 CDCOR3 .00997
 MACH .8496 CD4 .01020 CDCOR4 .00997
 ALPHA 2.5139 DEG CD5 .01039 CDCOR5 .01006

UPPER SURFACE				LOWER SURFACE				SPANWISE				
X/C	CP	P/L/PT	MLOC	X/C	CP	P/L/PT	MLOC	X/C	Y/(B/2)	CP	P/L/PT	MLOC
0.0000	1.0184	.9794	.1731	0.0000	1.0184	.9794	.1731	.1907	.7476	-.8757	.5592	.9550
.0132	-1.0541	.5156	1.0190	.0126	.7771	.9258	.3348	.1907	.4976	-.8417	.5638	.9430
.0259	-1.5166	.4157	1.1972	.0255	.5814	.8823	.4282	.1907	.2476	-.8500	.5640	.9459
.0759	-1.6729	.3916	1.2634	.0495	.3944	.8407	.5059	.1907	-.2524	-.8555	.5627	.9470
.1003	-1.9946	.3984	1.2297	.0753	.2727	.8136	.5328	.1907	-.5024	-.8451	.5648	.9445
.1507	-.8578	.5622	.9447	.1002	.1743	.7917	.5683	.1907	-.7524	-.8390	.5620	.9491
.2003	-.7928	.5767	.9258	.1503	.0868	.7723	.6211	.9002	.7476	-.8584	.6066	.8791
.2503	-.7916	.5749	.9254	.1975	-.0192	.7496	.6573	.9002	.4976	-.8677	.6045	.8823
.3001	-.7659	.5827	.9164	.2503	-.0700	.7374	.6766	.9002	.2476	-.8617	.6038	.8802
.3502	-.7478	.5878	.9084	.3001	-.1115	.7282	.6910	.9002	-.2524	-.8617	.6038	.8802
.4003	-.7113	.5948	.8974	.3907	-.1407	.7217	.7032	.9002	-.5024	-.8609	.6040	.8800
.4501	-.6811	.6015	.8889	.4001	-.1477	.7201	.7036	.9002	-.7524	-.8444	.6096	.8743
.5002	-.6531	.6033	.8842	.4501	-.1497	.7197	.7043	.8002	.7476	-1.1538	.6964	1.0557
.5502	-.6282	.6050	.8814	.5001	-.1153	.7275	.6923	.8002	.4976	-.8244	.6586	.7988
.6002	-.6025	.6079	.8770	.5997	-.0501	.7418	.6696	.8002	.2476	-.8320	.6569	.8013
.6500	-.6199	.6110	.8722	.6003	.0297	.7596	.6414	.8002	-.5024	-.8033	.6633	.7915
.7000	-.5814	.6237	.8525	.6500	.0867	.7722	.6211	.8002	-.7524	-.8000	.6640	.7903
.7500	-.5157	.6383	.8300	.7000	.1477	.7847	.5844					
.8002	-.4313	.6571	.8011	.7501	.2704	.8132	.5535					
.8502	-.2224	.7015	.7295	.8001	.3486	.8305	.5237					
.9001	-.0942	.7316	.6857	.8501	.4181	.8459	.4984					

TEST 167 PT 54.9888 PSI CM .8827 CD1 .01167 CDCOR1 .01134
 RUN 72 TT 105.5101 K CM -.1298 CD2 .01194 CDCOR2 .01153
 POINT 24 RC 26.8864 MILLION CC -.0049 CD3 .01213 CDCOR3 .01182
 MACH .8509 CD4 .01251 CDCOR4 .01207
 ALPHA 3.0141 DEG CD5 .01273 CDCOR5 .01231

UPPER SURFACE				LOWER SURFACE				SPANWISE				
X/C	CP	P/L/PT	MLOC	X/C	CP	P/L/PT	MLOC	X/C	Y/(B/2)	CP	P/L/PT	MLOC
0.0000	.9728	.4492	.2124	0.0000	.9728	.4492	.2124	.1907	.7476	-1.0475	.5196	1.0174
.0132	-1.1407	.4499	1.0669	.0126	.8234	.9360	.3099	.1907	.4976	-1.3571	.4506	1.1342
.0259	-1.6131	.3432	1.2395	.0255	.6291	.8927	.4372	.1907	.2476	-1.4323	.4339	1.1640
.0759	-1.8114	.3495	1.3268	.0495	.4366	.8499	.5093	.1907	-.2524	-1.4308	.4343	1.1634
.1003	-1.7491	.3634	1.2943	.0753	.3103	.8218	.5388	.1907	-.5024	-1.3590	.4502	1.1349
.1507	-1.4411	.4319	1.1675	.1002	.2094	.7994	.5769	.1907	-.7524	-1.0406	.5211	1.0149
.2003	-.7501	.5844	.9136	.1503	.1166	.7745	.6109	.9002	.7476	-.8839	.6005	.8805
.2503	-.7744	.5803	.9200	.1975	.0119	.7554	.6442	.9002	.4976	-.8814	.5988	.8811
.3001	-.7770	.5768	.9210	.2503	-.0471	.7422	.6648	.9002	.2476	-.8680	.5974	.8834
.3502	-.7559	.5845	.9136	.3001	-.0912	.7324	.6844	.9002	-.2524	-.8605	.5990	.8808
.4003	-.7314	.5899	.9050	.3907	-.1231	.7253	.6955	.9002	-.5024	-.8698	.5992	.8806
.4501	-.7040	.5960	.8955	.4001	-.1332	.7231	.6997	.9002	-.7524	-.8479	.6023	.8834
.5002	-.6754	.5979	.8825	.4501	-.1380	.7220	.7007	.8002	.7476	-1.1742	.6914	1.0642
.5502	-.6456	.6001	.8891	.5001	-.1074	.7248	.6800	.8002	.4976	-.8453	.6598	.8029
.6002	-.6100	.6036	.8837	.5997	-.0449	.7427	.6602	.8002	.2476	-.8414	.6545	.8030
.6500	-.6136	.6072	.8780	.6003	.0323	.7599	.6409	.8002	-.5024	-.8169	.6599	.7964
.7000	-.5438	.6205	.8574	.6500	.0874	.7722	.6212	.8002	-.7524	-.8142	.6665	.7957
.7500	-.4926	.6359	.8337	.7000	.1864	.7942	.5842					
.8002	-.4334	.6551	.8041	.7501	.2678	.8123	.5549					
.8502	-.2268	.7022	.7314	.8001	.3452	.8296	.5254					
.9001	-.0946	.7305	.6873	.8501	.4139	.8448	.4984					

TEST 167	PT	95.0007	PSI	CM	.9367	CD1	.01452	CDCOR1	.01463
RUN 72	YT	105.5750	K	CM	-.1262	CD2	.01475	CDCOR2	.01492
POINT 25	BC	24.6286	MILLION	CC	-.0141	CD3	.01489	CDCOR3	.01510
	MACH	.6498				CD4	.01540	CDCOR4	.01559
	ALPHA	3.4927	DEG			CD5	.01580	CDCOR5	.01559

UPPER SURFACE					LOWER SURFACE					SPANWISE				
X/C	CP	P/L/PT	MLOC		X/C	CP	P/L/PT	MLOC		X/C	Y/(B/2)	CP	P/L/PT	MLOC
0.0000	.9278	.9594	1.246		0.0000	.9278	.9594	1.246		.1507	.7476	-1.8764	.3811	1.2631
.0132	-1.3081	.4629	1.1178		.0126	.8713	.9469	1.2813		.1507	.4976	-1.7997	.3537	1.3161
.0259	-1.7003	.3758	1.2735		.0255	.8790	.9041	1.3034		.1507	.2476	-1.7875	.3564	1.3125
.0759	-1.9172	.3276	1.3735		.0495	.4893	.8611	1.4686		.1507	-.2524	-1.7765	.3589	1.3075
.1003	-1.8668	.3388	1.3494		.0753	.3547	.8321	1.5209		.1507	-.5024	-1.7988	.3539	1.3178
.1507	-1.7635	.3613	1.3026		.1002	.2558	.8102	1.5986		.1507	-.7524	-1.8161	.3445	1.2571
.2003	-.9420	.5442	.9775		.1503	.1555	.7879	1.7156		.3002	.7476	-.8945	.5991	.8906
.2503	-.7501	.5868	.9099		.1976	.0490	.7642	1.8363		.3002	.4976	-.8994	.5981	.8923
.3001	-.7353	.5901	.9048		.2503	-.0142	.7502	1.9563		.3002	.2476	-.7051	.5968	.8943
.3502	-.7365	.5898	.9052		.3001	-.0610	.7398	1.9727		.3002	-.2524	-.6995	.5980	.8924
.4003	-.7244	.5925	.9010		.3507	-.0935	.7322	1.8948		.3002	-.5024	-.6999	.5979	.8925
.4501	-.7044	.5969	.8941		.4001	-.1084	.7293	1.8892		.3002	-.7524	-.6868	.6009	.8879
.5002	-.6982	.5993	.8919		.4501	-.1164	.7275	1.8920		.8002	.7476	-1.1934	.6884	1.0692
.5502	-.6884	.6005	.8885		.5001	-.0886	.7337	1.8824		.8002	.4976	-.4370	.6543	.8622
.6002	-.6713	.6043	.8926		.5497	-.0298	.7469	1.8615		.8002	.2476	-.4414	.6553	.8637
.6500	-.6543	.6081	.8767		.6003	.0455	.7635	1.8352		.8002	-.5024	-.4417	.6604	.7959
.7000	-.5933	.6216	.8557		.6500	.0971	.7769	1.8167		.8002	-.7524	-.4465	.6609	.7952
.7500	-.5231	.6372	.8316		.7000	.1947	.7966	1.8113						
.8002	-.4358	.6566	.8018		.7501	.2749	.8144	1.8514						
.8002	-.2250	.7036	.7292		.8001	.3508	.8313	1.8224						
.8501	-.0439	.7325	.6847		.8501	.4190	.8464	1.8954						

Appendix O

Pressure Data for $M = 0.76$; $R = 4.4 \times 10^6$, 7.0×10^6 , 10.0×10^6 , 15.0×10^6 , 30.0×10^6 , and 40.0×10^6 ; Fixed Transition

The pressure measurements made on the NASA SC(3)-0712(B) airfoil are presented in coefficient form in graphs and tables in this appendix. The data are for a given Mach number through the Reynolds number range. The pressure data from the upper surface of the airfoil are plotted as open symbols, and the lower-surface data are plotted as solid symbols.

ORIGINAL - ~~SECRET~~
OF POOR QUALITY

TEST 1A7 PT 20.5555 PSI CN -.1452 CD1 .01430 CDCOR1 .01458
 RUN 56 TT 215.9271 K CM -.1054 CD2 .01375 CDCOR2 .01417
 POINT 11 RC 4.4125 MILLION CC .0004 CD3 .01374 CDCOR3 .01426
 MACH .7599 CD4 .01401 CDCOR4 .01469
 ALPHA -.0324 DEG CD5 .01330 CDCOR5 .01372

UPPER SURFACE				LOWER SURFACE				SPANWISE				
X/C	CP	P/L/PT	MLOC	X/C	CP	P/L/PT	MLOC	X/C	Y/(B/2)	CP	P/L/PT	MLOC
0.0000	.7148	.8806	.4298	0.0000	.7148	.8806	.4298	.1507	.7476	-.1161	.6531	.6042
.0132	.6484	.8624	.4645	.0126	-.7546	.4783	1.0829	.1507	.4976	-.1364	.6475	.8127
.0259	.3277	.7746	.6149	.0255	-.7090	.4907	1.0617	.1507	.2476	-.1361	.6476	.8126
.0759	-.0641	.6827	.7588	.0495	-.7397	.4823	1.0759	.1507	-.2524	-.1417	.6461	.8150
.1003	-.0560	.6695	.7789	.0753	-.8279	.4582	1.1175	.1507	-.5024	-.1504	.6437	.8186
.1507	-.1349	.6479	.8121	.1002	-.9281	.4307	1.1662	.1507	-.7524	-.1276	.6499	.8091
.2003	-.1807	.6394	.8314	.1503	-.9080	.4363	1.1562	.5002	.7476	-.3756	.5820	.9141
.2503	-.2309	.6217	.8526	.1976	-.8906	.4410	1.1477	.5002	.4976	-.3843	.5796	.9179
.3001	-.2714	.6105	.8699	.2503	-.9329	.4294	1.1685	.5002	.2476	-.3895	.5782	.9201
.3502	-.2901	.6055	.8776	.3001	-.9014	.4381	1.1530	.5002	-.2524	-.3853	.5794	.9183
.4003	-.3219	.5967	.8912	.3507	-.9823	.4159	1.1933	.5002	-.5024	-.3810	.5806	.9164
.4501	-.3539	.5880	.9049	.4001	-.8995	.4386	1.1521	.5002	-.7524	-.3682	.5841	.9110
.5002	-.3803	.5877	.9182	.4501	-.5012	.5476	.9686	.8002	.7476	-.3331	.5937	.8960
.5502	-.4120	.5721	.9298	.5001	-.3961	.5764	.9230	.8002	.4976	-.3362	.5928	.8973
.6002	-.4438	.5634	.9436	.5497	-.2767	.6091	.8720	.8002	.2476	-.3400	.5918	.8989
.6500	-.4656	.5574	.9530	.6003	-.1551	.6424	.8206	.8002	-.5024	-.3386	.5922	.8983
.7000	-.4471	.5624	.9450	.6500	-.0503	.6711	.7765	.8002	-.7524	-.3233	.5964	.8918
.7500	-.4030	.5745	.9259	.7000	.0448	.6971	.7365					
.8002	-.3345	.5933	.8965	.7501	.1227	.7185	.7035					
.8002	-.31420	.6460	.8151	.8001	.1852	.7356	.6768					
.9501	-.0124	.6813	.760P	.8501	.2386	.7502	.6538					

TEST 1A7 PT 20.5703 PSI CN .0181 CD1 .01248 CDCOR1 .01217
 RUN 58 TT 216.1764 K CM -.1131 CD2 .01200 CDCOR2 .01174
 POINT 12 RC 4.4105 MILLION CC .0092 CD3 .01196 CDCOR3 .01177
 MACH .7604 CD4 .01226 CDCOR4 .01205
 ALPHA -2.9838 DEG CD5 .01204 CDCOR5 .01178

UPPER SURFACE				LOWER SURFACE				SPANWISE				
X/C	CP	P/L/PT	MLOC	X/C	CP	P/L/PT	MLOC	X/C	Y/(B/2)	CP	P/L/PT	MLOC
0.0000	.7148	.8806	.4298	0.0000	.6880	.9212	.3443	.1507	.7476	-.2260	.6188	.8570
.0132	.6495	.8182	.5429	.0126	-.4320	.5618	.9460	.1507	.4976	-.2426	.6142	.8641
.0259	.1670	.7274	.6396	.0255	-.4562	.5551	.9566	.1507	.2476	-.2433	.6140	.8644
.0759	-.1457	.6410	.8278	.0495	-.5024	.5424	.9770	.1507	-.2524	-.2445	.6137	.8649
.1003	-.1775	.6322	.8363	.0753	-.7809	.4654	1.1049	.1507	-.5024	-.2527	.6114	.8684
.1507	-.2424	.6142	.8640	.1002	-.5624	.5258	1.0038	.1507	-.7524	-.2253	.6190	.8567
.2003	-.2749	.6053	.8779	.1503	-.6049	.5140	1.0230	.5002	.7476	-.4369	.5605	.9481
.2503	-.3202	.5927	.8974	.1976	-.7036	.4869	1.0684	.5002	.4976	-.4474	.5576	.9527
.3001	-.3577	.5832	.9124	.2503	-.7954	.4614	1.1118	.5002	.2476	-.4526	.5562	.9550
.3502	-.3790	.5765	.9228	.3001	-.8605	.4434	1.1435	.5002	-.2524	-.4424	.5590	.9505
.4003	-.4012	.5703	.9325	.3507	-.8731	.4399	1.1497	.5002	-.5024	-.4380	.5602	.9486
.4501	-.4280	.5629	.9442	.4001	-.5642	.5198	1.0136	.5002	-.7524	-.4239	.5641	.9424
.5002	-.4441	.5571	.9535	.4501	-.4888	.5461	.9710	.8002	.7476	-.3375	.5880	.9049
.5502	-.4745	.5495	.9655	.5001	-.3876	.5741	.9266	.8002	.4976	-.3413	.5869	.9065
.6002	-.5051	.5416	.9782	.5497	-.2574	.6101	.8704	.8002	.2476	-.3477	.5851	.9093
.6500	-.5187	.5380	.9840	.6003	-.1307	.6451	.8164	.8002	-.5024	-.3403	.5872	.9061
.7000	-.4846	.5473	.9691	.6500	-.0270	.6752	.7703	.8002	-.7524	-.3259	.5912	.8999
.7500	-.4264	.5634	.9435	.7000	.0775	.7027	.7280					
.8002	-.3462	.5855	.9086	.7501	.1569	.7246	.6939					
.8002	-.3130	.6431	.8195	.8001	.2201	.7421	.6666					
.9501	-.0144	.6773	.7671	.8501	.2734	.7568	.6434					

TEST 1A7 PT 20.5688 PSI CN .1709 CD1 .01179 CDCOR1 .01156
 RUN 58 TT 216.3042 K CM -.1173 CD2 .01139 CDCOR2 .01116
 POINT 14 RC 4.4056 MILLION CC .0153 CD3 .01132 CDCOR3 .01109
 MACH .7601 CD4 .01152 CDCOR4 .01128
 ALPHA -1.9795 DEG CD5 .01139 CDCOR5 .01116

UPPER SURFACE				LOWER SURFACE				SPANWISE				
X/C	CP	P/L/PT	MLOC	X/C	CP	P/L/PT	MLOC	X/C	Y/(B/2)	CP	P/L/PT	MLOC
0.0000	.9093	.9576	.2493	0.0000	.9993	.9576	.2493	.1507	.7476	-.3493	.5853	.9090
.0132	.3173	.7693	.6234	.0126	-.1496	.6404	.8237	.1507	.4976	-.3687	.5799	.9174
.0259	-.0228	.6754	.7699	.0255	-.2288	.6149	.8574	.1507	.2476	-.3702	.5795	.9181
.0759	-.3153	.5947	.8944	.0495	-.3167	.5943	.8950	.1507	-.2524	-.3706	.5794	.9182
.1003	-.3214	.5930	.8970	.0753	-.4138	.5675	.9371	.1507	-.5024	-.3772	.5776	.9211
.1507	-.3694	.5797	.9178	.1002	-.4379	.5608	.9476	.1507	-.7524	-.3439	.5868	.9067
.2003	-.3995	.5714	.9308	.1503	-.4755	.5505	.9641	.5002	.7476	-.5048	.5424	.9771
.2503	-.4233	.5649	.9412	.1976	-.5760	.5227	1.0088	.5002	.4976	-.5126	.5394	.9818
.3001	-.4407	.5573	.9532	.2503	-.6226	.5099	1.0298	.5002	.2476	-.5210	.5379	.9842
.3502	-.4649	.5534	.9594	.3001	-.6460	.5034	1.0406	.5002	-.2524	-.5103	.5408	.9795
.4003	-.4409	.5490	.9665	.3507	-.6265	.5088	1.0317	.5002	-.5024	-.5062	.5420	.9777
.4501	-.45039	.5426	.9786	.4001	-.5579	.5277	1.0007	.5002	-.7524	-.4916	.5460	.9712
.5002	-.5171	.5390	.9925	.4501	-.4740	.5509	.9634	.8002	.7476	-.3488	.5854	.9088
.5502	-.5384	.5331	.9920	.5001	-.3706	.5794	.9182	.8002	.4976	-.3515	.5847	.9100
.6002	-.5667	.5269	1.0020	.5497	-.2406	.6153	.8624	.8002	.2476	-.3573	.5831	.9125
.6500	-.5646	.5259	1.0037	.6003	-.1148	.6500	.8089	.8002	-.5024	-.3524	.5845	.9104
.7000	-.5151	.5395	.9816	.6500	-.0067	.6789	.7611	.8002	-.7524	-.3390	.5881	.9046
.7500	-.4444	.5500	.9504	.7000	.0953	.7080	.7197					
.8002	-.3561	.5834	.9120	.7501	.1775	.7307	.6844					
.8002	-.31384	.6435	.8189	.8001	.2425	.7467	.6583					
.9501	-.0160	.6773	.7670	.8501	.2963	.7635	.6327					

TEST 167 PT 20.5712 PSI CM .2430
 RUN 5P TT 216.3106 K CM -.1195
 POINT 15 RC 4.4049 MILLION CC .0169
 MACH .7598
 ALPHA -1.4867 DEG

CD1 .01162 CDCOR1 .01138
 CD2 .01134 CDCOR2 .01113
 CD3 .01131 CDCOR3 .01108
 CD4 .01146 CDCOR4 .01124
 CD5 .01129 CDCOR5 .01104

UPPER SURFACE				LOWER SURFACE				SPANWISE				
X/C	CP	P/L/PT	MLOC	X/C	CP	P/L/PT	MLOC	X/C	Y/(B/2)	CP	P/L/PT	MLOC
0.0000	1.0495	.9715	.2036	0.0000	1.0495	.9715	.2036	1.907	.7476	-.4171	.5666	.9385
.0132	.2187	.7421	.6666	.0126	-.0195	.6763	.7685	1.907	.4976	-.4393	.5605	.9482
.0259	-.1284	.6463	.8147	.0255	-.1216	.6481	.8118	1.907	.2476	-.4416	.5598	.9492
.0759	-.4167	.5667	.9383	.0495	-.2282	.6187	.8571	1.907	-.2524	-.4436	.5593	.9501
.1003	-.4029	.5705	.9323	.0753	-.3149	.5948	.8942	1.907	-.5024	-.4492	.5577	.9525
.1507	-.4413	.5599	.9490	.1002	-.3610	.5821	.9141	1.907	-.7524	-.4123	.5679	.9364
.2003	-.4930	.5567	.9542	.1503	-.4103	.5685	.9355	3.002	.7476	-.5425	.5320	.9638
.2503	-.4810	.5489	.9665	.1976	-.5078	.5415	.9784	3.002	.4976	-.5528	.5291	.9984
.3001	-.5043	.5425	.9768	.2503	-.5941	.5288	.9990	3.002	.2476	-.5581	.5276	1.0008
.3502	-.5092	.5412	.9790	.3001	-.5773	.5223	1.0094	3.002	-.2524	-.5484	.5303	.9964
.4003	-.5222	.5376	.9847	.3507	-.5726	.5237	1.0073	3.002	-.5024	-.5441	.5315	.9945
.4501	-.5416	.5322	.9924	.4001	-.5823	.5364	.9866	3.002	-.7524	-.5293	.5356	.9879
.5002	-.5531	.5290	.9985	.4501	-.4555	.5560	.9553	3.002	.7476	-.3559	.5835	.7119
.5502	-.5708	.5242	1.0065	.5001	-.3582	.5828	.9129	3.002	.4976	-.3576	.5830	.9126
.6002	-.5891	.5191	1.0148	.5497	-.2323	.6176	.8588	3.002	.2476	-.3623	.5817	.9147
.6500	-.5878	.5194	1.0142	.6003	-.1090	.6516	.8064	3.002	-.5024	-.3600	.5823	.9137
.7000	-.5286	.5358	.9876	.6500	-.0023	.6811	.7612	3.002	-.7524	-.3466	.5861	.9079
.7500	-.4519	.5570	.9537	.7000	.1012	.7097	.7171					
.8002	-.3600	.5823	.9137	.7501	.1864	.7332	.6806					
.9002	-.1391	.6433	.8192	.8001	.2541	.7519	.6512					
.9501	-.0184	.6766	.7680	.8501	.3102	.7674	.6269					

TEST 167 PT 20.5690 PSI CM .3164
 RUN 5P TT 216.2103 K CM -.1215
 POINT 16 RC 4.4069 MILLION CC .0174
 MACH .7597
 ALPHA -.9810 DEG

CD1 .01147 CDCOR1 .01128
 CD2 .01132 CDCOR2 .01112
 CD3 .01138 CDCOR3 .01113
 CD4 .01150 CDCOR4 .01128
 CD5 .01133 CDCOR5 .01108

UPPER SURFACE				LOWER SURFACE				SPANWISE				
X/C	CP	P/L/PT	MLOC	X/C	CP	P/L/PT	MLOC	X/C	Y/(B/2)	CP	P/L/PT	MLOC
0.0000	1.0871	.9818	.1619	0.0000	1.0871	.9818	.1619	1.907	.7476	-.4401	.5664	.9706
.0132	.1132	.7129	.7121	.0126	-.1006	.7095	.7175	1.907	.4976	-.5145	.5396	.9815
.0259	-.2389	.6157	.8618	.0255	-.0211	.6759	.7692	1.907	.2476	-.5180	.5386	.9830
.0759	-.5332	.5344	.9898	.0495	-.1428	.6422	.8209	1.907	-.2524	-.5186	.5385	.9833
.1003	-.4490	.5467	.9701	.0753	-.2255	.6194	.8560	1.907	-.5024	-.5229	.5373	.9852
.1507	-.5173	.5389	.9827	.1002	-.2874	.6023	.8825	1.907	-.7524	-.4812	.5488	.9667
.2003	-.5199	.5381	.9838	.1503	-.3458	.5862	.9076	3.002	.7476	-.5775	.5222	1.0096
.2503	-.5402	.5325	.9929	.1976	-.4416	.5598	.9493	3.002	.4976	-.5886	.5192	1.0146
.3001	-.5586	.5275	1.0011	.2503	-.4895	.5465	.9704	3.002	.2476	-.5939	.5177	1.0170
.3502	-.5559	.5282	.9999	.3001	-.5158	.5392	.9820	3.002	-.2524	-.5839	.5205	1.0125
.4003	-.5657	.5255	1.0043	.3507	-.5217	.5376	.9847	3.002	-.5024	-.5799	.5216	1.0107
.4501	-.5823	.5209	1.0118	.4001	-.4883	.5468	.9699	3.002	-.7524	-.5644	.5258	1.0037
.5002	-.5895	.5189	1.0150	.4501	-.4296	.5630	.9441	3.002	.7476	-.3574	.5830	.9126
.5502	-.6015	.5156	1.0204	.5001	-.3403	.5877	.9052	3.002	.4976	-.3595	.5824	.9135
.6002	-.6155	.5117	1.0268	.5497	-.2195	.6211	.8335	3.002	.2476	-.3643	.5811	.9156
.6500	-.6069	.5141	1.0229	.6003	-.0994	.6542	.8024	3.002	-.5024	-.3625	.5816	.9149
.7000	-.5341	.5331	.9919	.6500	.0050	.6830	.7582	3.002	-.7524	-.3502	.5850	.9095
.7500	-.4563	.5557	.9557	.7000	.1087	.7117	.7140					
.8002	-.3621	.5817	.9147	.7501	.1953	.7356	.6768					
.9002	-.1392	.6432	.8193	.8001	.2646	.7547	.6466					
.9501	-.0215	.6757	.7694	.8501	.3221	.7706	.6213					

TEST 167 PT 20.5344 PSI CM .3920
 RUN 5P TT 216.1604 K CM -.1225
 POINT 17 RC 4.3975 MILLION CC .0164
 MACH .7586
 ALPHA -.4811 DEG

CD1 .01163 CDCOR1 .01140
 CD2 .01159 CDCOR2 .01134
 CD3 .01160 CDCOR3 .01138
 CD4 .01160 CDCOR4 .01130
 CD5 .01153 CDCOR5 .01127

UPPER SURFACE				LOWER SURFACE				SPANWISE				
X/C	CP	P/L/PT	MLOC	X/C	CP	P/L/PT	MLOC	X/C	Y/(B/2)	CP	P/L/PT	MLOC
0.0000	1.1201	.9913	.1118	0.0000	1.1201	.9913	.1118	1.907	.7476	-.3655	.5280	1.0003
.0132	-.0053	.6849	.7594	.0126	.2133	.7420	.6667	1.907	.4976	-.3919	.5207	1.0121
.0259	-.3529	.5864	.9073	.0255	-.0746	.7039	.7260	1.907	.2476	-.3976	.5192	1.0146
.0759	-.7951	.4758	1.0870	.0495	-.0599	.6649	.7830	1.907	-.2524	-.3999	.5196	1.0139
.1003	-.5716	.5283	1.0030	.0753	-.1436	.6439	.8183	1.907	-.5024	-.3971	.5193	1.0144
.1507	-.5967	.5194	1.0143	.1002	-.2159	.6241	.8489	1.907	-.7524	-.3495	.5324	.9932
.2003	-.5845	.5227	1.0088	.1503	-.2816	.6060	.8768	3.002	.7476	-.6062	.5168	1.0185
.2503	-.5996	.5186	1.0156	.1976	-.3767	.5799	.9176	3.002	.4976	-.6194	.5132	1.0245
.3001	-.6148	.5144	1.0224	.2503	-.4273	.5660	.9395	3.002	.2476	-.6262	.5133	1.0276
.3502	-.6004	.5184	1.0199	.3001	-.4581	.5575	.9529	3.002	-.2524	-.6157	.5142	1.0228
.4003	-.6040	.5174	1.0176	.3507	-.4688	.5545	.9576	3.002	-.5024	-.6115	.5153	1.0209
.4501	-.6180	.5135	1.0238	.4001	-.4473	.5604	.9482	3.002	-.7524	-.5947	.5200	1.0133
.5002	-.6217	.5129	1.0255	.4501	-.3891	.5737	.9272	3.002	.7476	-.3552	.5858	.9083
.5502	-.6249	.5116	1.0270	.5001	-.3183	.5959	.8925	3.002	.4976	-.3595	.5844	.9101
.6002	-.6339	.5092	1.0310	.5497	-.2032	.6275	.8435	3.002	.2476	-.3645	.5832	.9123
.6500	-.6171	.5138	1.0235	.6003	-.0867	.6596	.7942	3.002	-.5024	-.3635	.5835	.9119
.7000	-.5430	.5341	.9903	.6500	.0150	.6875	.7513	3.002	-.7524	-.3525	.5865	.9071
.7500	-.4585	.5574	.9530	.7000	.1184	.7159	.7074					
.8002	-.3623	.5838	.9114	.7501	.2081	.7400	.6898					
.9002	-.1381	.6454	.8180	.8001	.2769	.7595	.6391					
.9501	-.0225	.6772	.7671	.8501	.3358	.7757	.6131					

OF FOUR QUARTERS

TEST 167 PT 20.5725 PSI CN .4740 CD1 .01182 CDCOR1 .01150
 RUN 58 TT 216.2200 K CM -.1250 CD2 .01178 CDCOR2 .01149
 POINT 18 RC 4.4020 MILLION CC .0154 CD3 .01185 CDCOR3 .01161
 MACH .7580 CD4 .01174 CDCOR4 .01151
 ALPHA .0261 DEG CD5 .01172 CDCOR5 .01144

UPPER SURFACE				LOWER SURFACE				SPANWISE				
X/C	CP	P/L/P/T	MLOC	X/C	CP	P/L/P/T	MLOC	X/C	Y/(B/2)	CP	P/L/P/T	MLOC
0.0000	1.1398	.9971	.0647	0.0000	1.1398	.9971	.0647	.1507	.7476	-.6462	.5086	1.0320
.0132	-.1130	.6544	.8021	.0126	.3232	.7737	.6163	.1507	.4976	-.6494	.5077	1.0334
.0259	-.4784	.5545	.9576	.0255	.1687	.7315	.6832	.1507	.2476	-.6508	.5074	1.0340
.0759	-.8389	.4559	1.1214	.0495	.0240	.6919	.7446	.1507	-.2524	-.6632	.5040	1.0397
.1003	-.8015	.4661	1.1037	.0753	-.0608	.6687	.7802	.1507	-.5024	-.6634	.5039	1.0397
.1507	-.6602	.5048	1.0383	.1002	-.1428	.6463	.8146	.1507	-.7524	-.6198	.5158	1.0201
.2003	-.6651	.5034	1.0405	.1507	-.2131	.6285	.8651	.5002	.7476	-.6348	.5117	1.0268
.2503	-.6557	.5060	1.0362	.1976	-.3094	.6007	.8850	.5002	.4976	-.6508	.5073	1.0341
.3001	-.6765	.5003	1.0457	.2503	-.3620	.5863	.9074	.5002	.2476	-.6570	.5057	1.0368
.3502	-.6681	.5026	1.0419	.3001	-.3960	.5770	.9220	.5002	-.2524	-.6419	.5098	1.0300
.4003	-.6447	.5290	1.0313	.3507	-.4122	.5726	.9290	.5002	-.5024	-.6371	.5111	1.0279
.4501	-.6532	.5067	1.0351	.4001	-.3991	.5762	.9233	.5002	-.7524	-.6187	.5161	1.0196
.5002	-.6542	.5064	1.0356	.4501	-.3804	.5868	.9067	.8002	.7476	-.3555	.5881	.9046
.5502	-.6508	.5073	1.0341	.5001	-.2880	.6064	.8762	.8002	.4976	-.3588	.5872	.9060
.6002	-.6520	.5070	1.0346	.5497	-.1807	.6359	.8306	.8002	.2476	-.3646	.5855	.9085
.6500	-.6261	.5141	1.0229	.6003	-.0694	.6664	.7838	.8002	-.5024	-.3600	.5869	.9066
.7000	-.5478	.5355	.9881	.6500	.0290	.6933	.7425	.8002	-.7524	-.3499	.5896	.9022
.7500	-.4619	.5590	.9504	.7000	.1312	.7212	.6992					
.8002	-.3644	.5857	.9085	.7501	.2191	.7453	.6616					
.9002	-.1398	.6471	.8134	.8001	.2912	.7650	.6304					
.9501	-.0288	.6775	.7668	.8501	.3514	.7815	.6038					

TEST 167 PT 20.4333 PSI CN .5419 CD1 .01219 CDCOR1 .01192
 RUN 58 TT 216.1305 K CM -.1251 CD2 .01217 CDCOR2 .01192
 POINT 19 RC 4.3764 MILLION CC .0140 CD3 .01216 CDCOR3 .01186
 MACH .7586 CD4 .01202 CDCOR4 .01178
 ALPHA .5152 DEG CD5 .01203 CDCOR5 .01176

UPPER SURFACE				LOWER SURFACE				SPANWISE				
X/C	CP	P/L/P/T	MLOC	X/C	CP	P/L/P/T	MLOC	X/C	Y/(B/2)	CP	P/L/P/T	MLOC
0.0000	1.1554	1.0014	0.0000	0.0000	1.1554	1.0014	0.0000	.1507	.7476	-.7377	.4840	1.0731
.0132	-.2040	.6299	.8399	.0126	.4151	.7991	.5750	.1507	.4976	-.9140	.4358	1.1570
.0259	-.5780	.5277	1.0008	.0255	.2502	.7540	.6478	.1507	.2476	-.9023	.4390	1.1513
.0759	-.8917	.4419	1.1461	.0495	.0949	.7116	.7142	.1507	-.2524	-.9128	.4362	1.1564
.1003	-.8966	.4406	1.1485	.0753	-.0045	.6868	.7524	.1507	-.5024	-.8817	.4447	1.1412
.1507	-.8083	.4401	1.1493	.1002	-.0816	.6633	.7885	.1507	-.7524	-.6878	.4977	1.0502
.2003	-.7977	.4676	1.1011	.1503	-.1605	.6418	.8216	.5002	.7476	-.6673	.5033	1.0408
.2503	-.6455	.5092	1.0310	.1976	-.2570	.6154	.8623	.5002	.4976	-.6848	.4985	1.0488
.3001	-.6800	.4998	1.0466	.2503	-.3143	.5997	.8865	.5002	.2476	-.6893	.4973	1.0508
.3502	-.7206	.4887	1.0632	.3001	-.3916	.5895	.9024	.5002	-.2524	-.6716	.5021	1.0428
.4003	-.7061	.4927	1.0585	.3507	-.3730	.5837	.9116	.5002	-.5024	-.6707	.5023	1.0424
.4501	-.6876	.4977	1.0501	.4001	-.3659	.5856	.9085	.5002	-.7524	-.6540	.5069	1.0348
.5002	-.6834	.4988	1.0487	.4501	-.3336	.5945	.8947	.8002	.7476	-.3525	.5893	.9028
.5502	-.6769	.5006	1.0452	.5001	-.2885	.6122	.8671	.8002	.4976	-.3560	.5883	.9043
.6002	-.6682	.5030	1.0412	.5497	-.1848	.6406	.8234	.8002	.2476	-.3607	.5870	.9063
.6500	-.6344	.5122	1.0260	.6003	-.0563	.6702	.7779	.8002	-.5024	-.3586	.5876	.9054
.7000	-.5485	.5357	.9877	.6500	.0395	.6964	.7376	.8002	-.7524	-.3497	.5900	.9016
.7500	-.4579	.5605	.9481	.7000	.1408	.7241	.6947					
.8002	-.3993	.5874	.9057	.7501	.2291	.7482	.6570					
.9002	-.1347	.6488	.8108	.8001	.3016	.7681	.6254					
.9501	-.0249	.6788	.7647	.8501	.3626	.7847	.5985					

TEST 167 PT 20.5081 PSI CN .6216 CD1 .01224 CDCOR1 .01198
 RUN 58 TT 216.0053 K CM -.1247 CD2 .01238 CDCOR2 .01213
 POINT 20 RC 4.4101 MILLION CC .0114 CD3 .01246 CDCOR3 .01219
 MACH .7590 CD4 .01235 CDCOR4 .01207
 ALPHA 1.0001 DEG CD5 .01245 CDCOR5 .01213

UPPER SURFACE				LOWER SURFACE				SPANWISE				
X/C	CP	P/L/P/T	MLOC	X/C	CP	P/L/P/T	MLOC	X/C	Y/(B/2)	CP	P/L/P/T	MLOC
0.0000	1.1472	.9987	1.0431	0.0000	1.1472	.9987	.0431	.1507	.7476	-.9290	.4277	1.1718
.0132	-.7989	.6010	.8846	.0126	.4875	.8173	.5445	.1507	.4976	-1.0195	.4027	1.2179
.0259	-.6795	.4963	1.0524	.0255	.3155	.7699	.6224	.1507	.2476	-.9778	.4142	1.1965
.0759	-.9671	.4172	1.1910	.0495	.1514	.7248	.6937	.1507	-.2524	-.9867	.4118	1.2010
.1003	-.9433	.4237	1.1790	.0753	.0574	.6990	.7337	.1507	-.5024	-1.0380	.3977	1.2276
.1507	-.9443	.4124	1.1997	.1002	-.0328	.6741	.7719	.1507	-.7524	-.8812	.4408	1.1481
.2003	-.9511	.4216	1.1829	.1503	-.1171	.6510	.8075	.5002	.7476	-.6572	.5024	1.0423
.2503	-.9700	.4164	1.1925	.1976	-.2153	.6239	.8490	.5002	.4976	-.6520	.5038	1.0399
.3001	-.9784	.4141	1.1968	.2503	-.2760	.6072	.8749	.5002	.2476	-.6600	.5016	1.0435
.3502	-.8887	.4387	1.1518	.3001	-.3164	.5961	.8921	.5002	-.2524	-.6665	.4998	1.0465
.4003	-.8416	.4957	1.0535	.3507	-.3421	.5891	.9032	.5002	-.5024	-.6662	.4996	1.0464
.4501	-.6609	.5014	1.0439	.4001	-.3401	.5896	.9023	.5002	-.7524	-.6674	.4996	1.0469
.5002	-.6638	.5006	1.0453	.4501	-.3137	.5969	.8910	.8002	.7476	-.3588	.5845	.9103
.5502	-.6725	.4962	1.0493	.5001	-.2544	.6132	.8637	.8002	.4976	-.3622	.5835	.9118
.6002	-.6786	.4965	1.0521	.5497	-.1557	.6403	.8238	.8002	.2476	-.3665	.5824	.9136
.6500	-.6501	.5044	1.0390	.6003	-.0510	.6691	.7795	.8002	-.5024	-.3665	.5824	.9136
.7000	-.5563	.5302	.9967	.6500	.0422	.6948	.7401	.8002	-.7524	-.3579	.5847	.9099
.7500	-.4616	.5562	.9549	.7000	.1420	.7222	.6977					
.8002	-.3625	.5835	.9119	.7501	.2294	.7462	.6601					
.9002	-.1393	.6449	.8168	.8001	.3021	.7662	.6283					
.9501	-.0298	.6750	.7706	.8501	.3633	.7831	.6012					

TEST 167	PT 19.8709	PSI	CN	.7216	CD1	-.01344	CDCDR1	.01315
RUN 58	TT 211.9334	K	CM	-.1317	CD2	-.01352	CDCDR2	.01320
POINT 21	RC 4.3726	MILLION	CC	.0104	CD3	-.01405	CDCDR3	.01370
	MACH .7587				CD4	-.01457	CDCDR4	.01413
	ALPHA 1.5274	DEG			CD5	-.01427	CDCDR5	.01384

UPPER SURFACE				LOWER SURFACE				SPANWISE				
X/C	CP	P _L /PT	MLOC	X/C	CP	P _L /PT	MLOC	X/C	Y/(B/2)	CP	P _L /PT	MLOC
0.0000	1.1516	.9998	.0188	0.0000	1.1516	.9998	.0188	.1507	.7476	-1.0158	.4022	1.2189
.0132	-.3783	.5780	.9206	.0126	.5623	.8373	.5098	.1507	.4976	-1.0572	.3908	1.2407
.0259	-.7633	.4718	1.0938	.0255	.3840	.7881	.5930	.1507	.2476	-1.0003	.4065	1.2109
.0759	-.9907	.4091	1.2059	.0495	.2150	.7415	.6675	.1507	-.2524	-1.0184	.4015	1.2202
.1003	-1.0706	.4009	1.2214	.0753	.1177	.7147	.7093	.1507	-.5024	-1.0834	.3836	1.2547
.1507	-1.0237	.4001	1.2230	.1002	.0235	.6887	.7494	.1507	-.7524	-1.0980	.4099	1.2045
.2003	-1.0372	.3963	1.2301	.1503	-.0668	.6638	.7877	.5002	.7476	-.9195	.4288	1.1698
.2503	-1.0410	.3953	1.2321	.1976	-.1665	.6364	.8299	.5002	.4976	-.9778	.4127	1.1993
.3001	-1.0870	.3826	1.2567	.2503	-.2305	.6187	.8571	.5002	.2476	-.9650	.4162	1.1993
.3502	-1.0881	.3823	1.2573	.3001	-.2744	.6066	.8758	.5002	-.2524	-.9502	.4203	1.1852
.4003	-1.0717	.3868	1.2484	.3507	-.3039	.5985	.8885	.5002	-.5024	-1.0016	.4062	1.2115
.4501	-.9954	.4079	1.2083	.4001	-.3066	.5977	.8896	.5002	-.7524	-.9258	.4270	1.1729
.5002	-.8982	.4347	1.1591	.4501	-.2854	.6036	.8805	.8002	.7476	-.3473	.5887	.9037
.5502	-.7308	.4808	1.0785	.5001	-.2313	.6185	.8575	.8002	.4976	-.3473	.5865	.9071
.6002	-.5885	.5200	1.0132	.5497	-.1367	.6446	.8173	.8002	.2476	-.3528	.5850	.9095
.6500	-.5546	.5294	.9980	.6003	-.0352	.6726	.7743	.8002	-.5024	-.3501	.5858	.9083
.7000	-.5114	.5413	.9788	.6500	.0559	.6977	.7357	.8002	-.7524	-.3407	.5884	.9043
.7500	-.4416	.5605	.9481	.7000	.1543	.7248	.6937					
.8002	-.3516	.5854	.9690	.7501	.2412	.7488	.6561					
.9002	-.1386	.6441	.8181	.8001	.3143	.7689	.6241					
.9501	-.0393	.6725	.7744	.8501	.3765	.7861	.5964					

TEST 167	PT 19.4449	PSI	CN	.8099	CD1	-.01692	CDCDR1	.01607
RUN 58	TT 207.0310	K	CM	-.1395	CD2	-.01686	CDCDR2	.01599
POINT 22	RC 4.4204	MILLION	CC	.0094	CD3	-.01863	CDCDR3	.01740
	MACH .7589				CD4	-.01988	CDCDR4	.01834
	ALPHA 2.0264	DEG			CD5	-.01836	CDCDR5	.01716

UPPER SURFACE				LOWER SURFACE				SPANWISE				
X/C	CP	P _L /PT	MLOC	X/C	CP	P _L /PT	MLOC	X/C	Y/(B/2)	CP	P _L /PT	MLOC
0.0000	1.1478	.9989	.0392	0.0000	1.1478	.9989	.0392	.1507	.7476	-1.1197	.3757	1.2702
.0132	-.4605	.5569	.9538	.0126	.6299	.8566	.4752	.1507	.4976	-1.1494	.3676	1.2864
.0259	-.8464	.4509	1.1303	.0255	.4466	.8062	.5631	.1507	.2476	-1.1034	.3802	1.2613
.0759	-1.0808	.3864	1.2492	.0495	.2743	.7589	.6401	.1507	-.2524	-1.1142	.3773	1.2672
.1003	-1.0800	.3867	1.2488	.0753	.1754	.7317	.6830	.1507	-.5024	-1.1631	.3638	1.2940
.1507	-1.0975	.3819	1.2581	.1002	.0771	.7046	.7249	.1507	-.7524	-1.1018	.3807	1.2605
.2003	-1.0980	.3817	1.2584	.1503	-.0174	.6787	.7649	.5002	.7476	-1.0673	.3901	1.2420
.2503	-1.1022	.3806	1.2606	.1976	-.1171	.6513	.8070	.5002	.4976	-1.0873	.3797	1.2624
.3001	-1.1499	.3675	1.2867	.2503	-.1826	.6333	.8347	.5002	.2476	-1.1249	.3743	1.2730
.3502	-1.1744	.3407	1.3003	.3001	-.2288	.6206	.8542	.5002	-.2524	-1.0944	.3827	1.2565
.4003	-1.1713	.3616	1.2986	.3507	-.2610	.6117	.8679	.5002	-.5024	-1.0949	.3826	1.2567
.4501	-1.1721	.3613	1.2991	.4001	-.2676	.6099	.8708	.5002	-.7524	-1.0686	.3898	1.2427
.5002	-1.0899	.3840	1.2540	.4501	-.2516	.6143	.8639	.8002	.7476	-.3223	.5949	.8941
.5502	-.9463	.4234	1.1796	.5001	-.2031	.6276	.8434	.8002	.4976	-.3277	.5934	.8964
.6002	-.8527	.5041	1.0395	.5497	-.1142	.6521	.8058	.8002	.2476	-.3312	.5925	.8979
.6500	-.8182	.5411	.9792	.6003	-.0172	.6787	.7648	.8002	-.5024	-.3271	.5936	.8962
.7000	-.4699	.5543	.9979	.6500	.0710	.7030	.7275	.8002	-.7524	-.3202	.5955	.8932
.7500	-.4116	.5704	.9325	.7000	.1677	.7295	.6861					
.8002	-.3339	.5917	.8991	.7501	.2533	.7531	.6493					
.9002	-.1379	.6456	.8158	.8001	.3264	.7732	.6173					
.9501	-.0435	.6715	.7759	.8501	.3891	.7904	.5893					

TEST 167	PT 18.7604	PSI	CN	.8573	CD1	.02223	CDCDR1	.02161
RUN 58	TT 203.1409	K	CM	-.1446	CD2	.02276	CDCDR2	.02216
POINT 23	RC 4.3775	MILLION	CC	.0105	CD3	.02539	CDCDR3	.02432
	MACH .7588				CD4	.02788	CDCDR4	.02662
	ALPHA 2.5355	DEG			CD5	.02410	CDCDR5	.02327

UPPER SURFACE				LOWER SURFACE				SPANWISE				
X/C	CP	P _L /PT	MLOC	X/C	CP	P _L /PT	MLOC	X/C	Y/(B/2)	CP	P _L /PT	MLOC
0.0000	1.1401	.9962	.0734	0.0000	1.1401	.9962	.0734	.1507	.7476	-1.1440	.3638	1.2941
.0132	-.5128	.5386	.9832	.0126	.6619	.8638	.4618	.1507	.4976	-1.1837	.3528	1.3166
.0259	-.8935	.4332	1.1618	.0255	.4781	.8129	.5518	.1507	.2476	-1.1374	.3656	1.2904
.0759	-1.1194	.3704	1.2804	.0495	.3007	.7638	.6323	.1507	-.2524	-1.1335	.3667	1.2882
.1003	-1.1392	.3676	1.2864	.0753	.1972	.7352	.6773	.1507	-.5024	-1.1947	.3498	1.3229
.1507	-1.1268	.3686	1.2845	.1002	.0989	.7080	.7198	.1507	-.7524	-1.1460	.3632	1.2952
.2003	-1.1506	.3620	1.2978	.1503	.0004	.6807	.7619	.5002	.7476	-1.1624	.3587	1.3045
.2503	-1.1616	.3589	1.3040	.1976	-.1031	.6520	.8059	.5002	.4976	-1.1824	.3532	1.3158
.3001	-1.1715	.3562	1.3097	.2503	-.1736	.6325	.8359	.5002	.2476	-1.1997	.3484	1.3259
.3502	-1.2100	.3455	1.3318	.3001	-.2235	.6187	.8572	.5002	-.2524	-1.1824	.3532	1.3159
.4003	-1.2207	.3426	1.3381	.3507	-.2597	.6087	.8727	.5002	-.5024	-1.1516	.3617	1.2984
.4501	-1.2394	.3374	1.3491	.4001	-.2708	.6056	.8775	.5002	-.7524	-1.1510	.3619	1.2980
.5002	-1.2275	.3407	1.3421	.4501	-.2584	.6090	.8722	.8002	.7476	-.3211	.5917	.8991
.5502	-1.1559	.3605	1.3008	.5001	-.2141	.6213	.8532	.8002	.4976	-.3183	.5924	.8980
.6002	-.8144	.4951	1.1229	.5497	-.1268	.6455	.8160	.8002	.2476	-.3188	.5923	.8982
.6500	-.5742	.5216	1.0108	.6003	-.0307	.6721	.7751	.8002	-.5024	-.3217	.5915	.8994
.7000	-.4784	.5481	.9679	.6500	.0560	.6961	.7382	.8002	-.7524	-.3207	.5918	.8990
.7500	-.4393	.5708	.9318	.7000	.1517	.7226	.6972					
.8002	-.3159	.5931	.8969	.7501	.2377	.7464	.6599					
.9002	-.1472	.6398	.8247	.8001	.3110	.7667	.6277					
.9501	-.0649	.6626	.7897	.8501	.3743	.7842	.5994					

ORIGINAL PAGE IS
OF POOR QUALITY

TEST 167	PT 18.3713	PSI	CN .8859	CD1 .03406	CDCOR1 .03282
RUN 5A	TT 200.0815	K	CM -1.462	CD2 .03479	CDCOR2 .03377
POINT 24	RC 4.3802	MILLION	CC .0117	CD3 .03364	CDCOR3 .03290
	MACH .7595			CD4 .03464	CDCOR4 .03346
	ALPHA 3.0243	DEG		CD5 .03247	CDCOR5 .03125

UPPER SURFACE				LOWER SURFACE				SPANWISE				
X/C	CP	P _o L/PT	MLOC	X/C	CP	P _o L/PT	MLOC	X/C	Y/(B/2)	CP	P _o L/PT	MLOC
0.0000	1.1359	.9952	.0828	0.0000	1.1359	.9952	.0828	.1507	.7476	-1.1930	.3515	1.3193
.0132	-.5622	.5258	1.0038	.0126	.7055	.8763	.4383	.1507	.4976	-1.2284	.3417	1.3399
.0259	-.9413	.4211	1.1839	.0255	.5197	.8249	.5314	.1507	.2476	-1.1952	.3509	1.3206
.0759	-1.1640	.3595	1.3029	.0495	.3392	.7750	.6143	.1507	-.2524	-1.1706	.3577	1.3066
.1003	-1.1768	.3560	1.3101	.0753	.2337	.7459	.6608	.1507	-.5024	-1.2242	.3429	1.3375
.1507	-1.1793	.3553	1.3115	.1002	.1325	.7179	.7045	.1507	-.7524	-1.1731	.3570	1.3080
.2003	-1.1703	.3578	1.3064	.1503	.0304	.6897	.7481	.5002	.7476	-1.2071	.3476	1.3275
.2503	-1.2017	.3491	1.3244	.1976	-.0745	.6607	.7926	.5002	.4976	-1.2239	.3430	1.3373
.3001	-1.2191	.3443	1.3345	.2103	-.1476	.6404	.8237	.5002	.2476	-1.2278	.3419	1.3395
.3502	-1.2447	.3372	1.3495	.3001	-.2005	.6258	.8462	.5002	-.2524	-1.2106	.3466	1.3295
.4003	-1.2603	.3329	1.3588	.3507	-.2405	.6148	.8633	.5002	-.5024	-1.1753	.3564	1.3092
.4501	-1.2817	.3270	1.3717	.4001	-.2557	.6106	.8698	.5002	-.7524	-1.2029	.3487	1.3251
.5002	-1.2656	.3314	1.3620	.4501	-.2473	.6129	.8662	.8002	.7476	-1.3253	.5913	.8997
.5502	-.9468	.4195	1.1867	.5001	-.2071	.6240	.8490	.8002	.4976	-.3285	.5904	.9011
.6002	-.6769	.4941	1.0561	.5497	-.1229	.6473	.8132	.8002	.2476	-.3396	.5874	.9059
.6500	-.5828	.5202	1.0131	.6003	-.0296	.6731	.7736	.8002	-.5024	-.3325	.5893	.9028
.7000	-.5037	.5420	.9777	.6500	.0555	.6966	.7374	.8002	-.7524	-.3264	.5910	.9001
.7500	-.4224	.5645	.9414	.7000	.1499	.7227	.6970					
.8002	-.3415	.5868	.9067	.7501	.2351	.7462	.6602					
.9002	-.1820	.6293	.8409	.8001	.3082	.7664	.6281					
.9501	-.1287	.5457	.9157	.8501	.3719	.7840	.5997					

TEST	167	PT	21.3681	PSI	CM	-.1142	CD1	.01313	CDCOR1	.01277
RUN	61	TT	160.3245	K	CM	-.1172	CD2	.01259	CDCOR2	.01229
POINT	53	RC	6.9708	MILLION	CC	.0017	CD3	.01251	CDCOR3	.01228
		MACH	.7614				CD4	.01296	CDCOR4	.01270
		ALPHA	-3.9917	DEG			CD5	.01242	CDCOR5	.01207

UPPER SURFACE				LOWER SURFACE				SPANWISE				
X/C	CP	P.L./PT	MLOC	X/C	CP	P.L./PT	MLOC	X/C	Y/(B/2)	CP	P.L./PT	MLOC
0.0000	.7361	.8844	.4226	0.0000	.7341	.8844	.4226	.1507	.7476	-.1190	.6488	.8110
.0132	-.6389	.8581	.4726	.0126	-.7238	.4819	1.0770	.1507	.4976	-.1330	.6450	.8169
.0259	-.3240	.7711	.6207	.0255	-.6722	.4961	1.0530	.1507	.2476	-.1324	.6451	.8167
.0759	-.0102	.6789	.7649	.0495	-.6858	.4923	1.0593	.1507	-.2524	-.1338	.6447	.8173
.1003	-.0543	.6667	.7835	.0753	-.8277	.4532	1.1265	.1507	-.5024	-.1400	.6430	.8199
.1907	-.1315	.6354	.8163	.1002	-.9296	.4251	1.1768	.1507	-.7524	-.1227	.6478	.8125
.2003	-.1858	.6304	.8393	.1503	-.8813	.4384	1.1527	.1507	-.7476	-.3779	.5773	.9218
.2503	-.2299	.6182	.8581	.1976	-.8909	.4357	1.1575	.5002	.4976	-.3866	.5750	.9218
.3001	-.2714	.6068	.8759	.2503	-.9228	.4269	1.1734	.5002	.2476	-.3918	.5735	.9278
.3502	-.3004	.5928	.8883	.3001	-.8760	.4398	1.1501	.5002	-.2524	-.3819	.5763	.9278
.4003	-.3293	.5808	.9007	.3507	-.9467	.4203	1.1854	.5002	-.5024	-.3782	.5773	.9219
.4501	-.3601	.5623	.9140	.4001	-.9642	.4155	1.1944	.5002	-.7524	-.3666	.5805	.9169
.5002	-.3886	.5744	.9264	.4501	-.9858	.4176	.9690	.8002	-.7476	-.3334	.5897	.9025
.5502	-.4213	.5654	.9407	.5001	-.9714	.3791	.9189	.8002	.4976	-.3374	.5885	.9076
.6002	-.4569	.5555	.9562	.5497	-.2543	.6115	.8686	.8002	.2476	-.3451	.5864	.9076
.6500	-.4805	.5490	.9666	.6003	-.1334	.6449	.8171	.8002	-.5024	-.3334	.5896	.9025
.7000	-.4992	.5549	.9573	.6500	-.0261	.6745	.7716	.8002	-.7524	-.3194	.5935	.8965
.7500	-.4135	.5675	.9372	.7000	.0760	.7027	.7282					
.8002	-.3437	.5868	.9070	.7501	.1615	.7263	.6916					
.9002	-.1498	.6406	.8236	.8001	.2309	.7454	.6616					
.9501	-.0241	.6750	.7707	.8501	.2893	.7616	.6300					

TFST	167	PT	21.3698	PSI	CM	-.0382	CD1	.01133	CDCOR1	.01108
RUN	61	TT	160.4087	K	CM	-.1215	CD2	.01060	CDCOR2	.01065
POINT	54	RC	6.9671	MILLION	CC	.0099	CD3	.01023	CDCOR3	.01064
		MACH	.7615				CD4	.01112	CDCOR4	.01087
		ALPHA	-3.0141	DEG			CD5	.01093	CDCOR5	.01066

UPPER SURFACE				LOWER SURFACE				SPANWISE				
X/C	CP	P.L./PT	MLOC	X/C	CP	P.L./PT	MLOC	X/C	Y/(B/2)	CP	P.L./PT	MLOC
0.0000	.8712	.9219	.3428	0.0000	.8712	.9219	.3428	.1507	.7476	-.2254	.6184	.8578
.0132	-.4976	.8185	.5425	.0125	-.4305	.5617	.9465	.1507	.4976	-.2420	.6138	.8649
.0259	-.1660	.7267	.6909	.0255	-.4519	.5558	.9559	.1507	.2476	-.2424	.6137	.8651
.0759	-.1506	.6391	.8259	.0495	-.4899	.5452	.9727	.1507	-.2524	-.2450	.6130	.8662
.1003	-.1776	.6317	.8374	.0753	-.8132	.4558	1.1219	.1507	-.5024	-.2508	.6114	.8687
.1507	-.2418	.6139	.8648	.1002	-.9558	.4270	1.0021	.1507	-.7524	-.2302	.6171	.8599
.2003	-.2822	.6027	.8821	.1503	-.9552	.4161	1.0199	.5002	.7476	-.4453	.5576	.9330
.2503	-.3225	.5916	.8995	.1976	-.6945	.4887	1.0655	.5002	.4976	-.4541	.5551	.9369
.3001	-.3587	.5815	.9152	.2503	-.7856	.4634	1.1087	.5002	.2476	-.4598	.5536	.9393
.3502	-.3802	.5756	.9245	.3001	-.8519	.4451	1.1408	.5002	-.2524	-.4503	.5562	.9352
.4003	-.4047	.5688	.9352	.3507	-.8672	.4409	1.1483	.5002	-.5024	-.4468	.5572	.9336
.4501	-.4328	.5611	.9475	.4001	-.9730	.5223	1.0098	.5002	-.7524	-.4331	.5604	.9485
.5002	-.4567	.5544	.9580	.4501	-.4795	.5481	.9681	.8002	.7476	-.3488	.5843	.9109
.5502	-.4834	.5465	.9707	.5001	-.3814	.5753	.9250	.8002	.4976	-.3525	.5833	.9125
.6002	-.5164	.5379	.9845	.5497	-.2522	.6110	.8693	.8002	.2476	-.3600	.5812	.9157
.6500	-.5341	.5330	.9923	.6003	-.1290	.6462	.8150	.8002	-.5024	-.3506	.5838	.9116
.7000	-.4981	.5430	.9763	.6500	-.0156	.6765	.7685	.8002	-.7524	-.3374	.5875	.9059
.7500	-.4386	.5595	.9500	.7000	.0897	.7056	.7236					
.8002	-.3584	.5816	.9150	.7501	.1769	.7298	.6861					
.9002	-.1500	.6393	.8254	.8001	.2470	.7492	.6557					
.9501	-.0236	.6743	.7719	.8501	.3058	.7654	.6298					

TEST	167	PT	21.3698	PSI	CM	-.1023	CD1	.01118	CDCOR1	.01097
RUN	61	TT	160.3913	K	CM	-.1252	CD2	.01082	CDCOR2	.01065
POINT	55	RC	6.9645	MILLION	CC	.0162	CD3	.01074	CDCOR3	.01059
		MACH	.7609				CD4	.01094	CDCOR4	.01079
		ALPHA	-1.9938	DEG			CD5	.01086	CDCOR5	.01063

UPPER SURFACE				LOWER SURFACE				SPANWISE				
X/C	CP	P.L./PT	MLOC	X/C	CP	P.L./PT	MLOC	X/C	Y/(B/2)	CP	P.L./PT	MLOC
0.0000	1.0007	.9582	.2476	0.0000	1.0007	.9582	.2476	.1507	.7476	-.3515	.5958	.9086
.0132	-.3178	.7701	.6223	.0126	-.1455	.6425	.8207	.1507	.4976	-.3709	.5804	.9169
.0259	-.0266	.6753	.7704	.0255	-.2248	.6207	.8543	.1507	.2476	-.3717	.5802	.9173
.0759	-.3240	.5934	.8967	.0495	-.3082	.5977	.8899	.1507	-.2524	-.3738	.5796	.9182
.1003	-.3741	.5933	.8968	.0753	-.4236	.5659	.9300	.1507	-.5024	-.3782	.5784	.9201
.1907	-.3711	.5804	.9170	.1002	-.4323	.5635	.9434	.1507	-.7524	-.3522	.5836	.9089
.2003	-.3938	.5741	.9288	.1503	-.4456	.5543	.9581	.5002	.7476	-.3555	.5806	.9001
.2503	-.4275	.5648	.9415	.1976	-.5651	.5270	1.0022	.5002	.4976	-.3524	.5822	.9040
.3001	-.4565	.5549	.9541	.2503	-.6083	.5150	1.0217	.5002	.2476	-.3500	.5867	.9045
.3502	-.4866	.5534	.9597	.3001	-.6297	.5042	1.0313	.5002	-.2524	-.3503	.5896	.9018
.4003	-.4886	.5486	.9673	.3507	-.6088	.5149	1.0219	.5002	-.5024	-.3509	.5905	.9003
.4501	-.5077	.5427	.9767	.4001	-.5448	.5325	.9932	.5002	-.7524	-.3505	.5939	.8948
.5002	-.5261	.5377	.9848	.4501	-.4848	.5546	.9578	.8002	.7476	-.3604	.5833	.9124
.5502	-.5488	.5314	.9949	.5001	-.3634	.5825	.9137	.8002	.4976	-.3637	.5824	.9138
.6002	-.5742	.5244	1.0063	.5497	-.2345	.6180	.8585	.8002	.2476	-.3707	.5805	.9168
.6500	-.5823	.5222	1.0099	.6003	-.1087	.6526	.8031	.8002	-.5024	-.3635	.5825	.9137
.7000	-.5292	.5368	.9862	.6500	-.0012	.6823	.7596	.8002	-.7524	-.3505	.5861	.9081
.7500	-.4573	.5586	.9545	.7000	.1052	.7116	.7144					
.8002	-.3697	.5808	.9184	.7501	.1936	.7399	.6765					
.9002	-.1522	.6407	.8235	.8001	.2643	.7554	.6458					
.9501	-.0250	.6757	.7697	.8501	.3236	.7717	.6197					

TEST 167 PT 21.3691 PSI CN .2654
 RUN 61 TT 160.4033 K CM -.1276
 POINT 56 RC 6.9629 MILLION CC .0177
 MACH .7608
 ALPHA -1.5071 DEG

UPPER SURFACE				LOWER SURFACE				SPANWISE				
X/C	CP	P/L/P/T	MLOC	X/C	CP	P/L/P/T	MLOC	X/C	Y/(B/2)	CP	P/L/P/T	MLOC
0.0000	1.0511	.9719	.2021	0.0000	1.0511	.9719	.2021	.1507	.7476	-.4171	.3667	.9386
.0132	.2215	.7429	.6655	.0126	-.0155	-.6775	-.7669	.1507	.4976	-.4395	.3605	.9484
.0259	-.1293	.6461	.8152	.0255	-.1179	-.6493	.8103	.1507	.2476	-.4414	.3600	.9492
.0759	-.4237	.3649	.9414	.0495	-.2199	-.6211	.8536	.1507	-.2524	-.4441	.3592	.9504
.1003	-.4033	.3705	.9325	.0753	-.3201	-.5934	.8966	.1507	-.5024	-.4472	.3584	.9517
.1507	-.4413	.3600	.9491	.1002	-.3548	-.5839	.9115	.1507	-.7524	-.4472	.3567	.9386
.2003	-.4538	.3560	.9555	.1503	-.3996	-.5715	.9310	.5002	.7476	-.5506	.5298	.9975
.2503	-.4841	.3482	.9680	.1976	-.4497	-.5447	.9735	.5002	.4976	-.5606	.5271	1.0020
.3001	-.5081	.3416	.9786	.2503	-.5405	-.5326	.9930	.5002	.2476	-.5664	.5255	1.0046
.3502	-.5154	.3396	.9818	.3001	-.5624	-.5266	1.0028	.5002	-.2524	-.5556	.5285	.9998
.4003	-.5291	.3358	.9879	.3507	-.5585	-.5277	1.0010	.5002	-.5024	-.5522	.5294	.9982
.4501	-.5485	.3304	.9966	.4001	-.5122	-.5404	.9804	.5002	-.7524	-.5394	.5329	.9925
.5002	-.5629	.3264	1.0030	.4501	-.4429	-.5596	.9499	.8002	.7476	-.3615	.5820	.9144
.5502	-.5815	.3212	1.0116	.5001	-.3470	-.5860	.9082	.8002	.4976	-.3659	.5808	.9163
.6002	-.6041	.3151	1.0216	.5497	-.2221	-.6205	.8546	.8002	.2476	-.3731	.5788	.9195
.6500	-.6070	.3143	1.0229	.6003	-.0990	-.6545	.8023	.8002	-.5024	-.3671	.5805	.9169
.7000	-.5423	.3321	.9938	.6500	.0067	-.6836	.7575	.8002	-.7524	-.3548	.5839	.9115
.7500	-.4627	.3541	.9585	.7000	.1134	-.7131	.7120					
.8002	-.3718	.3792	.9189	.7501	.2032	-.7379	.6734					
.8002	-.1512	.6401	.8245	.8001	.2759	-.7579	.6418					
.9501	-.6266	.6744	.7716	.8501	.3372	-.7749	.6147					

TEST 167 PT 21.3708 PSI CN .3420
 RUN 61 TT 160.3399 K CM -.1297
 POINT 57 RC 6.9644 MILLION CC .0183
 MACH .7602
 ALPHA -1.0061 DEG

UPPER SURFACE				LOWER SURFACE				SPANWISE				
X/C	CP	P/L/P/T	MLOC	X/C	CP	P/L/P/T	MLOC	X/C	Y/(B/2)	CP	P/L/P/T	MLOC
0.0000	1.0925	.9837	.1533	0.0000	1.0925	.9837	.1533	.1507	.7476	-.4922	.5483	.9678
.0132	.1123	.7144	.7100	.0126	.1074	.7130	.7121	.1507	.4976	-.5147	.5421	.9777
.0259	-.2440	.6165	.8608	.0255	-.0150	-.6794	.7640	.1507	.2476	-.5185	.5411	.9794
.0759	-.5453	.3337	.9412	.0495	-.1314	-.6473	.8133	.1507	-.2524	-.5206	.5405	.9803
.1003	-.4916	.3485	.9675	.0753	-.2252	-.6217	.8526	.1507	-.5024	-.5227	.5399	.9812
.1507	-.5184	.3411	.9793	.1002	-.2779	-.6072	.8752	.1507	-.7524	-.4885	.5493	.9641
.2003	-.5243	.3395	.9819	.1503	-.3316	-.5924	.8982	.5002	.7476	-.5873	.5222	1.0100
.2503	-.5434	.3341	.9906	.1976	-.4258	-.5665	.9388	.5002	.4976	-.5973	.5194	1.0145
.3001	-.5639	.3286	.9995	.2503	-.4713	-.5540	.9586	.5002	.2476	-.6031	.5178	1.0170
.3502	-.5833	.3228	.9992	.3001	-.4482	-.5472	.9695	.5002	-.2524	-.5906	.5213	1.0144
.4003	-.5719	.3264	1.0031	.3507	-.5019	-.5456	.9721	.5002	-.5024	-.5886	.5224	1.0097
.4501	-.5887	.3218	1.0106	.4001	-.4696	-.5545	.9579	.5002	-.7524	-.5727	.5262	1.0034
.5002	-.5993	.3189	1.0153	.4501	-.4133	-.5700	.9334	.8002	.7476	-.3684	.5823	.9139
.5502	-.6115	.3155	1.0208	.5001	-.3264	-.5938	.8960	.8002	.4976	-.3707	.5817	.9149
.6002	-.6256	.3106	1.0290	.5497	-.2072	-.6266	.8452	.8002	.2476	-.3771	.5799	.9177
.6500	-.6292	.3114	1.0271	.6003	-.0876	-.6595	.7947	.8002	-.5024	-.3702	.5810	.9147
.7000	-.5528	.3317	.9946	.6500	.0152	-.6877	.7512	.8002	-.7524	-.3579	.5852	.9094
.7500	-.4663	.3549	.9573	.7000	.1217	-.7170	.7061					
.8002	-.3755	.3864	.9170	.7501	.2125	-.7419	.6671					
.8002	-.1527	.6416	.8221	.8001	.2463	-.7622	.6350					
.9501	-.6270	.6756	.7699	.8501	.3488	-.7794	.6074					

TEST 167 PT 21.3743 PSI CN .4175
 RUN 61 TT 160.2634 K CM -.1299
 POINT 58 RC 6.9696 MILLION CC .0171
 MACH .7600
 ALPHA -1.4490 DEG

UPPER SURFACE				LOWER SURFACE				SPANWISE				
X/C	CP	P/L/P/T	MLOC	X/C	CP	P/L/P/T	MLOC	X/C	Y/(B/2)	CP	P/L/P/T	MLOC
0.0000	1.1212	.9914	.1113	0.0000	1.1212	.9914	.1113	.1507	.7476	-.5730	.5245	1.0061
.0132	.1004	.6837	.7573	.0126	.2219	.7436	.6645	.1507	.4976	-.5983	.5176	1.0175
.0259	-.1578	.5839	.9116	.0255	-.0820	-.7050	.7245	.1507	.2476	-.6036	.5161	1.0199
.0759	-.4637	.3665	1.0133	.0495	-.0502	-.6646	.7806	.1507	-.2524	-.6050	.5157	1.0205
.1003	-.4576	.3646	1.0059	.0753	-.1451	-.6424	.8208	.1507	-.5024	-.6022	.5165	1.0193
.1507	-.4804	.3560	1.0201	.1002	-.2089	-.6246	.8479	.1507	-.7524	-.5607	.5279	1.0086
.2003	-.4941	.3511	1.0167	.1503	-.2718	-.6075	.8747	.5002	.7476	-.6317	.5084	1.0326
.2503	-.5107	.3441	1.0231	.1976	-.3673	-.5817	.9157	.5002	.4976	-.6438	.5050	1.0382
.3001	-.5285	.3375	1.0314	.2503	-.4173	-.5674	.9374	.5002	.2476	-.6502	.5033	1.0411
.3502	-.5479	.3313	1.0246	.3001	-.4480	-.5590	.9508	.5002	-.2524	-.6391	.5063	1.0360
.4003	-.5682	.3266	1.0356	.3507	-.4562	-.5559	.9557	.5002	-.5024	-.6342	.5077	1.0338
.4501	-.5896	.3216	1.0388	.4001	-.4376	-.5619	.9462	.8002	.7476	-.6176	.5124	1.0260
.5002	-.6122	.3164	1.0398	.4501	-.3900	-.5750	.9255	.8002	.4976	-.3702	.5804	.9169
.5502	-.6374	.3113	1.0444	.5001	-.3104	-.5969	.8912	.8002	.2476	-.3728	.5797	.9181
.6002	-.6647	.3059	1.0400	.5497	-.1959	-.6284	.8423	.8002	-.5024	-.3784	.5782	.9205
.6500	-.6936	.3001	1.0019	.6003	-.0745	-.6605	.7430	.8002	.2476	-.3736	.5795	.9184
.7000	-.6248	.3230	.9663	.6500	.0207	-.6841	.7506	.8002	-.7524	-.3621	.5827	.9134
.7500	-.5498	.3460	.9303	.7000	.1265	-.7173	.7056					
.8002	-.4769	.3701	.8949	.7501	.2176	-.7424	.6663					
.8002	-.3062	.6409	.8231	.8001	.2725	-.7630	.6337					
.9501	-.6249	.6745	.7716	.8501	.3561	-.7805	.6055					

TFST	167	PT	21.3687	PSI		CN	.4901	CD1	-.01114	CDCOR1	.01067
RUN	61	TT	160.1630	K		CM	-.1314	CD2	-.01106	CDCOR2	.01080
POINT	59	RC	6.9768	MILLION		CC	.0166	CD3	-.01109	CDCOR3	.01087
		MACH	.7606					CD4	-.01104	CDCOR4	.01090
		ALPHA	.0000	DEG				CD5	-.01107	CDCOR5	.01083

UPPER SURFACE				LOWER SURFACE				SPANWISE				
X/C	CP	P/L/PT	MLOC	X/C	CP	P/L/PT	MLOC	X/C	Y/(B/2)	CP	P/L/PT	MLOC
0.0000	1.1440	.9978	.0562	0.0000	1.1440	.9978	.0562	.1507	.7476	-.6445	.3059	1.3368
.0132	-.0985	.6561	.7999	.0126	.3263	.7729	.8176	.1507	.4976	-.6128	.3146	1.0274
.0259	-.6691	.5541	.9585	.0255	.1718	.7304	.8891	.1507	.2476	-.6237	.3116	1.0273
.0759	-.8313	.4545	1.1242	.0495	-.0277	.6908	.7465	.1507	-.2524	-.6301	.3098	1.0502
.1003	-.7929	.4651	1.1058	.0753	-.0705	.6638	.7881	.1507	-.5024	-.6308	.3096	1.0305
.1507	-.6321	.5093	1.0311	.1002	-.1416	.6442	.8181	.1507	-.7524	-.6237	.3116	1.0273
.2003	-.6730	.4980	1.0498	.1503	-.2114	.6250	.8477	.5002	.7476	-.6685	.4993	1.0477
.2503	-.6777	.4967	1.0519	.1976	-.3081	.5984	.8889	.5002	.4976	-.6813	.4957	1.0536
.3001	-.6978	.4912	1.0612	.2503	-.3623	.5825	.9122	.5002	.2476	-.6854	.4966	1.0555
.3502	-.6974	.4913	1.0610	.3001	-.3967	.5740	.9270	.5002	-.2524	-.6865	.4993	1.0478
.4003	-.6704	.4988	1.0486	.3507	-.4038	.5693	.9344	.5002	-.5024	-.6577	.4995	1.0474
.4501	-.6630	.5008	1.0452	.4001	-.4001	.5731	.9255	.5002	-.7524	-.6524	.3037	1.0404
.5002	-.6777	.4967	1.0520	.4501	-.3607	.5839	.9115	.8002	.7476	-.3675	.5821	.9144
.5502	-.6822	.4955	1.0540	.5001	-.2888	.6037	.8806	.8002	.4976	-.3709	.5811	.9159
.6002	-.6840	.4950	1.0549	.5497	-.1792	.6338	.8340	.8002	.2476	-.3760	.5797	.9180
.6500	-.6616	.5012	1.0446	.6003	-.0863	.6649	.7863	.8002	-.5024	-.3721	.5808	.9164
.7000	-.5678	.5270	1.0022	.6500	.0312	.6917	.7431	.8002	-.7524	-.3613	.3038	.9117
.7500	-.4683	.5543	.9582	.7000	.0312	.6917	.7431					
.8002	-.3723	.5807	.9164	.7501	.2271	.7436	.8613					
.9002	-.1477	.6425	.8207	.8001	.3025	.7863	.8284					
.9501	-.0280	.6754	.7701	.8501	.3668	.7840	.5998					

TFST	167	PT	21.3849	PSI		CN	.5637	CD1	-.01144	CDCOR1	.01118
RUN	61	TT	160.2191	K		CM	-.1308	CD2	-.01137	CDCOR2	.01111
POINT	60	RC	6.9723	MILLION		CC	.0143	CD3	-.01151	CDCOR3	.01108
		MACH	.7594					CD4	-.01125	CDCOR4	.01099
		ALPHA	.4990	DEG				CD5	-.01131	CDCOR5	.01104

UPPER SURFACE				LOWER SURFACE				SPANWISE				
X/C	CP	P/L/PT	MLOC	X/C	CP	P/L/PT	MLOC	X/C	Y/(B/2)	CP	P/L/PT	MLOC
0.0000	1.1526	1.0002	0.0000	0.0000	1.1526	1.0002	0.0000	.1507	.7476	-.7710	.4713	1.0990
.0112	-.2015	.8279	.8432	.0126	.4232	.7996	.3742	.1507	.4976	-.9347	.4263	1.1746
.0259	-.5800	.5238	1.0073	.0255	.2577	.7341	.6479	.1507	.2476	-.9134	.4321	1.1640
.0759	-.9087	.4334	1.1616	.0495	.1024	.7114	.7146	.1507	-.2524	-.9190	.4366	1.1667
.1003	-.9055	.4343	1.1600	.0753	.0035	.6842	.7586	.1507	-.5024	-.9346	.4263	1.1745
.1507	-.9113	.4327	1.1529	.1002	-.0756	.6625	.7900	.1507	-.7524	-.9391	.4308	1.0559
.2003	-.8180	.4584	1.1174	.1503	-.1515	.6416	.8221	.5002	.7476	-.9958	.4911	1.0413
.2503	-.7561	.4748	1.0890	.1976	-.2481	.6151	.8630	.5002	.4976	-.9713	.4872	1.0679
.3001	-.6480	.5051	1.0381	.2503	-.3047	.5995	.8872	.5002	.2476	-.9716	.4862	1.0697
.3502	-.6910	.4933	1.0577	.3001	-.3418	.5893	.9030	.5002	-.2524	-.9732	.4899	1.0634
.4003	-.7119	.4875	1.0674	.3507	-.3637	.5833	.9125	.5002	-.5024	-.9667	.4917	1.0604
.4501	-.7114	.4877	1.0672	.4001	-.3561	.5854	.9092	.5002	-.7524	-.9759	.4966	1.0522
.5002	-.7112	.4877	1.0671	.4501	-.3245	.5941	.8956	.8002	.4976	-.9635	.5833	.9124
.5502	-.7038	.4898	1.0637	.5001	-.2602	.6117	.8682	.8002	.4976	-.9664	.5825	.9137
.6002	-.6901	.4935	1.0573	.5497	-.1572	.6400	.8245	.8002	.2476	-.9720	.5810	.9160
.6500	-.6591	.5020	1.0431	.6003	-.0492	.6697	.7789	.8002	-.5024	-.9690	.5818	.9148
.7000	-.5615	.5289	.9991	.6500	.0431	.6957	.7390	.8002	-.7524	-.9582	.3848	.9101
.7500	-.4837	.5558	.9599	.7000	.1483	.7240	.6431					
.8002	-.3876	.5822	.9141	.7501	.2366	.7489	.6561					
.9002	-.1430	.6440	.8185	.8001	.3142	.7697	.6231					
.9501	-.0262	.6761	.7692	.8501	.3792	.7675	.5941					

TFST	167	PT	21.4727	PSI		CN	.6602	CD1	-.01163	CDCOR1	.01136
RUN	61	TT	160.1717	K		CM	-.1332	CD2	-.01168	CDCOR2	.01141
POINT	61	RC	7.0072	MILLION		CC	.0120	CD3	-.01177	CDCOR3	.01152
		MACH	.7600					CD4	-.01170	CDCOR4	.01141
		ALPHA	1.0061	DEG				CD5	-.01194	CDCOR5	.01165

UPPER SURFACE				LOWER SURFACE				SPANWISE				
X/C	CP	P/L/PT	MLOC	X/C	CP	P/L/PT	MLOC	X/C	Y/(B/2)	CP	P/L/PT	MLOC
0.0000	1.1508	.9998	.0176	0.0000	1.1508	.9998	.0176	.1507	.7476	-.9379	.4265	1.1741
.0132	-.3037	.6066	.9855	.0126	.5821	.8217	.3370	.1507	.4976	-1.0267	.4021	1.2194
.0259	-.6930	.4937	1.0570	.0255	.3276	.7739	.6163	.1507	.2476	-.9809	.4147	1.1959
.0759	-.9745	.4165	1.1926	.0495	.1857	.7294	.6867	.1507	-.2524	-.9867	.4131	1.1988
.1003	-.9505	.4231	1.1883	.0753	-.0638	.7314	.7301	.1507	-.5024	-1.0445	.3973	1.2286
.1507	-.9920	.4117	1.2015	.1002	-.0203	.6784	.7656	.1507	-.7524	-.9869	.4405	1.1488
.2003	-.9706	.4175	1.1986	.1503	-.1021	.6559	.8001	.5002	.7476	-.9903	.4945	1.0557
.2503	-.9753	.4163	1.1930	.1976	-.2088	.6291	.8414	.5002	.4976	-.9737	.4990	1.0481
.3001	-1.0012	.4091	1.2062	.2503	-.2599	.6126	.8648	.5002	.2476	-.9671	.5009	1.0491
.3502	-.9919	.4117	1.2014	.3001	-.3001	.6316	.8639	.5002	-.2524	-.9688	.4943	1.0557
.4003	-.9149	.4592	1.1180	.3507	-.3259	.5945	.9050	.5002	-.5024	-.9703	.4863	1.0696
.4501	-.7093	.4892	1.0645	.4001	-.3237	.5951	.8940	.8002	-.7524	-.9677	.4887	1.0637
.5002	-.6834	.4972	1.0512	.4501	-.2983	.6020	.8632	.8002	.7476	-.9665	.5833	.9124
.5502	-.6876	.4993	1.0476	.5001	-.2483	.6179	.8586	.8002	.4976	-.9730	.5816	.9152
.6002	-.6748	.4997	1.0486	.5497	-.1476	.6448	.8172	.8002	.2476	-.9706	.5798	.9180
.6500	-.6540	.5039	1.0401	.6003	-.0382	.6735	.7732	.8002	-.5024	-.9729	.5816	.9191
.7000	-.5720	.5269	1.0022	.6500	.0532	.6983	.7346	.8002	-.7524	-.9614	.3848	.9101
.7500	-.4739	.5539	.9549	.7000	.1348	.7264	.6913					
.8002	-.3767	.5806	.9167	.7501	.2440	.7511	.6527					
.9002	-.1518	.6423	.8211	.8001	.3281	.7718	.6196					
.9501	-.0344	.6744	.7718	.8501	.3955	.7698	.5905					

OF POINT

TEST 167 PT 21.4872 PSI CM .7414 CD1 .01308 CDCOR1 .01275
 RUN 61 TT 160.2205 K CM -.1376 CD2 .01322 CDCOR2 .01289
 POINT 67 RC 7.0049 MILLION CC .0109 CD3 .01383 CDCOR3 .01337
 MACH .7592 CD4 .01416 CDCOR4 .01352
 ALPHA 1.4983 DEG CD5 .01415 CDCOR5 .01358

UPPER SURFACE				LOWER SURFACE				SPANWISE				
X/C	CP	P/L/PT	MLOC	X/C	CP	P/L/PT	MLOC	X/C	Y/(B/2)	CP	P/L/PT	MLOC
0.0000	1.1499	.9994	.0284	0.0000	1.1499	.9994	.0284	.1507	.7476	-.9878	-.4116	1.2015
.0132	-.3854	.5773	.9219	.0126	.5673	.8393	.5063	.1507	.4976	-1.0527	.3938	1.2352
.0259	-.7784	.4892	1.0986	.0255	.3884	.7900	.5900	.1507	.2476	-.8963	.4093	1.2709
.0759	-.9909	.4103	1.2031	.0495	.2200	.7437	.3642	.1507	-.2524	-1.0277	.4007	1.2221
.1003	-1.0230	.4020	1.2197	.0753	.1147	.7148	.7095	.1507	-.5024	-1.0898	.3847	1.2528
.1507	-1.0259	.4013	1.2210	.1002	.0277	.6909	.7404	.1507	-.7524	-1.0069	.4064	1.2113
.2003	-1.0361	.3984	1.2285	.1503	-.0593	.6669	.7832	.1507	-.5024	-1.0898	.4064	1.2113
.2503	-1.0442	.3961	1.2308	.1976	-.1586	.6397	.8251	.5002	.4976	-1.0179	.4034	1.2170
.3001	-1.0499	.3836	1.2350	.2503	-.2217	.6223	.8518	.5002	.2476	-1.0121	.4050	1.2146
.3502	-1.0456	.3847	1.2327	.3001	-.2644	.6106	.8700	.5002	-.2524	-.9918	.4105	1.2036
.4001	-1.0780	.3866	1.2492	.3507	-.2936	.6025	.8924	.5002	-.5024	-1.0383	.3978	1.2277
.4501	-1.0257	.4012	1.2211	.4001	-.2959	.6019	.8834	.5002	-.7524	-.9744	.4152	1.1949
.5002	-.9352	.4261	1.1749	.4501	-.2758	.6074	.8743	.8002	.7476	-.3473	.5878	.9054
.5502	-.7950	.4647	1.1085	.5001	-.2230	.6219	.8524	.8002	.4976	-.3592	.5865	.9106
.6002	-.6154	.5141	1.0233	.5497	-.1296	.6476	.8128	.8002	.2476	-.3662	.5826	.9136
.6500	-.5533	.5311	.9955	.6003	-.0206	.6754	.7702	.8002	-.5024	-.3612	.5839	.9114
.7000	-.5124	.5424	.9773	.6500	.0601	.6998	.7326	.8002	-.7524	-.3471	.5878	.9054
.7500	-.4485	.5598	.9493	.7000	.1605	.7274	.6899					
.8002	-.3628	.5835	.9121	.7501	.2496	.7519	.6514					
.8502	-.1490	.6423	.8210	.8001	.3249	.7726	.6184					
.9001	-.0359	.6734	.7733	.8501	.3906	.7906	.5890					

TEST 167 PT 21.4885 PSI CM .8280 CD1 .01687 CDCOR1 .01640
 RUN 61 TT 160.1779 K CM -.1460 CD2 .01675 CDCOR2 .01633
 POINT 63 RC 7.0087 MILLION CC .0102 CD3 .01874 CDCOR3 .01824
 MACH .7594 CD4 .01935 CDCOR4 .01875
 ALPHA 2.0060 DEG CD5 .01899 CDCOR5 .01800

UPPER SURFACE				LOWER SURFACE				SPANWISE				
X/C	CP	P/L/PT	MLOC	X/C	CP	P/L/PT	MLOC	X/C	Y/(B/2)	CP	P/L/PT	MLOC
0.0000	1.1462	.9985	.0461	0.0000	1.1462	.9985	.0461	.1507	.7476	-1.1171	.3771	1.2677
.0132	-.4440	.5364	.9549	.0126	.6330	.8376	.4735	.1507	.4976	-1.1451	.3694	1.2830
.0259	-.8564	.4497	1.1344	.0255	.4491	.8071	.5617	.1507	.2476	-1.0472	.3826	1.2569
.0759	-1.0807	.3871	1.2481	.0495	.2763	.7597	.6190	.1507	-.2524	-1.1197	.3764	1.2691
.1003	-1.0850	.3859	1.2504	.0753	.1696	.7304	.6852	.1507	-.5024	-1.1608	.3651	1.2817
.1507	-1.0879	.3844	1.2526	.1002	.0776	.7051	.7244	.1507	-.7524	-1.1465	.3690	1.2918
.2003	-1.0901	.3844	1.2526	.1503	-.0133	.6802	.7629	.1507	-.5024	-1.1608	.3651	1.2817
.2503	-1.0996	.3819	1.2534	.1976	-.1136	.6526	.8051	.5002	.7476	-1.0879	.3851	1.2520
.3001	-1.1905	.3679	1.2860	.2503	-.1794	.6346	.8329	.5002	.4976	-1.1156	.3775	1.2670
.3502	-1.1656	.3638	1.2944	.3001	-.2249	.6221	.8522	.5002	.2476	-1.1340	.3729	1.2769
.4003	-1.1466	.3635	1.2944	.3507	-.2375	.6131	.8660	.5002	-.2524	-1.1080	.3796	1.2628
.4501	-1.1720	.3621	1.2979	.4001	-.2484	.6114	.8686	.5002	-.5024	-1.1011	.3815	1.2591
.5002	-1.1147	.3747	1.2886	.4501	-.2484	.6156	.8621	.8002	.7476	-1.0836	.3863	1.2497
.5502	-1.0341	.3999	1.2236	.5001	-.2008	.6287	.8419	.8002	.4976	-.3353	.3918	.8992
.6002	-.8052	.4628	1.1098	.5497	-.1122	.6530	.8046	.8002	.2476	-.3386	.3909	.9006
.6500	-.5440	.5339	.9498	.6003	-.0150	.6797	.7636	.8002	-.5024	-.3352	.3918	.8991
.7000	-.4711	.5545	.9078	.6500	.0709	.7033	.7272	.8002	-.7524	-.3262	.3942	.8953
.7500	-.4105	.5711	.8318	.7000	.1697	.7304	.6851					
.8002	-.3385	.5914	.8997	.7501	.2578	.7546	.6471					
.8502	-.1435	.6444	.8178	.8001	.3331	.7753	.6140					
.9001	-.0398	.6729	.7740	.8501	.3991	.7934	.5843					

TEST 167 PT 21.3800 PSI CM .8872 CD1 .02276 CDCOR1 .02118
 RUN 61 TT 160.2170 K CM -.1330 CD2 .02260 CDCOR2 .02105
 POINT 64 RC 6.9877 MILLION CC .0110 CD3 .02811 CDCOR3 .02389
 MACH .7600 CD4 .02818 CDCOR4 .02540
 ALPHA 2.9060 DEG CD5 .02451 CDCOR5 .02274

UPPER SURFACE				LOWER SURFACE				SPANWISE				
X/C	CP	P/L/PT	MLOC	X/C	CP	P/L/PT	MLOC	X/C	Y/(B/2)	CP	P/L/PT	MLOC
0.0000	1.1402	.9986	.0696	0.0000	1.1402	.9986	.0696	.1507	.7476	-1.1731	.3595	1.3032
.0132	-.5224	.5387	.9432	.0126	.6742	.8683	.4536	.1507	.4976	-1.1754	.3588	1.3043
.0259	-.9107	.4317	1.1847	.0255	.4888	.8172	.5447	.1507	.2476	-1.1395	.3687	1.2844
.0759	-1.1312	.3710	1.2799	.0495	.3116	.7684	.6251	.1507	-.2524	-1.1410	.3683	1.2893
.1003	-1.1473	.3679	1.2860	.0753	.2021	.7382	.6729	.1507	-.5024	-1.1955	.3533	1.3159
.1507	-1.1333	.3704	1.2910	.1002	.1083	.7124	.7131	.1507	-.7524	-1.1803	.3574	1.3073
.2003	-1.1452	.3672	1.2978	.1503	.0132	.6862	.7536	.1507	-.5024	-1.1760	.3587	1.3048
.2503	-1.1645	.3618	1.2983	.1976	-.0647	.6576	.7971	.5002	.4976	-1.1913	.3544	1.3135
.3001	-1.1710	.3598	1.3024	.2503	-.1591	.6387	.8265	.5002	.2476	-1.2094	.3495	1.3238
.3502	-1.2164	.3475	1.3274	.3001	-.2079	.6253	.8472	.5002	-.2524	-1.1891	.3550	1.3122
.4003	-1.1845	.3618	1.3290	.3507	-.2441	.6153	.8626	.5002	-.5024	-1.1939	.3647	1.2924
.4501	-1.2379	.3416	1.3403	.4001	-.2530	.6126	.8668	.8002	.7476	-1.1602	.3630	1.2959
.5002	-1.2357	.3422	1.3390	.4501	-.2427	.6157	.8620	.8002	.4976	-.3239	.3934	.8967
.5502	-1.1959	.3532	1.3161	.5001	-.1991	.6277	.8454	.8002	.2476	-.3240	.3933	.8967
.6002	-.9795	.4128	1.1994	.5497	-.1134	.6513	.8071	.8002	.4976	-.3240	.3927	.8977
.6500	-.8122	.4539	1.0235	.6003	-.0183	.6775	.7669	.8002	-.5024	-.3275	.3924	.8983
.7000	-.6957	.4961	.9714	.6500	.0680	.7007	.7311	.8002	-.7524	-.3249	.3931	.8971
.7500	-.6074	.5304	.9326	.7000	.1641	.7278	.6892					
.8002	-.5238	.5634	.8967	.7501	.2510	.7519	.6513					
.8502	-.4149	.6477	.8205	.8001	.3271	.7727	.6182					
.9001	-.0546	.6722	.7822	.8501	.3936	.7910	.5885					

TEST 167	PT 21.4828	PSI	CN .9025	CD1 .03298	CDCOR1 .03203
RUN 61	TT 160.2142	K	CM -.1911	CD2 .03344	CDCOR2 .03264
POINT 65	RC 7.0100	MILLION	CC .0124	CD3 .03393	CDCOR3 .03251
	MACH .7804			CD4 .05354	CDCOR4 .03432
	ALPHA 3.0243	DEG		CD5 .02207	CDCOR5 .03127

UPPER SURFACE				LOWER SURFACE				SPANWISE				
X/C	CP	P _L /PT	MLOC	X/C	CP	P _L /PT	MLOC	X/C	Y/(B/2)	CP	P _L /PT	MLOC
0.0000	1.1361	.9955	.0906	0.0000	1.1361	.9955	.0806	.1507	.7476	-1.1951	.3930	1.3164
.0132	-.5673	.3260	1.0017	.0126	.7073	.8773	.4364	.1507	.4976	-1.2255	.3446	1.3339
.0259	-.9536	.4196	1.1868	.0255	.5216	.8261	.5293	.1507	.2476	-1.1996	.3518	1.3190
.0759	-1.1733	.3590	1.3040	.0493	.3402	.7761	.6127	.1507	-.2324	-1.1700	.3599	1.3022
.1003	-1.1839	.3561	1.3101	.0753	.2242	.7441	.6636	.1507	-.5024	-1.2183	.3466	1.3297
.1507	-1.1828	.3564	1.3094	.1002	.1310	.7187	.7034	.1507	-.7524	-1.1880	.3550	1.3124
.2003	-1.1704	.3598	1.3025	.1503	.0333	.6915	.7453	.1507	.4976	-1.2200	.3460	1.3311
.2503	-1.2028	.3509	1.3208	.1976	-.0733	.6622	.7905	.1502	.4976	-1.2299	.3434	1.3165
.3001	-1.2180	.3467	1.3296	.2503	-.1481	.6416	.8222	.1502	.2476	-1.2369	.3415	1.3400
.3502	-1.2402	.3406	1.3425	.3001	-.1996	.6274	.8440	.1502	-.2324	-1.2174	.3469	1.3292
.4003	-1.2530	.3371	1.3500	.3507	-.2401	.6162	.8612	.1502	-.5024	-1.1828	.3564	1.3094
.4501	-1.2800	.3296	1.3661	.4001	-.2954	.6120	.8678	.1502	-.7524	-1.2120	.3494	1.3261
.5002	-1.2824	.3290	1.3676	.4501	-.2984	.6139	.8648	.1502	.4976	-1.2426	.3479	.9052
.5502	-1.1405	.3659	1.2902	.5001	-.2104	.6244	.8486	.1502	.4976	-1.3491	.3862	.9079
.6002	-.7365	.4794	1.0812	.5497	-.1259	.6477	.8128	.1502	.2476	-1.3593	.3845	.9106
.6500	-.6000	.5170	1.0184	.6003	-.0315	.6737	.7728	.1502	-.5024	-1.3513	.3856	.9089
.7000	-.5177	.5397	.9916	.6500	.0500	.6961	.7383	.1502	-.7524	-1.3468	.3868	.9069
.7500	-.4351	.5625	.9452	.7000	.1462	.7269	.6972					
.8002	-.3940	.5848	.9101	.7501	.2341	.7469	.6593					
.8502	-.1984	.6277	.8435	.8001	.3086	.7674	.6267					
.9501	-.1106	.6519	.8063	.8501	.3745	.7856	.5973					

TEST 167	PT 21.4771	PSI	CN .9147	CD1 .03321	CDCOR1 .03158
RUN 61	TT 160.1390	K	CM -.1541	CD2 .03358	CDCOR2 .03193
POINT 66	RC 7.0162	MILLION	CC .0123	CD3 .03364	CDCOR3 .03301
	MACH .7811			CD4 .03343	CDCOR4 .03334
	ALPHA 3.0243	DEG		CD5 .03219	CDCOR5 .03088

UPPER SURFACE				LOWER SURFACE				SPANWISE				
X/C	CP	P _L /PT	MLOC	X/C	CP	P _L /PT	MLOC	X/C	Y/(B/2)	CP	P _L /PT	MLOC
0.0000	1.1343	.9949	.0856	0.0000	1.1343	.9949	.0856	.1507	.7476	-1.1942	.3924	1.3177
.0132	-.5677	.3253	1.0049	.0126	.7168	.8797	.4318	.1507	.4976	-1.2107	.3434	1.3324
.0259	-.9528	.4190	1.1879	.0255	.5297	.8281	.5261	.1507	.2476	-1.1949	.3522	1.3181
.0759	-1.1709	.3490	1.3044	.0493	.3515	.7789	.6082	.1507	-.2324	-1.1642	.3607	1.3067
.1003	-1.1815	.3544	1.3104	.0753	.2366	.7477	.6579	.1507	-.5024	-1.2116	.3476	1.3277
.1507	-1.1794	.3565	1.3093	.1002	.1419	.7211	.6997	.1507	-.7524	-1.1894	.3562	1.3098
.2003	-1.1716	.3587	1.3048	.1503	.0438	.6940	.7416	.1502	.4976	-1.2178	.3459	1.3313
.2503	-1.1898	.3509	1.3209	.1976	-.0612	.6650	.7861	.1502	.4976	-1.2263	.3436	1.3362
.3001	-1.2141	.3469	1.3292	.2503	-.1345	.6448	.8172	.1502	.2476	-1.2323	.3419	1.3397
.3502	-1.2429	.3400	1.3459	.3001	-.1866	.6303	.8393	.1502	-.2324	-1.2104	.3478	1.3272
.4003	-1.2540	.3359	1.3523	.3507	-.2269	.6193	.8564	.1502	-.5024	-1.1757	.3575	1.3071
.4501	-1.2812	.3284	1.3688	.4001	-.2412	.6133	.8626	.1502	-.7524	-1.2035	.3499	1.3230
.5002	-1.2842	.3276	1.3706	.4501	-.2341	.6173	.8593	.1502	.4976	-1.3318	.3904	.9014
.5502	-1.1480	.3657	1.2905	.5001	-.1947	.6282	.8423	.1502	.4976	-1.3363	.3881	.9033
.6002	-.7474	.4757	1.0875	.5497	-.1113	.6511	.8074	.1502	.2476	-1.3474	.3860	.9081
.6500	-.6043	.5192	1.0215	.6003	-.0184	.6748	.7680	.1502	-.5024	-1.3125	.3891	.9034
.7000	-.5178	.5390	.9827	.6500	.0640	.6996	.7330	.1502	-.7524	-1.3336	.3899	.9023
.7500	-.4322	.5627	.9449	.7000	.1604	.7282	.6917					
.8002	-.3967	.5852	.9078	.7501	.2473	.7502	.6541					
.8502	-.1835	.6313	.8380	.8001	.3221	.7708	.6213					
.9501	-.1171	.6496	.8096	.8501	.3862	.7890	.5917					

TEST 167	PT 21.4769	PSI	CN .8827	CD1 .02332	CDCOR1 .02159
RUN 61	TT 160.2278	K	CM -.1937	CD2 .02389	CDCOR2 .02143
POINT 67	RC 7.0187	MILLION	CC .0118	CD3 .02678	CDCOR3 .02440
	MACH .7814			CD4 .02860	CDCOR4 .02395
	ALPHA 2.3050	DEG		CD5 .02503	CDCOR5 .02324

UPPER SURFACE				LOWER SURFACE				SPANWISE				
X/C	CP	P _L /PT	MLOC	X/C	CP	P _L /PT	MLOC	X/C	Y/(B/2)	CP	P _L /PT	MLOC
0.0000	1.1440	.9973	.0616	0.0000	1.1440	.9973	.0616	.1507	.7476	-1.1948	.3612	1.2997
.0132	-.5043	.5412	.9792	.0126	.6752	.8676	.4549	.1507	.4976	-1.1611	.3594	1.3032
.0259	-.8917	.4340	1.1606	.0255	.4899	.8163	.5462	.1507	.2476	-1.1232	.3699	1.2820
.0759	-1.1135	.3726	1.2767	.0493	.3147	.7679	.6266	.1507	-.2324	-1.1233	.3699	1.2821
.1003	-1.1251	.3694	1.2831	.0753	.2092	.7375	.6740	.1507	-.5024	-1.1798	.3594	1.3116
.1507	-1.1166	.3717	1.2784	.1002	.1113	.7116	.7144	.1507	-.7524	-1.1655	.3582	1.3057
.2003	-1.1323	.3674	1.2871	.1503	.0169	.6854	.7548	.1502	.4976	-1.1624	.3590	1.3041
.2503	-1.1482	.3630	1.2965	.1976	-.0861	.6569	.7986	.1502	.4976	-1.1767	.3551	1.3121
.3001	-1.1567	.3607	1.3007	.2503	-.1548	.6376	.8282	.1502	.2476	-1.1934	.3583	1.3217
.3502	-1.2031	.3478	1.3273	.3001	-.2058	.6246	.8492	.1502	-.2324	-1.1737	.3559	1.3104
.4003	-1.2051	.3473	1.3284	.3507	-.2413	.6139	.8640	.1502	-.5024	-1.1385	.3637	1.2966
.4501	-1.2249	.3418	1.3400	.4001	-.2515	.6111	.8691	.1502	-.7524	-1.1438	.3642	1.2935
.5002	-1.2224	.3425	1.3386	.4501	-.2399	.6143	.8641	.1502	.4976	-1.3194	.3923	.8983
.5502	-1.1827	.3535	1.3135	.5001	-.1964	.6264	.8432	.1502	.4976	-1.3188	.3923	.8980
.6002	-1.0009	.4015	1.2205	.5497	-.1101	.6503	.8080	.1502	.2476	-1.3204	.3920	.8980
.6500	-.8151	.5105	1.0291	.6003	-.0143	.6767	.7681	.1502	-.5024	-1.3211	.3919	.8990
.7000	-.6947	.5438	.9749	.6500	.0701	.7001	.7321	.1502	-.7524	-1.3201	.3922	.8986
.7500	-.5945	.5688	.9352	.7000	.1779	.7272	.6901					
.8002	-.5145	.5923	.8983	.7501	.2556	.7515	.6520					
.8502	-.1429	.6415	.8223	.8001	.3307	.7723	.6149					
.9501	-.0532	.6660	.7946	.8501	.3969	.7906	.5801					

OF FOUR QUALITY

TEST 167	PT 21.4762	PSI	CM .8249	CD1 .01746	CDCDR1 .01683
RUN 61	TT 160.1809	K	CM -1.1501	CD2 .01757	CDCDR2 .01689
POINT 6R	RC 7.0162	MILLION	CC .0125	CD3 .01970	CDCDR3 .01894
	MACH .7616			CD4 .01986	CDCDR4 .01942
	ALPHA 2.0162	DEG		CD5 .01955	CDCDR5 .01910

UPPER SURFACE				LOWER SURFACE				SPANWISE				
X/C	CP	P _L /PT	MLOC	X/C	CP	P _L /PT	MLOC	X/C	Y/(B/2)	CP	P _L /PT	MLOC
0.0000	1.1509	.9992	.0342	0.0000	1.1509	.9992	.0342	.1507	.7476	-1.0923	.3778	1.2663
.0132	-.4344	.5600	.9491	.0126	.6230	.8529	.4820	.1507	.4976	-1.1219	.3696	1.2827
.0259	-.8249	.4519	1.1288	.0255	.4402	.8023	.5697	.1507	.2476	-1.0734	.3830	1.2561
.0759	-1.0535	.3885	1.2454	.0495	.2671	.7544	.6474	.1507	-.2524	-1.0963	.3767	1.2686
.1003	-1.0574	.3875	1.2475	.0753	.1572	.7239	.6983	.1507	-.5024	-1.1355	.3658	1.2902
.1507	-1.0649	.3854	1.2515	.1002	.0680	.6992	.7335	.1507	-.7524	-1.1175	.3708	1.2802
.2003	-1.0747	.3877	1.2568	.1503	-.0233	.6739	.7725	.5002	.7476	-1.0953	.3770	1.2680
.2503	-1.0791	.3814	1.2592	.1976	-.1256	.6456	.8160	.5002	.4976	-1.1146	.3716	1.2786
.3001	-1.1320	.3668	1.2883	.2503	-.1932	.6268	.8448	.5002	.2476	-1.1306	.3672	1.2875
.3502	-1.1482	.3623	1.2974	.3001	-.2400	.6139	.8648	.5002	-.2524	-1.1061	.3740	1.2739
.4003	-1.1515	.3614	1.2992	.3507	-.2734	.6046	.8792	.5002	-.5024	-1.0937	.3774	1.2671
.4501	-1.1598	.3591	1.3039	.4001	-.2802	.6027	.8821	.5002	-.7524	-1.0794	.3814	1.2593
.5002	-1.1754	.3686	1.2846	.4501	-.2640	.6072	.8751	.8002	.7476	-1.3258	.5901	.9018
.5502	-1.0625	.3861	1.2502	.5001	-.2153	.6207	.8542	.8002	.4976	-1.3250	.5903	.9014
.6002	-1.0417	.3918	1.2391	.5497	-.1242	.6460	.8154	.8002	.2476	-1.3255	.5902	.9017
.6500	-.6348	.5045	1.0390	.6003	-.0249	.6735	.7731	.6002	-.5024	-1.3269	.5859	.9022
.7000	-.4841	.5463	.9710	.6500	.0621	.6976	.7360	.8002	-.7524	-1.3229	.5903	.9005
.7500	-.4022	.5690	.9350	.7000	.1614	.7251	.6934					
.8002	-.3229	.5909	.9005	.7501	.2503	.7497	.6548					
.9002	-.1401	.6416	.8222	.8001	.3257	.7706	.6216					
.9501	-.0436	.6683	.7811	.8501	.3920	.7889	.5918					

TEST 167	PT 21.3662	PSI	CM .7553	CD1 .01335	CDCDR1 .01281
RUN 61	TT 160.1976	K	CM -1.1424	CD2 .01354	CDCDR2 .01302
POINT 6R	RC 6.9751	MILLION	CC .0121	CD3 .01416	CDCDR3 .01379
	MACH .7608			CD4 .01440	CDCDR4 .01408
	ALPHA 1.5237	DEG		CD5 .01444	CDCDR5 .01413

UPPER SURFACE				LOWER SURFACE				SPANWISE				
X/C	CP	P _L /PT	MLOC	X/C	CP	P _L /PT	MLOC	X/C	Y/(B/2)	CP	P _L /PT	MLOC
0.0000	1.1555	1.0006	0.0000	0.0000	1.1555	1.0006	0.0000	.1507	.7476	-.9910	.4071	1.2101
.0132	-.3678	.5794	.9186	.0126	.5733	.8376	.5059	.1507	.4976	-1.0411	.3932	1.2363
.0259	-.7590	.4712	1.0951	.0255	.3935	.7899	.5903	.1507	.2476	-.9828	.4094	1.2058
.0759	-.9780	.4107	1.2033	.0495	.2260	.7436	.6645	.1507	-.2524	-1.0144	.4006	1.2223
.1003	-1.0073	.4026	1.2185	.0753	.1177	.7136	.7112	.1507	-.5024	-1.0709	.3850	1.2523
.1507	-1.0095	.4020	1.2197	.1002	.0314	.6898	.7491	.1507	-.7524	-1.0901	.4073	1.2096
.2003	-1.0287	.3967	1.2258	.1503	-.0558	.6637	.7851	.5002	.7476	-1.0236	.3981	1.2271
.2503	-1.0340	.3952	1.2325	.1976	-.1561	.6379	.8277	.5002	.4976	-1.0458	.3919	1.2388
.3001	-1.0818	.3820	1.2581	.2503	-.2199	.6203	.8549	.5002	.2476	-1.0446	.3921	1.2383
.3502	-1.0819	.3820	1.2582	.3001	-.2637	.6082	.8737	.5002	-.2524	-1.0190	.3993	1.2247
.4003	-1.0777	.3831	1.2559	.3507	-.2937	.5999	.8865	.5002	-.5024	-1.0433	.3926	1.2375
.4501	-1.0527	.3900	1.2425	.4001	-.2961	.5992	.8876	.5002	-.7524	-1.0087	.4022	1.2193
.5002	-.9697	.4130	1.1991	.4501	-.2754	.6050	.8787	.8002	.7476	-1.3378	.5877	.9055
.5502	-.9635	.4147	1.1959	.5001	-.2217	.6198	.8557	.8002	.4976	-1.3440	.5860	.9082
.6002	-.7853	.4540	1.1077	.5497	-.1272	.6459	.8155	.8002	.2476	-1.3482	.5848	.9100
.6500	-.5555	.5275	1.0013	.6003	-.0255	.6740	.7723	.6002	-.5024	-1.3440	.5860	.9082
.7000	-.4842	.5472	.9695	.6500	.0639	.6988	.7342	.8002	-.7524	-1.3341	.5887	.9039
.7500	-.4243	.5638	.9432	.7000	.1645	.7266	.6911					
.8002	-.3449	.5857	.9086	.7501	.2536	.7512	.6525					
.9002	-.1406	.6422	.8211	.8001	.3292	.7721	.6191					
.9501	-.0333	.6719	.7756	.8501	.3947	.7902	.5897					

TEST 167	PT 21.3645	PSI	CM .6704	CD1 .01168	CDCDR1 .01141
RUN 61	TT 160.1466	K	CM -1.1356	CD2 .01177	CDCDR2 .01152
POINT 70	RC 6.9767	MILLION	CC .0126	CD3 .01189	CDCDR3 .01153
	MACH .7606			CD4 .01184	CDCDR4 .01154
	ALPHA 1.0265	DEG		CD5 .01201	CDCDR5 .01173

UPPER SURFACE				LOWER SURFACE				SPANWISE				
X/C	CP	P _L /PT	MLOC	X/C	CP	P _L /PT	MLOC	X/C	Y/(B/2)	CP	P _L /PT	MLOC
0.0000	1.1536	.9999	.0131	0.0000	1.1536	.9999	.0131	.1507	.7476	-.5008	.4222	1.1819
.0132	-.2845	.6013	.8843	.0126	.5050	.8201	.5397	.1507	.4976	-1.0054	.4016	1.2204
.0259	-.6715	.4941	1.0564	.0255	.3313	.7720	.6193	.1507	.2476	-.9616	.4137	1.1977
.0759	-.9534	.4160	1.1935	.0495	.1711	.7277	.6894	.1507	-.2524	-1.0668	.4123	1.2004
.1003	-.9279	.4230	1.1805	.0753	.0664	.6986	.7345	.1507	-.5024	-1.0296	.3949	1.2332
.1507	-.9772	.4108	1.2031	.1002	-.0168	.6755	.7700	.1507	-.7524	-1.0716	.4306	1.1522
.2003	-.9548	.4154	1.1942	.1503	-.0989	.6528	.8049	.5002	.7476	-.8308	.4500	1.1321
.2503	-.9626	.4134	1.1942	.1976	-.1976	.6254	.8470	.5002	.4976	-.8555	.4431	1.1443
.3001	-.9468	.4031	1.2175	.2503	-.2584	.6086	.8731	.5002	.2476	-.7870	.4621	1.1109
.3502	-.9471	.4039	1.2161	.3001	-.2995	.5972	.8907	.5002	-.2524	-1.0007	.4593	1.1175
.4003	-.9286	.4229	1.1408	.3507	-.3259	.5899	.9021	.5002	-.5024	-.9147	.4261	1.1746
.4501	-.8237	.4519	1.1287	.4001	-.3237	.5905	.9012	.5002	-.7524	-.8389	.4477	1.1361
.5002	-.7771	.4621	1.1110	.4501	-.2976	.5977	.8899	.8002	.7476	-1.3573	.5812	.9157
.5502	-.7083	.4839	1.0735	.5001	-.2384	.6141	.8645	.8002	.4976	-1.3629	.5796	.9182
.6002	-.6544	.4947	1.0447	.5497	-.1395	.6415	.8222	.8002	.2476	-1.3689	.5780	.9208
.6500	-.6173	.5091	1.0314	.6003	-.0346	.6706	.7775	.8002	-.5024	-1.3627	.5797	.9181
.7000	-.5574	.5271	1.0020	.6500	.0573	.6961	.7384	.8002	-.7524	-1.3509	.5830	.9110
.7500	-.4619	.5522	.9616	.7000	.1592	.7243	.6946					
.8002	-.3660	.5748	.9196	.7501	.2489	.7492	.6557					
.9002	-.1437	.6404	.8240	.8001	.3243	.7701	.6224					
.9501	-.0295	.6720	.7754	.8501	.3898	.7882	.5930					

TEST 167	PT 21.3665	PSI	CN .5857	CD1 .01143	CDCOR1 .01118
RUN 81	TT 160.1769	K	CM -.1338	CD2 .01136	CDCOR2 .C1110
POINT 71	RC 6.9769	MILLION	CC .0145	CD3 .01132	CDCOR3 .01099
	MACH .7609			CD4 .01122	CDCOR4 .01096
	ALPHA .5193	DEG		CD5 .01130	CDCOR5 .01102

UPPER SURFACE				LOWER SURFACE				SPANWISE				
X/C	CP	P/L/PT	MLOC	X/C	CP	P/L/PT	MLOC	X/C	Y/(B/2)	CP	P/L/PT	MLOC
0.0000	1.1570	1.0011	0.0000	0.0000	1.1570	1.0011	0.0000	1.507	.7476	-.8050	.4596	1.1133
.0132	-.1967	.6275	.8439	.0126	.4281	.7999	.5737	1.507	.4976	-.9371	.4231	1.1804
.0259	-.5755	.5229	1.0088	.0255	.2617	.7540	.6481	1.507	.2476	-.9139	.4295	1.1687
.0759	-.9088	.4369	1.1652	.0495	-.1126	.7128	.7125	1.507	-.2524	-.9153	.4291	1.1694
.1003	-.9019	.4328	1.1628	.0753	-.0064	.6835	.7577	1.507	-.5024	-.9376	.4229	1.1807
.1507	-.9127	.4298	1.1681	.1002	-.0718	.6619	.7900	1.507	-.7524	-.9703	.4874	1.0677
.2003	-.8439	.4488	1.1342	.1503	-.1487	.6407	.8235	1.507	-.7476	-.9746	.4840	1.0735
.2503	-.8689	.4419	1.1464	.1976	-.2461	.6138	.8649	1.507	-.4976	-.9726	.4812	1.0782
.3001	-.7276	.4809	1.0796	.2503	-.3037	.5979	.8896	1.507	-.2476	-.9718	.4798	1.0806
.3502	-.6670	.4976	1.0505	.3001	-.3418	.5874	.9060	1.507	-.2524	-.9726	.4813	1.0779
.4003	-.7069	.4866	1.0687	.3502	-.3642	.5812	.9157	1.507	-.5024	-.9695	.4887	1.0655
.4501	-.7235	.4820	1.0767	.4001	-.3568	.5833	.9125	1.507	-.7524	-.9683	.4937	1.0570
.5002	-.7322	.4796	1.0808	.4501	-.3244	.5922	.8985	1.507	-.7476	-.9642	.4912	1.0577
.5502	-.7340	.4791	1.0816	.5001	-.2589	.6103	.8704	1.507	-.4976	-.9653	.4809	1.0616
.6002	-.7168	.4839	1.0735	.5497	-.1549	.6390	.8261	1.507	-.2476	-.9698	.4812	1.0616
.6500	-.6744	.4956	1.0539	.6003	-.0461	.6690	.7830	1.507	-.5024	-.9644	.4812	1.0616
.7000	-.5719	.5239	1.0072	.6500	.0489	.6952	.7396	1.507	-.7524	-.9650	.4812	1.0616
.7500	-.4652	.5534	.9597	.7000	.1524	.7238	.6994	1.507				
.8002	-.3690	.5802	.9173	.7501	.2429	.7488	.6563					
.8502	-.2440	.6420	.8215	.8001	.3186	.7697	.6230					
.9002	-.1450	.6820	.7729	.8501	.3838	.7877	.5936					

TEST 167	PT 21.3684	PSI	CN .4932	CD1 01105	CDCOR1
RUN 61	TT 160.2410	K	CM -.1318	CD2 .01100	CDCOR2
POINT 72	RC 6.9712	MILLION	CC .0168	CD3 .01103	CDCOR3
	MACH .7604			CD4 .01097	CDCOR4
	ALPHA .0254	DEG		CD5 .01098	CDCOR5

UPPER SURFACE				LOWER SURFACE				SPANWISE				
X/C	CP	P/L/PT	MLOC	X/C	CP	P/L/PT	MLOC	X/C	Y/(B/2)	CP	P/L/PT	MLOC
0.0000	1.1427	.9969	.0666	0.0000	1.1427	.9969	.0666	1.507	.7476	-.6450	.5016	1.0438
.0132	-.0960	.6537	.8035	.0126	.3299	.7717	.6197	1.507	.4976	-.5997	.5142	1.0231
.0259	-.4659	.5513	.9631	.0255	-.1754	.7289	.6875	1.507	.2476	-.6523	.4996	1.0472
.0759	-.8247	.4518	1.1288	.0495	-.0343	.6898	.7480	1.507	-.2524	-.6354	.5043	1.0394
.1003	-.7940	.4603	1.1140	.0753	-.0712	.6606	.7929	1.507	-.5024	-.6143	.5101	1.0297
.1507	-.6436	.5006	1.0455	.1002	-.1417	.6411	.8229	1.507	-.7524	-.6224	.5079	1.0334
.2003	-.6595	.4987	1.0466	.1503	-.2121	.6216	.8530	1.507	-.4976	-.6789	.4922	1.0595
.2503	-.6880	.4897	1.0637	.1976	-.3092	.5946	.8947	1.507	-.2476	-.6880	.4897	1.0637
.3001	-.7081	.4841	1.0731	.2503	-.3642	.5794	.9185	1.507	-.2524	-.6739	.4936	1.0472
.3502	-.7066	.4846	1.0724	.3001	-.3996	.5696	.9339	1.507	-.5024	-.6751	.4933	1.0577
.4003	-.6413	.4888	1.0653	.3502	-.4172	.5647	.9416	1.507	-.7524	-.6633	.4966	1.0523
.4501	-.6740	.4936	1.0572	.4001	-.4032	.5686	.9355	1.507	-.4976	-.6680	.4978	1.0422
.5002	-.6824	.4913	1.0611	.4501	-.3631	.5797	.9180	1.507	-.2476	-.6630	.4978	1.0422
.5502	-.6894	.4893	1.0644	.5001	-.2900	.6000	.8864	1.507	-.4976	-.6394	.5780	1.0208
.6002	-.6950	.4875	1.0670	.5497	-.1800	.6304	.8397	1.507	-.2476	-.6739	.5767	1.0227
.6500	-.6715	.4943	1.0561	.6003	-.0671	.6617	.7512	1.507	-.5024	-.6715	.5774	1.0217
.7000	-.5703	.5223	1.0097	.6500	.0308	.6889	.7495					
.7500	-.4658	.5513	.9631	.7000	.1356	.7179	.7046					
.8002	-.3693	.5780	.9207	.7501	.2267	.7431	.6652					
.8502	-.2451	.6401	.8244	.8001	.3020	.7640	.6321					
.9002	-.1451	.6820	.7742	.8501	.3665	.7819	.6034					

TEST 167	PT 21.3684	PSI	CN .4213	CD1 .01092	CDCOR1 .01066
RUN 51	TT 160.2939	K	CM -.1307	CD2 .01080	CDCOR2 .01056
POINT 73	RC 6.9716	MILLION	CC .0172	CD3 .01079	CDCOR3 .01054
	MACH .7611			CD4 .01082	CDCOR4 .01053
	ALPHA -.4888	DEG		CD5 .01079	CDCOR5 .01056

UPPER SURFACE				LOWER SURFACE				SPANWISE				
X/C	CP	P/L/PT	MLOC	X/C	CP	P/L/PT	MLOC	X/C	Y/(B/2)	CP	P/L/PT	MLOC
0.0000	1.1211	.9908	.1190	0.0000	1.1211	.9908	.1190	1.507	.7476	-.5754	.5201	1.0134
.0132	.0092	.6823	.7596	.0126	-.2233	.7417	.6675	1.507	.4976	-.6008	.5130	1.0250
.0259	-.3934	.5817	.9149	.0255	-.0833	.7026	.7279	1.507	.2476	-.6072	.5113	1.0279
.0759	-.7881	.4611	1.1127	.0495	-.0419	.6682	.7812	1.507	-.2524	-.6084	.5109	1.0284
.1003	-.7679	.4522	1.1010	.0753	-.1776	.6388	.8204	1.507	-.5024	-.6051	.5119	1.0269
.1507	-.6076	.5112	1.0280	.1002	-.2097	.6215	.8530	1.507	-.7524	-.5628	.5236	1.0077
.2003	-.6032	.5124	1.0260	.1503	-.2729	.6040	.8801	1.507	-.4976	-.6433	.5012	1.0444
.2503	-.6157	.5089	1.0317	.1976	-.3694	.5772	.9214	1.507	-.2476	-.6576	.4954	1.0510
.3001	-.6456	.5006	1.0455	.2503	-.4207	.5630	.9444	1.507	-.2524	-.6541	.4986	1.0488
.3502	-.6291	.5052	1.0379	.3001	-.4528	.5541	.9585	1.507	-.5024	-.6479	.5000	1.0466
.4003	-.6195	.5079	1.0335	.3502	-.4845	.5509	.9637	1.507	-.7524	-.6328	.4986	1.0488
.4501	-.6412	.5018	1.0435	.4001	-.4419	.5571	.9537	1.507	-.4976	-.6479	.5000	1.0466
.5002	-.6591	.4969	1.0518	.4501	-.3927	.5708	.9321	1.507	-.2476	-.6283	.5054	1.0375
.5502	-.6613	.4963	1.0527	.5001	-.3115	.5933	.8964	1.507	-.4976	-.6369	.5779	1.0208
.6002	-.6676	.4945	1.0557	.5497	-.1959	.6254	.8471	1.507	-.2476	-.6397	.5772	1.0221
.6500	-.6596	.4967	1.0520	.6003	-.0791	.6578	.7972	1.507	-.4976	-.6373	.5756	1.0245
.7000	-.5678	.5222	1.0099	.6500	.0216	.6857	.7543	1.507	-.5024	-.6371	.5766	1.0229
.7500	-.4681	.5499	.9653	.7000	.1274	.7191	.7090					
.8002	-.3725	.5764	.9233	.7501	.2183	.7403	.6696					
.8502	-.2483	.6386	.8267	.8001	.2929	.7610	.6349					
.9002	-.1481	.6820	.7755	.8501	.3564	.7786	.6086					

CHECKED FOR
OF POOR QUALITY

TEST 167	PT 21.3687	PSI	CM	.3485	CD1	.01068	CDCOR1	.01043
RUN 61	TT 160.2151	K	CM	-.1313	CD2	.01053	CDCOR2	.01030
POINT 74	RC 6.9760	MILLION	CC	.0186	CD3	.01054	CDCOR3	.01033
	MACH				CD4	.01062	CDCOR4	.01041
	ALPHA	-.9877	DEG		CD5	.01048	CDCOR5	.01028

UPPER SURFACE				LOWER SURFACE				SPANWISE				
X/C	CP	P/L/PT	MLOC	X/C	CP	P/L/PT	MLOC	X/C	Y/(B/2)	CP	P/L/PT	MLOC
0.0000	1.1001	.9848	.1480	0.0000	1.1001	.9848	.1480	.1507	.7476	-.4949	.5415	.9787
.0132	-.1170	.7116	.7144	.0126	-.1160	.7113	.7149	.1507	.4976	-.5154	.5358	.9879
.0259	-.2382	.6128	.8665	.0255	-.0078	.6769	.7679	.1507	.2476	-.5201	.5344	.9901
.0759	-.5534	.5252	1.0350	.0495	-.1160	.6468	.8141	.1507	-.2524	-.5228	.5337	.9912
.1003	-.4903	.5427	.9767	.0753	-.2228	.6171	.8599	.1507	-.5024	-.5245	.5332	.9920
.1507	-.5199	.5345	.9900	.1002	-.2760	.6023	.8828	.1507	-.7524	-.4884	.5432	.9759
.2003	-.5270	.5325	.9932	.1503	-.3307	.5871	.9065	.5002	.7476	-.6004	.5121	1.0264
.2503	-.5488	.5265	1.0030	.1976	-.4278	.5601	.9490	.5002	.4976	-.6125	.5088	1.0320
.3001	-.5722	.5200	1.0136	.2503	-.4760	.5467	.9703	.5002	.2476	-.6189	.5070	1.0349
.3502	-.5714	.5202	1.0132	.3001	-.5037	.5390	.9827	.5002	-.2524	-.6061	.5105	1.0291
.4003	-.5806	.5176	1.0174	.3507	-.5101	.5372	.9856	.5002	-.5024	-.6003	.5121	1.0264
.4501	-.5998	.5123	1.0262	.4001	-.4750	.5470	.9699	.5002	-.7524	-.5838	.5168	1.0188
.5002	-.6171	.5075	1.0341	.4501	-.4149	.5637	.9633	.8002	.7476	-.3628	.5782	.9205
.5502	-.6259	.5051	1.0381	.5001	-.3251	.5686	.9041	.8002	.4976	-.3640	.5778	.9210
.6002	-.6449	.4998	1.0469	.5497	-.2039	.6223	.8518	.8002	.2476	-.3707	.5760	.9239
.6500	-.6439	.5000	1.0465	.6003	-.0837	.6558	.8003	.8002	-.5024	-.3645	.5777	.9212
.7000	-.5606	.5232	1.0083	.6500	.0203	.6847	.7599	.8002	-.7524	-.3535	.5808	.9164
.7500	-.4653	.5497	.9656	.7000	.0203	.7143	.7101					
.8002	-.3703	.5761	.9238	.7501	-.2176	.7395	.6709					
.9002	-.1460	.6384	.8270	.8001	-.2915	.7601	.6384					
.9501	-.0265	.6717	.7759	.8501	.3542	.7775	.6105					

TFST 167	PT 21.3732	PSI	CM	-.2716	CD1	.01060	CDCOR1	.01051
RUN 61	TT 160.0452	K	CM	-.1279	CD2	.01040	CDCOR2	.01034
POINT 76	RC 6.9829	MILLION	CC	.0178	CD3	.01037	CDCOR3	.01035
	MACH	.7604			CD4	.01050	CDCOR4	.01049
	ALPHA	-1.4867	DEG		CD5	.01033	CDCOR5	.01021

UPPER SURFACE				LOWER SURFACE				SPANWISE				
X/C	CP	P/L/PT	MLOC	X/C	CP	P/L/PT	MLOC	X/C	Y/(B/2)	CP	P/L/PT	MLOC
0.0000	1.0516	.9722	.2011	0.0000	1.0516	.9722	.2011	.1507	.7476	-.4212	.5663	.9392
.0132	.2149	.7416	.6676	.0126	-.0094	.6797	.7635	.1507	.4976	-.4432	.5602	.9488
.0259	-.1358	.6449	.8170	.0255	-.1127	.6513	.8072	.1507	.2476	-.4452	.5596	.9497
.0759	-.4294	.5640	.9428	.0495	-.2000	.6272	.8442	.1507	-.2524	-.4452	.5596	.9497
.1003	-.4081	.5699	.9335	.0753	-.3146	.5956	.8932	.1507	-.5024	-.4487	.5587	.9512
.1507	-.4447	.5598	.9495	.1002	-.3494	.5860	.9081	.1507	-.7524	-.4193	.5668	.9384
.2003	-.4697	.5529	.9665	.1503	-.3935	.5739	.9272	.5002	.7476	-.5501	.5307	.9961
.2503	-.4854	.5486	.9673	.1976	-.4891	.5475	.9690	.5002	.4976	-.5601	.5280	1.0005
.3001	-.5094	.5420	.9779	.2503	-.5322	.5357	.9881	.5002	.2476	-.5663	.5263	1.0033
.3502	-.5168	.5399	.9812	.3001	-.5546	.5295	.9980	.5002	-.2524	-.5530	.5299	.9974
.4003	-.5292	.5365	.9867	.3507	-.5510	.5305	.9945	.5002	-.5024	-.5501	.5307	.9961
.4501	-.5484	.5312	.9953	.4001	-.5067	.5427	.9768	.5002	-.7524	-.5370	.5344	.9902
.5002	-.5622	.5274	1.0015	.4501	-.4389	.5614	.9470	.8002	.7476	-.3616	.5827	.9134
.5502	-.5809	.5223	1.0099	.5001	-.3445	.5874	.9060	.8002	.4976	-.3667	.5813	.9156
.6002	-.6027	.5162	1.0197	.5497	-.2200	.6217	.8528	.8002	.2476	-.3741	.5792	.9188
.6500	-.6053	.5155	1.0209	.6003	-.0974	.6555	.8007	.8002	-.5024	-.3660	.5815	.9153
.7000	-.5417	.5330	.9923	.6500	.0079	.6845	.7562	.8002	-.7524	-.3533	.5850	.9098
.7500	-.4637	.5545	.9578	.7000	.1147	.7140	.7107					
.8002	-.3731	.5795	.9184	.7501	.2048	.7388	.6720					
.9002	-.1531	.6401	.8243	.8001	.2777	.7589	.6403					
.9501	-.0271	.6749	.7710	.8501	.3392	.7759	.6131					

TEST 167	PT 21.3671	PSI	CM	.1965	CD1	.01076	CDCOR1	.01058
RUN 61	TT 1.9.9797	K	CM	-.1251	CD2	.01045	CDCOR2	.01029
POINT 77	RC 6.9870	MILLION	CC	.0164	CD3	.01036	CDCOR3	.01024
	MACH	.7604			CD4	.01055	CDCOR4	.01042
	ALPHA	-1.9357	DEG		CD5	.01039	CDCOR5	.01016

UPPER SURFACE				LOWER SURFACE				SPANWISE				
X/C	CP	P/L/PT	MLOC	X/C	CP	P/L/PT	MLOC	X/C	Y/(B/2)	CP	P/L/PT	MLOC
0.0000	1.0045	.9592	.2445	0.0000	1.0045	.9592	.2445	.1507	.7476	-.3930	.5852	.9094
.0132	.3128	.7687	.6246	.0126	-.1356	.6451	.8167	.1507	.4976	-.3728	.5798	.9179
.0259	-.0325	.6735	.7730	.0255	-.2170	.6227	.8512	.1507	.2476	-.3745	.5793	.9187
.0759	-.3300	.5916	.9995	.0495	-.2857	.6038	.8805	.1507	-.2524	-.3770	.5786	.9198
.1003	-.2886	.5920	.8990	.0753	-.4154	.5681	.9364	.1507	-.5024	-.3815	.5774	.9217
.1507	-.3743	.5794	.9186	.1002	-.4287	.5644	.9422	.1507	-.7524	-.3555	.5845	.9105
.2003	-.4037	.5713	.9313	.1503	-.4619	.5552	.9567	.5002	.7476	-.5167	.5401	.9809
.2503	-.4295	.5641	.9425	.1976	-.5612	.5279	1.0007	.5002	.4976	-.5252	.5378	.9847
.3001	-.4583	.5562	.9552	.2503	-.6040	.5161	1.0200	.5002	.2476	-.5311	.5362	.9873
.3502	-.4692	.5532	.9600	.3001	-.6260	.5100	1.0299	.5002	-.2524	-.5206	.5390	.9826
.4003	-.4866	.5464	.9676	.3507	-.6063	.5134	1.0210	.5002	-.5024	-.5175	.5399	.9812
.4501	-.5087	.5423	.9773	.4001	-.5429	.5329	.9925	.5002	-.7524	-.5049	.5434	.9757
.5002	-.5269	.5373	.9854	.4501	-.4635	.5548	.9574	.8002	.7476	-.3617	.5828	.9132
.5502	-.5497	.5310	.9956	.5001	-.3624	.5727	.9134	.8002	.4976	-.3643	.5821	.9143
.6002	-.5745	.5242	1.0067	.5497	-.2337	.6181	.8583	.8002	.2476	-.3708	.5803	.9171
.6500	-.5930	.5219	1.0105	.6003	-.1082	.6527	.8051	.8002	-.5024	-.3637	.5823	.9140
.7000	-.5296	.5366	.9866	.6500	-.0009	.6823	.7596	.8002	-.7524	-.3505	.5859	.9083
.7500	-.4573	.5565	.9547	.7000	.1055	.7116	.7144					
.8002	-.3692	.5808	.9164	.7501	.1943	.7360	.6784					
.9002	-.1513	.6408	.8233	.8001	.2658	.7536	.6453					
.9501	-.0240	.6759	.7664	.8501	.3251	.7720	.6192					

TEST 167	PT 21.3697	PSI	CN .0457	CD1 .01117	CDCOR1 .01102
RUN 61	TT 159.9620	K	CM -.1209	CD2 .01077	CDCOR2 .01065
POINT 78	RC 6.9873	MILLION	CC .0102	CD3 .01069	CDCOR3 .01063
	MACH .7801			CD4 .01092	CDCOR4 .01085
	ALPHA -2.9836	DEG		CD5 .01080	CDCOR5 .01057

UPPER SURFACE				LOWER SURFACE				SPANWISE				
X/C	CP	P/L/PT	MLOC	X/C	CP	P/L/PT	MLOC	X/C	Y/(B/2)	CP	P/L/PT	MLOC
0.0000	.8738	.9230	.3401	0.0000	.8738	.9230	.3401	.1507	.7476	-.2309	.6184	.8579
.0132	.4876	.8165	.5459	.0126	-.4185	.5666	.9387	.1507	.4976	-.2483	.6136	.8654
.0259	.1552	.7248	.6938	.0255	-.4427	.5599	.9492	.1507	.2476	-.2492	.6133	.8657
.0759	-.1607	.6377	.8281	.0495	-.4603	.5551	.9570	.1507	-.2524	-.2518	.6126	.8668
.1003	-.1859	.6308	.8388	.0753	-.8053	.4599	1.1147	.1507	-.5024	-.2579	.6109	.8694
.1507	-.2486	.6135	.8655	.1002	-.5588	.5279	1.0006	.1507	-.7524	-.2376	.6165	.8608
.2003	-.2917	.6016	.8839	.1503	-.5923	.5187	1.0157	.5002	.7476	-.4466	.5589	.9510
.2503	-.3273	.5918	.8992	.1976	-.6914	.4914	1.0610	.5002	.4976	-.4555	.5564	.9548
.3001	-.3628	.5820	.9145	.2503	-.7794	.4671	1.1023	.5002	.2476	-.4614	.5548	.9574
.3502	-.3834	.5763	.9234	.3001	-.8385	.4508	1.1307	.5002	-.2524	-.4519	.5574	.9533
.4003	-.4070	.5698	.9337	.3507	-.7967	.4623	1.1105	.5002	-.5024	-.4483	.5584	.9517
.4501	-.4346	.5622	.9457	.4001	-.5716	.5244	1.0064	.5002	-.7524	-.4366	.5616	.9466
.5002	-.4574	.5559	.9557	.4501	-.4980	.5475	.9691	.8002	.7476	-.3491	.5858	.9086
.5502	-.4856	.5481	.9681	.5001	-.3846	.5760	.9240	.8002	.4976	-.3531	.5847	.9103
.6002	-.5159	.5397	.9815	.5497	-.2536	.6121	.8676	.8002	.2476	-.3605	.5826	.9135
.6500	-.5323	.5352	.9888	.6003	-.1259	.6473	.8133	.8002	-.5024	-.3516	.5851	.9096
.7000	-.4972	.5449	.9732	.6500	-.0165	.6775	.7669	.8002	-.7524	-.3379	.5888	.9038
.7500	-.4394	.5611	.9473	.7000	.0888	.7066	.7222					
.8002	-.3586	.5831	.9127	.7501	.1760	.7306	.6849					
.9002	-.1508	.6405	.8239	.8001	.2453	.7497	.6548					
.9501	-.0237	.6755	.7700	.8501	.3037	.7658	.6292					

TEST 167	PT 21.3706	PSI	CN -.1110	CD1 .01291	CDCOR1 .01247
RUN 61	TT 159.8333	K	CM -.1171	CD2 .01240	CDCOR2 .01206
POINT 79	RC 6.9938	MILLION	CC -.0020	CD3 .01219	CDCOR3 .01188
	MACH .7598			CD4 .01254	CDCOR4 .01212
	ALPHA -3.9815	DEG		CD5 .01197	CDCOR5 .01163

UPPER SURFACE				LOWER SURFACE				SPANWISE				
X/C	CP	P/L/PT	MLOC	X/C	CP	P/L/PT	MLOC	X/C	Y/(B/2)	CP	P/L/PT	MLOC
0.0000	.7380	.8853	.4206	0.0000	.7380	.8853	.4206	.1507	.7476	-.1218	.6479	.8124
.0132	.6322	.8561	.4762	.0126	-.7188	.4830	1.0751	.1507	.4976	-.1369	.6437	.8188
.0259	.3171	.7691	.6240	.0255	-.6673	.4982	1.0488	.1507	.2476	-.1369	.6437	.8188
.0759	-.0173	.6767	.7681	.0495	-.6622	.4976	1.0512	.1507	-.2524	-.1390	.6431	.8198
.1003	-.0597	.6651	.7861	.0753	-.8429	.4487	1.1343	.1507	-.5024	-.1451	.6414	.8223
.1507	-.1161	.6439	.8185	.1002	-.9348	.4234	1.1799	.1507	-.7524	-.1277	.6462	.8150
.2003	-.1863	.6301	.8398	.1503	-.8744	.4400	1.1498	.5002	.7476	-.3807	.5764	.9233
.2503	-.2340	.6169	.8602	.1976	-.8872	.4365	1.1561	.5002	.4976	-.3895	.5739	.9271
.3001	-.2753	.6055	.8778	.2503	-.9167	.4283	1.1708	.5002	.2476	-.3951	.5724	.9295
.3502	-.3042	.5975	.8902	.3001	-.8646	.4427	1.1450	.5002	-.2524	-.3862	.5749	.9257
.4003	-.3328	.5896	.9026	.3507	-.9517	.4187	1.1885	.5002	-.5024	-.3827	.5758	.9241
.4501	-.3636	.5811	.9159	.4001	-.9731	.4128	1.1994	.5002	-.7524	-.3712	.5790	.9192
.5002	-.3922	.5732	.9283	.4501	-.4877	.5468	.9701	.8002	.7476	-.3339	.5893	.9030
.5502	-.4250	.5641	.9426	.5001	-.3734	.5784	.9201	.8002	.4976	-.3391	.5879	.9053
.6002	-.4602	.5544	.9580	.5497	-.2568	.6106	.8699	.8002	.2476	-.3470	.5857	.9087
.6500	-.4837	.5479	.9684	.6003	-.1362	.6439	.8185	.8002	-.5024	-.3368	.5885	.9043
.7000	-.4622	.5539	.9549	.6500	-.0288	.6736	.7730	.8002	-.7524	-.3228	.5924	.8982
.7500	-.4162	.5666	.9387	.7000	.0737	.7019	.7294					
.8002	-.3459	.5860	.9082	.7501	.1565	.7236	.6927					
.9002	-.1504	.6400	.8246	.8001	.2291	.7448	.6626					
.9501	-.0262	.6743	.7719	.8501	.2881	.7611	.6368					

ORIGINAL PAGE IS
OF POOR QUALITY

TFST	167	PT	25.3431	PSI	CM	-.0976	CD1	.01203	CDCOR1	.01186
RUN	65	TT	140.3342	K	CM	-.1231	CD2	.01167	CDCOR2	.01193
POINT	31	RC	10.0181	MILLION	CC	.0024	CD3	.01143	CDCOR3	.01136
		MACH	.7614				CD4	.01141	CDCOR4	.01131
		ALPHA	-3.9815	DEG			CD5	.01099	CDCOR5	.01067

UPPER SURFACE				LOWER SURFACE				SPANWISE				
X/C	CP	P _L /PT	MLOC	X/C	CP	P _L /PT	MLOC	X/C	Y/(B/2)	CP	P _L /PT	MLOC
0.0000	.7374	.8853	.4209	0.0000	.7374	.8853	.4209	.1907	.7476	-.1168	.6496	.8101
.0132	.6381	.8579	.4731	.0126	-.7182	.4836	1.0743	.1907	.4976	-.1330	.6451	.8170
.0259	.3226	.7708	.6214	.0255	-.6166	.5116	1.0275	.1907	.2476	-.1337	.6449	.8173
.0759	-.0203	.6762	.7692	.0495	-.7222	.4825	1.0762	.1907	-.2524	-.1378	.6438	.8190
.1003	-.0593	.6654	.7857	.0753	-.8395	.4501	1.1321	.1907	-.5024	-.1425	.6425	.8210
.1507	-.1376	.6438	.8189	.1002	-.9254	.4264	1.1746	.1907	-.7524	-.1303	.6458	.8158
.2003	-.1851	.6307	.8391	.1503	-.8818	.4384	1.1529	.5002	.7476	-.3839	.5758	.9244
.2503	-.2326	.6176	.8593	.1976	-.8670	.4425	1.1456	.5002	.4976	-.3917	.5737	.9278
.3001	-.2749	.6059	.8774	.2503	-.8982	.4339	1.1610	.5002	.2476	-.3969	.5723	.9300
.3302	-.3009	.5988	.8886	.3001	-.8492	.4474	1.1369	.5002	-.2524	-.3879	.5748	.9261
.4003	-.3302	.5907	.9012	.3907	-.9532	.4187	1.1887	.5002	-.5024	-.3846	.5757	.9247
.4501	-.3623	.5818	.9150	.4501	-.9538	.4186	1.1889	.5002	-.7524	-.3733	.5788	.9198
.5002	-.3928	.5734	.9282	.4501	-.4782	.5498	.9656	.8002	.7476	-.3456	.5884	.9078
.5502	-.4265	.5641	.9429	.5001	-.3685	.5801	.9177	.8002	.4976	-.3489	.5855	.9092
.6002	-.4624	.5542	.9587	.5497	-.2523	.6122	.8677	.8002	.2476	-.3543	.5840	.9116
.6500	-.4827	.5486	.9676	.6003	-.1301	.6459	.8157	.8002	-.5024	-.3395	.5881	.9051
.7000	-.4679	.5527	.9611	.6500	-.0223	.6756	.7700	.8002	-.7524	-.3273	.5919	.8999
.7500	-.4216	.5655	.9408	.7000	.0859	.7055	.7240					
.8002	-.3487	.5856	.9091	.7501	.1170	.7307	.6850					
.9002	-.1595	.6378	.8282	.8001	.2521	.7914	.6524					
.9501	-.0335	.6725	.7748	.8501	.3140	.7685	.6292					

TEST	167	PT	25.3434	PSI	CM	-.0620	CD1	-.01036	CDCOR1	.01009
RUN	65	TT	140.3859	K	CM	-.1284	CD2	.01013	CDCOR2	.00990
POINT	32	RC	10.0132	MILLION	CC	.0109	CD3	.01008	CDCOR3	.00988
		MACH	.7614				CD4	.01010	CDCOR4	.00987
		ALPHA	-3.0141	DEG			CD5	.01001	CDCOR5	.00977

UPPER SURFACE				LOWER SURFACE				SPANWISE				
X/C	CP	P _L /PT	MLOC	X/C	CP	P _L /PT	MLOC	X/C	Y/(B/2)	CP	P _L /PT	MLOC
0.0000	.8731	.9226	.3411	0.0000	.8731	.9226	.3411	.1907	.7476	-.2259	.6191	.8570
.0132	.4916	.8173	.5447	.0126	-.4199	.5656	.9406	.1907	.4976	-.2412	.6149	.8635
.0259	.1843	.7269	.6908	.0255	-.4240	.5644	.9424	.1907	.2476	-.2423	.6146	.8640
.0759	-.1579	.6379	.8280	.0495	-.4686	.5521	.9620	.1907	-.2524	-.2455	.6137	.8653
.1003	-.1818	.6313	.8382	.0753	-.7981	.4611	1.1129	.1907	-.5024	-.2497	.6126	.8671
.1507	-.2466	.6134	.8658	.1002	-.5604	.5268	1.0028	.1907	-.7524	-.2344	.6168	.8666
.2003	-.2964	.6024	.8828	.1503	-.5844	.5201	1.0136	.5002	.7476	-.4492	.5575	.9534
.2503	-.3234	.5922	.8987	.1976	-.6819	.4932	1.0581	.5002	.4976	-.4576	.5552	.9571
.3001	-.3662	.5821	.9146	.2503	-.7700	.4689	1.0995	.5002	.2476	-.4627	.5537	.9594
.3502	-.3839	.5755	.9249	.3001	-.8280	.4529	1.1273	.5002	-.2524	-.4510	.5570	.9542
.4003	-.4068	.5692	.9349	.3507	-.7788	.4665	1.1037	.5002	-.5024	-.4478	.5579	.9528
.4501	-.4329	.5620	.9463	.4501	-.5598	.5269	1.0025	.5002	-.7524	-.4359	.5612	.9476
.5002	-.4602	.5544	.9583	.4501	-.4787	.5493	.9664	.8002	.7476	-.4382	.5626	.9137
.5502	-.4901	.5462	.9715	.5001	-.3764	.5776	.9216	.8002	.4976	-.3618	.5816	.9153
.6002	-.5223	.5373	.9858	.5497	-.2451	.6138	.8651	.8002	.2476	-.3681	.5799	.9180
.6500	-.5363	.5334	.9920	.6003	-.1168	.6493	.8105	.8002	-.5024	-.3524	.5842	.9113
.7000	-.5066	.5416	.9788	.6500	-.0073	.6795	.7641	.8002	-.7524	-.3413	.5873	.9065
.7500	-.4471	.5581	.9525	.7000	.1033	.7100	.7170					
.8002	-.3640	.5810	.9163	.7501	.1952	.7354	.6775					
.9002	-.1615	.6369	.8295	.8001	.2706	.7563	.6447					
.9501	-.0342	.6721	.7755	.8501	.3329	.7735	.6171					

TEST	167	PT	25.3764	PSI	CM	.2132	CD1	.00998	CDCOR1	.00975
RUN	65	TT	140.3056	K	CM	-.1317	CD2	.00979	CDCOR2	.00961
POINT	33	RC	10.0325	MILLION	CC	.0172	CD3	.00978	CDCOR3	.00966
		MACH	.7611				CD4	.00982	CDCOR4	.00967
		ALPHA	-1.9958	DEG			CD5	.00973	CDCOR5	.00950

UPPER SURFACE				LOWER SURFACE				SPANWISE				
X/C	CP	P _L /PT	MLOC	X/C	CP	P _L /PT	MLOC	X/C	Y/(B/2)	CP	P _L /PT	MLOC
0.0000	1.0033	.9587	.2463	0.0000	1.0033	.9587	.2463	.1907	.7476	-.3523	.5849	.9109
.0132	.3117	.7678	.6263	.0126	-.1295	.6460	.8156	.1907	.4976	-.3727	.5789	.9196
.0259	-.0292	.6737	.7731	.0255	-.2152	.6223	.8520	.1907	.2476	-.3747	.5783	.9205
.0759	-.3314	.5903	.9018	.0495	-.2870	.6025	.8827	.1907	-.2524	-.3795	.5770	.9226
.1003	-.3326	.5899	.9023	.0753	-.4037	.5703	.9331	.1907	-.5024	-.3817	.5764	.9235
.1507	-.3708	.5769	.9227	.1002	-.4210	.5655	.9407	.1907	-.7524	-.3612	.5821	.9146
.2003	-.3978	.5720	.9305	.1503	-.4513	.5572	.9539	.5002	.7476	-.5241	.5371	.9861
.2503	-.4320	.5625	.9454	.1976	-.5488	.5303	.9971	.5002	.4976	-.5326	.5348	.9898
.3001	-.4614	.5544	.9583	.2503	-.5905	.5188	1.0158	.5002	.2476	-.5378	.5333	.9922
.3502	-.4734	.5511	.9636	.3001	-.6117	.5129	1.0254	.5002	-.2524	-.5260	.5366	.9869
.4003	-.4508	.5463	.9713	.3507	-.5911	.5186	1.0161	.5002	-.5024	-.5236	.5372	.9858
.4501	-.5139	.5399	.9815	.4501	-.5300	.5355	.9887	.5002	-.7524	-.5112	.5406	.9804
.5002	-.5344	.5342	.9907	.4501	-.4538	.5563	.9550	.8002	.7476	-.4309	.5794	.9188
.5502	-.5586	.5276	1.0015	.5001	-.3545	.5839	.9118	.8002	.4976	-.3745	.5764	.9204
.6002	-.5858	.5200	1.0137	.5497	-.2264	.6193	.8568	.8002	.2476	-.3802	.5768	.9229
.6500	-.5919	.5184	1.0165	.6003	-.1012	.6538	.8036	.8002	-.5024	-.3687	.5800	.9179
.7000	-.5414	.5323	.9938	.6500	.0052	.6832	.7584	.8002	-.7524	-.3575	.5831	.9130
.7500	-.4666	.5530	.9606	.7000	.1157	.7137	.7114					
.8002	-.3756	.5781	.9209	.7501	.2082	.7392	.6715					
.9002	-.1630	.6367	.8298	.8001	.2846	.7603	.6382					
.9501	-.0340	.6724	.7751	.8501	.3479	.7778	.6102					

TEST 167 PT 25.3756 PSI CN .2889
 RUN 65 TT 140.3001 K CM -.1337 CD1 .00993 CDCOR1 .00976
 POINT 34 RC 10.0297 MILLION CC .0188 CD2 .00981 CDCOR2 .00967
 MACH .7607 CD3 .00981 CDCOR3 .00972
 ALPHA -1.4969 DEG CD4 .00988 CDCOR4 .00978
 CD5 .00973 CDCOR5 .00952

UPPER SURFACE				LOWER SURFACE				SPANWISE				
X/C	CP	P _L /PT	MLOC	X/C	CP	P _L /PT	MLOC	X/C	Y/(B/2)	CP	P _L /PT	MLOC
0.0000	1.6552	.9731	.1978	0.0000	1.0552	.9731	.1978	.1507	.7476	-.4208	.5661	.9398
.0132	.2103	.7401	.6701	.0126	.10039	.6832	.7584	.1507	.4976	-.4423	.5602	.9492
.0259	-.1336	.6453	.8167	.0255	-.1064	.6528	.8052	.1507	.2476	-.4459	.5592	.9507
.0759	-.4295	.5637	.9436	.0495	-.1971	.6278	.8436	.1507	-.2524	-.4507	.5579	.9528
.1003	-.4139	.5680	.9368	.0753	-.3016	.5990	.8883	.1507	-.5024	-.4520	.5575	.9534
.1507	-.4509	.5578	.9530	.1002	-.3410	.5881	.9052	.1507	-.7524	-.4279	.5641	.9429
.2003	-.4583	.5558	.9552	.1503	-.3836	.5764	.9236	.5002	.7476	-.5608	.5275	1.0016
.2503	-.4892	.5472	.9698	.1976	-.4780	.5503	.9649	.5002	.4976	-.5693	.5251	1.0054
.3001	-.5147	.5402	.9811	.2503	-.5209	.5385	.9838	.5002	.2476	-.5746	.5237	1.0078
.3502	-.5194	.5389	.9831	.3001	-.5418	.5327	.9931	.5002	-.2524	-.5630	.5269	1.0026
.4003	-.5530	.5351	.9892	.3502	-.5380	.5338	.9914	.5002	-.5024	-.5605	.5276	1.0015
.4501	-.5543	.5293	.9987	.4001	-.4499	.5457	.9723	.5002	-.7524	-.5481	.5310	.9959
.5002	-.5707	.5248	1.0061	.4501	-.4304	.5634	.9440	.8002	.7476	-.3745	.5788	.9197
.5502	-.5910	.5192	1.0132	.5001	-.3376	.5890	.9037	.8002	.4976	-.3779	.5779	.9211
.6002	-.6148	.5126	1.0259	.5497	-.2137	.6232	.8507	.8002	.2476	-.3837	.5763	.9236
.6500	-.6167	.5121	1.0268	.6003	-.0912	.6570	.7987	.8002	-.5024	-.3739	.5790	.9194
.7000	-.5548	.5292	.9989	.6500	.0128	.5856	.7547	.8002	-.7524	-.3630	.5820	.9147
.7500	-.4722	.5519	.9623	.7000	.1230	.7160	.7077					
.8002	-.3789	.5776	.9216	.7501	.2185	.7418	.6675					
.9002	-.1629	.6372	.8291	.8001	.2943	.7633	.6335					
.9501	-.0345	.6726	.7747	.8501	.3590	.7811	.6048					

TFST 167 PT 25.3768 PSI CN .3622
 RUN 65 TT 140.3106 K CM -.1356 CD1 .00997 CDCOR1 .00976
 POINT 35 RC 10.0269 MILLION CC .0193 CD2 .00988 CDCOR2 .00963
 MACH .7604 CD3 .00994 CDCOR3 .00974
 ALPHA -.9979 DEG CD4 .01005 CDCOR4 .00983
 CD5 .00988 CDCOR5 .00964

UPPER SURFACE				LOWER SURFACE				SPANWISE				
X/C	CP	P _L /PT	MLOC	X/C	CP	P _L /PT	MLOC	X/C	Y/(B/2)	CP	P _L /PT	MLOC
0.0000	1.0967	.9845	.1497	0.0000	1.0967	.9845	.1497	.1507	.7476	-.4897	.5467	.9707
.0132	.1132	.7130	.7124	.0126	.1246	.7162	.7075	.1507	.4976	-.5138	.5500	.9814
.0259	-.2393	.6158	.8622	.0255	-.0041	.6807	.7623	.1507	.2476	-.5188	.538	.9836
.0759	-.5383	.5332	.9923	.0495	-.1105	.6513	.8074	.1507	-.2524	-.5241	.5372	.9860
.1003	-.4967	.5447	.9738	.0753	-.2100	.6238	.8497	.1507	-.5024	-.5227	.5375	.9853
.1507	-.5245	.5371	.9861	.1002	-.2654	.6086	.8734	.1507	-.7524	-.4941	.5454	.9727
.2003	-.5216	.5379	.9848	.1503	-.3171	.5943	.8955	.5002	.7476	-.5973	.5170	1.0188
.2503	-.5471	.5308	.9962	.1976	-.4107	.5685	.9360	.5002	.4976	-.6082	.5140	1.0237
.3001	-.5699	.5245	1.0064	.2503	-.4561	.5559	.9559	.5002	.2476	-.6147	.5122	1.0267
.3502	-.5659	.5256	1.0046	.3001	-.4815	.5489	.9671	.5002	-.2524	-.6019	.5157	1.0208
.4003	-.5748	.5232	1.0086	.3502	-.4869	.5474	.9695	.5002	-.5024	-.5975	.5169	1.0189
.4501	-.5941	.5178	1.0174	.4001	-.4534	.5561	.9536	.5002	-.7524	-.5824	.5211	1.0121
.5002	-.6109	.5132	1.0250	.4501	-.4003	.5713	.9315	.8002	.7476	-.3731	.5788	.9197
.5502	-.6210	.5104	1.0296	.5001	-.3152	.5948	.8947	.8002	.4976	-.3762	.5780	.9210
.6002	-.6421	.5046	1.0391	.5497	-.1982	.6277	.8438	.8002	.2476	-.3818	.5764	.9235
.6500	-.6389	.5055	1.0377	.6003	-.0770	.6605	.7932	.8002	-.5024	-.3723	.5791	.9194
.7000	-.5646	.5260	1.0041	.6500	.0245	.6885	.7502	.8002	-.7524	-.3624	.5818	.9151
.7500	-.4725	.5514	.9631	.7000	.1340	.7188	.7034					
.8002	-.3769	.5778	.9214	.7501	.2274	.7445	.6632					
.9002	-.1587	.6380	.8279	.8001	.3058	.7662	.6288					
.9501	-.0320	.6730	.7741	.8501	.3717	.7844	.5994					

TEST 167 PT 25.3803 PSI CN .4369
 RUN 65 TT 140.2648 K CM -.1359 CD1 .01020 CDCOR1 .00994
 POINT 36 RC 10.0268 MILLION CC .0180 CD2 .01012 CDCOR2 .00990
 MACH .7596 CD3 .01015 CDCOR3 .01003
 ALPHA -.5091 DEG CD4 .01023 CDCOR4 .01006
 CD5 .01010 CDCOR5 .00984

UPPER SURFACE				LOWER SURFACE				SPANWISE				
X/C	CP	P _L /PT	MLOC	X/C	CP	P _L /PT	MLOC	X/C	Y/(B/2)	CP	P _L /PT	MLOC
0.0000	1.1226	.9919	.1079	0.0000	1.1226	.9919	.1079	.1507	.7476	-.5701	.5266	1.0031
.0132	-.0009	.6831	.7586	.0126	.2322	.7171	.6591	.1507	.4976	-.5965	.5193	1.0149
.0259	-.3569	.5852	.9098	.0255	.0887	.7377	.7207	.1507	.2476	-.6034	.5174	1.0181
.0759	-.7762	.4699	1.0977	.0495	-.0343	.6739	.7728	.1507	-.2524	-.6090	.5159	1.0206
.1003	-.5832	.5230	1.0090	.0753	-.1322	.6470	.8141	.1507	-.5024	-.6026	.5176	1.0177
.1507	-.6101	.5156	1.0211	.1002	-.1987	.6287	.8423	.1507	-.7524	-.5684	.5270	1.0023
.2003	-.5911	.5208	1.0125	.1503	-.2585	.6122	.8677	.5002	.7476	-.6369	.5082	1.0332
.2503	-.6114	.5132	1.0217	.1976	-.3518	.5866	.9076	.5002	.4976	-.6492	.5048	1.0388
.3001	-.6358	.5085	1.0327	.2503	-.4004	.5732	.9285	.5002	.2476	-.6560	.5029	1.0419
.3502	-.6148	.5143	1.0232	.3001	-.4296	.5652	.9412	.5002	-.2524	-.6434	.5064	1.0361
.4003	-.6160	.5139	1.0237	.3502	-.4419	.5618	.9466	.5002	-.5024	-.6391	.5076	1.0342
.4501	-.6346	.5088	1.0322	.4001	-.4195	.5680	.9368	.5002	-.7524	-.6208	.5126	1.0259
.5002	-.6505	.5045	1.0394	.4501	-.3745	.5803	.9173	.8002	.7476	-.3802	.5788	.9198
.5502	-.6545	.5034	1.0412	.5001	-.2977	.6015	.8844	.8002	.4976	-.3826	.5781	.9208
.6002	-.6640	.5008	1.0455	.5497	-.1846	.6325	.8363	.8002	.2476	-.3879	.5767	.9231
.6500	-.6545	.5034	1.0412	.6003	-.0894	.6642	.7876	.8002	-.5024	-.3787	.5792	.9192
.7000	-.5738	.5255	1.0048	.6500	.0293	.6913	.7459	.8002	-.7524	-.3682	.5821	.9146
.7500	-.4782	.5518	.9624	.7000	.1377	.7211	.6998					
.8002	-.3813	.5785	.9203	.7501	.2308	.7467	.6597					
.9002	-.1613	.6389	.8244	.8001	.3099	.7685	.6251					
.9501	-.0340	.6734	.7735	.8501	.3767	.7868	.5954					

TEST	167	PT	25.3778	PSI	CM	.9050	CD1	.01038	CDCOR1	.01015		
RUN	65	TT	140.5393	K	CM	-.1370	CD2	.01028	CDCOR2	.01005		
POINT	37	RC	10.0013	MILLION	CC	.0175	CD3	.01041	CDCOR3	.01019		
		MACH	.7601				CD4	.01044	CDCOR4	.01018		
		ALPHA	-.0102	DEG			CD5	.01036	CDCOR5	.01010		
UPPER SURFACE				LOWER SURFACE				SPANWISE				
X/C	CP	P/L/PT	MLOC	X/C	CP	P/L/PT	MLOC	X/C	Y/(B/2)	CP	P/L/PT	MLOC
0.0000	1.1418	.9969	.0670	0.0000	1.1418	.9960	.0670	.1507	.7476	-.6371	.5056	1.0371
.0132	-.0918	.6564	.7996	.0126	.3309	.7730	.6178	.1507	.4976	-.5928	.5181	1.0170
.0259	-.4558	.5559	.9559	.0255	.1750	.7300	.6860	.1507	.2476	-.6256	.5090	1.0318
.0759	-.8258	.4538	1.1257	.0495	.0374	.6920	.7448	.1507	-.2524	-.6280	.5084	1.0329
.1003	-.7944	.4624	1.1106	.0753	-.0615	.6647	.7868	.1507	-.5024	-.6073	.5141	1.0235
.1507	-.6323	.5072	1.0349	.1002	-.1357	.6443	.8182	.1507	-.7524	-.6160	.5117	1.0274
.2003	-.6556	.5007	1.0456	.1503	-.2033	.6236	.8877	.5002	.7476	-.6741	.4956	1.0541
.2503	-.6801	.4940	1.0568	.1976	-.2986	.5993	.9106	.5002	.4976	-.6826	.4925	1.0594
.3001	-.7011	.4882	1.0666	.2503	-.3517	.5746	.9294	.5002	.2476	-.6876	.4919	1.0603
.3502	-.7037	.4875	1.0678	.3001	-.3859	.5522	.9454	.5002	-.2524	-.6774	.4947	1.0556
.4003	-.6822	.4934	1.0578	.3507	-.4026	.5276	.9327	.5002	-.5024	-.6806	.4939	1.0571
.4501	-.6652	.4981	1.0500	.4001	-.3881	.5046	.9264	.5002	-.7524	-.6806	.4987	1.0489
.5002	-.6795	.4942	1.0566	.4501	-.3501	.5811	.9099	.8002	.7476	-.3729	.5788	.9219
.5502	-.6946	.4900	1.0636	.5001	-.2792	.6046	.8794	.8002	.4976	-.3779	.5774	.9198
.6002	-.6989	.4888	1.0656	.5497	-.1705	.6347	.8330	.8002	.2476	-.3832	.5759	.9242
.6500	-.6717	.4963	1.0930	.6003	-.0583	.6656	.7854	.8002	-.5024	-.3769	.5777	.9215
.7000	-.5786	.5220	1.0105	.6500	.0379	.6922	.7446	.8002	-.7524	-.3668	.5805	.9171
.7500	-.4745	.5508	.9641	.7000	.1451	.7218	.6988					
.8002	-.3767	.5777	.9214	.7501	.2377	.7473	.6588					
.9002	-.1567	.6385	.8272	.8001	.3170	.7692	.6240					
.9501	-.0335	.6725	.7749	.8501	.3843	.7878	.5939					

TEST	167	PT	25.3770	PSI	CM	.9944	CD1	.01075	CDCOR1	.01051		
RUN	65	TT	140.5077	K	CM	-.1382	CD2	.01068	CDCOR2	.01041		
POINT	38	RC	10.0044	MILLION	CC	.0150	CD3	.01079	CDCOR3	.01054		
		MACH	.7602				CD4	.01075	CDCOR4	.01047		
		ALPHA	.4990	DEG			CD5	.01065	CDCOR5	.01039		
UPPER SURFACE				LOWER SURFACE				SPANWISE				
X/C	CP	P/L/PT	MLOC	X/C	CP	P/L/PT	MLOC	X/C	Y/(B/2)	CP	P/L/PT	MLOC
0.0000	1.1493	.9988	.0409	0.0000	1.1483	.9988	.0409	.1507	.7476	-.7947	.4636	1.1086
.0132	-.2033	.6265	.6456	.0126	.4286	.8006	.5728	.1507	.4976	-.9525	.4202	1.1881
.0259	-.5715	.5251	1.0055	.0255	.2602	.7542	.6479	.1507	.2476	-.9182	.4296	1.1688
.0759	-.9219	.4280	1.1717	.0495	.1049	.7114	.7149	.1507	-.2524	-.9170	.4299	1.1683
.1003	-.9137	.4308	1.1666	.0753	.0125	.6860	.7542	.1507	-.5024	-.9360	.4247	1.1776
.1507	-.9277	.4270	1.1736	.1002	-.0703	.6632	.7892	.1507	-.7524	-.9310	.4257	1.0878
.2003	-.8330	.4531	1.1270	.1503	-.1450	.6426	.8208	.5002	.7476	-.7228	.4634	1.0747
.2503	-.8698	.4429	1.1449	.1976	-.2411	.6181	.8616	.5002	.4976	-.7408	.4785	1.0831
.3001	-.8851	.4938	1.0571	.2503	-.2971	.6007	.8896	.5002	.2476	-.7458	.4771	1.0854
.3502	-.8642	.4996	1.0675	.3001	-.3344	.5904	.9016	.5002	-.2524	-.7272	.4822	1.0747
.4003	-.7126	.4862	1.0699	.3507	-.3563	.5844	.9110	.5002	-.5024	-.7299	.4815	1.0780
.4501	-.7300	.4814	1.0780	.4001	-.3480	.5867	.9074	.5002	-.7524	-.7079	.4875	1.0677
.5002	-.7378	.4793	1.0816	.4501	-.3178	.5930	.8944	.8002	.7476	-.3763	.5789	.9197
.5502	-.7422	.4771	1.0837	.5001	-.2542	.6125	.8672	.8002	.4976	-.3801	.5778	.9213
.6002	-.7338	.4804	1.0798	.5497	-.1514	.6408	.8236	.8002	.2476	-.3848	.5765	.9233
.6500	-.6834	.4943	1.0364	.6003	-.0439	.6704	.7780	.8002	-.5024	-.3767	.5788	.9198
.7000	-.5828	.5220	1.0106	.6500	.0492	.6981	.7386	.8002	-.7524	-.3663	.5816	.9153
.7500	-.4777	.5509	.9639	.7000	.1548	.7252	.6935					
.8002	-.3794	.5780	.9210	.7501	.2464	.7504	.6539					
.9002	-.1589	.6387	.8267	.8001	.3290	.7723	.6190					
.9501	-.0387	.6719	.7758	.8501	.3940	.7910	.5883					

TEST	167	PT	25.3847	PSI	CM	.6802	CD1	.01110	CDCOR1	.01081		
RUN	65	TT	140.4706	K	CM	-.1388	CD2	.01117	CDCOR2	.01089		
POINT	39	RC	10.0178	MILLION	CC	.0131	CD3	.01136	CDCOR3	.01100		
		MACH	.7610				CD4	.01131	CDCOR4	.01097		
		ALPHA	1.0081	DEG			CD5	.01143	CDCOR5	.01104		
UPPER SURFACE				LOWER SURFACE				SPANWISE				
X/C	CP	P/L/PT	MLOC	X/C	CP	P/L/PT	MLOC	X/C	Y/(B/2)	CP	P/L/PT	MLOC
0.0000	1.1505	.9992	.0346	0.0000	1.1505	.9992	.0346	.1507	.7476	-.9015	.4317	1.1650
.0132	-.2832	.6027	.8824	.0126	.5035	.8202	.5397	.1507	.4976	-1.0138	.4007	1.2224
.0259	-.6625	.4978	1.0504	.0255	.3292	.7720	.6196	.1507	.2476	-.9618	.4151	1.1955
.0759	-.9630	.4147	1.1961	.0495	.1597	.7252	.6935	.1507	-.2524	-.9715	.4124	1.2005
.1003	-.9434	.4201	1.1861	.0753	.0666	.6994	.7336	.1507	-.5024	-1.0140	.4006	1.2225
.1507	-.9804	.4098	1.2033	.1002	-.0186	.6759	.7697	.1507	-.7524	-.8939	.4338	1.1612
.2003	-.9563	.4166	1.1927	.1503	-.1000	.6534	.8042	.5002	.7476	-.8720	.4399	1.1503
.2503	-.9654	.4141	1.1973	.1976	-.1987	.6261	.8463	.5002	.4976	-.8890	.4352	1.1588
.3001	-1.0118	.4012	1.2214	.2503	-.2595	.6093	.8897	.5002	.2476	-.8885	.4402	1.1339
.3502	-1.0011	.4042	1.2159	.3001	-.3001	.5980	.9008	.5002	-.2524	-.8279	.4521	1.1287
.4003	-.9359	.4222	1.1823	.3507	-.3258	.5909	.8998	.5002	-.5024	-.9063	.4304	1.1674
.4501	-.8279	.4521	1.1287	.4001	-.3232	.5916	.8996	.5002	-.7524	-.8759	.4388	1.1522
.5002	-.8134	.4561	1.1217	.4501	-.2986	.5985	.8890	.6002	.7476	-.3714	.5783	.9205
.5502	-.7605	.4707	1.0963	.5001	-.2467	.6144	.8642	.8002	.4976	-.3776	.5766	.9232
.6002	-.6931	.4894	1.0646	.5497	-.1419	.6418	.8221	.8002	.2476	-.3821	.5754	.9252
.6500	-.6108	.5121	1.0267	.6003	-.0369	.6708	.7774	.8002	-.5024	-.3756	.5771	.9225
.7000	-.5494	.5291	.9990	.6500	.0531	.6957	.7392	.8002	-.7524	-.3630	.5806	.9189
.7500	-.4670	.5519	.9623	.7000	.1572	.7245	.6946					
.8002	-.3723	.5781	.9209	.7501	.2465	.7487	.6550					
.9002	-.1551	.6391	.8277	.8001	.3275	.7716	.6202					
.9501	-.0340	.6716	.7762	.8501	.3955	.7904	.5946					

CO-1000 QUALITY

TEST 167 PT 25.3819 PSI CN .7663
 RUN 65 TT 140.5186 K CM -.1478
 POINT 40 RC 10.0093 MILLION CC .0132
 MACH .7802
 ALPHA 1.4969 DEG

CD1 .01311 CDCOR1 .01272
 CD2 .01326 CDCOR2 .01290
 CD3 .01345 CDCOR3 .01298
 CD4 .01387 CDCOR4 .01314
 CD5 .01425 CDCOR5 .01361

UPPER SURFACE				LOWER SURFACE				SPANWISE				
X/C	CP	P/L/PT	MLOC	X/C	CP	P/L/PT	MLOC	X/C	Y/(B/2)	CP	P/L/PT	MLOC
0.0000	1.1510	.9990	.0371	0.0000	1.1510	.9990	.0371	.1507	.7476	-.9967	.4141	1.1973
.0132	-.3629	.5789	.9196	.0126	.5744	.8390	.5071	.1507	.4976	-1.0330	.3929	1.2373
.0259	-.7410	.4739	1.0908	.0255	.3929	.7886	.5925	.1507	.2476	-.9796	.4077	1.2091
.0759	-.9891	.4051	1.2141	.0495	.2161	.7396	.6710	.1507	-.2524	-1.0182	.3970	1.2294
.1003	-.9846	.4063	1.2117	.0753	.1230	.7137	.7113	.1507	-.5024	-1.0590	.3857	1.2512
.1507	-1.0008	.4018	1.2203	.1002	-.0319	.6883	.7505	.1507	-.7524	-1.0105	.3991	1.2253
.2003	-1.0187	.3969	1.2297	.1503	-.0540	.6846	.7870	.5002	.7476	-1.0373	.3917	1.2395
.2503	-1.0267	.3946	1.2339	.1976	-.1541	.6368	.8297	.5002	.4976	-1.0934	.3872	1.2482
.3001	-1.0747	.3813	1.2597	.2503	-.2178	.6191	.8569	.5002	.2476	-1.0456	.3894	1.2440
.3502	-1.0757	.3810	1.2603	.3001	-.2612	.6071	.8756	.5002	-.2524	-1.0280	.3943	1.2346
.4003	-1.0720	.3821	1.2583	.3507	-.2908	.5989	.8854	.5002	-.5024	-1.0368	.3918	1.2393
.4501	-1.0497	.3883	1.2462	.4001	-.2927	.5984	.8892	.5002	-.7524	-1.0227	.3958	1.2318
.5002	-.9744	.4092	1.2064	.4501	-.2731	.6238	.8607	.8002	.7476	-.3411	.5849	.9101
.5502	-.9884	.4033	1.2137	.5001	-.2205	.6184	.8581	.8002	.4976	-.3424	.5846	.9107
.6002	-.9147	.4257	1.1759	.5497	-.1262	.6446	.8178	.8002	.2476	-.3452	.5838	.9119
.6500	-.6541	.4981	1.0500	.6003	-.0248	.6727	.7745	.8002	-.5024	-.3436	.5842	.9112
.7000	-.4849	.5450	.9733	.6500	.0629	.6970	.7371	.8002	-.7524	-.3364	.5862	.9081
.7500	-.4102	.5657	.9403	.7000	.1655	.7255	.6930					
.8002	-.3367	.5861	.9082	.7501	.2536	.7505	.6937					
.9002	-.1431	.6399	.8250	.8001	.3346	.7724	.6188					
.9501	-.0337	.6702	.7783	.8501	.4029	.7914	.5860					

TEST 167 PT 25.3213 PSI CN .8480
 RUN 65 TT 140.5380 K CM -.1956
 POINT 41 RC 9.9841 MILLION CC .0128
 MACH .7608
 ALPHA 2.0060 DEG

CD1 .01720 CDCOR1 .01679
 CD2 .01777 CDCOR2 .01740
 CD3 .01892 CDCOR3 .01850
 CD4 .01935 CDCOR4 .01876
 CD5 .01971 CDCOR5 .01918

UPPER SURFACE				LOWER SURFACE				SPANWISE				
X/C	CP	P/L/PT	MLOC	X/C	CP	P/L/PT	MLOC	X/C	Y/(B/2)	CP	P/L/PT	MLOC
0.0000	1.1505	.9993	.0312	0.0000	1.1505	.9993	.0312	.1507	.7476	-1.1005	.3784	1.2654
.0132	-.4476	.5585	.9518	.0126	.6375	.8578	.4732	.1507	.4976	-1.1123	.3752	1.2719
.0259	-.8262	.4541	1.1252	.0255	.4514	.8065	.5629	.1507	.2476	-1.0842	.3829	1.2566
.0759	-1.0750	.3855	1.2516	.0495	.2701	.7565	.6443	.1507	-.2524	-1.1109	.3756	1.2711
.1003	-1.0687	.3872	1.2483	.0753	.1748	.7302	.6857	.1507	-.5024	-1.1336	.3693	1.2836
.1507	-1.0829	.3833	1.2559	.1002	-.0784	.7036	.7269	.1507	-.7524	-1.1433	.3666	1.2889
.2003	-1.0680	.3874	1.2479	.1503	-.0112	.6789	.7650	.5002	.7476	-1.1073	.3766	1.2691
.2503	-1.0883	.3818	1.2588	.1976	-.1126	.6509	.8080	.5002	.4976	-1.1223	.3724	1.2773
.3001	-1.1398	.3679	1.2864	.2503	-.1791	.6326	.8362	.5002	.2476	-1.1378	.3681	1.2859
.3502	-1.1502	.3647	1.2920	.3001	-.2251	.6199	.8598	.5002	-.2524	-1.1085	.3762	1.2698
.4003	-1.1526	.3640	1.2941	.3507	-.2582	.6108	.8699	.5002	-.5024	-1.1059	.3769	1.2683
.4501	-1.1663	.3603	1.3018	.4001	-.2642	.6091	.8725	.5002	-.7524	-1.0901	.3813	1.2578
.5002	-1.1359	.3687	1.2848	.4501	-.2496	.6131	.8662	.8002	.7476	-.3291	.5912	.9003
.5502	-1.0705	.3867	1.2492	.5001	-.2025	.6261	.8462	.8002	.4976	-.3274	.5914	.8996
.6002	-1.0831	.3832	1.2560	.5497	-.1130	.6508	.8082	.8002	.2476	-.3282	.5907	.9000
.6500	-.7069	.4870	1.0686	.6003	-.0152	.6778	.7667	.8002	-.5024	-.3308	.5907	.9011
.7000	-.4948	.5455	.9725	.6500	.0702	.7013	.7305					
.7500	-.4055	.5701	.9334	.7000	.1711	.7292	.6873					
.8002	-.3241	.5926	.8982	.7501	.2601	.7537	.6486					
.9002	-.1401	.6433	.8197	.8001	.3391	.7755	.6139					
.9501	-.0392	.6712	.7769	.8501	.4076	.7944	.5830					

TEST 167 PT 25.3741 PSI CN .9100
 RUN 65 TT 140.5478 K CM -.1604
 POINT 42 RC 10.0128 MILLION CC .0123
 MACH .7620
 ALPHA 2.5050 DEG

CD1 .02342 CDCOR1 .02174
 CD2 .02373 CDCOR2 .02208
 CD3 .02738 CDCOR3 .02491
 CD4 .02765 CDCOR4 .02489
 CD5 .02846 CDCOR5 .02447

UPPER SURFACE				LOWER SURFACE				SPANWISE				
X/C	CP	P/L/PT	MLOC	X/C	CP	P/L/PT	MLOC	X/C	Y/(B/2)	CP	P/L/PT	MLOC
0.0000	1.1359	.9954	.0815	0.0000	1.1359	.9954	.0815	.1507	.7476	-1.1703	.3558	1.3027
.0132	-.5219	.5195	.9338	.0126	.6852	.8717	.4483	.1507	.4976	-1.1734	.3590	1.3044
.0259	-.8486	.4347	1.1296	.0255	.4975	.8194	.5411	.1507	.2476	-1.1461	.3645	1.2842
.0759	-1.1430	.3673	1.2475	.0495	.3147	.7691	.6242	.1507	-.2524	-1.1426	.3675	1.2974
.1003	-1.1405	.3680	1.2461	.0753	.2173	.7422	.6668	.1507	-.5024	-1.1436	.3642	1.3102
.1507	-1.1346	.3697	1.2528	.1002	.1180	.7149	.7095	.1507	-.7524	-1.1757	.3583	1.3058
.2003	-1.1361	.3693	1.2836	.1503	-.0243	.6890	.7494	.5002	.7476	-1.1826	.3645	1.3044
.2503	-1.1631	.3618	1.2986	.1976	-.0783	.6608	.7929	.5002	.4976	-1.1925	.3537	1.3153
.3001	-1.1707	.3597	1.3029	.2503	-.1474	.6417	.8221	.5002	.2476	-1.2064	.3499	1.3232
.3502	-1.2116	.3485	1.3262	.3001	-.1958	.6284	.8427	.5002	-.2524	-1.1871	.3552	1.3122
.4003	-1.2156	.3473	1.3286	.3507	-.2319	.6184	.8580	.5002	-.5024	-1.1593	.3629	1.2965
.4501	-1.2317	.3429	1.3479	.4001	-.2415	.6158	.8621	.5002	-.7524	-1.1610	.3624	1.2975
.5002	-1.2395	.3408	1.3424	.4501	-.2315	.6186	.8579	.8002	.7476	-.3265	.5924	.8985
.5502	-1.2042	.3505	1.3270	.5001	-.1892	.6302	.8399	.8002	.4976	-.3273	.5922	.8988
.6002	-1.1495	.3634	1.2911	.5497	-.1044	.6536	.8039	.8002	.2476	-.3299	.5914	.9000
.6500	-.6728	.4969	1.0519	.6003	-.0102	.6795	.7641	.8002	-.5024	-.3286	.5918	.8994
.7000	-.5130	.5410	.9798	.6500	.0724	.7023	.7290					
.7500	-.4152	.5679	.9369	.7000	.1717	.7296	.6865					
.8002	-.3258	.5926	.8982	.7501	.2594	.7538	.6485					
.9002	-.1453	.6423	.8213	.8001	.3377	.7754	.6140					
.9501	-.0549	.6672	.7830	.8501	.4063	.7943	.5832					

TEST 167 P: 25.3609 PSI CN .9174
 RUN 65 TT 140.5165 K CM -.1593
 POINT 44 RC 10.0110 MILLION CC .0145
 MACH .7620
 ALPHA 2.9939 DEG

CD1 .03383 CDCOR1 .03324
 CD2 .03368 CDCOR2 .03297
 CD3 .03545 CDCOR3 .03477
 CD4 .03548 CDCOR4 .03455
 CD5 .03286 CDCOR5 .03193

UPPER SURFACE				LOWER SURFACE				SPANWISE				
X/C	CP	P/L/PT	MLOC	X/C	CP	P/L/PT	MLOC	X/C	Y/(B/2)	CP	P/L/PT	MLOC
0.0000	1.1364	.9174	.0651	0.0000	1.1364	.9949	.0651	.1507	.7476	-1.1870	.3500	1.3230
.0132	-.5497		1.0026	.0126	.7222	.8800	.4313	.1507	.4976	-1.1988	.3467	1.3299
.0259	-.9210		1.1793	.0255	.5331	.8275	.3273	.1507	.2476	-1.1740	.3536	1.3155
.0759	-1.1637	.3565	1.3096	.0495	.3467	.7757	.6135	.1507	-.2524	-1.1503	.3402	1.3020
.1003	-1.1714	.3571	1.3083	.0753	.2482	.7484	.6571	.1507	-.5024	-1.1474	.3499	1.3233
.1507	-1.1644	.3562	1.3101	.1002	.1431	.7192	.7028	.1507	-.7524	-1.1696	.3548	1.3130
.2003	-1.1514	.3626	1.2970	.1503	.0473	.6926	.7439	.5002	.7476	-1.2085	.3440	1.3356
.2503	-1.1421	.3513	1.3202	.1976	-.0575	.6635	.7887	.5002	.4976	-1.2197	.3409	1.3422
.3001	-1.1981	.3469	1.3295	.2503	-.1301	.6434	.8196	.5002	.2476	-1.2209	.3406	1.3429
.3502	-1.2288	.3384	1.3475	.3001	-.1827	.6288	.8421	.5002	-.2524	-1.2048	.3450	1.3334
.4003	-1.2402	.3352	1.3543	.3507	-.2236	.6174	.8596	.5002	-.5024	-1.1760	.3530	1.3167
.4501	-1.2655	.3282	1.3695	.4001	-.2374	.6136	.8655	.5002	-.7524	-1.1931	.3483	1.3266
.5002	-1.2737	.3259	1.3745	.4501	-.2307	.6154	.8627	.8002	.7476	-1.3360	.5862	.9081
.5502	-1.1642	.3563	1.3100	.5001	-.1914	.6264	.8458	.8002	.4976	-1.3492	.5826	.9138
.6002	-.7850	.4613	1.1126	.5497	-.1083	.6494	.8103	.8002	.2476	-1.3617	.5791	.9193
.6503	-.6018	.5119	1.0271	.6003	-.0159	.6751	.7709	.8002	-.5024	-1.3409	.5849	.9103
.7000	-.5167	.5361	.9877	.6500	.0666	.6980	.7357	.8002	-.7524	-1.3275	.5886	.9044
.7500	-.4349	.5588	.9514	.7070	.1651	.7253	.6933					
.8002	-.3526	.5814	.9154	.7501	.2518	.7494	.6555					
.8077	-.1978	.6246	.8484	.8001	.3299	.7711	.6210					
.9501	-.1500	.6378	.8281	.9501	.3983	.7901	.5901					

TEST	167	PT	34.0631	PSI	CM	-.0055	CD1	.01142	CDCOR1	-.01121
RUN	64	TT	130.8329	K	CM	-.1286	CD2	.01095	CDCOR2	.01077
POINT	15	RC	14.9366	MILLION	CC	.0037	CD3	.01079	CDCOR3	.01069
		MACH	.7609				CD4	.01060	CDCOR4	.01044
		ALPHA	-3.9713	DEG			CD5	.01014	CDCOR5	.00985

UPPER SURFACE				LOWER SURFACE				SPANWISE				
X/C	CP	P _L /PT	MLOC	X/C	CP	P _L /PT	MLOC	X/C	Y/(B/2)	CP	P _L /PT	MLOC
0.0000	.7377	.0855	.4265	0.0000	.7377	.0855	.4205	.1507	.7476	-.1222	.6484	.8121
.0132	.6323	.0565	.4759	.0126	-.6841	.4935	1.0580	.1507	.4976	-.1366	.6445	.8182
.0259	.3210	.7709	.6215	.0255	-.6038	.5157	1.0212	.1507	.2476	-.1363	.6446	.8181
.0759	-.0283	.6743	.7723	.0495	-.6667	.4983	1.0500	.1507	-.2524	-.1415	.6431	.8203
.1003	-.0641	.6845	.7875	.0753	-.8455	.4491	1.1345	.1507	-.5024	-.1475	.6415	.8229
.1507	-.1421	.6430	.8204	.1002	-.9262	.4268	1.1743	.1507	-.7524	-.1354	.6448	.8177
.2003	-.1849	.6312	.8387	.1503	-.8755	.4408	1.1491	.5002	.7476	-.3900	.5746	.9267
.2503	-.2355	.6172	.8603	.1976	-.8629	.4443	1.1429	.5002	.4976	-.3964	.5729	.9295
.3001	-.2790	.6052	.8789	.2503	-.8735	.4413	1.1402	.5002	.2476	-.4013	.5715	.9316
.3502		.5981	.8900	.3001	-.8504	.4477	1.1349	.5002	-.2524	-.3915	.5742	.9273
.4003	-.3337	.5901	.9023	.3507	-.9524	.4196	1.1875	.5002	-.5024	-.3881	.5751	.9259
.4501	-.3841	.5818	.9155	.4001	-.9727	.4140	1.1979	.5002	-.7524	-.3769	.5782	.9210
.5002	-.3976	.5725	.9300	.4501	-.4756	.5310	.9641	.8002	.7476	-.9830	.4111	1.2032
.5502	-.4327	.5629	.9453	.5001	-.3867	.5810	.9166	.8002	.4976	-.3374	.5836	.9126
.6002	-.4689	.5529	.9611	.5497	-.2524	.6126	.8675	.8002	.2476	-.3619	.5824	.9145
.6500	-.4903	.5470	.9706	.6003	-.1297	.6464	.8153	.8002	-.5024	-.3429	.5876	.9083
.7000	-.4761	.5509	.9643	.6500	-.0230	.6758	.7701	.8002	-.7524	-.3291	.5914	.9004
.7500	-.4297	.5638	.9432	.7000	.0403	.7070	.7219					
.8002	-.3566	.5838	.9122	.7501	.1848	.7331	.6814					
.8502	-.1694	.6354	.8322	.8001	.2632	.7547	.6474					
.9001	-.0444	.6699	.7792	.8501	.3269	.7723	.6193					

TEST	167	PT	34.0619	PSI	CM	-.0478	CD1	.00998	CDCOR1	-.00978
RUN	64	TT	130.8195	K	CM	-.1314	CD2	.00969	CDCOR2	-.00952
POINT	16	RC	14.9447	MILLION	CC	.0117	CD3	.00972	CDCOR3	-.00962
		MACH	.7615				CD4	.00969	CDCOR4	-.00959
		ALPHA	-3.0063	DEG			CD5	.00968	CDCOR5	-.00944

UPPER SURFACE				LOWER SURFACE				SPANWISE				
X/C	CP	P _L /PT	MLOC	X/C	CP	P _L /PT	MLOC	X/C	Y/(B/2)	CP	P _L /PT	MLOC
0.0000	.0713	.9221	.3425	0.0000	.0713	.9221	.3425	.1507	.7476	-.2289	.6182	.8388
.0132	.4919	.8175	.5450	.0126	-.4038	.5698	.9342	.1507	.4976	-.2450	.6137	.8657
.0259	.1670	.7275	.6901	.0255	-.4133	.5672	.9384	.1507	.2476	-.2451	.6137	.8657
.0759	-.1660	.6355	.8320	.0495	-.4613	.5540	.9594	.1507	-.2524	-.2510	.6120	.8683
.1003	-.1866	.6298	.8408	.0753	-.8036	.4594	1.1163	.1507	-.5024	-.2559	.6107	.8704
.1507	-.2317	.6119	.8666	.1002	-.5581	.5272	1.0024	.1507	-.7524	-.2404	.6150	.8637
.2003	-.2843	.6028	.8823	.1503	-.5844	.5200	1.0143	.5002	.7476	-.4577	.5950	.9578
.2503	-.3270	.5911	.9009	.1976	-.6817	.4931	1.0588	.5002	.4976	-.4646	.5931	.9608
.3001	-.3651	.5805	.9174	.2503	-.7718	.4682	1.1011	.5002	.2476	-.4687	.5916	.9631
.3502	-.3853	.5750	.9262	.3001	-.8341	.4510	1.1311	.5002	-.2524	-.4587	.5947	.9592
.4003	-.4096	.5682	.9367	.3507	-.8200	.4549	1.1242	.5002	-.5024	-.4556	.5955	.9566
.4501	-.4369	.5607	.9487	.4001	-.5570	.5275	1.0019	.5002	-.7524	-.4439	.5987	.9518
.5002	-.4658	.5527	.9614	.4501	-.4775	.5495	.9666	.8002	.7476	-1.0308	.5968	1.2305
.5502	-.4874	.5440	.9754	.5001	-.3785	.5768	.9232	.8002	.4976	-.3722	.5786	.9205
.6002	-.5303	.5348	.9901	.5497	-.2476	.6130	.8688	.8002	.2476	-.3774	.5771	.9227
.6500	-.5464	.5304	.9972	.6003	-.1187	.6486	.8119	.8002	-.5024	-.3609	.5817	.9156
.7000	-.5169	.5386	.9840	.6500	-.0112	.6783	.7663	.8002	-.7524	-.3491	.5850	.9104
.7500	-.4949	.5527	.9586	.7000	.1641	.7101	.7171					
.8002	-.3718	.5787	.9203	.7501	.1998	.7366	.6740					
.8502	-.1714	.6340	.8343	.8001	.2781	.7582	.6418					
.9001	-.0429	.6695	.7797	.8501	.3424	.7759	.6133					

TEST	167	PT	34.0638	PSI	CM	-.2243	CD1	.00952	CDCOR1	-.00937
RUN	64	TT	130.5963	K	CM	-.1355	CD2	.00925	CDCOR2	-.00910
POINT	17	RC	14.9417	MILLION	CC	.0181	CD3	.00939	CDCOR3	-.00929
		MACH	.7608				CD4	.00937	CDCOR4	-.00929
		ALPHA	-1.9958	DEG			CD5	.00935	CDCOR5	-.00914

UPPER SURFACE				LOWER SURFACE				SPANWISE				
X/C	CP	P _L /PT	MLOC	X/C	CP	P _L /PT	MLOC	X/C	Y/(B/2)	CP	P _L /PT	MLOC
0.0000	1.0034	.9588	.2459	0.0000	1.0034	.9588	.2459	.1507	.7476	-.3560	.5938	.9123
.0132	.3110	.7679	.6283	.0126	-.1225	.6484	.9122	.1507	.4976	-.3755	.5786	.9203
.0259	-.0218	.6761	.7896	.0255	-.1869	.6306	.9395	.1507	.2476	-.3769	.5783	.9210
.0759	-.3589	.5885	.9099	.0495	-.2803	.6049	.9794	.1507	-.2524	-.3833	.5765	.9237
.1003	-.3585	.5894	.9035	.0753	-.4127	.5684	.9365	.1507	-.5024	-.3886	.5756	.9232
.1507	-.3839	.5784	.9239	.1002	-.4214	.5680	.9403	.1507	-.7524	-.3667	.5812	.9163
.2003	-.3977	.5725	.9300	.1503	-.4507	.5570	.9531	.5002	.7476	-.3324	.5934	.9092
.2503	-.4352	.5622	.9463	.1976	-.5488	.5309	.9965	.5002	.4976	-.3301	.5935	.9021
.3001	-.4669	.5536	.9600	.2503	-.5913	.5191	1.0156	.5002	.2476	-.3442	.5921	.9044
.3502	-.4764	.5508	.9644	.3001	-.6138	.5129	1.0258	.5002	-.2524	-.3328	.5933	.9094
.4003	-.4942	.5459	.9723	.3507	-.5924	.5188	1.0161	.5002	-.5024	-.3301	.5930	.9081
.4501	-.5182	.5393	.9829	.4001	-.5298	.5361	.9880	.5002	-.7524	-.3178	.5954	.9027
.5002	-.5401	.5333	.9926	.4501	-.4545	.5569	.9546	.8002	.7476	-1.0659	.5884	1.2463
.5502	-.5658	.5262	1.0041	.5001	-.3557	.5841	.9118	.8002	.4976	-.3840	.5783	.9241
.6002	-.5942	.5184	1.0169	.5497	-.2272	.6195	.8567	.8002	.2476	-.3889	.5749	.9260
.6500	-.6044	.5155	1.0215	.6001	-.1012	.6543	.8032	.8002	-.5024	-.3747	.5788	.9200
.7000	-.5533	.5296	.9983	.6500	.0031	.6830	.7590	.8002	-.7524	-.3631	.5821	.9150
.7500	-.4734	.5516	.9632	.7000	.1180	.7147	.7101					
.8002	-.3837	.5764	.9239	.7501	.2139	.7411	.6684					
.8502	-.1735	.6343	.8339	.8001	.2935	.7631	.6341					
.9001	-.0430	.6703	.7785	.8501	.3593	.7812	.6048					

TEST 147	PT	34.0637	PSI	CM	.3024	CD1	.00941	CDCOR1	.00922
RUN 64	TT	130.5442	K	CM	-.1393	CD2	.00926	CDCOR2	.00910
POINT 1A	RC	14.9505	MILLION	CC	.0197	CD3	.00936	CDCOR3	.00926
	MACH	.7608				CD4	.00938	CDCOR4	.00925
	ALPHA	-1.4959	DEG			CD5	.00934	CDCOR5	.00913

UPPER SURFACE				LOWER SURFACE				SPANWISE				
X/C	CP	P/L/PT	MLOC	X/C	CP	P/L/PT	MLOC	X/C	Y/(B/2)	CP	P/L/PT	MLOC
0.0000	1.0563	.9734	.1966	0.0000	1.0563	.9734	.1966	.1507	.7476	-.5269	.5649	.9421
.0132	.7071	.7395	.6713	.0126	.0133	.8661	.7542	.1507	.4976	-.4473	.5592	.9510
.0259	-.1277	.6473	.8139	.0255	-.0787	.6608	.7932	.1507	.2476	-.4498	.5585	.9521
.0759	-.4417	.5608	.9496	.0495	-.1895	.6303	.8401	.1507	-.2524	-.4561	.5560	.9549
.1003	-.4204	.5666	.9393	.0753	-.3077	.5977	.8906	.1507	-.5024	-.4577	.5564	.9556
.1507	-.4573	.5565	.9554	.1002	-.3401	.5888	.9045	.1507	-.7524	-.4541	.5629	.9452
.2003	-.4833	.5548	.9580	.1503	-.3813	.5774	.9223	.5002	.7476	-.5728	.5247	1.0066
.2543	-.4948	.5462	.9719	.1976	-.4758	.5514	.9435	.5002	.4976	-.5798	.5227	1.0097
.3001	-.5225	.5385	.9841	.2503	-.5197	.5393	.9829	.5002	.2476	-.5849	.5213	1.0120
.3502	-.5270	.5373	.9861	.3001	-.5410	.5334	.9924	.5002	-.2524	-.5718	.5249	1.0061
.4003	-.5403	.5336	.9920	.3507	-.5370	.5345	.9906	.5002	-.5024	-.5688	.5250	1.0048
.4501	-.5622	.5276	1.0018	.4001	-.4933	.5466	.9712	.5002	-.7524	-.5555	.5246	.9989
.5002	-.5813	.5221	1.0104	.4501	-.4293	.5642	.9431	.8002	.7476	-1.0737	.5297	1.2497
.5502	-.6024	.5165	1.0199	.5001	-.3366	.5897	.9030	.8002	.4976	-.3877	.5757	.9251
.6002	-.6278	.5095	1.0314	.5497	-.2126	.6239	.8499	.8002	.2476	-.3928	.5743	.9272
.6500	-.6540	.5078	1.0342	.6003	-.0895	.6578	.7977	.8002	-.5024	-.3785	.5782	.9211
.7000	-.6705	.5233	1.0055	.6500	.0125	.6859	.7545	.8002	-.7524	-.3672	.5813	.9162
.7500	-.4805	.5501	.9656	.7000	.1271	.7175	.7058					
.8002	-.3880	.5756	.9252	.7501	.2234	.7440	.6643					
.9002	-.1740	.6345	.8335	.8001	.3041	.7662	.6290					
.9501	-.0441	.6701	.7755	.8501	.3711	.7867	.5992					

TEST 147	PT	34.0681	PSI	CM	.3765	CD1	.00953	CDCOR1	.00934
RUN 64	TT	130.7078	K	CM	-.1399	CD2	.00943	CDCOR2	.00922
POINT 19	RC	14.9165	MILLION	CC	.0202	CD3	.00954	CDCOR3	.00935
	MACH	.7595				CD4	.00961	CDCOR4	.00942
	ALPHA	-.9979	DEG			CD5	.00948	CDCOR5	.00928

UPPER SURFACE				LOWER SURFACE				SPANWISE				
X/C	CP	P/L/PT	MLOC	X/C	CP	P/L/PT	MLOC	X/C	Y/(B/2)	CP	P/L/PT	MLOC
0.0000	1.0954	.9845	.1497	0.0000	1.0954	.9845	.1497	.1507	.7476	-.4996	.5467	.9711
.0132	.1041	.7123	.7137	.0126	.1343	.7208	.7009	.1507	.4976	-.5205	.5408	.9804
.0259	-.2339	.6195	.8567	.0255	-.0215	.6897	.7488	.1507	.2476	-.5235	.5400	.9817
.0759	-.5542	.5316	.9953	.0495	-.1014	.6559	.8007	.1507	-.2524	-.5284	.5387	.9839
.1003	-.5055	.5450	.9738	.0753	-.2132	.6252	.8479	.1507	-.5024	-.5273	.5390	.9834
.1507	-.5310	.5380	.9950	.1002	-.2625	.6117	.8689	.1507	-.7524	-.5003	.5464	.9715
.2003	-.5282	.5387	.9938	.1503	-.3122	.5980	.8900	.5002	.7476	-.6036	.5180	1.0174
.2503	-.5509	.5225	.9939	.1976	-.4036	.5729	.9293	.5002	.4976	-.6127	.5155	1.0215
.3001	-.5747	.5260	1.0045	.2503	-.4486	.5606	.9489	.5002	.2476	-.6186	.5159	1.0242
.3502	-.5716	.5268	1.0031	.3001	-.4732	.5536	.9596	.5002	-.2524	-.6033	.5181	1.0173
.4003	-.5797	.5266	1.0067	.3507	-.4778	.5526	.9618	.5002	-.5024	-.5989	.5193	1.0153
.4501	-.5982	.5195	1.0150	.4001	-.4473	.5610	.9483	.8002	-.7524	-.5841	.5234	1.0086
.5002	-.6152	.5149	1.0224	.4501	-.3953	.5752	.9257	.8002	.7476	-1.0762	.5283	1.2496
.5502	-.6266	.5117	1.0278	.5001	-.3115	.5982	.8897	.8002	.4976	-.3884	.5771	.9228
.6002	-.6475	.5060	1.0372	.5497	-.1936	.6306	.8396	.8002	.2476	-.3935	.5757	.9250
.6500	-.6645	.5063	1.0368	.6003	-.0748	.6632	.7894	.8002	-.5024	-.3788	.5798	.9186
.7000	-.6760	.5256	1.0050	.6500	.0240	.6903	.7477	.8002	-.7524	-.3671	.5830	.9136
.7500	-.4834	.5510	.9641	.7000	.1372	.7214	.6996					
.8002	-.3894	.5769	.9232	.7501	.2328	.7477	.6595					
.9002	-.1729	.6363	.8308	.8001	.3139	.7699	.6211					
.9501	-.0443	.6716	.7768	.8501	.3826	.7888	.5927					

TEST 147	PT	34.0702	PSI	CM	.4494	CD1	.00966	CDCOR1	.00942
RUN 64	TT	130.6263	K	CM	-.1396	CD2	.00961	CDCOR2	.00938
POINT 20	RC	14.9270	MILLION	CC	.0189	CD3	.00976	CDCOR3	.00954
	MACH	.7597				CD4	.00978	CDCOR4	.00959
	ALPHA	-.4990	DEG			CD5	.00963	CDCOR5	.00947

UPPER SURFACE				LOWER SURFACE				SPANWISE				
X/C	CP	P/L/PT	MLOC	X/C	CP	P/L/PT	MLOC	X/C	Y/(B/2)	CP	P/L/PT	MLOC
0.0000	1.1251	.9926	.1029	0.0000	1.1251	.9926	.1029	.1507	.7476	-.5764	.5254	1.0054
.0132	.0017	.7573	.6841	.0126	.2434	.7505	.6540	.1507	.4976	-.6025	.5182	1.0171
.0259	-.3397	.6305	.9010	.0255	-.1129	.7147	.7101	.1507	.2476	-.6080	.5167	1.0196
.0759	-.7964	.4649	1.1088	.0495	-.0245	.6769	.7693	.1507	-.2524	-.6132	.5153	1.0219
.1003	-.5845	.5232	1.0040	.0753	-.1381	.6457	.8163	.1507	-.5024	-.6057	.5174	1.0185
.1507	-.6161	.5145	1.0232	.1002	-.1960	.6209	.8407	.1507	-.7524	-.5723	.5265	1.0306
.2003	-.5491	.5219	1.0111	.1503	-.2552	.6136	.8658	.5002	.7476	-.6501	.5052	1.0386
.2503	-.6166	.5144	1.0234	.1976	-.3484	.5880	.9057	.5002	.4976	-.6625	.5018	1.0443
.3001	-.6478	.5059	1.0376	.2503	-.3988	.5742	.9274	.5002	.2476	-.6692	.4999	1.0474
.3502	-.6255	.5119	1.0274	.3001	-.4283	.5661	.9402	.5002	-.2524	-.6582	.5029	1.0423
.4003	-.6189	.5137	1.0245	.3507	-.4400	.5620	.9453	.5002	-.5024	-.6536	.5042	1.0402
.4501	-.6416	.5076	1.0345	.4001	-.4183	.5688	.9358	.5002	-.7524	-.6328	.5099	1.0380
.5002	-.6635	.5015	1.0447	.4501	-.3743	.5809	.9168	.8002	.7476	-1.0762	.5276	1.2470
.5502	-.6899	.5060	1.0672	.5001	-.2973	.6020	.8838	.8002	.4976	-.3899	.5766	.9236
.6002	-.6754	.4982	1.0502	.5497	-.1836	.6333	.8375	.8002	.2476	-.3943	.5744	.9254
.6500	-.6887	.5063	1.0466	.6003	-.0676	.6651	.7875	.8002	-.5024	-.3836	.5783	.9280
.7000	-.6947	.5220	1.0109	.6500	.0287	.6916	.7458	.8002	-.7524	-.3730	.5813	.9162
.7500	-.4832	.5510	.9641	.7000	.1408	.7223	.6982					
.8002	-.3875	.5773	.9225	.7501	.2363	.7486	.6571					
.9002	-.1849	.6371	.8245	.8001	.3177	.7709	.6215					
.9501	-.0410	.6724	.7753	.8501	.3867	.7899	.5907					

TEST	167	PT	34.0671	PSI		CM	.5325	CD1	.00992	CDCOR1	.00971
RUN	64	TT	130.5672	K		CM	-.1427	CD2	.00992	CDCOR2	.00967
POINT	21	RC	14.9520	MILLION		CC	.0153	CD3	.00999	CDCOR3	.00983
		MACH	.7610					CD4	.00998	CDCOR4	.00974
		ALPHA	.0204	DEG				CD5	.00986	CDCOR5	.00963

UPPER SURFACE				LOWER SURFACE				SPANWISE				
X/C	CP	P/L/PT	MLOC	X/C	CP	P/L/PT	MLOC	X/C	Y/(B/2)	CP	P/L/PT	MLOC
0.0000	1.1446	.9982	.0504	0.0000	1.1446	.9982	.0504	.1507	.7476	-.1533	-.3522	1.0265
.0132	-.1125	.6342	.8033	.0126	.3339	.7819	.6030	.1507	.4976	-.3982	-.5213	1.0120
.0259	-.4591	.3594	.9500	.0255	-.2033	.7412	.6647	.1507	.2476	-.4624	-.5038	1.0408
.0759	-.8933	.4515	1.1301	.0495	-.0618	.7519	.7298	.1507	-.2524	-.4340	-.5113	1.0281
.1003	-.8434	.4542	1.1253	.0753	-.0514	.6709	.7776	.1507	-.5024	-.3967	-.5223	1.0105
.1507	-.6582	.5049	1.0391	.1002	-.1210	.6516	.8072	.1507	-.7524	-.3647	-.5189	1.0100
.2003	-.6486	.5075	1.0347	.1503	-.1282	.6335	.7351	.5002	.7476	-.6071	.4977	1.0510
.2503	-.6867	.4971	1.0521	.1976	-.1217	.6079	.6747	.5002	.4976	-.6645	.4951	1.0554
.3001	-.7132	.4894	1.0642	.2502	-.3347	.5934	.6572	.5002	.2476	-.6941	.4946	1.0562
.3502	-.7214	.4876	1.0680	.3001	-.1674	.5845	.6112	.5002	-.2524	-.6620	.4984	1.0499
.4003	-.6927	.4954	1.0548	.3507	-.1851	.5796	.6189	.5002	-.5024	-.6858	.4974	1.0515
.4501	-.6770	.5017	1.0444	.4001	-.1708	.5635	.6127	.5002	-.7524	-.6659	.5023	1.0424
.5002	-.6894	.4964	1.0532	.4501	-.3159	.5911	.6977	.8002	.4976	-.10771	.3923	1.2428
.5502	-.7075	.4914	1.0616	.5001	-.2868	.6120	.8886	.8002	.4976	-.1908	.3783	.9209
.6002	-.7106	.4906	1.0630	.5497	-.1599	.6413	.8232	.8002	.2476	-.3945	.3771	.9229
.6500	-.6829	.4982	1.0503	.6003	-.0487	.6717	.7764	.8002	-.5024	-.3807	.3803	.9169
.7000	-.5950	.5222	1.0106	.6500	-.0440	.6970	.7374	.8002	-.7524	-.3706	.3836	.9126
.7500	-.4860	.5520	.9824	.7000	.1543	.7272	.6905					
.8002	-.3898	.5784	.9208	.7501	.2485	.7530	.6501					
.8502	-.1706	.6383	.8277	.8001	.3300	.7753	.6144					
.9001	-.0442	.6729	.7745	.8501	.3995	.7943	.5634					

TEST	167	PT	34.0611	PSI		CM	.6078	CD1	.01034	CDCOR1	.00999
RUN	64	TT	130.5307	K		CM	-.1418	CD2	.01028	CDCOR2	.01001
POINT	22	RC	14.9627	MILLION		CC	.0158	CD3	.01035	CDCOR3	.01020
		MACH	.7619					CD4	.01027	CDCOR4	.01017
		ALPHA	.4990	DEG				CD5	.01010	CDCOR5	.00986

UPPER SURFACE				LOWER SURFACE				SPANWISE				
X/C	CP	P/L/PT	MLOC	X/C	CP	P/L/PT	MLOC	X/C	Y/(B/2)	CP	P/L/PT	MLOC
0.0000	1.1476	.9787	.0433	0.0000	1.1476	.9987	.0433	.1507	.7476	-.7946	.4644	1.1876
.0132	-.1965	.6290	.8421	.0126	.4376	.8034	.5684	.1507	.4976	-.4989	.4198	1.1871
.0259	-.5480	.3323	.9527	.0255	-.2693	.7571	.6436	.1507	.2476	-.4181	.4305	1.1677
.0759	-.9386	.4246	1.1784	.0495	-.1259	.7176	.7095	.1507	-.2524	-.4160	.4310	1.1666
.1003	-.9175	.4306	1.1674	.0753	-.0110	.6860	.7543	.1507	-.5024	-.4677	.4223	1.1823
.1507	-.9334	.4263	1.1753	.1002	-.0649	.6652	.7865	.1507	-.7524	-.4390	.4059	1.0907
.2003	-.8251	.4561	1.1221	.1503	-.1381	.6450	.6175	.5002	.4976	-.7165	.4852	1.0708
.2503	-.8884	.4387	1.1529	.1974	-.2336	.6189	.6579	.5002	.4976	-.7325	.4815	1.0783
.3001	-.7454	.4780	1.0843	.2502	-.2904	.6031	.6821	.5002	.2476	-.7467	.4776	1.0749
.3502	-.6432	.5061	1.0371	.3001	-.3267	.5932	.6974	.5002	-.2524	-.7338	.4812	1.0789
.4003	-.7014	.4901	1.0638	.3507	-.1491	.5870	.6073	.5002	-.5024	-.7282	.4908	1.0763
.4501	-.7303	.4821	1.0772	.4001	-.1404	.5894	.6035	.5002	-.7524	-.6987	.4906	1.0626
.5002	-.7439	.4744	1.0836	.4501	-.3113	.5974	.6911	.8002	.7476	-1.0630	.3906	1.2421
.5502	-.7502	.4767	1.0866	.5001	-.2479	.6148	.6640	.8002	.4976	-.3859	.3769	.9232
.6002	-.7490	.4770	1.0860	.5497	-.1456	.6430	.8206	.8002	.2476	-.3881	.3760	.9245
.6500	-.7008	.4907	1.0635	.6003	-.0379	.6726	.7750	.8002	-.5024	-.3794	.3786	.9284
.7000	-.5920	.5202	1.0219	.6500	.0522	.6974	.7349	.8002	-.7524	-.3708	.3810	.9166
.7500	-.4795	.5511	.9639	.7000	.1608	.7272	.6905					
.8002	-.3833	.5776	.9220	.7501	.2537	.7528	.6504					
.8502	-.1858	.6375	.8290	.8001	.3349	.7751	.6147					
.9001	-.0409	.6718	.7762	.8501	.4045	.7943	.5635					

TEST	167	PT	34.0630	PSI		CM	.6984	CD1	.01120	CDCOR1	.01093
RUN	64	TT	130.5441	K		CM	-.1435	CD2	.01121	CDCOR2	.01092
POINT	23	RC	14.9674	MILLION		CC	.0135	CD3	.01139	CDCOR3	.01107
		MACH	.7624					CD4	.01124	CDCOR4	.01094
		ALPHA	1.0062	DEG				CD5	.01123	CDCOR5	.01093

UPPER SURFACE				LOWER SURFACE				SPANWISE				
X/C	CP	P/L/PT	MLOC	X/C	CP	P/L/PT	MLOC	X/C	Y/(B/2)	CP	P/L/PT	MLOC
0.0000	1.1436	.9976	.0582	0.0000	1.1436	.9976	.0582	.1507	.7476	-.9085	.4336	1.1821
.0132	-.3037	.5996	.8473	.0126	.5131	.8243	.5329	.1507	.4976	-1.0348	.3989	1.2263
.0259	-.6670	.5000	1.0473	.0255	.3350	.7754	.6143	.1507	.2476	-.9789	.4143	1.1972
.0759	-.9874	.4119	1.2018	.0495	-.1822	.7334	.6810	.1507	-.2524	-1.0019	.4080	1.2090
.1003	-.9704	.4166	1.1931	.0753	-.0659	.7014	.7306	.1507	-.5024	-1.0183	.4033	1.2178
.1507	-.16042	.4073	1.2164	.1002	-.0157	.6790	.7652	.1507	-.7524	-.9505	.4220	1.1830
.2003	-.4753	.4141	1.1877	.1503	-.0946	.6573	.7945	.5002	.7476	-.8284	.4553	1.1235
.2503	-.3854	.4124	1.2009	.1974	-.1914	.6307	.8195	.5002	.4976	-.8385	.4534	1.1269
.3001	-.10354	.3987	1.2266	.2502	-.2516	.6141	.8450	.5002	.2476	-.7750	.4689	1.0999
.3502	1.0221	.4023	1.2197	.3001	-.2915	.6032	.8420	.5002	-.2524	-.7750	.4689	1.0981
.4003	-.4434	.4240	1.1795	.3507	-.3167	.5962	.8928	.5002	-.5024	-.8332	.4688	1.1350
.4501	-.7490	.4637	1.1049	.4001	-.3133	.5972	.8914	.5002	-.7524	-.8342	.4640	1.1258
.5002	-.7669	.4725	1.0937	.4501	-.2907	.6074	.8817	.8002	.7476	-1.0556	.3531	1.2372
.5502	-.7161	.4864	1.0696	.5001	-.2335	.6151	.8573	.8002	.4976	-.3946	.3746	.9264
.6002	-.7816	.4959	1.0540	.5497	-.1362	.6439	.8161	.8002	.2476	-.3894	.3735	.9272
.6500	-.64602	.5077	1.0378	.6003	-.0322	.6744	.7722	.8002	-.5024	-.3859	.3772	.9226
.7000	-.5494	.5213	1.0120	.6500	.0551	.6984	.7352					
.7500	-.4502	.5486	.9690	.7000	.1622	.7278	.6905					
.8002	-.3435	.5751	.9256	.7501	.2542	.7532	.6498					
.8502	-.1742	.6354	.8322	.8001	.3354	.7755	.6141					
.9001	-.0511	.6592	.7802	.8501	.4054	.7947	.5627					

ORIGINAL PAGE IS
OF POOR QUALITY

TEST 167	PT 34.0661	PSI	CN .7843	CD1 .01286	CDCOR1 .01258
RUN 64	TT 130.4945	K	CM -.1514	CD2 .01304	CDCOR2 .01221
POINT 24	RC 14.9506	MILLION	CC .0134	CD3 .01318	CDCOR3 .01289
	MACH .7600			CD4 .01367	CDCOR4 .01320
	ALPHA 1.4969	DEG		CD5 .01423	CDCOR5 .01392

UPPER SURFACE				LOWER SURFACE				SPANWISE				
X/C	CP	P/L/PT	MLOC	X/C	CP	P/L/PT	MLOC	X/C	Y/(B/2)	CP	P/L/PT	MLOC
0.0000	1.1470	.9984	.0478	0.0000	1.1470	.9984	.0478	.1507	.7476	-1.0249	.4001	1.2239
.0132	-.3716	.5801	.9181	.0126	-.5852	-.8437	.4991	.1507	.4976	-1.0599	.3904	1.2424
.0259	-.7355	.4798	1.0812	.0255	-.4032	.7932	.5852	.1507	.2476	-.9895	.4099	1.2056
.0759	-1.0117	.4037	1.2171	.0495	-.2397	.7485	.6972	.1507	-.2524	-1.0481	.3977	1.2362
.1003	-1.0037	.4059	1.2129	.0753	-.1257	.7171	.7064	.1507	-.5024	-1.0798	.3850	1.2530
.1507	-1.0256	.3999	1.2243	.1002	-.0372	.6927	.7441	.1507	-.7524	-1.0757	.3861	1.2508
.2003	-1.0356	.3972	1.2295	.1503	-.0463	.6697	.7795	.5002	.7476	-1.0439	.3949	1.2339
.2503	-1.0397	.3960	1.2317	.1976	-.1446	.6426	.8211	.5002	.4976	-1.0654	.3889	1.2453
.3001	-1.0909	.3819	1.2590	.2503	-.2080	.6251	.8480	.5002	.2476	-1.0499	.3932	1.2371
.3502	-1.0967	.3863	1.2621	.3001	-.2507	.6134	.8662	.5002	-.2524	-1.0338	.3976	1.2286
.4003	-1.0893	.3823	1.2582	.3507	-.2797	.6054	.8786	.5002	-.5024	-1.0307	.3963	1.2312
.4501	-1.0707	.3875	1.2482	.4001	-.2806	.6051	.8790	.5002	-.7524	-1.0215	.4010	1.2222
.5002	-.9734	.4143	1.1973	.4501	-.2626	.6101	.8713	.8002	.7476	-.9608	.4177	1.1909
.5502	-.9834	.4115	1.2025	.5001	-.2107	.6244	.8492	.8002	.4976	-.9588	.5838	.9122
.6002	-.8837	.4390	1.1523	.5497	-.1178	.6500	.8098	.8002	.2476	-.9613	.5829	.9137
.6500	-.6092	.5146	1.0231	.6003	-.0174	.6776	.7673	.8002	-.5024	-.9531	.5852	.9101
.7000	-.4890	.5475	.9696	.6500	.0675	.7010	.7312	.8002	-.7524	-.9433	.5876	.9059
.7500	-.4310	.5637	.9439	.7000	.1729	.7301	.6861					
.8002	-.3567	.5842	.9117	.7501	.2637	.7551	.6468					
.9002	-.1586	.6389	.8268	.8001	.3444	.7773	.6112					
.9501	-.0425	.6707	.7779	.8501	.4144	.7906	.5796					

TEST 167	PT 34.0606	PSI	CN .8536	CD1 .01733	CDCOR1 .01678
RUN 64	TT 130.5725	K	CM -.1617	CD2 .01819	CDCOR2 .01769
POINT 26	RC 14.9435	MILLION	CC .0150	CD3 .01892	CDCOR3 .01829
	MACH .7607			CD4 .01959	CDCOR4 .01879
	ALPHA 2.0061	DEG		CD5 .01997	CDCOR5 .01921

UPPER SURFACE				LOWER SURFACE				SPANWISE				
X/C	CP	P/L/PT	MLOC	X/C	CP	P/L/PT	MLOC	X/C	Y/(B/2)	CP	P/L/PT	MLOC
0.0000	1.1482	.9991	.0521	0.0000	1.1482	.9981	.0521	.1507	.7476	-1.0797	.3790	1.2648
.0132	-.4197	.5624	.9400	.0126	-.6384	.8564	.4780	.1507	.4976	-1.1010	.3731	1.2765
.0259	-.7843	.4611	1.1134	.0255	-.4528	.8049	.5659	.1507	.2476	-1.0629	.3836	1.2556
.0759	-1.0603	.3844	1.2542	.0495	-.2850	.7582	.6417	.1507	-.2524	-1.0931	.3753	1.2721
.1003	-1.0449	.3887	1.2459	.0753	-.1703	.7263	.6920	.1507	-.5024	-1.1201	.3678	1.2871
.1507	-1.0576	.3851	1.2527	.1002	-.0786	.7009	.7315	.1507	-.7524	-1.1340	.3639	1.2949
.2003	-1.0604	.3843	1.2542	.1503	-.0099	.6763	.7694	.5002	.7476	-1.0988	.3737	1.2753
.2503	-1.0684	.3821	1.2586	.1976	-.1109	.6482	.8125	.5002	.4976	-1.1140	.3694	1.2837
.3001	-1.1180	.3683	1.2859	.2503	-.1779	.6296	.8412	.5002	.2476	-1.1263	.3660	1.2906
.3502	-1.1361	.3633	1.2961	.3001	-.2243	.6167	.8611	.5002	-.2524	-1.1037	.3723	1.2780
.4003	-1.1366	.3632	1.2964	.3507	-.2573	.6075	.8753	.5002	-.5024	-1.0953	.3746	1.2733
.4501	-1.1441	.3611	1.3006	.4001	-.2624	.6061	.8775	.5002	-.7524	-1.0746	.3804	1.2620
.5002	-1.1320	.3644	1.2938	.4501	-.2488	.6099	.8716	.8002	.7476	-.8741	.4161	1.1575
.5502	-1.0632	.3836	1.2538	.5001	-.2006	.6233	.8509	.8002	.4976	-.9319	.5901	.9024
.6002	-1.1070	.3714	1.2798	.5497	-.1106	.6483	.8124	.8002	.2476	-.9205	.5900	.9026
.6500	-.9244	.4221	1.1829	.6003	-.0123	.6736	.7704	.8002	-.5024	-.9221	.5895	.9033
.7000	-.5218	.5340	.9914	.6500	.0709	.6987	.7348	.8002	-.7524	-.93210	.5898	.9028
.7500	-.4018	.5674	.9381	.7000	.1751	.7277	.6899					
.8002	-.3160	.5912	.9007	.7501	.2652	.7527	.6505					
.9002	-.1358	.6413	.8231	.8001	.3457	.7751	.6147					
.9501	-.0387	.6683	.7817	.8501	.4158	.7946	.5829					

TEST 167	PT 34.0596	PSI	CN .9222	CD1 .02321	CDCOR1 .02182
RUN 64	TT 130.6003	K	CM -.1648	CD2 .02361	CDCOR2 .02232
POINT 27	RC 14.9381	MILLION	CC .0134	CD3 .02761	CDCOR3 .02544
	MACH .7607			CD4 .02741	CDCOR4 .02487
	ALPHA 2.5142	DEG		CD5 .02671	CDCOR5 .02502

UPPER SURFACE				LOWER SURFACE				SPANWISE				
X/C	CP	P/L/PT	MLOC	X/C	CP	P/L/PT	MLOC	X/C	Y/(B/2)	CP	P/L/PT	MLOC
0.0000	1.1360	.9955	.0801	0.0000	1.1360	.9955	.0801	.1507	.7476	-1.1768	.3595	1.3038
.0132	-.5119	.5424	.9779	.0126	-.6940	.8740	.4431	.1507	.4976	-1.1789	.3590	1.3049
.0259	-.8780	.4417	1.1475	.0255	-.5054	.8221	.5367	.1507	.2476	-1.1416	.3692	1.2841
.0759	-1.1507	.3667	1.2842	.0495	-.3362	.7756	.6140	.1507	-.2524	-1.1449	.3680	1.2865
.1003	-1.1425	.3690	1.2846	.0753	-.2191	.7434	.6652	.1507	-.5024	-1.1899	.3571	1.3088
.1507	-1.1303	.3723	1.2779	.1002	-.1234	.7171	.7064	.1507	-.7524	-1.1914	.3555	1.3120
.2003	-1.1317	.3719	1.2767	.1503	-.0315	.6918	.7455	.5002	.7476	-1.1859	.3571	1.3088
.2503	-1.1592	.3644	1.2939	.1976	-.0706	.6637	.7887	.5002	.4976	-1.1940	.3548	1.3155
.3001	-1.1699	.3614	1.2999	.2503	-.1404	.6445	.8182	.5002	.2476	-1.2036	.3516	1.3200
.3502	-1.2097	.3505	1.3224	.3001	-.1886	.6313	.8385	.5002	-.2524	-1.1898	.3571	1.3088
.4003	-1.2152	.3490	1.3256	.3507	-.2245	.6214	.8538	.5002	-.5024	-1.1558	.3633	1.2920
.4501	-1.2273	.3456	1.3325	.4001	-.2334	.6189	.8576	.5002	-.7524	-1.1584	.3646	1.2935
.5002	-1.2431	.3413	1.3417	.4501	-.2245	.6214	.8538	.8002	.7476	-.8824	.4405	1.1497
.5502	-1.2143	.3492	1.3250	.5001	-.1828	.6329	.8361	.8002	.4976	-.9291	.5926	.8985
.6002	-1.1699	.3614	1.2998	.5497	-.0982	.6501	.8003	.8002	.2476	-.9300	.5924	.8986
.6500	-.7455	.4781	1.0840	.6003	-.0040	.6820	.7605	.8002	-.5024	-.9265	.5934	.8973
.7000	-.5210	.5399	.9920	.6500	.0759	.7040	.7266	.8002	-.7524	-.9246	.5939	.8965
.7500	-.4164	.5626	.9361	.7000	.1780	.7321	.6830					
.8002	-.3273	.5931	.8976	.7501	.2667	.7565	.6446					
.9002	-.1470	.6427	.8210	.8001	.3465	.7784	.6093					
.9501	-.0554	.6679	.7822	.8501	.4164	.7977	.5779					

TEST 167	PT 34.0664	PSI	CN	.9642	C01	.03170	CDCOR1	.03091
RUN 64	TT 130.5105	K	CM	-.1650	C02	.03171	CDCOR2	.03108
POINT 28	RC 14.9540	MILLION	CC	.0127	C03	.03519	CDCOR3	.03459
	MACH .7605	DEG			C04	.03535	CDCOR4	.03465
	ALPHA 2.9938				C05	.03277	CDCOR5	.03184

UPPER SURFACE				LOWER SURFACE				SPANWISE				
X/C	CP	P/L/P	MLOC	X/C	CP	P/L/P	MLOC	X/C	Y/(B/2)	CP	P/L/P	MLOC
0.0000	1.1293	.9941	.0923	0.0000	1.1293	.9941	.0923	.1507	.7476	-1.2139	.3531	1.3170
.0132	-.5814	.5261	1.0043	.0126	.7411	.8879	.4158	.1507	.4976	-1.2269	.3495	1.3245
.0259	-.9540	.4241	1.1792	.0255	.5505	.8357	.5131	.1507	.2476	-1.2073	.3549	1.3133
.0759	-1.2114	.3537	1.3156	.0495	.3774	.7884	.5931	.1507	-.2524	-1.1879	.3602	1.3024
.1003	-1.2053	.3554	1.3122	.0753	.2582	.7558	.6457	.1507	-.5024	-1.2200	.3514	1.3205
.1507	-1.1944	.3573	1.3083	.1002	.1611	.7292	.6875	.1507	-.7524	-1.2017	.3564	1.3102
.2003	-1.1617	.3673	1.2879	.1503	.0651	.7029	.7283	.5002	.7476	-1.2346	.3474	1.3289
.2503	-1.2086	.3545	1.3140	.1976	-.0393	.6744	.7723	.5002	.4976	-1.2465	.3441	1.3357
.3001	-1.2297	.3487	1.3250	.2503	-.1125	.6544	.8030	.5002	.2476	-1.2482	.3437	1.3367
.3502	-1.2515	.3428	1.3386	.3001	-.1632	.6405	.8244	.5002	-.2524	-1.2267	.3496	1.3243
.4003	-1.2617	.3400	1.3445	.3507	-.2020	.6290	.8407	.5002	-.5024	-1.1989	.3572	1.3086
.4501	-1.2823	.3344	1.3566	.4001	-.2151	.6263	.8462	.5002	-.7524	-1.2120	.3536	1.3160
.5002	-1.3013	.3291	1.3679	.4501	-.2107	.6275	.8444	.8002	.7476	-.9035	.6380	1.1542
.5502	-1.2891	.3325	1.3606	.5001	-.1733	.6377	.8286	.8002	.4976	-.3395	.5923	.8990
.6002	-1.0881	.3875	1.2481	.5502	-.0922	.6599	.7945	.8002	.2476	-.3450	.5907	.9014
.6500	-.6534	.5064	1.0366	.6003	-.0006	.6850	.7560	.8002	-.5024	-.3340	.5938	.8967
.7000	-.5287	.5405	.9909	.6500	.0764	.7060	.7235	.8002	-.7524	-.3314	.5945	.8956
.7500	-.4304	.5674	.9381	.7000	.1771	.7336	.6806					
.8002	-.3379	.5927	.8983	.7501	.2653	.7577	.6426					
.9002	-.1616	.6409	.8237	.8001	.3445	.7794	.4078					
.9501	-.0791	.6635	.7890	.8501	.4143	.7985	.2765					

TEST 167	PT 34.0620	PSI	CN	.9041	C01	.05485	CDCOR1	.05368
RUN 64	TT 130.5193	K	CM	-.1529	C02	.04913	CDCOR2	.04820
POINT 29	RC 14.9513	MILLION	CC	.0162	C03	.04299	CDCOR3	.04196
	MACH .7606	DEG			C04	.03910	CDCOR4	.03628
	ALPHA 3.4985				C05	.03743	CDCOR5	.03644

UPPER SURFACE				LOWER SURFACE				SPANWISE				
X/C	CP	P/L/P	MLOC	X/C	CP	P/L/P	MLOC	X/C	Y/(B/2)	CP	P/L/P	MLOC
0.0000	1.1176	.9900	.1202	0.0000	1.1176	.9900	.1202	.1507	.7476	-1.2235	.3421	1.3400
.0132	-.6029	.5139	1.0243	.0126	.7497	.8881	.4153	.1507	.4976	-1.2396	.3376	1.3495
.0259	-.9770	.4103	1.2047	.0255	.5590	.8354	.5137	.1507	.2476	-1.2280	.3409	1.3426
.0759	-1.2267	.3412	1.3419	.0495	.3809	.7861	.5969	.1507	-.2524	-1.2152	.3444	1.3351
.1003	-1.2233	.3422	1.3299	.0753	.2601	.7527	.6506	.1507	-.5024	-1.2454	.3360	1.3529
.1507	-1.2187	.3434	1.3372	.1002	.1623	.7256	.6931	.1507	-.7524	-1.2040	.3475	1.3286
.2003	-1.1914	.3510	1.3213	.1503	.0608	.6975	.7367	.5002	.7476	-1.2544	.3336	1.3583
.2503	-1.2170	.3439	1.3362	.1976	-.0480	.6674	.7830	.5002	.4976	-1.2528	.3340	1.3573
.3001	-1.2468	.3357	1.3537	.2503	-.1822	.6458	.8163	.5002	.2476	-1.1039	.3752	1.2722
.3502	-1.2542	.3336	1.3582	.3001	-.1622	.6303	.8401	.5002	-.2524	-1.1276	.3666	1.2853
.4003	-1.2711	.3290	1.3683	.3507	-.2264	.6180	.8590	.5002	-.5024	-1.2042	.3475	1.3287
.4501	-1.2669	.3301	1.3658	.4001	-.2450	.6129	.8669	.5002	-.7524	-1.2329	.3395	1.3455
.5002	-.9869	.4076	1.2098	.4501	-.2452	.6128	.8670	.8002	.7476	-.9076	.4046	1.2134
.5502	-.6993	.4872	1.0687	.5001	-.2105	.6224	.8522	.8002	.4976	-.4005	.5699	.9342
.6002	-.4212	.5088	1.0326	.5502	-.1298	.6448	.8178	.8002	.2476	-.4239	.5634	.9444
.6500	-.3741	.5218	1.0112	.6003	-.0383	.6701	.7789	.8002	-.5024	-.3709	.5756	.9252
.7000	-.5282	.5345	.9906	.6500	.0379	.6912	.7464	.8002	-.7524	-.3338	.5828	.9139
.7500	-.4775	.5486	.9640	.7000	.1383	.7190	.7034					
.8002	-.4235	.5635	.9443	.7501	.2258	.7432	.6656					
.9002	-.3139	.5932	.8986	.8001	.3044	.7649	.6311					
.9501	-.2949	.6102	.8712	.8501	.735	.7841	.6002					

TEST	167	PT	43.9815	PSI	CN	-0.0394	CD1	.01073	CDCOR1	.01060
RUN	69	TT	96.8990	K	CM	-1.247	CD2	.01032	CDCOR2	.01024
POINT	86	RC	30.0135	MILLION	CC	.0062	CD3	.01023	CDCOR3	.01021
		MACH	.7614				CD4	.01018	CDCOR4	.01009
		ALPHA	-3.9815	DEG			CD5	.01002	CDCOR5	.00976

UPPER SURFACE				LOWER SURFACE				SPANWISE				
X/C	CP	P.L/PT	MLOC	X/C	CP	P.L/PT	MLOC	X/C	Y/(B/2)	CP	P.L/PT	MLOC
0.0000	.7437	.8878	.4175	0.0000	.7437	.8878	.4175	.1507	.7476	-.1326	.6476	.8160
.0132	.6296	.8565	.4776	.0126	-.6614	.5026	1.0456	.1507	.4976	-.1445	.6443	.8211
.0259	.3215	.7720	.6218	.0255	-.6077	.5173	1.0213	.1507	.2476	-.1424	.6449	.8202
.0759	-.0402	.6729	.7770	.0495	-.7334	.4829	1.0787	.1507	-.2524	-.1505	.6426	.8236
.1003	-.0732	.6638	.7910	.0753	-.8605	.4480	1.1390	.1507	-.5024	-.1572	.6408	.8264
.1507	-.1517	.6423	.8241	.1002	-.9150	.4331	1.1657	.1507	-.7524	-.1448	.6442	.8212
.2003	-.1895	.6320	.8401	.1503	-.8361	.4547	1.1272	.5002	.7476	-.4054	.5728	.9323
.2503	-.2433	.6172	.8629	.1976	-.8577	.4488	1.1377	.5002	.4976	-.4099	.5715	.9342
.3001	-.2892	.6046	.8824	.2503	-.3413	.3903	.9047	.5002	.2476	-.4149	.5702	.9364
.3502	-.3137	.5979	.8929	.3001	-.8673	.4462	1.1423	.5002	-.2524	-.4048	.5730	.9320
.4003	-.3428	.5900	.9052	.3507	-.9595	.4209	1.1879	.5002	-.5024	-.4021	.5737	.9308
.4501	-.3695	.5826	.9168	.4001	-1.0062	.4081	1.2116	.5002	-.7524	-.3903	.5769	.9257
.5002	-.4105	.5714	.9345	.4501	-.4595	.5579	.9555	.8002	.7476	-1.0346	.4003	1.2262
.5502	-.4482	.5610	.9508	.5001	-.3539	.5869	.9101	.8002	.4976	-.3717	.5820	.9177
.6002	-.4890	.5509	.9669	.5497	-.2424	.175	.8625	.8002	.2476	-.3752	.5811	.9192
.6500	-.5101	.5441	.9779	.6003	-.1193	.6512	.8104	.8002	-.5024	-.3499	.5880	.9084
.7000	-.4945	.5484	.9711	.6500	-.0163	.6795	.7669	.8002	-.7524	-.3446	.5894	.9061
.7500	-.4449	.5620	.9494	.7000	.1035	.7123	.7161					
.8002	-.3693	.5825	.9169	.7501	.2019	.7393	.6740					
.9002	-.1819	.6340	.8369	.8001	.2840	.7618	.6383					
.9501	-.0555	.6687	.7835	.8501	.3513	.7802	.6085					

TEST	167	PT	43.9084	PSI	CN	.1157	CD1	.00893	CDCOR1	.00875
RUN	69	TT	96.8764	K	CM	-1.405	CD2	.00877	CDCOR2	.00863
POINT	87	RC	29.9838	MILLION	CC	.0143	CD3	.00873	CDCOR3	.00866
		MACH	.7619				CD4	.00870	CDCOR4	.00857
		ALPHA	-3.0039	DEG			CD5	.00873	CDCOR5	.00850

UPPER SURFACE				LOWER SURFACE				SPANWISE				
X/C	CP	P.L/PT	MLOC	X/C	CP	P.L/PT	MLOC	X/C	Y/(B/2)	CP	P.L/PT	MLOC
0.0000	.8751	.9237	.3401	0.0000	.8751	.9237	.3401	.1507	.7476	-.2403	.6175	.8625
.0132	.4884	.8175	.5465	.0126	-.3844	.5780	.9241	.1507	.4976	-.2526	.6141	.8677
.0259	.1663	.7291	.6899	.0255	-.4136	.5699	.9367	.1507	.2476	-.2514	.6145	.8671
.0759	-.1782	.6345	.8361	.0495	-.4769	.5526	.9643	.1507	-.2524	-.2587	.6124	.8703
.1003	-.1957	.6298	.8435	.0753	-.8189	.4587	1.1203	.1507	-.5024	-.2654	.6106	.8731
.1507	-.2608	.6119	.8711	.1002	-.5567	.5307	.9996	.1507	-.7524	-.2511	.6145	.8670
.2003	-.2907	.6037	.8839	.1503	-.5775	.5250	1.0089	.5002	.7476	-.4743	.5533	.9632
.2503	-.3346	.5916	.9027	.1976	-.6741	.4985	1.0525	.5002	.4976	-.4791	.5520	.9653
.3001	-.3760	.5802	.9205	.2503	-.3080	.5989	.8913	.5002	.2476	-.4842	.5506	.9675
.3502	-.3982	.5742	.9301	.3001	-.8230	.4576	1.1222	.5002	-.2524	-.4715	.5540	.9620
.4003	-.4207	.5680	.9399	.3507	-.8033	.4630	1.1129	.5002	-.5024	-.4693	.5547	.9610
.4501	-.4440	.5616	.9499	.4001	-.5436	.5343	.9937	.5002	-.7524	-.4569	.5580	.9556
.5002	-.4807	.5515	.9600	.4501	-.4721	.5539	.9622	.8002	.7476	-1.0825	.3862	1.2530
.5502	-.5157	.5419	.9814	.5001	-.3731	.5810	.9193	.8002	.4976	-.3872	.5772	.9253
.6002	-.5503	.5324	.9967	.5497	-.2406	.6174	.8626	.8002	.2476	-.3917	.5760	.9273
.6500	-.5717	.5265	1.0063	.6003	-.1103	.6532	.8074	.8002	-.5024	-.3639	.5836	.9153
.7000	-.5381	.5259	.9913	.6500	-.0059	.6818	.7633	.8002	-.7524	-.3604	.5845	.9138
.7500	-.4718	.5540	.9621	.7000	.1163	.7154	.7113					
.8002	-.3870	.5772	.9252	.7501	.2162	.7428	.6684					
.9002	-.1861	.6324	.8395	.8001	.2994	.7656	.6321					
.9501	-.0570	.6678	.7849	.8501	.3680	.7844	.6016					

TEST	167	PT	43.9432	PSI	CN	.2534	CD1	.00865	CDCOR1	.00855
RUN	69	TT	97.0091	K	CM	-1.446	CD2	.00850	CDCOR2	.00844
POINT	88	RC	29.9315	MILLION	CC	.0194	CD3	.00852	CDCOR3	.00851
		MACH	.7612				CD4	.00854	CDCOR4	.00848
		ALPHA	-1.9958	DEG			CD5	.00857	CDCOR5	.00841

UPPER SURFACE				LOWER SURFACE				SPANWISE				
X/C	CP	P.L/PT	MLOC	X/C	CP	P.L/PT	MLOC	X/C	Y/(B/2)	CP	P.L/PT	MLOC
0.0000	1.0092	.9605	.2416	0.0000	1.0092	.9605	.2416	.1507	.7476	-.3734	.5812	.9191
.0132	.3119	.7692	.5264	.0126	-.0968	.6371	.8014	.1507	.4976	-.3887	.5770	.9257
.0259	-.0307	.6752	.7735	.0255	-.1825	.6335	.8376	.1507	.2476	-.3893	.5768	.9259
.0759	-.3568	.5857	.9119	.0495	-.2861	.6051	.8817	.1507	-.2524	-.3980	.5744	.9297
.1003	-.3502	.5875	.9091	.0753	-.4032	.5730	.9319	.1507	-.5024	-.4028	.5731	.9317
.1507	-.3987	.5742	.9300	.1002	-.4136	.5701	.9364	.1507	-.7524	-.3839	.5783	.9236
.2003	-.4016	.5734	.9312	.1503	-.4425	.5622	.9490	.5002	.7476	-.5590	.5303	1.0002
.2503	-.4489	.5604	.9518	.1976	-.3402	.5354	.99.9	.5002	.4976	-.5627	.5292	1.0019
.3001	-.4844	.5507	.9673	.2503	-.5821	.5239	1.0105	.5002	.2476	-.5679	.5278	1.0042
.3502	-.4928	.5484	.9710	.3001	-.6042	.5178	1.0205	.5002	-.2524	-.5563	.5310	.9990
.4003	-.5102	.5436	.9786	.3507	-.5834	.5236	1.0111	.5002	-.5024	-.5538	.5317	.9979
.4501	-.5325	.5375	.9885	.4001	-.5210	.5407	.9834	.5002	-.7524	-.5395	.5356	.9916
.5002	-.5635	.5290	1.0022	.4501	-.4481	.5607	.9514	.8002	.7476	-1.1260	.3747	1.2755
.5502	-.5933	.5208	1.0156	.5001	-.3498	.5876	.9099	.8002	.4976	-.4015	.5734	.9312
.6002	-.6229	.5127	1.0289	.5497	-.2207	.6230	.8538	.8002	.2476	-.4046	.5726	.9325
.6500	-.6424	.5073	1.0379	.6003	-.0940	.6578	.8002	.8002	-.5024	-.3818	.5788	.9227
.7000	-.5693	.5219	1.0138	.6500	.0065	.6854	.7577	.8002	-.7524	-.3799	.5794	.9218
.7500	-.4913	.5488	.9703	.7000	.1279	.7187	.7062					
.8002	-.3995	.5740	.9303	.7501	.2275	.7460	.6633					
.9002	-.1886	.6317	.8402	.8001	.3118	.7691	.6264					
.9501	-.0565	.6681	.7844	.8501	.3817	.7893	.5953					

TEST	167	PT	43.9441	PSI		CN	.3296	CD1	.00864	CDCOR1	.00844
RUN	69	TT	96.8970	K		CM	-.1466	CD2	.00852	CDCOR2	.00834
POINT	89	RC	29.9801	MILLION		CC	.0209	CD3	.00857	CDCOR3	.00848
		MACH	.7611					CD4	.00867	CDCOR4	.00853
		ALPHA	-1.4969	DEG				CD5	.00867	CDCOR5	.00844

UPPER SURFACE				LOWER SURFACE				SPANWISE				
X/C	CP	P/L/PT	MLOC	X/C	CP	P/L/PT	MLOC	X/C	Y/(B/2)	CP	P/L/PT	MLOC
0.0000	1.0596	.9744	.1936	0.0000	1.0596	.9744	.1936	.1507	.7476	-.4406	.5632	.9475
.0132	-.2152	.7430	.6882	.0126	.0352	.6935	.7451	.1507	.4976	-.4582	.5583	.9551
.0259	-.1349	.6470	.8169	.0259	-.0719	.6643	.7903	.1507	.2476	-.4600	.5579	.9559
.0759	-.4558	.5590	.9541	.0495	-.1915	.6315	.8408	.1507	-.2524	-.4682	.5556	.9595
.1003	-.4312	.5657	.9434	.0793	-.2974	.6024	.8858	.1507	-.5024	-.4709	.5549	.9607
.1507	-.4698	.5557	.9602	.1002	-.3308	.5933	.9001	.1507	-.7524	-.4487	.5609	.9510
.2003	-.4405	.5577	.9561	.1503	-.3710	.5823	.9173	.5002	.7476	-.5970	.5203	1.0164
.2503	-.5056	.5454	.9738	.1976	-.4652	.5564	.9582	.5002	.4976	-.6022	.5189	1.0188
.3001	-.5380	.5365	.9902	.2503	-.5079	.5447	.9769	.5002	.2476	-.6083	.5172	1.0215
.3502	-.5395	.5361	.9908	.3001	-.5268	.5390	.9861	.5002	-.2524	-.5950	.5209	1.0195
.4003	-.5519	.5327	.9963	.3507	-.5244	.5402	.9841	.5002	-.5024	-.5913	.5219	1.0139
.4501	-.5733	.5268	1.0059	.4001	-.4803	.5523	.9648	.5002	-.7524	-.5746	.5265	1.0064
.5002	-.6040	.5184	1.0196	.4501	-.4195	.5690	.9383	.8002	.7476	-1.1290	.5745	1.2762
.5502	-.6251	.5126	1.0291	.5001	-.3276	.5941	.9897	.8002	.4976	-.4022	.5737	.9308
.6002	-.6530	.5050	1.0417	.5497	-.2034	.6282	.8459	.8002	.2476	-.4050	.5729	.9320
.6500	-.6684	.5007	1.0487	.6003	-.0801	.6620	.7938	.8002	-.5024	-.3823	.5792	.9222
.7000	-.6842	.5183	1.0197	.6500	.0174	.6887	.7526	.8002	.2476	-.4050	.5729	.9320
.7500	-.4934	.5483	.9705	.7000	.1377	.7217	.7015	.8002	-.7524	-.3819	.5794	.9219
.8002	-.4000	.5743	.9299	.7501	.2367	.7488	.6589					
.9002	-.1865	.6328	.8388	.8001	.3214	.7720	.6218					
.9501	-.0542	.6691	.7829	.8501	.3923	.7915	.5901					

TEST	167	PT	43.9399	PSI		CN	.4037	CD1	.00876	CDCOR1	.00858
RUN	69	TT	96.8565	K		CM	-.1485	CD2	.00866	CDCOR2	.00844
POINT	90	RC	29.9817	MILLION		CC	.0214	CD3	.00874	CDCOR3	.00861
		MACH	.7604					CD4	.00881	CDCOR4	.00866
		ALPHA	-1.0081	DEG				CD5	.00878	CDCOR5	.00856

UPPER SURFACE				LOWER SURFACE				SPANWISE				
X/C	CP	P/L/PT	MLOC	X/C	CP	P/L/PT	MLOC	X/C	Y/(B/2)	CP	P/L/PT	MLOC
0.0000	1.0975	.9847	.1491	0.0000	1.0975	.9847	.1491	.1507	.7476	-.5126	.5430	.9797
.0132	-.1162	.7155	.7111	.0126	.1527	.7255	.6955	.1507	.4976	-.5323	.5376	.9884
.0259	-.2408	.6176	.8623	.0259	.0283	.6914	.7485	.1507	.2476	-.5356	.5367	.9898
.0759	-.5742	.5261	1.0070	.0495	-.1058	.6546	.8052	.1507	-.2524	-.5425	.5348	.9929
.1003	-.5159	.5421	.9811	.0793	-.2064	.6270	.8477	.1507	-.5024	-.5418	.5350	.9926
.1507	-.5452	.5340	.9941	.1002	-.2567	.6132	.8691	.1507	-.7524	-.5145	.5425	.9805
.2003	-.5182	.5415	.9821	.1503	-.3060	.5997	.8901	.5002	.7476	-.6407	.5078	1.0369
.2503	-.5962	.5286	1.0030	.1976	-.3987	.5742	.9300	.5002	.4976	-.6502	.5052	1.0412
.3001	-.5987	.5194	1.0179	.2503	-.4441	.5618	.9496	.5002	.2476	-.6565	.5035	1.0441
.3502	-.5877	.5224	1.0130	.3001	-.4691	.5549	.9606	.5002	-.2524	-.6419	.5075	1.0374
.4003	-.5958	.5202	1.0166	.3507	-.4737	.5537	.9626	.5002	-.5024	-.6379	.5086	1.0357
.4501	-.6145	.5150	1.0251	.4001	-.4414	.5625	.9485	.5002	-.7524	-.6156	.5147	1.0255
.5002	-.6510	.5050	1.0416	.4501	-.3903	.5766	.9263	.8002	.7476	-1.1285	.5740	1.2771
.5502	-.6660	.5009	1.0484	.5001	-.3054	.5998	.8899	.8002	.4976	-.4017	.5734	.9312
.6002	-.6805	.4969	1.0550	.5497	-.1866	.6324	.8394	.8002	.2476	-.4042	.5727	.9323
.6500	-.6944	.4931	1.0614	.6003	-.0670	.6652	.7888	.8002	-.5024	-.3815	.5790	.9225
.7000	-.6220	.5130	1.0284	.6500	.0278	.6913	.7487	.8002	.2476	-.4042	.5727	.9323
.7500	-.4934	.5483	.9712	.7000	.1466	.7239	.6981					
.8002	-.3991	.5741	.9301	.7501	.2448	.7508	.6358					
.9002	-.1839	.6332	.8382	.8001	.3295	.7740	.6186					
.9501	-.0525	.6692	.7827	.8501	.4008	.7936	.5866					

TEST	167	PT	43.9451	PSI		CN	.4785	CD1	.00885	CDCOR1	.00864
RUN	69	TT	96.8327	K		CM	-.1478	CD2	.00879	CDCOR2	.00858
POINT	91	RC	29.8647	MILLION		CC	.0199	CD3	.00891	CDCOR3	.00874
		MACH	.7552					CD4	.00900	CDCOR4	.00881
		ALPHA	-1.4990	DEG				CD5	.00897	CDCOR5	.00871

UPPER SURFACE				LOWER SURFACE				SPANWISE				
X/C	CP	P/L/PT	MLOC	X/C	CP	P/L/PT	MLOC	X/C	Y/(B/2)	CP	P/L/PT	MLOC
0.0000	1.1250	.9928	.1021	0.0000	1.1250	.9928	.1021	.1507	.7476	-.5944	.5243	1.0099
.0132	-.0035	.6872	.7550	.0126	.2618	.7576	.6450	.1507	.4976	-.6170	.5182	1.0200
.0259	-.3599	.5882	.9081	.0259	.1209	.7192	.7034	.1507	.2476	-.6222	.5160	1.0223
.0759	-.8281	.4607	1.1169	.0495	-.0263	.6791	.7675	.1507	-.2524	-.6288	.5150	1.0233
.1003	-.5930	.5247	1.0093	.0793	-.1269	.6517	.8097	.1507	-.5024	-.6224	.5167	1.0224
.1507	-.6326	.5139	1.0270	.1002	-.1874	.6352	.8351	.1507	-.7524	-.5913	.5252	1.0085
.2003	-.5885	.5259	1.0073	.1503	-.2451	.6195	.8594	.5002	.7476	-.6761	.5021	1.0465
.2503	-.6291	.5149	1.0254	.1976	-.3371	.5944	.8984	.5002	.4976	-.6877	.4989	1.0518
.3001	-.6683	.5042	1.0430	.2503	-.3857	.5812	.9191	.5002	.2476	-.6949	.4970	1.0531
.3502	-.6533	.5078	1.0371	.3001	-.4144	.5734	.9314	.5002	-.2524	-.6819	.5005	1.0492
.4003	-.6295	.5148	1.0235	.3507	-.4262	.5702	.9364	.5002	-.5024	-.6794	.5012	1.0480
.4501	-.6490	.5095	1.0343	.4001	-.4040	.5762	.9269	.5002	-.7524	-.6545	.5080	1.0368
.5002	-.6882	.4988	1.0520	.4501	-.3632	.5873	.9095	.8002	.7476	-1.1193	.5813	1.2628
.5502	-.7006	.4954	1.0577	.5001	-.2866	.6082	.8769	.8002	.4976	-.4040	.5762	.9289
.6002	-.7047	.4943	1.0596	.5497	-.1740	.6389	.8295	.8002	.2476	-.4074	.5733	.9284
.6500	-.6965	.4965	1.0558	.6003	-.0583	.6704	.7809	.8002	-.5024	-.3859	.5811	.9192
.7000	-.6198	.5174	1.0212	.6500	.0329	.6952	.7426					
.7500	-.4963	.5511	.9668	.7000	.1506	.7273	.6928					
.8002	-.4016	.5769	.9259	.7501	.2480	.7538	.6510					
.9002	-.1852	.6358	.8342	.8001	.3329	.7770	.6138					
.9501	-.0536	.6717	.7790	.8501	.4052	.7967	.5816					

TEST 167	PT 43.9445	PSI	CM	.5503	CD1	.00911	CDCDR1	.00889
RUN 59	TT 96.8657	K	CM	-.1488	CD2	.00900	CDCDR2	.00871
POINT 92	PC 29.9031	MILLION	CC	.0191	CD3	.00912	CDCDR3	.00890
	MACH .7571				CD4	.00920	CDCDR4	.00898
	ALPHA .0060	DEG			CD5	.00910	CDCDR5	.00886

UPPER SURFACE				LOWER SURFACE				SPANWISE				
X/C	CP	P _z L/PT	MLOC	X/C	CP	P _z L/PT	MLOC	X/C	Y/(B/2)	CP	P _z L/PT	MLOC
0.0000	1.1419	.9978	.0567	0.0000	1.1419	.9978	.0567	.1507	.7476	-.8602	.5094	1.0343
.0132	-.1089	.6588	.7987	.0126	.3659	.7875	.5966	.1507	.4976	-.5995	.5259	1.0074
.0259	-.4792	.5585	.9549	.0255	.2109	.7455	.6642	.1507	.2476	-.6856	.5026	1.0457
.0759	-.8662	.4536	1.1292	.0495	.0556	.7034	.7299	.1507	-.2524	-.6430	.5141	1.0266
.1003	-.8279	.4640	1.1111	.0753	-.0487	.6751	.7736	.1507	-.5024	-.5996	.5259	1.0074
.1507	-.6811	.5038	1.0437	.1002	-.1182	.6563	.8026	.1507	-.7524	-.6157	.5215	1.0145
.2003	-.6173	.5210	1.0192	.1503	-.1826	.6388	.8295	.5002	.7476	-.6985	.4991	1.0515
.2503	-.6928	.5006	1.0490	.1976	-.2752	.6138	.8682	.5002	.4976	-.7058	.4971	1.0548
.3001	-.7238	.4922	1.0670	.2503	-.3266	.5998	.8899	.5002	.2476	-.7077	.4966	1.0557
.3502	-.7331	.4897	1.0673	.3001	-.3584	.5912	.9033	.5002	-.2524	-.6948	.5001	1.0599
.4003	-.7062	.4970	1.0550	.3507	-.3757	.5865	.9107	.5002	-.5024	-.6996	.4988	1.0520
.4501	-.6743	.5056	1.0406	.4001	-.3606	.5906	.9043	.5002	-.7524	-.6789	.5044	1.0427
.5002	-.7002	.4986	1.0523	.4501	-.3284	.5994	.8906	.8002	.7476	-1.1164	.3858	1.2540
.5502	-.7190	.4935	1.0608	.5001	-.2599	.6179	.8618	.8002	.4976	-.6404	.5787	.9229
.6002	-.7282	.4910	1.0650	.5497	-.1539	.6466	.8175	.8002	.2476	-.6482	.5777	.9245
.6500	-.7064	.4969	1.0551	.6003	-.0429	.6767	.7712	.8002	-.5024	-.3844	.5842	.9144
.7000	-.6174	.5210	1.0192	.6500	.0446	.7004	.7346	.8002	-.7524	-.3849	.5840	.9146
.7500	-.4840	.5534	.9630	.7000	.1602	.7318	.6858					
.8002	-.4027	.5792	.9221	.7501	.2562	.7578	.6447					
.8501	-.1848	.6382	.8304	.8001	.3406	.7806	.6079					
.9501	-.0542	.6737	.7759	.8501	.4131	.8003	.5755					

TEST 167	PT 43.8112	PSI	CM	.6555	CD1	.00975	CDCDR1	.00950
RUN 59	TT 96.7871	K	CM	-.1549	CD2	.00974	CDCDR2	.00950
POINT 93	PC 30.0002	MILLION	CC	.0176	CD3	.00986	CDCDR3	.00951
	MACH .7637				CD4	.00977	CDCDR4	.00953
	ALPHA .4990	DEG			CD5	.00956	CDCDR5	.00929

UPPER SURFACE				LOWER SURFACE				SPANWISE				
X/C	CP	P _z L/PT	MLOC	X/C	CP	P _z L/PT	MLOC	X/C	Y/(B/2)	CP	P _z L/PT	MLOC
0.0000	1.1523	.9992	.0329	0.0000	1.1523	.9992	.0329	.1507	.7476	-.8174	.4550	1.1267
.0132	-.1733	.6330	.8185	.0126	.4536	.8062	.5656	.1507	.4976	-.9468	.4193	1.1908
.0259	-.5492	.5300	1.0007	.0255	.2899	.7610	.6396	.1507	.2476	-.9049	.4309	1.1697
.0759	-.9306	.4238	1.1826	.0495	.1298	.7167	.7092	.1507	-.2524	-.9060	.4306	1.1702
.1003	-.9010	.4319	1.1677	.0753	.0295	.6890	.7522	.1507	-.5024	-.9379	.4217	1.1863
.1507	-.8228	.4259	1.1786	.1002	-.0559	.6654	.7885	.1507	-.7524	-.8007	.4596	1.1186
.2003	-.7975	.4605	1.1171	.1503	-.1262	.6460	.8184	.5002	.7476	-.7832	.4645	1.1102
.2503	-.9605	.4371	1.1675	.1976	-.2216	.6196	.8591	.5002	.4976	-.7680	.4687	1.1030
.3001	-.8924	.4343	1.1635	.2503	-.2779	.6041	.8832	.5002	.2476	-.7836	.4644	1.1104
.3502	-.8600	.4599	1.1183	.3001	-.3147	.5939	.8991	.5002	-.2524	-.7914	.4622	1.1141
.4003	-.7078	.4853	1.0746	.3507	-.3376	.5876	.9090	.5002	-.5024	-.7729	.4673	1.1053
.4501	-.7454	.4748	1.0925	.4001	-.3270	.5905	.9044	.5002	-.7524	-.7896	.4627	1.1133
.5002	-.7969	.4607	1.1168	.4501	-.2985	.5984	.8921	.8002	.7476	-1.0660	.3864	1.2529
.5502	-.8295	.4578	1.1306	.5001	-.2337	.6163	.8643	.8002	.4976	-.3828	.5791	.9286
.6002	-.8407	.4486	1.1380	.5497	-.1303	.6449	.8202	.8002	.2476	-.3827	.5791	.9286
.6500	-.8007	.4596	1.1186	.6003	-.0220	.6748	.7741	.8002	-.5024	-.3623	.5808	.9197
.7000	-.6272	.5087	1.0355	.6500	.0648	.6988	.7371	.8002	-.7524	-.3672	.5794	.9218
.7500	-.4712	.5507	.9873	.7000	.1786	.7302	.6882					
.8002	-.3806	.5757	.9276	.7501	.2731	.7563	.6470					
.8501	-.1711	.6336	.8376	.8001	.3572	.7796	.6096					
.9501	-.0476	.6677	.7850	.8501	.4296	.7996	.5767					

TEST 167	PT 51.8097	PSI	CM	.7290	CD1	.01049	CDCDR1	.01024
RUN 59	TT 108.0196	K	CM	-.1523	CD2	.01052	CDCDR2	.01025
POINT 94	PC 30.0264	MILLION	CC	.0131	CD3	.01065	CDCDR3	.01026
	MACH .7591				CD4	.01063	CDCDR4	.01023
	ALPHA 1.0183	DEG			CD5	.01059	CDCDR5	.01032

UPPER SURFACE				LOWER SURFACE				SPANWISE				
X/C	CP	P _z L/PT	MLOC	X/C	CP	P _z L/PT	MLOC	X/C	Y/(B/2)	CP	P _z L/PT	MLOC
0.0000	1.1444	.9980	.0531	0.0000	1.1444	.9980	.0531	.1507	.7476	-.9200	.4332	1.1648
.0132	-.2774	.6062	.8791	.0126	.5253	.8285	.5268	.1507	.4976	-1.0314	.4027	1.2210
.0259	-.6705	.5014	1.0468	.0255	.3555	.7821	.6048	.1507	.2476	-.9688	.4198	1.1891
.0759	-.9479	.4119	1.2338	.0495	.1812	.7344	.6809	.1507	-.2524	-1.0082	.4091	1.2091
.1003	-.9442	.4266	1.1768	.0753	.0746	.7053	.7263	.1507	-.5024	-1.0152	.4071	1.2127
.1507	-.8604	.4112	1.2051	.1002	-.0073	.6829	.7609	.1507	-.7524	-.9722	.4189	1.1908
.2003	-.8129	.4296	1.1712	.1503	-.0862	.6613	.7941	.5002	.7476	-.9602	.4222	1.1848
.2503	-.9776	.4176	1.1932	.1976	-.1835	.6347	.8331	.5002	.4976	-.9787	.4171	1.1941
.3001	-.10340	.4020	1.2224	.2503	-.2441	.6181	.8608	.5002	.2476	-.9568	.4231	1.1831
.3502	-.10319	.4026	1.2213	.3001	-.2833	.6074	.8774	.5002	-.2524	-.9092	.4361	1.1595
.4003	-.9499	.4113	1.2049	.3507	-.3093	.6002	.8885	.5002	-.5024	-.9695	.4196	1.1895
.4501	-.8763	.4451	1.1434	.4001	-.3052	.6014	.8867	.5002	-.7524	-.9186	.4336	1.1641
.5002	-.8779	.4447	1.1442	.4501	-.2853	.6068	.8783	.8002	.7476	-1.0586	.3953	1.2332
.5502	-.8727	.4441	1.1417	.5001	-.2279	.6225	.8539	.8002	.4976	-.3923	.5775	.9240
.6002	-.8473	.4580	1.1208	.5497	-.1307	.6491	.8129	.8002	.2476	-.3931	.5773	.9243
.6500	-.7073	.4914	1.0637	.6003	-.0265	.6776	.7690	.8002	-.5024	-.3742	.5825	.9162
.7000	-.5468	.5353	.9914	.6500	.0551	.6999	.7345	.8002	-.7524	-.3762	.5820	.9170
.7500	-.4411	.5587	.9538	.7000	.1677	.7307	.6866					
.8002	-.3415	.5805	.9194	.7501	.2617	.7564	.6461					
.8501	-.1756	.6368	.8318	.8001	.3452	.7793	.6094					
.9501	-.0498	.6613	.7787	.8501	.4176	.7991	.5768					

TEST	167	PT	51.8132	PSI		CN	.8232	CD1	.01334	CDCOR1	.01296
RUN	69	TT	107.9641	K		CM	-.1632	CD2	.01360	CDCOR2	.01325
POINT	95	RC	30.0277	MILLION		CC	.0152	CD3	.01375	CDCOR3	.01337
		MACH	.7580					CD4	.01380	CDCOR4	.01351
		ALPHA	1.5071	DEG				CD5	.01462	CDCOR5	.01423

UPPER SURFACE				LOWER SURFACE				SPANWISE				
X/C	CP	P/L/PT	MLOC	X/C	CP	P/L/PT	MLOC	X/C	Y/(B/2)	CP	P/L/PT	MLOC
0.0000	1.1449	.9985	.0471	0.0000	1.1469	.9985	.0471	.1507	.7476	-1.0017	.4093	1.2086
.0132	-.3626	.9845	.9130	.0126	.5996	.8484	.4917	.1507	.4976	-1.0503	.3960	1.2338
.0259	-.7505	.4782	1.0880	.0255	.4236	.8001	.5751	.1507	.2476	-1.0049	.4085	1.2102
.0759	-1.0300	.3997	1.2279	.0495	.2483	.7521	.6531	.1507	-.2524	-1.0504	.3960	1.2338
.1003	-1.0149	.4057	1.2154	.0753	.1402	.7224	.6996	.1507	-.5024	-1.0749	.3893	1.2467
.1507	-1.0251	.4029	1.2207	.1002	.0502	.6978	.7379	.1507	-.7524	-1.0571	.3851	1.2548
.2003	-.9883	.4130	1.2018	.1503	-.0316	.6753	.7725	.5002	.7476	-1.0666	.3915	1.2424
.2503	-1.0380	.3994	1.2274	.1976	-.1300	.6483	.8141	.5002	.4976	-1.0792	.3881	1.2490
.3001	-1.0908	.3849	1.2552	.2503	-.1929	.6311	.8407	.5002	.2476	-1.0724	.3899	1.2494
.3502	-1.1025	.3817	1.2615	.3001	-.2336	.6199	.8579	.5002	-.2524	-1.0603	.3933	1.2390
.4003	-1.0913	.3868	1.2554	.3507	-.2645	.6114	.8711	.5002	-.5024	-1.0524	.3954	1.2349
.4501	-1.0816	.3874	1.2503	.4001	-.2642	.6115	.8709	.5002	-.7524	-1.0200	.4043	1.2180
.5002	-1.0165	.4053	1.2162	.4501	-.2490	.6157	.8645	.8002	.7476	-1.0505	.4234	1.1827
.5502	-1.0303	.4015	1.2233	.5001	-.1971	.6299	.8425	.8002	.4976	-1.0467	.5089	.9061
.6002	-1.0494	.3962	1.2333	.5497	-.1051	.6552	.8036	.8002	.2476	-1.0467	.5889	.9062
.6500	-.8763	.4437	1.1460	.6003	-.10051	.6826	.7614	.8002	-.5024	-1.0305	.5934	.8992
.7000	-.5109	.5439	.9775	.6500	.0730	.7042	.7279	.8002	-.7524	-1.0364	.5918	.9017
.7500	-.4106	.5714	.9337	.7000	.1842	.7345	.6808					
.8002	-.3404	.5906	.9035	.7501	.2761	.7597	.6409					
.9002	-.1554	.6414	.8248	.8001	.3588	.7824	.6043					
.9501	-.0419	.6725	.7769	.8501	.4309	.8021	.5718					

TEST	167	PT	51.7589	PSI		CN	.8895	CD1	.01823	CDCOR1	.01770
RUN	69	TT	107.9317	K		CM	-.1712	CD2	.01920	CDCOR2	.01873
POINT	96	RC	30.0366	MILLION		CC	.0159	CD3	.01972	CDCOR3	.01912
		MACH	.7592					CD4	.02057	CDCOR4	.01971
		ALPHA	2.0162	DEG				CD5	.02105	CDCOR5	.02062

UPPER SURFACE				LOWER SURFACE				SPANWISE				
X/C	CP	P/L/PT	MLOC	X/C	CP	P/L/PT	MLOC	X/C	Y/(B/2)	CP	P/L/PT	MLOC
0.0000	1.1427	.9973	.0626	0.0000	1.1427	.9973	.0626	.1507	.7476	-1.1070	.3803	1.2642
.0132	-.4254	.5672	.9403	.0126	.6454	.8609	.4688	.1507	.4976	-1.1149	.3781	1.2685
.0259	-.8230	.4582	1.1205	.0255	.4667	.8119	.5554	.1507	.2476	-1.0941	.3838	1.2573
.0759	-1.1004	.3821	1.2606	.0495	.2872	.7627	.6361	.1507	-.2524	-1.1151	.3781	1.2685
.1003	-1.0909	.3847	1.2556	.0753	.1761	.7322	.6844	.1507	-.5024	-1.1419	.3707	1.2832
.1507	-1.0721	.3899	1.2456	.1002	.0847	.7071	.7234	.1507	-.7524	-1.1660	.3641	1.2964
.2003	-1.0247	.4029	1.2208	.1503	-.0021	.6833	.7602	.5002	.7476	-1.1270	.3748	1.2750
.2503	-1.0921	.3844	1.2562	.1976	-.1030	.6557	.8028	.5002	.4976	-1.1403	.3712	1.2823
.3001	-1.1356	.3724	1.2797	.2503	-.1692	.6375	.8308	.5002	.2476	-1.1355	.3670	1.2906
.3502	-1.1596	.3659	1.2929	.3001	-.2145	.6251	.8500	.5002	-.2524	-1.1312	.3737	1.2773
.4003	-1.1556	.3670	1.2907	.3507	-.2476	.6160	.8640	.5002	-.5024	-1.1111	.3792	1.2664
.4501	-1.1666	.3639	1.2968	.4001	-.2513	.6150	.8656	.5002	-.7524	-1.0837	.3867	1.2517
.5002	-1.1623	.3651	1.2944	.4501	-.2421	.6175	.8617	.8002	.7476	-1.0911	.4368	1.1584
.5502	-1.1101	.3794	1.2659	.5001	-.1929	.6310	.8408	.8002	.4976	-1.0267	.5037	.8986
.6002	-1.1276	.3747	1.2753	.5497	-.1043	.6553	.8034	.8002	.2476	-1.0280	.5039	.8983
.6500	-1.1130	.3787	1.2674	.6003	-.0065	.6921	.7621	.8002	-.5024	-1.0329	.5953	.8961
.7000	-.5659	.5232	1.0109	.6500	.0698	.7030	.7298	.8002	-.7524	-1.0358	.5945	.8974
.7500	-.4159	.5698	.9362	.7000	.1794	.7331	.6829					
.8002	-.3242	.5950	.8967	.7501	.2710	.7582	.6432					
.9002	-.1447	.6442	.8204	.8001	.3532	.7808	.6070					
.9501	-.0429	.6721	.7774	.8501	.4254	.8006	.5744					

TEST	167	PT	51.5941	PSI		CN	.9451	CD1	.02467	CDCOR1	.02341
RUN	69	TT	107.8811	K		CM	-.1758	CD2	.02518	CDCOR2	.02395
POINT	97	RC	29.9896	MILLION		CC	.0161	CD3	.02980	CDCOR3	.02760
		MACH	.7604					CD4	.03047	CDCOR4	.02764
		ALPHA	2.5152	DEG				CD5	.02922	CDCOR5	.02719

UPPER SURFACE				LOWER SURFACE				SPANWISE				
X/C	CP	P/L/PT	MLOC	X/C	CP	P/L/PT	MLOC	X/C	Y/(B/2)	CP	P/L/PT	MLOC
0.0000	1.1329	.9945	.0887	0.0000	1.1329	.9945	.0887	.1507	.7476	-1.1616	.3648	1.2991
.0132	-.4811	.5515	.9652	.0126	.6968	.8748	.4425	.1507	.4976	-1.1730	.3616	1.3015
.0259	-.8805	.4419	1.1492	.0255	.5151	.8230	.5331	.1507	.2476	-1.1428	.3699	1.2848
.0759	-1.1526	.3672	1.2901	.0495	.3366	.7760	.6147	.1507	-.2524	-1.1390	.3709	1.2827
.1003	-1.1434	.3697	1.2851	.0753	.2234	.7448	.6645	.1507	-.5024	-1.1750	.3611	1.3026
.1507	-1.1307	.3732	1.2781	.1002	.1264	.7183	.7061	.1507	-.7524	-1.1829	.3589	1.3070
.2003	-1.0622	.3920	1.2414	.1503	.0366	.6936	.7443	.5002	.7476	-1.1881	.3575	1.3099
.2503	-1.1567	.3677	1.2891	.1976	-.0659	.6655	.7877	.5002	.4976	-1.1960	.3553	1.3144
.3001	-1.1615	.3648	1.2951	.2503	-.1346	.6466	.8167	.5002	.2476	-1.2033	.3533	1.3185
.3502	-1.2086	.3524	1.3204	.3001	-.1830	.6334	.8372	.5002	-.2524	-1.1849	.3584	1.3081
.4003	-1.2103	.3514	1.3225	.3507	-.2193	.6234	.8525	.5002	-.5024	-1.1499	.3680	1.2836
.4501	-1.2216	.3483	1.3290	.4001	-.2267	.6214	.8557	.5002	-.7524	-1.1440	.3696	1.2854
.5002	-1.2456	.3417	1.3428	.4501	-.2199	.6232	.8528	.8002	.7476	-1.0924	.4399	1.1599
.5502	-1.2204	.3485	1.3285	.5001	-.1771	.6350	.8347	.8002	.4976	-1.0338	.5020	.9014
.6002	-1.1841	.3572	1.3105	.5497	-.0925	.6582	.7989	.8002	.2476	-1.0370	.5911	.8978
.6500	-1.0731	.3891	1.2471	.6003	.0019	.6841	.7590	.8002	-.5024	-1.0255	.5942	.8978
.7000	-.5624	.5292	1.0012	.6500	.0768	.7046	.7273	.8002	-.7524	-1.0227	.5950	.8966
.7500	-.4295	.5657	.9427	.7000	.1844	.7342	.6812					
.8002	-.3321	.5924	.9007	.7501	.2743	.7589	.6422					
.9002	-.1496	.6425	.8230	.8001	.3560	.7813	.6061					
.9501	-.0627	.6664	.7863	.8501	.4278	.8010	.5736					

OF FOOT QUALITY

TEST 167	PT 51.4934	PSI	CN .9243	CD1 .03348	CDCOR1 .03265
RUN 69	TT 107.9014	K	CM -.1697	CD2 .03394	CDCOR2 .03330
POINT 98	RC 29.9240	MILLION	CC .0190	CD3 .03916	CDCOR3 .03803
	MACH .7609			CD4 .04060	CDCOR4 .03997
	ALPHA 3.0345	DEG		CD5 .03720	CDCOR5 .03629

UPPER SURFACE				LOWER SURFACE				SPANWISE				
X/C	CP	P/L/PT	MLOC	X/C	CP	P/L/PT	MLOC	X/C	Y/(B/2)	CP	P/L/PT	MLOC
0.0000	1.1341	.9942	.0916	0.0000	1.1341	.9942	.0916	.1507	.7476	-1.1659	.3573	1.3103
.0132	-.5008	.5415	.9814	.0126	.7155	.8783	.4358	.1507	.4976	-1.1752	.3547	1.3156
.0259	-.9007	.4307	1.1892	.0255	.9329	.8277	.5283	.1507	.2476	-1.1581	.3595	1.3058
.0759	-1.1645	.3577	1.3095	.0495	.3483	.7766	.6137	.1507	-.2524	-1.1435	.3635	1.2976
.1003	-1.1551	.3603	1.3042	.0753	.2318	.7443	.6652	.1507	-.5024	-1.1737	.3552	1.3147
.1507	-1.1539	.3606	1.3035	.1002	.1357	.7177	.7070	.1507	-.7524	-1.1626	.3582	1.3084
.2003	-1.0657	.3851	1.2949	.1503	.0398	.6912	.7481	.5002	.7476	-1.2053	.3464	1.3329
.2503	-1.1587	.3593	1.3062	.1976	-.0677	.6614	.7940	.5002	.4976	-1.2177	.3430	1.3402
.3001	-1.1835	.3524	1.3203	.2503	-.1423	.6407	.8258	.5002	.2476	-1.2194	.3425	1.3412
.3502	-1.2094	.3452	1.3353	.3001	-.1960	.6259	.8487	.5002	-.2524	-1.1940	.3495	1.3264
.4003	-1.2170	.3432	1.3397	.3507	-.373	.6144	.8664	.5002	-.5024	-1.1639	.3578	1.3092
.4501	-1.2314	.3392	1.3482	.4001	-.2506	.6108	.8721	.5002	-.7524	-1.1673	.3569	1.3112
.5002	-1.2620	.3307	1.3664	.4501	-.2502	.6109	.8720	.8002	.7476	-.9776	.4095	1.2084
.5502	-1.2963	.3223	1.3630	.5001	-.2075	.6227	.8536	.8002	.4976	-.3871	.5730	.9312
.6002	-1.0500	.3894	1.2465	.5477	-.1225	.6462	.8173	.8002	.2476	-.3958	.5705	.9350
.6500	-.6301	.5057	1.0398	.6003	-.0274	.6726	.7768	.8002	-.5024	-.3694	.5779	.9235
.7000	-.5202	.5361	.9900	.6500	.0465	.6930	.7452	.8002	-.7524	-.3523	.5826	.9160
.7500	-.4499	.5556	.9388	.7000	.1547	.7230	.6988					
.8002	-.3798	.5750	.9281	.7501	.2450	.7480	.6595					
.9002	-.2496	.6110	.8717	.8001	.3264	.7705	.6235					
.9501	-.1826	.6296	.8430	.8501	.3980	.7903	.5913					

TEST 167	PT 51.4899	PSI	CN .9614	CD1 .03328	CDCOR1 .03202
RUN 69	TT 108.1285	K	CM -.1738	CD2 .03349	CDCOR2 .03241
POINT 99	RC 29.7826	MILLION	CC .0173	CD3 .03878	CDCOR3 .03698
	MACH .7589			CD4 .03994	CDCOR4 .03915
	ALPHA 3.0446	DEG		CD5 .03669	CDCOR5 .03607

UPPER SURFACE				LOWER SURFACE				SPANWISE				
X/C	CP	P/L/PT	MLOC	X/C	CP	P/L/PT	MLOC	X/C	Y/(B/2)	CP	P/L/PT	MLOC
0.0000	1.1286	.9932	.0988	0.0000	1.1286	.9932	.0988	.1507	.7476	-1.1878	.3564	1.3121
.0132	-.5202	.5400	.9838	.0126	.7360	.8853	.4220	.1507	.4976	-1.2001	.3530	1.3191
.0259	-.9259	.4284	1.1734	.0255	.5523	.8348	.5160	.1507	.2476	-1.1808	.3564	1.3081
.0759	-1.1901	.3558	1.3134	.0495	.3720	.7852	.5997	.1507	-.2524	-1.1630	.3633	1.2982
.1003	-1.1801	.3589	1.3078	.0753	.2569	.7536	.6506	.1507	-.5024	-1.1914	.3594	1.3142
.1507	-1.1782	.3591	1.3078	.1002	.1545	.7254	.6949	.1507	-.7524	-1.1771	.3594	1.3081
.2003	-1.0847	.3848	1.2594	.1503	.0622	.7001	.7344	.5002	.7476	-1.2219	.3470	1.3318
.2503	-1.1788	.3589	1.3070	.1976	-.0434	.6710	.7792	.5002	.4976	-1.2357	.3433	1.3395
.3001	-1.2078	.3509	1.3235	.2503	-.1161	.6511	.8099	.5002	.2476	-1.2383	.3426	1.3410
.3502	-1.2325	.3441	1.3377	.3001	-.1683	.6367	.8320	.5002	-.2524	-1.2056	.3515	1.3222
.4003	-1.2408	.3419	1.3425	.3507	-.2087	.6256	.8492	.5002	-.5024	-1.1756	.3598	1.3052
.4501	-1.2562	.3376	1.3515	.4001	-.2206	.6223	.8542	.5002	-.7524	-1.1793	.3588	1.3073
.5002	-1.2878	.3289	1.3703	.4501	-.2182	.6230	.8532	.8002	.7476	-.9428	.4238	1.1819
.5502	-1.2846	.3298	1.3684	.5001	-.1790	.6338	.8365	.8002	.4976	-.3805	.5830	.9154
.6002	-1.1294	.3736	1.2775	.5497	-.0969	.6563	.8018	.8002	.2476	-.3600	.5785	.9225
.6500	-.6794	.4965	1.0551	.6003	-.0044	.6817	.7626	.8002	-.5024	-.3449	.5882	.9074
.7000	-.5336	.5363	.9898	.6500	.0691	.7020	.7314	.8002	-.7524	-.3335	.5913	.9025
.7500	-.4467	.5601	.9315	.7000	.1756	.7312	.6859					
.8002	-.3631	.5831	.9152	.7501	.2647	.7557	.6472					
.9002	-.2024	.6272	.8467	.8001	.3462	.7781	.6112					
.9501	-.1565	.6399	.8270	.8501	.4175	.7977	.5791					

TEST 167	PT 51.6081	PSI	CN .9146	CD1 .02339	CDCOR1 .02291
RUN 69	TT 107.9066	K	CM -.1734	CD2 .02366	CDCOR2 .02320
POINT 100	RC 29.9214	MILLION	CC .0178	CD3 .02787	CDCOR3 .02484
	MACH .7576			CD4 .02849	CDCOR4 .02690
	ALPHA 2.5137	DEG		CD5 .02777	CDCOR5 .02681

UPPER SURFACE				LOWER SURFACE				SPANWISE				
X/C	CP	P/L/PT	MLOC	X/C	CP	P/L/PT	MLOC	X/C	Y/(B/2)	CP	P/L/PT	MLOC
0.0000	1.1399	.9959	.0768	0.0000	1.1399	.9959	.0768	.1507	.7476	-1.1372	.3663	1.2919
.0132	-.4602	.5535	.9620	.0126	.6792	.8885	.4545	.1507	.4976	-1.1442	.3644	1.2958
.0259	-.8576	.4437	1.1461	.0255	.4987	.8186	.5439	.1507	.2476	-1.1177	.3717	1.2811
.0759	-1.1264	.3693	1.2859	.0495	.3152	.7679	.6278	.1507	-.2524	-1.1224	.3704	1.2837
.1003	-1.1187	.3715	1.2816	.0753	.2012	.7364	.6778	.1507	-.5024	-1.1981	.3606	1.3093
.1507	-1.1030	.3758	1.2730	.1002	.1058	.7100	.7100	.1507	-.7524	-1.1882	.3578	1.3086
.2003	-1.0470	.3913	1.2428	.1503	.0156	.6851	.7575	.5002	.7476	-1.1712	.3570	1.3110
.2503	-1.1285	.3688	1.2871	.1976	-.0886	.6563	.8019	.5002	.4976	-1.1796	.3546	1.3158
.3001	-1.1425	.3649	1.2948	.2503	-.1593	.6367	.8320	.5002	.2476	-1.1896	.3519	1.3215
.3502	-1.1819	.3540	1.3171	.3001	-.2088	.6230	.8531	.5002	-.2524	-1.1703	.3572	1.3105
.4003	-1.1840	.3534	1.3183	.3507	-.2558	.6100	.8732	.5002	-.5024	-1.1365	.3666	1.2915
.4501	-1.1938	.3507	1.3239	.4001	-.2546	.6104	.8727	.5002	-.7524	-1.1313	.3680	1.2886
.5002	-1.2267	.3417	1.3428	.4501	-.2454	.6129	.8688	.8002	.7476	-.9245	.4252	1.1794
.5502	-1.2006	.3488	1.3275	.5001	-.2028	.6247	.8506	.8002	.4976	-.3497	.5841	.9138
.6002	-1.1756	.3557	1.3135	.5497	-.1152	.6489	.8132	.8002	.2476	-.3939	.5829	.9196
.6500	-1.0714	.3845	1.2599	.6003	-.0185	.6756	.7720	.8002	-.5024	-.3457	.5852	.9120
.7000	-.5694	.3233	1.0108	.6500	.0582	.6969	.7393	.8002	-.7524	-.3373	.5875	.9084
.7500	-.4391	.3594	.9528	.7000	.1666	.7268	.6928					
.8002	-.3437	.3857	.9112	.7501	.2578	.7520	.6531					
.9002	-.1678	.6344	.8356	.8001	.3404	.7749	.6165					
.9501	-.0812	.6583	.7987	.8501	.4126	.7948	.5839					

TEST 167	PT	51.1957	PSI	CM	.8809	CD1	.01908	CDCOR1	.01838
RUN 69	TT	107.7590	K	CM	-.1729	CD2	.02012	CDCOR2	.01946
POINT 102	RC	29.8406	MILLION	CC	.0176	CD3	.02038	CDCOR3	.01974
	MACH	.7618				CD4	.02135	CDCOR4	.02092
	ALPHA	2.6060	DEG			CD5	.02173	CDCOR5	.02119

UPPER SURFACE				LOWER SURFACE				SPANWISE				
X/C	CP	P/L/PT	MLOC	X/C	CP	P/L/PT	MLOC	X/C	Y/(B/2)	CP	P/L/PT	MLOC
0.0000	1.1505	.9991	.0357	0.0000	1.1505	.9991	.0357	.1507	.7476	-1.0858	.3832	1.2584
.0132	-.3984	.5725	.9319	.0126	.6391	.8583	.4737	.1507	.4976	-1.0969	.3802	1.2645
.0259	-.7930	.4638	1.1106	.0255	.4615	.8094	.3997	.1507	.2476	-1.0724	.3869	1.2513
.0759	-1.0764	.3858	1.2534	.0495	.2832	.7603	.6400	.1507	-.2524	-1.0939	.3810	1.2628
.1003	-1.0664	.3885	1.2481	.0753	.1730	.7299	.6879	.1507	-.5024	-1.1181	.3743	1.2760
.1507	-1.0540	.3920	1.2415	.1002	.0812	.7048	.7273	.1507	-.7524	-1.1422	.3677	1.2892
.2003	-1.0118	.4036	1.2193	.1503	-.0056	.6807	.7642	.5002	.7476	-1.1130	.3757	1.2732
.2503	-1.0725	.3869	1.2513	.1976	-.1074	.6527	.8074	.5002	.4976	-1.1260	.3722	1.2803
.3001	-1.1195	.3749	1.2767	.2503	-.1747	.6341	.8560	.5002	.2476	-1.1398	.3683	1.2879
.3502	-1.1437	.3673	1.2901	.3001	-.2210	.6214	.8957	.5002	-.2524	-1.1170	.3746	1.2754
.4003	-1.1406	.3681	1.2883	.3507	-.2543	.6122	.8698	.5002	-.5024	-1.0961	.3804	1.2640
.4501	-1.1512	.3652	1.2942	.4001	-.2586	.6110	.8717	.5002	-.7524	-1.0698	.3876	1.2499
.5002	-1.1455	.3668	1.2911	.4501	-.2476	.6141	.8670	.8002	.7476	-.9128	.4309	1.1690
.5502	-1.0869	.3829	1.2590	.5001	-.1985	.6276	.8461	.8002	.4976	-.3315	.5910	.9030
.6002	-1.1180	.3744	1.2739	.5497	-.1079	.6526	.8076	.8002	.2476	-.3289	.5917	.9018
.6500	-1.1552	.3641	1.2965	.6003	-.0085	.6799	.7654	.8002	-.5024	-.3252	.5927	.9002
.7000	-.6420	.5055	1.0402	.6500	.0683	.7311	.7328	.8002	-.7524	-.3230	.5933	.8993
.7500	-.4285	.5642	.9450	.7000	.1786	.7315	.6855					
.8002	-.3271	.5922	.9011	.7501	.2709	.7369	.6454					
.8002	-.1433	.6428	.8226	.8001	.3533	.7796	.6089					
.9501	-.0426	.6705	.7799	.8501	.4256	.7995	.5762					

TEST 167	PT	51.2102	PSI	CM	.8173	CD1	.01476	CDCOR1	.01447
RUN 69	TT	107.7910	K	CM	-.1694	CD2	.01498	CDCOR2	.01470
POINT 103	RC	29.8715	MILLION	CC	.0182	CD3	.01497	CDCOR3	.01464
	MACH	.7626				CD4	.01496	CDCOR4	.01455
	ALPHA	1.5226	DEG			CD5	.01569	CDCOR5	.01315

UPPER SURFACE				LOWER SURFACE				SPANWISE				
X/C	CP	P/L/PT	MLOC	X/C	CP	P/L/PT	MLOC	X/C	Y/(B/2)	CP	P/L/PT	MLOC
0.0000	1.1501	.9984	.0478	0.0000	1.1501	.9984	.0478	.1507	.7476	-.9617	.4119	1.2038
.0132	-.3257	.5885	.9068	.0126	.5844	.8413	.5045	.1507	.4976	-1.0246	.3944	1.2368
.0259	-.7123	.4811	1.0810	.0255	.4099	.7928	.5872	.1507	.2476	-.9704	.4095	1.2084
.0759	-.9991	.4015	1.2234	.0495	.2348	.7442	.6655	.1507	-.2524	-1.0199	.3957	1.2343
.1003	-.9774	.4075	1.2120	.0753	.1281	.7145	.7119	.1507	-.5024	-1.0439	.3890	1.2472
.1507	-.9955	.4025	1.2214	.1002	.0371	.6893	.7510	.1507	-.7524	-1.0548	.3860	1.2530
.2003	-.9658	.4107	1.2060	.1503	-.0452	.6664	.7863	.5002	.7476	-1.0547	.3880	1.2529
.2503	-1.0119	.3979	1.2301	.1976	-.1452	.6386	.8290	.5002	.4976	-1.0649	.3832	1.2585
.3001	-1.0662	.3828	1.2592	.2503	-.2093	.6208	.8565	.5002	.2476	-1.0602	.3849	1.2559
.3502	-1.0801	.3790	1.2667	.3001	-.2527	.6088	.8752	.5002	-.2524	-1.0503	.3873	1.2506
.4003	-1.0727	.3810	1.2627	.3507	-.2833	.6003	.8884	.5002	-.5024	-1.0377	.3908	1.2438
.4501	-1.0686	.3822	1.2605	.4001	-.2830	.6004	.8883	.5002	-.7524	-1.0079	.3990	1.2280
.5002	-1.0688	.3993	1.2274	.4501	-.2661	.6051	.8810	.8002	.7476	-.9077	.4269	1.1763
.5502	-1.0217	.3952	1.2353	.5001	-.2119	.6201	.8576	.8002	.4976	-.3293	.5875	.9084
.6002	-1.0549	.3860	1.2531	.5497	-.1168	.6465	.8168	.8002	.2476	-.3285	.5877	.9080
.6500	-1.0664	.3828	1.2593	.6003	-.0144	.6750	.7731	.8002	-.5024	-.3196	.5902	.9041
.7000	-.7136	.4808	1.0815	.6500	.0670	.6976	.7382	.8002	-.7524	-.3250	.5887	.9065
.7500	-.4261	.5606	.9507	.7000	.1783	.7285	.6901					
.8002	-.3265	.5883	.9071	.7501	.2712	.7543	.6495					
.8002	-.1428	.6393	.8280	.8001	.3546	.7775	.6123					
.9501	-.0347	.6682	.7834	.8501	.4271	.7976	.5793					

TEST 167	PT	51.2067	PSI	CM	.7451	CD1	.01141	CDCOR1	.01109
RUN 69	TT	107.7148	K	CM	-.1597	CD2	.01138	CDCOR2	.01107
POINT 104	RC	29.8973	MILLION	CC	.0167	CD3	.01151	CDCOR3	.01103
	MACH	.7632				CD4	.01146	CDCOR4	.01117
	ALPHA	1.0289	DEG			CD5	.01121	CDCOR5	.01095

UPPER SURFACE				LOWER SURFACE				SPANWISE				
X/C	CP	P/L/PT	MLOC	X/C	CP	P/L/PT	MLOC	X/C	Y/(B/2)	CP	P/L/PT	MLOC
0.0000	1.1563	1.0006	0.0000	0.0000	1.1563	1.0006	0.0000	.1507	.7476	-.8823	.4352	1.1611
.0132	-.2606	.6095	.8740	.0126	.5279	.8271	.5293	.1507	.4976	-1.0075	.4034	1.2196
.0259	-.6432	.5040	1.0426	.0255	.3577	.7802	.6079	.1507	.2476	-.9459	.4204	1.1880
.0759	-.9726	.4131	1.2016	.0495	.1880	.7333	.6826	.1507	-.2524	-.8787	.4114	1.2047
.1003	-.9187	.4280	1.1743	.0753	.0836	.7045	.7274	.1507	-.5024	-.8866	.4092	1.2088
.1507	-.9784	.4115	1.2046	.1002	-.0029	.6807	.7643	.1507	-.7524	-.8437	.4211	1.1869
.2003	-.9201	.4276	1.1730	.1503	-.0607	.6592	.7973	.5002	.7476	-.8848	.4097	1.2079
.2503	-.9594	.4167	1.1949	.1976	-.1789	.6321	.8391	.5002	.4976	-.8944	.4071	1.2129
.3001	-1.0163	.4010	1.2242	.2503	-.2393	.6134	.8649	.5002	.2476	-.8913	.4229	1.2113
.3502	-1.0229	.3992	1.2277	.3001	-.2796	.6043	.8821	.5002	-.2524	-.8768	.4289	1.1834
.4003	-1.0023	.4049	1.2169	.3507	-.3063	.5949	.8936	.5002	-.5024	-.8804	.4109	1.2056
.4501	-.8924	.4352	1.1612	.4001	-.3013	.5983	.8915	.5002	-.7524	-.8392	.4223	1.1846
.5002	-.8987	.4335	1.1643	.4501	-.2799	.6042	.8823	.8002	.7476	-.8958	.4067	1.2136
.5502	-.8427	.4213	1.1864	.5001	-.2204	.6206	.8549	.8002	.4976	-.3644	.5899	.9187
.6002	-.8438	.4210	1.1869	.5497	-.1216	.6479	.8147	.8002	.2476	-.3624	.5814	.9179
.6500	-.8838	.4376	1.1569	.6003	-.0159	.6771	.7698	.8002	-.5024	-.3443	.5865	.9100
.7000	-.5584	.5274	1.0042	.6500	.0673	.7000	.7344	.8002	-.7524	-.3446	.5850	.9123
.7500	-.4250	.5642	.9451	.7000	.1806	.7313	.6858					
.8002	-.3525	.5842	.9135	.7501	.2749	.7573	.6446					
.8002	-.1592	.6376	.8307	.8001	.3588	.7805	.6074					
.9501	-.0403	.6704	.7802	.8501	.4314	.8005	.5744					

TEST 167	PT 43.7455	PSI	CM .0487	CD1 .00968	CDCOR1 .00942
RUN 69	TT 96.8880	K	CM -1.521	CD2 .00967	CDCOR2 .00942
POINT 105	RC 29.8695	MILLION	CC .0171	CD3 .00986	CDCOR3 .00931
	MACH .7622			CD4 .00975	CDCOR4 .00948
	ALPHA .5193	DEG		CD5 .00952	CDCOR5 .00922

UPPER SURFACE				LOWER SURFACE				SPANWISE				
X/C	CP	P/L/P/T	MLOC	X/C	CP	P/L/P/T	MLOC	X/C	Y/(B/2)	CP	P/L/P/T	MLOC
0.0000	1.1517	.9996	.0236	0.0000	1.1517	.9996	.0236	.1507	.7776	-.4287	.4564	1.1242
.0132	-.1823	.6337	.8374	.0126	.4494	.8070	.5643	.1507	.4976	-.9620	.4199	1.1897
.0259	-.5535	.5305	.4948	.0255	.2862	.7622	.6376	.1507	.2476	-.9188	.4317	1.1681
.0759	-.4419	.4254	1.1796	.0495	-.1220	.7172	.7085	.1507	-.2524	-.9156	.4376	1.1665
.1003	-.9095	.4342	1.1636	.0753	.0207	.6894	.7516	.1507	-.5024	-.9481	.4237	1.1827
.1507	-.9361	.4269	1.1187	.1002	-.0600	.6073	.7857	.1507	-.7524	-.8060	.4626	1.1134
.2003	-.8127	.4609	1.1768	.1503	-.1322	.6474	.8162	.5002	.7476	-.7493	.4782	1.0867
.2503	-.9109	.4334	1.1615	.1976	-.2287	.6210	.8570	.5002	.4976	-.7448	.4794	1.0846
.3001	-.9053	.4354	1.1643	.2503	-.2852	.6055	.8811	.5002	.2476	-.7809	.4695	1.0915
.3502	-.7890	.4671	1.1615	.3001	-.3220	.5954	.8968	.5002	-.2524	-.7946	.4658	1.1015
.4003	-.6679	.4923	1.10829	.3502	-.3448	.5891	.9066	.5002	-.5024	-.7697	.4726	1.0962
.4501	-.7456	.4792	1.0849	.4001	-.3348	.5919	.9023	.5002	-.7524	-.7832	.4689	1.1026
.5002	-.7933	.4661	1.1074	.4501	-.3074	.5994	.8906	.8002	.7476	-1.0884	.3852	1.2552
.5502	-.8147	.4603	1.1175	.5001	-.2426	.6172	.8630	.8002	.4976	-.3945	.5755	.9280
.6002	-.6184	.4591	1.1196	.5502	-.1391	.6456	.8191	.8002	.2476	-.3955	.5752	.9284
.6500	-.7644	.4741	1.0937	.6003	-.0300	.6755	.7731	.8002	-.5024	-.3765	.5804	.9202
.7000	-.6133	.5155	1.0243	.6500	.0556	.6990	.7368	.8002	-.7524	-.3797	.5796	.9216
.7500	-.4437	.5510	.8667	.7000	.1704	.7304	.6878					
.8002	-.3896	.5768	.9259	.7501	.1704	.7506	.6465					
.8502	-.1767	.6352	.8350	.8001	.3502	.7798	.8093					
.9001	-.0448	.6703	.7810	.8501	.4231	.7998	.8764					

TEST 167	PT 43.7410	PSI	CM .5658	CD1 .00934	CDCOR1 .00912
RUN 69	TT 96.8880	K	CM -1.533	CD2 .00931	CDCOR2 .00909
POINT 107	RC 29.9110	MILLION	CC .0198	CD3 .00937	CDCOR3 .00909
	MACH .7632			CD4 .00944	CDCOR4 .00911
	ALPHA .5103	DEG		CD5 .00933	CDCOR5 .00963

UPPER SURFACE				LOWER SURFACE				SPANWISE				
X/C	CP	P/L/P/T	MLOC	X/C	CP	P/L/P/T	MLOC	X/C	Y/(B/2)	CP	P/L/P/T	MLOC
0.0000	1.1465	.9977	.0574	0.0000	1.1465	.9977	.0574	.1507	.7476	-.8644	.4979	1.0534
.0132	-.0789	.6595	.7976	.0126	.3618	.7812	.6070	.1507	.4976	-.8850	.4922	1.0629
.0259	-.4476	.5578	.9560	.0255	.2098	.7392	.6741	.1507	.2476	-.7924	.4826	1.1135
.0759	-.8337	.4513	1.1331	.0495	.0513	.6955	.7422	.1507	-.2524	-.7698	.4688	1.1027
.1003	-.9308	.4578	1.1218	.0753	-.0461	.6086	.7837	.1507	-.5024	-.7101	.4853	1.0746
.1507	-.9078	.4583	1.1209	.1002	-.1211	.6479	.8155	.5002	.7476	-.7588	.4719	1.0976
.2003	-.8187	.5105	1.0325	.1503	-.1868	.6297	.8435	.5002	.4976	-.7588	.4719	1.0976
.2503	-.6235	.5092	1.0346	.1976	-.2824	.6033	.8844	.5002	.2476	-.7701	.4687	1.1029
.3001	-.7204	.4824	1.0794	.2503	-.3359	.5886	.9074	.5002	-.2524	-.7759	.4688	1.1027
.3502	-.7497	.4744	1.0932	.3001	-.3703	.5791	.9223	.5002	-.5024	-.7636	.4705	1.0997
.4003	-.7532	.4734	1.0948	.3502	-.3582	.5741	.9301	.5002	-.7524	-.7549	.4729	1.0956
.4501	-.7590	.4718	1.0375	.4001	-.3718	.5787	.9229	.8002	.7476	-1.0890	.3901	.9736
.5002	-.7741	.4676	1.1047	.4501	-.3362	.5885	.9075	.8002	.4976	-.3901	.5734	.9313
.5502	-.7780	.4658	1.1079	.5001	-.2641	.6084	.8763	.8002	.2476	-.3910	.5734	.9313
.6002	-.7913	.4629	1.1129	.5502	-.1546	.6396	.8299	.8002	-.5024	-.3738	.5781	.9238
.6500	-.7701	.4687	1.1028	.6003	-.0414	.6699	.7817	.8002	-.7524	-.3783	.5769	.9258
.7000	-.6332	.5065	1.0391	.6500	.0482	.6946	.7436					
.7500	-.4807	.5486	.9706	.7000	.1645	.7267	.6937					
.8002	-.3881	.5747	.9291	.7501	.1645	.7534	.6516					
.8502	-.1743	.6332	.8382	.8001	.3457	.7767	.6142					
.9001	-.0467	.6684	.7839	.8501	.4182	.7967	.6814					

TEST 167	PT 43.7685	PSI	CM .4458	CD1 .00896	CDCOR1 .00869
RUN 69	TT 96.4374	K	CM -1.538	CD2 .00891	CDCOR2 .00870
POINT 108	RC 29.9121	MILLION	CC .0205	CD3 .00897	CDCOR3 .00870
	MACH .7621			CD4 .00906	CDCOR4 .00879
	ALPHA .4888	DEG		CD5 .00893	CDCOR5 .00872

UPPER SURFACE				LOWER SURFACE				SPANWISE				
X/C	CP	P/L/P/T	MLOC	X/C	CP	P/L/P/T	MLOC	X/C	Y/(B/2)	CP	P/L/P/T	MLOC
0.0000	1.1299	.9933	.0485	0.0000	1.1299	.9933	.0485	.1507	.7476	-.5948	.5182	1.0199
.0132	-.0176	.6849	.7554	.0126	.2623	.7543	.6502	.1507	.4376	-.6134	.5131	1.0283
.0259	-.5455	.5869	.9101	.0255	.1225	.7154	.7107	.1507	.2476	-.6189	.5115	1.0300
.0759	-.4036	.4549	1.1149	.0495	-.0288	.6741	.7752	.1507	-.2524	-.6280	.5090	1.0349
.1003	-.8601	.4267	1.0223	.0753	-.1250	.6476	.8159	.1507	-.5024	-.6210	.5110	1.0319
.1507	-.9411	.5082	1.0383	.1002	-.1890	.6300	.8432	.1507	-.7524	-.5917	.5191	1.0185
.2003	-.8544	.5183	1.0197	.1503	-.2484	.6136	.8664	.5002	.7476	-.6902	.4919	1.0635
.2503	-.6258	.5096	1.0334	.1976	-.3436	.5874	.9043	.5002	.4976	-.6958	.4904	1.0661
.3001	-.7239	.4964	1.0560	.2503	-.3943	.5734	.9312	.5002	.2476	-.6974	.4899	1.0668
.3502	-.6853	.4933	1.0612	.3001	-.4250	.5650	.9445	.5002	-.2524	-.6883	.4924	1.0626
.4003	-.6762	.4974	1.0542	.3502	-.4370	.5617	.9444	.5002	-.5024	-.6958	.4904	1.0611
.4501	-.6763	.5012	1.0479	.4001	-.4136	.5681	.9396	.8002	.7476	-.6778	.4953	1.0577
.5002	-.6882	.4925	1.0625	.4501	-.3702	.5801	.9208	.8002	.4976	-.3979	.5724	.9328
.5502	-.7251	.4823	1.0797	.5001	-.2910	.6019	.8867	.8002	.2476	-.3977	.5725	.9327
.6002	-.7516	.4744	1.0927	.5502	-.1757	.6336	.8333	.8002	-.5024	-.3979	.5724	.9328
.6500	-.7549	.4741	1.0937	.6001	-.0585	.6659	.7877	.8002	-.7524	-.3849	.5760	.9272
.7000	-.6764	.5011	1.0441	.6500	.0341	.6914	.7484					
.7500	-.4881	.5474	.9723	.7000	.1524	.7240	.6979					
.8002	-.3911	.5743	.9248	.7501	.1524	.7510	.6534					
.8502	-.1791	.6327	.8369	.8001	.3357	.7745	.6178					
.9001	-.0484	.6686	.7836	.8501	.4082	.7945	.6831					

TEST 167 PT 43.7805 PSI CN .4144
 RUN 69 TT 96.8257 K CM -1506
 POINT 100 RC 29.9323 MILLION CC .0216
 MACH .7624
 ALPHA -.9877 DEG

CD1 .00869 CDCOR1 .00849
 CD2 .00863 CDCOR2 .00842
 CD3 .00864 CDCOR3 .00846
 CD4 .00874 CDCOR4 .00833
 CD5 .00867 CDCOR5 .00843

UPPER SURFACE				LOWER SURFACE				SPANWISE				
X/C	CP	P/L/PT	MLOC	X/C	CP	P/L/PT	MLOC	X/C	Y/(B/2)	CP	P/L/PT	MLOC
0.0000	1.1031	.9861	.1421	0.0000	1.1031	.9861	.1421	.1507	.7476	-.3186	.5404	.9838
.0132	.1125	.7139	.7137	.0126	-.1608	.7271	.6930	.1507	.4976	-.5378	.3352	.9923
.0259	-.2451	.6156	.8654	.0255	-.0357	.6927	.7464	.1507	.2476	-.5410	.3341	.9940
.0759	-.5897	.5209	1.0155	.0495	-.1015	.6530	.8045	.1507	-.2524	-.5423	.3323	.9970
.1003	-.5210	.5398	.9848	.0753	-.1965	.6289	.8647	.1507	-.5024	-.5476	.3325	.9967
.1507	-.5520	.5312	.9986	.1002	-.2519	.6137	.8673	.1507	-.7524	-.5216	.3396	.9851
.2003	-.5291	.5375	.9884	.1503	-.3018	.6000	.8896	.5002	.7476	-.6750	.5041	1.0431
.2503	-.5720	.5258	1.0075	.1976	-.3960	.5741	.9301	.5002	.4976	-.6608	.5014	1.0477
.3001	-.6088	.5156	1.0241	.2503	-.4421	.5614	.9502	.5002	.2476	-.6675	.5034	1.0508
.3502	-.5969	.5169	1.0287	.3001	-.4683	.5543	.9616	.5002	-.2524	-.6535	.5042	1.0430
.4003	-.6019	.5175	1.0210	.3537	-.4734	.5529	.9639	.5002	-.5024	-.6504	.5109	1.0319
.4501	-.6226	.5118	1.0303	.4001	-.4408	.5618	.9496	.5002	-.7524	-.6262	.5127	1.2798
.5002	-.6634	.5006	1.0489	.4501	-.3891	.5760	.9272	.6002	.7476	-1.1290	.5726	.9325
.5502	-.6827	.4953	1.0577	.5001	-.3040	.5994	.8905	.8002	.4976	-.4014	.5726	.9334
.6002	-.6938	.4923	1.0628	.5497	-.1846	.6222	.8397	.8002	.2476	-.4035	.5720	.9334
.6500	-.7069	.4887	1.0689	.6003	-.0646	.6632	.7889	.8002	-.5024	-.3788	.5789	.9227
.7000	-.6369	.5079	1.0368	.6500	.0307	.6914	.7485	.8002	-.7524	-.3811	.5782	.9237
.7500	-.4956	.5467	.9736	.7000	-.1500	.7242	.6976					
.8002	-.3988	.5734	.9313	.7501	.2486	.7513	.6550					
.9002	-.1837	.6325	.8393	.8001	.3337	.7747	.6175					
.9501	-.0527	.6885	.7838	.8501	.4056	.7944	.5853					

TEST 167 PT 43.7863 PSI CN .3373
 RUN 69 TT 96.9773 K CM -1484
 POINT 110 RC 29.8698 MILLION CC .0211
 MACH .7631
 ALPHA -1.4867 DEG

CD1 .00858 CDCOR1 .00842
 CD2 .00847 CDCOR2 .00836
 CD3 .00844 CDCOR3 .00830
 CD4 .00858 CDCOR4 .00850
 CD5 .00853 CDCOR5 .00833

UPPER SURFACE				LOWER SURFACE				SPANWISE				
X/C	CP	P/L/PT	MLOC	X/C	CP	P/L/PT	MLOC	X/C	Y/(B/2)	CP	P/L/PT	MLOC
0.0000	1.0595	.9740	.1951	0.0000	1.0595	.9740	.1951	.1507	.7476	-.4472	.5594	.9534
.0132	.2083	.7398	.6731	.0126	-.0400	.6935	.7453	.1507	.4976	-.4642	.5547	.9609
.0259	-.1407	.6438	.8219	.0255	-.0649	.6640	.7906	.1507	.2476	-.4684	.5541	.9618
.0759	-.4619	.5553	.9598	.0495	-.1909	.6299	.8432	.1507	-.2524	-.4737	.5521	.9651
.1003	-.4370	.5622	.9490	.0753	-.2910	.6024	.8859	.1507	-.5024	-.4784	.5514	.9662
.1507	-.4762	.5514	.9662	.1002	-.3285	.5921	.9020	.1507	-.7524	-.4541	.5575	.9564
.2003	-.4677	.5537	.9624	.1503	-.3699	.5807	.9195	.5002	.7476	-.6087	.5150	1.0252
.2503	-.5128	.5413	.9823	.1976	-.4662	.5542	.9618	.5002	.4976	-.6184	.5129	1.0287
.3001	-.5460	.5322	.9970	.2503	-.5100	.5421	.9811	.5002	.2476	-.6229	.5111	1.0316
.3502	-.5492	.5313	.9985	.3001	-.5332	.5357	.9914	.5002	-.2524	-.6078	.5153	1.0247
.4003	-.5805	.5282	1.0035	.3507	-.5287	.5370	.9893	.5002	-.5024	-.6031	.5165	1.0226
.4501	-.5822	.5223	1.0132	.4001	-.4835	.5494	.9694	.5002	-.7524	-.5855	.5219	1.0138
.5002	-.6188	.5122	1.0297	.4501	-.4210	.5666	.9420	.8002	.7476	-1.1321	.5709	1.2813
.5502	-.6342	.5079	1.0365	.5001	-.3267	.5920	.9021	.8002	.4976	-.4863	.5712	.9347
.6002	-.6660	.4992	1.0513	.5497	-.2040	.6263	.8488	.8002	.2476	-.4088	.5705	.9358
.6500	-.6901	.4926	1.0624	.6003	-.0803	.6604	.7963	.8002	-.5024	-.3813	.5775	.9248
.7000	-.6210	.5116	1.0308	.6500	.0175	.6873	.7549	.8002	-.7524	-.3829	.5771	.9255
.7500	-.4959	.5460	.9748	.7000	-.1380	.7204	.7035					
.8002	-.4023	.5718	.9338	.7501	.2374	.7478	.6605					
.9002	-.1885	.6306	.8422	.8001	.3222	.7711	.6233					
.9501	-.0564	.6869	.7862	.8501	.3933	.7907	.5914					

TEST 167 PT 43.9026 PSI CN .2324
 RUN 69 TT 96.8955 K CM -1435
 POINT 111 RC 29.9142 MILLION CC .0195
 MACH .7594
 ALPHA -1.9838 DEG

CD1 .00890 CDCOR1 .00838
 CD2 .00834 CDCOR2 .00826
 CD3 .00831 CDCOR3 .00828
 CD4 .00833 CDCOR4 .00827
 CD5 .00842 CDCOR5 .00822

UPPER SURFACE				LOWER SURFACE				SPANWISE				
X/C	CP	P/L/PT	MLOC	X/C	CP	P/L/PT	MLOC	X/C	Y/(B/2)	CP	P/L/PT	MLOC
0.0000	1.0100	.9610	.2399	0.0000	1.0100	.9610	.2399	.1507	.7476	-.3723	.5630	.9162
.0132	.3093	.7894	.6260	.0126	-.0919	.7597	.7974	.1507	.4976	-.3902	.5781	.9239
.0259	-.0351	.6752	.7735	.0255	-.1770	.6364	.8122	.1507	.2476	-.3911	.5778	.9243
.0759	-.3589	.5867	.9104	.0495	-.2879	.6061	.8802	.1507	-.2524	-.4013	.5759	.9287
.1003	-.3529	.5883	.9079	.0753	-.3978	.5760	.9272	.1507	-.5024	-.4054	.5759	.9304
.1507	-.3976	.5752	.9284	.1002	-.4105	.5725	.9326	.1507	-.7524	-.3864	.5791	.9273
.2003	-.4007	.5761	.9271	.1503	-.4402	.5644	.9455	.5002	.7476	-.5567	.5325	.9865
.2503	-.4494	.5619	.9495	.1976	-.5376	.5378	.9881	.5002	.4976	-.5603	.5319	.9881
.3001	-.4845	.5523	.9645	.2503	-.5778	.5268	1.0059	.5002	.2476	-.5657	.5301	1.0065
.3502	-.4894	.5510	.9699	.3001	-.5945	.5211	1.0151	.5002	-.2524	-.5584	.5326	.9964
.4003	-.5047	.5462	.9745	.3507	-.5784	.5266	1.0061	.5002	.7476	-.5339	.5333	.9952
.4501	-.5297	.5359	.9846	.4001	-.5194	.5427	.9801	.5002	-.5024	-.5393	.5373	.9888
.5002	-.5597	.5217	.9978	.4501	-.4483	.5622	.9490	.5002	-.7524	-.5393	.5373	.9888
.5502	-.5889	.5237	.0100	.5001	-.3512	.5887	.9072	.6002	.7476	-1.1303	.5757	1.2759
.6002	-.6175	.5159	1.0237	.5497	-.2227	.6239	.8523	.8002	.4976	-.4834	.5749	.9367
.6500	-.6577	.5104	1.0327	.5997	-.0961	.6595	.7991	.8002	.2476	-.4060	.5738	.9367
.7000	-.5839	.5291	1.0086	.6500	.0039	.6859	.7570	.8002	-.5024	-.3830	.5801	.9288
.7500	-.4900	.5508	.9672	.7000	.1255	.7191	.7055					
.8002	-.3893	.5756	.9278	.7501	.2256	.7465	.6625					
.9002	-.1892	.6331	.8384	.8001	.3099	.7696	.6238					
.9501	-.0554	.6896	.7822	.8501	.3804	.7889	.5944					

ORIGINAL PAGE IS
OF POOR QUALITY

TEST	1A7	PT	43.9001	PSI	CN	-0978	CD1	.00881	CDCOR1	.00870
RUN	69	TT	26.9166	K	CM	-.1397	CD2	.00860	CDCOR2	.00854
POINT	112	RC	29.9177	MILLION	CC	.0127	CD3	.00844	CDCOR3	.00842
		MACH	.7601				CD4	.00845	CDCOR4	.00842
		ALPHA	-2.9836	DEG			CD5	.00853	CDCOR5	.00831

UPPER SURFACE				LOWER SURFACE				SPANWISE				
X/C	CP	P/L/PT	MLOC	X/C	CP	P/L/PT	MLOC	X/C	Y/(B/2)	CP	P/L/PT	MLOC
0.0000	.8813	.9263	.3338	0.0000	.8826	.9263	.3338	.1507	.7476	-.2469	.6177	.8821
.0132	.8774	.8126	.5497	.0126	-.3717	.5836	.9152	.1507	.4976	-.2616	.6137	.8883
.0259	.1533	.7271	.6931	.0255	-.4026	.5752	.9285	.1507	.2476	-.2609	.6139	.8880
.0759	-.1889	.6336	.8376	.0495	-.4772	.5548	.9608	.1507	-.2524	-.2700	.6114	.8719
.1003	-.2063	.6288	.8449	.0753	-.8178	.4631	1.1126	.1507	-.5024	-.2757	.6099	.8743
.1507	-.2703	.6113	.8720	.1002	-.5631	.5113	.9985	.1507	-.7524	-.2812	.6138	.8682
.2003	-.2414	.6056	.8810	.1503	-.5750	.5281	1.0038	.5002	.7476	-.4783	.5545	.9813
.2503	-.3419	.5918	.9025	.1976	-.5733	.5012	1.0480	.5002	.4976	-.4828	.5533	.9831
.3001	-.3824	.5806	.9200	.2503	-.7401	.4775	1.0879	.5002	.2476	-.4881	.5518	.9855
.3502	-.3990	.5782	.9269	.3001	-.8076	.4645	1.1102	.5002	-.2524	-.4788	.5544	.9814
.4003	-.4221	.5699	.9379	.3507	-.7190	.4887	1.0689	.5002	-.5024	-.4786	.5531	.9803
.4501	-.4467	.5631	.9475	.4001	-.5907	.5320	.9974	.5002	-.7524	-.4631	.5586	.9547
.5002	-.4827	.5531	.9630	.4501	-.4805	.5538	.9622	.8002	.7476	-1.0023	.5867	1.2254
.5502	-.5165	.5441	.9779	.5001	-.3788	.5817	.9182	.8002	.4976	-.3916	.5782	.9237
.6002	-.5497	.5356	.9926	.5497	-.2455	.6141	.8615	.8002	.2476	-.3950	.5772	.9252
.6500	-.5704	.5293	1.0018	.6003	-.1147	.6538	.8064	.8002	-.5024	-.3682	.5846	.9137
.7000	-.5741	.5381	.9975	.6500	-.0107	.6923	.7626	.8002	-.7524	-.3682	.5851	.9129
.7500	-.4726	.5560	.9588	.7000	.1121	.7159	.7107					
.8002	-.3884	.6791	.8224	.7501	.2127	.7433	.6676					
.9007	-.1879	.6338	.8372	.8001	.2965	.7682	.6312					
.9511	-.0568	.6697	.7820	.8501	.3656	.7851	.6006					

TEST	1A7	PT	43.9046	PSI	CN	-0975	CD1	.01081	CDCOR1	.01072
RUN	69	TT	26.8284	K	CM	-.1349	CD2	.01035	CDCOR2	.01032
POINT	113	RC	29.9967	MILLION	CC	.0049	CD3	.01015	CDCOR3	.01019
		MACH	.7616				CD4	.01015	CDCOR4	.01015
		ALPHA	-3.9815	DEG			CD5	.00989	CDCOR5	.00967

UPPER SURFACE				LOWER SURFACE				SPANWISE				
X/C	CP	P/L/PT	MLOC	X/C	CP	P/L/PT	MLOC	X/C	Y/(B/2)	CP	P/L/PT	MLOC
0.0000	.7438	.8479	.4172	0.0000	.7438	.8879	.4172	.1507	.7476	-.1332	.6477	.8158
.0132	.6269	.8559	.4786	.0126	-.6661	.5017	1.0471	.1507	.4976	-.1458	.6443	.8211
.0259	.3185	.7715	.6227	.0255	-.4072	.5179	1.0204	.1507	.2476	-.1443	.6447	.8205
.0759	-.0420	.6727	.7773	.0495	-.7487	.4791	1.0451	.1507	-.2524	-.1524	.6425	.8219
.1003	-.0754	.6636	.7914	.0753	-.8594	.4448	1.1376	.1507	-.5024	-.1589	.6407	.8267
.1507	-.1537	.6421	.8245	.1002	-.9190	.4336	1.1649	.1507	-.7524	-.1680	.6437	.8220
.2003	-.1922	.6315	.8447	.1503	-.8098	.4624	1.1139	.5002	.7476	-.4079	.5725	.9328
.2503	-.2453	.6170	.8632	.1976	-.8369	.4550	1.1268	.5002	.4976	-.4122	.5715	.9346
.3001	-.2913	.6044	.8827	.2503	-.7449	.4802	1.0433	.5002	.2476	-.4176	.5699	.9389
.3502	-.3128	.5977	.8932	.3001	-.8823	.4425	1.1445	.5002	-.2524	-.4076	.5726	.9326
.4003	-.3441	.5900	.9051	.3507	-.8672	.4193	1.1408	.5002	-.5024	-.4067	.5733	.9314
.4501	-.3717	.5824	.9172	.4001	-1.0058	.4087	1.2104	.5002	-.7524	-.3927	.5766	.9262
.5002	-.4127	.5711	.9344	.4501	-.8635	.5572	.9588	.8002	.7476	-1.0391	.5996	1.2276
.5502	-.4405	.5638	.9513	.5001	-.7546	.5871	.9098	.8002	.4976	-.3748	.5815	.9145
.6002	-.4875	.5507	.9674	.5497	-.2431	.6178	.8623	.8002	.2476	-.3781	.5806	.9149
.6500	-.5127	.5438	.9794	.6003	-.1204	.6512	.8104	.8002	-.5024	-.3504	.5882	.9080
.7000	-.4986	.5441	.9715	.6500	-.0171	.6795	.7888	.8002	-.7524	-.3475	.5890	.9048
.7500	-.4573	.5617	.9499	.7000	.1026	.7123	.7161					
.8002	-.3771	.6823	.8174	.7501	.2013	.7393	.6739					
.9007	-.1846	.6334	.8373	.8001	.2837	.7619	.6380					
.9501	-.0575	.6645	.7839	.8501	.3519	.7805	.6091					

TEST 167
 RUN 71
 MACH .760
 R 30.0×10^6

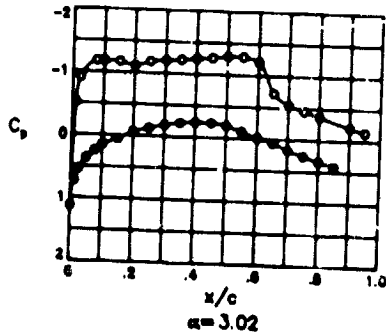
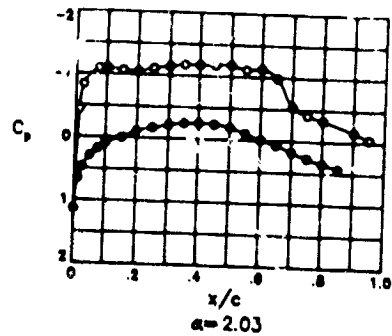
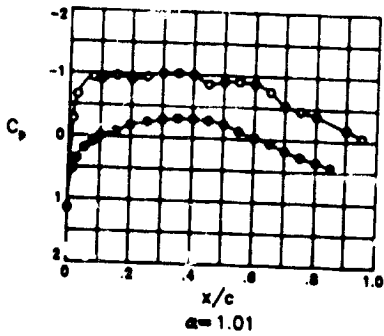
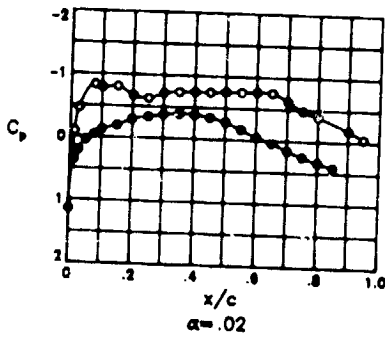
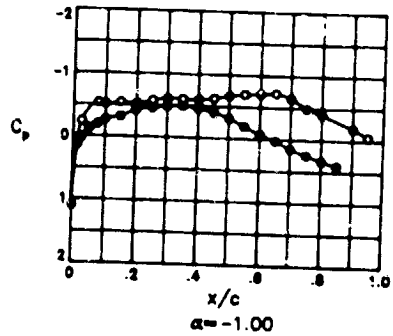
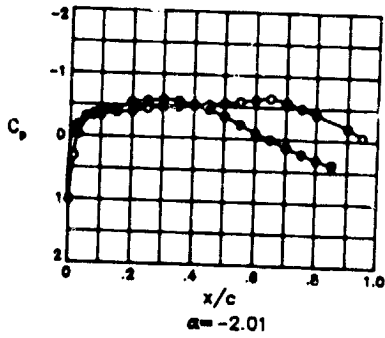
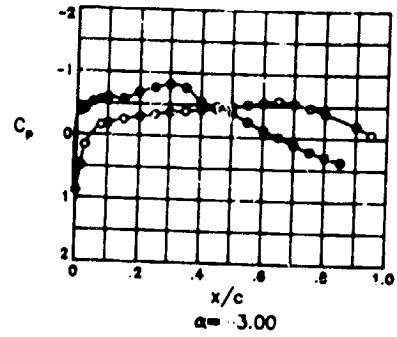
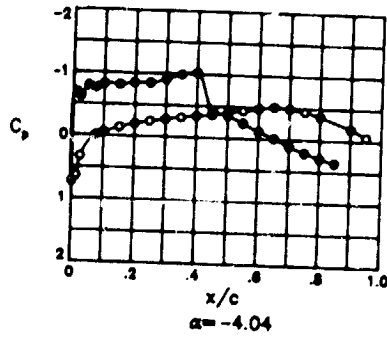

ORIGINAL PAGE IS
OF POOR QUALITY

TEST	167	PT	44.1027	PSI		CN	-0.0650	CD1	.01073	CDCOR1	.01056
RUN	71	TT	97.2359	K		CM	-1.1352	CD2	.01052	CDCOR2	.01041
POINT	8	RC	29.9380	MILLION		CC	.0023	CD3	.01026	CDCOR3	.01022
		MACH	.7613					CD4	.01000	CDCOR4	.00994
		ALPHA	-4.0426	DEG				CD5	.00956	CDCOR5	.00929

UPPER SURFACE				LOWER SURFACE				SPANWISE				
X/C	CP	P/L/PT	MLOC	X/C	CP	P/L/PT	MLOC	X/C	Y/(R/2)	CP	P/L/PT	MLOC
0.0000	.7302	.8846	.4239	0.0000	.7302	.8846	.4239	.1507	.7476	-.1248	.6509	.8110
.0132	.6380	.8594	.4722	.0126	-.6813	.4987	1.0521	.1507	.4976	-.1372	.6475	.8162
.0259	.3306	.7753	.5164	.0255	-.6203	.5154	1.0245	.1507	.2476	-.1362	.6486	.8145
.0759	-.0100	.6822	.7626	.0495	-.7911	.4687	1.1029	.1507	-.2524	-.1374	.6477	.8159
.1003	-.0583	.6690	.7930	.0753	-.7613	.4768	1.0890	.1507	-.5024	-.1454	.6452	.8196
.1507	-.1358	.6479	.8156	.1002	-.8200	.4608	1.1166	.1507	-.7524	-.1347	.6481	.8151
.2003	-.1979	.6309	.8456	.1503	-.8095	.4637	1.1116	.5002	.7476	-.3966	.5765	.9263
.2503	-.2402	.6193	.8718	.1976	-.8462	.4536	1.1291	.5002	.4976	-.4022	.5750	.9287
.3001	-.2789	.6007	.8970	.2503	-.8473	.4533	1.1296	.5002	.2476	-.4073	.5736	.9309
.3502	-.3109	.6000	.8997	.3001	-.9280	.4367	1.1591	.5002	-.2524	-.3947	.5771	.9255
.4003	-.3395	.5922	.9019	.3507	-.9893	.4145	1.1996	.5002	-.5024	-.3919	.5779	.9243
.4501	-.3631	.5857	.9119	.4001	-1.0248	.4048	1.2177	.5002	-.7524	-.3800	.5808	.9196
.5002	-.4041	.5745	.9295	.4501	-.4492	.5622	.9491	.8002	.7476	-1.0205	.5060	1.2155
.5502	-.4418	.5642	.9458	.5001	-.3506	.5891	.9066	.8002	.4976	-.3689	.5841	.9144
.6002	-.4792	.5540	.9621	.5497	-.2405	.6192	.8598	.8002	.2476	-.3748	.5825	.9169
.6500	-.5144	.5443	.9775	.6003	-.1166	.6531	.8075	.8002	-.5024	-.3462	.5903	.9047
.7000	-.4848	.5513	.9663	.6500	-.0148	.6809	.7646	.8002	-.7524	-.3380	.5926	.9012
.7500	-.4420	.5641	.9459	.7000	-.1064	.7141	.7134					
.8002	-.3690	.5841	.9145	.7501	.2059	.7413	.6708					
.9002	-.1850	.6344	.8363	.8001	.2905	.7644	.6341					
.9501	-.0608	.6684	.7640	.9501	.3595	.7833	.6036					

TEST	167	PT	44.1217	PSI		CN	.0980	CD1	.00851	CDCOR1	.00834
RUN	71	TT	97.1558	K		CM	-1.1410	CD2	.00842	CDCOR2	.00830
POINT	9	RC	29.9793	MILLION		CC	.0138	CD3	.00842	CDCOR3	.00836
		MACH	.7609					CD4	.00845	CDCOR4	.00838
		ALPHA	-3.0039	DEG				CD5	.00827	CDCOR5	.00804

UPPER SURFACE				LOWER SURFACE				SPANWISE				
X/C	CP	P/L/PT	MLOC	X/C	CP	P/L/PT	MLOC	X/C	Y/(R/2)	CP	P/L/PT	MLOC
0.0000	.8747	.9239	.3396	0.0000	.8747	.9239	.3396	.1507	.7476	-.2411	.6183	.8613
.0132	.4852	.8177	.5471	.0126	-.3794	.5804	.9203	.1507	.4976	-.2562	.6141	.8677
.0259	.1621	.7287	.6906	.0255	-.4139	.5702	.9352	.1507	.2476	-.2522	.6152	.8660
.0759	-.1576	.6411	.8260	.0495	-.5240	.5408	.9832	.1507	-.2524	-.2571	.6139	.8680
.1003	-.1912	.6319	.8402	.0753	-.5607	.5307	.9995	.1507	-.5024	-.2650	.6117	.8714
.1507	-.2544	.6146	.8669	.1002	-.6001	.5199	1.0170	.1507	-.7524	-.2502	.6158	.8651
.2003	-.2963	.6031	.8847	.1503	-.5773	.5262	1.0068	.5002	.7476	-.4715	.5552	.9602
.2503	-.3398	.5912	.9033	.1976	-.6816	.4976	1.0519	.5002	.4976	-.4770	.5537	.9626
.3001	-.3777	.5820	.9178	.2503	-.7623	.4755	1.0912	.5002	.2476	-.4825	.5521	.9650
.3502	-.3977	.5754	.9242	.3001	-.8165	.4607	1.1168	.5002	-.2524	-.4706	.5554	.9598
.4003	-.4217	.5688	.9385	.3507	-.7682	.4739	1.0940	.5002	-.5024	-.4680	.5561	.9587
.4501	-.4420	.5632	.9474	.4001	-.5477	.5343	.9937	.5002	-.7524	-.4568	.5592	.9538
.5002	-.4785	.5532	.9633	.4501	-.4768	.5537	.9625	.8002	.7476	-1.0742	.3901	1.2457
.5502	-.5132	.5437	.9795	.5001	-.3762	.5813	.9189	.8002	.4976	-.3866	.5784	.9234
.6002	-.5471	.5345	.9934	.5497	-.2430	.6177	.8621	.8002	.2476	-.3930	.5757	.9262
.6500	-.5787	.5258	1.0075	.6003	-.1112	.6538	.8064	.8002	-.5024	-.3674	.5837	.9151
.7000	-.5354	.5377	.9883	.6500	-.0081	.6821	.7629	.8002	-.7524	-.3608	.5855	.9123
.7500	-.4715	.5552	.9620	.7000	-.2178	.7160	.7104					
.8002	-.3880	.5780	.9240	.7501	.2172	.7438	.6669					
.9002	-.1694	.6324	.8394	.8001	.3033	.7673	.6293					
.9501	-.0607	.6677	.7851	.8501	.3741	.7868	.5979					

TEST	167	PT	44.1166	PSI		CN	.2515	CD1	.00825	CDCOR1	.00815
RUN	71	TT	97.1761	K		CM	-1.1455	CD2	.00821	CDCOR2	.00815
POINT	10	RC	29.9823	MILLION		CC	.0199	CD3	.00833	CDCOR3	.00833
		MACH	.7615					CD4	.00836	CDCOR4	.00835
		ALPHA	-2.0060	DEG				CD5	.00823	CDCOR5	.00808

UPPER SURFACE				LOWER SURFACE				SPANWISE				
X/C	CP	P/L/PT	MLOC	X/C	CP	P/L/PT	MLOC	X/C	Y/(R/2)	CP	P/L/PT	MLOC
0.0000	1.0079	.9604	.2420	0.0000	1.0079	.9604	.2420	.1507	.7476	-.3693	.5834	.9156
.0132	.3163	.7710	.6234	.0126	-.0956	.6583	.7995	.1507	.4976	-.3881	.5782	.9237
.0259	-.0300	.6762	.7719	.0255	-.1829	.6344	.8363	.1507	.2476	-.3859	.5788	.9228
.0759	-.3269	.5949	.8975	.0495	-.3119	.5941	.9911	.1507	-.2524	-.3920	.5771	.9254
.1003	-.3409	.5911	.9034	.0753	-.3593	.5961	.9113	.1507	-.5024	-.3983	.5754	.9281
.1507	-.3874	.5784	.9234	.1002	-.4368	.5703	.9361	.1507	-.7524	-.3792	.5806	.9199
.2003	-.4026	.5742	.9299	.1503	-.4421	.5614	.9471	.5002	.7476	-.5509	.5336	.9947
.2503	-.4498	.5613	.9504	.1976	-.3475	.5346	.9932	.5002	.4976	-.5561	.5322	.9970
.3001	-.4778	.5537	.9626	.2503	-.5795	.5258	1.0075	.5002	.2476	-.5617	.5307	.9995
.3502	-.4884	.5508	.9672	.3001	-.6009	.5199	1.0170	.5002	-.2524	-.5514	.5335	.9949
.4003	-.5072	.5436	.9755	.3507	-.5802	.5256	1.0078	.5002	-.5024	-.5493	.5341	.9940
.4501	-.5263	.5404	.9839	.4001	-.5197	.5422	.9710	.5002	-.7524	-.5363	.5376	.9883
.5002	-.5568	.5320	.9974	.4501	-.4473	.5622	.9493	.8002	.7476	-1.1139	.3795	1.2663
.5502	-.5663	.5239	1.0105	.5001	-.3498	.5887	.9073	.8002	.4976	-.3996	.5751	.9287
.6002	-.6147	.5162	1.0232	.5497	-.2212	.6239	.8525	.8002	.2476	-.4048	.5736	.9309
.6500	-.6436	.5082	1.0363	.6003	-.0931	.6589	.7985	.8002	-.5024	-.3842	.5793	.9220
.7000	-.5811	.5254	1.0082	.6500	.0060	.6861	.7567	.8002	-.7524	-.3788	.5807	.9197
.7500	-.4491	.5505	.9675	.7000	.1280	.7197	.7045					
.8002	-.3995	.5751	.9286	.7501	.2290	.7474	.6612					
.9002	-.1909	.6322	.8397	.8001	.3168	.7712	.6232					
.9501	-.0589	.6683	.7640	.8501	.3894	.7910	.5908					

TEST 167	PT 44.1300	PSI	CM	.4099	CD1 .00852	CDCOR1 .00831
RUN 71	TT 97.0774	K	CM	-.1518	CD2 .00848	CDCOR2 .00826
POINT 11	RC 30.0849	MILLION	CC	.0222	CD3 .00865	CDCOR3 .00839
	MACH .7637				CD4 .00867	CDCOR4 .00849
	ALPHA -.9979	DEG			CD5 .00851	CDCOR5 .00830

UPPER SURFACE				LOWER SURFACE				SPANWISE				
X/C	CP	P _L /PT	MLOC	X/C	CP	P _L /PT	MLOC	X/C	Y/(B/2)	CP	P _L /PT	MLOC
0.0000	1.0956	.9832	.1566	0.0000	1.0956	.9832	.1566	.1507	.7476	-.5175	.5353	.9921
.0132	-.1226	.7131	.7149	.0126	-.1508	.7209	.7028	.1507	.4976	-.5388	.5294	1.0016
.0259	-.2362	.6134	.8688	.0255	-.0247	.6858	.7570	.1507	.2476	-.5398	.5291	1.0021
.0759	-.5325	.5311	.9988	.0495	-.1246	.6444	.8209	.1507	-.2524	-.5434	.5281	1.0037
.1003	-.5093	.5376	.9884	.0753	-.1924	.6256	.8499	.1507	-.5024	-.5442	.5279	1.0041
.1507	-.5405	.5287	1.0024	.1002	-.2656	.6052	.8815	.1507	-.7524	-.5152	.5359	.9910
.2003	-.5229	.5338	.9945	.1503	-.3134	.5920	.9021	.5002	.7476	-.6549	.4972	1.0547
.2503	-.5759	.5191	1.0184	.1976	-.4174	.5631	.9476	.5002	.4976	-.6667	.4939	1.0602
.3001	-.6106	.5094	1.0343	.2503	-.4579	.5318	.9655	.5002	.2476	-.6739	.4919	1.0635
.3502	-.6017	.5119	1.0302	.3001	-.4858	.5441	.9779	.5002	-.2524	-.6631	.4949	1.0585
.4003	-.6014	.5120	1.0300	.3507	-.4906	.5428	.9800	.5002	-.5024	-.6623	.4951	1.0581
.4501	-.6260	.5052	1.0413	.4001	-.4561	.5523	.9647	.5002	-.7524	-.6398	.5013	1.0477
.5002	-.6705	.4928	1.0619	.4501	-.4009	.5677	.9403	.8002	.7476	-1.1020	.3730	1.2791
.5502	-.6977	.4852	1.0747	.5001	-.3131	.5920	.9020	.8002	.4975	-.3979	.5685	.9390
.6002	-.7095	.4820	1.0802	.5497	-.1921	.6256	.8498	.8002	.2476	-.4003	.5678	.9401
.6500	-.7240	.4779	1.0971	.6003	-.0698	.6596	.7975	.8002	-.5024	-.3830	.5726	.9325
.7000	-.6499	.4985	1.0524	.6500	.0254	.6860	.7568	.8002	-.7524	-.3824	.5728	.9322
.7500	-.4955	.5414	.9822	.7000	.1454	.7193	.7051					
.8002	-.3958	.5691	.9381	.7501	.2444	.7468	.6620					
.9002	-.1857	.6274	.8471	.8001	.3314	.7710	.6234					
.9501	-.0567	.6632	.7919	.8501	.4045	.7913	.5904					

TEST 167	PT 44.0940	PSI	CM	.5557	CD1 .00889	CDCOR1 .00859
RUN 71	TT 97.0257	K	CM	-.1495	CD2 .00889	CDCOR2 .00862
POINT 12	RC 29.9679	MILLION	CC	.0193	CD3 .00907	CDCOR3 .00887
	MACH .7587				CD4 .00898	CDCOR4 .00884
	ALPHA .0204	DEG			CD5 .00895	CDCOR5 .00873

UPPER SURFACE				LOWER SURFACE				SPANWISE				
X/C	CP	P _L /PT	MLOC	X/C	CP	P _L /PT	MLOC	X/C	Y/(B/2)	CP	P _L /PT	MLOC
0.0000	1.1416	.9967	.0690	0.0000	1.1416	.9967	.0690	.1507	.7476	-.6621	.5010	1.0482
.0132	-.0883	.6587	.7988	.0126	-.3636	.7829	.6041	.1507	.4976	-.7142	.4867	1.0722
.0259	-.4607	.5564	.9582	.0255	-.2108	.7409	.6714	.1507	.2476	-.7949	.4645	1.1101
.0759	-.8356	.4534	1.1296	.0495	-.0401	.6940	.7445	.1507	-.2524	-.7726	.4707	1.0995
.1003	-.7910	.4656	1.1083	.0753	-.0461	.6703	.7810	.1507	-.5024	-.6615	.5012	1.0479
.1507	-.8087	.4607	1.1167	.1002	-.1249	.6488	.8142	.1507	-.7524	-.6249	.5112	1.0313
.2003	-.6712	.4985	1.0524	.1503	-.1906	.6306	.8422	.5002	.7476	-.7438	.4786	1.0860
.2503	-.6334	.5089	1.0352	.1976	-.2937	.6023	.8861	.5002	.4976	-.7520	.4763	1.0898
.3001	-.7177	.4857	1.0739	.2503	-.3412	.5892	.9064	.5002	.2476	-.7576	.4748	1.0925
.3502	-.7395	.4749	1.0840	.3001	-.3751	.5799	.9210	.5002	-.2524	-.7631	.4733	1.0951
.4003	-.7460	.4780	1.0871	.3507	-.3927	.5750	.9287	.5002	-.5024	-.7633	.4732	1.0952
.4501	-.7474	.4776	1.0877	.4001	-.3784	.5790	.9225	.5002	-.7524	-.7513	.4765	1.0895
.5002	-.7547	.4756	1.0911	.4501	-.3446	.5883	.9079	.8002	.7476	-1.1061	.3790	1.2673
.5502	-.7567	.4750	1.0921	.5001	-.2757	.6072	.8784	.8002	.4976	-.3976	.5737	.9308
.6002	-.7636	.4731	1.0953	.5497	-.1642	.6378	.8310	.8002	.2476	-.3979	.5736	.9309
.6500	-.7536	.4759	1.0906	.6003	-.0500	.6692	.7827	.8002	-.5024	-.3873	.5765	.9263
.7000	-.6278	.5105	1.0326	.6500	.0375	.6933	.7456	.8002	-.7524	-.3861	.5769	.9258
.7500	-.4804	.5510	.9669	.7000	.1543	.7254	.6957					
.8002	-.3471	.5766	.9262	.7501	.2515	.7521	.6537					
.9002	-.1775	.6342	.8366	.8001	.3376	.7757	.6158					
.9501	-.0462	.6703	.7911	.8501	.4112	.7960	.5826					

TEST 167	PT 44.0974	PSI	CM	.7326	CD1 .01015	CDCOR1 .00984
RUN 71	TT 96.9631	K	CM	-.1571	CD2 .01017	CDCOR2 .00988
POINT 13	RC 30.0050	MILLION	CC	.0164	CD3 .01037	CDCOR3 .01013
	MACH .7589				CD4 .01018	CDCOR4 .00992
	ALPHA 1.0081	DEG			CD5 .01054	CDCOR5 .01020

UPPER SURFACE				LOWER SURFACE				SPANWISE				
X/C	CP	P _L /PT	MLOC	X/C	CP	P _L /PT	MLOC	X/C	Y/(B/2)	CP	P _L /PT	MLOC
0.0000	1.1499	.9949	.0406	0.0000	1.1499	.9989	.0406	.1507	.7476	-.9145	.4306	1.1702
.0132	-.2774	.6059	.8804	.0126	-.5316	.8287	.5273	.1507	.4976	-1.0120	.4037	1.2198
.0259	-.6608	.5004	1.0493	.0255	-.3598	.7814	.6067	.1507	.2476	-.9550	.4194	1.1905
.0759	-.9411	.4232	1.1835	.0495	-.1840	.7330	.6839	.1507	-.2524	-.9733	.4144	1.1999
.1003	-.9054	.4331	1.1657	.0753	-.0840	.7054	.7268	.1507	-.5024	-1.0179	.4021	1.2228
.1507	-.9718	.4348	1.1991	.1002	-.3066	.6805	.7633	.1507	-.7524	-.9104	.4317	1.1682
.2003	-.9173	.4799	1.1716	.1503	-.0814	.6598	.7972	.5002	.7476	-.9562	.4191	1.1912
.2503	-.9615	.4176	1.1938	.1976	-.1863	.6310	.8415	.5002	.4976	-.9873	.4105	1.2070
.3001	-1.0161	.4026	1.2219	.2503	-.2380	.6168	.8655	.5002	.2476	-.9590	.4183	1.1926
.3502	-1.0234	.4006	1.2257	.3001	-.2773	.6060	.8803	.5002	-.2524	-.9180	.4296	1.1720
.4003	-.9950	.4073	1.2130	.3507	-.3040	.5986	.8918	.5002	-.5024	-.9702	.4152	1.1983
.4501	-.8547	.4470	1.1408	.4001	-.2994	.5999	.8898	.5002	-.7524	-.9272	.4271	1.1766
.5002	-.8940	.4362	1.1600	.4501	-.2785	.6056	.8809	.8002	.7476	-1.0255	.4000	1.2268
.5502	-.9060	.4329	1.1660	.5001	-.2200	.6217	.8559	.8002	.4976	-.3803	.5776	.9246
.6002	-.8739	.4417	1.1802	.5497	-.1218	.6438	.8142	.8002	.2476	-.3816	.5773	.9252
.6500	-.7505	.4757	1.0909	.6003	-.0171	.6776	.7698	.8002	-.5024	-.3647	.5819	.9179
.7000	-.5363	.5347	.9831	.6500	.0651	.7002	.7349	.8002	-.7524	-.3602	.5831	.9160
.7500	-.4542	.5573	.9368	.7000	.1777	.7312	.6566					
.8002	-.3766	.5786	.9231	.7501	.2715	.7570	.6458					
.9002	-.1727	.6348	.8398	.8001	.3564	.7804	.6082					
.9501	-.0500	.6685	.7837	.8501	.4299	.8007	.5749					

ORIGINAL PAGE IS
OF POOR QUALITY

TEST 167	PT 48.8079	PSI	CM .8892	CD1 .01691	CDCOR1 .01645
RUN 71	TT 104.0273	K	CM -.1688	CD2 .01778	CDCOR2 .01723
POINT 14	PC 29.8809	MILLION	CC .0151	CD3 .01873	CDCOR3 .01780
	MACH .7574			CD4 .01942	CDCOR4 .01818
	ALPHA 2.0296	DEG		CD5 .01992	CDCOR5 .01950

UPPER SURFACE				LOWER SURFACE				SPANWISE				
X/C	CP	P _L /PT	MLOC	X/C	CP	P _L /PT	MLOC	X/C	Y/(B/2)	CP	P _L /PT	MLOC
0.0000	1.1406	.9970	.0654	0.0000	1.1406	.9970	.0654	.1507	.7476	-1.1288	.3780	1.2689
.0132	-.4404	.5658	.9428	.0126	.6509	.8635	.4643	.1507	.4976	-1.1322	.3770	1.2708
.0259	-.8376	.4574	1.1220	.0255	.4706	.8143	.5515	.1507	.2476	-1.0937	.3875	1.2502
.0759	-1.0949	.3872	1.2509	.0495	.2911	.7653	.6321	.1507	-.2524	-1.1078	.3837	1.2577
.1003	-1.0977	.3865	1.2523	.0753	.1792	.7348	.6806	.1507	-.5024	-1.1433	.3740	1.2767
.1507	-1.0651	.3954	1.2352	.1002	.0857	.7093	.7203	.1507	-.7524	-1.1655	.3680	1.2888
.2003	-1.0524	.3988	1.2286	.1503	.0006	.6861	.7562	.5002	.7476	-1.1345	.3764	1.2720
.2503	-1.1077	.3837	1.2577	.1976	-.1076	.6565	.8017	.5002	.4976	-1.1447	.3736	1.2775
.3001	-1.1390	.3752	1.2744	.2503	-.1567	.6404	.8265	.5002	.2476	-1.1604	.3694	1.2861
.3502	-1.1720	.3662	1.2924	.3001	-.2119	.6281	.8455	.5002	-.2524	-1.1392	.3751	1.2746
.4003	-1.1691	.3670	1.2908	.3507	-.2438	.6194	.8590	.5002	-.5024	-1.1171	.3812	1.2626
.4501	-1.1725	.3661	1.2927	.4001	-.2492	.6179	.8613	.5002	-.7524	-1.0883	.3890	1.2474
.5002	-1.1761	.3651	1.2947	.4501	-.2388	.6208	.8569	.8002	.7476	-.9219	.4344	1.1628
.5502	-1.1084	.3836	1.2580	.5001	-.1918	.6336	.8371	.8002	.4976	-.3366	.5941	.8983
.6002	-1.1284	.3781	1.2687	.5497	-.1041	.6575	.8002	.8002	.2476	-.3352	.5945	.8977
.6500	-.9664	.4168	1.1949	.6003	-.0058	.6843	.7589	.8002	-.5024	-.3294	.5960	.8953
.7000	-.5375	.5393	.9851	.6500	.0696	.7049	.7271	.8002	-.7524	-.3307	.5957	.8958
.7500	-.4089	.5744	.9293	.7000	.1752	.7348	.6805					
.8002	-.3303	.5958	.8957	.7501	.2708	.7598	.6410					
.9002	-.1540	.6439	.8212	.8001	.3544	.7826	.6042					
.9501	-.0465	.6732	.7760	.8501	.4274	.8025	.5714					

TEST 167	PT 48.0794	PSI	CM .9578	CD1 .03289	CDCOR1 .03198
RUN 71	TT 102.8868	K	CM -.1745	CD2 .03375	CDCOR2 .03289
POINT 15	PC 29.9655	MILLION	CC .0176	CD3 .04031	CDCOR3 .03926
	MACH .7593			CD4 .04020	CDCOR4 .03864
	ALPHA 3.0243	DEG		CD5 .03678	CDCOR5 .03551

UPPER SURFACE				LOWER SURFACE				SPANWISE				
X/C	CP	P _L /PT	MLOC	X/C	CP	P _L /PT	MLOC	X/C	Y/(B/2)	CP	P _L /PT	MLOC
0.0000	1.1315	.9939	.0937	0.0000	1.1315	.9939	.0937	.1507	.7476	-1.1923	.3547	1.3159
.0132	-.5173	.5404	.9834	.0126	.7255	.8822	.4283	.1507	.4976	-1.2092	.3501	1.3255
.0259	-.9107	.4322	1.1669	.0255	.5425	.8319	.5213	.1507	.2476	-1.1824	.3574	1.3103
.0759	-1.1767	.3590	1.3070	.0495	.3618	.7822	.6049	.1507	-.2524	-1.1545	.3640	1.2969
.1003	-1.1751	.3594	1.3062	.0753	.2436	.7497	.6571	.1507	-.5024	-1.1864	.3563	1.3126
.1507	-1.1717	.3604	1.3043	.1002	.1441	.7223	.7001	.1507	-.7524	-1.1835	.3571	1.3109
.2003	-1.1062	.3784	1.2682	.1503	.0525	.6971	.7392	.5002	.7476	-1.2178	.3477	1.3304
.2503	-1.1808	.3579	1.3094	.1976	-.0606	.6660	.7872	.5002	.4976	-1.2340	.3432	1.3398
.3001	-1.2000	.3526	1.3262	.2503	-.1262	.6480	.8150	.9002	.2476	-1.2369	.3425	1.3415
.3502	-1.2187	.3475	1.3309	.3001	-.1784	.6336	.8371	.5002	-.2524	-1.2061	.3509	1.3237
.4003	-1.2419	.3411	1.3444	.3507	-.2184	.6226	.8541	.5002	-.5024	-1.1771	.3589	1.3073
.4501	-1.2552	.3374	1.3522	.4001	-.2313	.6191	.8596	.5002	-.7524	-1.1604	.3580	1.3091
.5002	-1.2684	.3283	1.3719	.4501	-.2289	.6198	.8584	.8002	.7476	-.9611	.4183	1.1922
.5502	-1.2847	.3293	1.3697	.5001	-.1884	.6308	.8414	.8002	.4976	-.3654	.5822	.9171
.6002	-1.2090	.3501	1.3254	.5497	-.1057	.6536	.8063	.8002	.2476	-.3797	.5782	.9233
.6500	-.7237	.4936	1.0771	.6003	-.0108	.6797	.7661	.8002	-.5024	-.3592	.5839	.9144
.7000	-.5432	.5333	.9949	.6500	.0621	.6997	.7352	.8002	-.7524	-.3457	.5876	.9086
.7500	-.4532	.5580	.9552	.7000	.1690	.7292	.6894					
.8002	-.3684	.5814	.9183	.7501	.2585	.7538	.6506					
.9002	-.2035	.6267	.8478	.8001	.3415	.7766	.6140					
.9501	-.1351	.6495	.8186	.8501	.4136	.7964	.5815					

TEST 167
 RUN 70
 MACH .760
 R 40.0×10^6

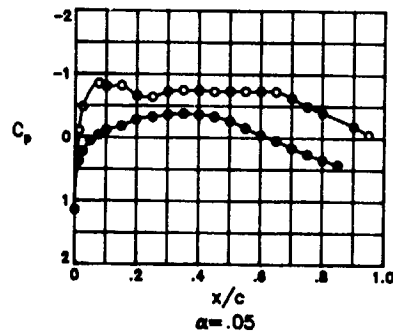
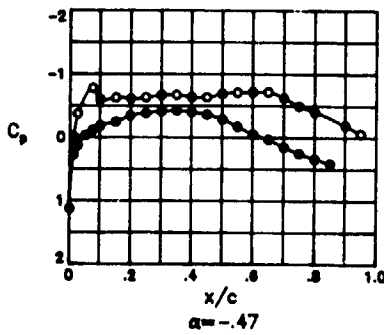
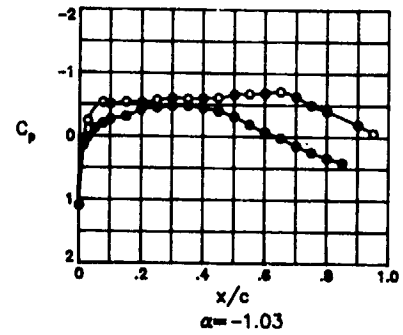
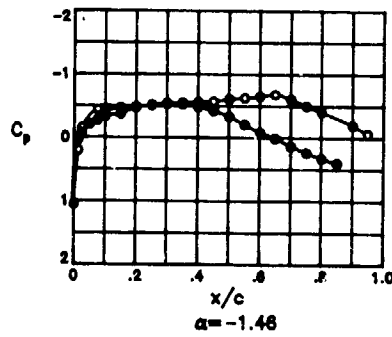
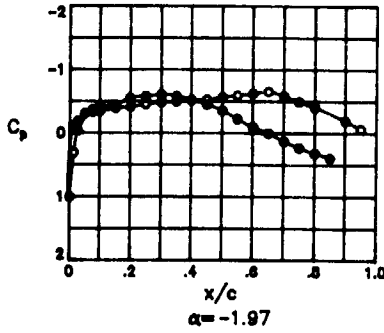
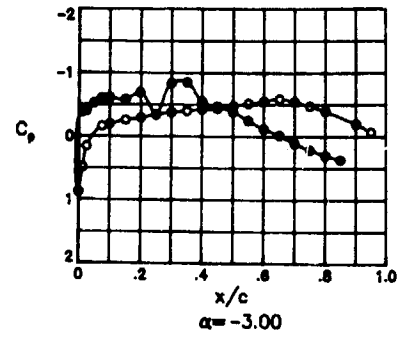
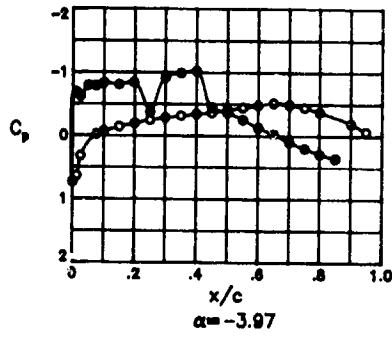

ORIGINAL PAGE IS
 OF POOR QUALITY



OPTIONAL PAGE 15
OF POOR QUALITY

TEST 167	PT 63.4603	PSI	CN	-.0418	CD1 .01012	CDCOR1 .01002
RUN 70	TT 102.1428	K	CM	-.1348	CD2 .00981	CDCOR2 .00976
POINT 1	RC 39.9660	MILLION	CC	.0073	CD3 .00944	CDCOR3 .00940
	MACH .7580				CD4 .00909	CDCOR4 .00906
	ALPHA -3.9738	DEG			CD5 .00866	CDCOR5 .00846

UPPER SURFACE				LOWER SURFACE				SPANWISE				
X/C	CP	P _L /PT	MLOC	X/C	CP	P _L /PT	MLOC	X/C	Y/(B/2)	CP	P _L /PT	MLOC
0.0000	.7310	.8857	.4219	0.0000	.7310	.8857	.4219	.1507	.7476	-.1334	.6508	.8119
.0132	.6334	.8592	.4729	.0126	-.6835	.5010	1.0491	.1507	.4976	-.1453	.6474	.8169
.0259	.3209	.7742	.6187	.0255	-.6227	.5176	1.0217	.1507	.2476	-.1392	.6491	.8143
.0759	-.0185	.6819	.7637	.0495	-.7939	.4710	1.0998	.1507	-.2524	-.1475	.6468	.8178
.1003	-.0668	.6687	.7840	.0753	-.7858	.4732	1.0960	.1507	-.5024	-.1568	.6443	.8217
.1507	-.1428	.6481	.8158	.1002	-.8322	.4606	1.1178	.1507	-.7524	-.1461	.6472	.8172
.2003	-.1934	.6343	.8371	.1503	-.8068	.4675	1.1059	.5002	.7476	-.4027	.5774	.9257
.2503	-.2466	.6198	.8594	.1976	-.8426	.4578	1.1228	.5002	.4976	-.4074	.5761	.9277
.3001	-.2853	.6093	.8758	.2503	-.3700	.5863	.9117	.5002	.2476	-.4121	.5748	.9298
.3502	-.3145	.6014	.8881	.3001	-.9182	.4372	1.1591	.5002	-.2524	-.4014	.5777	.9252
.4003	-.3436	.5935	.9005	.3507	-.9925	.4170	1.1939	.5002	-.5024	-.3977	.5787	.9236
.4501	-.3629	.5882	.9087	.4001	-1.0214	.4091	1.2105	.5002	-.7524	-.3868	.5817	.9189
.5002	-.4673	.5761	.9277	.4501	-.4408	.5648	.9455	.8002	.7476	-1.0438	.6030	1.2220
.5502	-.4454	.5658	.9440	.5001	-.3634	.5881	.9089	.8002	.4976	-.3753	.5848	.9140
.6002	-.4811	.5561	.9595	.5497	-.2533	.6180	.8623	.8002	.2476	-.3792	.5838	.9137
.6500	-.5172	.5462	.9752	.6003	-.1279	.6521	.8096	.8002	-.5024	-.3517	.5913	.9039
.7000	-.4908	.5534	.9637	.6500	-.0279	.6793	.7677	.8002	-.7524	-.3391	.5947	.8986
.7500	-.4450	.5659	.9439	.7000	.0974	.7134	.7149					
.8002	-.3730	.5855	.9130	.7501	.1987	.7410	.6718					
.9002	-.1912	.6349	.8361	.8001	.2855	.7646	.6342					
.9501	-.0671	.6687	.7841	.8501	.3563	.7838	.6031					

TEST 167	PT 63.4562	PSI	CN	.1151	CD1 .00833	CDCOR1 .00820
RUN 70	TT 102.0673	K	CM	-.1419	CD2 .00820	CDCOR2 .00811
POINT 2	RC 40.1369	MILLION	CC	.0153	CD3 .00813	CDCOR3 .00813
	MACH .7621				CD4 .00810	CDCOR4 .00806
	ALPHA -3.0019	DEG			CD5 .00791	CDCOR5 .00772

UPPER SURFACE				LOWER SURFACE				SPANWISE				
X/C	CP	P _L /PT	MLOC	X/C	CP	P _L /PT	MLOC	X/C	Y/(B/2)	CP	P _L /PT	MLOC
0.0000	.8756	.9239	.3396	0.0000	.8756	.9239	.3396	.1507	.7476	-.2445	.6170	.8639
.0132	.4879	.8177	.5465	.0126	-.3823	.5792	.9228	.1507	.4976	-.2587	.6131	.8699
.0259	.1593	.7277	.6927	.0255	-.4164	.5699	.9376	.1507	.2476	-.2335	.6145	.8677
.0759	-.1603	.6401	.8282	.0495	-.5244	.5403	.9848	.1507	-.2524	-.2626	.6120	.8716
.1003	-.1945	.6307	.8427	.0753	-.6059	.5179	1.0211	.1507	-.5024	-.2712	.6097	.8753
.1507	-.2589	.6136	.8692	.1002	-.6087	.5172	1.0224	.1507	-.7524	-.2571	.6133	.8693
.2003	-.2922	.6039	.8842	.1503	-.5828	.5243	1.0108	.5002	.7476	-.4791	.5527	.9649
.2503	-.3435	.5899	.9062	.1976	-.6486	.4953	1.0586	.5002	.4976	-.4834	.5515	.9668
.3001	-.3781	.5804	.9210	.2503	-.3376	.5915	.9036	.5002	.2476	-.4887	.5501	.9691
.3502	-.4005	.5742	.9370	.3001	-.8352	.4551	1.1274	.5002	-.2524	-.4776	.5531	.9642
.4003	-.4249	.5675	.9413	.3507	-.8509	.4508	1.1350	.5002	-.5024	-.4742	.5540	.9628
.4501	-.4424	.5627	.9489	.4001	-.5499	.5333	.9961	.5002	-.7524	-.4625	.5573	.9576
.5002	-.4835	.5515	.9688	.4501	-.4735	.5942	.9624	.8002	.7476	-1.1004	.3824	1.2619
.5502	-.5190	.5418	.9824	.5001	-.3803	.5798	.9220	.8002	.4976	-.3932	.5762	.9276
.6002	-.5519	.5327	.9970	.5497	-.2483	.6159	.8655	.8002	.2476	-.3981	.5749	.9297
.6500	-.5879	.5229	1.0130	.6003	-.1156	.6523	.8093	.9002	-.5024	-.3711	.5823	.9180
.7000	-.5425	.5353	.9928	.6500	-.0150	.6799	.7668	.8002	-.7524	-.3617	.5849	.9140
.7500	-.4752	.5538	.9632	.7000	.1124	.7148	.7129					
.8002	-.3920	.5766	.9270	.7501	.2150	.7429	.6687					
.9002	-.1944	.6307	.8427	.8001	.3028	.7670	.6304					
.9501	-.0652	.6661	.7881	.8501	.3749	.7867	.5983					

TEST 167	PT 63.4578	PSI	CN	.2572	CD1 .00798	CDCOR1 .00783
RUN 70	TT 102.0895	K	CM	-.1471	CD2 .00790	CDCOR2 .00780
POINT 3	RC 40.0532	MILLION	CC	.0200	CD3 .00801	CDCOR3 .00798
	MACH .7598				CD4 .00801	CDCOR4 .00794
	ALPHA -1.9748	DEG			CD5 .00791	CDCOR5 .00771

UPPER SURFACE				LOWER SURFACE				SPANWISE				
X/C	CP	P _L /PT	MLOC	X/C	CP	P _L /PT	MLOC	X/C	Y/(B/2)	CP	P _L /PT	MLOC
0.0000	1.0080	.9603	.2423	0.0000	1.0080	.9603	.2423	.1507	.7476	-.3777	.5810	.9201
.0132	.3088	.7689	.6273	.0126	-.0926	.6590	.7990	.1507	.4976	-.3988	.5766	.9271
.0259	-.0384	.6738	.7762	.0255	-.1805	.6349	.8362	.1507	.2476	-.3900	.5776	.9255
.0759	-.3339	.5929	.9014	.0495	-.3059	.6006	.8894	.1507	-.2524	-.3976	.5755	.9287
.1003	-.3473	.5893	.9071	.0753	-.3651	.5844	.9148	.1507	-.5024	-.4041	.5737	.9315
.1507	-.3924	.5769	.9265	.1002	-.4171	.5701	.9372	.1507	-.7524	-.3896	.5788	.9236
.2003	-.4123	.5715	.9351	.1503	-.4420	.5633	.9480	.5002	.7476	-.3589	.5313	.9993
.2503	-.4550	.5598	.9536	.1976	-.5500	.5338	.9954	.5002	.4976	-.3628	.5303	1.0010
.3001	-.4832	.5521	.9659	.2503	-.5804	.5254	1.0089	.5002	.2476	-.3674	.5290	1.0031
.3502	-.4960	.5486	.9715	.3001	-.6037	.5191	1.0193	.5002	-.2524	-.3590	.5324	.9976
.4003	-.5132	.5439	.9791	.3507	-.5837	.5245	1.0103	.5002	-.5024	-.3519	.5333	.9962
.4501	-.5279	.5398	.9856	.4001	-.5213	.5416	.9826	.5002	-.7524	-.3385	.5369	.9902
.5002	-.5624	.5303	1.0010	.4501	-.4494	.5613	.9512	.8002	.7476	-1.1310	.3747	1.2768
.5502	-.5933	.5219	1.0146	.5001	-.3507	.5883	.9086	.8002	.4976	-.4039	.5736	.9315
.6002	-.6205	.5145	1.0269	.5497	-.2220	.6236	.8537	.8002	.2476	-.4082	.5726	.9333
.6500	-.6539	.5053	1.0420	.6003	-.0932	.6586	.7993	.8002	-.5024	-.3826	.5796	.9223
.7000	-.6874	.5235	1.0120	.6500	.0029	.6852	.7587	.8002	-.7524	-.3756	.5815	.9191
.7500	-.6931	.5494	.9703	.7000	.1290	.7197	.7052					
.8002	-.6029	.5741	.9310	.7501	.2307	.7475	.6615					
.9002	-.1958	.6307	.8426	.8001	.3190	.7717	.6228					
.9501	-.0644	.6667	.7871	.8501	.3926	.7918	.5899					

TEST 167	PT	63.4619	PSI	CN	.3355	CD1	.00799	CDCOR1	.00789
RUN 70	TT	102.1322	K	CM	-1.489	CD2	.00795	CDCOR2	.00789
POINT 4	RC	39.9871	MILLION	CC	.0214	CD3	.00807	CDCOR3	.00807
	MACH	.7584				CD4	.00805	CDCOR4	.00802
	ALPHA	-1.4591	DEG			CD5	.60799	CDCOR5	.00785

UPPER SURFACE				LOWER SURFACE				SPANWISE				
X/C	CP	P _L /PT	MLOC	X/C	CP	P _L /PT	MLOC	X/C	Y/(B/2)	CP	P _L /PT	MLOC
0.0000	1.0569	.9740	.1953	0.0000	1.0569	.9740	.1953	-1.507	.7476	-4.506	.5624	.9494
.0132	.2053	.7415	.6710	.0126	.0400	.6963	.7414	-1.507	.4976	-4.687	.5575	.9573
.0259	-1.495	.6446	.8212	.0255	-0.680	.6669	.7869	-1.507	.2476	-4.665	.5581	.9563
.0759	-4.358	.5665	.9430	.0495	-2.052	.6294	.8447	-1.507	-.2524	-4.739	.5560	.9596
.1003	-4.336	.5671	.9421	.0753	-2.720	.6112	.8729	-1.507	-.5024	-4.791	.5546	.9618
.1507	-4.681	.5576	.9570	.1002	-3.328	.5945	.8988	-1.507	-.7524	-4.578	.5604	.9526
.2003	-4.767	.5593	.9608	.1259	-3.999	.5844	.9147	-1.507	-.7476	-6.009	.5214	1.0155
.2503	-5.157	.5446	.9779	.1503	-4.732	.5562	.9593	-1.507	-.4976	-6.008	.5198	1.0182
.3001	-5.407	.5378	.9888	.1776	-5.050	.5475	.9732	-1.507	-.2524	-5.977	.5222	1.0141
.3502	-5.460	.5364	.9912	.2001	-5.258	.5419	.9823	-1.507	-.5024	-5.938	.5233	1.0124
.4003	-5.581	.5331	.9965	.2503	-5.232	.5426	.9811	-1.507	-.7524	-5.770	.5279	1.0049
.4501	-5.691	.5300	1.0014	.3001	-4.795	.5545	.9620	-1.507	-.7476	-1.1457	.3726	1.2809
.5002	-6.067	.5198	1.0181	.3507	-4.219	.5703	.9370	-1.507	-.4976	-1.4089	.5738	.9314
.5502	-6.274	.5141	1.0274	.4001	-3.294	.5955	.8973	-1.507	-.2476	-4.120	.5729	.9328
.6002	-6.528	.5072	1.0389	.4501	-2.061	.6292	.8451	-1.507	-.5024	-3.859	.5801	.9215
.6500	-6.820	.4992	1.0521	.5001	-0.811	.6633	.7924	-1.507	-.7524	-3.813	.5813	.9195
.7000	-6.053	.5202	1.0175	.5500	.0120	.6887	.7532					
.7500	-4.981	.5434	.9701	.6000	.1364	.7227	.7005					
.8002	-4.067	.5744	.9305	.6500	.2372	.7502	.6572					
.8500	-1.962	.6318	.8409	.7000	.3252	.7742	.6197					
.9002	-1.0639	.6680	.7552	.7500	.3990	.7943	.5857					

TEST 167	PT	63.4565	PSI	CN	.4029	CD1	.00807	CDCOR1	.00788
RUN 70	TT	102.0993	K	CM	-1.513	CD2	.00800	CDCOR2	.00782
POINT 5	RC	40.0235	MILLION	CC	.0220	CD3	.00822	CDCOR3	.00815
	MACH	.7591				CD4	.00817	CDCOR4	.00808
	ALPHA	-1.0276	DEG			CD5	.60815	CDCOR5	.00796

UPPER SURFACE				LOWER SURFACE				SPANWISE				
X/C	CP	P _L /PT	MLOC	X/C	CP	P _L /PT	MLOC	X/C	Y/(B/2)	CP	P _L /PT	MLOC
0.0000	1.0959	.9843	.1514	0.0000	1.0959	.9843	.1514	-1.507	.7476	-4.5153	.5425	.9812
.0132	.1175	.7160	.7109	.0126	.1475	.7243	.6980	-1.507	.4976	-4.5372	.5363	.9909
.0259	-2.430	.6172	.8636	.0255	-.0233	.6902	.7509	-1.507	.2476	-4.5475	.5365	.9910
.0759	-5.318	.5380	.9885	.0495	-1.226	.6502	.8126	-1.507	-.2524	-4.5423	.5351	.9931
.1003	-5.111	.5437	.9794	.0753	-1.982	.6295	.8446	-1.507	-.5024	-4.5439	.5347	.9938
.1507	-5.383	.5362	.9914	.1002	-2.665	.6107	.8736	-1.507	-.7524	-4.5163	.5423	.9816
.2003	-5.296	.5386	.9875	.1503	-3.137	.5978	.8938	-1.507	-.4976	-6.446	.5071	1.0390
.2503	-5.715	.5271	1.0061	.1976	-4.167	.5696	.9381	-1.507	-.2476	-6.561	.5039	1.0443
.3001	-6.001	.5193	1.0190	.2503	-4.527	.5597	.9537	-1.507	-.2524	-6.627	.5021	1.0473
.3502	-5.906	.5219	1.0147	.3001	-4.796	.5523	.9655	-1.507	-.5024	-6.646	.5060	1.0409
.4003	-5.991	.5196	1.0185	.3507	-4.828	.5514	.9669	-1.507	-.7524	-6.654	.5069	1.0394
.4501	-6.098	.5166	1.0233	.4001	-4.494	.5606	.9523	-1.507	-.7476	-6.207	.5136	1.0282
.5002	-6.571	.5037	1.0447	.4501	-3.988	.5745	.9303	-1.507	-.4976	-1.1249	.3754	1.2754
.5502	-6.737	.4991	1.0523	.5001	-3.111	.5985	.8926	-1.507	-.2476	-4.051	.5727	.9331
.6002	-6.837	.4964	1.0569	.5497	-1.913	.6314	.8417	-1.507	-.2476	-4.084	.5718	.9345
.6500	-7.100	.4892	1.0690	.6003	-0.688	.6649	.7899	-1.507	-.5024	-3.821	.5791	.9231
.7000	-6.301	.5111	1.0325	.6500	.0222	.6899	.7514	-1.507	-.7524	-3.805	.5795	.9224
.7500	-4.968	.5476	.9730	.7000	.1460	.7238	.6987					
.8002	-4.034	.5732	.9323	.7501	.2460	.7512	.6555					
.8500	-1.921	.6311	.8420	.8001	.3343	.7755	.6167					
.9002	-1.0606	.6672	.7864	.8501	.4085	.7958	.5833					

TEST 167	PT	63.4536	PSI	CN	.4868	CD1	.00841	CDCOR1	.00818
RUN 70	TT	101.8522	K	CM	-1.510	CD2	.00839	CDCOR2	.00819
POINT 6	RC	40.2018	MILLION	CC	.0206	CD3	.00854	CDCOR3	.00842
	MACH	.7602				CD4	.00847	CDCOR4	.00834
	ALPHA	-4.736	DEG			CD5	.00845	CDCOR5	.00822

UPPER SURFACE				LOWER SURFACE				SPANWISE				
X/C	CP	P _L /PT	MLOC	X/C	CP	P _L /PT	MLOC	X/C	Y/(B/2)	CP	P _L /PT	MLOC
0.0000	1.1272	.9933	.0982	0.0000	1.1272	.9933	.0982	-1.507	.7476	-6.603	.5228	1.0131
.0132	-.0002	.8863	.7570	.0126	.2707	.7600	.6415	-1.507	.4976	-6.223	.5168	1.0229
.0259	-.3696	.5857	.9127	.0255	.1291	.7215	.7023	-1.507	.2476	-6.254	.5160	1.0243
.0759	-.7772	.4746	1.0936	.0495	-.0276	.6788	.7685	-1.507	-.2524	-6.318	.5142	1.0272
.1003	-.6012	.5226	1.0136	.0753	-.1116	.6559	.8037	-1.507	-.5024	-6.267	.5156	1.0249
.1507	-.6282	.5152	1.0256	.1002	-.1857	.6387	.8349	-1.507	-.7524	-6.950	.5243	1.0108
.2003	-.6110	.5199	1.0179	.1503	-.2420	.6204	.8586	-1.507	-.4976	-6.788	.5014	1.0484
.2503	-.6326	.5140	1.0276	.1976	-.3421	.5932	.9010	-1.507	-.2476	-6.905	.4982	1.0937
.3001	-.6681	.5043	1.0436	.2503	-.3811	.5825	.9177	-1.507	-.2524	-6.966	.4966	1.0565
.3502	-.6715	.5034	1.0451	.3001	-.4113	.5743	.9306	-1.507	-.5024	-6.833	.5002	1.0505
.4003	-.6377	.5126	1.0299	.3507	-.4221	.5714	.9352	-1.507	-.7524	-6.832	.5002	1.0504
.4501	-.6369	.5129	1.0295	.4001	-.4001	.5773	.9258	-1.507	-.7476	-6.572	.5073	1.0386
.5002	-.6882	.4986	1.0531	.4501	-.3615	.5879	.9093	-1.507	-.4976	-1.1324	.3779	1.2705
.5502	-.7116	.4925	1.0633	.5001	-.2836	.6090	.8763	-1.507	-.2476	-4.067	.5736	.9286
.6002	-.7181	.4907	1.0663	.5497	-.1716	.6396	.8290	-1.507	-.2476	-4.093	.5748	.9298
.6500	-.7176	.4909	1.0661	.6003	-.0542	.6716	.7797	-1.507	-.5024	-3.825	.5821	.9183
.7000	-.6256	.5159	1.0245	.6500	.0329	.6953	.7430	-1.507	-.7524	-3.833	.5819	.9186
.7500	-.4964	.5511	.9674	.7000	.1342	.7283	.6917					
.8002	-.4030	.5766	.9270	.7501	.2525	.7551	.6494					
.8500	-.1901	.6345	.8368	.8001	.3404	.7790	.6109					
.9002	-.0588	.6703	.7816	.8501	.4146	.7993	.5776					

ORIGINAL PART NO
OF POOR QUALITY

TEST	167	PT	63.4645	PSI	CM	.5672	CD1	.00865	CDCOR1	.00840
RUN	70	TT	102.1384	K	CM	-.1514	CD2	.00860	CDCOR2	.00838
POINT	7	RC	39.9909	MILLION	CC	.0191	CD3	.00882	CDCOR3	.00867
		NACH	.7586				CD4	.00871	CDCOR4	.00854
		ALPHA	.0503	DFG			CD5	.00870	CDCOR5	.00843

UPPER SURFACE				LOWER SURFACE				SPANWISE				
X/C	CP	P,L/PT	MLOC	X/C	CP	P,L/PT	MLOC	X/C	Y/(B/2)	CP	P,L/PT	MLOC
0.0000	1.1471	.9988	.0424	0.0000	1.1471	.9988	.0424	.1507	.7476	-.6666	.5047	1.0430
.0132	-.1044	.6578	.9008	.0126	.3740	.7882	.5459	.1507	.4976	-.7212	.4898	1.0676
.0259	-.4796	.5556	.9602	.0255	.2198	.7462	.6636	.1507	.2476	-.8041	.4673	1.1063
.0759	-.8515	.4543	1.1288	-.0495	.0553	.7013	.7337	.1507	-.2524	-.7778	.4744	1.0940
.1003	-.9052	.4670	1.1068	.0753	-.0379	.6760	.7729	.1507	-.5024	-.6515	.5088	1.0361
.1507	-.8212	.4626	1.1144	.1002	-.1152	.6549	.8053	.1507	-.7524	-.6250	.5160	1.0243
.2003	-.6619	.5060	1.0408	.1503	-.1806	.6371	.8328	.5002	.7476	-.7267	.4883	1.0723
.2503	-.6417	.5115	1.0317	.1976	-.2827	.6093	.8758	.5002	.4976	-.7340	.4863	1.0737
.3001	-.7276	.4881	1.0708	.2503	-.3266	.5973	.8945	.5002	.2476	-.7374	.4854	1.0753
.3502	-.7489	.4823	1.0506	.3001	-.3604	.5881	.9089	.5002	-.2524	-.7332	.4866	1.0733
.4003	-.7473	.4827	1.0799	.3507	-.3773	.5835	.9161	.5002	-.5024	-.7387	.4851	1.0759
.4501	-.7292	.4876	1.0715	.4001	-.3627	.5875	.9099	.5002	-.7524	-.7221	.4896	1.0682
.5002	-.7340	.4863	1.0737	.4501	-.3322	.5958	.8969	.8002	.7476	-1.1239	.3801	1.2660
.5502	-.7367	.4862	1.0740	.5001	-.2610	.6152	.8667	.8002	.4976	-.4034	.3764	.9273
.6002	-.7352	.4860	1.0743	.5497	-.1541	.6443	.8217	.8002	.2476	-.4047	.3761	.9278
.6500	-.7297	.4875	1.0717	.6003	-.0404	.6753	.7739	.8002	-.5024	-.3804	.3827	.9174
.7000	-.6287	.5150	1.0259	.6500	.0434	.6981	.7386	.8002	-.7524	-.3815	.3824	.9179
.7500	-.4930	.5520	.9660	.7000	.1633	.7308	.6878					
.8002	-.3969	.5782	.9245	.7501	.2605	.7572	.6460					
.9002	-.1840	.6362	.8342	.8001	.3478	.7810	.6076					
.9501	-.0526	.6720	.7790	.8501	.4221	.8013	.5742					

Appendix P

Pressure Data for $M = 0.78$; $R = 4.4 \times 10^6$, 7.0×10^6 , 10.0×10^6 , 15.0×10^6 , and 30.0×10^6 ; Fixed Transition

The pressure measurements made on the NASA SC(3)-0712(B) airfoil are presented in coefficient form in graphs and tables in this appendix. The data are for a given Mach number through the Reynolds number range. The pressure data from the upper surface of the airfoil are plotted as open symbols, and the lower-surface data are plotted as solid symbols.

TEST 167
 RUN 57
 MACH .780
 R 4.4×10^6

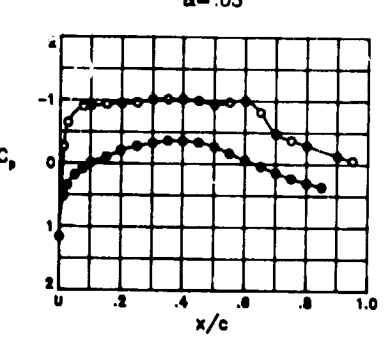
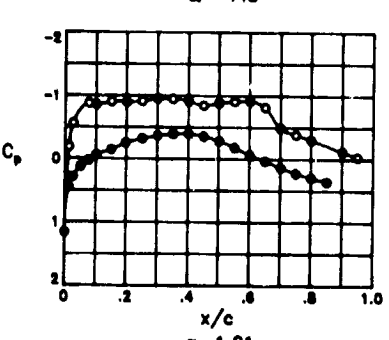
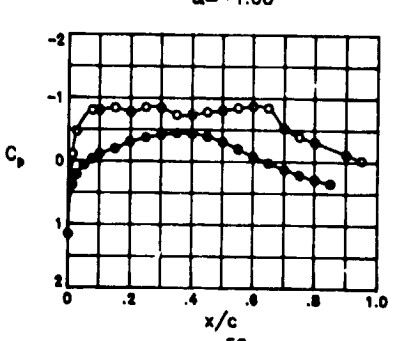
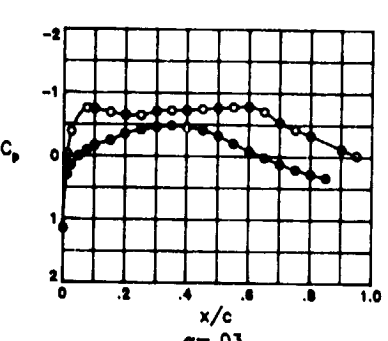
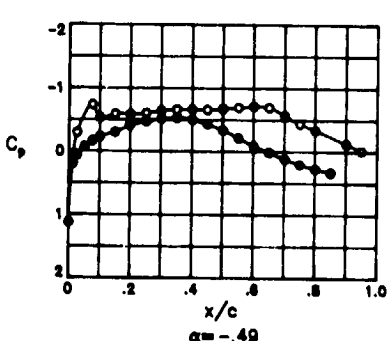
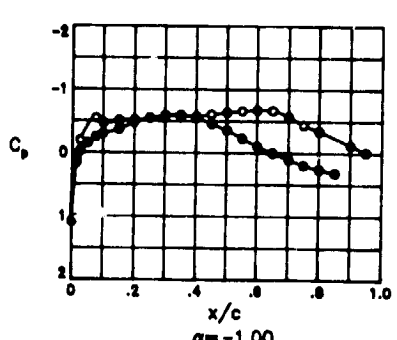
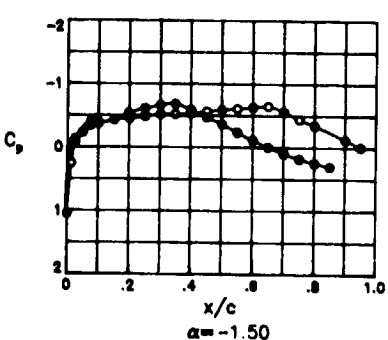
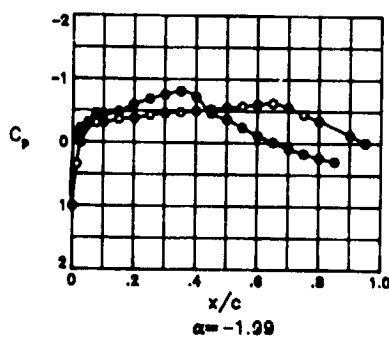
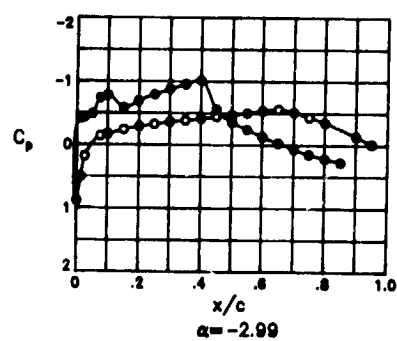
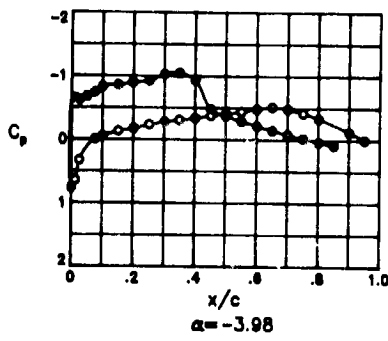

TEST 167	PT 20.6868	PSI	CM -1.882	CD1 .02742	CDCOR1 .02696
RUN 57	TT 220.0722	K	CM -0.760	CD2 .02685	CDCOR2 .02644
POINT 1	RC 4.3969	MILLION	CC .0069	CD3 .02631	CDCOR3 .02600
	MACH .7826			CD4 .02311	CDCOR4 .02270
	ALPHA -3.9815	DEG		CD5 .01905	CDCOR5 .01855

UPPER SURFACE				LOWER SURFACE				SPANWISE				
X/C	CP	P.L/PT	MLOC	X/C	CP	P.L/PT	MLOC	X/C	Y/(B/2)	CP	P.L/PT	MLOC
0.0000	.7670	.8866	.4179	0.0000	.7670	.8866	.4179	.1507	.7476	-.1214	.6322	.8364
.0132	.6415	.8507	.4860	.0126	-.6537	.4797	1.0804	.1507	.4976	-.1359	.6280	.8428
.0259	.3285	.7610	.6366	.0255	-.6213	.4890	1.0647	.1507	.2476	-.1353	.6282	.8425
.0759	-.0053	.6854	.7853	.0495	-.6768	.4731	1.0917	.1507	-.2524	-.1407	.6266	.8449
.1003	-.0526	.6519	.8061	.0753	-.7466	.4531	1.1264	.1507	-.5024	-.1449	.6254	.8468
.1507	-.1341	.6285	.8420	.1002	-.8392	.4277	1.1717	.1507	-.7524	-.1209	.6233	.8462
.2003	-.1712	.6179	.8584	.1503	-.8585	.4210	1.1839	.5002	.7476	-.3957	.5536	.9591
.2503	-.2353	.5995	.8869	.1976	-.8984	.4096	1.2051	.5002	.4976	-.4050	.5509	.9633
.3001	-.2786	.5871	.9062	.2503	-.9293	.4007	1.2217	.5002	.2476	-.4098	.5495	.9655
.3502	-.3081	.5787	.9194	.3001	-1.0278	.3725	1.2765	.5002	-.2524	-.4016	.5519	.9618
.4003	-.3400	.5695	.9338	.3507	-1.0499	.3662	1.2392	.5002	-.5024	-.3968	.5533	.9596
.4501	-.3751	.5595	.9497	.4001	-.9391	.3979	1.2271	.5002	-.7524	-.3830	.5572	.9533
.5002	-.4060	.5506	.9638	.4501	-.9822	.5288	.9989	.8002	.7476	-.3344	.5712	.9312
.5502	-.4431	.5400	.9808	.5001	-.9699	.5610	.9473	.8002	.4976	-.3350	.5710	.9315
.6002	-.4827	.5287	.9991	.5497	-.9899	.5839	.9113	.8002	.2476	-.3391	.5698	.9334
.6500	-.5140	.5197	1.0137	.6003	-.9264	.6050	.8784	.8002	-.5024	-.3358	.5707	.9319
.7000	-.4827	.5287	.9991	.6500	-.9461	.6251	.8473	.8002	-.7524	-.3237	.5742	.9264
.7500	-.4200	.5466	.9702	.7000	-.9807	.6438	.8184					
.8002	-.3364	.5706	.9322	.7501	-.9241	.6600	.7935					
.9002	-.1246	.6312	.8378	.8001	-.9339	.6766	.7680					
.9501	.0012	.6673	.7824	.8501	.0875	.6920	.7444					

TFST 167	PT 20.6815	PSI	CM -0.055	CD1 .01540	CDCOR1 .01495
RUN 57	TT 220.4362	K	CM -1.125	CD2 .01476	CDCOR2 .01436
POINT 2	RC 4.3692	MILLION	CC .0102	CD3 .01436	CDCOR3 .01400
	MACH .7771			CD4 .01430	CDCOR4 .01392
	ALPHA -2.9938	DEG		CD5 .01356	CDCOR5 .01312

UPPER SURFACE				LOWER SURFACE				SPANWISE				
X/C	CP	P.L/PT	MLOC	X/C	CP	P.L/PT	MLOC	X/C	Y/(B/2)	CP	P.L/PT	MLOC
0.0000	.8784	.9198	.3474	0.0000	.8784	.9198	.3474	.1507	.7476	-.2246	.6063	.8763
.0132	.5078	.8144	.5493	.0126	-.4135	.5526	.9606	.1507	.4976	-.2408	.6017	.8834
.0259	.1805	.7215	.6988	.0255	-.4392	.5453	.9723	.1507	.2476	-.2414	.6015	.8837
.0759	-.1408	.6301	.8395	.0495	-.4862	.5320	.9937	.1507	-.2524	-.2468	.6000	.8861
.1003	-.1711	.6213	.8528	.0753	-.5382	.4403	1.1137	.1507	-.5024	-.2511	.5988	.8880
.1507	-.2406	.6018	.8833	.1002	-.7844	.4472	1.1367	.1507	-.7524	-.2230	.6068	.8756
.2003	-.2895	.5879	.9050	.1503	-.8834	.5044	1.0390	.5002	.7476	-.4586	.5398	.9811
.2503	-.3249	.5778	.9207	.1976	-.8885	.4745	1.0893	.5002	.4976	-.4683	.5371	.9855
.3001	-.3628	.5671	.9377	.2503	-.7918	.4451	1.1404	.5002	.2476	-.4731	.5357	.9877
.3502	-.3867	.5603	.9485	.3001	-.8787	.4204	1.1890	.5002	-.2524	-.4637	.5384	.9835
.4003	-.4129	.5528	.9603	.3507	-.9568	.3982	1.2265	.5002	-.5024	-.4588	.5398	.9812
.4501	-.4446	.5438	.9747	.4001	-1.0152	.3816	1.2585	.5002	-.7524	-.4442	.5439	.9745
.5002	-.4697	.5367	.9862	.4501	-.9609	.5107	1.0284	.8002	.7476	-.3452	.5721	.9298
.5502	-.5017	.5276	1.0009	.5001	-.9559	.5690	.9346	.8002	.4976	-.3469	.5716	.9306
.6002	-.5368	.5176	1.0172	.5497	-.9243	.6019	.8832	.8002	.2476	-.3518	.5702	.9328
.6500	-.5605	.5108	1.0283	.6003	-.9284	.6337	.8340	.8002	-.5024	-.3466	.5716	.9305
.7000	-.5136	.5242	1.0064	.6500	-.9275	.6623	.7900	.8002	-.7524	-.3329	.5756	.9243
.7500	-.4380	.5457	.9717	.7000	-.9667	.6891	.7489					
.8002	-.3502	.5706	.9321	.7501	-.9166	.7116	.7139					
.9002	-.1348	.6319	.8368	.8001	.2145	.7311	.6838					
.9501	-.0122	.6667	.7833	.8501	.2728	.7477	.6578					

TFST 167	PT 20.6875	PSI	CM -1.497	CD1 .01321	CDCOR1 .01284
RUN 57	TT 220.4187	K	CM -1.179	CD2 .01270	CDCOR2 .01239
POINT 3	RC 4.3849	MILLION	CC .0155	CD3 .01256	CDCOR3 .01231
	MACH .7816			CD4 .01263	CDCOR4 .01237
	ALPHA -1.9857	DEG		CD5 .01242	CDCOR5 .01209

UPPER SURFACE				LOWER SURFACE				SPANWISE				
X/C	CP	P.L/PT	MLOC	X/C	CP	P.L/PT	MLOC	X/C	Y/(B/2)	CP	P.L/PT	MLOC
0.0000	1.0041	.9552	.2564	0.0000	1.0041	.9552	.2564	.1507	.7476	-.3472	.5703	.9326
.0132	.3468	.7680	.6255	.0126	-.1469	.6273	.8430	.1507	.4976	-.3860	.5649	.9411
.0259	.0061	.6709	.7768	.0255	-.2259	.6048	.8786	.1507	.2476	-.3869	.5646	.9415
.0759	-.3061	.5820	.9142	.0495	-.3141	.5797	.9178	.1507	-.2524	-.3703	.5637	.9430
.1003	-.3094	.5810	.9157	.0753	-.4641	.5370	.9857	.1507	-.5024	-.3727	.5630	.9441
.1507	-.3661	.5649	.9411	.1002	-.4491	.5412	.9788	.1507	-.7524	-.3375	.5730	.9283
.2003	-.3829	.5601	.9487	.1503	-.4877	.5303	.9966	.5002	.7476	-.5384	.5158	1.0201
.2503	-.4311	.5463	.9706	.1976	-.5973	.4990	1.0479	.5002	.4976	-.5489	.5128	1.0250
.3001	-.4643	.5369	.9890	.2503	-.6406	.4724	1.0928	.5002	.2476	-.5543	.5113	1.0276
.3502	-.4782	.5329	.9922	.3001	-.7585	.4531	1.1264	.5002	-.2524	-.5426	.5146	1.0221
.4003	-.4883	.5272	1.0015	.3507	-.8101	.4384	1.1524	.5002	-.5024	-.5374	.5161	1.0197
.4501	-.5270	.5190	1.0148	.4001	-.7261	.4623	1.1103	.5002	-.7524	-.5210	.5207	1.0120
.5002	-.5508	.5122	1.0260	.4501	-.6610	.5379	.9843	.8002	.7476	-.3487	.5698	.9333
.5502	-.5746	.5055	1.0371	.5001	-.6322	.5660	.9394	.8002	.4976	-.3472	.5703	.9326
.6002	-.6082	.4965	1.0521	.5497	-.2378	.6014	.8939	.8002	.2476	-.3495	.5696	.9337
.6500	-.6266	.4907	1.0618	.6003	-.1144	.6366	.8295	.8002	-.5024	-.3491	.5697	.9335
.7000	-.5941	.5113	1.0275	.6500	-.0077	.6670	.7828	.8002	-.7524	-.3400	.5723	.9294
.7500	-.4433	.5429	.9762	.7000	.0013	.6952	.7395					
.8002	-.3475	.5702	.9329	.7501	.1718	.7181	.7040					
.9002	-.1256	.6334	.8345	.8001	.2369	.7367	.6751					
.9501	-.0067	.6673	.7824	.8501	.2917	.7523	.6505					

ORIGINAL POINTS
OF POOR QUALITY

TEST 167	PT	20.6874	PSI		CN	-2271	CD1	.01250	CDCOR1	.01220
RUN 57	TT	220.4568	K		CM	-1197	CD2	.01213	CDCOR2	.01190
POINT 4	RC	4.3798	MILLION		CC	.0170	CD3	.01209	CDCOR3	.01189
	MACH	.7803					CD4	.01213	CDCOR4	.01193
	ALPHA	-1.4969	DEG				CD5	.01194	CDCOR5	.01164

UPPER SURFACE				LOWER SURFACE				SPANWISE				
X/C	CP	P/L/PT	MLOC	X/C	CP	P/L/PT	MLOC	X/C	Y/(B/2)	CP	P/L/PT	MLOC
0.0000	1.0495	.9681	.2155	0.0000	1.0495	.9681	.2155	.1507	.7476	-.4119	.5516	.9622
.0132	-.2564	.7421	.6866	.0126	-.0272	.6612	.7917	.1507	.4976	-.4348	.5451	.9727
.0259	-.0902	.6433	.8192	.0255	-.1274	.6327	.8356	.1507	.2476	-.4306	.5444	.9735
.0759	-.4041	.5938	.9587	.0495	-.2336	.6024	.8824	.1507	-.2524	-.4412	.5432	.9756
.1003	-.3870	.5587	.9909	.0793	-.3411	.5718	.9302	.1507	-.5024	-.4429	.5428	.9764
.1507	-.4359	.5444	.9732	.1002	-.4739	.5488	.9459	.1507	-.7524	-.4040	.5938	.9587
.2003	-.4539	.5396	.9814	.1503	-.4283	.5469	.9697	.5002	.7476	-.5800	.5037	1.0401
.2503	-.4889	.5297	.9975	.1976	-.5405	.5149	1.0213	.5002	.4976	-.5937	.4998	1.0466
.3001	-.5195	.5209	1.0117	.2503	-.6180	.4929	1.0582	.5002	.2476	-.5999	.4980	1.0495
.3502	-.5216	.5203	1.0127	.3001	-.6674	.4788	1.0820	.5002	-.2524	-.5899	.5009	1.0447
.4003	-.5396	.5152	1.0211	.3507	-.6869	.4732	1.0915	.5002	-.5024	-.5833	.5027	1.0418
.4501	-.5676	.5072	1.0342	.4001	-.5882	.5013	1.0440	.5002	-.7524	-.5632	.5085	1.0322
.5002	-.5951	.4994	1.0472	.4501	-.4725	.5343	.9900	.8007	.7476	-.3503	.5692	.9344
.5502	-.6114	.4947	1.0550	.5001	-.3647	.5650	.9409	.8002	.4976	-.3476	.5699	.9332
.6002	-.6327	.4887	1.0652	.5497	-.2351	.6020	.8830	.8002	.2476	-.3489	.5696	.9338
.6500	-.6499	.4841	1.0730	.6003	-.1100	.6377	.8279	.8002	-.5024	-.3521	.5686	.9352
.7000	-.5638	.5083	1.0329	.6500	-.0028	.6682	.7810	.8002	-.7524	-.3442	.5709	.9317
.7500	-.4431	.5427	.9765	.7000	.0980	.6969	.7368					
.8002	-.3455	.5705	.9322	.7501	.1802	.7204	.7006					
.9002	-.1233	.6339	.8338	.8001	.2458	.7391	.6714					
.9501	-.0078	.6668	.7432	.8501	.3009	.7548	.6466					

TEST 167	PT	20.6877	PSI		CN	.3039	CD1	.01238	CDCOR1	.01215
RUN 57	TT	220.3699	K		CM	-.1218	CD2	.01218	CDCOR2	.01200
POINT 5	RC	4.3901	MILLION		CC	.0176	CD3	.01213	CDCOR3	.01201
	MACH	.7797					CD4	.01214	CDCOR4	.01201
	ALPHA	-.9900	DEG				CD5	.01190	CDCOR5	.01165

UPPER SURFACE				LOWER SURFACE				SPANWISE				
X/C	CP	P/L/PT	MLOC	X/C	CP	P/L/PT	MLOC	X/C	Y/(B/2)	CP	P/L/PT	MLOC
0.0000	1.0880	.9	.1738	0.0000	1.0880	.9791	.1739	.1507	.7476	-.4847	.5309	.9955
.0132	-.1995	.7443	.7096	.0126	-.0878	.6941	.7412	.1507	.4976	-.5124	.5230	1.0083
.0259	-.1926	.6142	.8641	.0255	-.0316	.6600	.7935	.1507	.2476	-.5159	.5220	1.0099
.0759	-.5456	.5136	1.0238	.0495	-.1539	.6252	.8471	.1507	-.2524	-.5194	.5210	1.0116
.1003	-.4716	.5346	.9994	.0793	-.2519	.5973	.8903	.1507	-.5024	-.5192	.5211	1.0115
.1507	-.5142	.5225	1.0091	.1002	-.3058	.5819	.9143	.1507	-.7524	-.4737	.5341	.9904
.2003	-.5211	.5206	1.0123	.1503	-.3684	.5641	.9424	.5002	.7476	-.6270	.4904	1.0623
.2503	-.5515	.5119	1.0298	.1976	-.4788	.5326	.9927	.5002	.4976	-.6421	.4881	1.0676
.3001	-.5882	.5040	1.0439	.2503	-.5440	.5140	1.0230	.5002	.2476	-.6484	.4843	1.0726
.3502	-.5790	.5040	1.0396	.3001	-.5928	.5001	1.0460	.5002	-.2524	-.6404	.4866	1.0688
.4003	-.5792	.5040	1.0396	.3507	-.6018	.4976	1.0503	.5002	-.5024	-.6356	.4879	1.0645
.4501	-.6099	.4953	1.0541	.4001	-.5514	.5119	1.0265	.5002	-.7524	-.6143	.4940	1.0542
.5002	-.6411	.4863	1.0691	.4501	-.4602	.5379	.9842	.8002	.7476	-.3502	.5692	.9342
.5502	-.6633	.4800	1.0798	.5001	-.3579	.5671	.9377	.8002	.4976	-.3477	.5700	.9331
.6002	-.6772	.4761	1.0766	.5497	-.2297	.6036	.8805	.8002	.2476	-.3483	.5698	.9334
.6500	-.6690	.4784	1.0826	.6003	-.1057	.6389	.8251	.8002	-.5024	-.3537	.5683	.9358
.7000	-.5712	.5023	1.0358	.6500	.0009	.6693	.7793	.8002	-.7524	-.3482	.5698	.9333
.7500	-.4426	.5429	.9767	.7000	.1036	.6986	.7343					
.8002	-.3428	.5714	.9309	.7501	.1882	.7227	.6969					
.9002	-.1730	.6340	.8335	.8001	.2563	.7421	.6666					
.9501	-.0117	.6657	.7848	.8501	.3130	.7582	.6411					

TEST 167	PT	19.7532	PSI		CN	.3876	CD1	.01259	CDCOR1	.01238
RUN 57	TT	213.2681	K		CM	-.1253	CD2	.01249	CDCOR2	.01233
POINT 6	RC	4.3769	MILLION		CC	.0176	CD3	.01241	CDCOR3	.01227
	MACH	.7804					CD4	.01228	CDCOR4	.01214
	ALPHA	-.4888	DEG				CD5	.01213	CDCOR5	.01178

UPPER SURFACE				LOWER SURFACE				SPANWISE				
X/C	CP	P/L/PT	MLOC	X/C	CP	P/L/PT	MLOC	X/C	Y/(B/2)	CP	P/L/PT	MLOC
0.0000	1.1213	.9887	.1274	0.0000	1.1213	.9887	.1274	.1507	.7476	-.5629	.5049	1.0314
.0132	-.0655	.6879	.7507	.0126	.2000	.7262	.6914	.1507	.4976	-.5873	.5020	1.0429
.0259	-.7927	.5859	.9081	.0255	.0640	.6875	.7513	.1507	.2476	-.5915	.5088	1.0449
.0759	-.7324	.4607	1.1132	.0495	-.0699	.6494	.8099	.1507	-.2524	-.5941	.5080	1.0462
.1003	-.5318	.5178	1.0169	.0793	-.1621	.6231	.8504	.1507	-.5024	-.5914	.5088	1.0449
.1507	-.5909	.5010	1.0447	.1002	-.2314	.6034	.8809	.1507	-.7524	-.5406	.5153	1.0210
.2003	-.5858	.5024	1.0423	.1503	-.3020	.5832	.9123	.5002	.7476	-.6650	.4798	1.0802
.2503	-.6051	.4969	1.0514	.1976	-.4089	.5529	.9402	.5002	.4976	-.6787	.4765	1.0858
.3001	-.6425	.4852	1.0693	.2503	-.4714	.5350	.9889	.5002	.2476	-.6779	.4762	1.0864
.3502	-.6624	.4805	1.0790	.3001	-.5143	.5228	1.0088	.5002	-.2524	-.6692	.4798	1.0802
.4003	-.6622	.4807	1.0788	.3507	-.5315	.5179	1.0168	.5002	-.5024	-.6687	.4788	1.0819
.4501	-.6598	.4813	1.0776	.4001	-.4986	.5272	1.0015	.5002	-.7524	-.6545	.4828	1.0751
.5002	-.6743	.4772	1.0847	.4501	-.4305	.5466	.9702	.8002	.7476	-.3441	.5713	.9311
.5502	-.6945	.4715	1.0945	.5001	-.3367	.5734	.9278	.8002	.4976	-.3409	.5722	.9297
.6002	-.7139	.4659	1.1040	.5497	-.2126	.6087	.8724	.8002	.2476	-.3413	.5720	.9299
.6500	-.6862	.4710	1.0953	.6003	-.0915	.6432	.8194	.8002	-.5024	-.3467	.5705	.9323
.7000	-.5693	.5071	1.0344	.6500	.0136	.6731	.7734	.8002	-.7524	-.3435	.5714	.9308
.7500	-.4384	.5444	.9738	.7000	.1165	.7024	.7283					
.8002	-.3389	.5728	.9287	.7501	.2026	.7270	.6903					
.9002	-.1212	.6348	.8324	.8001	.2723	.7448	.6592					
.9501	-.0161	.6647	.7864	.8501	.3304	.7634	.6329					

TEST 167	PT 19.6626	PSI	CM .4632	CD1 .01301	CDCDR1 .01273
RUN 57	TT 211.2939	K	CM -.1273	CD2 .01300	CDCDR2 .01276
POINT 7	RC 4.4115	MILLION	CC .0172	CD3 .01297	CDCDR3 .01276
	MACH .7799			CD4 .01272	CDCDR4 .01246
	ALPHA .0289	DEG		CD5 .01265	CDCDR5 .01219

UPPER SURFACE				LOWER SURFACE				SPANWISE				
X/C	CP	P _L /PT	MLOC	X/C	CP	P _L /PT	MLOC	X/C	Y/(B/2)	CP	P _L /PT	MLOC
0.0000	1.1414	.9942	.0908	0.0000	1.1414	.9942	.0908	.1507	.7476	-.6254	-.4902	1.0627
.0132	-.0257	.6613	.7917	.0126	1.2933	.7573	.4504	.1507	.4976	-.6345	.4845	1.0690
.0259	-.3878	.9580	.9521	.0255	1.4511	.7100	.7166	.1507	.2476	-.7509	.4544	1.1241
.0759	-.7557	.4530	1.1265	.0495	-.0001	.6686	.7804	.1507	-.2524	-.6762	-.4757	1.0872
.1003	-.7486	.4556	1.1219	.0753	-.0932	.6420	.8212	.1507	-.5024	-.5921	.4997	1.0468
.1507	-.6809	.4715	1.0944	.1002	-.1697	.6202	.8548	.1507	-.7524	-.5952	.4988	1.0482
.2003	-.6502	.4831	1.0746	.1507	-.2465	.5983	.8888	.5002	.7476	-.7417	.4570	1.1195
.2503	-.6463	.4842	1.0727	.1976	-.3321	.5682	.9360	.5002	.4976	-.7554	.4531	1.1264
.3001	-.7102	.4660	1.1039	.2503	-.4165	.5458	.9657	.5002	.2476	-.7664	.4500	1.1319
.3502	-.7212	.4629	1.1093	.3001	-.4605	.5372	.9853	.5002	-.2524	-.7845	.4448	1.1410
.4003	-.7270	.4612	1.1122	.3502	-.4821	.5311	.9953	.5002	-.5024	-.7593	.4520	1.1283
.4501	-.7463	.4557	1.1218	.4001	-.4482	.5366	.9863	.5002	-.7524	-.7507	.4544	1.1240
.5002	-.7634	.4508	1.1304	.4501	-.4086	.5520	.9616	.8002	.7476	-.3396	.5717	.9304
.5502	-.7786	.4465	1.1380	.5001	-.3229	.5765	.9229	.8002	.4976	-.3355	.5729	.9285
.6002	-.7852	.4446	1.1413	.5502	-.2030	.6107	.8694	.8002	.2476	-.3349	.5731	.9282
.6500	-.7063	.4671	1.1020	.6003	-.0845	.6445	.8174	.8002	-.5024	-.3443	.5704	.9325
.7000	-.5331	.5165	1.0190	.6500	.0185	.6739	.7723	.8002	-.7524	-.3428	.5708	.9318
.7500	-.4232	.5479	.9682	.7000	.1213	.7032	.7271					
.8002	-.3298	.5745	.9260	.7501	.2084	.7281	.6886					
.9002	-.1189	.6347	.8325	.8001	.2793	.7483	.6569					
.9501	-.0182	.6634	.7884	.8501	.3384	.7652	.6301					

TEST 167	PT 18.8563	PSI	CM .5430	CD1 .01406	CDCDR1 .01360
RUN 57	TT 205.4599	K	CM -.1304	CD2 .01395	CDCDR2 .01353
POINT 8	RC 4.3988	MILLION	CC .0187	CD3 .01389	CDCDR3 .01349
	MACH .7803			CD4 .01363	CDCDR4 .01307
	ALPHA .5193	DEG		CD5 .01317	CDCDR5 .01275

UPPER SURFACE				LOWER SURFACE				SPANWISE				
X/C	CP	P _L /PT	MLOC	X/C	CP	P _L /PT	MLOC	X/C	Y/(B/2)	CP	P _L /PT	MLOC
0.0000	1.1526	.9971	.0642	0.0000	1.1526	.9971	.0642	.1507	.7476	-.7681	.4469	1.1372
.0132	-.1064	.6363	.8288	.0126	.3738	.7740	.6159	.1507	.4976	-.8784	.4153	1.1944
.0259	-.4717	.9318	.9940	.0255	.2164	.7289	.6873	.1507	.2476	-.8516	.4230	1.1803
.0759	-.8045	.4363	1.1558	.0495	.0620	.6847	.7537	.1507	-.2524	-.7574	.4216	1.1833
.1003	-.8099	.4350	1.1586	.0753	-.0342	.6571	.7980	.1507	-.5024	-.8780	.4155	1.1942
.1507	-.8429	.4246	1.1773	.1002	-.1156	.6338	.8338	.1507	-.7524	-.8689	.4754	1.0878
.2003	-.7802	.4435	1.1434	.1503	-.1987	.6100	.8706	.5002	.7476	-.8250	.4306	1.1684
.2503	-.9507	.4233	1.1798	.1976	-.3052	.5793	.9181	.5002	.4976	-.7996	.4379	1.1533
.3001	-.8466	.4244	1.1777	.2503	-.3727	.5602	.9486	.5002	.2476	-.8237	.4310	1.1659
.3502	-.7373	.4558	1.1217	.3001	-.4194	.5468	.9699	.5002	-.2524	-.8139	.4338	1.1607
.4003	-.7383	.4555	1.1222	.3502	-.4464	.5391	.9823	.5002	-.5024	-.8597	.4207	1.1845
.4501	-.7830	.4427	1.1448	.4001	-.4359	.5421	.9775	.5002	-.7524	-.8596	.4287	1.1845
.5002	-.8100	.4349	1.1587	.4501	-.3911	.5549	.9570	.8002	.7476	-.3331	.5716	.9307
.5502	-.8481	.4240	1.1784	.5001	-.3117	.5777	.9211	.8002	.4976	-.3224	.5746	.9259
.6002	-.8746	.4164	1.1924	.5497	-.1954	.6110	.8691	.8002	.2476	-.3186	.5763	.9233
.6500	-.8487	.4238	1.1788	.6003	-.0791	.6443	.8176	.8002	-.5024	-.3307	.5722	.9296
.7000	-.5250	.5166	1.0189	.6500	.0220	.6732	.7733					
.7500	-.1945	.5539	.9585	.7000	.1242	.7025	.7282					
.8002	-.3043	.5784	.9195	.7501	.2118	.7276	.6893					
.9002	-.1171	.6334	.8345	.8001	.2835	.7482	.6571					
.9501	-.0250	.6598	.7940	.8501	.3436	.7654	.6298					

TEST 167	PT 18.1383	PSI	CM .6275	CD1 .01685	CDCDR1 .01617
RUN 57	TT 200.4234	K	CM -.1350	CD2 .01706	CDCDR2 .01634
POINT 9	RC 4.3806	MILLION	CC .0157	CD3 .01627	CDCDR3 .01570
	MACH .7807			CD4 .01600	CDCDR4 .01546
	ALPHA 1.0141	DEG		CD5 .01574	CDCDR5 .01515

UPPER SURFACE				LOWER SURFACE				SPANWISE				
X/C	CP	P _L /PT	MLOC	X/C	CP	P _L /PT	MLOC	X/C	Y/(B/2)	CP	P _L /PT	MLOC
0.0000	1.1613	1.0000	.0074	0.0000	1.1613	1.0000	.0074	.1507	.7476	-.8325	.4259	1.1752
.0132	-.1905	.6146	.8636	.0126	.4513	.7975	.5775	.1507	.4976	-.9446	.3996	1.2240
.0259	-.5631	.9083	1.0325	.0255	.2861	.7504	.6535	.1507	.2476	-.9003	.4122	1.2003
.0759	-.8761	.4191	1.1875	.0495	.1259	.7048	.7248	.1507	-.2524	-.9068	.4103	1.2037
.1003	-.8573	.4244	1.1777	.0753	.0288	.6771	.7674	.1507	-.5024	-.9339	.3969	1.2290
.1507	-.9040	.4111	1.2022	.1002	-.0577	.6524	.8053	.1507	-.7524	-.8885	.4384	1.1525
.2003	-.8463	.4133	1.1991	.1503	-.1452	.6275	.8437	.5002	.7476	-.9270	.4046	1.2145
.2503	-.9114	.4090	1.2062	.1976	-.2505	.5974	.8902	.5002	.4976	-.9418	.4004	1.2225
.3001	-.9527	.3973	1.2284	.2503	-.3161	.5782	.9203	.5002	.2476	-.8940	.4140	1.1969
.3502	-.8493	.3982	1.2265	.3001	-.3856	.5646	.9416	.5002	-.2524	-.8927	.4144	1.1962
.4003	-.9005	.4098	1.2346	.3502	-.3956	.5561	.9552	.5002	-.5024	-.9746	.3910	1.2404
.4501	-.8441	.4282	1.1708	.4001	-.3926	.5569	.9538	.5002	-.7524	-.9213	.4062	1.2115
.5002	-.8448	.4166	1.1921	.4501	-.3575	.5670	.9379	.8002	.7476	-.3210	.5774	.9215
.5502	-.9060	.4106	1.2033	.5001	-.2872	.5870	.9065	.8002	.4976	-.3142	.5793	.9185
.6002	-.9177	.4072	1.2095	.5497	-.1769	.6184	.8574	.8002	.2476	-.3093	.5807	.9163
.6500	-.8146	.4366	1.1557	.6003	-.0645	.6505	.8093	.8002	-.5024	-.3179	.5782	.9202
.7000	-.4849	.5306	.9960	.6500	.0359	.6785	.7652					
.7500	-.3833	.5596	.9446	.7000	.1352	.7074	.7207					
.8002	-.3019	.5828	.9130	.7501	.2231	.7325	.6817					
.9002	-.1183	.6351	.8314	.8001	.2956	.7531	.6492					
.9501	-.0314	.6599	.7838	.8501	.3566	.7705	.6215					

ORIGINAL ENGINE
OF POOR QUALITY

TEST 167	PT 17.0218	PSI	CM	.0900	CD1 .01993	CDCOR1 .01922
RUN 57	TY 197.3250	K	CM	-.1411	CD2 .02116	CDCOR2 .02041
POINT 10	RC 4.3936	MILLION	CC	.0163	CD3 .02084	CDCOR3 .01990
	MACH .791				CD4 .02034	CDCOR4 .01912
	ALPHA 1.9172	DEG			CD5 .02111	CDCOR5 .02048

UPPER SURFACE				LOWER SURFACE				SPANWISE				
X/C	CP	P/L/PY	MLOC	X/C	CP	P/L/PY	MLOC	X/C	Y/(B/2)	CP	P/L/PY	MLOC
0.0700	1.1805	.9996	.0229	0.0700	1.1805	.9996	-.0229	.1507	.7476	-.9072	.4094	1.2056
.0132	-.2866	.9922	.8983	.0126	.5189	.8165	-.5458	.1507	.4976	-.9707	.3912	1.2400
.0259	-.0438	.4846	1.0722	.0255	.3468	.7674	-.8266	.1507	.2474	-.9033	.4105	1.2035
.0758	-.9009	.4112	1.2022	.0495	.1888	.7200	-.7012	.1507	-.7524	-.9435	.3990	1.2291
.1003	-.9152	.4071	1.2048	.0753	.6826	.6919	-.7446	.1507	-.5024	-.9963	.3839	1.2541
.1507	-.9385	.4604	1.2224	.1002	-.0090	.6636	-.7846	.1507	-.7524	-.8780	.4177	1.1901
.2003	-.9533	.3962	1.2304	.1503	-.1312	.6395	-.8252	.3002	.7476	-.9957	.3841	1.2538
.2503	-.9660	.3928	1.2374	.1976	-.2369	.6093	-.8718	.3002	.4976	-1.0145	.3767	1.2643
.3001	-1.0173	.3779	1.2659	.2503	-.2761	.5895	-.9025	.3002	.2476	-1.0065	.3816	1.2598
.3502	-1.0215	.3767	1.2682	.3001	-.3258	.5754	-.9247	.3002	-.2524	-.9900	.3857	1.2506
.4003	-1.0231	.3763	1.2691	.3507	-.3595	.5657	-.9399	.3002	-.5024	-1.0077	.3807	1.2605
.4501	-.9971	.3837	1.2545	.4001	-.3923	.5649	-.9412	.3002	-.7524	-.9814	.3882	1.2458
.5002	-.9617	.3995	1.2241	.4501	-.3346	.5728	-.9287	.8002	.7476	-.3079	.5864	.9167
.5502	-.9756	.3998	1.2426	.5001	-.2712	.5909	-.9003	.8002	.4976	-.2987	.5831	.9176
.6002	-1.0008	.3927	1.2566	.5502	-.1863	.6209	-.8539	.8002	.2476	-.2954	.5848	.9111
.6500	-.8190	.4346	1.1594	.6003	-.0978	.6519	-.8061	.8002	-.5024	-.3059	.5810	.9116
.7000	-.4777	.5320	.9939	.6500	.0387	.6794	-.7639	.8002	-.7524	.3127	.5791	.9111
.7500	-.3743	.5615	.9466	.7003	.1390	.7080	-.7198					
.8002	-.2819	.5850	.9096	.7501	.2246	.7330	-.6809					
.8502	-.1272	.6320	.8367	.8001	.3000	.7540	-.6479					
.9001	-.0537	.6530	.8044	.8501	.3621	.7717	-.6197					

ORIGINAL PAGE IS
OF POOR QUALITY

TEST 167	PT 21.9779	PSI	CN -.1608	CD1 .02165	CDCOR1 .02141
RUN 60	TT 165.0438	K	CM -.0953	CD2 .02258	CDCOR2 .02240
POINT 41	RC 6.9682	MILLION	CC .0064	CD3 .02387	CDCOR3 .02377
	MACH .7811			CD4 .02256	CDCOR4 .02237
	ALPHA -4.0120	DEG		CD5 .01895	CDCOR5 .01851

UPPER SURFACE				LOWER SURFACE				SPANWISE				
X/C	CP	P/L/PT	MLOC	X/C	CP	P/L/PT	MLOC	X/C	Y/(B/2)	CP	P/L/PT	MLOC
0.0000	.7677	.8874	.4165	0.0000	.7677	.8874	.4165	.1507	.7476	-.1160	.6350	.8322
.0132	.6445	.8522	.4873	.0126	-.6576	.4803	1.0796	.1507	.4976	-.1303	.6309	.8385
.0259	.3303	.7625	.6345	.0255	-.6166	.4920	1.0599	.1507	.2476	-.1297	.6311	.8383
.0759	-.0062	.6663	.7841	.0495	-.6535	.4815	1.0776	.1507	-.2524	-.1323	.6303	.8394
.1003	-.0492	.6540	.8029	.0753	-.7537	.4529	1.1270	.1507	-.5024	-.1386	.6285	.8422
.1507	-.1290	.6313	.8380	.1002	-.8648	.4211	1.1840	.1507	-.7524	-.1204	.6337	.8342
.2003	-.1833	.6158	.8614	.1503	-.8590	.4228	1.1809	.5002	.7476	-.3965	.5549	.9572
.2503	-.2324	.6017	.8836	.1976	-.9047	.4097	1.2051	.5002	.4976	-.4043	.5526	.9608
.3001	-.2768	.5890	.9034	.2503	-.9245	.4041	1.2157	.5002	.2476	-.4094	.5512	.9632
.3502	-.3055	.5809	.9162	.3001	-1.0230	.3759	1.2700	.5002	-.2524	-.4003	.5538	.9590
.4003	-.3378	.5716	.9307	.3507	-1.0361	.3722	1.2774	.5002	-.5024	-.3963	.5549	.9572
.4501	-.3734	.5615	.9468	.4001	-1.0603	.3653	1.2913	.5002	-.7524	-.3842	.5584	.9517
.5002	-.4063	.5521	.9617	.4501	-.5673	.5061	1.0364	.8002	.7476	-.3386	.5714	.9311
.5502	-.4441	.5413	.9790	.5001	-.3986	.5543	.9582	.8002	.4976	-.3400	.5710	.9317
.6002	-.4858	.5294	.9982	.5497	-.2916	.5848	.9100	.8002	.2476	-.3452	.5695	.9340
.6500	-.5197	.5197	1.0140	.6003	-.1881	.6144	.8640	.8002	-.5024	-.3372	.5718	.9305
.7000	-.4881	.5287	.9993	.6500	-.0915	.5420	.8215	.8002	-.7524	-.3257	.5751	.9253
.7500	-.4248	.5468	.9702	.7000	-.0026	.6674	.7825					
.8002	-.3425	.5703	.9329	.7501	.0725	.6888	.7496					
.9002	-.1322	.5303	.8394	.8001	.1378	.7075	.7207					
.9501	-.0041	.6669	.7831	.8501	.1954	.7239	.6952					

TEST 167	PT 21.9572	PSI	CM .0216	CD1 .01436	CDCOR1 .01412
RUN 60	TT 165.1464	K	CM -.1220	CD2 .01378	CDCOR2 .01361
POINT 42	RC 6.9626	MILLION	CC .0118	CD3 .01353	CDCOR3 .01341
	MACH .7806			CD4 .01345	CDCOR4 .01330
	ALPHA -3.0010	DEG		CD5 .01286	CDCOR5 .01243

UPPER SURFACE				LOWER SURFACE				SPANWISE				
X/C	CP	P/L/PT	MLOC	X/C	CP	P/L/PT	MLOC	X/C	Y/(B/2)	CP	P/L/PT	MLOC
0.0000	.8907	.9225	.3414	0.0000	.8907	.9225	.3414	.1507	.7476	-.2284	.6027	.8821
.0132	.5048	.8122	.5531	.0126	-.3907	.5563	.9549	.1507	.4976	-.2462	.5976	.8900
.0259	.1738	.7176	.7050	.0255	-.4174	.5487	.9671	.1507	.2476	-.2464	.5976	.8901
.0759	-.1515	.6247	.8481	.0495	-.4564	.5376	.9850	.1507	-.2524	-.2495	.5967	.8915
.1003	-.1768	.6175	.8593	.0753	-.7613	.4504	1.1312	.1507	-.5024	-.2554	.5950	.8941
.1507	-.2457	.5978	.8898	.1002	-.7817	.4446	1.1415	.1507	-.7524	-.2327	.6015	.8840
.2003	-.2903	.5850	.9097	.1503	-.5597	.5081	1.0331	.5002	.7476	-.4762	.5319	.9941
.2503	-.3332	.5728	.9289	.1976	-.6692	.4768	1.0856	.5002	.4976	-.4840	.5297	.9977
.3001	-.3735	.5613	.9471	.2503	-.7732	.4471	1.1372	.5002	.2476	-.4892	.5282	1.0001
.3502	-.3931	.5557	.9560	.3001	-.8616	.4218	1.1827	.5002	-.2524	-.4804	.5307	.9961
.4003	-.4218	.5474	.9691	.3507	-.9419	.3989	1.2255	.5002	-.5024	-.4767	.5318	.9943
.4501	-.4566	.5375	.9850	.4001	-1.0034	.3713	1.2595	.5002	-.7524	-.4641	.5354	.9885
.5002	-.4849	.5294	.9981	.4501	-.6240	.4897	1.0637	.8002	.7476	-.3960	.5662	.9392
.5502	-.5199	.5194	1.0144	.5001	-.3578	.5657	.9400	.8002	.4976	-.3974	.5658	.9398
.6002	-.5592	.5082	1.0329	.5497	-.2346	.6009	.8849	.8002	.2476	-.3625	.5644	.9421
.6500	-.5962	.4976	1.0504	.6003	-.1189	.6340	.8337	.8002	-.5024	-.3575	.5658	.9399
.7000	-.5302	.5108	1.0286	.6500	-.0148	.6637	.7880	.8002	-.7524	-.3467	.5689	.9350
.7500	-.4505	.5393	.9422	.7000	.0864	.6927	.7436					
.8002	-.3592	.5654	.9406	.7501	.1740	.7177	.7049					
.9002	-.1447	.6266	.8451	.8001	.2471	.7386	.6723					
.9501	-.0184	.6627	.7896	.8501	.3091	.7563	.6443					

TEST 167	PT 21.9608	PSI	CN .1807	CD1 .01204	CDCOR1 .01169
RUN 60	TT 165.1702	K	CM -.1265	CD2 .01161	CDCOR2 .01144
POINT 43	RC .9579	MILLION	CC .0163	CD3 .01140	CDCOR3 .01116
	MACH .7797			CD4 .01164	CDCOR4 .01138
	ALPHA -1.4958	DEG		CD5 .01193	CDCOR5 .01121

UPPER SURFACE				LOWER SURFACE				SPANWISE				
X/C	CP	P/L/PT	MLOC	X/C	CP	P/L/PT	MLOC	X/C	Y/(B/2)	CP	P/L/PT	MLOC
0.0000	1.0073	.9562	.2535	0.0000	1.0073	.9562	.2535	.1507	.7476	-.3493	.5701	.9331
.0132	.3465	.7664	.6282	.0126	-.1364	.6307	.8388	.1507	.4976	-.3702	.5641	.9425
.0259	-.0033	.6686	.7806	.0255	-.2165	.6079	.8741	.1507	.2476	-.3714	.5638	.9431
.0759	-.3175	.5792	.9189	.0495	-.3007	.5840	.9114	.1507	-.2524	-.3749	.5628	.9446
.1003	-.3161	.5795	.9183	.0753	-.4685	.5362	.9872	.1507	-.5024	-.3797	.5615	.9468
.1507	-.3708	.5640	.9428	.1002	-.4387	.5447	.9736	.1507	-.7524	-.3516	.5695	.9341
.2003	-.4326	.5578	.9526	.1503	-.4748	.5344	.9901	.5002	.7476	-.3509	.5727	1.0254
.2503	-.4379	.5449	.9732	.1976	-.5844	.5032	1.0412	.5002	.4976	-.3510	.5695	1.0292
.3001	-.4728	.5349	.9892	.2503	-.6737	.4778	1.0839	.5002	.2476	-.3570	.5691	1.0330
.3502	-.4815	.5325	.9932	.3001	-.7348	.4604	1.1139	.5002	-.2524	-.3573	.5709	1.0284
.4003	-.5036	.5262	1.0034	.3507	-.7745	.4491	1.1337	.5002	-.5024	-.3521	.5724	1.0260
.4501	-.5344	.5174	1.0177	.4001	-.6171	.4939	1.0567	.5002	-.7524	-.3367	.5769	1.0188
.5002	-.5635	.5091	1.0313	.4501	-.4601	.5366	.9834	.8002	.7476	-.3581	.5676	.9371
.5502	-.5857	.5028	1.0418	.5001	-.3609	.5668	.9384	.8002	.4976	-.3579	.5676	.9370
.6002	-.6215	.4926	1.0588	.5497	-.2332	.6034	.8815	.8002	.2476	-.3517	.5666	.9387
.6500	-.6519	.4840	1.0734	.6003	-.1079	.6388	.8264	.8002	-.5024	-.3610	.5668	.9384
.7000	-.5773	.5057	1.0378	.6500	-.0004	.6674	.7793	.8002	-.7524	-.3527	.5691	.9346
.7500	-.4541	.5403	.9806	.7000	.1042	.6992	.7335					
.8002	-.3587	.5674	.9374	.7501	.1912	.7240	.6952					
.9002	-.1341	.6302	.8396	.8001	.2615	.7440	.6638					
.9501	-.0144	.6654	.7854	.8501	.3206	.7608	.6372					

TEST	167	PT	21.9779	PSI	CN	.2595	CD1	.01155	CDCOR1	.01127		
RUN	60	TT	165.1313	K	CM	-.1292	CD2	.01121	CDCOR2	.01096		
POINT	44	RC	6.9628	MILLION	CC	.0180	CD3	.01110	CDCOR3	.01084		
		MACH	.7792				CD4	.01121	CDCOR4	.01095		
		ALPHA	-1.5071	DEG			CD5	.01105	CDCOR5	.01078		
UPPER SURFACE				LOWER SURFACE				SPANWISE				
X/C	CP	P/L/PT	MLOC	X/C	CP	P/L/PT	MLOC	X/C	Y/(B/2)	CP	P/L/PT	MLOC
0.0000	1.0540	.9695	.2107	0.0000	1.0540	.9695	.2107	.1507	.7476	-.4160	.5511	.9633
.0132	.2499	.7406	.6691	.0126	-.0143	.8654	.7853	.1507	.4976	-.4387	.5466	.9737
.0259	-.1000	.6410	.8229	.0255	-.1159	.6365	.8299	.1507	.2476	.4407	.5440	.9746
.0759	-.4160	.5511	.9633	.0495	-.2186	.6073	.8750	.1507	-.2524	.30	.5434	.9756
.1003	-.3929	.5576	.9529	.0753	-.3406	.5725	.9293	.1507	-.5024	.50	.5425	.9770
.1507	-.4398	.5443	.9742	.1002	-.3624	.5663	.9293	.1507	-.7524	.15	.5518	.9622
.2003	-.4590	.5388	.9830	.1503	-.4120	.5522	.9619	.5002	.7476	-.5951	.5001	1.0463
.2503	-.4945	.5287	.9993	.1976	-.5228	.5207	1.0124	.5002	.4976	-.6082	.5001	1.0526
.3001	-.5284	.5191	1.0150	.2503	-.5913	.5012	1.0445	.5002	.2476	-.6145	.4946	1.0555
.3502	-.5295	.5188	1.0155	.3001	-.6396	.4874	1.0676	.5002	-.2524	-.6046	.4974	1.0509
.4003	-.5472	.5137	1.0238	.3507	-.6419	.4868	1.0687	.5002	-.5024	-.5993	.5003	1.0483
.4501	-.5757	.5056	1.0372	.4001	-.6590	.4804	1.0293	.5002	-.7524	-.5803	.5043	1.0393
.5002	-.6102	.4957	1.0536	.4501	-.6573	.5393	.9822	.8002	.7476	-.3583	.5675	.9372
.5502	-.6320	.4896	1.0639	.5001	-.6536	.5688	.9351	.8002	.4976	-.3568	.5679	.9365
.6002	-.6519	.4839	1.0735	.5497	-.6245	.6056	.8777	.8002	.2476	-.3598	.5671	.9379
.6500	-.6764	.4769	1.0853	.6003	-.6095	.6412	.8227	.8002	-.5024	-.3604	.5669	.9382
.7000	-.6993	.4617	1.0436	.6500	.0074	.6716	.7760	.8002	-.7524	-.3529	.5690	.9348
.7500	-.4538	.5403	.9806	.7000	.1128	.7016	.7298					
.8002	-.3570	.5679	.9366	.7501	.2007	.7266	.6910					
.9002	-.1356	.6309	.8336	.8001	.2720	.7469	.6592					
.9501	-.0151	.6652	.7838	.8501	.3320	.7640	.6321					

TEST	167	PT	21.9798	PSI	CN	.3394	CD1	.01159	CDCOR1	.01129		
RUN	60	TT	165.1433	K	CM	-.1315	CD2	.01139	CDCOR2	.01113		
POINT	45	RC	6.9623	MILLION	CC	.0186	CD3	.01131	CDCOR3	.01110		
		MACH	.7791				CD4	.01137	CDCOR4	.01115		
		ALPHA	-1.0081	DEG			CD5	.01119	CDCOR5	.01090		
UPPER SURFACE				LOWER SURFACE				SPANWISE				
X/C	CP	P/L/PT	MLOC	X/C	CP	P/L/PT	MLOC	X/C	Y/(B/2)	CP	P/L/PT	MLOC
0.0000	1.0930	.9807	.1672	0.0000	1.0930	.9807	.1672	.1507	.7476	-.4889	.5305	.9964
.0132	.1514	.7127	.7126	.0126	.1033	.6990	.7338	.1507	.4976	-.5145	.5232	1.0000
.0259	-.2030	.6118	.8680	.0255	-.0172	.6647	.7865	.1507	.2476	-.5182	.5222	1.0100
.0759	-.5640	.5091	1.0314	.0495	-.1356	.6310	.8383	.1507	-.2524	.5195	.5218	1.0106
.1003	-.4762	.5341	.9906	.0753	-.2453	.5998	.8866	.1507	-.5024	.5210	.5214	1.0113
.1507	-.5172	.5224	1.0095	.1002	-.2884	.5876	.9057	.1507	-.7524	.4829	.5322	.9936
.2003	-.5253	.5201	1.0132	.1503	-.3481	.5706	.9324	.5002	.7476	-.6413	.4871	1.0688
.2503	-.5558	.5115	1.0275	.1976	-.4558	.5399	.9812	.5002	.4976	-.6535	.4836	1.0739
.3001	-.5969	.4998	1.0469	.2503	-.5167	.5226	1.0093	.5002	.2476	-.6585	.4822	1.0763
.3502	-.5963	.4999	1.0466	.3001	-.5591	.5105	1.0290	.5002	-.2524	-.6477	.4853	1.0711
.4003	-.5859	.5029	1.0417	.3507	-.5681	.5085	1.0323	.5002	-.5024	-.6451	.4861	1.0699
.4501	-.6143	.4948	1.0551	.4001	-.5184	.5221	1.0101	.5002	-.7524	-.6277	.4910	1.0615
.5002	-.6509	.4844	1.0727	.4501	-.4384	.5449	.9732	.8002	.7476	-.3581	.5677	.9369
.5502	-.6835	.4751	1.0884	.5001	-.3410	.5726	.9292	.8002	.2476	-.3573	.5685	.9357
.6002	-.7096	.4677	1.1012	.5497	-.2147	.6085	.8731	.8002	.4976	-.3554	.5680	.9365
.6500	-.7126	.4669	1.1026	.6003	-.0915	.6436	.8190	.8002	-.5024	-.3588	.5675	.9372
.7000	-.5944	.5005	1.0457	.6500	.0137	.6735	.7730	.8002	-.7524	-.3334	.5691	.9348
.7500	-.4500	.5416	.9755	.7000	.1197	.7037	.7266					
.8002	-.3528	.5692	.9345	.7501	.2093	.7292	.6870					
.9002	-.1340	.6315	.8376	.8001	.2822	.7499	.6545					
.9501	-.0166	.6649	.7862	.8501	.3436	.7674	.6266					

TEST	167	PT	21.9779	PSI	CN	.4243	CD1	.01186	CDCOR1	.01150		
RUN	60	TT	165.0723	K	CM	-.1344	CD2	.01172	CDCOR2	.01140		
POINT	46	RC	6.9579	MILLION	CC	.0183	CD3	.01167	CDCOR3	.01134		
		MACH	.7774				CD4	.01159	CDCOR4	.01127		
		ALPHA	-.4490	DEG			CD5	.01159	CDCOR5	.01116		
UPPER SURFACE				LOWER SURFACE				SPANWISE				
X/C	CP	P/L/PT	MLOC	X/C	CP	P/L/PT	MLOC	X/C	Y/(B/2)	CP	P/L/PT	MLOC
0.0000	1.1252	.9900	.1197	0.0000	1.1252	.9900	.1197	.1507	.7476	-.5698	.5089	1.0316
.0132	.0486	.6845	.7562	.0126	.2165	.7321	.8824	.1507	.4976	-.5895	.5034	1.0409
.0259	-.3117	.5822	.9141	.0255	.0779	.6726	.7434	.1507	.2476	-.5942	.5020	1.0431
.0759	-.7462	.4589	1.1165	.0495	-.0531	.6556	.8005	.1507	-.2524	-.5969	.5013	1.0444
.1003	-.5530	.5137	1.0237	.0753	-.1535	.6271	.8444	.1507	-.5024	-.5952	.5017	1.0436
.1507	-.5964	.5014	1.0441	.1002	-.2151	.6096	.8714	.1507	-.7524	-.5929	.5138	1.0237
.2003	-.6175	.4934	1.0541	.1503	-.2820	.5907	.9009	.5002	.7476	-.6895	.4775	1.0843
.2503	-.6127	.4968	1.0518	.1976	-.3856	.5612	.9472	.5002	.4976	-.6896	.4749	1.0887
.3001	-.6489	.4865	1.0691	.2503	-.4445	.5445	.9738	.5002	.2476	-.6909	.4746	1.0894
.3502	-.6704	.4803	1.0796	.3001	-.4826	.5337	.9912	.5002	-.2524	-.6819	.4772	1.0850
.4003	-.6745	.4792	1.0814	.3507	-.4983	.5292	.9984	.5002	-.5024	-.6777	.4783	1.0829
.4501	-.6753	.4790	1.0818	.4001	-.4690	.5376	.9850	.8002	-.7524	-.6668	.4809	1.0787
.5002	-.6917	.4744	1.0897	.4501	-.4079	.5549	.9572	.8002	.7476	-.3560	.5696	.9339
.5502	-.7125	.4684	1.0999	.5001	-.3189	.5802	.9173	.8002	.4976	-.3535	.5703	.9327
.6002	-.7315	.4631	1.1092	.5497	-.1979	.6145	.8638	.8002	.2476	-.3554	.5698	.9336
.6500	-.7336	.4625	1.1103	.6003	-.0782	.6485	.8115	.8002	-.5024	-.3551	.5693	.9334
.7000	-.5939	.5021	1.0430	.6500	.0246	.6777	.7667	.8002	-.7524	-.3502	.5712	.9312
.7500	-.4503	.5429	.9764	.7000	.1305	.7077	.7203					
.8002	-.3526	.5706	.9374	.7501	.2209	.7334	.6804					
.9002	-.1343	.6326	.8360	.8001	.2950	.7544	.6473					
.9501	-.0216	.6645	.7868	.8501	.3578	.7722	.6189					

TEST 167 PT 21.9742 PSI CN .5012
 RUN 60 TT 165.0584 K CM -.1379
 POINT 47 WC 6.9632 MILLION CC .0184
 MACH .7786
 ALPHA -.0070 DEG

UPPER SURFACE				LOWER SURFACE				SPANWISE				
X/C	CP	P/L/PT	MLOC	X/C	CP	P/L/PT	MLOC	X/C	Y/(B/2)	CP	P/L/PT	MLOC
0.0000	1.1436	.9951	.0840	0.0000	1.1436	.9951	.0840	.1507	.7476	-.6408	.4874	1.0676
.0132	-.0363	.6594	.7948	.0126	.3102	.7580	.6417	.1507	.4976	-.6688	.4794	1.0811
.0259	-.4017	.5554	.9564	.0255	.1593	.7150	.7090	.1507	.2476	-.7637	.4524	1.1278
.0759	-.7600	.4534	1.1260	.0495	-.0173	.6746	.7714	.1507	-.2524	-.7243	.4436	1.1082
.1003	-.7459	.5575	1.1184	.0753	-.0827	.6462	.8150	.1507	-.5024	-.5868	.5027	1.0419
.1507	-.7112	.4665	1.1033	.1002	-.1537	.6260	.8461	.1507	-.7524	-.5980	.4996	1.0472
.2003	-.6974	.4713	1.0951	.1503	-.2269	.6051	.8771	.5002	.7476	-.7597	.4535	1.1258
.2503	-.6205	.4649	1.0974	.1976	-.3304	.5787	.9243	.5002	.4976	-.7707	.4504	1.1313
.3001	-.7021	.4623	1.1104	.2503	-.3914	.5583	.9517	.5002	.2476	-.7782	.4483	1.1351
.3502	-.7287	.4599	1.1147	.3001	-.4323	.5467	.9703	.5002	-.2524	-.7914	.4445	1.1417
.4003	-.7374	.4548	1.1236	.3507	-.4520	.5408	.9797	.5002	-.5024	-.7703	.4505	1.1311
.4501	-.7552	.4491	1.1337	.4001	-.4338	.5463	.9710	.5002	-.7524	-.7597	.4535	1.1258
.5002	-.7754	.4431	1.1442	.4501	-.3837	.5605	.9483	.8002	.7476	-.3483	.5706	.9323
.6002	-.8284	.4340	1.1606	.5001	-.3019	.5838	.9116	.8002	.4976	-.3422	.5723	.9293
.6500	-.8741	.4338	1.1431	.5497	-.1853	.6170	.8600	.8002	.2476	-.3415	.5725	.9293
.7000	-.8740	.5064	1.0359	.6003	-.0685	.6502	.8088	.8002	-.5024	-.3456	.5713	.9312
.7500	-.4302	.5473	.9694	.6500	.0321	.6789	.7649	.8002	-.7524	-.3446	.5716	.9307
.8002	-.3350	.5732	.9282	.7000	.1375	.7088	.7187					
.9002	-.1297	.6328	.8356	.7501	.2279	.7345	.6787					
.9501	-.0229	.6632	.7889	.8001	.3027	.7550	.6451					
				.8501	.3664	.7739	.6161					

TEST 167 PT 21.8941 PSI CN .5466
 RUN 60 TT 165.1861 K CM -.1391
 POINT 48 WC 6.9383 MILLION CC .0169
 MACH .7802
 ALPHA .4990 DEG

UPPER SURFACE				LOWER SURFACE				SPANWISE				
X/C	CP	P/L/PT	MLOC	X/C	CP	P/L/PT	MLOC	X/C	Y/(B/2)	CP	P/L/PT	MLOC
0.0000	1.1606	1.0002	0.0000	0.0000	1.1606	1.0002	0.0000	.1507	.7476	-.7875	.4482	1.1353
.0132	-.1291	.6348	.8326	.0126	.4053	.7862	.5963	.1507	.4976	-.8931	.4183	1.1892
.0259	-.5016	.5292	.9985	.0255	.2433	.7403	.6676	.1507	.2476	-.8664	.4258	1.1753
.0759	-.8479	.4311	1.1659	.0495	.0894	.6967	.7374	.1507	-.2524	-.8697	.4249	1.1770
.1003	-.8441	.4321	1.1439	.0753	-.0107	.6683	.7810	.1507	-.5024	-.8943	.4179	1.1898
.1507	-.8637	.4266	1.1740	.1002	-.0893	.6460	.8153	.1507	.7524	-.7095	.4703	1.0967
.2003	-.7738	.4521	1.1284	.1503	-.1689	.6235	.8500	.5002	.7476	-.8321	.4356	1.1577
.2503	-.8678	.4254	1.1761	.1976	-.2715	.5944	.8951	.5002	.4976	-.7940	.4463	1.1385
.3001	-.8664	.4258	1.1753	.2503	-.3344	.5766	.9229	.5002	.2476	-.8175	.4397	1.1504
.3502	-.7828	.4495	1.1329	.3001	-.3768	.5646	.9419	.5002	-.2524	-.8060	.4429	1.1446
.4003	-.7201	.4647	1.1063	.3507	-.4014	.5576	.9530	.5002	-.5024	-.8577	.4283	1.1709
.4501	-.7802	.4502	1.1316	.4001	-.3917	.5603	.9486	.5002	-.7524	-.8558	.4288	1.1699
.5002	-.8088	.4421	1.1460	.4501	-.3524	.5714	.9311	.8002	.7476	-.3422	.5744	.9264
.5502	-.8451	.4319	1.1644	.5001	-.2800	.5920	.8988	.8002	.4976	-.3364	.5760	.9238
.6002	-.8716	.4243	1.1781	.5497	-.1689	.6235	.8500	.8002	.2476	-.3332	.5769	.9224
.6500	-.8566	.4266	1.1703	.6003	-.0557	.6556	.8006	.8002	-.5024	-.3400	.5750	.9254
.7000	-.4392	.5186	1.0159	.6500	.0422	.6833	.7580					
.7500	-.4144	.5539	.9588	.7000	.1464	.7124	.7124					
.8002	-.3294	.5780	.9207	.7501	.2370	.7385	.6724					
.9002	-.1270	.6353	.8317	.8001	.3123	.7598	.6388					
.9501	-.0234	.6647	.7865	.8501	.3765	.7780	.6095					

TEST 167 PT 22.0427 PSI CN .6640
 RUN 60 TT 165.8691 K CM -.1462
 POINT 49 WC 6.9484 MILLION CC .0175
 MACH .7807
 ALPHA .9974 DEG

UPPER SURFACE				LOWER SURFACE				SPANWISE				
X/C	CP	P/L/PT	MLOC	X/C	CP	P/L/PT	MLOC	X/C	Y/(B/2)	CP	P/L/PT	MLOC
0.0000	1.1610	.9997	.0208	0.0000	1.1610	.9997	.0208	.1507	.7476	-.8565	.4214	1.1797
.0132	-.1953	.6123	.8673	.0126	.4684	.8010	.5705	.1507	.4976	-.9398	.3996	1.2241
.0259	-.5729	.5044	1.0391	.0255	.3004	.7539	.6482	.1507	.2476	-.8966	.4120	1.2009
.0759	-.8810	.4164	1.1926	.0495	.1415	.7085	.7191	.1507	-.2524	-.9040	.4099	1.2048
.1003	-.8627	.4217	1.1429	.0753	-.0387	.6791	.7644	.1507	-.5024	-.9595	.3940	1.2348
.1507	-.9036	.4100	1.2046	.1002	-.0433	.6557	.8004	.1507	-.7524	-.8008	.4393	1.1510
.2003	-.8941	.4121	1.2006	.1503	-.1281	.6315	.8376	.5002	.7476	-.9412	.3992	1.2248
.2503	-.9149	.4067	1.2106	.1976	-.2328	.6016	.8839	.5002	.4976	-.9566	.3948	1.2332
.3001	-.9565	.3949	1.2731	.2503	-.2936	.5825	.9136	.5002	.2476	-.9365	.4006	1.2223
.3502	-.9946	.3943	1.2343	.3001	-.3457	.5693	.9343	.5002	-.2524	-.9108	.4079	1.2084
.4003	-.9431	.3977	1.2258	.3507	-.3751	.5609	.9476	.5002	-.5024	-.9789	.3885	1.2455
.4501	-.8800	.4281	1.1712	.4001	-.3718	.5619	.9461	.5002	-.7524	-.9244	.4040	1.2158
.5002	-.8868	.4148	1.1957	.4501	-.3391	.5712	.9314	.8002	.7476	-.3228	.5759	.9240
.5502	-.9248	.4039	1.2149	.5001	-.2712	.6021	.9010	.8002	.4976	-.3133	.5746	.9198
.6002	-.9640	.3984	1.2263	.5497	-.1632	.6215	.8531	.8002	.2476	-.3096	.5786	.9181
.6500	-.9738	.3899	1.2426	.6003	-.0523	.6531	.8043	.8002	-.5024	-.3155	.5780	.9207
.7000	-.9494	.4497	1.0469	.6500	.0433	.6804	.7624					
.7500	-.9385	.4543	.9582	.7000	.1468	.7130	.7168					
.8002	-.9047	.4810	.9159	.7501	.2372	.7358	.6766					
.9002	-.8224	.4330	.8353	.8001	.3127	.7574	.6426					
.9501	-.0320	.4589	.7454	.8501	.3772	.7758	.6131					

TFST	167	PT	22.1662	PSI	CN	.7365	CD1	.02225	CDCDR1	.02136
RUN	60	TT	165.9777	K	CM	-.1522	CD2	.02398	CDCDR2	.02307
POINT	50	RC	6.9780	MILLION	CC	.0177	CD3	.02320	CDCDR3	.02202
		MACH	.7805				CD4	.02216	CDCDR4	.02149
		ALPHA	1.5073	DEG			CD5	.02304	CDCDR5	.02234

UPPER SURFACE				LOWER SURFACE				SPANWISE				
X/C	CP	P/L/PT	MLOC	X/C	CP	P/L/PT	MLOC	X/C	Y/(B/2)	CP	P/L/PT	MLOC
0.0000	1.1580	.9992	.0327	0.0000	1.1580	.9992	.0327	.1507	.7476	-.9097	.4116	1.2016
.0132	-.7838	.5895	.9027	.0126	.5349	.8222	.5362	.1507	.4976	-.9824	.3909	1.2407
.0259	-.6888	.4861	1.0800	.0255	.3598	.7724	.6186	.1507	.2476	-.9177	.4093	1.2058
.0759	-.9121	.4109	1.2028	.0495	.1955	.7257	.6924	.1507	-.2524	-.9545	.3989	1.2255
.1003	-.9274	.4088	1.2110	.0753	.0911	.6960	.7384	.1507	-.5024	-1.0146	.3818	1.2585
.1507	-.9449	.4002	1.2230	.1002	.0039	.6713	.7765	.1507	-.7524	-.8978	.4150	1.1953
.2003	-.9730	.3936	1.2355	.1503	-.0850	.6460	.8153	.5002	.7476	-1.0131	.3822	1.2576
.2503	-.9780	.3922	1.2383	.1976	-.1900	.6161	.8613	.5002	.4976	-1.0292	.3776	1.2666
.3001	-1.0302	.3773	1.2672	.2503	-.2587	.5966	.8916	.5002	.2476	-1.0304	.3773	1.2673
.3502	-1.0342	.3762	1.2694	.3001	-.3068	.5829	.9129	.5002	-.2524	-1.0076	.3838	1.2546
.4003	-1.0400	.3746	1.2727	.3507	-.3399	.5735	.9277	.5002	-.5024	-1.0136	.3821	1.2579
.4501	-1.0394	.3747	1.2724	.4001	-.3422	.5729	.9268	.5002	-.7524	-.9921	.3882	1.2460
.5002	-.9557	.3965	1.2262	.4501	-.3173	.5800	.9176	.8002	.7476	-.9303	.5791	.9189
.5502	-.9985	.3892	1.2440	.5001	-.2570	.5971	.8908	.8002	.4976	-.9343	.5808	.9163
.6002	-1.0257	.3786	1.2647	.5497	-.1547	.6262	.8458	.8002	.2476	-.9151	.5811	.9157
.6500	-.9990	.3890	1.2443	.6003	-.0475	.6566	.7989	.8002	-.5024	-.9360	.5798	.9179
.7000	-.9354	.5180	1.0168	.6500	.0453	.6830	.7584	.8002	-.7524	-.9168	.5801	.9174
.7500	-.4016	.5560	.9555	.7000	.1477	.7121	.7135					
.8002	-.3113	.5817	.9149	.7501	.2378	.7377	.6736					
.9002	-.1377	.6310	.8394	.8001	.3137	.7593	.6396					
.9501	-.0543	.6547	.8019	.8501	.3791	.7779	.6098					

TEST	167	PT	22.1573	PSI	CN	.7916	CD1	.02696	CDCDR1	.02581
RUN	60	TT	166.2257	K	CM	-.1550	CD2	.02854	CDCDR2	.02744
POINT	51	RC	6.9578	MILLION	CC	.0176	CD3	.03219	CDCDR3	.03113
		MACH	.7800				CD4	.03233	CDCDR4	.03117
		ALPHA	2.0162	DEG			CD5	.03095	CDCDR5	.02958

UPPER SURFACE				LOWER SURFACE				SPANWISE				
X/C	CP	P/L/PT	MLOC	X/C	CP	P/L/PT	MLOC	X/C	Y/(B/2)	CP	P/L/PT	MLOC
0.0000	1.1566	.9991	.0352	0.0000	1.1566	.9991	.0352	.1507	.7476	-1.0272	.3806	1.2607
.0132	-.3583	.5701	.9332	.0126	.5924	.8393	.5064	.1507	.4976	-1.0549	.3728	1.2762
.0259	-.7448	.4606	1.1134	.0255	.4120	.7882	.5929	.1507	.2476	-1.0022	.3877	1.2469
.0759	-.9780	.3946	1.2337	.0495	.2425	.7402	.6697	.1507	-.2524	-1.0298	.3799	1.2622
.1003	-.9960	.3895	1.2435	.0753	.1381	.7107	.7158	.1507	-.5024	-1.0701	.3685	1.2849
.1507	-1.0024	.3877	1.2470	.1002	.0449	.6843	.7565	.1507	-.7524	-1.0360	.3782	1.2656
.2003	-1.0270	.3807	1.2606	.1503	-.0475	.6581	.7967	.5002	.7476	-1.0647	.3700	1.2818
.2503	-1.0234	.3817	1.2586	.1976	-.1528	.6283	.8425	.5002	.4976	-1.0797	.3658	1.2903
.3001	-1.0833	.3647	1.2924	.2503	-.2232	.6083	.8734	.5002	.2476	-1.0951	.3614	1.2992
.3502	-1.1018	.3595	1.3030	.3001	-.2739	.5940	.8957	.5002	-.2524	-1.0734	.3673	1.2868
.4003	-1.1090	.3577	1.3066	.3507	-.3105	.5836	.9119	.5002	-.5024	-1.0552	.3727	1.2764
.4501	-1.1200	.3544	1.3136	.4001	-.3178	.5815	.9151	.5002	-.7524	-1.0496	.3743	1.2733
.5002	-1.0954	.3613	1.2993	.4501	-.2989	.5869	.9068	.8002	.7476	-.9351	.5795	.9184
.5502	-1.0498	.3742	1.2734	.5001	-.2446	.6023	.8828	.8002	.4976	-.9329	.5801	.9174
.6002	-1.0931	.3620	1.2980	.5497	-.1472	.6299	.8401	.8002	.2476	-.9323	.5800	.9176
.6500	-.7860	.4489	1.1359	.6003	-.0435	.6592	.7950	.8002	-.5024	-.9375	.5788	.9194
.7000	-.5104	.5270	1.0021	.6500	.0470	.6849	.7556	.8002	-.7524	-.9329	.5801	.9174
.7500	-.4086	.5559	.9557	.7000	.1484	.7136	.7113					
.8002	-.3233	.5800	.9176	.7501	.2377	.7389	.6718					
.9002	-.1610	.6259	.8461	.8001	.3138	.7604	.6378					
.9501	-.0932	.6452	.8166	.8501	.3798	.7797	.6078					

TEST	167	PT	22.1579	PSI	CN	.8171	CD1	.03371	CDCDR1	.03265
RUN	60	TT	165.7770	K	CM	-.1540	CD2	.03379	CDCDR2	.03277
POINT	52	RC	6.9893	MILLION	CC	.0184	CD3	.03962	CDCDR3	.03857
		MACH	.7809				CD4	.04359	CDCDR4	.04240
		ALPHA	2.5152	DEG			CD5	.03911	CDCDR5	.03785

UPPER SURFACE				LOWER SURFACE				SPANWISE				
X/C	CP	P/L/PT	MLOC	X/C	CP	P/L/PT	MLOC	X/C	Y/(B/2)	CP	P/L/PT	MLOC
0.0000	1.1515	.9977	.0580	0.0000	1.1515	.9977	.0580	.1507	.7476	-1.0854	.3638	1.2942
.0132	-.4088	.5555	.9562	.0126	.6332	.8508	.4859	.1507	.4976	-1.0942	.3613	1.2993
.0259	-.7945	.4462	1.1387	.0255	.4504	.7990	.5752	.1507	.2476	-1.0536	.3728	1.2762
.0759	-1.0268	.3804	1.2612	.0495	.2776	.7500	.6543	.1507	-.2524	-1.0659	.3694	1.2831
.1003	-1.0435	.3757	1.2705	.0753	.1697	.7194	.7022	.1507	-.5024	-1.1084	.3573	1.3075
.1507	-1.0455	.3751	1.2716	.1002	.0756	.6928	.7434	.1507	-.7524	-1.0984	.3601	1.3017
.2003	-1.0559	.3722	1.2775	.1503	-.0219	.6652	.7859	.5002	.7476	-1.1197	.3541	1.3141
.2503	-1.0763	.3664	1.2890	.1976	-.1297	.6346	.8328	.5002	.4976	-1.1318	.3507	1.3212
.3001	-1.1053	.3562	1.3058	.2503	-.2038	.6136	.8652	.5002	.2476	-1.1464	.3465	1.3299
.3502	-1.1449	.3470	1.3240	.3001	-.2578	.5983	.8889	.5002	-.2524	-1.1283	.3517	1.3192
.4003	-1.1493	.3457	1.3316	.3507	-.2985	.5868	.9069	.5002	-.5024	-1.0928	.3617	1.2985
.4501	-1.1699	.3399	1.3439	.4001	-.3107	.5833	.9123	.5002	-.7524	-1.0984	.3601	1.3017
.5002	-1.1733	.3389	1.3460	.4501	-.2973	.5871	.9054	.8002	.7476	-.9390	.5753	.9249
.5502	-1.1342	.3500	1.3227	.5001	-.2475	.6013	.8844	.8002	.4976	-.9372	.5730	.9286
.6002	-.9641	.3982	1.2268	.5497	-.1530	.6280	.8430	.8002	.2476	-.9357	.5717	.9306
.6500	-.9554	.4027	1.0420	.6003	-.0514	.6568	.7987	.8002	-.5024	-.9348	.5708	.9320
.7000	-.4900	.5325	.9931	.6500	.0369	.6818	.7603	.8002	-.7524	-.9404	.5749	.9255
.7500	-.4149	.5538	.9190	.7000	.1374	.7103	.7163					
.8002	-.3435	.5740	.9269	.7501	.2269	.7356	.6770					
.9002	-.2089	.6122	.8674	.8001	.3024	.7571	.6431					
.9501	-.1567	.6270	.8446	.8501	.3688	.7759	.6130					

TEST 167	PT 26.2372	PSI	CN	-1179	CD1	.01711	CDCOR1	.01677
RUN 06	TT 145.5800	K	CM	-1133	CD2	.01648	CDCOR2	.01619
POINT 45	RC 9.9702	MILLION	CC	.0074	CD3	.01663	CDCOR3	.01643
	MACH .7802				CD4	.01616	CDCOR4	.01586
	ALPHA -3.9815	DEG			CD5	.01486	CDCOR5	.01436

UPPER SURFACE				LOWER SURFACE				SPANWISE				
X/C	CP	P _L /PT	MLOC	X/C	CP	P _L /PT	MLOC	X/C	Y/(B/2)	CP	P _L /PT	MLOC
0.0000	.7770	.8896	.4122	0.0000	.7770	.8896	.4122	.1507	.7770	-.1206	.6327	.8360
.0132	.6339	.8486	.4899	.0126	-.6359	.4852	1.0716	.1507	.4976	-.1369	.6280	.6132
.0259	.3199	.7587	.6406	.0255	-.3543	.5085	1.0326	.1507	.2476	-.1379	.6277	.8437
.0759	-.0230	.6606	.7931	.0495	-.6856	.4709	1.0959	.1507	-.2524	-.1422	.6265	.8435
.1003	-.0617	.6495	.8101	.0753	-.7566	.4506	1.1312	.1507	-.5024	-.1470	.6251	.8477
.1507	-.1417	.6266	.8453	.1002	-.8462	.4290	1.1772	.1507	-.7524	-.1335	.6290	.8417
.2003	-.1858	.6140	.8648	.1503	-.8426	.4260	1.1753	.5002	.7476	-.4079	.5504	.9646
.2503	-.2407	.5983	.8892	.1976	-.8618	.4205	1.1853	.5002	.4976	-.4151	.5484	.9679
.3001	-.2854	.5855	.9092	.2503	-.9144	.4055	1.2133	.5002	.2476	-.4200	.5470	.9701
.3502	-.3133	.5775	.9217	.3001	-.9966	.3819	1.2585	.5002	-.2524	-.4111	.5495	.9660
.4003	-.3450	.5684	.9360	.3507	-.9766	.3876	1.2474	.5002	-.5024	-.4080	.5504	.9646
.4501	-.3820	.5578	.9528	.4001	-1.0350	.3709	1.2802	.5002	-.7524	-.3963	.5537	.9593
.5002	-.4165	.5480	.9685	.4501	-.9759	.4517	1.1294	.8002	.7476	-.3342	.5658	.9402
.5502	-.4557	.5368	.9865	.5001	-.4163	.5480	.9884	.8002	.4976	-.3545	.5657	.9403
.6002	-.4996	.5242	1.0069	.5497	-.2815	.5866	.9075	.8002	.2476	-.3591	.5644	.9424
.6500	-.5346	.5142	1.0233	.6003	-.1553	.6227	.8513	.8002	-.5024	-.3457	.5682	.9363
.7000	-.5725	.5205	1.0129	.6500	-.0416	.6553	.8013	.8002	-.7524	-.3342	.5715	.9311
.7500	-.4394	.5414	.9790	.7000	.3627	.6851	.7553					
.8002	-.3525	.5663	.9394	.7501	.1487	.7097	.7174					
.9002	-.1500	.6242	.8490	.8001	.2207	.7304	.6853					
.9501	-.0210	.6612	.7922	.8501	.2802	.7474	.6586					

TEST 167	PT 26.2328	PSI	CN	.0460	CD1	.01297	CDCOR1	.01271
RUN 06	TT 145.6081	K	CM	-.1306	CD2	.01257	CDCOR2	.01235
POINT 46	RC 9.9680	MILLION	CC	.0126	CD3	.01224	CDCOR3	.01211
	MACH .7806				CD4	.01200	CDCOR4	.01182
	ALPHA -3.0141	DEG			CD5	.01162	CDCOR5	.01119

UPPER SURFACE				LOWER SURFACE				SPANWISE				
X/C	CP	P _L /PT	MLOC	X/C	CP	P _L /PT	MLOC	X/C	Y/(B/2)	CP	P _L /PT	MLOC
0.0000	.8923	.9226	.3412	0.0000	.8923	.9226	.3412	.1507	.7476	-.2240	.6030	.8818
.0132	.5061	.8120	.5536	.0126	-.3774	.5591	.9508	.1507	.4976	-.2426	.5977	.8901
.0259	.1762	.7176	.7052	.0255	-.4027	.5319	.9623	.1507	.2476	-.2440	.5973	.8908
.0759	-.1526	.6235	.8502	.0495	-.4446	.5399	.9815	.1507	-.2524	-.2485	.5960	.8928
.1003	-.1782	.6161	.8615	.0753	-.7405	.4552	1.1232	.1507	-.5024	-.2523	.5949	.8945
.1507	-.2482	.5961	.8926	.1002	-.7499	.4525	1.1280	.1507	-.7524	-.2351	.5999	.8868
.2003	-.2730	.5890	.9037	.1503	-.5548	.5083	1.0329	.5002	.7476	-.4804	.5296	.9981
.2503	-.3325	.5720	.9304	.1976	-.6588	.4785	1.0829	.5002	.4976	-.4876	.5276	1.0014
.3001	-.3735	.5602	.9490	.2503	-.7619	.4490	1.1340	.5002	.2476	-.4927	.5261	1.0038
.3502	-.3950	.5541	.9588	.3001	-.8479	.4244	1.1782	.5002	-.2524	-.4835	.5287	.9995
.4003	-.4217	.5464	.9710	.3507	-.9258	.4021	1.2196	.5002	-.5024	-.4805	.5331	.9925
.4501	-.4566	.5364	.9870	.4001	-.9847	.3852	1.2520	.5002	-.7524	-.4684	.5362	.9842
.5002	-.4895	.5270	1.0023	.4501	-.5908	.4980	1.0500	.8002	.7476	-.3630	.5632	.9442
.5502	-.5263	.5165	1.0195	.5001	-.3372	.5706	.9325	.8002	.4976	-.3629	.5632	.9442
.6002	-.5679	.5046	1.0391	.5497	-.2186	.6046	.8795	.8002	.2476	-.3676	.5619	.9463
.6500	-.6078	.4931	1.0582	.6003	-.1031	.6376	.8284	.8002	-.5024	-.3583	.5646	.9421
.7000	-.5748	.5026	1.0424	.6500	.0009	.6674	.7826	.8002	-.7524	-.3507	.5688	.9387
.7500	-.4606	.5353	.9889	.7000	.1071	.6978	.7358					
.8002	-.3616	.5636	.9436	.7501	.1985	.7240	.6953					
.9002	-.1539	.6231	.8508	.8001	.2755	.7460	.6608					
.9501	-.0262	.6596	.7945	.8501	.3397	.7644	.6316					

TEST 167	PT 26.2305	PSI	CN	.2105	CD1	.01070	CDCOR1	.01036
RUN 06	TT 145.5623	K	CM	-.1361	CD2	.01048	CDCOR2	.01018
POINT 48	RC 9.9743	MILLION	CC	.0179	CD3	.01035	CDCOR3	.01017
	MACH .7809				CD4	.01039	CDCOR4	.01011
	ALPHA -1.9958	DEG			CD5	.01029	CDCOR5	.00995

UPPER SURFACE				LOWER SURFACE				SPANWISE				
X/C	CP	P _L /PT	MLOC	X/C	CP	P _L /PT	MLOC	X/C	Y/(B/2)	CP	P _L /PT	MLOC
0.0000	1.0135	.9574	.2501	0.0000	1.0135	.9574	.2501	.1507	.7476	-.3485	.5680	.9367
.0132	.3429	.7657	.6295	.0126	-.1172	.6342	.8337	.1507	.4976	-.3697	.5626	.9463
.0259	-.0029	.6668	.7835	.0255	-.2059	.6088	.8729	.1507	.2476	-.3724	.5612	.9475
.0759	-.3173	.5769	.9226	.0495	-.2832	.5867	.9073	.1507	-.2524	-.3768	.5599	.9495
.1003	-.3209	.5759	.9242	.0753	-.4310	.5444	.9742	.1507	-.5024	-.3786	.5594	.9503
.1507	-.3771	.5598	.9496	.1002	-.4272	.5459	.9724	.1507	-.7524	-.3563	.5658	.9402
.2003	-.4003	.5532	.9602	.1503	-.4591	.5364	.9871	.5002	.7476	-.3683	.5052	1.0382
.2503	-.4412	.5415	.9789	.1976	-.5682	.5052	1.0381	.5002	.4976	-.3797	.5019	1.0436
.3001	-.4782	.5309	.9960	.2503	-.6572	.4797	1.0808	.5002	.2476	-.3861	.5001	1.0466
.3502	-.4873	.5283	1.0002	.3001	-.7179	.4624	1.1106	.5002	-.2524	-.3765	.5028	1.0420
.4003	-.5088	.5222	1.0102	.3507	-.7558	.4516	1.1295	.5002	-.5024	-.3579	.5041	1.0398
.4501	-.5427	.5125	1.0261	.4001	-.6138	.4922	1.0598	.5002	-.7524	-.3544	.5091	1.0316
.5002	-.5827	.5010	1.0450	.4501	-.4459	.5402	.9810	.8002	.7476	-.3671	.5627	.9451
.5502	-.6071	.4941	1.0566	.5001	-.3490	.5679	.9369	.8002	.4976	-.3629	.5639	.9432
.6002	-.6389	.4850	1.0719	.5497	-.2219	.6042	.8800	.8002	.2476	-.3646	.5634	.9439
.6500	-.6835	.4722	1.0936	.6003	-.0964	.6401	.8246	.8002	-.5024	-.3611	.5644	.9423
.7000	-.6444	.4834	1.0746	.6500	.0106	.6707	.7776	.8002	-.7524	-.3577	.5654	.9408
.7500	-.4626	.5354	.9887	.7000	.1203	.7021	.7293					
.8002	-.3582	.5652	.9410	.7501	.2126	.7284	.6883					
.9002	-.1459	.6259	.8464	.8001	.2889	.7503	.6541					
.9501	-.0197	.6620	.7909	.8501	.3522	.7683	.6253					

ORIGINAL PAGE IS
OF POOR QUALITY

TEST	167	PT	26.2390	PSI	CN	.2928	CD1	.01081	CDCOR1	.01053
RUN	86	TT	145.5836	K	CM	-.1378	CD2	.01063	CDCOR2	.01032
POINT	49	RC	9.9806	MILLION	CC	.0193	CD3	.01055	CDCOR3	.01034
		MACH	.7817				CD4	.01060	CDCOR4	.01032
		ALPHA	-1.4969	DEG			CD5	.01040	CDCOR5	.01011

UPPER SURFACE				LOWER SURFACE				SPANWISE				
X/C	CP	P/L/PT	MLOC	X/C	CP	P/L/PT	MLOC	X/C	Y/(B/2)	CP	P/L/PT	MLOC
0.0000	1.0595	.9716	.2033	0.0000	1.0595	.9716	.2033	.1507	.7476	-.4171	.5534	.9598
.0132	.2412	.7398	.6705	.0126	.0052	.6730	.7740	.1507	.4976	-.4387	.5473	.9696
.0259	-.1101	.6403	.8242	.0255	-.1053	.6417	.8221	.1507	.2476	-.4428	.5461	.9714
.0759	-.4167	.5535	.9597	.0495	-.1972	.6137	.8622	.1507	-.2524	-.4460	.5452	.9729
.1003	-.4029	.5574	.9534	.0753	-.3092	.5840	.9116	.1507	-.5024	-.4473	.5449	.9735
.1507	-.4481	.5446	.9739	.1002	-.3450	.5738	.9275	.1507	-.7524	-.4221	.5520	.9621
.2003	-.4629	.5404	.9806	.1503	-.3900	.5611	.9476	.5002	.7476	-.5969	.5025	1.0426
.2503	-.4966	.5309	.9960	.1976	-.4962	.5310	.9958	.5002	.4976	-.6097	.4989	1.0486
.3001	-.5301	.5214	1.0114	.2503	-.5524	.5151	1.0218	.5002	.2476	-.6162	.4970	1.0517
.3502	-.5634	.5125	1.0130	.3001	-.5933	.5035	1.0409	.5002	-.2524	-.6031	.5007	1.0455
.4003	-.5986	.5162	1.0200	.3507	-.5874	.5052	1.0381	.5002	-.5024	-.5989	.5019	1.0436
.4501	-.5774	.5080	1.0335	.4001	-.5234	.5233	1.0083	.5002	-.7524	-.5800	.5073	1.0347
.5002	-.6135	.4978	1.0504	.4501	-.4369	.5478	.9688	.8002	.7476	-.3681	.5673	.9378
.5502	-.6347	.4918	1.0605	.5001	-.3380	.5758	.9244	.8002	.4976	-.3663	.5678	.9370
.6002	-.6562	.4857	1.0707	.5497	-.2100	.6121	.8678	.8002	.2476	-.3693	.5669	.9384
.6500	-.6800	.4790	1.0822	.6003	-.0854	.6474	.8134	.8002	-.5024	-.3620	.5690	.9351
.7000	-.6126	.4980	1.0500	.6500	.0200	.6772	.7676	.8002	-.7524	-.3566	.5705	.9327
.7500	-.4650	.5398	.9816	.7000	.1301	.7084	.7195					
.8002	-.3648	.5682	.9364	.7501	.2229	.7347	.6786					
.8002	-.1496	.6292	.8414	.8001	.3002	.7566	.6441					
.9501	-.7241	.6647	.7867	.8501	.3646	.7748	.6149					

TEST	167	PT	26.2364	PSI	CN	.3718	CD1	.01084	CDCOR1	.01054
RUN	86	TT	145.5704	K	CM	-.1407	CD2	.01071	CDCOR2	.01046
POINT	50	RC	9.9708	MILLION	CC	.0201	CD3	.01072	CDCOR3	.01053
		MACH	.7802				CD4	.01076	CDCOR4	.01054
		ALPHA	-.9979	DEG			CD5	.01053	CDCOR5	.01023

UPPER SURFACE				LOWER SURFACE				SPANWISE				
X/C	CP	P/L/PT	MLOC	X/C	CP	P/L/PT	MLOC	X/C	Y/(B/2)	CP	P/L/PT	MLOC
0.0000	1.0979	.9822	.1605	0.0000	1.0979	.9822	.1605	.1507	.7476	-.4945	.5297	.9979
.0132	.1430	.7109	.7157	.0126	.1211	.7046	.7253	.1507	.4976	-.5183	.5229	1.0089
.0259	-.2095	.6107	.8700	.0255	-.0075	.6681	.7816	.1507	.2476	-.5240	.5213	1.0115
.0759	-.5523	.5133	1.0247	.0495	-.1173	.6369	.8295	.1507	-.2524	-.5276	.5203	1.0133
.1003	-.4890	.5313	.9954	.0753	-.2225	.6070	.8757	.1507	-.5024	-.5247	.5211	1.0119
.1507	-.5294	.5198	1.0141	.1002	-.2751	.5921	.8989	.1507	-.7524	-.4926	.5303	.9970
.2003	-.5347	.5183	1.0165	.1503	-.3310	.5762	.9238	.5002	.7476	-.6481	.4861	1.0701
.2503	-.5622	.5105	1.0294	.1976	-.4358	.5464	.9711	.5002	.4976	-.6588	.4830	1.0752
.3001	-.6043	.4985	1.0492	.2503	-.4931	.5301	.9973	.5002	.2476	-.6643	.4815	1.0779
.3502	-.6121	.4963	1.0529	.3001	-.5308	.5194	1.0147	.5002	-.2524	-.6540	.4844	1.0729
.4003	-.5960	.5009	1.0453	.3507	-.5374	.5175	1.0178	.5002	-.5024	-.6558	.4839	1.0738
.4501	-.6148	.4955	1.0542	.4001	-.4937	.5209	.9976	.5002	-.7524	-.6406	.4882	1.0665
.5002	-.6593	.4829	1.0755	.4501	-.4215	.5505	.9645	.8002	.7476	-.3700	.5691	.9413
.5502	-.6975	.4720	1.0940	.5001	-.3278	.5771	.9224	.8002	.4976	-.3637	.5669	.9385
.6002	-.7330	.4619	1.1114	.5497	-.2027	.6126	.8670	.8002	.2476	-.3641	.5668	.9386
.6500	-.7540	.4560	1.1218	.6003	-.0802	.6474	.8133	.8002	-.5024	-.3625	.5672	.9379
.7000	-.6516	.4851	1.0718	.6500	.0234	.6769	.7681	.8002	-.7524	-.3604	.5678	.9370
.7500	-.4577	.5402	.9811	.7000	.1333	.7081	.7200					
.8002	-.3577	.5686	.9388	.7501	.2266	.7346	.6787					
.8002	-.1461	.6287	.8421	.8001	.3048	.7568	.6439					
.9501	-.0242	.6633	.7989	.8501	.3703	.7754	.6139					

TEST	167	PT	26.2368	PSI	CN	.4475	CD1	.01135	CDCOR1	.01096
RUN	86	TT	145.4603	K	CM	-.1421	CD2	.01119	CDCOR2	.01083
POINT	51	RC	9.9773	MILLION	CC	.0195	CD3	.01117	CDCOR3	.01093
		MACH	.7796				CD4	.01112	CDCOR4	.01081
		ALPHA	-.4990	DEG			CD5	.01091	CDCOR5	.01053

UPPER SURFACE				LOWER SURFACE				SPANWISE				
X/C	CP	P/L/PT	MLOC	X/C	CP	P/L/PT	MLOC	X/C	Y/(B/2)	CP	P/L/PT	MLOC
0.0000	1.1251	.9896	.1220	0.0000	1.1251	.9896	.1220	.1507	.7476	-.5641	.5084	1.0329
.0132	.0541	.6845	.7564	.0126	.2271	.7338	.6800	.1507	.4976	-.5828	.5030	1.0417
.0259	-.3040	.5824	.9140	.0255	.0840	.6930	.7432	.1507	.2476	-.5890	.5013	1.0446
.0759	-.7345	.4598	1.1151	.0495	-.0413	.6573	.7982	.1507	-.2524	-.5981	.4986	1.0490
.1003	-.5671	.5075	1.0343	.0753	-.1406	.6290	.8417	.1507	-.5024	-.5909	.5007	1.0455
.1507	-.5988	.4985	1.0493	.1002	-.2062	.6103	.8705	.1507	-.7524	-.5554	.5108	1.0288
.2003	-.6084	.4957	1.0539	.1503	-.2695	.5923	.8986	.5002	.7476	-.6430	.4716	1.0947
.2503	-.6191	.4929	1.0585	.1976	-.3722	.5630	.9446	.5002	.4976	-.6700	.4688	1.0996
.3001	-.6462	.4850	1.0720	.2503	-.4298	.5466	.9707	.5002	.2476	-.6704	.4681	1.0984
.3502	-.6678	.4788	1.0825	.3001	-.4673	.5359	.9879	.5002	-.2524	-.6706	.4689	1.0993
.4003	-.6783	.4758	1.0875	.3507	-.4819	.5318	.9946	.5002	-.5024	-.6704	.4689	1.0993
.4501	-.6900	.4725	1.0933	.4001	-.4525	.5401	.9811	.5002	-.7524	-.6862	.4707	1.0863
.5002	-.7022	.4690	1.0992	.4501	-.3946	.5566	.9547	.8002	.7476	-.3608	.5663	.9394
.5502	-.7250	.4625	1.1105	.5001	-.3074	.5815	.9155	.8002	.4976	-.3553	.5679	.9368
.6002	-.7584	.4530	1.1271	.5497	-.1870	.6158	.8621	.8002	.2476	-.3545	.5676	.9373
.6500	-.7866	.4444	1.1423	.6003	-.0680	.6497	.8098	.8002	-.5024	-.3580	.5676	.9373
.7000	-.6516	.4823	1.0765	.6500	.0334	.6786	.7654	.8002	-.7524	-.3542	.5681	.9365
.7500	-.4467	.5418	.9784	.7000	.1422	.7096	.7176					
.8002	-.3484	.5697	.9340	.7501	.2391	.7361	.6764					
.8002	-.1401	.6202	.8414	.8001	.3137	.7584	.6411					
.9501	-.0229	.6625	.7961	.8501	.3799	.7773	.6108					

TEST	167	PT	26.2376	PSI		CN	.5255	CD1	-.01231	CDCOR1	-.01191
RUN	66	TT	145.3922	K		CM	-.1447	CD2	-.01227	CDCOR2	-.01190
POINT	52	RC	9.9875	MILLION		CC	.0194	CD3	-.01219	CDCOR3	-.01188
		MACH	.7800					CD4	-.01206	CDCOR4	-.01169
		ALPHA	-.0069	DEG				CD5	-.01190	CDCOR5	-.01147

UPPER SURFACE				LOWER SURFACE				SPANWISE				
X/C	CP	P _L /PT	MLOC	X/C	CP	P _L /PT	MLOC	X/C	Y/(B/2)	CP	P _L /PT	MLOC
0.0000	1.1511	.9973	.0617	0.0000	1.1511	.9973	.0617	.1507	.7476	-.6407	.4886	1.0657
.0132	-.0370	.6601	.7939	.0126	.3267	.7633	.6333	.1507	.4976	-.6903	.4746	1.0896
.0259	-.3989	.5573	.9536	.0255	.1726	.7196	.7022	.1507	.2476	-.7586	.4552	1.1272
.0759	-.7586	.4552	1.1232	.0495	.0338	.6802	.7630	.1507	-.2524	-.7313	.4629	1.1097
.1003	-.7598	.4549	1.1238	.0753	-.0653	.6520	.8063	.1507	-.5024	-.6186	.4949	1.0552
.1507	-.7470	.4585	1.1174	.1002	-.1385	.6312	.0382	.1507	-.7524	-.5943	.5018	1.0437
.2003	-.7021	.4712	1.0954	.1503	-.2089	.6113	.8694	.5002	.7476	-.7604	.4547	1.1241
.2503	-.6022	.4996	1.0474	.1976	-.3111	.5822	.9143	.5002	.4976	-.7757	.4503	1.1317
.3001	-.6874	.4754	1.0882	.2503	-.3708	.5653	.9410	.5002	.2476	-.7836	.4481	1.1357
.3502	-.7237	.4651	1.1059	.3001	-.4098	.5542	.9586	.5002	-.2524	-.7775	.4498	1.1326
.4003	-.7353	.4618	1.1116	.3507	-.4301	.5484	.9678	.5002	-.5024	-.7703	.4519	1.1290
.4501	-.7570	.4556	1.1224	.4001	-.4121	.5536	.9596	.5002	-.7524	-.7698	.4520	1.1288
.5002	-.7814	.4487	1.1346	.4501	-.3655	.5668	.9386	.8002	.7476	-.3522	.5706	.9326
.5502	-.7998	.4435	1.1438	.5001	-.2874	.5890	.9038	.8002	.4976	-.3442	.5728	.9291
.6002	-.8195	.4379	1.1538	.5497	-.1717	.6218	.8528	.8002	.2476	-.3426	.5733	.9283
.6500	-.8297	.4350	1.1590	.6003	-.0554	.6588	.8020	.8002	-.5024	-.3432	.5731	.9286
.7000	-.6471	.4966	1.0691	.6500	.0432	.6828	.7589	.8002	-.7524	-.3434	.5731	.9287
.7500	-.4311	.5482	.9682	.7000	.1513	.7135	.7116					
.8002	-.3358	.5752	.9253	.7500	.2445	.7400	.6703					
.9002	-.1335	.6327	.8360	.8001	.3238	.7625	.6347					
.9501	-.101	.6648	.7865	.8501	.3911	.7816	.6039					

TEST	167	PT	26.2404	PSI		CN	.6102	CD1	-.01394	CDCOR1	-.01342
RUN	66	TT	145.3970	K		CM	-.1477	CD2	-.01389	CDCOR2	-.01341
POINT	53	RC	9.9869	MILLION		CC	.0183	CD3	-.01401	CDCOR3	-.01356
		MACH	.7799					CD4	-.01340	CDCOR4	-.01246
		ALPHA	.4990	DEG				CD5	-.01292	CDCOR5	-.01230

UPPER SURFACE				LOWER SURFACE				SPANWISE				
X/C	CP	P _L /PT	MLOC	X/C	CP	P _L /PT	MLOC	X/C	Y/(B/2)	CP	P _L /PT	MLOC
0.0000	1.1527	.9974	.0610	0.0000	1.1527	.9974	.0610	.1507	.7476	-.7702	.4489	1.1343
.0132	-.1271	.6323	.8365	.0126	.4083	.7850	.5983	.1507	.4976	-.8928	.4139	1.1976
.0259	-.4916	.5283	1.0001	.0255	.2445	.7383	.6729	.1507	.2476	-.8568	.4242	1.1787
.0759	-.8442	.4278	1.1721	.0495	.0921	.6948	.7404	.1507	-.2524	-.8562	.4243	1.1783
.1003	-.8356	.4302	1.1676	.0753	-.0045	.6673	.7828	.1507	-.5024	-.8785	.4180	1.1900
.1507	-.8646	.4219	1.1827	.1002	-.0844	.6445	.8178	.1507	-.7524	-.7396	.4287	1.1170
.2003	-.7917	.4427	1.1452	.1503	-.1609	.6227	.8514	.5002	.7476	-.8532	.4252	1.1768
.2503	-.8654	.4217	1.1832	.1976	-.2632	.5935	.8967	.5002	.4976	-.8313	.4314	1.1654
.3001	-.8709	.4201	1.1860	.2503	-.3252	.5758	.9244	.5002	.2476	-.8153	.4360	1.1572
.3502	-.8132	.4386	1.1525	.3001	-.3674	.5638	.9434	.5002	-.2524	-.8127	.4367	1.1559
.4003	-.7335	.4593	1.1159	.3507	-.3916	.5569	.9543	.5002	-.5024	-.8420	.4284	1.1710
.4501	-.7744	.4477	1.1364	.4001	-.3814	.5598	.9497	.5002	-.7524	-.8718	.4199	1.1865
.5002	-.8164	.4357	1.1578	.4501	-.3441	.5704	.9329	.8002	.7476	-.3475	.5694	.9344
.5502	-.8546	.4248	1.1775	.5001	-.2732	.5906	.9011	.8002	.4976	-.3353	.5729	.9289
.6002	-.8984	.4123	1.2005	.5497	-.1635	.6219	.8526	.8002	.2476	-.3307	.5742	.9268
.6500	-.9239	.4050	1.2142	.6003	-.0505	.6542	.8029	.8002	-.5024	-.3356	.5728	.9290
.7000	-.6994	.4691	1.0991	.6500	.0458	.6816	.7608	.8002	-.7524	-.3409	.5713	.9314
.7500	-.4230	.5479	.9686	.7000	.1522	.7120	.7139					
.8002	-.3125	.5766	.9231	.7501	.2444	.7383	.6729					
.9002	-.1301	.6315	.8379	.8001	.3236	.7609	.6372					
.9501	-.0244	.6615	.7917	.8501	.3913	.7802	.6062					

TEST	167	PT	26.2031	PSI		CN	.7048	CD1	-.01748	CDCOR1	-.01673
RUN	66	TT	145.4133	K		CM	-.1539	CD2	-.01740	CDCOR2	-.01670
POINT	54	RC	9.9704	MILLION		CC	.0174	CD3	-.01722	CDCOR3	-.01664
		MACH	.7798					CD4	-.01677	CDCOR4	-.01625
		ALPHA	.9979	DEG				CD5	-.01587	CDCOR5	-.01494

UPPER SURFACE				LOWER SURFACE				SPANWISE				
X/C	CP	P _L /PT	MLOC	X/C	CP	P _L /PT	MLOC	X/C	Y/(B/2)	CP	P _L /PT	MLOC
0.0000	1.1622	1.0007	0.0000	0.0000	1.1622	1.0007	0.0000	.1507	.7476	-.8550	.4299	1.1682
.0132	-.2181	.6101	.8708	.0126	.4992	.8131	.5517	.1507	.4976	-.9575	.4009	1.2220
.0259	-.5912	.5045	1.0392	.0255	.3267	.7843	.6318	.1507	.2476	-.9052	.4157	1.1942
.0759	-.8967	.4182	1.1896	.0495	.1617	.7176	.7052	.1507	-.2524	-.9147	.4130	1.1992
.1003	-.8826	.4221	1.1825	.0753	.0738	.6927	.7437	.1507	-.5024	-.9560	.4013	1.2211
.1507	-.9240	.4104	1.2042	.1002	-.0160	.6673	.7828	.1507	-.7524	-.8282	.4375	1.1549
.2003	-.9142	.4131	1.1990	.1503	-.0970	.6444	.8180	.5002	.7476	-.9476	.4037	1.2167
.2503	-.9232	.4106	1.2037	.1976	-.1984	.6157	.8622	.5002	.4976	-.9630	.3993	1.2249
.3001	-.9709	.3971	1.2292	.2503	-.2617	.5978	.8900	.5002	.2476	-.9514	.4026	1.2187
.3502	-.9803	.3944	1.2342	.3001	-.3052	.5855	.9092	.5002	-.2524	-.9184	.4120	1.2012
.4003	-.9622	.3996	1.2345	.3507	-.3326	.5777	.9214	.5002	-.5024	-.9322	.4024	1.2191
.4501	-.9462	.4324	1.1637	.4001	-.3289	.5788	.9197	.5002	-.7524	-.9279	.4093	1.2062
.5002	-.8904	.4199	1.1965	.4501	-.3005	.5868	.9071	.8002	.7476	-.3263	.5795	.9186
.5502	-.9267	.4097	1.2055	.5001	-.2379	.6045	.8795	.8002	.4976	-.3215	.5809	.9164
.6002	-.9516	.4025	1.2189	.5497	-.1343	.6336	.8342	.8002	.2476	-.3189	.5816	.9153
.6500	-.9748	.3960	1.2313	.6003	-.0265	.6644	.7873	.8002	-.5024	-.3164	.5827	.9142
.7000	-.9801	.3977	1.0340	.6500	.0663	.6706	.7469	.8002	-.7524	-.3173	.5821	.9146
.7500	-.4016	.5582	.9922	.7000	.1713	.7203	.7010					
.8002	-.3155	.5826	.9136	.7501	.2627	.7462	.6705					
.9002	-.1282	.6336	.8316	.8001	.3420	.7686	.6248					
.9501	-.0268	.6643	.7874	.8501	.4101	.7879	.5937					

ORIGINAL PAGE IS
OF POOR QUALITY

TEST 167	PT 26.2338	PSI	CN .7521	C01 .02297	CDCOR1 .02188
RUN 66	TT 145.3831	K	CM -.1579	C02 .02305	CDCOR2 .02203
POINT 55	RC 9.9844	MILLION	CC .0189	C03 .02260	CDCOR3 .02156
	MACH .7797			C04 .02235	CDCOR4 .02139
	ALPHA 1.4970	DEG		C05 .02306	CDCOR5 .02145

UPPER SURFACE				LOWER SURFACE				SPANWISE				
X/C	CP	P _z L/P _T	MLOC	X/C	CP	P _z L/P _T	MLOC	X/C	Y/(B/2)	CP	P _z L/P _T	MLOC
0.0000	1.1520	.9977	.0575	0.0000	1.1520	.9977	.0575	.1507	.7476	-.8983	.4164	1.1929
.0132	-.2873	.5896	.9027	.0126	.5413	.8246	.5322	.1507	.4976	-.9864	.3914	1.2400
.0259	-.6667	.4821	1.0769	.0255	.3651	.7747	.6150	.1507	.2476	-.9277	.4081	1.2084
.0759	-.9267	.4083	1.2079	.0495	.1922	.7256	.6928	.1507	-.2524	-.9601	.3989	1.2257
.1003	-.9161	.4114	1.2023	.0753	.0961	.6983	.7350	.1507	-.5024	-.9992	.3878	1.2471
.1507	-.9489	.4021	1.2197	.1002	.0086	.6735	.7732	.1507	-.7524	-.9918	.4106	1.2037
.2003	-.9711	.3958	1.2317	.1503	-.0781	.6489	.8110	.5002	.7476	-1.0251	.3804	1.2616
.2503	-.9799	.3933	1.2365	.1976	-.1827	.6193	.8567	.5002	.4976	-1.0361	.3773	1.2677
.3001	-1.0297	.3791	1.2640	.2503	-.2513	.5998	.8868	.5002	.2476	-1.0293	.3793	1.2637
.3502	-1.0363	.3773	1.2676	.3001	-.2985	.5864	.9077	.5002	-.2524	-1.0176	.3826	1.2572
.4003	-1.0382	.3767	1.2687	.3507	-.3307	.5773	.9220	.5002	-.5024	-1.0170	.3827	1.2569
.4501	-1.0433	.3753	1.2715	.4001	-.3332	.5766	.9231	.5002	-.7524	-1.0031	.3867	1.2492
.5002	-.9567	.3999	1.2239	.4501	-.3103	.5831	.9129	.8002	.7476	-.3343	.5763	.9236
.5502	-.9935	.3894	1.2439	.5001	-.2930	.5994	.8876	.8002	.4976	-.3291	.5778	.9213
.6002	-1.0286	.3794	1.2633	.5497	-.1517	.6281	.8431	.8002	.2476	-.3270	.5784	.9203
.6500	-1.0585	.3710	1.2801	.6003	-.0453	.6582	.7967	.8002	-.5024	-.3323	.5769	.9227
.7000	-.6068	.4990	1.0483	.6500	.0447	.6838	.7575	.8002	-.7524	-.3267	.5785	.9202
.7500	-.4232	.5511	.9635	.7000	.1485	.7132	.7120					
.8002	-.3245	.5791	.9192	.7501	.2401	.7392	.6716					
.8502	-.1464	.6296	.8408	.8001	.3188	.7615	.6363					
.9001	-.0526	.6562	.7999	.8501	.3870	.7808	.6092					

TEST 167	PT 26.2305	PSI	CN .7982	C01 .02776	CDCOR1 .02698
RUN 66	TT 145.5662	K	CM -.1612	C02 .02912	CDCOR2 .02716
POINT 56	RC 9.9732	MILLION	CC .0197	C03 .03035	CDCOR3 .02927
	MACH .7808			C04 .03163	CDCOR4 .03057
	ALPHA 2.0060	DEG		C05 .03139	CDCOR5 .03036

UPPER SURFACE				LOWER SURFACE				SPANWISE				
X/C	CP	P _z L/P _T	MLOC	X/C	CP	P _z L/P _T	MLOC	X/C	Y/(B/2)	CP	P _z L/P _T	MLOC
0.0000	1.1600	.9999	.0145	0.0000	1.1600	.9999	.0145	.1507	.7476	-.9966	.3874	1.2477
.0132	-.3418	.5734	.9282	.0126	.5939	.8391	.5069	.1507	.4976	-1.0207	.3806	1.2611
.0259	-.7247	.4646	1.1067	.0255	.4131	.7878	.5939	.1507	.2476	-.9888	.3896	1.2435
.0759	-.9744	.3937	1.2336	.0495	.2366	.7376	.6740	.1507	-.2524	-1.0222	.3802	1.2619
.1003	-.9717	.3945	1.2341	.0753	.1413	.7106	.7161	.1507	-.5024	-1.0434	.3741	1.2738
.1507	-.9978	.3871	1.2484	.1002	.0486	.6842	.7568	.1507	-.7524	-1.0368	.3760	1.2701
.2003	-1.0127	.3829	1.2566	.1503	-.0427	.6583	.7966	.5002	.7476	-1.0593	.3696	1.2828
.2503	-1.0081	.3842	1.2541	.1976	-.1491	.6281	.8431	.5002	.4976	-1.0708	.3664	1.2894
.3001	-1.0680	.3671	1.2878	.2503	-.2207	.6078	.8745	.5002	.2476	-1.0848	.361	1.2974
.3502	-1.0827	.3630	1.2962	.3001	-.2715	.5933	.8969	.5002	-.2524	-1.0808	.3692	1.2837
.4003	-1.0878	.3615	1.2992	.3507	-.3082	.5829	.9132	.5002	-.5024	-1.0902	.3722	1.2777
.4501	-1.1046	.3568	1.3090	.4001	-.3154	.5809	.9164	.5002	-.7524	-1.0414	.3747	1.2727
.5002	-1.0830	.3629	1.2964	.4501	-.2980	.5858	.9087	.8002	.7476	-.3378	.5745	.9264
.5502	-1.0348	.3766	1.2690	.5001	-.2447	.6010	.8851	.8002	.4976	-.3393	.5741	.9271
.6002	-1.0848	.3624	1.2974	.5497	-.1464	.6289	.8419	.8002	.2476	-.3348	.5754	.9251
.6500	-.9477	.4013	1.2211	.6003	-.0421	.6585	.7963	.8002	-.5024	-.3399	.5739	.9274
.7000	-.5339	.5188	1.0156	.6500	.0464	.6836	.7577	.8002	-.7524	-.3271	.5775	.9217
.7500	-.4186	.5516	.9628	.70	.1498	.7130	.7124					
.8002	-.3322	.5761	.9239	.7501	.2409	.7389	.6720					
.8502	-.1775	.6200	.8555	.8001	.3198	.7612	.6366					
.9001	-.1014	.6416	.8222	.8501	.3806	.7808	.6092					

TEST 167	PT 26.2122	PSI	CN .8189	C01 .03353	CDCOR1 .03196
RUN 66	TT 145.4713	K	CM -.1601	C02 .03486	CDCOR2 .03336
POINT 57	RC 9.9753	MILLION	CC .0211	C03 .04117	CDCOR3 .03972
	MACH .7802			C04 .04340	CDCOR4 .04231
	ALPHA 2.5050	DEG		C05 .04026	CDCOR5 .03872

UPPER SURFACE				LOWER SURFACE				SPANWISE				
X/C	CP	P _z L/P _T	MLOC	X/C	CP	P _z L/P _T	MLOC	X/C	Y/(B/2)	CP	P _z L/P _T	MLOC
0.0000	1.1656	1.0010	0.0000	0.0000	1.1656	1.0010	0.0000	.1507	.7476	-1.0529	.3672	1.2876
.0132	-.3749	.5598	.9497	.0126	.6455	.8524	.4831	.1507	.4976	-1.0547	.3607	1.2887
.0259	-.7576	.4516	1.1295	.0255	.4607	.7996	.5743	.1507	.2476	-1.0242	.3754	1.2713
.0759	-1.0010	.3821	1.2582	.0495	.2820	.7486	.6568	.1507	-.2524	-1.0343	.3725	1.2770
.1003	-1.0069	.3804	1.2615	.0753	.1846	.7208	.7003	.1507	-.5024	-1.0609	.3650	1.2922
.1507	-1.0150	.3781	1.2641	.1002	.0861	.6976	.7439	.1507	-.7524	-1.0697	.324	1.2974
.2003	-1.0284	.3742	1.2736	.1503	-.0084	.6656	.7854	.5002	.7476	-1.0927	.3559	1.3108
.2503	-1.0425	.3702	1.2816	.1976	-.1169	.6346	.8330	.5002	.4976	-1.1018	.3533	1.3161
.3001	-1.0746	.3599	1.3025	.2503	-.1918	.6132	.8661	.5002	.2476	-1.1149	.3493	1.3239
.3502	-1.1118	.3504	1.3221	.3001	-.2472	.5974	.8906	.5002	-.2524	-1.0973	.3545	1.3135
.4003	-1.1199	.3481	1.3269	.3507	-.2894	.5854	.9094	.5002	-.5024	-1.0718	.3618	1.2986
.4501	-1.1386	.3428	1.3381	.4001	-.3016	.5819	.9149	.5002	-.7524	-1.0678	.3630	1.2962
.5002	-1.1477	.3401	1.3437	.4501	-.2891	.5854	.9093	.8002	.7476	-.3430	.5700	.9335
.5502	-1.1119	.3504	1.3221	.5001	-.2386	.5999	.8868	.8002	.4976	-.3369	.5661	.9397
.6002	-1.0414	.3705	1.2810	.5497	-.1424	.6273	.8443	.8002	.2476	-.3334	.5671	.9382
.6500	-.5964	.4976	1.0507	.6003	-.0399	.6566	.7992	.8002	-.5024	-.3345	.5668	.9387
.7000	-.4766	.5319	.9944	.6500	.0477	.6817	.7607	.8002	-.7524	-.3337	.5727	.9293
.7500	-.4069	.5518	.9624	.7000	.1508	.7111	.7153					
.8002	-.3130	.5700	.9335	.7501	.2410	.7368	.6752					
.8502	-.2233	.6042	.8800	.8001	.3200	.7594	.6395					
.9001	-.1812	.6162	.8614	.8501	.3891	.7792	.6079					

ORIGINAL FILE
OF POOR QUALITY

TEST 167 PT 31.4661 PSI CM -.1119 CD1 .01709 CDCOR1 .01671
 RUN 63 TT 124.9371 K CM -.1175 CD2 .01623 CDCOR2 .01591
 POINT 3 RC 14.9604 MILLION CC .0089 CD3 .01606 CDCOR3 .01583
 MACH .7813 CD4 .01488 CDCOR4 .01496
 ALPHA -3.9744 DEG CD5 .01288 CDCOR5 .01242

UPPER SURFACE				LOWER SURFACE				SPANWISE				
X/C	CP	P/L/PT	MLOC	X/C	CP	P/L/PT	MLOC	X/C	Y/(B/2)	CP	P/L/PT	MLOC
0.0000	.7797	.8909	.4099	0.0000	.7797	.8909	.4099	.1507	.7476	-.1272	.9321	.8374
.0132	.6303	.8482	.4909	.0126	-.6117	.4939	1.0576	.1507	.4976	-.1427	.8277	.8443
.0259	.3192	.7595	.6399	.0255	-.5359	.5155	1.0217	.1507	.2476	-.1424	.8277	.8441
.0759	-.0315	.6594	.7954	.0495	-.6510	.4826	1.0765	.1507	-.2524	-.1491	.8258	.8471
.1003	-.0677	.6491	.8113	.0753	-.7086	.4491	1.1345	.1507	-.5024	-.1548	.8242	.8496
.1507	-.1484	.6260	.8467	.1002	-.8344	.4246	1.1785	.1507	-.7524	-.1622	.8278	.8440
.2003	-.1926	.6134	.8663	.1503	-.8558	.4242	1.1792	.5002	.7476	-.4187	.5489	.9676
.2503	-.2467	.5980	.8902	.1976	-.8684	.4206	1.1858	.5002	.4976	-.4241	.5474	.9700
.3001	-.2931	.5847	.9109	.2503	-.9013	.4112	1.2031	.5002	.2476	-.4289	.5460	.9722
.3502	-.3178	.5777	.9220	.3001	-1.0054	.3815	1.2599	.5002	-.2524	-.4206	.5484	.9684
.4003	-.3504	.5684	.9366	.3507	-.9760	.3899	1.2436	.5002	-.5024	-.4168	.5495	.9667
.4501	-.3866	.5581	.9530	.4001	-1.0367	.3726	1.2775	.5002	-.7524	-.4056	.5527	.9616
.5002	-.4247	.5472	.9703	.4501	-.9084	.4092	1.2070	.8002	.7476	-1.0202	.3773	1.2682
.5502	-.4652	.5357	.9889	.5001	-.8281	.3462	.9719	.8002	.4976	-.3874	.5636	.9443
.6002	-.5091	.5231	1.0092	.5497	-.7292	.3587	.9047	.8002	.2476	-.3712	.5625	.9460
.6500	-.5488	.5118	1.0276	.6003	-.6489	.6259	.8470	.8002	-.5024	-.3570	.5665	.9396
.7000	-.5907	.5169	1.0193	.6500	-.5372	.6578	.7979	.8002	-.7524	-.3382	.5719	.9311
.7500	-.6430	.5391	.9833	.7000	.0697	.6883	.7510					
.8002	-.6960	.5645	.9428	.7501	.1585	.7136	.7119					
.9002	-.8659	.6211	.8544	.8001	.2330	.7349	.6787					
.9501	-.9371	.6578	.7979	.8501	.2946	.7524	.6510					

TEST 167 PT 31.4603 PSI CM .0498 CD1 .01245 CDCOR1 .01263
 RUN 63 TT 124.8929 K CM -.1324 CD2 .01241 CDCOR2 .01224
 POINT 4 RC 14.9734 MILLION CC .0141 CD3 .01198 CDCOR3 .01189
 MACH .7820 CD4 .01153 CDCOR4 .01138
 ALPHA -2.9938 DEG CD5 .01075 CDCOR5 .01039

UPPER SURFACE				LOWER SURFACE				SPANWISE				
X/C	CP	P/L/PT	MLOC	X/C	CP	P/L/PT	MLOC	X/C	Y/(B/2)	CP	P/L/PT	MLOC
0.0000	.8963	.9236	.3391	0.0000	.8963	.9236	.3391	.1507	.7476	-.2301	.6010	.8855
.0132	.5025	.8108	.5560	.0126	-.3648	.5625	.8440	.1507	.4976	-.2460	.5965	.8926
.0259	.1784	.7180	.7050	.0255	-.3736	.5600	.9500	.1507	.2476	-.2463	.5984	.8927
.0759	-.1616	.6204	.8551	.0495	-.4213	.5463	.9718	.1507	-.2524	-.2531	.5945	.8957
.1003	-.1826	.6146	.8644	.0753	-.4392	.4553	1.1237	.1507	-.5024	-.2582	.5930	.8980
.1507	-.2530	.5945	.8957	.1002	-.4796	.4494	1.1339	.1507	-.7524	-.2429	.5974	.8912
.2003	-.2900	.5839	.9123	.1503	-.5495	.5084	1.0314	.5002	.7476	-.4909	.5284	1.0039
.2503	-.3364	.5706	.9311	.1976	-.6339	.4797	1.0815	.5002	.4976	-.4960	.5249	1.0063
.3001	-.3789	.5584	.9424	.2503	-.7583	.4498	1.1332	.5002	.2476	-.5007	.5235	1.0085
.3502	-.4345	.5525	.9618	.3001	-.8486	.4245	1.1786	.5002	-.2524	-.4902	.5266	1.0036
.4003	-.4723	.5446	.9745	.3507	-.9297	.4008	1.2226	.5002	-.5024	-.4868	.5275	1.0020
.4501	-.5146	.5346	.9906	.4001	-.9897	.3835	1.2559	.5002	-.7524	-.4751	.5309	.9966
.5002	-.4975	.5245	1.0070	.4501	-.8450	.4536	1.1265	.8002	.7476	-1.0463	.3673	1.2880
.5502	-.5356	.5136	1.0249	.5001	-.7364	.5678	.9376	.8002	.4976	-.3722	.5604	.9493
.6002	-.5777	.5015	1.0448	.5497	-.6188	.6043	.8405	.8002	.2476	-.3747	.5596	.9505
.6500	-.6255	.4878	1.0677	.6003	-.5103	.6375	.8292	.8002	-.2524	-.3623	.5632	.9448
.7000	-.6837	.4941	1.0572	.6500	-.4011	.6666	.7843	.8002	-.7524	-.3462	.5678	.9376
.7500	-.7408	.5321	.9946	.7000	-.2892	.6979	.7361					
.8002	-.7979	.5616	.9474	.7501	.2016	.7247	.6947					
.9002	-.9648	.6198	.8564	.8001	.2809	.7474	.6591					
.9501	-.1038	.6584	.9001	.8501	.3471	.7663	.6290					

TEST 167 PT 31.4883 PSI CM .2193 CD1 .01027 CDCOR1 .00997
 RUN 63 TT 125.0034 K CM -.1398 CD2 .01000 CDCOR2 .00975
 POINT 5 RC 14.9517 MILLION CC .0186 CD3 .00992 CDCOR3 .00977
 MACH .7808 CD4 .00980 CDCOR4 .00964
 ALPHA -1.9857 DEG CD5 .00946 CDCOR5 .00937

UPPER SURFACE				LOWER SURFACE				SPANWISE				
X/C	CP	P/L/PT	MLOC	X/C	CP	P/L/PT	MLOC	X/C	Y/(B/2)	CP	P/L/PT	MLOC
0.0000	1.0097	.9567	.2524	0.0000	1.0097	.9567	.2524	.1507	.7476	-.3572	.5673	.9384
.0132	.3151	.7645	.6318	.0126	-.1142	.6365	.8306	.1507	.4976	-.3753	.5622	.9465
.0259	-.0025	.6683	.7817	.0255	-.1795	.6179	.8593	.1507	.2476	-.3773	.5616	.9474
.0759	-.3315	.5744	.9268	.0495	-.2730	.5907	.9016	.1507	-.2524	-.3836	.5598	.9503
.1003	-.3242	.5753	.9257	.0753	-.4379	.5443	.9750	.1507	-.5024	-.3869	.5588	.9517
.1507	-.3843	.5596	.9506	.1002	-.4301	.5406	.9714	.1507	-.7524	-.3662	.5648	.9424
.2003	-.4408	.5526	.9617	.1503	-.6214	.5376	.9857	.5002	.7476	-.5783	.5049	1.0392
.2503	-.4469	.5418	.9740	.1976	-.5702	.5066	1.0363	.5002	.4976	-.5866	.5020	1.0440
.3001	-.4453	.5308	.9967	.2503	-.6595	.4812	1.0789	.5002	.2476	-.5927	.5002	1.0469
.3502	-.4938	.5284	1.0006	.3001	-.7700	.4640	1.1085	.5002	-.2524	-.5819	.5033	1.0418
.4003	-.5148	.5224	1.0104	.3507	-.7805	.4524	1.1286	.5002	-.5024	-.5773	.5046	1.0397
.4501	-.5473	.5132	1.0259	.4001	-.6226	.4917	1.0612	.5002	-.7524	-.5596	.5097	1.0313
.5002	-.5895	.5011	1.0454	.4501	-.4503	.5408	.9804	.8002	.7476	-1.0561	.3682	1.2882
.5502	-.6144	.4941	1.0573	.5001	-.3541	.5682	.9369	.8002	.4976	-.3745	.5624	.9461
.6002	-.6431	.4859	1.0710	.5497	-.2263	.6046	.8800	.8002	.2476	-.3751	.5622	.9464
.6500	-.6857	.4737	1.0917	.6003	-.0998	.6406	.8241	.8002	-.5024	-.3707	.5635	.9444
.7000	-.7403	.4810	1.0793	.6500	.0062	.6708	.7779	.8002	-.7524	-.3600	.5665	.9396
.7500	-.7955	.5336	.9922	.7000	.1203	.7033	.7278					
.8002	-.8695	.5634	.9439	.7501	.2156	.7305	.6856					
.9002	-.9610	.6232	.8511	.8001	.2949	.7531	.6501					
.9501	-.1031	.6546	.7951	.8501	.3603	.7717	.6203					

TEST 167	PT 31.5415	PSI	CN	.3016	CD1	.01034	CDCOR1	.01007
RUN 63	TT 124.2362	K	CM	-.1424	CD2	.01016	CDCOR2	.00989
POINT 6	RC 14.9857	MILLION	CC	.0204	CD3	.01011	CDCOR3	.00991
	MACH				CD4	.01000	CDCOR4	.00979
	ALPHA	-1.4812	DEG		CD5	.00977	CDCOR5	.00945

UPPER SURFACE				LOWER SURFACE				SPANWISE				
X/C	CP	P/L/PT	MLOC	X/C	CP	P/L/PT	MLOC	X/C	Y/(B/2)	CP	P/L/PT	MLOC
0.0000	1.0568	.9702	.2085	0.0000	1.0568	.9702	.2085	.1507	.7476	-.4273	.5476	.9897
.0132	.2382	.7371	.6753	.0126	.0095	.6720	.7761	.1507	.4976	-.4478	.5418	.9790
.0259	-.0921	.6430	.8206	.0255	-.0808	.6463	.8159	.1507	.2476	-.4505	.5410	.9803
.0759	-.4322	.5462	.9719	.0495	-.1911	.6148	.8641	.1507	-.2524	-.4576	.5390	.9835
.1003	-.4109	.5523	.9622	.0753	-.3269	.5762	.9243	.1507	-.5024	-.4591	.5386	.9842
.1507	-.4581	.5388	.9937	.1002	-.3416	.5691	.9355	.1507	-.7524	-.4349	.5454	.9731
.2003	-.4721	.5349	.9902	.1503	-.3972	.5562	.9580	.5002	.7476	-.6200	.4927	1.0395
.2503	-.5076	.5247	1.0066	.1976	-.3069	.5249	1.0062	.5002	.4976	-.6301	.4899	1.0643
.3001	-.5488	.5130	1.0258	.2503	-.3727	.5062	1.0379	.5002	.2476	-.6363	.4881	1.0673
.3502	-.5439	.5144	1.0235	.3001	-.46215	.4923	1.0402	.5002	-.2524	-.6278	.4905	1.0632
.4003	-.5598	.5102	1.0305	.3507	-.4208	.4925	1.0298	.5002	-.5024	-.6286	.4903	1.0636
.4501	-.5906	.5011	1.0455	.4001	-.5448	.5150	1.0258	.5002	-.7524	-.6102	.4955	1.0548
.5002	-.4323	.4892	1.0653	.4501	-.4469	.5420	.9786	.8002	.7476	-1.0544	.3690	1.2846
.5502	-.8676	.4792	1.0824	.5001	-.3463	.5707	.9330	.8002	.4976	-.3728	.5631	.9450
.6002	-.6976	.4707	1.0970	.5497	-.2175	.6074	.8757	.8002	.2476	-.3727	.5632	.9449
.6500	-.7240	.4631	1.1100	.6003	-.0918	.6431	.8204	.8002	-.5024	-.3713	.5636	.9443
.7000	-.6795	.4758	1.0882	.6500	.0125	.6728	.7748	.8002	-.7524	-.3627	.5660	.9404
.7500	-.4703	.5354	.9894	.7000	-.1266	.7053	.7247					
.8002	-.3673	.5647	.9425	.7501	.7221	.7325	.6925					
.9002	-.1592	.6240	.8500	.8001	.3020	.7553	.6466					
.9501	-.0328	.6599	.7944	.8501	.3686	.7742	.6163					

TEST 167	PT 31.5471	PSI	CN	.3791	CD1	.01052	CDCOR1	.01022
RUN 63	TT 124.8471	K	CM	-.1439	CD2	.01038	CDCOR2	.01012
POINT 7	RC 14.9964	MILLION	CC	.0209	CD3	.01033	CDCOR3	.01011
	MACH				CD4	.01019	CDCOR4	.00995
	ALPHA	-.9807	DEG		CD5	.00996	CDCOR5	.00966

UPPER SURFACE				LOWER SURFACE				SPANWISE				
X/C	CP	P/L/PT	MLOC	X/C	CP	P/L/PT	MLOC	X/C	Y/(B/2)	CP	P/L/PT	MLOC
0.0000	1.0477	.9822	.1605	0.0000	1.0977	.9822	.1605	.1507	.7476	-.4980	.5297	.9986
.0132	-.1420	.7112	.7157	.0126	-.1278	.7071	.7219	.1507	.4976	-.5230	.5226	1.0101
.0259	-.1914	.6166	.8614	.0255	-.0161	.6755	.7707	.1507	.2476	-.5267	.5213	1.0118
.0759	-.5762	.5075	1.0349	.0495	-.1097	.6398	.8256	.1507	-.2524	-.5325	.5199	1.0145
.1003	-.4936	.5309	.9965	.0753	-.2337	.6046	.8799	.1507	-.5024	-.5299	.5706	1.0133
.1507	-.5343	.5194	1.0154	.1002	-.2778	.5922	.8993	.1507	-.7524	-.4998	.5291	.9994
.2003	-.5374	.5185	1.0247	.1503	-.3326	.5766	.9238	.5002	.7476	-.6327	.4958	1.0712
.2503	-.5650	.5107	1.0169	.1976	-.4377	.5468	.9710	.5002	.4976	-.6618	.4832	1.0755
.3001	-.6094	.4981	1.0349	.2503	-.4965	.5301	.9979	.5002	.2476	-.6656	.4821	1.0773
.3502	-.6187	.4954	1.0506	.3001	-.5364	.5188	1.0163	.5002	-.2524	-.6583	.4842	1.0738
.4003	-.6083	.4984	1.0549	.3507	-.5439	.5167	1.0198	.5002	-.5024	-.6645	.4824	1.0768
.4501	-.6179	.4957	1.0546	.4001	-.4996	.5292	.9993	.5002	-.7524	-.6321	.4860	1.0709
.5002	-.6600	.4837	1.0747	.4501	-.4257	.5502	.9656	.8002	.7476	-1.0413	.3756	1.2715
.5502	-.7005	.4722	1.0943	.5001	-.3318	.5768	.9234	.8002	.4976	-.3688	.5663	.9399
.6002	-.7383	.4615	1.1128	.5497	-.2057	.6124	.8676	.8002	.2476	-.3683	.5665	.9367
.6500	-.7629	.4545	1.1249	.6003	-.0822	.6476	.8136	.8002	-.5024	-.3703	.5659	.9406
.7000	-.6946	.4768	1.0865	.6500	.0200	.6766	.7690	.8002	-.7524	-.3629	.5660	.9373
.7500	-.6465	.5290	.9835	.7000	-.1339	.7089	.7192					
.8002	-.3626	.5681	.9372	.7501	.2300	.7351	.6768					
.9002	-.1563	.6266	.8440	.8001	.3110	.7591	.6405					
.9501	-.0322	.6617	.7918	.8501	.3791	.7784	.6095					

TEST 167	PT 31.5477	PSI	CN	.4630	CD1	.01097	CDCOR1	.01068
RUN 63	TT 124.8597	K	CM	-.1466	CD2	.01079	CDCOR2	.01048
POINT 8	RC 14.9969	MILLION	CC	.0205	CD3	.01068	CDCOR3	.01045
	MACH				CD4	.01052	CDCOR4	.01026
	ALPHA	-.4726	DEG		CD5	.01022	CDCOR5	.00986

UPPER SURFACE				LOWER SURFACE				SPANWISE				
X/C	CP	P/L/PT	MLOC	X/C	CP	P/L/PT	MLOC	X/C	Y/(B/2)	CP	P/L/PT	MLOC
0.0000	1.1222	.9892	.1250	0.0000	1.1222	.9892	.1250	.1507	.7476	-.5775	.5071	1.0355
.0132	-.0434	.6832	.7598	.0126	-.2306	.7363	.6765	.1507	.4976	-.5929	.5028	1.0427
.0259	-.2958	.5870	.9073	.0255	-.1019	.6990	.7332	.1507	.2476	-.5970	.5016	1.0447
.0759	-.7976	.4581	1.1222	.0495	-.0359	.6607	.7934	.1507	-.2524	-.6076	.4988	1.0497
.1003	-.6193	.4953	1.0552	.0753	-.1555	.6256	.8456	.1507	-.5024	-.5990	.5016	1.0456
.1507	-.6099	.4979	1.0504	.1002	-.2121	.6107	.8704	.1507	-.7524	-.5707	.5091	1.0323
.2003	-.6252	.4936	1.0580	.1503	-.2753	.5928	.8943	.5002	.7476	-.7143	.4883	1.1009
.2503	-.6399	.4894	1.0650	.1976	-.3782	.5636	.9442	.5002	.4976	-.7253	.4851	1.1044
.3001	-.6641	.4826	1.0766	.2503	-.4379	.5467	.9711	.5002	.2476	-.7311	.4836	1.1092
.3502	-.6790	.4783	1.0438	.3001	-.4765	.5358	.9887	.5002	-.2524	-.7237	.4857	1.1056
.4003	-.6827	.4745	1.0404	.3507	-.4916	.5315	.9956	.5002	-.5024	-.7255	.4852	1.1044
.4501	-.7097	.4697	1.0987	.4001	-.4630	.5396	.9825	.5002	-.7524	-.7317	.4834	1.1095
.5002	-.7281	.4664	1.1078	.4501	-.4050	.5561	.9562	.8002	.7476	-1.0312	.3785	1.2652
.5502	-.7474	.4589	1.1172	.5001	-.3184	.5804	.9174	.8002	.4976	-.3661	.5671	.9387
.6002	-.7798	.4498	1.1333	.5497	-.1969	.6151	.8637	.8002	.2476	-.3636	.5678	.9376
.6500	-.8172	.4392	1.1521	.6003	-.0794	.6492	.8111	.8002	-.5024	-.3703	.5659	.9404
.7000	-.7324	.4632	1.1098	.6500	.0234	.6775	.7676	.8002	-.7524	-.3698	.5672	.9366
.7500	-.6458	.5402	.9815	.7000	-.1362	.7095	.7142					
.8002	-.3572	.5686	.9447	.7501	.2320	.7367	.6759					
.9002	-.1559	.6267	.8458	.8001	.3138	.7599	.6392					
.9501	-.0353	.6609	.7931	.8501	.3824	.7794	.6080					

REPORT OF POOR QUALITY

TEST RUN POINT 167 63 9
 PT TT 31.5466 PSI
 RC 124.8633 K
 MACH 14.9958 MILLION
 ALPHA .7799 DEG
 CM .5394
 CM -1.1491
 CC .0202
 CD1 .01210
 CD2 .01210
 CD3 .01180
 CD4 .01157
 CD5 .01107
 CDCOR1 .01173
 CDCOR2 .01177
 CDCOR3 .01160
 CDCOR4 .01134
 CDCOR5 .01082

UPPER SURFACE				LOWER SURFACE				SPANWISE				
X/C	CP	P/L/PT	MLOC	X/C	CP	P/L/PT	MLOC	X/C	Y/(B/2)	CP	P/L/PT	MLOC
0.0000	1.1471	.9963	.0727	0.0000	1.1471	.9963	.0727	1.507	.7476	-.6645	.4833	1.0754
.0132	-.0423	.6594	.7954	.0126	.3304	.7650	.6310	1.507	.4976	-.7404	.4618	1.1122
.0259	-.3857	.5622	.9464	.0255	.1890	.7250	.6942	1.507	.2476	-.7729	.4526	1.1283
.0759	-.7842	.4494	1.1339	.0495	-.0435	.6838	.7479	1.507	-.2524	-.7724	.4527	1.1281
.1003	-.7947	.4464	1.1392	.0753	-.0753	.6502	.8096	1.507	-.5024	-.7334	.4636	1.1091
.1507	-.7690	.4537	1.1264	.1002	-.1409	.6316	.8382	1.507	-.7524	-.5690	.5047	.9396
.2003	-.7193	.4676	1.0477	.1503	-.2111	.6117	.8689	1.507	-.7476	-.7702	.4536	1.1270
.2503	-.6063	.4998	1.0800	.1976	-.3132	.5825	.9140	1.507	-.4976	-.7890	.4480	1.1364
.3001	-.6742	.4805	1.1044	.2503	-.3737	.5636	.9410	1.507	-.2476	-.7993	.4451	1.1415
.3502	-.7244	.4663	1.1131	.3001	-.4132	.5545	.9587	1.507	-.5024	-.7823	.4471	1.1380
.4003	-.7422	.4613	1.1054	.3507	-.4340	.5484	.9681	1.507	-.7524	-.7894	.4479	1.1360
.4501	-.7865	.4544	1.1252	.4001	-.4158	.5537	.9599	1.507	-.7476	-.8845	.4365	1.2404
.5002	-.7866	.4459	1.1402	.4501	-.3704	.5666	.9395	1.507	-.4976	-.8852	.4372	1.2406
.5502	-.8198	.4393	1.1519	.5001	-.2916	.5889	.9044	1.507	-.2476	-.8532	.4329	1.2329
.6002	-.8390	.4339	1.1618	.5497	-.1755	.6218	.8533	1.507	-.5024	-.8348	.4373	1.2356
.6500	-.8643	.4247	1.1746	.6003	-.0585	.6549	.8023	1.507	-.7476	-.8519	.4326	1.2326
.7000	-.7103	.4703	1.0975	.6500	.0185	.6824	.7601	1.507	-.5024	-.8519	.4326	1.2326
.7500	-.4374	.5474	.9697	.7000	.1505	.7141	.7111	1.507	-.7524	-.8519	.4326	1.2326
.8002	-.3420	.5746	.9268	.7501	.2457	.7411	.6690	1.507	-.7476	-.8519	.4326	1.2326
.8502	-.1458	.6302	.7404	.8001	.3278	.7643	.6322	1.507	-.7524	-.8519	.4326	1.2326
.9001	-.0290	.6832	.7895	.8501	.3973	.7840	.6004					

TEST RUN POINT 167 63 10
 PT TT 31.5466 PSI
 RC 124.9243 K
 MACH 14.9795 MILLION
 ALPHA .7793 DEG
 CM .6196
 CM -1.1477
 CC .0180
 CD1 .01373
 CD2 .01377
 CD3 .01397
 CD4 .01290
 CD5 .01213
 CDCOR1 .01327
 CDCOR2 .01317
 CDCOR3 .01353
 CDCOR4 .01246
 CDCOR5 .01163

UPPER SURFACE				LOWER SURFACE				SPANWISE				
X/C	CP	P/L/PT	MLOC	X/C	CP	P/L/PT	MLOC	X/C	Y/(B/2)	CP	P/L/PT	MLOC
0.0000	1.1507	.9975	.0599	0.0000	1.1507	.9975	.0599	1.507	.7476	-.7830	.4510	1.1312
.0132	-.1421	.6321	.6374	.0126	-.4185	.7906	.5197	1.507	.4976	-.8143	.4339	1.1082
.0259	-.4883	.5343	.9911	.0255	-.2539	.7440	.6644	1.507	.2476	-.8740	.4253	1.1772
.0759	-.8799	.4236	1.1803	.0495	-.1107	.7036	.7274	1.507	-.2524	-.8711	.4261	1.1758
.1003	-.8672	.4272	1.1737	.1002	-.0808	.6703	.7787	1.507	-.5024	-.8038	.4168	1.1927
.1507	-.8884	.4211	1.1848	.1503	-.1540	.6494	.8107	1.507	-.7524	-.7483	.4608	1.1140
.2003	-.8223	.4399	1.1509	.1976	-.2565	.5998	.8634	1.507	-.7476	-.8821	.4246	1.1712
.2503	-.8845	.4223	1.1827	.2503	-.3179	.5824	.9146	1.507	-.4976	-.8881	.4326	1.1640
.3001	-.8910	.4203	1.1960	.3001	-.3984	.5710	.9325	1.507	-.2476	-.8092	.4436	1.1443
.3502	-.8333	.4368	1.1564	.3507	-.3834	.5639	.9437	1.507	-.5024	-.8314	.4373	1.1556
.4003	-.7391	.4634	1.1095	.4001	-.3734	.5687	.9392	1.507	-.7524	-.8844	.4223	1.1626
.4501	-.7849	.4561	1.1222	.4501	-.3346	.5766	.9237	1.507	-.7476	-.9936	.3445	1.2408
.5002	-.8111	.4430	1.1452	.5001	-.2488	.5963	.8929	1.507	-.2476	-.8345	.4329	1.2304
.5502	-.8567	.4301	1.1684	.5497	-.1597	.6272	.8451	1.507	-.5024	-.8345	.4329	1.2304
.6002	-.9017	.4174	1.1916	.6003	-.0475	.6588	.7963	1.507	-.7476	-.8345	.4329	1.2304
.6500	-.9063	.4161	1.1940	.6500	.0461	.6853	.7556	1.507	-.5024	-.8345	.4329	1.2304
.7000	-.6534	.4876	1.0681	.7000	.1559	.7153	.7077	1.507	-.7524	-.8345	.4329	1.2304
.7500	-.4283	.5512	.9639	.7501	.2498	.7429	.6642	1.507	-.7476	-.8345	.4329	1.2304
.8002	-.3407	.5760	.9247	.8001	.3316	.7640	.6293	1.507	-.7524	-.8345	.4329	1.2304
.8502	-.1477	.6305	.8398	.8501	.4012	.7857	.5977					
.9001	-.0337	.6827	.7903									

TEST RUN POINT 167 63 11
 PT TT 31.5466 PSI
 RC 124.8733 K
 MACH 14.9943 MILLION
 ALPHA 1.0179 DEG
 CM .7104
 CM -1.1589
 CC .0193
 CD1 .01740
 CD2 .01722
 CD3 .01705
 CD4 .01631
 CD5 .01509
 CDCOR1 .01643
 CDCOR2 .01649
 CDCOR3 .01643
 CDCOR4 .01565
 CDCOR5 .01448

UPPER SURFACE				LOWER SURFACE				SPANWISE				
X/C	CP	P/L/PT	MLOC	X/C	CP	P/L/PT	MLOC	X/C	Y/(B/2)	CP	P/L/PT	MLOC
0.0000	1.1641	1.0012	0.0000	0.0000	1.1641	1.0012	0.0000	1.507	.7476	-.8272	.4373	1.1594
.0132	-.2030	.6141	.8653	.0126	-.4544	.8121	.5538	1.507	.4976	-.8952	.4011	1.2221
.0259	-.5587	.5141	1.0240	.0255	-.3233	.7631	.6340	1.507	.2476	-.9005	.4106	1.1932
.0759	-.9579	.4173	1.1916	.0495	-.1739	.7208	.7007	1.507	-.2524	-.9176	.4117	1.2022
.1003	-.9641	.4184	1.2040	.0753	-.0547	.6969	.7532	1.507	-.5024	-.9361	.4065	1.2116
.1507	-.9218	.4106	1.2043	.1002	-.0247	.6649	.7875	1.507	-.7524	-.9599	.4281	1.1721
.2003	-.9099	.4139	1.1981	.1503	-.1040	.6418	.8220	1.507	-.7476	-.9805	.4396	1.2250
.2503	-.9281	.4094	1.2066	.1976	-.2085	.6125	.8677	1.507	-.4976	-.9729	.4361	1.2317
.3001	-.8749	.4355	1.2327	.2503	-.2737	.5940	.8964	1.507	-.2476	-.9730	.4361	1.2317
.3502	-.8778	.4365	1.2309	.3001	-.3183	.5814	.9161	1.507	-.5024	-.9278	.4089	1.2075
.4003	-.8714	.4365	1.2309	.3507	-.3472	.5733	.9289	1.507	-.7524	-.9582	.4003	1.2237
.4501	-.8670	.4258	1.1762	.4001	-.3432	.5746	.9272	1.507	-.7476	-.9550	.4068	1.2116
.5002	-.8678	.4213	1.1866	.4501	-.3146	.5925	.9144	1.507	-.4976	-.9550	.4183	1.1901
.5502	-.9281	.4088	1.2077	.5001	-.2500	.6004	.9039	1.507	-.2476	-.9201	.4089	1.2160
.6002	-.9627	.3990	1.2262	.5497	-.1442	.6307	.8595	1.507	-.4976	-.9176	.4183	1.1901
.6503	-.10104	.3855	1.2521	.6003	-.0343	.6618	.8197	1.507	-.2476	-.9176	.4183	1.1901
.7000	-.7608	.4562	1.1221	.6500	.0548	.6876	.7520	1.507	-.5024	-.9176	.4183	1.1901
.7500	-.5208	.5524	.9020	.7000	.1641	.7196	.7042	1.507	-.7524	-.9176	.4183	1.1901
.8002	-.3140	.5827	.9142	.7501	.2594	.7493	.6627	1.507	-.7476	-.9176	.4183	1.1901
.8502	-.1290	.6350	.8329	.8001	.3417	.7693	.6298	1.507	-.7524	-.9176	.4183	1.1901
.9001	-.0288	.6840	.7884	.8501	.4119	.7882	.5936					

ORIGINAL PAGE IS
OF POOR QUALITY

TEST 167 PT 31.5412 PSI CM .7616
 RUN 63 TT 124.9519 K CM -.1628
 POINT 12 RC 14.9842 MILLION CC .0204
 WACH .7805
 ALPHA 1.5269 DEG

CD1 .02333 CDCOR1 .02266
 CD2 .02292 CDCOR2 .02204
 CD3 .02240 CDCOR3 .02115
 CD4 .02255 CDCOR4 .02183
 CD5 .02266 CDCOR5 .02188

UPPER SURFACE				LOWER SURFACE				SPANWISE				
X/C	CP	P/L/PT	MLOC	X/C	CP	P/L/PT	MLOC	X/C	Y/(B/2)	CP	P/L/PT	MLOC
0.0000	1.1596	.9996	.0230	0.0000	1.1596	.9996	.0230	.1507	.7476	-.8799	.4203	1.1863
.0132	-.2694	.5937	.8969	.0126	.5506	.8266	.5290	.1507	.4976	-.9839	.3908	1.2419
.0259	-.6268	.4922	1.0604	.0255	.3739	.7764	.6127	.1507	.2476	-.9136	.4102	1.2051
.0759	-.9217	.4084	1.2083	.0495	.2166	.7318	.6836	.1507	-.2524	-.9687	.3951	1.2716
.1003	-.9044	.4133	1.1992	.0753	.0947	.6972	.7373	.1507	-.5024	-1.0054	.4847	1.2537
.1507	-.9496	.4005	1.2232	.1002	-.0134	.6741	.7779	.1507	-.7524	-.9808	.3917	1.2402
.2003	-.9640	.3964	1.2310	.1503	-.0727	.6496	.8105	.1507	.7476	-1.0232	.3778	1.2636
.2503	-.9698	.3946	1.2342	.1976	-.1771	.6200	.8562	.1507	.4976	-1.0331	.3768	1.2692
.3001	-1.0248	.3791	1.2645	.2503	-.2461	.6073	.8866	.1507	.2476	-1.0261	.3768	1.2693
.3502	-1.0322	.3771	1.2586	.3001	-.2940	.5967	.9078	.1507	-.2524	-1.0090	.3836	1.2557
.4003	-1.0347	.3763	1.2701	.3507	-.3266	.5775	.9223	.1507	-.5024	-1.0206	.3834	1.2561
.4501	-1.0425	.3741	1.2744	.4001	-.3287	.5769	.9232	.1507	-.7524	-.9937	.3880	1.2473
.5002	-.9660	.3959	1.2321	.4501	-.3068	.5831	.9133	.8002	.7476	-.9918	.4169	1.1925
.5502	-.9865	.3900	1.2433	.5001	-.2478	.5999	.8873	.8002	.4976	-.9250	.5779	.9216
.6002	-1.0228	.3797	1.2634	.5497	-.1456	.6289	.8424	.8002	.2476	-.9234	.5784	.9209
.6500	-1.0696	.3664	1.2899	.6003	-.0384	.6593	.7955	.8002	-.5024	-.9253	.5779	.9217
.7000	-.7113	.4482	1.1012	.6500	.0502	.6845	.7568	.8002	-.7524	-.9272	.5773	.9226
.7500	-.4314	.5477	.9695	.7000	-.1579	.7151	.7096					
.8002	-.3215	.5789	.9201	.7501	-.2507	.7415	.6684					
.9002	-.1390	.6308	.8395	.8001	-.3321	.7646	.6317					
.9501	-.0463	.6571	.7990	.8501	-.4025	.7866	.5995					

TEST 167 PT 31.5421 PSI CM .8032
 RUN 63 TT 124.8314 K CM -.1662
 POINT 13 RC 15.0143 MILLION CC .0219
 WACH .7812
 ALPHA 2.6122 DEG

CD1 .02903 CDCOR1 .02814
 CD2 .02909 CDCOR2 .02919
 CD3 .03016 CDCOR3 .02939
 CD4 .03167 CDCOR4 .03085
 CD5 .03130 CDCOR5 .03048

UPPER SURFACE				LOWER SURFACE				SPANWISE				
X/C	CP	P/L/PT	MLOC	X/C	CP	P/L/PT	MLOC	X/C	Y/(B/2)	CP	P/L/PT	MLOC
0.0000	1.1490	.9962	.0737	0.0000	1.1490	.9962	.0737	.1507	.7476	-.9916	.3852	1.2526
.0132	-.3297	.5742	.8275	.0126	.5495	.8382	.5088	.1507	.4976	-1.0179	.3778	1.2672
.0259	-.6870	.4712	1.0943	.0255	.4138	.7864	.5964	.1507	.2476	-.9710	.3912	1.2411
.0759	-.9716	.3810	1.2414	.0495	.2538	.7407	.6695	.1507	-.2524	-1.0117	.3796	1.2637
.1003	-.9588	.3946	1.2345	.0753	.1330	.7062	.7233	.1507	-.5024	-1.0088	.3713	1.2801
.1507	-.9850	.3822	1.2488	.1002	-.0434	.6807	.7626	.1507	-.7524	-1.0055	.3690	1.2848
.2003	-.9981	.3834	1.2561	.1503	-.0454	.6553	.8017	.1507	.7476	-1.0531	.3671	1.2885
.2503	-1.0029	.3821	1.2598	.1976	-.1497	.6256	.8475	.1507	.4976	-1.0660	.3641	1.2946
.3001	-1.0597	.3628	1.2910	.2503	-.2221	.6049	.8799	.1507	.2476	-1.0809	.3598	1.3033
.3502	-1.0773	.3608	1.3012	.3001	-.2733	.5903	.9023	.1507	-.2524	-1.0576	.3664	1.2698
.4003	-1.0799	.3601	1.3027	.3507	-.3109	.5786	.9191	.1507	-.5024	-1.0446	.3702	1.2824
.4501	-1.0944	.3560	1.3112	.4001	-.3177	.5778	.9218	.1507	-.7524	-1.0311	.3740	1.2746
.5002	-1.0920	.3566	1.3098	.4501	-.3000	.5827	.9142	.8002	.7476	-.9962	.4068	1.2114
.5502	-1.0346	.3732	1.2763	.5001	-.2454	.5983	.8898	.8002	.4976	-.9453	.5698	.9345
.6002	-1.0804	.3599	1.3031	.5497	-.1908	.6233	.8640	.8002	.2476	-.9404	.5711	.9323
.6500	-1.0819	.3595	1.3039	.6003	-.0430	.6560	.8006	.8002	-.5024	-.9396	.5714	.9319
.7000	-.9688	.3900	1.0374	.6500	.0445	.6810	.7622	.8002	-.7524	-.9398	.5724	.9302
.7500	-.4261	.5467	.9712	.7000	-.1505	.7113	.7134					
.8002	-.3354	.5726	.9300	.7501	-.2423	.7374	.6747					
.9002	-.1759	.6181	.8590	.8001	-.3235	.7606	.6381					
.9501	-.1121	.6363	.8309	.8501	-.3939	.7807	.6058					

TEST 167 PT 31.5418 PSI CM .8283
 RUN 63 TT 124.7668 K CM -.1638
 POINT 14 RC 15.0235 MILLION CC .0219
 WACH .7810
 ALPHA 2.5396 DEG

CD1 .03329 CDCOR1 .03225
 CD2 .03453 CDCOR2 .03321
 CD3 .04063 CDCOR3 .03909
 CD4 .04176 CDCOR4 .03986
 CD5 .03934 CDCOR5 .03818

UPPER SURFACE				LOWER SURFACE				SPANWISE				
X/C	CP	P/L/PT	MLOC	X/C	CP	P/L/PT	MLOC	X/C	Y/(B/2)	CP	P/L/PT	MLOC
0.0000	1.1549	.9980	.0533	0.0000	1.1549	.9980	.0533	.1507	.7476	-1.0743	.3626	1.2976
.0132	-.3797	.5606	.9489	.0126	.6499	.8529	.524	.1507	.4976	-1.0621	.3661	1.2905
.0259	-.7623	.4575	1.1201	.0255	.4903	.8001	.6179	.1507	.2476	-1.0343	.3740	1.2747
.0759	-1.0217	.3796	1.2675	.0495	.2965	.7511	.6646	.1507	-.2524	-1.0510	.3693	1.2841
.1003	-1.0190	.3784	1.2659	.0753	.1729	.7181	.7049	.1507	-.5024	-1.0688	.3610	1.3008
.1507	-1.0231	.3773	1.2682	.1002	.0806	.6918	.7455	.1507	-.7524	-1.0578	.3562	1.3107
.2003	-1.0294	.3794	1.2718	.1503	-.0134	.6650	.7868	.1507	.7476	-1.1010	.3532	1.3160
.2503	-1.0593	.3698	1.2871	.1976	-.1217	.6342	.8343	.1507	.4976	-1.1149	.3521	1.3213
.3001	-1.0858	.3594	1.3040	.2503	-.1970	.6127	.8674	.1507	.2476	-1.1286	.3572	1.3294
.3502	-1.1143	.3512	1.3209	.3001	-.2520	.5970	.8917	.1507	-.2524	-1.1054	.3530	1.3156
.4003	-1.1213	.3493	1.3250	.3507	-.2942	.5856	.9105	.1507	-.5024	-1.0814	.3606	1.3016
.4501	-1.1344	.3453	1.3329	.4001	-.3082	.5816	.9150	.1507	-.7524	-1.0767	.3620	1.2909
.5002	-1.1597	.3383	1.3461	.4501	-.2947	.5849	.9137	.8002	.7476	-.9844	.3940	1.2337
.5502	-1.1392	.3462	1.3157	.5001	-.2448	.5991	.8885	.8002	.4976	-.9323	.5627	.9456
.6002	-1.0966	.3583	1.3105	.5497	-.1484	.6266	.8640	.8002	.2476	-.9683	.5639	.9438
.6500	-.9649	.3794	1.0821	.6003	-.0467	.6555	.8014	.8002	-.5024	-.9390	.5665	.9396
.7000	-.4934	.5282	1.0000	.6500	.0390	.6800	.7538	.8002	-.7524	-.9438	.5711	.9324
.7500	-.4187	.5495	.9686	.7000	-.1446	.7181	.7174					
.8002	-.3528	.5683	.9368	.7501	-.2485	.7397	.6712					
.9002	-.2295	.6034	.8618	.8001	-.3169	.7592	.6404					
.9501	-.1588	.6137	.8624	.8501	-.3874	.7793	.6081					

TEST 167 PT 57.1961 PSI CN -.0946
 RUN 68 TT 116.8792 K CM -.1287
 POINT 74 RC 29.9777 MILLION CC .0066
 MACH .7814
 ALPHA -3.9917 DEG

CD1 .01606 CDCOR1 .01580
 CD2 .01584 CDCOR2 .01566
 CD3 .01609 CDCOR3 .01601
 CD4 .01546 CDCOR4 .01528
 CD5 .01435 CDCOR5 .01392

UPPER SURFACE				LOWER SURFACE				SPANWISE				
X/C	CP	P/L/PT	MLOC	X/C	CP	P/L/PT	MLOC	X/C	Y/(B/2)	CP	P/L/PT	MLOC
0.0000	.7696	.8886	.4151	0.0000	.7696	.8886	.4151	.1507	.7476	-.1287	.6332	.8368
.0132	.6352	.8904	.4877	.0126	-.5991	.4990	1.0494	.1507	.4976	-.1398	.6301	.8416
.0259	.3306	.7638	.6338	.0255	-.5936	.5125	1.0280	.1507	.2476	-.1375	.6308	.8405
.0759	-.0320	.6607	.7944	.0495	-.6988	.4712	1.0974	.1507	-.2524	-.1443	.6288	.8436
.1003	-.0658	.6511	.8092	.0753	-.7774	.4489	1.1363	.1507	-.5024	-.1537	.6261	.8477
.1507	-.1466	.6282	.8446	.1002	-.8453	.4296	1.1708	.1507	-.7524	-.1398	.6301	.8417
.2003	-.1951	.6144	.8659	.1503	-.8444	.4298	1.1704	.5002	.7476	-.4241	.5493	.9682
.2503	-.2437	.6006	.8874	.1976	-.8518	.4277	1.1742	.5002	.4976	-.4275	.5483	.9698
.3001	-.2925	.5867	.9091	.2503	-.9138	.4101	1.2067	.5002	.2476	-.4321	.5470	.9719
.3502	-.3204	.5787	.9217	.3001	-1.0000	.3856	1.2533	.5002	-.2524	-.4210	.5502	.9668
.4003	-.3512	.5700	.9353	.3507	-.9683	.3746	1.2359	.5002	-.5024	-.4180	.5510	.9659
.4501	-.3842	.5606	.9502	.4001	-1.0517	.3709	1.2823	.5002	-.7524	-.4069	.5542	.9604
.5002	-.4289	.5479	.9704	.4501	-1.0555	.3698	1.2845	.8002	.7476	-1.0479	.3720	1.2801
.5502	-.4727	.5355	.9905	.5001	-.4076	.5540	.9607	.8002	.4976	-.3765	.5628	.9467
.6002	-.5176	.5227	1.0112	.5497	-.2406	.6014	.8860	.8002	.2476	-.3797	.5619	.9481
.6500	-.5645	.5094	1.0331	.6003	-.1097	.6387	.8284	.8002	-.5024	-.3543	.5691	.9367
.7000	-.5477	.5142	1.0252	.6500	-.0632	.6689	.7818	.8002	-.7524	-.3487	.5707	.9342
.7500	-.4637	.5380	.9863	.7000	.1060	.6999	.7340					
.8002	-.3740	.5635	.9456	.7501	.1965	.7257	.6940					
.9002	-.1774	.6194	.8581	.8001	.2741	.7477	.6594					
.9501	-.0498	.6557	.8022	.8501	.3380	.7659	.6305					

TFST 167 PT 57.1738 PSI CN .0834
 RUN 68 TT 116.8451 K CM -.1441
 POINT 75 RC 30.0363 MILLION CC .0139
 MACH .7840
 ALPHA -2.9938 DEG

CD1 .01248 CDCOR1 .01216
 CD2 .01206 CDCOR2 .01180
 CD3 .01176 CDCOR3 .01162
 CD4 .01140 CDCOR4 .01124
 CD5 .01118 CDCOR5 .01079

UPPER SURFACE				LOWER SURFACE				SPANWISE				
X/C	CP	P/L/PT	MLOC	X/C	CP	P/L/PT	MLOC	X/C	Y/(B/2)	CP	P/L/PT	MLOC
0.0000	.6936	.9238	.3390	0.0000	.6936	.9238	.3390	.1507	.7476	-.2382	.6020	.8851
.0132	.4999	.8119	.5349	.0126	-.3541	.5691	.9368	.1507	.4976	-.2502	.5986	.8904
.0259	.1787	.7205	.7020	.0255	-.3849	.5603	.9507	.1507	.2476	-.2490	.5989	.8899
.0759	-.1709	.6212	.8534	.0495	-.4463	.5429	.9785	.1507	-.2524	-.2557	.5971	.8929
.1003	-.1900	.6157	.8638	.0753	-.7660	.4520	1.1308	.1507	-.5024	-.2648	.5945	.8969
.1507	-.2590	.5961	.8943	.1002	-.7139	.4608	1.1050	.1507	-.7524	-.2479	.5993	.8894
.2003	-.2977	.5851	.9115	.1503	-.5566	.5115	1.0296	.5002	.7476	-.5007	.5274	1.0036
.2503	-.3402	.5730	.9305	.1976	-.6528	.4842	1.0733	.5002	.4976	-.5042	.5264	1.0052
.3001	-.3853	.5602	.9508	.2503	-.7564	.4547	1.1260	.5002	.2476	-.5090	.5250	1.0074
.3502	-.4095	.5533	.9618	.3001	-.8403	.4309	1.1685	.5002	-.2524	-.4962	.5287	1.0015
.4003	-.4342	.5463	.9730	.3507	-.9185	.4086	1.2094	.5002	-.5024	-.4940	.5293	1.0004
.4501	-.4662	.5372	.9876	.4001	-.9730	.3931	1.2388	.5002	-.7524	-.4823	.5326	.9951
.5002	-.5071	.5256	1.0065	.4501	-.5697	.5078	1.0358	.8002	.7476	-1.0820	.3622	1.3000
.5502	-.5485	.5138	1.0258	.5001	-.3073	.5824	.9158	.8002	.4976	-.3826	.5610	.9496
.6002	-.5907	.5018	1.0457	.5497	-.2022	.6123	.8692	.8002	.2476	-.3839	.5606	.9502
.6500	-.6348	.4864	1.0714	.6003	-.0876	.6448	.8189	.8002	-.5024	-.3621	.5668	.9404
.7000	-.6349	.4892	1.0866	.6500	.0103	.6727	.7760	.8002	-.7524	-.3629	.5665	.9407
.7500	-.4871	.5213	.9973	.7000	1.1271	.7059	.7248					
.8002	-.3785	.5621	.9478	.7501	.2239	.7334	.6819					
.9002	-.1777	.6194	.8582	.8001	.3065	.7569	.6448					
.9501	-.0492	.6557	.8021	.8501	.3747	.7763	.6137					

TEST 167 PT 57.1743 PSI CM .2505
 RUN 68 TT 116.8671 K CM -.1497
 POINT 76 RC 29.9455 MILLION CC .0202
 MACH .7802
 ALPHA -1.9864 DEG

CD1 .00946 CDCOR1 .00917
 CD2 .00921 CDCOR2 .00901
 CD3 .00915 CDCOR3 .00905
 CD4 .00911 CDCOR4 .00896
 CD5 .00911 CDCOR5 .00882

UPPER SURFACE				LOWER SURFACE				SPANWISE				
X/C	CP	P/L/PT	MLOC	X/C	CP	P/L/PT	MLOC	X/C	Y/(B/2)	CP	P/L/PT	MLOC
0.0000	1.0168	.9588	.2483	0.0000	1.0168	.9588	.2483	.1507	.7476	-.3641	.5663	.9412
.0132	.3412	.7666	.6790	.0126	-.0888	.6445	.8194	.1507	.4976	-.3808	.5613	.9487
.0259	.0002	.6698	.7804	.0255	-.1733	.6205	.8564	.1507	.2476	-.3814	.5614	.9490
.0759	-.3398	.5732	.9303	.0495	-.2778	.5908	.9026	.1507	-.2524	-.3922	.5593	.9539
.1003	-.3361	.5742	.9286	.0753	-.4250	.5490	.9687	.1507	-.5024	-.3997	.5562	.9573
.1507	-.3919	.5584	.9537	.1002	-.4188	.5507	.9659	.1507	-.7524	-.3789	.5621	.9479
.2003	-.4023	.5594	.9584	.1503	-.4501	.5418	.9802	.5002	.7476	-.5974	.5000	1.0487
.2503	-.4534	.5409	.9817	.1976	-.5583	.5111	1.0303	.5002	.4976	-.6051	.4978	1.0524
.3001	-.4978	.5283	1.0021	.2503	-.6481	.4856	1.0729	.5002	.2476	-.6101	.4963	1.0548
.3502	-.5006	.5275	1.0034	.3001	-.7050	.4694	1.1005	.5002	-.2524	-.6032	.4983	1.0515
.4003	-.5221	.5214	1.0134	.3507	-.7384	.4599	1.1170	.5002	-.5024	-.6021	.4986	1.0509
.4501	-.5538	.5124	1.0292	.4001	-.5825	.5042	1.0417	.5002	-.7524	-.5844	.5037	1.0426
.5002	-.6052	.4978	1.0324	.4501	-.4421	.5441	.9765	.8002	.7476	-1.0831	.3619	1.3005
.5502	-.6454	.4863	1.0716	.5001	-.3441	.5720	.9322	.8002	.4976	-.3743	.5634	.9458
.6002	-.6761	.4776	1.0864	.5497	-.2162	.6083	.8753	.8002	.2476	-.3709	.5643	.9443
.6500	-.7274	.4630	1.1115	.6003	-.0889	.6445	.8194	.8002	-.5024	-.3647	.5661	.9415
.7000	-.7662	.4520	1.1308	.6500	.0129	.6735	.7748	.8002	-.7524	-.3737	.5636	.9455
.7500	-.5046	.5263	1.0093	.7000	.1334	.7077	.7220					
.8002	-.3625	.5667	.9405	.7501	.2323	.7398	.6781					
.9002	-.1664	.6225	.8594	.8001	.3157	.7595	.6406					
.9501	-.0379	.6590	.7971	.8501	.3841	.7790	.6093					

ORIGINAL PAGE IS
OF POOR QUALITY

TEST 167	PT 57.1948	PSI	CN	.3334	CD1 .00946	CDCOR1 .00918
RUN 6A	TT 116.9584	K	CM	-.1533	CD2 .00929	CDCOR2 .00894
POINT 77	RC 29.8729	MILLION	CC	.0221	CD3 .00933	CDCOR3 .00905
	MACH .7780				CD4 .00929	CDCOR4 .00899
	ALPHA -1.4867	DEG			CD5 .00918	CDCOR5 .00891

UPPER SURFACE				LOWER SURFACE				SPANWISE				
X/C	CP	P/L/PT	MLOC	X/C	CP	P/L/PT	MLOC	X/C	Y/(B/2)	CP	P/L/PT	MLOC
0.0000	1.0607	.9712	.2051	0.0000	1.0607	.9717	.2051	.1507	.7476	-.4347	.5457	.9739
.0132	.2493	.7403	.6710	.0126	.0305	.678..	.7677	.1507	.4976	-.4528	.5406	.9822
.0259	-.0984	.6414	.8241	.0255	-.0742	.6483	.8135	.1507	.2476	-.4541	.5402	.9828
.0759	-.4373	.5450	.9751	.0495	-.1936	.6143	.8660	.1507	-.2524	-.4641	.5374	.9874
.1003	-.4163	.5510	.9655	.0753	-.3182	.5789	.9213	.1507	-.5024	-.4698	.5338	.9900
.1507	-.4646	.5372	.9876	.1002	-.3423	.5720	.9321	.1507	-.7524	-.4452	.5427	.9787
.2003	-.4645	.5373	.9876	.1503	-.3871	.5593	.9523	.5002	.7476	-.6389	.4876	1.0739
.2503	-.5128	.5235	1.0099	.1976	-.4962	.5282	1.0022	.5002	.4976	-.6483	.4850	1.0765
.3001	-.5631	.5092	1.0333	.2503	-.5617	.5096	1.0327	.5002	.2476	-.6538	.4834	1.0720
.3502	-.5642	.5089	1.0339	.3001	-.6079	.4965	1.0546	.5002	-.2524	-.6443	.4861	1.0723
.4003	-.5571	.5109	1.0305	.3507	-.6062	.4969	1.0537	.5002	-.5024	-.6450	.4859	1.0723
.4501	-.5928	.5008	1.0474	.4001	-.5341	.5175	1.0198	.5002	-.7524	-.6292	.4904	1.0647
.5002	-.6482	.4850	1.0738	.4501	-.4345	.5458	.9738	.8002	.7476	-1.0638	.3668	1.2906
.5502	-.6908	.4729	1.0945	.5001	-.3351	.5741	.9289	.8002	.4976	-.3641	.5658	.9319
.6002	-.7305	.4616	1.1140	.5497	-.2067	.6106	.8718	.8002	.2476	-.3591	.5673	.9396
.6500	-.7831	.4466	1.1403	.6003	-.0808	.6466	.8164	.8002	-.5024	-.3583	.5675	.9393
.7000	-.8191	.4364	1.1585	.6500	.0189	.6748	.7728	.8002	-.7524	-.3713	.5638	.9452
.7500	-.8235	.4205	1.0149	.7000	.1391	.7090	.7199					
.8002	-.8335	.4588	.9371	.7501	.2379	.7371	.6761					
.9002	-.1631	.6230	.8525	.8001	.3217	.7610	.6383					
.9501	-.0373	.6588	.7973	.8501	.3914	.7808	.6064					

TEST 167	PT 57.1974	PSI	CN	.4158	CD1 .01021	CDCOR1 .00992
RUN 6A	TT 116.7773	K	CM	-.1550	CD2 .01005	CDCOR2 .00967
POINT 7A	RC 30.3102	MILLION	CC	.0225	CD3 .01012	CDCOR3 .00982
	MACH .7811				CD4 .01001	CDCOR4 .00971
	ALPHA -1.9877	DEG			CD5 .00973	CDCOR5 .00942

UPPER SURFACE				LOWER SURFACE				SPANWISE				
X/C	CP	P/L/PT	MLOC	X/C	CP	P/L/PT	MLOC	X/C	Y/(B/2)	CP	P/L/PT	MLOC
0.0000	1.1000	.9829	.1573	0.0000	1.1000	.9829	.1573	.1507	.7476	-.5094	.5278	1.0030
.0132	.1507	.7145	.7115	.0126	.1465	.7133	.7133	.1507	.4976	-.5308	.5217	1.0128
.0259	-.2042	.6141	.8664	.0255	-.0248	.6788	.7666	.1507	.2476	-.5340	.5208	1.0144
.0759	-.6053	.5006	1.0476	.0495	-.1094	.6409	.8250	.1507	-.2524	-.5433	.5182	1.0187
.1003	-.5019	.5299	.9996	.0753	-.2231	.6087	.8747	.1507	-.5024	-.5456	.5175	1.0197
.1507	-.5449	.5178	1.0193	.1002	-.2670	.5963	.8940	.1507	-.7524	-.5164	.5258	1.0062
.2003	-.5379	.5197	1.0161	.1503	-.3209	.5811	.9179	.5002	.7476	-.6753	.4808	1.0809
.2503	-.5713	.5103	1.0317	.1976	-.4246	.5518	.9643	.5002	.4976	-.6823	.4789	1.0843
.3001	-.6208	.4963	1.0549	.2503	-.4822	.5355	.9905	.5002	.2476	-.6816	.4811	1.0840
.3502	-.6365	.4918	1.0624	.3001	-.5196	.5249	1.0077	.5002	-.2524	-.6748	.4810	1.0807
.4003	-.6370	.4917	1.0626	.3507	-.5242	.5236	1.0098	.5002	-.5024	-.6813	.4791	1.0838
.4501	-.6366	.4918	1.0624	.4001	-.4809	.5358	.9999	.5002	-.7524	-.6738	.4813	1.0802
.5002	-.6743	.4811	1.0805	.4501	-.4128	.5551	.9590	.8002	.7476	-1.0624	.3714	1.2814
.5502	-.7153	.4695	1.1003	.5001	-.3202	.5813	.9176	.8002	.4976	-.3635	.5690	.9369
.6002	-.7581	.4574	1.1213	.5497	-.1949	.6167	.8623	.8002	.2476	-.3585	.5704	.9347
.6500	-.8164	.4409	1.1504	.6003	-.0713	.6517	.8084	.8002	-.5024	-.3571	.5708	.9340
.7000	-.8465	.4324	1.1857	.6500	.0256	.6791	.7662	.8002	-.7524	-.3717	.5667	.9406
.7500	-.8265	.4229	1.0109	.7000	.1455	.7130	.7138					
.8002	-.8526	.4721	.9320	.7501	.2443	.7409	.6701					
.9002	-.1607	.6264	.8474	.8001	.3288	.7648	.6322					
.9501	-.0365	.6615	.7933	.8501	.3995	.7848	.5999					

TEST 167	PT 57.1951	PSI	CN	.4956	CD1 .01088	CDCOR1 .01054
RUN 6A	TT 116.9934	K	CM	-.1578	CD2 .01064	CDCOR2 .01023
POINT 7A	RC 29.8776	MILLION	CC	.0222	CD3 .01062	CDCOR3 .01079
	MACH .7708				CD4 .01063	CDCOR4 .01028
	ALPHA -1.4908	DEG			CD5 .01023	CDCOR5 .00981

UPPER SURFACE				LOWER SURFACE				SPANWISE				
X/C	CP	P/L/PT	MLOC	X/C	CP	P/L/PT	MLOC	X/C	Y/(B/2)	CP	P/L/PT	MLOC
0.0000	1.1239	.9894	.1238	0.0000	1.1239	.9894	.1238	.1507	.7476	-.5747	.5072	1.0367
.0132	.0622	.6880	.7525	.0126	.2462	.7402	.6712	.1507	.4976	-.5813	.5053	1.0398
.0259	-.2457	.5864	.9095	.0255	-.1097	.7015	.7316	.1507	.2476	-.5834	.5047	1.0406
.0759	-.7599	.4546	1.1262	.0495	-.0344	.6605	.7947	.1507	-.2524	-.5992	.5002	1.0483
.1003	-.6587	.4833	1.0767	.0753	-.1441	.6294	.8427	.1507	-.5024	-.5946	.5013	1.0461
.1507	-.6006	.4998	1.0489	.1002	-.2017	.6131	.8679	.1507	-.7524	-.5668	.5094	1.0330
.2003	-.6109	.4969	1.0538	.1503	-.2624	.5958	.8947	.5002	.7476	-.7328	.4623	1.1128
.2503	-.6431	.4877	1.0692	.1976	-.3644	.5669	.9403	.5002	.4976	-.7441	.4591	1.1183
.3001	-.6894	.4803	1.0818	.2503	-.4234	.5501	.9669	.5002	.2476	-.7523	.4588	1.1224
.3502	-.6810	.4767	1.0879	.3001	-.4616	.5393	.9843	.5002	-.2524	-.7444	.4590	1.1185
.4003	-.6918	.4739	1.0927	.3507	-.4748	.5356	.9903	.5002	-.5024	-.7382	.4600	1.1155
.4501	-.7109	.4685	1.1020	.4001	-.4441	.5443	.9763	.5002	-.7524	-.7384	.4607	1.1153
.5002	-.7489	.4577	1.1207	.4501	-.3890	.5599	.9513	.8002	.7476	-1.0147	.3823	1.1598
.5502	-.7748	.4504	1.1336	.5001	-.3024	.5845	.9125	.8002	.4976	-.3502	.5709	.9329
.6002	-.8079	.4410	1.1503	.5497	-.1812	.6189	.8589	.8002	.2476	-.3460	.5721	.9329
.6500	-.8576	.4269	1.1737	.6003	-.0608	.6531	.8062	.8002	-.5024	-.3436	.5728	.9300
.7000	-.8941	.4165	1.1947	.6500	.0338	.6799	.7649	.8002	-.7524	-.3616	.5677	.9300
.7500	-.9275	.4066	1.0147	.7000	.1521	.7135	.7129					
.8002	-.9413	.3934	.9299	.7501	.2501	.7413	.6695					
.9002	-.1530	.6269	.8466	.8001	.3345	.7633	.6314					
.9501	-.0340	.6607	.7945	.8501	.4057	.7855	.5987					

TEST 167	PT	57.3190	PSI	CN	.5722	CD1	.01327	CDCOR1	.01282
RUN 68	TT	116.9477	K	CM	-.1607	CD2	.01336	CDCOR2	.01297
POINT 80	RC	30.0197	MILLION	CC	.0228	CD3	.01307	CDCOR3	.01262
	MACH	.7816				CD4	.01298	CDCOR4	.01258
	ALPHA	.0407	DEG			CD5	.01257	CDCOR5	.01207

UPPER SURFACE				LOWER SURFACE				SPANWISE				
X/C	CP	P/L/PT	MLOC	X/C	CP	P/L/PT	MLOC	X/C	Y/(B/2)	CP	P/L/PT	MLOC
0.0000	1.1494	.9967	.0689	0.0000	1.1494	.9967	.0689	.1507	.7476	-.6676	.4813	1.0801
.0132	-.0287	.6625	.7916	.0126	.3518	.7705	.6231	.1507	.4976	-.7884	.4471	1.1395
.0259	-.3916	.5596	.9517	.0255	.2030	.7283	.6900	.1507	.2476	-.7781	.4500	1.1343
.0759	-.7775	.4502	1.1340	.0495	-.0456	.6836	.7592	.1507	-.2524	-.7767	.4504	1.1336
.1003	-.7778	.4501	1.1341	.0753	-.0650	.6522	.8075	.1507	-.5024	-.8036	.4428	1.1471
.1507	-.7885	.4471	1.1395	.1002	-.1296	.6339	.8357	.1507	-.7524	-.9005	.5032	1.0433
.2003	-.7056	.4706	1.0985	.1503	-.1987	.6143	.8660	.5002	.7476	-.7723	.4516	1.1314
.2503	-.6976	.4728	1.0946	.1976	-.3002	.5855	.9108	.5002	.4976	-.8005	.4436	1.1456
.3001	-.6386	.4896	1.0661	.2503	-.3621	.5680	.9385	.5002	.2476	-.8165	.4391	1.1536
.3502	-.7039	.4711	1.0976	.3001	-.4019	.5567	.9564	.5002	-.2524	-.8035	.4428	1.1470
.4003	-.7338	.4626	1.1123	.3507	-.4213	.5512	.9652	.5002	-.5024	-.8018	.4433	1.1462
.4501	-.7580	.4557	1.1243	.4001	-.4032	.5563	.9570	.5002	-.7524	-.7810	.4492	1.1358
.5002	-.8031	.4429	1.1469	.4501	-.3611	.5683	.9380	.8002	.7476	-.9803	.3927	1.2397
.5502	-.8379	.4330	1.1646	.5001	-.2828	.5905	.9031	.8002	.4976	-.8392	.5745	.9282
.6002	-.8702	.4239	1.1812	.5497	-.1666	.6234	.8519	.8002	.2476	-.8384	.5747	.9279
.6500	-.9147	.4113	1.2045	.6003	-.0495	.6567	.8007	.6002	-.5024	-.8310	.5768	.9246
.7000	-.9335	.4059	1.2145	.6500	.0417	.6825	.7609	.8002	-.7524	-.8471	.5722	.9318
.7500	-.9635	.3109	1.0306	.7000	.1591	.7158	.7094					
.8002	-.9357	.5755	.9267	.7501	.2565	.7435	.6661					
.9002	-.1360	.6321	.6385	.8001	.3412	.7675	.6279					
.9501	-.0238	.6639	.7895	.8501	.4131	.7878	.5949					

TEST 167	PT	47.7018	PSI	CN	.6553	CD1	.01697	CDCOR1	.01638
RUN 68	TT	103.8261	K	CM	-.1673	CD2	.01699	CDCOR2	.01644
POINT 81	RC	29.8759	MILLION	CC	.0233	CD3	.01731	CDCOR3	.01678
	MACH	.7838				CD4	.01608	CDCOR4	.01542
	ALPHA	.5397	DEG			CD5	.01560	CDCOR5	.01490

UPPER SURFACE				LOWER SURFACE				SPANWISE				
X/C	CP	P/L/PT	MLOC	X/C	CP	P/L/PT	MLOC	X/C	Y/(B/2)	CP	P/L/PT	MLOC
0.0000	1.1596	.9991	.0365	0.0000	1.1596	.9991	.0365	.1507	.7476	-.7608	.4521	1.1314
.0132	-.0916	.6427	.8230	.0126	.4278	.7906	.5910	.1507	.4976	-.8809	.4178	1.1929
.0259	-.4583	.5382	.9868	.0255	.2710	.7460	.6629	.1507	.2476	-.8390	.4298	1.1711
.0759	-.8486	.4270	1.1762	.0495	.1077	.6994	.7355	.1507	-.2524	-.8392	.4297	1.1712
.1003	-.8256	.4336	1.1642	.0753	-.0036	.6677	.7844	.1507	-.5024	-.8718	.4204	1.1882
.1507	-.8543	.4254	1.1790	.1002	-.0751	.6474	.8158	.1507	-.7524	-.7411	.4577	1.1215
.2003	-.7727	.4487	1.1373	.1503	-.1510	.6258	.8491	.5002	.7476	-.8845	.4188	1.1948
.2503	-.8520	.4261	1.1778	.1976	-.2540	.5964	.8946	.5002	.4976	-.8866	.4182	1.1959
.3001	-.8719	.4204	1.1882	.2503	-.3186	.5780	.9235	.5002	.2476	-.8344	.4311	1.1687
.3502	-.8594	.4240	1.1817	.3001	-.3620	.5657	.9430	.5002	-.2524	-.8151	.4366	1.1589
.4003	-.7635	.4513	1.1327	.3507	-.3875	.5584	.9545	.5002	-.5024	-.8828	.4173	1.1939
.4501	-.7769	.4475	1.1394	.4001	-.3760	.5617	.9493	.5002	-.7524	-.8611	.4235	1.1826
.5002	-.8341	.4312	1.1680	.4501	-.3409	.5717	.9335	.8002	.7476	-.9423	.4004	1.2256
.5502	-.8682	.4215	1.1863	.5001	-.2675	.5926	.9006	.8002	.4976	-.8281	.5753	.9277
.6002	-.9069	.4105	1.2066	.5497	-.1546	.6247	.8507	.8002	.2476	-.8324	.5741	.9297
.6500	-.9783	.3901	1.2452	.6003	-.0398	.6574	.8003	.8002	-.5024	-.8198	.5777	.9240
.7000	-.1.0434	.3716	1.2816	.6500	.0495	.6829	.7611	.8002	-.7524	-.8304	.5746	.9288
.7500	-.6171	.4930	1.0611	.7000	.1656	.7159	.7099					
.8002	-.3354	.5732	.9310	.7501	.2622	.7435	.6669					
.9002	-.1246	.6333	.8375	.8001	.3465	.7675	.6286					
.9501	-.0212	.6627	.7921	.8501	.4188	.7881	.5952					

TEST 167	PT	47.8185	PSI	CN	.7059	CD1	.02003	CDCOR1	.01948
RUN 68	TT	103.8713	K	CM	-.1694	CD2	.01996	CDCOR2	.01920
POINT 82	RC	29.9003	MILLION	CC	.0239	CD3	.02006	CDCOR3	.01916
	MACH	.7825				CD4	.01866	CDCOR4	.01748
	ALPHA	1.0081	DEG			CD5	.01764	CDCOR5	.01700

UPPER SURFACE				LOWER SURFACE				SPANWISE				
X/C	CP	P/L/PT	MLOC	X/C	CP	P/L/PT	MLOC	X/C	Y/(B/2)	CP	P/L/PT	MLOC
0.0000	1.1593	.9988	.0413	0.0000	1.1593	.9988	.0413	.1507	.7476	-.8015	.4391	1.1543
.0132	-.1542	.6227	.8538	.0126	.4796	.8048	.5675	.1507	.4976	-.9243	.4041	1.2186
.0259	-.5282	.5171	1.0211	.0255	.3178	.7586	.6428	.1507	.2476	-.8683	.4201	1.1889
.0759	-.8783	.4172	1.1942	.0495	.1457	.7095	.7200	.1507	-.2524	-.8961	.4121	1.2036
.1003	-.8513	.4243	1.1810	.0753	.0325	.6772	.7699	.1507	-.5024	-.9045	.4097	1.2080
.1507	-.8935	.4129	1.2022	.1002	-.0399	.6565	.8017	.1507	-.7524	-.8375	.4288	1.1728
.2003	-.8476	.4259	1.1781	.1503	-.1223	.6330	.8379	.5002	.7476	-.9515	.3963	1.2333
.2503	-.8874	.4146	1.1989	.1976	-.2253	.6033	.8639	.5002	.4976	-.9601	.3938	1.2380
.3001	-.9444	.3983	1.2295	.2503	-.2945	.5838	.9143	.5002	.2476	-.9643	.3926	1.2404
.3502	-.9466	.3977	1.2307	.3001	-.3407	.5706	.9351	.5002	-.2524	-.9320	.4019	1.2228
.4003	-.9388	.3999	1.2264	.3507	-.3705	.5621	.9485	.5002	-.5024	-.9483	.3972	1.2316
.4501	-.8598	.4225	1.1844	.4001	-.3661	.5634	.9465	.5002	-.7524	-.9172	.4061	1.2148
.5002	-.8738	.4185	1.1918	.4501	-.3380	.5714	.9339	.8002	.7476	-.9176	.4062	1.2147
.5502	-.9269	.4033	1.2200	.5001	-.2694	.5910	.9031	.8002	.4976	-.8345	.5724	.9323
.6002	-.9663	.3921	1.2414	.5497	-.1599	.6223	.8545	.8002	.2476	-.8391	.5711	.9343
.6500	-.1.0164	.3778	1.2893	.6003	-.0473	.6544	.8049	.8002	-.5024	-.8322	.5731	.9313
.7000	-.1.0796	.3597	1.3055	.6500	.0397	.6792	.7667	.8002	-.7524	-.8326	.5744	.9292
.7500	-.5408	.5135	1.0270	.7000	.1350	.7121	.7158					
.8002	-.3419	.5703	.9356	.7501	.2512	.7396	.6729					
.9002	-.1385	.6284	.8451	.8001	.3352	.7636	.6349					
.9501	-.0386	.6569	.8011	.8501	.4078	.7843	.6014					

ORIGINAL PAGE IS
OF POOR QUALITY

TEST 167	PT 47.8084	PSI	CM .7806	CD1 .02407	CDCDR1 .02314
RUN 68	TT 103.8898	K	CM -.1751	CD2 .02403	CDCDR2 .02321
POINT 83	RC 29.8225	MILLION	CC .0236	CD3 .02322	CDCDR3 .02189
	MACH .7796			CD4 .02319	CDCDR4 .02156
	ALPHA 1.5071	DEG		CD5 .02291	CDCDR5 .02201

UPPER SURFACE				LOWER SURFACE				SPANWISE				
X/C	CP	P _z L/PT	MLOC	X/C	CP	P _z L/PT	MLOC	X/C	Y/(B/2)	CP	P _z L/PT	MLOC
0.0000	-1.1553	.9981	.0522	0.0000	1.1553	.9981	.0522	.1507	.7476	-.8760	.4208	1.1874
.0132	-.2474	.5895	.8899	.0126	.5924	.8267	.5302	.1507	.4976	-.9708	.3939	1.2380
.0259	-.6238	.4925	1.0619	.0255	.3804	.7779	.6119	.1507	.2476	-.9031	.4131	1.2017
.0759	-.9278	.4061	1.2147	.0495	.2090	.7292	.6893	.1507	-.2524	-.9578	.3976	1.2309
.1003	-.8923	.4162	1.1960	.0753	.0957	.6969	.7394	.1507	-.5024	-.9877	.3891	1.2472
.1507	-.9360	.4638	1.2192	.1002	.0109	.6729	.7765	.1507	-.7524	-.9743	.3929	1.2398
.2003	-.9134	.4102	1.2071	.1503	-.0728	.6491	.8131	.5002	.7476	-1.0222	.3793	1.2663
.2503	-.9958	.3979	1.2303	.1976	-.1765	.6196	.8586	.5002	.4976	-1.0270	.3779	1.2690
.3001	-1.0117	.3823	1.2605	.2503	-.2432	.6006	.8880	.5002	.2476	-1.0212	.3796	1.2657
.3502	-1.0291	.3785	1.2679	.3001	-.2923	.5867	.9099	.5002	-.2524	-1.0138	.3817	1.2616
.4003	-1.0260	.3782	1.2684	.3507	-.3261	.5771	.9249	.5002	-.5024	-.9979	.3862	1.2528
.4501	-1.0225	.3792	1.2664	.4001	-.3750	.5771	.9249	.5002	-.7524	-.9742	.3929	1.2398
.5002	-.9678	.3948	1.2303	.4501	-.3054	.5830	.9157	.8002	.7476	-.9074	.4119	1.2039
.5502	-.9880	.3890	1.2474	.5001	-.2425	.6009	.8877	.8002	.4976	-.9337	.5749	.9283
.6002	-1.0290	.3774	1.2701	.5497	-.1418	.6295	.8434	.8002	.2476	-.9377	.5738	.9301
.6500	-1.0869	.3609	1.3030	.6003	-.0341	.6601	.7962	.8002	-.5024	-.9275	.5767	.9255
.7000	-1.0114	.3824	1.2603	.6500	.0504	.6841	.7592	.8002	-.7524	-.9193	.5790	.9218
.7500	-.4743	.3350	.9920	.7000	.1638	.7163	.7094					
.8002	-.3374	.5739	.9299	.7501	.2583	.7431	.6673					
.9002	-1.4811	.6277	.8462	.8001	.3420	.7669	.6295					
.9501	-.0636	.6517	.8091	.8501	.4145	.7816	.5961					

TEST 167	PT 47.8147	PSI	CM .8037	CD1 .02965	CDCDR1 .02887
RUN 68	TT 103.9255	K	CM -.1720	CD2 .03039	CDCDR2 .02956
POINT 84	RC 29.8062	MILLION	CC .0238	CD3 .03102	CDCDR3 .03024
	MACH .7793			CD4 .03206	CDCDR4 .03120
	ALPHA 2.0079	DEG		CD5 .03211	CDCDR5 .03125

UPPER SURFACE				LOWER SURFACE				SPANWISE				
X/C	CP	P _z L/PT	MLOC	X/C	CP	P _z L/PT	MLOC	X/C	Y/(B/2)	CP	P _z L/PT	MLOC
0.0000	1.1553	.9979	.9553	0.0000	1.1553	.9979	.0553	.1507	.7476	-.9624	.3948	1.2362
.0132	-.2981	.5840	.9141	.0126	.5968	.8388	.5302	.1507	.4976	-.9913	.3866	1.2521
.0259	-.6775	.4759	1.0900	.0255	.4209	.7887	.5941	.1507	.2476	-.9610	.3952	1.2355
.0759	-.9730	.3918	1.2420	.0495	.2464	.7390	.6738	.1507	-.2524	-.9965	.3851	1.2550
.1003	-.9534	.3974	1.2313	.0753	.1310	.7062	.7251	.1507	-.5024	-1.0266	.3765	1.2718
.1507	-.9685	.3936	1.2396	.1002	.0412	.6806	.7646	.1507	-.7524	-1.0446	.3714	1.2820
.2003	-.9394	.4013	1.2237	.1503	-.0466	.6536	.8031	.5002	.7476	-1.0491	.3701	1.2845
.2503	-.9872	.3877	1.2498	.1976	-.1529	.6253	.8498	.5002	.4976	-1.0571	.3678	1.2891
.3001	-1.0436	.3717	1.2814	.2503	-.2250	.6048	.8816	.5002	.2476	-1.0730	.3633	1.2982
.3502	-1.0654	.3654	1.2938	.3001	-.2769	.5900	.9046	.5002	-.2524	-1.0537	.3688	1.2871
.4003	-1.0640	.3650	1.2931	.3507	-.3159	.5789	.9221	.5002	-.5024	-1.0319	.3750	1.2748
.4501	-1.0784	.3618	1.3013	.4001	-.3212	.5774	.9244	.5002	-.7524	-1.0136	.3802	1.2645
.5002	-1.0723	.3635	1.2978	.4501	-.3055	.5819	.9174	.8002	.7476	-.9398	.4012	1.2240
.5502	-1.0296	.3756	1.2735	.5001	-.2485	.5981	.8920	.8002	.4976	-.9532	.5683	.9388
.6002	-1.0736	.3631	1.2986	.5497	-.1486	.6266	.8479	.8002	.2476	-.9480	.5698	.9365
.6500	-1.1272	.3478	1.3300	.6003	-.0427	.6567	.8014	.8002	-.5024	-.9349	.5692	.9373
.7000	-.6369	.4875	1.0704	.6500	.0411	.6806	.7646	.8002	-.7524	-.9338	.5738	.9301
.7500	-.4337	.5453	.9753	.7000	.1533	.7125	.7152					
.8002	-.3438	.5710	.9346	.7501	.2469	.7392	.6736					
.9002	-1.1948	.6134	.8683	.8001	.3306	.7630	.6358					
.9501	-.1344	.6306	.9417	.8501	.4030	.7836	.6025					

TEST 167	PT 47.8191	PSI	CM .8569	CD1 .03294	CDCDR1 .03178
RUN 68	TT 103.8590	K	CM -.1731	CD2 .03590	CDCDR2 .03474
POINT 85	RC 29.8403	MILLION	CC .0232	CD3 .04492	CDCDR3 .04366
	MACH .7795			CD4 .04699	CDCDR4 .04514
	ALPHA 2.5142	DEG		CD5 .04220	CDCDR5 .04045

UPPER SURFACE				LOWER SURFACE				SPANWISE				
X/C	CP	P _z L/PT	MLOC	X/C	CP	P _z L/PT	MLOC	X/C	Y/(B/2)	CP	P _z L/PT	MLOC
0.0000	1.1553	.9983	.0498	0.0000	1.1553	.9983	.0498	.1507	.7476	-1.0552	.3719	1.2809
.0132	-.3636	.5679	.9394	.0126	.6586	.8575	.4752	.1507	.4976	-1.0584	.3710	1.2827
.0259	-.7499	.4584	1.1202	.0255	.4786	.8065	.5646	.1507	.2476	-1.0349	.3777	1.2695
.0759	-1.0356	.3775	1.2694	.0495	.3035	.7569	.6455	.1507	-.2524	-1.0445	.3750	1.2748
.1003	-1.0287	.3794	1.2660	.0753	.1872	.7240	.6975	.1507	-.5024	-1.0773	.3657	1.2934
.1507	-1.0112	.3844	1.2563	.1002	.0916	.6969	.7395	.1507	-.7524	-1.0964	.3603	1.3044
.2003	-.9781	.3938	1.2382	.1503	.0011	.6712	.7791	.5002	.7476	-1.1084	.3569	1.3113
.2503	-1.0492	.3736	1.2775	.1976	-.1058	.6409	.8257	.5002	.4976	-1.1160	.3547	1.3157
.3001	-1.0809	.3647	1.2954	.2503	-.1792	.6202	.8578	.5002	.2476	-1.1277	.3514	1.3226
.3502	-1.1164	.3546	1.3160	.3001	-.2302	.6057	.8802	.5002	-.2524	-1.1038	.3582	1.3087
.4003	-1.1177	.3542	1.3168	.3507	-.2747	.5931	.8999	.5002	-.5024	-1.0736	.3667	1.2913
.4501	-1.1288	.3511	1.3233	.4001	-.2838	.5905	.9039	.5002	-.7524	-1.0660	.3689	1.2870
.5002	-1.1615	.3418	1.3427	.4501	-.2745	.5932	.8997	.8002	.7476	-.9411	.4043	1.2183
.5502	-1.1397	.3480	1.3297	.5001	-.2248	.6072	.8778	.8002	.4976	-.9311	.5681	.9391
.6002	-1.1195	.3537	1.3178	.5497	-.1306	.6339	.8365	.8002	.2476	-.9600	.5689	.9378
.6500	-.9467	.4027	1.2212	.6003	-.0292	.6627	.7922	.8002	-.5024	-.9364	.5699	.9362
.7000	-.5240	.5224	1.0124	.6500	.0511	.6854	.7572	.8002	-.7524	-.9348	.5760	.9266
.7500	-.4224	.5412	.9660	.7000	.1619	.7168	.7086					
.8002	-.3447	.5721	.9328	.7501	.2539	.7429	.6678					
.9002	-.2130	.6106	.8726	.8001	.3368	.7664	.6304					
.9501	-.1642	.6233	.8530	.8501	.4092	.7869	.5972					

References

1. Ladson, Charles L.; and Ray, Edward J.: Status of Advanced Airfoil Tests in the Langley 0.3-Meter Transonic Cryogenic Tunnel. *Advanced Aerodynamics—Selected NASA Research*, NASA CP-2208, 1981, pp. 37-53.
2. Ray, Edward J.; Ladson, Charles L.; Adcock, Jerry B.; Lawing, Pierce L.; and Hall, Robert M.: *Review of Design and Operational Characteristics of the 0.3-Meter Transonic Cryogenic Tunnel*. NASA TM-80123, 1979.
3. Johnson, William G., Jr; Hill, Acquilla S.; and Eichmann, Otto: *High Reynolds Number Tests of a NASA SC(3)-0712(B) Airfoil in the Langley 0.3-Meter Transonic Cryogenic Tunnel*. NASA TM-86371, 1985.
4. Mechtly, E. A.: *The International System of Units—Physical Constants and Conversion Factors (Second Revision)*. NASA SP-7012, 1973.
5. Kilgore, Robert A.; Adcock, Jerry B.; and Ray, Edward J.: The Cryogenic Transonic Wind Tunnel for High Reynolds Number Research. *Windtunnel Design and Testing Techniques*, AGARD-CP-174, 1976, pp. 1-1—1-20.
6. Kilgore, Robert A.: *Design Features and Operational Characteristics of the Langley 0.3-Meter Transonic Cryogenic Tunnel*. NASA TN D-8304, 1976.
7. Ladson, Charles L.; and Kilgore, Robert A.: *Instrumentation for Calibration and Control of a Continuous-Flow Cryogenic Tunnel*. NASA TM-81825, 1980.
8. Baals, Donald D.; and Mourhess, Mary J.: *Numerical Evaluation of the Wake-Survey Equations for Subsonic Flow Including the Effect of Energy Addition*. NACA WR L-5, 1945. (Formerly NACA ARR L5H27.)
9. Hall, Robert M.; and Adcock, Jerry B.: *Simulation of Ideal-Gas Flow by Nitrogen and Other Selected Gases at Cryogenic Temperatures*. NASA TP-1901, 1981.
10. Adcock, Jerry B.: *Real-Gas Effects Associated With One-Dimensional Transonic Flow of Cryogenic Nitrogen*. NASA TN D-8274, 1976.
11. Adcock, Jerry B.; and Johnson, Charles B.: *A Theoretical Analysis of Simulated Transonic Boundary Layers in Cryogenic-Nitrogen Wind Tunnels*. NASA TP-1631, 1980.

TABLE I. PRESSURE ORIFICE LOCATIONS

Upper surface			
Orifice no.	x/c	$y/(b/2)$	z/c
1	0.0000	0.0000	0.0000
2	.0132	.0924	.0206
3	.0259	.0626	.0274
^a 4	.0514	.0326	.0353
5	.0759	.0326	.0407
6	.1003	.0326	.0445
7	.1507	.0326	.0504
8	.2003	.0326	.0543
9	.2503	.0326	.0572
10	.3001	.0326	.0589
11	.3502	.0326	.0599
12	.4003	.0326	.0601
13	.4501	.0326	.0596
14	.5002	.0326	.0583
15	.5502	.0326	.0564
16	.6002	.0326	.0536
17	.6500	.0326	.0499
18	.7000	.0326	.0450
19	.7500	.0326	.0389
20	.8002	.0326	.0315
^{a,b} 21	.8500	.0326	.0228
^b 22	.9002	.0326	.0129
^c 23	.9501	.0976	.0016
^{a,c} 24	1.0000	.0000	-.0025

Lower surface			
Orifice no.	x/c	$y/(b/2)$	z/c
43	0.0126	-0.0324	-0.0127
44	.0255	-.0624	-.0185
45	.0495	-.0924	-.0263
46	.0753	-.0924	-.0326
47	.1002	-.0324	-.0376
48	.1503	-.0324	-.0457
49	.1976	-.0324	-.0517
50	.2503	-.0324	-.0566
51	.3001	-.0324	-.0594
52	.3507	-.0324	-.0608
53	.4001	-.0324	-.0607
54	.4501	-.0324	-.0591
55	.5001	-.0324	-.0558
56	.5497	-.0324	-.0508
57	.6003	-.0324	-.0446
58	.6500	-.0324	-.0375
59	.7000	-.0324	-.0299
60	.7501	-.0324	-.0220
61	.8001	-.0324	-.0148
^b 62	.8501	-.0324	-.0086
^{a,b} 63	.8986	-.0324	-.0047
^{a,c} 64	.9489	-.0974	-.0068

Spanwise			
Orifice no.	x/c	$y/(b/2)$	z/c
25	0.1507	0.7476	0.0504
26	.1507	.4976	.0504
27	.1507	.2476	.0504
28	.1507	-.2524	.0504
29	.1507	-.5024	.0503
30	.1507	-.7524	.0503
31	.5002	.7476	.0583
32	.5002	.4976	.0583
33	.5002	.2476	.0583
34	.5002	-.2524	.0583
35	.5002	-.5024	.0583
36	.5002	-.7524	.0584
37	.8002	.7476	.0315
38	.8002	.4976	.0315
39	.8002	.2476	.0315
^a 40	.8002	-.2524	.0315
41	.8002	-.5024	.0315
42	.8002	-.7524	.0315

^aThese tubes blocked or had high leak rates.
^bUsed 0.102-cm (0.040-in.) o.d. and 0.051-cm (0.020-in.) i.d. tubing.
^cUsed 0.051-cm (0.020-in.) o.d. and 0.025-cm (0.010-in.) i.d. tubing.

TABLE II. DESIGN AND MEASURED AIRFOIL COORDINATES

Upper surface		
x/c	z_{design}/c	z_{meas}/c
0.002	0.0092	0.0074
.005	.0141	.0131
.010	.0190	.0181
.020	.0252	.0247
.030	.0294	.0291
.040	.0327	.0325
.050	.0354	.0352
.070	.0397	.0397
.080	.0415	.0415
.100	.0446	.0445
.120	.0471	.0471
.150	.0504	.0504
.180	.0530	.0529
.200	.0544	.0544
.220	.0557	.0556
.250	.0572	.0572
.280	.0584	.0584
.300	.0590	.0589
.330	.0596	.0596
.350	.0599	.0599
.370	.0601	.0600
.400	.0601	.0601
.420	.0600	.0600
.450	.0596	.0596
.480	.0590	.0589
.500	.0584	.0583
.530	.0573	.0572
.550	.0564	.0563
.580	.0549	.0548
.600	.0537	.0536
.630	.0516	.0515
.650	.0500	.0499
.670	.0482	.0481
.700	.0451	.0450
.730	.0416	.0415
.750	.0390	.0389
.770	.0362	.0360
.800	.0316	.0315
.830	.0266	.0264
.850	.0230	.0228
.870	.0192	.0190
.900	.0131	.0129
.920	.0088	.0086
.940	.0042	.0040
.950	.0018	.0016
.960	-.0007	-.0009
.970	-.0033	-.0035
.980	-.0060	-.0062
.990	-.0088	-.0090
1.000	-.0117	-.0118

Lower surface		
x/c	z_{design}/c	z_{meas}/c
0.002	-0.0051	-.0039
.005	-.0081	-.0077
.010	-.0116	-.0113
.020	-.0165	-.0162
.030	-.0204	-.0202
.040	-.0238	-.0235
.050	-.0266	-.0264
.070	-.0316	-.0314
.080	-.0338	-.0336
.100	-.0377	-.0375
.120	-.0412	-.0410
.150	-.0458	-.0456
.180	-.0498	-.0496
.200	-.0521	-.0520
.230	-.0550	-.0549
.250	-.0566	-.0565
.280	-.0585	-.0584
.300	-.0595	-.0594
.330	-.0605	-.0604
.350	-.0609	-.0608
.380	-.0610	-.0609
.400	-.0608	-.0607
.430	-.0600	-.0599
.450	-.0591	-.0591
.480	-.0573	-.0572
.500	-.0558	-.0557
.530	-.0530	-.0529
.550	-.0509	-.0508
.580	-.0472	-.0471
.600	-.0446	-.0445
.620	-.0419	-.0418
.650	-.0376	-.0375
.680	-.0331	-.0329
.700	-.0299	-.0298
.720	-.0267	-.0266
.750	-.0221	-.0220
.770	-.0191	-.0190
.800	-.0149	-.0147
.820	-.0123	-.0121
.850	-.0088	-.0086
.880	-.0059	-.0057
.900	-.0049	-.0046
.930	-.0055	-.0051
.950	-.0074	-.0069
.960	-.0088	-.0082
.970	-.0105	-.0099
.980	-.0126	-.0120
.990	-.0150	-.0143
1.000	-.0177	-.0167

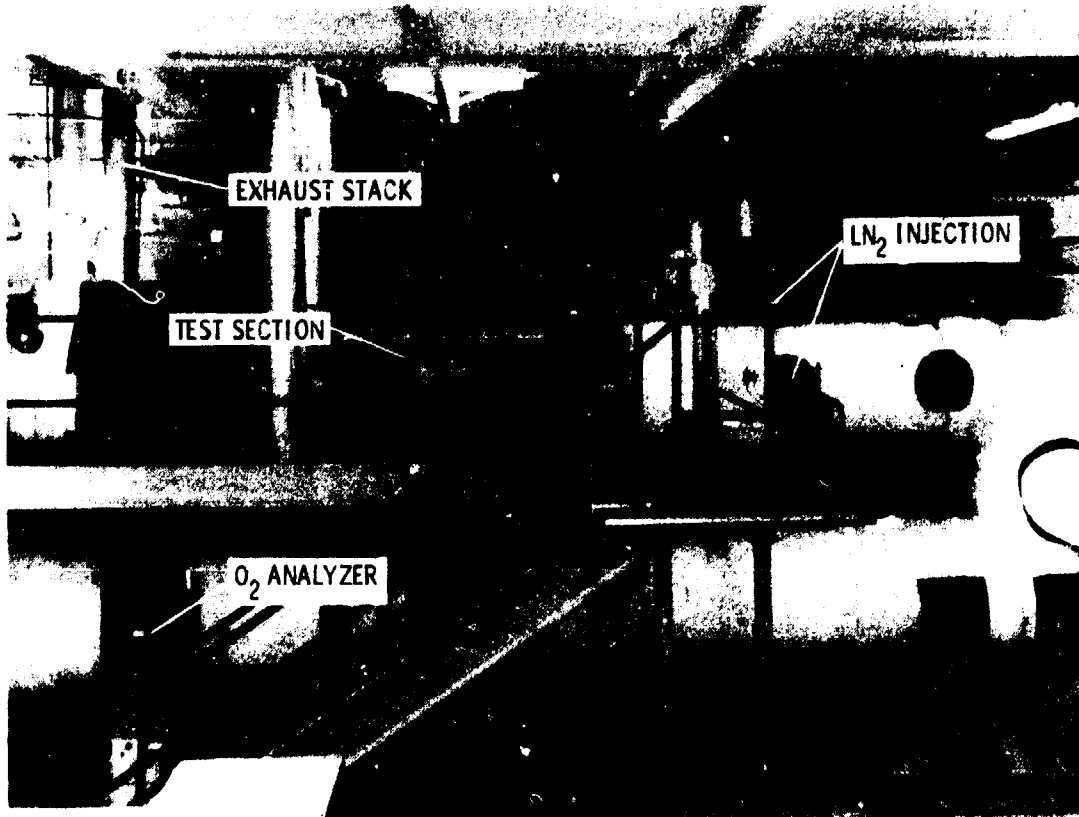

L-79-2147.1

(a) Photograph.

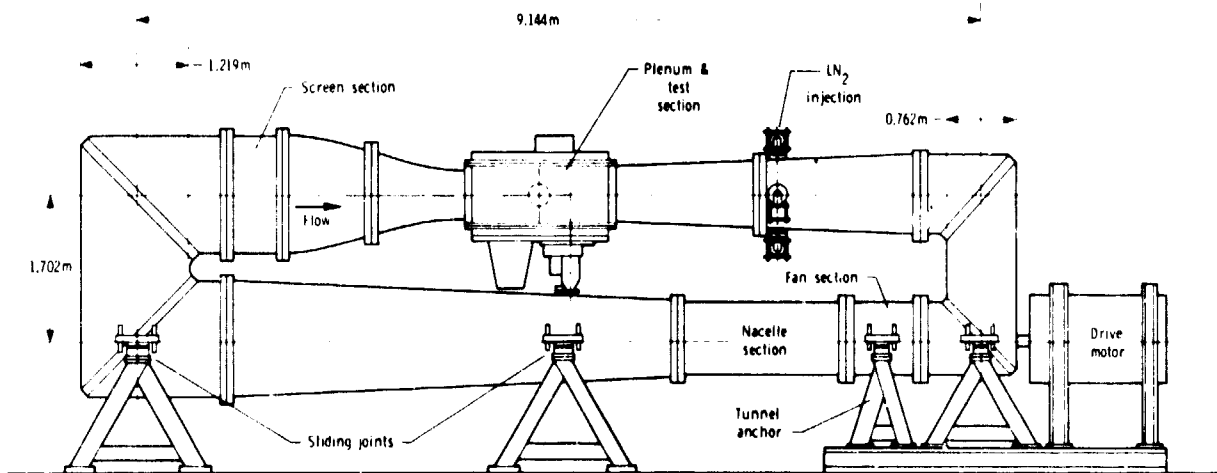

(b) Schematic drawing.

Figure 1. Elevation view of Langley 0.3-Meter Transonic Cryogenic Tunnel with two-dimensional test section installed.

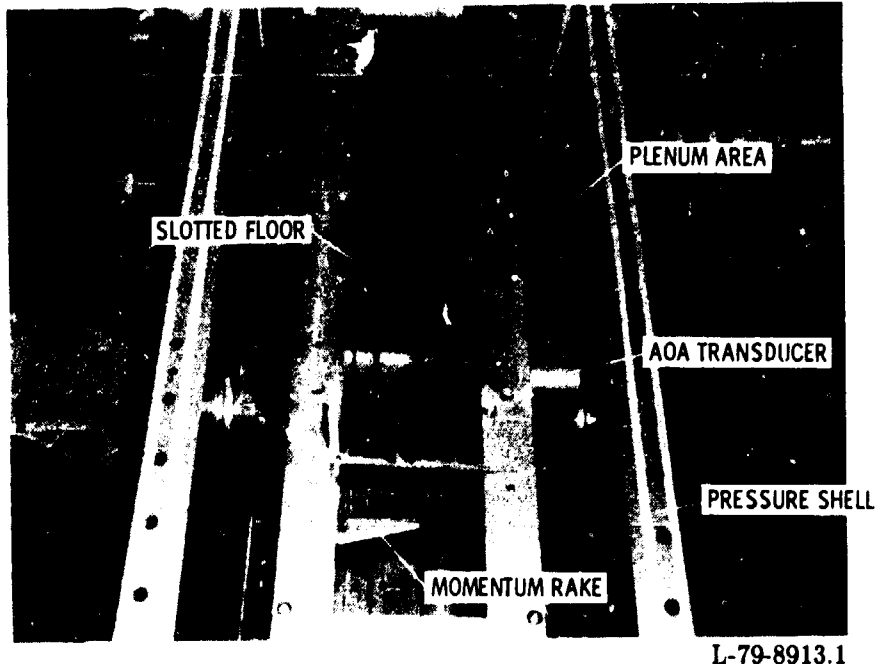

(a) Top-view photograph.

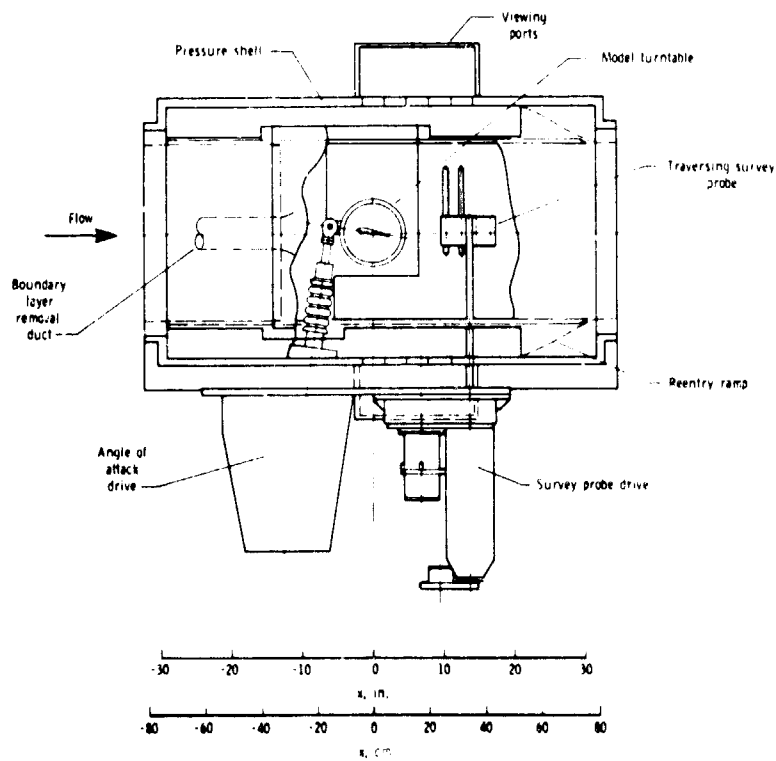

(b) Schematic drawing showing major components.

Figure 2. Two-dimensional test section of 0.3-m TCT.

ORIGINAL PAGE IS
OF POOR QUALITY.



L-83-3478

Figure 3. Model installed in test section of 0.3-m TCT.

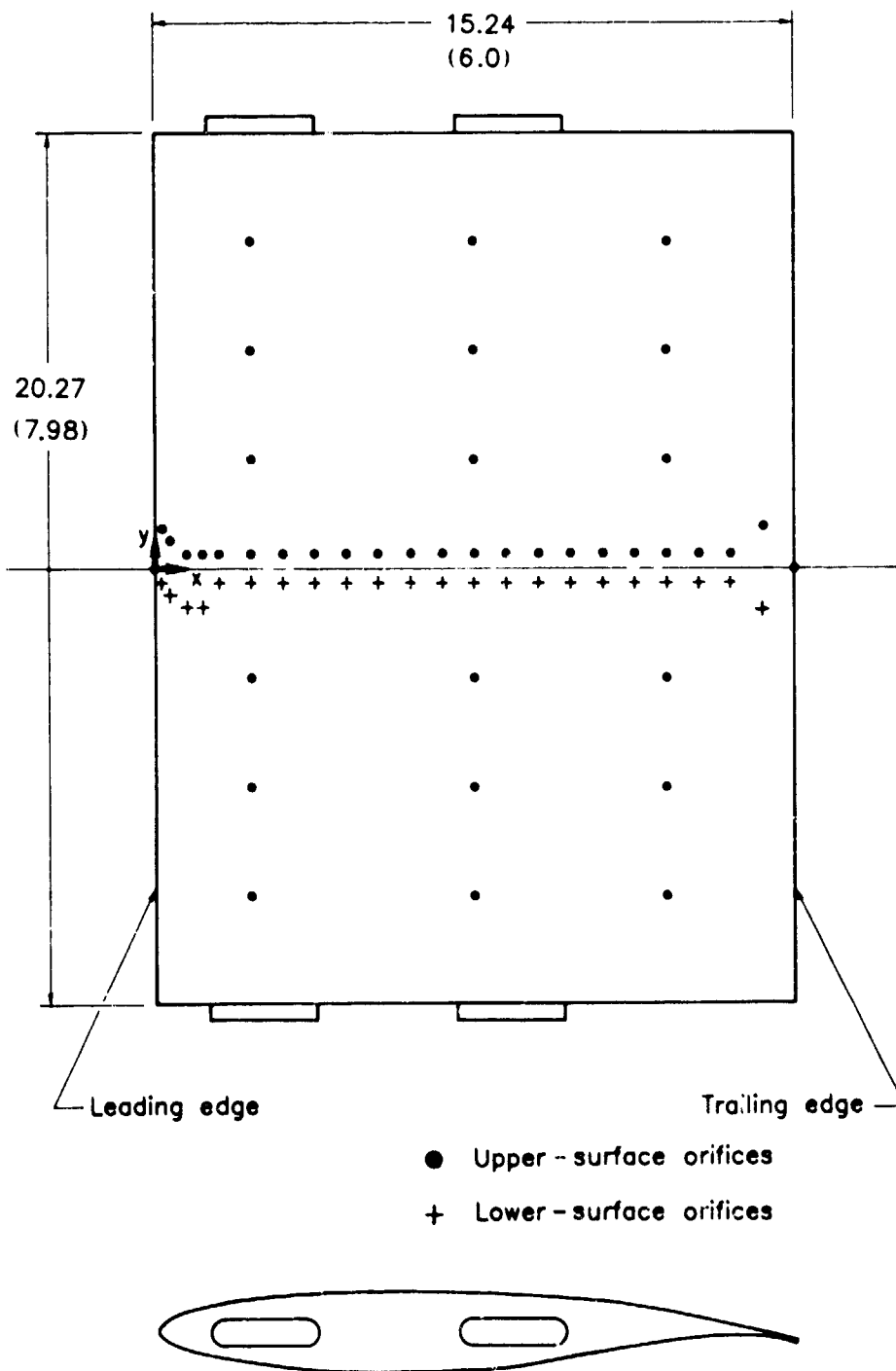

Figure 4. Schematic drawing of model showing orifice arrangement. All dimensions are in cm (in.).

ORIGINAL DESIGN
OF POOR QUALITY

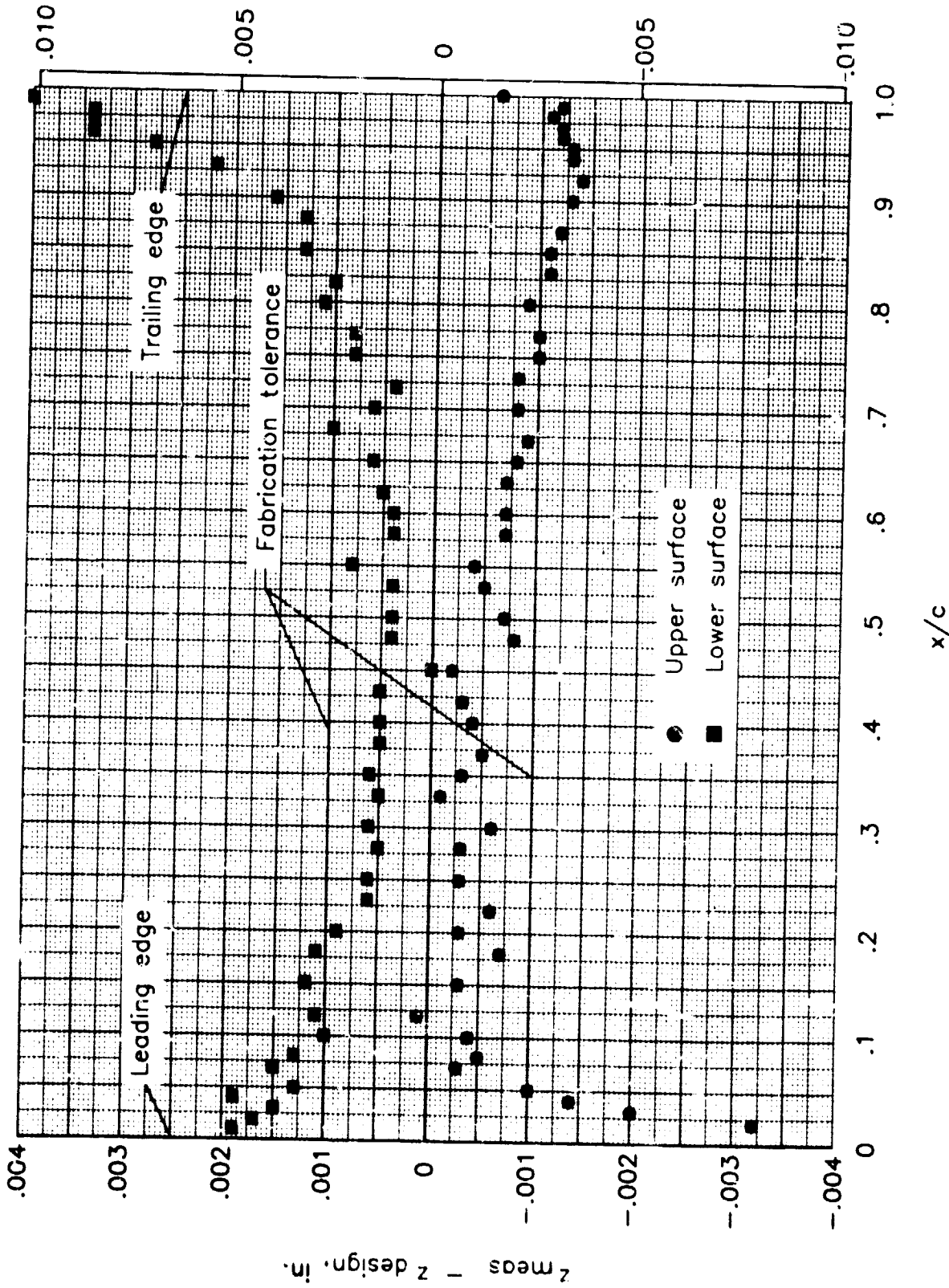

Figure 5. Measured airfoil coordinate error at centerline station.

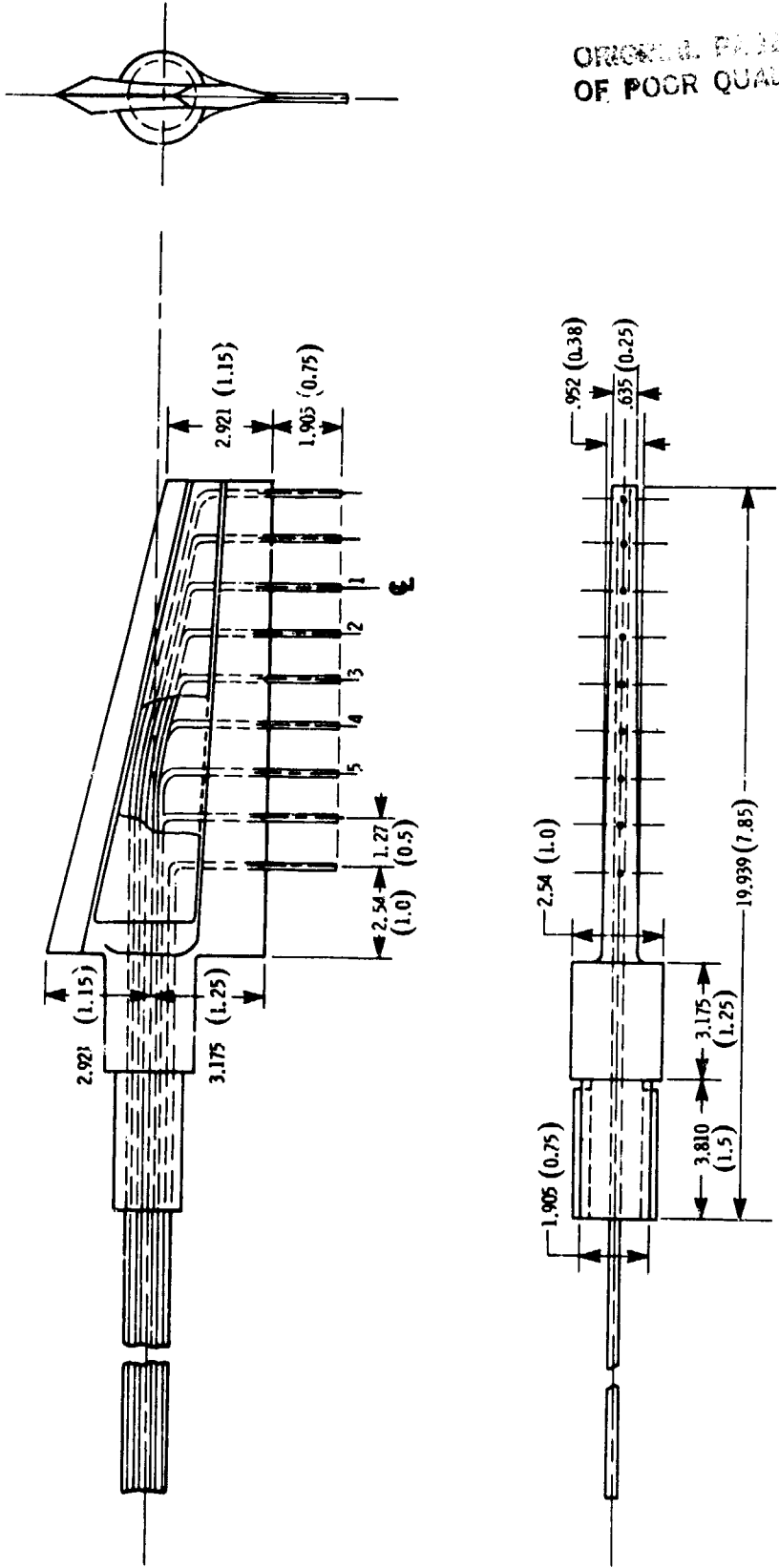

Figure 6. Details of wake survey probe. All measurements are in cm (in.).

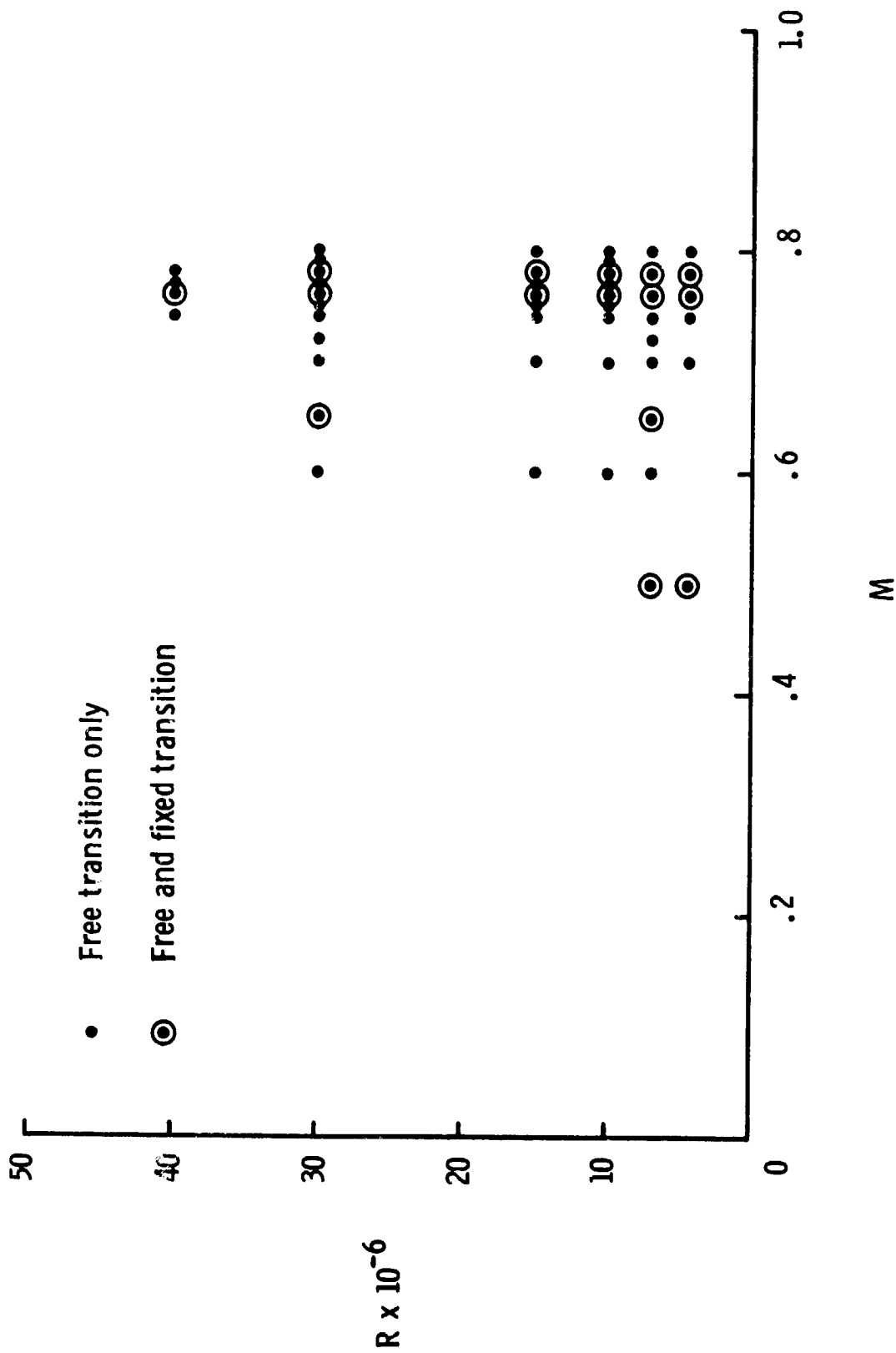

Figure 7. Range of Reynolds number and Mach number used in test program.

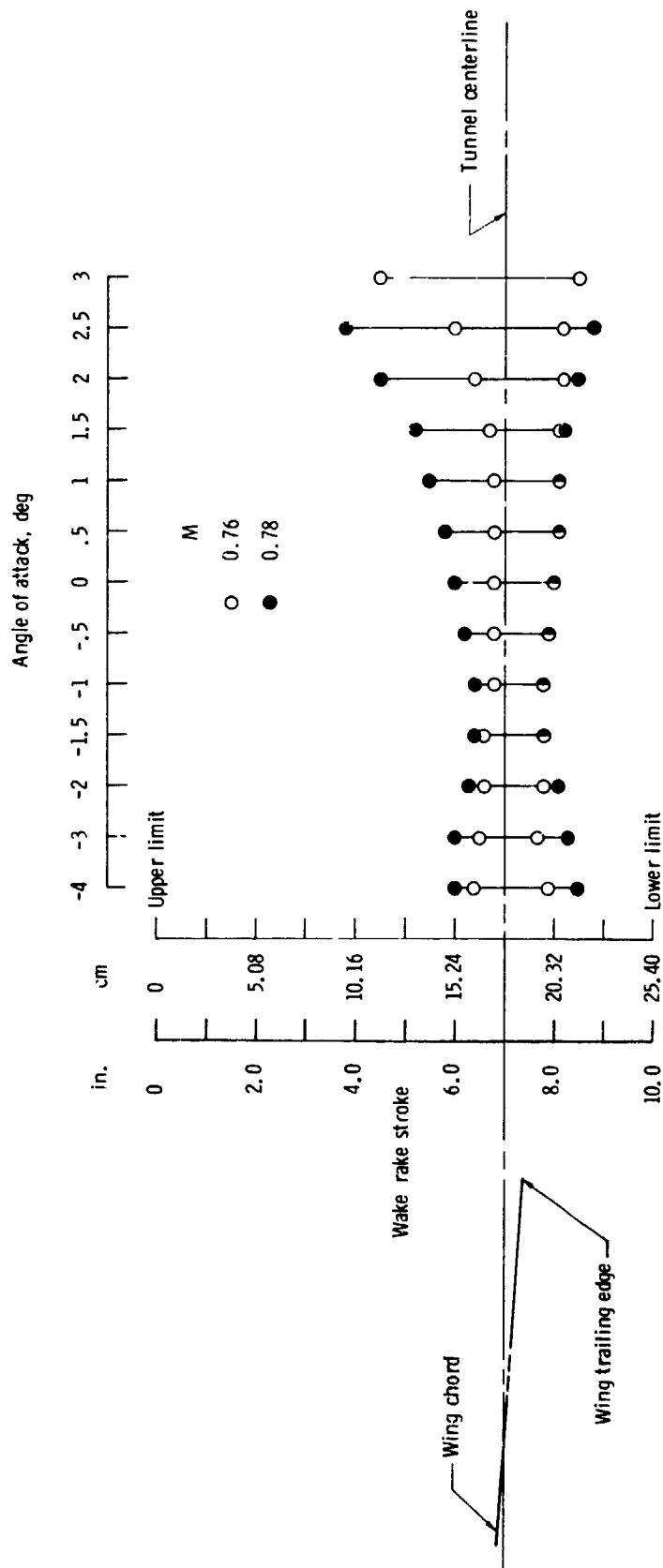

Figure 8. Variation of stroke length used to define the wake at $M = 0.76$ and $M = 0.78$.

ORIGINAL PAGE IS
OF POOR QUALITY

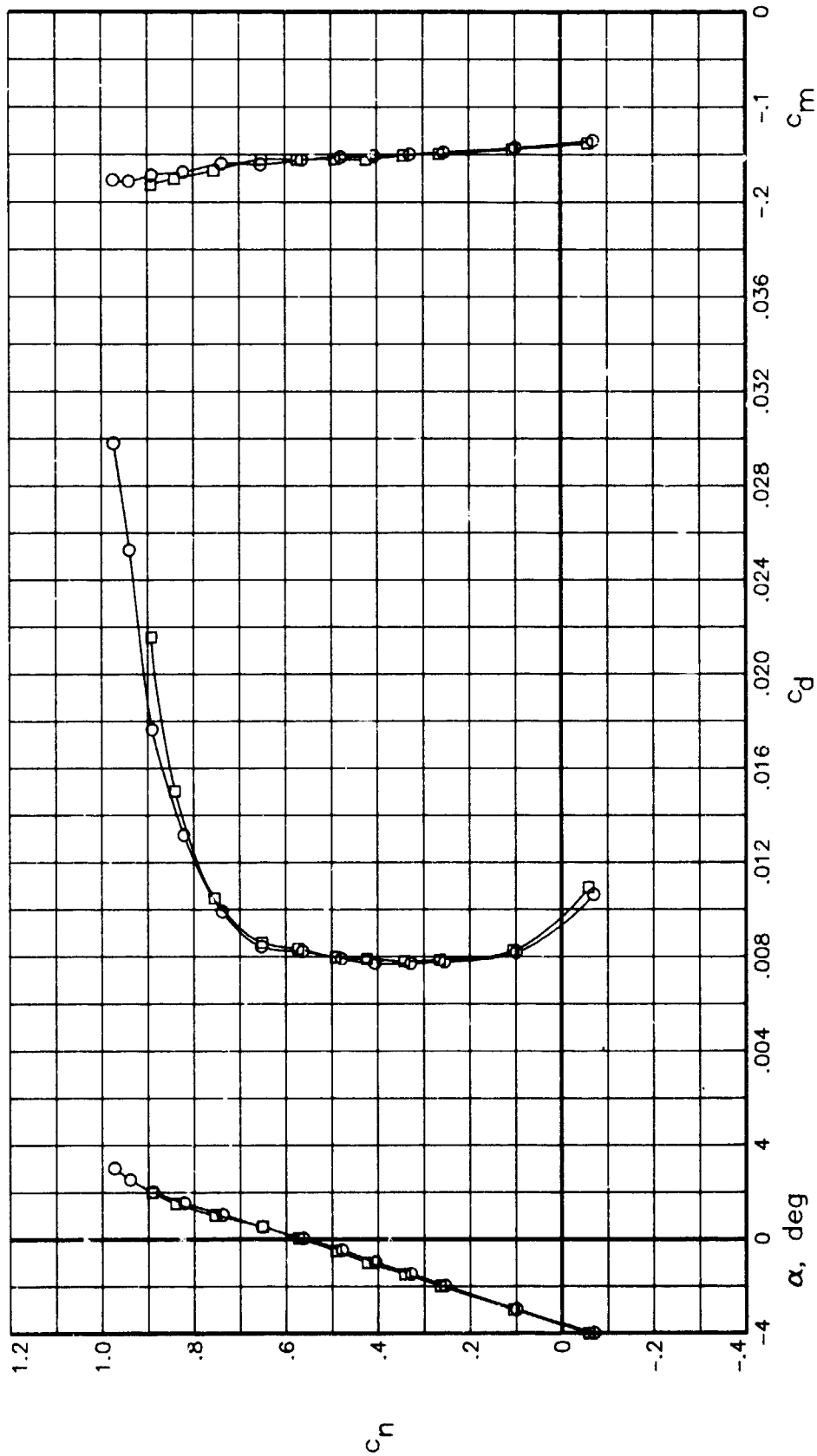

Figure 9. Repeatability of two sets of data (O, □) with free transition at $M = 0.76$ and $R = 30.0 \times 10^6$.

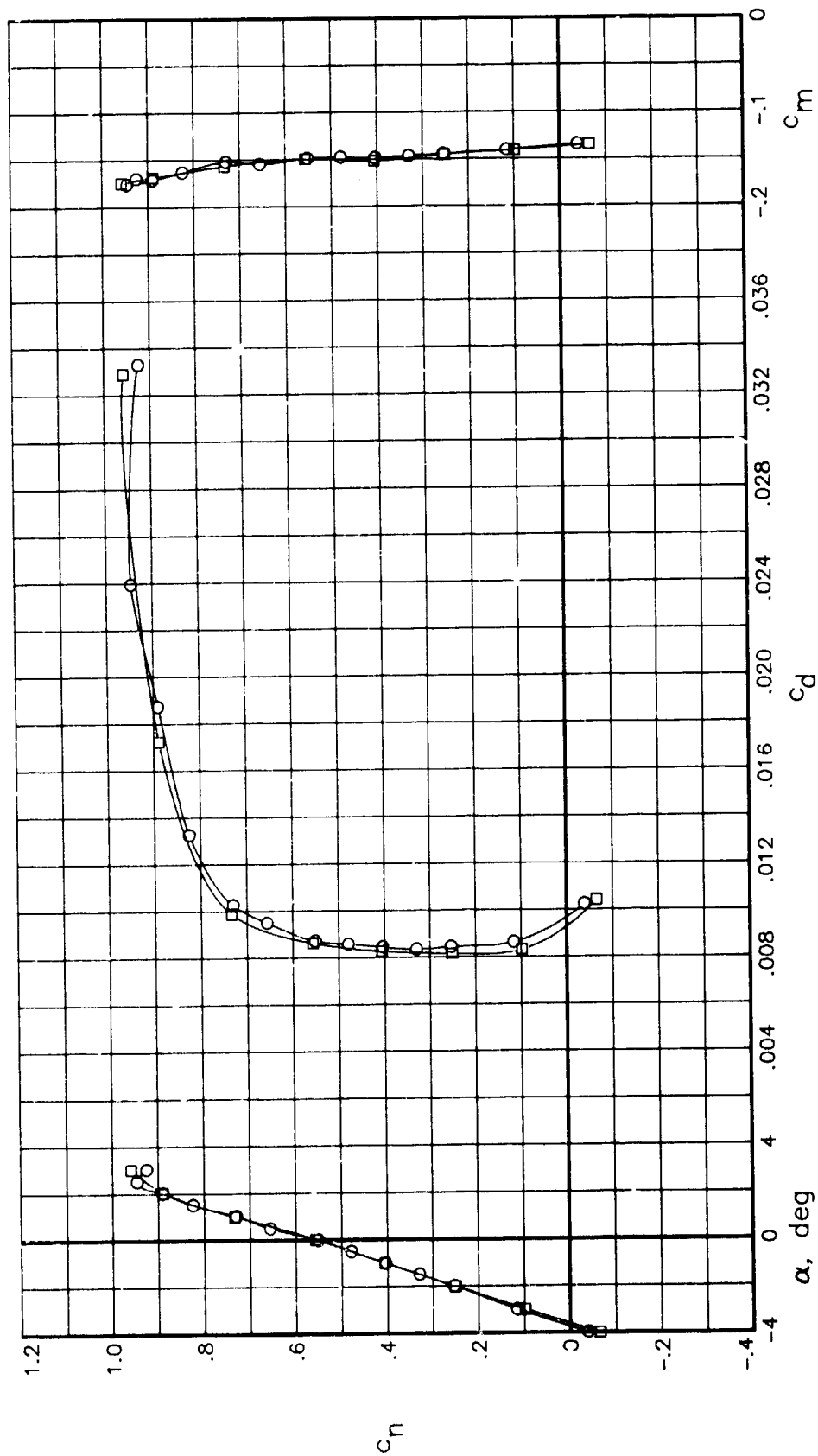

Figure 10. Repeatability of two sets of data (O, □) with fixed transitor. at $M = 0.76$ and $R = 30.0 \times 10^6$.

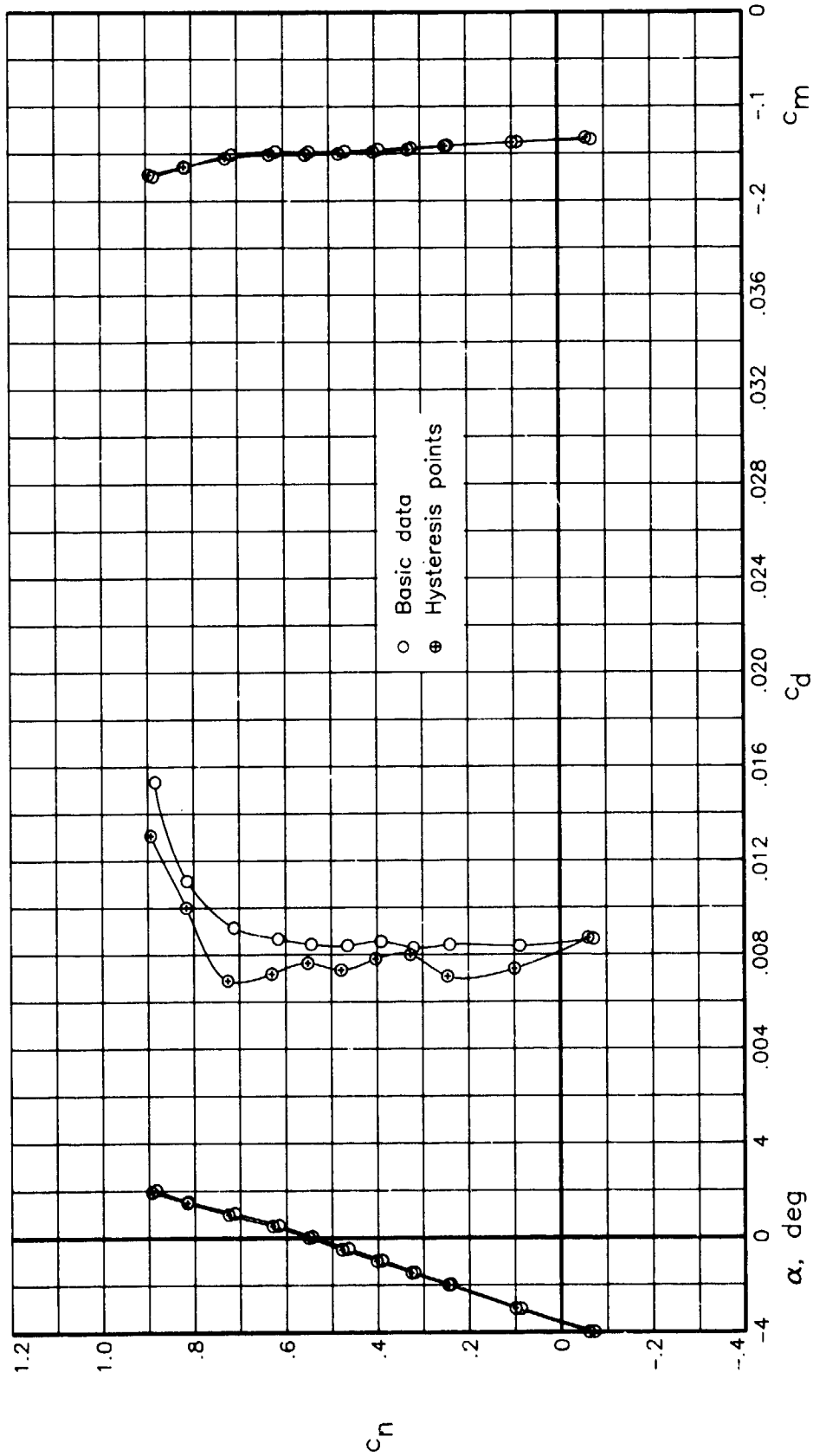

Figure 11. Hysteresis characteristics of data with free transition at $M = 0.76$ and $R = 7.0 \times 10^6$.

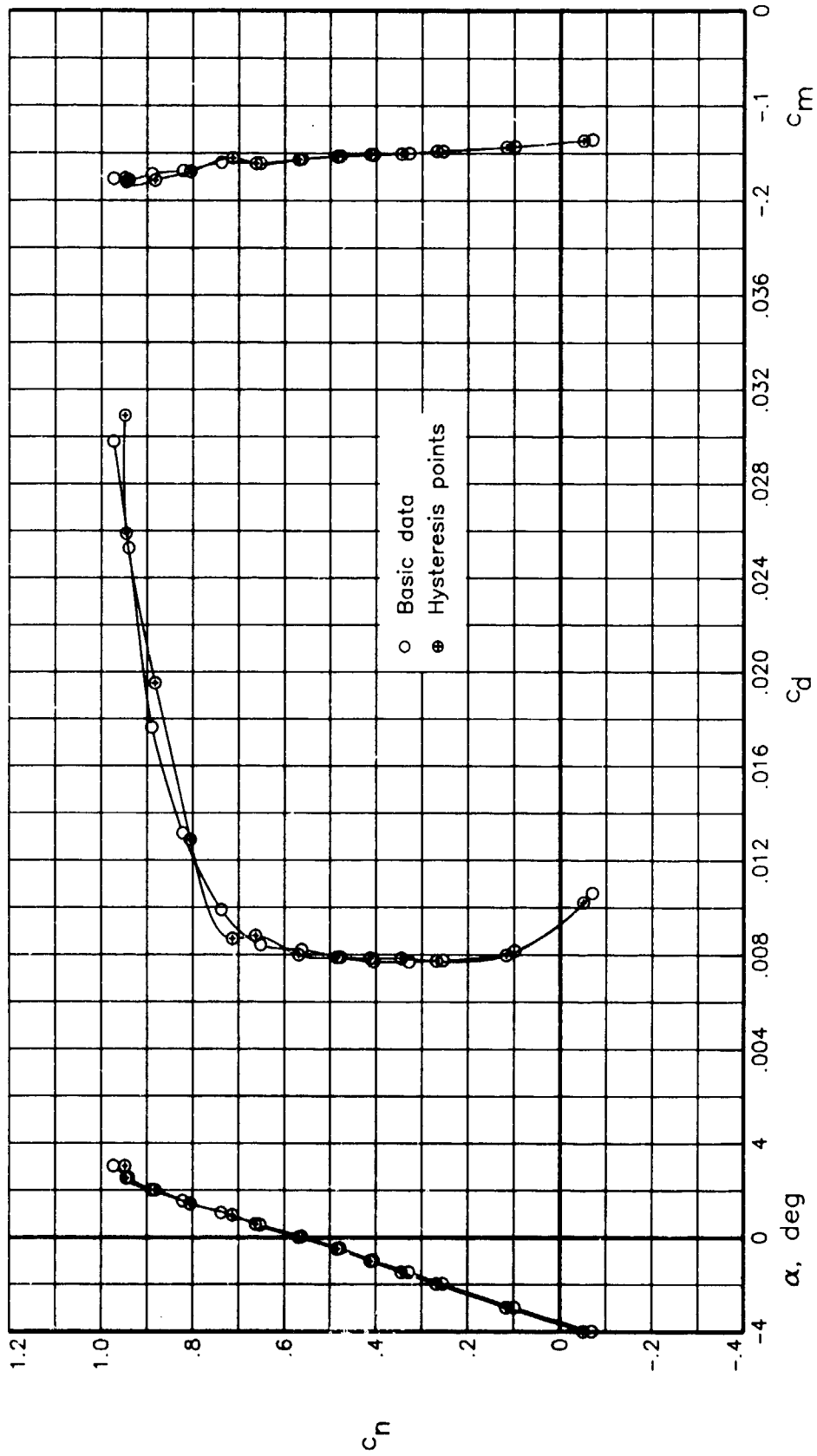

Figure 12. Hysteresis characteristics of data with free transition at $M = 0.76$ and $R = 30.0 \times 10^6$.

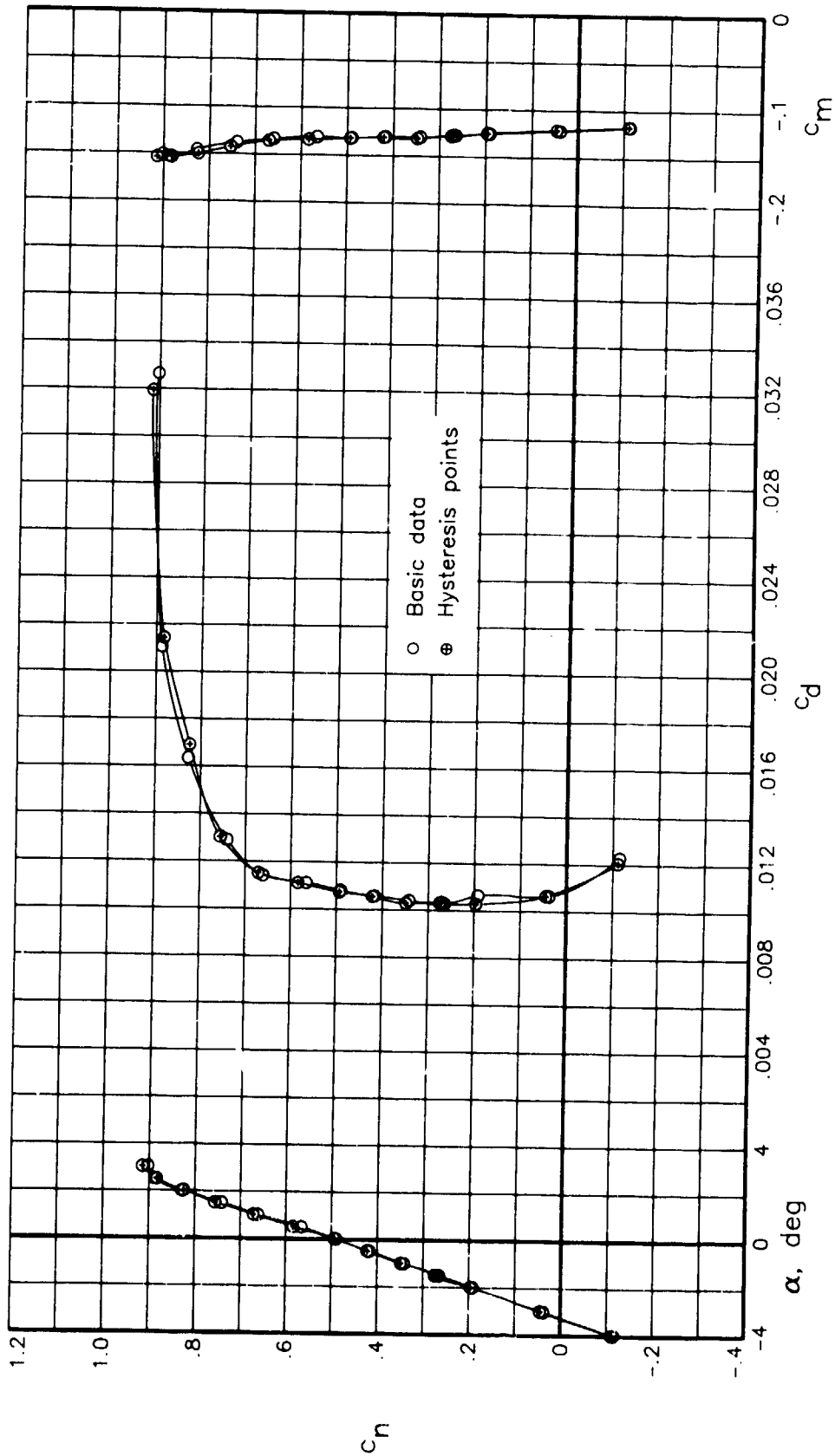

Figure 13. Hysteresis characteristics of data with fixed transition at $M = 0.76$ and $R = 7.0 \times 10^6$.

ORIGINAL PAGE IS
OF POOR QUALITY

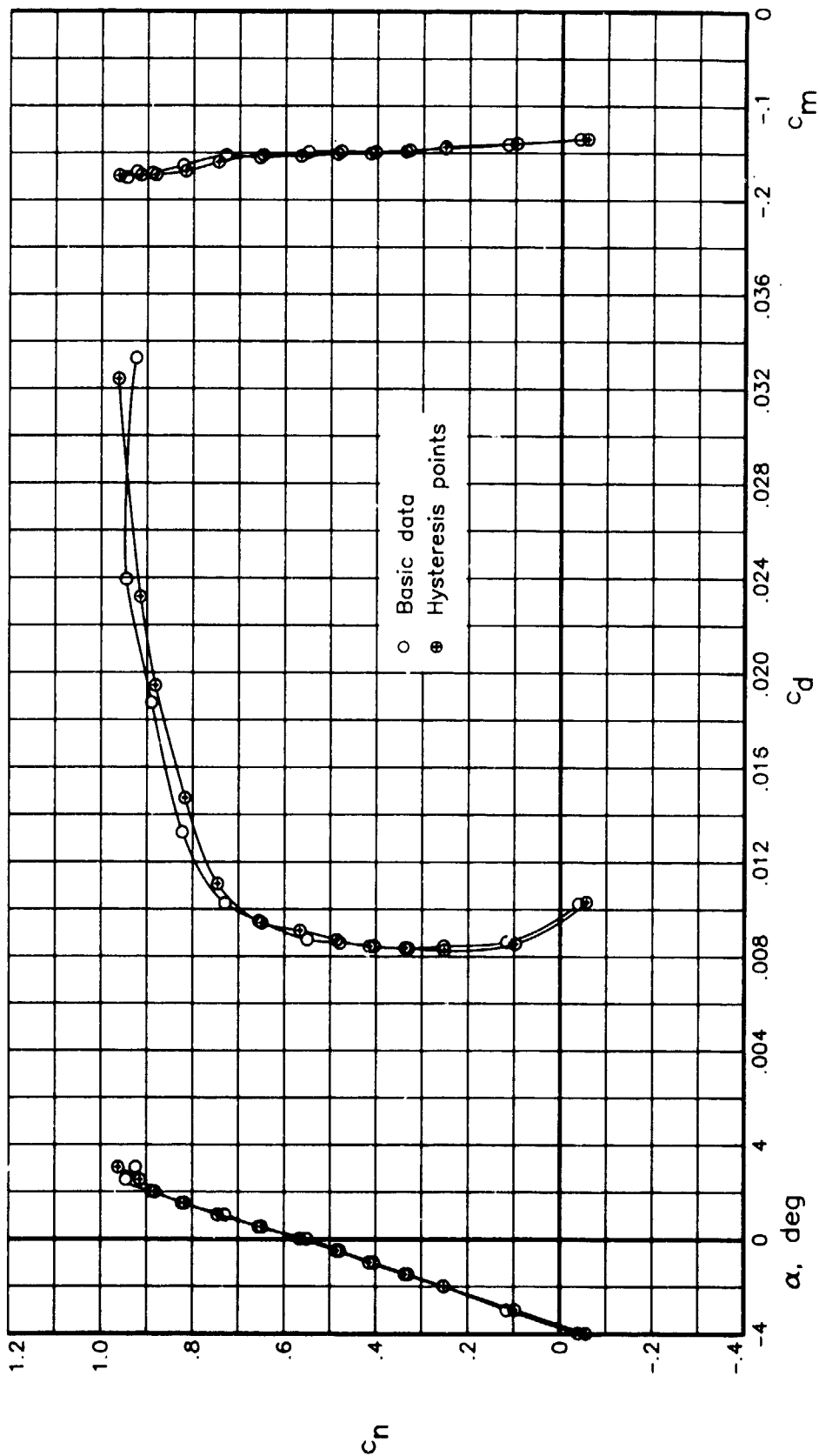

Figure 14. Hysteresis characteristics of data with fixed transition at $M = 0.76$ and $R = 30.0 \times 10^6$.

1. Report No. NASA TM-86370		2. Government Accession No.		3. Recipient's Catalog No.	
4. Title and Subtitle Pressure Distributions From High Reynolds Number Tests of a NASA SC(3) 0712(B) Airfoil in the Langley 0.3-Meter Transonic Cryogenic Tunnel				5. Report Date July 1985	
				6. Performing Organization Code 505-31-53-10	
7. Author(s) William G. Johnson, Jr., Acquilla S. Hill, and Otto Eichmann				8. Performing Organization Report No. L-15908	
				10. Work Unit No.	
9. Performing Organization Name and Address NASA Langley Research Center Hampton, VA 23665				11. Contract or Grant No.	
				13. Type of Report and Period Covered Technical Memorandum	
12. Sponsoring Agency Name and Address National Aeronautics and Space Administration Washington, DC 20546				14. Sponsoring Agency Code	
				15. Supplementary Notes	
16. Abstract <p>A wind tunnel investigation of a NASA 12-percent-thick, advanced-technology supercritical airfoil was conducted in the Langley 0.3-Meter Transonic Cryogenic Tunnel (TCT). This investigation represents another in the series of NASA/U.S. industry two-dimensional airfoil studies to be completed in the Advanced Technology Airfoil Tests program. Test temperature was varied from 220 K to 96 K at pressures ranging from 1.2 to 4.3 atm. Mach number was varied from 0.50 to 0.80. These variables provided a Reynolds number range from 4.4×10^6 to 40.0×10^6 based on a 15.24-cm (6.0-in.) airfoil chord. This investigation was designed to: (1) test a NASA advanced-technology airfoil from low to flight equivalent Reynolds numbers, (2) provide experience in cryogenic wind-tunnel model design and testing techniques, and (3) demonstrate the suitability of the 0.3-m TCT as an airfoil test facility. All the test objectives were met. The pressure data are presented without analysis in tabulated format and as plots of pressure coefficient versus position on the airfoil. This report was prepared for use in conjunction with the aerodynamic coefficient data published in NASA TM-86371. Data are included which demonstrate the effects of fixed transition. Also included are remarks on the model design and fabrication.</p> <p style="text-align: center;">ORIGINAL PAGE IS OF POOR QUALITY.</p>					
17. Key Words (Suggested by Author(s)) Supercritical airfoil Two-dimensional airfoil Cryogenic wind tunnel High Reynolds number			18. Distribution Statement Unclassified - Unlimited Subject Category 02		
19. Security Classif.(of this report) Unclassified		20. Security Classif.(of this page) Unclassified		21. No. of Pages 410	22. Price A18