

DOE/NASA/50194-43
NASA TM-86953

(NASA-TM-86953) COMPARATIVE EVALUATION OF
THREE ALTERNATIVE POWER CYCLES FOR WASTE
HEAT RECOVERY FROM THE EXHAUST OF ADIABATIC
DIESEL ENGINES Final Report (NASA) 27 p
HC A03/MF A01

NE5-32043

Unclas
CSCI 13F G3/85 21878

Comparative Evaluation of Three Alternative Power Cycles for Waste Heat Recovery from the Exhaust of Adiabatic Diesel Engines

M. Murray Bailey
National Aeronautics and Space Administration
Lewis Research Center

July 1985



Prepared for
U.S. Department of Energy
Conservation and Renewable Energy
Office of Vehicle and Engine R&D

DOE/NASA/50194-43
NASA TM-86953

Comparative Evaluation of Three Alternative Power Cycles for Waste Heat Recovery from the Exhaust of Adiabatic Diesel Engines

M. Murray Bailey
National Aeronautics and Space Administration
Lewis Research Center
Cleveland, Ohio 44135

July 1985

Work performed for
U.S. DEPARTMENT OF ENERGY
Conservation and Renewable Energy
Office of Vehicle and Engine R&D
Washington, D.C. 20545
Under Interagency Agreement DE-AI01-80CS50194

Summary

Three alternative power cycles were compared in application as an exhaust-gas heat-recovery system for use with advanced "adiabatic" diesel engines. The power cycle alternatives considered were steam Rankine, organic Rankine with RC-1 as the working fluid, and variations of an air Brayton cycle. The comparison was made in terms of the fuel economy and economic payback potential for heavy-duty trucks operating in line-haul service. The common baseline for the comparisons was the performance and cost of an adiabatic-turbocompound diesel engine in the same service.

The results indicate that, in terms of engine rated specific fuel consumption, a diesel/alternative-power-cycle engine offers a significant improvement over the turbocompound diesel baseline. The maximum improvement (12 percent) resulted from use of a Rankine cycle heat-recovery system in series with turbocompounding. Somewhat less improvement (9 percent) resulted from use of the Rankine cycle system in substitution for the turbocompounding.

Performance of the steam Rankine and the RC-1 organic Rankine systems were found to be potentially equal at the nominal 671 °C (1240 °F) diesel exhaust-gas temperature considered in the study. The air Brayton cycle alternatives studied, which included both simple-cycle and compression-intercooled configurations, were less effective and provided only about half the fuel consumption improvement of the Rankine cycle alternatives under the same conditions.

Highway average fuel economy was assumed to scale directly with the identified changes in engine rated specific fuel consumption. The amount of vehicle fuel saved with each improvement was then estimated on the basis of 161 000 km (100 000 mi) annual use. The value of the fuel saved was calculated using the 1983 average fuel price of \$0.32/liter (\$1.22/gal).

Capital and maintenance cost estimates were developed for each of the heat-recovery power cycle systems. These costs were integrated with the fuel savings results to identify the time required for net annual savings to pay back the initial capital investment. An earlier survey of industry sources has indicated that capital payback within a maximum of 3 years is required for a concept to be considered economically attractive.

The capital payback time results were consistent with the results on improvement in engine rated specific fuel consumption: The Rankine cycle heat-recovery system in series with turbocompounding showed the best payback time (3.2 yr), followed by the Rankine cycle system used in substitution for turbocompounding (4.7 yr); payback time for the air Brayton cycle alternatives were significantly longer.

The sensitivity of capital payback time to arbitrary increases in fuel price, not accompanied by corresponding hardware cost inflation, was examined. The results indicated that fuel price increases of 5 and 25 percent, respectively, would be required for the turbocompound-plus-Rankine cycle (series) system and the Rankine-substituted-for-turbocompound system to pay back capital within the maximum acceptable 3 yr time.

Introduction

The turbocharged diesel engine is currently the universally accepted powerplant for heavy-duty, long-haul truck applications. Although considered efficient by most standards, these engines nevertheless reject much of their fuel energy in the form of waste heat. The two major heat-loss mechanisms are conduction to the water jacket and hot gas flowing out through the exhaust stack.

The adiabatic engine of the future will feature insulated cylinders and thus eliminate the water jacket cooling. The typical adiabatic configuration will include a turbocompound power turbine to recover some of the waste heat from the high-temperature exhaust. More efficient exhaust-heat recovery is desirable, but can only be accomplished by the use of a more complex system involving an appropriate heat-recovery heat exchanger for transferring exhaust heat to a separate power cycle.

Historically, the Department of Energy (DOE) has investigated the Organic Rankine Cycle System (ORCS) for improved heat recovery from the exhaust of conventional diesels. The advent of the adiabatic engine with an exhaust temperature up to 50 percent higher than conventional engines suggests a different operating regime for which the DOE/NASA are currently investigating alternative power cycles for exhaust-heat recovery.

This report presents a comparative evaluation of three alternative power cycles: steam Rankine, organic Rankine, and air Brayton. The comparison is based on cycle data generated in three parallel NASA study contracts plus data generated at the Lewis Research Center on an Automotive-Gas-Turbine (AGT) derivative air Brayton system.

The comparative evaluation includes the power cycle's performance, annual fuel savings, cost, and economic payback when used for heat recovery from the exhaust of an adiabatic diesel operating in typical long-haul truck duty.

This work is part of the Department of Energy (DOE) Heavy-Duty Transport Technology Program with project management provided by the NASA Lewis Research Center. The specific project element is Advanced Adiabatic Diesel Technology; the task is Waste-Heat Utilization.

The power cycle data used in this comparative evaluation is based on information developed under DOE-funded contracts issued by NASA. The appropriate NASA Contractor Reports (CR's) are identified in the reference section of this report.

Adiabatic Diesel Baseline

The term "adiabatic diesel" as used in this report refers to a low heat rejection engine incorporating ceramic components as required to allow the elimination of the traditional water jacket/radiator cooling system. The engine is potentially more efficient and reliable, but it is actually not adiabatic according to the true meaning of the term. Current projections indicate that slightly over 50 percent (overall) of the fuel input energy will be rejected in the form of waste heat.

Waste heat leaves the adiabatic engine primarily in the form of hot gases flowing out through the exhaust stack. Significantly, the stack gas exits at temperatures in excess of 550 °C (1022 °F); making the gas stream an attractive heat source for use with most power cycles.

For purposes of comparing alternative power cycles, it was considered desirable to establish a set of standard or baseline adiabatic diesel conditions. This is particularly appropriate for this study, which was conducted on a noninterference basis; that is, the diesel cycle was adjusted as it normally would be for best diesel performance. No special compromises were introduced to provide increased exhaust energy or otherwise benefit any anticipated alternative power cycle. The resulting diesel exhaust conditions were then considered as a common heat source for all alternative power cycle evaluations.

Diesel Performance and Exhaust Conditions

The adiabatic diesel is currently in an early development stage with production of a fully insulated engine not anticipated until at least the mid 1990's. The major development effort in this country has been the U.S. Army Tank Automotive Command (TACOM)/Cummins Engine Company cooperative program (ref. 1). That program has included single-cylinder and multicylinder engine tests with various degrees of insulation installed.

The diesel data used in this report were obtained from a series of Diesel Cycle Simulator (DCS) calculations. (Information provided by V. Sudhakar, Cummins Engine Company.) The DCS was programmed to estimate the performance of an insulated engine with no water cooling and only minimal heat rejection to the engine oil. In this simulation the in-cylinder heat loss is reduced by 60 percent. Hence the term "60-percent adiabatic".

As illustrated in figures 1 and 2, four configurations of the 60-percent adiabatic engine were examined:

1. Turbocharged (TC).
2. Turbocharged-Aftercooled (TC/A).
3. Turbocharged-Turbocompound (TCPD).
4. Turbocharged-Turbocompound-Aftercooled (TCPD/A).

The parameters noted on the figures are the rated power (full throttle) conditions achieved in each case at 199 rad/sec (1900 rpm) engine speed. The simulations were established on the basis of an approximately 15 percent torque rise characteristic typical of engines for long-haul applications. The air-to-fuel ratio at rated power conditions for each illustrated engine is 28.

Significant with regard to potential waste-heat recovery are the exhaust-gas temperature and flow rate for each engine configuration. Gas temperature is seen to vary by a total of 100 °C or 18 percent among the four configurations shown in figures 1 and 2. The highest exhaust temperature (671 °C) is associated with the turbocharged engine without aftercooling (TC); the lowest temperature (571 °C) is associated with the turbocompound engine with aftercooling (TCPD/A). It should be noted, however, that the general trend of specific fuel consumption (sfc) shows higher exhaust-gas temperatures associated with higher relative fuel consumption.

Annual Fuel Expense Correlation

Engine performance is related to annual fuel expense first through the vehicle characteristics that influence highway fuel economy, then through the amount of annual use or driving, and finally through the average

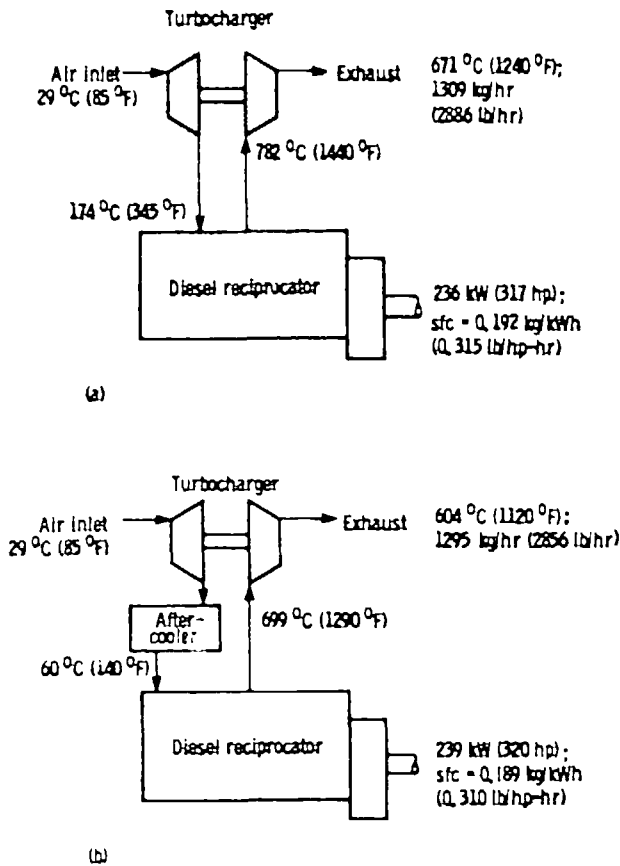

(a) Nonaftercooled (TC).
 (b) Aftercooled (TC/A).
 Figure 1.—Turbocharged diesel configurations.

price paid for fuel. In terms of relative complexity, these variables may be best discussed in reverse of the order mentioned above.

Fuel price.—Figure 3 illustrates the price range of diesel fuel over a 10-year period. The price shown is a pump price including average state tax. Bulk or contract prices may be lower. The data source (ref. 2) is updated to include prices through 1983.

The fuel price data shows a sharp rise in the 1978-to-1981 time period followed by a moderate decline in 1982 and again in 1983. For purposes of this study, the baseline diesel fuel price is established at the 1983 average price of \$0.32/liter (\$1.22/gal).

Annual use.—Annual use refers to the average number of highway kilometers (miles) driven per vehicle per year. At this point it should be noted that waste-heat utilization systems are targeted primarily for the class 8 tractor-trailer units with gross weights approaching the 36 000 kg (80 000 lb) limit and operating in line-haul or highway service between cities. Typical annual use for these vehicles is considered to be in the range of 161 000 km

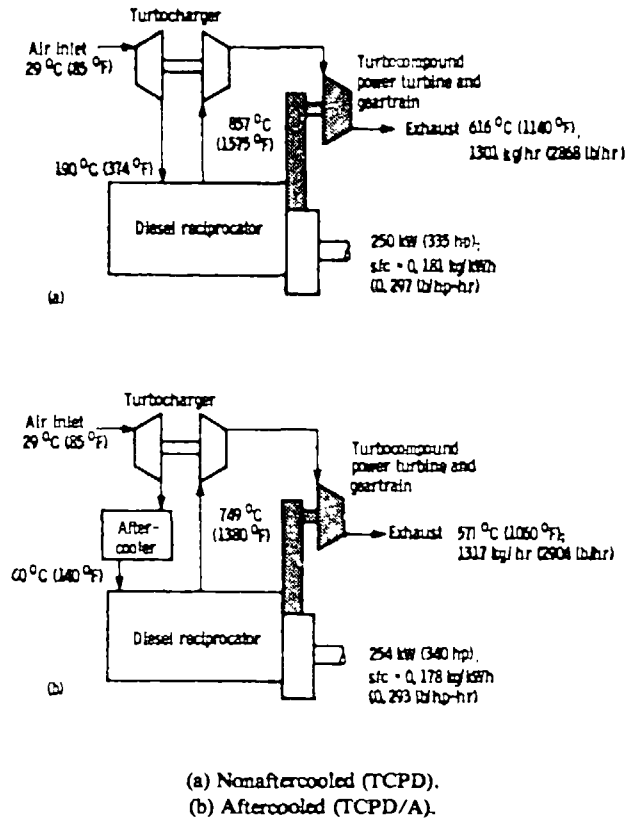

(a) Nonaftercooled (TCPD).
 (b) Aftercooled (TCPD/A).
 Figure 2.—Turbocompound diesel configurations.

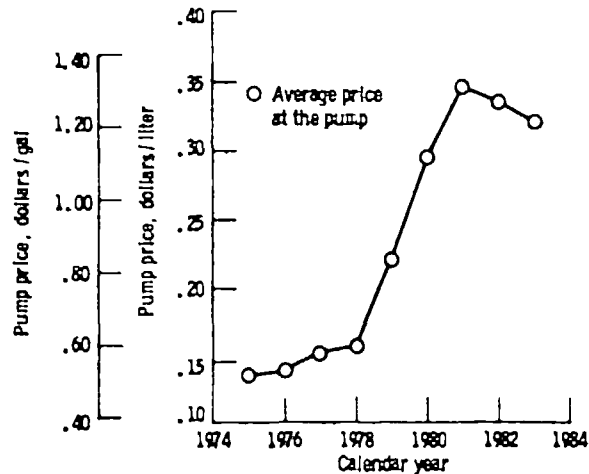

Figure 3.—Diesel fuel price history.

(100 000 mi). The transcontinental operators running coast-to-coast may average 240 000 km (150 000 mi) per year. For purposes of this study, the 161 000 km (100 000 mi) use rate will be adopted as illustrative of the majority of long-haul use.

Vehicle fuel economy.—The most complex element in the annual fuel expense equation is the determination of

average mission fuel economy; that is, the actual km/liter (mi/gal) experience of the trucks on the road. Over-the-road or mission average fuel economy is a complex integration of the engine specific fuel consumption characteristics with numerous vehicle and route variables. The proper evaluation of all these variables can only be accomplished via a computerized Vehicle-Mission-Simulation (VMS) model (ref. 3). Unfortunately, VMS modeling was not available within the scope of this study. The alternative approach used in this study involved evaluation of available truck performance data to establish trends that could be used to predict the impact of engine sfc improvements on mission fuel economy.

For mission fuel economy purposes, two types of vehicles were identified; the average truck and the fuel saver truck. Characteristics of both truck configurations are summarized in table I. The average configuration is considered to represent the median or average of vehicles in service today. Portions of the data on this configuration were taken from a current statistical abstract of the industry (ref. 4).

The fuel saver configuration represents the truck of the future now being developed by the industry (refs. 5 and 6). It incorporates the latest in state-of-the-art equipment for fuel economy improvement. The engine used is a current, water-cooled, production unit. The 3.4 km/liter (8.0 mi/gal) performance represents 50 percent better fuel economy than the average truck with only an 11 percent better engine. Obviously, the majority of the fuel economy improvement is due to the vehicle changes.

The question of interest for the future is "How will a fuel saver configuration of this type respond to further improvements in engine performance?" The precise answer could be best estimated with a proper VMS

program considering the complete map of each engine together with the appropriate vehicle characteristics. A less rigorous approach is to assume that, with vehicle characteristics constant, the vehicle fuel economy will improve in direct proportion to the change in engine rated sfc. The validity of this approach is supported by studies that indicate that 85 percent of truck mission fuel is consumed at throttle settings within 10 percent of full-throttle or rated conditions (ref. 7).

The curve in figure 4 shows how the fuel economy of the fuel saver truck would change if engine rated sfc improved over that of the engine presently installed. The

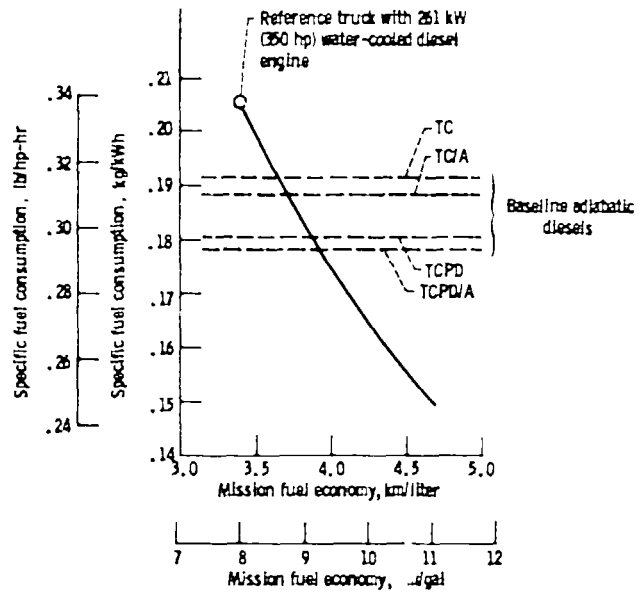

Figure 4.—Correlation of engine specific fuel consumption to truck fuel economy for the fuel saver truck configuration.

TABLE I.—CHARACTERISTICS OF VEHICLE CONFIGURATIONS FOR CLASS 8 TRUCKS

Characteristic	Average configuration	Fuel saver configuration
Age	3.5 yr	New
Aerodynamic aids	None	Cap roof fairing Gap fairings Trailer side fairings
Tires	Dual radials	Single-wide radials
Controls	Manual	Electronic speed/ cruise control
Engine rated sfc	0.231 kg/kWh (0.380 lb/hp-hr)	0.206 kg/kWh (0.338 lb/hp-hr)
Mission fuel economy at 33 000 kg (73 000 lb) gross wt.	2.3 km/liter (5.3 mi/gal)	3.4 km/liter (8.0 mi/gal)

curve is based on the assumption that fuel economy will change in proportion to the rated sfc change. Indicated on the curve is the 0.178 kg/kWh (0.293 lb/hp-hr) sfc level of the TCPD/A engine of figure 2; this is the best of the adiabatic diesel baseline engines. Engine sfc values below this level can only be achieved with the addition of the heat-recovery power cycles which are the subject of this comparative evaluation.

Overall correlation.—The final step in the process is to combine the sfc/fuel economy data of figure 4 with 161 000 km (100 000 mi) annual use to indicate the relationship of engine performance to annual fuel usage. This overall correlation is illustrated in figure 5. The annual fuel usage of the TCPD/A diesel, shown in figure 5, is the best diesel performance available, and is thus the baseline for measuring improvements available through use of the alternative power cycles.

Diesel Capital Cost Estimates

The objectives of the overall comparison effort included an evaluation of economic as well as technical or thermodynamic factors. Thus, each conceived diesel-plus-alternative-power-cycle compound engine system must be evaluated not only for the traditional sfc performance, but also in terms of its estimated user cost or purchase price as well. This requires the inclusion of engine price estimates as part of the adiabatic diesel baseline data.

As noted earlier, the adiabatic diesel is in an early development stage. Accordingly, purchase price data are not available. It is expected, however, that the cost of an adiabatic diesel will be approximately equal to that of its cooled counterpart (ref. 1). The reasoning here is that the

elimination of cooling system components (radiator, fan, pump, and lines) will produce a cost savings that approximately offsets the cost of the required advanced technology ceramic insulating materials. Accordingly, the price of current production engines is a guide to the price of the advanced adiabatic diesel.

Price data for production TC/A engines was gathered from several major engine manufacturers and plotted together in an attempt to identify a consistent price algorithm. The price used was the fleet price, which was understood to be approximately 30 percent below the full retail or list price. Fleet price is typically associated with purchases of 10 or more units; however, recent depressed sales in the trucking industry have resulted in fleet prices being extended to a wider range of buyers.

The TC/A price data showed some scatter which is considered to be typical of price data. After reviewing the data, a price of \$14 500 was established for the 239 kW (320 hp) engine. Also, the data indicated that the change in engine price with power level followed a nominal 0.7 exponent or logarithmic relationship. This relationship is illustrated in figure 6 by the solid line identified as TC/A diesel.

With the TC/A engine price algorithm established, it was next necessary to develop compatible algorithms for the other diesel configurations of figures 1 and 2. This was done by assigning a \$2000 price premium for turbocompounding (including the attendant power gain) and a \$500 credit or discount for nonaftercooled configurations. The resulting engine prices are illustrated by the small circles in figure 6. The appropriate dashed lines then establish the 0.7 exponent algorithm assumed for estimating the price impact of other engine size levels.

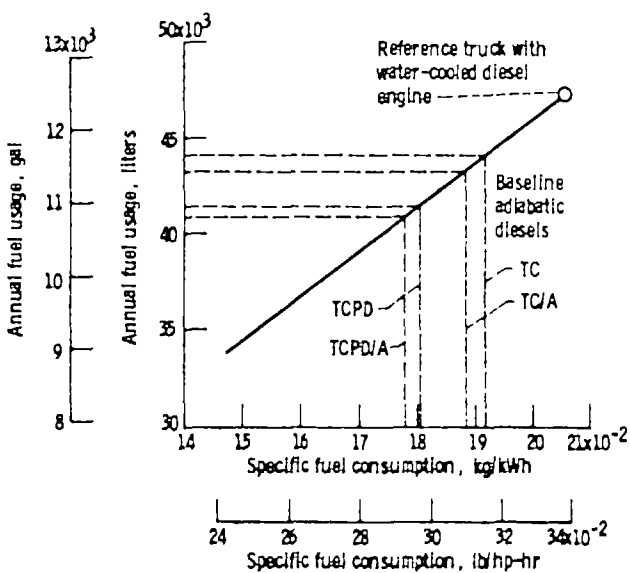

Figure 5.—Correlation of engine specific fuel consumption to annual fuel usage for the fuel saver truck configuration.

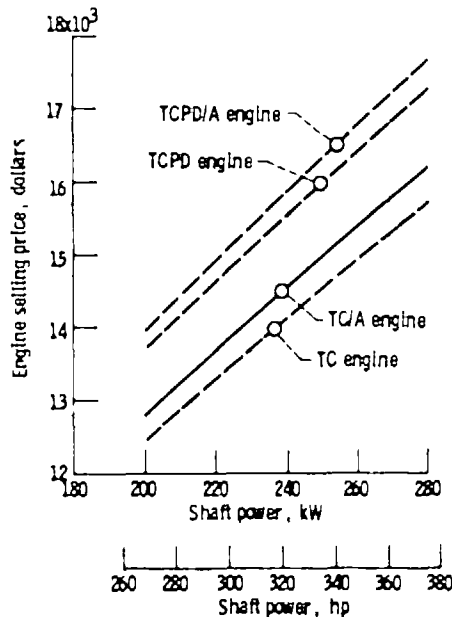

Figure 6.—Diesel engine price correlations.

Diesel Maintenance and Repair Costs

Maintenance and repair costs include all the labor and material expenses required to keep the diesel engine in operating condition. For long-haul operations of 161 000 km (100 000 mi) per year, these costs are very significant.

Contract repair.—For purposes of this study, diesel maintenance and repair costs were estimated on the basis of a contract repair program (ref. 8) which provides lifetime coverage at a levelized annual cost. The coverage includes all aspects of maintenance and repair except items resulting from neglect or accidents. As such, it includes overhauls as required during the contract period. A cost breakdown is available which allows separation of the conventional engine radiator and fan costs from the bulk of the maintenance and repair costs. The data available indicated that radiator and fan costs together account for approximately 11 percent of the overall maintenance and repair cost.

Figure 7 illustrates the adiabatic diesel contract maintenance and repair cost correlation developed for use in this study. The solid line was developed from two cost quotes for a conventional, water-cooled, TC/A diesel. The quotes were obtained for the 224 kW and 261 kW sizes. In each case the conventional engine radiator and fan costs were subtracted from the quote to simulate the adiabatic engine. Accordingly, the 239 kW (320 hp) point on the solid line is the estimate applicable to the adiabatic TC/A engine of figure 1. The line follows a 1.14 exponential relationship.

The appropriate points in figure 7 represent maintenance and repair estimates for the TC, TCPD, and

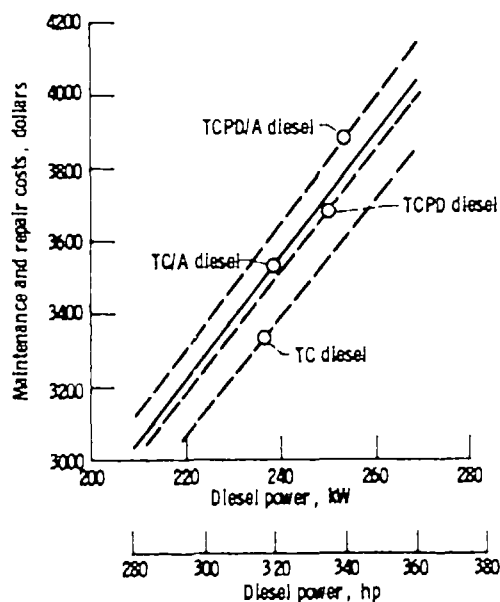

Figure 7.—Diesel maintenance and repair cost correlations. Levelized annual costs are based on a 7-year maintenance and repair contract and 161 000 km (100 000 mi) annual use.

TCPD/A adiabatic diesels of figures 1 and 2. In this regard, it was assumed that removing the air-cooled aftercooler with blower (TC/A to TC) would reduce maintenance by \$200 per year. Discussions with industry representatives resulted in an estimated additive cost of \$350 for maintenance of turbocompounding (TC/A to TCPD/A). The dashed lines follow a 1.14 exponential relationship allowing extrapolation of costs to other engine power levels.

Heat Recovery Power Cycle Configurations

The exhaust gases leaving an adiabatic diesel are significant in terms of potential recovery power; in fact, the potential power of the exhaust stream is nearly equal to the shaft output of these already efficient engines. Using 149 °C (300 °F) as a reasonable minimum heat-recovery heat exchanger temperature and 0.270 Kcal/kg °C (0.270 Btu/lb °F) as the average gas specific heat at constant pressure (C_p), the exhaust power potential of the TC diesel of figure 1 is 207 kW (277 hp) or 87 percent of the shaft power indicated.

Obviously there is a tremendous potential for waste-heat recovery and, therefore, improvement in overall sfc. The key is to employ a heat-recovery system that produces an adequate recovery benefit without exceeding tolerable limits on system complexity and cost.

The number and variation of heat-recovery power cycles and power cycle hardware configurations are very large. Significant among the power cycle alternatives would be steam Rankine, organic Rankine, and air Brayton. These alternatives were the subject of recently completed conceptual design studies which are the basis for this comparative evaluation. The Stirling cycle is a fourth alternative for which an equivalent conceptual design study is underway with a projected completion date in 1985.

Steam Rankine System

The technology base for steam Rankine systems is, of course, extensive in the areas of electric power generation, railway locomotives, and auxiliary power generation using process steam. The specific background for automotive systems dates to the early steam cars. A more recent, and probably more significant, base results from the Government-sponsored Rankine engine development work of the early 1970's (ref. 9). The conceptual design and performance data used in this comparative evaluation were developed in 1983 in a DOE-sponsored study of the steam Rankine power cycle for waste-heat recovery from adiabatic diesel truck engines (ref. 10).

ORIGINAL PAGE IS OF POOR QUALITY

Reheat cycle.—The typical high-performance steam Rankine system as used in large electric generating stations uses a reheat cycle. Reheat refers to a second heating of the partially expanded steam prior to further expansion in a low-pressure turbine. The reheat cycle provides improved performance but at the expense of added heat-exchanger surface and expander (turbine) hardware.

The potential of a reheat cycle was explored parametrically for the adiabatic diesel/heat-recovery application. The analysis indicated that the power cycle efficiency would indeed increase, but that the heat-recovery efficiency, and thus the amount of energy input to the cycle, would actually decrease because the reheat element interrupts the true countercurrent operating mode of the heat-recovery heat exchanger. The net result is a marginal half percent improvement in engine specific fuel consumption.

Simple cycle.—Based on the minimal fuel economy improvement indicated and in consideration of the added hardware complexity and expected cost, the reheat cycle was eliminated in favor of the simple cycle, illustrated schematically in figure 8. The system, as illustrated in figure 8, is recovering exhaust heat from the TC diesel of figure 1. The cycle performance shown, including final stack-gas temperature, results from an optimization of heat-exchanger sizes in consideration of cost as well as performance. The total power output (diesel plus Rankine) considered against the diesel fuel rate indicates an sfc of 0.165 kg/kWh (0.271 lb/hp-hr); a 14-percent improvement over that of the diesel core (see fig. 1).

Figure 9 is a layout showing the diesel/steam system as it might be installed in a truck. The major features are the condenser assembly replacing the now absent radiator in front of the adiabatic diesel, the heat-recovery steam generator replacing the truck muffler with similar back-pressure and muffling characteristics, and the power module which includes the expander and water feedpump. The expander is a two-cylinder piston device with design features similar to an earlier six-cylinder automotive engine (ref. 10). The expander operates at diesel speed with a chain drive to the diesel flywheel drive gear, thus avoiding the need for the multistage gear box associated with reduction from turbine speeds.

A piston expander was selected for the steam system to avoid the inherent low efficiencies associated with small axial-flow turbines. Water (steam) exhibits a high specific enthalpy; thus flow rates per unit power output are low. For low power levels the result typically is a very small turbine with the axial blades so short that normal tip clearance losses become relatively more significant, resulting in poor overall efficiency.

Organic Rankine System

The use of organic fluids in substitution for water in Rankine power systems originated in low-temperature systems where the particular characteristics of certain organic fluids offer a performance advantage. Organic Rankine systems were the subject of developmental efforts as a potential automotive engine in the early 1970's (ref. 9). The most recent automotive effort has

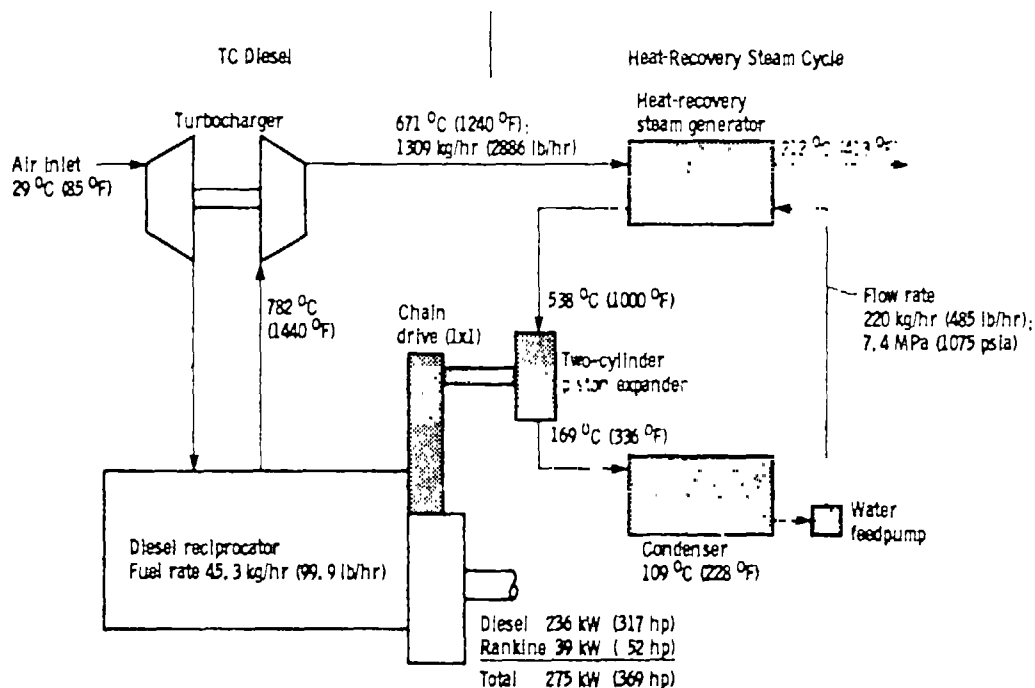

Figure 8.—Diesel/steam system schematic. Rankine cycle power output is based on highway operation with condenser fan declutched.

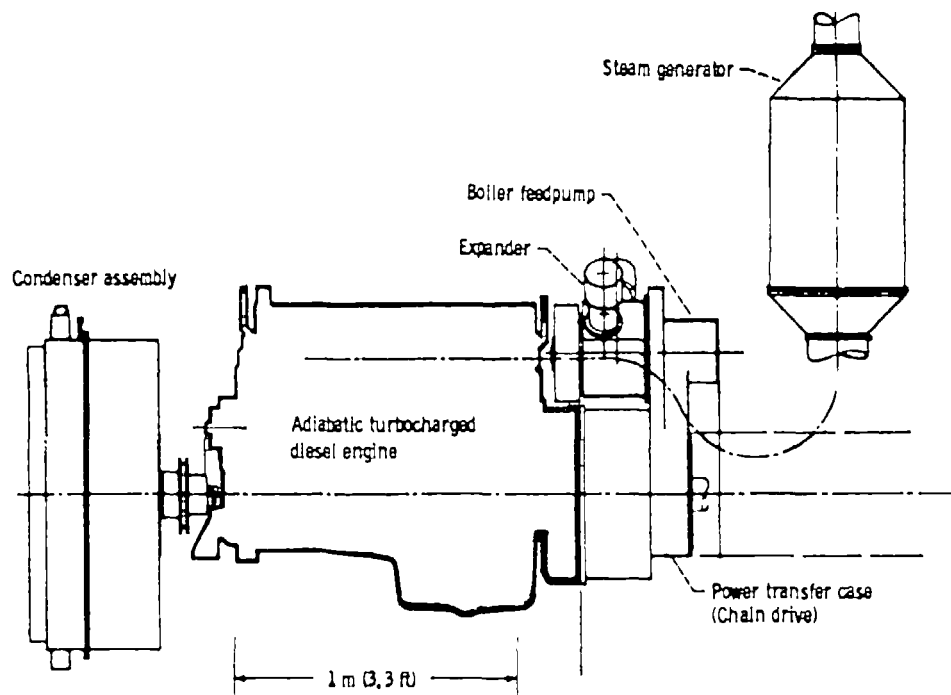

Figure 9.—Diesel/steam system layout.

been the DOE-sponsored Truck Bottoming Cycle Program (ref. 11).

The organic working fluid for the DOE Truck Bottoming Cycle Program was Fluorinal-85 with a maximum fluid working temperature of 288 °C (550 °F). The heat source was 482 °C (900 °F) exhaust gases from a conventional water-cooled diesel. The program was completed in 1982 with a highway test series showing 12 percent fuel economy improvement for the bottoming-cycle equipped truck over an otherwise identical truck.

The advent of higher exhaust-gas temperatures associated with the adiabatic diesel indicated a need for an organic working fluid with higher temperature capability. The fluid selected for this adiabatic diesel/organic Rankine conceptual design evaluation is a mixture known from an early automotive Rankine fluids study (ref. 12) as RC-1. The specific conceptual design data and system performance information used in this comparative evaluation are based on a 1983, DOE-sponsored, RC-1 bottoming cycle study (ref. 13).

The RC-1 effort of reference 13 included dynamic fluid loop testing to evaluate the thermal stability of RC-1 at temperature levels of interest for the adiabatic diesel application. Approximately 500 hr of testing were completed at each of three temperature levels; 371 °C (700 °F), 427 °C (800 °F), and 482 °C (900 °F). The test results indicated no evidence of thermal degradation of the fluid.

High-performance cycle.—In a manner somewhat analogous to the steam systems, the RC-1 power cycle can be configured either as a simple cycle or a high-performance cycle. In the high-performance cycle the liquid flow is divided; part is vaporized in a diesel exhaust heat-recovery heat exchanger and then expanded in a high-temperature turbine while the remainder is directed to an enlarged regenerator for vaporization at a lower temperature by the superheated vapor leaving the high-temperature turbine.

A preliminary analysis comparing the simple and the high-performance cycles indicated that over 85 percent of the potential fuel economy improvement is provided by the simple cycle configuration. A comparison of the two cycles indicated considerable additional complexity and potentially much greater cost associated with the high-performance cycle; that is, addition of the second vapor generator and turbine stage, increased controls to accommodate the flow split, and the fact that optimum performance involved a 66 °C (150 °F) higher operating temperature for the RC-1 working fluid.

On the basis of the relatively small performance difference and a reluctance to incorporate the more complex and costly system in a truck application, it was decided to emphasize the simple cycle configuration in the more detailed evaluation.

Simple cycle.—Figure 10 is a schematic of the simple-cycle RC-1 system with flow conditions noted for

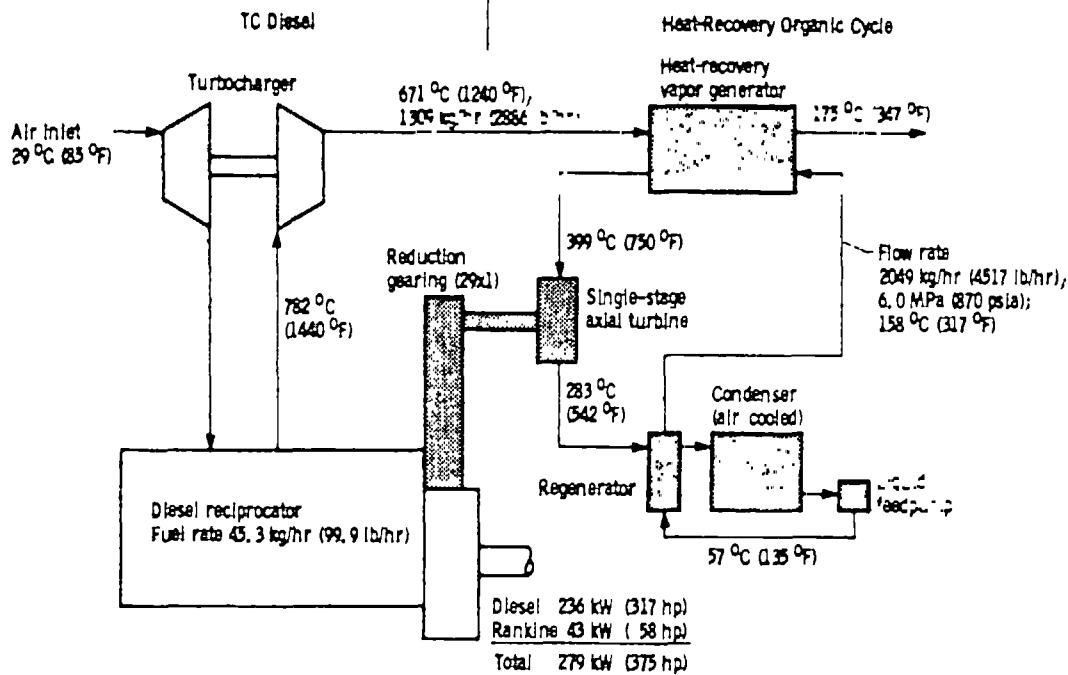

Figure 10.—Diesel/RC-1 organic system schematic. Rankine cycle power output is based on highway operation with condenser fan declutched.

operation with the TC diesel of figure 1. The organic (Rankine) system power output of 43 kW (58 hp) produces a resulting sfc of 0.162 kg/kWh (0.266 lb/hp-hr), which is a 15-percent improvement over the core diesel engine.

The RC-1 fluid system with a significantly higher weight-flow rate and thus lower specific work in the expansion process presents a more tractable single-stage turbine design problem than the parallel steam system of figure 8. The design used involves an 89 mm (3-1/2 in) diameter rotor operating at 55 000 rpm. The turbine design thermal efficiency estimate of 77 percent is based on design experience with previous organic turbines (ref. 14). The turbine gear box overall efficiency is 71 percent.

Figure 11 illustrates the RC-1 system installed in a cab-over diesel truck. In a manner similar to the steam system layout (fig. 9), the heat-recovery heat exchanger (vapor generator) replaces the truck muffler in a vertical position behind the diesel. A unique concept illustrated in figure 11 is the rear-mounted condenser with air scoop extending over the top of the truck cab in a manner similar to many diesel engine air-intake systems. The turbine gear box mates with the diesel at a standard power takeoff interface in the engine flywheel housing. The total speed reduction from turbine to diesel crankshaft is 29:1.

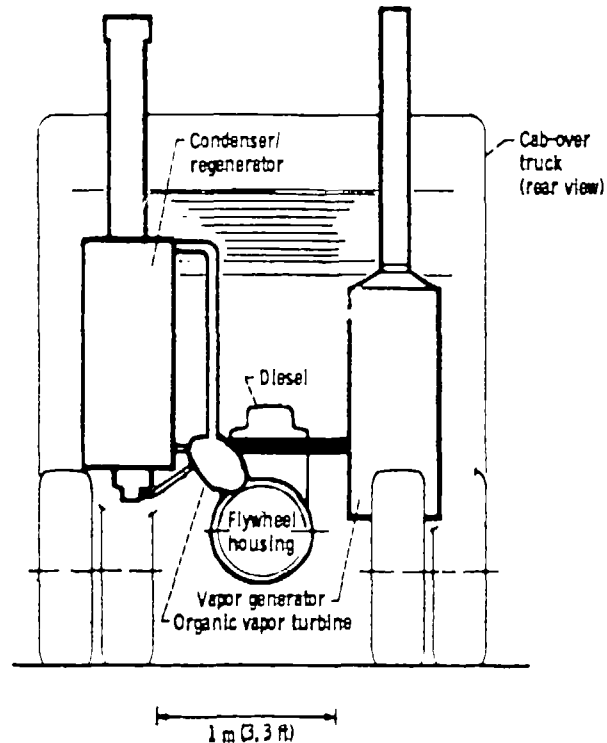

Figure 11.—Diesel/organic system layout.

Air Brayton System

The Brayton systems considered in this report are all open-cycle systems with air as the working fluid, and thus are free from the high-pressure working fluid containment problems associated with the closed-cycle steam or organic Rankine systems. In terms of minimizing any additional complexity, the air Brayton system could be considered as a next logical heat-recovery step beyond the turbocompound diesel of figure 2. The Brayton cycle system is distinguished from the turbocompound system by the incorporation of a major heat exchanger as part of the cycle. The role of the heat exchanger is reversed in the two major variations of the Brayton cycle as used for heat recovery.

Subatmospheric Brayton cycle.—Modification of the turbocompound system with a downstream heat-rejection heat exchanger (gas cooler) and compressor (exhauster) changes the system to a subatmospheric Brayton cycle configuration, as illustrated in figure 12. The use of a gas cooler and exhauster reduces the back pressure on the (turbocompound) power turbine to below atmospheric levels; thus the term "subatmospheric" configuration. The lower backpressure in the subatmospheric Brayton cycle effectively increases the pressure ratio and power (heat) extraction of the power turbine as compared to the turbocompound system of figure 2. The key to cycle net power performance, however, is in the compression work required to exhaust the gases to the atmosphere. Compression work, in turn,

is keyed to the gas temperature at the start of compression and thus to the design of the gas cooler as a heat exchanger.

The impact of heat-exchanger design on the performance of the subatmospheric Brayton system was evaluated parametrically (ref. 15) in comparison with a pressurized Brayton system. In the pressurized system the role of the heat exchanger is the more traditional role of heat recovery; that is, heat is recovered from the exhaust gas and transferred to the power cycle. As illustrated in figure 13, pressures in this power cycle loop are typically above atmospheric; thus the term "pressurized" Brayton cycle.

The Brayton cycle comparative analysis indicated that, in terms of net power recovery, the subatmospheric cycle is superior to the pressurized cycle only if the heat exchanger (gas cooler) is sized such that the exhaust-gas-to-ambient-air (approach) temperature difference is less than 45 °C (80 °F); or 64 °C (115 °F) if the cycle configuration includes one stage of compression intercooling.

The dependence of the performance of the subatmospheric cycle on the very close approach temperatures in the heat exchanger creates two problems relative to the cycle hardware: (1) heat exchanger size and cost increases asymptotically at the close-approach temperatures, and (2) the cold end of the heat exchanger is subject to high fouling rates and potentially subject to acid corrosion.

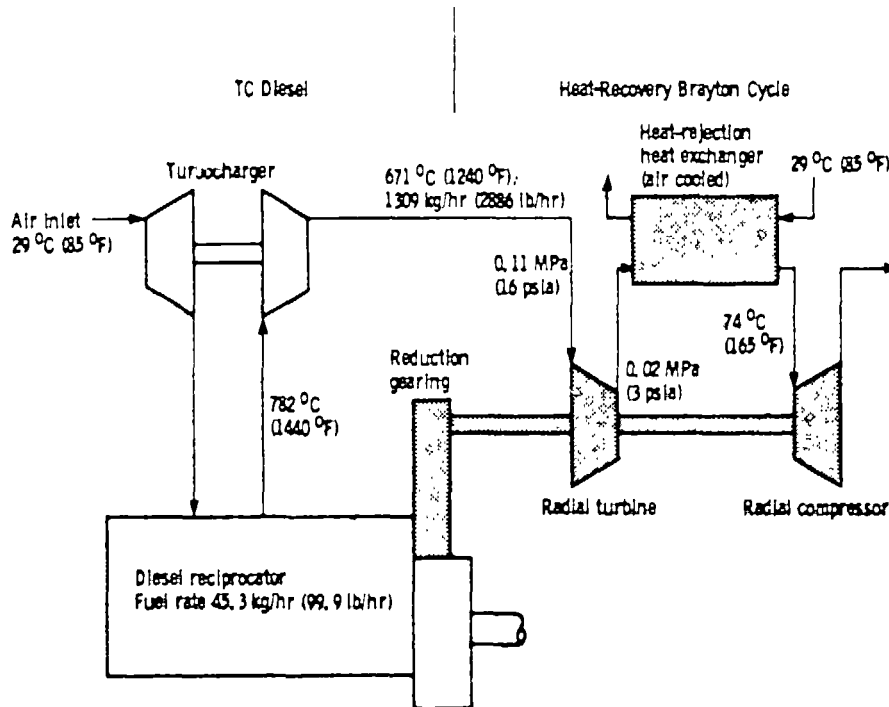

Figure 12.—Diesel/subatmospheric Brayton system schematic.

Information available from a previous experimental program involving high-effectiveness heat exchangers operating in a truck diesel exhaust environment indicates that fouling of heat-exchanger surfaces is a significant problem (ref. 16). Fouling is generally considered to occur more rapidly at lower diesel exhaust-gas temperatures. The accepted practice has been to avoid excessive fouling rates and/or acid corrosion by maintaining exhaust-gas temperatures in the heat exchanger above 149 °C (300 °F).

Figure 12 illustrates the impact of close-approach temperature on the fluid temperatures in the subatmospheric cycle. The 45 °C (80 °F) approach-temperature difference combined with the 29 °C (85 °F) ambient air temperature indicates a final exhaust-gas temperature of 74 °C (165 °F), obviously well below the 149 °C (300 °F) guideline mentioned above. Note that the same approach-temperature criteria applied to the pressurized cycle (fig. 13) does not similarly imply low exhaust-gas temperatures. The reason for this difference is the cycle configuration in which the lowest temperature in that heat exchanger is compressor discharge air at 225 °C (437 °F).

Ultimately, a decision was made to pick the pressurized Brayton system over the subatmospheric system. The decision was based on the fact that any positive performance margin for the subatmospheric system is keyed to a progressively larger and more expensive heat exchanger as well as to very low exhaust-gas temperatures

that aggravate the fouling and acid corrosion problem in the heat-rejection heat exchanger.

Pressurized Brayton-AGT adaptation.—The Brayton systems depicted in figures 12 and 13 are simple-cycle configurations in that they represent the simplest operating form for the Brayton cycle. Lowest capital or initial cost typically is associated with the simple-cycle configuration. In an attempt to establish the lowest possible capital cost, a simple-cycle, pressurized Brayton system based on a minimum modification adaptation of the DOE/NASA Automotive-Gas-Turbine (AGT) engine was investigated. (Information provided by D. Evans and R. Johnson, NASA Lewis Research Center.) The minimum modification approach to adaptation involves some performance compromise, but seeks to establish lowest capital cost by use of AGT components anticipated to be produced at high rates and low cost for future automotive applications.

The AGT adaptation to diesel exhaust-heat recovery centers on removal of the AGT's fired combustor and modification of ducting as required to permit the rotary regenerator to function as a heat-recovery heat exchanger. Use of the automotive rotating regenerator as a heat-recovery heat exchanger imposes performance penalties on the Brayton system due to leakage past the rotating-to-fixed element seals and the relatively high flow resistance or pressure loss associated with the regenerator core. Performance parameters for the AGT adaptation are illustrated in figure 13. The 19 kW (26 hp)

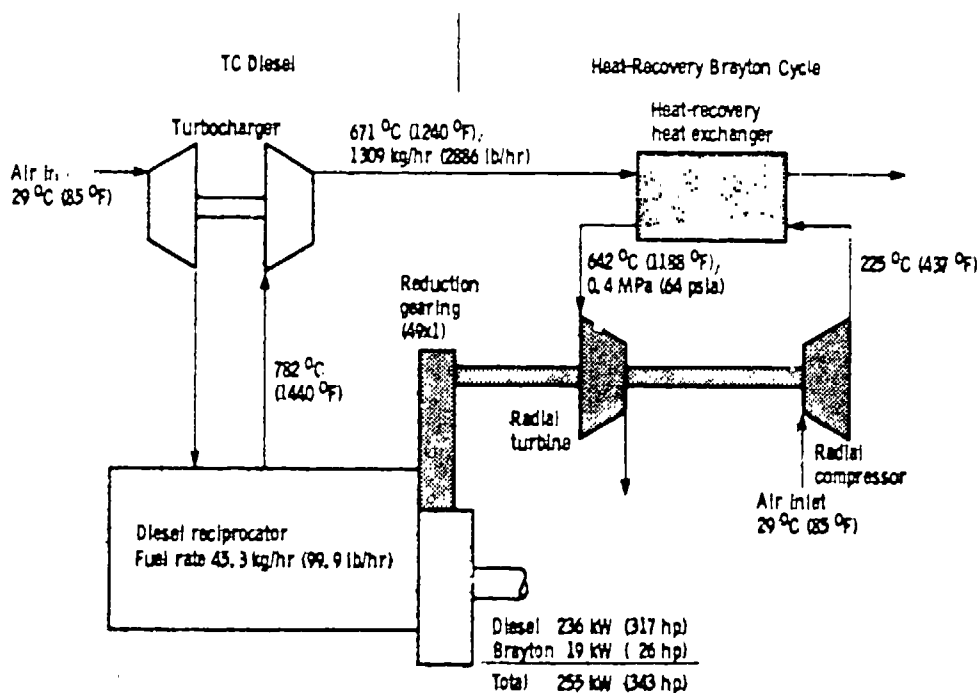

Figure 13.—Diesel/pressurized Brayton system schematic.

ORIGINAL PAGE IS
OF POOR QUALITY

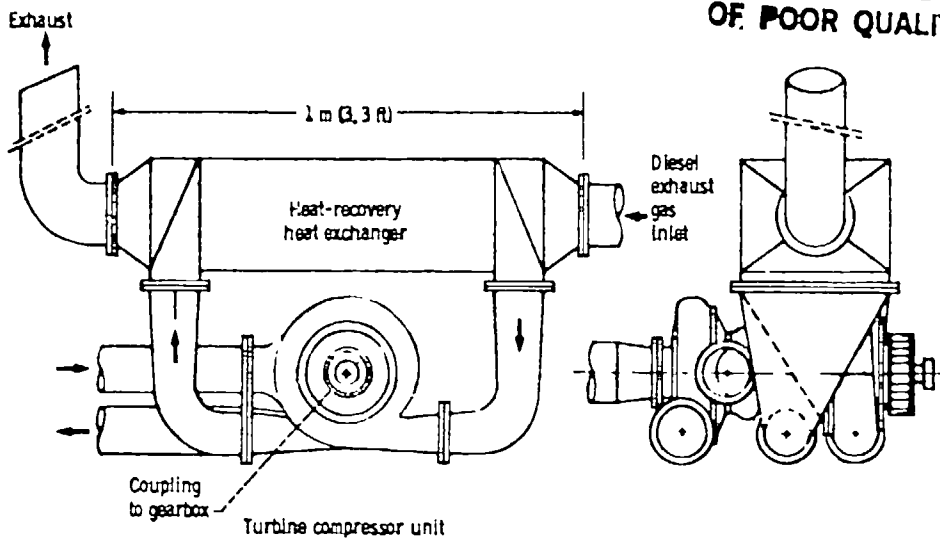

Figure 15.—Pressurized (intercooled) Brayton system layout.

Compound engine sfc was initially evaluated in a parametric phase in which all four of the diesel configurations, TC, TC/A, TCPA, and TCPD/A, were evaluated separately with each of the alternative power cycles. The parametric analysis indicated that from an overall sfc viewpoint, nonaftercooled diesels are preferred as the core for a compound engine system. As a diesel only, the nonaftercooled engines show a slightly higher sfc accompanied by a relatively higher exhaust-gas temperature (figs. 1 and 2). In the compound engine

configurations, including efficient exhaust-gas heat recovery, this sfc trend is reversed and the configurations with the nonaftercooled core show equal or better sfc results. Accordingly, the emphasis in the comparison efforts will be on the use of the nonaftercooled diesel engines (TC and TCPD) as the core units.

Figure 16 is a summary of the sfc results illustrating the diesel baseline data and the performance of the TC and TCPD diesel-plus-heat-recovery power cycle compound engine systems. The results illustrate an approximately

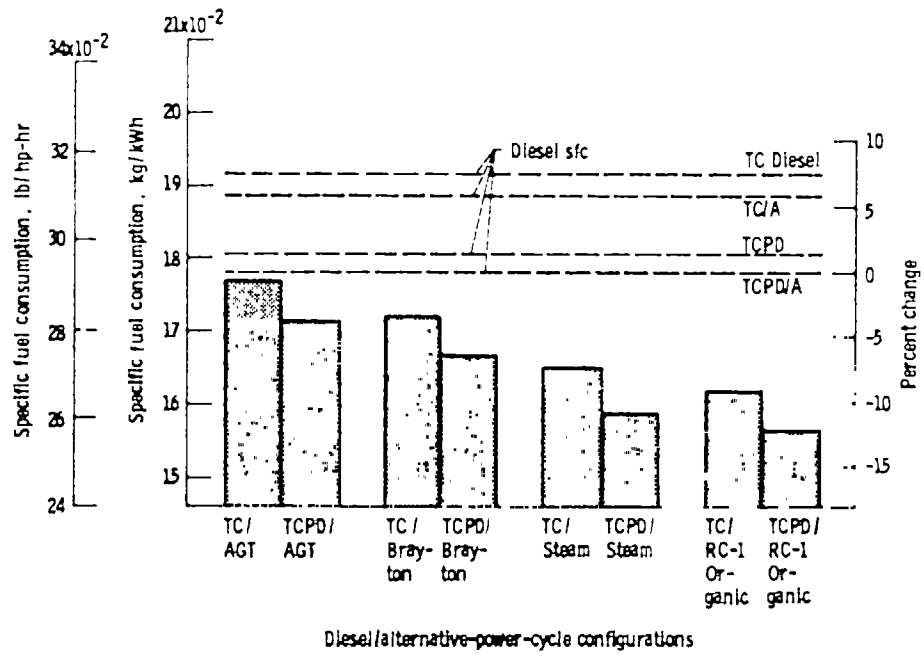

Figure 16.—Specific fuel consumption (sfc) for various diesel/alternative-power-cycle combinations.

19-percent range of sfc values between the worst baseline diesel (TC) and the best diesel/alternative-power-cycle configuration (TCPD/organic). The appeal of the turbocompound concept is evident in that it is clearly the simplest form of heat recovery but still produces an attractive 6 percent sfc gain (TCPD/A diesel as opposed to TC/A diesel). The diesel-plus-alternative-power-cycle results, however, indicate a potential for up to 12 percent more improvement over the TCPD/A performance.

Figure 17 shows how the sfc results of figure 16 combine with the fuel use correlation of figure 5 to produce an annual fuel use reduction for each compound engine system concept.

Capital Cost Comparisons

The purchase price or initial capital cost of a system is a major factor in the determination of its relative desirability. In the case of a fuel-efficient engine system the buyer is expecting annual fuel expense savings that will pay back the incremental or extra capital cost within some fraction of the useful life. The balance of the ownership period thus represents a net gain from the purchase decision.

Unfortunately, the cost estimates for advanced systems are typically less exact, or at least less uniform, than the performance estimates. Two of the major uncertainties involved are the anticipated production rate as it impacts unit manufacturing cost and the pricing environment which affects the markup ratio to selling price.

Production rate.—Figure 18 illustrates the relative impact or sensitivity of unit manufacturing cost to annual production rate. The points shown represent cost estimates of a Rankine heat-recovery system developed for three production rates (ref. 13). The 10 000-unit rate selected for use in this study is based on an assumption of 10 percent penetration into a class-8 diesel truck market

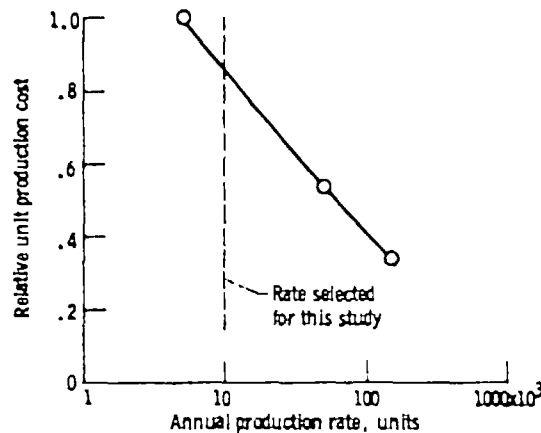

Figure 18.—Impact of production rate on unit production cost.

averaging 100 000 units per year. Class-8 diesel sales over a 6-yr period from 1977 to 1982 have ranged from a high of 158 000 units to a low of 67 000 units (ref. 17). Class 8 covers trucks from 15 000 kg (33 000 lb) gross vehicle weight up to the legal limit of 36 000 kg (80 000 lb) and trucks used in all types of service from local to long-haul. It is considered that heat-recovery cycles would be attractive to the fraction of the class-8 market represented by the high gross weight trucks in long-haul service.

Markup.—The markup ratio from unit manufacturing cost to selling price varies depending on market conditions and on the bargaining strength of the buyer. For this study a ratio of 2-to-1 was assumed as representative of average market conditions and the bargaining strength of a fleet purchaser. The resulting fleet price is considered to be consistent with the diesel engine price levels established in a previous section of this report.

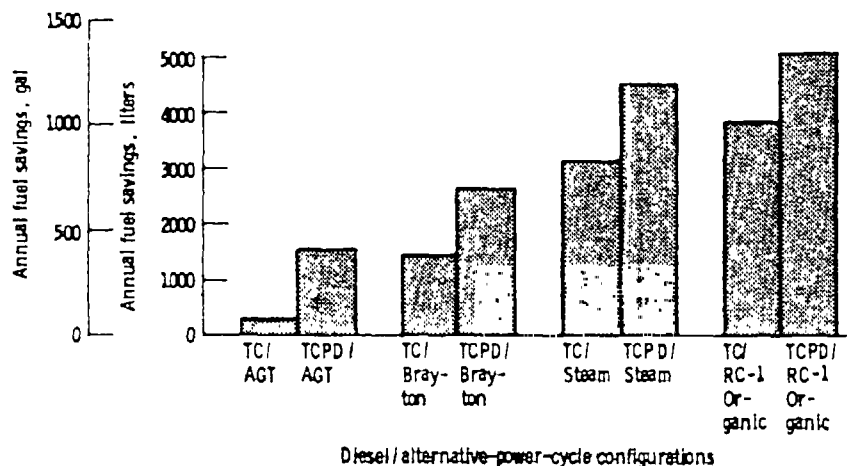

Figure 17.—Incremental annual fuel savings resulting from use of various diesel/alternative power cycles based on the TCPD/A diesel as the baseline configuration and 161 000 km (100 000 mi) annual use.

Cycle price estimates.—Table II is a tabulation of the estimated capital cost or purchase price of each of the several alternative-power-cycle systems under consideration. The data shown were developed independently in each case by an advocate for that system. In general, all prices were developed by estimating component unit manufacturing costs and then applying the common 2-to-1 markup factor to reflect installed price to a fleet purchaser.

The data in table II were developed on the basis of a production rate of 10 000 units per year, except for the AGT price which is based on a rate of 300 000 units. As discussed previously, the AGT system is assumed to represent a minimum modification of the automotive (passenger car) gas-turbine engine. Accordingly, the AGT price estimate reflects significant benefit from the automotive production. Figure 18 indicates that unit costs at the 300 000-unit production rate typical of automobile production lines may be only about one-third the cost of a comparable unit produced at the 10 000-unit rate.

Table II includes notations on selected physical parameters that are considered to be useful in rationalizing some of the more significant component price differences between systems. The heat exchangers, in addition to being sized by the surface area noted on the table, can be characterized as either plate-fin or finned-tube type. The plate-fin type, which for this study is unique to the intercooled Brayton system, is typically more compact and correspondingly less expensive than the finned-tube type.

The bottom line on table II is the indicated total price for each system. Within the limits of accuracy expected for a conceptual design study, the prices shown are considered to be reasonable. Accordingly, these prices

were used with appropriate adiabatic diesel prices to develop an overall price for the various compound engine systems.

Compound engine prices.—Compound engine prices were developed by combining the appropriate diesel core prices from figure 6 with the alternative-power-cycle system prices from table II and then scaling as required to reflect the compound engine price at a selected common power level of 261 kW (350 hp). An example of this overall procedure applied to the TC/steam compound engine system is as follows:

TC diesel	\$14 000
Steam cycle	+ \$ 6 070
Compound engine	\$20 070

The resulting compound engine system, as illustrated in figure 8 has a combined power output of 275 kW (369 hp). At this point, the 0.7 exponent price-scaling factor described earlier is applied to adjust to the common power level. The resulting price is then compared to the price of an equal power level TCPD/A diesel taken from figure 6:

TC/Steam	\$19 341
TCPD/A	– \$16 838
Increment	\$ 2 503

Note that the incremental difference shown for the equal power level compound engine system is considerably less than the \$4070 price difference between the turbocompound and steam system indicated in table II. The comparison at equal power levels acknowledges the higher efficiency and thus greater power contribution of the steam system.

TABLE II.—PRICE ESTIMATES FOR ALTERNATE POWER CYCLES

Power cycle hardware	Turbo-compound	AGT ^a	Brayton	Steam	Organic
Prime movers and speed reduction	\$2000 (1 wheel)	(b)	\$4273 (3 wheel)	\$2230 (2 cylinder)	\$2664 (1 wheel)
Heat-recovery heat exchanger (heat transfer area)	not applicable	(b)	\$1586 (39 m ²)	\$1750 (19 m ²)	\$3224 (43 m ²)
Heat-recovery heat exchanger (heat transfer area)	not applicable	not applicable	\$571 (39 m ²)	\$1060 (23 m ²)	\$1458 (39 m ²)
Controls and fluid inventory	not applicable	not applicable	not applicable	\$1030	\$1034
Total estimated price	\$2000	\$3070	\$6430	\$6070	\$8380

^aPrice estimate based on 300 000 units per year versus 10 000 units per year for other systems shown.

^bPrice breakdown by category not available.

Figure 19 illustrates the incremental difference (increase) in capital cost associated with each of the candidate alternative power cycles as applied to the TC diesel and also as applied to the TCPD diesel. Note that the lower exhaust-gas temperature of the TCPD diesel (fig. 2) results in downsizing of the alternative power cycle. Price estimates for these downsized units were scaled from the data of table II using the 0.7 exponent technique described previously. The AGT system was an exception for which cost scaling was not considered appropriate.

Maintenance and repair cost comparison.—The earlier discussion of the baseline adiabatic diesel maintenance and repair costs served to illustrate the importance of these costs in high kilometers (miles)-per-year long-haul trucking applications. The various system schematic diagrams presented in the cycle configurations section of this report show that in each case the alternative power cycle amounts to a rather significant subsystem addition to the diesel powerplant. The implication is that the maintenance and repair burden of these subsystems will also be significant.

The capital price breakdown in table II indicates that the hardware of the alternative power cycles can be segregated as to prime movers, heat exchangers, and controls/fluids. A similar approach is taken for the maintenance and repair costs as illustrated in table III. The costs shown in table III were developed by NASA (exceptions will be noted) with emphasis on the relative costs from system to system. In a manner similar to the adiabatic diesel maintenance and repair estimates, the power cycle estimates are based on a levelized annual payment for a lifetime maintenance and repair contract.

A starting point for the maintenance and repair cost estimates was a figure of \$350 received from Cummins Engine Company personnel as a preliminary estimated annual expense for the turbocompound power turbine and gear train, including fluid coupling. From this basis, the prime mover package estimates for the other alternative power cycles were developed by incrementally adding costs in relationship to perceived complexity. In the case of the steam and organic systems the need for a variable stroke fluid feedpump was also considered in the prime mover cost category.

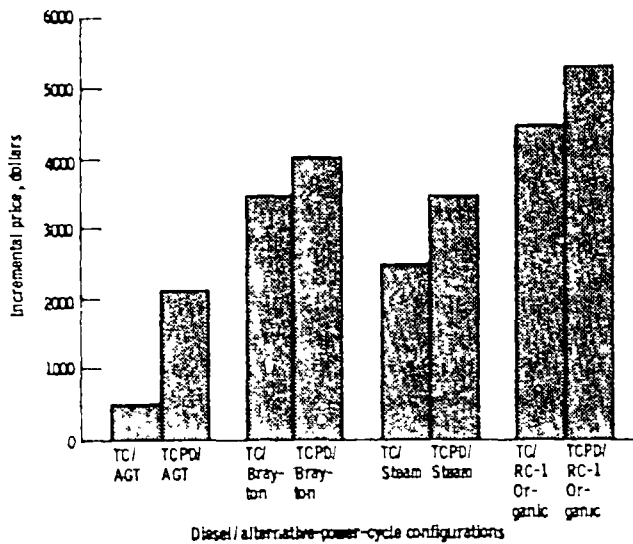

Figure 19.—Incremental price of various diesel/alternative-power-cycle combinations normalized to 261 kW (350 hp) total power. The incremental price is based on the TCPD/A diesel price of \$16 838.

TABLE III.—MAINTENANCE AND REPAIR COST ESTIMATES FOR ALTERNATE POWER CYCLES

Power cycle hardware	Turbo-compound	AGT	Brayton	Steam	Organic
Prime movers and speed reduction	\$350 (1 wheel)	\$400 (2 wheel)	\$450 (3 wheel)	*\$450 (2 cylinder)	*\$450 (1 wheel)
Heat-recovery heat exchanger	not applicable	\$400	\$200	\$400	\$400
Heat-rejection heat exchanger	not applicable	not applicable	\$200	\$400	\$400
Controls and fluid inventory	not applicable	not applicable	not applicable	\$250	\$350
Total estimated annual cost ^b	\$350	\$800	\$850	\$1500	\$1600

^aIncludes Rankine cycle working fluid feedpump.

^bLevelized annual cost based on a 7-year maintenance and repair contract and 160 000 km (100 000 mi) per year annual use.

Heat exchanger maintenance and repair costs were based on the radiator and fan data that had earlier been subtracted from the state-of-the-art diesel contract repair program (ref. 8) in the process of developing the adiabatic diesel maintenance and repair estimates of figure 7. The \$400 radiator and fan estimate was adjusted downward for the simpler gas-to-air heat exchangers used in the Brayton system. The AGT rotary regenerator with associated regenerator seals was a special case assigned the full \$400 cost. This is considered to be consistent with the \$340 cost estimated in the NASA study of the AGT heat-recovery system. (Information provided by D. Evans and R. Johnson, NASA Lewis Research Center.)

The maintenance and repair cost baseline for the controls and fluid inventory category was adapted from the estimate developed in reference 10 for the controls of the steam system. This cost was increased by \$100 for the organic system to allow for replacement of the organic fluid charge as required.

The maintenance and repair cost estimates from table III were combined with the adiabatic diesel maintenance and repair cost estimates of figure 7 in developing maintenance and repair costs for the various compound engine systems. An example of the process for the TC-plus-steam system is as follows:

TC diesel	\$3335
Steam cycle	+ \$1500
Compound engine	\$4835

Note that these costs are for a compound engine rated at 275 kW (369 hp) as illustrated in figure 8. Consistent with the cost estimating lines in figure 7, an exponent of 1.14 was used in adjusting these costs downward to reflect a common engine size of 261 kW (350 hp). At this point, the estimated maintenance and repair costs for this compound engine are compared to similar costs for the TCPD/A engine:

TC plus steam	\$4552
TCPD/A	- \$4015
Increment	\$ 537

Note that the \$537 increment differs from the result (\$1500 - \$350 = \$1150) obtained by working directly with the data in table III. The reason here, as with the capital cost data, is that the comparison at equal power levels acknowledges the higher efficiency and thus greater power contribution of the steam system. Figure 20 illustrates the incremental annual maintenance and repair costs associated with application of the various alternative power cycles to the TC diesel and as applied to the TCPD diesel. The figure shows the levelized annual cost for a 7-year maintenance and repair contract and 161 000 km (100 000 mi) annual use.

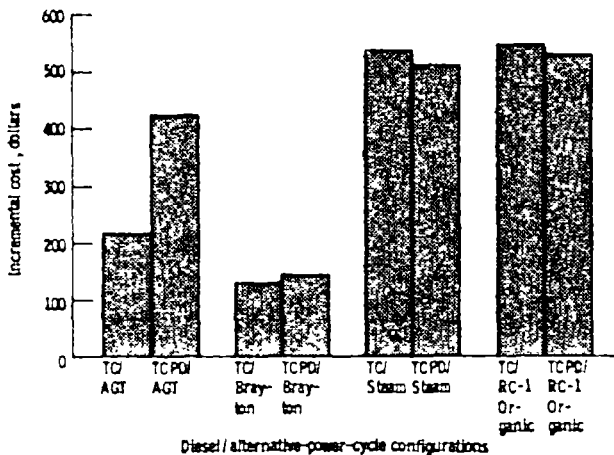

Figure 20.—Incremental annual maintenance and repair costs for various diesel/alternative-power-cycle combinations normalized to 261 kW (350 hp) total power. The incremental price is based on the TCPD/A diesel cost of \$4015 per year.

Economic Payback Comparisons

The prospects for widespread implementation of any of the diesel/alternative-power-cycle systems are entirely dependent on the ability of the systems to compete on an economic basis. One expression of the economic merit of a system is the operating time required to pay back or recover the initial investment increment. Recent marketing studies of the Organic Rankine Cycle System (ORCS) for long-haul truck applications have indicated that 2.5 to 3.0 yr is perceived as an acceptable payback time (ref. 18). A separate survey of heavy-duty trucking engine requirements (ref. 19) concluded that 1.5 to 2.0 yr is a desired payback time.

The concept of payback time as an economic measure is predicated on a simple reward/risk relationship which is apparent from the definition of the payback relationships as follows:

$$\text{Payback time} = \frac{\text{risk capital}}{\text{annual savings}} \quad (1)$$

$$\frac{\text{Net reward}}{\text{risk}} = \frac{(\text{lifetime X annual savings}) - \text{risk capital}}{\text{risk capital}} \quad (2)$$

$$= \frac{\text{lifetime}}{\text{payback time}} - 1 \quad (3)$$

Figure 21 illustrates the relationship of payback time to net reward/risk ratio for an assumed 7-year life typical of truck diesel engines. The figure indicates that 3 yr as a maximum acceptable payback period equates to a lifetime net reward/risk ratio of 1.33; that is, payback of the initial investment plus \$1.33 net reward on each \$1.00 invested. Payback in 2.3 yr (28 months) indicates a net

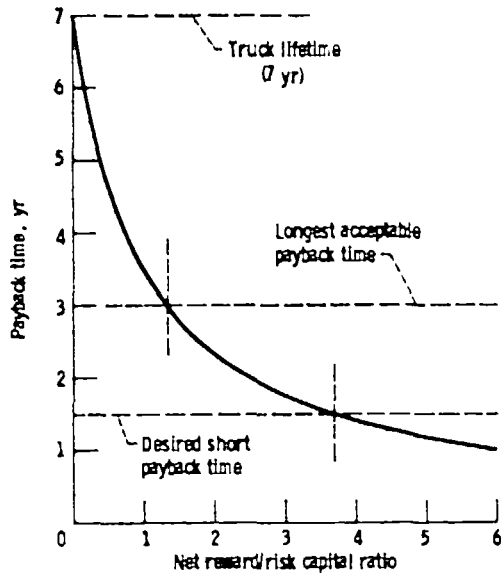

Figure 21.—Relationship of payback time to reward/risk ratio.

reward ratio of 2.0 or a \$2.00 net reward for every \$1.00 risked.

For payback calculations on the various diesel-plus-alternative-power-cycle combinations in this study, the risk capital is the price premium or incremental price increase over the competing TCPD/A diesel. The incremental price of the TC/steam system over a TCPD/A diesel is illustrated in figure 19 as \$2503. This dollar number is then modified by a factor of 0.85 to reflect an assumed 15-percent salvage value in the equipment at the end of the 7-year lifetime. The resulting risk capital amount is \$2128.

The annual savings is the fuel (expense) reduction minus the increased maintenance and repair burden associated with a more complex total engine system. All the values are incremental changes with reference to the TCPD/A diesel. The annual savings afforded by the TC/steam system can be calculated as follows using the fuel price of \$0.32/liter (\$1.22/gal):

Annual fuel expense reduction (fig. 17)	\$992
Annual increase in maintenance and repair costs (fig. 20)	- \$537
Annual savings (net)	<u>\$455</u>

The payback time for the TC/steam system can be calculated (eq. 1) as $\$2128/(\$455/\text{yr}) = 4.7 \text{ yr}$. Unfortunately, this result indicates the system is not economically attractive at current fuel prices.

Figures 22 and 23 illustrate the payback results for the various candidate alternative-power-cycle systems as applied to the TC diesel and as applied to the TCPD diesel. The payback results are presented as a function of fuel price, assuming an arbitrary increase in fuel price not

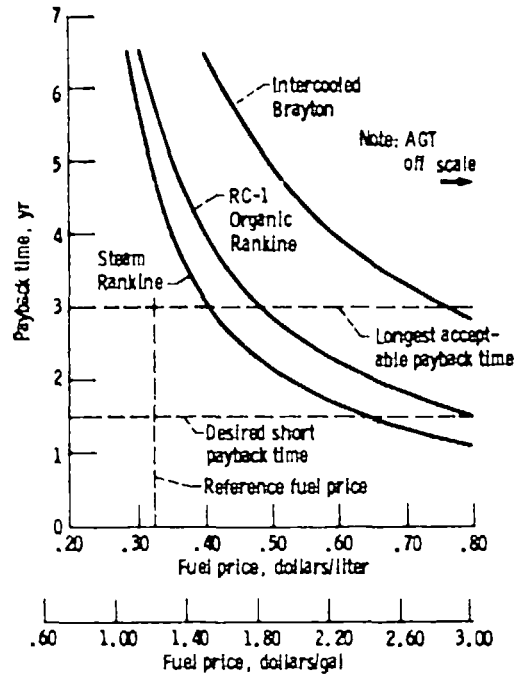

Figure 22.—Payback time for various TC diesel/alternative-power-cycle combinations with the TCPD/A diesel as a baseline for payback comparison.

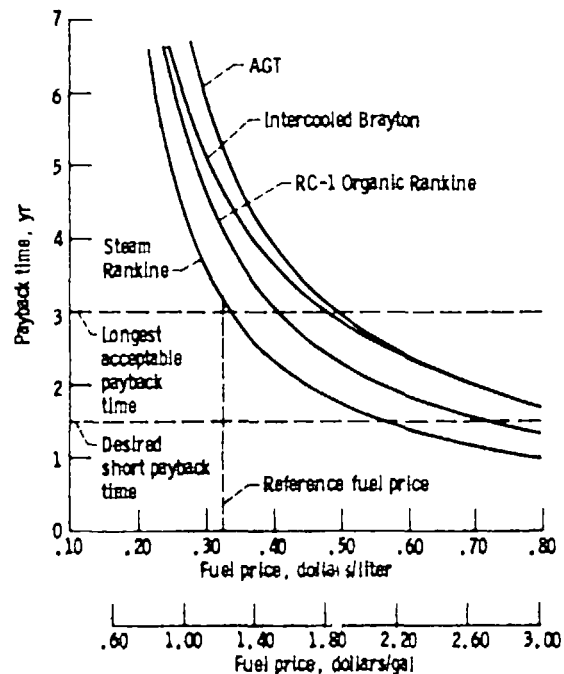

Figure 23.—Payback time for various TCPD diesel/alternative-power-cycle combinations with the TCPD/A diesel as a baseline for payback comparison.

accompanied by an increase in equipment and/or maintenance costs. In each case, the basis for payback comparison is a TCPD/A diesel of equal power.

The payback results indicate that, at the current fuel price, none of the candidate alternative-power-cycle systems is economically attractive as a replacement for the TCPD/A diesel. As fuel price increases, the first systems to become attractive are the Rankine cycle systems followed by the intercooled Brayton system. In all cases, use of the TCPD diesel is more attractive (provides quicker payback) than use of the TC diesel.

In an attempt to gain additional insight into the relative economic appeal of various engine configurations, the methods previously described were used to calculate the payback of a TCPD/A diesel versus the TC/A diesel. The results, based on the adiabatic diesel data in this report, indicate that the more fuel efficient TCPD/A diesel (versus TC/A) crosses the 3-year payback threshold at a fuel price of \$0.23/liter (\$0.87/gal) and at current fuel prices would payback in an attractive 1.92 yr.

Comparison of Steam Versus RC-1 Organic Fluid for Rankine Cycle

The Rankine power cycle is identified by the fact that the state of the working fluid changes from liquid to vapor and then back to liquid at specific locations in the closed-loop system. Because a change of state is involved, the unique characteristics of the working fluid in terms of the liquid-vapor phase interface (vapor dome) become important.

Steam is the selected working fluid for the vast majority of operating Rankine cycle power systems. Its characteristics of low cost and wide availability have made it the universal choice for direct-fired applications. For waste-heat applications, however, the various organic fluids have received consideration for their unique characteristics that provide better efficiency when coupled to a low-temperature heat source. The key factor involved here is the heat recovery efficiency which is a measure of the efficiency with which heat is extracted from the waste-heat stream.

Figures 24 and 25 are temperature as a function of enthalpy (t versus H) plots illustrating the steam Rankine and the RC-1 organic Rankine configurations introduced earlier in this report. Included on each plot are the vapor dome characteristics of the respective fluid as well as lines representing the diesel-exhaust stream of the TC adiabatic diesel as used in this study and the lower-temperature exhaust of a conventional water-cooled diesel engine.

The shape of the vapor dome influences heat-recovery efficiency via the location of the so-called pinch point, or point of minimum temperature difference between the exhaust-gas stream and the cycle working fluid. With RC-1 organic fluid, the vapor dome is skewed such that

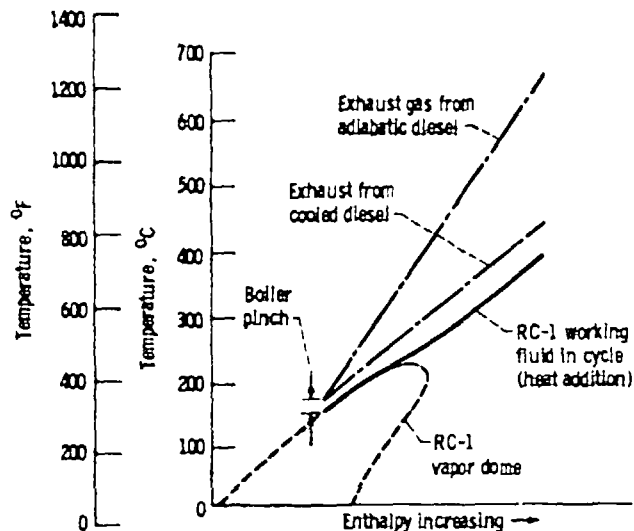

Figure 24.—Heat addition profile of RC-1 organic Rankine cycle.

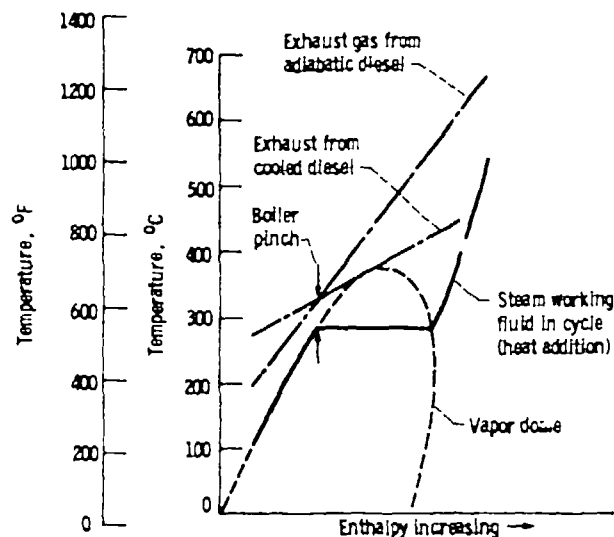

Figure 25.—Heat addition profile of steam Rankine cycle.

the pinch point is at the low temperature end of the heat exchanger (fig. 24). This location allows for efficient cooling of gas streams regardless of their starting temperature. In the steam system (fig. 25) the pinch point is in effect a pivot for the exhaust-gas cooling lines of various temperature origins. The result is that the high-temperature exhaust for the adiabatic diesel is actually cooled (heat recovered) to a lower final temperature than the exhaust stream from the conventional water-cooled diesel. This means that the steam system's heat-recovery efficiency improves significantly when used with the adiabatic diesel.

Another item illustrated in figures 24 and 25 is the fact that the steam system has been designed for a significantly wider pinch-temperature difference than the

RC-1 organic system. The pinch-temperature difference is a major factor impacting heat exchanger size. The wider pinch temperature used in the steam system represents a compromise in heat-addition efficiency and also accounts for most of the price difference between the steam and RC-1 organic systems as shown in table II.

Reducing the pinch-temperature difference of the steam system to equal that of the RC-1 organic system would allow the extraction of heat from the exhaust-gas stream down to a temperature of approximately 163 °C (325 °F). The additional heat recovered would boost the power level of the steam system to essentially equal that of the RC-1 organic system, but the corresponding requirement for increased vapor generator surface area (table II) would also boost the price to near that of the RC-1 organic system. Thus, the steam and RC-1 organic Rankine systems can be essentially equal in performance and price if both are configured with the same design philosophy for application with an adiabatic diesel.

Cycle Sensitivity to Diesel Exhaust Temperature

As discussed earlier, the adiabatic diesel is an advanced concept just entering the early developmental stages. Accordingly, the engine configuration and operating parameters are not fixed. Among the parameters subject to change is the exhaust-gas temperature. For this reason it is desirable to establish the sensitivity of the various alternative power cycles to variations in temperature of the diesel exhaust gases.

The most immediate and direct impact of exhaust-gas temperature on the alternative power cycles is the variation of power output. Typically, the alternative power cycles are capable of cooling exhaust gases to a final stack temperature in the range of 150 to 200 °C (300 to 400 °F). Based on 150 °C (300 °F) as the final stack temperature, increasing the exhaust gas starting temperature from 538 °C (1000 °F) up to 871 °C (1600 °F) results in an 86-percent increase in available temperature difference and thus, available energy.

The extent to which the energy available in higher-temperature exhaust gases can be utilized depends on the characteristics of the individual power cycles. Figure 26 illustrates the power output sensitivity of the RC-1 organic Rankine system, the intercooled Brayton system, and the steam Rankine system over a range of diesel exhaust-gas starting temperatures. Both the Brayton and steam systems display greater response to exhaust-gas temperature increases than the RC-1 organic system. The RC-1 organic system is the least responsive system because of limitations on the maximum safe-operating temperature of the RC-1 organic working fluid. Preliminary data from laboratory testing (ref. 13) indicates the RC-1 organic fluid may be stable at temperatures up to 480 °C (900 °F). For purposes of this

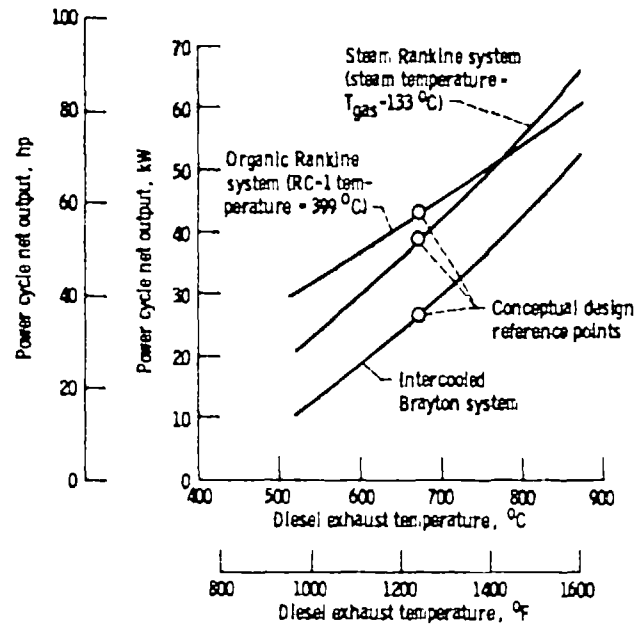

Figure 26.—Sensitivity of alternative power cycle performance to diesel exhaust temperature. (Diesel exhaust flow rate 1309 kg/hr (2886 lb/hr).)

study, however, an RC-1 organic fluid temperature limit of 400 °C (750 °F) was assumed to represent a safe margin against fluid deterioration in long-term service under field operating conditions.

The steam Rankine and the Brayton performance projections shown in figure 26 assume that the cycle working fluid (steam or air) peak temperature will be allowed to increase as the exhaust-gas or heat-source temperature increases. Accordingly, the performance benefits from improvements in cycle efficiency as well as from the increase in energy available in the diesel exhaust. The steam cycle receives an additional benefit from improvement in the gas-to-steam heat-recovery efficiency associated with the higher initial temperature of the heat source.

A significant point illustrated in figure 26 is that, in terms of cycle power performance, the Rankine systems remain superior to the Brayton system within the temperature range examined. Regarding the choice between steam or the RC-1 organic as the Rankine cycle working fluid, the higher gas-source temperatures favor the steam system. Note also that the data in figure 26 were developed from the specific conceptual design results for each cycle concept. As discussed in the previous section, the heat-recovery heat exchanger for the steam system is a compromise for cost at about half the surface area of the corresponding unit in the RC-1 organic system. The point is that the power performance curves shown in figure 26 are relative. Power performance of the steam and RC-1 organic Rankine systems would be approximately equal at the 671 °C

(1240 °F) exhaust-gas temperature level if the heat-recovery heat exchangers were of comparable size.

Technological Barriers

For purposes of this report, the term "technological barrier" refers to major technological problems that would deter an appropriate industrial source from pursuing an otherwise attractive diesel/heat-recovery power cycle system. This definition excludes the more routine product development problems as being the normal responsibility of the industry in bringing a new product to the market.

In general, the environment and operating requirements of a heat-recovery power cycle are consistent with state-of-the-art technology. Working as it does, with the heat rejected from a prime (diesel) cycle, the temperature levels of the heat-recovery power cycle are modest in comparison to the prime cycle. There are, however, technological barriers associated with efficient recovery of the heat from the diesel exhaust stream and with the operation of the steam and organic cycles.

Heat exchanger fouling.—Effective heat recovery within envelope limits of a typical truck configuration requires a compact heat exchanger with closely spaced passages. Previous experimental results (ref. 11) indicate that such heat exchangers are quickly fouled by the particulate laden diesel exhaust gases.

There are some preliminary data (ref. 1) on the adiabatic diesel that indicates particulate levels for such an engine may be dramatically lower than for conventional water-cooled engines. An anticipated trend toward the use of heavier grade fuels, however, would likely reintroduce the fouling problem. Accordingly, gas-side fouling of the heat-recovery heat exchanger remains a primary technological barrier that influences all power cycles.

Experimental work has been accomplished (refs. 20 to 22), and work is continuing (ref. 23), in regard to the fouling problem. The experimental investigations have related fouling rates to gas temperatures and metal temperatures in the heat exchanger. Methods of prevention and/or removal have included soot blowing and periodic water wash as well as a self-cleaning technique in which the cycle working fluid flow is interrupted for a period of time to allow metal temperatures to rise to the point where soot dries and flakes or can be blown off. The latter technique generally is not considered to be applicable to organic fluid systems due to a risk of overtemperature decomposition of any organic fluid residue remaining in the heat exchanger during the high-temperature operation.

Organic fluid characteristics.—The organic working fluid designated RC-1 is a mixture of 60 mole percent pentafluorobenzene and 40 mole percent

hexafluorobenzene. The fluid presently has an experimental status, having been examined in laboratory tests but never used in a Rankine power system of the type described in this report.

Acceptance of the RC-1 fluid for on-highway power cycle applications would require extensive experimental verification of the fluid characteristics in terms of thermal stability under operating conditions as well as potential environmental and/or safety hazards. Only preliminary work has been performed in this area to date (refs. 12 and 13).

Steam system freeze protection.—The water working fluid used in the steam system cannot be protected by an antifreeze, as is the water in a conventional engine cooling system, because of the significantly higher temperatures involved in the steam power system. Accordingly, the steam system could be subject to hardware failure because of water freezing during a shutdown period.

The old-time steam cars avoided the freezing problem by a combination of limiting winter exposure and operation on an open-cycle basis such that the system could be boiled dry prior to any period of cold weather shutdown. This approach is not acceptable for modern, high-performance applications, however.

Preliminary work indicates that proper sizing and design of the boiler and condenser water passages can allow for safe drainage to a protected sump during shutdown. Confirmation of this design approach by an appropriate system test is needed to remove this perceived barrier.

System cost and complexity.—The significant fuel economy improvement potential of the diesel/Rankine compound engine system is undisputed. Widespread implementation of the concept, however, is blocked by concerns for adequate economic and operational payback in view of the very significant hardware cost and complexity.

A potential for meaningful reduction in cost and complexity of the adiabatic diesel/Rankine system may lie in an integrated engine approach. The integrated approach involves the adaptation of one or more cylinders in the diesel block to Rankine power. The integration effort would include design of the Rankine vapor generator for close coupling to the engine within the engine compartment. Such an approach would require the services of both engine and vehicle designers.

Conclusions

The comparative evaluation of alternative power cycles for adiabatic diesel waste-heat recovery involved a complex integration of technical and economic factors. The major technical basis for the study is a series of heat-

recovery power cycle conceptual designs including estimates of cost and design point performance. Highway fuel economy was then assumed to scale on the basis of relative changes in engine design point performance.

The confidence level of the comparison could be improved by increased emphasis on the economic and mission factors. Specific steps for improvement would include review of capital and maintenance costs by an independent industry source, development of engine-part power maps, and use of a valid truck mission-simulation model to evaluate highway fuel economy.

With these limitations in mind, the study results indicate the following conclusions:

(1) Fuel saver trucks incorporating significant nonengine fuel saving features reduce the mission energy level and thus the economic justification for a heat-recovery power cycle.

(2) An increase in fuel price improves the economic justification for heat-recovery power cycles, but only to the extent that the fuel price change is not accompanied, or closely followed by, associated engine price inflation.

(3) The economic justification for turbocompounding is strong. The TCPD/A engine, compared against the TC/A engine, showed a very attractive payback time at current fuel prices.

(4) The economic justification for displacing the TCPD/A engine with a diesel/heat-recovery power cycle engine is weak. An arbitrary fuel price increase, not accompanied by hardware cost inflation, is needed to provide economic payback within even the maximum acceptable time period (3 yr).

(5) The fuel economy performance and the economic justification is best where the heat-recovery power cycle is used (added) in series with turbocompounding; that is, rather than as a substitute for turbocompounding.

(6) Among the heat-recovery power cycles studied, the Rankine cycle provides the best fuel economy; up to a 12-percent improvement over the TCPD/A engine. The Rankine cycle also shows the best relative economic justification of the heat-recovery power cycles studied.

(7) At the temperature levels indicated for the adiabatic diesel, the Rankine cycle working fluid can be either RC-1 organic or steam resulting in essentially the same power performance and economic payback. Regardless of which fluid is used, the design criteria should be a compromise between performance and cost.

(8) The diesel/Brayton systems are inferior to the diesel/Rankine systems in terms of fuel economy and economic justification. The low cost diesel/AGT adaptation shows only minimal fuel economy improvement over the TCPD/A engine. The optimized diesel/Brayton system costs as much as a diesel/Rankine system, but provides only half the fuel economy improvement.

(9) The major technological barriers associated with the heat-recovery power cycles are the indicated complexity and resulting capital and maintenance cost of the systems. These factors seriously weaken the economic attractiveness of the systems. An additional barrier is that of diesel exhaust-gas fouling the heat-recovery heat exchanger.

National Aeronautics and Space Administration
Lewis Research Center
April 18, 1985

References

1. Bryzik, Walter; and Kamo, Ray: TACOM/Cummins Adiabatic Engine Program. SAE Paper 830314, Feb. 1983.
2. American Trucking Trends 1979-1980. American Trucking Associations, Inc., Washington, D.C. 1981, p. 66.
3. Brands, Michael C.; Werner, John R.; and Hoehne, John L.: Vehicle Testing of Cummins Turbocompound Diesel Engine. (CTR-0746-80002, Cummins Engine Co.; NASA Contract EM-78-C-02-4936.) NASA-CR-159840, 1980, p. 11.
4. Cross, Rich: Private Fleets: The Dominant Role in U.S. Trucking. Commercial Carrier Journal, vol. 140, no. 6, June 1983, pp. 115, 116, 120-123, 126-129.
5. Geico Promises 10 MPG by 1990. Commercial Carrier Journal, vol. 140, no. 6, June 1983, p. 50.
6. Cummins Test Rig Nears 10 MPG. Heavy Duty Trucking, vol. 63, no. 1, Jan. 1984, p. 22.
7. Feasibility Test of Compounding the Internal Combustion Engine for Automotive Vehicles, Task II. COO-2690-1, Thermo-Electron Corporation, Waltham, MA, 1975, pp. 10-15.
8. Contract Repair-Operating for Profit. Bulletin 3382459, Cummins Engine Co., Columbus, IN, Jan. 1980.
9. Luchter, Stephen; and Renner, Roy A.: An Assessment of the Technology of Rankine Engines for Automobiles. ERDA 77-54, Apr. 1977.
10. Poulin, E., et al.: Steam Bottoming Cycle for Adiabatic Diesel Engine. (FMI-NAS-8273, Foster-Miller Associates; NASA Contract DEN3-300.) NASA CR-168255, 1984.
11. DiBella, Francis A.; DiNanno, Luco R.; and Koplrow, Michael D.: Laboratory and On-Highway Testing of Diesel Organic Rankine Compound Long-Haul Vehicle Engine. SAE Paper 830122, Feb. 1983.
12. Miller, D.R., et al.: Optimum Working Fluids for Automotive Rankine Engines. APTD-1563-Vol. 1 (PB239247/0), Executive Summary; APTD-1564-Vol. 2 (PB239248/8), Technical Section; APTD-1565-Vol. 3 (PB239249/6), Technical Section Appendices; F. Sindermann, APTD-1566-Vol. 4 (PB239250/4), Engine Design Optimization. Monsanto Research Corp., St. Louis, MO, June 1973.
13. DiNanno, L.R.; DiBella, F.A.; and Koplrow, M.D.: An RC-1 Organic Rankine Bottoming Cycle for an Adiabatic Diesel Engine. (TE4322-251-83, Thermo-Electron Corp.; NASA Contract DEN3-302.) NASA CR-168256, 1983.
14. Koplrow, Michael D.; and DiNanno, Luco: Status Report on Diesel Organic Rankine Compound Engine for Long Haul Trucks. Automotive Technology Development Contractors' Coordination Meeting. Conf - 811090, Oct. 1981, pp. 45-56.

15. Khalifa, H.E.: Waste Heat Recovery from Adiabatic Diesel Engines by Exhaust-Driven Brayton Cycles. (R83-956343, United Technologies Research Center; NASA Contract DEN3-304.) NASA CR-168257, 1984.
16. Diesel-Organic Rankine-Cycle Compound Engine for Long-Haul Trucks. TE 4257-168-83, Thermo-Electron Corp., Waltham, MA, Aug. 1983.
17. Industry Trends and Statistics. Commercial Carrier Journal, vol. 140, no. 6, June 1983, pp. 99, 100, 102, 104, 106.
18. Foster, Richard W.: Additional Market Research on Diesel Engines and Class 8 Diesel Trucks with Organic Rankine Bottoming Cycle Systems (ORCS), Escher-Foster Technology Associates Inc., St. Johns, MI, Apr. 1981, pp. 27, D-6.
19. Strawhorn, Larry W.; and Suski, Victor: Future Heavy Duty Trucking Engine Requirements, Proceedings of the Twenty-Second Automotive Technology Development Contractors' Coordination Meeting. SAE P-155, SAE, Warrendale, PA, 1985, pp. 2-260.
20. Mattso, Wayne S.: Shipboard Energy Savings with the Racer System. Nav. Eng. J., vol. 94, no. 1, Feb. 1982, pp. 63-69.
21. Engel, P.K.; Silvestrini, R.; and Thompson, R.E.: Corrosion and Fouling Potential in Diesel Exhausts. J. Eng. Power, vol. 101, no. 4, Oct. 1979, pp. 598-606.
22. Roberts, P.B.; and Marron, H.D.: Soot and the Combined Cycle Boiler. ASME Paper 79-GT-67, Mar. 1979.
23. Experimental Investigation of Fouling and Cleaning of a Waste Heat Recovery Heat Exchanger. TE-4527-199-84, Thermo-Electron Corp., Waltham, MA, 1985.

1. Report No. NASA TM-86953	2. Government Accession No.	3. Recipient's Catalog No.	
4. Title and Subtitle Comparative Evaluation of Three Alternative Power Cycles for Waste Heat Recovery from the Exhaust of Adiabatic Diesel Engines		5. Report Date July 1985	
		6. Performing Organization Code 778-34-12	
7. Author(s) M. Murray Bailey		8. Performing Organization Report No. E-2195	
		10. Work Unit No.	
9. Performing Organization Name and Address National Aeronautics and Space Administration Lewis Research Center Cleveland, Ohio 44135		11. Contract or Grant No.	
		13. Type of Report <input type="checkbox"/> Final <input checked="" type="checkbox"/> Period Covered Technical Memorandum	
12. Sponsoring Agency Name and Address U.S. Department of Energy Office of Vehicle and Engine R&D Washington, D.C. 20545		14. Sponsoring Agency Code DOE/NASA/50194-43	
		15. Supplementary Notes Final report. Prepared under Interagency Agreement DE-A101-80CS50194.	
16. Abstract Three alternative power cycles were compared in application as an exhaust-gas heat-recovery system for use with advanced "adiabatic" diesel engines. The power cycle alternatives considered were steam Rankine, organic Rankine with RC-1 as the working fluid, and variations of an air Brayton cycle. The comparison was made in terms of fuel economy and economic payback potential for heavy-duty trucks operating in line-haul service. The results indicate that, in terms of engine rated specific fuel consumption, a diesel/alternative-power-cycle engine offers a significant improvement over the turbocompound diesel used as the baseline for comparison. The maximum improvement resulted from the use of a Rankine cycle heat-recovery system in series with turbocompounding. The air Brayton cycle alternatives studied, which included both simple-cycle and compression-intercooled configurations, were less effective and provided about half the fuel consumption improvement of the Rankine cycle alternatives under the same conditions. Capital and maintenance cost estimates were also developed for each of the heat-recovery power cycle systems. These costs were integrated with the fuel savings to identify the time required for net annual savings to pay back the initial capital investment. The sensitivity of capital payback time to arbitrary increases in fuel price, not accompanied by corresponding hardware cost inflation, was also examined. The results indicate that a fuel price increase is required for the alternative power cycles to pay back capital within an acceptable time period.			
17. Key Words (Suggested by Author(s)) Diesel technology Waste heat utilization Brayton cycle Rankine cycle		18. Distribution Statement Unclassified - unlimited STAR Category 85 DOE Category UC-96	
19. Security Classif. (of this report) Unclassified	20. Security Classif. (of this page) Unclassified	21. No. of pages 24	22. Price* A02