

NASA-TM-87606 19860008822

NASA Technical Memorandum 87606

Performance Characteristics of an Isolated Coannular Plug Nozzle at Transonic Speeds

Charles E. Mercer and James R. Burley II

FOR REFERENCE

DECEMBER 1985

LIBRARY COPY

NOT TO BE REPRODUCED WITHOUT PERMISSION

LANGLEY RESEARCH CENTER
HAMPSHIRE, VIRGINIA
11-11-85



NASA Technical Memorandum 87606

**Performance Characteristics
of an Isolated Coannular Plug
Nozzle at Transonic Speeds**

Charles E. Mercer and James R. Burley II
Langley Research Center
Hampton, Virginia

NASA
National Aeronautics
and Space Administration

**Scientific and Technical
Information Branch**

1985

SUMMARY

The aerodynamic performance characteristics of an isolated coannular plug nozzle have been investigated in the Langley 16-Foot Transonic Tunnel. Thirty-seven configurations generated by the combination of three geometric variables - plug angle, shroud boattail length (fixed exit radius), and shroud extension length - were tested.

Results of the wind-tunnel test program indicate that axial movement of the shroud exit downstream, which increases the design nozzle pressure ratio, decreased nozzle performance for the nozzle pressure ratios typical of low-bypass-ratio turbojet engines. Scalloping the shroud boattail to simulate retracted noise suppressor hardware had negligible effects on nozzle performance.

INTRODUCTION

The design of propulsion systems for supersonic cruise vehicles (SCV) has received considerable effort since the early 1970's. The coannular plug nozzle, as a general class, has been utilized in many design studies because of its wide applicability to noise abatement schemes (refs. 1 through 3). Noise abatement devices are required in order to meet Federal Aviation Regulations (FAR's) stipulating noise limitations. Typically, these devices impair nozzle efficiency and thereby reduce the overall aerodynamic performance of the vehicle.

The objective of the current investigation was to provide experimental data at transonic speeds, which would allow meaningful trade studies to be conducted between weight, acoustic requirements, and nozzle performance. A similar nozzle investigation has been conducted in the Lewis 8 x 6-Foot Supersonic Wind Tunnel (ref. 4). The data of the current investigation were obtained at Mach numbers from 0.65 to 1.20 and nozzle pressure ratios (NPR) from 1.0 to 10.0. Model angle of attack was nominally maintained at 0° throughout the investigation.

SYMBOLS

The symbols used in the computer-generated tables are given in parentheses.

A	length of cylindrical body extension, cm
A_e	nozzle exit area, m ²
A_m	maximum cross-sectional area, m ²
A_t	nozzle throat area, m ²
B	length of boattail (curvature tangent point to exit), cm
(CFMD)	gross thrust-minus-drag coefficient, $\frac{F - D}{q_\infty A_m}$

C_p		local static-pressure coefficient, $\frac{p - p_\infty}{q_\infty}$
d		model maximum diameter, 15.24 cm
F		gross thrust, positive upstream, N
$F - D$		nozzle gross thrust minus external drag, N
F_i		ideal isentropic gross thrust based on measured mass flow, N
$\frac{F - D}{F_i}$	(FMDZFI)	gross thrust-minus-drag divided by ideal isentropic thrust
l		plug length, cm
M	(MACH)	free-stream Mach number
p		local static pressure, N/m^2
$p_{t,j}$		jet total pressure, N/m^2
$p_{t,j}/p_\infty$	(NPR)	ratio of jet total pressure to free-stream static pressure
p_∞		free-stream static pressure, N/m^2
	(P1-P15)	plug local static pressure divided by jet total pressure
q_∞		free-stream dynamic pressure, N/m^2
R		radius of curvature of plug truncation, cm
	(S1-S10)	shroud local static-pressure coefficient, $\frac{p - p_\infty}{q_\infty}$
w_i		ideal nozzle exhaust flow rate, kg/sec
w_p		measured nozzle exhaust flow rate, kg/sec
x		axial distance of plug pressure orifice location downstream of model station 112.38, cm
y		axial distance of shroud pressure orifice location downstream of model station 125.24, cm
α_p		plug angle, deg

APPARATUS AND METHODS

Wind Tunnel

The investigation was conducted in the Langley 16-Foot Transonic Tunnel, a single-return, atmospheric tunnel with an octagonal slotted-throat test section and continuous air exchange. The tunnel has a continuously variable airspeed up to a Mach number of 1.30. The average Reynolds number per meter varies from 9.71×10^6 at

a Mach number of 0.50 to 12.6×10^6 at a Mach number of 1.30. A complete description of this facility and its operating characteristics can be found in reference 5.

Model and Support System

Photographs of the air-powered nacelle installed in the test section are shown in figure 1. The sting-strut-supported turbojet-engine simulator model used in this investigation is illustrated in the sketch of figure 2. The model consisted of a cone-ogive forebody, a cylindrical section of 15.24 cm diameter, and an afterbody-plug combination consisting of a cylindrical section, a boattail, and a cone plug. The afterbody-plug combinations were detachable at model station 101.60 to facilitate configuration changes. Dry high-pressure air at a stagnation temperature of approximately 520°R was used to simulate the exhaust stream of the turbojet-engine simulator.

The model was supported in the tunnel by a sting-strut support system at the nose as shown in figures 1 and 2. Boundary-layer transition on the model was fixed by a 0.154-cm-wide strip of No. 100 grit at model station 2.54.

Nozzle/Plug Description

The class of nozzle under investigation in this study is a single-flow, truncated conical plug nozzle with a contoured translating shroud (ref. 2). Thirty-seven configurations were generated by the combination of three geometric variables - plug angle, shroud boattail length (fixed exit radius), and shroud extension length. The model hardware consisted of five plugs having angles from 10° to 20°, eight shrouds (boattails), and three shroud extensions. In addition, two shrouds having "scalloped" trailing edges (simulate retracted noise suppressor geometry) were tested. These shrouds were of the same design as two of the basic or "unscalloped" shrouds for comparison purposes. Photographs of the basic and scalloped shrouds installed on the model are shown in figure 1. Sketches showing design details of the shrouds and plugs are presented in figures 3 and 4, respectively. Table 1 presents the three geometric variables, nozzle expansion ratio, and design nozzle pressure ratio (NPR or $p_{t,j}/p_\infty$) for each nozzle configuration tested.

Tests

Tests were conducted in the Langley 16-Foot Transonic Tunnel statically ($M = 0$) and at Mach numbers from 0.65 to 1.20. NPR was varied from 1.0 (jet-off) to 10.0 depending on Mach number. Figure 5 shows a representative NPR operating schedule with Mach number for a low-bypass-ratio engine. Each range of NPR tested at a particular M included a scheduled NPR data point for this Mach number as obtained from figure 5.

Instrumentation and Data Reduction

Data obtained during the investigation were recorded simultaneously on magnetic tape and were reduced to coefficient form by the use of a computer. Approximately 50 frames of data were taken over a time period of 5 seconds for each data point and the average value was used for computations.

A six-component strain-gauge balance was used to measure forces and moments on that portion of the model downstream of the metric break at model station 67.31. (See fig. 2.) Static pressure taps were located on the plug and shroud surfaces as shown in figures 3 and 4. Jet total pressure and temperature were determined from three stagnation pressure probes and two thermocouple measurements, respectively. These measurements were obtained in the nozzle duct downstream of the flow-straightening screens and ahead of the plug support as seen in figure 2. Nozzle mass-flow rate was measured with a turbine-type flowmeter. Corrections were made to the force data to account for bellows/balance interaction tares as outlined in reference 6.

RESULTS AND DISCUSSION

Basic Data

A tabulation of the performance and pressure data for all configurations tested is given in tables 2 through 38. The static ($M = 0$) nozzle discharge coefficient and thrust ratio for configuration 17 are plotted as a function of NPR in figure 6. These data are representative of all configurations, with the results of configuration 17 being arbitrarily picked as the reference configuration for comparison purposes only, and do not represent any critical design condition. Similar results were obtained for all configurations. Since nozzle throat area did not vary with geometric changes, nozzle discharge coefficient (w_p/w_i) remained nearly constant (approximately 0.985) at all test conditions. The annular plug nozzle used in this investigation was operating off-design (overexpanded) at $M = 0$ and $NPR = 2.5$; this results in the low thrust ratio performance shown in the lower half of figure 6.

Wind-On Nozzle Performance

The effect of shroud boattail length B on nozzle performance as a function of NPR is presented in figure 7 at Mach numbers of 0.65 and 0.90. The plug used in this comparison had a 15° angle and an extension ratio A/d of 0.184. Only data for the 15° angle plug configuration are presented as a function of NPR since all the other plugs produced similar results. At the lower nozzle pressure ratios, large losses in performance are indicated as a result of overexpanded nozzle operation. However, as NPR is increased, the thrust-minus-drag ratio increases as the nozzle becomes fully expanded. The large losses shown at the lower NPR are a result of the high expansion ratios for these configurations. (See table 1.) Although varying B would change the boattail radius of curvature and thus have a small effect on drag, its primary effect is to change the nozzle expansion ratio and thrust for a given NPR. Therefore, the vast majority of the differences shown in figure 7 are effects of varying B on A_e/A_t (and thus thrust) and not effects of varying B on drag. The effect of increasing shroud boattail length B on thrust-minus-drag ratio at a representative nozzle pressure ratio for each test Mach number (fig. 5) is presented in figure 8 for three different plug angles. For the 12° and 18° angle plugs, extension length A was also varied. At the subsonic Mach numbers, extending the shroud boattail length (increasing B/d) generally produced a loss in performance for all three plugs similar to that shown in the previous figure. Moving the shroud exit plane further downstream of the throat by increasing extension length (increasing A/d) resulted in a loss of performance which varied from 2 to 6 percent depending on Mach number. At $M = 1.20$, the effect of shroud boattail length on nozzle performance is much smaller. This result is due to the nozzle operating near its design NPR at $M = 1.20$. (See table 1 and fig. 5.)

The effects of extension length on nozzle thrust-minus-drag ratio are presented in figures 9 and 10. As expected from the previous discussion, increasing extension length A produces similar effects on thrust-minus-drag ratio as increasing shroud boattail length B. This result confirms the previous hypothesis that the major effect of increasing shroud length is on thrust (by varying A_e/A_t) rather than on drag (by varying radius of curvature).

The effect of plug angle on nozzle performance for a representative nozzle pressure ratio is shown in figure 11. The plug angle for maximum performance tends to increase with increasing Mach number but this is primarily because NPR is closer to design NPR rather than any special advantage of a particular plug angle.

The effect of nozzle geometry representing a retracted noise suppressor (scalloped shroud) on $(F - D)/F_i$ is presented in figure 12 by comparing scalloped shroud configurations with similar configurations without scalloped shrouds. As shown in this figure, the effect on $(F - D)/F_i$ of scalloping the shroud trailing edge was negligible.

The variation of the plug static-pressure distributions as a function of nozzle pressure ratio for configuration 17 at Mach numbers of 0.65 and 0.90 is presented in figure 13. The plug static-pressure distributions shown in this figure are typical of plug-type nozzles. (See refs. 7 through 9.) The series of increases and decreases of local plug static pressure along the length of the plug are a result of alternating regions of expansion and compression of the jet flow starting with a Prandtl-Meyer expansion fan originating at the shroud lip.

The effect of NPR on the shroud external static pressures for configuration 17 at Mach numbers of 0.65 and 0.90 is shown in figure 14. At $M = 0.65$, the influence of the jet exhaust on the shroud is seen to extend forward to some station ahead of the tangent point ($y/B = 0.0$) of the shroud boattail to the cylindrical section. Jet operation decreased boattail static pressure for all nozzle pressure ratios tested but the data indicate that jet effects may become favorable (increase static pressure) at higher NPR's. At $M = 0.90$, jet operation produced aspiration effects only on the last 50 percent of the boattail surface (jet operation probably moved a standing shock on the boattail down to the nozzle exit). Further increases in NPR had only small effects on the surface static pressures (at y/B greater than 0.65).

Theory

A calculation of the flow field about the nozzle described by the geometry of configuration 17 was carried out at conditions equivalent to $M = 0.95$ and $NPR = 8.60$ using VNAP2 (ref. 10), a computer program which solves the two-dimensional, time-dependent, compressible Navier-Stokes equations. VNAP2 can solve either single- or dual-flowing geometries such as the internal/external flow about inlets and nozzles. For this nozzle calculation, the fluid was assumed to be inviscid and adiabatic and the flow field steady. The computational grid used to calculate the inviscid flow field is presented in figure 15. The grid was designed for high resolution in the region of the jet plume but did not include the truncated base of the plug (fig. 4). The upper surface of the computational grid is a constant pressure inflow-outflow boundary and for this case was 56.7 kN/m^2 (static pressure at $M = 0.95$). The total pressure at the inflow plane was initially set to 0.101 MN/m^2 for the external flow and 0.488 MN/m^2 ($p_{t,j}/p_\infty = 8.60$) for the internal nozzle flow. The total temperature was fixed at 530°R for both regions of the flow.

The computed Mach number contours of the flow field about the nozzle at $M = 0.95$ and $p_{t,j}/p_{\infty} = 8.60$ are shown on figure 16. Presented in figure 17 is a comparison of inviscid adiabatic theoretical calculation of plug pressure distribution with experimental data at a Mach number of 0.95 and nozzle pressure ratio of 8.6.

The Mach number contours of figure 16 show an expansion of the flow downstream of the throat, followed by a strong recompression at the shroud exit. The compression region extends from the shroud lip to approximately $x/l = 0.475$ on the plug. The experimental and computed plug pressure distributions (fig. 17) support this analysis; however, they also clearly illustrate the drawbacks of an inviscid calculation. The experimental data indicate that the flow separates at $x/l = 0.68$, but the VNAP2 calculations show a pressure recovery and no separation over the same region of the plug.

The Mach number contours also illustrate the large velocity gradient between the supersonic jet exhaust and the transonic free stream. The jet plume is roughly defined by the high velocity gradients and indicates that the nozzle is slightly over-expanded. The flow over the shroud boattail is accelerated before encountering a region of strong compression (shock) at the shroud exit plane. The curved sonic line near the throat indicates that the effective nozzle throat area may actually be larger than the geometric throat area. This may explain why the thrust ratios for some configurations approach unity at or near their design nozzle pressure ratios.

CONCLUSIONS

The aerodynamic performance characteristics of a coannular plug nozzle have been investigated in the Langley 16-Foot Transonic Tunnel. Thirty-seven configurations were generated by the combination of plug angle, shroud boattail length (fixed exit radius), and shroud extension length. The results of this investigation indicate the following conclusions:

1. Axial movement of the shroud exit downstream (increasing design nozzle pressure ratio) decreased thrust-minus-drag ratio at test conditions representative of a typical low-bypass-ratio turbojet engine.
2. Scalloping the shroud boattail to simulate retracted noise suppressor geometry had negligible effects on thrust-minus-drag ratio.
3. The flow field about the nozzle can be described by an axisymmetric inviscid, adiabatic fluid model and the plug static pressure predicted so long as the flow remains attached.

NASA Langley Research Center
Hampton, VA 23665-5225
October 9, 1985

REFERENCES

1. Knott, P. R.; Blozy, J. T.; and Staid, P. S.: Acoustic and Aerodynamic Performance Investigation of Inverted Velocity Profile Coannular Plug Nozzles. NASA CR-3149, 1981.
2. Schloemer, J. J.; Whittaker, R. W.; and Wolf, J. P.: Supersonic Cruise Vehicle Exhaust System Study. R80AEG275 (Contract NAS1-15675), General Electric Co., Apr. 1980. (Available as NASA CR-177981.)
3. Larson, Richard S.; Nelson, Douglas P.; and Stevens, Bradley S.: Aerodynamic and Acoustic Investigation of Inverted Velocity Profile Coannular Exhaust Nozzle Models and Development of Aerodynamic and Acoustic Prediction Procedures. NASA CR-3168, 1979.
4. Nelson, D. P.: Model Aerodynamic Test Results for a Refined Actuated Inlet Ejector Nozzle at Simulated Takeoff and Cruise Conditions - Final Report. NASA CR-168051, 1983.
5. Peddrew, Kathryn A., compiler: A User's Guide to the Langley 16-Foot Transonic Tunnel. NASA TM-83186, 1981.
6. Capone, Francis J.: Static Performance of Five Twin-Engine Nonaxisymmetric Nozzles With Vectoring and Reversing Capability. NASA TP-1224, 1978.
7. Berrier, Bobby L.; and Mercer, Charles E.: Off-Design Performance of Two Isentropic Plug Nozzles Designed for a Pressure Ratio of 16.5. NASA TN D-3852, 1967.
8. Berrier, Bobby L.: Effect of Plug and Shroud Geometry Variables on Plug-Nozzle Performance at Transonic Speeds. NASA TN D-5098, 1969.
9. Rabone, George R.: Low-Angle Plug Nozzle Performance Characteristics. AIAA Paper No. 66-664, June 1966.
10. Cline, Michael C.: VNAP2: A Computer Program for Computation of Two-Dimensional, Time-Dependent, Compressible, Turbulent Flow. LA-8872, Los Alamos Nat. Lab., Aug. 1981.

TABLE 1.- INDEX OF CONFIGURATIONS AND NOZZLE GEOMETRIC PARAMETERS

Configuration	α_p , deg	B/d	A/d	A_e/A_t	Design $p_{t,j}/p_\infty$	Table
1	18	0.152	0.064	1.424	5.62	2
2	18	0.061	0.064	1.273	4.42	3
3	18	0.061	0.303	2.064	11.26	4
4	18	0.152	0.303	2.151	12.10	5
5	18	0.194	0.064	1.736	8.25	6
6	18	0.484	0.064	2.386	14.43	7
7	18	0.484	0.303	2.876	19.65	8
8	18	0.194	0.303	2.431	14.92	9
9	12	0.061	0.064	1.166	3.59	10
10	12	0.152	0.064	1.215	3.98	11
11	12	0.152	0.303	1.729	8.19	12
12	12	0.061	0.303	1.679	7.75	13
13	12	0.484	0.064	1.929	9.98	14
14	12	0.194	0.064	1.486	6.13	15
15	12	0.194	0.303	2.002	10.66	16
16	12	0.484	0.303	2.353	14.10	17
17 (baseline)	15	0.162	0.184	1.766	8.51	18
18	15	0.162	0.000	1.248	4.23	19
19	15	0.162	0.367	2.215	12.72	20
20	15	0.090	0.184	1.570	6.83	21
21	15	0.814	0.184	3.040	21.56	22
22	15	0.270	0.184	1.903	9.75	23
23	15	0.055	0.184	1.319	4.79	24
24	20	0.162	0.184	2.022	10.84	25
25	10	0.162	0.184	1.130	4.72	26
^a 26	15	0.162	0.184	1.766	8.51	27
27	15	0.061	0.303	2.022	10.84	28
^a 28	15	0.061	0.303	2.022	10.84	29
29	18	0.152	0.184	1.787	8.73	30
30	18	0.061	0.184	1.676	7.24	31
31	18	0.194	0.184	2.122	11.74	32
32	18	0.484	0.184	2.649	17.09	33
33	15	0.162	0.064	1.440	5.75	34
34	15	0.162	0.303	2.058	11.21	35
^a 35	15	0.162	0.000	1.248	4.23	36
^a 36	18	0.061	0.064	1.273	4.42	37
^a 37	18	0.061	0.303	2.064	11.26	38

^aScalloped shroud configuration.

TABLE 2.- BASIC DATA FOR CONFIGURATION 1 WITH $\alpha_p = 18^\circ$,
 $B/d = 0.152$, AND $A/d = 0.064$

MACH	NPR	P1	P2	P3	P4	P5	P6	P7	P8	P9
0.00	2.01	.211	.361	.522	.522	.489	.509	.509	.509	.513
0.00	3.00	.218	.197	.272	.341	.327	.408	.290	.328	.417
0.00	4.00	.221	.197	.164	.170	.253	.378	.251	.194	.197
0.00	5.01	.222	.198	.164	.168	.204	.250	.264	.236	.218
0.00	6.00	.222	.199	.165	.168	.170	.155	.193	.201	.186
0.00	6.32	.222	.199	.165	.168	.161	.133	.166	.185	.184
.65	2.01	.211	.294	.391	.498	.666	.538	.535	.534	.539
.65	3.39	.213	.197	.162	.304	.395	.254	.360	.372	.301
.65	4.21	.217	.198	.162	.168	.318	.374	.322	.233	.195
.65	4.99	.220	.199	.164	.168	.268	.235	.276	.255	.255
.65	6.00	.221	.200	.165	.169	.223	.144	.173	.203	.201
.65	8.11	.221	.200	.165	.169	.165	.090	.075	.088	.116
.70	2.01	.214	.287	.384	.486	.701	.545	.542	.541	.545
.70	3.40	.211	.196	.162	.303	.413	.264	.361	.370	.302
.70	4.20	.216	.198	.162	.168	.335	.383	.325	.236	.197
.70	4.99	.220	.200	.164	.169	.280	.234	.278	.257	.262
.70	5.00	.220	.200	.164	.169	.280	.232	.277	.258	.263
.70	6.00	.221	.200	.165	.169	.233	.145	.172	.204	.203
.70	8.45	.221	.200	.165	.169	.166	.090	.067	.078	.099
.80	1.99	.214	.289	.374	.445	.780	.548	.560	.561	.564
.80	3.40	.214	.198	.161	.300	.456	.277	.373	.352	.321
.80	4.21	.214	.198	.160	.172	.369	.394	.352	.230	.209
.80	5.00	.218	.199	.163	.168	.310	.234	.290	.263	.304
.80	5.99	.221	.200	.164	.169	.259	.139	.174	.210	.207
.80	7.00	.221	.200	.165	.169	.222	.091	.111	.140	.165
.80	8.61	.221	.200	.165	.169	.180	.090	.060	.076	.091
.80	9.19	.221	.201	.166	.170	.169	.090	.059	.064	.085
.90	2.00	.218	.303	.363	.395	.867	.477	.516	.545	.566
.90	3.39	.214	.198	.161	.170	.511	.362	.383	.411	.322
.90	4.20	.212	.197	.159	.166	.411	.257	.320	.279	.275
.90	5.01	.216	.199	.163	.168	.345	.178	.210	.268	.309
.90	6.00	.220	.199	.164	.168	.287	.090	.134	.187	.222
.90	7.00	.221	.200	.165	.169	.246	.090	.064	.122	.172
.90	8.61	.221	.200	.165	.169	.200	.090	.058	.098	.115
.90	9.99	.221	.201	.166	.170	.172	.091	.059	.063	.090
.95	2.01	.214	.261	.335	.359	.909	.434	.475	.512	.543
.95	3.40	.213	.195	.158	.166	.537	.239	.329	.375	.401
.95	4.20	.214	.198	.161	.167	.434	.148	.241	.281	.325
.95	5.00	.215	.199	.162	.168	.365	.092	.166	.216	.236
.95	6.01	.219	.199	.164	.169	.303	.089	.148	.163	.175
.95	6.99	.221	.200	.165	.169	.261	.089	.117	.134	.142
.95	8.60	.221	.200	.165	.169	.212	.090	.058	.108	.110
.95	9.99	.221	.200	.166	.170	.183	.091	.059	.089	.095
1.20	2.00	.215	.205	.196	.225	1.216	.419	.438	.464	.521
1.20	3.39	.217	.196	.158	.168	.721	.215	.244	.263	.276
1.20	4.19	.213	.196	.157	.166	.587	.158	.182	.203	.221
1.20	4.98	.213	.196	.158	.165	.492	.100	.139	.160	.176
1.20	6.01	.215	.199	.163	.169	.409	.090	.098	.117	.134
1.20	7.02	.217	.200	.164	.169	.351	.091	.059	.088	.103
1.20	8.59	.221	.200	.165	.170	.287	.091	.058	.044	.069
1.20	9.99	.221	.200	.165	.170	.247	.091	.059	.043	.037

TABLE 2.- Continued

MACH	NPR	P10	P11	P12	P13	P14	P15	S1	S2	S3
0.00	2.01	.517	.522	.529	.539	.577	.581	-.001	-.001	-.001
0.00	3.00	.371	.318	.372	.429	.441	.449	-.001	-.001	-.001
0.00	4.00	.244	.363	.385	.367	.320	.328	-.001	-.002	-.002
0.00	5.01	.199	.190	.209	.276	.281	.300	-.001	-.002	-.002
0.00	6.00	.207	.237	.216	.209	.234	.250	-.002	-.003	-.003
0.00	6.32	.167	.246	.236	.223	.223	.238	-.002	-.003	-.003
.65	.99							-.378	-.521	-.476
.65	2.01	.543	.547	.552	.559	.590	.596	-.473	-.710	-.695
.65	3.39	.341	.317	.392	.396	.426	.431	-.506	-.787	-.770
.65	4.21	.107	.250	.365	.401	.365	.395	-.497	-.768	-.746
.65	4.99	.231	.206	.210	.263	.308	.333	-.480	-.729	-.700
.65	6.00	.200	.270	.255	.237	.256	.277	-.454	-.675	-.639
.65	8.11	.132	.175	.211	.214	.190	.205	-.389	-.559	-.513
.70	.98							-.387	-.535	-.479
.70	2.01	.549	.553	.557	.563	.593	.602	-.493	-.773	-.747
.70	3.40	.343	.324	.393	.399	.428	.430	-.531	-.866	-.848
.70	4.20	.196	.254	.372	.408	.372	.403	-.521	-.845	-.816
.70	4.99	.236	.208	.210	.263	.312	.334	-.499	-.786	-.749
.70	5.00	.237	.209	.210	.261	.312	.333	-.499	-.789	-.751
.70	6.00	.204	.274	.258	.239	.260	.282	-.473	-.724	-.680
.70	8.45	.124	.186	.198	.207	.185	.200	-.394	-.568	-.514
.80	.97							-.416	-.586	-.479
.80	1.99	.565	.567	.570	.574	.595	.606	-.471	-.915	-1.024
.80	3.40	.335	.365	.399	.403	.414	.425	-.478	-.928	-1.063
.80	4.21	.218	.254	.384	.418	.384	.418	-.475	-.924	-1.058
.80	5.00	.233	.210	.211	.268	.322	.327	-.473	-.920	-1.052
.80	5.99	.222	.296	.261	.241	.270	.290	-.472	-.920	-1.038
.80	7.00	.170	.194	.271	.264	.231	.252	-.462	-.906	-.944
.80	8.61	.144	.182	.189	.200	.188	.205	-.439	-.745	-.606
.80	9.19	.134	.151	.161	.171	.176	.192	-.426	-.665	-.541
.90	2.00	.573	.577	.578	.579	.582	.593	-.341	-.714	-.829
.90	3.39	.335	.408	.422	.379	.419	.427	-.340	-.713	-.829
.90	4.20	.378	.356	.317	.294	.354	.365	-.340	-.714	-.831
.90	5.01	.237	.326	.299	.293	.337	.349	-.338	-.711	-.828
.90	6.00	.286	.324	.298	.296	.274	.282	-.343	-.720	-.838
.90	7.00	.197	.259	.282	.277	.241	.263	-.342	-.720	-.837
.90	8.61	.135	.154	.168	.183	.196	.214	-.339	-.717	-.833
.90	9.99	.099	.110	.122	.133	.142	.157	-.339	-.720	-.828
.90	.95							-.348	-.673	-.541
.95	.93							-.274	-.613	-.585
.95	2.01	.561	.574	.580	.583	.583	.593	-.275	-.620	-.729
.95	3.40	.413	.364	.387	.436	.461	.470	-.273	-.618	-.728
.95	4.20	.308	.344	.403	.377	.347	.362	-.274	-.620	-.730
.95	5.00	.283	.290	.280	.343	.345	.379	-.273	-.618	-.728
.95	6.01	.189	.226	.248	.266	.285	.292	-.277	-.625	-.735
.95	6.99	.150	.163	.189	.215	.229	.237	-.274	-.621	-.731
.95	8.60	.114	.120	.128	.140	.161	.176	-.274	-.621	-.732
.95	9.99	.095	.098	.102	.109	.116	.130	-.270	-.616	-.725
1.20	.85							-.082	-.320	-.397
1.20	2.00	.549	.574	.593	.607	.620	.622	-.084	-.323	-.401
1.20	3.39	.303	.332	.396	.440	.456	.460	-.082	-.321	-.399
1.20	4.19	.236	.273	.325	.371	.389	.391	-.079	-.318	-.395
1.20	4.98	.189	.214	.280	.317	.335	.335	-.079	-.318	-.396
1.20	6.01	.147	.165	.231	.260	.275	.278	-.078	-.317	-.395
1.20	7.02	.118	.132	.192	.213	.224	.232	-.077	-.316	-.393
1.20	8.59	.081	.096	.144	.163	.176	.178	-.077	-.316	-.394
1.20	9.99	.059	.070	.113	.129	.141	.143	-.076	-.315	-.394

TABLE 2.- Concluded

MACH	NPR	S4	S5	S6	S7	CFMD	FMDZFI
0.00	2.01	-.001	-.002	-.000	-.002	.346	.884
0.00	3.00	-.002	-.002	-.000	-.002	.693	.965
0.00	4.00	-.002	-.002	-.001	-.002	1.048	.997
0.00	5.01	-.002	-.003	-.001	-.003	1.399	.999
0.00	6.00	-.003	-.003	-.001	-.003	1.752	1.001
0.00	6.32	-.003	-.004	-.001	-.003	1.866	1.001
.65	.99	-.384	-.259	-.172	-.122	-.086	0.000
.65	2.01	-.629	-.541	-.476	-.415	1.166	.875
.65	3.39	-.704	-.606	-.527	-.466	2.798	.978
.65	4.21	-.676	-.571	-.487	-.424	3.784	.997
.65	4.99	-.624	-.513	-.424	-.359	4.687	.996
.65	6.00	-.558	-.441	-.350	-.287	5.918	1.001
.65	9.11	-.425	-.304	-.216	-.164	8.362	.990
.70	.98	-.374	-.247	-.159	-.118	-.088	0.000
.70	2.01	-.658	-.549	-.472	-.408	.988	.870
.70	3.40	-.756	-.630	-.539	-.471	2.437	.980
.70	4.20	-.719	-.588	-.493	-.423	3.250	.997
.70	4.99	-.652	-.522	-.426	-.355	4.093	.996
.70	5.00	-.653	-.521	-.425	-.353	4.078	.996
.70	6.00	-.579	-.445	-.348	-.282	5.119	1.001
.70	8.45	-.413	-.287	-.194	-.145	7.610	.989
.80	.97	-.331	-.194	-.133	-.114	-.091	0.000
.80	1.99	-.902	-.547	-.437	-.377	.737	.856
.80	3.40	-1.142	-.926	-.709	-.625	1.835	.965
.80	4.21	-1.122	-.868	-.668	-.601	2.474	.988
.80	5.00	-1.047	-.701	-.556	-.504	3.086	.991
.80	5.99	-.922	-.521	-.415	-.387	3.988	1.000
.80	7.00	-.645	-.380	-.293	-.252	4.668	.999
.80	8.61	-.414	-.254	-.179	-.141	5.896	.990
.80	9.18	-.381	-.230	-.153	-.122	6.377	.987
.90	2.00	-.923	-.694	-.815	-.701	.524	.766
.90	3.39	-.934	-1.029	-1.077	-1.052	1.361	.915
.90	4.20	-.936	-1.035	-1.090	-1.093	1.875	.949
.90	5.01	-.933	-1.032	-1.076	-1.052	2.374	.965
.90	6.00	-.944	-1.041	-1.023	-1.010	3.045	.983
.90	7.00	-.943	-1.009	-.944	-.892	3.676	.987
.90	8.61	-.925	-.806	-.640	-.584	4.660	.983
.90	9.99	-.768	-.472	-.397	-.382	5.566	.984
.90	.95	-.284	-.184	-.158	-.173	-.113	0.000
.95	.93	-.382	-.236	-.201	-.191	-.098	0.000
.95	2.01	-.825	-.906	-.923	-.907	.447	.724
.95	3.40	-.824	-.916	-.968	-.996	1.203	.895
.95	4.20	-.827	-.919	-.971	-.991	1.659	.932
.95	5.00	-.825	-.917	-.963	-.951	2.106	.951
.95	6.01	-.833	-.924	-.918	-.902	2.691	.966
.95	6.99	-.828	-.909	-.860	-.842	3.232	.972
.95	8.60	-.829	-.828	-.759	-.657	4.169	.980
.95	9.99	-.820	-.747	-.602	-.529	4.957	.984
1.20	.85	-.447	-.381	-.300	-.252	-.186	0.000
1.20	2.00	-.471	-.535	-.570	-.572	.193	.495
1.20	3.39	-.470	-.535	-.573	-.604	.669	.794
1.20	4.19	-.465	-.531	-.569	-.598	.947	.854
1.20	4.98	-.466	-.532	-.569	-.589	1.233	.890
1.20	6.01	-.466	-.531	-.561	-.547	1.601	.919
1.20	7.02	-.464	-.528	-.522	-.508	1.963	.937
1.20	8.59	-.464	-.514	-.473	-.455	2.536	.955
1.20	9.99	-.463	-.476	-.437	-.387	3.053	.966

TABLE 3.- BASIC DATA FOR CONFIGURATION 2 WITH $\alpha_p = 18^\circ$,
 $B/d = 0.061$, AND $A/d = 0.064$

MACH	NPR	P1	P2	P3	P4	P5	P6	P7	P8	P9
0.00	2.00	.212	.402	.543	.524	.512	.514	.513	.514	.518
0.00	2.99	.214	.192	.395	.302	.347	.354	.361	.342	.352
0.00	4.01	.222	.192	.260	.309	.336	.270	.220	.213	.288
0.00	5.00	.223	.193	.259	.141	.205	.233	.206	.260	.220
0.00	6.00	.224	.194	.260	.123	.140	.161	.165	.153	.272
0.00	6.35	.224	.194	.260	.122	.106	.133	.163	.126	.230
0.00	2.01	.214	.399	.541	.519	.510	.511	.511	.512	.516
0.00	2.99	.215	.192	.402	.299	.347	.354	.362	.343	.350
0.00	3.99	.223	.192	.260	.310	.337	.265	.219	.214	.289
0.00	5.00	.223	.193	.259	.143	.206	.233	.207	.258	.219
0.00	6.01	.223	.193	.259	.121	.140	.160	.165	.153	.270
0.00	6.40	.223	.193	.259	.120	.103	.131	.162	.125	.225
.65	2.00	.215	.371	.521	.537	.526	.529	.531	.534	.541
.65	3.39	.215	.192	.264	.470	.316	.225	.255	.383	.437
.65	4.20	.218	.192	.262	.264	.320	.255	.275	.228	.253
.65	5.00	.222	.193	.261	.124	.187	.249	.186	.317	.262
.65	6.00	.223	.193	.260	.121	.127	.140	.177	.134	.257
.65	8.21	.224	.193	.261	.121	.068	.049	.085	.119	.135
.70	2.02	.216	.356	.504	.536	.525	.527	.529	.533	.540
.70	3.40	.214	.191	.263	.451	.319	.247	.265	.365	.418
.70	4.20	.217	.193	.263	.242	.315	.257	.300	.231	.268
.70	5.00	.222	.194	.262	.123	.183	.250	.185	.329	.272
.70	6.01	.223	.193	.261	.121	.110	.136	.178	.134	.254
.70	8.54	.224	.194	.261	.122	.069	.052	.092	.106	.118
.80	2.00	.222	.311	.448	.532	.539	.543	.544	.547	.555
.80	3.40	.213	.189	.260	.365	.342	.324	.299	.370	.353
.80	4.21	.214	.190	.260	.139	.284	.268	.358	.271	.259
.80	5.02	.218	.192	.260	.120	.148	.246	.190	.348	.302
.80	6.02	.223	.193	.259	.121	.071	.130	.182	.140	.258
.80	7.00	.224	.194	.260	.121	.068	.083	.105	.139	.199
.80	9.24	.224	.194	.260	.121	.068	.048	.086	.092	.099
.90	1.99	.212	.239	.357	.446	.507	.548	.564	.570	.577
.90	3.39	.214	.189	.260	.137	.244	.309	.380	.409	.330
.90	4.20	.216	.192	.262	.121	.187	.201	.247	.297	.366
.90	5.00	.216	.193	.261	.121	.143	.160	.174	.210	.253
.90	6.00	.221	.193	.260	.121	.069	.132	.138	.154	.177
.90	6.99	.224	.194	.260	.122	.069	.114	.116	.125	.138
.90	8.61	.224	.194	.260	.122	.069	.058	.095	.097	.104
.90	10.00	.224	.194	.260	.122	.069	.046	.082	.083	.085
.95	1.99	.221	.199	.253	.339	.490	.546	.566	.577	.590
.95	2.01	.214	.187	.243	.328	.487	.546	.565	.575	.587
.95	3.40	.214	.188	.259	.124	.170	.213	.336	.385	.408
.95	4.20	.216	.192	.262	.121	.085	.148	.235	.274	.321
.95	4.99	.215	.191	.261	.119	.136	.158	.168	.181	.196
.95	6.00	.219	.193	.260	.121	.074	.137	.138	.143	.149
.95	7.01	.223	.193	.260	.121	.068	.119	.118	.120	.124
.95	8.61	.224	.194	.260	.121	.068	.062	.097	.095	.096
.95	9.99	.224	.194	.261	.122	.069	.046	.082	.082	.081
1.20	2.01	.218	.190	.237	.339	.372	.396	.409	.463	.517
1.20	3.38	.202	.171	.234	.145	.198	.221	.232	.259	.283
1.20	4.16	.217	.190	.259	.124	.119	.163	.182	.187	.218
1.20	4.21	.216	.189	.259	.122	.115	.161	.179	.184	.214
1.20	4.99	.216	.191	.262	.122	.073	.124	.138	.153	.162
1.20	6.00	.215	.191	.261	.119	.066	.071	.104	.116	.127
1.20	6.99	.217	.193	.261	.122	.070	.047	.076	.088	.099
1.20	8.59	.221	.193	.261	.122	.069	.046	.037	.057	.070
1.20	10.00	.224	.193	.261	.122	.069	.046	.033	.028	.050

TABLE 3.- Continued

MACH	NPR	P10	P11	P12	P13	P14	P15	S1	S2	S3
0.00	2.00	.520	.525	.532	.540	.579	.582	-.001	-.001	.001
0.00	2.99	.370	.366	.372	.398	.449	.451	-.002	-.002	.001
0.00	4.01	.320	.334	.309	.287	.327	.332	-.002	-.002	.000
0.00	5.00	.206	.261	.219	.226	.282	.300	-.003	-.003	.000
0.00	6.00	.257	.219	.207	.253	.235	.247	-.003	-.003	-.001
0.00	6.35	.284	.243	.216	.219	.222	.237	-.004	-.004	-.001
0.00	2.01	.519	.524	.529	.539	.577	.582	-.001	-.001	-.000
0.00	2.99	.370	.368	.372	.398	.448	.452	-.002	-.002	-.000
0.00	3.99	.324	.336	.307	.287	.325	.331	-.002	-.002	-.000
0.00	5.00	.205	.260	.218	.228	.281	.300	-.003	-.003	-.000
0.00	6.01	.257	.219	.206	.252	.234	.246	-.003	-.003	-.000
0.00	6.40	.282	.246	.216	.218	.220	.235	-.004	-.004	-.000
.65	.97							-.330	-.348	-.630
.65	2.00	.546	.552	.558	.566	.602	.606	-.718	-.769	-.629
.65	3.39	.338	.269	.293	.420	.453	.465	-.742	-.797	-.623
.65	4.20	.240	.288	.348	.344	.366	.392	-.715	-.768	-.635
.65	5.00	.223	.294	.224	.217	.308	.314	-.665	-.713	-.639
.65	6.00	.301	.270	.239	.285	.246	.259	-.600	-.643	-.636
.65	8.21	.147	.159	.179	.204	.187	.202	-.458	-.489	-.635
.70	.96							-.324	-.339	-.434
.70	2.02	.544	.550	.557	.565	.601	.604	-.689	-.737	-.436
.70	3.40	.347	.281	.300	.415	.460	.465	-.715	-.770	-.434
.70	4.20	.231	.271	.350	.350	.372	.402	-.695	-.747	-.435
.70	5.00	.228	.296	.219	.215	.307	.310	-.661	-.708	-.434
.70	6.01	.303	.278	.246	.288	.239	.250	-.604	-.645	-.430
.70	8.54	.128	.138	.153	.174	.179	.198	-.443	-.471	-.431
.80	.94							-.318	-.334	-.142
.80	2.00	.559	.564	.570	.578	.611	.608	-.558	-.603	-.141
.80	3.40	.333	.354	.342	.404	.448	.446	-.557	-.603	-.137
.80	4.21	.218	.255	.315	.384	.385	.419	-.558	-.605	-.138
.80	5.02	.278	.227	.178	.242	.309	.316	-.558	-.604	-.141
.80	6.02	.299	.294	.283	.227	.204	.207	-.552	-.598	-.143
.80	7.00	.213	.239	.281	.260	.231	.246	-.535	-.578	-.139
.80	9.24	.107	.112	.118	.132	.153	.163	-.431	-.457	-.138
.90	.92							-.318	-.336	.067
.90	1.99	.578	.581	.584	.589	.610	.619	-.402	-.440	.069
.90	3.39	.391	.400	.355	.384	.449	.453	-.402	-.440	.070
.90	4.20	.371	.296	.247	.353	.399	.405	-.402	-.440	.069
.90	5.00	.290	.330	.334	.298	.273	.286	-.398	-.436	.072
.90	6.00	.212	.237	.260	.281	.281	.304	-.398	-.435	.071
.90	6.99	.152	.178	.200	.219	.234	.240	-.396	-.434	.072
.90	8.61	.111	.118	.126	.143	.162	.171	-.396	-.434	.070
.90	10.00	.089	.094	.097	.102	.110	.129	-.388	-.424	.069
.95	.90							-.292	-.316	.155
.95	1.99	.595	.601	.608	.615	.641	.649	-.326	-.361	.156
.95	2.01	.592	.598	.605	.613	.642	.647	-.327	-.361	.155
.95	3.40	.399	.351	.407	.431	.447	.454	-.326	-.360	.155
.95	4.20	.318	.378	.382	.336	.344	.349	-.326	-.361	.154
.95	4.99	.221	.246	.269	.291	.304	.311	-.331	-.366	.150
.95	6.00	.159	.177	.196	.216	.237	.245	-.329	-.364	.151
.95	7.01	.128	.138	.154	.170	.189	.200	-.328	-.363	.151
.95	8.61	.099	.103	.109	.118	.132	.148	-.323	-.357	.155
.95	9.99	.083	.086	.090	.095	.099	.114	-.323	-.358	.156
1.20	.82							-.112	-.136	.465
1.20	2.01	.547	.575	.596	.611	.624	.630	-.112	-.136	.466
1.20	3.38	.299	.337	.390	.427	.441	.432	-.112	-.136	.465
1.20	4.16	.247	.270	.313	.365	.385	.387	-.110	-.133	.469
1.20	4.21	.244	.268	.307	.362	.382	.384	-.110	-.133	.471
1.20	4.99	.190	.229	.268	.311	.333	.335	-.109	-.133	.473
1.20	6.00	.140	.174	.237	.264	.279	.282	-.107	-.131	.476
1.20	6.99	.109	.155	.195	.213	.230	.235	-.109	-.133	.478
1.20	8.59	.078	.120	.141	.153	.170	.175	-.109	-.132	.479
1.20	10.00	.064	.091	.104	.115	.128	.133	-.108	-.132	.482

TABLE 3.- Concluded

MACH	NPR	S4	S5	S6	S7	S8	S9	CFHD	FHDZFI
0.00	2.00	-.002	-.000	-.002	-.002	-.003	.000	.361	.923
0.00	2.99	-.002	-.000	-.003	-.003	-.004	-.001	.701	.980
0.00	4.01	-.003	-.001	-.003	-.003	-.005	-.001	1.050	.995
0.00	5.00	-.003	-.004	-.004	-.004	-.005	-.001	1.392	.997
0.00	6.00	-.004	-.005	-.005	-.005	-.005	-.001	1.742	.999
0.00	6.35	-.005	-.005	-.005	-.005	-.004	-.001	1.868	.999
0.00	2.01	.001	-.002	-.002	-.002	-.003	.001	.362	.926
0.00	2.99	.001	-.003	-.003	-.003	-.004	-.000	.698	.979
0.00	3.99	.000	-.003	-.004	-.004	-.005	-.001	1.042	.993
0.00	5.00	-.000	-.004	-.004	-.004	-.005	-.001	1.389	.999
0.00	6.01	-.000	-.004	-.005	-.005	-.006	-.001	1.746	1.000
0.00	6.40	-.000	-.004	-.005	-.006	-.006	-.001	1.883	.999
.65	.97	-.408	-.464	-.437	-.376	-.325	-.137	-.121	0.000
.65	2.00	-.941	-1.207	-1.176	-1.100	-1.170	-.715	1.211	.915
.65	3.39	-.978	-1.266	-1.232	-1.151	-1.232	-.764	2.812	.987
.65	4.20	-.937	-1.184	-1.145	-1.061	-1.140	-.673	3.772	.994
.65	5.00	-.862	-1.066	-1.026	-.948	-1.012	-.562	4.719	.994
.65	6.00	-.772	-.931	-.895	-.822	-.861	-.443	5.909	.997
.65	8.21	-.582	-.682	-.647	-.581	-.572	-.262	8.429	.978
.70	.96	-.398	-.449	-.423	-.360	-.301	-.132	-.120	0.000
.70	2.02	-.907	-1.149	-1.133	-1.077	-1.118	-.688	1.057	.909
.70	3.40	-.949	-1.240	-1.234	-1.168	-1.220	-.782	2.444	.985
.70	4.20	-.920	-1.178	-1.151	-1.087	-1.119	-.685	3.255	.992
.70	5.00	-.868	-1.081	-1.043	-.977	-.997	-.577	4.049	.993
.70	6.01	-.784	-.952	-.910	-.848	-.847	-.455	5.067	.996
.70	8.54	-.562	-.653	-.617	-.554	-.513	-.238	7.542	.974
.80	.94	-.390	-.425	-.402	-.327	-.264	-.130	-.124	0.000
.80	2.00	-.743	-.963	-.983	-.941	-.981	-.687	.770	.876
.80	3.40	-.746	-1.021	-1.156	-1.337	-1.508	-1.130	1.808	.954
.80	4.21	-.748	-1.024	-1.159	-1.274	-1.376	-1.053	2.441	.973
.80	5.02	-.748	-1.023	-1.126	-1.067	-1.156	-.858	3.087	.981
.80	6.02	-.740	-.967	-.949	-.910	-.918	-.647	3.882	.989
.80	7.00	-.711	-.849	-.812	-.753	-.717	-.481	4.632	.988
.80	9.24	-.550	-.620	-.583	-.499	-.425	-.232	6.329	.974
.90	.92	-.386	-.391	-.371	-.278	-.237	-.138	-.117	0.000
.90	1.99	-.556	-.781	-.895	-1.055	-1.308	-1.089	.528	.766
.90	3.39	-.556	-.782	-.896	-1.059	-1.320	-1.071	1.379	.916
.90	4.20	-.556	-.781	-.896	-1.060	-1.314	-.984	1.877	.943
.90	5.00	-.552	-.777	-.892	-1.069	-1.222	-.909	2.365	.956
.90	6.00	-.552	-.777	-.891	-1.024	-1.073	-.830	2.979	.964
.90	6.99	-.550	-.776	-.888	-.902	-.978	-.757	3.578	.966
.90	8.61	-.551	-.766	-.805	-.753	-.796	-.573	4.614	.972
.90	10.00	-.530	-.621	-.589	-.525	-.499	-.342	5.494	.974
.95	.90	-.376	-.386	-.365	-.288	-.261	-.160	-.099	0.000
.95	1.99	-.467	-.673	-.778	-.926	-1.147	-.963	.458	.736
.95	2.01	-.468	-.675	-.780	-.931	-1.164	-.999	.453	.727
.95	3.40	-.467	-.674	-.780	-.930	-1.166	-.955	1.210	.896
.95	4.20	-.468	-.675	-.781	-.932	-1.165	-.881	1.653	.927
.95	4.99	-.473	-.682	-.788	-.939	-1.136	-.836	2.099	.941
.95	6.00	-.471	-.679	-.785	-.913	-.968	-.745	2.661	.953
.95	7.01	-.470	-.679	-.784	-.824	-.886	-.686	3.233	.962
.95	8.61	-.464	-.671	-.756	-.714	-.774	-.578	4.127	.971
.95	9.99	-.464	-.658	-.679	-.631	-.663	-.470	4.937	.975
1.20	.82	-.206	-.314	-.307	-.277	-.290	-.190	-.178	0.000
1.20	2.01	-.208	-.351	-.427	-.527	-.686	-.596	.204	.517
1.20	3.38	-.208	-.352	-.428	-.526	-.689	-.595	.685	.804
1.20	4.16	-.205	-.349	-.424	-.523	-.685	-.596	.948	.853
1.20	4.21	-.205	-.349	-.425	-.523	-.685	-.592	.964	.856
1.20	4.99	-.205	-.349	-.425	-.523	-.684	-.514	1.239	.888
1.20	6.00	-.203	-.347	-.423	-.521	-.657	-.475	1.595	.913
1.20	6.99	-.205	-.349	-.425	-.515	-.557	-.419	1.955	.930
1.20	8.59	-.205	-.349	-.424	-.453	-.480	-.367	2.526	.946
1.20	10.00	-.205	-.349	-.415	-.392	-.425	-.317	3.035	.955

TABLE 4.- BASIC DATA FOR CONFIGURATION 3 WITH $\alpha_p = 18^\circ$,
 $B/d = 0.061$, AND $A/d = 0.303$

MACH	NPR	P1	P2	P3	P4	P5	P6	P7	P8	P9
0.00	2.01	.212	.396	.514	.499	.504	.509	.509	.509	.512
0.00	2.99	.216	.198	.301	.334	.407	.388	.292	.329	.395
0.00	4.02	.219	.198	.144	.249	.220	.306	.225	.363	.317
0.00	5.02	.220	.199	.144	.199	.111	.158	.160	.225	.237
0.00	6.00	.220	.200	.145	.167	.078	.138	.141	.159	.210
0.00	6.48	.220	.200	.145	.154	.078	.125	.132	.144	.182
0.00	2.00	.213	.386	.513	.498	.509	.511	.511	.511	.514
0.00	3.01	.214	.196	.297	.334	.395	.381	.291	.326	.397
0.00	4.00	.220	.198	.144	.252	.225	.310	.223	.362	.311
0.00	5.00	.221	.199	.144	.202	.110	.159	.161	.227	.238
0.00	6.01	.221	.199	.145	.169	.079	.138	.141	.159	.210
0.00	6.48	.221	.200	.145	.158	.079	.125	.133	.144	.182
.65	2.00	.213	.231	.408	.516	.475	.511	.525	.531	.537
.65	3.39	.216	.197	.144	.307	.252	.337	.424	.332	.280
.65	4.20	.217	.198	.144	.249	.170	.173	.201	.276	.362
.65	5.01	.221	.199	.144	.209	.094	.159	.158	.214	.242
.65	6.01	.221	.199	.145	.175	.080	.140	.142	.153	.196
.65	8.23	.221	.200	.145	.129	.077	.062	.110	.114	.125
.70	1.99	.215	.225	.382	.515	.471	.508	.526	.534	.541
.70	3.42	.215	.195	.142	.303	.213	.302	.380	.362	.311
.70	4.20	.216	.198	.144	.248	.165	.172	.191	.278	.356
.70	5.01	.220	.199	.144	.209	.085	.158	.156	.208	.245
.70	6.01	.221	.199	.145	.175	.079	.141	.142	.151	.192
.70	8.52	.221	.200	.146	.124	.078	.062	.108	.112	.121
.80	2.00	.217	.210	.297	.532	.429	.492	.517	.530	.541
.80	3.40	.216	.196	.143	.316	.216	.222	.235	.250	.272
.80	4.22	.216	.198	.144	.256	.161	.172	.173	.253	.317
.80	5.00	.218	.199	.144	.217	.079	.153	.150	.181	.254
.80	5.99	.221	.199	.145	.182	.079	.138	.141	.142	.172
.80	7.01	.222	.200	.145	.156	.079	.115	.129	.131	.137
.80	9.27	.221	.200	.146	.119	.079	.062	.098	.108	.117
.90	1.99	.218	.203	.259	.570	.440	.456	.489	.511	.530
.90	3.39	.216	.195	.143	.338	.209	.215	.228	.240	.255
.90	4.22	.216	.197	.143	.271	.184	.182	.180	.199	.224
.90	5.03	.216	.198	.144	.230	.124	.161	.158	.157	.185
.90	5.99	.220	.199	.145	.193	.081	.143	.143	.141	.145
.90	7.02	.221	.199	.145	.165	.079	.101	.128	.128	.131
.90	8.60	.222	.200	.145	.134	.079	.063	.110	.113	.121
.90	9.99	.222	.200	.146	.116	.079	.063	.074	.104	.117
.95	2.01	.213	.192	.213	.573	.349	.417	.457	.479	.501
.95	3.39	.216	.195	.142	.342	.200	.206	.219	.231	.242
.95	4.20	.216	.196	.143	.276	.190	.187	.182	.188	.199
.95	4.99	.217	.199	.145	.234	.152	.167	.163	.161	.168
.95	6.01	.218	.199	.144	.195	.082	.142	.142	.140	.141
.95	7.02	.221	.199	.145	.167	.078	.093	.125	.124	.127
.95	8.63	.222	.200	.146	.137	.079	.062	.098	.109	.118
.95	10.00	.222	.200	.146	.118	.079	.062	.055	.091	.112
1.20	2.02	.219	.205	.226	.822	.320	.349	.365	.388	.419
1.20	3.40	.216	.194	.141	.471	.152	.159	.177	.207	.233
1.20	4.21	.216	.195	.142	.376	.087	.123	.130	.151	.183
1.20	5.02	.215	.195	.140	.314	.078	.073	.121	.126	.146
1.20	5.99	.216	.197	.142	.263	.077	.062	.115	.115	.123
1.20	7.01	.216	.199	.145	.223	.079	.062	.078	.105	.115
1.20	8.59	.220	.200	.145	.181	.079	.063	.052	.047	.092
1.20	10.00	.221	.200	.146	.155	.079	.063	.052	.046	.092

TABLE 4.- Continued

MACH	NPR	P10	P11	P12	P13	P14	P15	S2	S3
0.00	2.01	.516	.521	.526	.537	.576	.578	-.002	-.003
0.00	2.99	.362	.333	.375	.418	.437	.443	-.003	-.003
0.00	4.02	.277	.218	.239	.319	.350	.374	-.004	-.004
0.00	5.02	.212	.348	.332	.281	.222	.233	-.003	-.004
0.00	6.00	.231	.184	.231	.262	.235	.250	-.004	-.005
0.00	6.48	.226	.212	.166	.240	.217	.232	-.005	-.005
0.00	2.00	.518	.523	.529	.539	.576	.580	-.002	.001
0.00	3.01	.363	.329	.369	.417	.439	.444	-.003	.001
0.00	4.00	.276	.221	.246	.324	.352	.376	-.003	.000
0.00	5.00	.213	.350	.331	.279	.220	.232	-.003	.001
0.00	6.01	.231	.184	.230	.262	.234	.250	-.004	-.000
0.00	6.48	.226	.212	.167	.240	.217	.232	-.005	-.001
.65	.97							-.341	-.358
.65	2.00	.540	.544	.548	.555	.583	.588	-.667	-.709
.65	3.39	.358	.380	.340	.336	.421	.428	-.748	-.798
.65	4.20	.349	.280	.272	.317	.359	.363	-.797	-.859
.65	5.01	.255	.368	.334	.275	.225	.238	-.776	-.836
.65	6.01	.224	.186	.265	.290	.256	.277	-.741	-.797
.65	6.23	.140	.164	.190	.205	.187	.202	-.644	-.687
.70	.97							-.336	-.353
.70	1.99	.545	.549	.552	.559	.583	.589	-.624	-.665
.70	3.42	.373	.332	.334	.384	.409	.422	-.709	-.757
.70	4.20	.349	.287	.295	.322	.357	.362	-.759	-.819
.70	5.01	.256	.371	.335	.277	.233	.246	-.748	-.808
.70	6.01	.224	.188	.275	.296	.260	.282	-.727	-.783
.70	6.52	.133	.152	.176	.200	.183	.199	-.640	-.686
.80	.95							-.334	-.348
.80	2.00	.546	.552	.555	.560	.581	.589	-.563	-.605
.80	3.40	.295	.320	.342	.360	.368	.377	-.579	-.627
.80	4.22	.338	.322	.330	.324	.331	.339	-.606	-.658
.80	5.00	.252	.378	.349	.294	.259	.272	-.607	-.659
.80	5.99	.219	.206	.290	.309	.270	.294	-.601	-.653
.80	7.01	.159	.196	.200	.231	.231	.251	-.601	-.653
.80	9.27	.122	.132	.145	.167	.174	.190	-.583	-.633
.90	.94							-.335	-.351
.90	1.99	.542	.552	.559	.566	.586	.595	-.440	-.481
.90	3.39	.272	.292	.313	.333	.337	.345	-.438	-.480
.90	4.22	.249	.274	.291	.307	.318	.323	-.442	-.485
.90	5.03	.216	.243	.265	.283	.293	.299	-.436	-.478
.90	5.99	.175	.206	.228	.251	.272	.278	-.437	-.479
.90	7.02	.135	.165	.195	.219	.240	.247	-.434	-.476
.90	8.60	.123	.126	.144	.173	.191	.198	-.442	-.485
.90	9.99	.122	.122	.123	.137	.158	.167	-.437	-.479
.95	.92							-.316	-.338
.95	2.01	.518	.532	.543	.554	.577	.585	-.364	-.403
.95	3.39	.255	.273	.293	.314	.331	.338	-.364	-.403
.95	4.20	.207	.219	.238	.256	.274	.283	-.367	-.406
.95	4.99	.178	.186	.196	.214	.237	.248	-.364	-.403
.95	6.01	.146	.159	.171	.184	.200	.214	-.360	-.399
.95	7.02	.129	.136	.151	.169	.188	.198	-.361	-.400
.95	8.63	.122	.123	.126	.139	.158	.172	-.358	-.397
.95	10.00	.123	.125	.123	.126	.136	.162	-.358	-.396
1.20	.83							-.141	-.166
1.20	2.02	.444	.468	.487	.500	.502	.512	-.142	-.168
1.20	3.40	.255	.281	.306	.327	.341	.348	-.139	-.165
1.20	4.21	.215	.247	.276	.304	.323	.330	-.138	-.164
1.20	5.02	.171	.202	.231	.259	.286	.294	-.137	-.163
1.20	5.99	.136	.155	.177	.201	.223	.231	-.136	-.162
1.20	7.01	.122	.136	.152	.170	.189	.197	-.135	-.161
1.20	8.59	.075	.125	.138	.152	.164	.175	-.135	-.161
1.20	10.00	.072	.069	.111	.124	.134	.144	-.132	-.158

TABLE 4.- Concluded

MACH	NPR	S4	S5	S6	S7	S8	S9	CFMD	FMDZFI
0.00	2.01	-.003	-.004	-.004	-.004	-.006	-.002	.344	.876
0.00	2.99	-.003	-.004	-.005	-.005	-.007	-.003	.671	.939
0.00	4.02	-.005	-.006	-.006	-.007	-.009	-.005	1.005	.949
0.00	5.02	-.004	-.005	-.005	-.005	-.006	-.001	1.338	.954
0.00	6.00	-.005	-.005	-.006	-.005	-.008	-.001	1.694	.968
0.00	6.48	-.005	-.005	-.005	-.005	-.009	-.001	1.866	.971
0.00	2.00	-.003	-.004	-.004	-.004	-.006	-.002	.342	.877
0.00	3.01	-.003	-.004	-.004	-.005	-.007	-.003	.676	.943
0.00	4.00	-.004	-.005	-.006	-.006	-.008	-.004	.996	.949
0.00	5.00	-.003	-.004	-.004	-.004	-.005	-.001	1.329	.951
0.00	6.01	-.004	-.005	-.006	-.005	-.007	-.001	1.695	.967
0.00	6.48	-.006	-.007	-.006	-.005	-.009	-.001	1.862	.969
.65	.97	-.400	-.447	-.474	-.361	-.317	-.130	-.128	0.000
.65	2.00	-.803	-.983	-.962	-.891	-.934	-.537	1.006	.758
.65	3.39	-.906	-1.148	-1.126	-1.043	-1.116	-.700	2.573	.899
.65	4.20	-.980	-1.265	-1.241	-1.139	-1.251	-.790	3.443	.909
.65	5.01	-.953	-1.216	-1.187	-1.090	-1.196	-.731	4.445	.943
.65	6.01	-.907	-1.130	-1.102	-1.015	-1.107	-.644	5.679	.965
.65	8.23	-.777	-.933	-.904	-.831	-.888	-.475	8.360	.976
.70	.97	-.394	-.439	-.415	-.352	-.299	-.129	-.128	0.000
.70	1.99	-.751	-.906	-.897	-.834	-.850	-.510	.826	.728
.70	3.42	-.859	-1.066	-1.051	-.981	-1.078	-.643	2.211	.884
.70	4.20	-.937	-1.218	-1.221	-1.136	-1.209	-.764	2.947	.904
.70	5.01	-.923	-1.192	-1.185	-1.097	-1.165	-.720	3.827	.940
.70	6.01	-.895	-1.134	-1.110	-1.023	-1.087	-.645	4.908	.963
.70	8.52	-.779	-.943	-.907	-.828	-.864	-.463	7.549	.978
.80	.95	-.389	-.423	-.400	-.327	-.266	-.132	-.130	0.000
.80	2.00	-.682	-.806	-.797	-.741	-.744	-.501	.589	.675
.80	3.40	-.715	-.860	-.836	-.779	-.788	-.534	1.561	.822
.80	4.22	-.750	-1.023	-1.131	-1.056	-1.170	-.866	2.240	.887
.80	5.00	-.752	-1.029	-1.162	-1.168	-1.267	-.968	2.898	.925
.80	5.99	-.745	-1.019	-1.138	-1.076	-1.186	-.892	3.694	.952
.80	7.01	-.746	-1.010	-1.071	-.984	-1.073	-.770	4.924	.960
.80	9.27	-.722	-.893	-.864	-.810	-.808	-.550	6.360	.978
.90	.94	-.384	-.385	-.372	-.285	-.241	-.136	-.125	0.000
.90	1.99	-.553	-.719	-.722	-.676	-.705	-.496	.413	.606
.90	3.39	-.555	-.777	-.896	-.970	-1.129	-.866	1.185	.792
.90	4.22	-.560	-.786	-.903	-1.069	-1.317	-1.091	1.710	.851
.90	5.03	-.553	-.777	-.893	-1.060	-1.312	-1.085	2.216	.894
.90	5.99	-.554	-.778	-.894	-1.061	-1.314	-1.090	2.853	.928
.90	7.02	-.551	-.774	-.890	-1.058	-1.301	-.969	3.512	.947
.90	8.60	-.561	-.787	-.904	-1.069	-1.164	-.889	4.617	.966
.90	9.99	-.555	-.780	-.896	-.980	-1.033	-.801	5.509	.975
.95	.92	-.375	-.385	-.367	-.296	-.265	-.159	-.117	0.000
.95	2.01	-.471	-.664	-.723	-.678	-.734	-.532	.362	.580
.95	3.39	-.472	-.677	-.784	-.926	-1.151	-.956	1.034	.769
.95	4.20	-.475	-.682	-.790	-.937	-1.175	-1.008	1.513	.844
.95	4.99	-.472	-.679	-.786	-.934	-1.171	-.986	1.967	.886
.95	6.01	-.468	-.674	-.781	-.929	-1.164	-.940	2.545	.919
.95	7.02	-.469	-.676	-.784	-.932	-1.165	-.877	3.156	.943
.95	8.63	-.466	-.673	-.781	-.930	-1.063	-.792	4.113	.965
.95	10.00	-.466	-.672	-.779	-.897	-.946	-.729	4.915	.975
1.20	.83	-.211	-.313	-.304	-.274	-.288	-.188	-.196	0.000
1.20	2.02	-.215	-.356	-.432	-.515	-.548	-.406	.153	.387
1.20	3.40	-.212	-.354	-.430	-.531	-.688	-.608	.582	.687
1.20	4.21	-.210	-.352	-.429	-.529	-.686	-.606	.874	.778
1.20	5.02	-.210	-.351	-.428	-.529	-.685	-.603	1.172	.836
1.20	5.99	-.208	-.350	-.427	-.528	-.684	-.593	1.524	.881
1.20	7.01	-.207	-.349	-.426	-.528	-.683	-.566	1.904	.911
1.20	8.59	-.207	-.350	-.426	-.529	-.682	-.514	2.496	.939
1.20	10.00	-.205	-.347	-.424	-.527	-.653	-.467	3.020	.956

TABLE 5.- BASIC DATA FOR CONFIGURATION 4 WITH $\alpha_p = 18^\circ$,
 $B/d = 0.152$, AND $A/d = 0.303$

MACH	NPR	P1	P2	P3	P4	P5	P6	P7	P8	P9
0.00	2.01	.216	.342	.497	.467	.473	.516	.516	.516	.521
0.00	3.01	.214	.193	.283	.397	.253	.348	.345	.327	.359
0.00	4.00	.221	.195	.143	.150	.199	.195	.190	.201	.213
0.00	5.01	.221	.196	.143	.103	.077	.147	.147	.164	.237
0.00	5.99	.222	.197	.144	.104	.078	.132	.137	.139	.176
0.00	6.50	.221	.196	.144	.104	.077	.117	.130	.132	.159
.65	2.01	.229	.255	.430	.458	.458	.501	.527	.535	.541
.65	3.40	.215	.193	.141	.207	.322	.355	.358	.353	.323
.65	4.21	.216	.195	.142	.111	.157	.168	.164	.221	.289
.65	4.99	.222	.197	.144	.104	.081	.151	.150	.164	.242
.65	6.00	.222	.197	.144	.104	.077	.136	.139	.141	.172
.65	8.22	.222	.197	.144	.104	.077	.062	.109	.114	.130
.70	2.01	.276	.299	.421	.450	.453	.491	.520	.533	.544
.70	3.39	.216	.194	.142	.187	.316	.366	.363	.345	.337
.70	4.19	.217	.196	.143	.108	.159	.170	.167	.221	.286
.70	5.02	.220	.196	.142	.103	.079	.150	.149	.164	.242
.70	5.99	.222	.197	.143	.103	.077	.137	.140	.141	.173
.70	8.50	.222	.197	.144	.104	.077	.062	.104	.111	.128
.80	2.01	.256	.274	.402	.446	.443	.480	.513	.532	.546
.80	3.39	.208	.186	.149	.154	.251	.356	.325	.331	.334
.80	4.22	.216	.194	.142	.107	.181	.179	.173	.202	.244
.80	5.01	.217	.196	.141	.101	.089	.150	.148	.162	.243
.80	6.00	.222	.197	.144	.104	.078	.138	.141	.141	.170
.80	7.00	.222	.197	.144	.104	.078	.122	.130	.131	.143
.80	9.20	.222	.197	.144	.104	.077	.062	.057	.092	.123
.90	2.00	.214	.220	.334	.405	.378	.446	.470	.499	.524
.90	2.00	.214	.220	.336	.412	.377	.446	.472	.501	.526
.90	3.40	.217	.193	.141	.146	.195	.205	.216	.228	.241
.90	4.21	.216	.194	.141	.105	.191	.187	.177	.189	.206
.90	4.99	.217	.196	.143	.103	.114	.160	.157	.157	.193
.90	6.00	.220	.196	.143	.102	.081	.145	.144	.143	.154
.90	6.99	.223	.197	.144	.103	.077	.121	.130	.130	.139
.90	8.60	.222	.197	.144	.103	.077	.062	.110	.113	.127
.90	9.99	.222	.197	.144	.104	.077	.062	.052	.087	.123
.95	2.01	.218	.210	.267	.358	.404	.358	.446	.472	.499
.95	3.40	.216	.193	.142	.135	.186	.195	.208	.221	.232
.95	4.18	.217	.195	.142	.105	.187	.185	.178	.183	.197
.95	4.99	.216	.195	.141	.101	.159	.168	.163	.161	.170
.95	5.99	.219	.197	.143	.103	.085	.144	.143	.141	.145
.95	7.02	.222	.197	.143	.103	.077	.103	.125	.124	.133
.95	8.62	.222	.197	.144	.104	.078	.063	.095	.107	.125
.95	9.99	.222	.198	.145	.104	.078	.063	.052	.086	.123
1.20	1.98	.221	.198	.191	.258	.341	.326	.329	.418	.458
1.20	3.40	.213	.188	.136	.119	.157	.163	.176	.198	.219
1.20	4.19	.218	.194	.142	.104	.086	.126	.132	.148	.175
1.20	5.00	.218	.195	.142	.103	.079	.081	.127	.128	.145
1.20	6.02	.217	.195	.142	.103	.078	.064	.103	.113	.129
1.20	7.00	.217	.197	.143	.104	.077	.062	.057	.088	.123
1.20	8.59	.221	.197	.144	.103	.077	.062	.050	.088	.123
1.20	9.94	.223	.198	.144	.104	.078	.063	.051	.088	.123

TABLE 5.- Continued

MACH	NPR	P10	P11	P12	P13	P14	P15	S1	S2	S3
0.00	2.01	.525	.528	.533	.540	.565	.568	-.001	-.001	-.002
0.00	3.01	.376	.360	.353	.397	.444	.450	-.001	-.001	-.002
0.00	4.00	.233	.254	.275	.296	.312	.314	-.001	-.001	-.002
0.00	5.01	.222	.325	.345	.302	.247	.263	-.001	-.001	-.002
0.00	5.99	.225	.204	.211	.263	.235	.250	-.002	-.001	-.002
0.00	6.50	.203	.218	.180	.239	.216	.231	-.002	-.002	-.004
.65	.99							-.375	-.514	-.469
.65	2.01	.544	.547	.553	.557	.584	.590	-.480	-.733	-.722
.65	3.40	.339	.351	.354	.380	.418	.419	-.531	-.835	-.840
.65	4.21	.323	.319	.314	.327	.331	.341	-.484	-.740	-.728
.65	4.99	.232	.343	.354	.309	.260	.277	-.485	-.742	-.729
.65	6.00	.222	.204	.265	.290	.256	.277	-.473	-.719	-.700
.65	8.22	.150	.177	.204	.206	.187	.202	-.443	-.661	-.631
.70	.98							-.382	-.527	-.472
.70	.98							-.383	-.528	-.473
.70	2.01	.549	.552	.558	.560	.583	.588	-.492	-.772	-.748
.70	3.39	.346	.352	.356	.385	.425	.427	-.541	-.900	-.898
.70	4.19	.321	.320	.322	.328	.325	.337	-.504	-.806	-.786
.70	5.02	.235	.344	.354	.308	.261	.277	-.509	-.819	-.799
.70	5.99	.223	.203	.275	.297	.260	.282	-.496	-.784	-.759
.70	8.50	.148	.172	.198	.206	.183	.199	-.457	-.697	-.658
.80	.97							-.415	-.583	-.478
.80	2.01	.553	.557	.563	.565	.587	.593	-.468	-.913	-.993
.80	3.39	.364	.366	.359	.380	.433	.437	-.472	-.919	-1.023
.80	4.22	.272	.295	.310	.318	.320	.325	-.467	-.915	-1.020
.80	5.01	.256	.353	.352	.305	.270	.285	-.471	-.922	-1.049
.80	6.00	.221	.206	.289	.308	.269	.293	-.473	-.929	-1.056
.80	7.00	.172	.205	.196	.237	.231	.251	-.467	-.922	-1.043
.80	9.20	.144	.186	.209	.202	.176	.191	-.461	-.906	-.991
.90	.95							-.346	-.666	-.541
.90	2.00	.540	.552	.562	.568	.584	.592	-.334	-.708	-.809
.90	2.00	.541	.553	.563	.568	.585	.593	-.342	-.718	-.819
.90	3.40	.255	.272	.293	.311	.312	.317	-.344	-.722	-.823
.90	4.21	.224	.246	.267	.286	.303	.307	-.343	-.722	-.838
.90	4.99	.232	.264	.287	.294	.301	.306	-.344	-.724	-.841
.90	6.00	.187	.212	.232	.254	.273	.279	-.339	-.717	-.834
.90	6.99	.153	.187	.208	.229	.241	.259	-.340	-.720	-.836
.90	8.60	.140	.152	.176	.198	.196	.214	-.341	-.722	-.838
.90	9.99	.133	.171	.176	.189	.168	.184	-.338	-.720	-.835
.95	.93							-.278	-.612	-.588
.95	2.01	.520	.536	.551	.559	.577	.585	-.276	-.621	-.730
.95	3.40	.243	.256	.276	.292	.303	.308	-.276	-.621	-.731
.95	4.18	.208	.222	.243	.262	.281	.286	-.280	-.627	-.739
.95	4.99	.180	.189	.200	.219	.241	.252	-.278	-.625	-.736
.95	5.99	.153	.167	.180	.193	.212	.225	-.272	-.618	-.729
.95	7.02	.140	.150	.169	.186	.206	.215	-.274	-.621	-.731
.95	8.62	.144	.152	.157	.174	.194	.203	-.272	-.620	-.731
.95	9.99	.114	.163	.174	.178	.172	.189	-.274	-.624	-.733
1.20	.85							-.083	-.321	-.399
1.20	1.98	.484	.513	.536	.548	.561	.564	-.086	-.324	-.402
1.20	3.40	.234	.255	.291	.300	.317	.323	-.088	-.327	-.406
1.20	4.19	.203	.231	.260	.285	.306	.314	-.088	-.328	-.406
1.20	5.00	.166	.195	.223	.246	.266	.273	-.087	-.328	-.406
1.20	6.02	.147	.170	.194	.217	.236	.243	-.086	-.326	-.405
1.20	7.00	.113	.164	.201	.225	.245	.250	-.084	-.324	-.403
1.20	8.59	.111	.088	.129	.181	.201	.204	-.082	-.323	-.402
1.20	9.94	.112	.089	.077	.137	.164	.167	-.083	-.324	-.402

TABLE 5.- Concluded

MAC4	NPR	S4	S5	S6	S7	CFMD	FMDZFI
0.00	2.01	-.003	-.004	-.005	-.007	.332	.848
0.00	3.01	-.002	-.003	-.004	-.005	.668	.929
0.00	4.00	-.002	-.002	-.002	-.003	.926	.882
0.00	5.01	-.002	-.002	-.002	-.003	1.320	.943
0.00	5.99	-.003	-.003	-.003	-.003	1.675	.961
0.00	6.50	-.004	-.004	-.004	-.005	1.860	.964
.65	.99	-.379	-.254	-.176	-.120	-.087	0.000
.65	2.01	-.658	-.558	-.489	-.415	1.022	.773
.65	3.40	-.790	-.707	-.646	-.581	2.614	.909
.65	4.21	-.668	-.565	-.500	-.394	3.440	.899
.65	4.99	-.666	-.570	-.501	-.432	4.427	.935
.65	6.00	-.633	-.530	-.455	-.384	5.686	.961
.65	8.22	-.555	-.440	-.362	-.287	8.346	.975
.70	.98	-.369	-.235	-.159	-.110	-.084	0.000
.70	.98	-.370	-.236	-.161	-.113	-.084	0.000
.70	2.01	-.660	-.532	-.451	-.363	.882	.768
.70	3.39	-.819	-.698	-.621	-.543	2.251	.907
.70	4.19	-.703	-.584	-.507	-.432	2.913	.894
.70	5.02	-.713	-.591	-.510	-.434	3.824	.936
.70	5.99	-.669	-.544	-.460	-.385	4.860	.960
.70	8.50	-.563	-.432	-.345	-.272	7.534	.977
.80	.97	-.332	-.192	-.137	-.110	-.090	0.000
.80	2.01	-.830	-.495	-.397	-.349	.651	.740
.80	3.39	-.936	-.613	-.505	-.424	1.670	.882
.80	4.22	-.905	-.530	-.420	-.337	2.246	.889
.80	5.01	-1.071	-.774	-.611	-.503	2.896	.927
.80	6.00	-1.038	-.675	-.535	-.462	3.765	.957
.80	7.00	-.978	-.582	-.466	-.401	4.536	.964
.80	9.20	-.759	-.423	-.335	-.283	6.357	.981
.90	.95	-.284	-.183	-.162	-.158	-.108	0.000
.90	2.00	-.756	-.528	-.452	-.410	.442	.648
.90	2.00	-.759	-.523	-.447	-.414	.451	.654
.90	3.40	-.789	-.604	-.516	-.471	1.216	.803
.90	4.21	-.936	-.894	-.795	-.682	1.713	.857
.90	4.99	-.947	-1.037	-1.089	-1.046	2.222	.895
.90	6.00	-.940	-1.036	-1.097	-1.084	2.862	.928
.90	6.99	-.943	-1.040	-1.094	-1.068	3.516	.947
.90	8.60	-.945	-1.042	-1.042	-1.017	4.588	.966
.90	9.99	-.942	-1.017	-.962	-.915	5.489	.974
.95	.93	-.386	-.236	-.207	-.191	-.098	0.000
.95	2.01	-.799	-.711	-.616	-.526	.384	.615
.95	3.40	-.813	-.799	-.760	-.680	1.079	.797
.95	4.18	-.838	-.924	-.976	-.966	1.511	.844
.95	4.99	-.835	-.925	-.982	-.997	1.982	.867
.95	5.99	-.827	-.917	-.975	-.988	2.540	.918
.95	7.02	-.830	-.921	-.975	-.963	3.155	.941
.95	8.62	-.830	-.920	-.930	-.903	4.105	.963
.95	9.99	-.833	-.916	-.877	-.844	4.947	.974
1.20	.85	-.444	-.376	-.300	-.252	-.186	0.000
1.20	1.98	-.472	-.532	-.534	-.502	.133	.352
1.20	3.40	-.476	-.526	-.552	-.522	.604	.709
1.20	4.19	-.477	-.540	-.582	-.600	.880	.786
1.20	5.00	-.477	-.540	-.582	-.606	1.173	.841
1.20	6.02	-.475	-.539	-.581	-.601	1.548	.885
1.20	7.00	-.474	-.537	-.578	-.586	1.906	.911
1.20	8.59	-.473	-.536	-.572	-.555	2.496	.940
1.20	9.94	-.473	-.537	-.549	-.528	3.012	.957

TABLE 6.- BASIC DATA FOR CONFIGURATION 5 WITH $\alpha_p = 18^\circ$,
 $B/d = 0.194$, AND $A/d = 0.064$

MACH	NPR	P1	P2	P3	P4	P5	P6	P7	P8	P9
0.00	2.00	.211	.383	.524	.514	.509	.509	.509	.509	.513
0.00	3.01	.213	.196	.297	.395	.446	.351	.293	.384	.381
0.00	4.00	.220	.197	.144	.196	.222	.317	.225	.376	.304
0.00	5.01	.221	.198	.144	.110	.165	.195	.273	.292	.199
0.00	6.01	.221	.198	.144	.110	.086	.073	.189	.244	.280
0.00	6.36	.220	.198	.143	.110	.085	.072	.164	.214	.250
0.00	2.00	.211	.386	.522	.514	.509	.510	.510	.511	.515
0.00	3.02	.212	.195	.293	.396	.441	.360	.287	.368	.388
0.00	4.00	.219	.196	.143	.199	.223	.317	.222	.376	.305
0.00	5.00	.220	.197	.143	.110	.166	.196	.274	.290	.198
0.00	6.01	.220	.197	.143	.110	.085	.073	.189	.245	.280
0.00	6.35	.220	.197	.144	.110	.085	.072	.164	.215	.251
.65	2.01	.213	.245	.374	.472	.526	.534	.532	.532	.537
.65	3.41	.212	.193	.141	.227	.250	.334	.412	.306	.319
.65	4.22	.214	.196	.143	.109	.207	.240	.285	.214	.396
.65	5.01	.218	.197	.144	.109	.170	.184	.236	.280	.207
.65	6.00	.221	.198	.145	.110	.086	.077	.160	.224	.296
.65	8.10	.221	.198	.145	.110	.085	.072	.081	.086	.105
.70	2.00	.214	.250	.367	.449	.515	.538	.539	.538	.542
.70	3.41	.214	.194	.142	.222	.248	.338	.417	.311	.327
.70	4.21	.214	.197	.143	.111	.207	.237	.285	.226	.403
.70	5.00	.217	.197	.143	.108	.171	.184	.231	.278	.208
.70	6.00	.220	.197	.144	.109	.085	.126	.169	.216	.270
.70	8.45	.221	.198	.145	.111	.086	.072	.081	.088	.138
.65	2.01	.213	.247	.375	.470	.524	.533	.531	.531	.536
.80	1.99	.211	.249	.371	.453	.514	.542	.548	.549	.555
.80	3.40	.213	.192	.141	.194	.254	.345	.412	.319	.358
.80	4.20	.214	.195	.142	.110	.207	.230	.287	.290	.410
.80	5.01	.214	.197	.143	.109	.172	.181	.218	.273	.213
.80	6.00	.220	.197	.144	.109	.086	.145	.165	.198	.247
.80	7.01	.220	.197	.144	.110	.085	.072	.096	.144	.202
.80	9.12	.221	.198	.145	.110	.086	.072	.081	.106	.125
.90	2.00	.216	.274	.352	.384	.426	.475	.512	.537	.556
.90	3.40	.213	.192	.140	.151	.211	.251	.303	.351	.379
.90	4.20	.216	.196	.145	.111	.186	.191	.211	.278	.355
.90	4.99	.214	.197	.142	.107	.108	.173	.174	.208	.249
.90	6.00	.217	.197	.144	.109	.085	.152	.158	.163	.190
.90	7.01	.220	.197	.144	.109	.085	.078	.139	.145	.156
.90	8.61	.221	.198	.144	.110	.086	.073	.081	.124	.132
.90	9.98	.221	.198	.145	.111	.086	.073	.081	.079	.116
.95	2.01	.214	.258	.337	.355	.379	.413	.446	.477	.506
.95	3.42	.213	.191	.141	.141	.201	.218	.245	.275	.306
.95	4.21	.214	.194	.142	.110	.171	.185	.193	.209	.234
.95	5.00	.215	.197	.144	.110	.137	.171	.170	.175	.188
.95	5.99	.215	.197	.144	.109	.085	.142	.149	.153	.160
.95	7.00	.219	.197	.144	.109	.084	.077	.125	.137	.141
.95	8.62	.221	.198	.145	.110	.086	.072	.081	.125	.128
.95	8.60	.221	.198	.145	.110	.086	.073	.081	.125	.128
.95	9.99	.221	.198	.145	.111	.086	.073	.081	.065	.113
1.20	2.00	.215	.229	.290	.301	.320	.350	.383	.416	.451
1.20	3.39	.204	.182	.147	.127	.116	.130	.208	.261	.300
1.20	4.19	.216	.193	.141	.108	.087	.079	.158	.186	.217
1.20	4.98	.215	.194	.142	.109	.086	.072	.123	.145	.167
1.20	5.99	.216	.196	.143	.108	.084	.070	.083	.110	.127
1.20	7.03	.215	.198	.145	.111	.086	.073	.080	.083	.097
1.20	7.00	.215	.197	.146	.111	.086	.073	.080	.084	.098
1.20	6.99	.215	.198	.146	.111	.086	.073	.080	.084	.098
1.20	8.61	.218	.197	.144	.110	.085	.072	.081	.060	.069
1.20	10.01	.221	.198	.145	.111	.086	.073	.081	.060	.049

TABLE 6.- Continued

MACH	NPR	P10	P11	P12	P13	P14	P15	S1	S2	S3
0.00	2.00	.517	.522	.527	.536	.572	.575	-.001	.001	.001
0.00	3.01	.324	.337	.409	.412	.414	.420	-.001	.001	.001
0.00	4.00	.287	.232	.257	.324	.352	.375	-.001	.001	.001
0.00	5.01	.281	.224	.205	.237	.281	.300	-.001	.000	.000
0.00	6.01	.307	.261	.196	.171	.177	.183	-.002	.000	-.000
0.00	6.36	.285	.294	.232	.192	.178	.183	-.002	.000	-.001
0.00	2.00	.518	.523	.529	.538	.575	.577	.001	-.001	.001
0.00	3.02	.332	.327	.401	.418	.417	.422	.000	-.001	.001
0.00	4.00	.286	.227	.260	.323	.352	.375	-.000	-.001	.000
0.00	5.00	.281	.225	.206	.239	.281	.300	-.001	-.002	-.000
0.00	6.01	.308	.261	.195	.170	.177	.183	-.001	-.002	.000
0.00	6.35	.286	.295	.233	.192	.178	.184	-.000	-.002	.000
.65	2.01	.540	.544	.547	.553	.583	.589	-.341	-.474	-.484
.65	3.41	.348	.365	.346	.345	.417	.421	-.362	-.507	-.523
.65	4.22	.334	.263	.225	.275	.358	.360	-.353	-.490	-.502
.65	5.01	.285	.284	.293	.278	.307	.332	-.344	-.473	-.480
.65	6.00	.345	.320	.237	.198	.182	.191	-.330	-.448	-.450
.65	8.10	.182	.214	.243	.219	.190	.205	-.290	-.383	-.373
.70	.97							-.274	-.353	-.334
.70	2.00	.544	.547	.551	.556	.582	.589	-.353	-.494	-.502
.70	3.41	.354	.362	.346	.357	.424	.426	-.376	-.535	-.551
.70	4.21	.336	.256	.227	.282	.369	.371	-.367	-.516	-.526
.70	5.00	.287	.297	.302	.287	.312	.335	-.356	-.497	-.502
.70	6.00	.296	.247	.215	.206	.239	.244	-.340	-.468	-.466
.70	8.45	.154	.174	.199	.211	.185	.200	-.289	-.383	-.369
.65	2.01	.539	.543	.547	.552	.581	.587	-.341	-.473	-.483
.80	.96							-.312	-.414	-.385
.80	1.99	.557	.560	.563	.567	.586	.594	-.387	-.609	-.642
.80	3.40	.359	.345	.360	.384	.425	.428	-.400	-.642	-.703
.80	4.20	.314	.243	.252	.311	.385	.400	-.397	-.638	-.696
.80	5.01	.288	.328	.320	.312	.322	.326	-.392	-.625	-.670
.80	6.00	.266	.230	.228	.233	.269	.293	-.379	-.579	-.585
.80	7.01	.231	.270	.297	.254	.222	.228	-.361	-.527	-.514
.80	9.12	.131	.140	.153	.174	.177	.193	-.311	-.420	-.392
.90	.94							-.302	-.525	-.590
.90	2.00	.564	.568	.570	.572	.576	.583	-.297	-.521	-.590
.90	3.40	.384	.390	.384	.393	.413	.421	-.300	-.524	-.594
.90	4.20	.369	.317	.318	.357	.386	.394	-.298	-.522	-.592
.90	4.99	.296	.366	.352	.300	.252	.268	-.298	-.522	-.592
.90	6.00	.228	.222	.268	.315	.280	.307	-.298	-.522	-.592
.90	7.01	.178	.216	.217	.199	.233	.242	-.295	-.519	-.589
.90	8.61	.139	.150	.167	.197	.196	.214	-.294	-.518	-.587
.90	9.98	.116	.120	.125	.136	.153	.169	-.295	-.519	-.588
.95	.92							-.238	-.445	-.510
.95	2.01	.527	.543	.554	.560	.560	.566	-.235	-.442	-.508
.95	3.42	.338	.366	.384	.399	.406	.413	-.234	-.441	-.506
.95	4.21	.259	.289	.314	.338	.359	.368	-.233	-.440	-.505
.95	5.00	.207	.228	.252	.278	.310	.319	-.233	-.440	-.505
.95	5.99	.174	.198	.219	.240	.273	.287	-.237	-.445	-.511
.95	7.00	.148	.163	.192	.211	.237	.246	-.233	-.440	-.506
.95	8.62	.129	.132	.137	.158	.184	.198	-.235	-.443	-.509
.95	8.60	.128	.132	.137	.156	.183	.197	-.234	-.441	-.507
.95	9.99	.113	.114	.115	.119	.133	.157	-.231	-.438	-.504
1.20	.84							-.059	-.202	-.250
1.20	2.00	.478	.501	.520	.534	.537	.542	-.060	-.204	-.252
1.20	3.39	.334	.366	.375	.423	.469	.460	-.060	-.203	-.251
1.20	4.19	.245	.288	.342	.390	.419	.422	-.059	-.202	-.250
1.20	4.98	.185	.235	.303	.331	.348	.353	-.056	-.199	-.247
1.20	5.99	.145	.197	.240	.259	.278	.282	-.056	-.199	-.246
1.20	7.03	.112	.146	.192	.209	.227	.230	-.056	-.198	-.246
1.20	7.00	.113	.146	.193	.209	.227	.231	-.056	-.198	-.246
1.20	6.99	.113	.147	.193	.210	.227	.231	-.057	-.200	-.248
1.20	8.61	.079	.101	.144	.157	.173	.177	-.057	-.200	-.248
1.20	10.01	.060	.072	.114	.126	.139	.143	-.057	-.199	-.247

TABLE 6.- Concluded

MACH	NPP	S4	S5	S7	CFMD	FMDZFI
0.00	2.00	.001	-.000	-.003	.345	.882
0.00	3.01	.001	-.000	-.003	.679	.944
0.00	4.00	.000	-.000	-.002	1.010	.959
0.00	5.01	-.000	-.001	-.003	1.367	.978
0.00	6.01	-.001	-.000	-.004	1.742	.994
0.00	6.36	-.001	-.000	-.004	1.875	.996
0.00	2.00	.001	.000	-.000	.342	.879
0.00	3.02	.001	.001	.000	.683	.944
0.00	4.00	.000	.001	.000	1.008	.960
0.00	5.00	-.000	-.000	-.000	1.366	.978
0.00	6.01	.000	-.000	-.000	1.741	.993
0.00	6.35	-.000	-.000	-.000	1.869	.996
.65	2.01	-.494	-.479	-.485	1.073	.811
.65	3.41	-.539	-.537	-.561	2.684	.932
.65	4.22	-.512	-.499	-.505	3.662	.963
.65	5.01	-.485	-.462	-.454	4.603	.980
.65	6.00	-.449	-.414	-.391	5.879	.998
.65	8.10	-.360	-.307	-.263	8.361	.992
.70	.97	-.315	-.249	-.194	-.090	0.000
.70	2.00	-.512	-.495	-.489	.927	.810
.70	3.41	-.569	-.565	-.579	2.312	.933
.70	4.21	-.538	-.523	-.521	3.171	.963
.70	5.00	-.509	-.484	-.468	3.988	.981
.70	6.00	-.466	-.428	-.397	5.061	.991
.70	8.45	-.353	-.292	-.240	7.570	.991
.65	2.01	-.493	-.478	-.483	1.080	.812
.80	.96	-.353	-.268	-.197	-.085	0.000
.80	1.99	-.649	-.582	-.527	.714	.817
.80	3.40	-.757	-.806	-.738	1.777	.933
.80	4.20	-.742	-.724	-.612	2.425	.966
.80	5.01	-.685	-.596	-.520	3.072	.984
.80	6.00	-.569	-.491	-.426	3.872	.989
.80	7.01	-.492	-.413	-.344	4.697	.997
.80	9.12	-.362	-.279	-.206	6.368	.991
.90	.94	-.600	-.344	-.198	-.090	0.000
.90	2.00	-.647	-.732	-.782	.526	.760
.90	3.40	-.650	-.738	-.792	1.358	.899
.90	4.20	-.649	-.737	-.790	1.870	.940
.90	4.99	-.649	-.737	-.791	2.382	.964
.90	6.00	-.649	-.737	-.791	3.035	.979
.90	7.01	-.646	-.734	-.787	3.649	.981
.90	8.61	-.644	-.730	-.686	4.696	.990
.90	9.98	-.639	-.543	-.281	5.613	.991
.95	.92	-.561	-.514	-.261	-.084	0.000
.95	2.01	-.560	-.641	-.692	.451	.721
.95	3.42	-.559	-.640	-.691	1.188	.872
.95	4.21	-.558	-.639	-.690	1.635	.916
.95	5.00	-.558	-.639	-.691	2.088	.941
.95	5.99	-.563	-.645	-.697	2.672	.962
.95	7.00	-.559	-.640	-.692	3.248	.974
.95	8.62	-.563	-.645	-.690	4.233	.988
.95	8.60	-.560	-.642	-.687	4.200	.987
.95	9.99	-.557	-.639	-.597	5.009	.992
1.20	.84	-.286	-.340	-.375	-.166	0.000
1.20	2.00	-.288	-.345	-.385	.205	.522
1.20	3.39	-.288	-.344	-.384	.663	.780
1.20	4.19	-.287	-.344	-.384	.951	.849
1.20	4.98	-.284	-.340	-.381	1.232	.886
1.20	5.99	-.283	-.340	-.380	1.594	.916
1.20	7.03	-.283	-.339	-.380	1.977	.937
1.20	7.00	-.282	-.339	-.379	1.972	.939
1.20	6.99	-.284	-.341	-.381	1.969	.938
1.20	8.61	-.284	-.341	-.381	2.571	.959
1.20	10.01	-.284	-.341	-.379	3.091	.971

TABLE 7.- BASIC DATA FOR CONFIGURATION 6 WITH $\alpha_p = 18^\circ$,
 $B/d = 0.484$, AND $A/d = 0.064$

MACH	NPP	P1	P2	P3	P4	P5	P6	P7	P8	P9
0.00	1.99	.213	.347	.495	.451	.460	.482	.506	.512	.517
0.00	3.00	.217	.196	.263	.385	.265	.315	.355	.344	.365
0.00	4.01	.221	.197	.143	.103	.169	.174	.252	.259	.391
0.00	5.00	.221	.198	.143	.103	.079	.136	.142	.141	.170
0.00	6.00	.221	.198	.143	.103	.079	.102	.131	.134	.134
0.00	6.57	.221	.198	.143	.103	.078	.066	.123	.128	.130
0.00	2.00	.211	.326	.494	.446	.455	.481	.504	.510	.514
0.00	3.01	.215	.196	.259	.385	.270	.306	.362	.351	.357
0.00	4.01	.220	.196	.142	.105	.170	.175	.255	.260	.391
0.00	5.02	.220	.197	.141	.102	.081	.136	.142	.141	.170
0.00	6.01	.221	.198	.142	.103	.078	.102	.131	.134	.134
0.00	6.55	.221	.198	.143	.103	.079	.066	.123	.128	.130
.65	2.01	.213	.200	.357	.453	.431	.446	.480	.508	.525
.65	3.39	.216	.196	.143	.243	.244	.240	.241	.243	.248
.65	4.20	.216	.195	.140	.112	.177	.178	.177	.189	.208
.65	5.00	.221	.198	.143	.104	.105	.153	.153	.149	.157
.65	6.01	.221	.198	.143	.104	.079	.120	.135	.137	.135
.65	8.21	.221	.199	.143	.104	.079	.064	.094	.112	.118
.70	1.99	.217	.204	.342	.446	.428	.448	.482	.511	.530
.70	3.42	.214	.194	.140	.237	.239	.234	.235	.239	.246
.70	4.20	.215	.196	.141	.108	.181	.181	.178	.188	.203
.70	5.00	.220	.197	.141	.102	.113	.155	.154	.150	.158
.70	6.00	.221	.197	.142	.103	.079	.124	.136	.137	.135
.70	8.53	.221	.199	.143	.104	.079	.064	.086	.110	.115
.80	2.01	.216	.207	.344	.407	.401	.437	.473	.504	.526
.80	3.41	.216	.194	.141	.239	.239	.230	.231	.235	.242
.80	4.20	.216	.197	.142	.111	.189	.187	.183	.189	.199
.80	4.99	.218	.198	.142	.104	.117	.158	.156	.153	.159
.80	5.99	.222	.198	.143	.103	.080	.130	.138	.139	.137
.80	6.98	.222	.198	.143	.104	.079	.067	.123	.126	.129
.80	9.16	.221	.199	.143	.104	.079	.064	.087	.110	.114
.90	2.04	.248	.256	.375	.402	.393	.433	.463	.494	.521
.90	2.00	.225	.230	.383	.415	.394	.439	.472	.506	.532
.90	3.40	.214	.192	.139	.217	.227	.222	.228	.236	.247
.90	4.19	.215	.195	.140	.118	.192	.190	.184	.193	.203
.90	5.01	.216	.197	.141	.103	.132	.163	.160	.157	.162
.90	5.99	.220	.198	.142	.103	.080	.138	.142	.141	.138
.90	6.99	.222	.198	.143	.103	.079	.073	.126	.128	.130
.90	8.60	.222	.199	.143	.104	.079	.065	.095	.112	.117
.90	9.98	.221	.199	.144	.104	.079	.065	.067	.106	.113
.95	2.00	.215	.217	.357	.383	.386	.410	.444	.482	.512
.95	3.40	.217	.195	.142	.189	.216	.217	.225	.234	.242
.95	4.19	.217	.196	.141	.113	.197	.196	.189	.187	.193
.95	4.99	.215	.197	.141	.102	.160	.172	.170	.165	.162
.95	6.00	.219	.198	.142	.103	.083	.143	.144	.142	.139
.95	6.99	.221	.198	.143	.104	.079	.077	.126	.127	.128
.95	8.00	.222	.199	.144	.104	.079	.065	.105	.115	.119
.95	8.61	.221	.199	.143	.104	.079	.065	.092	.112	.117
.95	10.00	.221	.199	.144	.104	.079	.065	.061	.103	.113
1.20	1.99	.213	.194	.204	.307	.338	.314	.310	.399	.437
1.20	3.41	.214	.189	.135	.113	.140	.161	.171	.183	.199
1.20	4.22	.211	.187	.131	.097	.096	.136	.142	.148	.156
1.20	4.98	.217	.196	.141	.102	.080	.114	.138	.134	.137
1.20	5.98	.218	.198	.143	.104	.079	.070	.119	.121	.124
1.20	7.00	.216	.198	.144	.104	.080	.065	.066	.107	.113
1.20	8.61	.221	.198	.143	.103	.079	.064	.055	.065	.071
1.20	10.01	.222	.199	.143	.103	.078	.064	.054	.063	.068

TABLE 7.- Continued

MACH	NPR	P10	P11	P12	P13	P14	P15	S1	S2	S3
0.00	1.99	.520	.525	.529	.537	.568	.571	-.000	-.000	.000
0.00	3.00	.360	.351	.381	.392	.433	.437	-.000	-.000	.000
0.00	4.01	.311	.240	.234	.327	.351	.374	-.000	-.000	.000
0.00	5.00	.228	.261	.315	.309	.281	.300	-.001	-.001	.000
0.00	6.00	.158	.204	.225	.253	.234	.250	-.001	-.001	.000
0.00	6.57	.141	.180	.206	.205	.214	.228	-.001	-.001	.001
0.00	2.00	.518	.522	.526	.534	.564	.567	-.000	-.000	-.000
0.00	3.01	.357	.355	.379	.387	.434	.438	-.000	-.000	-.000
0.00	4.01	.306	.235	.234	.327	.350	.374	-.000	-.001	-.001
0.00	5.02	.228	.259	.314	.308	.280	.299	-.000	-.001	-.001
0.00	6.01	.158	.203	.225	.253	.234	.250	-.001	-.001	-.001
0.00	6.55	.142	.180	.206	.206	.215	.229	-.001	-.001	-.001
.65	.99							-.144	-.158	-.166
.65	2.01	.533	.539	.542	.548	.571	.577	-.152	-.167	-.176
.65	3.39	.255	.265	.281	.301	.324	.333	-.142	-.156	-.164
.65	4.20	.228	.254	.271	.289	.302	.307	-.153	-.169	-.179
.65	5.00	.184	.207	.228	.251	.270	.277	-.157	-.173	-.182
.65	6.01	.153	.198	.226	.250	.255	.276	-.158	-.174	-.184
.65	8.21	.123	.135	.159	.188	.187	.202	-.154	-.170	-.179
.70	.99							-.150	-.164	-.173
.70	1.99	.539	.546	.549	.554	.575	.583	-.153	-.169	-.179
.70	3.42	.255	.268	.286	.307	.329	.337	-.146	-.161	-.171
.70	4.20	.220	.245	.263	.281	.297	.303	-.155	-.172	-.182
.70	5.00	.181	.202	.222	.245	.266	.273	-.156	-.172	-.183
.70	6.00	.154	.198	.226	.249	.260	.279	-.161	-.178	-.189
.70	8.53	.121	.130	.151	.178	.183	.198	-.157	-.173	-.184
.80	.98							-.164	-.182	-.194
.80	2.01	.538	.546	.550	.555	.572	.581	-.165	-.183	-.196
.80	3.41	.252	.269	.290	.315	.339	.345	-.162	-.180	-.192
.80	4.20	.209	.228	.247	.264	.283	.292	-.166	-.185	-.198
.80	4.99	.178	.197	.215	.237	.261	.269	-.168	-.188	-.202
.80	5.99	.156	.197	.224	.246	.267	.275	-.174	-.194	-.208
.80	6.98	.131	.159	.196	.211	.231	.241	-.173	-.193	-.207
.80	9.16	.119	.125	.137	.157	.176	.189	-.167	-.186	-.200
.90	.98							-.182	-.208	-.231
.90	2.04	.533	.546	.552	.557	.571	.575	-.175	-.201	-.224
.90	2.00	.546	.557	.562	.566	.581	.590	-.175	-.201	-.223
.90	3.40	.261	.280	.301	.323	.342	.345	-.174	-.200	-.222
.90	4.19	.213	.231	.250	.269	.288	.296	-.176	-.202	-.225
.90	5.01	.176	.190	.205	.226	.251	.259	-.176	-.202	-.225
.90	5.99	.158	.192	.216	.235	.256	.265	-.177	-.204	-.226
.90	6.99	.132	.162	.198	.218	.240	.249	-.176	-.203	-.225
.90	8.60	.122	.128	.148	.179	.192	.205	-.174	-.201	-.223
.90	9.98	.117	.121	.129	.144	.164	.170	-.175	-.201	-.224
.95	.97							-.141	-.166	-.189
.95	2.00	.533	.548	.557	.565	.579	.588	-.141	-.166	-.188
.95	3.40	.252	.266	.282	.300	.319	.323	-.136	-.161	-.183
.95	4.19	.195	.201	.211	.224	.241	.255	-.138	-.163	-.185
.95	4.99	.166	.172	.178	.194	.193	.210	-.136	-.161	-.183
.95	6.00	.140	.153	.167	.179	.193	.203	-.137	-.162	-.184
.95	6.99	.128	.134	.157	.178	.197	.209	-.137	-.162	-.184
.95	8.00	.123	.125	.137	.165	.185	.197	-.137	-.162	-.184
.95	8.61	.121	.124	.130	.152	.175	.186	-.136	-.161	-.184
.95	10.00	.117	.122	.125	.134	.152	.164	-.136	-.161	-.183
1.20	.99							-.014	-.029	-.044
1.20	1.99	.470	.496	.514	.532	.551	.559	-.015	-.029	-.044
1.20	3.41	.214	.227	.244	.260	.277	.289	-.013	-.027	-.041
1.20	4.22	.167	.185	.206	.223	.241	.248	-.013	-.027	-.041
1.20	4.98	.139	.150	.169	.192	.216	.223	-.013	-.027	-.041
1.20	5.98	.125	.130	.142	.157	.175	.185	-.012	-.026	-.041
1.20	7.00	.117	.121	.130	.144	.160	.165	-.011	-.025	-.040
1.20	8.61	.084	.124	.130	.143	.157	.163	-.011	-.025	-.038
1.20	10.01	.074	.082	.110	.138	.150	.151	-.011	-.025	-.038

TABLE 7.- Concluded

MACH	NPR	S4	S5	S6	S7	S8	S9	CFMD	FMDZFI
0.00	1.99	-.000	-.000	-.001	-.000	-.001	-.001	.316	.811
0.00	3.00	-.000	-.001	-.001	-.001	-.001	-.001	.654	.911
0.00	4.01	-.001	-.001	-.001	-.001	-.001	-.001	.960	.911
0.00	5.00	-.001	-.001	-.001	-.001	-.001	-.001	1.294	.926
0.00	6.00	-.001	-.001	-.001	-.001	-.001	-.001	1.660	.947
0.00	6.57	-.001	-.001	-.001	-.001	-.002	-.002	1.864	.954
0.00	2.00	-.000	-.000	-.001	-.001	.001	-.001	.316	.810
0.00	3.01	-.000	-.001	-.001	-.001	.001	-.001	.657	.914
0.00	4.01	-.001	-.001	-.001	-.001	.001	-.001	.961	.910
0.00	5.02	-.001	-.001	-.001	-.001	.001	-.001	1.298	.926
0.00	6.01	-.001	-.001	-.001	-.001	.001	-.001	1.658	.946
0.00	6.55	-.001	-.001	-.001	-.001	.000	-.002	1.854	.952
.65	.99	-.185	-.196	-.209	-.207	-.224	-.152	-.088	0.000
.65	2.01	-.197	-.215	-.232	-.235	-.267	-.201	.944	.707
.65	3.39	-.184	-.198	-.212	-.212	-.234	-.171	2.384	.831
.65	4.20	-.201	-.219	-.237	-.244	-.278	-.208	3.327	.879
.65	5.00	-.205	-.225	-.244	-.249	-.285	-.223	4.308	.909
.65	6.01	-.206	-.227	-.246	-.252	-.298	-.227	5.555	.945
.65	8.21	-.201	-.220	-.239	-.243	-.278	-.211	8.334	.972
.70	.99	-.193	-.205	-.218	-.217	-.232	-.156	-.082	0.000
.70	1.99	-.201	-.218	-.235	-.236	-.271	-.199	.782	.691
.70	3.42	-.192	-.207	-.222	-.220	-.243	-.177	2.073	.830
.70	4.20	-.204	-.224	-.242	-.245	-.280	-.210	2.888	.878
.70	5.00	-.205	-.225	-.245	-.249	-.283	-.219	3.706	.908
.70	6.00	-.213	-.234	-.254	-.261	-.302	-.232	4.811	.944
.70	8.53	-.206	-.226	-.245	-.249	-.279	-.213	7.554	.975
.80	.98	-.217	-.234	-.248	-.244	-.280	-.174	-.078	0.000
.80	2.01	-.221	-.244	-.262	-.265	-.316	-.215	.595	.680
.80	3.41	-.216	-.236	-.252	-.250	-.290	-.186	1.570	.823
.80	4.20	-.223	-.246	-.266	-.268	-.319	-.216	2.196	.876
.80	4.99	-.228	-.254	-.276	-.280	-.343	-.242	2.833	.906
.80	5.99	-.236	-.263	-.286	-.293	-.365	-.257	3.689	.943
.80	6.98	-.234	-.261	-.284	-.290	-.357	-.252	4.502	.959
.80	9.16	-.225	-.250	-.271	-.274	-.312	-.227	6.340	.979
.90	.98	-.267	-.319	-.358	-.368	-.404	-.255	-.063	0.000
.90	2.04	-.260	-.311	-.353	-.375	-.446	-.285	.499	.706
.90	2.00	-.260	-.312	-.354	-.377	-.452	-.302	.481	.701
.90	3.40	-.259	-.311	-.353	-.374	-.436	-.272	1.236	.824
.90	4.19	-.262	-.315	-.360	-.386	-.469	-.322	1.735	.879
.90	5.01	-.262	-.316	-.360	-.387	-.474	-.344	2.250	.909
.90	5.99	-.264	-.318	-.364	-.393	-.489	-.372	2.911	.944
.90	6.99	-.263	-.317	-.362	-.392	-.488	-.370	3.567	.962
.90	8.60	-.260	-.315	-.360	-.388	-.484	-.359	4.632	.980
.90	9.98	-.260	-.314	-.358	-.382	-.479	-.327	5.552	.983
.95	.97	-.225	-.280	-.325	-.361	-.450	-.357	-.055	0.000
.95	2.00	-.224	-.279	-.325	-.359	-.453	-.361	.427	.688
.95	3.40	-.220	-.275	-.320	-.355	-.449	-.357	1.119	.829
.95	4.19	-.222	-.277	-.323	-.357	-.451	-.360	1.563	.878
.95	4.99	-.220	-.275	-.321	-.355	-.449	-.358	2.020	.911
.95	6.00	-.221	-.276	-.322	-.356	-.448	-.360	2.606	.939
.95	6.99	-.221	-.276	-.323	-.356	-.450	-.360	3.197	.958
.95	8.00	-.220	-.276	-.322	-.356	-.451	-.359	3.801	.971
.95	8.61	-.220	-.275	-.321	-.356	-.454	-.358	4.173	.978
.95	10.00	-.219	-.274	-.321	-.355	-.454	-.358	4.987	.985
1.20	.88	-.066	-.102	-.134	-.161	-.214	-.174	-.148	0.000
1.20	1.99	-.066	-.103	-.135	-.162	-.217	-.177	.168	.435
1.20	3.41	-.063	-.100	-.133	-.160	-.214	-.176	.626	.735
1.20	4.22	-.063	-.100	-.132	-.160	-.214	-.176	.911	.811
1.20	4.98	-.063	-.100	-.132	-.161	-.215	-.177	1.192	.858
1.20	5.98	-.063	-.099	-.132	-.160	-.214	-.176	1.564	.898
1.20	7.00	-.062	-.098	-.130	-.159	-.214	-.176	1.934	.922
1.20	8.61	-.060	-.097	-.129	-.157	-.212	-.175	2.532	.949
1.20	10.01	-.059	-.097	-.130	-.157	-.213	-.176	3.063	.964

TABLE 8.- BASIC DATA FOR CONFIGURATION 7 WITH $\alpha_p = 18^\circ$,
 $B/d = 0.484$, AND $A/d = 0.303$

MACH	NPR	P1	P2	P3	P4	P5	P6	P7	P8	P9
0.00	2.03	.214	.311	.479	.438	.433	.445	.449	.463	.489
0.00	3.00	.216	.193	.268	.375	.264	.339	.348	.286	.321
0.00	4.00	.221	.195	.143	.102	.172	.177	.241	.247	.320
0.00	5.01	.222	.196	.144	.102	.079	.136	.139	.138	.139
0.00	6.01	.221	.196	.144	.102	.078	.084	.123	.124	.123
0.00	6.70	.221	.197	.144	.103	.078	.064	.106	.113	.114
0.00	2.01	.216	.311	.469	.444	.432	.447	.455	.471	.494
0.00	3.00	.214	.193	.267	.378	.268	.335	.346	.290	.322
0.00	4.01	.221	.196	.144	.103	.169	.176	.240	.252	.314
0.00	5.02	.221	.196	.143	.102	.090	.137	.141	.141	.142
0.00	5.95	.222	.197	.145	.103	.078	.092	.127	.128	.126
0.00	6.47	.222	.199	.145	.103	.079	.066	.116	.120	.119
.65	2.01	.216	.226	.388	.447	.425	.433	.440	.454	.470
.65	3.41	.215	.193	.142	.150	.254	.343	.233	.271	.262
.65	4.21	.217	.194	.141	.118	.198	.198	.193	.193	.191
.65	5.02	.220	.196	.143	.102	.132	.162	.161	.160	.155
.65	6.04	.221	.196	.144	.102	.079	.097	.127	.128	.126
.65	6.02	.222	.196	.144	.102	.079	.099	.128	.129	.126
.65	7.83	.223	.198	.146	.104	.079	.063	.067	.106	.107
.70	2.01	.217	.226	.377	.451	.427	.432	.440	.454	.469
.70	3.41	.216	.194	.144	.112	.238	.336	.245	.279	.262
.70	4.20	.218	.196	.143	.112	.199	.198	.193	.193	.191
.70	5.02	.220	.195	.143	.102	.135	.162	.161	.161	.155
.70	6.00	.222	.197	.144	.102	.078	.101	.129	.130	.127
.70	7.94	.223	.198	.146	.104	.079	.063	.065	.105	.107
.80	2.01	.237	.247	.372	.449	.419	.423	.435	.451	.465
.80	3.40	.216	.193	.143	.111	.239	.341	.255	.262	.252
.80	4.18	.215	.194	.141	.117	.201	.202	.196	.197	.194
.80	4.99	.219	.196	.143	.101	.141	.164	.163	.162	.157
.80	6.02	.221	.196	.143	.101	.080	.107	.129	.130	.127
.80	7.03	.222	.197	.144	.102	.078	.063	.107	.114	.114
.80	9.29	.222	.197	.145	.103	.078	.062	.052	.097	.101
.90	2.01	.214	.231	.390	.449	.414	.422	.437	.453	.466
.90	3.19	.217	.194	.142	.180	.312	.347	.262	.229	.264
.90	3.41	.217	.194	.142	.108	.225	.335	.277	.243	.246
.90	4.21	.216	.195	.143	.109	.202	.201	.195	.195	.193
.90	5.02	.218	.197	.144	.103	.131	.164	.163	.163	.157
.90	6.00	.221	.197	.144	.102	.079	.113	.132	.133	.129
.90	7.02	.222	.197	.144	.103	.079	.064	.114	.118	.116
.90	8.62	.222	.197	.145	.103	.078	.062	.059	.103	.105
.90	10.01	.222	.198	.145	.103	.078	.063	.051	.093	.099
.95	2.00	.217	.234	.383	.440	.383	.421	.418	.436	.449
.95	3.41	.213	.188	.140	.118	.171	.215	.283	.251	.249
.95	4.21	.217	.195	.143	.108	.204	.202	.197	.196	.193
.95	5.02	.218	.197	.144	.104	.120	.165	.164	.163	.157
.95	6.01	.220	.196	.144	.103	.080	.117	.134	.135	.131
.95	7.03	.222	.196	.144	.102	.077	.065	.114	.118	.116
.95	8.57	.222	.197	.145	.103	.078	.063	.055	.100	.102
.95	9.99	.222	.197	.145	.103	.078	.064	.051	.089	.095
1.20	2.00	.218	.213	.256	.367	.379	.334	.294	.355	.373
1.20	3.42	.214	.188	.136	.123	.167	.170	.173	.183	.188
1.20	4.27	.216	.192	.140	.102	.105	.152	.155	.157	.149
1.20	4.21	.216	.193	.141	.102	.105	.155	.157	.159	.151
1.20	4.97	.218	.196	.143	.103	.086	.114	.138	.140	.135
1.20	6.03	.217	.196	.143	.102	.076	.065	.110	.118	.115
1.20	7.00	.218	.197	.144	.103	.079	.064	.054	.102	.102
1.20	8.59	.221	.197	.144	.103	.078	.063	.050	.053	.067
1.20	10.00	.222	.197	.145	.103	.080	.064	.051	.048	.051

TABLE 8.- Continued

MACH	NPR	P10	P11	P12	P13	P14	P15	S1	S2	S3
0.00	2.03	.509	.518	.523	.529	.552	.552	-.000	-.000	.001
0.00	3.00	.396	.371	.344	.394	.447	.450	-.000	-.000	.001
0.00	4.00	.338	.277	.239	.306	.352	.366	-.001	-.001	.001
0.00	5.01	.160	.184	.207	.227	.224	.247	-.001	-.001	.001
0.00	6.01	.118	.122	.140	.154	.164	.169	-.001	-.001	.001
0.00	6.70	.112	.108	.115	.136	.156	.163	-.001	-.001	.001
0.00	2.01	.514	.524	.528	.533	.553	.554	-.000	-.000	-.000
0.00	3.00	.391	.376	.341	.394	.442	.447	-.000	-.000	-.000
0.00	4.01	.342	.282	.237	.300	.351	.364	-.001	-.001	-.001
0.00	5.02	.163	.186	.207	.228	.227	.240	-.001	-.001	-.001
0.00	5.95	.121	.126	.143	.157	.168	.171	-.001	-.001	-.001
0.00	6.47	.116	.112	.121	.139	.155	.158	-.001	-.001	-.001
.65	.98							-.145	-.161	-.176
.65	2.01	.497	.521	.535	.547	.571	.577	-.146	-.163	-.179
.65	3.41	.278	.342	.402	.353	.396	.401	-.160	-.179	-.196
.65	4.21	.191	.191	.195	.199	.203	.231	-.137	-.153	-.168
.65	5.02	.153	.154	.154	.156	.163	.189	-.133	-.149	-.164
.65	6.04	.122	.119	.125	.134	.143	.154	-.142	-.160	-.176
.65	6.02	.122	.119	.126	.134	.143	.155	-.142	-.159	-.175
.65	7.83	.108	.107	.104	.111	.136	.154	-.150	-.170	-.186
.70	.98							-.151	-.167	-.184
.70	2.01	.496	.521	.535	.548	.572	.578	-.148	-.166	-.183
.70	3.41	.273	.329	.405	.360	.398	.403	-.161	-.180	-.198
.70	4.20	.189	.191	.195	.199	.204	.231	-.140	-.157	-.173
.70	5.02	.153	.154	.155	.156	.162	.189	-.135	-.151	-.166
.70	6.00	.123	.120	.126	.134	.143	.156	-.144	-.162	-.179
.70	7.94	.108	.107	.104	.110	.134	.152	-.153	-.173	-.191
.80	.97							-.164	-.184	-.204
.80	2.01	.489	.515	.531	.545	.568	.572	-.159	-.179	-.199
.80	3.40	.268	.326	.409	.362	.405	.410	-.172	-.194	-.216
.80	4.18	.194	.195	.197	.200	.202	.232	-.152	-.172	-.191
.80	4.99	.156	.156	.157	.159	.166	.192	-.150	-.169	-.187
.80	6.02	.123	.121	.126	.133	.141	.155	-.157	-.178	-.198
.80	7.03	.113	.109	.110	.124	.143	.154	-.163	-.185	-.206
.80	9.29	.103	.103	.101	.102	.115	.143	-.164	-.186	-.207
.90	.97							-.180	-.209	-.239
.90	2.01	.491	.518	.534	.549	.570	.576	-.173	-.201	-.231
.90	3.19	.306	.368	.395	.369	.445	.451	-.180	-.209	-.240
.90	3.41	.261	.315	.410	.369	.409	.415	-.180	-.209	-.239
.90	4.21	.191	.192	.195	.197	.197	.227	-.172	-.200	-.230
.90	5.02	.155	.155	.155	.155	.159	.185	-.167	-.195	-.224
.90	6.00	.125	.123	.129	.136	.143	.158	-.172	-.201	-.231
.90	7.02	.115	.111	.112	.124	.139	.151	-.174	-.203	-.233
.90	8.62	.106	.105	.102	.106	.127	.148	-.173	-.202	-.233
.90	10.01	.101	.103	.100	.101	.110	.139	-.173	-.202	-.232
.95	.96							-.144	-.171	-.201
.95	2.00	.473	.502	.521	.539	.562	.568	-.138	-.165	-.195
.95	3.41	.290	.302	.312	.372	.395	.403	-.137	-.164	-.194
.95	4.21	.191	.192	.194	.195	.191	.223	-.138	-.166	-.196
.95	5.02	.155	.155	.155	.153	.154	.179	-.135	-.162	-.192
.95	6.01	.127	.123	.123	.125	.130	.144	-.138	-.165	-.195
.95	7.03	.115	.112	.109	.112	.121	.138	-.138	-.166	-.196
.95	8.57	.103	.104	.102	.102	.109	.137	-.136	-.164	-.194
.95	9.99	.097	.099	.099	.101	.103	.127	-.137	-.165	-.195
1.20	.87							-.018	-.033	-.052
1.20	2.00	.355	.436	.461	.491	.515	.522	-.023	-.038	-.057
1.20	3.42	.196	.207	.218	.227	.241	.262	-.022	-.038	-.058
1.20	4.27	.148	.153	.158	.159	.165	.185	-.021	-.037	-.056
1.20	4.21	.150	.156	.161	.162	.167	.188	-.020	-.036	-.056
1.20	4.97	.132	.129	.126	.123	.125	.152	-.021	-.037	-.057
1.20	6.03	.113	.112	.109	.106	.112	.136	-.021	-.037	-.056
1.20	7.00	.102	.103	.104	.102	.104	.122	-.022	-.038	-.057
1.20	8.59	.091	.095	.097	.100	.105	.110	-.020	-.036	-.056
1.20	10.00	.052	.058	.095	.104	.110	.116	-.019	-.035	-.054

TABLE 8.- Concluded

MACH	NPR	S4	S5	S6	S7	S8	S9	CFMD	FMDZFI
0.00	2.03	-.000	-.001	.002	-.001	-.001	.001	.304	.758
0.00	3.00	-.000	-.001	.001	-.001	-.001	.001	.642	.894
0.00	4.00	-.001	-.001	-.000	-.001	-.001	.000	.935	.888
0.00	5.01	-.001	-.001	-.000	-.001	-.002	-.000	1.231	.880
0.00	6.01	-.001	-.001	-.000	-.001	-.002	.000	1.597	.911
0.00	6.70	-.001	-.001	.000	-.002	-.002	.000	1.853	.925
0.00	2.01	-.000	-.001	.002	-.001	.003	-.001	.295	.752
0.00	3.00	-.000	-.001	.001	-.001	.002	-.001	.643	.898
0.00	4.01	-.001	-.001	.001	-.001	.001	-.001	.937	.888
0.00	5.02	-.001	-.001	.001	-.001	.001	-.002	1.234	.881
0.00	5.95	-.001	-.001	.001	-.001	.000	-.002	1.570	.908
0.00	6.47	-.001	-.001	-.000	-.001	-.003	-.001	1.764	.920
.65	.98	-.188	-.199	-.154	-.208	-.220	-.143	-.073	0.000
.65	2.01	-.192	-.207	-.166	-.224	-.245	-.175	.896	.674
.65	3.41	-.211	-.230	-.193	-.254	-.286	-.215	2.494	.857
.65	4.21	-.179	-.190	-.158	-.200	-.211	-.140	3.250	.853
.65	5.02	-.174	-.183	-.140	-.189	-.196	-.119	4.215	.888
.65	6.04	-.188	-.203	-.158	-.220	-.246	-.169	5.464	.914
.65	6.62	-.188	-.202	-.161	-.219	-.246	-.170	5.394	.913
.65	7.83	-.199	-.217	-.180	-.239	-.277	-.199	7.666	.946
.70	.98	-.196	-.208	-.171	-.216	-.230	-.150	-.072	0.000
.70	2.01	-.196	-.212	-.177	-.229	-.249	-.176	.762	.663
.70	3.41	-.213	-.233	-.200	-.258	-.288	-.213	2.127	.850
.70	4.20	-.185	-.196	-.162	-.207	-.221	-.141	2.787	.851
.70	5.02	-.178	-.188	-.156	-.193	-.200	-.124	3.662	.886
.70	6.00	-.192	-.207	-.167	-.225	-.245	-.169	4.630	.913
.70	7.94	-.206	-.224	-.192	-.247	-.279	-.205	6.789	.949
.80	.97	-.219	-.235	-.214	-.249	-.256	-.166	-.069	0.000
.80	2.01	-.215	-.233	-.203	-.255	-.268	-.181	.576	.654
.80	3.40	-.234	-.258	-.233	-.288	-.313	-.229	1.613	.846
.80	4.18	-.205	-.221	-.206	-.233	-.236	-.159	2.122	.852
.80	4.99	-.202	-.216	-.195	-.224	-.226	-.144	2.772	.889
.80	6.02	-.214	-.232	-.202	-.255	-.269	-.182	3.584	.914
.80	7.03	-.223	-.246	-.224	-.276	-.299	-.220	4.447	.935
.80	9.29	-.225	-.247	-.225	-.274	-.305	-.221	6.346	.967
.90	.97	-.267	-.317	-.323	-.379	-.401	-.229	-.052	0.000
.90	2.01	-.258	-.306	-.304	-.366	-.394	-.243	.462	.668
.90	3.19	-.268	-.320	-.324	-.394	-.452	-.332	1.164	.836
.90	3.41	-.268	-.320	-.326	-.394	-.453	-.335	1.287	.845
.90	4.21	-.256	-.300	-.304	-.334	-.330	-.192	1.720	.858
.90	5.02	-.249	-.286	-.276	-.303	-.279	-.147	2.220	.895
.90	6.00	-.258	-.306	-.297	-.368	-.396	-.242	2.826	.918
.90	7.02	-.261	-.312	-.317	-.383	-.437	-.315	3.502	.938
.90	8.62	-.261	-.312	-.318	-.390	-.450	-.338	4.562	.962
.90	10.01	-.261	-.311	-.319	-.386	-.442	-.322	5.536	.976
.95	.96	-.229	-.283	-.302	-.365	-.440	-.357	-.048	0.000
.95	2.00	-.222	-.276	-.286	-.359	-.432	-.349	.409	.666
.95	3.41	-.222	-.276	-.285	-.359	-.432	-.350	1.093	.813
.95	4.21	-.224	-.278	-.289	-.363	-.437	-.351	1.543	.862
.95	5.02	-.220	-.273	-.282	-.358	-.428	-.334	1.998	.900
.95	6.01	-.223	-.277	-.288	-.362	-.434	-.351	2.563	.920
.95	7.03	-.224	-.278	-.289	-.363	-.435	-.353	3.166	.941
.95	8.57	-.222	-.276	-.287	-.361	-.433	-.351	4.078	.963
.95	9.99	-.223	-.277	-.288	-.363	-.435	-.352	4.947	.976
1.20	.87	-.067	-.099	-.079	-.155	-.202	-.158	-.141	0.000
1.20	2.00	-.073	-.106	-.106	-.163	-.209	-.169	.173	.444
1.20	3.42	-.074	-.108	-.108	-.165	-.210	-.171	.602	.703
1.20	4.27	-.073	-.107	-.107	-.164	-.209	-.170	.910	.796
1.20	4.21	-.073	-.106	-.106	-.165	-.209	-.170	.891	.793
1.20	4.97	-.074	-.108	-.108	-.166	-.211	-.172	1.171	.845
1.20	6.03	-.073	-.107	-.108	-.165	-.210	-.171	1.562	.891
1.20	7.00	-.074	-.108	-.109	-.167	-.211	-.172	1.924	.915
1.20	8.59	-.073	-.107	-.107	-.166	-.210	-.171	2.511	.942
1.20	10.00	-.071	-.107	-.108	-.167	-.214	-.173	3.037	.958

TABLE 9.- BASIC DATA FOR CONFIGURATION 8 WITH $\alpha_p = 18^\circ$,
 $B/d = 0.194$, AND $A/d = 0.303$

MACH	NPR	P1	P2	P3	P4	P5	P6	P7	P8	P9
0.00	2.00	.212	.369	.504	.475	.500	.502	.510	.513	.517
0.00	2.98	.215	.197	.292	.413	.336	.341	.315	.354	.388
0.00	4.02	.219	.196	.142	.104	.249	.267	.269	.351	.323
0.00	5.01	.220	.197	.142	.103	.200	.138	.142	.140	.189
0.00	6.01	.220	.198	.143	.103	.166	.104	.130	.130	.132
0.00	6.58	.220	.198	.143	.104	.152	.068	.124	.126	.125
0.00	2.00	.214	.366	.504	.474	.499	.500	.511	.516	.516
0.00	3.00	.213	.194	.291	.424	.333	.340	.322	.354	.384
0.00	4.02	.219	.196	.142	.109	.249	.270	.270	.353	.320
0.00	5.00	.220	.197	.143	.103	.200	.138	.142	.141	.190
0.00	6.01	.220	.198	.143	.103	.166	.101	.130	.131	.132
0.00	6.61	.220	.198	.144	.104	.151	.066	.124	.127	.124
.65	2.03	.215	.231	.403	.444	.491	.454	.496	.520	.529
.65	3.39	.215	.195	.143	.155	.293	.373	.235	.273	.403
.65	4.18	.216	.197	.143	.104	.238	.181	.179	.197	.220
.65	4.99	.220	.197	.143	.103	.199	.140	.144	.142	.171
.65	6.00	.221	.198	.144	.104	.166	.115	.132	.133	.131
.65	8.25	.221	.198	.144	.104	.121	.063	.105	.111	.112
.70	1.99	.215	.231	.399	.450	.499	.459	.499	.528	.539
.70	3.39	.212	.191	.145	.151	.293	.373	.246	.278	.393
.70	4.20	.214	.195	.141	.103	.237	.181	.179	.196	.215
.70	5.00	.218	.197	.142	.102	.199	.141	.145	.142	.171
.70	6.00	.221	.198	.143	.103	.166	.116	.132	.133	.130
.70	8.55	.221	.198	.144	.104	.116	.063	.101	.109	.110
.80	2.00	.224	.236	.384	.455	.498	.452	.492	.524	.539
.80	3.40	.215	.194	.142	.127	.292	.353	.273	.313	.367
.80	4.20	.216	.196	.142	.104	.237	.182	.180	.193	.206
.80	5.01	.216	.197	.143	.103	.199	.145	.148	.145	.173
.80	6.00	.220	.198	.143	.103	.166	.119	.133	.134	.130
.80	7.01	.221	.198	.144	.103	.142	.067	.124	.126	.123
.80	9.23	.221	.198	.144	.104	.108	.062	.074	.104	.104
.90	2.00	.213	.226	.360	.443	.498	.428	.463	.502	.524
.90	3.40	.211	.189	.138	.175	.293	.219	.230	.248	.256
.90	4.22	.215	.195	.141	.106	.236	.191	.186	.189	.193
.90	5.01	.215	.196	.143	.103	.199	.159	.156	.154	.159
.90	6.03	.218	.197	.143	.103	.165	.131	.137	.137	.131
.90	6.98	.221	.198	.144	.104	.142	.071	.125	.127	.123
.90	8.60	.221	.198	.144	.104	.116	.063	.107	.112	.112
.90	10.01	.221	.199	.144	.104	.099	.063	.075	.104	.104
.95	1.99	.214	.214	.295	.364	.499	.350	.437	.469	.493
.95	3.42	.214	.192	.140	.148	.291	.196	.209	.222	.228
.95	4.23	.215	.194	.141	.103	.235	.176	.176	.177	.180
.95	5.02	.215	.196	.142	.102	.198	.160	.159	.156	.153
.95	5.99	.216	.197	.142	.102	.166	.138	.140	.138	.133
.95	7.00	.221	.198	.144	.104	.142	.082	.125	.125	.123
.95	8.63	.221	.198	.143	.104	.115	.063	.085	.107	.106
.95	9.99	.221	.199	.144	.104	.100	.063	.054	.099	.100
1.20	2.02	.211	.190	.191	.336	.491	.320	.253	.420	.441
1.20	3.01	.217	.193	.143	.159	.330	.188	.199	.219	.230
1.20	3.42	.214	.191	.138	.112	.290	.151	.165	.178	.192
1.20	4.21	.215	.193	.139	.101	.235	.130	.133	.142	.150
1.20	4.98	.217	.196	.142	.103	.199	.097	.132	.134	.133
1.20	5.98	.216	.196	.142	.103	.166	.065	.112	.118	.116
1.20	7.01	.216	.197	.143	.104	.141	.063	.090	.109	.106
1.20	8.62	.218	.198	.143	.103	.115	.061	.053	.082	.093
1.20	10.04	.221	.198	.143	.104	.099	.063	.051	.048	.052

TABLE 9.- Continued

MACH	NPR	P10	P11	P12	P13	P14	P15	S1	S2	S3
0.00	2.00	.520	.524	.529	.537	.570	.573	-.001	-.001	-.001
0.00	2.98	.353	.352	.382	.405	.435	.441	-.001	-.001	-.001
0.00	4.02	.271	.222	.262	.314	.350	.374	-.001	-.002	-.002
0.00	5.01	.239	.284	.327	.305	.281	.300	-.001	-.001	-.002
0.00	6.01	.171	.217	.227	.261	.235	.250	-.002	-.002	-.003
0.00	6.58	.144	.188	.210	.225	.214	.229	-.002	-.003	-.003
0.00	2.00	.520	.523	.528	.537	.569	.572	-.001	-.001	-.001
0.00	3.00	.347	.354	.377	.400	.435	.441	-.001	-.001	-.001
0.00	4.02	.272	.224	.263	.315	.351	.374	-.001	-.002	-.002
0.00	5.00	.239	.285	.327	.306	.282	.300	-.001	-.002	-.002
0.00	6.01	.171	.217	.226	.261	.235	.250	-.001	-.002	-.002
0.00	6.61	.143	.187	.209	.223	.213	.228	-.002	-.003	-.003
.65	.98							-.262	-.337	-.321
.65	2.03	.535	.539	.543	.550	.576	.581	-.325	-.447	-.454
.65	3.39	.367	.327	.313	.397	.429	.440	-.357	-.497	-.512
.65	4.18	.245	.269	.283	.296	.301	.307	-.324	-.446	-.453
.65	4.99	.238	.278	.308	.310	.293	.309	-.345	-.481	-.495
.65	6.00	.162	.217	.240	.284	.257	.278	-.336	-.466	-.476
.65	8.25	.114	.128	.151	.181	.186	.201	-.310	-.422	-.430
.70	.98							-.273	-.352	-.334
.70	1.99	.546	.551	.554	.561	.585	.591	-.330	-.457	-.461
.70	3.39	.371	.337	.317	.398	.430	.441	-.363	-.512	-.526
.70	4.20	.240	.261	.276	.292	.301	.305	-.331	-.459	-.465
.70	5.00	.237	.277	.304	.306	.292	.306	-.357	-.505	-.520
.70	6.00	.162	.218	.243	.288	.261	.283	-.349	-.491	-.502
.70	8.55	.112	.123	.142	.171	.183	.196	-.321	-.441	-.441
.80	.97							-.312	-.414	-.388
.80	2.00	.548	.555	.560	.566	.588	.594	-.363	-.542	-.545
.80	3.40	.365	.360	.332	.399	.432	.442	-.390	-.517	-.555
.80	4.20	.224	.248	.267	.284	.299	.303	-.362	-.542	-.546
.80	5.01	.236	.273	.294	.298	.293	.302	-.386	-.518	-.569
.80	6.00	.164	.222	.250	.295	.270	.294	-.385	-.512	-.555
.80	7.01	.131	.164	.200	.224	.231	.252	-.373	-.584	-.610
.80	9.23	.107	.115	.129	.152	.175	.182	-.352	-.518	-.514
.90	.96							-.300	-.522	-.590
.90	2.00	.541	.553	.562	.570	.587	.595	-.297	-.519	-.591
.90	3.40	.272	.285	.303	.323	.339	.342	-.295	-.518	-.589
.90	4.22	.197	.206	.221	.237	.255	.263	-.293	-.515	-.587
.90	5.01	.176	.193	.211	.232	.253	.259	-.297	-.521	-.593
.90	6.03	.146	.184	.210	.229	.248	.255	-.296	-.521	-.593
.90	6.98	.123	.148	.183	.210	.230	.238	-.296	-.521	-.593
.90	8.60	.112	.115	.130	.160	.182	.189	-.294	-.518	-.591
.90	10.01	.105	.108	.113	.126	.148	.163	-.291	-.515	-.587
.95	.94							-.241	-.446	-.512
.95	1.99	.516	.534	.548	.559	.579	.586	-.238	-.444	-.512
.95	3.42	.236	.246	.262	.277	.292	.292	-.234	-.440	-.507
.95	4.23	.185	.190	.200	.212	.226	.226	-.236	-.442	-.510
.95	5.02	.158	.166	.174	.182	.197	.214	-.235	-.441	-.509
.95	5.99	.132	.143	.156	.166	.176	.192	-.234	-.441	-.509
.95	7.00	.120	.123	.138	.156	.171	.180	-.238	-.446	-.514
.95	8.63	.107	.110	.113	.126	.149	.162	-.236	-.444	-.512
.95	9.99	.101	.104	.107	.112	.120	.143	-.234	-.441	-.509
1.20	.86							-.063	-.203	-.251
1.20	2.02	.475	.501	.521	.536	.552	.558	-.067	-.205	-.255
1.20	3.01	.247	.258	.279	.296	.315	.326	-.069	-.207	-.255
1.20	3.42	.207	.222	.243	.261	.279	.287	-.068	-.206	-.255
1.20	4.21	.167	.189	.210	.228	.247	.256	-.068	-.206	-.255
1.20	4.98	.136	.152	.176	.195	.214	.224	-.067	-.205	-.254
1.20	5.98	.118	.126	.141	.159	.180	.189	-.067	-.206	-.256
1.20	7.01	.106	.110	.120	.132	.150	.164	-.065	-.204	-.253
1.20	8.62	.094	.099	.106	.117	.131	.137	-.065	-.203	-.253
1.20	10.04	.061	.099	.111	.121	.133	.139	-.067	-.205	-.256

TABLE 9.- Concluded

MACH	NPR	S4	S5	S7	CFMD	FMDZFI
0.00	2.00	.001	-.002	-.000	.328	.837
0.00	2.98	.001	-.002	-.000	.661	.927
0.00	4.02	.000	-.003	-.002	.993	.935
0.00	5.01	.000	-.003	-.000	1.290	.920
0.00	6.01	-.001	-.003	-.001	1.664	.946
0.00	6.58	-.000	-.004	-.001	1.870	.952
0.00	2.00	-.002	-.002	-.004	.331	.848
0.00	3.00	-.002	-.003	-.004	.670	.934
0.00	4.02	-.002	-.003	-.005	.990	.935
0.00	5.00	-.002	-.003	-.003	1.283	.917
0.00	6.01	-.002	-.003	-.004	1.655	.943
0.00	6.61	-.003	-.004	-.005	1.872	.950
.65	.98	-.303	-.253	-.185	-.094	0.000
.65	2.03	-.458	-.443	-.419	1.003	.738
.65	3.39	-.525	-.525	-.514	2.590	.895
.65	4.18	-.458	-.447	-.427	3.299	.870
.65	4.99	-.508	-.512	-.511	4.314	.907
.65	6.00	-.484	-.479	-.466	5.561	.940
.65	8.25	-.427	-.402	-.377	8.411	.967
.70	.98	-.314	-.259	-.187	-.092	0.000
.70	1.99	-.462	-.440	-.406	.818	.720
.70	3.39	-.536	-.526	-.504	2.207	.889
.70	4.20	-.467	-.451	-.419	2.848	.869
.70	5.00	-.531	-.529	-.523	3.709	.906
.70	6.00	-.509	-.500	-.481	4.782	.939
.70	8.55	-.437	-.408	-.363	7.603	.971
.80	.97	-.355	-.279	-.192	-.090	0.000
.80	2.00	-.529	-.468	-.400	.613	.703
.80	3.40	-.658	-.584	-.512	1.673	.877
.80	4.20	-.531	-.471	-.402	2.170	.865
.80	5.01	-.696	-.654	-.581	2.827	.904
.80	6.00	-.669	-.614	-.545	3.670	.938
.80	7.01	-.606	-.543	-.474	4.484	.956
.80	9.23	-.495	-.435	-.362	6.416	.976
.90	.96	-.608	-.367	-.191	-.094	0.000
.90	2.00	-.645	-.733	-.658	.449	.651
.90	3.40	-.644	-.733	-.752	1.189	.791
.90	4.22	-.641	-.730	-.677	1.702	.853
.90	5.01	-.648	-.738	-.783	2.211	.887
.90	6.03	-.648	-.739	-.785	2.896	.926
.90	6.98	-.648	-.738	-.785	3.528	.947
.90	8.60	-.645	-.736	-.782	4.600	.967
.90	10.01	-.642	-.732	-.778	5.319	.978
.95	.94	-.562	-.544	-.260	-.090	0.000
.95	1.99	-.563	-.647	-.685	.375	.608
.95	3.42	-.558	-.642	-.683	1.078	.790
.95	4.23	-.561	-.646	-.690	1.538	.852
.95	5.02	-.560	-.644	-.689	1.991	.890
.95	5.99	-.560	-.645	-.689	2.565	.923
.95	7.00	-.565	-.650	-.695	3.175	.945
.95	8.63	-.564	-.649	-.694	4.155	.966
.95	9.99	-.561	-.645	-.690	4.956	.977
1.20	.86	-.286	-.346	-.371	-.171	0.000
1.20	2.02	-.290	-.349	-.380	.151	.383
1.20	3.01	-.293	-.351	-.382	.468	.650
1.20	3.42	-.292	-.350	-.382	.601	.701
1.20	4.21	-.293	-.351	-.382	.889	.788
1.20	4.98	-.292	-.351	-.383	1.173	.842
1.20	5.98	-.294	-.352	-.384	1.549	.887
1.20	7.01	-.291	-.350	-.382	1.925	.916
1.20	8.62	-.291	-.350	-.382	2.525	.944
1.20	10.04	-.294	-.353	-.385	3.076	.959

TABLE 10.- BASIC DATA FOR CONFIGURATION 9 WITH $\alpha_p = 12^\circ$,
 $B/d = 0.061$, AND $A/d = 0.064$

MACH	NPR	P1	P2	P3	P5	P6	P7	P8	P9
0.00	2.01	.279	.498	.527	.505	.506	.508	.504	.503
0.00	3.01	.280	.332	.398	.275	.316	.427	.318	.277
0.00	4.01	.283	.249	.260	.263	.276	.274	.263	.242
0.00	5.01	.284	.199	.259	.155	.166	.204	.290	.243
0.00	6.00	.284	.167	.258	.089	.112	.113	.155	.270
0.00	6.44	.284	.156	.257	.077	.088	.112	.090	.219
0.00	2.00	.278	.403	.532	.506	.508	.509	.506	.505
0.00	3.02	.280	.237	.399	.275	.311	.427	.321	.276
0.00	4.02	.284	.238	.262	.265	.276	.275	.261	.243
0.00	5.01	.284	.239	.261	.155	.167	.204	.290	.244
0.00	6.01	.284	.239	.260	.090	.112	.113	.156	.270
0.00	6.45	.284	.240	.257	.077	.087	.112	.090	.218
.65	2.00	.282	.366	.542	.508	.510	.513	.512	.513
.65	3.40	.283	.238	.267	.293	.295	.273	.295	.372
.65	4.19	.283	.240	.265	.250	.191	.296	.258	.322
.65	5.00	.285	.240	.264	.146	.174	.140	.276	.290
.65	5.98	.286	.240	.265	.096	.102	.117	.095	.209
.65	8.29	.285	.240	.259	.062	.043	.048	.054	.064
.70	2.00	.280	.352	.542	.511	.513	.517	.515	.516
.70	3.40	.284	.238	.267	.294	.297	.283	.275	.369
.70	4.20	.283	.240	.266	.246	.190	.307	.260	.326
.70	5.00	.284	.239	.265	.146	.175	.137	.264	.294
.70	5.99	.285	.240	.265	.097	.103	.118	.094	.199
.70	8.69	.285	.240	.264	.062	.040	.043	.047	.077
.80	2.02	.280	.285	.498	.512	.513	.516	.515	.516
.80	3.42	.283	.237	.264	.297	.346	.305	.253	.297
.80	4.19	.283	.239	.262	.235	.193	.349	.277	.302
.80	5.00	.283	.240	.262	.146	.180	.135	.227	.300
.80	6.01	.286	.240	.262	.093	.105	.119	.094	.184
.80	7.01	.286	.240	.262	.062	.075	.082	.084	.070
.80	9.49	.286	.240	.263	.062	.039	.036	.045	.062
.90	1.99	.282	.231	.292	.536	.534	.537	.535	.537
.90	3.40	.285	.237	.264	.211	.357	.370	.336	.332
.90	4.21	.284	.239	.265	.133	.196	.299	.348	.269
.90	5.00	.284	.241	.261	.065	.164	.139	.238	.286
.90	5.99	.285	.240	.260	.062	.104	.125	.102	.128
.90	7.00	.286	.240	.260	.062	.077	.091	.086	.077
.90	8.00	.286	.241	.260	.062	.046	.060	.081	.065
.90	8.61	.286	.241	.260	.063	.040	.051	.057	.065
.90	9.98	.286	.241	.261	.062	.039	.030	.037	.044
.95	1.99	.283	.232	.253	.415	.487	.524	.538	.548
.95	3.40	.285	.238	.264	.189	.212	.225	.333	.384
.95	4.20	.284	.239	.264	.140	.181	.160	.188	.290
.95	5.00	.284	.240	.264	.064	.116	.133	.131	.181
.95	6.02	.283	.240	.263	.062	.086	.128	.099	.106
.95	6.98	.286	.240	.263	.062	.044	.087	.090	.081
.95	8.60	.286	.241	.264	.062	.039	.055	.068	.065
.95	10.00	.286	.241	.264	.062	.039	.033	.040	.051
1.20	2.00	.285	.234	.257	.431	.409	.418	.437	.452
1.20	3.40	.284	.233	.258	.216	.242	.244	.263	.259
1.20	4.18	.286	.238	.266	.163	.188	.175	.195	.213
1.20	5.01	.284	.238	.267	.092	.133	.142	.148	.166
1.20	4.99	.284	.238	.264	.092	.133	.142	.148	.166
1.20	6.00	.285	.240	.264	.065	.098	.122	.109	.120
1.20	6.97	.284	.241	.263	.063	.047	.082	.094	.092
1.20	8.62	.285	.240	.262	.062	.039	.045	.060	.071
1.20	9.96	.287	.241	.262	.063	.040	.029	.041	.062

TABLE 10.- Continued

MACH	NPR	P10	P11	P12	P13	P14	P15	S1	S2	S3
0.00	2.01	.502	.501	.473	.492	.513	.526	-.001	-.001	-.001
0.00	3.01	.359	.400	.307	.325	.322	.333	-.002	-.002	-.002
0.00	4.01	.239	.260	.252	.245	.252	.259	-.002	-.003	-.003
0.00	5.01	.256	.179	.142	.197	.191	.199	-.003	-.003	-.003
0.00	6.00	.274	.220	.212	.142	.141	.143	-.004	-.004	-.004
0.00	6.44	.277	.259	.206	.085	.126	.143	-.004	-.005	-.005
0.00	2.00	.504	.502	.476	.492	.515	.528	-.001	-.001	-.001
0.00	3.02	.354	.403	.311	.324	.321	.332	-.002	-.002	-.002
0.00	4.02	.237	.261	.252	.245	.252	.260	-.002	-.002	-.003
0.00	5.01	.256	.179	.143	.197	.192	.199	-.003	-.003	-.003
0.00	6.01	.274	.219	.215	.141	.140	.143	-.004	-.004	-.004
0.00	6.45	.277	.260	.208	.085	.126	.143	-.004	-.005	-.005
.65	.96							-.362	-.393	-.424
.65	2.00	.513	.511	.483	.523	.537	.548	-.627	-.678	-.732
.65	3.40	.313	.310	.276	.307	.303	.314	-.614	-.663	-.714
.65	4.19	.222	.215	.241	.257	.252	.254	-.599	-.603	-.647
.65	5.00	.269	.249	.175	.199	.195	.190	-.491	-.528	-.564
.65	5.98	.272	.270	.294	.095	.144	.157	-.416	-.445	-.475
.65	8.29	.109	.117	.131	.153	.159	.171	-.262	-.279	-.297
.70	.95							-.353	-.384	-.417
.70	2.00	.516	.514	.485	.528	.544	.554	-.617	-.666	-.721
.70	3.40	.325	.313	.289	.306	.303	.312	-.613	-.662	-.717
.70	4.20	.222	.215	.237	.259	.254	.255	-.562	-.607	-.657
.70	5.00	.273	.259	.181	.200	.196	.190	-.495	-.534	-.578
.70	5.99	.256	.271	.293	.098	.146	.159	-.414	-.446	-.485
.70	8.69	.102	.105	.111	.123	.130	.148	-.231	-.248	-.264
.80	.94							-.344	-.366	-.387
.80	2.02	.516	.514	.486	.527	.545	.557	-.551	-.596	-.647
.80	3.42	.357	.353	.321	.297	.299	.309	-.552	-.598	-.650
.80	4.19	.222	.221	.210	.256	.254	.263	-.544	-.589	-.638
.80	5.00	.306	.270	.196	.194	.193	.194	-.515	-.554	-.597
.80	6.01	.217	.263	.282	.105	.156	.171	-.437	-.466	-.499
.80	7.01	.086	.161	.196	.167	.217	.226	-.354	-.376	-.401
.80	9.49	.078	.087	.092	.093	.097	.115	-.172	-.184	-.205
.90	.92							-.330	-.351	-.370
.90	1.99	.535	.532	.500	.553	.569	.577	-.401	-.439	-.482
.90	3.40	.337	.302	.308	.313	.320	.335	-.397	-.434	-.477
.90	4.21	.214	.296	.252	.258	.269	.277	-.398	-.436	-.478
.90	5.00	.311	.226	.168	.214	.213	.223	-.401	-.439	-.482
.90	5.99	.177	.224	.263	.161	.208	.216	-.395	-.432	-.474
.90	7.00	.087	.140	.174	.188	.189	.206	-.371	-.400	-.431
.90	8.00	.092	.120	.130	.135	.135	.156	-.278	-.292	-.310
.90	8.61	.090	.110	.116	.119	.115	.137	-.222	-.234	-.248
.90	9.98	.063	.093	.096	.096	.091	.107	-.123	-.130	-.141
.95	.90							-.298	-.321	-.346
.95	1.99	.549	.548	.515	.570	.584	.592	-.325	-.359	-.398
.95	3.40	.328	.345	.353	.309	.334	.349	-.327	-.362	-.401
.95	4.20	.336	.300	.237	.265	.275	.289	-.327	-.362	-.401
.95	5.00	.249	.287	.283	.195	.225	.240	-.324	-.359	-.398
.95	6.02	.120	.137	.192	.239	.242	.252	-.322	-.357	-.396
.95	6.98	.091	.105	.149	.194	.190	.205	-.324	-.358	-.396
.95	8.60	.056	.088	.116	.123	.120	.128	-.237	-.250	-.264
.95	10.00	.051	.079	.092	.094	.092	.091	-.101	-.108	-.117
1.20	.80							-.113	-.136	-.163
1.20	2.00	.465	.475	.462	.522	.523	.531	-.109	-.132	-.159
1.20	3.40	.264	.272	.272	.295	.297	.302	-.108	-.131	-.158
1.20	4.18	.220	.218	.223	.239	.239	.241	-.106	-.130	-.157
1.20	5.01	.180	.186	.191	.203	.201	.200	-.106	-.129	-.156
1.20	4.99	.180	.186	.192	.204	.201	.200	-.109	-.132	-.159
1.20	6.00	.134	.148	.158	.175	.172	.170	-.107	-.130	-.157
1.20	6.97	.103	.115	.128	.152	.149	.146	-.107	-.130	-.157
1.20	8.62	.067	.077	.089	.121	.118	.116	-.110	-.133	-.160
1.20	9.96	.056	.054	.065	.100	.097	.095	-.106	-.128	-.153

TABLE 10.- Concluded

MACH	NPR	S4	S5	S6	S7	S8	S9	CFMD	FMDZFI
0.00	2.01	-.001	-.002	-.002	-.002	-.000	-.000	.365	.925
0.00	3.01	-.002	-.003	-.004	-.003	-.002	-.002	.699	.972
0.00	4.01	-.003	-.003	-.004	-.004	-.003	-.002	1.037	.982
0.00	5.01	-.003	-.002	-.005	-.004	-.003	-.002	1.374	.980
0.00	6.00	-.004	-.001	-.006	-.004	-.002	-.001	1.713	.980
0.00	6.44	-.005	-.007	-.007	-.004	-.001	-.000	1.865	.978
0.00	2.00	-.002	-.002	-.002	-.002	-.003	.001	.365	.923
0.00	3.02	-.002	-.003	-.003	-.003	-.004	-.000	.700	.958
0.00	4.02	-.003	-.004	-.004	-.004	-.005	-.001	1.035	.977
0.00	5.01	-.003	-.004	-.004	-.004	-.005	-.001	1.371	.978
0.00	6.01	-.004	-.004	-.006	-.004	-.007	-.001	1.713	.973
0.00	6.45	-.004	-.004	-.006	-.004	-.007	-.001	1.864	.970
.65	.96	-.479	-.554	-.527	-.473	-.421	-.200	-.110	0.000
.65	2.00	-.833	-1.034	-1.000	-.928	-.989	-.487	1.230	.916
.65	3.40	-.810	-.995	-.960	-.888	-.947	-.523	2.786	.957
.65	4.19	-.731	-.879	-.844	-.777	-.812	-.449	3.683	.961
.65	5.00	-.635	-.747	-.714	-.652	-.659	-.343	4.565	.962
.65	5.98	-.534	-.617	-.585	-.525	-.501	-.251	5.706	.961
.65	8.29	-.336	-.380	-.350	-.295	-.235	-.102	8.361	.957
.70	.95	-.470	-.531	-.505	-.452	-.387	-.215	-.114	0.000
.70	2.00	-.824	-1.016	-.988	-.927	-.957	-.463	1.044	.911
.70	3.40	-.818	-1.006	-.972	-.906	-.932	-.524	2.378	.953
.70	4.20	-.746	-.896	-.859	-.795	-.801	-.457	3.187	.959
.70	5.00	-.653	-.764	-.729	-.666	-.647	-.345	3.964	.960
.70	5.99	-.544	-.619	-.585	-.525	-.479	-.271	4.929	.958
.70	8.69	-.300	-.336	-.306	-.247	-.178	-.087	7.534	.945
.80	.94	-.433	-.475	-.454	-.396	-.316	-.195	-.122	0.000
.80	2.02	-.736	-.942	-.925	-.884	-.908	-.502	.794	.885
.80	3.42	-.740	-.986	-.993	-.935	-.981	-.602	1.822	.934
.80	4.19	-.726	-.904	-.865	-.823	-.806	-.598	2.414	.948
.80	5.00	-.677	-.771	-.742	-.691	-.616	-.499	3.017	.951
.80	6.01	-.562	-.626	-.596	-.539	-.440	-.332	3.768	.950
.80	7.01	-.450	-.496	-.464	-.400	-.308	-.227	4.610	.965
.80	9.49	-.229	-.246	-.217	-.153	-.079	-.079	6.339	.932
.90	.92	-.408	-.413	-.393	-.311	-.261	-.169	-.123	0.000
.90	1.99	-.556	-.782	-.897	-1.052	-1.321	-.831	.553	.799
.90	3.40	-.550	-.776	-.890	-1.045	-1.287	-.917	1.379	.906
.90	4.21	-.551	-.776	-.891	-1.005	-1.059	-.889	1.866	.928
.90	5.00	-.555	-.781	-.880	-.831	-.912	-.785	2.367	.939
.90	5.99	-.545	-.714	-.689	-.652	-.644	-.659	2.978	.950
.90	7.00	-.485	-.514	-.484	-.393	-.336	-.486	3.610	.952
.90	8.00	-.346	-.356	-.330	-.244	-.167	-.206	4.163	.942
.90	8.61	-.279	-.289	-.262	-.183	-.108	-.094	4.528	.940
.90	9.98	-.162	-.170	-.143	-.074	-.006	.013	5.350	.936
.95	.90	-.388	-.403	-.384	-.322	-.286	-.266	-.121	0.000
.95	1.99	-.466	-.669	-.777	-.914	-1.144	-.509	.484	.786
.95	3.40	-.469	-.677	-.783	-.927	-1.161	-.841	1.234	.905
.95	4.20	-.468	-.677	-.783	-.911	-.970	-.813	1.675	.929
.95	5.00	-.465	-.673	-.776	-.771	-.837	-.725	2.105	.942
.95	6.02	-.463	-.665	-.720	-.659	-.712	-.602	2.692	.961
.95	6.98	-.461	-.601	-.573	-.539	-.520	-.502	3.216	.960
.95	8.60	-.293	-.290	-.259	-.165	-.101	-.221	4.070	.952
.95	10.00	-.136	-.139	-.113	-.042	.023	-.067	4.819	.948
1.20	.80	-.208	-.332	-.341	-.309	-.326	-.168	-.190	0.000
1.20	2.00	-.204	-.348	-.423	-.526	-.683	-.426	.233	.600
1.20	3.40	-.204	-.348	-.423	-.526	-.683	-.496	.696	.815
1.20	4.18	-.202	-.346	-.421	-.524	-.669	-.490	.959	.861
1.20	5.01	-.202	-.346	-.421	-.518	-.559	-.469	1.244	.889
1.20	4.99	-.205	-.350	-.426	-.523	-.561	-.438	1.246	.888
1.20	6.00	-.203	-.347	-.421	-.439	-.464	-.412	1.589	.906
1.20	6.97	-.203	-.346	-.406	-.370	-.402	-.361	1.926	.918
1.20	8.62	-.205	-.326	-.326	-.297	-.295	-.305	2.517	.930
1.20	9.96	-.196	-.269	-.250	-.225	-.196	-.197	2.966	.933

TABLE 11.- BASIC DATA FOR CONFIGURATION 10 WITH $\alpha_p = 12^\circ$,
 $B/d = 0.152$, AND $A/d = 0.064$

MACH	NPR	P1	P2	P3	P4	P5	P6	P7	P8	P9
0.00	2.01	.289	.235	.506	.513	.504	.504	.505	.501	.501
0.00	3.01	.293	.240	.186	.397	.293	.339	.360	.356	.319
0.00	4.02	.295	.241	.178	.280	.328	.239	.230	.220	.294
0.00	5.02	.296	.243	.179	.280	.167	.217	.150	.181	.233
0.00	6.01	.296	.244	.179	.280	.133	.136	.149	.101	.138
0.00	6.47	.296	.244	.180	.280	.133	.103	.129	.100	.085
0.00	2.01	.292	.241	.467	.523	.506	.504	.500	.502	.502
0.00	3.01	.296	.240	.180	.401	.295	.337	.333	.359	.319
0.00	4.01	.298	.241	.178	.280	.329	.240	.249	.220	.294
0.00	5.00	.298	.243	.179	.280	.171	.219	.200	.187	.231
0.00	6.01	.299	.243	.179	.280	.135	.136	.166	.102	.137
0.00	6.48	.298	.244	.180	.280	.135	.103	.154	.100	.085
0.00	2.00	.291	.240	.500	.517	.506	.506	.500	.505	.505
0.00	2.99	.295	.243	.195	.402	.297	.340	.355	.357	.328
0.00	4.00	.298	.245	.185	.282	.331	.240	.233	.222	.296
0.00	5.02	.298	.246	.185	.282	.170	.217	.151	.185	.233
0.00	6.00	.298	.247	.186	.282	.134	.136	.149	.103	.140
0.00	6.50	.298	.247	.186	.281	.135	.102	.128	.101	.085
0.00	2.00	.291	.243	.494	.522	.508	.505	.507	.505	.505
0.00	3.00	.293	.242	.186	.404	.296	.337	.358	.361	.324
0.00	4.01	.298	.243	.184	.283	.330	.240	.231	.221	.296
0.00	4.99	.298	.245	.185	.283	.172	.219	.152	.190	.232
0.00	6.02	.298	.245	.186	.283	.134	.136	.149	.103	.139
0.00	6.52	.298	.245	.186	.283	.134	.102	.127	.101	.086
.65	1.99	.289	.259	.363	.488	.536	.525	.518	.516	.516
.65	3.39	.296	.239	.177	.320	.433	.239	.271	.289	.388
.65	4.19	.298	.241	.178	.282	.279	.251	.215	.229	.215
.65	5.00	.299	.243	.179	.282	.169	.219	.174	.144	.237
.65	6.02	.298	.243	.179	.281	.135	.134	.146	.104	.099
.65	8.28	.299	.244	.179	.280	.135	.073	.101	.076	.076
.65	2.02	.288	.249	.354	.489	.530	.516	.511	.507	.508
.65	3.41	.294	.242	.183	.313	.434	.248	.232	.279	.372
.65	4.21	.296	.244	.184	.285	.275	.253	.200	.231	.215
.65	5.01	.298	.243	.184	.284	.170	.217	.155	.146	.237
.65	6.01	.299	.245	.185	.284	.135	.134	.155	.105	.098
.65	8.31	.299	.246	.185	.283	.135	.073	.062	.075	.077
.70	1.99	.287	.261	.360	.481	.537	.528	.522	.518	.518
.70	3.40	.296	.239	.178	.312	.432	.242	.238	.282	.383
.70	4.22	.296	.241	.177	.281	.274	.253	.202	.230	.211
.70	4.99	.299	.242	.178	.281	.171	.222	.156	.144	.236
.70	6.02	.299	.243	.178	.281	.136	.135	.154	.104	.096
.70	8.61	.298	.244	.178	.280	.135	.073	.081	.069	.075
.70	2.00	.293	.241	.365	.503	.535	.523	.519	.516	.518
.70	3.41	.293	.240	.183	.315	.433	.246	.237	.277	.374
.70	4.20	.296	.243	.184	.285	.276	.254	.203	.232	.214
.70	5.00	.299	.243	.185	.284	.171	.219	.156	.145	.236
.70	6.01	.299	.244	.185	.284	.135	.136	.157	.105	.099
.70	8.65	.299	.245	.185	.283	.135	.073	.055	.067	.076
.80	2.00	.294	.257	.348	.466	.536	.533	.526	.521	.521
.80	3.40	.295	.239	.177	.296	.437	.244	.247	.283	.379
.80	4.19	.297	.242	.178	.281	.276	.258	.209	.234	.211
.80	5.00	.298	.242	.178	.282	.165	.226	.158	.142	.233
.80	6.00	.299	.242	.178	.281	.135	.140	.159	.106	.099
.80	7.00	.299	.243	.178	.281	.135	.089	.113	.104	.078

TABLE 11.- Continued

MACH	NPR	P1	P2	P3	P4	P5	P6	P7	P8	P9
.80	9.36	.298	.244	.179	.280	.135	.073	.046	.056	.069
.80	2.00	.293	.242	.351	.473	.537	.531	.525	.520	.522
.80	3.36	.295	.242	.184	.311	.439	.251	.251	.266	.375
.80	3.40	.294	.241	.183	.291	.439	.251	.249	.277	.368
.80	4.20	.294	.242	.184	.283	.276	.258	.211	.234	.213
.80	5.00	.298	.243	.185	.285	.167	.225	.159	.143	.233
.80	5.98	.299	.244	.186	.284	.135	.139	.159	.107	.100
.80	7.00	.299	.244	.185	.284	.135	.088	.112	.105	.079
.80	9.38	.299	.245	.186	.283	.135	.072	.046	.055	.069
.90	2.01	.294	.245	.309	.403	.508	.542	.541	.534	.533
.90	3.40	.297	.240	.178	.277	.275	.332	.384	.305	.295
.90	4.23	.295	.240	.177	.278	.137	.281	.200	.325	.291
.90	5.03	.297	.241	.178	.281	.135	.204	.165	.142	.212
.90	6.00	.299	.243	.179	.282	.136	.118	.162	.110	.105
.90	7.01	.299	.243	.179	.281	.136	.074	.121	.105	.081
.90	8.62	.299	.243	.179	.281	.135	.073	.063	.083	.077
.90	10.00	.299	.244	.180	.281	.136	.073	.045	.050	.063
.90	2.00	.289	.241	.305	.407	.513	.545	.544	.538	.539
.90	3.41	.295	.242	.183	.280	.308	.331	.367	.307	.306
.90	4.19	.295	.243	.184	.282	.135	.280	.206	.330	.302
.90	5.00	.295	.244	.184	.284	.134	.198	.169	.144	.214
.90	6.06	.299	.244	.185	.284	.135	.114	.161	.111	.105
.90	6.02	.299	.244	.185	.284	.135	.115	.162	.111	.106
.90	7.01	.299	.244	.185	.284	.135	.074	.121	.105	.082
.90	8.57	.300	.246	.186	.284	.136	.073	.064	.082	.078
.90	9.99	.299	.246	.186	.283	.135	.073	.045	.050	.064
.95	2.01	.294	.237	.185	.267	.438	.489	.526	.538	.548
.95	3.40	.296	.238	.175	.275	.195	.230	.217	.310	.389
.95	4.19	.297	.241	.178	.279	.136	.164	.184	.165	.258
.95	5.01	.297	.241	.178	.281	.136	.127	.173	.128	.144
.95	5.98	.299	.242	.178	.282	.136	.077	.150	.111	.098
.95	7.02	.298	.242	.178	.281	.135	.072	.099	.107	.082
.95	8.59	.298	.243	.178	.281	.136	.072	.052	.088	.077
.95	9.99	.298	.244	.179	.281	.135	.073	.044	.057	.071
.95	2.01	.293	.237	.184	.267	.426	.491	.525	.537	.548
.95	3.41	.294	.241	.181	.277	.193	.222	.217	.319	.388
.95	4.19	.295	.243	.183	.280	.135	.163	.184	.171	.272
.95	5.01	.294	.243	.184	.282	.135	.127	.173	.129	.145
.95	6.00	.299	.244	.184	.283	.135	.076	.147	.112	.098
.95	7.01	.299	.244	.185	.282	.135	.073	.098	.107	.083
.95	8.63	.299	.245	.185	.282	.135	.073	.048	.086	.078
.95	8.61	.300	.245	.186	.283	.136	.073	.048	.086	.079
.95	10.00	.299	.246	.186	.283	.135	.073	.045	.055	.071
1.20	2.01	.295	.238	.204	.266	.448	.435	.413	.436	.456
1.20	3.38	.295	.238	.174	.273	.224	.249	.235	.250	.270
1.20	4.22	.295	.238	.175	.275	.137	.182	.201	.178	.199
1.20	4.99	.297	.241	.178	.279	.136	.144	.176	.139	.151
1.20	6.02	.296	.242	.178	.280	.136	.098	.113	.119	.108
1.20	7.02	.297	.242	.177	.282	.135	.073	.087	.111	.089
1.20	8.65	.299	.242	.178	.282	.135	.073	.048	.066	.080
1.20	8.63	.299	.243	.178	.282	.135	.073	.045	.065	.080
1.20	10.01	.300	.244	.179	.282	.136	.073	.045	.037	.073
1.20	2.07	.288	.234	.201	.264	.436	.428	.410	.422	.442
1.20	2.00	.290	.234	.198	.264	.456	.432	.427	.438	.457
1.20	3.39	.296	.241	.183	.275	.221	.245	.232	.245	.272
1.20	4.21	.295	.242	.182	.278	.136	.180	.200	.182	.199
1.20	5.02	.293	.241	.182	.278	.133	.142	.175	.139	.150
1.20	6.01	.295	.244	.184	.282	.135	.097	.113	.120	.111
1.20	7.00	.295	.244	.184	.283	.135	.073	.087	.112	.091
1.20	8.65	.299	.244	.185	.283	.135	.073	.045	.064	.081
1.20	9.99	.300	.245	.186	.284	.136	.074	.046	.037	.074

TABLE 11.- Continued

MACH	NPR	P10	P11	P12	P13	P14	P15	S1	S2	S3
0.00	2.01	.500	.498	.476	.408	.519	.536	.001	.001	.001
0.00	3.01	.334	.350	.338	.314	.323	.336	.002	.001	.000
0.00	4.02	.272	.288	.234	.247	.244	.247	.003	.000	-.000
0.00	5.02	.209	.275	.206	.177	.178	.185	.003	-.000	-.000
0.00	6.01	.234	.213	.213	.113	.146	.159	.004	-.000	-.000
0.00	6.47	.186	.234	.205	.096	.149	.163	.004	.000	.000
0.00	1.00	.998	.999	.999	.999	.999	.999	.000	.003	.000
0.00	2.01	.500	.499	.476	.412	.519	.535	.000	.002	-.001
0.00	3.01	.333	.351	.338	.315	.324	.337	.001	.001	-.002
0.00	4.01	.273	.288	.235	.247	.244	.247	.001	.001	-.002
0.00	5.00	.210	.274	.203	.178	.179	.186	.002	.001	-.002
0.00	6.01	.234	.213	.213	.114	.146	.158	.002	.000	-.003
0.00	6.48	.186	.234	.204	.096	.149	.163	.002	.000	-.004
0.00	2.00	.502	.500	.479	.412	.521	.537	.002	-.001	-.001
0.00	2.99	.340	.348	.341	.319	.327	.341	.001	-.001	-.001
0.00	4.00	.273	.289	.237	.249	.246	.247	.001	-.002	-.002
0.00	5.02	.210	.274	.205	.177	.178	.185	.000	-.003	-.003
0.00	6.00	.234	.213	.214	.114	.145	.155	.000	-.003	-.003
0.00	6.50	.182	.234	.207	.095	.149	.164	.000	-.004	-.004
0.00	2.00	.501	.500	.479	.410	.521	.537	.001	.002	-.001
0.00	3.00	.334	.351	.341	.316	.325	.338	.001	.002	-.002
0.00	4.01	.272	.288	.237	.249	.246	.247	.001	.001	-.002
0.00	4.99	.211	.273	.204	.179	.179	.187	.000	.001	-.002
0.00	6.02	.234	.213	.213	.113	.144	.155	-.000	.000	-.003
0.00	6.52	.181	.233	.206	.096	.149	.163	-.000	.000	-.003
.65	.97							-.367	-.540	-.491
.65	1.99	.515	.512	.482	.514	.546	.559	-.375	-.568	-.521
.65	3.39	.355	.277	.265	.305	.302	.312	-.383	-.588	-.547
.65	4.19	.298	.255	.291	.222	.234	.245	-.362	-.552	-.507
.65	5.00	.209	.274	.256	.185	.194	.201	-.333	-.498	-.449
.65	6.02	.175	.227	.203	.124	.188	.200	-.295	-.436	-.384
.65	8.28	.064	.111	.119	.129	.130	.145	-.211	-.309	-.252
.65	.97							-.404	-.556	-.505
.65	2.02	.507	.504	.476	.507	.536	.550	-.414	-.586	-.539
.65	3.41	.361	.292	.264	.303	.300	.307	-.419	-.597	-.554
.65	4.21	.301	.252	.291	.219	.234	.244	-.400	-.562	-.514
.65	5.01	.208	.271	.255	.181	.193	.199	-.373	-.515	-.462
.65	6.01	.173	.227	.205	.122	.187	.200	-.333	-.449	-.394
.65	8.31	.064	.111	.119	.128	.129	.144	-.245	-.319	-.263
.70	.97							-.378	-.563	-.507
.70	1.99	.517	.513	.483	.518	.550	.563	-.393	-.607	-.551
.70	3.40	.363	.283	.266	.304	.300	.311	-.401	-.631	-.580
.70	4.22	.300	.253	.295	.220	.235	.245	-.380	-.587	-.532
.70	4.99	.207	.272	.262	.182	.197	.204	-.350	-.531	-.473
.70	6.02	.155	.226	.202	.161	.197	.207	-.308	-.457	-.396
.70	8.61	.060	.110	.114	.118	.118	.134	-.204	-.295	-.234
.70	.97							-.416	-.576	-.518
.70	2.00	.515	.512	.483	.519	.547	.560	-.437	-.630	-.576
.70	3.41	.368	.293	.267	.305	.302	.309	-.441	-.640	-.589
.70	4.20	.300	.254	.295	.221	.237	.247	-.418	-.594	-.539
.70	5.00	.207	.267	.263	.175	.196	.202	-.391	-.544	-.483
.70	6.01	.159	.225	.203	.146	.194	.206	-.345	-.466	-.404
.70	8.65	.059	.109	.114	.117	.117	.133	-.241	-.307	-.243
.80	.95							-.409	-.666	-.550
.80	2.00	.520	.515	.485	.524	.556	.569	-.423	-.871	-.883
.80	3.40	.374	.291	.273	.309	.306	.315	-.425	-.881	-.934
.80	4.19	.297	.252	.300	.227	.243	.252	-.420	-.848	-.760
.80	5.00	.204	.254	.278	.172	.204	.213	-.402	-.704	-.566
.80	6.00	.130	.217	.197	.211	.216	.220	-.359	-.552	-.450
.80	7.00	.073	.106	.158	.171	.166	.181	-.305	-.444	-.354

TABLE 11.- Continued

MACH	NPR	P10	P11	P12	P13	P14	P15	S1	S2	S3
.80	9.36	.057	.097	.104	.104	.101	.116	-.195	-.270	-.193
.80	.95							-.452	-.678	-.558
.80	2.00	.519	.514	.495	.524	.555	.567	-.470	-.881	-.873
.80	3.36	.373	.302	.277	.314	.312	.317	-.471	-.890	-.971
.80	3.40	.375	.303	.278	.310	.307	.313	-.463	-.881	-.966
.80	4.20	.296	.251	.299	.227	.244	.253	-.459	-.867	-.856
.80	5.00	.205	.253	.278	.166	.204	.211	-.448	-.747	-.593
.80	5.98	.129	.217	.199	.212	.216	.221	-.403	-.565	-.457
.80	7.00	.072	.111	.159	.172	.160	.180	-.344	-.450	-.359
.80	9.38	.057	.097	.104	.104	.101	.116	-.231	-.277	-.198
.90	.93							-.311	-.682	-.673
.90	2.01	.530	.524	.491	.530	.567	.580	-.312	-.699	-.792
.90	3.40	.296	.342	.355	.329	.333	.338	-.308	-.696	-.789
.90	4.23	.297	.240	.243	.237	.239	.250	-.308	-.697	-.790
.90	5.03	.242	.300	.288	.158	.200	.212	-.305	-.696	-.790
.90	6.00	.124	.153	.206	.234	.236	.239	-.302	-.694	-.787
.90	7.01	.081	.095	.153	.175	.172	.186	-.295	-.684	-.698
.90	8.62	.057	.099	.116	.121	.115	.131	-.273	-.403	-.243
.90	10.00	.059	.080	.098	.099	.094	.103	-.190	-.227	-.136
.90	.93							-.344	-.698	-.677
.90	2.00	.534	.528	.496	.535	.572	.584	-.345	-.711	-.797
.90	3.41	.302	.329	.347	.330	.334	.338	-.344	-.714	-.801
.90	4.19	.295	.242	.243	.240	.243	.253	-.341	-.713	-.794
.90	5.00	.248	.305	.289	.154	.200	.210	-.337	-.710	-.791
.90	6.06	.122	.147	.205	.235	.237	.241	-.330	-.693	-.781
.90	6.02	.123	.149	.207	.235	.237	.241	-.333	-.695	-.783
.90	7.01	.081	.096	.158	.172	.169	.183	-.340	-.704	-.700
.90	8.57	.058	.100	.116	.121	.116	.131	-.317	-.406	-.247
.90	9.99	.059	.081	.098	.099	.095	.102	-.230	-.238	-.143
.95	.91							-.254	-.598	-.658
.95	2.01	.549	.546	.513	.569	.583	.592	-.251	-.599	-.685
.95	3.40	.339	.317	.342	.323	.341	.355	-.247	-.598	-.684
.95	4.19	.329	.326	.252	.262	.266	.280	-.245	-.597	-.683
.95	5.01	.206	.248	.283	.227	.256	.262	-.243	-.597	-.683
.95	5.98	.112	.127	.185	.229	.229	.242	-.241	-.598	-.683
.95	7.02	.080	.095	.145	.177	.172	.186	-.239	-.597	-.683
.95	8.59	.059	.059	.108	.124	.118	.124	-.235	-.591	-.575
.95	9.99	.057	.045	.085	.092	.090	.089	-.219	-.296	-.146
.95	.91							-.279	-.607	-.666
.95	2.01	.547	.545	.513	.569	.582	.590	-.275	-.606	-.694
.95	3.41	.336	.321	.341	.323	.340	.355	-.277	-.609	-.696
.95	4.19	.333	.314	.251	.261	.266	.281	-.276	-.608	-.695
.95	5.01	.211	.255	.286	.213	.249	.257	-.273	-.606	-.692
.95	6.00	.110	.126	.181	.227	.227	.241	-.275	-.609	-.695
.95	7.01	.080	.095	.147	.176	.171	.186	-.273	-.608	-.693
.95	8.63	.059	.057	.108	.124	.120	.122	-.269	-.597	-.573
.95	8.61	.059	.058	.108	.124	.120	.122	-.268	-.598	-.562
.95	10.00	.058	.045	.084	.092	.090	.089	-.255	-.305	-.145
1.20	.78							-.078	-.309	-.371
1.20	2.01	.464	.478	.462	.524	.525	.533	-.071	-.306	-.367
1.20	3.38	.262	.277	.282	.296	.298	.304	-.067	-.304	-.366
1.20	4.22	.215	.215	.226	.247	.243	.240	-.066	-.306	-.367
1.20	4.99	.171	.183	.191	.209	.205	.203	-.063	-.303	-.364
1.20	6.02	.123	.140	.152	.176	.172	.170	-.061	-.304	-.365
1.20	7.02	.092	.105	.119	.151	.147	.144	-.057	-.302	-.364
1.20	8.65	.065	.068	.079	.117	.113	.110	-.054	-.302	-.364
1.20	8.63	.064	.068	.079	.118	.114	.110	-.056	-.305	-.367
1.20	10.01	.061	.050	.056	.094	.091	.088	-.052	-.303	-.365
1.20	.77							-.083	-.314	-.376
1.20	2.07	.451	.464	.452	.506	.509	.517	-.080	-.311	-.372
1.20	2.00	.465	.478	.464	.524	.528	.535	-.080	-.312	-.373
1.20	3.39	.257	.276	.283	.290	.296	.302	-.080	-.312	-.373
1.20	4.21	.214	.217	.227	.229	.234	.240	-.080	-.312	-.373
1.20	5.02	.168	.181	.190	.208	.204	.201	-.079	-.310	-.372
1.20	6.01	.122	.140	.152	.175	.172	.171	-.078	-.309	-.371
1.20	7.00	.091	.105	.119	.151	.147	.144	-.079	-.310	-.371
1.20	8.65	.065	.067	.079	.117	.113	.110	-.078	-.309	-.371
1.20	9.99	.061	.050	.057	.094	.091	.088	-.077	-.308	-.370

TABLE 11.- Continued

MACH	NPR	S4	S5	S6	S7	CFMD	FMDZFI
0.00	2.01	-.002	.001	-.000	.000	.358	.906
0.00	3.01	-.002	.001	-.000	-.000	.694	.961
0.00	4.02	-.002	.000	-.000	-.001	1.033	.975
0.00	5.02	-.003	-.000	-.000	-.001	1.375	.978
0.00	6.01	-.003	-.001	.000	-.000	1.702	.970
0.00	6.47	-.004	-.001	.000	-.000	1.865	.970
0.00	2.01	-.002	-.002	-.002	-.002	.359	.908
0.00	3.01	-.002	-.002	-.002	-.002	.694	.961
0.00	4.01	-.002	-.003	-.003	-.003	1.032	.976
0.00	5.00	-.003	-.003	-.003	-.003	1.366	.977
0.00	6.01	-.003	-.003	-.003	-.003	1.702	.970
0.00	6.48	-.004	-.004	-.004	-.004	1.867	.970
0.00	2.00	.002	-.002	.001	.002	.354	.902
0.00	2.99	.001	-.002	.000	.001	.686	.955
0.00	4.00	.001	-.002	.000	.000	1.024	.973
0.00	5.02	.000	-.003	-.000	-.000	1.370	.976
0.00	6.00	-.000	-.004	-.000	-.000	1.696	.969
0.00	6.50	-.001	-.004	.000	-.000	1.872	.969
0.00	2.00	-.002	-.002	.001	-.002	.356	.905
0.00	3.00	-.002	-.002	.001	-.002	.689	.955
0.00	4.01	-.002	-.002	.001	-.002	1.029	.973
0.00	4.99	-.003	-.003	.001	-.003	1.359	.977
0.00	6.02	-.003	-.003	.000	-.003	1.700	.968
0.00	6.52	-.003	-.003	.000	-.003	1.872	.969
.65	.97	-.430	-.322	-.241	-.180	-.071	0.000
.65	1.99	-.461	-.369	-.299	-.229	1.192	.912
.65	3.39	-.492	-.401	-.320	-.262	2.775	.964
.65	4.19	-.448	-.349	-.268	-.210	3.669	.969
.65	5.00	-.388	-.283	-.205	-.147	4.622	.974
.65	6.02	-.320	-.212	-.139	-.089	5.768	.972
.65	8.28	-.186	-.078	-.022	.014	8.370	.962
.65	.97	-.419	-.338	-.241	-.165	-.068	0.000
.65	2.02	-.456	-.390	-.304	-.242	1.243	.917
.65	3.41	-.475	-.410	-.314	-.252	2.804	.964
.65	4.21	-.432	-.358	-.261	-.198	3.709	.968
.65	5.01	-.377	-.297	-.203	-.142	4.630	.973
.65	6.01	-.305	-.222	-.139	-.083	5.781	.970
.65	8.31	-.165	-.087	-.018	-.081	8.400	.960
.70	.97	-.435	-.319	-.235	-.175	-.073	0.000
.70	1.99	-.477	-.373	-.297	-.228	1.037	.915
.70	3.40	-.512	-.409	-.324	-.266	2.431	.964
.70	4.22	-.462	-.352	-.267	-.210	3.213	.969
.70	4.99	-.401	-.287	-.206	-.154	3.984	.974
.70	6.02	-.324	-.208	-.134	-.087	4.979	.973
.70	8.61	-.163	-.054	.000	.026	7.574	.959
.70	.97	-.425	-.332	-.235	-.171	-.070	0.000
.70	2.00	-.483	-.406	-.311	-.243	1.045	.914
.70	3.41	-.500	-.421	-.321	-.256	2.432	.963
.70	4.70	-.447	-.362	-.263	-.198	3.180	.966
.70	5.00	-.390	-.300	-.204	-.144	3.987	.972
.70	6.01	-.310	-.219	-.131	-.078	5.028	.971
.70	8.65	-.149	-.062	.000	.012	7.617	.956
.80	.95	-.431	-.293	-.214	-.197	-.085	0.000
.80	2.00	-.616	-.396	-.315	-.263	.797	.911
.80	3.40	-.697	-.432	-.341	-.288	1.861	.962
.80	4.19	-.523	-.363	-.276	-.226	2.466	.969
.80	5.00	-.436	-.290	-.210	-.163	3.068	.973
.80	6.00	-.344	-.207	-.137	-.102	3.835	.975
.80	7.00	-.260	-.132	-.073	-.044	4.590	.970

TABLE 11.- Concluded

MACH	NPR	S4	S5	S6	S7	CFMD	FMDZFI
.80	9.36	-.112	-.003	.036	.049	6.357	.957
.80	.95	-.421	-.303	-.211	-.174	-.081	0.000
.80	2.00	-.578	-.403	-.309	-.256	.812	.913
.80	3.36	-.769	-.459	-.354	-.301	1.823	.959
.80	3.40	-.782	-.457	-.353	-.294	1.832	.958
.80	4.20	-.550	-.376	-.279	-.222	2.428	.965
.80	5.00	-.429	-.300	-.208	-.158	3.045	.972
.80	5.98	-.333	-.214	-.133	-.092	3.792	.973
.80	7.00	-.248	-.140	-.068	-.037	4.607	.966
.80	9.38	-.100	-.009	.041	.056	6.384	.954
.90	.93	-.455	-.246	-.212	-.210	-.117	0.000
.90	2.01	-.855	-.985	-1.010	-.973	.581	.827
.90	3.40	-.852	-.985	-1.019	-.993	1.396	.920
.90	4.23	-.853	-.984	-.969	-.923	1.905	.941
.90	5.03	-.853	-.907	-.802	-.683	2.402	.955
.90	6.00	-.819	-.527	-.418	-.407	3.024	.971
.90	7.01	-.466	-.236	-.206	-.198	3.607	.966
.90	8.62	-.136	-.031	-.011	-.005	4.565	.961
.90	10.00	-.051	.043	.063	.068	5.445	.958
.90	.93	-.441	-.256	-.212	-.197	-.111	0.000
.90	2.00	-.843	-.983	-.987	-.900	.572	.831
.90	3.41	-.849	-.999	-1.023	-.989	1.420	.923
.90	4.19	-.841	-.989	-.966	-.916	1.868	.938
.90	5.00	-.838	-.919	-.816	-.681	2.365	.952
.90	6.06	-.798	-.529	-.413	-.374	3.022	.969
.90	6.02	-.801	-.540	-.419	-.371	3.002	.969
.90	7.01	-.426	-.232	-.193	-.186	3.644	.964
.90	8.57	-.127	-.037	-.005	.004	4.594	.959
.90	9.99	-.042	.035	.065	.073	5.444	.955
.95	.91	-.578	-.294	-.245	-.219	-.113	0.000
.95	2.01	-.746	-.868	-.907	-.886	.501	.799
.95	3.40	-.746	-.869	-.904	-.892	1.247	.911
.95	4.19	-.744	-.867	-.873	-.838	1.671	.934
.95	5.01	-.743	-.857	-.810	-.722	2.135	.953
.95	5.98	-.743	-.785	-.681	-.570	2.673	.962
.95	7.02	-.739	-.604	-.439	-.412	3.232	.961
.95	8.59	-.336	-.163	-.138	-.173	4.104	.961
.95	9.99	-.051	.026	.035	.029	4.890	.961
.95	.91	-.566	-.305	-.246	-.218	-.108	0.000
.95	2.01	-.738	-.877	-.906	-.868	.505	.801
.95	3.41	-.740	-.881	-.906	-.884	1.246	.911
.95	4.19	-.739	-.879	-.876	-.838	1.669	.931
.95	5.01	-.736	-.867	-.809	-.728	2.119	.948
.95	6.00	-.739	-.790	-.677	-.559	2.683	.959
.95	7.01	-.732	-.591	-.427	-.382	3.221	.957
.95	8.63	-.314	-.155	-.128	-.125	4.101	.958
.95	8.61	-.304	-.151	-.124	-.118	4.088	.958
.95	10.00	-.036	.025	.043	.046	4.871	.958
1.20	.78	-.415	-.473	-.441	-.367	-.197	0.000
1.20	2.01	-.412	-.497	-.526	-.533	.243	.619
1.20	3.38	-.410	-.496	-.524	-.526	.705	.827
1.20	4.22	-.412	-.497	-.519	-.507	.990	.870
1.20	4.99	-.409	-.493	-.493	-.479	1.244	.891
1.20	6.02	-.410	-.484	-.451	-.410	1.603	.909
1.20	7.02	-.409	-.444	-.400	-.309	1.945	.920
1.20	8.65	-.407	-.371	-.261	-.218	2.514	.932
1.20	8.63	-.411	-.373	-.263	-.211	2.517	.933
1.20	10.01	-.401	-.256	-.169	-.148	2.996	.938
1.20	.77	-.407	-.475	-.435	-.372	-.195	0.000
1.20	2.07	-.403	-.502	-.522	-.503	.264	.639
1.20	2.00	-.404	-.503	-.525	-.525	.251	.635
1.20	3.39	-.404	-.504	-.524	-.518	.708	.829
1.20	4.21	-.404	-.504	-.517	-.492	.979	.866
1.20	5.02	-.403	-.502	-.493	-.469	1.259	.890
1.20	6.01	-.401	-.490	-.448	-.409	1.590	.907
1.20	7.00	-.402	-.449	-.398	-.308	1.940	.918
1.20	8.65	-.401	-.375	-.257	-.205	2.511	.930
1.20	9.99	-.393	-.261	-.166	-.141	2.978	.936

TABLE 12.- BASIC DATA FOR CONFIGURATION 11 WITH $\alpha_p = 12^\circ$,
 $B/d = 0.152$, AND $A/d = 0.303$

MACH	NPP	P1	P2	P3	P4	P5	P6	P7	P8	P9
0.00	2.01	.287	.241	.469	.436	.476	.499	.503	.504	.516
0.00	3.01	.291	.244	.159	.227	.238	.243	.268	.313	.365
0.00	4.01	.295	.246	.160	.111	.113	.199	.212	.311	.200
0.00	5.00	.295	.247	.160	.111	.112	.106	.197	.250	.289
0.00	6.01	.295	.248	.161	.111	.112	.104	.090	.220	.267
0.00	6.50	.295	.248	.161	.111	.112	.104	.090	.185	.239
0.00	2.00	.288	.242	.471	.440	.477	.501	.504	.498	.517
0.00	2.99	.292	.244	.160	.227	.237	.244	.271	.314	.364
0.00	4.00	.295	.246	.159	.110	.111	.200	.213	.310	.200
0.00	5.00	.296	.247	.160	.110	.112	.107	.198	.249	.288
0.00	6.02	.295	.247	.160	.110	.111	.103	.091	.221	.267
0.00	6.51	.295	.248	.161	.110	.111	.104	.090	.185	.239
.65	2.00	.286	.237	.309	.373	.419	.470	.511	.529	.537
.65	3.42	.288	.243	.158	.110	.124	.199	.264	.304	.420
.65	4.23	.293	.245	.159	.109	.111	.197	.205	.309	.211
.65	5.00	.296	.247	.161	.111	.112	.124	.199	.247	.277
.65	6.02	.296	.247	.161	.111	.112	.104	.090	.211	.265
.65	8.23	.296	.248	.161	.111	.112	.104	.090	.181	.126
.70	1.99	.289	.240	.310	.381	.426	.475	.515	.533	.541
.70	3.41	.289	.244	.158	.111	.120	.201	.266	.309	.417
.70	4.21	.292	.246	.160	.111	.112	.198	.206	.309	.213
.70	5.01	.296	.246	.160	.111	.112	.139	.199	.247	.275
.70	6.00	.296	.248	.161	.111	.112	.104	.091	.210	.267
.70	8.57	.296	.248	.161	.111	.112	.104	.090	.181	.120
.80	2.00	.290	.242	.320	.380	.427	.475	.515	.535	.546
.80	3.41	.290	.244	.159	.112	.111	.207	.257	.314	.422
.80	4.20	.291	.246	.161	.112	.112	.199	.207	.309	.220
.80	4.99	.295	.247	.160	.110	.112	.149	.200	.242	.277
.80	6.01	.296	.247	.161	.111	.112	.104	.091	.200	.269
.80	7.02	.296	.248	.161	.111	.112	.104	.091	.180	.193
.80	9.26	.296	.248	.161	.111	.112	.104	.091	.181	.120
.90	2.01	.288	.247	.308	.337	.383	.433	.478	.511	.536
.90	3.41	.291	.245	.160	.112	.114	.205	.217	.272	.344
.90	4.22	.291	.246	.160	.112	.112	.136	.200	.230	.275
.90	5.01	.292	.247	.160	.111	.112	.105	.182	.215	.257
.90	6.01	.297	.248	.161	.111	.112	.104	.090	.181	.209
.90	7.01	.297	.248	.161	.112	.112	.105	.090	.181	.117
.90	8.61	.296	.248	.161	.111	.112	.105	.090	.181	.118
.90	10.00	.296	.248	.161	.111	.112	.104	.090	.181	.120
.95	2.01	.290	.240	.270	.291	.325	.371	.415	.453	.488
.95	3.39	.292	.244	.160	.112	.111	.117	.189	.221	.279
.95	4.22	.291	.246	.160	.111	.111	.104	.101	.194	.253
.95	5.01	.291	.247	.161	.111	.112	.104	.090	.181	.164
.95	6.01	.296	.247	.160	.110	.112	.103	.089	.180	.115
.95	6.99	.297	.248	.161	.112	.113	.105	.090	.181	.117
.95	8.63	.297	.249	.161	.111	.112	.105	.090	.181	.118
.95	9.98	.296	.249	.161	.111	.112	.105	.090	.181	.120
1.20	2.00	.292	.240	.199	.225	.252	.287	.331	.373	.418
1.20	3.40	.292	.242	.158	.111	.109	.103	.093	.208	.291
1.20	4.20	.291	.243	.159	.111	.111	.103	.090	.181	.223
1.20	4.98	.292	.246	.160	.111	.111	.103	.089	.182	.180
1.20	6.01	.291	.247	.161	.112	.112	.104	.090	.181	.117
1.20	7.04	.292	.247	.161	.112	.113	.105	.090	.180	.115
1.20	8.63	.297	.248	.161	.112	.113	.105	.090	.180	.116
1.20	9.98	.297	.249	.161	.112	.113	.105	.090	.181	.117

TABLE 12.- Continued

MACH	NPR	P10	P11	P12	P13	P14	P15	S1	S2	S3
0.00	2.01	.515	.511	.474	.484	.519	.530	-.001	-.001	-.001
0.00	3.01	.385	.373	.341	.316	.346	.351	-.001	-.002	-.002
0.00	4.01	.396	.317	.197	.238	.234	.256	-.001	-.002	-.002
0.00	5.00	.172	.198	.237	.192	.199	.215	-.002	-.003	-.003
0.00	6.01	.268	.255	.152	.142	.141	.147	-.002	-.003	-.003
0.00	6.50	.234	.239	.173	.142	.138	.141	-.002	-.004	-.004
0.00	2.00	.516	.512	.476	.482	.519	.532	-.001	-.001	-.001
0.00	2.99	.383	.375	.341	.318	.348	.360	-.001	-.002	-.002
0.00	4.00	.397	.317	.193	.248	.243	.258	-.001	-.002	-.002
0.00	5.00	.172	.200	.233	.189	.199	.211	-.002	-.002	-.002
0.00	6.02	.267	.254	.152	.147	.143	.145	-.002	-.003	-.003
0.00	6.51	.234	.238	.173	.146	.141	.137	-.002	-.004	-.004
.65	.98							-.373	-.488	-.437
.65	2.00	.530	.521	.489	.485	.552	.566	-.416	-.571	-.523
.65	3.42	.299	.346	.338	.299	.304	.321	-.451	-.640	-.608
.65	4.23	.324	.353	.262	.220	.222	.237	-.449	-.635	-.601
.65	5.00	.143	.157	.270	.182	.212	.229	-.445	-.625	-.588
.65	6.02	.280	.268	.165	.152	.150	.152	-.436	-.610	-.570
.65	8.23	.148	.154	.158	.068	.112	.115	-.387	-.527	-.481
.70	.98							-.382	-.501	-.444
.70	1.99	.534	.526	.496	.492	.559	.572	-.436	-.609	-.552
.70	3.41	.303	.364	.339	.302	.306	.323	-.472	-.688	-.650
.70	4.21	.338	.358	.255	.223	.225	.239	-.471	-.686	-.644
.70	5.01	.160	.161	.278	.180	.214	.231	-.468	-.676	-.631
.70	6.00	.287	.268	.169	.155	.153	.153	-.459	-.659	-.611
.70	8.57	.132	.142	.146	.068	.110	.114	-.397	-.544	-.486
.80	.98							-.406	-.539	-.450
.80	2.00	.541	.534	.508	.509	.566	.578	-.468	-.659	-.639
.80	3.41	.312	.376	.332	.307	.314	.328	-.474	-.881	-.988
.80	4.20	.367	.370	.237	.230	.232	.247	-.473	-.880	-.988
.80	4.99	.163	.175	.289	.178	.220	.236	-.474	-.880	-.987
.80	6.01	.301	.268	.177	.155	.154	.153	-.470	-.876	-.978
.80	7.02	.210	.233	.192	.121	.127	.136	-.463	-.861	-.902
.80	9.26	.111	.123	.125	.069	.105	.108	-.440	-.683	-.549
.90	.95							-.357	-.654	-.567
.90	2.01	.541	.541	.524	.525	.568	.576	-.354	-.703	-.799
.90	3.41	.364	.348	.366	.315	.336	.346	-.352	-.700	-.796
.90	4.22	.336	.381	.271	.231	.241	.256	-.352	-.702	-.799
.90	5.01	.259	.235	.201	.160	.223	.229	-.350	-.698	-.795
.90	6.01	.269	.279	.220	.142	.163	.173	-.350	-.699	-.796
.90	7.01	.187	.240	.204	.130	.142	.160	-.348	-.697	-.794
.90	8.61	.081	.141	.156	.077	.125	.127	-.344	-.694	-.790
.90	10.00	.075	.096	.108	.069	.095	.098	-.345	-.696	-.793
.95	.94							-.289	-.604	-.630
.95	2.01	.513	.531	.534	.541	.562	.566	-.288	-.609	-.697
.95	3.39	.340	.367	.338	.322	.360	.375	-.284	-.606	-.695
.95	4.22	.299	.319	.254	.249	.266	.276	-.283	-.605	-.694
.95	5.01	.190	.241	.276	.217	.266	.271	-.280	-.602	-.690
.95	6.01	.136	.154	.201	.221	.224	.232	-.281	-.603	-.692
.95	6.99	.110	.114	.139	.186	.187	.197	-.280	-.602	-.691
.95	8.63	.074	.080	.090	.142	.141	.140	-.279	-.602	-.692
.95	9.98	.075	.053	.068	.104	.103	.106	-.282	-.605	-.694
1.20	.83							-.096	-.319	-.380
1.20	2.00	.447	.471	.483	.509	.524	.532	-.096	-.319	-.381
1.20	3.40	.317	.333	.294	.282	.292	.306	-.094	-.318	-.380
1.20	4.20	.245	.255	.243	.225	.237	.246	-.092	-.316	-.378
1.20	4.98	.194	.206	.216	.192	.198	.205	-.092	-.316	-.378
1.20	6.01	.147	.162	.164	.152	.161	.165	-.091	-.316	-.378
1.20	7.04	.116	.127	.133	.140	.140	.139	-.091	-.316	-.378
1.20	8.63	.074	.088	.099	.108	.107	.106	-.090	-.315	-.377
1.20	9.98	.074	.065	.075	.080	.081	.093	-.091	-.315	-.377

TABLE 12.- Concluded

MACH	NPP	S4	S5	S6	S7	CFMD	FMDZFI
0.00	2.01	.001	-.001	.003	.000	.332	.841
0.00	3.01	.001	-.001	.003	.000	.627	.869
0.00	4.01	.001	-.002	.003	-.000	.991	.937
0.00	5.00	-.000	-.001	.004	.000	1.350	.964
0.00	6.01	-.001	-.002	.004	.001	1.715	.976
0.00	6.50	-.002	-.003	.006	.002	1.889	.976
0.00	2.00	-.002	-.001	.001	.001	.328	.835
0.00	2.99	-.002	-.001	.001	.001	.621	.867
0.00	4.00	-.002	-.001	.001	.001	.984	.934
0.00	5.00	-.003	-.001	.000	.001	1.347	.962
0.00	6.02	-.004	-.002	.000	.001	1.714	.974
0.00	6.51	-.004	-.002	.000	.001	1.888	.974
.65	.98	-.357	-.267	-.187	-.125	-.092	0.000
.65	2.00	-.443	-.359	-.278	-.218	1.021	.769
.65	3.42	-.544	-.491	-.407	-.332	2.604	.896
.65	4.23	-.534	-.474	-.390	-.326	3.568	.935
.65	5.00	-.519	-.454	-.368	-.303	4.563	.958
.65	6.02	-.498	-.428	-.339	-.275	5.807	.973
.65	8.23	-.401	-.316	-.246	-.194	8.442	.979
.70	.98	-.359	-.261	-.180	-.121	-.093	0.000
.70	1.99	-.461	-.363	-.277	-.220	.873	.768
.70	3.41	-.574	-.505	-.415	-.337	2.225	.893
.70	4.21	-.564	-.489	-.397	-.328	3.056	.933
.70	5.01	-.548	-.467	-.375	-.305	3.896	.957
.70	6.00	-.526	-.441	-.347	-.276	4.933	.972
.70	8.57	-.397	-.307	-.216	-.151	7.598	.980
.80	.98	-.341	-.222	-.150	-.108	-.095	0.000
.80	2.00	-.552	-.368	-.282	-.233	.660	.760
.80	3.41	-.962	-.605	-.467	-.391	1.694	.886
.80	4.20	-.972	-.587	-.453	-.378	2.318	.926
.80	4.99	-.934	-.542	-.424	-.358	2.970	.952
.80	6.01	-.878	-.495	-.388	-.326	3.788	.969
.80	7.02	-.645	-.405	-.312	-.252	4.537	.968
.80	9.26	-.406	-.275	-.192	-.141	6.373	.980
.90	.95	-.330	-.194	-.164	-.151	-.118	0.000
.90	2.01	-.850	-.935	-.860	-.740	.482	.689
.90	3.41	-.848	-.994	-1.029	-1.023	1.289	.846
.90	4.22	-.850	-.996	-1.033	-1.034	1.803	.895
.90	5.01	-.846	-.993	-1.029	-1.024	2.310	.927
.90	6.01	-.848	-.994	-1.027	-1.000	2.953	.947
.90	7.01	-.845	-.991	-1.002	-.955	3.586	.958
.90	8.61	-.841	-.945	-.860	-.716	4.627	.974
.90	10.00	-.840	-.717	-.534	-.476	5.532	.973
.95	.94	-.477	-.247	-.207	-.186	-.122	0.000
.95	2.01	-.745	-.879	-.906	-.880	.393	.625
.95	3.39	-.742	-.877	-.912	-.911	1.136	.837
.95	4.22	-.741	-.876	-.911	-.914	1.600	.890
.95	5.01	-.738	-.873	-.908	-.906	2.069	.927
.95	6.01	-.740	-.875	-.908	-.892	2.657	.950
.95	6.99	-.739	-.874	-.897	-.857	3.222	.964
.95	8.63	-.739	-.873	-.845	-.787	4.178	.975
.95	9.98	-.742	-.852	-.767	-.664	4.955	.975
1.20	.83	-.413	-.419	-.361	-.273	-.203	0.000
1.20	2.00	-.415	-.509	-.528	-.506	.172	.442
1.20	3.40	-.414	-.509	-.534	-.537	.648	.759
1.20	4.20	-.412	-.508	-.533	-.537	.937	.830
1.20	4.98	-.412	-.508	-.533	-.536	1.217	.871
1.20	6.01	-.412	-.508	-.533	-.529	1.590	.905
1.20	7.04	-.412	-.508	-.531	-.513	1.966	.927
1.20	8.63	-.411	-.507	-.516	-.488	2.552	.948
1.20	9.98	-.411	-.505	-.489	-.461	3.047	.958

TABLE 13.- BASIC DATA FOR CONFIGURATION 12 WITH $\alpha_p = 12^\circ$,
 $B/d = 0.061$, AND $A/d = 0.303$

MACH	NPR	P1	P2	P4	P5	P6	P7	P8	P9
0.00	2.00	.281	.270	.476	.502	.506	.509	.505	.505
0.00	2.99	.286	.247	.237	.276	.418	.366	.333	.364
0.00	4.00	.287	.247	.113	.193	.203	.295	.217	.369
0.00	5.01	.287	.248	.112	.104	.189	.223	.298	.243
0.00	6.00	.287	.249	.113	.103	.099	.169	.213	.263
0.00	6.38	.287	.248	.113	.103	.099	.169	.177	.228
0.00	2.00	.279	.316	.473	.501	.507	.508	.505	.505
0.00	3.01	.286	.246	.232	.265	.404	.379	.325	.361
0.00	4.01	.287	.246	.113	.193	.204	.295	.219	.366
0.00	5.01	.287	.248	.113	.104	.188	.222	.298	.246
0.00	6.01	.287	.248	.113	.103	.101	.169	.211	.263
0.00	6.38	.287	.248	.113	.103	.101	.169	.176	.228
.65	2.00	.283	.245	.352	.404	.466	.512	.530	.530
.65	3.40	.285	.246	.117	.209	.221	.314	.413	.321
.65	4.20	.287	.247	.114	.180	.203	.268	.252	.255
.65	5.01	.288	.248	.114	.106	.192	.215	.278	.246
.65	6.01	.288	.248	.113	.105	.101	.168	.188	.253
.65	8.10	.288	.249	.113	.104	.102	.169	.102	.098
.70	2.04	.286	.250	.337	.380	.440	.492	.519	.533
.70	2.00	.284	.249	.349	.399	.460	.507	.529	.542
.70	3.43	.283	.239	.120	.207	.214	.310	.408	.330
.70	4.21	.286	.246	.111	.173	.202	.259	.259	.233
.70	5.00	.289	.248	.112	.108	.192	.212	.269	.247
.70	6.01	.288	.248	.113	.104	.101	.168	.183	.250
.70	8.37	.288	.249	.113	.104	.102	.169	.102	.080
.80	2.02	.284	.240	.337	.381	.433	.480	.512	.527
.80	3.40	.285	.244	.114	.199	.208	.286	.382	.371
.80	4.18	.287	.247	.113	.109	.206	.217	.291	.212
.80	5.01	.287	.247	.113	.105	.181	.207	.235	.262
.80	6.02	.288	.247	.113	.105	.101	.168	.115	.237
.80	7.00	.288	.249	.114	.105	.102	.168	.102	.133
.80	9.11	.288	.248	.113	.104	.101	.168	.102	.066
.90	2.02	.282	.243	.323	.357	.389	.426	.461	.492
.90	3.41	.284	.243	.113	.181	.205	.221	.265	.317
.90	4.20	.286	.247	.115	.106	.162	.204	.222	.270
.90	5.00	.287	.248	.114	.105	.102	.169	.222	.238
.90	6.01	.288	.248	.113	.105	.101	.168	.103	.171
.90	6.99	.288	.248	.113	.105	.101	.168	.101	.073
.90	8.60	.289	.249	.114	.105	.102	.169	.102	.066
.90	9.98	.288	.249	.114	.104	.102	.169	.103	.067
.95	2.00	.284	.242	.307	.332	.357	.390	.425	.458
.95	3.40	.285	.244	.114	.107	.127	.196	.246	.303
.95	4.23	.285	.245	.113	.104	.099	.166	.171	.249
.95	5.00	.287	.247	.113	.104	.100	.168	.103	.155
.95	6.02	.288	.248	.114	.105	.101	.168	.101	.072
.95	6.99	.289	.249	.114	.106	.102	.168	.102	.067
.95	8.58	.289	.249	.114	.105	.102	.169	.102	.067
.95	10.02	.289	.249	.114	.104	.102	.169	.102	.066
1.20	1.99	.289	.243	.263	.268	.271	.306	.353	.401
1.20	3.01	.285	.241	.113	.111	.109	.198	.290	.328
1.20	3.42	.283	.239	.108	.103	.096	.169	.254	.286
1.20	4.20	.287	.246	.111	.104	.097	.166	.189	.218
1.20	5.02	.286	.247	.115	.107	.100	.168	.105	.166
1.20	6.01	.287	.248	.115	.106	.101	.169	.102	.121
1.20	7.00	.287	.248	.115	.106	.102	.169	.102	.068
1.20	8.63	.288	.248	.113	.106	.101	.168	.101	.066
1.20	10.01	.289	.249	.114	.105	.102	.169	.102	.066

TABLE 13.- Continued

MACH	NPR	P10	P11	P12	P13	P14	P15	S1	S2	S3
0.00	2.00	.499	.502	.475	.492	.518	.531	-.002	-.002	-.002
0.00	2.99	.331	.334	.344	.327	.333	.350	-.002	-.002	-.002
0.00	4.00	.319	.213	.187	.255	.250	.273	-.002	-.002	-.002
0.00	5.01	.145	.223	.177	.200	.198	.209	-.002	-.002	-.003
0.00	6.00	.252	.232	.155	.154	.151	.145	-.003	-.003	-.003
0.00	6.38	.238	.229	.165	.148	.145	.142	-.003	-.003	-.004
0.00	2.00	.503	.501	.475	.488	.517	.530	-.002	-.002	.000
0.00	3.01	.332	.321	.343	.326	.332	.349	-.002	-.002	.000
0.00	4.01	.320	.219	.185	.254	.249	.272	-.002	-.002	.000
0.00	5.01	.147	.221	.177	.199	.197	.209	-.003	-.003	-.001
0.00	6.01	.251	.233	.156	.154	.151	.146	-.004	-.003	-.001
0.00	6.38	.238	.230	.167	.149	.146	.142	-.004	-.003	-.001
.65	.97							-.331	-.349	-.365
.65	2.00	.522	.513	.490	.490	.549	.564	-.582	-.626	-.669
.65	3.40	.296	.308	.328	.292	.303	.326	-.690	-.743	-.799
.65	4.20	.370	.306	.206	.239	.235	.243	-.673	-.725	-.779
.65	5.01	.158	.229	.209	.199	.205	.218	-.661	-.711	-.763
.65	6.01	.269	.250	.192	.154	.155	.153	-.623	-.670	-.717
.65	8.10	.118	.159	.161	.093	.133	.142	-.520	-.557	-.593
.70	.96							-.327	-.343	-.359
.70	2.04	.518	.509	.485	.484	.545	.559	-.576	-.618	-.662
.70	2.00	.525	.517	.494	.493	.553	.567	-.573	-.619	-.667
.70	3.43	.301	.310	.321	.294	.303	.325	-.666	-.717	-.771
.70	4.21	.378	.307	.203	.238	.233	.247	-.660	-.710	-.764
.70	5.00	.165	.224	.230	.196	.207	.221	-.652	-.701	-.754
.70	6.01	.273	.253	.207	.149	.153	.154	-.626	-.673	-.722
.70	8.37	.102	.138	.154	.115	.135	.142	-.515	-.551	-.587
.80	.95							-.320	-.334	-.350
.80	2.02	.527	.523	.506	.512	.554	.565	-.538	-.581	-.628
.80	3.40	.326	.330	.308	.300	.307	.331	-.557	-.603	-.655
.80	4.18	.400	.324	.219	.239	.234	.252	-.554	-.601	-.653
.80	5.01	.214	.157	.277	.156	.215	.232	-.557	-.604	-.655
.80	6.02	.278	.258	.233	.112	.148	.157	-.551	-.598	-.649
.80	7.00	.185	.215	.208	.125	.145	.157	-.544	-.590	-.639
.80	9.11	.078	.095	.125	.139	.137	.136	-.502	-.538	-.578
.90	.93							-.321	-.337	-.353
.90	2.02	.513	.525	.525	.529	.553	.558	-.401	-.439	-.481
.90	3.41	.347	.358	.344	.301	.330	.341	-.404	-.442	-.484
.90	4.20	.256	.352	.325	.194	.245	.261	-.401	-.439	-.481
.90	5.00	.290	.219	.159	.224	.229	.246	-.399	-.437	-.479
.90	6.01	.193	.239	.242	.150	.177	.196	-.398	-.436	-.478
.90	6.99	.127	.164	.194	.168	.185	.193	-.397	-.436	-.477
.90	8.60	.048	.082	.130	.156	.158	.160	-.398	-.436	-.478
.90	9.98	.046	.066	.094	.119	.119	.117	-.393	-.431	-.473
.95	.92							-.295	-.317	-.339
.95	2.00	.485	.508	.524	.533	.546	.550	-.328	-.363	-.401
.95	3.40	.349	.345	.357	.296	.338	.355	-.329	-.365	-.403
.95	4.23	.297	.319	.249	.270	.274	.287	-.329	-.365	-.403
.95	5.00	.198	.234	.273	.208	.258	.264	-.326	-.362	-.400
.95	6.02	.122	.137	.179	.233	.233	.242	-.325	-.361	-.399
.95	6.99	.092	.106	.158	.194	.190	.203	-.326	-.361	-.399
.95	8.58	.057	.100	.117	.127	.126	.130	-.323	-.358	-.396
.95	10.02	.046	.076	.090	.096	.096	.098	-.323	-.358	-.397
1.20	.83							-.112	-.135	-.161
1.20	1.99	.433	.460	.477	.493	.509	.517	-.117	-.140	-.167
1.20	3.01	.335	.323	.323	.327	.333	.347	-.116	-.140	-.166
1.20	3.42	.296	.298	.282	.283	.293	.302	-.115	-.138	-.164
1.20	4.20	.234	.240	.238	.228	.237	.244	-.113	-.137	-.163
1.20	5.02	.185	.197	.202	.195	.199	.203	-.112	-.136	-.162
1.20	6.01	.140	.154	.161	.168	.168	.169	-.111	-.135	-.160
1.20	7.00	.106	.121	.130	.146	.144	.143	-.111	-.134	-.160
1.20	8.63	.051	.082	.094	.117	.115	.112	-.111	-.135	-.160
1.20	10.01	.045	.046	.071	.095	.093	.090	-.109	-.132	-.158

TABLE 13.- Concluded

MACH	NPR	S4	S6	S7	S8	S9	CFMD	FMDZFI
0.00	2.00	-.002	-.003	-.003	-.005	-.004	.338	.860
0.00	2.99	-.002	-.003	-.003	-.004	-.004	.646	.896
0.00	4.00	-.002	-.003	-.003	-.004	-.003	.997	.943
0.00	5.01	-.003	-.004	-.003	-.005	-.003	1.356	.965
0.00	6.00	-.003	-.004	-.004	-.005	-.004	1.715	.976
0.00	6.38	-.004	-.005	-.004	-.006	-.004	1.853	.979
0.00	2.00	-.002	-.003	-.004	-.005	-.003	.339	.860
0.00	3.01	-.002	-.003	-.004	-.005	-.004	.649	.896
0.00	4.01	-.003	-.003	-.004	-.004	-.004	1.000	.946
0.00	5.01	-.003	-.004	-.005	-.005	-.004	1.357	.966
0.00	6.01	-.005	-.006	-.005	-.007	-.005	1.716	.976
0.00	6.38	-.004	-.006	-.005	-.008	-.006	1.854	.979
.65	.97	-.408	-.436	-.379	-.324	-.201	-.123	0.000
.65	2.00	-.756	-.865	-.792	-.860	-.431	1.023	.765
.65	3.40	-.909	-1.127	-1.044	-1.126	-.597	2.607	.897
.65	4.20	-.885	-1.083	-1.002	-1.080	-.620	3.569	.933
.65	5.01	-.864	-1.043	-.963	-1.036	-.601	4.551	.955
.65	6.01	-.810	-.957	-.881	-.940	-.553	5.761	.971
.65	8.10	-.666	-.757	-.689	-.708	-.401	8.310	.978
.70	.96	-.402	-.427	-.369	-.304	-.231	-.123	0.000
.70	2.04	-.753	-.873	-.805	-.835	-.392	.902	.762
.70	2.00	-.761	-.886	-.815	-.847	-.412	.882	.764
.70	3.43	-.882	-1.105	-1.044	-1.083	-.520	2.266	.894
.70	4.21	-.875	-1.089	-1.021	-1.059	-.569	3.065	.929
.70	5.00	-.862	-1.058	-.988	-1.020	-.580	3.898	.951
.70	6.01	-.823	-.984	-.911	-.932	-.558	4.966	.968
.70	8.37	-.661	-.747	-.678	-.669	-.356	7.523	.979
.80	.95	-.393	-.403	-.338	-.263	-.295	-.127	0.000
.80	2.02	-.717	-.841	-.801	-.799	-.512	.660	.737
.80	3.40	-.746	-1.031	-.966	-1.029	-.618	1.698	.877
.80	4.18	-.744	-1.101	-1.024	-1.119	-.685	2.303	.914
.80	5.01	-.747	-1.086	-1.006	-1.092	-.789	2.992	.943
.80	6.02	-.741	-1.009	-.946	-.993	-.751	3.796	.960
.80	7.00	-.729	-.895	-.852	-.841	-.643	4.567	.966
.80	9.11	-.656	-.721	-.665	-.574	-.466	6.339	.980
.90	.93	-.390	-.373	-.286	-.234	-.229	-.126	0.000
.90	2.02	-.555	-.880	-.877	-.975	-.646	.480	.677
.90	3.41	-.558	-.898	-1.037	-1.319	-.852	1.291	.839
.90	4.20	-.555	-.894	-1.033	-1.318	-.941	1.791	.891
.90	5.00	-.553	-.892	-1.031	-1.313	-.960	2.305	.924
.90	6.01	-.552	-.891	-1.030	-1.221	-.950	2.946	.943
.90	6.99	-.551	-.891	-1.009	-1.083	-.922	3.589	.960
.90	8.60	-.552	-.883	-.851	-.935	-.815	4.655	.975
.90	9.98	-.547	-.785	-.730	-.768	-.728	5.510	.972
.95	.92	-.380	-.368	-.295	-.257	-.189	-.117	0.000
.95	2.00	-.469	-.779	-.866	-.949	-.581	.404	.648
.95	3.40	-.471	-.783	-.912	-1.171	-.822	1.140	.830
.95	4.23	-.471	-.784	-.913	-1.173	-.863	1.622	.888
.95	5.00	-.468	-.780	-.908	-1.166	-.871	2.074	.924
.95	6.02	-.467	-.779	-.907	-1.113	-.858	2.665	.948
.95	6.99	-.468	-.781	-.900	-.974	-.810	3.240	.961
.95	8.58	-.464	-.773	-.778	-.844	-.685	4.112	.964
.95	10.02	-.465	-.753	-.695	-.763	-.616	4.989	.971
1.20	.83	-.205	-.302	-.278	-.281	-.093	-.188	0.000
1.20	1.99	-.212	-.429	-.513	-.574	-.350	.183	.470
1.20	3.01	-.211	-.429	-.521	-.689	-.470	.511	.702
1.20	3.42	-.210	-.427	-.519	-.687	-.493	.654	.756
1.20	4.20	-.209	-.426	-.518	-.686	-.509	.937	.825
1.20	5.02	-.208	-.425	-.517	-.685	-.521	1.228	.866
1.20	6.01	-.206	-.424	-.516	-.682	-.521	1.583	.898
1.20	7.00	-.206	-.423	-.515	-.661	-.506	1.945	.921
1.20	8.63	-.206	-.424	-.510	-.563	-.488	2.551	.942
1.20	10.01	-.204	-.421	-.472	-.493	-.459	3.037	.950

TABLE 14.- BASIC DATA FOR CONFIGURATION 13 WITH $\alpha_p = 12^\circ$,
 $B/d = 0.484$, AND $A/d = 0.064$

MACH	NPR	P1	P2	P3	P4	P5	P6	P7	P8	P9
0.00	2.01	.281	.239	.374	.411	.426	.466	.497	.502	.502
0.00	3.00	.280	.241	.163	.152	.221	.246	.308	.376	.352
0.00	4.01	.288	.244	.164	.114	.119	.120	.217	.248	.292
0.00	5.00	.288	.245	.165	.114	.119	.120	.112	.191	.219
0.00	6.00	.288	.245	.165	.114	.118	.120	.111	.104	.158
0.00	6.46	.288	.245	.165	.114	.118	.121	.112	.104	.097
0.00	2.00	.282	.238	.373	.415	.419	.465	.499	.505	.506
0.00	3.02	.282	.241	.163	.171	.224	.247	.302	.372	.332
0.00	4.01	.287	.244	.164	.114	.119	.120	.216	.246	.296
0.00	5.01	.287	.245	.164	.113	.118	.120	.111	.190	.218
0.00	6.00	.287	.245	.165	.113	.118	.120	.111	.104	.158
0.00	6.47	.288	.246	.165	.114	.118	.121	.111	.104	.098
.65	2.02	.281	.235	.242	.309	.354	.390	.427	.463	.494
.65	3.32	.283	.240	.162	.114	.119	.121	.230	.317	.416
.65	3.42	.285	.243	.165	.116	.119	.123	.224	.279	.354
.65	4.20	.285	.244	.164	.113	.117	.120	.158	.215	.263
.65	5.00	.289	.244	.164	.113	.118	.119	.111	.195	.211
.65	6.02	.289	.245	.165	.113	.118	.120	.110	.104	.114
.65	8.15	.290	.246	.165	.114	.119	.121	.112	.104	.097
.70	2.00	.283	.238	.249	.306	.351	.388	.426	.464	.495
.70	3.41	.284	.243	.164	.115	.118	.122	.222	.258	.341
.70	4.20	.284	.244	.165	.114	.118	.120	.146	.216	.261
.70	5.01	.287	.244	.165	.114	.119	.120	.110	.195	.210
.70	6.02	.288	.245	.165	.114	.119	.120	.111	.104	.106
.70	7.01	.288	.246	.166	.114	.119	.121	.112	.104	.098
.70	8.44	.288	.246	.166	.114	.119	.121	.112	.104	.098
.80	2.01	.283	.238	.250	.303	.346	.383	.420	.457	.489
.80	3.42	.285	.242	.164	.115	.118	.120	.217	.237	.310
.80	4.22	.284	.244	.165	.115	.118	.121	.127	.215	.253
.80	5.01	.285	.245	.165	.115	.119	.121	.111	.197	.210
.80	6.01	.288	.245	.166	.114	.119	.121	.111	.105	.098
.80	6.99	.288	.246	.166	.114	.119	.121	.112	.105	.098
.80	9.15	.288	.246	.166	.114	.119	.121	.112	.105	.097
.90	2.01	.283	.238	.266	.309	.348	.385	.422	.460	.492
.90	3.41	.286	.242	.164	.115	.118	.120	.211	.229	.285
.90	4.19	.285	.244	.165	.115	.118	.121	.116	.212	.234
.90	4.22	.285	.244	.164	.115	.117	.120	.115	.212	.234
.90	5.02	.284	.244	.165	.114	.118	.121	.111	.196	.209
.90	6.02	.287	.245	.166	.114	.120	.121	.111	.104	.126
.90	7.02	.289	.245	.166	.114	.119	.121	.111	.105	.098
.90	8.62	.288	.246	.166	.114	.119	.121	.112	.105	.098
.90	10.01	.288	.246	.166	.114	.119	.121	.112	.105	.097
.95	1.99	.284	.239	.265	.303	.336	.372	.409	.445	.477
.95	3.42	.285	.241	.164	.115	.118	.121	.143	.208	.216
.95	4.22	.285	.243	.164	.115	.118	.120	.110	.116	.199
.95	5.01	.284	.244	.165	.115	.118	.121	.111	.105	.158
.95	5.99	.286	.245	.166	.115	.120	.121	.112	.105	.098
.95	6.00	.286	.246	.166	.115	.120	.121	.112	.105	.098
.95	7.01	.288	.246	.166	.114	.120	.121	.111	.104	.098
.95	8.61	.288	.246	.166	.114	.119	.121	.112	.105	.097
.95	10.02	.288	.246	.166	.114	.119	.121	.112	.105	.097
1.20	2.02	.286	.238	.193	.229	.258	.285	.319	.355	.389
1.20	3.41	.285	.238	.158	.110	.113	.114	.112	.113	.172
1.20	4.18	.289	.244	.164	.114	.117	.119	.105	.103	.104
1.20	5.02	.286	.243	.164	.115	.119	.120	.108	.104	.098
1.20	6.01	.287	.245	.166	.116	.119	.121	.111	.105	.099
1.20	7.02	.286	.245	.166	.115	.119	.122	.111	.105	.098
1.20	8.63	.287	.245	.165	.115	.120	.121	.109	.104	.097
1.20	10.00	.289	.246	.166	.115	.120	.121	.112	.105	.098

TABLE 14.- Continued

MACH	NPR	P10	P11	P12	P13	P14	P15	S1	S2	S3
0.00	2.01	.501	.497	.471	.464	.521	.535	-.000	-.000	-.000
0.00	3.00	.359	.326	.359	.343	.331	.351	-.000	-.000	-.000
0.00	4.01	.185	.373	.281	.231	.233	.248	-.000	-.001	-.001
0.00	5.00	.287	.263	.159	.190	.193	.203	-.001	-.001	-.001
0.00	6.00	.224	.244	.243	.113	.154	.169	-.001	-.001	-.001
0.00	6.46	.204	.217	.218	.099	.151	.161	-.001	-.001	-.001
0.00	2.00	.503	.500	.474	.463	.524	.538	-.000	.001	-.000
0.00	3.02	.360	.326	.347	.323	.341	.345	-.000	.001	-.000
0.00	4.01	.183	.374	.281	.229	.233	.248	-.001	.000	-.001
0.00	5.01	.286	.266	.159	.190	.192	.202	-.001	.000	-.001
0.00	6.00	.224	.244	.244	.113	.154	.168	-.001	.000	-.001
0.00	6.47	.203	.216	.218	.099	.151	.161	-.001	-.000	-.001
.65	.99							-.146	-.161	-.176
.65	2.02	.513	.518	.508	.503	.544	.550	-.147	-.163	-.178
.65	3.32	.335	.311	.323	.299	.315	.336	-.161	-.178	-.195
.65	3.42	.386	.285	.304	.304	.308	.330	-.161	-.178	-.195
.65	4.20	.268	.185	.361	.163	.262	.274	-.161	-.179	-.196
.65	5.00	.272	.258	.161	.204	.203	.217	-.159	-.177	-.194
.65	6.02	.209	.243	.254	.130	.166	.180	-.157	-.174	-.191
.65	8.15	.094	.156	.142	.143	.142	.148	-.148	-.165	-.181
.70	.98							-.149	-.165	-.181
.70	2.00	.515	.523	.514	.511	.551	.557	-.149	-.166	-.183
.70	3.41	.391	.298	.317	.302	.312	.334	-.164	-.182	-.201
.70	4.20	.272	.182	.363	.165	.268	.279	-.164	-.183	-.202
.70	5.01	.270	.259	.162	.206	.204	.218	-.162	-.180	-.199
.70	6.02	.206	.243	.255	.134	.170	.183	-.159	-.179	-.197
.70	7.01	.144	.187	.188	.144	.166	.179	-.156	-.175	-.193
.70	8.44	.094	.138	.133	.138	.137	.141	-.150	-.167	-.184
.80	.97							-.162	-.181	-.201
.80	2.01	.512	.523	.519	.519	.552	.558	-.163	-.183	-.203
.80	3.42	.371	.339	.339	.289	.316	.337	-.173	-.194	-.217
.80	4.22	.278	.189	.367	.170	.277	.286	-.177	-.198	-.221
.80	5.01	.269	.258	.163	.213	.210	.226	-.174	-.195	-.218
.80	6.01	.200	.243	.261	.144	.180	.193	-.175	-.196	-.219
.80	6.99	.118	.186	.188	.158	.174	.186	-.171	-.192	-.214
.80	9.15	.094	.101	.124	.125	.124	.125	-.156	-.175	-.195
.90	.97							-.178	-.205	-.236
.90	2.01	.515	.529	.530	.532	.560	.565	-.175	-.203	-.234
.90	3.41	.348	.361	.353	.306	.336	.354	-.178	-.206	-.237
.90	4.19	.289	.268	.373	.195	.278	.290	-.177	-.205	-.237
.90	4.22	.289	.249	.371	.191	.281	.291	-.179	-.207	-.239
.90	5.02	.264	.259	.166	.226	.224	.244	-.178	-.205	-.237
.90	6.02	.196	.245	.275	.139	.188	.200	-.177	-.205	-.237
.90	7.02	.102	.187	.193	.171	.184	.197	-.175	-.202	-.234
.90	8.62	.094	.121	.130	.142	.141	.143	-.174	-.201	-.232
.90	10.01	.094	.092	.102	.108	.108	.108	-.170	-.196	-.227
.95	.96							-.141	-.167	-.197
.95	1.99	.503	.525	.536	.543	.559	.563	-.142	-.168	-.199
.95	3.42	.249	.302	.343	.344	.378	.390	-.137	-.163	-.193
.95	4.22	.208	.255	.247	.298	.324	.337	-.138	-.164	-.194
.95	5.01	.188	.216	.252	.235	.253	.274	-.138	-.164	-.195
.95	5.99	.095	.142	.204	.238	.240	.250	-.136	-.162	-.192
.95	6.00	.095	.141	.203	.238	.239	.249	-.136	-.162	-.192
.95	7.01	.094	.102	.144	.197	.194	.205	-.136	-.162	-.192
.95	8.61	.094	.092	.093	.147	.146	.149	-.139	-.165	-.195
.95	10.02	.094	.092	.072	.111	.110	.112	-.137	-.163	-.193
1.20	.87							-.017	-.032	-.052
1.20	2.02	.417	.445	.467	.480	.491	.500	-.012	-.027	-.046
1.20	3.41	.223	.284	.320	.297	.315	.325	-.014	-.029	-.049
1.20	4.18	.180	.225	.239	.253	.259	.264	-.013	-.028	-.047
1.20	5.02	.097	.185	.191	.211	.212	.215	-.012	-.027	-.046
1.20	6.01	.095	.146	.153	.172	.173	.173	-.011	-.026	-.046
1.20	7.02	.095	.111	.128	.144	.143	.143	-.010	-.025	-.044
1.20	8.63	.094	.091	.093	.109	.107	.108	-.010	-.025	-.045
1.20	10.00	.094	.092	.069	.084	.084	.085	-.010	-.025	-.045

TABLE 14.- Concluded

MACH	NPR	S4	S5	S6	S7	S8	S9	CFMD	FMDZFI
0.00	2.01	-.000	.001	.001	-.000	-.001	.001	.314	.794
0.00	3.00	-.000	.001	.001	-.000	-.001	.001	.624	.861
0.00	4.01	-.001	.001	.001	-.000	-.001	-.000	.973	.922
0.00	5.00	-.001	.001	.001	-.000	-.001	-.000	1.333	.954
0.00	6.00	-.001	.001	.001	.000	-.002	-.000	1.698	.968
0.00	6.46	-.001	.001	.001	.000	-.002	.000	1.863	.971
0.00	2.00	-.000	.001	.001	-.000	.002	.002	.312	.792
0.00	3.02	-.000	.000	.001	-.001	.002	.001	.629	.864
0.00	4.01	-.001	.000	.001	-.001	.001	.000	.975	.922
0.00	5.01	-.001	-.000	.001	-.001	.001	.000	1.339	.953
0.00	6.00	-.001	-.000	.001	-.001	.000	-.000	1.699	.968
0.00	6.47	-.001	.000	.001	-.001	.000	-.000	1.866	.970
.65	.99	-.189	-.201	-.203	-.207	-.224	-.096	-.084	0.000
.65	2.02	-.191	-.206	-.212	-.217	-.242	-.146	.997	.736
.65	3.32	-.211	-.231	-.243	-.253	-.293	-.192	2.470	.872
.65	3.42	-.211	-.231	-.241	-.253	-.293	-.206	2.561	.878
.65	4.20	-.212	-.232	-.244	-.254	-.294	-.214	3.524	.924
.65	5.00	-.209	-.228	-.240	-.249	-.287	-.212	4.490	.949
.65	6.02	-.206	-.225	-.236	-.244	-.281	-.208	5.752	.964
.65	8.15	-.194	-.210	-.220	-.224	-.248	-.190	8.420	.982
.70	.98	-.194	-.206	-.210	-.213	-.224	-.173	-.089	0.000
.70	2.00	-.197	-.212	-.220	-.224	-.245	-.162	.846	.735
.70	3.41	-.218	-.239	-.252	-.262	-.300	-.217	2.202	.877
.70	4.20	-.218	-.239	-.252	-.263	-.301	-.224	3.047	.923
.70	5.01	-.215	-.236	-.250	-.258	-.293	-.223	3.890	.946
.70	6.02	-.213	-.232	-.248	-.252	-.284	-.219	4.972	.963
.70	7.01	-.208	-.226	-.239	-.243	-.273	-.202	6.028	.976
.70	8.44	-.198	-.214	-.223	-.227	-.248	-.176	7.552	.982
.80	.97	-.217	-.233	-.241	-.239	-.256	-.237	-.088	0.000
.80	2.01	-.221	-.241	-.253	-.253	-.276	-.186	.648	.733
.80	3.42	-.237	-.263	-.278	-.290	-.332	-.236	1.691	.873
.80	4.22	-.241	-.269	-.287	-.295	-.339	-.261	2.365	.923
.80	5.01	-.238	-.264	-.281	-.288	-.329	-.254	3.003	.946
.80	6.01	-.239	-.265	-.282	-.288	-.327	-.240	3.783	.964
.80	6.99	-.233	-.257	-.272	-.276	-.311	-.231	4.647	.977
.80	9.15	-.212	-.230	-.241	-.242	-.260	-.196	6.361	.982
.90	.97	-.265	-.316	-.355	-.370	-.404	-.339	-.071	0.000
.90	2.01	-.263	-.315	-.352	-.374	-.426	-.272	.528	.751
.90	3.41	-.267	-.320	-.360	-.391	-.473	-.356	1.333	.874
.90	4.19	-.266	-.320	-.360	-.392	-.475	-.366	1.828	.919
.90	4.22	-.268	-.322	-.363	-.392	-.474	-.373	1.864	.922
.90	5.02	-.267	-.321	-.361	-.391	-.473	-.371	2.377	.948
.90	6.02	-.266	-.320	-.360	-.390	-.471	-.368	3.024	.966
.90	7.02	-.263	-.316	-.356	-.385	-.463	-.359	3.681	.980
.90	8.62	-.261	-.312	-.349	-.371	-.425	-.299	4.711	.985
.90	10.01	-.254	-.301	-.334	-.339	-.353	-.227	5.600	.985
.95	.96	-.226	-.280	-.321	-.363	-.439	-.385	-.071	0.000
.95	1.99	-.228	-.284	-.326	-.374	-.443	-.364	.463	.740
.95	3.42	-.221	-.276	-.316	-.368	-.435	-.352	1.201	.874
.95	4.22	-.223	-.277	-.319	-.370	-.437	-.354	1.682	.926
.95	5.01	-.223	-.278	-.319	-.371	-.439	-.354	2.127	.946
.95	5.99	-.221	-.275	-.316	-.368	-.435	-.351	2.704	.970
.95	6.00	-.221	-.275	-.316	-.368	-.434	-.351	2.716	.971
.95	7.01	-.221	-.275	-.316	-.368	-.434	-.350	3.297	.979
.95	8.61	-.224	-.278	-.319	-.373	-.438	-.354	4.250	.985
.95	10.02	-.222	-.276	-.317	-.351	-.436	-.351	5.042	.986
1.20	.87	-.070	-.106	-.132	-.163	-.216	-.113	-.154	0.000
1.20	2.02	-.064	-.100	-.128	-.160	-.210	-.166	.221	.551
1.20	3.41	-.066	-.102	-.131	-.163	-.211	-.171	.670	.776
1.20	4.18	-.065	-.101	-.129	-.162	-.210	-.170	.952	.844
1.20	5.02	-.064	-.099	-.128	-.160	-.209	-.170	1.257	.885
1.20	6.01	-.063	-.099	-.127	-.159	-.207	-.170	1.618	.915
1.20	7.02	-.062	-.097	-.125	-.157	-.204	-.167	1.980	.934
1.20	8.63	-.062	-.097	-.125	-.158	-.204	-.168	2.577	.953
1.20	10.00	-.062	-.097	-.125	-.157	-.204	-.168	3.078	.963

TABLE 15.- BASIC DATA FOR CONFIGURATION 14 WITH $\alpha_p = 12^\circ$,
 $B/d = 0.194$, AND $A/d = 0.064$

MACH	NPR	P1	P2	P3	P4	P5	P6	P7	P8	P9
0.00	1.99	.282	.238	.390	.417	.422	.467	.501	.506	.508
0.00	3.02	.284	.240	.164	.165	.222	.246	.307	.380	.335
0.00	4.00	.288	.243	.166	.115	.118	.120	.217	.248	.293
0.00	4.98	.288	.244	.167	.115	.119	.121	.112	.191	.220
0.00	6.00	.288	.245	.167	.115	.118	.121	.112	.105	.157
0.00	6.48	.288	.244	.167	.115	.118	.121	.111	.104	.098
0.00	1.99	.280	.237	.391	.419	.420	.468	.500	.500	.508
0.00	3.02	.283	.242	.165	.149	.219	.246	.313	.394	.333
0.00	4.00	.288	.245	.166	.115	.119	.122	.216	.246	.296
0.00	5.02	.288	.245	.166	.114	.118	.121	.110	.190	.218
0.00	6.00	.288	.246	.167	.114	.118	.121	.110	.104	.158
0.00	6.49	.288	.246	.167	.114	.118	.121	.111	.104	.098
.65	2.00	.280	.236	.243	.307	.354	.392	.432	.464	.497
.65	3.39	.283	.242	.165	.115	.118	.143	.228	.288	.371
.65	4.22	.285	.243	.165	.115	.119	.121	.156	.214	.260
.65	4.98	.288	.245	.167	.115	.119	.121	.113	.195	.211
.65	6.00	.288	.245	.167	.115	.118	.121	.112	.104	.111
.65	8.19	.288	.246	.167	.115	.119	.121	.113	.104	.098
.70	2.01	.280	.236	.261	.310	.353	.392	.463	.465	.496
.70	3.41	.283	.241	.164	.114	.116	.131	.242	.270	.350
.70	4.18	.285	.245	.166	.115	.119	.122	.181	.217	.261
.70	4.99	.288	.245	.167	.115	.119	.121	.132	.196	.208
.70	6.02	.289	.246	.168	.115	.119	.122	.109	.106	.105
.70	8.49	.288	.246	.167	.115	.118	.121	.093	.105	.098
.80	2.00	.285	.239	.257	.306	.348	.388	.444	.461	.493
.80	3.42	.283	.240	.163	.113	.115	.124	.229	.239	.313
.80	4.21	.285	.244	.166	.115	.118	.121	.166	.214	.253
.80	4.99	.287	.244	.167	.115	.119	.121	.122	.198	.210
.80	6.01	.288	.245	.167	.115	.119	.121	.106	.104	.101
.80	7.00	.288	.245	.167	.115	.119	.121	.106	.105	.099
.80	9.24	.288	.246	.168	.115	.119	.121	.097	.105	.098
.90	2.02	.281	.237	.277	.310	.347	.386	.429	.460	.492
.90	3.40	.286	.242	.166	.116	.118	.122	.219	.232	.292
.90	4.17	.286	.244	.167	.116	.119	.122	.140	.213	.235
.90	5.00	.286	.245	.167	.116	.119	.122	.113	.198	.210
.90	6.00	.289	.245	.167	.115	.119	.121	.105	.105	.137
.90	7.01	.289	.245	.168	.115	.119	.121	.107	.105	.098
.90	8.62	.289	.246	.168	.115	.119	.122	.103	.106	.098
.90	10.01	.289	.246	.168	.115	.119	.121	.105	.105	.098
.95	1.99	.283	.238	.265	.298	.334	.371	.423	.441	.475
.95	3.40	.285	.241	.165	.115	.118	.125	.147	.209	.217
.95	4.21	.284	.242	.165	.113	.116	.119	.111	.122	.197
.95	5.02	.285	.244	.167	.115	.118	.121	.113	.105	.167
.95	5.01	.285	.244	.167	.115	.119	.122	.113	.105	.152
.95	5.99	.288	.245	.168	.115	.119	.122	.113	.105	.098
.95	7.01	.289	.245	.168	.115	.119	.121	.113	.106	.098
.95	8.61	.289	.245	.168	.115	.119	.122	.113	.106	.098
1.20	1.97	.278	.233	.221	.252	.279	.308	.346	.371	.406
1.20	1.99	.285	.238	.206	.239	.264	.292	.335	.356	.393
1.20	3.38	.283	.236	.158	.108	.109	.112	.109	.116	.185
1.20	4.21	.285	.240	.163	.113	.116	.119	.111	.101	.101
1.20	4.99	.285	.242	.166	.115	.118	.121	.113	.103	.096
1.20	5.99	.285	.243	.167	.116	.118	.121	.114	.105	.099
1.20	7.01	.285	.244	.167	.115	.119	.122	.113	.105	.098
1.20	8.62	.288	.245	.167	.115	.120	.122	.114	.106	.099
1.20	9.99	.289	.246	.168	.116	.120	.122	.113	.106	.098

TABLE 15.- Continued

MACH	NPR	P10	P11	P12	P13	P14	P15	S1	S2	S3
0.00	1.99	.505	.502	.477	.470	.526	.540	-.000	.000	-.000
0.00	3.02	.361	.323	.347	.330	.340	.345	-.000	.000	-.000
0.00	4.00	.186	.373	.283	.229	.232	.248	-.000	.000	-.000
0.00	4.98	.289	.264	.162	.192	.195	.204	-.000	.000	-.000
0.00	6.00	.224	.244	.244	.113	.155	.168	-.001	.000	-.001
0.00	6.48	.203	.216	.218	.099	.151	.160	-.001	.001	-.001
0.00	1.99	.504	.502	.476	.470	.526	.540	-.000	-.000	-.000
0.00	3.02	.363	.319	.342	.335	.340	.343	-.000	-.000	-.000
0.00	4.00	.185	.373	.283	.228	.233	.249	-.000	-.001	-.001
0.00	5.02	.286	.269	.162	.190	.191	.202	-.001	-.001	-.001
0.00	6.00	.224	.244	.244	.114	.154	.168	-.001	-.001	-.001
0.00	6.49	.202	.215	.218	.099	.151	.161	-.001	-.001	-.001
.65	.98							-.147	-.159	-.177
.65	2.00	.515	.521	.511	.507	.548	.554	-.147	-.160	-.179
.65	3.39	.378	.284	.310	.304	.310	.332	-.163	-.176	-.199
.65	4.22	.270	.177	.356	.160	.263	.274	-.158	-.172	-.193
.65	4.98	.273	.259	.164	.205	.203	.217	-.160	-.174	-.194
.65	6.00	.210	.244	.256	.132	.167	.180	-.158	-.174	-.193
.65	8.19	.094	.153	.141	.143	.141	.147	-.149	-.162	-.182
.70	.99							-.150	-.163	-.182
.70	2.01	.515	.522	.515	.511	.549	.555	-.150	-.164	-.185
.70	3.41	.386	.295	.317	.302	.312	.333	-.164	-.179	-.201
.70	4.18	.270	.183	.368	.162	.265	.276	-.165	-.181	-.203
.70	4.99	.272	.257	.161	.207	.206	.221	-.162	-.177	-.200
.70	6.02	.207	.243	.257	.132	.171	.183	-.158	-.174	-.197
.70	8.49	.094	.136	.133	.138	.136	.140	-.149	-.162	-.184
.80	.98							-.165	-.181	-.203
.80	.98							-.163	-.179	-.201
.80	2.00	.515	.526	.523	.522	.554	.560	-.163	-.181	-.204
.80	3.42	.369	.340	.339	.293	.316	.336	-.176	-.196	-.221
.80	4.21	.277	.191	.372	.167	.273	.284	-.178	-.197	-.223
.80	4.99	.270	.255	.161	.214	.212	.229	-.176	-.195	-.220
.80	6.01	.201	.244	.264	.145	.178	.192	-.173	-.192	-.218
.80	7.00	.118	.186	.189	.159	.174	.186	-.171	-.189	-.214
.80	9.24	.094	.099	.123	.125	.123	.123	-.157	-.173	-.196
.90	.98							-.180	-.206	-.238
.90	2.02	.514	.527	.529	.532	.557	.562	-.176	-.201	-.234
.90	3.40	.350	.362	.351	.311	.338	.354	-.179	-.205	-.239
.90	4.17	.289	.283	.374	.197	.274	.287	-.179	-.205	-.239
.90	5.00	.265	.258	.167	.226	.225	.245	-.178	-.203	-.237
.90	6.00	.198	.247	.278	.135	.185	.199	-.178	-.204	-.237
.90	7.01	.104	.188	.195	.171	.185	.197	-.176	-.202	-.235
.90	8.62	.094	.122	.131	.143	.141	.143	-.174	-.199	-.232
.90	10.01	.094	.092	.103	.112	.110	.109	-.171	-.195	-.228
.95	.96							-.141	-.165	-.197
.95	1.99	.501	.522	.535	.544	.558	.562	-.138	-.162	-.194
.95	3.40	.250	.302	.343	.354	.377	.389	-.136	-.160	-.192
.95	4.21	.206	.249	.252	.303	.325	.337	-.135	-.159	-.191
.95	5.02	.190	.217	.253	.233	.250	.272	-.136	-.160	-.193
.95	5.01	.184	.211	.251	.237	.257	.275	-.136	-.160	-.193
.95	5.99	.095	.144	.211	.242	.244	.252	-.138	-.162	-.194
.95	7.01	.094	.101	.147	.199	.196	.206	-.137	-.161	-.193
.95	8.61	.094	.091	.091	.146	.145	.148	-.136	-.159	-.192
1.20	.86							-.011	-.024	-.046
1.20	1.97	.432	.458	.481	.495	.504	.512	-.011	-.024	-.045
1.20	1.99	.421	.449	.473	.489	.498	.507	-.013	-.026	-.048
1.20	3.38	.226	.287	.316	.298	.315	.328	-.015	-.028	-.049
1.20	4.21	.179	.224	.241	.254	.260	.264	-.014	-.027	-.048
1.20	4.99	.097	.185	.193	.213	.214	.217	-.012	-.025	-.047
1.20	5.99	.095	.147	.154	.174	.173	.175	-.013	-.026	-.047
1.20	7.01	.094	.112	.128	.144	.143	.144	-.012	-.025	-.047
1.20	8.62	.094	.092	.092	.108	.107	.108	-.011	-.024	-.046
1.20	9.99	.094	.092	.069	.085	.084	.085	-.012	-.025	-.046

TABLE 15.- Concluded

MACH	NPR	S4	S5	S6	S7	S8	S9	CFMD	FMDZFI
0.00	1.99	-.000	.001	.001	.000	-.001	.000	.307	.785
0.00	3.02	-.000	.001	.001	.000	-.001	-.000	.626	.860
0.00	4.00	-.000	-.000	-.000	.000	-.001	-.000	.972	.922
0.00	4.98	-.000	-.001	-.000	.000	-.001	-.000	1.331	.956
0.00	6.00	-.001	-.001	-.000	.000	-.001	.000	1.701	.971
0.00	6.48	-.001	-.000	.000	.001	-.002	.000	1.872	.972
0.00	1.99	-.000	-.000	-.000	.001	-.001	.003	.310	.790
0.00	3.02	-.000	-.000	-.001	.001	-.001	.001	.629	.863
0.00	4.00	-.001	-.001	-.001	.000	-.001	-.000	.971	.921
0.00	5.02	-.001	-.001	-.001	.000	-.001	-.001	1.341	.954
0.00	6.00	-.001	-.001	-.001	.000	-.002	-.002	1.698	.968
0.00	6.49	-.001	-.001	-.002	-.000	-.002	-.002	1.872	.970
.65	.98	-.190	.397	-.206	-.207	-.224	.050	-.087	0.000
.65	2.00	-.193	-.035	-.211	-.217	-.226	.002	.970	.727
.65	3.39	-.212	-.060	-.244	-.251	-.278	-.049	2.542	.875
.65	4.22	-.208	-.056	-.239	-.248	-.272	-.044	3.555	.925
.65	4.98	-.210	-.053	-.234	-.247	-.267	-.041	4.462	.945
.65	6.00	-.207	-.055	-.237	-.243	-.270	-.043	5.713	.961
.65	8.19	-.194	-.053	-.233	-.238	-.266	-.040	8.407	.980
.70	.99	-.195	-.199	-.212	-.213	-.228	-.366	-.090	0.000
.70	2.01	-.199	-.206	-.220	-.225	-.246	-.302	.836	.729
.70	3.41	-.217	-.230	-.252	-.262	-.299	-.305	2.208	.875
.70	4.18	-.219	-.233	-.254	-.264	-.302	-.302	3.014	.921
.70	4.99	-.216	-.228	-.250	-.257	-.294	-.312	3.882	.945
.70	6.02	-.212	-.223	-.246	-.250	-.287	-.310	4.946	.961
.70	8.49	-.203	-.204	-.222	-.224	-.246	-.309	7.581	.980
.80	.98	-.219	-.229	-.255	-.256	-.258	-.432	-.086	0.000
.80	.98	-.218	-.227	-.245	-.254	-.255	-.402	-.085	0.000
.80	2.00	-.221	-.235	-.253	-.268	-.276	-.302	.641	.729
.80	3.42	-.241	-.261	-.284	-.311	-.336	-.301	1.678	.869
.80	4.21	-.243	-.264	-.289	-.315	-.341	-.305	2.324	.919
.80	4.99	-.240	-.260	-.284	-.309	-.333	-.305	2.957	.943
.80	6.01	-.237	-.256	-.279	-.306	-.325	-.305	3.773	.962
.80	7.00	-.233	-.250	-.273	-.278	-.310	-.306	4.600	.976
.80	9.24	-.213	-.223	-.237	-.240	-.260	-.300	6.368	.981
.90	.98	-.266	-.309	-.347	-.374	-.381	-.299	-.064	0.000
.90	2.02	-.263	-.309	-.350	-.387	-.417	-.284	.532	.756
.90	3.40	-.268	-.316	-.362	-.410	-.472	-.285	1.326	.870
.90	4.17	-.268	-.316	-.363	-.411	-.475	-.284	1.817	.916
.90	5.00	-.266	-.314	-.360	-.408	-.469	-.287	2.356	.944
.90	6.00	-.267	-.314	-.360	-.407	-.468	-.289	3.013	.962
.90	7.01	-.265	-.312	-.357	-.405	-.466	-.284	3.653	.977
.90	8.62	-.261	-.306	-.348	-.390	-.426	-.286	4.692	.983
.90	10.01	-.256	-.297	-.335	-.359	-.355	-.287	5.623	.988
.95	.96	-.226	-.275	-.320	-.366	-.439	-.375	-.065	0.000
.95	1.99	-.223	-.273	-.319	-.365	-.436	-.325	.457	.736
.95	3.40	-.221	-.269	-.316	-.362	-.433	-.322	1.190	.871
.95	4.21	-.220	-.268	-.314	-.361	-.432	-.321	1.653	.919
.95	5.02	-.221	-.270	-.317	-.363	-.435	-.326	2.136	.945
.95	5.01	-.221	-.270	-.316	-.363	-.434	-.323	2.113	.944
.95	5.99	-.223	-.272	-.319	-.365	-.437	-.327	2.710	.969
.95	7.01	-.222	-.270	-.317	-.365	-.435	-.324	3.286	.978
.95	8.61	-.221	-.269	-.316	-.365	-.434	-.323	4.210	.983
1.20	.86	-.063	-.094	-.126	-.157	-.206	.034	-.151	0.000
1.20	1.97	-.062	-.094	-.127	-.159	-.207	.023	.216	.558
1.20	1.99	-.065	-.096	-.129	-.165	-.211	.022	.210	.540
1.20	3.38	-.067	-.098	-.131	-.165	-.212	.022	.659	.770
1.20	4.21	-.066	-.097	-.130	-.167	-.210	.024	.964	.845
1.20	4.99	-.064	-.095	-.128	-.166	-.208	.026	1.245	.881
1.20	5.99	-.065	-.095	-.128	-.166	-.208	.026	1.605	.912
1.20	7.01	-.064	-.094	-.127	-.165	-.207	.028	1.981	.933
1.20	8.62	-.063	-.094	-.126	-.164	-.206	.030	2.565	.950
1.20	9.99	-.064	-.094	-.127	-.163	-.206	.031	3.072	.960

TABLE 16.- BASIC DATA FOR CONFIGURATION 15 WITH $\alpha_p = 12^\circ$,
 $B/d = 0.194$, AND $A/d = 0.303$

MACH	NPR	P1	P2	P4	P5	P6	P7	P8	P9
0.00	2.01	.280	.278	.428	.466	.490	.507	.505	.504
0.00	3.01	.284	.233	.148	.227	.330	.429	.329	.349
0.00	4.00	.287	.244	.114	.105	.175	.197	.259	.253
0.00	5.01	.287	.245	.113	.104	.101	.175	.184	.238
0.00	6.01	.287	.245	.114	.104	.101	.090	.154	.181
0.00	6.46	.286	.245	.114	.103	.101	.090	.084	.170
0.00	2.00	.282	.247	.427	.466	.490	.508	.505	.505
0.00	3.01	.285	.242	.149	.227	.331	.430	.326	.349
0.00	4.01	.287	.244	.113	.104	.173	.197	.257	.254
0.00	5.01	.287	.245	.113	.104	.101	.175	.184	.237
0.00	6.00	.288	.245	.114	.104	.102	.090	.154	.181
0.00	6.44	.287	.245	.114	.104	.102	.090	.084	.170
.65	2.01	.283	.238	.335	.367	.402	.437	.473	.503
.65	3.41	.284	.244	.115	.134	.199	.203	.255	.319
.65	4.21	.286	.244	.113	.104	.103	.191	.198	.285
.65	5.01	.287	.245	.113	.105	.101	.175	.184	.219
.65	6.01	.288	.245	.114	.104	.102	.089	.159	.175
.65	8.05	.287	.246	.114	.104	.102	.090	.084	.090
.70	2.01	.283	.238	.333	.364	.400	.436	.472	.501
.70	3.42	.284	.244	.115	.129	.198	.202	.246	.305
.70	4.21	.286	.244	.114	.104	.103	.191	.197	.286
.70	5.00	.287	.245	.114	.105	.102	.176	.185	.218
.70	6.01	.287	.245	.114	.104	.102	.089	.161	.175
.70	8.34	.287	.246	.114	.104	.102	.089	.084	.091
.80	2.00	.282	.237	.334	.365	.400	.437	.471	.501
.80	3.40	.285	.244	.115	.109	.199	.204	.245	.303
.80	4.21	.285	.245	.115	.104	.103	.192	.196	.286
.80	5.01	.287	.245	.114	.105	.102	.176	.185	.214
.80	6.00	.287	.244	.113	.104	.101	.089	.164	.175
.80	7.00	.288	.245	.114	.105	.102	.089	.085	.091
.80	9.05	.287	.246	.114	.104	.102	.090	.084	.090
.90	2.00	.283	.236	.333	.366	.395	.429	.463	.492
.90	3.41	.285	.242	.115	.122	.195	.203	.215	.246
.90	4.22	.285	.244	.115	.103	.101	.155	.182	.189
.90	5.01	.287	.245	.114	.104	.102	.093	.172	.178
.90	5.99	.288	.245	.114	.105	.102	.089	.137	.170
.90	6.99	.288	.246	.114	.105	.102	.090	.085	.091
.90	8.64	.288	.246	.114	.105	.102	.090	.085	.091
.90	10.00	.288	.246	.114	.104	.102	.090	.085	.091
.95	1.99	.284	.235	.305	.340	.366	.395	.425	.456
.95	3.39	.286	.242	.117	.144	.187	.197	.203	.221
.95	4.21	.285	.244	.115	.104	.108	.162	.179	.180
.95	5.01	.286	.245	.115	.104	.103	.090	.113	.154
.95	6.00	.288	.245	.115	.105	.102	.090	.085	.091
.95	7.01	.288	.246	.115	.105	.103	.090	.085	.091
.95	8.60	.288	.246	.114	.105	.102	.090	.085	.091
.95	10.01	.288	.246	.114	.104	.102	.090	.085	.091
1.20	2.00	.287	.236	.248	.272	.297	.327	.359	.392
1.20	3.41	.285	.235	.111	.102	.097	.098	.137	.180
1.20	4.21	.286	.241	.113	.103	.098	.086	.084	.101
1.20	4.98	.287	.244	.114	.104	.099	.087	.083	.091
1.20	6.02	.285	.245	.115	.104	.102	.090	.085	.092
1.20	7.02	.287	.245	.115	.105	.103	.090	.085	.092
1.20	8.61	.289	.246	.115	.106	.103	.090	.085	.091
1.20	10.00	.288	.246	.115	.105	.103	.090	.085	.091

TABLE 16.- Continued

MACH	NPR	P10	P11	P12	P13	P14	P15	S1	S2	S3
0.00	2.01	.503	.501	.474	.490	.517	.530	-.001	-.001	-.001
0.00	3.01	.330	.335	.345	.326	.332	.348	-.001	-.001	-.001
0.00	4.00	.382	.326	.216	.249	.243	.251	-.001	-.001	-.001
0.00	5.01	.255	.165	.143	.164	.233	.247	-.001	-.002	-.002
0.00	6.01	.237	.266	.217	.149	.145	.162	-.002	-.002	-.003
0.00	6.46	.222	.239	.240	.100	.132	.144	-.002	-.003	-.003
0.00	2.00	.503	.502	.475	.487	.518	.531	-.001	-.001	-.001
0.00	3.01	.332	.333	.345	.326	.331	.348	-.001	-.001	-.001
0.00	4.01	.378	.329	.217	.247	.241	.250	-.001	-.001	-.001
0.00	5.01	.256	.166	.139	.164	.233	.248	-.001	-.002	-.002
0.00	6.00	.238	.267	.216	.150	.146	.162	-.002	-.002	-.002
0.00	6.44	.223	.241	.241	.099	.132	.144	-.002	-.003	-.003
.65	.98							-.261	-.335	-.322
.65	2.01	.520	.523	.512	.507	.549	.555	-.287	-.381	-.376
.65	3.41	.337	.357	.316	.309	.319	.332	-.324	-.445	-.455
.65	4.21	.207	.390	.303	.228	.234	.243	-.337	-.467	-.481
.65	5.01	.260	.178	.131	.231	.260	.263	-.334	-.460	-.471
.65	6.01	.222	.270	.210	.154	.154	.170	-.323	-.442	-.450
.65	8.05	.114	.158	.165	.151	.154	.164	-.300	-.402	-.401
.70	.97							-.270	-.349	-.334
.70	2.01	.519	.524	.516	.513	.551	.557	-.298	-.399	-.392
.70	3.42	.337	.349	.328	.315	.325	.337	-.334	-.464	-.474
.70	4.21	.211	.392	.304	.231	.238	.246	-.349	-.492	-.506
.70	5.00	.260	.179	.133	.233	.261	.264	-.346	-.484	-.496
.70	6.01	.220	.268	.205	.156	.156	.172	-.335	-.464	-.471
.70	8.34	.100	.138	.156	.151	.151	.159	-.306	-.413	-.410
.80	.97							-.309	-.412	-.387
.80	2.00	.521	.529	.526	.525	.558	.563	-.339	-.479	-.466
.80	3.40	.342	.346	.338	.334	.344	.355	-.376	-.581	-.606
.80	4.21	.220	.396	.306	.238	.245	.252	-.386	-.617	-.668
.80	5.01	.262	.183	.138	.237	.263	.269	-.385	-.604	-.638
.80	6.00	.216	.260	.192	.164	.163	.190	-.376	-.580	-.600
.80	7.00	.172	.210	.218	.109	.176	.188	-.367	-.562	-.575
.80	9.05	.099	.104	.127	.141	.140	.143	-.333	-.470	-.456
.90	.95							-.294	-.516	-.585
.90	.95							-.298	-.520	-.589
.90	2.00	.515	.530	.534	.537	.559	.563	-.296	-.520	-.592
.90	3.41	.279	.308	.318	.314	.345	.359	-.299	-.523	-.596
.90	4.22	.261	.285	.362	.199	.285	.303	-.291	-.514	-.587
.90	5.01	.208	.248	.198	.246	.254	.275	-.296	-.519	-.592
.90	5.99	.179	.223	.236	.172	.183	.204	-.300	-.526	-.599
.90	6.99	.100	.153	.201	.192	.213	.220	-.298	-.523	-.596
.90	8.64	.099	.077	.138	.157	.160	.164	-.293	-.517	-.591
.90	10.00	.099	.073	.087	.125	.124	.124	-.293	-.517	-.590
.95	.93							-.236	-.443	-.511
.95	1.99	.481	.503	.520	.530	.542	.545	-.236	-.442	-.511
.95	3.39	.239	.258	.283	.299	.312	.323	-.234	-.441	-.510
.95	4.21	.193	.222	.246	.268	.278	.284	-.235	-.442	-.511
.95	5.01	.175	.198	.233	.251	.256	.262	-.235	-.443	-.512
.95	6.00	.104	.168	.204	.223	.224	.237	-.236	-.443	-.512
.95	7.01	.100	.112	.165	.190	.187	.199	-.236	-.444	-.513
.95	8.60	.099	.073	.093	.144	.143	.150	-.233	-.441	-.509
.95	10.01	.099	.073	.068	.115	.113	.114	-.233	-.441	-.510
1.20	.87							-.067	-.209	-.259
1.20	2.00	.419	.446	.470	.480	.491	.500	-.065	-.208	-.258
1.20	3.41	.242	.303	.300	.283	.312	.325	-.065	-.209	-.259
1.20	4.21	.203	.230	.247	.254	.260	.263	-.064	-.208	-.258
1.20	4.98	.167	.185	.196	.211	.215	.219	-.063	-.206	-.257
1.20	6.02	.101	.144	.154	.171	.173	.176	-.062	-.205	-.255
1.20	7.02	.100	.115	.125	.147	.146	.146	-.061	-.204	-.254
1.20	8.61	.100	.073	.092	.111	.110	.111	-.061	-.204	-.254
1.20	10.00	.099	.073	.071	.092	.090	.089	-.062	-.205	-.255

TABLE 16.- Concluded

MACH	NPR	S4	S5	S7	CFMD	FMDZFI
0.00	2.01	-.001	-.002	-.003	.327	.828
0.00	3.01	-.001	-.002	-.003	.636	.878
0.00	4.00	-.001	-.002	-.003	.961	.910
0.00	5.01	-.002	-.003	-.003	1.344	.956
0.00	6.01	-.003	-.003	-.004	1.701	.965
0.00	6.46	-.003	-.004	-.004	1.859	.967
0.00	2.00	-.001	-.000	-.003	.326	.825
0.00	3.01	-.002	-.000	-.003	.638	.877
0.00	4.01	-.002	-.000	-.003	.964	.912
0.00	5.01	-.002	-.001	-.003	1.347	.958
0.00	6.00	-.003	-.001	-.004	1.696	.965
0.00	6.44	-.003	-.002	-.004	1.853	.967
.65	.98	-.304	-.251	-.190	-.101	0.000
.65	2.01	-.366	-.325	-.279	.975	.728
.65	3.41	-.462	-.454	-.446	2.525	.866
.65	4.21	-.491	-.488	-.487	3.503	.912
.65	5.01	-.478	-.467	-.456	4.529	.951
.65	6.01	-.453	-.435	-.412	5.738	.961
.65	8.05	-.394	-.359	-.315	8.334	.984
.70	.97	-.314	-.255	-.190	-.101	0.000
.70	2.01	-.380	-.334	-.281	.844	.727
.70	3.42	-.479	-.466	-.453	2.190	.866
.70	4.21	-.515	-.507	-.499	3.011	.910
.70	5.00	-.502	-.487	-.470	3.921	.951
.70	6.01	-.472	-.449	-.419	4.952	.960
.70	8.34	-.399	-.357	-.305	7.532	.985
.80	.97	-.354	-.274	-.195	-.096	0.000
.80	2.00	-.440	-.368	-.298	.640	.726
.80	3.40	-.603	-.550	-.497	1.662	.865
.80	4.21	-.690	-.633	-.564	2.303	.909
.80	5.01	-.641	-.582	-.524	3.017	.949
.80	6.00	-.591	-.528	-.465	3.792	.959
.80	7.00	-.556	-.482	-.412	4.644	.978
.80	9.05	-.429	-.356	-.280	6.313	.986
.90	.95	-.598	-.342	-.188	-.102	0.000
.90	.95	-.603	-.346	-.192	-.103	0.000
.90	2.00	-.647	-.734	-.726	.494	.705
.90	3.41	-.652	-.740	-.791	1.288	.839
.90	4.22	-.642	-.730	-.783	1.800	.899
.90	5.01	-.647	-.736	-.789	2.330	.934
.90	5.99	-.655	-.744	-.797	2.986	.953
.90	6.99	-.651	-.741	-.794	3.668	.976
.90	8.64	-.646	-.735	-.786	4.738	.985
.90	10.00	-.645	-.731	-.656	5.607	.984
.95	.93	-.561	-.545	-.268	-.103	0.000
.95	1.99	-.562	-.644	-.694	.418	.671
.95	3.39	-.561	-.644	-.692	1.111	.815
.95	4.21	-.563	-.646	-.696	1.599	.884
.95	5.01	-.563	-.646	-.697	2.082	.925
.95	6.00	-.563	-.647	-.697	2.672	.952
.95	7.01	-.564	-.647	-.698	3.275	.968
.95	8.60	-.561	-.644	-.695	4.202	.980
.95	10.01	-.562	-.645	-.692	5.036	.984
1.20	.87	-.295	-.353	-.386	-.178	0.000
1.20	2.00	-.294	-.353	-.391	.193	.494
1.20	3.41	-.295	-.354	-.392	.649	.750
1.20	4.21	-.294	-.353	-.391	.943	.829
1.20	4.98	-.293	-.352	-.390	1.227	.871
1.20	6.02	-.291	-.350	-.389	1.606	.908
1.20	7.02	-.291	-.350	-.388	1.980	.932
1.20	8.61	-.290	-.349	-.388	2.573	.953
1.20	10.00	-.291	-.350	-.388	3.100	.964

TABLE 17.- BASIC DATA FOR CONFIGURATION 16 WITH $\alpha_p = 12^\circ$,
 $B/d = 0.484$, AND $A/d = 0.303$

MACH	NPR	P1	P2	P3	P4	P5	P6	P7	P8	P9
0.00	2.00	.282	.238	.383	.406	.406	.440	.444	.464	.485
0.00	3.00	.288	.244	.162	.112	.206	.254	.290	.410	.289
0.00	4.00	.290	.245	.163	.113	.104	.101	.169	.180	.282
0.00	5.00	.290	.246	.163	.113	.103	.101	.089	.078	.154
0.00	6.02	.290	.246	.164	.113	.102	.101	.089	.078	.076
0.00	6.57	.289	.246	.164	.113	.102	.101	.089	.078	.076
0.00	2.00	.282	.238	.387	.410	.405	.440	.445	.464	.485
0.00	3.00	.288	.242	.162	.149	.206	.254	.290	.410	.289
0.00	4.00	.289	.244	.163	.109	.103	.101	.170	.180	.285
0.00	5.01	.289	.245	.163	.106	.103	.101	.088	.079	.154
0.00	6.00	.290	.246	.164	.108	.103	.101	.089	.078	.076
0.00	6.58	.289	.246	.164	.111	.102	.101	.089	.078	.076
.65	2.00	.285	.239	.253	.330	.327	.355	.383	.409	.436
.65	3.42	.285	.242	.162	.178	.227	.225	.226	.230	.235
.65	4.22	.290	.244	.163	.119	.104	.103	.098	.156	.166
.65	5.00	.290	.245	.164	.109	.104	.101	.089	.078	.098
.65	6.01	.290	.245	.164	.104	.103	.100	.088	.077	.083
.65	8.19	.290	.246	.164	.107	.102	.101	.089	.077	.075
.70	2.00	.281	.234	.255	.319	.329	.357	.384	.411	.438
.70	3.41	.285	.242	.163	.174	.227	.226	.225	.230	.234
.70	4.21	.289	.244	.162	.117	.103	.111	.115	.156	.167
.70	5.01	.291	.245	.164	.108	.104	.101	.089	.078	.106
.70	6.00	.290	.245	.164	.108	.103	.101	.089	.078	.084
.70	8.47	.290	.246	.164	.107	.103	.101	.089	.078	.076
.80	2.01	.283	.235	.261	.311	.328	.355	.382	.408	.435
.80	3.39	.286	.242	.163	.162	.225	.223	.221	.226	.232
.80	4.22	.288	.244	.164	.119	.103	.102	.091	.111	.161
.80	5.03	.290	.245	.163	.109	.104	.101	.088	.083	.126
.80	6.02	.291	.246	.164	.107	.104	.101	.089	.078	.085
.80	7.01	.290	.246	.164	.107	.104	.101	.089	.078	.076
.80	9.15	.290	.246	.164	.111	.103	.101	.089	.078	.076
.90	2.02	.285	.239	.270	.311	.331	.357	.383	.408	.435
.90	3.42	.285	.241	.162	.149	.216	.218	.216	.222	.230
.90	4.22	.286	.244	.164	.114	.103	.123	.164	.181	.180
.90	5.02	.289	.245	.163	.105	.102	.101	.091	.104	.144
.90	6.00	.291	.245	.164	.101	.103	.100	.087	.078	.093
.90	7.01	.291	.246	.164	.108	.104	.101	.089	.078	.076
.90	8.60	.291	.247	.165	.113	.104	.101	.090	.078	.076
.90	10.03	.290	.247	.164	.112	.103	.101	.089	.078	.076
.95	2.00	.284	.237	.272	.310	.335	.361	.387	.413	.439
.95	3.42	.286	.243	.163	.131	.205	.213	.213	.217	.227
.95	4.21	.286	.243	.163	.109	.107	.144	.188	.189	.186
.95	5.00	.288	.245	.164	.106	.102	.101	.092	.152	.165
.95	6.00	.291	.246	.165	.110	.104	.101	.089	.078	.098
.95	7.01	.291	.246	.165	.111	.104	.101	.089	.078	.076
.95	8.61	.291	.246	.165	.113	.104	.101	.089	.078	.076
.95	10.03	.290	.247	.165	.113	.103	.101	.090	.078	.076
1.20	2.02	.292	.245	.208	.247	.266	.293	.313	.331	.357
1.20	3.40	.287	.240	.161	.109	.102	.109	.144	.173	.179
1.20	4.22	.286	.242	.161	.108	.101	.098	.091	.153	.168
1.20	5.00	.286	.244	.163	.112	.103	.100	.088	.080	.104
1.20	6.02	.286	.244	.164	.112	.102	.101	.088	.077	.077
1.20	7.01	.289	.246	.164	.113	.103	.101	.089	.078	.076
1.20	8.60	.291	.246	.164	.112	.104	.101	.089	.078	.076
1.20	10.01	.291	.247	.165	.114	.104	.102	.090	.078	.076

TABLE 17.- Continued

MACH	NPR	P10	P11	P12	P13	P14	P15	S1	S2	S3
0.00	2.00	.499	.501	.477	.484	.522	.534	-.000	-.000	.001
0.00	3.00	.336	.378	.297	.337	.339	.354	-.000	-.000	.001
0.00	4.00	.235	.338	.332	.238	.246	.256	-.000	-.000	.001
0.00	5.00	.160	.175	.238	.209	.222	.259	-.001	-.001	.001
0.00	6.02	.138	.149	.152	.168	.176	.190	-.001	-.001	.001
0.00	6.57	.084	.139	.147	.153	.154	.177	-.001	-.001	.001
0.00	2.00	.499	.501	.477	.479	.522	.535	-.000	-.000	-.000
0.00	3.00	.335	.378	.298	.336	.339	.354	-.000	-.000	-.000
0.00	4.00	.233	.340	.330	.239	.247	.256	-.001	-.001	-.001
0.00	5.01	.160	.175	.236	.208	.222	.259	-.001	-.001	-.001
0.00	6.00	.139	.150	.153	.169	.177	.191	-.001	-.001	-.001
0.00	6.58	.083	.139	.147	.153	.154	.177	-.001	-.001	-.001
.65	.98							-.145	-.160	-.171
.65	2.00	.462	.485	.502	.511	.523	.526	-.137	-.152	-.162
.65	3.42	.241	.252	.268	.275	.291	.316	-.147	-.163	-.174
.65	4.22	.181	.240	.206	.287	.324	.331	-.162	-.180	-.193
.65	5.00	.149	.153	.161	.217	.245	.249	-.158	-.176	-.188
.65	6.01	.145	.152	.153	.164	.172	.193	-.154	-.171	-.183
.65	8.19	.072	.073	.130	.138	.135	.146	-.150	-.167	-.179
.70	.98							-.149	-.165	-.176
.70	2.00	.463	.485	.502	.510	.523	.526	-.140	-.156	-.167
.70	3.41	.241	.251	.267	.273	.291	.316	-.149	-.166	-.178
.70	4.21	.174	.227	.215	.283	.319	.323	-.164	-.183	-.197
.70	5.01	.150	.154	.162	.215	.242	.246	-.161	-.179	-.194
.70	6.00	.145	.152	.154	.165	.172	.194	-.159	-.177	-.191
.70	8.47	.072	.072	.127	.136	.132	.142	-.152	-.170	-.183
.80	.98							-.164	-.184	-.199
.80	2.01	.459	.482	.501	.509	.521	.525	-.153	-.172	-.187
.80	3.39	.239	.250	.266	.270	.291	.316	-.165	-.184	-.201
.80	4.22	.162	.193	.237	.282	.315	.323	-.176	-.198	-.217
.80	5.03	.152	.154	.162	.206	.227	.230	-.172	-.194	-.213
.80	6.02	.146	.152	.154	.165	.172	.196	-.170	-.191	-.209
.80	7.01	.076	.135	.145	.146	.146	.169	-.169	-.190	-.209
.80	9.15	.072	.072	.115	.132	.127	.131	-.163	-.184	-.201
.90	.97							-.181	-.209	-.237
.90	2.02	.459	.482	.501	.511	.523	.526	-.173	-.199	-.226
.90	3.42	.238	.249	.264	.268	.290	.313	-.175	-.203	-.230
.90	4.22	.183	.193	.203	.211	.222	.226	-.174	-.202	-.230
.90	5.02	.156	.155	.166	.187	.199	.204	-.178	-.206	-.234
.90	6.00	.147	.153	.154	.168	.176	.199	-.178	-.206	-.234
.90	7.01	.084	.139	.147	.147	.150	.173	-.176	-.204	-.233
.90	8.60	.073	.073	.127	.137	.133	.145	-.176	-.204	-.232
.90	10.03	.072	.072	.077	.124	.120	.119	-.173	-.201	-.229
.95	.96							-.143	-.169	-.196
.95	2.00	.462	.484	.503	.513	.524	.528	-.139	-.165	-.192
.95	3.42	.236	.246	.260	.260	.284	.303	-.139	-.165	-.193
.95	4.21	.189	.195	.202	.201	.214	.224	-.141	-.167	-.195
.95	5.00	.165	.162	.165	.170	.178	.182	-.140	-.166	-.194
.95	6.00	.147	.152	.154	.149	.161	.168	-.138	-.164	-.192
.95	7.01	.076	.134	.144	.145	.143	.164	-.142	-.168	-.196
.95	8.61	.073	.073	.125	.136	.129	.142	-.141	-.168	-.196
.95	10.03	.072	.073	.073	.117	.114	.115	-.135	-.161	-.189
1.20	.87							-.026	-.041	-.059
1.20	2.02	.380	.404	.430	.438	.450	.463	-.021	-.036	-.054
1.20	3.40	.185	.200	.221	.222	.234	.250	-.019	-.035	-.052
1.20	4.22	.170	.168	.169	.169	.179	.181	-.019	-.034	-.052
1.20	5.00	.151	.156	.160	.154	.157	.160	-.018	-.033	-.051
1.20	6.02	.076	.096	.140	.141	.139	.143	-.018	-.033	-.050
1.20	7.01	.073	.073	.111	.131	.128	.128	-.017	-.032	-.050
1.20	8.60	.072	.072	.073	.111	.108	.105	-.017	-.032	-.050
1.20	10.01	.073	.073	.073	.091	.089	.088	-.018	-.033	-.051

TABLE 17.- Concluded

MACH	NPR	S4	S5	S6	S7	S8	S9	CFMD	FMDZFI
0.00	2.00	-.000	-.000	.001	-.000	-.001	-.000	.293	.747
0.00	3.00	-.000	-.000	.001	-.001	-.003	-.001	.603	.838
0.00	4.00	-.001	-.001	.001	-.001	-.002	-.001	.931	.883
0.00	5.00	-.001	-.001	.001	-.001	-.001	-.001	1.290	.921
0.00	6.02	-.001	-.001	.000	-.001	-.002	-.002	1.658	.941
0.00	6.57	-.001	-.002	.001	-.002	-.002	-.002	1.856	.946
0.00	2.00	-.000	-.000	-.000	-.000	-.001	-.001	.292	.745
0.00	3.00	-.000	-.001	-.001	-.001	-.001	-.001	.604	.839
0.00	4.00	-.001	-.001	-.001	-.001	-.001	-.001	.933	.883
0.00	5.01	-.001	-.001	-.001	-.001	-.001	-.001	1.294	.922
0.00	6.00	-.001	-.001	-.001	-.001	-.002	-.001	1.648	.941
0.00	6.58	-.001	-.001	-.001	-.002	-.002	-.001	1.857	.946
.65	.98	-.188	-.199	-.199	-.208	-.221	-.165	-.087	0.000
.65	2.00	-.179	-.191	-.195	-.202	-.216	-.154	.849	.637
.65	3.42	-.192	-.205	-.211	-.218	-.235	-.166	2.460	.843
.65	4.22	-.214	-.234	-.240	-.261	-.298	-.196	3.430	.895
.65	5.00	-.209	-.228	-.241	-.254	-.289	-.227	4.330	.907
.65	6.01	-.203	-.220	-.229	-.243	-.272	-.219	5.582	.934
.65	8.19	-.199	-.215	-.223	-.234	-.261	-.207	8.332	.967
.70	.98	-.194	-.205	-.205	-.215	-.227	-.222	-.087	0.000
.70	2.00	-.184	-.196	-.201	-.208	-.222	-.153	.736	.635
.70	3.41	-.197	-.210	-.216	-.224	-.241	-.165	2.118	.839
.70	4.21	-.217	-.236	-.237	-.265	-.300	-.184	2.932	.890
.70	5.01	-.214	-.235	-.248	-.261	-.296	-.226	3.752	.905
.70	6.00	-.211	-.231	-.245	-.252	-.283	-.226	4.823	.933
.70	8.47	-.203	-.220	-.229	-.240	-.265	-.209	7.510	.969
.80	.98	-.219	-.235	-.241	-.245	-.257	-.242	-.085	0.000
.80	2.01	-.206	-.221	-.229	-.233	-.247	-.165	.566	.635
.80	3.39	-.221	-.241	-.253	-.252	-.268	-.188	1.605	.828
.80	4.22	-.240	-.266	-.279	-.295	-.332	-.220	2.249	.879
.80	5.03	-.235	-.261	-.274	-.290	-.327	-.238	2.861	.898
.80	6.02	-.231	-.255	-.270	-.281	-.314	-.242	3.685	.931
.80	7.01	-.231	-.255	-.270	-.290	-.312	-.241	4.510	.947
.80	9.15	-.222	-.242	-.254	-.262	-.287	-.220	6.315	.974
.90	.97	-.268	-.319	-.366	-.374	-.403	-.379	-.072	0.000
.90	2.02	-.255	-.299	-.327	-.337	-.348	-.253	.469	.661
.90	3.42	-.261	-.309	-.341	-.360	-.387	-.243	1.271	.826
.90	4.22	-.261	-.311	-.345	-.370	-.414	-.259	1.728	.858
.90	5.02	-.265	-.317	-.354	-.386	-.450	-.296	2.255	.891
.90	6.00	-.265	-.317	-.354	-.389	-.459	-.315	2.911	.930
.90	7.01	-.263	-.315	-.353	-.385	-.453	-.335	3.573	.948
.90	8.60	-.263	-.315	-.352	-.384	-.448	-.335	4.650	.972
.90	10.03	-.259	-.309	-.346	-.370	-.415	-.310	5.601	.980
.95	.96	-.227	-.280	-.322	-.360	-.439	-.435	-.070	0.000
.95	2.00	-.222	-.276	-.315	-.355	-.435	-.371	.415	.663
.95	3.42	-.224	-.278	-.318	-.359	-.438	-.362	1.123	.813
.95	4.21	-.226	-.280	-.321	-.360	-.440	-.365	1.561	.859
.95	5.00	-.225	-.278	-.318	-.358	-.438	-.361	1.991	.886
.95	6.00	-.222	-.276	-.315	-.356	-.435	-.357	2.566	.920
.95	7.01	-.227	-.281	-.322	-.361	-.441	-.366	3.214	.944
.95	8.61	-.226	-.281	-.322	-.360	-.441	-.365	4.192	.970
.95	10.03	-.220	-.273	-.312	-.353	-.432	-.355	5.000	.980
1.20	.87	-.078	-.113	-.139	-.169	-.218	-.126	-.158	0.000
1.20	2.02	-.073	-.109	-.136	-.167	-.217	-.164	.192	.486
1.20	3.40	-.072	-.108	-.135	-.167	-.217	-.177	.606	.710
1.20	4.22	-.071	-.107	-.134	-.166	-.217	-.179	.902	.793
1.20	5.00	-.071	-.107	-.134	-.166	-.216	-.180	1.193	.847
1.20	6.02	-.070	-.106	-.133	-.165	-.216	-.181	1.568	.888
1.20	7.01	-.069	-.105	-.132	-.164	-.215	-.181	1.942	.916
1.20	8.60	-.069	-.104	-.131	-.163	-.213	-.180	2.538	.944
1.20	10.01	-.070	-.105	-.132	-.164	-.214	-.181	3.077	.959

TABLE 18.- BASIC DATA FOR CONFIGURATION 17 WITH $\alpha_p = 15^\circ$,
 $B/d = 0.162$, AND $A/d = 0.184$

MACH	NPR	P1	P2	P3	P4	P5	P6	P7	P8	P9
0.00	2.00	.243	.360	.488	.478	.503	.507	.506	.506	.507
0.00	3.01	.242	.225	.154	.294	.357	.389	.298	.315	.391
0.00	4.01	.245	.227	.154	.106	.188	.195	.286	.228	.407
0.00	5.00	.245	.229	.155	.107	.149	.166	.208	.271	.195
0.00	6.01	.244	.229	.156	.106	.078	.062	.165	.227	.277
0.00	6.36	.244	.229	.156	.107	.078	.062	.153	.187	.242
0.00	2.00	.244	.343	.495	.478	.510	.520	.509	.507	.507
0.00	2.99	.243	.226	.155	.304	.369	.375	.315	.322	.383
0.00	4.00	.245	.228	.155	.105	.191	.202	.288	.229	.401
0.00	5.00	.244	.229	.155	.105	.152	.173	.206	.269	.200
0.00	6.00	.244	.229	.156	.105	.082	.070	.164	.233	.276
0.00	6.43	.244	.229	.156	.105	.082	.066	.152	.172	.236
.65	2.01	.242	.220	.359	.482	.505	.517	.520	.519	.521
.65	3.38	.245	.225	.154	.114	.207	.256	.358	.396	.311
.65	4.21	.244	.228	.155	.107	.186	.196	.261	.231	.365
.65	5.01	.244	.228	.155	.106	.151	.170	.197	.261	.205
.65	6.00	.245	.229	.156	.106	.080	.072	.154	.191	.273
.65	7.98	.244	.230	.157	.107	.080	.061	.153	.098	.098
.70	2.00	.244	.221	.352	.483	.508	.524	.527	.526	.528
.70	3.39	.246	.224	.155	.108	.206	.255	.355	.396	.318
.70	4.20	.244	.227	.154	.106	.186	.194	.263	.231	.375
.70	5.00	.245	.228	.155	.106	.152	.169	.196	.260	.205
.70	6.01	.246	.229	.156	.106	.079	.072	.153	.186	.274
.70	8.39	.245	.229	.156	.106	.079	.061	.153	.097	.087
.80	1.99	.244	.229	.391	.473	.504	.525	.537	.537	.540
.80	3.41	.246	.222	.154	.108	.204	.262	.351	.392	.344
.80	4.22	.245	.224	.154	.106	.187	.197	.263	.238	.392
.80	5.01	.244	.234	.155	.106	.153	.170	.194	.258	.206
.80	6.00	.246	.237	.156	.106	.080	.073	.153	.180	.286
.80	7.01	.246	.238	.156	.106	.079	.062	.153	.118	.143
.80	9.11	.245	.230	.156	.107	.080	.061	.153	.097	.067
.90	2.00	.244	.216	.249	.385	.424	.495	.509	.525	.538
.90	3.41	.247	.221	.153	.116	.198	.220	.252	.290	.332
.90	4.19	.247	.225	.155	.107	.170	.193	.191	.239	.288
.90	5.00	.245	.226	.155	.107	.081	.159	.176	.195	.246
.90	5.97	.245	.227	.155	.107	.080	.068	.153	.213	.231
.90	7.02	.246	.228	.156	.107	.080	.066	.153	.097	.161
.90	8.63	.245	.229	.156	.107	.079	.065	.153	.097	.066
.90	9.89	.245	.229	.156	.107	.080	.065	.153	.097	.066
.95	2.01	.245	.220	.263	.319	.360	.414	.431	.462	.491
.95	3.40	.246	.220	.152	.108	.180	.194	.207	.244	.283
.95	4.20	.246	.223	.154	.106	.092	.149	.171	.211	.244
.95	5.00	.245	.226	.154	.106	.079	.071	.152	.177	.234
.95	6.01	.245	.227	.155	.107	.080	.067	.152	.098	.149
.95	7.01	.246	.228	.156	.107	.080	.066	.153	.097	.080
.95	8.60	.245	.229	.156	.107	.080	.066	.153	.097	.066
.95	10.02	.245	.229	.156	.107	.080	.065	.153	.097	.066
1.20	1.99	.249	.222	.229	.275	.306	.356	.363	.396	.431
1.20	3.42	.247	.219	.151	.107	.089	.097	.193	.253	.294
1.20	4.21	.247	.220	.151	.105	.080	.074	.152	.186	.219
1.20	5.01	.246	.222	.153	.106	.080	.070	.152	.144	.166
1.20	6.01	.247	.225	.155	.108	.081	.071	.154	.097	.122
1.20	7.01	.244	.226	.155	.107	.080	.068	.151	.096	.094
1.20	8.59	.245	.228	.156	.107	.080	.068	.152	.097	.066
1.20	10.01	.246	.229	.156	.107	.080	.067	.153	.097	.066

TABLE 18.- Continued

MACH	NPR	P10	P11	P12	P13	P14	P15	S1	S2	S3
0.00	2.00	.509	.507	.505	.442	.539	.546	-.001	-.001	-.001
0.00	3.01	.351	.304	.348	.334	.376	.380	-.001	-.001	-.002
0.00	4.01	.292	.194	.211	.224	.303	.321	-.001	-.001	-.001
0.00	5.00	.237	.284	.236	.193	.206	.217	-.001	-.001	-.001
0.00	6.01	.308	.239	.168	.124	.138	.142	-.001	-.002	-.002
0.00	6.36	.278	.259	.183	.144	.125	.129	-.001	-.002	-.002
0.00	2.00	.510	.508	.505	.442	.538	.545	-.001	-.001	-.001
0.00	2.99	.355	.304	.364	.329	.376	.379	-.001	-.002	-.002
0.00	4.00	.291	.194	.211	.228	.305	.323	-.001	-.001	-.002
0.00	5.00	.220	.281	.234	.195	.205	.216	-.001	-.002	-.002
0.00	6.00	.309	.240	.169	.124	.140	.143	-.002	-.003	-.003
0.00	6.43	.273	.261	.187	.146	.128	.131	-.002	-.003	-.004
.65	.98							-.356	-.463	-.433
.65	2.01	.524	.522	.521	.472	.557	.566	-.426	-.599	-.593
.65	3.38	.336	.330	.315	.284	.343	.356	-.447	-.632	-.629
.65	4.21	.370	.250	.191	.210	.285	.297	-.435	-.609	-.602
.65	5.01	.197	.300	.287	.217	.220	.232	-.427	-.594	-.584
.65	6.00	.340	.262	.208	.160	.131	.134	-.411	-.565	-.549
.65	7.98	.134	.180	.234	.177	.192	.191	-.368	-.488	-.461
.70	.98							-.368	-.483	-.445
.70	2.00	.530	.529	.528	.481	.565	.574	-.445	-.640	-.632
.70	3.39	.341	.329	.316	.285	.345	.359	-.467	-.681	-.677
.70	4.20	.367	.247	.196	.220	.293	.302	-.456	-.656	-.647
.70	5.00	.204	.303	.293	.221	.222	.235	-.445	-.633	-.620
.70	6.01	.343	.265	.215	.166	.131	.134	-.429	-.601	-.582
.70	8.39	.110	.146	.205	.186	.186	.191	-.373	-.498	-.464
.80	.97							-.408	-.559	-.484
.80	1.99	.541	.540	.539	.495	.576	.585	-.459	-.798	-.908
.80	3.41	.353	.312	.325	.294	.358	.371	-.466	-.808	-.922
.80	4.22	.365	.248	.210	.227	.297	.305	-.464	-.806	-.920
.80	5.01	.221	.321	.302	.235	.227	.236	-.465	-.807	-.920
.80	6.00	.349	.270	.237	.161	.136	.136	-.462	-.802	-.901
.80	7.01	.204	.283	.234	.178	.200	.210	-.454	-.778	-.775
.80	9.11	.080	.099	.136	.174	.177	.192	-.408	-.575	-.502
.90	.95							-.343	-.633	-.654
.90	2.00	.545	.547	.547	.508	.580	.587	-.339	-.634	-.736
.90	3.41	.360	.369	.366	.318	.379	.392	-.342	-.638	-.740
.90	4.19	.330	.324	.282	.232	.317	.330	-.342	-.639	-.742
.90	5.00	.274	.231	.321	.263	.258	.274	-.342	-.639	-.741
.90	5.97	.283	.247	.176	.124	.195	.213	-.347	-.645	-.748
.90	7.02	.184	.222	.234	.215	.195	.199	-.336	-.631	-.733
.90	8.63	.073	.113	.189	.196	.195	.214	-.339	-.635	-.737
.90	9.89	.050	.074	.095	.151	.170	.173	-.338	-.634	-.738
.95	.93							-.273	-.543	-.630
.95	2.01	.514	.531	.542	.541	.557	.561	-.275	-.546	-.641
.95	3.40	.324	.355	.374	.364	.400	.408	-.273	-.545	-.640
.95	4.20	.287	.298	.311	.309	.340	.347	-.275	-.547	-.642
.95	5.00	.263	.301	.249	.207	.279	.299	-.273	-.545	-.641
.95	6.01	.196	.230	.265	.250	.237	.247	-.272	-.544	-.640
.95	7.01	.147	.176	.194	.219	.229	.241	-.272	-.545	-.640
.95	8.60	.117	.131	.140	.150	.160	.171	-.274	-.547	-.642
.95	10.02	.080	.106	.113	.118	.123	.130	-.272	-.545	-.641
1.20	.84							-.081	-.269	-.337
1.20	1.99	.460	.485	.505	.514	.528	.535	-.083	-.272	-.339
1.20	3.42	.319	.324	.309	.281	.352	.363	-.084	-.273	-.340
1.20	4.21	.246	.260	.269	.239	.290	.297	-.084	-.274	-.342
1.20	5.01	.192	.209	.223	.203	.252	.256	-.082	-.272	-.339
1.20	6.01	.143	.159	.178	.168	.217	.219	-.080	-.270	-.338
1.20	7.01	.110	.124	.140	.142	.184	.187	-.079	-.269	-.337
1.20	8.59	.073	.086	.098	.102	.142	.145	-.078	-.268	-.336
1.20	10.01	.049	.060	.074	.077	.114	.116	-.080	-.270	-.338

TABLE 18.- Concluded

MACH	NPR	S4	S5	S6	S7	CFMD	FMDZFI
0.00	2.00	-.000	-.002	-.001	.001	.338	.863
0.00	3.01	-.001	-.002	-.001	.000	.667	.924
0.00	4.01	-.000	-.002	-.000	-.001	1.008	.950
0.00	5.00	-.000	-.002	-.001	-.001	1.361	.971
0.00	6.01	-.001	-.002	-.001	-.001	1.738	.988
0.00	6.36	-.001	-.002	-.001	-.001	1.884	.999
0.00	2.00	-.002	-.002	.001	-.000	.339	.866
0.00	2.99	-.002	-.002	.000	-.000	.660	.924
0.00	4.00	-.002	-.002	.001	.001	1.000	.947
0.00	5.00	-.002	-.003	.000	-.000	1.359	.968
0.00	6.00	-.003	-.003	-.000	-.000	1.731	.985
0.00	6.43	-.004	-.004	-.001	-.000	1.888	.987
.65	.98	-.383	-.343	-.287	-.247	-.082	0.000
.65	2.01	-.567	-.547	-.514	-.496	1.092	.812
.65	3.38	-.606	-.589	-.559	-.544	2.630	.913
.65	4.21	-.575	-.554	-.520	-.498	3.654	.954
.65	5.01	-.553	-.528	-.490	-.463	4.620	.974
.65	6.00	-.513	-.484	-.440	-.408	5.800	.981
.65	7.98	-.417	-.381	-.326	-.290	8.343	1.004
.70	.98	-.388	-.342	-.290	-.236	-.081	0.000
.70	2.00	-.597	-.570	-.531	-.504	.919	.806
.70	3.39	-.646	-.621	-.586	-.562	2.272	.914
.70	4.20	-.612	-.585	-.545	-.517	3.161	.953
.70	5.00	-.581	-.549	-.505	-.472	3.986	.967
.70	6.01	-.538	-.502	-.453	-.414	5.042	.980
.70	8.39	-.410	-.367	-.309	-.266	7.618	.998
.80	.97	-.392	-.328	-.252	-.202	-.081	0.000
.80	1.99	-.936	-.844	-.623	-.515	.708	.812
.80	3.41	-.984	-1.033	-.957	-.763	1.751	.910
.80	4.22	-.981	-1.009	-.884	-.648	2.422	.952
.80	5.01	-.961	-.885	-.645	-.516	3.065	.968
.80	6.00	-.834	-.639	-.493	-.425	3.871	.982
.80	7.01	-.587	-.488	-.407	-.351	4.725	.996
.80	9.11	-.413	-.349	-.276	-.225	6.393	.990
.90	.95	-.464	-.302	-.211	-.176	-.095	0.000
.90	2.00	-.796	-.856	-.895	-.875	.507	.728
.90	3.41	-.800	-.861	-.915	-.972	1.348	.881
.90	4.19	-.801	-.862	-.917	-.975	1.856	.925
.90	5.00	-.801	-.862	-.917	-.975	2.373	.949
.90	5.97	-.808	-.869	-.925	-.982	3.026	.969
.90	7.02	-.793	-.854	-.908	-.960	3.700	.987
.90	8.63	-.797	-.857	-.899	-.852	4.744	.991
.90	9.89	-.795	-.814	-.684	-.478	5.589	.992
.95	.93	-.600	-.457	-.288	-.229	-.081	0.000
.95	2.01	-.694	-.748	-.771	-.829	.457	.724
.95	3.40	-.695	-.752	-.802	-.857	1.190	.874
.95	4.20	-.698	-.754	-.805	-.860	1.664	.923
.95	5.00	-.696	-.753	-.803	-.860	2.127	.950
.95	6.01	-.695	-.752	-.803	-.859	2.710	.967
.95	7.01	-.695	-.752	-.803	-.857	3.300	.981
.95	8.60	-.698	-.755	-.804	-.820	4.302	1.003
.95	10.02	-.696	-.753	-.781	-.718	5.109	.999
1.20	.84	-.376	-.416	-.431	-.405	-.150	0.000
1.20	1.99	-.378	-.419	-.451	-.485	.225	.581
1.20	3.42	-.380	-.421	-.454	-.492	.702	.814
1.20	4.21	-.381	-.422	-.456	-.494	.995	.877
1.20	5.01	-.379	-.420	-.454	-.492	1.274	.904
1.20	6.01	-.378	-.419	-.453	-.491	1.642	.935
1.20	7.01	-.376	-.418	-.451	-.489	2.009	.953
1.20	8.59	-.376	-.417	-.451	-.485	2.591	.968
1.20	10.01	-.378	-.419	-.452	-.468	3.153	.985

TABLE 19.- BASIC DATA FOR CONFIGURATION 18 WITH $\alpha_p = 15^\circ$,
 $B/d = 0.162$, AND $A/d = 0.000$

MACH	NPR	P1	P2	P3	P4	P5	P6	P7	P8	P9
0.00	2.00	.247	.442	.525	.507	.506	.505	.507	.506	.507
0.00	2.82	.253	.271	.331	.450	.333	.345	.406	.361	.340
0.00	3.01	.249	.267	.206	.453	.332	.268	.362	.407	.304
0.00	4.01	.251	.272	.206	.247	.274	.328	.264	.236	.212
0.00	5.00	.255	.273	.206	.163	.156	.190	.233	.262	.256
0.00	6.00	.256	.274	.206	.163	.102	.108	.140	.176	.221
0.00	6.37	.256	.274	.207	.163	.092	.092	.115	.147	.177
0.00	2.00	.247	.457	.524	.508	.507	.509	.507	.507	.508
0.00	2.99	.248	.269	.206	.456	.335	.276	.370	.398	.305
0.00	3.99	.253	.272	.205	.250	.277	.333	.262	.235	.211
0.00	5.01	.254	.273	.206	.165	.156	.187	.231	.261	.259
0.00	6.02	.254	.274	.207	.165	.103	.109	.137	.174	.215
0.00	6.40	.254	.274	.207	.165	.093	.095	.113	.145	.174
.65	2.00	.247	.292	.549	.516	.512	.513	.516	.518	.523
.65	3.41	.251	.267	.204	.320	.412	.309	.257	.247	.318
.65	4.19	.251	.269	.204	.221	.216	.269	.292	.291	.251
.65	5.01	.251	.272	.206	.163	.149	.162	.199	.242	.292
.65	6.00	.254	.273	.206	.163	.104	.101	.117	.143	.174
.65	8.05	.256	.275	.207	.164	.086	.056	.055	.057	.071
.70	2.00	.247	.284	.550	.520	.515	.517	.520	.522	.527
.70	3.01	.249	.265	.204	.458	.355	.280	.313	.441	.354
.70	3.41	.249	.266	.204	.321	.419	.316	.248	.254	.312
.70	4.21	.251	.271	.206	.219	.210	.260	.298	.299	.263
.70	5.00	.251	.272	.206	.165	.151	.161	.195	.240	.295
.70	5.99	.254	.273	.206	.164	.106	.104	.116	.139	.171
.70	8.36	.255	.274	.207	.165	.087	.054	.052	.052	.079
.80	2.00	.247	.296	.551	.531	.526	.528	.532	.533	.538
.80	3.41	.250	.266	.203	.319	.448	.335	.233	.259	.306
.80	4.21	.250	.268	.205	.207	.213	.256	.314	.310	.271
.80	5.01	.251	.272	.206	.166	.152	.157	.183	.227	.300
.80	6.00	.254	.273	.207	.165	.106	.105	.113	.129	.158
.80	6.98	.255	.274	.207	.165	.087	.079	.077	.087	.100
.80	9.26	.255	.274	.207	.165	.087	.053	.043	.062	.087

TABLE 19.- Continued

MACH	NPR	P1	P2	P3	P4	P5	P6	P7	P8	P9
.90	1.99	.248	.257	.335	.457	.548	.564	.562	.560	.563
.90	3.39	.251	.266	.203	.170	.288	.362	.319	.417	.357
.90	4.21	.251	.267	.204	.165	.140	.259	.314	.332	.237
.90	5.01	.251	.270	.205	.165	.090	.125	.199	.282	.341
.90	6.01	.251	.272	.206	.165	.087	.096	.109	.130	.217
.90	7.01	.255	.273	.206	.165	.086	.066	.080	.091	.103
.90	8.62	.256	.274	.207	.165	.087	.053	.053	.055	.063
.90	8.60	.256	.274	.207	.165	.087	.053	.053	.055	.063
.90	9.98	.256	.274	.207	.165	.087	.053	.037	.064	.077
.90	10.01	.255	.274	.207	.165	.087	.053	.037	.065	.077
.95	2.02	.248	.256	.196	.305	.446	.537	.553	.561	.570
.95	3.41	.251	.265	.202	.164	.182	.196	.289	.373	.359
.95	4.21	.251	.268	.204	.165	.139	.143	.170	.274	.324
.95	5.00	.251	.269	.205	.165	.090	.115	.122	.172	.239
.95	5.98	.251	.272	.206	.165	.087	.089	.089	.108	.180
.95	6.99	.254	.273	.206	.165	.087	.055	.070	.079	.106
.95	8.61	.256	.274	.207	.165	.087	.053	.052	.079	.091
.95	10.00	.256	.274	.207	.165	.087	.053	.037	.055	.068
1.20	.84	.962	.958	.953	.957	.951	.942	.940	.949	.982
1.20	1.97	.253	.260	.202	.334	.411	.434	.423	.439	.472
1.20	1.99	.251	.258	.199	.330	.404	.431	.419	.433	.466
1.20	3.40	.251	.261	.199	.163	.200	.220	.241	.255	.268
1.20	4.20	.252	.265	.202	.165	.153	.163	.179	.193	.210
1.20	4.22	.252	.265	.203	.165	.152	.160	.176	.191	.208
1.20	4.19	.253	.266	.203	.166	.153	.161	.178	.192	.209
1.20	4.98	.252	.267	.205	.166	.099	.126	.137	.148	.165
1.20	6.00	.252	.268	.205	.166	.087	.097	.102	.109	.123
1.20	6.97	.252	.271	.206	.166	.087	.067	.079	.085	.095
1.20	7.01	.251	.271	.206	.166	.088	.064	.078	.084	.094
1.20	8.61	.252	.273	.206	.165	.087	.053	.050	.056	.064
1.20	9.98	.255	.274	.207	.166	.087	.053	.037	.041	.046

TABLE 19.- Continued

MACH	NPR	P10	P11	P12	P13	P14	P15	S1	S2	S3
0.00	2.00	.511	.509	.508	.444	.544	.549	-.001	-.001	-.001
0.00	2.82	.381	.382	.362	.322	.391	.396	-.001	-.001	-.001
0.00	3.01	.300	.373	.399	.301	.345	.355	-.001	-.001	-.001
0.00	4.01	.257	.280	.309	.270	.282	.280	-.001	-.002	-.002
0.00	5.00	.220	.192	.184	.167	.226	.233	-.002	-.002	-.002
0.00	6.00	.269	.244	.207	.164	.142	.151	-.002	-.003	-.003
0.00	6.37	.254	.263	.232	.178	.152	.158	-.002	-.003	-.003
0.00	2.00	.511	.510	.509	.445	.544	.550	-.001	-.001	-.001
0.00	2.99	.309	.379	.395	.303	.348	.358	-.001	-.001	-.001
0.00	3.99	.260	.284	.312	.271	.281	.279	-.001	-.002	-.002
0.00	5.01	.222	.192	.184	.165	.224	.230	-.002	-.003	-.003
0.00	6.02	.270	.247	.210	.166	.142	.152	-.002	-.003	-.004
0.00	6.40	.251	.265	.237	.181	.154	.159	-.003	-.004	-.004
0.00	2.00							-.000	-.001	-.001
0.00	3.00							-.001	-.001	-.001
0.00	4.00							-.001	-.002	-.002
0.00	5.02							-.002	-.002	-.002
0.00	6.01							-.002	-.003	-.003
0.00	6.34							-.003	-.003	-.003
0.00	2.00							-.001	-.001	-.001
0.00	3.02							-.001	-.002	-.002
0.00	4.00							-.001	-.002	-.002
0.00	5.01							-.002	-.003	-.003
0.00	6.01							-.002	-.003	-.003
0.00	6.39							-.003	-.003	-.004
.65	.98							-.371	-.488	-.456
.65	2.00	.526	.526	.526	.474	.569	.574	-.436	-.612	-.607
.65	3.41	.406	.354	.306	.242	.322	.332	-.434	-.604	-.593
.65	4.19	.218	.235	.244	.247	.312	.317	-.414	-.567	-.549
.65	5.01	.277	.236	.211	.172	.213	.215	-.386	-.517	-.491
.65	6.00	.268	.290	.271	.215	.181	.187	-.352	-.459	-.427
.65	8.05	.110	.144	.166	.181	.191	.195	-.282	-.352	-.310
.65	.98							-.370	-.486	-.454
.65	2.00							-.437	-.613	-.607
.65	3.42							-.428	-.595	-.583
.65	4.21							-.406	-.557	-.539
.65	5.00							-.380	-.509	-.482
.65	6.01							-.346	-.459	-.421
.65	8.21							-.272	-.342	-.298
.70	.97							-.384	-.509	-.472
.70	2.00	.531	.531	.531	.480	.574	.578	-.455	-.655	-.648
.70	3.01	.304	.330	.427	.367	.390	.389	-.457	-.655	-.645
.70	3.41	.408	.362	.303	.251	.326	.336	-.447	-.639	-.624
.70	4.21	.222	.233	.239	.239	.310	.316	-.427	-.594	-.570
.70	5.00	.286	.245	.216	.173	.212	.215	-.398	-.541	-.511
.70	5.99	.264	.293	.282	.224	.191	.195	-.361	-.476	-.438
.70	8.36	.111	.123	.138	.155	.168	.172	-.275	-.341	-.293
.70	.98							-.383	-.508	-.471
.70	1.99							-.453	-.633	-.645
.70	3.39							-.448	-.638	-.623
.70	4.20							-.426	-.593	-.570
.70	5.01							-.398	-.539	-.508
.70	6.01							-.359	-.472	-.434
.70	8.55							-.270	-.335	-.288
.80	.97							-.421	-.585	-.509
.80	2.00	.541	.541	.541	.498	.586	.589	-.464	-.803	-.915
.80	3.41	.417	.379	.288	.262	.336	.347	-.463	-.804	-.917
.80	4.21	.226	.232	.238	.238	.313	.321	-.461	-.800	-.897
.80	5.01	.304	.270	.232	.179	.206	.209	-.450	-.748	-.688
.80	6.00	.248	.296	.301	.251	.206	.210	-.415	-.591	-.512
.80	6.98	.122	.202	.239	.246	.232	.253	-.371	-.489	-.418
.80	9.26	.092	.097	.103	.111	.118	.136	-.269	-.321	-.255

TABLE 19.- Continued

MACH	NPR	P10	P11	P12	P13	P14	P15	S1	S2	S3
.80	2.01							-.465	-.805	-.918
.80	3.39							-.466	-.807	-.920
.80	4.19							-.463	-.801	-.890
.80	4.19							-.462	-.800	-.894
.80	5.00							-.451	-.746	-.683
.80	5.97							-.415	-.587	-.510
.80	7.01							-.364	-.476	-.408
.80	9.47							-.264	-.316	-.251
.90	.95							-.341	-.631	-.669
.90	1.99	.563	.562	.560	.515	.603	.611	-.338	-.630	-.732
.90	3.39	.308	.307	.371	.342	.389	.385	-.341	-.635	-.737
.90	4.21	.263	.306	.304	.279	.307	.307	-.339	-.634	-.736
.90	5.01	.299	.204	.176	.195	.253	.259	-.339	-.634	-.736
.90	6.01	.249	.301	.292	.192	.181	.177	-.334	-.628	-.730
.90	7.01	.122	.191	.215	.244	.241	.258	-.332	-.626	-.727
.90	8.62	.091	.120	.128	.139	.138	.159	-.327	-.600	-.497
.90	8.60	.090	.120	.129	.139	.138	.160	-.329	-.601	-.497
.90	9.98	.082	.085	.090	.094	.097	.113	-.295	-.334	-.214
.90	10.01	.082	.085	.089	.093	.096	.112	-.293	-.326	-.212
.90	.95							-.336	-.626	-.675
.90	1.99							-.343	-.637	-.740
.90	3.40							-.339	-.633	-.735
.90	4.24							-.342	-.637	-.740
.90	4.19							-.339	-.632	-.735
.90	5.01							-.341	-.636	-.739
.90	5.99							-.341	-.637	-.740
.90	6.99							-.340	-.635	-.737
.90	8.60							-.331	-.590	-.462
.90	9.99							-.289	-.318	-.208
.95	.93							-.274	-.544	-.630
.95	2.02	.573	.574	.573	.530	.614	.619	-.272	-.543	-.637
.95	3.41	.390	.391	.344	.302	.377	.389	-.272	-.542	-.636
.95	4.21	.318	.251	.354	.308	.331	.335	-.273	-.545	-.640
.95	5.00	.268	.308	.249	.205	.281	.304	-.267	-.538	-.632
.95	5.98	.196	.218	.274	.223	.239	.249	-.275	-.548	-.643
.95	6.99	.144	.163	.175	.206	.218	.223	-.269	-.541	-.636
.95	8.61	.099	.107	.116	.124	.131	.148	-.268	-.539	-.634
.95	10.00	.077	.085	.091	.096	.100	.105	-.270	-.535	-.497
.95	.93							-.273	-.543	-.632
.95	2.01							-.275	-.545	-.641
.95	3.41							-.274	-.545	-.641
.95	4.20							-.271	-.541	-.636
.95	4.99							-.275	-.547	-.643
.95	5.99							-.274	-.546	-.642
.95	7.00							-.275	-.547	-.643
.95	8.60							-.272	-.543	-.638
.95	9.99							-.271	-.533	-.487
1.20	.84							-.077	-.265	-.333
1.20	1.97	.502	.525	.548	.556	.602	.605	-.079	-.268	-.335
1.20	1.99	.495	.518	.542	.549	.596	.599	-.079	-.267	-.335
1.20	3.40	.277	.285	.300	.286	.361	.366	-.077	-.266	-.333
1.20	4.20	.226	.235	.246	.232	.297	.297	-.075	-.263	-.331
1.20	4.22	.225	.234	.245	.230	.296	.295	-.079	-.268	-.335
1.20	4.19	.226	.236	.247	.232	.297	.297	-.077	-.266	-.333
1.20	4.98	.181	.195	.212	.201	.255	.254	-.077	-.266	-.333
1.20	5.00	.136	.190	.171	.168	.219	.217	-.077	-.265	-.333
1.20	6.97	.106	.117	.133	.146	.190	.190	-.076	-.264	-.332
1.20	7.01	.105	.116	.132	.145	.189	.188	-.076	-.264	-.332
1.20	8.61	.072	.080	.091	.134	.146	.145	-.077	-.266	-.334
1.20	9.98	.054	.060	.069	.112	.117	.115	-.078	-.266	-.334
1.20	.82							-.077	-.264	-.332
1.20	1.98							-.080	-.267	-.336
1.20	3.40							-.079	-.266	-.335
1.20	4.19							-.080	-.268	-.336
1.20	4.98							-.080	-.268	-.336
1.20	5.96							-.080	-.266	-.335
1.20	6.00							-.080	-.267	-.335
1.20	7.00							-.080	-.267	-.335
1.20	8.58							-.080	-.266	-.334
1.20	10.03							-.079	-.266	-.334
1.20	10.01							-.079	-.266	-.334

TABLE 19.- Continued

MACH	NPR	S4	S5	S6	S7	CFMD	FMDZFI
0.00	2.00	-.001	-.001	-.001	-.002	.372	.948
0.00	2.82	-.001	-.002	-.002	-.002	.655	.987
0.00	3.01	-.002	-.002	-.002	-.002	.720	.991
0.00	4.01	-.002	-.002	-.002	-.003	1.063	1.002
0.00	5.00	-.002	-.003	-.003	-.003	1.409	1.002
0.00	6.00	-.003	-.003	-.003	-.003	1.757	.995
0.00	6.37	-.003	-.003	-.003	-.004	1.884	.992
0.00	2.00	-.001		.002	.002	.366	.937
0.00	2.99	-.001		.001	.001	.701	.979
0.00	3.99	-.002		.001	.001	1.038	.987
0.00	5.01	-.003		.000	-.000	1.397	.995
0.00	6.02	-.004		-.000	-.000	1.739	.988
0.00	6.40	-.004		-.000	-.000	1.879	.990
0.00	2.00	-.001	.001	.002	.009	.362	.930
0.00	3.00	-.002	.001	.001	.017	.701	.976
0.00	4.00	-.002	.000	.001	.025	1.044	.990
0.00	5.02	-.002	-.000	.000	.030	1.398	.994
0.00	6.01	-.003	-.000	-.000	.035	1.737	.989
0.00	6.34	-.004	-.000	-.001	.036	1.860	.992
0.00	2.00	-.001	.003	.003	.005	.364	.931
0.00	3.02	-.002	.002	.002	.009	.708	.976
0.00	4.00	-.002	.002	.001	.015	1.047	.990
0.00	5.01	-.003	.001	.000	.021	1.396	.995
0.00	6.01	-.004	-.000	-.000	.027	1.739	.989
0.00	6.39	-.004	-.000	-.000	.029	1.877	.990
.65	.98	-.413	-.366	-.319	-.272	-.074	0.000
.65	2.00	-.587	-.564	-.541	-.518	1.261	.938
.65	3.41	-.566	-.534	-.502	-.470	2.893	.996
.65	4.19	-.515	-.478	-.440	-.402	3.805	1.003
.65	5.01	-.452	-.410	-.366	-.323	4.759	1.001
.65	6.00	-.381	-.336	-.288	-.242	5.976	1.002
.65	8.05	-.258	-.209	-.158	-.113	8.379	.986
.65	.98	-.409	-.303	-.253	-.052	-.071	0.000
.65	2.00	-.585	-.526	-.498	-.018	1.240	.929
.65	3.42	-.554	-.480	-.445	.032	2.876	.982
.65	4.21	-.503	-.414	-.377	.061	3.803	.988
.65	5.00	-.445	-.341	-.300	.088	4.726	.989
.65	6.01	-.375	-.276	-.222	.123	5.852	.989
.65	8.21	-.244	-.152	-.093	.196	8.411	.978
.70	.97	-.420	-.369	-.314	-.263	-.082	0.000
.70	2.00	-.620	-.590	-.559	-.528	1.103	.958
.70	3.01	-.612	-.578	-.541	-.506	2.124	.999
.70	3.41	-.588	-.550	-.508	-.471	2.502	1.005
.70	4.21	-.528	-.485	-.439	-.395	3.305	1.010
.70	5.00	-.464	-.417	-.366	-.318	4.108	1.008
.70	5.99	-.386	-.336	-.283	-.233	5.128	1.006
.70	8.36	-.238	-.185	-.129	-.084	7.481	.989
.70	.98	-.416	-.300	-.247	-.052	-.071	0.000
.70	1.99	-.612	-.540	-.508	-.021	1.053	.929
.70	3.39	-.584	-.500	-.460	.014	2.457	.985
.70	4.20	-.525	-.430	-.384	.036	3.276	.991
.70	5.01	-.458	-.352	-.303	.063	4.067	.990
.70	6.01	-.379	-.276	-.219	.099	5.089	.990
.70	8.55	-.231	-.125	-.068	.186	7.629	.974
.80	.97	-.418	-.347	-.278	-.222	-.059	0.000
.80	2.00	-.970	-.946	-.922	-.888	.830	.952
.80	3.41	-.973	-.933	-.874	-.844	1.904	.996
.80	4.21	-.819	-.616	-.481	-.409	2.531	1.002
.80	5.01	-.533	-.451	-.378	-.318	3.132	.998
.80	6.00	-.422	-.352	-.283	-.226	3.906	.998
.80	6.98	-.338	-.272	-.205	-.153	4.698	1.001
.80	9.26	-.183	-.124	-.066	-.023	6.359	.975
.80	2.01	-.970	-.784	-.583	-.029	.825	.933

TABLE 19.- Concluded

MACH	NPR	S4	S5	S6	S7	CFMD	FMDZFI
.80	3.39	-.966	-.693	-.525	-.001	1.874	.983
.80	4.19	-.782	-.460	-.392	.019	2.507	.991
.80	4.19	-.797	-.461	-.392	.017	2.485	.988
.80	5.00	-.529	-.367	-.307	.038	3.116	.988
.80	5.97	-.419	-.271	-.215	.066	3.865	.989
.80	7.01	-.327	-.188	-.135	.096	4.743	.995
.80	9.47	-.179	-.063	-.012	.168	6.523	.968
.90	.95	-.498	-.325	-.233	-.190	-.087	0.000
.90	1.99	-.794	-.850	-.908	-.960	.592	.866
.90	3.39	-.800	-.857	-.915	-.967	1.441	.959
.90	4.21	-.798	-.855	-.914	-.965	1.940	.972
.90	5.01	-.799	-.856	-.914	-.953	2.443	.982
.90	6.01	-.792	-.846	-.855	-.753	3.039	.984
.90	7.01	-.774	-.723	-.545	-.379	3.673	.991
.90	8.62	-.265	-.174	-.111	-.078	4.658	.980
.90	8.60	-.266	-.176	-.112	-.080	4.650	.980
.90	9.98	-.123	-.063	-.011	.017	5.490	.976
.90	10.01	-.122	-.062	-.011	.018	5.542	.976
.90	.95	-.520	-.220	-.177	-.065	-.105	0.000
.90	1.99	-.795	-.901	-.955	-.040	.571	.834
.90	3.40	-.790	-.903	-.954	-.014	1.419	.941
.90	4.24	-.795	-.909	-.959	.005	1.941	.958
.90	4.19	-.790	-.903	-.954	.003	1.892	.955
.90	5.01	-.795	-.907	-.941	.020	2.416	.968
.90	5.99	-.795	-.819	-.672	.045	3.032	.974
.90	6.99	-.756	-.388	-.300	.071	3.697	.985
.90	8.60	-.254	-.092	-.059	.110	4.630	.972
.90	9.99	-.120	.001	.031	.144	5.472	.968
.95	.93	-.606	-.468	-.302	-.236	-.085	0.000
.95	2.02	-.695	-.747	-.800	-.849	.521	.828
.95	3.41	-.695	-.747	-.801	-.849	1.272	.937
.95	4.21	-.698	-.751	-.805	-.854	1.727	.960
.95	5.00	-.691	-.743	-.797	-.841	2.150	.973
.95	5.98	-.702	-.755	-.805	-.789	2.775	.989
.95	6.99	-.694	-.744	-.732	-.620	3.264	.980
.95	8.61	-.566	-.570	-.344	-.259	4.154	.977
.95	10.00	-.251	-.148	-.089	-.063	4.991	.980
.95	.93	-.611	-.289	-.221	-.083	-.104	0.000
.95	2.01	-.693	-.794	-.843	-.055	.503	.798
.95	3.41	-.693	-.797	-.844	-.029	1.261	.921
.95	4.20	-.688	-.792	-.839	-.013	1.688	.943
.95	4.99	-.695	-.800	-.844	.004	2.147	.960
.95	5.99	-.694	-.796	-.785	.027	2.703	.967
.95	7.00	-.695	-.723	-.591	.052	3.260	.968
.95	8.60	-.670	-.339	-.249	.088	4.122	.966
.95	9.99	-.248	-.074	-.048	.122	4.931	.969
1.20	.84	-.375	-.411	-.434	-.410	-.173	0.000
1.20	1.97	-.377	-.415	-.452	-.487	.237	.623
1.20	1.99	-.377	-.414	-.452	-.487	.244	.631
1.20	3.40	-.375	-.412	-.449	-.484	.723	.851
1.20	4.20	-.373	-.410	-.447	-.482	.997	.892
1.20	4.22	-.377	-.415	-.452	-.487	1.010	.893
1.20	4.19	-.375	-.413	-.450	-.485	1.001	.894
1.20	4.98	-.375	-.413	-.450	-.485	1.276	.917
1.20	6.00	-.375	-.412	-.449	-.470	1.638	.937
1.20	6.97	-.374	-.411	-.447	-.450	1.979	.948
1.20	7.01	-.374	-.411	-.446	-.447	1.989	.947
1.20	8.61	-.376	-.412	-.411	-.360	2.563	.957
1.20	9.98	-.376	-.393	-.342	-.219	3.057	.962
1.20	.82	-.370	-.426	-.404	-.048	-.182	0.000
1.20	1.98	-.374	-.446	-.480	-.027	.274	.586
1.20	3.40	-.373	-.445	-.479	-.006	.706	.825
1.20	4.19	-.374	-.446	-.480	.005	.983	.871
1.20	4.98	-.374	-.447	-.480	.018	1.251	.895
1.20	5.96	-.373	-.445	-.474	.034	1.590	.915
1.20	6.00	-.374	-.445	-.473	.035	1.605	.915
1.20	7.00	-.373	-.443	-.445	.052	1.957	.928
1.20	8.58	-.372	-.440	-.355	.080	2.510	.940
1.20	10.03	-.371	-.328	-.202	.111	3.026	.947
1.20	10.01	-.371	-.328	-.204	.107	3.018	.947

TABLE 20.- BASIC DATA FOR CONFIGURATION 19 WITH $\alpha_P = 15^\circ$,
 $B/d = 0.162$, AND $A/d = 0.367$

MACH	NPR	P1	P2	P3	P4	P5	P6	P7	P8	P9
0.00	2.00	.244	.348	.484	.450	.458	.484	.508	.510	.511
0.00	3.00	.247	.221	.153	.284	.352	.356	.367	.343	.327
0.00	4.00	.251	.224	.154	.110	.190	.188	.187	.185	.190
0.00	5.01	.251	.225	.154	.106	.078	.128	.139	.141	.166
0.00	6.00	.250	.226	.155	.107	.078	.062	.128	.135	.138
0.00	6.48	.250	.226	.156	.107	.078	.062	.115	.128	.134
0.00	2.01	.243	.347	.481	.449	.455	.491	.508	.510	.508
0.00	3.00	.247	.222	.154	.288	.349	.358	.365	.348	.327
0.00	4.01	.250	.224	.153	.123	.199	.197	.201	.204	.208
0.00	5.01	.251	.225	.155	.107	.079	.128	.140	.142	.166
0.00	6.01	.250	.225	.155	.106	.078	.064	.128	.135	.138
0.00	6.53	.250	.225	.155	.107	.078	.062	.111	.129	.134
.65	2.01	.246	.242	.451	.416	.444	.449	.497	.525	.531
.65	3.40	.247	.222	.154	.217	.225	.221	.227	.234	.250
.65	4.21	.249	.223	.153	.108	.194	.193	.191	.187	.187
.65	5.02	.251	.225	.154	.105	.080	.130	.140	.142	.162
.65	6.00	.251	.225	.155	.106	.077	.066	.130	.136	.137
.65	8.16	.251	.226	.155	.107	.078	.061	.069	.069	.073
.70	2.00	.247	.238	.445	.430	.443	.447	.494	.528	.534
.70	3.41	.246	.221	.153	.219	.226	.220	.226	.233	.248
.70	4.21	.248	.223	.152	.109	.194	.193	.192	.187	.188
.70	5.01	.252	.225	.155	.106	.082	.131	.142	.143	.163
.70	6.00	.252	.225	.155	.106	.077	.068	.131	.136	.137
.70	8.44	.251	.226	.155	.107	.078	.061	.069	.066	.062
.80	2.02	.246	.230	.445	.461	.428	.424	.480	.514	.531
.80	3.41	.245	.219	.151	.212	.223	.217	.226	.234	.249
.80	4.20	.247	.223	.153	.111	.195	.194	.192	.187	.188
.80	5.02	.250	.224	.153	.105	.080	.132	.142	.142	.166
.80	6.01	.252	.225	.154	.105	.077	.072	.132	.136	.137
.80	7.00	.252	.226	.155	.106	.077	.061	.096	.128	.132
.80	9.17	.251	.226	.155	.107	.078	.061	.069	.066	.063
.90	2.01	.247	.228	.300	.382	.403	.402	.421	.469	.496
.90	3.40	.247	.217	.152	.204	.225	.220	.227	.232	.240
.90	4.21	.247	.223	.154	.108	.193	.194	.193	.189	.188
.90	4.99	.248	.223	.153	.105	.099	.149	.151	.148	.150
.90	5.99	.251	.224	.154	.105	.078	.099	.132	.135	.135
.90	7.00	.252	.226	.155	.106	.077	.063	.078	.129	.132
.90	8.61	.252	.226	.155	.107	.078	.062	.069	.070	.120
.90	10.01	.251	.226	.156	.107	.079	.062	.069	.067	.063
.95	1.99	.245	.258	.353	.361	.365	.380	.409	.437	.462
.95	3.00	.245	.216	.158	.217	.226	.234	.251	.261	.272
.95	3.40	.247	.219	.153	.176	.220	.218	.221	.225	.227
.95	4.20	.246	.221	.152	.108	.188	.190	.190	.185	.184
.95	5.01	.247	.223	.153	.106	.119	.160	.160	.156	.154
.95	6.00	.251	.224	.154	.106	.078	.115	.134	.135	.135
.95	6.99	.252	.226	.155	.106	.078	.063	.076	.120	.128
.95	8.61	.252	.226	.156	.107	.078	.062	.069	.067	.103
.95	9.99	.251	.226	.155	.107	.078	.062	.069	.066	.063
1.20	2.00	.247	.241	.300	.315	.320	.328	.351	.374	.402
1.20	3.30	.249	.220	.153	.115	.149	.157	.162	.168	.183
1.20	4.19	.249	.221	.153	.107	.081	.086	.138	.140	.145
1.20	5.01	.248	.221	.153	.106	.078	.065	.091	.126	.133
1.20	6.02	.247	.223	.153	.106	.077	.061	.070	.072	.107
1.20	7.00	.249	.225	.155	.107	.079	.063	.070	.068	.064
1.20	8.60	.252	.226	.155	.107	.079	.062	.070	.067	.063
1.20	10.00	.252	.226	.155	.107	.079	.062	.070	.067	.063

TABLE 20.- Continued

MACH	NPR	P10	P11	P12	P13	P14	P15	S1	S2	S3
0.00	2.00	.513	.511	.509	.461	.536	.541	-.001	-.002	-.002
0.00	3.00	.360	.349	.346	.309	.368	.375	-.001	-.002	-.002
0.00	4.00	.197	.213	.230	.229	.245	.249	-.001	-.002	-.002
0.00	5.01	.230	.194	.308	.303	.281	.297	-.002	-.002	-.002
0.00	6.00	.185	.223	.181	.216	.235	.251	-.002	-.003	-.003
0.00	6.48	.167	.223	.216	.143	.204	.211	-.003	-.004	-.004
0.00	2.01	.511	.509	.507	.458	.533	.538	-.001	-.002	-.002
0.00	3.00	.357	.350	.349	.307	.368	.374	-.001	-.002	-.002
0.00	4.01	.205	.204	.213	.221	.248	.258	-.001	-.002	-.002
0.00	5.01	.230	.195	.308	.304	.281	.297	-.001	-.002	-.002
0.00	6.01	.185	.225	.181	.215	.234	.250	-.002	-.002	-.002
0.00	6.53	.166	.222	.222	.146	.200	.207	-.002	-.003	-.003
.65	.98							-.346	-.449	-.418
.65	2.01	.533	.531	.528	.482	.561	.569	-.433	-.611	-.608
.65	3.40	.269	.293	.318	.338	.353	.357	-.381	-.513	-.490
.65	4.21	.189	.192	.202	.211	.233	.248	-.274	-.346	-.314
.65	5.02	.231	.208	.312	.310	.301	.314	-.439	-.622	-.620
.65	6.00	.178	.220	.185	.231	.256	.277	-.428	-.602	-.596
.65	8.16	.128	.162	.198	.205	.189	.204	-.412	-.569	-.555
.70	.98							-.360	-.469	-.432
.70	2.00	.537	.536	.533	.490	.566	.574	-.446	-.642	-.634
.70	3.41	.266	.290	.316	.337	.353	.357	-.396	-.541	-.514
.70	4.21	.189	.192	.202	.210	.231	.243	-.282	-.356	-.320
.70	5.01	.232	.211	.318	.310	.300	.312	-.458	-.666	-.663
.70	6.00	.178	.219	.186	.234	.260	.282	-.449	-.646	-.638
.70	8.44	.116	.157	.195	.205	.185	.201	-.424	-.595	-.576
.80	.98							-.400	-.539	-.470
.80	2.02	.539	.540	.538	.499	.570	.578	-.456	-.791	-.887
.80	3.41	.268	.293	.319	.340	.357	.361	-.449	-.746	-.703
.80	4.20	.190	.193	.203	.211	.230	.243	-.325	-.414	-.356
.80	5.02	.233	.227	.333	.298	.290	.296	-.465	-.804	-.913
.80	6.01	.179	.220	.187	.243	.269	.293	-.462	-.803	-.914
.80	7.00	.149	.194	.228	.166	.198	.202	-.459	-.799	-.908
.80	9.17	.113	.118	.153	.195	.176	.192	-.452	-.781	-.818
.90	.95							-.341	-.628	-.646
.90	2.01	.519	.531	.537	.513	.573	.579	-.338	-.631	-.731
.90	3.40	.251	.265	.284	.303	.323	.330	-.338	-.631	-.730
.90	4.21	.188	.189	.195	.200	.217	.222	-.334	-.618	-.650
.90	4.99	.173	.198	.223	.246	.268	.274	-.338	-.633	-.733
.90	5.99	.144	.182	.205	.219	.240	.253	-.340	-.635	-.735
.90	7.00	.139	.156	.203	.184	.209	.221	-.341	-.638	-.739
.90	8.61	.129	.142	.152	.173	.188	.200	-.336	-.630	-.731
.90	10.01	.113	.128	.160	.167	.169	.180	-.332	-.627	-.728
.95	.93							-.276	-.545	-.629
.95	1.99	.486	.507	.523	.532	.541	.543	-.276	-.548	-.642
.95	3.00	.284	.298	.316	.332	.355	.366	-.277	-.549	-.642
.95	3.40	.232	.239	.250	.256	.284	.296	-.276	-.547	-.641
.95	4.20	.185	.186	.190	.191	.207	.213	-.277	-.549	-.642
.95	5.01	.161	.169	.177	.180	.200	.214	-.273	-.545	-.639
.95	6.00	.138	.146	.161	.174	.187	.191	-.275	-.547	-.641
.95	6.99	.133	.141	.150	.171	.186	.194	-.273	-.545	-.639
.95	8.61	.125	.142	.150	.156	.166	.185	-.274	-.547	-.641
.95	9.99	.113	.109	.147	.158	.157	.166	-.271	-.544	-.638
1.20	.85							-.087	-.274	-.341
1.20	2.00	.428	.453	.476	.490	.501	.506	-.087	-.274	-.342
1.20	3.38	.205	.227	.251	.272	.292	.303	-.089	-.277	-.344
1.20	4.19	.159	.186	.216	.237	.258	.261	-.087	-.274	-.342
1.20	5.01	.141	.161	.188	.206	.220	.226	-.086	-.274	-.342
1.20	6.02	.129	.150	.174	.198	.208	.211	-.085	-.274	-.341
1.20	7.00	.117	.107	.149	.188	.197	.197	-.084	-.272	-.340
1.20	8.60	.116	.107	.083	.133	.152	.151	-.083	-.271	-.339
1.20	10.00	.115	.107	.082	.100	.118	.119	-.082	-.271	-.338

TABLE 20.- Concluded

MACH	NPP	S4	S7	CFMD	FMDZFI
0.00	2.00	-.001	-.005	.319	.818
0.00	3.00	-.001	-.004	.645	.901
0.00	4.00	-.001	-.003	.915	.870
0.00	5.01	-.001	-.004	1.321	.942
0.00	6.00	-.002	-.004	1.691	.967
0.00	6.48	-.003	-.003	1.862	.969
0.00	2.01	-.002	-.005	.326	.832
0.00	3.00	-.002	-.004	.648	.908
0.00	4.01	-.002	-.002	.923	.878
0.00	5.01	-.002	-.003	1.310	.938
0.00	6.01	-.003	-.003	1.685	.961
0.00	6.53	-.003	-.004	1.873	.965
.65	.98	-.373	-.234	-.099	0.000
.65	2.01	-.588	-.521	1.019	.771
.65	3.40	-.452	-.333	2.447	.852
.65	4.21	-.273	-.168	3.327	.876
.65	5.02	-.602	-.537	4.398	.934
.65	6.00	-.574	-.495	5.684	.964
.65	8.16	-.524	-.417	8.377	.988
.70	.98	-.380	-.228	-.094	0.000
.70	2.00	-.604	-.508	.869	.765
.70	3.41	-.468	-.333	2.126	.851
.70	4.21	-.274	-.159	2.885	.876
.70	5.01	-.636	-.551	3.808	.933
.70	6.00	-.608	-.510	4.920	.964
.70	8.44	-.537	-.410	7.590	.991
.80	.98	-.385	-.200	-.096	0.000
.80	2.02	-.835	-.448	.657	.748
.80	3.41	-.549	-.334	1.613	.846
.80	4.20	-.290	-.148	2.177	.872
.80	5.02	-.968	-.683	2.927	.928
.80	6.01	-.970	-.582	3.773	.963
.80	7.00	-.926	-.489	4.573	.971
.80	9.17	-.652	-.377	6.412	.991
.90	.95	-.445	-.174	-.112	0.000
.90	2.01	-.789	-.611	.454	.658
.90	3.40	-.785	-.741	1.209	.810
.90	4.21	-.518	-.237	1.717	.865
.90	4.99	-.791	-.923	2.226	.901
.90	5.99	-.796	-.963	2.884	.937
.90	7.00	-.800	-.972	3.574	.957
.90	8.61	-.789	-.962	4.610	.975
.90	10.01	-.787	-.953	5.539	.984
.95	.93	-.590	-.225	-.109	0.000
.95	1.99	-.699	-.843	.380	.621
.95	3.00	-.700	-.837	.864	.758
.95	3.40	-.693	-.551	1.095	.807
.95	4.20	-.689	-.516	1.538	.860
.95	5.01	-.696	-.835	1.990	.896
.95	6.00	-.698	-.856	2.569	.924
.95	6.99	-.696	-.854	3.159	.947
.95	8.61	-.698	-.857	4.150	.972
.95	9.99	-.695	-.853	4.981	.985
1.20	.85	-.381	-.405	-.193	0.000
1.20	2.00	-.378	-.491	.164	.427
1.20	3.38	-.378	-.495	.594	.705
1.20	4.19	-.372	-.493	.879	.790
1.20	5.01	-.371	-.493	1.180	.846
1.20	6.02	-.381	-.493	1.560	.893
1.20	7.00	-.381	-.492	1.926	.921
1.20	8.60	-.380	-.491	2.525	.949
1.20	10.00	-.380	-.491	3.058	.965

TABLE 21.- BASIC DATA FOR CONFIGURATION 20 WITH $\alpha_p = 15^\circ$,
 $B/d = 0.090$, AND $A/d = 0.184$

MACH	NPR	P1	P2	P3	P4	P5	P6	P7	P8	P9
0.00	2.01	.244	.390	.491	.503	.505	.503	.504	.503	.504
0.00	3.01	.245	.227	.155	.249	.321	.425	.320	.359	.329
0.00	4.01	.248	.230	.156	.145	.225	.324	.224	.347	.281
0.00	5.00	.250	.232	.157	.107	.166	.219	.293	.323	.239
0.00	6.00	.249	.233	.158	.107	.165	.142	.169	.226	.246
0.00	6.40	.249	.233	.158	.107	.165	.141	.135	.186	.231
.65	2.01	.245	.234	.414	.518	.524	.520	.521	.521	.524
.65	3.41	.249	.226	.156	.232	.266	.308	.440	.297	.271
.65	4.20	.249	.228	.157	.108	.212	.296	.265	.312	.276
.65	5.00	.249	.230	.157	.107	.167	.206	.273	.344	.268
.65	6.01	.249	.231	.158	.107	.166	.141	.152	.201	.261
.65	8.14	.249	.232	.158	.107	.164	.141	.094	.078	.094
.70	2.01	.245	.236	.394	.513	.527	.524	.524	.524	.526
.70	3.41	.247	.225	.154	.229	.265	.312	.439	.298	.281
.70	4.21	.247	.228	.156	.112	.211	.292	.268	.308	.290
.70	5.00	.249	.230	.157	.108	.167	.201	.274	.348	.278
.70	6.02	.250	.231	.157	.108	.166	.141	.152	.198	.263
.70	8.42	.250	.232	.158	.108	.164	.141	.084	.066	.083
.80	2.00	.246	.220	.307	.435	.507	.525	.531	.533	.536
.80	3.41	.247	.224	.154	.195	.230	.330	.424	.344	.299
.80	4.20	.248	.227	.156	.108	.200	.253	.309	.277	.346
.80	5.00	.247	.229	.157	.108	.167	.142	.275	.330	.282
.80	6.00	.250	.231	.157	.107	.167	.141	.093	.191	.268
.80	7.00	.251	.232	.158	.108	.166	.141	.083	.117	.151
.80	9.13	.250	.232	.158	.108	.164	.141	.084	.055	.065
.90	1.99	.247	.234	.318	.359	.395	.431	.468	.501	.528
.90	3.41	.247	.223	.153	.116	.199	.263	.339	.387	.351
.90	4.19	.249	.227	.156	.107	.167	.174	.271	.332	.238
.90	5.01	.248	.228	.156	.108	.166	.141	.202	.227	.285
.90	6.01	.248	.231	.158	.108	.167	.141	.084	.153	.180
.90	7.01	.251	.231	.158	.108	.167	.141	.083	.057	.116
.90	8.60	.251	.232	.158	.108	.165	.142	.084	.055	.043
.95	2.00	.246	.233	.308	.340	.368	.396	.424	.453	.482
.95	3.41	.248	.224	.153	.106	.163	.144	.266	.373	.363
.95	4.21	.248	.226	.155	.107	.166	.142	.153	.226	.320
.95	5.00	.248	.228	.157	.108	.167	.142	.084	.146	.229
.95	6.01	.248	.230	.158	.108	.167	.142	.083	.102	.147
.95	7.01	.250	.231	.158	.108	.167	.142	.083	.064	.120
.95	8.58	.251	.232	.158	.108	.166	.142	.084	.055	.100
.95	10.02	.250	.232	.158	.108	.165	.142	.084	.055	.057
1.20	2.00	.247	.219	.221	.258	.299	.336	.376	.414	.449
1.20	3.42	.248	.222	.153	.107	.142	.154	.238	.265	.276
1.20	4.21	.249	.224	.154	.107	.162	.131	.173	.199	.219
1.20	5.00	.250	.227	.156	.107	.166	.131	.096	.152	.172
1.20	5.99	.249	.228	.157	.108	.167	.143	.083	.109	.128
1.20	6.98	.249	.229	.158	.109	.167	.143	.084	.057	.098
1.20	8.60	.248	.231	.158	.108	.168	.142	.083	.055	.041
1.20	10.01	.251	.232	.158	.108	.167	.141	.083	.055	.040

TABLE 21.- Continued

MACH	NPR	P10	P11	P12	P13	P14	P15	S1	S2	S3
0.00	2.01	.507	.505	.502	.436	.538	.545	-.001	-.002	.001
0.00	3.01	.350	.356	.338	.303	.366	.376	-.002	-.003	.000
0.00	4.01	.281	.223	.241	.245	.293	.305	-.002	-.003	-.000
0.00	5.00	.180	.152	.141	.224	.252	.261	-.003	-.004	-.001
0.00	6.00	.197	.204	.185	.142	.171	.174	-.003	-.005	-.002
0.00	8.40	.189	.166	.216	.164	.162	.162	-.004	-.006	-.002
.65	.97							-.405	-.543	-.443
.65	2.01	.525	.525	.523	.472	.561	.569	-.652	-1.084	-1.013
.65	3.41	.304	.373	.351	.270	.323	.333	-.674	-1.133	-1.055
.65	4.20	.265	.271	.229	.225	.280	.290	-.659	-1.083	-.998
.65	5.00	.216	.169	.140	.197	.247	.254	-.633	-1.014	-.932
.65	6.01	.213	.224	.217	.170	.171	.173	-.588	-.912	-.826
.65	8.14	.131	.165	.140	.169	.189	.204	-.487	-.710	-.627
.70	.97							-.400	-.522	-.402
.70	2.01	.529	.529	.527	.479	.565	.573	-.646	-1.123	-1.031
.70	3.41	.310	.372	.351	.269	.326	.337	-.675	-1.271	-1.158
.70	4.21	.272	.271	.231	.216	.279	.290	-.667	-1.219	-1.108
.70	5.00	.224	.167	.141	.187	.248	.254	-.648	-1.126	-1.014
.70	6.02	.217	.231	.223	.173	.172	.173	-.608	-.974	-.863
.70	8.42	.112	.159	.140	.170	.186	.201	-.489	-.713	-.598
.80	.96							-.401	-.486	-.297
.80	2.00	.539	.538	.536	.492	.574	.584	-.535	-.943	-.838
.80	3.41	.335	.355	.329	.281	.336	.353	-.540	-1.115	-1.043
.80	4.20	.295	.281	.241	.212	.287	.295	-.537	-1.132	-1.075
.80	5.00	.199	.174	.207	.175	.254	.266	-.535	-1.116	-1.044
.80	6.00	.226	.269	.256	.167	.170	.172	-.536	-1.026	-.930
.80	7.00	.212	.178	.170	.216	.231	.236	-.532	-.924	-.761
.80	9.13	.080	.103	.142	.158	.177	.186	-.496	-.740	-.488
.90	.93							-.371	-.446	-.248
.90	1.99	.544	.551	.554	.540	.569	.573	-.384	-.876	-.856
.90	3.41	.342	.372	.332	.287	.351	.368	-.390	-.896	-1.066
.90	4.19	.357	.328	.321	.220	.272	.288	-.390	-.897	-1.071
.90	5.01	.250	.180	.281	.258	.274	.288	-.386	-.891	-1.065
.90	6.01	.225	.264	.232	.170	.217	.233	-.387	-.894	-1.067
.90	7.01	.159	.184	.199	.240	.241	.264	-.383	-.888	-1.043
.90	8.60	.083	.122	.153	.195	.196	.215	-.383	-.888	-.890
.95	.90							-.308	-.453	-.306
.95	2.00	.507	.526	.540	.540	.553	.555	-.318	-.780	-.803
.95	3.41	.376	.370	.343	.306	.376	.389	-.318	-.784	-.946
.95	4.21	.349	.270	.268	.302	.334	.347	-.314	-.778	-.940
.95	5.00	.271	.315	.269	.197	.267	.285	-.317	-.783	-.946
.95	6.01	.186	.211	.241	.234	.240	.248	-.316	-.783	-.946
.95	7.01	.139	.154	.167	.184	.203	.207	-.310	-.774	-.927
.95	8.58	.107	.114	.122	.130	.135	.154	-.320	-.788	-.856
.95	10.02	.088	.091	.096	.101	.105	.113	-.312	-.773	-.756
1.20	.82							-.105	-.385	-.343
1.20	2.00	.474	.496	.513	.518	.542	.549	-.104	-.424	-.539
1.20	3.42	.291	.284	.296	.276	.351	.360	-.105	-.425	-.540
1.20	4.21	.230	.232	.249	.229	.285	.292	-.102	-.423	-.538
1.20	5.00	.185	.192	.201	.194	.248	.251	-.101	-.422	-.537
1.20	5.99	.145	.152	.162	.154	.211	.213	-.102	-.424	-.540
1.20	6.98	.113	.124	.134	.130	.183	.182	-.104	-.425	-.541
1.20	8.60	.075	.087	.098	.100	.144	.141	-.102	-.424	-.534
1.20	10.01	.035	.062	.074	.080	.116	.113	-.103	-.425	-.506

TABLE 21.- Concluded

MACH	NPR	S4	S5	S6	S8	CFMD	FMDZFI
0.00	2.01	-.003	-.003	-.004	-.004	.351	.891
0.00	3.01	-.003	-.003	-.003	-.003	.663	.917
0.00	4.01	-.003	-.004	-.004	-.003	1.025	.968
0.00	5.00	-.004	-.004	-.004	-.004	1.382	.986
0.00	6.00	-.005	-.005	-.005	-.004	1.730	.987
0.00	6.40	-.006	-.006	-.006	-.005	1.879	.989
.65	.97	-.270	-.199	-.158	-.125	-.103	0.000
.65	2.01	-.872	-.708	-.581	-.403	1.117	.839
.65	3.41	-.918	-.752	-.627	-.432	2.732	.940
.65	4.20	-.851	-.685	-.572	-.388	3.687	.965
.65	5.00	-.766	-.608	-.508	-.341	4.688	.979
.65	6.01	-.643	-.506	-.411	-.330	5.845	.983
.65	8.14	-.437	-.333	-.292	-.240	8.435	.987
.70	.97	-.245	-.191	-.154	-.127	-.104	0.000
.70	2.01	-.807	-.670	-.562	-.403	.968	.842
.70	3.41	-.879	-.713	-.603	-.443	2.343	.940
.70	4.21	-.814	-.662	-.558	-.405	3.179	.967
.70	5.00	-.731	-.594	-.496	-.358	3.980	.980
.70	6.02	-.621	-.501	-.411	-.293	5.069	.984
.70	8.42	-.406	-.312	-.242	-.184	7.678	1.005
.80	.96	-.200	-.170	-.150	-.134	-.110	0.000
.80	2.00	-.669	-.627	-.602	-.576	.688	.789
.80	3.41	-.878	-.834	-.796	-.768	1.769	.922
.80	4.20	-.939	-.882	-.838	-.808	2.395	.954
.80	5.00	-.872	-.826	-.787	-.758	3.022	.968
.80	6.00	-.718	-.685	-.653	-.623	3.893	.990
.80	7.00	-.586	-.549	-.516	-.480	4.716	.997
.80	9.13	-.344	-.286	-.241	-.214	6.370	.988
.90	.93	-.200	-.184	-.174	-.165	-.124	0.000
.90	1.99	-.770	-.719	-.682	-.660	.485	.712
.90	3.41	-1.145	-1.183	-1.206	-1.166	1.333	.875
.90	4.19	-1.160	-1.190	-1.165	-1.137	1.822	.916
.90	5.01	-1.131	-1.083	-1.064	-1.061	2.339	.943
.90	6.01	-1.014	-.995	-.986	-.968	2.992	.962
.90	7.01	-.933	-.921	-.908	-.865	3.626	.975
.90	8.60	-.806	-.761	-.717	-.688	4.669	.982
.95	.90	-.240	-.223	-.214	-.204	-.126	0.000
.95	2.00	-.737	-.702	-.670	-.641	.431	.697
.95	3.41	-1.028	-1.063	-1.109	-1.060	1.176	.861
.95	4.21	-1.023	-1.054	-1.041	-1.010	1.619	.906
.95	5.00	-1.018	-.990	-.959	-.956	2.089	.933
.95	6.01	-.910	-.885	-.885	-.876	2.671	.953
.95	7.01	-.832	-.822	-.816	-.783	3.204	.961
.95	8.58	-.773	-.745	-.707	-.671	4.177	.975
.95	10.02	-.664	-.621	-.582	-.562	4.977	.978
1.20	.82	-.285	-.258	-.242	-.229	-.189	0.000
1.20	2.00	-.594	-.608	-.642	-.656	.190	.489
1.20	3.42	-.600	-.622	-.659	-.644	.673	.785
1.20	4.21	-.599	-.622	-.659	-.621	.951	.848
1.20	5.00	-.598	-.619	-.629	-.597	1.235	.886
1.20	5.99	-.597	-.591	-.562	-.557	1.601	.916
1.20	6.98	-.549	-.520	-.517	-.514	1.964	.936
1.20	8.60	-.472	-.463	-.460	-.441	2.551	.954
1.20	10.01	-.439	-.429	-.415	-.387	3.096	.969

TABLE 22.- BASIC DATA FOR CONFIGURATION 21 WITH $\alpha_p = 15^\circ$,
 $B/d = 0.814$, AND $A/d = 0.184$

MACH	NPR	P1	P2	P3	P4	P5	P6	P7	P8	P9
0.00	1.99	.244	.257	.431	.422	.408	.426	.438	.450	.463
0.00	3.01	.244	.224	.153	.166	.253	.334	.295	.317	.303
0.00	4.00	.248	.228	.154	.107	.080	.149	.150	.235	.244
0.00	5.00	.249	.230	.155	.107	.140	.165	.165	.165	.161
0.00	6.01	.249	.230	.155	.107	.079	.062	.069	.067	.127
0.00	6.42	.248	.230	.156	.107	.079	.062	.069	.066	.104
0.00	6.71	.248	.230	.156	.107	.079	.062	.069	.066	.074
0.00	2.01	.243	.258	.429	.419	.403	.421	.432	.444	.457
0.00	2.99	.245	.223	.153	.172	.268	.338	.294	.315	.308
0.00	4.00	.248	.227	.155	.122	.201	.200	.201	.203	.202
0.00	5.00	.249	.228	.155	.107	.140	.165	.165	.165	.161
0.00	6.00	.249	.228	.156	.107	.079	.062	.070	.067	.127
0.00	6.72	.248	.228	.156	.107	.079	.062	.069	.066	.072
.65	1.99	.247	.219	.238	.368	.434	.413	.416	.430	.443
.65	3.40	.248	.224	.154	.143	.182	.200	.225	.241	.230
.65	4.20	.246	.226	.154	.107	.192	.193	.191	.189	.188
.65	5.01	.247	.228	.155	.107	.131	.165	.165	.164	.161
.65	6.01	.249	.229	.156	.107	.079	.062	.069	.085	.122
.65	6.42	.249	.229	.156	.108	.079	.062	.069	.066	.064
.70	2.00	.245	.218	.223	.357	.424	.397	.411	.426	.438
.70	3.40	.247	.224	.153	.158	.220	.222	.221	.225	.226
.70	4.21	.247	.225	.154	.107	.188	.190	.189	.187	.187
.70	5.00	.247	.228	.155	.107	.129	.165	.165	.164	.161
.70	5.99	.249	.229	.156	.107	.079	.063	.070	.086	.123
.70	6.72	.249	.229	.156	.108	.079	.062	.069	.066	.065
.80	2.00	.245	.217	.226	.374	.384	.381	.412	.412	.428
.80	3.42	.247	.223	.152	.138	.209	.213	.213	.218	.220
.80	4.20	.247	.225	.154	.107	.181	.186	.185	.183	.184
.80	4.99	.247	.227	.155	.107	.120	.165	.165	.164	.161
.80	5.99	.248	.228	.156	.107	.079	.062	.069	.085	.126
.80	7.01	.249	.229	.156	.107	.079	.061	.069	.066	.064
.80	9.36	.249	.229	.156	.108	.079	.062	.069	.066	.064
.90	2.00	.245	.216	.263	.401	.349	.378	.392	.401	.420
.90	3.40	.247	.222	.152	.149	.205	.208	.209	.214	.218
.90	4.21	.248	.224	.153	.107	.173	.182	.182	.180	.181
.90	5.00	.247	.225	.154	.107	.096	.161	.161	.161	.159
.90	6.01	.247	.227	.155	.107	.079	.063	.070	.076	.123
.90	7.00	.249	.228	.156	.108	.079	.062	.069	.066	.065
.90	8.60	.250	.229	.156	.108	.080	.062	.069	.066	.065
.90	10.01	.249	.229	.156	.108	.079	.062	.069	.066	.064
.95	2.02	.246	.217	.269	.404	.342	.362	.393	.390	.415
.95	3.41	.246	.220	.150	.156	.202	.204	.205	.210	.216
.95	4.20	.248	.224	.154	.107	.164	.178	.179	.178	.178
.95	5.00	.247	.225	.154	.107	.088	.157	.158	.158	.156
.95	6.00	.247	.227	.156	.108	.079	.063	.069	.071	.104
.95	7.00	.248	.228	.156	.108	.079	.062	.069	.066	.065
.95	8.62	.250	.229	.156	.108	.079	.062	.069	.066	.065
.95	9.99	.249	.229	.157	.108	.080	.062	.069	.066	.065
1.20	3.40	.248	.220	.150	.107	.142	.155	.160	.166	.174
1.20	4.22	.247	.221	.151	.105	.082	.078	.116	.139	.143
1.20	5.00	.249	.224	.154	.108	.081	.063	.070	.067	.071
1.20	6.00	.248	.225	.154	.107	.080	.062	.068	.065	.065
1.20	7.00	.248	.226	.155	.108	.080	.062	.068	.065	.065
1.20	8.62	.247	.228	.155	.108	.079	.061	.069	.066	.064
1.20	10.01	.249	.229	.156	.108	.080	.062	.070	.066	.065

TABLE 22.- Continued

MACH	NPR	P10	P11	P12	P13	P14	P15	S1	S2	S3
0.00	1.99	.477	.487	.498	.459	.528	.535	-.000	-.000	.001
0.00	3.01	.301	.347	.335	.296	.353	.364	-.000	-.000	.001
0.00	4.00	.290	.346	.272	.185	.266	.271	-.000	-.000	.001
0.00	5.00	.155	.153	.156	.152	.183	.213	-.000	-.001	.001
0.00	6.01	.132	.133	.175	.202	.217	.226	-.000	-.001	.001
0.00	6.42	.127	.131	.135	.170	.192	.200	-.000	-.001	.001
0.00	6.71	.123	.128	.129	.142	.164	.182	-.000	-.001	-.000
0.00	2.01	.471	.481	.493	.456	.523	.530	.001	-.000	-.000
0.00	2.99	.307	.346	.337	.305	.357	.367	.001	-.000	-.000
0.00	4.00	.201	.201	.201	.191	.217	.243	.001	-.001	-.001
0.00	5.00	.156	.153	.157	.151	.185	.213	.001	-.001	-.001
0.00	6.00	.132	.133	.173	.201	.217	.225	.001	-.001	-.001
0.00	6.72	.123	.128	.130	.139	.162	.180	.001	-.001	-.001
.65	.97							-.079	-.111	-.109
.65	1.99	.455	.463	.475	.447	.519	.527	-.072	-.105	-.105
.65	3.40	.254	.244	.234	.247	.264	.277	-.078	-.114	-.116
.65	4.20	.187	.185	.187	.180	.198	.219	-.079	-.115	-.116
.65	5.01	.156	.152	.155	.148	.179	.210	-.080	-.117	-.119
.65	6.01	.129	.129	.129	.140	.160	.166	-.081	-.122	-.126
.65	8.42	.064	.096	.118	.122	.115	.137	-.076	-.121	-.124
.70	.97							-.080	-.113	-.112
.70	2.00	.451	.459	.471	.444	.515	.523	-.073	-.106	-.106
.70	3.40	.227	.228	.232	.231	.248	.263	-.077	-.113	-.114
.70	4.21	.186	.184	.186	.180	.198	.218	-.079	-.116	-.118
.70	5.00	.156	.153	.155	.148	.178	.210	-.080	-.118	-.121
.70	5.99	.130	.130	.128	.136	.157	.163	-.081	-.123	-.128
.70	8.72	.064	.086	.115	.120	.114	.132	-.081	-.123	-.128
.80	.96							-.085	-.123	-.123
.80	2.00	.442	.451	.464	.437	.508	.517	-.077	-.115	-.115
.80	3.42	.221	.223	.229	.227	.245	.263	-.082	-.123	-.124
.80	4.20	.184	.183	.185	.181	.198	.214	-.083	-.125	-.127
.80	4.99	.156	.153	.155	.147	.175	.207	-.085	-.127	-.130
.80	5.99	.131	.131	.129	.128	.148	.156	-.085	-.129	-.135
.80	7.01	.091	.119	.123	.123	.115	.146	-.087	-.133	-.139
.80	9.36	.064	.072	.111	.117	.113	.124	-.085	-.131	-.137
.90	.95							-.094	-.145	-.146
.90	2.00	.433	.443	.456	.431	.500	.510	-.085	-.135	-.136
.90	3.40	.221	.224	.231	.230	.254	.273	-.089	-.144	-.147
.90	4.21	.181	.181	.183	.178	.195	.213	-.090	-.145	-.148
.90	5.00	.155	.152	.154	.147	.170	.197	-.091	-.146	-.151
.90	6.01	.131	.132	.131	.123	.139	.151	-.091	-.147	-.153
.90	7.00	.085	.119	.123	.123	.117	.140	-.089	-.146	-.152
.90	8.60	.064	.096	.117	.121	.114	.133	-.089	-.147	-.153
.90	10.01	.064	.061	.105	.115	.112	.116	-.090	-.147	-.153
.95	.95							-.090	-.172	-.187
.95	2.02	.425	.436	.450	.425	.493	.503	-.087	-.166	-.179
.95	3.41	.219	.223	.231	.229	.258	.280	-.087	-.171	-.187
.95	4.20	.179	.179	.181	.177	.193	.211	-.088	-.171	-.187
.95	5.00	.153	.151	.152	.147	.166	.188	-.089	-.172	-.188
.95	6.00	.127	.129	.130	.124	.130	.143	-.088	-.170	-.185
.95	7.00	.077	.118	.122	.123	.118	.136	-.086	-.168	-.184
.95	8.62	.064	.085	.115	.119	.115	.127	-.085	-.168	-.183
.95	9.99	.064	.061	.103	.114	.112	.116	-.087	-.169	-.183
1.20	3.40	.180	.187	.196	.193	.218	.242	-.006	-.065	-.081
1.20	4.22	.143	.142	.143	.140	.154	.155	-.005	-.064	-.080
1.20	5.00	.124	.129	.133	.130	.129	.139	-.003	-.065	-.082
1.20	6.00	.066	.105	.121	.122	.117	.129	-.004	-.066	-.083
1.20	7.00	.065	.061	.109	.115	.112	.114	-.002	-.065	-.082
1.20	8.62	.064	.060	.062	.104	.103	.105	-.002	-.065	-.083
1.20	10.01	.064	.060	.060	.054	.077	.082	-.002	-.065	-.084

TABLE 22.- Concluded

MACH	NPR	S4	S5	S6	CFMD	FMDZFI
0.00	1.99	-.000	-.000	-.001	.262	.679
0.00	3.01	-.001	-.000	-.001	.587	.812
0.00	4.00	-.000	-.001	-.001	.912	.864
0.00	5.00	-.001	-.001	-.001	1.264	.900
0.00	6.01	-.001	-.001	-.001	1.623	.923
0.00	6.42	-.001	-.001	-.001	1.764	.924
0.00	6.71	-.001	-.001	-.001	1.863	.925
0.00	2.01	-.000	-.000	-.001	.274	.693
0.00	2.99	-.001	-.000	-.001	.580	.812
0.00	4.00	-.001	-.001	-.001	.904	.857
0.00	5.00	-.001	-.001	-.001	1.257	.898
0.00	6.00	-.001	-.001	-.002	1.614	.919
0.00	6.72	-.002	-.001	-.002	1.884	.935
.65	.97	-.115	-.105	-.112	-.097	0.000
.65	1.99	-.114	-.106	-.119	.757	.576
.65	3.40	-.126	-.120	-.142	2.308	.798
.65	4.20	-.125	-.117	-.130	3.269	.857
.65	5.01	-.130	-.123	-.138	4.235	.893
.65	6.01	-.141	-.140	-.165	5.321	.900
.65	8.42	-.141	-.136	-.164	8.429	.950
.70	.97	-.117	-.107	-.115	-.097	0.000
.70	2.00	-.114	-.105	-.119	.637	.563
.70	3.40	-.121	-.114	-.128	1.967	.793
.70	4.21	-.126	-.117	-.131	2.835	.856
.70	5.00	-.130	-.123	-.138	3.648	.892
.70	5.99	-.141	-.139	-.163	4.598	.898
.70	8.72	-.142	-.140	-.164	7.606	.954
.80	.96	-.127	-.116	-.122	-.095	0.000
.80	2.00	-.121	-.111	-.122	.485	.554
.80	3.42	-.131	-.122	-.136	1.515	.785
.80	4.20	-.133	-.123	-.135	2.145	.852
.80	4.99	-.139	-.130	-.146	2.791	.892
.80	5.99	-.146	-.142	-.165	3.502	.896
.80	7.01	-.152	-.150	-.176	4.327	.918
.80	9.36	-.149	-.147	-.172	6.420	.965
.90	.95	-.146	-.132	-.136	-.078	0.000
.90	2.00	-.139	-.127	-.135	.394	.568
.90	3.40	-.151	-.141	-.153	1.182	.780
.90	4.21	-.152	-.139	-.148	1.703	.854
.90	5.00	-.156	-.146	-.157	2.216	.893
.90	6.01	-.160	-.153	-.169	2.790	.899
.90	7.00	-.160	-.153	-.171	3.433	.921
.90	8.60	-.161	-.154	-.171	4.527	.958
.90	10.01	-.161	-.153	-.171	5.531	.977
.95	.95	-.195	-.180	-.181	-.045	0.000
.95	2.02	-.185	-.170	-.174	.390	.618
.95	3.41	-.196	-.184	-.193	1.082	.797
.95	4.20	-.197	-.183	-.190	1.544	.862
.95	5.00	-.199	-.188	-.197	2.017	.903
.95	6.00	-.195	-.183	-.193	2.524	.903
.95	7.00	-.194	-.183	-.193	3.119	.930
.95	8.62	-.193	-.182	-.192	4.121	.964
.95	9.99	-.192	-.181	-.192	4.999	.979
1.20	3.40	-.092	-.087	-.093	.600	.706
1.20	4.22	-.091	-.087	-.092	.863	.765
1.20	5.00	-.093	-.088	-.093	1.158	.827
1.20	6.00	-.094	-.089	-.094	1.543	.880
1.20	7.00	-.094	-.098	-.093	1.919	.914
1.20	8.62	-.095	-.099	-.094	2.544	.949
1.20	10.01	-.097	-.091	-.096	3.075	.965

TABLE 23.- BASIC DATA FOR CONFIGURATION 22 WITH $\alpha_p = 15^\circ$,
 $B/d = 0.270$, AND $A/d = 0.184$

MACH	NPR	P1	P2	P3	P4	P5	P6	P7	P8	P9
0.00	1.99	.244	.308	.486	.433	.470	.508	.512	.511	.512
0.00	3.01	.241	.225	.154	.248	.244	.253	.271	.309	.348
0.00	4.00	.242	.226	.154	.108	.155	.168	.172	.257	.317
0.00	5.01	.243	.228	.154	.108	.079	.151	.160	.197	.244
0.00	6.00	.243	.228	.155	.108	.079	.116	.147	.176	.230
0.00	6.33	.243	.228	.155	.108	.079	.062	.107	.157	.246
0.00	2.00	.244	.286	.478	.429	.470	.507	.511	.511	.510
0.00	3.01	.244	.224	.154	.249	.244	.253	.270	.307	.347
0.00	4.00	.244	.226	.154	.107	.156	.168	.172	.257	.318
0.00	5.00	.245	.228	.155	.108	.080	.152	.160	.196	.245
0.00	5.99	.244	.228	.155	.108	.079	.120	.148	.176	.230
0.00	6.41	.244	.228	.156	.108	.079	.062	.107	.150	.239
.65	2.00	.243	.216	.315	.455	.461	.492	.516	.523	.526
.65	3.40	.246	.223	.154	.213	.227	.222	.224	.230	.242
.65	4.19	.244	.227	.153	.110	.137	.167	.168	.239	.269
.65	5.01	.244	.227	.154	.108	.080	.153	.160	.189	.242
.65	5.99	.244	.228	.155	.108	.078	.126	.148	.172	.218
.65	8.09	.243	.228	.155	.108	.079	.062	.107	.146	.132
.70	1.99	.245	.219	.297	.436	.462	.495	.519	.527	.531
.70	3.42	.244	.221	.152	.175	.219	.215	.219	.230	.245
.70	4.19	.244	.225	.151	.110	.140	.167	.168	.238	.278
.70	4.99	.244	.227	.154	.108	.081	.154	.161	.188	.243
.70	5.99	.244	.228	.155	.108	.078	.128	.148	.172	.217
.70	8.39	.243	.229	.155	.108	.079	.062	.107	.146	.132
.80	1.99	.243	.221	.337	.418	.434	.493	.523	.534	.540
.80	3.39	.248	.222	.154	.111	.194	.200	.224	.259	.295
.80	4.19	.246	.224	.154	.107	.127	.168	.168	.238	.293
.80	5.01	.244	.226	.153	.106	.080	.153	.160	.187	.242
.80	6.02	.245	.228	.155	.107	.079	.131	.148	.171	.212
.80	7.01	.245	.229	.156	.107	.078	.066	.107	.147	.148
.80	8.62	.245	.229	.156	.108	.079	.062	.107	.146	.132
.80	9.13	.245	.229	.156	.108	.080	.062	.108	.146	.133
.80	9.07	.245	.229	.156	.108	.080	.062	.108	.146	.133
.90	1.98	.244	.223	.341	.393	.415	.467	.507	.531	.546
.90	3.39	.245	.219	.151	.147	.199	.205	.218	.244	.271
.90	4.20	.247	.224	.155	.109	.163	.173	.176	.210	.258
.90	5.01	.245	.226	.154	.108	.081	.151	.158	.174	.225
.90	5.98	.244	.228	.155	.108	.080	.123	.148	.171	.199
.90	6.99	.245	.228	.156	.108	.079	.065	.108	.148	.144
.90	7.01	.245	.228	.155	.108	.079	.062	.107	.148	.142
.90	8.60	.244	.229	.156	.108	.079	.062	.107	.146	.132
.90	9.97	.244	.229	.156	.108	.079	.062	.107	.146	.133
.95	2.00	.244	.217	.226	.371	.361	.403	.462	.495	.518
.95	3.40	.246	.218	.150	.133	.187	.192	.202	.225	.249
.95	4.20	.246	.221	.150	.106	.113	.162	.169	.183	.206
.95	4.99	.247	.226	.154	.108	.081	.096	.132	.166	.210
.95	6.02	.243	.227	.154	.107	.079	.063	.107	.148	.153
.95	6.99	.244	.228	.155	.108	.079	.062	.108	.148	.132
.95	8.60	.244	.229	.156	.108	.079	.062	.107	.147	.132
.95	9.98	.244	.229	.156	.109	.080	.062	.107	.146	.133
1.20	2.03	.238	.209	.213	.258	.294	.327	.361	.391	.424
1.20	3.39	.247	.218	.148	.104	.092	.098	.116	.160	.260
1.20	4.17	.249	.222	.152	.105	.080	.068	.103	.143	.203
1.20	5.03	.247	.221	.152	.107	.079	.062	.104	.142	.142
1.20	6.01	.247	.223	.154	.108	.079	.062	.106	.146	.132
1.20	6.99	.246	.226	.155	.108	.079	.062	.108	.149	.132
1.20	8.61	.244	.228	.155	.108	.080	.062	.108	.148	.132
1.20	10.00	.245	.229	.155	.108	.080	.062	.108	.147	.133

TABLE 23.- Continued

MACH	NPP	P10	P11	P12	P13	P14	P15	S1	S2	S3
0.00	1.99	.514	.512	.508	.456	.537	.544	.001	.000	.001
0.00	3.01	.378	.382	.371	.309	.383	.395	.001	.000	.001
0.00	4.00	.390	.302	.218	.203	.281	.297	.000	-.000	.001
0.00	5.01	.181	.267	.349	.251	.205	.223	.000	-.000	.001
0.00	6.00	.265	.200	.154	.152	.186	.193	.000	.000	-.000
0.00	6.33	.286	.302	.251	.162	.113	.119	.001	.001	-.000
0.00	2.00	.501	.511	.507	.454	.536	.543	-.001	-.001	.001
0.00	3.01	.333	.382	.371	.311	.384	.395	-.001	-.001	.002
0.00	4.00	.251	.302	.218	.204	.282	.297	-.001	-.001	.001
0.00	5.00	.201	.268	.350	.252	.207	.224	-.001	-.001	.001
0.00	5.99	.168	.197	.153	.156	.189	.196	-.001	-.002	.001
0.00	6.41	.157	.297	.254	.166	.116	.123	-.001	-.002	.001
.65	.99							-.286	-.382	-.342
.65	2.00	.646	.527	.525	.479	.558	.568	-.303	-.425	-.398
.65	3.40	.334	.289	.318	.336	.356	.361	-.267	-.353	-.310
.65	4.19	.439	.351	.258	.187	.260	.277	-.320	-.452	-.431
.65	5.01	.241	.274	.365	.270	.224	.241	-.316	-.445	-.422
.65	5.99	.295	.200	.177	.173	.208	.217	-.314	-.439	-.414
.65	8.09	.167	.175	.227	.211	.170	.175	-.295	-.407	-.383
.70	.99							-.299	-.400	-.357
.70	1.99	.657	.533	.531	.486	.565	.575	-.314	-.443	-.414
.70	3.42	.346	.301	.328	.334	.358	.363	-.284	-.380	-.339
.70	4.19	.440	.349	.258	.197	.267	.284	-.333	-.475	-.454
.70	4.99	.248	.287	.368	.273	.224	.239	-.330	-.471	-.447
.70	5.99	.294	.200	.181	.177	.213	.223	-.326	-.462	-.436
.70	8.39	.152	.152	.205	.207	.176	.181	-.304	-.421	-.386
.80	.99							-.339	-.470	-.409
.80	1.99	.622	.542	.541	.500	.574	.584	-.358	-.546	-.502
.80	3.39	.365	.351	.353	.339	.383	.389	-.354	-.536	-.492
.80	4.19	.295	.344	.258	.211	.284	.300	-.378	-.616	-.584
.80	5.01	.247	.310	.372	.274	.214	.225	-.373	-.602	-.566
.80	6.02	.206	.201	.191	.184	.222	.233	-.369	-.588	-.546
.80	7.01	.177	.291	.295	.202	.169	.183	-.365	-.574	-.525
.80	8.62	.144	.134	.187	.208	.185	.189	-.344	-.510	-.456
.80	9.13	.137	.111	.146	.178	.177	.189	-.341	-.501	-.443
.80	9.07	.137	.113	.150	.181	.178	.189	-.340	-.498	-.441
.90	.97							-.299	-.582	-.639
.90	1.98	.670	.555	.556	.517	.587	.597	-.295	-.578	-.645
.90	3.39	.392	.335	.357	.358	.384	.389	-.295	-.578	-.646
.90	4.20	.317	.322	.289	.272	.339	.348	-.296	-.581	-.650
.90	5.01	.267	.306	.338	.262	.228	.239	-.292	-.576	-.643
.90	5.98	.224	.228	.225	.176	.231	.246	-.293	-.578	-.646
.90	6.99	.194	.274	.284	.212	.158	.166	-.289	-.572	-.639
.90	7.01	.194	.277	.284	.211	.158	.168	-.292	-.577	-.644
.90	8.60	.158	.141	.218	.219	.194	.198	-.290	-.575	-.643
.90	9.97	.137	.070	.113	.138	.169	.182	-.291	-.576	-.644
.95	.95							-.236	-.496	-.560
.95	2.00	.619	.543	.549	.519	.579	.586	-.237	-.499	-.564
.95	3.40	.373	.302	.330	.350	.368	.372	-.231	-.493	-.557
.95	4.20	.301	.258	.289	.303	.323	.330	-.235	-.498	-.563
.95	4.99	.260	.286	.271	.226	.293	.303	-.234	-.498	-.562
.95	6.02	.236	.245	.285	.236	.211	.224	-.229	-.493	-.557
.95	6.99	.202	.187	.218	.228	.244	.252	-.232	-.496	-.560
.95	8.60	.163	.125	.155	.173	.189	.190	-.231	-.495	-.559
.95	9.98	.140	.066	.120	.133	.139	.147	-.229	-.494	-.558
1.20	.86							-.064	-.247	-.292
1.20	2.03	.667	.476	.495	.503	.517	.522	-.062	-.246	-.292
1.20	3.39	.422	.364	.380	.317	.360	.366	-.060	-.244	-.289
1.20	4.17	.332	.258	.289	.276	.306	.314	-.058	-.242	-.287
1.20	5.03	.265	.198	.228	.217	.263	.269	-.059	-.243	-.288
1.20	6.01	.213	.152	.174	.176	.219	.222	-.057	-.241	-.286
1.20	6.99	.172	.120	.136	.141	.184	.187	-.056	-.240	-.285
1.20	8.61	.140	.084	.096	.099	.139	.143	-.054	-.238	-.283
1.20	10.00	.130	.065	.072	.076	.113	.115	-.055	-.240	-.285

TABLE 23.- Concluded

MACH	NPR	S4	S5	S6	S8	CFMD	FMDZFI
0.00	1.99	-.001	-.001	-.002	.068	.324	.835
0.00	3.01	-.001	-.001	-.001	.094	.625	.869
0.00	4.00	-.001	-.001	-.002	.084	.984	.933
0.00	5.01	-.002	-.002	-.002	.081	1.354	.964
0.00	6.00	-.002	-.003	-.003	.093	1.714	.977
0.00	6.33	-.002	-.003	-.003	.085	1.843	.985
0.00	2.00	-.001	-.001	-.002	-.021	.325	.838
0.00	3.01	-.001	-.001	-.001	-.019	.625	.872
0.00	4.00	-.001	-.001	-.001	-.017	.981	.933
0.00	5.00	-.002	-.002	-.002	-.014	1.343	.960
0.00	5.99	-.002	-.002	-.002	-.009	1.700	.973
0.00	6.41	-.002	-.002	-.003	-.019	1.864	.982
.65	.99	-.320	-.279	-.245	.298	-.079	0.000
.65	2.00	-.390	-.361	-.342	.192	1.009	.766
.65	3.40	-.286	-.247	-.213	.332	2.541	.881
.65	4.19	-.429	-.405	-.390	.094	3.547	.934
.65	5.01	-.418	-.392	-.376	.148	4.560	.959
.65	5.99	-.409	-.379	-.363	.165	5.794	.975
.65	8.09	-.361	-.330	-.301	.228	8.433	.991
.70	.99	-.331	-.286	-.248	.251	-.075	0.000
.70	1.99	-.401	-.367	-.343	.162	.861	.760
.70	3.42	-.315	-.276	-.247	.250	2.220	.884
.70	4.19	-.447	-.419	-.400	.099	3.066	.936
.70	4.99	-.438	-.409	-.389	.096	3.929	.959
.70	5.99	-.424	-.392	-.370	.123	4.998	.976
.70	8.39	-.366	-.326	-.295	.238	7.574	.991
.80	.99	-.361	-.304	-.250	.019	-.077	0.000
.80	1.99	-.463	-.414	-.370	-.093	.657	.763
.80	3.39	-.456	-.409	-.367	-.098	1.676	.885
.80	4.19	-.543	-.494	-.455	-.202	2.361	.937
.80	5.01	-.525	-.475	-.434	-.174	3.002	.957
.80	6.02	-.503	-.452	-.408	-.146	3.841	.979
.80	7.01	-.480	-.426	-.379	-.107	4.666	.996
.80	8.62	-.411	-.356	-.307	-.022	5.982	.992
.80	9.13	-.395	-.338	-.287	.013	6.324	.992
.80	9.07	-.395	-.340	-.290	.011	6.367	.992
.90	.97	-.526	-.313	-.217	.109	-.099	0.000
.90	1.98	-.712	-.757	-.754	-.240	.492	.723
.90	3.39	-.713	-.758	-.762	-.394	1.302	.865
.90	4.20	-.717	-.766	-.801	-.722	1.834	.917
.90	5.01	-.710	-.760	-.794	-.701	2.324	.941
.90	5.98	-.713	-.763	-.797	-.709	2.974	.966
.90	6.99	-.706	-.756	-.790	-.696	3.600	.977
.90	7.01	-.711	-.761	-.795	-.700	3.636	.979
.90	8.60	-.710	-.760	-.792	-.538	4.684	.989
.90	9.97	-.711	-.759	-.755	-.236	5.601	.992
.95	.95	-.612	-.504	-.315	.123	-.101	0.000
.95	2.00	-.627	-.670	-.699	-.432	.416	.669
.95	3.40	-.620	-.665	-.699	-.439	1.134	.843
.95	4.20	-.626	-.672	-.706	-.445	1.606	.900
.95	4.99	-.626	-.672	-.706	-.460	2.076	.936
.95	6.02	-.620	-.667	-.700	-.463	2.658	.958
.95	6.99	-.624	-.671	-.705	-.490	3.259	.976
.95	8.60	-.623	-.670	-.703	-.473	4.182	.984
.95	9.98	-.621	-.668	-.702	-.580	4.972	.985
1.20	.86	-.339	-.371	-.396	-.172	-.182	0.000
1.20	2.03	-.339	-.369	-.398	-.195	.193	.485
1.20	3.39	-.336	-.364	-.396	-.187	.641	.757
1.20	4.17	-.334	-.361	-.394	-.187	.927	.833
1.20	5.03	-.335	-.361	-.395	-.194	1.242	.881
1.20	6.01	-.332	-.357	-.392	-.191	1.596	.914
1.20	6.99	-.332	-.356	-.391	-.186	1.961	.936
1.20	8.61	-.330	-.352	-.389	-.183	2.556	.959
1.20	10.00	-.332	-.364	-.391	-.182	3.087	.971

TABLE 24.- BASIC DATA FOR CONFIGURATION 23 WITH $\alpha_p = 15^\circ$,
 $B/d = 0.055$, AND $A/d = 0.184$

MACH	NPR	P1	P2	P3	P4	P5	P6	P7	P8	P9
0.00	2.00	.242	.422	.518	.509	.508	.506	.507	.508	.508
0.00	3.01	.242	.223	.294	.406	.359	.349	.290	.335	.394
0.00	3.99	.243	.227	.159	.126	.221	.320	.231	.356	.290
0.00	5.00	.243	.228	.160	.109	.080	.210	.290	.349	.270
0.00	6.02	.242	.228	.160	.109	.079	.125	.166	.226	.273
0.00	6.00	.242	.228	.160	.109	.079	.125	.166	.227	.275
0.00	6.39	.242	.228	.160	.109	.079	.111	.134	.185	.238
0.00	2.00	.243	.416	.518	.512	.509	.507	.508	.508	.508
0.00	3.00	.243	.223	.299	.409	.394	.334	.306	.333	.379
0.00	3.99	.243	.226	.158	.119	.224	.322	.233	.337	.295
0.00	5.01	.243	.227	.158	.110	.083	.207	.298	.350	.273
0.00	6.00	.242	.227	.159	.110	.082	.121	.155	.239	.278
0.00	6.42	.242	.227	.159	.110	.081	.106	.140	.183	.240
.65	2.00	.245	.238	.416	.523	.524	.521	.522	.522	.525
.65	3.40	.245	.221	.157	.227	.273	.311	.429	.295	.272
.65	4.20	.244	.225	.159	.111	.200	.264	.285	.202	.312
.65	4.98	.244	.227	.159	.110	.089	.187	.284	.361	.316
.65	5.00	.243	.227	.159	.110	.082	.186	.283	.361	.321
.65	6.01	.243	.227	.159	.110	.081	.106	.143	.174	.272
.65	8.05	.243	.228	.160	.110	.081	.106	.069	.080	.076
.70	2.01	.244	.230	.368	.507	.524	.521	.521	.521	.525
.70	3.41	.246	.222	.157	.218	.258	.322	.430	.306	.279
.70	4.21	.244	.224	.158	.110	.199	.253	.288	.199	.339
.70	5.00	.243	.227	.159	.110	.088	.187	.254	.320	.286
.70	6.00	.244	.228	.159	.111	.082	.107	.142	.161	.272
.70	8.42	.242	.228	.159	.109	.080	.104	.069	.070	.072
.80	2.01	.243	.221	.307	.425	.501	.522	.527	.528	.532
.80	3.42	.245	.220	.156	.145	.224	.327	.416	.337	.316
.80	4.20	.246	.223	.157	.110	.195	.211	.292	.235	.401
.80	5.01	.244	.226	.159	.110	.121	.174	.207	.264	.233
.80	6.00	.243	.227	.159	.110	.082	.107	.142	.200	.243
.80	6.99	.244	.228	.160	.111	.082	.107	.069	.099	.112
.80	9.20	.243	.228	.159	.111	.082	.106	.068	.052	.096
.90	2.00	.243	.223	.306	.353	.397	.439	.475	.505	.529
.90	3.40	.244	.218	.155	.143	.194	.220	.269	.328	.368
.90	4.19	.247	.223	.157	.110	.129	.179	.201	.253	.291
.90	5.03	.244	.223	.158	.110	.083	.125	.174	.190	.254
.90	5.01	.245	.224	.159	.110	.082	.121	.175	.191	.257
.90	6.01	.244	.227	.159	.110	.081	.106	.143	.153	.163
.90	6.99	.244	.227	.159	.111	.081	.106	.069	.125	.132
.90	8.58	.244	.228	.160	.111	.082	.107	.069	.081	.103
.90	8.60	.243	.228	.160	.111	.082	.107	.069	.082	.103
.90	9.99	.243	.228	.160	.111	.082	.107	.069	.049	.090
.95	2.00	.245	.228	.304	.337	.365	.396	.426	.456	.485
.95	3.41	.246	.220	.156	.111	.106	.163	.241	.323	.369
.95	4.21	.246	.221	.156	.107	.080	.115	.162	.230	.293
.95	4.99	.246	.224	.159	.109	.079	.109	.102	.170	.206
.95	5.98	.244	.227	.160	.110	.079	.110	.076	.141	.155
.95	6.00	.244	.226	.160	.110	.080	.110	.075	.141	.155
.95	7.00	.243	.227	.159	.109	.078	.109	.068	.120	.127
.95	8.61	.243	.228	.160	.110	.079	.110	.069	.079	.103
.95	8.61	.244	.228	.161	.110	.080	.111	.070	.079	.104
.95	10.02	.243	.228	.160	.110	.080	.110	.070	.048	.090
1.20	2.00	.250	.220	.208	.255	.302	.341	.384	.421	.454
1.20	3.39	.249	.221	.155	.111	.089	.184	.238	.266	.287
1.20	4.19	.248	.221	.155	.107	.078	.117	.175	.200	.221
1.20	4.19	.248	.222	.157	.110	.081	.113	.174	.199	.220
1.20	5.01	.247	.223	.158	.112	.082	.112	.126	.150	.170
1.20	6.02	.246	.223	.158	.110	.080	.110	.072	.110	.128
1.20	6.00	.247	.224	.159	.111	.081	.111	.071	.111	.128
1.20	7.00	.246	.225	.160	.111	.080	.111	.069	.060	.097
1.20	8.62	.244	.227	.160	.110	.080	.111	.070	.048	.042
1.20	8.62	.244	.227	.160	.110	.080	.111	.070	.048	.041
1.20	10.01	.244	.228	.160	.110	.080	.111	.070	.048	.037

TABLE 24.- Continued

MACH	NPR	P10	P11	P12	P13	P14	P15	S1	S2	S3
0.00	2.00	.510	.509	.507	.443	.541	.547	.001	.000	-.004
0.00	3.01	.357	.304	.341	.327	.376	.381	.000	-.000	-.004
0.00	3.99	.279	.223	.234	.246	.298	.309	.000	-.000	-.004
0.00	5.00	.189	.147	.135	.233	.246	.252	-.000	-.001	-.004
0.00	6.02	.290	.212	.168	.132	.151	.155	-.001	-.001	-.006
0.00	6.00	.290	.212	.168	.132	.152	.156	-.002	-.001	-.006
0.00	6.39	.273	.237	.198	.151	.129	.132	-.001	-.001	-.006
0.00	2.00	.512	.510	.508	.443	.541	.548	-.002	-.003	-.001
0.00	3.00	.359	.312	.343	.328	.375	.377	-.002	-.003	-.001
0.00	3.99	.277	.226	.235	.244	.302	.309	-.003	-.004	-.001
0.00	5.01	.166	.142	.137	.233	.244	.252	-.003	-.004	-.001
0.00	6.00	.287	.211	.172	.130	.155	.155	-.004	-.005	-.002
0.00	6.42	.272	.238	.196	.156	.127	.131	-.004	-.006	-.002
.65	.97							-.369	-.444	-.377
.65	2.00	.527	.527	.526	.478	.565	.572	-.765	-1.129	-1.080
.65	3.40	.306	.374	.349	.269	.326	.333	-.805	-1.204	-1.139
.65	4.20	.295	.288	.234	.200	.280	.282	-.768	-1.121	-1.050
.65	4.98	.211	.158	.144	.201	.241	.250	-.723	-1.029	-.956
.65	5.00	.211	.156	.141	.204	.239	.247	-.722	-1.027	-.956
.65	6.01	.321	.260	.237	.169	.140	.139	-.652	-.898	-.832
.65	8.05	.123	.171	.220	.190	.191	.206	-.518	-.677	-.621
.70	.96							-.367	-.436	-.358
.70	2.01	.528	.527	.526	.480	.565	.572	-.729	-1.059	-.972
.70	3.41	.308	.369	.350	.276	.330	.337	-.782	-1.199	-1.092
.70	4.21	.304	.288	.224	.193	.284	.284	-.760	-1.128	-1.030
.70	5.00	.220	.186	.180	.187	.249	.255	-.733	-1.045	-.950
.70	6.00	.323	.273	.247	.174	.140	.140	-.661	-.924	-.838
.70	8.42	.089	.138	.191	.192	.185	.201	-.500	-.664	-.594
.80	.95							-.359	-.412	-.311
.80	2.01	.534	.533	.533	.491	.570	.580	-.611	-.951	-.850
.80	3.42	.325	.344	.340	.286	.341	.353	-.618	-1.068	-1.299
.80	4.20	.351	.245	.201	.219	.304	.305	-.618	-1.070	-1.204
.80	5.01	.198	.262	.301	.232	.234	.249	-.618	-1.054	-1.010
.80	6.00	.292	.269	.204	.157	.149	.154	-.611	-.958	-.861
.80	6.99	.192	.251	.260	.255	.231	.248	-.606	-.821	-.716
.80	9.20	.106	.114	.125	.140	.154	.161	-.472	-.591	-.485
.90	.93							-.357	-.369	-.269
.90	2.00	.541	.548	.551	.534	.570	.574	-.452	-.800	-.866
.90	3.40	.375	.368	.335	.311	.377	.391	-.452	-.803	-1.053
.90	4.19	.347	.349	.272	.224	.311	.319	-.451	-.805	-1.068
.90	5.03	.265	.218	.286	.314	.279	.299	-.453	-.809	-1.072
.90	5.01	.265	.218	.294	.313	.278	.298	-.456	-.811	-1.074
.90	6.01	.204	.241	.209	.177	.254	.277	-.452	-.805	-1.007
.90	6.99	.143	.172	.213	.181	.206	.219	-.458	-.816	-.873
.90	8.58	.108	.115	.126	.143	.155	.168	-.454	-.754	-.696
.90	8.60	.107	.114	.124	.141	.153	.166	-.445	-.754	-.700
.90	9.99	.093	.096	.100	.103	.110	.128	-.432	-.566	-.489
.95	.91							-.330	-.372	-.285
.95	2.00	.510	.530	.543	.543	.557	.560	-.375	-.705	-.840
.95	3.41	.374	.392	.335	.312	.388	.402	-.374	-.708	-.945
.95	4.21	.345	.285	.305	.330	.327	.337	-.369	-.703	-.940
.95	4.99	.231	.288	.274	.222	.292	.305	-.370	-.705	-.943
.95	5.98	.167	.182	.213	.230	.244	.246	-.369	-.704	-.908
.95	6.00	.166	.181	.213	.230	.244	.246	-.372	-.708	-.910
.95	7.00	.135	.143	.156	.181	.195	.199	-.371	-.706	-.813
.95	8.61	.106	.110	.115	.118	.130	.147	-.372	-.696	-.671
.95	8.61	.106	.110	.115	.118	.131	.147	-.371	-.695	-.664
.95	10.02	.091	.092	.095	.096	.100	.117	-.368	-.623	-.561
1.20	.82							-.142	-.316	-.269
1.20	2.00	.477	.499	.515	.520	.542	.549	-.142	-.371	-.540
1.20	3.39	.302	.294	.303	.282	.354	.362	-.142	-.371	-.541
1.20	4.19	.239	.247	.250	.231	.286	.293	-.141	-.371	-.541
1.20	4.19	.238	.247	.250	.231	.286	.292	-.143	-.371	-.541
1.20	5.01	.187	.202	.216	.200	.246	.250	-.140	-.371	-.541
1.20	6.02	.142	.156	.172	.167	.214	.216	-.137	-.368	-.538
1.20	6.00	.143	.156	.172	.167	.214	.217	-.139	-.370	-.539
1.20	7.00	.110	.127	.137	.142	.187	.188	-.138	-.369	-.527
1.20	8.62	.074	.084	.096	.126	.147	.145	-.136	-.367	-.431
1.20	8.62	.074	.084	.096	.125	.146	.145	-.137	-.367	-.430
1.20	10.01	.042	.062	.073	.107	.118	.117	-.136	-.364	-.370

TABLE 24.- Concluded

MACH	NPR	S4	S5	S6	S7	S8	CFMD	FMDZFI
0.00	2.00	-.004	-.001	-.005	-.002	.049	.352	.902
0.00	3.01	-.005	-.001	-.006	-.003	.067	.686	.951
0.00	3.99	-.004	-.000	-.004	-.004	.063	1.015	.964
0.00	5.00	-.005	-.001	-.005	-.004	.077	1.376	.982
0.00	6.02	-.004	-.002	-.005	-.004	.089	1.738	.987
0.00	6.00	-.004	-.002	-.005	-.004	.089	1.734	.987
0.00	6.39	-.004	-.001	-.005	-.004	.096	1.868	.985
0.00	2.00	-.005	-.005	-.002	-.007	-.009	.351	.904
0.00	3.00	-.005	-.005	-.002	-.007	-.001	.683	.951
0.00	3.99	-.004	-.004	-.001	-.005	-.013	1.012	.962
0.00	5.01	-.005	-.005	-.001	-.005	-.004	1.376	.981
0.00	6.00	-.006	-.006	-.002	-.006	-.009	1.734	.988
0.00	6.42	-.006	-.006	-.002	-.006	-.021	1.876	.984
.65	.97	-.259	-.178	-.162	-.147	.251	-.129	0.000
.65	2.00	-1.011	-.852	-.716	-.658	-.269	1.096	.830
.65	3.40	-1.097	-.930	-.767	-.717	-.284	2.706	.935
.65	4.20	-.992	-.819	-.676	-.629	-.213	3.662	.964
.65	4.98	-.881	-.704	-.581	-.537	-.161	4.619	.981
.65	5.00	-.880	-.702	-.580	-.537	-.175	4.641	.985
.65	6.01	-.737	-.564	-.466	-.426	-.089	5.800	.984
.65	8.05	-.497	-.361	-.299	-.269	.074	8.414	.954
.70	.96	-.243	-.173	-.158	-.147	.377	-.126	0.000
.70	2.01	-.883	-.773	-.708	-.668	-.282	.940	.818
.70	3.41	-1.004	-.882	-.826	-.780	-.330	2.320	.932
.70	4.21	-.934	-.792	-.728	-.693	-.291	3.168	.962
.70	5.00	-.845	-.686	-.624	-.592	-.195	3.993	.977
.70	6.00	-.711	-.552	-.492	-.464	-.100	5.018	.984
.70	8.42	-.447	-.325	-.280	-.265	.143	7.662	.999
.80	.95	-.213	-.162	-.153	-.146	.406	-.129	0.000
.80	2.01	-.789	-.741	-.728	-.721	-.259	.678	.772
.80	3.42	-1.230	-1.195	-1.208	-1.173	-.490	1.736	.908
.80	4.20	-1.144	-1.107	-1.118	-1.086	-.490	2.376	.948
.80	5.01	-.988	-.928	-.917	-.892	-.477	3.021	.964
.80	6.00	-.790	-.732	-.724	-.710	-.343	3.816	.976
.80	6.99	-.611	-.548	-.528	-.517	-.182	4.716	.993
.80	9.20	-.359	-.281	-.260	-.253	.152	6.350	.981
.90	.93	-.200	-.165	-.163	-.158	.250	-.129	0.000
.90	2.00	-.849	-.819	-.824	-.821	-.366	.488	.704
.90	3.40	-1.147	-1.180	-1.156	-1.148	-.429	1.324	.878
.90	4.19	-1.176	-1.166	-1.142	-1.139	-.430	1.825	.921
.90	5.03	-1.080	-1.038	-1.050	-1.052	-.431	2.380	.949
.90	5.01	-1.074	-1.032	-1.044	-1.048	-.431	2.365	.947
.90	6.01	-.952	-.926	-.948	-.942	-.427	2.997	.967
.90	6.99	-.865	-.835	-.832	-.822	-.330	3.643	.972
.90	8.58	-.651	-.603	-.592	-.585	-.092	4.660	.977
.90	8.60	-.660	-.612	-.599	-.593	-.161	4.639	.977
.90	9.99	-.407	-.365	-.355	-.353	.145	5.547	.980
.95	.91	-.225	-.192	-.191	-.187	-.030	-.121	0.000
.95	2.00	-.908	-.786	-.800	-.798	-.407	.423	.683
.95	3.41	-1.053	-1.092	-1.076	-1.057	-.407	1.178	.865
.95	4.21	-1.048	-1.056	-1.025	-1.015	-.406	1.621	.909
.95	4.99	-.996	-.943	-.946	-.941	-.407	2.088	.939
.95	5.98	-.854	-.827	-.845	-.838	-.406	2.642	.956
.95	6.00	-.849	-.825	-.840	-.833	-.407	2.671	.957
.95	7.00	-.784	-.758	-.768	-.758	-.407	3.239	.966
.95	8.61	-.662	-.618	-.606	-.599	-.226	4.186	.975
.95	8.61	-.654	-.611	-.596	-.589	-.141	4.171	.974
.95	10.02	-.514	-.471	-.462	-.459	-.080	4.982	.980
1.20	.82	-.255	-.228	-.227	-.224	-.201	-.196	0.000
1.20	2.00	-.617	-.644	-.681	-.647	-.349	.174	.451
1.20	3.39	-.620	-.649	-.669	-.652	-.349	.657	.777
1.20	4.19	-.620	-.646	-.644	-.630	-.349	.944	.844
1.20	4.19	-.620	-.645	-.635	-.624	-.349	.945	.845
1.20	5.01	-.616	-.601	-.585	-.581	-.349	1.239	.883
1.20	6.02	-.574	-.530	-.534	-.533	-.349	1.605	.914
1.20	6.00	-.572	-.526	-.531	-.531	-.349	1.600	.914
1.20	7.00	-.494	-.469	-.483	-.481	-.349	1.960	.934
1.20	8.62	-.413	-.393	-.398	-.393	-.348	2.547	.952
1.20	8.62	-.413	-.393	-.397	-.393	-.348	2.548	.952
1.20	10.01	-.369	-.341	-.335	-.331	-.231	3.063	.962

TABLE 25.- BASIC DATA FOR CONFIGURATION 24 WITH $\alpha_p = 20^\circ$,
 $B/d = 0.162$, AND $A/d = 0.184$

MACH	NPR	P1	P2	P3	P4	P5	P6	P7	P8	P9
0.00	2.01	.310	.269	.376	.488	.507	.503	.503	.502	.502
0.00	2.99	.328	.278	.170	.207	.260	.356	.440	.299	.365
0.00	4.00	.333	.279	.170	.129	.212	.317	.359	.214	.216
0.00	5.01	.333	.280	.171	.128	.159	.249	.252	.303	.190
0.00	6.02	.332	.279	.172	.128	.159	.249	.153	.206	.212
0.00	6.41	.332	.279	.172	.128	.159	.250	.132	.164	.199
0.00	2.02	.310	.263	.366	.487	.506	.501	.501	.499	.500
0.00	3.00	.327	.271	.169	.210	.259	.356	.441	.297	.364
0.00	3.99	.334	.273	.170	.129	.217	.317	.358	.220	.219
0.00	5.01	.333	.275	.171	.128	.158	.249	.253	.307	.189
0.00	5.99	.333	.276	.171	.128	.159	.249	.156	.213	.213
0.00	6.44	.333	.276	.171	.128	.158	.249	.142	.167	.196
.65	2.00	.311	.266	.321	.357	.450	.525	.533	.520	.514
.65	3.40	.321	.273	.167	.132	.256	.343	.260	.421	.342
.65	4.18	.332	.277	.171	.128	.162	.306	.399	.303	.175
.65	5.01	.333	.276	.171	.128	.159	.249	.230	.320	.200
.65	6.01	.333	.276	.171	.128	.159	.249	.154	.193	.230
.65	8.21	.332	.277	.172	.128	.159	.250	.132	.090	.084
.70	2.00	.312	.265	.322	.357	.450	.527	.535	.526	.515
.70	3.40	.321	.272	.169	.129	.258	.345	.260	.423	.339
.70	4.20	.330	.274	.170	.127	.161	.304	.401	.308	.171
.70	5.00	.333	.275	.171	.128	.159	.249	.229	.323	.201
.70	6.00	.334	.276	.172	.129	.160	.249	.154	.196	.233
.70	8.55	.333	.277	.172	.128	.159	.250	.132	.089	.074
.80	2.00	.313	.265	.321	.357	.449	.524	.536	.523	.519
.80	3.42	.316	.269	.167	.131	.256	.344	.268	.424	.334
.80	4.19	.327	.273	.170	.127	.163	.317	.398	.284	.171
.80	5.00	.333	.275	.171	.128	.160	.249	.227	.332	.204
.80	6.00	.334	.275	.171	.129	.160	.249	.153	.194	.238
.80	6.00	.334	.275	.171	.129	.159	.249	.153	.194	.238
.80	6.00	.334	.275	.171	.129	.159	.249	.153	.193	.238
.80	6.00	.334	.275	.171	.129	.160	.249	.153	.193	.238
.80	7.00	.334	.276	.172	.129	.160	.250	.133	.127	.150
.80	9.28	.333	.277	.172	.128	.159	.250	.132	.087	.061
.90	2.00	.312	.261	.289	.324	.393	.468	.518	.545	.534
.90	3.38	.316	.271	.169	.128	.178	.310	.382	.377	.349
.90	4.19	.322	.272	.170	.127	.160	.249	.310	.359	.259
.90	5.01	.330	.274	.171	.128	.162	.248	.138	.291	.229
.90	6.00	.334	.275	.172	.129	.160	.249	.132	.175	.244
.90	7.01	.334	.275	.171	.129	.159	.249	.132	.136	.156
.90	8.60	.334	.276	.172	.129	.159	.250	.133	.122	.078
.90	10.00	.334	.277	.172	.128	.159	.250	.133	.124	.053
.95	2.01	.315	.263	.191	.239	.276	.343	.408	.468	.498
.95	3.46	.314	.268	.167	.127	.158	.246	.216	.255	.342
.95	3.99	.317	.271	.170	.129	.161	.249	.221	.259	.347
.95	4.20	.321	.272	.169	.126	.159	.248	.164	.180	.243
.95	5.01	.326	.273	.171	.128	.161	.248	.132	.139	.154
.95	5.97	.335	.275	.172	.129	.161	.249	.131	.104	.117
.95	7.00	.335	.275	.171	.129	.159	.249	.131	.078	.089
.95	8.63	.334	.275	.171	.129	.159	.249	.132	.074	.058
.95	8.59	.335	.276	.172	.130	.160	.250	.133	.076	.057
.95	10.03	.334	.276	.172	.128	.159	.250	.132	.078	.048
1.20	1.99	.321	.266	.190	.214	.252	.328	.399	.457	.453
1.20	3.40	.318	.268	.167	.129	.157	.252	.242	.308	.274
1.20	4.18	.317	.270	.167	.125	.158	.249	.183	.245	.251
1.20	4.97	.318	.273	.171	.128	.161	.250	.135	.201	.169
1.20	5.99	.322	.273	.170	.127	.160	.248	.130	.159	.131
1.20	7.00	.329	.275	.172	.129	.162	.249	.132	.124	.100
1.20	8.57	.335	.276	.172	.129	.160	.249	.132	.116	.066
1.20	10.02	.335	.276	.172	.130	.160	.250	.132	.119	.048

TABLE 25.- Continued

MACH	NPR	P10	P11	P12	P13	P14	P15	S1	S2	S3
0.00	2.01	.499	.489	.368	.489	.514	.535	-.001	-.001	-.001
0.00	2.99	.374	.320	.248	.322	.324	.341	-.001	-.001	-.001
0.00	4.00	.224	.321	.234	.235	.230	.255	-.001	-.002	-.002
0.00	5.01	.176	.152	.115	.189	.186	.200	-.001	-.002	-.002
0.00	6.02	.131	.136	.150	.152	.150	.160	-.002	-.002	-.003
0.00	6.41	.137	.096	.148	.149	.149	.156	-.002	-.003	-.003
0.00	2.02	.497	.488	.368	.491	.515	.535	-.001	-.001	-.001
0.00	3.00	.376	.318	.247	.321	.322	.340	-.001	-.001	-.001
0.00	3.99	.226	.322	.231	.236	.230	.254	-.001	-.001	-.001
0.00	5.01	.176	.150	.115	.190	.187	.200	-.001	-.002	-.002
0.00	5.99	.130	.145	.146	.152	.152	.160	-.002	-.002	-.002
0.00	6.44	.138	.097	.145	.147	.148	.155	-.002	-.002	-.003
.65	.97							-.381	-.501	-.470
.65	2.00	.505	.490	.375	.528	.537	.560	-.379	-.506	-.490
.65	3.40	.242	.269	.230	.309	.304	.321	-.403	-.549	-.532
.65	4.18	.164	.177	.171	.267	.261	.272	-.391	-.535	-.516
.65	5.01	.197	.168	.154	.198	.192	.195	-.373	-.504	-.479
.65	6.01	.138	.122	.158	.157	.157	.163	-.349	-.467	-.434
.65	8.21	.120	.110	.067	.109	.106	.114	-.287	-.369	-.332
.70	.96							-.391	-.518	-.481
.70	2.00	.507	.492	.377	.533	.540	.563	-.397	-.537	-.506
.70	3.40	.242	.272	.224	.311	.306	.322	-.420	-.585	-.565
.70	4.20	.169	.176	.166	.264	.259	.268	-.411	-.568	-.545
.70	5.00	.205	.168	.151	.199	.193	.195	-.390	-.531	-.503
.70	6.00	.139	.122	.158	.157	.158	.164	-.363	-.488	-.450
.70	8.55	.104	.114	.062	.104	.100	.110	-.285	-.362	-.319
.80	.96							-.428	-.599	-.519
.80	2.00	.510	.496	.384	.540	.547	.567	-.453	-.751	-.705
.80	3.42	.256	.269	.227	.312	.306	.321	-.459	-.791	-.873
.80	4.19	.193	.182	.176	.266	.259	.272	-.457	-.780	-.806
.80	5.00	.231	.166	.135	.198	.192	.195	-.446	-.725	-.664
.80	6.00	.141	.129	.161	.158	.159	.165	-.423	-.618	-.546
.80	6.00	.141	.129	.162	.158	.159	.165	-.423	-.617	-.545
.80	6.00	.141	.129	.161	.158	.159	.165	-.423	-.617	-.545
.80	6.00	.141	.129	.161	.158	.159	.165	-.425	-.621	-.548
.80	7.00	.160	.099	.116	.138	.135	.137	-.387	-.526	-.458
.80	9.28	.078	.111	.063	.094	.092	.097	-.297	-.368	-.305
.90	.94							-.343	-.632	-.674
.90	2.00	.525	.509	.434	.546	.564	.579	-.342	-.633	-.735
.90	3.38	.326	.308	.233	.315	.308	.316	-.344	-.636	-.739
.90	4.19	.233	.228	.171	.254	.249	.261	-.346	-.639	-.741
.90	5.01	.255	.210	.157	.191	.190	.198	-.344	-.637	-.740
.90	6.00	.153	.141	.167	.169	.171	.176	-.337	-.628	-.730
.90	7.01	.162	.105	.092	.141	.139	.141	-.338	-.629	-.731
.90	8.60	.111	.115	.062	.103	.100	.104	-.332	-.622	-.706
.90	10.00	.064	.096	.066	.086	.083	.093	-.324	-.546	-.382
.95	.93							-.283	-.550	-.638
.95	2.01	.517	.520	.483	.556	.570	.578	-.276	-.546	-.641
.95	3.46	.385	.320	.224	.309	.310	.319	-.274	-.542	-.637
.95	3.39	.387	.325	.229	.316	.317	.325	-.275	-.544	-.639
.95	4.20	.246	.317	.244	.255	.258	.269	-.272	-.541	-.636
.95	5.01	.175	.165	.200	.236	.238	.244	-.277	-.547	-.642
.95	5.97	.184	.124	.157	.186	.186	.192	-.273	-.542	-.638
.95	7.00	.140	.120	.110	.144	.145	.151	-.274	-.543	-.639
.95	8.63	.087	.124	.066	.105	.102	.105	-.272	-.541	-.637
.95	8.59	.085	.125	.066	.105	.103	.105	-.272	-.541	-.637
.95	10.03	.058	.105	.067	.085	.082	.081	-.271	-.540	-.634
1.20	.81							-.085	-.271	-.338
1.20	1.99	.455	.449	.353	.508	.502	.519	-.085	-.272	-.340
1.20	3.40	.284	.278	.207	.271	.269	.277	-.084	-.271	-.339
1.20	4.18	.209	.217	.173	.220	.217	.221	-.083	-.270	-.338
1.20	4.97	.179	.166	.140	.187	.182	.183	-.083	-.270	-.338
1.20	5.99	.164	.129	.105	.154	.148	.147	-.084	-.271	-.339
1.20	7.00	.108	.127	.080	.119	.118	.120	-.081	-.268	-.336
1.20	8.57	.077	.085	.073	.094	.092	.093	-.081	-.267	-.336
1.20	10.02	.053	.064	.064	.074	.073	.074	-.080	-.267	-.335

TABLE 25.- Concluded

MAC4	NPR	S4	S5	S6	S7	CFMD	FMDZFI
0.00	2.01	-.001	.000	-.002	-.001	.336	.840
0.00	2.99	-.001	.000	-.002	-.001	.656	.910
0.00	4.00	-.002	-.000	-.002	-.002	1.011	.951
0.00	5.01	-.002	-.001	-.003	-.002	1.370	.972
0.00	6.02	-.003	-.001	-.003	-.002	1.719	.975
0.00	6.41	-.003	-.000	-.004	-.003	1.865	.978
0.00	2.02	-.002	-.002	-.002	-.002	.339	.842
0.00	3.00	-.001	-.002	-.002	-.001	.660	.907
0.00	3.99	-.002	-.002	-.002	-.002	1.008	.949
0.00	5.01	-.002	-.002	-.002	-.002	1.365	.972
0.00	5.99	-.002	-.003	-.003	-.003	1.706	.973
0.00	6.44	-.003	-.003	-.003	-.003	1.869	.975
.65	.97	-.427	-.326	-.289	-.397	-.074	0.000
.65	2.00	-.442	-.361	-.339	-.410	1.112	.823
.65	3.40	-.503	-.427	-.414	-.474	2.743	.929
.65	4.18	-.485	-.416	-.399	-.454	3.690	.957
.65	5.01	-.440	-.417	-.401	-.411	4.634	.962
.65	6.01	-.400	-.347	-.301	-.355	5.806	.969
.65	8.21	-.283	-.232	-.158	-.235	8.458	.967
.70	.96	-.431	-.317	-.276	-.384	-.073	0.000
.70	2.00	-.440	-.367	-.341	-.422	.950	.828
.70	3.40	-.527	-.441	-.421	-.493	2.352	.935
.70	4.20	-.506	-.439	-.399	-.470	3.189	.961
.70	5.00	-.460	-.383	-.343	-.421	3.966	.961
.70	6.00	-.399	-.310	-.278	-.361	4.976	.967
.70	8.55	-.266	-.206	-.162	-.214	7.592	.966
.80	.96	-.429	-.280	-.228	-.360	-.080	0.000
.80	2.00	-.545	-.384	-.343	-.461	.735	.832
.80	3.42	-.768	-.470	-.426	-.589	1.812	.930
.80	4.19	-.639	-.440	-.402	-.522	2.442	.958
.80	5.00	-.535	-.392	-.351	-.463	3.042	.959
.80	6.00	-.456	-.317	-.279	-.390	3.830	.966
.80	6.00	-.456	-.318	-.279	-.391	3.839	.967
.80	6.00	-.456	-.317	-.279	-.390	3.838	.967
.80	6.00	-.456	-.316	-.279	-.390	3.838	.967
.80	6.00	-.458	-.318	-.280	-.392	3.840	.967
.80	7.00	-.379	-.242	-.206	-.314	4.602	.970
.80	9.28	-.235	-.134	-.103	-.175	6.399	.967
.90	.94	-.505	-.218	-.182	-.316	-.105	0.000
.90	2.00	-.797	-.497	-.433	-.658	.538	.772
.90	3.38	-.801	-.909	-.970	-.862	1.361	.893
.90	4.19	-.804	-.912	-.974	-.865	1.877	.928
.90	5.01	-.802	-.912	-.970	-.864	2.375	.941
.90	6.00	-.791	-.894	-.913	-.852	2.975	.955
.90	7.01	-.792	-.784	-.621	-.837	3.621	.962
.90	8.60	-.592	-.255	-.202	-.361	4.608	.965
.90	10.00	-.218	-.075	-.053	-.136	5.500	.967
.95	.93	-.609	-.303	-.229	-.457	-.111	0.000
.95	2.01	-.700	-.800	-.850	-.756	.481	.759
.95	3.46	-.695	-.796	-.852	-.751	1.254	.894
.95	3.39	-.697	-.798	-.854	-.753	1.216	.890
.95	4.20	-.694	-.795	-.850	-.750	1.654	.920
.95	5.01	-.701	-.803	-.858	-.757	2.149	.948
.95	5.97	-.696	-.797	-.845	-.752	2.671	.956
.95	7.00	-.697	-.795	-.803	-.753	3.238	.958
.95	8.63	-.695	-.709	-.576	-.744	4.163	.963
.95	8.59	-.695	-.684	-.548	-.742	4.136	.964
.95	10.03	-.648	-.296	-.237	-.505	4.967	.967
1.20	.81	-.380	-.436	-.421	-.420	-.184	0.000
1.20	1.99	-.383	-.453	-.493	-.423	.226	.585
1.20	3.40	-.381	-.452	-.492	-.422	.702	.814
1.20	4.18	-.380	-.451	-.492	-.421	.975	.860
1.20	4.97	-.380	-.451	-.491	-.421	1.251	.887
1.20	5.99	-.381	-.452	-.491	-.422	1.611	.909
1.20	7.00	-.379	-.449	-.482	-.419	1.962	.922
1.20	8.57	-.378	-.444	-.444	-.419	2.518	.935
1.20	10.02	-.377	-.414	-.381	-.417	3.032	.941

TABLE 26.- BASIC DATA FOR CONFIGURATION 25 WITH $\alpha_p = 10^\circ$,
 $B/d = 0.162$, AND $A/d = 0.184$

MACH	NPR	P1	P2	P3	P4	P5	P6	P7	P8	P9
0.00	2.00	.191	.364	.519	.503	.510	.513	.515	.531	.525
0.00	3.02	.193	.182	.283	.384	.443	.345	.314	.398	.391
0.00	4.00	.198	.184	.136	.185	.205	.303	.244	.412	.337
0.00	5.00	.200	.186	.136	.101	.155	.166	.182	.258	.238
0.00	6.01	.199	.186	.136	.101	.077	.144	.148	.182	.234
0.00	6.44	.199	.186	.136	.102	.077	.133	.139	.164	.209
0.00	2.00	.191	.375	.502	.502	.510	.514	.516	.532	.526
0.00	3.00	.193	.183	.288	.373	.437	.342	.313	.407	.388
0.00	4.01	.198	.184	.136	.182	.204	.292	.253	.401	.346
0.00	5.00	.199	.186	.136	.105	.152	.162	.181	.262	.239
0.00	6.01	.199	.186	.137	.105	.076	.139	.147	.184	.241
0.00	6.49	.199	.186	.137	.105	.076	.131	.137	.162	.207
.65	2.00	.205	.259	.399	.476	.509	.529	.537	.549	.551
.65	3.41	.192	.182	.135	.228	.251	.345	.402	.329	.365
.65	4.20	.196	.185	.136	.105	.178	.179	.251	.304	.383
.65	4.99	.199	.186	.136	.105	.156	.164	.175	.253	.245
.65	6.01	.200	.186	.136	.105	.076	.141	.147	.177	.233
.65	8.21	.200	.187	.137	.106	.076	.066	.118	.126	.140
.70	2.00	.205	.256	.390	.467	.504	.527	.538	.552	.556
.70	3.40	.194	.184	.136	.226	.239	.338	.402	.353	.377
.70	4.22	.196	.185	.136	.105	.179	.179	.249	.308	.382
.70	5.01	.198	.185	.136	.104	.156	.164	.175	.252	.246
.70	6.00	.200	.187	.137	.105	.077	.143	.148	.176	.232
.70	8.52	.200	.187	.137	.106	.076	.064	.116	.123	.135
.80	2.00	.194	.267	.401	.468	.505	.529	.542	.557	.565
.80	3.39	.194	.183	.136	.224	.230	.305	.379	.388	.379
.80	4.20	.194	.184	.136	.105	.181	.181	.248	.325	.376
.80	5.01	.197	.185	.136	.105	.158	.165	.175	.255	.248
.80	6.01	.199	.186	.136	.105	.077	.145	.149	.175	.234
.80	7.01	.200	.186	.137	.105	.076	.128	.133	.143	.167
.80	9.22	.200	.187	.137	.106	.076	.063	.110	.117	.127
.90	2.02	.246	.288	.385	.437	.461	.485	.503	.524	.541
.90	3.40	.192	.181	.142	.257	.256	.251	.252	.256	.264
.90	4.21	.195	.184	.136	.159	.198	.192	.198	.223	.248
.90	5.01	.195	.185	.135	.106	.160	.166	.163	.186	.236
.90	5.99	.198	.186	.136	.105	.085	.151	.150	.153	.178
.90	7.00	.200	.187	.137	.105	.077	.128	.132	.137	.147
.90	8.62	.200	.187	.137	.105	.076	.069	.119	.123	.128
.90	10.01	.200	.187	.137	.106	.076	.064	.108	.116	.124
.95	2.00	.199	.235	.361	.418	.432	.449	.463	.485	.501
.95	3.41	.192	.179	.137	.244	.248	.241	.244	.247	.251
.95	4.22	.194	.184	.136	.160	.203	.198	.193	.202	.210
.95	5.02	.195	.185	.136	.105	.168	.170	.167	.170	.181
.95	6.02	.197	.185	.136	.104	.084	.147	.145	.146	.151
.95	7.00	.199	.186	.137	.105	.077	.121	.130	.131	.134
.95	8.61	.200	.187	.137	.106	.077	.065	.115	.120	.125
.95	9.98	.200	.187	.138	.106	.077	.063	.096	.114	.126
1.20	1.97	.211	.255	.313	.333	.348	.360	.384	.413	.442
1.20	2.02	.200	.246	.308	.323	.334	.344	.367	.395	.424
1.20	3.39	.194	.179	.133	.133	.174	.176	.190	.216	.244
1.20	4.22	.195	.182	.135	.106	.150	.165	.159	.166	.184
1.20	5.00	.195	.184	.136	.106	.081	.145	.141	.142	.154
1.20	5.01	.195	.184	.136	.106	.081	.144	.140	.141	.154
1.20	6.00	.195	.185	.137	.106	.080	.069	.121	.125	.135
1.20	6.98	.196	.186	.136	.104	.077	.062	.084	.112	.125
1.20	8.61	.198	.185	.136	.105	.077	.063	.054	.096	.092
1.20	10.03	.200	.186	.137	.105	.077	.063	.053	.096	.092

TABLE 26.- Continued

MACH	NPR	P10	P11	P12	P13	S1	S2	S3
0.00	2.00	.533	.544	.557	.574	-.001	-.001	-.001
0.00	3.02	.330	.390	.441	.442	-.001	-.001	-.002
0.00	4.00	.250	.215	.340	.389	-.001	-.002	-.002
0.00	5.00	.283	.366	.351	.310	-.001	-.002	-.002
0.00	6.01	.241	.196	.289	.265	-.002	-.003	-.003
0.00	6.44	.247	.221	.192	.247	-.002	-.003	-.003
0.00	2.00	.533	.543	.556	.572	-.001	-.001	-.002
0.00	3.00	.330	.400	.442	.438	-.001	-.001	-.002
0.00	4.01	.259	.212	.335	.387	-.001	-.002	-.002
0.00	5.00	.276	.365	.349	.308	-.001	-.002	-.002
0.00	6.01	.244	.193	.288	.265	-.002	-.003	-.003
0.00	6.49	.247	.224	.188	.245	-.003	-.003	-.004
.65	.98					-.349	-.451	-.420
.65	2.00	.556	.564	.571	.577	-.436	-.618	-.618
.65	3.41	.370	.357	.386	.430	-.479	-.697	-.712
.65	4.20	.351	.289	.318	.367	-.462	-.661	-.667
.65	4.99	.322	.381	.346	.308	-.450	-.638	-.638
.65	6.01	.242	.214	.311	.292	-.431	-.603	-.598
.65	8.21	.159	.186	.213	.212	-.394	-.539	-.521
.70	.98					-.360	-.469	-.432
.70	2.00	.562	.568	.573	.577	-.441	-.637	-.634
.70	3.40	.355	.364	.407	.428	-.496	-.746	-.764
.70	4.22	.352	.293	.328	.370	-.482	-.714	-.721
.70	5.01	.329	.382	.344	.307	-.471	-.689	-.689
.70	6.00	.242	.228	.316	.298	-.452	-.651	-.643
.70	8.52	.151	.174	.201	.208	-.406	-.560	-.537
.80	.98					-.405	-.552	-.481
.80	2.00	.573	.579	.582	.585	-.456	-.788	-.894
.80	3.39	.369	.393	.393	.421	-.460	-.798	-.916
.80	4.20	.341	.324	.356	.369	-.462	-.800	-.918
.80	5.01	.351	.382	.335	.302	-.462	-.802	-.920
.80	6.01	.240	.263	.327	.310	-.459	-.794	-.910
.80	7.01	.208	.232	.210	.260	-.457	-.788	-.890
.80	9.22	.138	.155	.176	.198	-.441	-.729	-.690
.91	.95					-.334	-.618	-.654
.90	.95					-.339	-.625	-.650
.90	2.02	.554	.564	.570	.574	-.337	-.627	-.731
.90	3.40	.281	.308	.341	.372	-.337	-.629	-.733
.90	4.21	.277	.301	.319	.335	-.335	-.626	-.731
.90	5.01	.273	.303	.315	.317	-.336	-.627	-.732
.90	5.99	.221	.251	.276	.302	-.334	-.625	-.731
.90	7.00	.181	.219	.231	.266	-.338	-.631	-.737
.90	8.62	.137	.155	.183	.209	-.335	-.627	-.733
.90	10.01	.126	.133	.147	.168	-.334	-.626	-.732
.95	.93					-.275	-.544	-.632
.95	2.00	.519	.533	.543	.550	-.275	-.544	-.641
.95	3.41	.260	.276	.300	.328	-.273	-.543	-.640
.95	4.22	.219	.236	.258	.281	-.271	-.541	-.639
.95	5.02	.193	.205	.224	.250	-.273	-.544	-.641
.95	6.02	.164	.182	.200	.222	-.270	-.539	-.637
.95	7.00	.142	.159	.183	.208	-.268	-.538	-.635
.95	8.61	.127	.134	.147	.173	-.267	-.537	-.635
.95	9.98	.128	.129	.134	.145	-.268	-.537	-.635
1.20	.84					-.082	-.270	-.339
1.20	1.97	.467	.490	.509	.521	-.080	-.267	-.336
1.20	2.02	.450	.473	.493	.505	-.082	-.270	-.339
1.20	3.39	.268	.295	.322	.345	-.083	-.272	-.341
1.20	4.22	.210	.238	.270	.304	-.081	-.269	-.339
1.20	5.00	.173	.201	.232	.266	-.078	-.266	-.335
1.20	5.01	.173	.200	.232	.265	-.079	-.267	-.336
1.20	6.00	.151	.171	.195	.222	-.079	-.267	-.336
1.20	6.98	.138	.155	.175	.198	-.079	-.266	-.336
1.20	8.61	.105	.139	.154	.176	-.080	-.268	-.337
1.20	10.03	.076	.103	.129	.149	-.079	-.267	-.336

TABLE 26.- Concluded

MACH	NPR	S4	S5	CFMD	FMDZFI
0.00	2.00	.001	-.003	.334	.851
0.00	3.02	.001	-.003	.678	.931
0.00	4.00	.000	-.004	.989	.936
0.00	5.00	.001	-.003	1.348	.960
0.00	6.01	-.000	-.003	1.709	.970
0.00	6.44	-.001	-.004	1.864	.972
0.00	2.00	-.002	.001	.337	.859
0.00	3.00	-.002	.001	.669	.928
0.00	4.01	-.003	.000	.989	.932
0.00	5.00	-.002	.001	1.344	.957
0.00	6.01	-.003	.000	1.699	.966
0.00	6.49	-.004	-.000	1.874	.969
.65	.98	-.364	-.284	-.095	0.000
.65	2.00	-.588	-.551	1.000	.754
.65	3.41	-.696	-.695	2.597	.896
.65	4.20	-.643	-.626	3.506	.914
.65	4.99	-.609	-.581	4.523	.946
.65	6.01	-.563	-.522	5.707	.960
.65	8.21	-.476	-.414	8.385	.974
.70	.98	-.370	-.278	-.093	0.000
.70	2.00	-.598	-.553	.868	.754
.70	3.40	-.740	-.720	2.217	.890
.70	4.22	-.688	-.653	3.008	.913
.70	5.01	-.653	-.608	3.859	.945
.70	6.00	-.601	-.543	4.886	.960
.70	8.52	-.485	-.408	7.545	.976
.80	.98	-.383	-.255	-.093	0.000
.80	2.00	-.874	-.569	.678	.771
.80	3.39	-.968	-.993	1.645	.868
.80	4.20	-.972	-1.100	2.262	.901
.80	5.01	-.974	-1.063	2.935	.936
.80	6.01	-.963	-.865	3.737	.957
.80	7.01	-.872	-.552	4.552	.962
.80	9.22	-.537	-.388	6.351	.977
.90	.95	-.489	-.221	-.110	0.000
.90	.95	-.473	-.215	-.108	0.000
.90	2.02	-.782	-.833	.484	.689
.90	3.40	-.784	-.836	1.203	.792
.90	4.21	-.782	-.907	1.711	.858
.90	5.01	-.784	-.910	2.239	.901
.90	5.99	-.782	-.908	2.872	.931
.90	7.00	-.789	-.915	3.550	.946
.90	8.62	-.784	-.910	4.600	.966
.90	10.01	-.783	-.908	5.516	.972
.95	.93	-.596	-.298	-.108	0.000
.95	2.00	-.690	-.797	.405	.651
.95	3.41	-.689	-.804	1.072	.782
.95	4.22	-.687	-.804	1.532	.849
.95	5.02	-.690	-.807	1.994	.887
.95	6.02	-.685	-.801	2.563	.917
.95	7.00	-.683	-.800	3.133	.937
.95	8.61	-.682	-.799	4.088	.960
.95	9.98	-.683	-.799	4.900	.969
1.20	.84	-.373	-.434	-.195	0.000
1.20	1.97	-.370	-.452	.155	.407
1.20	2.02	-.373	-.455	.171	.428
1.20	3.39	-.375	-.458	.597	.695
1.20	4.22	-.373	-.456	.888	.780
1.20	5.00	-.369	-.452	1.167	.832
1.20	5.01	-.370	-.453	1.174	.833
1.20	6.00	-.371	-.454	1.543	.877
1.20	6.98	-.370	-.453	1.894	.902
1.20	8.61	-.371	-.454	2.503	.930
1.20	10.03	-.370	-.454	3.031	.946

TABLE 27.- BASIC DATA FOR CONFIGURATION 26 WITH $\alpha_p = 15^\circ$,
 $B/d = 0.162$, AND $A/d = 0.184$

MACH	NPR	P1	P2	P3	P4	P5	P6	P7	P8	P9
0.00	2.00	.244	.391	.493	.498	.508	.507	.507	.507	.508
0.00	3.01	.243	.221	.242	.362	.369	.361	.319	.319	.368
0.00	4.01	.248	.225	.149	.104	.194	.242	.260	.383	.319
0.00	5.01	.247	.226	.149	.103	.157	.168	.229	.252	.188
0.00	6.00	.247	.227	.150	.104	.077	.061	.175	.238	.282
0.00	6.37	.247	.227	.150	.104	.077	.060	.152	.199	.250
0.00	2.01	.244	.378	.494	.496	.505	.504	.504	.504	.504
0.00	3.01	.244	.221	.253	.371	.380	.355	.321	.324	.359
0.00	4.00	.248	.225	.149	.104	.194	.244	.258	.385	.316
0.00	5.00	.249	.227	.149	.104	.157	.169	.231	.251	.188
0.00	6.00	.248	.227	.150	.104	.077	.061	.176	.240	.282
0.00	6.35	.248	.228	.150	.104	.077	.061	.153	.202	.252
.65	2.01	.245	.219	.345	.484	.506	.517	.519	.519	.522
.65	3.40	.246	.221	.148	.105	.205	.295	.394	.344	.334
.65	4.20	.246	.224	.149	.104	.187	.193	.276	.217	.403
.65	5.00	.248	.225	.149	.104	.158	.167	.203	.261	.196
.65	6.00	.249	.227	.150	.104	.077	.061	.152	.199	.287
.65	8.08	.248	.228	.150	.104	.077	.060	.123	.099	.102
.70	2.01	.244	.217	.328	.473	.504	.518	.521	.521	.524
.70	3.41	.246	.221	.148	.106	.205	.286	.386	.352	.340
.70	4.17	.247	.224	.150	.104	.188	.193	.278	.219	.407
.70	4.20	.246	.223	.149	.104	.186	.192	.275	.218	.403
.70	5.00	.247	.225	.149	.104	.158	.166	.199	.259	.196
.70	6.01	.249	.226	.150	.104	.078	.061	.149	.193	.290
.70	8.44	.248	.228	.150	.104	.077	.060	.121	.097	.093
.80	2.01	.240	.223	.347	.437	.496	.520	.527	.529	.533
.80	3.40	.247	.220	.147	.114	.204	.262	.363	.371	.366
.80	4.21	.246	.222	.147	.102	.184	.188	.268	.227	.410
.80	5.01	.246	.224	.149	.104	.158	.166	.190	.251	.196
.80	6.00	.248	.225	.149	.102	.082	.086	.148	.220	.298
.80	6.99	.249	.227	.150	.104	.077	.061	.132	.131	.147
.80	9.01	.249	.228	.150	.105	.077	.060	.121	.094	.079
.90	2.01	.243	.220	.298	.350	.394	.438	.468	.497	.520
.90	3.40	.248	.220	.148	.155	.202	.205	.236	.275	.323
.90	4.18	.249	.223	.149	.107	.182	.178	.183	.210	.250
.90	4.20	.247	.222	.148	.104	.181	.178	.182	.211	.252
.90	5.01	.247	.224	.149	.104	.080	.151	.165	.180	.218
.90	6.00	.248	.226	.150	.105	.078	.062	.122	.194	.207
.90	7.01	.250	.226	.150	.104	.077	.061	.120	.090	.167
.90	8.60	.249	.227	.150	.104	.077	.060	.120	.089	.066
.95	1.99	.245	.229	.303	.334	.360	.391	.420	.449	.477
.95	3.40	.247	.218	.146	.117	.179	.181	.199	.237	.277
.95	4.22	.247	.221	.148	.103	.114	.145	.164	.194	.225
.95	4.20	.248	.222	.149	.105	.121	.151	.166	.193	.223
.95	5.00	.246	.223	.148	.103	.078	.068	.119	.160	.226
.95	5.98	.247	.225	.150	.104	.077	.060	.120	.094	.142
.95	6.01	.247	.225	.150	.105	.078	.061	.120	.094	.138
.95	7.01	.249	.226	.149	.103	.076	.059	.119	.089	.094
.95	8.61	.249	.227	.149	.104	.077	.059	.120	.088	.065
.95	10.00	.249	.228	.150	.105	.077	.060	.120	.088	.064
1.20	2.01	.242	.219	.251	.282	.305	.330	.354	.384	.418
1.20	3.41	.246	.215	.143	.103	.086	.090	.203	.263	.296
1.20	4.20	.249	.220	.147	.103	.078	.063	.145	.192	.224
1.20	5.02	.247	.220	.147	.102	.076	.059	.121	.156	.173
1.20	4.99	.248	.221	.148	.104	.078	.061	.122	.157	.174
1.20	6.98	.247	.224	.149	.104	.076	.058	.119	.091	.100
1.20	7.01	.247	.224	.150	.105	.078	.061	.120	.091	.099
1.20	8.60	.247	.225	.149	.104	.078	.061	.120	.089	.066
1.20	10.01	.250	.227	.150	.105	.078	.061	.120	.088	.064

TABLE 27.- Continued

MACH	NPR	P10	P11	P12	P13	P14	P15	S1	S2	S3
0.00	2.00	.510	.508	.506	.446	.541	.547	-.002	.001	.001
0.00	3.01	.356	.316	.338	.327	.382	.381	-.002	.001	.001
0.00	4.01	.218	.218	.242	.250	.314	.325	-.003	.000	-.000
0.00	5.01	.305	.249	.213	.191	.214	.215	-.003	.000	-.000
0.00	6.00	.308	.226	.158	.123	.143	.147	-.004	-.000	-.001
0.00	6.37	.282	.252	.179	.134	.125	.126	-.005	-.001	-.001
0.00	2.01	.507	.505	.503	.444	.538	.544	.000	-.002	-.002
0.00	3.01	.358	.320	.340	.325	.383	.381	.000	-.002	-.002
0.00	4.00	.216	.221	.242	.252	.315	.325	-.000	-.003	-.003
0.00	5.00	.307	.247	.213	.192	.215	.216	-.000	-.003	-.003
0.00	6.00	.307	.224	.158	.123	.142	.147	.000	-.003	-.003
0.00	6.35	.283	.250	.178	.133	.125	.125	-.000	-.003	-.003
.65	.97							-.262	-.207	-.165
.65	2.01	.525	.523	.522	.477	.560	.568	-.562	-.519	-.457
.65	3.40	.323	.321	.326	.284	.342	.352	-.669	-.613	-.524
.65	4.20	.314	.222	.218	.218	.292	.302	-.612	-.554	-.475
.65	5.00	.263	.299	.272	.212	.224	.229	-.566	-.508	-.432
.65	6.00	.343	.257	.196	.153	.133	.136	-.516	-.455	-.381
.65	8.08	.137	.181	.230	.176	.190	.194	-.414	-.347	-.276
.70	.96							-.260	-.204	-.161
.70	2.01	.526	.525	.525	.480	.562	.571	-.577	-.529	-.463
.70	3.41	.323	.321	.328	.286	.347	.356	-.704	-.636	-.536
.70	4.17	.315	.227	.229	.221	.298	.308	-.646	-.582	-.494
.70	4.20	.319	.226	.224	.220	.295	.304	-.642	-.579	-.491
.70	5.00	.255	.308	.279	.220	.226	.231	-.591	-.526	-.443
.70	6.01	.344	.261	.206	.155	.135	.138	-.538	-.469	-.389
.70	8.44	.116	.150	.209	.180	.185	.197	-.400	-.327	-.253
.80	.95							-.256	-.196	-.153
.80	2.01	.535	.535	.535	.492	.572	.582	-.682	-.532	-.459
.80	3.40	.329	.319	.338	.296	.364	.368	-1.067	-1.013	-.780
.80	4.21	.336	.240	.234	.224	.294	.305	-1.060	-.983	-.712
.80	5.01	.246	.345	.288	.257	.220	.222	-1.008	-.814	-.561
.80	6.00	.339	.258	.181	.137	.148	.153	-.845	-.589	-.443
.80	6.99	.221	.283	.239	.199	.200	.203	-.558	-.425	-.334
.80	9.01	.088	.102	.143	.180	.179	.195	-.388	-.299	-.220
.90	.93							-.246	-.173	-.139
.90	2.01	.535	.543	.548	.533	.565	.568	-.854	-.835	-.734
.90	3.40	.358	.372	.373	.319	.383	.394	-.868	-.928	-.950
.90	4.18	.293	.315	.309	.281	.337	.348	-.866	-.931	-.962
.90	4.20	.294	.313	.306	.281	.335	.346	-.871	-.937	-.968
.90	5.01	.246	.278	.312	.258	.254	.264	-.860	-.925	-.955
.90	6.00	.260	.241	.177	.145	.220	.245	-.862	-.928	-.951
.90	7.01	.180	.222	.252	.189	.171	.181	-.864	-.929	-.927
.90	8.60	.093	.129	.173	.191	.196	.211	-.871	-.917	-.826
.95	.91							-.317	-.215	-.172
.95	1.99	.501	.521	.536	.540	.551	.554	-.754	-.780	-.722
.95	3.40	.320	.354	.374	.370	.402	.408	-.758	-.816	-.840
.95	4.22	.262	.289	.313	.318	.342	.349	-.760	-.820	-.850
.95	4.20	.258	.288	.314	.321	.344	.351	-.763	-.824	-.854
.95	5.00	.254	.298	.255	.201	.293	.312	-.758	-.818	-.847
.95	5.98	.201	.224	.267	.237	.234	.247	-.757	-.818	-.842
.95	6.01	.200	.222	.266	.238	.232	.245	-.759	-.819	-.843
.95	7.01	.130	.175	.190	.213	.227	.237	-.755	-.816	-.826
.95	8.61	.112	.130	.139	.148	.155	.173	-.761	-.816	-.765
.95	10.00	.069	.106	.114	.120	.124	.130	-.756	-.766	-.647
1.20	.79							-.414	-.383	-.333
1.20	2.01	.446	.471	.492	.503	.517	.523	-.422	-.460	-.472
1.20	3.41	.317	.317	.312	.284	.351	.360	-.423	-.464	-.487
1.20	4.20	.248	.258	.270	.243	.285	.292	-.421	-.462	-.485
1.20	5.02	.195	.209	.220	.204	.247	.251	-.419	-.460	-.482
1.20	4.99	.196	.210	.221	.205	.249	.253	-.419	-.460	-.483
1.20	6.98	.115	.126	.142	.140	.181	.186	-.419	-.459	-.476
1.20	7.01	.114	.125	.141	.139	.180	.185	-.417	-.458	-.473
1.20	8.60	.080	.085	.098	.102	.142	.145	-.422	-.461	-.452
1.20	10.01	.060	.068	.073	.077	.114	.116	-.422	-.457	-.420

TABLE 27.- Concluded

MACH	NPR	S4	S5	S6	S7	CFMD	FMDZFI
0.00	2.00	-.086	-.077	-.067	-.055	.343	.881
0.00	3.01	-.117	-.105	-.090	-.074	.675	.938
0.00	4.01	-.022	-.021	-.015	-.014	1.004	.951
0.00	5.01	-.021	-.015	-.015	-.014	1.360	.970
0.00	6.00	-.020	-.015	-.015	-.014	1.728	.987
0.00	6.37	-.019	-.015	-.015	-.014	1.858	.987
0.00	2.01	-.084	-.078	-.074	-.063	.347	.887
0.00	3.01	-.112	-.102	-.094	-.080	.674	.939
0.00	4.00	-.020	-.018	-.021	-.019	1.002	.951
0.00	5.00	-.014	-.014	-.010	-.020	1.360	.973
0.00	6.00	-.013	-.014	-.007	-.020	1.724	.986
0.00	6.35	-.013	-.014	-.008	-.021	1.863	.993
.65	.97	-.118	-.122	-.098	-.100	-.120	0.000
.65	2.01	-.618	-.627	-.615	-.588	1.069	.803
.65	3.40	-1.065	-1.054	-1.023	-.838	2.664	.916
.65	4.20	-.860	-.853	-.826	-.640	3.633	.955
.65	5.00	-.730	-.723	-.699	-.516	4.588	.968
.65	6.00	-.622	-.614	-.588	-.404	5.807	.983
.65	8.08	-.472	-.462	-.427	-.249	8.433	.996
.70	.96	-.117	-.123	-.099	-.100	-.120	0.000
.70	2.01	-.598	-.610	-.599	-.573	.910	.794
.70	3.41	-1.013	-1.007	-.984	-.817	2.281	.915
.70	4.17	-.834	-.829	-.811	-.651	3.109	.953
.70	4.20	-.829	-.825	-.806	-.644	3.151	.954
.70	5.00	-.708	-.702	-.682	-.519	3.947	.967
.70	6.01	-.611	-.603	-.580	-.411	5.016	.982
.70	8.44	-.434	-.424	-.388	-.226	7.574	.993
.80	.95	-.117	-.122	-.103	-.106	-.119	0.000
.80	2.01	-.526	-.543	-.533	-.517	.690	.787
.80	3.40	-1.123	-1.119	-1.082	-.954	1.734	.907
.80	4.21	-.999	-.999	-.994	-.874	2.390	.950
.80	5.01	-.859	-.857	-.840	-.702	3.060	.976
.80	6.00	-.697	-.695	-.693	-.548	3.847	.986
.80	6.99	-.526	-.521	-.492	-.350	4.664	.995
.80	9.01	-.384	-.376	-.339	-.206	6.408	1.006
.90	.93	-.132	-.137	-.122	-.126	-.123	0.000
.90	2.01	-.666	-.673	-.658	-.641	.489	.706
.90	3.40	-1.173	-1.166	-1.100	-.979	1.314	.872
.90	4.18	-1.153	-1.138	-1.100	-.968	1.817	.920
.90	4.20	-1.154	-1.138	-1.102	-.966	1.836	.920
.90	5.01	-1.103	-1.085	-1.047	-.909	2.327	.943
.90	6.00	-1.067	-1.048	-1.005	-.865	2.962	.964
.90	7.01	-1.035	-1.017	-.968	-.831	3.613	.973
.90	8.60	-.975	-.962	-.906	-.763	4.704	.985
.95	.91	-.162	-.167	-.155	-.158	-.116	0.000
.95	1.99	-.675	-.663	-.639	-.609	.418	.681
.95	3.40	-1.052	-1.044	-.985	-.876	1.153	.856
.95	4.22	-1.028	-1.015	-.982	-.860	1.638	.911
.95	4.20	-1.030	-1.016	-.983	-.860	1.627	.908
.95	5.00	-.994	-.978	-.947	-.822	2.083	.938
.95	5.98	-.955	-.938	-.901	-.774	2.640	.956
.95	6.01	-.953	-.936	-.896	-.768	2.663	.957
.95	7.01	-.926	-.908	-.867	-.741	3.238	.970
.95	8.61	-.884	-.867	-.819	-.695	4.176	.978
.95	10.00	-.814	-.805	-.731	-.612	4.978	.983
1.20	.79	-.223	-.228	-.217	-.215	-.218	0.000
1.20	2.01	-.480	-.481	-.464	-.438	.194	.491
1.20	3.41	-.646	-.641	-.612	-.557	.660	.773
1.20	4.20	-.627	-.620	-.598	-.522	.944	.842
1.20	5.02	-.602	-.593	-.573	-.490	1.237	.884
1.20	4.99	-.599	-.590	-.567	-.484	1.227	.883
1.20	6.98	-.559	-.548	-.526	-.442	1.957	.936
1.20	7.01	-.550	-.539	-.511	-.426	1.968	.937
1.20	8.60	-.528	-.516	-.481	-.398	2.569	.959
1.20	10.01	-.505	-.494	-.455	-.373	3.094	.969

TABLE 28.- BASIC DATA FOR CONFIGURATION 27 WITH $\alpha_p = 15^\circ$,
 $B/d = 0.061$, AND $A/d = 0.303$

MACH	NPP	P1	P2	P3	P4	P5	P6	P7	P8	P9
0.00	2.00	.246	.375	.499	.479	.505	.507	.507	.507	.507
0.00	3.00	.247	.230	.221	.391	.300	.324	.336	.343	.350
0.00	4.01	.253	.234	.155	.109	.177	.179	.250	.241	.394
0.00	5.01	.253	.235	.155	.109	.086	.161	.170	.238	.226
0.00	6.02	.253	.236	.155	.109	.080	.131	.141	.176	.232
0.00	6.46	.253	.236	.156	.109	.080	.062	.069	.171	.229
0.00	2.00	.246	.323	.503	.482	.506	.507	.508	.508	.508
0.00	3.00	.248	.228	.205	.401	.302	.314	.325	.358	.351
0.00	4.00	.249	.233	.154	.110	.178	.181	.247	.249	.390
0.00	5.00	.253	.234	.154	.109	.088	.155	.168	.244	.229
0.00	6.01	.253	.235	.155	.109	.082	.131	.142	.175	.234
0.00	6.40	.253	.235	.155	.109	.082	.061	.119	.171	.233
0.00	6.40	.253	.235	.155	.109	.082	.061	.120	.171	.233
.65	2.00	.248	.228	.359	.470	.476	.506	.519	.523	.526
.65	3.40	.249	.227	.152	.113	.197	.215	.281	.338	.356
.65	4.20	.249	.229	.153	.108	.159	.174	.217	.265	.351
.65	4.98	.249	.232	.154	.109	.084	.152	.163	.239	.244
.65	6.00	.252	.233	.154	.109	.081	.133	.140	.162	.214
.65	8.08	.254	.235	.155	.110	.082	.060	.066	.118	.089
.70	2.02	.245	.229	.333	.441	.459	.497	.513	.519	.523
.70	2.00	.248	.224	.325	.447	.464	.500	.517	.522	.526
.70	3.40	.250	.227	.152	.124	.194	.212	.273	.331	.355
.70	4.18	.249	.229	.151	.107	.148	.174	.214	.272	.354
.70	4.22	.249	.229	.152	.108	.144	.173	.210	.271	.342
.70	4.20	.250	.230	.153	.109	.144	.174	.211	.272	.347
.70	5.00	.249	.232	.154	.108	.083	.151	.160	.231	.251
.70	6.00	.251	.233	.154	.109	.081	.132	.139	.159	.210
.70	8.34	.254	.236	.155	.110	.082	.060	.066	.118	.079
.80	2.00	.249	.222	.267	.383	.439	.482	.510	.522	.531
.80	3.41	.248	.225	.151	.134	.189	.202	.247	.297	.332
.80	4.21	.249	.228	.152	.108	.096	.168	.178	.268	.321
.80	4.99	.249	.230	.153	.107	.081	.146	.151	.197	.268
.80	5.99	.249	.233	.154	.109	.081	.125	.136	.150	.186
.80	7.00	.253	.234	.154	.109	.082	.063	.086	.150	.170
.80	9.12	.254	.236	.155	.110	.082	.060	.066	.118	.078
.90	2.00	.247	.225	.286	.336	.376	.416	.439	.468	.493
.90	3.40	.250	.227	.153	.131	.196	.207	.220	.246	.275
.90	4.19	.250	.230	.154	.110	.101	.170	.172	.190	.227
.90	5.00	.249	.232	.155	.110	.083	.146	.144	.153	.177
.90	6.00	.251	.234	.155	.110	.082	.071	.129	.140	.150
.90	1.99	.245	.231	.308	.351	.381	.410	.438	.467	.493
.90	3.41	.250	.225	.152	.136	.188	.196	.218	.247	.280
.90	4.21	.249	.227	.152	.108	.109	.160	.168	.194	.241
.90	5.00	.249	.229	.153	.108	.082	.137	.142	.155	.184
.90	6.00	.249	.232	.154	.109	.081	.070	.129	.140	.149
.90	7.00	.250	.233	.154	.109	.081	.060	.068	.118	.162
.90	8.61	.254	.235	.155	.109	.081	.059	.065	.118	.079
.90	8.62	.254	.235	.155	.110	.082	.061	.066	.118	.078
.90	8.60	.255	.235	.155	.110	.082	.061	.066	.118	.079
.90	9.97	.254	.236	.155	.110	.082	.060	.066	.118	.078
.95	2.00	.249	.225	.273	.321	.359	.392	.408	.434	.459
.95	3.41	.250	.227	.153	.121	.182	.192	.197	.222	.246
.95	4.23	.250	.229	.168	.109	.094	.162	.163	.174	.193
.95	4.70	.250	.230	.154	.109	.096	.163	.165	.175	.195
.95	5.00	.250	.231	.155	.109	.084	.148	.145	.151	.160
.95	6.04	.249	.233	.154	.109	.082	.064	.067	.118	.158
.95	6.00	.250	.233	.155	.110	.082	.063	.067	.119	.160
.95	7.00	.253	.234	.155	.110	.082	.063	.066	.118	.086
.95	8.61	.254	.235	.155	.110	.082	.062	.066	.119	.079
.95	9.99	.254	.236	.156	.110	.082	.062	.066	.119	.079
1.20	1.93	.253	.226	.228	.276	.323	.362	.372	.398	.430
1.20	2.01	.249	.221	.213	.255	.304	.340	.351	.376	.407
1.20	3.40	.250	.224	.153	.108	.082	.115	.144	.196	.260
1.20	4.22	.250	.227	.154	.108	.080	.069	.071	.148	.214
1.20	5.00	.250	.229	.158	.108	.080	.067	.070	.116	.165
1.20	6.00	.250	.231	.154	.109	.083	.065	.066	.119	.081
1.20	7.00	.250	.232	.155	.110	.083	.064	.066	.119	.079
1.20	8.62	.251	.234	.155	.110	.082	.063	.066	.118	.079
1.20	8.61	.251	.234	.155	.110	.082	.063	.066	.118	.079
1.20	10.00	.254	.235	.155	.110	.082	.063	.066	.118	.079

TABLE 28.- Continued

MACH	NPR	P10	P11	P12	P13	P14	P15	S1	S2	S3
0.00	2.00	.511	.509	.506	.445	.539	.546	-.000	.000	.000
0.00	3.00	.354	.339	.351	.309	.372	.374	-.001	-.000	.000
0.00	4.01	.318	.219	.214	.233	.297	.313	-.000	.000	.001
0.00	5.01	.158	.327	.293	.213	.194	.204	-.001	-.001	-.000
0.00	6.02	.245	.168	.176	.213	.181	.193	-.001	-.002	.000
0.00	6.46	.274	.296	.261	.165	.113	.123	-.001	-.002	.000
0.00	2.00	.511	.509	.506	.447	.539	.546	-.002	-.002	-.002
0.00	3.00	.337	.349	.365	.312	.356	.353	-.002	-.003	-.003
0.00	4.00	.310	.215	.226	.236	.298	.314	-.002	-.002	-.002
0.00	5.00	.151	.336	.287	.214	.187	.201	-.003	-.003	-.003
0.00	6.01	.241	.164	.191	.209	.184	.195	-.004	-.004	-.004
0.00	6.40	.279	.294	.224	.160	.116	.126	-.004	-.005	-.005
0.00	6.40	.279	.293	.223	.160	.116	.126	-.005	-.005	-.005
.65	.98							-.257	-.274	-.289
.65	2.00	.528	.527	.525	.483	.560	.568	-.574	-.617	-.657
.65	3.40	.342	.343	.333	.263	.341	.355	-.644	-.693	-.744
.65	4.20	.369	.262	.209	.234	.288	.298	-.678	-.729	-.780
.65	4.98	.162	.339	.336	.244	.189	.203	-.654	-.702	-.750
.65	6.00	.238	.171	.162	.225	.221	.234	-.626	-.671	-.714
.65	8.06	.134	.175	.226	.213	.190	.206	-.545	-.582	-.616
.70	.97							-.277	-.312	-.348
.70	2.02	.525	.525	.524	.484	.559	.567	-.564	-.595	-.636
.70	2.00	.528	.528	.527	.486	.562	.571	-.557	-.598	-.639
.70	3.40	.351	.345	.338	.267	.346	.360	-.634	-.682	-.734
.70	4.18	.370	.266	.221	.239	.287	.300	-.671	-.722	-.777
.70	4.22	.375	.268	.216	.236	.283	.297	-.669	-.720	-.776
.70	4.20	.374	.268	.216	.238	.285	.298	-.672	-.723	-.779
.70	5.00	.168	.336	.347	.244	.187	.205	-.654	-.704	-.758
.70	6.00	.240	.174	.165	.225	.233	.247	-.631	-.678	-.727
.70	8.34	.114	.152	.205	.207	.187	.203	-.541	-.579	-.616
.80	.96							-.320	-.338	-.353
.80	2.00	.535	.536	.536	.498	.570	.578	-.522	-.563	-.604
.80	3.41	.352	.350	.348	.296	.367	.376	-.554	-.600	-.649
.80	4.21	.381	.292	.242	.247	.285	.300	-.558	-.605	-.656
.80	4.99	.196	.357	.357	.232	.206	.213	-.556	-.603	-.654
.80	5.99	.241	.194	.217	.166	.258	.271	-.561	-.608	-.659
.80	7.00	.195	.236	.250	.177	.143	.149	-.554	-.601	-.652
.80	9.12	.059	.102	.150	.193	.178	.193	-.530	-.572	-.615
.90	.93							-.313	-.338	-.342
.90	2.00	.513	.526	.535	.532	.547	.549	-.393	-.437	-.467
.90	3.40	.306	.333	.353	.351	.379	.384	-.394	-.439	-.470
.90	4.19	.264	.300	.299	.274	.336	.343	-.392	-.437	-.468
.90	5.00	.222	.254	.291	.283	.287	.296	-.391	-.436	-.467
.90	6.00	.182	.233	.236	.172	.241	.257	-.389	-.434	-.465
.90	.94							-.327	-.347	-.362
.90	1.99	.513	.526	.536	.536	.546	.549	-.398	-.436	-.476
.90	3.41	.313	.340	.357	.348	.381	.388	-.402	-.440	-.481
.90	4.21	.278	.309	.295	.273	.336	.344	-.405	-.443	-.485
.90	5.00	.232	.260	.304	.287	.273	.284	-.403	-.442	-.483
.90	6.00	.180	.233	.236	.176	.244	.261	-.401	-.439	-.481
.90	7.00	.167	.194	.250	.206	.161	.174	-.400	-.438	-.480
.90	8.61	.128	.131	.142	.163	.179	.190	-.402	-.441	-.483
.90	9.62	.128	.131	.140	.161	.177	.189	-.398	-.436	-.477
.90	8.60	.128	.131	.141	.162	.178	.190	-.398	-.436	-.478
.90	9.97	.084	.116	.119	.125	.133	.147	-.401	-.440	-.481
.95	.92							-.287	-.316	-.326
.95	2.00	.481	.501	.516	.522	.531	.533	-.324	-.366	-.393
.95	3.41	.269	.298	.325	.344	.363	.367	-.320	-.362	-.389
.95	4.23	.214	.237	.267	.281	.301	.310	-.319	-.360	-.388
.95	4.20	.216	.240	.269	.283	.304	.313	-.321	-.362	-.390
.95	5.00	.175	.193	.215	.236	.254	.264	-.320	-.361	-.389
.95	6.04	.174	.190	.235	.227	.247	.257	-.318	-.359	-.387
.95	6.00	.175	.192	.240	.226	.247	.258	-.321	-.362	-.390
.95	7.00	.144	.153	.168	.201	.216	.222	-.322	-.364	-.392
.95	8.61	.116	.125	.132	.137	.147	.164	-.316	-.357	-.385
.95	9.99	.059	.108	.112	.115	.119	.129	-.318	-.359	-.387
1.20	.91							-.110	-.139	-.156
1.20	1.93	.455	.480	.500	.510	.522	.527	-.112	-.138	-.156
1.20	2.01	.433	.459	.480	.490	.503	.508	-.112	-.141	-.158
1.20	3.40	.282	.301	.348	.300	.361	.376	-.110	-.139	-.156
1.20	4.22	.242	.262	.282	.262	.289	.297	-.108	-.137	-.154
1.20	5.00	.191	.209	.231	.216	.258	.264	-.107	-.136	-.153
1.20	6.00	.142	.161	.181	.177	.221	.225	-.107	-.136	-.153
1.20	7.00	.102	.125	.142	.144	.187	.190	-.106	-.135	-.152
1.20	8.62	.057	.079	.098	.108	.144	.146	-.104	-.133	-.150
1.20	8.61	.057	.078	.098	.109	.144	.147	-.107	-.136	-.153
1.20	10.00	.057	.044	.070	.094	.116	.117	-.108	-.136	-.154

TABLE 28.- Concluded

MACH	NPR	S4	S5	S6	S7	S8	S10	CFMD	FMDZFI
0.00	2.00	.003	-.000	-.001	-.004	-.005	-.002	.338	.868
0.00	3.00	.002	-.000	-.001	-.005	-.005	-.003	.671	.937
0.00	4.01	.002	-.000	-.000	-.004	-.004	-.000	.979	.930
0.00	5.01	.000	-.000	-.002	-.005	-.005	-.001	1.344	.959
0.00	6.02	.000	-.000	-.002	-.006	-.005	-.001	1.715	.975
0.00	6.46	.000	-.000	-.001	-.007	-.005	-.001	1.882	.982
0.00	2.00	-.003	-.003	-.003	-.004	-.000	-.005	.339	.864
0.00	3.00	-.003	-.004	-.004	-.004	-.005	-.007	.680	.943
0.00	4.00	-.003	-.003	-.003	-.004	-.004	-.004	.990	.935
0.00	5.00	-.003	-.003	-.004	-.004	-.004	-.004	1.352	.963
0.00	6.01	-.005	-.005	-.006	-.006	-.006	-.006	1.725	.976
0.00	6.40	-.006	-.006	-.007	-.007	-.007	-.007	1.876	.982
0.00	6.40	-.006	-.006	-.007	-.007	-.007	-.007	1.873	.981
.65	.98	-.329	-.385	-.369	-.367	-.332	-.157	-.139	0.000
.65	2.00	-.744	-.868	-.887	-.883	-.827	-.568	1.013	.761
.65	3.40	-.845	-.993	-1.024	-1.023	-.973	-.738	2.537	.877
.65	4.20	-.881	-1.032	-1.064	-1.054	-.992	-.745	3.547	.931
.65	4.98	-.945	-.985	-1.009	-.996	-.938	-.687	4.509	.953
.65	6.00	-.801	-.927	-.941	-.927	-.877	-.614	5.779	.974
.65	8.08	-.686	-.787	-.786	-.771	-.726	-.458	8.423	.994
.70	.97	-.399	-.467	-.452	-.426	-.366	-.149	-.141	0.000
.70	2.02	-.724	-.861	-.899	-.896	-.845	-.526	.864	.745
.70	2.00	-.725	-.853	-.880	-.894	-.853	-.532	.855	.743
.70	3.40	-.836	-.985	-1.011	-1.028	-1.018	-.714	2.169	.873
.70	4.18	-.883	-1.047	-1.082	-1.086	-1.054	-.748	3.021	.926
.70	4.22	-.881	-1.046	-1.082	-1.087	-1.058	-.746	3.059	.928
.70	4.20	-.884	-1.048	-1.084	-1.088	-1.064	-.747	3.052	.927
.70	5.00	-.859	-1.011	-1.038	-1.037	-1.016	-.696	3.894	.951
.70	6.00	-.820	-.957	-.973	-.967	-.944	-.623	4.981	.973
.70	8.34	-.688	-.791	-.791	-.778	-.748	-.434	7.601	.995
.80	.96	-.392	-.449	-.425	-.402	-.331	-.142	-.149	0.000
.80	2.00	-.680	-.794	-.802	-.793	-.742	-.523	.592	.682
.80	3.41	-.739	-.898	-.953	-.962	-.936	-.707	1.642	.856
.80	4.21	-.747	-.917	-1.022	-1.142	-1.146	-.960	2.298	.908
.80	4.99	-.745	-.914	-1.020	-1.139	-1.120	-.949	2.916	.935
.80	5.99	-.751	-.921	-1.021	-1.089	-1.031	-.854	3.810	.965
.80	7.00	-.743	-.908	-.976	-.962	-.931	-.719	4.659	.981
.80	9.12	-.696	-.817	-.797	-.758	-.727	-.479	6.383	.987
.90	.93	-.386	-.010	-.379	-.371	-.280	-.132	-.127	0.000
.90	2.00	-.550	-.010	-.719	-.736	-.698	-.509	.447	.645
.90	3.40	-.555	-.010	-.771	-.897	-1.056	-1.087	1.233	.817
.90	4.19	-.553	-.010	-.768	-.895	-1.056	-1.073	1.742	.881
.90	5.00	-.552	-.010	-.768	-.894	-1.056	-1.012	2.268	.917
.90	6.00	-.550	-.010	-.765	-.891	-1.052	-.942	2.915	.947
.90	.94	-.398	-.437	-.402	-.381	-.281	-.147	-.116	0.000
.90	1.99	-.549	-.678	-.722	-.714	-.671	-.496	.450	.657
.90	3.41	-.556	-.695	-.782	-.897	-1.049	-1.103	1.253	.823
.90	4.21	-.559	-.699	-.786	-.901	-1.053	-1.092	1.788	.889
.90	5.00	-.557	-.697	-.784	-.900	-1.051	-1.026	2.301	.922
.90	6.00	-.555	-.694	-.781	-.896	-1.047	-.953	2.955	.950
.90	7.00	-.554	-.694	-.781	-.896	-1.040	-.890	3.616	.965
.90	8.61	-.557	-.698	-.785	-.898	-.940	-.801	4.758	.992
.90	8.62	-.551	-.691	-.778	-.889	-.917	-.780	4.675	.980
.90	8.60	-.552	-.692	-.779	-.890	-.918	-.780	4.657	.978
.90	9.97	-.556	-.696	-.782	-.867	-.817	-.697	5.567	.979
.95	.92	-.371	-.008	-.368	-.362	-.283	-.154	-.115	0.000
.95	2.00	-.471	-.008	-.658	-.722	-.687	-.531	.397	.639
.95	3.41	-.467	-.008	-.664	-.781	-.918	-.992	1.093	.805
.95	4.23	-.466	-.009	-.664	-.781	-.918	-.964	1.558	.867
.95	4.20	-.468	-.009	-.667	-.783	-.921	-.967	1.542	.865
.95	5.00	-.467	-.009	-.666	-.782	-.920	-.914	2.008	.904
.95	6.04	-.465	-.009	-.664	-.781	-.918	-.847	2.628	.941
.95	6.00	-.468	-.009	-.667	-.784	-.922	-.849	2.621	.941
.95	7.00	-.470	-.009	-.670	-.788	-.928	-.788	3.213	.957
.95	8.61	-.463	-.008	-.662	-.778	-.860	-.692	4.126	.972
.95	9.99	-.465	-.008	-.665	-.774	-.774	-.623	4.971	.981
1.20	.91	-.208	-.010	-.307	-.320	-.314	-.211	-.192	0.000
1.20	1.93	-.209	-.010	-.344	-.427	-.500	-.387	.154	.423
1.20	2.01	-.212	-.010	-.346	-.430	-.508	-.392	.176	.451
1.20	3.40	-.210	-.010	-.345	-.429	-.528	-.602	.615	.726
1.20	4.22	-.208	-.010	-.344	-.428	-.527	-.597	.916	.814
1.20	5.00	-.207	-.010	-.343	-.427	-.526	-.586	1.202	.863
1.20	6.00	-.207	-.010	-.343	-.427	-.526	-.539	1.573	.902
1.20	7.00	-.207	-.010	-.342	-.427	-.525	-.496	1.945	.927
1.20	8.62	-.205	-.010	-.340	-.425	-.522	-.437	2.539	.951
1.20	8.61	-.207	-.010	-.343	-.428	-.525	-.440	2.543	.951
1.20	10.00	-.208	-.011	-.344	-.429	-.509	-.400	3.073	.964

TABLE 29.- BASIC DATA FOR CONFIGURATION 28 WITH $\alpha_p = 15^\circ$,
 $B/d = 0.061$, AND $A/d = 0.303$

MACH	NPR	P1	P2	P3	P4	P5	P7	P8	P9
0.00	2.01	.245	.364	.505	.493	.504	.504	.503	.505
0.00	3.00	.247	.225	.203	.407	.342	.316	.347	.354
0.00	4.02	.249	.228	.155	.107	.191	.284	.340	.356
0.00	5.01	.253	.230	.156	.107	.103	.191	.256	.201
0.00	6.01	.253	.230	.156	.107	.079	.143	.187	.246
0.00	6.41	.253	.230	.156	.107	.078	.114	.184	.239
0.00	2.00	.244	.356	.506	.498	.508	.509	.508	.509
0.00	3.01	.246	.223	.231	.406	.370	.317	.353	.345
0.00	4.01	.248	.227	.154	.111	.193	.282	.346	.350
0.00	4.99	.254	.230	.155	.108	.120	.183	.251	.205
0.00	6.00	.253	.230	.155	.107	.080	.143	.186	.244
0.00	6.37	.253	.230	.155	.108	.081	.127	.181	.240
.65	2.01	.247	.225	.343	.466	.479	.514	.518	.521
.65	3.41	.249	.224	.153	.111	.197	.315	.357	.359
.65	4.18	.250	.226	.154	.106	.165	.237	.255	.378
.65	5.01	.249	.228	.154	.106	.086	.163	.230	.229
.65	5.98	.252	.229	.155	.108	.080	.140	.162	.219
.65	8.03	.254	.231	.155	.108	.080	.067	.110	.109
.70	2.01	.248	.221	.306	.430	.470	.513	.518	.523
.70	3.41	.249	.223	.153	.117	.193	.300	.353	.364
.70	4.18	.249	.225	.153	.104	.160	.237	.257	.379
.70	5.00	.249	.227	.155	.105	.083	.163	.226	.229
.70	6.01	.251	.229	.156	.106	.077	.139	.159	.212
.70	8.33	.254	.231	.156	.106	.077	.069	.103	.098
.80	2.00	.249	.225	.289	.377	.428	.499	.515	.526
.80	3.39	.249	.223	.154	.125	.187	.261	.313	.344
.80	4.18	.250	.226	.155	.107	.090	.184	.262	.350
.80	4.97	.250	.227	.155	.107	.079	.154	.200	.232
.80	5.99	.249	.229	.156	.107	.079	.139	.147	.184
.80	6.98	.253	.230	.156	.107	.079	.080	.142	.160
.80	9.08	.254	.230	.155	.107	.078	.066	.101	.076
.90	2.00	.245	.254	.344	.374	.385	.425	.445	.468
.90	3.38	.248	.220	.153	.146	.188	.223	.246	.273
.90	4.20	.249	.223	.152	.107	.134	.165	.184	.220
.90	5.00	.249	.225	.154	.105	.081	.144	.152	.176
.90	6.00	.249	.227	.155	.106	.077	.131	.138	.145
.90	6.99	.250	.229	.155	.106	.078	.070	.103	.159
.90	8.59	.254	.230	.155	.107	.079	.067	.101	.076
.90	10.00	.254	.230	.154	.107	.078	.066	.100	.074
.95	1.99	.247	.256	.340	.364	.371	.402	.420	.442
.95	3.41	.248	.220	.152	.124	.168	.194	.221	.247
.95	4.19	.250	.224	.154	.106	.088	.151	.168	.194
.95	5.00	.249	.225	.153	.104	.077	.137	.146	.160
.95	6.00	.249	.227	.155	.106	.078	.116	.129	.137
.95	6.99	.250	.229	.155	.106	.078	.069	.101	.096
.95	8.60	.254	.230	.155	.107	.079	.067	.100	.075
.95	9.99	.254	.231	.155	.107	.079	.067	.100	.075
1.20	1.98	.244	.240	.287	.309	.319	.351	.374	.403
1.20	3.38	.251	.221	.151	.108	.092	.140	.198	.237
1.20	4.20	.249	.222	.152	.105	.079	.071	.156	.213
1.20	5.00	.250	.224	.153	.105	.078	.064	.105	.156
1.20	6.00	.250	.225	.154	.106	.079	.066	.103	.110
1.20	6.98	.250	.227	.155	.107	.079	.065	.102	.080
1.20	8.59	.249	.228	.155	.107	.079	.066	.101	.076
1.20	9.99	.251	.230	.155	.107	.079	.067	.100	.075

TABLE 29.- Continued

MACH	NPR	P10	P11	P12	P13	P14	P15	S1	S2	S3
0.00	2.01	.507	.506	.503	.442	.538	.544	-.002	-.003	-.004
0.00	3.00	.347	.337	.359	.316	.360	.357	-.002	-.004	-.005
0.00	4.02	.236	.188	.242	.241	.310	.322	-.003	-.004	-.004
0.00	5.01	.260	.305	.245	.194	.192	.200	-.004	-.006	-.006
0.00	6.01	.236	.164	.232	.196	.186	.187	-.004	-.007	-.007
0.00	6.41	.278	.294	.224	.149	.123	.125	-.005	-.008	-.008
0.00	2.00	.512	.510	.507	.448	.541	.548	-.002	-.003	-.004
0.00	3.01	.343	.338	.360	.314	.358	.355	-.002	-.004	-.004
0.00	4.01	.231	.191	.241	.249	.313	.321	-.003	-.004	-.004
0.00	4.99	.263	.304	.242	.199	.192	.200	-.003	-.005	-.005
0.00	6.00	.231	.162	.231	.195	.185	.187	-.004	-.006	-.006
0.00	6.37	.281	.266	.199	.153	.124	.131	-.005	-.007	-.008
.65	.97							-.286	-.403	-.209
.65	2.01	.524	.523	.522	.479	.558	.565	-.610	-.938	-.716
.65	3.41	.316	.334	.329	.274	.340	.350	-.752	-1.074	-.694
.65	4.18	.346	.247	.219	.231	.285	.297	-.750	-1.071	-.698
.65	5.01	.165	.349	.323	.241	.190	.205	-.717	-1.017	-.642
.65	5.98	.224	.163	.203	.222	.239	.248	-.692	-.971	-.594
.65	8.03	.136	.184	.230	.214	.192	.207	-.620	-.850	-.473
.70	.96							-.286	-.401	-.203
.70	2.01	.526	.526	.524	.480	.561	.569	-.601	-.915	-.669
.70	3.41	.331	.341	.327	.274	.345	.358	-.743	-1.037	-.704
.70	4.18	.359	.258	.228	.229	.287	.298	-.749	-1.053	-.720
.70	5.00	.181	.352	.332	.235	.194	.204	-.728	-1.019	-.675
.70	6.01	.226	.163	.178	.227	.251	.259	-.707	-.980	-.625
.70	8.33	.115	.149	.203	.208	.188	.203	-.619	-.830	-.461
.80	.95							-.289	-.396	-.196
.80	2.00	.533	.535	.536	.504	.566	.572	-.567	-.799	-.571
.80	3.39	.357	.353	.343	.290	.365	.376	-.615	-.912	-.750
.80	4.18	.366	.280	.270	.245	.288	.301	-.619	-1.114	-.993
.80	4.97	.204	.377	.320	.214	.209	.221	-.625	-1.130	-1.000
.80	5.99	.222	.175	.195	.197	.270	.293	-.625	-1.059	-.915
.80	6.98	.189	.240	.227	.154	.171	.176	-.619	-.956	-.797
.80	9.08	.085	.107	.166	.189	.178	.194	-.601	-.787	-.552
.90	.93							-.299	-.392	-.194
.90	2.00	.490	.507	.522	.527	.536	.538	-.439	-.615	-.446
.90	3.38	.304	.331	.353	.356	.379	.384	-.452	-.898	-.985
.90	4.20	.257	.292	.307	.302	.339	.346	-.452	-.919	-1.036
.90	5.00	.211	.242	.278	.270	.293	.300	-.456	-.925	-.999
.90	6.00	.161	.196	.215	.220	.246	.254	-.452	-.919	-.940
.90	6.99	.162	.173	.227	.195	.188	.204	-.452	-.917	-.888
.90	8.59	.128	.133	.140	.158	.174	.188	-.449	-.889	-.799
.90	10.00	.108	.117	.121	.123	.130	.151	-.448	-.840	-.727
.95	.90							-.296	-.398	-.211
.95	1.99	.461	.480	.498	.510	.521	.524	-.367	-.585	-.458
.95	3.41	.272	.301	.329	.348	.367	.371	-.372	-.794	-.948
.95	4.19	.223	.254	.286	.301	.321	.327	-.379	-.810	-.928
.95	5.00	.176	.196	.219	.237	.253	.259	-.372	-.802	-.884
.95	6.00	.148	.162	.179	.196	.211	.218	-.373	-.804	-.831
.95	6.99	.143	.154	.166	.184	.201	.210	-.372	-.800	-.787
.95	8.60	.121	.126	.133	.137	.141	.164	-.374	-.787	-.712
.95	9.99	.081	.108	.112	.115	.115	.129	-.368	-.742	-.645
1.20	.81							-.144	-.340	-.258
1.20	1.98	.428	.453	.475	.489	.501	.506	-.146	-.428	-.385
1.20	3.38	.282	.305	.336	.297	.368	.380	-.146	-.445	-.616
1.20	4.20	.244	.265	.279	.265	.298	.297	-.147	-.446	-.568
1.20	5.00	.189	.212	.232	.216	.261	.258	-.143	-.442	-.531
1.20	6.00	.142	.161	.191	.178	.225	.223	-.143	-.442	-.497
1.20	6.98	.098	.122	.141	.143	.187	.191	-.143	-.441	-.471
1.20	8.59	.056	.080	.097	.112	.147	.147	-.143	-.440	-.428
1.20	9.99	.054	.050	.072	.097	.118	.117	-.142	-.433	-.392

TABLE 29.- Concluded

MACH	NPR	S4	S6	S7	CFND	FMDZFI
0.00	2.01	-.072	-.057	-.036	.352	.885
0.00	3.00	-.087	-.069	-.041	.684	.943
0.00	4.02	-.048	-.037	-.025	1.014	.948
0.00	5.01	-.024	-.019	-.010	1.370	.968
0.00	6.01	-.021	-.013	-.008	1.733	.978
0.00	6.41	-.022	-.014	-.007	1.908	.995
0.00	2.00	-.072	-.057	-.037	.344	.878
0.00	3.01	-.086	-.069	-.042	.687	.943
0.00	4.01	-.044	-.029	-.018	1.009	.945
0.00	4.99	-.023	-.017	-.010	1.358	.965
0.00	6.00	-.019	-.012	-.007	1.771	1.001
0.00	6.37	-.022	-.013	-.008	1.866	.981
.65	.97	-.168	-.168	-.192	-.157	0.000
.65	2.01	-.638	-.699	-.697	1.021	.762
.65	3.41	-1.213	-1.239	-.930	2.579	.885
.65	4.18	-1.216	-1.222	-.788	3.559	.935
.65	5.01	-1.121	-1.108	-.640	4.547	.957
.65	5.98	-1.036	-1.008	-.562	5.793	.978
.65	8.03	-.889	-.844	-.407	8.382	.995
.70	.96	-.167	-.166	-.190	-.158	0.000
.70	2.01	-.616	-.673	-.679	.863	.748
.70	3.41	-1.171	-1.191	-.943	2.203	.881
.70	4.18	-1.210	-1.210	-.838	3.043	.932
.70	5.00	-1.127	-1.112	-.728	3.912	.956
.70	6.01	-1.043	-1.020	-.662	5.030	.977
.70	8.33	-.869	-.825	-.458	7.588	.995
.80	.95	-.167	-.169	-.190	-.158	0.000
.80	2.00	-.622	-.659	-.641	.625	.712
.80	3.39	-1.111	-1.111	-.944	1.643	.866
.80	4.18	-1.361	-1.289	-1.019	2.285	.915
.80	4.97	-1.374	-1.286	-.986	2.962	.944
.80	5.99	-1.275	-1.187	-.903	3.840	.972
.80	6.98	-1.148	-1.070	-.812	4.628	.976
.80	9.08	-.914	-.852	-.579	6.365	.991
.90	.93	-.171	-.173	-.193	-.151	0.000
.90	2.00	-.562	-.536	-.486	.470	.675
.90	3.38	-1.184	-1.136	-1.013	1.236	.824
.90	4.20	-1.257	-1.187	-.982	1.783	.891
.90	5.00	-1.238	-1.148	-.907	2.316	.927
.90	6.00	-1.184	-1.078	-.846	2.960	.951
.90	6.99	-1.134	-1.013	-.797	3.623	.966
.90	8.59	-1.046	-.918	-.715	4.678	.980
.90	10.00	-.984	-.856	-.662	5.604	.984
.95	.90	-.180	-.183	-.201	-.128	0.000
.95	1.99	-.563	-.534	-.483	.419	.680
.95	3.41	-1.109	-1.054	-.939	1.113	.818
.95	4.19	-1.137	-1.066	-.869	1.591	.883
.95	5.00	-1.103	-1.022	-.803	2.057	.922
.95	6.00	-1.050	-.954	-.746	2.626	.939
.95	6.99	-1.010	-.901	-.704	3.228	.962
.95	8.60	-.936	-.817	-.635	4.201	.978
.95	9.99	-.871	-.752	-.580	5.008	.984
1.20	.81	-.205	-.209	-.220	-.194	0.000
1.20	1.98	-.459	-.458	-.405	.194	.503
1.20	3.38	-.715	-.682	-.615	.641	.750
1.20	4.20	-.704	-.659	-.539	.946	.834
1.20	5.00	-.675	-.623	-.483	1.235	.880
1.20	6.00	-.641	-.580	-.436	1.613	.917
1.20	6.98	-.619	-.550	-.410	1.980	.940
1.20	8.59	-.578	-.497	-.374	2.589	.962
1.20	9.99	-.542	-.454	-.341	3.116	.973

TABLE 30.- BASIC DATA FOR CONFIGURATION 29 WITH $\alpha_p = 18^\circ$,
 $B/d = 0.152$, AND $A/d = 0.184$

MACH	NPR	P1	P2	P3	P4	P5	P6	P7	P8	P9
0.00	2.01	.212	.356	.501	.493	.509	.510	.511	.517	.517
0.00	3.04	.211	.192	.241	.342	.330	.386	.287	.337	.404
0.00	2.98	.214	.194	.267	.365	.375	.380	.298	.363	.397
0.00	4.01	.219	.195	.144	.105	.193	.208	.290	.321	.393
0.00	5.00	.220	.196	.144	.105	.164	.171	.221	.277	.201
0.00	6.01	.219	.196	.144	.104	.080	.104	.183	.245	.293
0.00	6.42	.219	.196	.144	.104	.079	.066	.158	.206	.255
.65	2.00	.223	.231	.414	.491	.521	.532	.534	.540	.542
.65	3.39	.214	.194	.143	.202	.216	.258	.346	.370	.378
.65	4.20	.214	.193	.141	.106	.190	.196	.288	.234	.407
.65	5.00	.219	.195	.143	.103	.169	.173	.213	.269	.199
.65	6.02	.220	.196	.144	.104	.082	.080	.172	.233	.310
.65	8.17	.220	.196	.145	.105	.079	.064	.147	.102	.114
.70	2.00	.224	.235	.412	.487	.521	.534	.538	.544	.546
.70	3.41	.212	.193	.143	.212	.219	.252	.333	.366	.379
.70	4.20	.215	.195	.143	.107	.191	.196	.289	.232	.410
.70	5.00	.219	.195	.143	.103	.170	.173	.212	.268	.199
.70	6.02	.220	.196	.144	.104	.080	.081	.170	.238	.313
.70	8.50	.220	.196	.145	.105	.079	.064	.147	.102	.102
.80	2.00	.210	.225	.408	.474	.509	.533	.541	.551	.554
.80	3.42	.213	.193	.142	.210	.219	.244	.325	.369	.382
.80	4.20	.215	.195	.144	.105	.188	.190	.287	.247	.422
.80	5.02	.217	.195	.144	.104	.169	.173	.203	.264	.199
.80	6.01	.220	.196	.145	.105	.081	.146	.174	.215	.262
.80	7.01	.220	.196	.145	.105	.080	.065	.147	.137	.183
.80	9.22	.220	.196	.145	.105	.079	.064	.147	.102	.075
.90	1.99	.212	.205	.324	.380	.440	.489	.517	.540	.551
.90	3.40	.213	.192	.143	.243	.234	.231	.252	.281	.312
.90	4.21	.215	.195	.144	.109	.196	.191	.203	.243	.277
.90	5.00	.216	.196	.145	.105	.145	.164	.179	.208	.252
.90	6.02	.219	.195	.144	.103	.085	.141	.172	.194	.215
.90	6.99	.221	.196	.145	.105	.080	.068	.147	.167	.198
.90	8.43	.220	.196	.145	.104	.079	.064	.146	.101	.131
.90	8.59	.221	.197	.145	.105	.080	.066	.147	.102	.131
.90	10.02	.220	.197	.145	.105	.079	.065	.147	.102	.072
.95	2.01	.214	.257	.340	.370	.394	.416	.443	.474	.495
.95	3.42	.214	.193	.142	.239	.234	.221	.234	.249	.264
.95	4.21	.214	.194	.142	.122	.196	.188	.191	.206	.221
.95	4.99	.215	.195	.143	.104	.124	.158	.174	.188	.202
.95	6.01	.219	.196	.144	.105	.081	.068	.146	.180	.205
.95	7.00	.221	.197	.145	.105	.081	.067	.147	.103	.174
.95	8.59	.221	.197	.145	.106	.080	.066	.147	.102	.106
.95	9.98	.221	.197	.145	.106	.080	.065	.147	.102	.073
1.20	2.00	.213	.229	.290	.313	.338	.354	.383	.419	.445
1.20	3.42	.210	.186	.135	.100	.114	.115	.189	.264	.306
1.20	4.21	.214	.193	.140	.100	.087	.069	.147	.198	.232
1.20	5.00	.216	.196	.143	.104	.084	.065	.147	.134	.178
1.20	5.98	.215	.196	.144	.104	.082	.066	.147	.104	.131
1.20	6.01	.215	.196	.144	.105	.084	.067	.147	.103	.130
1.20	6.98	.217	.196	.144	.105	.081	.067	.147	.102	.078
1.20	8.59	.219	.196	.145	.105	.081	.067	.146	.102	.073
1.20	9.99	.221	.197	.145	.105	.081	.067	.147	.102	.073

TABLE 30.- Continued

MACH	NPR	P10	P11	P12	P13	P14	P15	S1	S2	S3
0.00	2.01	.518	.523	.528	.538	.573	.577	-.001	-.001	-.002
0.00	3.04	.341	.329	.379	.418	.426	.430	-.001	-.002	-.002
0.00	2.98	.334	.350	.404	.412	.426	.428	-.001	-.002	-.002
0.00	4.01	.290	.211	.232	.336	.352	.375	-.001	-.002	-.002
0.00	5.00	.267	.309	.268	.259	.282	.292	-.001	-.002	-.002
0.00	6.01	.316	.255	.212	.176	.178	.179	-.002	-.003	-.003
0.00	6.42	.291	.298	.229	.201	.190	.190	-.002	-.003	-.003
.65	.98							-.374	-.511	-.467
.65	2.00	.544	.547	.551	.558	.586	.593	-.482	-.731	-.722
.65	3.39	.344	.333	.370	.359	.397	.402	-.501	-.765	-.759
.65	4.20	.334	.248	.217	.316	.367	.382	-.494	-.752	-.744
.65	5.00	.285	.344	.314	.299	.268	.279	-.486	-.734	-.721
.65	6.02	.345	.294	.231	.194	.181	.183	-.477	-.713	-.695
.65	8.17	.148	.212	.257	.215	.199	.204	-.425	-.616	-.583
.70	.98							-.383	-.523	-.472
.70	2.00	.547	.551	.554	.561	.588	.594	-.498	-.779	-.767
.70	3.41	.342	.355	.365	.355	.400	.406	-.520	-.830	-.820
.70	4.20	.338	.250	.221	.317	.373	.386	-.518	-.824	-.814
.70	5.00	.292	.351	.318	.302	.261	.270	-.508	-.798	-.781
.70	6.02	.346	.299	.230	.189	.178	.180	-.497	-.769	-.746
.70	8.50	.128	.183	.243	.211	.184	.200	-.437	-.644	-.603
.80	.97							-.415	-.580	-.476
.80	2.00	.555	.559	.562	.568	.591	.599	-.472	-.905	-1.025
.80	3.42	.359	.370	.361	.369	.403	.410	-.472	-.908	-1.049
.80	4.20	.338	.256	.258	.315	.386	.396	-.474	-.912	-1.056
.80	5.02	.319	.373	.331	.280	.232	.238	-.472	-.908	-1.051
.80	6.01	.236	.262	.228	.240	.269	.292	-.474	-.912	-1.054
.80	7.01	.273	.310	.275	.257	.231	.252	-.473	-.910	-1.041
.80	9.22	.100	.125	.207	.203	.176	.191	-.457	-.857	-.787
.90	.95							-.340	-.653	-.535
.90	1.99	.558	.565	.570	.577	.597	.606	-.338	-.705	-.825
.90	3.40	.341	.368	.384	.394	.398	.407	-.339	-.707	-.828
.90	4.21	.312	.326	.342	.356	.349	.364	-.338	-.707	-.828
.90	5.00	.291	.323	.328	.304	.274	.292	-.341	-.711	-.833
.90	6.02	.248	.245	.203	.266	.281	.308	-.338	-.707	-.829
.90	6.99	.220	.260	.260	.222	.180	.192	-.338	-.708	-.830
.90	8.63	.155	.172	.195	.220	.196	.215	-.336	-.706	-.828
.90	8.59	.156	.174	.198	.221	.197	.215	-.340	-.712	-.835
.90	10.02	.121	.133	.146	.166	.169	.185	-.335	-.705	-.827
.95	.93							-.280	-.609	-.576
.95	2.01	.515	.531	.542	.549	.550	.555	-.275	-.616	-.728
.95	3.42	.286	.313	.340	.366	.383	.388	-.275	-.616	-.731
.95	4.21	.241	.269	.297	.325	.345	.351	-.274	-.615	-.730
.95	4.99	.223	.250	.271	.295	.315	.324	-.271	-.613	-.727
.95	6.01	.216	.254	.261	.237	.279	.288	-.271	-.613	-.728
.95	7.00	.183	.194	.224	.248	.244	.256	-.272	-.613	-.729
.95	8.59	.147	.152	.158	.180	.202	.212	-.270	-.612	-.727
.95	9.98	.124	.130	.132	.137	.155	.166	-.273	-.616	-.729
1.20	.84							-.089	-.326	-.405
1.20	2.00	.468	.490	.508	.519	.524	.530	-.085	-.323	-.402
1.20	3.42	.335	.370	.383	.407	.462	.464	-.085	-.322	-.402
1.20	4.21	.261	.293	.328	.366	.399	.403	-.084	-.322	-.402
1.20	5.00	.205	.237	.276	.320	.348	.353	-.084	-.322	-.404
1.20	5.98	.156	.182	.225	.267	.291	.295	-.082	-.319	-.402
1.20	6.01	.155	.180	.223	.266	.290	.294	-.081	-.318	-.402
1.20	6.98	.120	.140	.181	.228	.247	.250	-.080	-.317	-.401
1.20	8.59	.061	.096	.120	.178	.195	.198	-.080	-.317	-.401
1.20	9.99	.056	.054	.086	.140	.157	.159	-.079	-.317	-.401

TABLE 30.- Concluded

MACH	NPR	S4	S5	S6	S7	CFMD	FMDZFI
0.00	2.01	-.002	-.003	-.003	-.004	.341	.868
0.00	3.04	-.002	-.003	-.003	-.004	.681	.930
0.00	2.98	-.002	-.003	-.003	-.004	.659	.929
0.00	4.01	-.002	-.002	-.003	-.003	.994	.946
0.00	5.00	-.002	-.003	-.003	-.003	1.358	.974
0.00	6.01	-.003	-.003	-.004	-.004	1.732	.990
0.00	6.42	-.003	-.004	-.004	-.004	1.883	.992
.65	.98	-.379	-.257	-.172	-.106	-.095	0.000
.65	2.00	-.662	-.561	-.492	-.404	1.039	.793
.65	3.39	-.703	-.601	-.529	-.447	2.605	.901
.65	4.20	-.686	-.586	-.513	-.438	3.589	.945
.65	5.00	-.659	-.553	-.476	-.399	4.576	.968
.65	6.02	-.626	-.513	-.430	-.349	5.847	.988
.65	8.17	-.503	-.384	-.300	-.228	8.390	.986
.70	.98	-.370	-.236	-.159	-.100	-.094	0.000
.70	2.00	-.685	-.563	-.482	-.388	.909	.794
.70	3.41	-.736	-.606	-.522	-.433	2.262	.902
.70	4.20	-.730	-.605	-.521	-.437	3.106	.944
.70	5.00	-.693	-.566	-.479	-.399	3.956	.968
.70	6.02	-.654	-.520	-.430	-.344	5.053	.988
.70	8.50	-.504	-.370	-.282	-.209	7.580	.985
.80	.97	-.328	-.190	-.134	-.100	-.100	0.000
.80	2.00	-.926	-.574	-.461	-.377	.680	.774
.80	3.42	-1.056	-.734	-.581	-.467	1.704	.889
.80	4.20	-1.121	-.872	-.673	-.581	2.352	.934
.80	5.02	-1.084	-.787	-.617	-.538	3.014	.960
.80	6.01	-1.019	-.644	-.516	-.443	3.845	.974
.80	7.01	-.925	-.518	-.416	-.357	4.702	.991
.80	9.22	-.495	-.323	-.241	-.184	6.431	.983
.90	.95	-.281	-.181	-.160	-.139	-.116	0.000
.90	1.99	-.869	-.721	-.600	-.524	.463	.678
.90	3.40	-.933	-.969	-.952	-.812	1.250	.834
.90	4.21	-.936	-1.033	-1.093	-1.084	1.773	.892
.90	5.00	-.942	-1.040	-1.100	-1.089	2.295	.927
.90	6.02	-.938	-1.036	-1.085	-1.057	2.934	.949
.90	6.99	-.939	-1.036	-1.033	-1.005	3.572	.965
.90	8.63	-.937	-1.007	-.949	-.905	4.623	.976
.90	8.59	-.944	-.993	-.930	-.831	4.640	.977
.90	10.02	-.932	-.877	-.738	-.662	5.510	.978
.95	.93	-.359	-.221	-.194	-.166	-.111	0.000
.95	2.01	-.823	-.779	-.699	-.607	.403	.646
.95	3.42	-.829	-.917	-.968	-.949	1.118	.817
.95	4.21	-.828	-.918	-.975	-.991	1.563	.874
.95	4.99	-.825	-.916	-.972	-.982	2.007	.908
.95	6.01	-.826	-.916	-.964	-.931	2.611	.941
.95	7.00	-.827	-.917	-.923	-.882	3.188	.958
.95	8.59	-.826	-.902	-.851	-.811	4.126	.974
.95	9.98	-.830	-.849	-.790	-.688	4.952	.979
1.20	.84	-.447	-.381	-.306	-.256	-.196	0.000
1.20	2.00	-.474	-.530	-.510	-.489	.180	.459
1.20	3.42	-.474	-.538	-.579	-.596	.626	.729
1.20	4.21	-.473	-.538	-.579	-.599	.915	.812
1.20	5.00	-.474	-.539	-.580	-.596	1.206	.859
1.20	5.98	-.471	-.535	-.576	-.578	1.563	.896
1.20	6.01	-.470	-.535	-.575	-.570	1.568	.896
1.20	6.98	-.469	-.533	-.568	-.544	1.919	.920
1.20	8.59	-.469	-.532	-.526	-.506	2.523	.947
1.20	9.99	-.468	-.524	-.491	-.473	3.046	.960

TABLE 31.- BASIC DATA FOR CONFIGURATION 30 WITH $\alpha_p = 18^\circ$,
 $B/d = 0.061$, AND $A/d = 0.184$

MACH	NPR	P1	P2	P3	P4	P5	P6	P7	P8	P9
0.00	2.00	.211	.411	.522	.514	.512	.511	.511	.513	.516
0.00	2.99	.214	.199	.302	.393	.447	.361	.298	.372	.399
0.00	4.00	.218	.199	.143	.194	.219	.315	.230	.377	.316
0.00	5.00	.219	.201	.143	.105	.167	.204	.283	.286	.197
0.00	6.00	.219	.201	.144	.105	.078	.135	.193	.246	.293
0.00	6.39	.219	.201	.144	.105	.078	.109	.164	.209	.257
0.00	2.00	.211	.402	.518	.517	.514	.512	.511	.512	.515
0.00	3.00	.214	.196	.303	.399	.454	.357	.313	.370	.394
0.00	4.00	.217	.197	.142	.194	.220	.312	.234	.368	.318
0.00	5.00	.218	.198	.143	.111	.163	.207	.285	.280	.204
0.00	6.00	.218	.199	.143	.111	.078	.134	.171	.253	.294
0.00	6.43	.218	.199	.143	.111	.078	.105	.153	.215	.255
.65	2.00	.214	.240	.407	.513	.534	.531	.531	.533	.539
.65	3.40	.214	.195	.143	.227	.263	.344	.403	.297	.333
.65	4.20	.215	.197	.142	.119	.205	.259	.272	.290	.383
.65	5.00	.218	.198	.143	.111	.170	.191	.252	.273	.203
.65	6.00	.218	.198	.143	.110	.079	.104	.159	.243	.311
.65	8.16	.218	.199	.144	.111	.078	.075	.082	.093	.090
.70	2.00	.231	.249	.384	.497	.531	.534	.535	.538	.543
.70	3.40	.213	.193	.140	.224	.251	.350	.406	.309	.345
.70	4.21	.214	.196	.142	.113	.202	.243	.277	.311	.395
.70	5.01	.217	.197	.142	.109	.172	.186	.240	.266	.201
.70	6.01	.219	.198	.143	.111	.080	.077	.158	.248	.308
.70	8.48	.218	.199	.144	.111	.078	.074	.082	.083	.135
.80	2.00	.213	.216	.326	.446	.506	.527	.536	.541	.548
.80	3.41	.214	.194	.142	.187	.225	.330	.404	.352	.374
.80	4.18	.215	.197	.143	.112	.195	.204	.293	.307	.403
.80	5.01	.217	.198	.143	.111	.173	.174	.196	.255	.226
.80	5.99	.218	.198	.143	.110	.082	.148	.163	.190	.233
.80	6.99	.219	.198	.143	.111	.078	.078	.139	.163	.184
.80	9.23	.218	.198	.143	.111	.078	.074	.082	.096	.122
.90	1.99	.216	.242	.328	.386	.429	.452	.481	.507	.530
.90	3.41	.215	.195	.142	.168	.206	.236	.286	.330	.364
.90	4.20	.215	.196	.143	.112	.189	.183	.196	.248	.296
.90	5.00	.215	.197	.142	.110	.129	.159	.165	.186	.245
.90	6.01	.218	.198	.143	.111	.081	.128	.160	.164	.182
.90	7.02	.218	.198	.143	.111	.079	.077	.121	.149	.151
.90	8.57	.219	.199	.143	.111	.078	.076	.082	.124	.125
.90	9.98	.219	.199	.143	.112	.078	.075	.082	.062	.109
.95	2.01	.217	.251	.328	.362	.390	.406	.431	.456	.481
.95	3.41	.213	.193	.141	.164	.194	.205	.236	.271	.308
.95	4.18	.214	.194	.139	.114	.181	.179	.187	.203	.226
.95	5.01	.215	.198	.143	.111	.101	.155	.162	.172	.189
.95	6.00	.217	.198	.142	.110	.081	.079	.148	.157	.163
.95	7.00	.218	.198	.143	.111	.078	.077	.083	.139	.140
.95	8.62	.219	.198	.143	.111	.079	.077	.082	.094	.118
.95	9.99	.219	.199	.144	.112	.079	.077	.082	.061	.105
1.20	1.99	.223	.241	.295	.313	.345	.356	.383	.413	.447
1.20	3.39	.215	.194	.141	.103	.106	.143	.227	.270	.303
1.20	4.22	.214	.193	.140	.101	.091	.079	.171	.202	.228
1.20	5.02	.215	.195	.142	.103	.084	.074	.094	.155	.178
1.20	5.99	.215	.196	.144	.103	.081	.073	.081	.113	.135
1.20	7.01	.215	.197	.145	.105	.081	.076	.081	.062	.100
1.20	8.61	.217	.198	.143	.110	.080	.078	.081	.058	.048
1.20	9.98	.219	.198	.143	.111	.079	.078	.082	.058	.045

TABLE 31.- Continued

MACH	NPR	P10	P11	P12	P13	P14	P15	S1	S2	S3
0.00	2.00	.520	.525	.530	.541	.577	.582	-.002	-.002	.001
0.00	2.99	.319	.343	.410	.422	.419	.423	-.002	-.002	.000
0.00	4.00	.276	.221	.255	.329	.352	.376	-.002	-.002	-.000
0.00	5.00	.269	.210	.190	.239	.281	.301	-.003	-.003	-.000
0.00	6.00	.316	.246	.183	.167	.187	.187	-.003	-.004	-.000
0.00	6.39	.292	.288	.216	.185	.193	.192	-.004	-.004	.000
0.00	2.00	.519	.524	.529	.540	.576	.582	-.002	-.002	.002
0.00	3.00	.324	.344	.404	.422	.419	.424	-.002	-.002	.001
0.00	4.00	.280	.225	.251	.326	.352	.376	-.003	-.003	.001
0.00	5.00	.255	.211	.191	.240	.282	.301	-.003	-.004	-.000
0.00	6.00	.315	.248	.186	.165	.186	.186	-.004	-.005	-.000
0.00	6.43	.290	.290	.223	.191	.194	.193	-.005	-.005	-.000
.65	.97							-.324	-.345	-.349
.65	2.00	.542	.546	.550	.558	.587	.593	-.681	-.734	-.773
.65	3.40	.356	.351	.338	.359	.418	.424	-.743	-.801	-.851
.65	4.20	.327	.245	.215	.289	.366	.376	-.726	-.783	-.831
.65	5.00	.284	.267	.279	.277	.298	.310	-.702	-.756	-.801
.65	6.00	.353	.290	.224	.192	.183	.183	-.662	-.712	-.753
.65	8.16	.176	.215	.243	.217	.188	.204	-.540	-.578	-.599
.70	.97							-.321	-.339	-.344
.70	2.00	.546	.550	.553	.560	.584	.593	-.643	-.690	-.728
.70	3.40	.355	.343	.342	.373	.419	.424	-.706	-.763	-.811
.70	4.21	.308	.225	.219	.309	.371	.392	-.698	-.753	-.801
.70	5.01	.293	.300	.291	.293	.291	.303	-.683	-.735	-.779
.70	6.01	.353	.295	.218	.185	.176	.182	-.651	-.699	-.739
.70	8.48	.165	.187	.208	.211	.184	.200	-.529	-.565	-.593
.80	.95							-.318	-.334	-.339
.80	2.00	.551	.554	.556	.562	.576	.587	-.546	-.592	-.630
.80	3.41	.326	.357	.374	.365	.409	.417	-.555	-.604	-.645
.80	4.18	.310	.246	.269	.314	.387	.404	-.556	-.604	-.645
.80	5.01	.294	.367	.329	.293	.244	.252	-.556	-.605	-.646
.80	5.99	.235	.194	.225	.291	.270	.294	-.552	-.600	-.642
.80	6.99	.213	.253	.238	.212	.217	.226	-.547	-.595	-.635
.80	9.23	.128	.137	.152	.176	.175	.191	-.509	-.548	-.579
.90	.94							-.318	-.338	-.345
.90	1.99	.543	.552	.555	.559	.556	.566	-.400	-.440	-.473
.90	3.41	.382	.386	.387	.389	.408	.419	-.400	-.440	-.473
.90	4.20	.332	.328	.336	.364	.354	.372	-.398	-.437	-.470
.90	5.00	.276	.331	.342	.308	.262	.280	-.397	-.436	-.469
.90	6.01	.230	.237	.235	.307	.280	.307	-.399	-.438	-.471
.90	7.02	.166	.216	.232	.213	.233	.240	-.397	-.436	-.469
.90	8.57	.126	.136	.155	.190	.197	.212	-.397	-.436	-.469
.90	9.98	.108	.112	.118	.131	.150	.165	-.393	-.433	-.465
.95	.91							-.292	-.314	-.327
.95	2.01	.504	.522	.534	.542	.540	.549	-.328	-.364	-.393
.95	3.41	.342	.370	.385	.398	.400	.412	-.325	-.361	-.391
.95	4.18	.253	.284	.310	.336	.348	.358	-.325	-.361	-.391
.95	5.01	.215	.239	.261	.287	.302	.310	-.325	-.361	-.391
.95	6.00	.177	.214	.242	.266	.287	.295	-.322	-.359	-.388
.95	7.00	.145	.161	.196	.222	.234	.244	-.326	-.363	-.393
.95	8.42	.118	.122	.128	.145	.172	.181	-.321	-.357	-.386
.95	9.99	.106	.107	.108	.112	.121	.146	-.322	-.358	-.388
1.20	.83							-.110	-.134	-.152
1.20	1.99	.475	.499	.518	.531	.531	.541	-.112	-.136	-.155
1.20	3.39	.330	.352	.378	.420	.469	.476	-.111	-.136	-.154
1.20	4.22	.259	.291	.322	.364	.398	.400	-.110	-.134	-.153
1.20	5.02	.204	.239	.279	.319	.342	.347	-.111	-.135	-.153
1.20	5.99	.156	.193	.239	.267	.281	.286	-.108	-.132	-.151
1.20	7.01	.119	.166	.197	.216	.232	.237	-.108	-.132	-.151
1.20	8.61	.090	.117	.136	.154	.168	.174	-.109	-.133	-.152
1.20	9.98	.076	.089	.101	.113	.126	.134	-.107	-.131	-.150

TABLE 31.- Concluded

MACH	NPP	S4	S5	S6	S7	S8	S9	CFMD	FMDZFI
0.00	2.00	-.000	-.003	-.003	-.004	-.005	-.000	.349	.893
0.00	2.99	-.001	-.003	-.004	-.004	-.005	-.001	.673	.941
0.00	4.00	-.001	-.004	-.004	-.004	-.005	-.001	1.008	.959
0.00	5.00	-.002	-.004	-.005	-.005	-.006	-.001	1.365	.978
0.00	6.00	-.001	-.005	-.006	-.004	-.006	-.001	1.735	.993
0.00	6.39	-.001	-.006	-.006	-.004	-.005	-.001	1.880	.996
0.00	2.00	-.002	-.003	-.004	-.004	-.005	.000	.349	.890
0.00	3.00	-.003	-.003	-.004	-.004	-.005	-.001	.676	.944
0.00	4.00	-.003	-.004	-.004	-.004	-.005	-.000	1.008	.959
0.00	5.00	-.004	-.005	-.006	-.005	-.007	-.001	1.363	.978
0.00	6.00	-.004	-.005	-.006	-.005	-.008	-.001	1.734	.993
0.00	6.43	-.004	-.005	-.005	-.005	-.008	-.001	1.894	.996
.65	.97	-.395	-.453	-.426	-.375	-.319	-.198	-.127	0.000
.65	2.00	-.885	-1.125	-1.109	-1.044	-1.110	-.522	1.066	.802
.65	3.40	-.980	-1.286	-1.271	-1.186	-1.284	-.665	2.657	.920
.65	4.20	-.956	-1.234	-1.214	-1.133	-1.227	-.703	3.625	.954
.65	5.00	-.919	-1.156	-1.136	-1.064	-1.151	-.688	4.631	.973
.65	6.00	-.861	-1.065	-1.046	-.973	-1.044	-.636	5.851	.991
.65	8.16	-.686	-.825	-.817	-.753	-.772	-.493	8.398	.987
.70	.97	-.390	-.439	-.419	-.363	-.299	-.225	-.126	0.000
.70	2.00	-.834	-1.034	-1.032	-.981	-1.008	-.412	.890	.782
.70	3.40	-.932	-1.218	-1.228	-1.173	-1.225	-.608	2.280	.914
.70	4.21	-.921	-1.200	-1.198	-1.145	-1.188	-.675	3.127	.950
.70	5.01	-.898	-1.153	-1.138	-1.086	-1.118	-.680	3.952	.970
.70	6.01	-.852	-1.064	-1.042	-.987	-1.009	-.633	5.034	.989
.70	8.48	-.682	-.812	-.791	-.733	-.729	-.490	7.598	.985
.80	.95	-.383	-.425	-.403	-.339	-.266	-.493	-.130	0.000
.80	2.00	-.720	-.901	-.895	-.851	-.866	-.513	.650	.738
.80	3.41	-.740	-1.022	-1.153	-1.214	-1.306	-.740	1.704	.889
.80	4.18	-.740	-1.024	-1.158	-1.279	-1.366	-.854	2.321	.929
.80	5.01	-.740	-1.025	-1.151	-1.141	-1.247	-.918	3.001	.957
.80	6.00	-.736	-1.012	-1.073	-1.009	-1.100	-.881	3.782	.968
.80	6.99	-.729	-.965	-.964	-.915	-.945	-.819	4.596	.979
.80	9.23	-.665	-.761	-.753	-.697	-.627	-.618	6.377	.983
.90	.94	-.383	-.395	-.373	-.287	-.238	-.458	-.130	0.000
.90	1.99	-.550	-.773	-.848	-.797	-.867	-.531	.460	.666
.90	3.41	-.550	-.782	-.896	-1.049	-1.318	-.773	1.285	.843
.90	4.20	-.547	-.779	-.892	-1.046	-1.320	-.903	1.776	.895
.90	5.00	-.546	-.779	-.892	-1.048	-1.321	-.951	2.293	.926
.90	6.01	-.548	-.781	-.895	-1.051	-1.304	-.959	2.952	.950
.90	7.02	-.546	-.779	-.893	-1.045	-1.161	-.932	3.586	.959
.90	8.57	-.547	-.780	-.893	-.933	-1.007	-.899	4.609	.973
.90	9.98	-.543	-.772	-.849	-.787	-.865	-.765	5.527	.979
.95	.91	-.368	-.385	-.366	-.296	-.261	-.246	-.117	0.000
.95	2.01	-.464	-.671	-.771	-.777	-.839	-.393	.407	.649
.95	3.41	-.462	-.675	-.781	-.923	-1.165	-.671	1.120	.820
.95	4.18	-.462	-.676	-.781	-.924	-1.171	-.724	1.552	.872
.95	5.01	-.462	-.676	-.782	-.925	-1.174	-.816	2.033	.909
.95	6.00	-.459	-.673	-.779	-.922	-1.164	-.826	2.609	.938
.95	7.00	-.464	-.679	-.785	-.928	-1.080	-.826	3.208	.953
.95	8.62	-.457	-.671	-.776	-.848	-.896	-.766	4.126	.970
.95	9.99	-.459	-.673	-.770	-.736	-.810	-.718	4.955	.979
1.20	.83	-.198	-.309	-.301	-.276	-.284	-.123	-.189	0.000
1.20	1.99	-.203	-.351	-.425	-.524	-.632	-.327	.180	.461
1.20	3.39	-.203	-.351	-.425	-.528	-.688	-.453	.622	.731
1.20	4.22	-.201	-.350	-.424	-.527	-.688	-.485	.918	.812
1.20	5.02	-.202	-.350	-.425	-.527	-.688	-.507	1.211	.862
1.20	5.99	-.199	-.348	-.423	-.525	-.685	-.512	1.560	.896
1.20	7.01	-.199	-.348	-.423	-.525	-.684	-.511	1.933	.919
1.20	8.61	-.200	-.349	-.424	-.526	-.620	-.493	2.533	.944
1.20	9.98	-.199	-.348	-.422	-.509	-.536	-.471	3.041	.959

TABLE 32.- BASIC DATA FOR CONFIGURATION 31 WITH $\alpha_p = 18^\circ$,
 $B/d = 0.194$, AND $A/d = 0.184$

MACH	NPR	P1	P2	P3	P4	P5	P6	P7	P8	P9
0.00	2.00	.212	.387	.506	.486	.505	.511	.511	.512	.514
0.00	2.99	.213	.197	.294	.398	.345	.393	.292	.331	.400
0.00	4.00	.218	.198	.144	.117	.194	.226	.273	.374	.352
0.00	5.01	.219	.199	.144	.111	.086	.156	.156	.217	.246
0.00	6.02	.220	.199	.145	.109	.079	.134	.139	.152	.200
0.00	6.48	.219	.199	.144	.108	.078	.120	.130	.139	.174
0.00	1.99	.217	.384	.509	.489	.509	.514	.513	.514	.517
0.00	3.00	.211	.196	.290	.408	.324	.387	.296	.327	.401
0.00	4.01	.218	.198	.144	.113	.191	.212	.279	.360	.361
0.00	5.01	.218	.199	.144	.109	.085	.156	.156	.217	.246
0.00	6.02	.219	.199	.144	.107	.078	.134	.139	.152	.201
0.00	6.49	.219	.199	.144	.107	.078	.119	.130	.138	.173
.65	2.01	.218	.226	.386	.460	.478	.512	.525	.530	.535
.65	3.41	.215	.197	.144	.158	.211	.237	.313	.354	.370
.65	4.20	.216	.200	.145	.113	.161	.171	.185	.275	.344
.65	5.01	.217	.199	.144	.109	.081	.156	.154	.193	.252
.65	6.00	.219	.200	.145	.108	.079	.137	.141	.146	.183
.65	8.19	.219	.200	.145	.105	.079	.063	.108	.113	.122
.70	2.02	.210	.219	.362	.461	.473	.508	.523	.530	.536
.70	3.41	.211	.193	.141	.185	.213	.231	.280	.325	.354
.70	4.19	.212	.197	.142	.114	.161	.171	.184	.275	.346
.70	4.99	.215	.199	.144	.109	.083	.157	.154	.190	.253
.70	6.01	.218	.199	.144	.107	.079	.137	.140	.145	.179
.70	8.47	.219	.200	.145	.105	.079	.063	.102	.111	.119
.80	2.01	.222	.231	.359	.460	.470	.507	.527	.537	.546
.80	3.40	.214	.195	.141	.222	.223	.228	.254	.289	.325
.80	4.20	.216	.199	.145	.113	.163	.173	.183	.275	.346
.80	5.01	.215	.199	.144	.109	.082	.157	.153	.188	.254
.80	6.00	.219	.200	.145	.108	.080	.139	.142	.145	.176
.80	7.01	.219	.200	.145	.107	.080	.099	.127	.129	.140
.80	9.19	.219	.200	.145	.104	.079	.063	.084	.105	.113
.90	.96	.994	.994	.994	.990	.993	.984	.979	.973	.971
.90	2.01	.215	.220	.327	.396	.409	.477	.508	.529	.545
.90	3.00	.216	.195	.152	.237	.248	.262	.276	.292	.314
.90	3.40	.216	.196	.143	.245	.247	.237	.239	.243	.253
.90	4.19	.216	.197	.143	.118	.192	.187	.183	.198	.219
.90	5.00	.215	.199	.144	.110	.087	.154	.154	.152	.203
.90	5.97	.217	.200	.145	.108	.080	.139	.142	.140	.147
.90	7.00	.219	.200	.145	.106	.080	.109	.130	.130	.132
.90	8.59	.219	.200	.145	.105	.079	.063	.107	.112	.117
.90	10.02	.219	.200	.145	.103	.079	.063	.080	.104	.111
.95	2.00	.214	.202	.252	.378	.390	.427	.466	.494	.517
.95	3.40	.216	.195	.143	.230	.242	.231	.230	.233	.238
.95	4.20	.216	.197	.144	.117	.198	.193	.184	.187	.198
.95	5.01	.215	.199	.144	.110	.157	.168	.164	.161	.168
.95	6.00	.216	.200	.145	.108	.084	.143	.142	.140	.142
.95	7.02	.218	.199	.145	.106	.080	.086	.124	.123	.126
.95	8.62	.219	.200	.145	.104	.078	.063	.098	.109	.114
.95	10.01	.220	.200	.145	.103	.079	.063	.061	.098	.110
1.20	2.01	.215	.227	.285	.317	.326	.330	.355	.386	.421
1.20	3.39	.214	.193	.138	.128	.155	.159	.174	.201	.228
1.20	4.23	.214	.193	.138	.113	.094	.137	.138	.145	.168
1.20	5.02	.216	.197	.143	.111	.085	.117	.132	.127	.135
1.20	6.00	.216	.199	.145	.109	.083	.064	.107	.113	.119
1.20	7.00	.215	.199	.145	.107	.082	.064	.053	.094	.109
1.20	7.00	.216	.200	.145	.107	.082	.064	.053	.093	.109
1.20	8.60	.216	.200	.145	.105	.080	.064	.052	.056	.082
1.20	9.99	.219	.200	.145	.103	.080	.063	.052	.056	.081

TABLE 32.- Continued

MACH	NPR	P10	P11	P12	P13	P14	P15	S1	S2	S3
0.00	2.00	.519	.523	.529	.539	.576	.578	-.001	-.001	-.001
0.00	2.99	.360	.340	.375	.418	.436	.439	-.001	-.001	-.001
0.00	4.00	.254	.210	.276	.342	.352	.376	-.001	-.001	-.002
0.00	5.01	.190	.348	.344	.293	.228	.239	-.001	-.001	-.002
0.00	6.02	.237	.195	.186	.262	.234	.250	-.002	-.002	-.002
0.00	6.48	.220	.220	.174	.237	.218	.232	-.002	-.002	-.002
0.00	1.99	.521	.525	.530	.540	.576	.579	-.001	-.001	-.001
0.00	3.00	.362	.339	.368	.417	.437	.442	-.001	-.001	-.001
0.00	4.01	.265	.212	.273	.339	.351	.375	-.001	-.001	-.002
0.00	5.01	.188	.348	.344	.294	.229	.240	-.001	-.002	-.002
0.00	6.02	.236	.194	.193	.262	.234	.250	-.001	-.002	-.002
0.00	6.49	.219	.221	.175	.234	.217	.231	-.002	-.002	-.003
.65	.98							-.265	-.338	-.323
.65	2.01	.539	.543	.546	.554	.581	.587	-.337	-.462	-.471
.65	3.41	.349	.357	.353	.351	.391	.398	-.356	-.496	-.512
.65	4.20	.366	.303	.257	.316	.357	.363	-.359	-.499	-.515
.65	5.01	.206	.364	.356	.302	.243	.255	-.350	-.483	-.495
.65	6.00	.227	.201	.252	.291	.256	.277	-.338	-.461	-.468
.65	8.19	.136	.198	.185	.205	.188	.203	-.306	-.409	-.406
.70	.98							-.276	-.354	-.337
.70	2.02	.540	.541	.545	.555	.580	.586	-.343	-.475	-.483
.70	3.41	.360	.367	.354	.369	.385	.394	-.362	-.507	-.522
.70	4.19	.363	.302	.274	.325	.359	.366	-.373	-.527	-.544
.70	4.99	.213	.368	.359	.305	.249	.260	-.365	-.511	-.524
.70	6.01	.225	.202	.258	.295	.260	.281	-.351	-.486	-.493
.70	8.47	.131	.148	.172	.200	.184	.200	-.313	-.421	-.415
.80	.97							-.314	-.414	-.388
.80	2.01	.550	.554	.557	.563	.585	.592	-.377	-.575	-.589
.80	3.40	.354	.371	.375	.378	.387	.398	-.388	-.612	-.650
.80	4.20	.358	.309	.315	.334	.354	.363	-.398	-.639	-.702
.80	5.01	.233	.379	.359	.303	.257	.267	-.396	-.633	-.689
.80	6.00	.224	.208	.281	.308	.270	.294	-.387	-.612	-.649
.80	7.01	.164	.202	.204	.216	.231	.251	-.374	-.569	-.578
.80	9.19	.122	.132	.147	.171	.176	.192	-.339	-.479	-.463
.90	.96							-.305	-.528	-.594
.90	.96							-.299	-.519	-.586
.90	2.01	.554	.562	.567	.574	.593	.602	-.297	-.519	-.591
.90	3.00	.338	.365	.386	.403	.407	.415	-.297	-.519	-.590
.90	3.40	.268	.291	.319	.350	.375	.381	-.299	-.522	-.594
.90	4.19	.244	.272	.293	.315	.329	.334	-.297	-.520	-.591
.90	5.00	.254	.301	.320	.315	.311	.322	-.302	-.527	-.599
.90	5.97	.190	.227	.258	.290	.282	.309	-.298	-.521	-.593
.90	7.00	.142	.180	.208	.235	.241	.264	-.295	-.518	-.589
.90	8.59	.123	.134	.155	.186	.196	.209	-.301	-.526	-.598
.90	10.02	.117	.121	.127	.141	.161	.169	-.292	-.514	-.586
.95	.94							-.239	-.444	-.511
.95	2.00	.434	.548	.559	.570	.591	.599	-.233	-.437	-.504
.95	3.40	.246	.258	.278	.301	.327	.342	-.237	-.443	-.510
.95	4.20	.206	.217	.235	.257	.284	.296	-.239	-.446	-.513
.95	5.01	.180	.189	.201	.221	.246	.259	-.241	-.448	-.516
.95	6.00	.148	.163	.176	.190	.209	.223	-.233	-.439	-.506
.95	7.02	.130	.140	.160	.180	.202	.211	-.235	-.442	-.510
.95	8.62	.119	.123	.129	.146	.171	.182	-.236	-.443	-.510
.95	10.01	.117	.120	.122	.128	.142	.159	-.234	-.440	-.508
1.20	.85							-.065	-.207	-.255
1.20	2.01	.449	.474	.495	.507	.510	.515	-.060	-.202	-.250
1.20	3.49	.250	.275	.301	.323	.338	.345	-.060	-.202	-.251
1.20	4.23	.196	.227	.256	.284	.309	.317	-.059	-.200	-.249
1.20	5.02	.152	.175	.203	.230	.266	.276	-.061	-.203	-.252
1.20	6.00	.132	.150	.172	.195	.221	.231	-.061	-.202	-.251
1.20	7.00	.122	.138	.155	.174	.194	.200	-.058	-.199	-.248
1.20	7.00	.122	.138	.156	.175	.194	.201	-.059	-.200	-.249
1.20	8.60	.076	.119	.140	.154	.170	.175	-.060	-.201	-.250
1.20	9.99	.076	.063	.113	.129	.143	.146	-.060	-.202	-.251

TABLE 32.- Concluded

MACH	NPR	S5	S7	CFND	FMDZFI
0.00	2.00	-.002	-.003	.336	.862
0.00	2.99	-.002	-.003	.670	.938
0.00	4.00	-.003	-.004	.982	.932
0.00	5.01	-.003	-.003	1.343	.957
0.00	6.02	-.003	-.004	1.706	.970
0.00	6.48	-.003	-.004	1.871	.972
0.00	1.99	-.001	-.003	.335	.868
0.00	3.00	-.001	-.003	.672	.941
0.00	4.01	-.002	-.004	.980	.928
0.00	5.01	-.001	-.003	1.337	.953
0.00	6.02	-.002	-.004	1.700	.968
0.00	6.49	-.002	-.004	1.871	.970
.65	.98	-.252	-.193	-.101	0.000
.65	2.01	-.466	-.454	1.018	.758
.65	3.41	-.533	-.543	2.534	.875
.65	4.20	-.532	-.540	3.464	.913
.65	5.01	-.499	-.494	4.486	.948
.65	6.00	-.457	-.438	5.747	.967
.65	8.19	-.365	-.324	8.424	.979
.70	.98	-.258	-.194	-.098	0.000
.70	2.02	-.467	-.445	.476	.753
.70	3.41	-.529	-.522	2.172	.868
.70	4.19	-.557	-.557	2.981	.913
.70	4.99	-.523	-.511	3.852	.947
.70	6.01	-.475	-.448	4.956	.968
.70	8.47	-.363	-.314	7.587	.981
.80	.97	-.275	-.198	-.094	0.000
.80	2.01	-.515	-.457	.658	.744
.80	3.40	-.593	-.528	1.628	.857
.80	4.20	-.782	-.678	2.281	.910
.80	5.01	-.682	-.585	2.958	.944
.80	6.00	-.568	-.496	3.754	.967
.80	7.01	-.488	-.420	4.589	.971
.80	9.19	-.362	-.288	6.376	.984
.90	.96	-.356	-.196	-.100	0.000
.90	.96	-.356	-.196	-.102	0.000
.90	2.01	-.734	-.773	.473	.682
.90	3.00	-.733	-.784	.997	.794
.90	3.40	-.737	-.782	1.235	.817
.90	4.19	-.735	-.788	1.738	.878
.90	5.00	-.743	-.797	2.299	.922
.90	5.97	-.736	-.790	2.915	.949
.90	7.00	-.733	-.787	3.572	.964
.90	8.59	-.743	-.795	4.666	.978
.90	10.02	-.729	-.738	5.547	.983
.95	.94	-.536	-.265	-.096	0.000
.95	2.00	-.637	-.687	.388	.631
.95	3.40	-.645	-.696	1.091	.806
.95	4.20	-.648	-.699	1.558	.870
.95	5.01	-.651	-.702	2.040	.910
.95	6.00	-.641	-.692	2.592	.937
.95	7.02	-.645	-.696	3.213	.957
.95	8.62	-.645	-.697	4.166	.976
.95	10.01	-.643	-.692	4.988	.984
1.20	.85	-.350	-.385	-.177	0.000
1.20	2.01	-.346	-.384	.181	.463
1.20	3.39	-.346	-.385	.624	.734
1.20	4.23	-.344	-.383	.918	.812
1.20	5.02	-.348	-.387	1.210	.859
1.20	6.00	-.347	-.386	1.574	.899
1.20	7.00	-.343	-.382	1.943	.924
1.20	7.00	-.344	-.383	1.938	.923
1.20	8.60	-.345	-.384	2.544	.951
1.20	9.99	-.347	-.386	3.082	.966

TABLE 33.- BASIC DATA FOR CONFIGURATION 32 WITH $\alpha_p = 18^\circ$,
 $B/d = 0.484$, AND $A/d = 0.184$

MACH	NPR	P1	P2	P3	P4	P5	P6	P7	P8	P9
0.00	2.02	.211	.310	.488	.438	.442	.457	.470	.497	.509
0.00	3.01	.213	.194	.255	.380	.275	.325	.355	.300	.357
0.00	4.01	.218	.195	.143	.103	.156	.167	.234	.259	.357
0.00	5.00	.220	.196	.144	.103	.081	.143	.146	.143	.150
0.00	5.99	.220	.196	.144	.103	.078	.098	.128	.128	.126
0.00	6.66	.219	.196	.144	.103	.078	.063	.114	.117	.118
0.00	2.00	.212	.312	.476	.446	.444	.460	.475	.501	.514
0.00	2.99	.212	.193	.263	.400	.269	.321	.358	.303	.370
0.00	4.01	.217	.194	.143	.103	.158	.169	.237	.258	.357
0.00	5.02	.219	.196	.144	.103	.080	.143	.145	.142	.149
0.00	6.02	.219	.196	.144	.103	.078	.095	.127	.127	.126
0.00	6.64	.219	.196	.144	.103	.078	.063	.114	.117	.119
.65	2.01	.236	.240	.357	.450	.427	.434	.447	.472	.499
.65	3.40	.215	.194	.144	.105	.236	.345	.262	.256	.272
.65	4.22	.214	.195	.143	.112	.195	.194	.190	.189	.190
.65	5.00	.216	.196	.143	.102	.118	.157	.155	.151	.150
.65	6.01	.219	.196	.144	.103	.079	.100	.129	.129	.128
.65	8.27	.219	.197	.145	.104	.079	.063	.074	.106	.108
.70	2.00	.219	.217	.340	.448	.425	.434	.449	.474	.501
.70	3.39	.212	.190	.144	.126	.240	.345	.265	.248	.256
.70	4.18	.216	.196	.144	.112	.197	.196	.191	.190	.192
.70	5.00	.216	.196	.144	.102	.122	.159	.157	.152	.151
.70	6.00	.219	.196	.144	.102	.079	.104	.130	.129	.129
.70	8.59	.219	.197	.145	.104	.079	.063	.070	.104	.107
.80	1.99	.228	.232	.353	.437	.405	.431	.447	.472	.500
.80	3.41	.215	.193	.142	.225	.238	.233	.232	.231	.235
.80	4.20	.215	.195	.144	.106	.196	.194	.190	.188	.191
.80	5.00	.215	.197	.144	.103	.121	.160	.158	.154	.152
.80	5.98	.218	.196	.144	.102	.082	.108	.131	.131	.130
.80	7.00	.219	.197	.145	.103	.079	.064	.116	.118	.119
.80	9.25	.219	.197	.145	.103	.079	.063	.070	.103	.106
.90	2.01	.214	.226	.376	.432	.387	.431	.439	.463	.493
.90	3.42	.214	.192	.141	.113	.189	.282	.290	.240	.298
.90	4.22	.215	.194	.143	.103	.192	.191	.187	.183	.187
.90	4.99	.215	.196	.144	.103	.134	.164	.161	.156	.154
.90	6.00	.216	.197	.144	.103	.080	.113	.134	.133	.132
.90	7.01	.219	.197	.145	.103	.079	.065	.120	.121	.121
.90	8.59	.220	.197	.145	.104	.079	.063	.089	.108	.110
.90	10.00	.220	.197	.145	.104	.079	.063	.058	.100	.104
.95	2.00	.216	.229	.377	.413	.381	.416	.419	.447	.478
.95	3.41	.215	.192	.146	.221	.235	.228	.227	.229	.234
.95	4.19	.216	.194	.143	.104	.190	.192	.188	.183	.186
.95	5.01	.216	.196	.144	.103	.138	.167	.166	.162	.157
.95	6.00	.215	.197	.144	.103	.080	.131	.138	.136	.135
.95	7.00	.219	.197	.145	.103	.079	.070	.120	.121	.121
.95	8.58	.220	.197	.145	.104	.079	.063	.075	.105	.108
.95	10.03	.219	.197	.145	.104	.079	.063	.054	.097	.101
1.20	2.01	.216	.194	.208	.382	.319	.300	.300	.312	.398
1.20	3.40	.213	.189	.141	.150	.177	.170	.165	.168	.182
1.20	4.19	.217	.194	.142	.104	.105	.143	.146	.144	.146
1.20	5.00	.217	.195	.143	.104	.084	.080	.130	.128	.127
1.20	6.01	.216	.195	.143	.104	.081	.064	.116	.117	.115
1.20	7.02	.215	.196	.144	.103	.080	.063	.065	.105	.105
1.20	8.61	.217	.197	.145	.104	.080	.064	.050	.047	.063
1.20	9.97	.220	.197	.145	.104	.080	.064	.052	.047	.055

TABLE 33.- Continued

MACH	NPR	P10	P11	P12	P13	P14	P15	S1	S2	S3
0.00	2.02	.516	.521	.524	.531	.556	.558	-.000	-.000	-.000
0.00	3.01	.394	.336	.359	.407	.437	.443	-.000	-.000	-.000
0.00	4.01	.337	.257	.238	.331	.351	.360	-.001	-.001	-.001
0.00	5.00	.181	.209	.230	.251	.255	.264	-.001	-.001	-.001
0.00	5.99	.124	.142	.166	.182	.196	.204	-.001	-.001	-.001
0.00	6.66	.116	.123	.153	.182	.199	.206	-.001	-.001	-.001
0.00	2.00	.520	.525	.528	.535	.558	.561	-.000	-.000	-.000
0.00	2.99	.386	.335	.370	.410	.436	.441	-.000	-.000	-.000
0.00	4.01	.335	.256	.237	.331	.351	.361	-.000	-.000	-.000
0.00	5.02	.182	.210	.232	.253	.257	.266	-.001	-.001	-.001
0.00	6.02	.124	.142	.167	.183	.197	.205	-.001	-.001	-.001
0.00	6.64	.116	.124	.155	.183	.199	.207	-.001	-.001	-.001
.65	.98							-.146	-.160	-.176
.65	2.01	.518	.532	.539	.546	.567	.574	-.146	-.162	-.179
.65	3.40	.362	.389	.346	.332	.422	.427	-.161	-.179	-.198
.65	4.22	.193	.198	.210	.221	.237	.254	-.142	-.157	-.173
.65	5.00	.157	.165	.174	.187	.207	.218	-.147	-.163	-.180
.65	6.01	.125	.136	.157	.173	.184	.189	-.153	-.169	-.187
.65	8.27	.111	.111	.118	.143	.170	.177	-.153	-.170	-.188
.70	.98							-.150	-.165	-.182
.70	2.00	.524	.536	.543	.551	.571	.578	-.149	-.166	-.184
.70	3.39	.366	.393	.347	.341	.426	.433	-.163	-.181	-.201
.70	4.18	.194	.199	.211	.222	.238	.256	-.146	-.162	-.179
.70	5.00	.158	.164	.172	.183	.203	.215	-.150	-.166	-.184
.70	6.00	.126	.136	.156	.171	.183	.188	-.155	-.173	-.191
.70	8.59	.110	.111	.115	.137	.164	.173	-.155	-.173	-.192
.80	.98							-.164	-.182	-.202
.80	1.99	.524	.539	.548	.556	.572	.581	-.159	-.178	-.199
.80	3.41	.244	.250	.267	.285	.308	.322	-.159	-.178	-.199
.80	4.20	.192	.196	.207	.217	.233	.252	-.157	-.176	-.197
.80	5.00	.157	.163	.170	.179	.196	.210	-.161	-.181	-.202
.80	5.98	.127	.136	.155	.170	.181	.186	-.168	-.189	-.211
.80	7.00	.117	.118	.142	.170	.188	.196	-.168	-.189	-.212
.80	9.25	.108	.110	.111	.124	.149	.163	-.165	-.186	-.208
.90	.97							-.181	-.208	-.239
.90	2.01	.520	.537	.548	.558	.573	.581	-.173	-.200	-.231
.90	3.42	.340	.361	.368	.375	.425	.432	-.176	-.203	-.235
.90	4.22	.190	.194	.204	.213	.230	.246	-.171	-.198	-.229
.90	4.99	.159	.164	.171	.178	.195	.210	-.173	-.200	-.231
.90	6.00	.129	.137	.154	.168	.179	.183	-.174	-.201	-.233
.90	7.01	.119	.121	.143	.168	.186	.193	-.173	-.201	-.233
.90	8.59	.112	.111	.114	.138	.165	.174	-.173	-.201	-.233
.90	10.00	.107	.109	.110	.117	.138	.155	-.173	-.200	-.232
.95	.96							-.142	-.168	-.199
.95	2.00	.506	.529	.544	.556	.572	.579	-.140	-.166	-.197
.95	3.41	.241	.250	.265	.279	.298	.317	-.141	-.167	-.198
.95	4.19	.188	.190	.198	.204	.216	.236	-.135	-.161	-.192
.95	5.01	.157	.159	.161	.160	.162	.189	-.137	-.163	-.194
.95	6.00	.130	.130	.139	.146	.155	.167	-.136	-.162	-.194
.95	7.00	.120	.117	.124	.139	.155	.165	-.135	-.161	-.192
.95	8.58	.110	.111	.111	.118	.139	.155	-.135	-.161	-.192
.95	10.03	.104	.107	.109	.112	.121	.146	-.134	-.160	-.191
1.20	.86							-.015	-.030	-.051
1.20	2.01	.407	.458	.488	.510	.531	.537	-.014	-.029	-.049
1.20	3.40	.196	.208	.228	.240	.257	.273	-.013	-.027	-.048
1.20	4.19	.145	.149	.165	.173	.188	.202	-.013	-.027	-.048
1.20	5.00	.126	.126	.136	.145	.165	.172	-.012	-.027	-.047
1.20	6.01	.114	.114	.119	.123	.135	.153	-.012	-.027	-.047
1.20	7.02	.106	.108	.111	.114	.124	.136	-.014	-.029	-.049
1.20	8.61	.098	.105	.111	.117	.125	.132	-.013	-.027	-.047
1.20	9.97	.063	.070	.110	.121	.130	.134	-.014	-.028	-.049

TABLE 33.- Concluded

MACH	NPR	S4	S5	S6	S7	S8	S9	CFMD	FMDZFI
0.00	2.02	-.000	-.001	-.000	-.001	-.001	-.001	.313	.789
0.00	3.01	-.000	-.001	-.001	-.001	-.001	-.001	.652	.905
0.00	4.01	-.001	-.001	-.001	-.001	-.001	-.001	.940	.891
0.00	5.00	-.001	-.001	-.001	-.001	-.002	-.002	1.257	.899
0.00	5.99	-.001	-.001	-.001	-.001	-.002	-.002	1.617	.924
0.00	6.66	-.001	-.002	-.001	-.002	-.003	-.002	1.864	.937
0.00	2.00	-.000	-.000	-.000	-.001	-.000	-.001	.304	.779
0.00	2.99	-.000	-.001	-.000	-.001	-.001	-.001	.648	.911
0.00	4.01	-.001	-.001	-.001	-.001	-.001	-.001	.941	.891
0.00	5.02	-.001	-.001	-.001	-.001	-.001	-.001	1.263	.900
0.00	6.02	-.001	-.001	-.001	-.001	-.001	-.001	1.625	.925
0.00	6.64	-.001	-.001	-.000	-.001	-.001	-.001	1.854	.936
.65	.98	-.188	-.200	-.232	-.209	-.224	-.169	-.088	0.000
.65	2.01	-.192	-.207	-.207	-.225	-.251	-.163	.895	.672
.65	3.40	-.214	-.235	-.236	-.261	-.300	-.216	2.496	.864
.65	4.22	-.186	-.199	-.222	-.210	-.228	-.191	3.301	.866
.65	5.00	-.193	-.209	-.220	-.225	-.249	-.185	4.220	.893
.65	6.01	-.201	-.219	-.223	-.240	-.272	-.196	5.460	.924
.65	6.67	-.203	-.222	-.234	-.243	-.275	-.213	8.374	.962
.70	.98	-.195	-.208	-.273	-.217	-.233	-.187	-.083	0.000
.70	2.00	-.198	-.214	-.218	-.231	-.259	-.177	.755	.661
.70	3.39	-.218	-.239	-.230	-.265	-.305	-.199	2.115	.858
.70	4.18	-.192	-.206	-.224	-.217	-.237	-.186	2.807	.864
.70	5.00	-.199	-.215	-.223	-.230	-.256	-.182	3.632	.892
.70	6.00	-.207	-.225	-.227	-.247	-.281	-.193	4.686	.924
.70	6.59	-.208	-.227	-.238	-.249	-.282	-.213	7.522	.965
.80	.98	-.218	-.235	-.342	-.244	-.261	-.233	-.078	0.000
.80	1.99	-.215	-.236	-.254	-.253	-.280	-.187	.557	.644
.80	3.41	-.215	-.233	-.260	-.242	-.259	-.208	1.939	.804
.80	4.20	-.212	-.229	-.242	-.241	-.259	-.181	2.168	.863
.80	5.00	-.219	-.238	-.248	-.253	-.278	-.189	2.791	.892
.80	5.98	-.229	-.253	-.252	-.277	-.314	-.201	3.585	.922
.80	7.00	-.231	-.256	-.266	-.283	-.323	-.227	4.463	.946
.80	9.25	-.227	-.251	-.264	-.275	-.311	-.228	6.338	.973
.90	.97	-.267	-.317	-.378	-.368	-.392	-.297	-.064	0.000
.90	2.01	-.258	-.308	-.343	-.366	-.414	-.265	.465	.666
.90	3.42	-.264	-.319	-.352	-.391	-.469	-.319	1.277	.840
.90	4.22	-.257	-.306	-.346	-.354	-.379	-.277	1.722	.862
.90	4.99	-.259	-.309	-.344	-.364	-.404	-.255	2.219	.896
.90	6.00	-.261	-.314	-.351	-.382	-.451	-.311	2.875	.925
.90	7.01	-.262	-.315	-.352	-.388	-.467	-.337	3.524	.947
.90	8.59	-.262	-.315	-.354	-.388	-.465	-.352	4.597	.969
.90	10.00	-.260	-.312	-.355	-.380	-.449	-.343	5.561	.981
.95	.96	-.227	-.282	-.392	-.361	-.440	-.416	-.059	0.000
.95	2.00	-.225	-.280	-.327	-.359	-.439	-.366	.410	.659
.95	3.41	-.227	-.282	-.325	-.363	-.443	-.365	1.106	.808
.95	4.19	-.220	-.275	-.315	-.355	-.434	-.356	1.536	.863
.95	5.01	-.222	-.277	-.318	-.357	-.436	-.358	2.010	.901
.95	6.00	-.222	-.277	-.317	-.357	-.436	-.358	2.579	.926
.95	7.00	-.221	-.276	-.316	-.356	-.435	-.357	3.167	.947
.95	8.58	-.220	-.275	-.315	-.355	-.435	-.356	4.099	.968
.95	10.03	-.219	-.274	-.315	-.355	-.435	-.356	4.980	.981
1.20	.86	-.068	-.105	-.035	-.164	-.216	-.131	-.150	0.000
1.20	2.01	-.066	-.103	-.118	-.162	-.214	-.170	.175	.447
1.20	3.40	-.065	-.101	-.125	-.159	-.209	-.174	.606	.714
1.20	4.19	-.065	-.100	-.126	-.159	-.209	-.176	.890	.795
1.20	5.00	-.064	-.100	-.126	-.158	-.207	-.175	1.186	.849
1.20	6.01	-.064	-.100	-.126	-.158	-.207	-.175	1.561	.893
1.20	7.02	-.067	-.102	-.129	-.160	-.209	-.177	1.947	.920
1.20	8.61	-.064	-.100	-.125	-.158	-.206	-.174	2.527	.946
1.20	9.97	-.066	-.101	-.127	-.159	-.208	-.175	3.049	.961

TABLE 34.- BASIC DATA FOR CONFIGURATION 33 WITH $\alpha_P = 15^\circ$,
 $B/d = 0.162$, AND $A/d = 0.064$

MACH	NPR	P1	P2	P3	P4	P5	P6	P7	P8	P9
0.00	2.00	.246	.348	.529	.511	.506	.505	.505	.506	.507
0.00	3.00	.247	.224	.162	.295	.344	.437	.280	.325	.411
0.00	4.01	.252	.226	.162	.129	.298	.382	.269	.216	.187
0.00	5.01	.253	.228	.162	.129	.175	.229	.277	.275	.217
0.00	6.01	.253	.229	.163	.129	.168	.130	.176	.211	.213
0.00	6.36	.253	.229	.163	.129	.168	.108	.144	.183	.207
0.00	2.00	.246	.341	.530	.511	.507	.510	.505	.505	.506
0.00	3.01	.247	.222	.160	.293	.351	.442	.283	.321	.409
0.00	4.00	.252	.226	.161	.129	.298	.386	.268	.215	.186
0.00	5.01	.253	.227	.162	.129	.174	.232	.278	.273	.215
0.00	6.00	.253	.228	.163	.129	.168	.132	.177	.211	.212
0.00	6.03	.254	.229	.163	.130	.168	.129	.173	.208	.213
.65	1.99	.248	.247	.402	.520	.535	.532	.520	.522	.526
.65	2.00	.250	.245	.398	.518	.534	.530	.518	.520	.525
.65	3.39	.249	.223	.161	.267	.382	.269	.378	.340	.278
.65	4.21	.249	.225	.162	.129	.247	.350	.394	.251	.187
.65	5.00	.251	.227	.162	.129	.170	.198	.257	.303	.260
.65	5.99	.254	.228	.163	.129	.169	.126	.145	.192	.231
.65	8.07	.254	.229	.163	.129	.168	.096	.062	.071	.093
.70	.98	.248	.248	.400	.518	.538	.537	.525	.526	.531
.70	1.99	.248	.248	.400	.518	.538	.537	.525	.526	.531
.70	3.41	.249	.223	.160	.264	.377	.275	.379	.335	.282
.70	4.21	.249	.225	.161	.129	.244	.350	.400	.260	.186
.70	5.00	.250	.227	.162	.129	.169	.194	.253	.308	.267
.70	6.01	.253	.228	.163	.129	.169	.125	.140	.184	.232
.80	1.99	.249	.251	.406	.519	.541	.544	.533	.535	.540
.80	3.42	.249	.222	.160	.258	.370	.286	.393	.353	.288
.80	4.20	.250	.224	.161	.130	.236	.376	.409	.251	.177
.80	5.01	.249	.226	.162	.129	.170	.188	.245	.317	.291
.80	6.01	.252	.227	.163	.129	.169	.123	.135	.172	.235
.80	7.02	.254	.228	.163	.129	.169	.096	.092	.106	.135
.80	7.00	.254	.228	.163	.129	.169	.096	.092	.107	.136
.80	9.05	.254	.229	.163	.129	.169	.096	.059	.053	.060
.90	2.00	.248	.249	.342	.370	.412	.468	.501	.535	.556
.90	3.41	.250	.221	.160	.130	.247	.334	.366	.418	.333
.90	4.23	.250	.223	.161	.128	.170	.251	.296	.308	.204
.90	5.00	.250	.225	.162	.130	.170	.105	.207	.260	.321
.90	6.00	.250	.227	.163	.129	.170	.097	.091	.136	.230
.90	7.02	.253	.228	.163	.129	.169	.096	.061	.091	.124
.90	7.00	.253	.228	.163	.129	.169	.096	.060	.091	.125
.90	8.59	.254	.229	.163	.129	.169	.096	.056	.051	.073
.90	9.99	.254	.229	.163	.129	.169	.096	.057	.041	.057
.95	2.01	.247	.233	.341	.332	.367	.415	.447	.493	.528
.95	3.40	.250	.222	.161	.129	.170	.196	.297	.388	.363
.95	4.21	.250	.223	.161	.129	.170	.148	.162	.268	.332
.95	4.99	.250	.225	.164	.130	.170	.098	.122	.182	.246
.95	6.02	.250	.227	.198	.129	.170	.097	.090	.103	.180
.95	7.00	.252	.227	.198	.129	.169	.096	.060	.077	.119
.95	8.61	.254	.229	.163	.130	.169	.096	.058	.076	.097
.95	10.01	.254	.229	.163	.130	.169	.096	.058	.042	.080
1.20	2.02	.248	.217	.187	.219	.316	.402	.426	.439	.466
1.20	3.41	.250	.220	.204	.127	.168	.217	.241	.265	.279
1.20	4.21	.251	.222	.159	.129	.170	.164	.180	.199	.216
1.20	5.00	.251	.224	.160	.129	.171	.105	.140	.154	.171
1.20	6.00	.251	.225	.161	.130	.171	.099	.105	.114	.128
1.20	7.01	.250	.226	.162	.130	.170	.098	.064	.087	.098
1.20	8.60	.251	.228	.163	.130	.170	.097	.058	.050	.066
1.20	9.99	.254	.228	.163	.130	.169	.097	.058	.041	.045

TABLE 34.- Continued

MACH	NPR	P10	P11	P12	P13	P14	P15	S1	S2	S3
0.00	2.00	.509	.508	.507	.445	.541	.547	-.001	.001	-.001
0.00	3.00	.351	.299	.355	.340	.385	.384	-.001	.001	-.001
0.00	4.01	.235	.297	.345	.289	.266	.267	-.001	.000	-.002
0.00	5.01	.184	.164	.167	.180	.252	.259	-.002	-.000	-.002
0.00	6.01	.196	.223	.184	.149	.167	.174	-.002	-.000	-.002
0.00	6.36	.173	.227	.213	.160	.165	.167	-.003	.000	-.002
0.00	2.00	.509	.508	.505	.443	.541	.547	-.001	.001	.002
0.00	3.01	.355	.298	.349	.338	.386	.385	-.001	.001	.002
0.00	4.00	.238	.297	.345	.287	.267	.267	-.001	.001	.001
0.00	5.01	.183	.164	.167	.180	.252	.259	-.002	.000	.000
0.00	6.00	.198	.221	.183	.148	.167	.174	-.002	-.000	.001
0.00	6.03	.193	.225	.187	.149	.167	.173	-.003	-.001	-.001
.65	.98							-.362	-.473	-.442
.65	1.99	.529	.529	.526	.477	.569	.576	-.429	-.601	-.595
.65	2.00	.527	.527	.524	.475	.567	.575	-.430	-.603	-.598
.65	3.39	.307	.289	.371	.309	.355	.353	-.442	-.620	-.614
.65	4.21	.165	.199	.264	.294	.353	.359	-.428	-.594	-.582
.65	5.00	.232	.189	.168	.169	.242	.245	-.408	-.557	-.539
.65	5.99	.195	.256	.231	.179	.182	.183	-.381	-.510	-.485
.65	8.07	.124	.148	.127	.205	.190	.206	-.322	-.414	-.381
.70	.98							-.372	-.488	-.452
.70	1.99	.533	.533	.531	.485	.573	.581	-.448	-.643	-.635
.70	3.41	.309	.291	.366	.311	.358	.356	-.462	-.665	-.657
.70	4.21	.165	.201	.256	.293	.357	.362	-.448	-.637	-.622
.70	5.00	.240	.194	.168	.171	.242	.245	-.427	-.595	-.573
.70	6.01	.194	.261	.240	.186	.187	.186	-.397	-.538	-.508
.80	.97							-.415	-.572	-.497
.80	1.99	.541	.541	.540	.498	.581	.589	-.462	-.801	-.913
.80	3.42	.307	.304	.377	.318	.363	.360	-.468	-.809	-.923
.80	4.20	.185	.206	.254	.313	.368	.371	-.463	-.802	-.915
.80	5.01	.257	.201	.170	.180	.241	.243	-.458	-.797	-.896
.80	6.01	.197	.274	.257	.202	.197	.195	-.449	-.750	-.696
.80	7.02	.181	.154	.192	.237	.230	.251	-.416	-.604	-.525
.80	7.00	.182	.154	.196	.238	.231	.252	-.424	-.625	-.539
.80	9.05	.075	.097	.139	.160	.164	.170	-.343	-.441	-.374
.90	.94							-.342	-.633	-.661
.90	2.00	.561	.562	.560	.536	.588	.595	-.338	-.631	-.732
.90	3.41	.304	.321	.389	.337	.374	.371	-.339	-.632	-.734
.90	4.23	.353	.320	.349	.244	.268	.281	-.336	-.630	-.731
.90	5.00	.248	.201	.288	.220	.242	.251	-.338	-.632	-.734
.90	6.00	.242	.333	.309	.213	.179	.187	-.338	-.632	-.733
.90	7.02	.178	.164	.197	.265	.240	.263	-.335	-.629	-.732
.90	7.00	.180	.164	.201	.266	.241	.264	-.338	-.633	-.735
.90	8.59	.089	.110	.150	.182	.182	.195	-.335	-.630	-.732
.90	9.99	.076	.095	.110	.119	.122	.127	-.332	-.623	-.658
.95	.93							-.275	-.545	-.630
.95	2.01	.549	.562	.568	.557	.588	.594	-.274	-.545	-.639
.95	3.40	.383	.381	.354	.308	.381	.390	-.274	-.547	-.641
.95	4.21	.335	.250	.316	.310	.336	.344	-.273	-.545	-.640
.95	4.99	.284	.306	.235	.204	.277	.300	-.276	-.550	-.645
.95	6.02	.201	.219	.270	.227	.222	.236	-.274	-.547	-.642
.95	7.00	.155	.167	.180	.207	.223	.233	-.273	-.545	-.640
.95	8.61	.105	.113	.122	.131	.141	.158	-.272	-.545	-.640
.95	10.01	.084	.089	.095	.102	.106	.115	-.271	-.544	-.638
1.20	.84							-.083	-.272	-.339
1.20	2.02	.490	.511	.529	.529	.583	.589	-.080	-.269	-.336
1.20	3.41	.282	.286	.299	.281	.359	.365	-.078	-.266	-.334
1.20	4.21	.226	.237	.247	.232	.297	.296	-.080	-.269	-.337
1.20	5.00	.185	.192	.206	.201	.255	.254	-.077	-.265	-.333
1.20	6.00	.142	.154	.163	.164	.217	.217	-.076	-.264	-.332
1.20	7.01	.110	.119	.134	.138	.186	.185	-.076	-.264	-.332
1.20	8.60	.076	.084	.096	.122	.146	.144	-.078	-.268	-.336
1.20	9.99	.056	.064	.074	.095	.117	.115	-.077	-.266	-.334

TABLE 34.- Concluded

MACH	NPR	S7	S8	CFMD	FMDZFI
0.00	2.00	-.000	.000	.351	.898
0.00	3.00	.000	.000	.684	.951
0.00	4.01	-.001	-.000	1.037	.981
0.00	5.01	-.001	-.000	1.397	.997
0.00	6.01	-.000	.000	1.745	.994
0.00	6.36	.000	.000	1.873	.995
0.00	2.00	.001	-.002	.353	.904
0.00	3.01	.002	-.002	.690	.958
0.00	4.00	.001	-.002	1.032	.979
0.00	5.01	.000	-.002	1.394	.995
0.00	6.00	.000	-.002	1.739	.993
0.00	6.03	-.000	-.003	1.751	.993
.65	.98	-.244	-.346	-.080	0.000
.65	1.99	-.491	-.546	1.153	.876
.65	2.00	-.494	-.549	1.166	.877
.65	3.39	-.496	-.560	2.800	.971
.65	4.21	-.441	-.517	3.776	.994
.65	5.00	-.376	-.463	4.691	.995
.65	5.99	-.302	-.398	5.844	.996
.65	8.07	-.178	-.279	8.379	.995
.70	.98	-.235	-.345	-.077	0.000
.70	1.99	-.509	-.576	.994	.879
.70	3.41	-.511	-.589	2.432	.973
.70	4.21	-.454	-.543	3.280	.995
.70	5.00	-.385	-.483	4.065	.995
.70	6.01	-.303	-.409	5.105	.997
.80	.97	-.201	-.333	-.082	0.000
.80	1.99	-.590	-.949	.759	.879
.80	3.42	-.658	-1.011	1.864	.969
.80	4.20	-.510	-.903	2.491	.994
.80	5.01	-.394	-.614	3.116	.996
.80	6.01	-.305	-.444	3.895	.998
.80	7.02	-.226	-.359	4.738	1.002
.80	7.00	-.232	-.365	4.684	1.001
.80	9.05	-.110	-.230	6.418	.997
.90	.94	-.172	-.307	-.103	0.000
.90	2.00	-.896	-.845	.551	.799
.90	3.41	-.955	-.850	1.415	.934
.90	4.23	-.952	-.847	1.918	.960
.90	5.00	-.954	-.850	2.409	.974
.90	6.00	-.934	-.849	3.039	.985
.90	7.02	-.809	-.847	3.715	.997
.90	7.00	-.814	-.850	3.712	.997
.90	8.59	-.337	-.690	4.705	.993
.90	9.99	-.136	-.267	5.564	.987
.95	.93	-.221	-.454	-.093	0.000
.95	2.01	-.844	-.747	.481	.771
.95	3.40	-.847	-.749	1.250	.921
.95	4.21	-.846	-.748	1.709	.952
.95	4.99	-.851	-.753	2.165	.970
.95	6.02	-.837	-.750	2.742	.980
.95	7.00	-.782	-.748	3.301	.986
.95	8.61	-.569	-.744	4.215	.985
.95	10.01	-.329	-.671	5.017	.987
1.20	.84	-.403	-.415	-.179	0.000
1.20	2.02	-.481	-.413	.222	.562
1.20	3.41	-.479	-.410	.707	.831
1.20	4.21	-.482	-.414	1.001	.884
1.20	5.00	-.478	-.409	1.274	.914
1.20	6.00	-.476	-.409	1.629	.937
1.20	7.01	-.468	-.408	1.992	.952
1.20	8.60	-.424	-.413	2.591	.965
1.20	9.99	-.367	-.410	3.093	.972

TABLE 35.- BASIC DATA FOR CONFIGURATION 34 WITH $\alpha_P = 15^\circ$,
 $B/d = 0.162$, AND $A/d = 0.303$

MACH	NPR	P1	P2	P3	P4	P5	P7	P8	P9
0.00	2.00	.246	.309	.491	.451	.471	.509	.509	.509
0.00	3.01	.248	.225	.164	.289	.384	.372	.364	.314
0.00	4.00	.249	.227	.159	.108	.085	.161	.237	.298
0.00	5.01	.254	.229	.157	.107	.078	.149	.157	.233
0.00	6.00	.254	.230	.156	.108	.079	.135	.139	.177
0.00	6.43	.254	.230	.155	.108	.079	.126	.134	.166
0.00	2.01	.247	.287	.497	.450	.471	.507	.507	.507
0.00	3.01	.248	.224	.161	.310	.386	.375	.376	.315
0.00	3.99	.249	.228	.158	.108	.084	.161	.237	.297
0.00	5.01	.253	.229	.156	.108	.079	.149	.157	.233
0.00	6.01	.253	.230	.155	.108	.079	.134	.139	.177
0.00	6.40	.253	.230	.155	.108	.079	.127	.135	.167
.65	2.01	.247	.228	.375	.469	.452	.513	.523	.526
.65	3.41	.249	.223	.159	.118	.197	.208	.229	.260
.65	4.19	.250	.225	.157	.108	.083	.159	.218	.259
.65	5.01	.249	.227	.156	.108	.079	.150	.155	.230
.65	6.00	.252	.229	.155	.108	.080	.136	.140	.170
.65	7.98	.254	.230	.153	.108	.079	.067	.066	.137
.70	2.00	.248	.228	.371	.468	.448	.514	.526	.530
.70	3.39	.250	.223	.159	.120	.195	.213	.236	.266
.70	4.19	.250	.225	.158	.108	.081	.159	.220	.261
.70	4.99	.249	.227	.156	.107	.078	.150	.156	.232
.70	5.98	.251	.229	.156	.108	.080	.137	.140	.169
.70	8.31	.254	.230	.152	.108	.079	.067	.066	.137
.80	1.99	.247	.233	.381	.459	.420	.513	.530	.539
.80	3.40	.248	.221	.159	.132	.192	.214	.236	.259
.80	4.20	.250	.225	.158	.107	.082	.161	.213	.270
.80	4.99	.249	.226	.156	.107	.078	.150	.156	.233
.80	6.00	.249	.228	.155	.107	.079	.137	.140	.168
.80	6.99	.252	.229	.153	.106	.079	.108	.131	.149
.80	9.01	.254	.230	.152	.108	.079	.067	.065	.137
.90	2.00	.244	.221	.297	.387	.402	.460	.495	.517
.90	3.40	.248	.219	.158	.144	.187	.205	.222	.238
.90	4.19	.250	.224	.158	.108	.135	.163	.171	.205
.90	4.98	.250	.225	.155	.105	.085	.144	.146	.165
.90	5.99	.249	.227	.155	.107	.079	.131	.134	.146
.90	6.99	.250	.229	.153	.108	.079	.075	.131	.147
.90	8.58	.255	.230	.152	.108	.079	.067	.065	.137
.90	8.60	.254	.230	.152	.108	.079	.067	.065	.136
.90	9.89	.254	.230	.151	.108	.079	.067	.065	.137
.95	1.99	.246	.217	.228	.357	.356	.438	.463	.489
.95	3.39	.248	.220	.158	.139	.182	.196	.212	.227
.95	4.19	.250	.224	.157	.107	.141	.164	.166	.184
.95	4.98	.250	.225	.155	.106	.085	.140	.145	.158
.95	4.99	.250	.225	.155	.107	.080	.139	.144	.158
.95	6.00	.249	.226	.154	.107	.079	.113	.128	.140
.95	7.01	.250	.228	.153	.108	.079	.066	.066	.136
.95	8.59	.254	.229	.152	.108	.079	.067	.065	.137
.95	9.98	.255	.230	.151	.108	.079	.067	.065	.137
.95	9.97	.254	.230	.151	.108	.080	.067	.065	.137
1.20	1.98	.249	.220	.254	.280	.306	.361	.390	.421
1.20	3.40	.251	.221	.160	.108	.090	.139	.164	.202
1.20	4.19	.251	.223	.157	.107	.080	.070	.073	.161
1.20	4.99	.251	.224	.155	.107	.080	.065	.064	.140
1.20	5.98	.250	.224	.153	.106	.079	.064	.062	.138
1.20	6.99	.250	.226	.152	.107	.079	.064	.063	.137
1.20	8.59	.250	.227	.151	.108	.080	.066	.065	.137
1.20	9.99	.251	.229	.151	.108	.079	.067	.065	.137

TABLE 35.- Continued

MACH	NPR	P10	P11	P12	P13	P14	P15	S1	S2	S3
0.00	2.00	.511	.509	.506	.454	.537	.544	-.001	-.001	-.002
0.00	3.01	.342	.362	.362	.298	.357	.358	-.001	-.002	-.002
0.00	4.00	.361	.298	.235	.243	.297	.307	-.001	-.001	-.002
0.00	5.01	.214	.253	.361	.281	.212	.225	-.001	-.002	-.002
0.00	6.00	.232	.201	.144	.209	.235	.250	-.002	-.002	-.003
0.00	6.43	.217	.239	.170	.153	.199	.211	-.002	-.003	-.003
0.00	2.01	.509	.508	.504	.451	.535	.543	-.001	-.001	-.002
0.00	3.01	.332	.368	.369	.297	.356	.357	-.001	-.002	-.002
0.00	3.99	.362	.300	.236	.241	.297	.307	-.001	-.002	-.002
0.00	5.01	.213	.256	.361	.280	.209	.223	-.002	-.002	-.002
0.00	6.01	.232	.200	.143	.209	.235	.250	-.002	-.003	-.003
0.00	6.40	.218	.237	.168	.163	.202	.215	-.003	-.004	-.004
.65	.99							-.350	-.455	-.423
.65	2.01	.528	.526	.524	.481	.558	.566	-.422	-.591	-.584
.65	3.41	.296	.325	.343	.333	.365	.369	-.401	-.553	-.539
.65	4.19	.360	.345	.269	.210	.282	.293	-.446	-.633	-.632
.65	5.01	.219	.271	.376	.285	.217	.229	-.437	-.616	-.611
.65	6.00	.225	.199	.151	.231	.256	.277	-.428	-.598	-.589
.65	7.98	.143	.182	.231	.216	.193	.208	-.406	-.555	-.537
.70	.99							-.362	-.472	-.434
.70	2.00	.532	.531	.529	.487	.562	.571	-.438	-.627	-.616
.70	3.39	.300	.328	.346	.339	.368	.372	-.414	-.578	-.560
.70	4.19	.359	.342	.268	.216	.289	.299	-.465	-.679	-.676
.70	4.99	.219	.283	.380	.282	.218	.229	-.456	-.660	-.655
.70	5.98	.225	.198	.152	.235	.261	.263	-.448	-.642	-.631
.70	8.31	.127	.154	.205	.208	.188	.204	-.417	-.578	-.555
.80	.97							-.401	-.541	-.473
.80	1.99	.542	.541	.540	.501	.574	.583	-.460	-.794	-.887
.80	3.40	.289	.315	.338	.346	.365	.369	-.446	-.726	-.703
.80	4.20	.356	.332	.266	.243	.307	.317	-.466	-.806	-.919
.80	4.99	.221	.297	.384	.278	.224	.231	-.465	-.804	-.918
.80	6.00	.225	.197	.155	.243	.270	.294	-.462	-.802	-.914
.80	6.99	.182	.232	.223	.147	.185	.191	-.460	-.798	-.905
.80	9.01	.103	.116	.148	.190	.180	.196	-.449	-.764	-.750
.90	.95							-.345	-.633	-.649
.90	.95							-.343	-.631	-.652
.90	2.00	.531	.538	.541	.508	.577	.585	-.341	-.633	-.735
.90	3.40	.258	.281	.307	.327	.347	.352	-.339	-.631	-.732
.90	4.19	.237	.270	.296	.304	.329	.334	-.340	-.632	-.734
.90	4.98	.215	.239	.287	.284	.300	.306	-.343	-.636	-.738
.90	5.99	.169	.212	.212	.237	.257	.274	-.341	-.634	-.737
.90	6.99	.161	.182	.230	.188	.196	.209	-.339	-.631	-.734
.90	8.58	.103	.162	.176	.199	.197	.215	-.337	-.630	-.732
.90	8.60	.103	.161	.176	.200	.196	.215	-.339	-.632	-.735
.90	9.89	.103	.103	.145	.159	.164	.177	-.339	-.633	-.735
.95	.92							-.277	-.547	-.633
.95	1.99	.510	.523	.534	.516	.566	.572	-.278	-.549	-.643
.95	3.39	.241	.260	.283	.305	.329	.337	-.275	-.545	-.640
.95	4.19	.204	.223	.246	.271	.291	.299	-.277	-.548	-.643
.95	4.98	.175	.197	.217	.235	.249	.257	-.280	-.552	-.647
.95	4.99	.175	.196	.216	.233	.248	.256	-.277	-.547	-.642
.95	6.00	.153	.167	.189	.204	.217	.224	-.274	-.544	-.639
.95	7.01	.133	.182	.193	.215	.235	.246	-.273	-.543	-.638
.95	8.59	.103	.152	.162	.167	.170	.191	-.271	-.541	-.635
.95	9.98	.103	.080	.136	.142	.140	.154	-.273	-.544	-.639
.95	9.97	.103	.080	.136	.143	.141	.155	-.275	-.546	-.642
1.20	.84							-.088	-.275	-.342
1.20	1.98	.446	.469	.490	.503	.513	.517	-.087	-.275	-.342
1.20	3.40	.237	.269	.305	.319	.348	.356	-.087	-.275	-.343
1.20	4.19	.222	.265	.294	.275	.328	.331	-.087	-.275	-.343
1.20	4.99	.177	.208	.236	.228	.283	.286	-.085	-.273	-.340
1.20	5.98	.119	.156	.182	.184	.234	.237	-.084	-.272	-.340
1.20	6.99	.103	.120	.141	.147	.191	.197	-.083	-.271	-.338
1.20	8.59	.103	.073	.096	.105	.148	.151	-.084	-.272	-.339
1.20	9.99	.103	.073	.060	.083	.119	.120	-.083	-.271	-.338

TABLE 35.- Concluded

MACH	NPR	S4	S5	S6	S7	CFMD	FMDZFI
0.00	2.00	-.002	.016	-.003	-.003	.333	.842
0.00	3.01	-.002	.037	-.003	-.004	.673	.922
0.00	4.00	-.002	-.001	-.002	-.002	.974	.916
0.00	5.01	-.002	-.006	-.002	-.003	1.349	.954
0.00	6.00	-.003	-.001	-.003	-.003	1.728	.977
0.00	6.43	-.003	-.007	-.004	-.004	1.882	.976
0.00	2.01	-.002	-.002	-.003	-.003	.333	.840
0.00	3.01	-.002	-.003	-.003	-.004	.671	.925
0.00	3.99	-.002	-.002	-.002	-.003	.972	.917
0.00	5.01	-.003	-.003	-.003	-.003	1.351	.955
0.00	6.01	-.003	-.004	-.004	-.004	1.730	.977
0.00	6.40	-.004	-.005	-.005	-.005	1.871	.977
.65	.99	-.378	-.539	-.283	-.236	-.090	0.000
.65	2.01	-.562	-.741	-.509	-.483	1.029	.772
.65	3.41	-.510	-.681	-.435	-.386	2.508	.862
.65	4.19	-.616	-.800	-.572	-.551	3.496	.920
.65	5.01	-.591	-.771	-.540	-.514	4.521	.952
.65	6.00	-.565	-.742	-.504	-.473	5.829	.979
.65	7.98	-.504	-.676	-.430	-.389	8.487	.999
.70	.99	-.383	-.266	-.279	-.228	-.086	0.000
.70	2.00	-.584	-.672	-.516	-.482	.880	.770
.70	3.39	-.523	-.483	-.442	-.387	2.135	.860
.70	4.19	-.653	-.709	-.596	-.567	3.041	.922
.70	4.99	-.626	-.647	-.563	-.530	3.881	.949
.70	5.98	-.598	-.716	-.525	-.487	5.023	.980
.70	8.31	-.512	-.623	-.420	-.374	7.606	1.000
.80	.97	-.390	-.381	-.254	-.198	-.090	0.000
.80	1.99	-.833	-.450	-.527	-.456	.677	.768
.80	3.40	-.583	-.369	-.424	-.354	1.650	.859
.80	4.20	-.983	-.758	-.967	-.791	2.328	.920
.80	4.99	-.980	-.773	-.897	-.676	2.980	.948
.80	6.00	-.966	-.900	-.736	-.556	3.858	.981
.80	6.99	-.899	-.815	-.557	-.460	4.656	.985
.80	9.01	-.580	-.466	-.400	-.340	6.371	1.000
.90	.95	-.465	-.260	-.211	-.171	-.107	0.000
.90	.95	-.472	-.220	-.214	-.174	-.108	0.000
.90	2.00	-.794	-.737	-.768	-.651	.476	.680
.90	3.40	-.789	-.595	-.775	-.694	1.264	.831
.90	4.19	-.796	-.397	-.905	-.953	1.782	.893
.90	4.98	-.800	-.631	-.915	-.967	2.320	.932
.90	5.99	-.799	-.531	-.914	-.966	2.988	.959
.90	6.99	-.795	-.628	-.911	-.963	3.647	.975
.90	8.58	-.794	-.725	-.909	-.952	4.721	.993
.90	8.60	-.797	-.662	-.912	-.954	4.755	.993
.90	9.89	-.798	-.233	-.909	-.903	5.608	.993
.95	.92	-.610	-.035	-.314	-.234	-.103	0.000
.95	1.99	-.701	-.612	-.797	-.792	.399	.641
.95	3.39	-.697	-.456	-.783	-.791	1.115	.818
.95	4.19	-.701	-.613	-.808	-.857	1.585	.879
.95	4.98	-.705	-.404	-.812	-.861	2.061	.917
.95	4.99	-.700	-.340	-.807	-.856	2.060	.917
.95	6.00	-.697	-.338	-.804	-.853	2.648	.945
.95	7.01	-.695	-.488	-.803	-.851	3.303	.980
.95	8.59	-.693	-.576	-.800	-.843	4.230	.991
.95	9.98	-.698	-.580	-.804	-.824	5.078	.992
.95	9.97	-.700	-.461	-.806	-.825	5.082	.993
1.20	.84	-.383	.446	-.432	-.401	-.183	0.000
1.20	1.98	-.384	.297	-.457	-.485	.184	.478
1.20	3.40	-.384	.212	-.459	-.493	.646	.751
1.20	4.19	-.385	-.023	-.459	-.494	.935	.828
1.20	4.99	-.382	-.001	-.457	-.491	1.234	.878
1.20	5.98	-.382	.042	-.456	-.491	1.608	.917
1.20	6.99	-.380	-.169	-.455	-.490	1.989	.942
1.20	8.59	-.381	-.233	-.456	-.490	2.596	.965
1.20	9.99	-.380	-.232	-.455	-.486	3.134	.979

TABLE 36.- BASIC DATA FOR CONFIGURATION 35 WITH $\alpha_p = 15^\circ$,
 $B/d = 0.162$, AND $A/d = 0.000$

MACH	NPR	P1	P2	P3	P4	P5	P6	P7	P8	P9
0.00	2.01	.247	.519	.515	.506	.504	.504	.503	.502	.504
0.00	3.00	.249	.268	.433	.369	.255	.356	.391	.297	.315
0.00	4.01	.254	.271	.196	.271	.280	.293	.259	.233	.233
0.00	5.00	.255	.272	.196	.163	.170	.189	.252	.257	.252
0.00	6.00	.255	.272	.197	.153	.103	.114	.154	.210	.240
0.00	6.41	.254	.272	.197	.147	.090	.105	.118	.169	.217
0.00	2.01	.248	.519	.516	.505	.503	.503	.503	.503	.504
0.00	3.00	.249	.269	.435	.370	.251	.352	.396	.298	.312
0.00	2.00	.248	.521	.517	.508	.506	.506	.505	.505	.507
0.00	3.02	.249	.268	.431	.373	.250	.344	.400	.299	.307
0.00	4.01	.254	.272	.197	.270	.280	.293	.259	.234	.233
0.00	5.00	.255	.273	.196	.163	.170	.189	.252	.257	.251
0.00	6.01	.255	.273	.197	.152	.102	.113	.154	.210	.240
0.00	6.44	.255	.273	.197	.145	.089	.103	.116	.167	.216
.65	2.02	.247	.379	.539	.509	.509	.512	.514	.516	.520
.65	3.21	.251	.264	.196	.380	.371	.290	.295	.374	.404
.65	3.42	.250	.267	.195	.332	.386	.271	.249	.269	.329
.65	4.21	.250	.270	.196	.206	.209	.267	.286	.293	.248
.65	5.02	.254	.272	.196	.165	.162	.154	.198	.269	.299
.65	4.99	.254	.272	.197	.165	.163	.156	.202	.271	.299
.65	6.01	.256	.273	.197	.154	.102	.106	.117	.143	.219
.65	8.17	.256	.273	.197	.125	.078	.063	.054	.057	.063
.70	2.01	.248	.361	.543	.513	.512	.515	.517	.519	.524
.70	3.21	.251	.267	.195	.377	.386	.294	.289	.361	.413
.70	4.21	.251	.270	.196	.200	.208	.262	.291	.300	.253
.70	5.00	.253	.272	.197	.166	.163	.153	.192	.271	.304
.70	6.01	.256	.272	.197	.155	.103	.106	.115	.135	.210
.70	8.53	.257	.273	.198	.125	.078	.060	.053	.051	.079
.80	2.00	.251	.302	.551	.528	.524	.527	.530	.532	.537
.80	3.42	.251	.266	.194	.333	.446	.324	.237	.272	.325
.80	4.21	.251	.269	.196	.190	.212	.254	.313	.314	.254
.80	5.00	.251	.271	.197	.167	.167	.148	.177	.268	.313
.80	6.00	.256	.273	.197	.156	.103	.107	.113	.123	.170
.80	7.00	.257	.273	.197	.127	.082	.091	.071	.086	.099
.80	9.32	.256	.273	.197	.125	.078	.057	.051	.050	.086
.90	1.99	.250	.260	.334	.463	.550	.563	.559	.556	.560
.90	3.41	.252	.267	.194	.162	.264	.351	.369	.385	.291
.90	4.20	.253	.269	.196	.126	.130	.251	.309	.288	.228
.90	4.98	.252	.271	.197	.125	.089	.125	.227	.273	.313
.90	6.03	.253	.272	.196	.124	.082	.110	.102	.126	.221
.90	6.99	.257	.273	.197	.125	.080	.093	.074	.091	.101
.90	8.66	.257	.273	.197	.125	.078	.059	.055	.057	.058
.90	9.97	.257	.274	.198	.125	.078	.055	.048	.041	.074
.95	2.00	.251	.259	.190	.333	.457	.543	.558	.567	.576
.95	3.42	.251	.266	.194	.160	.191	.191	.261	.366	.369
.95	4.22	.252	.269	.195	.125	.128	.144	.166	.257	.322
.95	5.02	.252	.270	.197	.125	.087	.120	.120	.148	.238
.95	5.99	.253	.273	.198	.125	.081	.106	.087	.102	.141
.95	7.01	.256	.273	.197	.124	.079	.080	.067	.081	.086
.95	8.59	.257	.274	.198	.125	.078	.056	.056	.054	.063
.95	10.02	.257	.273	.198	.125	.077	.054	.047	.041	.048
1.20	2.00	.253	.261	.193	.354	.405	.422	.413	.431	.463
1.20	3.39	.252	.264	.216	.163	.202	.222	.243	.257	.267
1.20	4.22	.252	.266	.194	.142	.154	.157	.181	.195	.208
1.20	4.99	.253	.268	.196	.125	.097	.129	.137	.148	.166
1.20	5.99	.253	.271	.197	.125	.082	.114	.097	.111	.128
1.20	6.99	.252	.272	.197	.126	.080	.088	.072	.087	.096
1.20	8.63	.252	.273	.197	.124	.078	.056	.059	.057	.064
1.20	9.98	.257	.274	.198	.125	.077	.053	.048	.042	.051

TABLE 36.- Continued

MACH	NPR	P10	P11	P12	P13	P14	P15	S1	S2	S3
0.00	2.01	.507	.506	.501	.438	.541	.546	-.001	-.001	-.002
0.00	3.00	.389	.365	.321	.296	.365	.376	-.004	-.001	-.002
0.00	4.01	.268	.277	.299	.253	.281	.278	-.004	-.001	-.002
0.00	5.00	.214	.177	.184	.174	.237	.243	-.003	-.000	-.001
0.00	6.00	.252	.214	.175	.141	.153	.158	-.002	.000	-.007
0.00	6.41	.250	.234	.198	.146	.132	.141	-.002	-.001	-.008
0.00	2.01	.507	.506	.504	.439	.540	.547	.002	-.002	-.002
0.00	3.00	.389	.368	.322	.294	.363	.374	.001	-.003	-.004
0.00	2.00	.510	.509	.506	.441	.543	.549	.001	-.005	-.005
0.00	3.02	.383	.372	.323	.292	.359	.371	-.000	-.005	-.006
0.00	4.01	.269	.277	.297	.253	.279	.278	.000	-.006	-.006
0.00	5.00	.214	.177	.185	.175	.237	.243	-.001	-.006	-.006
0.00	6.01	.251	.214	.175	.140	.152	.158	-.003	-.006	-.006
0.00	6.44	.248	.234	.198	.147	.131	.140	-.003	-.006	-.006
.65	.96							-.287	-.241	-.212
.65	2.02	.525	.525	.523	.471	.566	.571	-.601	-.536	-.449
.65	3.21	.317	.286	.312	.321	.390	.395	-.587	-.535	-.469
.65	3.42	.385	.324	.301	.259	.329	.338	-.571	-.519	-.455
.65	4.21	.226	.234	.241	.242	.312	.317	-.500	-.444	-.384
.65	5.02	.281	.213	.195	.174	.223	.225	-.432	-.373	-.314
.65	4.99	.280	.211	.196	.175	.225	.228	-.434	-.375	-.316
.65	6.01	.275	.286	.242	.187	.151	.163	-.365	-.303	-.246
.65	6.17	.111	.151	.177	.196	.188	.204	-.234	-.169	-.119
.70	.95							-.285	-.237	-.205
.70	2.01	.529	.529	.530	.477	.571	.575	-.634	-.562	-.467
.70	3.21	.332	.288	.308	.314	.389	.396	-.618	-.559	-.483
.70	4.21	.229	.234	.239	.240	.313	.318	-.520	-.457	-.389
.70	5.00	.292	.220	.200	.176	.223	.225	-.444	-.378	-.313
.70	6.01	.273	.294	.262	.195	.153	.166	-.361	-.294	-.233
.70	6.53	.108	.121	.140	.162	.173	.175	-.204	-.137	-.086
.80	.94							-.277	-.222	-.188
.80	2.00	.541	.542	.536	.494	.585	.589	-1.004	-.849	-.601
.80	3.42	.398	.365	.297	.265	.336	.347	-1.021	-.869	-.601
.80	4.21	.237	.231	.235	.243	.319	.325	-.807	-.539	-.423
.80	5.00	.319	.245	.204	.178	.218	.221	-.488	-.387	-.310
.80	6.00	.269	.309	.305	.211	.168	.175	-.375	-.290	-.221
.80	7.00	.184	.218	.258	.248	.189	.192	-.290	-.210	-.149
.80	9.32	.092	.096	.104	.113	.125	.136	-.142	-.072	-.025
.90	.93							-.268	-.195	-.168
.90	1.99	.561	.560	.559	.511	.602	.610	-.862	-.932	-.976
.90	3.41	.322	.380	.373	.299	.348	.361	-.864	-.936	-.979
.90	4.20	.355	.352	.276	.242	.279	.291	-.862	-.934	-.972
.90	4.98	.214	.186	.298	.240	.281	.285	-.865	-.937	-.946
.90	6.03	.259	.301	.227	.153	.195	.199	-.856	-.874	-.769
.90	6.99	.144	.200	.235	.256	.236	.240	-.729	-.485	-.346
.90	8.66	.084	.119	.128	.140	.142	.158	-.183	-.099	-.067
.90	9.97	.084	.087	.093	.097	.099	.114	-.072	-.005	.025
.95	.91							-.344	-.238	-.200
.95	2.00	.579	.580	.581	.537	.620	.625	-.753	-.818	-.859
.95	3.42	.402	.361	.337	.323	.392	.401	-.752	-.818	-.859
.95	4.22	.308	.291	.367	.306	.316	.321	-.759	-.826	-.864
.95	5.02	.280	.295	.229	.208	.297	.315	-.754	-.821	-.840
.95	5.99	.206	.234	.274	.224	.238	.250	-.754	-.813	-.766
.95	7.01	.109	.175	.196	.224	.241	.246	-.751	-.732	-.597
.95	8.59	.085	.112	.132	.141	.143	.158	-.602	-.350	-.250
.95	10.02	.057	.084	.098	.102	.103	.107	-.136	-.063	-.044
1.20	.78							-.410	-.399	-.359
1.20	2.00	.490	.514	.543	.547	.593	.596	-.412	-.457	-.490
1.20	3.39	.276	.285	.303	.285	.360	.365	-.413	-.458	-.491
1.20	4.22	.221	.233	.244	.227	.292	.293	-.412	-.458	-.489
1.20	4.99	.183	.192	.208	.195	.250	.251	-.413	-.458	-.485
1.20	5.99	.138	.155	.171	.166	.214	.213	-.411	-.456	-.463
1.20	6.99	.109	.121	.140	.138	.187	.185	-.412	-.452	-.427
1.20	8.63	.077	.083	.098	.113	.148	.147	-.412	-.408	-.350
1.20	9.98	.052	.064	.075	.110	.120	.119	-.401	-.342	-.215

TABLE 36.- Concluded

MACH	NPR	S4	S6	S7	S8	CFMD	FMDZFI
0.00	2.01	-.011	-.024	-.013	-.014	.373	.944
0.00	3.00	-.011	-.010	-.016	-.011	.706	.985
0.00	4.01	-.009	-.010	-.016	-.011	1.048	.994
0.00	5.00	-.008	-.010	-.015	-.009	1.393	.997
0.00	6.00	-.008	-.009	-.014	-.008	1.730	.990
0.00	6.41	-.007	-.009	-.014	-.008	1.871	.987
0.00	2.01	-.019	-.022	-.018	-.022	.371	.946
0.00	3.00	-.016	-.011	-.005	-.015	.703	.981
0.00	2.00	-.023	-.026	-.007	-.026	.370	.947
0.00	3.02	-.019	-.012	-.008	-.016	.712	.986
0.00	4.01	-.018	-.012	-.008	-.015	1.045	.992
0.00	5.00	-.018	-.012	-.008	-.015	1.391	.996
0.00	6.01	-.018	-.012	-.008	-.015	1.733	.989
0.00	6.44	-.018	-.012	-.008	-.014	1.881	.986
.65	.96	-.108	-.145	-.083	-.110	-.108	0.000
.65	2.02	-1.075	-1.093	-.833	-1.073	1.257	.940
.65	3.21	-.790	-.808	-.589	-.780	2.630	.988
.65	3.42	-.746	-.763	-.543	-.738	2.875	.988
.65	4.21	-.601	-.617	-.394	-.599	3.773	.994
.65	5.02	-.492	-.504	-.279	-.483	4.705	.994
.65	4.99	-.495	-.507	-.281	-.486	4.688	.994
.65	6.01	-.396	-.402	-.185	-.387	5.843	.989
.65	8.17	-.241	-.236	-.037	-.233	8.459	.982
.70	.95	-.109	-.143	-.087	-.111	-.107	0.000
.70	2.01	-.978	-1.012	-.810	-.980	1.081	.940
.70	3.21	-.771	-.792	-.591	-.764	2.270	.988
.70	4.21	-.595	-.608	-.395	-.586	3.267	.994
.70	5.00	-.485	-.491	-.280	-.475	4.046	.993
.70	6.01	-.379	-.380	-.178	-.369	5.039	.990
.70	8.53	-.200	-.191	-.013	-.191	7.557	.976
.80	.94	-.110	-.139	-.093	-.112	-.109	0.000
.80	2.00	-.786	-.832	-.759	-.785	.805	.927
.80	3.42	-.920	-.927	-.713	-.919	1.883	.983
.80	4.21	-.674	-.678	-.464	-.671	2.487	.992
.80	5.00	-.473	-.471	-.286	-.464	3.089	.992
.80	6.00	-.363	-.356	-.180	-.354	3.891	.990
.80	7.00	-.275	-.265	-.100	-.265	4.658	.985
.80	9.32	-.126	-.113	.033	-.117	6.410	.970
.90	.93	-.124	-.153	-.114	-.128	-.116	0.000
.90	1.99	-1.204	-1.192	-1.077	-1.194	.575	.841
.90	3.41	-1.101	-1.089	-.949	-1.081	1.435	.946
.90	4.20	-1.048	-1.026	-.893	-1.026	1.909	.963
.90	4.98	-1.006	-.977	-.848	-.985	2.398	.972
.90	6.03	-.905	-.879	-.717	-.895	3.019	.976
.90	6.99	-.625	-.588	-.380	-.610	3.653	.983
.90	8.66	-.167	-.157	-.034	-.157	4.633	.974
.90	9.97	-.058	-.047	.070	-.050	5.439	.970
.95	.91	-.154	-.184	-.149	-.157	-.115	0.000
.95	2.00	-1.069	-1.057	-.950	-1.061	.496	.807
.95	3.42	-.974	-.963	-.836	-.957	1.260	.927
.95	4.22	-.939	-.922	-.798	-.919	1.713	.951
.95	5.02	-.892	-.865	-.746	-.872	2.153	.965
.95	5.99	-.841	-.809	-.688	-.824	2.685	.971
.95	7.01	-.757	-.732	-.570	-.749	3.259	.976
.95	8.59	-.497	-.451	-.265	-.480	4.137	.973
.95	10.02	-.130	-.121	-.014	-.122	4.940	.974
1.20	.78	-.232	-.252	-.212	-.235	-.205	0.000
1.20	2.00	-.646	-.653	-.578	-.639	.229	.593
1.20	3.39	-.571	-.574	-.500	-.562	.708	.839
1.20	4.22	-.548	-.544	-.456	-.537	.996	.884
1.20	4.99	-.525	-.519	-.432	-.514	1.265	.909
1.20	5.99	-.495	-.480	-.396	-.483	1.612	.929
1.20	6.99	-.468	-.468	-.364	-.458	1.968	.942
1.20	8.63	-.421	-.398	-.301	-.413	2.549	.953
1.20	9.98	-.362	-.339	-.205	-.357	3.038	.958

TABLE 37.- BASIC DATA FOR CONFIGURATION 36 WITH $\alpha_p = 18^\circ$,
 $B/d = 0.061$, AND $A/d = 0.064$

MACH	NPR	P1	P2	P3	P4	P5	P6	P7	P8	P9
0.00	1.99	.217	.501	.528	.514	.511	.513	.512	.514	.516
0.00	3.00	.215	.194	.425	.291	.339	.350	.366	.336	.355
0.00	3.99	.221	.195	.265	.321	.341	.222	.216	.226	.316
0.00	5.00	.221	.195	.174	.192	.209	.248	.232	.210	.192
0.00	6.00	.221	.196	.172	.107	.157	.173	.179	.222	.217
0.00	6.35	.220	.196	.172	.104	.148	.137	.166	.187	.227
0.00	2.01	.222	.495	.525	.509	.506	.508	.508	.509	.513
0.00	2.99	.211	.198	.430	.294	.337	.349	.371	.336	.353
0.00	4.00	.219	.194	.262	.321	.340	.220	.215	.227	.313
0.00	5.00	.220	.195	.173	.195	.210	.248	.230	.209	.192
0.00	6.01	.220	.195	.171	.106	.157	.172	.179	.221	.216
0.00	6.35	.220	.195	.171	.104	.148	.137	.166	.187	.227
.65	2.01	.216	.387	.528	.529	.521	.525	.527	.531	.538
.65	3.40	.213	.193	.286	.461	.289	.256	.271	.413	.366
.65	4.20	.214	.194	.170	.264	.308	.323	.260	.209	.218
.65	4.99	.219	.196	.170	.120	.177	.243	.293	.273	.242
.65	5.99	.221	.197	.171	.105	.147	.118	.165	.185	.283
.65	8.17	.220	.196	.171	.103	.067	.076	.061	.079	.146
.70	2.01	.221	.372	.515	.533	.525	.529	.531	.534	.542
.70	3.00	.213	.193	.346	.349	.383	.346	.354	.403	.378
.70	3.38	.214	.194	.282	.447	.301	.288	.298	.394	.343
.70	4.18	.214	.196	.168	.252	.305	.346	.261	.215	.215
.70	4.99	.219	.197	.170	.114	.175	.235	.296	.289	.259
.70	6.00	.220	.197	.170	.104	.144	.112	.158	.179	.289
.70	8.48	.221	.197	.171	.103	.067	.070	.055	.090	.132
.80	2.02	.214	.307	.449	.528	.534	.537	.539	.543	.550
.80	3.40	.213	.192	.164	.338	.313	.401	.338	.314	.319
.80	4.17	.214	.195	.165	.131	.282	.368	.285	.256	.256
.80	4.20	.215	.196	.168	.109	.279	.374	.285	.250	.256
.80	5.01	.216	.196	.168	.101	.175	.224	.316	.340	.242
.80	6.01	.221	.197	.170	.103	.103	.102	.147	.213	.297
.80	7.01	.221	.198	.171	.103	.069	.083	.093	.108	.200
.80	9.23	.221	.198	.171	.103	.067	.044	.053	.096	.105
.90	1.99	.216	.271	.359	.421	.484	.533	.559	.569	.577
.90	3.39	.215	.194	.165	.109	.242	.322	.389	.374	.399
.90	4.19	.214	.194	.165	.101	.173	.205	.258	.307	.367
.90	5.00	.215	.197	.168	.102	.126	.162	.177	.218	.258
.90	5.98	.218	.197	.169	.102	.075	.130	.140	.152	.182
.90	6.99	.220	.197	.170	.102	.067	.108	.116	.125	.138
.90	8.62	.221	.197	.171	.102	.066	.057	.091	.099	.106
.90	8.61	.221	.198	.171	.103	.067	.056	.090	.099	.106
.90	10.01	.221	.198	.172	.103	.067	.043	.063	.078	.087
.95	2.01	.214	.201	.216	.310	.495	.545	.561	.573	.586
.95	3.40	.213	.190	.162	.108	.173	.202	.322	.385	.418
.95	4.21	.215	.195	.165	.104	.128	.120	.201	.277	.329
.95	4.99	.215	.196	.167	.102	.073	.094	.138	.205	.241
.95	5.98	.217	.197	.169	.102	.079	.124	.135	.144	.156
.95	6.98	.220	.197	.170	.102	.067	.099	.112	.120	.128
.95	6.99	.220	.197	.170	.103	.067	.102	.113	.121	.129
.95	8.62	.220	.197	.170	.102	.066	.057	.090	.093	.098
.95	9.99	.220	.198	.171	.102	.066	.042	.073	.077	.080
1.20	1.98	.219	.199	.205	.319	.380	.406	.414	.464	.517
1.20	3.39	.214	.190	.166	.118	.182	.215	.231	.253	.265
1.20	4.19	.214	.192	.164	.104	.154	.148	.162	.185	.212
1.20	4.99	.215	.194	.163	.102	.104	.104	.130	.148	.163
1.20	6.00	.215	.196	.168	.103	.070	.083	.104	.101	.123
1.20	7.00	.215	.197	.169	.103	.068	.070	.062	.085	.100
1.20	8.60	.218	.197	.170	.103	.067	.044	.052	.054	.068
1.20	9.99	.221	.198	.171	.103	.067	.043	.032	.039	.046

TABLE 37.- Continued

MACH	NPR	P10	P11	P12	P13	P14	P15	S1	S2	S3
0.00	1.99	.522	.527	.534	.544	.583	.587	-.002	-.003	-.001
0.00	3.00	.362	.370	.368	.398	.447	.452	-.002	-.003	-.002
0.00	3.99	.331	.330	.273	.260	.327	.333	-.004	-.007	-.008
0.00	5.00	.199	.223	.254	.284	.281	.300	-.007	-.012	-.013
0.00	6.00	.200	.193	.206	.203	.234	.249	-.010	-.015	-.017
0.00	6.35	.204	.205	.193	.211	.222	.228	-.010	-.015	-.020
0.00	2.01	.517	.523	.529	.540	.579	.584	-.002	-.003	-.003
0.00	2.99	.364	.373	.368	.397	.447	.453	-.002	-.003	-.004
0.00	4.00	.330	.329	.271	.258	.325	.331	-.004	-.007	-.008
0.00	5.00	.199	.224	.255	.284	.281	.300	-.007	-.011	-.013
0.00	6.01	.200	.193	.205	.204	.234	.248	-.010	-.015	-.017
0.00	6.35	.204	.205	.192	.211	.221	.228	-.011	-.015	-.019
.65	.96							-.294	-.416	-.215
.65	2.01	.543	.549	.555	.564	.600	.604	-.754	-1.073	-.647
.65	3.40	.295	.289	.358	.431	.451	.457	-.794	-1.236	-.886
.65	4.20	.264	.327	.361	.355	.360	.367	-.766	-1.184	-.839
.65	4.99	.210	.204	.222	.265	.308	.333	-.719	-1.098	-.757
.65	5.99	.273	.238	.234	.205	.226	.232	-.652	-.983	-.652
.65	8.17	.172	.197	.235	.215	.188	.203	-.521	-.778	-.468
.70	.95							-.292	-.410	-.209
.70	2.01	.547	.553	.559	.567	.602	.605	-.743	-1.038	-.661
.70	3.00	.364	.404	.411	.404	.464	.470	-.789	-1.254	-.920
.70	3.38	.319	.308	.376	.422	.442	.446	-.788	-1.269	-.926
.70	4.18	.260	.335	.375	.368	.360	.366	-.769	-1.224	-.853
.70	4.99	.214	.199	.215	.257	.312	.338	-.725	-1.115	-.750
.70	6.00	.290	.252	.233	.200	.228	.235	-.659	-.990	-.635
.70	8.48	.146	.162	.193	.208	.184	.199	-.495	-.735	-.413
.80	.94							-.293	-.404	-.199
.80	2.02	.554	.560	.565	.572	.604	.609	-.619	-.953	-.773
.80	3.40	.384	.359	.347	.373	.449	.450	-.630	-1.208	-1.271
.80	4.17	.276	.308	.344	.366	.355	.368	-.625	-1.199	-1.180
.80	4.20	.266	.311	.344	.370	.354	.369	-.627	-1.201	-1.166
.80	5.01	.174	.208	.226	.263	.322	.350	-.622	-1.162	-1.031
.80	6.01	.329	.267	.191	.174	.243	.250	-.615	-.990	-.788
.80	7.01	.236	.286	.273	.213	.204	.202	-.594	-.872	-.562
.80	9.23	.113	.121	.132	.158	.174	.183	-.453	-.649	-.327
.90	.91							-.301	-.397	-.195
.90	1.99	.578	.579	.582	.584	.600	.610	-.457	-.923	-1.131
.90	3.39	.347	.387	.386	.385	.440	.447	-.452	-.923	-1.015
.90	4.19	.315	.294	.356	.355	.356	.366	-.452	-.922	-.957
.90	5.00	.295	.333	.289	.259	.316	.322	-.451	-.920	-.894
.90	5.98	.215	.238	.264	.287	.281	.299	-.450	-.907	-.823
.90	6.99	.156	.184	.204	.223	.239	.245	-.449	-.874	-.752
.90	8.62	.113	.122	.133	.150	.165	.174	-.444	-.759	-.598
.90	8.61	.113	.122	.133	.151	.166	.174	-.442	-.750	-.591
.90	10.01	.091	.096	.102	.111	.122	.130	-.431	-.585	-.331
.95	.89							-.304	-.411	-.220
.95	2.01	.590	.597	.604	.611	.639	.641	-.376	-.804	-1.003
.95	3.40	.380	.408	.392	.407	.461	.467	-.374	-.808	-.910
.95	4.21	.355	.383	.316	.331	.400	.408	-.375	-.810	-.846
.95	4.99	.288	.288	.342	.357	.327	.343	-.374	-.806	-.796
.95	5.98	.169	.188	.208	.224	.241	.248	-.372	-.797	-.730
.95	6.98	.136	.147	.164	.185	.202	.209	-.372	-.775	-.670
.95	6.99	.136	.147	.166	.186	.204	.211	-.376	-.777	-.671
.95	8.62	.103	.108	.115	.125	.139	.153	-.370	-.704	-.569
.95	9.99	.083	.088	.094	.102	.113	.119	-.369	-.627	-.470
1.20	.80							-.137	-.337	-.253
1.20	1.98	.551	.580	.602	.619	.632	.636	-.143	-.445	-.616
1.20	3.39	.291	.321	.377	.430	.453	.455	-.142	-.445	-.555
1.20	4.19	.232	.258	.303	.367	.396	.397	-.140	-.443	-.510
1.20	4.99	.188	.211	.243	.303	.340	.343	-.139	-.442	-.475
1.20	6.00	.142	.169	.205	.257	.283	.286	-.139	-.440	-.433
1.20	7.00	.108	.133	.187	.223	.238	.242	-.139	-.437	-.397
1.20	8.60	.076	.096	.147	.164	.181	.187	-.138	-.416	-.342
1.20	9.99	.058	.092	.114	.127	.141	.147	-.139	-.382	-.294

TABLE 37.- Concluded

MACH	NPR	S4	S5	S6	CFMD	FMDZFI
0.00	1.99	-.017	-.017	-.017	.364	.941
0.00	3.00	-.011	-.007	-.006	.706	.984
0.00	3.99	-.016	-.012	-.010	1.045	.996
0.00	5.00	-.022	-.016	-.014	1.398	.997
0.00	6.00	-.027	-.021	-.018	1.742	.993
0.00	6.35	-.030	-.023	-.020	1.864	.992
0.00	2.01	-.018	-.017	-.017	.371	.946
0.00	2.99	-.010	-.007	-.006	.703	.988
0.00	4.00	-.015	-.011	-.009	1.051	.997
0.00	5.00	-.018	-.016	-.014	1.394	.996
0.00	6.01	-.024	-.020	-.018	1.744	.992
0.00	6.35	-.025	-.022	-.020	1.865	.992
.65	.96	-.172	-.176	-.197	-.147	0.000
.65	2.01	-1.263	-1.234	-.764	1.223	.917
.65	3.40	-1.269	-1.193	-.740	2.821	.985
.65	4.20	-1.182	-1.114	-.725	3.755	.993
.65	4.99	-1.075	-1.017	-.689	4.669	.990
.65	5.99	-.950	-.893	-.631	5.866	.992
.65	8.17	-.742	-.668	-.498	8.347	.980
.70	.95	-.170	-.173	-.193	-.146	0.000
.70	2.01	-1.201	-1.166	-.834	1.044	.908
.70	3.00	-1.357	-1.261	-.866	2.026	.970
.70	3.38	-1.339	-1.231	-.849	2.413	.979
.70	4.18	-1.236	-1.136	-.792	3.213	.989
.70	4.99	-1.093	-1.022	-.718	4.032	.988
.70	6.00	-.948	-.898	-.638	5.051	.991
.70	8.48	-.687	-.625	-.460	7.517	.975
.80	.94	-.169	-.172	-.191	-.148	0.000
.80	2.02	-1.112	-1.070	-.906	.767	.870
.80	3.40	-1.371	-1.261	-1.075	1.824	.954
.80	4.17	-1.287	-1.177	-1.040	2.422	.970
.80	4.20	-1.273	-1.161	-1.036	2.452	.971
.80	5.01	-1.187	-1.080	-.955	3.066	.976
.80	6.01	-1.046	-.948	-.771	3.851	.983
.80	7.01	-.865	-.793	-.588	4.627	.982
.80	9.23	-.591	-.550	-.386	6.317	.969
.90	.91	-.173	-.175	-.193	-.140	0.000
.90	1.99	-1.182	-1.117	-.831	.539	.776
.90	3.39	-1.078	-.992	-.834	1.381	.917
.90	4.19	-1.021	-.928	-.822	1.865	.942
.90	5.00	-.957	-.864	-.793	2.369	.956
.90	5.98	-.893	-.806	-.753	2.976	.964
.90	6.99	-.833	-.756	-.712	3.584	.964
.90	8.62	-.734	-.674	-.607	4.575	.964
.90	8.61	-.729	-.668	-.601	4.563	.964
.90	10.01	-.580	-.531	-.364	5.468	.966
.95	.89	-.189	-.192	-.209	-.122	0.000
.95	2.01	-1.050	-.986	-.728	.459	.729
.95	3.40	-.968	-.900	-.726	1.211	.894
.95	4.21	-.902	-.813	-.721	1.663	.927
.95	4.99	-.852	-.764	-.698	2.092	.943
.95	5.98	-.791	-.709	-.660	2.632	.950
.95	6.98	-.740	-.665	-.627	3.190	.959
.95	6.99	-.741	-.665	-.630	3.223	.960
.95	8.62	-.662	-.601	-.568	4.126	.966
.95	9.99	-.596	-.549	-.494	4.920	.968
1.20	.80	-.204	-.206	-.217	-.189	0.000
1.20	1.98	-.642	-.604	-.426	.194	.502
1.20	3.39	-.579	-.555	-.393	.677	.798
1.20	4.19	-.541	-.499	-.392	.956	.853
1.20	4.99	-.509	-.453	-.385	1.236	.885
1.20	6.00	-.467	-.407	-.367	1.594	.910
1.20	7.00	-.433	-.374	-.348	1.953	.929
1.20	8.60	-.385	-.333	-.318	2.526	.945
1.20	9.99	-.346	-.299	-.292	3.030	.953

TABLE 38.- BASIC DATA FOR CONFIGURATION 37 WITH $\alpha_p = 18^\circ$,
 $B/d = 0.061$, AND $A/d = 0.303$

MACH	NPR	P1	P2	P3	P4	P5	P6	P7	P8	P9
0.00	2.01	.211	.398	.516	.502	.505	.508	.508	.509	.512
0.00	3.01	.215	.195	.298	.396	.424	.367	.296	.344	.393
0.00	4.00	.219	.197	.144	.206	.233	.312	.211	.360	.291
0.00	5.00	.220	.198	.144	.103	.151	.164	.193	.255	.202
0.00	5.99	.220	.198	.145	.104	.077	.139	.142	.176	.233
0.00	6.42	.220	.198	.145	.103	.077	.125	.133	.153	.204
.65	2.00	.213	.228	.405	.447	.478	.509	.522	.528	.535
.65	3.39	.213	.195	.143	.202	.232	.318	.412	.337	.303
.65	4.20	.217	.198	.144	.104	.173	.173	.226	.282	.371
.65	5.00	.220	.199	.145	.104	.109	.160	.160	.227	.238
.65	5.99	.221	.199	.145	.104	.077	.140	.142	.156	.201
.65	8.20	.220	.200	.145	.104	.076	.062	.108	.113	.123
.70	2.00	.223	.235	.380	.457	.471	.504	.520	.528	.536
.70	3.40	.215	.196	.144	.133	.209	.269	.371	.372	.352
.70	4.20	.216	.198	.144	.104	.169	.173	.210	.284	.366
.70	5.00	.220	.199	.145	.104	.094	.159	.158	.217	.241
.70	6.00	.221	.199	.145	.104	.078	.139	.142	.152	.196
.70	8.50	.220	.200	.145	.104	.078	.062	.105	.110	.118
.80	2.02	.259	.274	.338	.418	.432	.475	.498	.512	.528
.80	3.40	.216	.196	.144	.141	.211	.227	.249	.275	.302
.80	4.20	.216	.198	.145	.105	.164	.172	.175	.262	.325
.80	5.00	.218	.199	.144	.104	.078	.151	.149	.183	.248
.80	6.01	.220	.199	.145	.104	.078	.134	.139	.139	.175
.80	7.01	.220	.199	.145	.104	.078	.101	.128	.128	.135
.80	9.23	.220	.200	.145	.104	.078	.062	.084	.105	.111
.90	1.99	.254	.343	.373	.383	.393	.403	.426	.454	.485
.90	2.00	.233	.311	.362	.379	.390	.402	.426	.454	.483
.90	3.41	.214	.194	.142	.169	.207	.214	.229	.241	.257
.90	4.19	.217	.198	.145	.105	.181	.181	.182	.198	.216
.90	5.00	.217	.199	.145	.104	.144	.163	.159	.159	.180
.90	5.99	.220	.199	.145	.104	.082	.143	.142	.139	.144
.90	6.99	.221	.199	.145	.104	.079	.101	.128	.127	.127
.90	8.60	.221	.200	.145	.104	.078	.062	.102	.110	.115
.90	10.01	.221	.200	.145	.104	.078	.062	.059	.100	.108
.95	1.99	.220	.271	.339	.363	.378	.387	.406	.428	.454
.95	3.39	.215	.194	.143	.152	.200	.205	.218	.229	.240
.95	4.20	.215	.196	.143	.104	.175	.177	.177	.185	.197
.95	5.01	.216	.197	.144	.104	.148	.166	.162	.160	.165
.95	6.01	.218	.198	.144	.103	.082	.142	.142	.139	.139
.95	7.00	.221	.199	.146	.104	.079	.091	.125	.123	.124
.95	8.61	.221	.199	.145	.104	.078	.062	.083	.105	.109
.95	10.01	.221	.200	.145	.104	.078	.062	.052	.088	.101
1.20	1.98	.215	.230	.291	.314	.330	.341	.361	.386	.416
1.20	3.41	.214	.191	.141	.106	.151	.162	.176	.204	.233
1.20	4.21	.216	.195	.144	.106	.083	.113	.127	.147	.179
1.20	5.01	.216	.195	.144	.104	.080	.064	.120	.123	.143
1.20	5.99	.216	.198	.145	.105	.080	.062	.100	.111	.120
1.20	7.00	.216	.198	.144	.103	.077	.060	.065	.102	.108
1.20	8.61	.219	.198	.145	.104	.078	.062	.051	.047	.080
1.20	10.00	.220	.199	.145	.104	.078	.062	.051	.045	.078

TABLE 38.- Continued

MACH	NPR	P10	P11	P12	P13	P14	P15	S1	S2	S3
0.00	2.01	.517	.521	.527	.537	.576	.580	-.002	-.003	-.004
0.00	3.01	.340	.336	.389	.415	.426	.430	-.003	-.004	-.005
0.00	4.00	.281	.221	.257	.323	.351	.375	-.004	-.006	-.007
0.00	5.00	.290	.340	.278	.262	.232	.242	-.005	-.007	-.007
0.00	5.99	.210	.174	.270	.262	.235	.250	-.004	-.006	-.009
0.00	6.42	.228	.198	.166	.245	.219	.234	-.004	-.006	-.008
.65	.96							-.278	-.393	-.199
.65	2.00	.540	.544	.548	.556	.584	.589	-.608	-.964	-.765
.65	3.39	.365	.360	.330	.354	.422	.430	-.710	-1.144	-.946
.65	4.20	.327	.269	.284	.313	.360	.364	-.792	-1.180	-.765
.65	5.00	.283	.371	.321	.265	.226	.237	-.760	-1.117	-.695
.65	5.99	.222	.183	.268	.291	.256	.277	-.717	-1.040	-.611
.65	8.20	.139	.164	.191	.199	.188	.203	-.633	-.880	-.473
.70	.96							-.277	-.390	-.193
.70	2.00	.542	.546	.550	.557	.584	.589	-.590	-.923	-.685
.70	3.40	.362	.320	.356	.385	.404	.414	-.700	-1.091	-.811
.70	4.20	.335	.279	.297	.319	.358	.362	-.773	-1.147	-.778
.70	5.00	.277	.373	.328	.272	.233	.245	-.760	-1.112	-.719
.70	6.00	.221	.186	.278	.296	.260	.282	-.727	-1.048	-.643
.70	8.50	.131	.150	.176	.197	.183	.199	-.643	-.894	-.478
.80	.94							-.286	-.393	-.192
.80	2.02	.537	.545	.549	.556	.575	.577	-.564	-.824	-.575
.80	3.40	.328	.350	.364	.377	.385	.394	-.610	-.888	-.685
.80	4.20	.340	.318	.329	.325	.332	.341	-.625	-1.090	-.914
.80	5.00	.282	.371	.333	.286	.269	.281	-.623	-1.155	-1.017
.80	6.01	.218	.197	.295	.309	.269	.293	-.622	-1.125	-.967
.80	7.01	.161	.196	.202	.247	.231	.251	-.616	-1.042	-.862
.80	9.23	.118	.128	.143	.168	.175	.191	-.608	-.856	-.609
.90	.93							-.298	-.392	-.193
.90	1.99	.510	.527	.538	.544	.544	.549	-.450	-.753	-.612
.90	2.00	.507	.523	.534	.540	.540	.546	-.446	-.711	-.560
.90	3.41	.275	.295	.316	.337	.347	.355	-.454	-.890	-.819
.90	4.19	.237	.262	.280	.298	.312	.319	-.451	-.919	-1.061
.90	5.00	.202	.223	.246	.270	.286	.292	-.450	-.919	-1.022
.90	5.99	.167	.191	.211	.232	.254	.262	-.450	-.921	-.982
.90	6.99	.133	.162	.188	.212	.233	.241	-.453	-.924	-.941
.90	8.60	.116	.118	.136	.166	.184	.191	-.449	-.915	-.863
.90	10.01	.112	.113	.113	.126	.151	.164	-.450	-.898	-.798
.95	.90							-.299	-.400	-.214
.95	1.99	.476	.495	.510	.520	.523	.528	-.377	-.670	-.546
.95	3.39	.254	.271	.291	.311	.327	.332	-.376	-.808	-.964
.95	4.20	.206	.218	.238	.257	.275	.285	-.376	-.809	-.964
.95	5.01	.173	.180	.189	.204	.225	.238	-.371	-.803	-.913
.95	6.01	.143	.153	.163	.174	.188	.204	-.373	-.806	-.874
.95	7.00	.126	.132	.142	.157	.174	.185	-.375	-.809	-.836
.95	8.61	.112	.115	.119	.128	.143	.160	-.369	-.798	-.767
.95	10.01	.109	.111	.112	.116	.125	.146	-.373	-.795	-.718
1.20	.82							-.142	-.334	-.254
1.20	1.98	.440	.463	.485	.498	.505	.511	-.148	-.440	-.430
1.20	3.41	.256	.283	.309	.330	.344	.350	-.148	-.446	-.654
1.20	4.21	.213	.243	.273	.301	.321	.330	-.145	-.444	-.595
1.20	5.01	.169	.198	.226	.252	.277	.285	-.145	-.444	-.560
1.20	5.99	.134	.155	.178	.202	.223	.231	-.146	-.446	-.527
1.20	7.00	.116	.130	.147	.166	.185	.193	-.144	-.444	-.504
1.20	8.61	.091	.122	.134	.147	.159	.170	-.144	-.444	-.465
1.20	10.00	.068	.092	.111	.123	.132	.142	-.143	-.441	-.433

TABLE 38.- Concluded

MACH	NPR	S4	S5	S6	CFMD	FMDZFI
0.00	2.01	-.064	-.054	-.037	.348	.881
0.00	3.01	-.075	-.067	-.046	.679	.940
0.00	4.00	-.105	-.082	-.051	1.010	.955
0.00	5.00	-.049	-.041	-.026	1.345	.959
0.00	5.99	-.038	-.023	-.012	1.705	.971
0.00	6.42	-.038	-.020	-.011	1.858	.973
.65	.96	-.161	-.159	-.185	-.158	0.000
.65	2.00	-.596	-.670	-.711	.991	.745
.65	3.39	-.771	-.827	-.832	2.569	.892
.65	4.20	-1.303	-1.324	-.936	3.454	.909
.65	5.00	-1.215	-1.226	-.772	4.455	.944
.65	5.99	-1.100	-1.094	-.615	5.695	.965
.65	8.20	-.917	-.887	-.464	8.329	.975
.70	.96	-.159	-.157	-.181	-.154	0.000
.70	2.00	-.565	-.631	-.666	.825	.725
.70	3.40	-.787	-.833	-.822	2.177	.876
.70	4.20	-1.281	-1.296	-.972	2.958	.904
.70	5.00	-1.218	-1.220	-.827	3.856	.940
.70	6.00	-1.107	-1.094	-.695	4.932	.964
.70	8.50	-.898	-.874	-.499	7.566	.976
.80	.94	-.165	-.163	-.186	-.155	0.000
.80	2.02	-.592	-.628	-.606	.602	.682
.80	3.40	-.915	-.952	-.886	1.572	.827
.80	4.20	-1.308	-1.268	-1.027	2.244	.888
.80	5.00	-1.421	-1.342	-1.049	2.896	.923
.80	6.01	-1.347	-1.267	-.972	3.744	.952
.80	7.01	-1.225	-1.151	-.883	4.515	.961
.80	9.23	-.978	-.927	-.657	6.386	.976
.90	.93	-.171	-.170	-.191	-.149	0.000
.90	1.99	-.743	-.620	-.636	.439	.639
.90	2.00	-.677	-.567	-.576	.439	.635
.90	3.41	-1.114	-1.085	-.951	1.204	.796
.90	4.19	-1.287	-1.220	-1.043	1.679	.850
.90	5.00	-1.271	-1.190	-.966	2.212	.896
.90	5.99	-1.238	-1.147	-.900	2.868	.929
.90	6.99	-1.197	-1.093	-.854	3.543	.950
.90	8.60	-1.124	-1.005	-.776	4.581	.966
.90	10.01	-1.063	-.939	-.711	5.527	.976
.95	.90	-.184	-.183	-.204	-.125	0.000
.95	1.99	-.626	-.574	-.556	.392	.632
.95	3.39	-1.180	-1.126	-1.005	1.059	.784
.95	4.20	-1.179	-1.113	-.948	1.524	.852
.95	5.01	-1.140	-1.066	-.867	1.987	.895
.95	6.01	-1.108	-1.023	-.801	2.570	.925
.95	7.00	-1.069	-.974	-.756	3.165	.944
.95	8.61	-1.004	-.894	-.687	4.095	.966
.95	10.01	-.963	-.846	-.637	4.968	.975
1.20	.82	-.199	-.198	-.212	-.193	0.000
1.20	1.98	-.488	-.505	-.467	.169	.439
1.20	3.41	-.746	-.709	-.660	.610	.711
1.20	4.21	-.725	-.683	-.592	.899	.797
1.20	5.01	-.706	-.659	-.544	1.192	.849
1.20	5.99	-.679	-.626	-.490	1.563	.893
1.20	7.00	-.661	-.603	-.455	1.945	.922
1.20	8.61	-.623	-.552	-.411	2.544	.948
1.20	10.00	-.594	-.514	-.381	3.070	.963



Baseline plug nozzle

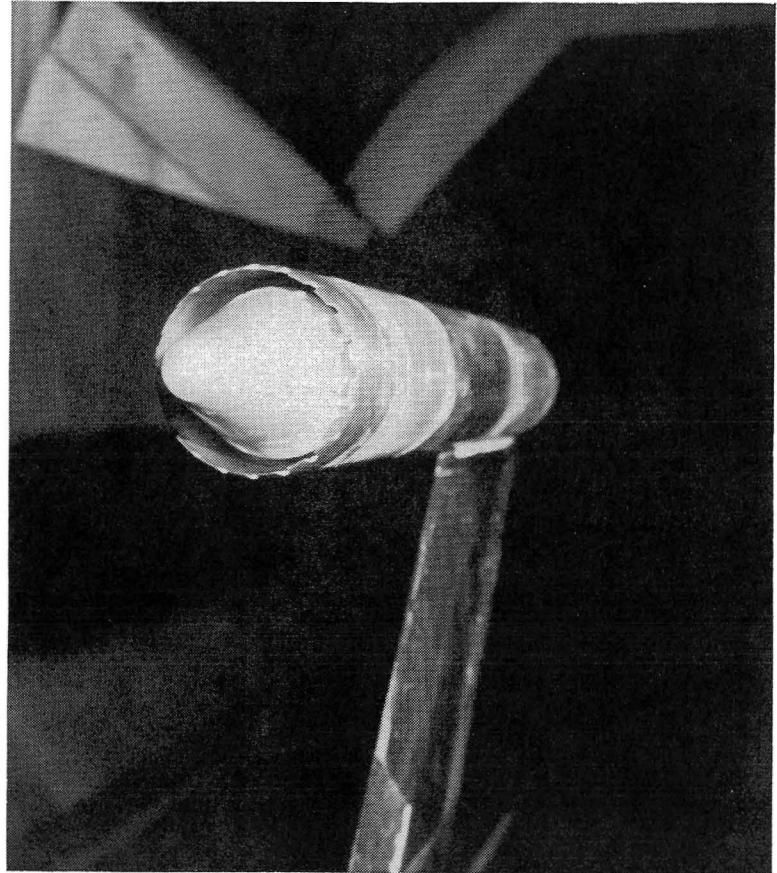

Scalloped shroud configuration

L-85-148

Figure 1.- Isolated nozzle installation in Langley 16-Foot Transonic Tunnel for baseline configuration and scalloped shroud configuration.

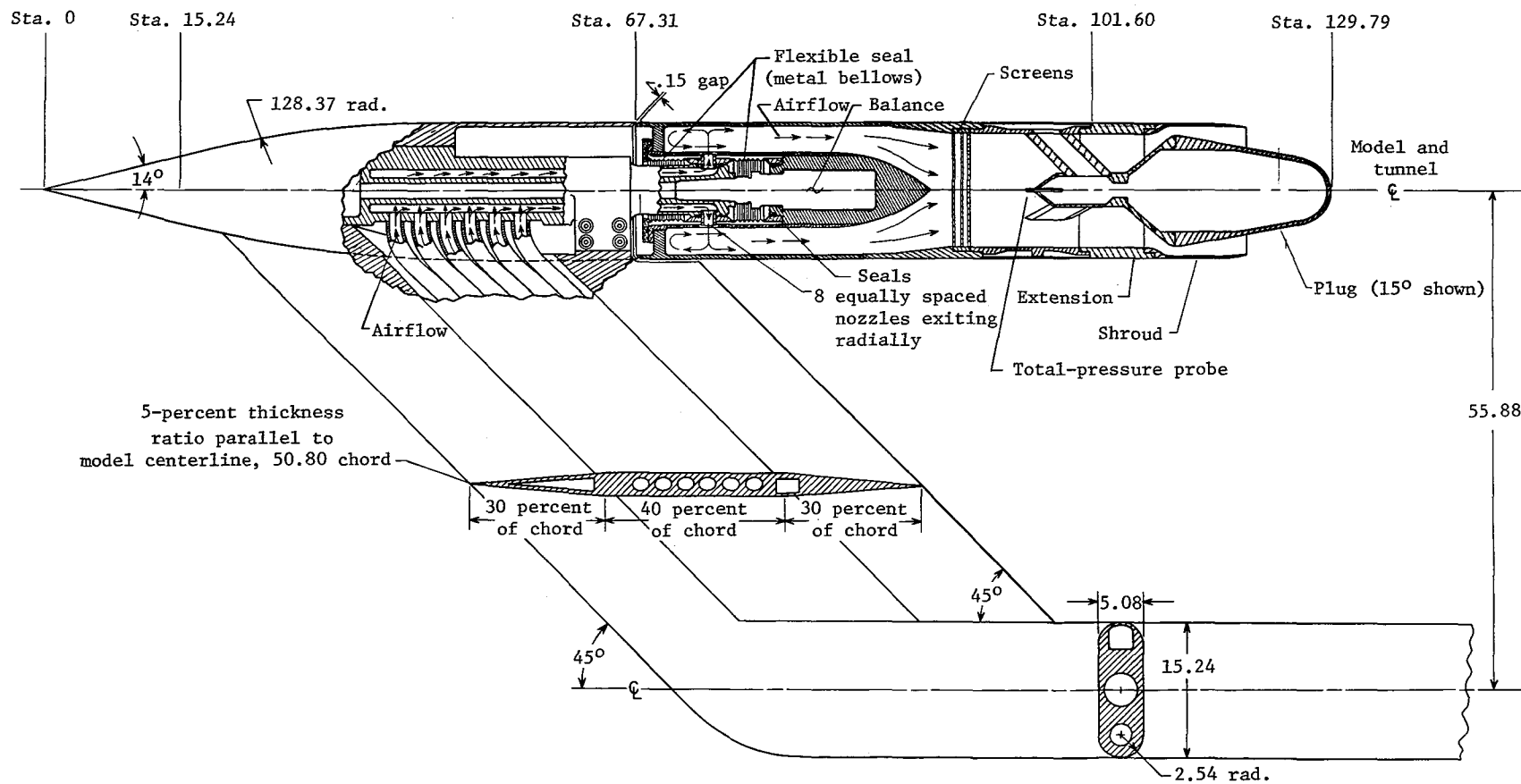

Figure 2.- Sketch showing general arrangement of model. Linear dimensions are in centimeters.

Shroud	B/d
1	0.152
2	0.194
3	0.162
4	0.090
5	0.814
6	0.270
7	0.055
8	0.061
9	0.484
10†	0.162
11†	0.061

Extension	A/d
1	0.000
1	0.064
3	0.184
4	0.367
5	0.303

† Scalloped shrouds

Shrouds 1-7, 10, 11

Orifice	y/B
1	0.0000
2	0.3150
3	0.4470
4	0.5470
5	0.6320
6	0.7070
7	0.7740
8	0.8360

Shrouds 8, 9

Orifice	y/B
1	0.0000
2	0.0520
3	0.1040
4	0.1620
5	0.2250
6	0.2900
7	0.3670
8	0.4520
9	0.5510
10	0.6820

Note: Omit orifice number 8 for shrouds 3 and 5.

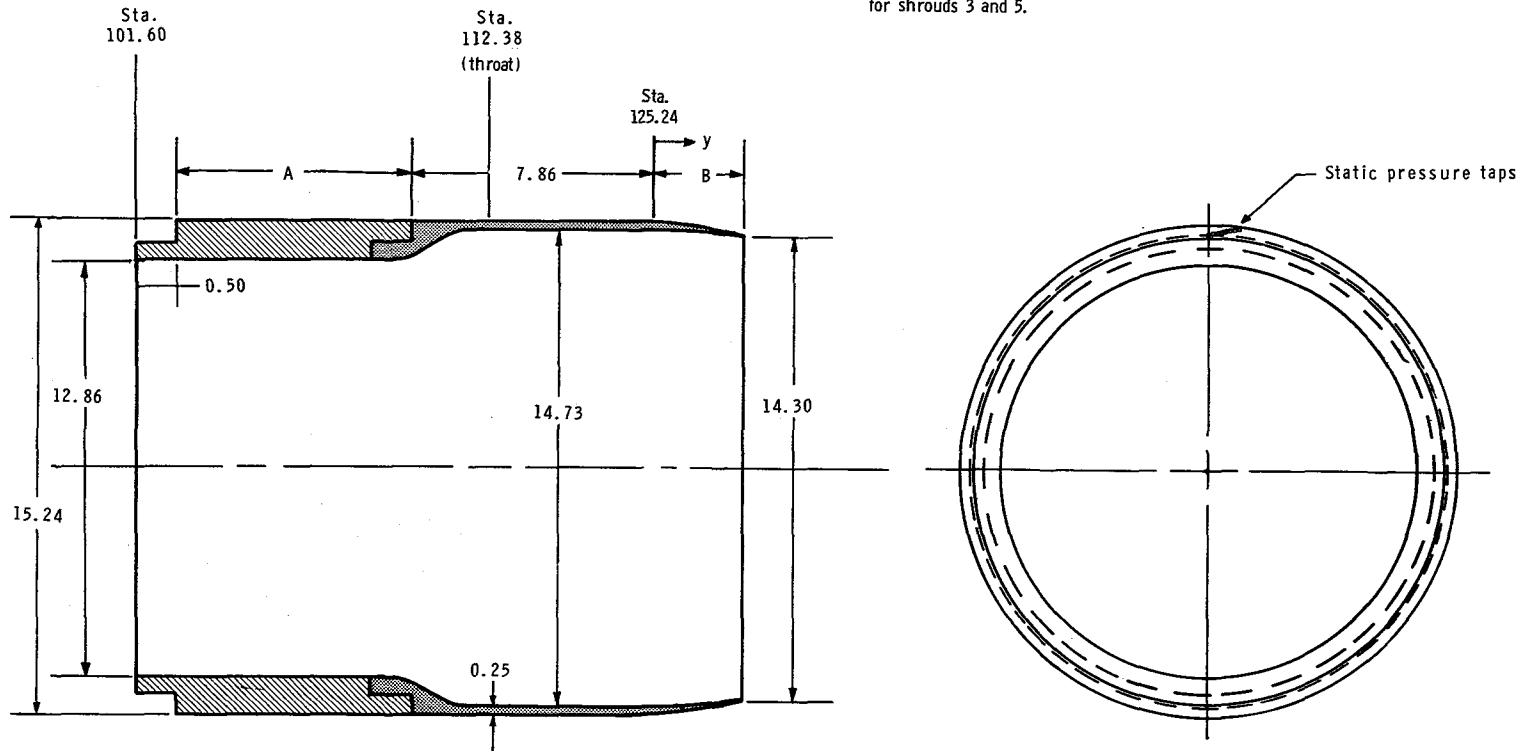

(a) Basic nozzles.

Figure 3.- Nozzle shroud and extension dimensions and static pressure tap locations. All dimensions are in centimeters.

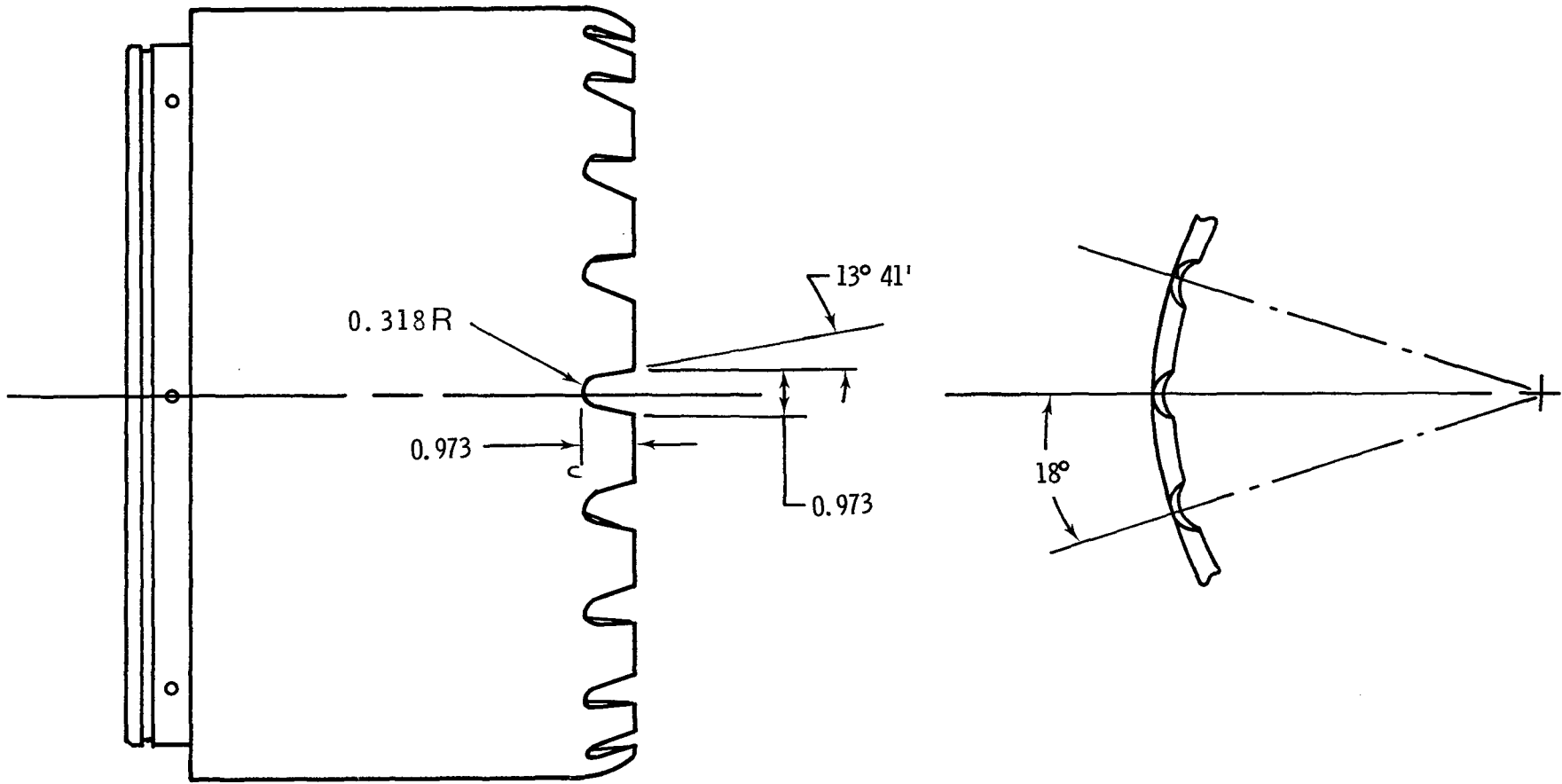

(b) Scalloped shroud.

Figure 3.- Concluded.

Plug	Plug Angle α_p , deg	R
1	10	3.825
2	12	3.194
3	15	2.134
4	18	0.914
5	20	0.013

Orifice	x/l
1	0.036
2	0.109
3	0.182
4	0.255
5	0.328
6	0.401
7	0.474
8	0.547
9	0.620
10	0.693
11	0.766
12	0.839
13	0.912
14	0.985
15	1.000

Note: Omit orifice numbers
14 and 15 for the 20°
plug.

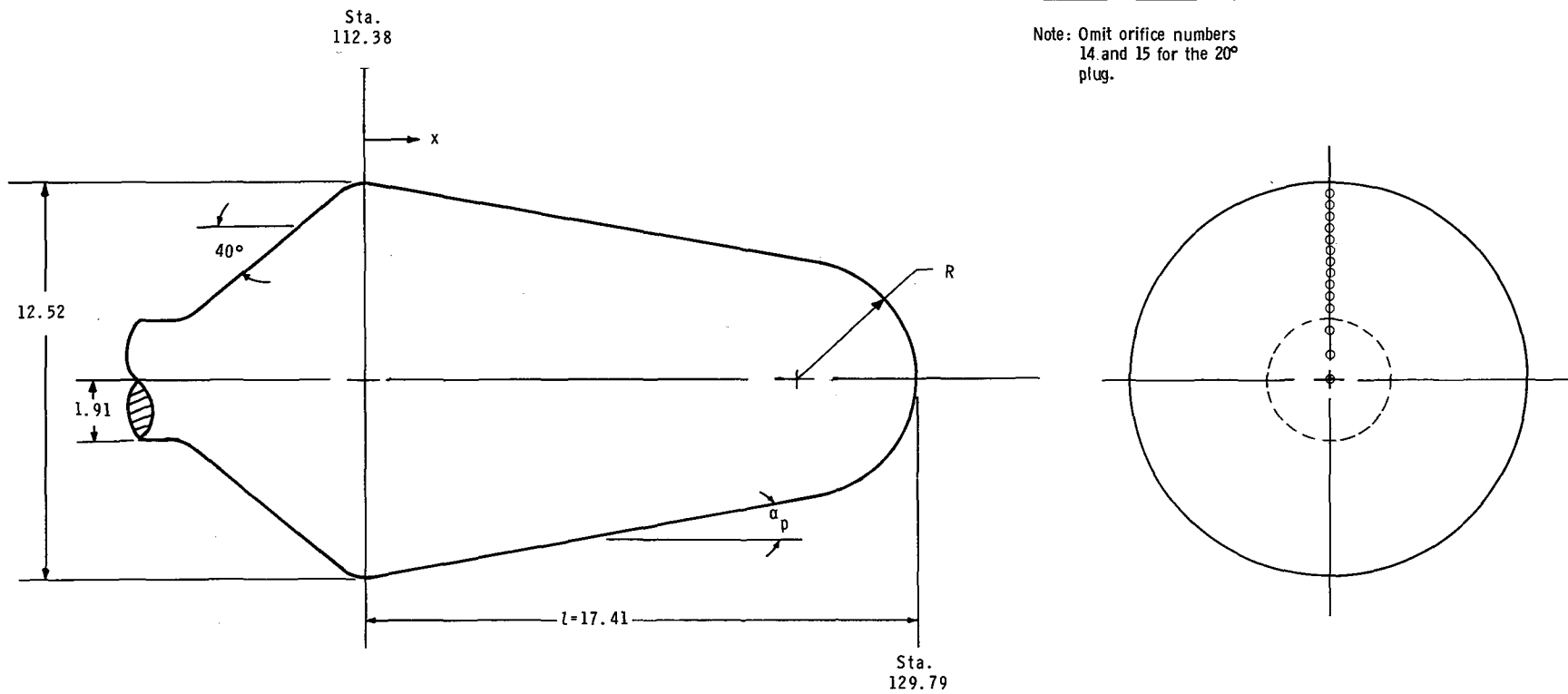

Figure 4.- Nozzle plug dimensions and static pressure tap locations. All dimensions are in centimeters.

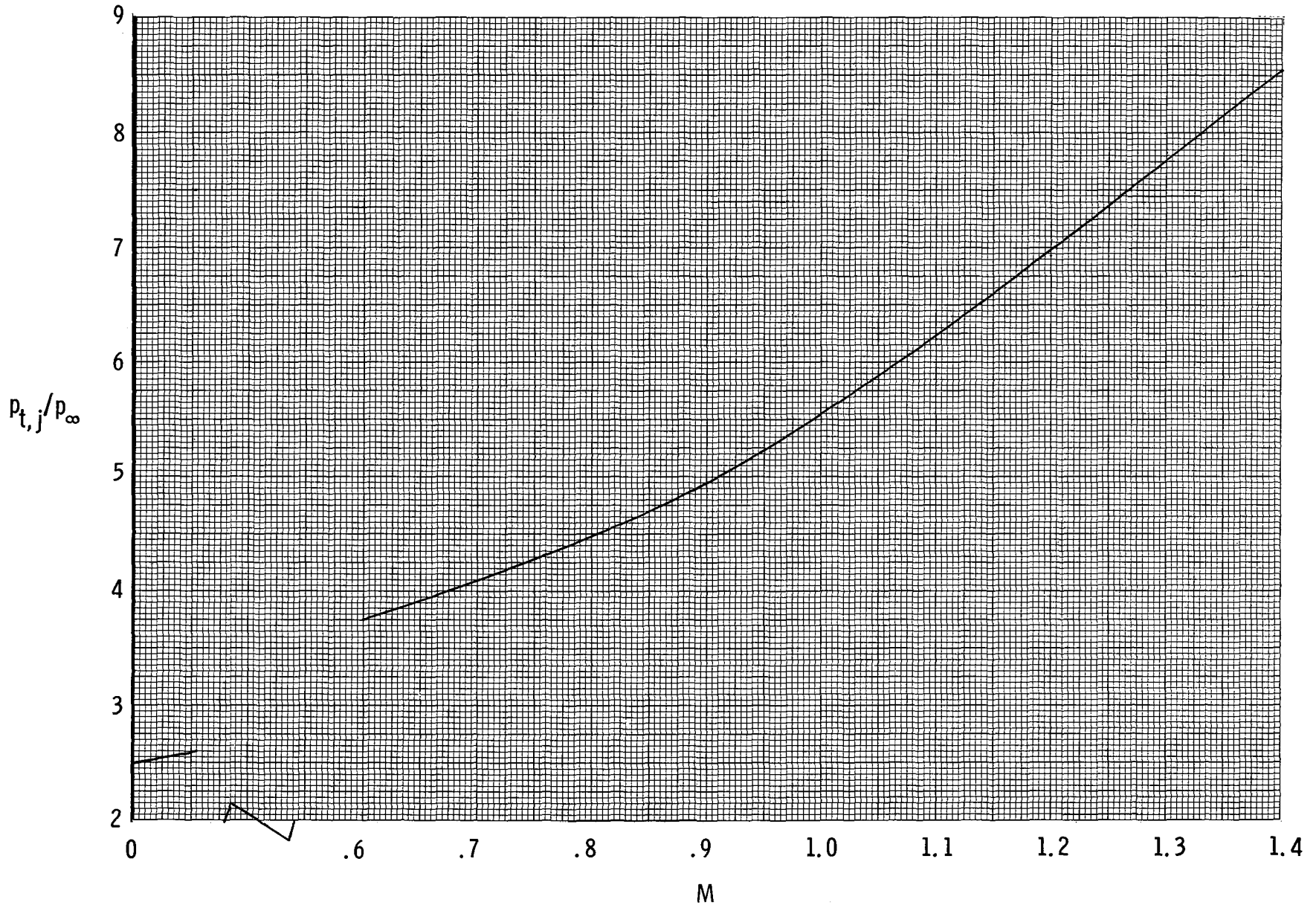

Figure 5.- Representative nozzle pressure ratio schedule for an advanced, low-bypass-ratio turbojet engine at maximum rotational speed.

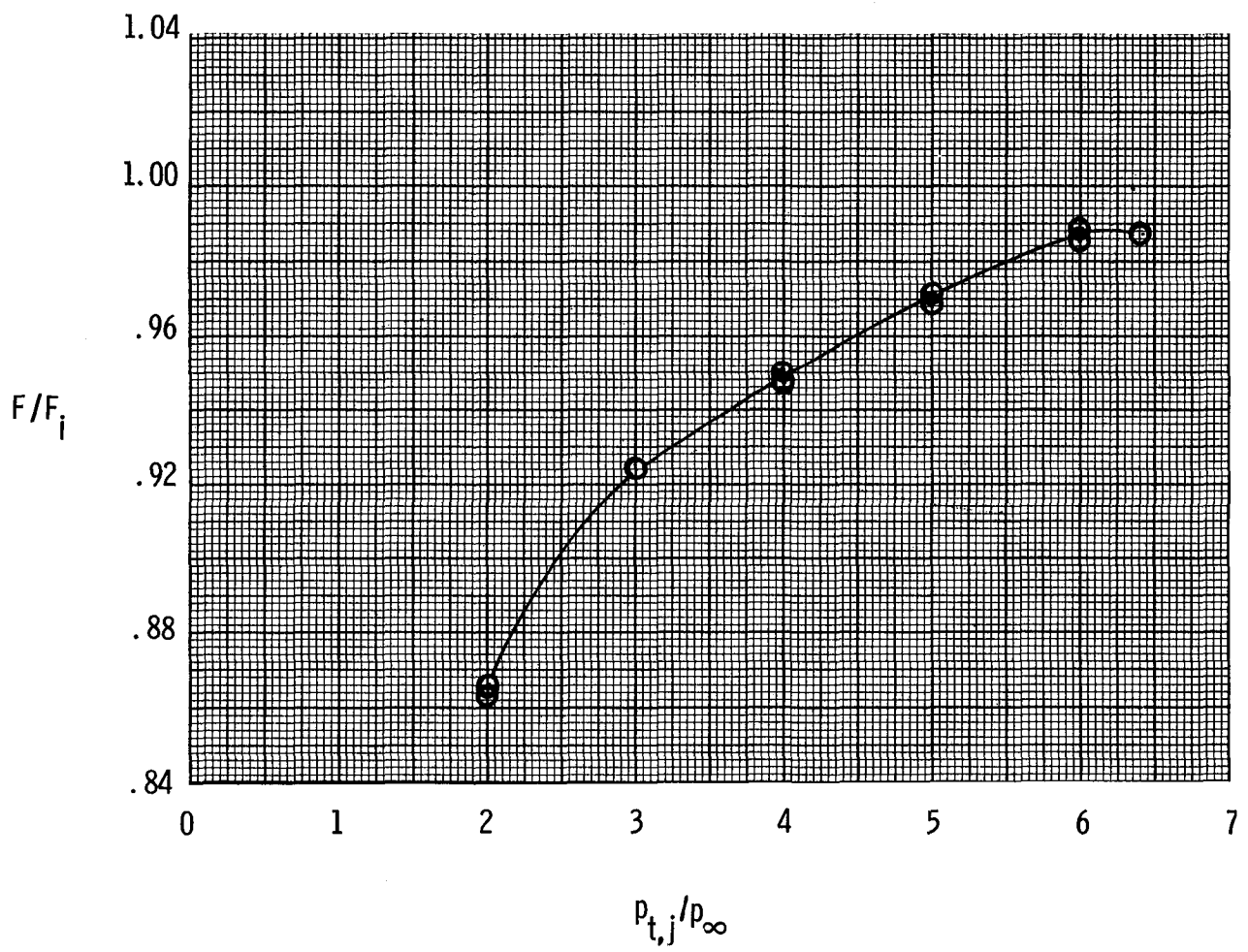
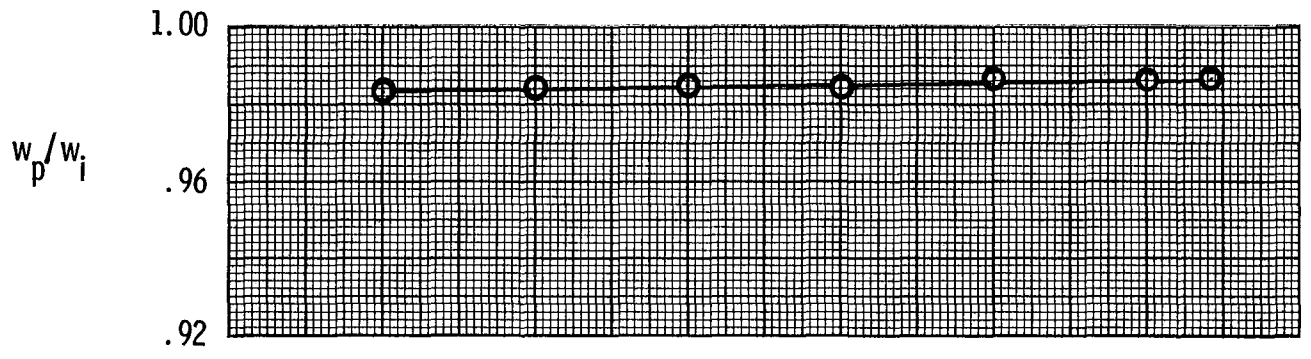

Figure 6.- Static nozzle performance as a function of nozzle pressure ratio for configuration 17.

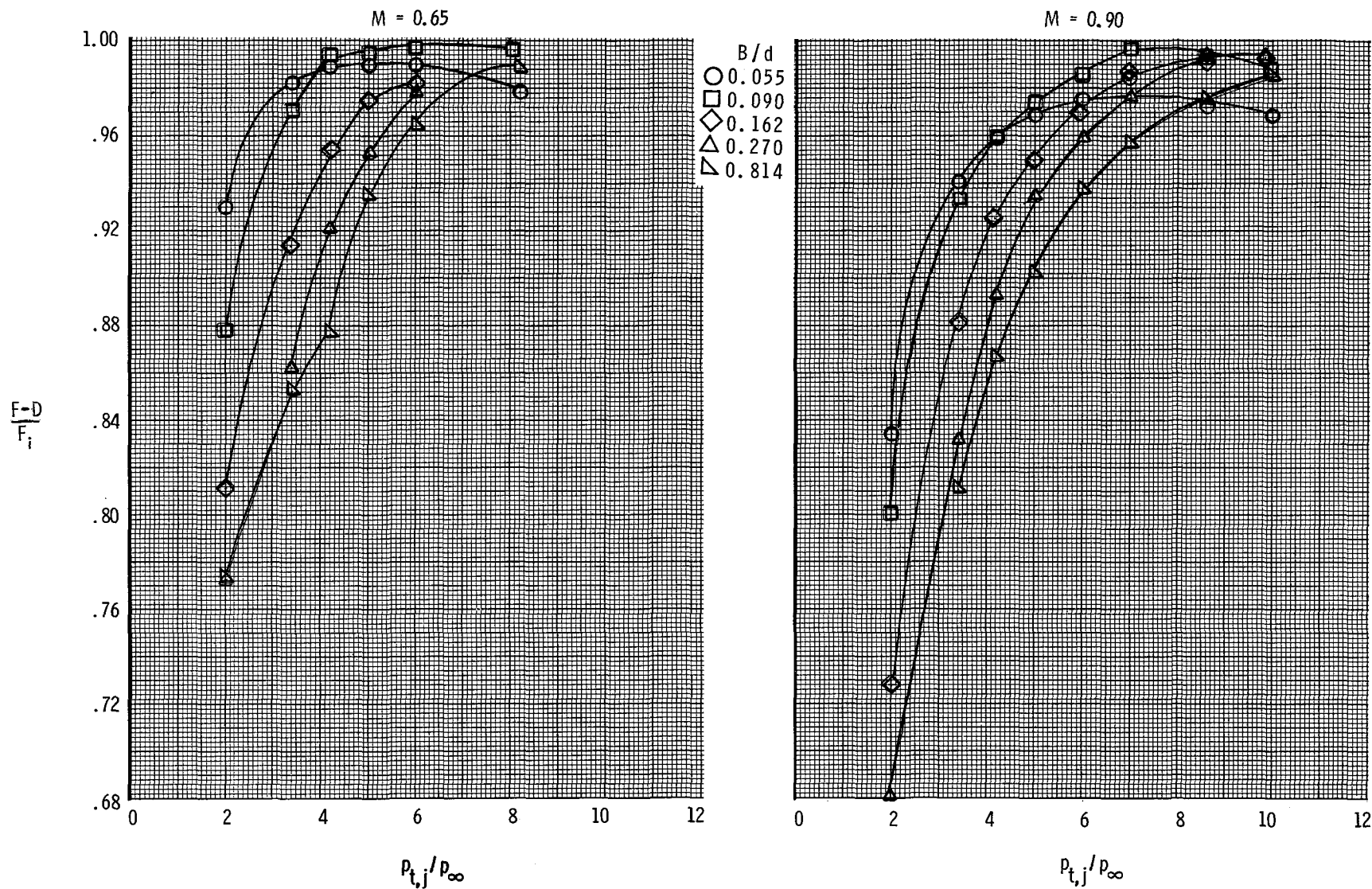
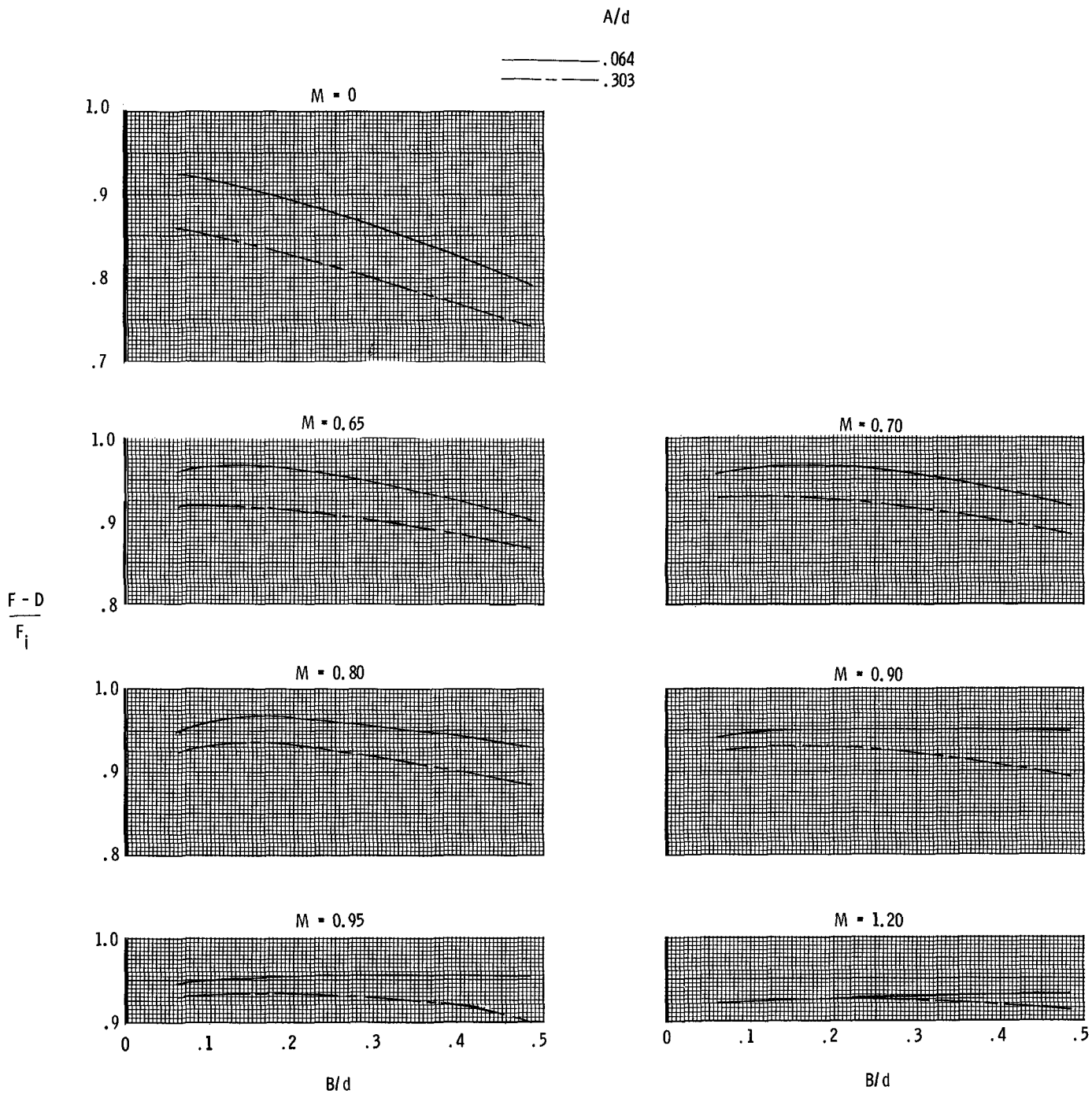

Figure 7.- Effect of shroud boattail length on nozzle performance as function of nozzle pressure ratio.
 $\alpha_p = 15^\circ$; $A/d = 0.184$.



(a) $\alpha_p = 12^\circ$.

Figure 8.- Effect of shroud boattail length on nozzle performance for representative nozzle pressure ratio.

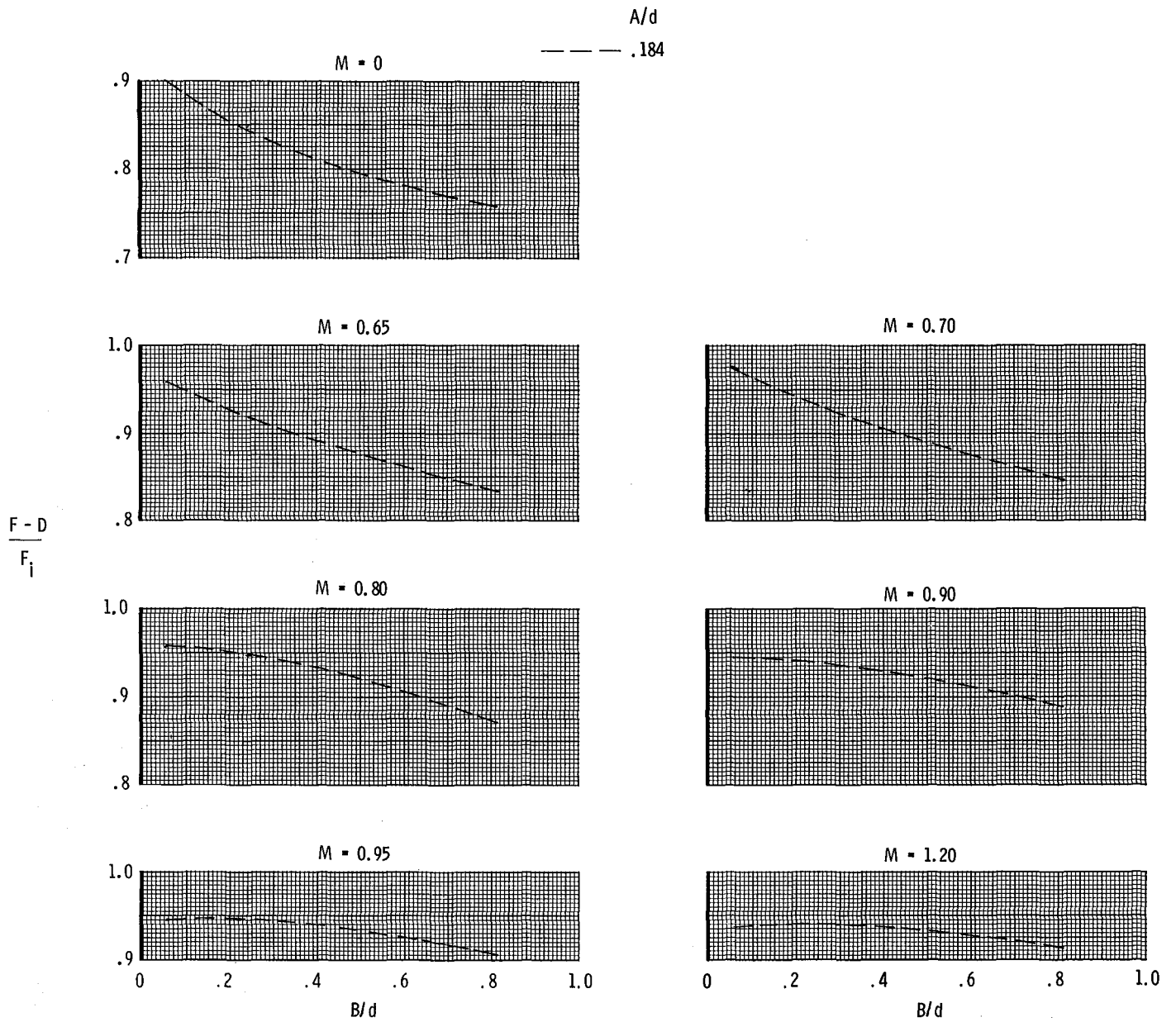
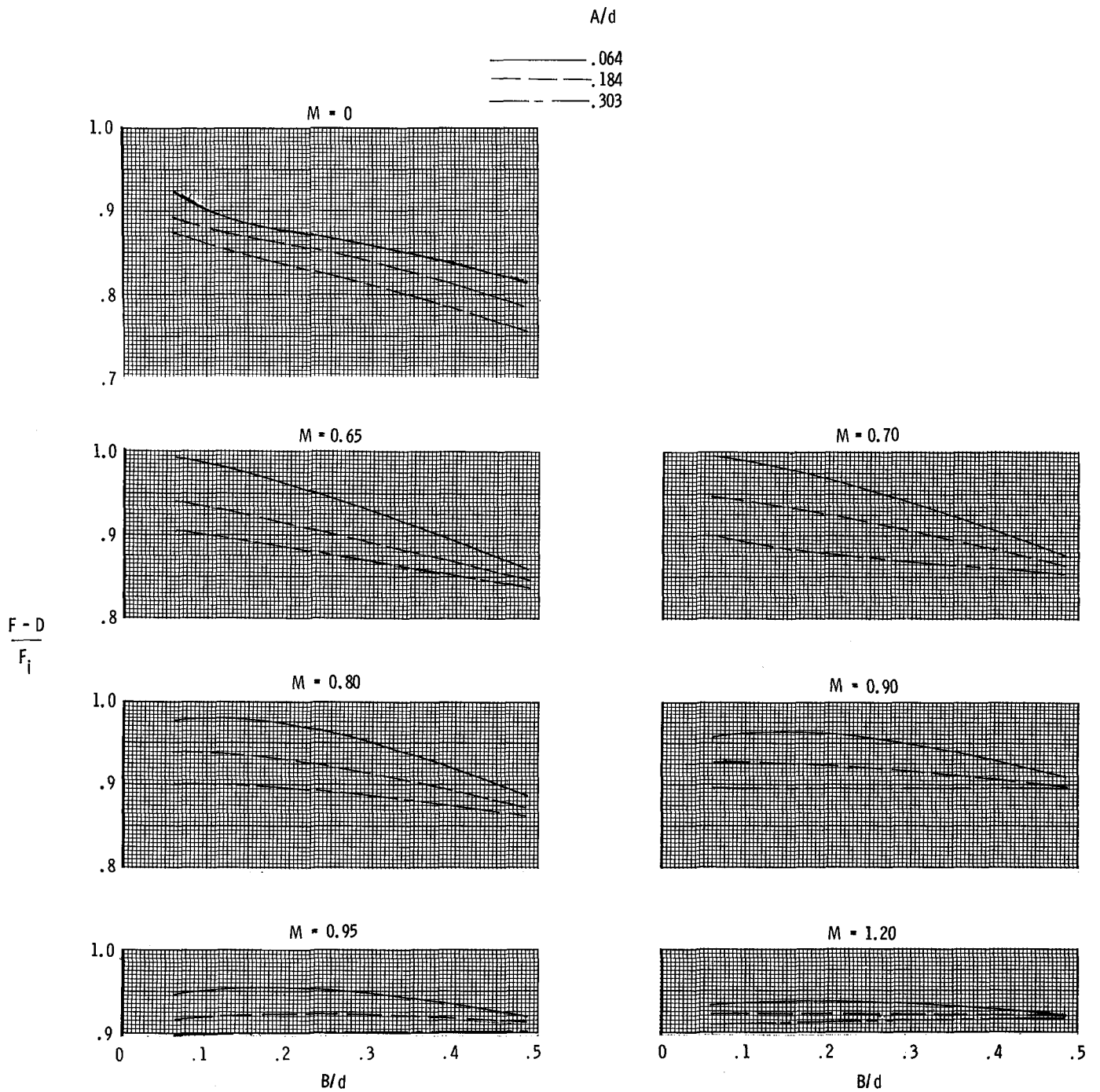

Figure 8.- Continued.



(c) $\alpha_p = 18^\circ$.

Figure 8.- Concluded.

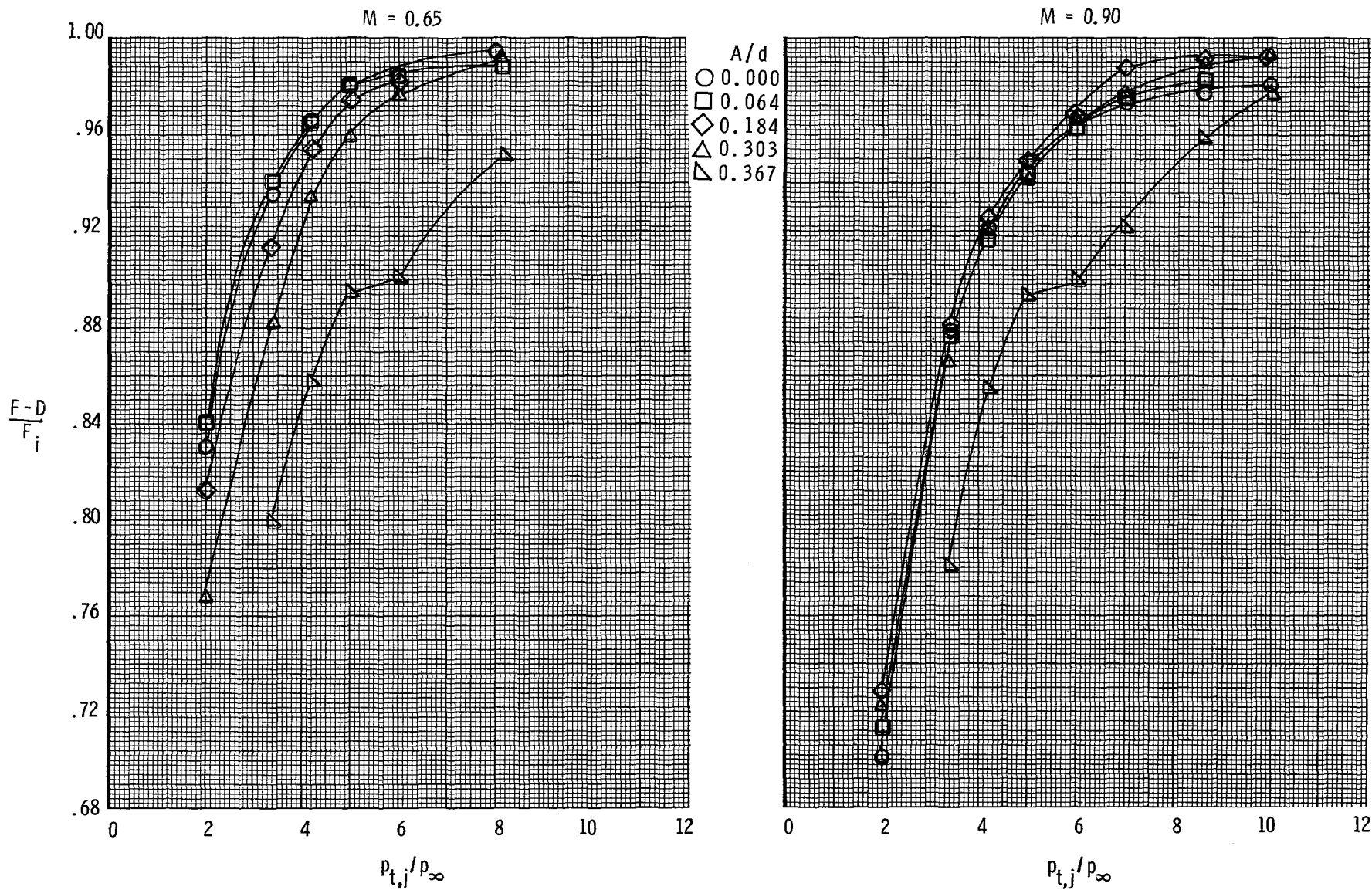

Figure 9.- Effect of extension length on nozzle performance as function of nozzle pressure ratio.
 $\alpha_p = 15^\circ$; $B/d = 0.162$.

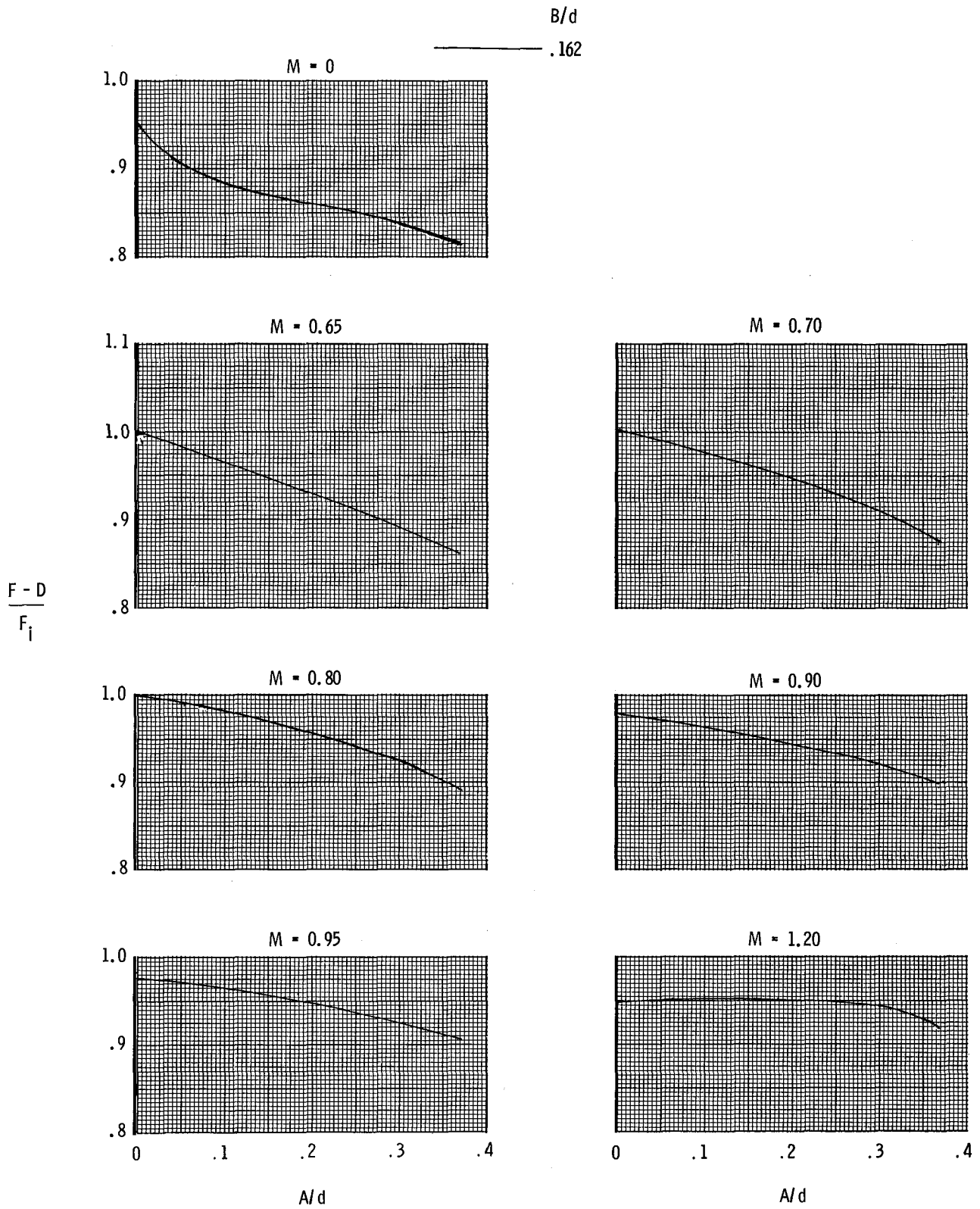

Figure 10.- Effect of extension length on nozzle performance for representative nozzle pressure ratio. $\alpha_p = 15^\circ$.

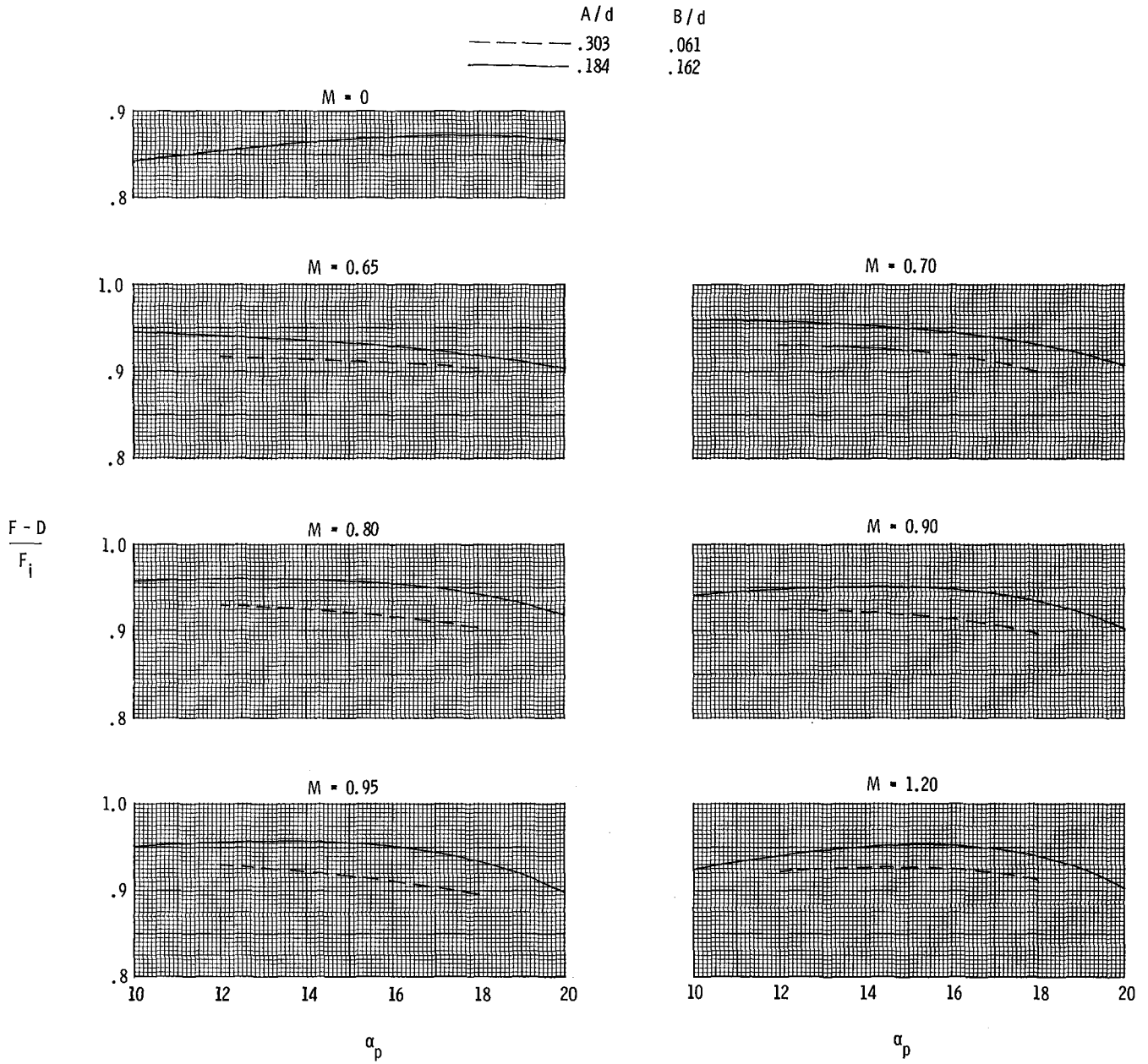

Figure 11.- Effect of plug angle on nozzle performance for representative nozzle pressure ratio.

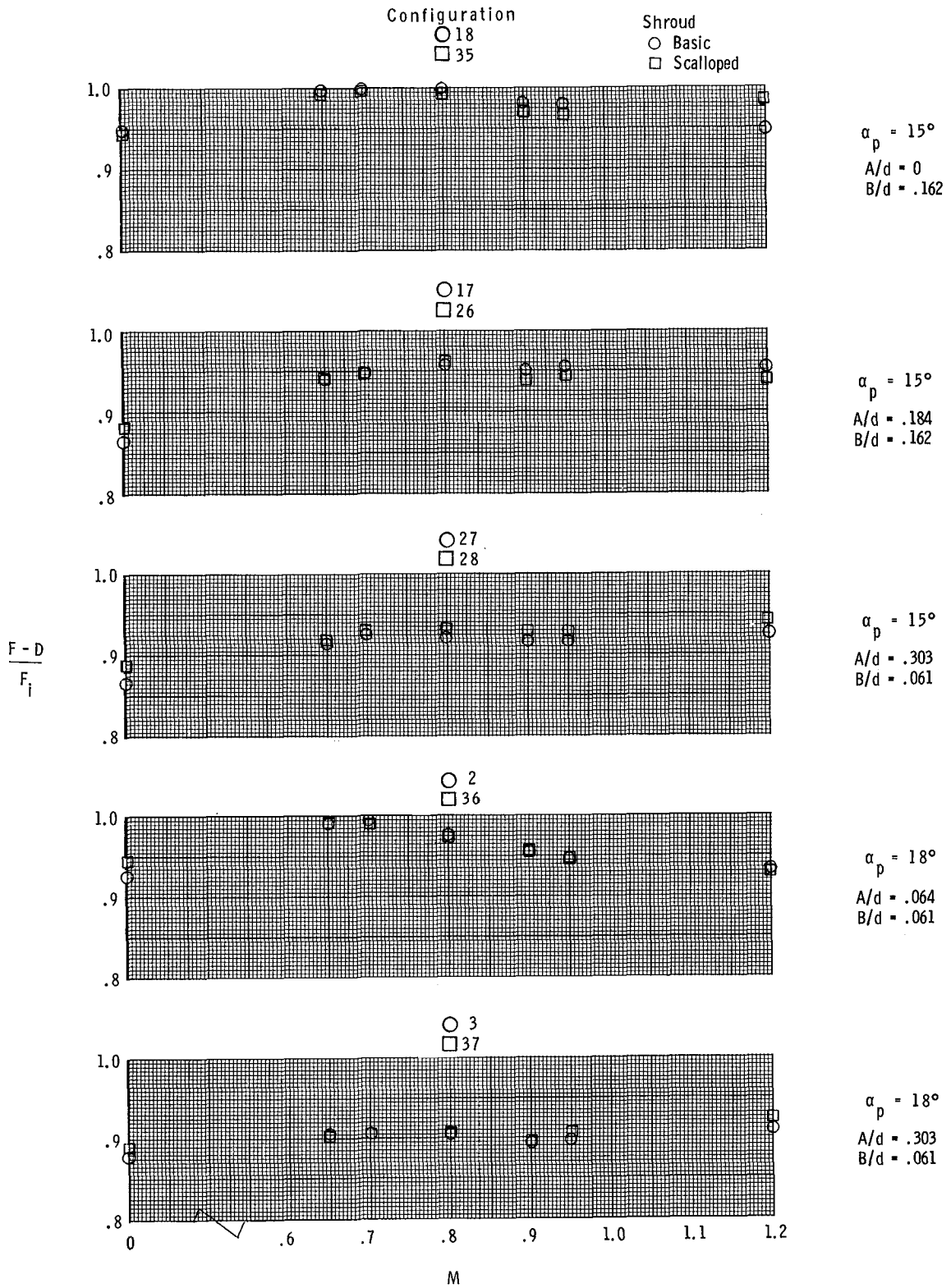

Figure 12.- Effect of scalloped shroud geometry on nozzle performance as function of Mach number at representative nozzle pressure ratio.

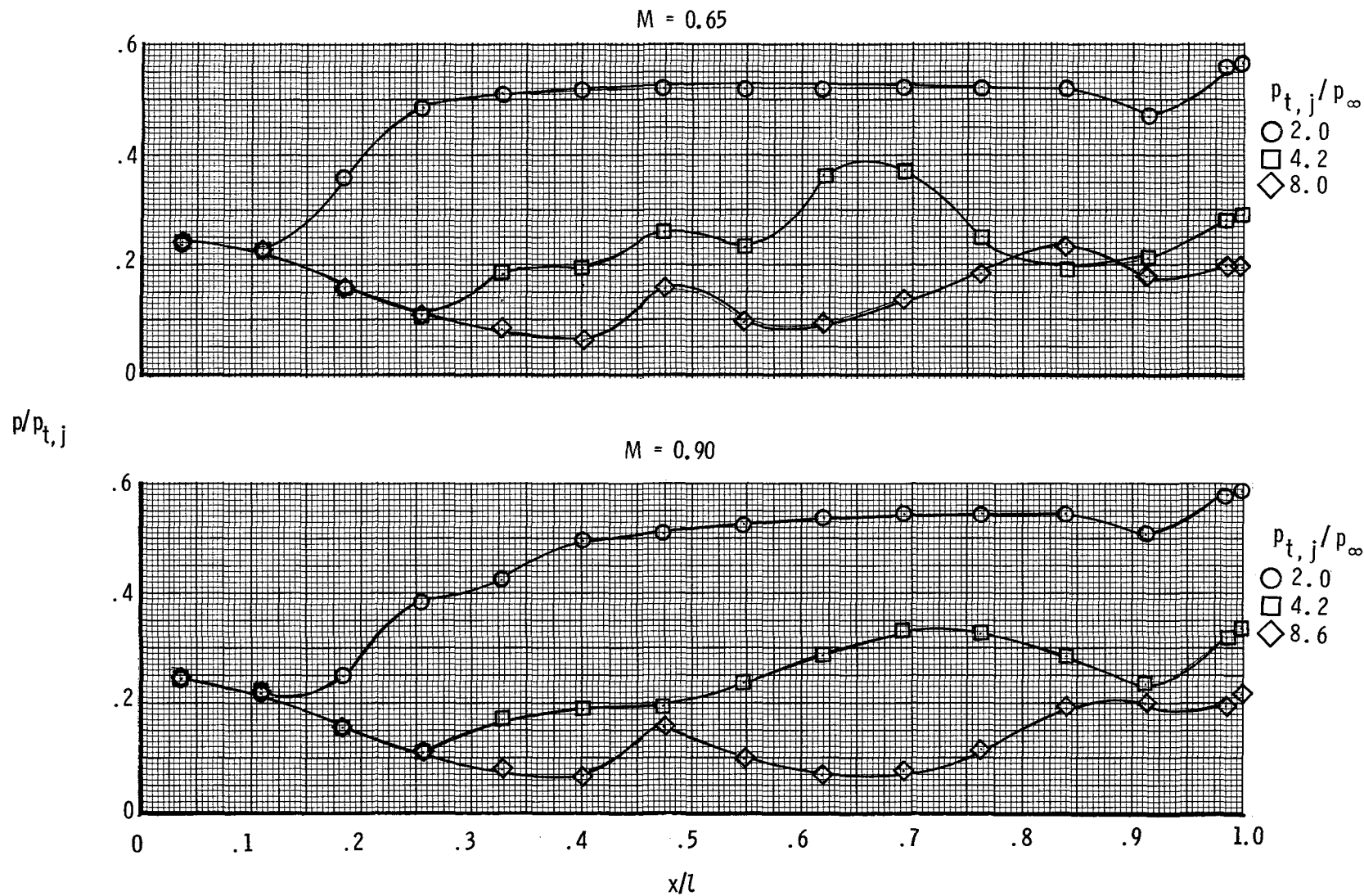

Figure 13.- Effect of jet total-pressure ratio on the plug static-pressure distributions for configuration 17.

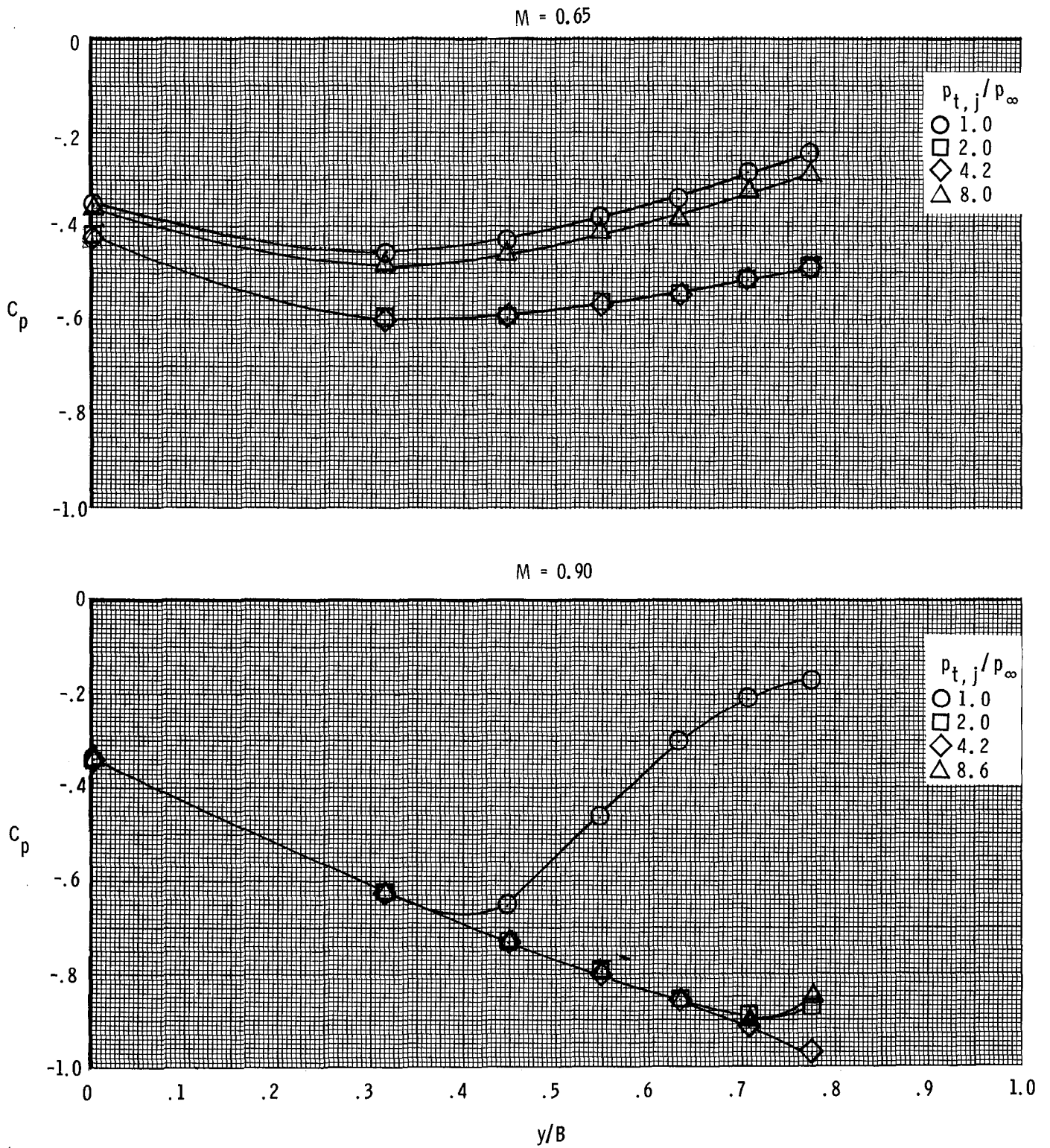

Figure 14.- Effect of jet total-pressure ratio on the shroud static-pressure distributions for configuration 17.

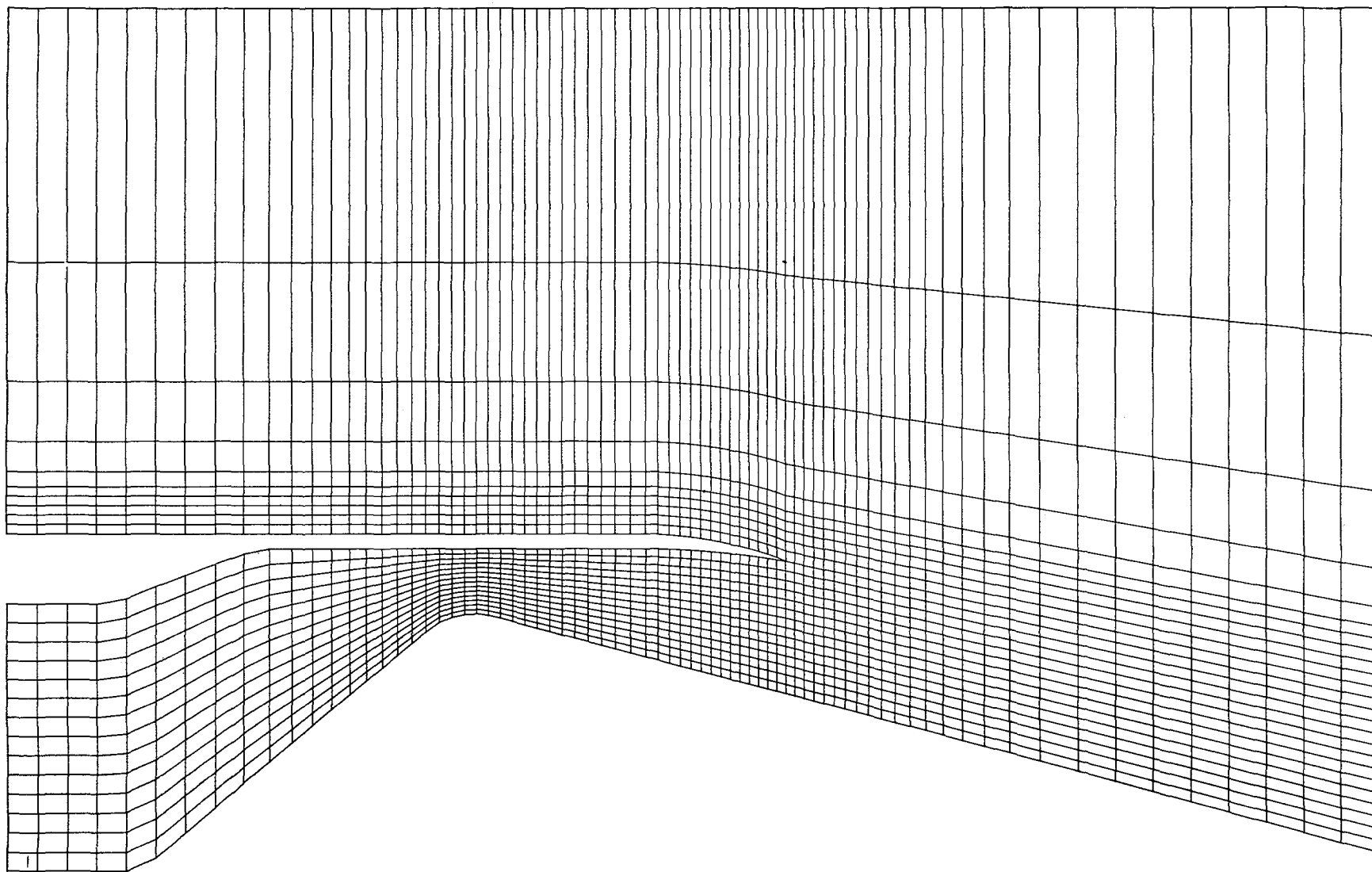

Figure 15.- Computational grid about nozzle (configuration 17) used to calculate inviscid flow field at $M = 0.95$ and $p_{t,j}/p_{\infty} = 8.60$.

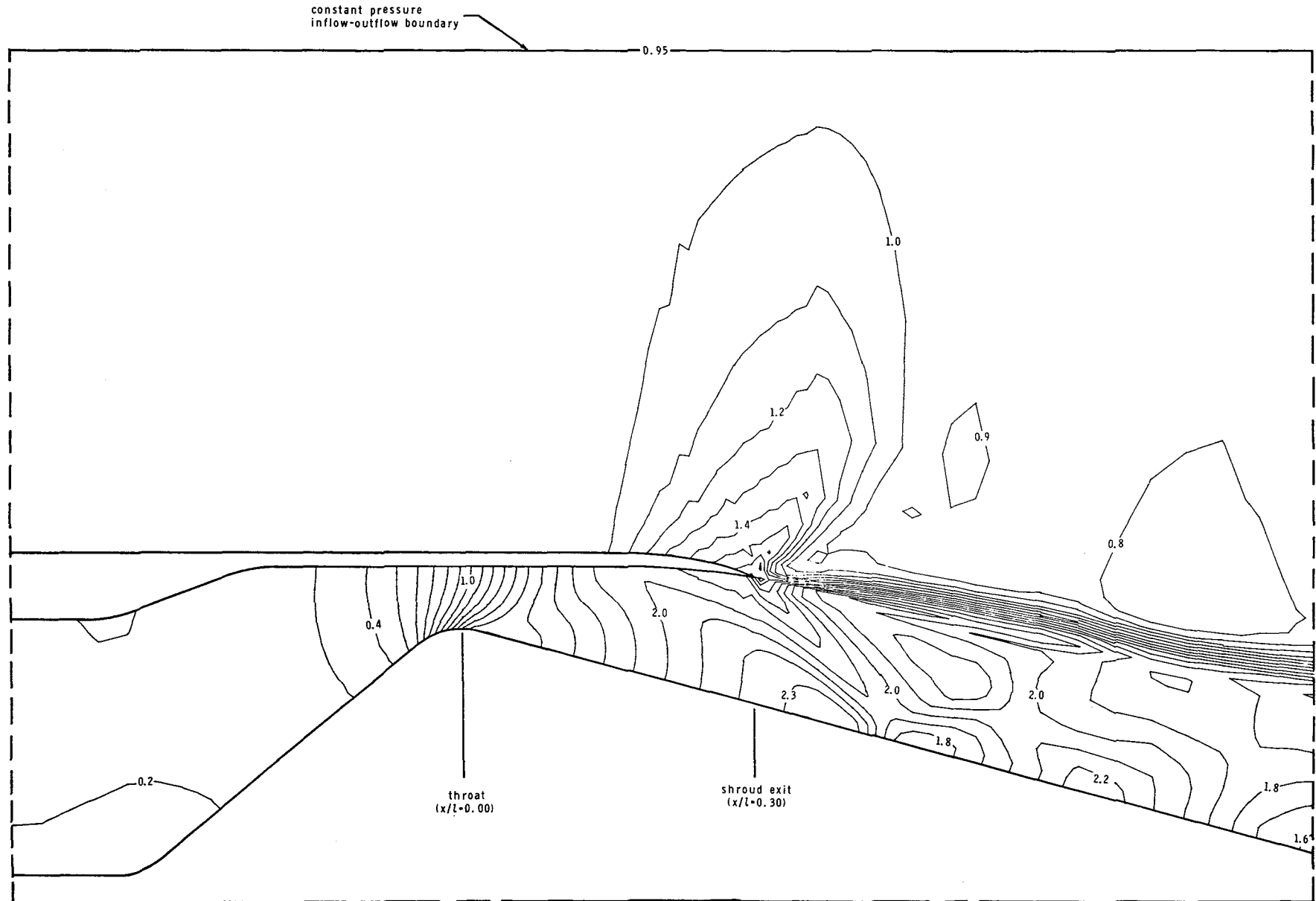

Figure 16.- Computed Mach number contours of flow field about nozzle (configuration 17) at $M = 0.95$ and $P_{t,j}/P_{\infty} = 8.60$.

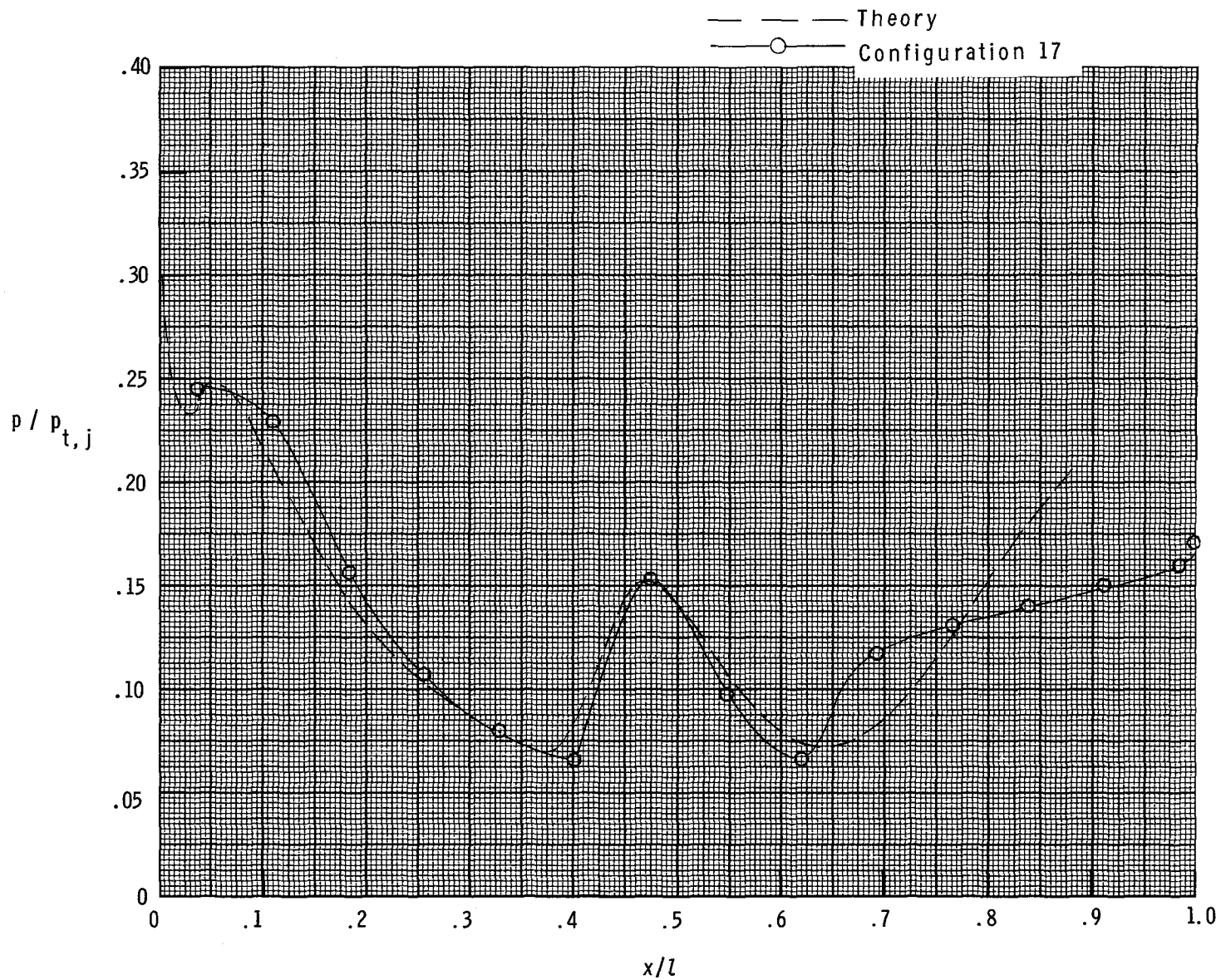

Figure 17.- Comparison of inviscid, adiabatic theoretical calculation (VNAP2) of plug pressure distribution with experimental data at Mach number of 0.95 and nozzle pressure ratio of 8.6.

1. Report No. NASA TM-87606		2. Government Accession No.		3. Recipient's Catalog No.	
4. Title and Subtitle Performance Characteristics of an Isolated Coannular Plug Nozzle at Transonic Speeds				5. Report Date December 1985	
				6. Performing Organization Code 505-40-90-01	
7. Author(s) Charles E. Mercer and James R. Burley II				8. Performing Organization Report No. L-16008	
9. Performing Organization Name and Address NASA Langley Research Center Hampton, VA 23665-5225				10. Work Unit No.	
				11. Contract or Grant No.	
12. Sponsoring Agency Name and Address National Aeronautics and Space Administration Washington, DC 20546-0001				13. Type of Report and Period Covered Technical Memorandum	
				14. Sponsoring Agency Code	
15. Supplementary Notes					
16. Abstract An investigation was conducted in the Langley 16-Foot Transonic Tunnel to evaluate the performance characteristics of a coannular plug nozzle at static conditions (Mach number of 0) and at Mach numbers from 0.65 to 1.20. Jet total pressure ratio was varied from 1.0 (jet off) to 10.0. Thirty-seven configurations generated by the combination of three geometric variables - plug angle, shroud boattail length (fixed exit radius), and shroud extension length - were tested.					
17. Key Words (Suggested by Author(s)) Jet effects Propulsion performance Nozzle geometry			18. Distribution Statement Unclassified - Unlimited Subject Category 02		
19. Security Classif. (of this report) Unclassified		20. Security Classif. (of this page) Unclassified		21. No. of Pages 146	22. Price A07

**National Aeronautics and
Space Administration
Code NIT-4**

**Washington, D.C.
20546-0001**

Official Business
Penalty for Private Use, \$300

**BULK RATE
POSTAGE & FEES PAID
NASA Washington, DC
Permit No. G-27**



**POSTMASTER: If Undeliverable (Section 158
Postal Manual) Do Not Return**
