

ANALYSIS OF DATA FROM NASA B-57B GUST GRADIENT PROGRAM

by

Walter Frost
Ming-Chang Lin
Ho-Pen Chang
and
Erik Ringnes

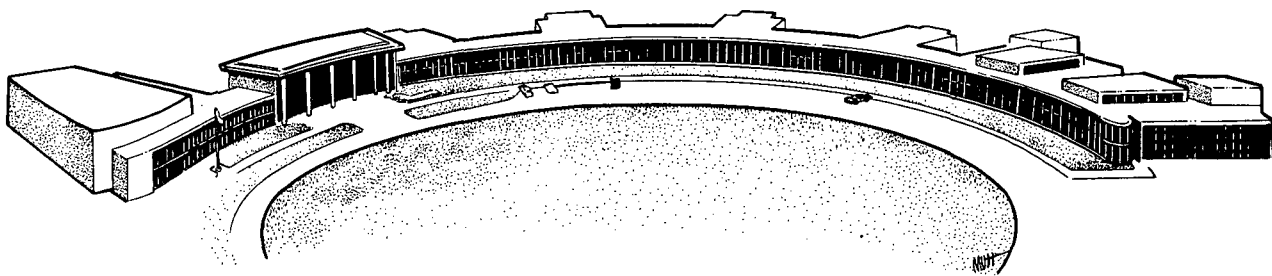

{NASA-CR-178736} ANALYSIS OF DATA FROM NASA N86-23604
E-57B GUST GRADIENT PROGRAM Final Report
{Tennessee Univ.} 500 p HC A21/MF A01
CSCL 01C Unclas
G3/08 15939

THE UNIVERSITY of TENNESSEE SPACE INSTITUTE

Tullahoma, Tennessee

**Final Report
Prepared Under
NASA Contract NAS8-36177
and
NASA Contract NAS8-35347**

for

**George C. Marshall Space Flight Center
National Aeronautics and Space Administration**

**ANALYSIS OF DATA FROM NASA B-57B
GUST GRADIENT PROGRAM**

by

**Walter Frost
Ming-Chang Lin
Ho-Pen Chang
and
Erik Ringnes**

September 1985

**Atmospheric Science Division
The University of Tennessee Space Institute
Tullahoma, Tennessee 37388-8897**

ACKNOWLEDGMENTS

The authors wish to express their appreciation and thanks to several people who were very helpful and to a great extent responsible for this research effort being accomplished. Realizing that it is not possible to name everyone who contributed to the effort, it is nevertheless important to mention some of them. Special acknowledgment is due to John Houbolt, Harold Murrow, and Robert Sleeper of the NASA Langley Research Center and to Wenneth Painter, Jack Ehernberger, and to the ground and flight crews of the B-57B aircraft at the NASA Dryden Flight Research Facility. A special note of appreciation is also due to Warren Campbell, Margaret Alexander, and Dennis Camp of the NASA Marshall Space Flight Center for their technical direction and encouragement. Richard Tobiason (NASA Headquarters) is also gratefully acknowledged.

TABLE OF CONTENTS

SECTION	PAGE
1.0 INTRODUCTION	1
2.0 STATISTICAL ANALYSIS OF DATA	7
2.1 Flight Path Information	8
2.2 Time Histories of Gust Velocities and Gust Velocity Differences	8
2.3 Average Turbulence Parameters and Integral Length Scales	9
2.4 Probability Density Function for Gust Velocities and Gust Velocity Differences	15
2.5 Single-Point Auto-correlation Coefficient of Gust Velocities	25
2.6 Two-point Auto-correlation Coefficient of Gust Velocities	27
2.7 Normalized Auto-spectra of Gust Velocities	33
2.8 Normalized Two-point Auto-spectra of Gust Velocities	49
2.9 Two-point Cross-spectra of Gust Velocities	59
2.10 List of All Parameters Measured and Their Range of Values	60
3.0 CONCLUSION	66
REFERENCES	68
APPENDIX A	69

LIST OF TABLES

TABLE	PAGE
1. Gust Gradient Flights During JAWS 1982	4
2. Summary of B-57B Flight Data During JAWS	6
3. Mean Airspeed (m/s) for Flight 6, July 14, 1982	11
4. Average and Standard Deviation of Mean Airspeed Difference Between Probes	12
5. Turbulence Intensity for All Runs of Flight 6	13
6. Standard Deviation of Velocity Difference for All Runs of Flight 6	14
7. Turbulence Length Scales for All Runs of Flight 6	16
8. The Value of the Parameter r of Non-Gaussian Probability Density Function for All Runs of Flight 6	24

LIST OF FIGURES

FIGURE	PAGE
1. NASA B-57B Gust Gradient Program	2
2. Comparison of probability density function for gust velocities and their differences with theory, Flight 6, Run 42	20
3. Flow chart of non-Gaussian turbulence probability model	21
4. Comparison of probability density function for gust velocities and their differences with theory, Flight 6, Run 5	23
5. Comparison of single-point auto-correlation of gust velocities with theoretical model; composite of Runs 2 through 13	28
6. Comparison of single-point auto-correlation of gust velocities with theoretical model; composite of Runs 14 through 23	29
7. Comparison of single-point auto-correlation of gust velocities with theoretical model; composite of Runs 24 through 33	30
8. Comparison of single-point auto-correlation of gust velocities with theoretical model; Composite of Runs 34 through 46	31
9. Normalized auto-spectra of gust velocities showing spike in the longitudinal spectra, Flight 6, Run 5	37
10. Spectra of variables used to compute W_z	39
11. Normalized auto-spectra of gust velocities showing influence of the Houbolt correction factor, Flight 6, Run 42	41
12. Comparison of theoretical and FFT computer algorithm for an idealized time history	

	$X(t) = e^{-a t }$ with and without correction	42
13.	Comparison of auto-spectra of gust velocities with von Karman model, Runs 2 through 24	45
14.	Comparison of auto-spectra of gust velocities with von Karman model, Runs 25 through 46	46
15.	Illustration of selection of reference $\Phi(\kappa_{ref})$ for normalized auto-spectra of W_{zR} velocity, Flight 6, Run 42	50
16.	Normalized auto-spectra of gust velocities, Flight 6, Run 42	51
17.	Coincident spectra and quadrature spectra of gust velocities, Flight 6, Run 42	54
18.	Terminology of the two-point auto-correlation development	56
19.	Comparison of the two-point auto-spectrum with Houbolt and Sen's normal equation and the rederived equation, Flight 6, Run 42	58
20.	Coincident spectra and quadrature spectra of gust velocities, Flight 6, Run 39	61

NOMENCLATURE

V	Mean airspeed of aircraft, m/s
V_R, V_C, V_L	Aircraft airspeed computed from impact pressure at right wing tip boom, nose boom, and left wing tip boom, respectively, m/s
R, C, L	Designation of right wing tip, nose, and left wing tip, respectively
L	Integral length scale, m
X, Y, Z	Longitudinal, lateral, vertical directions with respect to aircraft frame
W_X, W_Y, W_Z	Gust velocity component in X, Y, Z direction, respectively, m/s
n	Number of degrees of freedom in normalized Student T probability density function
r	An adjustable number in a non-Gaussian probability density function
f	Cyclic frequency, Hz
s	Spatial lag distance, m
$R_x(\tau)$	Single-point auto-correlation function in time domain, m^2/sec^2
$B_x(\tau)$	Single-point auto-correlation coefficient in time domain
$B_{W_X}(s)$	von Karman single-point auto-correlation coefficient in spatial lag domain

$R_x(s, \tau)$	Two-point auto-correlation function, m^2/sec^2
$B_x(s, \tau)$	Two-point auto-correlation coefficient
$R_{x,x'}(s, \tau)$	Two-point auto-correlation function, m^2/sec^2
$R_{W_x W_x}(\zeta)$	Auto-correlation for two points at a spatial distance of ζ , m^2/sec^2
$R_{W_n W_n}(\zeta)$	Conventional longitudinal correlation for two points at a spatial distance of ζ , m^2/sec^2
$R_{W_p W_p}(\zeta)$	Conventional lateral correlation for two points at a spatial distance of ζ , m^2/sec^2
$S_{x,x'}(s, f)$	Two-sided two-point auto-spectrum density function, m^2/sec
$S_x(f)$	Two-sided single-point auto-spectrum density function, m^2/sec
$C_{x,x'}(s, f)$	Coincident spectral density function, the real part of a one-sided spectrum density function, m^2/sec
$Q_{x,x'}(s, f)$	Quadrature spectral density function, the imaginary part of a one-sided spectrum density function, m^2/sec
M	Mach number of aircraft
T_c	Computed free-stream temperature, $^{\circ}C$
T_o	Total temperature, $^{\circ}C$

p, p_s	Free-stream static pressure measured at the airplane nose boom, κP_a
$C.F.$	Houbolt's digitizing correction factor
q_C	Impact pressure, P_a
q_{CR}, q_{CC}, q_{CL}	Impact pressure measured at aircraft right wing tip boom, nose boom, and left wing tip boom, respectively, P_a
B_e	Bandwidth, Hz
T_r	Total time record of a turbulence data set, second
T_r'	Time length of each segment of a turbulence data set, second
$q, SEG.$	Number of separate segments for a turbulence data set
E_r	Normalized standard error, $\sqrt{\frac{1}{B_e T_r}}$
T	Total time, seconds
V_E	East-west component of the airplane inertial velocity measured by INS, positive toward east, m/sec
V_N	North-south component of the airplane inertial velocity measured by INS, positive toward north, m/sec
$p(x)$	Probability density function

Greek Symbols

σ	Standard deviation, m/sec
$\sigma_{WX}, \sigma_{WY}, \sigma_{WZ}$	Standard deviation of gust velocity components, WX, WY, WZ , respectively
κ	Wave number, $\omega/V, m^{-1}$
ω	Spatial frequency, rad/sec
τ	Time lag, sec
ζ	Degrees of freedom, $2B_e T_r$
Δt	Time increment, sec
Δ	Difference
$\frac{d}{dt}$	
ψ	Airplane heading measured in a horizontal plane clockwise from true north, rad
$\dot{\psi}$	Yaw rate measured by body-mounted yaw-rate transducer (positive with nose going right) rad/sec
$\Phi(\kappa)$	Spectrum in the domain of wave number, $m^3/(sec^2/rad)$
$\Phi_x(f)$	One-sided single-point auto-spectrum in the domain of cyclic frequency, m^2/sec
$\Phi_{WX}(\kappa), \Phi_{WY}(\kappa), \Phi_{WZ}(\kappa)$	Auto-spectrum density function of the theoretical von Karman model, $m^3/(sec^2/rad)$
$\Phi'_{\kappa,q}$	Spectrum at frequency f_κ of the

qth time slice, m^2/sec

$\Phi(\omega)$

Spectrum in the domain of spatial frequency, $m^2/(sec/rad)$

$\Phi_{x,x'}(s, f)$

One-sided two-point auto-spectrum density function, m^2/sec

$\theta_{x,x'}(s, f)$

Phase angle of $\Phi_{x,x'}(s, f)$, *rad*

Superscripts

—

A bar over a symbol indicates average over an entire run in an aircraft flight

^

A caret over a symbol indicates the quantity is given with respect to the mean for the entire run in an aircraft flight

1.0 INTRODUCTION

The purpose of the Gust Gradient Program is to study low-altitude, spanwise turbulence during takeoff, landing, and level flight near severe weather formation where non-homogeneous turbulence may exist. Traditional aerodynamic analyses treat turbulence as a gust acting uniformly over the entire aircraft at any given instant. This assumption is reasonable for a small aircraft encountering turbulence with long length scales, but for large aircraft and small turbulence length scales, such as occur near the ground or under storm conditions, spanwise variation of turbulence gusts is not negligible. The gust velocity distribution along the span can generate rolling and yawing moments. If the velocity variation is large and develops suddenly, the pilot will have difficulty controlling the airplane, and may even lose control. Also, the structural integrity of the aircraft may be severely challenged. Theoretical analyses have been developed which do address the effects of spanwise gust distributions (see for a review, Frost and Lin (1983)). These analyses call for two-point spatial turbulence correlations (i.e., cross-correlations) which are computed based on the assumption of isotropic turbulence. However, very few flight experiments have been carried out to measure these correlations and, thus, provide verification of the isotropic turbulence model assumption.

The NASA B-57B Gust Gradient Program was initiated to provide these measurements. The B-57B was instrumented with three probes: one at the left wing tip; one at the center on the nose; and one at the right wing tip. Figure 1 conceptually illustrates the Gust Gradient Program. The lower right-hand side shows the B-57B aircraft with the three probes.

**MEASUREMENT OF WIND VARIATION
OVER SPAN OF AN AIRFOIL**

- PROGRAM DEVELOPMENT 1961
- MEASUREMENT TESTS 1962-63
- DATA ANALYSIS 1962-1964
- DESIGN CRITERIA
- SIMULATION STUDIES
- FLIGHT CREW TRAINING

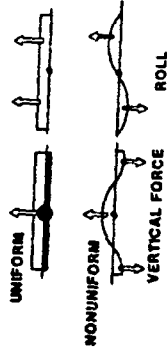

**RANDOM GUSTS ASSUMED TO BE
COMPOSED OF SINUSOIDAL GUSTS**

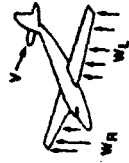

**THREE OF THE KEY FEATURES
OF SPATIAL OR SPANWISE GUST
VARIATIONS**

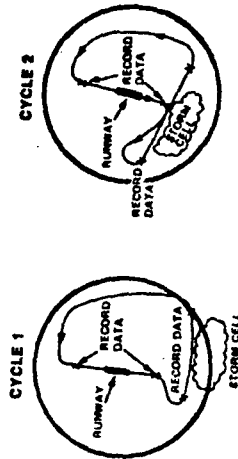

ALT AGL	1000 m (3280 ft)	760 m (2490 ft)	500 m (1640 ft)	250 m (820 ft)

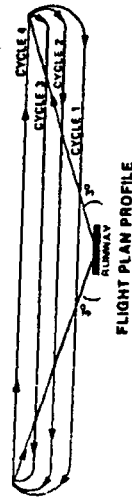

FLIGHT PATH FOR THUNDERSTORM CASE



B-57B GUST GRADIENT AIRCRAFT

Figure 1. NASA B-57B Gust Gradient Program

The upper right-hand side of the figure shows gust wind velocity variation along the wing span. Obviously, asymmetric wind variation will generate rolling moments. The upper middle sketch illustrates the difference between a uniform gust and a nonuniform gust along the wing span. The lower left-hand side of Figure 1 shows the conceptual flight path of the B-57B aircraft, including takeoff, landing, and level flight. For safety reasons, the aircraft only flew outside the storm cells instead of through them to detect the near wind field influenced by the storm.

The data presented in this report were gathered when the Gust Gradient Program joined the Joint Airport Weather Studies (JAWS) Project in Denver, Colorado, from July 7 to July 23, 1982. During the JAWS Project, 11 data collection flights were flown. These flights were carried out in a controlled airspace and it was not possible to fly in all details the conceptual flight paths. Therefore, most of the flight paths are straight and level but are near, in many cases, severe microbursts. Table 1 shows the flight number, date, start time (Mountain Daylight Time, MDT), end time (MDT), and general comments about each flight. Only three flights (Flights 6, 7, and 10) encountered severe turbulence. Analyses of the data gathered on these three flights have been carried out.

The Gust Gradient Program was a joint program between three NASA centers. NASA Dryden Flight Research Center operated and maintained the aircraft. The raw data tapes were sent to NASA Langley Research Center where the initial conversion into engineering units was carried out. NASA Marshall Space Flight Center managed the program.

The data were stored on magnetic tapes in binary form. The tapes are then sent to The University of Tennessee Space Institute (UTSI) for

Table 1. Gust Gradient Flights During JAWS 1982

<u>FLIGHT</u>	<u>DATE</u>	<u>START</u>	<u>END</u>	<u>COMMENTS</u>
1	7/7	15:41:38	15:59:39	Landmark Familiarization Flight
2	7/8	14:49:11	16:40:35	Light to Moderate Turbulence
3	7/9	13:17:10	15:42:34	Light to Moderate Turbulence with Data Correlation with JAWS 02 (King Air 200) and JAWS 30 (HS 125)
4	7/11	14:46:07	17:02:44	Moderate Turbulence and Lightning
5	7/13	15:20:18	16:44:56	ILS Approaches to Stapleton in Light Turbulence
6	7/14	13:41:13	15:55:21	Severe Turbulence and Outflows Visible on Radar
7	7/15	14:08:13	16:26:20	Outflows, Severe Turbulence, and ILS Approaches
8	7/17	15:49:35	17:17:56	Rain with Light to Moderate Turbulence
9	7/20	15:59:30	18:35:52	Light to Moderate Turbulence with some ILS Approaches
10	7/21	16:05:05	18:04:40	Good Downburst with Moderate to Severe Turbulence
11	7/22	13:36:09	15:24:45	Light and Moderate Turbulence

analysis. Because of the different computer systems at NASA Langley (CDC System) and UTSI (VAX System), programs for converting data have been developed. Of the three flights analyzed, results from Flight 6 on July 14, 1982, are reported here. The flight data include six tapes constituting 44 runs. Two runs are of too short a time duration for meaningful statistical analysis and have been excluded. Flight 7 data for July 15, 1982, includes one tape of five runs; and Flight 10 data for July 21, 1982, includes two tapes of 10 runs. One run for Flight 10 is also too short for meaningful analysis. These details are summarized in Table 2. The statistical analysis of the data for Flight 6 only is given in this report. The analysis procedures and description of results is described in Section 2.0. Comprehensive data sets are given in Appendix A. Conclusions drawn from the analysis are presented in Section 3.0.

Table 2. Summary of B-57B Flight Data During JAWS.

<u>Flight No.</u>	<u>Date</u>	<u>No. of Tapes</u>	<u>No. of Runs</u>	<u>No. of Runs Eliminated</u>
6	July 14, 1982	6	44	2
7	July 15, 1982	1	5	0
10	July 21, 1982	2	10	1

Short Runs:

<u>Run No.</u>	<u>No. of Datum Points</u>
Flight 6, Run 7	N = 1207
Flight 6, Run 9	N = 647
Flight 10, Run 17	N = 847

2.0 STATISTICAL ANALYSIS OF DATA

Statistical analysis of the B-57B Program data for 44 runs from Flight 6 on July 14, 1982, is described in this section. General information and statistical values for each run are given in Appendix A. For each run, ten pages containing the following information per page are provided:

- 1st Page: Flight path information;
- 2nd Page: Time histories of gust velocities and gust velocity differences;
- 3rd Page: Average turbulence parameters and integral length scales;
- 4th Page: Probability density function for gust velocities and gust velocity differences;
- 5th Page: Single-point auto-correlation coefficient of gust velocities;
- 6th Page: Two-point auto-correlation coefficient of gust velocities;
- 7th Page: Normalized auto-spectra of gust velocities;
- 8th Page: Normalized two-point auto-spectra of gust velocities;
- 9th Page: Two-point cross-spectra of gust velocities;
- 10th Page: List of all parameters measured and their range of values.

The method of computing the statistical results presented in Appendix A is described in detail in the following subsections.

2.1 Flight Path Information

Flight direction on a topographical map, the altitude of the flight relative to the terrain contours, and horizontal wind vector recorded along the flight path are shown and plotted on the 1st page for each run in Appendix A. Also tabulated on these pages is the date, the time (MDT) at which the run began, and the duration of the run in seconds.

The terrain over which the B-57B flew, in most cases, was flat. The altitude of each run relative to the ground ranges from 250 feet in Run 23 to 2600 feet in Run 3. Most runs are flown at an altitude where it can be assumed that the ground does not influence the turbulent wind field. In Runs 23 and 24, this assumption cannot be applied.

In some runs, the wind direction is nearly perpendicular to the flight path (see Run 2 as an example). In other runs, the wind direction is along the flight path, as in Run 16 and Run 24. Many runs have a nearly constant wind direction, as in Runs 2, 14, 15, 18, 20, 24, 34, 37, and 39. But in Runs 3, 4, 11, 13, 16, 23, 25, 26, 30, 31, 40 and 43, the wind direction changes substantially along the flight path. This suggests the B-57B airplane may have flown near a microburst. A microburst is a downdraft which, at the surface, spreads out in all radial directions. The diameter of a microburst is less than 4 km. An aircraft flying through a small-scale microburst in a takeoff or landing approach will first encounter increasing head winds, then the downdraft, and finally, increasing tail wind. The lift of the aircraft will increase initially, but later will be drastically reduced due to loss of airspeed. Several accidents have been contributed to microbursts.

2.2 Time Histories of Gust Velocities and Gust Velocity Differences

The 2nd page for each run in Appendix A shows the gust velocity time histories at the left wing tip, the center, and the right wing tip. Also, spatial velocity differences for all combinations of the three probes are plotted for the longitudinal, lateral, and vertical velocity components. The sampling rate is 40 per second. Only 120 seconds worth of data is plotted for illustration purposes, but the total data record is used in all analyses.

There are no great variations between velocities measured at the three positions. As is later shown, the length scale of the turbulence is larger than the wing span of the B-57B airplane (19.5 meters); and thus the difference between the wind measurement at each of the three probes is small. The velocity difference between any two positions is calculated. If the ratio of velocity difference to airspeed is large, the spatial variation of turbulence is significant. For example, in Run 17, Flight 6, the maximum velocity difference of the vertical component between the right wing tip and the center is 15 m/s, and the mean airspeed is 107 m/s. This represents a 14 percent spatial wind variation to airspeed ratio, which is significant in terms of airplane controlability. Inspection of the lateral wind component for Run 10 and Run 27, also in Run 28 after 50 seconds of the run has elapsed, indicate these data are bad. The source creating these bad data is not presently known.

2.3 Average Turbulence Parameters and Integral Length Scales

The 3rd page for each run in Appendix A is a tabulated listing of the average values of several important turbulence parameters for the left, center, and right probes designated with subscripts L , C , and R , respectively. The statistical parameters include mean airspeed, standard deviation of

the gust velocity, standard deviation of the gust velocity difference, and the integral length scale. In analyzing the data, the total time history is truncated such that the total record is a multiple of segments of 512 (or 1024) datum points. The reason for segmenting the data files will be explained later.

Table 3 shows the mean airspeed for all runs in Flight 6. The average mean airspeed for all runs is 105 m/s. The mean airspeeds at the individual right, center, and left probes are 106.0, 104.2, and 105.2 m/s, respectively. The average and standard deviation of the mean airspeed differences between all three probes and the average value at individual probes are shown in Table 4. The mean airspeeds at the right and left probes are larger than the mean airspeed at the nose by 1.82 and 1.03 m/s, respectively. This is believed to be due to the influence from the unsymmetric wake produced from the nose of the airplane.

Table 5 lists the standard deviation of gust velocities for all runs of Flight 6. The standard deviation of the gust velocities varies from 0.65 to 5.93 m/s for the longitudinal component, and from 0.73 to 7.48 m/s for the lateral component. Bad data produce unreasonably high values for Runs 10 and 27. The vertical gust component standard deviation ranges from 0.62 to 4.25 m/s. The standard deviation of the gust velocity differences lie between a low of 0.37 and a high of 1.97 m/s for the longitudinal component. The lateral gust component standard deviation ranges from 0.29 to 1.79 m/s, and the vertical component from 0.34 to 1.96 m/s. Table 6 lists the standard deviations of the gust velocity differences. The standard deviation of the gust velocity, itself, is always larger than the standard deviation of the gust velocity difference between probes. This is expected because in the

Table 3. Mean Airspeed (m/s) for Flight 6, July 14, 1982.

Run No.	\bar{V}_L	\bar{V}_C	\bar{V}_R	Run No.	\bar{V}_L	\bar{V}_C	\bar{V}_R
2	121.2	120.3	122.2	25	104.8	103.0	104.2
3	111.5	110.7	112.4	26	108.0	106.2	107.3
4	108.4	107.7	109.5	27	105.9	104.1	105.0
5	104.0	103.3	105.0	28	106.2	105.1	106.9
6	127.2	125.9	128.0	29	106.1	104.9	106.7
8	101.6	100.7	102.4	30	106.4	105.2	107.0
10	106.4	105.2	107.0	31	102.5	101.5	103.3
11	106.2	105.1	106.9	32	98.4	97.6	99.3
12	107.8	106.7	108.6	33	97.3	96.4	98.2
13	112.1	110.9	112.8	34	104.4	103.4	105.3
14	102.2	101.3	103.1	35	107.6	106.6	108.4
15	101.5	100.5	102.4	36	107.8	106.8	108.7
16	107.0	105.9	107.8	37	104.5	103.4	105.2
17	97.9	96.8	98.5	38	94.9	94.0	95.7
18	103.5	102.4	104.1	39	107.0	106.0	107.9
19	96.6	95.5	97.3	40	105.8	104.6	106.4
20	103.3	102.2	104.0	41	105.1	104.1	106.0
21	96.4	95.6	97.6	42	110.3	109.2	111.1
22	102.5	101.6	103.4	43	102.7	101.7	103.5
23	103.8	102.7	104.5	44	106.9	105.8	107.7
24	102.9	101.9	103.7	46	104.9	103.8	105.5

**Table 4. Average and Standard Deviation of Mean
Airspeed Difference Between Probes.**

$$|\overline{\Delta V}_{RC}| = 1.82m/s \quad \sigma_{RC} = 0.09m/s$$

$$|\overline{\Delta V}_{CL}| = 1.03m/s \quad \sigma_{CL} = 0.14m/s$$

$$|\overline{\Delta V}_{RL}| = 0.79m/s \quad \sigma_{RL} = 0.15m/s$$

$$\overline{V}_R = 106.02m/s$$

$$\overline{V}_C = 104.2 m/s$$

$$\overline{V}_L = 105.23m/s$$

Table 5. Turbulence Intensity for All Runs of Flight 6.

Run No.	$\sigma_{W_{XR}}$	$\sigma_{W_{XC}}$	$\sigma_{W_{XL}}$	$\sigma_{W_{YR}}$	$\sigma_{W_{YC}}$	$\sigma_{W_{YL}}$	$\sigma_{W_{ZR}}$	$\sigma_{W_{ZC}}$	$\sigma_{W_{ZL}}$
2	1.22	1.12	1.13	1.01	1.00	0.96	1.40	1.42	1.45
3	3.73	3.68	3.75	1.73	1.81	1.77	2.24	2.04	2.10
4	1.03	0.97	0.98	1.91	1.92	1.97	1.22	1.20	1.23
5	1.26	1.19	1.26	1.97	2.02	1.97	1.14	1.09	1.17
6	0.98	0.93	0.97	0.86	0.85	0.86	0.68	0.62	0.65
8	2.31	2.46	2.71	3.50	3.53	3.54	3.95	3.87	4.65
10	3.12	3.11	3.17	20.88	20.50	20.63	2.60	2.59	2.71
11	3.87	3.80	3.88	3.25	3.38	3.28	3.44	3.39	3.45
12	2.35	2.29	2.39	1.64	1.66	1.54	2.09	2.03	2.15
13	4.75	4.62	4.69	2.37	2.37	2.31	2.36	2.22	2.25
14	0.91	0.93	0.95	0.73	0.76	0.73	0.94	0.87	0.98
15	1.17	1.14	1.23	1.85	1.86	1.87	0.98	0.74	0.94
16	3.39	3.39	3.41	1.13	1.15	1.11	1.19	1.17	1.20
17	3.75	3.75	3.81	4.77	4.77	4.64	3.30	3.31	3.41
18	4.09	4.24	4.40	4.14	4.21	4.11	4.25	4.16	4.09
19	2.41	2.42	2.45	3.55	3.62	3.44	3.10	3.11	3.19
20	2.10	2.13	2.11	2.25	2.40	2.33	3.77	3.51	3.57
21	3.48	3.46	3.67	3.00	3.30	3.27	3.57	3.42	3.44
22	2.44	2.34	2.48	4.06	4.00	3.87	3.58	3.64	3.68
23	2.44	2.42	2.41	7.45	7.48	7.44	1.57	1.55	1.55
24	1.21	1.16	1.19	0.74	0.78	0.80	0.95	0.94	1.07
25	3.50	3.44	3.49	6.04	5.97	5.92	2.26	2.21	2.43
26	2.56	2.53	2.56	5.11	5.14	5.06	2.10	1.89	2.00
27	4.96	4.94	5.06	314.62	309.15	312.16	0.83	0.83	0.82
28	0.72	0.65	0.70	0.80	0.82	0.79	0.72	0.71	0.68
29	3.84	3.82	3.92	2.10	2.18	2.21	2.38	2.22	2.42
30	3.21	3.01	3.04	4.73	4.76	4.72	2.53	2.40	2.42
31	2.01	1.91	2.04	5.28	5.19	5.16	1.51	1.47	1.53
32	1.50	1.53	1.62	2.79	2.81	2.79	1.41	1.30	1.39
33	4.39	4.52	4.68	2.42	2.46	2.29	2.91	2.81	2.92
34	2.53	2.48	2.59	2.01	2.08	2.02	1.99	1.82	2.04
35	2.01	1.91	2.09	3.32	3.35	3.28	2.28	2.09	2.20
36	2.49	2.44	2.48	4.26	4.21	4.18	1.85	1.70	1.92
37	2.28	2.22	2.27	4.41	4.48	4.45	1.63	1.52	1.62
38	5.49	5.51	5.75	3.29	3.48	3.41	3.24	3.09	3.26
39	5.82	5.75	5.93	3.04	3.08	3.06	2.84	2.69	2.84
40	2.14	2.06	2.15	2.80	2.86	2.85	2.99	2.92	3.65
41	2.47	2.40	2.43	2.06	2.10	2.08	2.49	2.31	2.44
42	3.46	3.43	3.49	2.67	2.69	2.63	2.83	2.71	2.72
43	4.85	4.74	4.82	3.35	3.48	3.50	3.09	2.88	3.00
44	3.26	3.12	3.27	3.53	3.55	3.59	2.72	2.57	2.70
46	3.19	2.98	3.04	3.28	3.37	3.22	2.78	2.50	2.68

Table 6. Standard Deviation of Velocity Difference for All Runs of Flight 6.

Run No.	$\sigma_{\Delta W_{XCL}}$	$\sigma_{\Delta W_{XRC}}$	$\sigma_{\Delta W_{XRL}}$	$\sigma_{\Delta W_{YCL}}$	$\sigma_{\Delta W_{YRC}}$	$\sigma_{\Delta W_{YRL}}$	$\sigma_{\Delta W_{ZCL}}$	$\sigma_{\Delta W_{ZRC}}$	$\sigma_{\Delta W_{ZRL}}$
2	0.49	0.51	0.71	0.39	0.39	0.40	0.48	0.46	0.54
3	0.64	0.65	0.82	0.60	0.59	0.65	0.66	0.72	0.83
4	0.49	0.53	0.67	0.46	0.43	0.48	0.52	0.48	0.56
5	0.53	0.53	0.68	0.48	0.46	0.51	0.56	0.52	0.60
6	0.37	0.38	0.48	0.29	0.33	0.32	0.34	0.36	0.38
8	1.12	1.02	1.30	1.11	1.02	1.11	1.34	1.23	1.52
10	1.00	1.07	1.31	1.05	1.10	1.21	1.08	1.17	1.34
11	1.23	1.19	1.54	1.26	1.28	1.36	1.34	1.35	1.53
12	0.77	0.71	0.89	0.76	0.79	0.82	0.85	0.86	0.93
13	0.59	0.60	0.76	0.56	0.57	0.62	0.65	0.68	0.77
14	0.50	0.51	0.60	0.45	0.43	0.47	0.54	0.51	0.61
15	0.55	0.54	0.70	0.49	0.47	0.53	0.52	0.45	0.56
16	0.43	0.45	0.56	0.39	0.41	0.44	0.46	0.45	0.51
17	1.17	1.26	1.45	1.24	1.32	1.41	1.48	1.47	1.50
18	1.45	1.46	1.67	1.52	1.54	1.68	1.66	1.62	1.93
19	1.13	1.17	1.46	1.27	1.19	1.29	1.44	1.29	1.69
20	1.13	1.28	1.50	1.34	1.42	1.37	1.45	1.33	1.66
21	1.51	1.55	1.97	1.79	1.61	1.78	1.63	1.70	1.96
22	1.11	1.24	1.44	1.08	1.19	1.22	1.33	1.33	1.47
23	0.59	0.63	0.75	0.58	0.58	0.64	0.67	0.69	0.75
24	0.43	0.44	0.53	0.40	0.40	0.43	0.41	0.46	0.50
25	0.97	0.91	1.18	0.94	0.95	1.02	1.05	1.06	1.19
26	0.88	0.96	1.21	0.87	0.92	0.92	0.95	1.00	1.05
27	0.47	0.51	0.64	5.66	3.37	3.10	0.46	0.51	0.53
28	0.43	0.44	0.56	0.39	0.35	0.38	0.42	0.43	0.49
29	1.01	1.08	1.34	1.10	1.09	1.08	1.17	1.22	1.30
30	0.98	0.96	1.21	1.00	0.94	1.01	1.12	1.03	1.29
31	0.74	0.82	1.04	0.77	0.75	0.77	0.86	0.95	0.96
32	0.65	0.72	0.86	0.63	0.68	0.72	0.70	0.74	0.78
33	1.09	1.12	1.37	1.07	1.09	1.19	1.28	1.22	1.39
34	0.89	0.94	1.19	0.87	0.90	0.95	1.04	0.99	1.13
35	0.91	0.99	1.26	0.88	0.92	0.91	0.95	1.07	1.15
36	0.90	0.88	1.12	0.86	0.85	0.90	0.97	1.02	1.22
37	0.72	0.73	0.91	0.73	0.69	0.75	0.81	0.87	0.97
38	1.35	1.35	1.70	1.39	1.35	1.43	1.47	1.48	1.61
39	1.13	1.17	1.43	1.10	1.10	1.15	1.31	1.29	1.47
40	0.88	0.97	1.14	1.01	0.96	1.04	1.09	1.05	1.27
41	1.01	1.02	1.24	0.95	0.97	1.04	1.11	1.17	1.31
42	1.00	1.03	1.24	0.97	0.98	1.06	1.14	1.16	1.32
43	1.16	1.24	1.49	1.24	1.25	1.39	1.48	1.52	1.59
44	1.10	1.12	1.38	1.04	1.08	1.19	1.24	1.28	1.43
46	1.39	1.43	1.80	1.37	1.39	1.43	1.56	1.53	1.79

gust velocity difference, the low-frequency content of the data is effectively removed by the differencing process; but the gust velocity, itself, includes both low and high frequencies.

The integral length scale is obtained by integrating the one-point spatial lag auto-correlation coefficient from zero to infinity. Theoretically, the auto-correlation coefficient converges to unity at zero lag and zero at large spatial lags. Due to noise in the measured data, the auto-correlation coefficient may oscillate about zero. The integral length scale is, therefore, obtained by integrating the one-point auto-correlation coefficient to the point where the auto-correlation first becomes zero.

Table 7 lists the integral length scale for all runs of Flight 6. The length scales of the lateral and the vertical components are multiplied by a factor of two as is suggested in the literature. The integral length scales range from a low of 139 meters to a high of 1929 meters for the longitudinal component, from a low of 105 meters to a high of 3824 meters for the lateral component, and from a low of 110 meters to a high of 1697 meters for the vertical component. In general, the integral length scales of the vertical component are smaller than the integral length scales of the longitudinal or lateral components.

2.4 Probability Density Function for Gust Velocities and Gust Velocity Differences

The probability density function for the turbulent wind velocities is defined by the expression:

$$p(x) = \lim_{\Delta x \rightarrow 0} \frac{\text{Prob}[x < x(t) \leq x + \Delta x]}{\Delta x}$$

Table 7. Turbulence Length Scales for All Runs of Flight 6.

Run No.	LW_{XR}	LW_{XC}	LW_{XL}	LW_{YR}	LW_{YC}	LW_{YL}	LW_{ZR}	LW_{ZC}	LW_{ZL}
2	1163	1329	1272	627	550	645	1467	1592	1563
3	1038	1043	1042	559	541	554	1050	976	940
4	216	302	260	1141	1116	1159	694	678	617
5	722	801	763	2932	2878	2920	351	405	411
6	599	599	655	651	718	698	875	866	477
8	387	411	411.9	1179	1122	1214	522	560	538
10	896	894	866				286	302	267
11	622	645	642	924	896	908	827	1161	1006
12	367	359	379	291	290	324	334	392	375
13	1300	1270	1275	2516	2448	2562	1539	1631	1697
14	339	373	337	125	105	124	186.2	198	382
15	505	500	480	1733	1757	1824	712	694	675
16	1546	1535	1540	697	637	640	1136	1237	1169
17	250	251	264	2192	2138	2208	261	277	246
18	261	258	255	1155	1136	1198	425	520	428
19	194	190	190	1467	1560	1579	307	330	308
20	362	436	376	312	128	144	167	205	198
21	146	153	166	275	258	253	158	194	158
22	149	139	151	1106	1048	1053	478	541	496
23	776	799	807	3824	3736	3776	811	1021	767
24	821	840	805	1218	1032	1278	1108	1256	1469
25	1055	1014	1004	2002	1940	2014	247	261	258
26	753	769	709	1734	1699	1706	291	304	343
27	1914	1891	1913	224	220	222	443	1060	303
28	402	124	415	642	847	869	862	858	853
29	592	599	592	634	553	604	379	387	385
30	971	955	930	2074	2004	2038	636	600	581
31	890	901	915	2676	2592	2628	110	215	116
32	629	656	674	1798	1735	1806	221	224	222
33	1912	1929	1914	878	813	744	1079	1323	1237
34	773	718	671	638	592	596	834	484	1115
35	186	184	184	788	753	791	361	397	363
36	460	439	415	1632	1588	1637	297	357	339
37	354	353	349	2072	2036	2070	224	223	212
38	1128	1123	1140	813	719	680	246	267	249
39	1349	1335	1337	811	776	806	258	287	265
40	437	424	368	645	613	658	562	556	523
41	911	876	905	802	715	706	235	250	237
42	824	790	814	2172	2118	2088	451	511	461
43	1080	1082	1107	2336	2226	2322	479	581	505
44	503	464	446	877	827	831	647	771	740
46	420	370	370	468	454	506	155	178	161

where $x(t)$ may be $W_X, W_Y, W_Z, \Delta W_X, \Delta W_Y,$ or $\Delta W_Z,$ respectively, and $Prob [x < x(t) \leq x + \Delta x]$ is the probability that the turbulence wind velocity at a time t lies within a specified speed interval. The Gaussian probability density function is given by:

$$p(x) = \frac{1}{\sigma\sqrt{2\pi}} e^{-\frac{(x-\bar{x})^2}{2\sigma^2}}$$

where \bar{x} is the mean value of $x(t)$ and σ is the standard deviation of wind velocity. The normalized Gaussian density distribution is used in the comparison with the experimental data.

The 4th page for each run in Appendix A contains the probability density function of the turbulence wind velocities. Data measured by the B-57B airplane for all three different probe positions and for all three velocity components (longitudinal W_X , lateral, W_Y , and vertical W_Z) are plotted. The normal probability density function (solid line in each figure) is superimposed for comparison. The upper half of the figure shows probability distributions of the three individual gust velocity components. On the bottom half of the figure, the probability distributions of the gust velocity differences are shown. The letters $CR, CL,$ and RL indicate the probe positions between which the difference is calculated: CR refers to the right wing tip and the center; CL refers to the center and the left wing tip; and RL refers to the right and left wing tips. The results of these probability density calculations for the turbulence measured during Flight 6 do not fit the normalized Gaussian distribution very well. One reason may be the short time record used in the computation. For example, in the

time history for Run 16, the wind velocity of the longitudinal component, W_X , goes from a large positive value to a small negative value over the duration of the run. After becoming a negative W_X , it never again obtains a positive value, however. In turn, the probability density of the longitudinal velocity component for this run, Run 16, is not of a normalized form. The reverse situation (going from a negative value to a positive value) occurs to the longitudinal component in Runs 27, 38, and 39, and to the lateral component in Runs 23, 25, 26, 31, and 37.

When comparing the velocity difference between two different positions, the probability density function is symmetric or more nearly the Gaussian form. Nevertheless, the experimental probability exceeds the magnitude of the theoretical Gaussian probability at the most probable velocity.

The results obtained from Runs 10 and 27 for the lateral component, and in Run 28 for all three components indicate bad data.

Since the normalized Gaussian probability density underestimates the probability of velocities near the mean velocity, and tails of the distribution while overpredicting intermediate values, new probability models were investigated.

The Student T probability density function was first analyzed. Bandat and Piersol (1971) reported that the normalized Student T probability density function is given by:

$$p(x) = \frac{\Gamma[(n+1)/2]}{\sqrt{\pi n} \Gamma(n/2)} \left[1 + \frac{x^2}{n} \right]^{-(n+1)/2}$$

where n is the number of degrees of freedom. A comparison of Student T (with $n = 2$), the Gaussian probability, and a sample of the the measured data is shown in Figure 2. The Student T distribution, however, underestimates values near the mean velocity even more than the Gaussian probability. When the degrees of freedom approach infinity, the Student T model becomes identical to the Gaussian form. Since the measured data are always higher than the Gaussian model near zero (mean velocity), the Student T model is not a good distribution for modeling atmospheric turbulence.

Another distribution used to correlate the data is a non-Gaussian probability density model by Reeves, et al. (1974). This model combines three independent Gaussian functions, $a(t)$, $b(t)$, and $c(t)$. The procedure of combining these functions is shown in Figure 3. The first step is to multiply the Gaussian probability density function $a(t)$ by $b(t)$. The probability distribution for the product $d(t) = a(t) b(t)$ is:

$$p_d(x) = \int_0^{\infty} \left[p_a(\eta) p_b\left(\frac{x}{\eta}\right) + p_a(-\eta) p_b\left(-\frac{x}{\eta}\right) \right] \frac{d\eta}{\eta}$$

This new probability function is then added to the Gaussian function $c(t)$ after first multiplying both functions by appropriate scale factors. The resulting variate $u(t)$

$$u(t) = c(t) \frac{1}{\sqrt{1+r^2}} + d(t) \frac{r}{\sqrt{1+r^2}}$$

then has non-Gaussian probability density function:

---- Non-Gaussian
 ——— Gaussian
 - - - Student T

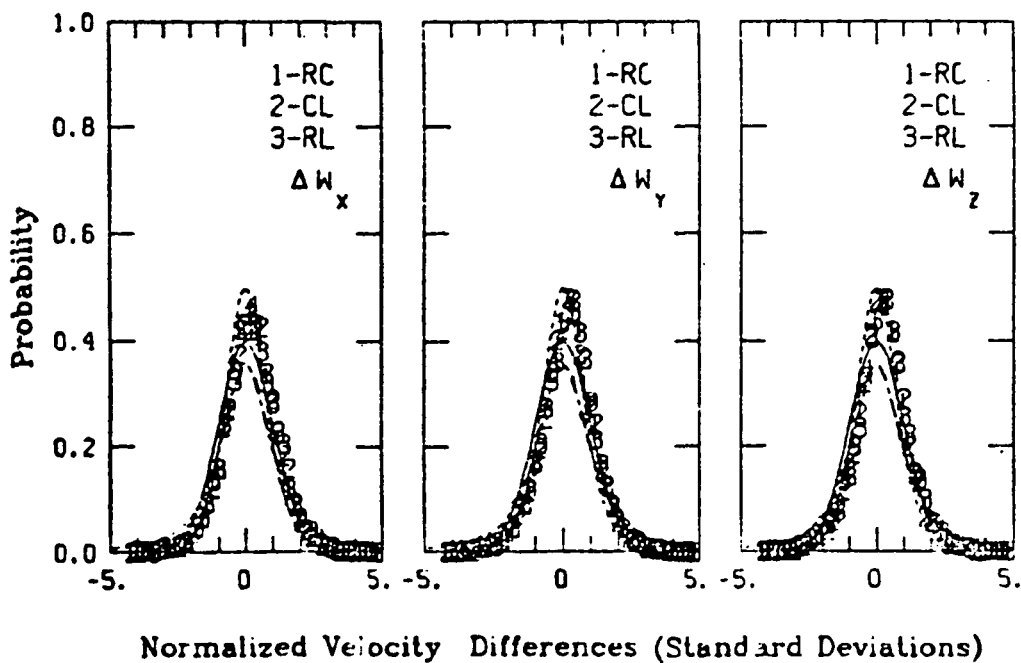
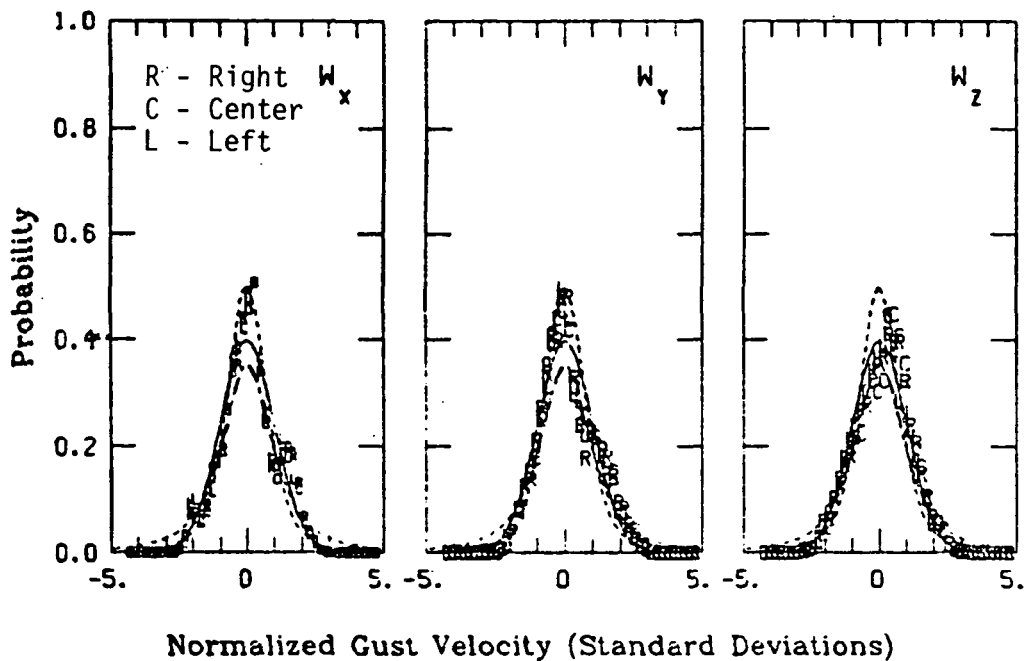

Figure 2. Comparison of probability density function for gust velocities and their differences with theory, Flight 6, Run 42. ($n = 2$, $r = 1.5$)

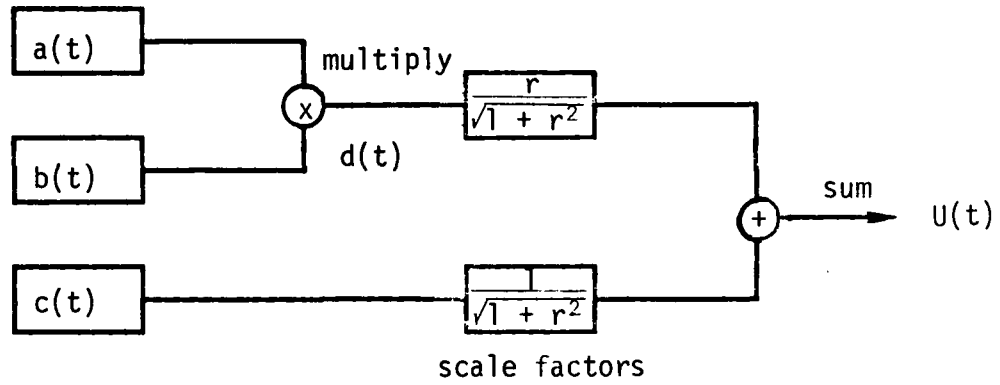

Figure 3. Flow chart of non-Gaussian Turbulence probability model.

$$p\left(\frac{x}{\sigma}\right) = \frac{1}{\sigma} \frac{(1+r^2)^{\frac{1}{2}}}{\pi} \int_0^{\infty} \left[\frac{2}{1+2\xi^2 r^2}\right]^{\frac{1}{2}} \exp\left[-\xi^2 - \frac{1}{2}\left(\frac{x}{\sigma}\right)^2 \frac{(1+r^2)}{(1+2\xi^2 r^2)}\right] d\xi$$

where r is an adjustable parameter. A detailed derivation of this equation is given by Reeves, et al. (1974 and 1976). The range of the parameter r is from zero to infinity. If r equals zero, the function is exactly the Gaussian function; however, as r increases, the value of the non-Gaussian probability density function at zero increases. The non-Gaussian probability density function with an r value equal to 1.5, the Student T probability density function with the degree of freedom, n , equal to 2, and the Gaussian probability density function are compared with typical measured data in Figure 2.

The non-Gaussian density function fits this particular set of measured data best for $r = 3$, as shown in Figure 4. By adjusting r , the non-Gaussian form provides the closest fit to the experimental values. The value of r which gives the best fit of the data, however, changes for different velocity components and from run to run. Hence, the value of r depends upon the velocity component being curve fit as well as the particular run. Table 8 lists suitable values of r for the three components of the gust velocities and gust velocity differences from Flight 6. Bad data sets are marked with the symbol X . For some data sets, the shape of the probability density is not a symmetric bell shape (for example, the longitudinal component of gust velocity for Run 3), and these runs are marked with a Δ symbol. The r value varies from 0.5 to 7.5. The average value for all runs is $r = 2$. The standard deviation of the distribution for r is slightly larger for gust velocity than for gust velocity difference. On the other hand, the mean values of

---- Non-Gaussian
 ——— Gaussian
 - - Student T

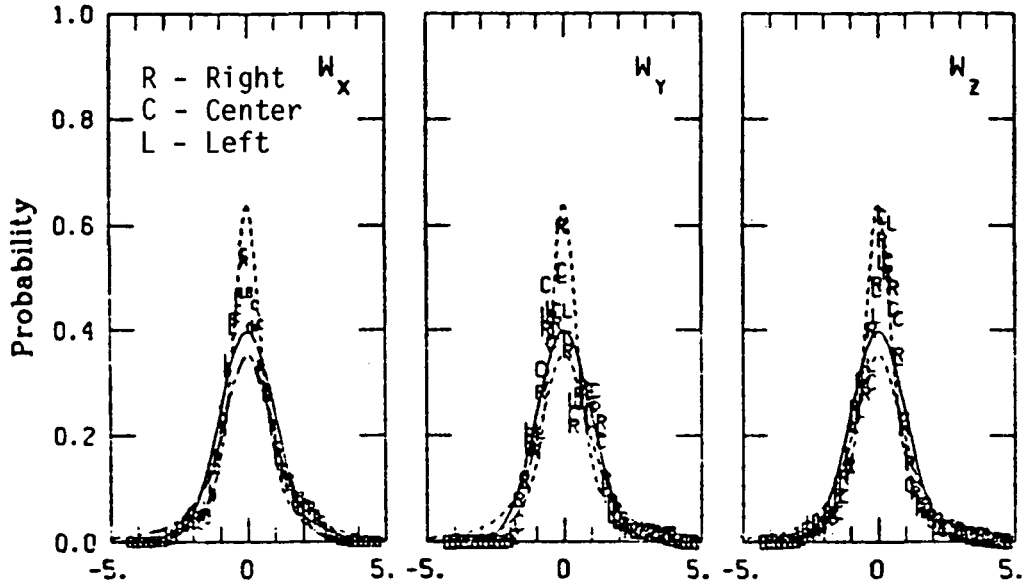

Normalized Gust Velocity (Standard Deviations)

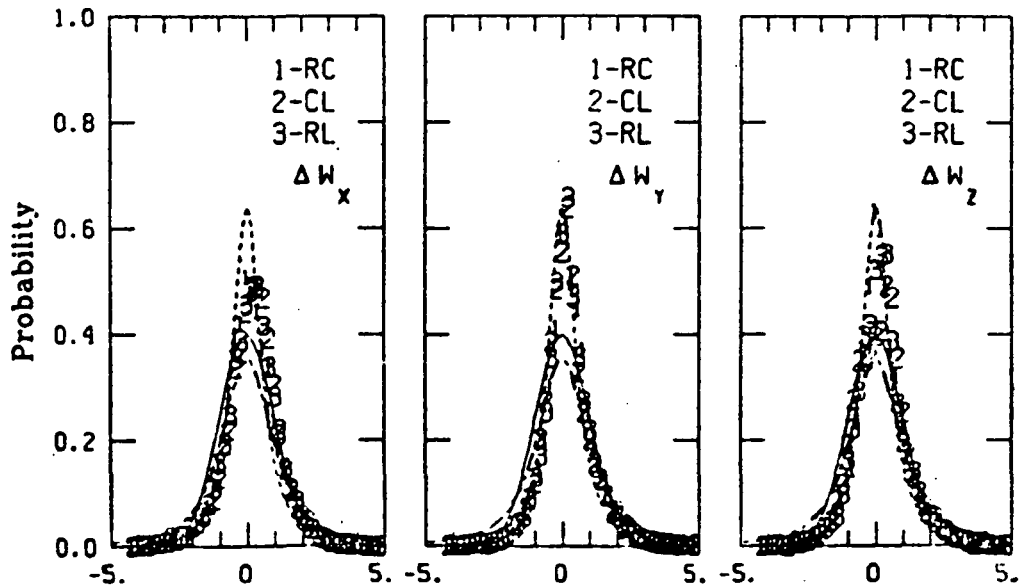

Normalized Velocity Differences (Standard Deviations)

Figure 4. Comparison of probability density function for gust velocities and their differences with theory, Flight 6, Run 5. ($n = 2$, $r = 3$)

Table 8. The Value of the Parameter r of Non-Gaussian Probability Density Function for All Runs of Flight 6.

Run No.	r_{W_X}	r_{W_Y}	r_{W_Z}	$r_{\Delta W_X}$	$r_{\Delta W_Y}$	$r_{\Delta W_Z}$
2	Δ	2.5	7.5	2	2.5	3
3	Δ	Δ	1.5	2	3	3.5
4	3	2.5	4	2	2.5	3
5	2	2.5	3	1.5	3.5	3
6	1	2	1.5	1	1.5	2
8	4	3	6	1.5	2	3
10	Δ	X	3.5	2	X	2.5
11	Δ	1	2	2.5	2.5	2.5
12	2.5	1.5	2.5	2	2.5	2
13	Δ	2	1.5	1.5	2.5	2.5
14	1	1	1.5	1.5	2	2
15	1.5	Δ	1.5	1.5	2	2
16	Δ	1.5	3	1.5	1.5	2
17	3.5	Δ	1.5	1.5	2.5	3
18	1	1.5	2.5	2	2.5	3
19	2	Δ	1.5	1.5	2	2
20	1	1.5	5	2.5	3.5	3
21	3.5	2.5	1.5	2	2.5	2.5
22	2.5	3	4	2.5	2	2.5
23	3.5	Δ	2.5	2.5	3.5	4.5
24	1.5	2.5	2	1.5	2.5	2
25	Δ	Δ	2.5	2	2.5	3
26	3.5	Δ	3.5	2.5	2.5	2
27	Δ	X	2.5	1.5	X	1.5
28	X	X	X	X	X	X
29	2	1	1	1.5	2	2.5
30	Δ	Δ	1	2.5	2.5	2.5
31	1.5	Δ	1.5	1.5	2	1.5
32	1.5	1	1.5	1.5	1.5	2
33	2.5	1.5	2	2	1.5	2
34	2	1	1	2	2	2
35	1	1.5	1.5	1.5	2	2
36	Δ	Δ	1.5	1.5	2	2
37	3	Δ	1.5	1.5	2	2
38	Δ	1	1.5	2	2	2
39	Δ	0.5	2	1.5	1.5	1.5
40	1.5	1.5	2.5	1.5	2	2
41	1	1	2.5	1.5	1.5	2
42	1.5	1.5	1.5	1.5	1.5	1.5
43	Δ	Δ	2	1.5	2	2.5
44	1	1.5	1.5	1.5	1.5	2
46	1	1.5	1.5	1.5	1.5	2
Average	2	1.7	2.3	1.8	2.2	2.3
Total	average	=	2			
σ	0.95	0.69	1.35	0.28	0.55	0.60

r for the probability distribution components of gust velocity and for gust velocity differences vary little.

2.5 Single-point Auto-correlation Coefficient of Gust Velocities

The single-point auto-correlation function for the turbulence wind velocity is defined as

$$R_x(\tau) = \lim_{T \rightarrow \infty} \frac{1}{T} \int_0^T x(t)x(t + \tau)dt$$

where $x(t)$ is time history of turbulence wind velocity with zero mean value, and τ is the lag time. This correlation when normalized by the variance is called the correlation coefficient and is defined as:

$$B_x(\tau) = \frac{R_x(\tau)}{\sigma_x^2}$$

where σ_x is the standard deviation. The single-point auto-correlation coefficient, $B_x(\tau)$, has an absolute value equal to or less than unity. An alternate method for calculating the auto-correlation is to use a Fast Fourier Transform (FFT) as described later.

The single-point auto-correlation coefficients of the severe turbulence wind velocities at three different positions, right wing tip, left wing tip, and nose, are presented on the 5th page of each data set for a given run in Appendix A. Correlation coefficients for all three wind components, the longitudinal, lateral and vertical, are given. The symbols W_X , W_Y , and W_Z indicate the longitudinal, lateral, and vertical components relative to the aircraft frame of reference, respectively. Subscripts R , L , and C refer to

the positions of right wing tip, left wing tip, and center, respectively. For example, W_{XR} presents the longitudinal component at the right wing tip. All auto-correlation coefficients are plotted with the spatial lag distance as the independent variable. Calculated auto-correlation coefficients decrease from unity to zero and fluctuate about the zero axis as the spatial lag distance becomes large. The area obtained by integrating the single-point auto-correlation coefficient from zero lag to the point where the correlation coefficient first becomes zero is multiplied by the mean airspeed to estimate the integral length scale. Since the mean airspeed remains nearly constant throughout the flight, the plots of the auto-correlation coefficients indicate the relative size of the integral length scales. There are no significant differences between the correlation from the three different recording stations for a given wind velocity component, but there is a difference for the different components.

The single-point auto-correlation coefficient of the vertical component decays faster than the lateral and longitudinal components. A slower decay of the auto-correlation coefficient is related to the low frequency of the wind velocity. For example, in Run 17, there is lower frequency content in the lateral component than in the longitudinal component as is seen in the figure of the wind velocity time histories. As expected, the decay of the single-point auto-correlation coefficient is slower for the lateral component than the longitudinal component. The results indicate bad data for the lateral component in Runs 10 and 27, and for all three components in Run 28.

The theoretical model for the single-point auto-correlation coefficient, $B(s)$, developed by von Karman for three velocity components is expressed:

$$B_{W_X}(s) = \frac{2^{\frac{2}{3}}}{\Gamma(\frac{1}{3})} \left(\frac{s}{aL}\right)^{\frac{1}{3}} K_{\frac{1}{3}}\left(\frac{s}{aL}\right)$$

$$B_{W_Y}(s) = \frac{2^{\frac{2}{3}}}{\Gamma(\frac{1}{3})} \left(\frac{s}{aL}\right)^{\frac{1}{3}} \left[K_{\frac{1}{3}}\left(\frac{s}{aL}\right) - \left(\frac{s}{2aL}\right) K_{\frac{2}{3}}\left(\frac{s}{aL}\right) \right]$$

$$B_{W_Z}(s) = \frac{2^{\frac{2}{3}}}{\Gamma(\frac{1}{3})} \left(\frac{s}{aL}\right)^{\frac{1}{3}} \left[K_{\frac{1}{3}}\left(\frac{s}{aL}\right) - \left(\frac{s}{2aL}\right) K_{\frac{2}{3}}\left(\frac{s}{aL}\right) \right]$$

where $a = 1.33$, K is a modified Bessel function of the second kind, L is the turbulence length scale, and s is the spatial lag distance. Comparisons of the theoretical models with the experimental data are shown in Figures 5 through 8. For the longitudinal velocity component, the auto-correlation coefficient of the measured data is higher in value than that predicted by the theoretical von Karman model. For the lateral velocity component, the auto-correlation coefficient agrees with the von Karman model; but for the vertical velocity component, the auto-correlation coefficient is lower than the value predicted by the von Karman model.

2.6 Two-point Auto-correlation Coefficient of Gust Velocities

The two-point auto-correlation of turbulence is a correlation between the same velocity components at two different positions separated by a distance s . The two-point auto-correlation function, $R_x(s, \tau)$, is defined as:

$$R_x(s, \tau) = \lim_{T \rightarrow \infty} \frac{1}{T} \int_0^T x(\xi, t) x(\xi + s, t + \tau) dt$$

where s is the separation distance, τ is the lagtime, and x designates any one of the velocity components W_X , W_Y , or W_Z . The symbol ξ indicates position. The two-point auto-correlation is normalized with the product

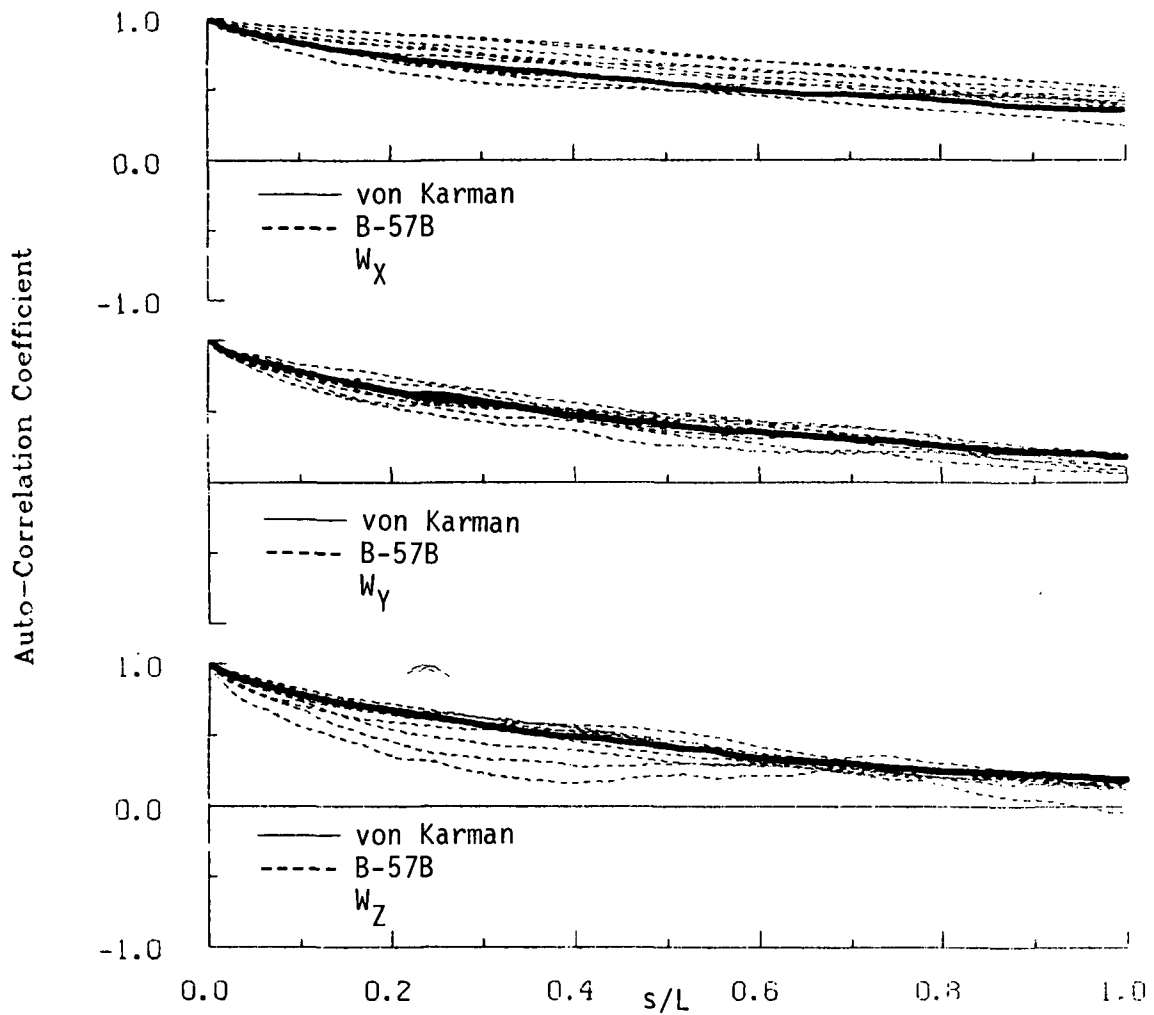

Figure 5. Comparison of single-point auto-correlation of gust velocities with theoretical model; composite of Runs 2 through 13.

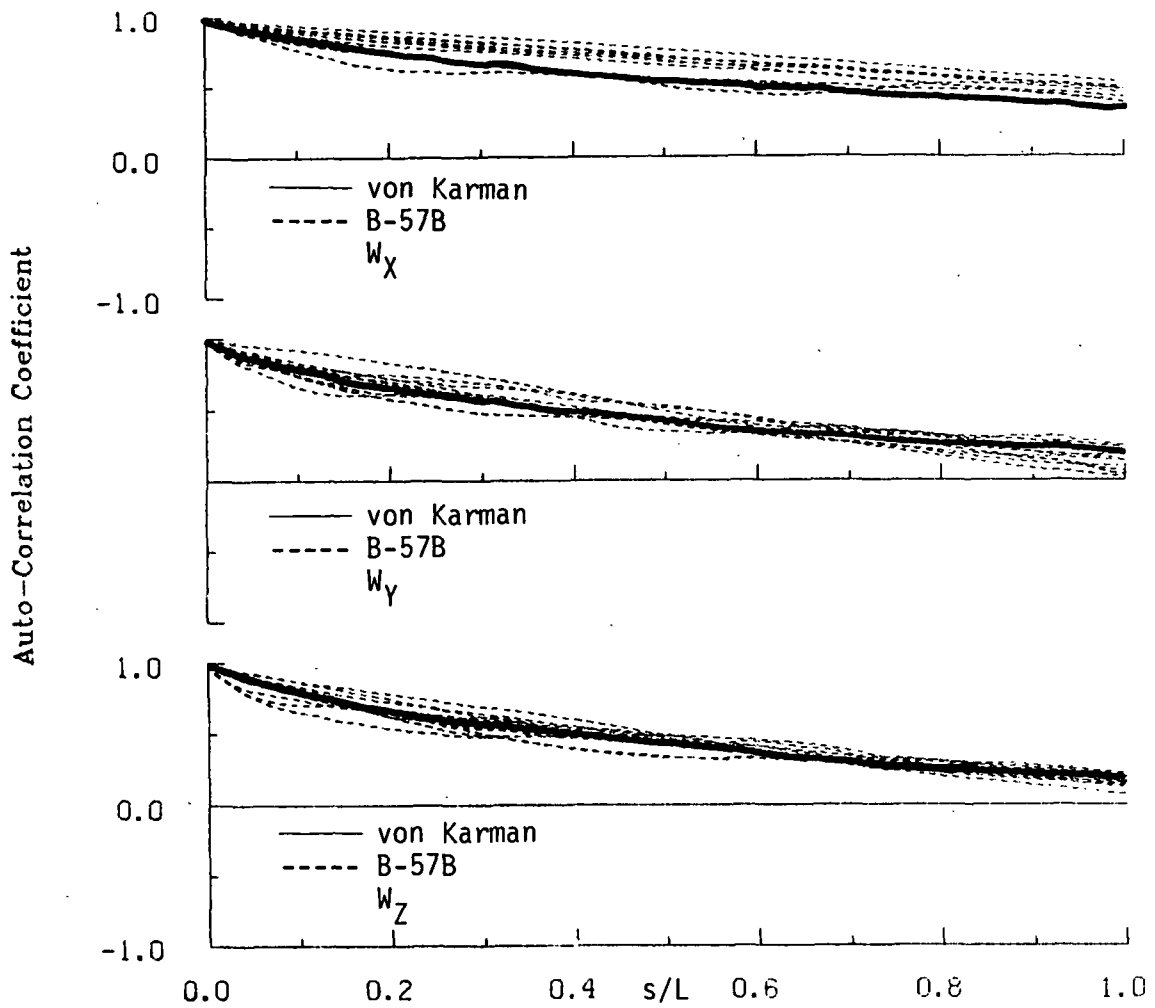

Figure 6. Comparison of single-point auto-correlation of gust velocities with theoretical model; composite of Runs 14 through 23.

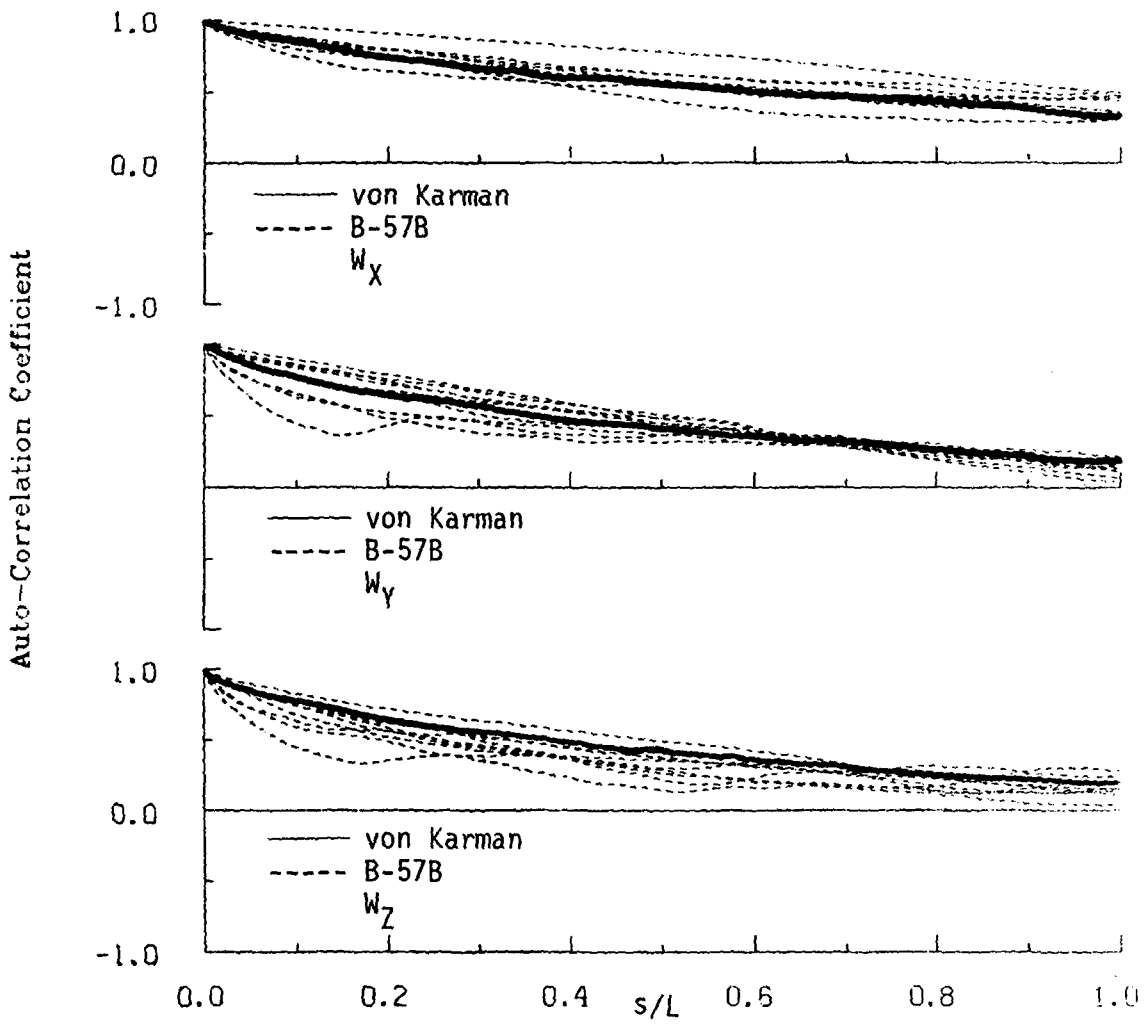

Figure 7. Comparison of single-point auto-correlation of gust velocities with theoretical model; Composite of Runs 24 through 33.

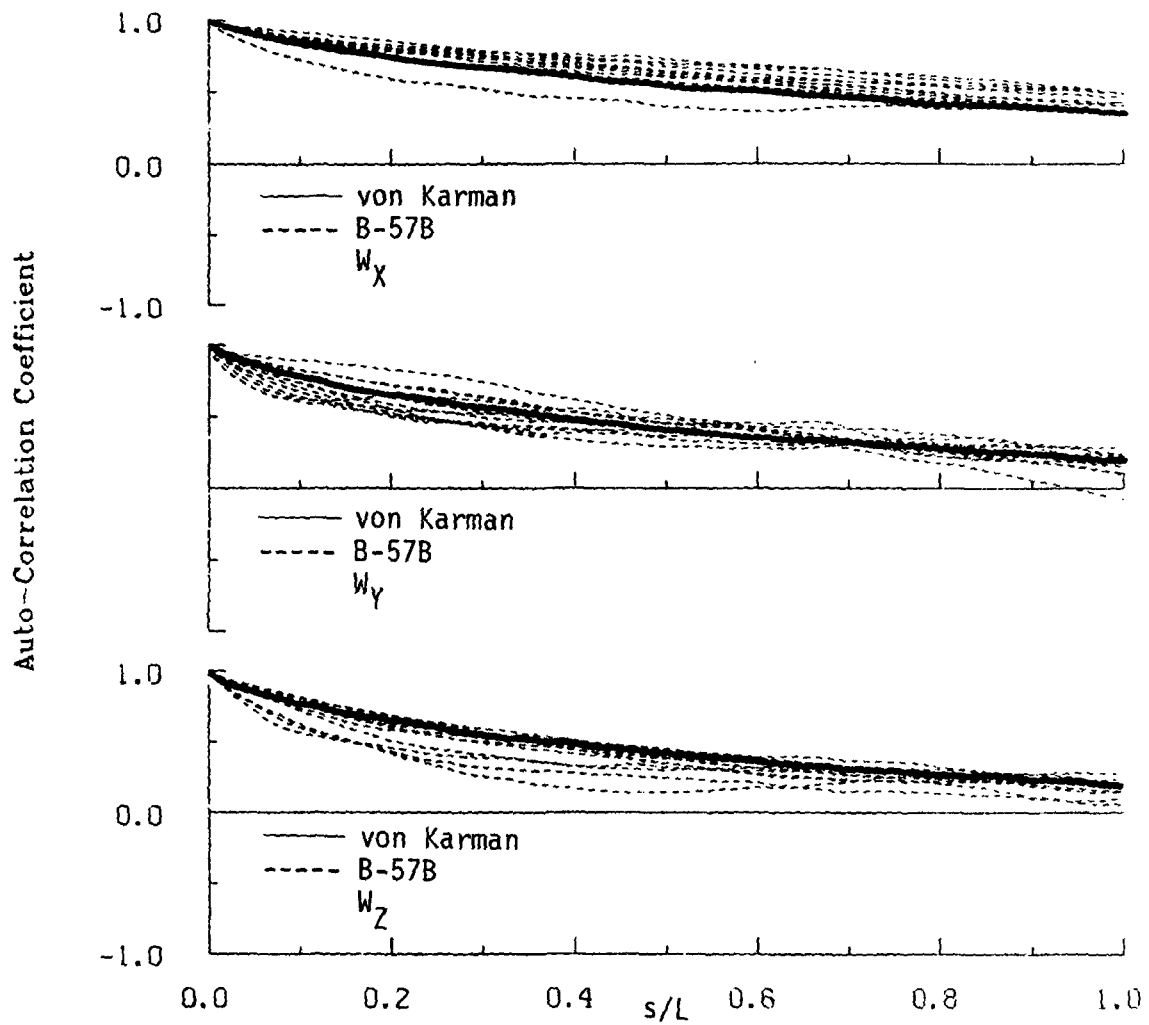

Figure 8. Comparison of single-point auto-correlation of gust velocities with theoretical model; Composite of Runs 34 through 46.

of the standard deviations for positions ξ and $\xi + s$, respectively. The two-point auto-correlation coefficient is defined as:

$$B_x(s, \tau) = \frac{R_x(s, \tau)}{\sigma_x \sigma_{x'}}$$

where σ_x and $\sigma_{x'}$ are the standard deviations of $x(\xi, t)$ and $x(\xi + s, t)$, respectively. The absolute value of $B_x(s, \tau)$ is less than one. The Fast Fourier Transform technique is also an alternative method to calculate the two-point auto-correlation.

The two-point auto-correlation coefficients are plotted on the 6th page of the data set for each run in Appendix A. All three components, W_X , W_Y , and W_Z are correlated between all three measuring stations. The right wing tip and the center is designated by RC , the center and left wing tip by CL , and the right wing tip and left wing tip by RL . For example, the subscript $W_{X_{RC}}$ represents a correlation between the longitudinal components at the right wing tip and the center position.

Since the time histories of the same component at the three different positions do not differ much, the two-point auto-correlation coefficients are similar to the single-point auto-correlation coefficients. This is a direct consequence of the fact that the characteristic length scale of the turbulence is very large compared to the length of the aircraft wing span. As expected, at zero spatial lag, the two-point auto-correlation is not unity. In general, the two-point auto-correlations decay faster for the vertical component than for the longitudinal or the lateral component.

The correlations are also related to the wind direction along the flight path, which is shown on the first page for each run in of Appendix A. To understand this effect, first consider the longitudinal wind velocity compo-

ment. When the longitudinal wind velocity component changes gradually from a head wind to a tail wind (or vice versa), the correlations decay slowly. Examples that illustrate this are Runs 3, 13, 16, 23, 25, 26, 29, 30, 42, and 43. If the longitudinal wind component changes very quickly from a head wind to a tail wind and back to a head wind repeatedly, the correlations decay faster than in the previous case. Examples are Runs 17 and 40. In other cases, the longitudinal wind component does not change polarity (i.e., remains either a head wind or a tail wind for the duration of the flight), and the magnitude changes smoothly. The correlations then decay very slowly as illustrated by Runs 31, 32, 33, 34, 38, 39 and 41.

Now consider the lateral wind velocity component. When the wind changes direction gradually from the left side to the right side (or vice versa), the correlations decay rapidly as shown by Runs 11, 33, 44, and 46. In other cases, the wind does not change direction, but the magnitude of the wind velocity changes smoothly. The correlations then decay slowly as in Runs 13, 25, 31, 32, 36, 37, 42 and 43.

The effect of bad data is again observed in runs Runs 10, 27 (lateral component only) and Run 28 (all three components) and should be discarded.

2.7 Normalized Auto-spectra of Gust Velocities

The single-point auto-spectrum density function of turbulence is a measure of the frequency distribution of the wind kinetic energy. The auto-spectrum is defined as the Fourier transform of the single-point auto-correlation in the following way:

$$S_x(f) = \int_{-\infty}^{\infty} R_x(\tau) e^{-j2\pi f\tau} d\tau$$

where f is frequency, τ is lag time, and j is $\sqrt{-1}$ and x is any of the three wind velocity components W_X , W_Y , and W_Z . In this equation, the frequency f ranges from negative to positive infinity. This spectrum is two-sided; but because of the symmetry of the single-point auto-correlation, the spectrum is also symmetric:

$$S_x(f) = S_x(-f)$$

The negative frequency does not have a physical meaning and, hence, the one-sided spectrum density function is introduced:

$$\begin{aligned}\Phi_x(f) &= 2S_x(f) \\ &= 2 \int_{-\infty}^{\infty} R_x(\tau) e^{-j2\pi f\tau} d\tau\end{aligned}$$

The frequency ranges from zero to infinity. Since the single-point auto-correlation function is an even function of τ , and there is no phase angle, the auto-spectrum is given by the real part of the Fourier transform only:

$$\Phi_x(f) = 4 \int_0^{\infty} R_x(\tau) \cos 2\pi f\tau d\tau$$

Similarly, the single-point auto-correlation is the Fourier inverse transform of the single-point auto-spectrum.

$$R_x(\tau) = \int_0^{\infty} \Phi_x(f) \cos(2\pi f\tau) df$$

when τ equals zero, this becomes the square of the standard deviation:

$$\begin{aligned}R_x(0) &= \int_0^{\infty} \Phi_x(f) df \\ &= \sigma_x^2\end{aligned}$$

An integration of the auto-spectrum between two frequency limits, f_1 and f_2 , represents the wind kinetic energy in the frequency range f_1 to f_2 .

Another way to calculate the auto-spectrum density function is by applying a direct Fourier transform to the turbulence wind velocity data. This method is much more convenient and saves computer time; therefore, it is used to compute all auto-spectra given in this report.

The theoretical von Karman model for the auto-spectrum density function, Φ , for all three velocity components is expressed as follows:

$$\Phi_{W_X}(K) = \sigma_{W_X}^2 \frac{2L_{W_X}}{\pi} \frac{1}{[1 + (1.339L_{W_X}K)^2]^{\frac{5}{6}}}$$

$$\Phi_{W_Y}(K) = \sigma_{W_Y}^2 \frac{L_{W_Y}}{\pi} \frac{1 + \frac{8}{3}(1.339L_{W_Y}K)^2}{[1 + (1.339L_{W_Y}K)^2]^{\frac{11}{6}}}$$

$$\Phi_{W_Z}(K) = \sigma_{W_Z}^2 \frac{L_{W_Z}}{\pi} \frac{1 + \frac{8}{3}(1.339L_{W_Z}K)^2}{[1 + (1.339L_{W_Z}K)^2]^{\frac{11}{6}}}$$

σ is the standard deviation; L is the integral length scale; κ is the wave number, ω/V ; ω is spatial frequency and V is mean airspeed. On a logarithmic plot, an increase in the standard deviation will increase the area under the curve. The length scale also affects the shape of the spectrum primarily in the location of the "knee" of the curve.

In computing the auto-spectrum density function of turbulence, the data record is normally divided into segments each of 512 datum points. However, in some runs, because longer time records were available, the segments consist of 1024 datum points. The number of datum points in each segment determines the lowest frequency of turbulence wind energy in

the computed spectrum. On the other hand, the accuracy of the spectrum increases with the number of segments used. The highest frequency of the auto-spectrum is the cutoff frequency, or Nyquist frequency, f_c , and is given by one half of the sampling rate. The B-57B airplane instrumentation has a sampling rate of 40 Hz; therefore, the cutoff frequency is 20 Hz. The lowest frequency is 0.078 Hz for 512 datum points and 0.039 Hz for 1024 datum points. The auto-spectrum is normalized by the square of the standard deviation. The normalized auto-spectrum is plotted versus wave number κ on the 7th page for each run in Appendix A. The figures on this page present spectra for each run at all three recording positions and for all three wind components. In order to eliminate the uncertainty occurring at high frequency (which is discussed later), the auto-spectra are plotted only to a frequency of 5 Hz.

In Figure 9, the normalized auto-spectra of gust velocities are plotted for Run 5 of Flight 6. An abnormal spike occurs in the left wing tip spectrum of the longitudinal component at a frequency of about 10 Hz. Wind components are calculated from several parameters measured by various instruments on the B-57B airplane. To determine the source of this spike in the spectra, each of the parameters used to calculate W_X were carefully analyzed. The longitudinal wind component is calculated in the following way:

$$W_X(t) = \hat{V}_E(t)\sin\bar{\psi} + \hat{V}_N(t)\cos\bar{\psi} - \hat{V}(t) + \ell_y\hat{\psi}(t)$$

$$\hat{V}(t) = (65.76881)(0.3048)M\sqrt{T_c}$$

$$M = \left(5 \left(\frac{q_c}{p} + 1 \right)^{2/7} - 1 \right)^{1/2}$$

ORIGINAL PAGE IS
OF POOR QUALITY

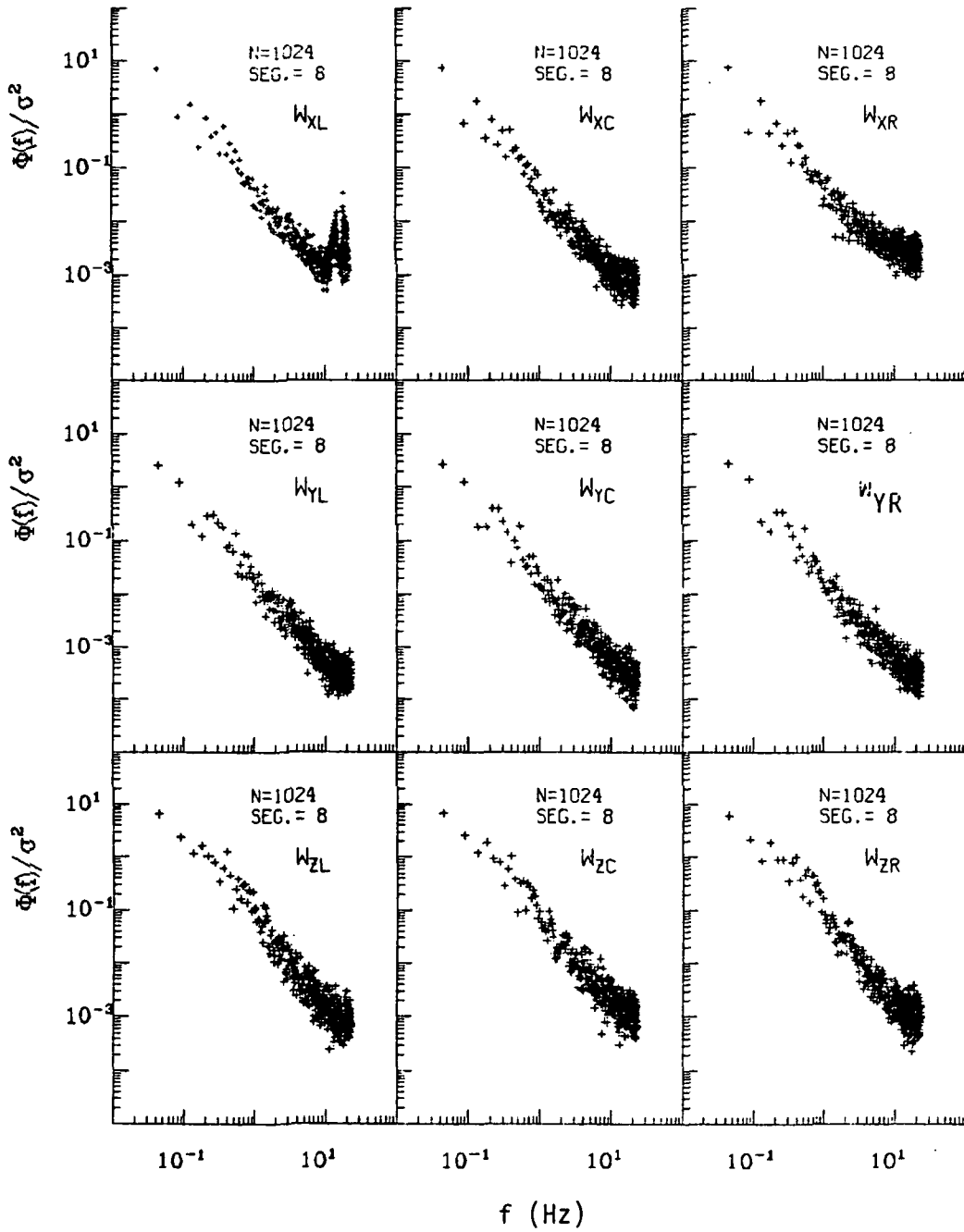

Figure 9. Normalized auto-spectra of gust velocities showing spike in the longitudinal spectra, Flight 6, Run 5.

$$T_c = T_o / \left(\frac{q_c}{p} + 1 \right)^{2/7} = \frac{T_o}{1 + 0.2M^2}$$

where the symbols are defined in the list of nomenclature. In these equations, only the term $\hat{V}(t)$ differs noticeably at the three different probes. The parameters used to compute $\hat{V}(t)$ are q_c , p , and T_c . Thus, these parameters need to be investigated further. Figure 10 shows the spectra for these parameters. There is an obvious problem with the measurement of impact pressure at the left wing tip boom, and a slight problem with the measurement of free stream-static pressure. The spectrum for the free stream-static pressure approaches a constant at roughly 5 Hz indicating a high noise level. Velocities computed from measurements at all the probes use the same free-stream static pressure measurement.

Several spectra for q_{CL} and for P_e showed these same characteristics while others behaved perfectly normally. It is believed that water droplets in the pitot tube inlet were responsible for these data abnormalities. Since this error always occurs at frequencies higher than 5 Hz, the spectra presented in the report are truncated at 5 Hz.

Additional biasing in the energy spectrum is identified by a rise in the high-frequency region. Houbolt suggests this is due to the "top hat" digitizing of turbulence data and proposes a correction factor to account for this effect:

$$C.F. = \left[\frac{2(1 - \cos \omega \Delta t)}{(\omega \Delta t)^2} \right]^2$$

Here ω is spatial frequency and Δt is the time increment. This correction

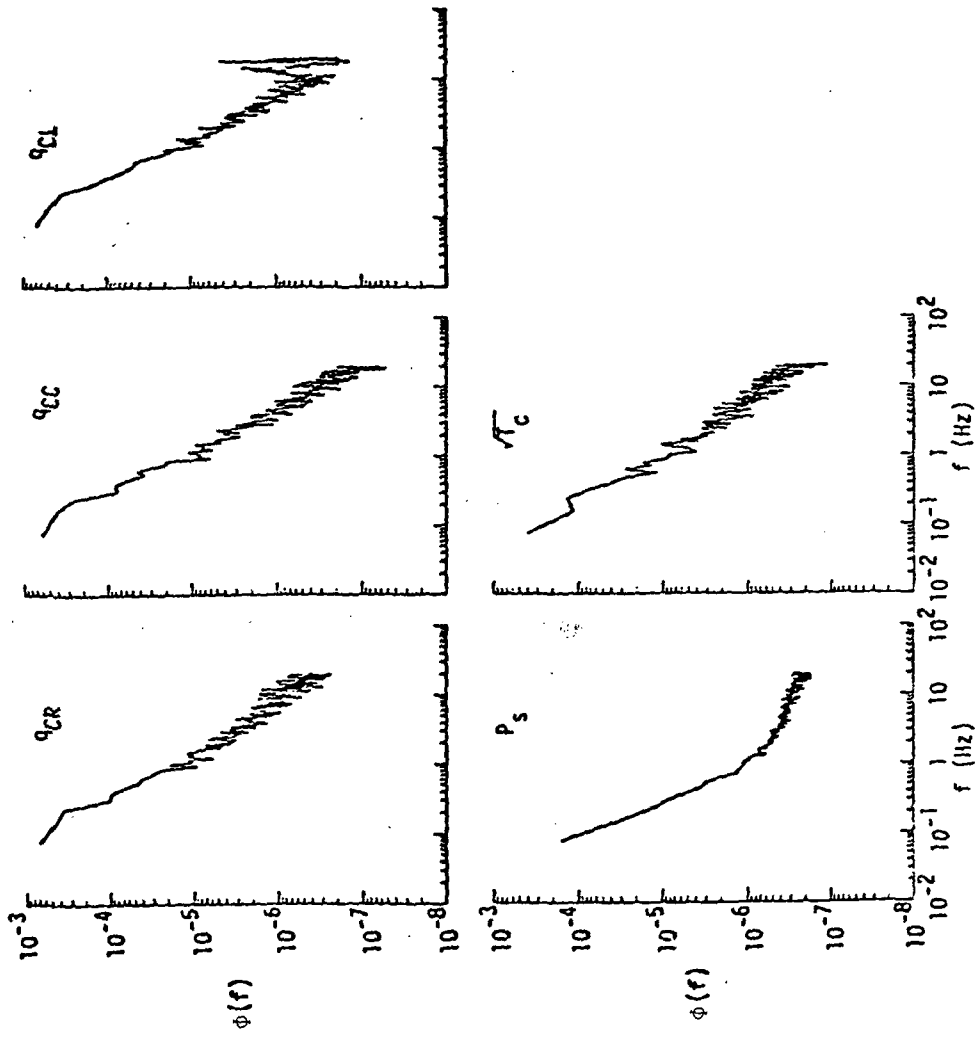

Figure 10. Spectra of variables used to compute W_x .

factor has almost no influence on the signal in the low-frequency region, but it decreases the spectrum value in the high-frequency region. In Figure 11, the effect of this correlation factor is illustrated. Symbol 1 represents the spectrum without, and Symbol 2 represents the spectrum with, the correction factor. The difference between Symbols 1 and 2 is obviously greatest in the high-frequency region.

To analyze the influence of the Houbolt correction factor, a decaying exponential time series given by:

$$X(t) = e^{-a|t|}, -\frac{T}{2} < t < \frac{T}{2}$$

is investigated. The decay rate is defined by the constant, a . From this equation, the single-point auto-correlation is calculated using the Fast Fourier computer algorithm. In turn, by taking a Fourier Transform of the auto-correlation, the exact spectrum is obtained. The exact result is:

$$\Phi(f, T) = \frac{2}{T} \left[\frac{2a - 2(a \cos \pi f T - 2\pi f \sin \pi f T) e^{-\frac{aT}{2}}}{a^2 + 4\pi^2 f^2} \right]^2$$

T is total record time. To check the correction factor, the analytical curve is digitized with the following described parameters: $a = 0.1$, $\Delta t = 0.1$ second, $N = 512$, $\Delta f = 0.039 Hz$, and $T = 51.2$ seconds. These results are shown in Figure 12. The solid line represents the exact spectrum, and the symbols represent the digitized signal without the correction factor and with the correction factor, respectively. The theoretical line coincides with

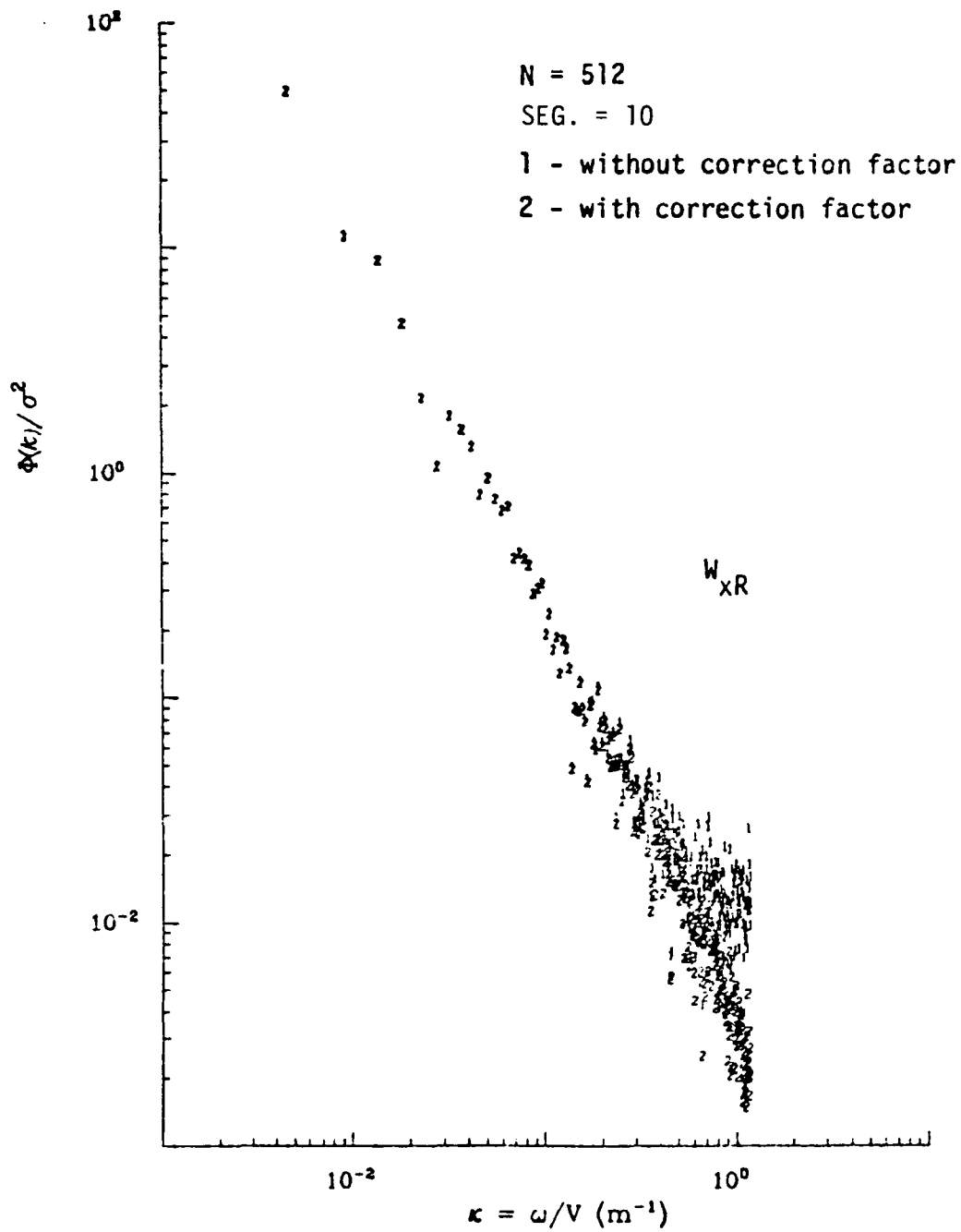

Figure 11. Normalized auto-spectra of gust velocities showing influence of the Houbolt correction factor, Flight 6, Run 42.

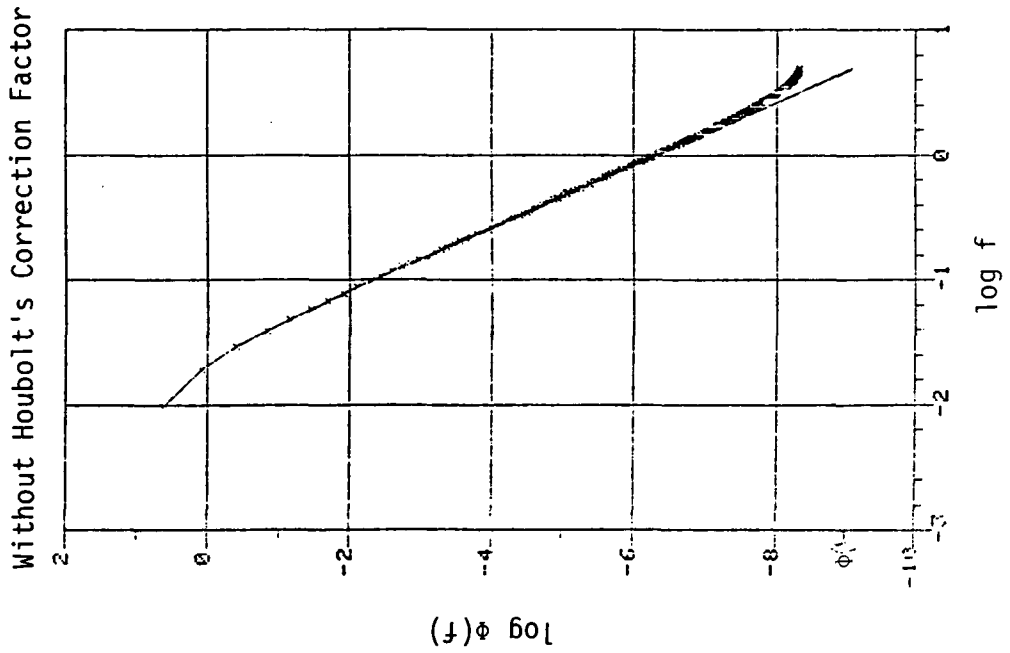
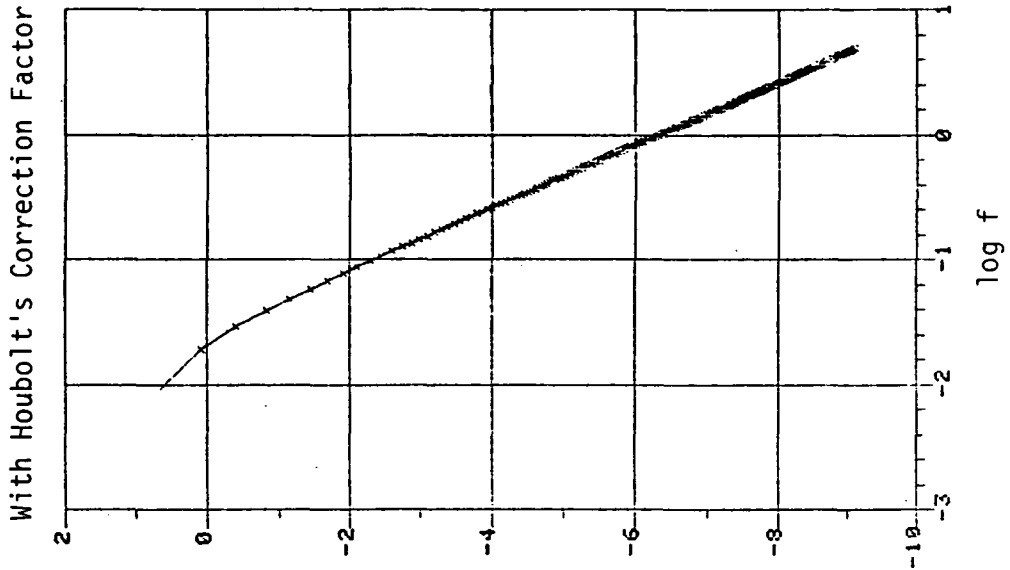

Figure 12. Comparison of theoretical and FFT computer algorithm for an idealized time history $X(t) = e^{-a|t|}$ with and without correction.

the exact spectrum, when the correction factor is applied. Although the correction has not been used in the analysis, it is recommended for use in subsequent analyses.

As mentioned previously, smoothing is accomplished in all spectra plots by ensemble averaging. The smoothing procedure is carried out in the following way.

The original time record, T_r , is divided into q separate segments, where each time segment is of length T_r' . The smooth spectrum is given by:

$$\Phi_k = \frac{1}{q} [\Phi'_{k,1} + \Phi'_{k,2} + \dots + \Phi'_{k,q}]$$

where $\Phi'_{k,q}$ is the spectrum at frequency f_k of the q th time slice. The bandwidth B_e with this approach becomes $1/T_r'$. Thus, the degree of freedom is:

$$\eta = 2B_e T_r = 2q$$

The normalized standard error, E_r , is then given by

$$E_r = \sqrt{\frac{1}{B_e T_r}} = \sqrt{\frac{1}{q}}$$

Therefore, the larger the value of q becomes, the smaller the normalized standard error. In this study, the parameters used are Δt equals 0.025 second; f_c is 20 Hz. The total sampling time, T_r , for each run ranges in length from 38.4 seconds to 128 seconds; the total number of datum points,

N , varies from 1536 to 5120. The number of segments, q , varies from 8 to 10 depending upon the length of each run. The time segments, T' , are either 12.8 seconds (512 datum points) or 25.6 seconds (1024 data points). The bandwidth, B_e , is either 0.039 Hz or 0.078 Hz. Calculations of rms error range from 32 percent in Run 33 to 58 percent in Run 8.

In Figure 13, the von Karman spectrum model is compared with the normalized auto-spectra of all three gust velocity components from Run 2 through Run 24, measured at the center probe. The experimental data fit the von Karman spectrum reasonably well considering the data are, in fact, nonstationary in the statistical sense. However, there is substantial scatter in the data. Longer data records would reduce the scatter, i.e., more effective ensemble averaging. Figures 13 and 14 illustrate this phenomena. Figure 14 is a similar comparison of the von Karman model with measured data, but it is taken from Runs 25 to 46. The average number of segments used in the ensemble average in Figure 13 is 4.7; but in Figure 14, it is 5.9. Thus, the measured data given in Figure 14 are slightly smoother than those in Figure 13. Due to the length of the records, no results below 0.039 Hz can be calculated. Note also other techniques of selecting L would provide a better fit to the von Karman model (see Houbolt, et al. 1964).

Comparison of von Karman's theoretical auto-spectrum model with experimental data measured by the B-57B airplane is shown on Page 7 of the Appendix for each run. The symbols W_X , W_Y , and W_Z represent the longitudinal, lateral and vertical components, N is the number of data points, and SEG . represents the number of segments used in each run.

Generally, the experimental auto-spectra compares reasonably well with the von Karman spectrum model. A few cases, however, where the

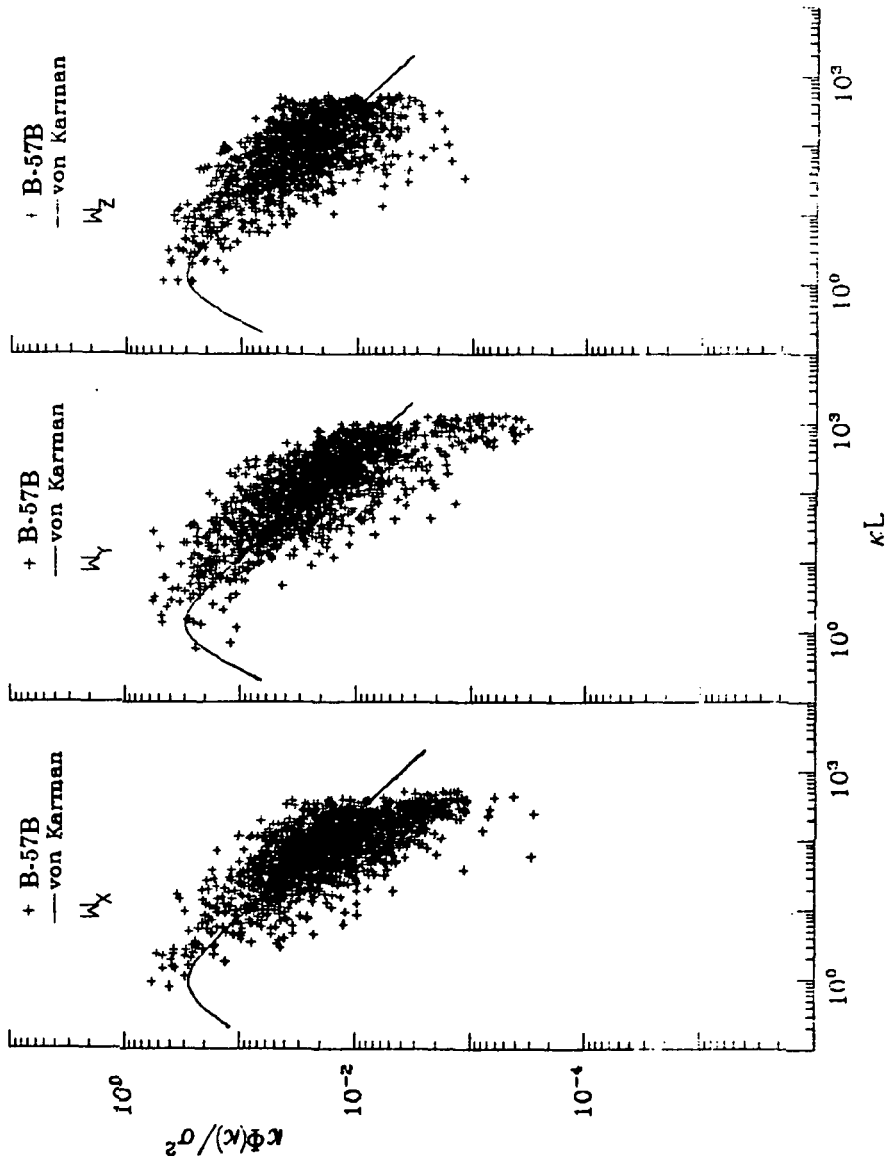

Figure 13. Comparison of auto-spectra of gust velocities with von Karman model, Runs 2 through 24.

ORIGINAL PAGE IS
OF POOR QUALITY

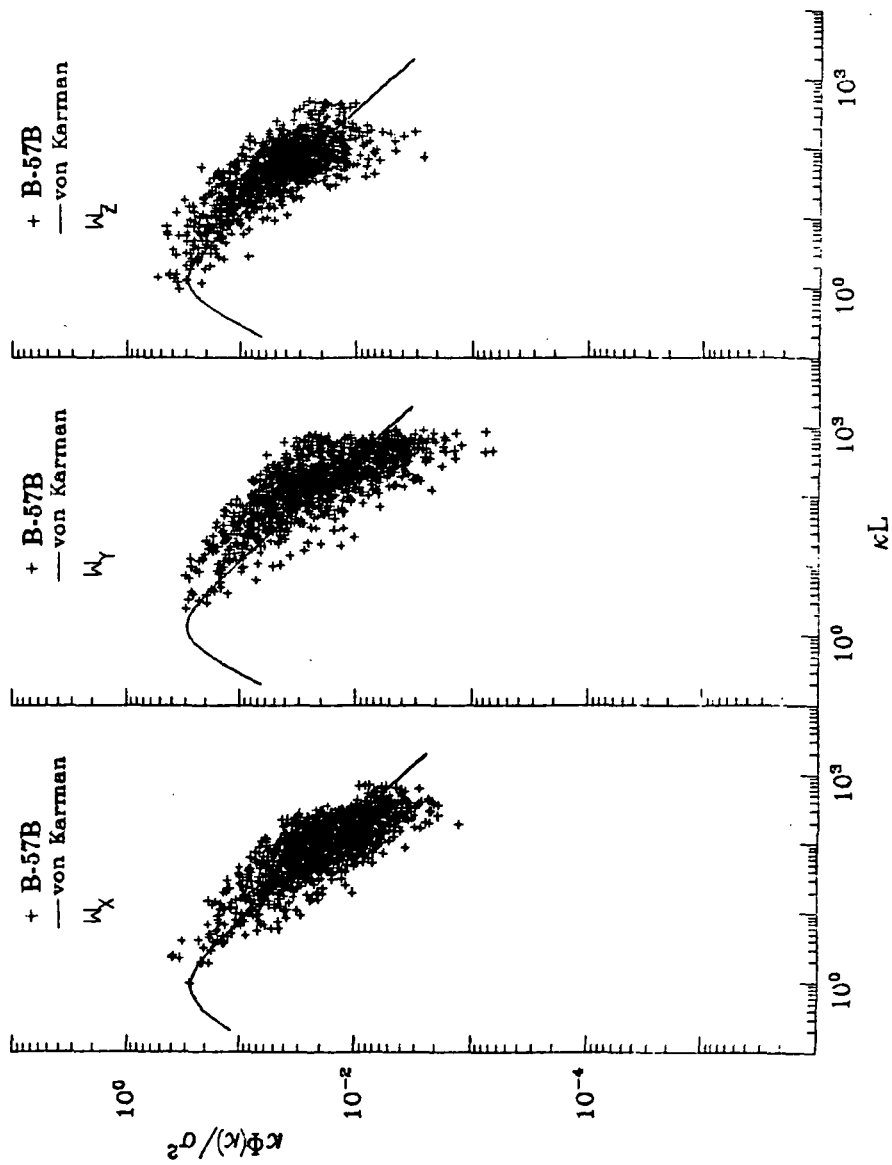

Figure 14. Comparison of auto-spectra of gust velocities with von Karman model, Runs 25 through 46.

experimental auto-spectrum does not fit the theoretical model, may be explained as follows. First, consider the case where the value of the experimental auto-spectrum is larger than the value of the von Karman spectrum model at a given wave number. Such examples are the longitudinal component in Run 41; the lateral component in Runs 24, 33, 41, 42, and 43; the vertical component in Runs 11, 16, 24, 33, 34, 43, and 44. The von Karman spectrum model is a function of the integral length scale. In this case, the large integral length scale resulted in a poor fit for the experimental auto-spectrum with the von Karman model. The explanation for the large integral length scale can be found by examining the plot of the single-point auto-correlation coefficient. The auto-correlation normally reaches zero and then oscillates in a sinusoidal manner about zero. But, in the cases under discussion, the auto-correlation does not reach zero before the sinusoidal behavior begins. Thus, only at a large spatial lag does the auto-correlation become zero, which, as noted earlier, is taken as the cut-off of the integration in the length scale calculations.

A second case to consider is the situation where the value of the experimental auto-spectrum is less than the value of the von Karman spectrum. Examples are the longitudinal component in Runs 3, 13, and 16; and the lateral component in Runs 23, 25, 31, and 37. In these cases, the integral length scale which is used in the von Karman model is too small to provide a reliable fit with the experimental spectrum. In turn, the auto-correlation coefficient decays linearly and too quickly. The reason for this rapid decay is that the corresponding time histories display the following behavior. Dividing the time history into two parts, one half is above zero, and the other is consistently less than zero. These records apparently contain considerable

patchiness or nonstationarity.

Because the proper length scale is difficult to determine, calculations of auto-spectrum without directly computing the length scale was investigated. Consider the equation for the von Karman spectrum model. The length scale is one of the parameters, but the length scale can be combined with other parameters to form a new variable. This new variable can be determined by applying a curve fitting technique to the experimental data. For example, the von Karman model for the longitudinal component is expressed:

$$\Phi(\kappa) = \frac{2\sigma^2 L}{\pi} \frac{1}{[1 + (1.339 L\kappa)^2]^{5/6}}$$

assuming that $L\kappa \gg 1$.

$$\Phi(\kappa) = \frac{2\sigma^2 L}{\pi} \frac{1}{(1.339 L\kappa)^{5/3}}$$

$$\Phi(\kappa) = \frac{2\sigma^2}{\pi L^{2/3}} \frac{1}{(1.339\kappa)^{5/3}}$$

By rearranging this equation, it becomes:

$$\frac{\sigma^2}{L^{2/3}} = \frac{\pi}{2} (1.339\kappa)^{5/3} \Phi(\kappa)$$

At a certain wave number, say κ_1 , there is a corresponding value of the experimental spectrum $\Phi(\kappa_1)$ illustrated in Figure 15. The parameter

$(\sigma^2/L^{2/3})$ can then be evaluated at several wave numbers and an average estimated.

The spectrum equation of the von Karman model can be written:

$$\Phi(\kappa) = \frac{2}{\pi} \sigma^5 \left(\frac{L^{2/3}}{\sigma^2} \right)^{3/2} \frac{1}{\left[1 + (1.339\sigma^3\kappa)^2 \left(\frac{L^{2/3}}{\sigma^2} \right)^3 \right]^{5/6}}$$

Now the value of $(\sigma^2/L^{2/3})$ is substituted into this equation and the von Karman spectrum is evaluated without use of the integral length scale.

Figure 16 shows a comparison of experimental data with the von Karman spectrum equation using the integral length scale and that determined by the curve fit method for Run 42. The curve fit always passes through the data to which it has been fitted. The von Karman spectrum, based on the directly integrated integral length scale model, correlates most data well but is not as reliable as the $(L^{2/3}/\sigma^2)$ parameter model.

2.8 Normalized Two-point Auto-spectra of Gust Velocities

The two-point auto-spectrum density function is defined as the Fourier transform of the two-point auto-correlation function between the same velocity component at two different positions. It is expressed as:

$$S_{x,x'}(s, f) = \int_{-\infty}^{\infty} R_{x,x'}(s, \tau) e^{-j2\pi f\tau} d\tau$$

where subscripts x and x' denote the velocity components for the same direction (i.e., longitudinal, lateral or vertical) but separated by the spatial separation distances. The frequency f is a parameter that can vary between

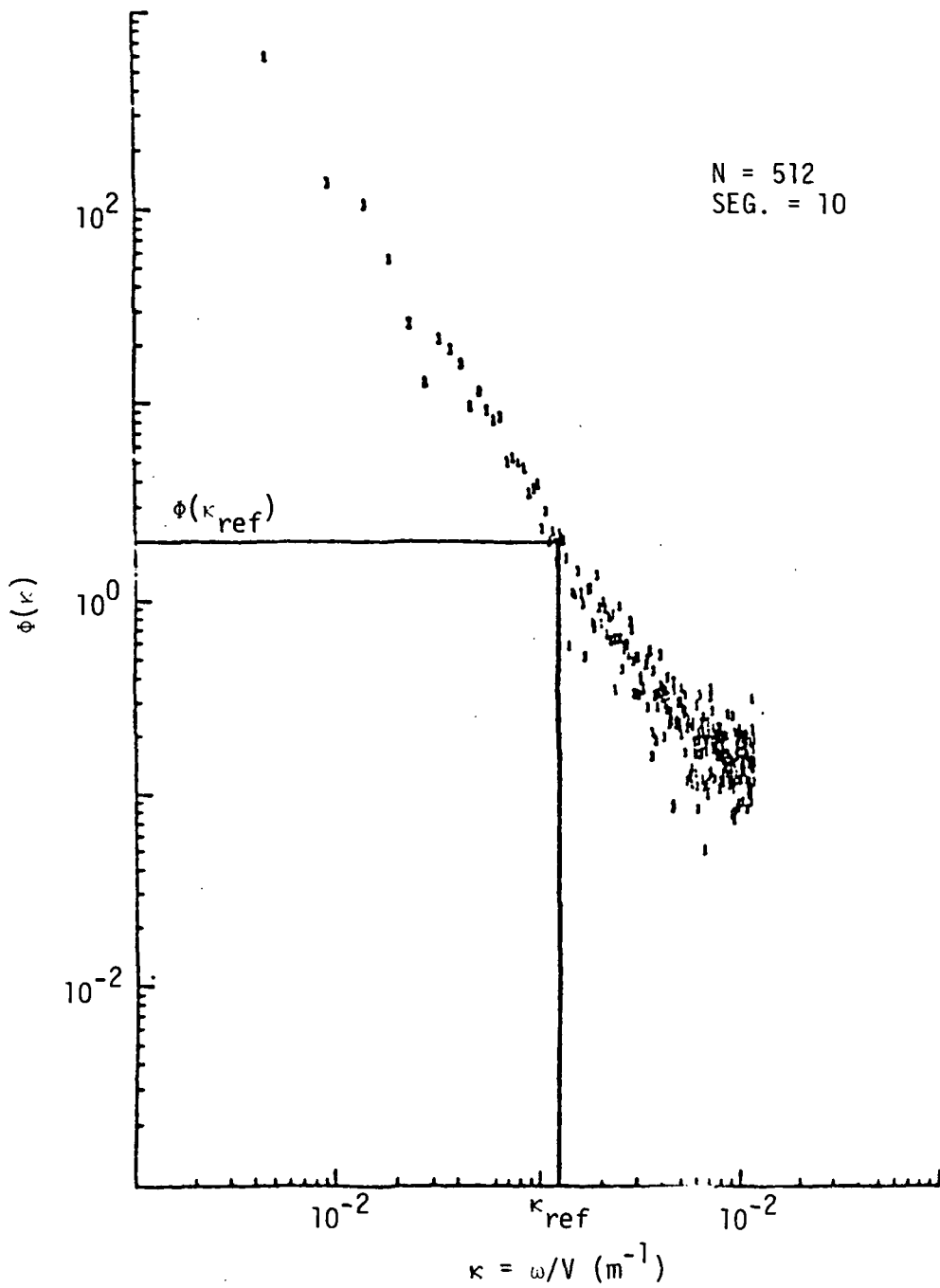

Figure 15. Illustration of selection of reference $\phi(\kappa_{\text{ref}})$ for normalized auto-spectra of W_{xR} velocity, Flight 6, Run 42.

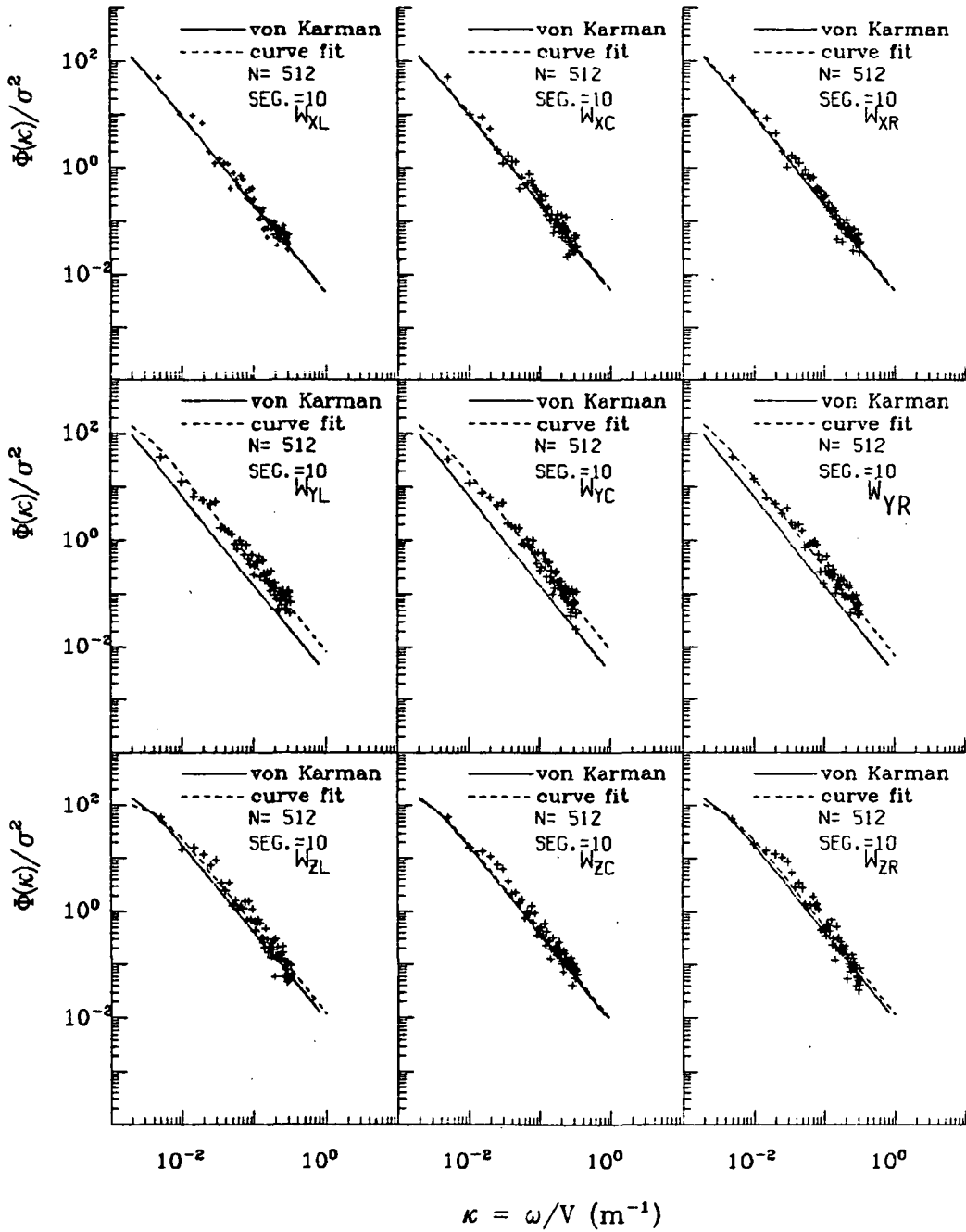

Figure 16. Normalized auto-spectra of gust velocities, Flight 6, Run 42.

minus and plus infinity. The two-point correlation $R_{x,x'}(s, \tau)$ is integrated over time, τ , from negative to positive infinity. Because $R_{x,x'}(s, \tau)$ is not an even function, the spectrum density function $S_{x,x'}(s, f)$ is generally a complex number and is called a two-sided spectrum. The one-sided two-point auto-spectrum density function $\Phi_{x,x'}(s, f)$ is similar, but it is defined only for all positive frequencies as:

$$\begin{aligned}\Phi_{x,x'}(s, f) &= 2 \int_{-\infty}^{\infty} R_{x,x'}(s, \tau) e^{-j2\pi f\tau} d\tau \\ &= C_{x,x'}(s, f) - jQ_{x,x'}(s, f)\end{aligned}$$

where the real part, $C_{x,x'}(s, f)$ is called the coincident spectral density function, and the imaginary part, $Q_{x,x'}(s, f)$, is called the quadrature spectral density function. It is convenient in practice to represent the two-point auto-spectrum in terms of a magnitude and a phase angle in the following way:

$$\Phi_{x,x'}(s, f) = |\Phi_{x,x'}(s, f)| e^{-j\theta_{x,x'}(s, f)}$$

where

$$|\Phi_{x,x'}(s, f)| = \sqrt{C_{x,x'}^2(s, f) + Q_{x,x'}^2(s, f)},$$

and

$$\theta_{x,x'}(s, f) = \tan^{-1} \left[\frac{Q_{x,x'}(s, f)}{C_{x,x'}(s, f)} \right]$$

Another method to compute the two-point auto-spectrum is to perform a direct Fourier transform on the two turbulence wind velocity time histories. This method is used because it is convenient and fast. The quadrature spectrum, $Q_{x,x'}$, is always smaller than the coincident spectrum, $C_{x,x'}$, for frequencies less than about 0.4 Hz. However, for higher frequencies, these two spectra are of the same order. Figure 17 shows this phenomena for Flight 6, Run 42. Plotted are the three velocity components correlated between the right wing tip and the center position. The coincident spectra have the highest value at a frequency equal to 0.078 Hz, and then decrease to near zero at a frequency equal to 1 Hz. The quadrature spectra have values near zero for all frequencies. The results are similar for other runs, except that the coincident spectra decay faster in some of the runs. The magnitude of the two-point auto-spectrum is normalized by dividing it with the product of the standard deviations for the individual velocity time histories at each location in space.

On the 8th page for each run in Appendix A, the normalized two-point auto-spectra are plotted versus wave number, κ . The figures include three different separation positions and three velocity components. The subscriptions CL , RC , and RL represent the separation positions between the center and the left wing tip, between right wing tip and the center, and between the right and left wing tips, respectively. For example, W_{XCL} represents the longitudinal velocity component correlated between the center and the left wing tip. N is the number of datum points in each segment of the time history used for calculating the spectrum by the fast Fourier transform technique. Frequencies higher than 5 Hz were not plotted because of the uncertainty in the data at high frequencies, as described earlier.

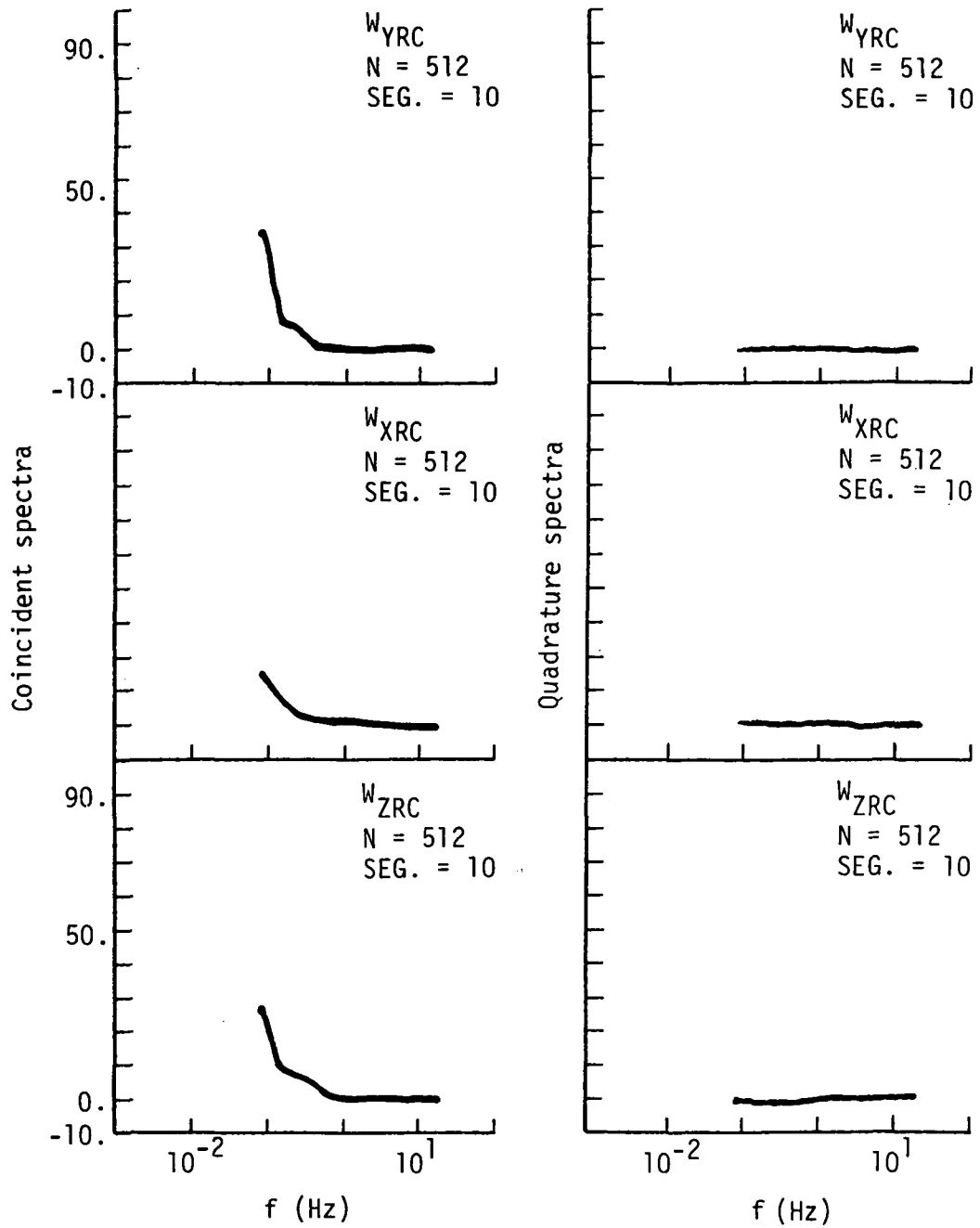

Figure 17. Coincident spectra and quadrature spectra of gust velocities, Flight 6, Run 42.

The magnitude of the two-point auto-spectra decays almost linearly in the high-frequency region on a logarithmic plot.

The results of the two-point auto-correlation calculations are close to the results of the single-point auto-correlation calculations for the same velocity component. The theoretical model of the two-point auto-spectrum developed by Houbolt and Sen (1972) shows that this spectrum is a function of the ratio of separation distance to length scale (s/L). Not surprisingly, when s/L approaches zero, the properties of the two-point auto-spectrum approach the properties of the single-point auto-spectrum. In Flight 6, the values of s/L range from 0.0051 to 0.13 for the longitudinal, from 0.0025 to 0.156 for the lateral, and from 0.0058 to 0.189 for the vertical velocity component. Again, abnormal results in Runs 10, 27, and 28 are attributed to bad data.

Houbolt and Sen developed a theoretical model for the two-point auto-spectra function. They considered the gust field to be homogeneous and isotropic. In their derivation, the velocity fluctuation, W_X , was taken as the value perpendicular to the line of separation. This, however, is not correct since W_X is generally defined in the direction of the aircraft body axis. Figure 18 illustrates the various parameters referred to in the text.

To correct Houbolt and Sen's two-point auto-spectral function, a Fourier transform of the correlation:

$$R_{W_X W_X}(\zeta) = \frac{s^2}{\xi^2 + s^2} R_{W_N W_N}(\xi) + \frac{\xi^2}{\xi^2 + s^2} R_{W_P W_P}(\zeta)$$

is required where $R_{W_N W_N}(\zeta)$ and $R_{W_P W_P}(\zeta)$ are the conventional longitu-

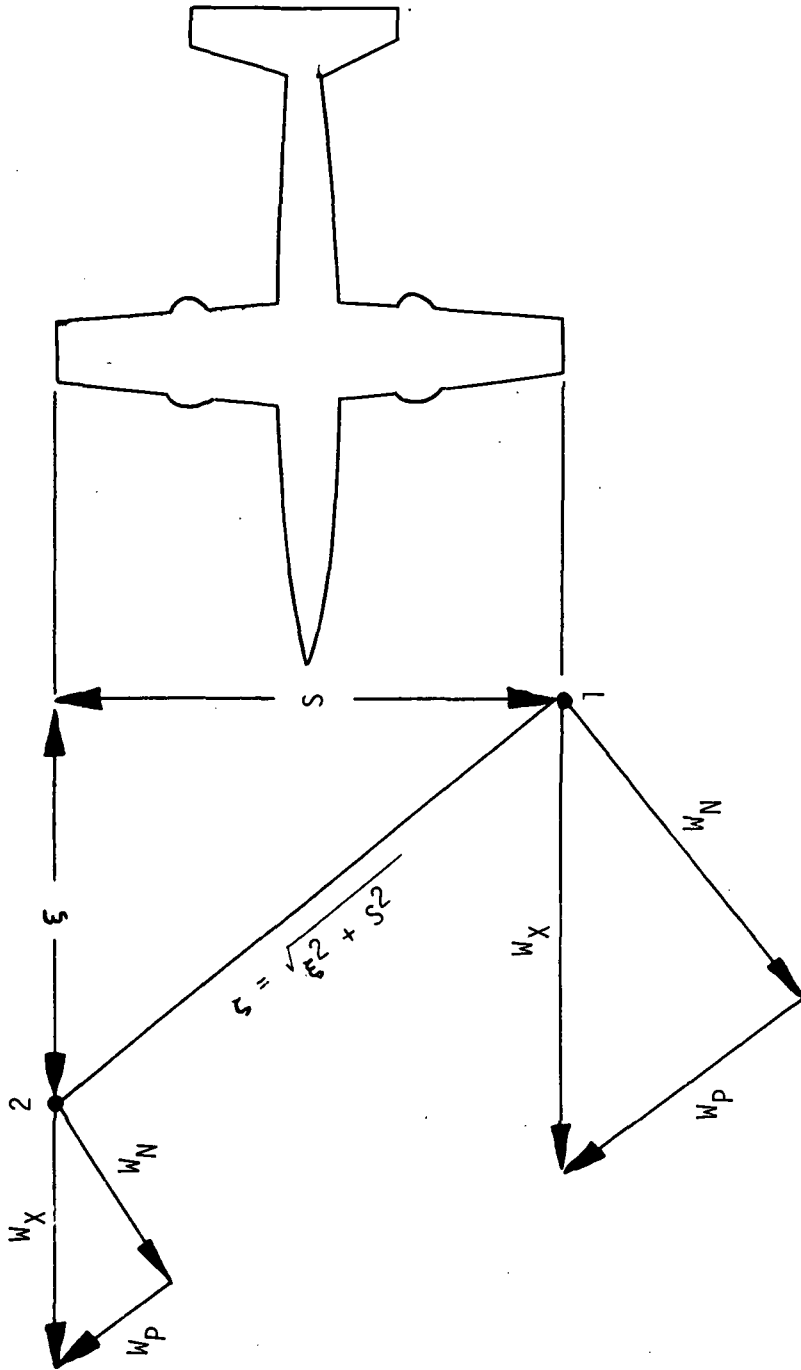

Figure 18. Terminology of the two-point auto-correlation development.

dinal and lateral turbulence correlations (Frost and Moulden, 1977). By performing a Fourier transform on the two correlation functions, $R_{W_N W_N}$ and $R_{W_P W_P}$, a corrected equation for the spectrum can be found. This equation is complicated, but has a closed form integral solution reported by Campbell and Foster, 1954. The solution of $\Phi_{W_X W_X}$ is:

$$\Phi_{W_X W_X}(\omega) = \sigma_{W_X}^2 \left(\frac{L}{V} \right)^2 \left\{ 0.054 \left[4.781 \frac{\sigma^{5/3}}{Z^{5/6}} K_{5/6}(Z) - \frac{\sigma^{11/3}}{Z^{11/6}} K_{11/6}(Z) \right] + 0.097 \left[\sigma^{5/3} Z^{1/6} K_{1/6}(Z) \right] \right\}$$

where

$$\sigma = \frac{S}{L}, Z = \frac{\sigma}{1.339} \sqrt{1 + (1.339\nu)^2}, \nu = \frac{\omega L}{V}$$

L is the length scale, V is the mean airspeed, and K is a modified Bessel function of the second kind.

Houbolt and Sen's original equation was given by:

$$\Phi_{W_N W_N}(\omega) = 0.389 \sigma_{W_N}^2 \frac{L}{V} \frac{\sigma^{5/3}}{Z^{5/6}} K_{5/6}(Z)$$

The new equation, and Houbolt and Sen's original version, are compared to experimental data in Figure 19. The new equation is plotted as a solid line and Houbolt and Sen's equation is represented by a dashed line. The flight data is the computed two-point auto-spectra of the longitudinal velocity component between the right wing tip and the center position for Flight

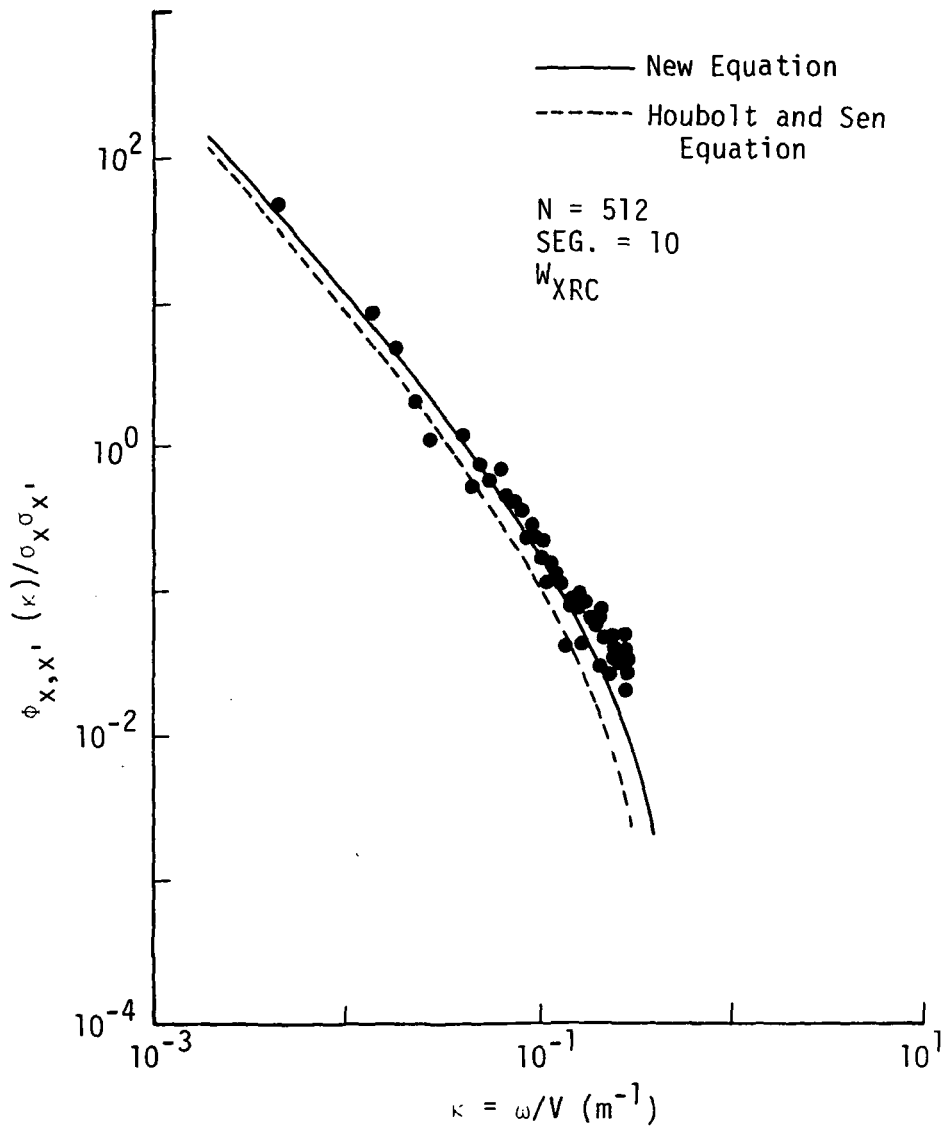

Figure 19. Comparison of the two-point auto-spectrum with Houbolt and Sen's normal equation and the rederived equation, Flight 6, Run 42.

6, Run 42. The new equation gives slightly better agreement with the experimental data than Houbolt and Sen's original equation.

2.9 Two-point Cross-spectra of Gust Velocities

The cross-spectrum density function of two different velocity components is found by taking a Fourier transform of the cross-correlation function. The two different velocity components can be taken at the same location or at two different locations. The equation for the two-point cross-spectrum is similar to that for the two-point auto-spectrum except that different velocity components are used.

The magnitude of the cross-spectra of turbulence velocities versus wave number, κ , are plotted on the 9th page for each run in Appendix A. This figure includes all possible combinations of the three velocity components between the three positions. The symbols *LL*, *LC*, *LR*, *CL*, *CC*, *CR*, *RL*, *RC*, and *RR* represent the positions at which the two velocity components were measured. Frequencies higher than 5 Hz are still cut off because of the uncertainty in high-frequency measurements.

Since the time histories of the same velocity component at the three positions are similar, the cross-spectra have similar shapes for the same two velocity components at various locations. For example, the $W_X W_Z$ components have the cross-spectra plots that look alike for all nine location combinations: *LL*, *LC*, *LR*, *CL*, *CC*, *CR*, *RL*, *RC*, and *RR*. For $W_X W_Z$, $W_X W_Y$, and $W_Y W_Z$, the cross-spectra show different energy distributions for low wave numbers (κ less than 0.03), see Run 18. For higher wave number between 0.03 and 0.3, the cross-spectra have nearly the same shape for a given run. In theory, the cross-spectrum between the longitudinal and

vertical velocity components in the atmospheric boundary is larger than the cross-spectrum between the lateral and vertical velocity components, and between the longitudinal and lateral velocity components. For Flight 6, the cross-spectrum between the lateral and vertical velocity components is about the same order of magnitude as the cross-spectrum between the longitudinal and vertical velocity component. This suggests at the altitude of Flight 6 measurements, the turbulence is approaching isotropic conditions.

The relation between the coincident spectrum and quadrature spectrum in a two-point auto-spectrum is much different from a single-point cross-spectrum. The quadrature spectrum of a single-point cross-spectrum does not need to be less than the coincident spectrum in the low-frequency region. Figure 20 shows the coincident and quadrature parts of the cross-spectrum for Run 39 measured at the center probe. The quadrature spectrum of $W_X W_Z$ is larger than the coincident spectrum in the low-frequency region in Run 39. The same phenomenon occurs to $W_Y W_Z$ and $W_X W_Y$ spectra. However, for the other runs, it is difficult to say which spectrum is larger.

2.10 List of All Parameters Measured and Their Range of Values

On the 10th page for each run in Appendix A, a table is presented for each run which lists all parameters recorded during a flight: the units, the maximum and minimum values, the mean value, the root mean square value and the total number of data points for each parameter. These parameters are stored on magnetic tapes in the following order:

1. Mountain Daylight time in seconds for each record (t);
2. Roll rate measured by body-mounted roll-rate transducer (positive

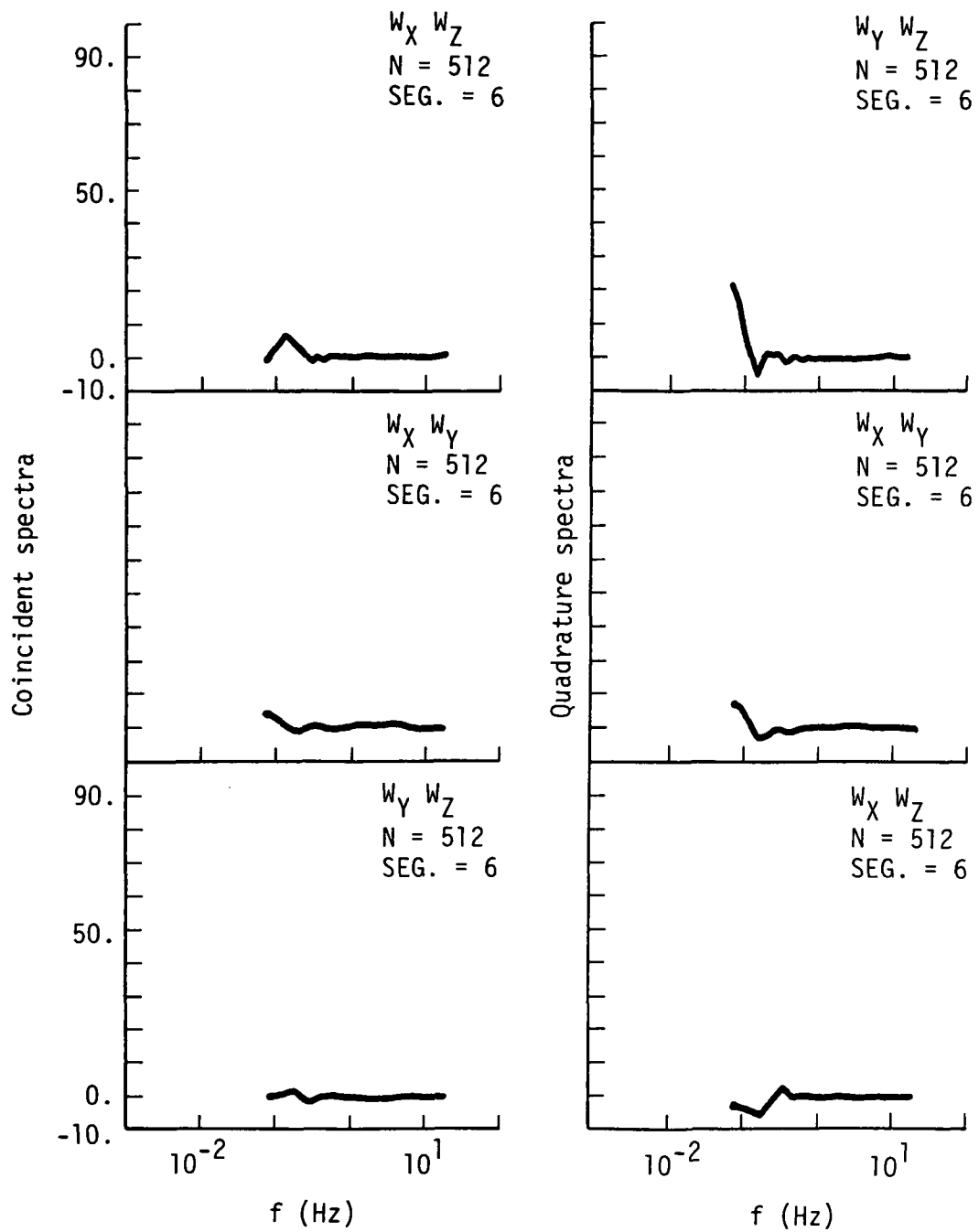

Figure 20. Coincident spectra and quadrature spectra of gust velocities, Flight 6, Run 39.

- with right wing going down), rad/s ($\dot{\phi}$);
3. Normal acceleration at c.g. (positive up) g units (a_n);
 4. Pitch rate measured by body-mounted pitch-rate transducer (positive with nose going up), rad/s ($\dot{\theta}$);
 5. Pitch attitude measured in the vertical plane (positive with nose up), rad (θ);
 6. Roll attitude of airplane with reference to horizontal (positive with right wing down), rad (ϕ);
 7. Airplane heading measured in a horizontal plane clockwise from true north (always positive), 0 to 360° range, (ψ_1);
 8. Sensitive airplane heading obtained from ψ_1 with arbitrary zero at the instant the data switch is turned on (positive with nose right) $\pm 15^\circ$ range ($\Delta\psi_1$);
 9. Airplane heading measured in a horizontal plane clockwise from true north (always positive) 240° to 600° range (ψ_2);
 10. Sensitive airplane heading obtained from ψ_2 , with arbitrary zero at the instant the data switch is turned on (positive with nose right) $\pm 15^\circ$ range ($\Delta\psi_2$);
 11. Normal acceleration at the left wing tip (positive up), g units (a_{nL});
 12. Normal acceleration at the right wing tip (positive up), g units (a_{nR});
 13. Longitudinal acceleration at the c.g (positive forward), g units (a_x);
 14. Lateral acceleration at the c.g (positive toward right wing), g units (a_y);
 15. Angle of attack measured at the airplane nose boom (positive with flow vane trailing edge up), rad (α_c);
 16. Angle of sideslip measured at the airplane nose boom (positive with flow vane trailing edge toward right), rad (β_c);

17. Temperature of the INS pallet, $^{\circ}F(T_I)$;
18. Temperature of the instrument pallet, $^{\circ}F(T_p)$;
19. Vertical acceleration of the INS stable element (positive up), g units (a_z);
20. Angle of attack measured at the right wing tip boom (positive with flow vane trailing edge up), rad (α_R);
21. Angle of sideslip measured at right wing tip boom (positive with flow vane trailing edge toward right), rad (β_R);
22. Angle of attack measured at the left wing tip boom (positive with flow vane trailing edge up), rad (α_L);
23. Angle of sideslip measured at the left wing tip boom (positive with flow vane trailing edge toward right), rad (β_L);
24. Yaw rate measured by a body-mounted yaw-rate transducer (positive with nose going right), rad/s ($\dot{\psi}$);
25. Total temperature, $^{\circ}C (T_o)$;
26. Impact pressure measured at the left wing tip boom, $Pa (q_{cL})$;
27. Impact pressure measured at the airplane nose boom, $Pa (q_{cC})$;
28. Impact pressure measured at the right wing tip boom, $Pa (q_{cR})$;
29. Free-stream static pressure measured at the airplane nose boom, $KPa (p)$;
30. Temperature of IRT, $^{\circ}C T_{IRT}$;
31. Distance to go from the present position of the aircraft to the next waypoint set on the INS (always positive), $m(\Delta\ell)$;
32. Bearing to destination, i.e., bearing from the aircraft's present position to the next waypoint set on the INS, measured in a horizontal plane clockwise from true north (always positive), deg (γ_B);

33. Longitude of aircraft as measured by INS, deg (LONG);
34. Latitude of aircraft as measured by INS, deg (LAT);
35. Track angle of airplane measured in a horizontal plane clockwise from true north (always positive), deg (γ_T);
36. Airplane heading, measured in a horizontal plane clockwise from true north, rad (ψ);
37. East-west component of the airplane inertial velocity as measured by INS (positive toward east), m/s (V_E);
38. North-south component of the airplane inertial velocity as measured by the INS (positive toward north), m/s (V_N);
39. Pressure-derived altitude based on standard atmosphere tables, κm (h_p);
40. Computed free-stream temperature, $^{\circ}C$ (T_c);
41. Computed east-west wind component (positive toward east), knots (W_E);
42. Computed north-south wind component (positive toward north), knots (W_N);
43. Computed magnitude of wind vector, knots (W);
44. Computed direction of wind vector, deg (γ_W);
45. True airspeed computed from impact pressure measurement at right wing tip boom, m/s (V_R);
46. True airspeed computed from impact pressure measurement at the airplane nose boom, m/s (V_C);
47. True airspeed computed from the impact pressure measurement at left wing tip boom, m/s (V_L);

48. Incremental pressure-derived altitude with reference to value at beginning of run (positive when altitude increases), m (Δh_p);
49. Computed uncorrected inertial displacement, m (Δh_z);
50. Computed longitudinal component of gust velocity at right wing tip boom (positive in direction of flight path), m/s (W_{XR});
51. Computed longitudinal component of gust velocity at airplane centerline nose boom (positive in direction of flight path), m/s (W_{XC});
52. Computed longitudinal component of gust velocity at left wing tip boom (positive in direction of flight path), m/s (W_{XL});
53. Computed lateral component of gust velocity at right wing tip (positive toward right), m/s (W_{YR});
54. Computed lateral component of gust velocity at airplane centerline nose boom (positive toward right), m/s (W_{YC});
55. Computed lateral component of gust velocity at left wing tip boom (positive toward right), m/s (W_{YL});
56. Computed vertical component of gust velocity at right wing tip boom (positive up), m/s (W_{ZR});
57. Computed vertical component of gust velocity at airplane centerline nose boom (positive up), m/s (W_{ZC});
58. Computed vertical component of gust velocity at left wing tip boom (positive up), m/s (W_{ZL});

3.0 CONCLUSION

The statistical analysis of the turbulence measured in Flight 6 of the NASA B-57B over Denver, Colorado, from July 7 to July 23, 1982, includes the calculations of average turbulence parameters, integral length scales, probability density functions, single-point auto-correlation coefficients, two-point auto-correlation coefficients, normalized auto-spectra, normalized two-point auto-spectra, and two-point cross-spectra for the gust velocities. The probability density function of the turbulence is best represented by Reeves' non-Gaussian model which is a function of the parameter r . When the value of r is zero, the probability is, in effect, a Gaussian probability. When r approaches infinity, the probability will approach a modified Bessel function of the second kind and of the first order. Additional analysis is required to determine how r is related to the severity of the turbulence.

Comparison of the single-point auto-correlation coefficients with the theoretical model developed by von Karman shows that the auto-correlation coefficients of the longitudinal velocity component are higher in value than that predicted by the model. For the lateral velocity component, the auto-correlation coefficients agree with the von Karman model, but for the vertical velocity component, the auto-correlation coefficients are lower than the model. Since the time histories of the same gust component at three different positions of the NASA B-57B do not differ much, the two-point auto-correlation coefficients are similar to the single-point auto-correlation coefficient. The results appear to be very accurate up to 5 Hz; but at frequencies higher than 5 Hz, errors will occur because of noise in the signal and biasing due to possible water in the pressure sensors. Generally, the

von Karman single-point auto-spectra models using the integral length scale fit the data well. Applying Houbolt's digitizing correction factor, however, will bring the data into better agreement with the theory. Curve-fitting the data to obtain a value of the parameter ($L^{2/3}/\sigma^2$), however, improves data correlation with the von Karman model.

As to the two-point auto-spectrum of the gust velocities, the quadrature spectrum is always smaller than the coincident spectrum for frequencies less than about 0.4 Hz. The coincident spectra have the highest value at a frequency of about 0.078 Hz and then decrease to near zero at a frequency of approximately 1 Hz. The quadrature spectrum of a single-point cross-spectrum, however, is not always less than the coincident spectrum in the lower frequency region. Houbolt and Sen's model of the two-point auto-spectrum for the longitudinal velocity component in its original form does not agree with the data as well as the new corrected form of the equation. The two models predict lower values than the data in the high-frequency region.

In general, the turbulence behaves very similarly to isotropic homogeneous atmospheric turbulence. This may be a consequence of the fact that the ratio of the 19.5m span of the B-57B turbulence length scale is small. Additional flights at lower levels and perhaps closer to the storm front may be required to further investigate the non-isotropic turbulence.

REFERENCES

Bendat, J. S., and A. G. Piersol (1971): "Random Data: Analysis and Measurement Procedures." New York, John Wiley & Son, Inc.

Reeves, P. M., G. S. Campbell, V. M. Ganzer and R. G. Joppa (1974): "Development and Application of a Non-Gaussian Atmospheric Turbulence Model for Use in Flight Simulators." NASA CR-2451.

Reeves, P. M., R. G. Joppa, and V. M. Ganzer (1976): "A Non-Gaussian Model of Continuous Atmospheric Turbulence for Use in Aircraft Design." NASA CR-2639.

Houbolt, J. C. and Asim Sen (1972): "Cross-Spectral Functions Based on von Karman's Spectral Equation." NASA CR-2011.

Frost, W. and T. H. Moulden (1977): "Handbook on Turbulence." New York, Plenus Press.

Campbell, G. A. and R. M. Foster (1954): "Fourier Integrals for Practical Applications." D. Van Nostrand Company, Inc. (New York).

Frost, W. and M. C. Lin (1983): "Statistical Analysis of Turbulence Data from the NASA Marshall Space Flight Center Atmospheric Boundary Layer Tower Array Facility," NASA CR-3737.

Houbolt, J. C., R. Steiner, and K. G. Pratt (1964): "Dynamic Response of Airplanes to Atmospheric Turbulence Including Flight Data on Input and Response," NASA TR R-199.

APPENDIX A

ORIGINAL PAGE IS
OF POOR QUALITY

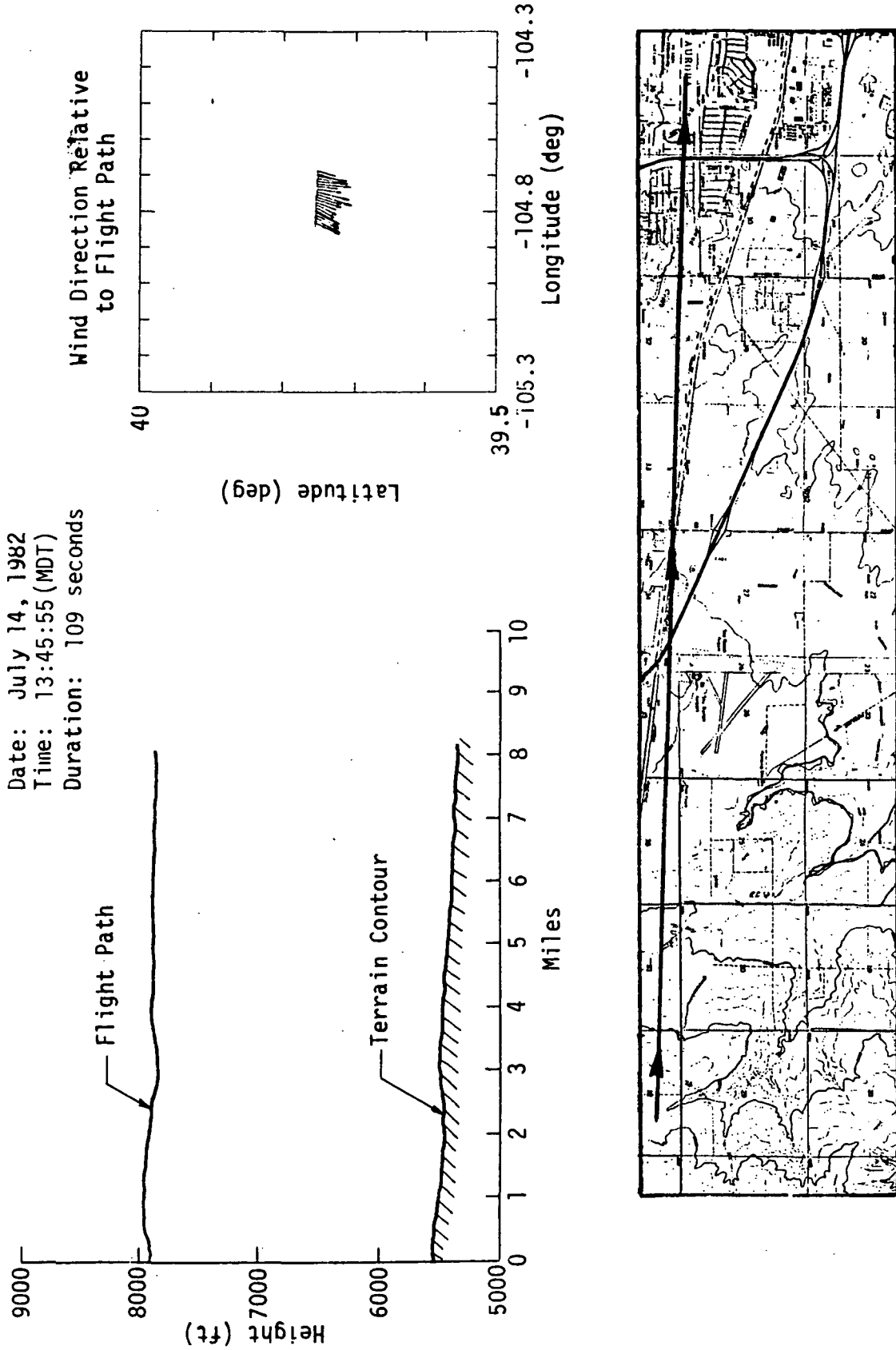

Figure A.1. Flight path information, Flight 6, Run 2.

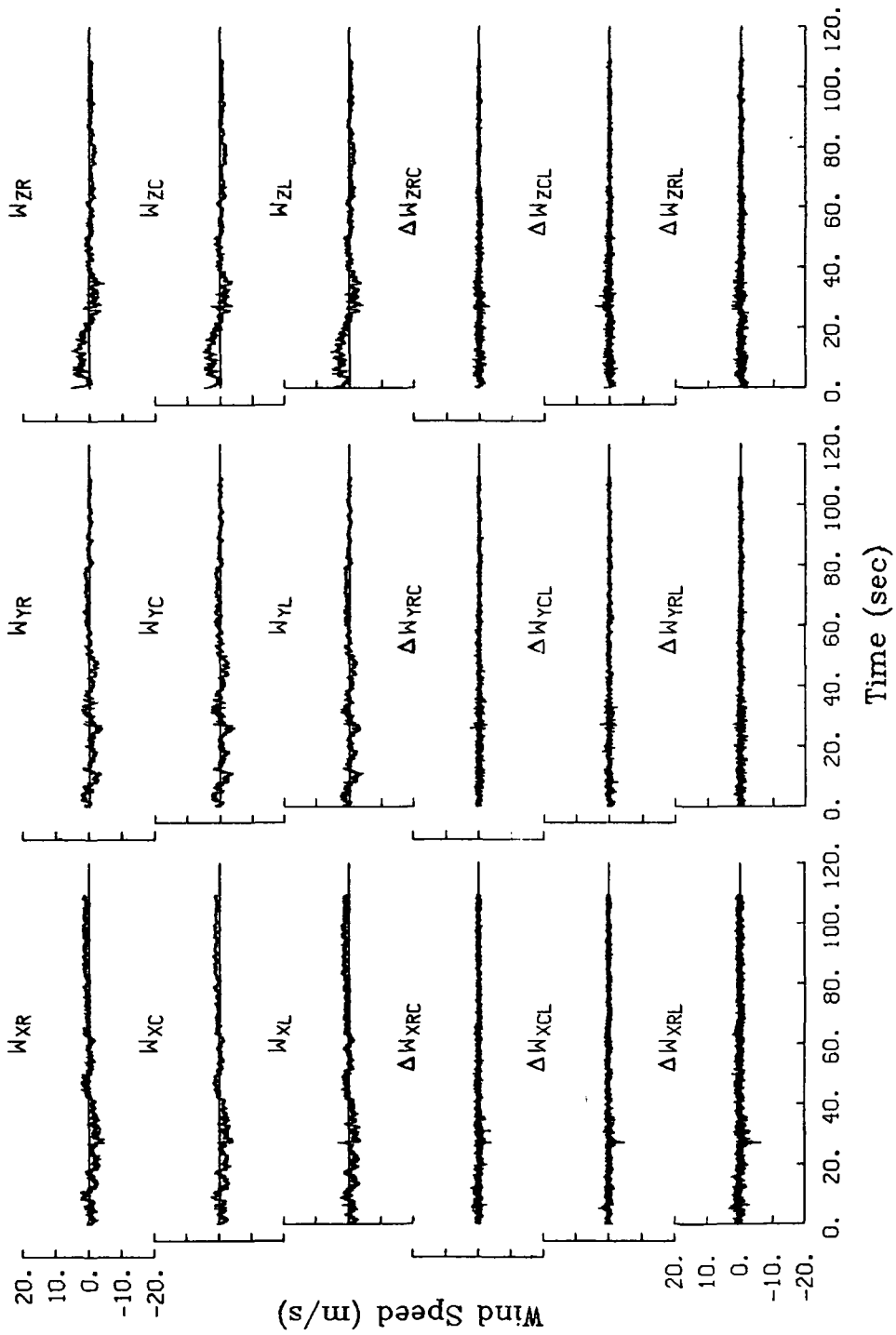

Figure A.2. Time histories of gust velocities and gust velocity differences, Flight 6, Run 2.

TABLE A.1. Average Turbulence Parameters and Integral Length Scales, Flight 6, Run 2.

I. Mean Airspeed (m/s)			II. Standard Deviation of Gust Velocities (m/s)		
V_L	V_C	V_R	$\sigma_{W_{XL}}$	$\sigma_{W_{XC}}$	$\sigma_{W_{XR}}$
121.2	120.3	122.2	1.13	1.12	1.22
			$\sigma_{W_{YL}}$	$\sigma_{W_{YC}}$	$\sigma_{W_{YR}}$
			0.96	1.00	1.01
			$\sigma_{W_{ZL}}$	$\sigma_{W_{ZC}}$	$\sigma_{W_{ZR}}$
			1.45	1.42	1.40
III. Standard Deviation of Gust Velocity Differences (m/s)			IV. Integral Length Scale (m)		
$\sigma_{\Delta W_{XCL}}$	$\sigma_{\Delta W_{XRC}}$	$\sigma_{\Delta W_{XRL}}$	$L_{W_{XL}}$	$L_{W_{XC}}$	$L_{W_{XR}}$
0.49	0.51	0.71	1272	1329	1163
$\sigma_{\Delta W_{YCL}}$	$\sigma_{\Delta W_{YRC}}$	$\sigma_{\Delta W_{YRL}}$	$L_{W_{YL}}$	$L_{W_{YC}}$	$L_{W_{YR}}$
0.39	0.39	0.40	645	550	627
$\sigma_{\Delta W_{ZCL}}$	$\sigma_{\Delta W_{ZRC}}$	$\sigma_{\Delta W_{ZRL}}$	$L_{W_{ZL}}$	$L_{W_{ZC}}$	$L_{W_{ZR}}$
0.48	0.46	0.54	1563	1592	1467

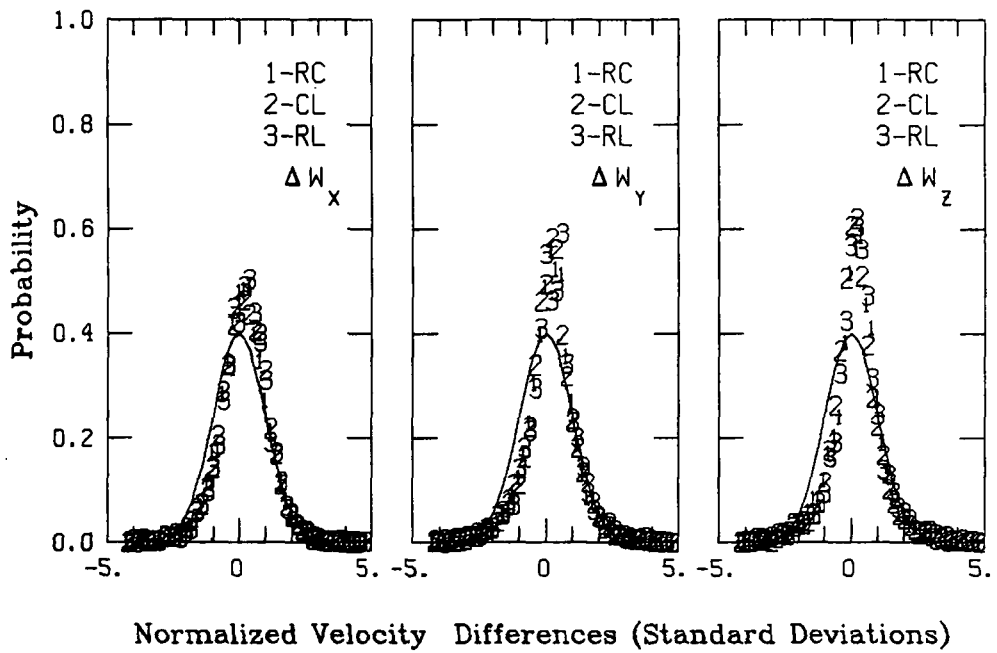
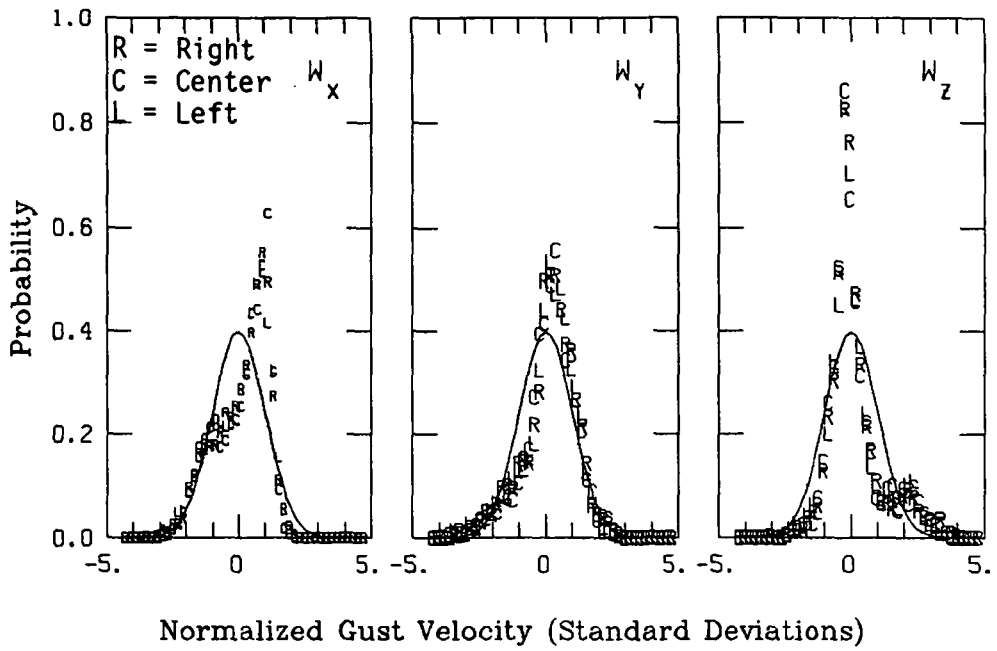

Figure A.3. Probability density function for gust velocities and gust velocity differences, Flight 6, Run 2.

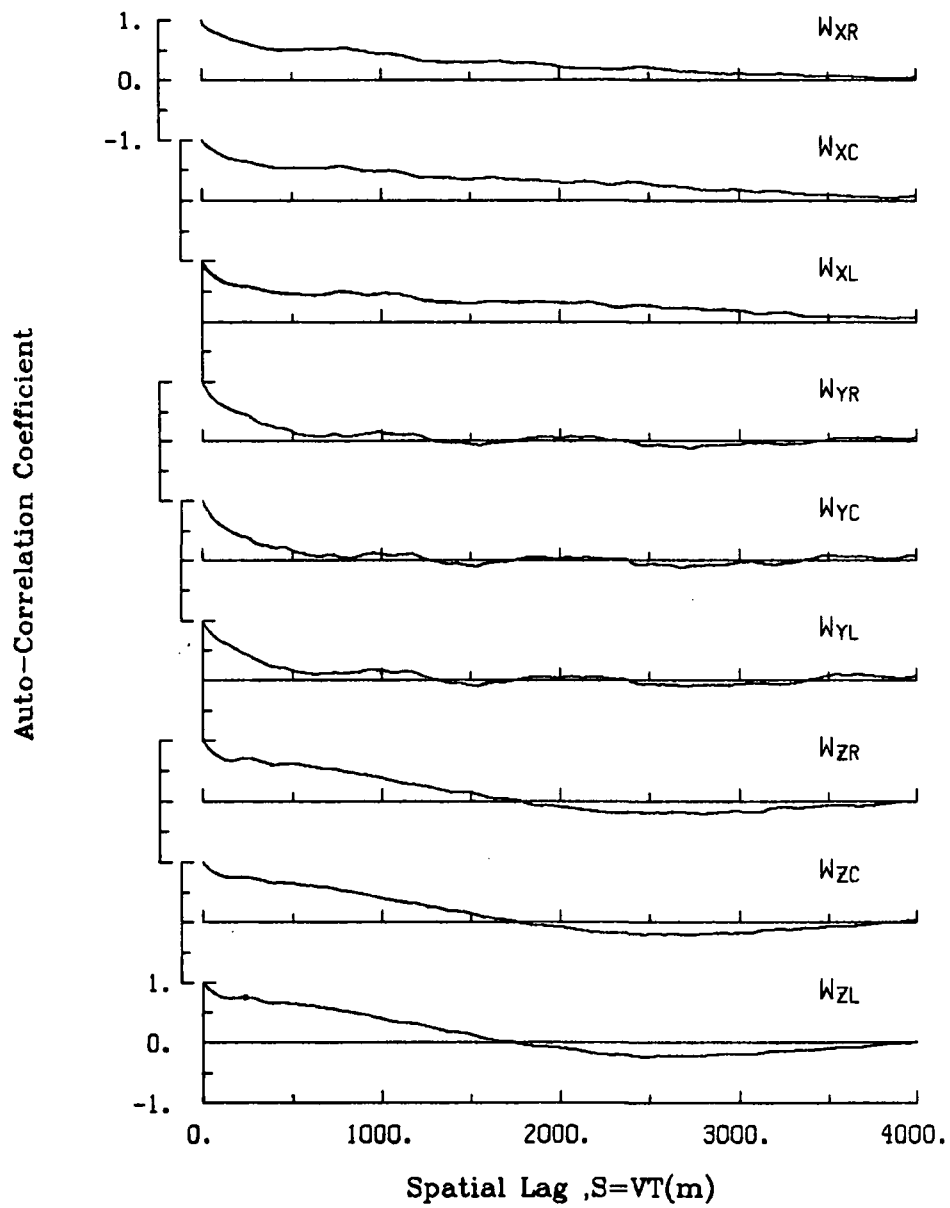

Figure A.4. Single-point auto-correlation coefficient of gust velocities, Flight 6, Run 2.

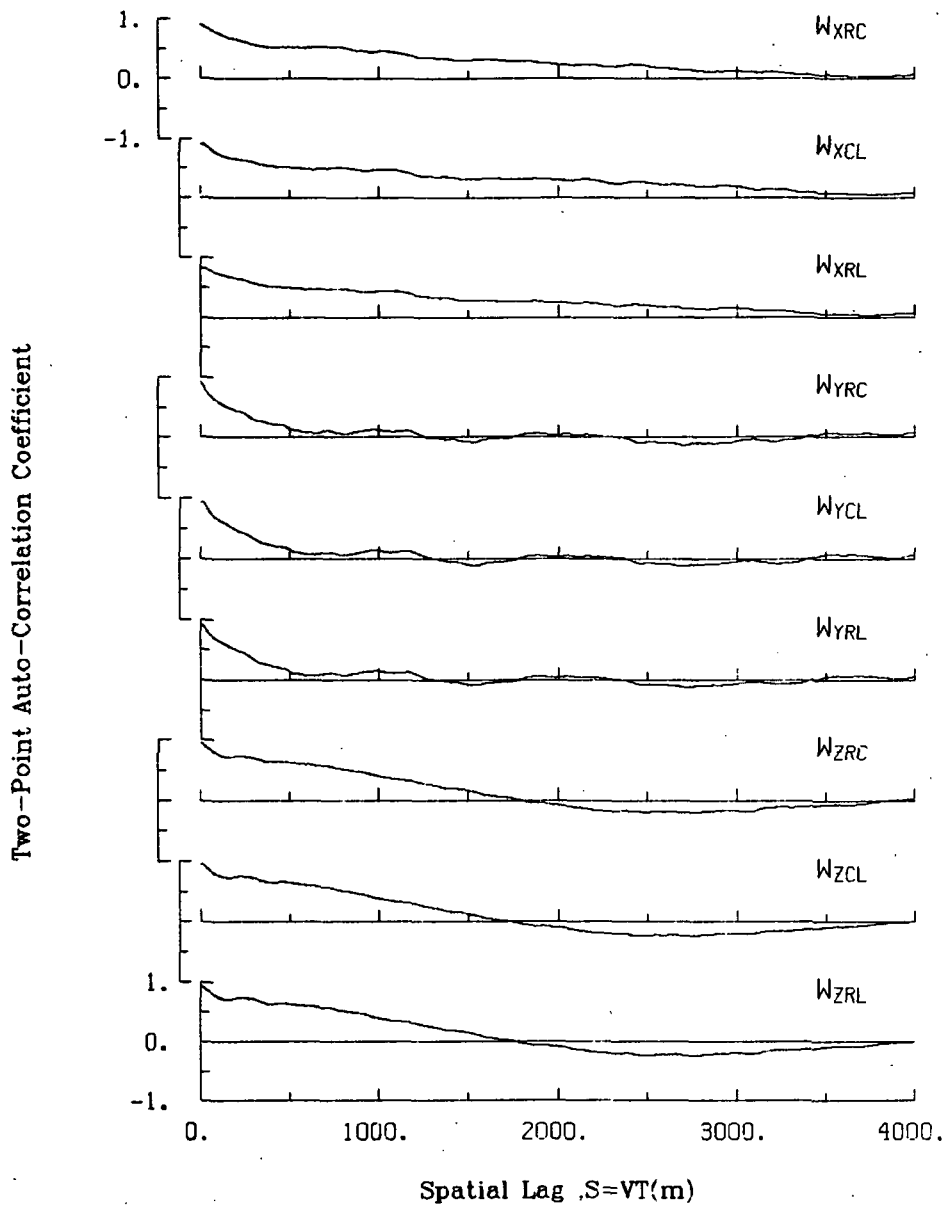

Figure A.5. Two-point auto-correlation coefficient of gust velocities, Flight 6, Run 2.

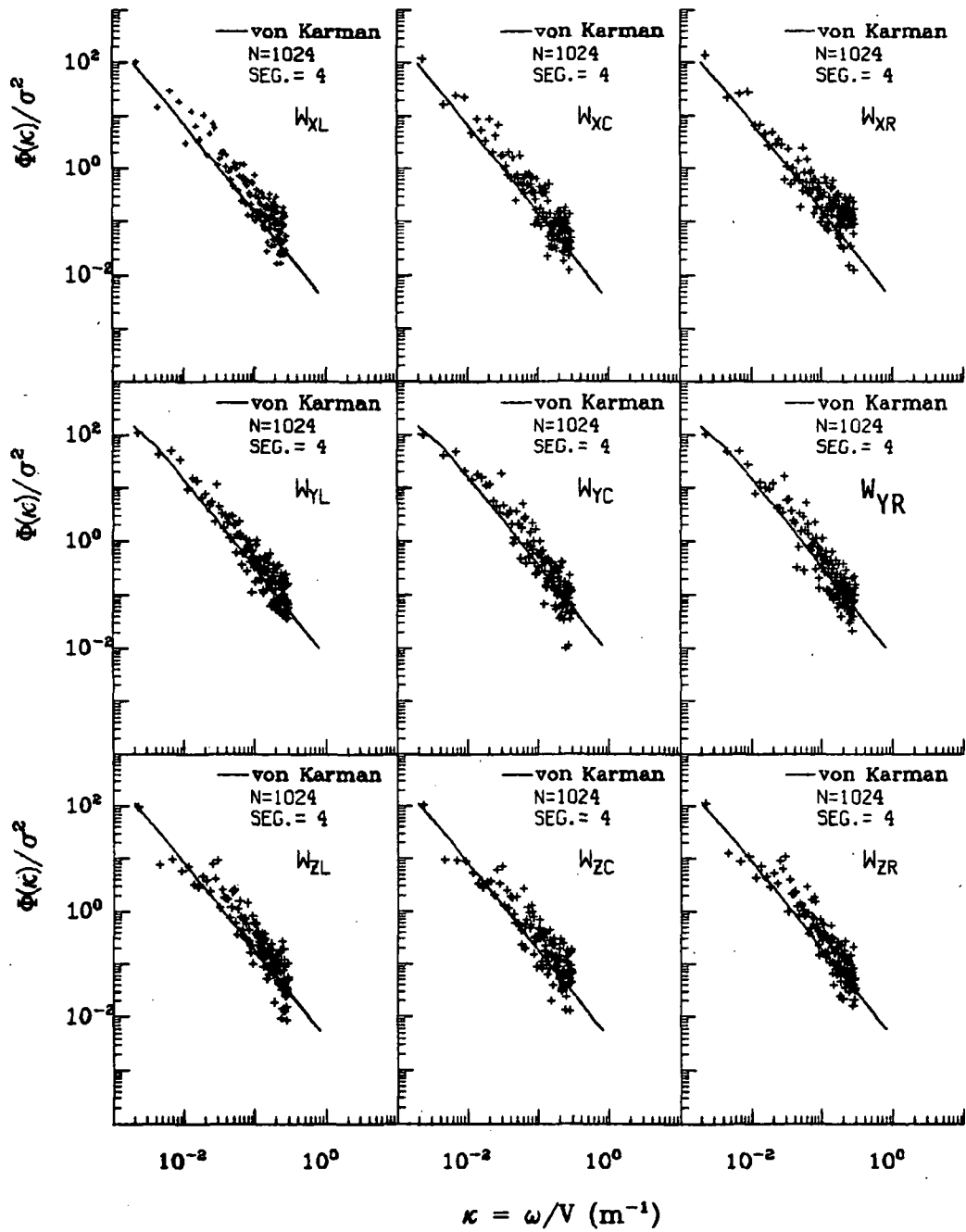

Figure A.6. Normalized auto-spectra of gust velocities, Flight 6, Run 2.

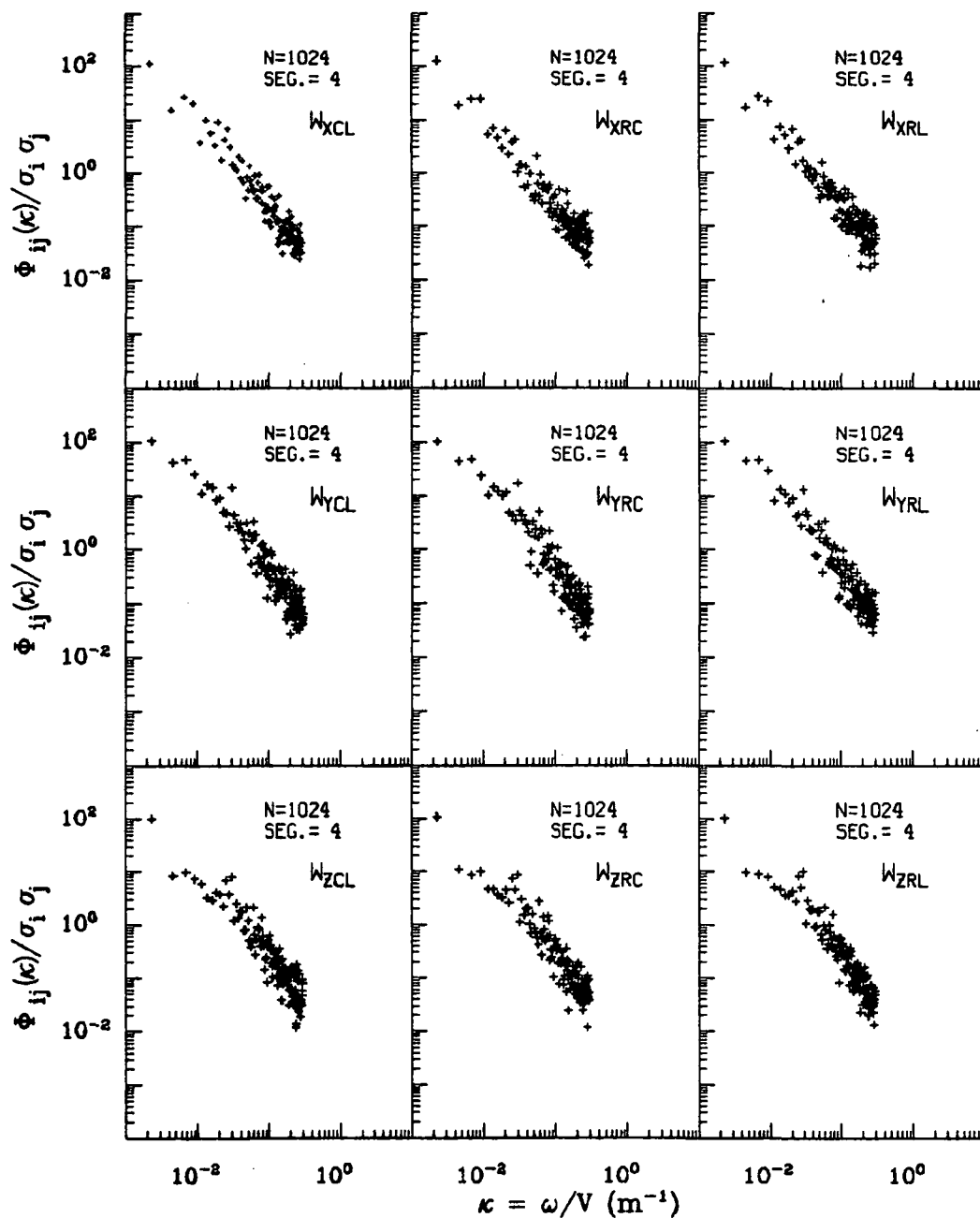

Figure A.7. Normalized two-point auto-spectra of gust velocities, Flight 6, Run 2.

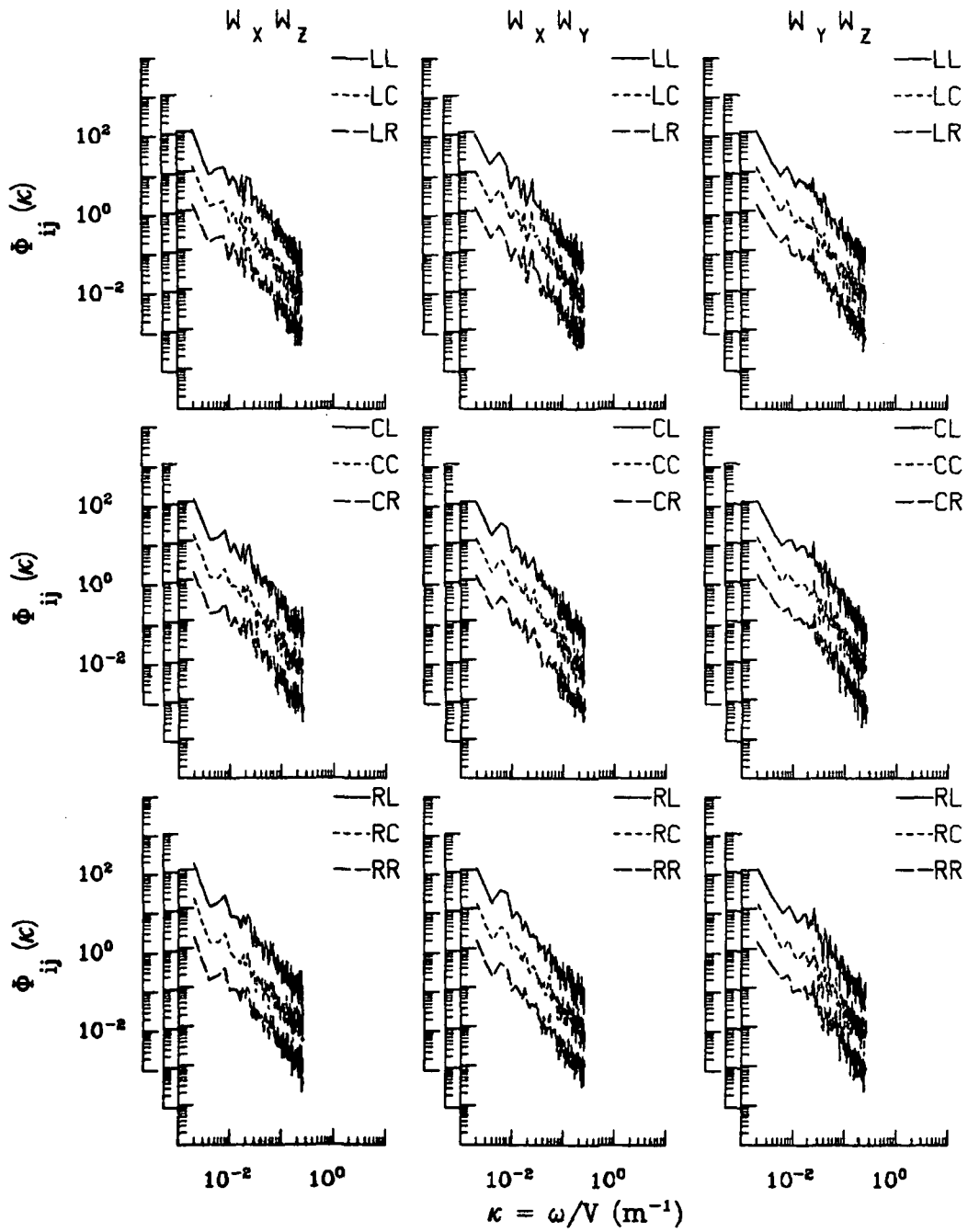
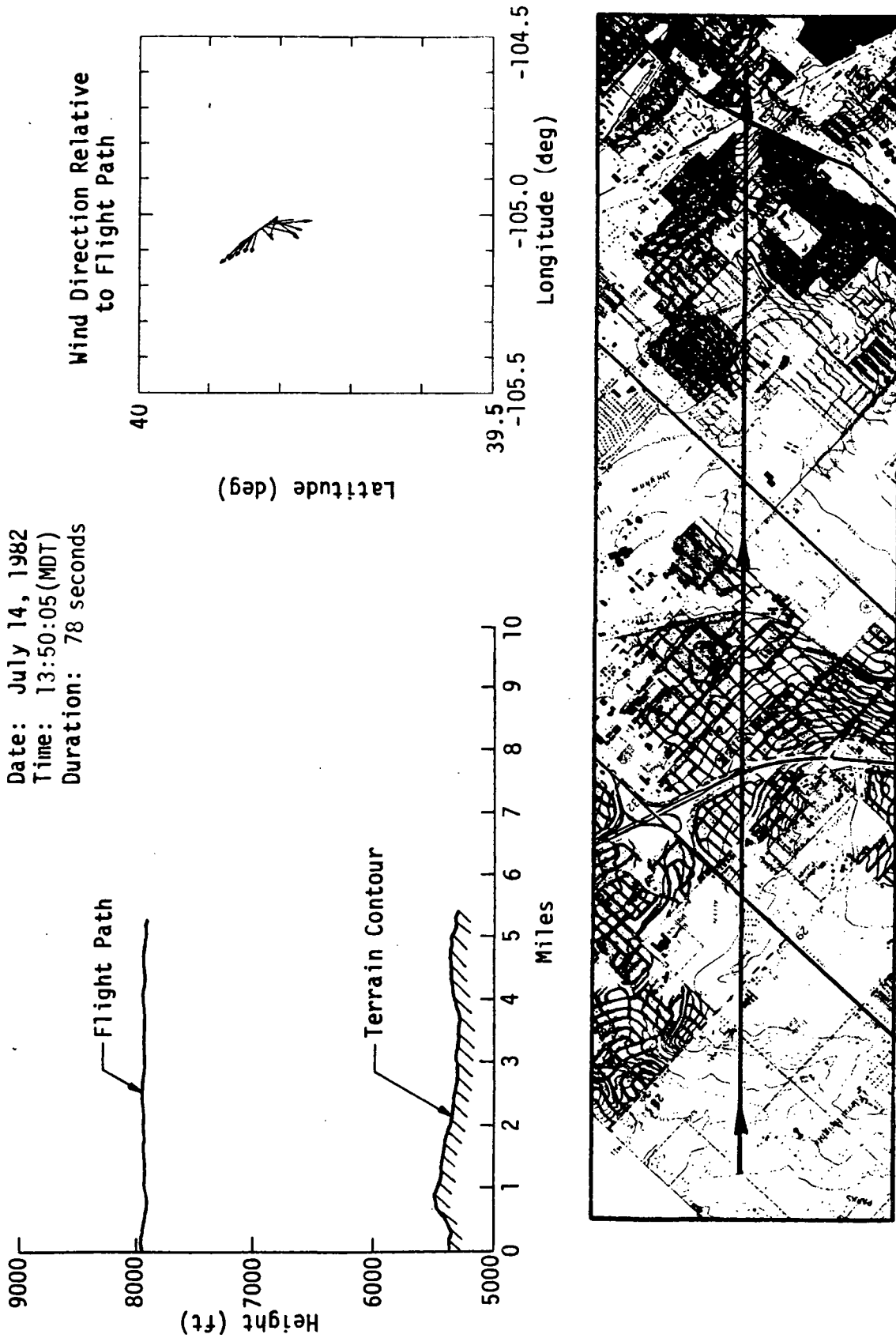

Figure A.8. Two-point cross-spectra of gust velocities, Flight 6, Run 2.

TABLE A.2. List of All Parameters Measured and Their Range of Values,
Flight 6, Run 2.

		START TIME = 49555.4388	STOP TIME = 49664.6138				
CHANNEL	UNITS	HIGH	LOW	MEAN	RMS	POINTS	
2 PHI DOT	RAD/SEC	.070	-.099	-.00312	.02051	4367	
3 ACCL N CG	G UNITS	1.300	.598	.99372	.99597	4367	
4 THETA DOT	RAD/SEC	.045	-.033	.00494	.00894	4367	
5 THETA	RAD	.062	.008	.04226	.04376	4367	
6 PHI	RAD	.068	-.104	-.01153	.02588	4367	
7 PSI 1	DEGREES	273.879	269.652	271.32161	271.32272	4367	
8 DEL PSI 1	DEGREES	1.582	-2.474	-.73382	1.06268	4367	
9 PSI 2	DEGREES	271.335	267.462	269.18582	269.18692	4367	
10 DEL PSI 2	DEGREES	1.227	-2.801	-1.06147	1.30520	4367	
11 ACCL N LT	G UNITS	1.685	.330	1.01157	1.02036	4367	
12 ACCL N RT	G UNITS	1.759	.251	1.02622	1.03719	4367	
13 ACCL X CG	G UNITS	.677	.019	.04435	.04506	4367	
14 ACCL Y CG	G UNITS	.213	-.187	.00801	.06275	4367	
15 ALPHA CTR	RAD	.006	-.061	-.02507	.02594	4367	
16 BETA CTR	RAD	.020	-.073	-.02177	.02430	4367	
17 TEMP I	DEG F	111.396	109.597	110.43740	110.43848	4367	
18 TEMP P	DEG F	89.647	89.467	89.60903	89.60906	4367	
19 ACCL Z INS	G UNITS	1.332	.553	1.00215	1.00463	4367	
20 ALPHA RT	RAD	.016	-.053	-.01960	.02110	4367	
21 BETA RT	RAD	.052	-.034	.01299	.01639	4367	
22 ALPHA LT	RAD	.021	-.058	-.01736	.01873	4367	
23 BETA LT	RAD	.012	-.072	-.02644	.02817	4367	
24 PSI DOT	RAD/SEC	.039	-.035	.00330	.00991	4367	
25 TEMP TOT	DEG C	31.098	29.914	30.40423	30.40585	4367	
26 OC LT	PSID	1.067	.898	.97588	.97651	4367	
27 OC CTR	PSID	1.050	.891	.96142	.96207	4367	
28 OC RT	PSID	1.093	.915	.99221	.99294	4367	
29 PS	PSIA	10.979	10.927	10.95826	10.95827	4367	
30 TEMP IRT	DEG C	28.445	25.534	26.81273	26.82397	4367	
31 D TO G	METERS	8769139.8918756035.930	*****				4367
32 B TO D	DEGREES	80.516	80.412	80.46386	80.46387	4367	
33 LONG	DEGREES	-104.693	-104.839	-104.76115	104.76116	4367	
34 LAT	DEGREES	39.755	39.752	39.75407	39.75407	4367	
35 TRK ANG	DEGREES	272.651	270.814	271.50367	271.50426	4367	
36 HDG	RADIANS	4.788	4.715	4.74643	4.74645	4367	
37 VE	M/SEC	-119.616	-124.601	-122.39509	122.40376	4367	
38 VN	M/SEC	5.714	1.802	3.23802	3.45109	4367	
39 ALTITUDE	KM	2.430	2.392	2.40747	2.40749	4367	
40 TEMPC	DEGREES C	23.881	22.751	23.19801	23.19873	4367	
41 EW WND SPD	KNOTS	2.913	-9.347	-4.43574	4.92013	4367	
42 NS WND SPD	KNOTS	-1.773	-15.637	-6.71558	6.97546	4367	
43 WIND SPEED	KNOTS	16.250	1.847	8.32219	8.53608	4367	
44 WIND DIREC	DEGREES	359.981	.104	42.06074	67.00409	4367	
45 AIRSPEED R	M/SEC	128.106	117.665	122.16261	122.18359	4367	
46 AIRSPEED C	M/SEC	125.644	116.119	120.31060	120.32969	4367	
47 AIRSPEED L	M/SEC	126.579	116.519	121.18580	121.20421	4367	
48 DELTA ALT	METERS	18.110	-19.650	-4.51043	10.06603	4367	
49 INRTL DISP	METERS	16.724	-19.872	-4.71472	10.09869	4367	
50 UG RIGHT	M/SEC	2.537	-4.374	-.00000	1.20877	4367	
51 UG CENTER	M/SEC	2.396	-3.895	.00000	1.10697	4367	
52 UG LEFT	M/SEC	3.172	-3.404	.00000	1.12080	4367	
53 VG RIGHT	M/SEC	2.643	-4.054	.00326	.97500	4367	
54 VG CENTER	M/SEC	2.591	-4.563	.00347	.96989	4367	
55 VG LEFT	M/SEC	2.419	-4.377	.00391	.93178	4367	
56 WG RIGHT	M/SEC	5.439	-4.436	.00511	1.36188	4367	
57 WG CENTER	M/SEC	4.816	-3.611	.00623	1.37941	4367	
58 WG LEFT	M/SEC	5.469	-4.375	.00477	1.40635	4367	

ORIGINAL PAGE IS
OF POOR QUALITY



A.11

Figure A.9. Flight path information, Flight 6, Run 3.

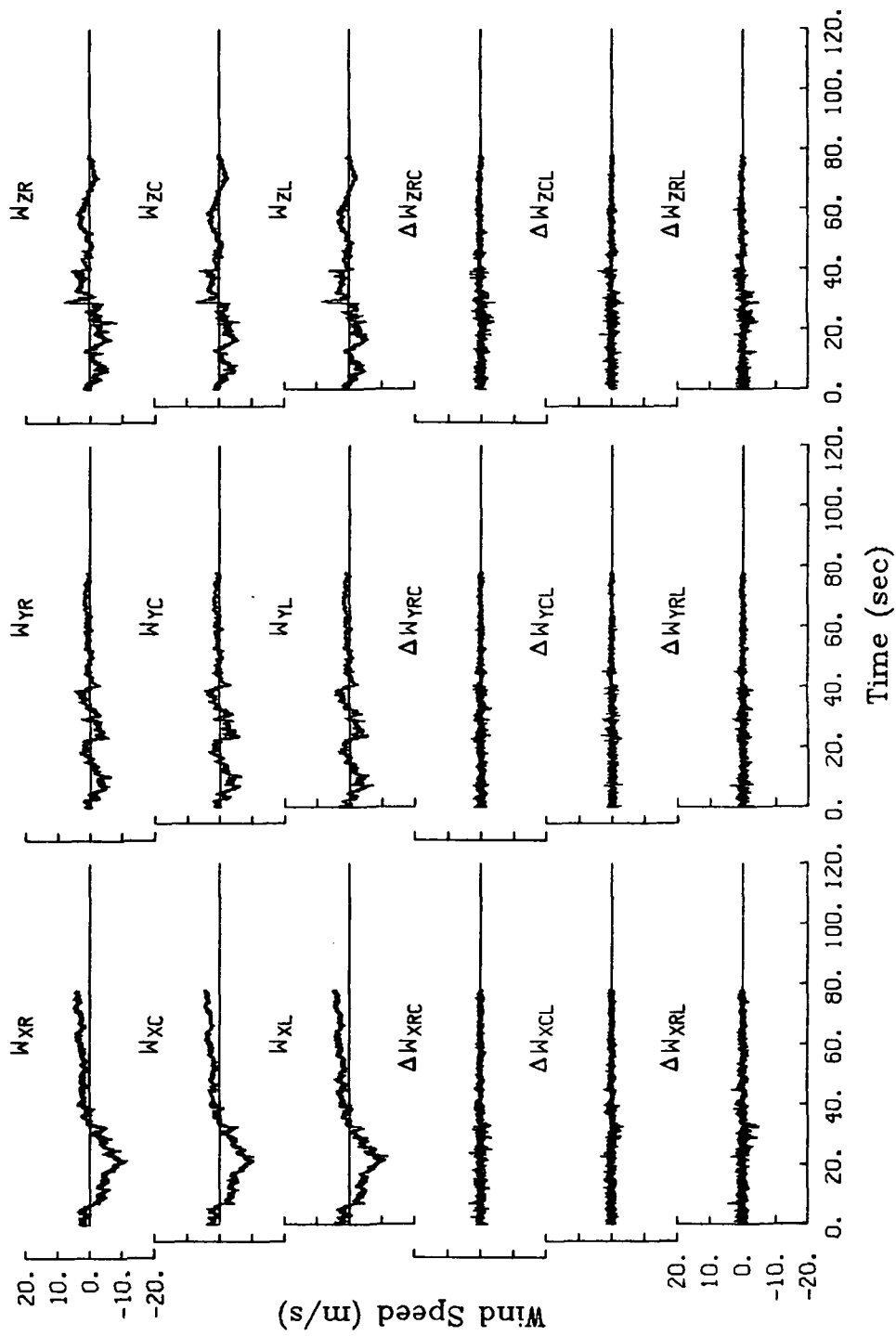

Figure A.10. Time histories of gust velocities and gust velocity differences, Flight 6, Run 3.

TABLE A.3. Average Turbulence Parameters and Integral Length Scales, Flight 6, Run 3.

I. Mean Airspeed (m/s)			II. Standard Deviation of Gust Velocities (m/s)		
v_L	v_C	v_R	$\sigma_{W_{XL}}$	$\sigma_{W_{XC}}$	$\sigma_{W_{XR}}$
111.5	110.7	112.4	3.75	3.68	3.73
			$\sigma_{W_{YL}}$	$\sigma_{W_{YC}}$	$\sigma_{W_{YR}}$
			1.77	1.81	1.73
			$\sigma_{W_{ZL}}$	$\sigma_{W_{ZC}}$	$\sigma_{W_{ZR}}$
			2.10	2.04	2.24
III. Standard Deviation of Gust Velocity Differences (m/s)			IV. Integral Length Scale (m).		
$\sigma_{\Delta W_{XCL}}$	$\sigma_{\Delta W_{XRC}}$	$\sigma_{\Delta W_{XRL}}$	$L_{W_{XL}}$	$L_{W_{XC}}$	$L_{W_{XR}}$
0.64	0.65	0.82	1042	1043	1038
$\sigma_{\Delta W_{YCL}}$	$\sigma_{\Delta W_{YRC}}$	$\sigma_{\Delta W_{YRL}}$	$L_{W_{YL}}$	$L_{W_{YC}}$	$L_{W_{YR}}$
0.60	0.59	0.65	554	541	559
$\sigma_{\Delta W_{ZCL}}$	$\sigma_{\Delta W_{ZRC}}$	$\sigma_{\Delta W_{ZRL}}$	$L_{W_{ZL}}$	$L_{W_{ZC}}$	$L_{W_{ZR}}$
0.66	0.72	0.83	940	976	1050

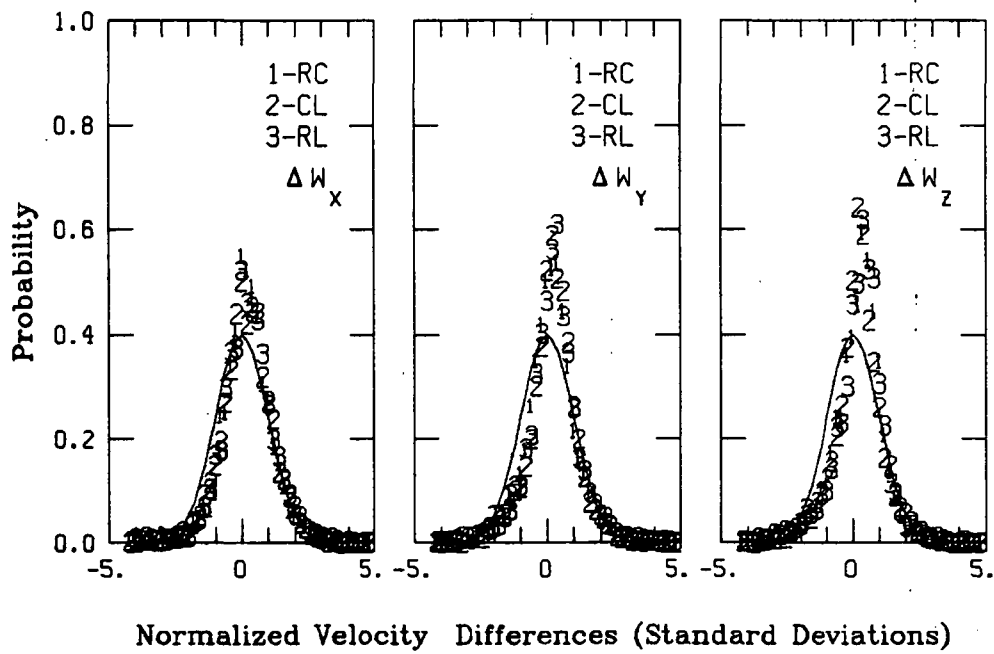
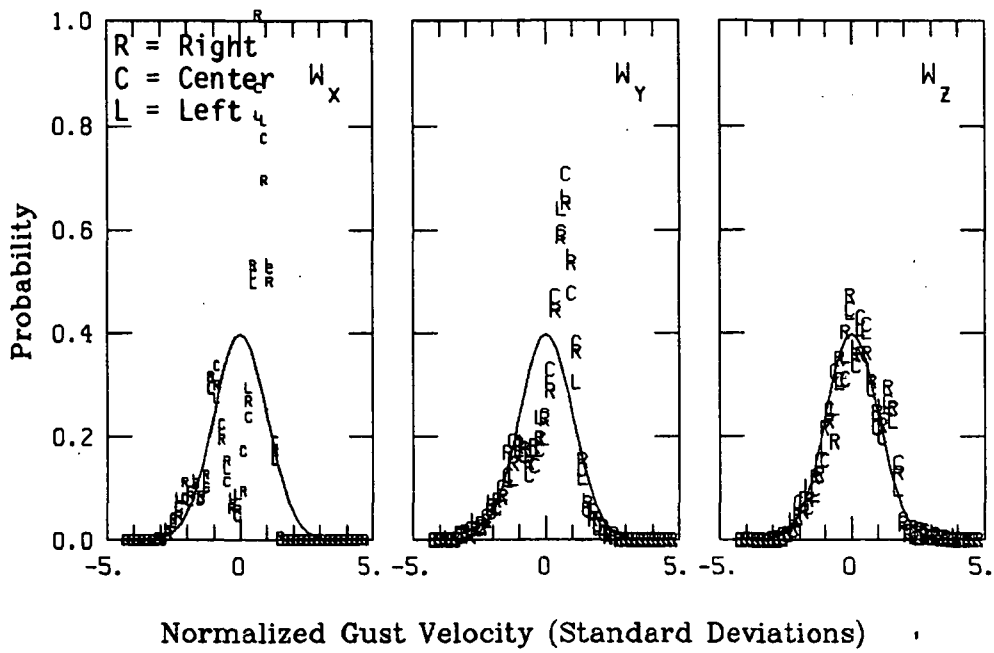

Figure A.11. Probability density function for gust velocities and gust velocity differences, Flight 6, Run 3.

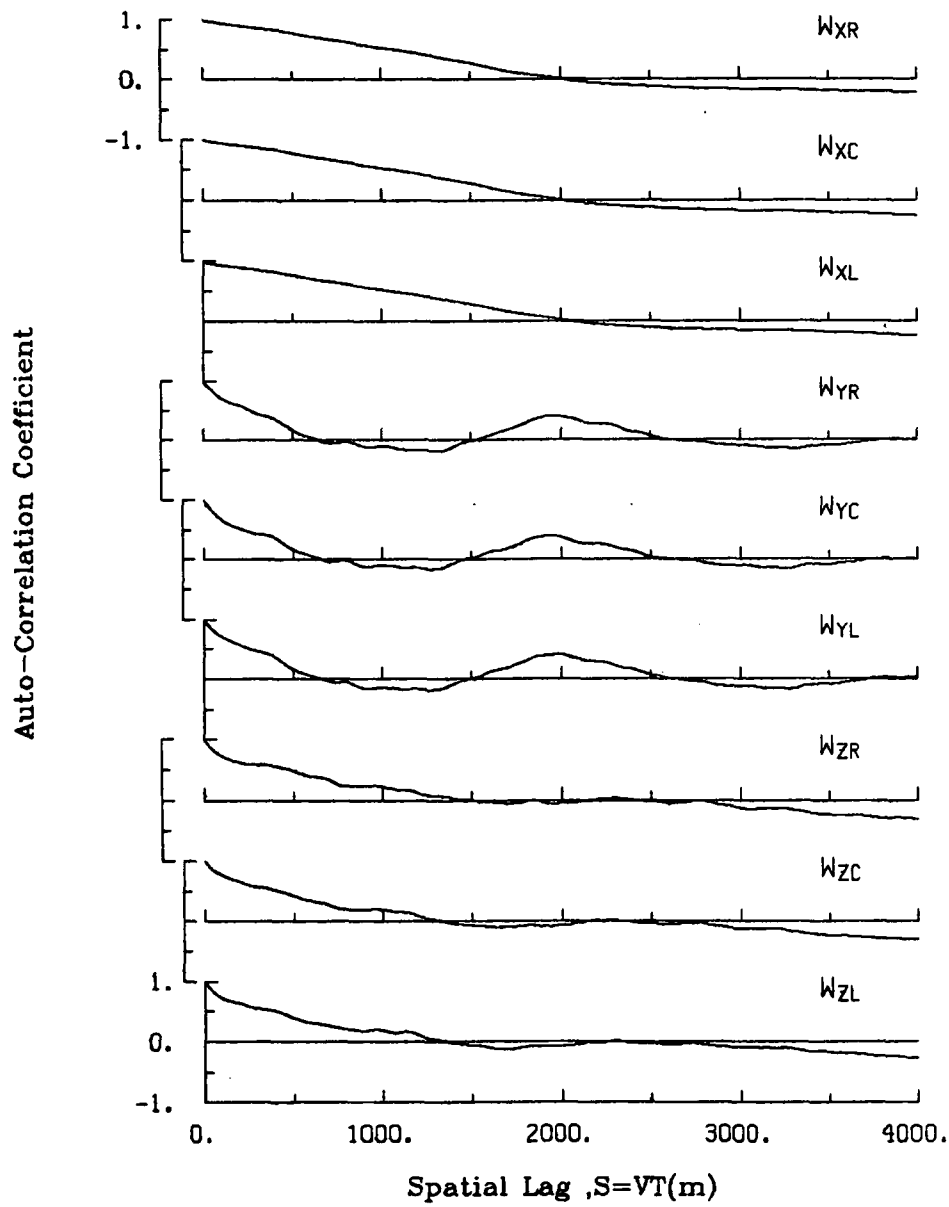

Figure A.12. Single-point auto-correlation coefficient of gust velocities, Flight 6, Run 3.

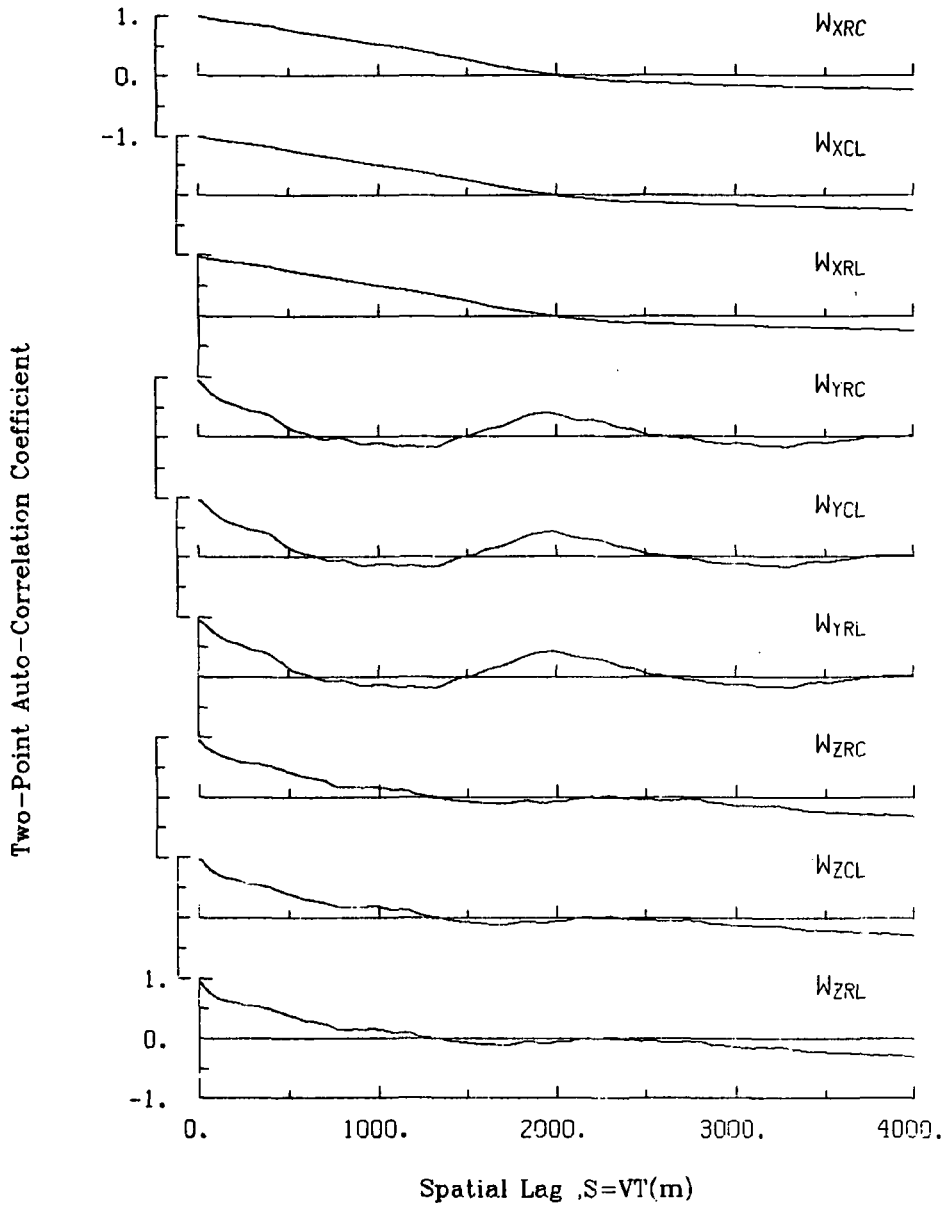

Figure A.13. Two-point auto-correlation coefficient of gust velocities, Flight 6, Run 3.

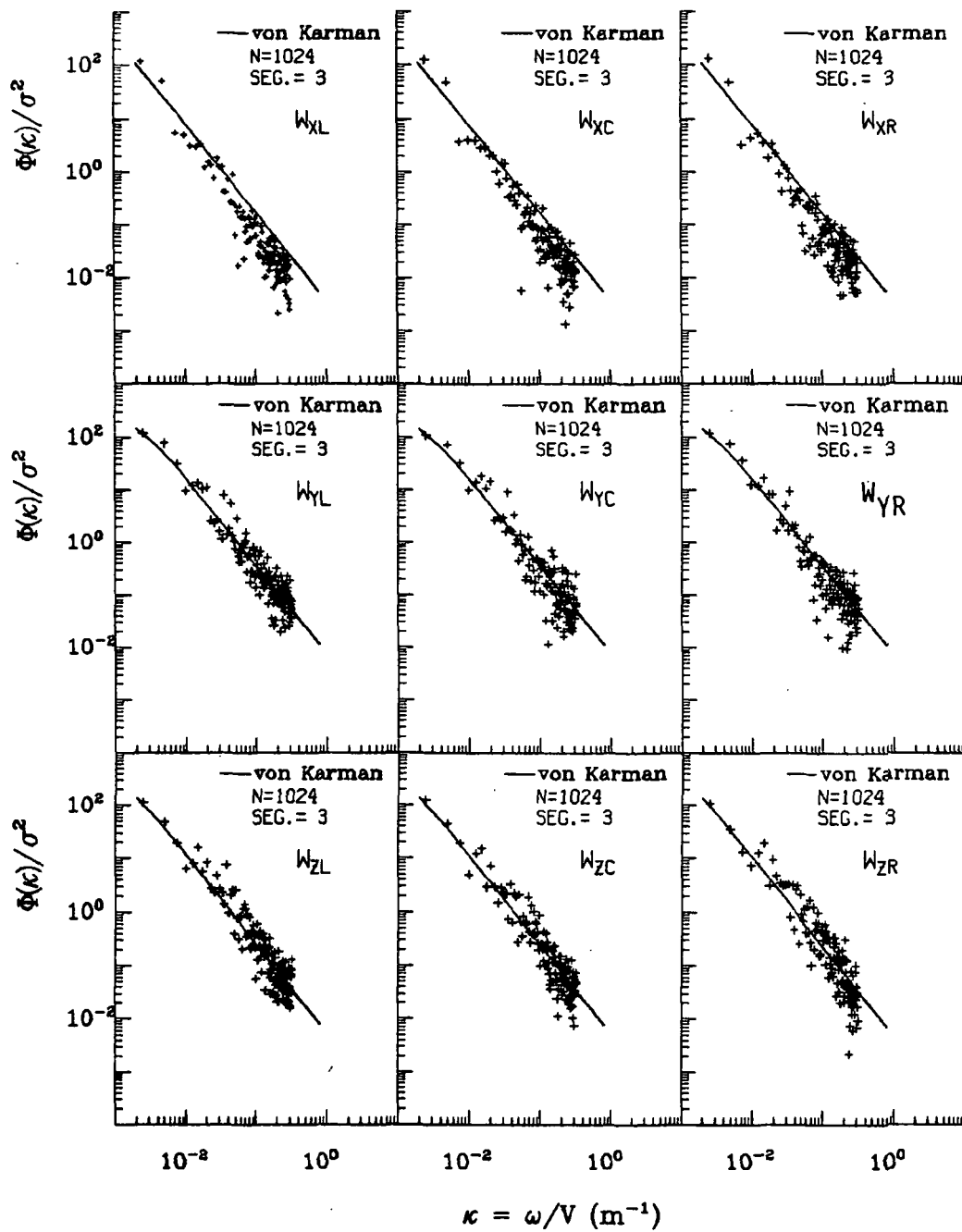

Figure A.14. Normalized auto-spectra of gust velocities, Flight 6, Run 3.

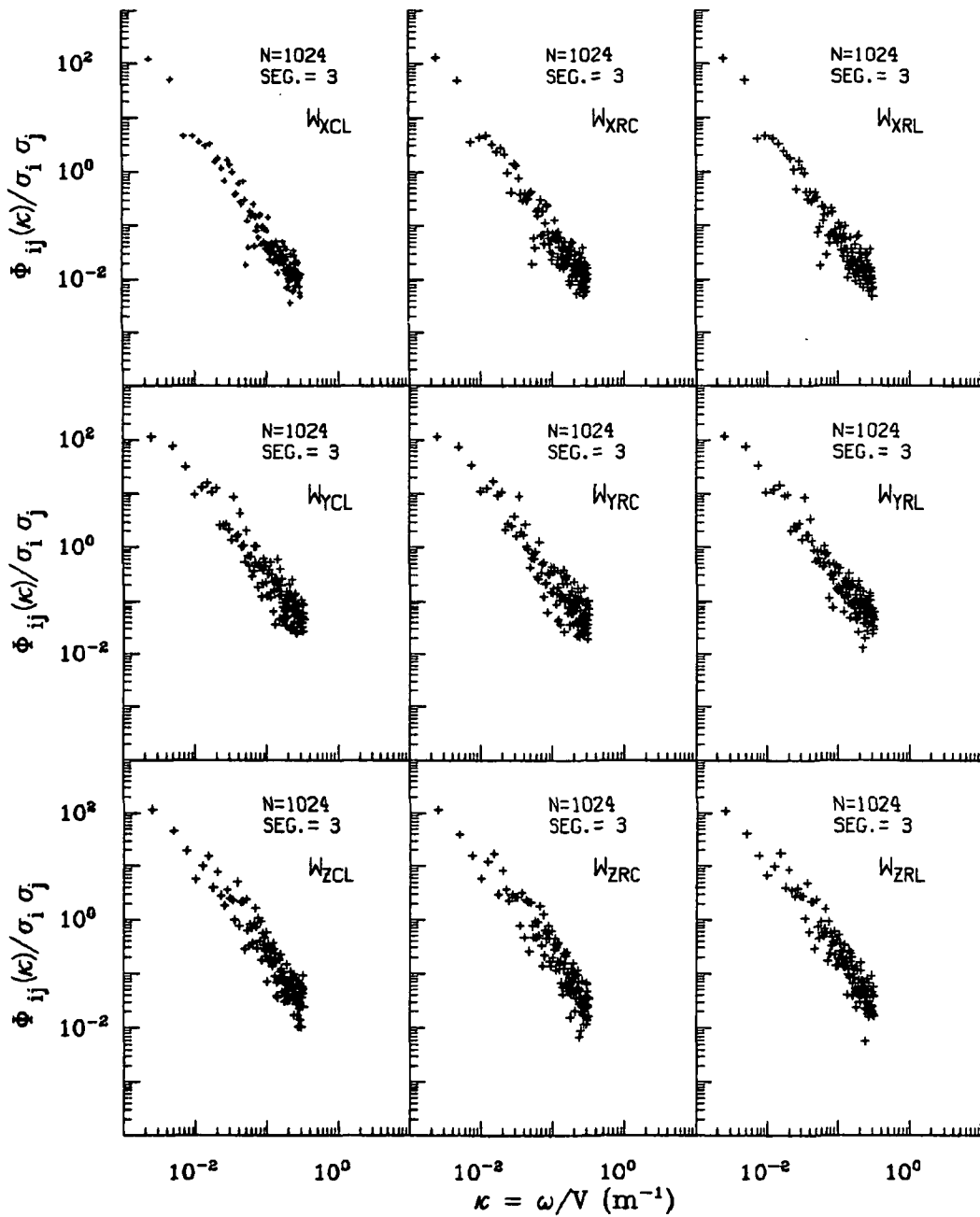

Figure A.15. Normalized two-point auto-spectra of gust velocities, Flight 6, Run 3.

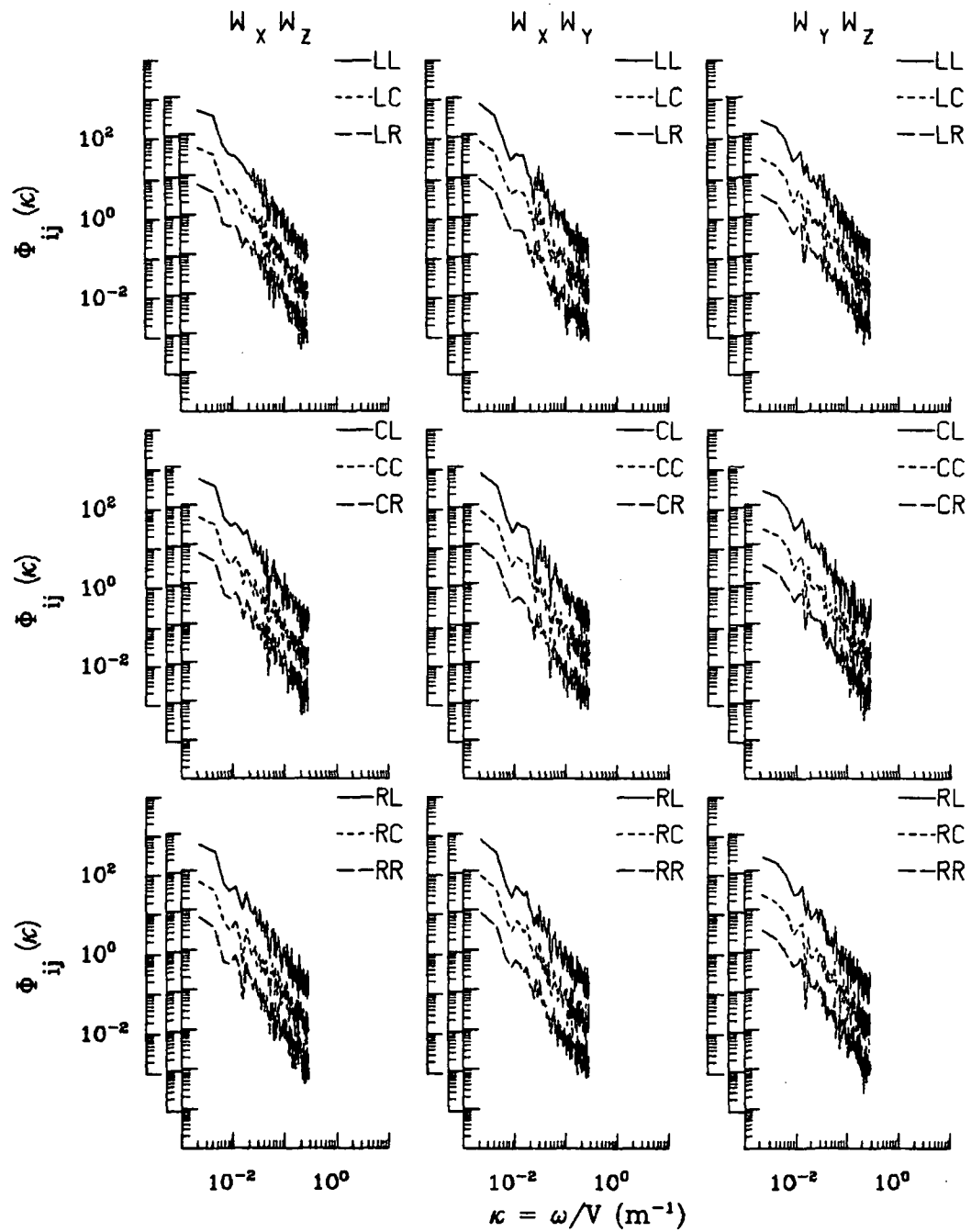

Figure A.16. Two-point cross-spectra of gust velocities, Flight 6, Run 3.

ORIGINAL PAGE IS
OF POOR QUALITY

TABLE A.4. List of All Parameters Measured and Their Range of Values,
Flight 6, Run 3.

START TIME = 49805.4844

STOP TIME = 49883.5094

CHANNEL	UNITS	HIGH	LOW	MEAN	RMS	POINTS
2 PHI DOT	RAD/SEC	.072	-.088	-.00324	.02078	3121
3 ACCL N CG	G UNITS	1.627	.642	.99422	.99850	3121
4 THETA DOT	RAD/SEC	.037	-.045	.00481	.01095	3121
5 THETA	RAD	.094	.031	.06292	.06434	3121
6 PHI	RAD	.041	-.069	-.00889	.02096	3121
7 PSI 1	DEGREES	313.321	308.397	310.69637	310.69764	3121
8 DEL PSI 1	DEGREES	2.904	-1.857	.51978	1.02301	3121
9 PSI 2	DEGREES	314.988	310.660	312.55654	312.55775	3121
10 DEL PSI 2	DEGREES	2.874	-1.802	.51022	1.01485	3121
11 ACCL N LT	G UNITS	2.020	.160	1.01168	1.02621	3121
12 ACCL N RT	G UNITS	1.859	.182	1.02835	1.04275	3121
13 ACCL X CG	G UNITS	.139	.032	.06434	.06518	3121
14 ACCL Y CG	G UNITS	.175	-.159	.00796	.05271	3121
15 ALPHA CTR	RAD	.658	-.054	-.01048	.01490	3121
16 BETA CTR	RAD	.636	-.072	-.02107	.02740	3121
17 TEMP I	DEG F	107.798	106.899	107.33032	107.33056	3121
18 TEMP P	DEG F	90.006	89.647	89.83471	89.83472	3121
19 ACCL Z INS	G UNITS	1.633	.620	1.00459	1.00892	3121
20 ALPHA RT	RAD	.068	-.060	-.00229	.01282	3121
21 BETA RT	RAD	.663	-.035	.01447	.02156	3121
22 ALPHA LT	RAD	.069	-.039	.00071	.01119	3121
23 BETA LT	RAD	.021	-.085	-.02642	.03106	3121
24 PSI DOT	RAD/SEC	.035	-.027	.00346	.01146	3121
25 TEMP TOT	DEG C	29.914	28.240	28.94907	28.95259	3121
26 QC LT	PSID	.975	.758	.82327	.82447	3121
27 QC CTR	PSID	.944	.751	.81163	.81273	3121
28 QC RT	PSID	.993	.763	.83729	.83843	3121
29 PS	PSIA	10.979	10.680	10.95411	10.95412	3121
30 TEMP IRT	DEG C	24.966	13.439	20.73977	20.83180	3121
31 D TO G	METERS	8742922.2148737460.433	*****	*****	*****	3121
32 B TO D	DEGREES	80.291	80.229	80.26050	80.26050	3121
33 LONG	DEGREES	-105.006	-105.082	-105.04370	105.04370	3121
34 LAT	DEGREES	39.858	39.804	39.83064	39.83064	3121
35 TPK ANG	DEGREES	313.111	311.510	312.08458	312.08480	3121
36 HDG	RADIANS	5.496	5.410	5.45239	5.45241	3121
37 VE	M/SEC	-82.071	-85.818	-84.17617	84.18227	3121
38 VN	M/SEC	78.414	73.974	76.04477	76.05794	3121
39 ALTITUDE	KM	2.612	2.392	2.41049	2.41049	3121
40 TEMPC	DEGREES C	23.458	22.310	22.84278	22.84376	3121
41 EW WND SPD	KNOTS	9.351	-16.032	-7.78967	9.22385	3121
42 NS WND SPD	KNOTS	7.154	-17.897	-.60240	6.27648	3121
43 WIND SPEED	KNOTS	18.503	2.391	10.84520	11.15677	3121
44 WIND DIR EC	DEGREES	359.998	.072	105.75741	129.53243	3121
45 AIRSPEED R	M/SEC	122.176	107.545	112.42393	112.45970	3121
46 AIRSPEED C	M/SEC	119.203	106.668	110.73093	110.76639	3121
47 AIRSPEED L	M/SEC	121.133	107.221	111.49930	111.53747	3121
48 DELTA ALT	METERS	195.070	-24.882	-6.41525	8.34518	3121
49 INRTL DISP	METERS	0.000	-15.034	-5.23568	6.93721	3121
50 UG RIGHT	M/SEC	5.250	-11.902	-.00000	3.73122	3121
51 UG CENTER	M/SEC	4.576	-10.520	-.00000	3.68761	3121
52 UG LEFT	M/SEC	4.812	-11.826	-.00000	3.75082	3121
53 VG RIGHT	M/SEC	4.611	-6.089	-.01278	1.71976	3121
54 VG CENTER	M/SEC	4.474	-6.336	-.01492	1.79824	3121
55 VG LEFT	M/SEC	4.239	-7.339	-.01482	1.76225	3121
56 WG RIGHT	M/SEC	7.622	-8.356	-.04249	2.22740	3121
57 WG CENTER	M/SEC	6.933	-6.061	-.03757	2.03396	3121
58 WG LEFT	M/SEC	8.091	-5.981	-.03986	2.09167	3121

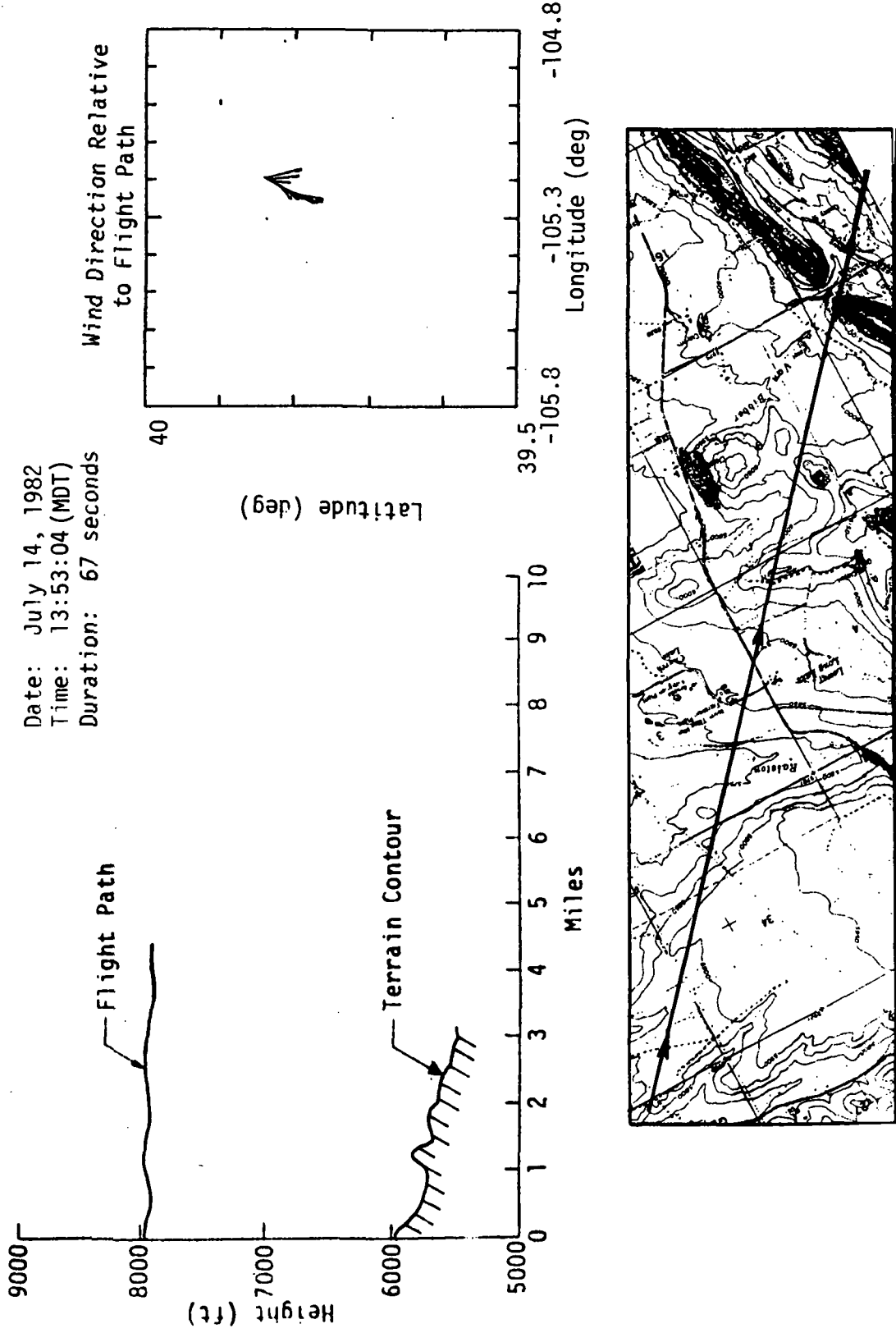

Figure A.17. Flight path information, Flight 6, Run 4.

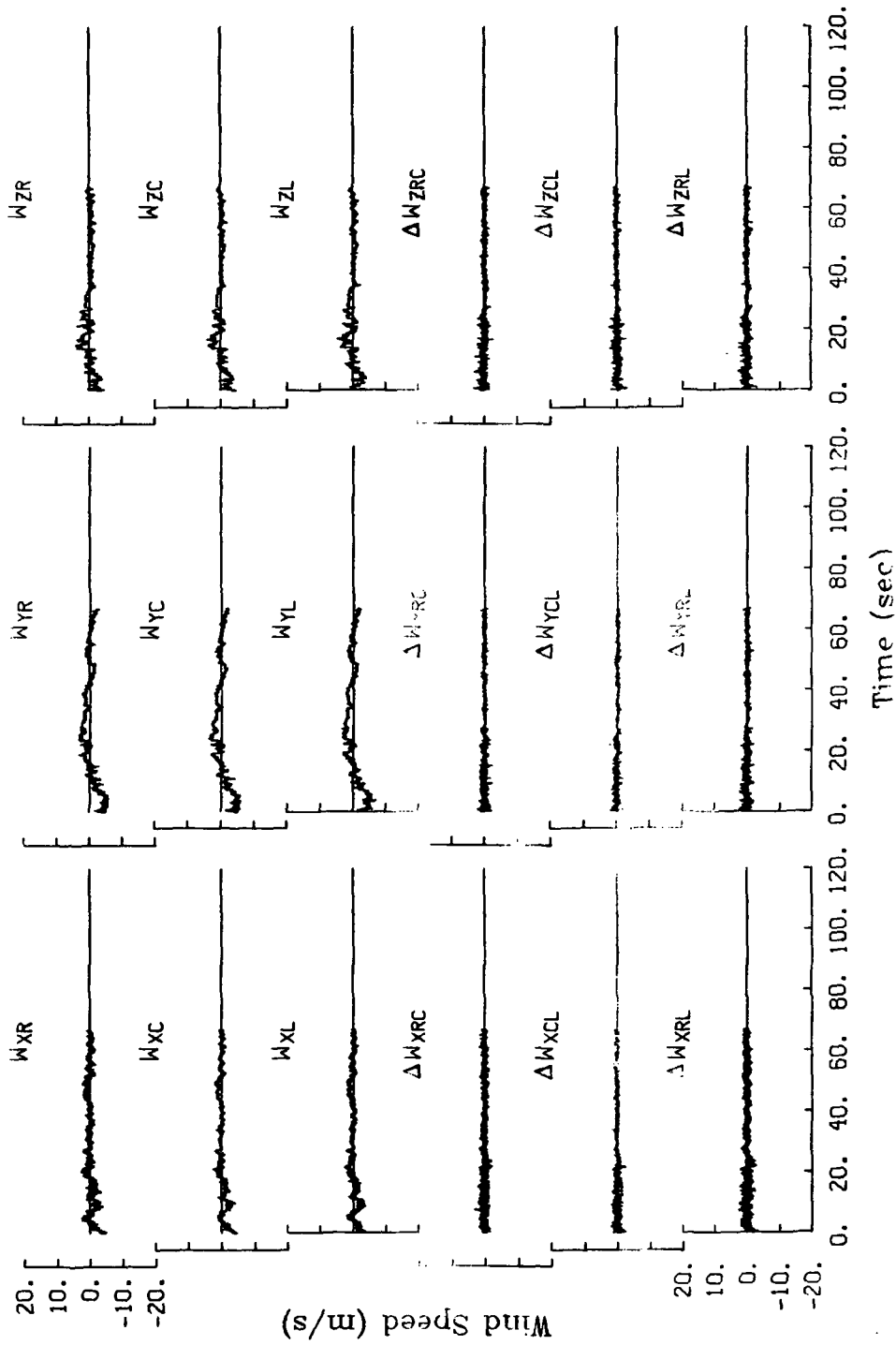

Figure A.18. Time histories of gust velocities and gust velocity differences, Flight 6, Run 4.

I. Mean Airspeed (m/s)

v_L	v_C	v_R
108.4	107.7	109.5

II. Standard Deviation of Gust Velocities (m/s)

$\sigma_{W_{XL}}$	$\sigma_{W_{XC}}$	$\sigma_{W_{XR}}$
0.98	0.97	1.03
$\sigma_{W_{YL}}$	$\sigma_{W_{YC}}$	$\sigma_{W_{YR}}$
1.97	1.92	1.91
$\sigma_{W_{ZL}}$	$\sigma_{W_{ZC}}$	$\sigma_{W_{ZR}}$
1.23	1.20	1.22

III. Standard Deviation of Gust Velocity Differences (m/s)

$\sigma_{\Delta W_{XCL}}$	$\sigma_{\Delta W_{XRC}}$	$\sigma_{\Delta W_{XRL}}$
0.49	0.53	0.67
$\sigma_{\Delta W_{YCL}}$	$\sigma_{\Delta W_{YRC}}$	$\sigma_{\Delta W_{YRL}}$
0.46	0.43	0.48
$\sigma_{\Delta W_{ZCL}}$	$\sigma_{\Delta W_{ZRC}}$	$\sigma_{\Delta W_{ZRL}}$
0.52	0.48	0.56

IV. Integral Length Scale (m).

$L_{W_{XL}}$	$L_{W_{XC}}$	$L_{W_{XR}}$
260	302	216
$L_{W_{YL}}$	$L_{W_{YC}}$	$L_{W_{YR}}$
1159	1116	1141
$L_{W_{ZL}}$	$L_{W_{ZC}}$	$L_{W_{ZR}}$
617	678	694

TABLE A.5. Average Turbulence Parameters and Integral Length Scales, Flight 6, Run 4.

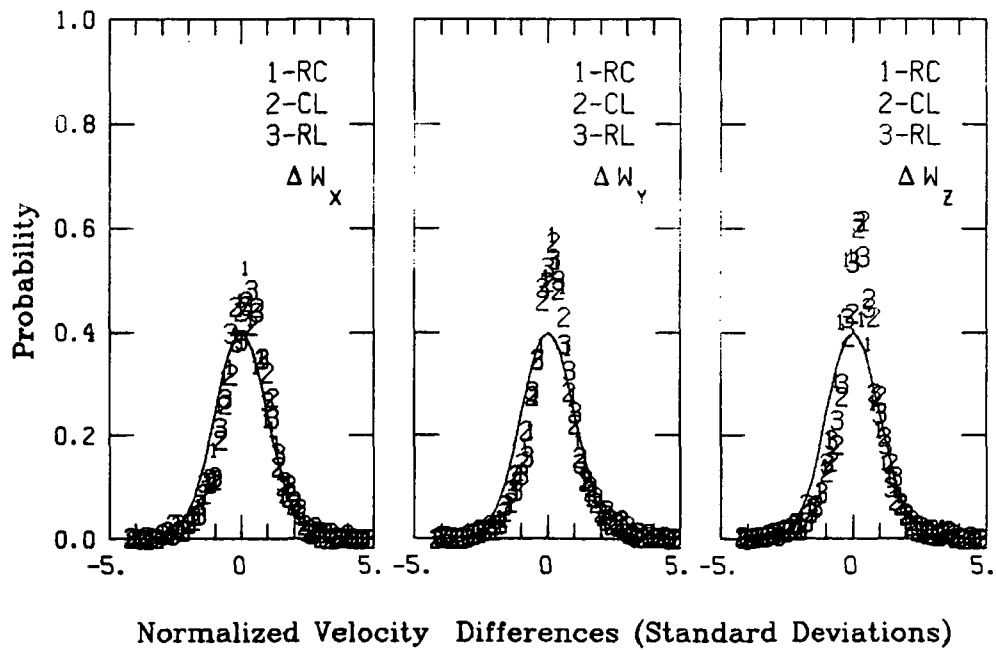
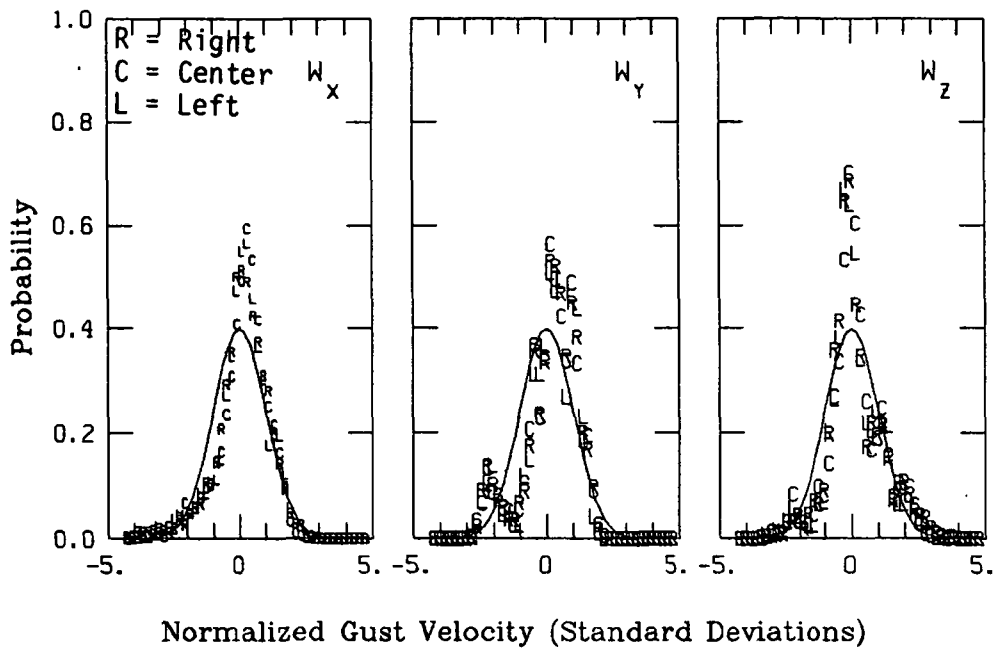

Figure A.19. Probability density function for gust velocities and gust velocity differences, Flight 6, Run 4.

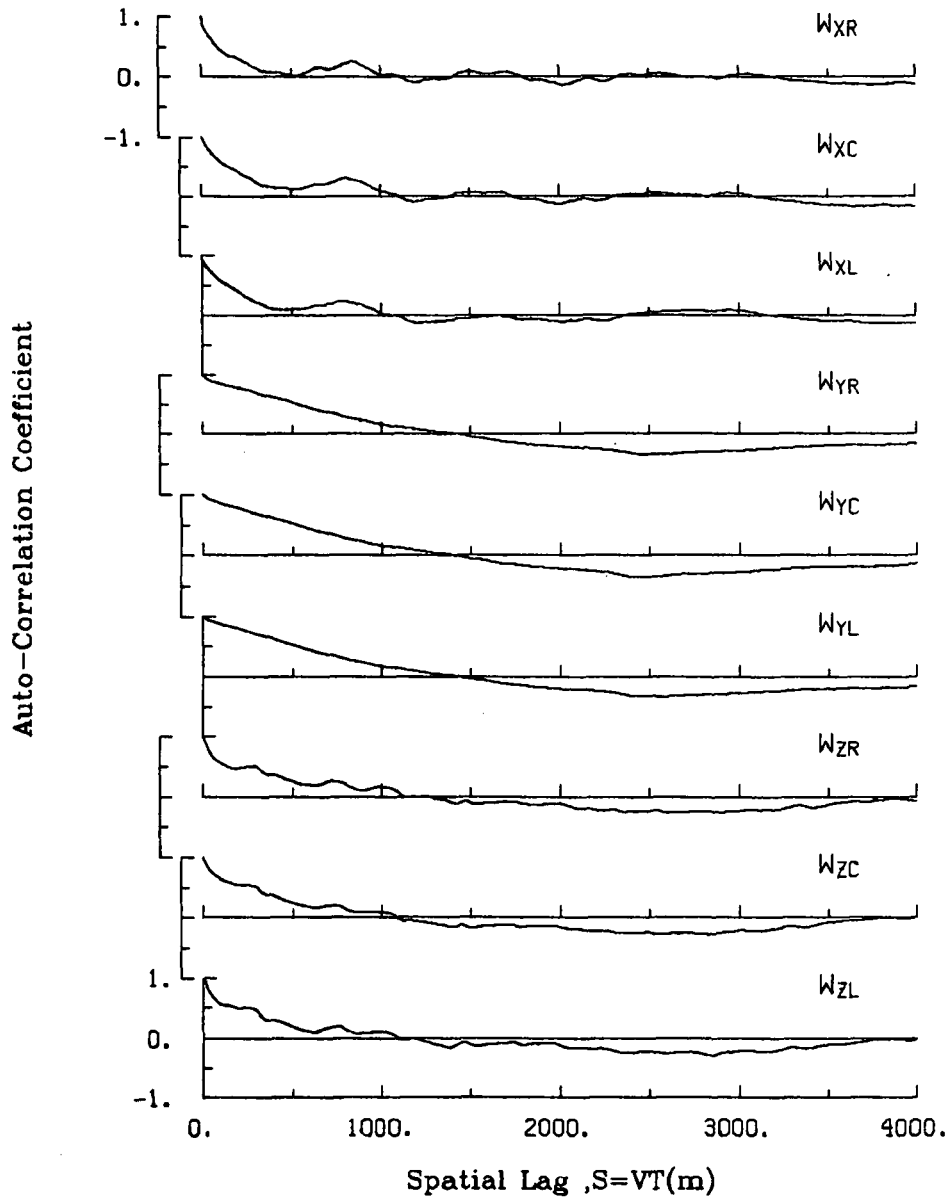

Figure A.20. Single-point auto-correlation coefficient of gust velocities, Flight 6, Run 4.

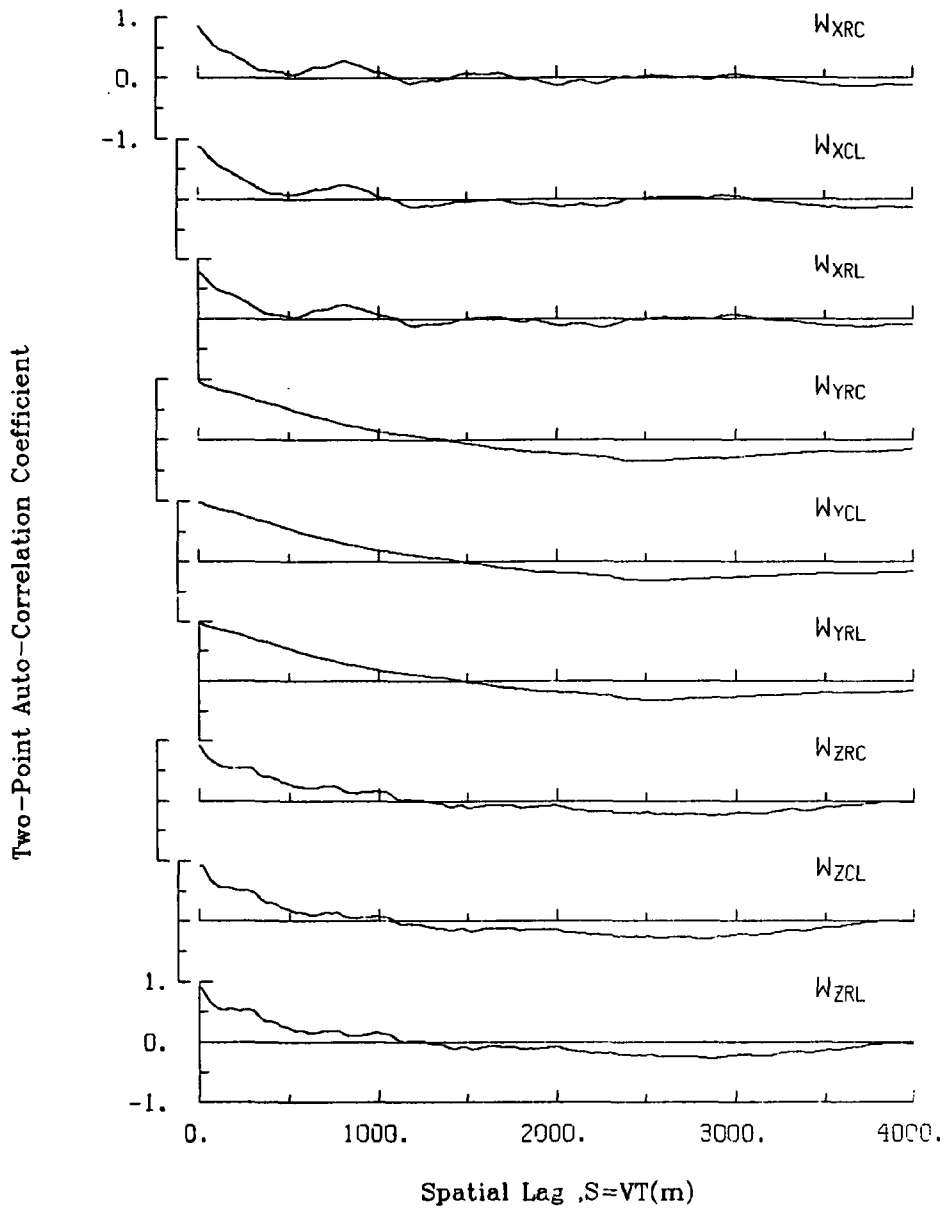

Figure A.21. Two-point auto-correlation coefficient of gust velocities, Flight 6, Run 4.

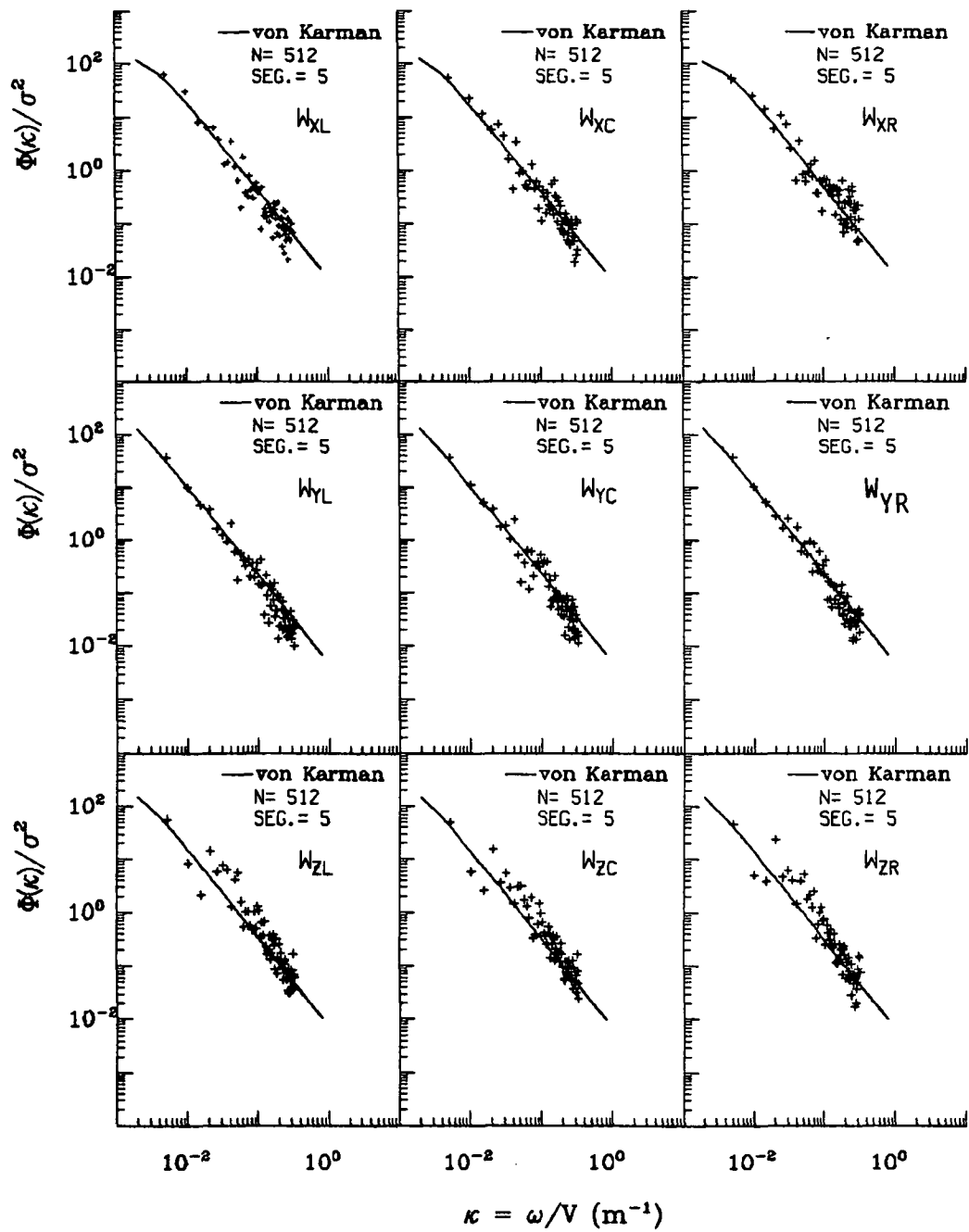

Figure A.22. Normalized auto-spectra of gust velocities, Flight 6, Run 4.

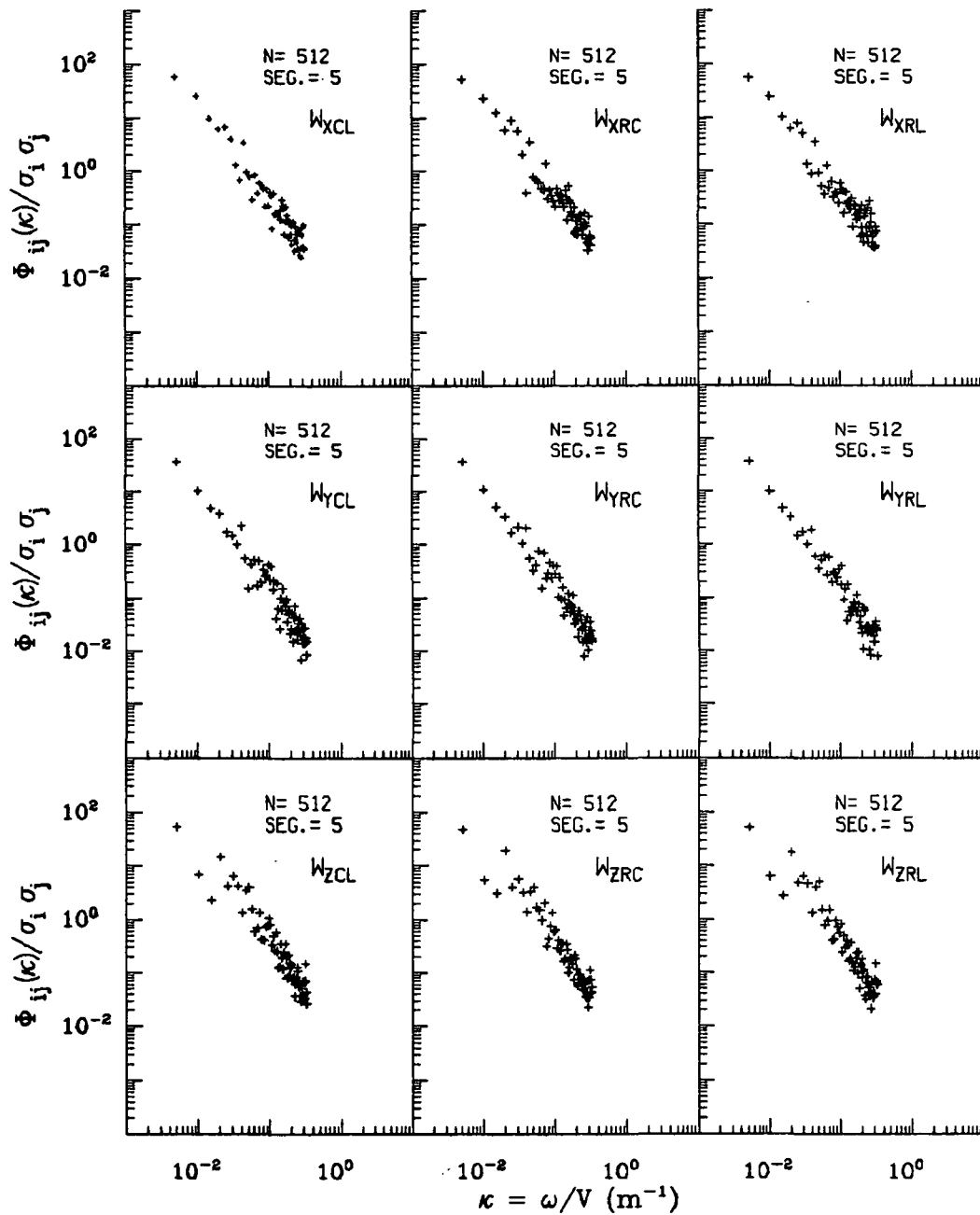

Figure A.23. Normalized two-point auto-spectra of gust velocities, Flight 6, Run 4.

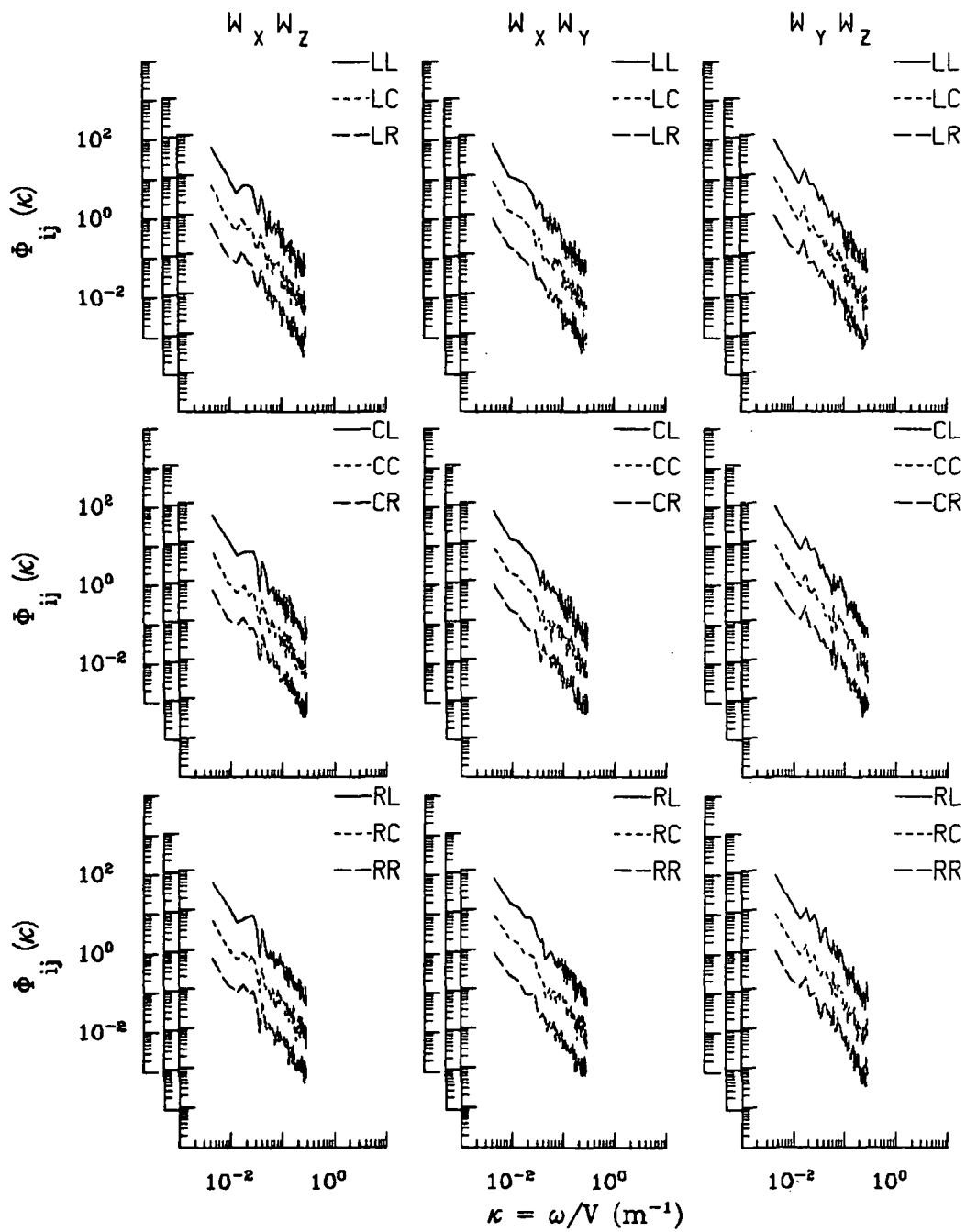
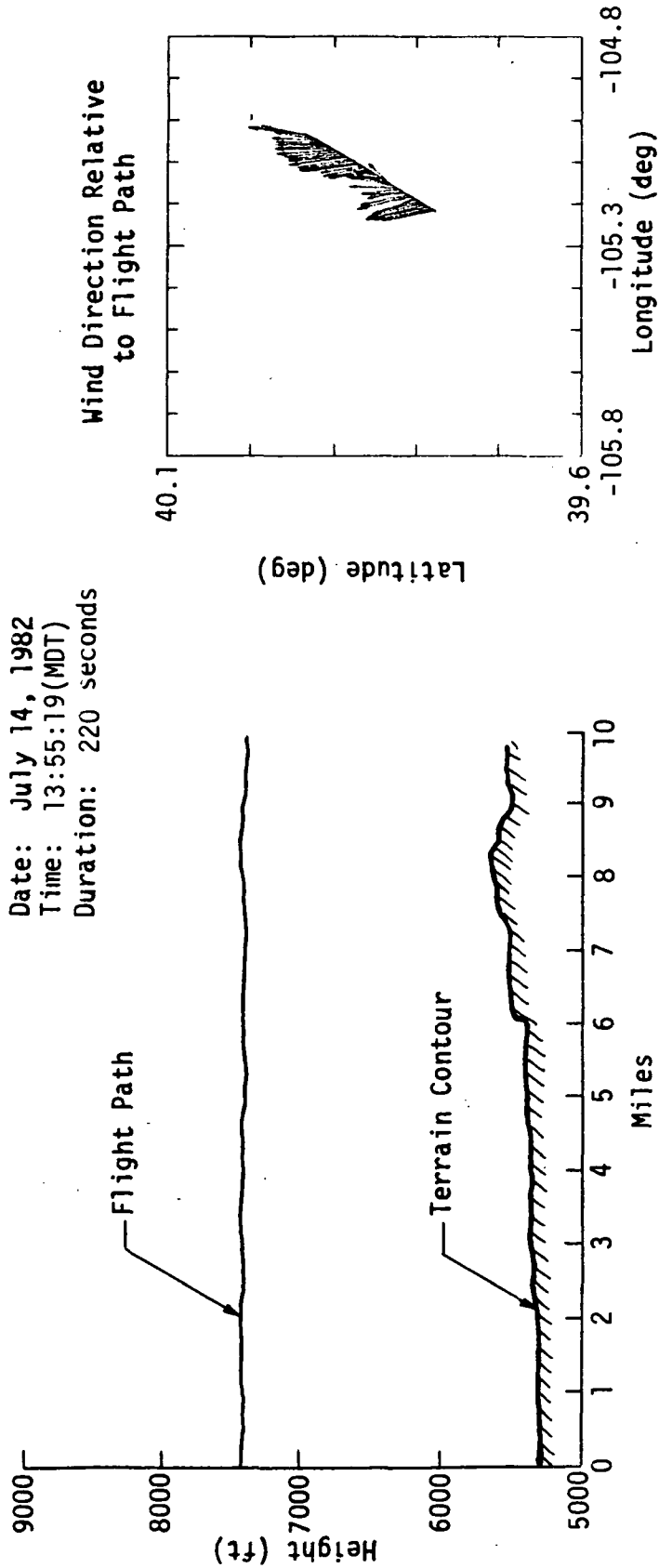

Figure A.24. Two-point cross-spectra of gust velocities, Flight 6, Run 4.

ORIGINAL PAGE IS
OF POOR QUALITY

TABLE A.6. List of All Parameters Measured and Their Range of Values,
Flight 6, Run 4.

		START TIME = 49983.5647	STOP TIME = 50050.6647		POINTS	
CHANNEL	UNITS	HIGH	LOW	MEAN	RMS	
2 PHI DOT	RAD/SEC	.091	-.066	-.00283	.01781	2684
3 ACCL N CG	G UNITS	1.293	.743	.99291	.99529	2684
4 THETA DOT	RAD/SEC	.029	-.033	.00433	.00828	2684
5 THETA	RAD	.097	.044	.06338	.06433	2684
6 PHI	RAD	.042	-.055	-.01429	.02436	2684
7 PSI 1	DEGREEFS	221.749	217.874	220.18189	220.18367	2684
8 DEL PSI 1	DEGREES	-.327	-4.061	-1.88476	2.07056	2684
9 PSI 2	DEGREES	583.261	579.727	581.82887	581.82949	2684
10 DEL PSI 2	DEGREES	-.481	-4.242	-2.06824	2.24112	2684
11 ACCL N LT	G UNITS	1.778	.440	1.01031	1.01795	2684
12 ACCL N RT	G UNITS	1.495	.399	1.02689	1.03394	2684
13 ACCL X CG	G UNITS	.133	.038	.07836	.08118	2684
14 ACCL Y CG	G UNITS	.169	-.146	.01505	.04168	2684
15 ALPHA CTR	RAD	.034	-.029	-.00556	.01106	2684
16 BETA CTR	RAD	.041	-.047	-.00462	.01537	2684
17 TEMP I	DEG F	106.539	105.819	106.13871	106.13888	2684
18 TEMP P	DEG F	90.006	89.826	89.89843	89.89847	2684
19 ACCL Z INS	G UNITS	1.285	.751	1.00476	1.00707	2684
20 ALPHA RT	RAD	.056	-.021	.00596	.01297	2684
21 BETA RT	RAD	.073	-.011	.03009	.03312	2684
22 ALPHA LT	RAD	.054	-.017	.00762	.01297	2684
23 BETA LT	RAD	.029	-.047	-.01116	.01711	2684
24 PSI DOT	RAD/SEC	.033	-.027	.00300	.01106	2684
25 TEMP TOT	DEG C	28.530	27.453	28.27712	28.27952	2684
26 OC LT	PSID	.839	.659	.77768	.77898	2684
27 OC CTR	PSID	.827	.664	.76766	.76890	2684
28 OC RT	PSID	.858	.671	.79386	.79516	2684
29 PS	PSIA	10.966	10.928	10.94477	10.94478	2684
30 TEMP IRT	DEG C	19.717	17.880	19.09111	19.09499	2684
31 D TO G	METERS	8727818.7658722005.619	*****	*****	*****	2684
32 B TO D	DEGREES	80.158	80.130	80.14442	80.14442	2684
33 LONG	DEGREES	-105.194	-105.251	-105.22186	105.22186	2684
34 LAT	DEGREES	39.842	39.792	39.81719	39.81719	2684
35 TRK ANG	DEGREES	222.453	219.846	221.46507	221.46663	2684
36 HDG	RADIANS	3.696	3.829	3.86850	3.86853	2684
37 VE	M/SEC	-66.683	-76.635	-73.54235	73.61339	2684
38 VN	M/SEC	-79.190	-85.614	-83.09585	83.11787	2684
39 ALTITUDE	KM	2.430	2.402	2.41729	2.41730	2684
40 TEMPC	DEGREES C	23.216	22.100	22.49604	22.49700	2684
41 EW WND SPD	KNOTS	9.174	-9.308	-3.09424	4.56038	2684
42 NS WND SPD	KNOTS	-.177	-13.973	-5.67368	6.15738	2684
43 WIND SPEED	KNOTS	14.186	2.910	7.42542	7.66227	2684
44 WIND DIREC	DEGREEFS	359.947	.030	91.36132	146.35400	2684
45 AIRSPEED P	M/SEC	113.792	100.949	109.51228	109.55540	2684
46 AIRSPEED C	M/SEC	111.724	100.437	107.73473	107.77641	2684
47 AIRSPEED L	M/SEC	112.532	100.083	108.41707	108.46061	2684
48 DELTA ALT	METERS	2.870	-25.156	-9.49684	11.60598	2684
49 INRTL DISP	METERS	0.000	-23.903	-11.00873	12.86281	2684
50 UG RIGHT	M/SEC	2.922	-4.777	.00000	1.01469	2684
51 UG CENTER	M/SEC	2.533	-4.499	.00000	.95252	2684
52 UG LEFT	M/SEC	2.820	-3.840	.00000	.97071	2684
53 VG RIGHT	M/SEC	3.459	-3.390	.00741	1.89446	2684
54 VG CENTER	M/SEC	3.934	-5.667	.00539	1.90553	2684
55 VG LEFT	M/SEC	3.552	-6.676	.00808	1.95181	2684
56 WG RIGHT	M/SEC	3.893	-4.305	-.00760	1.20733	2684
57 WG CENTER	M/SEC	4.189	-4.193	-.00448	1.18024	2684
58 WG LEFT	M/SEC	4.554	-4.099	-.00579	1.21073	2684



ORIGINAL PAGE IS
 OF POOR QUALITY

Figure A.25. Flight path information, Flight 6, Run 5.

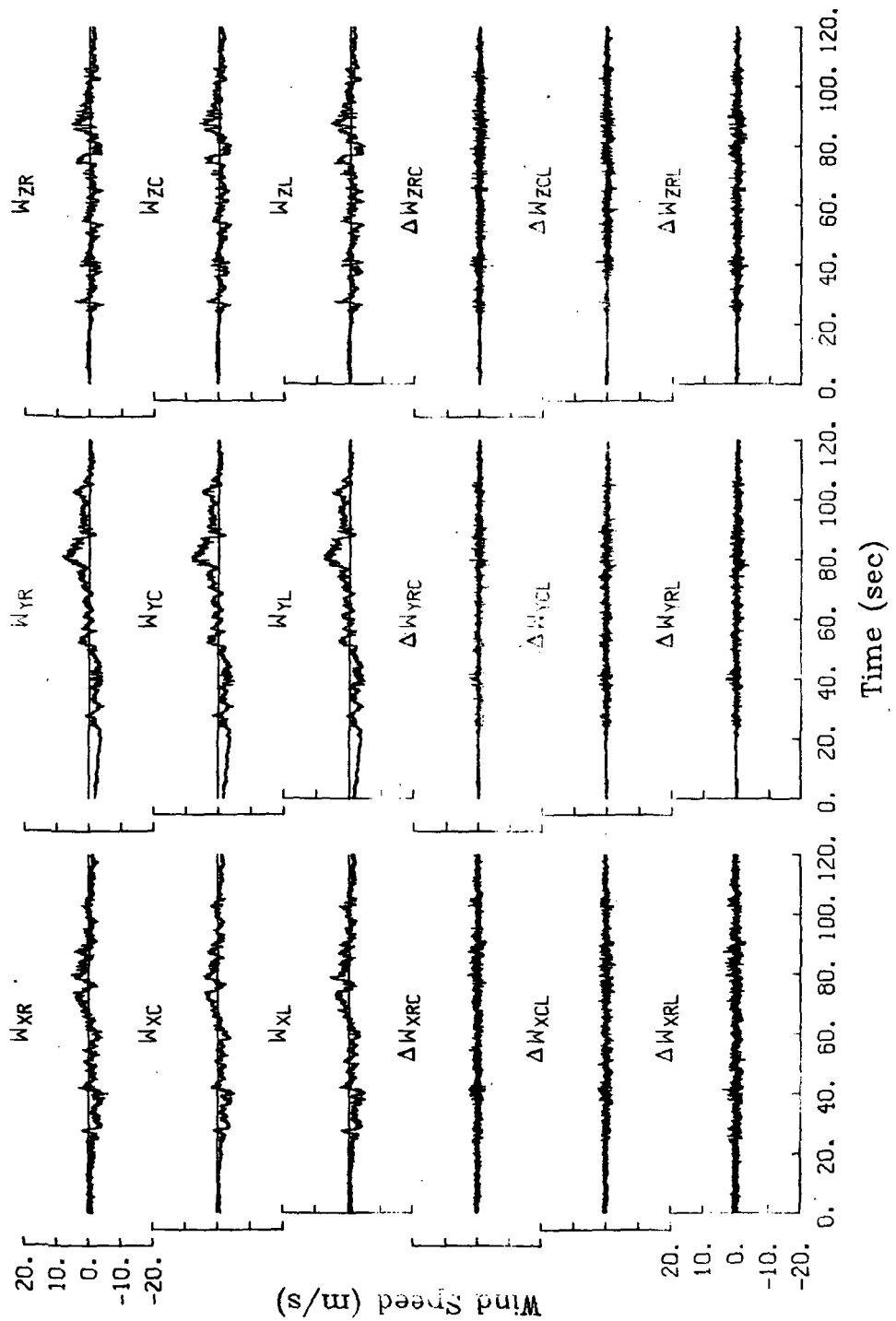

Figure A.26. Time histories of gust velocities and gust velocity differences, Flight 6, Run 5.

TABLE A.7. Average Turbulence Parameters and Integral Length Scales, Flight 6, Run 5.

I. Mean Airspeed (m/s)

V_L	V_C	V_R
104.0	103.3	105.0

II. Standard Deviation of Gust Velocities (m/s)

$\sigma_{W_{XL}}$	$\sigma_{W_{XC}}$	$\sigma_{W_{XR}}$
1.26	1.19	1.26
$\sigma_{W_{YL}}$	$\sigma_{W_{YC}}$	$\sigma_{W_{YR}}$
1.97	2.02	1.97
$\sigma_{W_{ZL}}$	$\sigma_{W_{ZC}}$	$\sigma_{W_{ZR}}$
1.17	1.09	1.14

III. Standard Deviation of Gust Velocity Differences (m/s)

$\sigma_{\Delta W_{XCL}}$	$\sigma_{\Delta W_{XRC}}$	$\sigma_{\Delta W_{XRL}}$
0.53	0.53	0.68
$\sigma_{\Delta W_{YCL}}$	$\sigma_{\Delta W_{YRC}}$	$\sigma_{\Delta W_{YRL}}$
0.48	0.46	0.51
$\sigma_{\Delta W_{ZCL}}$	$\sigma_{\Delta W_{ZRC}}$	$\sigma_{\Delta W_{ZRL}}$
0.56	0.52	0.60

IV. Integral Length Scale (m).

$L_{W_{XL}}$	$L_{W_{XC}}$	$L_{W_{XR}}$
763	801	722
$L_{W_{YL}}$	$L_{W_{YC}}$	$L_{W_{YR}}$
2920	2878	2932
$L_{W_{ZL}}$	$L_{W_{ZC}}$	$L_{W_{ZR}}$
411	405	351

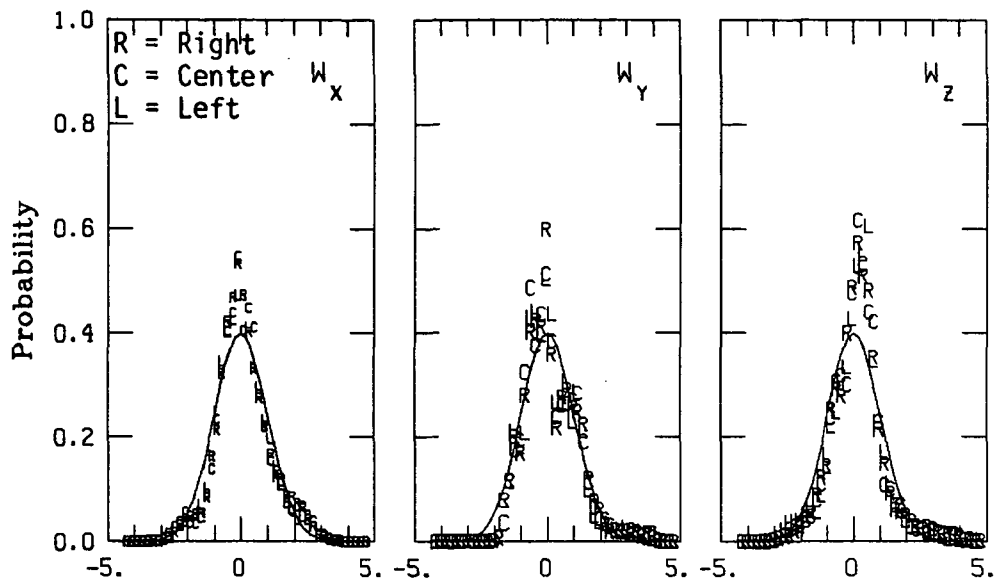

Normalized Gust Velocity (Standard Deviations)

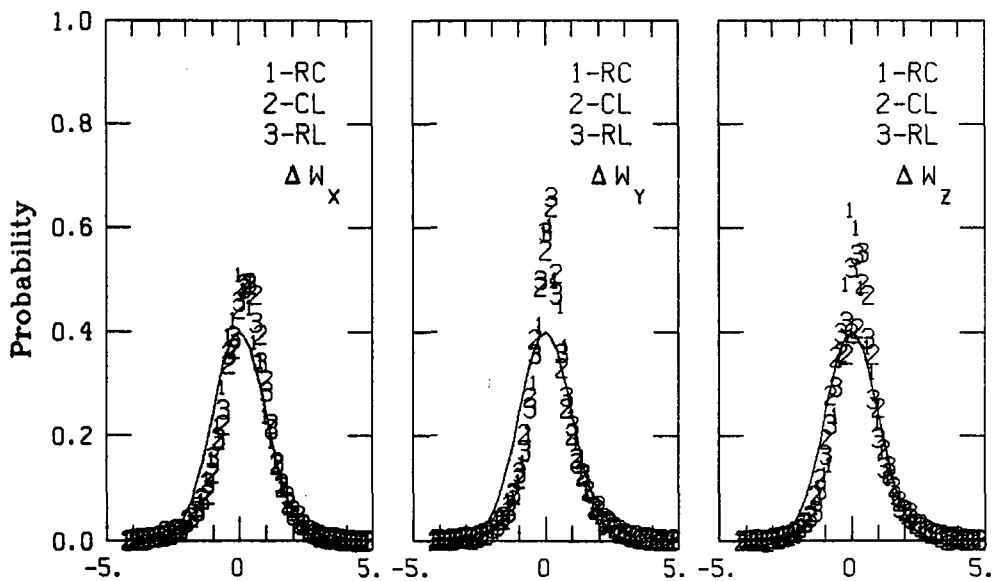

Normalized Velocity Differences (Standard Deviations)

Figure A.27. Probability density function for gust velocities and gust velocity differences, Flight 6, Run 5.

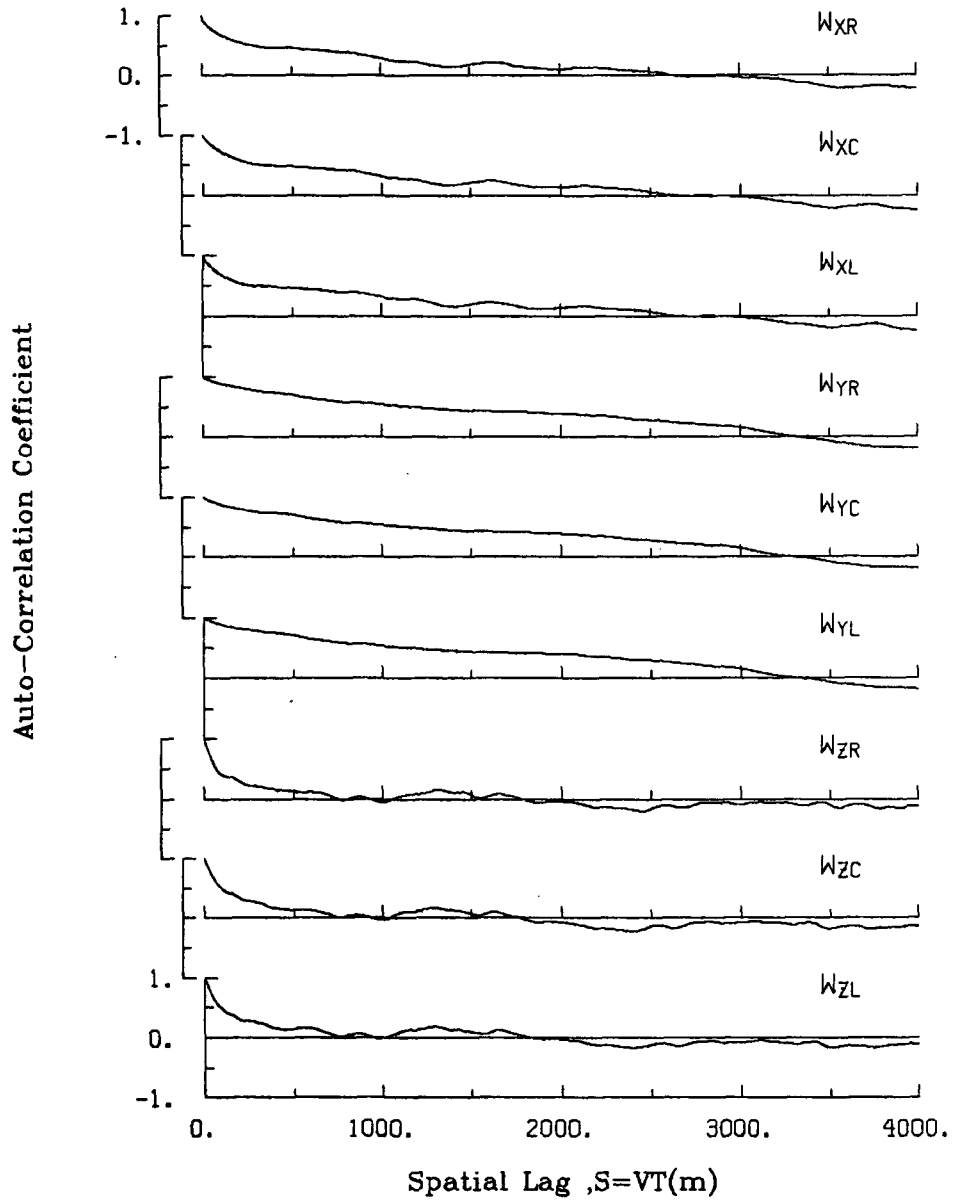

Figure A.28. Single-point auto-correlation coefficient of gust velocities, Flight 6, Run 5.

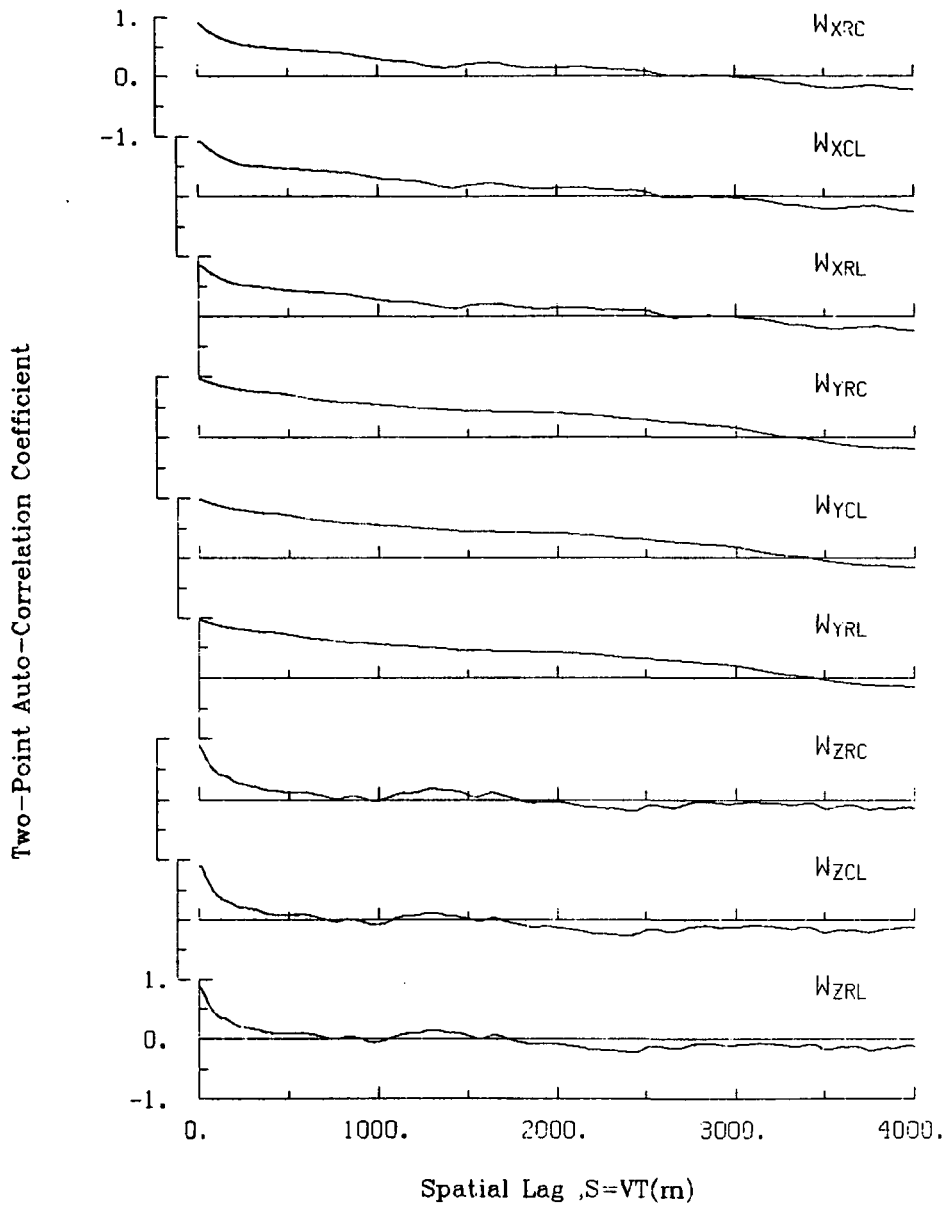

Figure A.29. Two-point auto-correlation coefficient of gust velocities, Flight 6, Run 5.

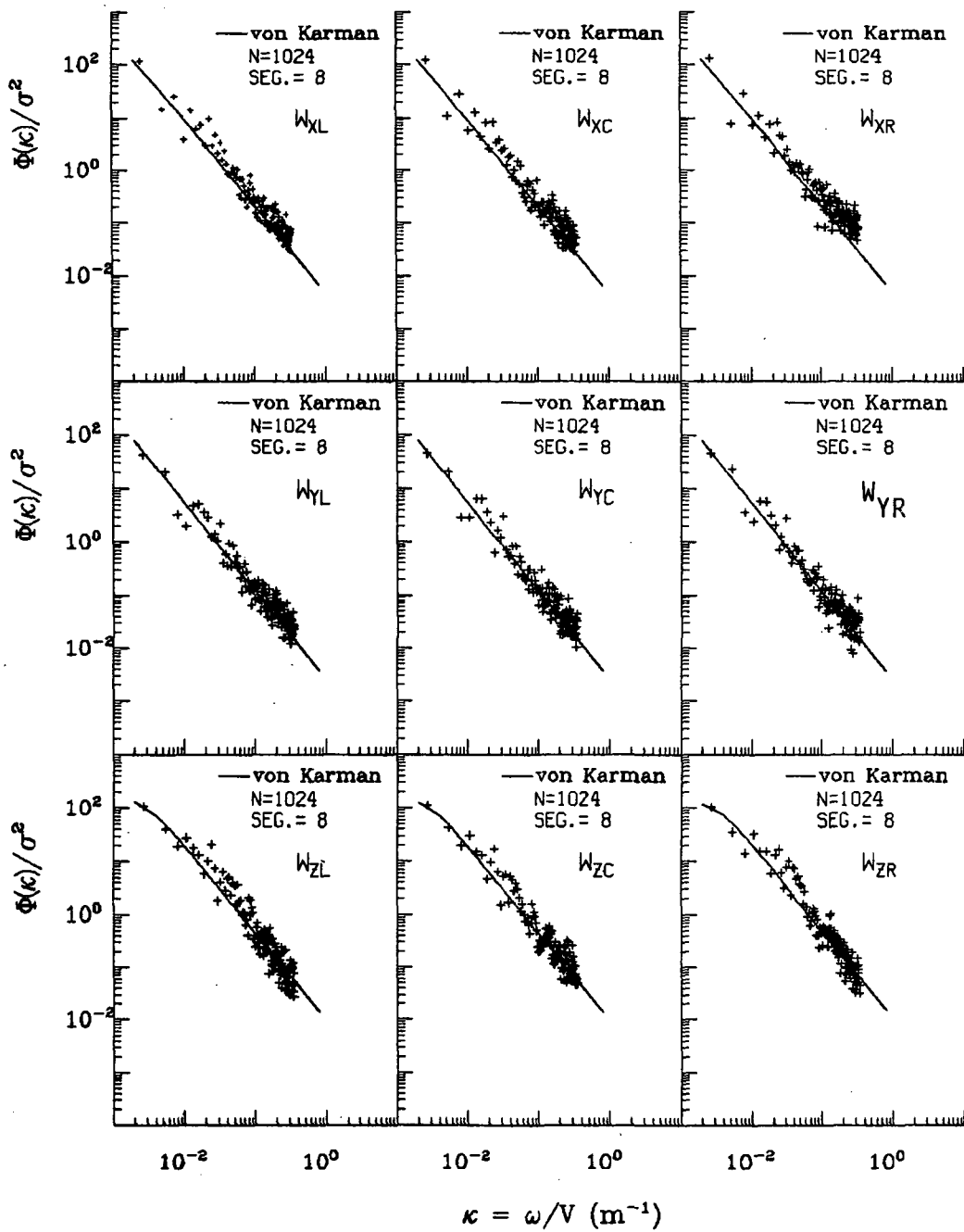

Figure A.30. Normalized auto-spectra of gust velocities, Flight 6, Run 5.

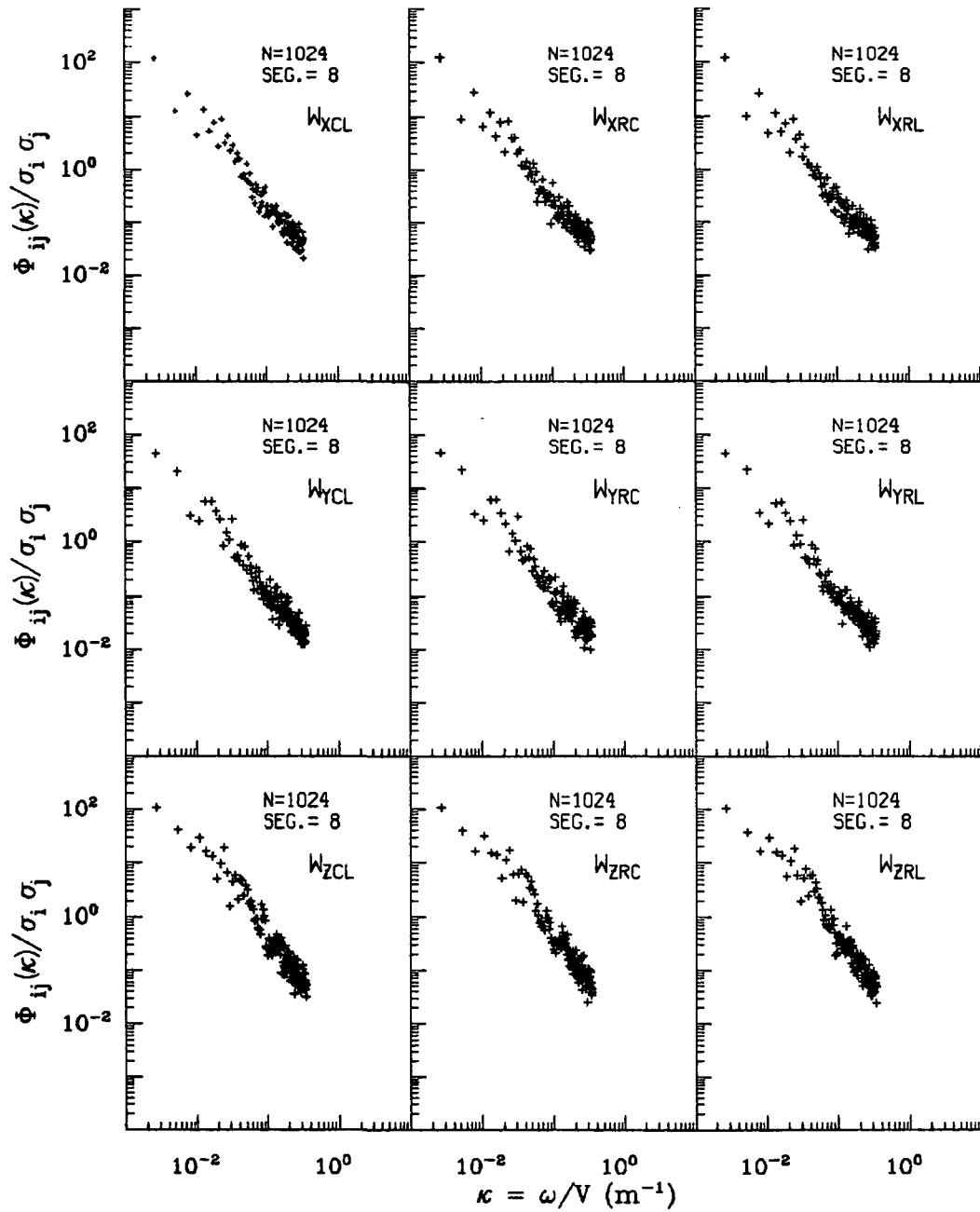

Figure A.31. Normalized two-point auto-spectra of gust velocities, Flight 6, Run 5.

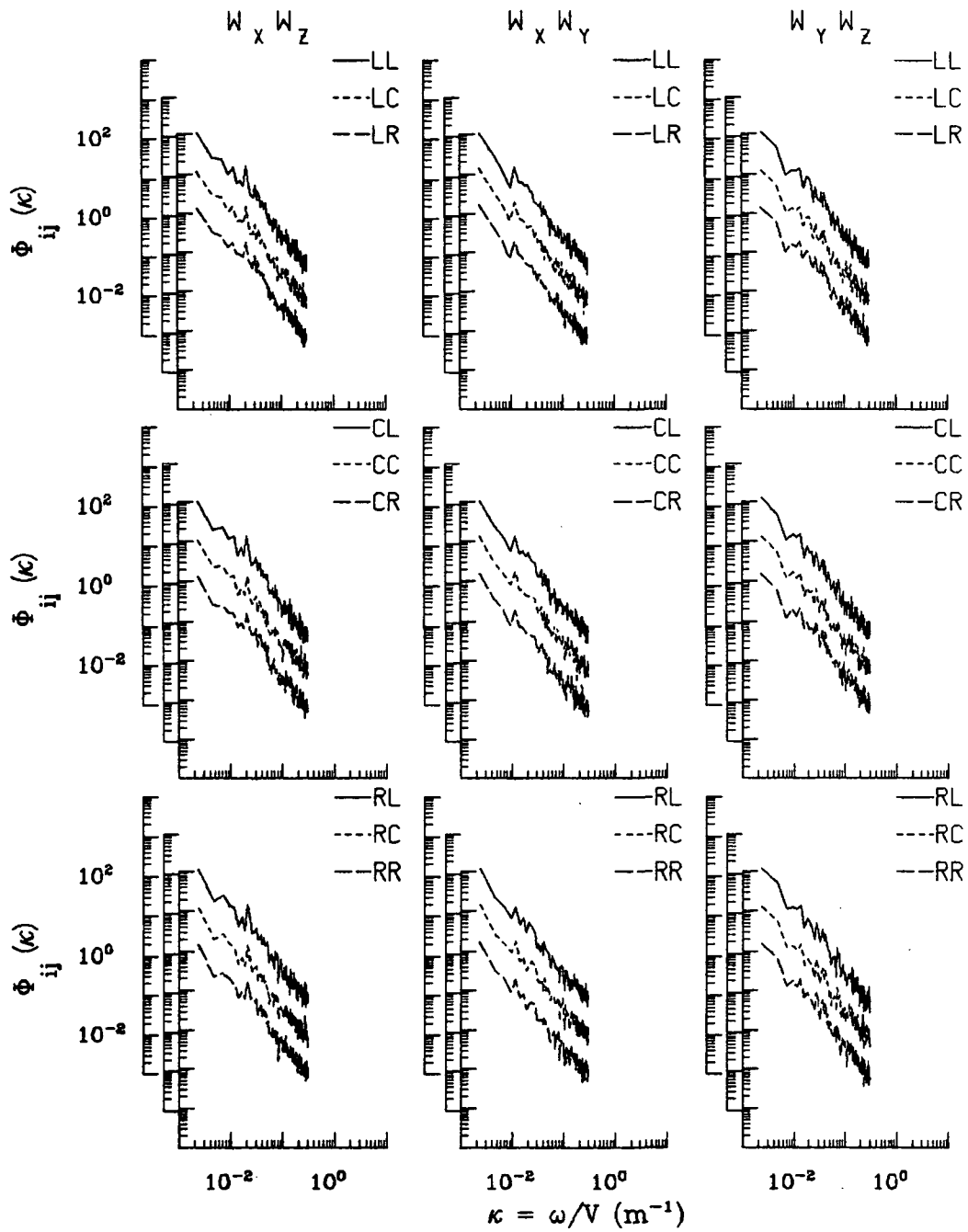

Figure A.32. Two-point cross-spectra of gust velocities, Flight 6, Run 5.

ORIGINAL PAGE IS
OF POOR QUALITY

TABLE A.8. List of All Parameters Measured and Their Range of Values, Flight 6, Run 5.

		START TIME = 50119.3050	STOP TIME = 50339.8050				
CHANNEL	UNITS	HIGH	LOW	MEAN	RMS	POINTS	
2 PHI DOT	RAD/SEC	.072	-.091	-.00269	.01681	8820	
3 ACCL N CG	G UNITS	1.405	.598	.99269	.99521	8820	
4 THETA DOT	RAD/SEC	.050	-.041	.00487	.00960	8820	
5 THETA	RAD	.119	.038	.07529	.07674	8820	
6 PHI	RAD	.071	-.087	-.01416	.02443	8820	
7 PSI 1	DEGREES	47.381	39.294	42.69511	42.72805	8820	
8 DEL PSI 1	DEGREES	-15.081	-15.081	-15.08145	15.08145	8820	
9 PSI 2	DEGREES	406.872	401.240	403.89753	403.89867	8820	
10 DEL PSI 2	DEGREES	-15.092	-15.092	-15.09198	15.09198	8820	
11 ACCL N LT	G UNITS	1.584	.276	1.01043	1.01767	8820	
12 ACCL N RT	G UNITS	1.650	.219	1.02649	1.03414	8820	
13 ACCL X CG	G UNITS	.157	.030	.07369	.07561	8820	
14 ACCL Y CG	G UNITS	.162	-.146	.01275	.04444	8820	
15 ALPHA CTR	RAD	.062	-.047	.00259	.01100	8820	
16 BETA CTR	RAD	.065	-.063	-.00701	.01619	8820	
17 TEMP I	DEG F	105.819	104.200	104.98570	104.98678	8820	
18 TEMP P	DEG F	90.006	89.826	89.97672	89.97674	8820	
19 ACCL Z INS	G UNITS	1.395	.628	1.00300	1.00544	8820	
20 ALPHA RT	RAD	.074	-.039	.01516	.01932	8820	
21 BETA RT	RAD	.087	-.027	.02900	.03193	8820	
22 ALPHA LT	RAD	.082	-.030	.01708	.02095	8820	
23 BETA LT	RAD	.045	-.066	-.01406	.01948	8820	
24 PSI DOT	RAD/SEC	.045	-.031	.00293	.01041	8820	
25 TEMP TOT	DEG C	30.111	28.733	29.54759	29.54858	8820	
26 QC LT	PSID	.810	.625	.72406	.72504	8820	
27 QC CTR	PSID	.796	.626	.71451	.71541	8820	
28 QC RT	PSID	.822	.641	.73897	.73991	8820	
29 PS	PSIA	11.220	10.953	11.16922	11.16922	8820	
30 TEMP IRT	DEG C	21.511	5.738	17.96417	18.39268	8820	
31 D TO G	METERS	8743166.054	8724751.258	*****	*****	8820	
32 R TO D	DEGREES	80.247	80.157	80.20184	80.20184	8820	
33 LONG	DEGREES	-105.033	-105.216	-105.12401	105.12402	8820	
34 LAT	DEGREES	39.935	39.777	39.85618	39.85620	8820	
35 TRK ANG	DEGREES	44.722	40.404	41.76970	41.78378	8820	
36 HDG	RADIANS	.818	.714	.76373	.76394	8820	
37 VE	M/SEC	76.890	67.498	71.13980	71.17836	8820	
38 VN	M/SEC	81.710	75.593	79.65279	79.66807	8820	
39 ALTITUDE	KM	2.411	2.219	2.25514	2.25515	8820	
40 TEMPC	DEGREES C	24.702	23.486	24.23264	24.23327	8820	
41 EW WND SPD	KNOTS	12.946	-12.386	-1.61147	4.26244	8820	
42 NS WND SPD	KNOTS	17.053	.084	10.81328	11.11099	8820	
43 WIND SPEED	KNOTS	17.561	2.931	11.63981	11.90052	8820	
44 WIND DIREC	DEGREES	269.493	120.177	173.57846	174.84177	8820	
45 AIRSPEED R	M/SEC	110.625	97.935	105.02261	105.05458	8820	
46 AIRSPEED C	M/SEC	108.842	96.832	103.30915	103.34013	8820	
47 AIRSPEED L	M/SEC	109.834	96.736	103.98006	104.01337	8820	
48 DELTA ALT	METERS	137.888	-54.284	-18.09718	19.40637	8820	
49 INRTL DISP	METERS	0.000	-32.911	-20.29578	21.63720	8820	
50 UG RIGHT	M/SEC	5.270	-5.869	.00000	1.38508	8820	
51 UG CENTER	M/SEC	4.609	-4.949	.00000	1.31898	8820	
52 UG LEFT	M/SEC	5.387	-4.978	.00000	1.40710	8820	
53 VG RIGHT	M/SEC	8.610	-4.284	-.02269	1.98759	8820	
54 VG CENTER	M/SEC	8.252	-4.442	-.02282	2.02529	8820	
55 VG LEFT	M/SEC	7.948	-4.446	-.02177	1.97693	8820	
56 WG RIGHT	M/SEC	5.907	-4.133	.00099	1.15474	8820	
57 WG CENTER	M/SEC	5.940	-3.650	.00304	1.12373	8820	
58 WG LEFT	M/SEC	6.026	-4.293	.00186	1.20869	8820	

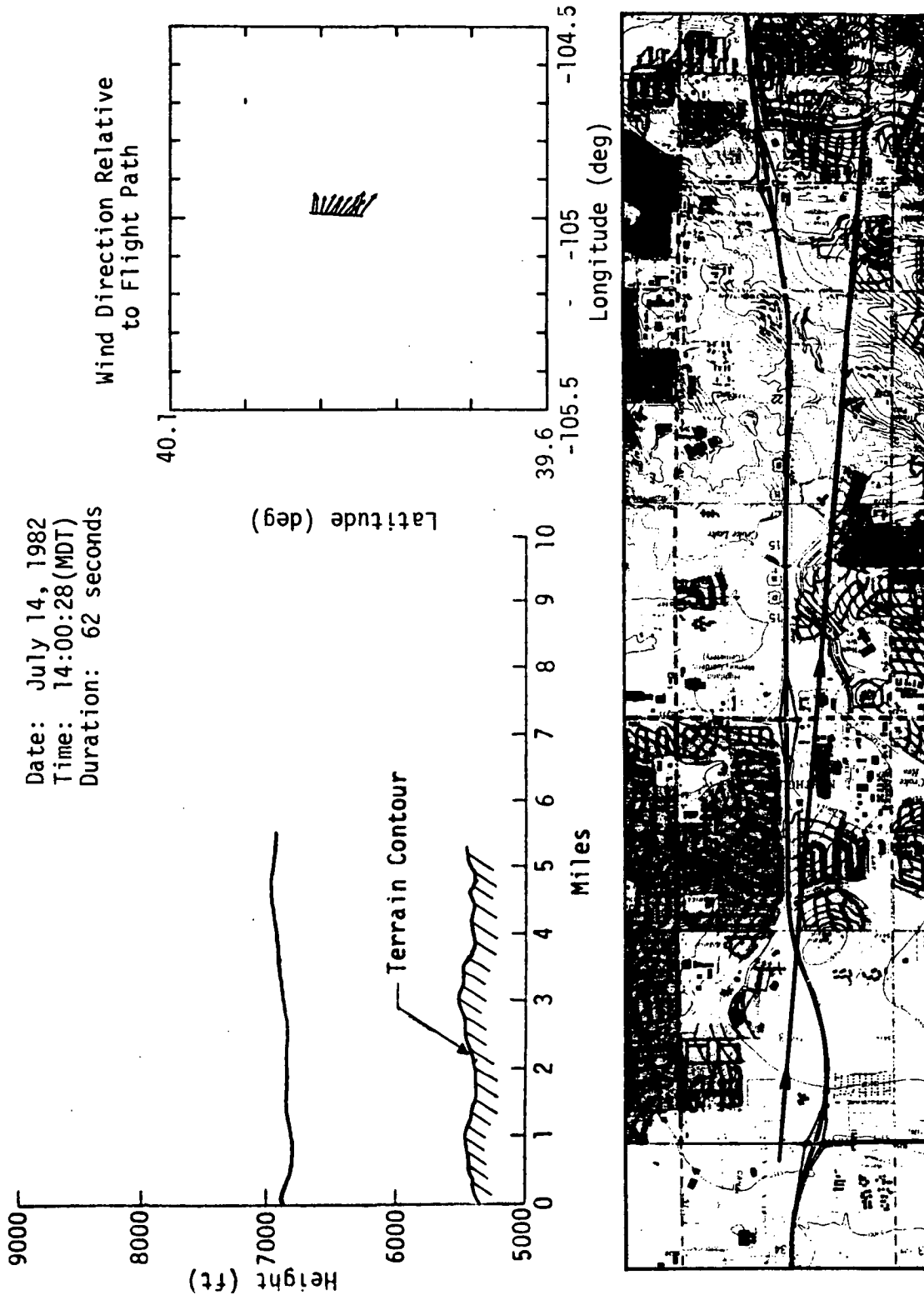

Figure A.33. Flight path information, Flight 6, Run 6.

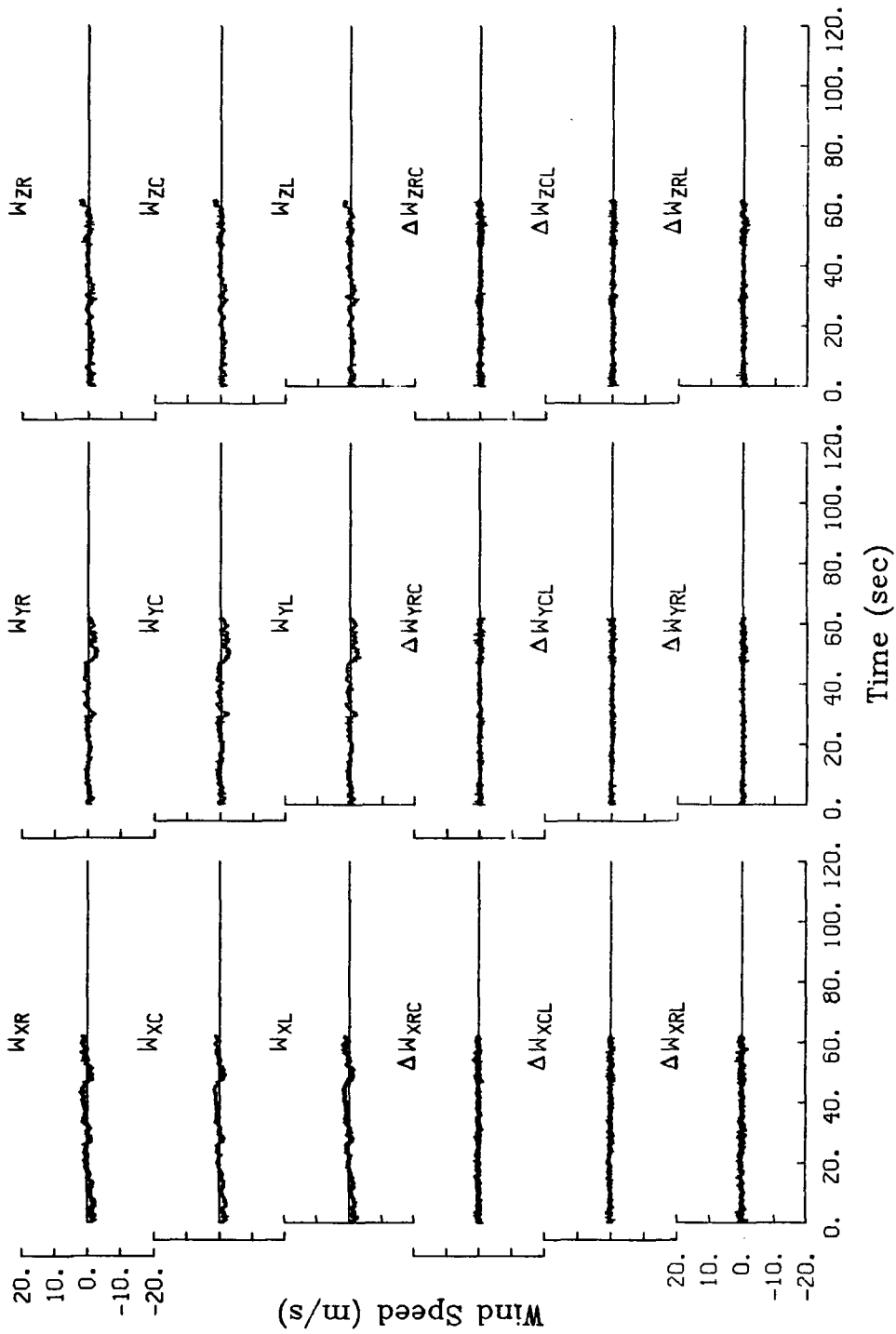

Figure A.34. Time histories of gust velocities and gust velocity differences, Flight 6, Run 6.

TABLE A.9. Average Turbulence Parameters and Integral Length Scales, Flight 6, Run 6.

I. Mean Airspeed (m/s)			II. Standard Deviation of Gust Velocities (m/s)		
V_L	V_C	V_R	$\sigma_{W_{XL}}$	$\sigma_{W_{XC}}$	$\sigma_{W_{XR}}$
127.2	125.9	128.0	0.97	0.93	0.98
			$\sigma_{W_{YL}}$	$\sigma_{W_{YC}}$	$\sigma_{W_{YR}}$
			0.86	0.85	0.86
			$\sigma_{W_{ZL}}$	$\sigma_{W_{ZC}}$	$\sigma_{W_{ZR}}$
			0.65	0.62	0.68
III. Standard Deviation of Gust Velocity Differences (m/s)			IV. Integral Length Scale (m).		
$\sigma_{\Delta W_{XCL}}$	$\sigma_{\Delta W_{XRC}}$	$\sigma_{\Delta W_{XRL}}$	$L_{W_{XL}}$	$L_{W_{XC}}$	$L_{W_{XR}}$
0.37	0.38	0.48	655	599	599
$\sigma_{\Delta W_{YCL}}$	$\sigma_{\Delta W_{YRC}}$	$\sigma_{\Delta W_{YRL}}$	$L_{W_{YL}}$	$L_{W_{YC}}$	$L_{W_{YR}}$
0.29	0.33	0.32	698	718	651
$\sigma_{\Delta W_{ZCL}}$	$\sigma_{\Delta W_{ZRC}}$	$\sigma_{\Delta W_{ZRL}}$	$L_{W_{ZL}}$	$L_{W_{ZC}}$	$L_{W_{ZR}}$
0.34	0.36	0.38	477	866	875

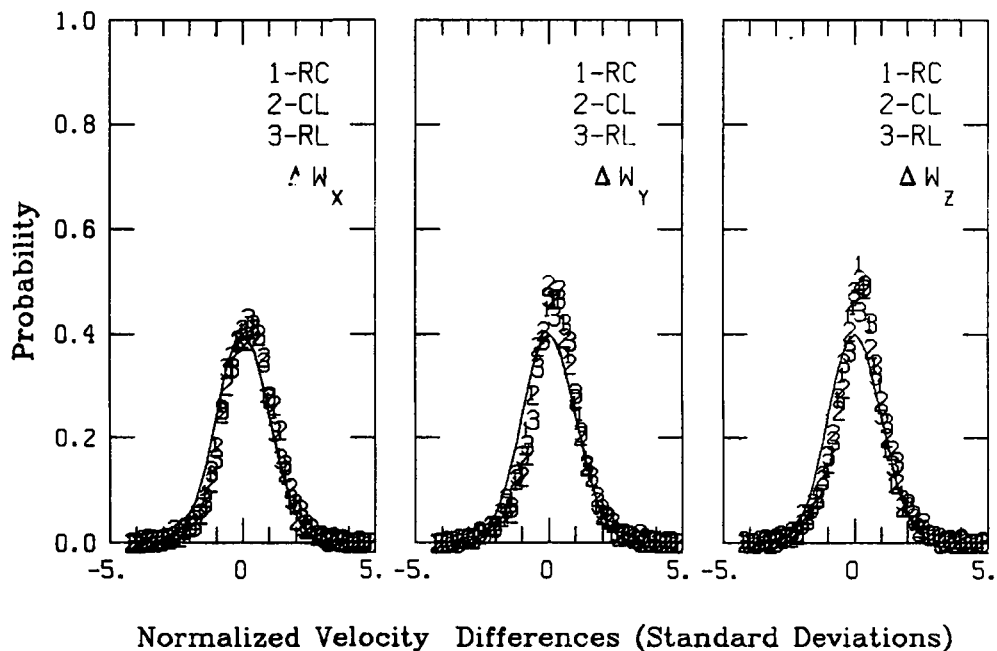
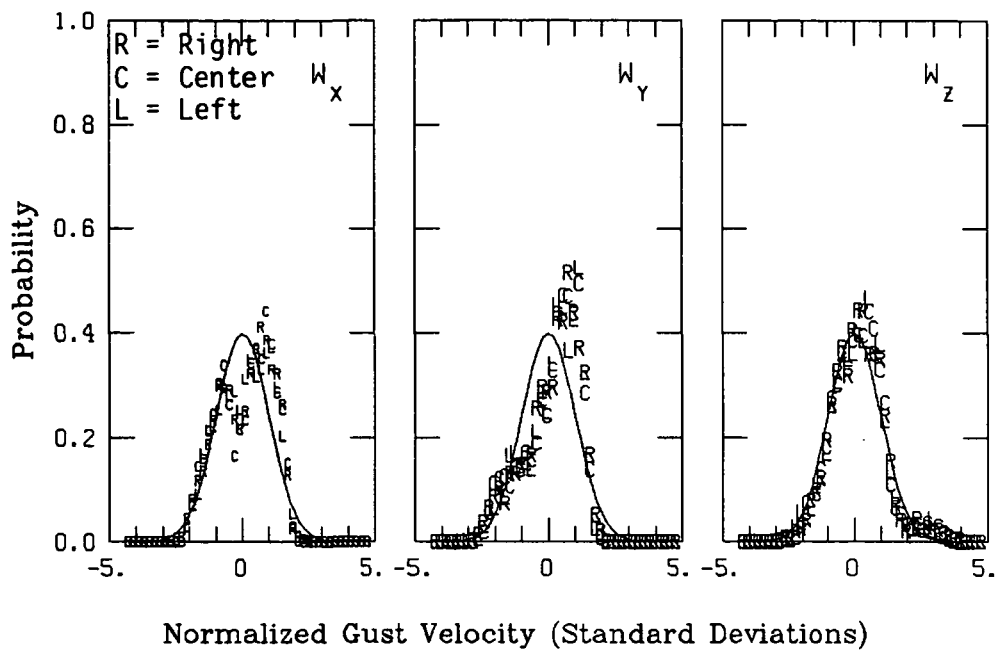

Figure A.35. Probability density function for gust velocities and gust velocity differences, Flight 6, Run 6.

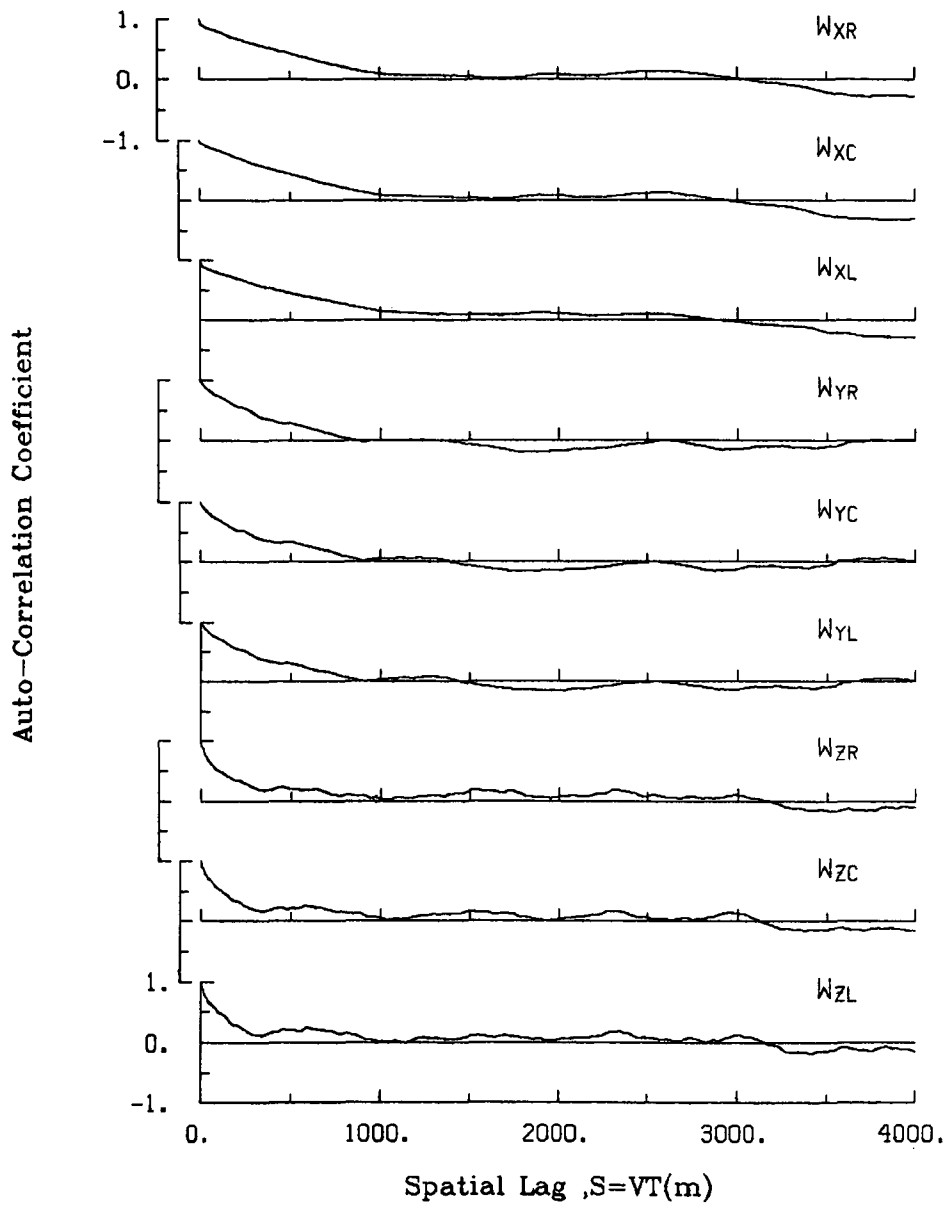

Figure A.36. Single-point auto-correlation coefficient of gust velocities, Flight 6, Run 6.

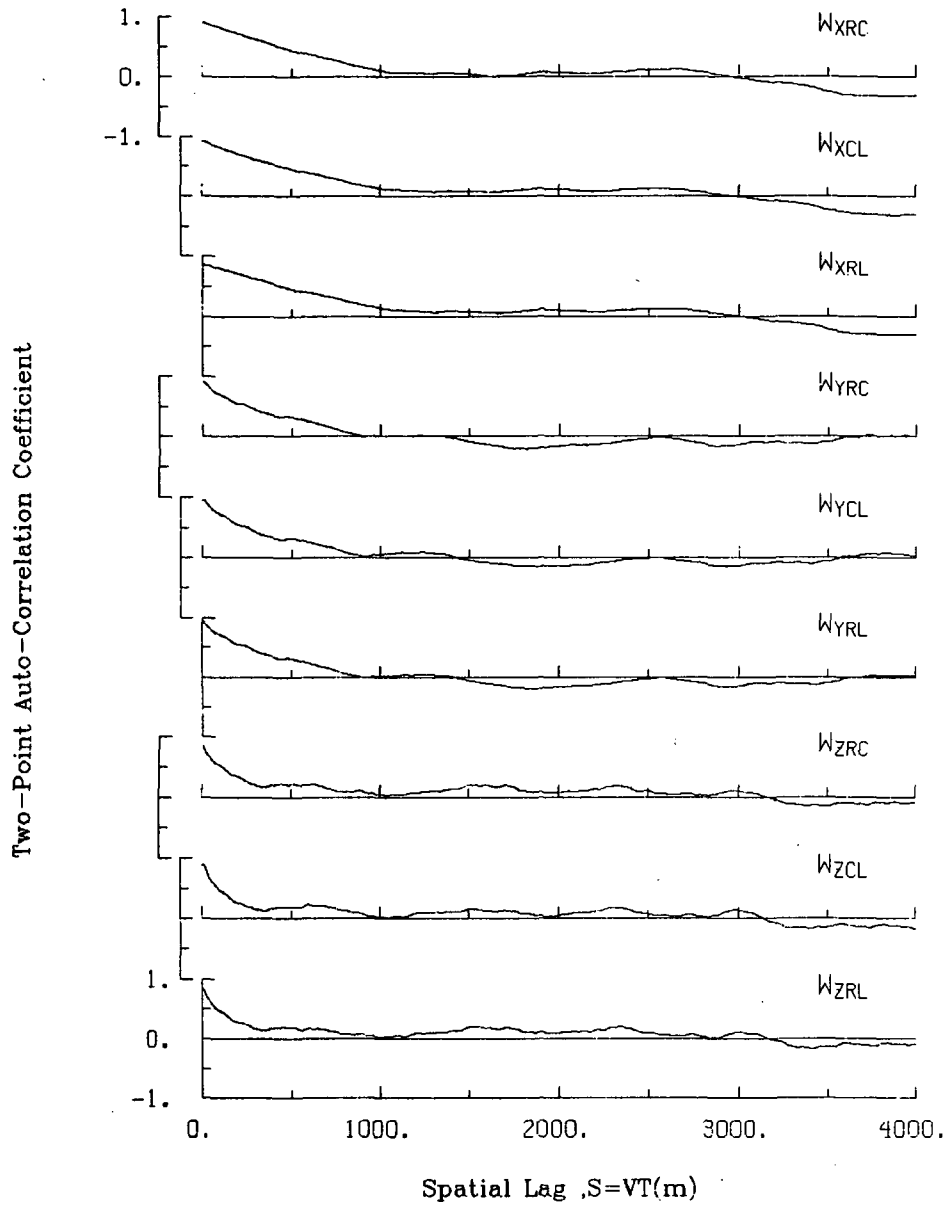

Figure A.37. Two-point auto-correlation coefficient of gust velocities, Flight 6, Run 6.

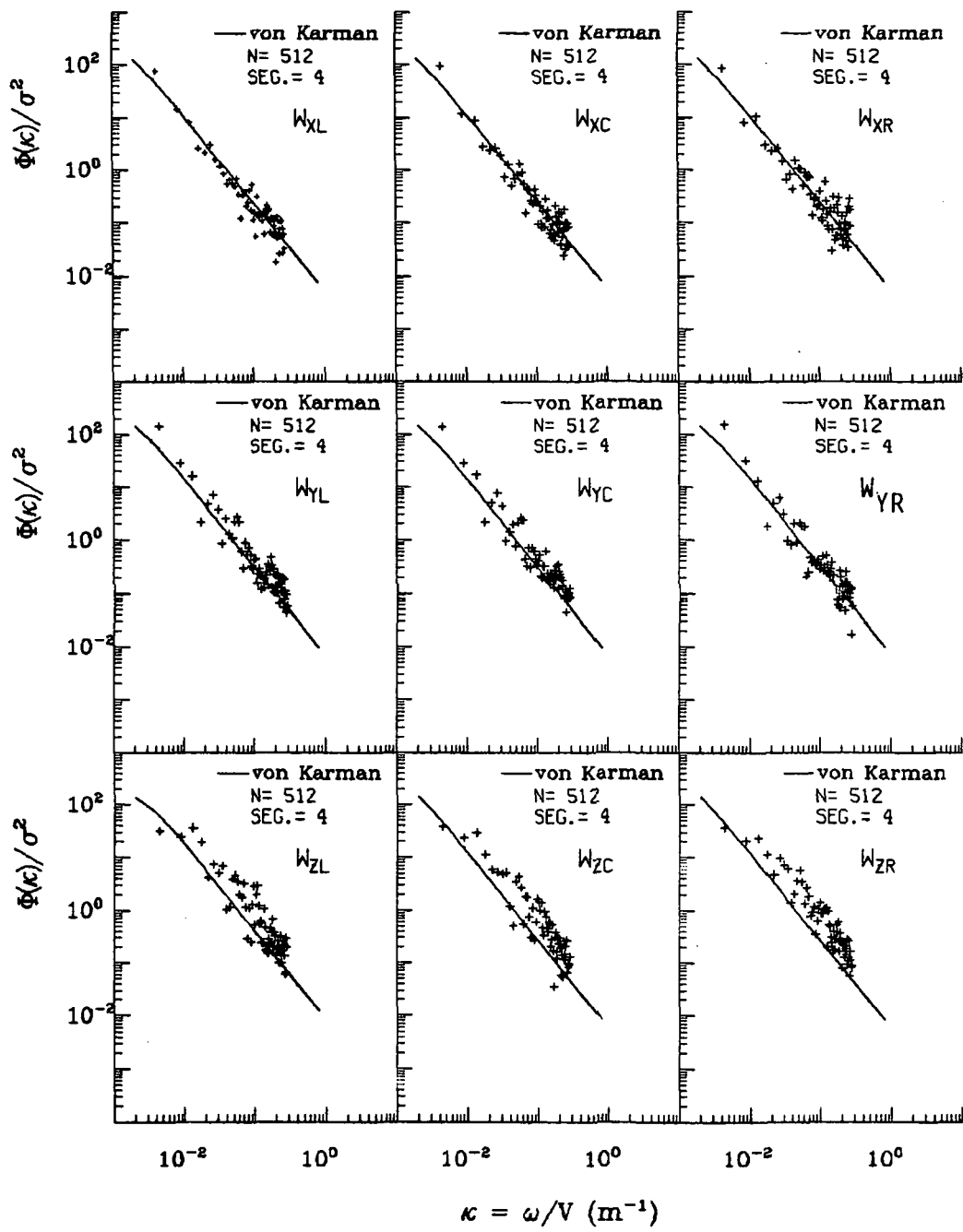

Figure A.38. Normalized auto-spectra of gust velocities, Flight 6, Run 6.

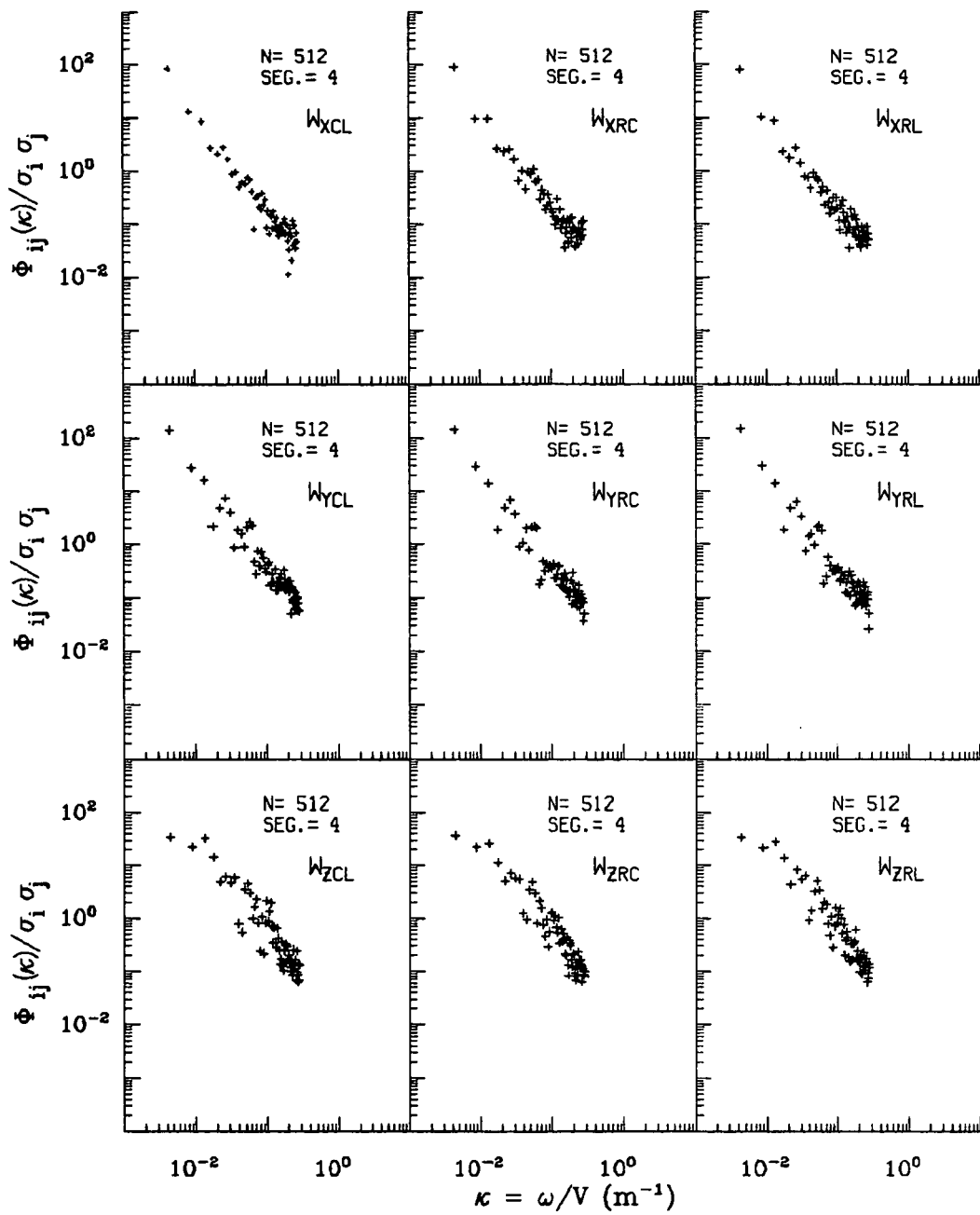

Figure A.39. Normalized two-point auto-spectra of gust velocities, Flight 6, Run 6.

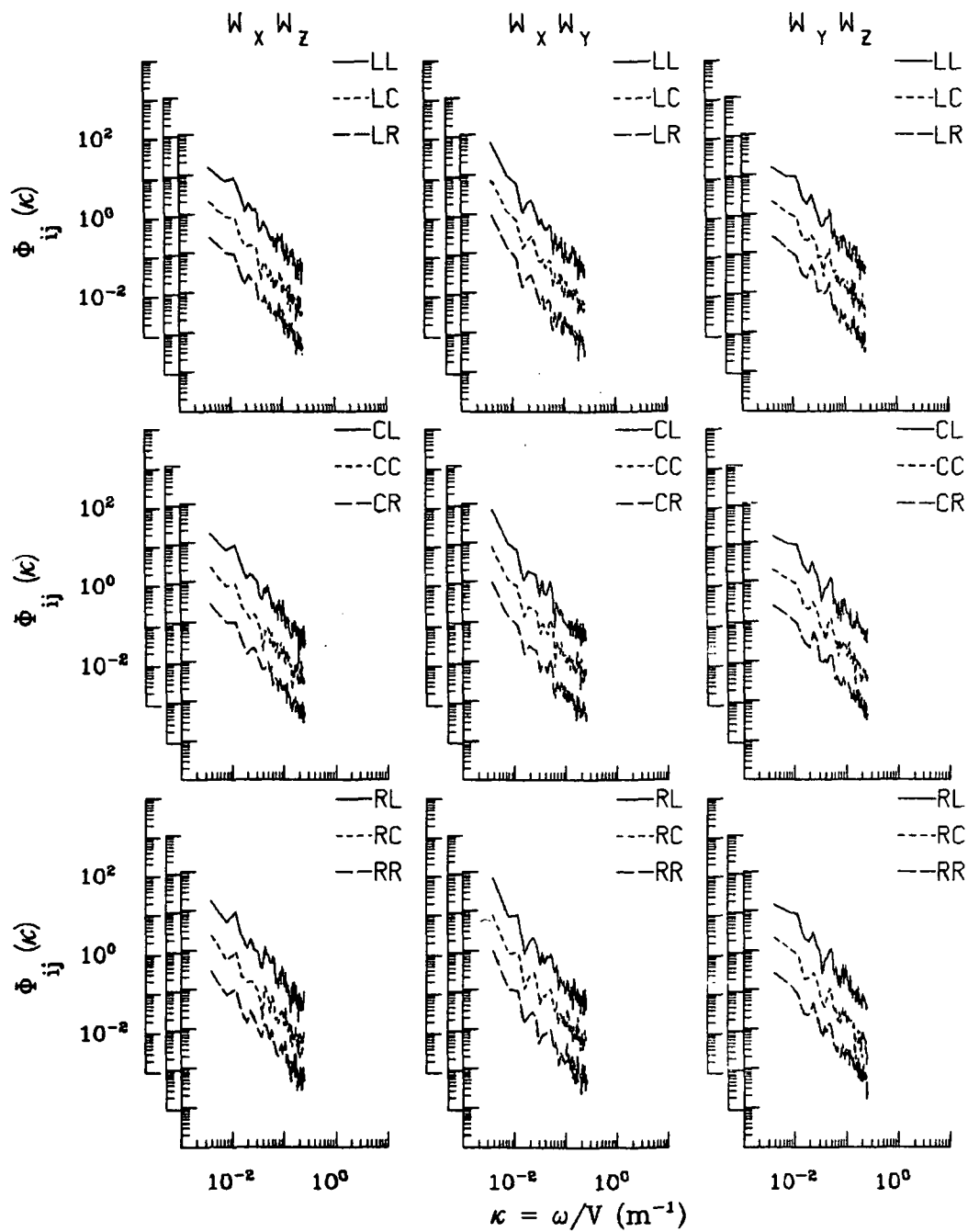

Figure A.40. Two-point cross-spectra of gust velocities, Flight 6, Run 6.

ORIGINAL PAGE IS
OF POOR QUALITY

TABLE A.10. List of All Parameters Measured and Their Range of Values, Flight 6, Run 6.

START TIME = 50428.6107		STOP TIME = 50490.6857				
CHANNEL	UNITS	HIGH	LOW	MEAN	RMS	POINTS
2 PHI DOT	RAD/SEC	.042	-.060	-.00338	.01392	2483
3 ACCL N CG	G UNITS	1.257	.813	1.00089	1.00309	2483
4 THETA DOT	RAD/SEC	.037	-.018	.00520	.00893	2483
5 THETA	RAD	.057	.007	.03411	.03595	2483
6 PHI	RAD	.051	-.081	-.02030	.03077	2483
7 PSI 1	DEGREES	187.583	182.299	185.06099	185.06572	2483
8 DEL PSI 1	DEGREES	1.258	-3.708	-1.11855	1.71416	2483
9 PSI 2	DEGREES	545.226	540.298	542.97195	542.97343	2483
10 DEL PSI 2	DEGREES	.933	-4.036	-1.42698	1.93100	2483
11 ACCL N LT	G UNITS	1.490	.556	1.01348	1.02071	2483
12 ACCL N RT	G UNITS	1.564	.539	1.03298	1.04025	2483
13 ACCL X CG	GUNITS	.057	-.009	.02337	.02579	2483
14 ACCL Y CG	G UNITS	.196	-.157	.00757	.04716	2483
15 ALPHA CTR	RAD	-.007	-.050	-.03472	.03525	2483
16 BETA CTR	RAD	-.002	-.051	-.02319	.02504	2483
17 TEMP I	DEG F	103.841	103.481	103.58465	103.58469	2483
18 TEMP P	DEG F	90.610	89.826	90.00601	90.00601	2483
19 ACCL Z INS	G UNITS	1.285	.826	1.00756	1.00980	2483
20 ALPHA RT	PAD	-.000	-.050	-.03013	.03094	2483
21 BETA RT	RAD	.032	-.016	.01134	.01419	2483
22 ALPHA LT	RAD	.004	-.046	-.02760	.02836	2483
23 BETA LT	RAD	-.008	-.053	-.02833	.02970	2483
24 PSI DOT	RAD/SEC	.031	-.019	.00263	.00938	2483
25 TEMP TCT	DEG C	34.345	33.262	33.72498	33.72636	2483
26 QC LT	PSID	1.228	1.001	1.11203	1.11357	2483
27 QC CTR	PSID	1.194	.992	1.08860	1.09016	2483
28 QC RT	PSID	1.244	1.021	1.12582	1.12735	2483
29 PS	PSIA	11.426	11.132	11.39266	11.39267	2483
30 TEMP IRT	DEG C	29.851	19.312	27.68251	27.71173	2483
31 D TO G	METERS	8746711.48887447	20.193	*****	*****	2483
32 P TO D	DEGREES	80.291	80.282	80.28641	80.29641	2483
33 LONG	DEGREES	-104.986	-104.994	-104.99027	104.99027	2483
34 LAT	DEGREES	39.915	39.845	39.87974	39.87975	2483
35 TRK ANG	DEGREES	186.743	182.965	184.83937	184.84427	2483
36 HDG	RACTIONS	3.285	3.195	3.24291	3.24300	2483
37 VE	M/SEC	-6.465	-15.388	-10.80429	11.25805	2483
38 VN	M/SEC	-122.561	-129.667	-126.31506	126.33540	2483
39 ALTITUDE	KM	2.282	2.073	2.09625	2.09627	2483
40 TEMPC	DEGREES C	26.194	25.526	25.82766	25.82801	2483
41 EW WND SPD	KNOTS	14.546	6.079	9.47973	9.64597	2483
42 NS WND SPD	KNOTS	1.600	-6.354	-2.71471	3.17152	2483
43 WIND SPEED	KNOTS	14.679	6.154	10.01628	10.15389	2483
44 WIND DIREC	DEGREES	308.574	261.925	286.28368	286.47090	2483
45 AIRSPEED R	M/SEC	134.202	122.138	127.99894	128.02818	2483
46 AIRSPEED C	M/SEC	132.142	120.417	125.02934	125.96772	2483
47 AIRSPEED L	M/SEC	133.704	120.906	127.22719	127.26699	2483
48 DELTA ALT	METERS	190.245	-18.897	4.46942	9.33149	2483
49 INRTL DISP	METERS	15.716	-13.749	4.58905	9.19484	2483
50 UG RIGHT	M/SEC	2.264	-2.662	-.00000	.97980	2483
51 UG CENTER	M/SEC	1.802	-2.548	-.00000	.90778	2483
52 UG LEFT	M/SEC	2.288	-2.837	.00000	.96193	2483
53 VG RIGHT	M/SEC	1.653	-2.788	-.06271	.91206	2483
54 VG CENTER	M/SEC	1.843	-2.665	-.06019	.92141	2483
55 VG LEFT	M/SEC	1.670	-3.106	-.06200	.91674	2483
56 WG RIGHT	M/SEC	2.827	-2.403	-.02655	.75956	2483
57 WG CENTER	M/SEC	2.485	-1.959	-.02548	.68957	2483
58 WG LEFT	M/SEC	2.563	-2.791	-.02475	.73229	2483

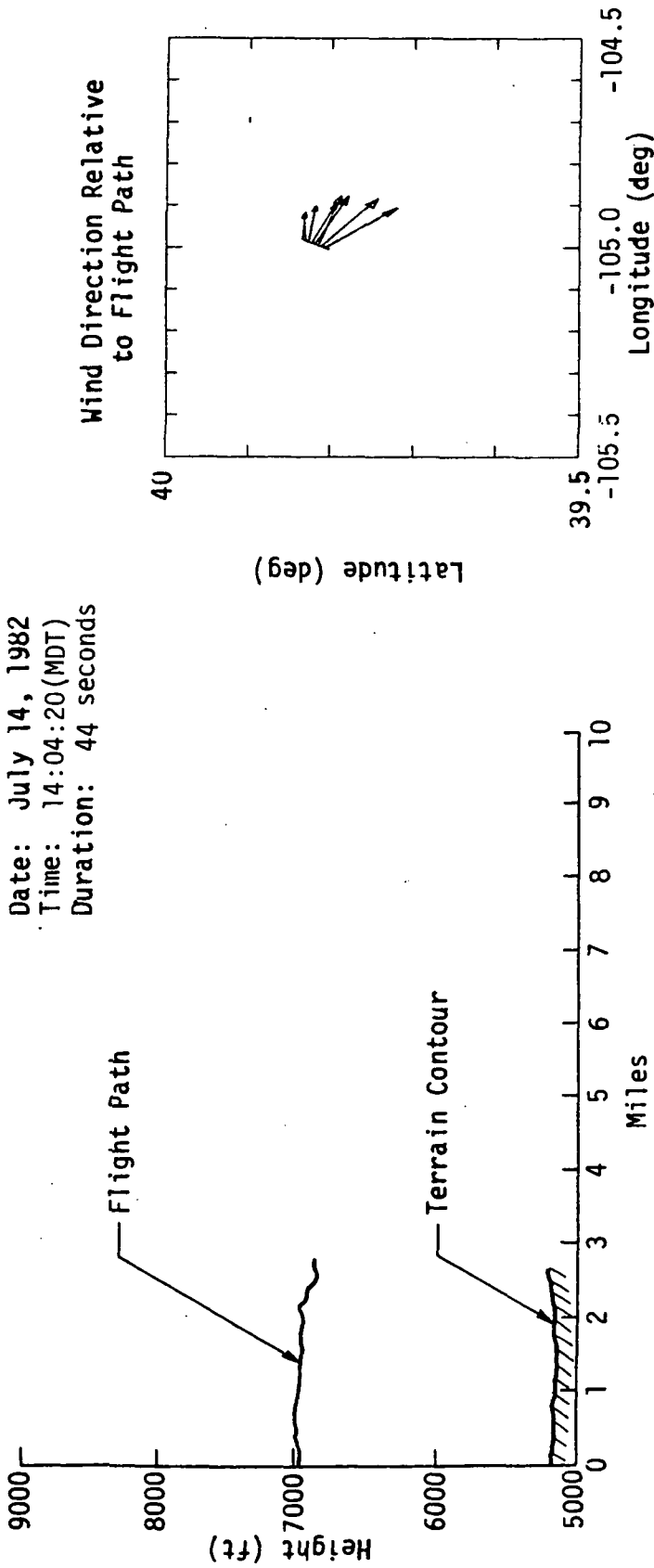

Figure A.41. Flight path information, Flight 6, Run 8.

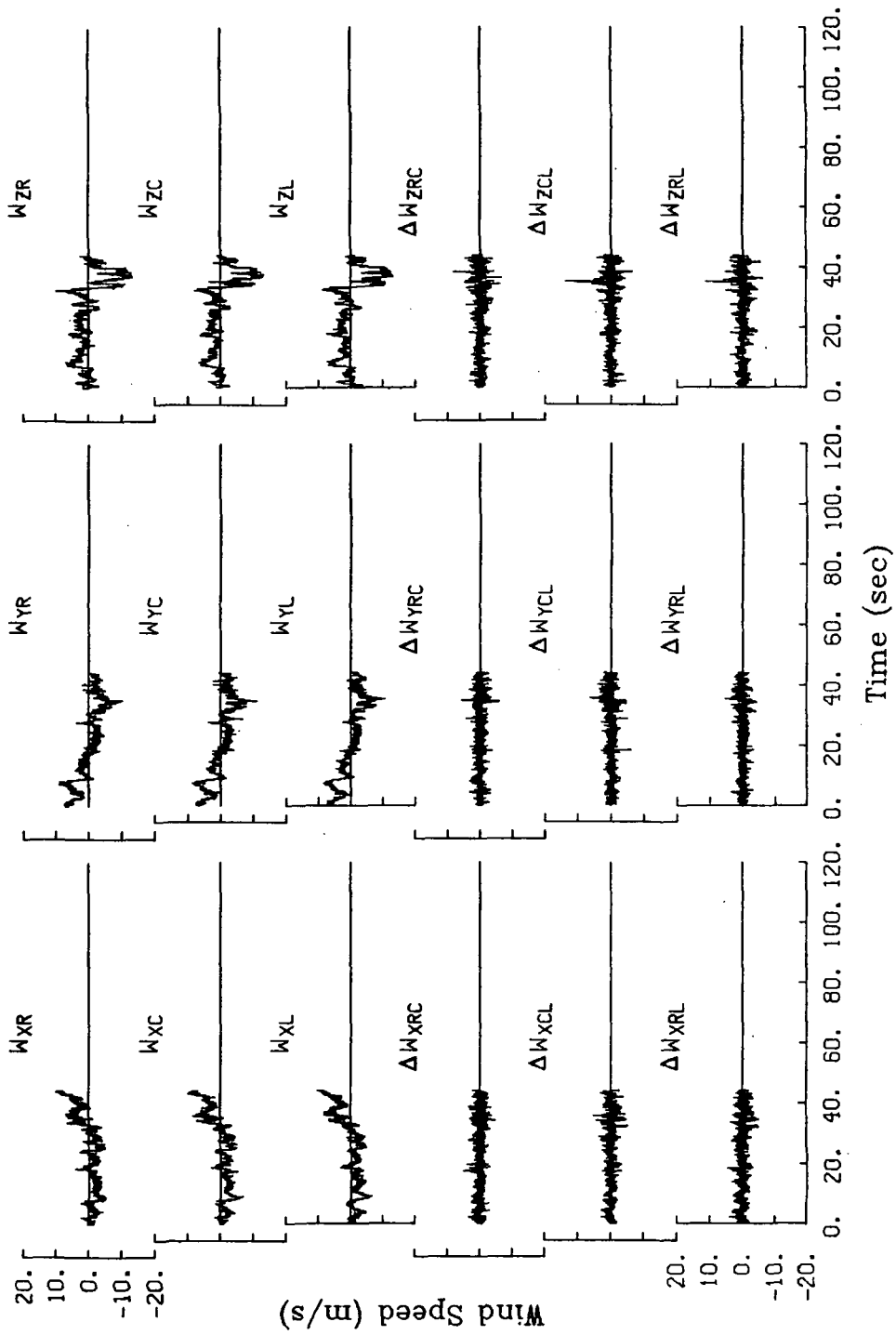

Figure A.42. Time histories of gust velocities and gust velocity differences, Flight 6, Run 8.

TABLE A.11. Average Turbulence Parameters and Integral Length Scales, Flight 6, Run 8.

I. Mean Airspeed (m/s)			II. Standard Deviation of Gust Velocities (m/s)		
V_L	V_C	V_R	$\sigma_{W_{XL}}$	$\sigma_{W_{XC}}$	$\sigma_{W_{XR}}$
101.6	100.7	102.4	2.71	2.46	2.31
III. Standard Deviation of Gust Velocity Differences (m/s)					
$\sigma_{\Delta W_{XCL}}$	$\sigma_{\Delta W_{XRC}}$	$\sigma_{\Delta W_{XRL}}$	$\sigma_{W_{YL}}$	$\sigma_{W_{YC}}$	$\sigma_{W_{YR}}$
1.12	1.02	1.30	3.54	3.53	3.50
$\sigma_{\Delta W_{YCL}}$	$\sigma_{\Delta W_{YRC}}$	$\sigma_{\Delta W_{YRL}}$	$\sigma_{W_{ZL}}$	$\sigma_{W_{ZC}}$	$\sigma_{W_{ZR}}$
1.11	1.02	1.11	4.05	3.87	3.95
$\sigma_{\Delta W_{ZCL}}$	$\sigma_{\Delta W_{ZRC}}$	$\sigma_{\Delta W_{ZRL}}$	IV. Integral Length Scale (m)		
1.34	1.23	1.52	$L_{W_{XL}}$	$L_{W_{XC}}$	$L_{W_{XR}}$
			412	411	387
			$L_{W_{YL}}$	$L_{W_{YC}}$	$L_{W_{YR}}$
			1214	1122	1179
			$L_{W_{ZL}}$	$L_{W_{ZC}}$	$L_{W_{ZR}}$
			538	560	522

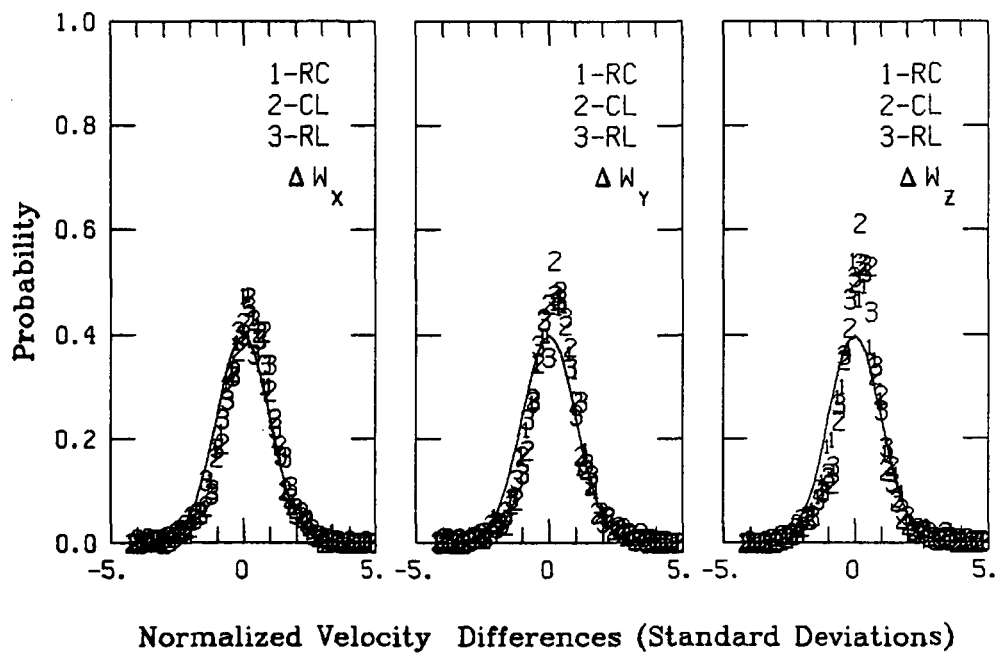
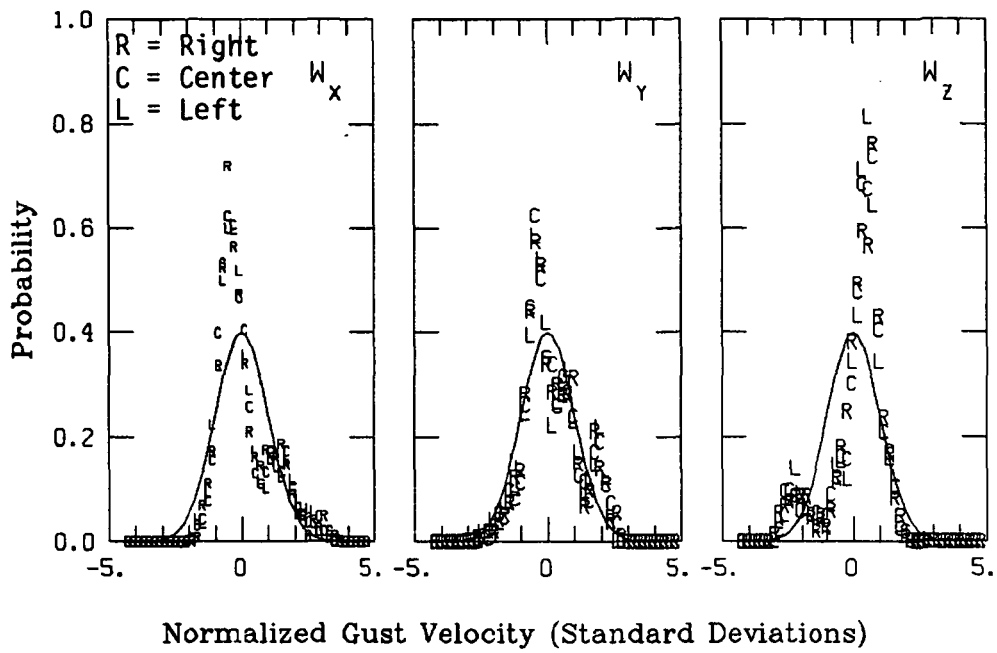

Figure A.43. Probability density function for gust velocities and gust velocity differences, Flight 6, Run 8.

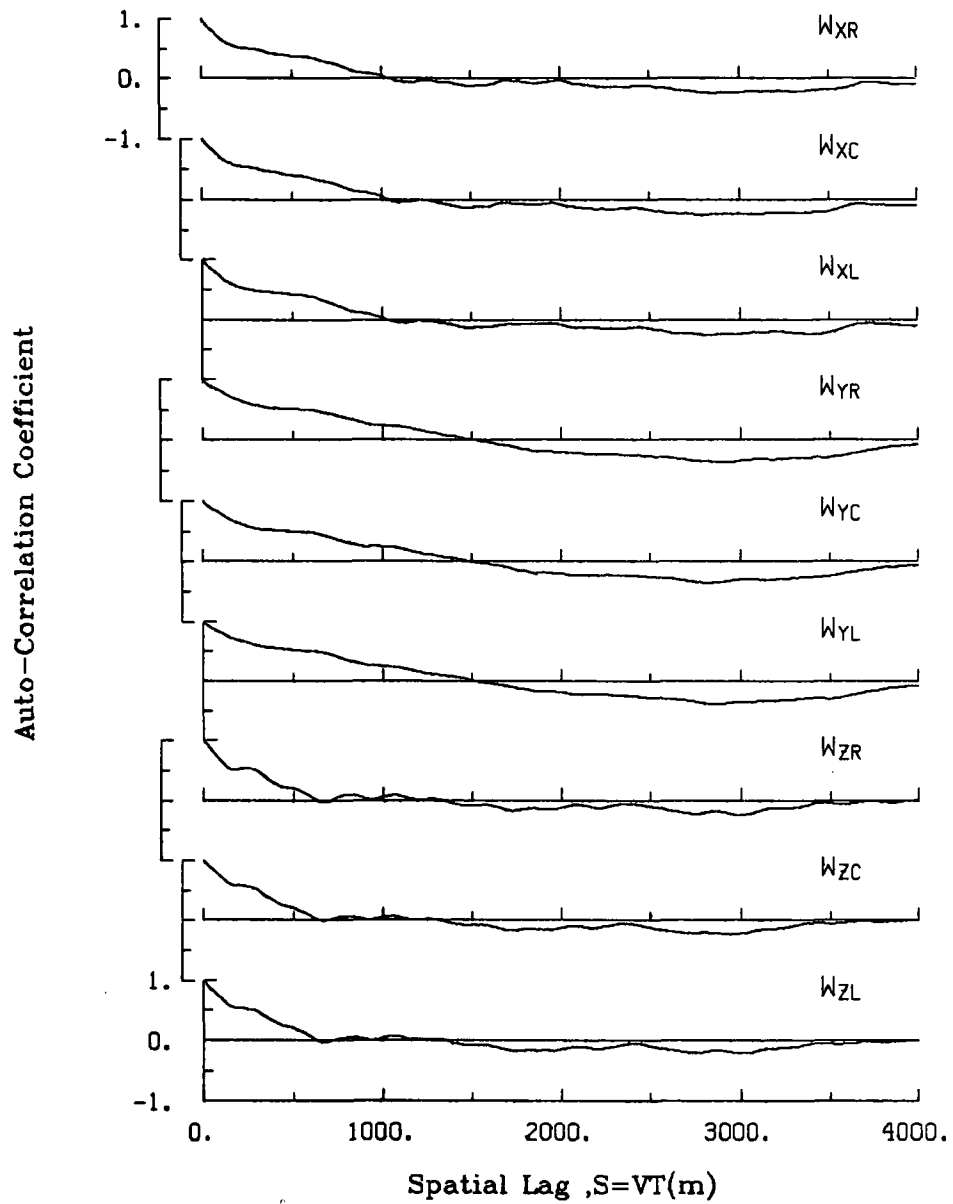

Figure A.44. Single-point auto-correlation coefficient of gust velocities, Flight 6, Run 8.

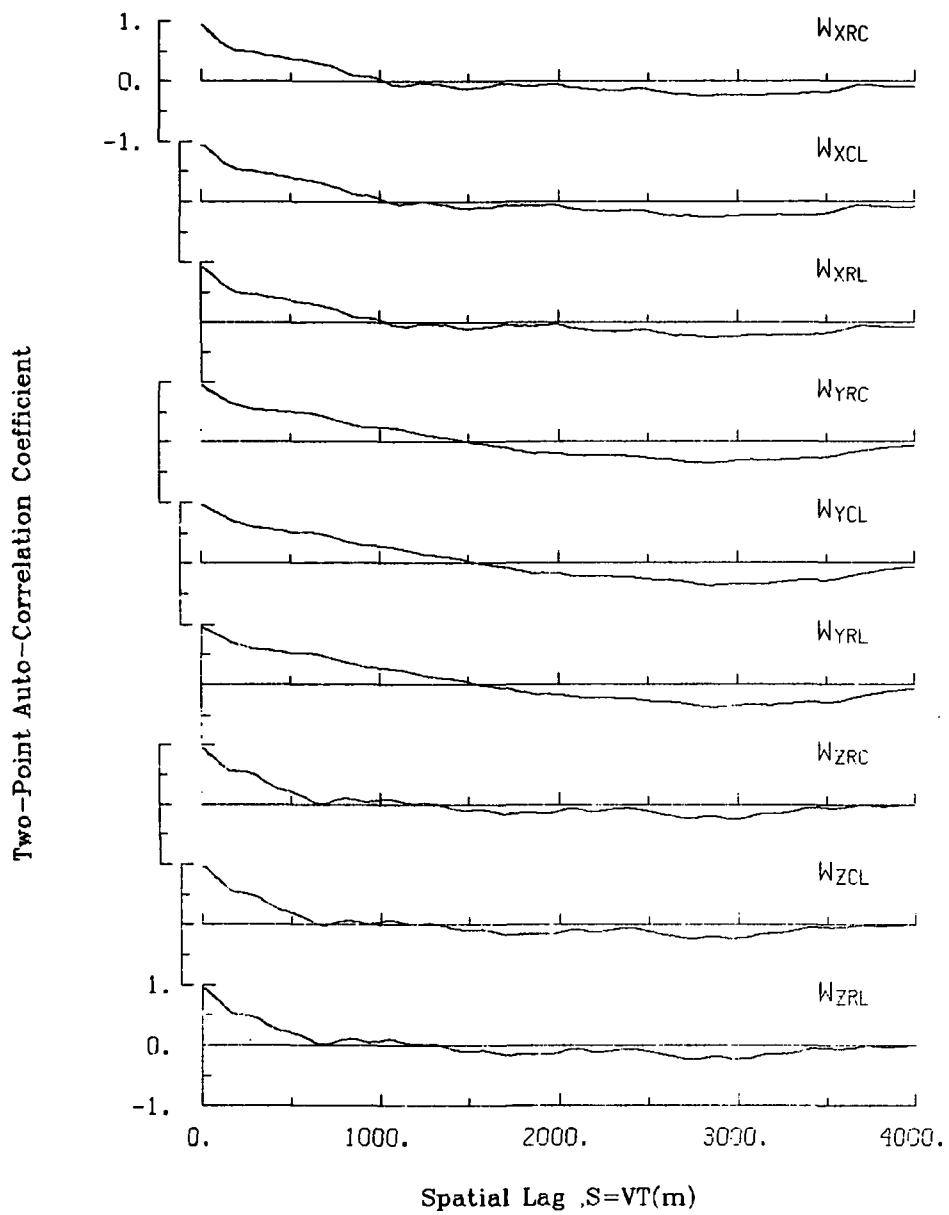

Figure A.45. Two-point auto-correlation coefficient of gust velocities, Flight 6, Run 8.

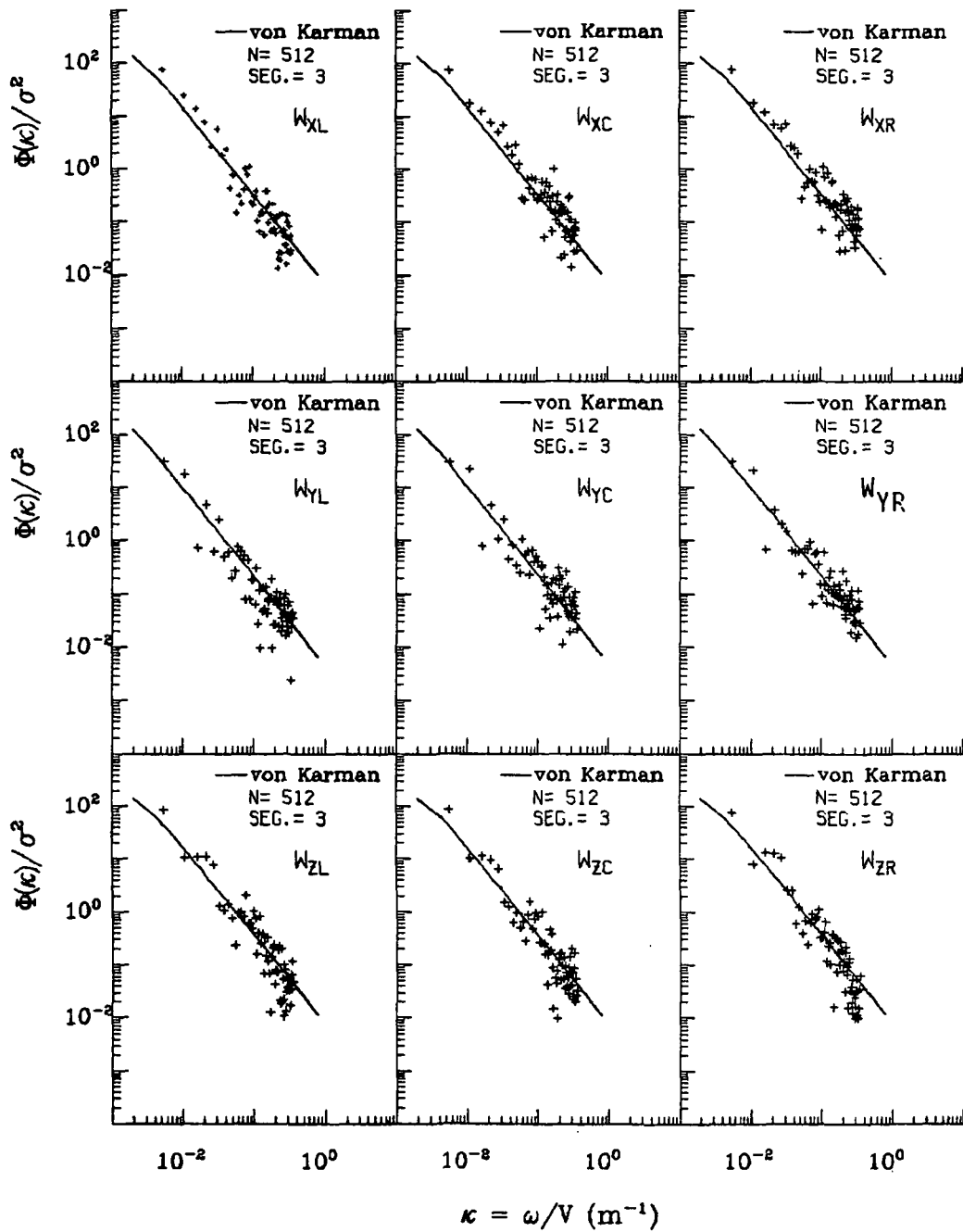

Figure A.46. Normalized auto-spectra of gust velocities, Flight 6, Run 8.

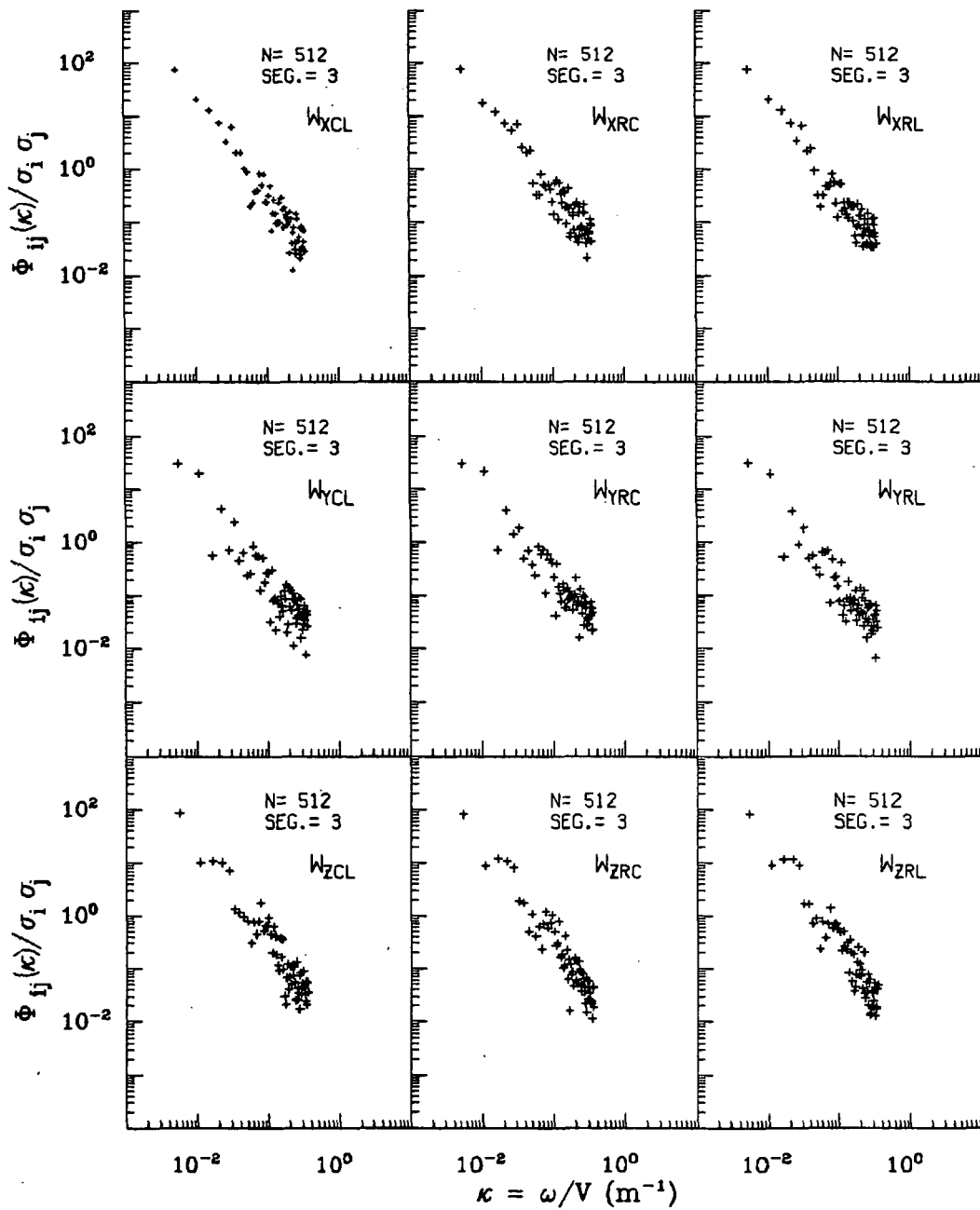

Figure A.47. Normalized two-point auto-spectra of gust velocities, Flight 6, Run 8.

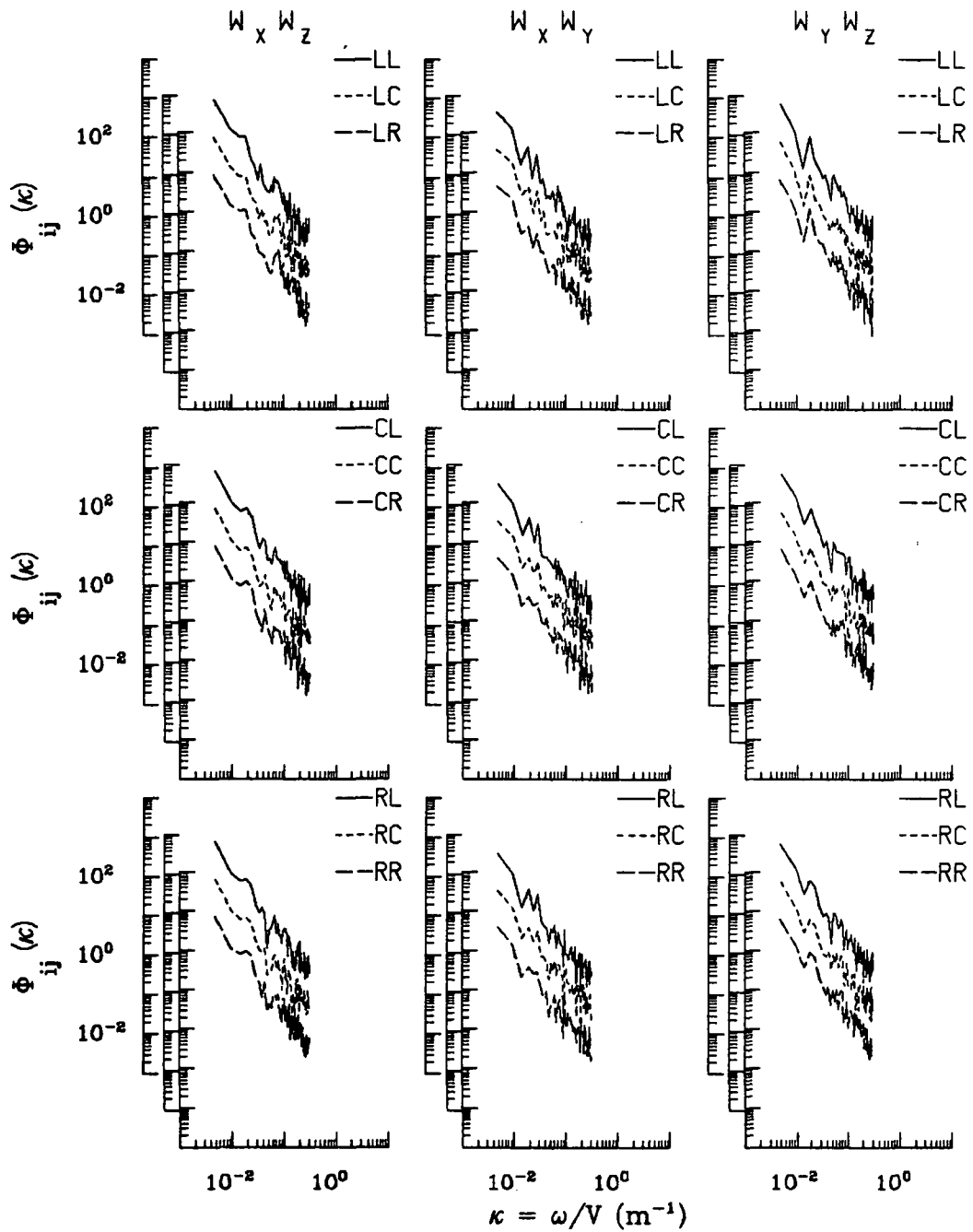

Figure A.48. Two-point cross-spectra of gust velocities, Flight 6, Run 8.

**ORIGINAL PAGE IS
OF POOR QUALITY**

TABLE A.12. List of All Parameters Measured and Their Range of Values,
Flight 6, Run 8.

		START TIME • 50660.3312		STOP TIME • 50704.6812			
CHANNEL	UNITS	HIGH	LOW	MEAN	RMS		
2 PHI DOT	RAD/SEC	.174	-.203	-.00299	.03979	1774	
3 ACCL N CG	G UNITS	1.319	-.988	.24233	.98619	1774	
4 THETA DOT	RAD/SEC	.074	-.049	.00560	.01804	1774	
5 THETA	RAD	.159	.028	.06805	.07672	1774	
6 PHI	RAD	.027	-.143	-.02451	.04010	1774	
7 PSI 1	DEGREES	215.409	208.364	212.69610	212.70021	1774	
8 DEL PSI 1	DEGREES	3.374	-3.444	.79414	1.51749	1774	
9 PSI 2	DEGREES	577.262	570.574	574.66218	574.66360	1774	
10 DEL PSI 2	DEGREES	3.226	-3.683	.65793	1.45830	1774	
11 ACCL N LT	G UNITS	2.385	-.153	1.00628	1.04962	1774	
12 ACCL N RT	G UNITS	2.388	.002	1.02219	1.05830	1774	
13 ACCL X CG	GUNITS	.190	.013	.07240	.07744	1774	
14 ACCL Y CG	G UNITS	.169	-.153	.00649	.04530	1774	
15 ALPHA CTR	RAD	.108	-.100	.00568	.02565	1774	
16 BETA CTR	RAD	.046	-.132	-.02270	.03688	1774	
17 TEMP I	DEG F	104.740	104.021	104.32743	104.32769	1774	
18 TEMP P	DEG F	90.186	90.006	90.01833	90.01834	1774	
19 ACCL Z INS	G UNITS	1.578	.248	.99982	1.01440	1774	
20 ALPHA RT	RAD	.109	-.090	.01555	.03168	1774	
21 BETA RT	RAD	.078	-.083	.01371	.02927	1774	
22 ALPHA LT	RAD	.109	-.104	.01824	.03167	1774	
23 BETA LT	RAD	.035	-.115	-.02990	.03935	1774	
24 PSI DOT	RAD/SEC	.072	-.047	.00376	.02102	1774	
25 TEMP TOT	DEG C	31.391	29.324	30.58600	30.58919	1774	
26 OC LT	PSID	.789	.548	.69984	.70147	1774	
27 OC CTP	PSID	.775	.540	.68636	.68780	1774	
28 OC RT	PSID	.802	.562	.71087	.71220	1774	
29 PS	PSIA	11.408	11.332	11.36180	11.36181	1774	
30 TEMP IRT	DEG C	26.275	16.841	24.03299	24.13850	1774	
31 D TO G	METERS	8745926.3238743122.163	*****	*****	*****	1774	
32 B TO D	DEGREES	80.304	80.293	80.29820	80.29820	1774	
33 LONG	DEGREES	-104.977	-105.003	-104.99048	104.99048	1774	
34 LAT	DEGREES	39.837	39.802	39.81985	39.81985	1774	
35 TRK ANG	DEGREES	211.962	207.390	209.75281	209.75801	1774	
36 HDG	RADIANS	3.782	3.660	3.73629	3.73637	1774	
37 VE	M/SEC	-45.370	-51.063	-49.12517	49.15723	1774	
38 VN	M/SEC	-81.682	-89.478	-85.94697	85.98026	1774	
39 ALTITUDE	KM	2.139	2.085	2.11804	2.11809	1774	
40 TEMPC	DEGREES C	25.982	24.775	25.53851	25.53938	1774	
41 EW WND SPD	KNOTS	34.524	4.018	17.76145	18.51880	1774	
42 NS WND SPD	KNOTS	5.887	-27.355	-7.58334	10.45265	1774	
43 WIND SPEED	KNOTS	40.397	4.284	20.34195	21.25516	1774	
44 WIND DIREC	DEGREES	340.726	236.350	289.54371	290.16391	1774	
45 AIRSPEED R	M/SEC	108.709	91.117	102.40183	102.45117	1774	
46 AIRSPEED C	M/SEC	106.930	89.413	100.65187	100.70629	1774	
47 AIRSPEED L	M/SEC	107.836	89.982	101.60862	101.66954	1774	
48 DELTA ALT	METERS	20.040	-33.674	-1.04461	13.21205	1774	
49 INRTL DISP	METERS	12.470	-31.109	-1.12069	12.50029	1774	
50 UG RIGHT	M/SEC	10.052	-5.099	-.00000	2.89803	1774	
51 UG CENTER	M/SEC	9.983	-6.566	-.00000	3.07606	1774	
52 UG LEFT	M/SEC	10.420	-6.363	-.00000	3.28473	1774	
53 VG RIGHT	M/SEC	9.011	-10.135	-.02614	3.35853	1774	
54 VG CENTER	M/SEC	8.648	-11.006	-.02602	3.39950	1774	
55 VG LEFT	M/SEC	8.533	-10.721	-.01972	3.42451	1774	
56 WG RIGHT	M/SEC	9.913	-13.116	.04793	4.09810	1774	
57 WG CENTER	M/SEC	8.000	-13.043	.05927	4.06992	1774	
58 WG LEFT	M/SEC	8.635	-13.225	.06483	4.23581	1774	

Date: July 14, 1982
 Time: 14:08:08(MDT)
 Duration: 69 seconds

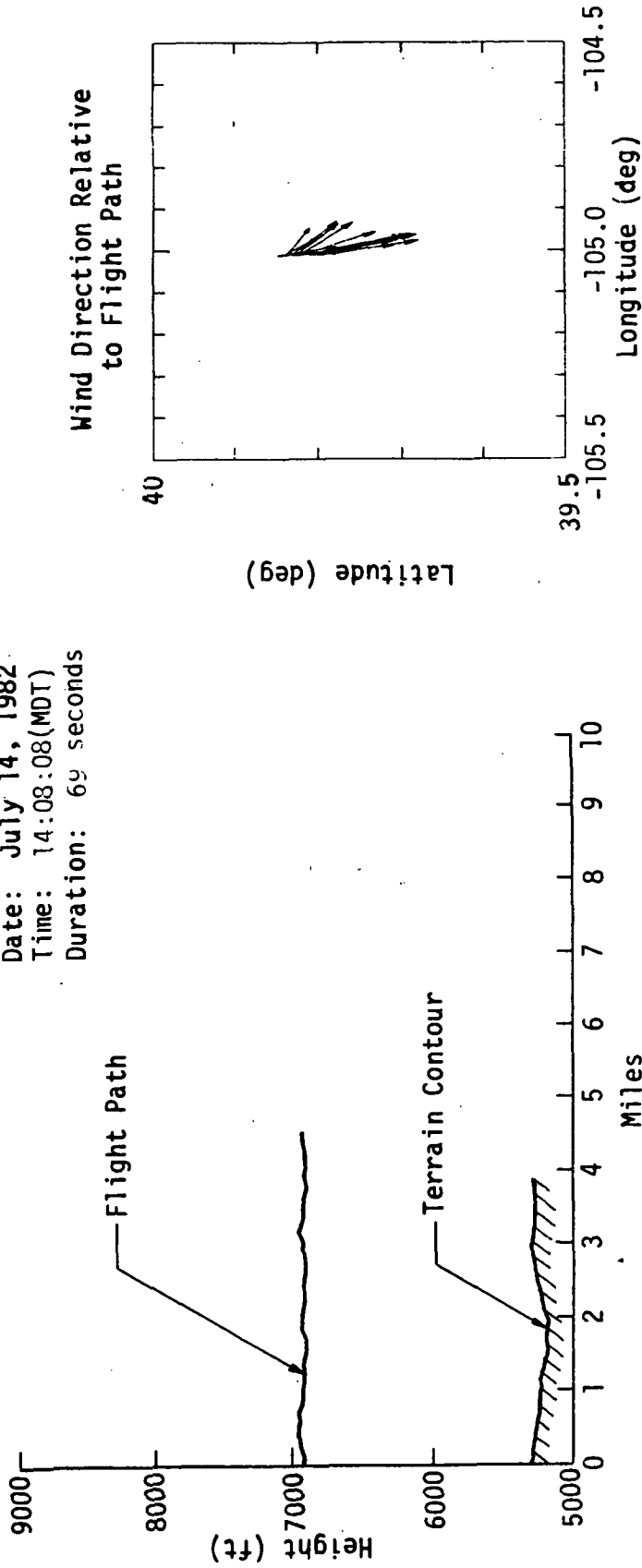

A.61

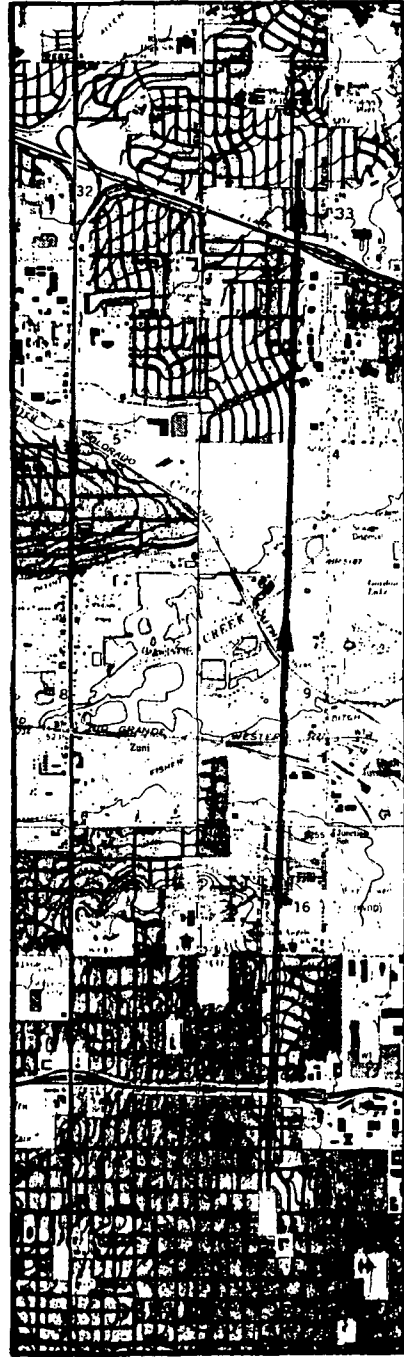

Figure A.49. Flight path information, Flight 6, Run 10.

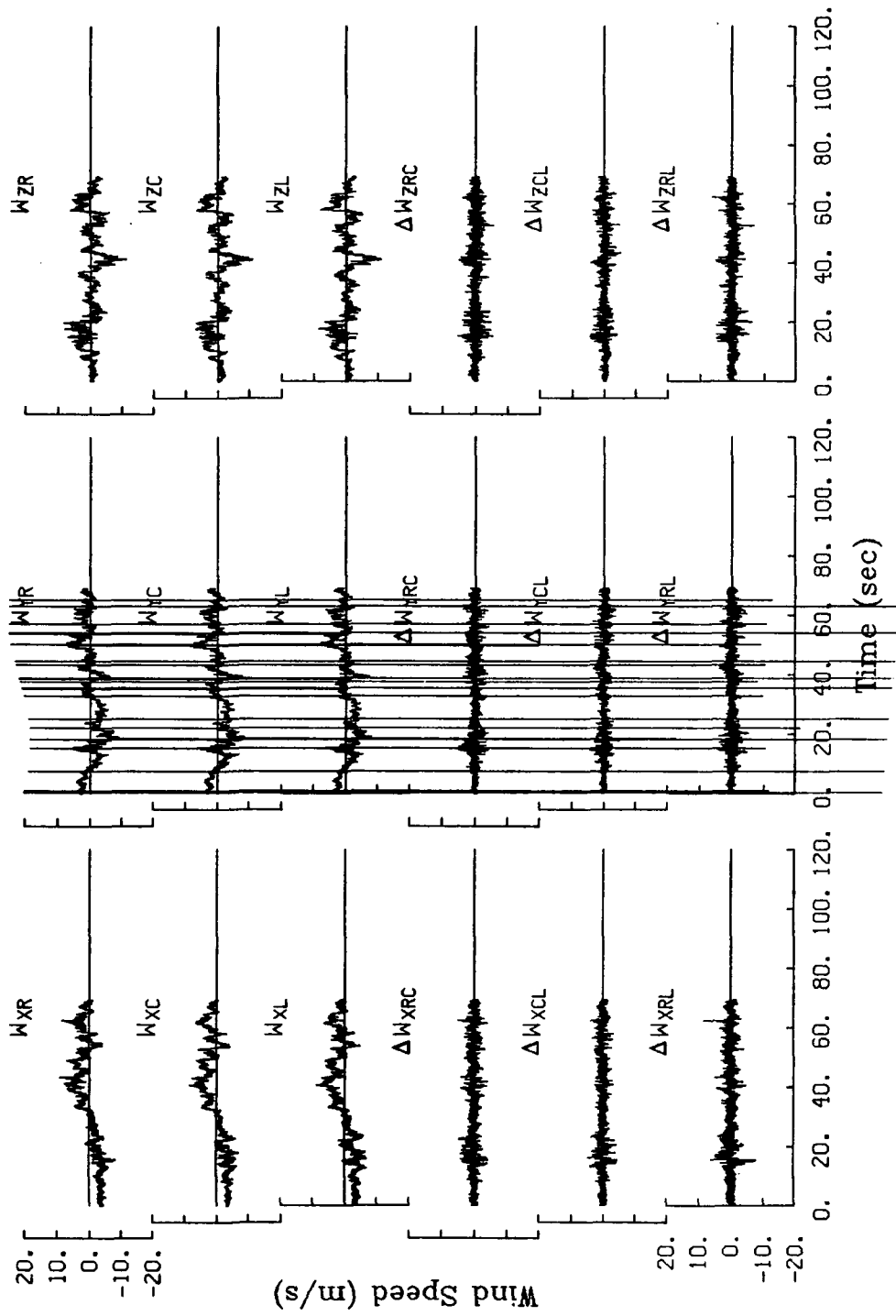

Figure A.50. Time histories of gust velocities and gust velocity differences, Flight 6, Run 10.

TABLE A.13. Average Turbulence Parameters and Integral Length Scales, Flight 6, Run 10.

I. Mean Airspeed (m/s)			II. Standard Deviation of Gust Velocities (m/s)		
V_L	V_C	V_R	$\sigma_{W_{XL}}$	$\sigma_{W_{XC}}$	$\sigma_{W_{XR}}$
106.3	105.2	107.0	3.17	3.11	3.12
			$\sigma_{W_{YL}}$	$\sigma_{W_{YC}}$	$\sigma_{W_{YR}}$
			20.63	20.50	20.88
			$\sigma_{W_{ZL}}$	$\sigma_{W_{ZC}}$	$\sigma_{W_{ZR}}$
			2.71	2.59	2.60
III. Standard Deviation of Gust Velocity Differences (m/s)			IV. Integral Length Scale (m).		
$\sigma_{\Delta W_{XCL}}$	$\sigma_{\Delta W_{XRC}}$	$\sigma_{\Delta W_{XRL}}$	$L_{W_{XL}}$	$L_{W_{XC}}$	$L_{W_{XR}}$
1.00	1.07	1.31	866	894	896
$\sigma_{\Delta W_{YCL}}$	$\sigma_{\Delta W_{YRC}}$	$\sigma_{\Delta W_{YRL}}$	$L_{W_{YL}}$	$L_{W_{YC}}$	$L_{W_{YR}}$
1.05	1.10	1.21	3	3	3
$\sigma_{\Delta W_{ZCL}}$	$\sigma_{\Delta W_{ZRC}}$	$\sigma_{\Delta W_{ZRL}}$	$L_{W_{ZL}}$	$L_{W_{ZC}}$	$L_{W_{ZR}}$
1.08	1.17	1.34	267	302	286

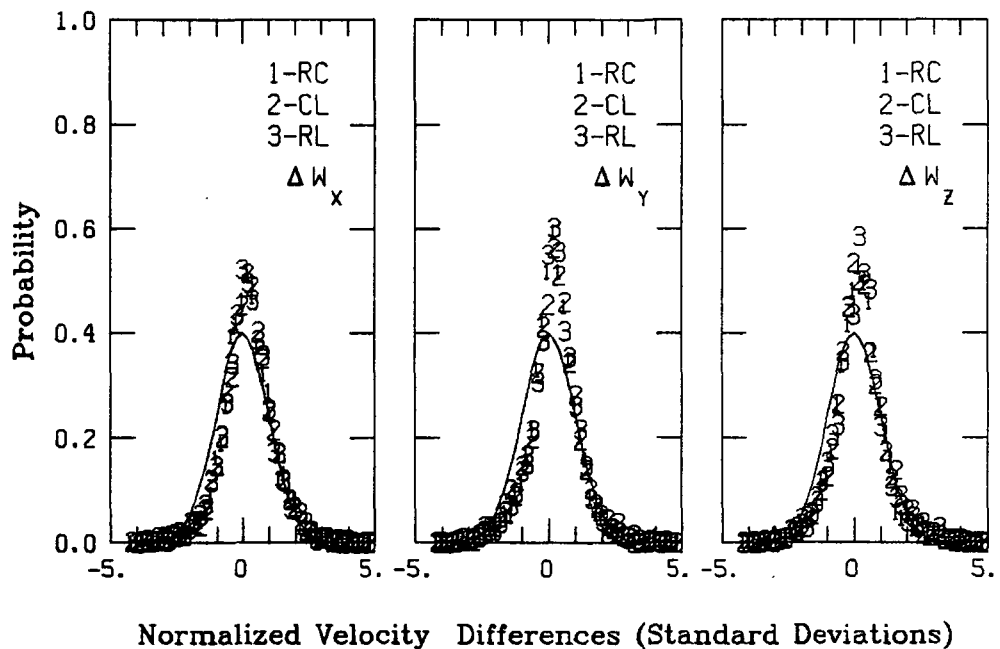
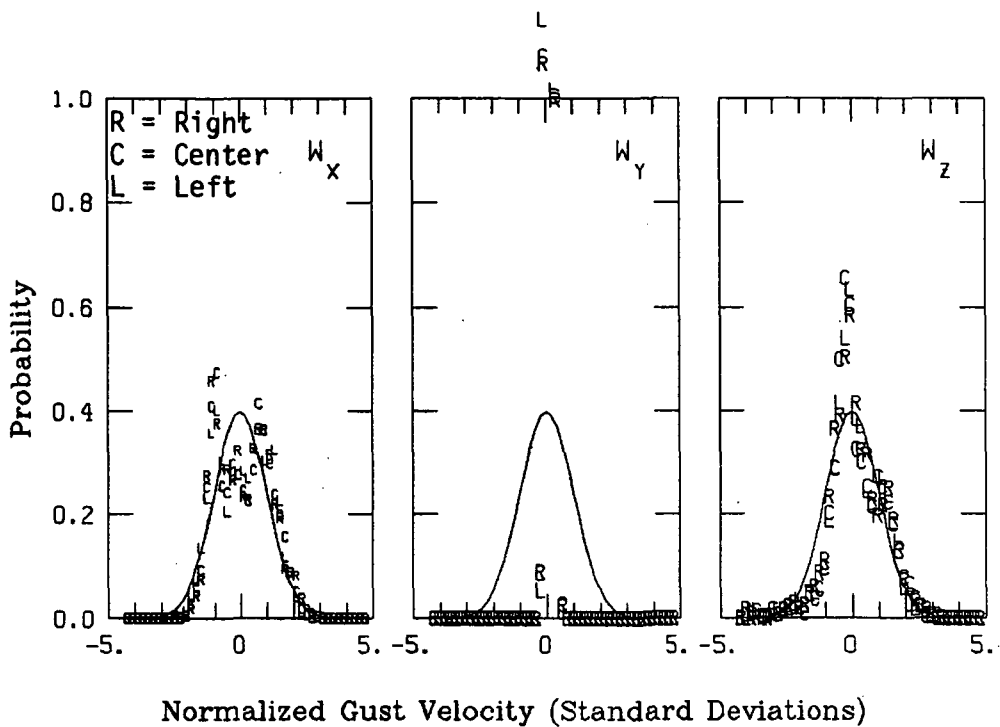

Figure A.51. Probability density function for gust velocities and gust velocity differences, Flight 6, Run 10.

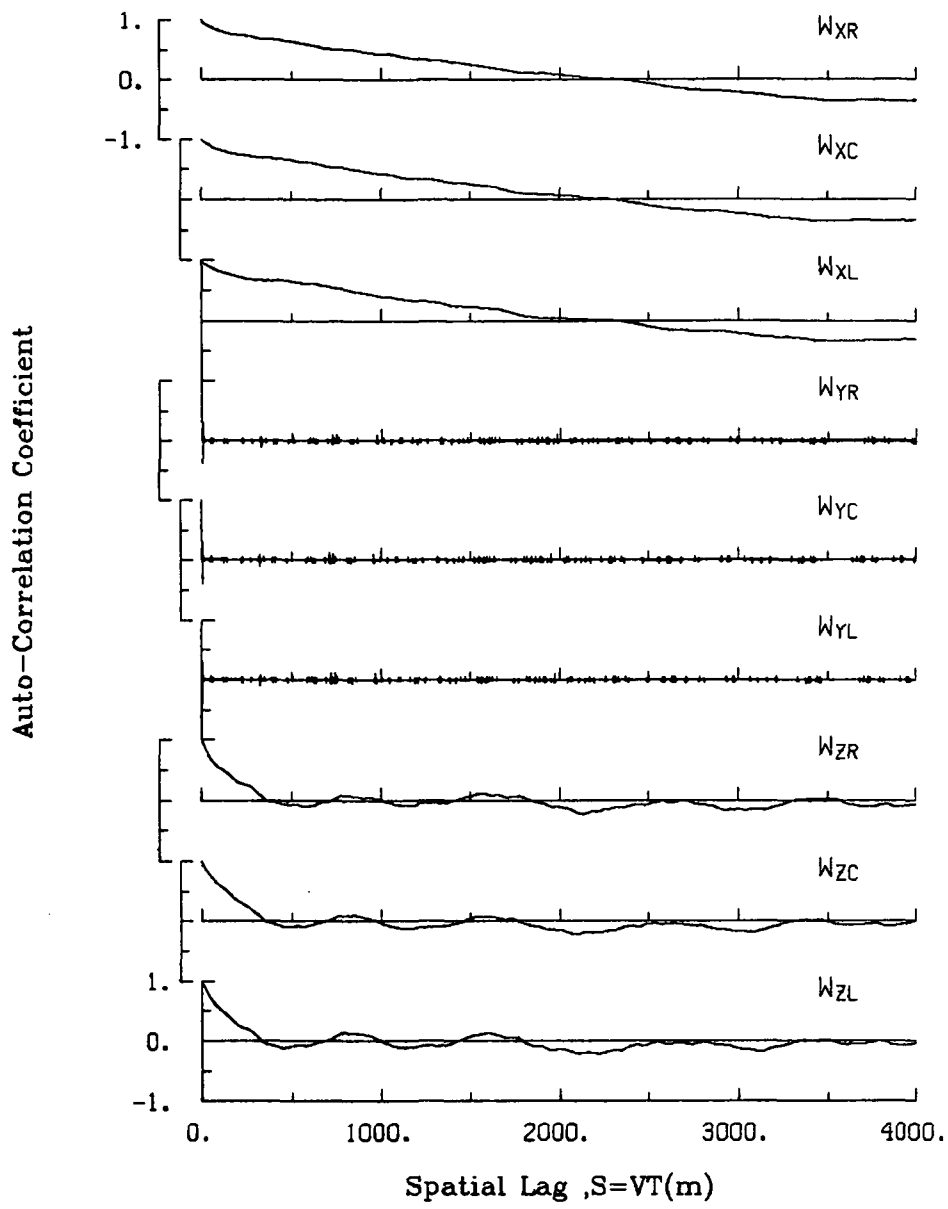

Figure A.52. Single-point auto-correlation coefficient of gust velocities, Flight 6, Run 10.

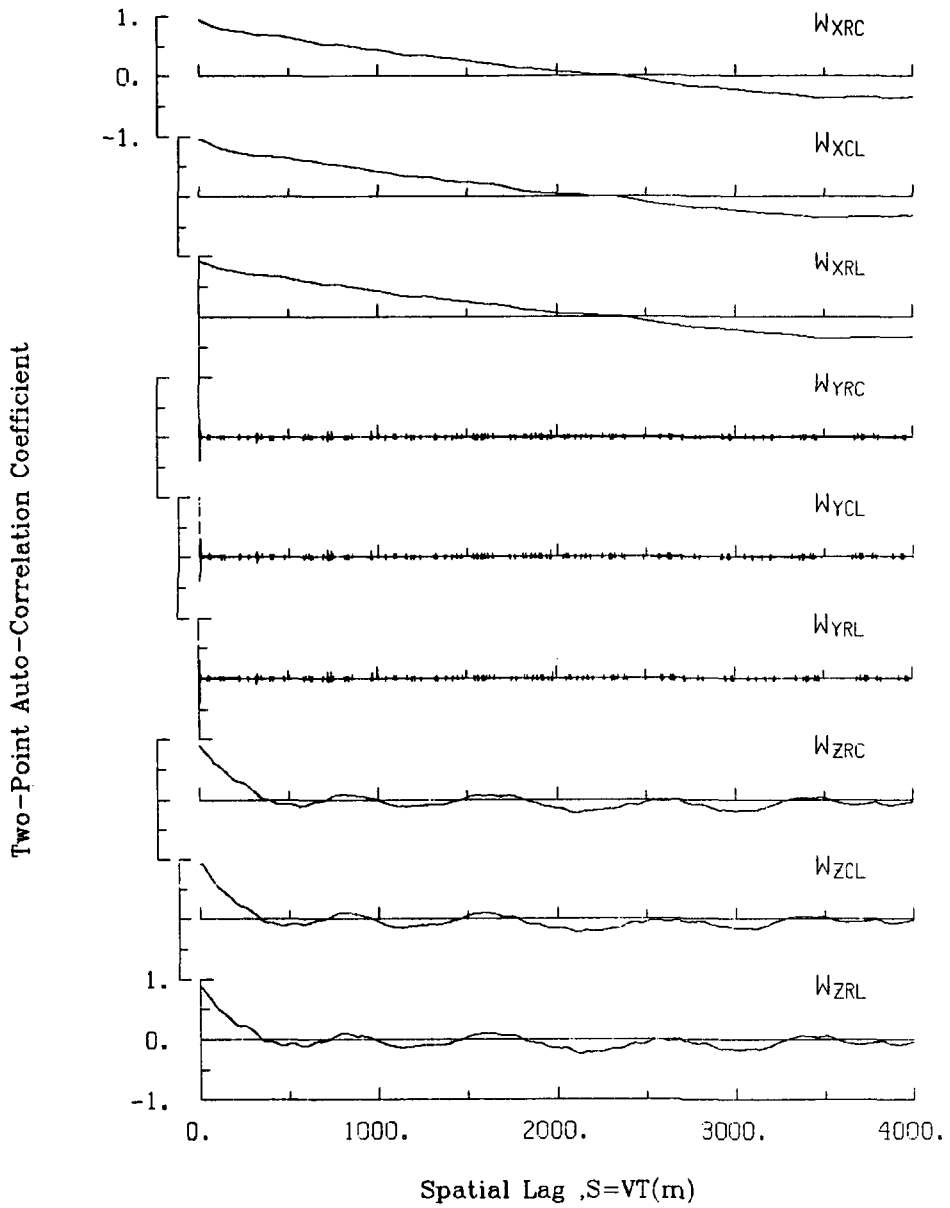

Figure A.53. Two-point auto-correlation coefficient of gust velocities, Flight 6, Run 10.

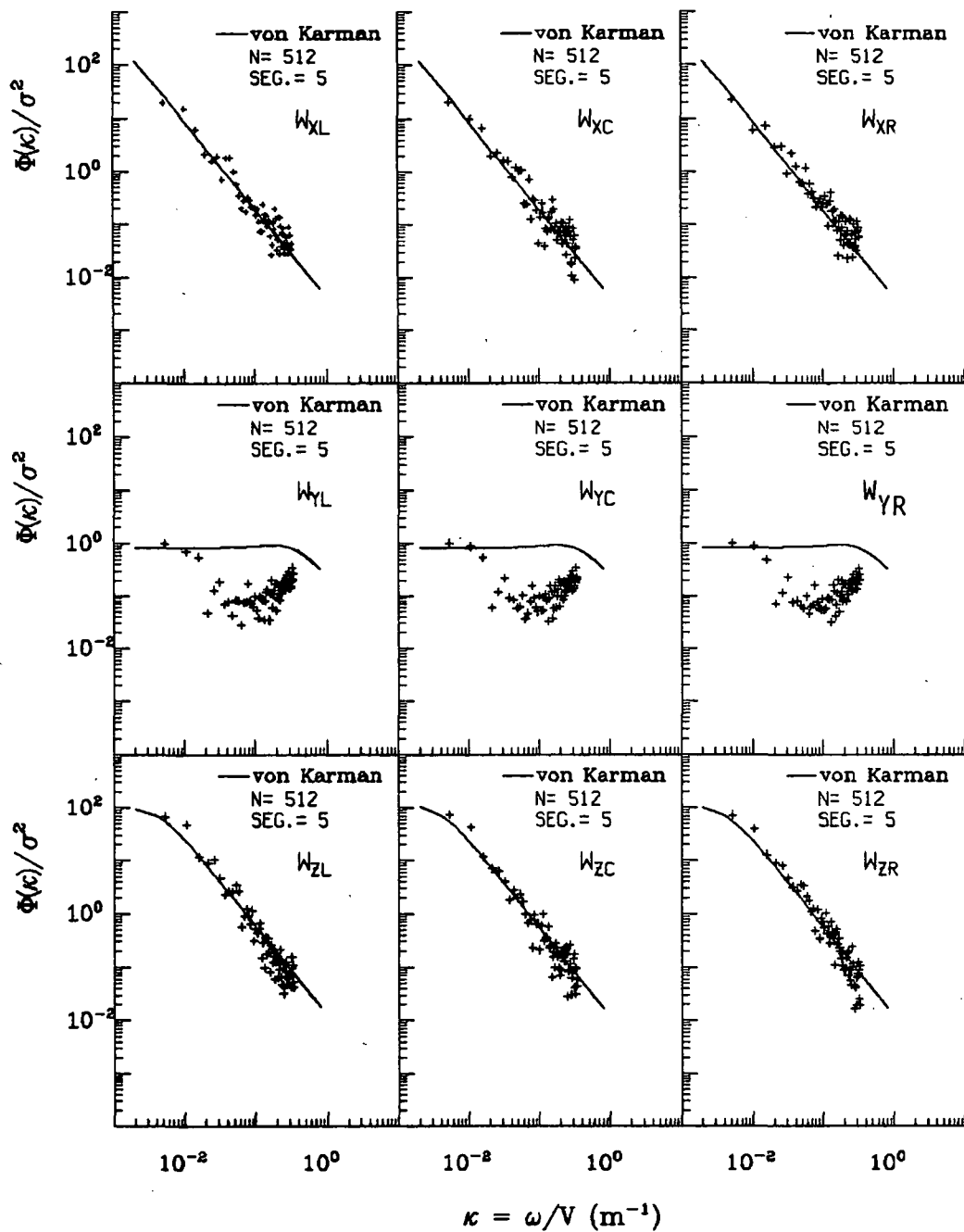

Figure A.54. Normalized auto-spectra of gust velocities, Flight 6, Run 10.

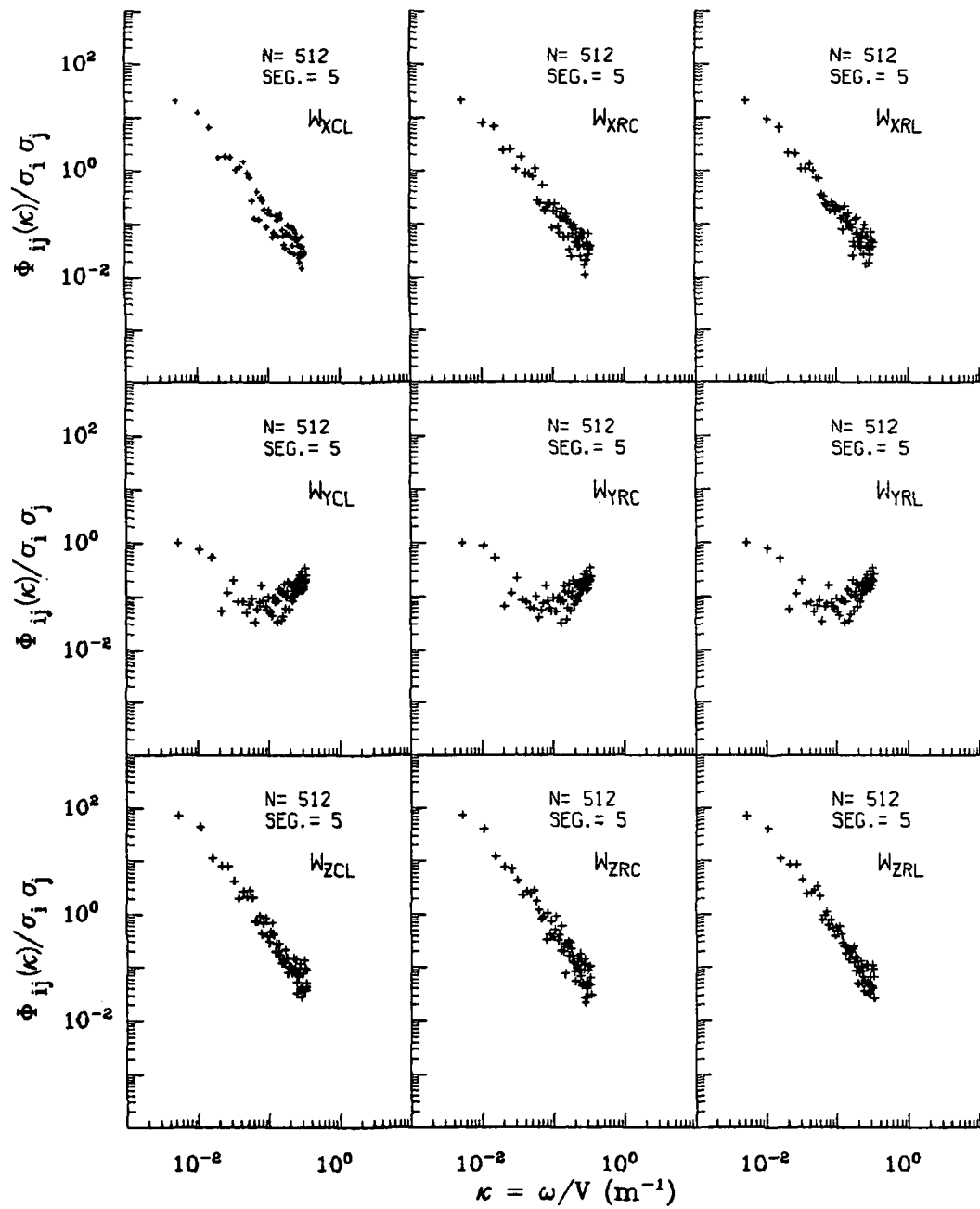

Figure A.55. Normalized two-point auto-spectra of gust velocities, Flight 6, Run 10.

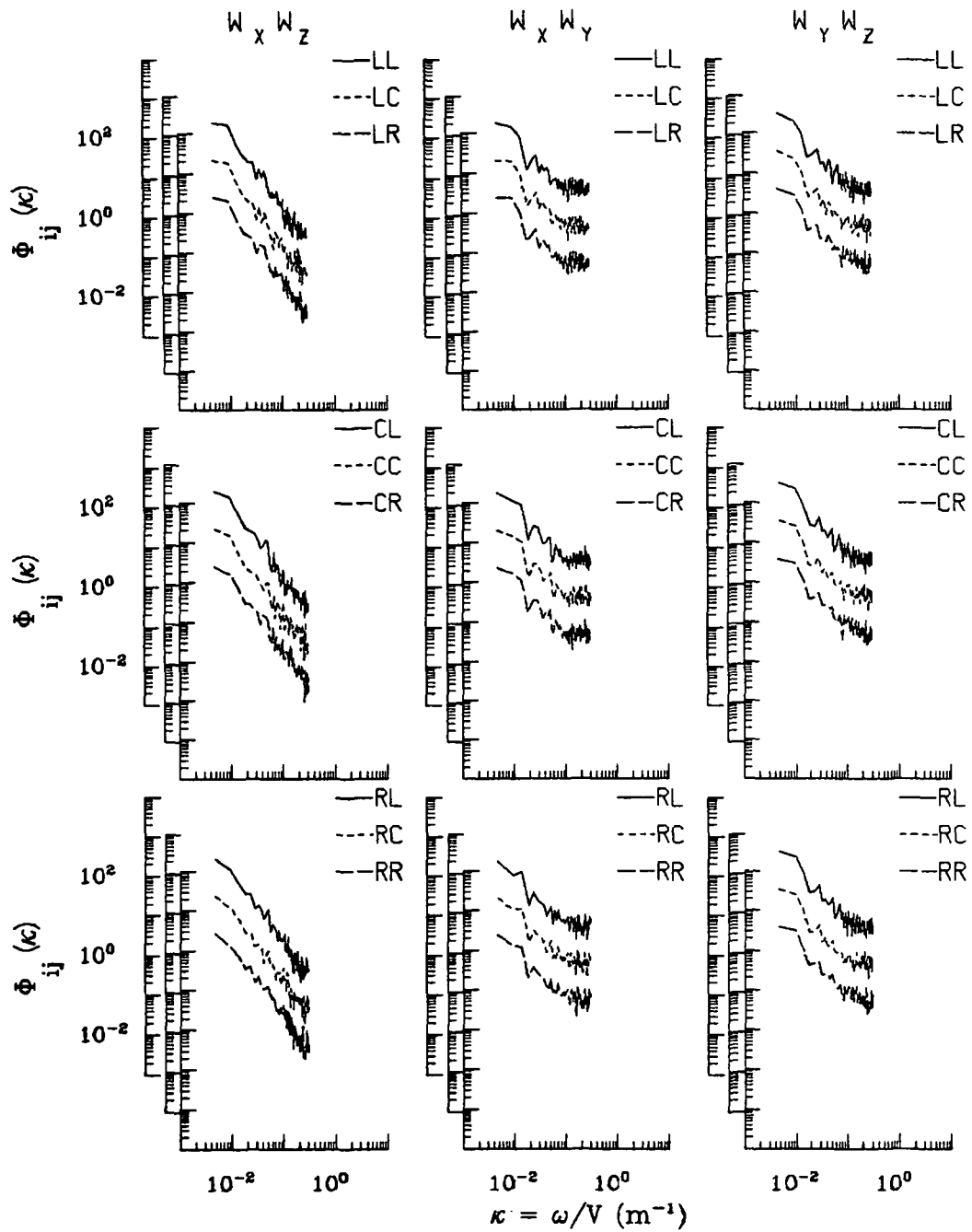

Figure A.56. Two-point cross-spectra of gust velocities, Flight 6, Run 10.

ORIGINAL PAGE IS
OF POOR QUALITY

TABLE A.14. List of All Parameters Measured and Their Range of Values, Flight 6, Run 10.

		START TIME = 50888.3766		STOP TIME = 50957.5766			
CHANNEL	UNITS	HIGH	LOW	MEAN	RMS	POINTS	
2 PHI DOT	RAD/SEC	.111	-.113	-.00313	.03061	2768	
3 ACCL N CG	G UNITS	-.988	-.988	-.98774	.98774	2768	
4 THETA DOT	RAD/SEC	.078	-.054	.00588	.01698	2768	
5 THETA	RAD	.132	.024	.06787	.07093	2768	
6 PHI	RAD	.053	-.079	-.01214	.02991	2768	
7 PSI 1	DEGREES	183.708	176.311	179.58811	179.59268	2768	
8 DEL PSI 1	DEGREES	4.109	-3.120	.17890	1.31236	2768	
9 PSI 2	DEGREES	541.706	534.313	537.60727	537.60877	2768	
10 DEL PSI 2	DEGREES	3.903	-3.331	-.01719	1.29578	2768	
11 ACCL N LT	G UNITS	2.307	-.246	1.01045	1.04596	2768	
12 ACCL N RT	G UNITS	2.117	-.517	1.02517	1.05800	2768	
13 ACCL X CG	G UNITS	.153	.025	.08002	.08322	2768	
14 ACCL Y CG	G UNITS	.165	-.114	.00964	.03889	2768	
15 ALPHA CTR	RAD	.057	-.065	-.00429	.01775	2768	
16 BETA CTR	RAD	.057	-.104	-.01729	.03070	2768	
17 TEMP I	DEG F	103.661	102.941	103.32871	103.32879	2768	
18 TEMP P	DEG F	90.186	90.006	90.17989	90.17990	2768	
19 ACCL Z INS	G UNITS	1.688	.518	1.00426	1.01364	2768	
20 ALPHA RT	RAD	.064	-.051	.00559	.01944	2768	
21 BETA RT	RAD	.084	-.067	.01772	.02905	2768	
22 ALPHA LT	RAD	.077	-.062	.00848	.02029	2768	
23 BETA LT	RAD	.042	-.106	-.02485	.03382	2768	
24 PSI DOT	RAD/SEC	.072	-.050	.00308	.02057	2768	
25 TEMP TOT	DEG C	31.783	30.505	31.21927	31.22030	2768	
26 QC LT	PSID	.876	.649	.76703	.76798	2768	
27 QC CTR	PSID	.850	.636	.75168	.75256	2768	
28 OC RT	PSID	.895	.650	.77854	.77942	2768	
29 PS	PSIA	11.392	11.356	11.37537	11.37538	2768	
30 TEMP IRT	DEG C	26.090	18.086	24.24345	24.28960	2768	
31 D TO G	METERS	8743405.0188742293.354	*****	*****	*****	2768	
32 B TO D	DEGREES	80.295	80.279	80.28717	80.28717	2768	
33 LONG	DEGREES	-105.008	-105.010	-105.00882	105.00882	2768	
34 LAT	DEGREES	39.849	39.779	39.81396	39.81397	2768	
35 TRK ANG	DEGREES	179.655	177.397	178.55736	178.55840	2768	
36 HDG	RADIANS	5.051	1.231	3.14310	3.14907	2768	
37 VE	M/SEC	5.141	.743	2.86916	3.10177	2768	
38 VM	M/SEC	-106.581	-114.469	-111.46387	111.49899	2768	
39 ALTITUDE	KM	2.122	2.097	2.10845	2.10845	2768	
40 TEMPC	DEGREES C	26.559	24.832	25.70599	25.70818	2768	
41 EW WND SPD	KNOTS	211.599	-195.855	9.37796	25.63697	2768	
42 NS WND SPD	KNOTS	1.054	-295.580	-15.19986	30.20866	2768	
43 WIND SPEED	KNOTS	357.398	2.770	20.54753	39.62092	2768	
44 WIND DIREC	DEGREES	359.779	.034	310.58021	315.73217	2768	
45 AIRSPEED R	M/SEC	114.492	98.121	107.04284	107.07135	2768	
46 AIRSPEED C	M/SEC	111.662	97.123	105.22172	105.25050	2768	
47 AIRSPEED L	M/SEC	113.420	98.046	106.26405	106.29486	2768	
48 DELTA ALT	METERS	8.972	-16.652	-4.91937	7.58788	2768	
49 INRTL DISP	METERS	6.036	-13.868	-4.56191	7.09406	2768	
50 UG RIGHT	M/SEC	9.270	-8.189	.00000	3.04123	2768	
51 UG CENTER	M/SEC	8.462	-6.839	.00000	3.03199	2768	
52 UG LEFT	M/SEC	8.785	-7.108	.00000	3.08611	2768	
53 VG RIGHT	M/SEC	216.182	-211.920	-.00046	20.79883	2768	
54 VG CENTER	M/SEC	206.917	-209.619	-.00531	20.40824	2768	
55 VG LEFT	M/SEC	208.157	-213.526	-.00436	20.53857	2768	
56 WG RIGHT	M/SEC	8.142	-11.056	.02631	2.55247	2768	
57 WG CENTER	M/SEC	6.895	-10.782	.03033	2.53922	2768	
58 WG LEFT	M/SEC	8.411	-10.754	.03045	2.65394	2768	

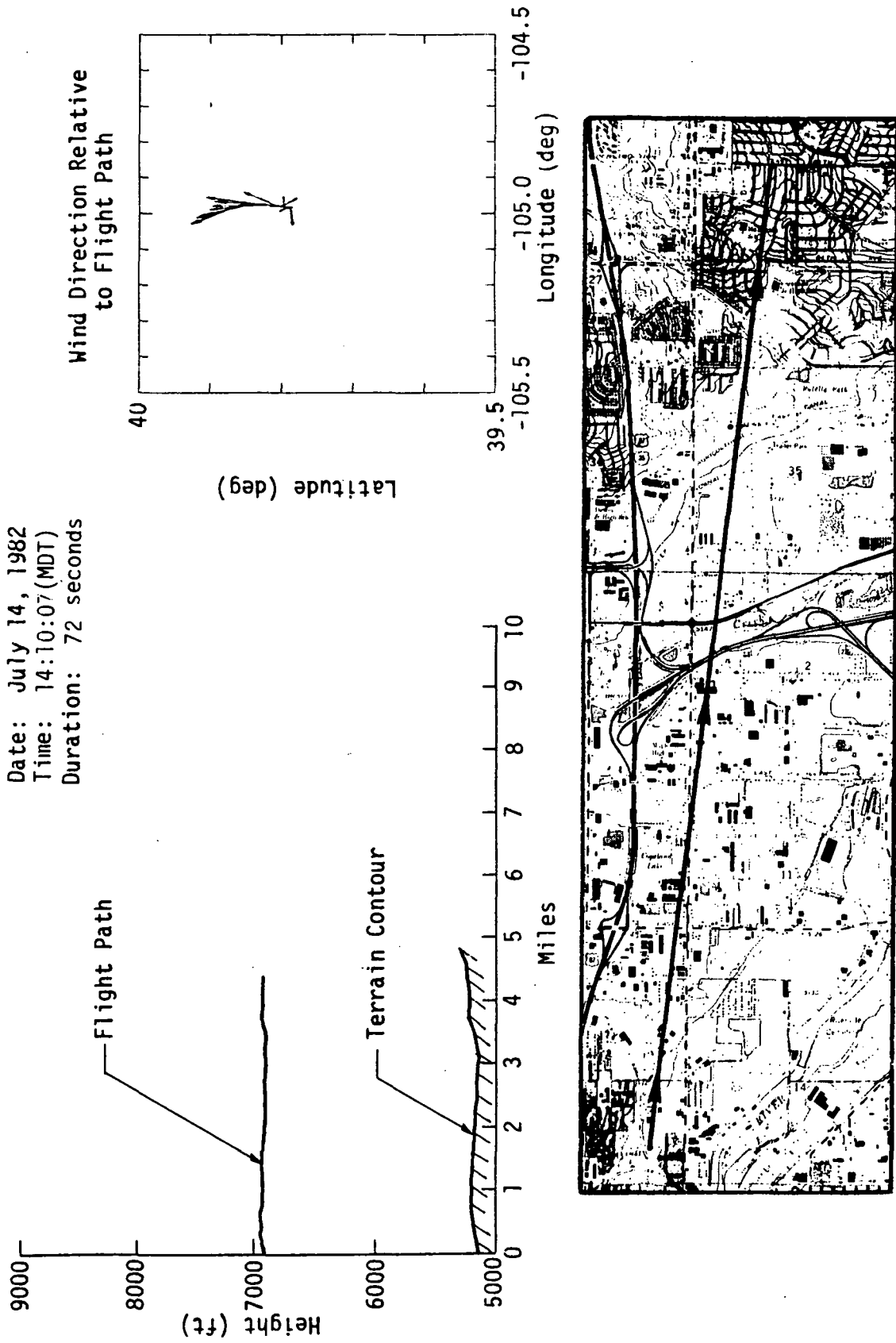

Figure A.57. Flight path information, Flight 6, Run 11.

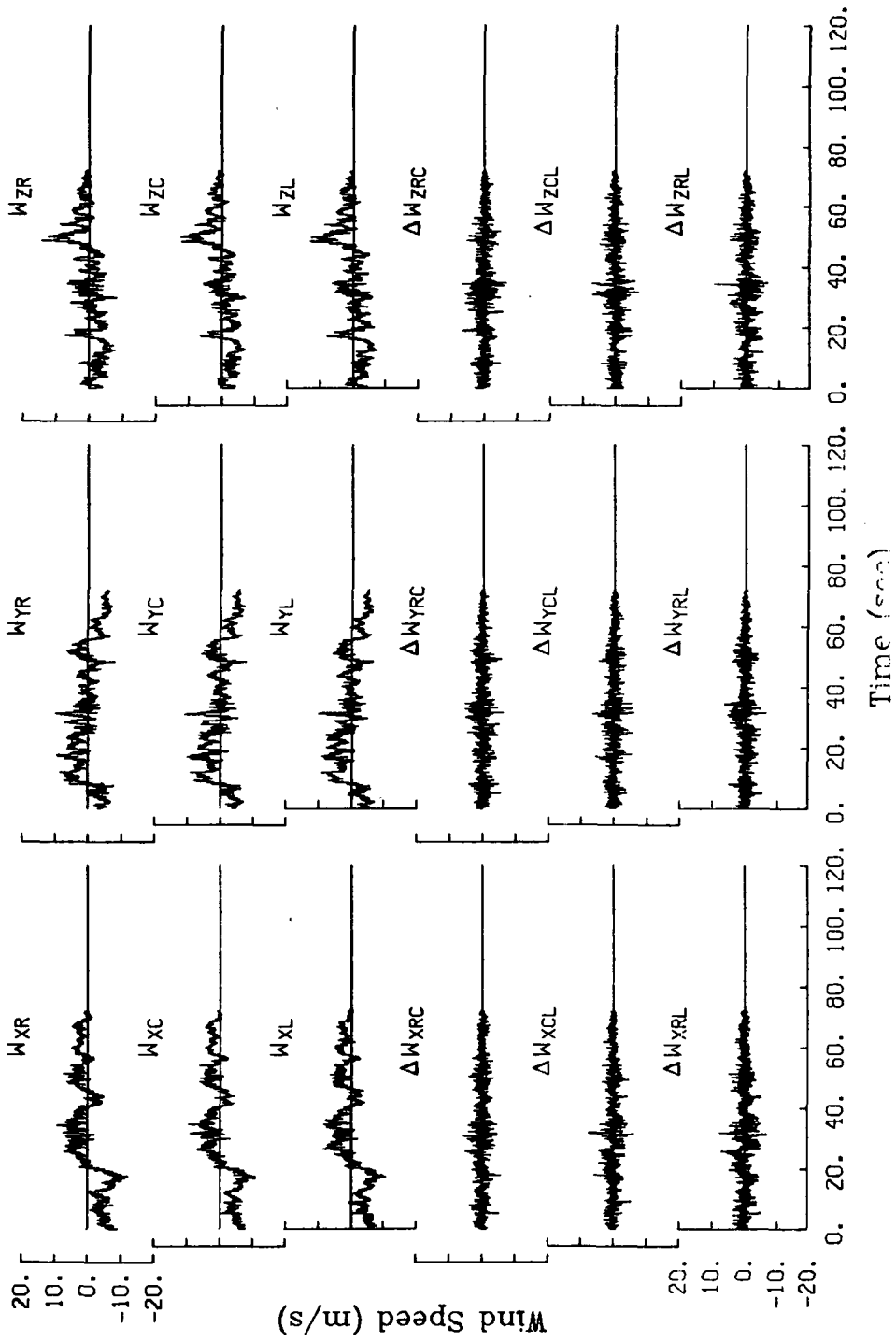
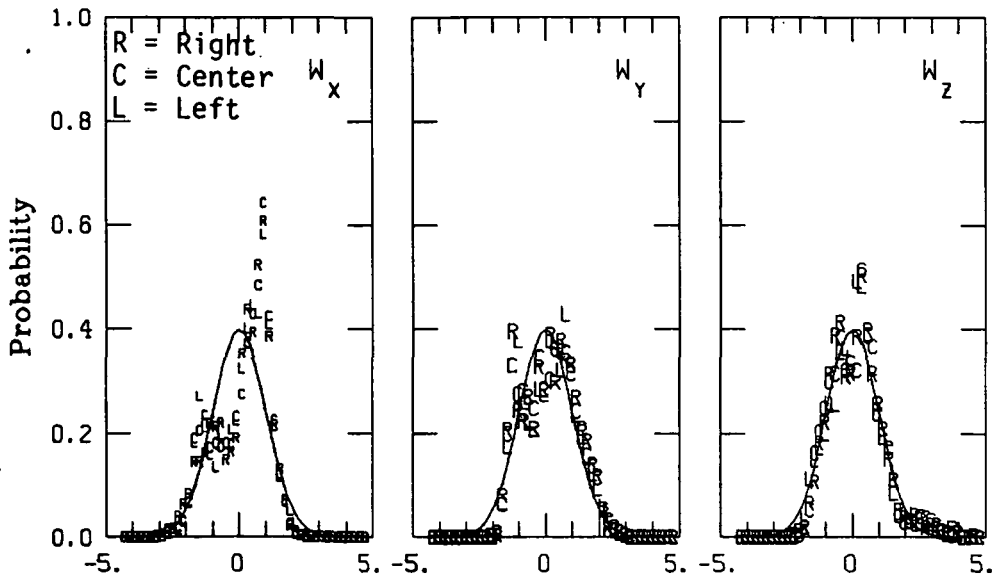

Figure A.58. Time histories of gust velocities and gust velocity differences, Flight 6, Run 11.

TABLE A.15. Average Turbulence Parameters and Integral Length Scales, Flight 6, Run 11.

I. Mean Airspeed (m/s)			II. Standard Deviation of Gust Velocities (m/s)		
v_L	v_C	v_R	$\sigma_{w_{XL}}$	$\sigma_{w_{XC}}$	$\sigma_{w_{XR}}$
106.2	105.1	106.9	3.88	3.80	3.87
			$\sigma_{w_{YL}}$	$\sigma_{w_{YC}}$	$\sigma_{w_{YR}}$
			3.28	3.38	3.25
			$\sigma_{w_{ZL}}$	$\sigma_{w_{ZC}}$	$\sigma_{w_{ZR}}$
			3.45	3.39	3.44
III. Standard Deviation of Gust Velocity Differences (m/s)			IV. Integral Length Scale (m).		
$\sigma_{\Delta w_{XCL}}$	$\sigma_{\Delta w_{XRC}}$	$\sigma_{\Delta w_{XRL}}$	$L_{w_{XL}}$	$L_{w_{XC}}$	$L_{w_{XR}}$
1.23	1.19	1.54	642	645	622
$\sigma_{\Delta w_{YCL}}$	$\sigma_{\Delta w_{YRC}}$	$\sigma_{\Delta w_{YRL}}$	$L_{w_{YL}}$	$L_{w_{YC}}$	$L_{w_{YR}}$
1.26	1.28	1.36	908	896	924
$\sigma_{\Delta w_{ZCL}}$	$\sigma_{\Delta w_{ZRC}}$	$\sigma_{\Delta w_{ZRL}}$	$L_{w_{ZL}}$	$L_{w_{ZC}}$	$L_{w_{ZR}}$
1.34	1.35	1.53	1006	1161	827



Normalized Gust Velocity (Standard Deviations)

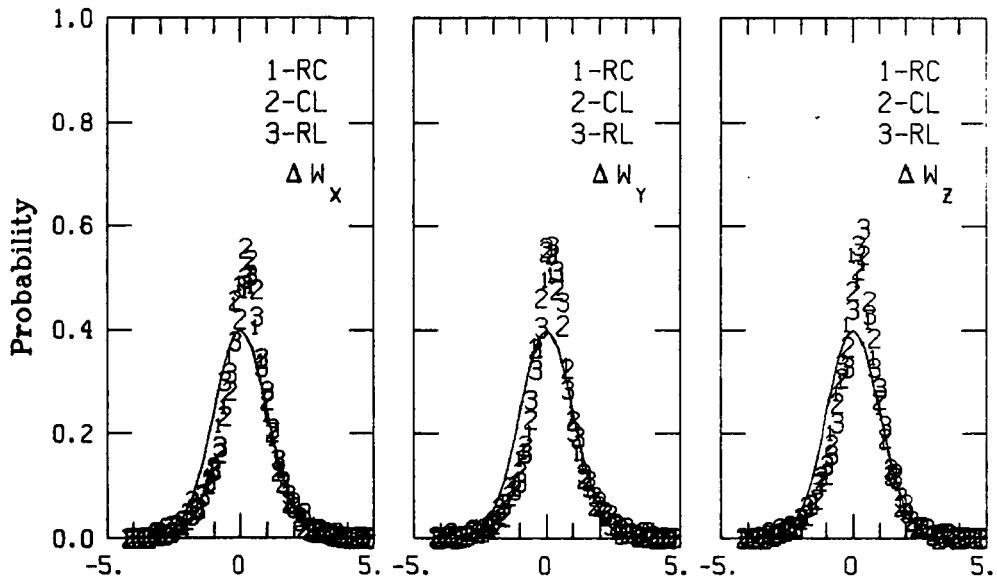

Normalized Velocity Differences (Standard Deviations)

Figure A.59. Probability density function for gust velocities and gust velocity differences, Flight 6, Run 11.

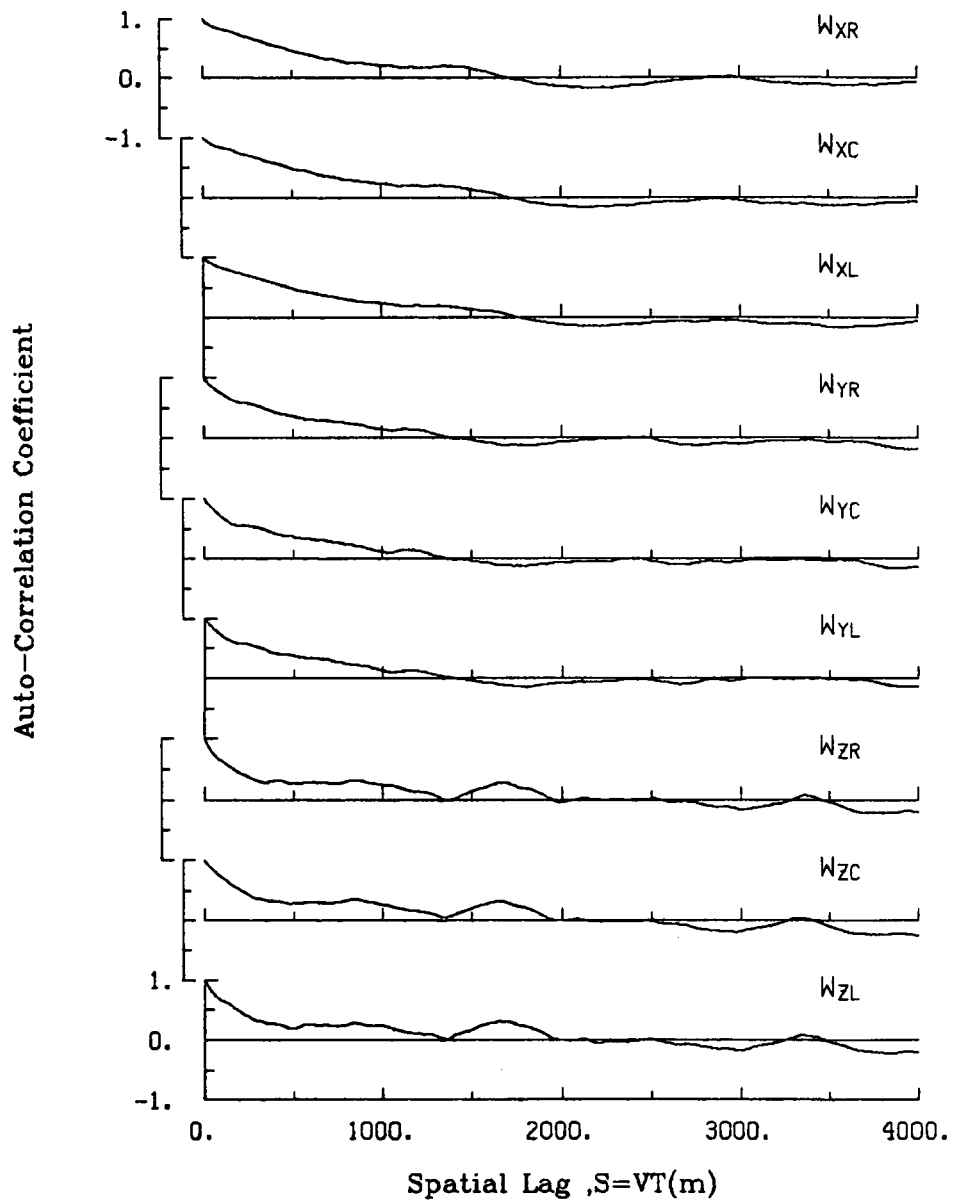

Figure A.60. Single-point auto-correlation coefficient of gust velocities, Flight 6, Run 11.

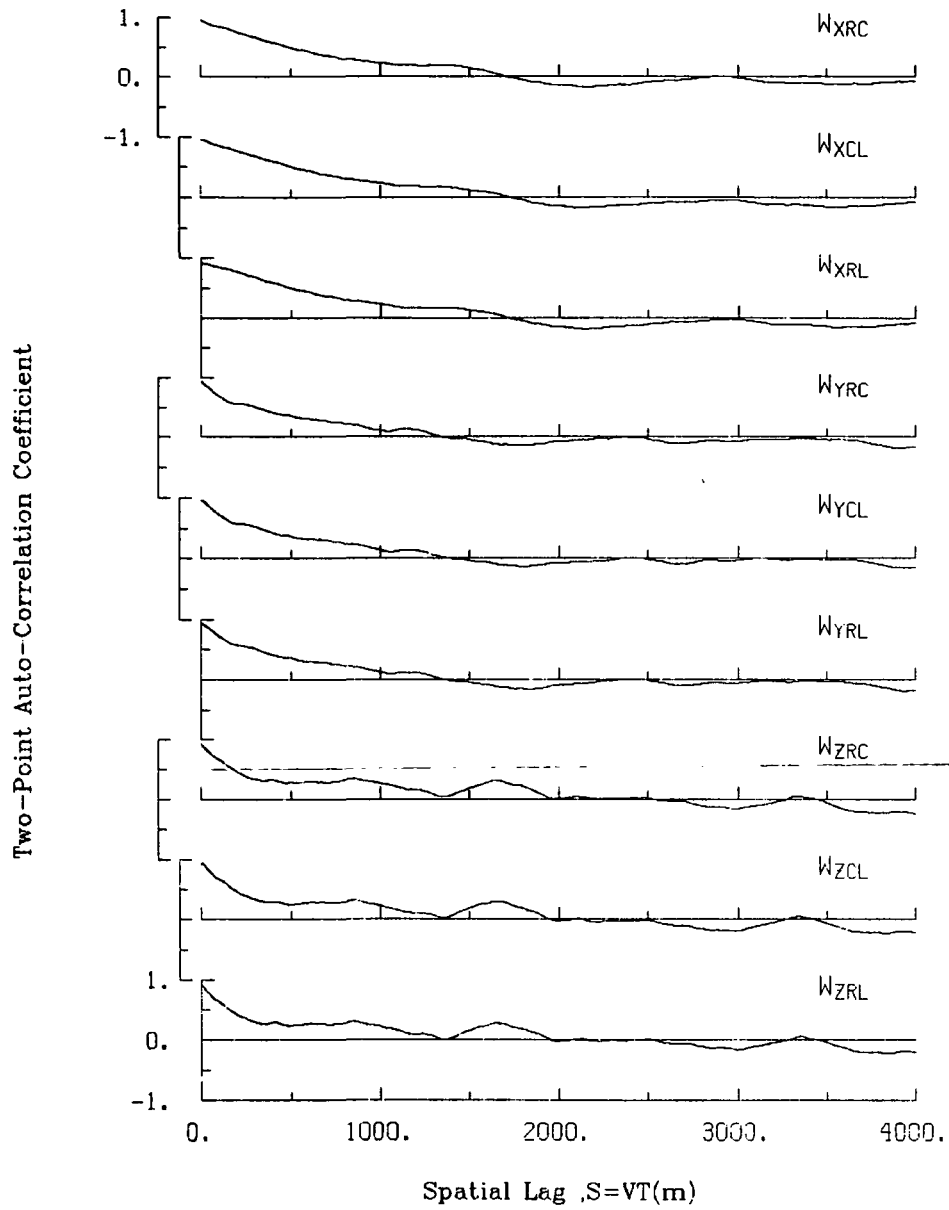

Figure A.61. Two-point auto-correlation coefficient of gust velocities, Flight 6, Run 11.

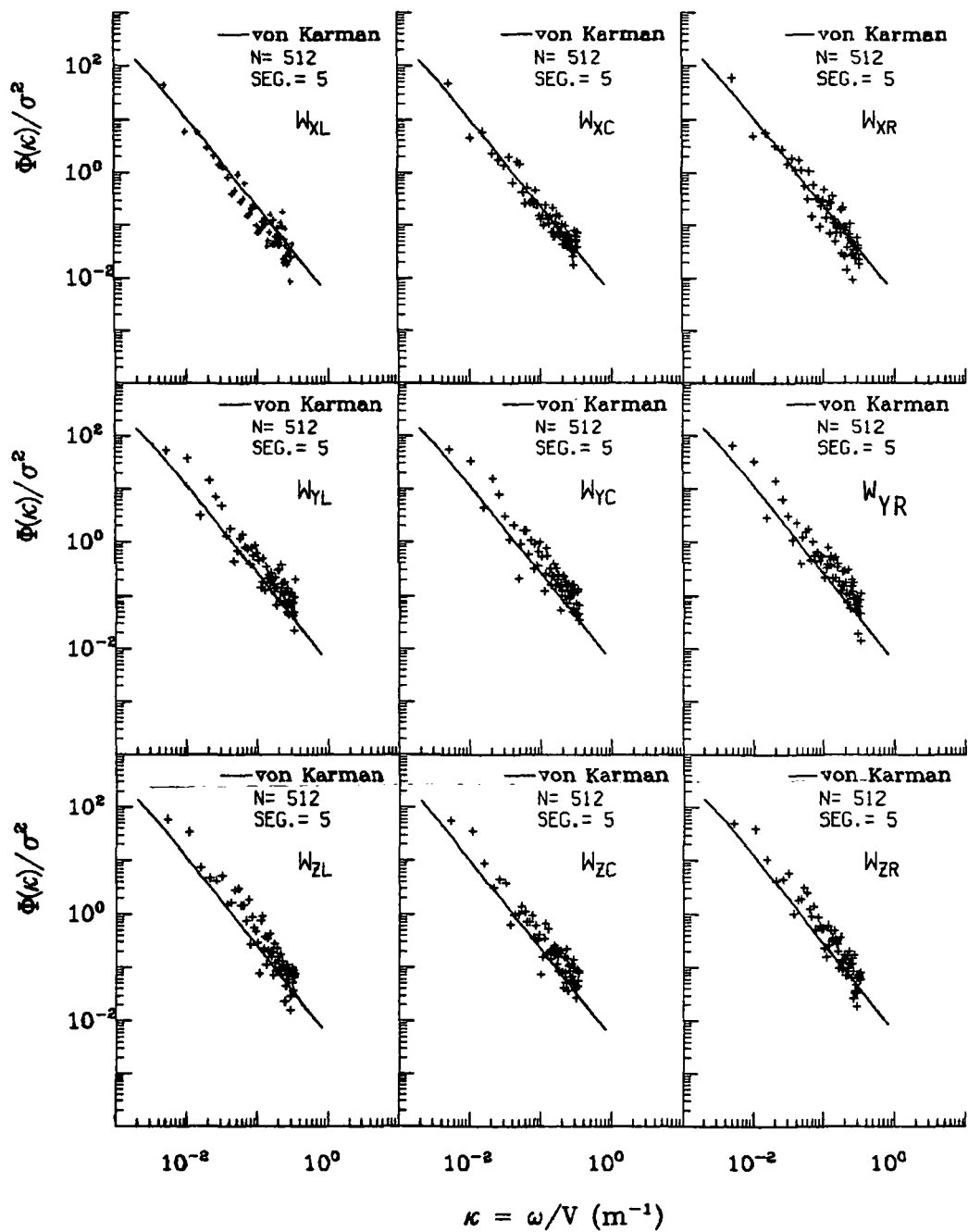

Figure A.62. Normalized auto-spectra of gust velocities, Flight 6, Run 11.

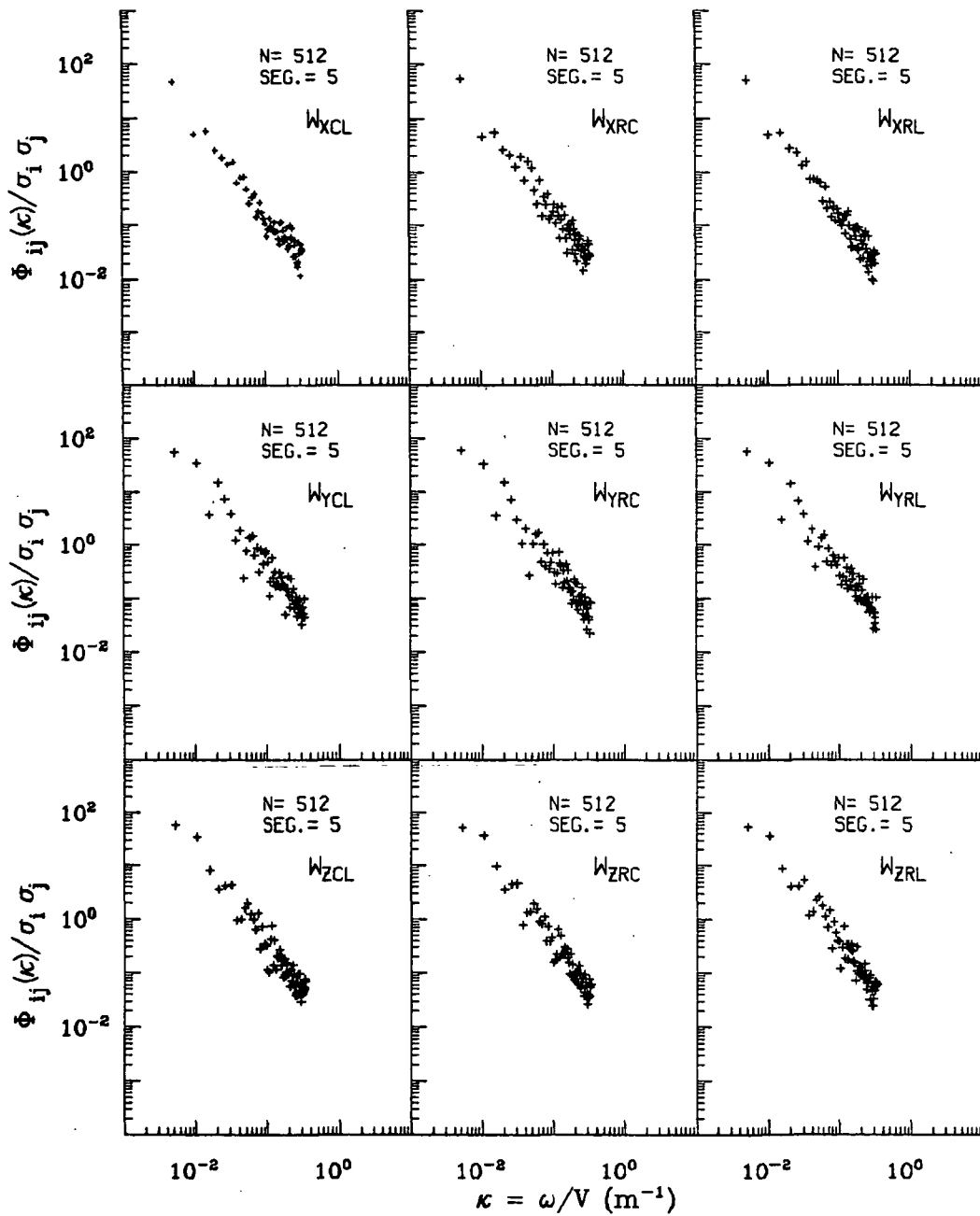

Figure A.63. Normalized two-point auto-spectra of gust velocities, Flight 6, Run 11.

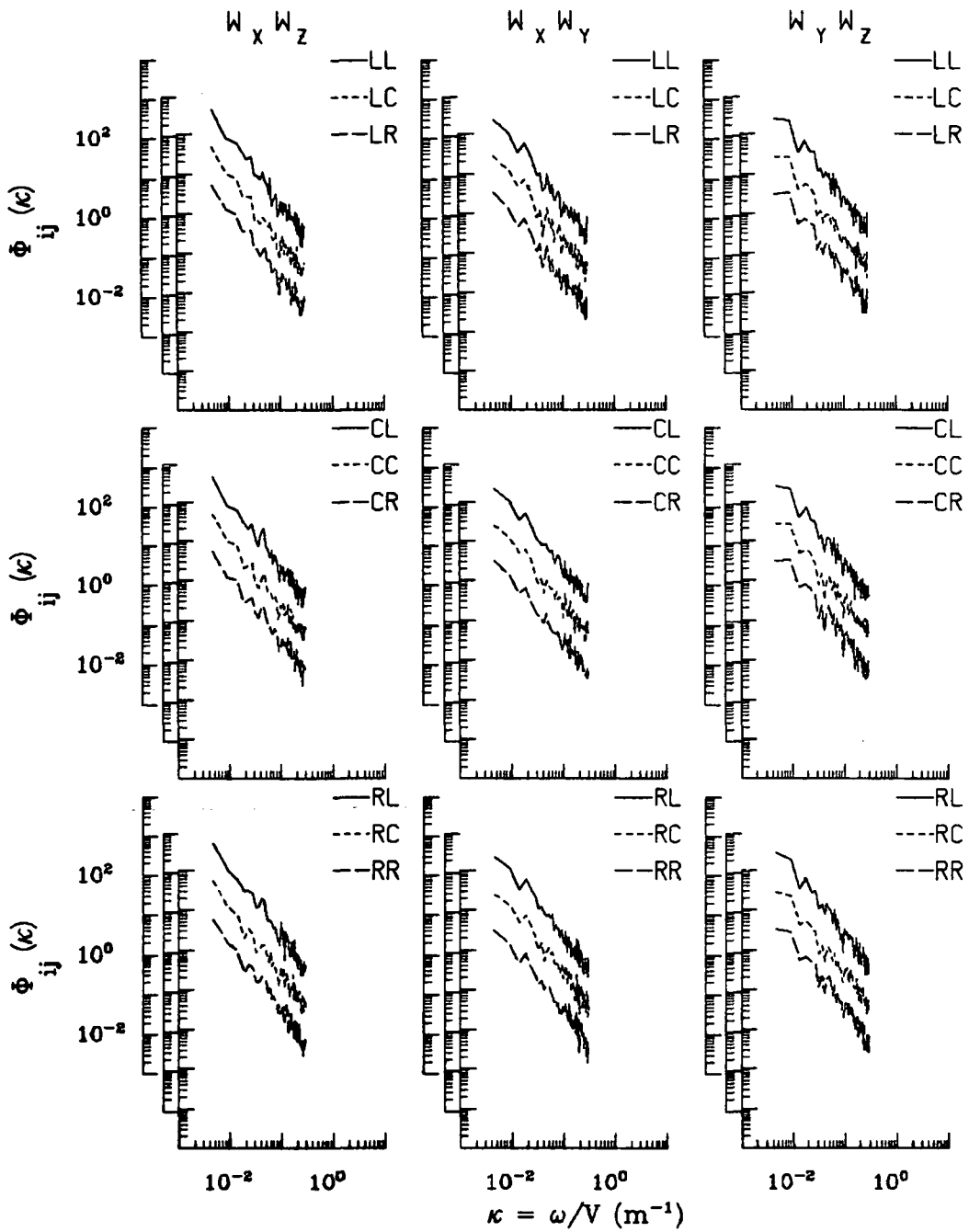

Figure A.64. Two-point cross-spectra of gust velocities, Flight 6, Run 11.

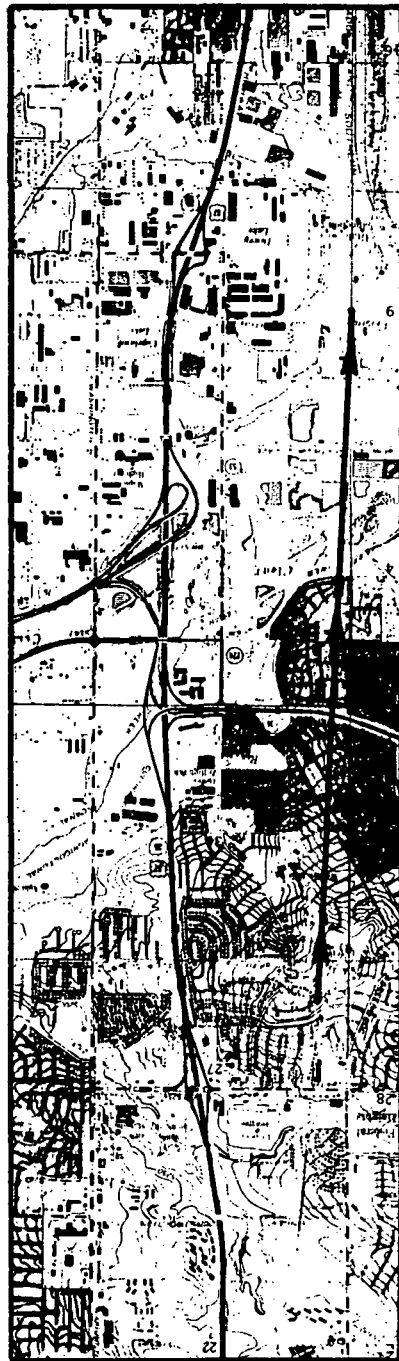
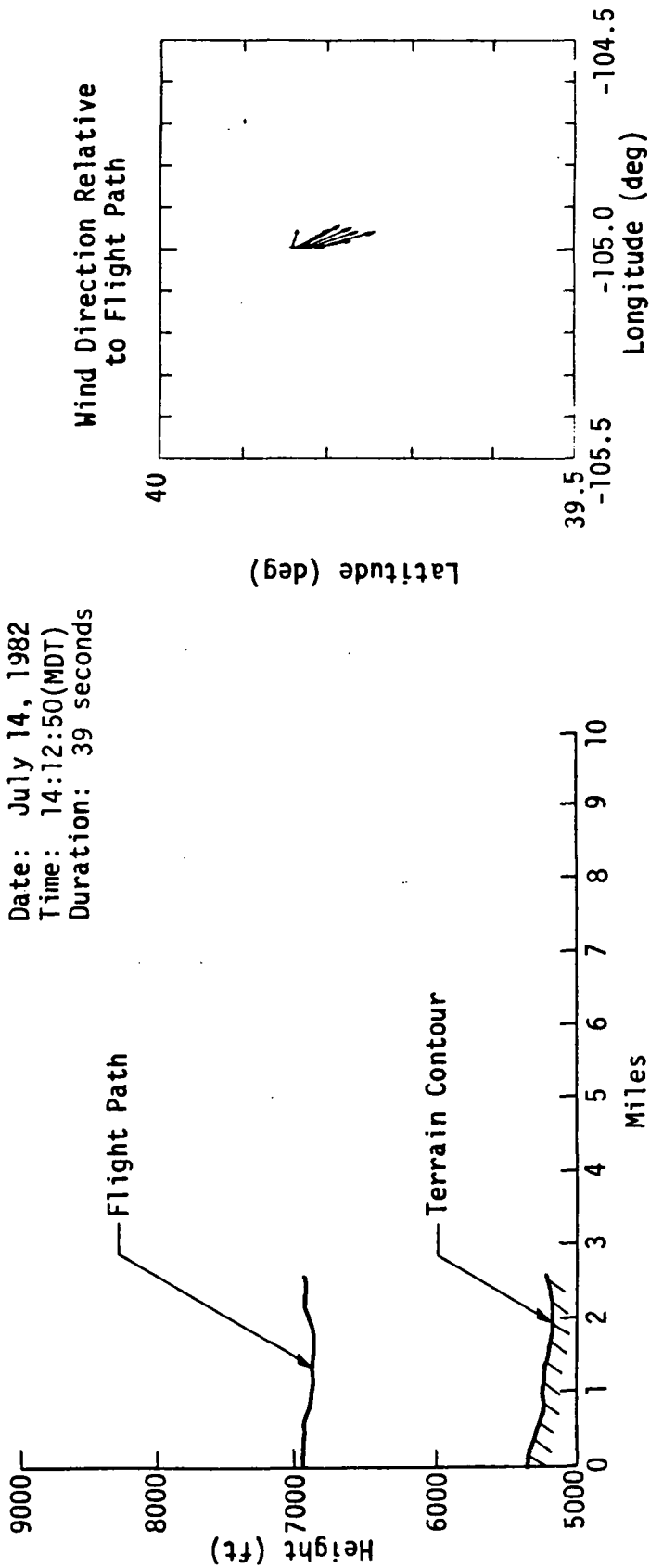

Figure A.65. Flight path information, Flight 6, Run 12.

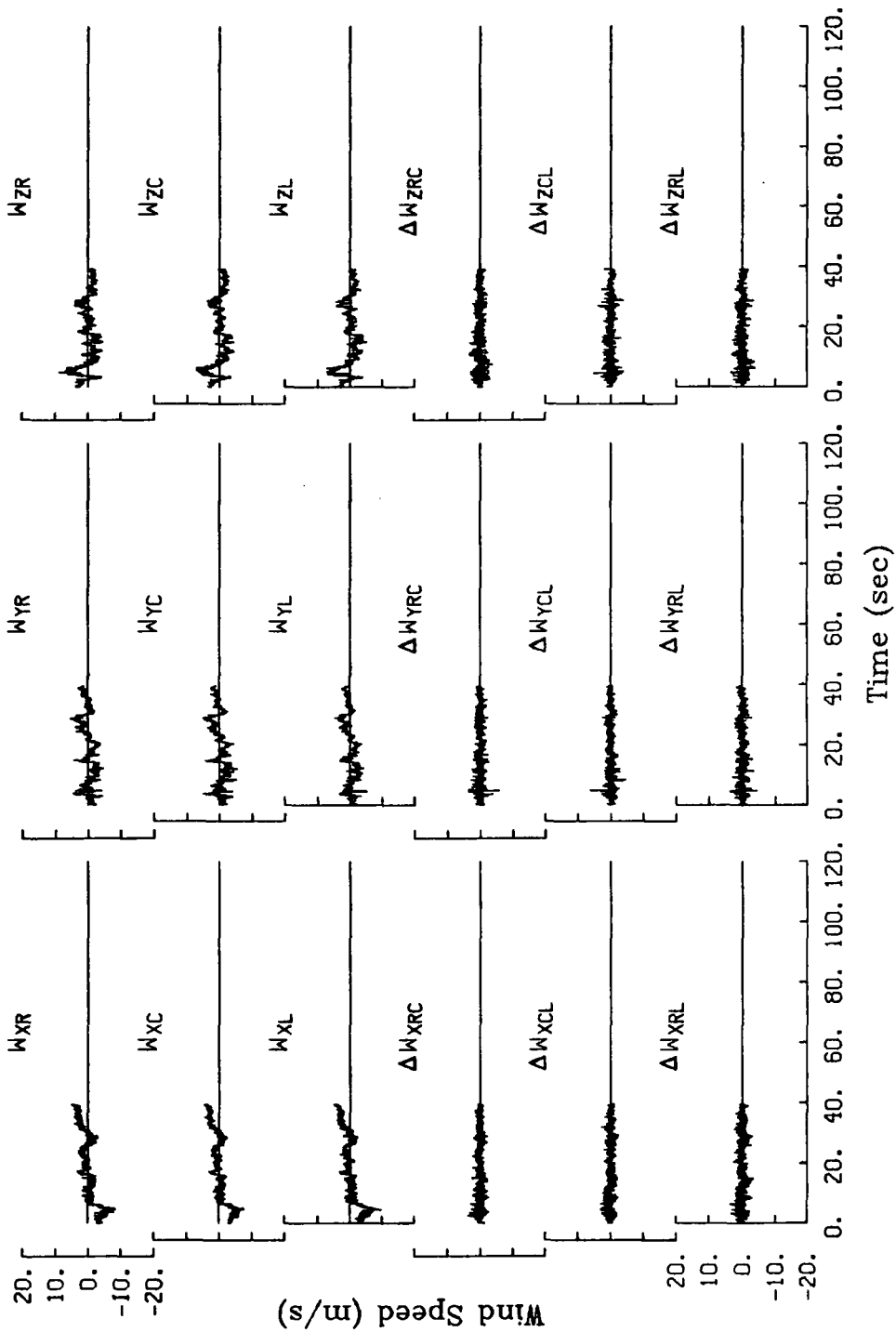

Figure A.66. Time histories of gust velocities and gust velocity differences, Flight 6, Run 12.

TABLE A.16. Average Turbulence Parameters and Integral Length Scales, Flight 6, Run 12.

I. Mean Airspeed (m/s)			II. Standard Deviation of Gust Velocities (m/s)		
V_L	V_C	V_R	$\sigma_{W_{XL}}$	$\sigma_{W_{XC}}$	$\sigma_{W_{XR}}$
107.8	106.7	108.6	2.39	2.29	2.35
			$\sigma_{W_{YL}}$	$\sigma_{W_{YC}}$	$\sigma_{W_{YR}}$
			1.54	1.66	1.64
			$\sigma_{W_{ZL}}$	$\sigma_{W_{ZC}}$	$\sigma_{W_{ZR}}$
			2.15	2.03	2.09
III. Standard Deviation of Gust Velocity Differences (m/s)			IV. Integral Length Scale (m).		
$\sigma_{\Delta W_{XCL}}$	$\sigma_{\Delta W_{XRC}}$	$\sigma_{\Delta W_{XRL}}$	$L_{W_{XL}}$	$L_{W_{XC}}$	$L_{W_{XR}}$
0.77	0.71	0.89	379	359	367
$\sigma_{\Delta W_{YCL}}$	$\sigma_{\Delta W_{YRC}}$	$\sigma_{\Delta W_{YRL}}$	$L_{W_{YL}}$	$L_{W_{YC}}$	$L_{W_{YR}}$
0.76	0.79	0.82	324	290	291
$\sigma_{\Delta W_{ZCL}}$	$\sigma_{\Delta W_{ZRC}}$	$\sigma_{\Delta W_{ZRL}}$	$L_{W_{ZL}}$	$L_{W_{ZC}}$	$L_{W_{ZR}}$
0.85	0.86	0.93	375	392	334

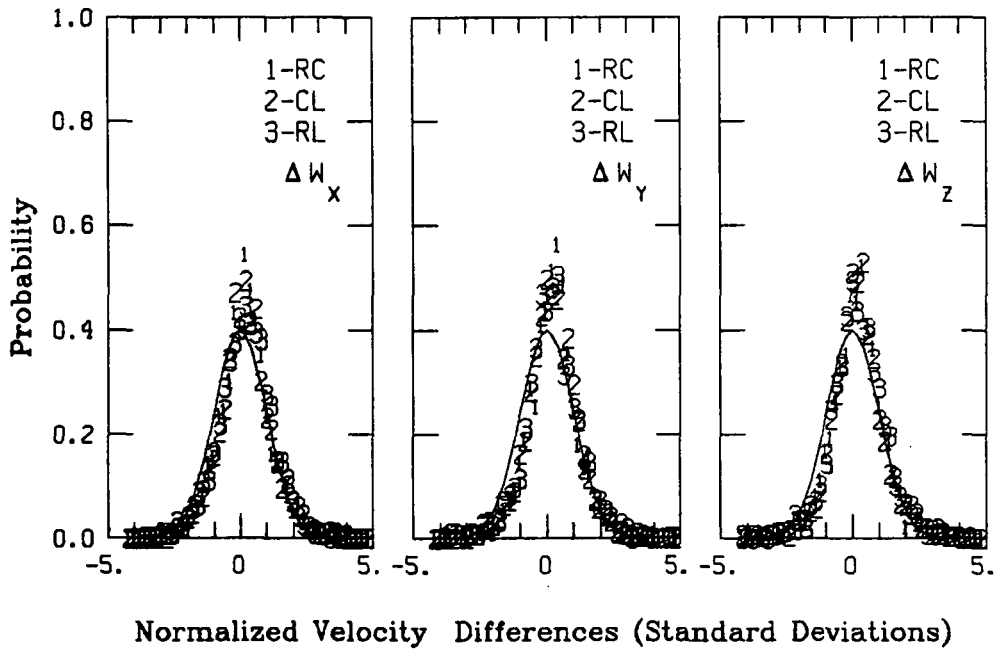
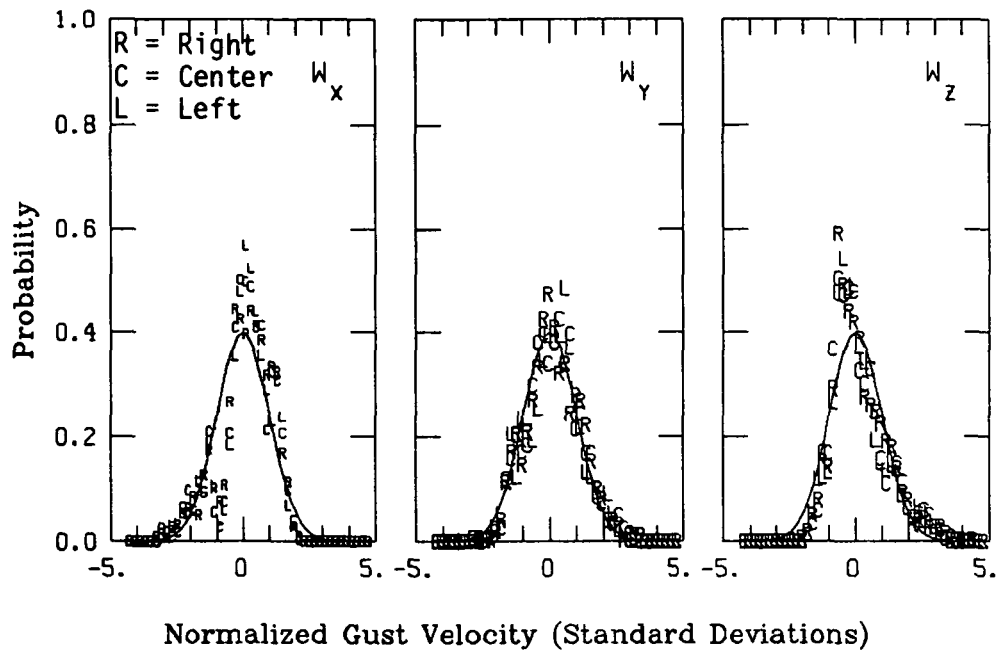

Figure A.67. Probability density function for gust velocities and gust velocity differences, Flight 6, Run 12.

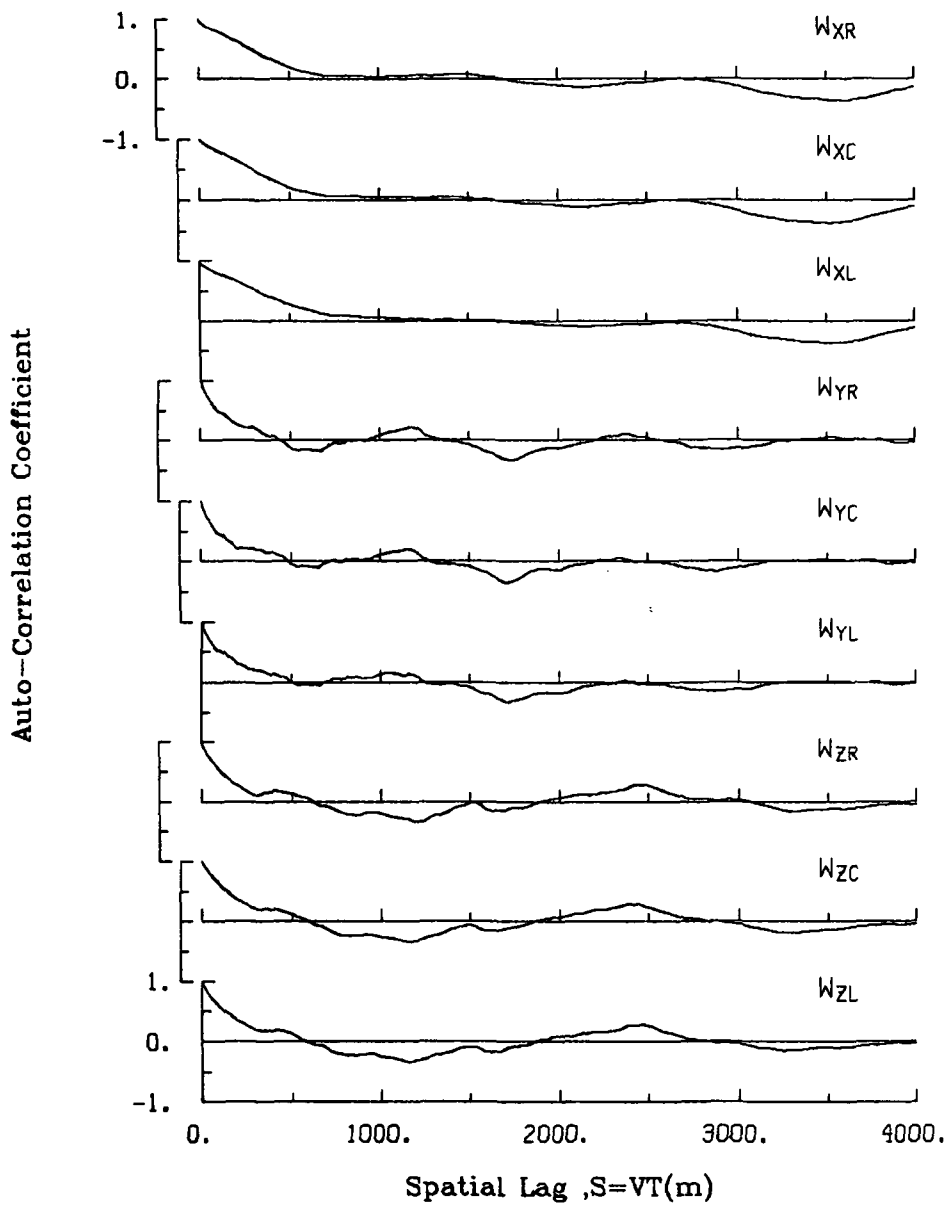

Figure A.68. Single-point auto-correlation coefficient of gust velocities, Flight 6, Run 12.

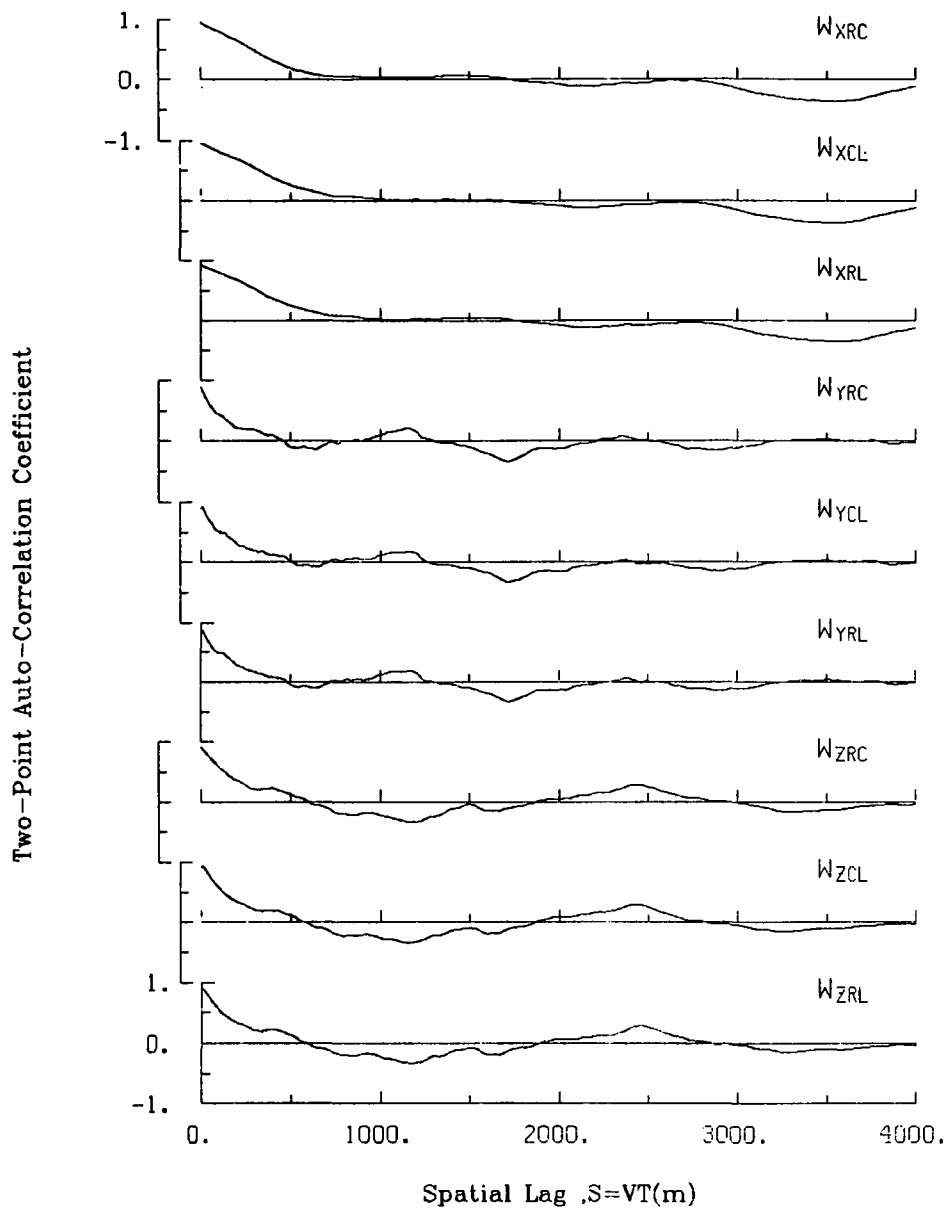

Figure A.69. Two-point auto-correlation coefficient of gust velocities, Flight 6, Run 12.

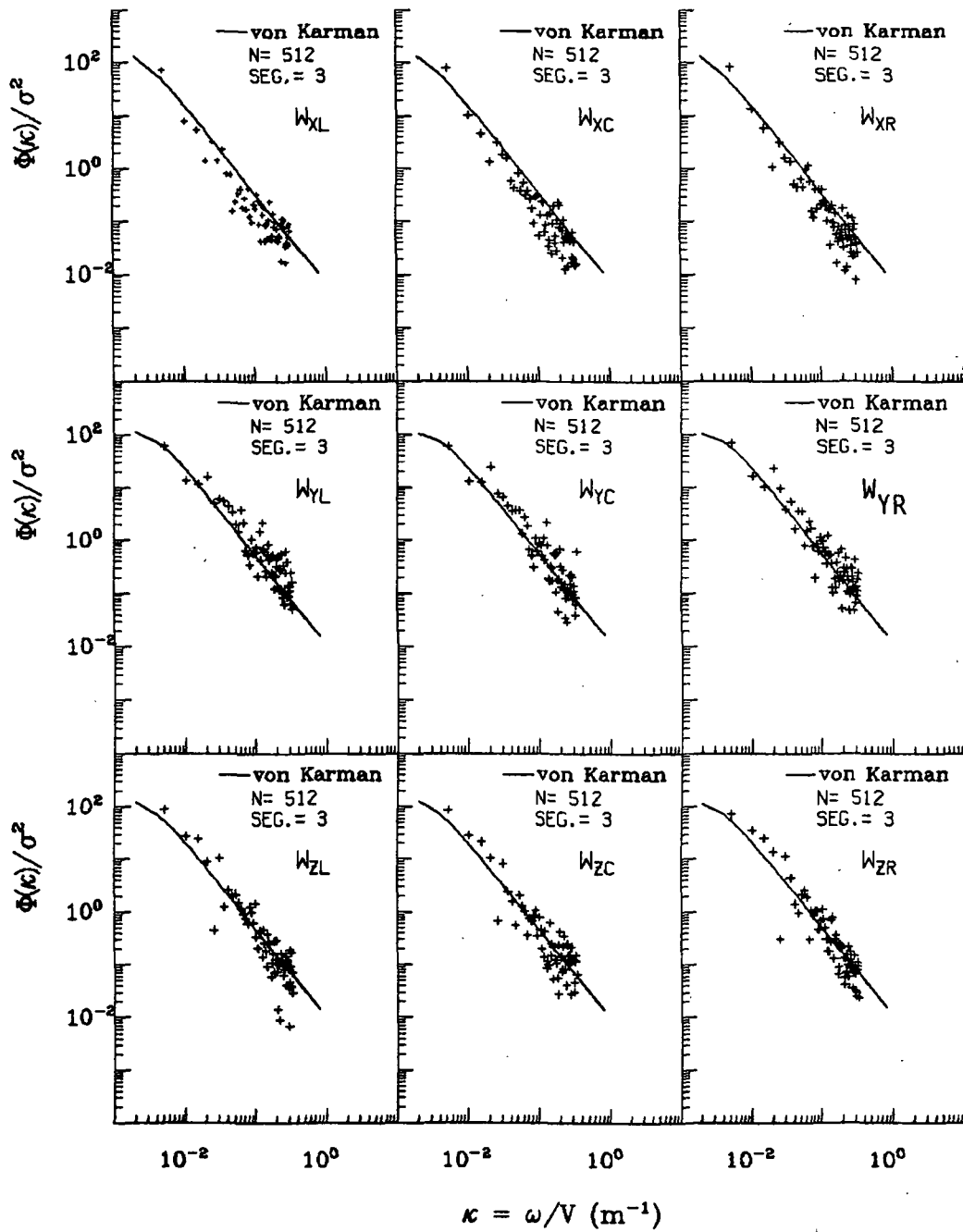

Figure A.70. Normalized auto-spectra of gust velocities, Flight 6, Run 12.

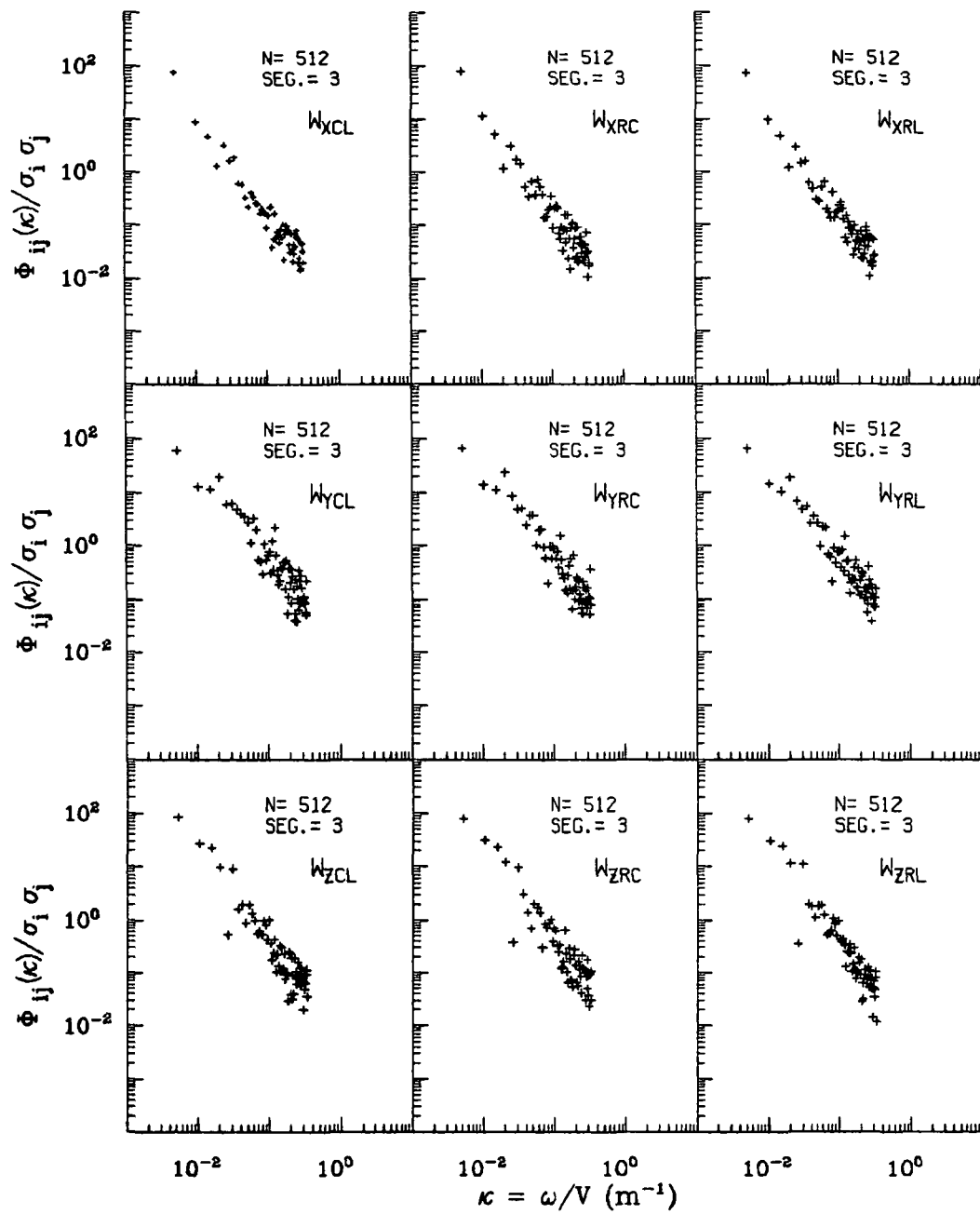

Figure A.71. Normalized two-point auto-spectra of gust velocities, Flight 6, Run 12.

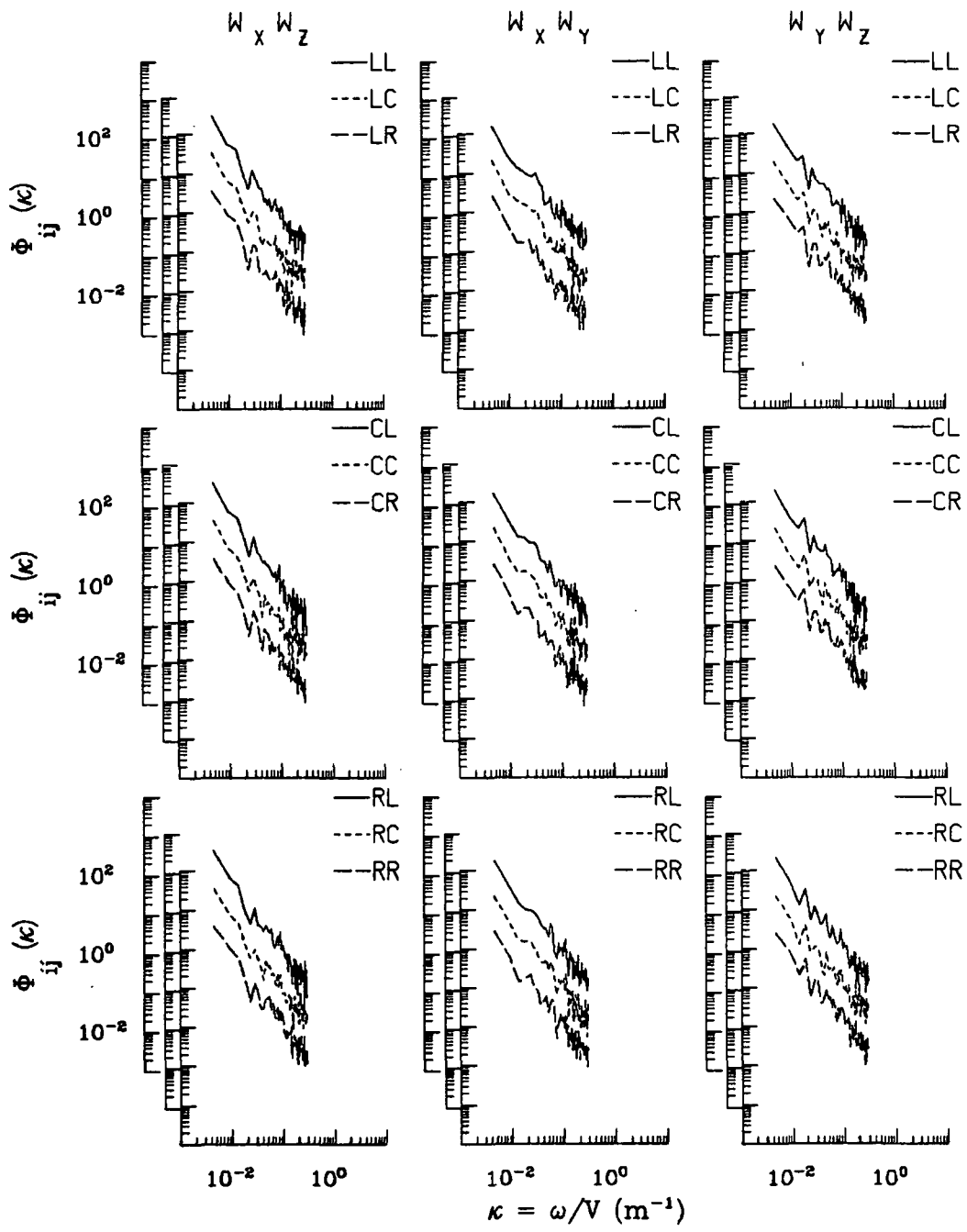

Figure A.72. Two-point cross-spectra of gust velocities, Flight 6, Run 12.

ORIGINAL PAGE IS
OF POOR QUALITY

TABLE A.17. List of All Parameters Measured and Their Range of Values,
Flight 6, Run 12.

		START TIME • 51170.2472	STOP TIME • 51209.6472				
CHANNEL	UNITS	HIGH	LOW	MEAN	RMS	POINTS	
2 PHI DOT	RAD/SEC	.062	-.064	-.00304	.02231	1576	
3 ACCL N CG	G UNITS	-.988	-.988	-.98774	.98774	1576	
4 THETA DCT	RAD/SEC	.052	-.049	.00643	.01473	1576	
5 THETA	RAD	.111	.027	.07646	.07947	1576	
6 PHI	RAD	.029	-.080	-.02127	.03112	1576	
7 PSI 1	DEGREES	184.413	180.186	182.08173	182.08485	1576	
8 DEL PSI 1	DEGREES	2.434	-1.357	.30705	1.09754	1576	
9 PSI 2	DEGREES	542.058	538.185	540.07757	540.07857	1576	
10 DEL PSI 2	DEGREES	2.315	-1.449	.20428	1.07351	1576	
11 ACCL N LT	G UNITS	1.988	.205	1.00470	1.03125	1576	
12 ACCL N RT	G UNITS	2.086	-.068	1.01963	1.04544	1576	
13 ACCL X CG	G UNITS	.124	.040	.07911	.08064	1576	
14 ACCL Y CG	G UNITS	.134	-.136	.00923	.04338	1576	
15 ALPHA CTR	RAD	.036	-.051	-.00894	.01590	1576	
16 BETA CTR	RAD	.045	-.070	-.01826	.02791	1576	
17 TEMP I	DEG F	101.862	101.322	101.59499	101.59505	1576	
18 TEMP P	DEG F	90.366	90.186	90.36268	90.36268	1576	
19 ACCL Z INS	G UNITS	1.491	.624	.95910	1.00669	1576	
20 ALPHA RT	RAD	.047	-.046	-.00128	.01573	1576	
21 BETA RT	RAD	.076	-.035	.01687	.02550	1576	
22 ALPHA LT	RAD	.048	-.042	.00222	.01432	1576	
23 BETA LT	RAD	.030	-.083	-.02533	.03180	1576	
24 PSI DOT	RAD/SEC	.043	-.029	.00219	.01576	1576	
25 TEMP TOT	DEG C	31.785	30.997	31.39238	31.39290	1576	
26 QC LT	PSID	.941	.714	.78944	.79040	1576	
27 QC CTR	PSID	.892	.705	.77305	.77393	1576	
28 QC RT	PSID	.936	.726	.80176	.80270	1576	
29 PS	PSIA	11.396	11.359	11.37760	11.37761	1576	
30 TEMP IRT	DEG C	25.348	16.001	23.70841	23.78185	1576	
31 D TO G	METERS	8744668.1098743795.162	*****	*****	*****	1576	
32 B TO D	DEGREES	80.298	80.291	80.29431	80.29431	1576	
33 LONG	DEGREES	-104.994	-104.996	-104.99495	104.99495	1576	
34 LAT	DEGREES	39.844	39.805	39.82446	39.82446	1576	
35 TRK ANG	DEGREES	182.591	180.650	181.62804	181.62881	1576	
36 HDG	RADIANS	3.226	3.158	3.18847	3.18853	1576	
37 VE	M/SEC	-1.324	-5.014	-3.21335	3.37586	1576	
38 VN	M/SEC	-109.937	-112.440	-111.30852	111.30990	1576	
39 ALTITUDE	KM	2.120	2.094	2.10687	2.10688	1576	
40 TEMPC	CEGREES C	26.277	24.999	25.72662	25.72826	1576	
41 EW WND SPD	KNOTS	16.929	-2.010	7.26860	7.96615	1576	
42 NS WND SPD	KNOTS	4.991	-17.820	-9.50517	10.49829	1576	
43 WIND SPEED	KNOTS	20.738	1.120	12.73116	13.17853	1576	
44 WIND DIREC	DEGREES	359.647	.430	313.47283	316.98033	1576	
45 AIRSPEED R	M/SEC	117.021	103.546	108.58302	108.61235	1576	
46 AIRSPEED C	M/SEC	114.310	102.120	106.66822	106.69806	1576	
47 AIRSPEED L	M/SEC	117.359	102.760	107.76448	107.79463	1576	
48 DELTA ALT	METERS	1.514	-24.648	-11.37162	13.44466	1576	
49 INRTL DISP	METERS	.114	-21.096	-10.43838	12.72263	1576	
50 UG RIGHT	M/SEC	4.933	-8.176	.00000	2.37432	1576	
51 UG CENTER	M/SEC	4.404	-7.584	.00000	2.31523	1576	
52 UG LEFT	M/SEC	4.964	-9.725	.00000	2.41943	1576	
53 VG RIGHT	M/SEC	5.318	-4.563	-.02033	1.64573	1576	
54 VG CENTER	M/SEC	4.932	-5.004	-.02132	1.66057	1576	
55 VG LEFT	M/SEC	4.767	-5.158	-.02629	1.53378	1576	
56 WG RIGHT	M/SEC	8.691	-4.551	.02515	2.08389	1576	
57 WG CENTER	M/SEC	7.148	-4.181	.02639	2.02024	1576	
58 WG LEFT	M/SEC	7.106	-5.088	.02826	2.14503	1576	

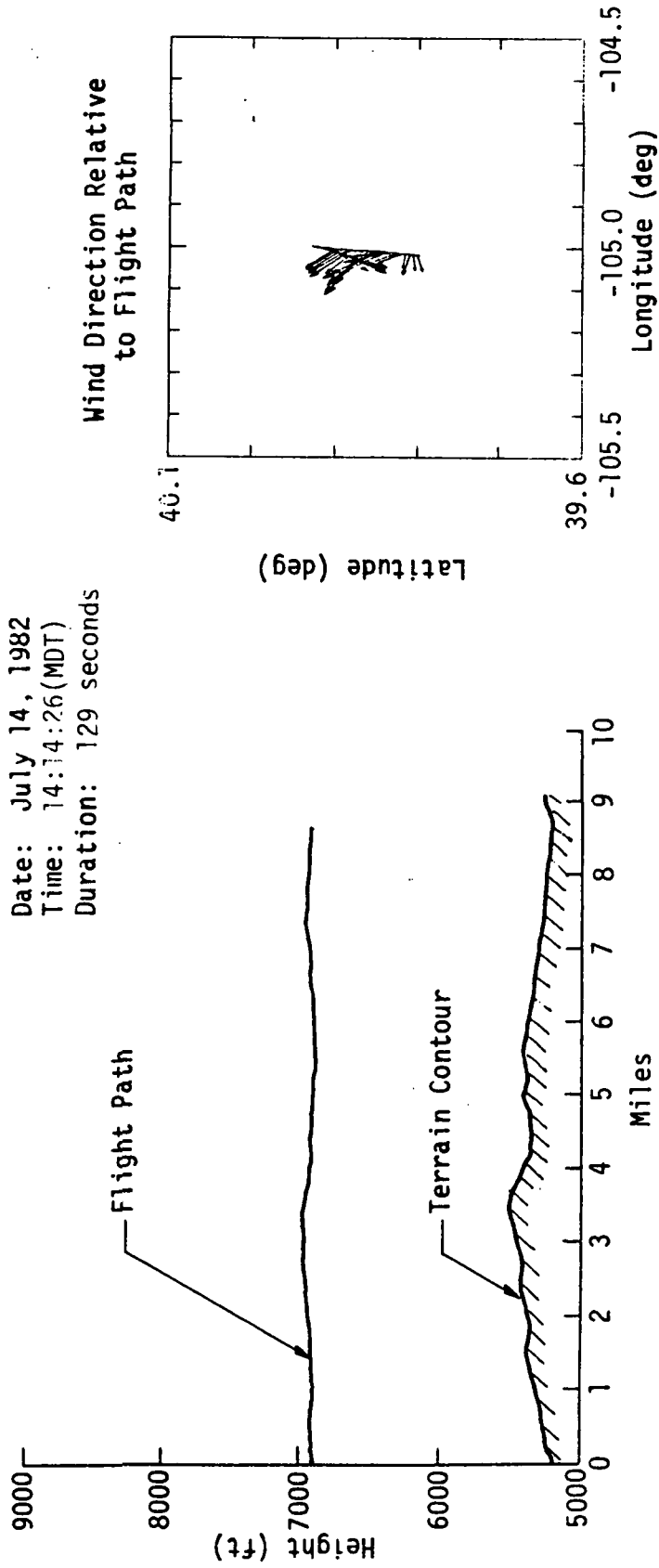

Figure A.73. Flight path information, Flight 6, Run 13.

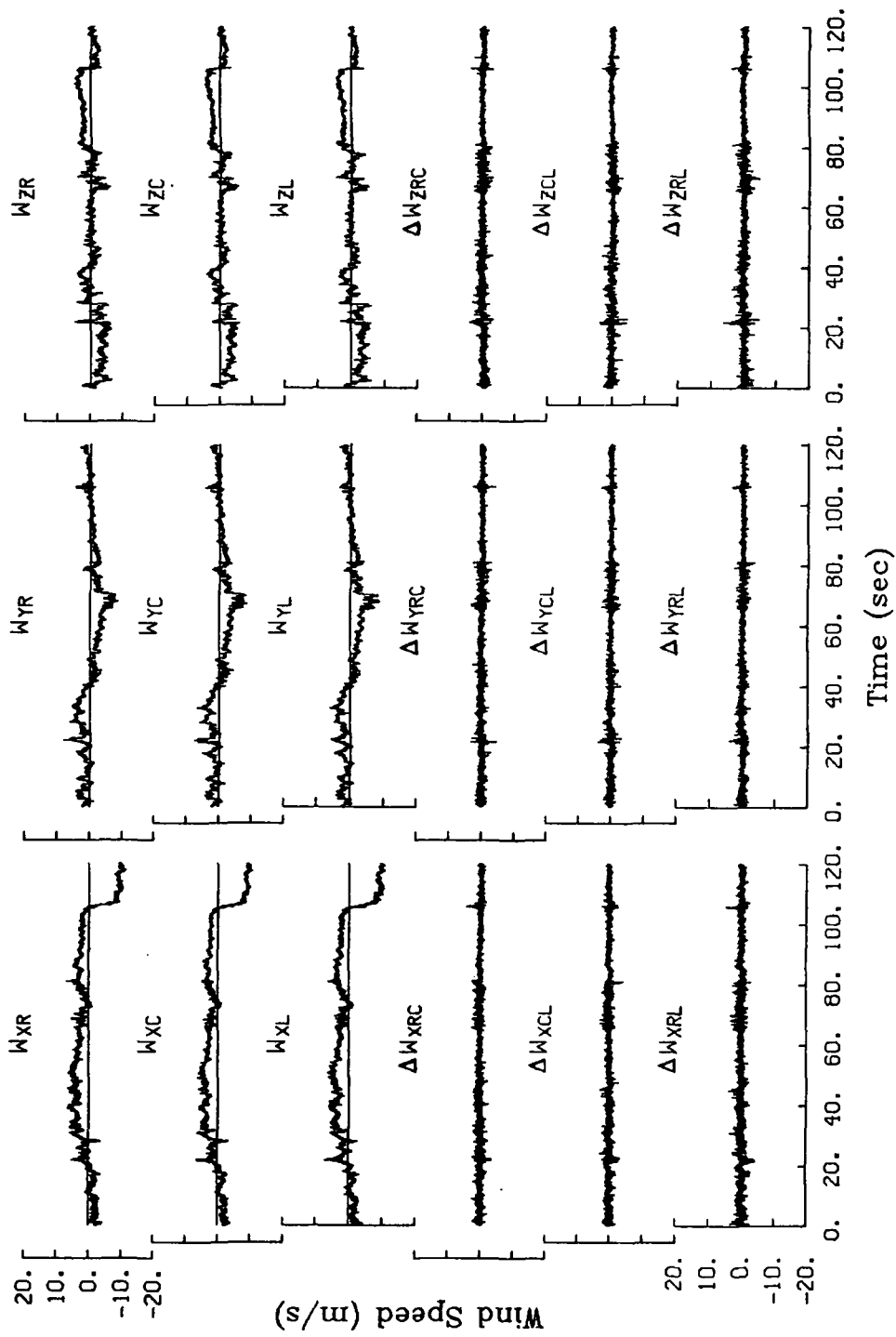

Figure A.74. Time histories of gust velocities and gust velocity differences, Flight 6, Run 13.

TABLE A.18. Average Turbulence Parameters and Integral Length Scales,

I. Mean Airspeed (m/s)			II. Standard Deviation of Gust Velocities (m/s)		
V_L	V_C	V_R	$\sigma_{W_{XL}}$	$\sigma_{W_{XC}}$	$\sigma_{W_{XR}}$
112.1	110.9	112.8	4.69	4.62	4.75
			$\sigma_{W_{YL}}$	$\sigma_{W_{YC}}$	$\sigma_{W_{YR}}$
			2.31	2.37	2.37
			$\sigma_{W_{ZL}}$	$\sigma_{W_{ZC}}$	$\sigma_{W_{ZR}}$
			2.25	2.22	2.36
III. Standard Deviation of Gust Velocity Differences (m/s)			IV. Integral Length Scale (m)		
$\sigma_{\Delta W_{XCL}}$	$\sigma_{\Delta W_{XRC}}$	$\sigma_{\Delta W_{XRL}}$	$L_{W_{XL}}$	$L_{W_{XC}}$	$L_{W_{XR}}$
0.59	0.60	0.76	1275	1270	1300
$\sigma_{\Delta W_{YCL}}$	$\sigma_{\Delta W_{YRC}}$	$\sigma_{\Delta W_{YRL}}$	$L_{W_{YL}}$	$L_{W_{YC}}$	$L_{W_{YR}}$
0.56	0.57	0.62	2562	2448	2516
$\sigma_{\Delta W_{ZCL}}$	$\sigma_{\Delta W_{ZRC}}$	$\sigma_{\Delta W_{ZRL}}$	$L_{W_{ZL}}$	$L_{W_{ZC}}$	$L_{W_{ZR}}$
0.65	0.68	0.77	1697	1631	1539

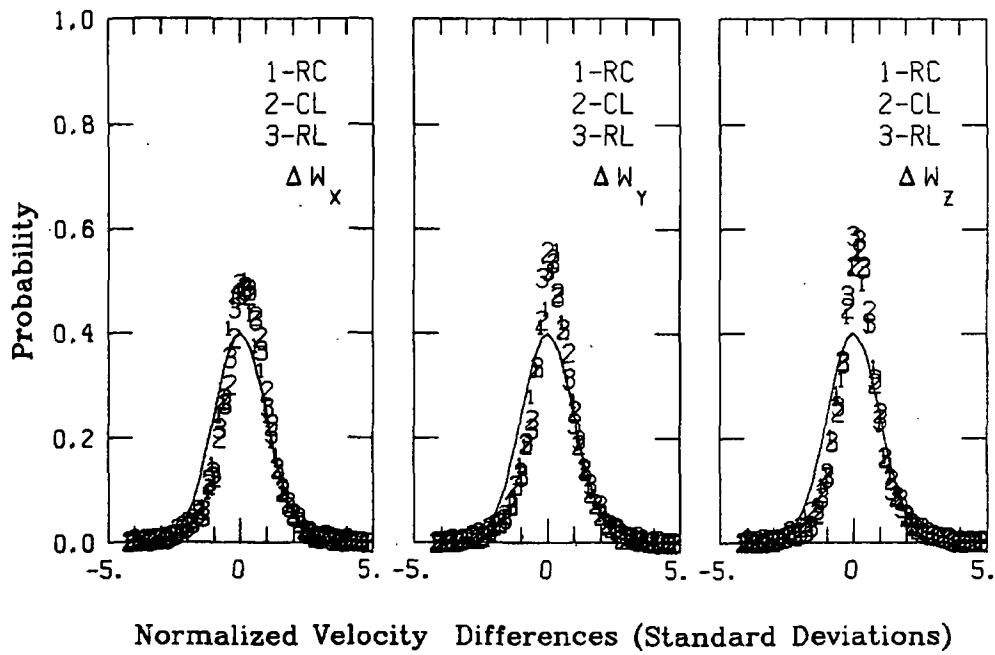
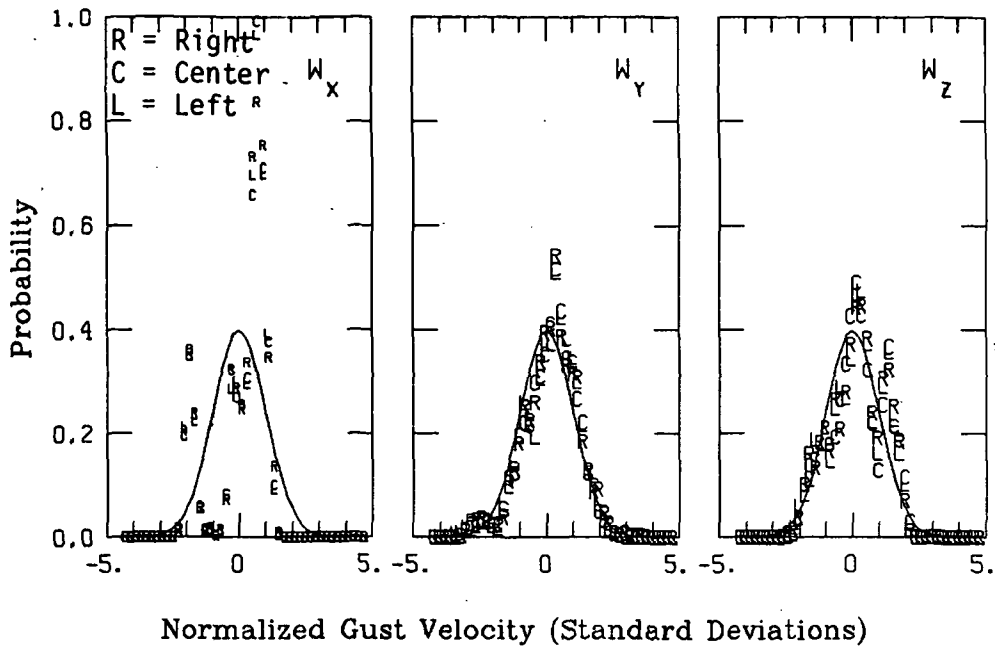

Figure A.75. Probability density function for gust velocities and gust velocity differences, Flight 6, Run 13.

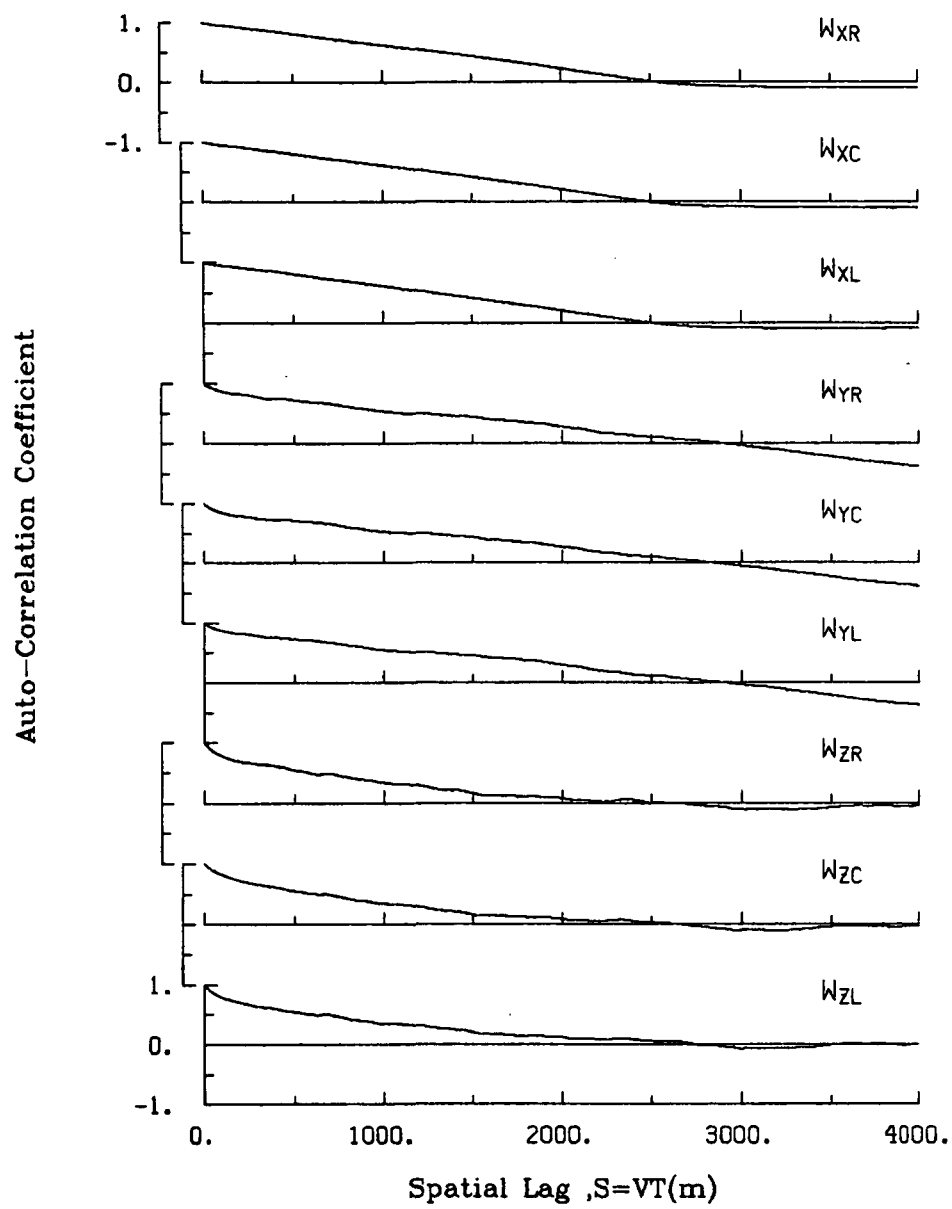

Figure A.76. Single-point auto-correlation coefficient of gust velocities, Flight 6, Run 13.

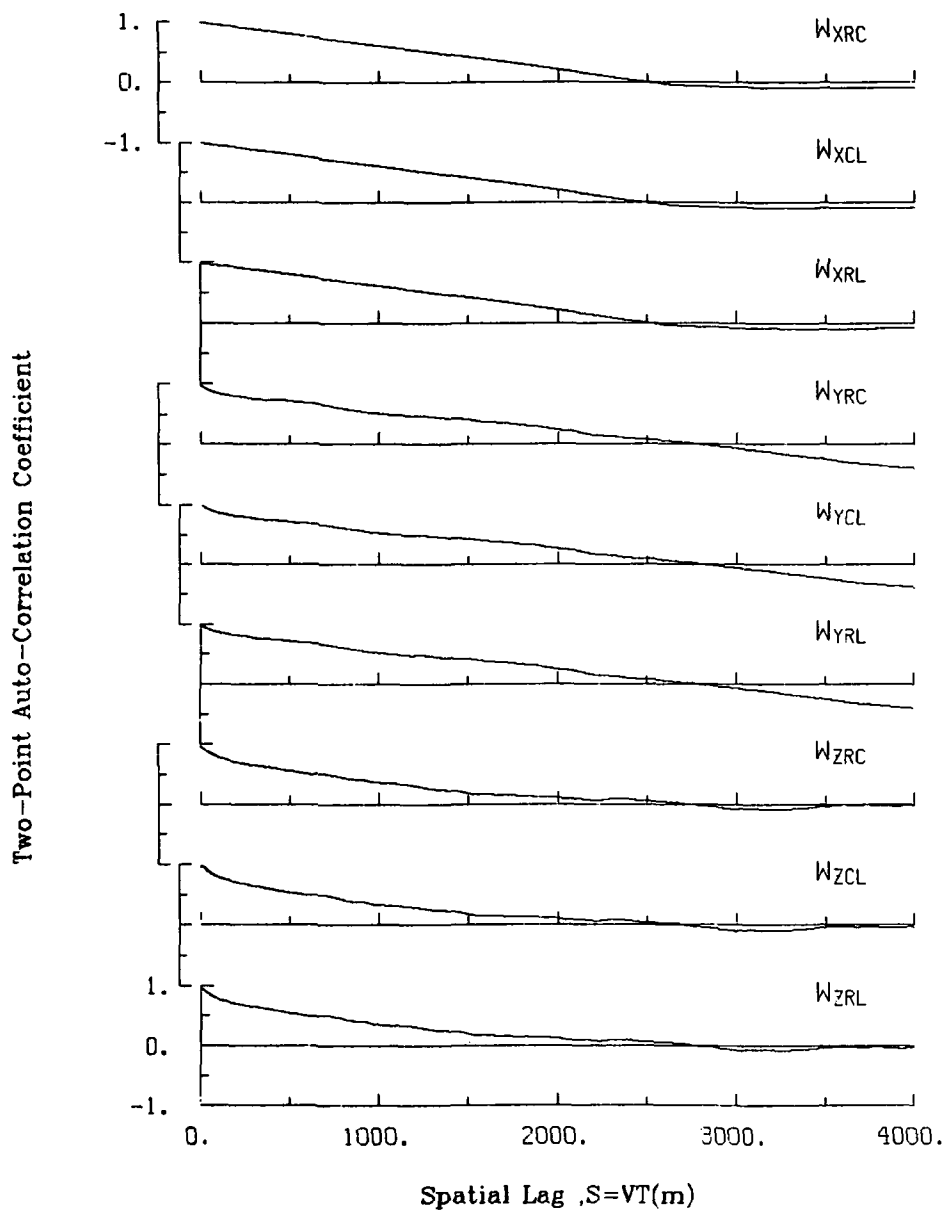

Figure A.77. Two-point auto-correlation coefficient of gust velocities, Flight 6, Run 13.

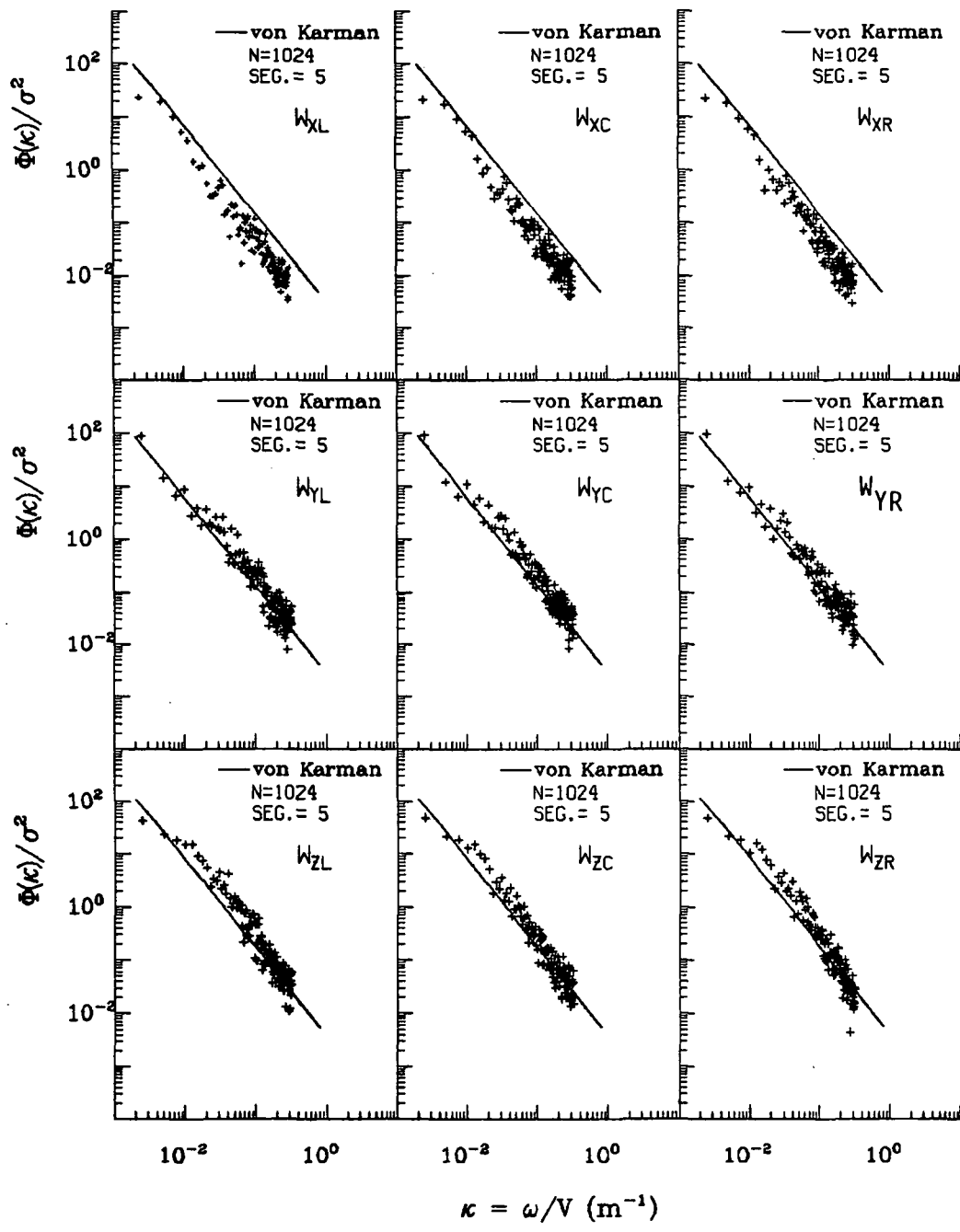

Figure A.78. Normalized auto-spectra of gust velocities, Flight 6, Run 13.

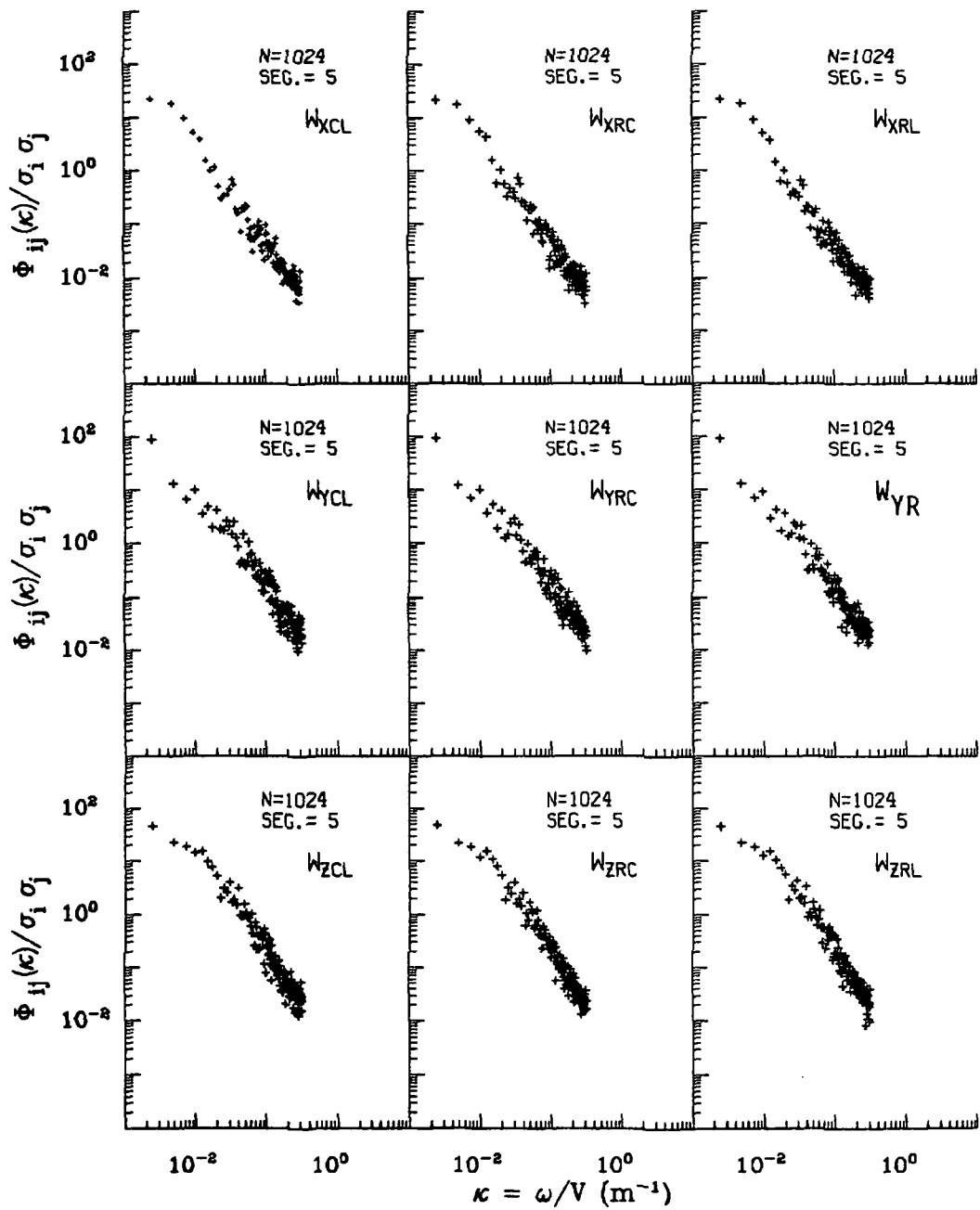

Figure A.79. Normalized two-point auto-spectra of gust velocities, Flight 6, Run 13.

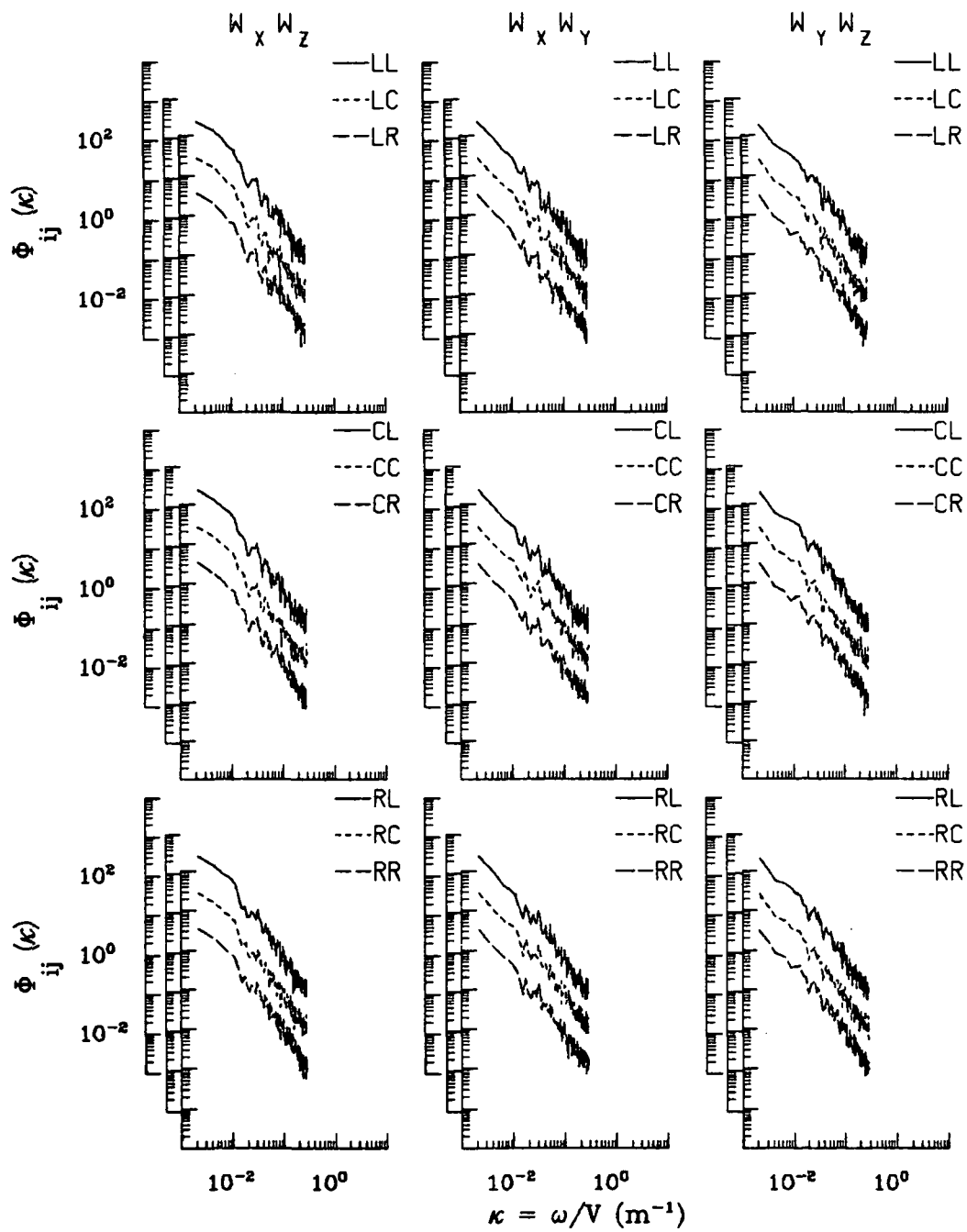

Figure A.80. Two-point cross-spectra of gust velocities, Flight 6, Run 13.

TABLE A.20. List of All Parameters Measured and Their Range of Values, Flight 6, Run 13.

		START TIME = 51266.3674	STOP TIME = 51395.7674				
CHANNEL	UNITS	HIGH	LOW	MEAN	RMS	POINTS	
2 PHI DOT	RAD/SEC	.081	-.087	-.00293	.02265	5176	
3 ACCL N CG	G UNITS	-.988	-.988	-.98774	.98774	5176	
4 THETA DOT	RAD/SEC	.058	-.049	.00569	.01250	5176	
5 THETA	RAD	.106	.005	.05467	.05966	5176	
6 PHI	RAD	.071	-.077	-.00671	.02832	5176	
7 PSI 1	DEGREES	9.700	3.719	7.31598	7.39399	5176	
8 DEL PSI 1	DEGREES	3.727	-1.798	1.64122	1.94792	5176	
9 PSI 2	DEGREES	367.443	361.810	365.23699	365.23845	5176	
10 DEL PSI 2	DEGREES	3.463	-2.066	1.37174	1.72629	5176	
11 ACCL N LT	G UNITS	1.825	.168	1.01087	1.02288	5176	
12 ACCL N RT	G UNITS	1.798	.346	1.02537	1.03705	5176	
13 ACCL X CG	G UNITS	.126	-.018	.05268	.05849	5176	
14 ACCL Y CG	G UNITS	.223	-.222	.00796	.05483	5176	
15 ALPHA CTR	PAD	.053	-.074	-.01541	.02073	5176	
16 BETA CTR	RAD	.059	-.077	-.02128	.02796	5176	
17 TEMP I	DEG F	100.603	100.063	100.24713	100.24718	5176	
18 TEMP P	DEG F	90.545	90.366	90.37968	90.37970	5176	
19 ACCL Z INS	G UNITS	1.593	.518	1.00281	1.00670	5176	
20 ALPHA PT	RAD	.078	-.058	-.00536	.01684	5176	
21 BETA RT	RAD	.098	-.031	.01344	.02130	5176	
22 ALPHA LT	RAD	.069	-.065	-.00372	.01482	5176	
23 BETA LT	RAD	.032	-.081	-.02718	.03181	5176	
24 PSI DOT	RAD/SEC	.048	-.037	.00353	.01312	5176	
25 TEMP IDT	DEG C	32.671	30.210	31.40146	31.40523	5176	
26 QC LT	PSID	1.109	.701	.85912	.86533	5176	
27 QC CTR	PSID	1.076	.690	.84123	.84729	5176	
28 QC RT	PSID	1.127	.715	.87114	.87745	5176	
29 PS	PSIA	11.385	11.341	11.36876	11.36876	5176	
30 TEMP IRT	DEG C	24.219	19.109	22.20841	22.23702	5176	
31 D TO G	METERS	0745955.5848741898.086	*****	*****	*****	5176	
32 B TO D	DEGREES	80.285	80.272	80.27820	80.27820	5176	
33 LONG	DEGREES	-104.998	-105.017	-105.00729	105.00729	5176	
34 LAT	DEGREES	39.929	39.799	39.86359	39.86360	5176	
35 TRK ANG	DEGREES	8.091	3.580	6.55789	6.65132	5176	
36 HDG	RADIANS	.179	.079	.14098	.14226	5176	
37 VE	M/SEC	15.667	6.923	12.75865	12.92836	5176	
38 VN	M/SEC	116.476	107.057	111.10203	111.12976	5176	
39 ALTITUDE	KM	2.133	2.101	2.11312	2.11313	5176	
40 TEMPC	DEGREES C	26.235	23.063	25.25722	25.27419	5176	
41 EW WND SPD	KNOTS	5.554	-25.184	-9.97586	10.88719	5176	
42 NS WND SPD	KNOTS	15.573	-18.280	3.17713	9.71923	5176	
43 WIND SPEED	KNOTS	27.180	.129	13.82806	14.59432	5176	
44 WIND DIFEC	DEGREES	347.009	13.840	108.80332	116.25303	5176	
45 AIRSPEED R	M/SEC	127.644	102.728	112.84093	113.01689	5176	
46 AIRSPEED C	M/SEC	124.804	100.961	110.93788	111.11001	5176	
47 AIRSPEED L	M/SEC	126.681	101.855	112.08051	112.25469	5176	
48 DELTA ALT	METERS	24.305	-6.894	4.88784	8.96447	5176	
49 INRTL DISP	METERS	24.574	-6.772	6.62826	10.74572	5176	
50 UG PIGHT	M/SEC	6.886	-11.374	-.00000	4.79897	5176	
51 UG CENTER	M/SEC	6.413	-11.113	-.00000	4.66924	5176	
52 UG LEFT	M/SEC	7.195	-11.563	-.00000	4.74315	5176	
53 VG RIGHT	M/SEC	8.283	-8.162	-.00061	2.36615	5176	
54 VG CENTER	M/SEC	7.669	-8.248	.00564	2.36909	5176	
55 VG LEFT	M/SEC	6.082	-8.545	.00358	2.30661	5176	
56 WG RIGHT	M/SEC	4.949	-6.451	-.01959	2.35893	5176	
57 WG CENTER	M/SEC	4.555	-6.104	-.01256	2.21233	5176	
58 WG LEFT	M/SEC	4.703	-5.852	-.01172	2.24896	5176	

ORIGINAL PAGE IS
OF POOR QUALITY

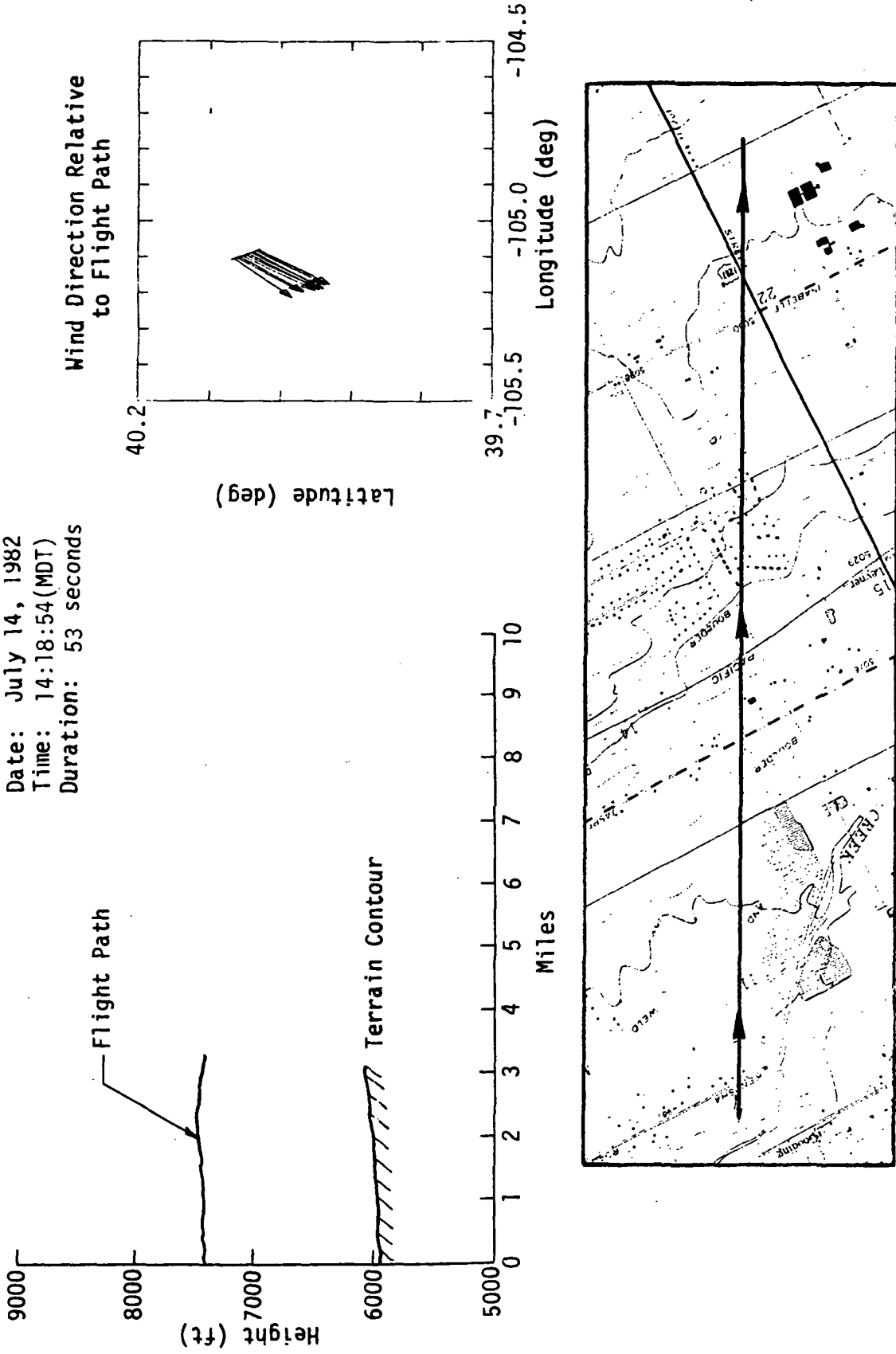

Figure A.81. Flight path information, Flight 6, Run 14.

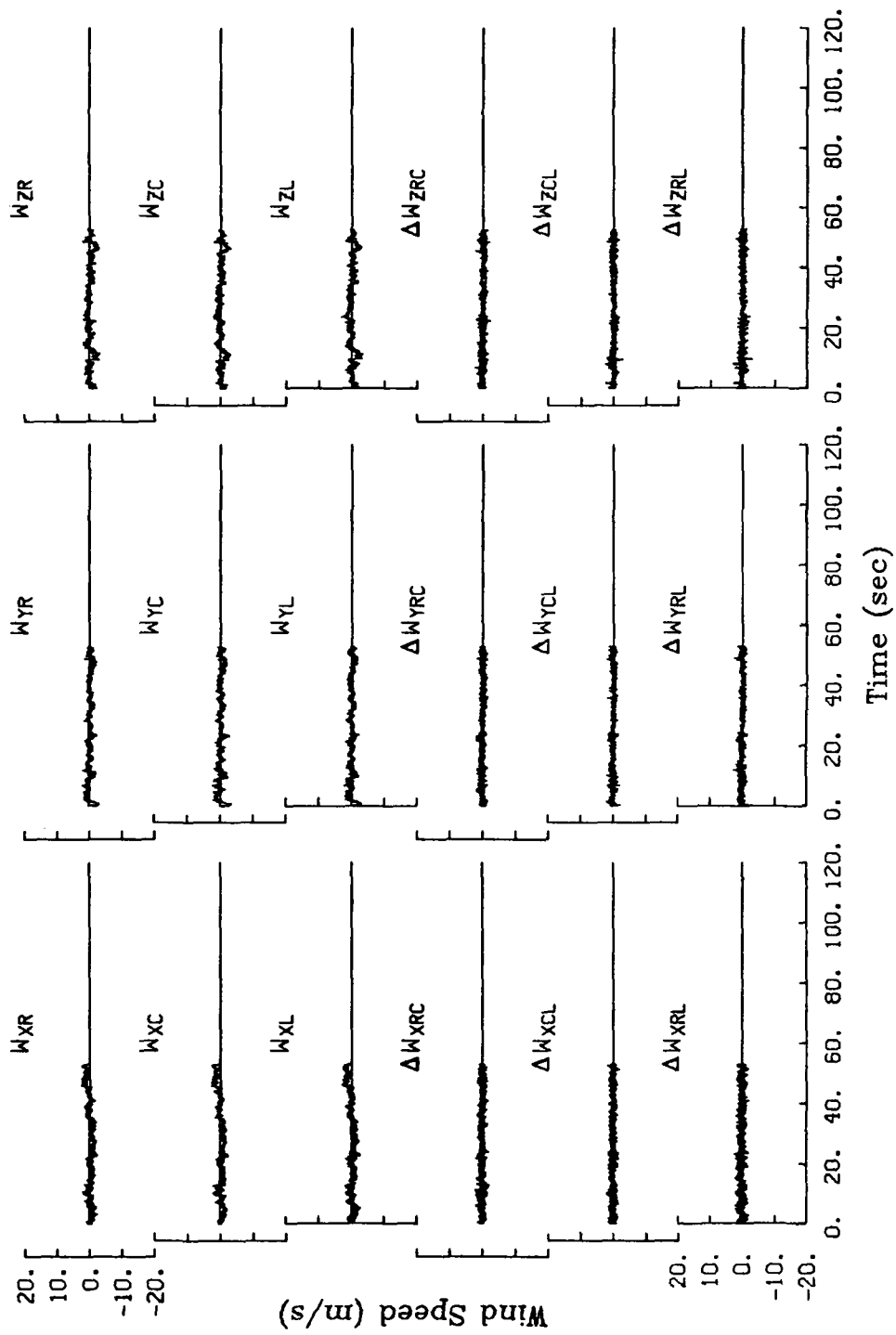

Figure A.82. Time histories of gust velocities and gust velocity differences, Flight 6, Run 14.

TABLE A.21. Average Turbulence Parameters and Integral Length Scales, Flight 6, Run 14.

I. Mean Airspeed (m/s)			II. Standard Deviation of Gust Velocities (m/s)		
V_L	V_C	V_R	$\sigma_{W_{XL}}$	$\sigma_{W_{XC}}$	$\sigma_{W_{XR}}$
102.2	101.3	103.1	0.95	0.93	0.91
III. Standard Deviation of Gust Velocity Differences (m/s)			$\sigma_{W_{YL}}$	$\sigma_{W_{YC}}$	$\sigma_{W_{YR}}$
0.73	0.76	0.74	$\sigma_{W_{ZL}}$	$\sigma_{W_{ZC}}$	$\sigma_{W_{ZR}}$
0.98	0.87	0.94	IV. Integral Length Scale (m).		
$\sigma_{\Delta W_{XCL}}$	$\sigma_{\Delta W_{XRC}}$	$\sigma_{\Delta W_{XRL}}$	$L_{W_{XL}}$	$L_{W_{XC}}$	$L_{W_{XR}}$
0.50	0.51	0.60	337	373	339
$\sigma_{\Delta W_{YCL}}$	$\sigma_{\Delta W_{YRC}}$	$\sigma_{\Delta W_{YRL}}$	$L_{W_{YL}}$	$L_{W_{YC}}$	$L_{W_{YR}}$
0.45	0.43	0.47	124	105	125
$\sigma_{\Delta W_{ZCL}}$	$\sigma_{\Delta W_{ZRC}}$	$\sigma_{\Delta W_{ZRL}}$	$L_{W_{ZL}}$	$L_{W_{ZC}}$	$L_{W_{ZR}}$
0.54	0.51	0.61	382	198	186

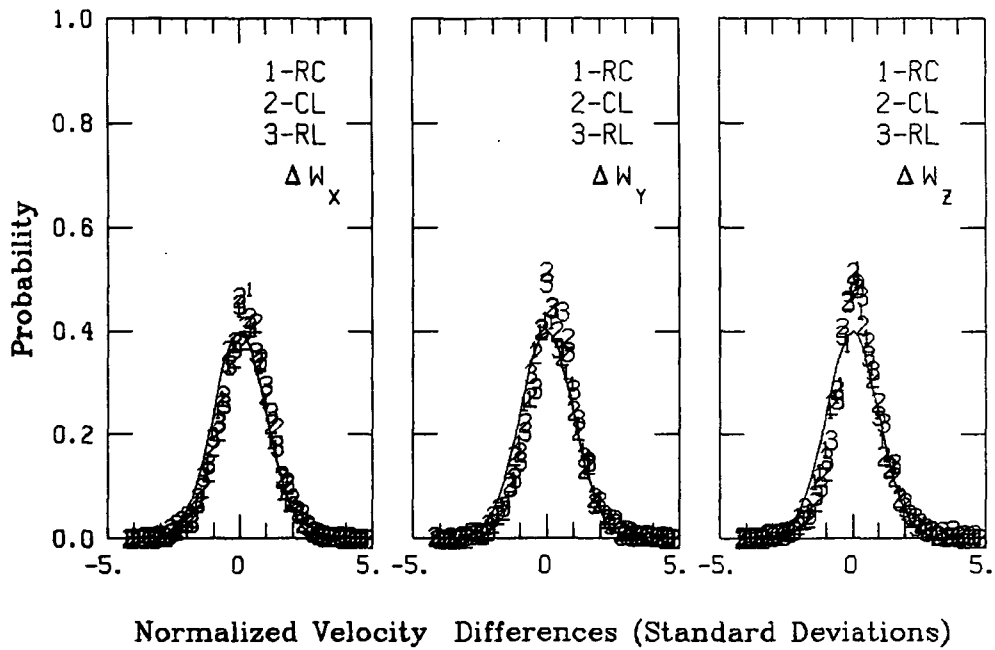
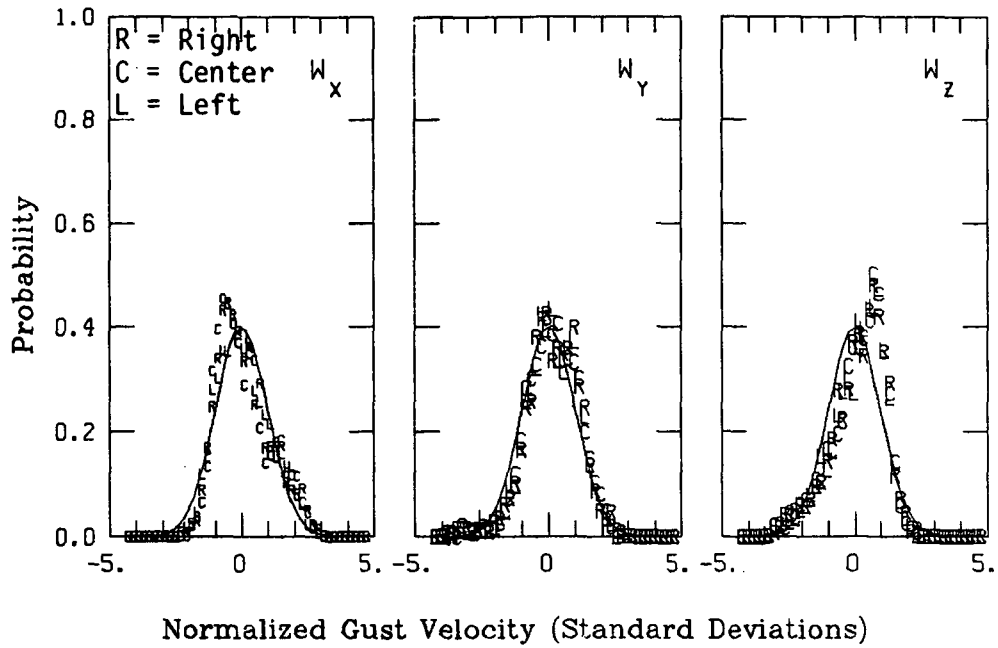

Figure A.83. Probability density function for gust velocities and gust velocity differences, Flight 6, Run 14.

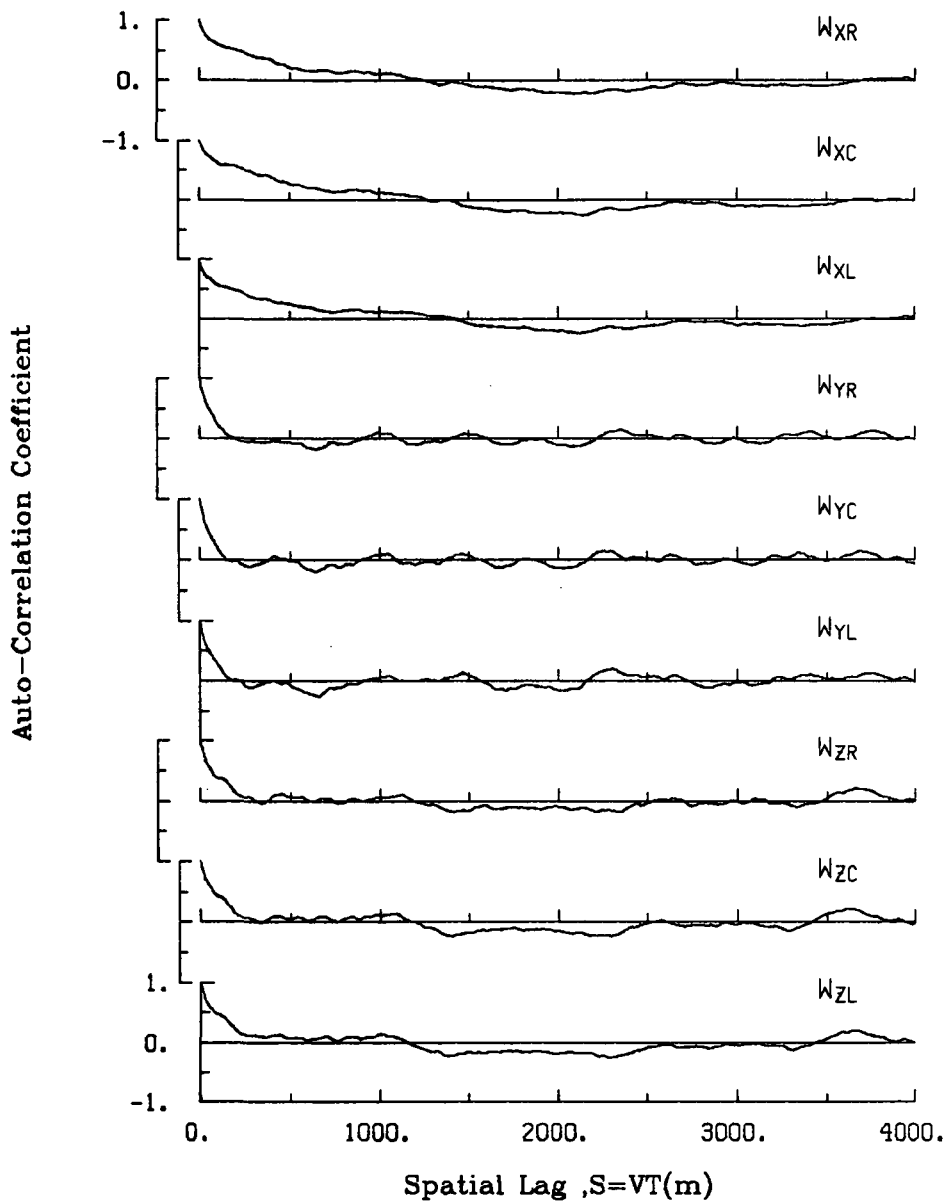

Figure A.84. Single-point auto-correlation coefficient of gust velocities, Flight 6, Run 14.

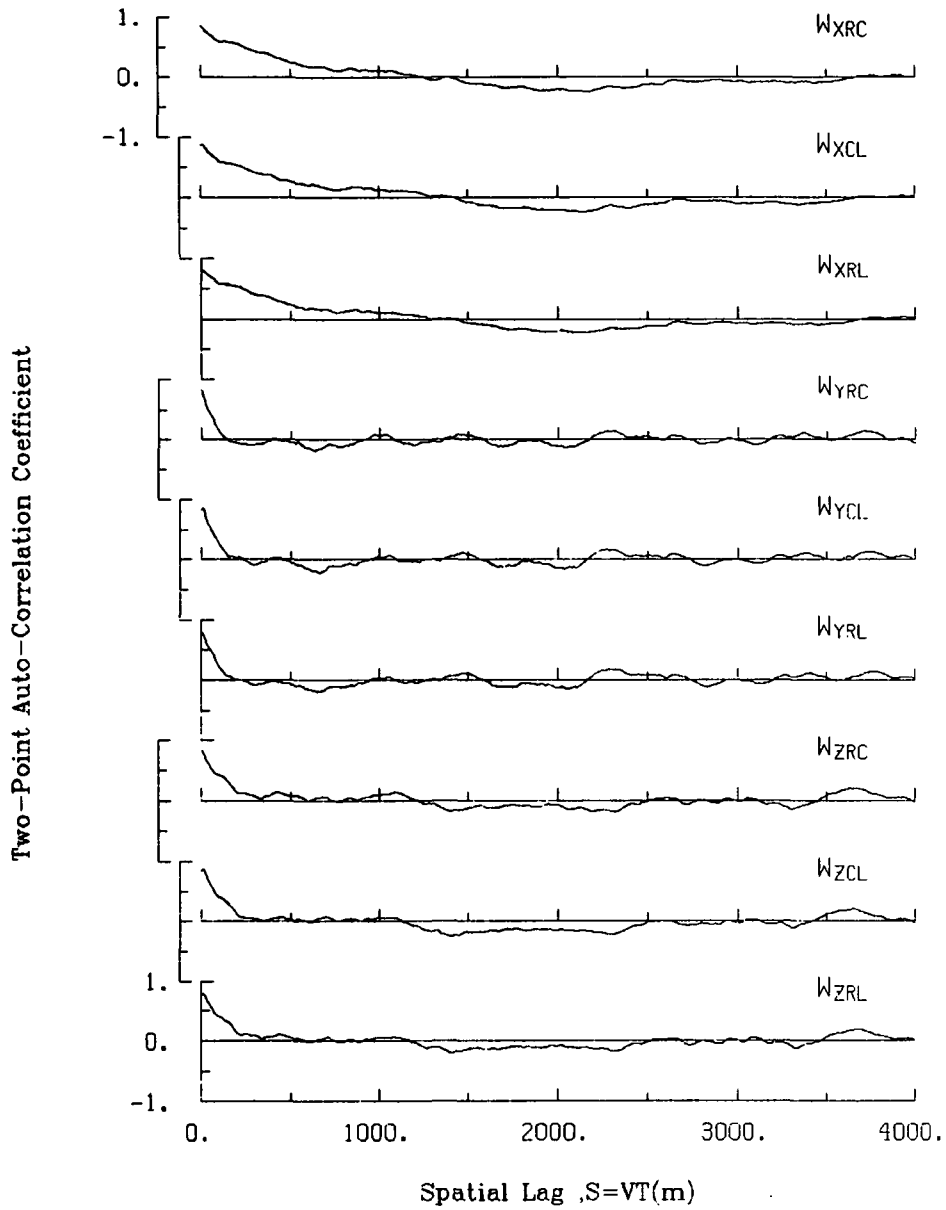

Figure A.85. Two-point auto-correlation coefficient of gust velocities, Flight 6, Run 14.

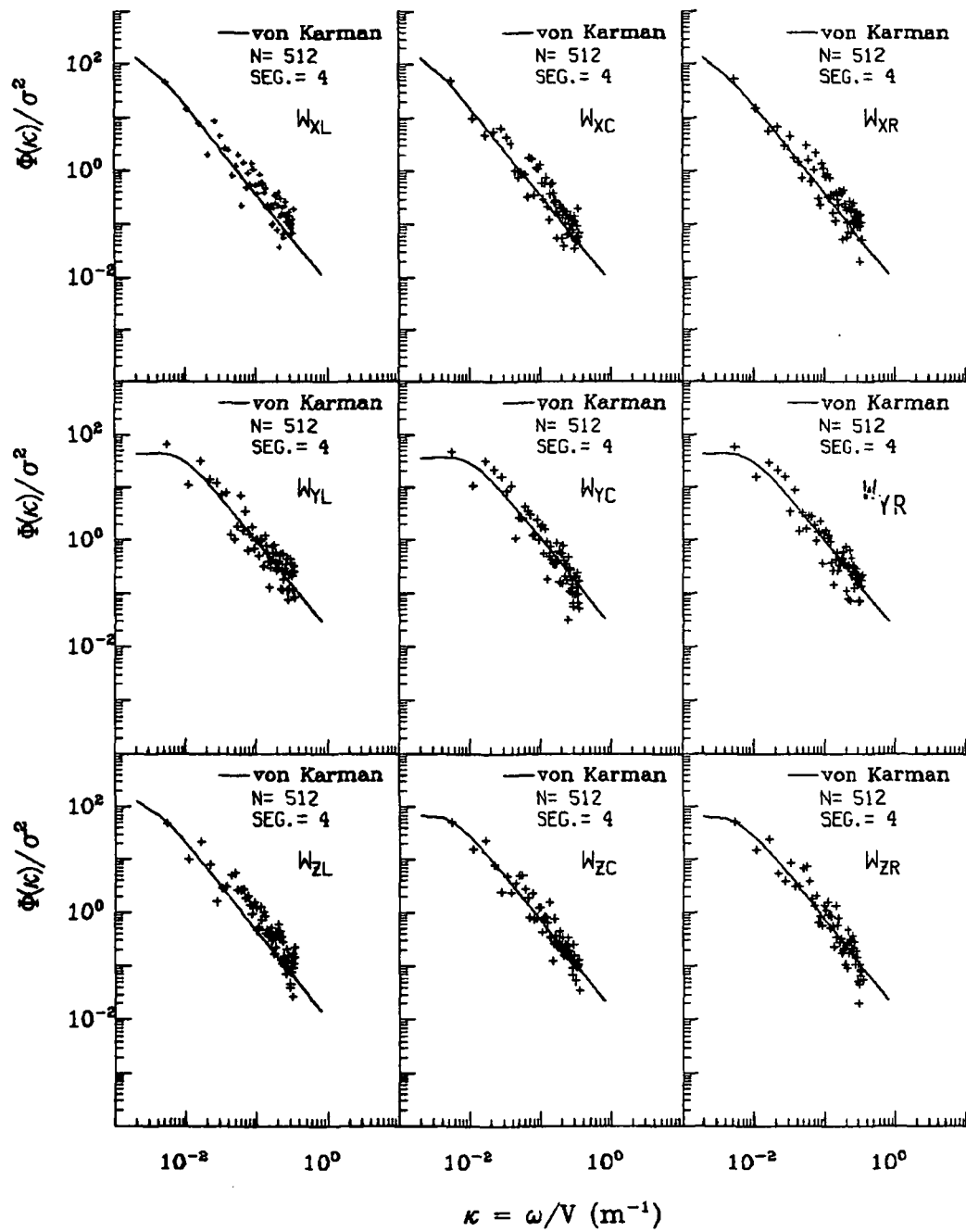

Figure A.86. Normalized auto-spectra of gust velocities, Flight 6, Run 14.

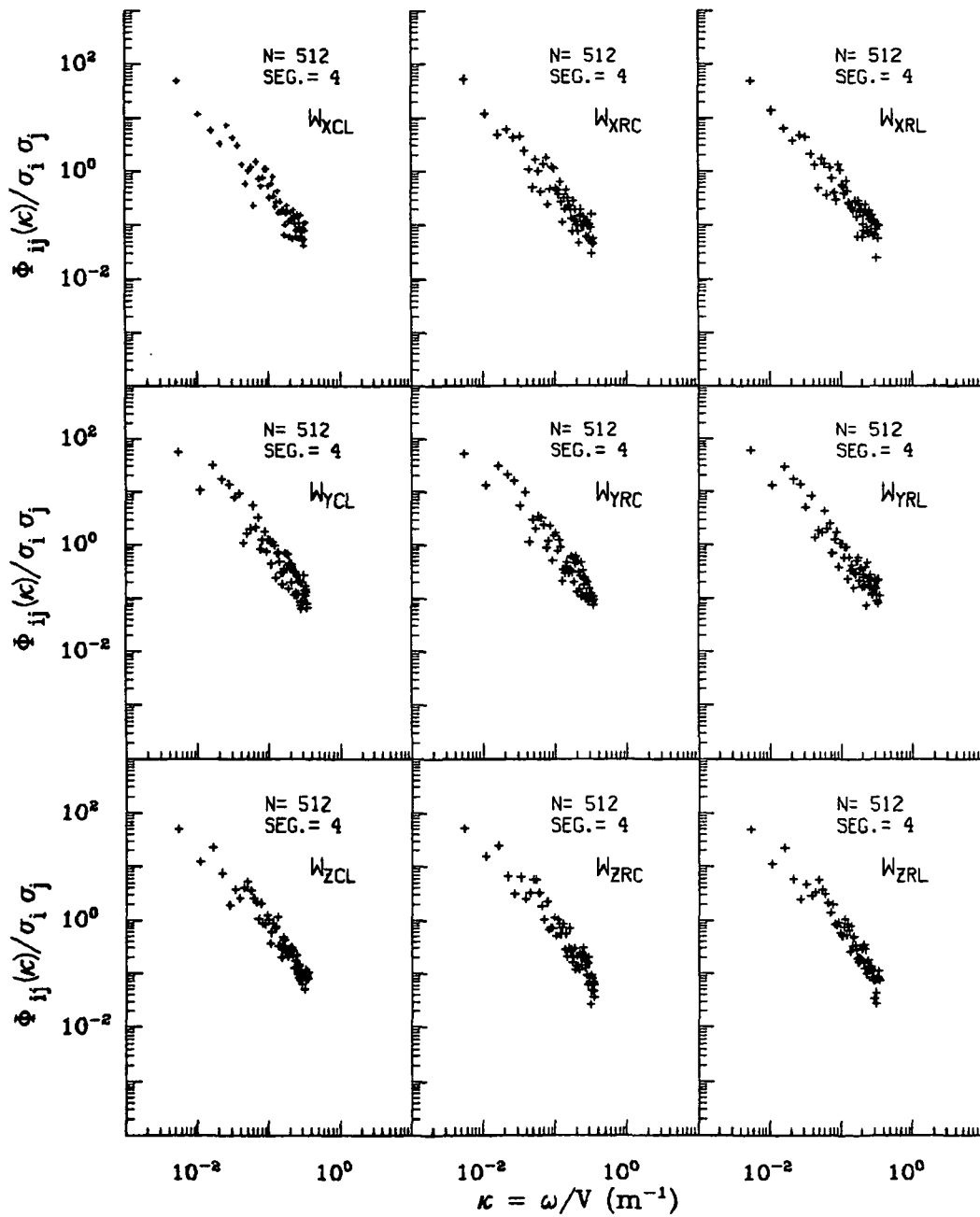

Figure A.87. Normalized two-point auto-spectra of gust velocities, Flight 6, Run 14.

ORIGINAL PAGE IS
OF POOR QUALITY

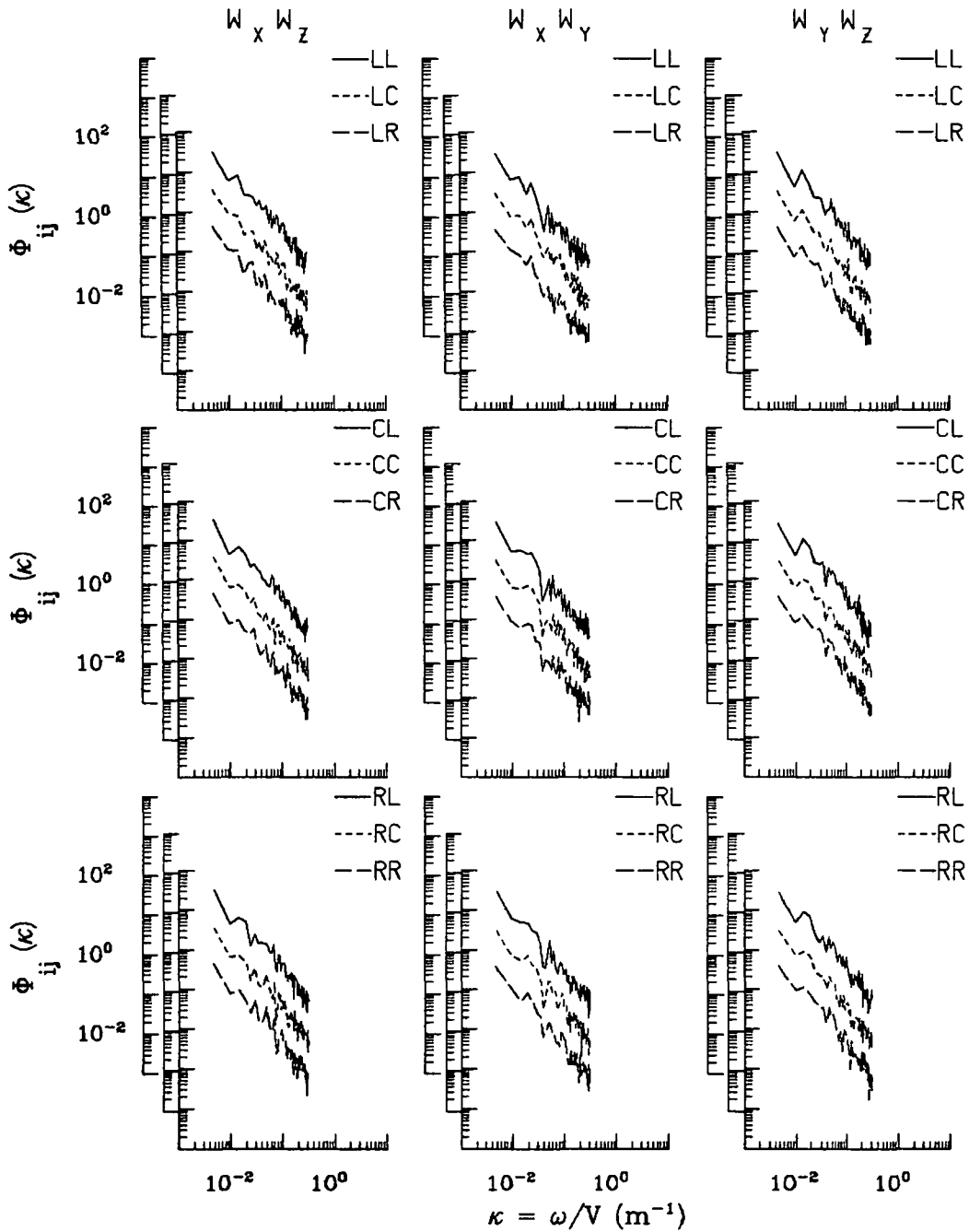
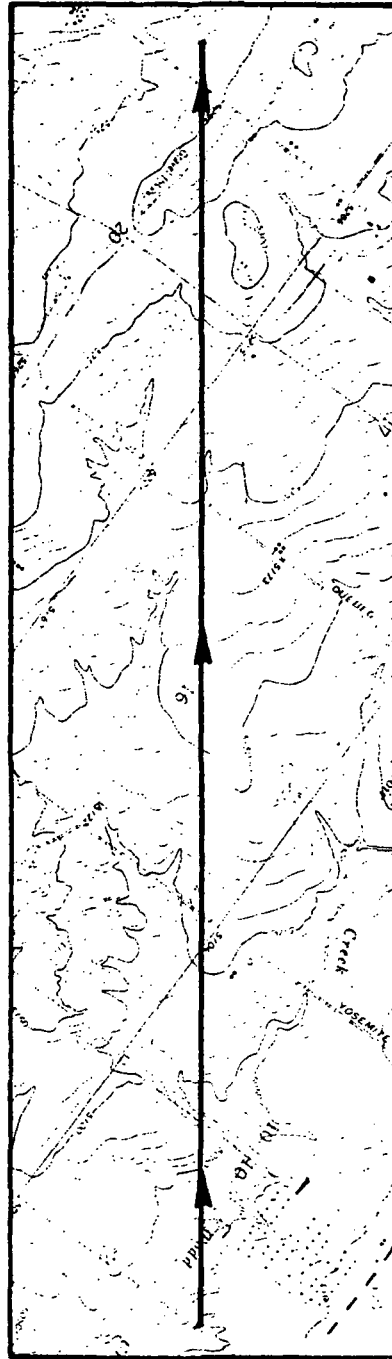
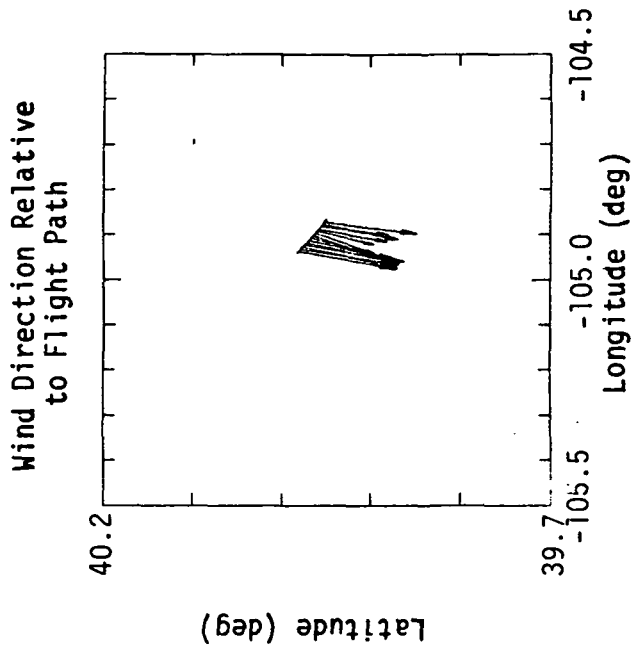
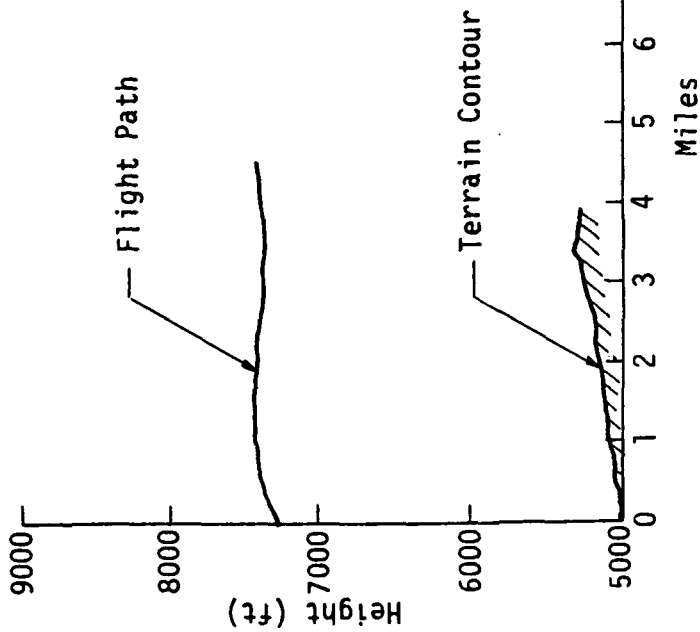

Figure A.88. Two-point cross-spectra of gust velocities, Flight 6, Run 14.

TABLE A.22. List of All Parameters Measured and Their Range of Values, Flight 6, Run 14.

		START TIME = 51534.6178	STOP TIME = 51587.6178				
CHANNEL	UNITS	HIGH	LOW	MEAN	RMS	POINTS	
2	PHI DOT	RAD/SEC	.038	-.044	-.00240	.01383	2120
3	ACCL N CG	G UNITS	-.988	-.988	-.98774	.98774	2120
4	THETA DOT	RAD/SEC	.037	-.018	.00547	.00918	2120
5	THETA	RAD	.093	.050	.07118	.07212	2120
6	PHI	RAD	.029	-.034	.00342	.01369	2120
7	PSI 1	DEGREES	341.859	337.280	339.92446	339.92567	2120
8	DEL PSI 1	DEGREES	3.022	-1.240	1.23042	1.51986	2120
9	PSI 2	DEGREES	340.336	336.111	338.66490	338.66606	2120
10	DEL PSI 2	DEGREES	2.875	-1.390	1.09608	1.41220	2120
11	ACCL N LT	G UNITS	1.442	.579	1.00474	1.01191	2120
12	ACCL N RT	G UNITS	1.525	.461	1.01802	1.02518	2120
13	ACCL X CG	GUNITS	.129	.040	.08510	.08660	2120
14	ACCL Y CG	G UNITS	.176	-.161	.00910	.05854	2120
15	ALPHA CTR	RAD	.029	-.023	.00089	.00815	2120
16	BETA CTR	RAD	.021	-.051	-.01563	.01886	2120
17	TEMP I	DEG F	100.243	100.063	100.19237	100.19241	2120
18	TEMP P	DEG F	90.545	90.366	90.48423	90.48426	2120
19	ACCL Z INS	G UNITS	1.265	.771	.94881	1.00065	2120
20	ALPHA RT	RAD	.048	-.011	.01730	.01960	2120
21	BETA RT	RAD	.053	-.004	.02038	.02255	2120
22	ALPHA LT	RAD	.049	-.012	.02040	.02227	2120
23	BETA LT	RAD	.010	-.054	-.02270	.02465	2120
24	PSI DOT	RAD/SEC	.025	-.016	.00408	.00789	2120
25	TEMP TGT	DEG C	28.733	27.748	28.17497	28.17560	2120
26	QC LT	PSID	.745	.626	.70134	.70184	2120
27	QC CTR	PSID	.729	.621	.68808	.68856	2120
28	QC RT	PSID	.766	.642	.71302	.71351	2120
29	PS	PSIA	11.178	11.145	11.15970	11.15970	2120
30	TEMP IRT	DEG C	17.880	12.776	16.23253	16.29063	2120
31	D TO G	METERS	8741039.770	8739566.976	*****	*****	2120
32	B TO D	DEGREES	80.197	80.171	80.18422	80.18422	2120
33	LONG	DEGREES	-105.079	-105.106	-105.09224	105.09224	2120
34	LAT	DEGREES	40.071	40.029	40.04958	40.04958	2120
35	TRK ANG	DEGREES	335.652	331.598	333.41964	333.42120	2120
36	HDG	PADIANS	5.966	5.889	5.93368	5.93371	2120
37	VE	M/SEC	-40.846	-44.205	-43.02988	43.03556	2120
38	VN	M/SEC	90.419	81.084	86.13058	86.16735	2120
39	ALTITUDE	KM	2.272	2.249	2.26196	2.26196	2120
40	TEMPC	DEGREES C	23.359	22.814	23.06800	23.06814	2120
41	EW WND SPD	KNOTS	-14.471	-24.839	-19.14337	19.21208	2120
42	NS WND SPD	KNOTS	-13.781	-23.103	-18.55176	18.63525	2120
43	WIND SPEED	KNOTS	32.317	22.620	26.72617	26.76521	2120
44	WIND DIPEC	DEGREES	58.620	36.589	45.91237	46.09625	2120
45	AIRSPPEED R	M/SEC	106.819	97.833	103.06016	103.07799	2120
46	AIRSPPEED C	M/SEC	104.176	96.256	101.28034	101.29795	2120
47	AIRSPPEED L	M/SEC	105.328	96.660	102.23043	102.24853	2120
48	DELTA ALT	METERS	22.468	-1.191	12.06542	13.35872	2120
49	INRTL DISP	METERS	20.888	0.000	12.10621	13.51076	2120
50	UG RIGHT	M/SEC	2.809	-2.225	-.00000	.93557	2120
51	UG CENTER	M/SEC	2.770	-2.218	-.00000	.94757	2120
52	UG LEFT	M/SEC	2.884	-2.636	-.00000	.96699	2120
53	VG RIGHT	M/SEC	2.155	-2.902	-.02446	.73694	2120
54	VG CENTER	M/SEC	2.244	-3.218	-.02421	.76331	2120
55	VG LEFT	M/SEC	2.100	-2.865	-.02372	.73156	2120
56	WG RIGHT	M/SEC	2.149	-3.082	.01042	.93544	2120
57	WG CENTER	M/SEC	2.011	-2.893	.01233	.86537	2120
58	WG LEFT	M/SEC	2.941	-3.532	.01246	.97105	2120

Date: July 14, 1982
 Time: 14:28:03(MDT)
 Duration: 73 seconds



ORIGINAL PAGE IS
 OF POOR QUALITY.

A.110

Figure A.89. Flight path information, Flight 6, Run 15.

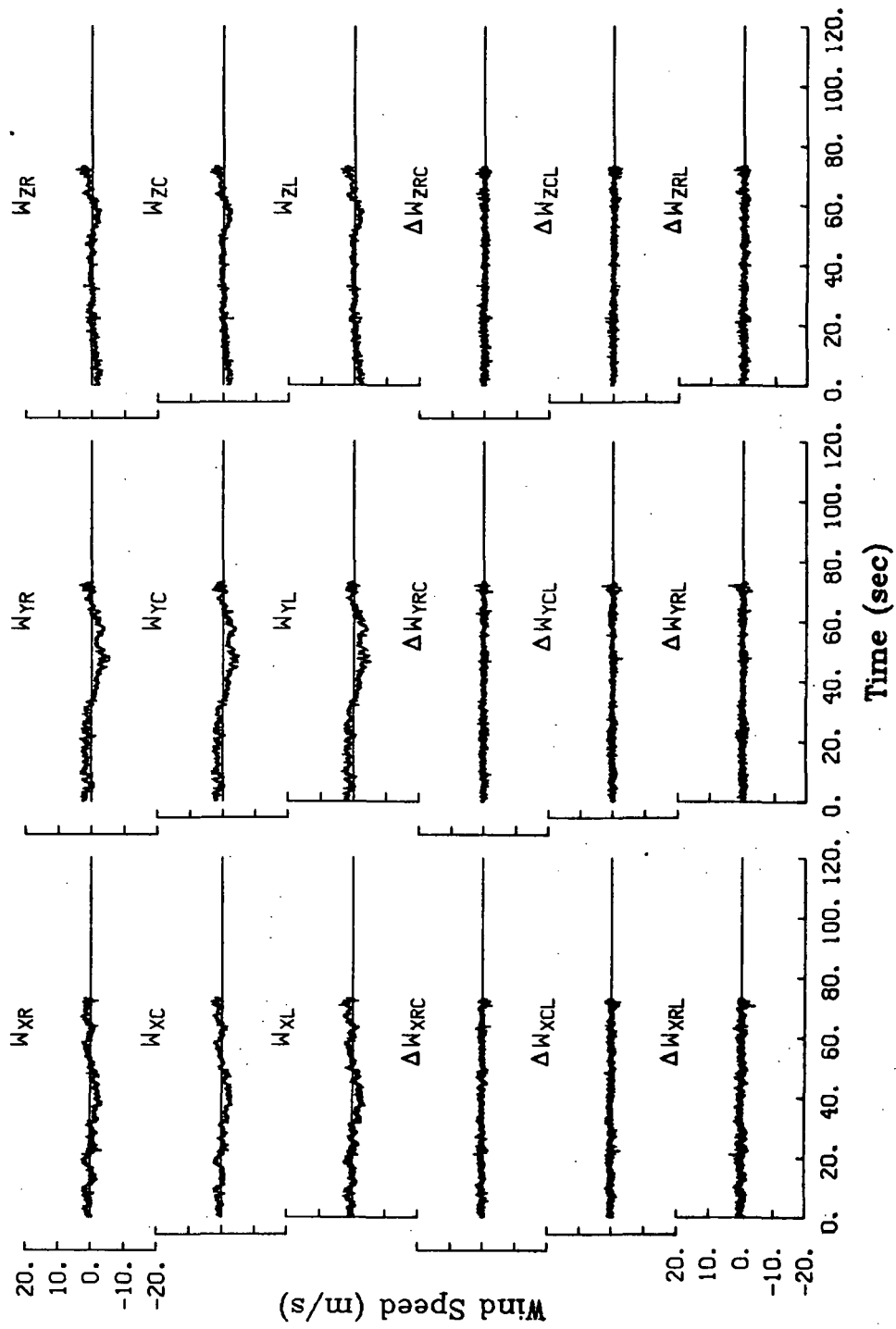

Figure A.90. Time histories of gust velocities and gust velocity differences, Flight 6, Run 15.

TABLE A.23. Average Turbulence Parameters and Integral Length Scales, Flight 6, Run 15.

I. Mean Airspeed (m/s)

V_L	V_C	V_R
101.5	100.5	102.4

II. Standard Deviation of Gust Velocities (m/s)

$\sigma_{W_{XL}}$	$\sigma_{W_{XC}}$	$\sigma_{W_{XR}}$
1.23	1.14	1.17
$\sigma_{W_{YL}}$	$\sigma_{W_{YC}}$	$\sigma_{W_{YR}}$
1.87	1.86	1.85
$\sigma_{W_{ZL}}$	$\sigma_{W_{ZC}}$	$\sigma_{W_{ZR}}$
0.94	0.94	0.98

III. Standard Deviation of Gust Velocity Differences (m/s)

$\sigma_{\Delta W_{XCL}}$	$\sigma_{\Delta W_{XRC}}$	$\sigma_{\Delta W_{XRL}}$
0.55	0.54	0.70
$\sigma_{\Delta W_{YCL}}$	$\sigma_{\Delta W_{YRC}}$	$\sigma_{\Delta W_{YRL}}$
0.49	0.47	0.53
$\sigma_{\Delta W_{ZCL}}$	$\sigma_{\Delta W_{ZRC}}$	$\sigma_{\Delta W_{ZRL}}$
0.52	0.45	0.56

IV. Integral Length Scale (m).

$L_{W_{XL}}$	$L_{W_{XC}}$	$L_{W_{XR}}$
480	500	505
$L_{W_{YL}}$	$L_{W_{YC}}$	$L_{W_{YR}}$
1824	1757	1733
$L_{W_{ZL}}$	$L_{W_{ZC}}$	$L_{W_{ZR}}$
675	694	712

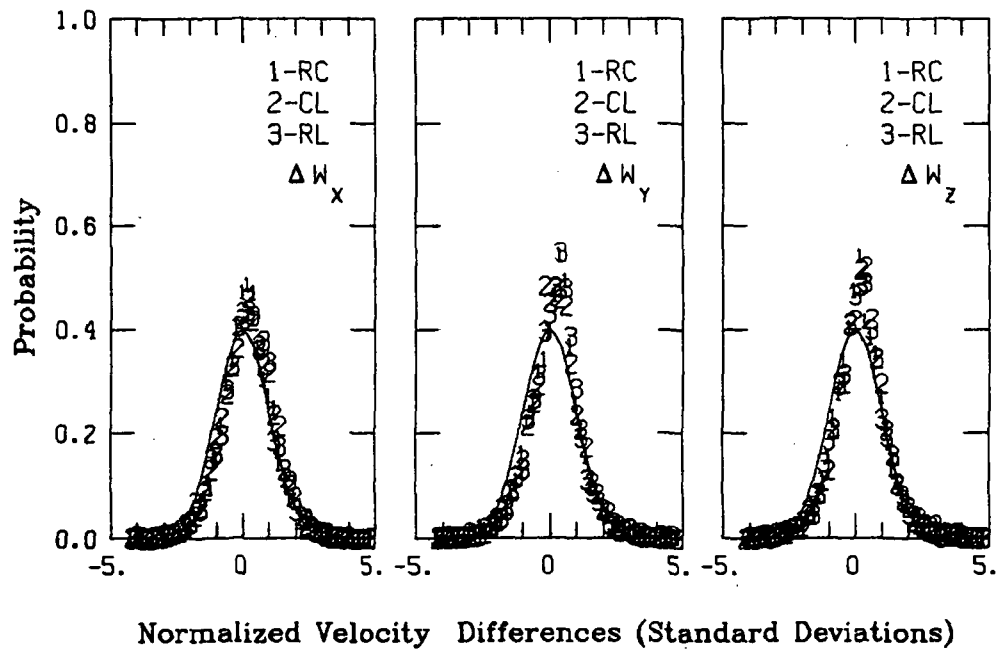
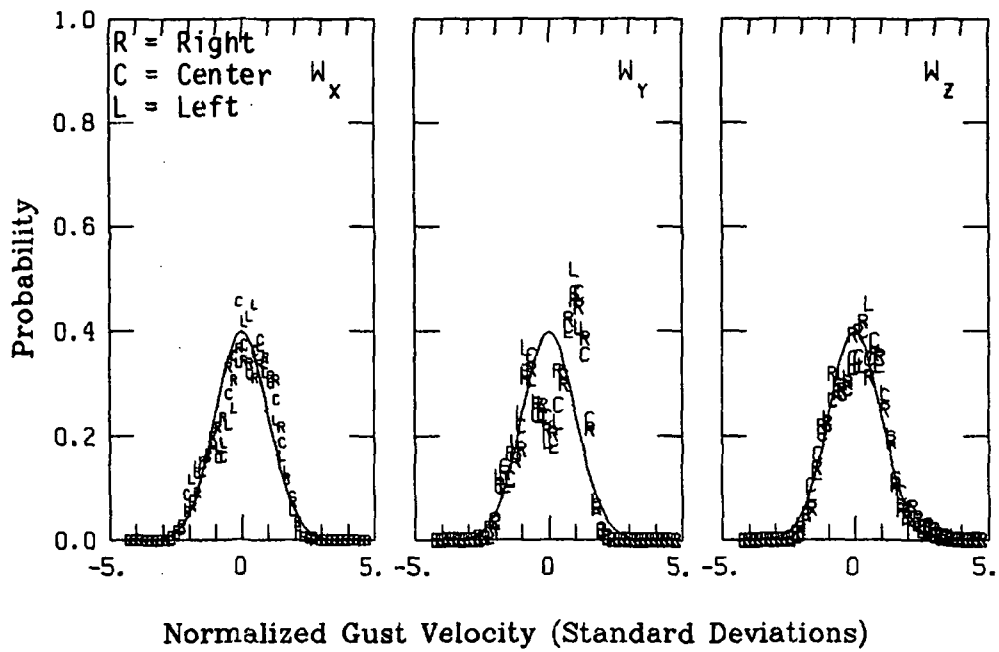

Figure A.91. Probability density function for gust velocities and gust velocity differences, Flight 6, Run 15.

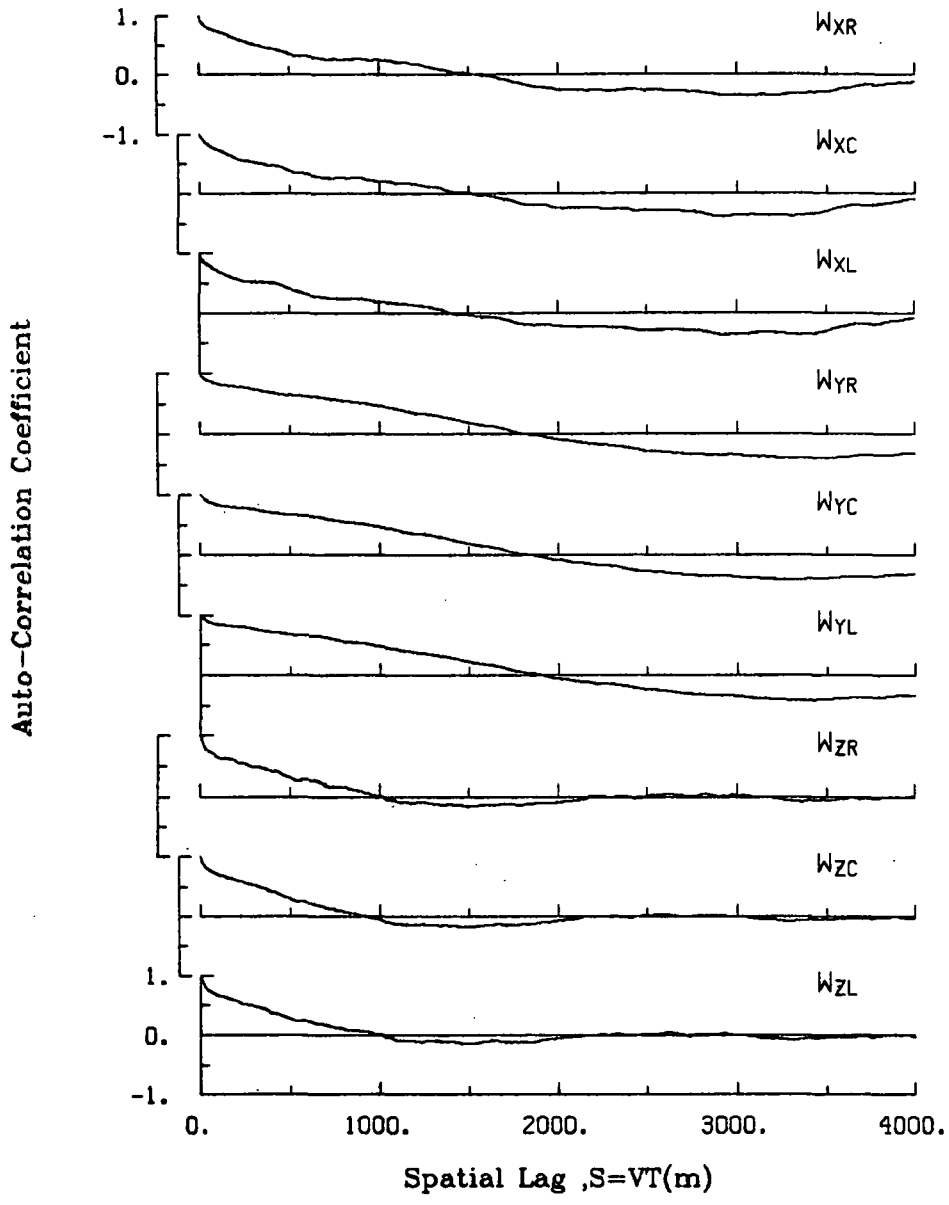

Figure A.92. Single-point auto-correlation coefficient of gust velocities, Flight 6, Run 15.

C-3

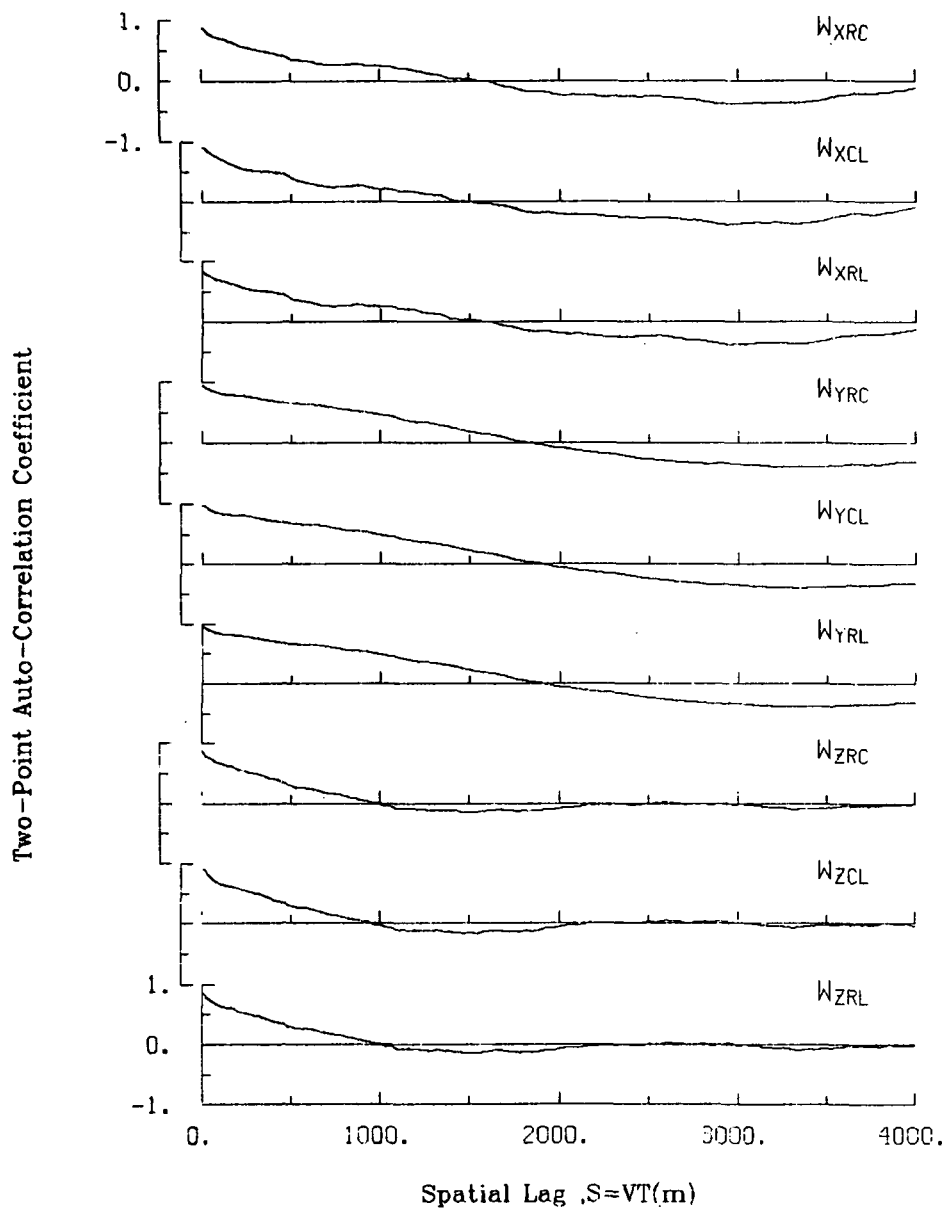

Figure A.93. Two-point auto-correlation coefficient of gust velocities, Flight 6, Run 15.

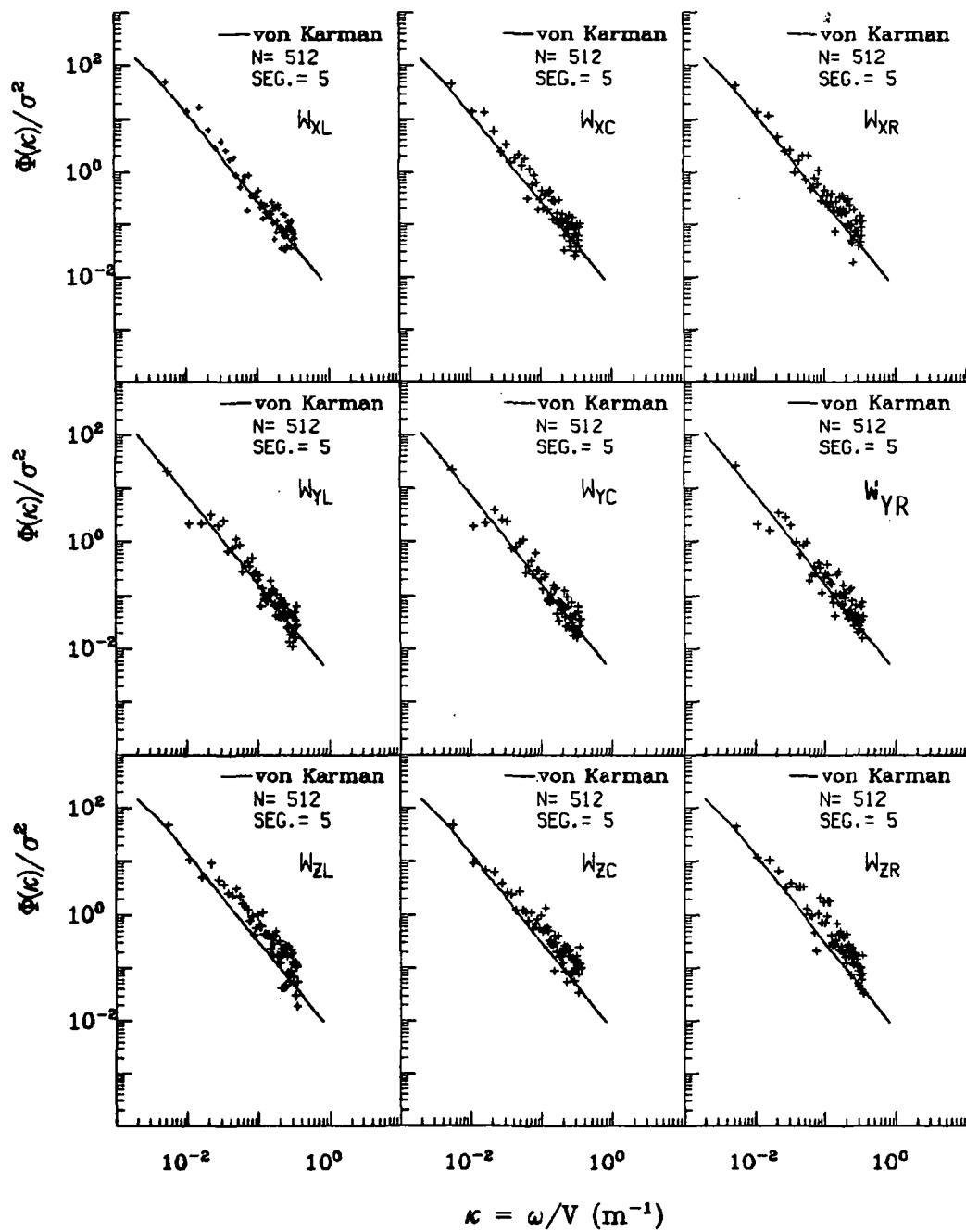

Figure A.94. Normalized auto-spectra of gust velocities, Flight 6, Run 15.

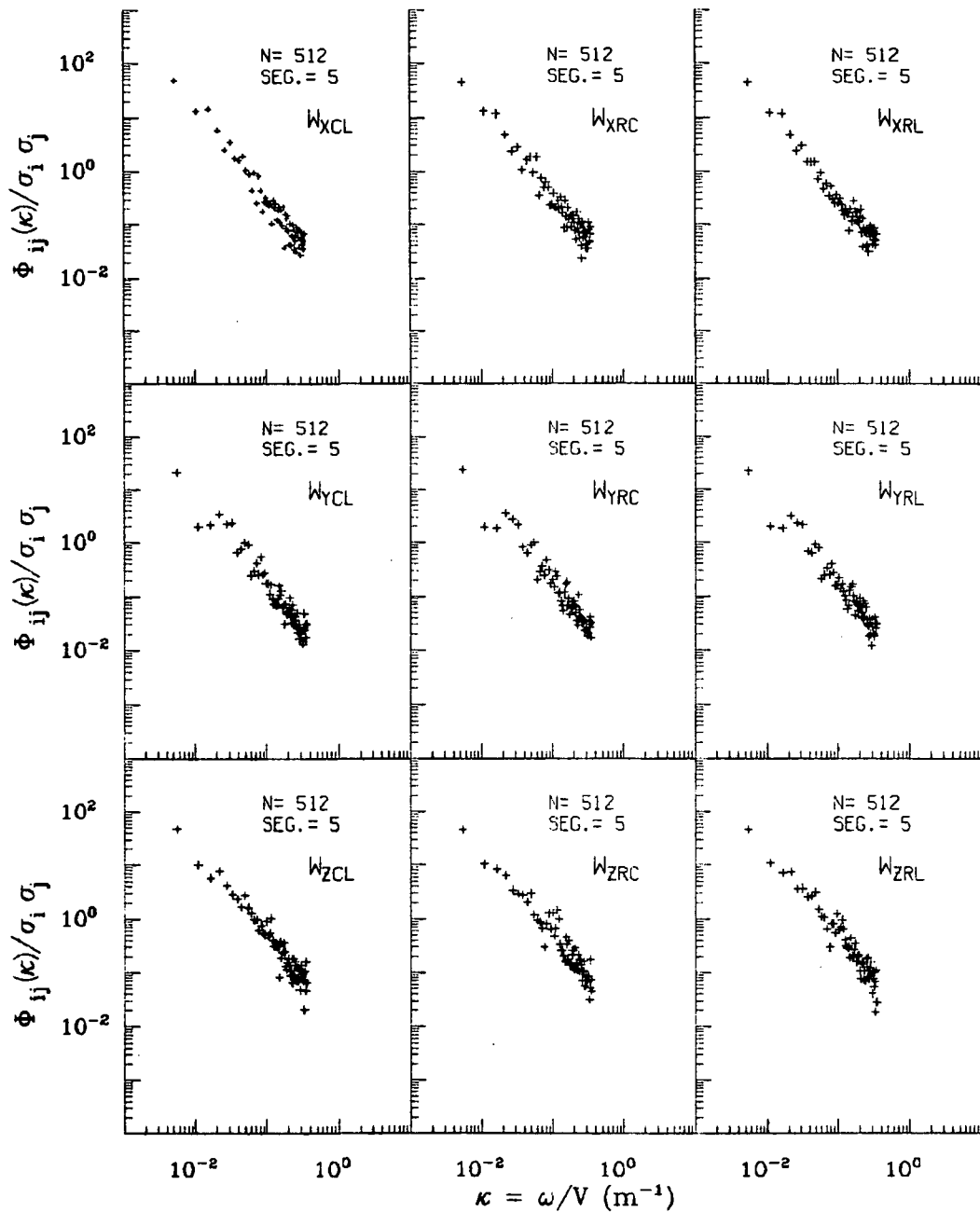

Figure A.95. Normalized two-point auto-spectra of gust velocities, Flight 6, Run 15.

ORIGINAL PAGE IS
OF POOR QUALITY.

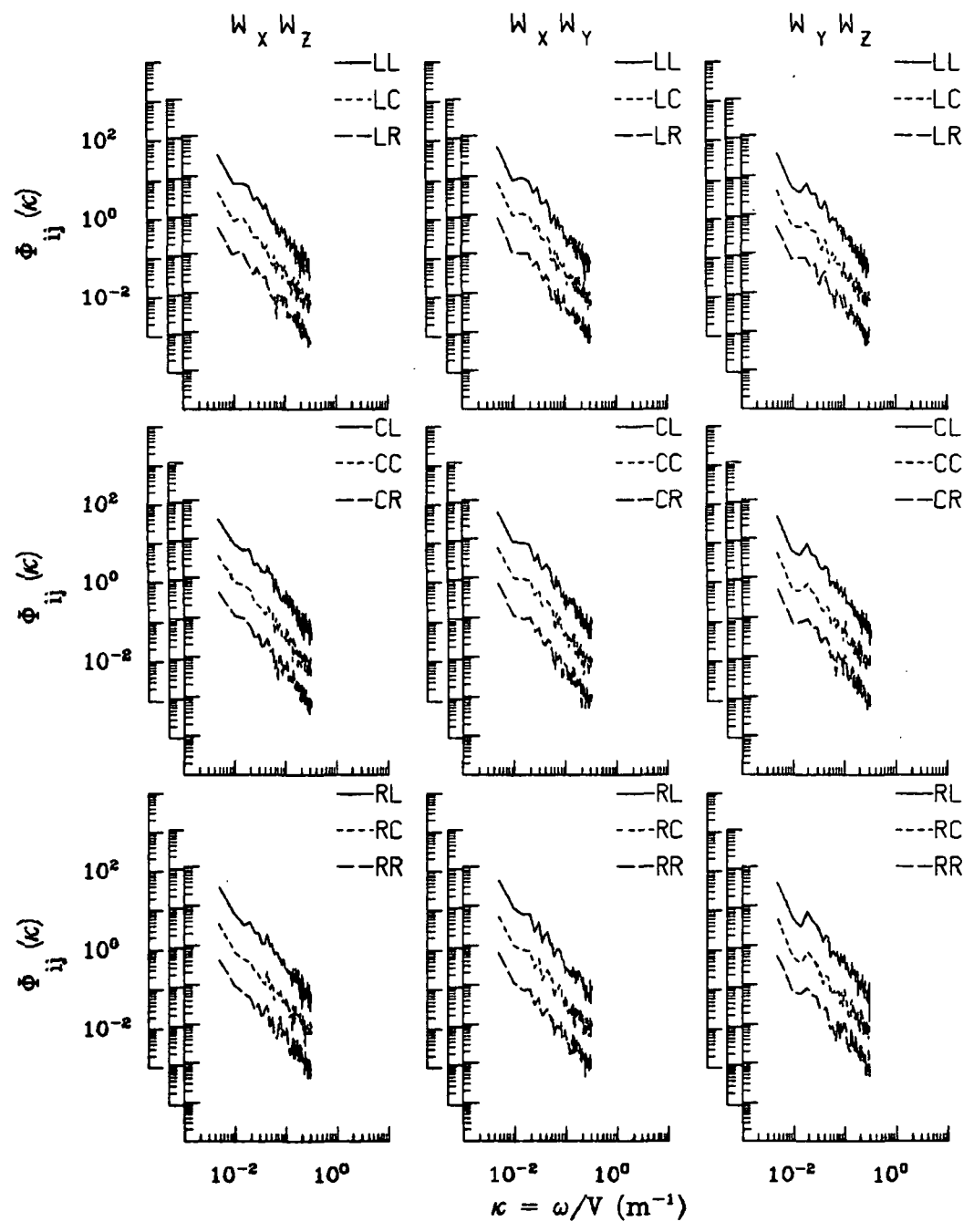

Figure A.96. Two-point cross-spectra of gust velocities, Flight 6, Run 15.

ORIGINAL PAGE IS
OF POOR QUALITY

TABLE A.24. List of All Parameters Measured and Their Range of Values, Flight 6, Run 15.

		START TIME = 52083.3289	STOP TIME = 52156.6289				
CHANNEL	UNITS	HIGH	LOW	MEAN	RMS	POINTS	
2 PHI DOT	RAD/SEC	.066	-.044	-.00080	.01534	2932	
3 ACCL N CG	G UNITS	-.988	-.988	-.98774	.98774	2932	
4 THETA DOT	RAD/SEC	.040	-.037	.00520	.00936	2932	
5 THETA	RAD	.079	-.019	.05756	.06128	2932	
6 PHI	RAD	.145	-.051	-.01393	.03328	2932	
7 PSI 1	DEGREES	115.376	109.036	112.70519	112.71181	2932	
8 DEL PSI 1	DEGREES	1.582	-4.560	-1.01255	1.58114	2932	
9 PSI 2	DEGREES	477.633	471.649	475.05116	475.05266	2932	
10 DEL PSI 2	DEGREES	1.256	-4.830	-1.30520	1.77979	2932	
11 ACCL N LT	G UNITS	1.810	.238	1.00479	1.01487	2932	
12 ACCL N RT	G UNITS	1.806	.235	1.01722	1.02712	2932	
13 ACCL X CG	G UNITS	.082	.023	.05731	.05794	2932	
14 ACCL Y CG	G UNITS	.210	-.189	.00960	.07259	2932	
15 ALPHA CTR	RAD	.019	-.034	-.00299	.00683	2932	
16 BETA CTR	RAD	.025	-.050	-.01622	.02013	2932	
17 TEMP I	DEG F	99.343	98.984	99.15933	99.15934	2932	
18 TEMP P	DEG F	90.545	90.366	90.37155	90.37156	2932	
19 ACCL Z INS	G UNITS	1.200	.746	.99543	.99699	2932	
20 ALPHA RT	RAD	.041	-.013	.01120	.01313	2932	
21 BETA RT	RAD	.056	-.011	.01967	.02261	2932	
22 ALPHA LT	RAD	.035	-.016	.01256	.01428	2932	
23 BETA LT	RAD	.016	-.060	-.02227	.02480	2932	
24 PSI DOT	RAD/SEC	.025	-.019	.00291	.00954	2932	
25 TEMP TOT	DEG C	28.733	27.254	28.17089	28.17255	2932	
26 QC LT	PSID	.742	.636	.69199	.69241	2932	
27 QC CTR	PSID	.725	.621	.67849	.67888	2932	
28 QC RT	PSID	.771	.644	.70426	.70466	2932	
29 PS	PSIA	11.232	11.151	11.17185	11.17186	2932	
30 TEMP IRT	DEG C	19.515	14.510	17.04082	17.06934	2932	
31 C TO G	METERS	8757459.9558751773.606	*****	*****	*****	2932	
32 B TO D	DEGREES	80.356	80.299	80.32786	80.32787	2932	
33 LONG	DEGREES	-104.865	-104.940	-104.90291	104.90291	2932	
34 LAT	DEGREES	39.982	39.948	39.96458	39.96458	2932	
35 TRK ANG	DEGREES	122.360	118.189	120.36620	120.37541	2932	
36 HDG	RADIANS	2.033	1.924	1.98733	1.98745	2932	
37 VE	M/SEC	89.709	86.749	87.63211	87.63494	2932	
38 VN	M/SEC	-47.120	-55.610	-51.33899	51.43156	2932	
39 ALTITUDE	KM	2.268	2.210	2.25326	2.25328	2932	
40 TEMPC	DEGREES C	23.724	22.139	23.13803	23.14119	2932	
41 EW WND SPD	KNOTS	.143	-13.043	-7.04303	7.36981	2932	
42 NS WND SPD	KNOTS	-8.888	-25.178	-17.83465	18.18689	2932	
43 WINJ SPEED	KNOTS	26.096	10.126	19.32270	19.62338	2932	
44 WIND DIPEC	DEGREES	359.382	.393	21.99832	24.04324	2932	
45 AIRSPEED P	M/SEC	106.900	98.088	102.39877	102.41215	2932	
46 AIRSPEED C	M/SEC	103.777	96.400	100.54715	100.56036	2932	
47 AIRSPEED L	M/SEC	105.023	97.500	101.52052	101.53484	2932	
48 DELTA ALT	METERS	3.363	-54.520	-11.67177	15.79434	2932	
49 INRTL DISP	METERS	3.985	-54.429	-12.25759	16.72048	2932	
50 UG RIGHT	M/SEC	2.818	-3.388	-.00000	1.20347	2932	
51 UG CENTER	M/SEC	3.204	-3.193	-.00000	1.20247	2932	
52 UG LEFT	M/SEC	4.216	-3.730	-.00000	1.29620	2932	
53 VG RIGHT	M/SEC	3.679	-5.193	-.01988	1.79344	2932	
54 VG CENTER	M/SEC	3.399	-4.696	-.02248	1.79292	2932	
55 VG LEFT	M/SEC	3.439	-4.806	-.02406	1.79706	2932	
56 WG RIGHT	M/SEC	4.976	-2.863	-.01340	1.12933	2932	
57 WG CENTER	M/SEC	4.070	-2.784	-.01361	1.05785	2932	
58 WG LEFT	M/SEC	4.298	-2.655	-.01306	1.06971	2932	

ORIGINAL PAGE IS
OF POOR QUALITY

Date: July 14, 1982
Time: 14:30:03(MDT)
Duration: 96 seconds

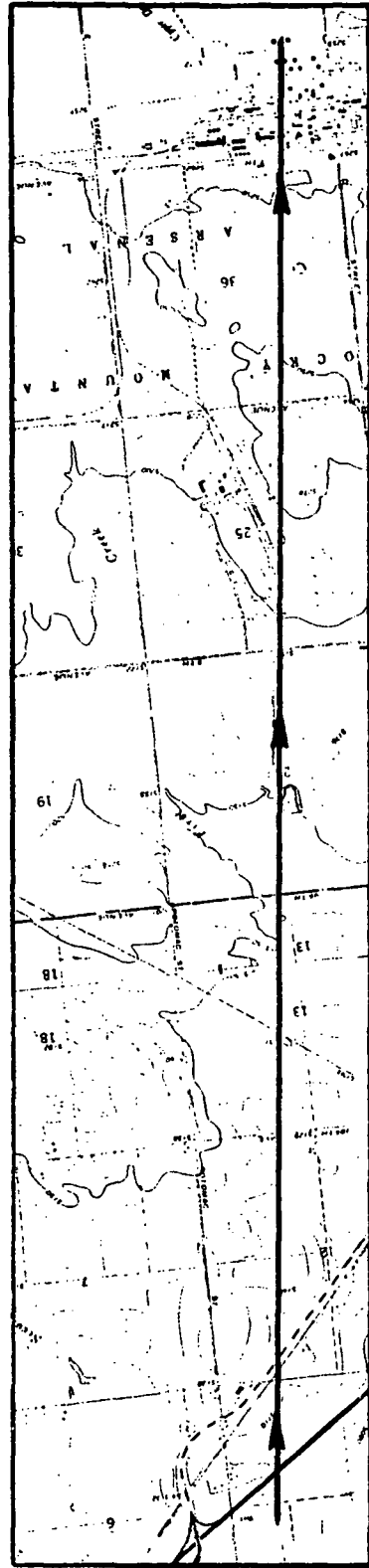
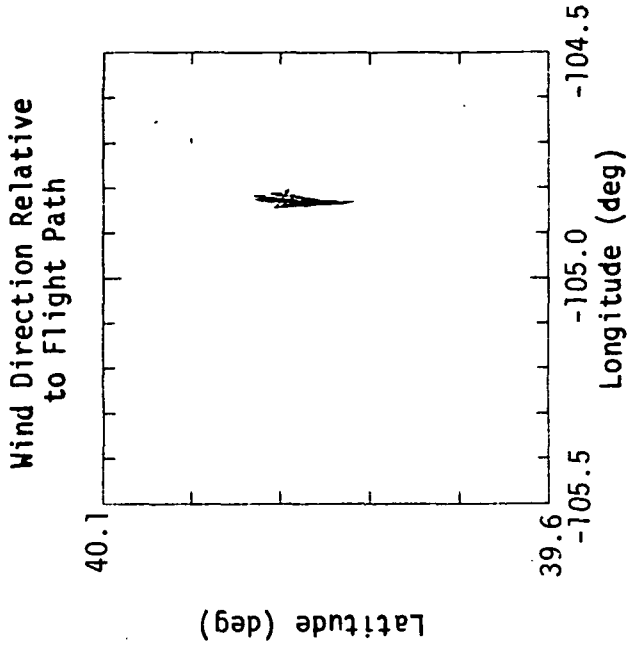
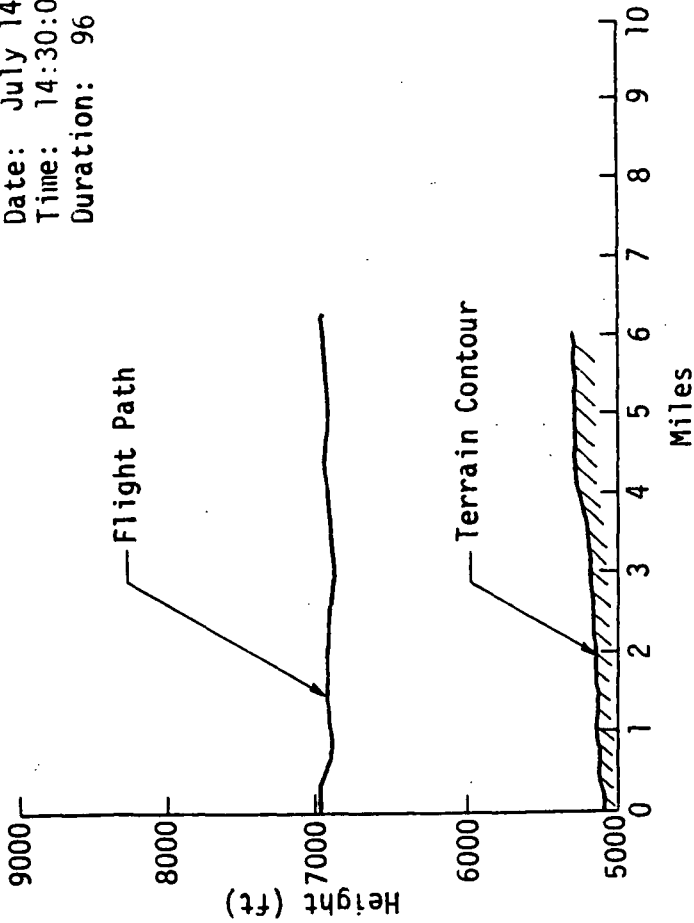

Figure A.97. Flight path information, Flight 6, Run 16.

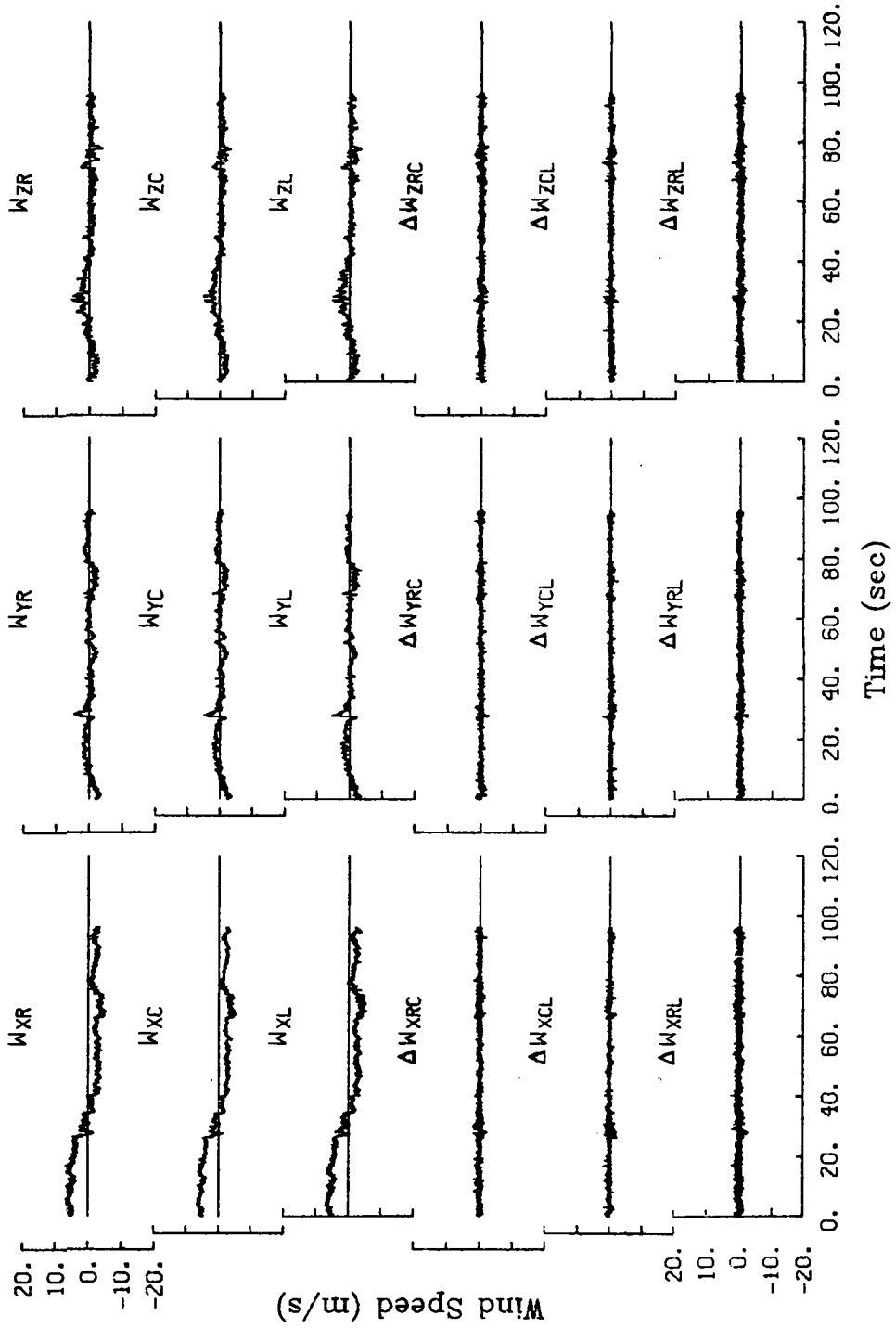

Figure A.98. Time histories of gust velocities and gust velocity differences, Flight 6, Run 16.

TABLE A.25. Average Turbulence Parameters and Integral Length Scales, Flight 6, Run 16.

I. Mean Airspeed (m/s)			II. Standard Deviation of Gust Velocities (m/s)		
V_L	V_C	V_R	$\sigma_{W_{XL}}$	$\sigma_{W_{XC}}$	$\sigma_{W_{XR}}$
107.0	105.9	107.8	3.41	3.39	3.39
			$\sigma_{W_{YL}}$	$\sigma_{W_{YC}}$	$\sigma_{W_{YR}}$
			1.11	1.15	1.13
			$\sigma_{W_{ZL}}$	$\sigma_{W_{ZC}}$	$\sigma_{W_{ZR}}$
			1.20	1.17	1.19
III. Standard Deviation of Gust Velocity Differences (m/s)			IV. Integral Length Scale (m).		
$\sigma_{\Delta W_{XCL}}$	$\sigma_{\Delta W_{XRC}}$	$\sigma_{\Delta W_{XRL}}$	$L_{W_{XL}}$	$L_{W_{XC}}$	$L_{W_{XR}}$
0.43	0.45	0.56	1540	1535	1546
$\sigma_{\Delta W_{YCL}}$	$\sigma_{\Delta W_{YRC}}$	$\sigma_{\Delta W_{YRL}}$	$L_{W_{YL}}$	$L_{W_{YC}}$	$L_{W_{YR}}$
0.39	0.41	0.44	640	637	697
$\sigma_{\Delta W_{ZCL}}$	$\sigma_{\Delta W_{ZRC}}$	$\sigma_{\Delta W_{ZRL}}$	$L_{W_{ZL}}$	$L_{W_{ZC}}$	$L_{W_{ZR}}$
0.46	0.45	0.51	1169	1237	1136

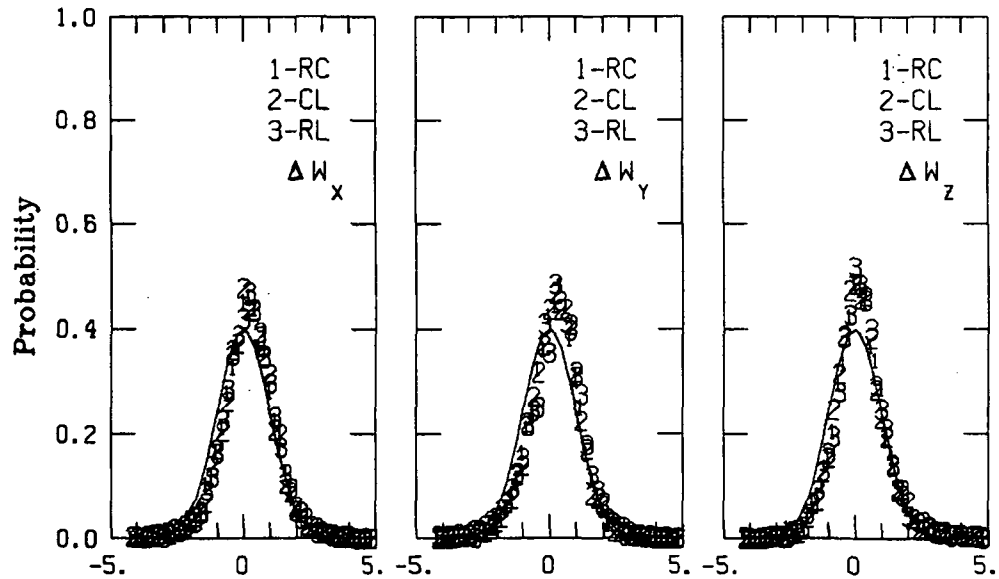
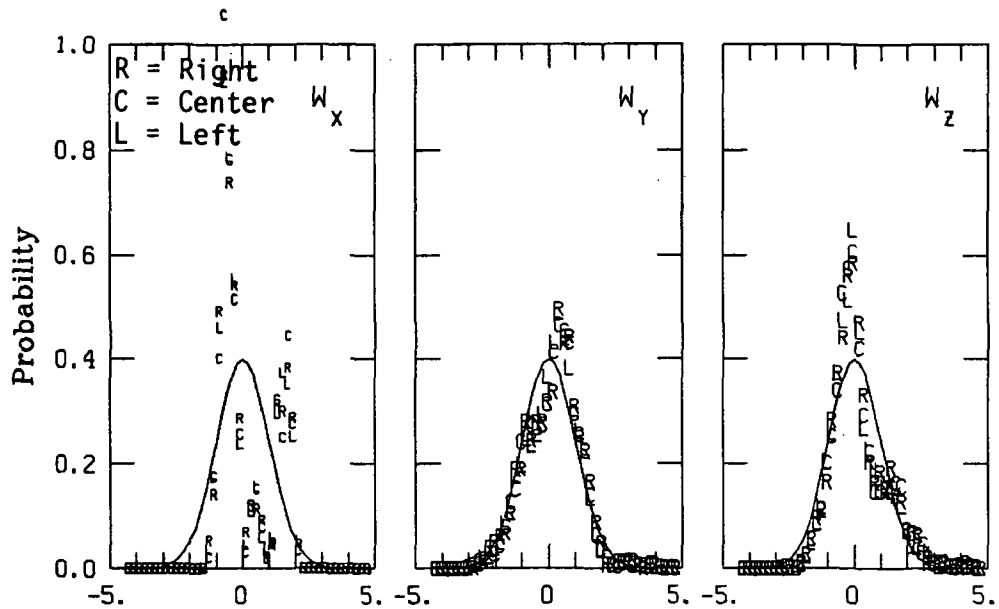

Figure A.99. Probability density function for gust velocities and gust velocity differences, Flight 6, Run 16.

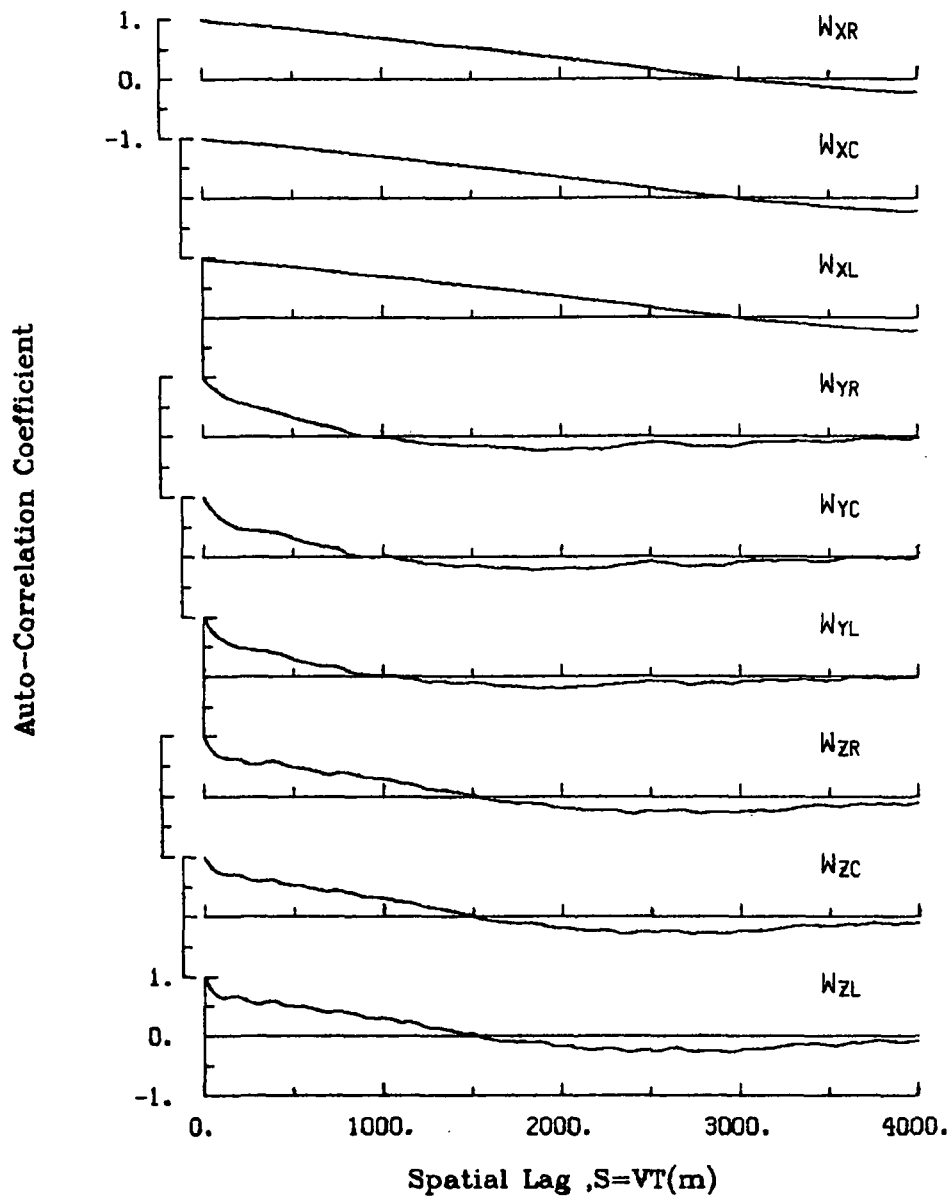

Figure A.100. Single-point auto-correlation coefficient of gust velocities, Flight 6, Run 16.

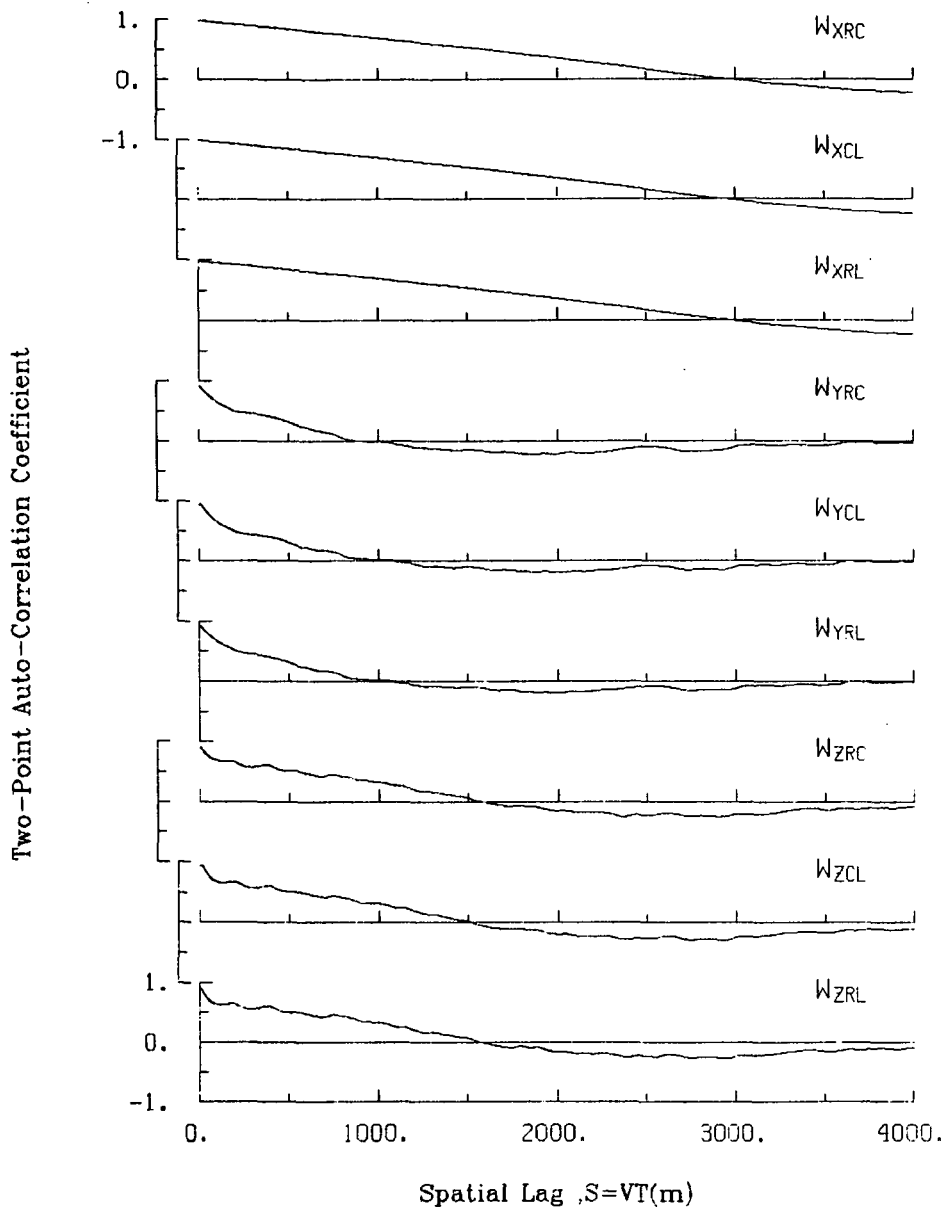

Figure A.101. Two-point auto-correlation coefficient of gust velocities, Flight 6, Run 16.

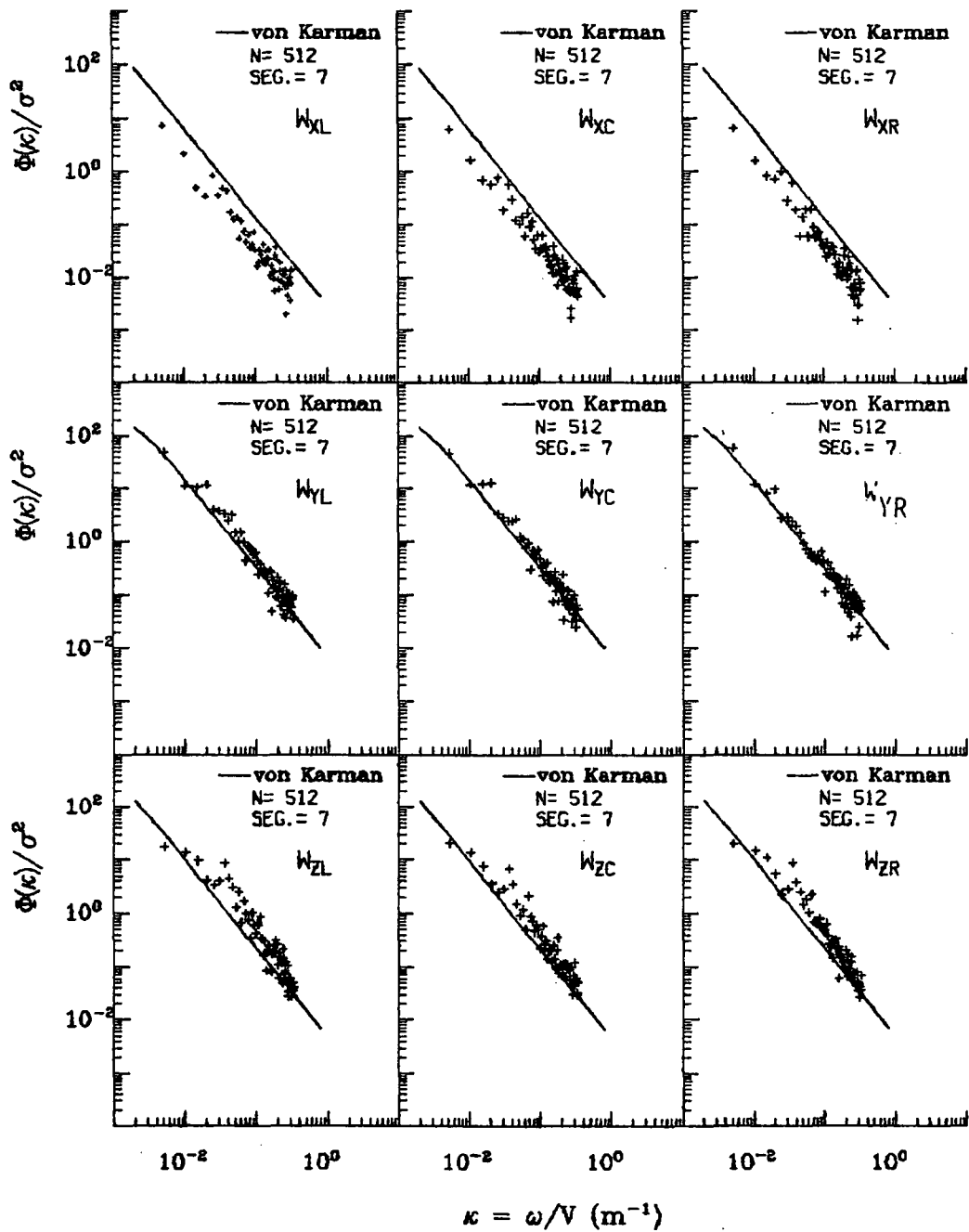

Figure A.102. Normalized auto-spectra of gust velocities, Flight 6, Run 16.

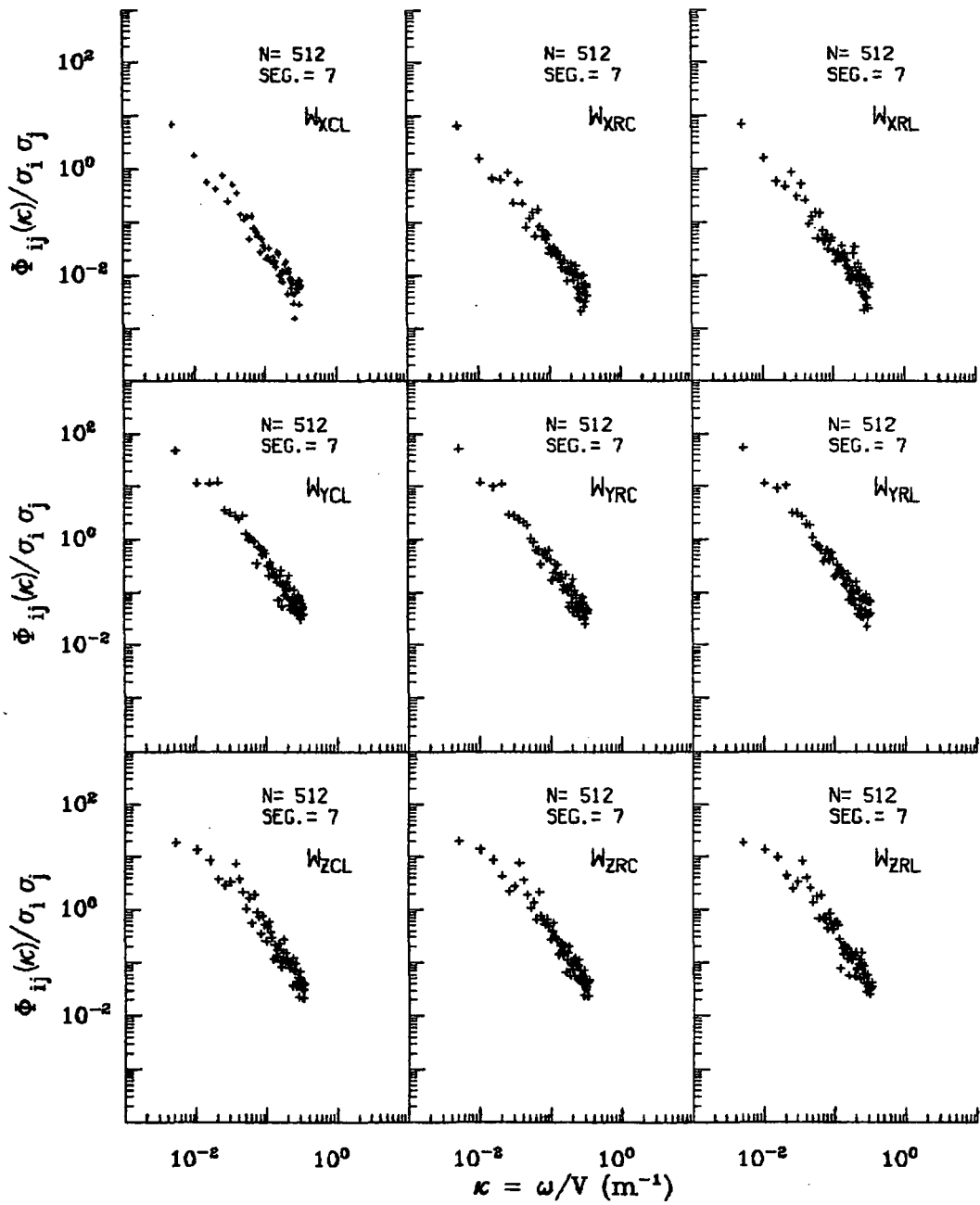

Figure A.103. Normalized two-point auto-spectra of gust velocities, Flight 6, Run 16.

ORIGINAL PAGE IS
OF POOR QUALITY

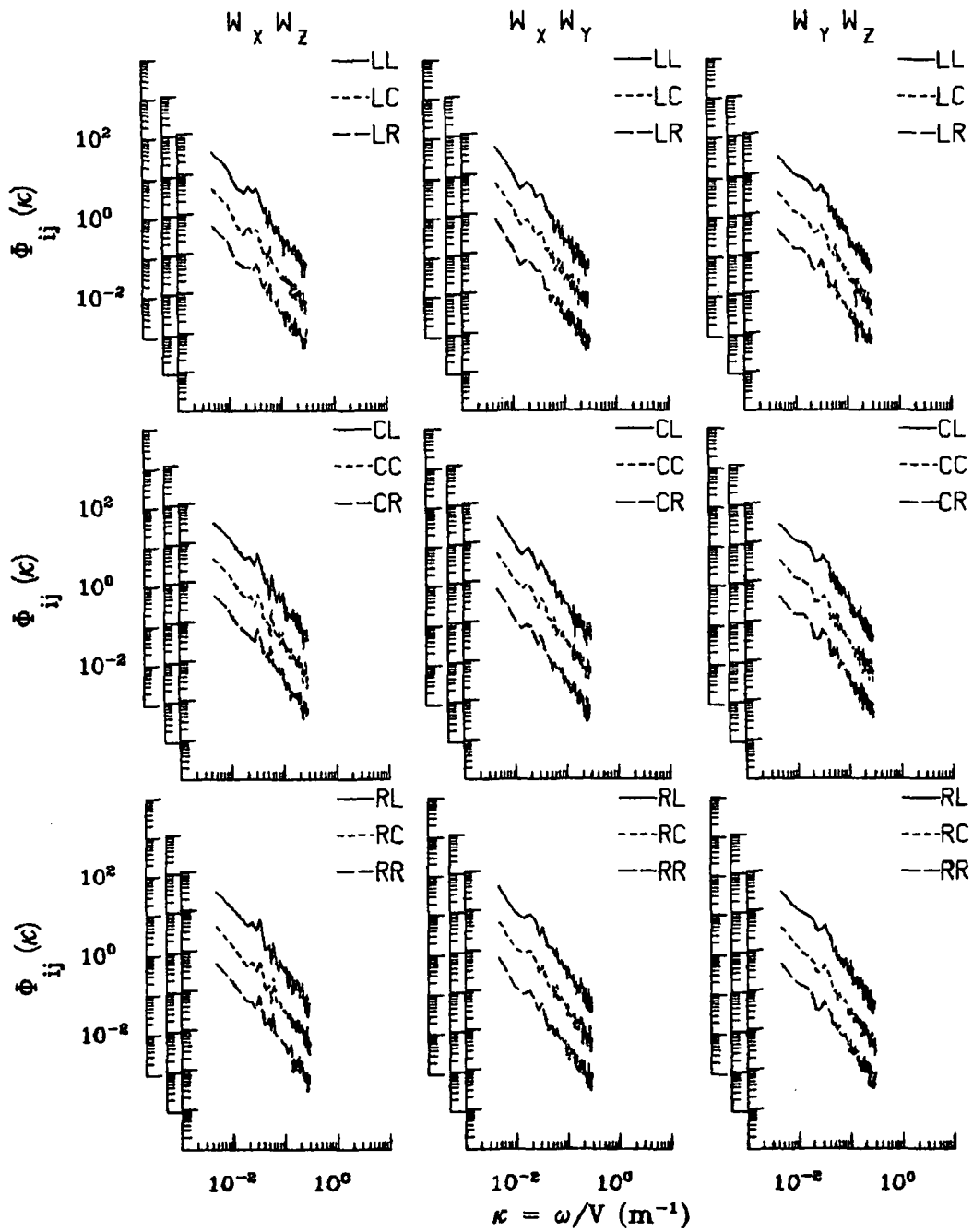

Figure A.104. Two-point cross-spectra of gust velocities, Flight 6, Run 16.

ORIGINAL PAGE IS
OF POOR QUALITY

TABLE A.26. List of All Parameters Measured and Their Range of Values, Flight 6, Run 16.

		START TIME • 52203.3041		STOP TIME • 52299.5291			
CHANNEL	UNITS	HIGH	LOW	MEAN	RMS	POINTS	
2 PHI DOT	RAD/SEC	.062	-.052	-.00304	.01444	3849	
3 ACCL N CG	G UNITS	-.988	-.988	-.98774	.98774	3849	
4 THETA DOT	RAD/SEC	.033	-.021	.00592	.00997	3849	
5 THETA	RAD	.106	.016	.05495	.05628	3849	
6 PHI	RAD	.028	-.070	-.00828	.01937	3849	
7 PSI 1	DEGREES	174.902	171.387	173.36213	173.36399	3849	
8 DEL PSI 1	DEGREES	1.934	-1.387	.40296	.88380	3849	
9 PSI 2	DEGREES	533.250	529.736	531.58282	531.58337	3849	
10 DEL PSI 2	DEGREES	1.727	-1.566	.21066	.81041	3849	
11 ACCL N LT	G UNITS	1.597	.516	1.00992	1.01734	3849	
12 ACCL N RT	G UNITS	1.688	.485	1.02359	1.03089	3849	
13 ACCL X CG	GUNITS	.073	-.007	.03508	.03741	3849	
14 ACCL Y CG	G UNITS	.204	-.176	.00714	.04786	3849	
15 ALPHA CTR	RAD	.022	-.041	-.01249	.01577	3849	
16 BETA CTR	RAD	.036	-.069	-.02149	.02444	3849	
17 TEMP I	DEG F	99.523	99.163	99.44343	99.44348	3849	
18 TEMP P	DEG F	90.545	90.366	90.36937	90.36938	3849	
19 ACCL Z INS	G UNITS	1.261	.744	1.00060	1.00286	3849	
20 ALPHA RT	RAD	.029	-.036	-.00372	.01131	3849	
21 BETA RT	RAD	.062	-.027	.01386	.01730	3849	
22 ALPHA LT	RAD	.033	-.032	-.00359	.01094	3849	
23 BETA LT	RAD	.031	-.069	-.02747	.02952	3849	
24 PSI DOT	RAD/SEC	.039	-.033	.00349	.01004	3849	
25 TEMP TOT	DEG C	32.474	30.603	31.83615	31.83878	3849	
26 QC LT	PSID	.889	.631	.77804	.78035	3849	
27 QC CTR	PSID	.868	.619	.76070	.76292	3849	
28 QC RT	PSID	.899	.643	.78948	.79177	3849	
29 PS	PSIA	11.404	11.358	11.38102	11.38102	3849	
30 TEMP IRT	DEG C	23.838	14.939	22.54041	22.57985	3849	
31 D TO G	METERS	8758552.35887579	33.005	*****	*****	3849	
32 B TO D	DEGREES	80.404	80.379	80.39196	80.39196	3849	
33 LONG	DEGREES	-104.831	-104.843	-104.83714	104.83714	3849	
34 LAT	DEGREES	39.908	39.820	39.86246	39.86247	3849	
35 TRK ANG	DEGREES	174.991	172.795	174.04490	174.04618	3849	
36 HDG	RADIANS	3.059	2.998	3.03136	3.03139	3849	
37 VE	M/SEC	13.034	8.642	10.62068	10.68262	3849	
38 VN	M/SEC	-90.396	-109.878	-101.46122	101.61652	3849	
39 ALTITUDE	KM	2.121	2.088	2.10446	2.10447	3849	
40 TEMPC	DEGREES C	26.701	25.826	26.25128	26.25204	3849	
41 EW WND SPD	KNOTS	10.672	-6.832	2.44573	3.28767	3849	
42 NS WND SPD	KNOTS	17.633	-5.156	7.71576	10.05797	3849	
43 WIND SPEED	KNOTS	17.866	.147	9.64861	10.58167	3849	
44 WIND DIREC	DEGREES	359.905	.190	217.40532	224.79726	3849	
45 AIRSPEED R	M/SEC	114.825	97.684	107.79592	107.87112	3849	
46 AIRSPEED C	M/SEC	112.843	95.837	105.85722	105.93168	3849	
47 AIRSPEED L	M/SEC	114.251	96.762	107.02757	107.10424	3849	
48 DELTA ALT	METERS	10.516	-22.049	-5.98500	8.72594	3849	
49 INRTL CISP	METERS	7.940	-20.092	-6.92817	9.30952	3849	
50 UG RIGHT	M/SEC	6.985	-5.140	-.00000	3.32752	3849	
51 UG CENTER	M/SEC	6.700	-5.096	-.00000	3.33086	3849	
52 UG LEFT	M/SEC	6.909	-5.446	-.00000	3.34381	3849	
53 VG RIGHT	M/SEC	4.365	-3.313	-.03762	1.10860	3849	
54 VG CENTER	M/SEC	5.061	-3.616	-.03586	1.11995	3849	
55 VG LEFT	M/SEC	5.166	-3.432	-.03287	1.08356	3849	
56 WG RIGHT	M/SEC	5.156	-3.531	.02143	1.16558	3849	
57 WG CENTER	M/SEC	4.873	-3.152	.02405	1.15043	3849	
58 WG LEFT	M/SEC	5.266	-3.236	.02452	1.17514	3849	

ORIGINAL PAGE IS
OF POOR QUALITY

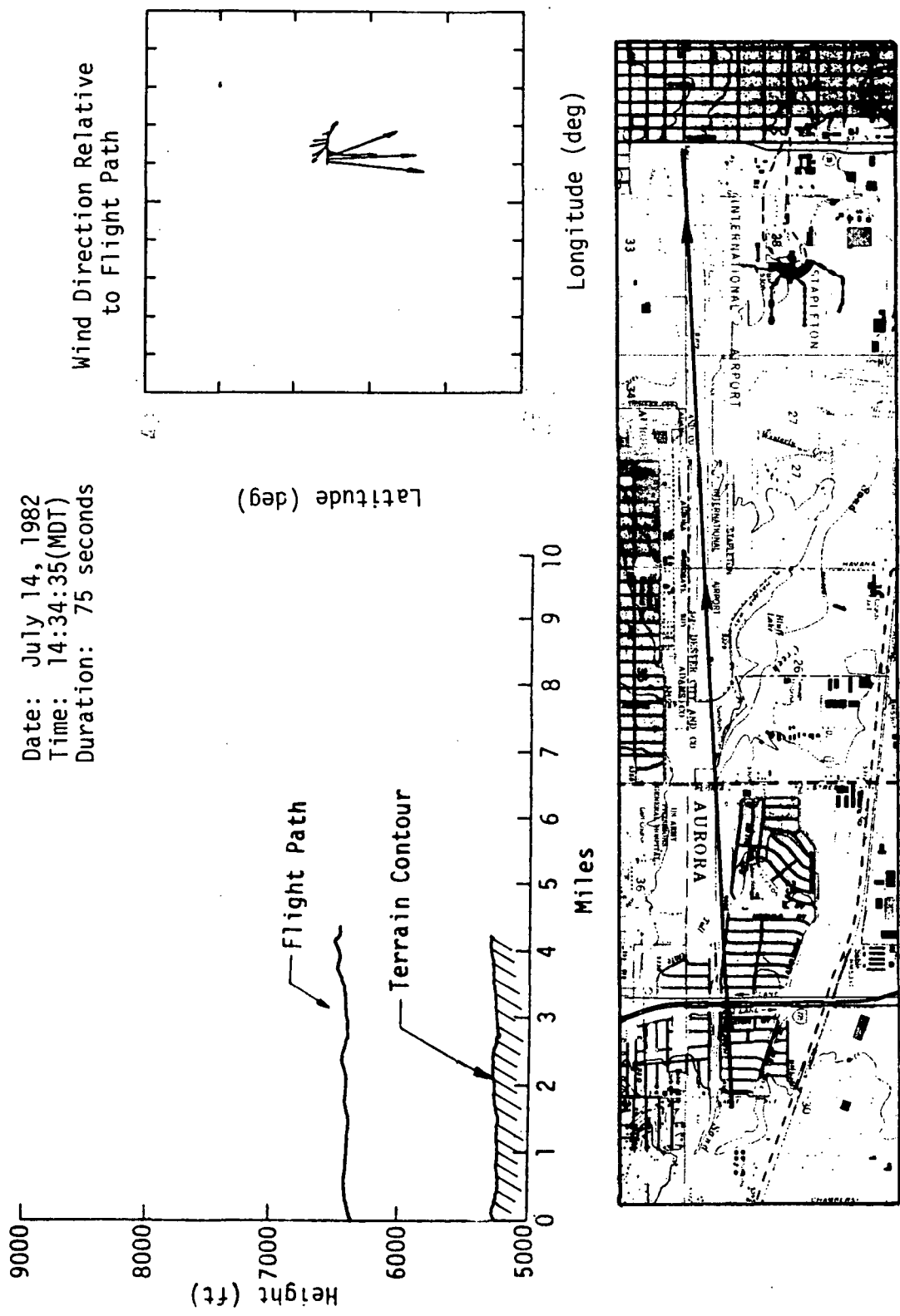

Figure A.105. Flight path information, Flight 6, Run 17.

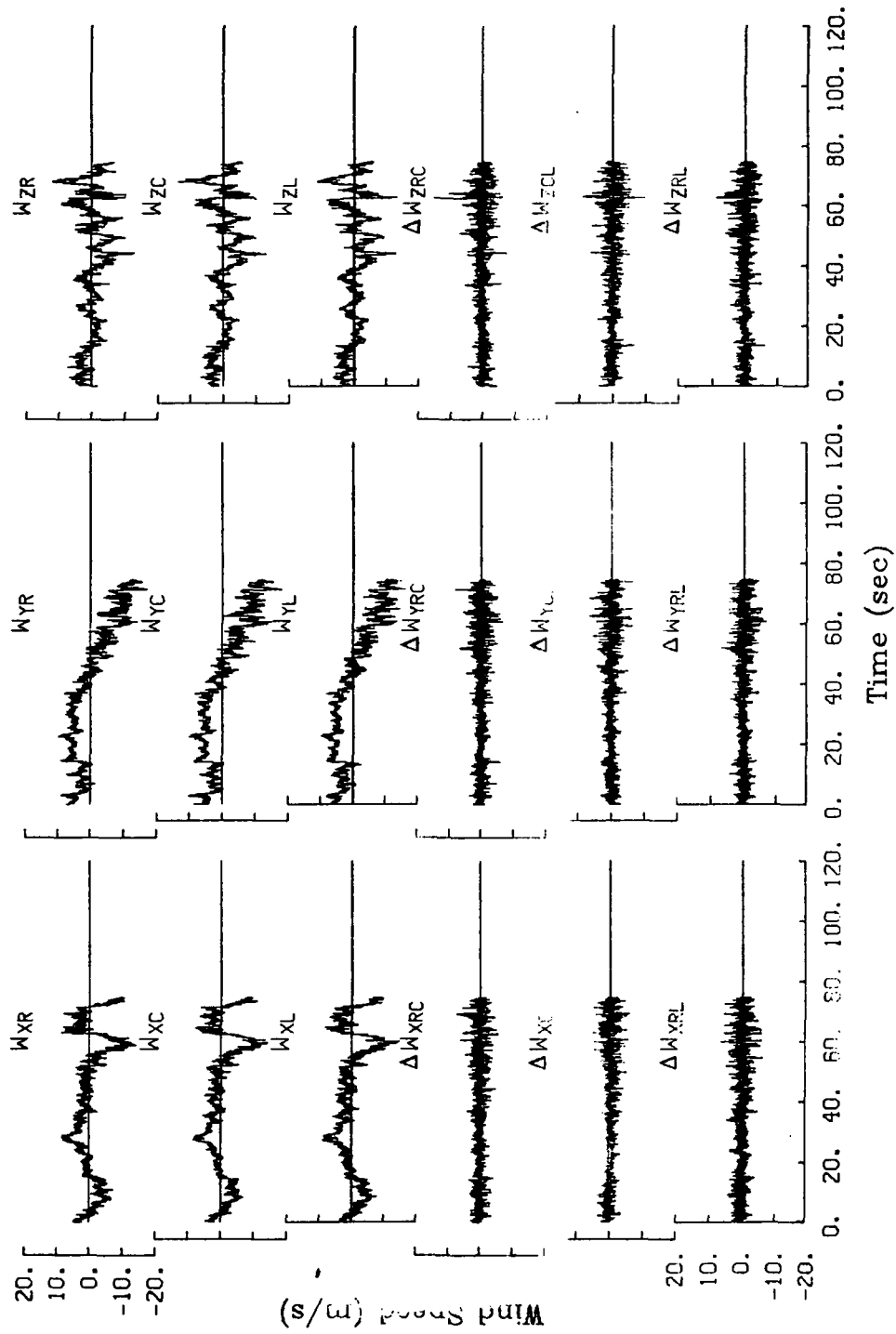

Figure A.106. Time histories of gust velocities and gust velocity differences, Flight 6, Run 17.

TABLE A.27. Average Turbulence Parameters and Integral Length Scales, Flight 6, Run 17.

I. Mean Airspeed (m/s)			II. Standard Deviation of Gust Velocities (m/s)		
V_L	V_C	V_R	$\sigma_{W_{XL}}$	$\sigma_{W_{XC}}$	$\sigma_{W_{XR}}$
97.9	9.8	98.5	3.81	3.75	3.75
			$\sigma_{W_{YL}}$	$\sigma_{W_{YC}}$	$\sigma_{W_{YR}}$
			4.64	4.77	4.77
			$\sigma_{W_{ZL}}$	$\sigma_{W_{ZC}}$	$\sigma_{W_{ZR}}$
			3.41	3.31	3.30
III. Standard Deviation of Gust Velocity Differences (m/s)			IV. Integral Length Scale (m)		
$\sigma_{\Delta W_{XCL}}$	$\sigma_{\Delta W_{XRC}}$	$\sigma_{\Delta W_{XRL}}$	$L_{W_{XL}}$	$L_{W_{XC}}$	$L_{W_{XR}}$
1.17	1.26	1.45	264	251	250
$\sigma_{\Delta W_{YCL}}$	$\sigma_{\Delta W_{YRC}}$	$\sigma_{\Delta W_{YRL}}$	$L_{W_{YL}}$	$L_{W_{YC}}$	$L_{W_{YR}}$
1.24	1.32	1.41	2208	2138	2192
$\sigma_{\Delta W_{ZCL}}$	$\sigma_{\Delta W_{ZRC}}$	$\sigma_{\Delta W_{ZRL}}$	$L_{W_{ZL}}$	$L_{W_{ZC}}$	$L_{W_{ZR}}$
1.48	1.47	1.50	246	277	261

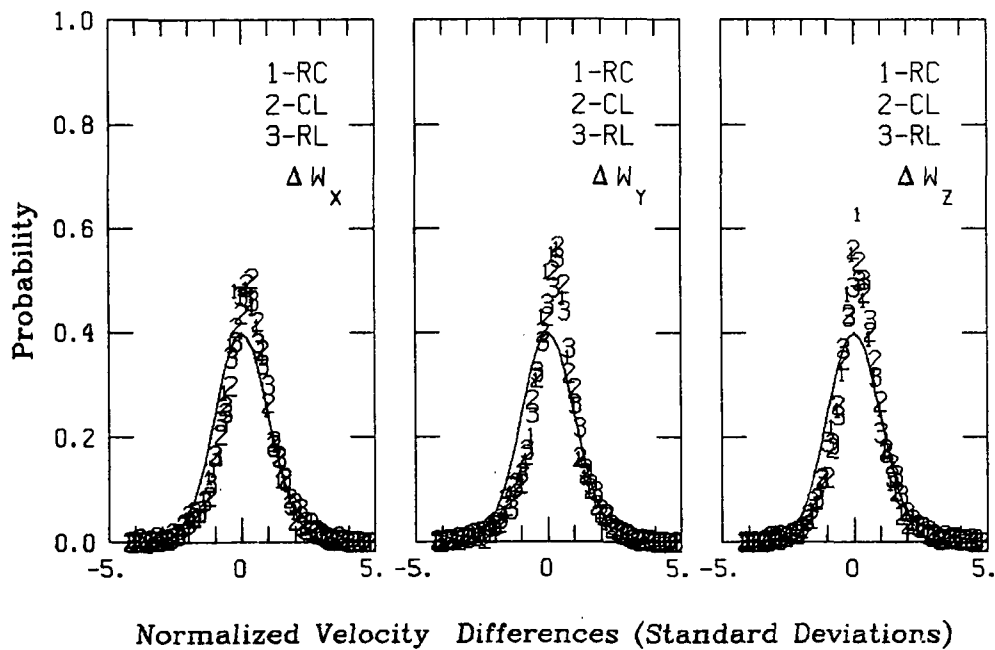
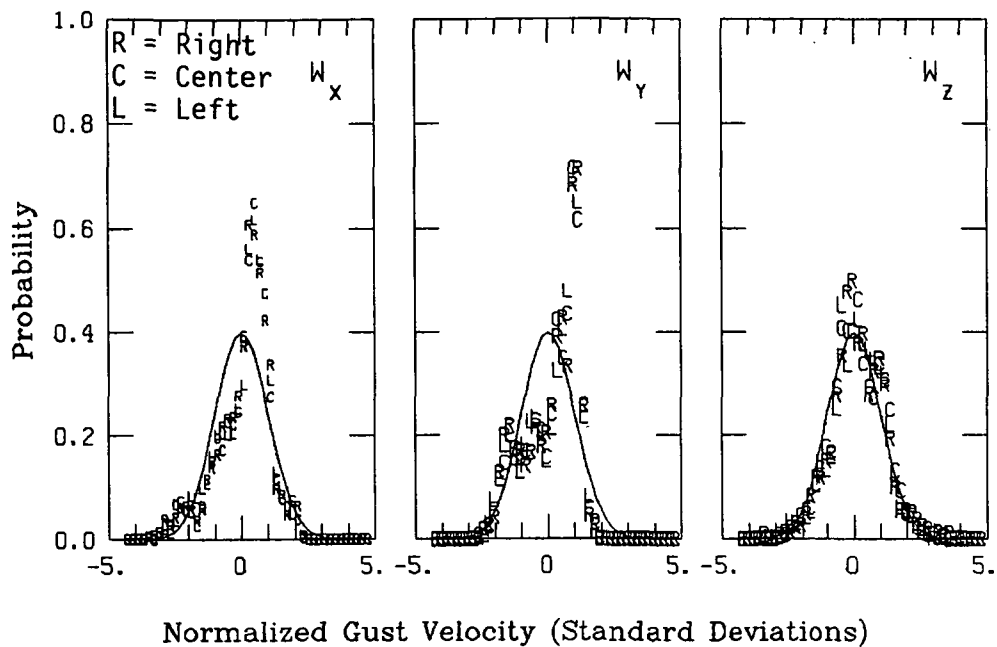

Figure A.107. Probability density function for gust velocities and gust velocity differences, Flight 6, Run 17.

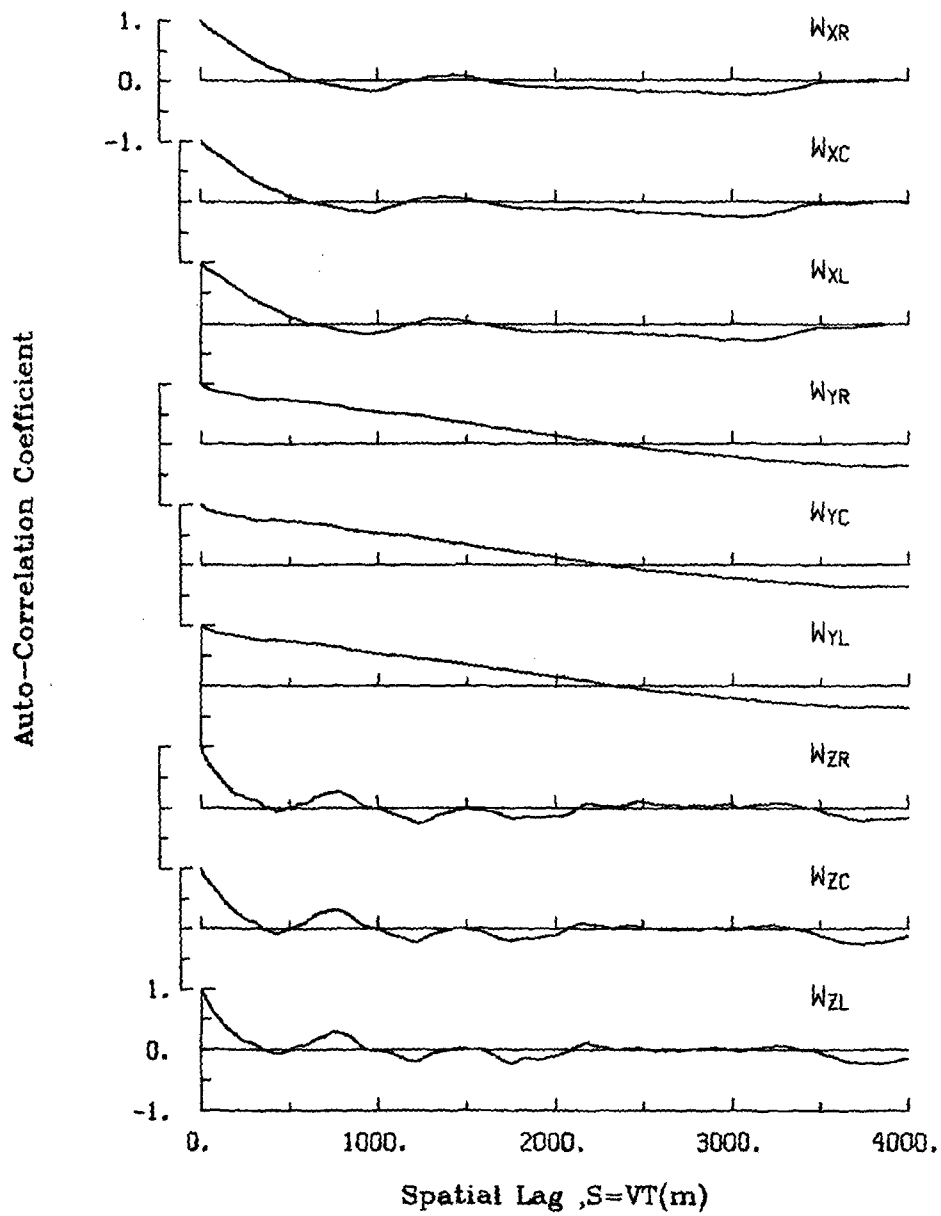

Figure A.108. Single-point auto-correlation coefficient of gust velocities, Flight 6, Run 17.

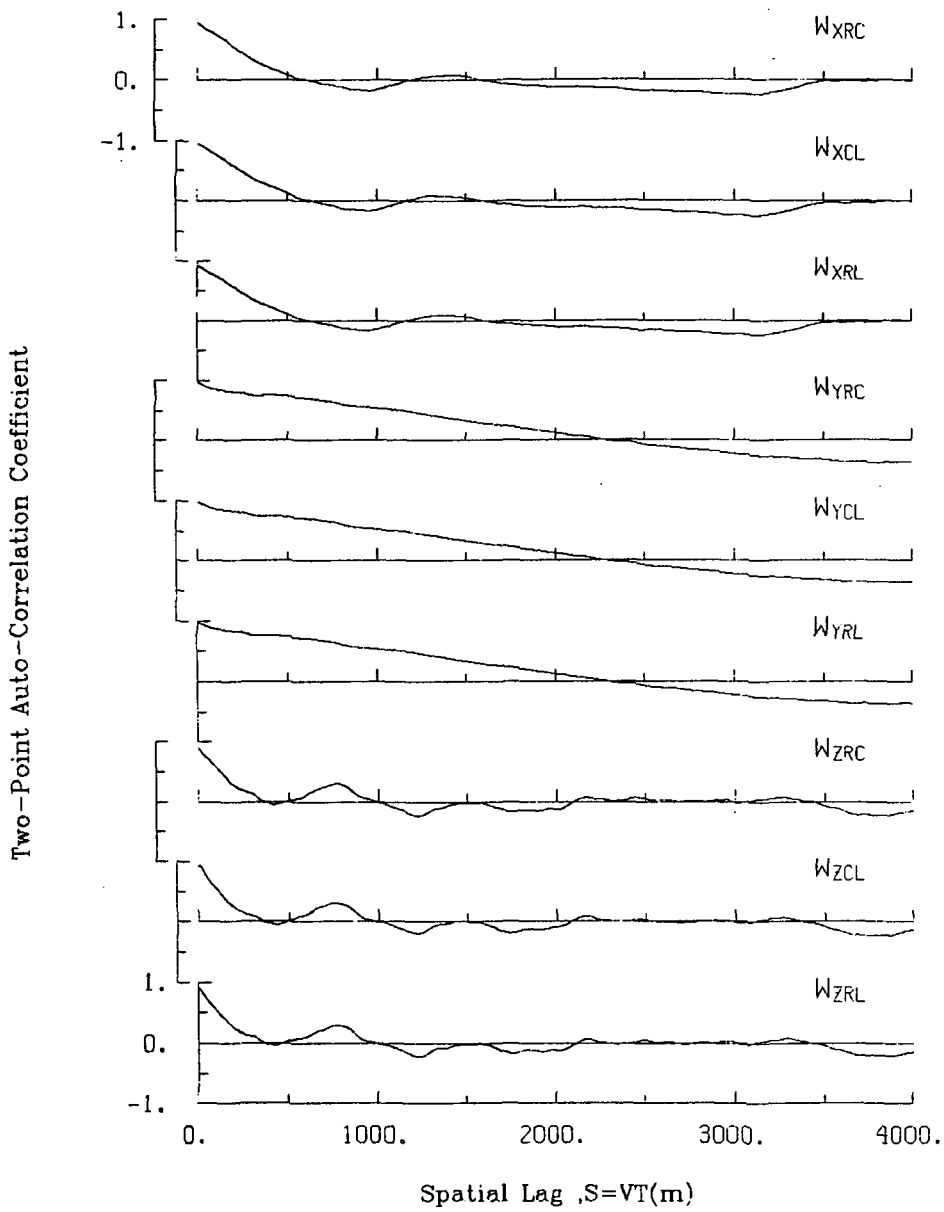

Figure A.109. Two-point auto-correlation coefficient of gust velocities, Flight 6, Run 17.

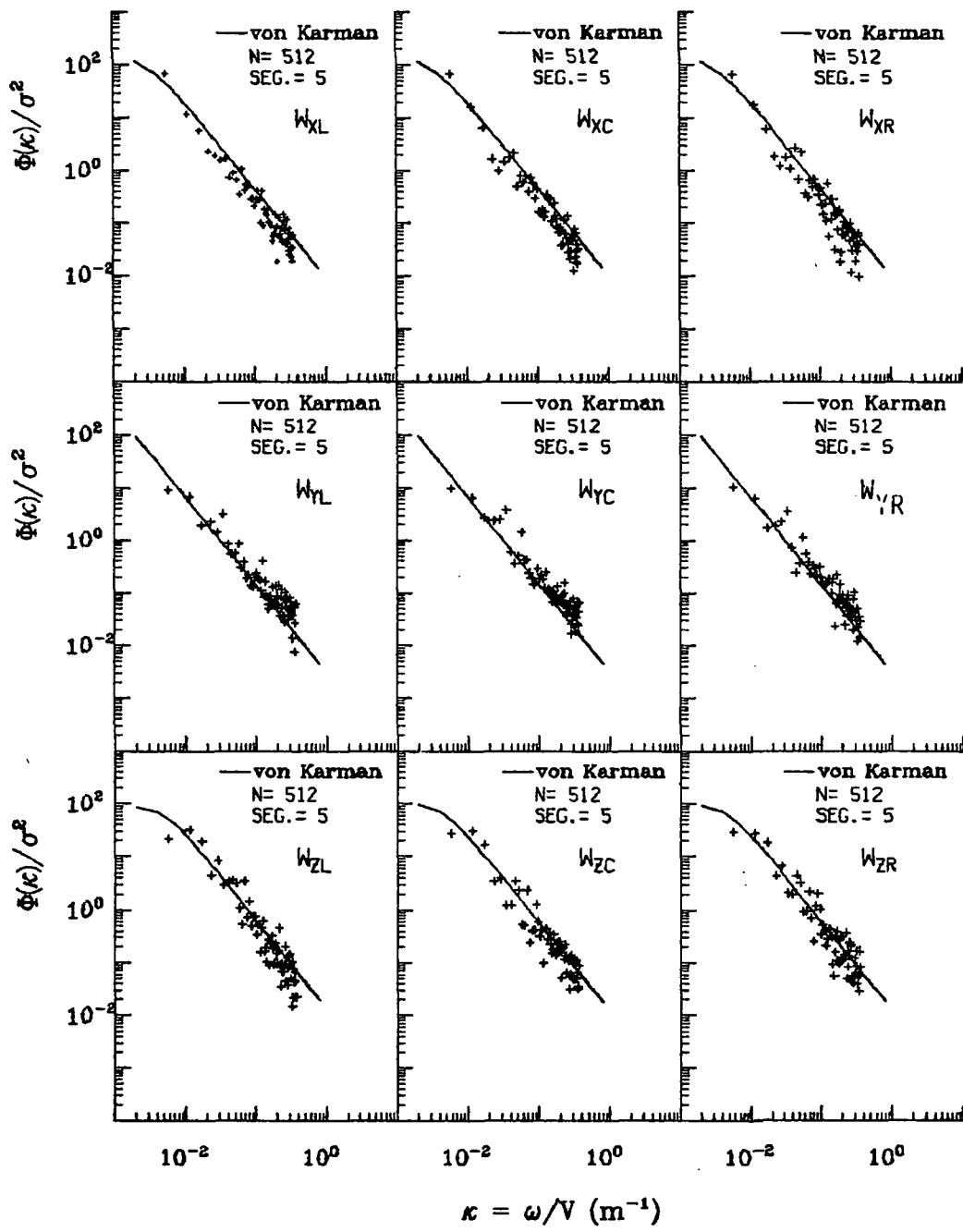

Figure A.110. Normalized auto-spectra of gust velocities, Flight 6, Run 17.

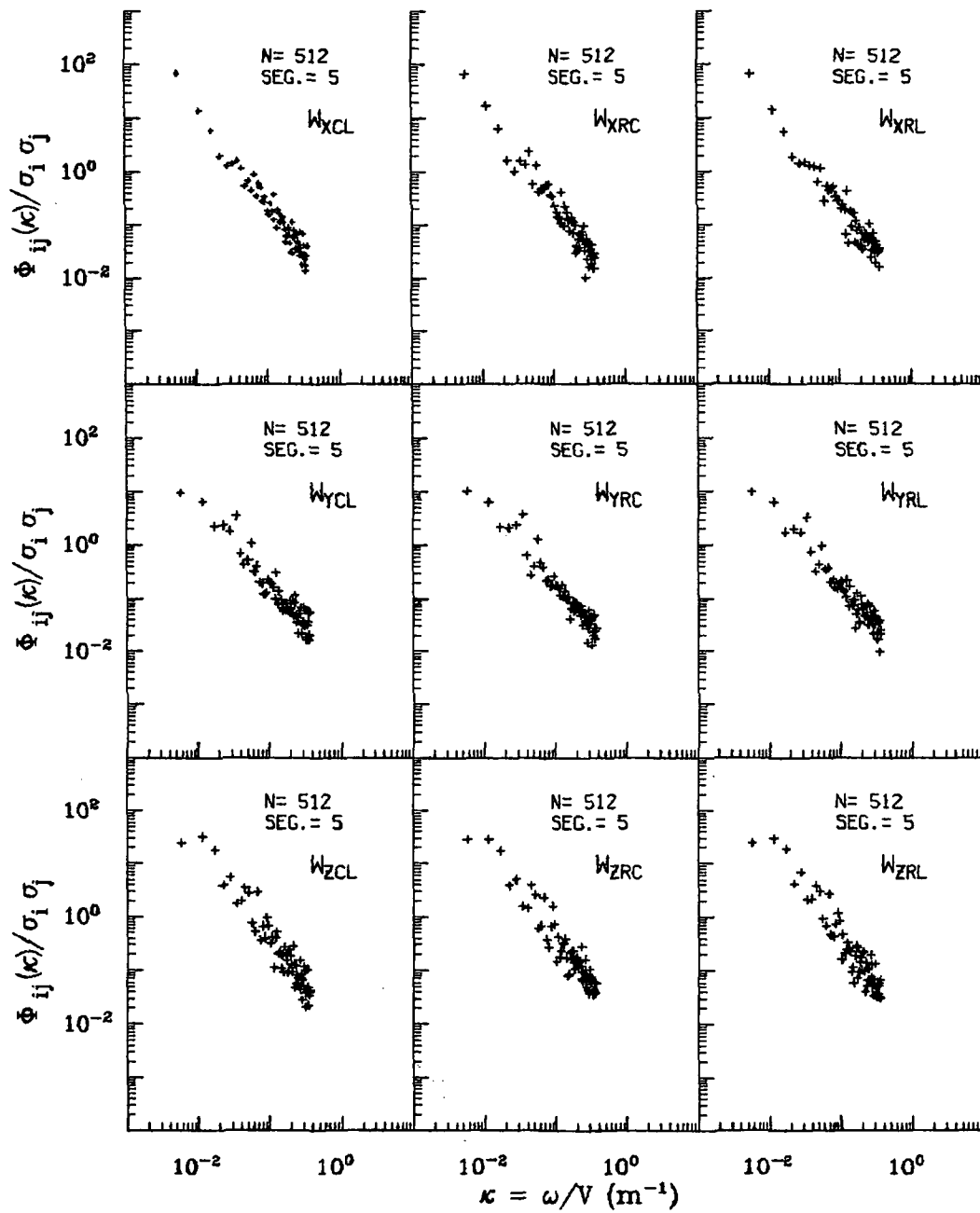

Figure A.111. Normalized two-point auto-spectra of gust velocities, Flight 6, Run 17.

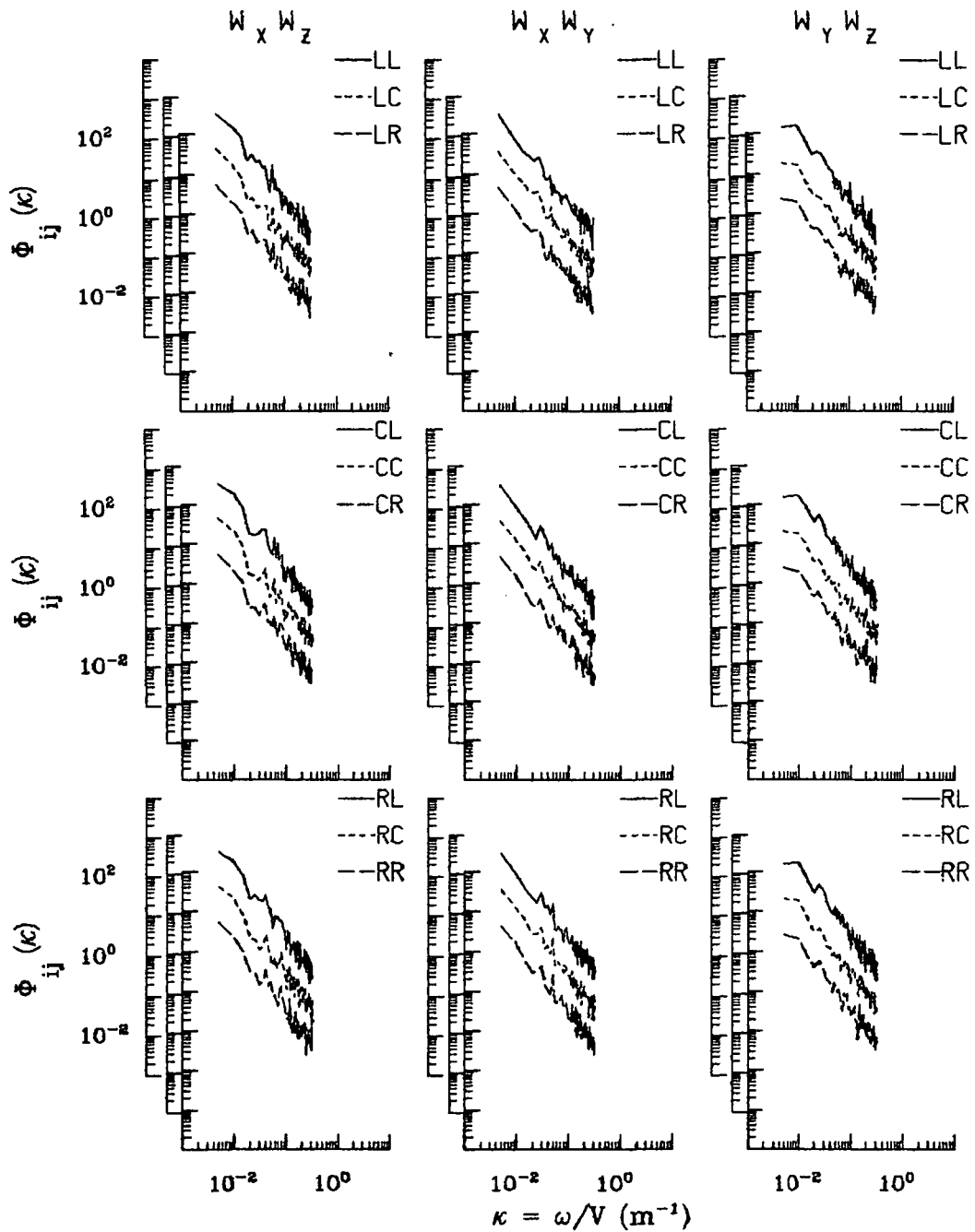

Figure A.112. Two-point cross-spectra of gust velocities, Flight 6, Run 17.

ORIGINAL PAGE IS
OF POOR QUALITY

TABLE A.28. List of All Parameters Measured and Their Range of Values, Flight 6, Run 17.

		START TIME = 52474.7196	STOP TIME = 52549.3196				
CHANNEL	UNITS	HIGH	LOW	MEAN	RMS	POINTS	
2	PHI DOT	RAD/SEC	.209	-.217	-.00170	.04546	2984
3	ACCL N CG	G UNITS	-.988	-.988	-.98774	.98774	2984
4	THETA DOT	RAD/SEC	.122	-.113	.00652	.02451	2984
5	THETA	RAD	.174	.023	.08875	.09447	2984
6	PHI	RAD	.074	-.128	-.01293	.03573	2984
7	PSI 1	DEGREES	275.280	265.777	270.74801	270.75425	2984
8	DEL PSI 1	DEGREES	7.371	-1.857	3.08773	3.59689	2984
9	PSI 2	DEGREES	272.743	263.590	268.55558	268.56166	2984
10	DEL PSI 2	DEGREES	7.166	-2.007	2.89207	3.42674	2984
11	ACCL N LT	G UNITS	2.945	-1.779	1.01073	1.08158	2984
12	ACCL N RT	G UNITS	2.434	-.775	1.02259	1.08794	2984
13	ACCL X CG	G UNITS	.231	.017	.08352	.08997	2984
14	ACCL Y CG	G UNITS	.168	-.173	.00220	.04995	2984
15	ALPHA CTR	RAD	.132	-.162	.00539	.02780	2984
16	BETA CTR	RAD	.079	-.167	-.03174	.04545	2984
17	TEMP I	DEG F	99.703	99.163	99.47933	99.47937	2984
18	TEMP P	DEG F	90.545	90.366	90.37427	90.37428	2984
19	ACCL Z INS	G UNITS	1.693	-.253	1.00389	1.02006	2984
20	ALPHA RT	RAD	.152	-.139	.01270	.03302	2984
21	BETA RT	RAD	.098	-.123	.00510	.03051	2984
22	ALPHA LT	RAD	.123	-.165	.01262	.03141	2984
23	BETA LT	RAD	.044	-.163	-.03944	.04893	2984
24	PSI DOT	RAD/SEC	.066	-.056	.00491	.02069	2984
25	TEMP TOT	DEG C	33.065	29.717	31.74151	31.75509	2984
26	QC LT	PSID	.827	.508	.65888	.66230	2984
27	QC CTR	PSID	.804	.502	.64457	.64776	2984
28	QC RT	PSID	.829	.512	.66707	.67026	2984
29	PS	PSIA	11.612	11.484	11.59329	11.59329	2984
30	TEMP IRT	DEG C	25.534	16.422	22.06122	22.15978	2984
31	D TO G	METERS	8757893.9908750806.508	*****	*****	*****	2984
32	B TO D	DEGREES	80.426	80.370	80.39767	80.39767	2984
33	LONG	DEGREES	-104.817	-104.902	-104.86002	104.86003	2984
34	LAT	DEGREES	39.757	39.755	39.75631	39.75631	2984
35	TRK ANG	DEGREES	272.482	267.132	270.95910	270.96365	2984
36	HDC	RADIANS	4.812	4.646	4.73520	4.73532	2984
37	VE	M/SEC	-91.779	-100.650	-96.39310	96.43963	2984
38	VN	M/SEC	4.165	-4.814	1.65304	3.11851	2984
39	ALTITUDE	KM	2.032	1.942	1.95573	1.95575	2984
40	TEPC	DEGREES C	28.207	25.182	27.06536	27.07667	2984
41	EW WND SPD	KNOTS	26.188	-15.593	.39163	7.26085	2984
42	NS WND SPD	KNOTS	12.856	-41.349	-6.92807	13.45640	2984
43	WIND SPEED	KNOTS	43.674	.296	12.21474	15.29034	2984
44	WIND DIREC	DEGREES	359.962	.291	171.00709	210.53264	2984
45	AIRSPD R	M/SEC	109.707	86.526	98.46400	98.57609	2984
46	AIRSPD C	M/SEC	107.757	85.742	96.81699	96.93120	2984
47	AIRSPD L	M/SEC	109.538	86.239	97.85946	97.98041	2984
48	DELTA ALT	METERS	81.851	-7.789	5.55690	9.55902	2984
49	INRTL DISP	METERS	20.372	-6.078	5.08689	8.67669	2984
50	UG RIGHT	M/SEC	8.629	-13.898	-.00000	3.84998	2984
51	UG CENTER	M/SEC	8.301	-13.942	-.00000	3.84131	2984
52	UG LEFT	M/SEC	8.647	-14.850	.00000	3.89621	2984
53	VG RIGHT	M/SEC	9.882	-16.800	.01417	5.93950	2984
54	VG CENTER	M/SEC	10.185	-17.674	.01795	5.94000	2984
55	VG LEFT	M/SEC	9.664	-16.259	.03311	5.82704	2984
56	WG RIGHT	M/SEC	12.361	-12.819	.02433	3.47526	2984
57	WG CENTER	M/SEC	13.838	-12.940	.03258	3.46751	2984
58	WG LEFT	M/SEC	11.341	-13.187	.02656	3.54615	2984

Date: July 14, 1982
 Time: 14:36:24(MDT)
 Duration: 46 seconds

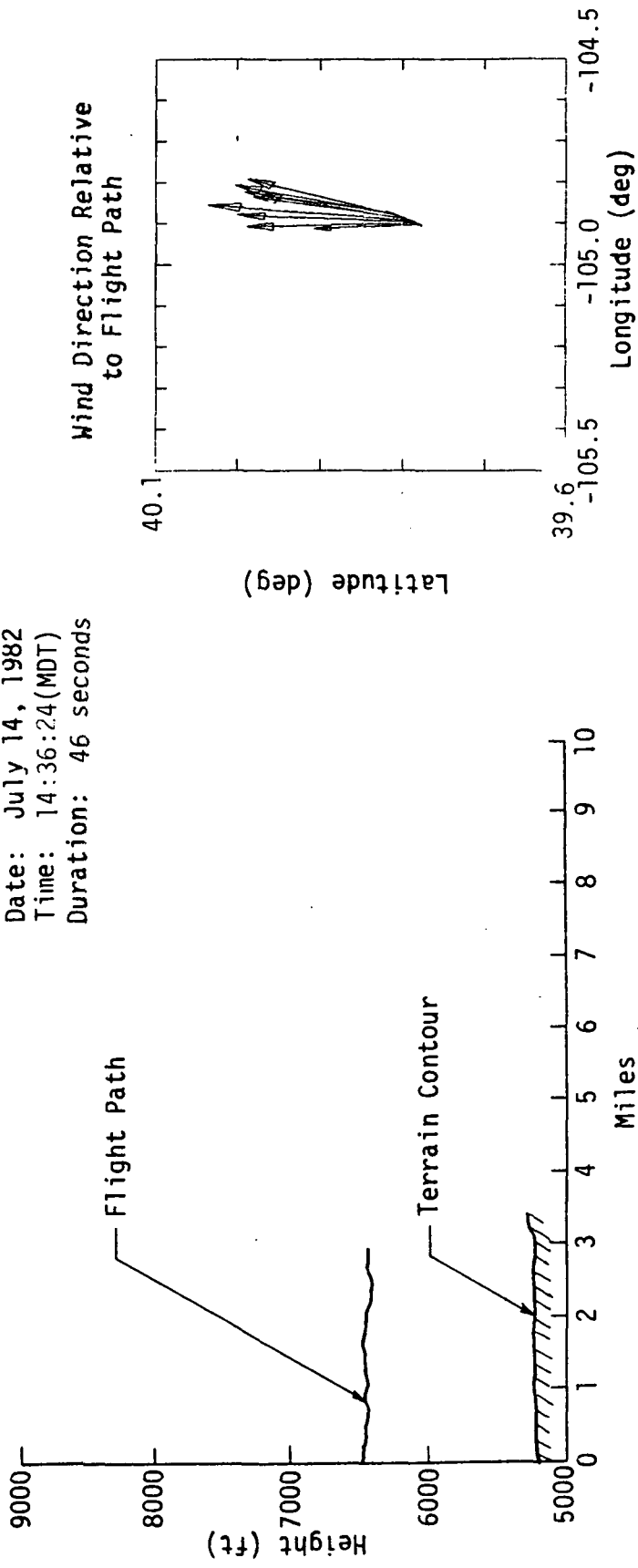

A.140

ORIGINAL PAGE IS
 OF POOR QUALITY

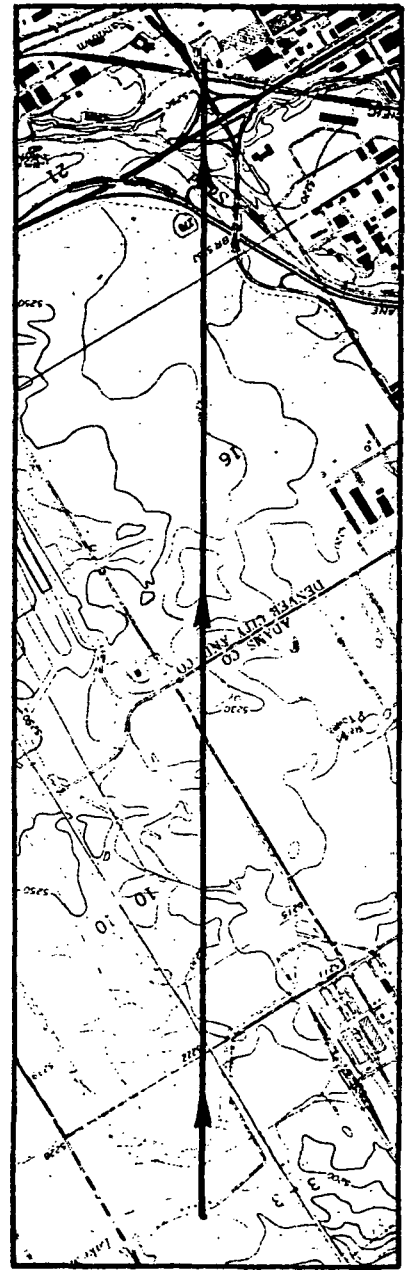

Figure A.113. Flight path information, Flight 6, Run 18.

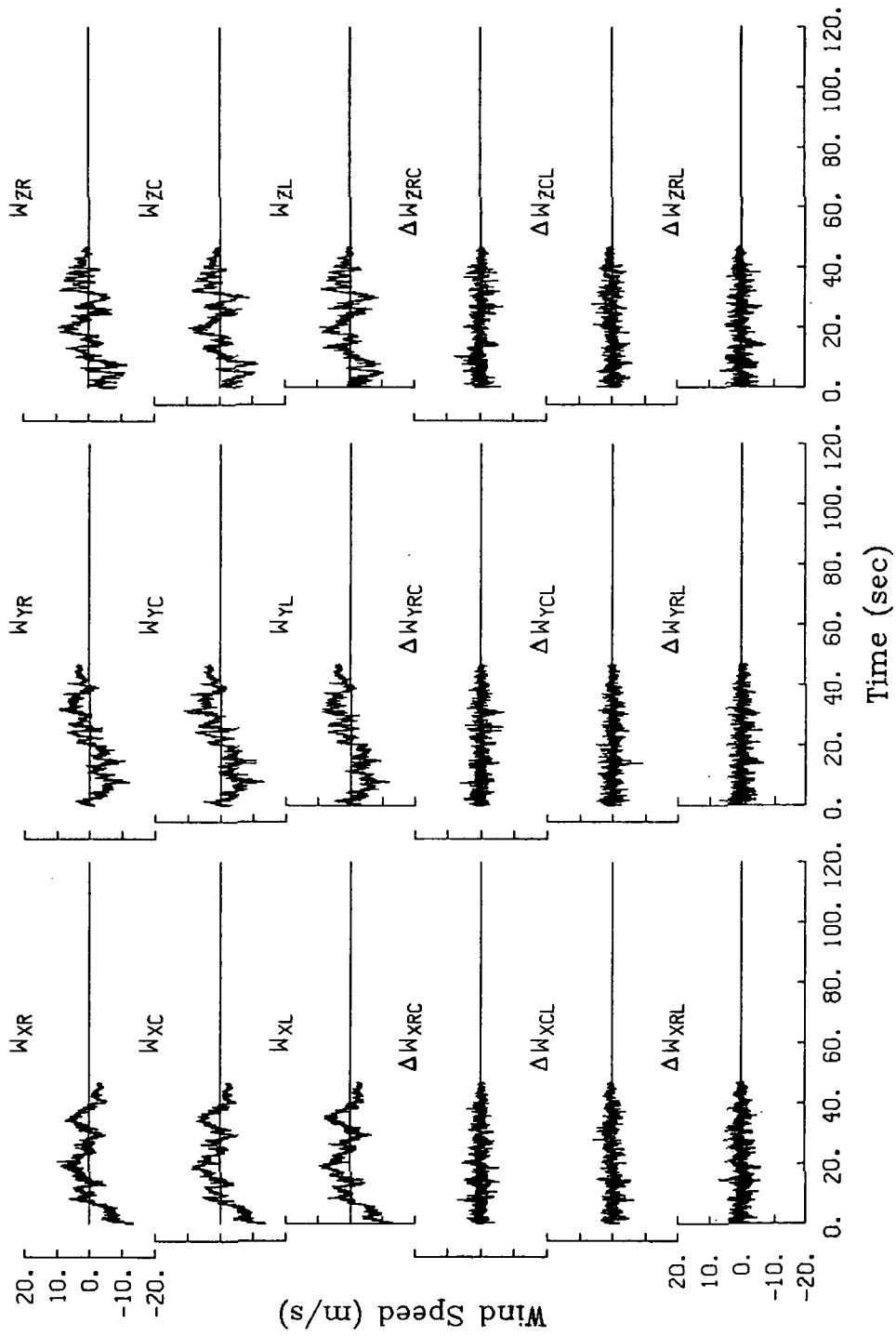
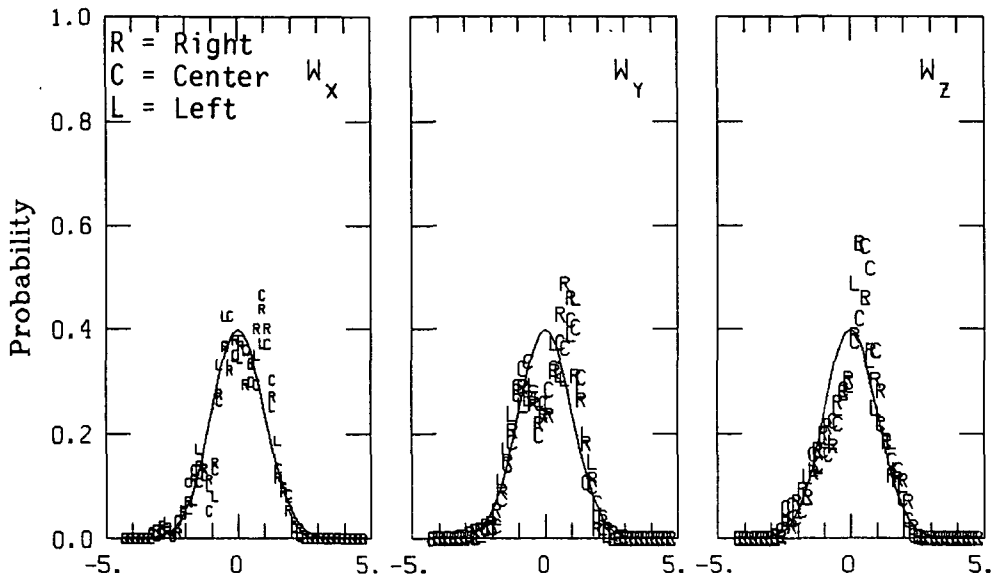

Figure A.114. Time histories of gust velocities and gust velocity differences, Flight 6, Run 18.

TABLE A.29. Average Turbulence Parameters and Integral Length Scales, Flight 6, Run 18.

I. Mean Airspeed (m/s)			II. Standard Deviation of Gust Velocities (m/s)		
V_L	V_C	V_R	$\sigma_{W_{XL}}$	$\sigma_{W_{XC}}$	$\sigma_{W_{XR}}$
103.5	102.4	104.1	4.40	4.24	4.09
			$\sigma_{W_{YL}}$	$\sigma_{W_{YC}}$	$\sigma_{W_{YR}}$
			4.11	4.21	4.14
			$\sigma_{W_{ZL}}$	$\sigma_{W_{ZC}}$	$\sigma_{W_{ZR}}$
			4.09	4.16	4.25
III. Standard Deviation of Gust Velocity Differences (m/s)			IV. Integral Length Scale (m)		
$\sigma_{\Delta W_{XCL}}$	$\sigma_{\Delta W_{XRC}}$	$\sigma_{\Delta W_{XRL}}$	$L_{W_{XL}}$	$L_{W_{XC}}$	$L_{W_{XR}}$
1.45	1.46	1.67	255	258	261
$\sigma_{\Delta W_{YCL}}$	$\sigma_{\Delta W_{YRC}}$	$\sigma_{\Delta W_{YRL}}$	$L_{W_{YL}}$	$L_{W_{YC}}$	$L_{W_{YR}}$
1.52	1.54	1.68	1198	1136	1155
$\sigma_{\Delta W_{ZCL}}$	$\sigma_{\Delta W_{ZRC}}$	$\sigma_{\Delta W_{ZRL}}$	$L_{W_{ZL}}$	$L_{W_{ZC}}$	$L_{W_{ZR}}$
1.66	1.62	1.93	428	520	425



Normalized Gust Velocity (Standard Deviations)

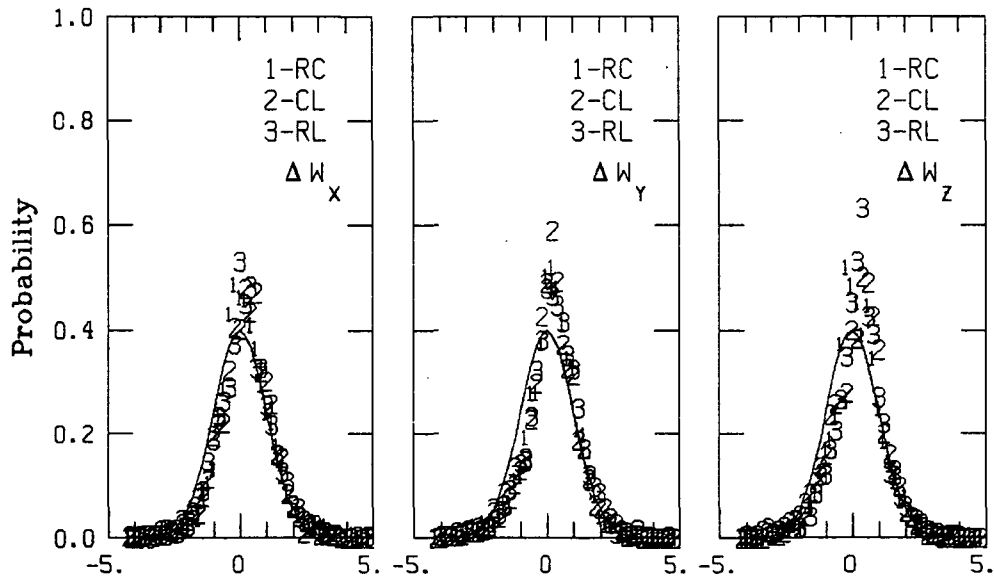

Normalized Velocity Differences (Standard Deviations)

Figure A.115. Probability density function for gust velocities and gust velocity differences, Flight 6, Run 18.

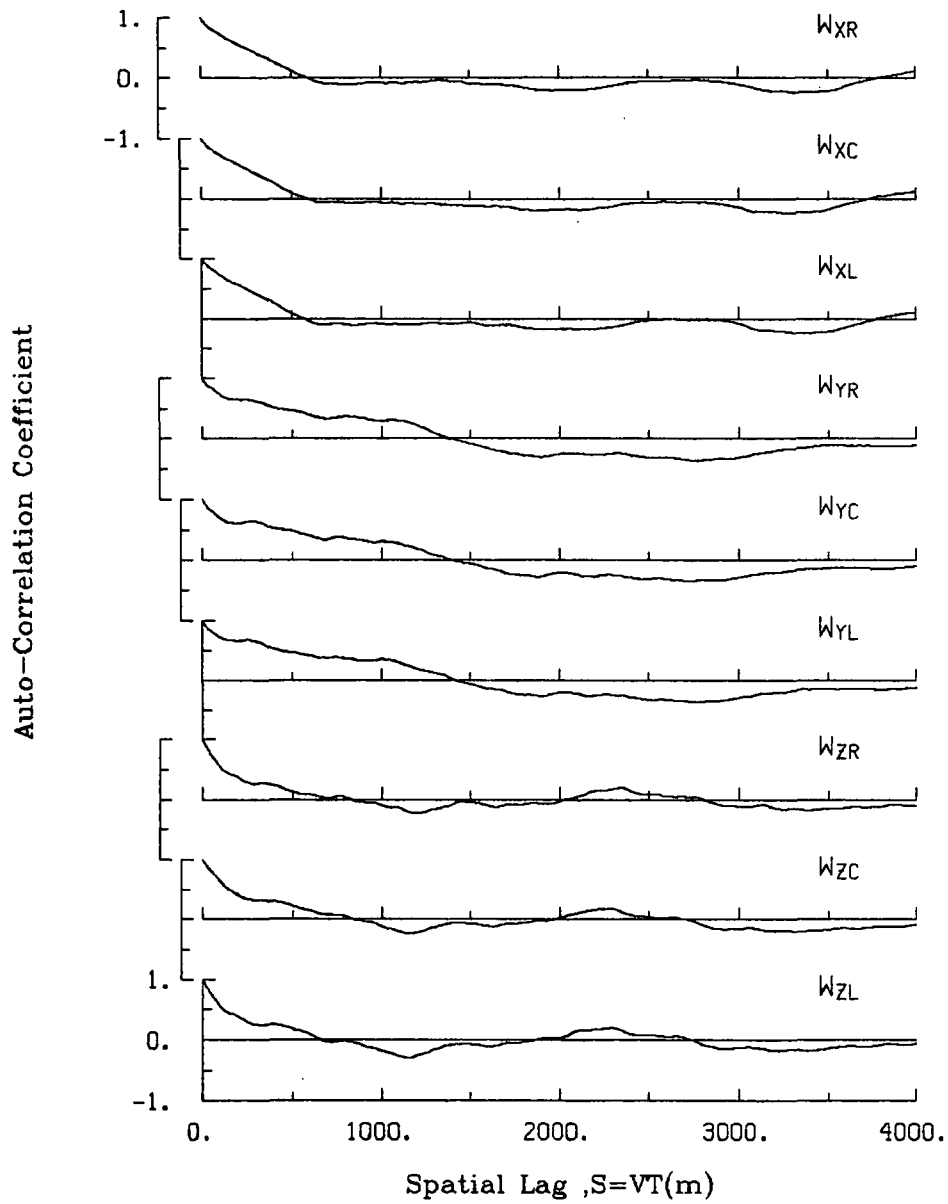

Figure A.116. Single-point auto-correlation coefficient of gust velocities, Flight 6, Run 18.

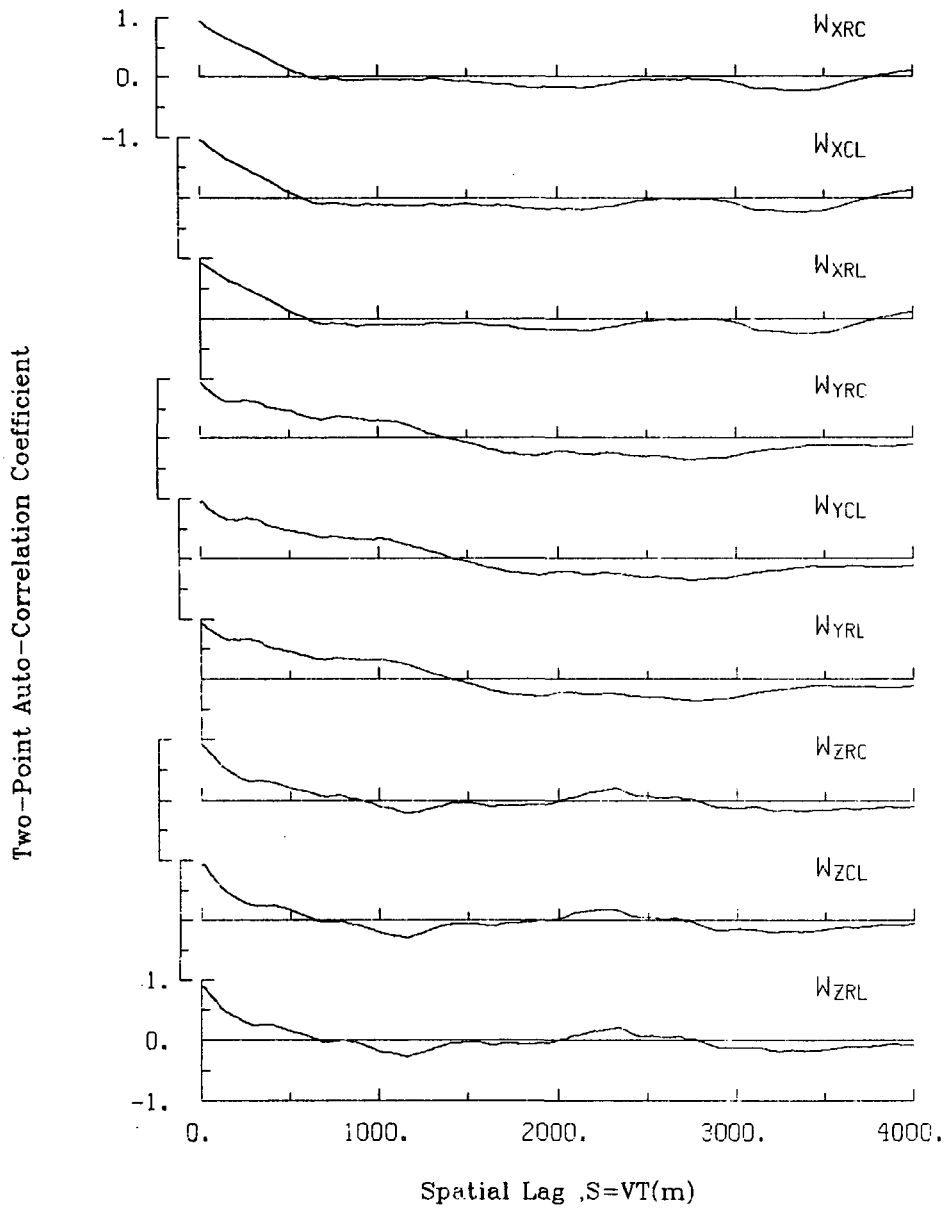

Figure A.117. Two-point auto-correlation coefficient of gust velocities, Flight 6, Run 18.

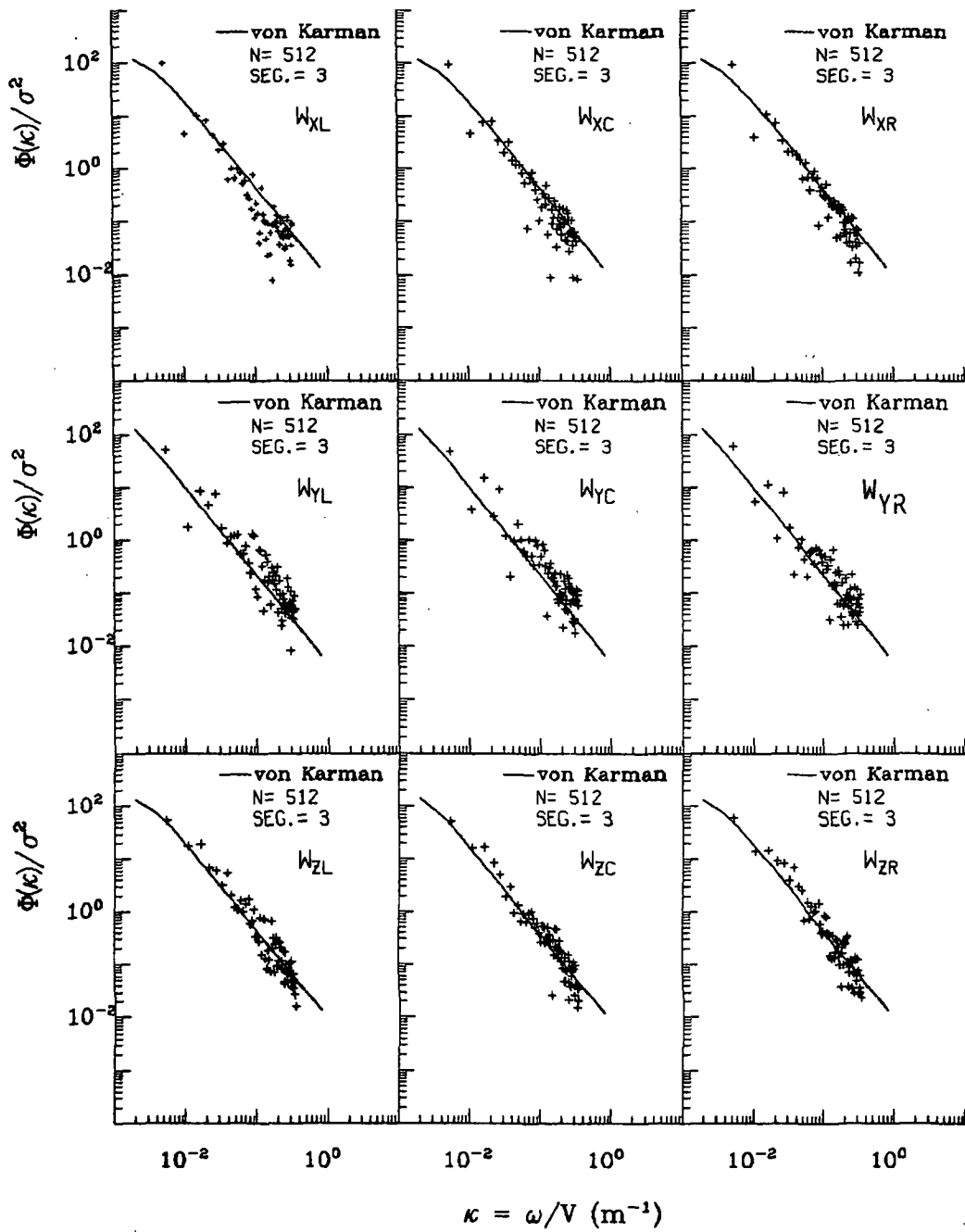

Figure A.118. Normalized auto-spectra of gust velocities, Flight 6, Run 18.

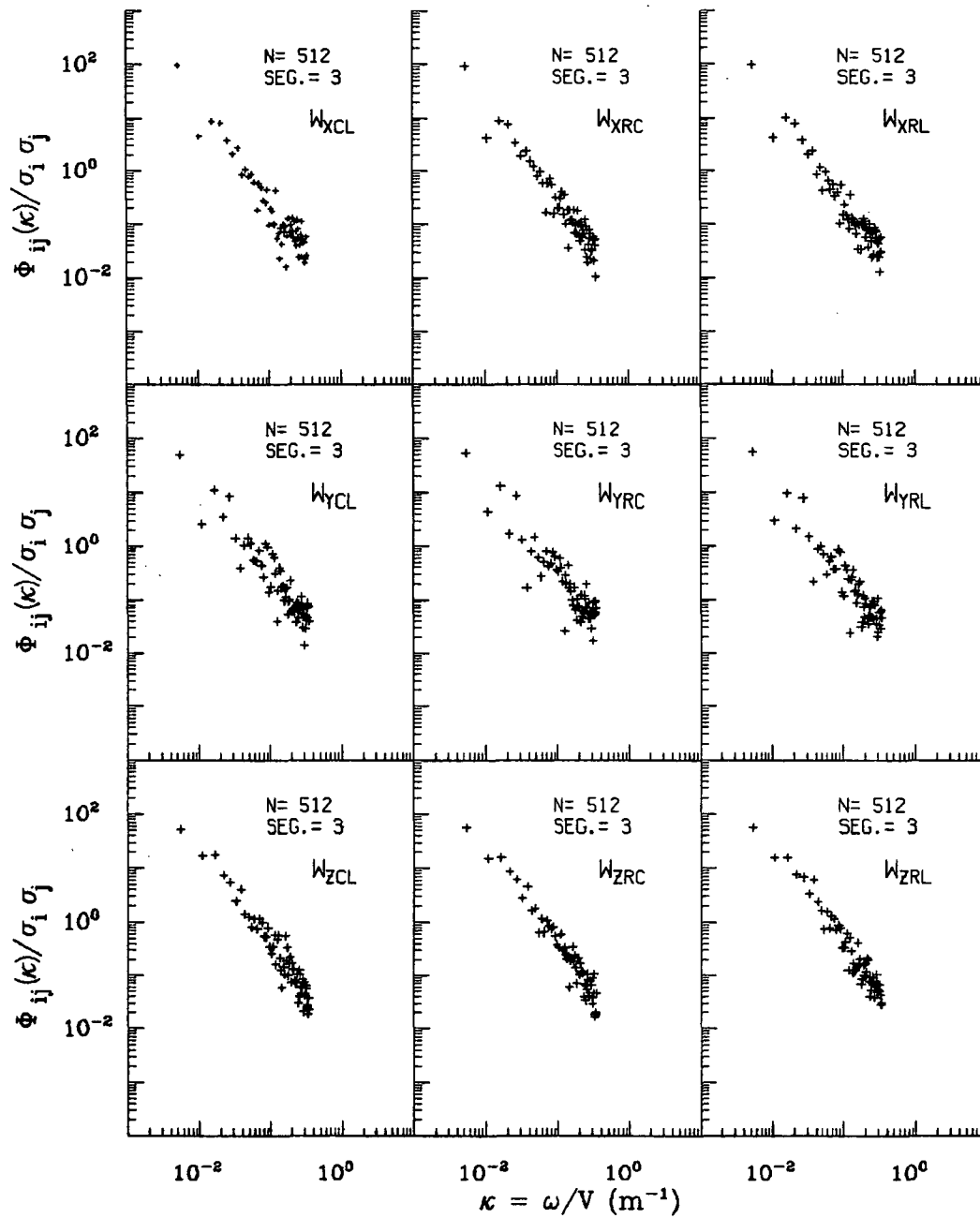

Figure A.119. Normalized two-point auto-spectra of gust velocities, Flight 6, Run 18.

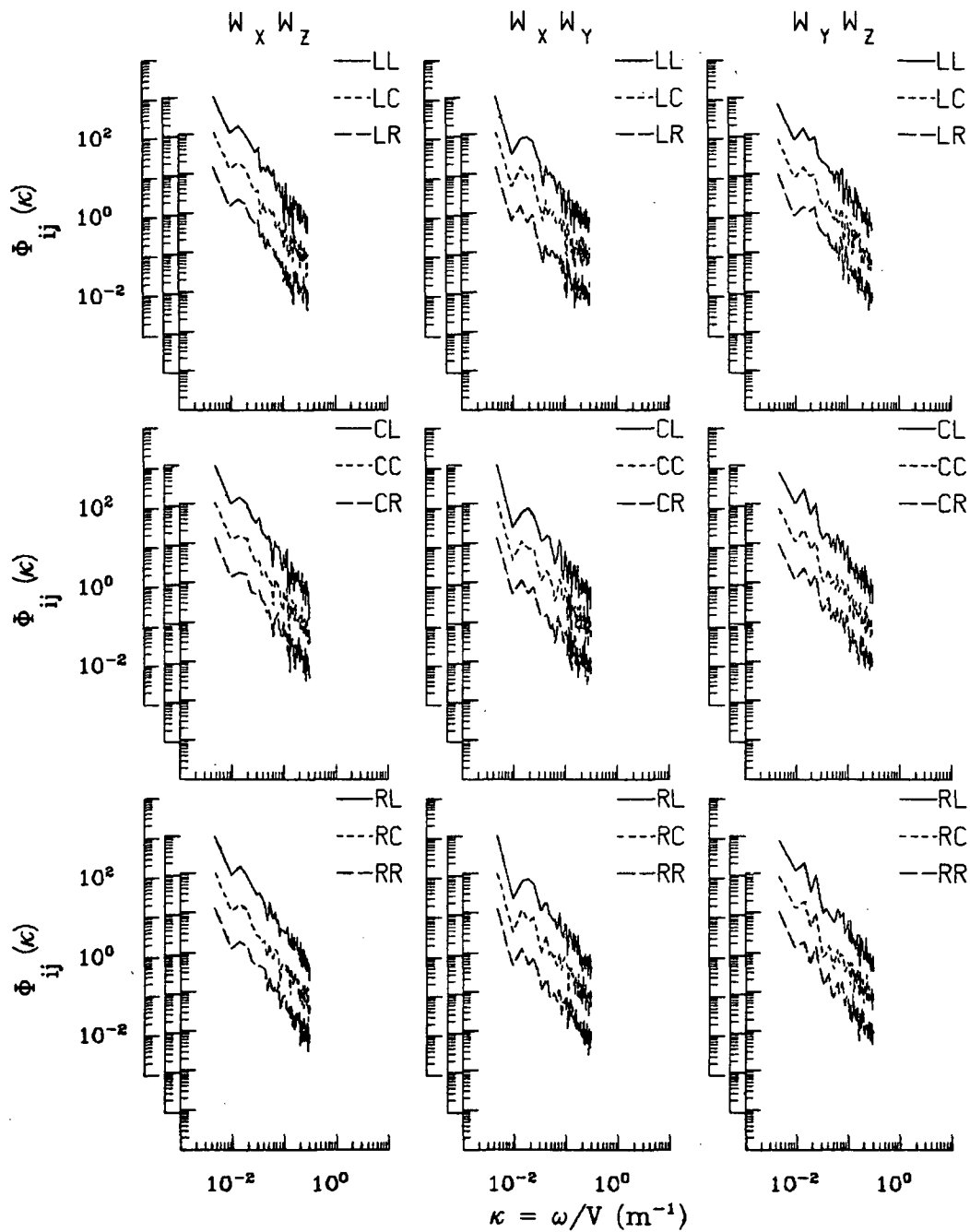

Figure A.120. Two-point cross-spectra of gust velocities, Flight 6, Run 18.

ORIGINAL PAGE IS
OF POOR QUALITY

TABLE A.30. List of All Parameters Measured and Their Range of Values,
Flight 6, Run 18.

		START TIME = 52584.5399	STOP TIME = 52631.3149				
CHANNEL	UNITS	HIGH	LOW	MEAN	RMS	POINTS	
2 PHI DJT	RAD/SEC	.195	-.207	-.00258	.06040	1871	
3 ACCL N CG	G UNITS	-.988	-.988	-.98774	.98774	1871	
4 THETA DOT	RAD/SEC	.087	-.084	.00333	.02547	1871	
5 THETA	RAD	.153	-.012	.07550	.08620	1871	
6 PHI	RAD	.145	-.127	.00356	.04152	1871	
7 PSI 1	DEGREES	35.765	25.910	31.45116	31.49658	1871	
8 DEL PSI 1	DEGREES	6.342	-3.003	2.35194	2.87551	1871	
9 PSI 2	DEGREES	397.367	388.214	393.41160	393.41494	1871	
10 DEL PSI 2	DEGREES	6.108	-3.389	2.06283	2.66879	1871	
11 ACCL N LT	G UNITS	2.588	-.636	1.00169	1.08411	1871	
12 ACCL N RT	G UNITS	2.747	-.247	1.01300	1.08702	1871	
13 ACCL X CG	G UNITS	.318	.017	.15350	.17344	1871	
14 ACCL Y CG	G UNITS	.157	-.118	.00152	.03783	1871	
15 ALPHA CTR	RAD	.092	-.081	-.00708	.03364	1871	
16 BETA CTR	RAD	.070	-.159	-.03934	.05356	1871	
17 TEMP I	DEG F	99.163	97.724	98.39555	98.39612	1871	
18 TEMP P	DEG F	90.545	90.366	90.46761	90.46765	1871	
19 ACCL Z INS	G UNITS	1.645	.415	1.00154	1.02298	1871	
20 ALPHA RT	RAD	.114	-.092	-.00050	.03735	1871	
21 BETA RT	RAD	.078	-.100	-.00414	.03295	1871	
22 ALPHA LT	RAD	.102	-.075	.00208	.03573	1871	
23 BETA LT	RAD	.048	-.141	-.04514	.05598	1871	
24 PSI DOT	RAD/SEC	.072	-.068	.00388	.02713	1871	
25 TEMP TOT	DEG C	34.049	29.520	31.36908	31.39065	1871	
26 QC LT	PSID	1.004	.474	.74758	.76334	1871	
27 QC CTR	PSID	.989	.478	.73113	.74626	1871	
28 QC RT	PSID	1.026	.481	.75578	.77157	1871	
29 PS	PSIA	11.604	11.566	11.58484	11.58485	1871	
30 TEMP IRT	DEG C	26.090	12.776	20.59054	21.00565	1871	
31 D TO G	METERS	8754689.93387510	12.826	*****	*****	1871	
32 B TO D	DEGREES	80.379	80.365	80.37110	80.37110	1871	
33 LONG	DEGREES	-104.870	-104.904	-104.88784	104.88784	1871	
34 LAT	DEGREES	39.819	39.776	39.79683	39.79684	1871	
35 TRK ANG	DEGREES	32.552	30.151	31.27949	31.28723	1871	
36 HDG	RADIANS	.643	.475	.57156	.57234	1871	
37 VE	M/SEC	70.764	49.790	62.60382	62.98293	1871	
38 VN	M/SEC	112.245	83.533	102.85307	103.25508	1871	
39 ALTITUDE	KM	1.975	1.948	1.96161	1.96162	1871	
40 TEMPC	DEGREES C	27.299	25.081	26.09496	26.09952	1871	
41 EW WND SPD	KNOTS	24.320	-16.134	7.90204	10.95496	1871	
42 NS WND SPD	KNOTS	54.570	14.987	36.70662	37.43329	1871	
43 WIND SPEED	KNOTS	55.573	15.448	38.30342	39.00336	1871	
44 WIND DIREC	DEGREES	225.526	149.256	191.73120	192.09765	1871	
45 AIPSPEED R	M/SEC	121.605	83.853	104.08300	104.62399	1871	
46 AIPSPEED C	M/SEC	119.295	83.638	102.41479	102.94240	1871	
47 AIPSPEED L	M/SEC	120.086	83.232	103.52548	104.06756	1871	
48 DELTA ALT	METERS	20.633	-5.974	7.32828	9.68465	1871	
49 INRTL DISP	METERS	20.283	-12.200	4.10521	9.37802	1871	
50 UG RIGHT	M/SEC	9.760	-13.188	.00000	3.92471	1871	
51 UG CENTER	M/SEC	8.526	-13.847	.00000	4.00853	1871	
52 UG LEFT	M/SEC	9.174	-13.089	.00000	4.17415	1871	
53 VG RIGHT	M/SEC	9.684	-12.167	.16674	3.94106	1871	
54 VG CENTER	M/SEC	11.376	-13.122	.18613	4.03599	1871	
55 VG LEFT	M/SEC	8.716	-11.808	.19356	3.96635	1871	
56 WG RIGHT	M/SEC	9.557	-11.531	.10974	3.96695	1871	
57 WG CENTER	M/SEC	9.480	-11.527	.13023	3.89513	1871	
58 WG LEFT	M/SEC	9.369	-10.305	.08614	3.79883	1871	

Date: July 14, 1982
 Time: 14:38:24(MDT)
 Duration: 61 seconds

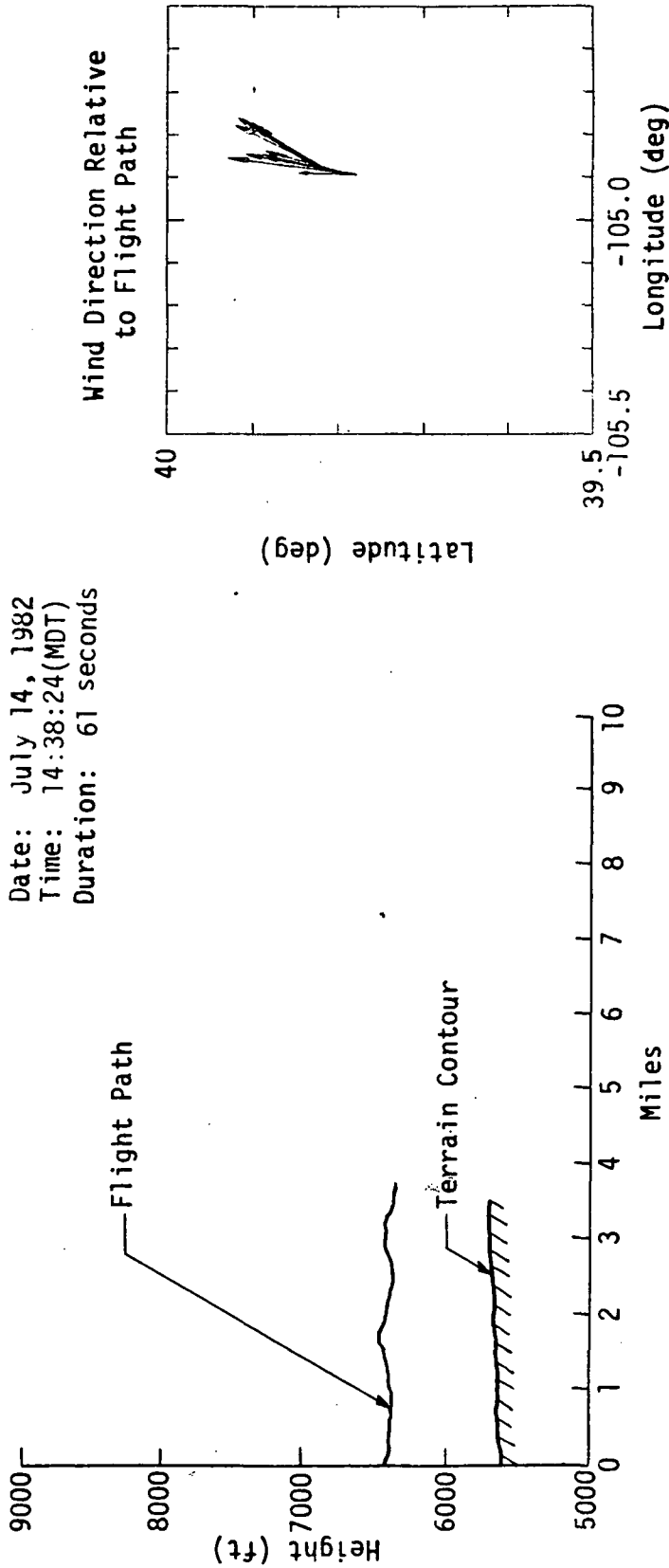

Latitude (deg)

Wind Direction Relative to Flight Path

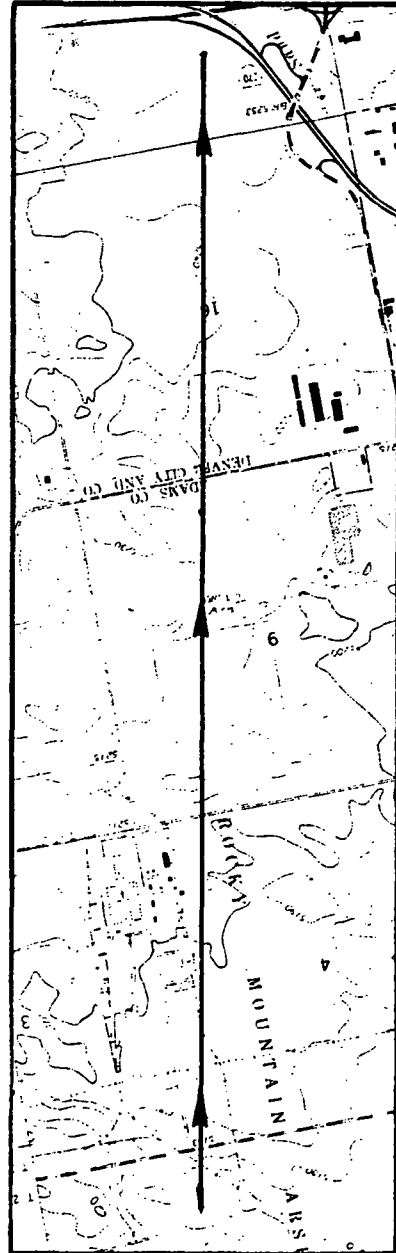
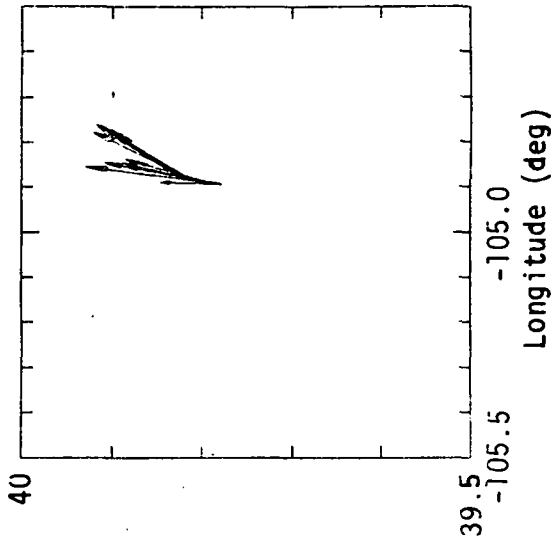

Figure A.121. Flight path information, Flight 6, Run 19.

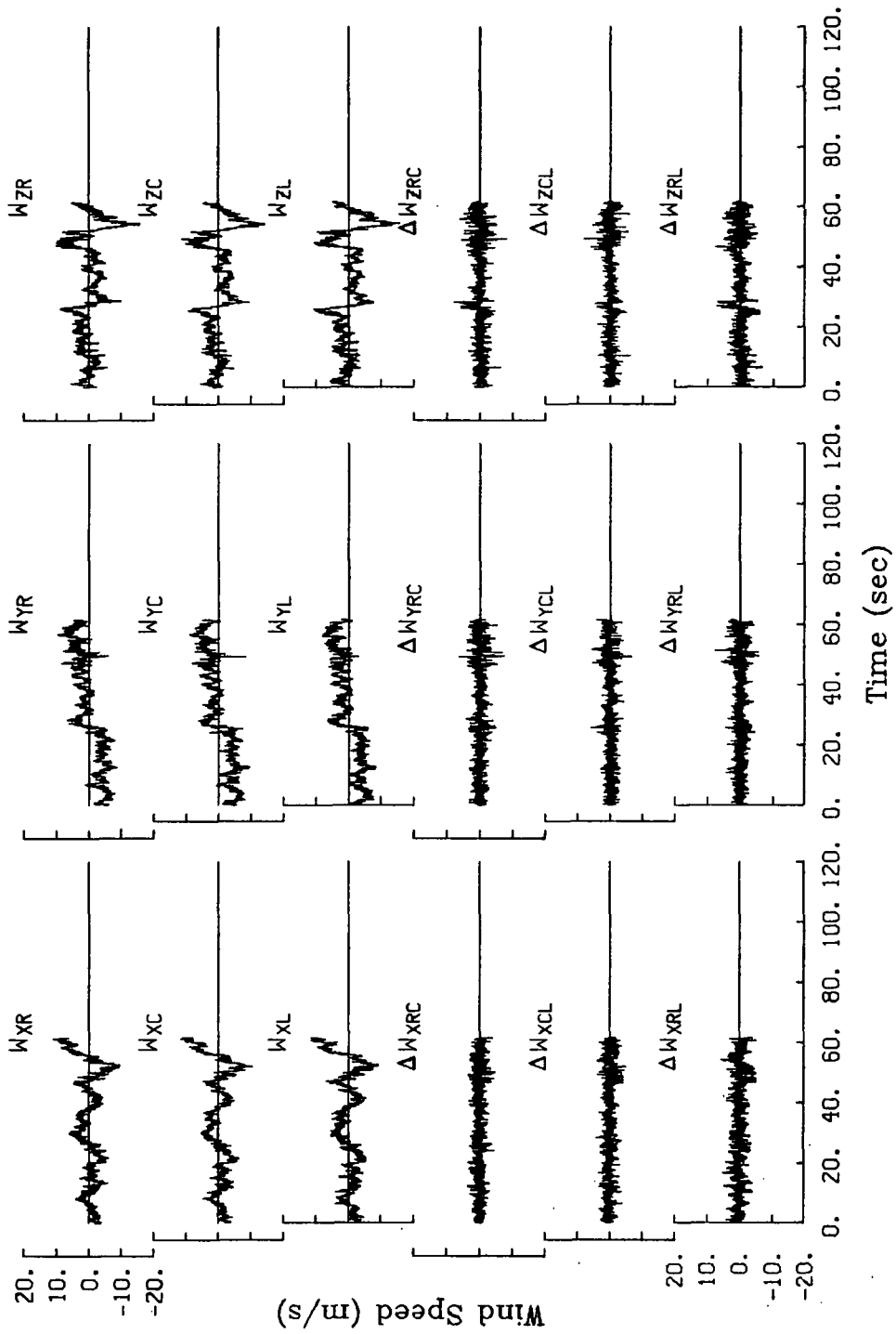

Figure A.122. Time histories of gust velocities and gust velocity differences, Flight 6, Run 19.

TABLE A.31. Average Turbulence Parameters and Integral Length Scales, Flight 6, Run 19.

I. Mean Airspeed (m/s)			II. Standard Deviation of Gust Velocities (m/s)		
V_L	V_C	V_R	$\sigma_{W_{XL}}$	$\sigma_{W_{XC}}$	$\sigma_{W_{XR}}$
96.6	95.5	97.3	2.45	2.42	2.41
			$\sigma_{W_{YL}}$	$\sigma_{W_{YC}}$	$\sigma_{W_{YR}}$
			3.44	3.62	3.55
			$\sigma_{W_{ZL}}$	$\sigma_{W_{ZC}}$	$\sigma_{W_{ZR}}$
			3.19	3.11	3.10
III. Standard Deviation of Gust Velocity Differences (m/s)			IV. Integral Length Scale (m)		
$\sigma_{\Delta W_{XCL}}$	$\sigma_{\Delta W_{XRC}}$	$\sigma_{\Delta W_{XRL}}$	$L_{W_{XL}}$	$L_{W_{XC}}$	$L_{W_{XR}}$
1.13	1.17	1.46	190	190	194
$\sigma_{\Delta W_{YCL}}$	$\sigma_{\Delta W_{YRC}}$	$\sigma_{\Delta W_{YRL}}$	$L_{W_{YL}}$	$L_{W_{YC}}$	$L_{W_{YR}}$
1.27	1.19	1.29	1579	1560	1467
$\sigma_{\Delta W_{ZCL}}$	$\sigma_{\Delta W_{ZRC}}$	$\sigma_{\Delta W_{ZRL}}$	$L_{W_{ZL}}$	$L_{W_{ZC}}$	$L_{W_{ZR}}$
1.44	1.29	1.69	308	330	307

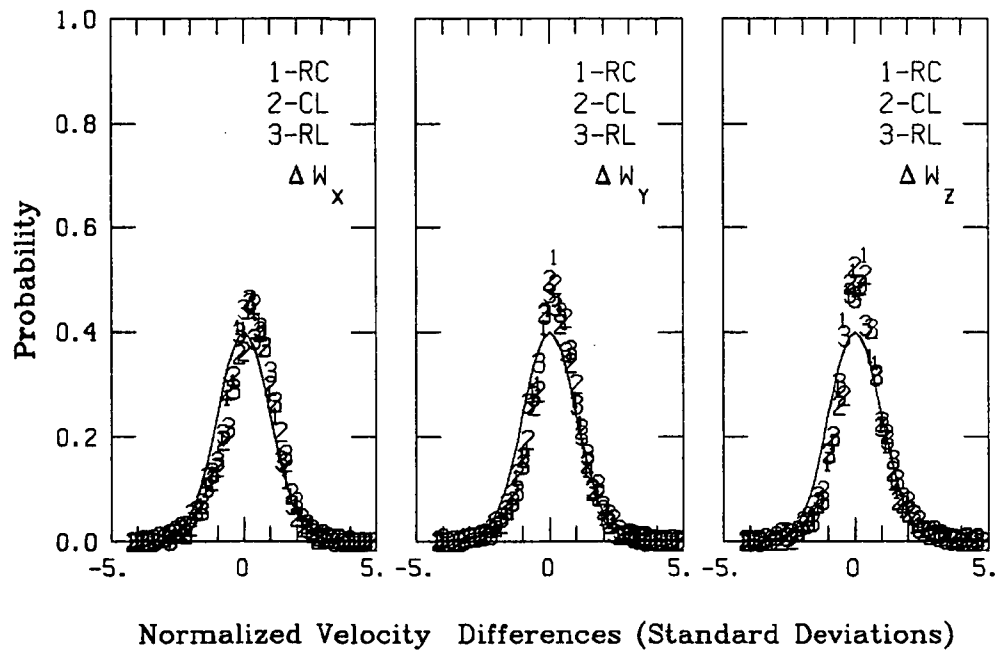
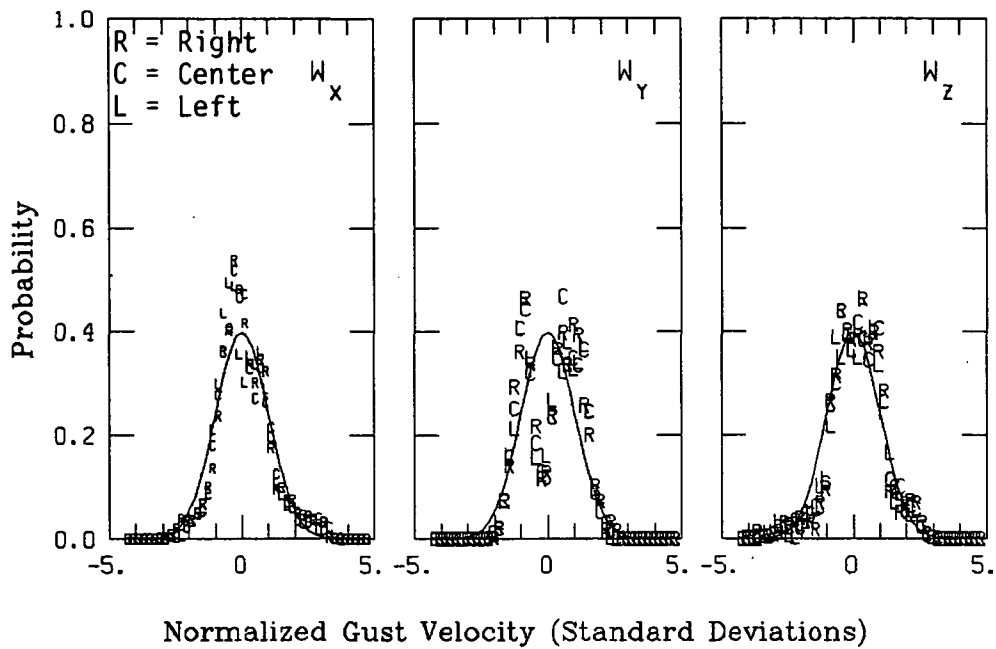

Figure A.123. Probability density function for gust velocities and gust velocity differences, Flight 6, Run 19.

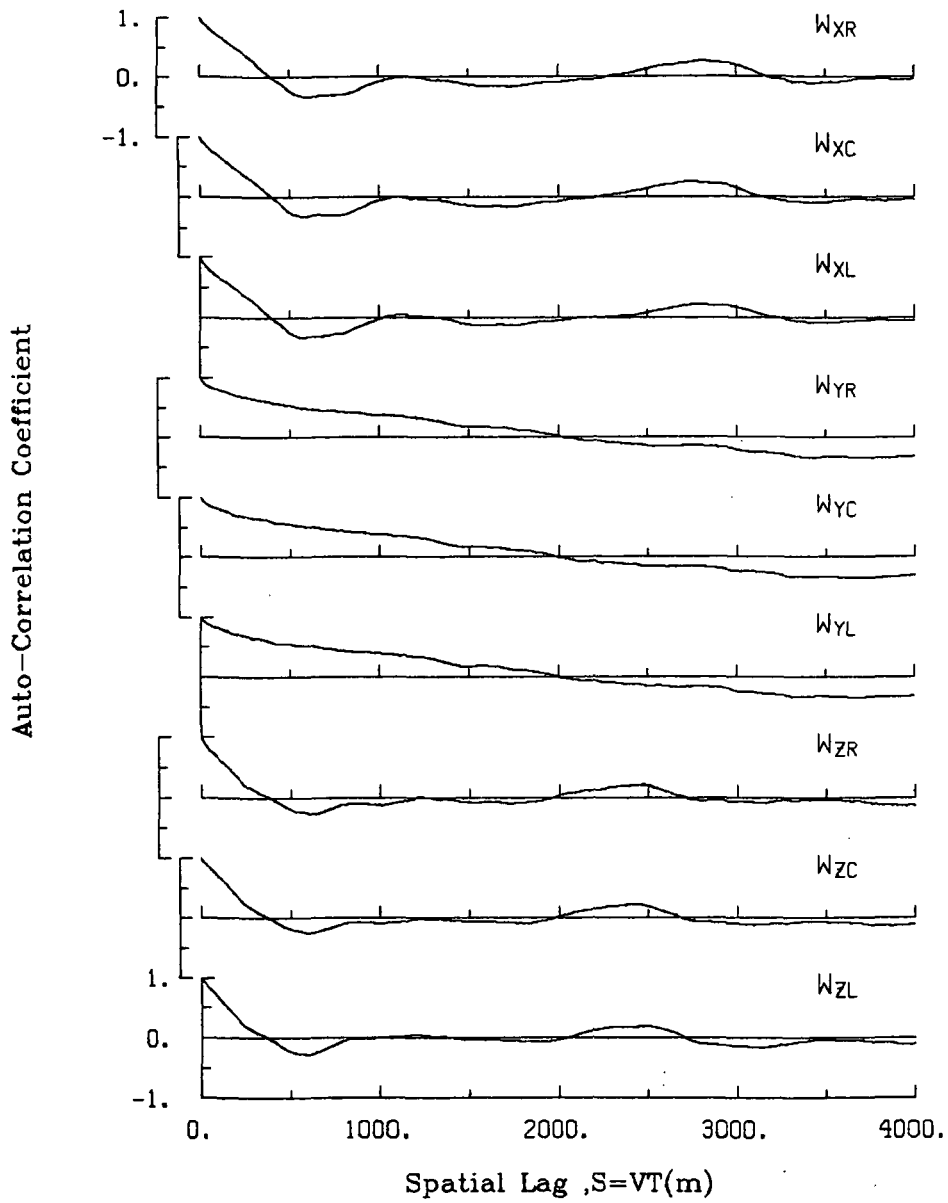

Figure A.124. Single-point auto-correlation coefficient of gust velocities, Flight 6, Run 19.

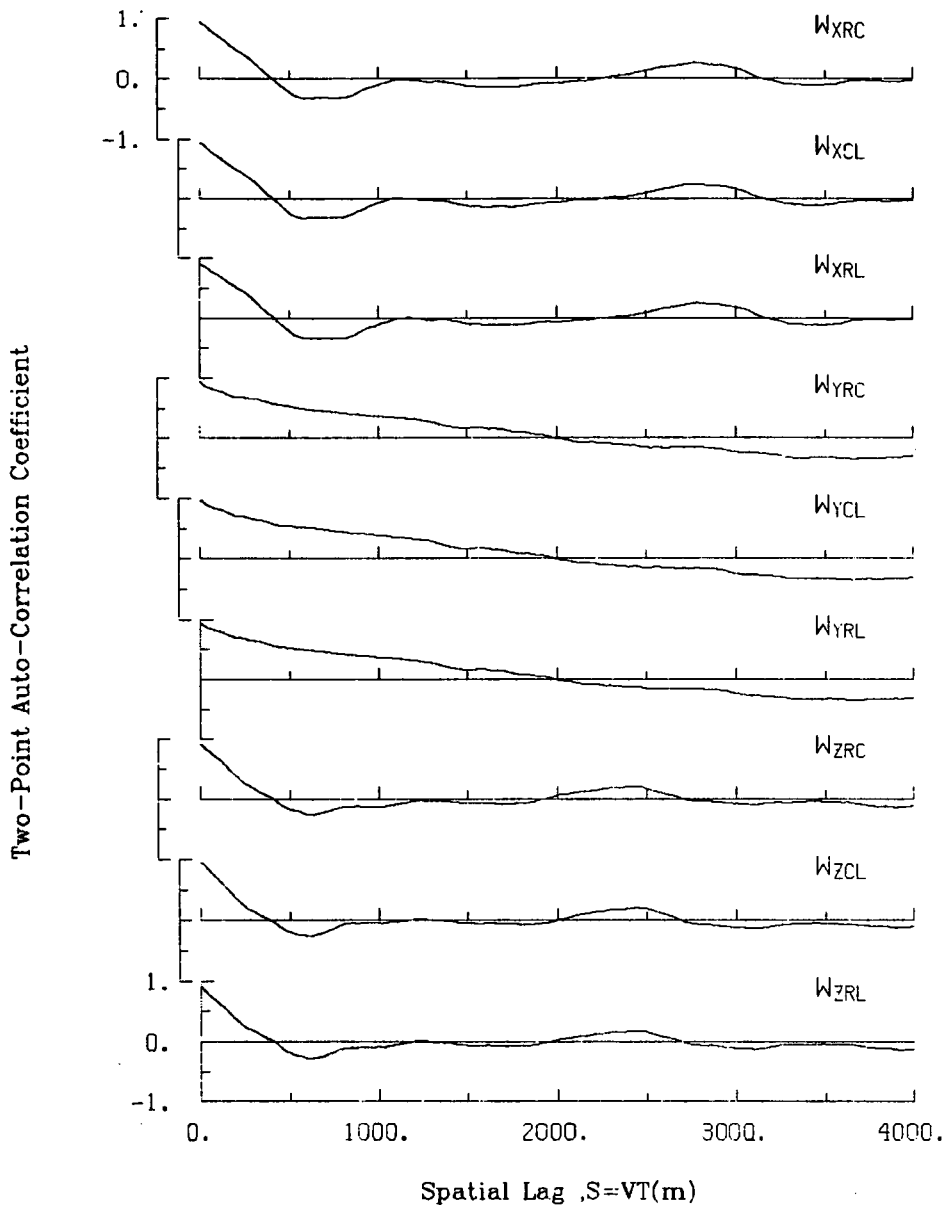

Figure A.125. Two-point auto-correlation coefficient of gust velocities, Flight 6, Run 19.

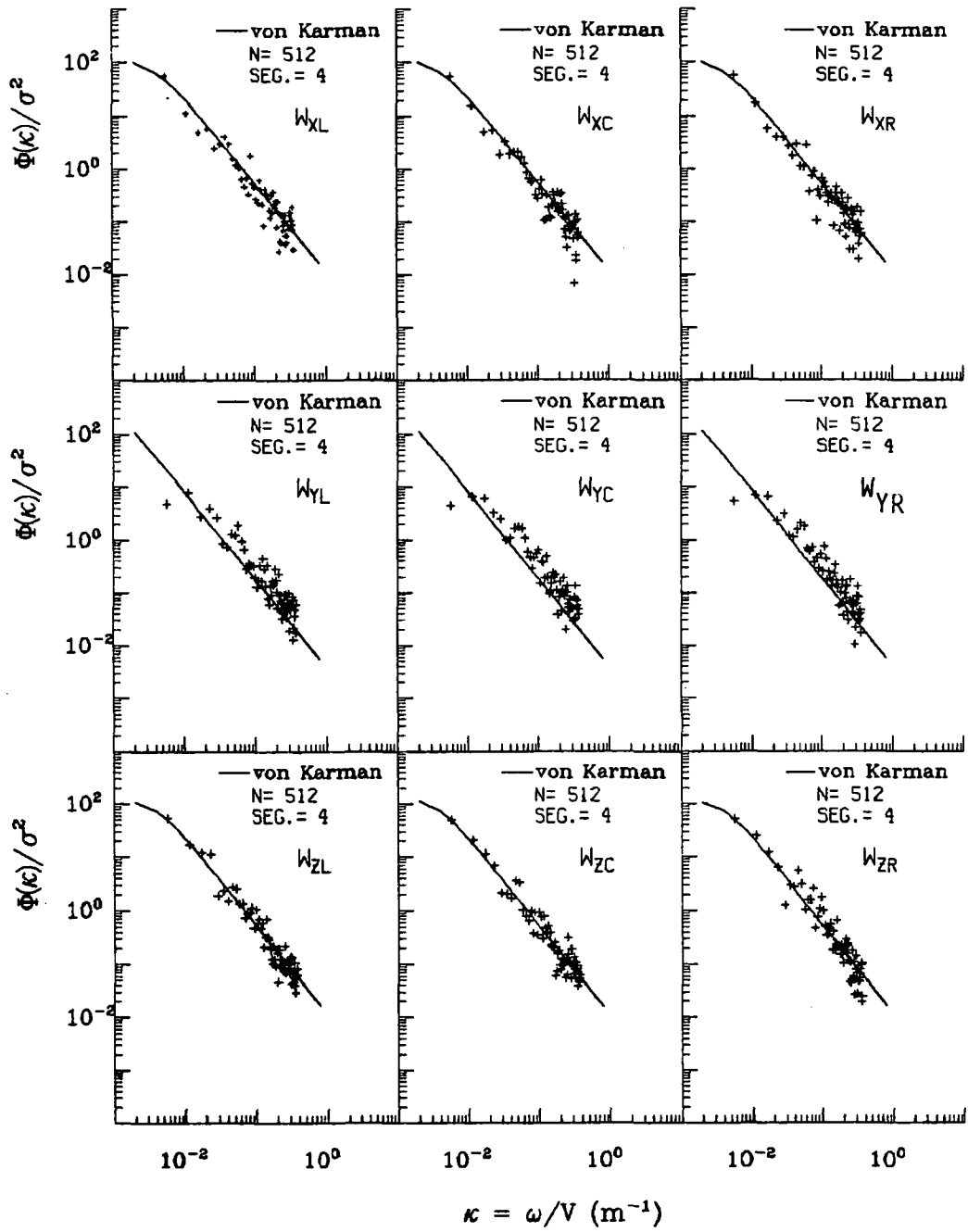

Figure A.126. Normalized auto-spectra of gust velocities, Flight 6, Run 19.

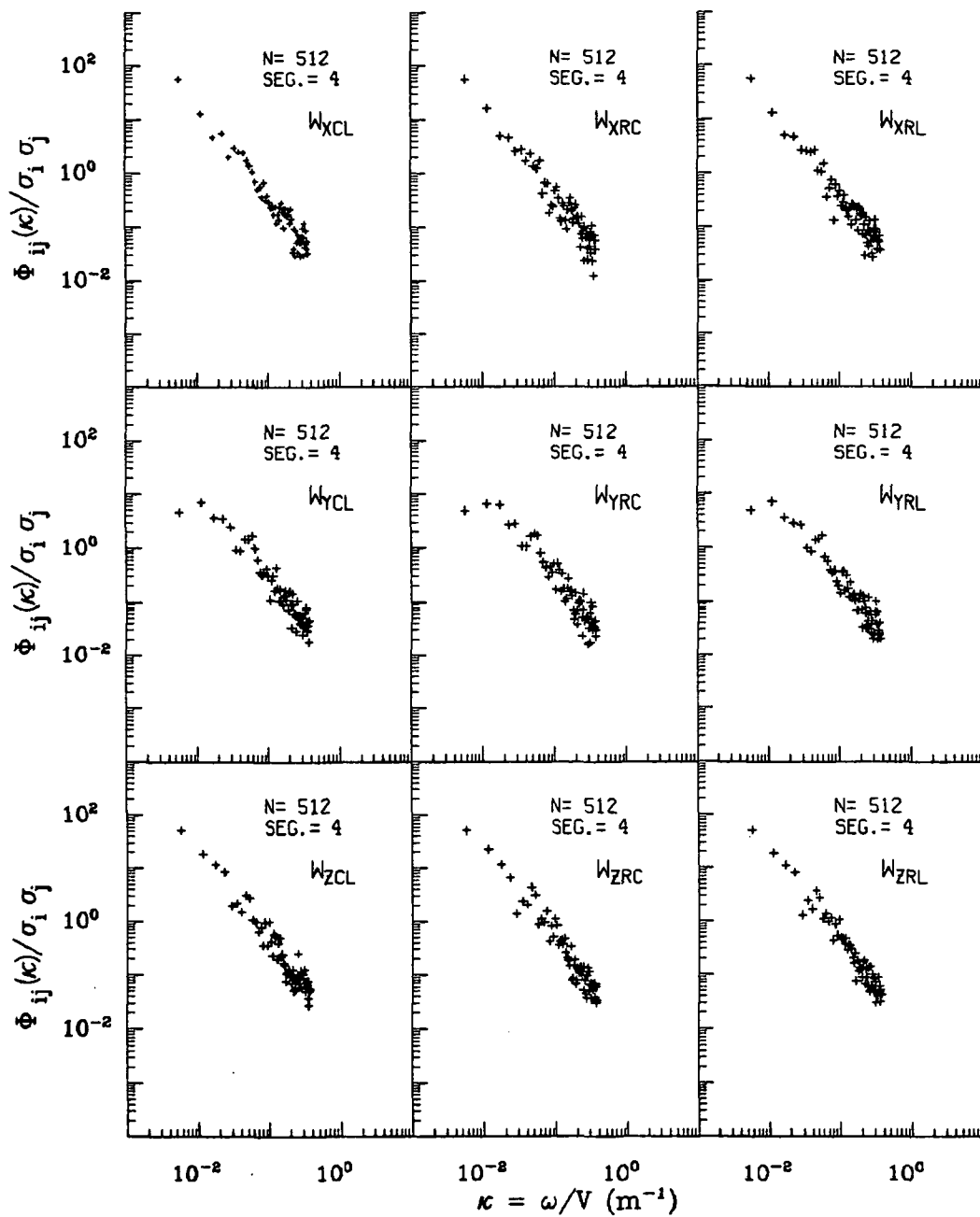

Figure A.127. Normalized two-point auto-spectra of gust velocities, Flight 6, Run 19.

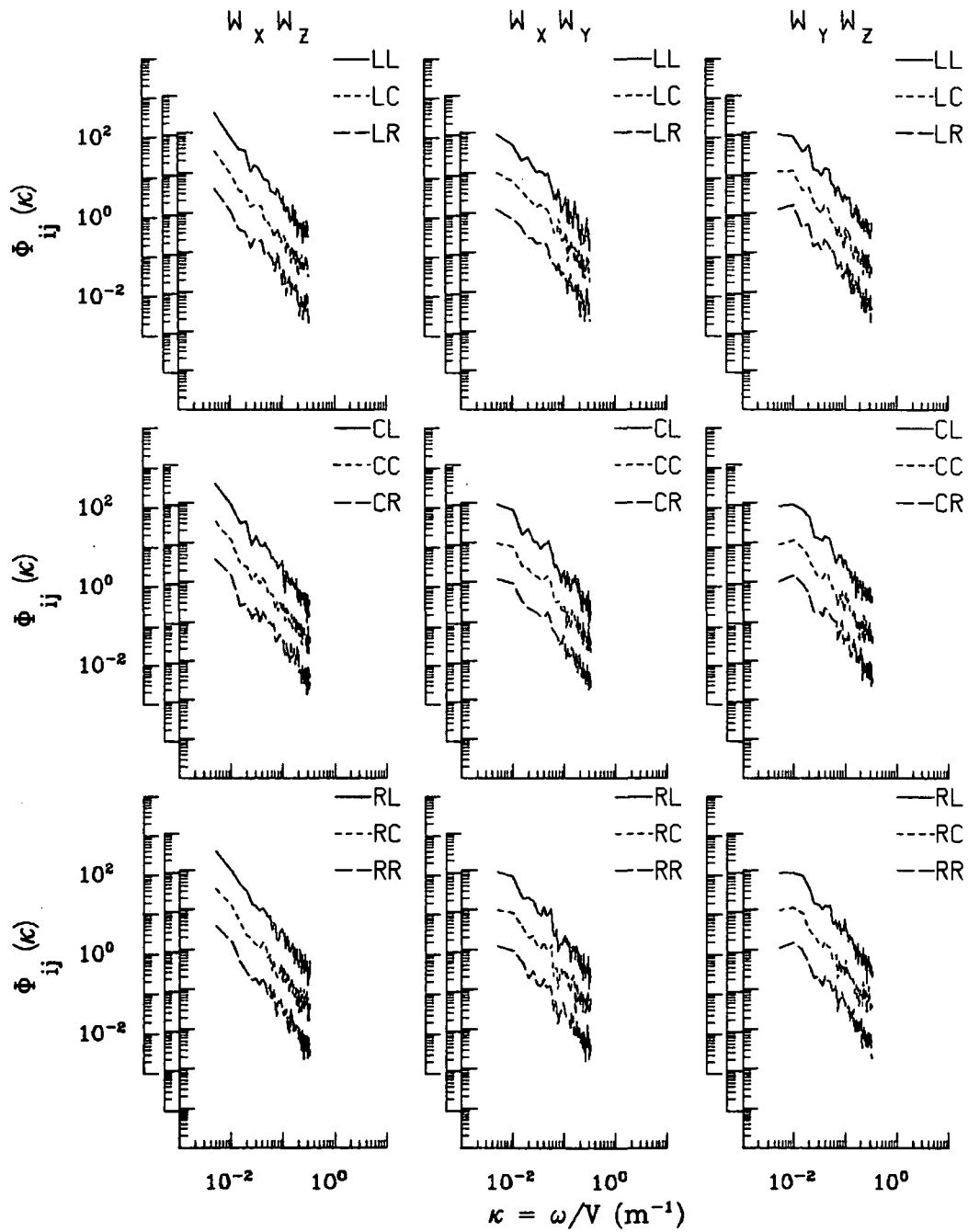

Figure A.128. Two-point cross-spectra of gust velocities, Flight 6, Run 19.

**ORIGINAL PAGE IS
OF POOR QUALITY**

TABLE A.32. List of All Parameters Measured and Their Range of Values,
Flight 6, Run 19.

START TIME = 52704.6901

STOP TIME = 52766.2901

CHANNEL	UNITS	HIGH	LOW	MEAN	RMS	POINTS
2 PHI DOT	RAD/SEC	.195	-.140	-.00296	.04568	2464
3 ACCL N CG	G UNITS	-.988	-.988	-.98774	.98774	2464
4 THETA DOT	RAD/SEC	.089	-.074	.00696	.02189	2464
5 THETA	RAD	.138	.027	.08364	.08753	2464
6 PHI	RAD	.085	-.142	-.00324	.03751	2464
7 PSI 1	DEGREES	194.979	185.469	191.80679	191.81632	2464
8 DEL PSI 1	DEGREES	7.048	-7.323	-1.19551	2.48680	2464
9 PSI 2	DEGREES	557.548	543.466	549.52867	549.53279	2464
10 DEL PSI 2	DEGREES	1.521	-7.594	-1.56996	2.45186	2464
11 ACCL N LT	G UNITS	2.378	-.916	1.01457	1.06988	2464
12 ACCL N RT	G UNITS	3.042	-.363	1.02964	1.08828	2464
13 ACCL X CG	GUNITS	.200	.001	.07291	.07944	2464
14 ACCL Y CG	G UNITS	.181	-.198	.00464	.05013	2464
15 ALPHA CTR	RAD	.118	-.090	.00689	.02856	2464
16 BETA CTR	RAD	.073	-.136	-.02491	.04228	2464
17 TEMP I	DEG F	98.984	98.264	98.69812	98.69824	2464
18 TEMP P	DEG F	90.725	90.545	90.54659	90.54659	2464
19 ACCL Z INS	G UNITS	1.561	.312	1.00751	1.02198	2464
20 ALPHA RT	RAD	.141	-.077	.01623	.03498	2464
21 BETA RT	RAD	.110	-.077	.01097	.03335	2464
22 ALPHA LT	RAD	.107	-.081	.01678	.03253	2464
23 BETA LT	RAD	.054	-.123	-.03388	.04510	2464
24 PSI DOT	RAD/SEC	.080	-.070	.00379	.02652	2464
25 TEMP TOT	DEG C	31.687	29.422	31.01732	31.02043	2464
26 QC LT	PSID	.786	.472	.64352	.64675	2464
27 QC CTR	PSID	.759	.457	.62902	.63201	2464
28 QC RT	PSID	.776	.478	.65209	.65508	2464
29 PS	PSIA	11.623	11.564	11.59795	11.59796	2464
30 TEMP IRT	DEG C	25.534	18.906	21.76447	21.79981	2464
31 D TO G	METERS	8753817.2988751939.418	*****	*****	*****	2464
32 B TO D	DEGREES	80.371	80.370	80.37043	80.37043	2464
33 LONG	DEGREES	-104.881	-104.893	-104.88735	104.88735	2464
34 LAT	DEGREES	39.826	39.780	39.80218	39.80218	2464
35 TRK ANG	DEGREES	192.722	190.089	191.39770	191.39871	2464
36 HDG	RADIANS	3.418	3.254	3.36306	3.36324	2464
37 VE	M/SEC	-14.968	-18.960	-16.83823	16.85999	2464
38 VN	M/SEC	-79.477	-88.226	-83.35918	83.40849	2464
39 ALTITUDE	KM	1.976	1.935	1.95249	1.95250	2464
40 TEMPC	DEGREES C	27.294	25.101	26.46305	26.46615	2464
41 EW WND SPD	KNOTS	30.837	-6.486	12.72001	15.10623	2464
42 NS WND SPD	KNOTS	39.468	-4.024	17.90769	18.84510	2464
43 WIND SPEED	KNOTS	40.473	.418	23.05311	24.15235	2464
44 WIND DIREC	DEGREES	298.586	88.507	212.72362	213.65975	2464
45 AIRSPEED R	M/SEC	105.990	83.417	97.25571	97.36520	2464
46 AIRSPEED C	M/SEC	104.772	81.645	95.54755	95.65967	2464
47 AIRSPEED L	M/SEC	106.565	82.937	96.61565	96.73505	2464
48 DELTA ALT	METERS	16.447	-24.091	-6.97398	10.78014	2464
49 INRTL DISP	METERS	10.140	-23.988	-5.89437	10.00285	2464
50 UG RIGHT	M/SEC	11.172	-9.346	-.00000	3.20215	2464
51 UG CENTER	M/SEC	11.603	-10.301	-.00000	3.25581	2464
52 UG LEFT	M/SEC	11.531	-9.250	-.00000	3.35707	2464
53 VG RIGHT	M/SEC	9.794	-8.477	-.11567	3.92306	2464
54 VG CENTER	M/SEC	8.954	-9.466	-.11009	3.94191	2464
55 VG LEFT	M/SEC	7.763	-8.703	-.10724	3.74048	2464
56 WG RIGHT	M/SEC	10.137	-15.526	-.03404	3.70736	2464
57 WG CENTER	M/SEC	11.373	-13.960	-.02507	3.68525	2464
58 WG LEFT	M/SEC	10.656	-15.337	-.02231	3.85930	2464

Date: July 14, 1982
 Time: 14:40:04(MDT)
 Duration: 50 seconds

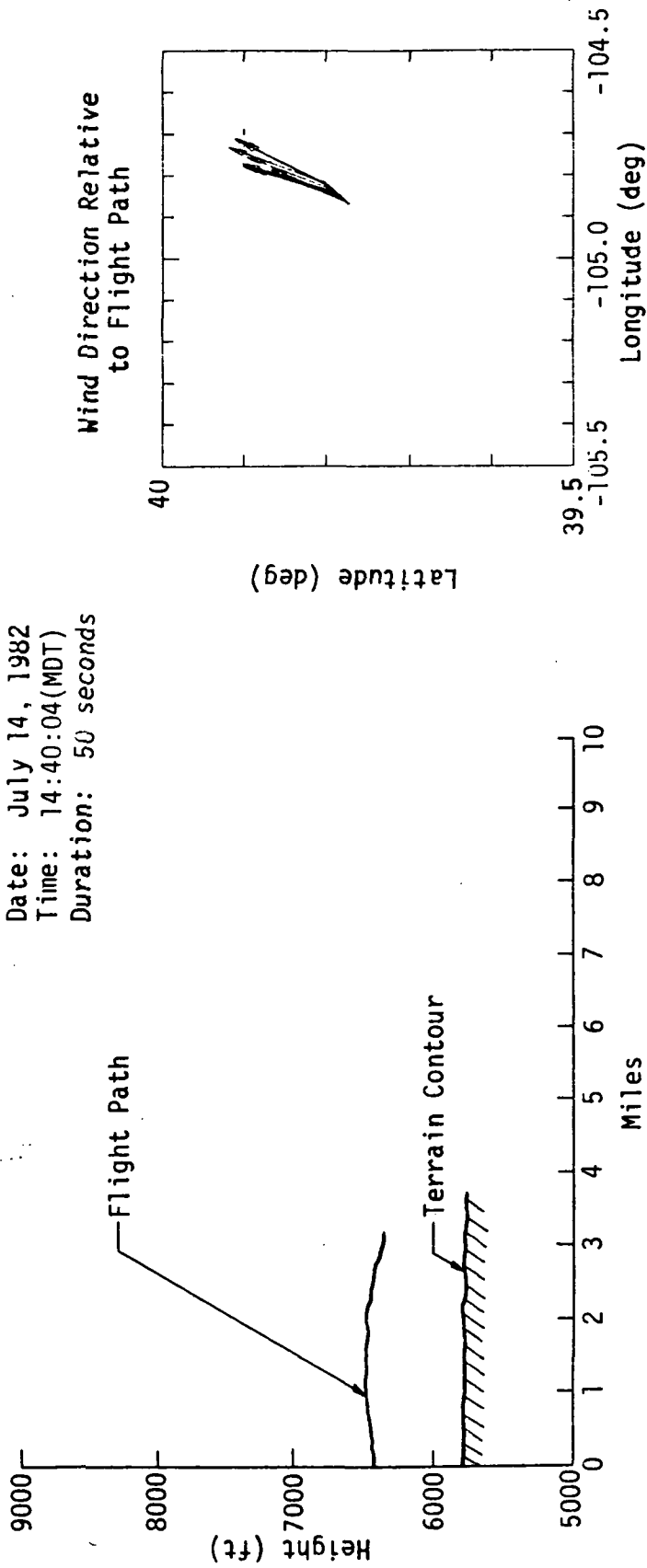

Figure A.129. Flight path information, Flight 6, Run 20.

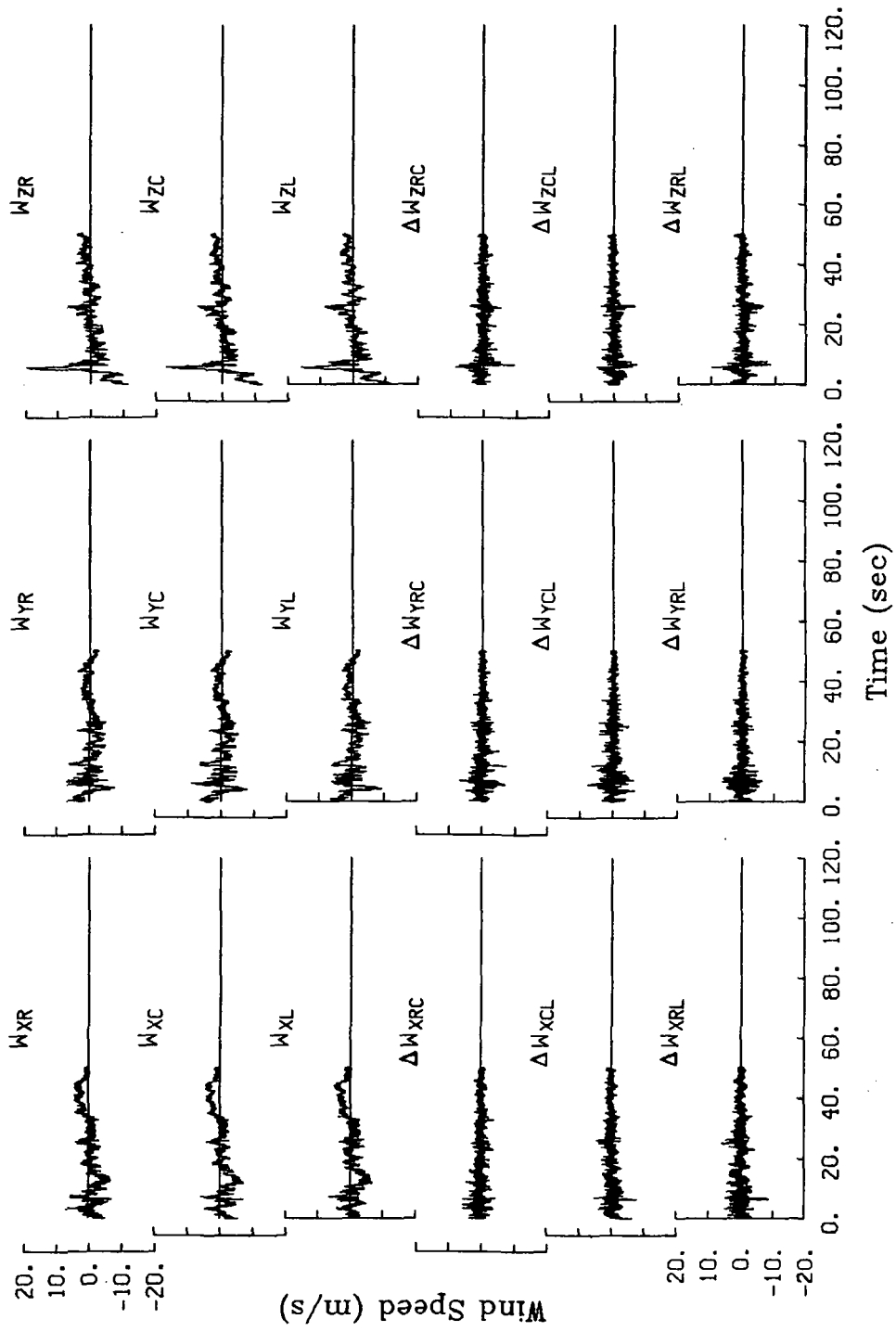

Figure A.130. Time histories of gust velocities and gust velocity differences, Flight 6, Run 20.

TABLE A.33. Average Turbulence Parameters and Integral Length Scales, Flight 6, Run 20.

I. Mean Airspeed (m/s)

v_L	v_C	v_R
103.3	102.2	104.0

II. Standard Deviation of Gust Velocities (m/s)

$\sigma_{W_{XL}}$	$\sigma_{W_{XC}}$	$\sigma_{W_{XR}}$
2.11	2.13	2.10
$\sigma_{W_{YL}}$	$\sigma_{W_{YC}}$	$\sigma_{W_{YR}}$
2.33	2.40	2.25
$\sigma_{W_{ZL}}$	$\sigma_{W_{ZC}}$	$\sigma_{W_{ZR}}$
3.57	3.51	3.77

III. Standard Deviation of Gust Velocity Differences (m/s)

$\sigma_{\Delta W_{XCL}}$	$\sigma_{\Delta W_{XRC}}$	$\sigma_{\Delta W_{XRL}}$
1.13	1.28	1.50
$\sigma_{\Delta W_{YCL}}$	$\sigma_{\Delta W_{YRC}}$	$\sigma_{\Delta W_{YRL}}$
1.34	1.42	1.37
$\sigma_{\Delta W_{ZCL}}$	$\sigma_{\Delta W_{ZRC}}$	$\sigma_{\Delta W_{ZRL}}$
1.45	1.33	1.66

IV. Integral Length Scale (m).

$L_{W_{XL}}$	$L_{W_{XC}}$	$L_{W_{XR}}$
376	436	362
$L_{W_{YL}}$	$L_{W_{YC}}$	$L_{W_{YR}}$
144	128	312
$L_{W_{ZL}}$	$L_{W_{ZC}}$	$L_{W_{ZR}}$
198	205	167

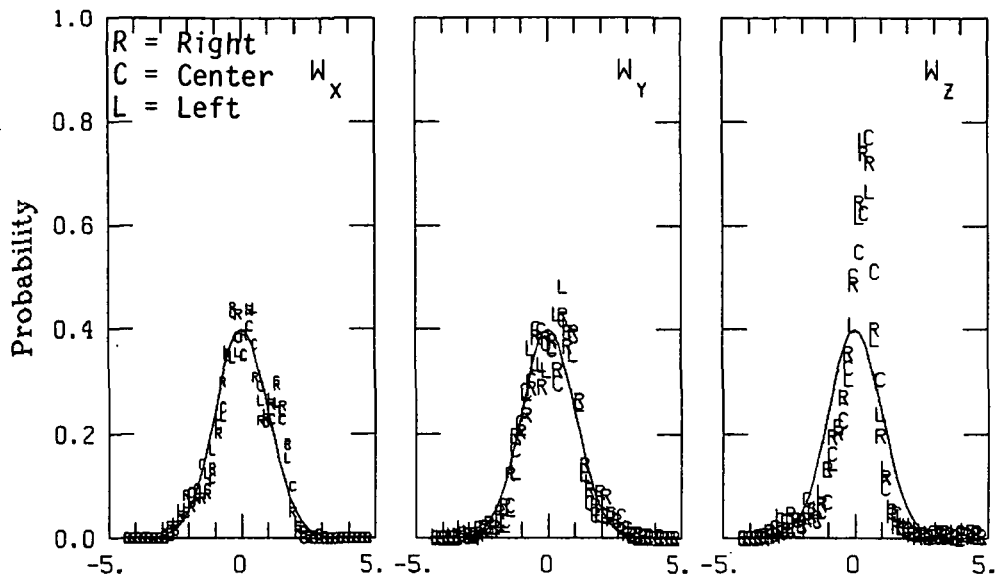

Normalized Gust Velocity (Standard Deviations)

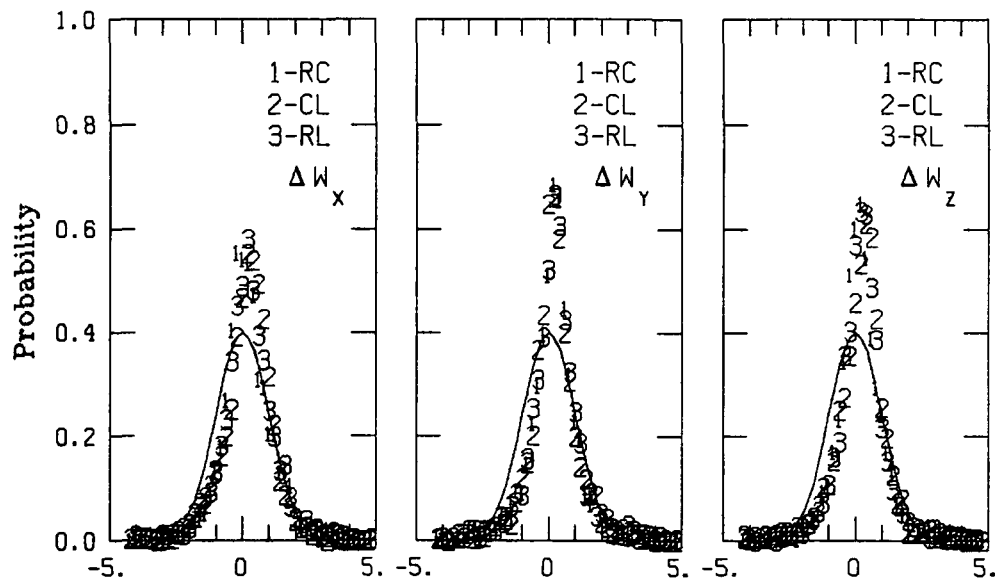

Normalized Velocity Differences (Standard Deviations)

Figure A.131. Probability density function for gust velocities and gust velocity differences, Flight 6, Run 20.

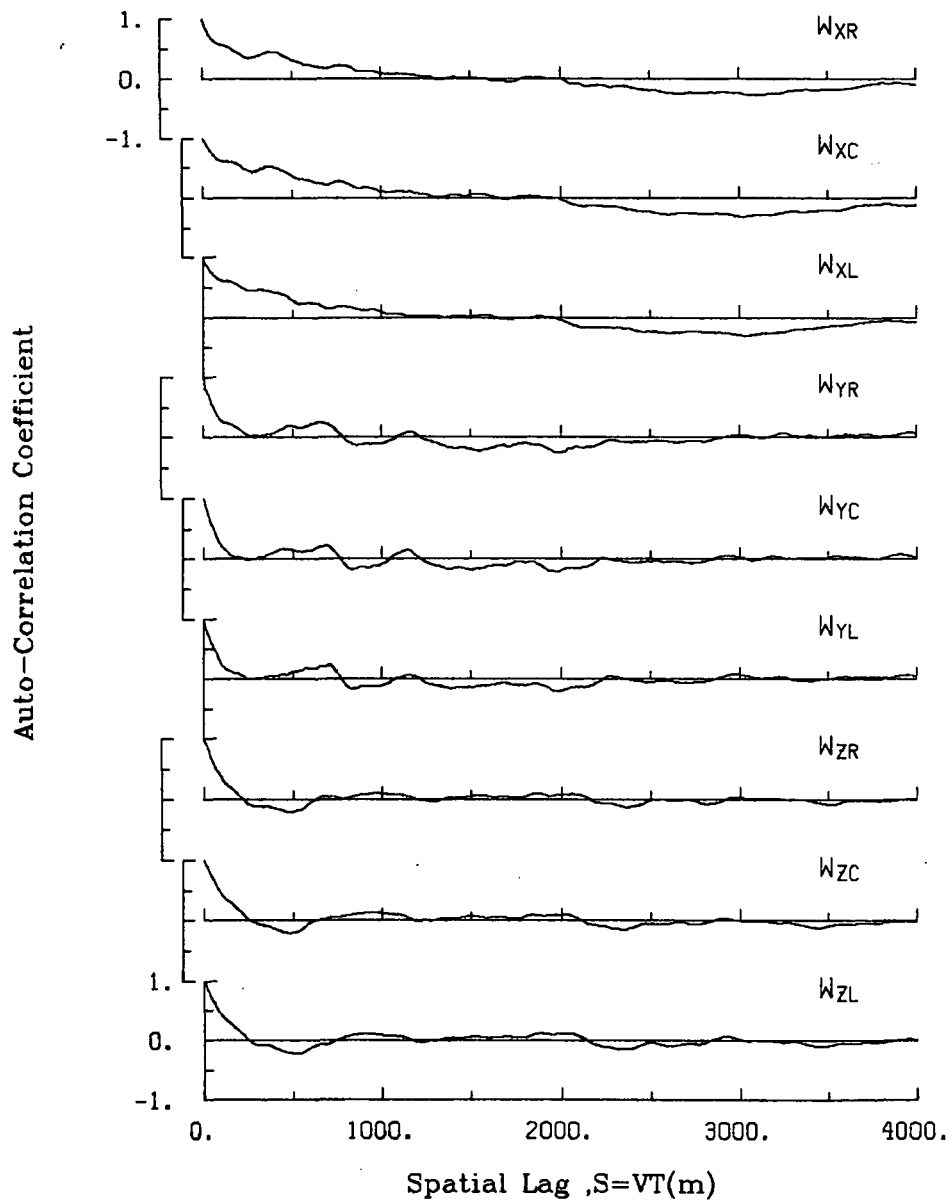

Figure A.132. Single-point auto-correlation coefficient of gust velocities, Flight 6, Run 20.

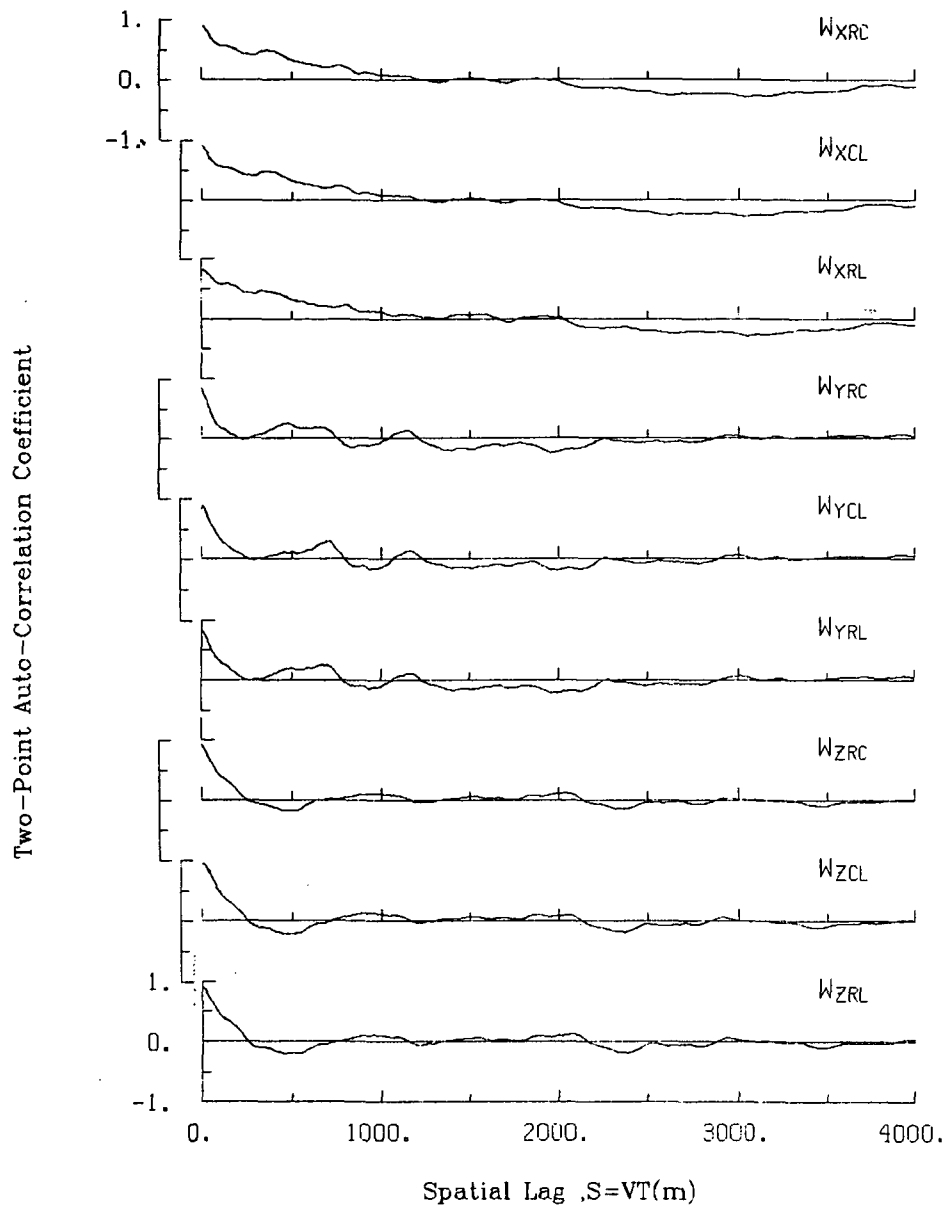

Figure A.133. Two-point auto-correlation coefficient of gust velocities, Flight 6, Run 20.

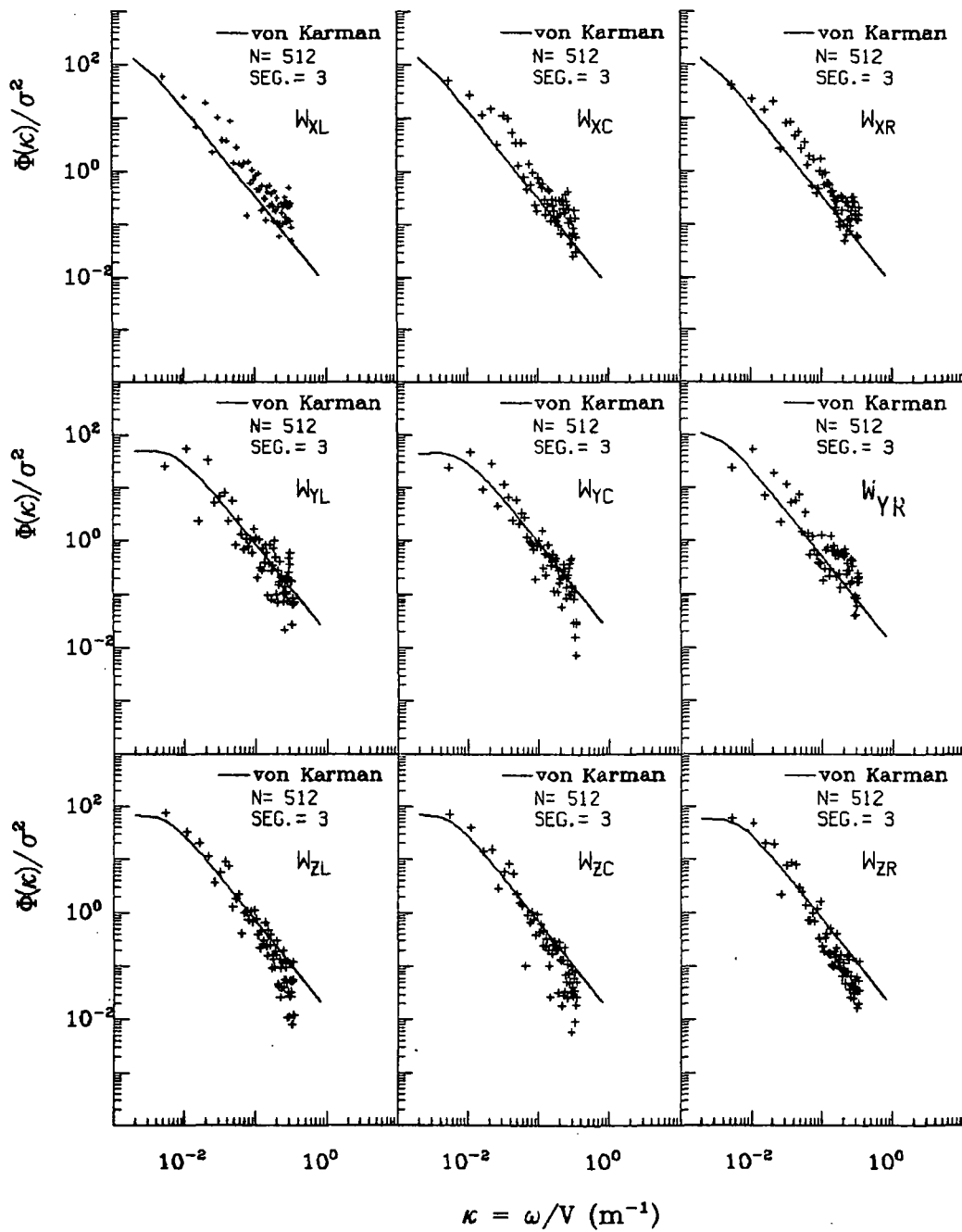

Figure A.134. Normalized auto-spectra of gust velocities, Flight 6, Run 20.

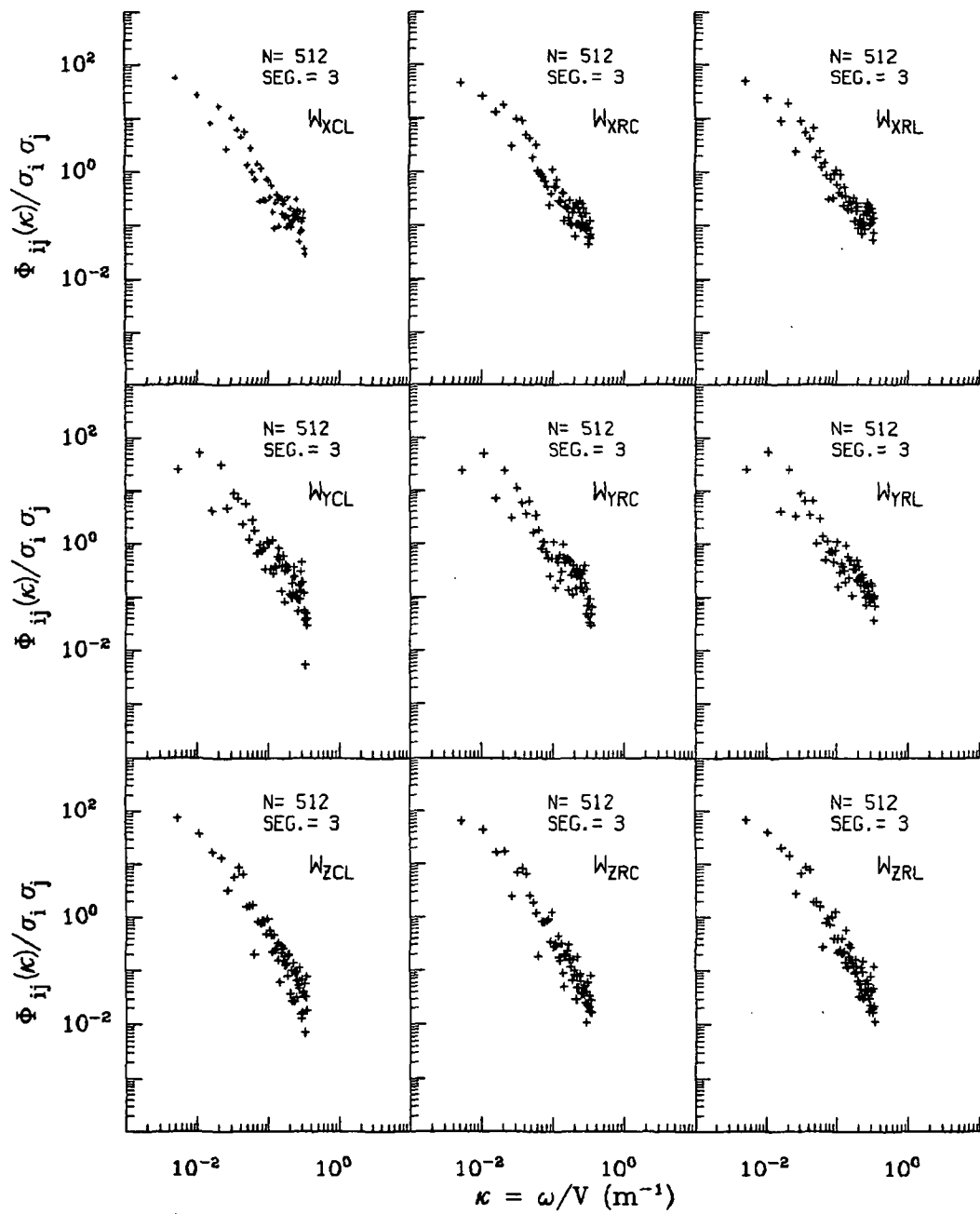

Figure A.135. Normalized two-point auto-spectra of gust velocities, Flight 6, Run 20.

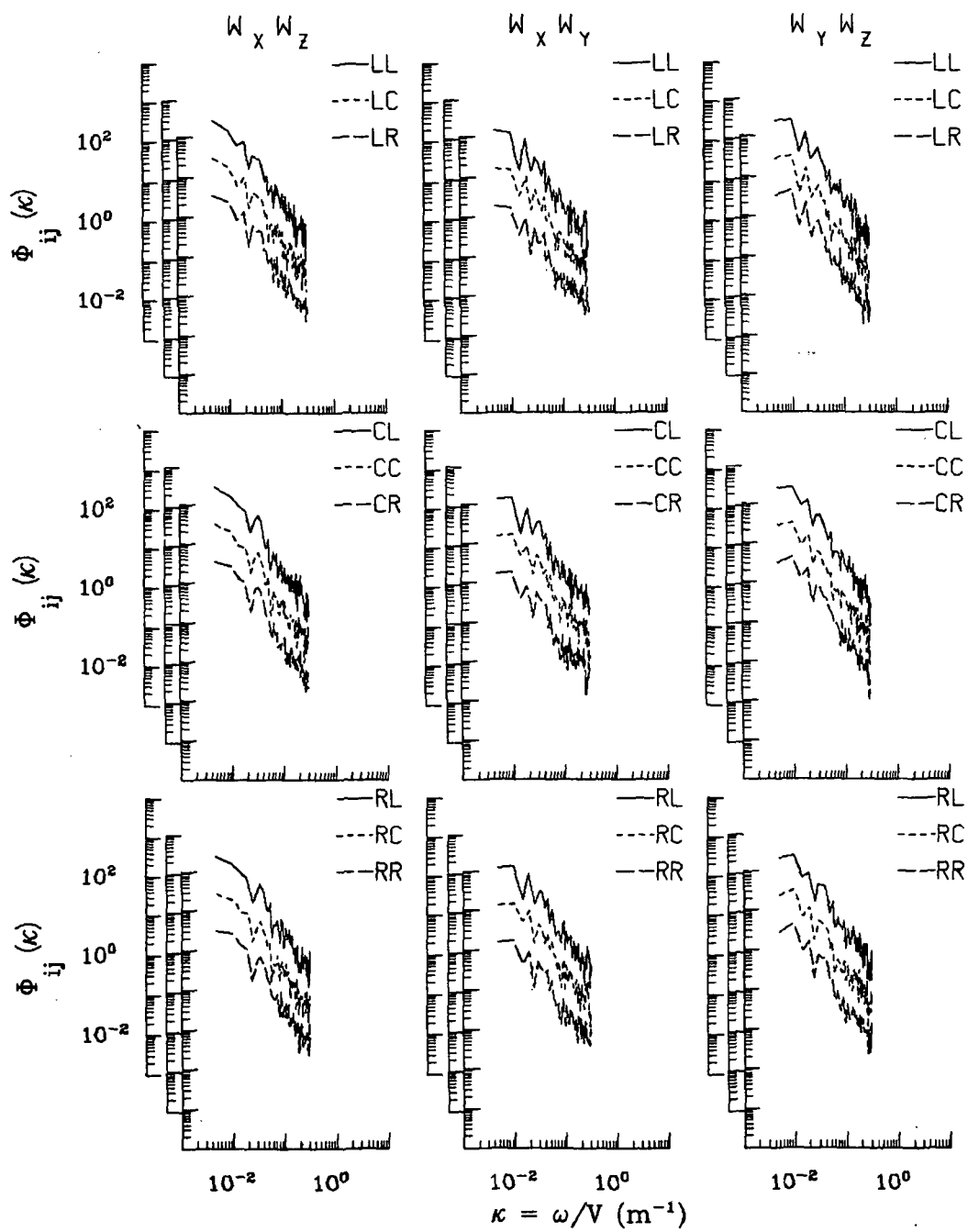

Figure A.136. Two-point cross-spectra of gust velocities, Flight 6, Run 20.

ORIGINAL PAGE IS
OF POOR QUALITY

TABLE A.34. List of All Parameters Measured and Their Range of Values,
Flight 6, Run 20.

		START TIME = 52804.3152	STOP TIME = 52854.5652			
CHANNEL	UNITS	HIGH	LOW	MEAN	RMS	
2 PHI DOT	RAD/SEC	.234	-.135	-.00373	.03946	2010
3 ACCL N CG	G UNITS	-.988	-.988	-.98774	.98774	2010
4 THETA DOT	RAD/SEC	.122	-.157	.00343	.02364	2010
5 THETA	RAD	.192	.027	.07552	.08809	2010
6 PHI	RAD	.088	-.118	-.01264	.03459	2010
7 PSI 1	DEGREES	56.554	48.452	53.50850	53.52779	2010
8 DEL PSI 1	DEGREES	4.168	-3.855	1.13628	1.80927	2010
9 PSI 2	DEGREES	415.673	407.928	412.72897	412.73128	2010
10 DEL PSI 2	DEGREES	3.873	-4.213	.80630	1.62778	2010
11 ACCL N LT	G UNITS	2.751	-1.227	1.01258	1.06829	2010
12 ACCL N RT	G UNITS	3.096	-1.343	1.02750	1.07798	2010
13 ACCL X CG	GUNITS	.398	.036	.12597	.14404	2010
14 ACCL Y CG	G UNITS	.124	-.100	.00643	.03352	2010
15 ALPHA CTR	RAD	.164	-.155	-.00725	.03304	2010
16 BETA CTR	RAD	.119	-.152	-.02825	.04592	2010
17 TEMP I	DEG F	98.804	98.084	98.33777	98.33794	2010
18 TEMP P	DEG F	90.725	90.545	90.59107	90.59110	2010
19 ACCL Z INS	G UNITS	2.092	-.044	1.01042	1.02853	2010
20 ALPHA RT	RAD	.205	-.144	.00053	.03711	2010
21 BETA RT	RAD	.134	-.111	.00680	.03210	2010
22 ALPHA LT	RAD	.152	-.141	-.00016	.03169	2010
23 BETA LT	RAD	.061	-.159	-.03402	.04643	2010
24 PSI DOT	RAD/SEC	.080	-.113	.00327	.02725	2010
25 TEMP TOT	DEG C	33.557	30.210	32.40597	32.41698	2010
26 QC LT	PSID	.863	.504	.73629	.74211	2010
27 QC CTR	PSID	.843	.481	.72098	.72633	2010
28 QC RT	PSID	.874	.475	.74739	.75312	2010
29 PS	PSIA	11.634	11.567	11.58941	11.58943	2010
30 TEMP IRT	DEG C	27.188	10.560	22.91253	23.46166	2010
31 D TO G	METERS	8759064.42287540	26.688	*****	*****	2010
32 B TO D	DEGREES	80.419	80.389	80.40342	80.40342	2010
33 LONG	DEGREES	-104.814	-104.868	-104.84199	104.84200	2010
34 LAT	DEGREES	39.804	39.773	39.78779	39.78779	2010
35 TRK ANG	DEGREES	54.559	52.259	52.88599	52.88838	2010
36 HDG	RADIANS	.983	.838	.92853	.92888	2010
37 VE	M/SEC	97.816	81.338	91.52749	91.69507	2010
38 VN	M/SEC	75.396	58.102	69.35211	69.53321	2010
39 ALTITUDE	KM	1.974	1.927	1.95844	1.95847	2010
40 TEMPC	DEGREES C	27.687	25.859	27.18321	27.18495	2010
41 EW WND SPD	KNOTS	25.917	4.464	15.57736	16.19384	2010
42 NS WND SPD	KNOTS	31.316	3.551	20.25756	20.72973	2010
43 WIND SPEED	KNOTS	36.500	11.022	25.95807	26.30518	2010
44 WIND DIR EC	DEGREES	260.654	191.760	217.69841	217.96397	2010
45 AIRSPEED R	M/SEC	112.605	83.236	104.04720	104.25837	2010
46 AIRSPEED C	M/SEC	110.559	83.862	102.23846	102.43991	2010
47 AIRSPEED L	M/SEC	111.875	85.743	103.28117	103.49810	2010
48 DELTA ALT	METERS	43.542	-3.157	28.01745	30.29206	2010
49 INRTL DISP	METERS	41.682	-6.033	26.55113	29.92756	2010
50 UG RIGHT	M/SEC	6.945	-6.843	.00000	2.24124	2010
51 UG CENTER	M/SEC	5.710	-7.003	.00000	2.31205	2010
52 UG LEFT	M/SEC	6.445	-6.545	.00000	2.25835	2010
53 VG RIGHT	M/SEC	6.977	-7.533	-.01178	2.09730	2010
54 VG CENTER	M/SEC	9.013	-7.649	-.00316	2.20645	2010
55 VG LEFT	M/SEC	6.466	-9.300	.00048	2.13889	2010
56 WG RIGHT	M/SEC	19.927	-11.561	.16088	3.44830	2010
57 WG CENTER	M/SEC	17.020	-11.978	.18542	3.23233	2010
58 WG LEFT	M/SEC	15.904	-12.394	.16906	3.25304	2010

Date: July 14, 1982
 Time: 14:41:58 (MDT)
 Duration: 41 seconds

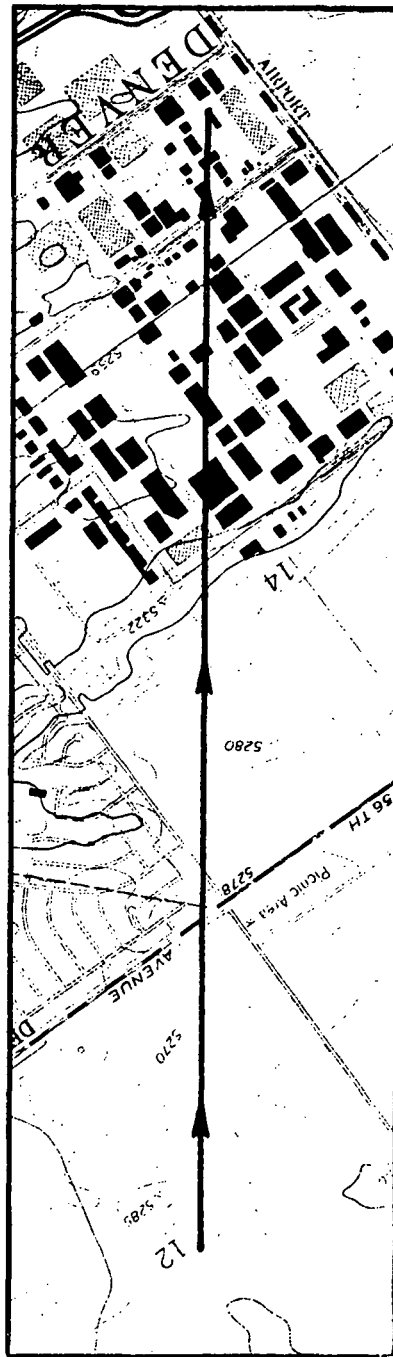
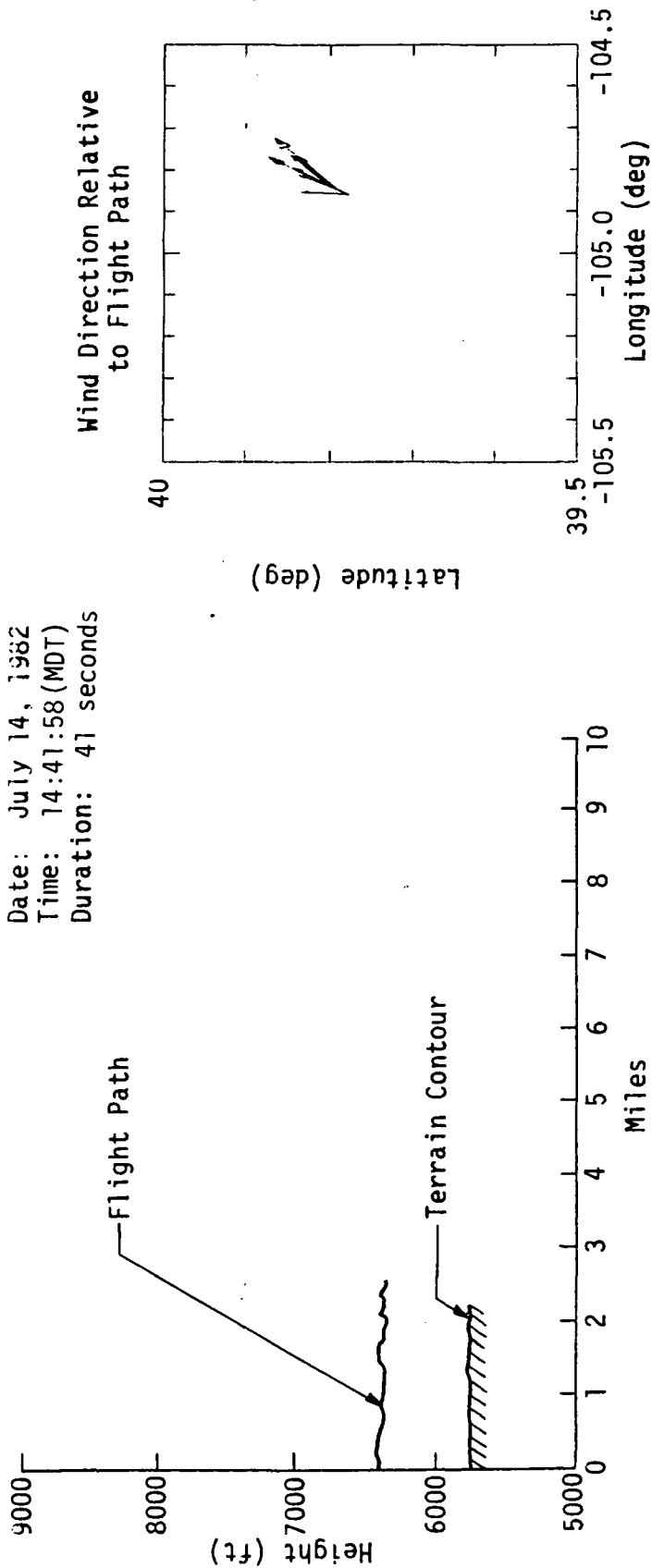

ORIGINAL PAGE IS
 OF POOR QUALITY

Figure A.137. Flight path information, Flight 6, Run 21.

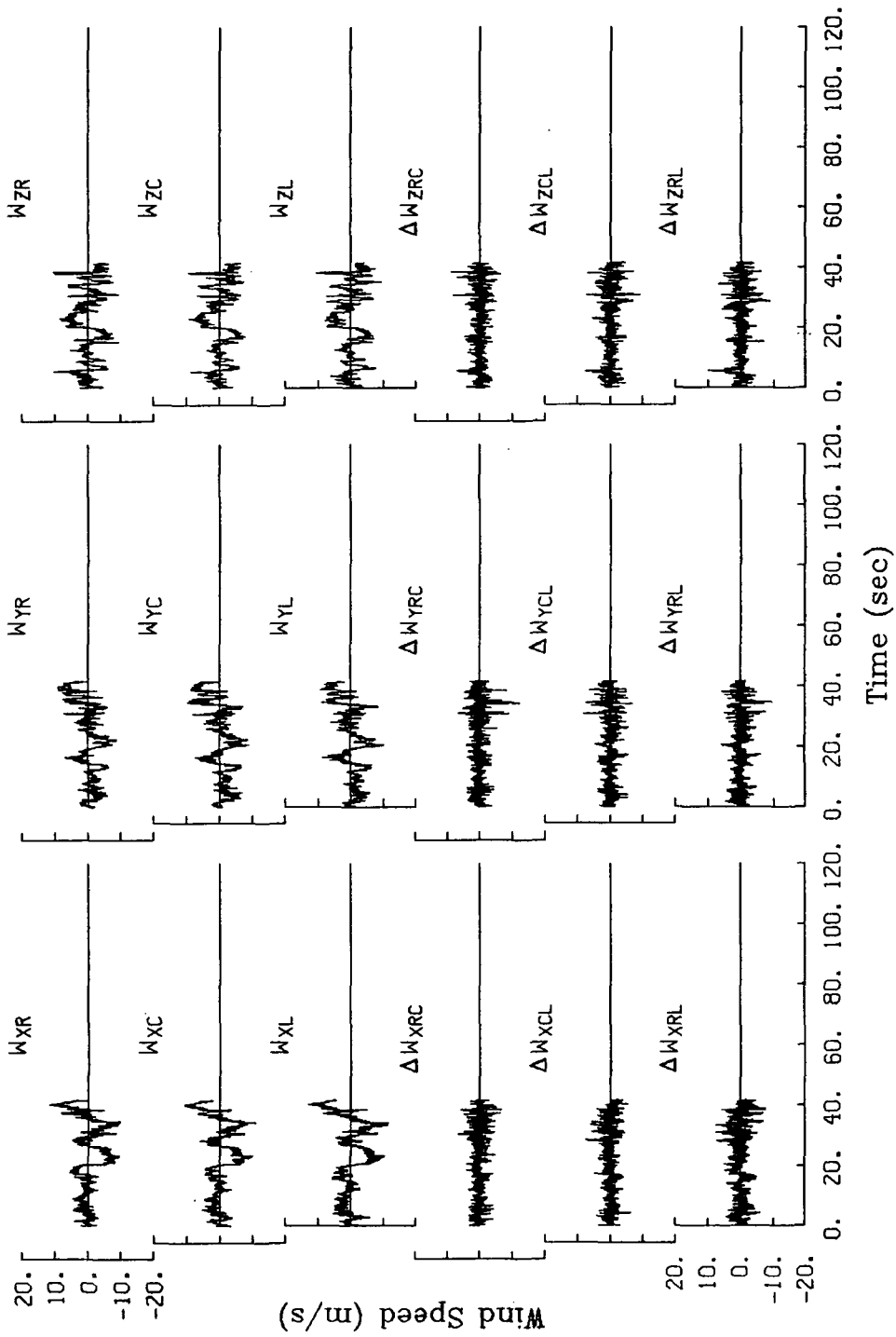
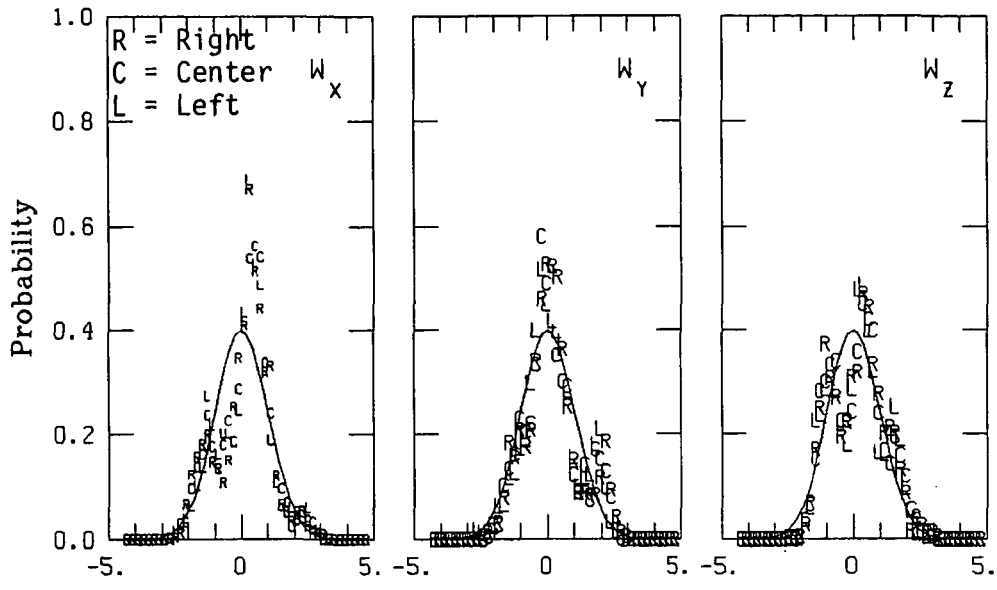

Figure A.138. Time histories of gust velocities and gust velocity differences, Flight 6, Run 21.

TABLE A.35. Average Turbulence Parameters and Integral Length Scales, Flight 6, Run 21.

I. Mean Airspeed (m/s)			II. Standard Deviation of Gust Velocities (m/s)		
V_L	V_C	V_R	$\sigma_{W_{XL}}$	$\sigma_{W_{XC}}$	$\sigma_{W_{XR}}$
96.4	95.6	97.6	3.67	3.46	3.48
			$\sigma_{W_{YL}}$	$\sigma_{W_{YC}}$	$\sigma_{W_{YR}}$
			3.27	3.30	3.00
			$\sigma_{W_{ZL}}$	$\sigma_{W_{ZC}}$	$\sigma_{W_{ZR}}$
			3.44	3.42	3.57
III. Standard Deviation of Gust Velocity Differences (m/s)			IV. Integral Length Scale (m).		
$\sigma_{\Delta W_{XCL}}$	$\sigma_{\Delta W_{XRC}}$	$\sigma_{\Delta W_{XRL}}$	$L_{W_{XL}}$	$L_{W_{XC}}$	$L_{W_{XR}}$
1.51	1.55	1.97	166	153	147
$\sigma_{\Delta W_{YCL}}$	$\sigma_{\Delta W_{YRC}}$	$\sigma_{\Delta W_{YRL}}$	$L_{W_{YL}}$	$L_{W_{YC}}$	$L_{W_{YR}}$
1.79	1.61	1.78	253	258	275
$\sigma_{\Delta W_{ZCL}}$	$\sigma_{\Delta W_{ZRC}}$	$\sigma_{\Delta W_{ZRL}}$	$L_{W_{ZL}}$	$L_{W_{ZC}}$	$L_{W_{ZR}}$
1.63	1.70	1.96	158	194	158

ORIGINAL PAGE IS
OF POOR QUALITY



Normalized Gust Velocity (Standard Deviations)

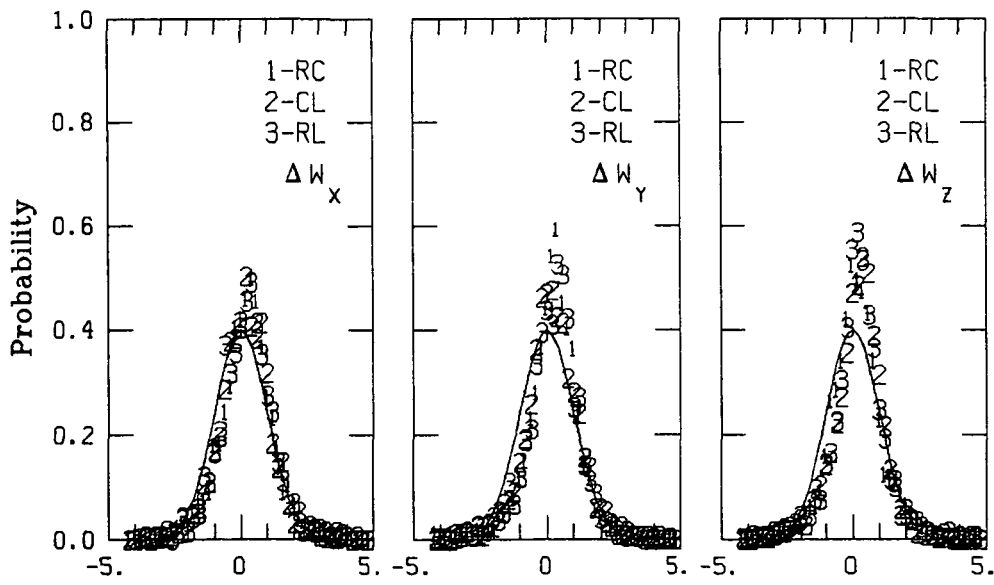

Normalized Velocity Differences (Standard Deviations)

Figure A.139. Probability density function for gust velocities and gust velocity differences, Flight 6, Run 21.

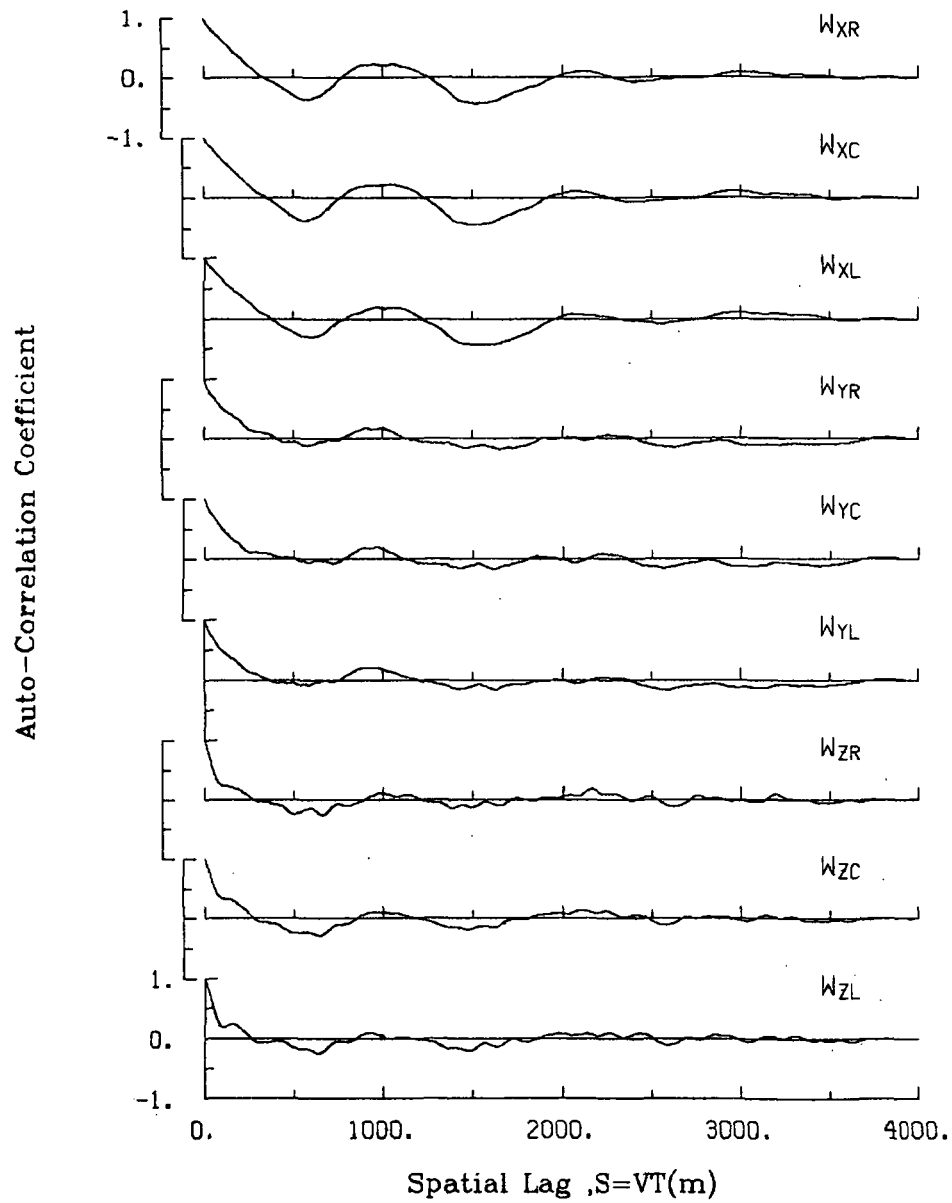

Figure A.140. Single-point auto-correlation coefficient of gust velocities, Flight 6, Run 21.

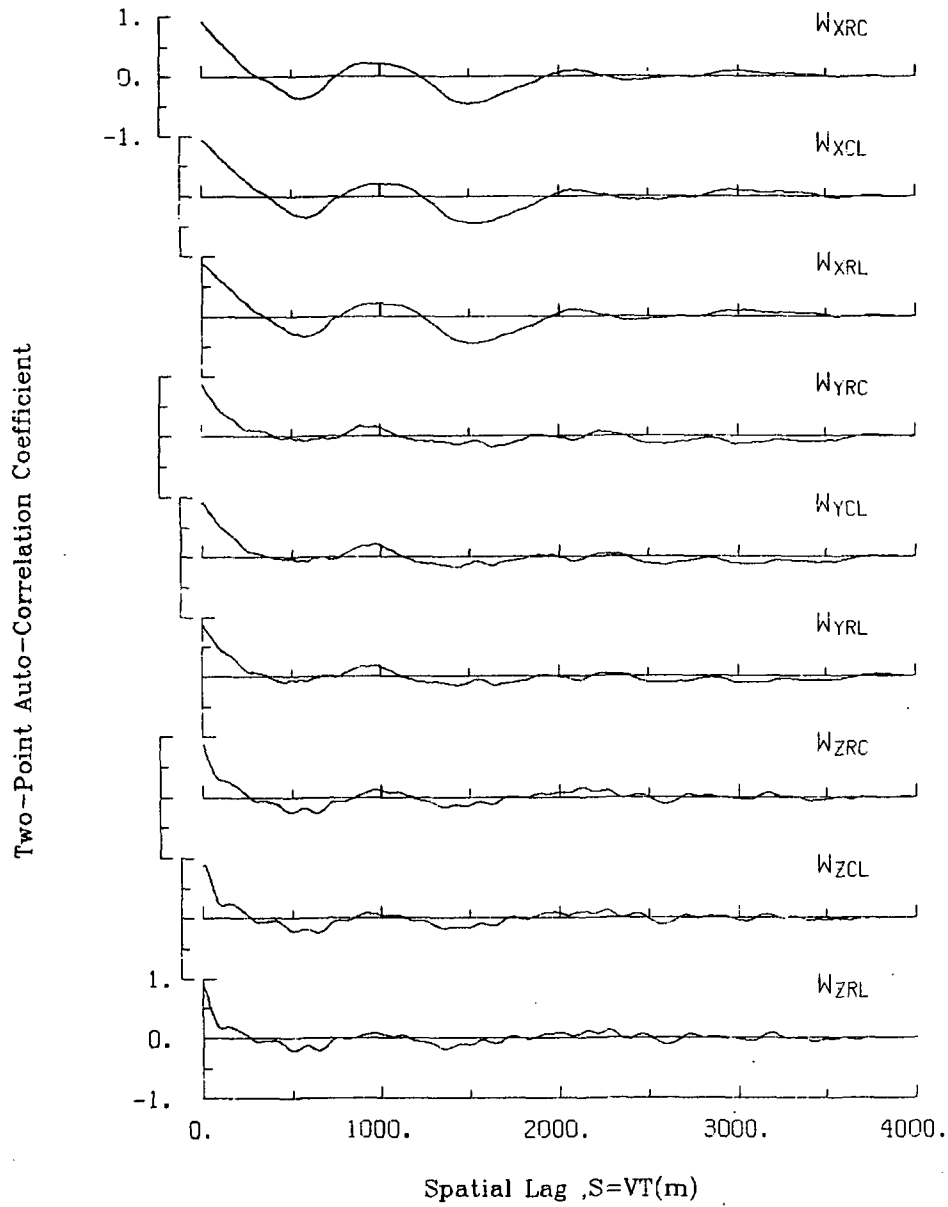

Figure A.141. Two-point auto-correlation coefficient of gust velocities, Flight 6, Run 21.

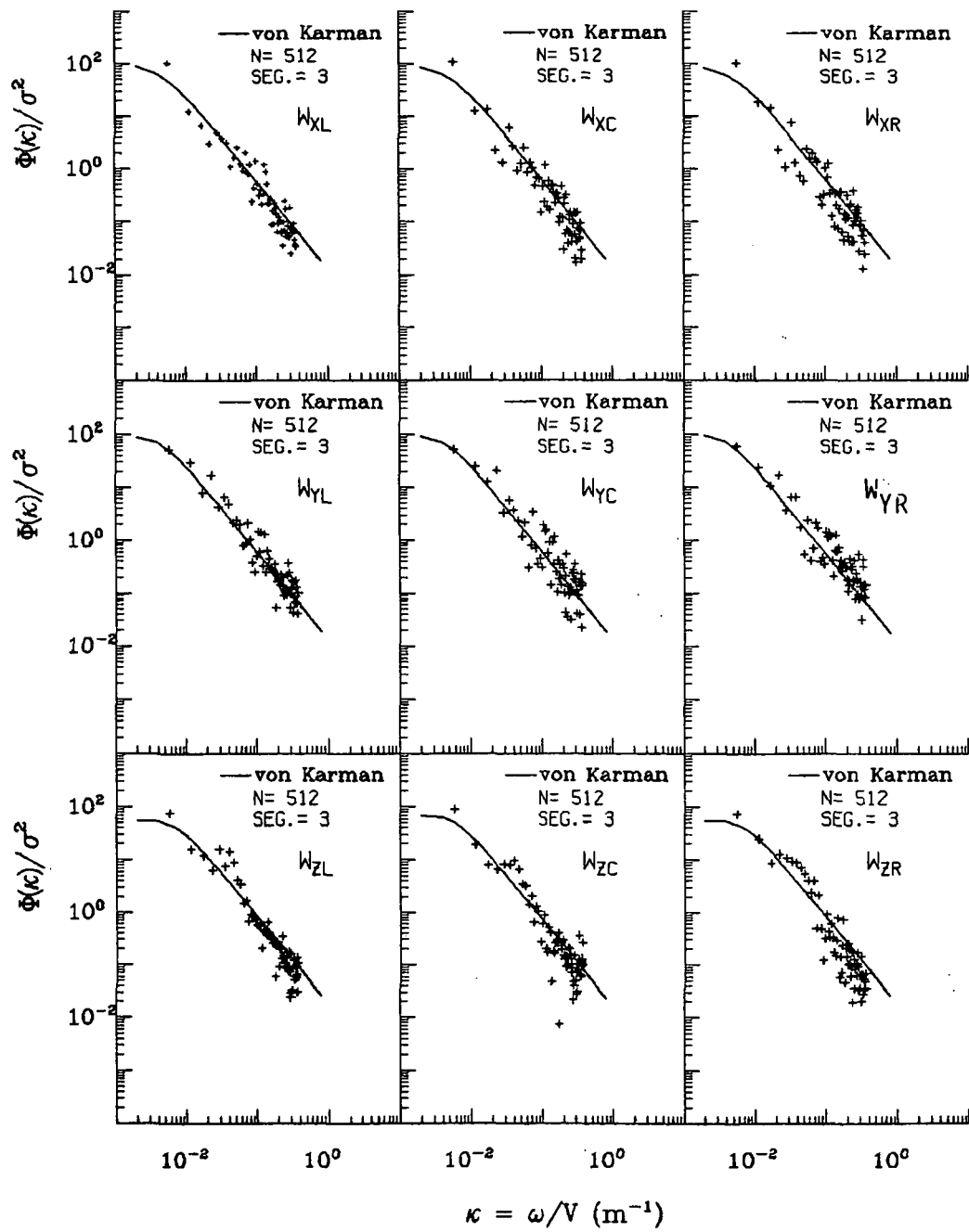

Figure A.142. Normalized auto-spectra of gust velocities, Flight 6, Run 21.

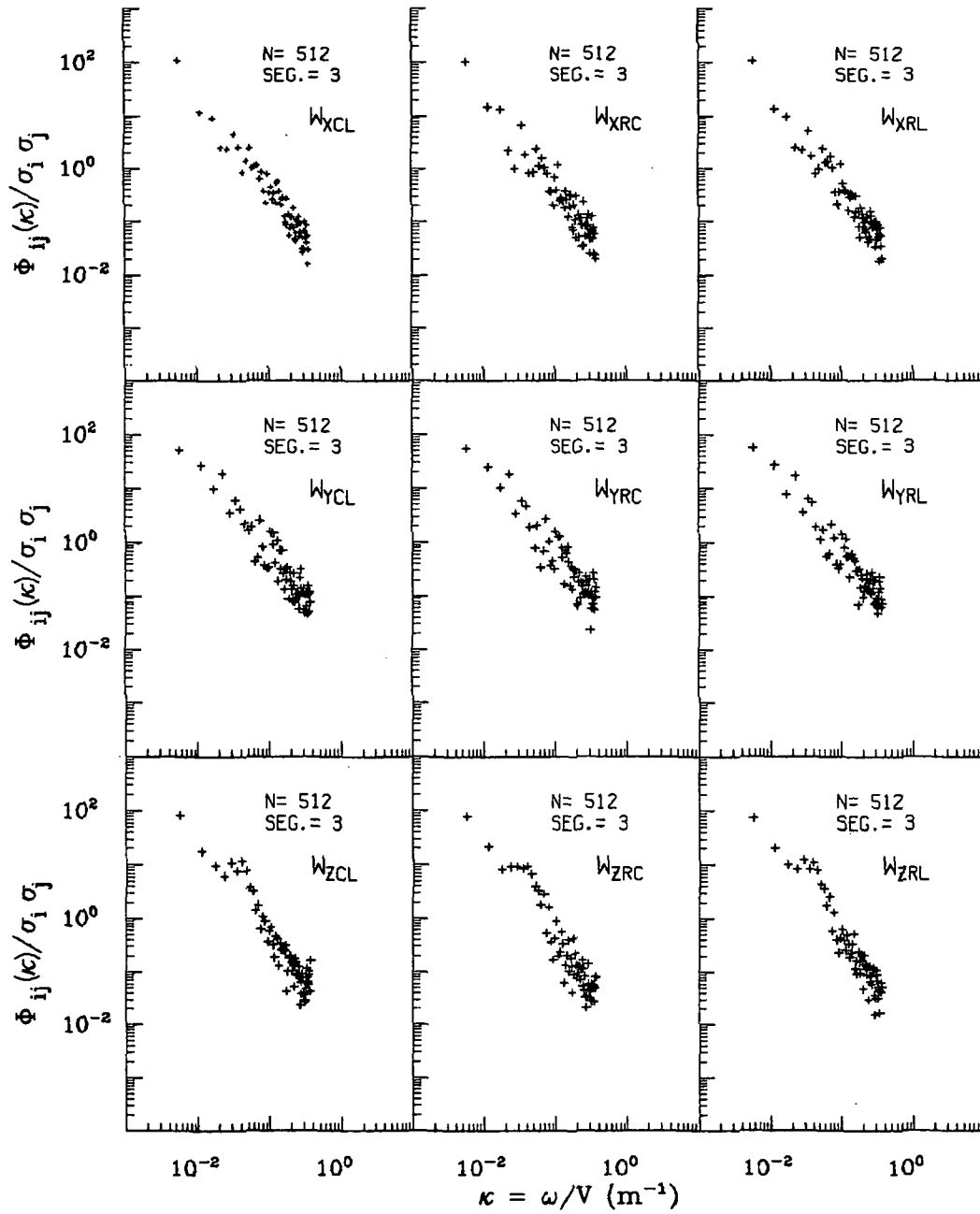

Figure A.143. Normalized two-point auto-spectra of gust velocities, Flight 6, Run 21.

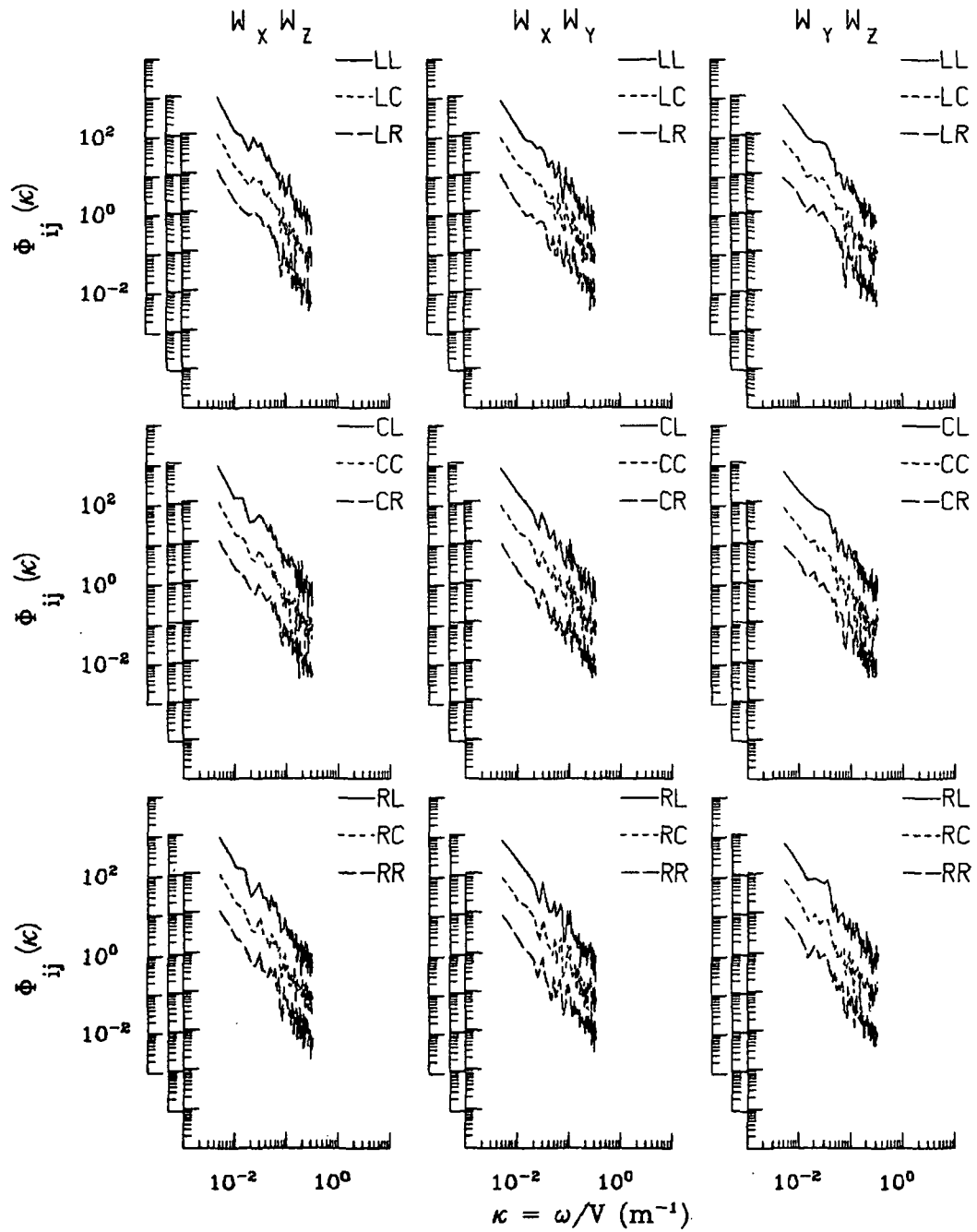

Figure A.144. Two-point cross-spectra of gust velocities, Flight 6, Run 21.

**ORIGINAL PAGE IS
OF POOR QUALITY**

TABLE A.36. List of All Parameters Measured and Their Range of Values, Flight 6, Run 21.

		START TIME = 52918.6904	STOP TIME = 52960.2904			
CHANNEL	UNITS	HIGH	LOW	MEAN	RMS	POINTS
2 PHI DOT	RAD/SEC	.187	-.211	-.00081	.05916	1664
3 ACCL N CG	G UNITS	-.988	-.988	-.98774	.98774	1664
4 THETA DOT	RAD/SEC	.124	-.142	.00692	.02833	1664
5 THETA	RAD	.133	.004	.06964	.07536	1664
6 PHI	RAD	.172	-.103	.00628	.04803	1664
7 PSI 1	DEGREES	220.333	210.125	214.42823	214.44213	1664
8 DEL PSI 1	DEGREES	6.930	-2.885	1.36186	2.75481	1664
9 PSI 2	DEGREES	581.839	571.982	576.29671	576.30144	1664
10 DEL PSI 2	DEGREES	6.841	-3.095	1.19723	2.68900	1664
11 ACCL N LT	G UNITS	3.800	-1.446	1.00561	1.12389	1664
12 ACCL N RT	G UNITS	3.744	-1.556	1.02663	1.13564	1664
13 ACCL X CG	G UNITS	.229	.017	.07388	.07956	1664
14 ACCL Y CG	G UNITS	.196	-.147	.00737	.05112	1664
15 ALPHA CTR	RAD	.126	-.104	.00494	.03205	1664
16 BETA CTR	RAD	.119	-.155	-.01737	.05996	1664
17 TEMP I	DEG F	98.624	98.084	98.40822	98.40826	1664
18 TEMP P	DEG F	90.725	90.545	90.72444	90.72444	1664
19 ACCL Z INS	G UNITS	2.273	-.061	1.00324	1.03396	1664
20 ALPHA RT	RAD	.158	-.086	.01505	.03660	1664
21 BETA RT	RAD	.156	-.098	.01681	.05416	1664
22 ALPHA LT	RAD	.126	-.106	.01295	.03800	1664
23 BETA LT	RAD	.099	-.149	-.02629	.05866	1664
24 PSI DOT	RAD/SEC	.093	-.074	.00231	.04145	1664
25 TEMP TOT	DEG C	32.472	30.899	31.79919	31.80051	1664
26 QC LT	PSID	.816	.475	.63856	.64090	1664
27 QC CTR	PSID	.781	.493	.62800	.63002	1664
28 QC RT	PSID	.793	.504	.65518	.65727	1664
29 PS	PSIA	11.630	11.581	11.60876	11.60877	1664
30 TEMP IRT	DEG C	25.905	20.918	23.94578	23.96379	1664
31 D TO G	METERS	8757342.9128754752.941	*****	*****	*****	1664
32 B TO D	DEGREEES	80.404	80.393	80.39881	80.39881	1664
33 LONG	DEGREEES	-104.835	-104.860	-104.84752	104.84752	1664
34 LAT	DEGREEES	39.806	39.780	39.79275	39.79275	1664
35 TRK ANG	DEGREEES	218.318	214.233	215.72319	215.72528	1664
36 HDG	RADIANS	3.867	3.690	3.76632	3.76657	1664
37 VE	M/SEC	-49.668	-54.592	-51.24423	51.25803	1664
38 VN	M/SEC	-68.740	-73.019	-71.16422	71.17224	1664
39 ALTITUDE	KM	1.964	1.930	1.94498	1.94499	1664
40 TEMPC	DEGREEES C	27.936	26.197	27.24434	27.24673	1664
41 EW WND SPD	KNOTS	32.712	-12.838	11.68084	14.53317	1664
42 NS WND SPD	KNOTS	36.161	-.405	10.32649	11.70199	1664
43 WIND SPEED	KNOTS	37.479	3.931	17.34749	18.65877	1664
44 WIND DIRECTION	DEGREEES	272.262	98.002	223.01084	225.29530	1664
45 AIRSPEED R	M/SEC	107.219	85.973	97.60199	97.67514	1664
46 AIRSPEED C	M/SEC	106.327	85.011	95.59349	95.66572	1664
47 AIRSPEED L	M/SEC	108.631	83.439	96.36692	96.45035	1664
48 DELTA ALT	METERS	2.631	-31.884	-16.88124	18.44360	1664
49 INPTL DISP	METERS	0.000	-29.527	-20.04487	21.64417	1664
50 UG RIGHT	M/SEC	11.618	-9.683	-.00000	3.84191	1664
51 UG CENTER	M/SEC	10.664	-10.652	-.00000	3.87109	1664
52 UG LEFT	M/SEC	13.014	-11.653	-.00000	4.18771	1664
53 VG RIGHT	M/SEC	9.241	-8.562	-.06347	3.36266	1664
54 VG CENTER	M/SEC	9.720	-8.802	-.06555	3.60657	1664
55 VG LEFT	M/SEC	9.336	-10.182	-.05988	3.51979	1664
56 WG RIGHT	M/SEC	10.808	-9.085	-.04443	3.57624	1664
57 WG CENTER	M/SEC	9.601	-7.651	-.03628	3.43912	1664
58 WG LEFT	M/SEC	10.658	-9.245	-.02823	3.46054	1664

Date: July 14, 1982
 Time: 14:43:10 (MDT)
 Duration: 46 seconds

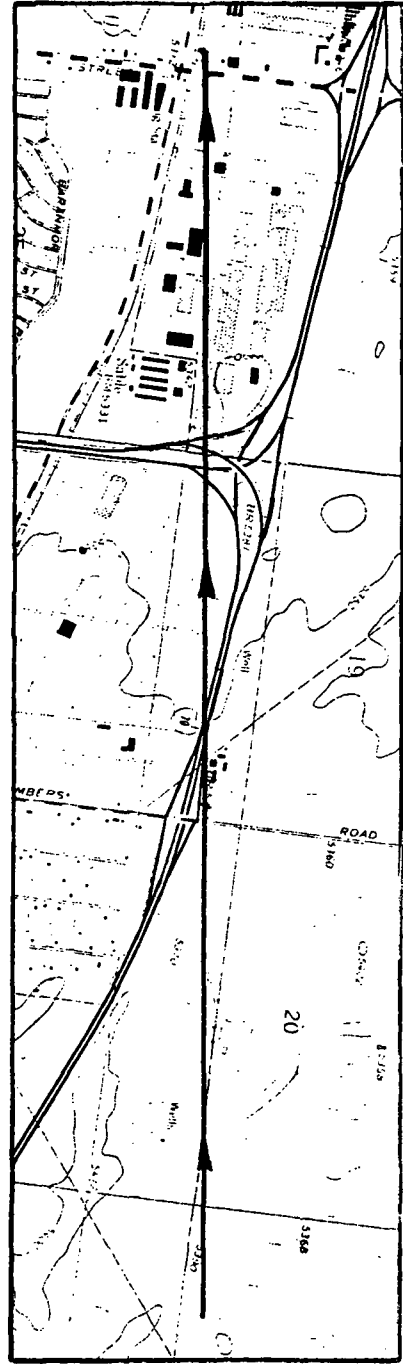
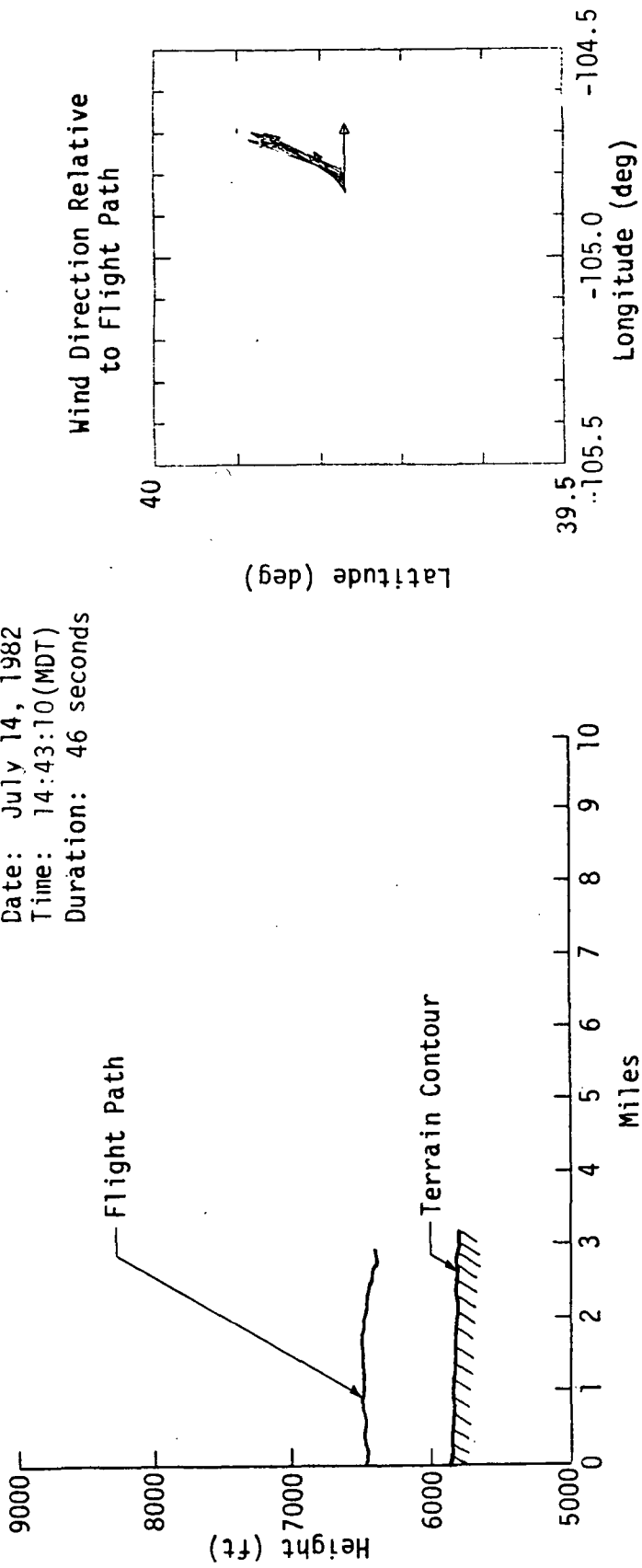

Figure A.145. Flight path information, Flight 6, Run 22.

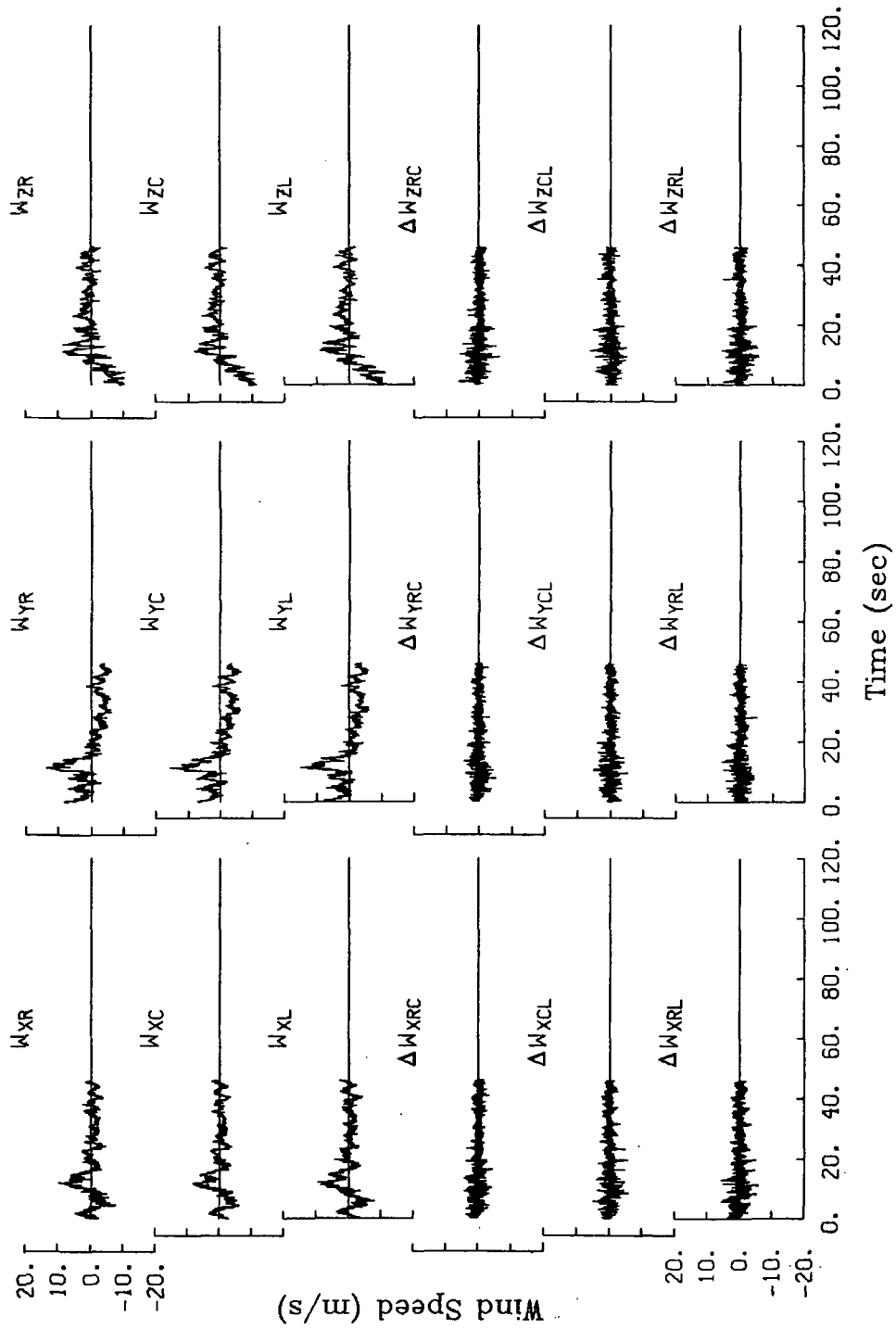
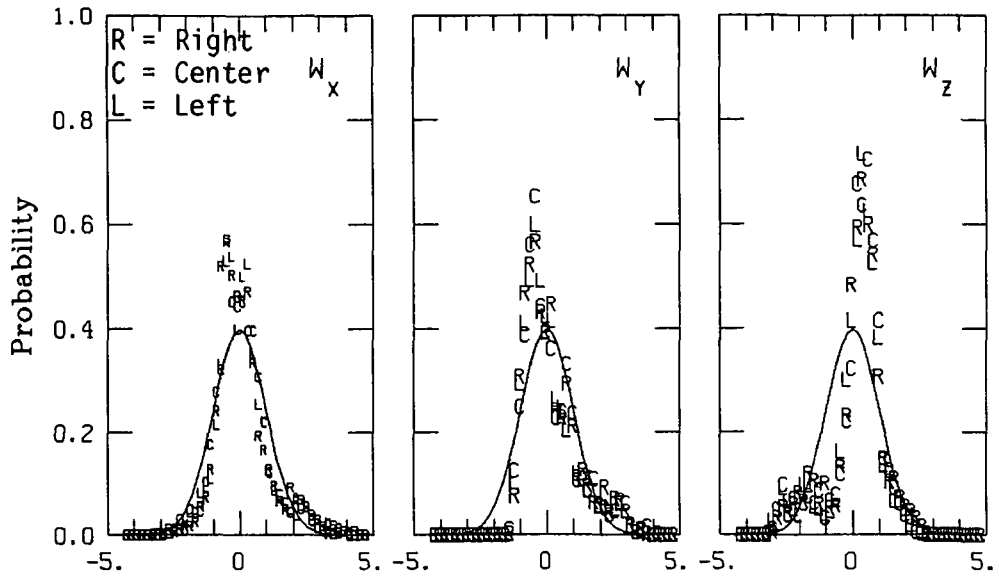

Figure A.146. Time histories of gust velocities and gust velocity differences, Flight 6, Run 22.

TABLE A.37. Average Turbulence Parameters and Integral Length Scales, Flight 6, Run 22.

I. Mean Airspeed (m/s)			II. Standard Deviation of Gust Velocities (m/s)		
V_L	V_C	V_R	$\sigma_{W_{XL}}$	$\sigma_{W_{XC}}$	$\sigma_{W_{XR}}$
102.5	101.6	103.4	2.48	2.34	2.44
			$\sigma_{W_{YL}}$	$\sigma_{W_{YC}}$	$\sigma_{W_{YR}}$
			3.87	4.00	4.06
			$\sigma_{W_{ZL}}$	$\sigma_{W_{ZC}}$	$\sigma_{W_{ZR}}$
			3.68	3.64	3.58
III. Standard Deviation of Gust Velocity Differences (m/s)			IV. Integral Length Scale (m).		
$\sigma_{\Delta W_{XCL}}$	$\sigma_{\Delta W_{XRC}}$	$\sigma_{\Delta W_{XRL}}$	$L_{W_{XL}}$	$L_{W_{XC}}$	$L_{W_{XR}}$
1.11	1.24	1.44	151	139	149
$\sigma_{\Delta W_{YCL}}$	$\sigma_{\Delta W_{YRC}}$	$\sigma_{\Delta W_{YRL}}$	$L_{W_{YL}}$	$L_{W_{YC}}$	$L_{W_{YR}}$
1.08	1.19	1.22	1053	1048	1106
$\sigma_{\Delta W_{ZCL}}$	$\sigma_{\Delta W_{ZRC}}$	$\sigma_{\Delta W_{ZRL}}$	$L_{W_{ZL}}$	$L_{W_{ZC}}$	$L_{W_{ZR}}$
1.33	1.33	1.47	496	541	478



Normalized Gust Velocity (Standard Deviations)

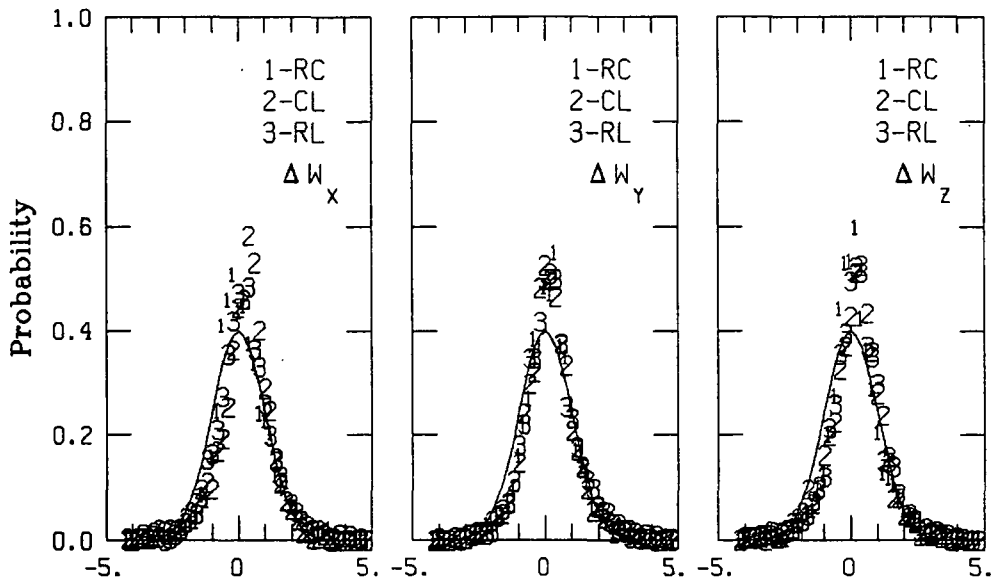

Normalized Velocity Differences (Standard Deviations)

Figure A.147. Probability density function for gust velocities and gust velocity differences, Flight 6, Run 22.

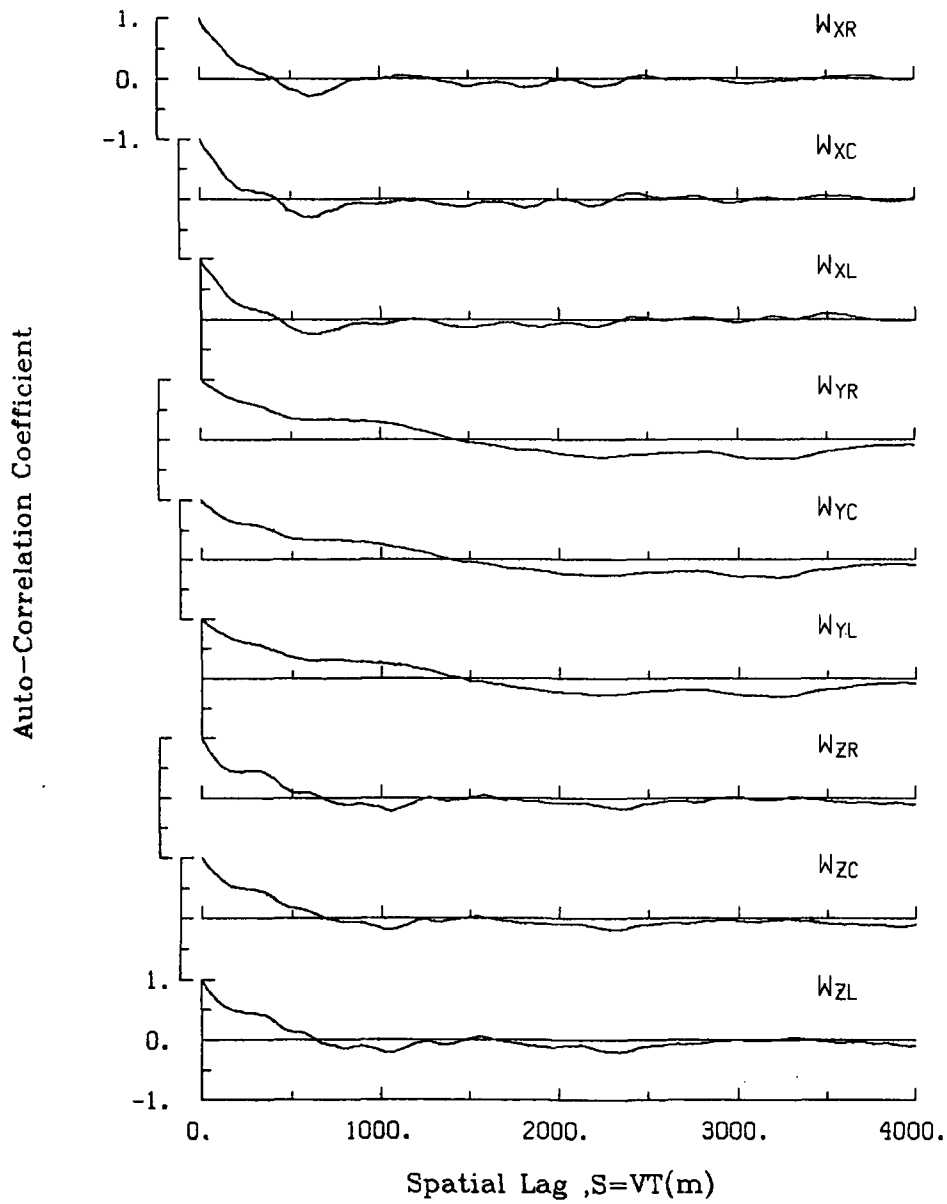

Figure A.148. Single-point auto-correlation coefficient of gust velocities, Flight 6, Run 22.

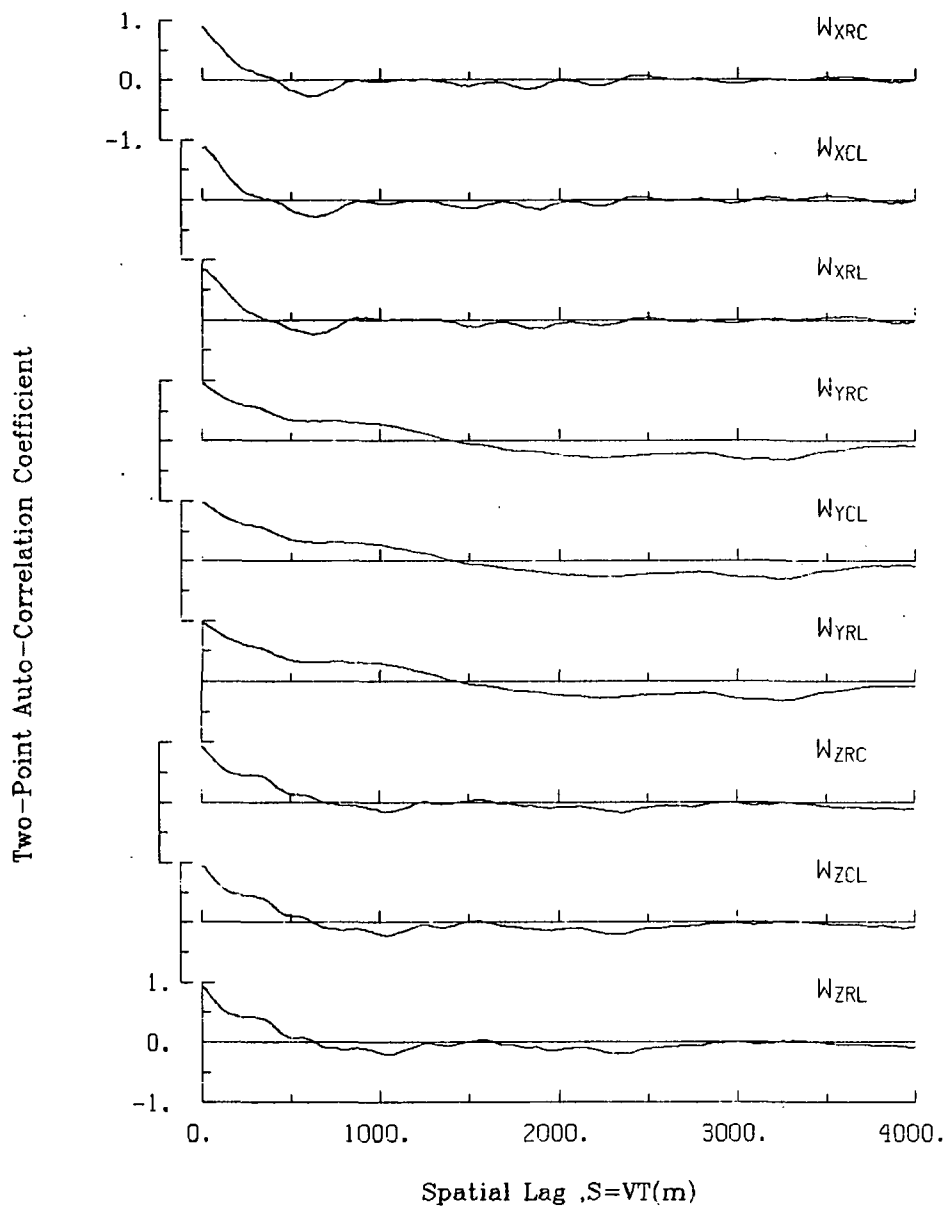

Figure A.149. Two-point auto-correlation coefficient of gust velocities, Flight 6, Run 22.

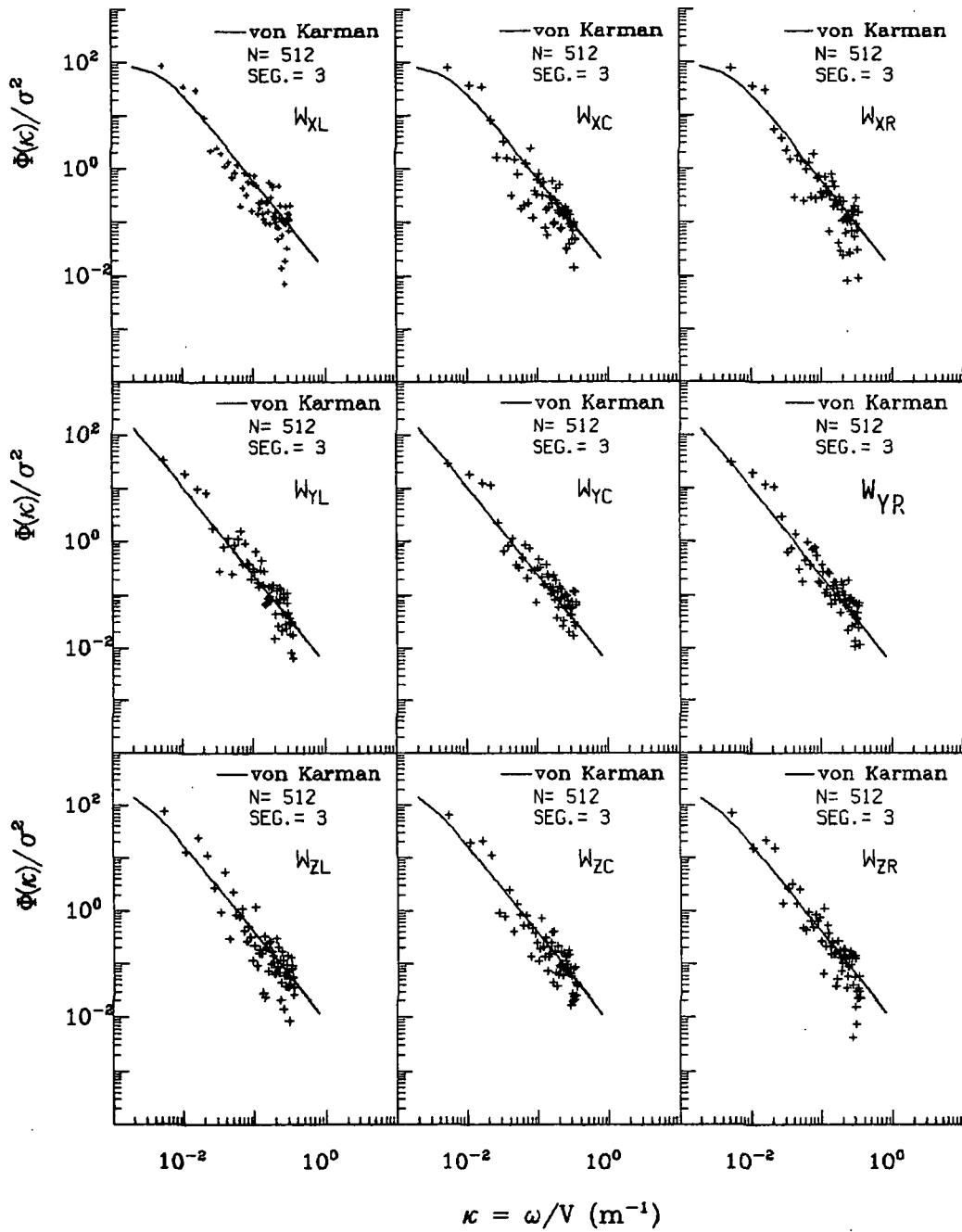

Figure A.150. Normalized auto-spectra of gust velocities, Flight 6, Run 22.

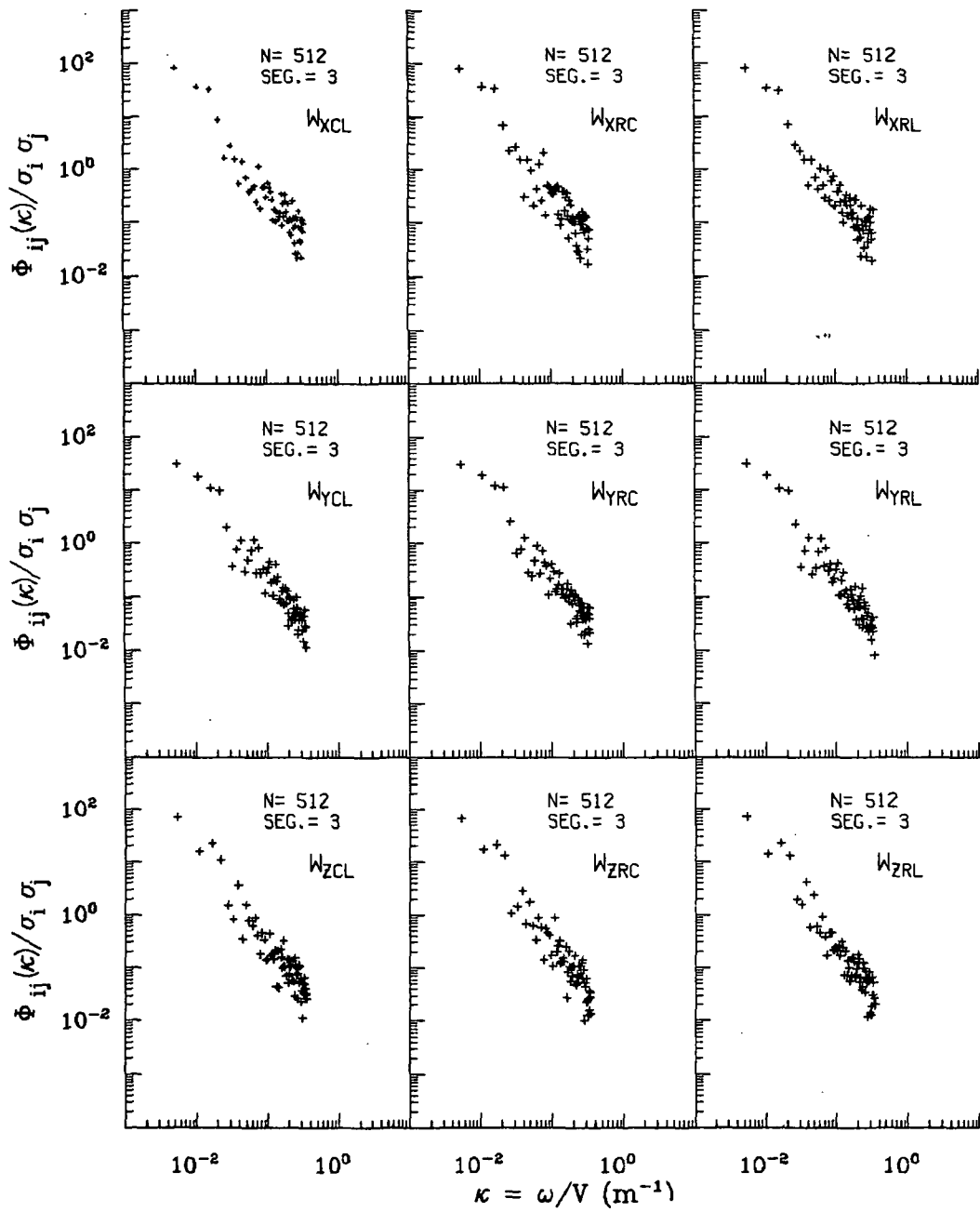

Figure A.151. Normalized two-point auto-spectra of gust velocities, Flight 6, Run 22.

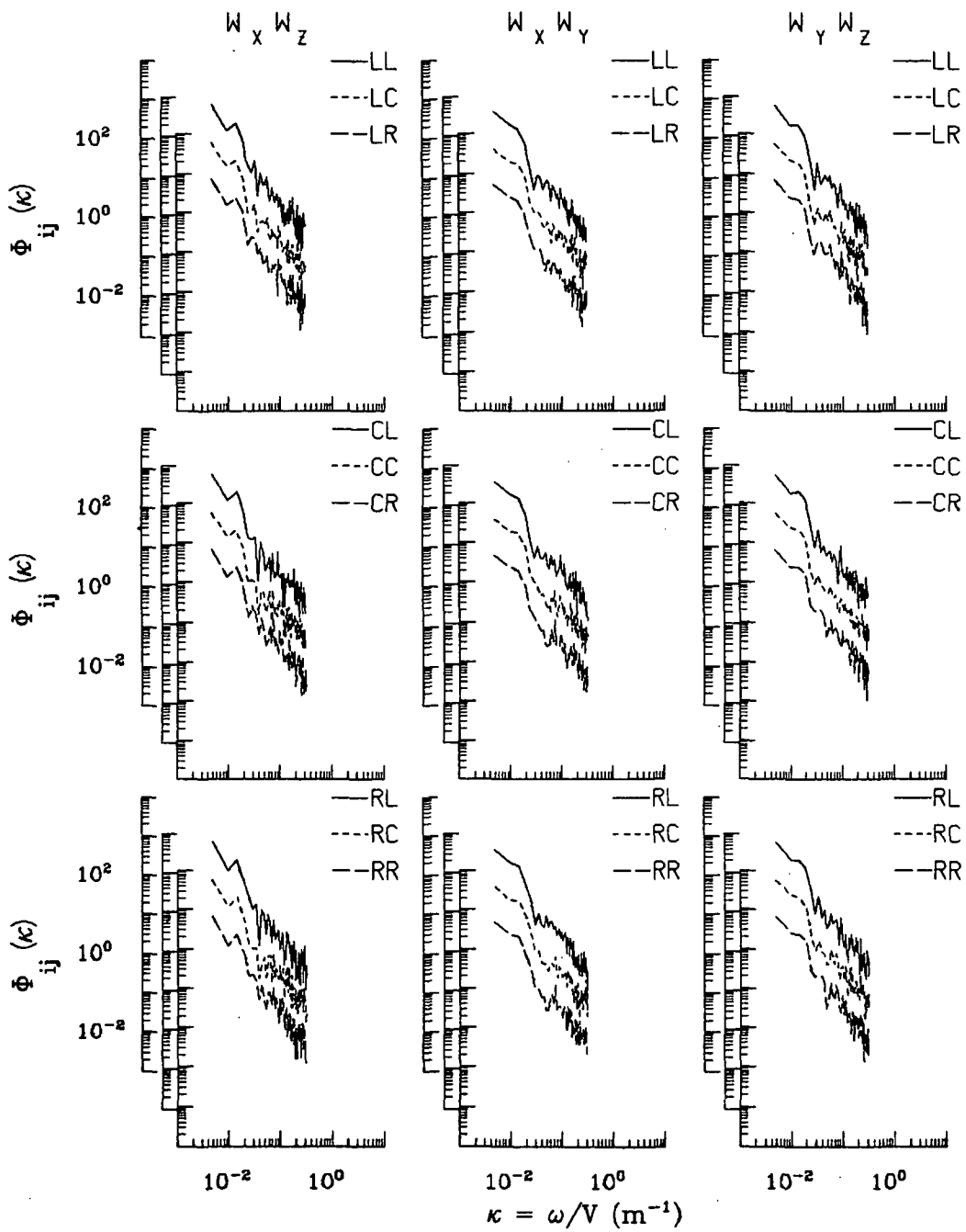

Figure A.152. Two-point cross-spectra of gust velocities, Flight 6, Run 22.

ORIGINAL PAGE IS
OF POOR QUALITY

TABLE A.38. List of All Parameters Measured and Their Range of Values,
Flight 6, Run 22.

		START TIME = 52990.3705	STOP TIME = 53036.4455			
CHANNEL	UNITS	HIGH	LOW	MEAN	RMS	
2 PHI DOT	RAD/SEC	.105	-.172	-.00283	.04419	1843
3 ACCL N CG	G UNITS	-.988	-.988	-.98774	.98774	1843
4 THETA DOT	RAD/SEC	.079	-.060	.00350	.01700	1843
5 THETA	RAD	.181	.030	.07443	.08715	1843
6 PHI	RAD	.050	-.127	-.02673	.04460	1843
7 PSI 1	DEGREES	86.493	76.631	83.81470	83.83719	1843
8 DEL PSI 1	DEGREES	5.490	-4.325	2.79380	3.39169	1843
9 PSI 2	DEGREES	444.541	435.036	441.91883	441.92280	1843
10 DEL PSI 2	DEGREES	5.255	-4.507	2.57447	3.20726	1843
11 ACCL N LT	G UNITS	2.273	-.307	1.00330	1.04979	1843
12 ACCL N RT	G UNITS	2.354	-.216	1.01659	1.05486	1843
13 ACCL X CG	GUNITS	.262	.024	.12149	.13763	1843
14 ACCL Y CG	G UNITS	.133	-.091	.01151	.03303	1843
15 ALPHA CTR	RAD	.076	-.076	-.00758	.02569	1843
16 BETA CTR	RAD	.082	-.137	-.01872	.03519	1843
17 TEMP I	DEG F	98.264	97.724	98.01275	98.01286	1843
18 TEMP P	DEG F	90.905	90.725	90.73602	90.73603	1843
19 ACCL Z INS	G UNITS	1.479	.284	1.00042	1.01116	1843
20 ALPHA RT	RAD	.097	-.073	-.00064	.02859	1843
21 BETA RT	RAD	.104	-.075	.01575	.03031	1843
22 ALPHA LT	RAD	.090	-.077	-.00214	.02770	1843
23 BETA LT	RAD	.062	-.146	-.02602	.03739	1843
24 PSI DOT	RAD/SEC	.103	-.066	.00472	.02565	1843
25 TEMP TOT	DEG C	33.853	30.212	32.38554	32.40210	1843
26 QC IT	PSID	.895	.520	.72472	.73174	1843
27 QC CTR	PSID	.862	.506	.71109	.71788	1843
28 QC RT	PSID	.897	.509	.73747	.74494	1843
29 PS	PSIA	11.604	11.550	11.56959	11.56960	1843
30 TEMP IRT	DEG C	29.328	17.050	24.76924	25.03831	1843
31 D TO G	METERS	8760971.2518755879.872*****				1843
32 B TO D	DEGREES	80.444	80.406	80.42410	80.42410	1843
33 LONG	DEGREES	-104.785	-104.844	-104.81595	104.81596	1843
34 LAT	DEGREES	39.774	39.768	39.77097	39.77097	1843
35 TRK ANG	DEGREES	83.270	79.896	81.92032	81.92492	1843
36 HDG	RADIANS	1.517	1.341	1.46847	1.46887	1843
37 VE	M/SEC	118.206	98.420	111.24998	111.44137	1843
38 VN	M/SEC	21.070	11.670	15.92429	16.12511	1843
39 ALTITUDE	KM	1.986	1.948	1.97224	1.97226	1843
40 TEMPC	DEGREES C	27.899	26.043	27.22379	27.22644	1843
41 EW WND SPD	KNOTS	38.293	8.834	19.53997	20.10128	1843
42 NS WND SPD	KNOTS	27.222	-14.979	14.64819	16.56572	1843
43 WIND SPEED	KNOTS	40.684	9.034	25.63871	26.04773	1843
44 WIND DIR EC	DEGREES	291.604	209.430	233.76620	234.39958	1843
45 AIRSPEED P	M/SEC	114.119	86.274	103.40042	103.67006	1843
46 AIRSPEED C	M/SEC	111.898	86.071	101.59011	101.83991	1843
47 AIRSPEED L	M/SEC	113.967	87.220	102.53491	102.79019	1843
48 DELTA ALT	METERS	33.600	-3.768	20.16525	22.22558	1843
49 INRTL DISP	METERS	31.365	-6.735	17.63709	21.17311	1843
50 UG RIGHT	M/SEC	9.848	-7.711	.00000	2.29812	1843
51 UG CENTER	M/SEC	8.556	-6.124	.00000	2.21342	1843
52 UG LEFT	M/SEC	9.408	-7.847	.00000	2.35747	1843
53 VG RIGHT	M/SEC	13.972	-6.200	-.12695	4.01426	1843
54 VG CENTER	M/SEC	15.673	-6.394	-.11394	3.94579	1843
55 VG LEFT	M/SEC	15.041	-5.885	-.10724	3.82357	1843
56 WG RIGHT	M/SEC	8.589	-10.433	.14935	3.36516	1843
57 WG CENTER	M/SEC	8.292	-11.383	.16089	3.42857	1843
58 WG LEFT	M/SEC	9.036	-11.200	.13440	3.45362	1843

Date: July 14, 1982
 Time: 14:46:10 (MDT)
 Duration: 193 seconds

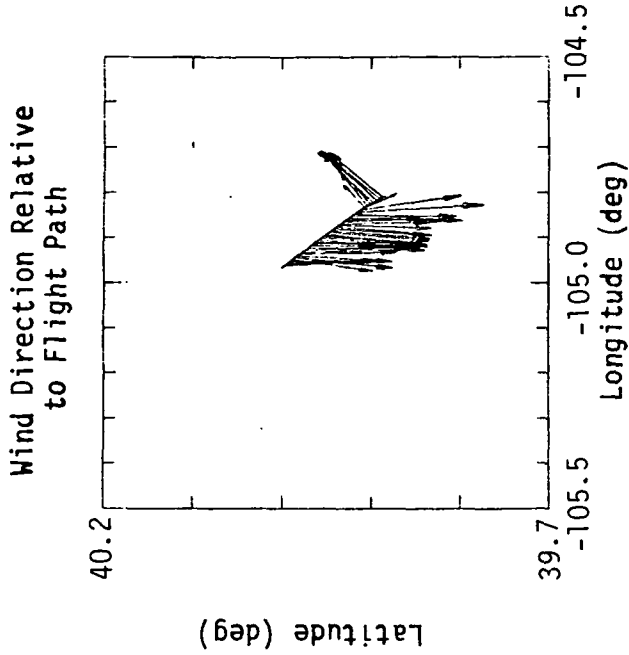
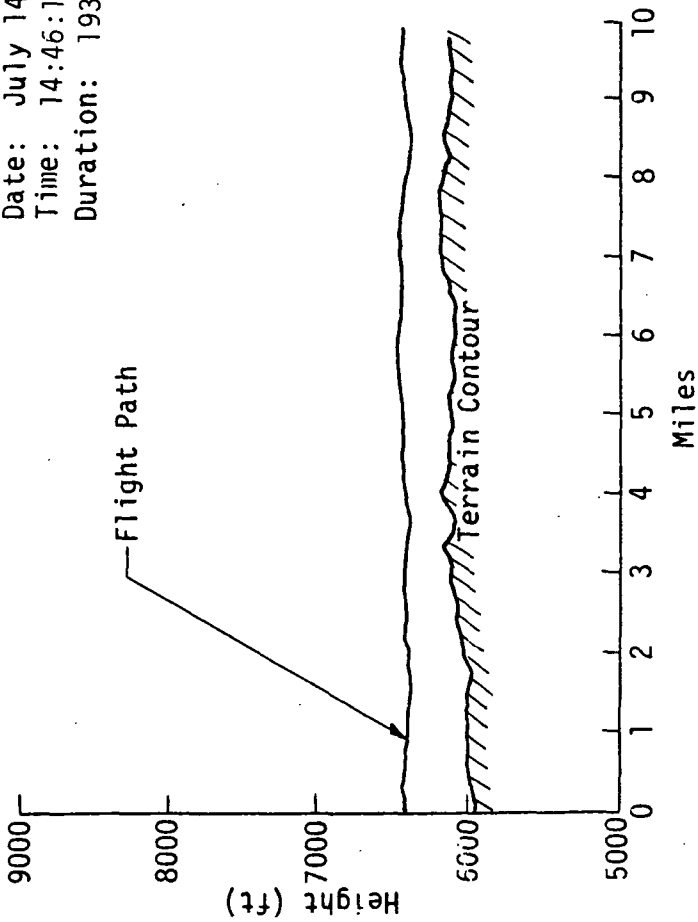

ORIGINAL PAGE IS
 OF POOR QUALITY

Figure A.153. Flight path information, Flight 6, Run 23.

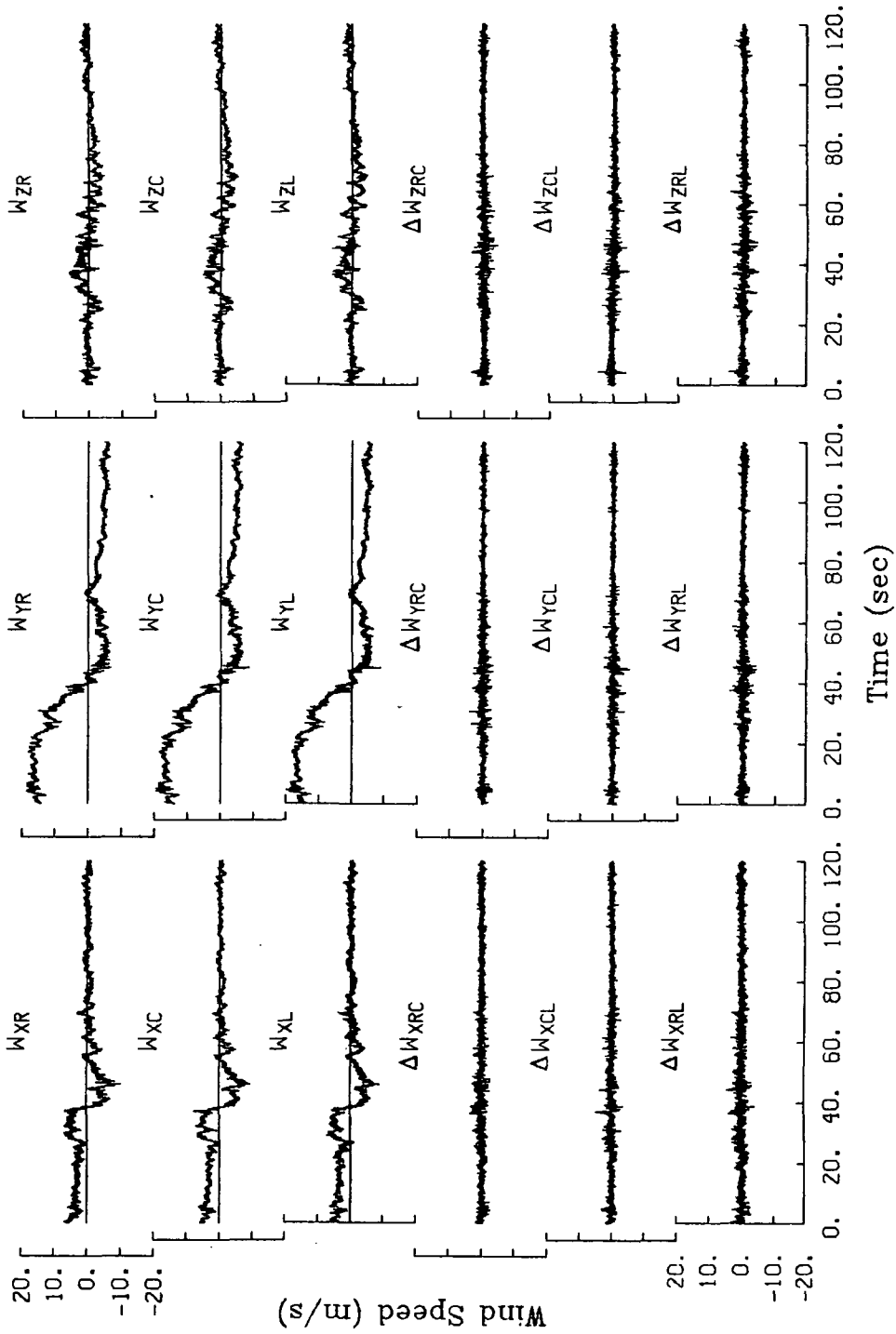
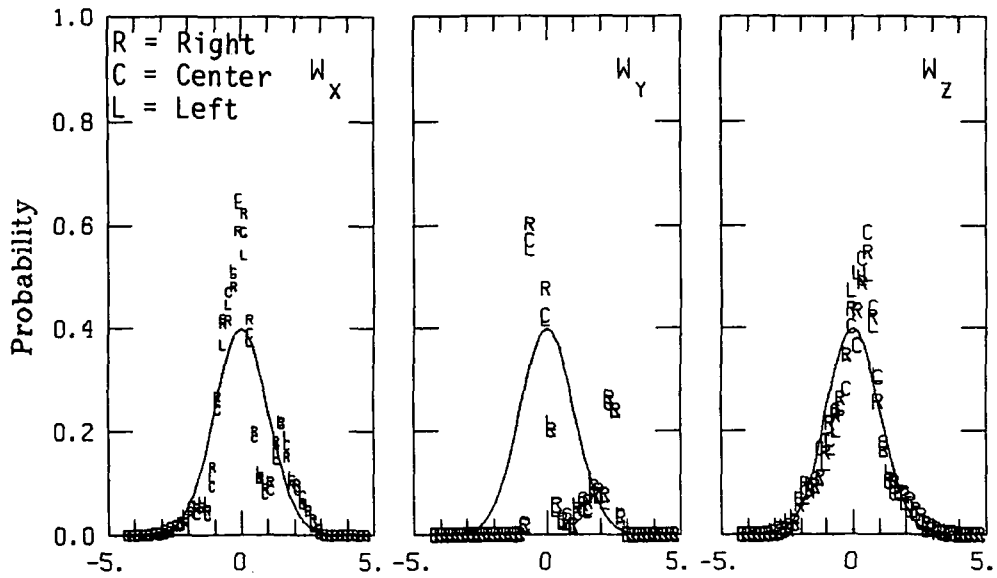

Figure A.154. Time histories of gust velocities and gust velocity differences, Flight 6, Run 23.

TABLE A.39. Average Turbulence Parameters and Integral Length Scales, Flight 6, Run 23.

I. Mean Airspeed (m/s)			II. Standard Deviation of Gust Velocities (m/s)		
V_L	V_C	V_R	$\sigma_{W_{XL}}$	$\sigma_{W_{XC}}$	$\sigma_{W_{XR}}$
103.8	102.7	104.5	2.41	2.43	2.44
			$\sigma_{W_{YL}}$	$\sigma_{W_{YC}}$	$\sigma_{W_{YR}}$
			7.44	7.48	7.45
			$\sigma_{W_{ZL}}$	$\sigma_{W_{ZC}}$	$\sigma_{W_{ZR}}$
			1.55	1.55	1.57
III. Standard Deviation of Gust Velocity Differences (m/s)			IV. Integral Length Scale (m)		
$\sigma_{\Delta W_{XCL}}$	$\sigma_{\Delta W_{XRC}}$	$\sigma_{\Delta W_{XRL}}$	$L_{W_{XL}}$	$L_{W_{XC}}$	$L_{W_{XR}}$
0.59	0.63	0.75	807	799	776
$\sigma_{\Delta W_{YCL}}$	$\sigma_{\Delta W_{YRC}}$	$\sigma_{\Delta W_{YRL}}$	$L_{W_{YL}}$	$L_{W_{YC}}$	$L_{W_{YR}}$
0.58	0.58	0.64	3776	3736	3824
$\sigma_{\Delta W_{ZCL}}$	$\sigma_{\Delta W_{ZRC}}$	$\sigma_{\Delta W_{ZRL}}$	$L_{W_{ZL}}$	$L_{W_{ZC}}$	$L_{W_{ZR}}$
0.67	0.69	0.75	767	1021	811



Normalized Gust Velocity (Standard Deviations)

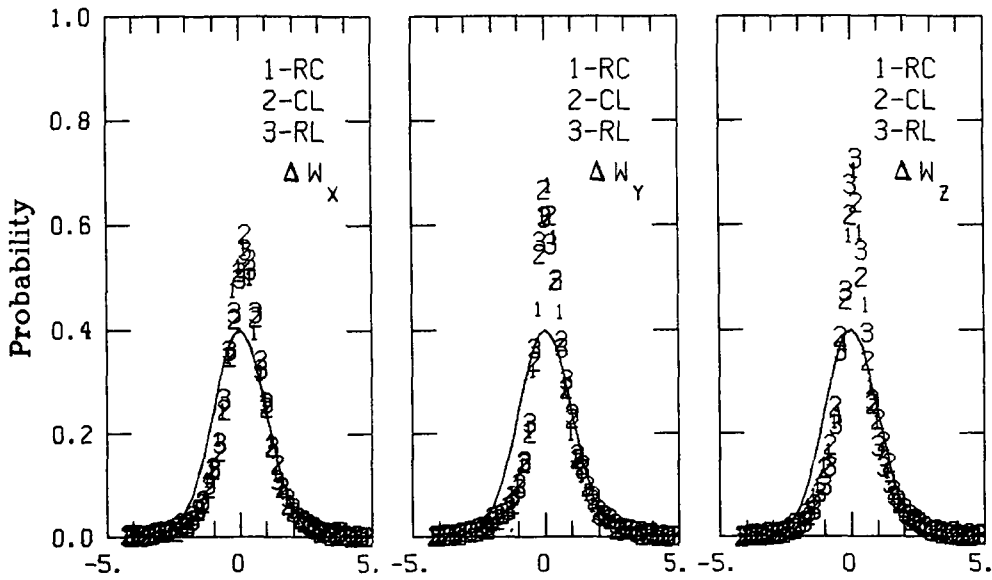

Normalized Velocity Differences (Standard Deviations)

Figure A.155. Probability density function for gust velocities and gust velocity differences, Flight 6, Run 23.

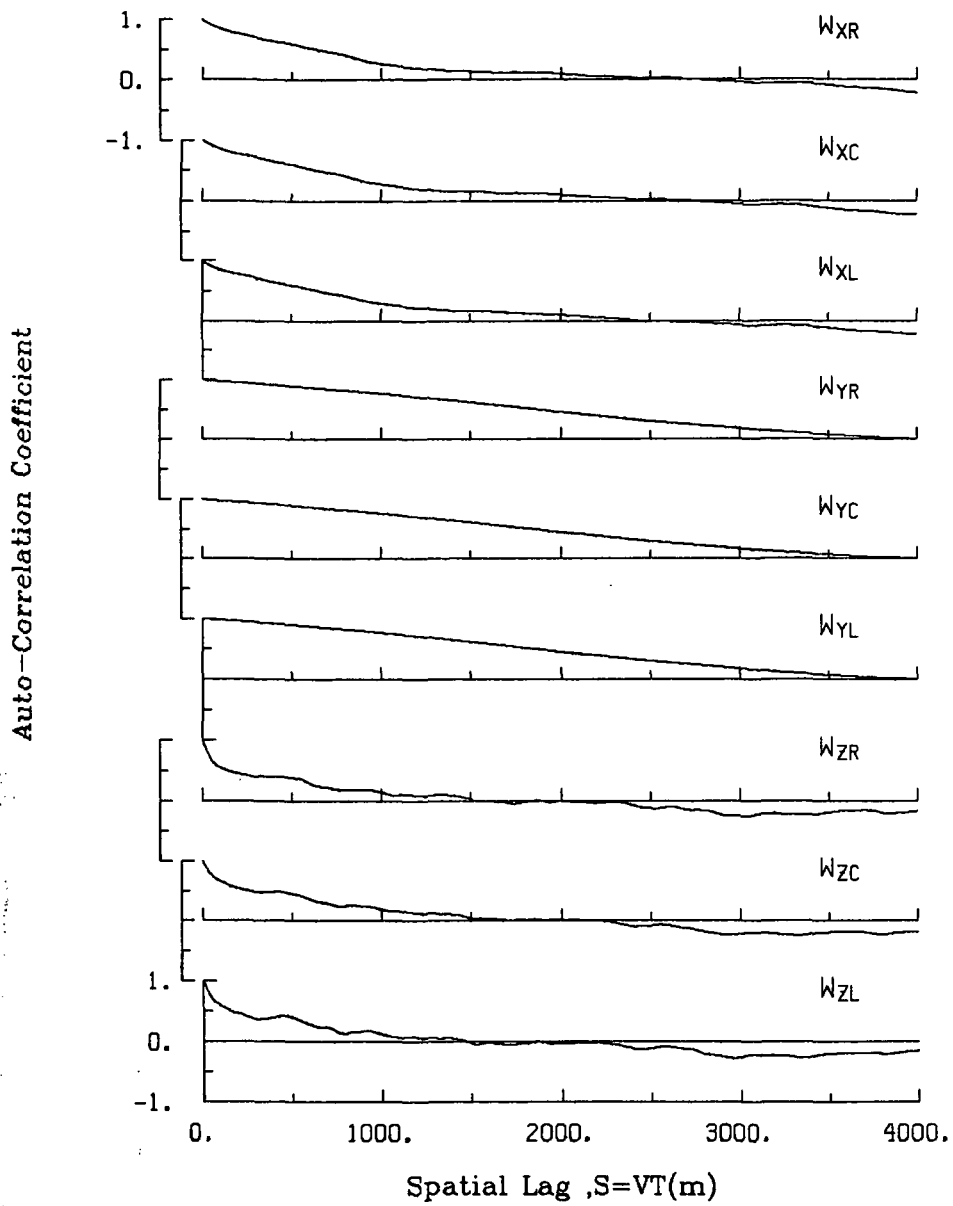

Figure A.156. Single-point auto-correlation coefficient of gust velocities, Flight 6, Run 23.

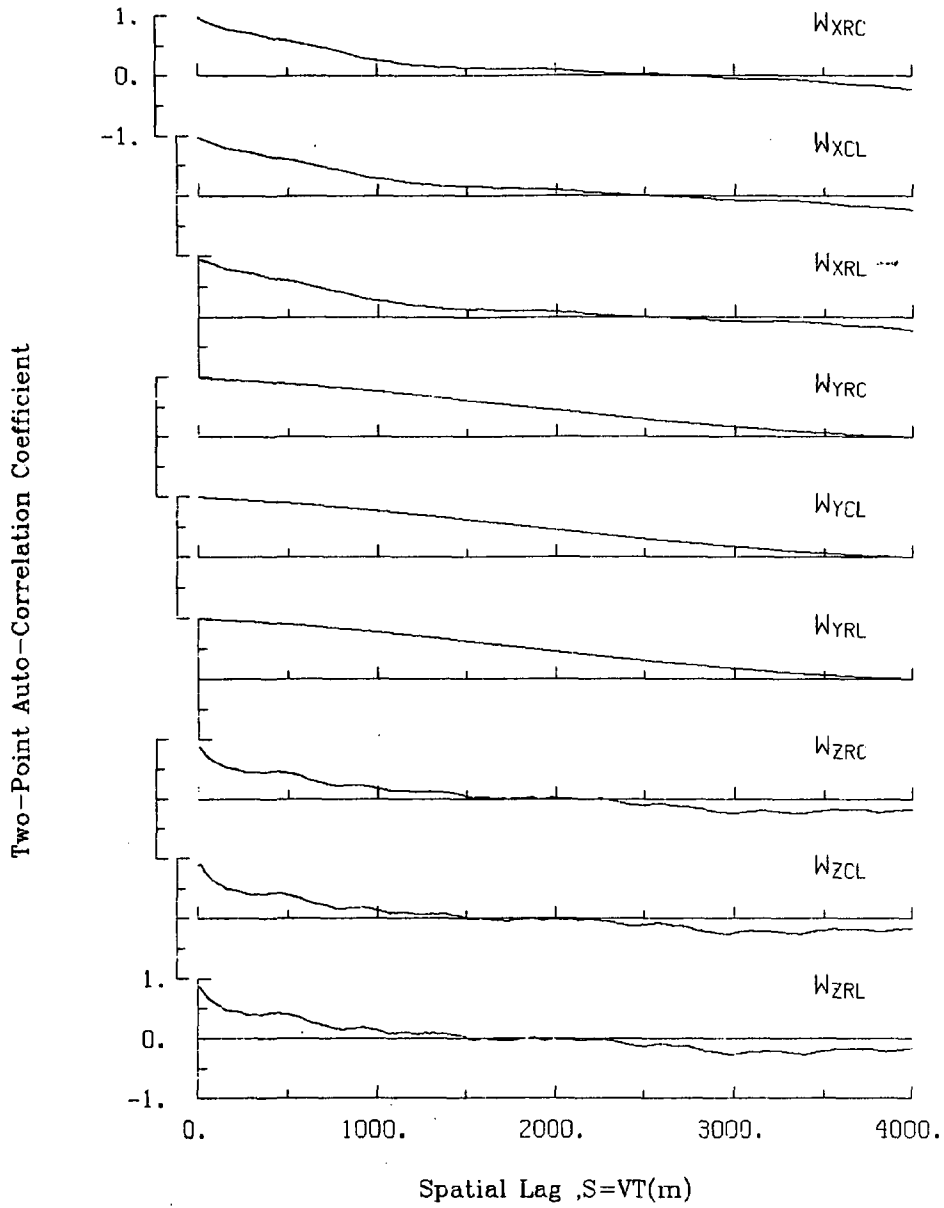

Figure A.157. Two-point auto-correlation coefficient of gust velocities, Flight 6, Run 23.

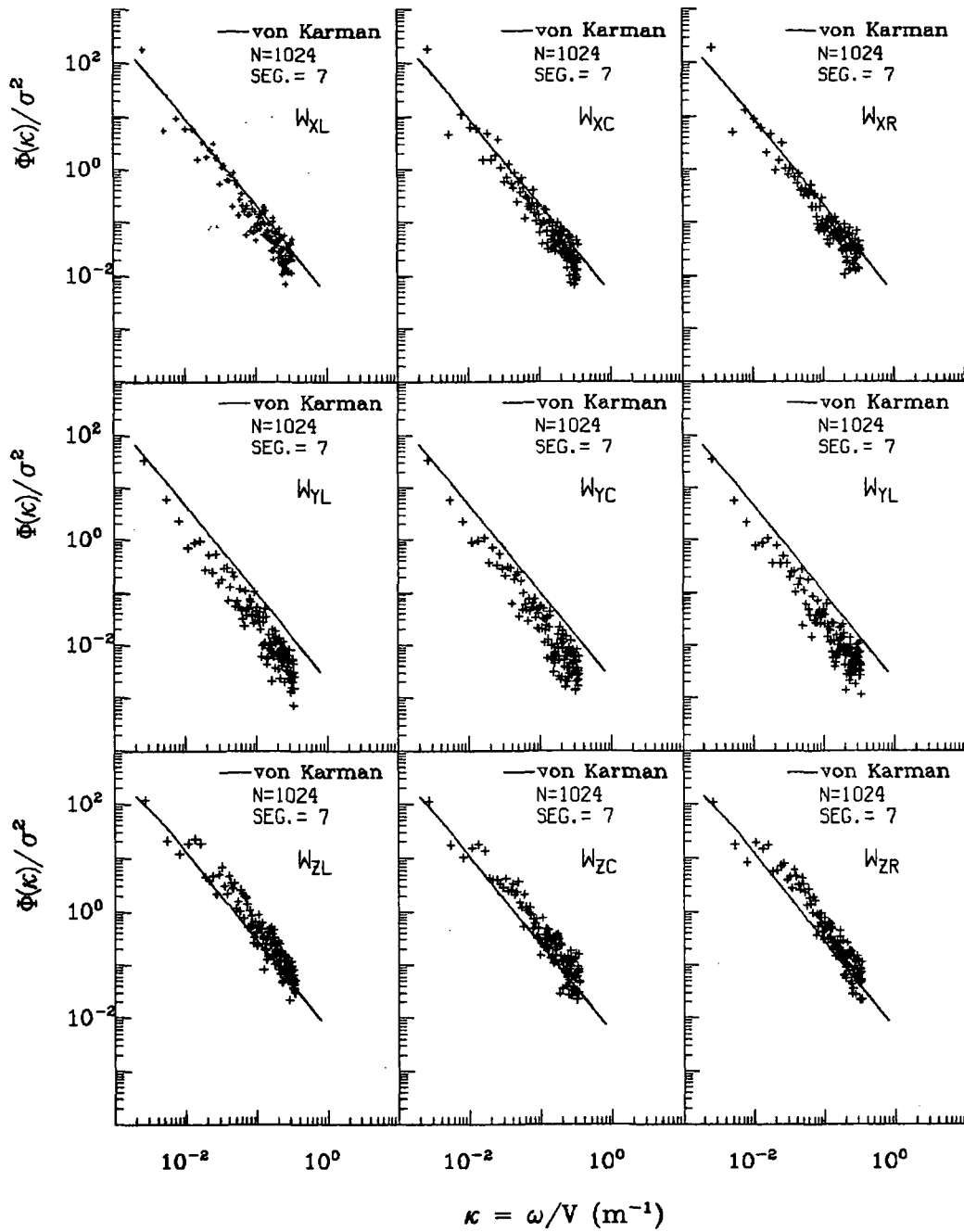

Figure A.158. Normalized auto-spectra of gust velocities, Flight 6, Run 23.

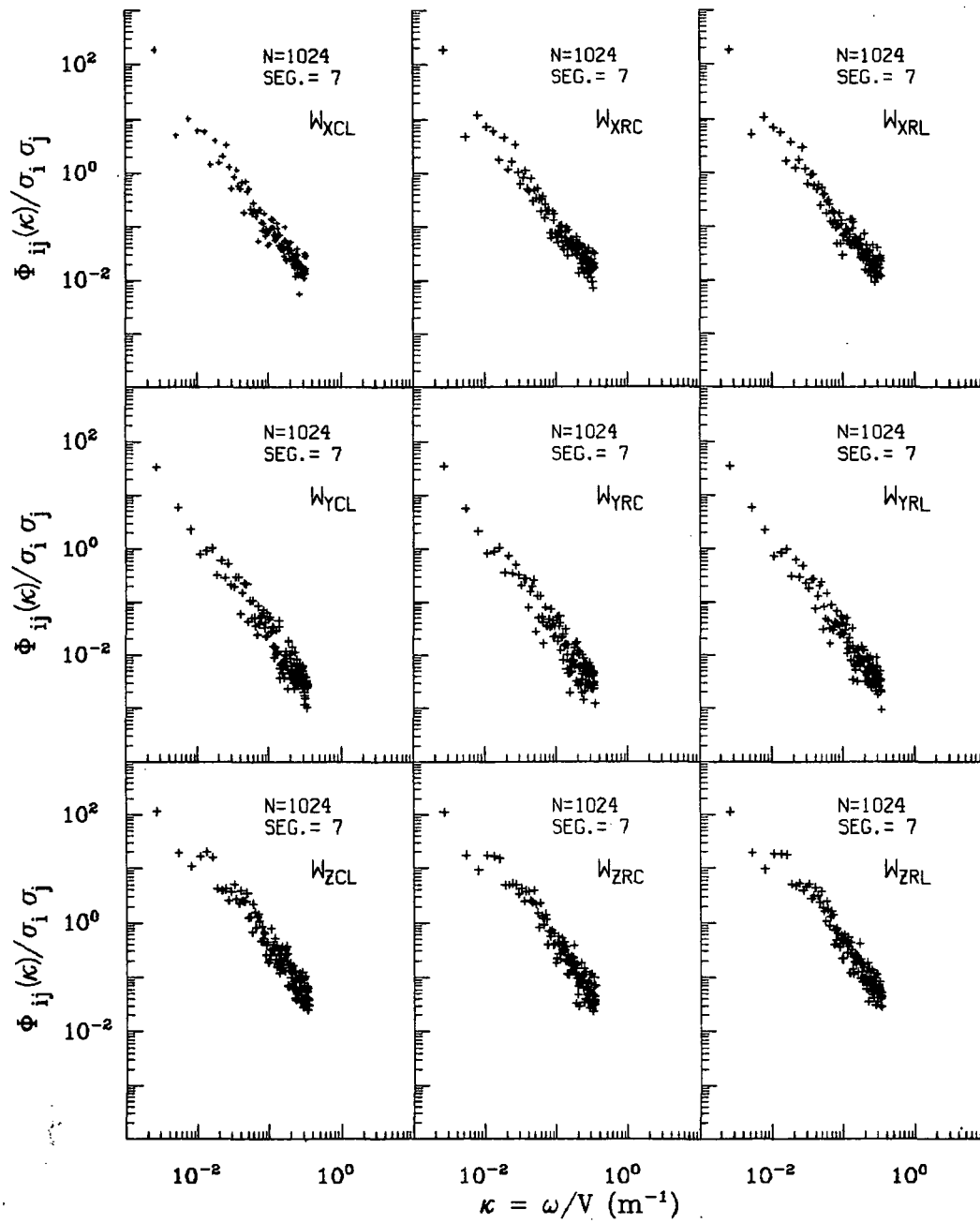

Figure A.159. Normalized two-point auto-spectra of gust velocities, Flight 6, Run 23.

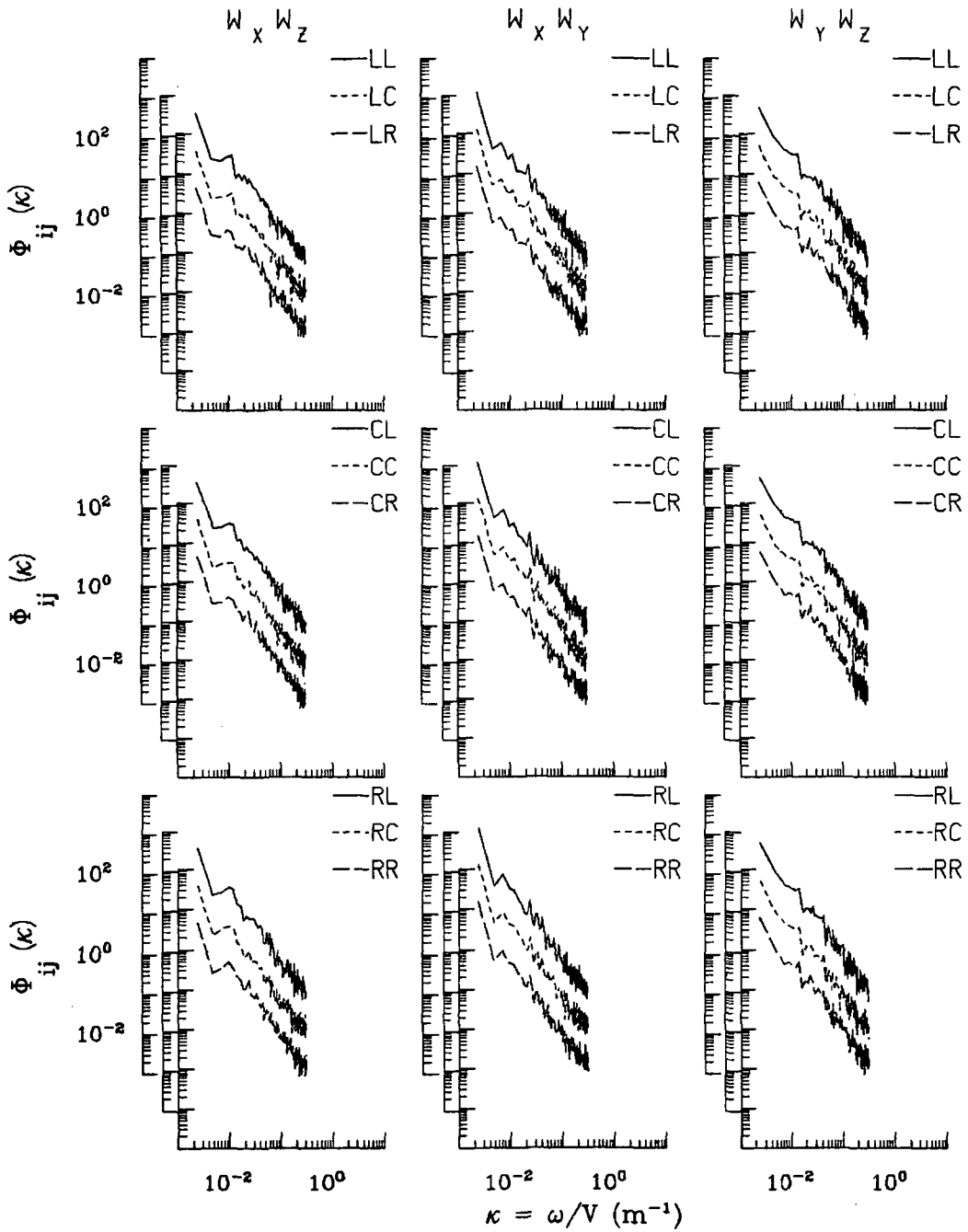

Figure A.160. Two-point cross-spectra of gust velocities, Flight 6, Run 23.

ORIGINAL PAGE IS
OF POOR QUALITY

TABLE A.40. List of All Parameters Measured and Their Range of Values,
Flight 6, Run 23.

START TIME = 53170.3109 STOP TIME = 53363.7609

CHANNEL	UNITS	HIGH	LOW	MEAN	RMS	POINTS
2 PHI DOT	RAD/SEC	.112	-.125	-.00295	.02595	7738
3 ACCL N CG	G UNITS	-.988	-.988	-.98774	.98774	7738
4 THETA DOT	RAD/SEC	.060	-.044	.00600	.01173	7738
5 THETA	RAD	.106	.028	.06149	.06428	7738
6 PHI	RAD	.065	-.151	-.01872	.03662	7738
7 PSI 1	DEGREES	318.964	310.158	314.60206	314.60874	7738
8 DEL PSI 1	DEGREES	4.462	-1.886	1.06459	1.46634	7738
9 PSI 2	DEGREES	318.509	312.172	315.06911	315.07068	7738
10 DEL PSI 2	DEGREES	6.608	-2.037	2.15514	2.97909	7738
11 ACCL N LT	G UNITS	2.319	-.123	1.01313	1.03131	7738
12 ACCL N RT	G UNITS	2.171	-.332	1.02620	1.04389	7738
13 ACCL X CG	G UNITS	.114	-.010	.05927	.06287	7738
14 ACCL Y CG	G UNITS	.158	-.154	.00983	.04515	7738
15 ALPHA CTR	RAD	.032	-.064	-.01289	.01713	7738
16 BETA CTR	RAD	.051	-.111	-.01805	.02416	7738
17 TEMP I	DEG F	98.444	97.904	98.33294	98.33303	7738
18 TEMP P	DEG F	91.265	90.905	91.06143	91.06146	7738
19 ACCL Z INS	G UNITS	1.459	.557	1.00435	1.00887	7738
20 ALPHA RT	RAD	.049	-.062	-.00431	.01376	7738
21 BETA RT	RAD	.074	-.059	.01661	.02212	7738
22 ALPHA LT	RAD	.039	-.065	-.00389	.01335	7738
23 BETA LT	RAD	.037	-.117	-.02370	.02792	7738
24 PSI DOT	RAD/SEC	.047	-.035	.00334	.01223	7738
25 TEMP TOT	DEG C	32.868	29.619	30.99356	31.00330	7738
26 QC LT	PSID	.894	.626	.74468	.74612	7738
27 QC CTR	PSID	.877	.629	.72894	.73036	7738
28 QC RT	PSID	.914	.644	.75594	.75742	7738
29 PS	PSIA	11.612	11.570	11.59178	11.59179	7738
30 TEMP IRT	DEG C	27.188	15.152	21.67480	21.89621	7738
31 D TO G	METERS	8761088.2948749959.437*****				7738
32 B TO D	DEGREES	80.407	80.278	80.34369	80.34370	7738
33 LONG	DEGREES	-104.808	-104.966	-104.88488	104.88489	7738
34 LAT	DEGREES	40.001	39.886	39.94511	39.94513	7738
35 TRK ANG	DEGREES	321.944	309.800	313.32654	313.35062	7738
36 HDG	RADIANS	5.560	5.446	5.49857	5.49860	7738
37 VE	M/SEC	-61.959	-74.543	-69.84850	69.94730	7738
38 VN	M/SEC	80.372	60.149	66.08023	66.38855	7738
39 ALTITUDE	KM	1.972	1.943	1.95678	1.95679	7738
40 TEMPC	DEGREES C	27.322	24.638	25.74040	25.74712	7738
41 EW WND SPD	KNOTS	26.697	-9.680	2.68083	8.42233	7738
42 NS WND SPD	KNOTS	18.435	-34.265	-15.27560	19.71128	7738
43 WIND SPEED	KNOTS	34.285	.228	21.06640	21.43525	7738
44 WIND DIREC	DEGREES	359.997	.007	174.17824	235.12447	7738
45 AIRSPEED R	M/SEC	114.875	96.597	104.53087	104.58107	7738
46 AIRSPEED C	M/SEC	112.541	95.576	102.68868	102.73759	7738
47 AIRSPEED L	M/SEC	113.630	95.292	103.76756	103.81691	7738
48 DELTA ALT	METERS	19.297	-10.027	3.92072	7.77175	7738
49 INRTL DISP	METERS	17.829	-9.816	4.61329	8.46133	7738
50 UG RIGHT	M/SEC	6.959	-10.088	-.00000	2.38505	7738
51 UG CENTER	M/SEC	7.679	-9.352	-.00000	2.37221	7738
52 UG LEFT	M/SEC	7.038	-9.115	-.00000	2.35646	7738
53 VG RIGHT	M/SEC	18.662	-7.580	.00035	7.21743	7738
54 VG CENTER	M/SEC	19.663	-8.275	.00068	7.24409	7738
55 VG LEFT	M/SEC	19.668	-8.656	.00261	7.19960	7738
56 WG RIGHT	M/SEC	5.927	-5.422	.00368	1.56147	7738
57 WG CENTER	M/SEC	5.517	-5.014	.00663	1.52780	7738
58 WG LEFT	M/SEC	6.139	-5.779	.00215	1.54623	7738

Date: July 14, 1982
Time: 14:50:50(MDT)
Duration: 87 seconds

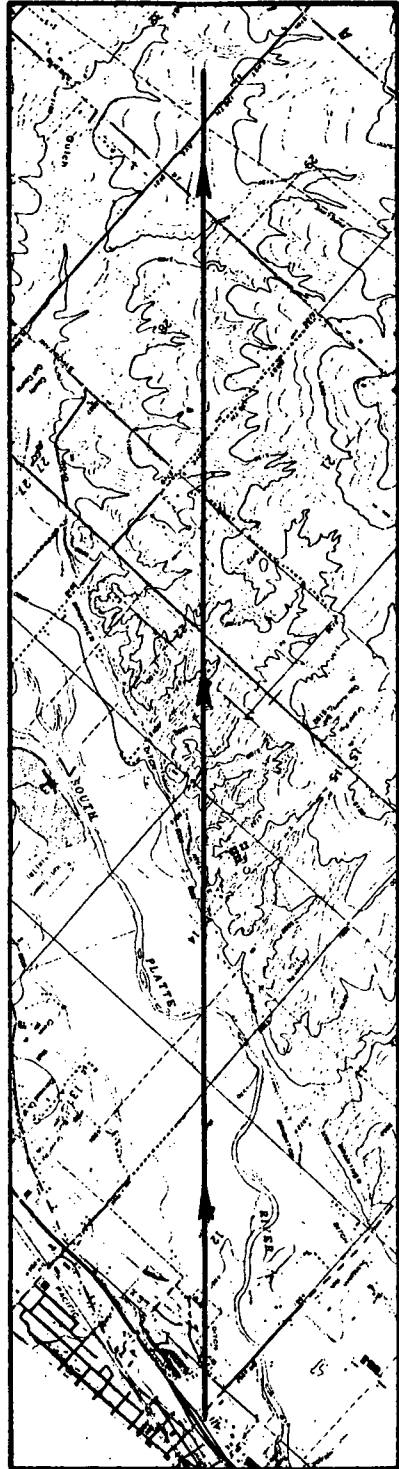
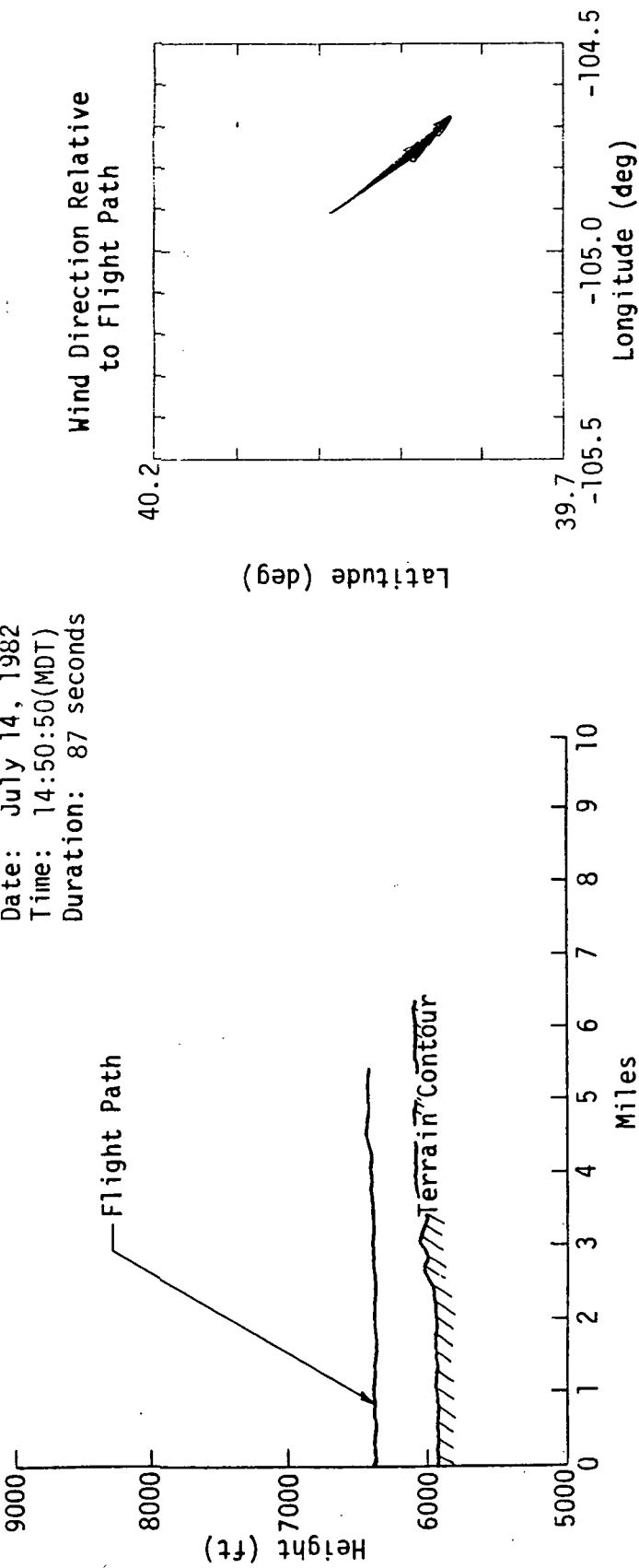

Figure A.161. Flight path information, Flight 6, Kun 24.

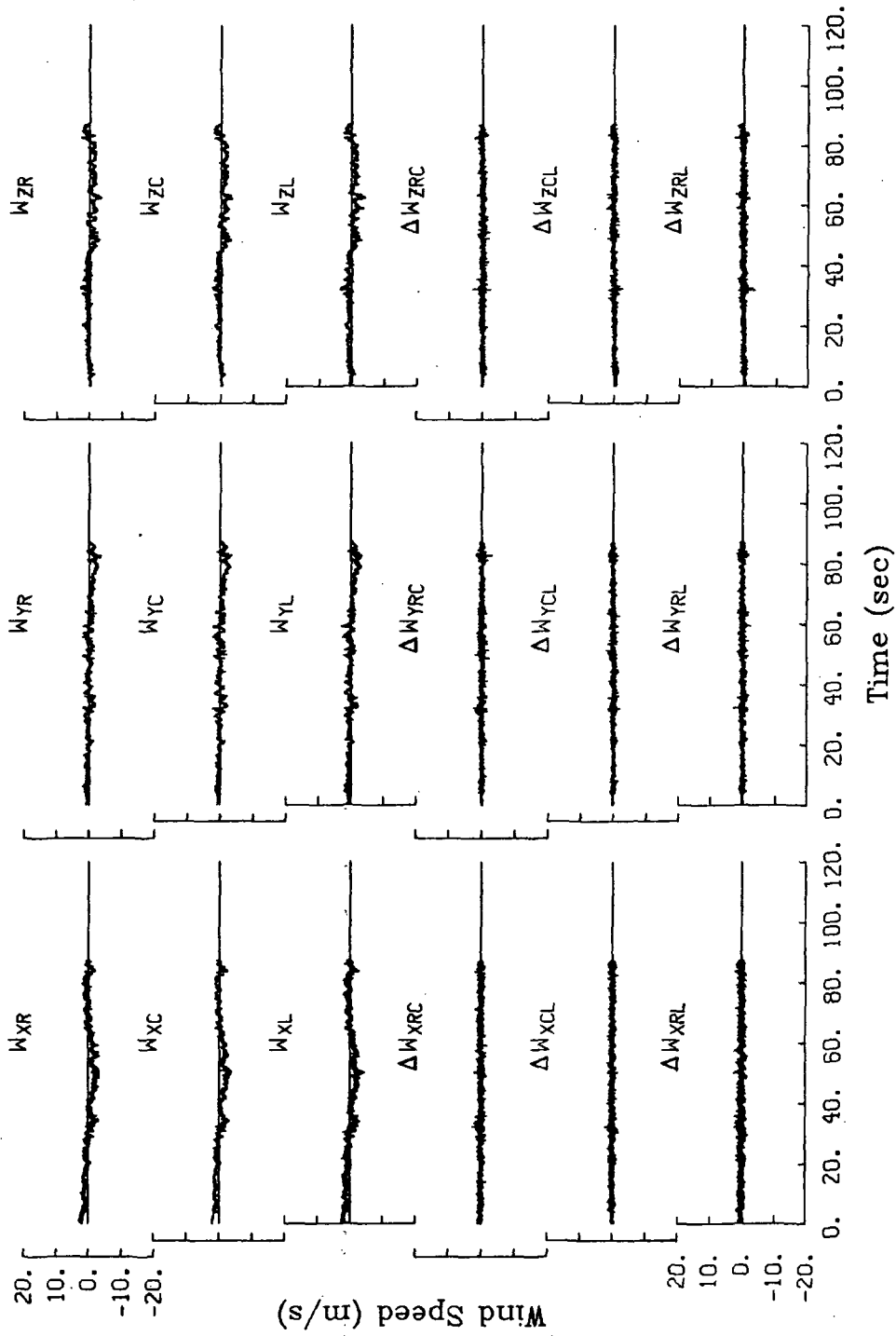
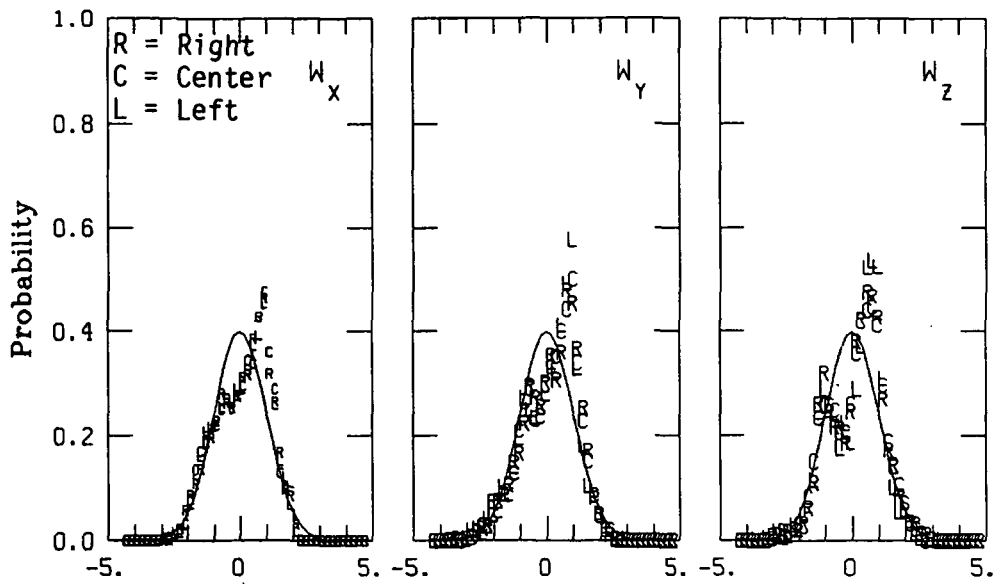

Figure A.162. Time histories of gust velocities and gust velocity differences, Flight 6, Run 24.

TABLE A.41. Average Turbulence Parameters and Integral Length Scales, Flight 6, Run 24.

I. Mean Airspeed (m/s)			II. Standard Deviation of Gust Velocities (m/s)		
V_L	V_C	V_R	$\sigma_{W_{XL}}$	$\sigma_{W_{XC}}$	$\sigma_{W_{XR}}$
102.9	101.9	103.7	1.19	1.16	1.21
III. Standard Deviation of Gust Velocity Differences (m/s)			$\sigma_{W_{YL}}$	$\sigma_{W_{YC}}$	$\sigma_{W_{YR}}$
			0.80	0.78	0.74
$\sigma_{\Delta W_{XCL}}$	$\sigma_{\Delta W_{XRC}}$	$\sigma_{\Delta W_{XRL}}$	$\sigma_{W_{ZL}}$	$\sigma_{W_{ZC}}$	$\sigma_{W_{ZR}}$
0.43	0.44	0.53	1.07	0.94	0.97
$\sigma_{\Delta W_{YCL}}$	$\sigma_{\Delta W_{YRC}}$	$\sigma_{\Delta W_{YRL}}$	IV. Integral Length Scale (m).		
0.40	0.40	0.43	$L_{W_{XL}}$	$L_{W_{XC}}$	$L_{W_{XR}}$
			805	840	821
$\sigma_{\Delta W_{ZCL}}$	$\sigma_{\Delta W_{ZRC}}$	$\sigma_{\Delta W_{ZRL}}$	$L_{W_{YL}}$	$L_{W_{YC}}$	$L_{W_{YR}}$
0.41	0.46	0.50	1278	1032	1218
			$L_{W_{ZL}}$	$L_{W_{ZC}}$	$L_{W_{ZR}}$
			1469	1256	1108



Normalized Gust Velocity (Standard Deviations)

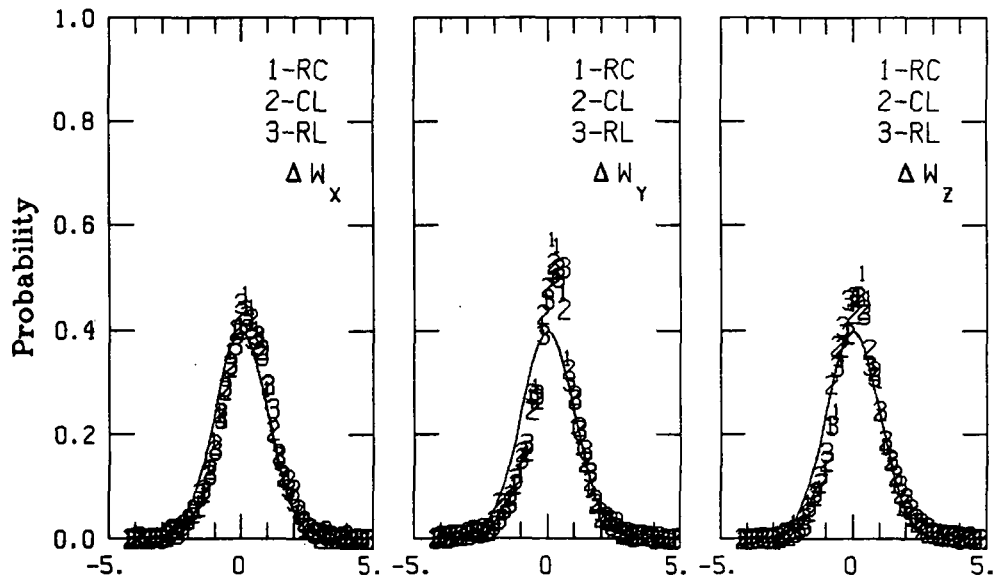

Normalized Velocity Differences (Standard Deviations)

Figure A.163. Probability density function for gust velocities and gust velocity differences, Flight 6, Run 24.

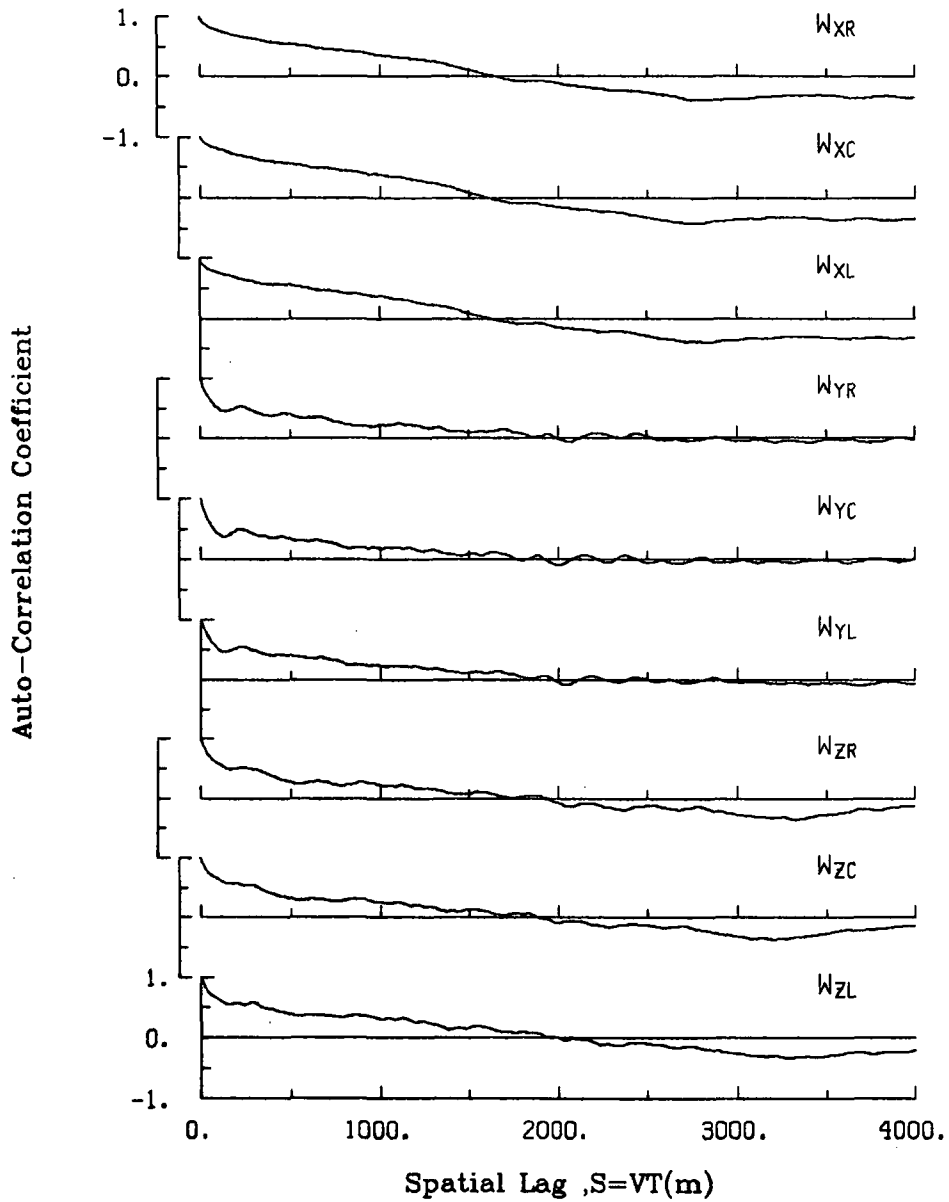

Figure A.164. Single-point auto-correlation coefficient of gust velocities, Flight 6, Run 24.

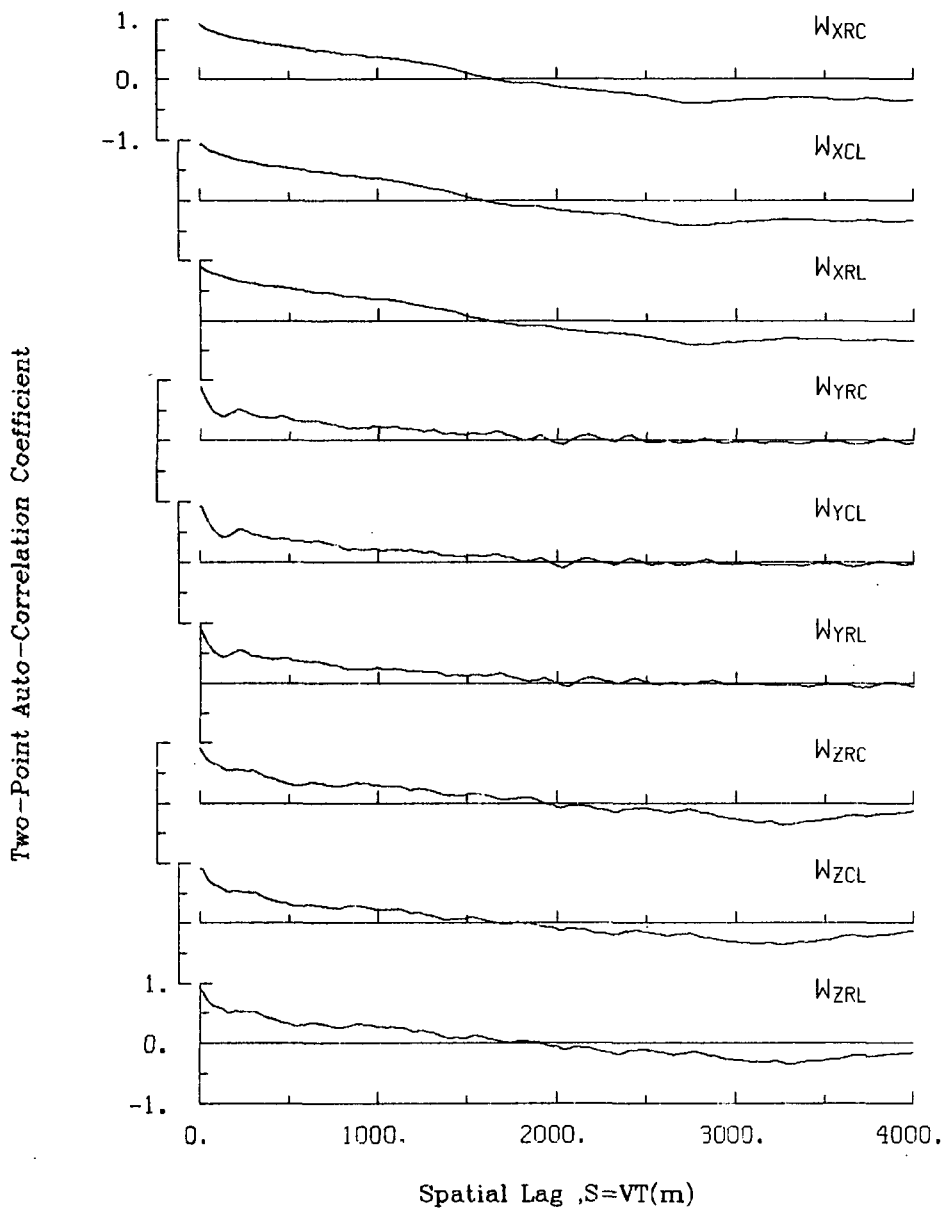

Figure A.165. Two-point auto-correlation coefficient of gust velocities, Flight 6, Run 24.

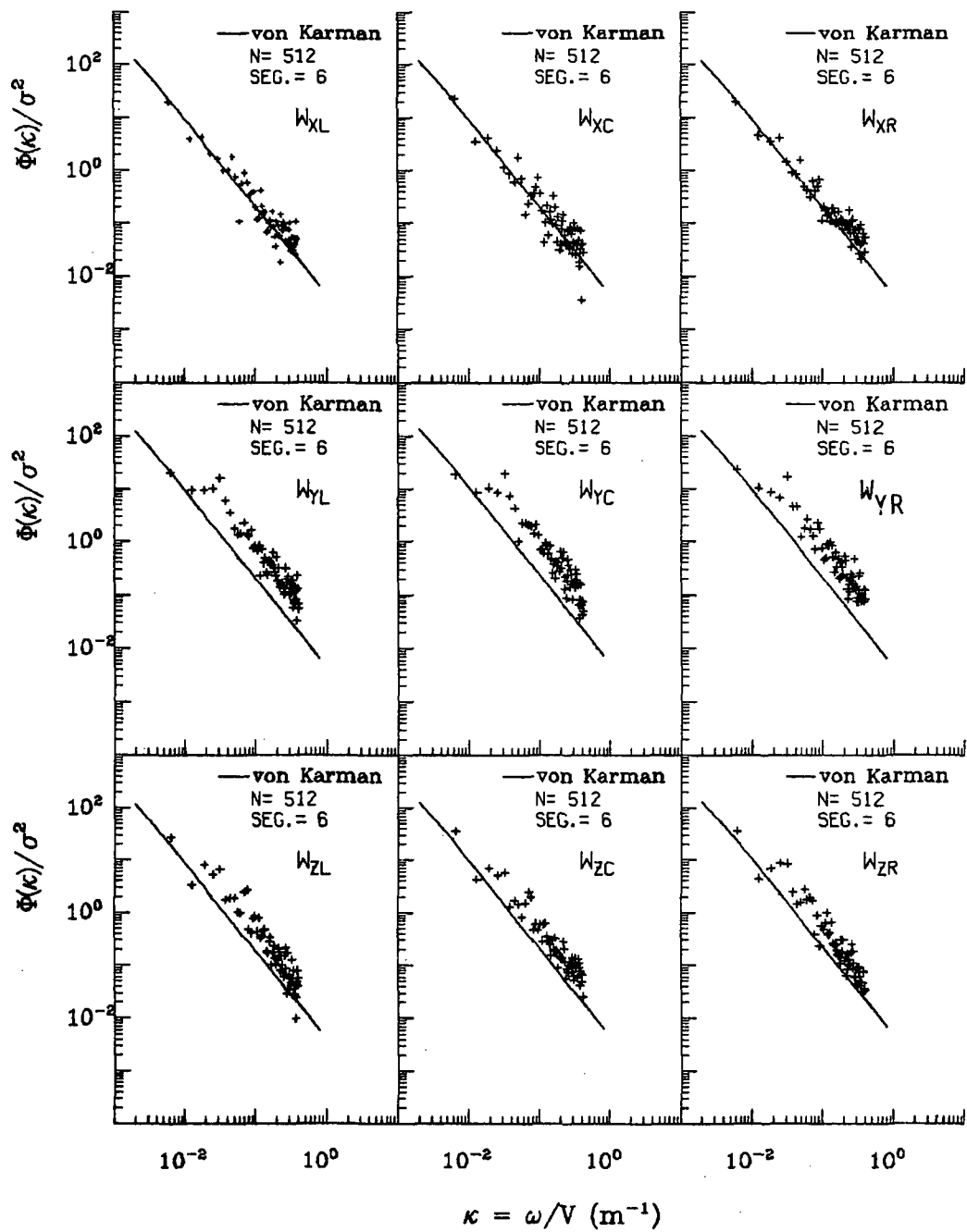

Figure A.166. Normalized auto-spectra of gust velocities, Flight 6, Run 24.

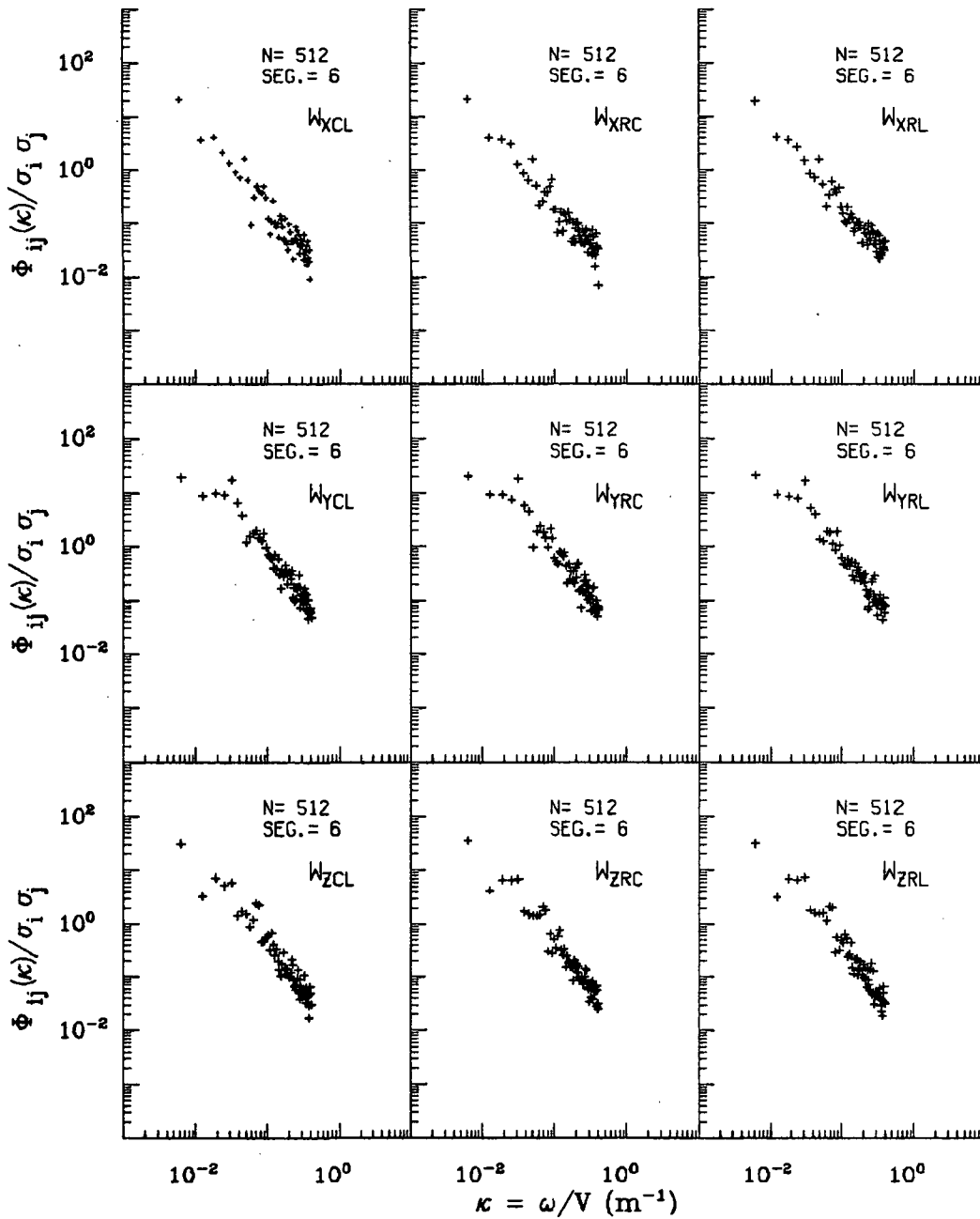

Figure A.167. Normalized two-point auto-spectra of gust velocities, Flight 6, Run 24.

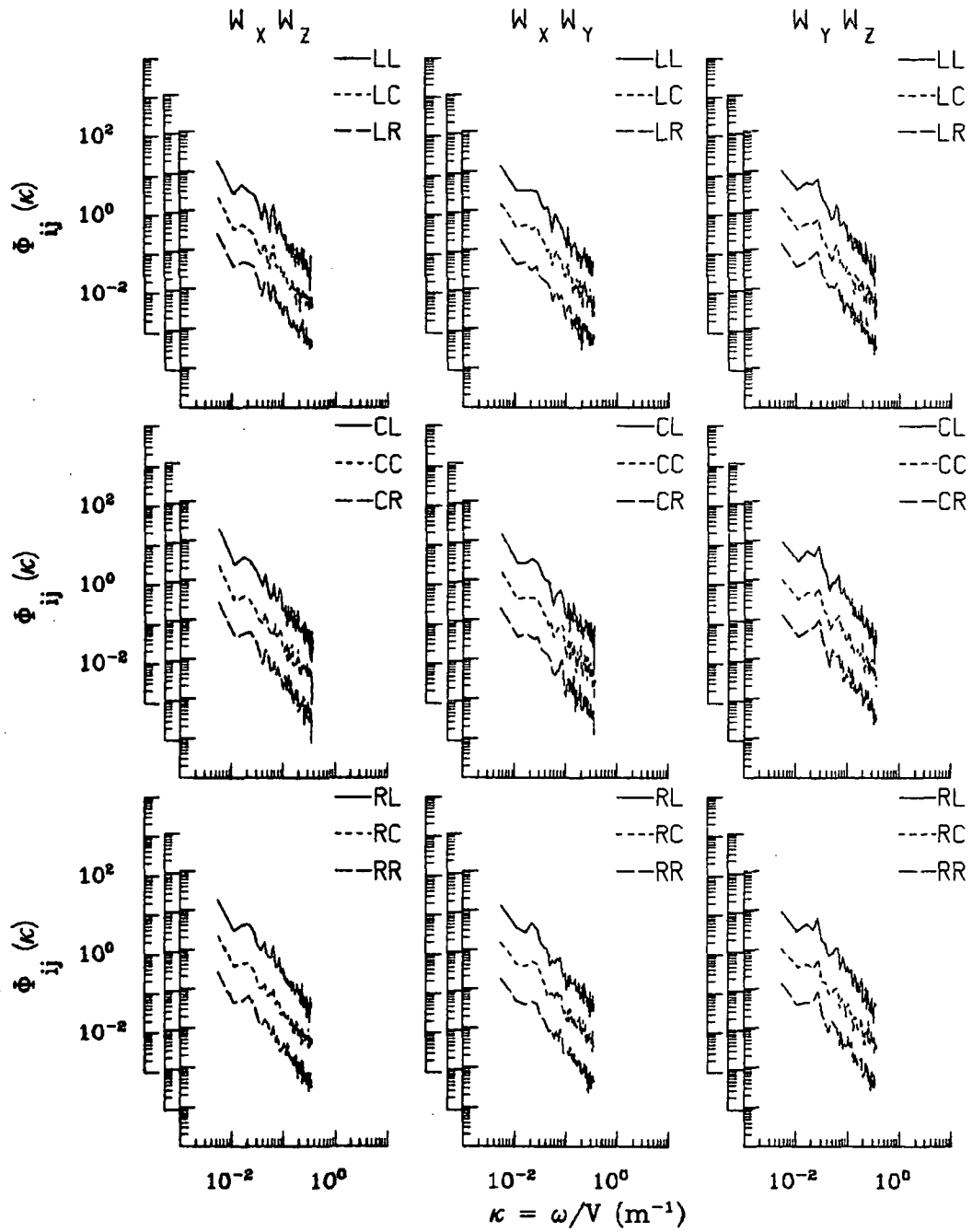

Figure A.168. Two-point cross-spectra of gust velocities, Flight 6, Run 24.

ORIGINAL PAGE IS
OF POOR QUALITY

TABLE A.42. List of All Parameters Measured and Their Range of Values, Flight 6, Run 24.

		START TIME = 53450.2814	STOP TIME = 53537.6064			
CHANNEL	UNITS	HIGH	LOW	MEAN	RMS	POINTS
2 PHI DOT	RAD/SEC	.050	-.087	-.00318	.01687	3493
3 ACCL N CG	G UNITS	-.988	-.988	-.98774	.98774	3493
4 THETA DOT	RAD/SEC	.039	-.025	.00572	.00913	3493
5 THETA	RAD	.086	.038	.06000	.06166	3493
6 PHI	RAD	.045	-.055	-.01664	.02243	3493
7 PSI 1	DEGREES	136.509	131.226	133.89999	133.91222	3493
8 DEL PSI 1	DEGREES	.053	-2.856	-1.42388	1.59390	3493
9 PSI 2	DEGREES	495.940	493.123	494.50336	494.50387	3493
10 DEL PSI 2	DEGREES	-.126	-5.389	-2.81626	3.34503	3493
11 ACCL N LT	G UNITS	1.739	.423	1.01135	1.01892	3493
12 ACCL N RT	G UNITS	1.643	.515	1.02330	1.03104	3493
13 ACCL X CG	G UNITS	.098	.015	.05311	.05519	3493
14 ACCL Y CG	G UNITS	.173	-.133	.01089	.04354	3493
15 ALPHA CTR	RAD	.023	-.037	-.01071	.01383	3493
16 BETA CTR	PAD	.018	-.054	-.02055	.02281	3493
17 TEMP I	DEG F	98.444	95.746	98.07926	98.07963	3493
18 TEMP P	DEG F	91.444	91.085	91.26788	91.26788	3493
19 ACCL Z INS	G UNITS	1.222	.750	1.00186	1.00357	3493
20 ALPHA RT	RAD	.042	-.019	.00505	.01114	3493
21 BETA RT	RAD	.059	-.013	.01801	.02008	3493
22 ALPHA LT	RAD	.051	-.026	.01110	.01484	3493
23 BETA LT	RAD	.017	-.056	-.02454	.02625	3493
24 PSI DOT	RAD/SEC	.031	-.016	.00317	.00784	3493
25 TEMP TOT	DEG C	31.293	29.520	30.35857	30.36105	3493
26 QC LT	PSID	.818	.620	.73412	.73582	3493
27 QC CTR	PSID	.802	.615	.71910	.72077	3493
28 QC RT	PSID	.830	.637	.74591	.74763	3493
29 PS	PSIA	11.616	11.573	11.59746	11.59746	3493
30 TEMP IPT	DEG C	20.914	16.632	19.64369	19.66558	3493
31 D TO G	METERS	8760781.0568754631.411	*****	*****	*****	3493
32 B TO D	DEGREES	80.391	80.320	80.35594	80.35594	3493
33 LONG	DEGREES	-104.820	-104.908	-104.86388	104.86389	3493
34 LAT	DEGREES	39.987	39.923	39.95447	39.95448	3493
35 TRK ANG	DEGREES	135.290	132.816	133.85318	133.85556	3493
36 HDG	RADIANS	2.373	2.320	2.34565	2.34569	3493
37 VE	M/SEC	88.305	81.507	85.50226	85.52241	3493
38 VN	M/SEC	-76.750	-85.467	-82.10193	82.15584	3493
39 ALTITUDE	KM	1.970	1.940	1.95283	1.95285	3493
40 TEMPC	DEGREES C	25.810	24.442	25.18711	25.18952	3493
41 EW WND SPD	KNOTS	32.397	20.651	27.57554	27.63905	3493
42 NS WND SPD	KNOTS	-12.515	-22.771	-18.19812	18.31452	3493
43 WIND SPEED	KNOTS	37.358	26.380	33.08414	33.15628	3493
44 WIND DIRFC	DEGREES	311.683	293.236	303.38374	303.39839	3493
45 AIRSPEED R	M/SEC	109.292	96.086	103.71888	103.77746	3493
46 AIRSPEED C	M/SEC	107.457	94.423	101.87765	101.93557	3493
47 AIRSPEED L	M/SEC	108.538	94.766	102.91350	102.97182	3493
48 DFLTA ALT	METERS	6.242	-23.889	-11.06568	14.00521	3493
49 INRTL DISP	METERS	4.793	-24.781	-11.96518	15.05785	3493
50 UG RIGHT	M/SEC	2.731	-3.189	.00000	1.17380	3493
51 UG CENTER	M/SEC	2.261	-3.434	.00000	1.12940	3493
52 UG LEFT	M/SEC	2.438	-4.214	.00000	1.16538	3493
53 VG RIGHT	M/SEC	2.041	-3.318	.00196	.85848	3493
54 VG CENTER	M/SEC	2.518	-3.282	.00098	.89045	3493
55 VG LEFT	M/SEC	2.618	-3.194	.00445	.93718	3493
56 WG RIGHT	M/SEC	2.832	-3.359	.01311	.98950	3493
57 WG CENTER	M/SEC	2.692	-3.135	.01606	.95468	3493
58 WG LEFT	M/SEC	3.459	-4.147	.01627	1.06854	3493

Date: July 14, 1982
 Time: 14:53:37 (MDT)
 Duration: 73 seconds

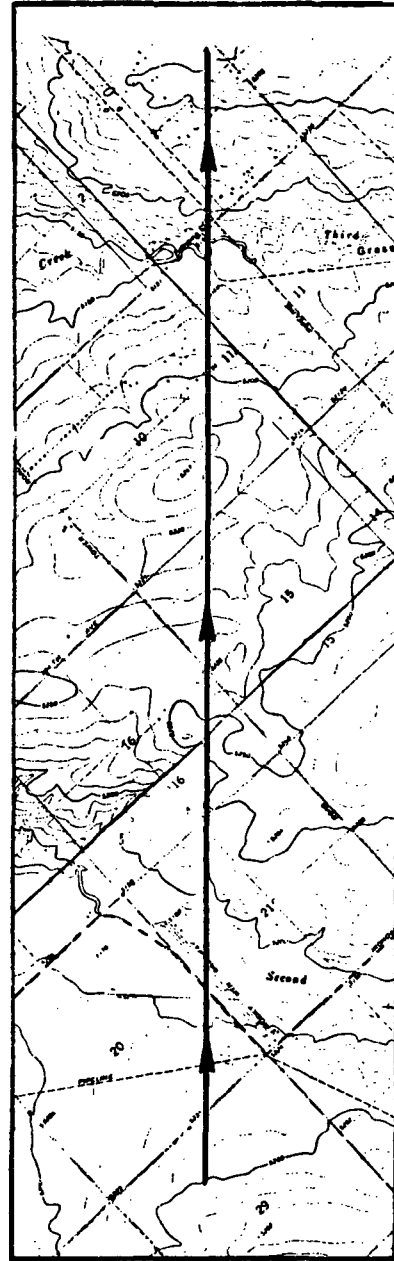
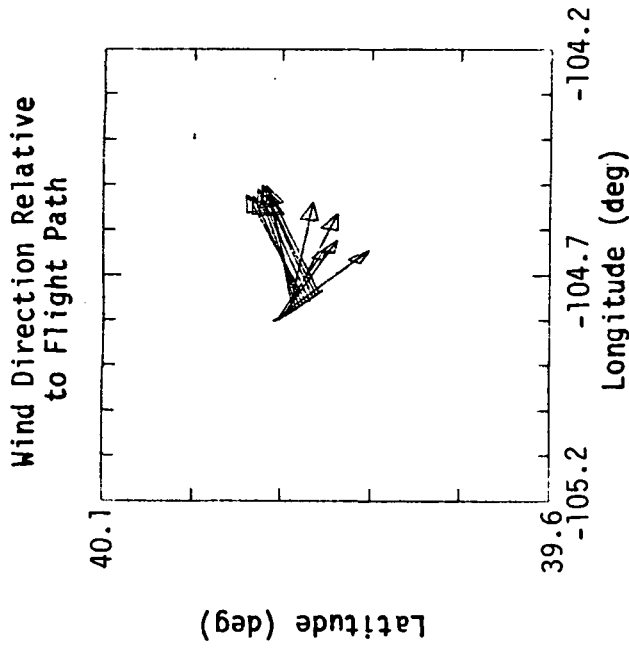
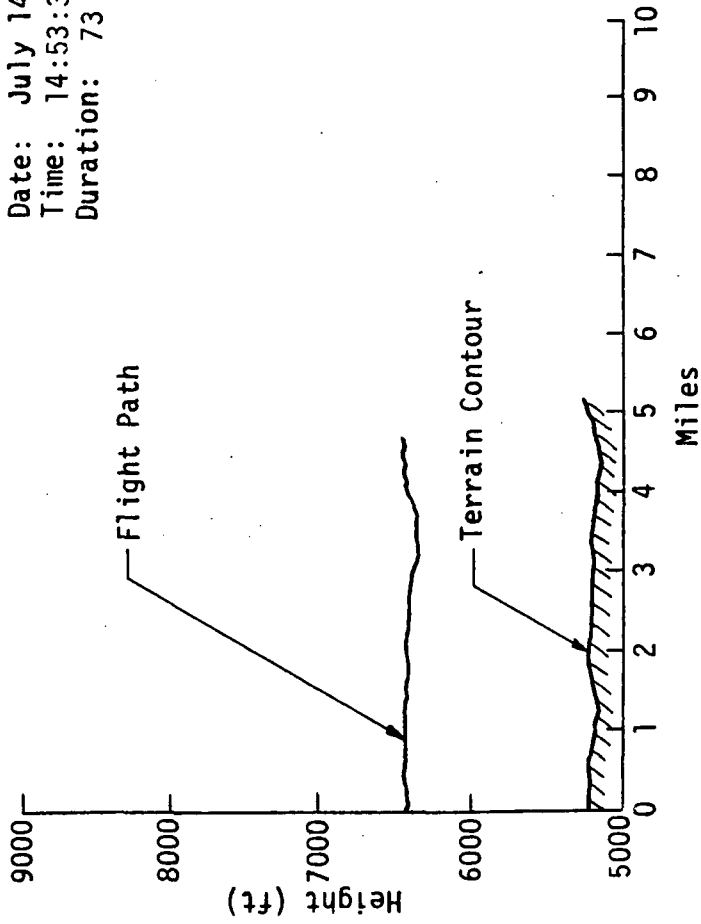

Figure A.169. Flight path information, Flight 6, Run 25.

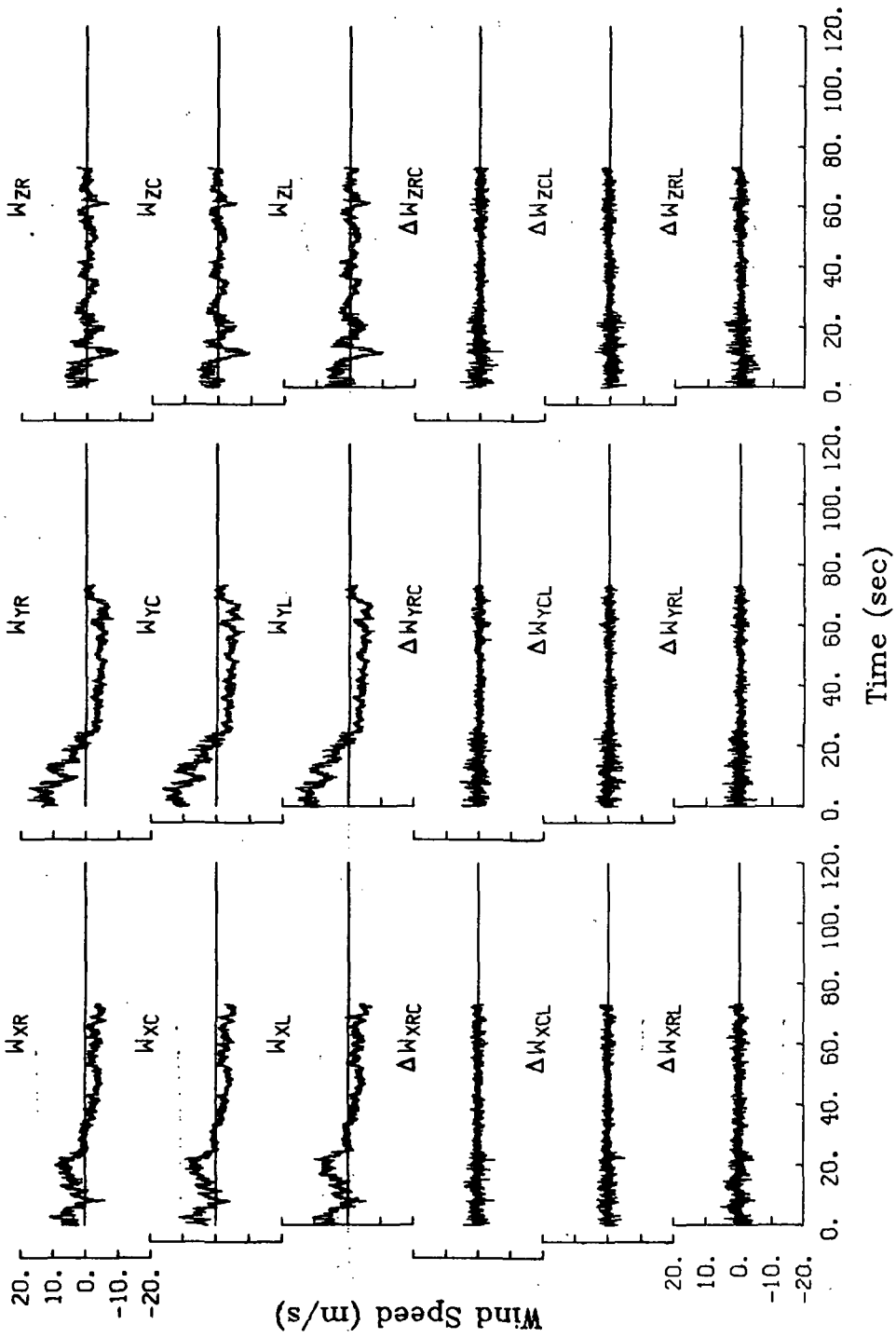

Figure A.170. Time histories of gust velocities and gust velocity differences, Flight 6, Run 25.

TABLE A.43. Average Turbulence Parameters and Integral Length Scales, Flight 6, Run 25.

I. Mean Airspeed (m/s)			II. Standard Deviation of Gust Velocities (m/s)		
V_L	V_C	V_R	$\sigma_{W_{XL}}$	$\sigma_{W_{XC}}$	$\sigma_{W_{XR}}$
104.2	103.0	104.8	3.49	3.44	3.50
			$\sigma_{W_{YL}}$	$\sigma_{W_{YC}}$	$\sigma_{W_{YR}}$
			5.92	6.00	6.04
			$\sigma_{W_{ZL}}$	$\sigma_{W_{ZC}}$	$\sigma_{W_{ZR}}$
			2.43	2.21	2.26
III. Standard Deviation of Gust Velocity Differences (m/s)			IV. Integral Length Scale (m).		
$\sigma_{\Delta W_{XCL}}$	$\sigma_{\Delta W_{XRC}}$	$\sigma_{\Delta W_{XRL}}$	$L_{W_{XL}}$	$L_{W_{XC}}$	$L_{W_{XR}}$
0.97	0.91	1.18	1004	1014	1055
$\sigma_{\Delta W_{YCL}}$	$\sigma_{\Delta W_{YRC}}$	$\sigma_{\Delta W_{YRL}}$	$L_{W_{YL}}$	$L_{W_{YC}}$	$L_{W_{YR}}$
0.94	0.95	1.02	2014	1940	2002
$\sigma_{\Delta W_{ZCL}}$	$\sigma_{\Delta W_{ZRC}}$	$\sigma_{\Delta W_{ZRL}}$	$L_{W_{ZL}}$	$L_{W_{ZC}}$	$L_{W_{ZR}}$
1.05	1.06	1.19	258	261	247

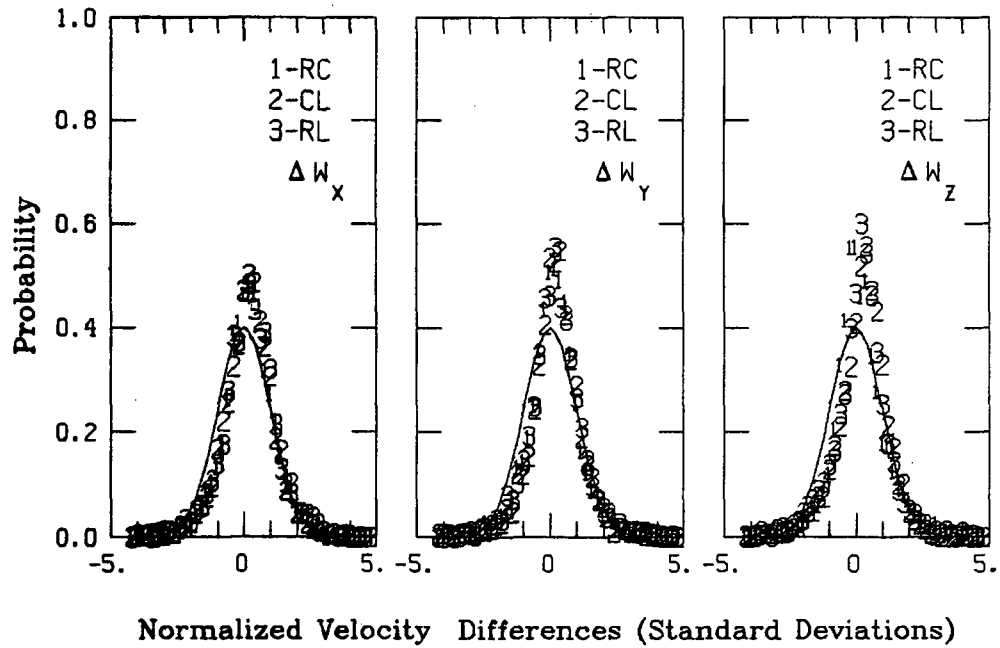
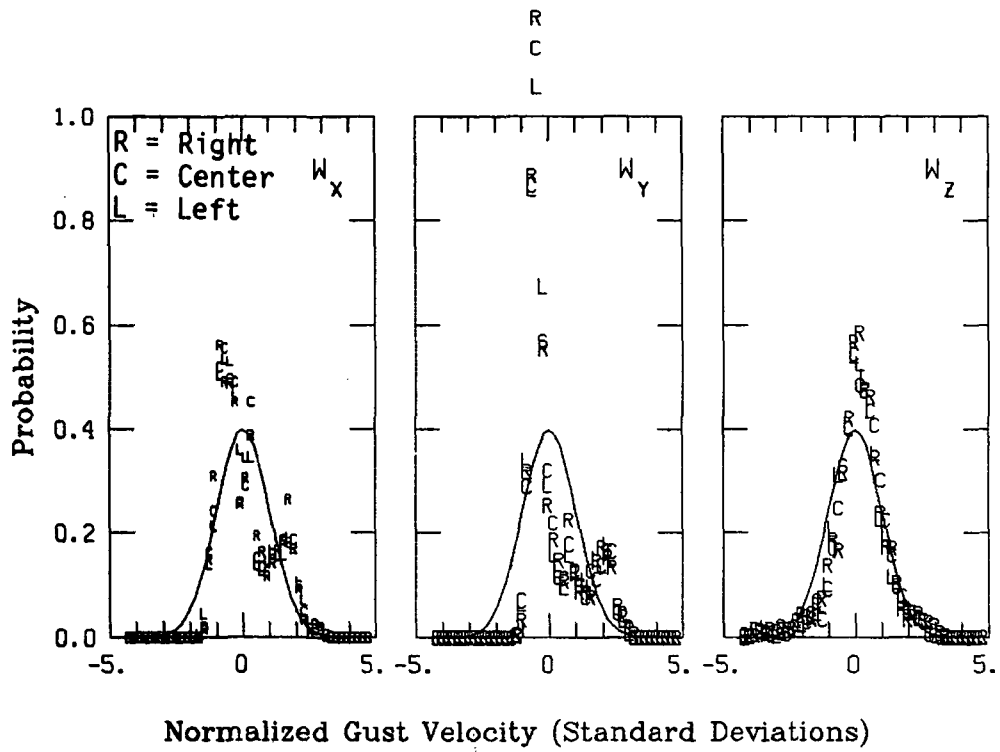

Figure A.171. Probability density function for gust velocities and gust velocity differences, Flight 6, Run 25.

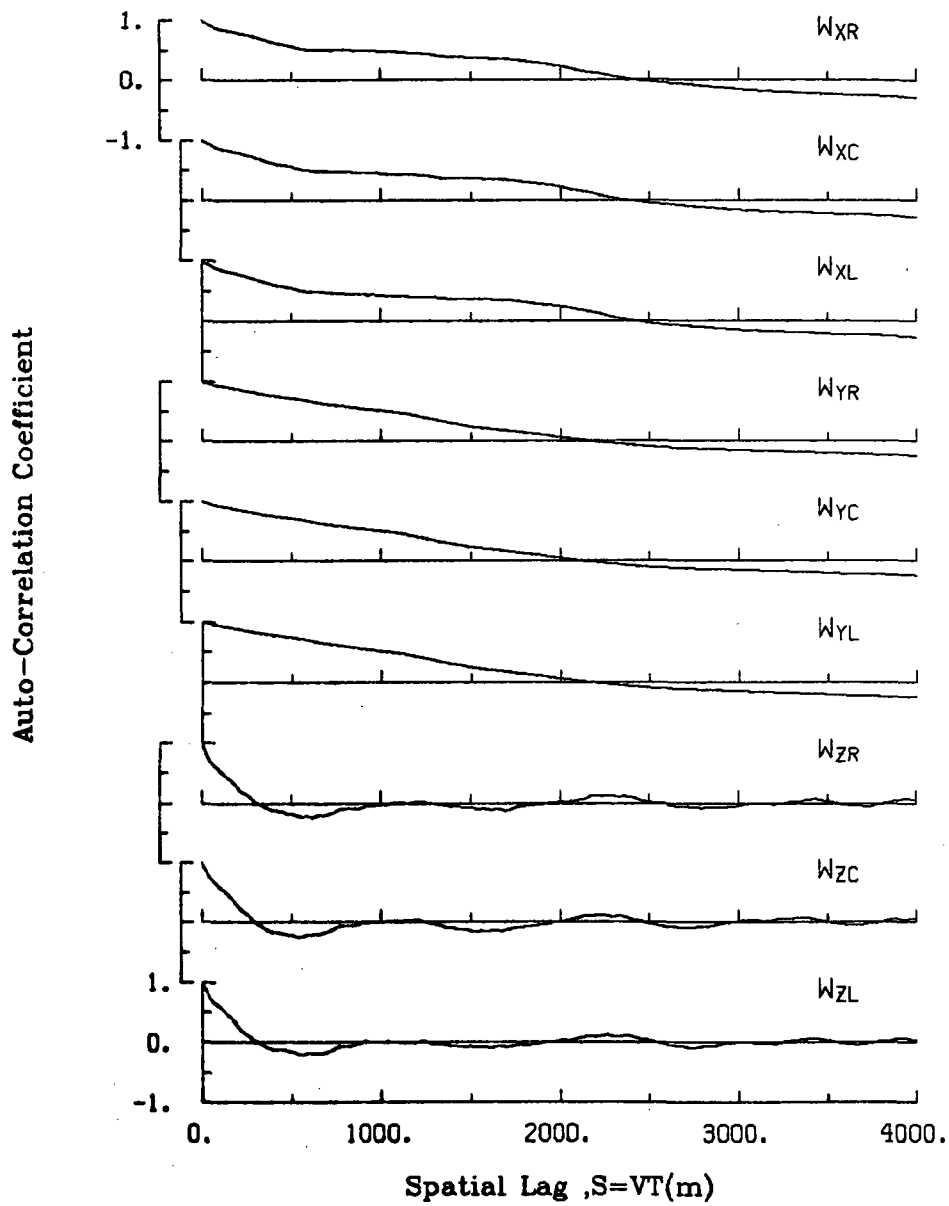

Figure A.172. Single-point auto-correlation coefficient of gust velocities, Flight 6, Run 25.

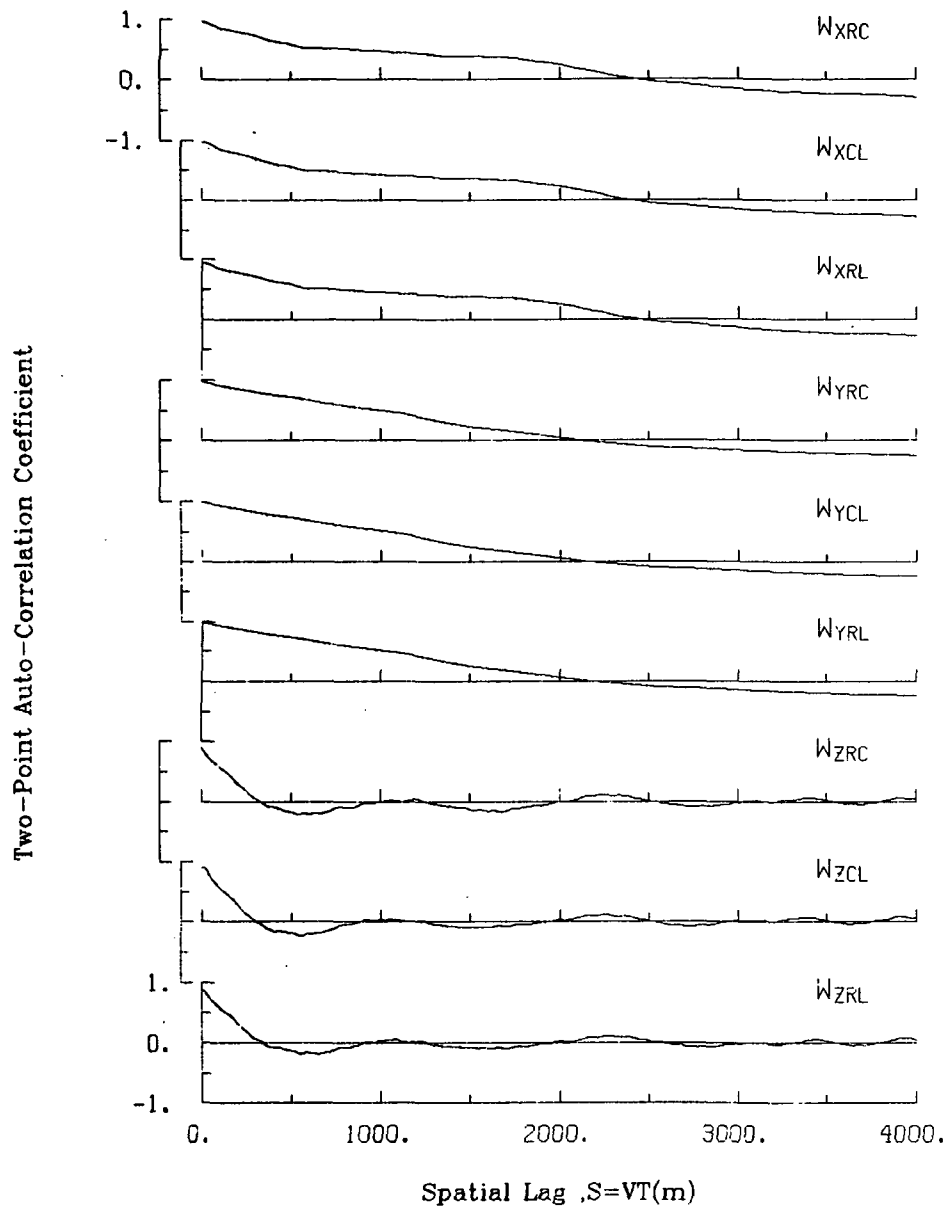

Figure A.173. Two-point auto-correlation coefficient of gust velocities, Flight 6, Run 25.

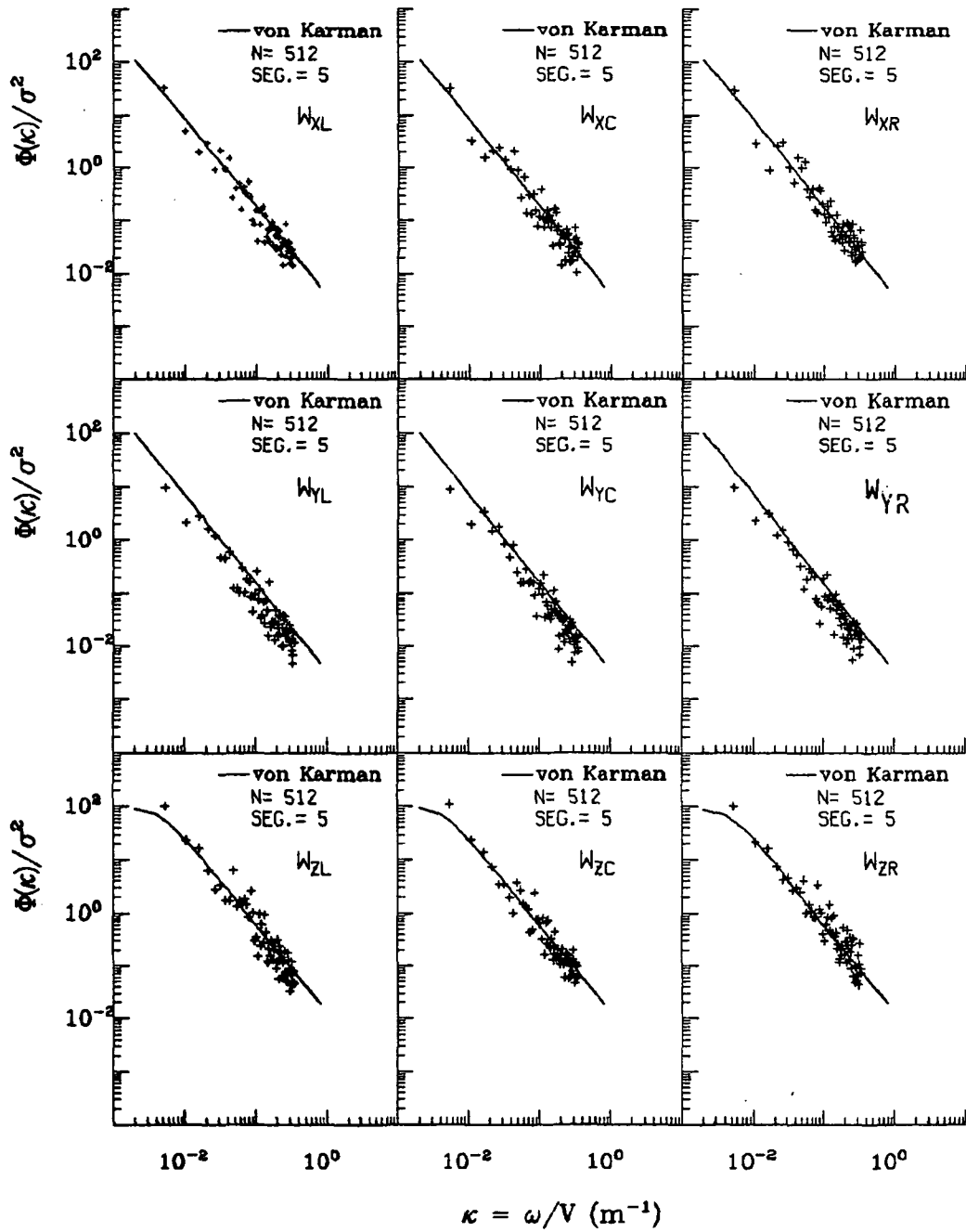

Figure A.174. Normalized auto-spectra of gust velocities, Flight 6, Run 25.

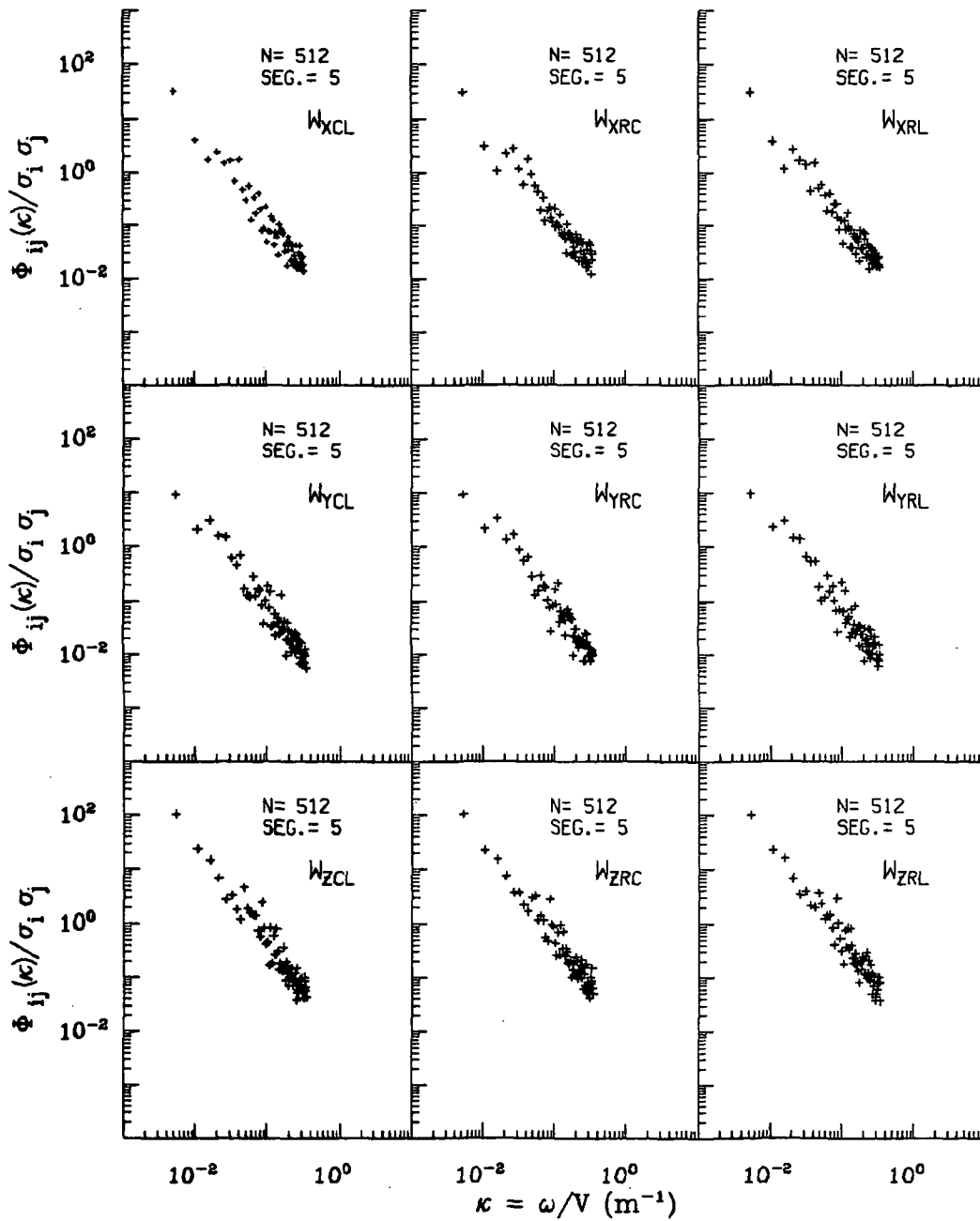

Figure A.175. Normalized two-point auto-spectra of gust velocities, Flight 6, Run 25.

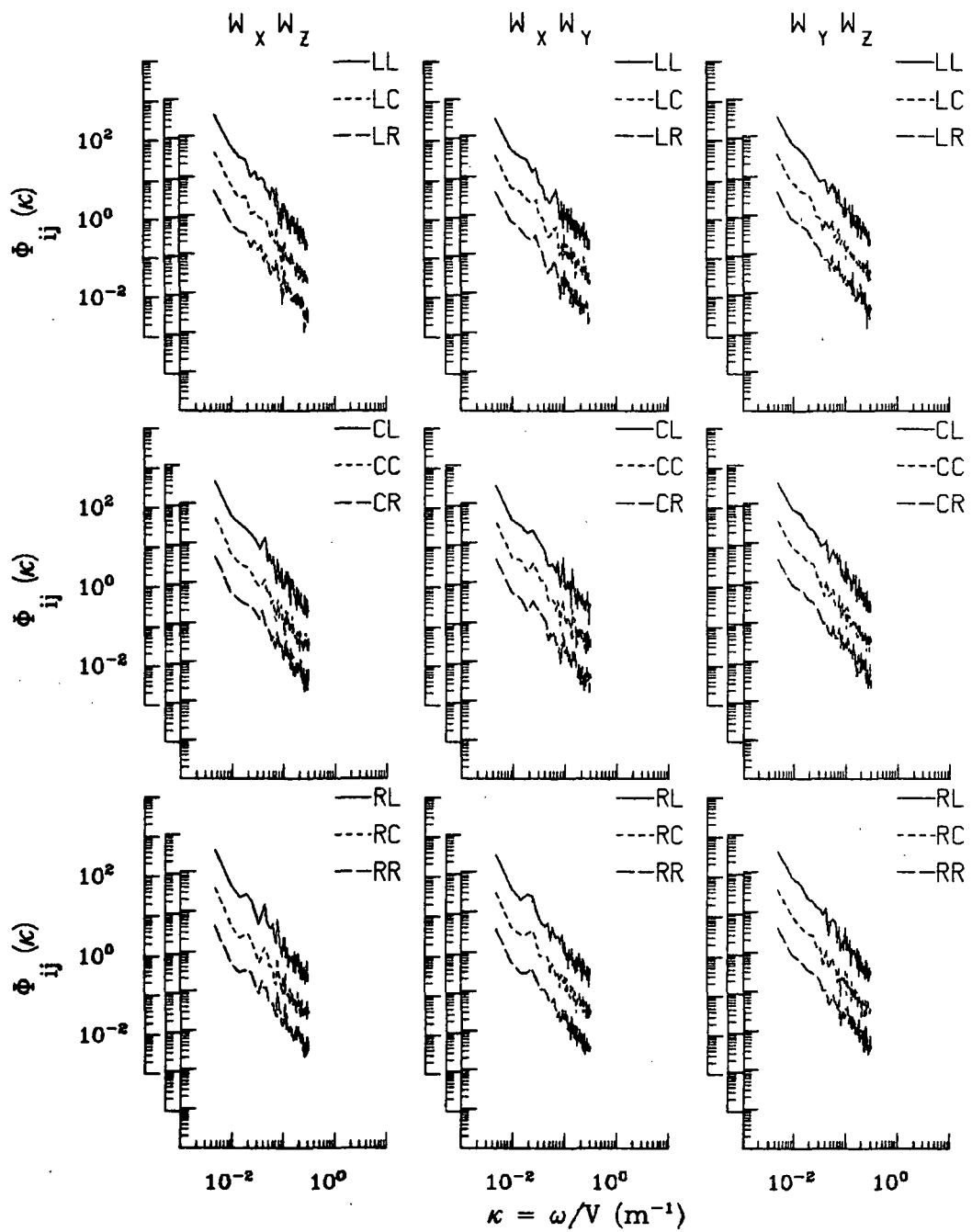

Figure A.176. Two-point cross-spectra of gust velocities, Flight 6, Run 25.

ORIGINAL PAGE IS
OF POOR QUALITY

TABLE A.44. List of All Parameters Measured and Their Range of Values,
Flight 6, Run 25.

START TIME = 53557.4966 STOP TIME = 53630.7216

CHANNEL	UNITS	HIGH	LOW	MEAN	RMS	POINTS
2 PHI DOT	RAD/SEC	.109	-.135	-.00375	.03088	2929
3 ACCL N CG	G UNITS	-.988	-.988	-.98774	.98774	2929
4 THETA DOT	RAD/SEC	.070	-.064	.00603	.01634	2929
5 THETA	RAD	.090	.018	.05098	.05322	2929
6 PHI	RAD	.038	-.125	-.03005	.04408	2929
7 PSI 1	DEGREES	149.190	140.736	144.62341	144.63336	2929
8 DEL PSI 1	DEGREES	6.431	-1.680	2.11333	2.69405	2929
9 PSI 2	DEGREES	507.909	500.164	503.73375	503.73639	2929
10 DEL PSI 2	DEGREES	6.196	-1.919	1.88821	2.52022	2929
11 ACCL N LT	G UNITS	2.736	-.083	1.01202	1.04704	2929
12 ACCL N RT	G UNITS	2.265	.018	1.02362	1.05658	2929
13 ACCL X CG	G UNITS	.145	-.007	.05526	.05987	2929
14 ACCL Y CG	G UNITS	.151	-.136	.00408	.04809	2929
15 ALPHA CTR	RAD	.079	-.065	-.01377	.02197	2929
16 BETA CTR	RAD	.060	-.142	-.03344	.04455	2929
17 TEMP I	DEG F	98.444	95.929	98.21106	98.21144	2929
18 TEMP P	DEG F	91.444	91.265	91.37498	91.37502	2929
19 ACCL Z INS	G UNITS	1.795	.608	1.00183	1.01066	2929
20 ALPHA RT	RAD	.082	-.056	-.00168	.01963	2929
21 BETA RT	RAD	.121	-.102	.00425	.02675	2929
22 ALPHA LT	RAD	.113	-.049	.00186	.01953	2929
23 BETA LT	RAD	.054	-.130	-.03708	.04583	2929
24 PSI DOT	RAD/SEC	.066	-.068	.00290	.02161	2929
25 TEMP TGT	DEG C	33.065	29.914	31.86240	31.87291	2929
26 QC LT	PSID	.845	.565	.74907	.75134	2929
27 QC CTR	PSID	.825	.543	.73174	.73395	2929
28 OC RT	PSID	.853	.570	.75797	.76026	2929
29 PS	PSIA	11.633	11.580	11.59788	11.59789	2929
30 TEMP IRT	DEG C	24.408	20.320	22.07959	22.10369	2929
31 D TO G	METERS	8766774.6438762053.901	*****	*****	*****	2929
32 B TO D	DEGREES	80.463	80.406	80.43367	80.43367	2929
33 LONG	DEGREES	-104.734	-104.802	-104.76930	104.76930	2929
34 LAT	DEGREES	39.909	39.853	39.88029	39.88029	2929
35 TRK ANG	DEGREES	141.867	132.540	136.54180	136.58133	2929
36 HDG	RADIANS	2.593	2.449	2.51593	2.51611	2929
37 VE	M/SEC	86.019	69.613	79.85717	80.06585	2929
38 VN	M/SEC	-77.655	-89.946	-84.04857	84.12690	2929
39 ALTITUDE	KM	1.965	1.928	1.95254	1.95256	2929
40 TEMPC	DEGREES C	27.568	25.295	26.57718	26.58160	2929
41 EW WND SPD	KNOTS	53.936	17.553	43.46234	44.04142	2929
42 NS WND SPD	KNOTS	16.612	-30.114	2.55542	11.54064	2929
43 WIND SPEED	KNOTS	55.718	20.682	45.10352	45.52837	2929
44 WIND DIRECTION	DEGREES	314.974	250.583	268.41385	268.90716	2929
45 AIRSPEED R	M/SEC	111.144	91.116	104.75830	104.84020	2929
46 AIRSPEED C	M/SEC	109.349	89.006	102.97022	103.05066	2929
47 AIRSPEED L	M/SEC	110.652	90.769	104.15521	104.23705	2929
48 DELTA ALT	METERS	10.091	-26.596	-2.40713	9.55184	2929
49 INRTL DISP	METERS	6.261	-25.908	-2.60415	10.05822	2929
50 UG RIGHT	M/SEC	10.943	-5.952	.00000	3.55011	2929
51 UG CENTER	M/SEC	11.107	-5.538	.00000	3.49711	2929
52 UG LEFT	M/SEC	10.490	-6.930	.00000	3.56121	2929
53 VG RIGHT	M/SEC	17.581	-8.071	.02554	5.81679	2929
54 VG CENTER	M/SEC	16.352	-7.992	.03411	5.74169	2929
55 VG LEFT	M/SEC	16.068	-7.615	.03025	5.71047	2929
56 WG RIGHT	M/SEC	6.950	-9.461	-.06281	2.16809	2929
57 WG CENTER	M/SEC	6.177	-9.422	-.05586	2.12456	2929
58 WG LEFT	M/SEC	7.278	-9.867	-.06514	2.31192	2929

Date: July 14, 1982
 Time: 14:54:35(MDT)
 Duration: 68 seconds

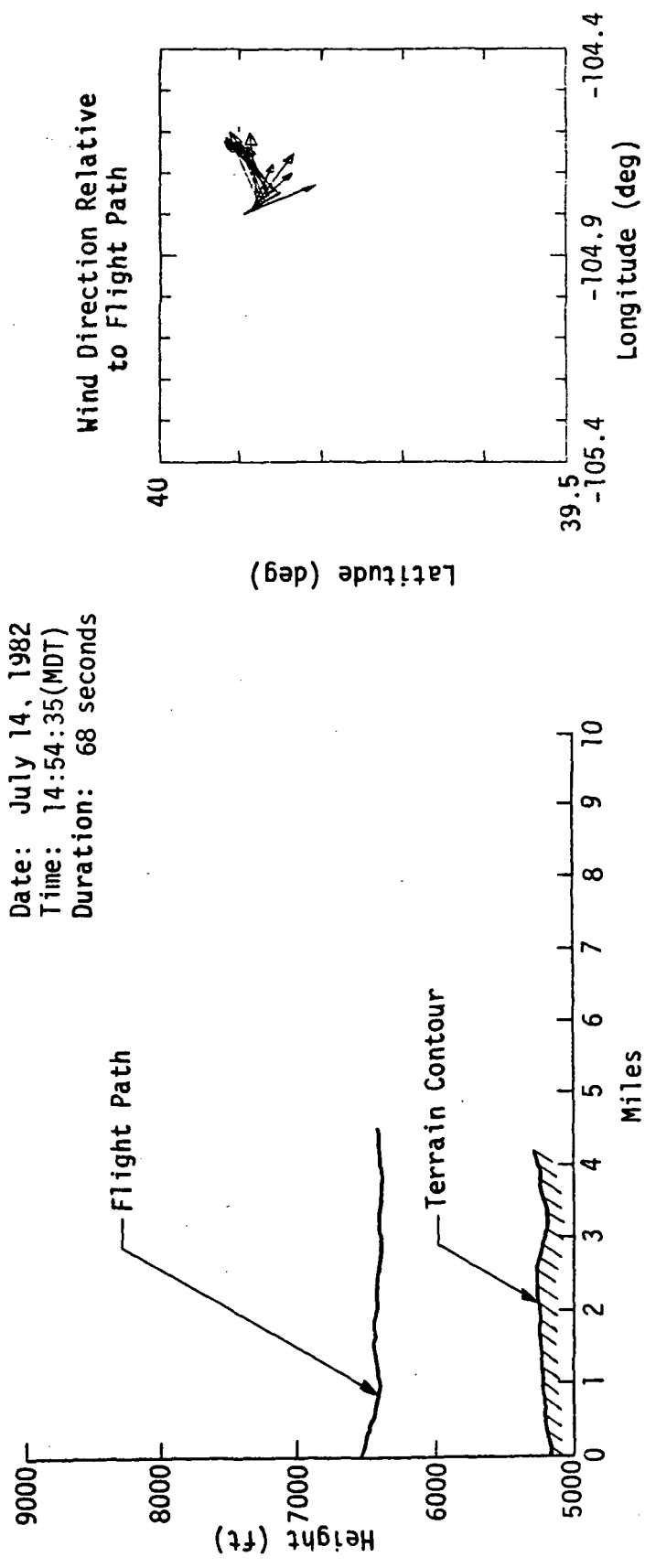

A.220

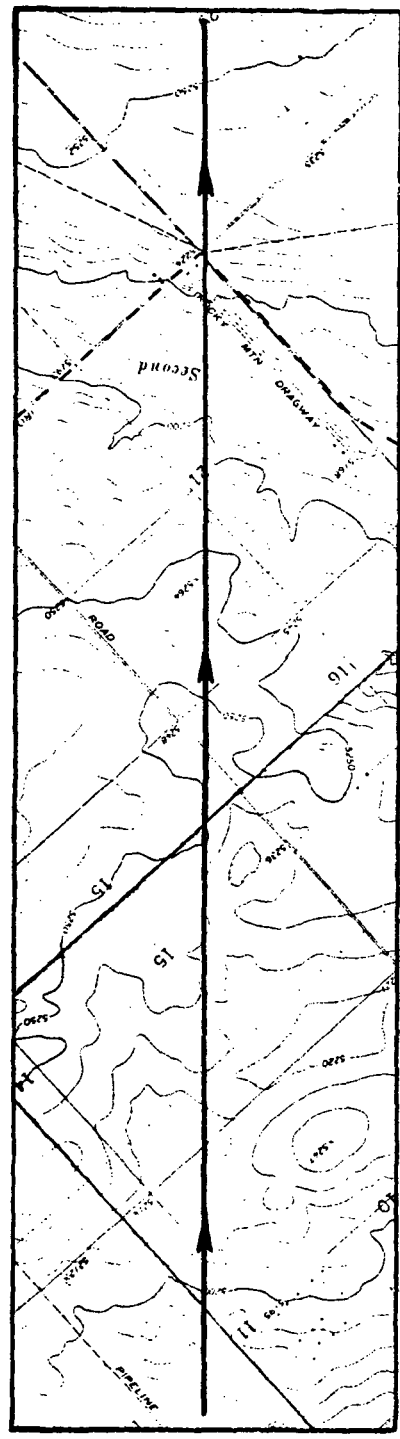

Figure A.177. Flight path information, Flight 6, Run 26.

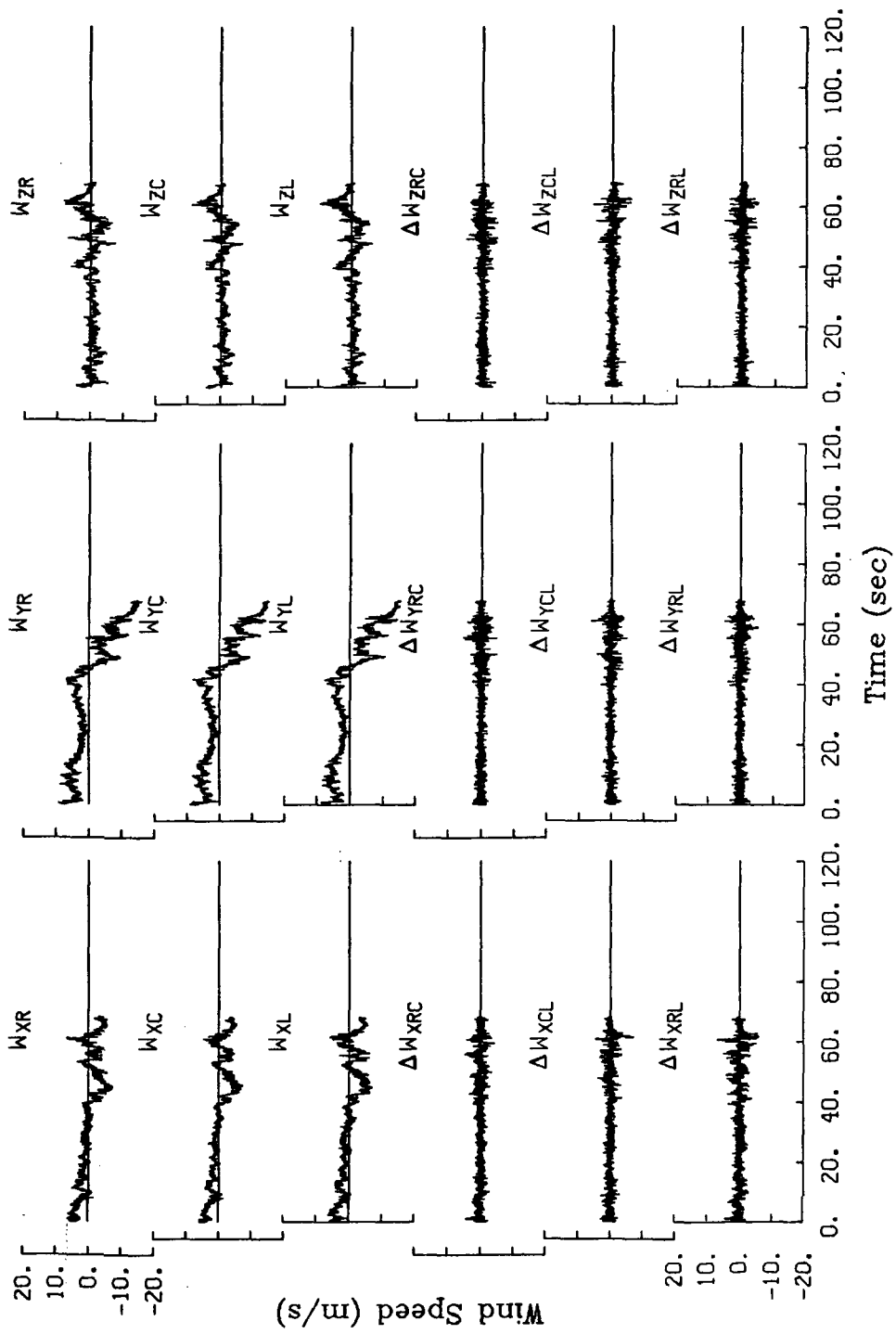
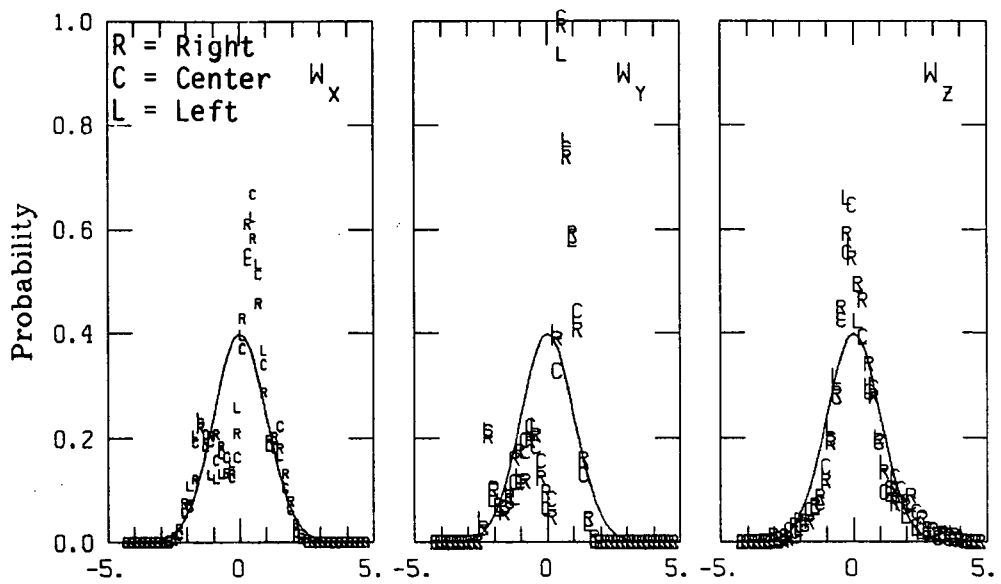

Figure A.178. Time histories of gust velocities and gust velocity differences, Flight 6, Run 26.

TABLE A.45. Average Turbulence Parameters and Integral Length Scales, Flight 6, Run 26.

I. Mean Airspeed (m/s)			II. Standard Deviation of Gust Velocities (m/s)		
V_L	V_C	V_R	$\frac{\sigma}{W_{XL}}$	$\frac{\sigma}{W_{XC}}$	$\frac{\sigma}{W_{XR}}$
107.3	106.2	108.0	2.56	2.53	2.56
			$\frac{\sigma}{W_{YL}}$	$\frac{\sigma}{W_{YC}}$	$\frac{\sigma}{W_{YR}}$
			5.06	5.14	5.11
			$\frac{\sigma}{W_{ZL}}$	$\frac{\sigma}{W_{ZC}}$	$\frac{\sigma}{W_{ZR}}$
			2.00	1.89	2.10
III. Standard Deviation of Gust Velocity Differences (m/s)			IV. Integral Length Scale (m).		
$\frac{\sigma_{\Delta W}}{W_{XCL}}$	$\frac{\sigma_{\Delta W}}{W_{XRC}}$	$\frac{\sigma_{\Delta W}}{W_{XRL}}$	$L_{W_{XL}}$	$L_{W_{XC}}$	$L_{W_{XR}}$
0.88	0.96	1.21	709	769	753
$\frac{\sigma_{\Delta W}}{W_{YCL}}$	$\frac{\sigma_{\Delta W}}{W_{YRC}}$	$\frac{\sigma_{\Delta W}}{W_{YRL}}$	$L_{W_{YL}}$	$L_{W_{YC}}$	$L_{W_{YR}}$
0.87	0.92	0.92	1706	1699	1734
$\frac{\sigma_{\Delta W}}{W_{ZCL}}$	$\frac{\sigma_{\Delta W}}{W_{ZRC}}$	$\frac{\sigma_{\Delta W}}{W_{ZRL}}$	$L_{W_{ZL}}$	$L_{W_{ZC}}$	$L_{W_{ZR}}$
0.95	1.00	1.05	343	304	291



Normalized Gust Velocity (Standard Deviations)

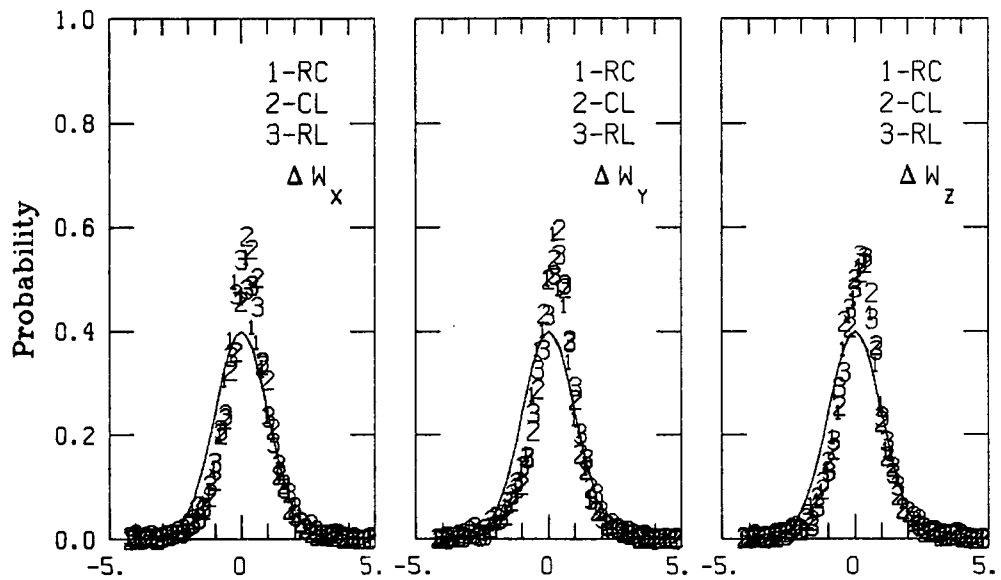

Normalized Velocity Differences (Standard Deviations)

Figure A.179. Probability density function for gust velocities and gust velocity differences, Flight 6, Run 26.

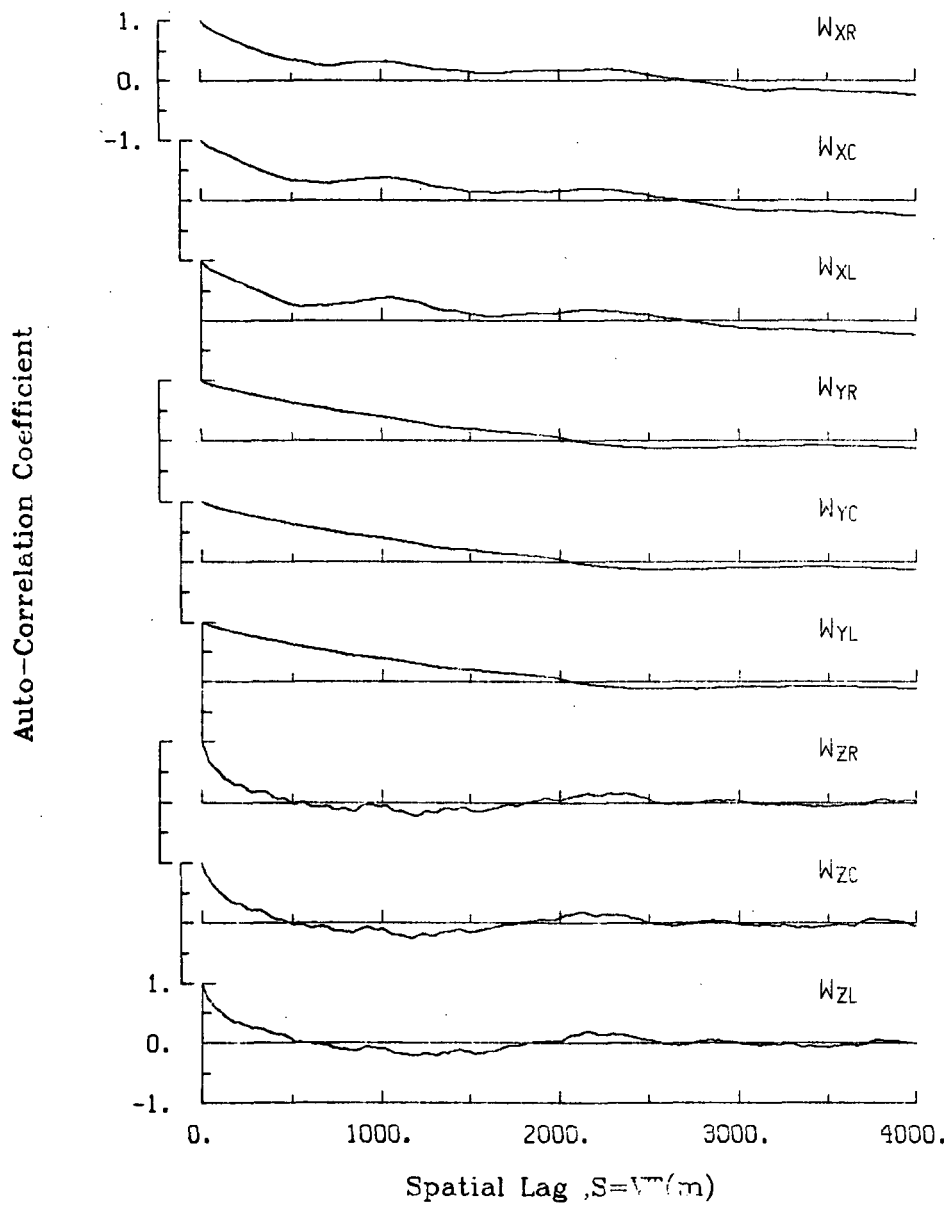

Figure A.180. Single-point auto-correlation coefficient of gust velocities, Flight 6, Run 26.

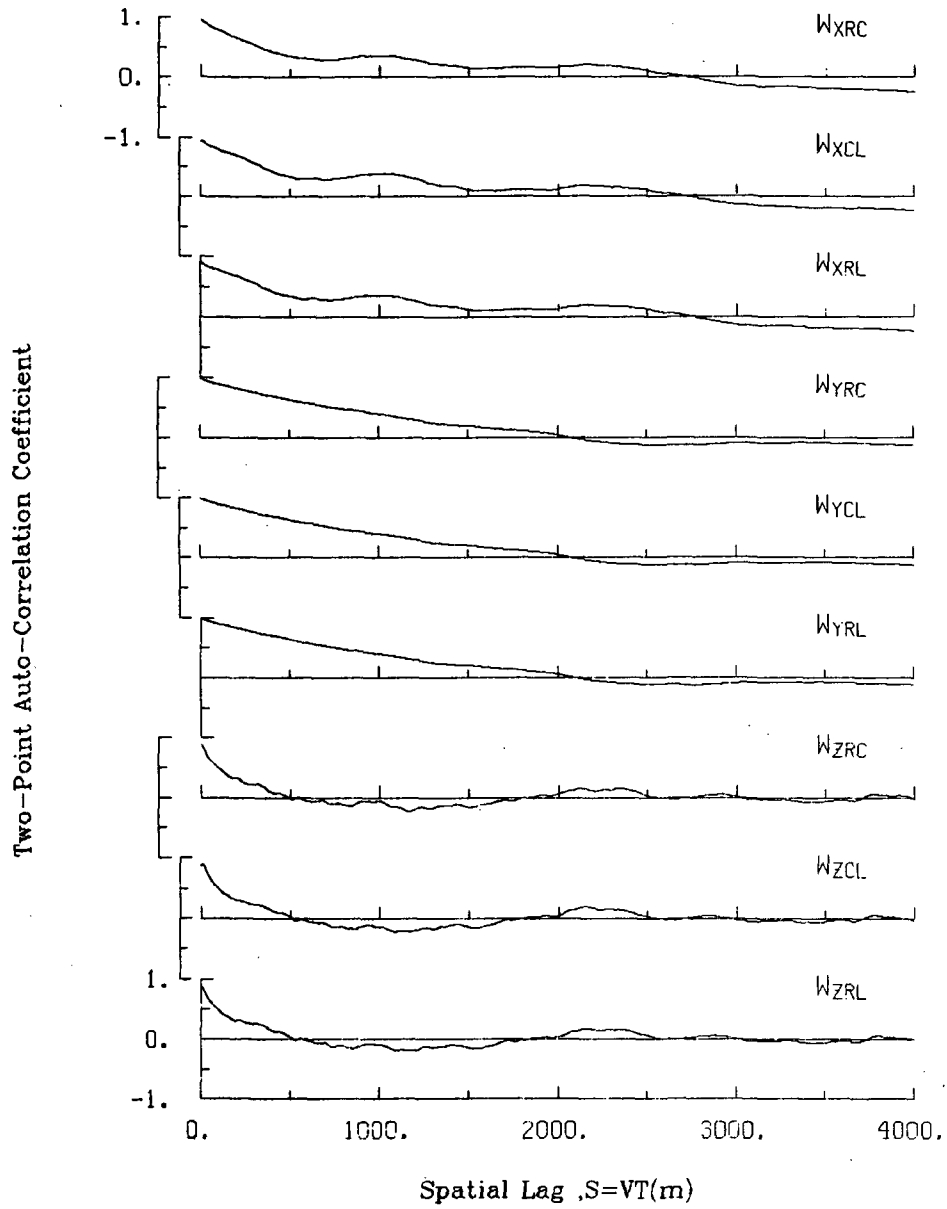

Figure A.181. Two-point auto-correlation coefficient of gust velocities, Flight 6, Run 26.

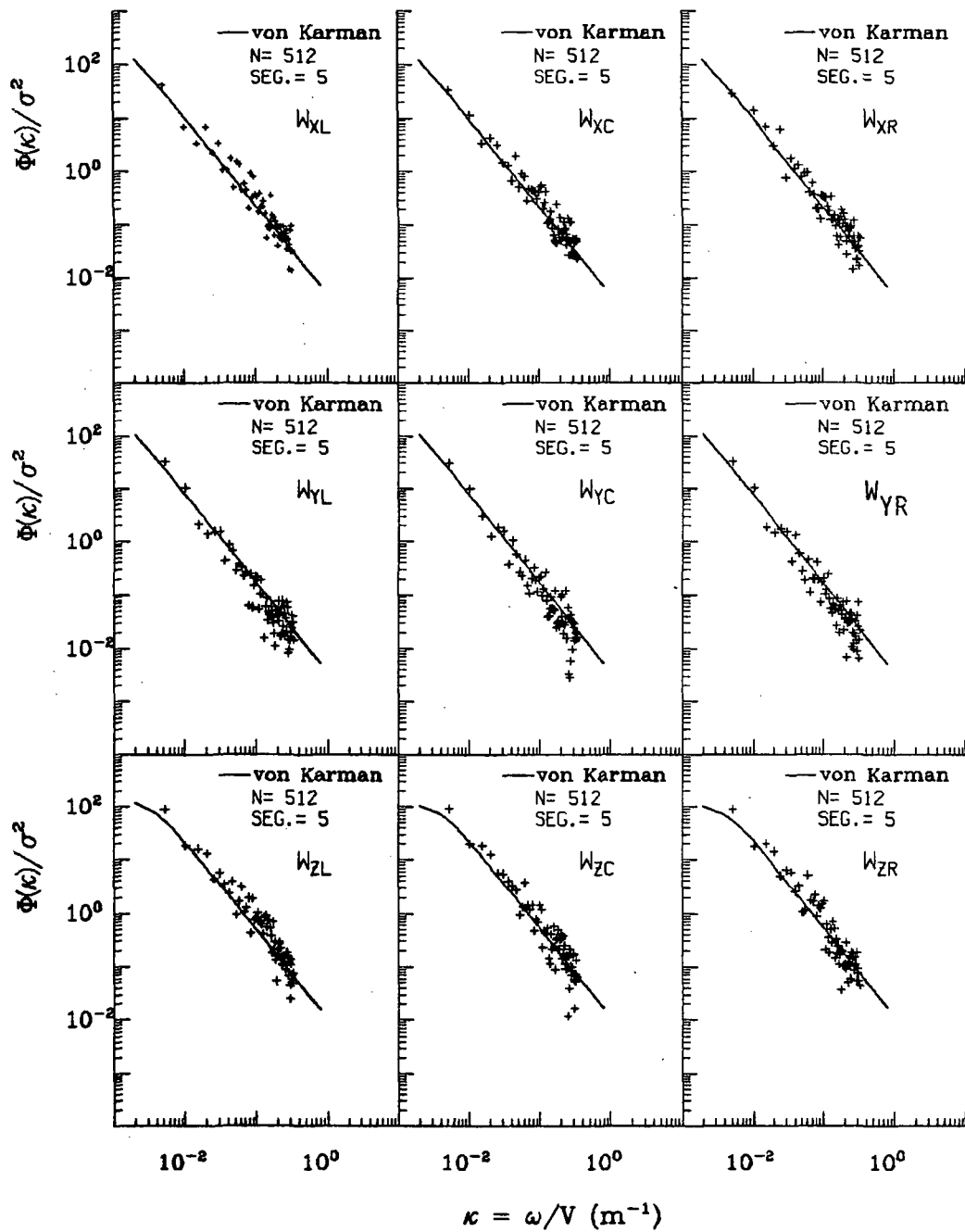

Figure A.182. Normalized auto-spectra of gust velocities, Flight 6, Run 26.

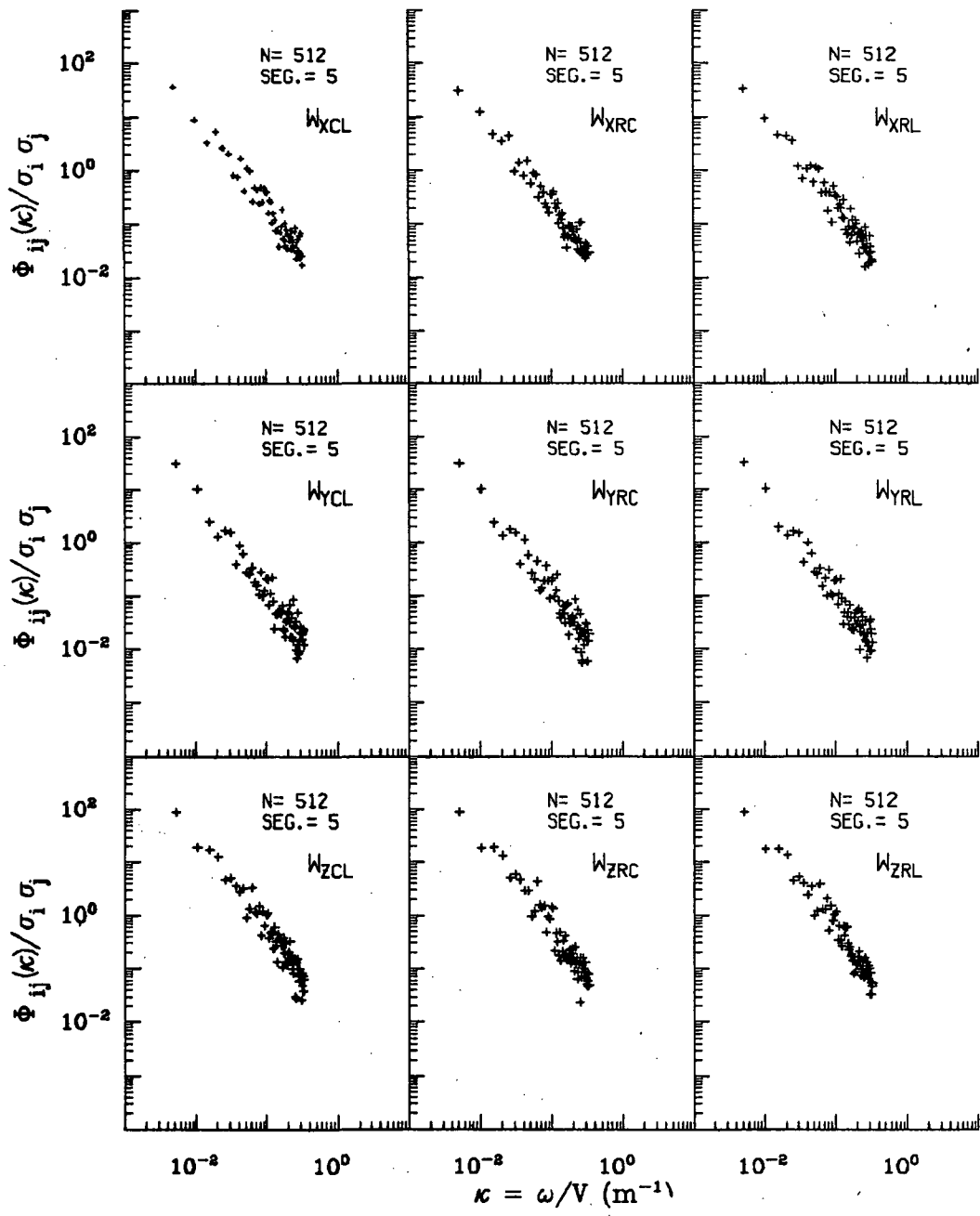

Figure A.183. Normalized two-point auto-spectra of gust velocities, Flight 6, Run 26.

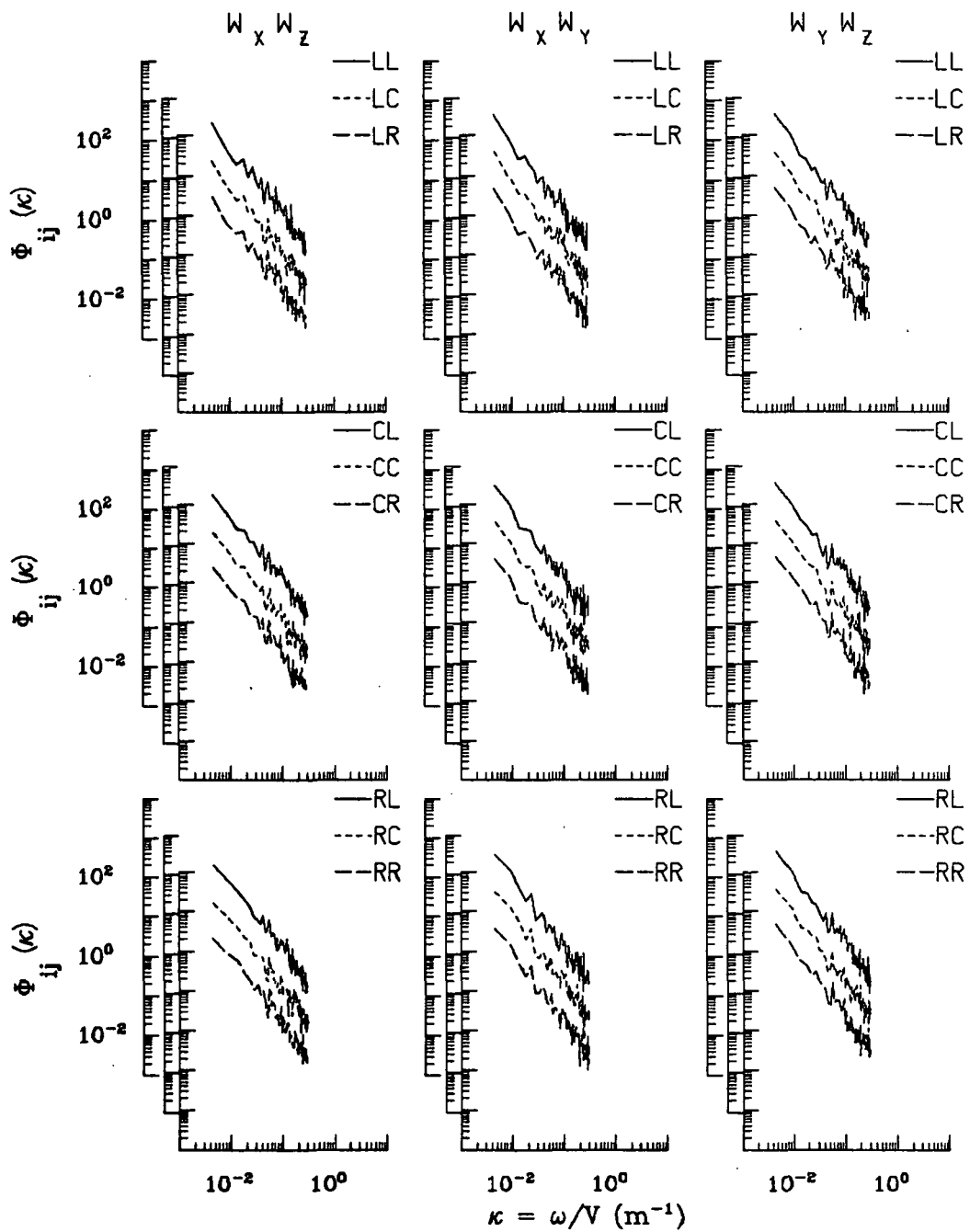

Figure A.184. Two-point cross-spectra of gust velocities, Flight 6, Run 26.

ORIGINAL PAGE IS
OF POOR QUALITY

TABLE A.46. List of All Parameters Measured and Their Range of Values,
Flight 6, Run 26.

		START TIME = 53675.4568		STOP TIME = 53743.5568			
CHANNEL	UNITS	HIGH	LOW	MEAN	RMS	POINTS	
2 PHI DOT	RAD/SEC	.109	-.107	-.00341	.02931	2724	
3 ACCL N CG	G UNITS	-.988	-.988	-.98774	.98774	2724	
4 THETA DOT	RAD/SEC	.060	-.053	.00658	.01497	2724	
5 THETA	RAD	.074	-.019	.04090	.04456	2724	
6 PHI	RAD	.032	-.109	-.02083	.03558	2724	
7 PSI 1	DEGREES	313.328	305.579	309.18925	309.19392	2724	
8 DEL PSI 1	DEGREES	3.345	-4.149	-.78181	1.85405	2724	
9 PSI 2	DEGREES	314.995	307.947	311.09599	311.10036	2724	
10 DEL PSI 2	DEGREES	3.021	-4.330	-1.00904	1.94879	2724	
11 ACCL N LT	G UNITS	2.275	-.028	1.01383	1.04506	2724	
12 ACCL N RT	G UNITS	2.208	.175	1.02757	1.05803	2724	
13 ACCL X CG	G UNITS	.110	-.011	.03383	.03663	2724	
14 ACCL Y CG	G UNITS	.177	-.146	.00589	.04839	2724	
15 ALPHA CTR	RAD	.067	-.078	-.01920	.02396	2724	
16 BETA CTR	RAD	.037	-.129	-.02849	.03657	2724	
17 TEMP I	DEG F	98.084	93.227	96.99723	96.99994	2724	
18 TEMP P	DEG F	91.621	91.265	91.44358	91.44358	2724	
19 ACCL Z INS	G UNITS	1.657	.470	1.00402	1.01315	2724	
20 ALPHA RT	RAD	.055	-.083	-.01241	.02028	2724	
21 BETA RT	RAD	.064	-.080	.00678	.02186	2724	
22 ALPHA LT	RAD	.086	-.061	-.01094	.01882	2724	
23 BETA LT	RAD	.021	-.129	-.03321	.03928	2724	
24 PSI DOT	RAD/SEC	.074	-.045	.00503	.01958	2724	
25 TEMP TOT	DEG C	33.065	30.505	32.15773	32.16451	2724	
26 QC LT	PSID	.905	.663	.79432	.79513	2724	
27 QC CTR	PSID	.888	.658	.77808	.77880	2724	
28 QC RT	PSID	.920	.655	.80567	.80639	2724	
29 PS	PSIA	11.611	11.535	11.58983	11.58984	2724	
30 TEMP IRT	DEG C	24.408	21.904	23.30971	23.31669	2724	
31 D TO G	METERS	8765643.2268762044.147*****				2724	
32 B TO D	DEGREES	80.455	80.411	80.43301	80.43301	2724	
33 LONG	DEGREES	-104.746	-104.799	-104.77254	104.77254	2724	
34 LAT	DEGREES	39.894	39.849	39.87229	39.87229	2724	
35 TRK ANG	DEGREES	318.987	313.660	317.70011	317.70310	2724	
36 HDG	RADIANS	5.499	5.366	5.42571	5.42580	2724	
37 VE	M/SEC	-64.173	-67.527	-65.61357	65.61953	2724	
38 VN	M/SEC	76.007	63.761	72.18454	72.26490	2724	
39 ALTITUDE	KM	1.996	1.943	1.95814	1.95816	2724	
40 TEMPC	DEGREES C	27.345	25.240	26.54258	26.54946	2724	
41 EW WND SPD	KNOTS	38.722	1.608	24.60439	25.41093	2724	
42 NS WND SPD	KNOTS	21.505	-26.745	.98975	10.71889	2724	
43 WIND SPEED	KNOTS	39.898	10.744	27.17396	27.57916	2724	
44 WIND DIPEC	DEGREES	351.395	232.222	270.92836	272.21699	2724	
45 AIRSPEED R	M/SEC	115.055	97.503	108.01910	108.04203	2724	
45 AIRSPEED C	M/SEC	113.053	97.754	106.19533	106.21847	2724	
47 AIRSPEED L	M/SEC	114.113	98.048	107.26962	107.29579	2724	
48 DELTA ALT	METERS	4.256	-48.594	-33.88065	35.25742	2724	
49 INPTL DISP	METERS	0.000	-47.135	-34.82629	36.15133	2724	
50 UG RIGHT	M/SEC	6.705	-7.318	-.00000	2.67094	2724	
51 UG CFNTR	M/SEC	5.841	-7.190	-.00000	2.63426	2724	
52 UG LEFT	M/SEC	5.878	-6.925	-.00000	2.68457	2724	
53 VG RIGHT	M/SEC	9.401	-15.906	.01078	5.86964	2724	
54 VG CENTER	M/SEC	8.971	-15.141	.01064	5.89164	2724	
55 VG LEFT	M/SEC	8.997	-15.200	.01027	5.82879	2724	
56 WG RIGHT	M/SEC	8.218	-7.543	-.02672	2.05904	2724	
57 WG CENTER	M/SEC	9.047	-6.364	-.02384	1.85112	2724	
58 WG LEFT	M/SEC	9.598	-6.127	-.02578	1.95965	2724	

Date: July 14, 1982
 Time: 14:56:25(MDT)
 Duration: 104 seconds

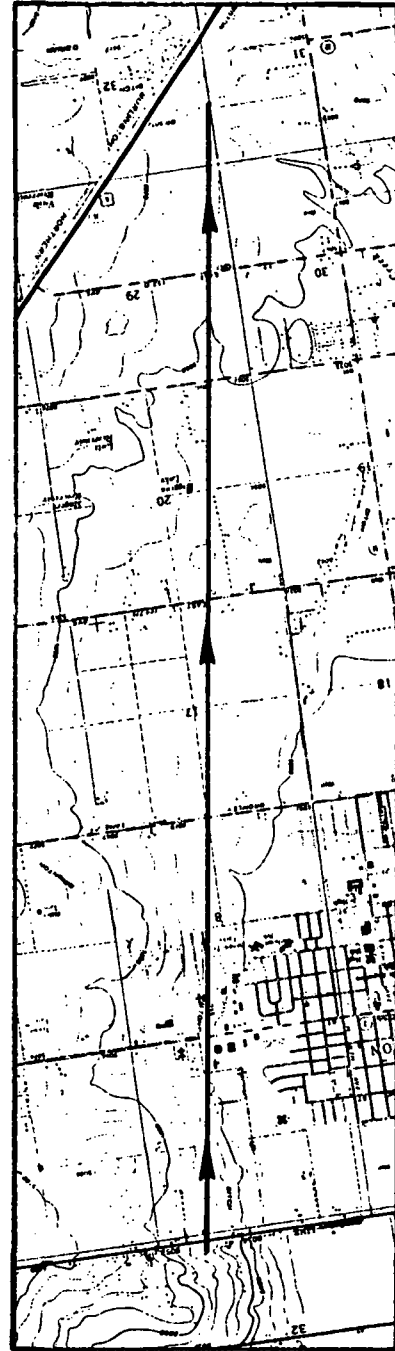
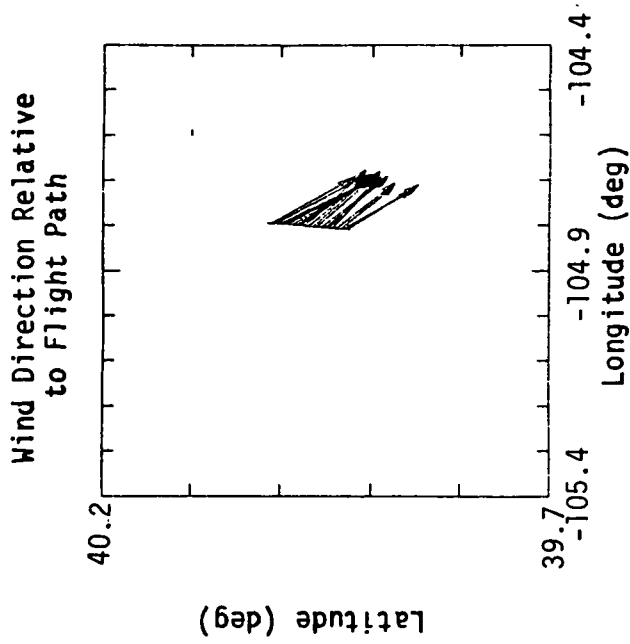
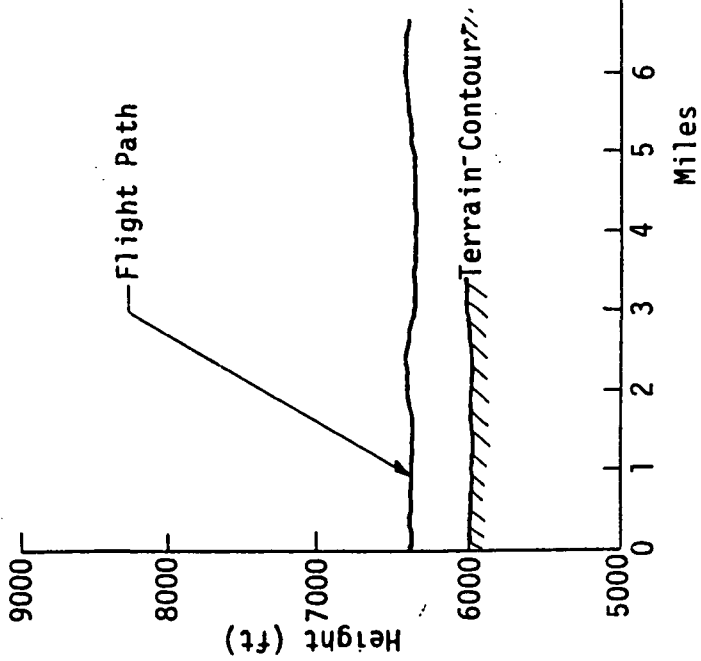

Figure A.185. Flight path information, Flight 6, Run 27.

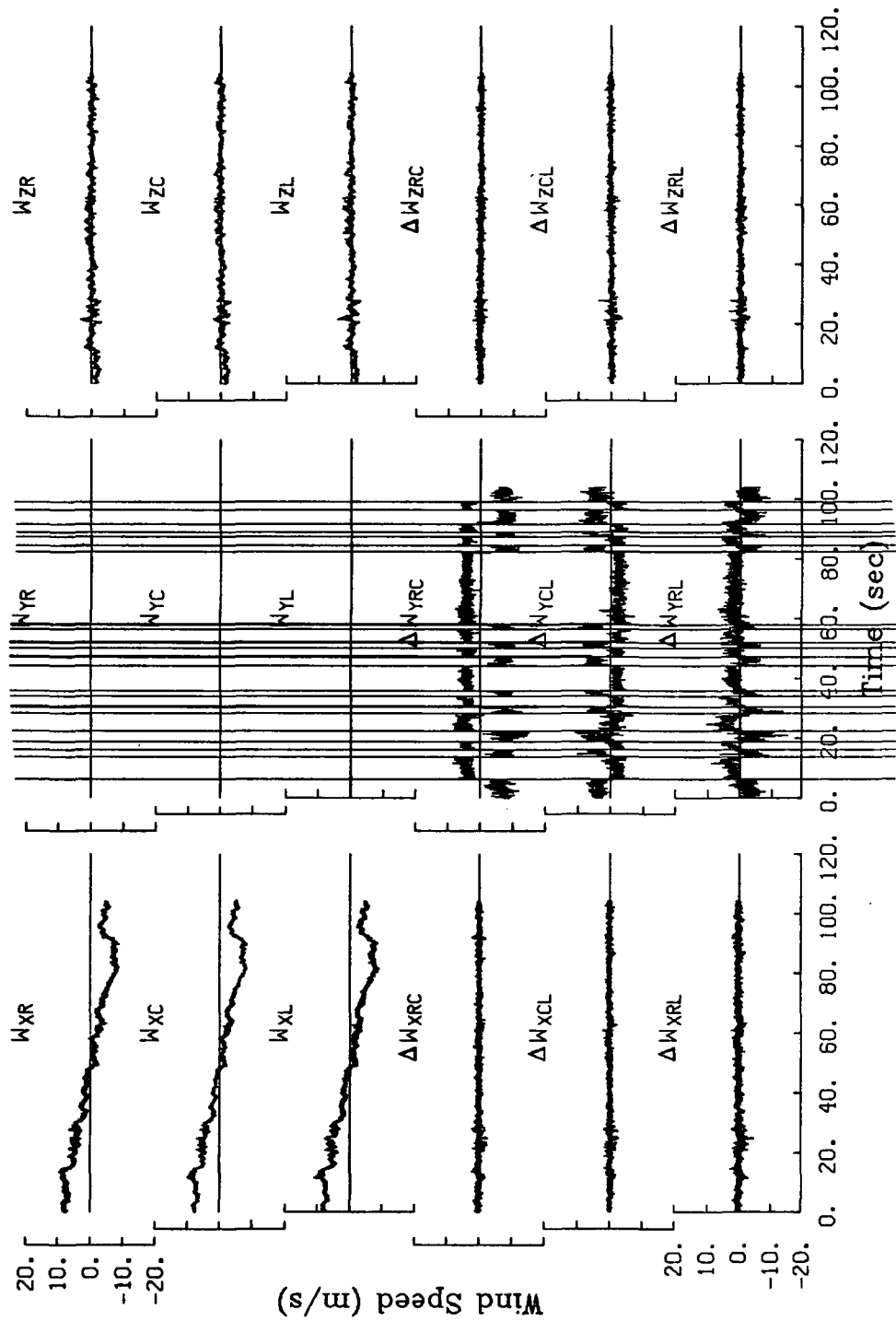

Figure A.186. Time histories of gust velocities and gust velocity differences, Flight 6, Run 27.

TABLE A.47. Average Turbulence Parameters and Integral Length Scales, Flight 6, Run 27.

I. Mean Airspeed (m/s)			II. Standard Deviation of Gust Velocities (m/s)		
V_L	V_C	V_R	$\sigma_{W_{XL}}$	$\sigma_{W_{XC}}$	$\sigma_{W_{XR}}$
105.0	104.0	105.9	5.06	4.94	4.96
			$\sigma_{W_{YL}}$	$\sigma_{W_{YC}}$	$\sigma_{W_{YR}}$
			312.16	309.15	314.62
			$\sigma_{W_{ZL}}$	$\sigma_{W_{ZC}}$	$\sigma_{W_{ZR}}$
			0.82	0.83	0.83
III. Standard Deviation of Gust Velocity Differences (m/s)			IV. Integral Length Scale (m)		
$\sigma_{\Delta W_{XCL}}$	$\sigma_{\Delta W_{XRC}}$	$\sigma_{\Delta W_{XRL}}$	$L_{W_{XL}}$	$L_{W_{XC}}$	$L_{W_{XR}}$
0.47	0.51	0.64	1913	1891	1914
$\sigma_{\Delta W_{YCL}}$	$\sigma_{\Delta W_{YRC}}$	$\sigma_{\Delta W_{YRL}}$	$L_{W_{YL}}$	$L_{W_{YC}}$	$L_{W_{YR}}$
5.66	3.37	3.10	222	220	224
$\sigma_{\Delta W_{ZCL}}$	$\sigma_{\Delta W_{ZRC}}$	$\sigma_{\Delta W_{ZRL}}$	$L_{W_{ZL}}$	$L_{W_{ZC}}$	$L_{W_{ZR}}$
0.46	0.51	0.53	303	1060	443

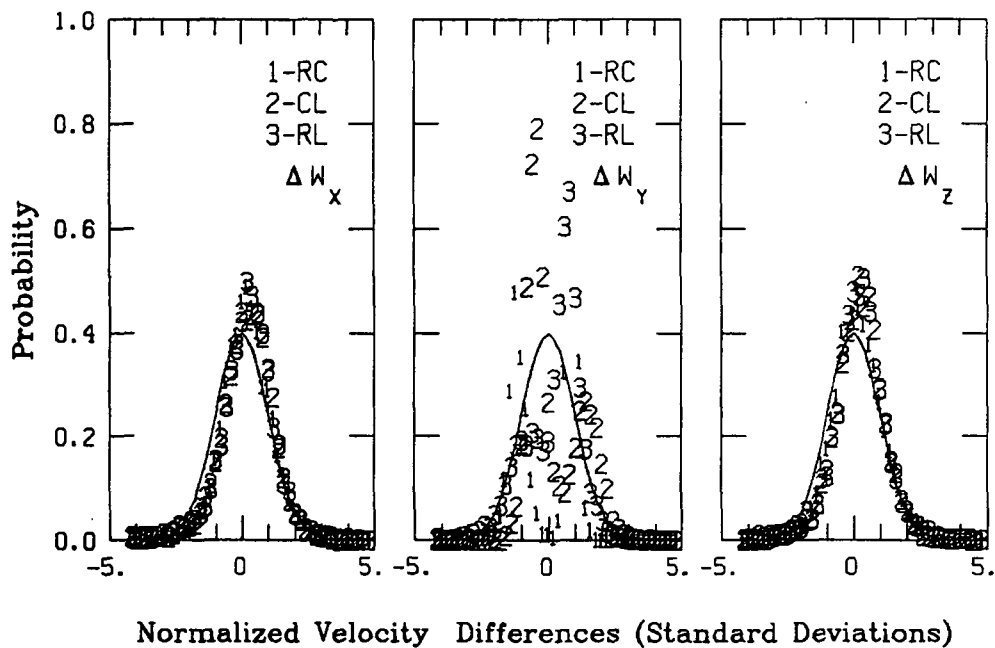
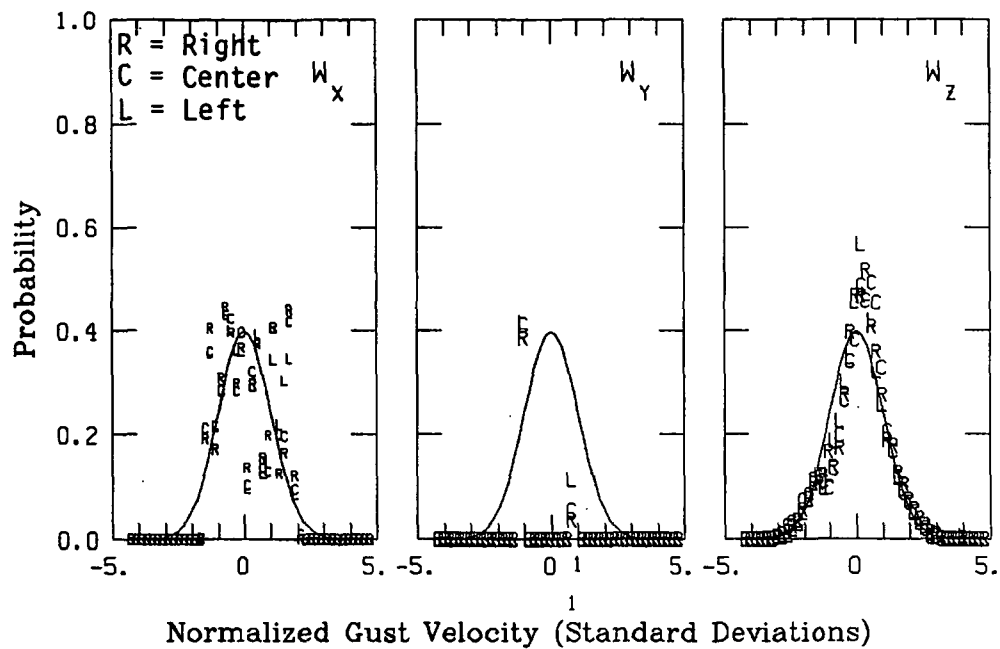

Figure A.187. Probability density function for gust velocities and gust velocity differences, Flight 6, Run 27.

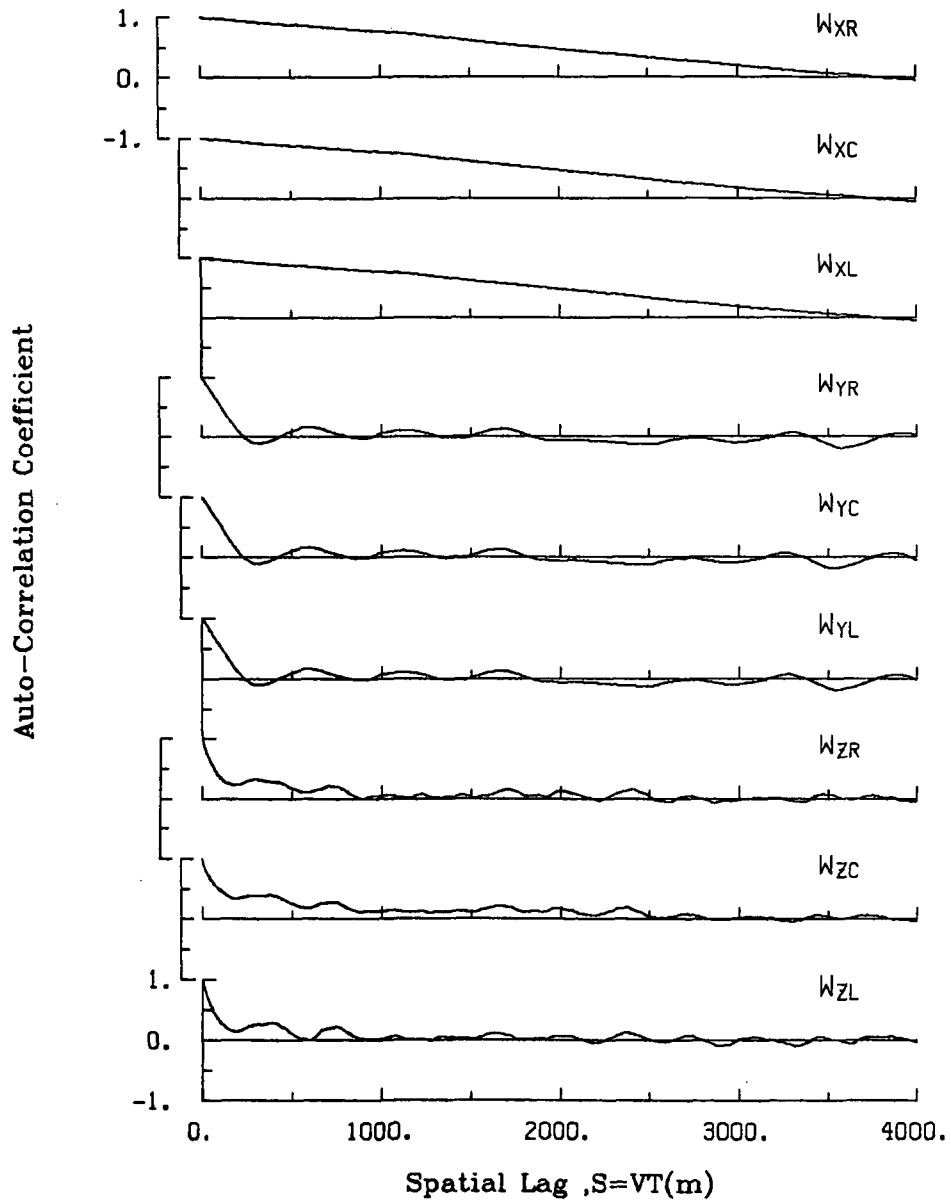

Figure A.188. Single-point auto-correlation coefficient of gust velocities, Flight 6, Run 27.

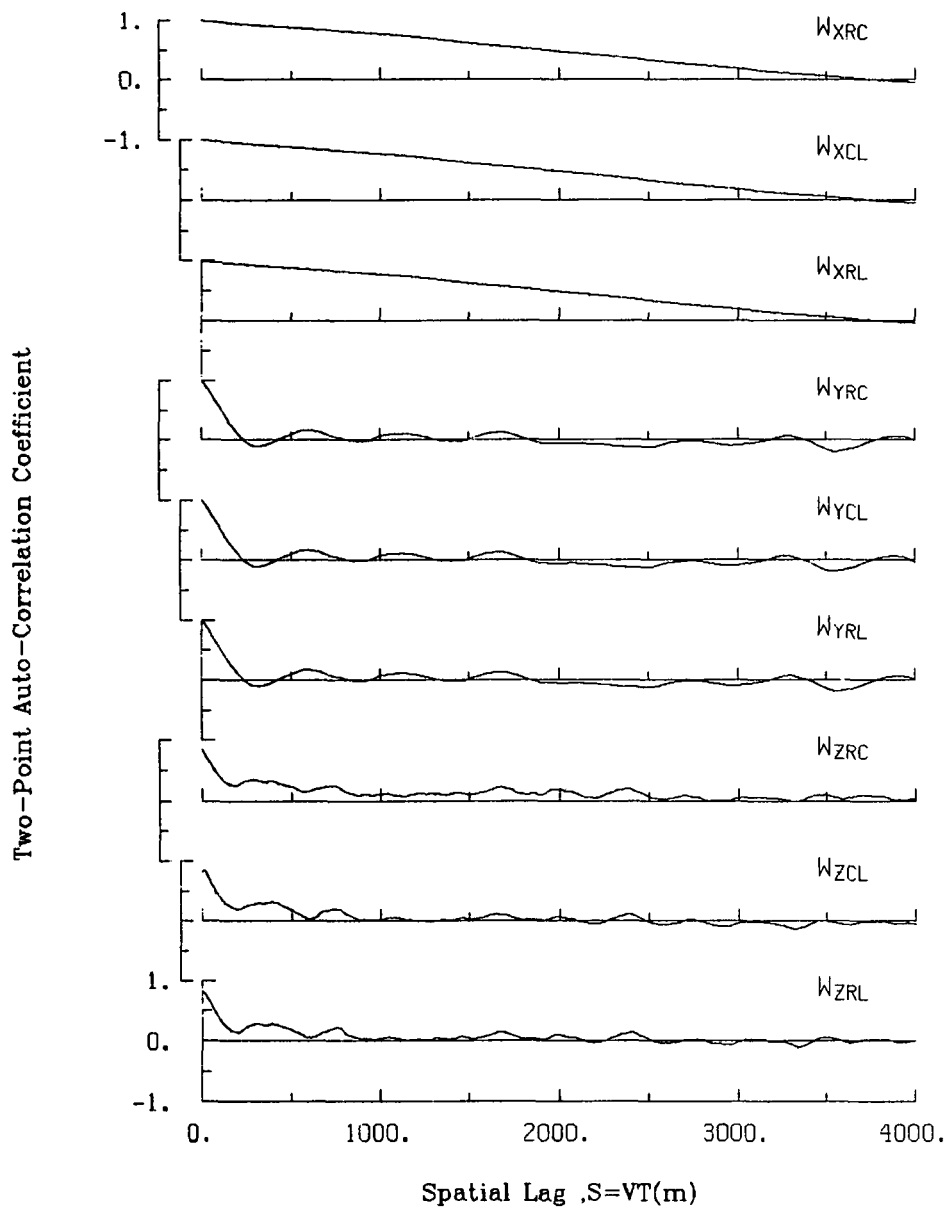

Figure A.189. Two-point auto-correlation coefficient of gust velocities, Flight 6, Run 27.

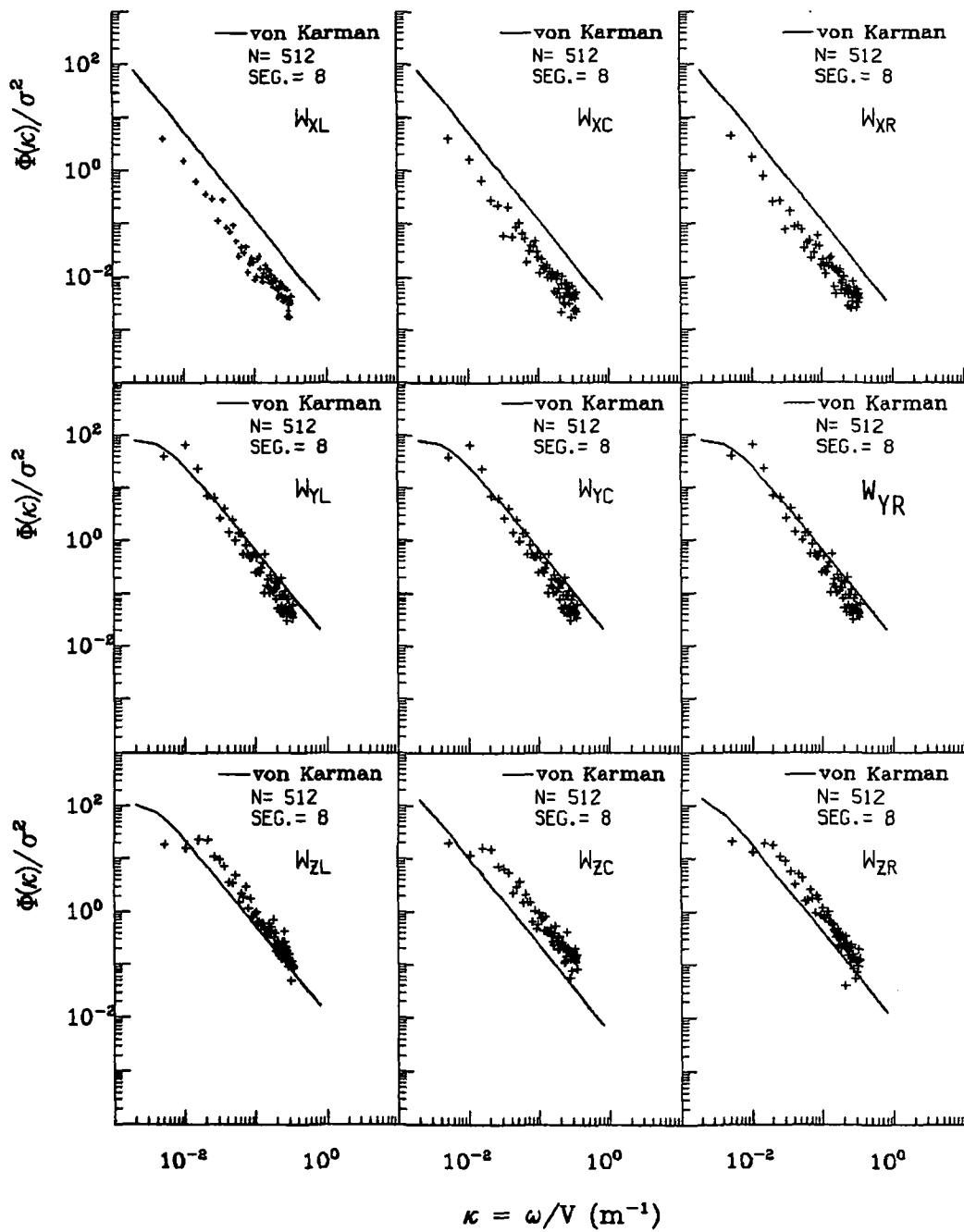

Figure A.190. Normalized auto-spectra of gust velocities, Flight 6, Run 27.

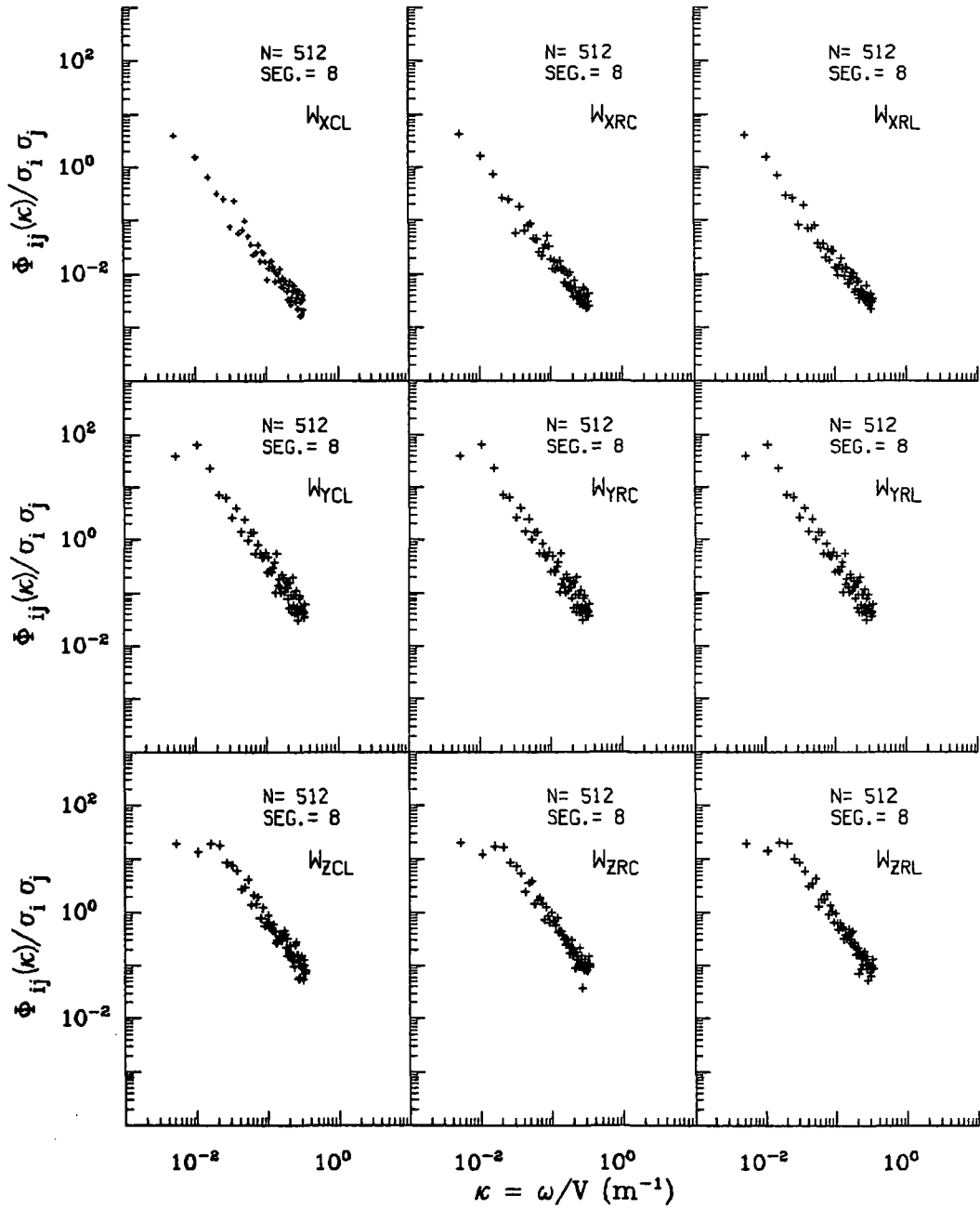

Figure A.191. Normalized two-point auto-spectra of gust velocities, Flight 6, Run 27.

ORIGINAL PAGE IS
OF POOR QUALITY

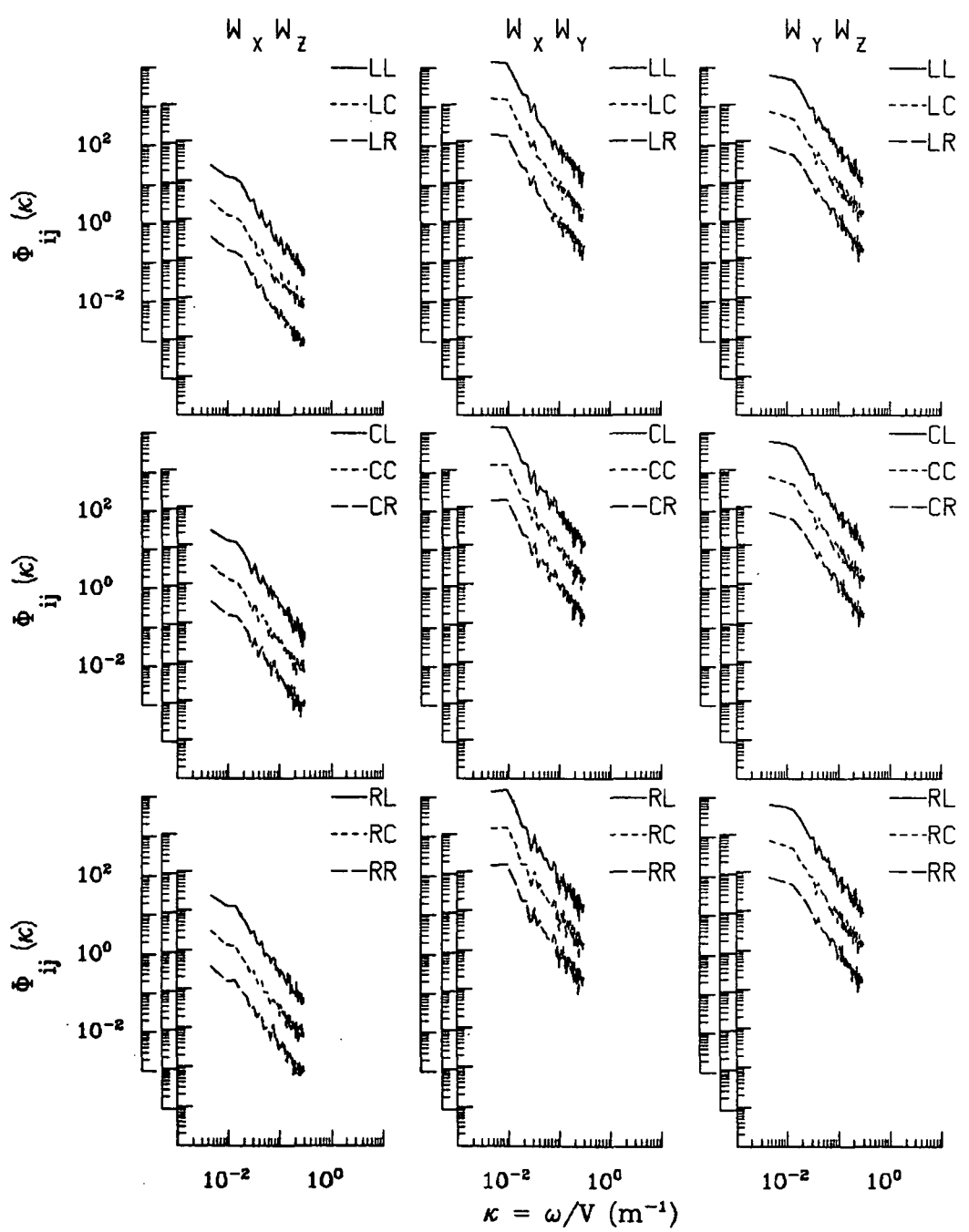

Figure A.192. Two-point cross-spectra of gust velocities, Flight 6, Run 27.

TABLE A.48. List of All Parameters Measured and Their Range of Values, Flight 6, Run 27.

		START TIME • 53785.3720	STOP TIME • 53889.6470				
CHANNEL	UNITS	HIGH	LOW	MEAN	RMS	POINTS	
2	PHI DOT	RAD/SEC	.068	-.080	-.00303	.01883	4171
3	ACCL N CG	G UNITS	-.988	-.988	-.98774	.98774	4171
4	THETA DOT	RAD/SEC	.043	-.025	.00540	.01003	4171
5	THETA	RAD	.103	.006	.05186	.05454	4171
6	PHI	RAD	.055	-.063	-.01397	.02618	4171
7	PSI 1	DEGREES	359.118	-.155	110.30789	198.56757	4171
8	DEL PSI 1	DEGREES	1.875	-1.709	.11985	.73438	4171
9	PSI 2	DEGREES	359.698	356.178	357.87745	357.87814	4171
10	DEL PSI 2	DEGREES	14.988	-.713	4.62859	8.32074	4171
11	ACCL N LT	G UNITS	1.685	.322	1.00869	1.01793	4171
12	ACCL N RT	G UNITS	1.565	.531	1.02246	1.03037	4171
13	ACCL X CG	G UNITS	.110	.009	.05993	.06357	4171
14	ACCL Y CG	G UNITS	.193	-.129	.01414	.04673	4171
15	ALPHA CTR	RAD	.020	-.041	-.01807	.02037	4171
16	BETA CTR	RAD	.025	-.040	-.01112	.01561	4171
17	TEMP I	DEG F	98.444	90.709	95.52146	95.53396	4171
18	TEMP P	DEG F	91.797	91.444	91.56511	91.56515	4171
19	ACCL Z INS	G UNITS	1.316	.783	1.00078	1.00309	4171
20	ALPHA RT	RAD	.041	-.035	-.00807	.01338	4171
21	BETA RT	RAD	.052	-.002	.02290	.02507	4171
22	ALPHA LT	RAD	.047	-.034	-.00684	.01311	4171
23	BETA LT	RAD	.013	-.045	-.01612	.01900	4171
24	PSI DOT	RAD/SEC	.027	-.023	.00354	.00903	4171
25	TEMP TOT	DEG C	31.687	29.619	30.68270	30.68651	4171
26	QC LT	PSID	.869	.624	.76528	.76767	4171
27	QC CTR	PSID	.846	.625	.75061	.75286	4171
28	QC RT	PSID	.885	.660	.77867	.78096	4171
29	PS	PSIA	11.608	11.570	11.59368	11.59368	4171
30	TEMP IRT	DEG C	21.314	16.632	20.34004	20.34497	4171
31	D TO G	METERS	8764770.2788761829.568	*****	*****	*****	4171
32	B TO D	DEGREES	80.399	80.391	80.39505	80.39505	4171
33	LONG	DEGREES	-104.793	-104.808	-104.80091	104.80091	4171
34	LAT	DEGREES	40.015	39.925	39.96917	39.96918	4171
35	TRK ANG	DEGREES	8.651	5.685	7.28535	7.33214	4171
36	HGD	RADIANS	6.283	.000	2.21048	3.71756	4171
37	VE	M/SEC	15.055	8.977	12.34130	12.45083	4171
38	VN	M/SEC	99.634	89.985	96.34134	96.38442	4171
39	ALTITUDE	KM	1.972	1.945	1.95546	1.95547	4171
40	TEMPC	DEGREES C	25.731	24.958	25.28630	25.28666	4171
41	EW WND SPD	KNOTS	28.263	14.619	20.70162	20.80934	4171
42	NS WND SPD	KNOTS	-6.385	-22.965	-14.95049	15.29264	4171
43	WIND SPEED	KNOTS	31.009	18.737	25.72530	25.82428	4171
44	WIND DIREC	DEGREES	321.803	286.104	305.63957	305.71820	4171
45	AIRSPD R	M/SEC	112.888	97.825	105.93768	106.01335	4171
46	AIRSPD C	M/SEC	110.451	95.249	104.05305	104.12892	4171
47	AIRSPD L	M/SEC	111.889	95.175	105.03829	105.11803	4171
48	DELTA ALT	METERS	15.352	-11.584	-1.38348	7.14911	4171
49	INPTL DISP	METERS	13.410	-11.127	-1.63479	7.88164	4171
50	UG RIGHT	M/SEC	9.502	-8.811	-.00000	4.95643	4171
51	UG CENTER	M/SEC	10.043	-8.337	-.00000	4.93419	4171
52	UG LEFT	M/SEC	11.143	-8.895	-.00000	5.05634	4171
53	VG RIGHT	M/SEC	247.305	-460.057	2.39228	315.03190	4171
54	VG CENTER	M/SEC	242.017	-452.443	2.23621	309.54880	4171
55	VG LEFT	M/SEC	245.086	-456.245	2.09729	312.55804	4171
56	WG RIGHT	M/SEC	3.231	-2.923	.00925	.83293	4171
57	WG CENTER	M/SEC	2.294	-2.858	.01366	.82569	4171
58	WG LEFT	M/SEC	4.019	-3.056	.00784	.81866	4171

Date: July 14, 1982
 Time: 15:01:21(MDT)
 Duration: 60 seconds

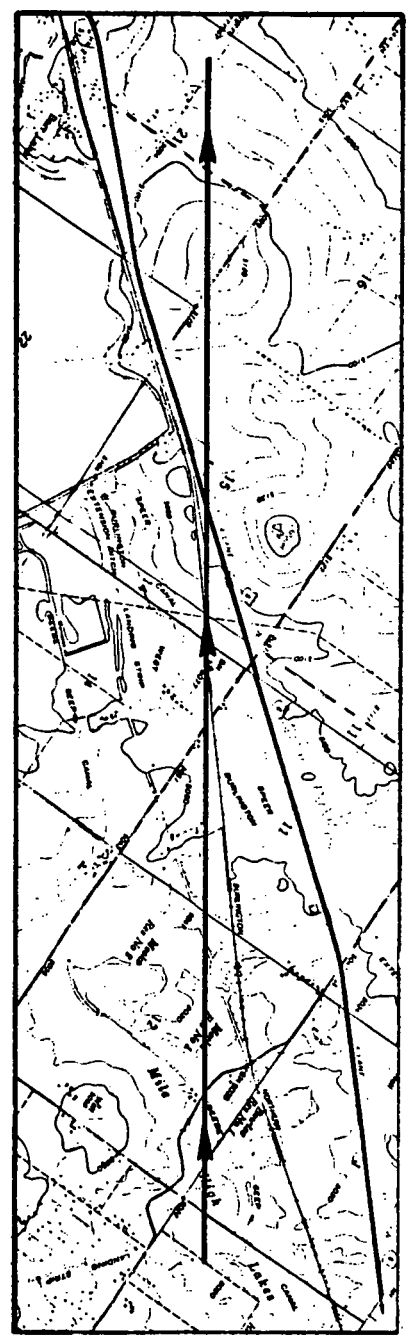
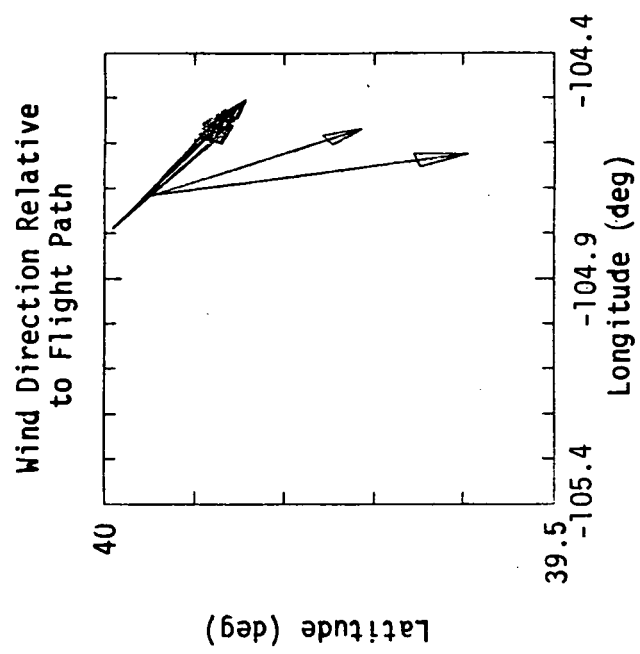
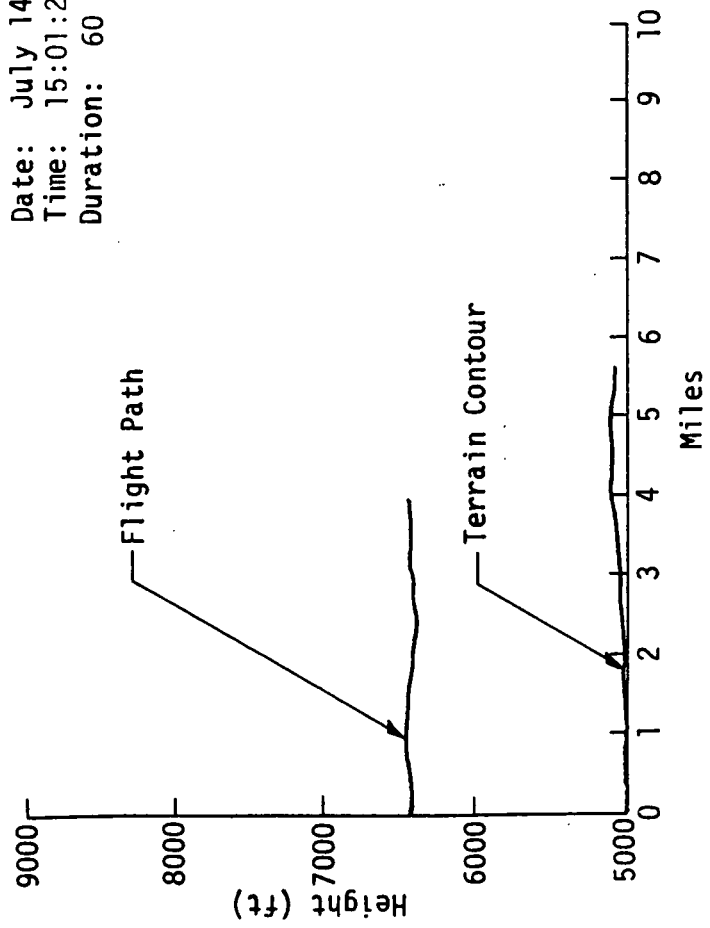

Figure A.193. Flight path information, Flight 6, Run 28.

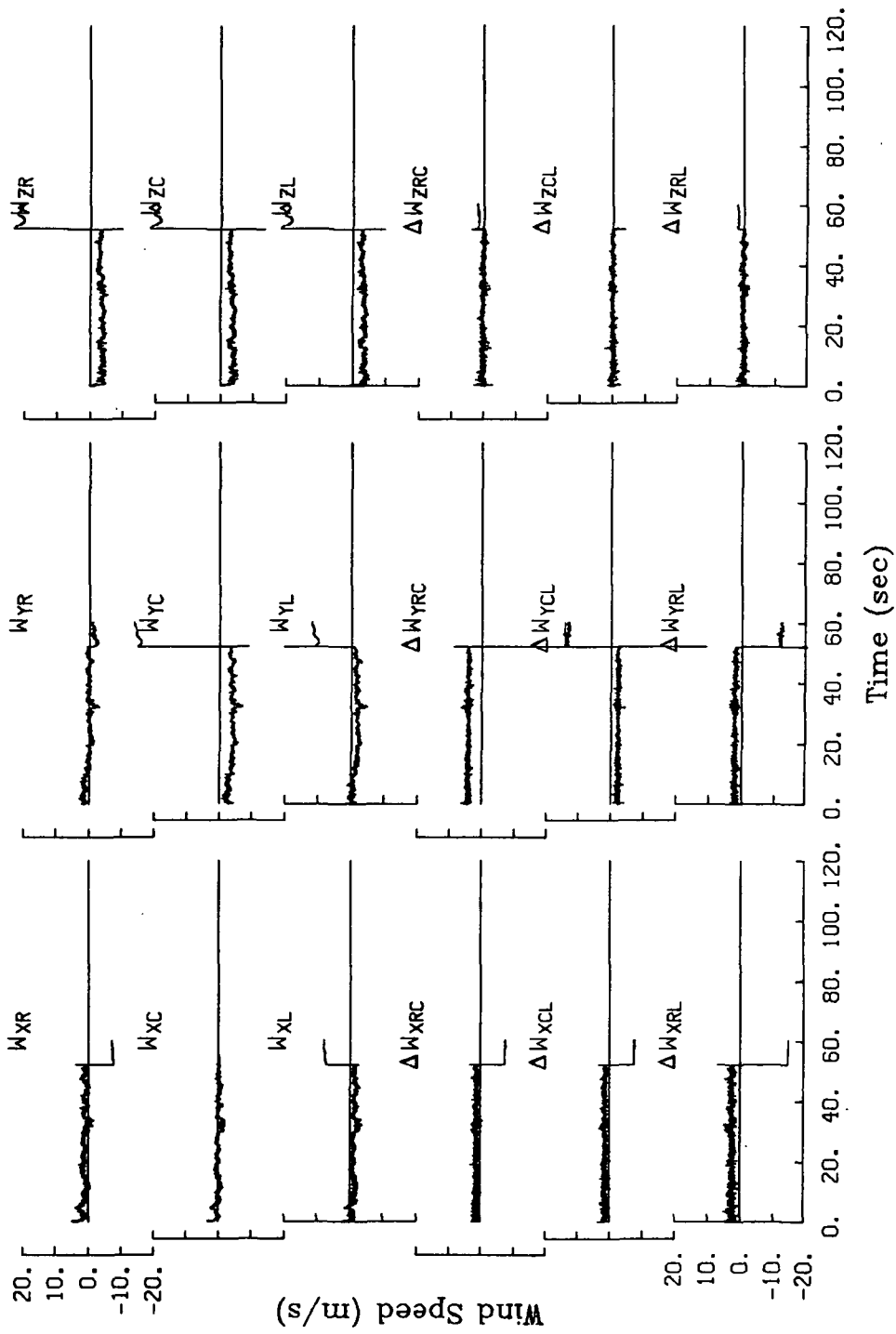

Figure A.194. Time histories of gust velocities and gust velocity differences, Flight 6, Run 28.

TABLE A.49. Average Turbulence Parameters and Integral Length Scales, Flight 6, Run 28.

I. Mean Airspeed (m/s)

V_L	V_C	V_R
106.2	105.1	106.9

II. Standard Deviation of Gust Velocities (m/s)

$\sigma_{W_{XL}}$	$\sigma_{W_{XC}}$	$\sigma_{W_{XR}}$
0.70	0.65	0.72
$\sigma_{W_{YL}}$	$\sigma_{W_{YC}}$	$\sigma_{W_{YR}}$
0.79	0.82	0.80
$\sigma_{W_{ZL}}$	$\sigma_{W_{ZC}}$	$\sigma_{W_{ZR}}$
0.68	0.71	0.72

III. Standard Deviation of Gust Velocity Differences (m/s)

$\sigma_{\Delta W_{XCL}}$	$\sigma_{\Delta W_{XRC}}$	$\sigma_{\Delta W_{XRL}}$
0.43	0.44	0.56
$\sigma_{\Delta W_{YCL}}$	$\sigma_{\Delta W_{YRC}}$	$\sigma_{\Delta W_{YRL}}$
0.39	0.35	0.38
$\sigma_{\Delta W_{ZCL}}$	$\sigma_{\Delta W_{ZRC}}$	$\sigma_{\Delta W_{ZRL}}$
0.42	0.43	0.49

IV. Integral Length Scale (m)

$L_{W_{XL}}$	$L_{W_{XC}}$	$L_{W_{XR}}$
415	124	402
$L_{W_{YL}}$	$L_{W_{YC}}$	$L_{W_{YR}}$
869	847	642
$L_{W_{ZL}}$	$L_{W_{ZC}}$	$L_{W_{ZR}}$
853	858	862

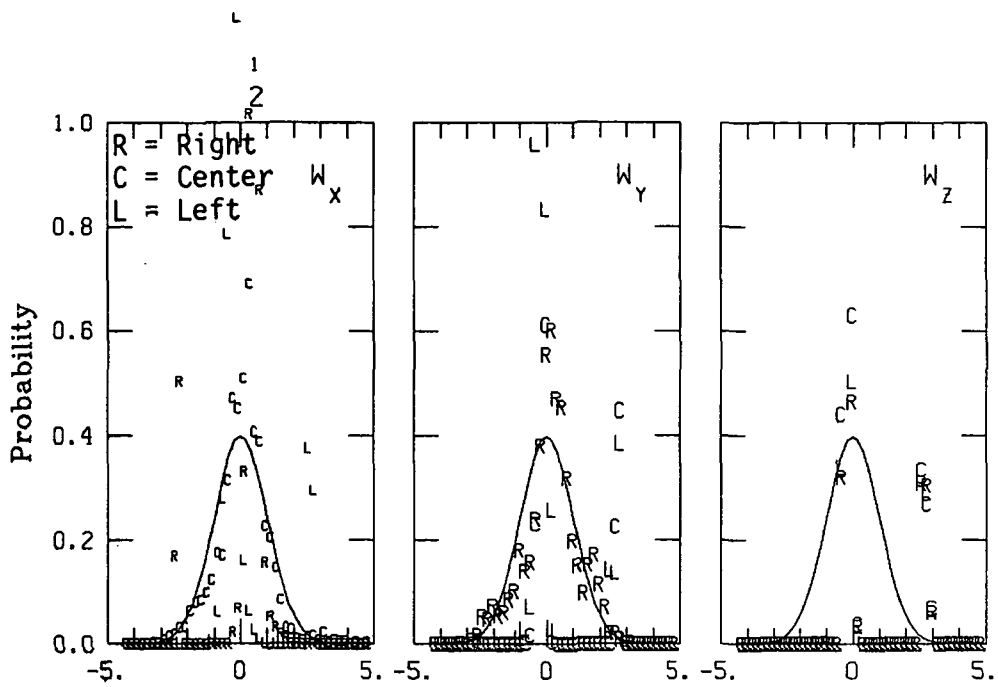

Normalized Gust Velocity (Standard Deviations)

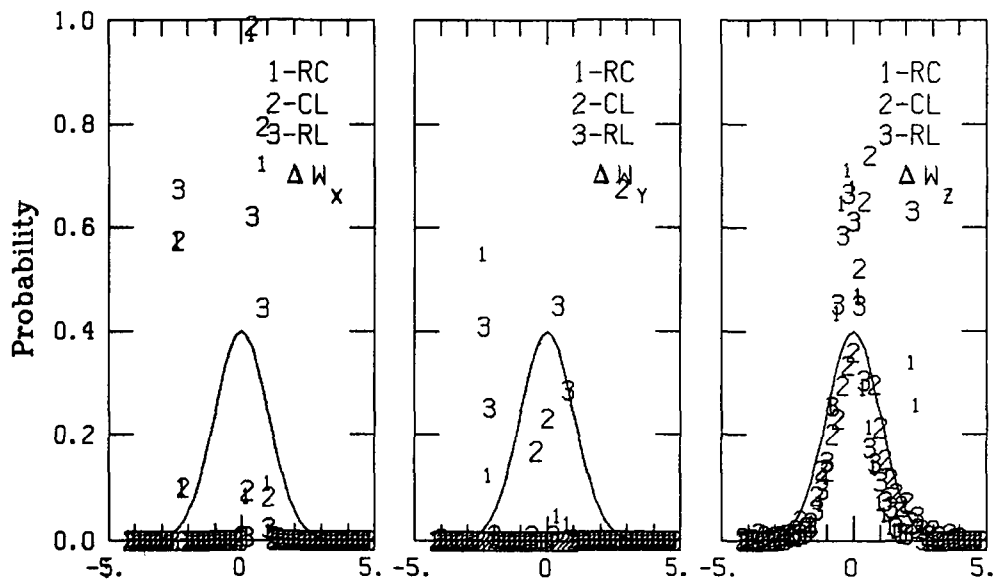

Normalized Velocity Differences (Standard Deviations)

Figure A.195. Probability density function for gust velocities and gust velocity differences, Flight 6, Run 28.

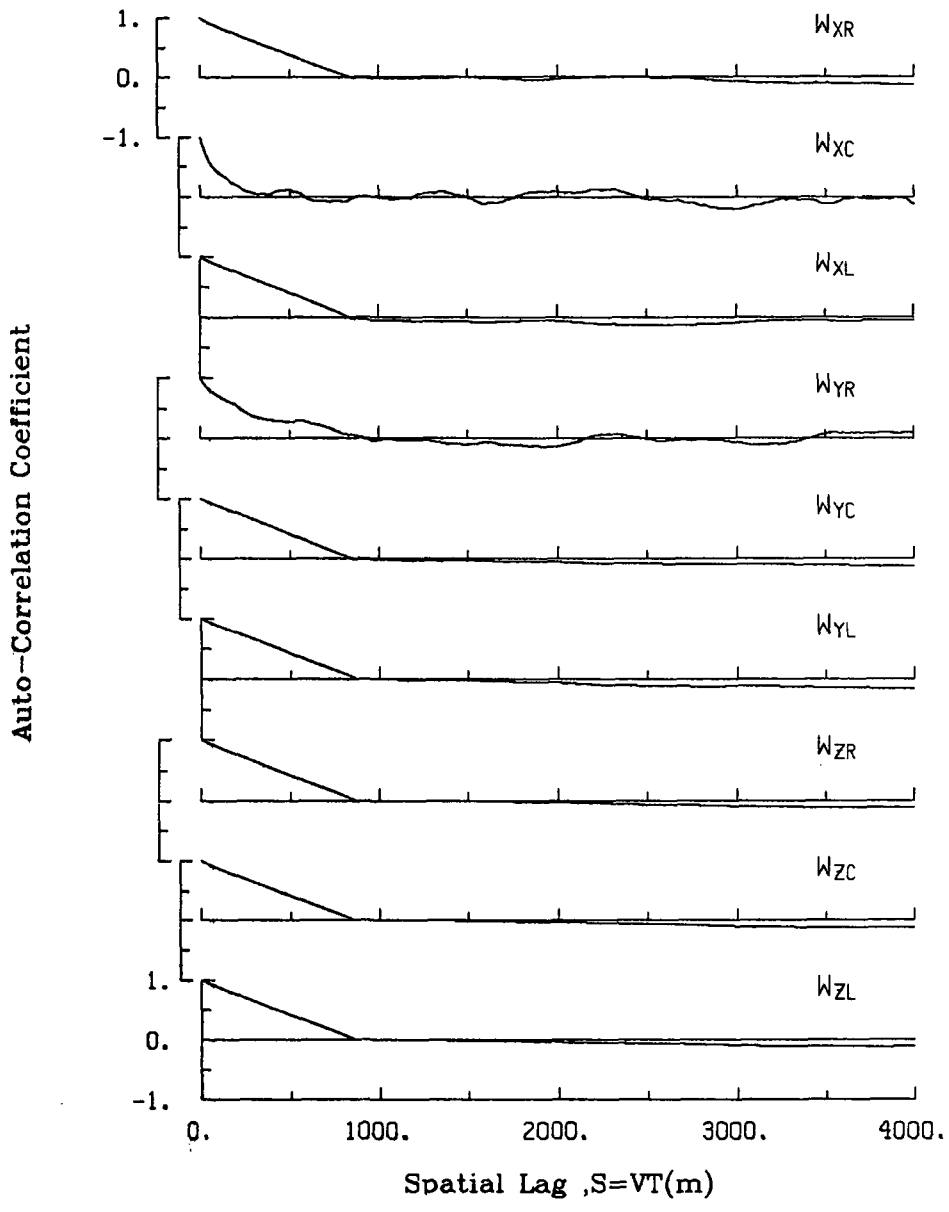

Figure A.196. Single-point auto-correlation coefficient of gust velocities, Flight 6, Run 28.

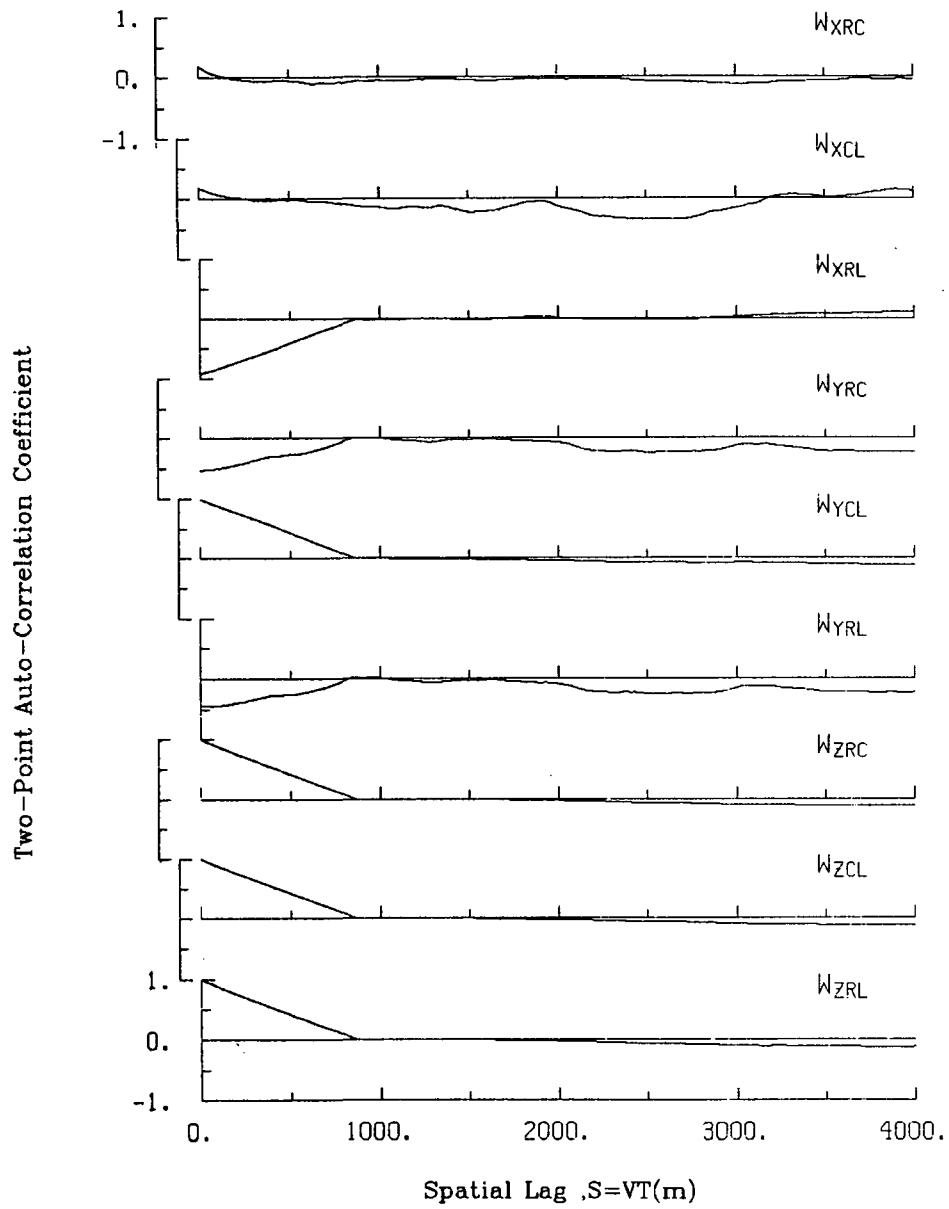

Figure A.197. Two-point auto-correlation coefficient of gust velocities, Flight 6, Run 28.

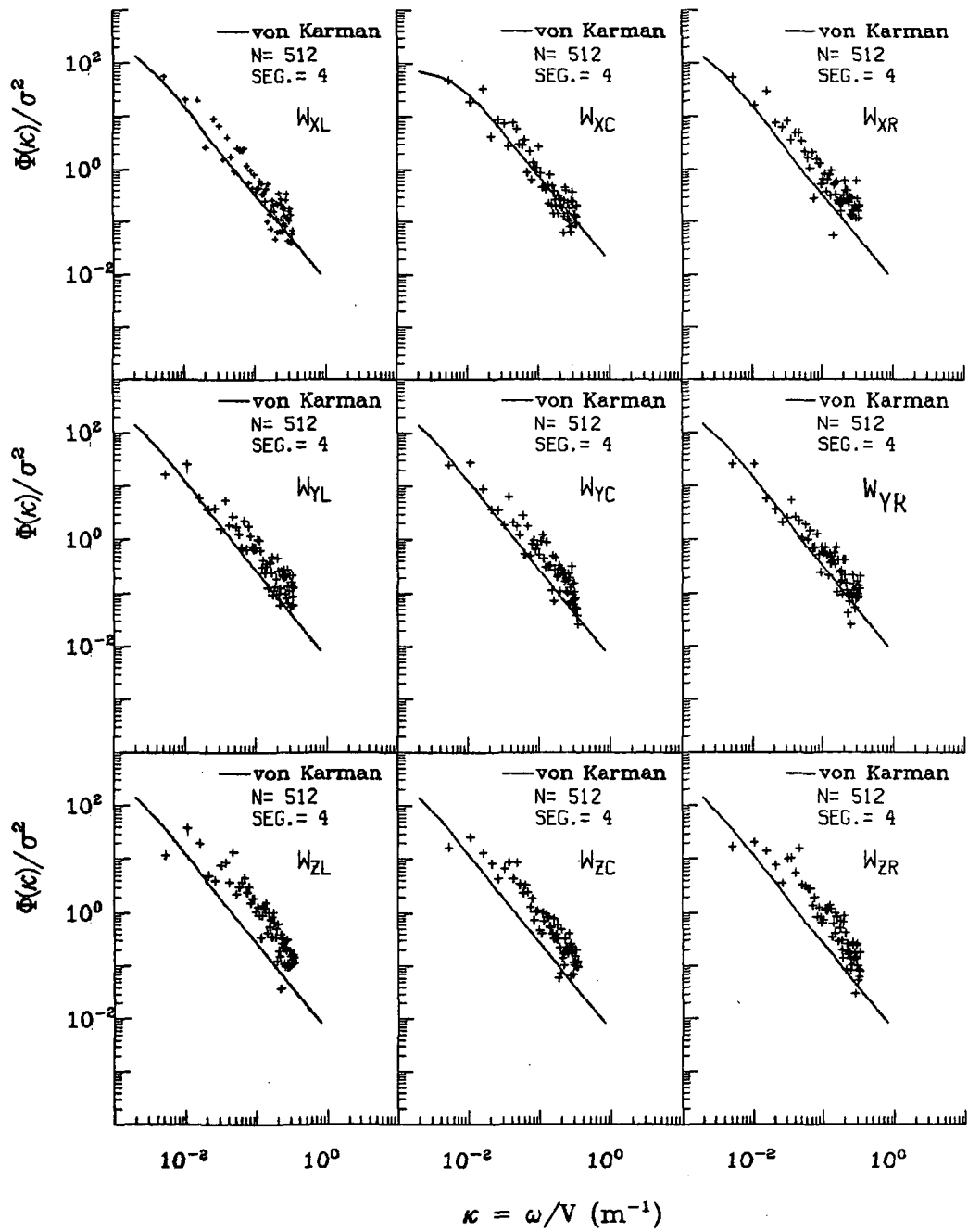

Figure A.198. Normalized auto-spectra of gust velocities, Flight 6, Run 28.

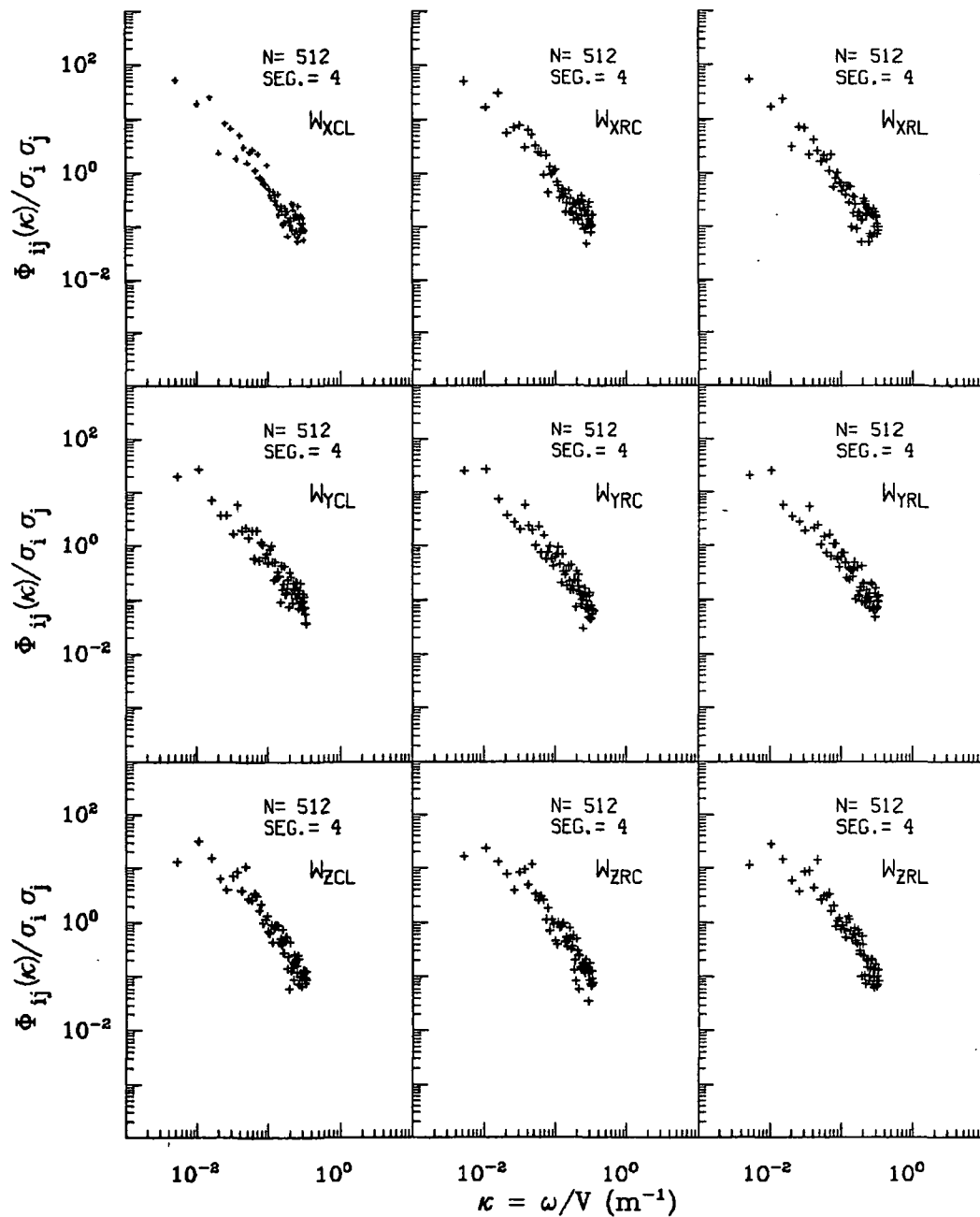

Figure A.199. Normalized two-point auto-spectra of gust velocities, Flight 6, Run 28.

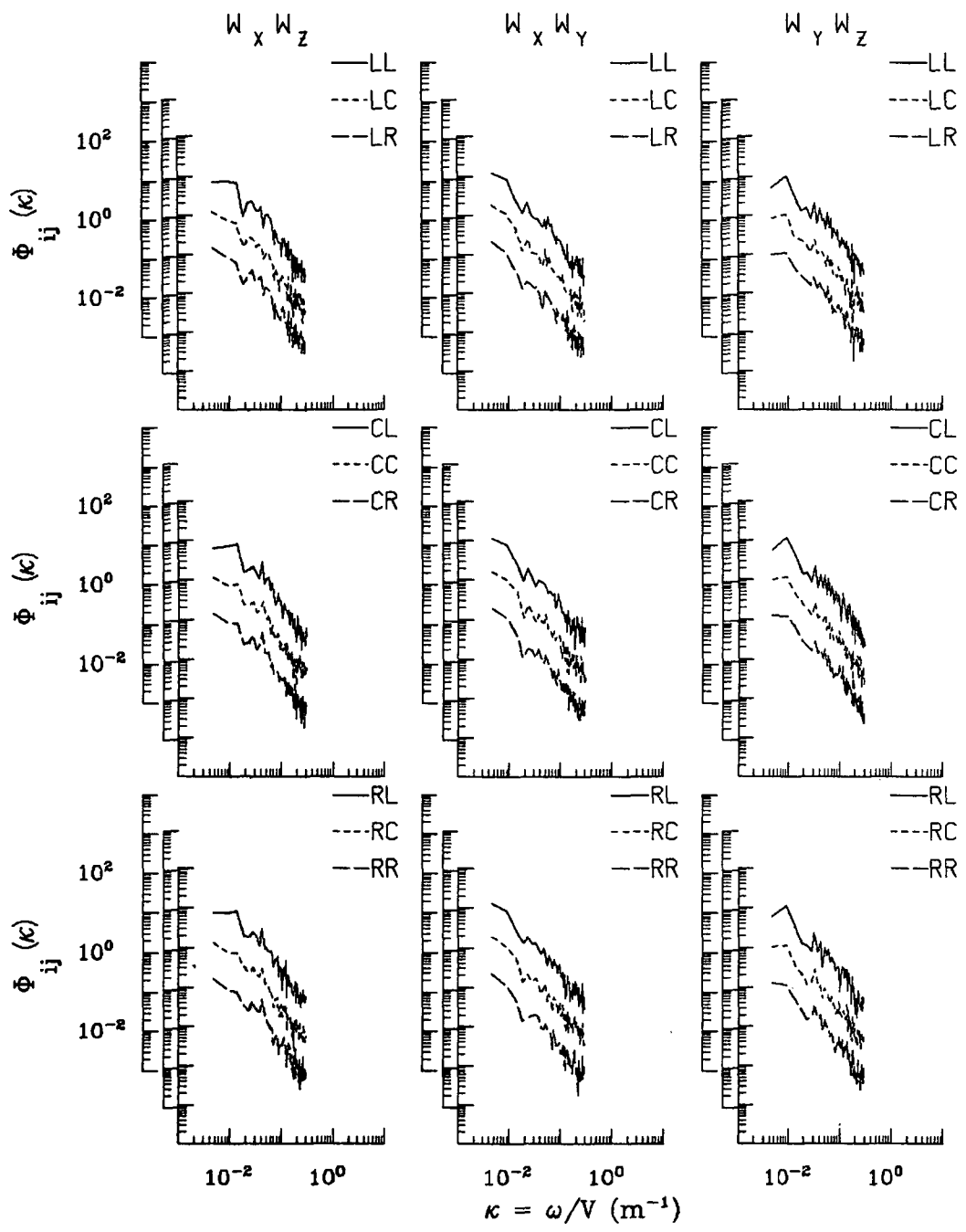

Figure A.200. Two-point cross-spectra of gust velocities, Flight 6, Run 28.

ORIGINAL PAGE IS
OF POOR QUALITY

TABLE A.50. List of All Parameters Measured and Their Range of Values,
Flight 6, Run 28.

START TIME = 54081.5624 STOP TIME = 54141.9374

CHANNEL	UNITS	HIGH	LOW	MEAN	RMS	POINTS
2 PHI DOT	RAD/SEC	.038	-.058	-.00467	.01391	2415
3 ACCL N CG	G UNITS	-.182	-.988	-.98741	.98754	2415
4 THETA DOT	RAD/SEC	.044	-.449	-.01228	.04879	2415
5 THETA	RAD	.068	-.018	.03563	.04020	2415
6 PHI	RAD	.084	-.066	.00062	.03564	2415
7 PSI 1	DEGREES	161.518	79.494	128.54818	129.16212	2415
8 DEL PSI 1	DEGREES	5.490	-4.656	.15133	2.16766	2415
9 PSI 2	DEGREES	487.491	406.168	475.49316	476.18863	2415
10 DEL PSI 2	DEGREES	.903	-6.571	-.64675	.98265	2415
11 ACCL N LT	G UNITS	1.514	.438	1.00894	1.01555	2415
12 ACCL N RT	G UNITS	1.488	-1.332	1.04047	1.04906	2415
13 ACCL X CG	G UNITS	.422	.021	.09365	.15983	2415
14 ACCL Y CG	G UNITS	.760	-.136	.11051	.28255	2415
15 ALPHA CTR	RAD	.203	-.079	.00999	.07688	2415
16 BETA CTR	RAD	.187	-.073	.00902	.07161	2415
17 TEMP I	DEG F	98.444	.407	97.43101	97.47850	2415
18 TEMP P	DEG F	91.804	-18.414	83.85549	86.23968	2415
19 ACCL Z INS	G UNITS	1.213	-.243	.99137	.99321	2415
20 ALPHA RT	RAD	.198	-.072	.01913	.07347	2415
21 BETA RT	RAD	.053	-.016	.01294	.01769	2415
22 ALPHA LT	RAD	.200	-.076	.02354	.07382	2415
23 BETA LT	RAD	.162	-.059	-.00817	.04156	2415
24 PSI DOT	RAD/SEC	.912	-.234	.12503	.33226	2415
25 TEMP TOT	DEG C	35.034	29.601	31.40757	31.44043	2415
26 QC LT	PSID	.820	.727	.77946	.77965	2415
27 QC CTR	PSID	.799	.709	.76369	.76388	2415
28 QC RT	PSID	.831	.726	.79123	.79143	2415
29 PS	PSIA	11.615	11.583	11.59626	11.59627	2415
30 TEMP IRT	DEG C	20.119	-159.660	11.55175	21.80909	2415
31 D TO G	PETERS	8770481.0118764833.677	*****	*****	*****	2415
32 B TO D	DEGREES	80.459	80.400	80.42964	80.42964	2415
33 LONG	DEGREES	-104.711	-104.787	-104.74898	104.74898	2415
34 LAT	DEGREES	39.990	39.950	39.96989	39.96989	2415
35 TRK ANG	DEGREES	125.060	123.843	124.43135	124.43186	2415
36 HDG	RADIANS	2.213	2.156	2.18268	2.18271	2415
37 VE	M/SEC	108.840	106.061	107.27685	107.27998	2415
38 VN	M/SEC	-71.679	-74.671	-73.47960	73.48575	2415
39 ALTITUDE	KM	1.963	1.940	1.95366	1.95367	2415
40 TEMPC	DEGREES C	29.605	24.265	25.90867	25.94984	2415
41 EW WND SPD	KNOTS	51.395	17.204	40.18662	41.15919	2415
42 NS WND SPD	KNOTS	-14.185	-70.334	-28.37259	32.50367	2415
43 WIND SPEED	KNOTS	72.408	44.956	-51.90798	52.44585	2415
44 WIND DIREC	DEGREES	346.253	285.429	303.41662	303.87318	2415
45 AIRSPEED R	M/SEC	109.403	102.502	106.94353	106.94884	2415
46 AIRSPEED C	M/SEC	107.332	101.281	105.10826	105.11319	2415
47 AIRSPEED L	M/SEC	108.705	102.584	106.16297	106.16799	2415
48 DELTA ALT	METERS	5.748	-16.746	-3.50797	6.67720	2415
49 INRTL DISP	METERS	15.563	-17.235	-.47227	10.28763	2415
50 UG RIGHT	M/SEC	5.056	-7.681	.00000	3.00323	2415
51 UG CENTER	M/SEC	3.411	-2.084	.00000	.60706	2415
52 UG LEFT	M/SEC	7.956	-3.857	.00000	3.11029	2415
53 VG RIGHT	M/SEC	3.059	-2.992	.24306	.98604	2415
54 VG CENTER	M/SEC	26.330	-8.723	.23813	9.92128	2415
55 VG LEFT	M/SEC	20.429	-5.038	.22412	4.37135	2415
56 WG RIGHT	M/SEC	23.404	-9.967	.00539	8.51901	2415
57 WG CENTER	M/SEC	21.761	-13.532	-.26181	7.96903	2415
58 WG LEFT	M/SEC	21.734	-9.824	-.15974	7.92025	2415

Date: July 14, 1982
Time: 15:03:43 (MDT)
Duration: 84 seconds

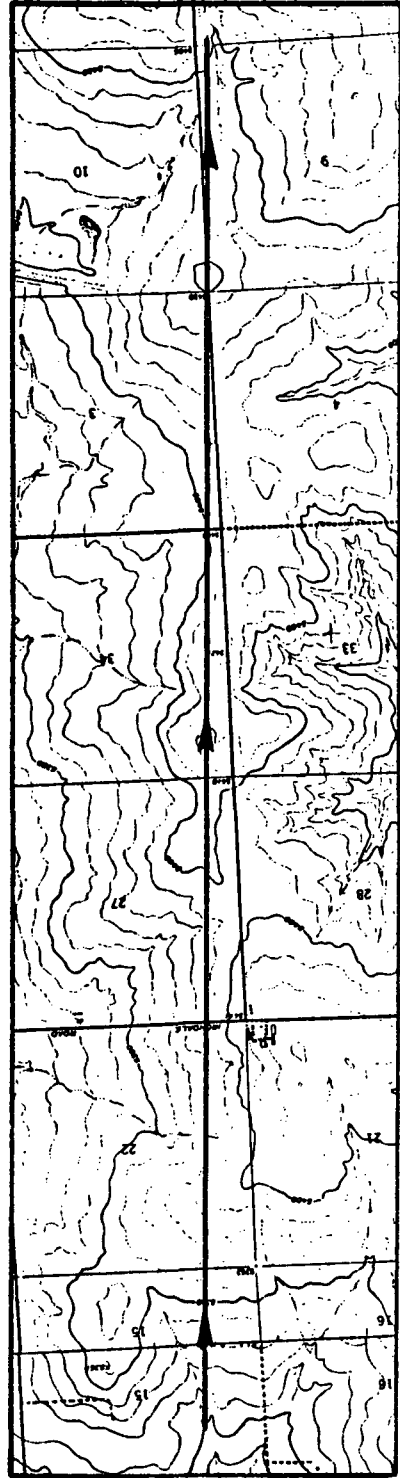
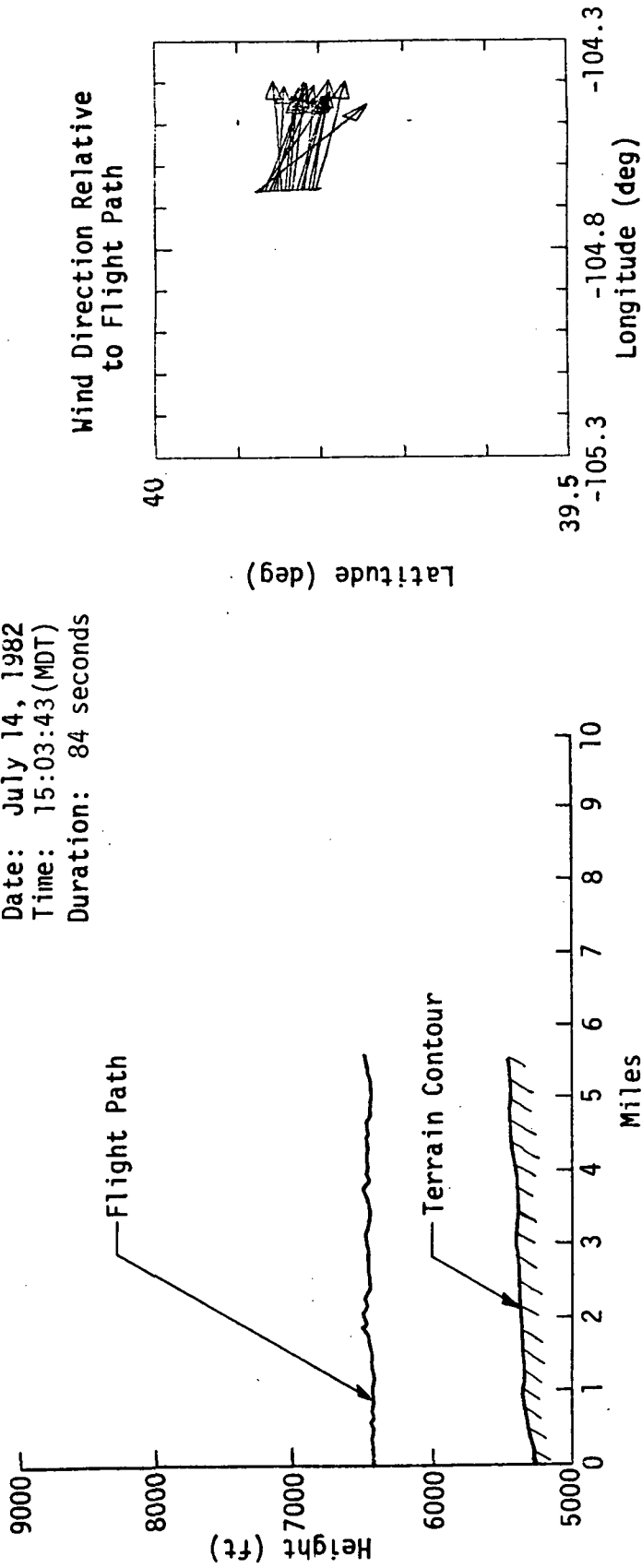

Figure A.201. Flight path information, Flight 6, Run 29.

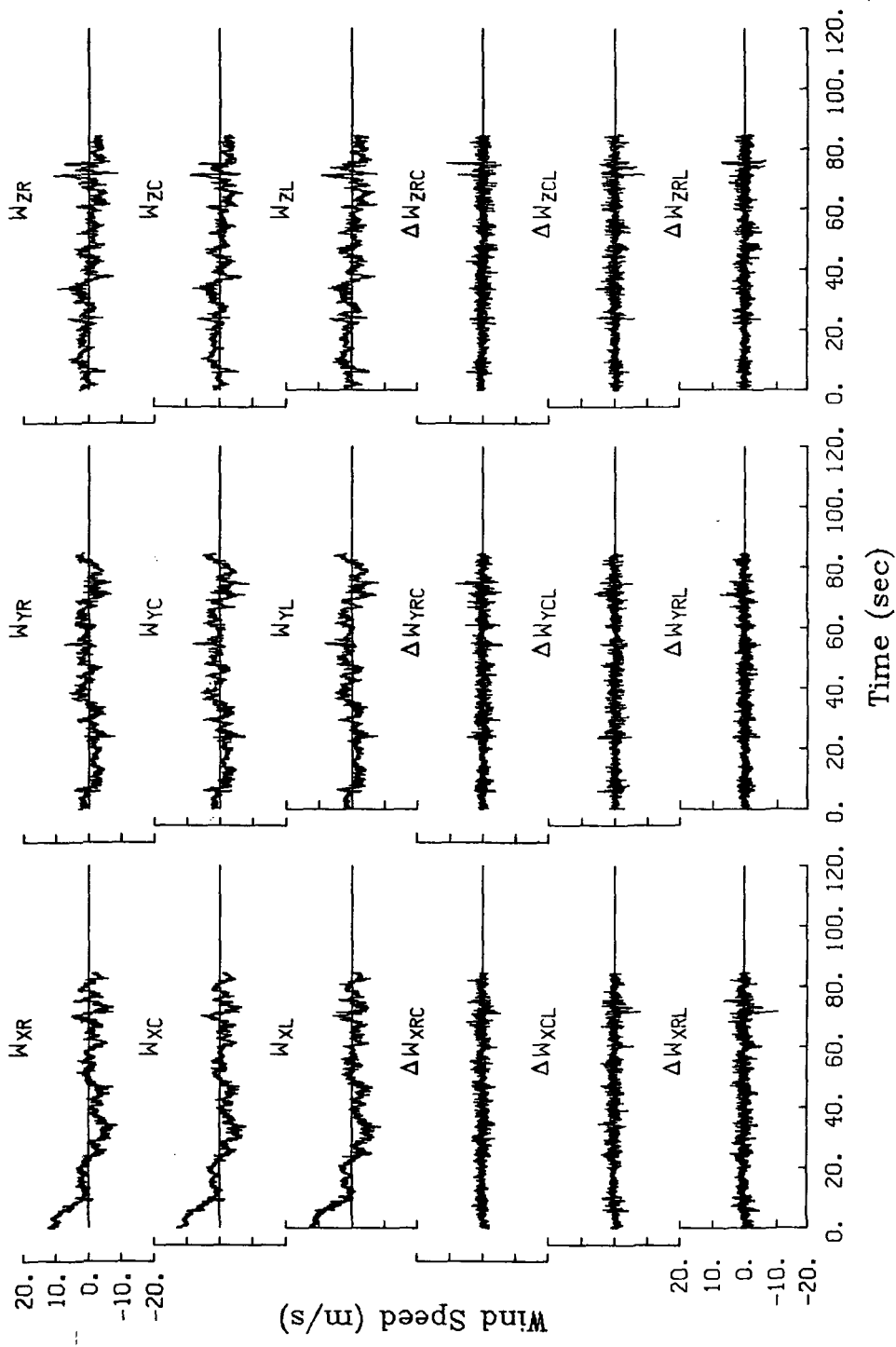

Figure A.202. Time histories of gust velocities and gust velocity differences, Flight 6, Run 29.

TABLE A.52. Average Turbulence Parameters and Integral Length Scales, Flight 6, Run 29.

I. Mean Airspeed (m/s)

V_L	V_C	V_R
106.1	104.9	106.7

II. Standard Deviation of Gust Velocities (m/s)

$\sigma_{W_{XL}}$	$\sigma_{W_{XC}}$	$\sigma_{W_{XR}}$
3.92	3.82	3.84
$\sigma_{W_{YL}}$	$\sigma_{W_{YC}}$	$\sigma_{W_{YR}}$
2.21	2.18	2.10
$\sigma_{W_{ZL}}$	$\sigma_{W_{ZC}}$	$\sigma_{W_{ZR}}$
2.42	2.22	2.38

III. Standard Deviation of Gust Velocity Differences (m/s)

$\sigma_{\Delta W_{XCL}}$	$\sigma_{\Delta W_{XRC}}$	$\sigma_{\Delta W_{XRL}}$
1.01	1.08	1.34
$\sigma_{\Delta W_{YCL}}$	$\sigma_{\Delta W_{YRC}}$	$\sigma_{\Delta W_{YRL}}$
1.10	1.09	1.08
$\sigma_{\Delta W_{ZCL}}$	$\sigma_{\Delta W_{ZRC}}$	$\sigma_{\Delta W_{ZRL}}$
1.17	1.22	1.30

IV. Integral Length Scale (m)

$L_{W_{XL}}$	$L_{W_{XC}}$	$L_{W_{XR}}$
592	599	592
$L_{W_{YL}}$	$L_{W_{YC}}$	$L_{W_{YR}}$
604	553	634
$L_{W_{ZL}}$	$L_{W_{ZC}}$	$L_{W_{ZR}}$
385	387	379

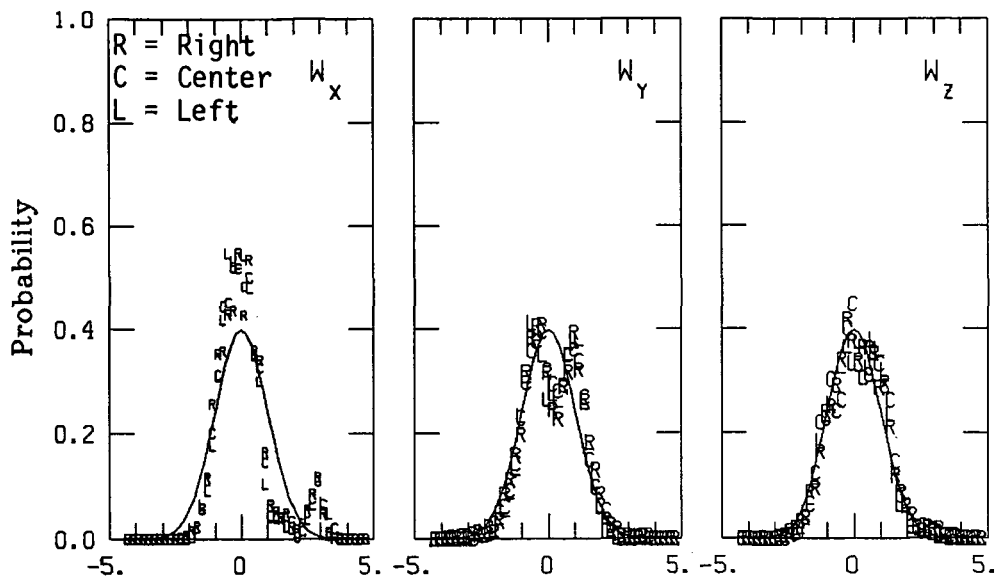

Normalized Gust Velocity (Standard Deviations)

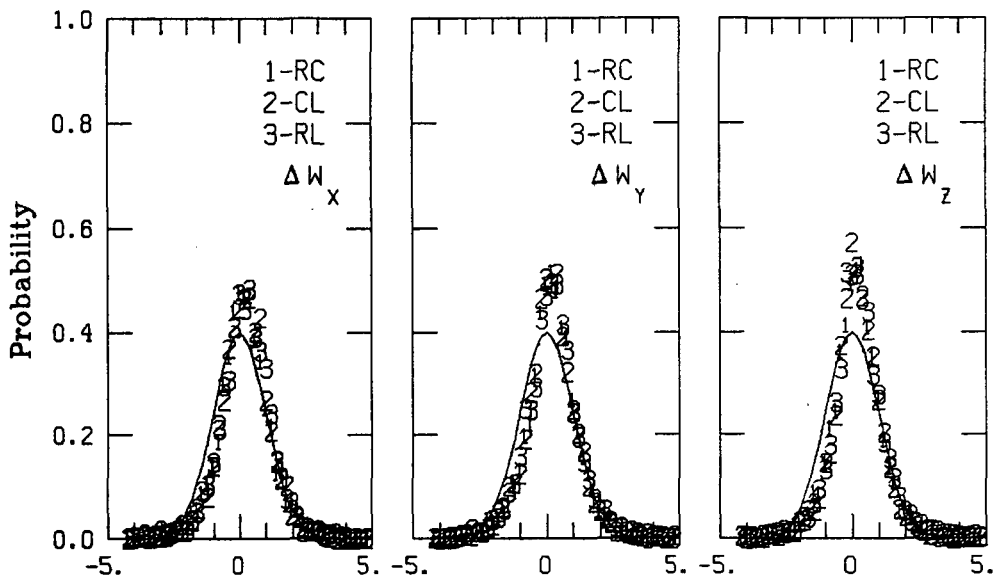

Normalized Velocity Differences (Standard Deviations)

Figure A.203. Probability density function for gust velocities and gust velocity differences, Flight 6, Run 29.

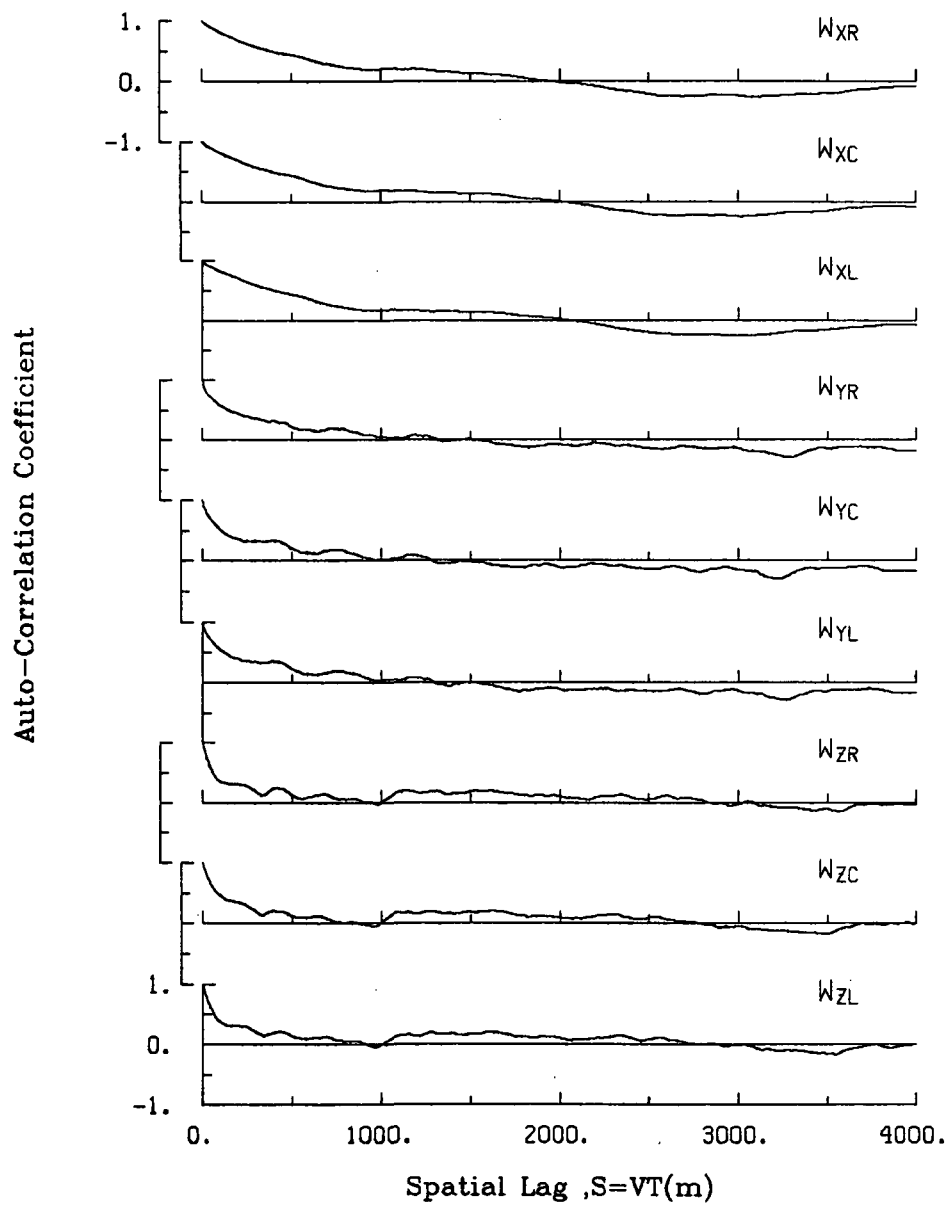

Figure A.204. Single-point auto-correlation coefficient of gust velocities, Flight 6, Run 29.

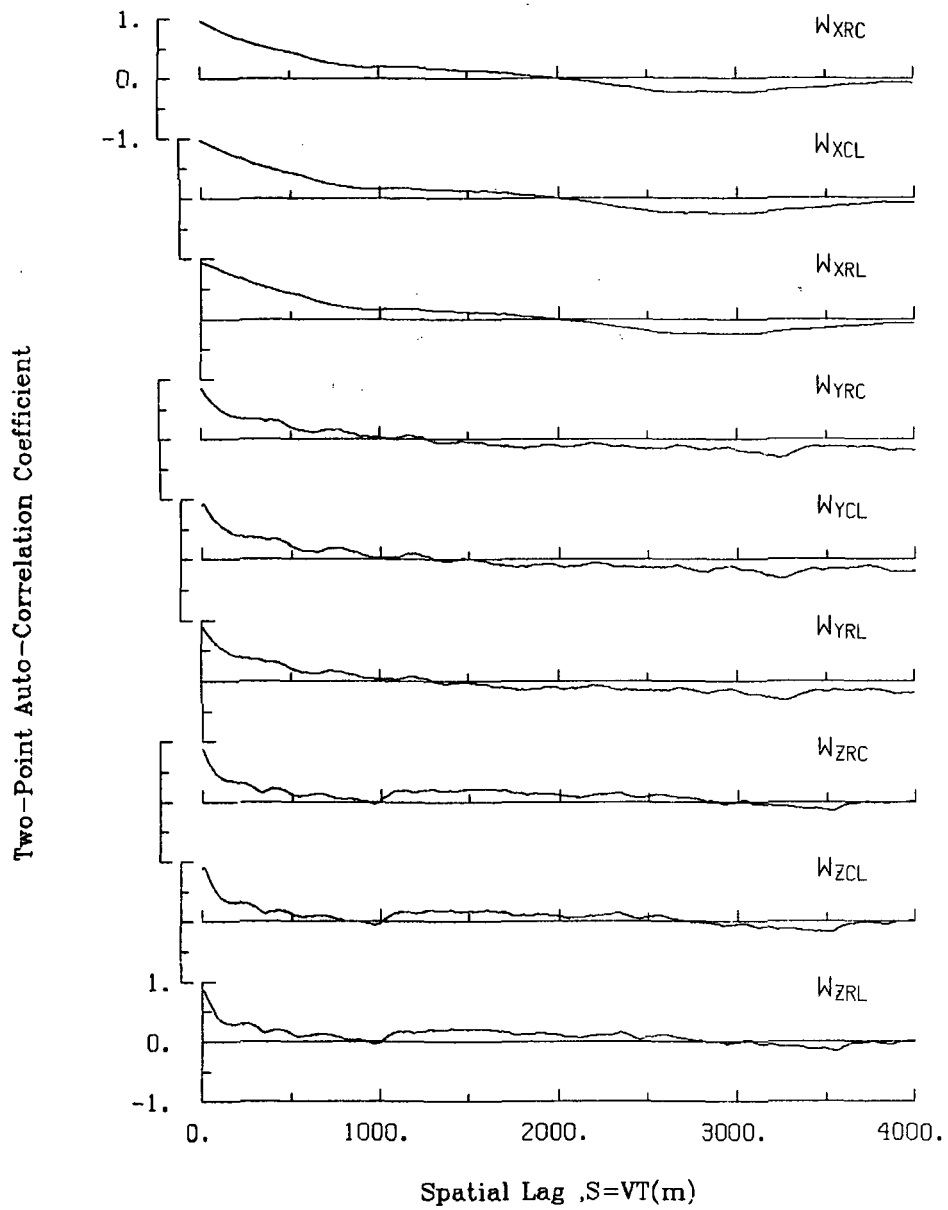

Figure A.205. Two-point auto-correlation coefficient of gust velocities, Flight 6, Run 29.

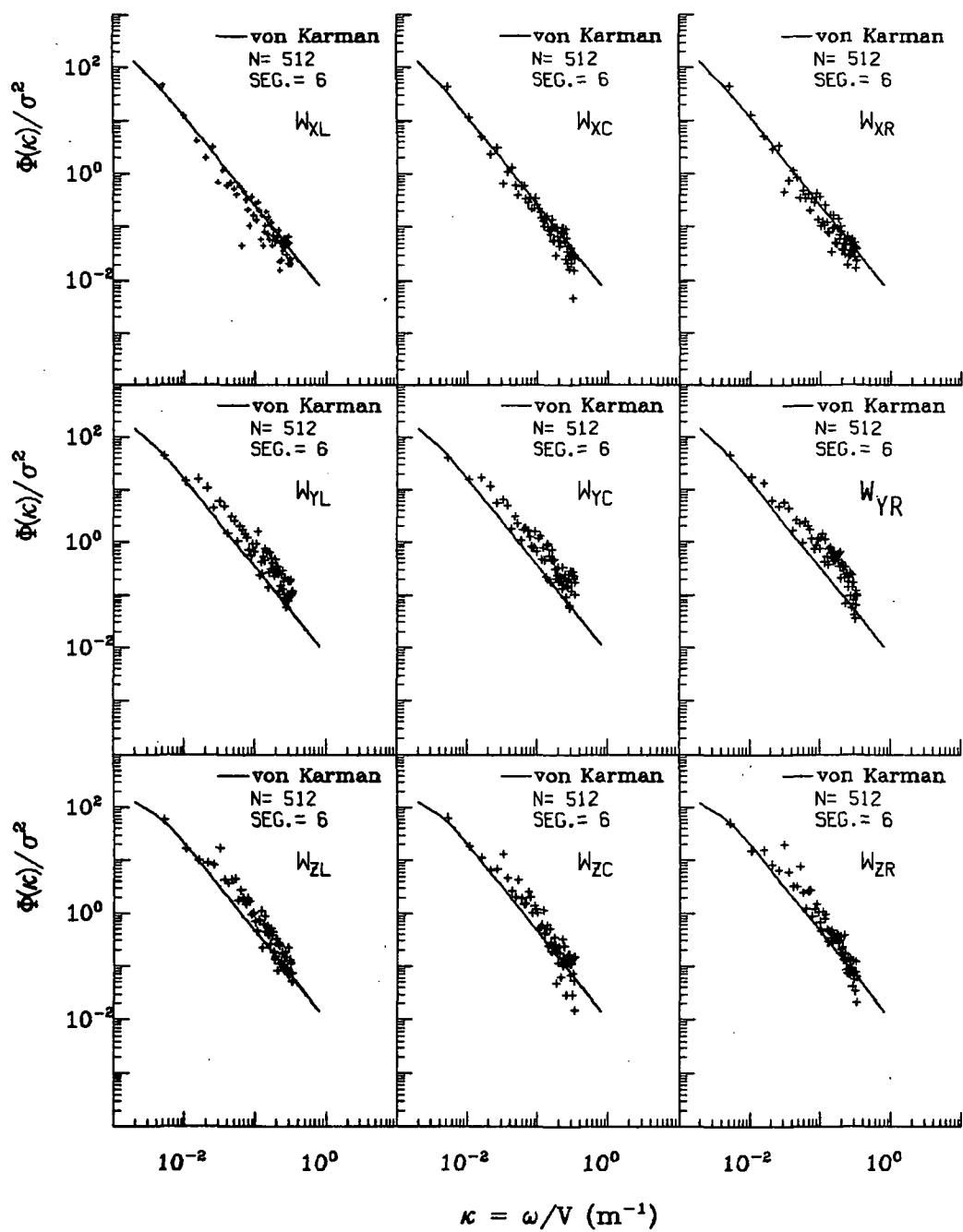

Figure A.206. Normalized auto-spectra of gust velocities, Flight 6, Run 29.

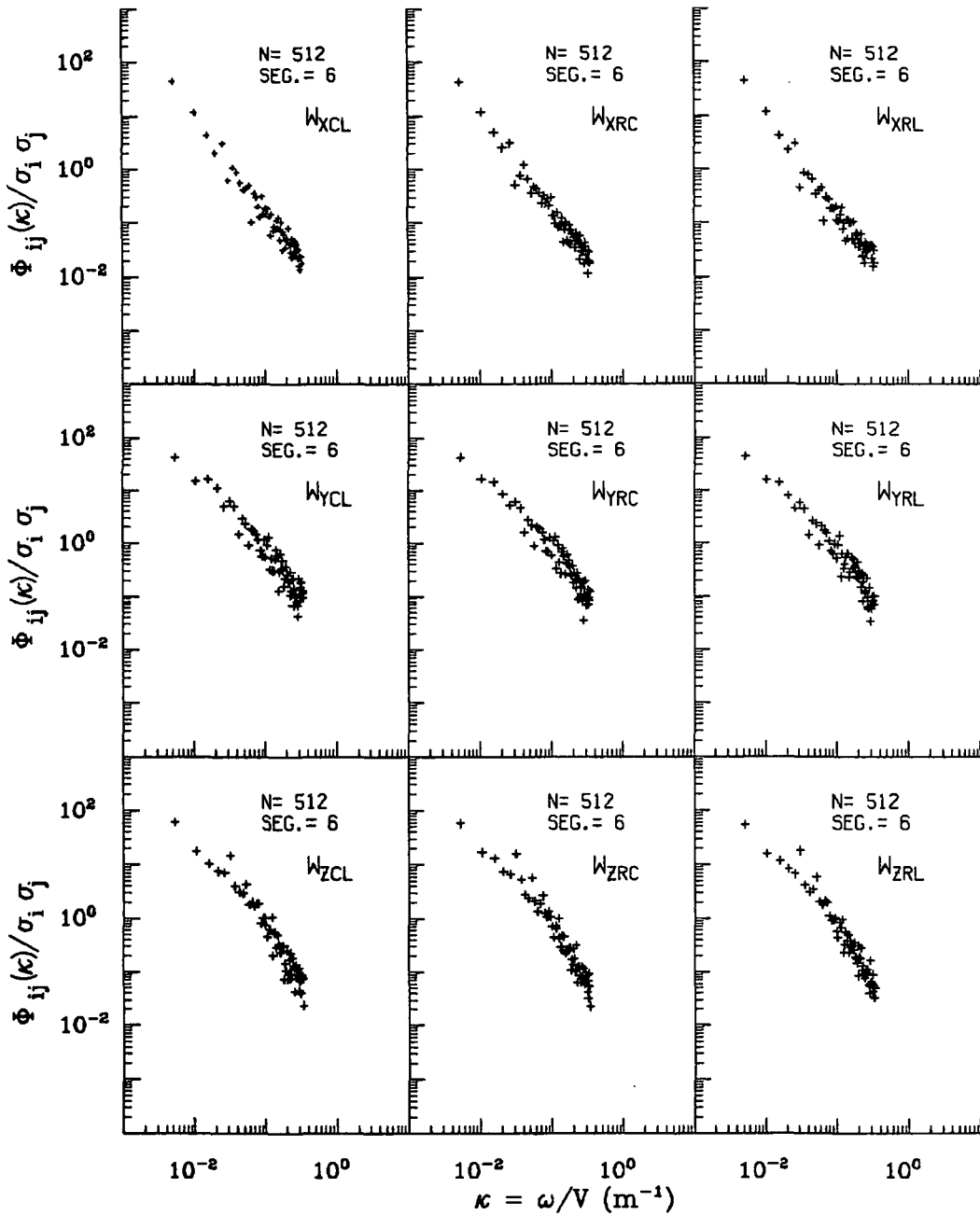

Figure A.207. Normalized two-point auto-spectra of gust velocities, Flight 6, Run 29.

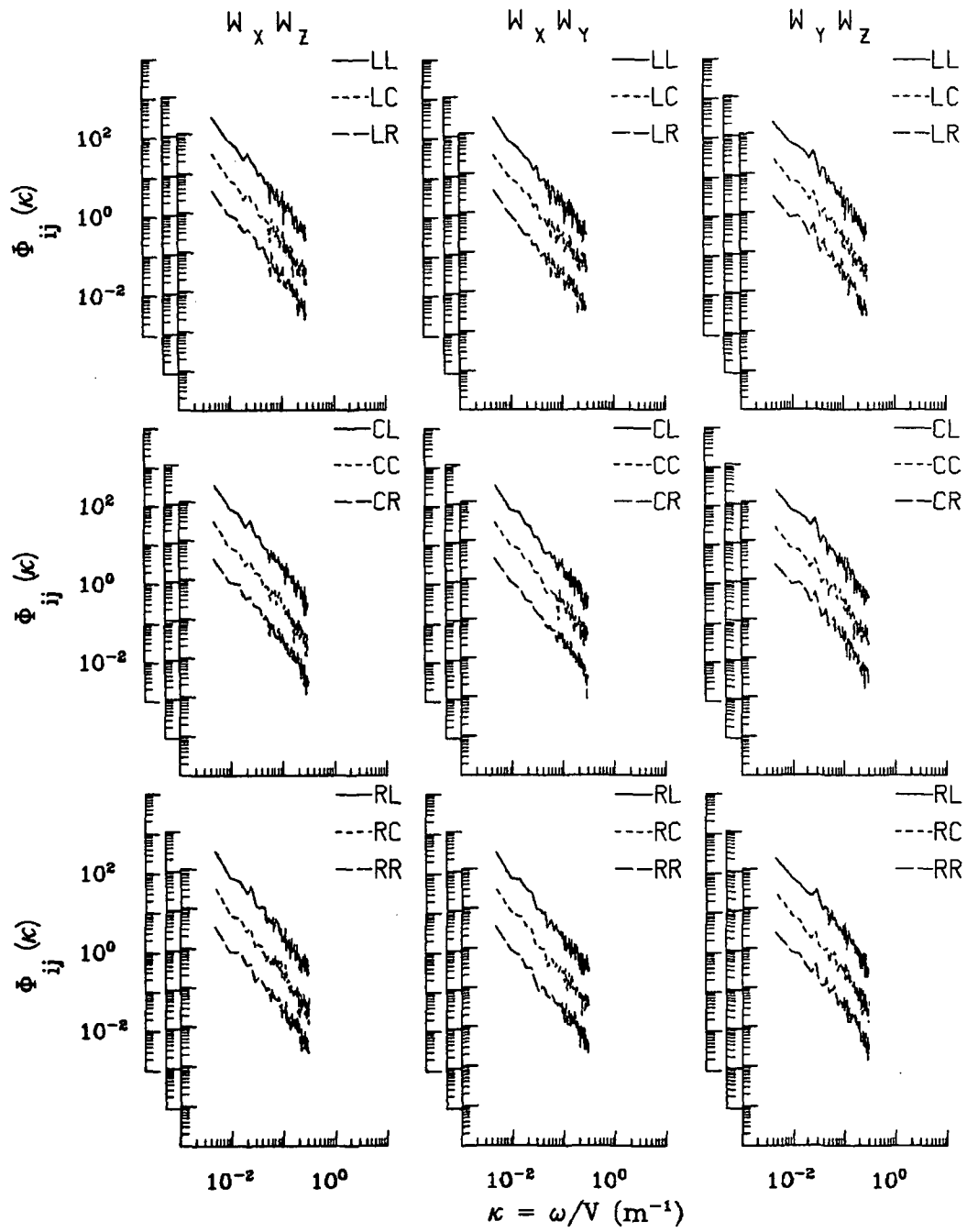

Figure A.208. Two-point cross-spectra of gust velocities, Flight 6, Run 29.

TABLE A.53. List of All Parameters Measured and Their Range of Values, Flight 6, Run 29.

		START TIME = 54223.7177	STOP TIME = 54308.3177				
CHANNEL	UNITS	HIGH	LOW	MEAN	RMS	POINTS	
2 PHI DOT	RAD/SEC	.125	-.343	-.00344	.04356	3384	
3 ACCL N CG	G UNITS	-.988	-.988	-.98774	.98774	3384	
4 THETA DOT	RAD/SEC	.085	-.091	.00619	.01832	3384	
5 THETA	RAD	.103	-.002	.05159	.05643	3384	
6 PHI	RAD	.087	-.182	-.00756	.03804	3384	
7 PSI 1	DEGREES	190.048	182.299	187.01269	187.01805	3384	
8 DEL PSI 1	DEGREES	3.962	-3.679	1.05041	1.73403	3384	
9 PSI 2	DEGREES	547.691	540.298	544.80294	544.80462	3384	
10 DEL PSI 2	DEGREES	3.756	-3.919	.82329	1.60931	3384	
11 ACCL N LT	G UNITS	2.074	-1.267	1.01063	1.06409	3384	
12 ACCL N RT	G UNITS	2.473	-1.171	1.02558	1.07778	3384	
13 ACCL X CG	G UNITS	.126	-.026	.03662	.04606	3384	
14 ACCL Y CG	G UNITS	.187	-.136	.00477	.04343	3384	
15 ALPHA CTR	RAD	.065	-.104	-.01834	.02672	3384	
16 BETA CTR	RAD	.067	-.109	-.02820	.03982	3384	
17 TEMP I	DEG F	99.163	98.264	98.67065	98.67095	3384	
18 TEMP P	DEG F	91.984	91.804	91.81465	91.81466	3384	
19 ACCL Z INS	G UNITS	1.574	-.069	1.00161	1.01558	3384	
20 ALPHA PT	RAD	.074	-.126	-.01181	.02397	3384	
21 BETA RT	RAD	.091	-.078	.00652	.02578	3384	
22 ALPHA LT	RAD	.077	-.114	-.00798	.02296	3384	
23 BETA LT	RAD	.056	-.113	-.03412	.04301	3384	
24 PSI DOT	RAD/SEC	.052	-.054	.00245	.02116	3384	
25 TEMP TOT	DEG C	33.360	30.407	32.51286	32.51760	3384	
26 QC LT	PSID	.966	.598	.77622	.78074	3384	
27 QC CTR	PSID	.930	.591	.75840	.76267	3384	
28 QC RT	PSID	.975	.613	.78548	.78991	3384	
29 PS	PSIA	11.596	11.553	11.57622	11.57623	3384	
30 TEMP IRT	DEG C	23.456	18.086	21.31747	21.35874	3384	
31 D TO G	METERS	8773441.229872509.760	*****	*****	*****	3384	
32 R TO D	DEGREES	80.527	80.506	80.51672	80.51672	3384	
33 LONG	DEGREES	-104.654	-104.660	-104.65717	104.65717	3384	
34 LAT	DEGREES	39.880	39.798	39.83760	39.83761	3384	
35 TRK ANG	DEGREES	177.729	173.066	176.34817	176.35187	3384	
36 HDG	RADIANS	3.330	3.190	3.27725	3.27735	3384	
37 VE	M/SEC	12.048	4.379	6.81378	7.05962	3384	
38 VN	M/SEC	-97.244	-113.507	-106.73341	106.87026	3384	
39 ALTITUDE	KM	1.984	1.954	1.96762	1.96762	3384	
40 TEMPC	DEGREES C	28.159	25.602	27.02289	27.02910	3384	
41 EW WND SPD	KNOTS	64.551	30.455	46.54551	46.76113	3384	
42 NS WND SPD	KNOTS	7.713	-31.148	-6.38143	9.58546	3384	
43 WIND SPEED	KNOTS	64.683	30.917	47.53741	47.73347	3384	
44 WIND DIREC	DEGREES	308.414	260.922	277.72412	277.86274	3384	
45 AIRSPEED P	M/SEC	118.726	94.750	106.69984	108.84328	3384	
46 AIRSPEED C	M/SEC	115.965	93.058	104.88739	105.02774	3384	
47 AIRSPEED L	M/SEC	118.119	93.632	106.07943	106.22622	3384	
48 DELTA ALT	METERS	14.656	-15.468	-1.47708	6.02598	3384	
49 INRTL DISP	METERS	10.550	-15.089	-.35223	7.45477	3384	
50 UG RIGHT	M/SEC	12.481	-8.711	-.00000	3.73346	3384	
51 UG CENTER	M/SEC	13.055	-7.920	-.00000	3.71257	3384	
52 UG LEFT	M/SEC	13.229	-8.957	-.00000	3.80655	3384	
53 VG RIGHT	M/SEC	7.374	-7.754	-.03696	2.12556	3384	
54 VG CENTER	M/SEC	8.114	-8.979	-.03566	2.22554	3384	
55 VG LEFT	M/SEC	8.118	-7.981	-.03855	2.25526	3384	
56 WG RIGHT	M/SEC	10.532	-8.533	.02071	2.40451	3384	
57 WG CENTER	M/SEC	9.151	-6.631	.01828	2.25173	3384	
58 WG LEFT	M/SEC	9.350	-7.512	.01857	2.44044	3384	

Date: July 14, 1982
 Time: 15:05:56 (MDT)
 Duration: 85 seconds

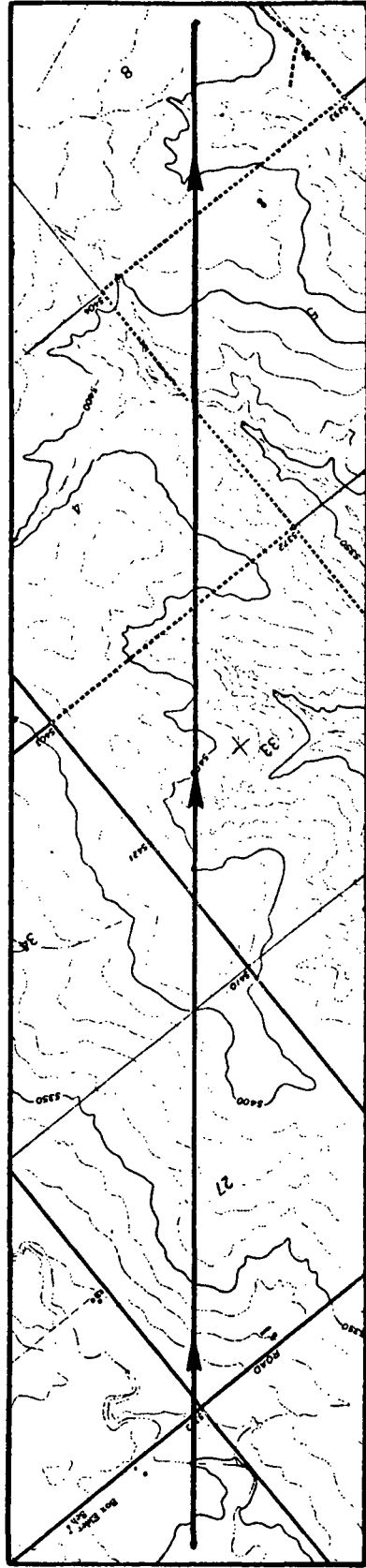
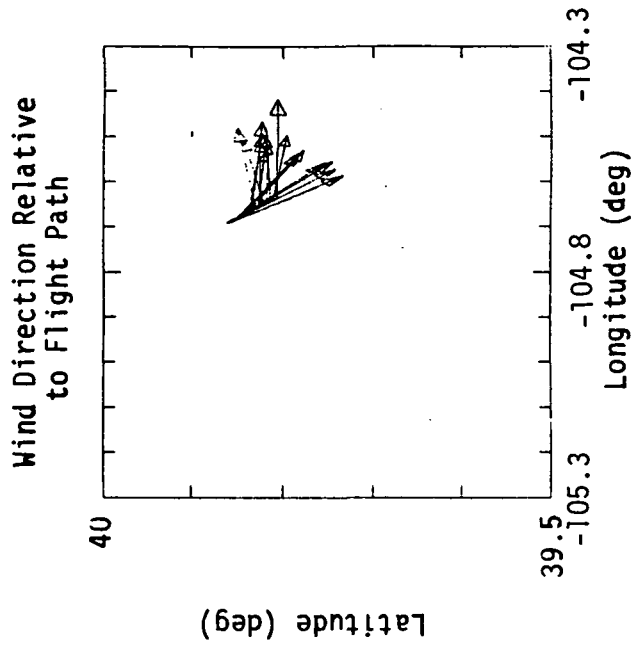
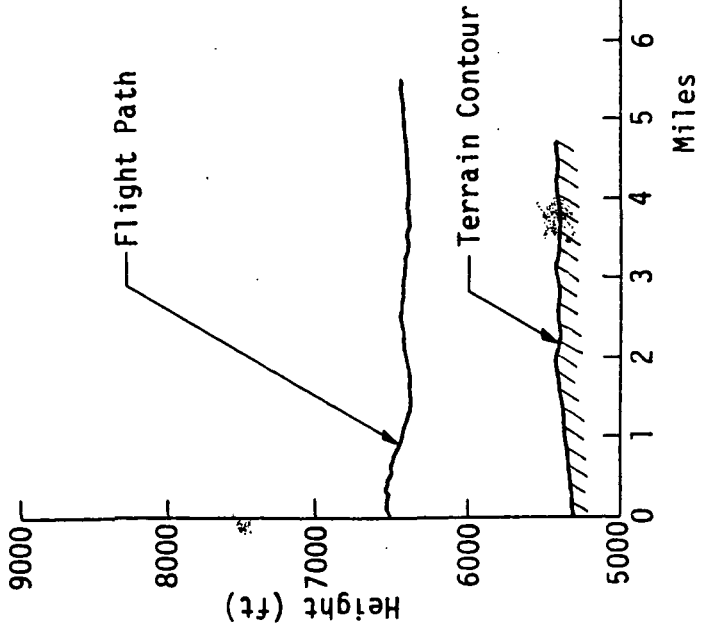

Figure A.209. Flight path information, Flight 6, Run 30.

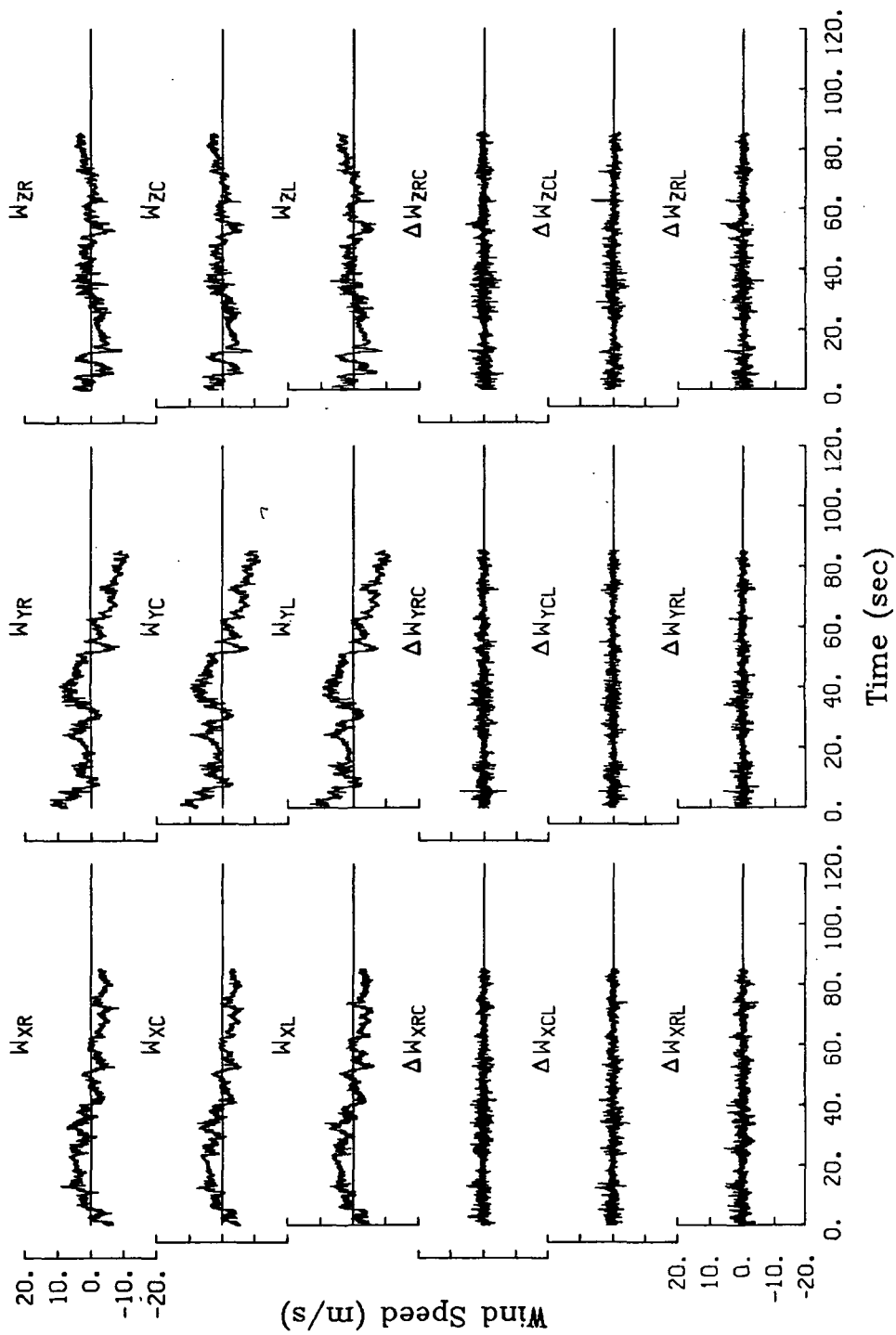
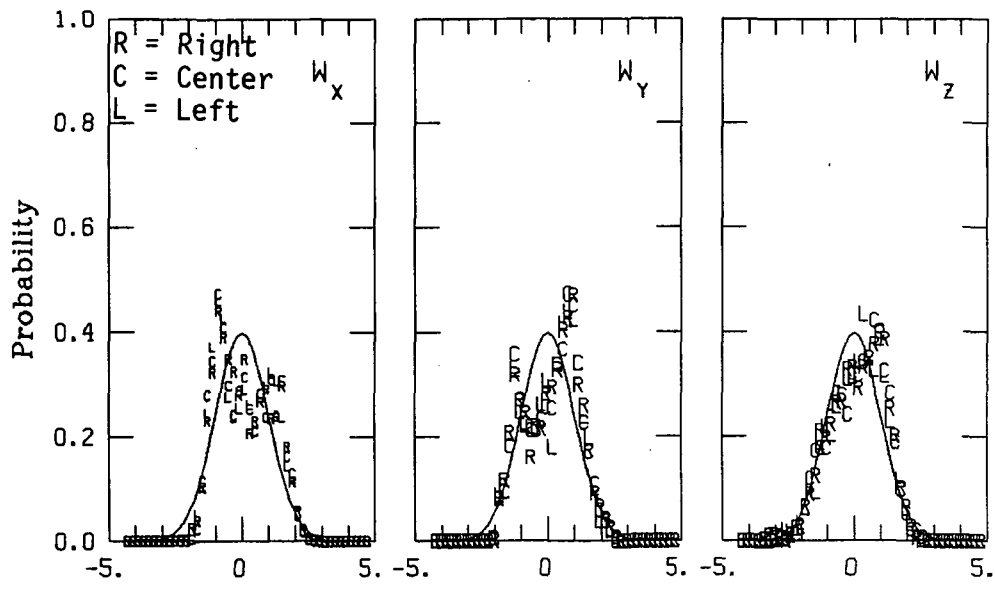

Figure A.210. Time histories of gust velocities and gust velocity differences, Flight 6, Run 30.

TABLE A.54. Average Turbulence Parameters and Integral Length Scales, Flight 6, Run 30.

I. Mean Airspeed (m/s)			II. Standard Deviation of Gust Velocities (m/s)		
V_L	V_C	V_R	$\sigma_{W_{XL}}$	$\sigma_{W_{XC}}$	$\sigma_{W_{XR}}$
106.4	105.2	107.0	3.04	3.01	3.21
			$\sigma_{W_{YL}}$	$\sigma_{W_{YC}}$	$\sigma_{W_{YR}}$
			4.72	4.76	4.73
			$\sigma_{W_{ZL}}$	$\sigma_{W_{ZC}}$	$\sigma_{W_{ZR}}$
			2.42	2.40	2.53
III. Standard Deviation of Gust Velocity Differences (m/s)			IV. Integral Length Scale (m)		
$\sigma_{\Delta W_{XCL}}$	$\sigma_{\Delta W_{XRC}}$	$\sigma_{\Delta W_{XRL}}$	$L_{W_{XL}}$	$L_{W_{XC}}$	$L_{W_{XR}}$
0.98	0.96	1.21	930	955	972
$\sigma_{\Delta W_{YCL}}$	$\sigma_{\Delta W_{YRC}}$	$\sigma_{\Delta W_{YRL}}$	$L_{W_{YL}}$	$L_{W_{YC}}$	$L_{W_{YR}}$
1.00	0.94	1.01	2038	2004	2074
$\sigma_{\Delta W_{ZCL}}$	$\sigma_{\Delta W_{ZRC}}$	$\sigma_{\Delta W_{ZRL}}$	$L_{W_{ZL}}$	$L_{W_{ZC}}$	$L_{W_{ZR}}$
1.12	1.03	1.29	581	600	636



Normalized Gust Velocity (Standard Deviations)

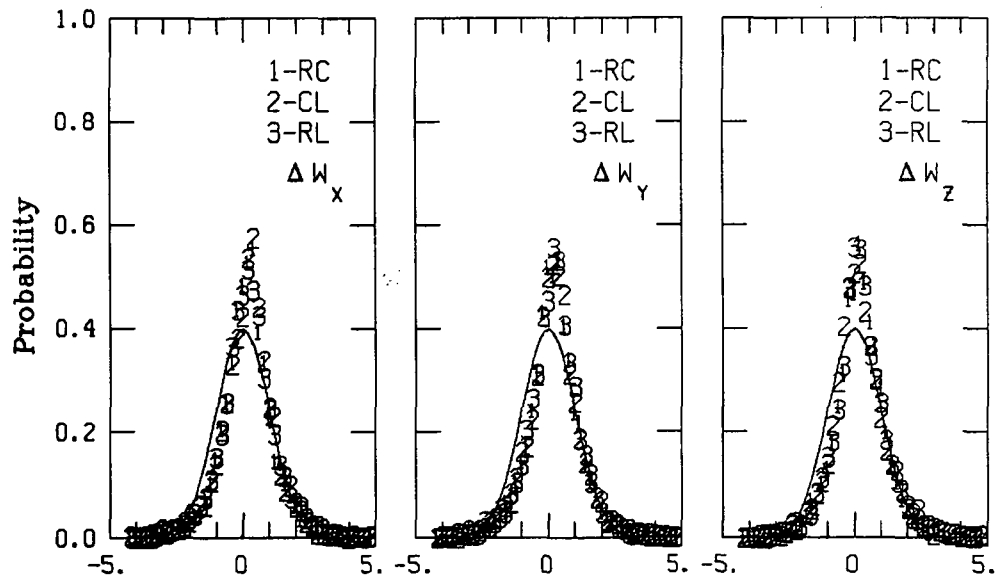

Normalized Velocity Differences (Standard Deviations)

Figure A.211. Probability density function for gust velocities and gust velocity differences, Flight 6, Run 30.

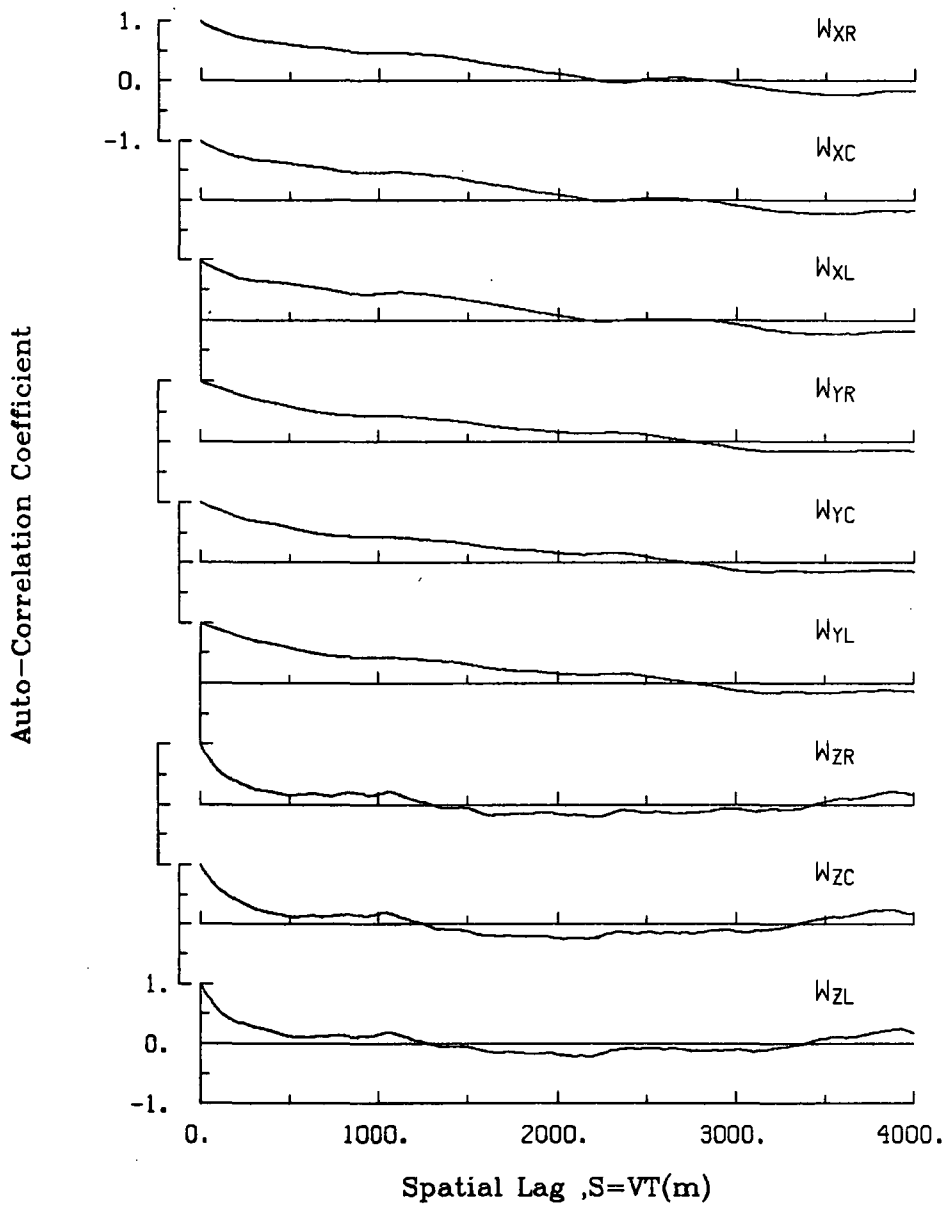

Figure A.212. Single-point auto-correlation coefficient of gust velocities, Flight 6, Run 30.

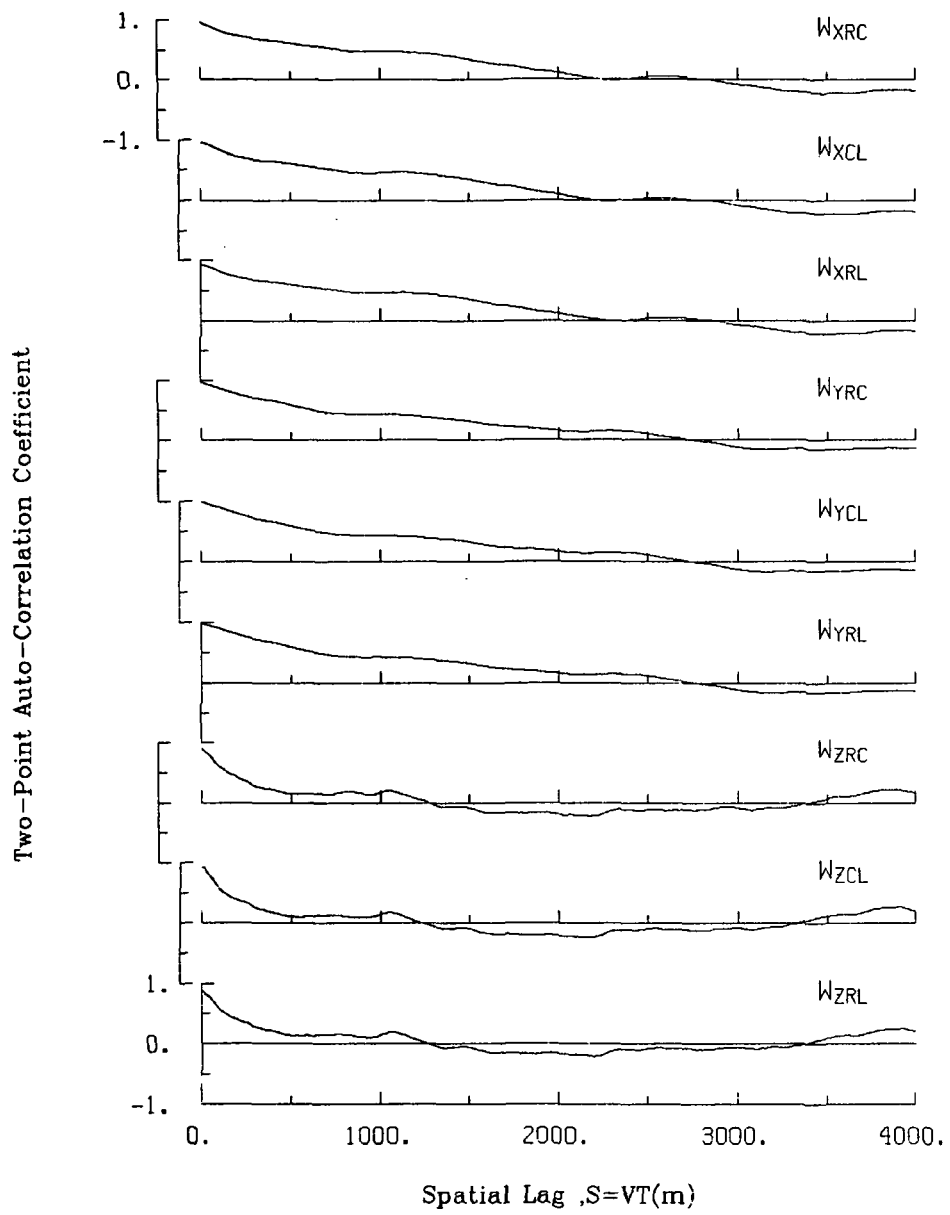

Figure A.213. Two-point auto-correlation coefficient of gust velocities, Flight 6, Run 30.

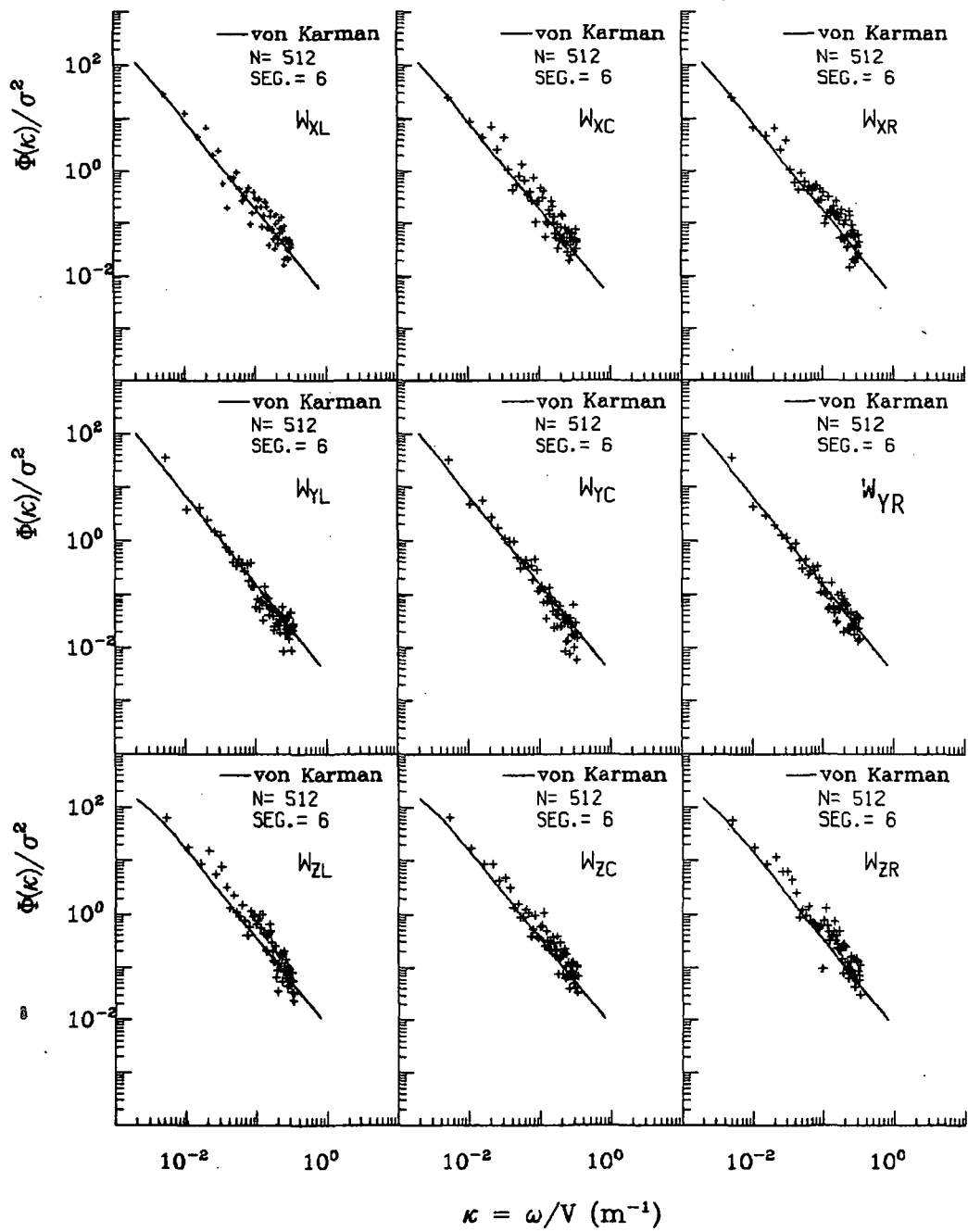

Figure A.214. Normalized auto-spectra of gust velocities, Flight 6, Run 30.

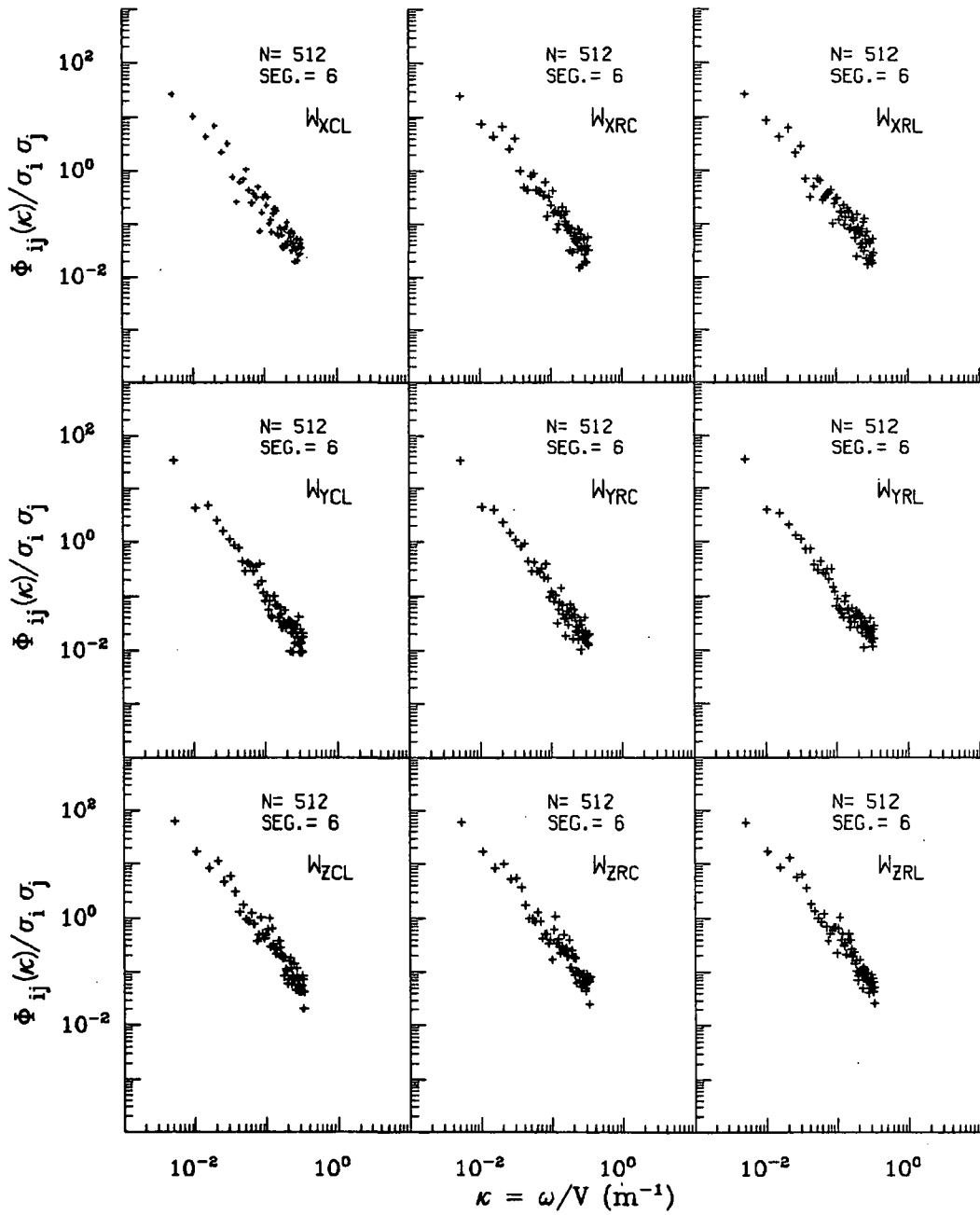

Figure A.215. Normalized two-point auto-spectra of gust velocities, Flight 6, Run 30.

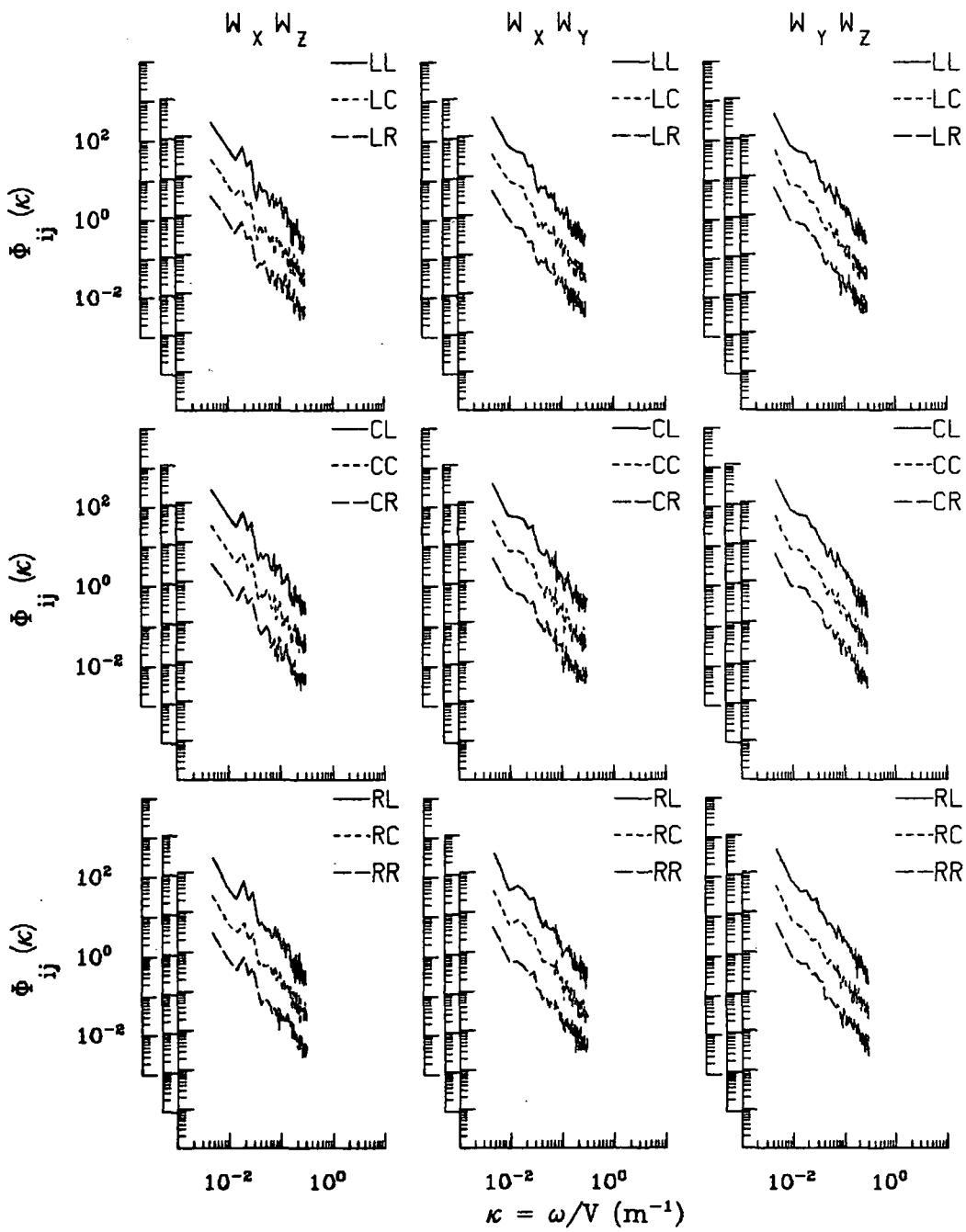

Figure A.216. Two-point cross-spectra of gust velocities, Flight 6, Run 30.

TABLE A.55. List of All Parameters Measured and Their Range of Values, Flight 6, Run 30.

		START TIME = 54356.3579		STOP TIME = 54441.6579			
CHANNEL	UNITS	HIGH	LOW	MEAN	RMS	POINTS	
2 PHI DOT	RAD/SEC	.132	-.135	-.00150	.04142	3412	
3 ACCL N CG	G UNITS	-.988	-.988	-.98774	.98774	3412	
4 THETA DOT	RAD/SEC	.079	-.060	.00564	.01666	3412	
5 THETA	RAD	.103	-.001	.04840	.05292	3412	
6 PHI	PAD	.136	-.110	-.02117	.04347	3412	
7 PSI 1	DEGREES	320.373	308.749	314.24767	314.26091	3412	
8 DEL PSI 1	DEGREES	3.198	-5.824	-1.64363	2.46791	3412	
9 PSI 2	DEGREES	319.565	310.764	314.87559	314.88076	3412	
10 DEL PSI 2	DEGREES	3.079	-8.300	-2.92570	4.09844	3412	
11 ACCL N LT	G UNITS	2.448	-.955	1.01079	1.04968	3412	
12 ACCL N RT	G UNITS	2.093	-.519	1.01890	1.05776	3412	
13 ACCL X CG	G UNITS	.102	-.011	.04816	.05077	3412	
14 ACCL Y CG	G UNITS	.159	-.169	.00497	.04975	3412	
15 ALPHA CTR	RAD	.032	-.106	-.01998	.02523	3412	
16 BETA CTR	RAD	.067	-.121	-.02873	.04342	3412	
17 TEMP I	DEG F	98.804	97.904	98.57292	98.57307	3412	
18 TEMP P	DEG F	92.163	91.980	91.99004	91.99005	3412	
19 ACCL Z INS	G UNITS	1.443	-.044	.99784	1.00812	3412	
20 ALPHA PT	RAD	.034	-.101	-.01528	.02331	3412	
21 BETA RT	RAD	.093	-.087	.00540	.02970	3412	
22 ALPHA LT	RAD	.049	-.119	-.01486	.02236	3412	
23 BETA LT	RAD	.046	-.121	-.03372	.04469	3412	
24 PSI DOT	RAD/SEC	.076	-.074	.00348	.02745	3412	
25 TEMP TOT	DEG C	33.360	30.407	32.04335	32.05635	3412	
26 QC LT	PSID	.903	.642	.78101	.78203	3412	
27 QC CTR	PSID	.869	.643	.76344	.76441	3412	
28 QC RT	PSID	.916	.671	.79030	.79142	3412	
29 PS	PSIA	11.615	11.535	11.58567	11.58569	3412	
30 TEMP IRT	DEG C	24.408	18.086	21.80008	21.86582	3412	
31 D TO G	METERS	8774265.40887704	27.366	*****	*****	3412	
32 B TO D	DEGREES	80.538	80.489	80.51337	80.51337	3412	
33 LONG	DEGREES	-104.634	-104.692	-104.66286	104.66286	3412	
34 LAT	DEGREES	39.862	39.806	39.83497	39.83497	3412	
35 TRK ANG	DEGREES	325.455	317.116	321.35711	321.36557	3412	
36 HDG	RADIANS	5.582	5.420	5.49545	5.49555	3412	
37 VE	M/SEC	-53.718	-61.446	-57.93842	57.97028	3412	
38 VN	M/SEC	78.243	66.133	72.56208	72.65609	3412	
39 ALTITUDE	KM	1.996	1.941	1.96103	1.96107	3412	
40 TEMPC	DEGREES C	28.254	24.815	26.53023	26.55050	3412	
41 EW WND SPD	KNOTS	52.127	15.857	28.08552	28.79453	3412	
42 NS WND SPD	KNOTS	11.029	-28.177	-7.28048	12.43682	3412	
43 WIND SPEED	KNOTS	52.259	16.485	30.91928	31.36558	3412	
44 WIND DIREC	DEGREES	329.356	248.534	284.74801	285.46080	3412	
45 AIRSPEED R	M/SEC	115.263	99.025	107.00765	107.04173	3412	
46 AIRSPEED C	M/SEC	111.922	96.971	105.21899	105.24900	3412	
47 AIRSPEED L	M/SEC	113.990	96.826	106.39384	106.42542	3412	
48 DELTA ALT	METERS	15.399	-40.356	-19.95947	23.20803	3412	
49 INRTL DISP	METERS	10.377	-44.998	-22.26094	25.79148	3412	
50 UG RIGHT	M/SEC	8.971	-8.132	-.00000	3.29787	3412	
51 UG CENTER	M/SEC	7.670	-6.339	-.00000	3.08852	3412	
52 UG LEFT	M/SEC	8.616	-6.351	-.00000	3.10426	3412	
53 VG RIGHT	M/SEC	12.424	-11.131	-.01143	5.27921	3412	
54 VG CENTER	M/SEC	12.930	-11.465	-.01478	5.28487	3412	
55 VG LEFT	M/SEC	13.307	-11.410	-.01349	5.24296	3412	
56 WG RIGHT	M/SEC	5.860	-9.138	-.01176	2.59836	3412	
57 WG CENTER	M/SEC	5.923	-8.781	-.01627	2.44739	3412	
58 WG LEFT	M/SEC	6.993	-8.637	-.01342	2.51175	3412	

Date: July 14, 1982
 Time: 15:08:20(MDT)
 Duration: 81 seconds

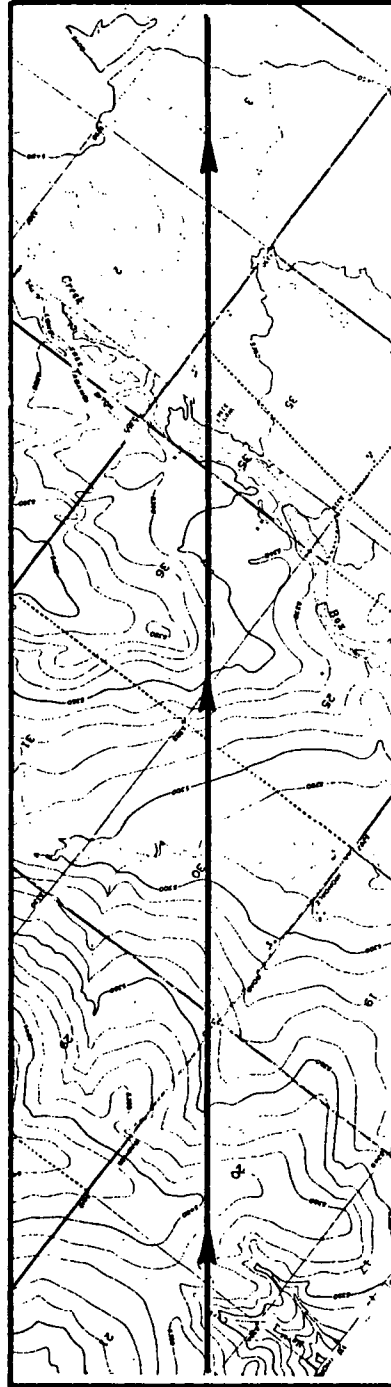
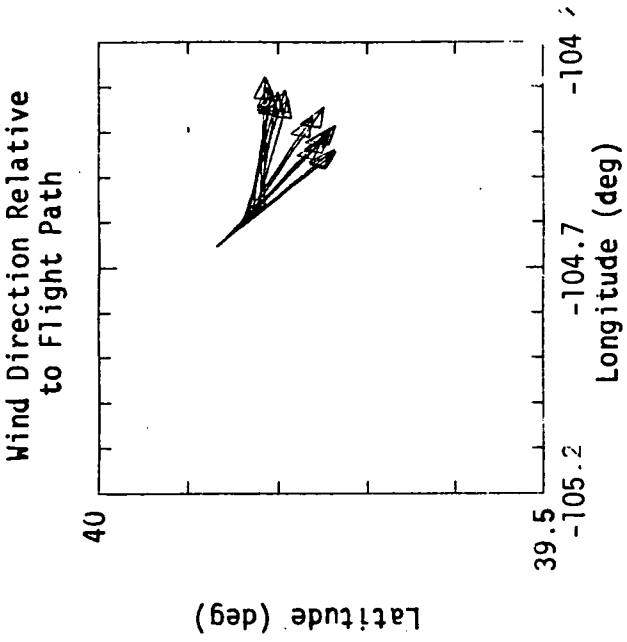
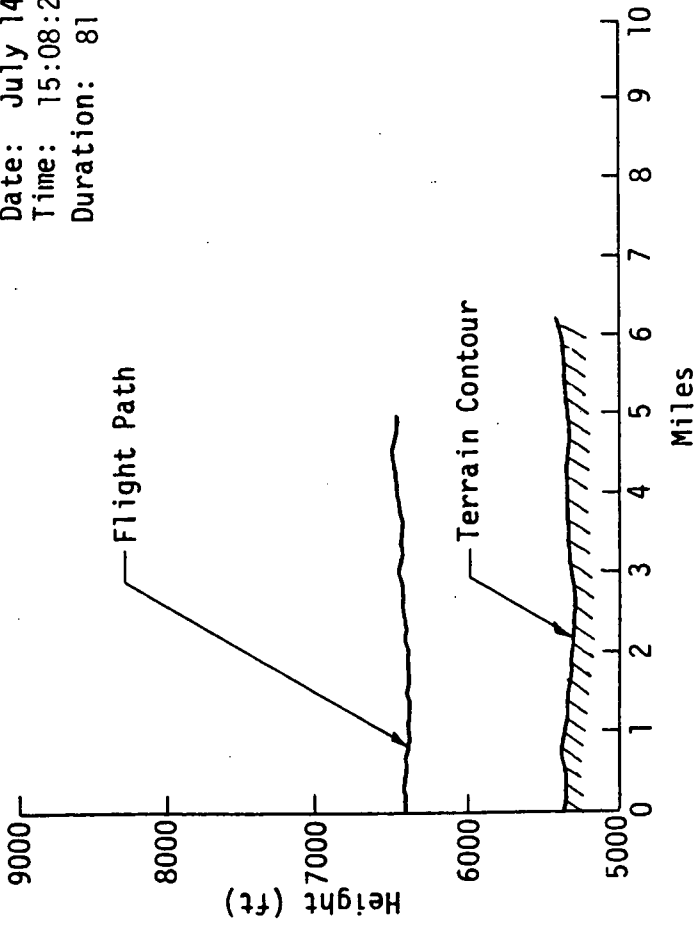

Figure A.217. Flight path information, Flight 6, Run 31.

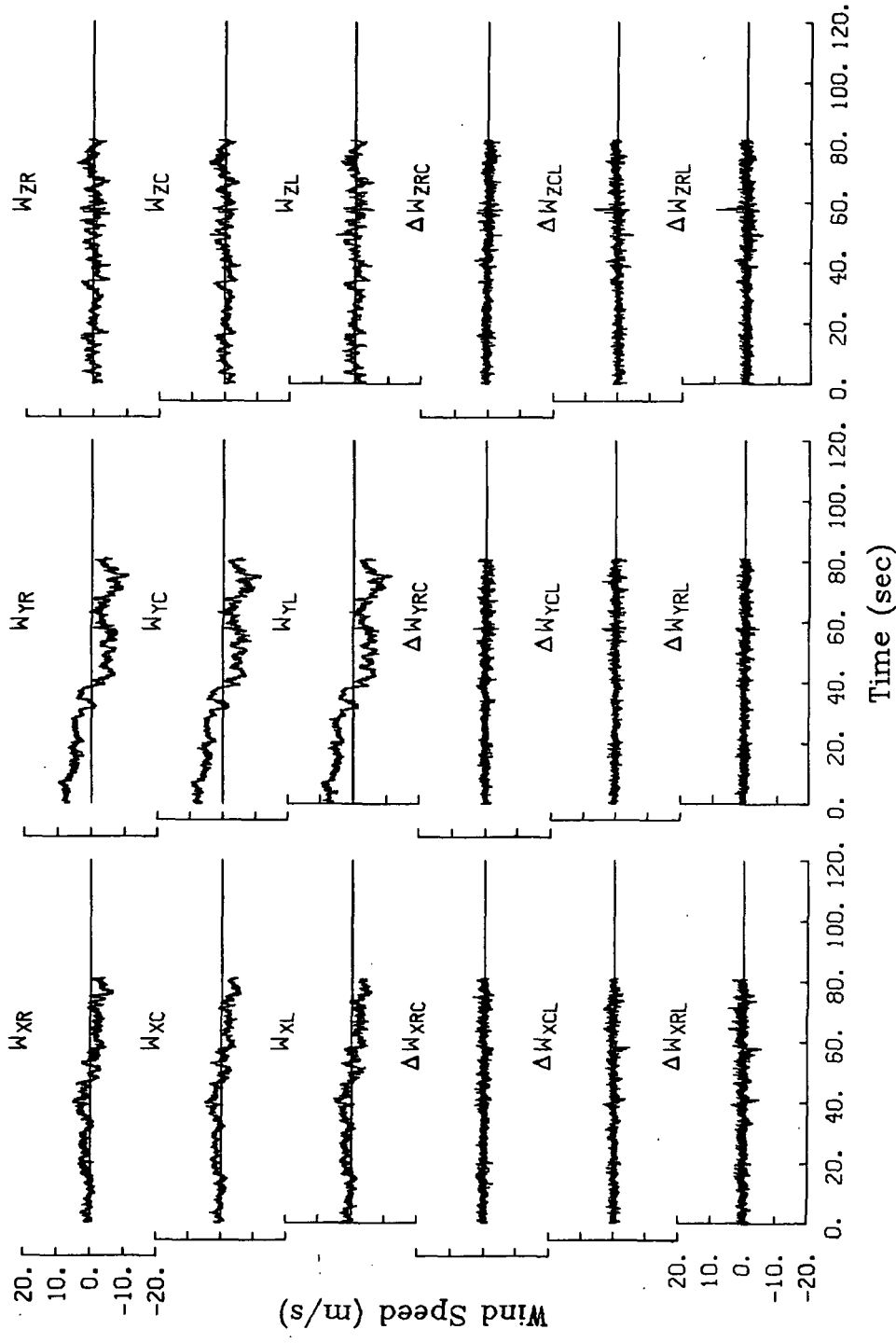

Figure A.228. Time histories of gust velocities and gust velocity differences, Flight 6, Run 31.

TABLE A.56. Average Turbulence Parameters and Integral Length Scales, Flight 6, Run 31.

I. Mean Airspeed (m/s)

V_L	V_C	V_R
102.5	101.5	103.3

II. Standard Deviation of Gust Velocities (m/s)

$\sigma_{W_{XL}}$	$\sigma_{W_{XC}}$	$\sigma_{W_{XR}}$
2.04	1.91	2.01
$\sigma_{W_{YL}}$	$\sigma_{W_{YC}}$	$\sigma_{W_{YR}}$
5.16	5.19	5.28
$\sigma_{W_{ZL}}$	$\sigma_{W_{ZC}}$	$\sigma_{W_{ZR}}$
1.53	1.47	1.51

III. Standard Deviation of Gust Velocity Differences (m/s)

$\sigma_{\Delta W_{XCL}}$	$\sigma_{\Delta W_{XRC}}$	$\sigma_{\Delta W_{XRL}}$
0.74	0.82	1.04
$\sigma_{\Delta W_{YCL}}$	$\sigma_{\Delta W_{YRC}}$	$\sigma_{\Delta W_{YRL}}$
0.77	0.75	0.77
$\sigma_{\Delta W_{ZCL}}$	$\sigma_{\Delta W_{ZRC}}$	$\sigma_{\Delta W_{ZRL}}$
0.86	0.95	0.96

IV. Integral Length Scale (m).

$L_{W_{XL}}$	$L_{W_{XC}}$	$L_{W_{XR}}$
915	901	890
$L_{W_{YL}}$	$L_{W_{YC}}$	$L_{W_{YR}}$
2628	2592	2676
$L_{W_{ZL}}$	$L_{W_{ZC}}$	$L_{W_{ZR}}$
116	215	110

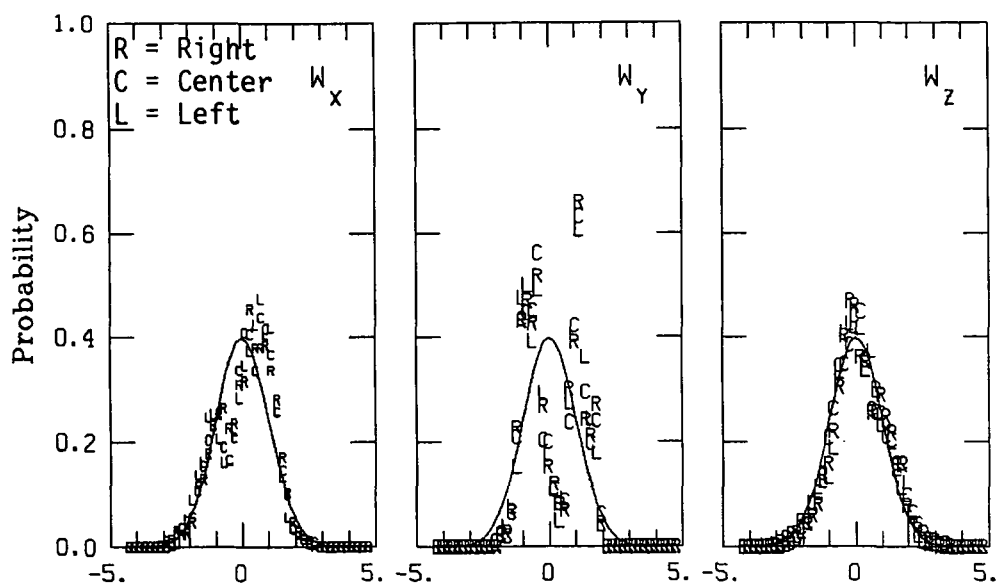

Normalized Gust Velocity (Standard Deviations)

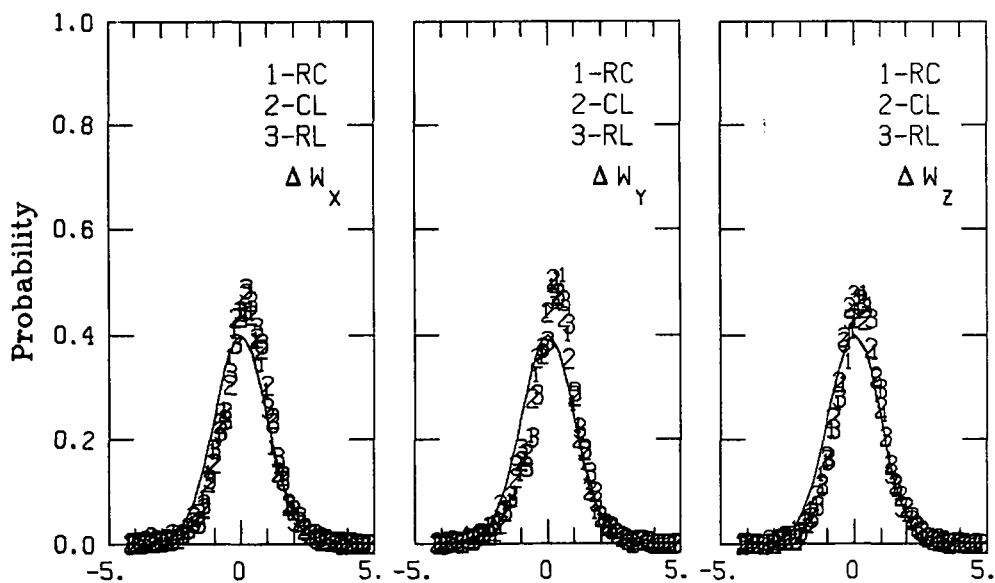

Normalized Velocity Differences (Standard Deviations)

Figure A.230. Probability density function for gust velocities and gust velocity differences, Flight 6, Run 31.

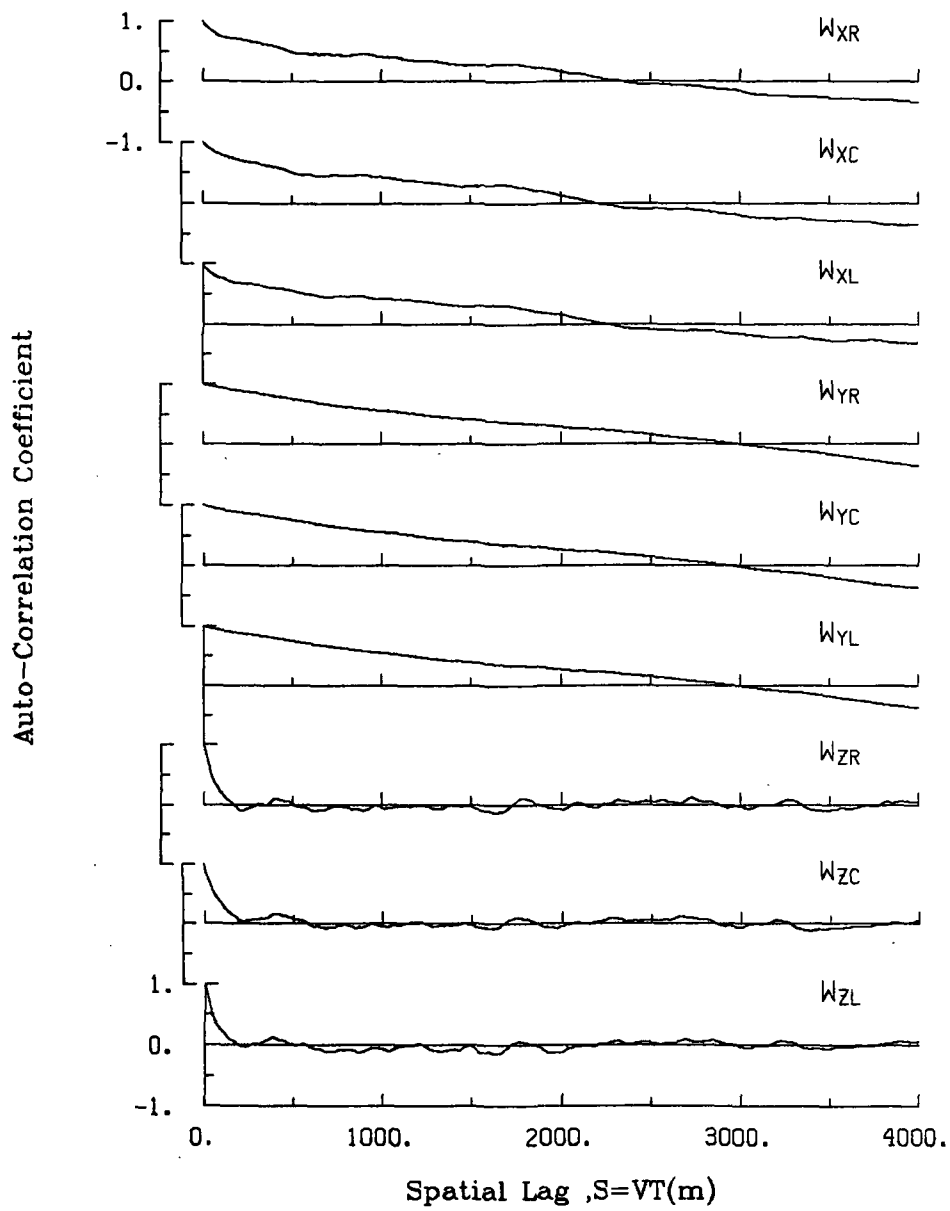

Figure A.229. Single-point auto-correlation coefficient of gust velocities, Flight 6, Run 31.

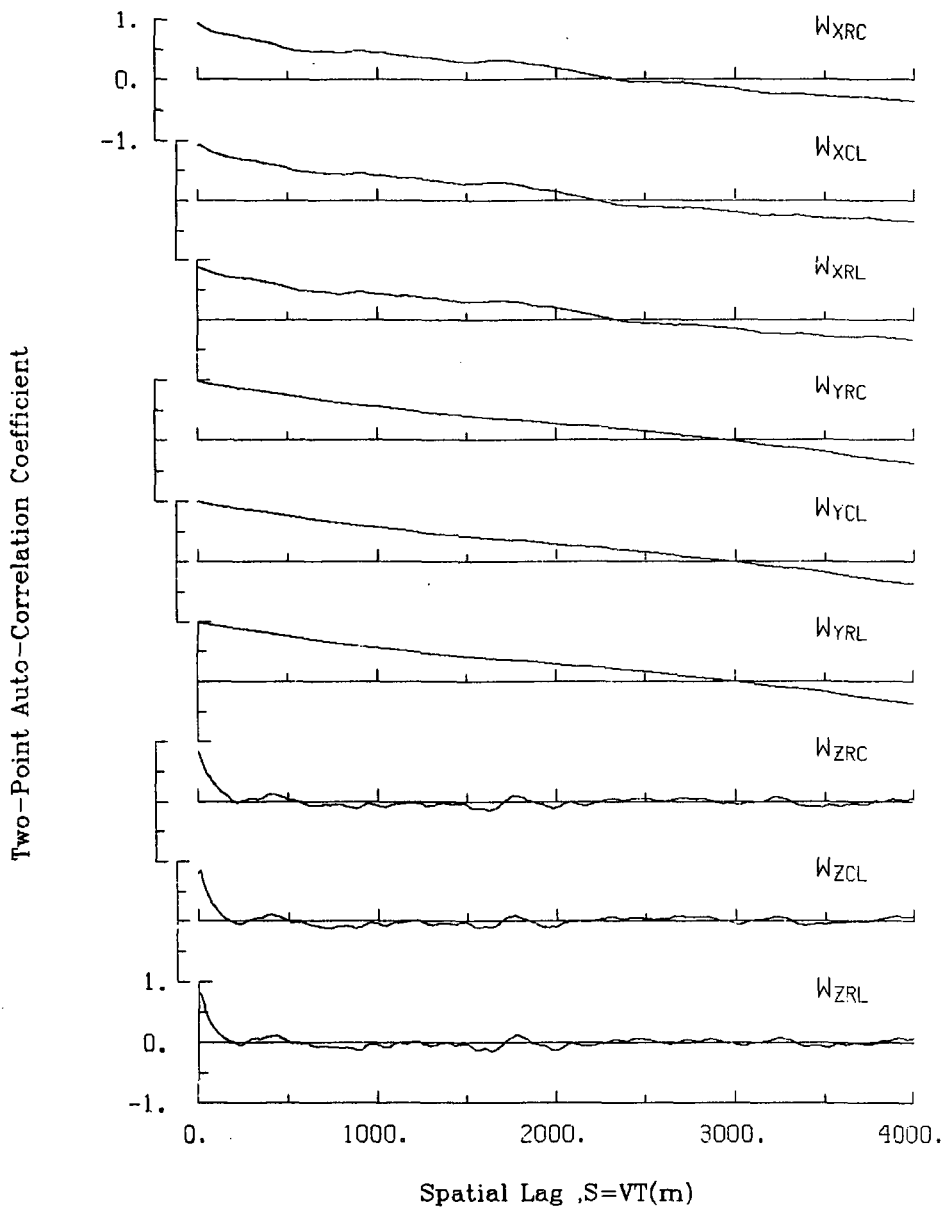

Figure A.231. Two-point auto-correlation coefficient of gust velocities, Flight 6, Run 31.

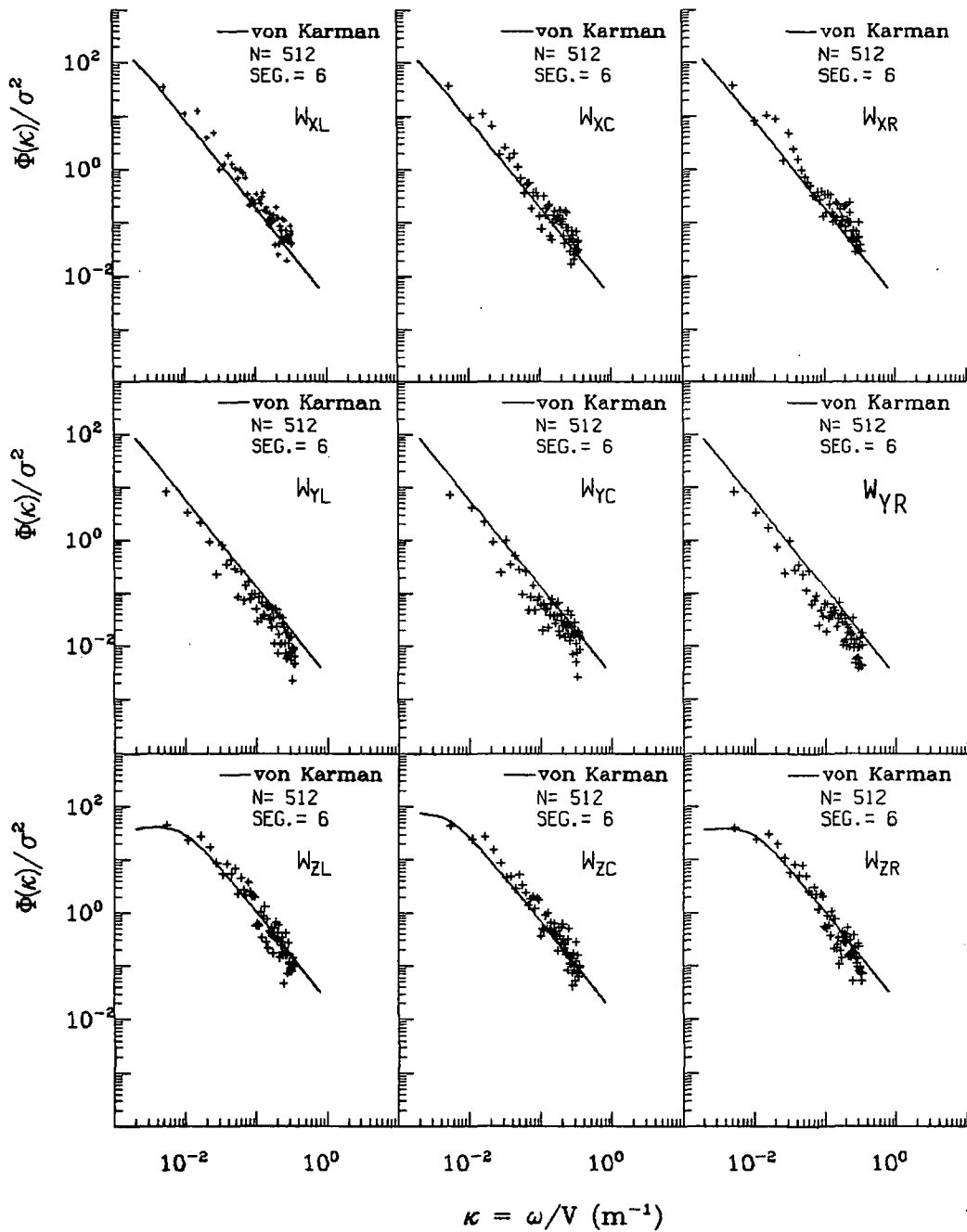

Figure A.232. Normalized auto-spectra of gust velocities, Flight 6, Run 31.

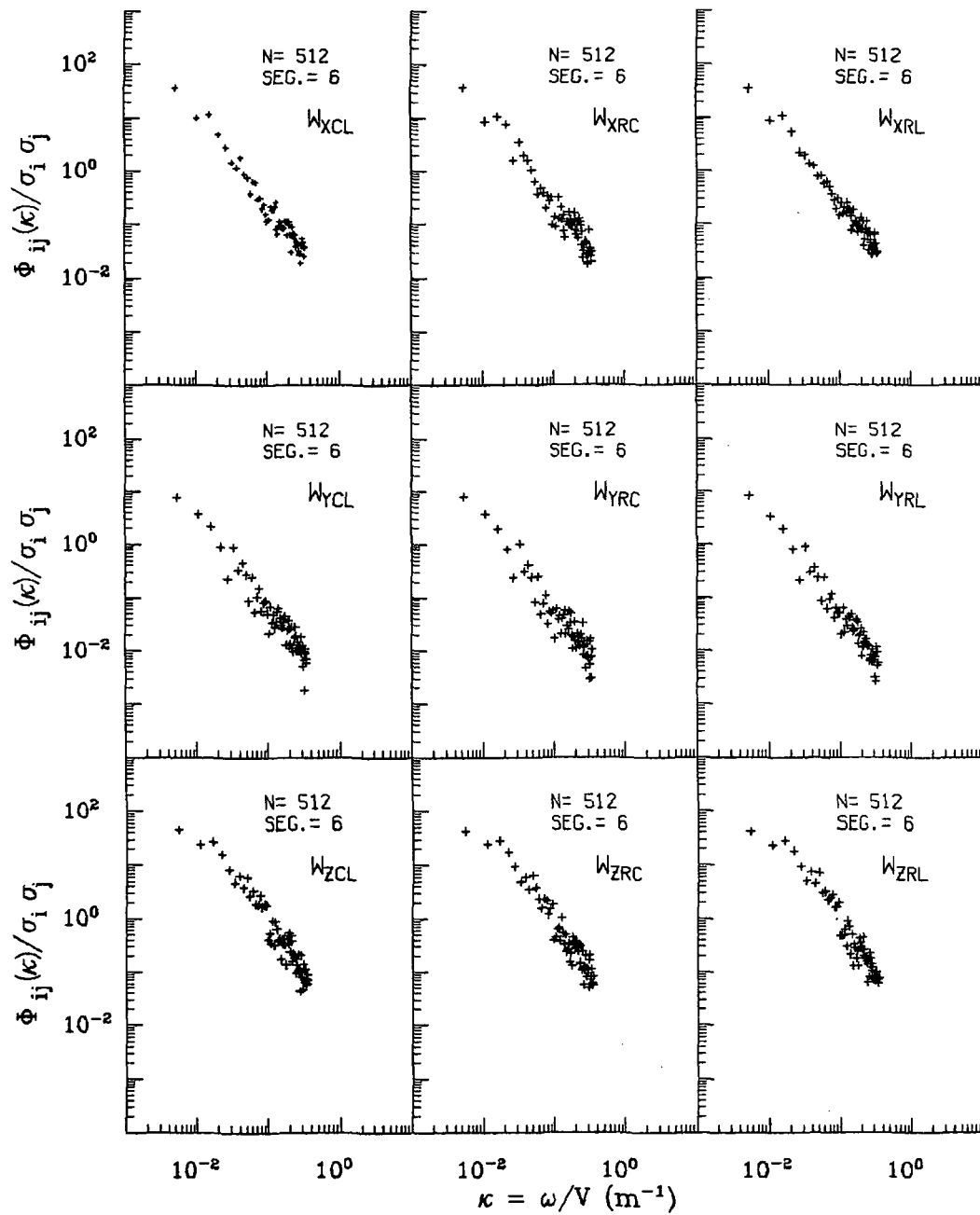

Figure A.233. Normalized two-point auto-spectra of gust velocities, Flight 6, Run 31.

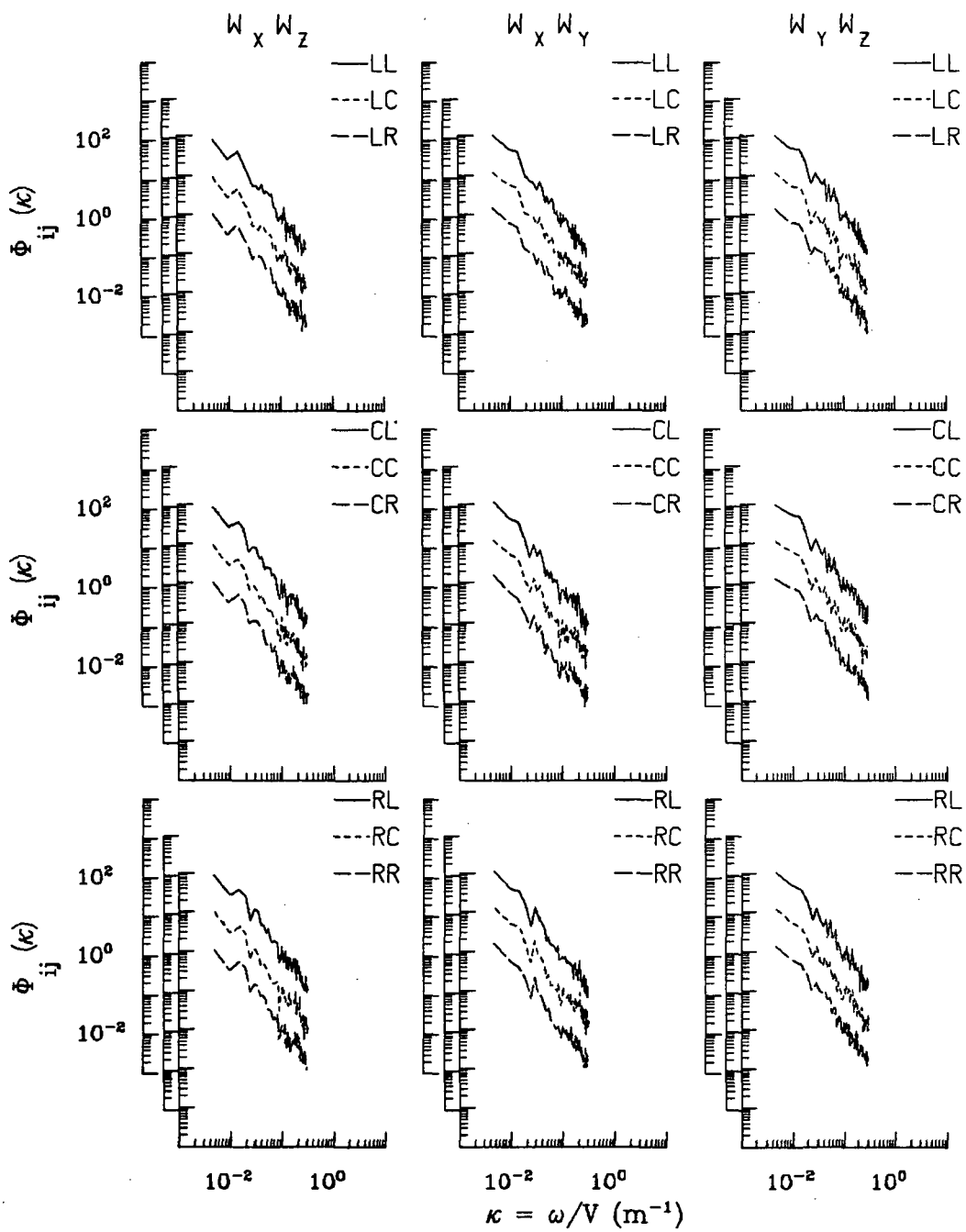

Figure A.234. Two-point cross-spectra of gust velocities, Flight 6, Run 31.

TABLE A.57. List of All Parameters Measured and Their Range of Values, Flight 6, Run 31.

START TIME = 54500.3731		STOP TIME = 54581.5231					
CHANNEL	UNITS	HIGH	LOW	MEAN	RMS	POINTS	
2 PHI DOT	RAD/SEC	.119	-.087	-.00356	.02844	3246	
3 ACCL N CG	G UNITS	-.988	-.988	-.98774	.98774	3246	
4 THETA DOT	RAD/SEC	.056	-.047	.00534	.01350	3246	
5 THETA	RAD	.101	.024	.05225	.05511	3246	
6 PHI	RAD	.030	-.083	-.02370	.03358	3246	
7 PSI 1	DEGREES	135.805	126.295	129.53603	129.54448	3246	
8 DEL PSI 1	DEGREES	5.226	-1.828	1.32683	1.87939	3246	
9 PSI 2	DEGREES	495.236	488.195	491.32235	491.32409	3246	
10 DEL PSI 2	DEGREES	7.401	-2.007	1.18977	1.88496	3246	
11 ACCL N LT	G UNITS	2.618	-.410	1.00977	1.03574	3246	
12 ACCL N RT	G UNITS	2.349	.104	1.02389	1.04913	3246	
13 ACCL X CG	G UNITS	.155	.005	.06955	.07566	3246	
14 ACCL Y CG	G UNITS	.169	-.145	.00918	.04394	3246	
15 ALPHA CTR	RAD	.044	-.065	-.01476	.02188	3246	
16 BETA CTR	RAD	.041	-.095	-.02082	.03046	3246	
17 TEMP I	DEG F	98.624	98.084	98.28256	98.28266	3246	
18 TEMP P	DEG F	92.163	91.984	92.13824	92.13826	3246	
19 ACCL Z INS	G UNITS	1.601	.482	1.00273	1.01069	3246	
20 ALPHA RT	RAD	.060	-.066	-.00484	.01960	3246	
21 BETA RT	RAD	.079	-.040	.01492	.02503	3246	
22 ALPHA LT	RAD	.062	-.059	-.00254	.01963	3246	
23 BETA LT	RAD	.035	-.087	-.02478	.03211	3246	
24 PSI DOT	RAD/SEC	.062	-.037	.00286	.01673	3246	
25 TEMP TOT	DEG C	33.459	29.520	31.46964	31.50318	3246	
26 QC LT	PSID	.863	.553	.72550	.72950	3246	
27 QC CTR	PSID	.836	.547	.71196	.71574	3246	
28 QC RT	PSID	.877	.576	.73816	.74210	3246	
29 PS	PSIA	11.614	11.559	11.59065	11.59066	3246	
30 TEMP IRT	DEG C	24.029	16.841	20.25643	20.35419	3246	
31 D TO G	METERS	8780913.1108773855.757*****				3246	
32 B TO D	DEGREES	80.587	80.513	80.54929	80.54929	3246	
33 LONG	DEGREES	-104.558	-104.653	-104.60699	104.60699	3246	
34 LAT	DEGREES	39.869	39.814	39.84177	39.84178	3246	
35 TRK ANG	DEGREES	128.897	123.966	126.78799	126.79934	3246	
35 HDG	RADIANS	2.358	2.231	2.28765	2.28778	3246	
37 VE	M/SEC	107.050	90.856	100.66850	100.81730	3246	
39 VN	M/SEC	-71.326	-77.864	-75.06089	75.08105	3246	
39 ALTITUDE	KM	1.979	1.941	1.95757	1.95760	3246	
40 TEMPC	DEGREES C	27.749	24.975	26.32574	26.34328	3246	
41 EW WND SPD	KNOTS	62.144	37.047	49.71676	50.06849	3246	
42 NS WND SPD	KNOTS	7.812	-29.016	-13.16749	16.03517	3246	
43 WIND SPEED	KNOTS	63.638	44.511	52.42342	52.57357	3246	
44 WIND DIREC	DEGREES	306.547	262.187	285.32931	285.55232	3246	
45 AIRSPEED R	M/SEC	112.635	91.537	103.33756	103.47682	3246	
46 AIRSPEED C	M/SEC	110.046	89.272	101.52771	101.66367	3246	
47 AIRSPEED L	M/SEC	111.776	89.790	102.46276	102.60521	3246	
48 DELTA ALT	METERS	9.127	-28.891	-12.60057	16.68684	3246	
49 INRTL DISP	METERS	11.525	-26.161	-10.25378	15.62155	3246	
50 UG RIGHT	M/SEC	5.370	-6.456	.00000	2.07041	3246	
51 UG CENTER	M/SEC	5.108	-5.480	.00000	1.97986	3246	
52 UG LEFT	M/SEC	5.575	-5.742	.00000	2.12244	3246	
53 VG RIGHT	M/SEC	9.869	-10.585	-.04291	5.22491	3246	
54 VG CENTER	M/SEC	9.522	-11.285	-.03644	5.14116	3246	
55 VG LEFT	M/SEC	9.383	-11.300	-.03539	5.11095	3246	
56 WG RIGHT	M/SEC	5.031	-4.979	-.00442	1.50163	3246	
57 WG CENTER	M/SEC	4.813	-4.654	.01003	1.45553	3246	
58 WG LEFT	M/SEC	6.032	-5.519	-.00849	1.52213	3246	

Date: July 14, 1982
 Time: 15:10:33 (MDT)
 Duration: 81 seconds

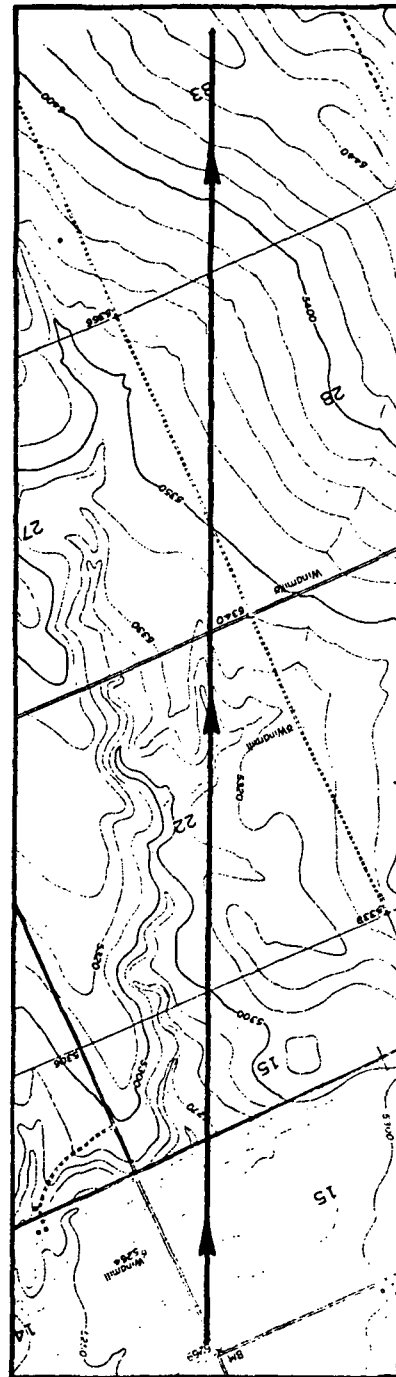
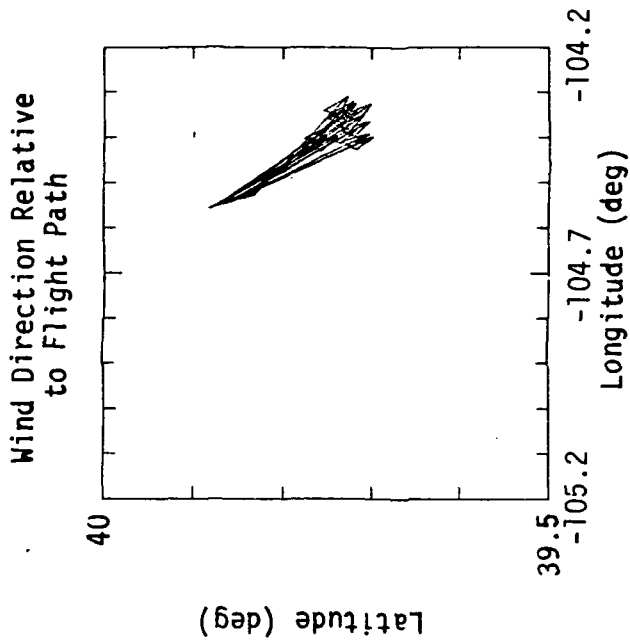
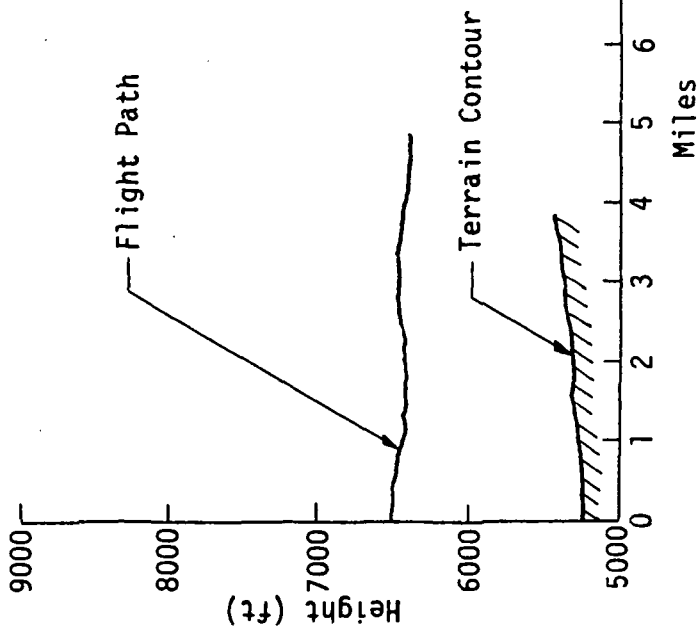

Figure A.235. Flight path information, Flight 6, Run 32.

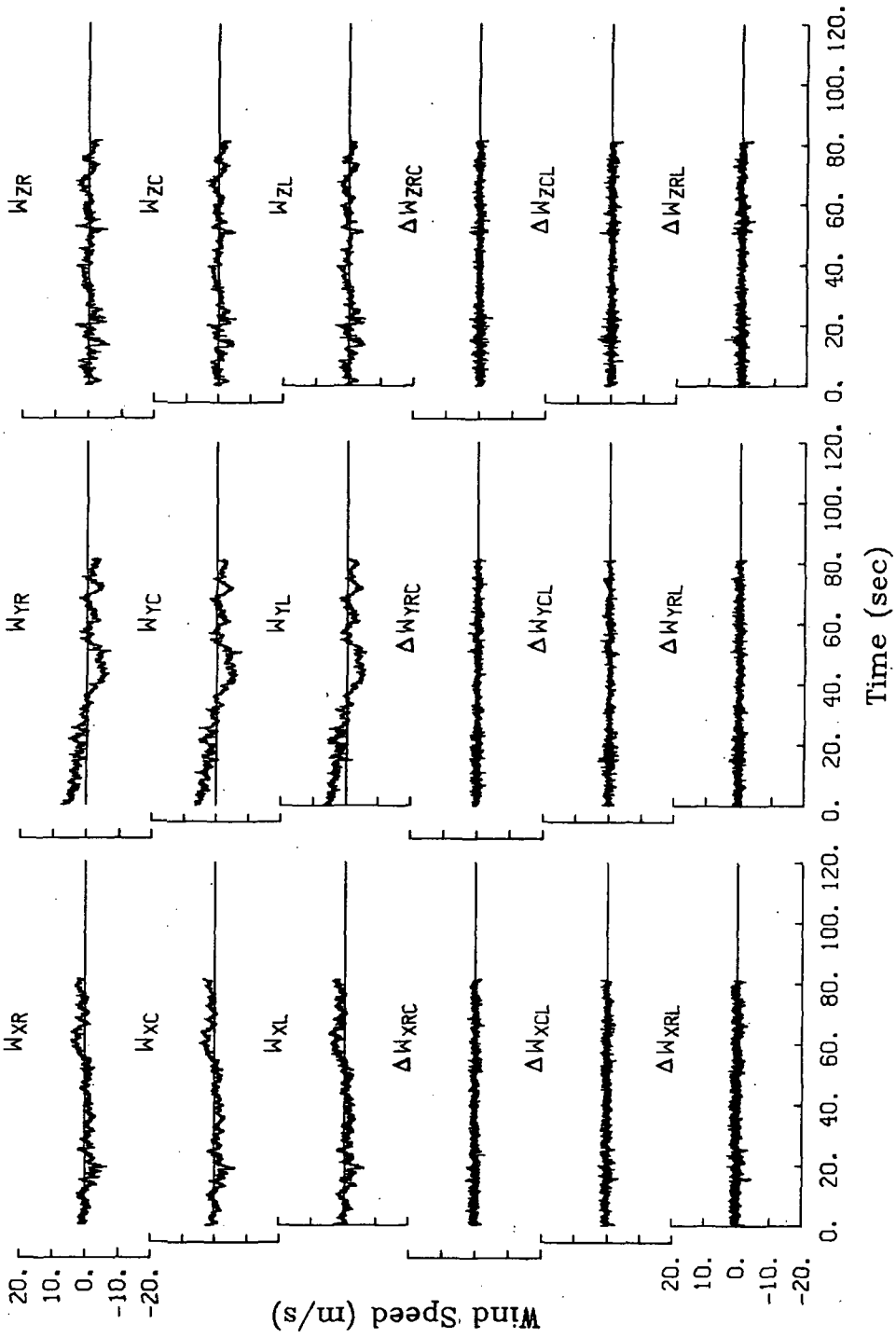

Figure A.236. Time histories of gust velocities and gust velocity differences, Flight 6, Run 32.

TABLE A.58. Average Turbulence Parameters and Integral Length Scales, Flight 6, Run 32.

I. Mean Airspeed (m/s)

V_L	V_C	V_R
98.4	97.6	99.3

II. Standard Deviation of Gust Velocities (m/s)

$\sigma_{W_{XL}}$	$\sigma_{W_{XC}}$	$\sigma_{W_{XR}}$
1.62	1.53	1.50
$\sigma_{W_{YL}}$	$\sigma_{W_{YC}}$	$\sigma_{W_{YR}}$
2.79	2.81	2.79
$\sigma_{W_{ZL}}$	$\sigma_{W_{ZC}}$	$\sigma_{W_{ZR}}$
1.39	1.30	1.41

III. Standard Deviation of Gust Velocity Differences (m/s)

$\sigma_{\Delta W_{XCL}}$	$\sigma_{\Delta W_{XRC}}$	$\sigma_{\Delta W_{XRL}}$
0.65	0.72	0.86
$\sigma_{\Delta W_{YCL}}$	$\sigma_{\Delta W_{YRC}}$	$\sigma_{\Delta W_{YRL}}$
0.63	0.68	0.72
$\sigma_{\Delta W_{ZCL}}$	$\sigma_{\Delta W_{ZRC}}$	$\sigma_{\Delta W_{ZRL}}$
0.70	0.74	0.78

IV. Integral Length Scale (m).

$L_{W_{XL}}$	$L_{W_{XC}}$	$L_{W_{XR}}$
674	656	629
$L_{W_{YL}}$	$L_{W_{YC}}$	$L_{W_{YR}}$
1806	1735	1798
$L_{W_{ZL}}$	$L_{W_{ZC}}$	$L_{W_{ZR}}$
222	224	221

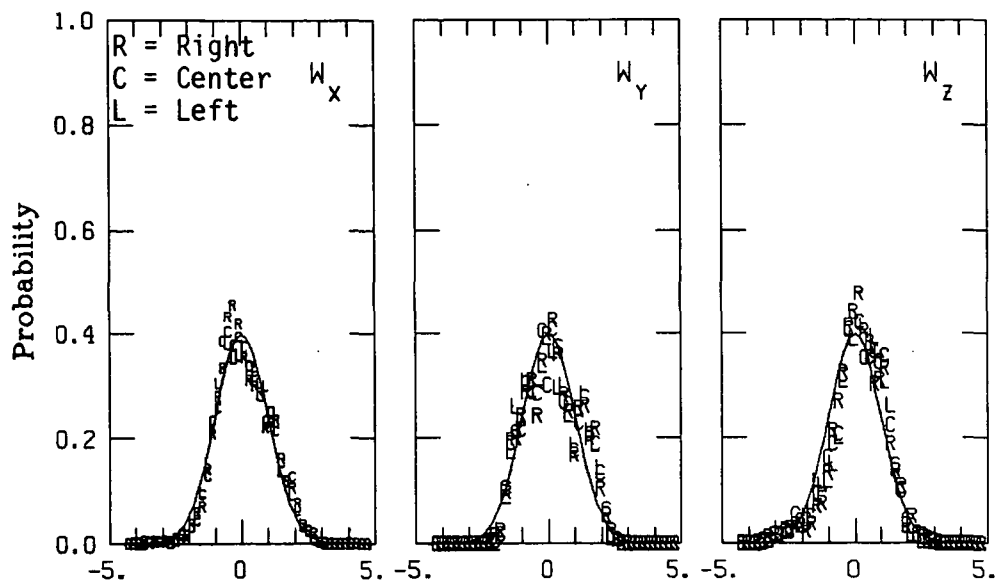

Normalized Gust Velocity (Standard Deviations)

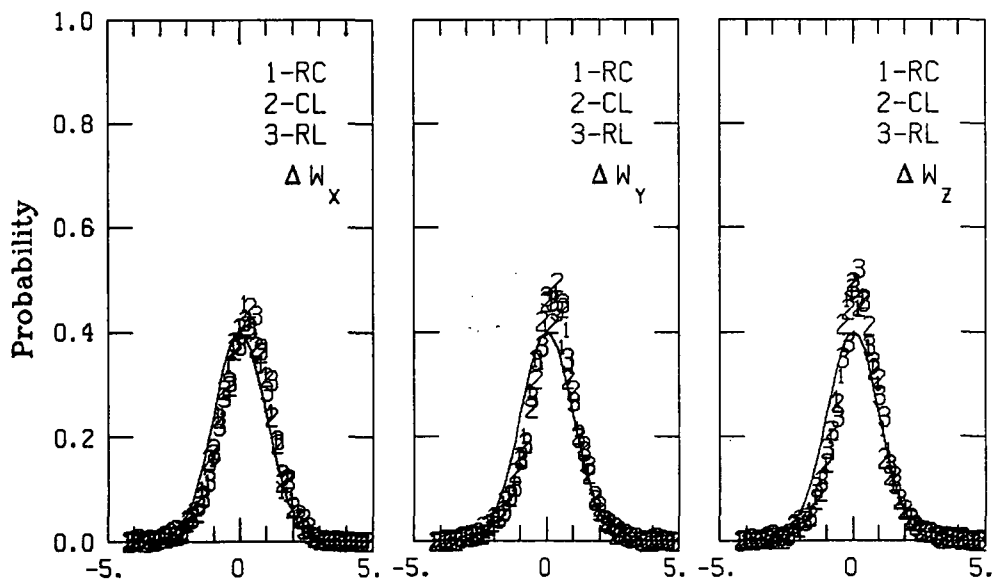

Normalized Velocity Differences (Standard Deviations)

Figure A.237. Probability density function for gust velocities and gust velocity differences, Flight 6, Run 32.

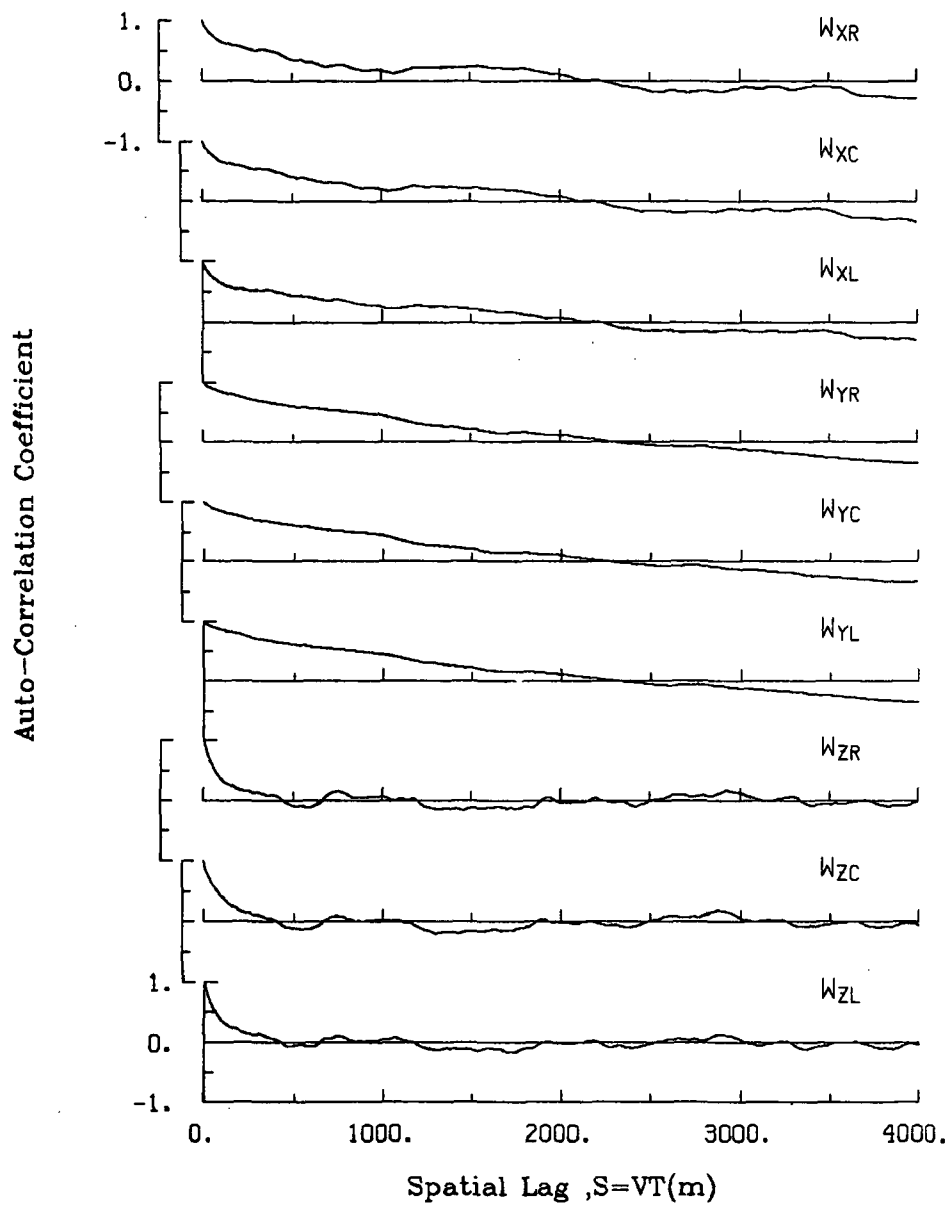

Figure A.238. Single-point auto-correlation coefficient of gust velocities, Flight 6, Run 32.

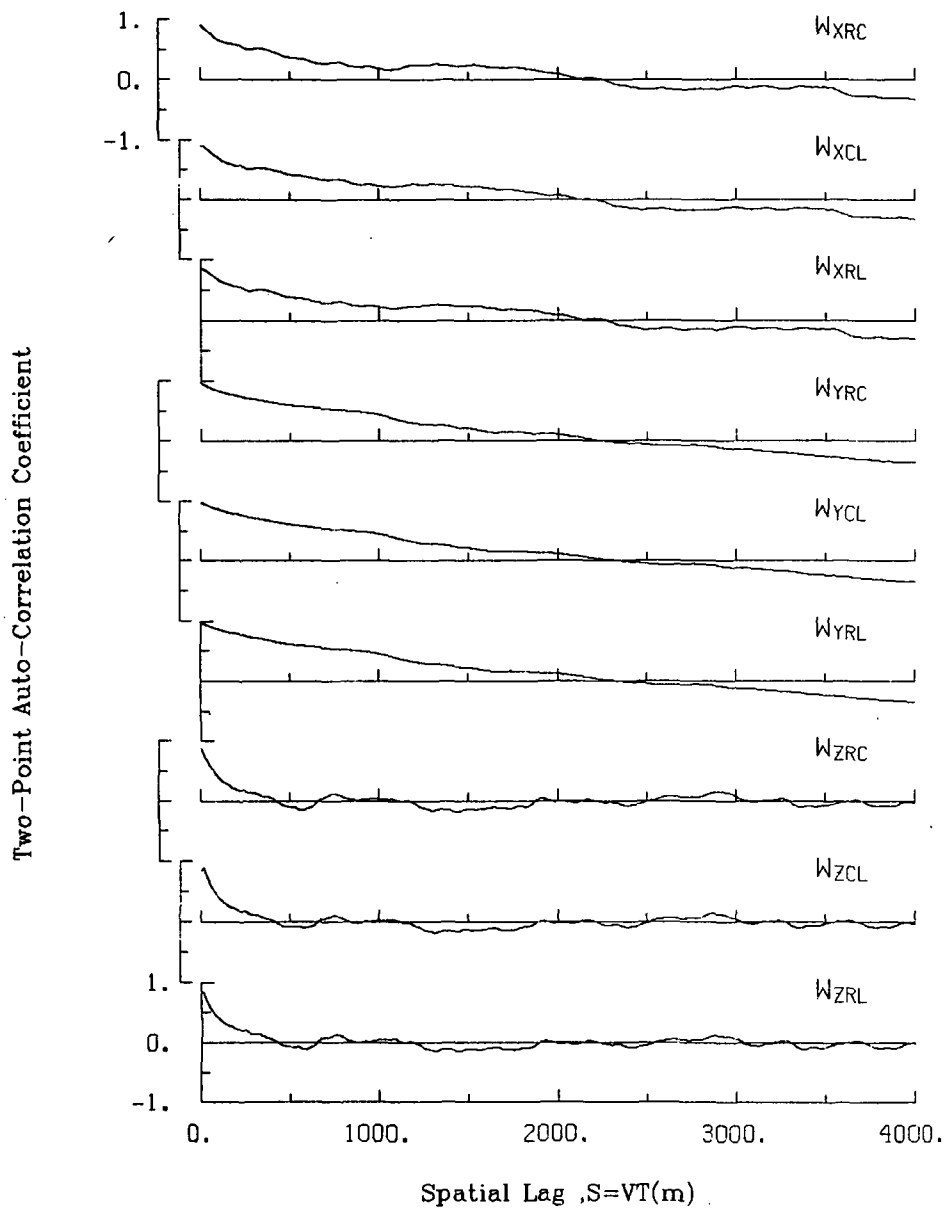

Figure A.239. Two-point auto-correlation coefficient of gust velocities, Flight 6, Run 32.

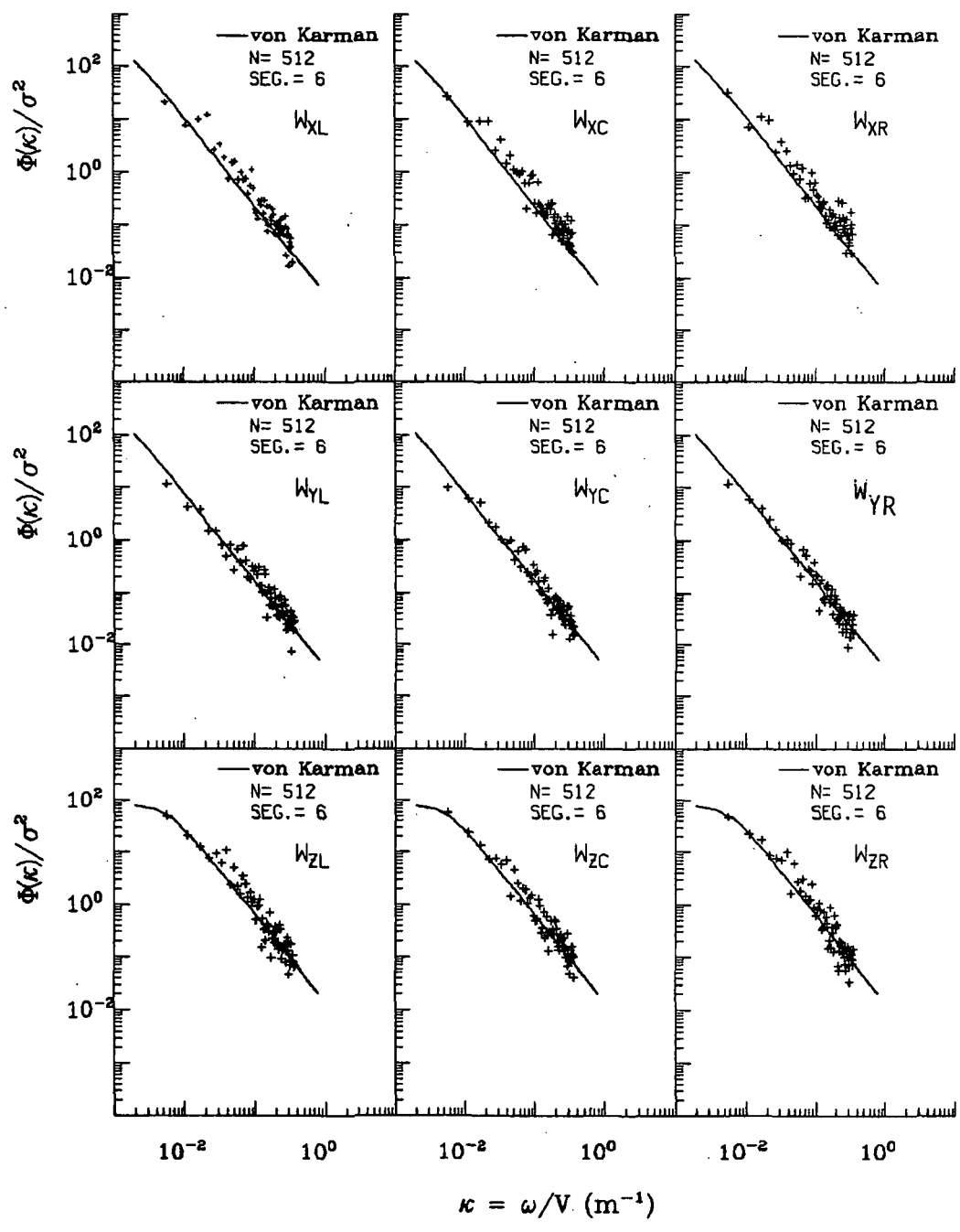

Figure A.240. Normalized auto-spectra of gust velocities, Flight 6, Run 32.

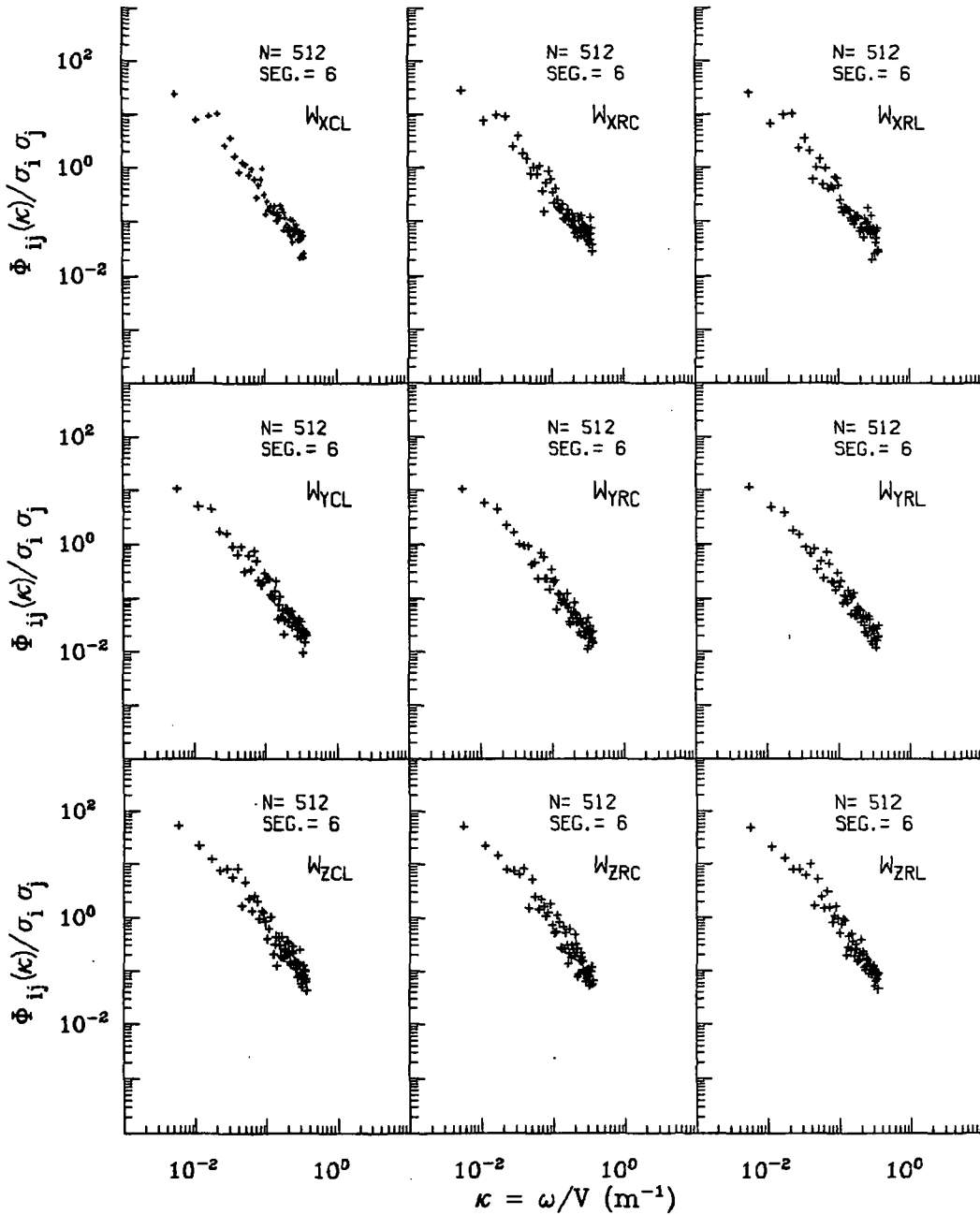

Figure A.241. Normalized two-point auto-spectra of gust velocities, Flight 6, Run 32.

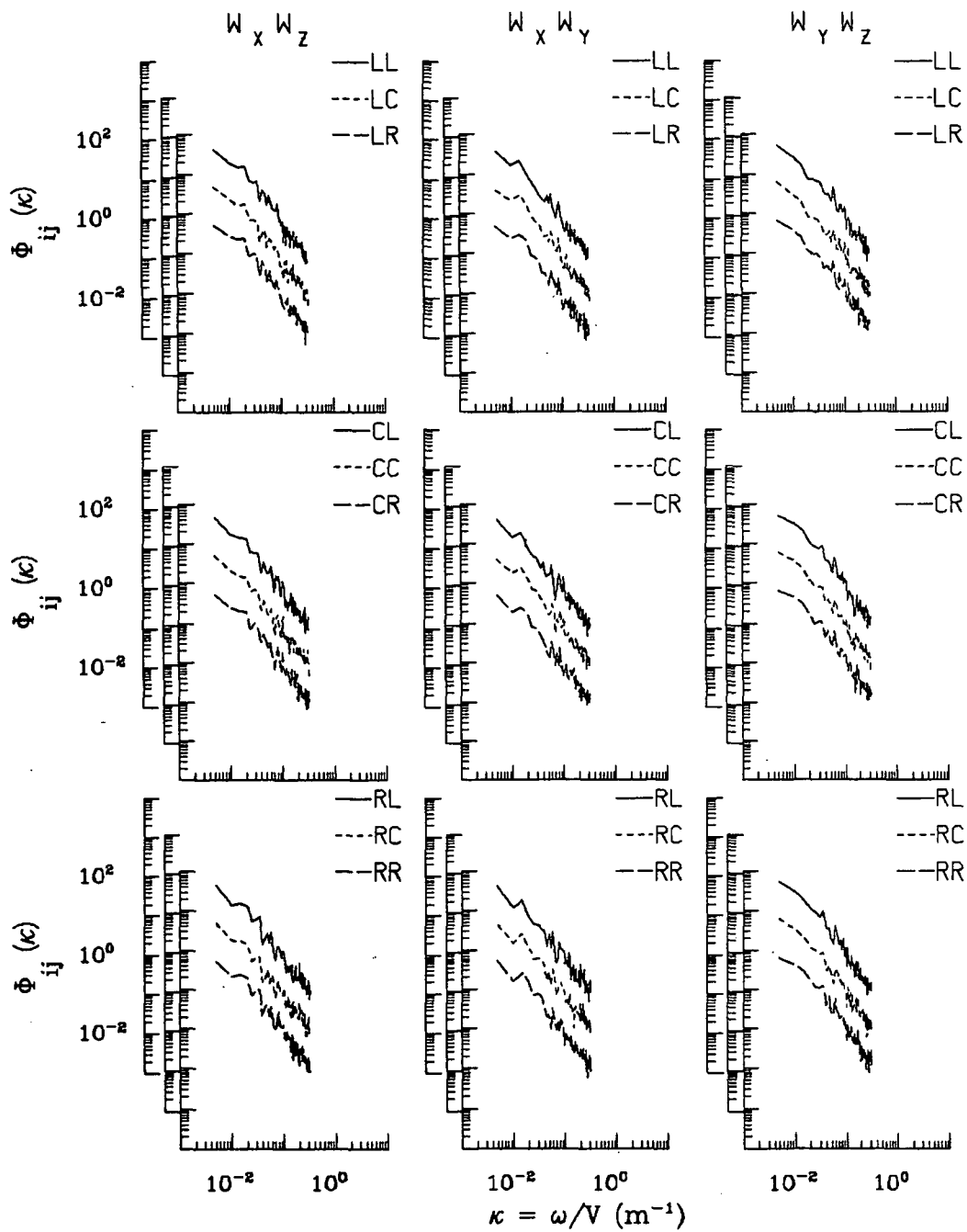

Figure A.242. Two-point cross-spectra of gust velocities, Flight 6, Run 32.

TABLE A.59. List of All Parameters Measured and Their Range of Values, Flight 6, Run 32.

START TIME = 54633.3133		STOP TIME = 54714.6383					
CHANNEL	UNITS	HIGH	LOW	MEAN	RMS	POINTS	
2 PHI DOT	RAD/SEC	.087	-.097	-.00291	.02995	3253	
3 ACCL N CG	G UNITS	-.988	-.988	-.98774	.98774	3253	
4 THETA DOT	RAD/SEC	.048	-.027	.00636	.01256	3253	
5 THETA	RAD	.083	.023	.05887	.06018	3253	
6 PHI	RAD	.064	-.167	-.01381	.04153	3253	
7 PSI 1	DEGREES	331.292	325.304	328.63927	328.64157	3253	
8 DEL PSI 1	DEGREES	3.815	-2.239	1.23549	1.72975	3253	
9 PSI 2	DEGREES	330.126	324.142	327.71542	327.71759	3253	
10 DEL PSI 2	DEGREES	3.726	-2.360	1.11600	1.64891	3253	
11 ACCL N LT	G UNITS	1.934	.260	1.01585	1.03350	3253	
12 ACCL N RT	G UNITS	1.861	.142	1.02666	1.04399	3253	
13 ACCL X CG	G UNITS	.106	-.005	.05723	.06107	3253	
14 ACCL Y CG	G UNITS	.153	-.117	.00976	.03901	3253	
15 ALPHA CTR	RAD	.034	-.054	-.00748	.01393	3253	
16 BETA CTR	RAD	.046	-.072	-.01644	.02687	3253	
17 TEMP I	DEG F	98.444	98.084	98.29691	98.29699	3253	
18 TEMP P	DEG F	92.343	92.163	92.16807	92.16808	3253	
19 ACCL Z INS	G UNITS	1.380	.545	1.00594	1.01111	3253	
20 ALPHA RT	RAD	.056	-.055	.00239	.01352	3253	
21 BETA RT	RAD	.080	-.030	.01801	.02675	3253	
22 ALPHA LT	RAD	.046	-.054	.00301	.01297	3253	
23 BETA LT	RAD	.036	-.074	-.02198	.02911	3253	
24 PSI DOT	RAD/SEC	.039	-.035	.00462	.01562	3253	
25 TEMP IDT	DEG C	31.391	29.916	30.60689	30.60830	3253	
26 QC LT	PSID	.759	.603	.66774	.66841	3253	
27 QC CTR	PSID	.751	.587	.65563	.65626	3253	
28 QC RT	PSID	.777	.614	.68010	.68074	3253	
29 PS	PSIA	11.609	11.553	11.58528	11.58529	3253	
30 TEMP IRT	DEG C	22.684	19.717	21.04391	21.05456	3253	
31 D TO G	METERS	8703838.5668782229.222	*****	*****	*****	3253	
32 B TO D	DEGREES	80.605	80.575	80.59005	80.59005	3253	
33 LONG	DEGREES	-104.526	-104.557	-104.54106	104.54106	3253	
34 LAT	DEGREES	39.883	39.831	39.85753	39.85754	3253	
35 TRK ANG	DEGREES	338.322	332.093	335.61794	335.62396	3253	
36 HDG	RADIANS	5.777	5.669	5.73140	5.73145	3253	
37 VE	M/SEC	-28.463	-36.768	-31.97488	32.06712	3253	
38 VN	M/SEC	75.167	67.450	70.58813	70.62811	3253	
39 ALTITUDE	KM	1.984	1.945	1.96131	1.96133	3253	
40 TEMPC	DEGREES C	26.430	25.469	25.86711	25.86768	3253	
41 EW WND SPD	KNOTS	46.022	22.610	34.62664	35.00290	3253	
42 NS WND SPD	KNOTS	-15.391	-35.013	-25.83890	26.06852	3253	
43 WIND SPEED	KNOTS	55.412	34.409	43.48318	43.64368	3253	
44 WIND DIREC	DEGREES	325.573	290.018	307.00007	307.06815	3253	
45 AIRSPEED R	M/SEC	105.987	94.515	99.33437	99.35705	3253	
46 AIRSPEED C	M/SEC	104.195	92.422	97.56558	97.58851	3253	
47 AIRSPEED L	M/SEC	104.803	93.685	98.44388	98.46795	3253	
48 DELTA ALT	METERS	1.507	-37.350	-20.93445	22.63288	3253	
49 INRTL DISP	METERS	0.000	-35.345	-20.06137	21.76206	3253	
50 UG RIGHT	M/SEC	4.206	-6.358	-.00000	1.52472	3253	
51 UG CENTER	M/SEC	4.629	-6.243	-.00000	1.55784	3253	
52 UG LEFT	M/SEC	4.603	-5.931	-.00000	1.63915	3253	
53 VG RIGHT	M/SEC	7.648	-6.626	.00602	2.77538	3253	
54 VG CENTER	M/SEC	6.663	-7.185	.00661	2.79468	3253	
55 VG LEFT	M/SEC	6.683	-5.784	.00499	2.76955	3253	
56 WG RIGHT	M/SEC	4.247	-6.096	-.00135	1.41402	3253	
57 WG CENTER	M/SEC	3.985	-4.673	.00078	1.30600	3253	
58 WG LEFT	M/SEC	3.976	-5.067	-.00197	1.37563	3253	

ORIGINAL PAGE IS
OF POOR QUALITY

Date: July 14, 1982
Time: 15:13:06 (MDT)
Duration: 144 seconds

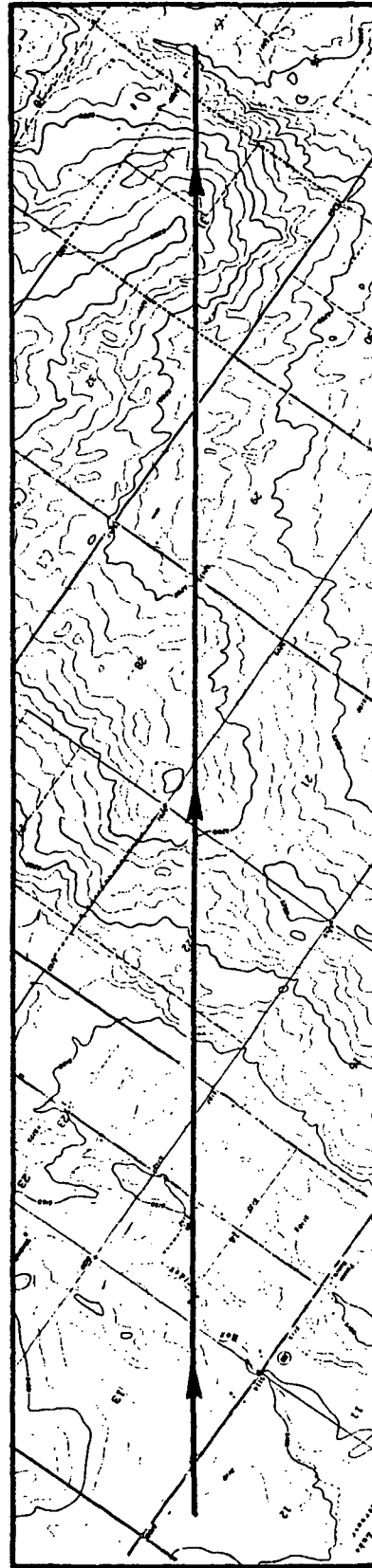
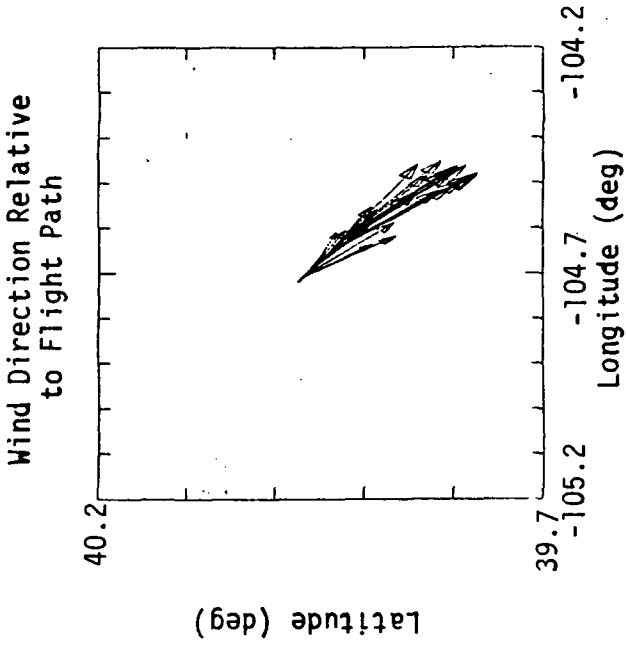
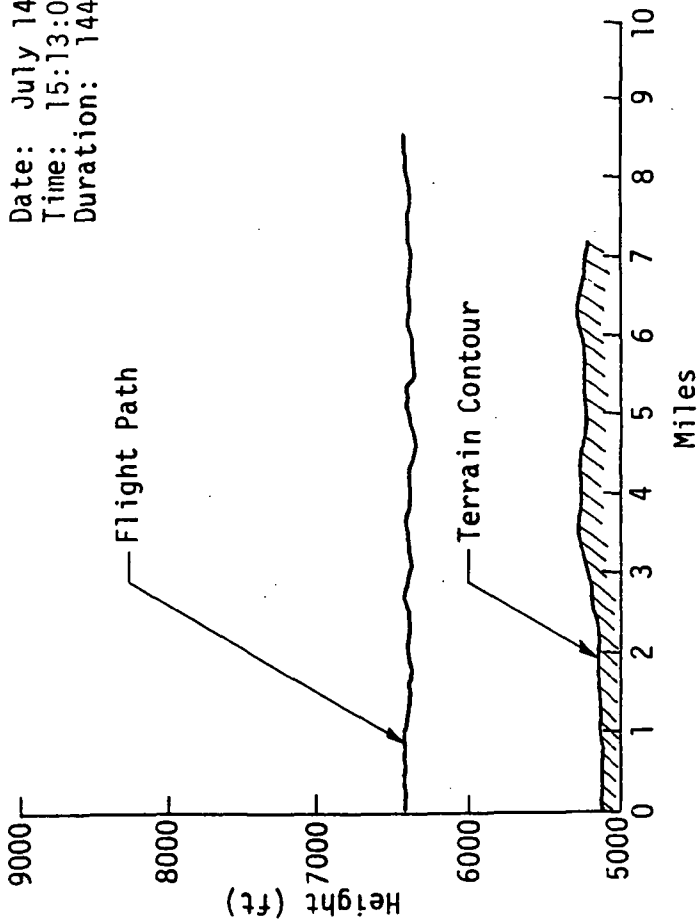

Figure A.243. Flight path information, Flight 6, Run 33.

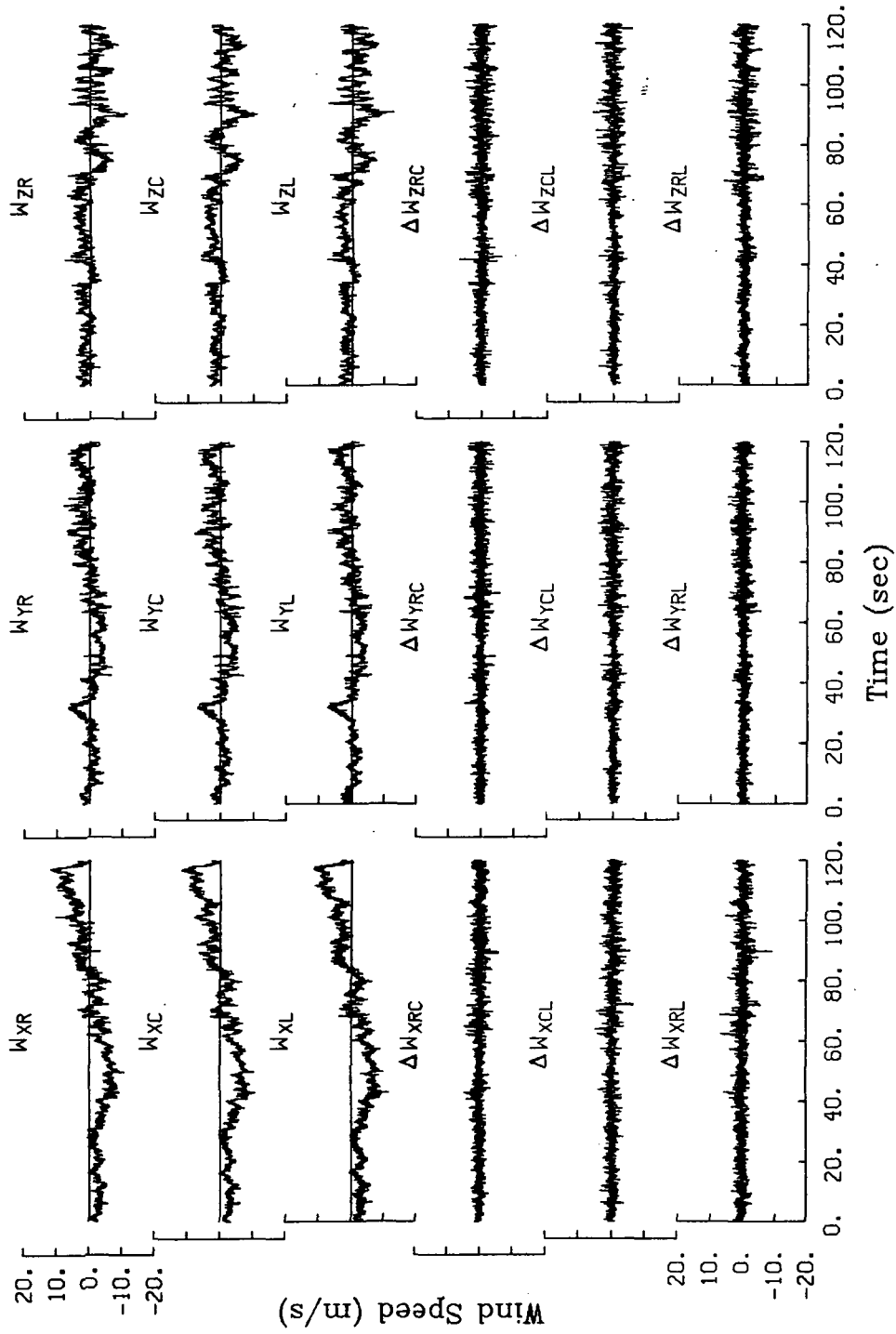

Figure A.244. Time histories of gust velocities and gust velocity differences, Flight 6, Run 33.

TABLE A.60. Average Turbulence Parameters and Integral Length Scales, Flight 6, Run 33.

I. Mean Airspeed (m/s)

V_L	V_C	V_R
97.3	96.4	98.2

II. Standard Deviation of Gust Velocities (m/s)

$\sigma_{W_{XL}}$	$\sigma_{W_{XC}}$	$\sigma_{W_{XR}}$
4.69	4.52	4.39
$\sigma_{W_{YL}}$	$\sigma_{W_{YC}}$	$\sigma_{W_{YR}}$
2.29	2.46	2.42
$\sigma_{W_{ZL}}$	$\sigma_{W_{ZC}}$	$\sigma_{W_{ZR}}$
2.92	2.81	2.91

III. Standard Deviation of Gust Velocity Differences (m/s)

$\sigma_{\Delta W_{XCL}}$	$\sigma_{\Delta W_{XRC}}$	$\sigma_{\Delta W_{XRL}}$
1.09	1.12	1.37
$\sigma_{\Delta W_{YCL}}$	$\sigma_{\Delta W_{YRC}}$	$\sigma_{\Delta W_{YRL}}$
1.07	1.09	1.19
$\sigma_{\Delta W_{ZCL}}$	$\sigma_{\Delta W_{ZRC}}$	$\sigma_{\Delta W_{ZRL}}$
1.28	1.22	1.39

IV. Integral Length Scale (m).

$L_{W_{XL}}$	$L_{W_{XC}}$	$L_{W_{XR}}$
1914	1929	1912
$L_{W_{YL}}$	$L_{W_{YC}}$	$L_{W_{YR}}$
744	813	878
$L_{W_{ZL}}$	$L_{W_{ZC}}$	$L_{W_{ZR}}$
1237	1323	1079

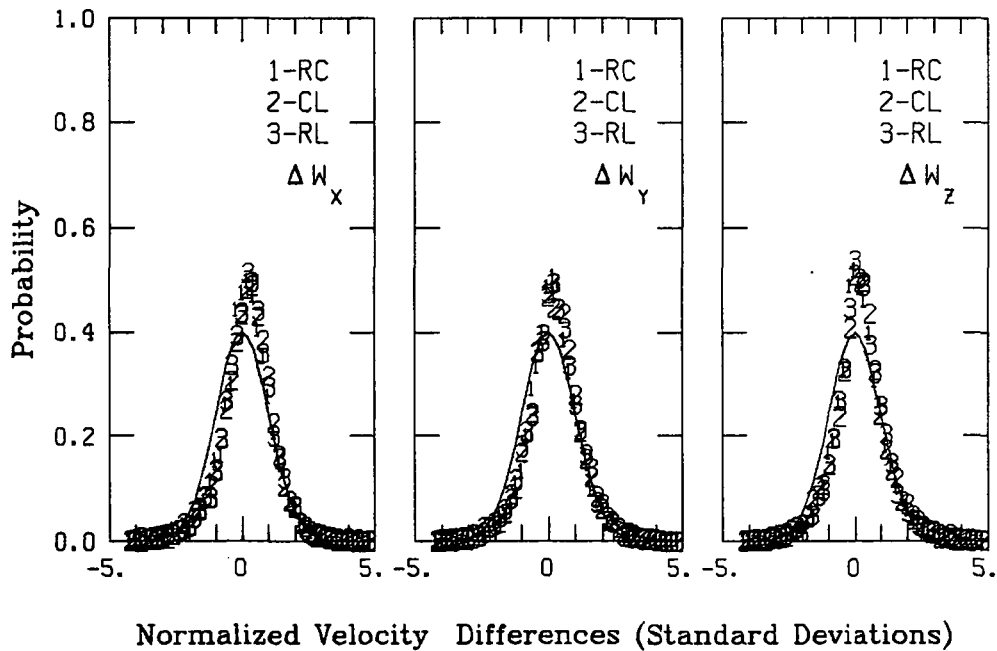
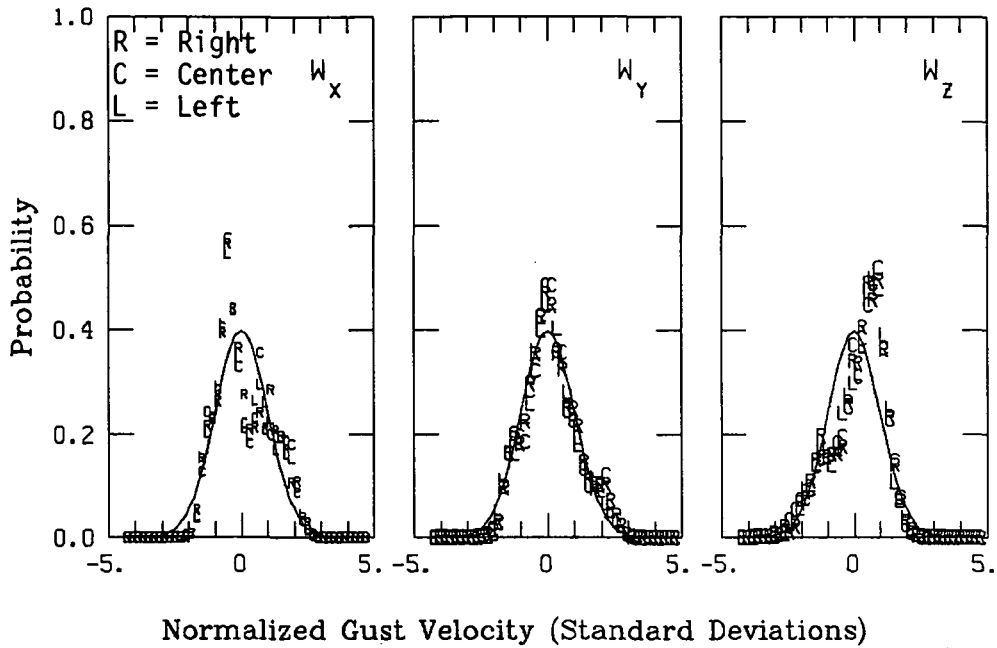

Figure A.245. Probability density function for gust velocities and gust velocity differences, Flight 6, Run 33.

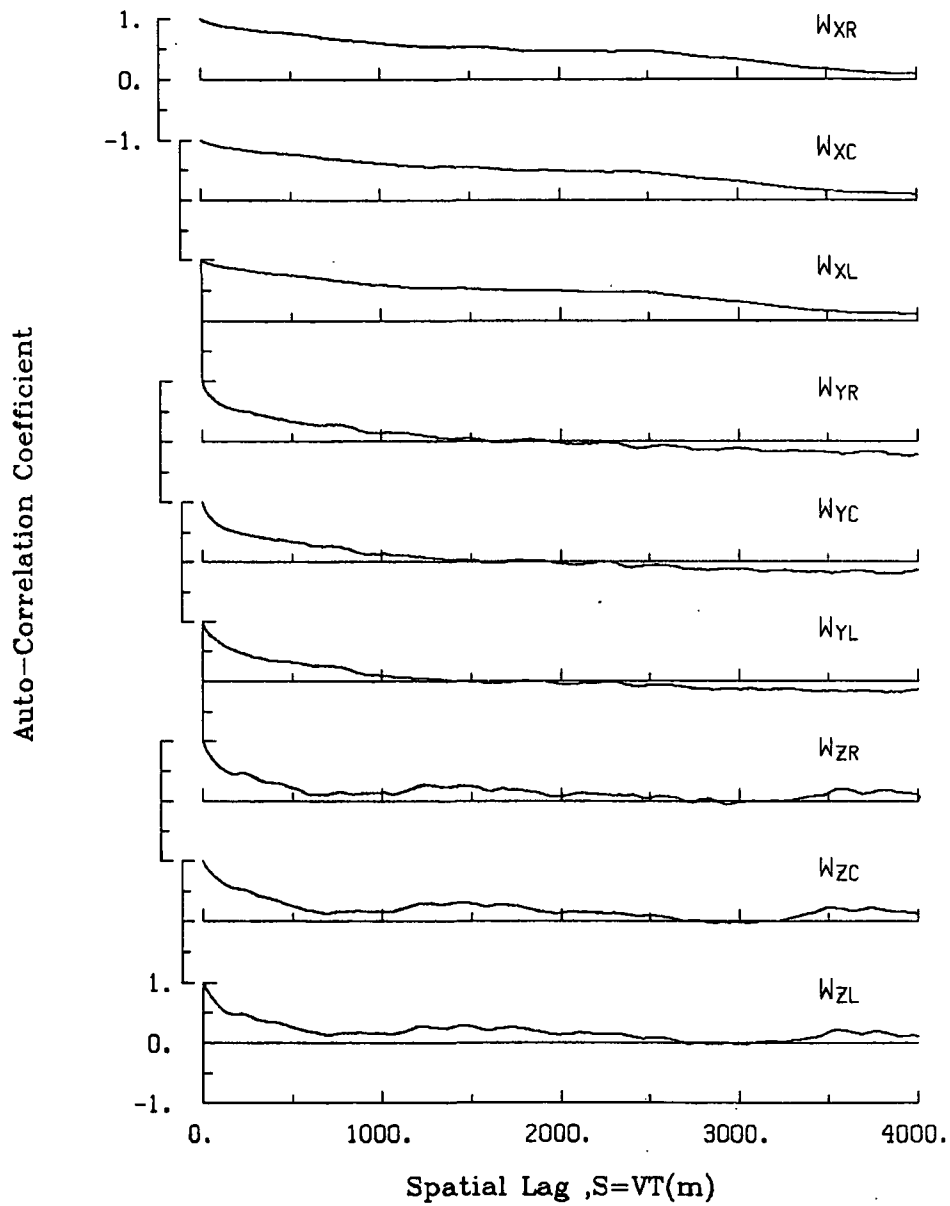

Figure A.246. Single-point auto-correlation coefficient of gust velocities, Flight 6, Run 33.

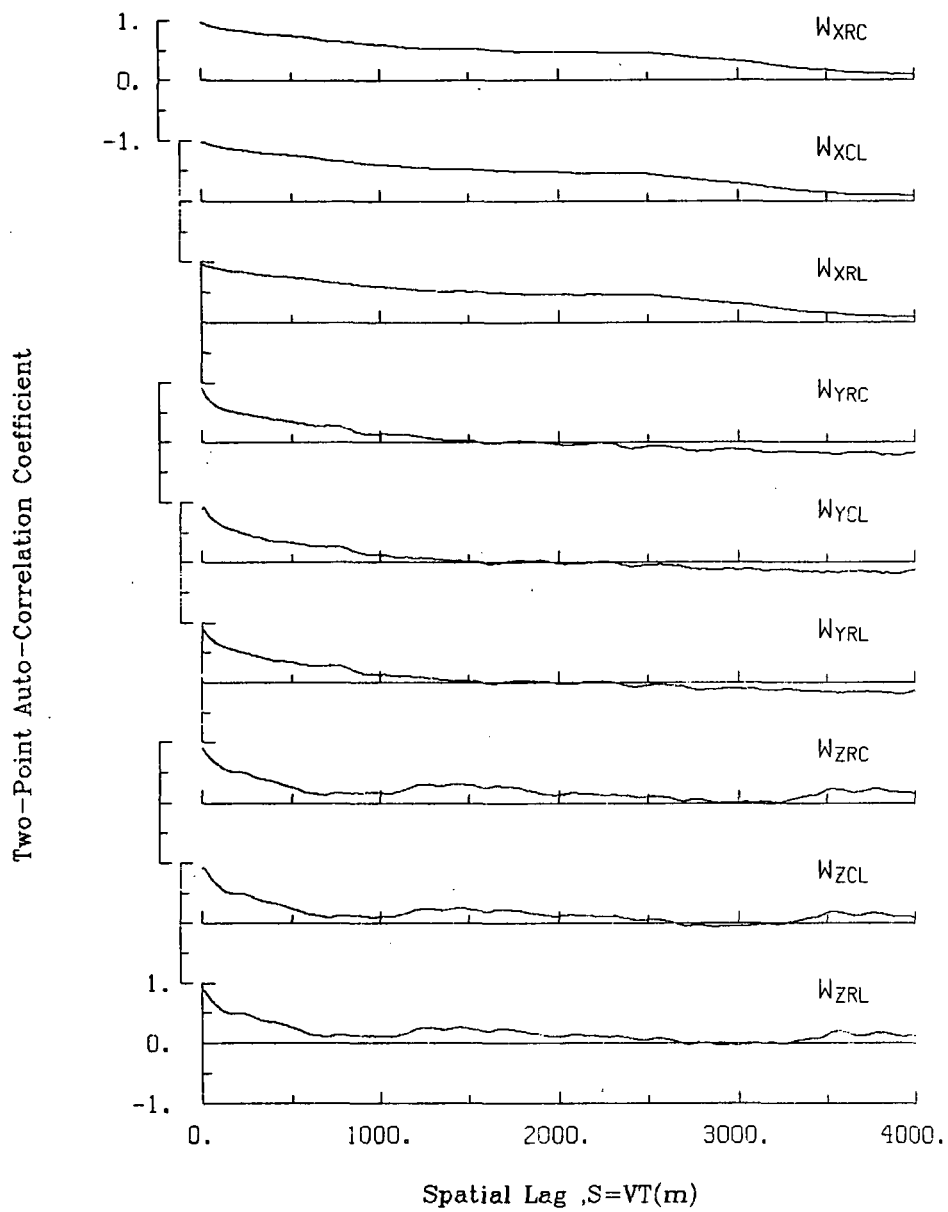

Figure A.247. Two-point auto-correlation coefficient of gust velocities, Flight 6, Run 33.

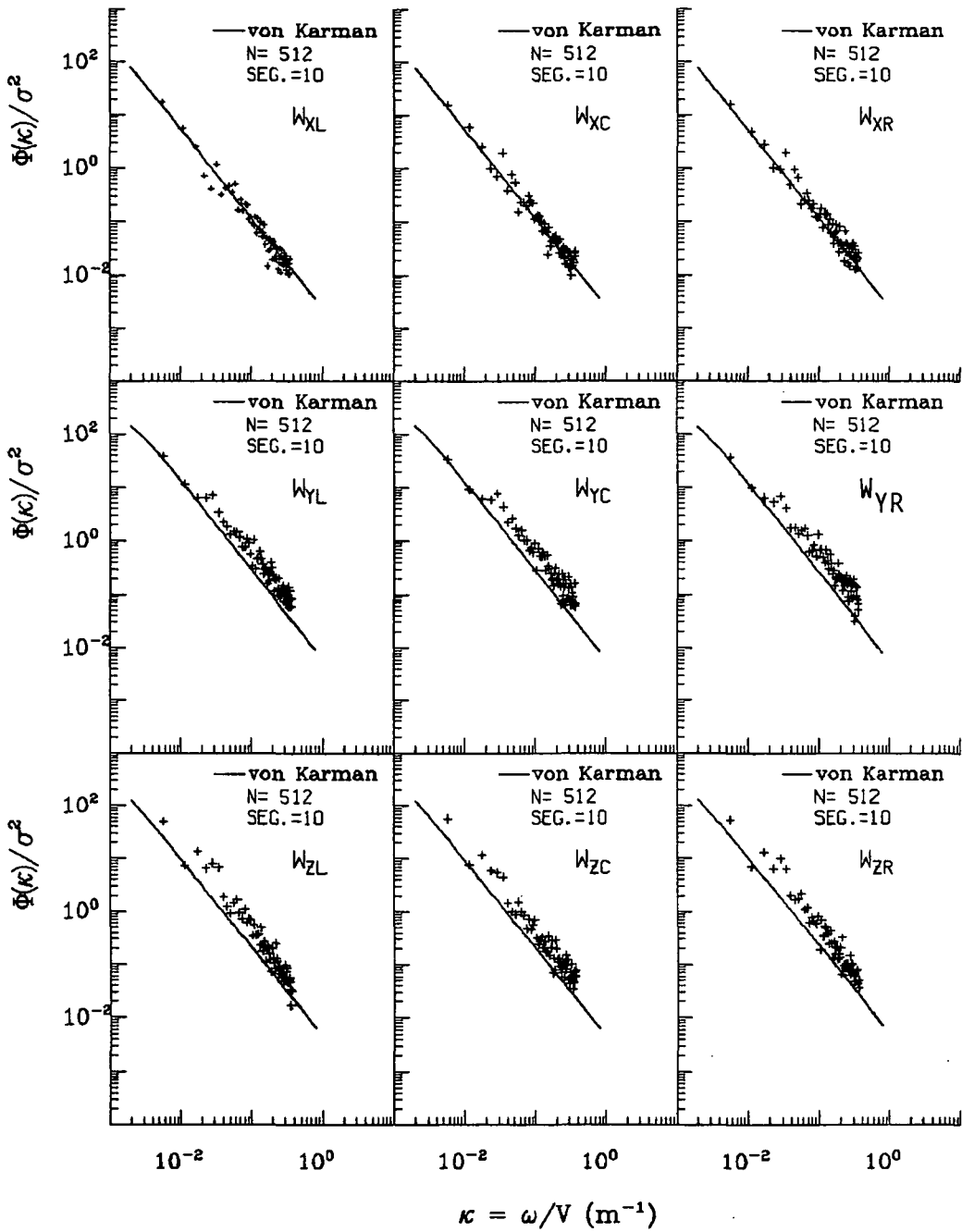

Figure A.248. Normalized auto-spectra of gust velocities, Flight 6, Run 33.

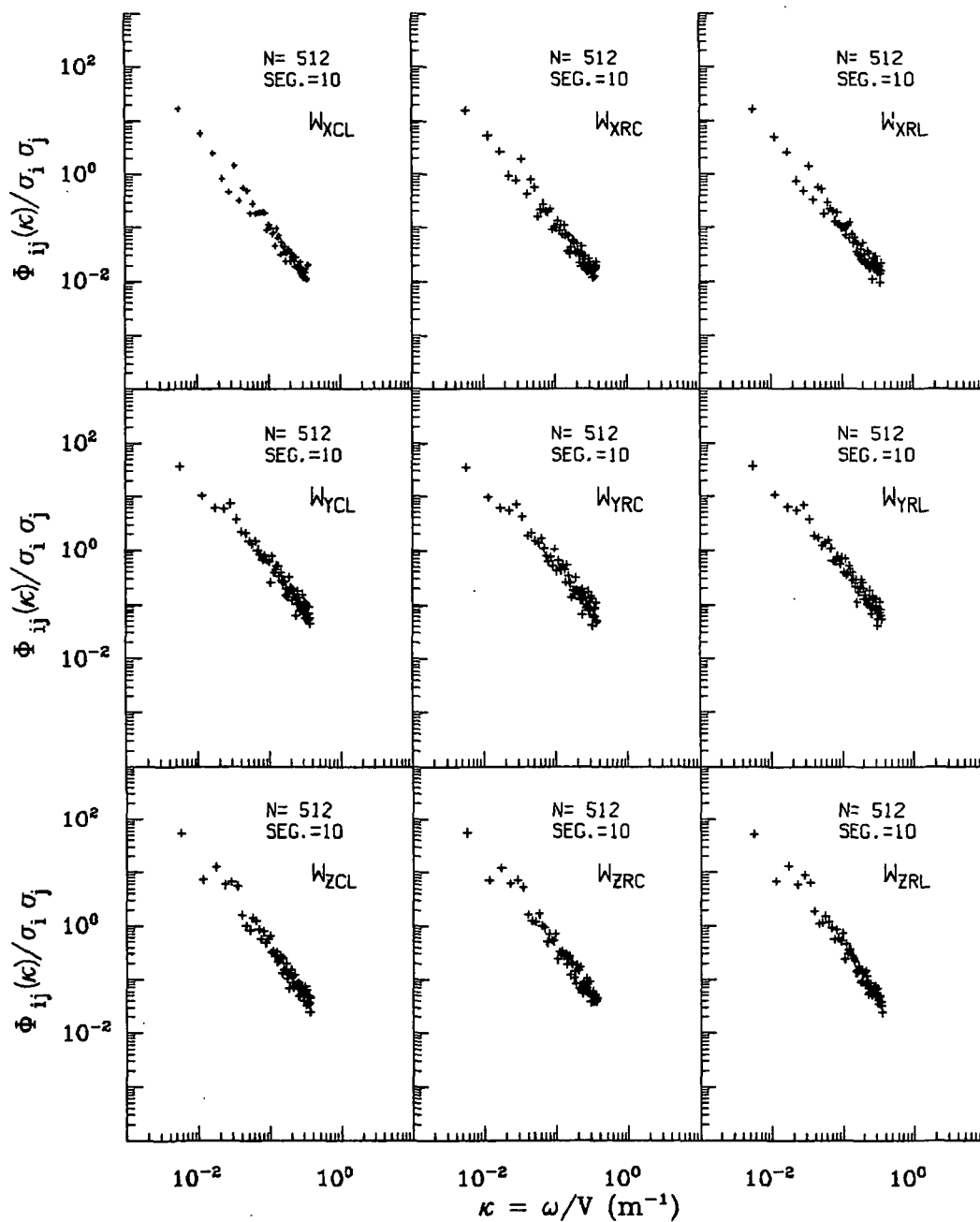

Figure A.249. Normalized two-point auto-spectra of gust velocities, Flight 6, Run 33.

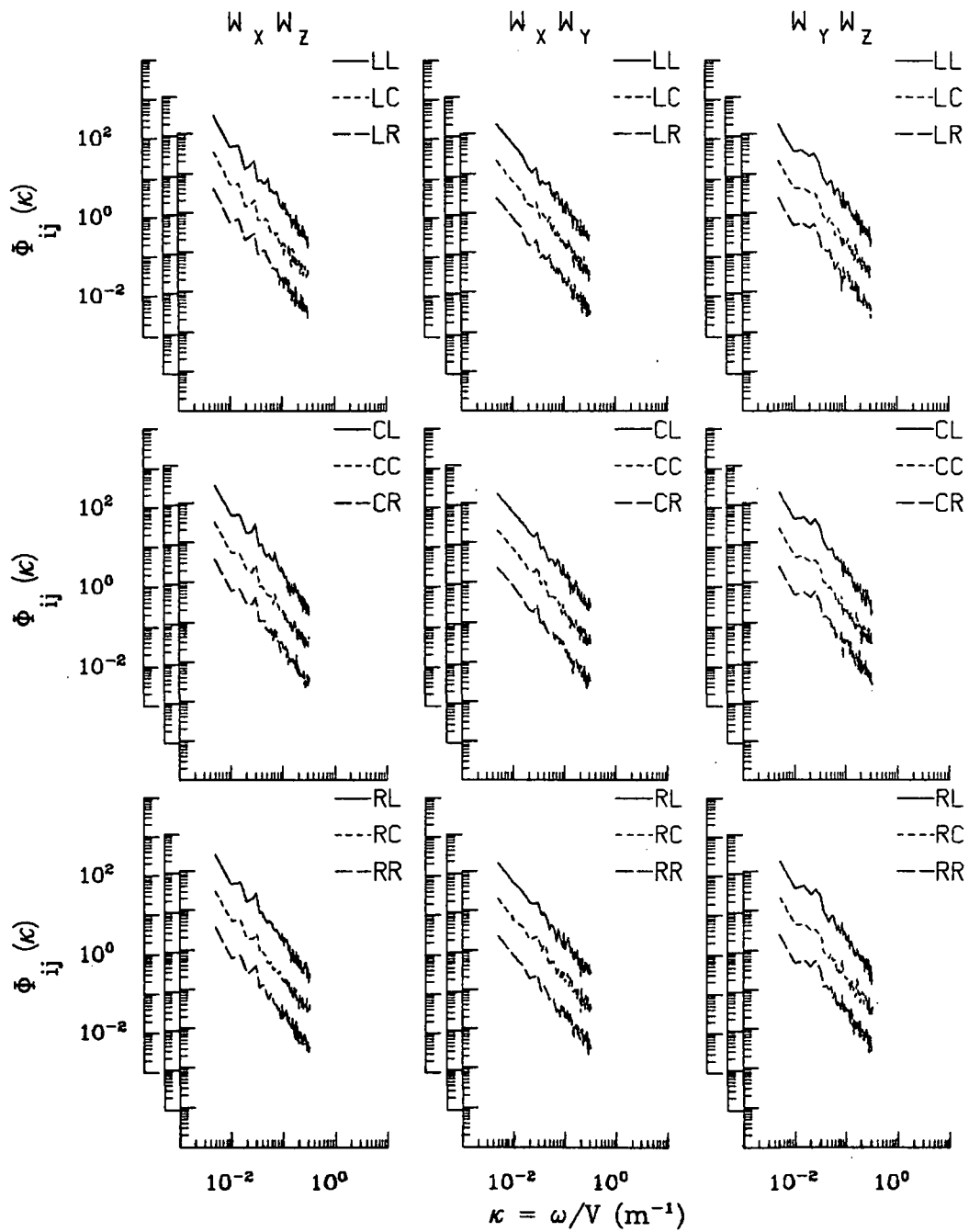

Figure A.250. Two-point cross-spectra of gust velocities, Flight 6, Run 33.

**ORIGINAL PAGE IS
OF POOR QUALITY**

TABLE A.61. List of All Parameters Measured and Their Range of Values,
Flight 6, Run 33.

		START TIME = 54786.7186	STOP TIME = 54931.3186				
CHANNEL	UNITS	HIGH	LOW	MEAN	RMS	POINTS	
2 PHI DOT	RAD/SEC	.170	-.148	-.00328	.03691	5784	
3 ACCL N CG	G UNITS	-.988	-.988	-.98774	.98774	5784	
4 THETA DOT	RAD/SEC	.079	-.070	.00610	.01748	5784	
5 THETA	RAD	.145	.032	.08220	.08618	5784	
6 PHI	RAD	.071	-.084	-.01177	.02937	5784	
7 PSI 1	DEGREES	305.931	298.535	302.66804	302.67090	5784	
8 DEL PSI 1	DEGREES	4.256	-2.828	1.12369	1.72800	5784	
9 PSI 2	DEGREES	307.947	300.907	304.68018	304.68290	5784	
10 DEL PSI 2	DEGREES	4.197	-2.831	1.07682	1.69010	5784	
11 ACCL N LT	G UNITS	2.453	-.707	1.01025	1.05279	5784	
12 ACCL N RT	G UNITS	2.490	-.776	1.02369	1.06677	5784	
13 ACCL X CG	G UNITS	.201	.019	.09164	.09814	5784	
14 ACCL Y CG	G UNITS	.139	-.136	.01008	.03693	5784	
15 ALPHA CTR	RAD	.090	-.079	-.00648	.02125	5784	
16 BETA CTR	RAD	.079	-.132	-.01663	.03125	5784	
17 TEMP I	DEG F	98.444	97.724	98.17143	98.17152	5784	
18 TEMP P	DEG F	92.519	92.163	92.33100	92.33102	5784	
19 ACCL Z INS	G UNITS	1.680	.332	1.00493	1.01745	5784	
20 ALPHA RT	RAD	.110	-.078	.00712	.02424	5784	
21 BETA RT	RAD	.118	-.138	.01747	.03013	5784	
22 ALPHA LT	RAD	.105	-.068	.00840	.02279	5784	
23 BETA LT	RAD	.062	-.106	-.02273	.03254	5784	
24 PSI DOT	RAD/SEC	.076	-.058	.00318	.01930	5784	
25 TEMP TOT	DEG C	31.194	28.536	30.06563	30.06855	5784	
26 QC LT	PSID	.776	.544	.65473	.65617	5784	
27 QC CTR	PSID	.753	.531	.64226	.64354	5784	
29 QC RT	PSID	.774	.530	.66639	.66767	5784	
29 PS	PSIA	11.660	11.124	11.60676	11.60677	5784	
30 TEMP IPT	DEG C	16.632	4.556	12.59466	12.93295	5784	
31 C TO G	PETERS	8778542.3628770261.263	*****	*****	*****	5784	
32 B TO D	DEGREES	80.535	80.449	80.49318	80.49319	5784	
33 LONG	DEGREES	-104.607	-104.718	-104.66145	104.66145	5784	
34 LAT	DEGREES	39.974	39.914	39.94334	39.94335	5784	
35 TRK ANG	DEGREES	306.121	303.064	304.69599	304.69684	5784	
36 HDG	PADIANS	5.364	5.237	5.30829	5.30834	5784	
37 VE	M/SEC	-62.091	-75.696	-65.95620	66.03677	5784	
39 VN	M/SEC	49.810	42.331	45.65887	45.70057	5784	
39 ALTITUDE	KM	2.287	1.909	1.94636	1.94638	5784	
40 TEMPC	DEGREES C	26.621	24.160	25.43627	25.44220	5784	
41 EW WND SPD	KNOTS	40.373	6.112	25.03413	25.91668	5784	
42 NS WND SPD	KNOTS	3.699	-39.691	-18.98181	20.42865	5784	
43 WIND SPEED	KNOTS	52.190	9.450	31.81763	33.00006	5784	
44 WIND DIR	DEGREES	340.250	257.002	306.19002	306.36833	5784	
45 AIRSPEED R	M/SEC	105.809	87.807	98.16046	98.20513	5784	
46 AIRSPEED C	M/SEC	104.154	87.948	96.39958	96.44495	5784	
47 AIRSPEED L	M/SEC	105.685	88.911	97.30766	97.35828	5784	
48 DELTA ALT	METERS	333.488	-44.630	-7.49217	10.40430	5784	
49 INRTL DISP	METERS	2.468	-24.247	-8.13939	10.16541	5784	
50 UG RIGHT	M/SEC	11.939	-10.582	-.00000	4.45218	5784	
51 UG CENTER	M/SEC	11.774	-10.481	-.00000	4.58399	5784	
52 UG LEFT	M/SEC	13.557	-11.724	-.00000	4.72180	5784	
53 VG RIGHT	M/SEC	7.937	-10.063	-.03200	2.40780	5784	
54 VG CENTER	M/SEC	7.808	-6.950	-.03587	2.44730	5784	
55 VG LEFT	M/SEC	7.458	-7.393	-.03442	2.27749	5784	
56 WG RIGHT	M/SEC	9.141	-11.378	.02001	2.90225	5784	
57 WG CENTER	M/SEC	6.406	-10.714	.02269	2.79609	5784	
58 WG LEFT	M/SEC	7.715	-12.648	.02964	2.91104	5784	

Date: July 14, 1982
 Time: 15:16:49 (MDT)
 Duration: 93 seconds

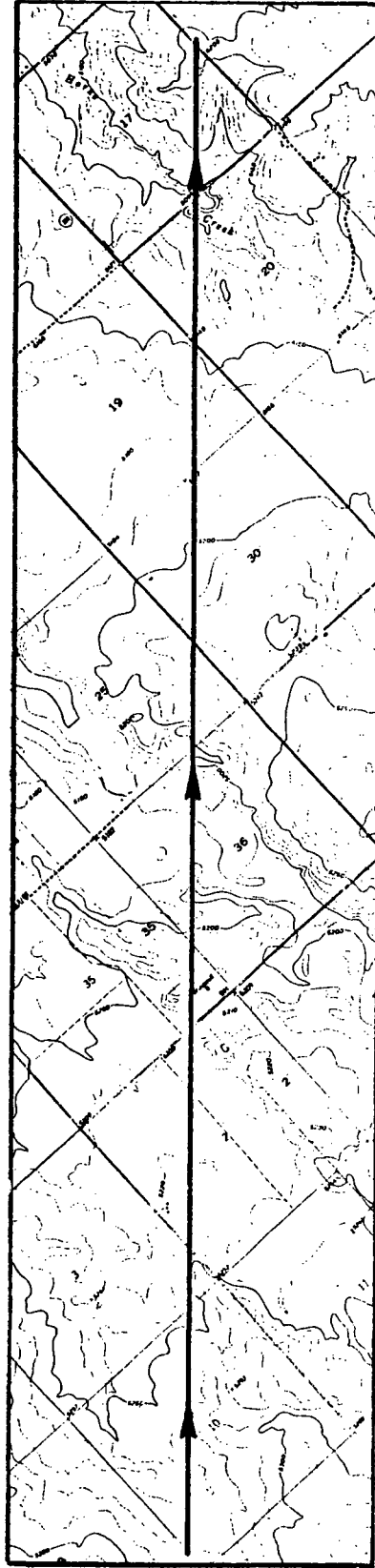
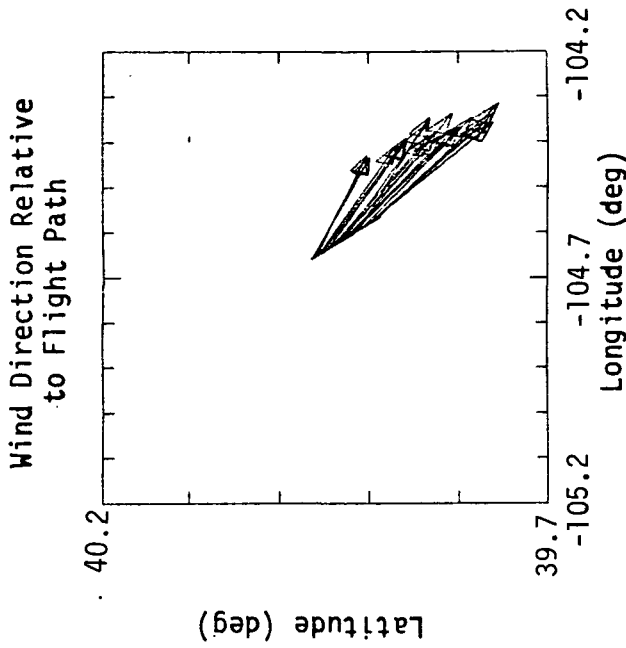
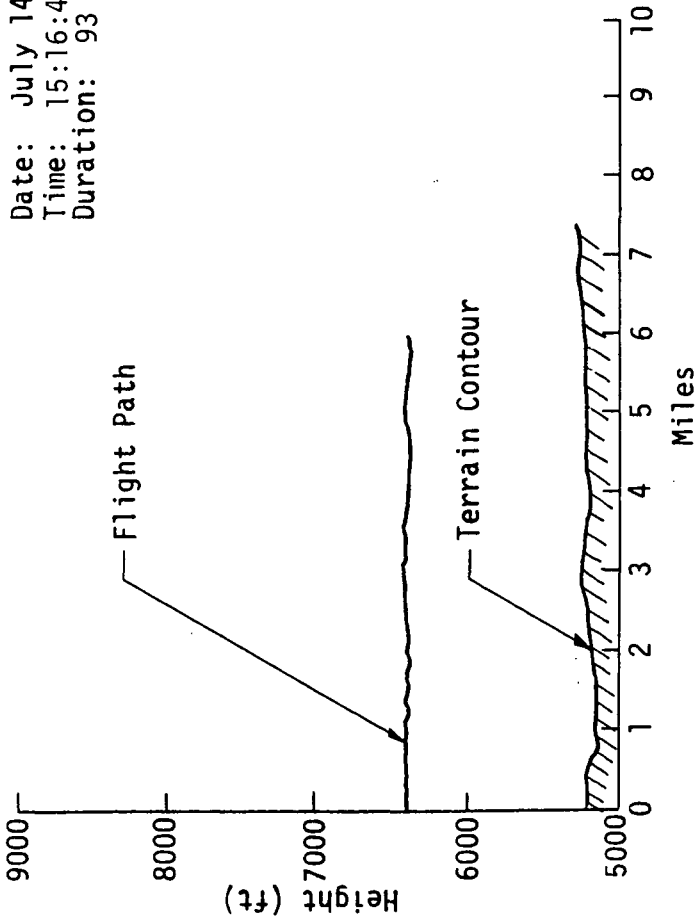

A. 300

Figure A.251. Flight path information, Flight 6, Run 34.

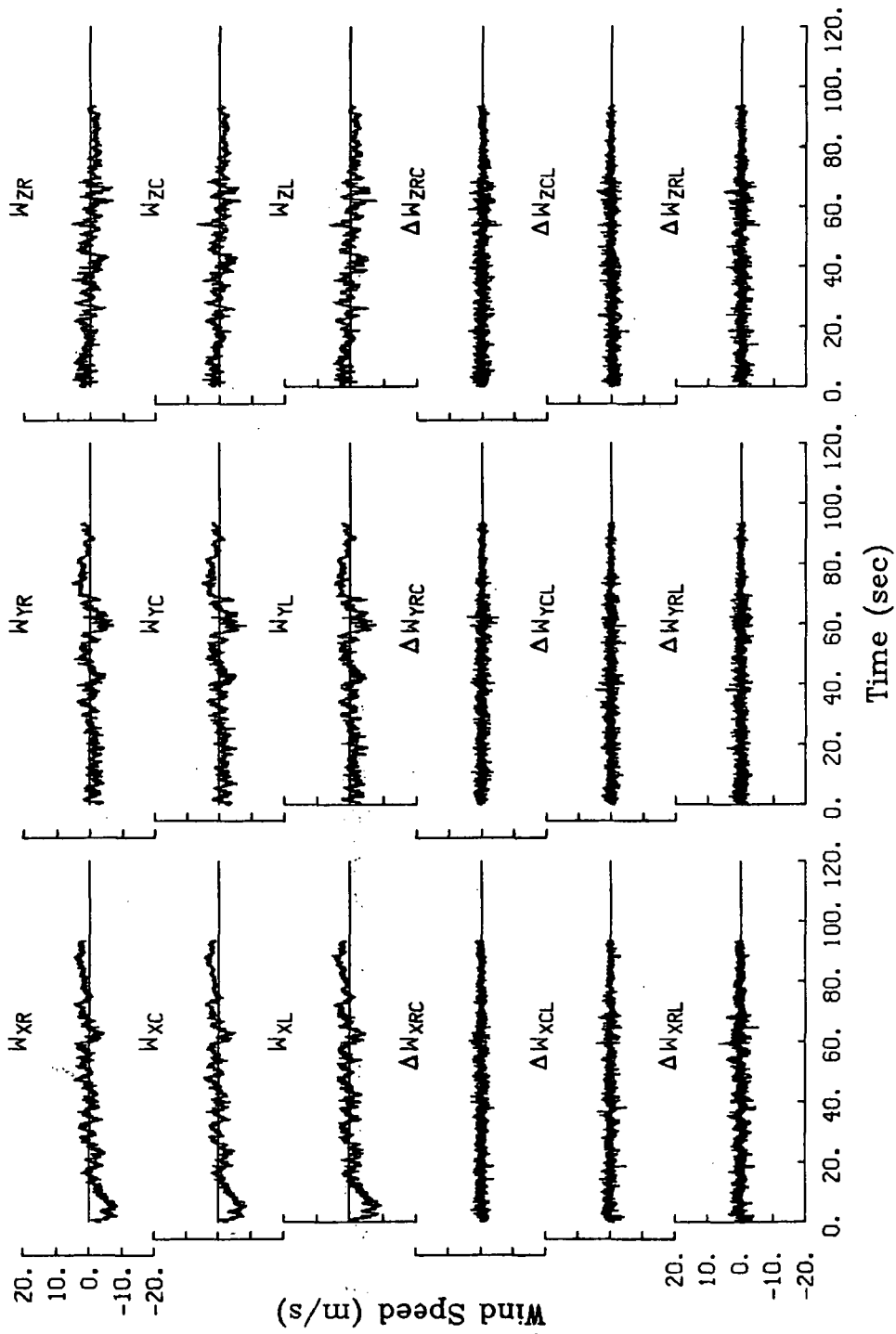

Figure A.252. Time histories of gust velocities and gust velocity differences, Flight 6, Run 34.

TABLE A.62. Average Turbulence Parameters and Integral Length Scales, Flight 6, Run 34.

I. Mean Airspeed (m/s)			II. Standard Deviation of Gust Velocities (m/s)		
V_L	V_C	V_R	$\sigma_{W_{XL}}$	$\sigma_{W_{XC}}$	$\sigma_{W_{XR}}$
104.4	103.4	105.3	2.59	2.48	2.53
			$\sigma_{W_{YL}}$	$\sigma_{W_{YC}}$	$\sigma_{W_{YR}}$
			2.02	2.08	2.01
			$\sigma_{W_{ZL}}$	$\sigma_{W_{ZC}}$	$\sigma_{W_{ZR}}$
			2.04	1.82	1.99
III. Standard Deviation of Gust Velocity Differences (m/s)			IV. Integral Length Scale (m).		
$\sigma_{\Delta W_{XCL}}$	$\sigma_{\Delta W_{XRC}}$	$\sigma_{\Delta W_{XRL}}$	$L_{W_{XL}}$	$L_{W_{XC}}$	$L_{W_{XR}}$
0.89	0.94	1.19	671	718	773
$\sigma_{\Delta W_{YCL}}$	$\sigma_{\Delta W_{YRC}}$	$\sigma_{\Delta W_{YRL}}$	$L_{W_{YL}}$	$L_{W_{YC}}$	$L_{W_{YR}}$
0.87	0.90	0.95	596	592	638
$\sigma_{\Delta W_{ZCL}}$	$\sigma_{\Delta W_{ZRC}}$	$\sigma_{\Delta W_{ZRL}}$	$L_{W_{ZL}}$	$L_{W_{ZC}}$	$L_{W_{ZR}}$
1.04	0.99	1.13	1115	484	834

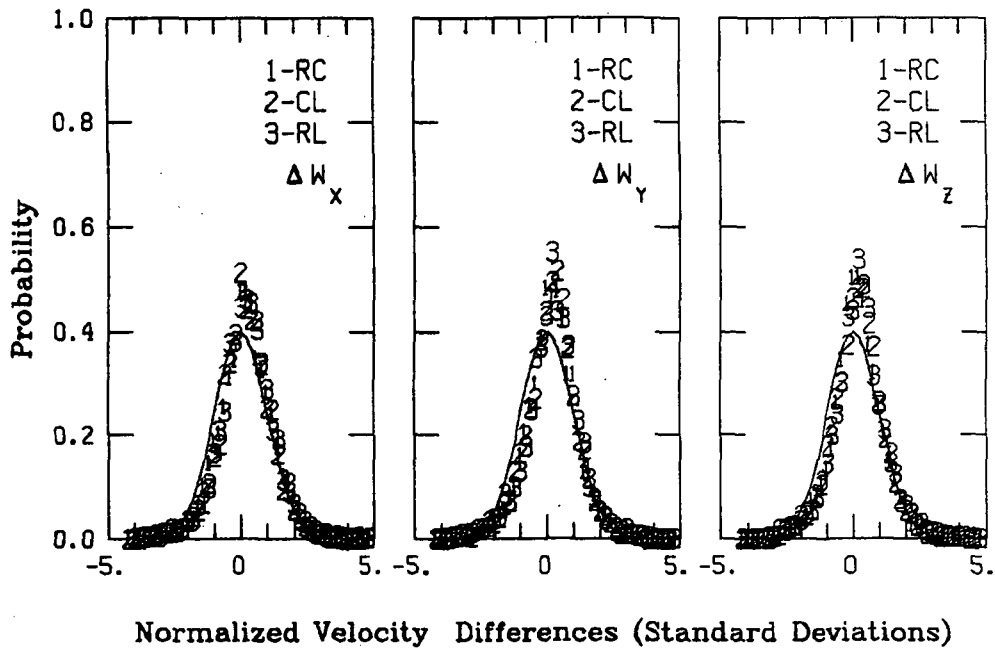
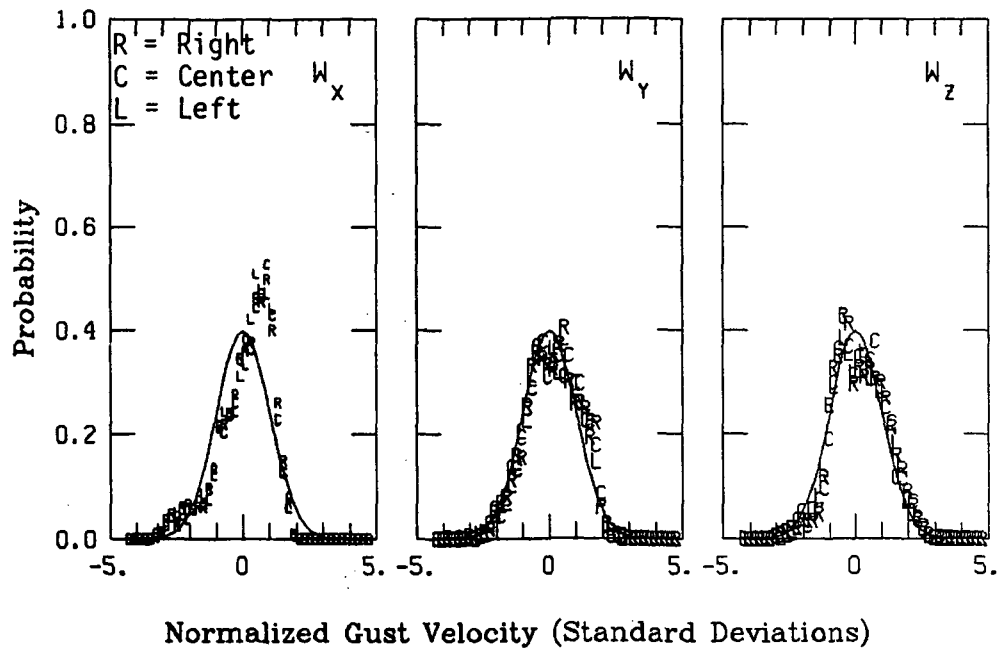

Figure A.253. Probability density function for gust velocities and gust velocity differences, Flight 6, Run 34.

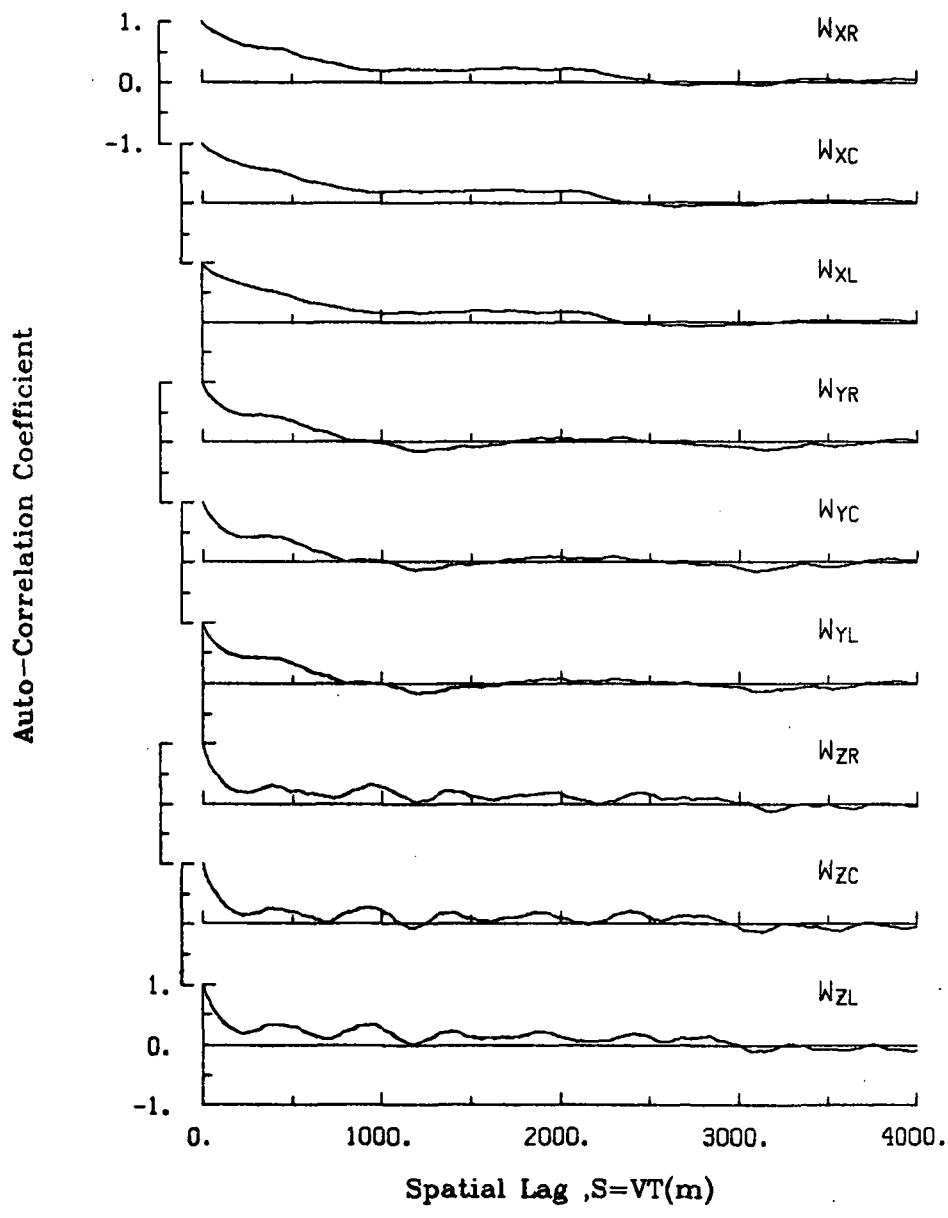

Figure A.254. Single-point auto-correlation coefficient of gust velocities, Flight 6, Run 34.

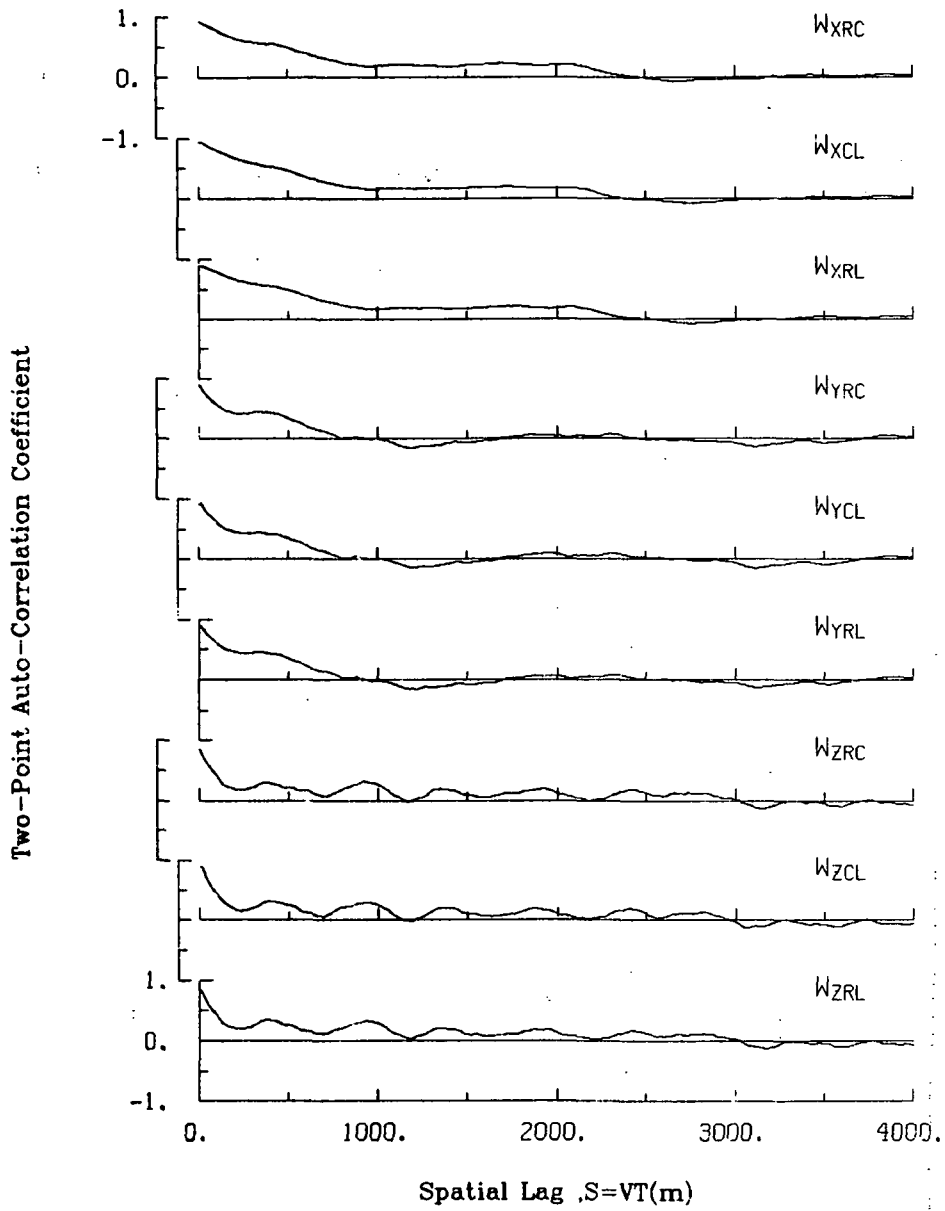

Figure A.255. Two-point auto-correlation coefficient of gust velocities, Flight 6, Run 34.

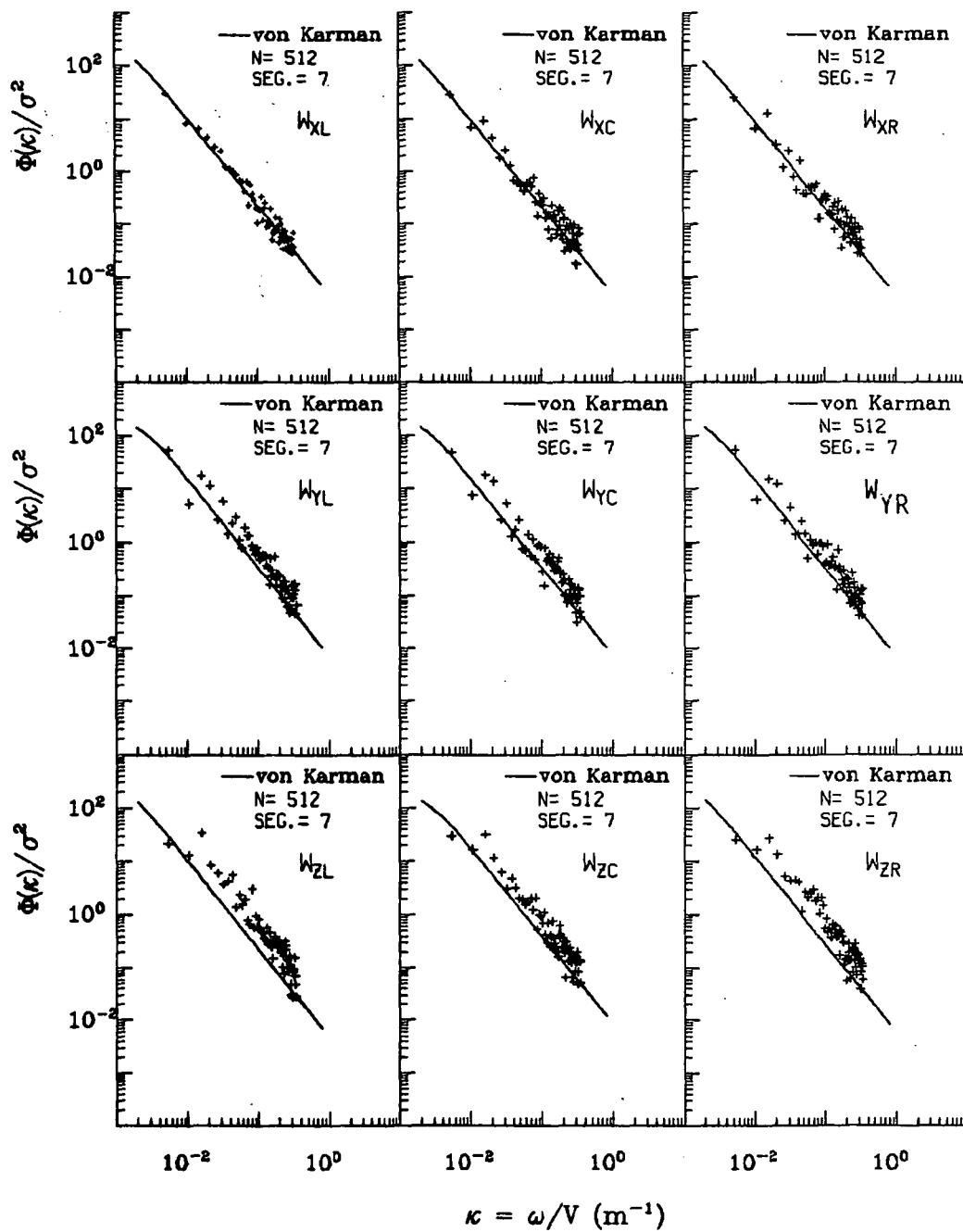

Figure A.256. Normalized auto-spectra of gust velocities, Flight 6, Run 34.

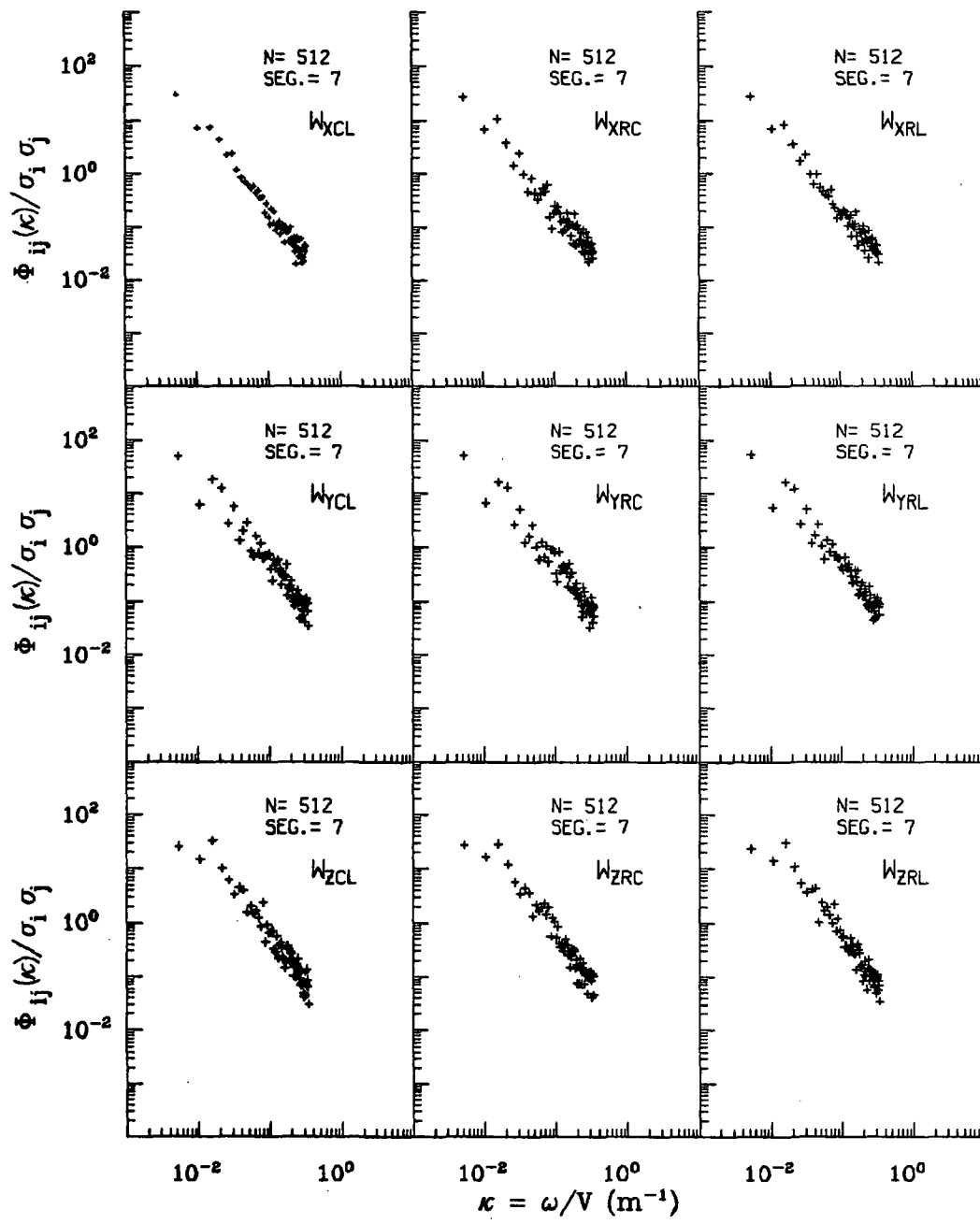

Figure A.257. Normalized two-point auto-spectra of gust velocities, Flight 6, Run 34.

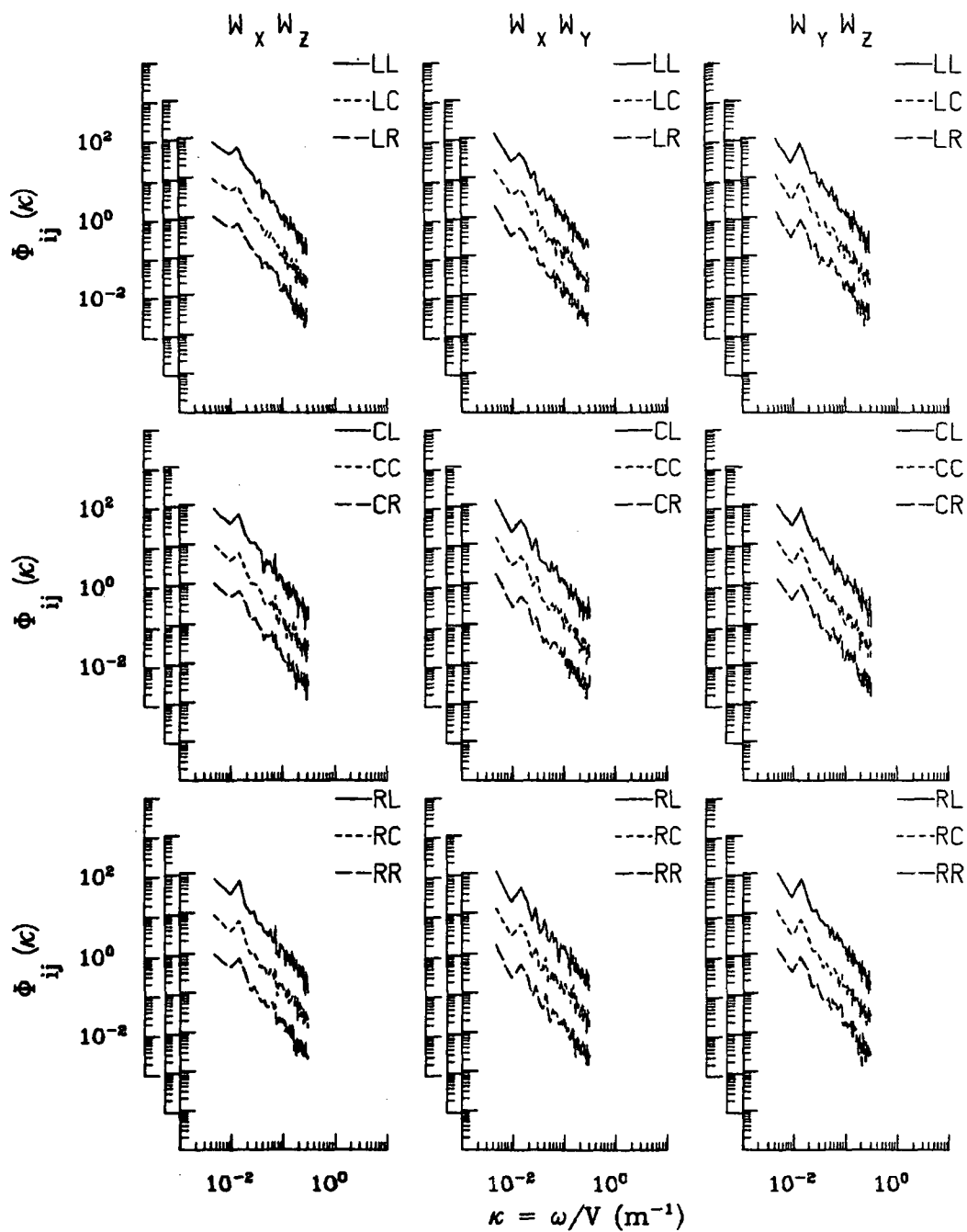

Figure A.258. Two-point cross-spectra of gust velocities, Flight 6, Run 34.

C-5

TABLE A.63. List of All Parameters Measured and Their Range of Values, Flight 6, Run 34.

START TIME = 55009.7189		STOP TIME = 55103.3189				
CHANNEL	UNITS	HIGH	LOW	MEAN	RMS	POINTS
2 PHI DOT	RAD/SEC	.128	-.133	-.00342	.03617	3744
3 ACCL N CG	G UNITS	-.988	-.988	-.98774	.98774	3744
4 THETA DOT	RAD/SEC	.072	-.049	.00605	.01475	3744
5 THETA	RAD	.079	.019	.04862	.05038	3744
6 PHI	RAD	.057	-.111	-.01297	.03306	3744
7 PSI 1	DEGREES	146.020	138.975	142.20724	142.21209	3744
8 DEL PSI 1	DEGREES	3.579	-3.150	.01757	1.14997	3744
9 PSI 2	DEGREES	505.086	498.059	501.38409	501.38536	3744
10 DEL PSI 2	DEGREES	3.520	-3.330	-.09880	1.15295	3744
11 ACCL N LT	G UNITS	2.309	.127	1.01108	1.04447	3744
12 ACCL N RT	G UNITS	2.420	-.236	1.02421	1.05858	3744
13 ACCL X CG	G UNITS	.108	.005	.05088	.05379	3744
14 ACCL Y CG	G UNITS	.167	-.143	.01420	.04965	3744
15 ALPHA CTR	RAD	.045	-.069	-.01631	.02167	3744
16 BETA CTR	RAD	.052	-.083	-.01406	.02655	3744
17 TEMP I	DEG F	97.904	97.365	97.65938	97.65949	3744
18 TEMP P	DEG F	92.523	92.343	92.39095	92.39099	3744
19 ACCL Z INS	G UNITS	1.526	.415	1.00267	1.01106	3744
20 ALPHA RT	RAD	.057	-.053	.00342	.01501	3744
21 BETA RT	RAD	.081	-.039	.02200	.03013	3744
22 ALPHA LT	RAD	.055	-.055	.00432	.01526	3744
23 BETA LT	RAD	.044	-.093	-.01754	.02755	3744
24 PSI DOT	RAD/SEC	.047	-.041	.00334	.01732	3744
25 TEMP TOT	DEG C	32.080	29.619	30.76657	30.77297	3744
26 OC LT	PSID	.916	.670	.75544	.75678	3744
27 OC CTR	PSID	.889	.657	.74155	.74282	3744
28 OC RT	PSID	.917	.682	.76943	.77075	3744
29 PS	PSIA	11.667	11.325	11.60633	11.60633	3744
30 TEMP IRT	DEG C	15.152	8.063	13.65616	13.71274	3744
31 D TO G	METERS	8781697.6518775113.971	*****	*****	*****	3744
32 B TO D	DEGREES	80.569	80.490	80.53013	80.53013	3744
33 LONG	DEGREES	-104.564	-104.659	-104.61128	104.61128	3744
34 LAT	DEGREES	39.965	39.887	39.92564	39.92565	3744
35 TRK ANG	DEGREES	137.883	136.115	136.82359	136.82423	3744
36 HDG	PADIANS	2.535	2.417	2.47286	2.47294	3744
37 VE	M/SEC	88.940	85.651	87.06648	87.07146	3744
38 VN	M/SEC	-91.296	-94.667	-92.71491	92.71873	3744
39 ALTITUDE	KM	2.144	1.905	1.94667	1.94668	3744
40 TEMPC	DEGREES C	26.340	24.425	25.43653	25.44042	3744
41 FW WND SPD	KNOTS	61.234	34.797	46.82274	46.94765	3744
42 NS WND SPD	KNOTS	-4.983	-31.366	-20.75382	21.41187	3744
43 WIND SPEED	KNOTS	62.619	36.036	51.45601	51.59990	3744
44 WIND DIPEC	DEGREES	306.443	276.251	293.73613	293.79008	3744
45 AIRSPEED P	M/SEC	115.007	99.407	105.32870	105.37107	3744
46 AIRSPEED C	M/SEC	113.043	97.624	103.44526	103.48666	3744
47 AIRSPEED L	M/SEC	114.693	98.464	104.38598	104.42937	3744
48 DELTA ALT	METERS	207.001	-31.831	9.87299	12.34200	3744
49 INRTL DISP	METERS	20.985	0.000	13.15567	14.02453	3744
50 UG PIGHT	M/SEC	4.650	-8.538	.00000	2.52999	3744
51 UG CENTER	M/SEC	4.536	-8.651	.00000	2.47754	3744
52 UG LEFT	M/SEC	5.419	-9.335	.00000	2.58126	3744
53 VG RIGHT	M/SEC	5.524	-6.757	-.00546	1.99429	3744
54 VG CENTER	M/SEC	5.352	-8.365	-.00439	2.06950	3744
55 VG LEFT	M/SEC	5.030	-7.574	-.00730	2.00985	3744
56 WG RIGHT	M/SEC	5.848	-6.444	.00281	1.96394	3744
57 WG CENTER	M/SEC	7.044	-6.161	-.00020	1.79981	3744
58 WG LEFT	M/SEC	6.653	-7.641	.00724	2.01710	3744

ORIGINAL PAGE IS
OF POOR QUALITY

Date: July 14, 1982
Time: 15:21:25 (MDT)
Duration: 68 seconds

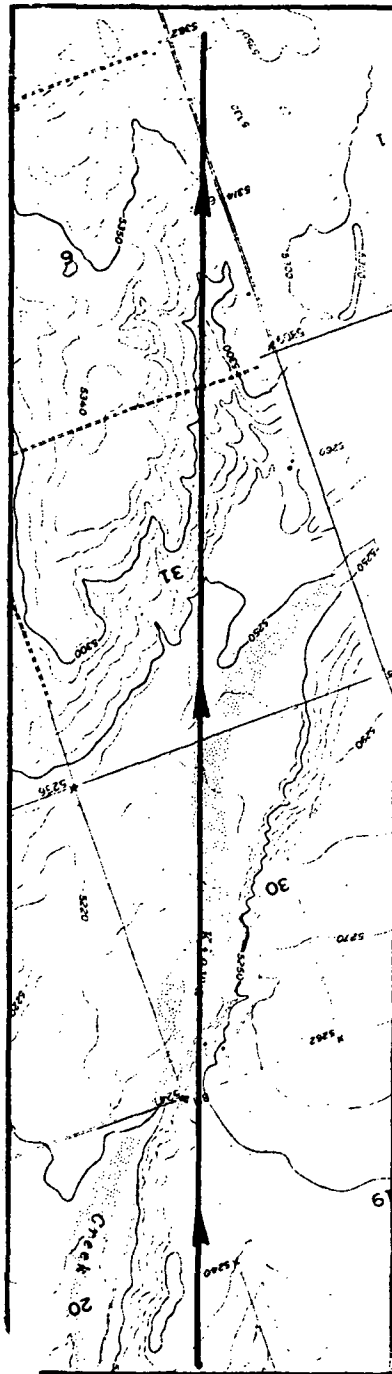
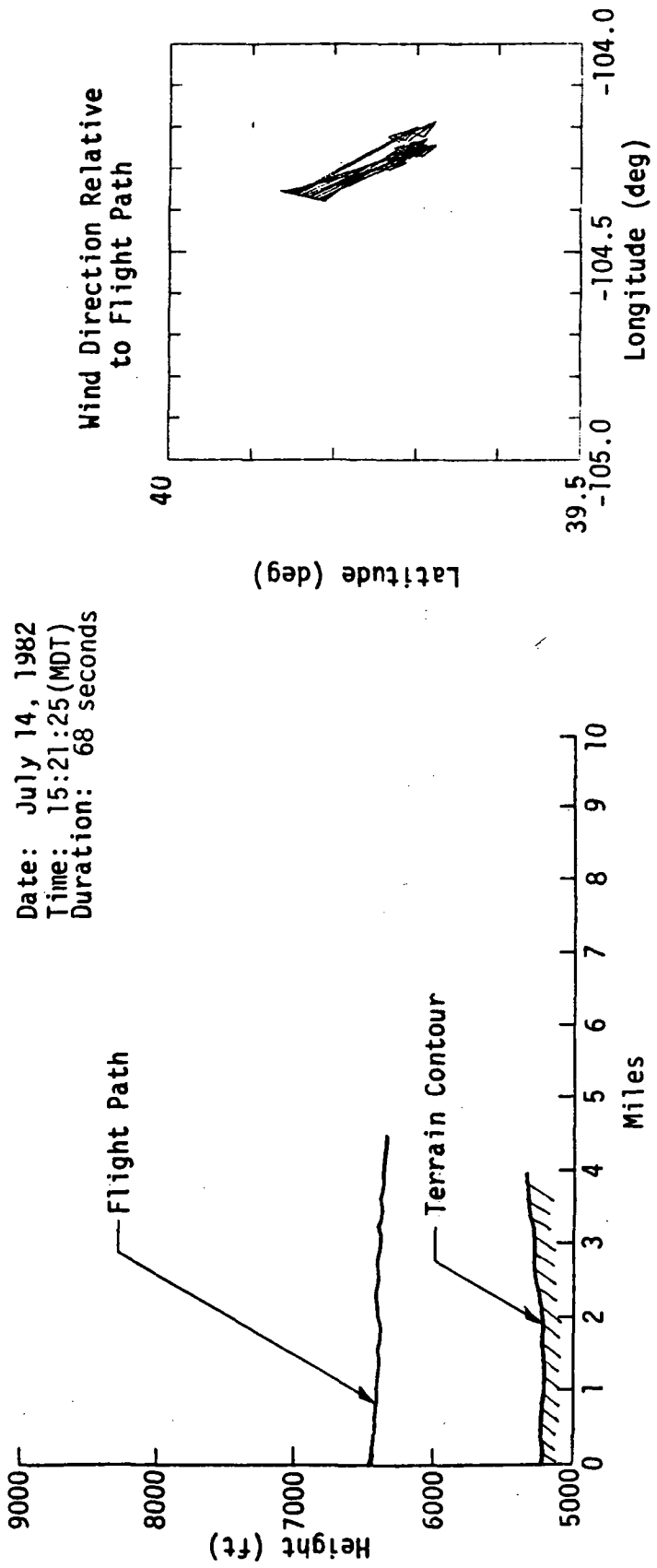

Figure A.259. Flight path information, Flight 6, Run 35.

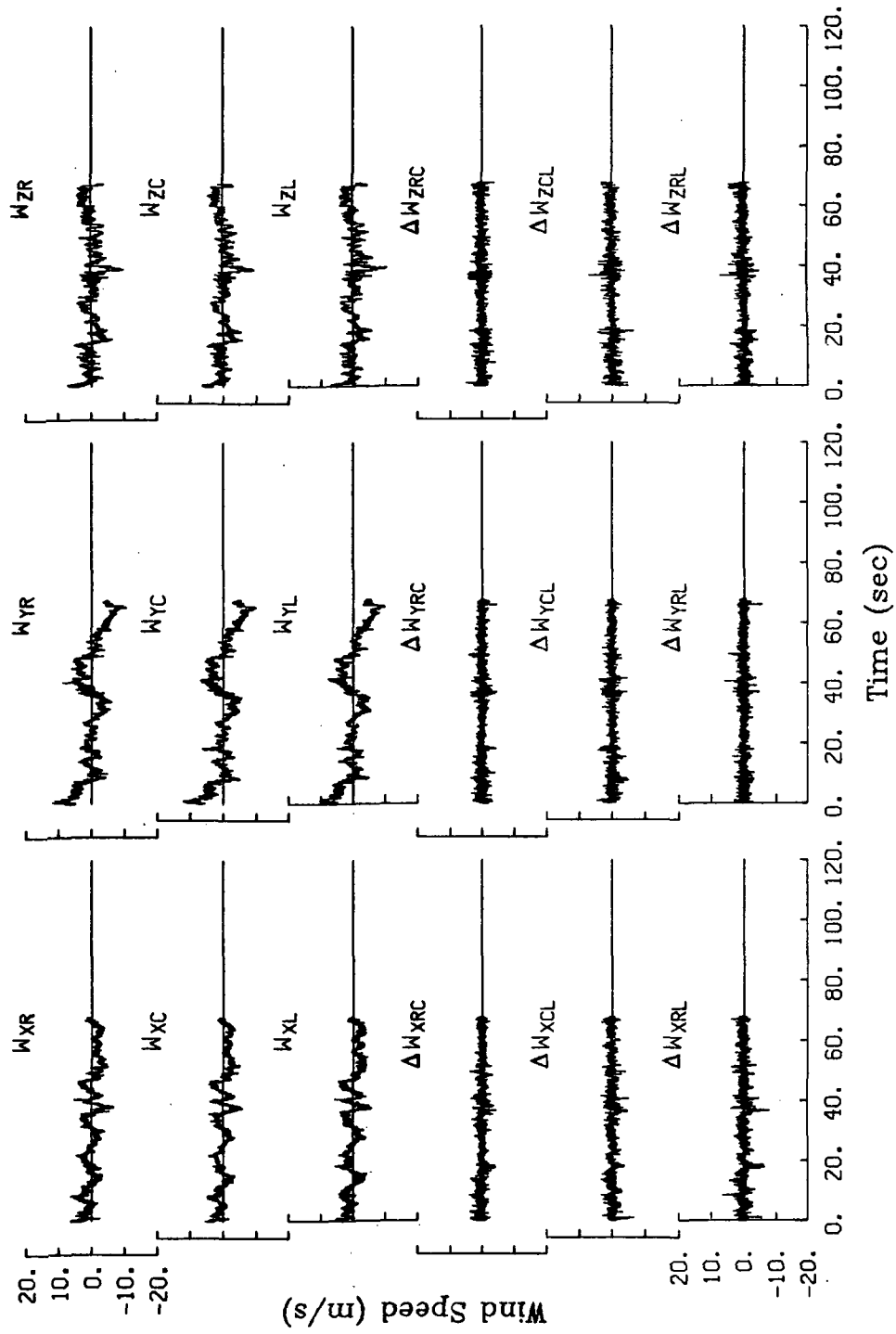
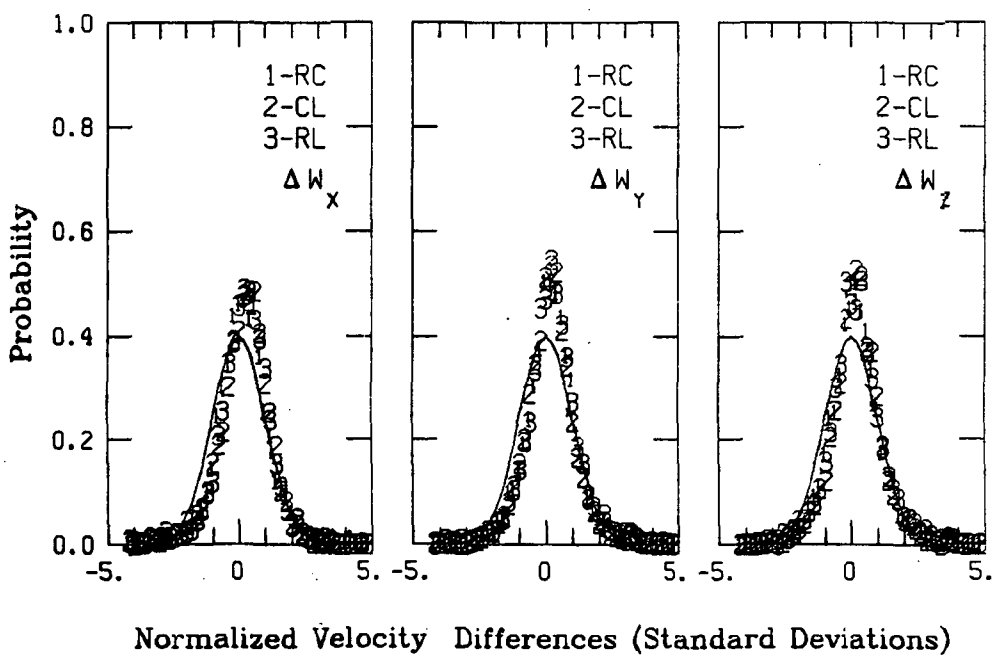
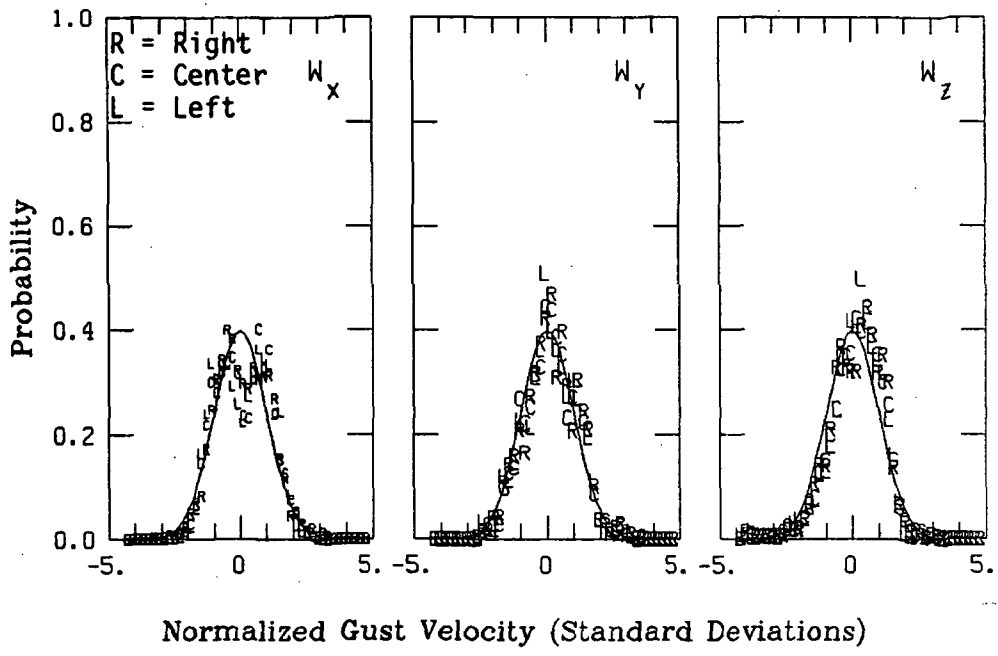

Figure A.260. Time histories of gust velocities and gust velocity differences, Flight 6, Run 35.

TABLE A.64. Average Turbulence Parameters and Integral Length Scales, Flight 6, Run 35.

I. Mean Airspeed (m/s)			II. Standard Deviation of Gust Velocities (m/s)		
V_L	V_C	V_R	$\sigma_{W_{XL}}$	$\sigma_{W_{XC}}$	$\sigma_{W_{XR}}$
107.6	106.6	108.4	2.09	1.91	2.01
			$\sigma_{W_{YL}}$	$\sigma_{W_{YC}}$	$\sigma_{W_{YR}}$
			3.28	3.35	3.32
			$\sigma_{W_{ZL}}$	$\sigma_{W_{ZC}}$	$\sigma_{W_{ZR}}$
			2.20	2.09	2.28
III. Standard Deviation of Gust Velocity Differences (m/s)			IV. Integral Length Scale (m)		
$\sigma_{\Delta W_{XCL}}$	$\sigma_{\Delta W_{XRC}}$	$\sigma_{\Delta W_{XRL}}$	$L_{W_{XL}}$	$L_{W_{XC}}$	$L_{W_{XR}}$
0.91	0.99	1.26	184	184	187
$\sigma_{\Delta W_{YCL}}$	$\sigma_{\Delta W_{YRC}}$	$\sigma_{\Delta W_{YRL}}$	$L_{W_{YL}}$	$L_{W_{YC}}$	$L_{W_{YR}}$
0.88	0.92	0.91	791	753	788
$\sigma_{\Delta W_{ZCL}}$	$\sigma_{\Delta W_{ZRC}}$	$\sigma_{\Delta W_{ZRL}}$	$L_{W_{ZL}}$	$L_{W_{ZC}}$	$L_{W_{ZR}}$
0.95	1.07	1.15	363	397	361



. Probability density function for gust velocities and gust velocity differences, Flight 6, Run 35.

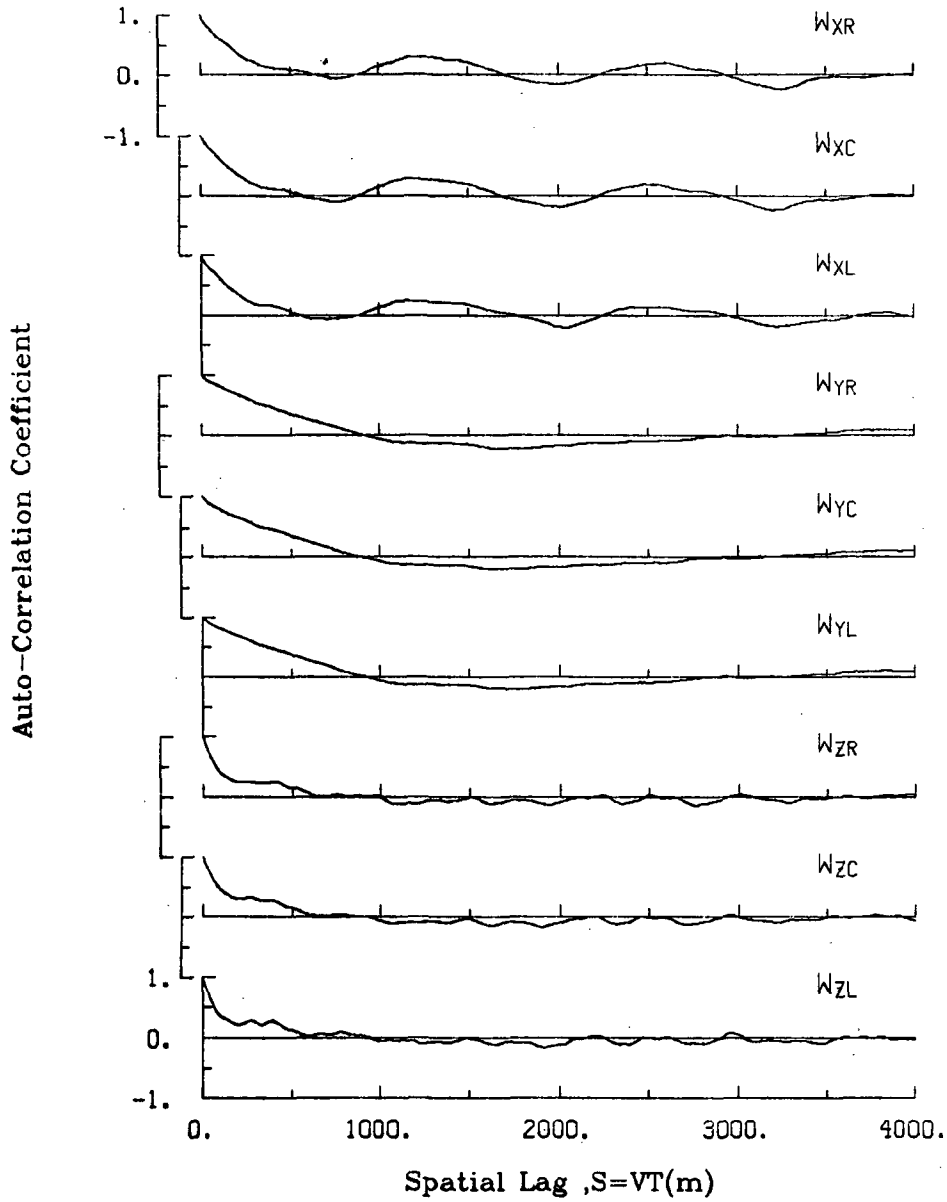

Figure A.246. Single-point auto-correlation coefficient of gust velocities, Flight 6, Run 35.

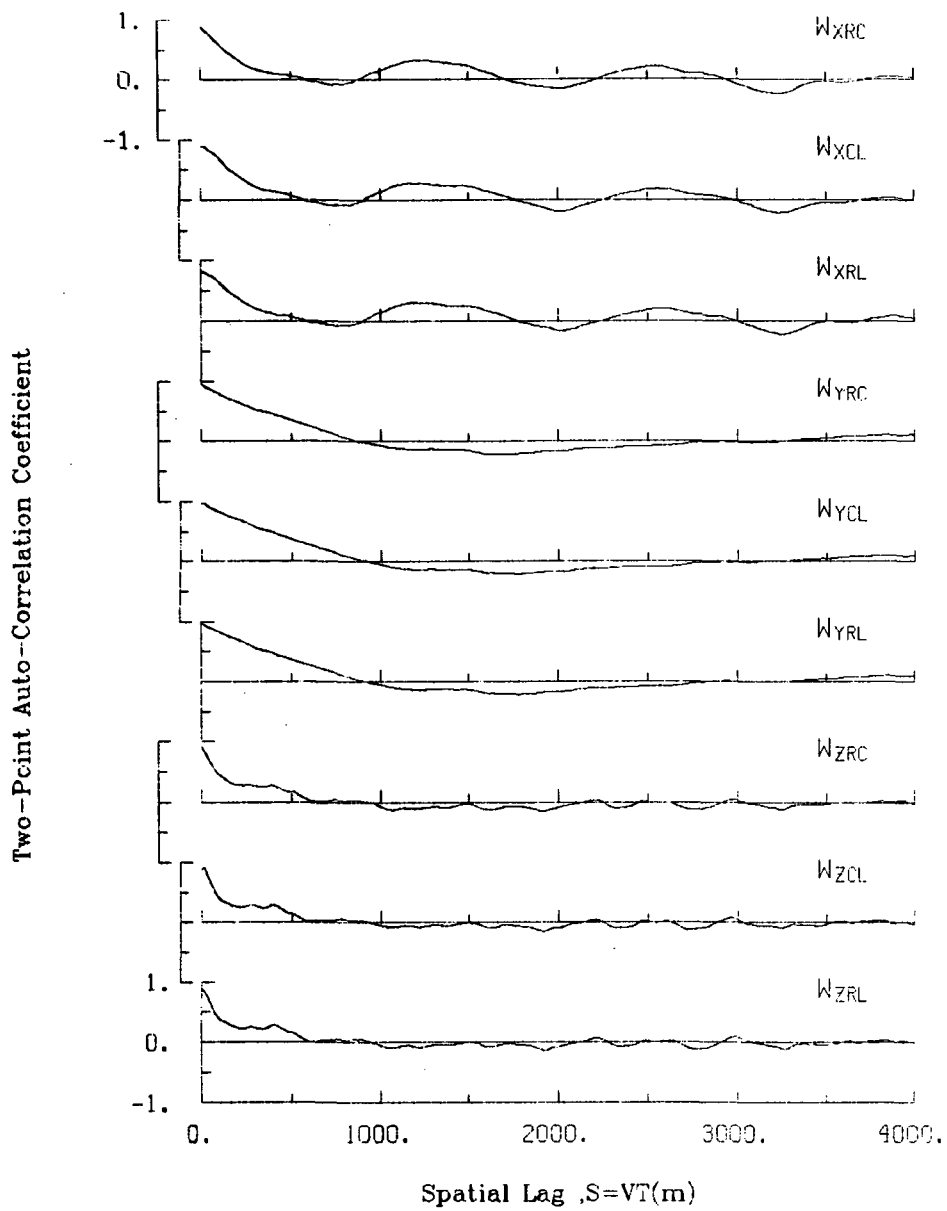

Figure A.261. Two-point auto-correlation coefficient of gust velocities, Flight 6, Run 35.

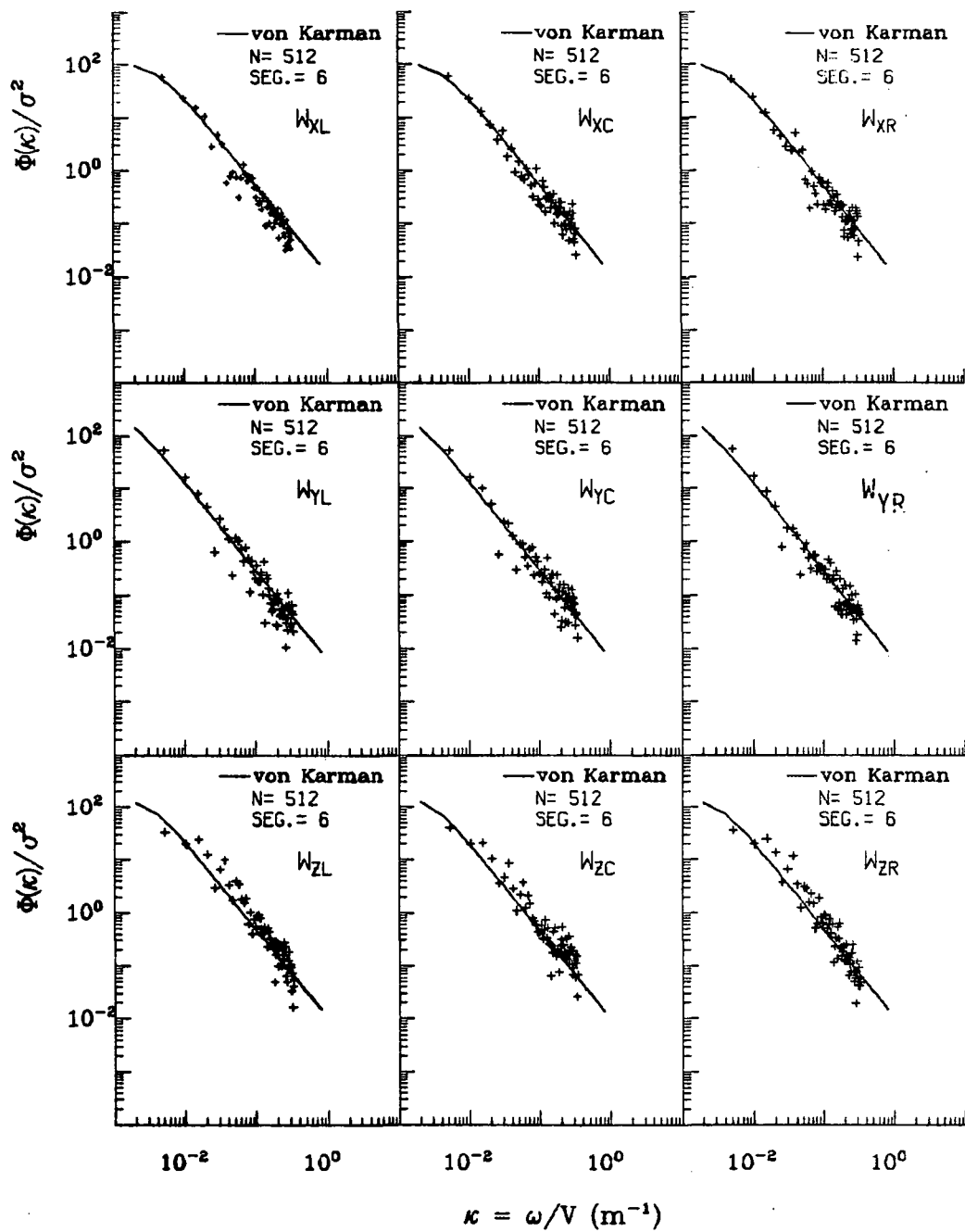

Figure A.262. Normalized auto-spectra of gust velocities, Flight 6, Run 35.

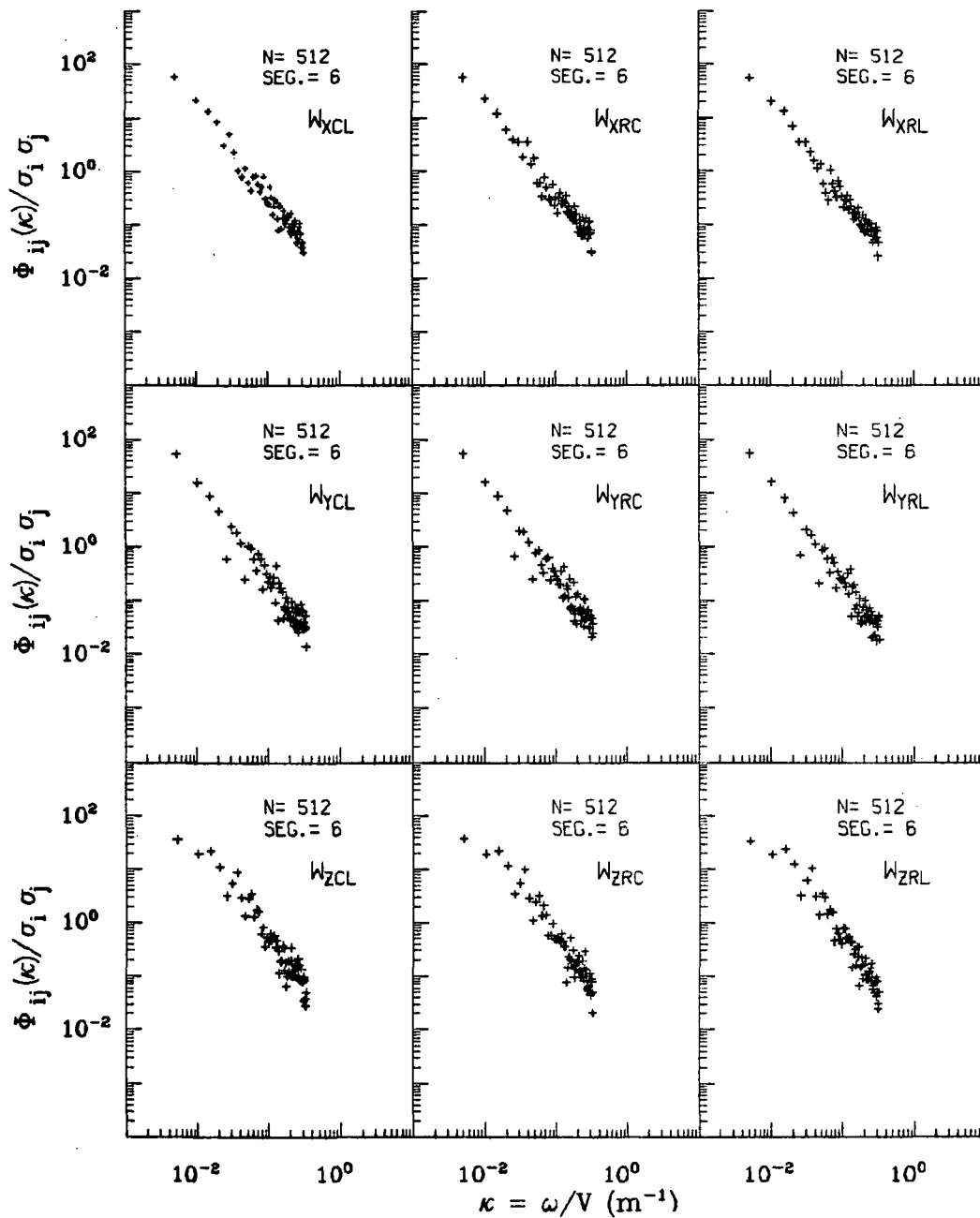

Figure A.263. Normalized two-point auto-spectra of gust velocities, Flight 6, Run 35.

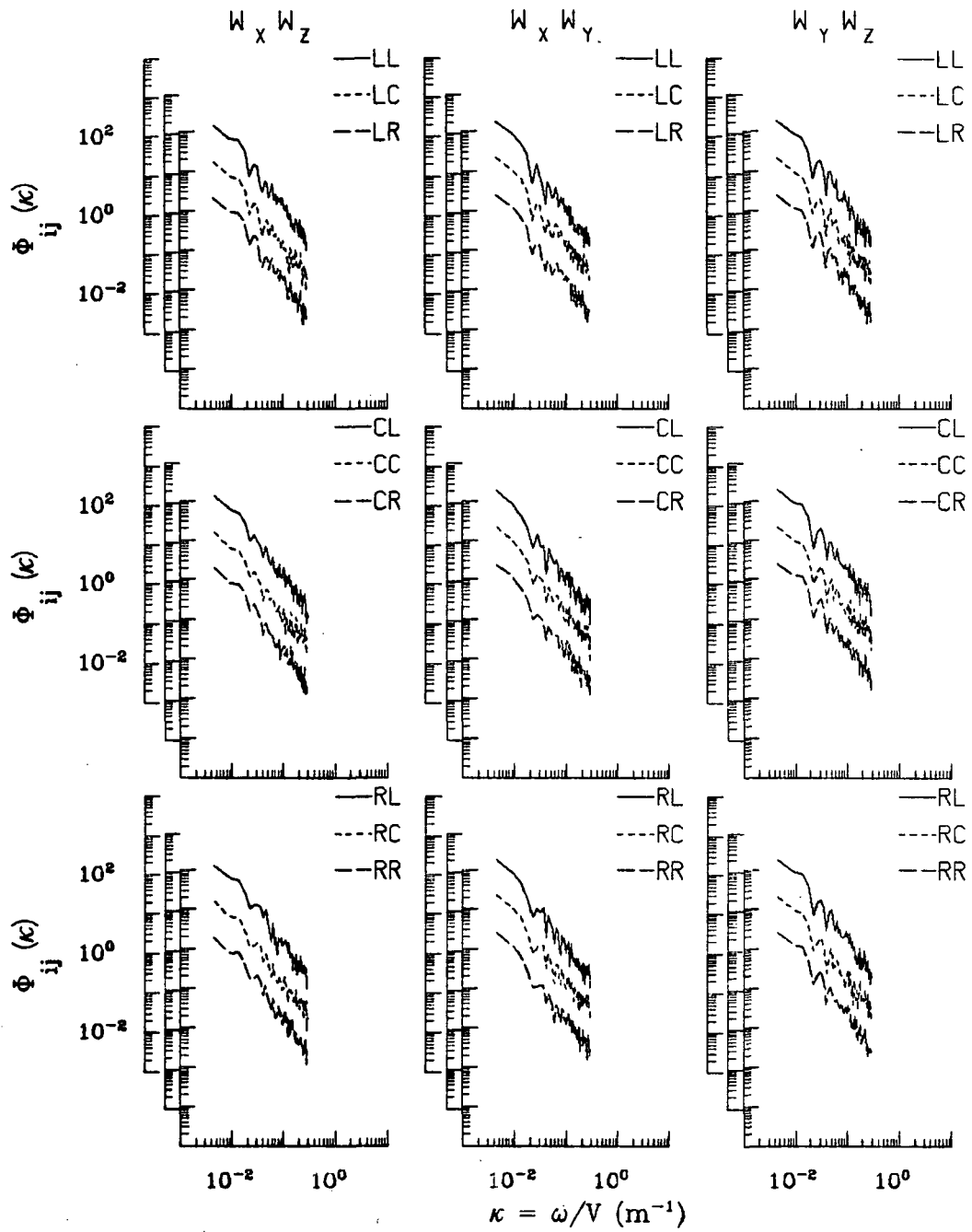

Figure A.264. Two-point cross-spectra of gust velocities, Flight 6, Run 35.

TABLE A.65. List of All Parameters Measured and Their Range of Values, Flight 6, Run 35.

		START TIME = 55285.3543		STOP TIME = 55353.3043			
CHANNEL	UNITS	HIGH	LOW	MEAN	RMS	POINTS	
2	PHI DOT	RAD/SEC	.095	-.099	-.00338	.03385	2718
3	ACCL N CG	G UNITS	-.988	-.988	-.98774	.98774	2718
4	THETA DOT	RAD/SEC	.070	-.047	.00586	.01629	2718
5	THETA	RAD	.092	.020	.04795	.05007	2718
6	PHI	RAD	.099	-.119	-.01006	.03914	2718
7	PSI 1	DEGREES	13.582	4.776	9.02313	9.22877	2718
8	DEL PSI 1	DEGREES	8.694	.347	4.33168	4.73575	2718
9	PSI 2	DEGREES	371.316	362.867	366.86255	366.86734	2718
10	DEL PSI 2	DEGREES	8.371	-.067	3.98418	4.42246	2718
11	ACCL N LT	G UNITS	2.298	-.438	1.00968	1.05372	2718
12	ACCL N RT	G UNITS	2.288	-.338	1.02202	1.06064	2718
13	ACCL X CG	G UNITS	.120	.011	.04955	.05131	2718
14	ACCL Y CG	G UNITS	.173	-.195	.01067	.05095	2718
15	ALPHA CTR	RAD	.045	-.081	-.02319	.02756	2718
16	BETA CTR	RAD	.073	-.115	-.01748	.02996	2718
17	TEMP I	DEG F	97.724	97.365	97.47397	97.47402	2718
18	TEMP P	DEG F	92.703	92.523	92.54734	92.54736	2718
19	ACCL Z INS	G UNITS	1.716	.427	.99980	1.01037	2718
20	ALPHA RT	RAD	.062	-.068	-.01223	.02005	2718
21	BETA RT	RAD	.103	-.060	.01693	.02769	2718
22	ALPHA LT	RAD	.059	-.072	-.01249	.02042	2718
23	BETA LT	RAD	.054	-.115	-.02211	.03107	2718
24	PSI DOT	RAD/SEC	.062	-.054	.00465	.02079	2718
25	TEMP TOT	DEG C	33.065	31.785	32.42029	32.42126	2718
26	QC LT	PSID	.899	.717	.80012	.80063	2718
27	QC CTR	PSID	.888	.705	.78437	.78481	2718
28	QC RT	PSID	.936	.715	.81260	.81310	2718
29	PS	PSIA	11.655	11.387	11.61012	11.61013	2718
30	TEMP IRT	DEG C	21.708	19.312	20.58946	20.59785	2718
31	D TO G	METERS	8799137.088	8795967.168	*****	*****	2718
32	B TO D	DEGREES	80.714	80.707	80.71034	80.71034	2718
33	LONG	DEGREES	-104.353	-104.378	-104.36563	104.36563	2718
34	LAT	DEGREES	39.866	39.811	39.83869	39.83869	2718
35	TRK ANG	DEGREES	21.881	18.634	19.90451	19.92664	2718
36	HDG	RADIANS	.251	.100	.17238	.17589	2718
37	VE	M/SFC	35.668	30.916	32.75383	32.78213	2718
38	VW	M/SEC	91.921	88.390	90.49852	90.50571	2718
39	ALTITUDE	KM	2.100	1.913	1.94403	1.94406	2718
40	TEMP C	DEGREES C	27.372	26.225	26.76605	26.76681	2718
41	EW WND SPD	KNOTS	48.924	6.029	24.63383	25.59948	2718
42	NS WND SPD	KNOTS	-17.423	-38.796	-27.41379	27.62350	2718
43	WIND SPEED	KNOTS	57.673	24.643	37.30196	37.66154	2718
44	WIND DIREC	DEGREES	345.840	296.238	318.82575	318.95269	2718
45	AIRSPD R	M/SEC	116.223	101.773	108.42732	108.44349	2718
46	AIRSPD C	M/SEC	113.220	101.076	106.57343	106.58758	2718
47	AIRSPD L	M/SEC	113.985	101.921	107.61115	107.62759	2718
48	DELTA ALT	METERS	177.115	-10.421	20.99786	22.91983	2718
49	INRTL DISP	METERS	33.615	0.000	21.19528	22.69835	2718
50	UG RIGHT	M/SEC	6.371	-6.567	-.00000	1.97873	2718
51	UG CENTER	M/SEC	5.436	-5.729	-.00000	1.87465	2718
52	UG LEFT	M/SEC	5.861	-5.778	-.00000	2.06551	2718
53	VG RIGHT	M/SEC	12.026	-10.131	-.00057	3.52266	2718
54	VG CENTER	M/SEC	12.321	-9.742	-.00384	3.52605	2718
55	VG LEFT	M/SEC	10.401	-9.609	-.01005	3.47414	2718
56	WG RIGHT	M/SEC	7.471	-9.913	-.01703	2.27860	2718
57	WG CENTER	M/SEC	6.582	-9.447	-.01888	2.08804	2718
58	WG LEFT	M/SEC	7.672	-10.679	-.01758	2.20457	2718

Date: July 14, 1982
 Time: 15:23:55 (MDT)
 Duration: 57 seconds

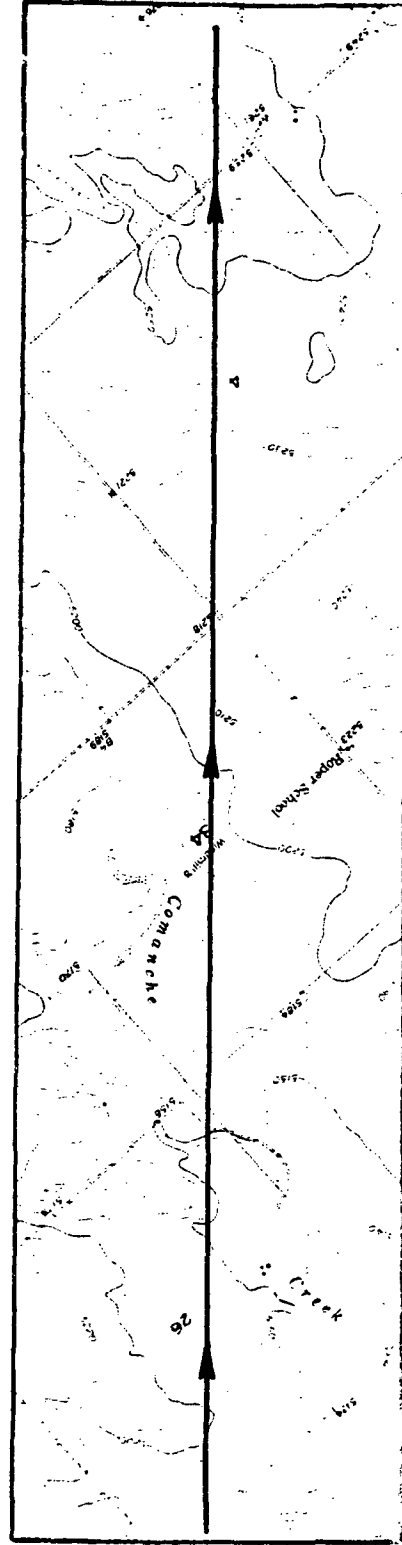
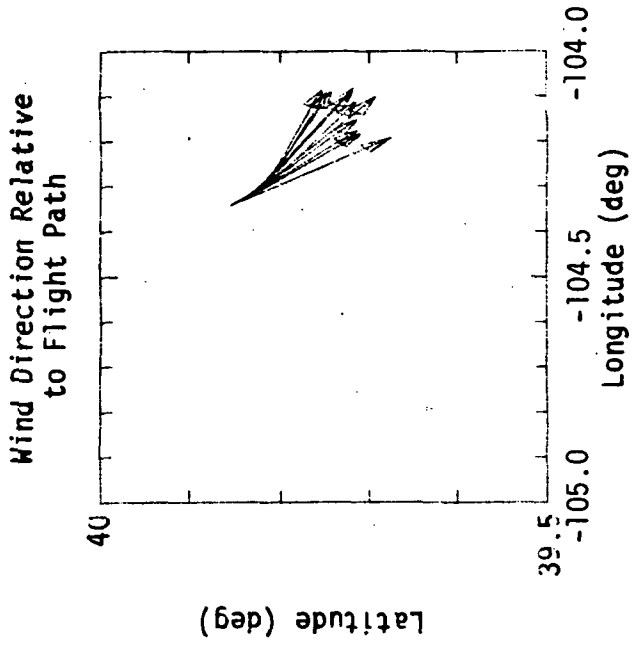
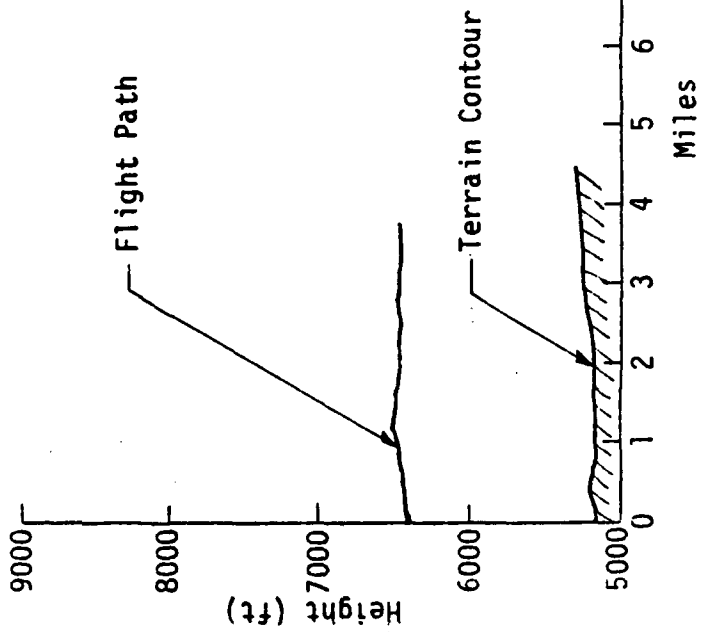

Figure A.265. Flight path information, Flight 6, Run 36.

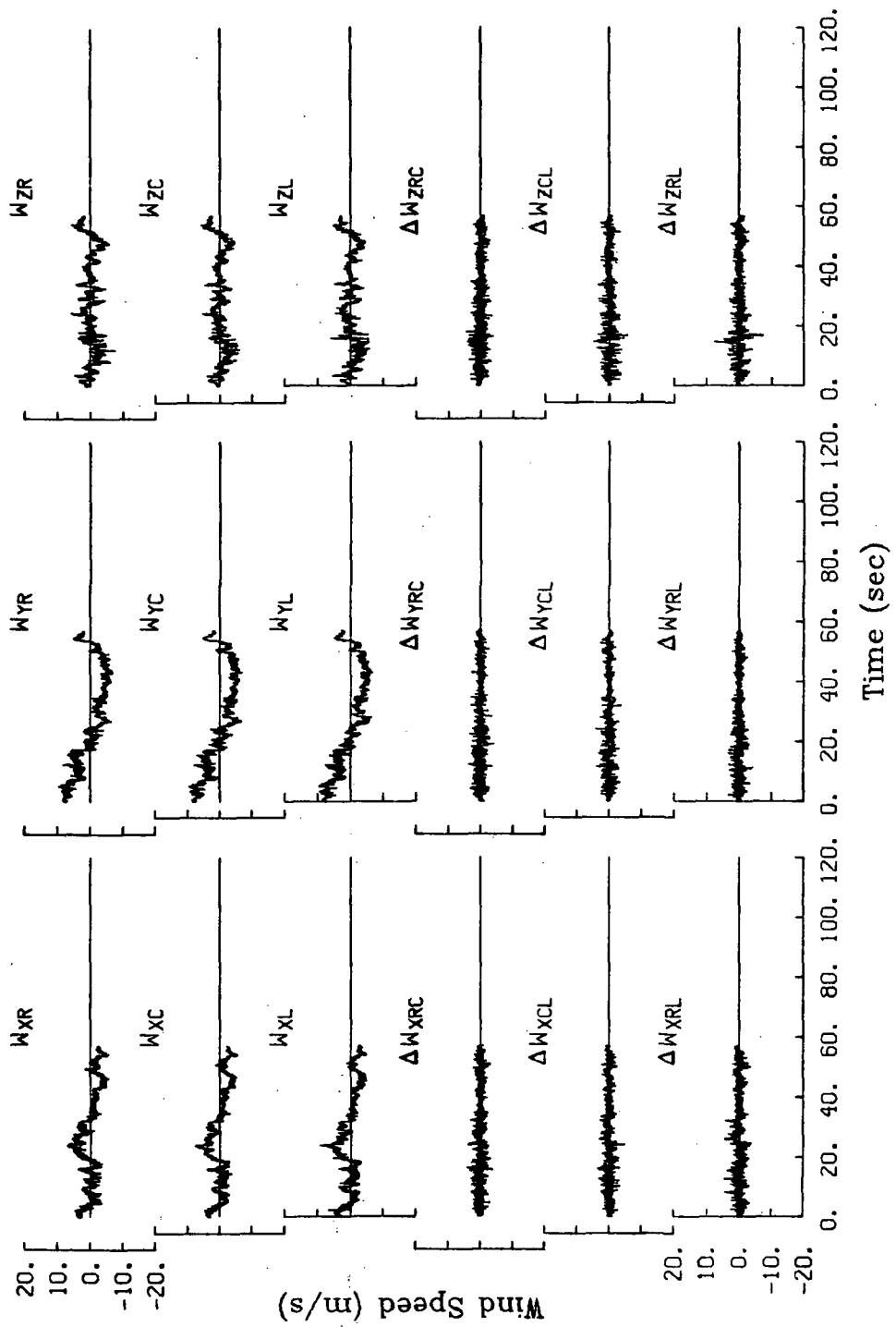

Figure A.266. Time histories of gust velocities and gust velocity differences, Flight 6, Run 36.

TABLE A.66. Average Turbulence Parameters and Integral Length Scales, Flight 6, Run 36.

I. Mean Airspeed (m/s)

V_L	V_C	V_R
107.9	106.8	108.7

II. Standard Deviation of Gust Velocities (m/s)

$\sigma_{W_{XL}}$	$\sigma_{W_{XC}}$	$\sigma_{W_{XR}}$
2.48	2.44	2.49
$\sigma_{W_{YL}}$	$\sigma_{W_{YC}}$	$\sigma_{W_{YR}}$
4.18	4.21	4.26
$\sigma_{W_{ZL}}$	$\sigma_{W_{ZC}}$	$\sigma_{W_{ZR}}$
1.92	1.70	1.85

III. Standard Deviation of Gust Velocity Differences (m/s)

$\sigma_{\Delta W_{XCL}}$	$\sigma_{\Delta W_{XRC}}$	$\sigma_{\Delta W_{XRL}}$
0.90	0.88	1.12
$\sigma_{\Delta W_{YCL}}$	$\sigma_{\Delta W_{YRC}}$	$\sigma_{\Delta W_{YRL}}$
0.86	0.85	0.90
$\sigma_{\Delta W_{ZCL}}$	$\sigma_{\Delta W_{ZRC}}$	$\sigma_{\Delta W_{ZRL}}$
0.97	1.02	1.22

IV. Integral Length Scale (m).

$L_{W_{XL}}$	$L_{W_{XC}}$	$L_{W_{XR}}$
415	439	460
$L_{W_{YL}}$	$L_{W_{YC}}$	$L_{W_{YR}}$
1637	1588	1632
$L_{W_{ZL}}$	$L_{W_{ZC}}$	$L_{W_{ZR}}$
339	357	297

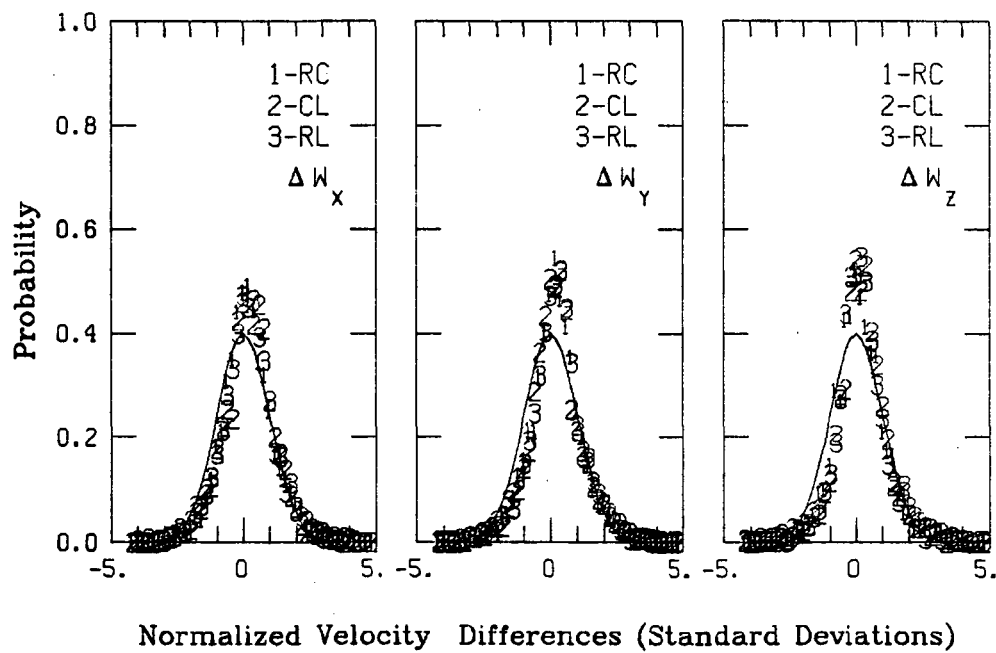
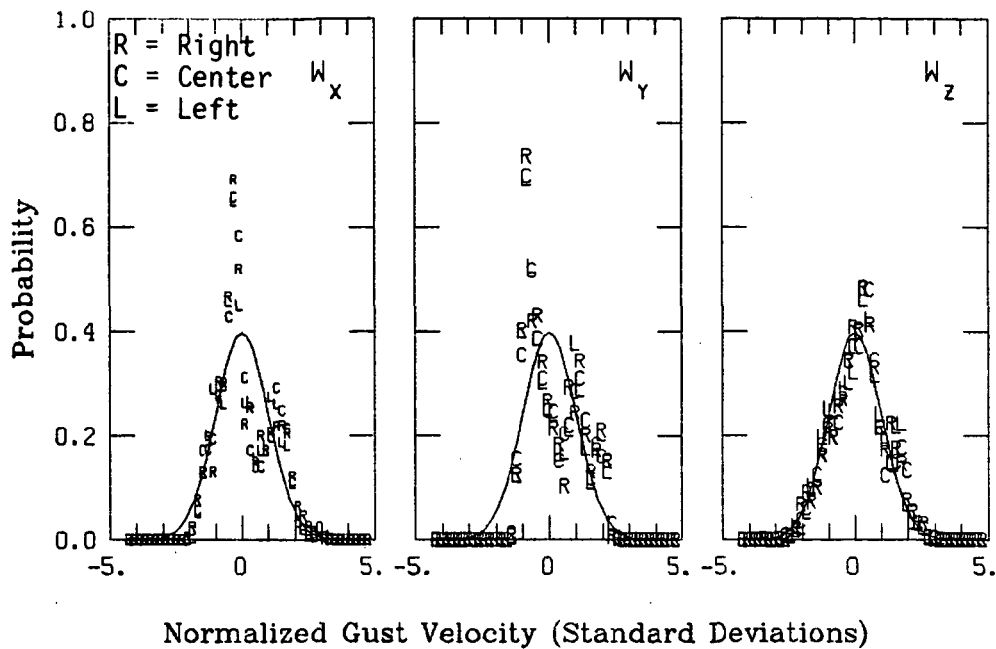

Figure A.267. Probability density function for gust velocities and gust velocity differences, Flight 6, Run 36.

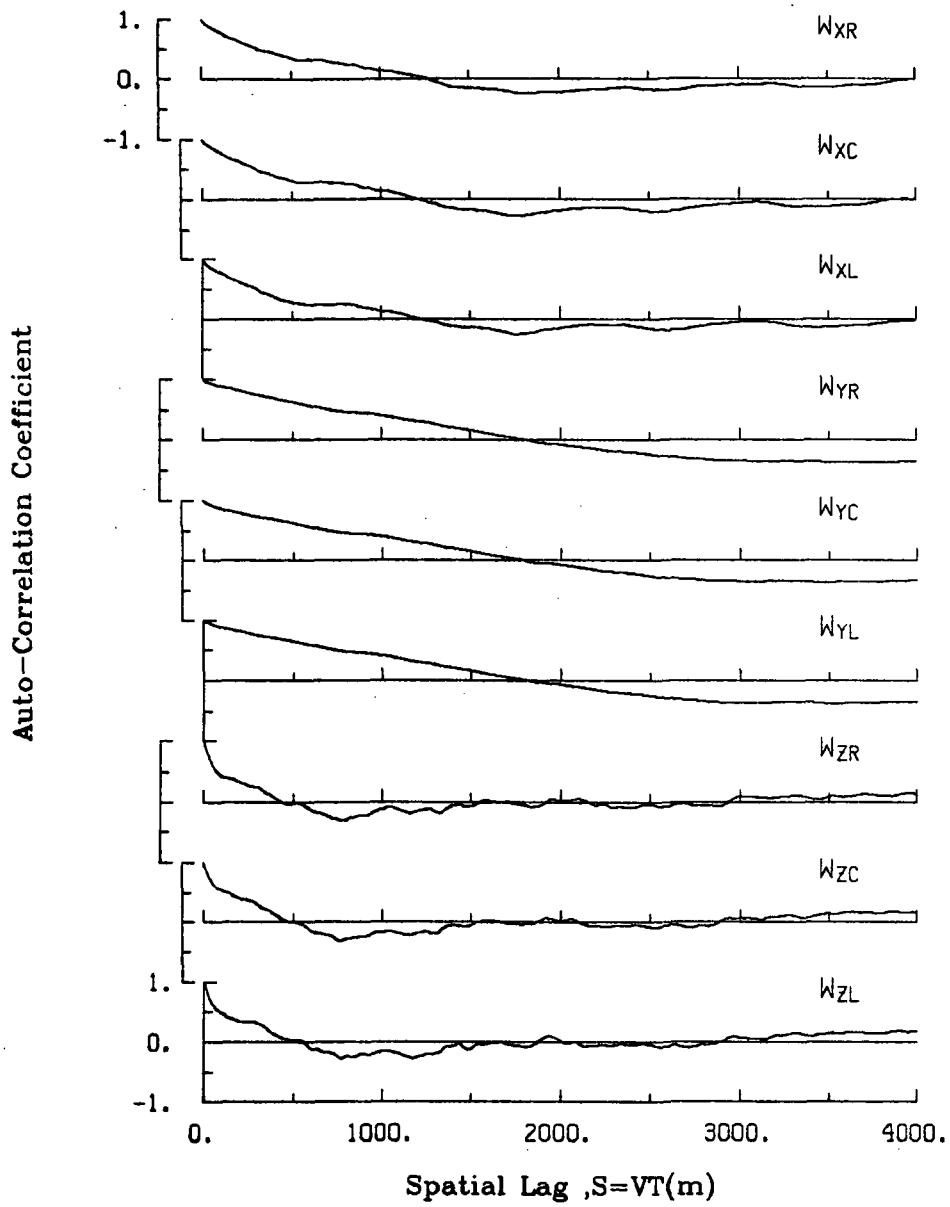

Figure A.268. Single-point auto-correlation coefficient of gust velocities, Flight 6, Run 36.

ORIGINAL PAGE IS
OF POOR QUALITY

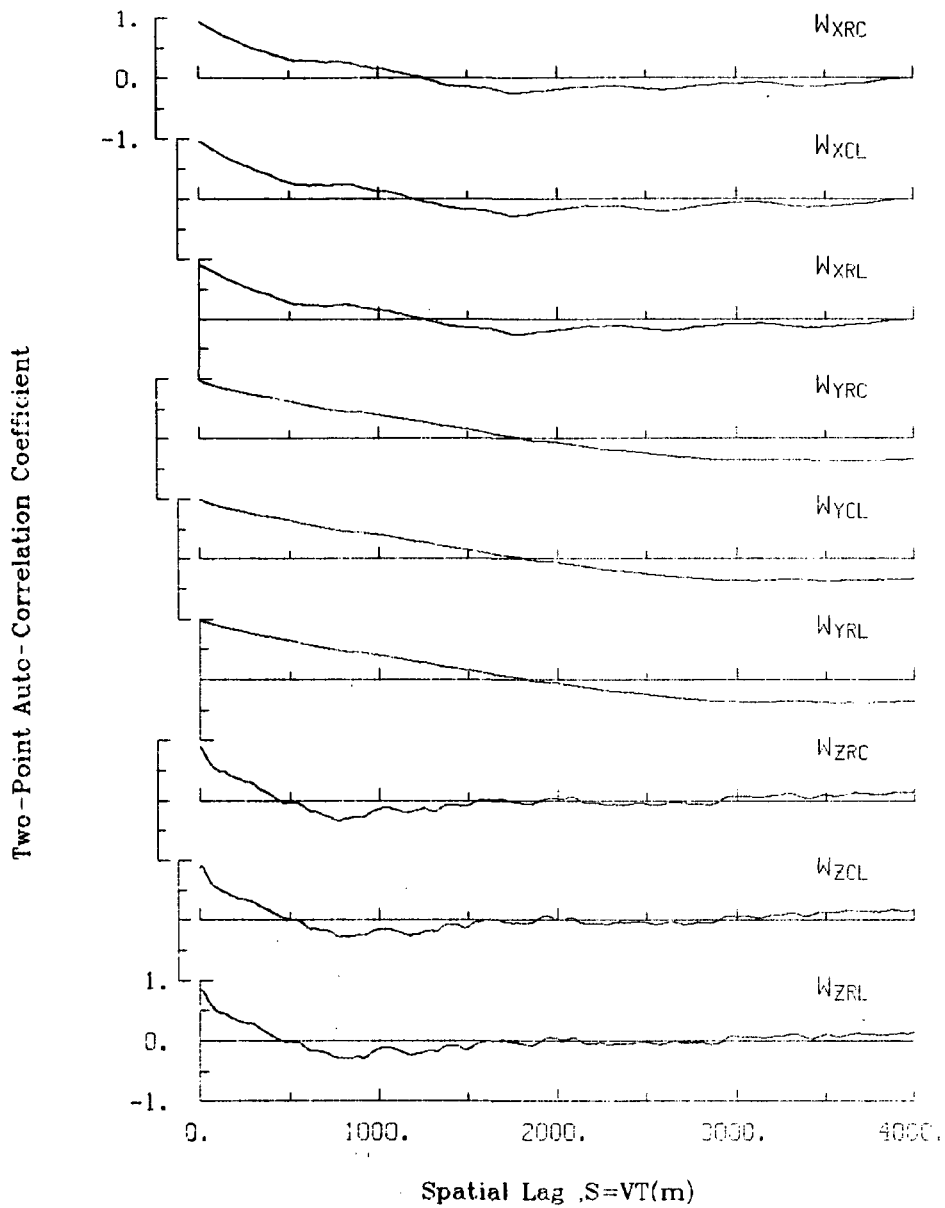

Figure A.269. Two-point auto-correlation coefficient of gust velocities, Flight 6, Run 36.

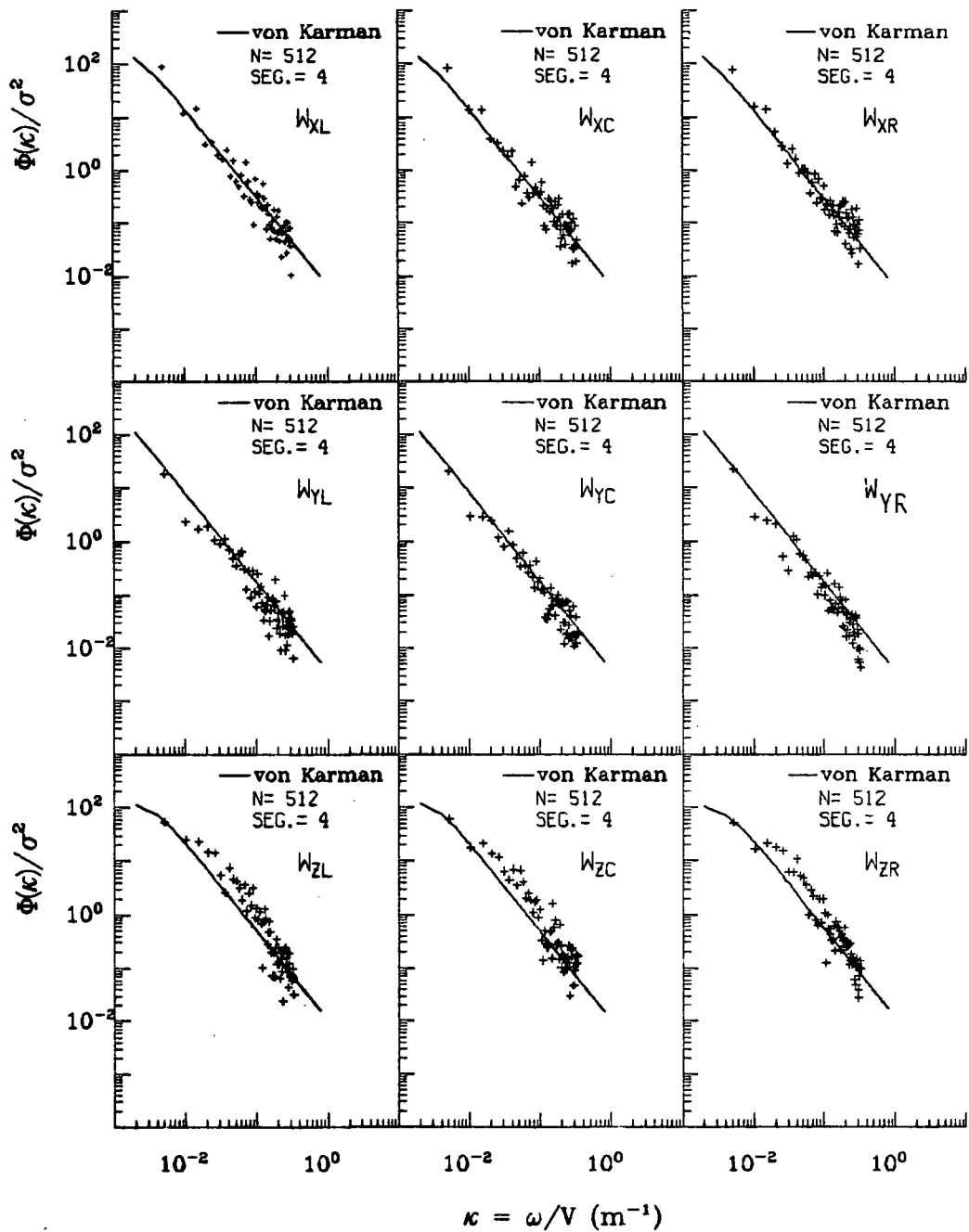

Figure A.270. Normalized auto-spectra of gust velocities, Flight 6, Run 36.

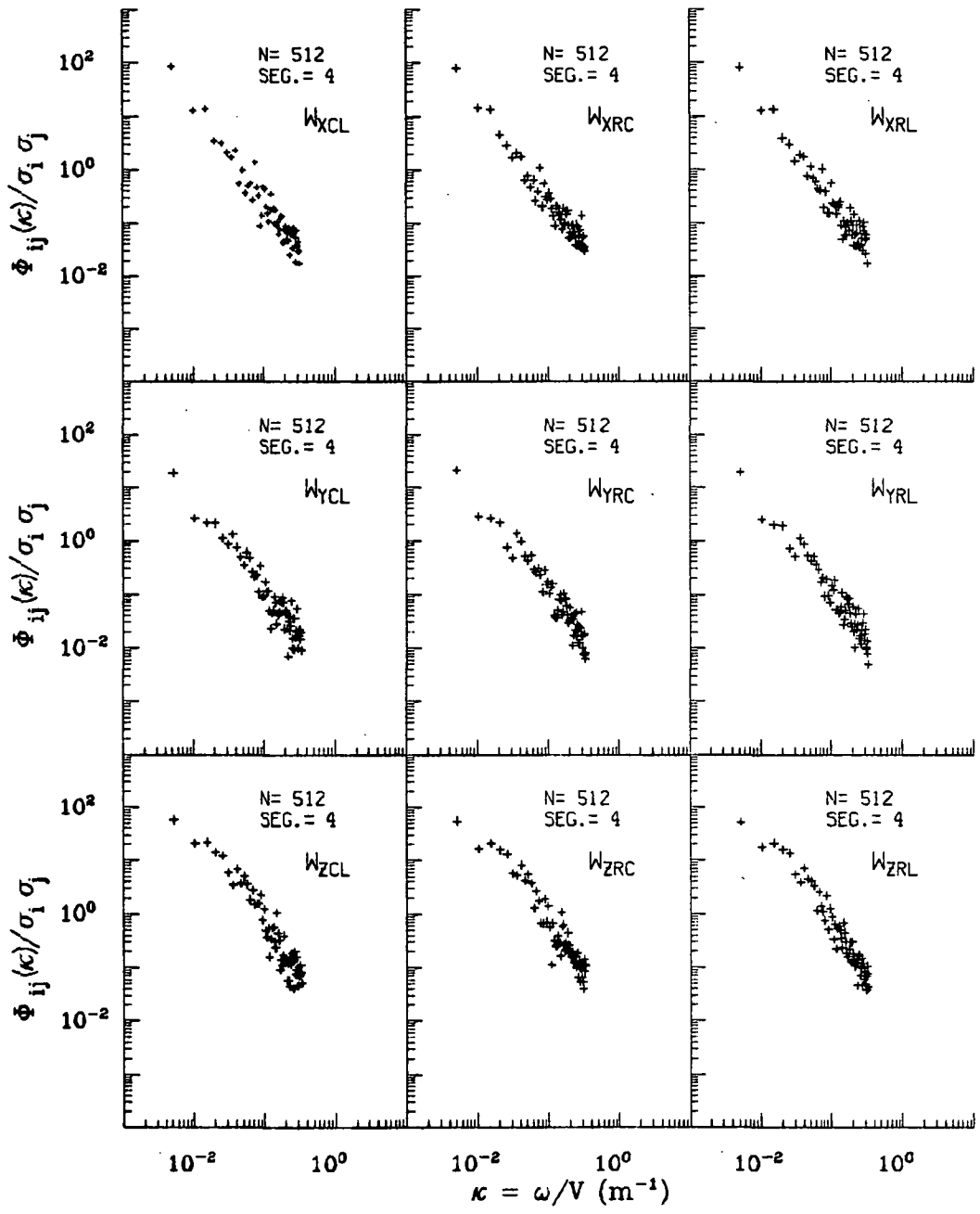

Figure A.271. Normalized two-point auto-spectra of gust velocities, Flight 6, Run 36.

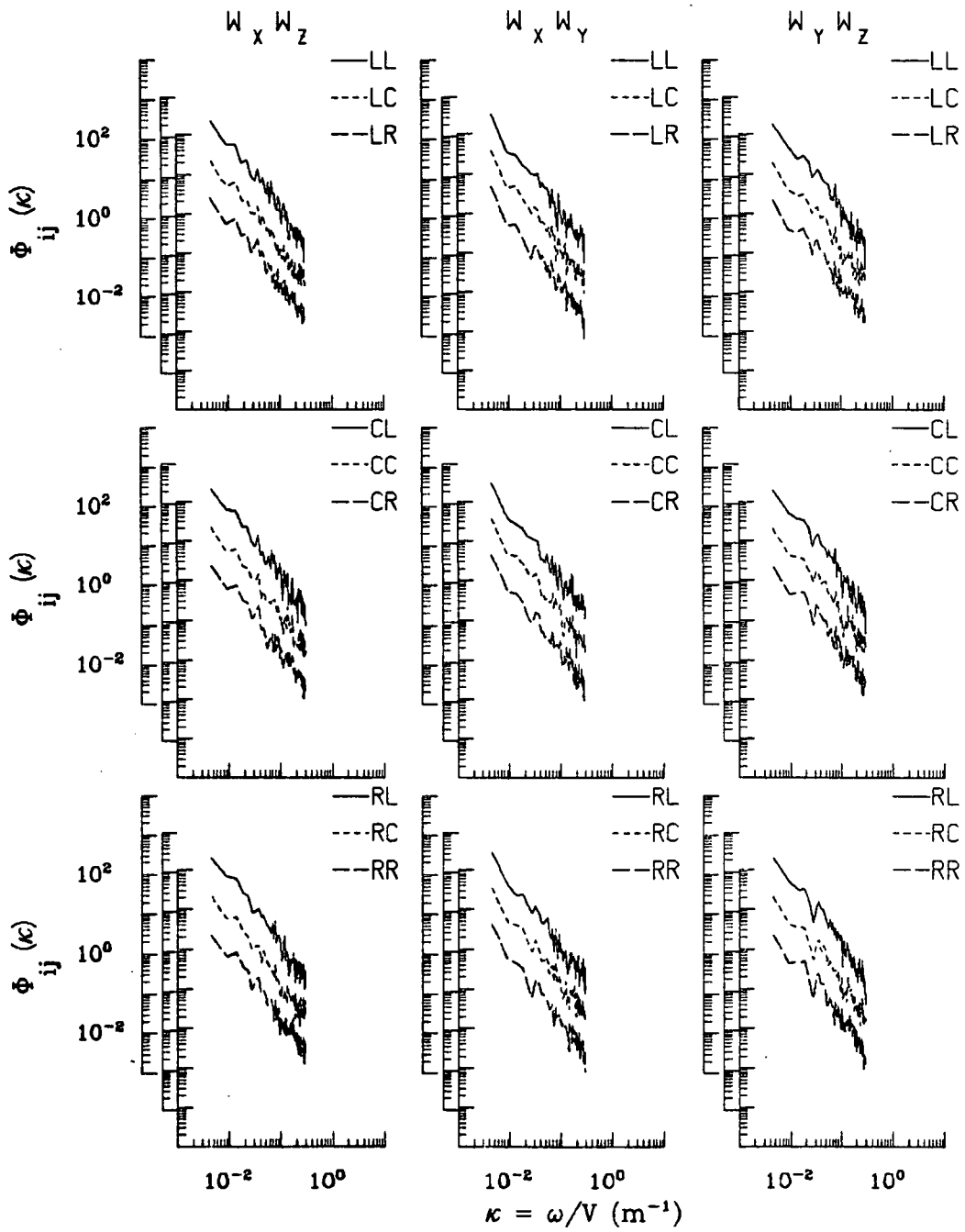

Figure A.272. Two-point cross-spectra of gust velocities, Flight 6, Run 36.

ORIGINAL PAGE IS
OF POOR QUALITY

TABLE A.67. List of All Parameters Measured and Their Range of Values, Flight 6, Run 36.

		START TIME • 55435.4796	STOP TIME • 55492.6296				
CHANNEL	UNITS	HIGH	LOW	MEAN	RMS	POINTS	
2 PHI DOT	RAD/SEC	.150	-.150	-.00318	.03604	2286	
3 ACCL N CG	G UNITS	-.988	-.988	-.98774	.98774	2286	
4 THETA DOT	RAD/SEC	.056	-.058	.00528	.01419	2286	
5 THETA	RAD	.080	.010	.04882	.05151	2286	
6 PHI	RAD	.069	-.101	-.02130	.03655	2286	
7 PSI 1	DEGREES	145.315	135.453	140.89133	140.90043	2286	
8 DEL PSI 1	DEGREES	4.609	-4.678	.46417	1.65305	2286	
9 PSI 2	DEGREES	504.389	495.236	500.12913	500.13153	2286	
10 DEL PSI 2	DEGREES	4.491	-4.801	.31513	1.61443	2286	
11 ACCL N LT	G UNITS	1.966	-.248	1.01241	1.04670	2286	
12 ACCL N RT	G UNITS	2.342	-.130	1.02570	1.05720	2286	
13 ACCL X CG	G UNITS	.108	.005	.05256	.05573	2286	
14 ACCL Y CG	G UNITS	.205	-.155	.00895	.05558	2286	
15 ALPHA CTR	RAD	.027	-.065	-.02379	.02720	2286	
16 BETA CTR	RAD	.042	-.079	-.01972	.03028	2286	
17 TEMP I	DEG F	97.724	97.365	97.47489	97.47494	2286	
18 TEMP P	DEG F	92.883	92.703	92.76033	92.76037	2286	
19 ACCL Z INS	G UNITS	1.483	.509	1.00380	1.01150	2286	
20 ALPHA RT	RAD	.035	-.064	-.01647	.02207	2286	
21 BETA RT	RAD	.069	-.041	.01374	.02507	2286	
22 ALPHA LT	RAD	.049	-.083	-.01626	.02198	2286	
23 BETA LT	RAD	.033	-.074	-.02480	.03246	2286	
24 PSI DOT	RAD/SEC	.056	-.052	.00235	.02009	2286	
25 TEMP TOT	DEG C	34.049	31.194	32.54743	32.55178	2286	
26 QC LT	PSID	.881	.665	.80116	.80214	2286	
27 QC CTR	PSID	.869	.669	.78564	.78656	2286	
28 QC RT	PSID	.902	.702	.81406	.81503	2286	
29 PS	PSIA	11.605	11.561	11.57935	11.57935	2286	
30 TEMP IPT	DEG C	24.974	19.109	21.73182	21.77920	2286	
31 D TO G	METERS	8803745.66487998	10.086	*****	*****	2286	
32 B TO D	DEGREES	80.770	80.723	80.74615	80.74615	2286	
33 LONG	DEGREES	-104.285	-104.342	-104.31420	104.31421	2286	
34 LAT	DEGREES	39.855	39.806	39.83044	39.83045	2286	
35 TRK ANG	DEGREES	139.783	136.347	137.97297	137.97860	2286	
36 HDG	RADIANS	2.525	2.358	2.45009	2.45025	2286	
37 VE	M/SEC	88.349	82.361	85.47921	85.50950	2286	
38 VN	M/SEC	-92.401	-97.315	-94.73209	94.74661	2286	
39 ALTITUDE	KM	1.978	1.948	1.96544	1.96545	2286	
40 TEMPC	DEGREES C	28.160	25.881	26.86774	26.87018	2286	
41 EW WND SPD	KNOTS	51.213	20.739	36.95518	37.52780	2286	
42 NS WND SPD	KNOTS	-7.867	-37.966	-21.75357	22.77954	2286	
43 WIND SPEED	KNOTS	58.149	30.530	43.63255	43.90038	2286	
44 WIND DIREC	DEGREES	326.282	280.825	300.74349	300.93688	2286	
45 AIRSPEED R	M/SEC	114.299	101.159	108.66604	108.69750	2286	
46 AIRSPEED C	M/SEC	112.224	98.773	106.79631	106.82718	2286	
47 AIRSPEED L	M/SEC	112.998	98.481	107.82069	107.85297	2286	
48 DELTA ALT	METERS	14.250	-16.446	1.31820	6.71156	2286	
49 INRTL DISP	METERS	17.244	-15.440	2.54708	8.45292	2286	
50 UG RIGHT	M/SEC	7.272	-5.506	.00000	2.54329	2286	
51 UG CENTER	M/SEC	7.789	-5.426	.00000	2.49424	2286	
52 UG LEFT	M/SEC	9.185	-4.908	.00000	2.53571	2286	
53 VG RIGHT	M/SEC	9.579	-6.759	.01414	4.15286	2286	
54 VG CENTER	M/SEC	9.514	-6.877	.01394	4.11184	2286	
55 VG LEFT	M/SEC	9.596	-6.334	.01041	4.07982	2286	
56 WG RIGHT	M/SEC	5.696	-7.362	-.00415	2.03344	2286	
57 WG CENTER	M/SEC	5.662	-5.744	-.00512	1.93508	2286	
58 WG LEFT	M/SEC	5.896	-5.668	-.01152	2.09458	2286	

Date: July 14, 1982
Time: 15:25:49 (MDT)
Duration: 82 seconds

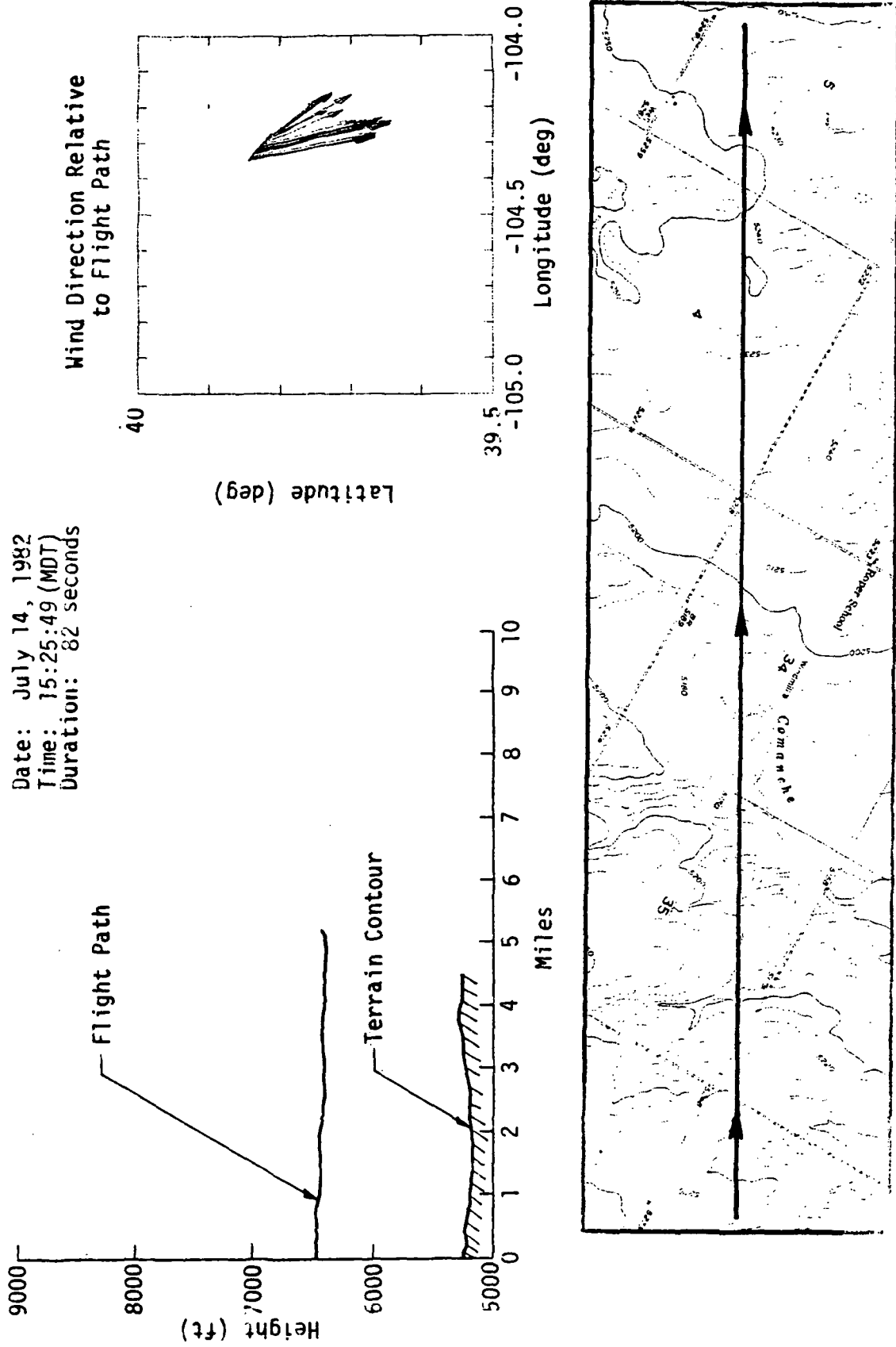

Figure A.273. Flight path information, Flight 6, Run 37.

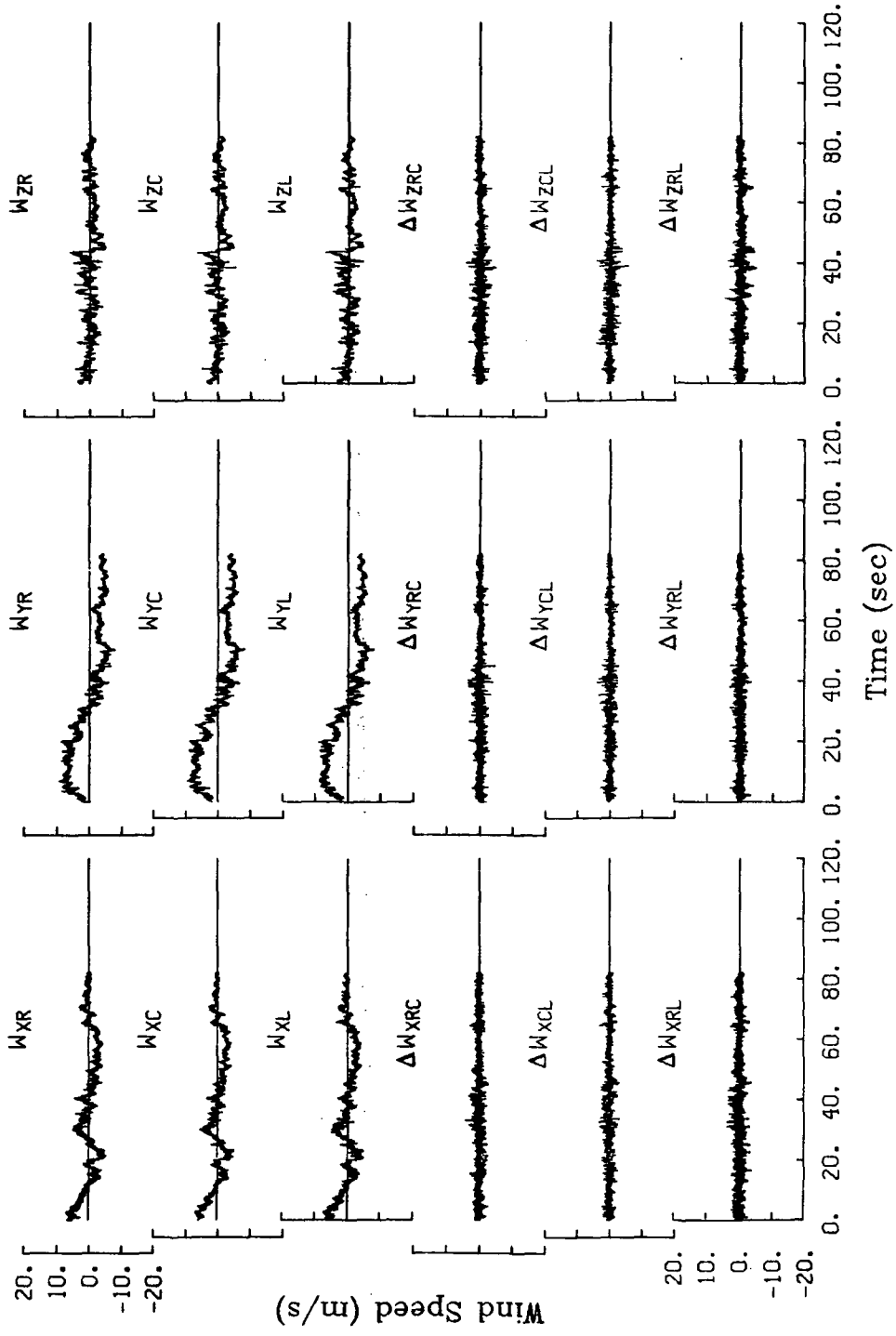

Figure A.274. Time histories of gust velocities and gust velocity differences, Flight 6, Run 37.

TABLE A.68. Average Turbulence Parameters and Integral Length Scales, Flight 6, Run 37.

I. Mean Airspeed (m/s)			II. Standard Deviation of Gust Velocities (m/s)		
V_L	V_C	V_R	$\sigma_{W_{XL}}$	$\sigma_{W_{XC}}$	$\sigma_{W_{XR}}$
104.5	103.4	105.2	2.27	2.22	2.28
			$\sigma_{W_{YL}}$	$\sigma_{W_{YC}}$	$\sigma_{W_{YR}}$
			4.45	4.48	4.41
			$\sigma_{W_{ZL}}$	$\sigma_{W_{ZC}}$	$\sigma_{W_{ZR}}$
			1.62	1.52	1.63
III. Standard Deviation of Gust Velocity Differences (m/s)			IV. Integral Length Scale (m).		
$\sigma_{\Delta W_{XCL}}$	$\sigma_{\Delta W_{XRC}}$	$\sigma_{\Delta W_{XRL}}$	$L_{W_{XL}}$	$L_{W_{XC}}$	$L_{W_{XR}}$
0.72	0.73	0.91	349	353	354
$\sigma_{\Delta W_{YCL}}$	$\sigma_{\Delta W_{YRC}}$	$\sigma_{\Delta W_{YRL}}$	$L_{W_{YL}}$	$L_{W_{YC}}$	$L_{W_{YR}}$
0.73	0.69	0.75	2070	2036	2072
$\sigma_{\Delta W_{ZCL}}$	$\sigma_{\Delta W_{ZRC}}$	$\sigma_{\Delta W_{ZRL}}$	$L_{W_{ZL}}$	$L_{W_{ZC}}$	$L_{W_{ZR}}$
0.81	0.87	0.97	212	223	224

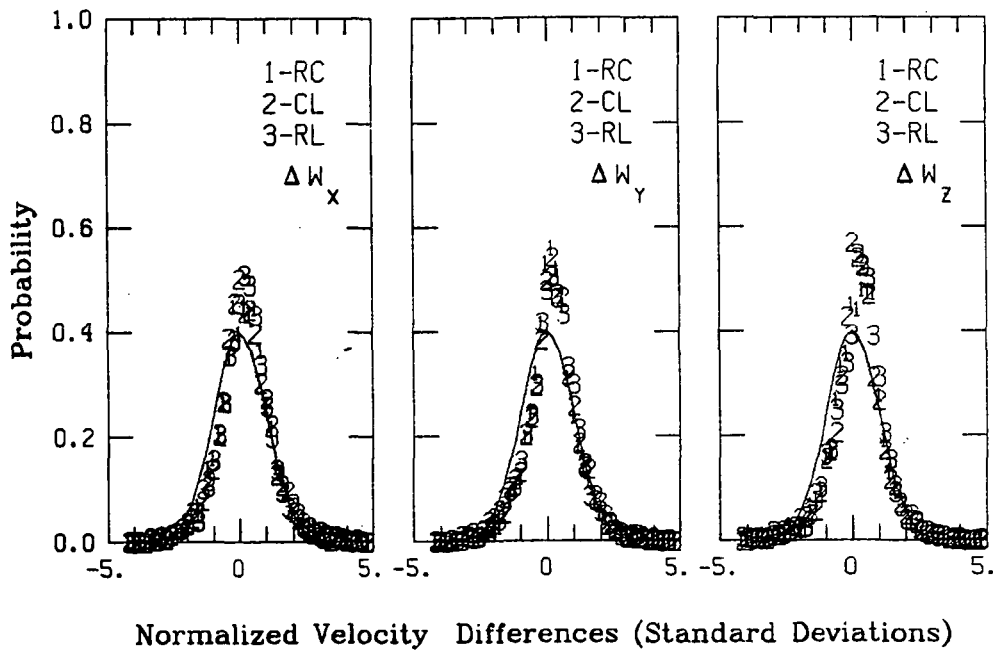
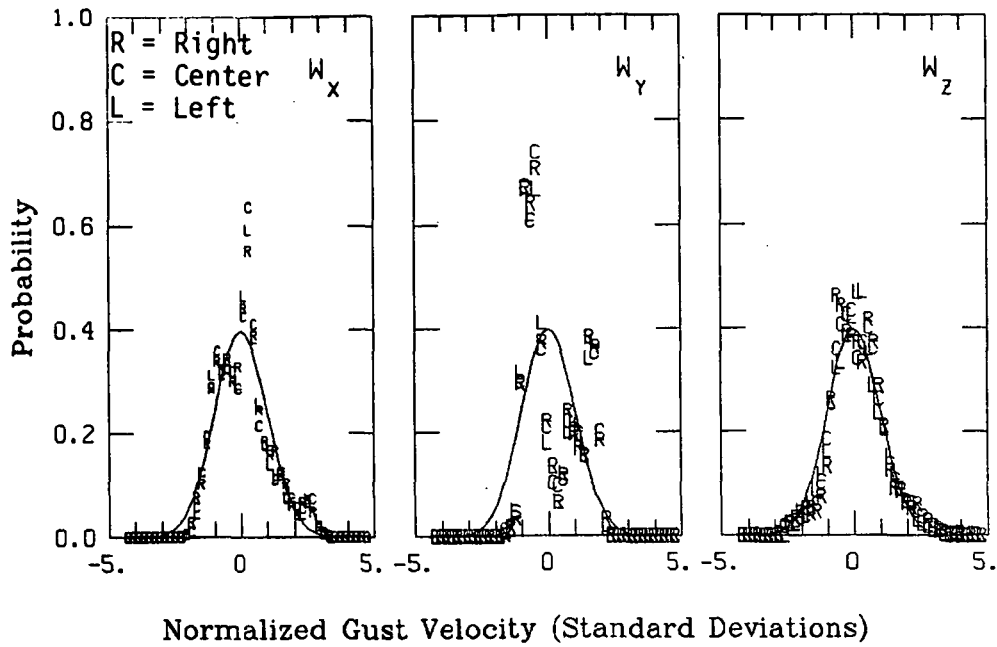

Figure A.275. Probability density function for gust velocities and gust velocity differences, Flight 6, Run 37.

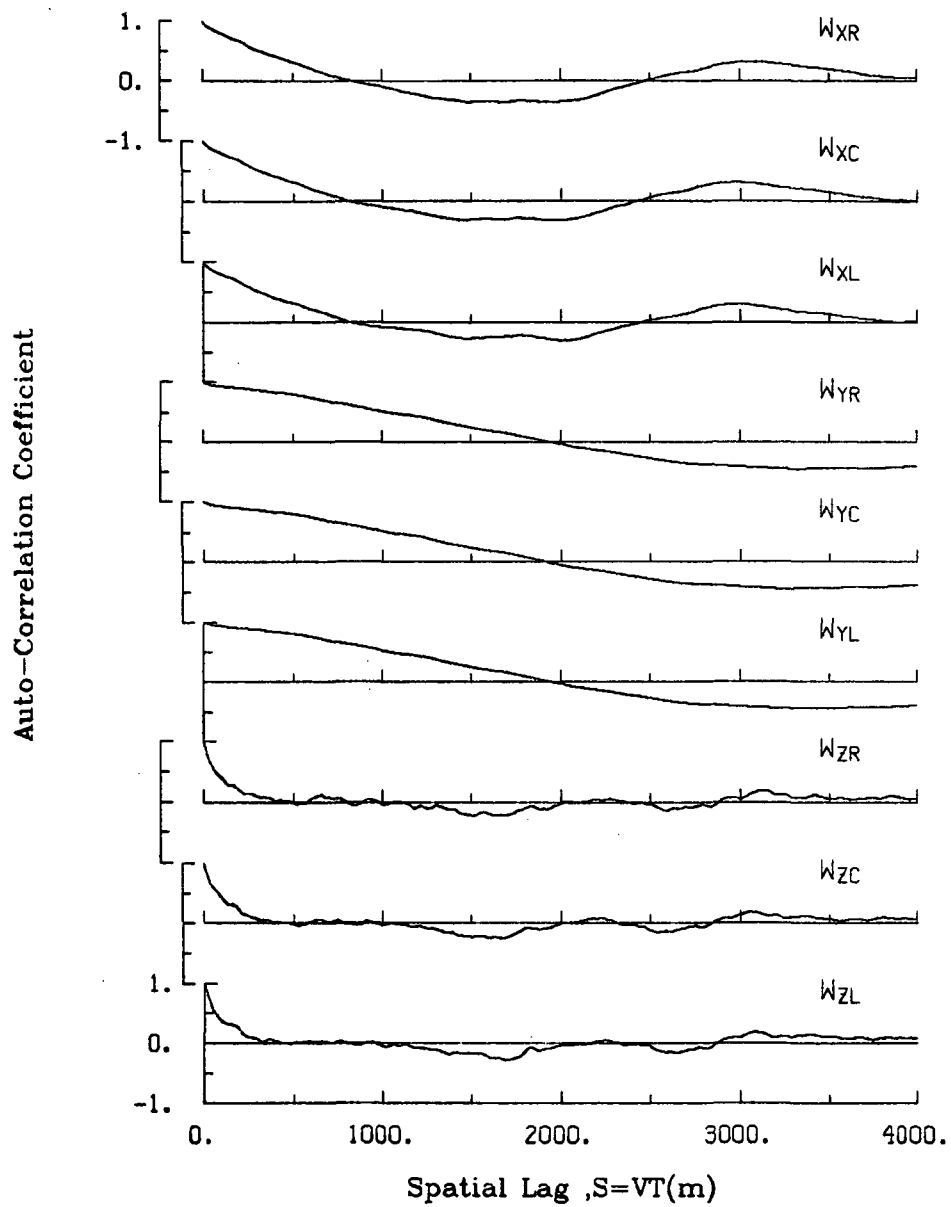

Figure A.276. Single-point auto-correlation coefficient of gust velocities, Flight 6, Run 37.

ORIGINAL PAGE IS
OF POOR QUALITY

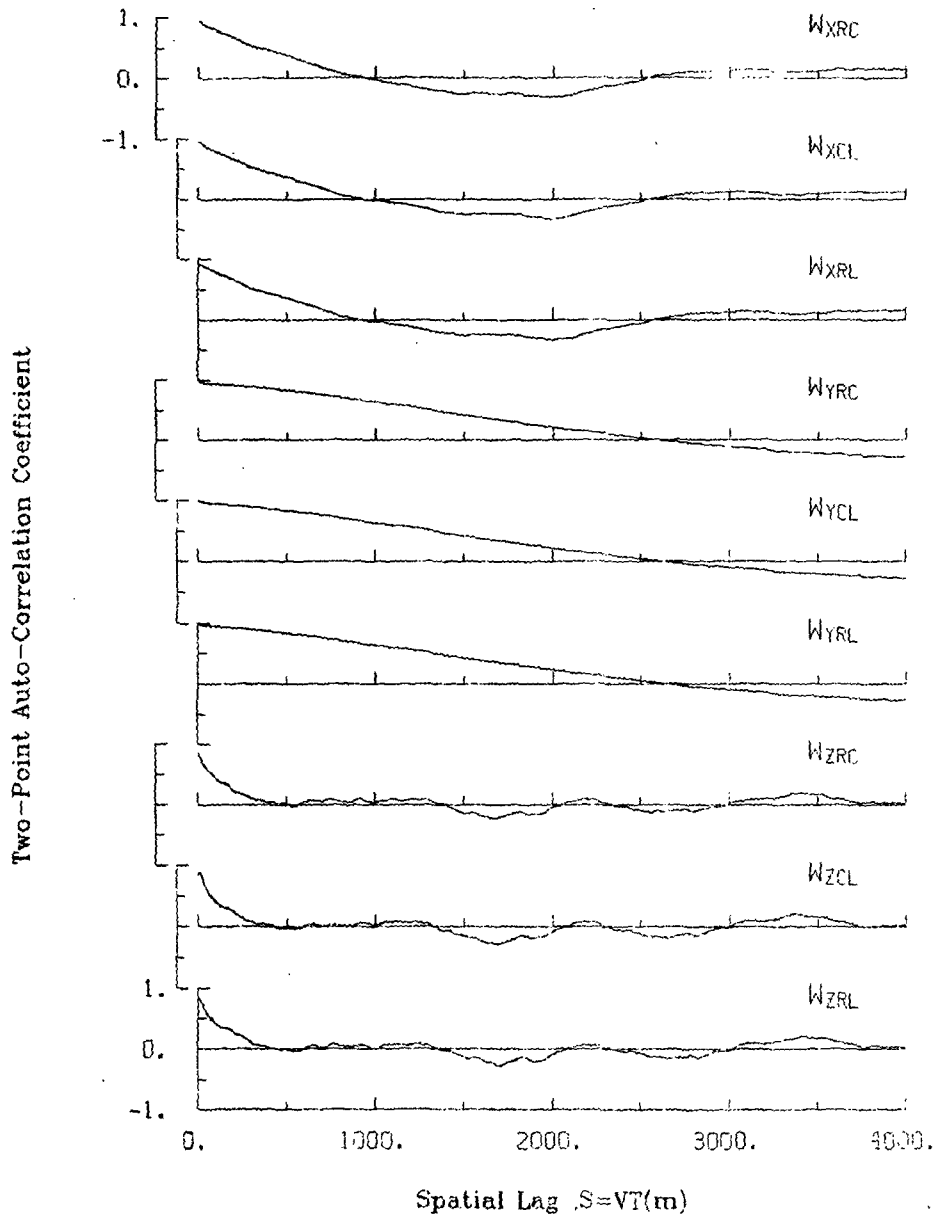

Figure A.277. Two-point auto-correlation coefficient of gust velocities, Flight 6, Run 37.

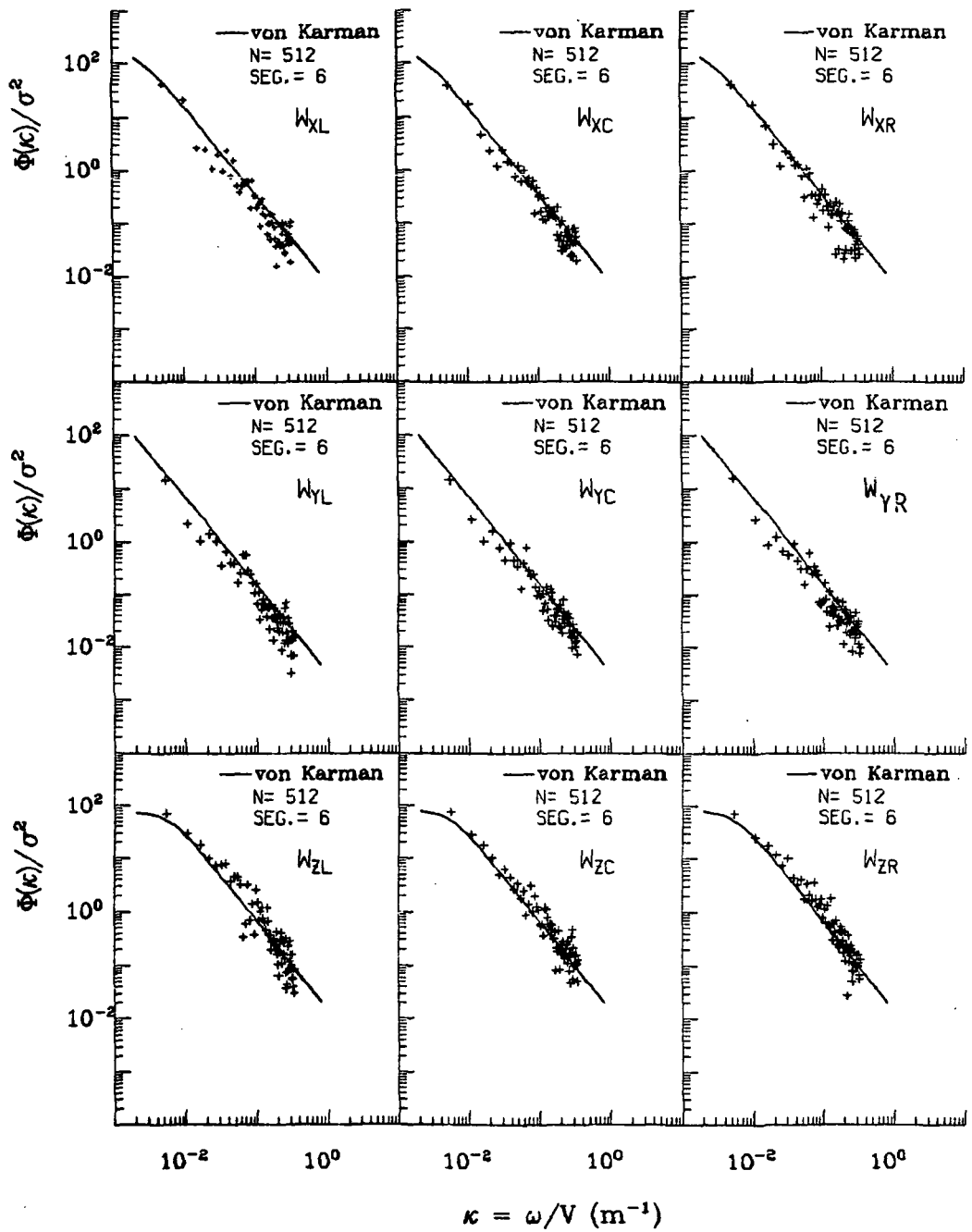

Figure A.278. Normalized auto-spectra of gust velocities, Flight 6, Run 37.

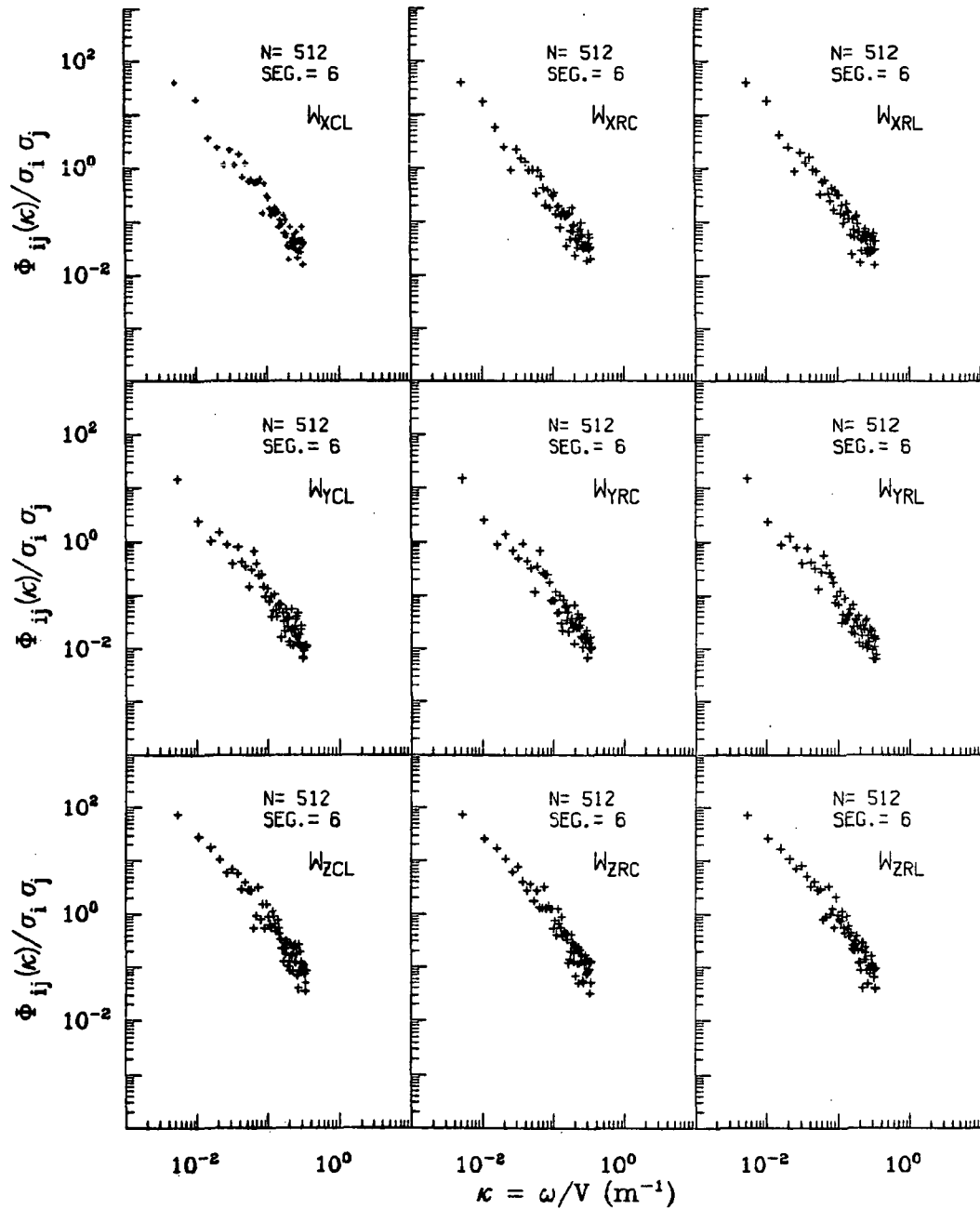

Figure A.279. Normalized two-point auto-spectra of gust velocities, Flight 6, Run 37.

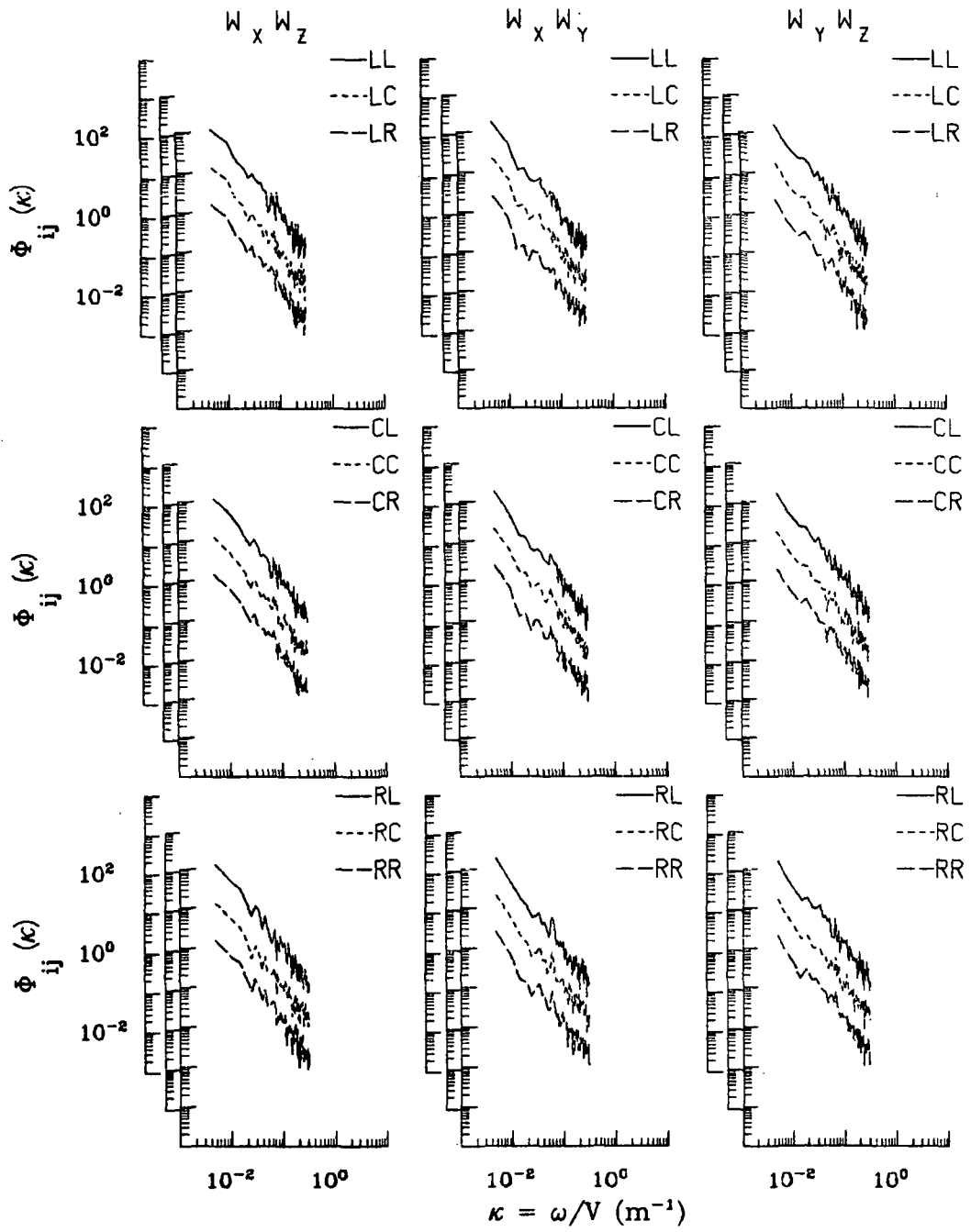

Figure A.280. Two-point cross-spectra of gust velocities, Flight 6, Run 37.

ORIGINAL PAGE IS
OF POOR QUALITY

TABLE A.69. List of All Parameters Measured and Their Range of Values,
Flight 6, Run 37.

		START TIME = 55549.4097	STOP TIME = 55631.6347				
CHANNEL	UNITS	HIGH	LOW	MEAN	RMS		
2	PHI DOT	RAD/SEC	.134	-.091	-.00292	.02969	3289
3	ACCL N CG	G UNITS	-.988	-.988	-.98774	.98774	3289
4	THETA DOT	RAD/SEC	.054	-.045	.00641	.01298	3289
5	THETA	RAD	.079	.019	.04907	.05071	3289
6	PHI	RAD	.059	-.087	-.01464	.03435	3289
7	PSI 1	DEGREES	304.868	297.485	301.03588	301.04029	3289
8	DEL PSI 1	DEGREES	2.110	-4.913	-1.48293	2.20261	3289
9	PSI 2	DEGREES	306.539	299.850	303.14423	303.14844	3289
10	DEL PSI 2	DEGREES	1.933	-4.976	-1.60693	2.27413	3289
11	ACCL N LT	G UNITS	2.238	-.488	1.01460	1.04147	3289
12	ACCL N RT	G UNITS	2.558	.105	1.02708	1.05097	3289
13	ACCL X CG	GUNITS	.094	.007	.04301	.04447	3289
14	ACCL Y CG	G UNITS	.161	-.152	.00823	.04573	3289
15	ALPHA CTR	RAD	.035	-.074	-.01876	.02219	3289
16	BETA CTR	RAD	.029	-.100	-.02116	.03008	3289
17	TEMP I	DEG F	98.444	97.724	98.01436	98.01450	3289
18	TEMP P	DEG F	93.062	92.703	92.88271	92.88271	3289
19	ACCL Z INS	G UNITS	1.395	.542	1.00455	1.01046	3289
20	ALPHA RT	RAD	.032	-.062	-.01344	.01900	3289
21	BETA RT	RAD	.057	-.059	.01273	.02303	3289
22	ALPHA LT	RAD	.040	-.065	-.01152	.01724	3289
23	BETA LT	RAD	.019	-.100	-.02696	.03336	3289
24	PSI DOT	RAD/SEC	.052	-.043	.00349	.01602	3289
25	TEMP TOT	DEG C	32.868	30.899	31.96564	31.97022	3289
26	QC LT	PSID	.860	.665	.75267	.75407	3289
27	QC CTR	PSID	.839	.656	.73724	.73836	3289
28	QC RT	PSID	.876	.678	.76376	.76494	3289
29	PS	PSIA	11.616	11.417	11.59552	11.59553	3289
30	TEMP IRT	DEG C	23.456	20.320	22.26972	22.27804	3289
31	D TO G	METERS	8804740.5318799049.306	*****	*****	*****	3289
32	B TO D	DEGREEES	80.776	80.720	80.74798	80.74798	3289
33	LONG	DEGREES	-104.275	-104.349	-104.31161	104.31161	3289
34	LAT	DEGREES	39.845	39.813	39.82955	39.82955	3289
35	TRK ANG	DEGREEES	302.601	294.685	299.01940	299.02883	3289
36	HDG	RADIANS	5.344	5.219	5.27990	5.27998	3289
37	VE	M/SEC	-75.633	-79.375	-77.36219	77.36751	3289
38	VN	M/SEC	48.604	35.126	43.01279	43.20825	3289
39	ALTITUDE	KM	2.079	1.940	1.95418	1.95421	3289
40	TEMPC	DEGREEES C	28.001	25.996	26.63962	26.64276	3289
41	EW WND SPD	KNOTS	30.469	6.342	16.68617	17.43130	3289
42	NS WND SPD	KNOTS	-9.724	-43.559	-27.94163	29.11404	3289
43	WIND SPEED	KNOTS	45.368	17.025	33.44439	33.93343	3289
44	WIND DIREC	DEGREEES	348.604	294.798	327.64846	327.94229	3289
45	AIRSPEED R	M/SEC	112.590	99.161	105.21123	105.25087	3289
46	AIRSPEED C	M/SEC	110.238	97.594	103.40906	103.44771	3289
47	AIRSPEED L	M/SEC	111.541	98.236	104.47403	104.51463	3289
48	DELTA ALT	METERS	105.858	-33.336	-18.88896	21.15987	3289
49	INPTL DISP	METERS	1.106	-31.042	-17.22785	19.52640	3289
50	UG RIGHT	M/SEC	6.958	-5.420	-.00000	2.22459	3289
51	UG CENTER	M/SEC	6.598	-4.854	-.00000	2.16837	3289
52	UG LEFT	M/SEC	7.080	-4.927	-.00000	2.21435	3289
53	VG PIGHT	M/SEC	9.261	-7.592	-.02226	4.38797	3289
54	VG CENTER	M/SEC	9.186	-7.947	-.02495	4.45959	3289
55	VG LEFT	M/SEC	9.028	-7.804	-.03043	4.43147	3289
56	WG RIGHT	M/SEC	6.121	-4.734	-.02240	1.59069	3289
57	WG CENTER	M/SEC	6.473	-5.081	-.02100	1.48903	3289
58	WG LEFT	M/SEC	7.026	-4.635	-.02116	1.58769	3289

Date: July 14, 1982
 Time: 15:29:38 (MDT)
 Duration: 76 seconds

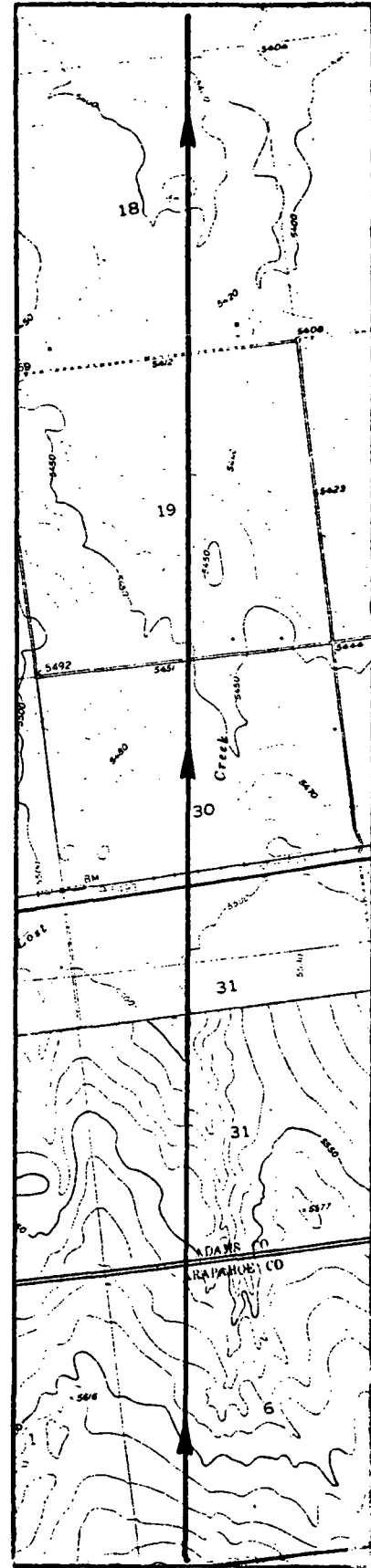
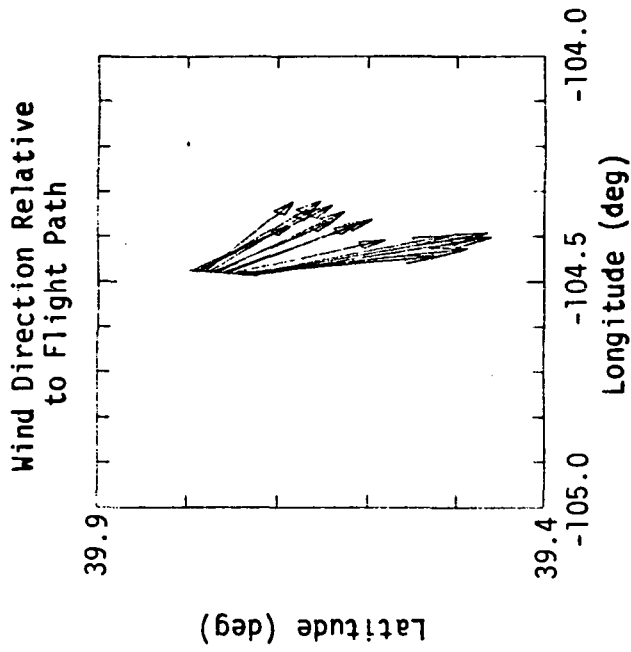
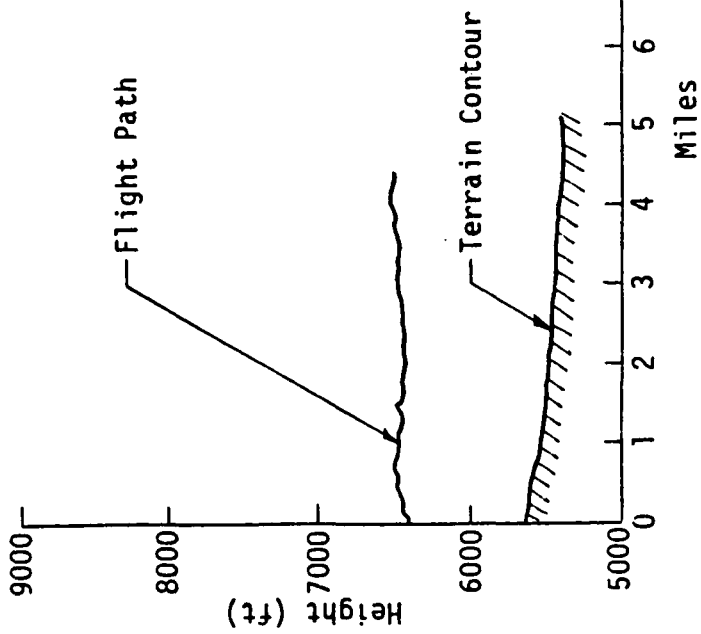

Figure A.281. Flight path information, Flight 6, Run 38.

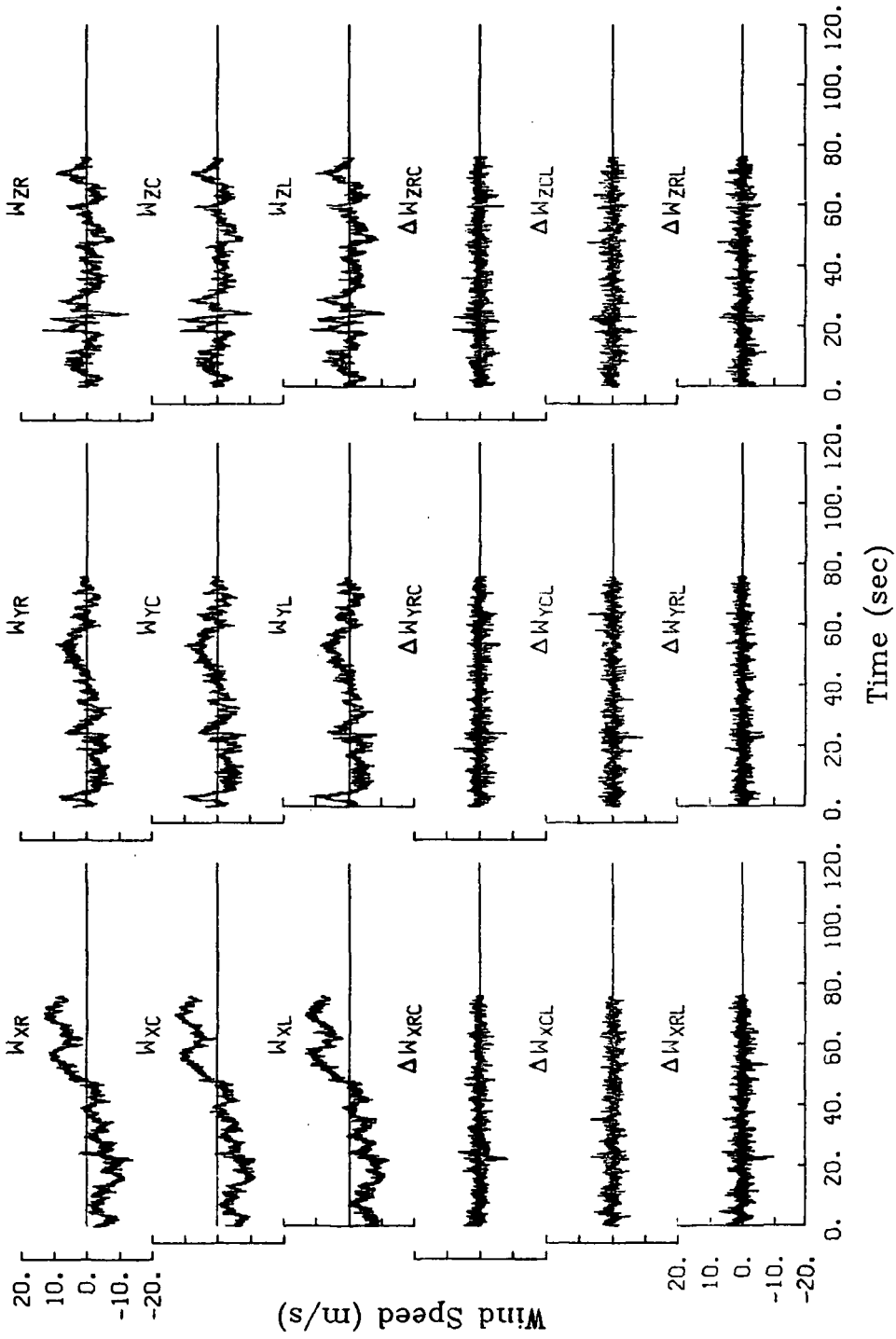

Figure A.282. Time histories of gust velocities and gust velocity differences, Flight 6, Run 38.

TABLE A.70. Average Turbulence Parameters and Integral Length Scales, Flight 6, Run 38.

I. Mean Airspeed (m/s)

v_L	v_C	v_R
94.9	94.0	95.7

II. Standard Deviation of Gust Velocities (m/s)

$\sigma_{W_{XL}}$	$\sigma_{W_{XC}}$	$\sigma_{W_{XR}}$
5.75	5.51	5.49
$\sigma_{W_{YL}}$	$\sigma_{W_{YC}}$	$\sigma_{W_{YR}}$
3.41	3.48	3.29
$\sigma_{W_{ZL}}$	$\sigma_{W_{ZC}}$	$\sigma_{W_{ZR}}$
3.26	3.09	3.24

III. Standard Deviation of Gust Velocity Differences (m/s)

$\sigma_{\Delta W_{XCL}}$	$\sigma_{\Delta W_{XRC}}$	$\sigma_{\Delta W_{XRL}}$
1.35	1.35	1.70
$\sigma_{\Delta W_{YCL}}$	$\sigma_{\Delta W_{YRC}}$	$\sigma_{\Delta W_{YRL}}$
1.39	1.35	1.43
$\sigma_{\Delta W_{ZCL}}$	$\sigma_{\Delta W_{ZRC}}$	$\sigma_{\Delta W_{ZRL}}$
1.47	1.48	1.61

IV. Integral Length Scale (m).

$L_{W_{XL}}$	$L_{W_{XC}}$	$L_{W_{XR}}$
1140	1123	1128
$L_{W_{YL}}$	$L_{W_{YC}}$	$L_{W_{YR}}$
680	719	813
$L_{W_{ZL}}$	$L_{W_{ZC}}$	$L_{W_{ZR}}$
249	267	246

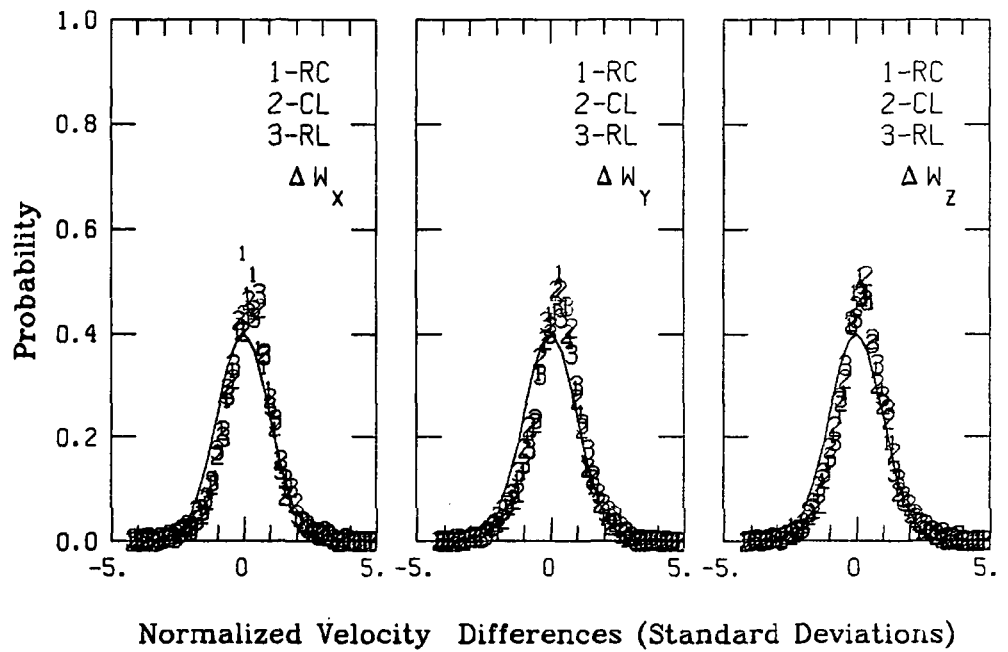
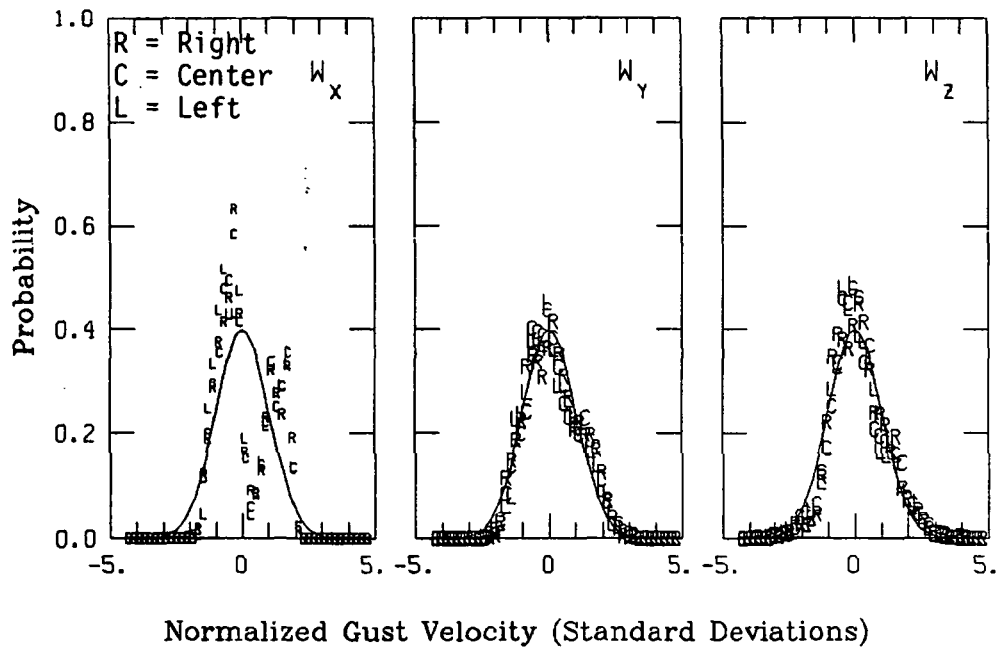

Figure A.283. Probability density function for gust velocities and gust velocity differences, Flight 6, Run 38.

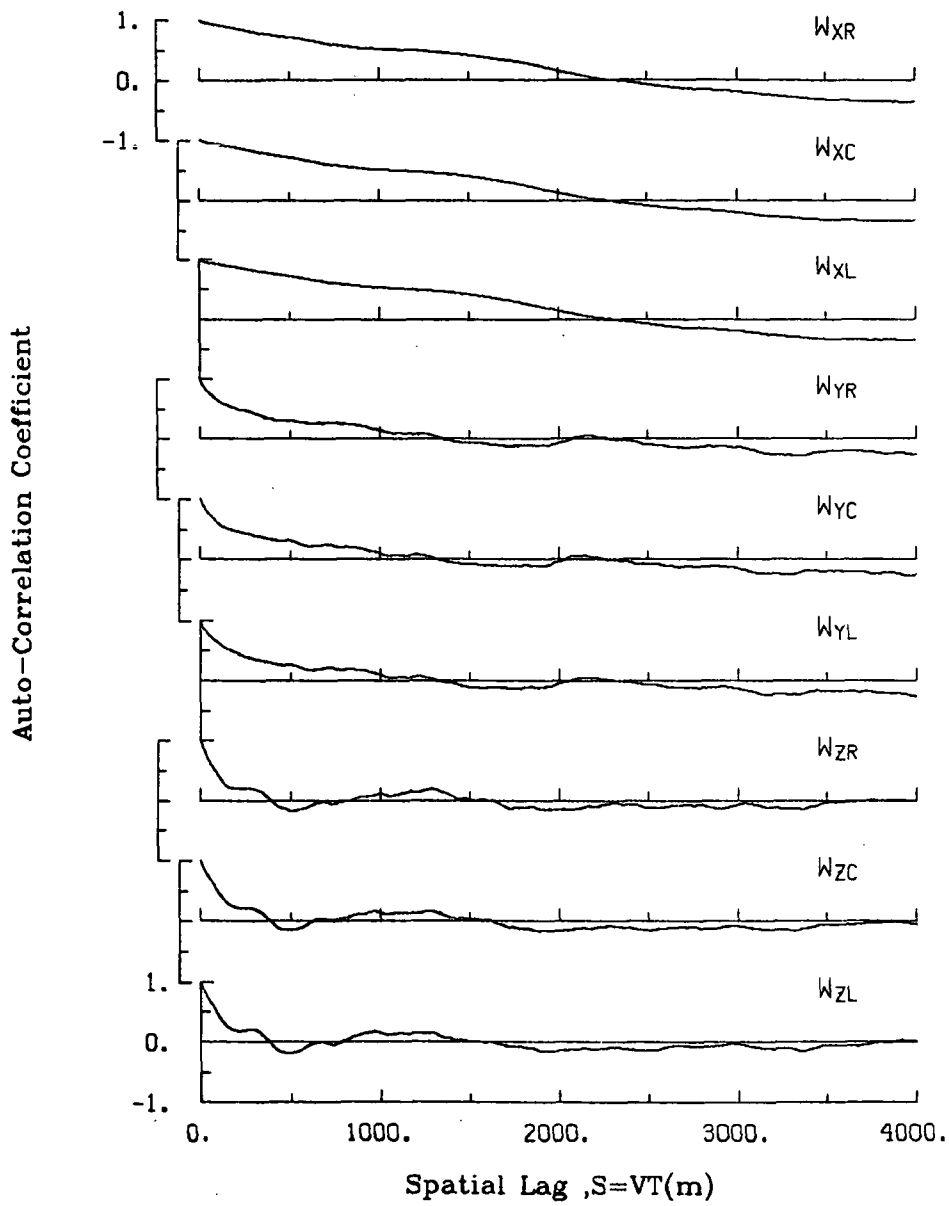

Figure A.284. Single-point auto-correlation coefficient of gust velocities, Flight 6, Run 38.

ORIGINAL PAGE IS
OF POOR QUALITY

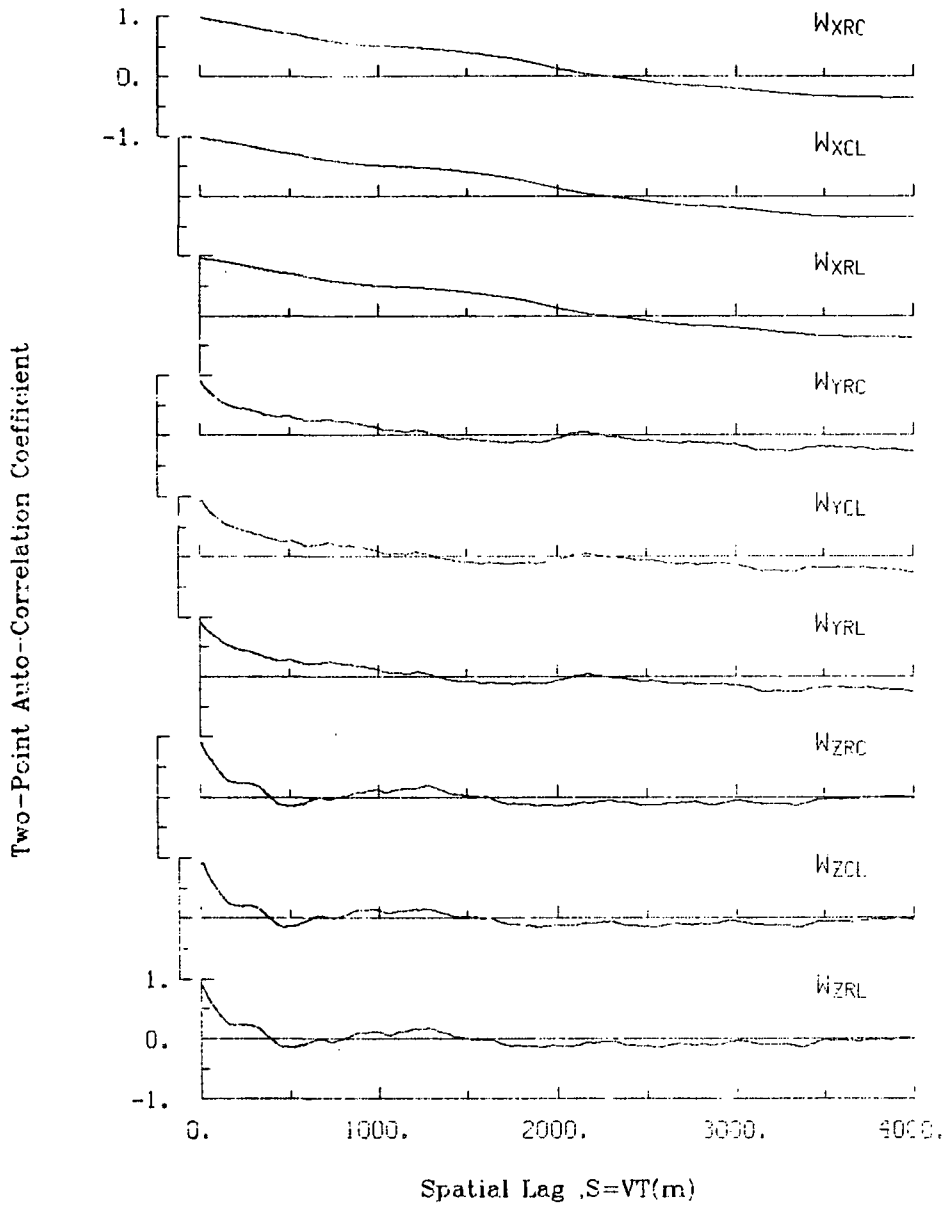

Figure A.285. Two-point auto-correlation coefficient of gust velocities, Flight 6, Run 38.

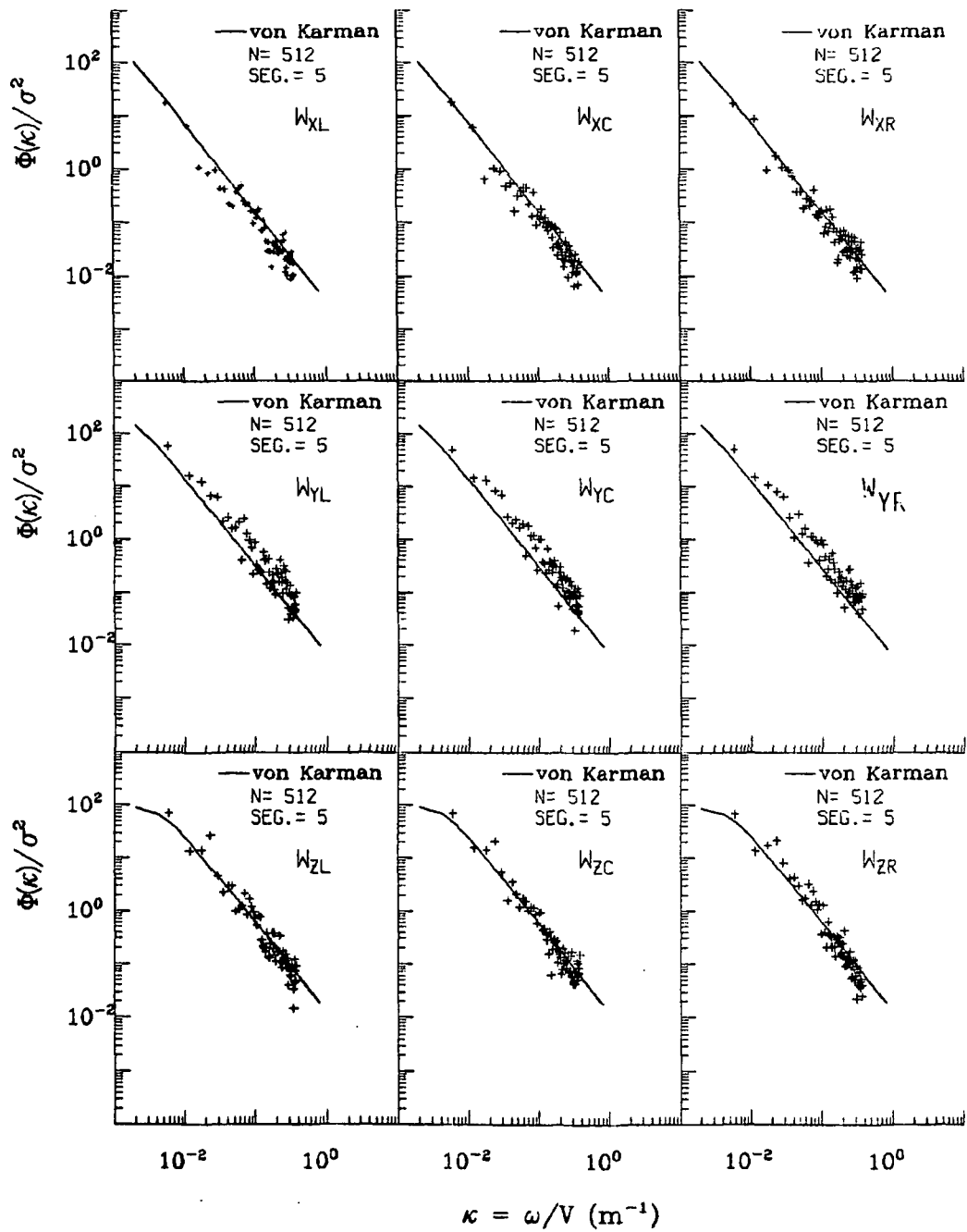

Figure A.286. Normalized auto-spectra of gust velocities, Flight 6, Run 38.

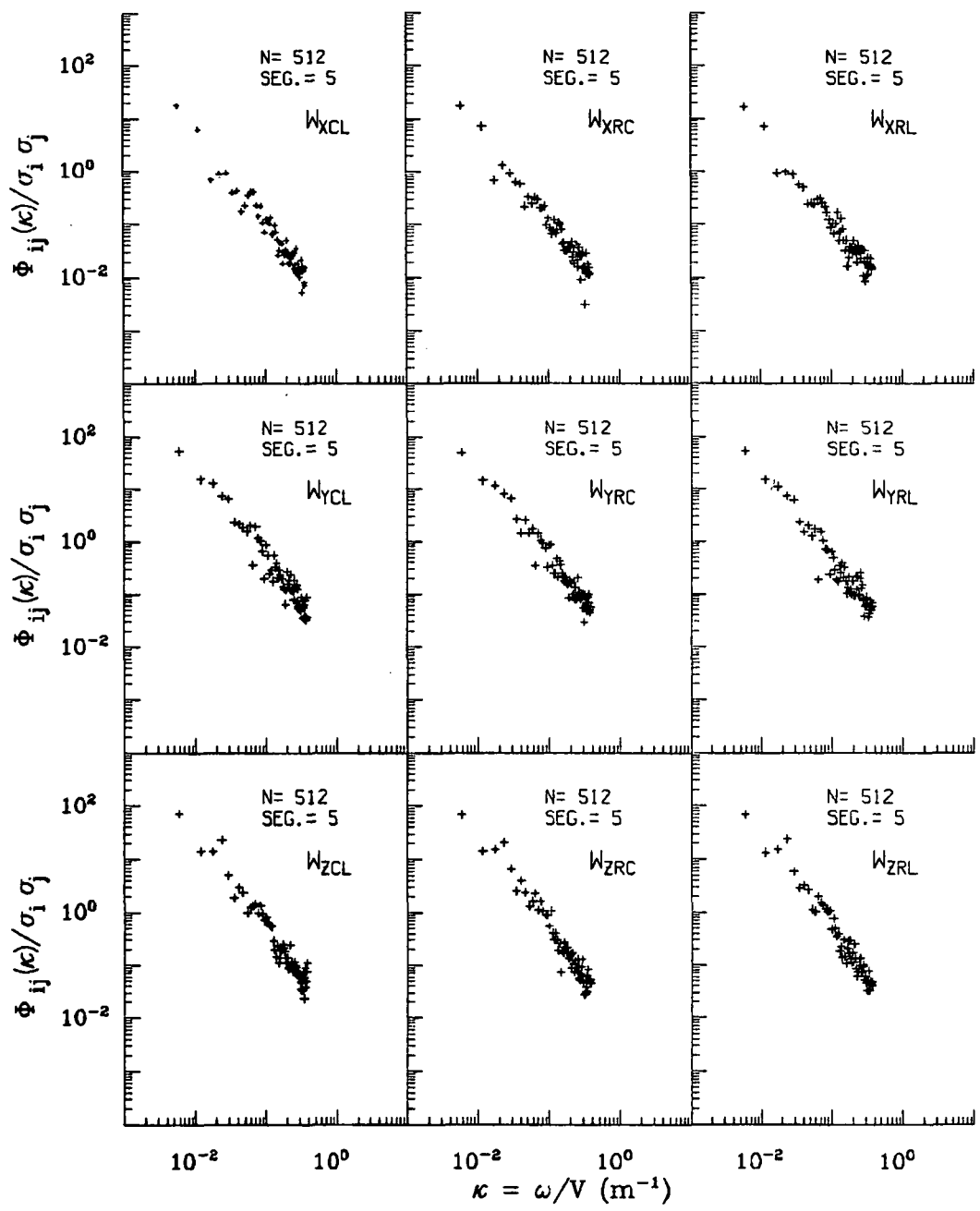

Figure A.287. Normalized two-point auto-spectra of gust velocities, Flight 6, Run 38.

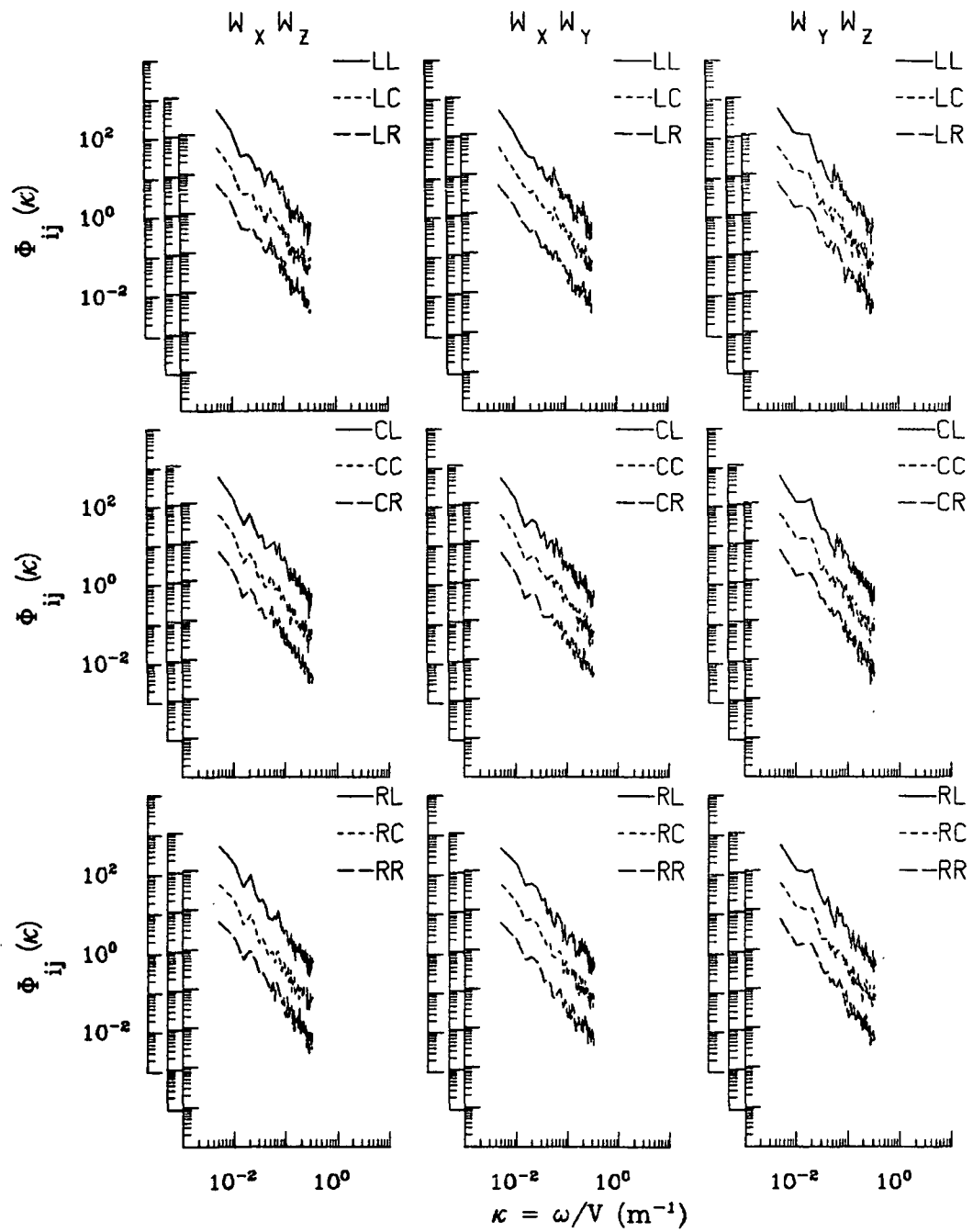

Figure A.288. Two-point cross-spectra of gust velocities, Flight 6, Run 38.

ORIGINAL PAGE IS
OF POOR QUALITY

TABLE A.71. List of All Parameters Measured and Their Range of Values,
Flight 6, Run 38.

START TIME = 55778.4101		STOP TIME = 55854.5601					
CHANNE	UNITS	HIGH	LOW	MEAN	RMS	POINTS	
2	PHI DOT	RAD/SEC	.185	-.203	-.00422	.05195	3046
3	ACCL N CG	G UNITS	-.988	-.988	-.98774	.98774	3046
4	THETA DOT	RAD/SEC	.099	-.089	.00526	.02003	3046
5	THETA	RAD	.142	.017	.08705	.09250	3046
6	PHI	RAD	.093	-.172	-.00769	.04553	3046
7	PSI 1	DEGREES	197.797	188.287	192.60910	192.61851	3046
8	DEL PSI 1	DEGREES	13.102	-1.357	3.87888	5.26117	3046
9	PSI 2	DEGREES	560.012	545.930	550.99383	551.00461	3046
10	DEL PSI 2	DEGREES	7.666	-1.566	2.82123	3.39272	3046
11	ACCL N LT	G UNITS	2.728	-1.017	1.00524	1.06651	3046
12	ACCL N RT	G UNITS	2.653	-1.234	1.01784	1.08046	3046
13	ACCL X CG	G UNITS	.225	-.001	.09954	.10879	3046
14	ACCL Y CG	G UNITS	.165	-.181	.01078	.04264	3046
15	ALPHA CTR	RAD	.107	-.111	-.00232	.02641	3046
16	BETA CTR	RAD	.085	-.116	-.01296	.04036	3046
17	TEMP I	DEG F	84.772	84.412	84.58360	84.58366	3046
18	TEMP P	DEG F	93.242	92.883	93.06622	93.06622	3046
19	ACCL Z INS	G UNITS	1.997	.059	.99955	1.01761	3046
20	ALPHA RT	RAD	.119	-.119	.00594	.02989	3046
21	BETA RT	RAD	.111	-.077	.02074	.04011	3046
22	ALPHA LT	RAD	.111	-.095	.00727	.02836	3046
23	BETA LT	RAD	.078	-.127	-.02040	.04077	3046
24	PSI DOT	RAD/SEC	.097	-.062	.00385	.02798	3046
25	TEMP TOT	DEG C	31.194	28.733	30.04202	30.04632	3046
26	QC LT	PSID	.772	.449	.62099	.62492	3046
27	QC CTR	PSID	.751	.457	.61003	.61371	3046
28	QC RT	PSID	.816	.477	.63242	.63615	3046
29	PS	PSIA	11.600	11.549	11.57711	11.57712	3046
30	TEMP IRT	DEG C	19.515	8.063	17.18616	17.30297	3046
31	D TO G	METERS	8787613.2108785335.744	*****	*****	*****	3046
32	B TO D	DEGREES	80.653	80.646	80.64962	80.64962	3046
33	LONG	DEGREES	-104.474	-104.486	-104.47962	104.47962	3046
34	LAT	DEGREES	39.798	39.724	39.76100	39.76100	3046
35	TRK ANG	DEGREES	188.178	184.097	186.53306	186.53501	3046
36	HOG	RADIANS	3.466	3.298	3.37798	3.37815	3046
37	VE	M/SEC	-8.060	-15.583	-12.51078	12.63522	3046
38	VN	M/SEC	-106.080	-118.157	-108.52544	108.55997	3046
39	ALTITUDE	KM	1.986	1.951	1.96700	1.96701	3046
40	TEMPC	DEGREES C	26.281	24.919	25.62738	25.62817	3046
41	EW WND SPD	KNOTS	38.766	-2.099	20.76440	22.18553	3046
42	NS WND SPD	KNOTS	-12.406	-59.971	-33.90849	35.83173	3046
43	WIND SPEED	KNOTS	64.839	13.712	41.28316	42.14393	3046
44	WIND DIRECTION	DEGREES	359.190	.376	326.22605	326.80205	3046
45	AIR SPEED R	M/SEC	108.577	83.452	95.72375	95.86241	3046
46	AIR SPEED C	M/SEC	104.174	81.775	94.04197	94.18176	3046
47	AIR SPEED L	M/SEC	105.624	80.992	94.85890	95.00807	3046
48	DELTA ALT	METERS	29.967	-4.967	10.68019	13.64230	3046
49	INPTL DISP	METERS	24.435	-1.819	9.29277	12.11193	3046
50	UG RIGHT	M/SEC	12.796	-13.886	.00000	6.40211	3046
51	UG CENTER	M/SEC	13.172	-11.294	.00000	6.38536	3046
52	UG LEFT	M/SEC	13.388	-12.019	.00000	6.57386	3046
53	VG RIGHT	M/SEC	9.312	-7.958	-.01110	3.12067	3046
54	VG CENTER	M/SEC	10.147	-8.189	-.00870	3.29584	3046
55	VG LEFT	M/SEC	11.679	-8.140	-.00758	3.23397	3046
56	WG RIGHT	M/SEC	13.243	-12.711	.04382	3.28752	3046
57	WG CENTER	M/SEC	11.653	-10.150	.04700	3.11261	3046
58	WG LEFT	M/SEC	11.716	-10.399	.04061	3.27418	3046

ORIGINAL PAGE IS
OF POOR QUALITY.

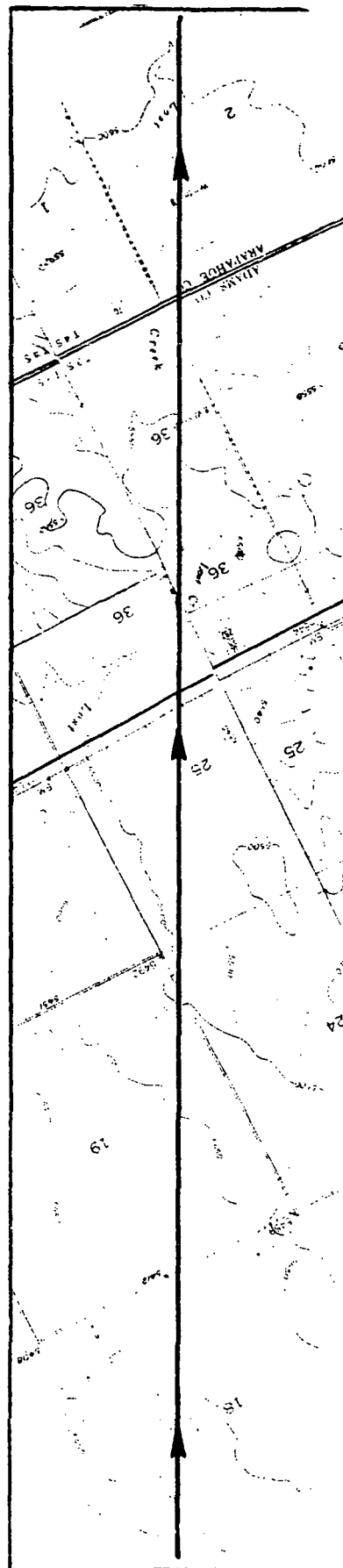
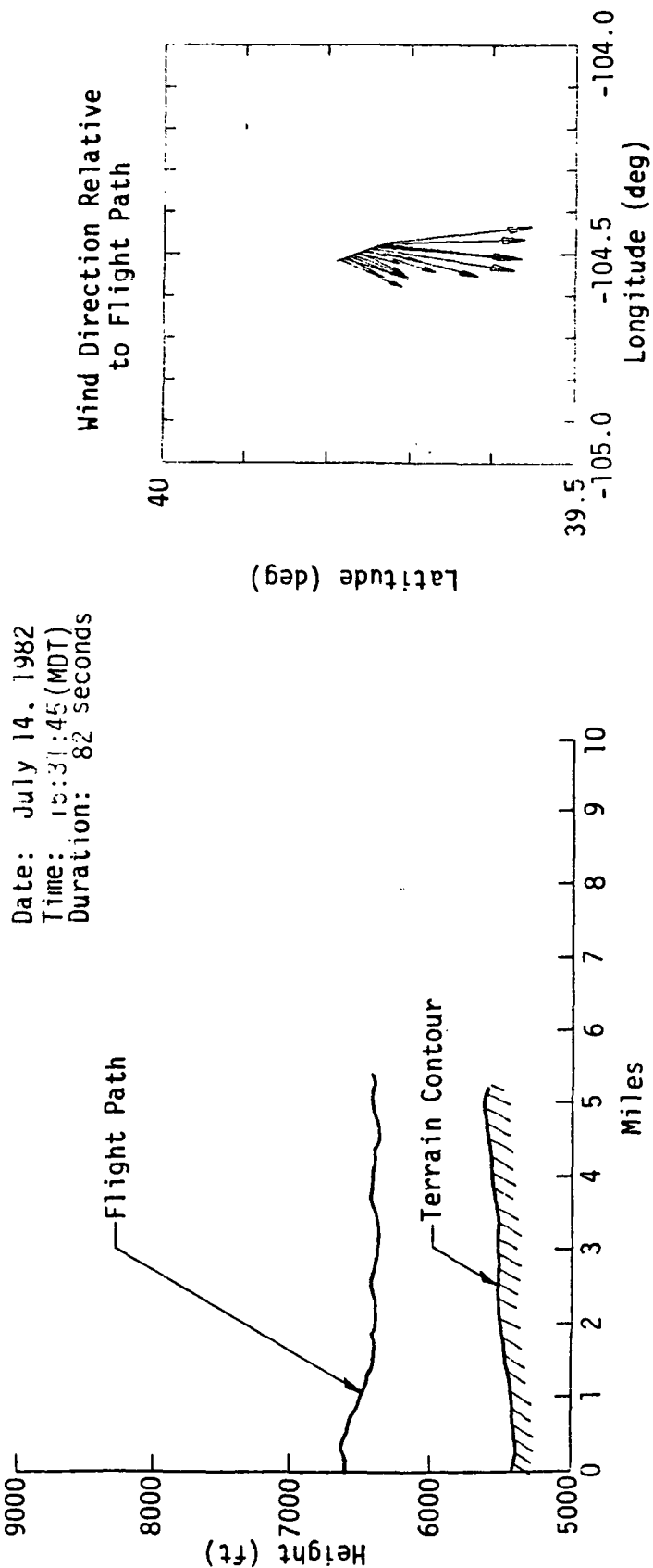

Figure A.289. Flight path information, Flight 6, Run 39.

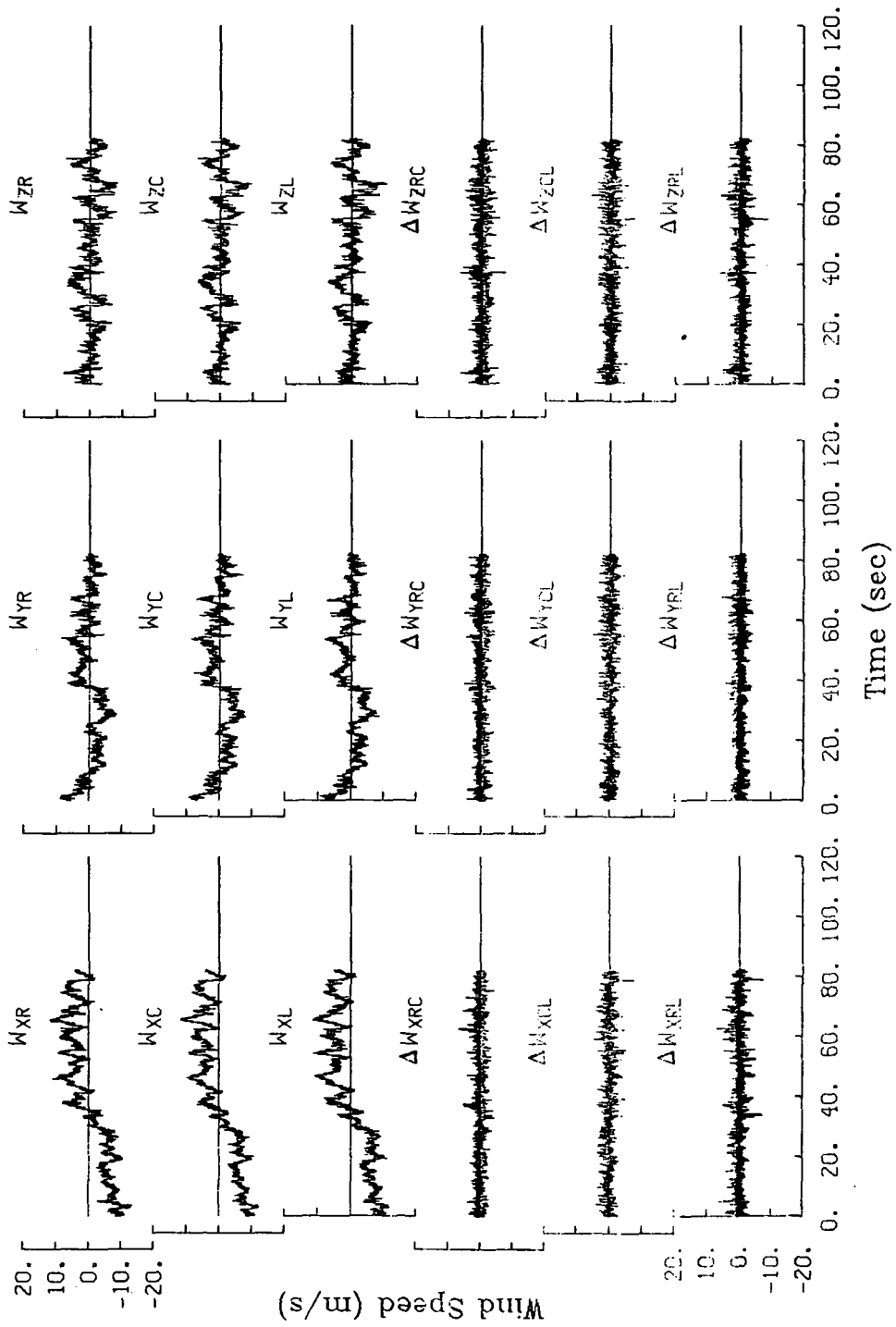

Figure A.290. Time histories of gust velocities and gust velocity differences, Flight 6, Run 39.

Figure A.291. Average Turbulence Parameters and Integral Length Scales, Flight 6, Run 39.

I. Mean Airspeed (m/s)

V_L	V_C	V_R
107.1	106.0	107.9

II. Standard Deviation of Gust Velocities (m/s)

$\sigma_{W_{XL}}$	$\sigma_{W_{XC}}$	$\sigma_{W_{XR}}$
5.93	5.75	5.82
$\sigma_{W_{YL}}$	$\sigma_{W_{YC}}$	$\sigma_{W_{YR}}$
3.06	3.08	3.04
$\sigma_{W_{ZL}}$	$\sigma_{W_{ZC}}$	$\sigma_{W_{ZR}}$
2.84	2.69	2.84

III. Standard Deviation of Gust Velocity Differences (m/s)

$\sigma_{\Delta W_{XCL}}$	$\sigma_{\Delta W_{XRC}}$	$\sigma_{\Delta W_{XRL}}$
1.13	1.17	1.43
$\sigma_{\Delta W_{YCL}}$	$\sigma_{\Delta W_{YRC}}$	$\sigma_{\Delta W_{YRL}}$
1.10	1.10	1.15
$\sigma_{\Delta W_{ZCL}}$	$\sigma_{\Delta W_{ZRC}}$	$\sigma_{\Delta W_{ZRL}}$
1.31	1.29	1.47

IV. Integral Length Scale (m)

$L_{W_{XL}}$	$L_{W_{XC}}$	$L_{W_{XR}}$
1337	1335	1349
$L_{W_{YL}}$	$L_{W_{YC}}$	$L_{W_{YR}}$
806	776	811
$L_{W_{ZL}}$	$L_{W_{ZC}}$	$L_{W_{ZR}}$
265	287	258

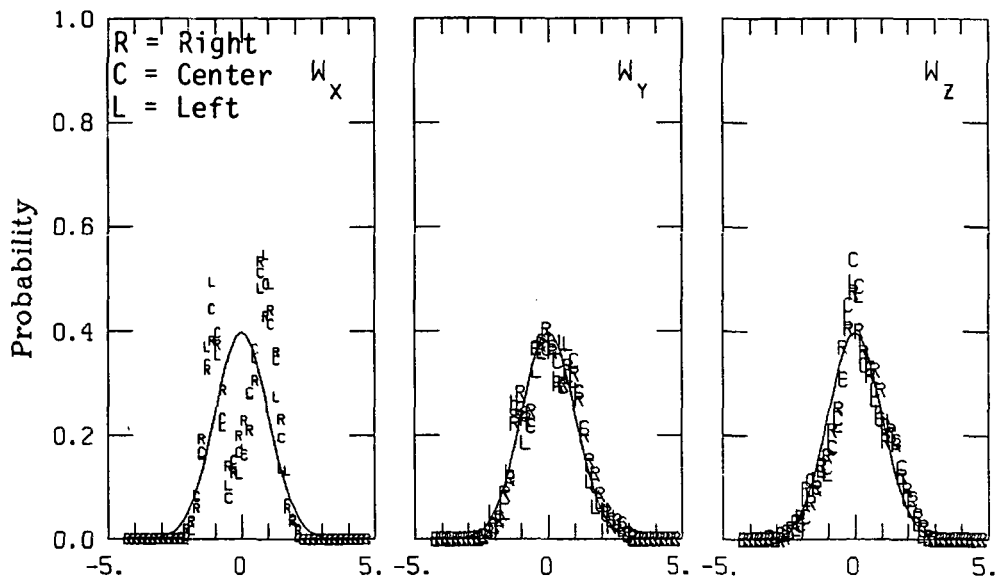

Normalized Gust Velocity (Standard Deviations)

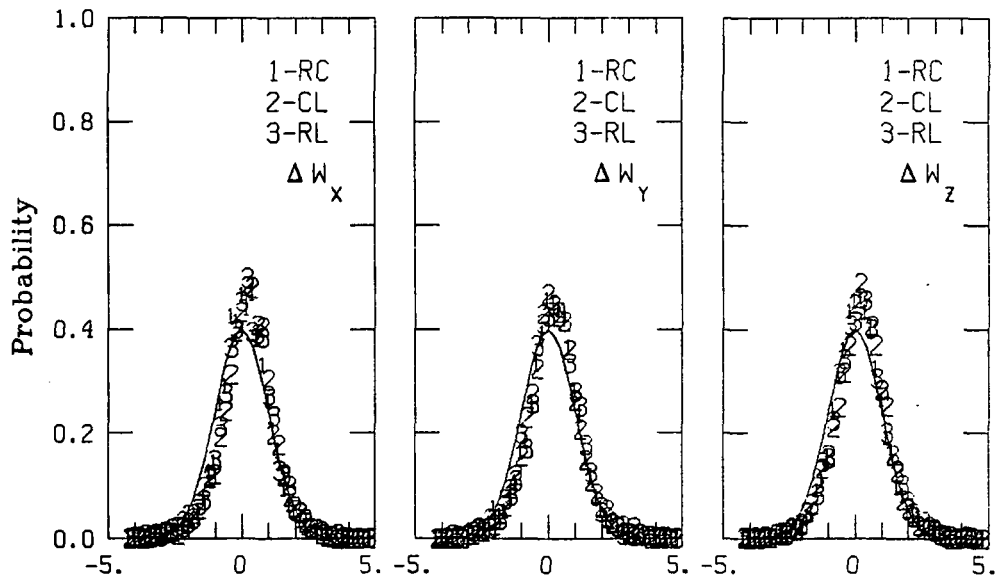

Normalized Velocity Differences (Standard Deviations)

Figure A.292. Probability density function for gust velocities and gust velocity differences, Flight 6, Run 39.

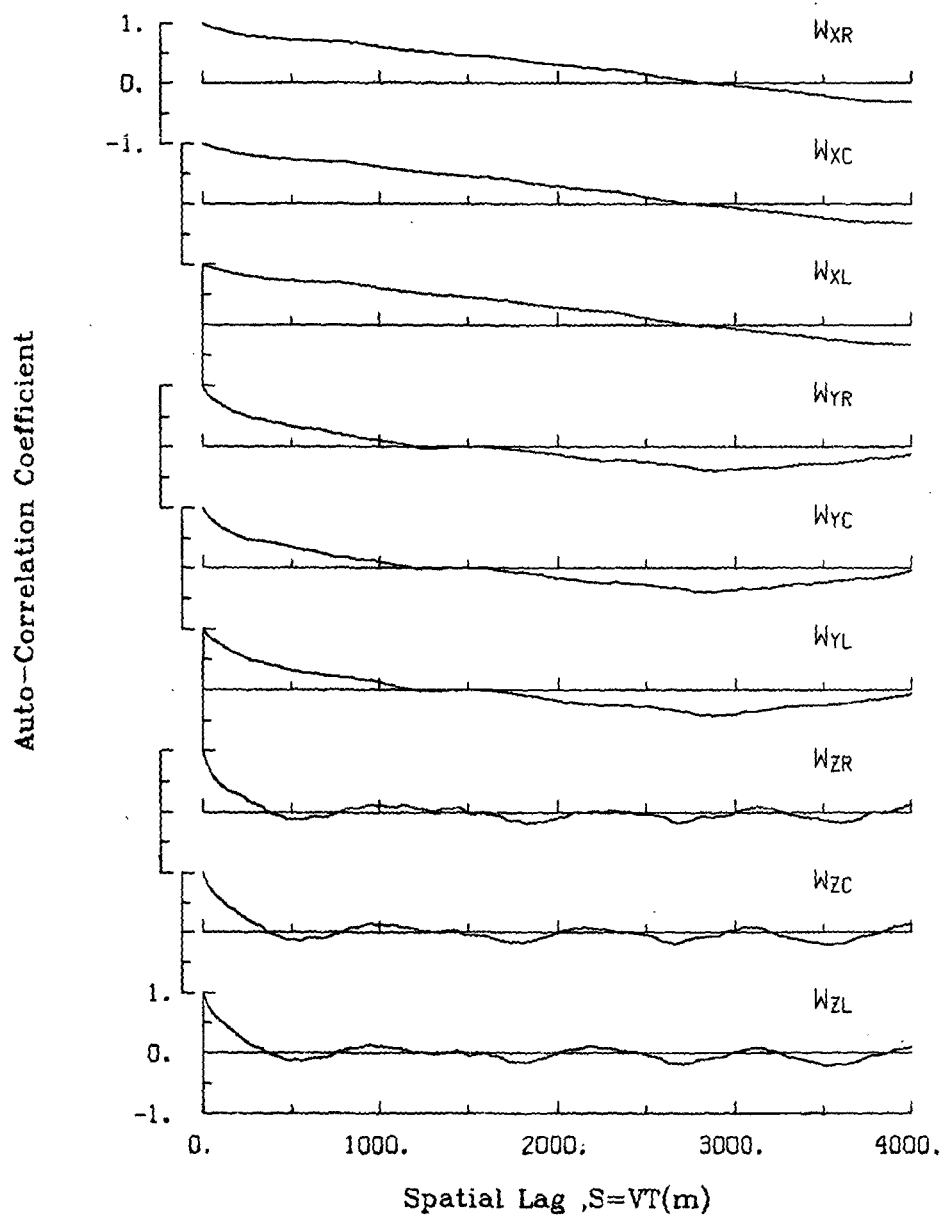

Figure A.293. Single-point auto-correlation coefficient of gust velocities, Flight 6, Run 39.

ORIGINAL PAGE IS
OF POOR QUALITY

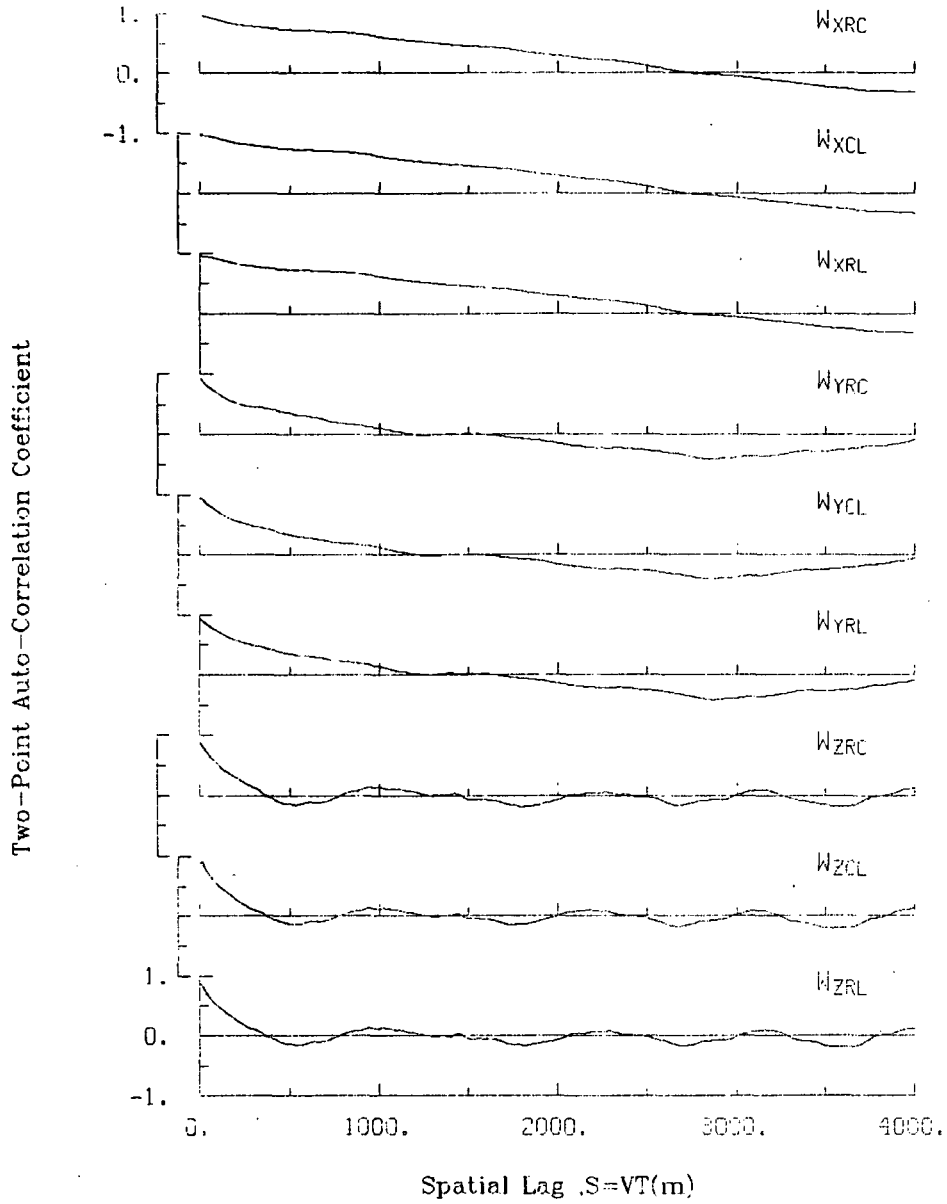

Figure A.294. Two-point auto-correlation coefficient of gust velocities, Flight 6, Run 39.

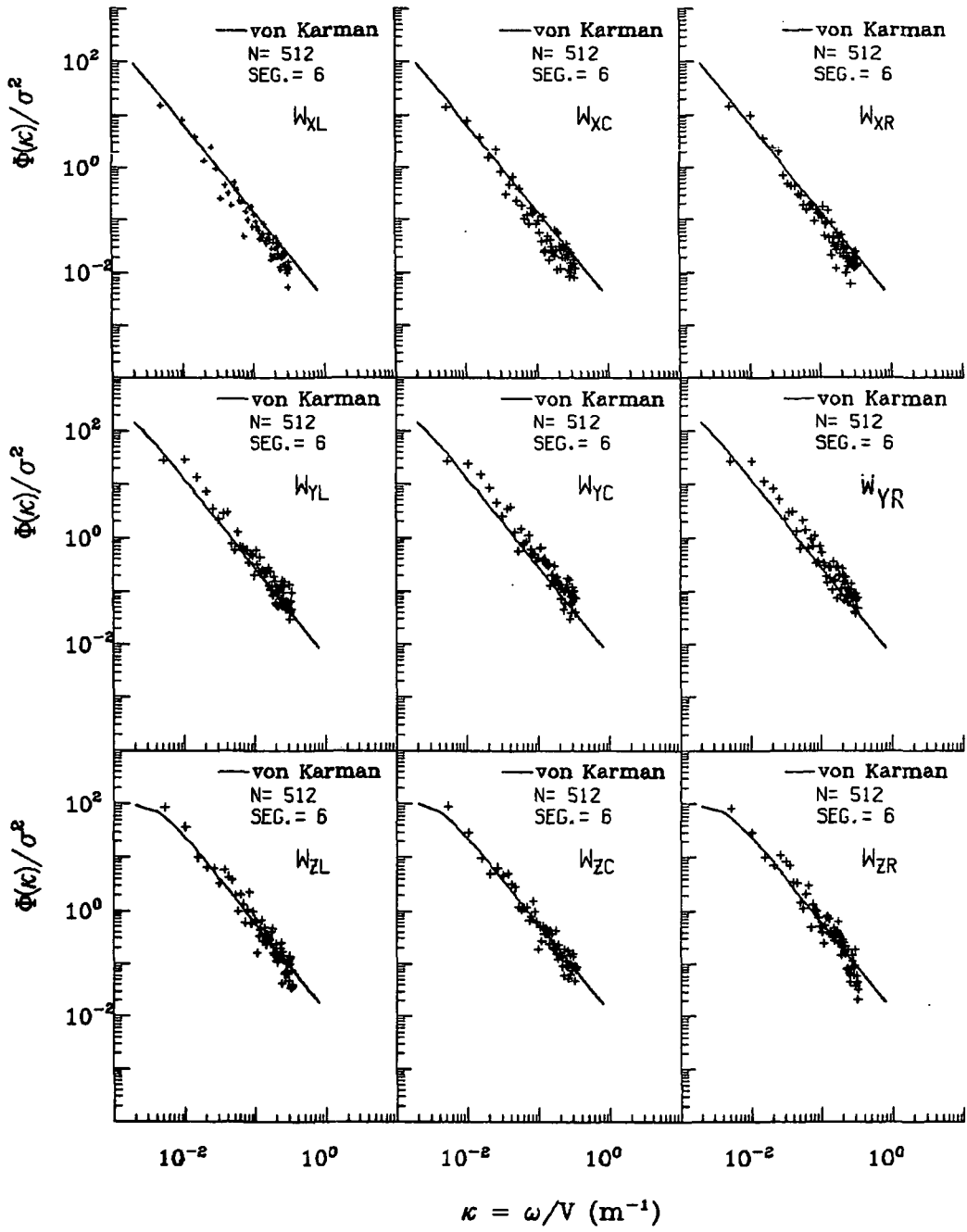

Figure A.295. Normalized auto-spectra of gust velocities, Flight 6, Run 39.

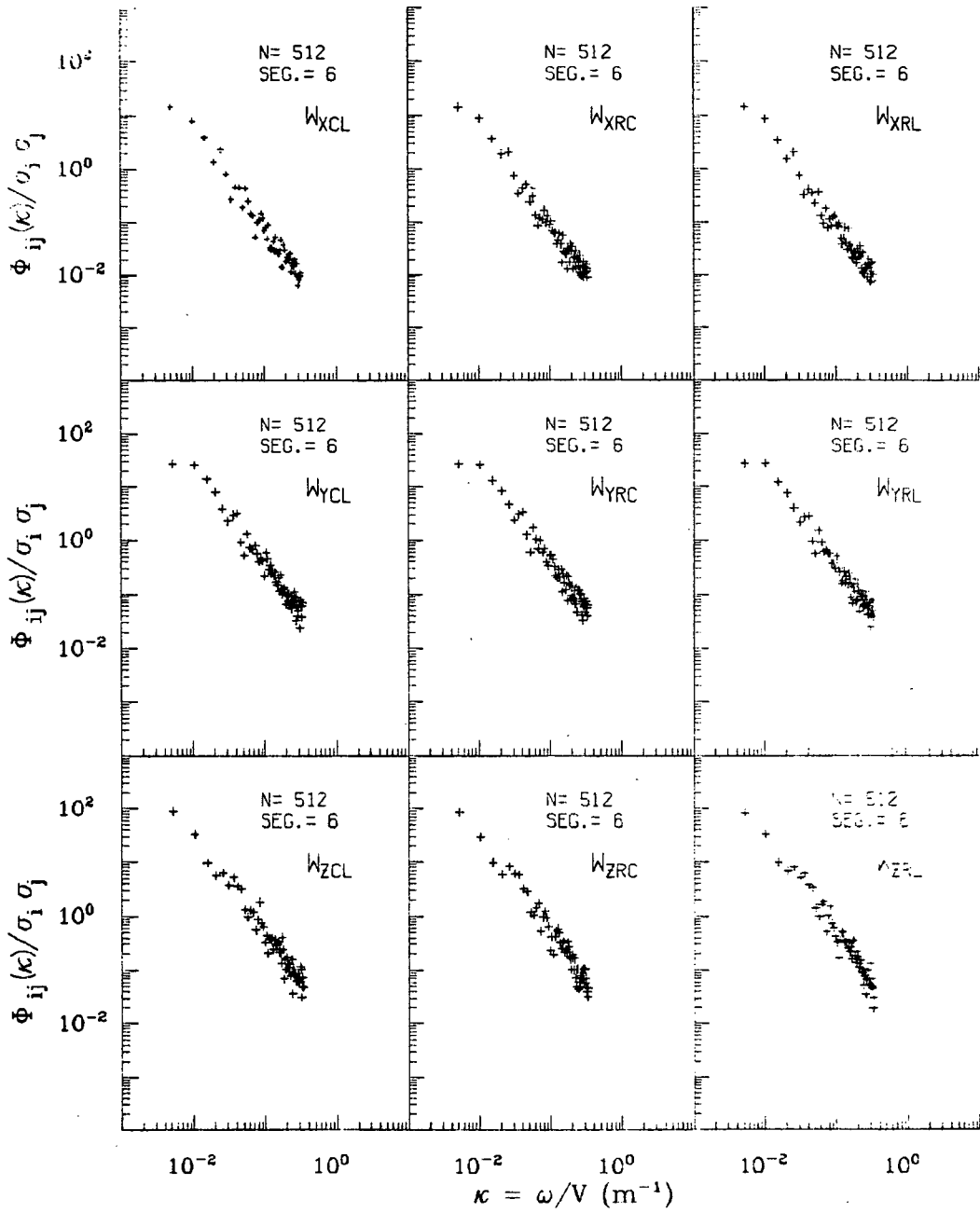

Figure A.296. Normalized two-point auto-spectra of gust velocities, Flight 6, Run 39.

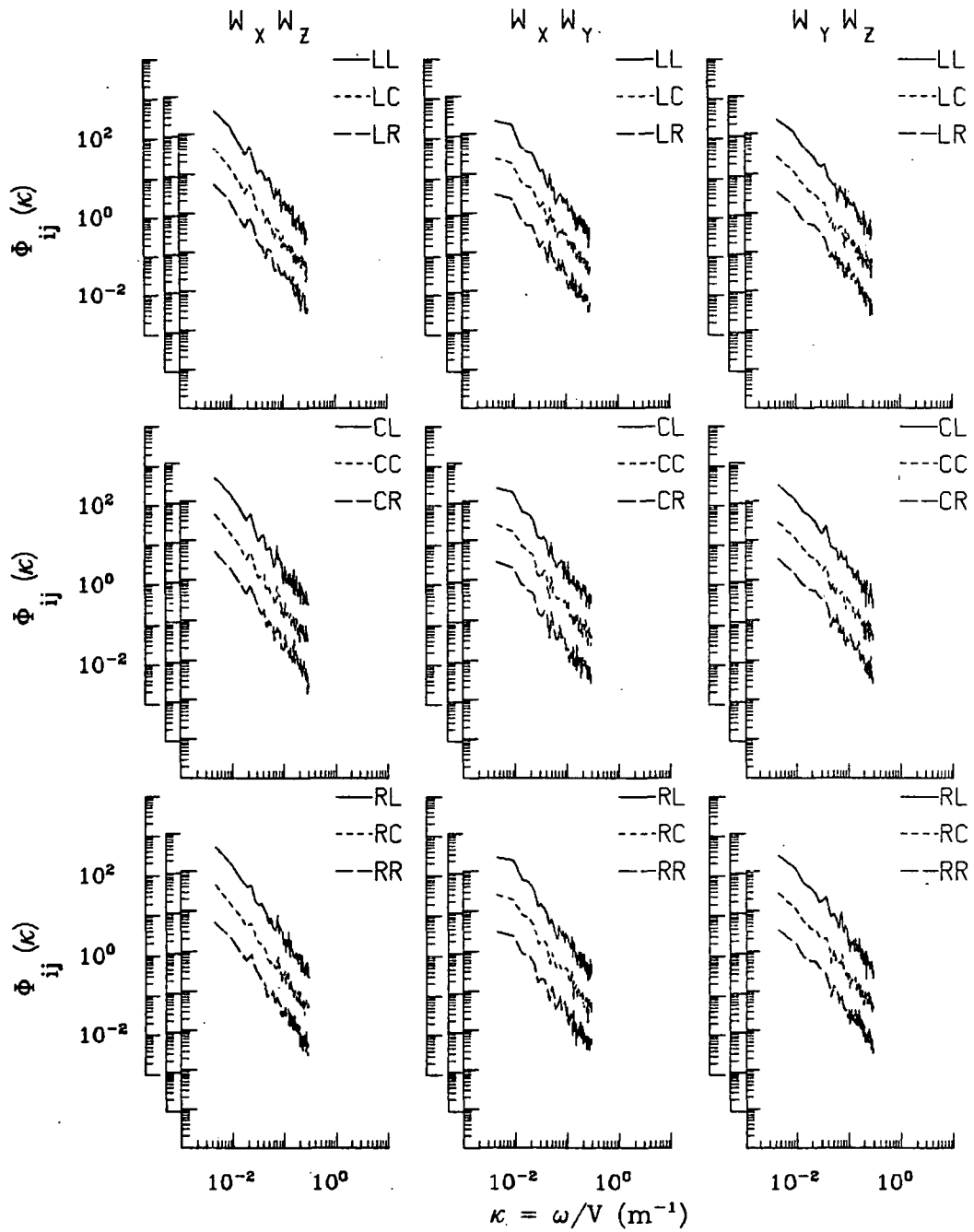

Figure A.297. Two-point cross-spectra of gust velocities, Flight 6, Run 39.

**ORIGINAL PAGE IS
OF POOR QUALITY**

TABLE A.72. List of All Parameters Measured and Their Range of Values, Flight 6, Run 39.

		START TIME • 55905.2702	STOP TIME • 55987.6202				
CHANNEL	UNITS	HIGH	LOW	MEAN	RMS	POINTS	
2	PHI DOT	RAD/SEC	.172	-.154	-.00237	.04220	3294
3	ACCL N CG	G UNITS	-.988	-.988	-.98774	.98774	3294
4	THETA DOT	RAD/SEC	.072	-.064	.00582	.01914	3294
5	THETA	PAD	.118	-.003	.05137	.05789	3294
6	PHI	PAD	.106	-.108	-.01141	.03592	3294
7	PSI 1	DEGREES	338.329	330.940	335.03794	335.04171	3294
8	DEL PSI 1	DEGREES	3.961	-3.327	.83103	1.78121	3294
9	PSI 2	DEGREES	337.160	329.774	333.89185	333.89542	3294
10	DEL PSI 2	DEGREES	3.726	-3.536	.61627	1.68869	3294
11	ACCL N LT	G UNITS	2.330	-.558	1.01041	1.07086	3294
12	ACCL N RT	G UNITS	2.476	-.402	1.02234	1.08120	3294
13	ACCL X CG	G UNITS	.130	-.012	.05864	.06468	3294
14	ACCL Y CG	G UNITS	.175	-.187	.01240	.04468	3294
15	BETA CTR	RAD	.045	-.107	-.02544	.03164	3294
16	BETA CTR	PAD	.088	-.115	-.01404	.03103	3294
17	TEMP I	DEG F	84.409	83.693	84.01969	84.01978	3294
18	TEMP P	DEG F	93.242	93.062	93.13788	93.13793	3294
19	ACCL Z INS	G UNITS	1.641	.225	1.00125	1.01663	3294
20	ALPHA RT	RAD	.048	-.109	-.02146	.03053	3294
21	BETA RT	RAD	.101	-.079	.01899	.03191	3294
22	ALPHA LT	RAD	.049	-.107	-.02031	.02841	3294
23	BETA LT	RAD	.085	-.105	-.02040	.03242	3294
24	PSI DOT	RAD/SEC	.062	-.054	.00387	.02234	3294
25	TEMP TOT	DEG C	32.277	29.816	31.04272	31.04845	3294
26	QC LT	PSID	.965	.646	.79508	.79859	3294
27	QC CTR	PSID	.938	.640	.77999	.78322	3294
28	QC RT	PSID	.982	.653	.80809	.81140	3294
29	PS	PSIA	11.628	11.502	11.59280	11.59284	3294
30	TEMP IRT	DEG C	20.918	14.295	17.42756	17.54250	3294
31	D TO G	METERS	8786506.1768783867.827	*****	*****	*****	3294
32	B TO D	DEGREES	80.661	80.619	80.64035	80.64035	3294
33	LONG	DEGREES	-104.472	-104.517	-104.49450	104.49450	3294
34	LAT	DEGREES	39.789	39.726	39.75742	39.75743	3294
35	TRK ANG	DEGREES	332.736	329.602	331.38115	331.38225	3294
36	HDG	RADIANS	5.903	5.772	5.84631	5.84638	3294
37	VE	M/SFC	-44.833	-48.747	-46.83838	46.85199	3294
38	VN	M/SEC	88.191	83.083	85.88067	85.89522	3294
39	ALTITUDE	KM	2.019	1.932	1.95609	1.95622	3294
40	TEMP C	DEGREES C	26.301	24.697	25.43610	25.43739	3294
41	EW WND SPD	KNOTS	16.791	-22.972	-6.53624	9.05188	3294
42	NS WND SPD	KNOTS	1.088	-41.946	-20.94099	23.52898	3294
43	WIND SPEED	KNOTS	42.388	1.127	-23.30554	25.21010	3294
44	WIND DIREC	DEGREES	359.972	.010	72.36975	134.20406	3294
45	AIRSPED R	M/SEC	119.079	97.222	107.87838	107.98769	3294
46	AIRSPED C	M/SEC	116.443	96.273	106.02898	106.13773	3294
47	AIRSPED L	M/SEC	117.697	96.780	107.01836	107.13515	3294
48	DELTA ALT	METERS	12.271	-75.207	-51.00719	55.55011	3294
49	INRTL DISP	METERS	9.396	-74.293	-50.95554	56.20205	3294
50	UG RIGHT	M/SEC	11.647	-13.348	-.00000	5.70688	3294
51	UG CENTER	M/SEC	11.720	-12.158	-.00000	5.63682	3294
52	UG LEFT	M/SEC	11.380	-11.957	-.00000	5.82163	3294
53	VG RIGHT	M/SEC	8.778	-8.283	-.02960	2.97476	3294
54	VG CENTER	M/SEC	9.409	-7.626	-.02785	3.01477	3294
55	VG LEFT	M/SEC	9.237	-8.620	-.02914	2.99643	3294
56	WG RIGHT	M/SEC	8.078	-8.164	.01888	2.82416	3294
57	WG CENTER	M/SEC	7.080	-9.264	.02525	2.67412	3294
58	WG LEFT	M/SEC	7.472	-10.473	.02381	2.83194	3294

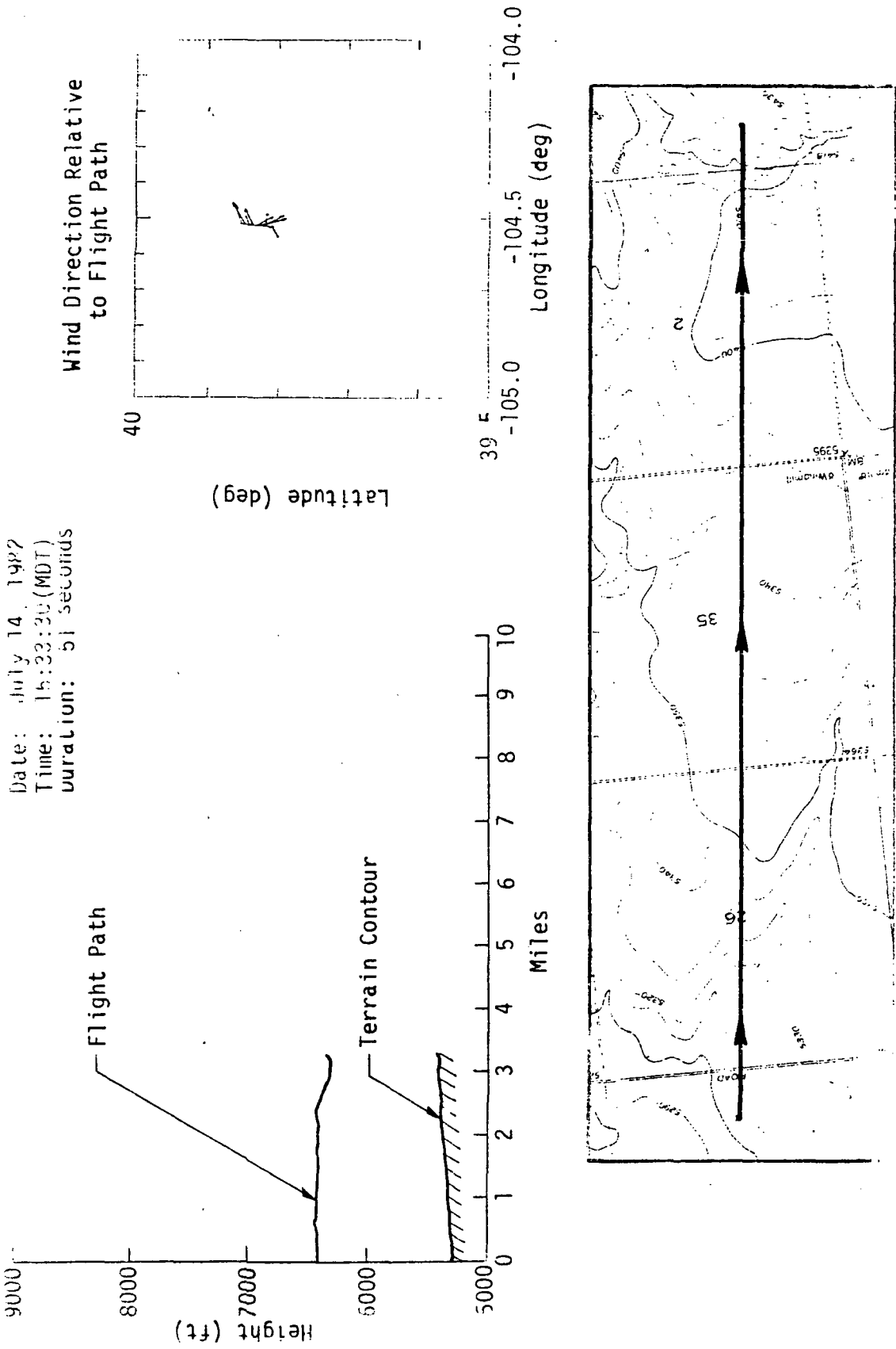

TABLE A.73. Flight path information, Flight 6, Run 40.

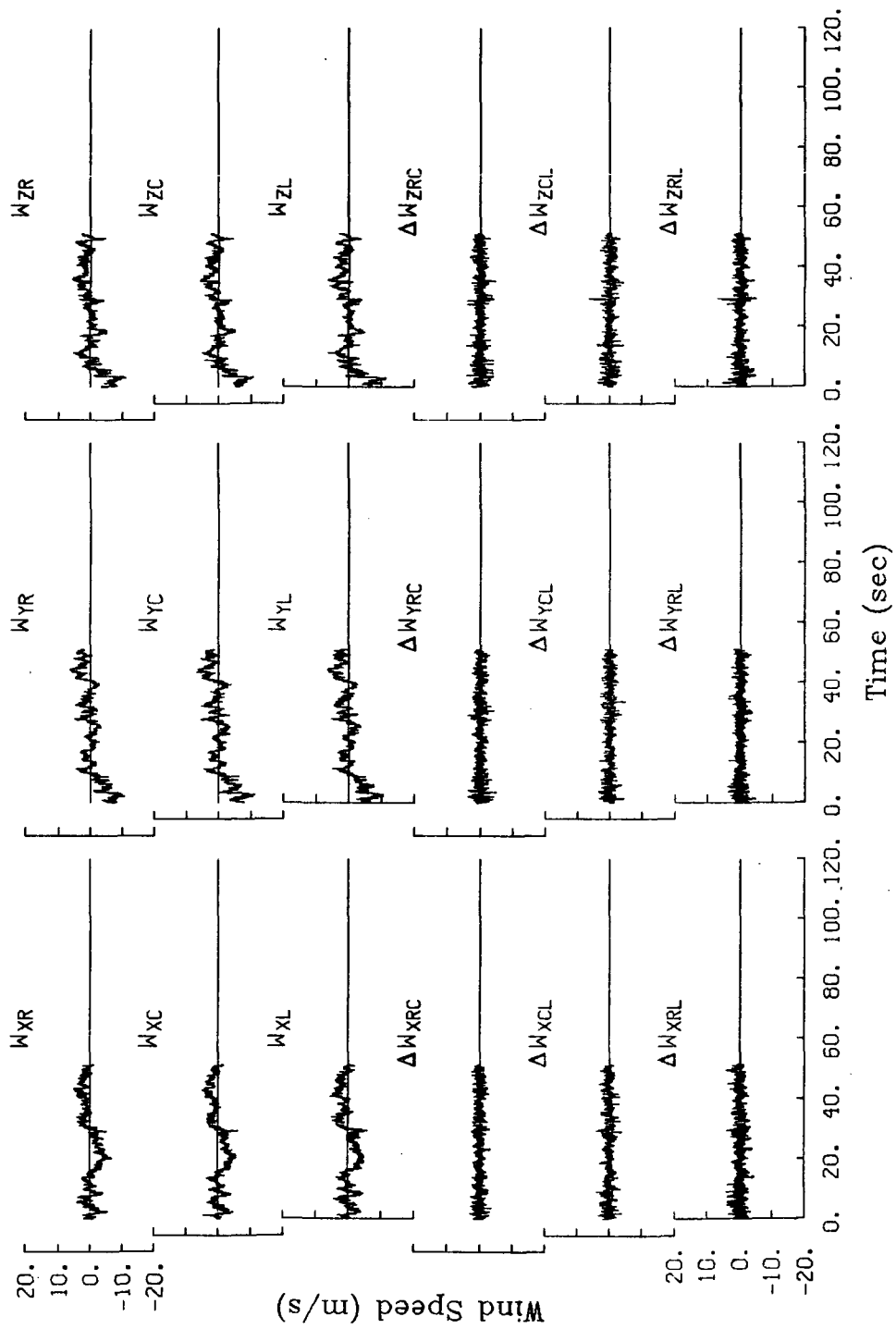

Figure A.298. Time histories of gust velocities and gust velocity differences, Flight 6, Run 40.

TABLE A.71. Average Turbulence Parameters and Integral Length Scales, Flight 6, Run 40.

I. Mean Airspeed (m/s)			II. Standard Deviation of Gust Velocities (m/s)		
V_L	V_C	V_R	$\frac{\sigma}{W_{XL}}$	$\frac{\sigma}{W_{XC}}$	$\frac{\sigma}{W_{XR}}$
105.8	104.6	106.4	2.15	2.06	2.14
			$\frac{\sigma}{W_{YL}}$	$\frac{\sigma}{W_{YC}}$	$\frac{\sigma}{W_{YR}}$
			2.85	2.86	2.80
			$\frac{\sigma}{W_{ZL}}$	$\frac{\sigma}{W_{ZC}}$	$\frac{\sigma}{W_{ZR}}$
			3.05	2.92	2.99
III. Standard Deviation of Gust Velocity Differences (m/s)			IV. Integral Length Scale (m)		
$\frac{\sigma_{\Delta W_{XCL}}}{\Delta W_{XCL}}$	$\frac{\sigma_{\Delta W_{XRC}}}{\Delta W_{XRC}}$	$\frac{\sigma_{\Delta W_{XRL}}}{\Delta W_{XRL}}$	$L_{W_{XL}}$	$L_{W_{XC}}$	$L_{W_{XR}}$
0.88	0.97	1.14	368	424	437
$\frac{\sigma_{\Delta W_{YCL}}}{\Delta W_{YCL}}$	$\frac{\sigma_{\Delta W_{YRC}}}{\Delta W_{YRC}}$	$\frac{\sigma_{\Delta W_{YRL}}}{\Delta W_{YRL}}$	$L_{W_{YL}}$	$L_{W_{YC}}$	$L_{W_{YR}}$
1.01	0.96	1.04	658	613	645
$\frac{\sigma_{\Delta W_{ZCL}}}{\Delta W_{ZCL}}$	$\frac{\sigma_{\Delta W_{ZRC}}}{\Delta W_{ZRC}}$	$\frac{\sigma_{\Delta W_{ZRL}}}{\Delta W_{ZRL}}$	$L_{W_{ZL}}$	$L_{W_{ZC}}$	$L_{W_{ZR}}$
1.09	1.05	1.27	523	556	562

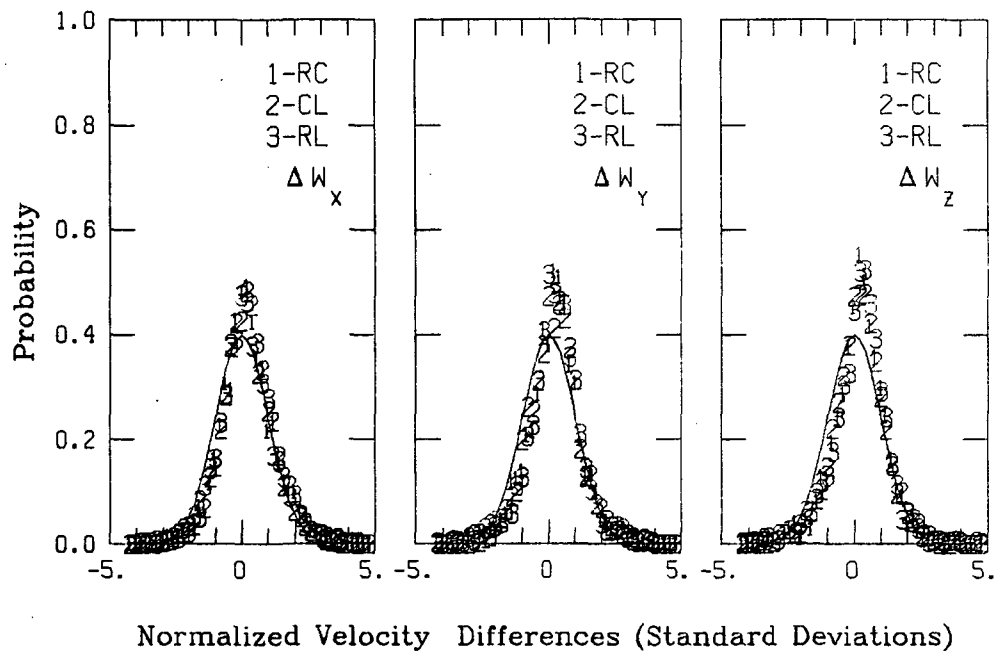
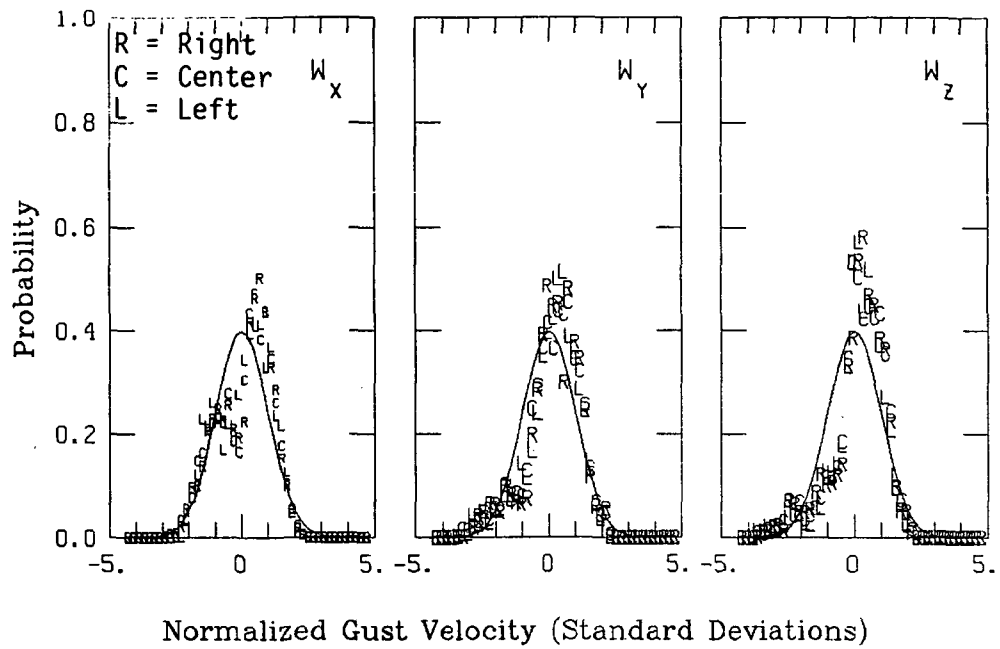

Figure A.299. Probability density function for gust velocities and gust velocity differences, Flight 6, Run 40.

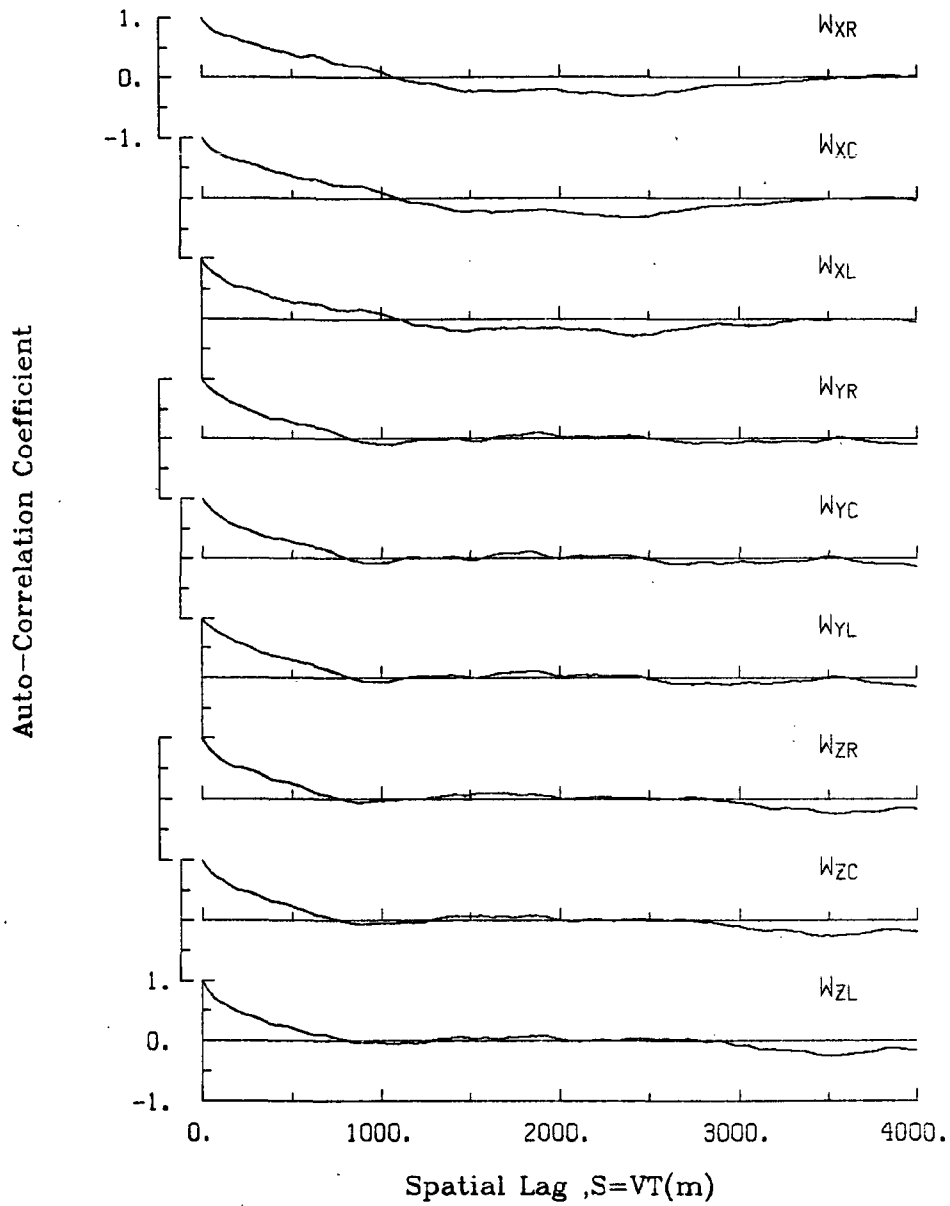

Figure A.300. Single-point auto-correlation coefficient of gust velocities, Flight 6, Run 40.

ORIGINAL PAGE IS
OF POOR QUALITY

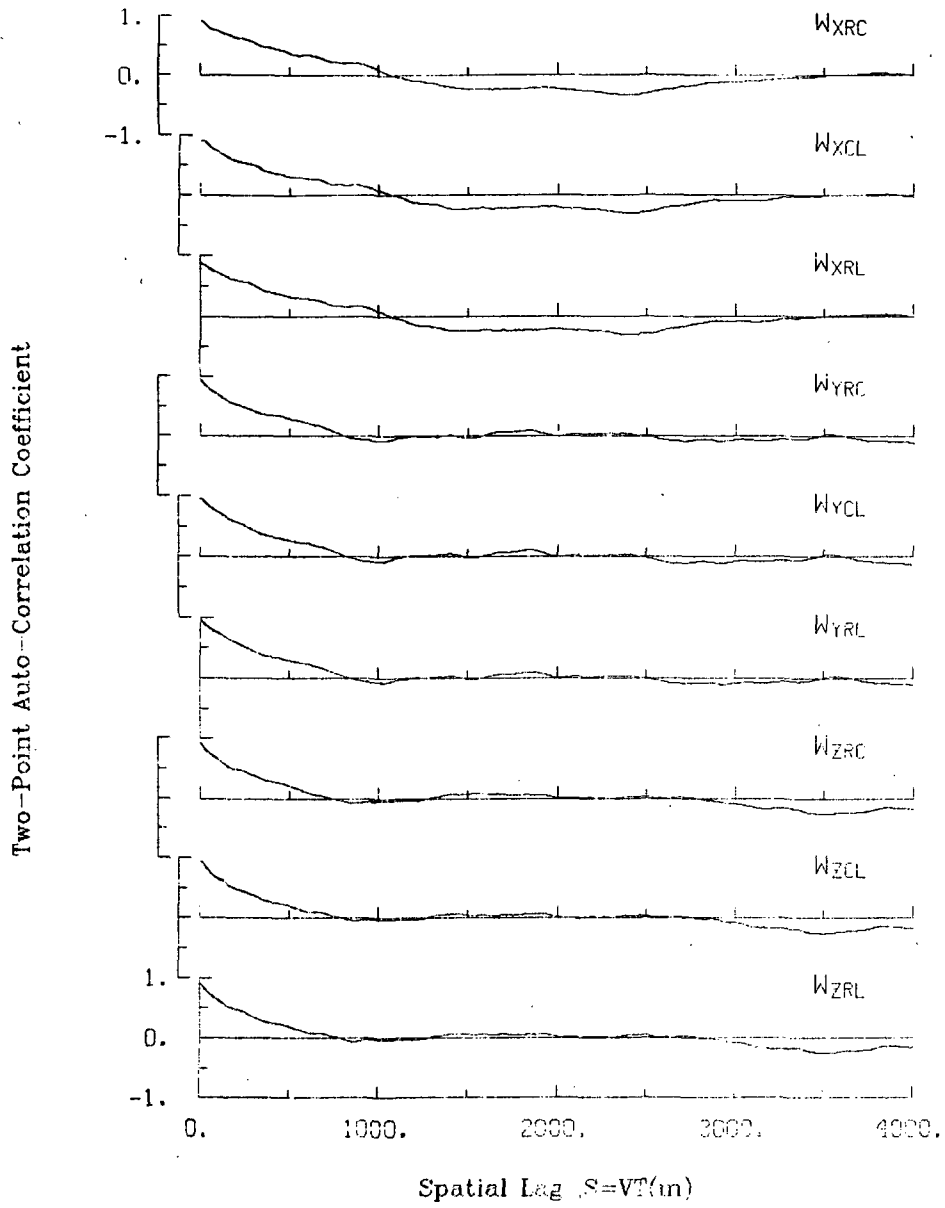

Figure A.301. Two-point auto-correlation coefficient of gust velocities, Flight 6, Run 40.

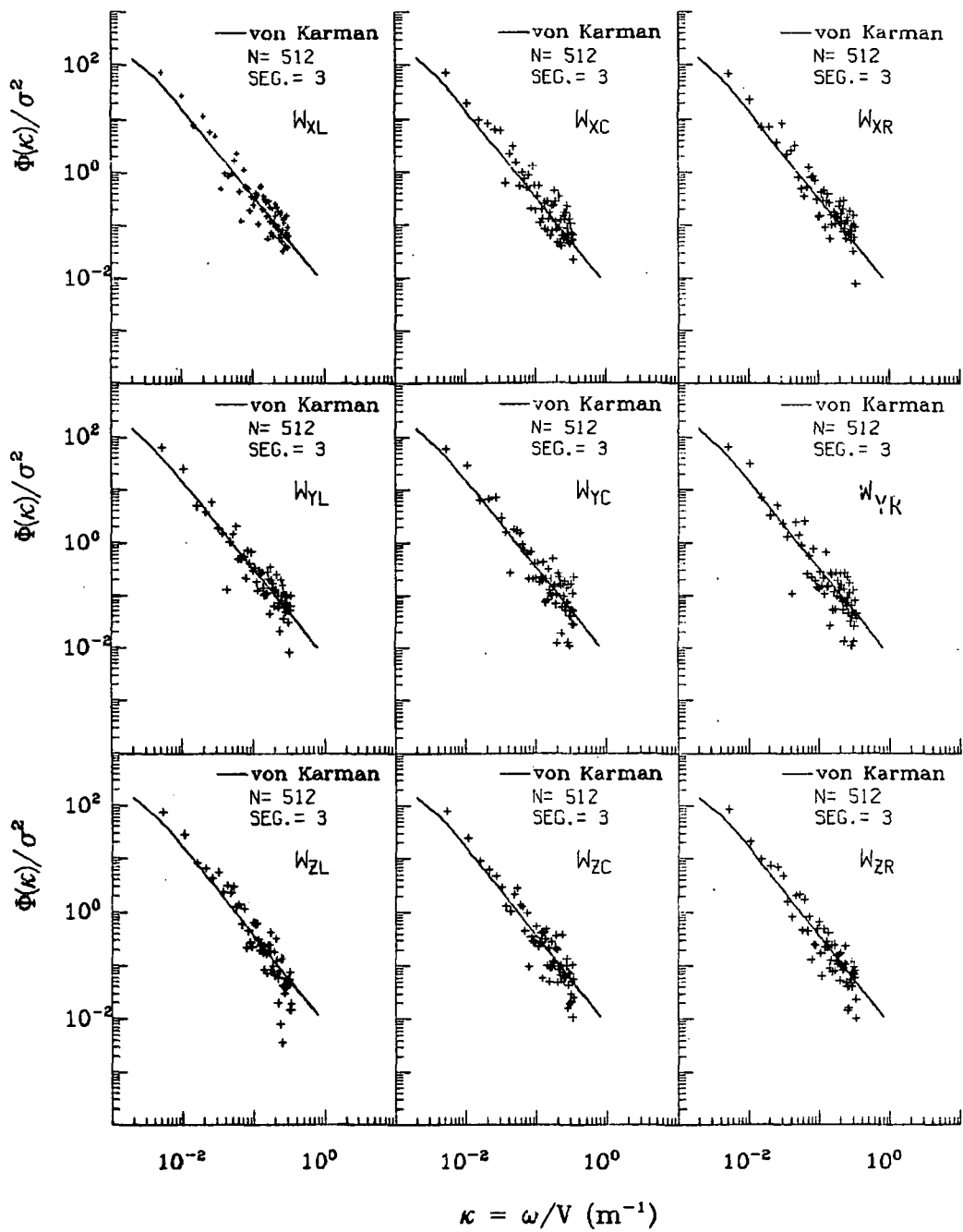

Figure A.302. Normalized auto-spectra of gust velocities, Flight 6, Run 40.

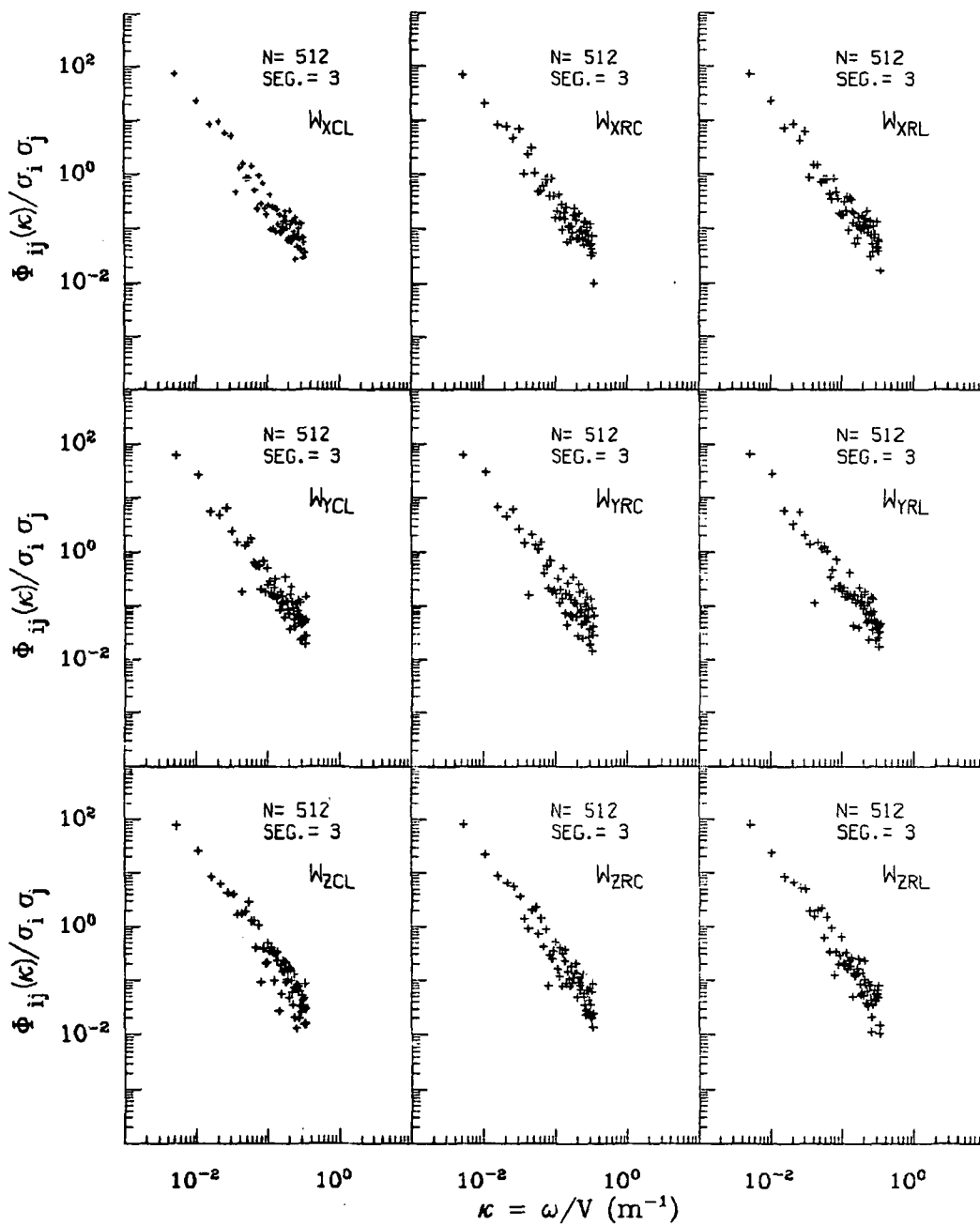

Figure A.303. Normalized two-point auto-spectra of gust velocities, Flight 6, Run 40.

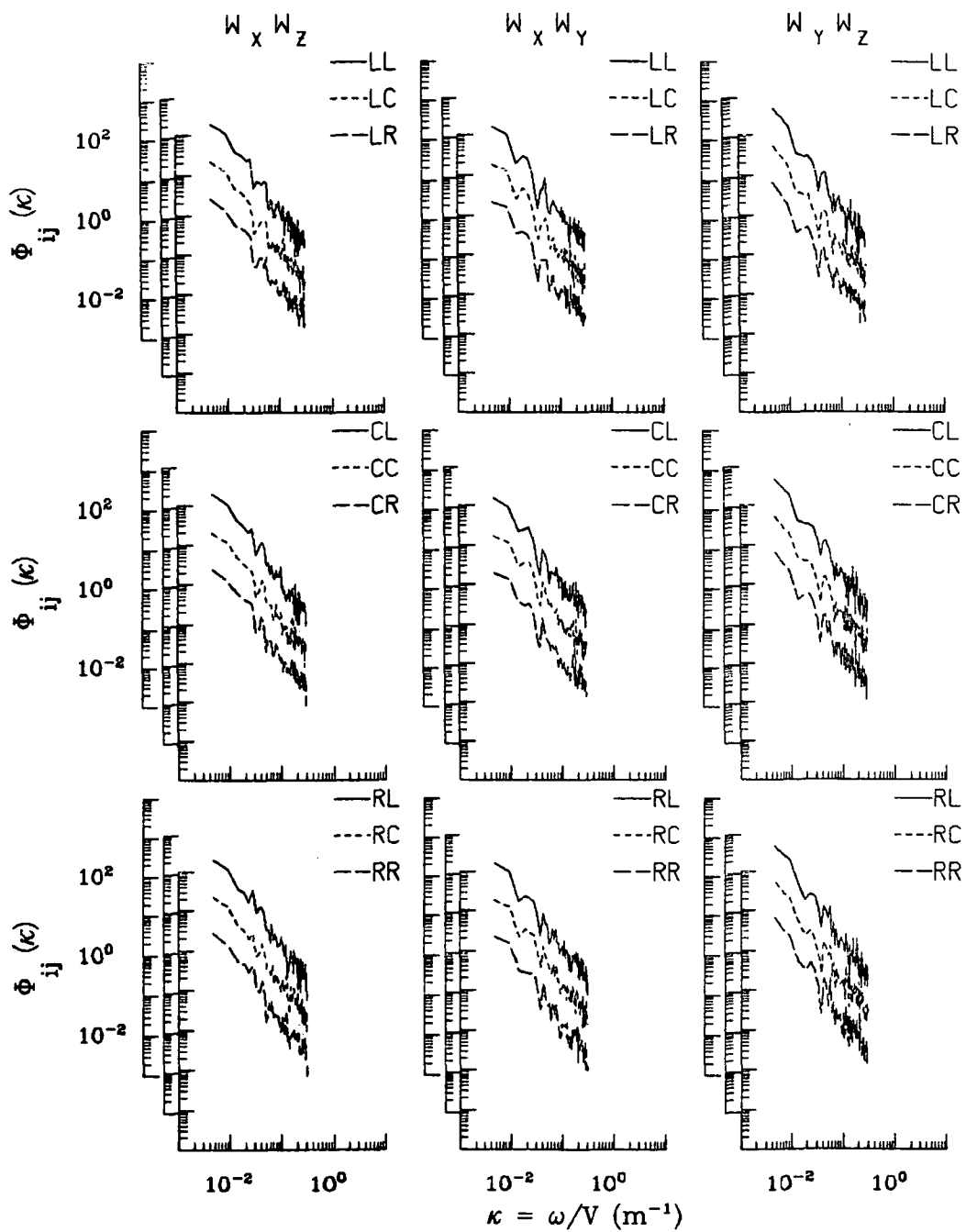

Figure A.304. Two-point cross-spectra of gust velocities, Flight 6, Run 40.

ORIGINAL PAGE IS
OF POOR QUALITY

TABLE A.72. List of All Parameters Measured and Their Range of Values, Flight 6, Run 40.

		START TIME - 56010.3354	STOP TIME - 56061.8104			
CHANNEL	UNITS	HIGH	LOW	MEAN	RMS	POINT
2 PHI DOT	RAD/SEC	.179	-.146	-.00267	.03714	2051
3 ACCL N CG	G UNITS	-.988	-.988	-.98774	.98774	2051
4 THETA DOT	RAD/SEC	.058	-.051	.00505	.01624	2051
5 THETA	RAD	.128	.013	.04891	.05807	2051
6 PHI	RAD	.066	-.058	.00414	.02405	2051
7 PSI 1	DEGREES	6.185	.197	3.26515	3.57634	2051
8 DEL PSI 1	DEGREEES	2.493	-3.356	-.48054	1.51600	2051
9 PSI 2	DEGREES	364.275	358.290	361.27731	361.28005	2051
10 DEL PSI 2	DEGREES	2.315	-3.595	-.71680	1.60520	2051
11 ACCL N LT	G UNITS	2.230	-.527	1.01654	1.05549	2051
12 ACCL N RT	G UNITS	2.140	-.122	1.02990	1.06547	2051
13 ACCL X CG	G UNITS	.200	.007	.07273	.08177	2051
14 ACCL Y CG	G UNITS	.153	-.145	.01367	.04644	2051
15 ALPHA CTR	RAD	.053	-.080	-.02279	.02794	2051
16 BETA CTR	RAD	.058	-.100	-.01318	.03069	2051
17 TEMP I	DEG F	84.053	83.693	83.88773	83.88783	2051
18 TEMP P	DEG F	93.242	93.062	93.17067	93.17071	2051
19 ACCL Z INS	G UNITS	1.558	.525	1.00885	1.01933	2051
20 ALPHA RT	RAD	.067	-.071	-.01971	.02614	2051
21 BETA RT	RAD	.079	-.056	.01963	.03161	2051
22 ALPHA LT	RAD	.058	-.065	-.01607	.02290	2051
23 BETA LT	RAD	.047	-.100	-.01774	.03064	2051
24 PSI DOT	RAD/SEC	.066	-.047	.00393	.02554	2051
25 TEMP TOT	DEG C	31.096	29.520	30.37338	30.37563	2051
26 OC LT	PSID	.879	.645	.77702	.77858	2051
27 OC CTR	PSID	.867	.614	.75952	.76108	2051
28 OC RT	PSID	.885	.646	.78587	.78748	2051
29 PS	PSIA	11.634	11.576	11.59347	11.59348	2051
30 TEMP IFT	DEG C	17.050	13.212	15.65904	15.69241	2051
31 D TO G	METERS	8785262.5928783843.443	*****	*****	*****	2051
32 B TO D	DEGREEES	80.612	80.608	80.60972	80.60972	2051
33 LONG	DEGREEES	-104.515	-104.522	-104.51875	104.51875	2051
34 LAT	DEGREEES	39.857	39.809	39.83249	39.83249	2051
35 YPK ANG	DEGREEES	7.872	3.470	6.08472	6.20982	2051
36 HDG	RADIANS	.122	.017	.06842	.07318	2051
37 VE	M/SEC	14.954	5.936	11.13383	11.42302	2051
38 VN	M/SEC	108.181	97.900	103.61092	103.64896	2051
39 ALTITUDE	KM	1.968	1.978	1.95561	1.95564	2051
40 TEMPC	DEGREEES C	25.564	24.006	24.92045	24.92148	2051
41 EW WND SPD	KNOTS	18.739	-16.000	5.09189	7.81928	2051
42 NS WND SPD	KNOTS	8.277	-12.067	-1.24068	4.29801	2051
43 WIND SPEED	KNOTS	19.287	.379	8.18661	8.92267	2051
44 WIND DIREC	DEGREEES	359.950	.049	249.19380	262.91773	2051
45 AIRSPEED R	M/SEC	112.823	96.610	106.37677	106.47153	2051
46 AIRSPEED C	M/SEC	111.370	94.278	104.61910	104.67288	2051
47 AIRSPEED L	M/SEC	112.439	96.532	105.79126	105.84438	2051
48 DELTA ALT	METERS	32.074	-8.112	19.73527	22.47333	2051
49 INPTL DISP	METERS	28.663	-7.178	18.49654	21.15555	2051
50 UG RIGHT	M/SEC	5.046	-6.615	-.00000	2.23875	2051
51 UG CENTER	M/SEC	4.838	-5.778	.00000	2.17632	2051
52 UG LEFT	M/SEC	5.488	-5.840	.00000	2.22041	2051
53 VG RIGHT	M/SEC	6.225	-10.546	-.00650	2.96758	2051
54 VG CENTER	M/SEC	6.761	-10.882	-.00893	3.02734	2051
55 VG LEFT	M/SEC	6.417	-10.571	-.00758	3.01135	2051
56 WG RIGHT	M/SEC	5.824	-10.724	.06696	2.84189	2051
57 WG CENTER	M/SEC	5.714	-10.528	.06524	2.74410	2051
58 WG LEFT	M/SEC	6.267	-11.191	.06250	2.86020	2051

ORIGINAL PAGE IS
OF POOR QUALITY

Date: July 14, 1982
Time: 15:35:14 (MDT)
Duration: 108 seconds

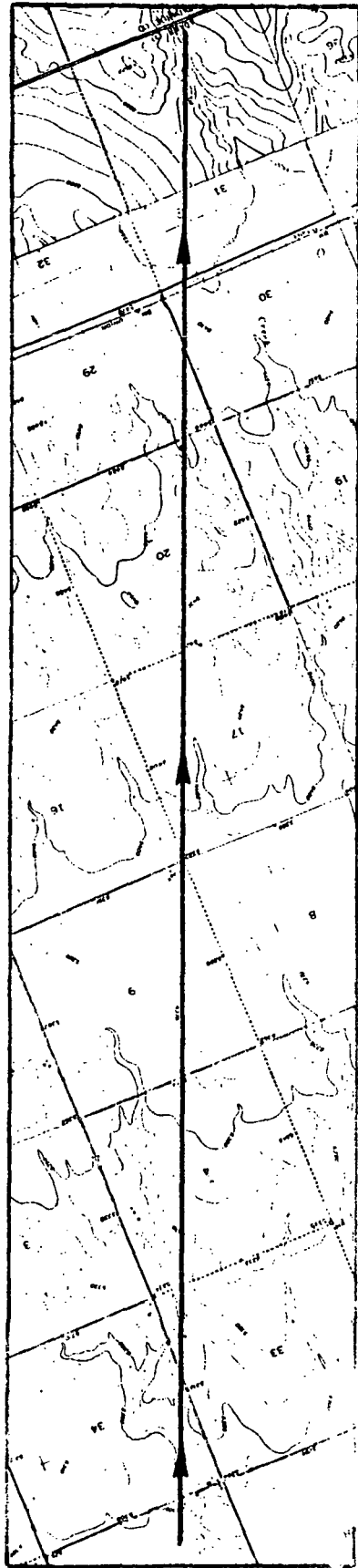
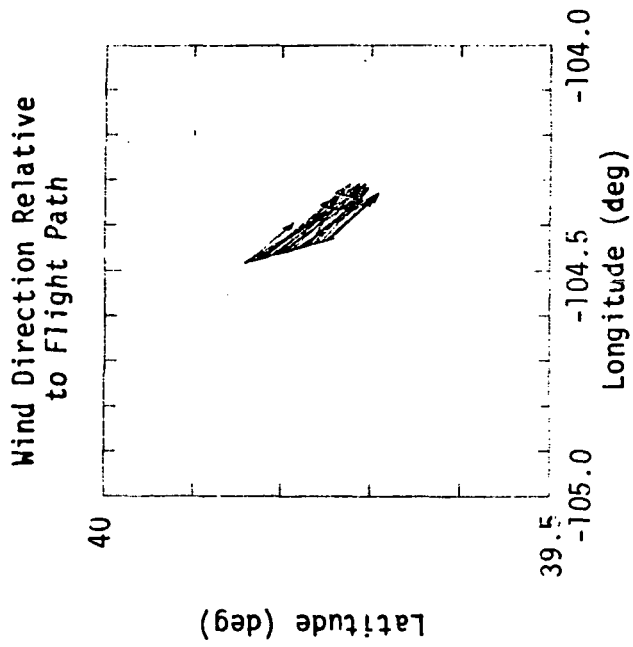
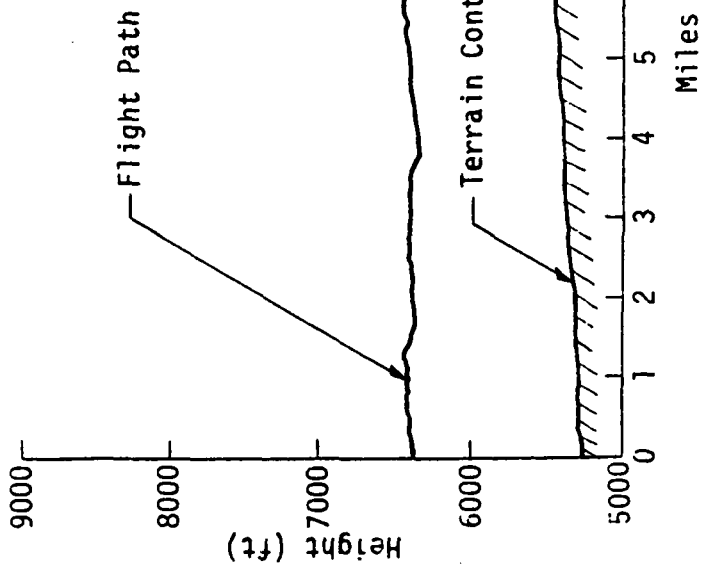

Figure A.305. Flight path information, Flight 6, Run 41.

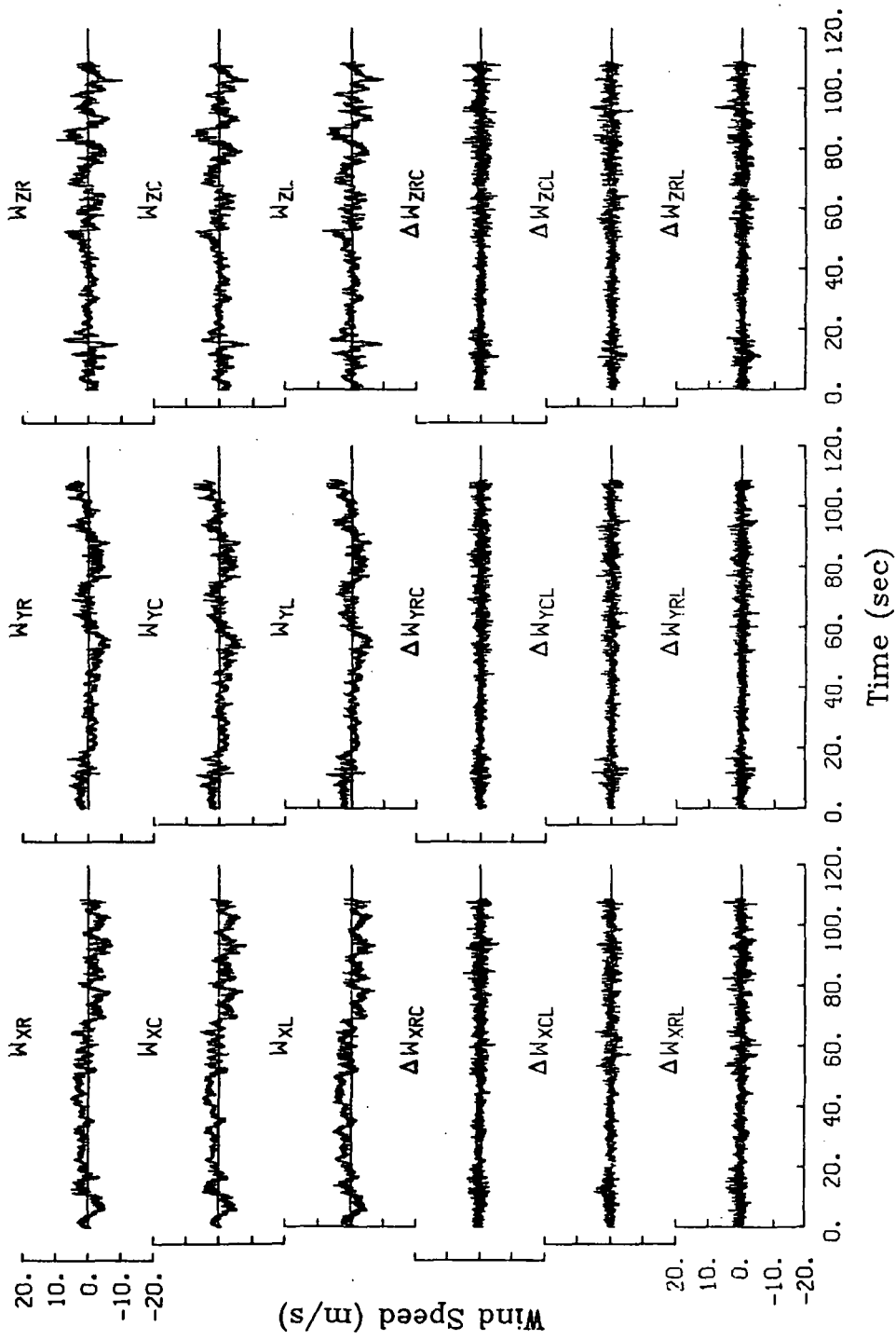
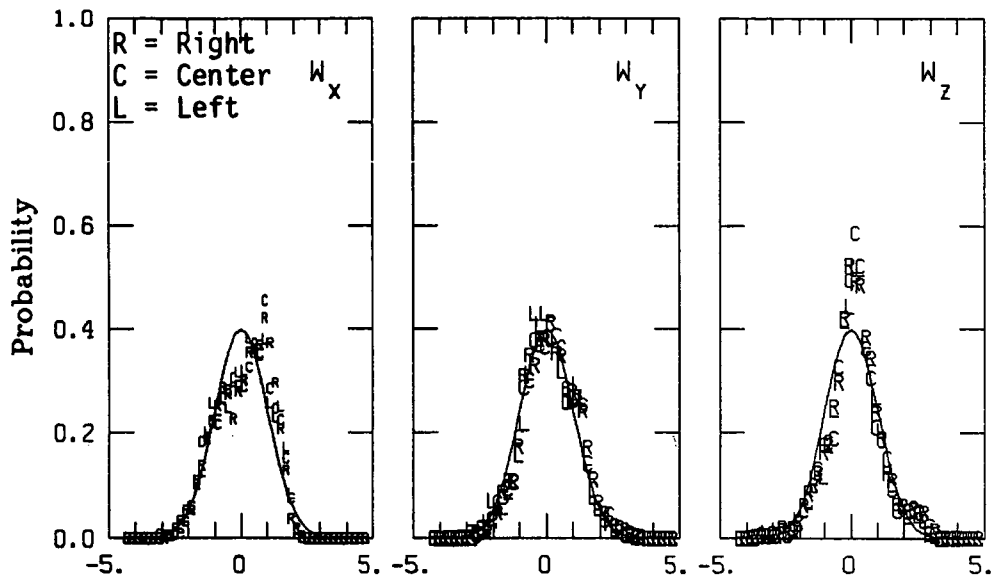

Figure A.306. Time histories of gust velocities and gust velocity differences, Flight 6, Run 41.

TABLE A.74. Average Turbulence Parameters and Integral Length Scales, Flight 6, Run 41.

I. Mean Airspeed (m/s)			II. Standard Deviation of Gust Velocities (m/s)		
V_L	V_C	V_R	$\sigma_{W_{XL}}$	$\sigma_{W_{XC}}$	$\sigma_{W_{XR}}$
105.1	104.1	106.0	2.43	2.40	2.47
			$\sigma_{W_{YL}}$	$\sigma_{W_{YC}}$	$\sigma_{W_{YR}}$
			2.08	2.10	2.06
			$\sigma_{W_{ZL}}$	$\sigma_{W_{ZC}}$	$\sigma_{W_{ZR}}$
			2.44	2.31	2.49
III. Standard Deviation of Gust Velocity Differences (m/s)			IV. Integral Length Scale (m)		
$\sigma_{\Delta W_{XCL}}$	$\sigma_{\Delta W_{XRC}}$	$\sigma_{\Delta W_{XRL}}$	$L_{W_{XL}}$	$L_{W_{XC}}$	$L_{W_{XR}}$
1.01	1.02	1.24	905	876	911
$\sigma_{\Delta W_{YCL}}$	$\sigma_{\Delta W_{YRC}}$	$\sigma_{\Delta W_{YRL}}$	$L_{W_{YL}}$	$L_{W_{YC}}$	$L_{W_{YR}}$
0.95	0.97	1.04	706	715	802
$\sigma_{\Delta W_{ZCL}}$	$\sigma_{\Delta W_{ZRC}}$	$\sigma_{\Delta W_{ZRL}}$	$L_{W_{ZL}}$	$L_{W_{ZC}}$	$L_{W_{ZR}}$
1.11	1.17	1.31	237	260	235



Normalized Gust Velocity (Standard Deviations)

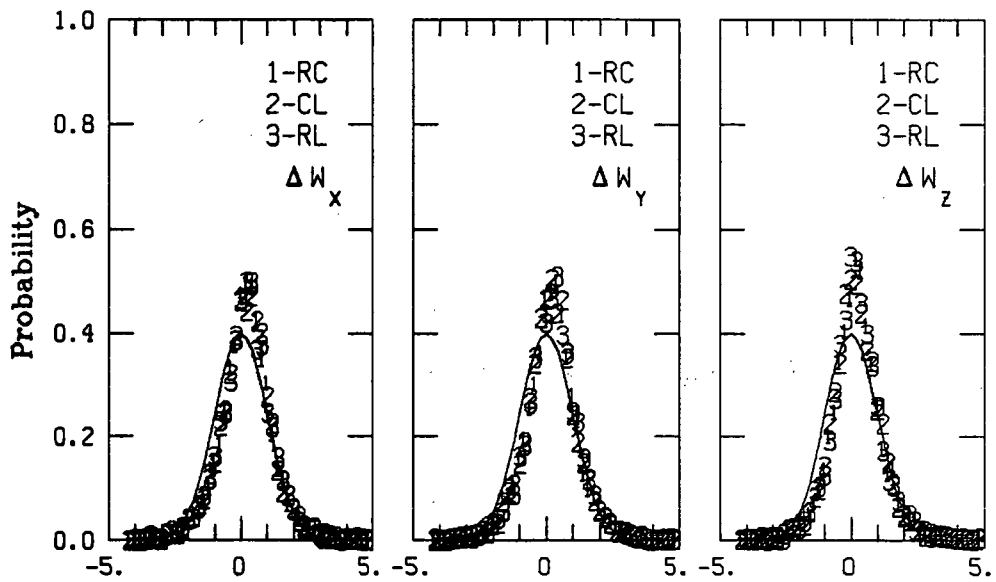

Normalized Velocity Differences (Standard Deviations)

Figure A.307. Probability density function for gust velocities and gust velocity differences, Flight 6, Run 41.

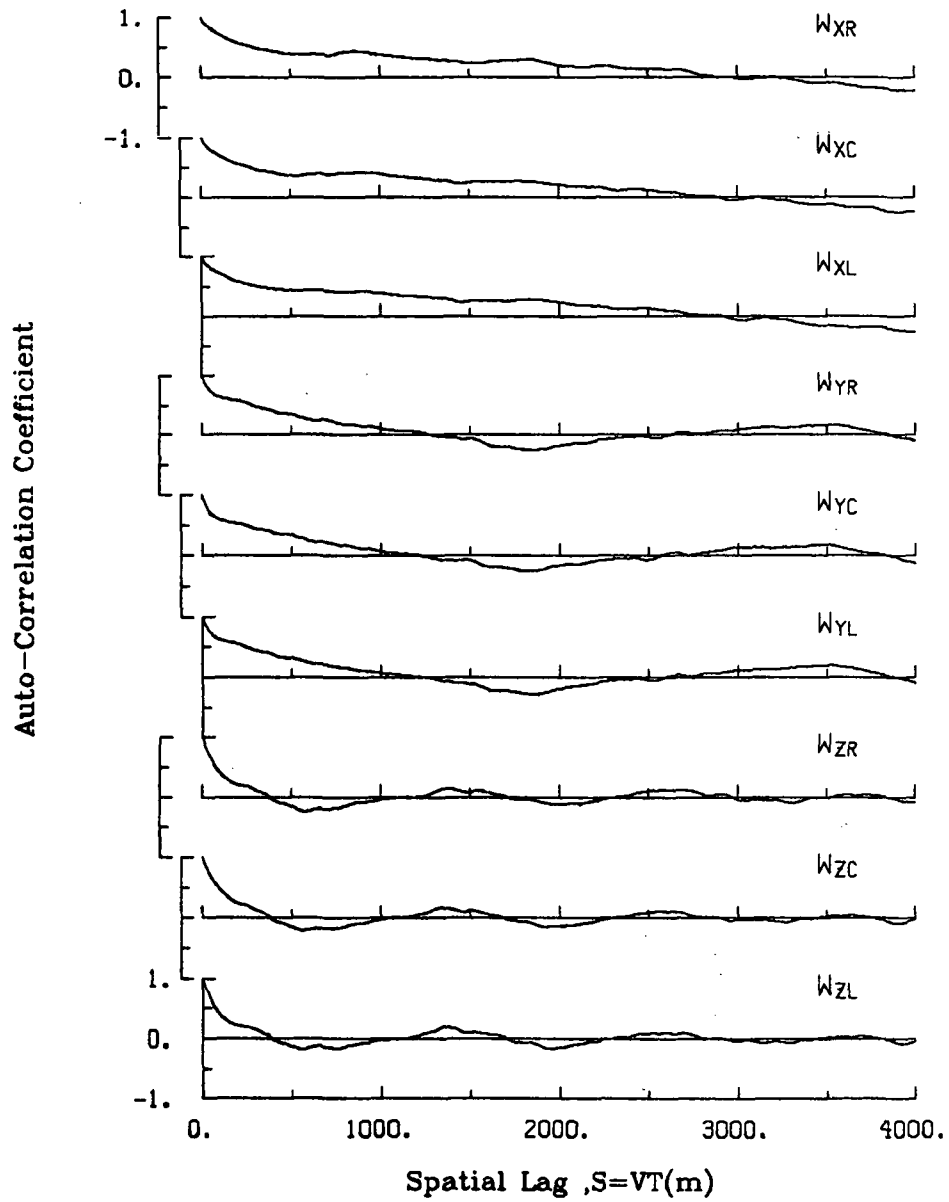

Figure A.308. Single-point auto-correlation coefficient of gust velocities, Flight 6, Run 41.

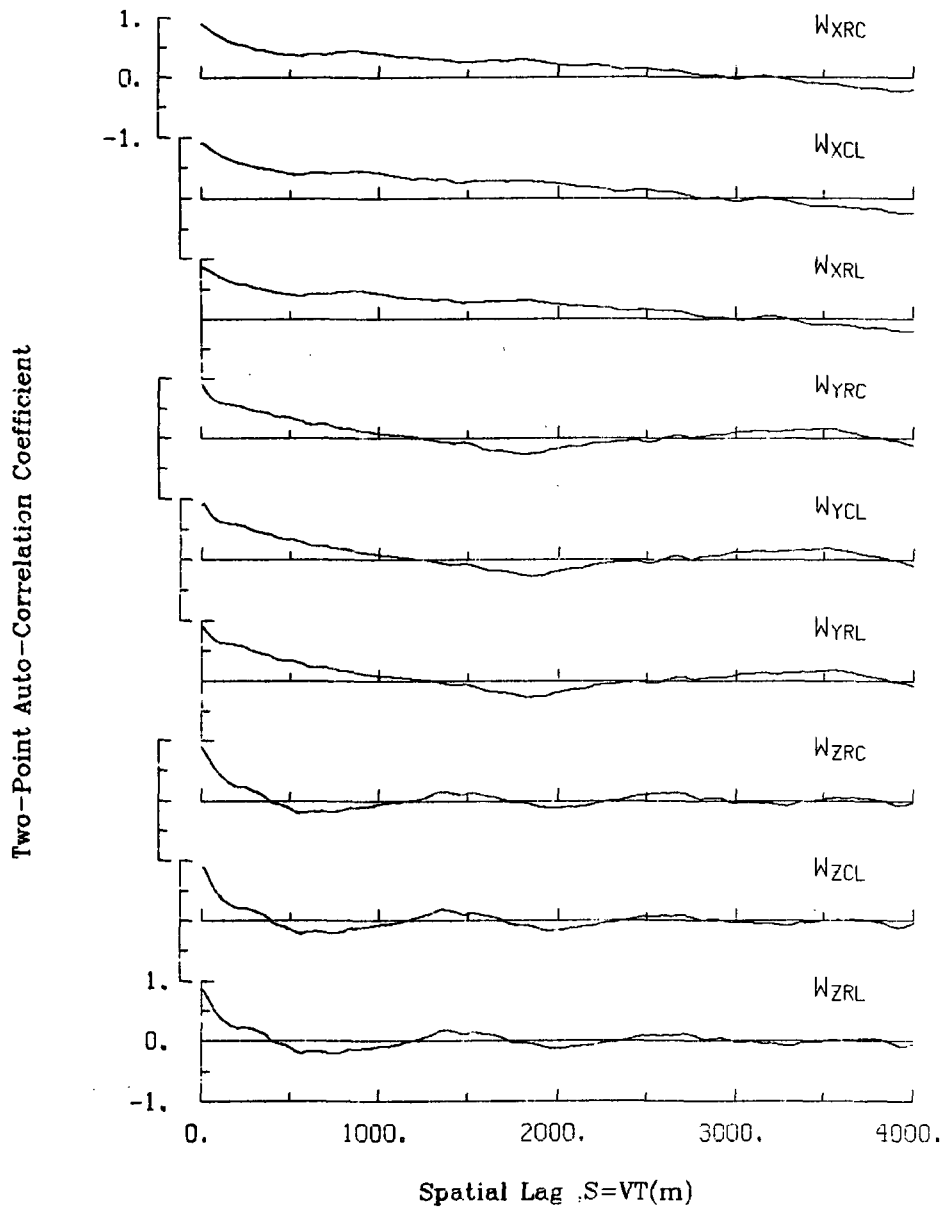

Figure A.309. Two-point auto-correlation coefficient of gust velocities, Flight 6, Run 41.

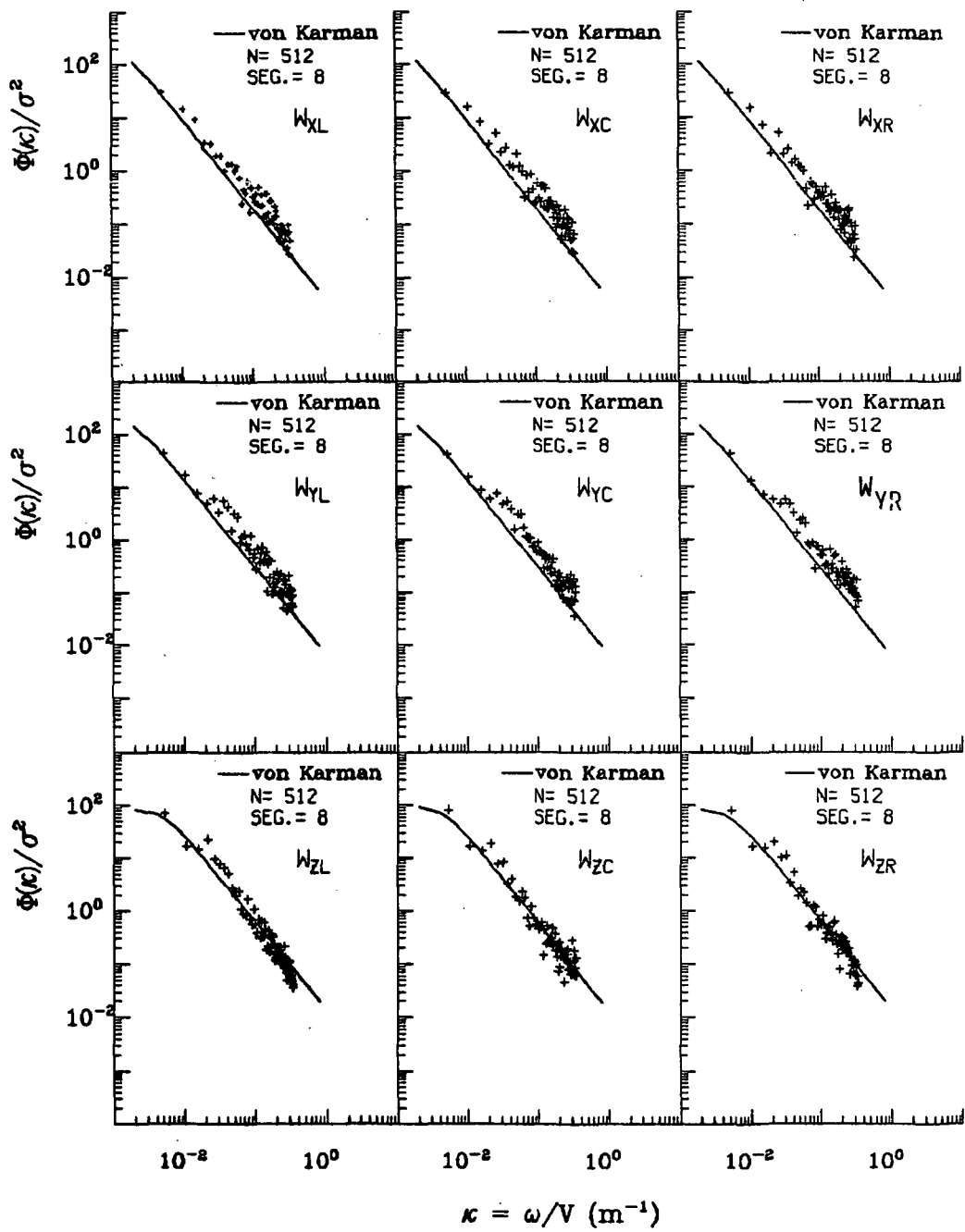

Figure A.310. Normalized auto-spectra of gust velocities, Flight 6, Run 41.

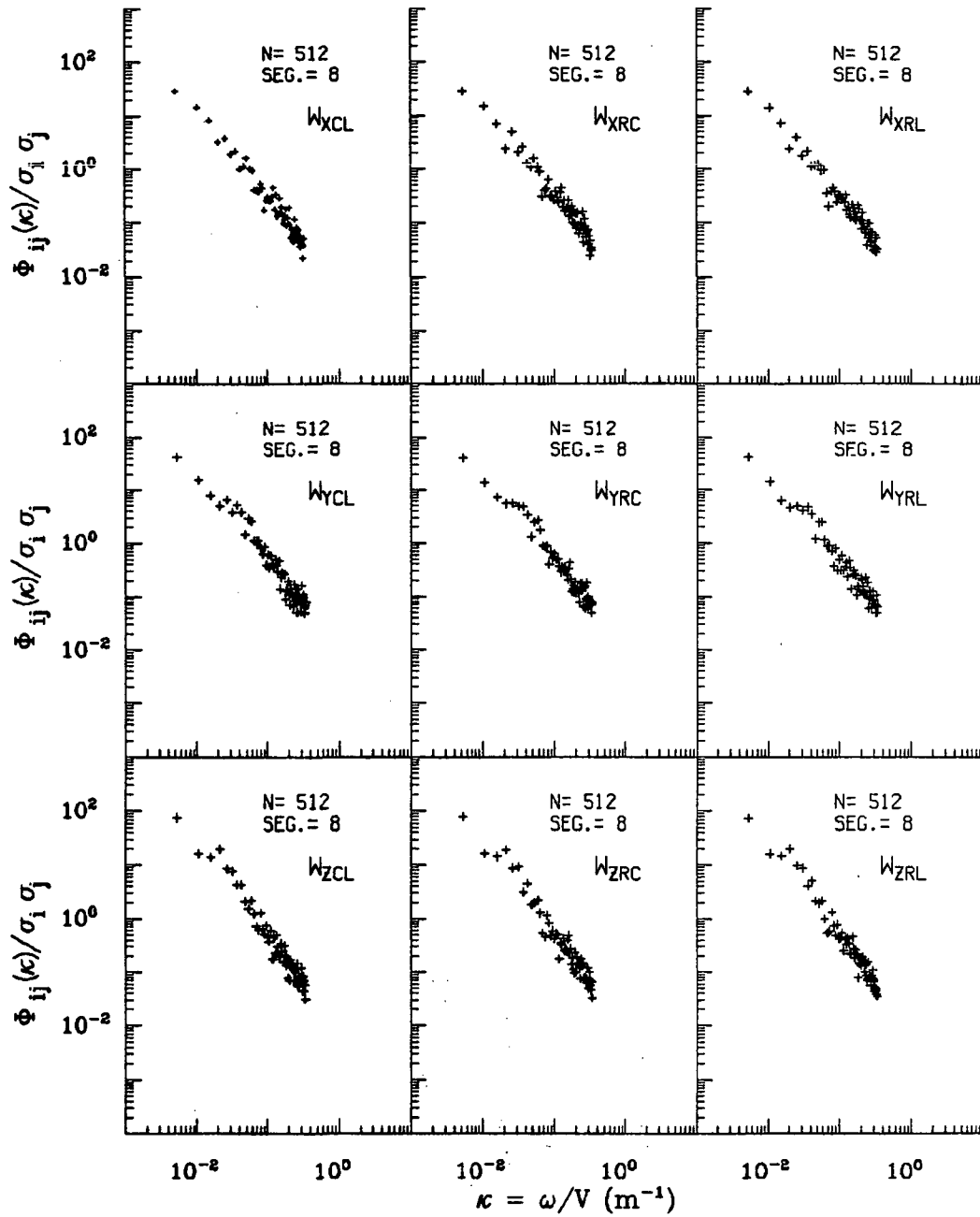

Figure A.311. Normalized two-point auto-spectra of gust velocities, Flight 6, Run 41.

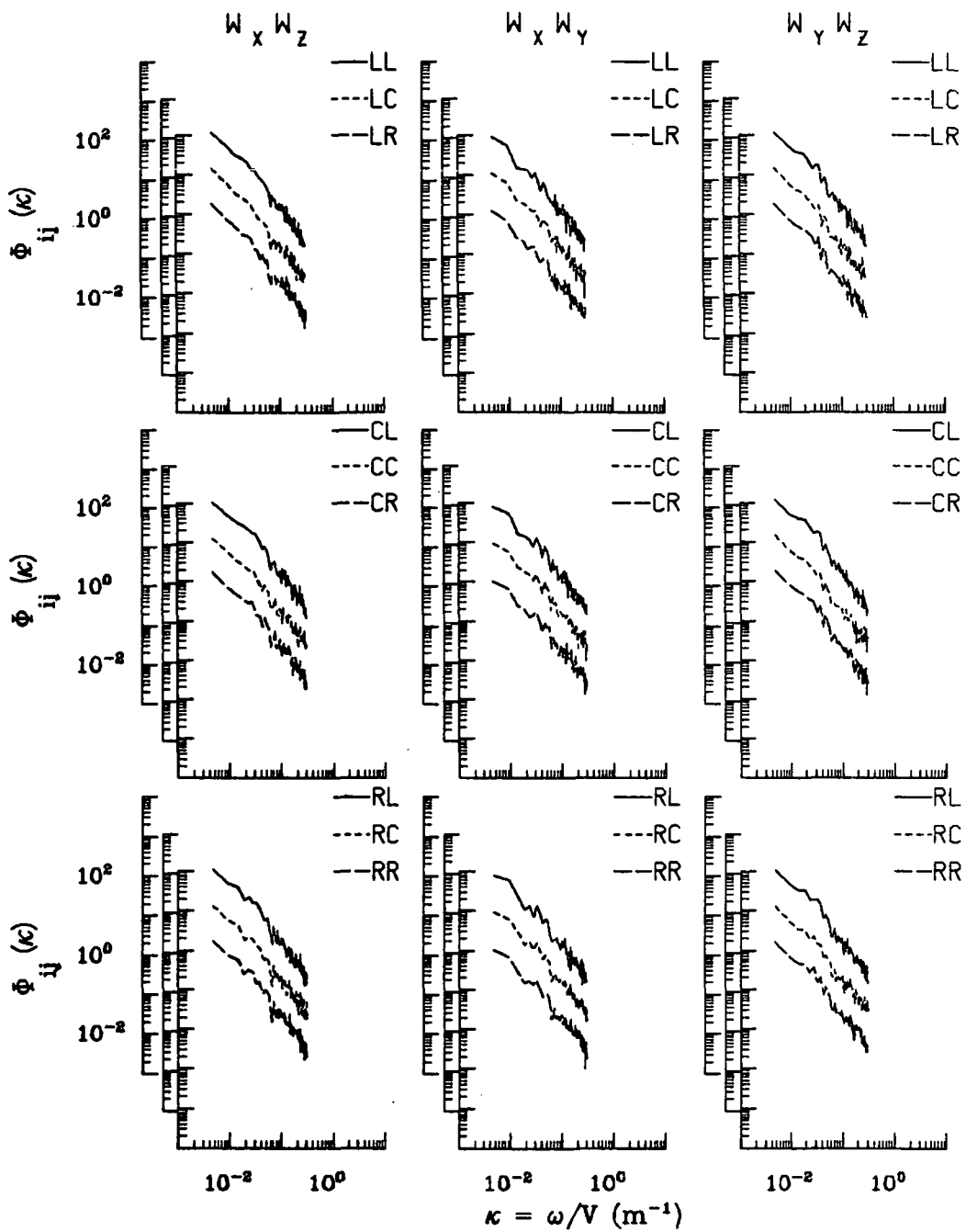

Figure A.312. Two-point cross-spectra of gust velocities, Flight 6, Run 41.

ORIGINAL PAGE IS
OF POOR QUALITY

TABLE A.75. List of All Parameters Measured and Their Range of Values,
Flight 6, Run 41.

		START TIME = 56114.5905	STOP TIME = 56223.5155					
CHANNEL	UNITS	HIGH	LOW	MEAN	RMS	POINTS		
2 PHI DOT	RAD/SEC	.195	-.264	-.00222	.04297	4357		
3 ACCL N CG	G UNITS	-.988	-.988	-.98774	.98774	4357		
4 THETA DOT	RAD/SEC	.078	-.068	.00607	.01724	4357		
5 THETA	RAD	.087	.009	.04813	.05054	4357		
6 PHI	RAD	.135	-.167	-.01356	.03833	4357		
7 PSI 1	DEGREES	164.336	158.348	161.19206	161.19659	4357		
8 DEL PSI 1	DEGREES	1.081	-4.854	-1.95960	2.29254	4357		
9 PSI 2	DEGREES	522.695	517.063	519.77113	519.77245	4357		
10 DEL PSI 2	DEGREES	.786	-5.154	-2.25919	2.55204	4357		
11 ACCL N LT	G UNITS	2.610	-.487	1.01637	1.06592	4357		
12 ACCL N RT	G UNITS	2.607	-.597	1.02977	1.07588	4357		
13 ACCL X CG	G UNITS	.168	-.005	.05129	.05566	4357		
14 ACCL Y CG	G UNITS	.171	-.166	.01118	.04804	4357		
15 ALPHA CTR	RAD	.077	-.090	-.02254	.02871	4357		
16 BETA CTR	RAD	.069	-.078	-.01485	.02585	4357		
17 TEMP I	DEG F	84.053	83.693	83.89523	83.89529	4357		
18 TEMP P	DEG F	93.242	93.062	93.23297	93.23298	4357		
19 ACCL Z INS	G UNITS	1.870	.343	1.00706	1.02082	4357		
20 ALPHA RT	RAD	.093	-.089	-.01504	.02499	4357		
21 BETA RT	RAD	.083	-.035	.01871	.02674	4357		
22 ALPHA LT	RAD	.088	-.084	-.01518	.02465	4357		
23 BETA LT	RAD	.038	-.078	-.02068	.02820	4357		
24 PSI DOT	RAD/SEC	.045	-.035	.00300	.01679	4357		
25 TEMP TOT	DEG C	33.163	28.930	31.19861	31.20785	4357		
26 OC LT	PSID	.923	.638	.76579	.76743	4357		
27 OC CTR	PSID	.906	.622	.75010	.75178	4357		
28 OC RT	PSID	.929	.648	.77810	.77986	4357		
29 PS	PSIA	11.644	11.478	11.60552	11.60553	4357		
30 TEMP IRT	DEG C	20.119	13.212	17.83910	17.92344	4357		
31 D TO G	PETERS	8790627.0726787803.405	*****				4357	
32 R TO D	DEGREES	80.689	80.632	80.66049	80.66049	4357		
33 LONG	DEGREES	-104.426	-104.482	-104.45448	104.45448	4357		
34 LAT	DEGREES	39.843	39.739	39.79119	39.79120	4357		
35 TRK ANG	DEGREES	159.919	156.300	157.58712	157.58888	4357		
36 HDG	RADIANS	2.867	2.761	2.81306	2.81315	4357		
37 VE	M/SEC	46.972	38.004	43.78572	43.84302	4357		
38 VN	M/SEC	-101.787	-109.307	-105.94567	105.97256	4357		
39 ALTITUDE	KM	2.036	1.921	1.94723	1.94726	4357		
40 TEMPC	DEGREES C	27.232	24.043	25.80170	25.80765	4357		
41 EW WND SPD	KNOTS	38.152	6.096	22.65012	23.14678	4357		
42 NS WND SPD	KNOTS	-.365	-24.866	-13.56281	14.19384	4357		
43 WIND SPEED	KNOTS	40.733	10.891	-26.67774	27.15214	4357		
44 WIND DIREC	DEGREES	334.831	271.113	300.90150	301.02587	4357		
45 AIRSPEED R	M/SEC	115.665	97.010	105.95941	106.01603	4357		
46 AIRSPEED C	M/SEC	114.320	95.086	104.07812	104.13384	4357		
47 AIRSPEED L	M/SEC	115.371	96.280	105.14001	105.19363	4357		
48 DELTA ALT	METERS	65.825	-49.786	-23.42937	25.57826	4357		
49 INPTL DISP	METERS	0.000	-51.255	-25.80172	27.70937	4357		
50 UG RIGHT	M/SEC	5.270	-6.931	.00000	2.43528	4357		
51 UG CENTER	M/SEC	5.847	-7.793	.00000	2.37548	4357		
52 UG LEFT	M/SEC	5.190	-7.325	.00000	2.41428	4357		
53 VG RIGHT	M/SEC	7.816	-6.558	.00916	2.15967	4357		
54 VG CENTER	M/SEC	7.644	-7.428	.01171	2.20949	4357		
55 VG LEFT	M/SEC	8.407	-6.326	.00985	2.20379	4357		
56 WG RIGHT	M/SEC	9.588	-10.109	-.01669	2.46867	4357		
57 WG CENTER	M/SEC	8.524	-8.568	-.01234	2.28815	4357		
58 WG LEFT	M/SEC	8.609	-9.651	-.01840	2.42078	4357		

ORIGINAL PAGE IS
OF POOR QUALITY

Date: July 14, 1982
Time: 15:38:3(MDT)
Duration: 142 seconds

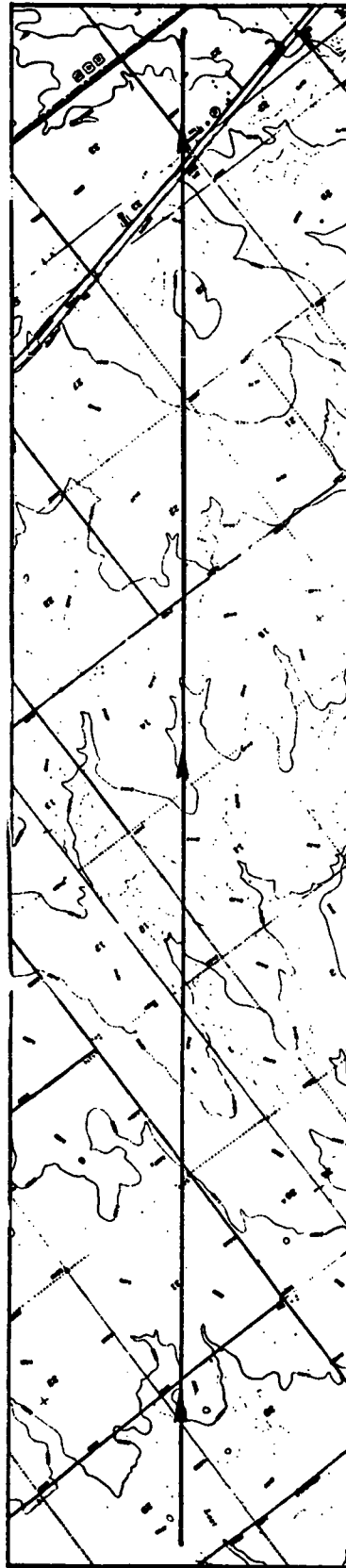
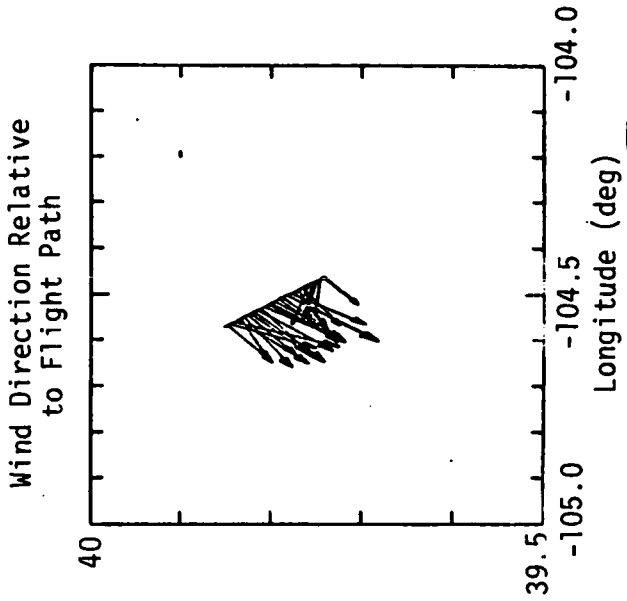
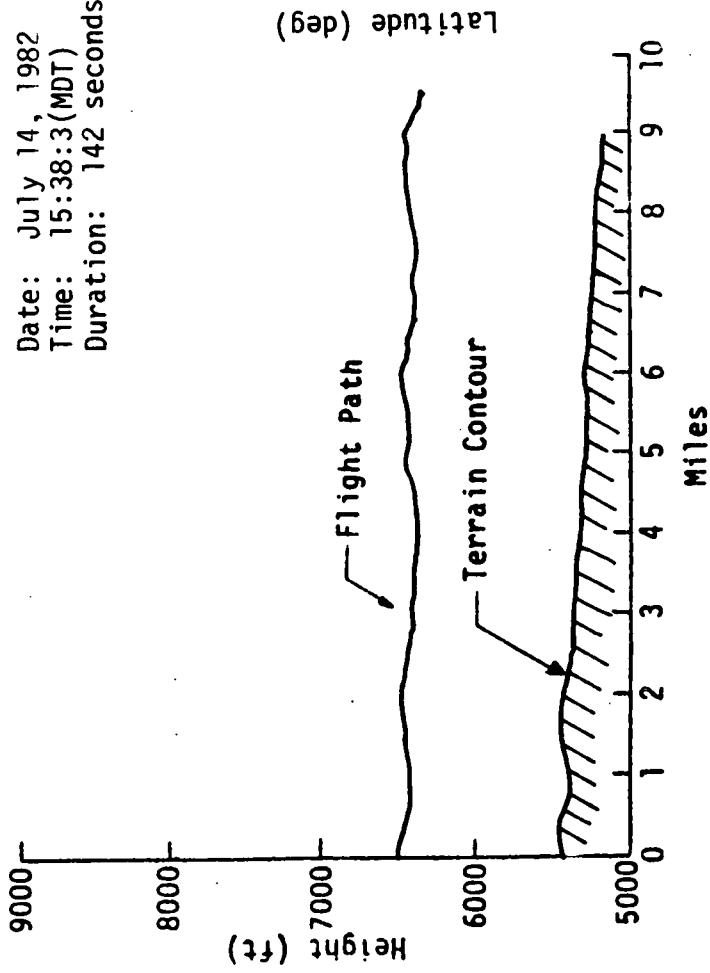

Figure A.313. Flight path information, Flight 6, Run 42.

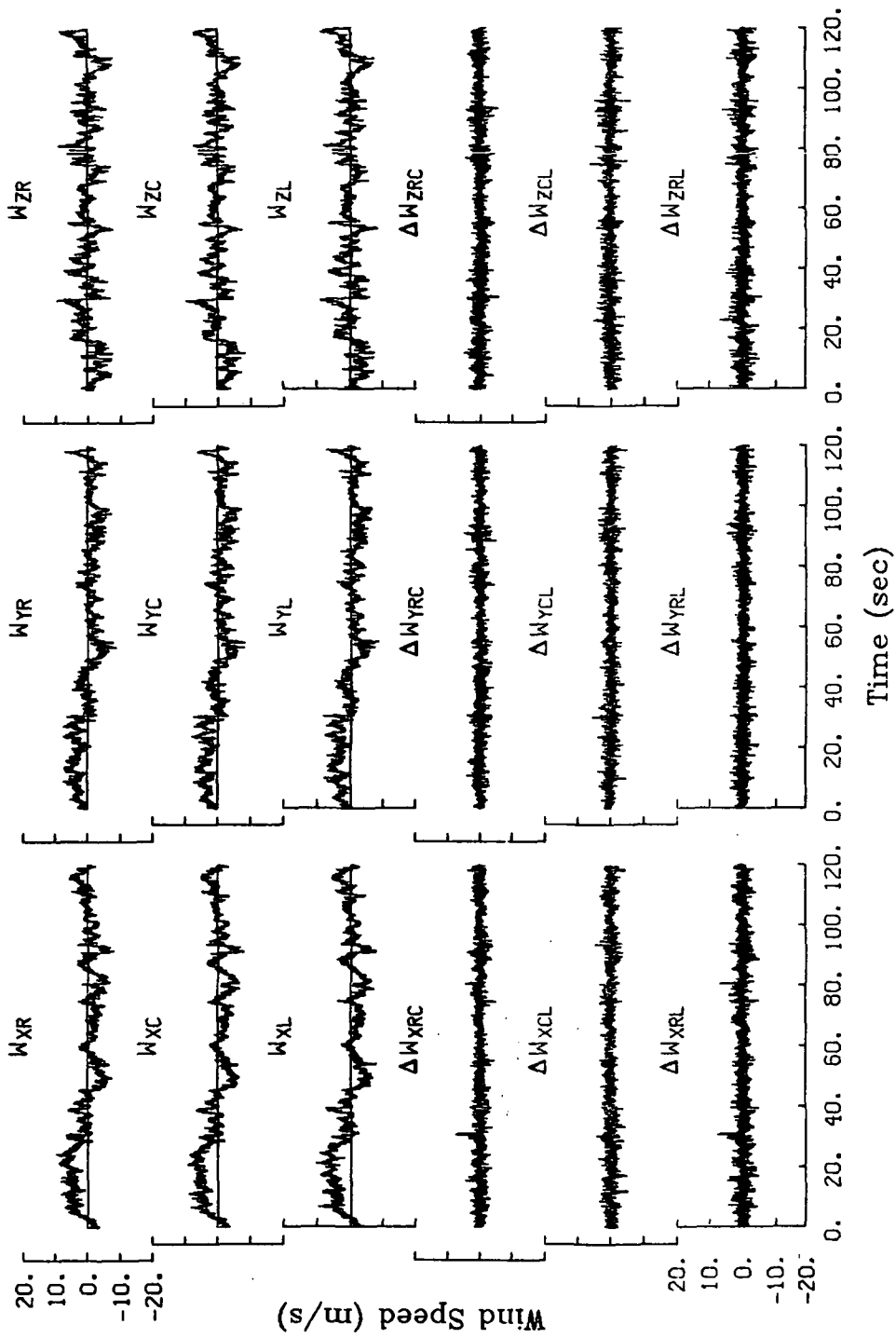

Figure A.314. Time histories of gust velocities and gust velocity differences, Flight 6, Run 42.

TABLE A.76. Average Turbulence Parameters and Integral Length Scales, Flight 6, Run 42.

I. Mean Airspeed (m/s)

v_L	v_C	v_R
110.3	109.2	111.1

II. Standard Deviation of Gust Velocities (m/s)

$\sigma_{W_{XL}}$	$\sigma_{W_{XC}}$	$\sigma_{W_{XR}}$
3.49	3.43	3.46
$\sigma_{W_{YL}}$	$\sigma_{W_{YC}}$	$\sigma_{W_{YR}}$
2.63	2.69	2.67
$\sigma_{W_{ZL}}$	$\sigma_{W_{ZC}}$	$\sigma_{W_{ZR}}$
2.72	2.71	2.83

III. Standard Deviation of Gust Velocity Differences (m/s)

$\sigma_{\Delta W_{XCL}}$	$\sigma_{\Delta W_{XRC}}$	$\sigma_{\Delta W_{XRL}}$
1.00	1.03	1.24
$\sigma_{\Delta W_{YCL}}$	$\sigma_{\Delta W_{YRC}}$	$\sigma_{\Delta W_{YRL}}$
0.97	0.98	1.06
$\sigma_{\Delta W_{ZCL}}$	$\sigma_{\Delta W_{ZRC}}$	$\sigma_{\Delta W_{ZRL}}$
1.14	1.16	1.32

IV. Integral Length Scale (m).

$L_{W_{XL}}$	$L_{W_{XC}}$	$L_{W_{XR}}$
814	790	824
$L_{W_{YL}}$	$L_{W_{YC}}$	$L_{W_{YR}}$
2088	2118	2172
$L_{W_{ZL}}$	$L_{W_{ZC}}$	$L_{W_{ZR}}$
461	511	451

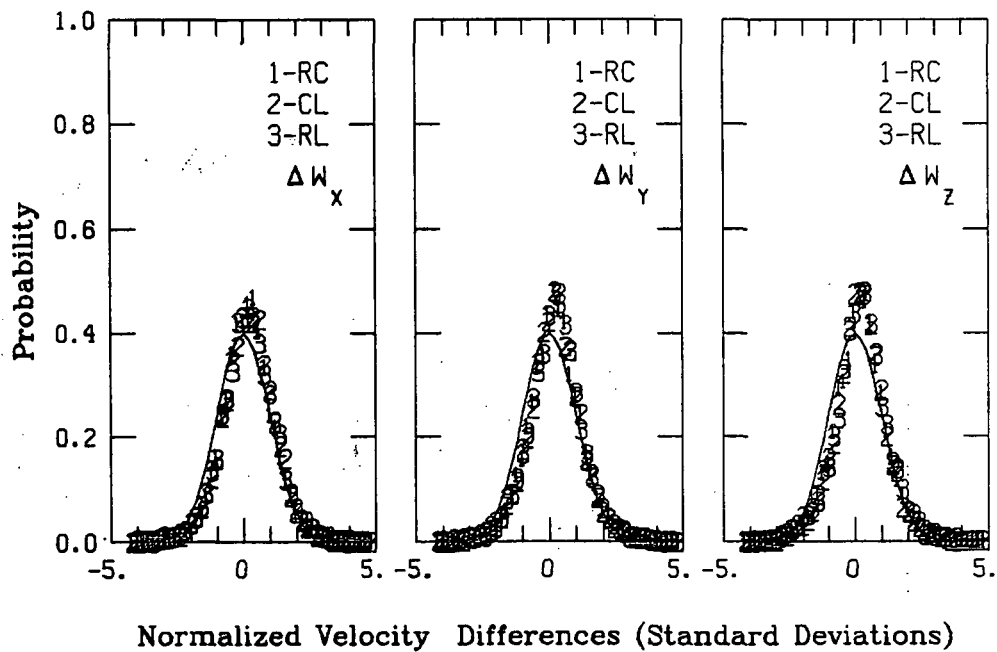
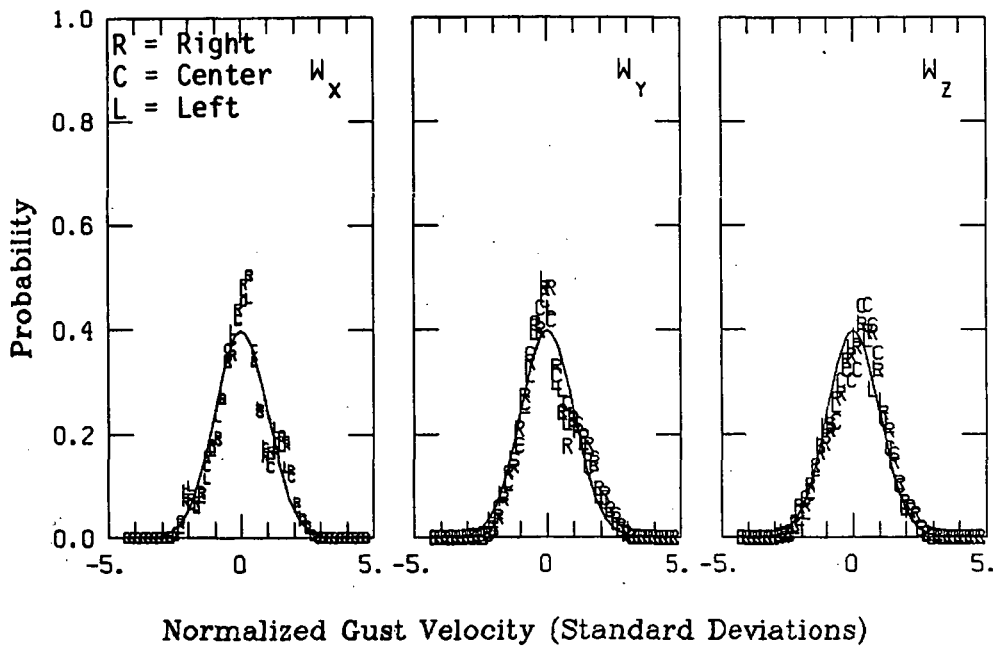

Figure A.315. Probability density function for gust velocities and gust velocity differences, Flight 6, Run 42.

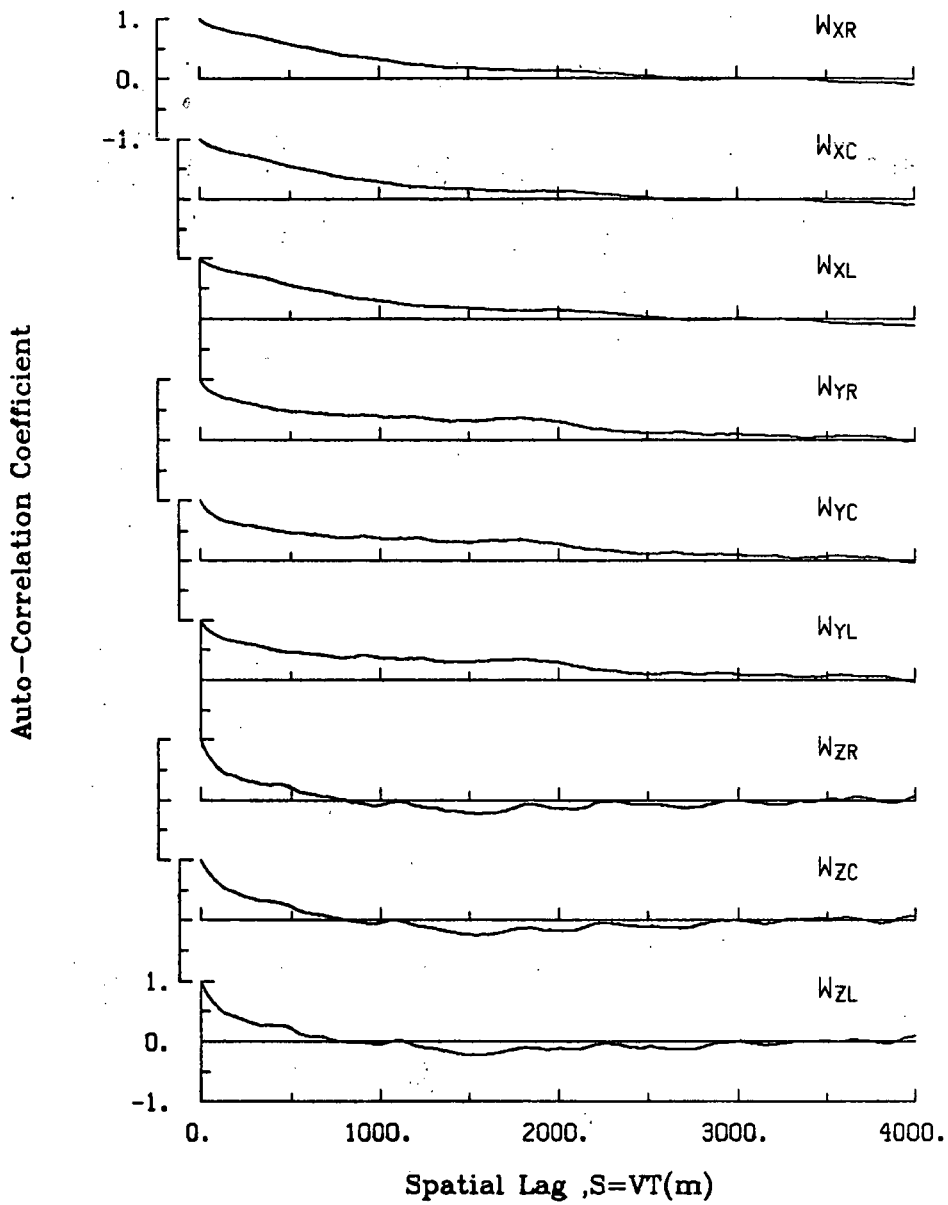

Figure A.316. Single-point auto-correlation coefficient of gust velocities, Flight 6, Run 42.

ORIGINAL PAGE IS
OF POOR QUALITY

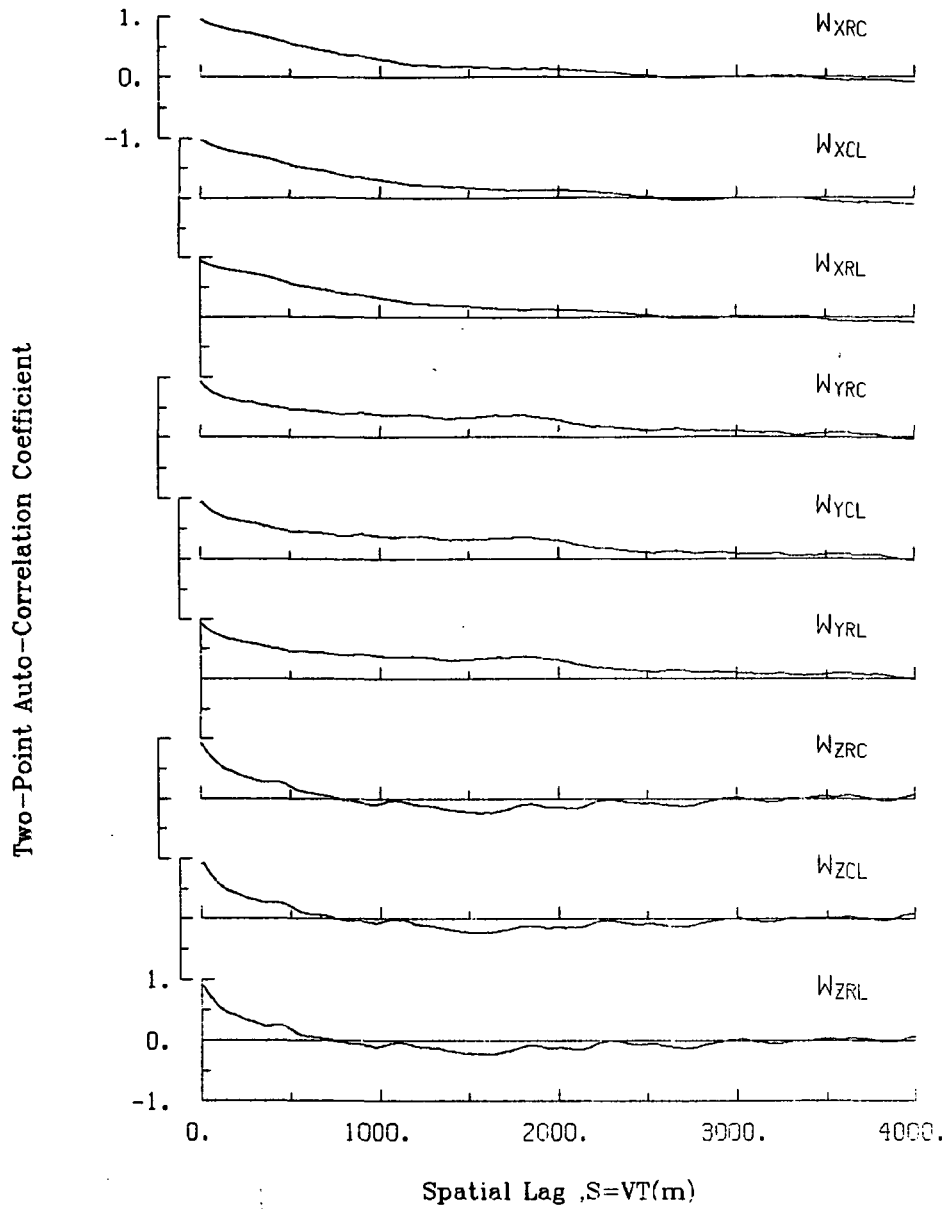

Figure A.317. Two-point auto-correlation coefficient of gust velocities, Flight 6, Run 42.

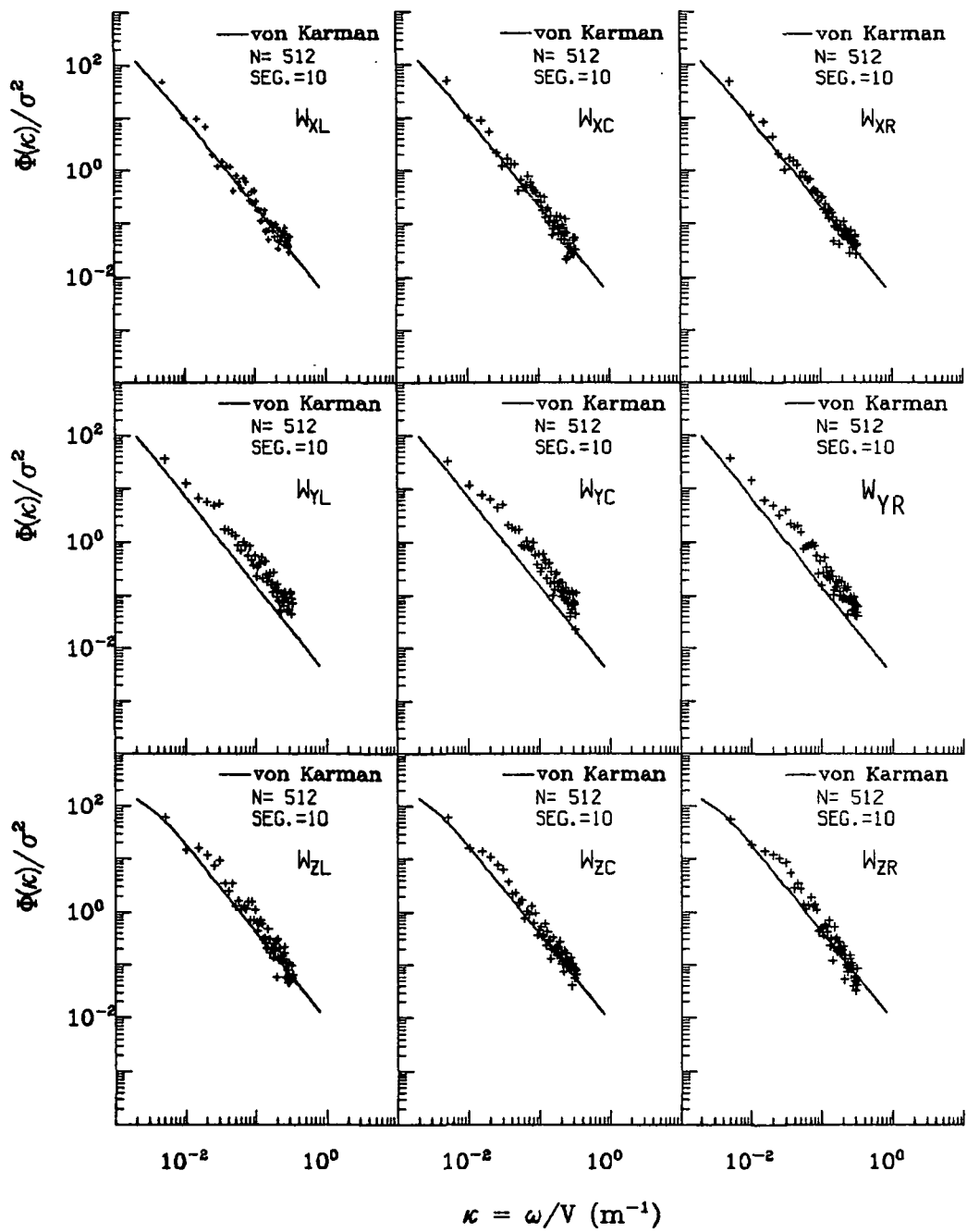

Figure A.318. Normalized auto-spectra of gust velocities, Flight 6, Run 42.

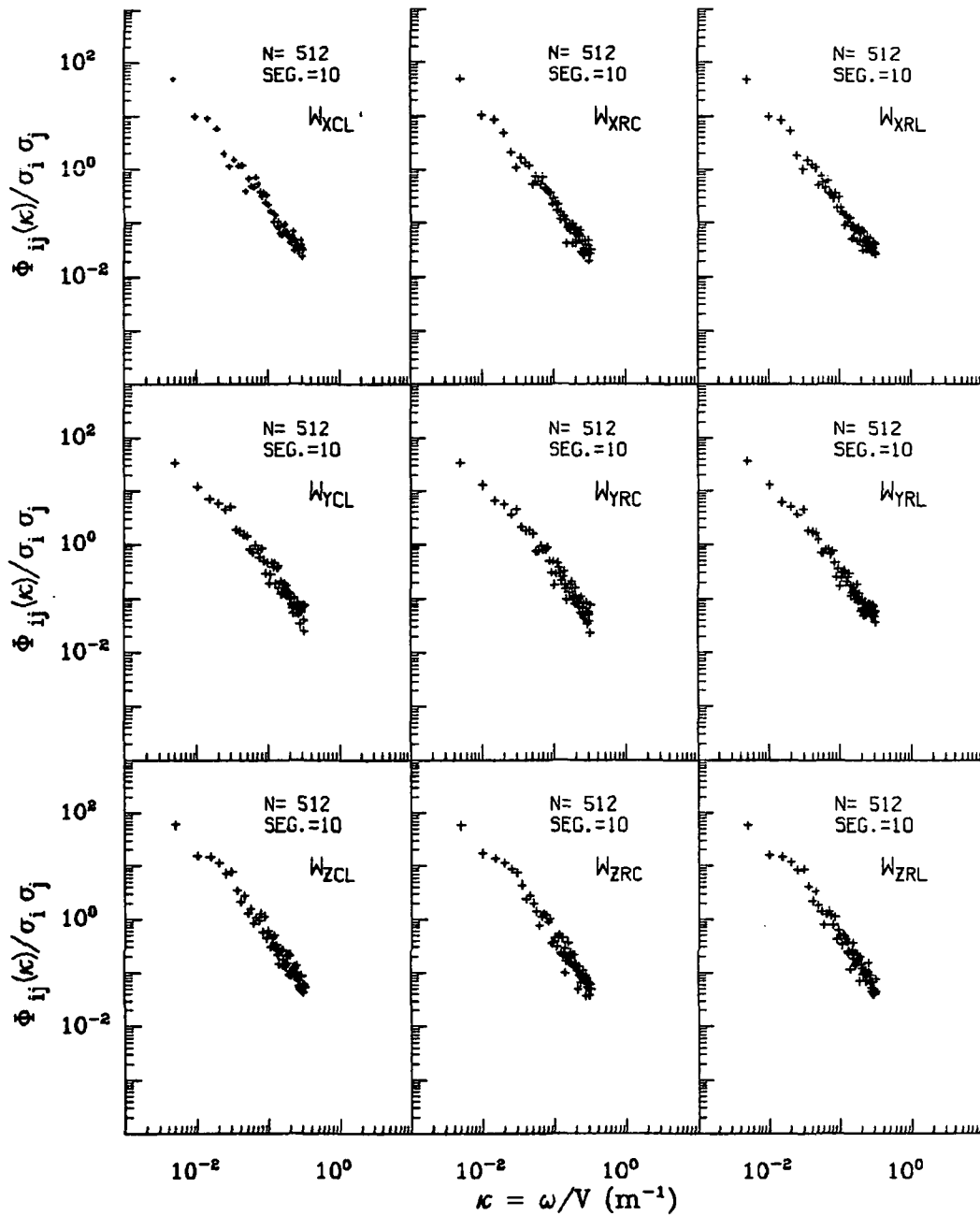

Figure A.319. Normalized two-point auto-spectra of gust velocities, Flight 6, Run 42.

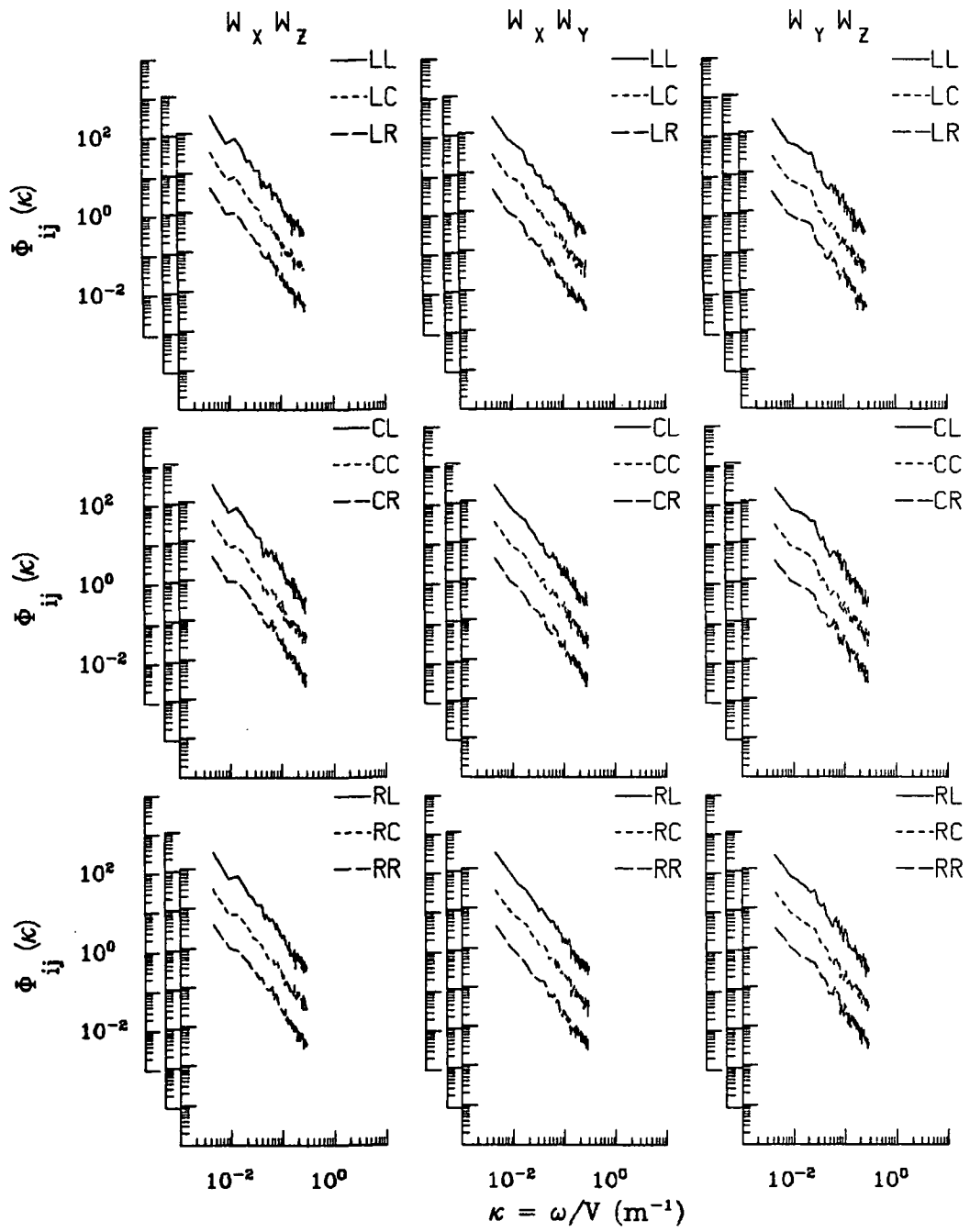
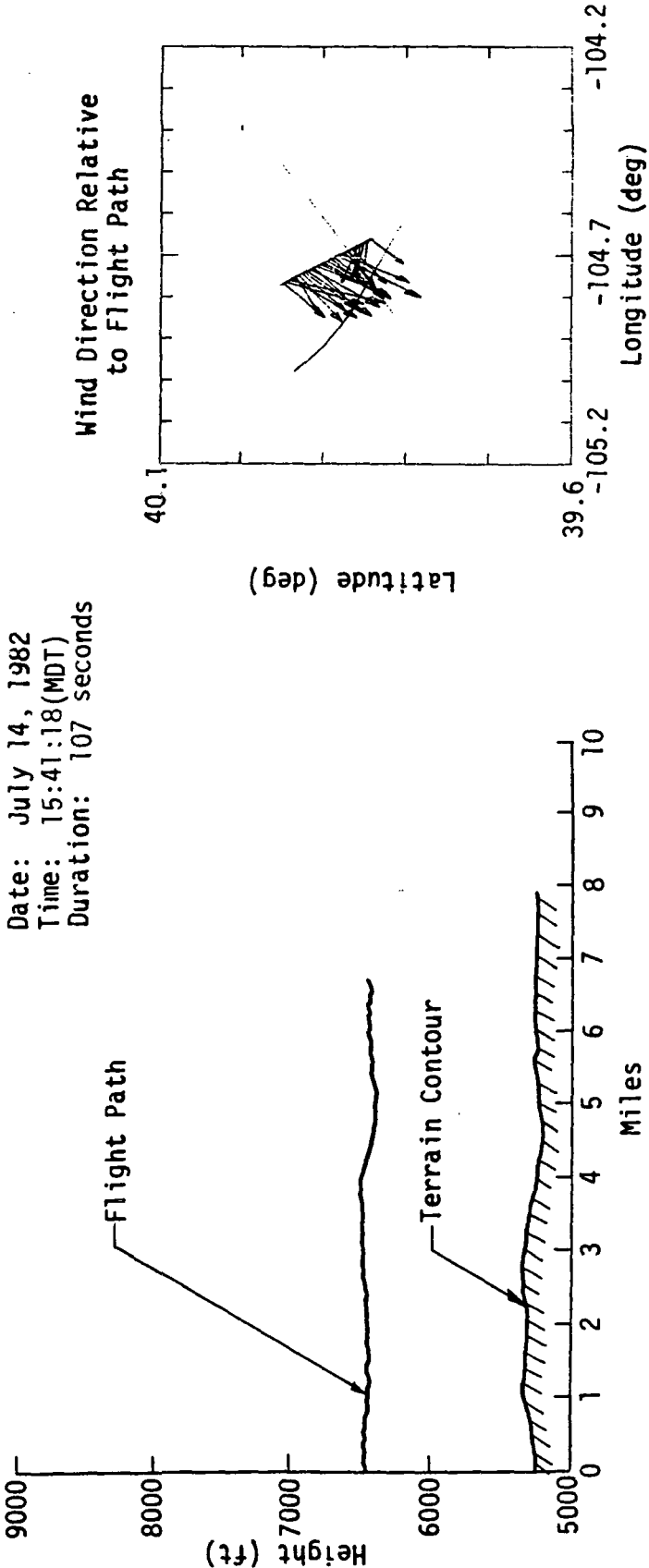

Figure A.320. Two-point cross-spectra of gust velocities, Flight 6, Run 42.

TABLE A.77. List of All Parameters Measured and Their Range of Values, Flight 6, Run 42.

		START TIME = 56283.4507		STOP TIME = 56425.6007			
CHANNEL	UNITS	HIGH	LOW	MEAN	RMS	POINTS	
2	PHI DOT	RAD/SEC	.138	-.182	-.00265	.03744	5686
3	ACCL N CG	G UNITS	-.988	-.988	-.98774	.98774	5686
4	THETA DOT	RAD/SEC	.097	-.072	.00613	.01818	5686
5	THETA	RAD	.105	.004	.04765	.05252	5686
6	PHI	RAD	.066	-.102	-.01209	.03206	5686
7	PSI 1	DEGREES	330.587	322.838	326.98084	326.98348	5686
8	DEL PSI 1	DEGREES	4.667	-2.972	1.15246	1.73963	5686
9	PSI 2	DEGREES	329.422	322.029	326.08771	326.09023	5686
10	DEL PSI 2	DEGREES	4.578	-3.095	1.01141	1.65204	5686
11	ACCL N LT	G UNITS	2.682	-1.189	1.01321	1.07128	5686
12	ACCL N RT	G UNITS	2.875	-.740	1.02660	1.08265	5686
13	ACCL X CG	G UNITS	.184	-.016	.05184	.06614	5686
14	ACCL Y CG	G UNITS	.206	-.159	.01174	.04861	5686
15	ALPHA CTR	RAD	.033	-.129	-.03048	.03583	5686
16	BETA CTR	RAD	.047	-.104	-.01628	.02841	5686
17	TEMP I	DEG F	83.693	83.153	83.36934	83.36942	5686
18	TEMP P	DEG F	93.422	93.242	93.25097	93.25098	5686
19	ACCL Z INS	G UNITS	1.734	-.029	1.00453	1.02099	5686
20	ALPHA RT	RAD	.046	-.133	-.02804	.03527	5686
21	BETA RT	RAD	.083	-.061	.01666	.02695	5686
22	ALPHA LT	RAD	.053	-.124	-.02711	.03390	5686
23	BETA LT	RAD	.041	-.107	-.02246	.03089	5686
24	PSI DOT	RAD/SEC	.074	-.047	.00343	.02006	5686
25	TEMP TOT	DEG C	33.360	29.520	31.59253	31.60951	5686
26	QC LT	PSID	1.096	.621	.84609	.85206	5686
27	QC CTR	PSID	1.071	.623	.82872	.83446	5686
28	QC RT	PSID	1.118	.664	.85894	.86478	5686
29	PS	PSIA	11.628	11.566	11.59495	11.59496	5686
30	TEMP IRT	DEG C	20.119	6.907	16.19509	16.46314	5686
31	D TO G	METERS	8787725.3768780405	2.99*****	*****	*****	5686
32	B TO D	DEGREES	80.666	80.571	80.61816	80.61817	5686
33	LONG	DEGREES	-104.461	-104.572	-104.51618	104.51618	5686
34	LAT	DEGREES	39.852	39.741	39.79765	39.79766	5686
35	TRK ANG	DEGREES	324.209	320.742	322.43791	322.43935	5686
36	HDG	RADIANS	5.765	5.629	5.70170	5.70175	5686
37	VE	M/SEC	-61.562	-71.762	-66.74599	66.80405	5686
38	VN	M/SEC	94.584	80.655	86.86699	86.98877	5686
39	ALTITUDE	KM	1.974	1.931	1.95458	1.95460	5686
40	TEMPC	DEGREES C	27.805	23.602	25.64363	25.66275	5686
41	EW WND SPD	KNOTS	-1.285	-28.606	-16.14936	16.64620	5686
42	NS WND SPD	KNOTS	10.401	-28.671	-10.30237	12.73165	5686
43	WIND SPEED	KNOTS	34.969	5.427	20.44743	20.95668	5686
44	WIND DIREC	DEGREES	133.063	3.773	60.22856	64.02796	5686
45	AIRSPD P	M/SEC	126.395	98.444	111.68026	111.25600	5686
46	AIRSPD C	M/SEC	123.772	95.446	109.15326	109.32959	5686
47	AIRSPD L	M/SEC	125.129	95.282	110.26048	110.44126	5686
48	DELTA ALT	METERS	.162	-43.030	-19.74658	21.87875	5686
49	INRTL DISP	METERS	0.000	-41.335	-18.71720	21.30954	5686
50	UG RIGHT	M/SEC	9.835	-9.772	-.00000	3.50538	5686
51	UG CENTER	M/SEC	9.232	-9.407	-.00000	3.47702	5686
52	UG LEFT	M/SEC	10.304	-9.043	-.00000	3.53921	5686
53	VG RIGHT	M/SEC	7.669	-8.354	-.03780	2.61037	5686
54	VG CENTER	M/SEC	8.288	-8.053	-.03310	2.62578	5686
55	VG LEFT	M/SEC	8.061	-8.403	-.02826	2.57109	5686
56	WG RIGHT	M/SEC	9.348	-8.789	.02436	2.93621	5686
57	WG CENTER	M/SEC	9.432	-8.853	.03277	2.88509	5686
58	WG LEFT	M/SEC	8.829	-10.260	.01775	2.85266	5686

Date: July 14, 1982
Time: 15:41:18 (MDT)
Duration: 107 seconds



A.390

Figure A.321. Flight path information, Flight 6, Run 43.

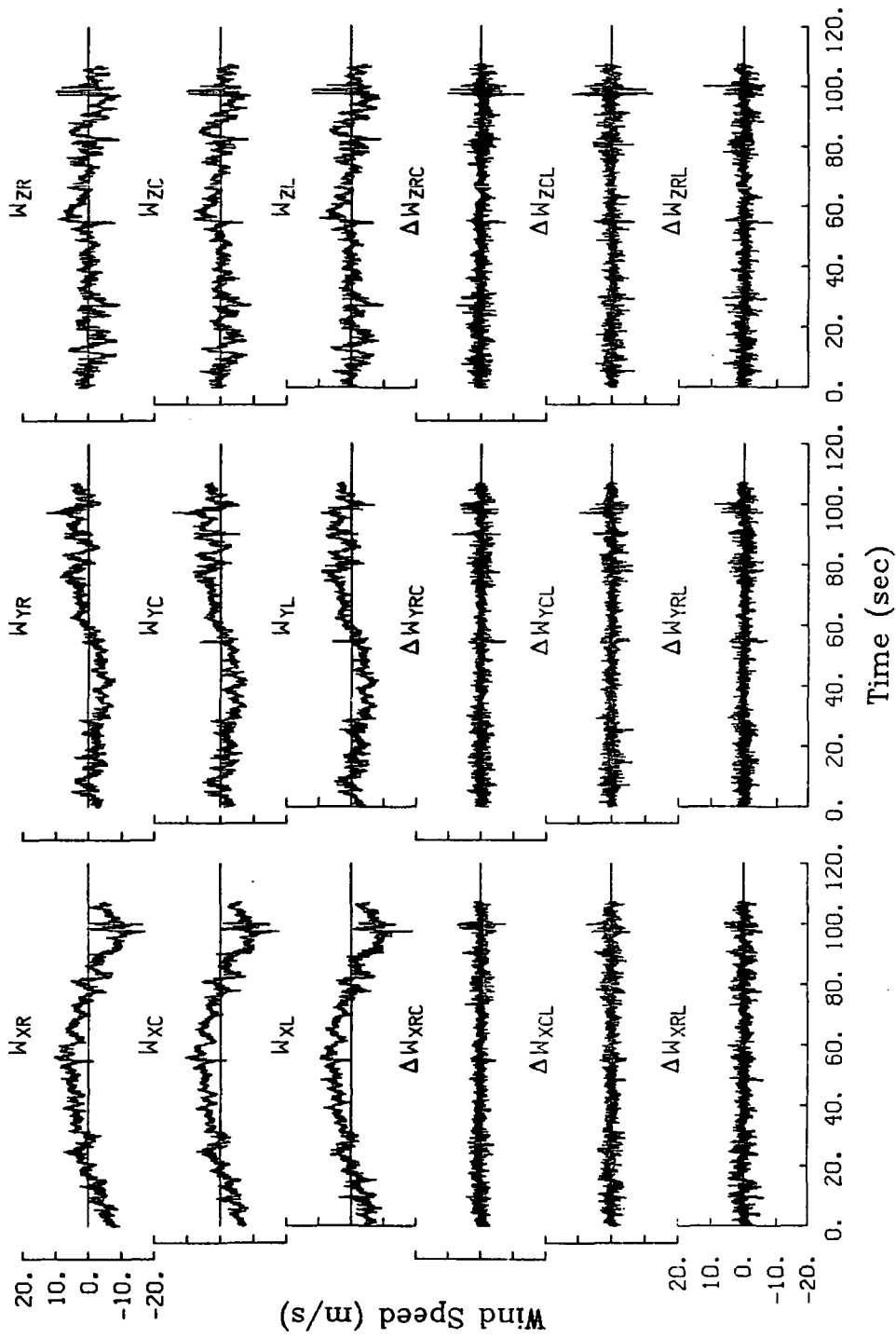

Figure A.322. Time histories of gust velocities and gust velocity differences, Flight 6, Run 43.

Figure A.323. Average Turbulence Parameters and Integral Length Scales, Flight 6, Run 43.

I. Mean Airspeed (m/s)

V_L	V_C	V_R
102.7	101.7	103.5

II. Standard Deviation of Gust Velocities (m/s)

$\sigma_{W_{XL}}$	$\sigma_{W_{XC}}$	$\sigma_{W_{XR}}$
4.82	4.74	4.85
$\sigma_{W_{YL}}$	$\sigma_{W_{YC}}$	$\sigma_{W_{YR}}$
3.50	3.48	3.35
$\sigma_{W_{ZL}}$	$\sigma_{W_{ZC}}$	$\sigma_{W_{ZR}}$
3.00	2.88	3.09

III. Standard Deviation of Gust Velocity Differences (m/s)

$\sigma_{\Delta W_{XCL}}$	$\sigma_{\Delta W_{XRC}}$	$\sigma_{\Delta W_{XRL}}$
1.16	1.24	1.49
$\sigma_{\Delta W_{YCL}}$	$\sigma_{\Delta W_{YRC}}$	$\sigma_{\Delta W_{YRL}}$
1.24	1.25	1.39
$\sigma_{\Delta W_{ZCL}}$	$\sigma_{\Delta W_{ZRC}}$	$\sigma_{\Delta W_{ZRL}}$
1.48	1.52	1.59

IV. Integral Length Scale (m).

$L_{W_{XL}}$	$L_{W_{XC}}$	$L_{W_{XR}}$
1107	1082	1080
$L_{W_{YL}}$	$L_{W_{YC}}$	$L_{W_{YR}}$
2322	2226	2336
$L_{W_{ZL}}$	$L_{W_{ZC}}$	$L_{W_{ZR}}$
505	581	479

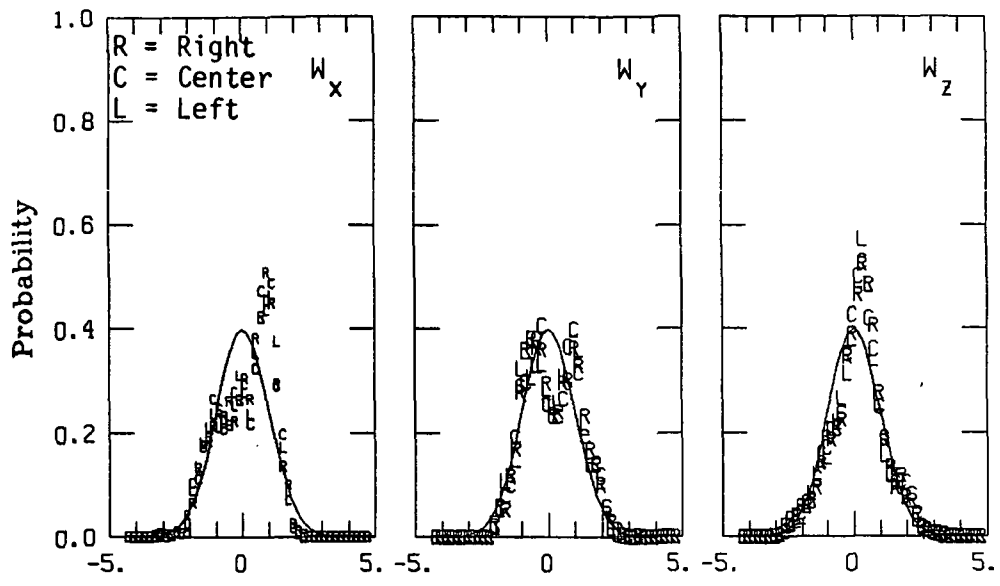

Normalized Gust Velocity (Standard Deviations)

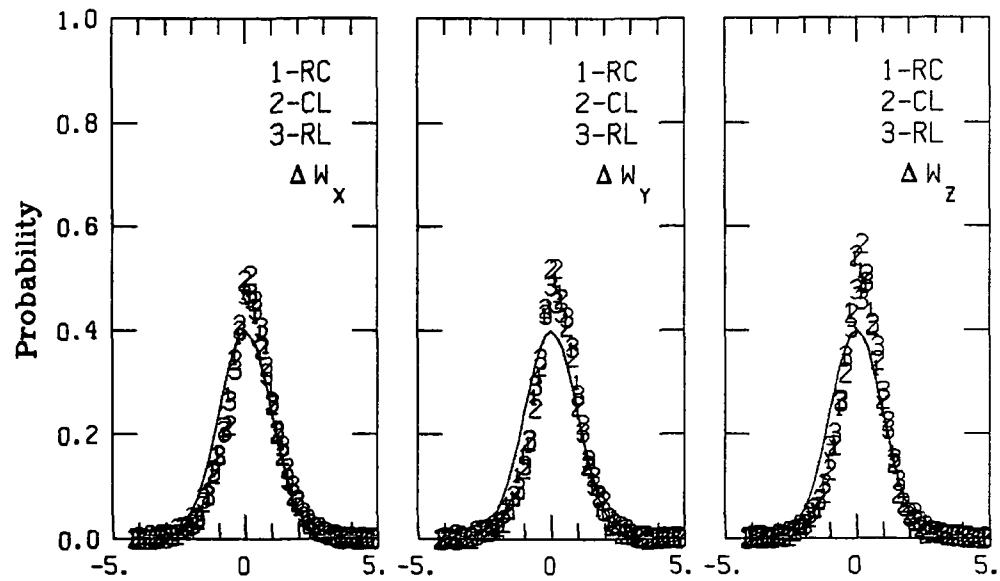

Normalized Velocity Differences (Standard Deviations)

Figure A.324. Probability density function for gust velocities and gust velocity differences, Flight 6, Run 43.

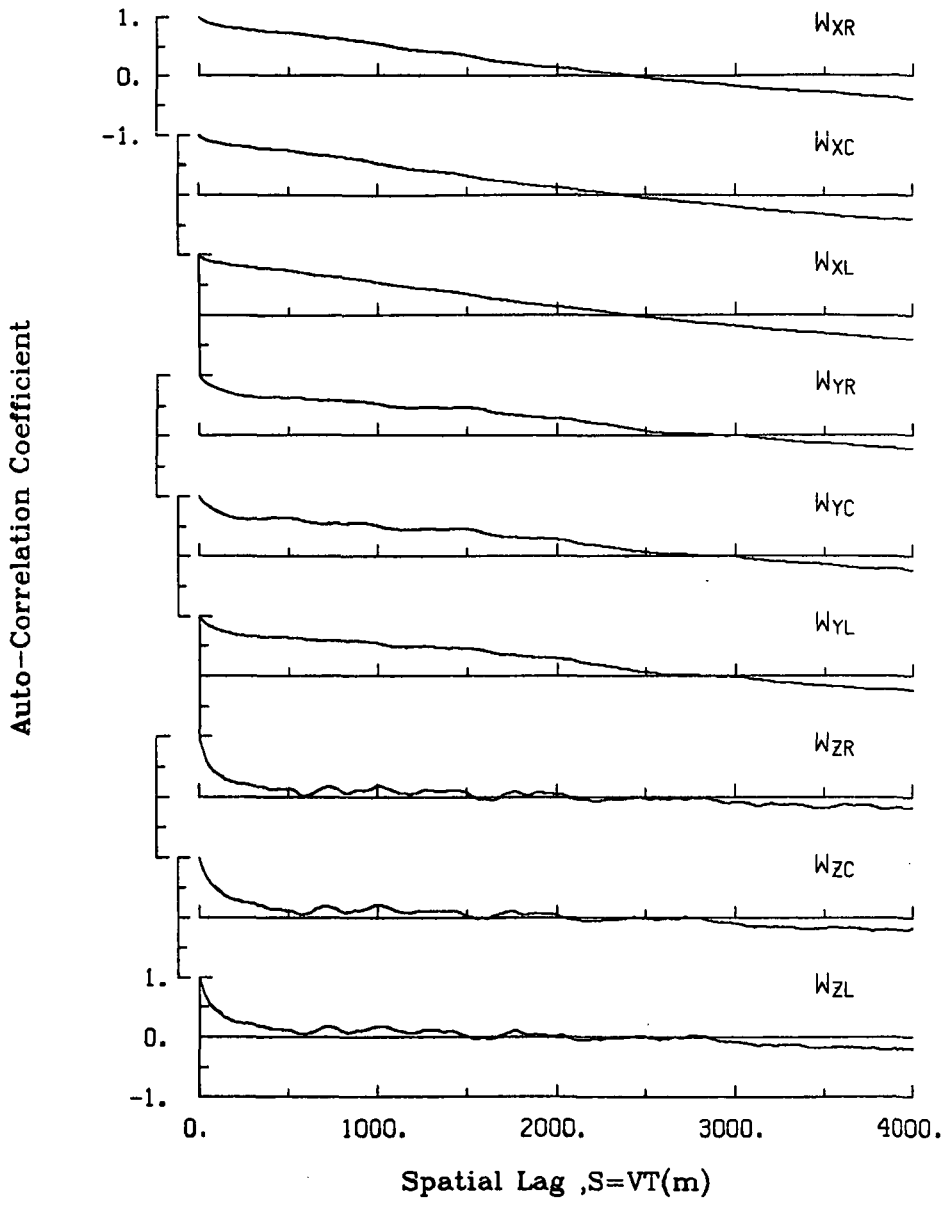

Figure A.325. Single-point auto-correlation coefficient of gust velocities, Flight 6, Run 43.

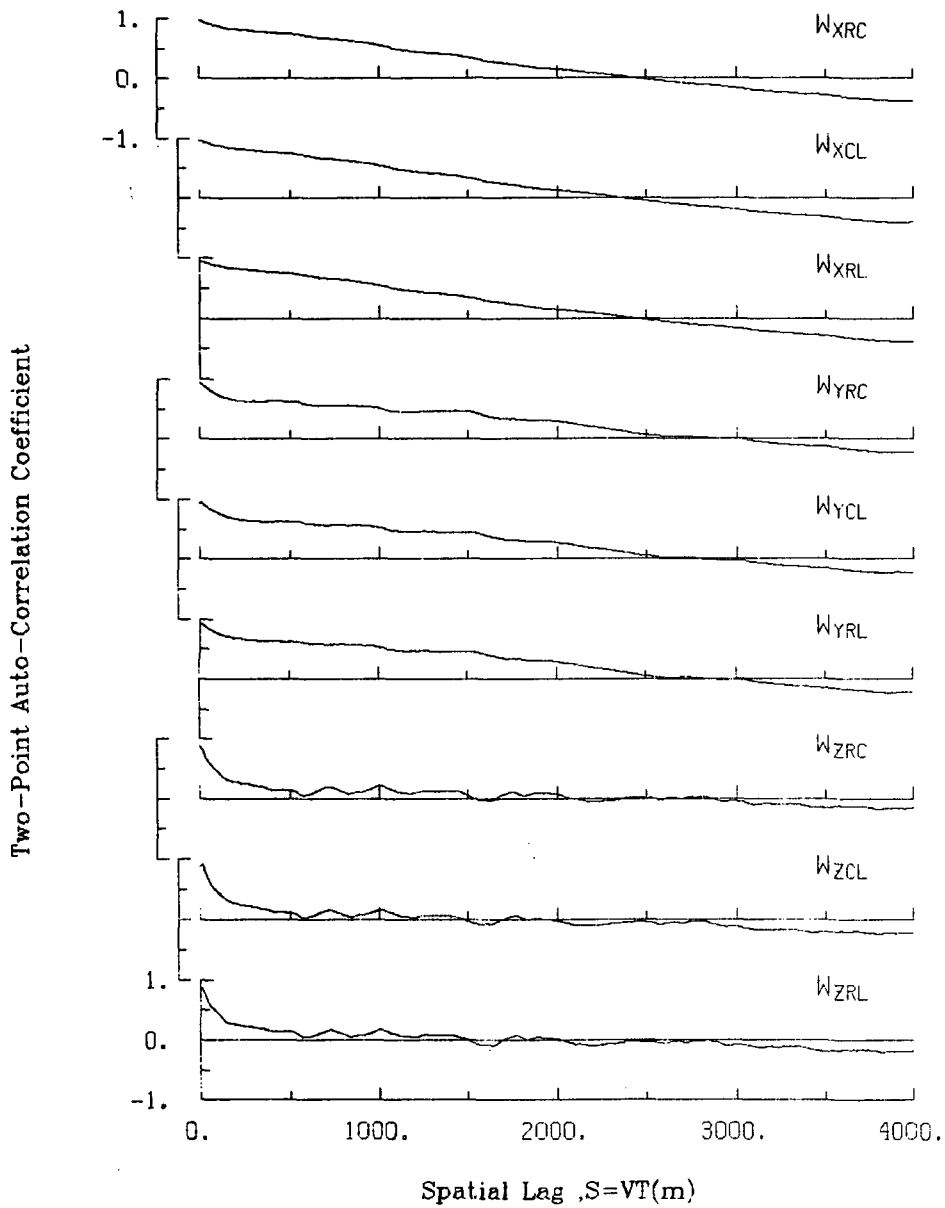

Figure A.326. Two-point auto-correlation coefficient of gust velocities, Flight 6, Run 43.

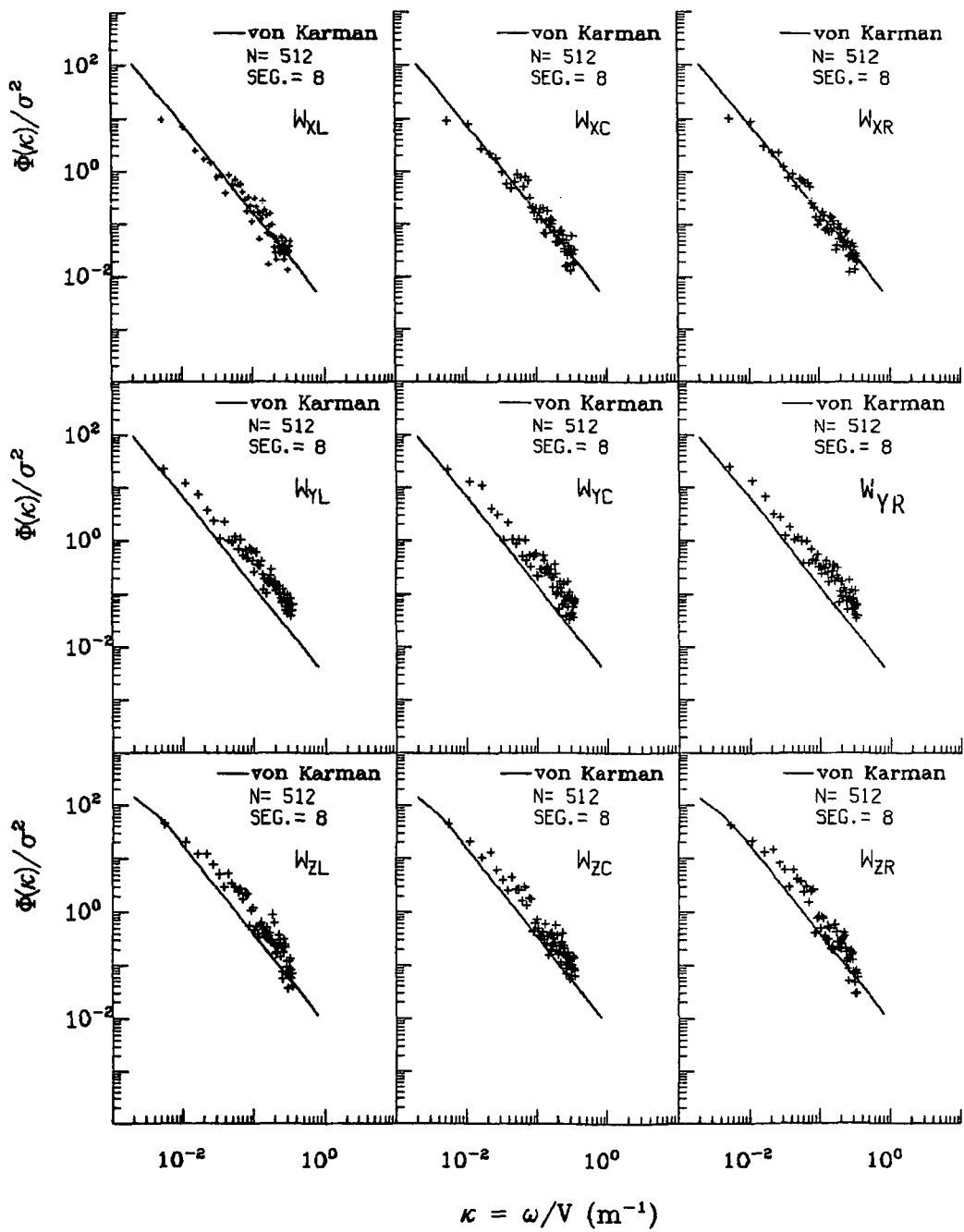

Figure A.327. Normalized auto-spectra of gust velocities, Flight 6, Run 43.

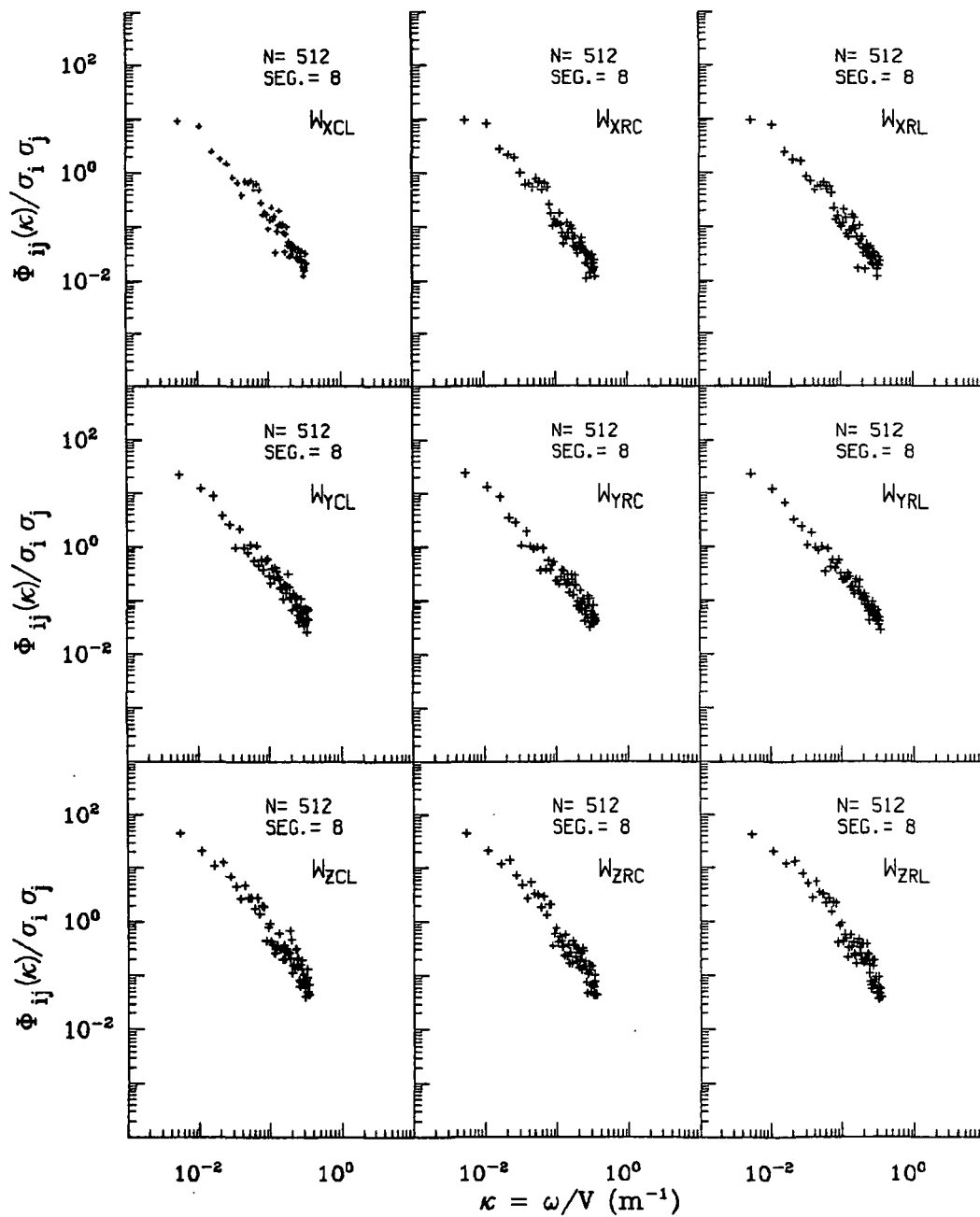

Figure A.328. Normalized two-point auto-spectra of gust velocities, Flight 6, Run 43.

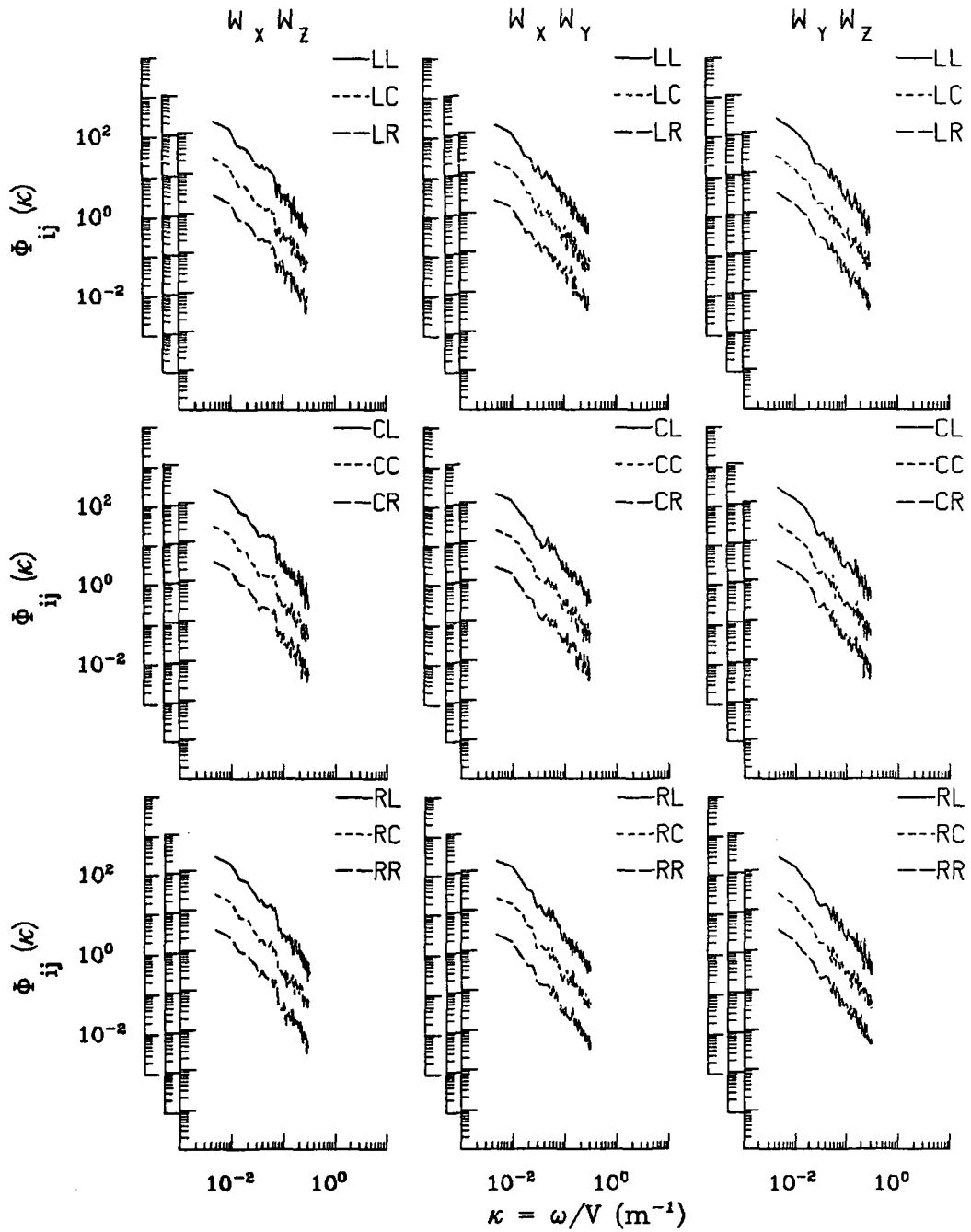

Figure A.329. Two-point cross-spectra of gust velocities, Flight 6, Run 43.

TABLE A.78. List of All Parameters Measured and Their Range of Values,
Flight 6, Run 43.

		START TIME = 56478.4260	STOP TIME = 56585.6010				
CHANNEL	UNITS	HIGH	LOW	MEAN	RMS	POINTS	
2 PHI DOT	RAD/SEC	.165	-.223	-.00211	.05105	4287	
3 ACCL N CG	G UNITS	-.988	-.988	-.98774	.98774	4287	
4 THETA DOT	RAD/SEC	.144	-.105	.00569	.02057	4287	
5 THETA	RAD	.131	.006	.06641	.07204	4287	
6 PHI	RAD	.112	-.127	-.00446	.03860	4287	
7 PSI 1	DEGREES	277.753	268.947	272.97135	272.97574	4287	
8 DEL PSI 1	DEGREES	2.611	-6.089	-2.03655	2.55042	4287	
9 PSI 2	DEGREES	275.207	266.758	270.72327	270.72745	4287	
10 DEL PSI 2	DEGREES	2.344	-6.329	-2.30509	2.76279	4287	
11 ACCL N LT	G UNITS	4.264	-1.949	1.01291	1.09187	4287	
12 ACCL N RT	G UNITS	3.873	-1.213	1.02445	1.09776	4287	
13 ACCL X CG	GUNITS	.194	-.026	.07407	.08655	4287	
14 ACCL Y CG	G UNITS	.214	-.136	.01026	.04311	4287	
15 ALPHA CTR	RAD	.085	-.101	-.01883	.03039	4287	
16 BETA CTR	RAD	.091	-.164	-.01776	.03627	4287	
17 TEMP I	DEG F	83.513	82.973	83.27383	83.27389	4287	
18 TEMP P	DEG F	93.422	93.242	93.39636	93.39638	4287	
19 ACCL Z INS	G UNITS	2.543	.007	1.00390	1.02453	4287	
20 ALPHA RT	RAD	.082	-.120	-.01173	.02967	4287	
21 BETA RT	RAD	.108	-.086	.01651	.03253	4287	
22 ALPHA LT	RAD	.102	-.098	-.01102	.02909	4287	
23 BETA LT	RAD	.069	-.151	-.02360	.03746	4287	
24 PSI DOT	RAD/SEC	.085	-.072	.00357	.02446	4287	
25 TEMP TOT	DEG C	33.656	28.634	30.58369	30.61276	4287	
26 QC LT	PSID	1.063	.541	.73396	.74242	4287	
27 QC CTR	PSID	1.024	.525	.71899	.72723	4287	
28 QC RT	PSID	1.055	.541	.74459	.75316	4287	
29 PS	PSIA	11.634	11.420	11.59036	11.59036	4287	
30 TEMP IRT	DEG C	18.497	7.371	14.90966	15.01359	4287	
31 D TO G	METERS	8776211.2518763565.709	*****	*****	*****	4287	
32 B TO D	DEGREES	80.530	80.429	80.48134	80.48134	4287	
33 LONG	DEGREES	-104.626	-104.777	-104.69931	104.69932	4287	
34 LAT	DEGREES	39.877	39.874	39.87481	39.87481	4287	
35 TRK ANG	DEGREES	273.969	269.759	271.34337	271.34574	4287	
36 HDG	RADIANS	4.860	4.702	4.77535	4.77543	4287	
37 VE	M/SEC	-112.109	-129.658	-120.20902	120.37454	4287	
38 VN	M/SEC	8.447	-.483	2.90284	3.80837	4287	
39 ALTITUDE	KM	2.077	1.928	1.95777	1.95780	4287	
40 TEMPC	DEGREES C	27.311	23.804	25.40764	25.42082	4287	
41 EW WND SPD	KNOTS	-1.586	-57.239	-36.67383	37.84368	4287	
42 NS WND SPD	KNOTS	14.280	-24.765	-10.11370	11.92790	4287	
43 WIND SPEED	KNOTS	58.641	6.886	38.49696	39.67895	4287	
44 WIND DIREC	DEGREES	173.662	31.506	74.95791	75.57034	4287	
45 AIRSPEED R	M/SEC	122.975	88.693	103.45700	103.74037	4287	
46 AIRSPEED C	M/SEC	121.142	87.353	101.70340	101.93078	4287	
47 AIRSPEED L	M/SEC	123.909	88.657	102.73223	103.01391	4287	
48 DELTA ALT	METERS	113.721	-35.422	-5.41792	10.78235	4287	
49 INRTL DISP	METERS	19.632	-17.614	-2.44869	9.07060	4287	
50 UG RIGHT	M/SEC	10.697	-17.261	.00000	4.84265	4287	
51 UG CENTER	M/SEC	10.519	-17.429	.00000	4.73009	4287	
52 UG LEFT	M/SEC	9.432	-18.897	.00000	4.81697	4287	
53 VG RIGHT	M/SEC	12.859	-7.612	.06192	3.34388	4287	
54 VG CENTER	M/SEC	14.425	-7.787	.06730	3.47412	4287	
55 VG LEFT	M/SEC	9.372	-8.146	.06633	3.48612	4287	
56 WG RIGHT	M/SEC	10.188	-9.725	.01266	3.09410	4287	
57 WG CENTER	M/SEC	10.455	-9.034	.02866	2.86406	4287	
58 WG LEFT	M/SEC	12.177	-9.581	.00414	2.99761	4287	

Date: July 14, 1982
 Time: 15:43:46 (MDT)
 Duration: 74 seconds

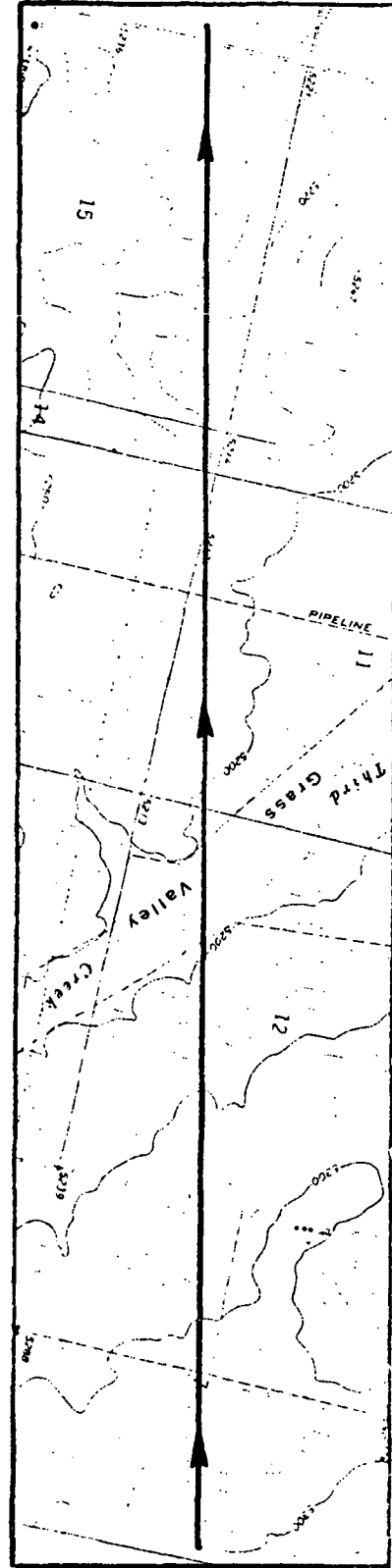
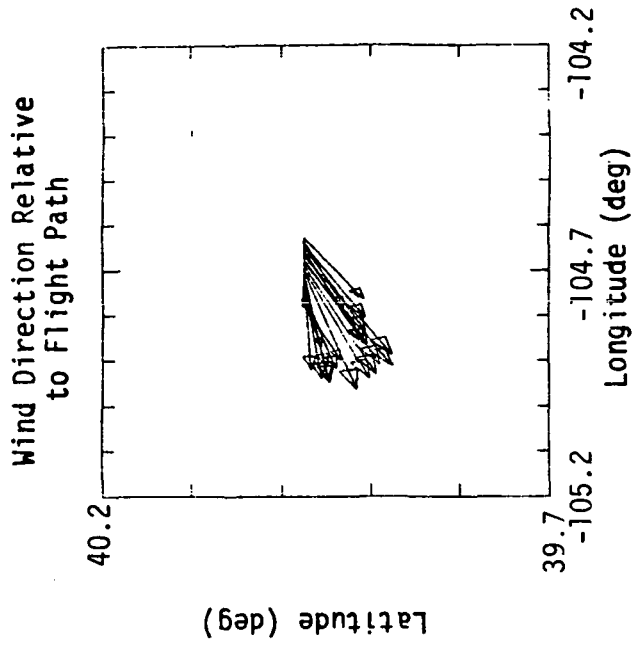
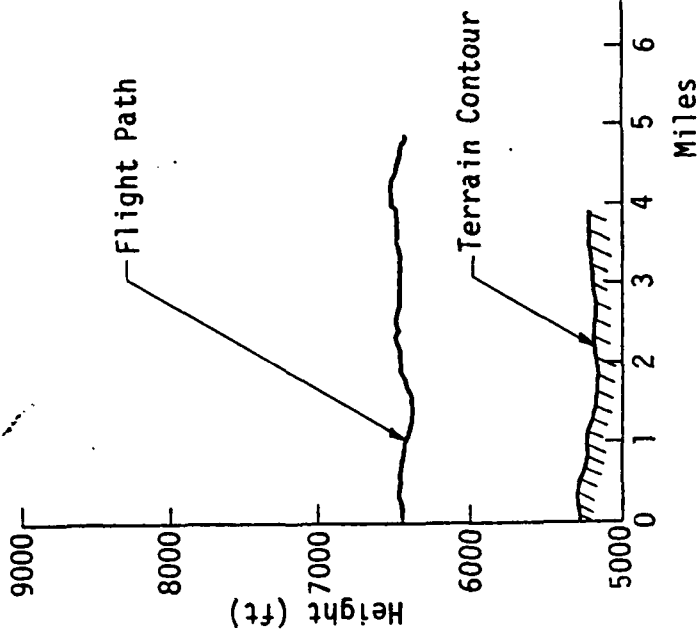

Figure A.330. Flight path information, Flight 6, Run 44.

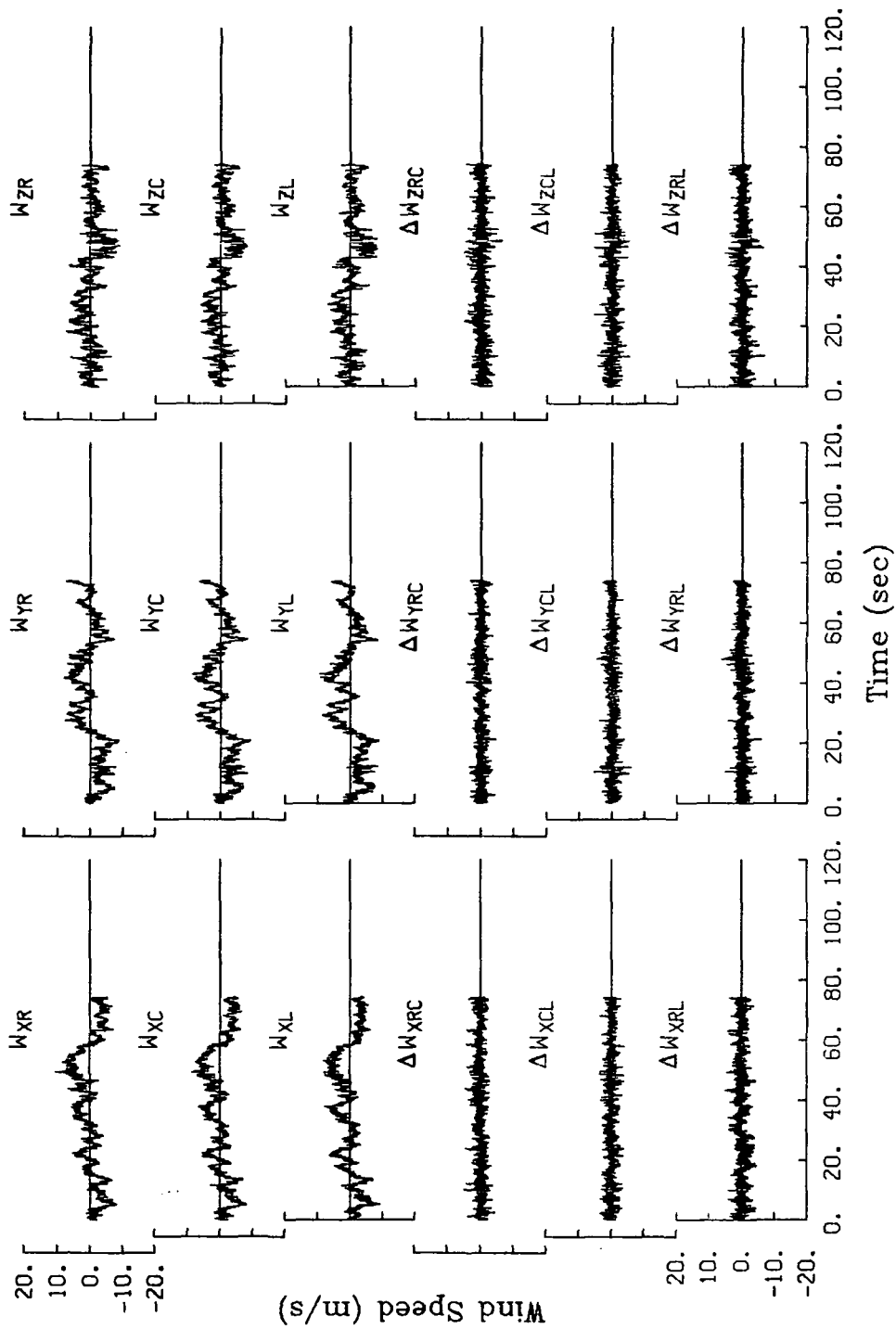

Figure A.331. Time histories of gust velocities and gust velocity differences, Flight 6, Run 44.

Figure A.332. Average Turbulence Parameters and Integral Length Scales, Flight 6, Run 44.

I. Mean Airspeed (m/s)

V_L	V_C	V_R
106.9	105.8	107.7

II. Standard Deviation of Gust Velocities (m/s)

$\sigma_{W_{XL}}$	$\sigma_{W_{XC}}$	$\sigma_{W_{XR}}$
3.27	3.12	3.26
$\sigma_{W_{YL}}$	$\sigma_{W_{YC}}$	$\sigma_{W_{YR}}$
3.59	3.55	3.53
$\sigma_{W_{ZL}}$	$\sigma_{W_{ZC}}$	$\sigma_{W_{ZR}}$
2.70	2.57	2.72

III. Standard Deviation of Gust Velocity Differences (m/s)

$\sigma_{\Delta W_{XCL}}$	$\sigma_{\Delta W_{XRC}}$	$\sigma_{\Delta W_{XRL}}$
1.10	1.12	1.38
$\sigma_{\Delta W_{YCL}}$	$\sigma_{\Delta W_{YRC}}$	$\sigma_{\Delta W_{YRL}}$
1.04	1.08	1.19
$\sigma_{\Delta W_{ZCL}}$	$\sigma_{\Delta W_{ZRC}}$	$\sigma_{\Delta W_{ZRL}}$
1.24	1.28	1.43

IV. Integral Length Scale (m).

$L_{W_{XL}}$	$L_{W_{XC}}$	$L_{W_{XR}}$
446	464	503
$L_{W_{YL}}$	$L_{W_{YC}}$	$L_{W_{YR}}$
831	827	877
$L_{W_{ZL}}$	$L_{W_{ZC}}$	$L_{W_{ZR}}$
740	771	647

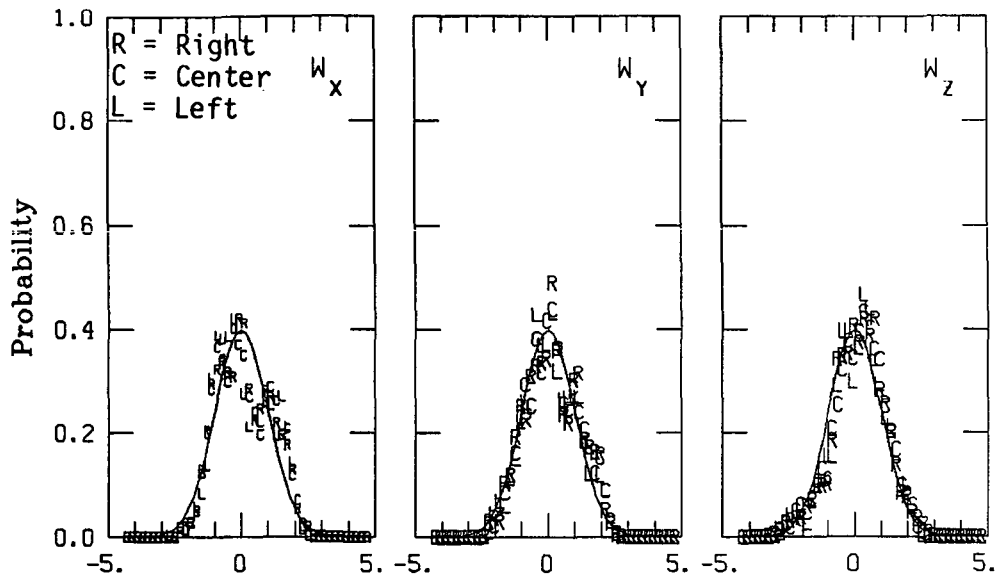

Normalized Gust Velocity (Standard Deviations)

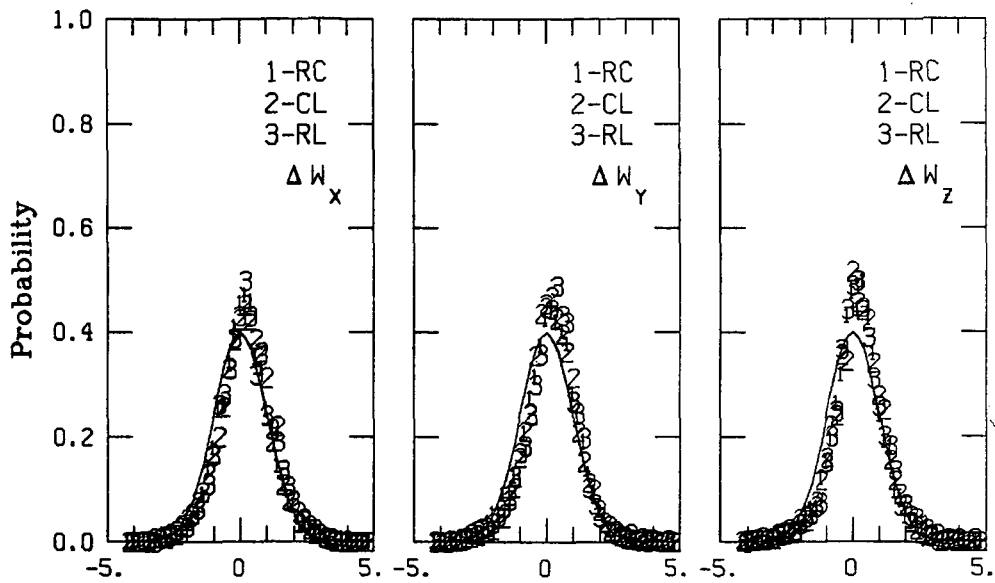

Normalized Velocity Differences (Standard Deviations)

Figure A.333. Probability density function for gust velocities and gust velocity differences, Flight 6, Run 44.

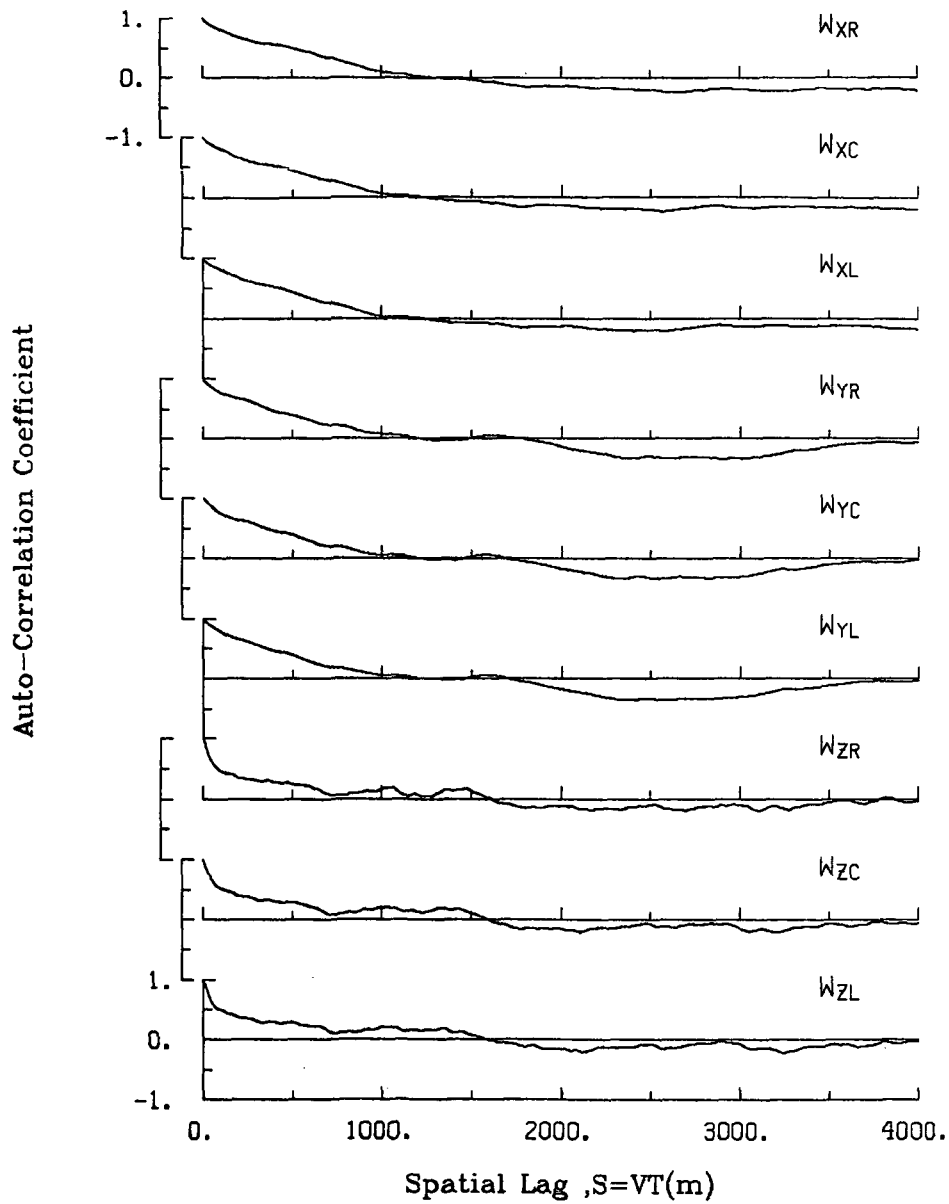

Figure A.334. Single-point auto-correlation coefficient of gust velocities, Flight 6, Run 44.

ORIGINAL PAGE IS
OF POOR QUALITY

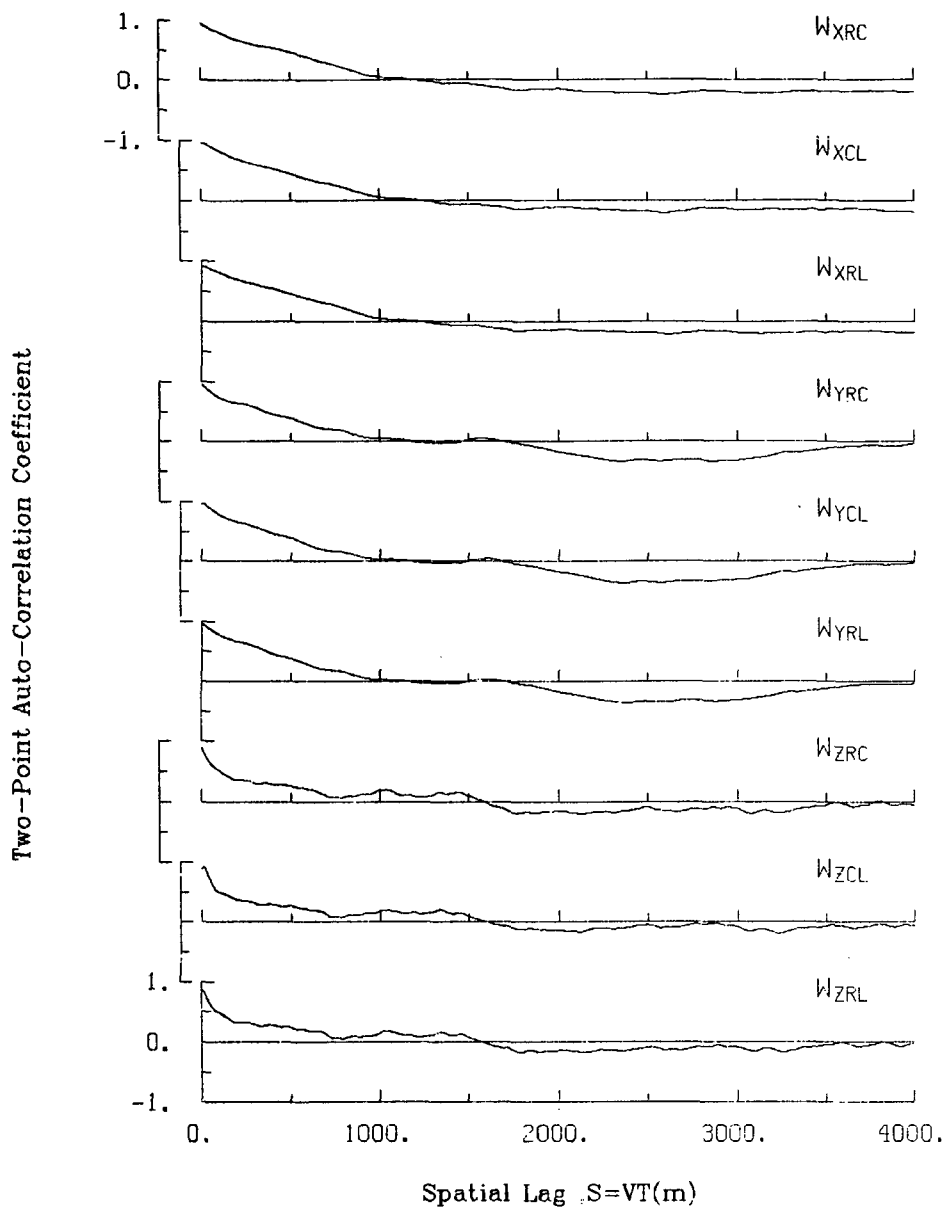

Figure A.335. Two-point auto-correlation coefficient of gust velocities, Flight 6, Run 44.

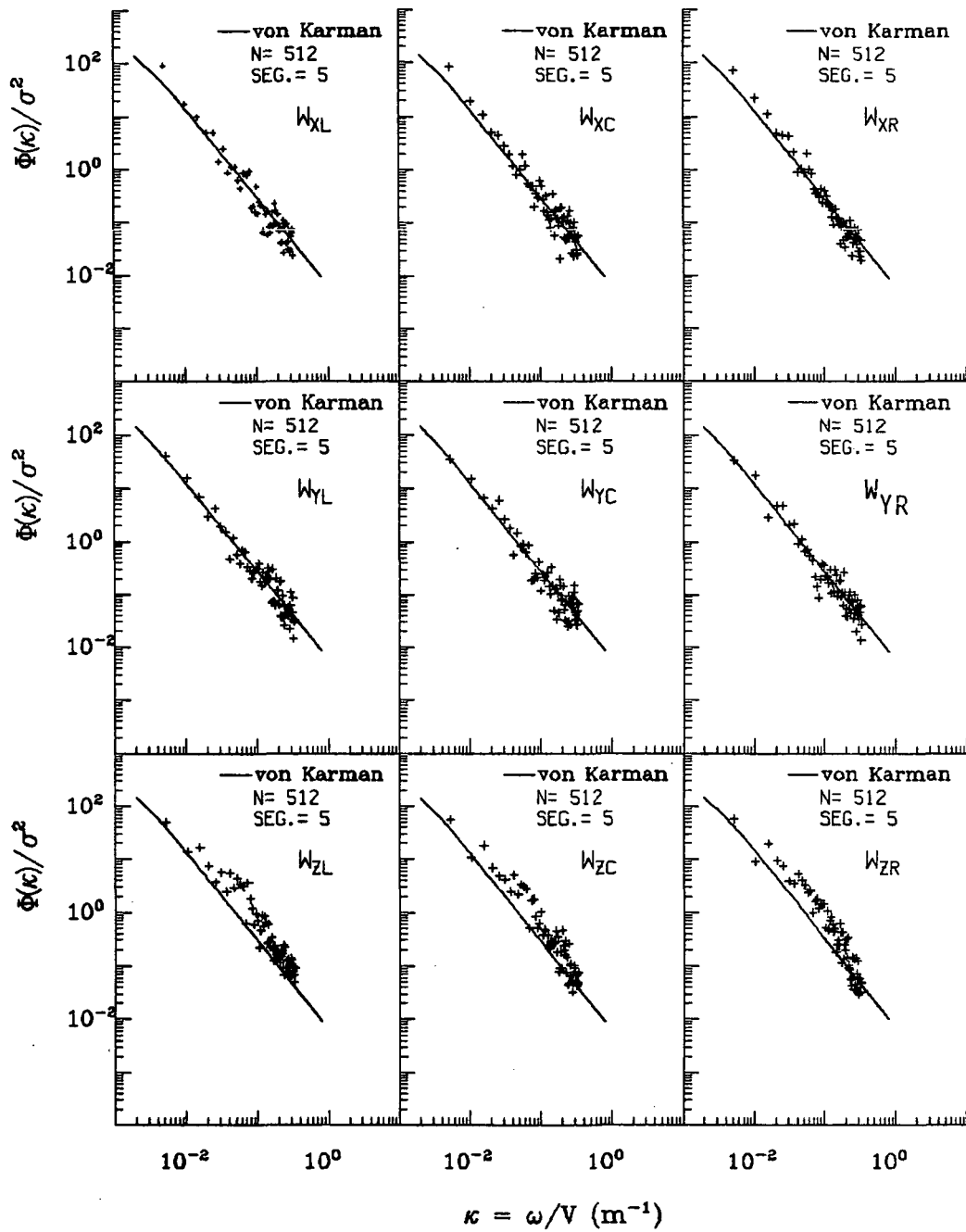

Figure A.336. Normalized auto-spectra of gust velocities, Flight 6, Run 44.

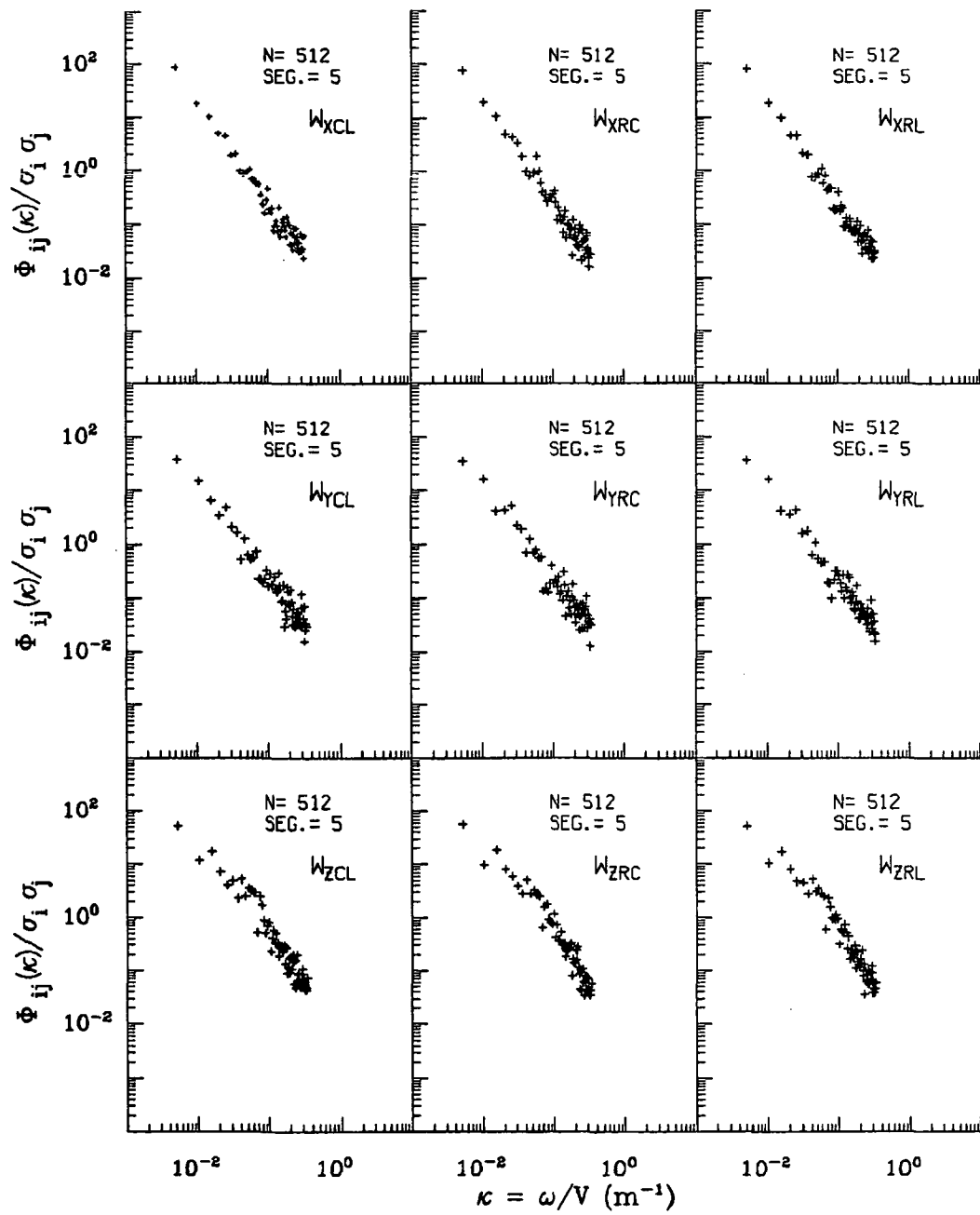

Figure A.337. Normalized two-point auto-spectra of gust velocities, Flight 6, Run 44.

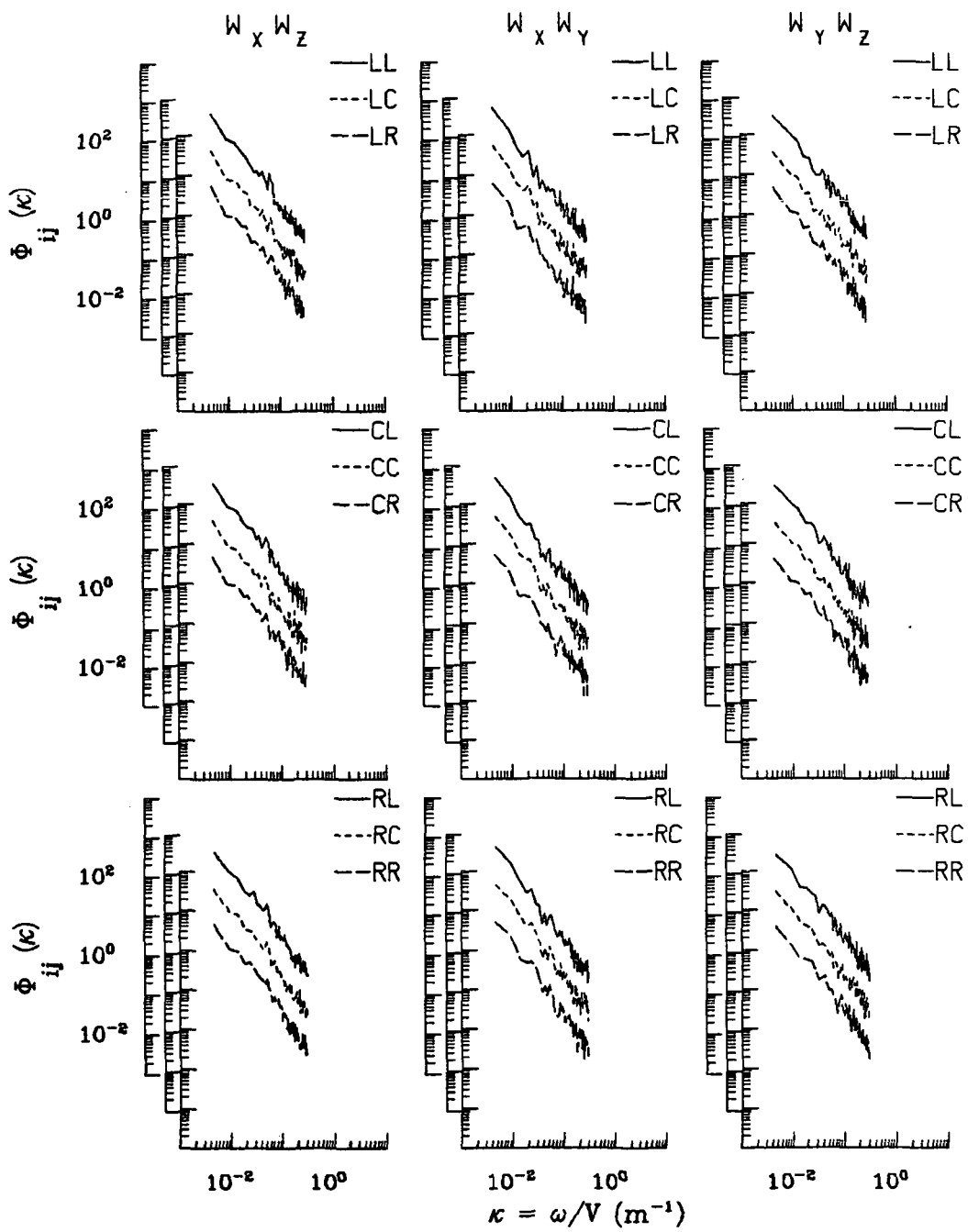
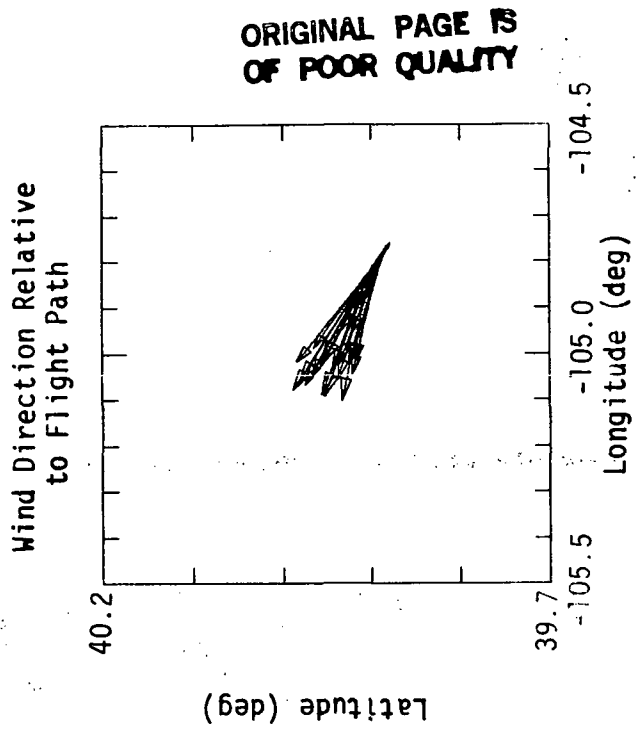
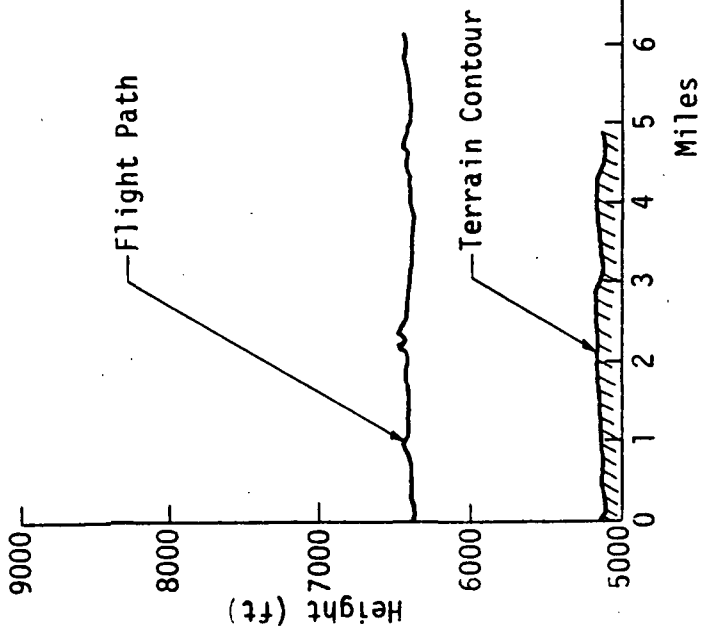

Figure A.338. Two-point cross-spectra of gust velocities, Flight 6, Run 44.

TABLE A.79. List of All Parameters Measured and Their Range of Values, Flight 6, Run 44.

		START TIME = 56626.3912		STOP TIME = 56700.6162			
CHANNEL	UNITS	HIGH	LOW	MEAN	RMS	POINTS	
2 PHI DOT	RAD/SEC	.172	-.142	-.00284	.04280	2969	
3 ACCL N CG	G UNITS	-.988	-.988	-.98774	.98774	2969	
4 THETA DOT	RAD/SEC	.087	-.072	.00573	.01874	2969	
5 THETA	RAD	.113	.011	.05185	.05854	2969	
6 PHI	RAD	.083	-.104	-.01745	.04126	2969	
7 PSI 1	DEGREES	103.400	95.299	99.41393	99.43132	2969	
8 DEL PSI 1	DEGREES	2.875	-5.001	-1.10287	2.14398	2969	
9 PSI 2	DEGREES	461.087	453.342	457.08981	457.09335	2969	
10 DEL PSI 2	DEGREES	2.432	-5.447	-1.52037	2.38423	2969	
11 ACCL N LT	G UNITS	2.736	-.332	1.00689	1.06444	2969	
12 ACCL N RT	G UNITS	2.591	-.488	1.01763	1.06730	2969	
13 ACCL X CG	G UNITS	.120	-.044	.02933	.04181	2969	
14 ACCL Y CG	G UNITS	.186	-.139	.00793	.04089	2969	
15 ALPHA CTR	RAD	.043	-.097	-.02670	.03328	2969	
16 BETA CTR	RAD	.045	-.095	-.02077	.03340	2969	
17 TEMP I	DEG F	83.693	82.613	83.21405	83.21458	2969	
18 TEMP P	DEG F	93.422	93.242	93.41608	93.41609	2969	
19 ACCL Z INS	G UNITS	1.617	.165	.99584	1.01176	2969	
20 ALPHA RT	RAD	.063	-.104	-.02323	.03187	2969	
21 BETA RT	RAD	.073	-.053	.01255	.02667	2969	
22 ALPHA LT	RAD	.058	-.100	-.02288	.03142	2969	
23 BETA LT	RAD	.030	-.087	-.02639	.03558	2969	
24 PSI DOT	RAD/SEC	.047	-.054	.00184	.02154	2969	
25 TEMP TOT	DEG C	32.671	29.028	31.01379	31.02677	2969	
26 QC LT	PSID	1.088	.623	.79363	.79976	2969	
27 QC CTR	PSID	1.043	.614	.77785	.78371	2969	
28 QC RT	PSID	1.075	.614	.80569	.81195	2969	
29 PS	PSIA	11.652	11.384	11.58289	11.58290	2969	
30 TEMP IRT	DEG C	18.497	14.295	16.71458	16.72667	2969	
31 D TO G	METERS	8770378.5988764277.722	*****	*****	*****	2969	
32 B TO D	DEGREES	80.481	80.429	80.45594	80.45594	2969	
33 LONG	DEGREES	-104.697	-104.772	-104.73364	104.73365	2969	
34 LAT	DEGREES	39.894	39.883	39.88779	39.88779	2969	
35 TRK ANG	DEGREES	101.960	97.137	100.47697	100.48582	2969	
36 HDG	RADIANS	1.820	1.676	1.74834	1.74866	2969	
37 VE	M/SEC	97.149	80.124	86.53513	86.66680	2969	
38 VN	M/SEC	-10.052	-20.039	-16.03883	16.25031	2969	
39 ALTITUDE	KM	2.102	1.915	1.96298	1.96301	2969	
40 TEMPC	DEGREES C	28.087	23.719	25.42017	25.44130	2969	
41 EW WND SPD	KNCTS	-18.335	-46.753	-33.31267	33.87255	2969	
42 NS WND SPD	KNOTS	25.855	-9.113	9.49499	11.66758	2969	
43 WIND SPEED	KNOTS	52.056	19.379	35.27327	35.82572	2969	
44 WIND DIREC	DEGREES	139.353	72.722	105.63259	106.22153	2969	
45 AIRSPEED R	M/SEC	124.065	94.557	107.65803	107.84998	2969	
46 AIRSPEED C	M/SEC	122.215	94.631	105.83196	106.01463	2969	
47 AIRSPEED L	M/SEC	124.768	95.298	106.87040	107.05936	2969	
48 DELTA ALT	METERS	145.409	-42.042	6.12173	13.31611	2969	
49 INRTL DISP	METERS	31.824	-17.133	9.77187	16.22331	2969	
50 UG RIGHT	M/SEC	10.347	-8.111	-.00000	3.35474	2969	
51 UG CENTER	M/SEC	8.418	-7.864	-.00000	3.22618	2969	
52 UG LEFT	M/SEC	7.868	-9.206	-.00000	3.33703	2969	
53 VG RIGHT	M/SEC	8.000	-8.631	-.09730	3.41329	2969	
54 VG CENTER	M/SEC	8.741	-8.900	-.08698	3.42994	2969	
55 VG LEFT	M/SEC	9.450	-8.710	-.07784	3.45060	2969	
56 WG RIGHT	M/SEC	7.409	-8.858	.02468	2.61717	2969	
57 WG CENTER	M/SEC	6.156	-7.664	.03482	2.47887	2969	
58 WG LEFT	M/SEC	6.889	-8.376	.02997	2.61382	2969	

Date: July 14, 1982
 Time: 15:48:14 (MDT)
 Duration: 96 seconds



ORIGINAL PAGE IS
 OF POOR QUALITY

A.410

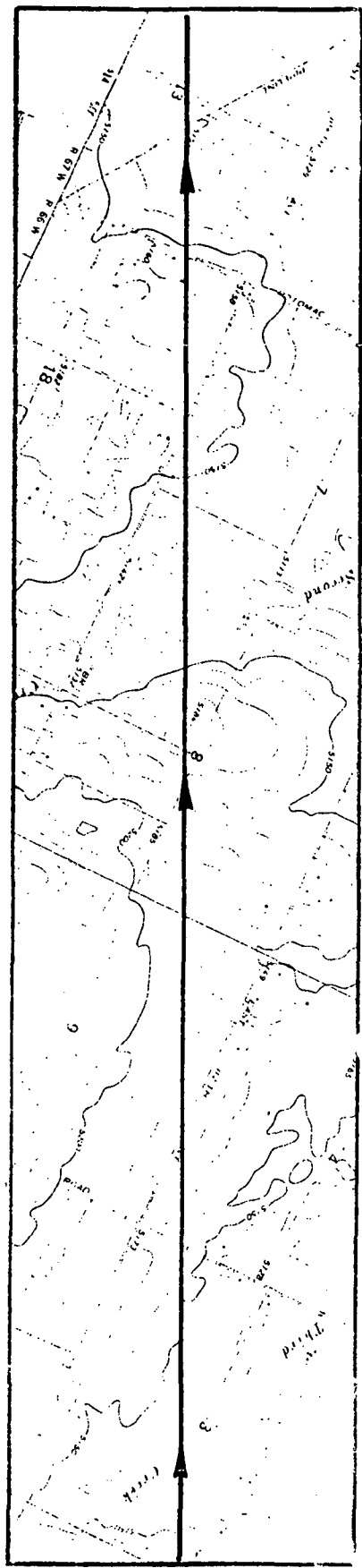

Figure A.339. Flight path information, Flight 6, Run 4b.

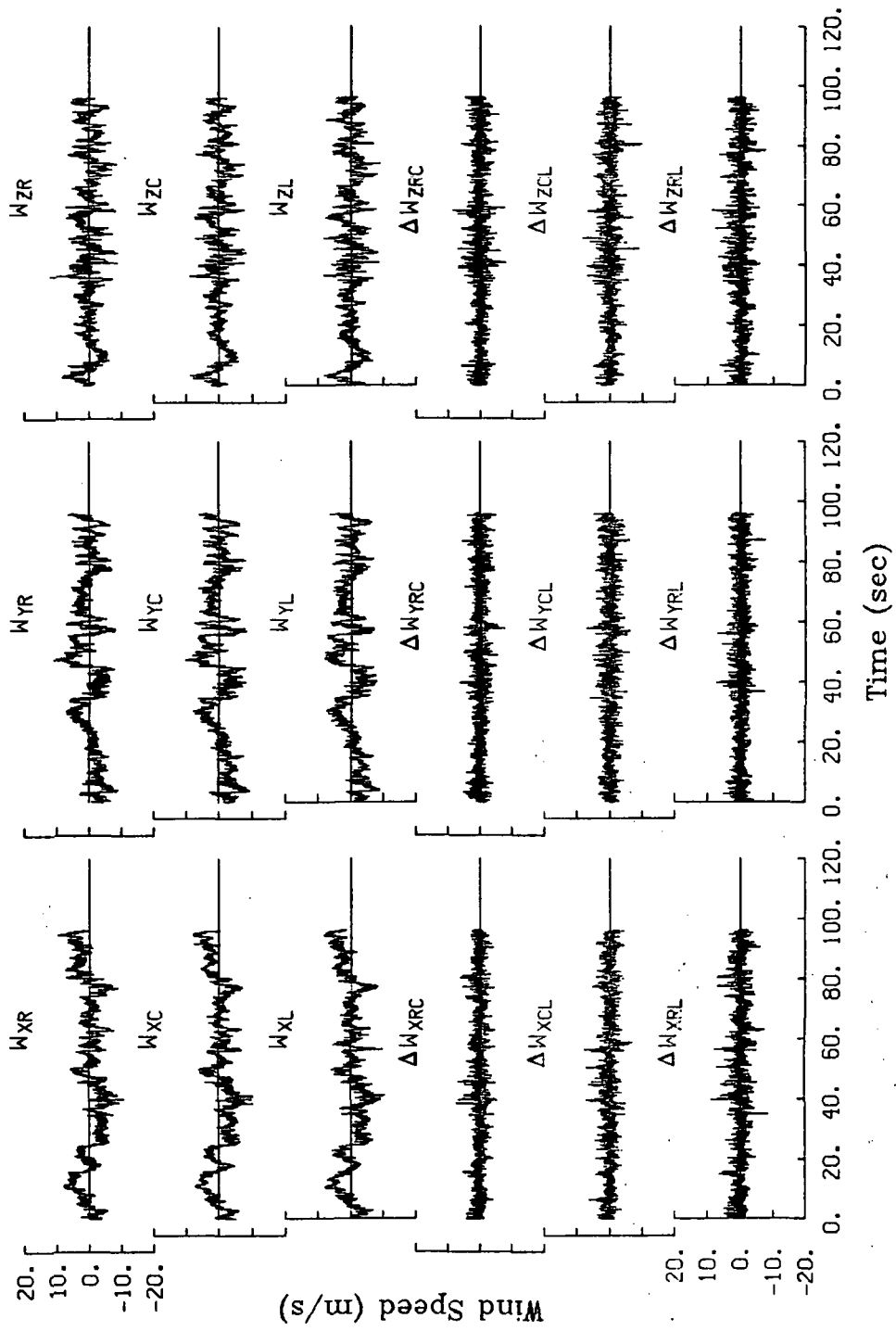
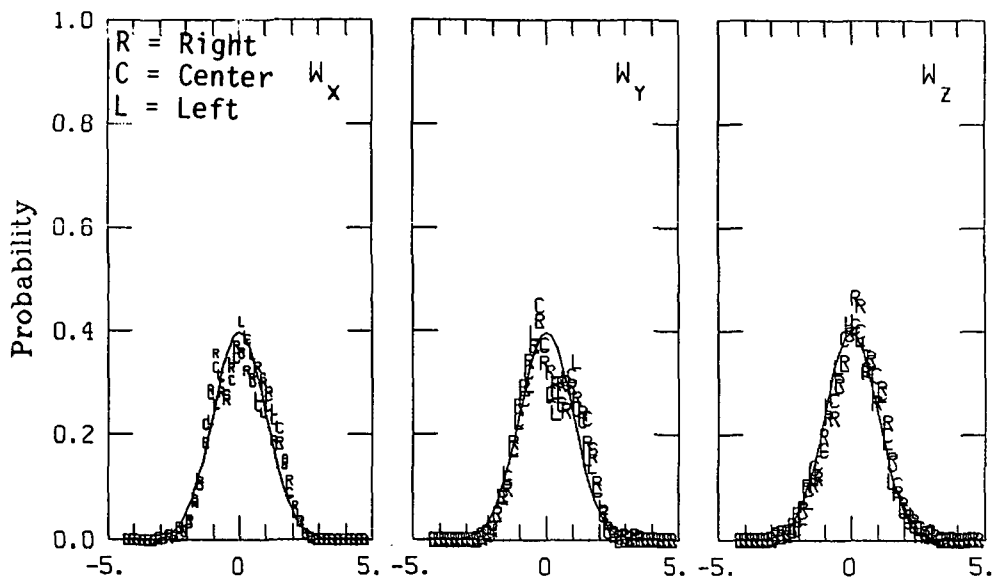

Figure A.340. Time histories of gust velocities and gust velocity differences, Flight 6, Run 46.

TABLE A.80. Average Turbulence Parameters and Integral Length Scales, Flight 6, Run 46.

I. Mean Airspeed (m/s)			II. Standard Deviation of Gust Velocities (m/s)		
V_L	V_C	V_R	$\sigma_{W_{XL}}$	$\sigma_{W_{XC}}$	$\sigma_{W_{XR}}$
104.9	103.8	105.5	3.04	2.98	3.19
			$\sigma_{W_{YL}}$	$\sigma_{W_{YC}}$	$\sigma_{W_{YR}}$
			3.22	3.37	3.28
			$\sigma_{W_{ZL}}$	$\sigma_{W_{ZC}}$	$\sigma_{W_{ZR}}$
			2.68	2.50	2.75
III. Standard Deviation of Gust Velocity Differences (m/s)			IV. Integral Length Scale (m)		
$\sigma_{\Delta W_{XCL}}$	$\sigma_{\Delta W_{XRC}}$	$\sigma_{\Delta W_{XRL}}$	$L_{W_{XL}}$	$L_{W_{XC}}$	$L_{W_{XR}}$
1.39	1.43	1.80	370	370	420
$\sigma_{\Delta W_{YCL}}$	$\sigma_{\Delta W_{YRC}}$	$\sigma_{\Delta W_{YRL}}$	$L_{W_{YL}}$	$L_{W_{YC}}$	$L_{W_{YR}}$
1.37	1.39	1.43	506	454	468
$\sigma_{\Delta W_{ZCL}}$	$\sigma_{\Delta W_{ZRC}}$	$\sigma_{\Delta W_{ZRL}}$	$L_{W_{ZL}}$	$L_{W_{ZC}}$	$L_{W_{ZR}}$
1.56	1.53	1.79	161	178	155



Normalized Gust Velocity (Standard Deviations)

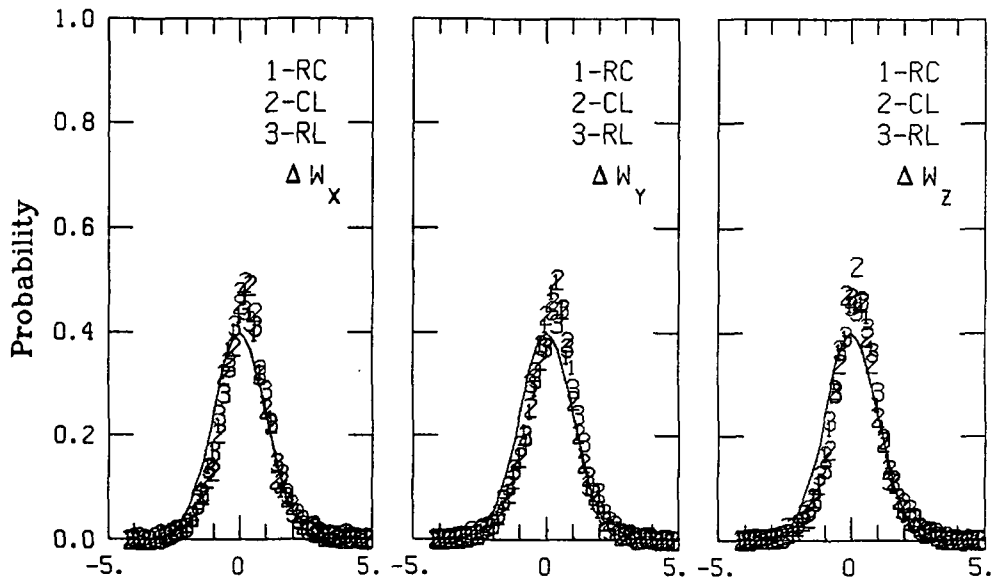

Normalized Velocity Differences (Standard Deviations)

Figure A.341. Probability density function for gust velocities and gust velocity differences; Flight 6, Run 46.

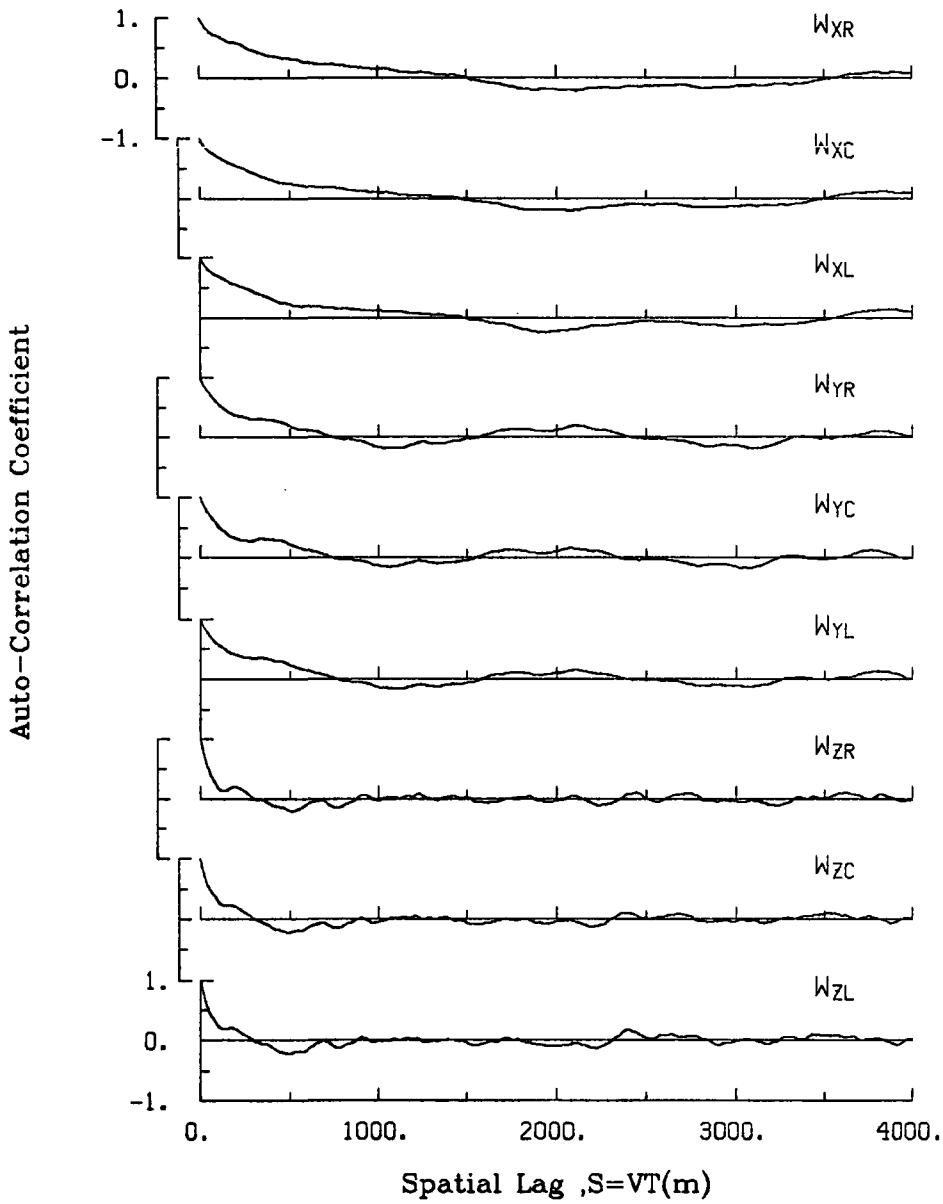

Figure A.342. Single-point auto-correlation coefficient of gust velocities, Flight 6, Run 46.

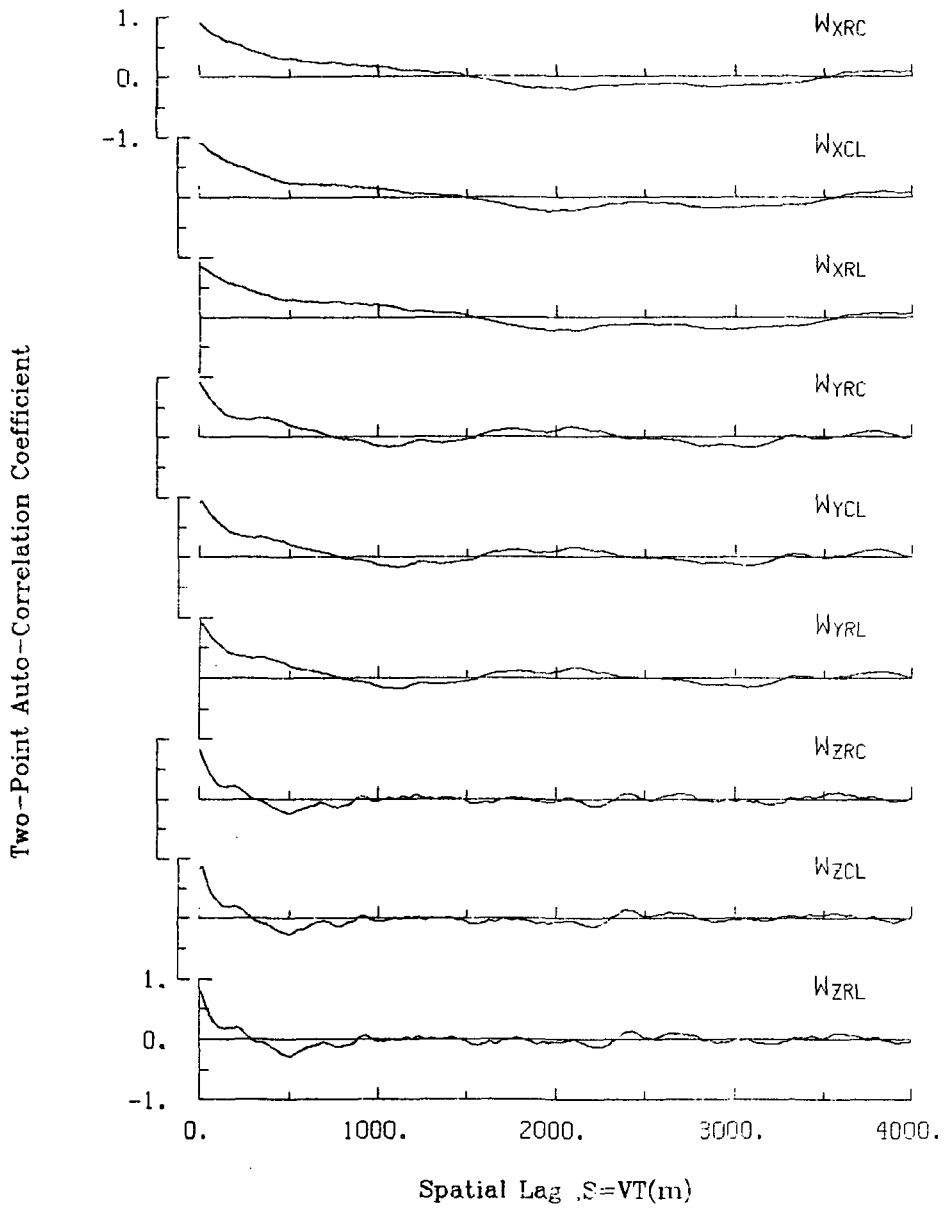

Figure A.343. Two-point auto-correlation coefficient of gust velocities, Flight 6, Run 46.

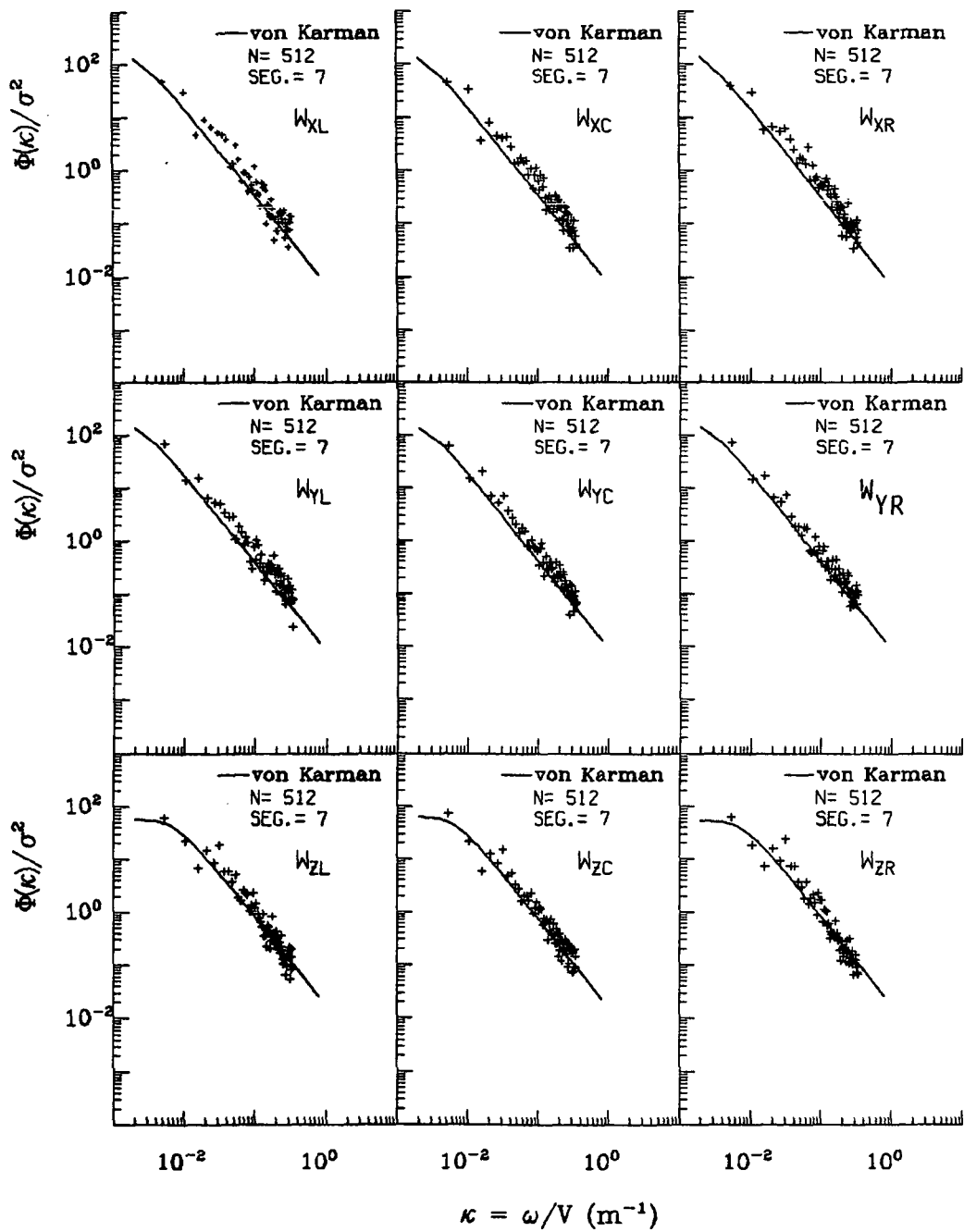

Figure A.344. Normalized auto-spectra of gust velocities, Flight 6, Run 46.

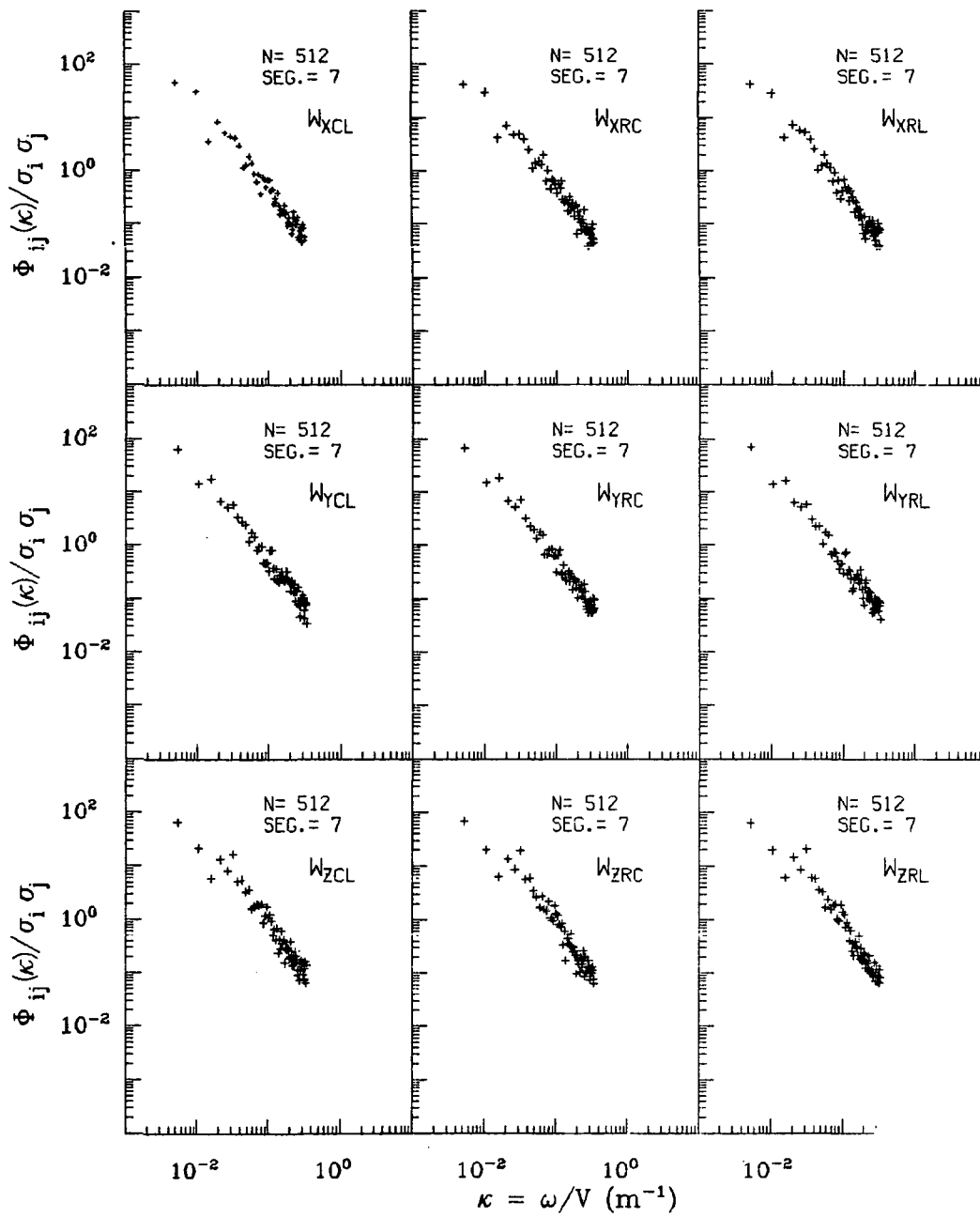

Figure A.345. Normalized two-point auto-spectra of gust velocities, Flight 6, Run 46.

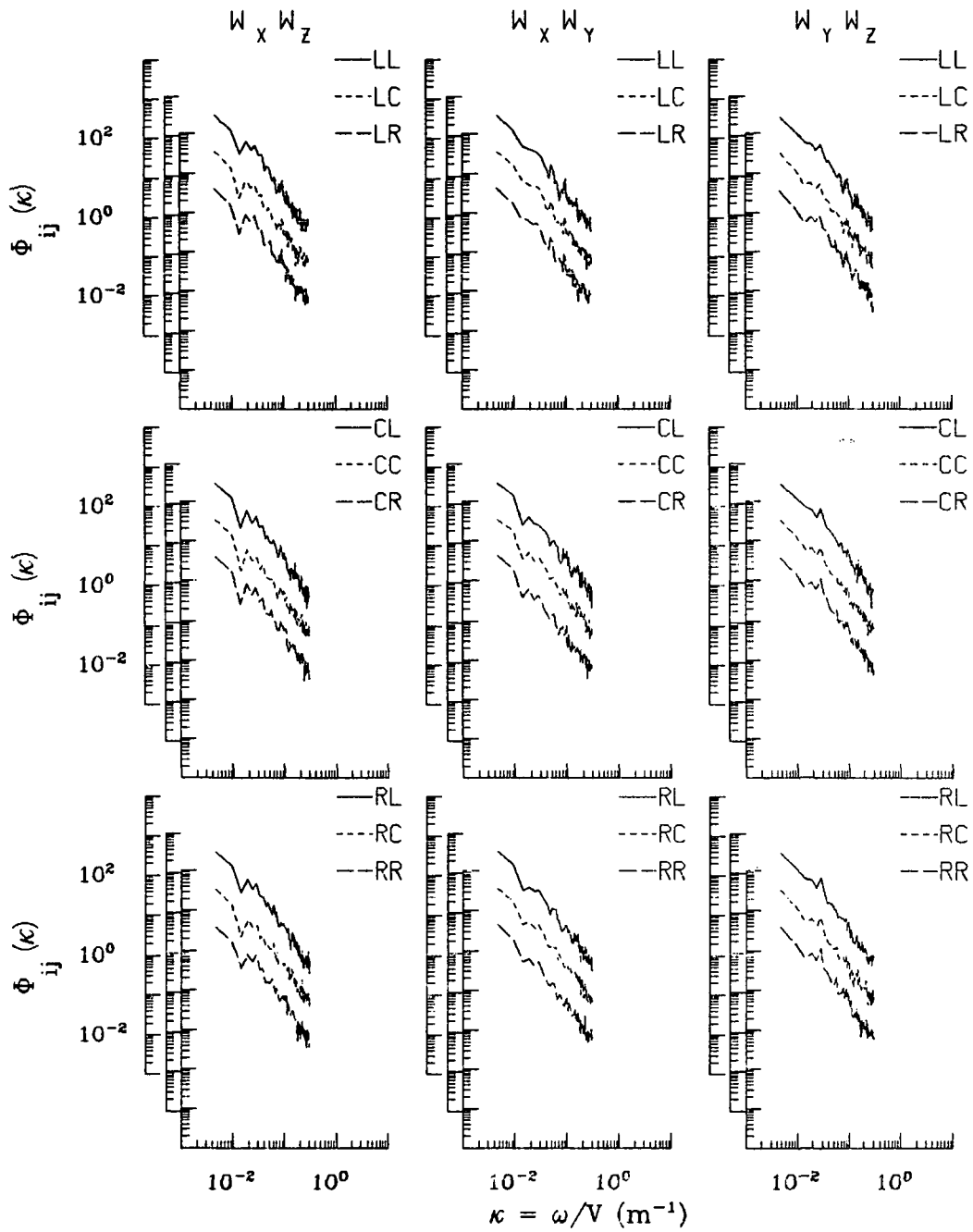

Figure A.346. Two-point cross-spectra of gust velocities, Flight 6, Run 46.

**ORIGINAL PAGE IS
OF POOR QUALITY**

TABLE A.81. List of All Parameters Measured and Their Range of Values, Flight 6, Run 46.

		START TIME = 56894.4615		STOP TIME = 56990.6865			
CHANNEL	UNITS	HIGH	LOW	MEAN	RMS	POINTS	
2	PHI DOT	RAD/SEC	.258	-.154	-.00288	.05378	3849
3	ACCL N CG	G UNITS	-.988	-.988	-.98774	.98774	3849
4	THETA DOT	RAD/SEC	.107	-.093	.00362	.02221	3849
5	THETA	RAD	.084	-.002	.04705	.05071	3849
6	PHI	RAD	.115	-.126	-.00682	.03697	3849
7	PSI 1	DEGREES	120.307	106.922	113.39553	113.41419	3849
8	DEL PSI 1	DEGREES	6.842	-6.353	.04088	2.05479	3849
9	PSI 2	DEGREES	482.555	469.191	475.65688	475.66109	3849
10	DEL PSI 2	DEGREES	6.490	-6.594	-.25712	2.05621	3849
11	ACCL N LT	G UNITS	2.929	-.976	1.01435	1.09597	3849
12	ACCL N RT	G UNITS	3.030	-.838	1.02626	1.10270	3849
13	ACCL X CG	G UNITS	.139	-.014	.05503	.06207	3849
14	ACCL Y CG	G UNITS	.198	-.198	.01267	.05424	3849
15	ALPHA CTR	RAD	.062	-.119	-.02436	.03284	3849
16	BETA CTR	RAD	.148	-.199	-.01385	.04592	3849
17	TEMP I	DEG F	83.333	82.973	83.07717	83.07723	3849
18	TEMP P	DEG F	93.602	93.422	93.50863	93.50867	3849
19	ACCL Z INS	G UNITS	1.965	-.170	1.00498	1.02776	3849
20	ALPHA RT	RAD	.085	-.122	-.02124	.03258	3849
21	BETA RT	RAD	.167	-.154	.01832	.04371	3849
22	ALPHA LT	RAD	.048	-.124	-.02072	.03111	3849
23	BETA LT	RAD	.141	-.181	-.01948	.04401	3849
24	PSI DOT	RAD/SEC	.122	-.159	.00396	.03455	3849
25	TEMP TOT	DEG C	32.868	29.914	31.40905	31.41576	3849
26	QC LT	PSID	.999	.603	.76186	.76539	3849
27	QC CTR	PSID	.974	.595	.74575	.74919	3849
28	QC RT	PSID	1.008	.611	.77098	.77477	3849
29	PS	PSIA	11.628	11.558	11.60257	11.60257	3849
30	TEMP IRT	DEG C	19.312	15.790	17.68589	17.70696	3849
31	D TO G	METERS	8765589.5818	758762.061	*****	*****	3849
32	B TO D	DEGREES	80.445	80.380	80.41270	80.41270	3849
33	LONG	DEGREES	-104.753	-104.841	-104.79690	104.79691	3849
34	LAT	DEGREES	39.909	39.877	39.89324	39.89325	3849
35	TRK ANG	DEGREES	117.223	112.655	115.24902	115.25749	3849
36	HDG	RADIANS	2.122	1.885	1.99948	1.99982	3849
37	VE	M/SEC	82.307	75.324	78.14245	78.17488	3849
38	VN	M/SEC	-32.000	-39.415	-36.83561	36.90653	3849
39	ALTITUDE	KM	1.980	1.931	1.94928	1.94929	3849
40	TEMPC	DEGREES C	27.909	24.367	26.03865	26.05199	3849
41	EW WND SPD	KNOTS	-14.279	-47.641	-30.32309	30.97777	3849
42	NS WND SPD	KNOTS	35.653	-4.635	14.64767	15.92313	3849
43	WIND SPEED	KNOTS	53.949	18.294	34.31207	34.83057	3849
44	WIND DIR	DEGREES	146.061	82.470	116.03084	116.57383	3849
45	AIR SPEED R	M/SEC	120.130	94.373	105.46249	105.58074	3849
46	AIR SPEED C	M/SEC	119.042	93.167	103.76903	103.87774	3849
47	AIR SPEED L	M/SEC	119.600	93.813	104.85960	104.96945	3849
48	DELTA ALT	METERS	28.368	-20.576	-2.62153	7.81801	3849
49	INRTL DISP	METERS	8.693	-19.730	-2.48577	7.31611	3849
50	UG RIGHT	M/SEC	9.814	-10.437	-.00000	3.29538	3849
51	UG CENTER	M/SEC	8.041	-10.228	-.00000	3.10570	3849
52	UG LEFT	M/SEC	8.154	-10.710	-.00000	3.18449	3849
53	VG RIGHT	M/SEC	11.332	-8.678	.02548	3.27241	3849
54	VG CENTER	M/SEC	10.363	-9.188	.02318	3.36527	3849
55	VG LEFT	M/SEC	8.161	-8.590	.01855	3.20853	3849
56	WG RIGHT	M/SEC	12.060	-8.653	.01224	2.76657	3849
57	WG CENTER	M/SEC	9.112	-7.778	.00632	2.48878	3849
58	WG LEFT	M/SEC	8.371	-8.846	.00349	2.65923	3849