

NASA Contractor Report 178015

ALESEP: Part II A Computer Program for the Analysis of Leading Edge Separation Bubbles on Infinite Swept Wings

R.L. Davis and J.E. Carter
United Technologies Research Center
East Hartford, CT 06108

CONTRACT NAS1-16585
JANUARY 1986

(NASA-CR-178015) ALESEP. PART 2: A COMPUTER
PROGRAM FOR THE ANALYSIS OF LEADING EDGE
SEPARATION BUBBLES ON INFINITE SWEPT WINGS
(United Technologies Corp.) 75 p
HC A04/MF A01

N86-24664

Unclas
43349
CSCL 01A G3/02



National Aeronautics and
Space Administration

Langley Research Center
Hampton, Virginia 23665

ALESEP: PART II- A Computer Program for the Analysis
of Leading Edge Separation Bubbles on Infinite Swept Wings

TABLE OF CONTENTS

	<u>Page</u>
SUMMARY	2
LIST OF SYMBOLS	3
GENERAL DESCRIPTION	6
Introduction	6
Technical Approach	6
USER INSTRUCTIONS	9
Code Description	9
Input Description	9
Output Description	19
REFERENCES	28
FIGURES	30
APPENDIX A - SAMPLE CASE	37

ALESEP: PART II- A Computer Program for the Analysis
of Leading Edge Separation Bubbles on Infinite Swept Wings

SUMMARY

A program called ALESEP is presented for the analysis of the inviscid-viscous interaction which occurs due to the presence of a closed laminar-transitional separation bubble on an airfoil or infinite swept wing. The ALESEP code provides an iterative solution of the boundary layer equations expressed in an inverse formulation coupled to a Cauchy integral representation of the inviscid flow. This interaction analysis is treated as a local perturbation to a known solution obtained from a global airfoil analysis; hence, part of the required input to the ALESEP code are the reference displacement thickness and tangential velocity distributions. Special windward differencing may be used in the reversed flow regions of the separation bubble to accurately account for the flow direction in the discretization of the streamwise convection of momentum. The ALESEP code contains a forced transition model based on a streamwise intermittency function, a natural transition model based on a solution of the integral form of the turbulent kinetic energy equation, and an empirical natural transition model. In addition, wall suction may be applied to the boundary layer to either control its growth or alleviate the separation bubble. Complete documentation of the two-dimensional code was originally given in NASA Contract Report 172310. An updated set of instructions for the input, output, and program usage for both two-dimensional airfoils and infinite swept wings is given herein along with a sample case.

LIST OF SYMBOLS

a	Structural coefficient
c	Airfoil chord
c_f	Skin friction coefficient
D	Damping factor applied to mixing and dissipation lengths
\tilde{f}	Perturbation stream function
F	Velocity ratio, u/u_e
g	Total enthalpy ratio, H/H_e
H	Total enthalpy
l	Mixing length or ratio of local to edge density times molecular viscosity product
L	Reference length or dissipation length
m	Perturbation mass flow
n	Coordinate normal to reference displacement surface
N	Coordinate measured normal to reference displacement surface from the body surface
Pr	Prandtl number
Pr_T	Turbulent Prandtl number
\bar{q}	Magnitude of fluctuating velocities
Re	Reference Reynolds number
Re_θ	Local momentum thickness Reynolds number
\tilde{R}_θ	Correlated momentum thickness Reynolds number
R_T	Turbulent Reynolds number
s, S	Coordinates along reference displacement surface
Tu	Turbulence level
u	Velocity component normal to leading edge along the x-direction parallel to reference displacement surface

v	Velocity component along the y-direction normal to reference displacement surface
V	Transformed normal velocity in Prandtl transposition theorem
w	Velocity component tangent to leading edge along the z-direction
W	Velocity ratio, w/w_e
x	Coordinate direction normal to leading edge
X	Coordinate direction (absolute frame) parallel to free stream direction
y	Coordinate direction normal to surface
z	Coordinate direction tangent to leading edge
Z	Coordinate direction (absolute frame) perpendicular to free stream direction in reference plane of airfoil surface
α	Windward differencing weighting operator
β	Pressure gradient parameter
δ	Boundary layer thickness
δ^*	Displacement thickness
δ_T	Stress thickness
ϵ	Eddy viscosity coefficient
κ	von Karman constant
Λ	Sweep angle
η	Transformed normal coordinate
ν	Kinematic viscosity coefficient
μ	Molecular viscosity coefficient
ξ	Transformed tangential coordinate
ϕ	Velocity potential
ρ	Density
ψ	Stream function
ω	Interaction relaxation parameter

Subscripts

e	Edge of boundary layer
I	Inviscid
ref	Reference solution
t_1	Start of transition
t_2	End of transition
T	Turbulent
v	Viscous
∞	Free stream
1	Start of interaction region
2	End of interaction region

Superscripts

'	Perturbation quantity
+	Inner wall non-dimensionalized coordinate
k	Global inviscid-viscous iteration counter

GENERAL DESCRIPTION

Introduction

It was pointed out by Tani (Ref. 1) that airfoils at moderate incidence angles, prior to either leading edge stall or thin airfoil stall, experience local separation bubbles just downstream of the peak suction (minimum pressure) regions. Figure 1 shows a schematic diagram of an airfoil leading edge bubble which occurs if the Reynolds number is sufficiently low so that the boundary layer remains laminar up to the minimum pressure point. Downstream of this point, separation occurs almost immediately since laminar boundary layers, in contrast with turbulent flows, are extremely sensitive to adverse pressure gradients. A separation bubble forms in which a recirculating streamline pattern is bounded by a shear layer. Since shear layer flows tend to be highly unstable to flow disturbances, transition from laminar to turbulent flow generally occurs in this shear layer. Further downstream, the turbulent mixing between the shear layer flow with the lower dead air region results in entrainment of higher energy air which energizes the flow near the surface thereby resulting in flow reattachment with subsequent turbulent boundary layer flow downstream. As shown in Fig. 1, the initial position of the separation bubble is characterized by a pressure plateau followed by a pressure recovery region after the transition process is initiated, but prior to flow reattachment.

Technical Approach

The approach taken in the ALESEP code for the analysis of closed leading edge separation bubbles is based on an inviscid-viscous interaction technique in which the boundary layer equations are solved iteratively with an inviscid analysis through displacement thickness coupling. Experimental studies (Refs. 2-5) have shown that these closed transitional separation bubbles occupy only a few percent of the airfoil chord. Since the resultant interaction is highly localized, the leading edge transitional bubble problem is treated as a linear perturbation to a known global airfoil solution. The use of a perturbation approach permits an accurate analysis of the flow field structure in this region in contrast with the extremely difficult problem of trying to resolve this small scale phenomena while simultaneously solving the global airfoil flow field. In contrast with previous perturbation treatments of this problem, the approach taken in ALESEP accounts for the influence of the global viscous airfoil flow on the local interaction analysis. A detailed discussion of the approach taken in the ALESEP technique can be found in Refs. 6-9.

The local inviscid analysis in the ALESEP procedure assumes that the disturbance field induced by the presence of a transitional separation bubble can be treated as a small disturbance to the global airfoil flow. An asymptotic analysis is presented in Ref. 8 which formally shows that under a particular limiting condition, the disturbance field induced by the transitional displacement surface can be represented by a distribution of

sources placed along a reference displacement surface as shown in Fig. 2. The reference displacement surface is usually defined as the displacement thickness which would exist in the local region due to an attached turbulent boundary layer. It, as well as the reference velocity distribution, are obtained from an airfoil analysis code such as that presented in Refs. 10 or 11 in which instantaneous transition from laminar to turbulent flow is assumed to occur at the predicted laminar separation point. Calculation of the perturbation velocity which occurs due to the difference between the separation bubble displacement thickness and the reference displacement surface as shown in Fig. 2, is performed through a Cauchy integral of the chordwise distributed sources using potential flow considerations. Upon integration of this Cauchy integral for the perturbed velocity, the local inviscid velocity distribution, u_e , due to the interaction with the separation bubble is determined by adding the perturbation velocity and the reference velocity solution. For infinite swept wings, the two-dimensional Cauchy integral analysis remains unchanged along a line perpendicular to the wing leading edge since the spanwise component of the boundary layer edge velocity is constant and therefore, is unaffected by the viscous displacement thickness.

The viscous solution technique used in ALESEP is an extension of the inverse boundary layer procedure presented by Carter (Ref. 12). In this procedure, a perturbation stream function is introduced into the boundary layer equations for the simplification of boundary conditions. The continuity equation is eliminated and the stream function definition is subsequently added to the governing equation set which also include the momentum and energy equations. The governing equations are solved for the local perturbation stream function, two velocity ratios, total enthalpy ratio, and viscous edge velocity, u_e , for a prescribed streamwise distribution of perturbation mass flow, $m = \rho_e u_e \delta_e^*$. The numerical solution of the governing equations is obtained using an implicit finite difference technique which is first order accurate in the streamwise direction and second order accurate in the normal direction.

Since the boundary layer equations are parabolic, an instability will arise when the solution marching direction is opposite to the flow direction. Reyhner and Flugge Lotz (FLARE) (Ref. 13) have shown that this instability is easily avoided by assuming that the streamwise convection terms are zero in reversed flow regions. It is apparent, however, that a loss of accuracy in the converged solution is incurred due to the negligence of the streamwise convection terms. As an improvement to the FLARE approximation, a windward finite difference operator may be used in the ALESEP code to calculate the streamwise gradient terms in reversed flow regions. The effects of using the more accurate windward differencing scheme are described in detail in Refs. 8 and 9.

The transition from laminar to turbulent flow in the separated shear layer may be modeled using one of three possible techniques available in the ALESEP code. A simple forced transition model in which the onset and length of transition are specified may be used in conjunction with either the Cebeci-Smith (Ref. 14) or the McDonald-Fish-Kreskovsky (Refs. 15 and 16) turbulence models. The forced transition model is based on the

streamwise intermittency distribution which was established by Dhawan and Narasimha (Ref. 17). The natural transition model of McDonald and Fish (Ref. 15) may also be used with the McDonald-Fish-Kreskovsky turbulence model to automatically predict the transition location. Finally, a correlation developed by Roberts (Ref. 18) using data from several transitional separation bubble experiments may be used to predict the instantaneous transition location. Details of these transition and turbulence models in conjunction with the ALESEP inviscid-viscous interaction technique may be found in Refs. 6-9.

A wall suction distribution may be input by the user to control the boundary layer growth or to investigate the effects of suction on a separation bubble. With this option, the amount of suction required to alleviate a separation bubble on an airfoil or infinite swept wing can be determined. Technical details of the wall suction boundary condition can be found in Ref. 9.

The present interaction iteration procedure is based on the inviscid-viscous iteration technique presented by Carter (Ref. 19) and is adopted to the present scheme as outlined in Fig. 3. The key feature of this iteration procedure is that the update formula permits the inverse boundary layer analysis to be directly linked to the inviscid analysis which accounts for displacement thickness effects. It was found by Kwon and Fletcher (Ref. 20) that convergence could be accelerated by making several inner loop passes through the Cauchy integral and the update formula with the boundary layer prediction of the edge velocity frozen at its current global iteration value. This technique is used in the present interaction iteration and has been found to significantly accelerate the global convergence rate of the scheme.

USER INSTRUCTIONS

Code Description

A flow chart of the ALESEP code is shown in Fig. 4. The code has been written to allow for one of two possible modes of operation to be performed. The first mode allows for a direct finite difference boundary layer calculation for a prescribed edge velocity distribution. The second mode allows for an inviscid-viscous interaction calculation for a prescribed reference displacement surface and reference edge velocity distribution.

The ALESEP code is written in FORTRAN IV language and takes 206,000 octal word storage locations. Typically 20-40 global inviscid-viscous iterations are required to reduce residuals in inviscid-viscous edge velocities to 10^{-3} . On a Cyber 175 computer using the Cebeci-Smith turbulence model, a two-dimensional inviscid-viscous interaction calculation takes approximately 12 seconds per iteration. Using the McDonald-Fish-Kreskovsky turbulence model, an interaction calculation takes approximately 80 seconds per iteration. This increase in computing time is a result of the iterative solution of the turbulent kinetic energy equation required for this model. An inviscid-viscous interaction calculation on an infinite swept wing using the Cebeci-Smith turbulence model typically takes 17 seconds per iteration.

Input Description

The input to the ALESEP code is read in five separate blocks. The first block is a namelist file, MASTER, used to define parameters which control the mode of operation, the chordwise computational grid, and input/output options. The second block of input contains the prescribed reference pressure, reference displacement surface, free stream turbulence level and wall suction distributions. The third input block is a namelist file, INPUT, which defines the controlling parameters for the boundary layer solution procedure. The fourth block is used to define experimental data which may be used in subsequent plots of the results. Finally, the last block of information required for inviscid-viscous interaction cases is the chordwise velocity ratio, perturbation stream function, total enthalpy ratio, spanwise velocity ratio and eddy viscosity profiles at the initial station of the interaction region and the initial guess of the perturbation mass flow distribution.

The first three blocks of input information are necessary to execute a direct boundary layer calculation. The input variable, IFIN, located in the MASTER namelist must be set to 2 and INVRSE in the INPUT namelist must be set to 0. The computational grid is determined by the following variables:

Chordwise - IGRID, AK1, AK2, DS, MMAX, SSWTCH, SPIVOT, IPIVOT, AKI1, AKI2, IVGINX, IMAX (namelist MASTER)

Normal - DETA, AK, NMAX1 (namelist Input)

A laminar similarity solution is used at the initial station with a free stream Mach number, AMES, and gradient, $BETAS = (1/M_e)(dM/d\xi)$ prescribed in namelist INPUT. The user has a choice of transition and turbulence models through the definition of variables, STRANS, KTRAN, TRNLEN, and ITRBMD located in namelist INPUT. For ITRBMD = 0, the Cebeci-Smith turbulence model is used with transition occurring according to specified values of STRANS, KTRAN, and TRNLEN. For ITRBMD = 1 or 2, the McDonald-Fish or McDonald-Fish-Kreskovsky natural transition turbulence model is used and transition is predicted automatically.

For an inviscid-viscous interaction calculation, input blocks 1, 2, 3 and 5 are necessary. The input variable, IFIN, located in namelist MASTER, must be set to 3 and INVRSE in the INPUT namelist must be set to 1. A total of IQUIT global inviscid-viscous iterations are performed. The structure of the computational grid is determined by the same variables previously mentioned for a direct boundary layer calculation with some required constraints which are discussed below. Velocity ratios, perturbation stream function, total enthalpy ratio and viscosity profiles at the initial station of the interaction region are required in the fifth input block (NSTART=1 in INPUT namelist) and are obtained from a direct boundary layer calculation extending from the leading edge to the initial station of the inviscid-viscous interaction calculation located somewhat ahead of the laminar separation point. For INTERP=0 in namelist INPUT, the values of AK and NMAX1 which define the computational grid in the normal direction in namelist INPUT should be the same as that used in the direct boundary layer calculation. The value of DETA in namelist INPUT should be the value used in the direct boundary layer calculation scaled by $\sqrt{2\xi} / \rho_e u_e r \delta^*$ due to the different definitions of the normal coordinate used in the direct and inverse boundary layer formulations. This scaling is performed automatically in subroutine CONVRT at the last computational station of the direct boundary layer calculation when IPRNEW has been set to 1. The value of DETA for the interaction calculation can then be found in the converted profile information for the last station printed out at the end of the direct boundary layer calculation. The value of XCO in namelist INPUT for the interacting calculation should be defined as the value of XC at the last computational station of the direct calculation. The value of AHO also in namelist INPUT should be defined as the value of AH at the last computational station of the direct calculation scaled by the inverse over direct DETA ratio. As in the direct calculation, the user has a choice of transition and turbulence models through definition of the input variables STRANS, KTRAN, TRNLEN, and ITRBMD. In addition to the models described in the direct boundary layer calculation, a forced transition model may be used with the McDonald-Fish (Ref. 15) or McDonald-Fish-Kreskovsky (Ref. 16) turbulence models by setting KTRAN=IQUIT and defining STRANS and TRNLEN. To use the natural transition model of McDonald and Fish with these turbulence models, KTRAN must be set to 0. Special windward differencing may be used in the reverse flow region of the separation bubble through definition of IWINDD and IWINDG in namelist INPUT. Detailed results using the different turbulence models and windward differencing scheme may be found in Refs. 6-9.

Detailed Input Description

Input Block 1:

The first block of input is read in from subroutine Main in a namelist called MASTER. This information defines the chordwise computational mesh and parameters controlling input and output.

INPLT	Number of global iterations between calls to plotting routines.
IQUIT	Total number of global inviscid-viscous iterations to be computed. Set IQUIT=1 for a direct boundary layer calculation.
RFDT	Relaxation factor applied to the perturbation mass flow in the inviscid-viscous update procedure.
RFVN	Relaxation factor for the injection velocity to represent viscous effects (inactive, set = 1.0).
MMAX	Total number of chordwise grid points used in the boundary layer calculation.
SSWTCH	Arclength location measured from the nose of the body where the boundary layer calculation is initiated.
IPLOT	Value of the global iteration counter at which the plot subroutines are first called.
AK1	The ratio of adjacent grid sizes used in generating the boundary layer grid in the chordwise direction beginning at SSWTCH.
AK2	The ratio of adjacent grid sizes at SSTING where SSTING > SSWTCH.
SSTING	Location where secondary boundary layer stretching, AK2, in the chordwise direction is initiated.
DS	Increment in arclength used at start of boundary layer mesh which begins at SSWTCH.
IVT1	Index in the inviscid chordwise arrays where the tangential velocity VT is read into program (inactive, set = 0).
IVT2	Last index where VT (I) is read into program (inactive, set = 0).
ISMOTH	If equals zero, no smoothing is used; if equals 1, the smoothed VT distribution is used.

MIT2 Inactive, set = 0.

SSTOP Arclength location measured along the reference surface where the calculation is terminated downstream.

ITEK Inactive, set = 0.

IAXI If equals 0, two dimensional or infinite swept wing flow; if equals 1, axisymmetric flow.

IFIN If equals 1, program terminates after initial inviscid calculation (this initial inviscid calculation is made with no boundary layer effect). If equals 2, program terminates after initial inviscid calculation and one pass through boundary layer solver. If equals 3, program operates in full interactive mode and terminates after IQUIT iterations.

IFILET If equals 1, the offset distance between the circular arc, hard surface and a cubic filet coordinate surface will be computed (set = 0).

XT1
XT2
XSTING
YSTING
RADIUS
THICK
XLO

IWRPMF If equals 0, bypass. If equals 1, the perturbation mass flow distribution is written to unit 13 for later restart.

CHORD Reference length which allows rescaling the original chordwise distance measured from the nose to an alternate coordinate system measured from another location located at distance XOR from the nose.

XOR Chordwise location in the original coordinate where the origin of the new coordinate x/c is located. Both XOR and CHORD are used to shift and rescale the axial coordinate used in the program.

SIO Shift factor which allows the inviscid calculation to start at a downstream location on an open nose body where the flow is not disturbed near the nose. SIO is the distance from the original nose of the body to the downstream location where the inviscid calculation is started (set = 0).

IPLTX If equals zero, bypass. If equals 1, then the program generates a plot file which will later generate the plots on a TEKTRONICS unit for studying the results of individual iterations. The user may select the global iteration(s) for which plots are to be generated.

NDCP If equals 0, bypass. If equals 1, then experimental CP data versus x/c will be read into the program and plotted on CALCOMP plot from subroutine PLOTCP.

NDDT If equals 0, bypass. If equals 1, then experimental displacement thickness distribution versus x/c will be read into the program and plotted along with the computed displacement thickness distribution.

NDCF If equals 0, bypass. If equals 1, then experimental skin friction data versus x/c will be read into the program and plotted along with the computed skin friction distribution.

NDUE If equals 0, bypass. If equals 1, experimental tangential velocity data versus x/c will be read in and plotted along with the tangential velocity computed solution.

IPRINT(I) Array containing global iteration values at which station output is printed (array length = 100).

IGRID If equals 0, inviscid and boundary layer mesh are generated by their own parameters.

If equals 1, inviscid mesh is set by its own parameters (IMAX, SINO, AKI1, AKI2, SPIVOT, IPIVOT, IVGINX - as described below) and boundary layer mesh is set equal to the inviscid mesh for $S > SSWTCH$.

If equals -1, inviscid mesh is set equal to the mesh at which geometry is input (i.e., XO, YO, SO) and boundary layer mesh is set equal to inviscid mesh for $S > SSWTCH$.

If equals -2, inviscid mesh is set equal to the mesh at which geometry is input and boundary layer mesh is generated by its own parameters.

IMAX Maximum number of points in chordwise direction for the inviscid mesh.

SINO The arclength at first point in inviscid mesh, or $SI(1)$.

AKI1 Ratio of adjacent grid sizes used in generating the inviscid grid in the chordwise direction between SINO and SPIVOT.

AKI2 Ratio of adjacent grid sizes used in generating the inviscid grid in the chordwise direction for $S > SPIVOT$.

SPIVOT Arclength at which geometric progression constant changes from AKI1 to AKI2.

IPIVOT Chordwise mesh index at SPIVOT.

IVGINX If equals 0, uniform inviscid mesh; if equals 1, a variable mesh using AKI1, AKI2 is used.

LOADDT If equals 0, reference displacement thickness, DTO = 0; if equals 1, DTO is read in the second input block.

LOADSI If equals 0, compute arclength from X0, Y0; if equals 1, arc-length is read in the second input block.

LOADCP If equals 0, compute CPO using Cauchy integral; if equals 1, CPO is read in the second input block.

SWPANG Sweep angle (degrees) of infinite swept wing; should be 0.0 for two-dimensional calculations.

Input Block 2:

The second block of input is read in from subroutine INVO in a formatted block. This block of information contains the reference displacement surface, reference velocity, edge turbulence level, and wall suction distributions.

ITITLE Card 1: A brief title for the configuration (I2A6).

IXY Card 2: Number of points at which inviscid input including reference solution is read in. (I3)

XO Card 3: Cartesian distance in horizontal direction.

YO Cartesian distance in vertical direction.

SO Arclength measured from stagnation point.

CPO Pressure coefficient, $(P - P_\infty) / \frac{1}{2} \rho_\infty Q_\infty^2$, from reference solution.

DTO Displacement thickness from reference solution.

TUO Edge turbulence level.

RVWO Wall suction level, $\rho v_w / \rho_\infty Q_\infty$

NOTE: IXY values of XO, YO, SO, CPO, DTO, TUO, RVWO are read in (4F10.7, form E10.5, 2F10.7 format.

GAM Card 4: γ , the specific heat ratio.

AMINF M_∞ , freestream Mach number; set to 0.0 for incompressible flow.

NOTE: GAM, AMINF are read in with 2F10.7 format.

Input Block 3:

The third block of input is read in from subroutine TURBID in a namelist called INPUT. The information in this block is used to define the computational grid in the normal direction, the reference free stream flow conditions, the transition and turbulence model, and further output parameters.

NMAX1 Total number of grid points which are used across the boundary layer in the normal direction.

NMXOLD Total number of grid points in the initial profile of the interaction calculation.

DETA Increment in the transformed normal grid spacing, $\Delta\eta$, adjacent to the wall.

AK Ratio of adjacent step sizes in the eta, η , direction which is used to generate the mesh across the boundary layer. A uniform mesh (AK=1) is not currently allowed.

INVERSE If equals 0, then a direct boundary layer calculation is to be performed; if equals 1, then an interacting boundary layer calculation is to be performed.

JPFMAX Total number of points used in the initial guess for the perturbation mass flow distribution, PMFIN to be read in the fifth input block. In the case of restart, i.e., if IRESTR equal to 1, then JPFMAX should be set equal to MMAX.

IRESTR If equals 0, bypass; if equals 1, then a restart capability is used. In this case, the input array for PMFIN obtained from a previous calculation are read from unit 12.

INTERP If equals 0, bypass; if equals 1, then profiles at the initial interaction station are to be interpolated onto the interaction grid (set = 0).

IPRNEW If equals 0, bypass. If equals 1, the computed profiles at $M=MMAX$ from a direct boundary layer calculation are converted from direct variables to inverse variables. Principally, this involves a change in the stream function and in the transformed normal coordinate eta, η .

NSTART If equals 0, program is initiated with the solution of the self-similar equations. If equals 1, profiles for the velocity ratios, stream function, total enthalpy ratio, and viscosity versus eta, η , are read from the fifth input block.

NQMAX Maximum number of column iterations which can be used in the boundary layer solution procedure.

NPRRES If equals 0, bypass; if equals 1, boundary layer residual information will be printed.

MFIG(I) Array of index values of the chordwise stations where profiles in the boundary layer solution are printed (array length = 100).

JMAX The maximum number of boundary layer profiles to be printed out. If JMAX equals zero, then there will be no profiles printed, in which case, MFIG is set to a hundred zeros.

ITPRO Global iteration counter at which detailed boundary layer residual and profile information is printed out.

PMFO Multiplicative factor which is used to rescale the perturbation mass flow.

AHO Initial value of the static temperature integral across the boundary layer which appears explicitly in the boundary layer equations. This parameter is needed when NSTART = 1, i.e., the boundary layer solution is initiated with specified profiles instead of internally generated self-similar solutions.

XCO Initial value of the transformed (Levy Lees) ξ variable which is needed when NSTART = 1.

RESG Maximum change in the dependent variable allowed between successive column iterations in the boundary layer calculation. Typical value used is 10^{-4} .

IPLLOT(I) Array containing an index to determine which plots are desired by the user (array length = 8). If IPLLOT(I) is equal to 0, plot is bypassed; if IPLLOT(I) is equal to 1, then the plot is made. The following order is used in the plotting subroutine. Plot #1 is DT (*, displacement thickness) versus x/c . Plot #2 is CF versus x/c . Plot #3 is UE (VT, the inviscid tangential velocity) versus x/c . Plot #4 is Beta (pressure gradient parameter) versus x/c . Plot #5 is VN versus x/c . Plots #6, 7 and 8 control the plotting of profiles across the boundary layer.

WAKCON The Clauser constant in the Cebeci-Smith eddy viscosity law is varied linearly from 0.0168 at $S=SWK1$ to $0.0168/WAKCON$ at $S=SWK2$ (set WAKCON=1.0, SWK1=10000, SWK2=20000 to deactivate this option).

YORIGN(I) Array containing the origin of the Y axis for each of the respective plots listed above (array length = 8).

YSCALE(I) Array containing the scale factor for each of these plots (array length = 8). If the scale factor exceeds 1000, then the scale for these particular plots is determined automatically.

YIN(I) Array containing the number of inches for Y axis in each of the plots listed above (array length = 8).

XORIGIN(I) Array containing the origin for X axis in each of these plots (array length = 8).

XSCALE(I) Array containing the scale factor for X axis (array length = 8); Again if this parameter exceeds 1000, the scale factor is determined automatically.

XIN(I) Array containing the number of inches used along the X axis in the respective plots (array length = 8).

XL Reference dimensional length used to convert the present X to a dimensional distance.

NDATA If equals 0, bypass; if equals 1, experimental data will be read from the fourth input block to be plotted with numerical results.

BETAS Value of the pressure gradient parameter, $(1/M)(dM/dS)$, which is required in the self-similar solution.

AMES Value of the streamwise Mach number required in the self-similar solution; set to 0.0 for incompressible flow.

GW Value of the total enthalpy ratio at the wall.

TINFD Reference free stream temperature in degrees Rankine which is required in the Sutherland law for molecular viscosity.

PRT Turbulent Prandtl number.

PR Prandtl number.

REINF Reynolds number based on the reference (free stream) properties and based on the length which is used to nondimensionalize the coordinate used in the calculation.

STRANS Nondimensional distance along the body at which instantaneous transition is assumed to occur.

KTRAN For Cebeci-Smith turbulence model - (ITRBMD=0): equal to 0, fully laminar calculation; equal to 1, instantaneous transition occurs at STRANS; equal to 2, transition occurs over TRNLEN starting at STRANS; equal to 5, transition occurs instantaneously according to the Roberts transition correlation. For McDonald-Fish turbulence model - (ITRBMD=1,2): KTRAN is the global iteration number when the McDonald-Fish natural transition model begins to predict the transition location. Forced transition over TRNLEN starting at STRANS is used for all global iterations prior to KTRAN.

IWINDD Global iteration number when convection windward difference operation is effective.

IWINDG If equals 0, do not use windward differencing in energy equation; if equals 1, use windward differencing on convection terms in energy equation starting on the IWINDD global iteration.

IWINDS If equals 0, do not use windward differencing on stream function; if equals 1, use windward differencing on stream function in momentum and energy equations starting on the IWINDD global iteration. This option is not recommended at this time (set = 0).

ITRBMD If equals 0, Cebeci-Smith turbulence model; if equals 1, McDonald-Fish turbulence model; equals 2, McDonald-Fish-Kreskovsky turbulence model.

ALFSEP Multiplication factor on the Clauser constant in the three-dimensional Cebeci-Smith turbulence model from the point of transition to downstream.

Input Block 4:

The fourth block of input is read in from subroutine TURBID in a formatted block only when NDATA \neq 0. This block of information contains experimental data which may be plotted along with the numerical results.

IDST
 ICFST Card 1: Number of experimental data points to be read for DTE,
 IUST CFE, or U1 (I3). Data is read in order of DTE, CFE,
 and then U1.

J Card 2: Index of experimental data point (I3).

XDTE
 XCF Cartesian distance in horizontal direction for
 XU1 experimental values of DTE, CFE or U1.

DTE Experimental values of δ^* (NDDT \neq 0)
 CFE Experimental values of C_f (NDCF \neq 0)
 U1 Experimental values of U_e (NDUE = 0)

NOTE: IDST, ICFST, or IUST values of
 J, XDTE, XCF or XU1 and
 DTE, CFE, or U1 are read in (I3, 2F8.4) format
 Experimental data points are read in the order of
 DTE(δ^*), CFE(C_f), followed by U1(U_e)

Input Block 5:

The fifth block of input is read in from subroutine TURBID in a formatted block only when NSTART=1. This block of information contains profiles for the chordwise velocity ratio, perturbation stream function, total enthalpy ratio, and spanwise velocity ratio to be used at the initial station of the interaction calculation. For ITRBMD \neq 0, the scalar quantities necessary to initialize the turbulent kinetic energy equation as well as the eddy viscosity profiles are also read in this block. The initial guess distribution for the perturbation mass flow parameter is also read in this formatted block.

Values of PSI11, PSI12, PSI31, PSI32, EMFK, ALINF, A1MFK, DTINC, DELTU, and A2MA3 are read in 5F16.8 format when ITRBMD \neq 0. These variables define the scalar quantities required for the McDonald-Fish-Kreskovsky turbulence model at the initial station of the interaction case. These values are stored in unit 14 of a direct boundary layer calculation when IPRNEW = 1. See the output description section for the definition of these variables.

NMAX values of YNI, EPSBB, and EPSHB in a 3E16.8 format are read next when ITRBMD \neq 0. These arrays define the viscosity profiles for the McDonald-Fish-Kreskovsky turbulence model at the initial station. These values are stored in unit 14 of a direct boundary layer calculation when IPRNEW = 1. See the output description for the definition of these variables.

NMXOLD values of NN, ETABD, FBD, PSI, GBD and WBD are read in a I5, 5E16.8 format. These arrays define the chordwise velocity ratio, perturbation stream function, total enthalpy ratio and spanwise velocity ratio profiles at the initial station. These values are stored in unit 14 of a direct boundary layer calculation when IPRNEW = 1. See the output description section for the definition of these variables.

JPFMAX values of PMFIN in a 7F10.7 format followed by JPFMAX values of SPMF in the same format are read in to define the initial distribution of the perturbation mass flow.

Output Description

An example test case for a transitional separation bubble on a flat plate swept 26.5 degrees to the free stream is given in Appendix A. Detailed experimental data for this flow was obtained by Horton (Ref. 4) at a free stream velocity of 51.9 ft./sec and a unit Reynolds number of 2.77×10^4 per inch. The free stream turbulence level was .0025.

In this case, the reference pressure distribution was taken to be the inviscid solution calculated by Woodward (Ref. 21) for Horton's configuration. A direct boundary layer calculation was run from the leading edge stagnation point of the flat plate to $x=7.0$ inches using the reference pressure distribution as the edge boundary condition. The chordwise velocity ratio, perturbation stream function, total enthalpy ratio, and spanwise velocity ratio profiles were taken at $x=7.0$ inches from the direct calculation and used as initial profiles for the interacting calculation. The reference displacement thickness was calculated from a fully turbulent direct boundary layer calculation using the reference pressure distribution as the edge boundary condition. A total of 91 grid points were distributed evenly between $x=7.0$ and $x=16.0$ inches in the interaction calculation. The three-dimensional Cebeci-Smith turbulence model as described in Ref. 22 was used with transition being predicted with the Roberts transition correlation. Windward differencing was used in this calculation although a similar calculation using the FLARE approximation was found to give nearly the same results. A comparison between the predicted experimental pressure and displacement thickness distributions is shown in Figs. 5a and 5b. The predicted skin friction distributions are shown in Fig. 5c. Further comparisons of predicted results using the ALESEP technique with experimental data may be found in Refs. 6-9.

The notation used in the output of the ALESEP code conforms to that used in the description of the governing equations in Refs. 6-9. A dictionary of the variables used in the output can be found in the following section.

Reference Distribution Output

XO, YO XB, YB	Input Cartesian coordinates of body shape.
S0	Input arclength.
CPO	Input reference pressure coefficient.
DT0	Input reference displacement thickness.
TU0, TUB	Input boundary layer edge turbulence level.
RVWO, RVWB	Input wall suction level, $\rho v_w / \rho_\infty Q_\infty$
VT	Input boundary layer edge velocity at same location as input body coordinates.
SI	Body arclength measured from stagnation point at nose of body to same location as input body coordinates.

XOC Shifted and rescaled value of chordwise coordinate, XO.
 $XOC = (XO - XOR)/CHORD$

PMF,PMFB Input perturbation mass flow paramter, $m = \rho_e u_e r_o^i \delta^*$
(interacting case only).

S Body arclength measured from stagnation point to boundary layer
computational stations.

SPMF Body arclength measured from stagnation point to boundary layer
stations where perturbation mass flow is defined.

XOCBL Same as XOC, but measured from stagnation point to boundary
layer computational stations.

RO If flow is axisymmetric, RO is the body radius; for 2-D or
infinite swept wing flow, RO=1.

VTBL Boundary layer edge velocity at boundary layer computational
stations.

Similarity Solution Output

NQ Boundary layer column iteration counter.

RES1 Maximum change in dependent variable between two successive
column iterations.

AHO Static temperature integral, h.

FNW Normalized wall shear, $\left. \frac{\partial F}{\partial \eta} \right|_{\eta=0}$ where $F = u/u_e$

ETA Transformed coordinate normal to surface, η .

F Chordwise velocity ratio, $u/u_e = F$.

SF Transformed stream function, \tilde{f} .

G Total enthalpy ratio, $H/H_e = G$.

W Spanwise velocity ratio, $w/w_e = W$

Initial Profiles

If NSTART equals 0, then the initial profile is the same as the laminar self-similar solution. If NSTART equals 1, then the initial profiles are

the same as those which are read in (ETABD = ETA, FBD = F, PSI = SF, GBD = G, WBD = W). Note however that if INTERP equals 1, then these profiles have been interpolated onto a new η -mesh.

Station Output (Summary Chart No. 1)

- M Chordwise station index
- PMF In direct calculation, this is $\sqrt{2\xi}$ where ξ is the streamwise Levy Lees variable; in an interacting case this is the prescribed distribution of perturbation mass flow, $m = \rho_e u_e r_0^1 \delta^*$.
- PMFCHK This is $\rho_e u_e r_0^1 \delta^*$; in an inverse calculation, this quantity is a check to see that the computed velocity profiles give the same displacement thickness as that prescribed and thus, in the interacting mode, PMFCHK should always be equal to PMF.
- BETA Pressure gradient parameter, $\beta = (1/M_e)(dM_e/d\xi)$.
- BETCHK Calculated pressure gradient parameter (interacting case only).
- UEP Boundary layer edge velocity. In direct mode, UEP is the same as the prescribed VTBL; in the inverse mode, it is computed as part of the solution.
- AMACH Boundary layer edge Mach number.
- AH Static temperature integral, $h = \int_0^\infty (T/T_e - 1)d\eta$.
- CF Chordwise component of skin friction coefficient based on free stream dynamic head, $C_f = \tau_{wx}^*/\frac{1}{2}\rho_\infty^*Q_\infty^{*2}$ where asterisk denotes dimensional quantity.
- CFZ Spanwise component of skin friction coefficient based on free stream dynamic head, $C_{fz} = \tau_{wz}^*/\frac{1}{2}\rho_\infty^*Q_\infty^{*2}$
- ALPHW Angle of limiting streamline relative to chordwise direction (degrees)
- NMCH Index where inner and outer edge viscosity laws are matched (Cebeci-Smith turbulence model).
- RTHETA Reynolds number based on momentum thickness.

McDonald-Fish-Kreskovsky Turbulence Model Output (ITRBMD \neq 0)

- MREF Reference free stream Mach number. Same as AMINF in third input block.

TREFD Reference free stream static temperature. Same as TINFD in INPUT namelist.

TREF Nondimensional reference free stream static temperature.

REYREF Reference free stream Reynolds number. Same as REINF in INPUT namelist.

ME2 Boundary layer edge Mach number at current streamwise station.

UE2 Nondimensional boundary layer edge velocity at current streamwise station.

TE2 Nondimensional boundary layer edge temperature at current streamwise station.

RHOE2 Nondimensional boundary layer edge density at current streamwise station.

TU2 Boundary layer edge turbulence level at current streamwise station.

RO2 Geometry coefficient, R_0 , at current streamwise station.

QE2 Boundary layer edge perturbation velocity magnitude at current streamwise station.

MUE2 Nondimensional boundary layer edge molecular viscosity at current streamwise station.

ME1 Boundary layer edge Mach number at previous streamwise station.

UE1 Nondimensional boundary layer edge velocity at previous streamwise station.

TE1 Nondimensional boundary layer edge temperature at previous streamwise station.

RHOE1 Nondimensional boundary layer edge density at previous streamwise station.

RO1 Geometry coefficient, R_0 , at previous streamwise station.

QE1 Boundary layer edge perturbation velocity magnitude at previous streamwise station.

ACLINF Free stream dissipation length, L , at current streamwise station.

ALINFN Free stream mixing length, ℓ , at current streamwise station.

ALINFO Free stream mixing length, ℓ , at previous streamwise station.

ALMFKN Structural coefficient, a_1 , at current streamwise station.

ALMFKO Structural coefficient, a_1 , at previous streamwise station.

A2MFK Structural coefficient, a_2 , at current streamwise station.

A3MFK Structural coefficient, a_3 , at current streamwise station.

BLTHK Boundary layer thickness at current streamwise station scaled by $\sqrt{Re_\infty}$.

DELIN Inner boundary layer thickness at current streamwise station.

DELTU2 Value of turbulent displacement thickness, δ_τ , at current streamwise station.

DELTU1 Value of turbulent displacement thickness, δ_τ , at previous streamwise station.

DTINC2 Incompressible displacement thickness at current streamwise station.

VEDGE Nondimensional boundary layer edge normal velocity component, v_e , at current streamwise station.

NDELTU Index of normal grid point where DELTU2 is located.

NINNER Index of normal grid point where DELIN is located.

PSI11N Value of first set of terms of the ϕ_1 integral in turbulent kinetic energy equation at current streamwise station.

PSI12N Value of second set of terms of the ϕ_1 integral in the turbulent kinetic energy equation of the current streamwise station.

PSI110 Value of first set of terms of the ϕ_1 integral in the turbulent kinetic energy equation at the previous streamwise station.

PSI120 Value of second set of terms of the ϕ_1 integral in the turbulent kinetic energy equation at the previous streamwise station.

PSI21N Value of the ϕ_2 integral in the turbulent kinetic energy equation at the current streamwise station.

PSI31N Value of the first set of terms of the ϕ_3 integral in the turbulent kinetic energy equation at the current streamwise station.

PSI32N Value of the second set of terms of the ϕ_3 integral in the turbulent kinetic energy equation at the current streamwise station.

EMFK Value of the source term, E, in the turbulent kinetic energy equation at the current streamwise station.

RTAU Value of the turbulent Reynolds number, R_τ , at the current streamwise station.

RTHEAT Value of the correlated momentum thickness Reynolds number, \tilde{R}_θ , at the current streamwise station.

A2MA3N Value of the difference of structural coefficient, $a_2 - a_3$, at the current streamwise station.

Profile Output

ETA Transformed normal coordinate, η .

YBL Nondimensional physical distance from surface.

F2 Chordwise velocity ratio, u/u_e .

SF2 Transformed stream function, \tilde{f} .

G2 Total enthalpy ratio, H/H_e .

EPSBAR $1 + \epsilon/\mu$ where ϵ is the eddy viscosity coefficient and μ is the molecular viscosity coefficient.

RHOMUR $l = \rho\mu/\rho_e\mu_e$.

T Static temperature ratio, T/T_e .

W2 Spanwise velocity ratio, w/w_e .

BETZ Streamline angle relative to free stream direction (degrees).

ALPHZ Streamline angle relative to chordwise direction (degrees).

For ITRBMD $\neq 0$, the following additional profiles are printed:

YN Nondimensional physical distance from the surface scaled by $\sqrt{Re_\infty}$

YPLUS Nondimensional scaled distance from the surface, $y^+ = y\sqrt{\tau/\rho\nu}$

DUDY Nondimensional velocity normal gradient, $\partial F/\partial YN$

TAU Shear stress, $(\mu + \mu_T) \partial u/\partial YN$

DAMP Damping factor squared, \mathcal{D}^2 .

FUN Local mixing length distribution in normal direction.

FMFK McDonald-Kreskovsky function, f_T , on mixing length formula.

Station Output (Summary Chart No. 2)

M Chordwise index.

XLE Cartesian coordinate of station location.

S Chordwise arclength location

DT* Scaled displacement thickness, $\delta^* \sqrt{Re_\infty}$.

THETA* Scaled momentum thickness, $\theta \sqrt{Re_\infty}$.

CPBLBR C_p obtained from interacting boundary layer calculation referenced to chordwise dynamic head, $C_p = (P^* - P_\infty^*) / \frac{1}{2} \rho_\infty U_\infty^2$ free stream.

CPBL C_p obtained from interacting boundary layer calculation, referenced to free stream dynamic head, $C_p = (P^* - P_\infty^*) / \frac{1}{2} \rho_\infty Q_\infty^2$

UEP u_e obtained from interacting boundary layer calculation.

QW Heat transfer coefficient at the wall.

STAN Stanton number.

STRINT Intermittency parameter in chordwise direction.

CFX Scaled chordwise skin friction coefficient, $c_f \sqrt{Re_\infty}$.

Summary of Convergence History

INTRAC Interaction global iteration counter.

DDTMAX Maximum change in DT.

RMSDT Root mean square change in DT.

SMDT Chordwise arclength location where DDTMAX occurs.

DUEMAX Maximum change in UE.

RMSUE Root mean square change in UE.

SMUE Chordwise arclength location for maximum change in UE.

DSFMAX Maximum change in perturbation stream function, \tilde{f} .
 DFMAX Maximum change in velocity ratio, F .
 DGMAX Maximum change in total enthalpy ratio, G .

Brief Description of Files

The following files are used to write information for plotting, restart, and interaction purposes.

<u>Unit Number</u>	<u>Purpose</u>
8	Write velocity and temperature profiles to be used for plotting purposes later on (TURBID).
9	Write stream function profile to be used for plotting purposes later on (TURBID).
10	Write eddy viscosity coefficient profile to be used for plotting purposes later on (TURBID).
12	Read information for restart run (TURBID).
13	Write information for later restart (WR13).
14	Write the profiles in inverse variables from a direct boundary layer run at the last chordwise station (CONVRT).
17	Write the weak interaction solution from a direct boundary layer run for use as a reference solution (TURBID).
18	Direct access file to store information for windward differencing scheme (TURBID).
22	Write station quantities for Tektronics plotting (WR22).

REFERENCES

1. Tani, I.: Low Speed Flows Involving Bubble Separations, Progress in Aeronautical Sciences, Vol. 5, Pergamon Press, 1964.
2. Gault, D. E.: An Experimental Investigation of Separated Laminar Flow, NACA TN 3505, September 1955.
3. Mueller, T. J. and Batill, S. M.: Experimental Studies of the Laminar Separation Bubbles on a Two-Dimensional Airfoil at Low Reynolds Numbers, AIAA Paper 80-1440, 1980.
4. Horton, H. P.: Laminar Separation Bubbles in Two and Three Dimensional Incompressible Flow, Ph.D. Thesis, University of London, (Queen Mary College), 1968.
5. Roberts, W. B.: A Study of the Effect of Reynolds Number and Laminar Separation Bubbles on the Flow Through Axial Compressor Cascades, Ph.D. Thesis, Von Karman Institute, 1973.
6. Vatsa, V. N. and Carter, J. E.: Analysis of Airfoil Leading Edge Separation Bubbles, AIAA Journal, Vol. 22, No. 12, December, 1984, pp 1697-1704.
7. Carter, J. E. and Vatsa, V. N.: Analysis of Airfoil Leading Edge Separation Bubbles, NASA CR-165935, May 1982.
8. Davis, R. L. and Carter, J. E.: Analysis of Airfoil Transitional Separation Bubbles, NASA CR-3791, 1984.
9. Davis, R. L. and Carter, J. E.: "Analysis of Transitional Separation Bubbles on Infinite Swept Wings", NASA CR-3956, 1986.
10. Stevens, W. A., Goreadia, S. H. and Braden, J. A.: A Mathematical Model for Two-Dimensional Multi-Component Airfoils in Viscous Flows, NASA CR-1843, July 1971.
11. Melnik, R. E., Chow, R. and Mead, H. T.: Theory of Viscous Transonic Flow Over Airfoils at High Reynolds Number, AIAA Paper 77-680, June 1977.
12. Carter, J. E.: Inverse Boundary Layer Theory and Comparison with Experiment, NASA TP-1208, September 1978.
13. Reyhner, T. A. and Flugge Lotz, I.: The Interaction of a Shock Wave with a Laminar Boundary Layer, Int. Journal of Non-Linear Mech., Vol. 3, No. 2, June 1968, pp. 173-179.
14. Cebeci, T. and Smith, A. M. O.: Analysis of Turbulent Boundary Layers, Academic Press, 1974.

15. McDonald, H., and Fish, R. W.: Practical Calculation of Transitional Boundary Layers, Int. J. Heat Mass Transfer, Vol. 16, pp. 1729-1944, 1973.
16. McDonald, H. and Kreskovsky, J. P.: Effect of Free Stream Turbulence on the Turbulent Boundary Layer, Int. J. Heat Mass Transfer, Vol. 17, pp. 705-716, 1974.
17. Dhawan, S. and Narasimha, R.: Some Properties of Boundary Layer Flow During Transition from Laminar to Turbulent Motion, J. Fluid Mechanics, Vol. 3, 1958.
18. Roberts, W. B.: "Calculation of Laminar Separation Bubbles and Their Effect on Airfoil Performance", AIAA Journal, Vol. 18, No. 1, pp 25-30, January, 1980.
19. Carter, J. E.: A New Boundary Layer Inviscid Iteration Technique for Separated Flow, AIAA Paper 79-1450, July 22-23, 1979.
20. Kwon, O. K. and Pletcher: R. H.: Prediction of Incompressible Separated Boundary Layers Including Viscous-Inviscid Interaction, J. Fluids Engineering, Vol. 101, pp. 466-472, December 1979.
21. Woodward, D. S.: "An Investigation of the Parameters Controlling the Behavior of Laminar Separation Bubbles", Royal Aircraft Establishment Tech. Memo. Aero 1003, August, 1967.
22. Cebeci, T., Kaups, K, Mosinkis, G. J., and Rehn, J. A.: "Some Problems of the Calculation of Three-Dimensional Boundary Layer Flows on General Configurations", NASA CR-2285, July, 1973.

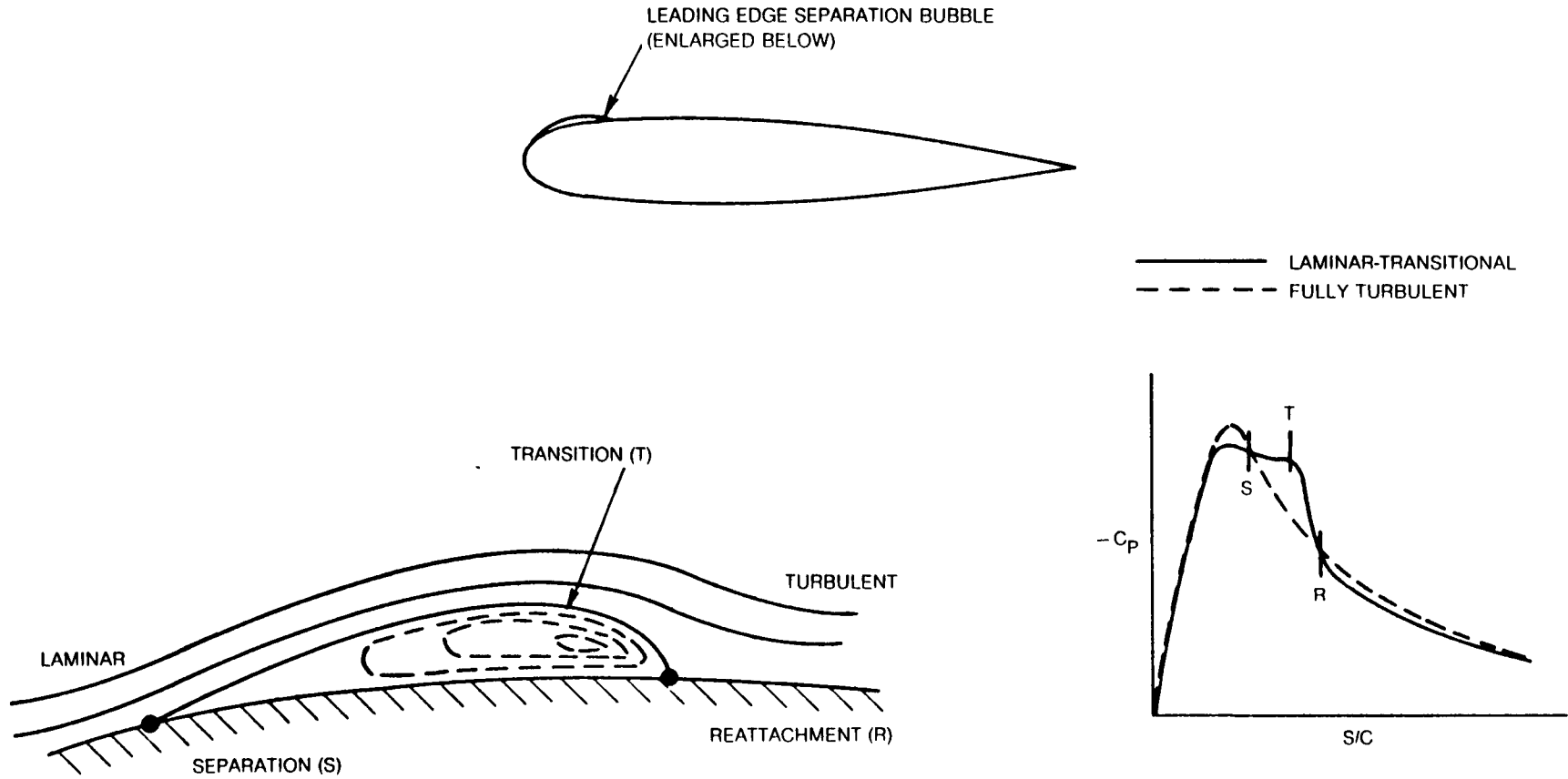

Fig. 1 Schematic diagram of airfoil laminar-transitional separation bubble and pressure distribution

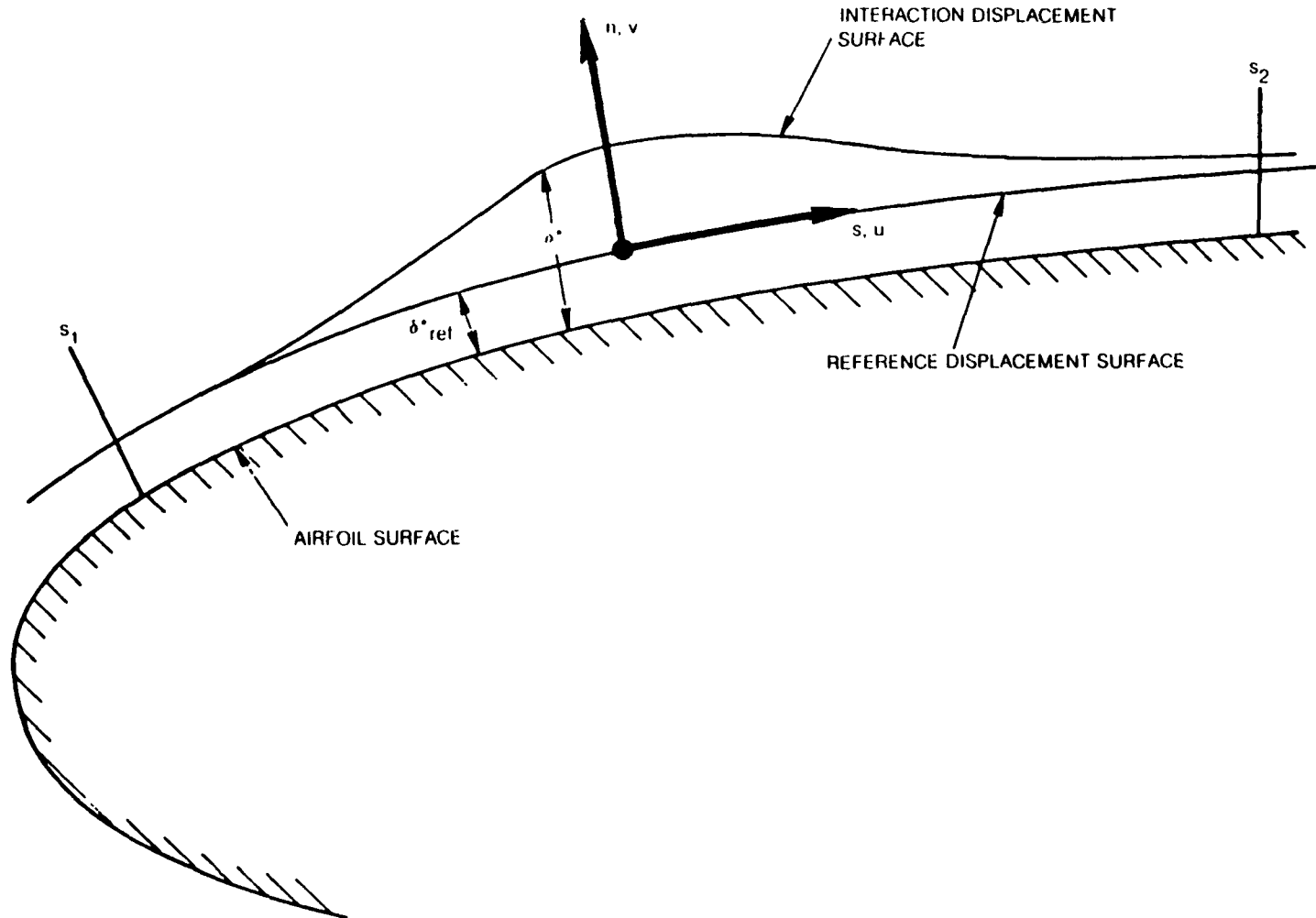

Fig. 2 Local interaction region coordinate system

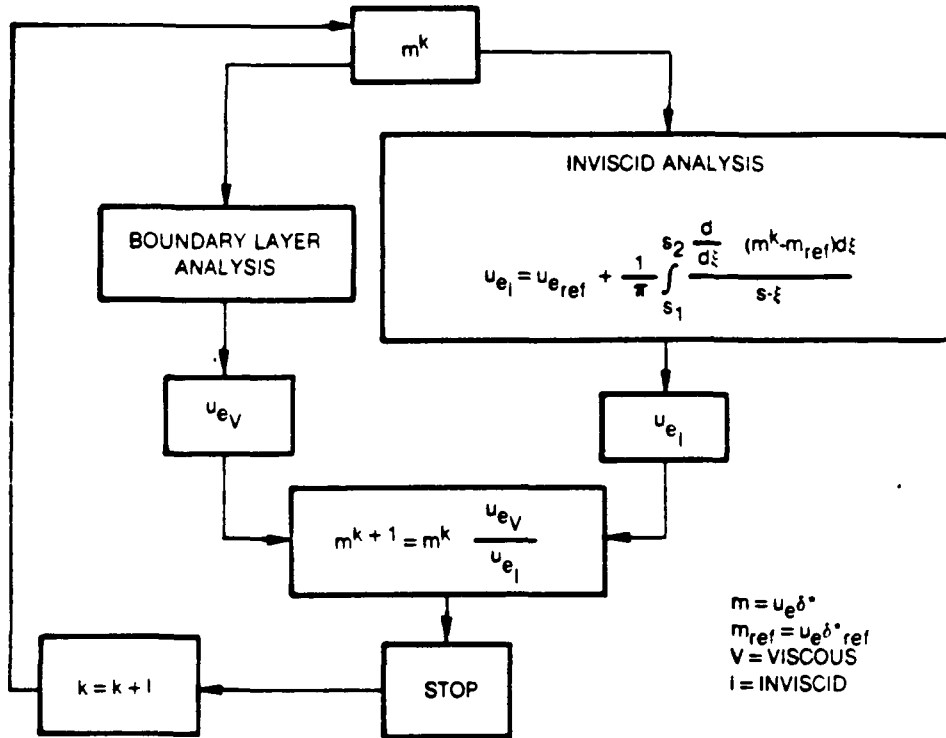

Fig. 3 Inviscid-viscous iteration procedure

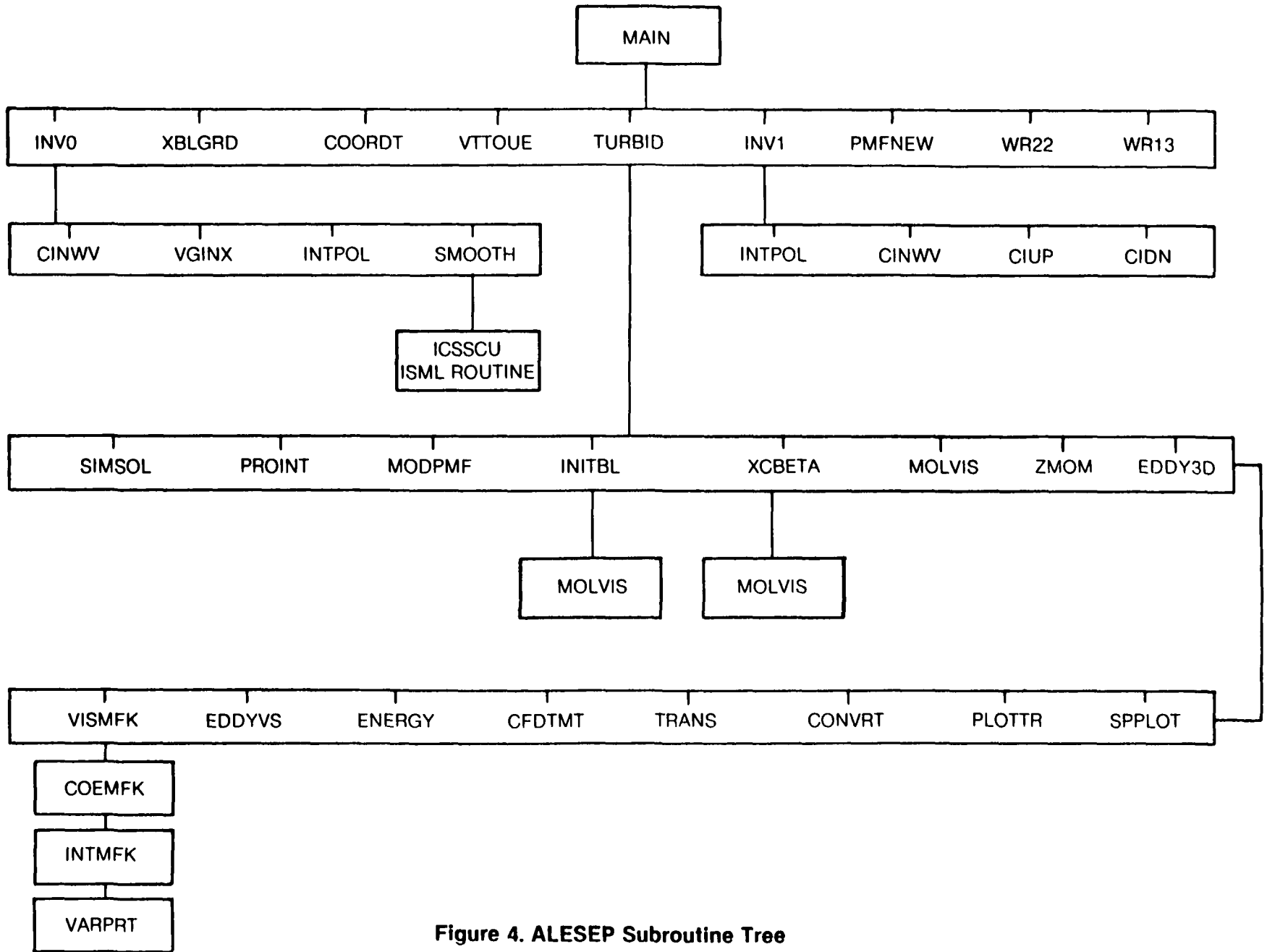

Figure 4. ALESEP Subroutine Tree

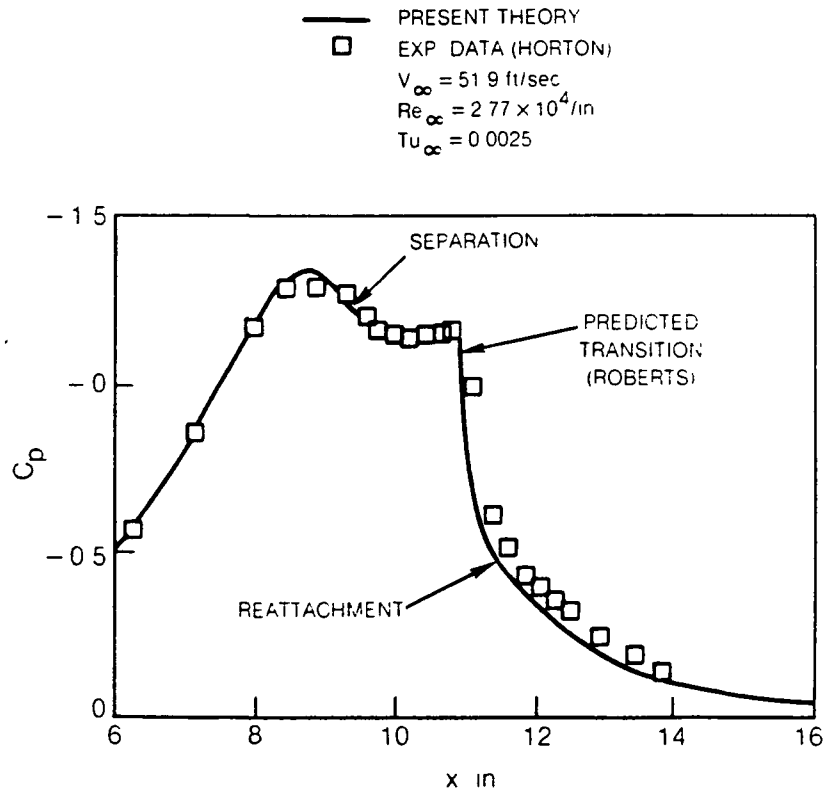

Figure 5a. Predicted Pressure Distribution

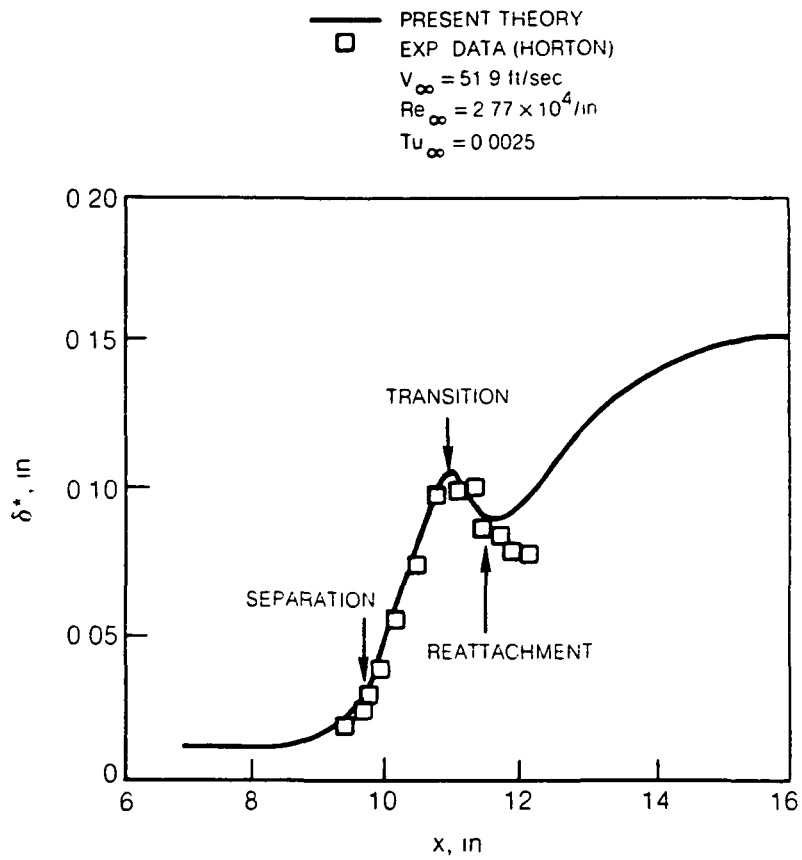

Figure 5b. Predicted Displacement Thickness Distribution

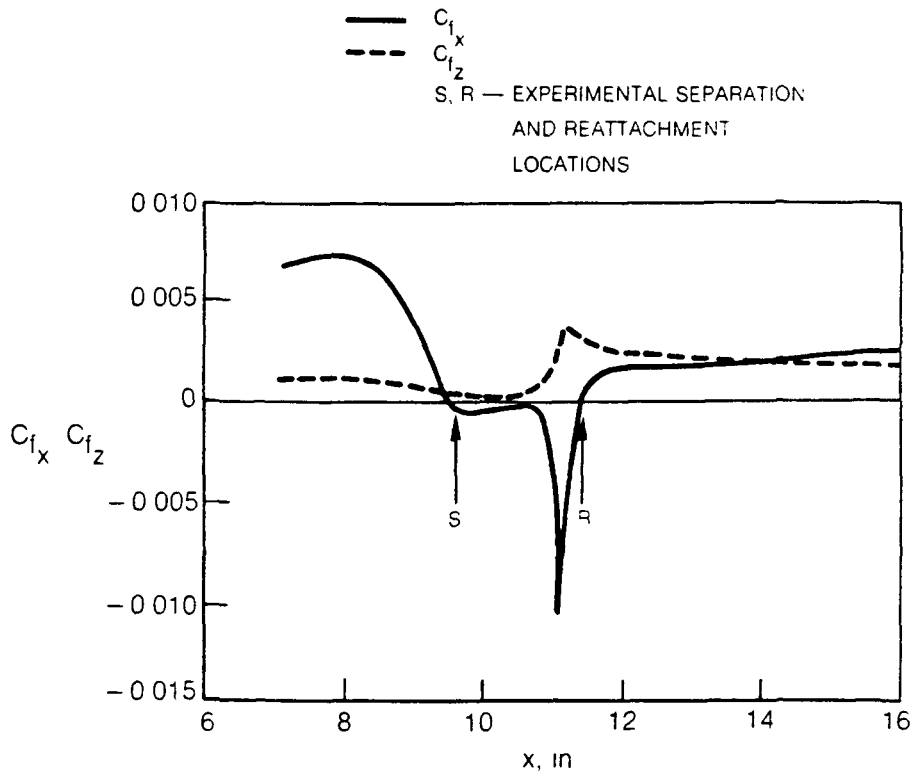

Figure 5c. Predicted Skin Friction Distributions

HORTON SWEPT FLAT PLATE - TURBULENT INTERACTING

```

$MASTER
INTPLT=199,
IQUIT=100,
RFDT=C.5,
RFVN=1.,
MMAX=161,
SSWTCF=7.0001,
IPLOT=159,
IGRID=-1,
AK1=1.0C,
AK2=1.0C,
SSTING=C.,
DS=.1C,
IVT1=C,
IVT2=C,
ISMOTH=0,
MIT2=25,
SSTOP=16.0,
ITEK=0,
IAXI=C,
IFIN=3,
IFILET=0,
XT1=C.,
XT2=C.,
XSTING=0.,
YSTING=0.,
RADIUS=0.,
XLO=C., THICK=C., SIO=0., XOR=0., CHORD=1.,
IMRPMF = 1,
IPLTX = 1,
NDCP = 0,
NDDT = 1,
NDCF = 0,
NDUE = 1,
LOADSI=0, LOACCP=1, LOADDT=1, IMAX=161, SINO=0.,
SPIVOT= 16.00, IPIVOT=161, AKI1= 1.0 , AKI2= 1.0000, IVCINX=0 ,
SWPANG=26.5,
IPRINT=1,2,3,4,5,10,20,30,40,50,51,52,53,54,55,56,57,58,59,
        60,70,80,90,100,76*C,

```

\$END
HORTON SWEPT FLAT PLATE - TURBULENT INTERACTING

161

.00C000	.000000	.000000	.800898.0C000	.C02500	.00
.10C0C0	.CC0000	.000000	.740072.20097-002	.C02500	.C0
.20C000	.CC0000	.000000	.593607.23850-002	.C02500	.C0
.30C000	.CC0000	.00C000	.437297.28549-002	.C02500	.00
.40C000	.CC0000	.000000	.317737.34410-002	.C02500	.00
.50C0C0	.CC0000	.000000	.238176.41008-002	.CC2500	.00
.60C0C0	.CC0000	.000000	.186678.47919-002	.C02500	.00
.70C000	.CC0000	.000000	.150275.54590-002	.C02500	.00
.80C000	.CC0000	.0000C0	.121550.60771-002	.C02500	.C0
.90C000	.CC0000	.00C000	.098829.66726-002	.CC2500	.00
1.00C000	.CC0000	.000000	.081322.72646-002	.C02500	.00
1.10C0C0	.CC0000	.00C000	.068237.78607-002	.C02500	.00
1.20C000	.CC0000	.00C000	.058537.84583-002	.C02500	.00
1.30C0C0	.CC0000	.0000C0	.050685.70391-002	.C02500	.00
1.40C0C0	.CC0000	.0000C0	.043584.95891-002	.C02500	.C0
1.50C0C0	.CC0000	.000000	.036843.10108-001	.CC2500	.00
1.60C000	.CC0000	.000000	.030416.10707-001	.CC2500	.C0
1.70C0C0	.CC0000	.000000	.024171.11074-001	.CC2500	.C0

ORIGINAL PAGE IS,
OF POOR QUALITY

1.80C0C0	.CC0000	.000000	.017685.11514-001	.C02500	.00
1.90C0C0	.CC0000	.000000	.010608.11915-001	.C02500	.00
2.00C0C0	.CC0000	.000000	.003015.12285-001	.C02500	.00
2.10C0C0	.CC0000	.000000	-.004871.12631-001	.C02500	.00
2.20C0C0	.CC0000	.000000	-.012811.12963-001	.C02500	.00
2.30C0C0	.CC0000	.000000	-.020628.13289-001	.C02500	.00
2.40C0C0	.CC0000	.000000	-.028303.13607-001	.C02500	.00
2.50C0C0	.CC0000	.000000	-.035912.13917-001	.C02500	.00
2.60C0C0	.CC0000	.000000	-.043529.14217-001	.C02500	.00
2.70C0C0	.CC0000	.000000	-.051195.14505-001	.C02500	.00
2.80C0C0	.CC0000	.000000	-.058920.14783-001	.C02500	.00
2.90C0C0	.CC0000	.000000	-.066703.15051-001	.C02500	.00
3.00C0C0	.CC0000	.000000	-.074561.15310-001	.C02500	.00
3.10C0C0	.CC0000	.000000	-.082550.15557-001	.C02500	.00
3.20C0C0	.CC0000	.000000	-.090730.15791-001	.C02500	.00
3.30C0C0	.CC0000	.000000	-.099086.16014-001	.C02500	.00
3.40C0C0	.CC0000	.000000	-.107571.16227-001	.C02500	.00
3.50C0C0	.CC0000	.000000	-.116194.16432-001	.C02500	.00
3.60C0C0	.CC0000	.000000	-.125022.16626-001	.C02500	.00
3.70C0C0	.CC0000	.000000	-.134097.16807-001	.C02500	.00
3.80C0C0	.CC0000	.000000	-.143372.16980-001	.C02500	.00
3.90C0C0	.CC0000	.000000	-.152884.17142-001	.C02500	.00
4.00C0C0	.CC0000	.000000	-.162848.17286-001	.C02500	.00
4.10C0C0	.CC0000	.000000	-.173501.17404-001	.C02500	.00
4.20C0C0	.CC0000	.000000	-.184755.17504-001	.C02500	.00
4.30C0C0	.CC0000	.000000	-.196371.17594-001	.C02500	.00
4.40C0C0	.CC0000	.000000	-.208232.17681-001	.C02500	.00
4.50C0C0	.CC0000	.000000	-.220371.17761-001	.C02500	.00
4.60C0C0	.CC0000	.000000	-.232826.17834-001	.C02500	.00
4.70C0C0	.CC0000	.000000	-.245578.17901-001	.C02500	.00
4.80C0C0	.CC0000	.000000	-.258857.17953-001	.C02500	.00
4.90C0C0	.CC0000	.000000	-.273294.17970-001	.C02500	.00
5.00C0C0	.CC0000	.000000	-.289516.17936-001	.C02500	.00
5.10C0C0	.CC0000	.000000	-.307244.17868-001	.C02500	.00
5.20C0C0	.CC0000	.000000	-.325814.17793-001	.C02500	.00
5.30C0C0	.CC0000	.000000	-.344847.17722-001	.C02500	.00
5.40C0C0	.CC0000	.000000	-.364306.17654-001	.C02500	.00
5.50C0C0	.CC0000	.000000	-.384224.17588-001	.C02500	.00
5.60C0C0	.CC0000	.000000	-.404556.17525-001	.C02500	.00
5.70C0C0	.CC0000	.000000	-.425462.17459-001	.C02500	.00
5.80C0C0	.CC0000	.000000	-.447453.17376-001	.C02500	.00
5.90C0C0	.CC0000	.000000	-.471030.17266-001	.C02500	.00
6.00C0C0	.CC0000	.000000	-.495939.17141-001	.C02500	.00
6.10C0C0	.CC0000	.000000	-.521725.17016-001	.C02500	.00
6.20C0C0	.CC0000	.000000	-.548323.16892-001	.C02500	.00
6.30C0C0	.CC0000	.000000	-.576019.16762-001	.C02500	.00
6.40C0C0	.CC0000	.000000	-.604924.16624-001	.C02500	.00
6.50C0C0	.CC0000	.000000	-.634757.16489-001	.C02500	.00
6.60C0C0	.CC0000	.000000	-.665423.16356-001	.C02500	.00
6.70C0C0	.CC0000	.000000	-.697292.16219-001	.C02500	.00
6.80C0C0	.CC0000	.000000	-.730799.16070-001	.C02500	.00
6.90C0C0	.CC0000	.000000	-.765653.15919-001	.C02500	.00
7.00C0C0	.CC0000	.000000	-.801264.15777-001	.C02500	.00
7.10C0C0	.CC0000	.000000	-.837140.15652-001	.C02500	.00
7.20C0C0	.CC0000	.000000	-.872957.15549-001	.C02500	.00
7.30C0C0	.CC0000	.000000	-.908661.15463-001	.C02500	.00
7.40C0C0	.CC0000	.000000	-.944498.15389-001	.C02500	.00
7.50C0C0	.CC0000	.000000	-.980881.15318-001	.C02500	.00
7.60C0C0	.CC0000	.000000	-1.018345.15243-001	.C02500	.00
7.70C0C0	.CC0000	.000000	-1.057284.15157-001	.C02500	.00
7.80C0C0	.CC0000	.000000	-1.097335.15071-001	.C02500	.00

7.900000	.CC0000	.000000	-1.137410.15000-001	.CC02500	.00
8.000000	.CC0000	.000000	-1.175650.14970-001	.CC02500	.00
8.100000	.CC0000	.000000	-1.210015.15004-001	.CC02500	.00
8.200000	.CC0000	.000000	-1.240249.15097-001	.CC02500	.00
8.300000	.CC0000	.000000	-1.267967.15219-001	.CC02500	.00
8.400000	.CC0000	.000000	-1.294165.15353-001	.CC02500	.00
8.500000	.CC0000	.000000	-1.318292.15510-001	.CC02500	.00
8.600000	.CC0000	.000000	-1.338903.15711-001	.CC02500	.00
8.700000	.CC0000	.000000	-1.354777.15970-001	.CC02500	.00
8.800000	.CC0000	.000000	-1.365151.16299-001	.CC02500	.00
8.900000	.CC0000	.000000	-1.369687.16702-001	.CC02500	.00
9.000000	.CC0000	.000000	-1.369080.17171-001	.CC02500	.00
9.100000	.CC0000	.000000	-1.364027.17698-001	.CC02500	.00
9.200000	.CC0000	.000000	-1.354870.18284-001	.CC02500	.00
9.300000	.CC0000	.000000	-1.340762.18953-001	.CC02500	.00
9.400000	.CC0000	.000000	-1.320395.19743-001	.CC02500	.00
9.500000	.CC0000	.000000	-1.293100.20687-001	.CC02500	.00
9.600000	.CC0000	.000000	-1.260954.21759-001	.CC02500	.00
9.700000	.CC0000	.000000	-1.226404.22920-001	.CC02500	.00
9.800000	.CC0000	.000000	-1.190673.24153-001	.CC02500	.00
9.900000	.CC0000	.000000	-1.153673.25476-001	.CC02500	.00
10.000000	.CC0000	.000000	-1.114931.26924-001	.CC02500	.00
10.100000	.CC0000	.000000	-1.074945.28501-001	.CC02500	.00
10.200000	.CC0000	.000000	-1.034257.30206-001	.CC02500	.00
10.300000	.CC0000	.000000	-.993015.32054-001	.CC02500	.00
10.400000	.CC0000	.000000	-.950727.34099-001	.CC02500	.00
10.500000	.CC0000	.000000	-.906862.36417-001	.CC02500	.00
10.600000	.CC0000	.000000	-.862081.39019-001	.CC02500	.00
10.700000	.CC0000	.000000	-.817482.41879-001	.CC02500	.00
10.800000	.CC0000	.000000	-.774012.44960-001	.CC02500	.00
10.900000	.CC0000	.000000	-.732288.48229-001	.CC02500	.00
11.000000	.CC0000	.000000	-.692293.51700-001	.CC02500	.00
11.100000	.CC0000	.000000	-.653796.55412-001	.CC02500	.00
11.200000	.CC0000	.000000	-.617178.59318-001	.CC02500	.00
11.300000	.CC0000	.000000	-.583362.63243-001	.CC02500	.00
11.400000	.CC0000	.000000	-.552597.67071-001	.CC02500	.00
11.500000	.CC0000	.000000	-.523767.70968-001	.CC02500	.00
11.600000	.CC0000	.000000	-.495826.75154-001	.CC02500	.00
11.700000	.CC0000	.000000	-.468472.79711-001	.CC02500	.00
11.800000	.CC0000	.000000	-.442011.84570-001	.CC02500	.00
11.900000	.CC0000	.000000	-.416812.89630-001	.CC02500	.00
12.000000	.CC0000	.000000	-.392684.94967-001	.CC02500	.00
12.100000	.CC0000	.000000	-.369534.10660+000	.CC02500	.00
12.200000	.CC0000	.000000	-.347647.10638+000	.CC02500	.00
12.300000	.CC0000	.000000	-.327247.11212+000	.CC02500	.00
12.400000	.CC0000	.000000	-.308141.11786+000	.CC02500	.00
12.500000	.CC0000	.000000	-.290258.12354+000	.CC02500	.00
12.600000	.CC0000	.000000	-.273695.12899+000	.CC02500	.00
12.700000	.CC0000	.000000	-.258277.13424+000	.CC02500	.00
12.800000	.CC0000	.000000	-.243615.13956+000	.CC02500	.00
12.900000	.CC0000	.000000	-.229781.14475+000	.CC02500	.00
13.000000	.CC0000	.000000	-.217181.14928+000	.CC02500	.00
13.100000	.CC0000	.000000	-.205695.15325+000	.CC02500	.00
13.200000	.CC0000	.000000	-.194865.15713+000	.CC02500	.00
13.300000	.CC0000	.000000	-.184502.16099+000	.CC02500	.00
13.400000	.CC0000	.000000	-.174861.16442+000	.CC02500	.00
13.500000	.CC0000	.000000	-.166313.16697+000	.CC02500	.00
13.600000	.CC0000	.000000	-.158714.16888+000	.CC02500	.00
13.700000	.CC0000	.000000	-.151639.17062+000	.CC02500	.00
13.800000	.CC0000	.000000	-.144832.17239+000	.CC02500	.00
13.900000	.CC0000	.000000	-.138252.17414+000	.CC02500	.00

ORIGINAL PAGE IS
OF POOR QUALITY

14.00C001	.CC0000	.000000	-.131884.17592+000	.C02500	.00
14.10C001	.CC0000	.000000	-.125654.17775+000	.C02500	.00
14.20C001	.CC0000	.000000	-.119530.17965+000	.C02500	.00
14.30C001	.CC0000	.000000	-.113554.18156+000	.C02500	.00
14.40C001	.CC0000	.000000	-.107775.18341+000	.C02500	.00
14.50C001	.CC0000	.000000	-.102127.18528+000	.C02500	.00
14.60C001	.CC0000	.000000	-.096567.18722+000	.C02500	.00
14.700001	.CC0000	.000000	-.091186.18909+000	.C02500	.00
14.80C001	.CC0000	.000000	-.086246.19058+000	.C02500	.00
14.90C001	.CC0000	.000000	-.081988.19144+000	.C02500	.00
15.00C001	.CC0000	.000000	-.078291.19186+000	.C02500	.00
15.10C001	.CC0000	.000000	-.074952.19209+000	.C02500	.00
15.20C001	.CC0000	.000000	-.071867.19220+000	.C02500	.00
15.300001	.CC0000	.000000	-.068932.19230+000	.C02500	.00
15.400001	.CC0000	.000000	-.066052.19245+000	.C02500	.00
15.500001	.CC0000	.000000	-.063187.19270+000	.C02500	.00
15.60C001	.CC0000	.000000	-.060357.19299+000	.C02500	.00
15.700001	.CC0000	.000000	-.057632.19326+000	.C02500	.00
15.80C001	.CC0000	.000000	-.055078.19343+000	.C02500	.00
15.900001	.CC0000	.000000	-.052663.19355+000	.C02500	.00
16.00C001	.CC0000	.000000	-.050316.19369+000	.C02500	.00

1.4 .00

07 \$INPUT
 NMAX1=100,
 NMXQLC=100,
 DETA=0.28944524E-03,
 AK=1.09,
 INVRSE=1,
 JPFMAX=2,
 IRESTR=C,
 INTERP=C,
 IPRNEH=1,
 NSTART=1,
 MFIG(1)=6,11,16,21,22,23,24,25,26,27,28,29,30,31,32,33,
 34,35,36,37,38,39,40,41,42,43,44,45,46,47,48,
 49,50,51,52,53,54,55,56,57,58,59,60,61,62,63,
 64,65,66,67,68,69,70,71,76,81,86,91,42*0,

NQMAX=10,
 NPRRES=0,
 JMAX=32,
 ITPRO=100,
 PMFO=1.C,
 AHO=0.,
 XCO=6.6912675,
 RESG=.1E-03,
 IPLUT(1)=1,1,C,C,0,1,0,0,
 YORIGN(1)=0.,-1.,6*0.,
 YSCALE(1)=.01,7*1.,
 YIN(1)=8*4.,
 XORIGN(1)=0.,C.,0.,0.,0.,0.,0.,0.,
 XSCALE(1)=.2,.2,.2,.2,.2,.2,.2,.2,
 XIN=6.,6.,6.,5*6.,
 XL=1.C,
 NDATA=1,
 BETAS=1.0,
 AMES=C.00,
 GW=1.C,
 TINFO=530.,
 PRT=0.95,
 PR=0.72,
 RLINF=7.77241+C4,

STRANS=10.95,KTRAN=5,TRNLEN=0.1,
 SMK1=1000.,SMK2=2000.,WAKCON=1.,
 ALFSEP=5.C,
 IWINDC=50,
 IWINDG=C,
 IWINDS=0,
 ITR8MU=C,
 \$END

14
 1 9.3968 .0193
 2 9.6768 .0248
 3 9.7548 .C305
 4 9.9338 .C395
 5 10.2023 .0561
 6 10.4707 .0747
 7 10.7392 .C981
 8 11.0077 .0996
 9 11.2762 .1007
 10 11.4104 .0863
 11 11.4599 .C872
 12 11.6342 .0846
 13 11.8131 .C799
 14 12.0816 .0774

29
 1 0.0000 .0000
 2 0.8949 .8378
 3 2.2373 .9038
 4 3.5797 .9612
 5 4.4747 1.0074
 6 5.3696 1.0756
 7 6.2645 1.1687
 8 7.1595 1.2884
 9 8.0097 1.4034
 10 8.4768 1.4436
 11 8.9046 1.4457
 12 9.3390 1.4379
 13 9.6205 1.4152
 14 9.7954 1.4016
 15 10.0546 1.3958
 16 10.2575 1.3936
 17 10.4885 1.3967
 18 10.7082 1.3967
 19 10.9336 1.4038
 20 11.1421 1.3159
 21 11.4182 1.1877
 22 11.6210 1.1488
 23 11.8689 1.1136
 24 12.0887 1.0968
 25 12.3080 1.0773
 26 12.5394 1.0645
 27 12.9902 1.0252
 28 13.4522 .9987
 29 13.8715 .9726

1	.C0000000	.00000000	.00000000	.1C000000+C01	.00C00000
2	.28944524-003	.25158711-003	.17381574-003	.1CC00000+C01	.12C53039-003
3	.60494056-003	.52576268-003	.36318003-003	.1CC0000C+CC1	.25190852-003
4	.94883045-003	.82454946-003	.56947441-003	.1CC0000C+CC1	.39511067-003
5	.13230705-002	.11501503-002	.79420145-003	.1CC0000C+CC1	.55120102-003
6	.1732246C-002	.1504964C-002	.10385950-002	.1CC0000C+CC1	.72133950-003
7	.21775434-002	.1891602C-002	.13056311-002	.1CC0000C+CC1	.11679044-003
8	.26630721-002	.2312910C-002	.15970402-002	.1CC0000C+CC1	.11699120-003

14

ORIGINAL PAGE IS
 OF POOR QUALITY

9	.31921393-002	.27719822-002	.19123198-002	.1C00000C+001	.13292662-002
10	.37688771-002	.32721891-002	.22567483-002	.1C00000C+CC1	.15694305-002
11	.43575213-002	.38171989-002	.26317998-002	.1C00000C+0C1	.18312097-002
12	.50827434-002	.44110030-002	.30401599-002	.1C00000C+CC1	.21165489-002
13	.58296356-002	.50579447-002	.34847427-002	.1C00000C+0C1	.24275686-002
14	.66437481-002	.57627492-002	.39687091-002	.1C00000C+CC1	.27665802-002
15	.75311306-002	.65305560-002	.44954857-002	.1C00000C+0C1	.31361028-002
16	.84983776-002	.73669544-002	.50687857-002	.1C000000+001	.35388823-002
17	.95526769-002	.82780216-002	.56926303-002	.1C00000C+0C1	.39779121-002
18	.10701863-001	.92703634-002	.63713716-002	.1C000000+001	.44564544-002
19	.11954476-001	.10351159-001	.71097165-002	.1C000000+001	.49780656-002
20	.13319824-001	.11528208-001	.79127525-002	.1C000000+CC1	.55466216-002
21	.14808054-001	.12809982-001	.87859726-002	.1C0C000C+CC1	.61663475-002
22	.16430224-001	.14205679-001	.97353040-002	.1C0C0000+0C1	.68418487-002
23	.18192389-001	.15725281-001	.10767134-001	.1C000000+001	.75781448-002
24	.20125660-001	.17379619-001	.11888339-001	.1C000000+001	.83807075-002
25	.22226447-001	.19180438-001	.13106313-001	.1C00000C+001	.92555006-002
26	.24516273-001	.21140467-001	.14428996-001	.1C00000C+CC1	.10209025-001
27	.27012182-001	.23273498-001	.15864898-001	.1C00000C+CC1	.11248366-001
28	.29732725-001	.25594461-001	.17423128-001	.1C00000C+CC1	.12381247-001
29	.32698115-001	.28119511-001	.19113416-001	.1C00000C+001	.13616086-001
30	.35593039-001	.30866112-001	.20946132-001	.1C00000C+001	.14962060-001
31	.39453571-001	.33853135-001	.22932301-001	.1C00000C+001	.16429169-001
32	.43293838-001	.37100944-001	.25083613-001	.1C00000C+001	.18028315-001
33	.47479729-001	.40631495-001	.27412422-001	.1C00000C+001	.19771381-001
34	.52042350-001	.44468451-001	.29931739-001	.1C00000C+001	.21671316-001
35	.57015607-001	.48637244-001	.32655206-001	.1C00000C+001	.23742238-001
36	.62436456-001	.53165216-001	.35597064-001	.1C00000C+001	.25699532-001
37	.68345184-001	.58081687-001	.38772089-001	.1C000000+001	.28459966-001
38	.74785695-001	.63418059-001	.42195515-001	.1C000000+001	.31141816-001
39	.81805853-001	.69207891-001	.45882923-001	.1C00000C+001	.34065000-001
40	.89457826-001	.75486977-001	.49865094-001	.1C00000C+001	.37251225-001
41	.97798474-001	.82293393-001	.54112832-001	.1C00000C+001	.40724144-001
42	.10688978+000	.89667541-001	.58686717-001	.1C00000C+CC1	.44509534-001
43	.11675931+000	.97652148-001	.635886830-001	.1C0C000C+001	.48635476-001
44	.12760069+000	.10629224+000	.68827388-001	.1C000000+001	.53132566-001
45	.13537420+000	.11563507+000	.74421316-001	.1C00000C+CC1	.58034129-001
46	.15220733+000	.12572999+000	.80379731-001	.1C000000+001	.63376458-001
47	.16619543+000	.13662825+000	.86711319-001	.1C000000+001	.69199068-001
48	.18144247+000	.14838273+000	.93421623-001	.1C00000C+001	.75544967-001
49	.19806173+000	.16104756+000	.10051219+000	.1C00000C+001	.82460942-001
50	.21617674+000	.17467764+000	.10797960+000	.1C00000C+001	.89997864-001
51	.23592209+000	.18932800+000	.11581434+000	.1C00000C+001	.98211009-001
52	.25744452+000	.20505304+000	.12399962+000	.1C00000C+001	.10716038+000
53	.28090357+000	.22190555+000	.13250986+000	.1C00000C+001	.11691102+000
54	.30647478+000	.23993556+000	.14130930+000	.1C00000C+CC1	.12753336+000
55	.33434695+000	.25918896+000	.15035032+000	.1C00000C+001	.13910348+000
56	.36472762+000	.27970587+000	.15957175+000	.1C00000C+CC1	.15170336+000
57	.39784255+000	.30151879+000	.16885716+000	.1C00000C+001	.16542103+000
58	.43393784+000	.32465046+000	.17823325+000	.1C00000C+CC1	.18035066+000
59	.47328108+000	.34911152+000	.18746835+000	.1C00000C+CC1	.19659233+000
60	.51616649+000	.37489794+000	.19647127+000	.1C000000+CC1	.21425171+000
61	.56291091+000	.40198827+000	.20590955+000	.1C00000C+001	.23343923+000
62	.61386234+000	.43034088+000	.21315446+000	.1C00000C+CC1	.25426879+000
63	.66939940+000	.45989117+000	.22047186+000	.1C00000C+CC1	.27685584+000
64	.72993480+000	.49054899+000	.22683406+000	.1C00000C+001	.30131442+000
65	.79591838+000	.52219641+000	.23201824+000	.1C00000C+001	.32775319+000
66	.86784048+000	.55478605+000	.23579253+000	.1C00000C+001	.35620976+000
67	.94623557+000	.59784024+000	.23792218+000	.1C00000C+001	.38694335+000
68	.10316062+001	.62145109+000	.23917855+000	.1C00000C+001	.41682510+000
69	.11242474+001	.65528187+000	.24134920+000	.1C00000C+001	.44922516+000

70	.12263514+001	.68906954+000	.23224980+000	.1C00000C+CC1	.49220134+000
71	.13370124+001	.72252853+000	.22573748+000	.1C00000C+CC1	.53153458+000
72	.14576330+001	.7553555C+000	.21672514+000	.1C00000C+CC1	.57271665+0C0
73	.15891054+0C1	.78723466+000	.20519644+000	.1C00000C+CC1	.61542659+000
74	.17324187+001	.81784322+000	.19122140+000	.1C00000C+CC1	.65921320+000
75	.18886258+001	.84685656+000	.17497243+000	.1C0C000C+CC1	.70348218+000
76	.20588916+001	.87395342+000	.15674044+000	.1C00000C+CC1	.74749297+000
77	.22444813+001	.89882231+000	.13695005+000	.1C0C000C+001	.79037119+000
78	.24467741+001	.92117117+000	.11617013+000	.1C00000C+CC1	.83114232+000
79	.26672732+001	.94074338+000	.95113028-001	.1C00000C+CC1	.86879130+000
80	.29076173+0C1	.95734257+000	.74611649-001	.1C00000C+CC1	.90235022+000
81	.31695923+001	.97086614+000	.55561945-001	.1C00000C+CC1	.93100992+000
82	.34551450+001	.9813427C+000	.38822565-001	.1C00000C+CC1	.95424275+000
83	.37663975+001	.98896192+000	.25077622-001	.1C00000C+CC1	.971912C6+000
84	.41056628+001	.99408121+000	.14691982-001	.1C0C000C+CC1	.98433354+000
85	.44754618+001	.99719513+000	.76118484-002	.1C00000C+CC1	.99225223+000
86	.48785429+001	.9988654C+000	.33681542-002	.1C00000C+CC1	.99671604+000
87	.53179013+001	.99962779+000	.12092218-002	.1C00000C+001	.99886543+000
88	.57968017+001	.99990902+000	.32363459-003	.1C00000C+CC1	.99970594+000
89	.63188034+001	.99998607+000	.54355711-004	.1C00000C+CC1	.99995172+000
90	.68877852+001	.99999931+000	.31068921-005	.1C00000C+001	.99999727+000
91	.75079754+001	.10000C01+001	-.26822090-006	.1C00000C+CC1	.10C0000C+001
92	.81839826+001	.10000000+001	.13411045-006	.1C000000+CC1	.10C00001+001
93	.892083C5+001	.10000000+001	.12665987-006	.1C0C000C+CC1	.10C00000+001
94	.97239947+001	.10000C0C+001	.12665987-006	.1C00000C+CC1	.10C00000+001
95	.10599444+002	.1000000C+001	.12293458-006	.1C00000G+CC1	.1000C000+001
96	.11553683+002	.1000000C+001	.29802322-007	.1C000C0C+CC1	.10000000+001
97	.125938C4+002	.1000000C+001	.14156103-006	.1C0C000C+CC1	.10000000+001
98	.13727536+002	.1000000C+001	.13783574-006	.1C000000+CC1	.10C00000+0C1
99	.149633C4+002	.100C000C+001	.13783574-006	.1C0C000C+CC1	.10C00000+001
100	.16310251+0C2	.10000C0C+001	.13783574-006	.1C00000C+CC1	.1000000C+001
2.528	29.75				
7.0	16.00				

 * HORTON SWEEP FLAT PLATE - TURBULENT INTERACTING *

I	XC	YO	SO	CPD	DTD	TUD	RVWD
1	.00000	.00000	.00000	.80090	.00000	.00250	.00000
2	.10000	.00000	.10000	.74007	.00201	.00250	.00000
3	.20000	.00000	.20000	.59361	.00239	.00250	.00000
4	.30000	.00000	.30000	.43730	.00285	.00250	.00000
5	.40000	.00000	.40000	.31774	.00344	.00250	.00000
6	.50000	.00000	.50000	.23818	.00410	.00250	.00000
7	.60000	.00000	.60000	.18668	.00479	.00250	.00000
8	.70000	.00000	.70000	.15028	.00546	.00250	.00000
9	.80000	.00000	.80000	.12155	.00608	.00250	.00000
10	.90000	.00000	.90000	.09883	.00667	.00250	.00000
11	1.00000	.00000	1.00000	.08132	.00726	.00250	.00000
12	1.10000	.00000	1.10000	.06824	.00786	.00250	.00000
13	1.20000	.00000	1.20000	.05854	.00846	.00250	.00000
14	1.30000	.00000	1.30000	.05069	.00904	.00250	.00000
15	1.40000	.00000	1.40000	.04358	.00959	.00250	.00000
16	1.50000	.00000	1.50000	.03684	.01011	.00250	.00000
17	1.60000	.00000	1.60000	.03042	.01060	.00250	.00000
18	1.70000	.00000	1.70000	.02417	.01107	.00250	.00000
19	1.80000	.00000	1.80000	.01769	.01151	.00250	.00000
20	1.90000	.00000	1.90000	.01061	.01192	.00250	.00000
21	2.00000	.00000	2.00000	.00302	.01229	.00250	.00000
22	2.10000	.00000	2.10000	-.00487	.01263	.00250	.00000
23	2.20000	.00000	2.20000	-.01281	.01296	.00250	.00000
24	2.30000	.00000	2.30000	-.02063	.01329	.00250	.00000
25	2.40000	.00000	2.40000	-.02830	.01361	.00250	.00000
26	2.50000	.00000	2.50000	-.03591	.01392	.00250	.00000
27	2.60000	.00000	2.60000	-.04353	.01422	.00250	.00000
28	2.70000	.00000	2.70000	-.05120	.01451	.00250	.00000
29	2.80000	.00000	2.80000	-.05892	.01478	.00250	.00000
30	2.90000	.00000	2.90000	-.06670	.01505	.00250	.00000
31	3.00000	.00000	3.00000	-.07456	.01531	.00250	.00000
32	3.10000	.00000	3.10000	-.08255	.01556	.00250	.00000
33	3.20000	.00000	3.20000	-.09073	.01579	.00250	.00000
34	3.30000	.00000	3.30000	-.09909	.01601	.00250	.00000
35	3.40000	.00000	3.40000	-.10757	.01623	.00250	.00000
36	3.50000	.00000	3.50000	-.11619	.01643	.00250	.00000
37	3.60000	.00000	3.60000	-.12502	.01663	.00250	.00000
38	3.70000	.00000	3.70000	-.13410	.01681	.00250	.00000
39	3.80000	.00000	3.80000	-.14337	.01698	.00250	.00000
40	3.90000	.00000	3.90000	-.15288	.01714	.00250	.00000
41	4.00000	.00000	4.00000	-.16265	.01729	.00250	.00000
42	4.10000	.00000	4.10000	-.17350	.01740	.00250	.00000
43	4.20000	.00000	4.20000	-.18476	.01750	.00250	.00000
44	4.30000	.00000	4.30000	-.19627	.01759	.00250	.00000
45	4.40000	.00000	4.40000	-.20823	.01768	.00250	.00000
46	4.50000	.00000	4.50000	-.22037	.01776	.00250	.00000
47	4.60000	.00000	4.60000	-.23283	.01783	.00250	.00000
48	4.70000	.00000	4.70000	-.24558	.01790	.00250	.00000
49	4.80000	.00000	4.80000	-.25866	.01795	.00250	.00000

50	4.90000	.00000	4.90000	-.27329	.01797	.00250	.00000
51	5.00000	.00000	5.00000	-.28952	.01794	.00250	.00000
52	5.10000	.00000	5.10000	-.30724	.01787	.00250	.00000
53	5.20000	.00000	5.20000	-.32581	.01779	.00250	.00000
54	5.30000	.00000	5.30000	-.34485	.01772	.00250	.00000
55	5.40000	.00000	5.40000	-.36431	.01765	.00250	.00000
56	5.50000	.00000	5.50000	-.38422	.01759	.00250	.00000
57	5.60000	.00000	5.60000	-.40456	.01753	.00250	.00000
58	5.70000	.00000	5.70000	-.42546	.01746	.00250	.00000
59	5.80000	.00000	5.80000	-.44745	.01738	.00250	.00000
60	5.90000	.00000	5.90000	-.47103	.01727	.00250	.00000
61	6.00000	.00000	6.00000	-.49594	.01714	.00250	.00000
62	6.10000	.00000	6.10000	-.52173	.01702	.00250	.00000
63	6.20000	.00000	6.20000	-.54832	.01689	.00250	.00000
64	6.30000	.00000	6.30000	-.57602	.01676	.00250	.00000
65	6.40000	.00000	6.40000	-.60492	.01662	.00250	.00000
66	6.50000	.00000	6.50000	-.63476	.01649	.00250	.00000
67	6.60000	.00000	6.60000	-.66542	.01636	.00250	.00000
68	6.70000	.00000	6.70000	-.69729	.01622	.00250	.00000
69	6.80000	.00000	6.80000	-.73080	.01607	.00250	.00000
70	6.90000	.00000	6.90000	-.76565	.01592	.00250	.00000
71	7.00000	.00000	7.00000	-.80126	.01578	.00250	.00000
72	7.10000	.00000	7.10000	-.83714	.01565	.00250	.00000
73	7.20000	.00000	7.20000	-.87296	.01555	.00250	.00000
74	7.30000	.00000	7.30000	-.90866	.01546	.00250	.00000
75	7.40000	.00000	7.40000	-.94450	.01539	.00250	.00000
76	7.50000	.00000	7.50000	-.98088	.01532	.00250	.00000
77	7.60000	.00000	7.60000	-1.01835	.01524	.00250	.00000
78	7.70000	.00000	7.70000	-1.05728	.01516	.00250	.00000
79	7.80000	.00000	7.80000	-1.09734	.01507	.00250	.00000
80	7.90000	.00000	7.90000	-1.13741	.01500	.00250	.00000
81	8.00000	.00000	8.00000	-1.17565	.01497	.00250	.00000
82	8.10000	.00000	8.10000	-1.21002	.01500	.00250	.00000
83	8.20000	.00000	8.20000	-1.24025	.01510	.00250	.00000
84	8.30000	.00000	8.30000	-1.26797	.01522	.00250	.00000
85	8.40000	.00000	8.40000	-1.29417	.01535	.00250	.00000
86	8.50000	.00000	8.50000	-1.31829	.01551	.00250	.00000
87	8.60000	.00000	8.60000	-1.33890	.01571	.00250	.00000
88	8.70000	.00000	8.70000	-1.35478	.01597	.00250	.00000
89	8.80000	.00000	8.80000	-1.36515	.01630	.00250	.00000
90	8.90000	.00000	8.90000	-1.36969	.01670	.00250	.00000
91	9.00000	.00000	9.00000	-1.36908	.01717	.00250	.00000
92	9.10000	.00000	9.10000	-1.36403	.01770	.00250	.00000
93	9.20000	.00000	9.20000	-1.35487	.01828	.00250	.00000
94	9.30000	.00000	9.30000	-1.34076	.01895	.00250	.00000
95	9.40000	.00000	9.40000	-1.32204	.01974	.00250	.00000
96	9.50000	.00000	9.50000	-1.29931	.02069	.00250	.00000
97	9.60000	.00000	9.60000	-1.26995	.02176	.00250	.00000
98	9.70000	.00000	9.70000	-1.22640	.02292	.00250	.00000
99	9.80000	.00000	9.80000	-1.19067	.02415	.00250	.00000
100	9.90000	.00000	9.90000	-1.15367	.02548	.00250	.00000
101	10.00000	.00000	10.00000	-1.11493	.02692	.00250	.00000
102	10.10000	.00000	10.10000	-1.07495	.02850	.00250	.00000
103	10.20000	.00000	10.20000	-1.03426	.03021	.00250	.00000
104	10.30000	.00000	10.30000	-.99302	.03205	.00250	.00000
105	10.40000	.00000	10.40000	-.95073	.03410	.00250	.00000
106	10.50000	.00000	10.50000	-.90686	.03642	.00250	.00000
107	10.60000	.00000	10.60000	-.86208	.03902	.00250	.00000
108	10.70000	.00000	10.70000	-.81748	.04188	.00250	.00000
109	10.80000	.00000	10.80000	-.77401	.04496	.00250	.00000
110	10.90000	.00000	10.90000	-.73279	.04823	.00250	.00000

ORIGINAL PAGE IS
OF POOR QUALITY

111	11.00000	.00000	11.00000	-.69229	.05170	.00250	.00000
112	11.10000	.00000	11.10000	-.65380	.05541	.00250	.00000
113	11.20000	.00000	11.20000	-.61718	.05932	.00250	.00000
114	11.30000	.00000	11.30000	-.58336	.06324	.00250	.00000
115	11.40000	.00000	11.40000	-.55260	.06707	.00250	.00000
116	11.50000	.00000	11.50000	-.52377	.07097	.00250	.00000
117	11.60000	.00000	11.60000	-.49583	.07515	.00250	.00000
118	11.70000	.00000	11.70000	-.46847	.07971	.00250	.00000
119	11.80000	.00000	11.80000	-.44201	.08457	.00250	.00000
120	11.90000	.00000	11.90000	-.41681	.08963	.00250	.00000
121	12.00000	.00000	12.00000	-.39268	.09497	.00250	.00000
122	12.10000	.00000	12.10000	-.36953	.10060	.00250	.00000
123	12.20000	.00000	12.20000	-.34765	.10638	.00250	.00000
124	12.30000	.00000	12.30000	-.32725	.11212	.00250	.00000
125	12.40000	.00000	12.40000	-.30814	.11786	.00250	.00000
126	12.50000	.00000	12.50000	-.29026	.12354	.00250	.00000
127	12.60000	.00000	12.60000	-.27370	.12899	.00250	.00000
128	12.70000	.00000	12.70000	-.25828	.13424	.00250	.00000
129	12.80000	.00000	12.80000	-.24362	.13956	.00250	.00000
130	12.90000	.00000	12.90000	-.22978	.14475	.00250	.00000
131	13.00000	.00000	13.00000	-.21718	.14928	.00250	.00000
132	13.10000	.00000	13.10000	-.20570	.15325	.00250	.00000
133	13.20000	.00000	13.20000	-.19487	.15713	.00250	.00000
134	13.30000	.00000	13.30000	-.18450	.16099	.00250	.00000
135	13.40000	.00000	13.40000	-.17486	.16442	.00250	.00000
136	13.50000	.00000	13.50000	-.16631	.16697	.00250	.00000
137	13.60000	.00000	13.60000	-.15871	.16888	.00250	.00000
138	13.70000	.00000	13.70000	-.15164	.17062	.00250	.00000
139	13.80000	.00000	13.80000	-.14483	.17239	.00250	.00000
140	13.90000	.00000	13.90000	-.13825	.17416	.00250	.00000
141	14.00000	.00000	14.00000	-.13188	.17592	.00250	.00000
142	14.10000	.00000	14.10000	-.12565	.17775	.00250	.00000
143	14.20000	.00000	14.20000	-.11953	.17965	.00250	.00000
144	14.30000	.00000	14.30000	-.11355	.18156	.00250	.00000
145	14.40000	.00000	14.40000	-.10778	.18341	.00250	.00000
146	14.50000	.00000	14.50000	-.10213	.18528	.00250	.00000
147	14.60000	.00000	14.60000	-.09657	.18722	.00250	.00000
148	14.70000	.00000	14.70000	-.09119	.18909	.00250	.00000
149	14.80000	.00000	14.80000	-.08625	.19058	.00250	.00000
150	14.90000	.00000	14.90000	-.08199	.19144	.00250	.00000
151	15.00000	.00000	15.00000	-.07829	.19186	.00250	.00000
152	15.10000	.00000	15.10000	-.07495	.19209	.00250	.00000
153	15.20000	.00000	15.20000	-.07187	.19220	.00250	.00000
154	15.30000	.00000	15.30000	-.06893	.19230	.00250	.00000
155	15.40000	.00000	15.40000	-.06605	.19245	.00250	.00000
156	15.50000	.00000	15.50000	-.06319	.19270	.00250	.00000
157	15.60000	.00000	15.60000	-.06036	.19299	.00250	.00000
158	15.70000	.00000	15.70000	-.05763	.19326	.00250	.00000
159	15.80000	.00000	15.80000	-.05508	.19343	.00250	.00000
160	15.90000	.00000	15.90000	-.05266	.19355	.00250	.00000
161	16.00000	.00000	16.00000	-.05032	.19369	.00250	.00000

I	SI	SMCOTH VT	INPUT VT
1	.000000	.003595	.003093
2	.100000	.229116	.244649
3	.200000	.427669	.455303
4	.300000	.581569	.603001
5	.400000	.687330	.695105
6	.500000	.752970	.750154

7	.600C00	.791220	.783728
8	.7C0C00	.813784	.806618
9	.800C00	.828560	.824231
10	.9C0C00	.839608	.837901
11	1.000C00	.848497	.848284
12	1.1C0C00	.855718	.855962
13	1.2C0C00	.861543	.861609
14	1.3C0C00	.866322	.866154
15	1.4C0C00	.870437	.870243
16	1.500C00	.874194	.874108
17	1.6C0C00	.877800	.877776
18	1.7C0C00	.881412	.881327
19	1.8C0C00	.885158	.884969
20	1.9C0C00	.889119	.888988
21	2.000C00	.893295	.893248
22	2.1C0C00	.897613	.897652
23	2.2C0C00	.901978	.902064
24	2.3C0C00	.906310	.906386
25	2.4C0C00	.910576	.910610
26	2.500C00	.914781	.914778
27	2.6C0C00	.918948	.918932
28	2.700C00	.923104	.923094
29	2.8C0C00	.927267	.927269
30	2.900C00	.931452	.931456
31	3.000C00	.935672	.935665
32	3.100C00	.939943	.939924
33	3.200C00	.944275	.944266
34	3.3C0C00	.948670	.948680
35	3.4C0C00	.953127	.953141
36	3.5C0C00	.957647	.957654
37	3.6C0C00	.962240	.962252
38	3.7C0C00	.966920	.966956
39	3.800C00	.971713	.971740
40	3.900C00	.976657	.976623
41	4.000C00	.981607	.981711
42	4.1C0C00	.987193	.987121
43	4.2C0C00	.992802	.992805
44	4.3C0C00	.998583	.998638
45	4.400C00	1.004485	1.004559
46	4.5C0C00	1.010486	1.010583
47	4.6C0C00	1.016406	1.016727
48	4.7C0C00	1.022292	1.022979
49	4.800C00	1.029569	1.029449
50	4.9C0C00	1.036708	1.036437
51	5.000C00	1.044430	1.044233
52	5.1C0C00	1.052693	1.052688
53	5.2C0C00	1.061358	1.061471
54	5.3C0C00	1.070272	1.070399
55	5.4C0C00	1.079339	1.079451
56	5.5C0C00	1.088531	1.088637
57	5.6C0C00	1.097885	1.097936
58	5.700C00	1.107494	1.107416
59	5.8C0C00	1.117474	1.117301
60	5.9C0C00	1.127896	1.127802
61	6.0C0C00	1.138753	1.138792
62	6.1C0C00	1.149987	1.150058
63	6.2C0C00	1.161553	1.161564
64	6.3C0C00	1.173436	1.173425
65	6.4C0C00	1.185632	1.185678
66	6.5C0C00	1.198139	1.198192
67	6.6C0C00	1.210976	1.210921

ORIGINAL PAGE IS
OF POOR QUALITY

68	6.700000	1.224181	1.224010
69	6.800000	1.237761	1.237621
70	6.900000	1.251638	1.251623
71	7.000000	1.265666	1.265769
72	7.100000	1.279687	1.279862
73	7.200000	1.293600	1.293779
74	7.300000	1.307397	1.307505
75	7.400000	1.321164	1.321138
76	7.500000	1.335043	1.334837
77	7.600000	1.349157	1.348797
78	7.700000	1.363514	1.363155
79	7.800000	1.377931	1.377767
80	7.900000	1.392039	1.392235
81	8.000000	1.405390	1.405901
82	8.100000	1.417645	1.418070
83	8.200000	1.428716	1.428691
84	8.300000	1.438723	1.438358
85	8.400000	1.447783	1.447437
86	8.500000	1.455838	1.455747
87	8.600000	1.462655	1.462809
88	8.700000	1.467948	1.468225
89	8.800000	1.471507	1.471754
90	8.900000	1.473267	1.473294
91	9.000000	1.473283	1.473088
92	9.100000	1.471628	1.471372
93	9.200000	1.468277	1.468257
94	9.300000	1.463089	1.463444
95	9.400000	1.455922	1.456469
96	9.500000	1.446821	1.447069
97	9.600000	1.436097	1.435918
98	9.700000	1.424187	1.423837
99	9.800000	1.411454	1.411234
100	9.900000	1.398087	1.398063
101	10.000000	1.384160	1.384138
102	10.100000	1.369709	1.369618
103	10.200000	1.354757	1.354682
104	10.300000	1.339278	1.339374
105	10.400000	1.323222	1.323493
106	10.500000	1.306592	1.306817
107	10.600000	1.289525	1.289569
108	10.700000	1.272273	1.272159
109	10.800000	1.255114	1.254958
110	10.900000	1.238275	1.238223
111	11.000000	1.221906	1.221966
112	11.100001	1.206128	1.206111
113	11.200001	1.191079	1.190834
114	11.300001	1.176872	1.176550
115	11.400000	1.163495	1.163402
116	11.500000	1.150781	1.150945
117	11.600001	1.138514	1.138742
118	11.700001	1.126551	1.126667
119	11.800001	1.114866	1.114863
120	11.900001	1.103496	1.103503
121	12.000001	1.092487	1.092516
122	12.100001	1.081893	1.081869
123	12.200001	1.071777	1.071706
124	12.300001	1.062187	1.062146
125	12.400001	1.053140	1.053114
126	12.500001	1.044628	1.044589
127	12.600001	1.036625	1.036630
128	12.700001	1.029089	1.029167

129	12.800C01	1.021984	1.022019
130	12.900CC1	1.015306	1.015228
131	13.0C0CC1	1.009065	1.009004
132	13.1C0CC1	1.003238	1.003296
133	13.2C0CC1	.997780	.997884
134	13.3C0CC1	.992669	.992678
135	13.4C0CC1	.987929	.987810
136	13.500C01	.983587	.983474
137	13.6C0C01	.979615	.979603
138	13.7C0C01	.975930	.975985
139	13.8C0CC1	.972439	.972491
140	13.9C0C01	.969071	.969102
141	14.0C0CC1	.965787	.965811
142	14.1C0CC1	.962563	.962581
143	14.200C01	.959392	.959394
144	14.3C0CC1	.956276	.956275
145	14.4C0C01	.953216	.953248
146	14.5C0C01	.950220	.950281
147	14.6C0CC1	.947312	.947351
148	14.7C0CC1	.944548	.944507
149	14.8C0C01	.941597	.941888
150	14.9C0C01	.939709	.939625
151	15.000C01	.937681	.937656
152	15.100CC1	.935864	.935874
153	15.200C01	.934192	.934224
154	15.3C0CC1	.932606	.932652
155	15.4C0CC1	.931062	.931107
156	15.500CC1	.929542	.929567
157	15.600C01	.928053	.928043
158	15.7C0C01	.926611	.926574
159	15.8C0CC1	.925230	.925195
160	15.900CC1	.923907	.923889
161	16.000CC1	.922617	.922618

I	SI	SMOOTH PMF	INPUT PMF
1	.000C00	.000015	.000000
2	.1C0C00	.000631	.000496
3	.2C0C00	.001246	.001086
4	.3C0C00	.001859	.001722
5	.4C0C00	.002468	.002392
6	.500C00	.003073	.003076
7	.600C00	.003672	.003756
8	.7C0C00	.004264	.004403
9	.8C0C00	.004847	.005009
10	.9C0C00	.005420	.005591
11	1.0C0C00	.005982	.006162
12	1.1C0C00	.006533	.006728
13	1.2C0C00	.007071	.007288
14	1.3C0C00	.007595	.007829
15	1.4C0C00	.008106	.008345
16	1.500C00	.008602	.008835
17	1.6C0C00	.009083	.009307
18	1.7C0C00	.009549	.009760
19	1.8C0C00	.010001	.010190
20	1.9C0C00	.010438	.010542
21	2.0C0C00	.010861	.010974
22	2.1C0C00	.011270	.011338
23	2.2C0C00	.011666	.011703
24	2.3C0C00	.012048	.012045

ORIGINAL PAGE IS
OF POOR QUALITY

25	2.4C0C00	.012418	.012391
26	2.500C00	.012776	.012731
27	2.600C00	.013123	.013064
28	2.700C00	.013459	.013389
29	2.800C00	.013785	.013708
30	2.900C00	.014100	.014019
31	3.000C00	.014406	.014325
32	3.100C00	.014702	.014622
33	3.200C00	.014989	.014911
34	3.300C00	.015268	.015192
35	3.400C00	.015537	.015467
36	3.500C00	.015797	.015736
37	3.600C00	.016049	.015998
38	3.700C00	.016292	.016252
39	3.800C00	.016527	.016500
40	3.900C00	.016753	.016741
41	4.000C00	.016969	.016970
42	4.100C00	.017177	.017180
43	4.200C00	.017376	.017378
44	4.300C00	.017565	.017570
45	4.400C00	.017746	.017762
46	4.500C00	.017917	.017949
47	4.600C00	.018079	.018132
48	4.700000	.018231	.018312
49	4.800C00	.018374	.018482
50	4.900C00	.018507	.018625
51	5.000C00	.018632	.018729
52	5.100C00	.018747	.018809
53	5.200C00	.018853	.018887
54	5.300C00	.018951	.018970
55	5.400C00	.019041	.019057
56	5.500C00	.019123	.019147
57	5.600C00	.019197	.019241
58	5.700000	.019264	.019334
59	5.800C00	.019325	.019414
60	5.900C00	.019379	.019473
61	6.000C00	.019427	.019520
62	6.100C00	.019470	.019569
63	6.200C00	.019508	.019621
64	6.300C00	.019542	.019669
65	6.400C00	.019573	.019711
66	6.500C00	.019602	.019757
67	6.600C00	.019629	.019806
68	6.700C00	.019656	.019852
69	6.800C00	.019684	.019889
70	6.900C00	.019713	.019925
71	7.000C00	.019746	.019970
72	7.100000	.019784	.020032
73	7.200C00	.019828	.020117
74	7.300C00	.019882	.020218
75	7.400C00	.019945	.020331
76	7.500C00	.020022	.020447
77	7.600C00	.020114	.020560
78	7.700C00	.020224	.020661
79	7.800C00	.020356	.020764
80	7.900C00	.020513	.020884
81	8.000C00	.020698	.021046
82	8.100C00	.020915	.021277
83	8.200C00	.021169	.021569
84	8.300C00	.021463	.021890
85	8.400C00	.021801	.022222

86	8.500000	.022194	.022579
87	8.600000	.022640	.022982
88	8.700000	.023147	.023448
89	8.800000	.023721	.023988
90	8.900000	.024368	.024607
91	9.000000	.025094	.025294
92	9.100000	.025904	.026040
93	9.200000	.026806	.026846
94	9.300000	.027805	.027737
95	9.400000	.028909	.028755
96	9.500000	.030123	.029936
97	9.600000	.031454	.031244
98	9.700000	.032908	.032634
99	9.800000	.034492	.034086
100	9.900000	.036210	.035617
101	10.000000	.038069	.037267
102	10.100000	.040074	.039035
103	10.200000	.042229	.040920
104	10.300000	.044538	.042932
105	10.400000	.047006	.045130
106	10.500000	.049632	.047590
107	10.600000	.052419	.050318
108	10.700000	.055366	.053277
109	10.800000	.058471	.056423
110	10.900000	.061731	.059718
111	11.000000	.065141	.063176
112	11.100001	.068694	.066803
113	11.200001	.072385	.070638
114	11.300001	.076204	.074409
115	11.400000	.080142	.078031
116	11.500000	.084187	.081680
117	11.600001	.088328	.085581
118	11.700001	.092551	.089808
119	11.800001	.096840	.094284
120	11.900001	.101177	.098907
121	12.000001	.105543	.103753
122	12.100001	.109918	.108836
123	12.200001	.114280	.114008
124	12.300001	.118606	.119088
125	12.400001	.122874	.124120
126	12.500001	.127061	.129048
127	12.600001	.131145	.133715
128	12.700001	.135107	.138155
129	12.800001	.138928	.142633
130	12.900001	.142591	.146954
131	13.000001	.146083	.150624
132	13.100001	.149391	.153755
133	13.200001	.152508	.156798
134	13.300001	.155428	.159811
135	13.400001	.158149	.162416
136	13.500001	.160671	.164211
137	13.600001	.162996	.165435
138	13.700001	.165131	.166523
139	13.800001	.167083	.167648
140	13.900001	.168859	.168779
141	14.000001	.170468	.169906
142	14.100001	.171917	.171099
143	14.200001	.173215	.172355
144	14.300001	.174370	.173621
145	14.400001	.175388	.174835
146	14.500001	.176275	.176000

ORIGINAL PAGE IS
OF POOR QUALITY

147	14.600C01	.177038	.177363
148	14.700C01	.177683	.178597
149	14.800C01	.178215	.179505
150	14.900C01	.178642	.179882
151	15.000C01	.178970	.179899
152	15.100C01	.179209	.179772
153	15.200C01	.179367	.179558
154	15.300C01	.179453	.179349
155	15.400C01	.179477	.179191
156	15.500C01	.179448	.179128
157	15.600C01	.179376	.179103
158	15.700C01	.179270	.179070
159	15.800C01	.179137	.178960
160	15.900C01	.178988	.178819
161	16.000C01	.178830	.178702

SMOOTHED REFERENCE SOLUTION ON COMPUTATIONAL MESH

I	SI	XB	YB	VT	PMFB	TUR	RVWB
1	.00000	.00000	.00000	.00360	.00002	.00250	.00000
2	.10000	.10000	.00000	.22912	.00063	.00250	.00000
3	.20000	.20000	.00000	.42767	.00125	.00250	.00000
4	.30000	.30000	.00000	.58157	.00186	.00250	.00000
5	.40000	.40000	.00000	.68733	.00247	.00250	.00000
6	.50000	.50000	.00000	.75297	.00307	.00250	.00000
7	.60000	.60000	.00000	.79122	.00367	.00250	.00000
8	.70000	.70000	.00000	.81378	.00426	.00250	.00000
9	.80000	.80000	.00000	.82856	.00485	.00250	.00000
10	.90000	.90000	.00000	.83961	.00542	.00250	.00000
11	1.00000	1.00000	.00000	.84850	.00598	.00250	.00000
12	1.10000	1.10000	.00000	.85572	.00653	.00250	.00000
13	1.20000	1.20000	.00000	.86154	.00707	.00250	.00000
14	1.30000	1.30000	.00000	.86632	.00760	.00250	.00000
15	1.40000	1.40000	.00000	.87044	.00811	.00250	.00000
16	1.50000	1.50000	.00000	.87419	.00860	.00250	.00000
17	1.60000	1.60000	.00000	.87780	.00908	.00250	.00000
18	1.70000	1.70000	.00000	.88141	.00955	.00250	.00000
19	1.80000	1.80000	.00000	.88516	.01000	.00250	.00000
20	1.90000	1.90000	.00000	.88912	.01044	.00250	.00000
21	2.00000	2.00000	.00000	.89329	.01086	.00250	.00000
22	2.10000	2.10000	.00000	.89761	.01127	.00250	.00000
23	2.20000	2.20000	.00000	.90198	.01167	.00250	.00000
24	2.30000	2.30000	.00000	.90631	.01205	.00250	.00000
25	2.40000	2.40000	.00000	.91058	.01242	.00250	.00000
26	2.50000	2.50000	.00000	.91478	.01278	.00250	.00000
27	2.60000	2.60000	.00000	.91895	.01312	.00250	.00000
28	2.70000	2.70000	.00000	.92310	.01346	.00250	.00000
29	2.80000	2.80000	.00000	.92727	.01378	.00250	.00000
30	2.90000	2.90000	.00000	.93145	.01410	.00250	.00000
31	3.00000	3.00000	.00000	.93567	.01441	.00250	.00000
32	3.10000	3.10000	.00000	.93994	.01470	.00250	.00000
33	3.20000	3.20000	.00000	.94427	.01499	.00250	.00000
34	3.30000	3.30000	.00000	.94867	.01527	.00250	.00000
35	3.40000	3.40000	.00000	.95313	.01554	.00250	.00000
36	3.50000	3.50000	.00000	.95765	.01580	.00250	.00000
37	3.60000	3.60000	.00000	.96224	.01605	.00250	.00000
38	3.70000	3.70000	.00000	.96692	.01629	.00250	.00000
39	3.80000	3.80000	.00000	.97171	.01653	.00250	.00000

40	3.90000	3.90000	.0C000	.97666	.01675	.00250	.00000
41	4.00000	4.00000	.00000	.98181	.01697	.00250	.00000
42	4.10000	4.10000	.00000	.98719	.01718	.00250	.0C000
43	4.20000	4.20000	.00000	.99280	.01738	.00250	.0C000
44	4.30000	4.30000	.00000	.99858	.01757	.00250	.0C000
45	4.40000	4.40000	.0C000	1.00448	.01775	.00250	.0C000
46	4.50000	4.50000	.00000	1.01049	.01792	.00250	.0C000
47	4.60000	4.60000	.0C000	1.01661	.01808	.00250	.00000
48	4.70000	4.70000	.0C000	1.02292	.01823	.00250	.0C000
49	4.80000	4.80000	.00000	1.02957	.01837	.00250	.00000
50	4.90000	4.90000	.0C000	1.03671	.01851	.00250	.00000
51	5.00000	5.00000	.00000	1.04443	.01863	.00250	.0C000
52	5.10000	5.10000	.0C000	1.05269	.01875	.00250	.0C000
53	5.20000	5.20000	.00000	1.06136	.01885	.00250	.0C000
54	5.30000	5.30000	.00000	1.07027	.01895	.00250	.0C000
55	5.40000	5.40000	.00000	1.07934	.01904	.00250	.00000
56	5.50000	5.50000	.0C000	1.08853	.01912	.00250	.0C000
57	5.60000	5.60000	.00000	1.09789	.01920	.00250	.0C000
58	5.70000	5.70000	.00000	1.10749	.01926	.00250	.00000
59	5.80000	5.80000	.0C000	1.11747	.01932	.00250	.0C000
60	5.90000	5.90000	.0C000	1.12790	.01938	.00250	.0C000
61	6.00000	6.00000	.0C000	1.13875	.01943	.00250	.0C000
62	6.10000	6.10000	.0C000	1.14999	.01947	.00250	.0C000
63	6.20000	6.20000	.0C000	1.16155	.01951	.00250	.0C000
64	6.30000	6.30000	.00000	1.17344	.01954	.00250	.0C000
65	6.40000	6.40000	.00000	1.18563	.01957	.00250	.0C000
66	6.50000	6.50000	.00000	1.19814	.01960	.00250	.0C000
67	6.60000	6.60000	.0C000	1.21098	.01963	.00250	.00000
68	6.70000	6.70000	.00000	1.22418	.01966	.00250	.0C000
69	6.80000	6.80000	.00000	1.23776	.01968	.00250	.00000
70	6.90000	6.90000	.00000	1.25164	.01971	.00250	.0C000
71	7.00000	7.00000	.00000	1.26587	.01975	.00250	.00000
72	7.10000	7.10000	.00000	1.27969	.01978	.00250	.00000
73	7.20000	7.20000	.00000	1.29360	.01983	.00250	.00000
74	7.30000	7.30000	.00000	1.30740	.01988	.00250	.00000
75	7.40000	7.40000	.00000	1.32116	.01995	.00250	.0C000
76	7.50000	7.50000	.0C000	1.33504	.02002	.00250	.0C000
77	7.60000	7.60000	.0C000	1.34916	.02011	.00250	.0C000
78	7.70000	7.70000	.00000	1.36351	.02022	.00250	.00000
79	7.80000	7.80000	.0C000	1.37793	.02036	.00250	.0C000
80	7.90000	7.90000	.00000	1.39204	.02051	.00250	.00000
81	8.00000	8.00000	.0C000	1.40539	.02070	.00250	.0C000
82	8.10000	8.10000	.00000	1.41765	.02091	.00250	.00000
83	8.20000	8.20000	.0C000	1.42872	.02117	.00250	.0C000
84	8.30000	8.30000	.0C000	1.43872	.02146	.00250	.00000
85	8.40000	8.40000	.00000	1.44778	.02180	.00250	.0C000
86	8.50000	8.50000	.0C000	1.45584	.02219	.00250	.0C000
87	8.60000	8.60000	.0C000	1.46265	.02264	.00250	.0C000
88	8.70000	8.70000	.0C000	1.46795	.02315	.00250	.0C000
89	8.80000	8.80000	.00000	1.47151	.02372	.00250	.0C000
90	8.90000	8.90000	.0C000	1.47327	.02437	.00250	.00000
91	9.00000	9.00000	.00000	1.47328	.02509	.00250	.0C000
92	9.10000	9.10000	.00000	1.47163	.02590	.00250	.0C000
93	9.20000	9.20000	.00000	1.46828	.02681	.00250	.0C000
94	9.30000	9.30000	.0C000	1.46309	.02781	.00250	.0C000
95	9.40000	9.40000	.00000	1.45592	.02891	.00250	.0C000
96	9.50000	9.50000	.00000	1.44692	.03012	.00250	.0C000
97	9.60000	9.60000	.0C000	1.43610	.03145	.00250	.0C000
98	9.70000	9.70000	.0C000	1.42419	.03291	.00250	.0C000
99	9.80000	9.80000	.0C000	1.41145	.03449	.00250	.0C000
100	9.90000	9.90000	.0C000	1.39809	.03621	.00250	.0C000

ORIGINAL PAGE IS
OF POOR QUALITY

101	10.00000	10.00000	.00000	1.38416	.03807	.00250	.0C000
102	10.10000	10.10000	.00000	1.36971	.04007	.00250	.0C000
103	10.20000	10.20000	.0C000	1.35476	.04223	.00250	.0C000
104	10.30000	10.30000	.00000	1.33928	.04454	.00250	.0C000
105	10.40000	10.40000	.00000	1.32322	.04701	.00250	.0C000
106	10.50000	10.50000	.00000	1.30659	.04963	.00250	.0C000
107	10.60000	10.60000	.00000	1.28953	.05242	.00250	.0C000
108	10.70000	10.70000	.00000	1.27227	.05537	.00250	.00000
109	10.80000	10.80000	.00000	1.25511	.05847	.00250	.0C000
110	10.90000	10.90000	.00000	1.23828	.06173	.00250	.00000
111	11.00000	11.00000	.00000	1.22191	.06514	.00250	.00000
112	11.10000	11.10000	.00000	1.20613	.06869	.00250	.00000
113	11.20000	11.20000	.00000	1.19108	.07239	.00250	.0C000
114	11.30000	11.30000	.00000	1.17687	.07620	.00250	.0C000
115	11.40000	11.40000	.0C000	1.16349	.08014	.00250	.00000
116	11.50000	11.50000	.00000	1.15078	.08419	.00250	.00000
117	11.60000	11.60000	.00000	1.13851	.08833	.00250	.0C000
118	11.70000	11.70000	.00000	1.12655	.09255	.00250	.0C000
119	11.80000	11.80000	.00000	1.11487	.09684	.00250	.0C000
120	11.90000	11.90000	.0C000	1.10350	.10118	.00250	.00000
121	12.00000	12.00000	.0C000	1.09249	.10554	.00250	.00000
122	12.10000	12.10000	.00000	1.08189	.10992	.00250	.0C000
123	12.20000	12.20000	.00000	1.07178	.11428	.00250	.0C000
124	12.30000	12.30000	.00000	1.06219	.11861	.00250	.0C000
125	12.40000	12.40000	.0C000	1.05314	.12287	.00250	.00000
126	12.50000	12.50000	.00000	1.04463	.12706	.00250	.00000
127	12.60000	12.60000	.0C000	1.03663	.13115	.00250	.00000
128	12.70000	12.70000	.00000	1.02909	.13511	.00250	.0C000
129	12.80000	12.80000	.00000	1.02198	.13893	.00250	.00000
130	12.90000	12.90000	.00000	1.01531	.14259	.00250	.0C000
131	13.00000	13.00000	.00000	1.00906	.14608	.00250	.00000
132	13.10000	13.10000	.00000	1.00324	.14939	.00250	.0C000
133	13.20000	13.20000	.00000	.99778	.15251	.00250	.00000
134	13.30000	13.30000	.0C000	.99267	.15543	.00250	.0C000
135	13.40000	13.40000	.00000	.98793	.15815	.00250	.00000
136	13.50000	13.50000	.0C000	.98359	.16067	.00250	.0C000
137	13.60000	13.60000	.0C000	.97962	.16300	.00250	.00000
138	13.70000	13.70000	.0C000	.97593	.16513	.00250	.0C000
139	13.80000	13.80000	.0C000	.97244	.16708	.00250	.0C000
140	13.90000	13.90000	.00000	.96907	.16886	.00250	.00000
141	14.00000	14.00000	.0C000	.96579	.17047	.00250	.00000
142	14.10000	14.10000	.00000	.96256	.17192	.00250	.0C000
143	14.20000	14.20000	.00000	.95939	.17322	.00250	.0C000
144	14.30000	14.30000	.0C000	.95628	.17437	.00250	.00000
145	14.40000	14.40000	.00000	.95322	.17539	.00250	.00000
146	14.50000	14.50000	.0C000	.95022	.17628	.00250	.0C000
147	14.60000	14.60000	.0C000	.94731	.17704	.00250	.0C000
148	14.70000	14.70000	.0C000	.94455	.17768	.00250	.0C000
149	14.80000	14.80000	.0C000	.94200	.17822	.00250	.0C000
150	14.90000	14.90000	.00000	.93971	.17864	.00250	.0C000
151	15.00000	15.00000	.0C000	.93768	.17897	.00250	.0C000
152	15.10000	15.10000	.0C000	.93586	.17921	.00250	.0C000
153	15.20000	15.20000	.00000	.93419	.17937	.00250	.00000
154	15.30000	15.30000	.0C000	.93261	.17945	.00250	.0C000
155	15.40000	15.40000	.0C000	.93106	.17948	.00250	.00000
156	15.50000	15.50000	.0C000	.92954	.17945	.00250	.00000
157	15.60000	15.60000	.0C000	.92805	.17938	.00250	.0C000
158	15.70000	15.70000	.0C000	.92661	.17927	.00250	.0C000
159	15.80000	15.80000	.0C000	.92523	.17914	.00250	.0C000
160	15.90000	15.90000	.0C000	.92391	.17899	.00250	.0C000
161	16.00000	16.00000	.0C000	.92262	.17883	.00250	.0C000

*** STREAMWISE LOCATIONS OF BOUNDARY LAYER CALCULATION, BODY RADIUS, FROM SUBROUTINE XBLGRD ***

M	S	XOCBL	RO
1	.7000000E+01	.70001000E+01	.10000000E+01
2	.7100000E+01	.71000000E+01	.10000000E+01
3	.7200000E+01	.72000000E+01	.10000000E+01
4	.7300000E+01	.73000000E+01	.10000000E+01
5	.7400000E+01	.74000000E+01	.10000000E+01
6	.7500000E+01	.75000000E+01	.10000000E+01
7	.7600000E+01	.76000000E+01	.10000000E+01
8	.7700000E+01	.77000000E+01	.10000000E+01
9	.7800000E+01	.78000000E+01	.10000000E+01
10	.7900000E+01	.79000000E+01	.10000000E+01
11	.8000000E+01	.80000000E+01	.10000000E+01
12	.8100000E+01	.81000000E+01	.10000000E+01
13	.8200000E+01	.82000000E+01	.10000000E+01
14	.8300000E+01	.83000000E+01	.10000000E+01
15	.8400000E+01	.84000000E+01	.10000000E+01
16	.8500000E+01	.85000000E+01	.10000000E+01
17	.8600000E+01	.86000000E+01	.10000000E+01
18	.8700000E+01	.87000000E+01	.10000000E+01
19	.8800000E+01	.88000000E+01	.10000000E+01
20	.8900000E+01	.89000000E+01	.10000000E+01
21	.9000000E+01	.90000000E+01	.10000000E+01
22	.9100000E+01	.91000000E+01	.10000000E+01
23	.9200000E+01	.92000000E+01	.10000000E+01
24	.9300000E+01	.93000000E+01	.10000000E+01
25	.9400000E+01	.94000000E+01	.10000000E+01
26	.9500000E+01	.95000000E+01	.10000000E+01
27	.9600000E+01	.96000000E+01	.10000000E+01
28	.9700000E+01	.97000000E+01	.10000000E+01
29	.9800000E+01	.98000000E+01	.10000000E+01
30	.9900000E+01	.99000000E+01	.10000000E+01
31	.1000000E+02	.10000000E+02	.10000000E+01
32	.1010000E+02	.10100000E+02	.10000000E+01
33	.1020000E+02	.10200000E+02	.10000000E+01
34	.1030000E+02	.10300000E+02	.10000000E+01
35	.1040000E+02	.10400000E+02	.10000000E+01
36	.1050000E+02	.10500000E+02	.10000000E+01
37	.1060000E+02	.10600000E+02	.10000000E+01
38	.1070000E+02	.10700000E+02	.10000000E+01
39	.1080000E+02	.10800000E+02	.10000000E+01
40	.1090000E+02	.10900000E+02	.10000000E+01
41	.1100000E+02	.11000000E+02	.10000000E+01
42	.1110000E+02	.11100000E+02	.10000000E+01
43	.1120000E+02	.11200000E+02	.10000000E+01
44	.1130000E+02	.11300000E+02	.10000000E+01
45	.1140000E+02	.11400000E+02	.10000000E+01
46	.1150000E+02	.11500000E+02	.10000000E+01
47	.1160000E+02	.11600000E+02	.10000000E+01
48	.1170000E+02	.11700000E+02	.10000000E+01
49	.1180000E+02	.11800000E+02	.10000000E+01
50	.1190000E+02	.11900000E+02	.10000000E+01
51	.1200000E+02	.12000000E+02	.10000000E+01
52	.1210000E+02	.12100000E+02	.10000000E+01
53	.1220000E+02	.12200000E+02	.10000000E+01
54	.1230000E+02	.12300000E+02	.10000000E+01
55	.1240000E+02	.12400000E+02	.10000000E+01
56	.1250000E+02	.12500000E+02	.10000000E+01
57	.1260000E+02	.12600000E+02	.10000000E+01

ORIGINAL PAGE IS
OF POOR QUALITY

58	.12700001E+02	.12700001E+02	.100C0000E+01
59	.12800001E+02	.12800001E+02	.100C0000E+01
60	.12900001E+02	.12900001E+02	.100C0000E+01
61	.13000001E+02	.13000001E+02	.100C0000E+01
62	.13100001E+02	.13100001E+02	.100C0000E+01
63	.13200001E+02	.13200001E+02	.100C0000E+01
64	.13300001E+02	.13300001E+02	.100C0000E+01
65	.13400001E+02	.13400001E+02	.100C0000E+01
66	.13500001E+02	.13500001E+02	.100C0000E+01
67	.13600001E+02	.13600001E+02	.100C0000E+01
68	.13700001E+02	.13700001E+02	.100C0000E+01
69	.13800001E+02	.13800001E+02	.100C0000E+01
70	.13900001E+02	.13900001E+02	.100C0000E+01
71	.14000001E+02	.14000001E+02	.100C0000E+01
72	.14100001E+02	.14100001E+02	.100C0000E+01
73	.14200001E+02	.14200001E+02	.100C0000E+01
74	.14300001E+02	.14300001E+02	.100C0000E+01
75	.14400001E+02	.14400001E+02	.100C0000E+01
76	.14500001E+02	.14500001E+02	.100C0000E+01
77	.14600001E+02	.14600001E+02	.100C0000E+01
78	.14700001E+02	.14700001E+02	.100C0000E+01
79	.14800001E+02	.14800001E+02	.100C0000E+01
80	.14900001E+02	.14900001E+02	.100C0000E+01
81	.15000001E+02	.15000001E+02	.100C0000E+01
82	.15100001E+02	.15100001E+02	.100C0000E+01
83	.15200001E+02	.15200001E+02	.100C0000E+01
84	.15300001E+02	.15300001E+02	.100C0000E+01
85	.15400001E+02	.15400001E+02	.100C0000E+01
86	.15500001E+02	.15500001E+02	.100C0000E+01
87	.15600001E+02	.15600001E+02	.100C0000E+01
88	.15700001E+02	.15700001E+02	.100C0000E+01
89	.15800001E+02	.15800001E+02	.100C0000E+01
90	.15900001E+02	.15900001E+02	.100C0000E+01
91	.16000001E+02	.16000001E+02	.100C0000E+01

T(I), I=1, ISTOP	** TANGENTIAL	SURFACE	VELOCITY	**					
.35952428E-02	.22911628E+0C	.42766905E+00	.58156935E+00	.68733008E+0C	.75296780E+00	.79122039E+00	.81378386E+00	.87419363E+0C	.90631049E+0C
.82856C48E+0C	.83760789E+0C	.84849675E+0C	.85571814E+0C	.86154337E+00	.86632233E+00	.87043710E+00	.87419363E+0C	.87780016E+0C	.88141172E+00
.87780016E+0C	.88141172E+00	.88515811E+00	.88911939E+0C	.89329450E+0C	.89761289E+00	.90197768E+00	.90631049E+0C	.91057642E+0C	.91478054E+0C
.91057642E+0C	.91478054E+0C	.91894777E+0C	.92310363E+0C	.92726711E+00	.93145198E+00	.93567222E+00	.93994286E+0C	.94427475E+00	.94867005E+0C
.94427475E+00	.94867005E+0C	.95312667E+0C	.95764676E+00	.96223973E+00	.96692040E+00	.97171252E+00	.97657333E+0C	.98180674E+0C	.98719317E+0C
.98180674E+0C	.98719317E+0C	.99280204E+00	.99858288E+0C	.10044849E+01	.10104857E+01	.10166059E+01	.10229216E+01	.10295694E+01	.10367080E+01
.10295694E+01	.10367080E+01	.10444295E+01	.10526934E+01	.10613582E+01	.10702724E+01	.10793392E+01	.10885311E+01	.10978852E+01	.11074945E+01
.10978852E+01	.11074945E+01	.11174738E+01	.11278964E+01	.11387535E+01	.11499874E+01	.11615527E+01	.11734355E+01	.11856318E+01	.11981389E+01
.11856318E+01	.11981389E+01	.12109758E+01	.12241809E+01	.123776C5E+01	.12516379E+01	.12656655E+01	.12796869E+01	.12936C01E+01	.13073969E+01
.12936C01E+01	.13073969E+01	.13211638E+01	.13350430E+01	.13491572E+01	.13635144E+01	.13779315E+01	.13920392E+01	.14053905E+01	.14176451E+01
.14053905E+01	.14176451E+01	.1428716C+01	.14387234E+01	.14477834E+01	.14558382E+01	.14626549E+01	.14679477E+01	.14715069E+01	.14732666E+01
.14715069E+01	.14732666E+01	.1473283C+01	.14716280E+01	.14682773E+01	.14630887E+01	.14559218E+01	.14468212E+01	.14360966E+01	.1424187C+01
.14360966E+01	.1424187C+01	.14114538E+01	.1398C875E+01	.13841596E+01	.13697093E+01	.13547567E+01	.13392783E+01	.13232223E+01	.13065923E+01
.13232223E+01	.13065923E+01	.12895251E+01	.12722727E+01	.12551142E+01	.12382752E+01	.12219061E+01	.12061282E+01	.11910791E+01	.11768720E+01
.11910791E+01	.11768720E+01	.11634948E+01	.115C7810E+01	.11385136E+01	.11265515E+01	.11148664E+01	.11034958E+01	.10924871E+01	.10811533E+01
.10924871E+01	.10811533E+01	.1071776E+01	.1062186E+01	.1052139E+01	.10446277E+01	.10366250E+01	.10290893E+01	.1021984C+01	.10153058E+01
.1021984C+01	.10153058E+01	.10090646E+01	.10022384E+01	.99778013E+00	.99266861E+00	.98792853E+00	.98358672E+00	.97961516E+0C	.97593045E+0C
.97961516E+0C	.97593045E+0C	.97243892E+0C	.969C7142E+0C	.96578685E+0C	.96256321E+00	.95939241E+00	.95627552E+00	.95321594E+0C	.9502201C+0C
.95321594E+0C	.9502201C+0C	.9473125C+0C	.94454766E+0C	.94199645E+0C	.9397C923E+00	.93768096E+00	.93586354E+00	.93419198E+0C	.93260577E+0C
.93419198E+0C	.93260577E+0C	.93106196E+0C	.92954239E+0C	.928C5258E+0C	.92661074E+00	.92523042E+00	.92390699E+0C	.92261716E+0C	

INTRAC= 1

VTBL(M), M=1, MMAX

.12656795E+01	.12796869E+01	.12936001E+01	.13073969E+01	.13211638E+01	.13350430E+01	.13491572E+01	.13635144E+01
.13779315E+01	.13920392E+01	.14053905E+01	.14176451E+01	.1428716CE+01	.14387234E+01	.14477834E+01	.14558382E+01
.14626549E+01	.14679477E+01	.14715069E+01	.14732666E+01	.14732830E+01	.14716280E+01	.14682773E+01	.14630887E+01
.14559218E+01	.14468212E+01	.14360966E+01	.14241870E+01	.14114538E+01	.13980875E+01	.13841596E+01	.13697093E+01
.13547567E+01	.13392783E+01	.13232223E+01	.13065923E+01	.12895251E+01	.12722727E+01	.12551142E+01	.12382752E+01
.12219061E+01	.12061282E+01	.11910791E+01	.11768720E+01	.11634948E+01	.11507810E+01	.11385136E+01	.11265515E+01
.11148664E+01	.11034958E+01	.10924871E+01	.10818934E+01	.10717768E+01	.10621868E+01	.10531398E+01	.10446277E+01
.1036625CE+01	.10290893E+01	.1021984CE+01	.10153058E+01	.10090646E+01	.10032384E+01	.99778013E+00	.99266861E+00
.98792853E+00	.98358672E+00	.97961516E+00	.97593045E+00	.97243892E+00	.96907142E+00	.96578685E+00	.96256321E+00
.95939241E+00	.95627552E+00	.95321594E+00	.95022010E+00	.9473125CE+00	.94454766E+00	.94199685E+00	.93970923E+00
.93768096E+00	.93586354E+00	.93419198E+00	.93260577E+00	.93106196E+00	.92954239E+00	.92805258E+00	.92661074E+00
.92523042E+00	.92390699E+00	.92261716E+00					

PMFWI(P),M=1,MPAX (WITHOUT RESCRT SCALING)							
.19783874E-01	.19783874E-01	.19828457E-01	.19881594E-01	.19945349E-01	.20022006E-01	.20114104E-01	.20224461E-01
.20356184E-01	.20512669E-01	.20697579E-01	.20914826E-01	.21168553E-01	.21463148E-01	.21803260E-01	.22193818E-01
.22640C24E-01	.23147334E-01	.2372143CE-01	.24368194E-01	.25093683E-01	.25904112E-01	.26805827E-01	.27805257E-01
.28908858E-01	.30123045E-01	.31454133E-01	.329C8318E-01	.34491651E-01	.36209994E-01	.38068936E-01	.40073671E-01
.42228860E-01	.44538473E-01	.47005613E-01	.49632330E-01	.52419435E-01	.55366409E-01	.58471350E-01	.61730981E-01
.65140668E-01	.68694485E-01	.72385107E-01	.762C4C88E-01	.80141731E-01	.84187246E-01	.88328360E-01	.92551076E-01
.96839735E-01	.10117684E+00	.10554322E+00	.10991822E+00	.11428004E+00	.11860616E+00	.12287388E+00	.12706083E+00
.13114545E+00	.13510747E+00	.13892832E+00	.14259146E+00	.14608279E+00	.14939104E+00	.15250792E+00	.15542802E+00
.15814878E+00	.16067051E+00	.16299629E+00	.16513149E+00	.167C8309E+00	.16885901E+00	.17046758E+00	.17191709E+00
.17321548E+00	.17437016E+00	.17538802E+00	.17627543E+00	.17703843E+00	.17768295E+00	.17821512E+00	.17864167E+00
.17897013E+00	.17920880E+00	.17936663E+00	.17945290E+00	.17947704E+00	.17944843E+00	.17937628E+00	.17926959E+00
.17913717E+00	.17898771E+00	.17882978E+00					

INITIAL GUESS CN PMF
.25280CCGE+01 .29750000E+02

SPMF
.700C0C00E+01 .16000000E+02

INTERPOLATED PMF DISTRIBUTION FROM INITIAL GUESS ONTO COMPUTATIONAL MESH							
.25283025E+01	.28304667E+01	.31329333E+01	.34354000E+01	.37378667E+01	.40403333E+01	.43428000E+01	.46452667E+01
.49477333E+01	.52502000E+01	.55526667E+01	.58551333E+01	.61576000E+01	.64600667E+01	.67625333E+01	.70650000E+01
.73674667E+01	.76699333E+01	.79724000E+01	.82748667E+01	.85773333E+01	.88798000E+01	.91822667E+01	.94847333E+01
.97872000E+01	.10089667E+02	.10392133E+02	.10694600E+02	.10997067E+02	.11299533E+02	.11602000E+02	.11904467E+02
.12206933E+02	.12509400E+02	.12811867E+02	.13114333E+02	.13416800E+02	.13719267E+02	.14021733E+02	.14324200E+02
.14626667E+02	.14929133E+02	.15231600E+02	.15534067E+02	.15836533E+02	.16139000E+02	.16441467E+02	.16743933E+02
.17046403E+02	.17348870E+02	.17651336E+02	.17953803E+02	.18256270E+02	.18558736E+02	.18861203E+02	.19163670E+02
.19466136E+02	.19768603E+02	.20071070E+02	.20373536E+02	.20676003E+02	.20978470E+02	.21280936E+02	.21583403E+02
.21885870E+02	.22188336E+02	.22490803E+02	.22793270E+02	.23095736E+02	.23398203E+02	.23700670E+02	.24003136E+02
.24305603E+02	.24608070E+02	.24910536E+02	.25213003E+02	.25515470E+02	.25817936E+02	.26120403E+02	.26422870E+02
.26725336E+02	.27027803E+02	.27330270E+02	.27632736E+02	.27935203E+02	.28237670E+02	.28540136E+02	.28842603E+02
.29145C7CE+02	.29447536E+02	.29750003E+02					

57

ORIGINAL PAGE IS
OF POOR QUALITY

*** INITIAL PROFILES ***

N	ETA(N)	F1(N)	SF1(N)	G1(N)	T(N)	W1(N)
1	.00000E+00	.00000E+00	.00000E+00	1.00000E+00	1.00000E+00	.00000E+00
2	2.89445E-04	2.51587E-04	1.73816E-04	1.00000E+00	1.00000E+00	1.20530E-04
3	6.04941E-04	5.25763E-04	3.63180E-04	1.00000E+00	1.00000E+00	2.51909E-04
4	9.48830E-04	8.24549E-04	5.69474E-04	1.00000E+00	1.00000E+00	3.95111E-04
5	1.32367E-03	1.15015E-03	7.94201E-04	1.00000E+00	1.00000E+00	5.51201E-04
6	1.73225E-03	1.50496E-03	1.03900E-03	1.00000E+00	1.00000E+00	7.21340E-04
7	2.17759E-03	1.89160E-03	1.30563E-03	1.00000E+00	1.00000E+00	9.06790E-04
8	2.66302E-03	2.31291E-03	1.59604E-03	1.00000E+00	1.00000E+00	1.10893E-03
9	3.19214E-03	2.77198E-03	1.91232E-03	1.00000E+00	1.00000E+00	1.32927E-03
10	3.76888E-03	3.27219E-03	2.25675E-03	1.00000E+00	1.00000E+00	1.56943E-03
11	4.39752E-03	3.81720E-03	2.63180E-03	1.00000E+00	1.00000E+00	1.83121E-03
12	5.08274E-03	4.41100E-03	3.04016E-03	1.00000E+00	1.00000E+00	2.11655E-03
13	5.82464E-03	5.05794E-03	3.48474E-03	1.00000E+00	1.00000E+00	2.42757E-03
14	6.64375E-03	5.76275E-03	3.96871E-03	1.00000E+00	1.00000E+00	2.76658E-03
15	7.53113E-03	6.53056E-03	4.49549E-03	1.00000E+00	1.00000E+00	3.13610E-03
16	8.49838E-03	7.36695E-03	5.06879E-03	1.00000E+00	1.00000E+00	3.53888E-03
17	9.55268E-03	8.27802E-03	5.69263E-03	1.00000E+00	1.00000E+00	3.97791E-03
18	1.07019E-02	9.27036E-03	6.37137E-03	1.00000E+00	1.00000E+00	4.45645E-03
19	1.19545E-02	1.03512E-02	7.10972E-03	1.00000E+00	1.00000E+00	4.97807E-03
20	1.33198E-02	1.15282E-02	7.91275E-03	1.00000E+00	1.00000E+00	5.54662E-03
21	1.48081E-02	1.28100E-02	8.78597E-03	1.00000E+00	1.00000E+00	6.16635E-03
22	1.64302E-02	1.42057E-02	9.73530E-03	1.00000E+00	1.00000E+00	6.84185E-03
23	1.81984E-02	1.57253E-02	1.07671E-02	1.00000E+00	1.00000E+00	7.57814E-03
24	2.01257E-02	1.73796E-02	1.18883E-02	1.00000E+00	1.00000E+00	8.38071E-03
25	2.22264E-02	1.91804E-02	1.31063E-02	1.00000E+00	1.00000E+00	9.25550E-03
26	2.45163E-02	2.11405E-02	1.44290E-02	1.00000E+00	1.00000E+00	1.02090E-02
27	2.70122E-02	2.32735E-02	1.58649E-02	1.00000E+00	1.00000E+00	1.12484E-02
28	2.97327E-02	2.55945E-02	1.74231E-02	1.00000E+00	1.00000E+00	1.23812E-02
29	3.26981E-02	2.81195E-02	1.91134E-02	1.00000E+00	1.00000E+00	1.36161E-02
30	3.59304E-02	3.08661E-02	2.09461E-02	1.00000E+00	1.00000E+00	1.49621E-02
31	3.94536E-02	3.38531E-02	2.29323E-02	1.00000E+00	1.00000E+00	1.64292E-02
32	4.32938E-02	3.71009E-02	2.50836E-02	1.00000E+00	1.00000E+00	1.80283E-02
33	4.74797E-02	4.06315E-02	2.74124E-02	1.00000E+00	1.00000E+00	1.97714E-02
34	5.20423E-02	4.44685E-02	2.99317E-02	1.00000E+00	1.00000E+00	2.16713E-02
35	5.70156E-02	4.86372E-02	3.26552E-02	1.00000E+00	1.00000E+00	2.37422E-02
36	6.24365E-02	5.31652E-02	3.55971E-02	1.00000E+00	1.00000E+00	2.59995E-02
37	6.83452E-02	5.80817E-02	3.87721E-02	1.00000E+00	1.00000E+00	2.84600E-02
38	7.47857E-02	6.34181E-02	4.21955E-02	1.00000E+00	1.00000E+00	3.11418E-02
39	8.18058E-02	6.92079E-02	4.58829E-02	1.00000E+00	1.00000E+00	3.40650E-02
40	8.94578E-02	7.54870E-02	4.98501E-02	1.00000E+00	1.00000E+00	3.72512E-02
41	9.77985E-02	8.22934E-02	5.41128E-02	1.00000E+00	1.00000E+00	4.07241E-02
42	1.06890E-01	8.96675E-02	5.86867E-02	1.00000E+00	1.00000E+00	4.45095E-02
43	1.16759E-01	9.76521E-02	6.35868E-02	1.00000E+00	1.00000E+00	4.86355E-02
44	1.27601E-01	1.06292E-01	6.88274E-02	1.00000E+00	1.00000E+00	5.31326E-02
45	1.39374E-01	1.15635E-01	7.44213E-02	1.00000E+00	1.00000E+00	5.80341E-02
46	1.52207E-01	1.25730E-01	8.03797E-02	1.00000E+00	1.00000E+00	6.33765E-02
47	1.66195E-01	1.36628E-01	8.67113E-02	1.00000E+00	1.00000E+00	6.91991E-02
48	1.81442E-01	1.48383E-01	9.34216E-02	1.00000E+00	1.00000E+00	7.55450E-02
49	1.98062E-01	1.61048E-01	1.00512E-01	1.00000E+00	1.00000E+00	8.24609E-02
50	2.16177E-01	1.74678E-01	1.07980E-01	1.00000E+00	1.00000E+00	8.99979E-02
51	2.35922E-01	1.89328E-01	1.15814E-01	1.00000E+00	1.00000E+00	9.82110E-02
52	2.57444E-01	2.05053E-01	1.24000E-01	1.00000E+00	1.00000E+00	1.07160E-01
53	2.80904E-01	2.21906E-01	1.32510E-01	1.00000E+00	1.00000E+00	1.16911E-01
54	3.06475E-01	2.39936E-01	1.41309E-01	1.00000E+00	1.00000E+00	1.27533E-01
55	3.34347E-01	2.59149E-01	1.50350E-01	1.00000E+00	1.00000E+00	1.39103E-01
56	3.64728E-01	2.79706E-01	1.59572E-01	1.00000E+00	1.00000E+00	1.51703E-01
57	3.97842E-01	3.01510E-01	1.68897E-01	1.00000E+00	1.00000E+00	1.65421E-01

58	4.33938E-01	3.24650E-01	1.78233E-01	1.0C0C0E+00	1.00000E+00	1.80351E-01
59	4.73282E-01	3.49112E-01	1.87468E-01	1.0C0C0E+00	1.00000E+00	1.96592E-01
60	5.16166E-01	3.74899E-01	1.96471E-01	1.0C0C0E+00	1.00000E+00	2.14252E-01
61	5.62911E-01	4.01988E-01	2.05091E-01	1.0C0C0E+00	1.00000E+00	2.33439E-01
62	6.13862E-01	4.30341E-01	2.13154E-01	1.0C0C0E+00	1.00000E+00	2.54269E-01
63	6.69399E-01	4.59891E-01	2.20472E-01	1.0C0C0E+00	1.00000E+00	2.76856E-01
64	7.29935E-01	4.90549E-01	2.26834E-01	1.0C0C0E+00	1.00000E+00	3.01314E-01
65	7.95918E-01	5.22196E-01	2.32018E-01	1.0C0C0E+00	1.00000E+00	3.27753E-01
66	8.67840E-01	5.54686E-01	2.35793E-01	1.0C0C0E+00	1.00000E+00	3.56270E-01
67	9.46235E-01	5.87840E-01	2.37922E-01	1.0C0C0E+00	1.00000E+00	3.86943E-01
68	1.03169E+00	6.21451E-01	2.38179E-01	1.0C0C0E+00	1.00000E+00	4.19825E-01
69	1.12483E+00	6.55282E-01	2.36349E-01	1.0C0C0E+00	1.00000E+00	4.54926E-01
70	1.22635E+00	6.85070E-01	2.32250E-01	1.0C0C0E+00	1.00000E+00	4.92201E-01
71	1.33701E+00	7.22529E-01	2.25737E-01	1.0C0C0E+00	1.00000E+00	5.31535E-01
72	1.45763E+00	7.55356E-01	2.16725E-01	1.0C0C0E+00	1.00000E+00	5.72717E-01
73	1.58911E+00	7.87235E-01	2.05196E-01	1.0C0C0E+00	1.00000E+00	6.15427E-01
74	1.73242E+00	8.17843E-01	1.91221E-01	1.0C0C0E+00	1.00000E+00	6.59213E-01
75	1.88863E+00	8.46857E-01	1.74972E-01	1.0C0C0E+00	1.00000E+00	7.03482E-01
76	2.05884E+00	8.73953E-01	1.56740E-01	1.0C0C0E+00	1.00000E+00	7.47493E-01
77	2.24448E+00	8.98822E-01	1.36950E-01	1.0C0C0E+00	1.00000E+00	7.90371E-01
78	2.44677E+00	9.21171E-01	1.16170E-01	1.0C0C0E+00	1.00000E+00	8.31142E-01
79	2.66727E+00	9.40743E-01	9.51130E-02	1.0C0C0E+00	1.00000E+00	8.68791E-01
80	2.90762E+00	9.57343E-01	7.46116E-02	1.0C0C0E+00	1.00000E+00	9.02350E-01
81	3.16959E+00	9.70866E-01	5.55619E-02	1.0C0C0E+00	1.00000E+00	9.31010E-01
82	3.45514E+00	9.81343E-01	3.88226E-02	1.0C0C0E+00	1.00000E+00	9.54243E-01
83	3.76640E+00	9.88962E-01	2.50776E-02	1.0C0C0E+00	1.00000E+00	9.71912E-01
84	4.10566E+00	9.94081E-01	1.46920E-02	1.0C0C0E+00	1.00000E+00	9.84334E-01
85	4.47546E+00	9.97195E-01	7.61185E-03	1.0C0C0E+00	1.00000E+00	9.92252E-01
86	4.87854E+00	9.98865E-01	3.36815E-03	1.0C0C0E+00	1.00000E+00	9.96716E-01
87	5.31790E+00	9.99628E-01	1.20922E-03	1.0C0C0E+00	1.00000E+00	9.98865E-01
88	5.79680E+00	9.99909E-01	3.23635E-04	1.0C0C0E+00	1.00000E+00	9.99706E-01
89	6.31880E+00	9.99986E-01	5.43557E-05	1.0C0C0E+00	1.00000E+00	9.99952E-01
90	6.88778E+00	9.99999E-01	3.10689E-06	1.0C0C0E+00	1.00000E+00	9.99997E-01
91	7.50797E+00	1.00000E+00	-2.68221E-07	1.0C0C0E+00	1.00000E+00	1.00000E+00
92	8.18398E+00	1.00000E+00	1.34110E-07	1.0C0C0E+00	1.00000E+00	1.00000E+00
93	8.92083E+00	1.00000E+00	1.26660E-07	1.0C0C0E+00	1.00000E+00	1.00000E+00
94	9.72399E+00	1.0C0C0E+00	1.26660E-07	1.0C0C0E+00	1.00000E+00	1.00000E+00
95	1.05994E+01	1.00000E+00	1.22935E-07	1.0C0C0E+00	1.00000E+00	1.00000E+00
96	1.15537E+01	1.00000E+00	2.98023E-08	1.0C0C0E+00	1.00000E+00	1.00000E+00
97	1.25938E+01	1.00000E+00	1.41561E-07	1.0C0C0E+00	1.00000E+00	1.00000E+00
98	1.37275E+01	1.00000E+00	1.37836E-07	1.0C0C0E+00	1.00000E+00	1.00000E+00
99	1.44633E+01	1.00000E+00	1.37836E-07	1.0C0C0E+00	1.00000E+00	1.00000E+00
100	1.63103E+01	1.00000E+00	1.37836E-07	1.0C0C0E+00	1.00000E+00	1.00000E+00

ORIGINAL PAGE IS
OF POOR QUALITY

INTRAC= 1

M = 1 S(1) = 7.00010E+00 PMF(1) = 2.5283CE+00 UEP(1) = 1.26568E+00 AH(1) = .0C000E+00 AMACH = .00000E+00 XC = 6.69127E+00

*** INVERSE B.L. CALCULATIONS - SUMMARY CHART NO. 1 ***

M	XOCBL(M)	NU	PMF(M)	PMFCHK(M)	BETA(M)	RETCHK	UEP(M)	AMACH(M)	AH(M)	CF(M)	CFZ(M)	ALPHW(M)	NMCH	RTHETA(M)
2	7.1C00	3	.2830E+01	.2830E+01	-.3652E-01	-.3652E-01	1.2598	.0000	.0000E+00	.4213E-02	.9590E-03	.1282E+02	0	205.80
3	7.2C00	3	.3133E+01	.3133E+01	-.5335E-01	-.5335E-01	1.2512	.0000	.0000E+00	.3020E-02	.8607E-03	.1591E+02	0	215.18
4	7.3C00	3	.3435E+01	.3435E+01	-.5661E-01	-.5661E-01	1.2420	.0000	.0000E+00	.2242E-02	.7847E-03	.1929E+02	0	224.37
5	7.4C00	3	.3738E+01	.3738E+01	-.5551E-01	-.5551E-01	1.2330	.0000	.0000E+00	.1692E-02	.7224E-03	.2312E+02	0	233.22
6	7.5C00	3	.4040E+01	.4040E+01	-.5278E-01	-.5278E-01	1.2244	.0000	.0000E+00	.1285E-02	.6698E-03	.2752E+02	0	241.70
7	7.6C00	3	.4343E+01	.4343E+01	-.4949E-01	-.4949E-01	1.2163	.0000	.0000E+00	.9764E-03	.6245E-03	.3260E+02	0	249.82
8	7.7C00	3	.4645E+01	.4645E+01	-.4609E-01	-.4609E-01	1.2087	.0000	.0000E+00	.7364E-03	.5849E-03	.3846E+02	0	257.59
9	7.8C00	3	.4948E+01	.4948E+01	-.4271E-01	-.4271E-01	1.2016	.0000	.0000E+00	.5471E-03	.5491E-03	.4516E+02	0	265.03

.14102904E+01	.13007079E+01	.12069280E+01	.11627404E+01	.11417472E+01	.11286471E+01	.11179508E+01	.11080579E+01
.1098405E+01	.10888030E+01	.10792487E+01	.10697839E+01	.10604758E+01	.10513932E+01	.10425926E+01	.10341135E+01
.10259854E+01	.10182259E+01	.10108447E+01	.10038538E+01	.99726064E+00	.99106638E+00	.98526212E+00	.97983984E+00
.9747949CE+0C	.97012053E+0C	.96579748E+0C	.96179279E+0C	.95806813E+0C	.95458720E+0C	.95132029E+00	.94824363E+00
.94533599E+0C	.94259805E+0C	.94001078E+0C	.93757549E+0C	.93529542E+00	.93318073E+00	.93124518E+00	.92949805E+00
.92793624E+0C	.92654519E+0C	.92530289E+0C	.92418632E+0C	.92317511E+00	.92225605E+00	.92141961E+00	.92067406E+0C
.91958559E+0C	.91948157E+0C	.91878626E+00					

*** SUMMARY OF CONVERGENCE HISTORY ***

INTRAC	DDTMAX	RMSDT	SMDT	DUEMAX	RMSUE	SMUE	DSFMAX	DFMAX	DGMAX
90	-.888CCE-03	.60502E-04	.11000E+02	-.2663CE-03	.98338E-05	.97000E+01	-I	-I	-I

*** SUMMARY OF CONVERGENCE HISTORY ***

INTRAC	DDTMAX	RMSDT	SMDT	DUEMAX	RMSUE	SMUE	DSFMAX	DFMAX	DGMAX
91	-.766C5E-03	.51952E-04	.10200E+02	-.23675E-03	.86086E-05	.97000E+01	-I	-I	-I

*** SUMMARY OF CONVERGENCE HISTORY ***

09

INTRAC	DDTMAX	RMSDT	SMDT	DUEMAX	RMSUE	SMUE	DSFMAX	DFMAX	DGMAX
92	-.66869E-03	.44448E-04	.10100E+02	-.21003E-03	.75195E-05	.97000E+01	-I	-I	-I

*** SUMMARY OF CONVERGENCE HISTORY ***

INTRAC	DDTMAX	RMSDT	SMDT	DUEMAX	RMSUE	SMUE	DSFMAX	DFMAX	DGMAX
93	-.58295E-03	.37877E-04	.10100E+02	-.18593E-03	.65532E-05	.97000E+01	-I	-I	-I

*** SUMMARY OF CONVERGENCE HISTORY ***

INTRAC	DDTMAX	RMSDT	SMDT	DUEMAX	RMSUE	SMUE	DSFMAX	DFMAX	DGMAX
94	-.50675E-03	.32138E-04	.10100E+02	-.16444E-03	.56976E-05	.96000E+01	-I	-I	-I

*** SUMMARY OF CONVERGENCE HISTORY ***

INTRAC	DDTMAX	RMSDT	SMDT	DUEMAX	RMSUE	SMUE	DSFMAX	DFMAX	DGMAX
95	-.44095E-03	.27139E-04	.10000E+02	-.14544E-03	.47415E-05	.96000E+01	-I	-I	-I

*** SUMMARY OF CONVERGENCE HISTORY ***

INTRAC	DDTMAX	RMSDT	SMDT	DUEMAX	RMSUE	SMUE	DSFMAX	DFMAX	DGMAX
--------	--------	-------	------	--------	-------	------	--------	-------	-------

96 -.38257E-03 .22797E-04 .10000E+02 -.12835E-03 .42747E-05 .96000E+01 -I -I -I

*** SUMMARY OF CONVERGENCE HISTORY ***

INTRAC ODTMAX RMSDT SMDT DUEPAX RMSUE SMUE DSFMAX DFMAX DGMAX
 97 -.33091E-03 .19038E-04 .10000E+02 -.11301E-03 .36880E-05 .96000E+01 -I -I -I

*** SUMMARY OF CONVERGENCE HISTORY ***

INTRAC ODTMAX RMSDT SMDT DUEPAX RMSUE SMUE DSFMAX DFMAX DGMAX
 98 -.28553E-03 .15800E-04 .99000E+01 -.99271E-04 .31735E-05 .96000E+01 -I -I -I

*** SUMMARY OF CONVERGENCE HISTORY ***

INTRAC ODTMAX RMSDT SMDT DUEPAX RMSUE SMUE DSFMAX DFMAX DGMAX
 99 -.24660E-03 .13016E-04 .99000E+01 -.86985E-04 .27228E-05 .96000E+01 -I -I -I

INTRAC=100

61

M = 1 S(1) = 7.00010E+00 PMF(1) = 2.52830E+00 UEP(1) = 1.26568E+00 AH(1) = .00000E+00 AMACH = .00000E+00 XC = 6.69127E+00

*** INVERSE B.L. CALCULATIONS - SUMMARY CHART NO. 1 ***

M	XOCEL(M)	NO	PMF(M)	PMFCHK(M)	BETA(M)	BETCHK	UEP(M)	AMACH(M)	AH(M)	CF(M)	CFZ(M)	ALPHW(M)	NPCH	RTHETA(M)
2	7.1000	2	.2536E+01	.2536E+01	.8505E-01	.8505E-01	1.2794	.0000	.0000E+00	.6696E-02	.1118E-02	.9481E+01	0	197.29
3	7.2000	2	.2546E+01	.2546E+01	.8291E-01	.8291E-01	1.2932	.0000	.0000E+00	.6785E-02	.1119E-02	.9365E+01	0	197.91
4	7.3000	2	.2557E+01	.2557E+01	.8062E-01	.8062E-01	1.3068	.0000	.0000E+00	.6869E-02	.1120E-02	.9259E+01	0	198.62
5	7.4000	2	.2569E+01	.2569E+01	.7886E-01	.7886E-01	1.3204	.0000	.0000E+00	.6956E-02	.1121E-02	.9151E+01	0	199.40
6	7.5000	2	.2581E+01	.2581E+01	.7757E-01	.7757E-01	1.3341	.0000	.0000E+00	.7052E-02	.1122E-02	.9040E+01	0	200.21

PROFILES AT M= 6 S(P)=R 7.50000E+00 INVRSE= 1 PMF(M)= 2.58140E+00 BETA(M)= 7.75679E-02

N	ETA(N)	YBL(N)	F2(N)	SF2(N)	G2(N)	EPSRAR(N)	RHOMUR(N)	T(N)
1	.00000E+00	-I	.00000E+00	.00000E+00	1.00000E+00	1.00000E+00	1.00000E+00	1.00000E+00
2	2.89445E-04	3.36372E-06	2.46453E-04	1.66008E-04	1.00000E+00	1.00000E+00	1.00000E+00	1.00000E+00
3	6.04941E-04	7.03018E-06	5.15037E-04	3.46869E-04	1.00000E+00	1.00000E+00	1.00000E+00	1.00000E+00
4	9.48830E-04	1.10266E-05	8.07735E-04	5.43904E-04	1.00000E+00	1.00000E+00	1.00000E+00	1.00000E+00
5	1.32367E-03	1.53827E-05	1.12671E-03	7.58547E-04	1.00000E+00	1.00000E+00	1.00000E+00	1.00000E+00
6	1.73225E-03	2.01309E-05	1.47430E-03	9.92360E-04	1.00000E+00	1.00000E+00	1.00000E+00	1.00000E+00
7	2.17759E-03	2.53064E-05	1.85308E-03	1.24704E-03	1.00000E+00	1.00000E+00	1.00000E+00	1.00000E+00
8	2.66302E-03	3.09477E-05	2.26584E-03	1.52444E-03	1.00000E+00	1.00000E+00	1.00000E+00	1.00000E+00
9	3.19214E-03	3.70967E-05	2.71560E-03	1.82655E-03	1.00000E+00	1.00000E+00	1.00000E+00	1.00000E+00
10	3.76888E-03	4.37991E-05	3.20568E-03	2.15556E-03	1.00000E+00	1.00000E+00	1.00000E+00	1.00000E+00
11	4.39752E-03	5.11048E-05	3.73967E-03	2.51384E-03	1.00000E+00	1.00000E+00	1.00000E+00	1.00000E+00
12	5.08274E-03	5.90679E-05	4.32149E-03	2.90394E-03	1.00000E+00	1.00000E+00	1.00000E+00	1.00000E+00
13	5.82964E-03	6.77478E-05	4.95539E-03	3.32866E-03	1.00000E+00	1.00000E+00	1.00000E+00	1.00000E+00
14	6.64375E-03	7.72084E-05	5.64601E-03	3.79103E-03	1.00000E+00	1.00000E+00	1.00000E+00	1.00000E+00
15	7.52111E-03	8.75213E-05	6.49841E-03	4.29471E-03	1.00000E+00	1.00000E+00	1.00000E+00	1.00000E+00

ORIGINAL PAGE IS
OF POOR QUALITY

87	1.00000E+00	-3.92730E-09	1.75564E+01
88	1.00000E+00	-2.71096E-08	1.75564E+01
89	1.00000E+00	-2.59788E-09	1.75564E+01
90	1.00000E+00	1.14897E-09	1.75564E+01
91	1.00000E+00	-7.02582E-09	1.75564E+01
92	1.00000E+00	-2.58098E-09	1.75564E+01
93	1.00000E+00	1.57389E-09	1.75564E+01
94	1.00000E+00	-3.68435E-11	1.75564E+01
95	1.00000E+00	1.32922E-10	1.75564E+01
96	1.00000E+00	1.35049E-09	1.75564E+01
97	1.00000E+00	2.59533E-11	1.75564E+01
98	1.00000E+00	-6.19827E-10	1.75564E+01
99	1.00000E+00	5.29244E-11	1.75564E+01
100	1.00000E+00	0.00000E+00	1.75564E+01

M	XOCP(L) (M)	KO	PMF (M)	PMFCHK (M)	BETA (M)	BETCHK	UEP (M)	AMACH (M)	AH (M)	CF (M)	CFZ (M)	ALPHW (M), NMCH	RTHETA (M)
42	11.1000	8	.2204E+02	.2204E+02	-.5967E+00	-.5955E+00	1.3007	.0000	.0000E+00	-.1071E-01	.2323E-02	-.1223E+02	67 773.91

PROFILES AT M= 42 S(M)=R 1.11000E+01 INVRSE= 1 PPF(M)= 2.20399E+01 BETA(M)= -5.96731E-01

N	ETA(N)	YBL(N)	F2(N)	SF2(N)	G2(N)	EPSBAR(N)	RHOMUR(N)	T(N)
1	0.00000E+00	2.94552E-05	-1.00000E+00	0.00000E+00	1.00000E+00	1.00000E+00	1.00000E+00	1.00000E+00
2	2.89445E-04	6.15613E-05	-3.35116E-03	-1.00000E+00	1.00000E+00	1.00000E+00	1.00000E+00	1.00000E+00
3	6.04941E-04	9.65570E-05	-6.97632E-03	-3.08406E-02	1.00000E+00	1.00000E+00	1.00000E+00	1.00000E+00
4	9.48830E-04	1.34702E-04	-1.08950E-02	-4.81561E-02	1.00000E+00	1.00000E+00	1.00000E+00	1.00000E+00
5	1.32367E-03	1.76281E-04	-1.51277E-02	-6.68520E-02	1.00000E+00	1.00000E+00	1.00000E+00	1.00000E+00
6	1.73225E-03	2.21601E-04	-2.46198E-02	-1.08754E-01	1.00000E+00	1.00001E+00	1.00000E+00	1.00000E+00
7	2.17759E-03	2.71001E-04	-2.99232E-02	-1.32145E-01	1.00000E+00	1.00002E+00	1.00000E+00	1.00000E+00
8	2.66302E-03	3.24846E-04	-3.56279E-02	-1.57302E-01	1.00000E+00	1.00004E+00	1.00000E+00	1.00000E+00
9	3.19214E-03	3.83537E-04	-4.17562E-02	-1.84307E-01	1.00000E+00	1.00008E+00	1.00000E+00	1.00000E+00
10	3.76888E-03	4.47511E-04	-4.83300E-02	-2.13259E-01	1.00000E+00	1.00015E+00	1.00000E+00	1.00000E+00
11	4.39752E-03	5.17242E-04	-5.53703E-02	-2.44244E-01	1.00000E+00	1.00025E+00	1.00000E+00	1.00000E+00
12	5.08274E-03	5.93249E-04	-6.29264E-02	-2.77345E-01	1.00000E+00	1.00043E+00	1.00000E+00	1.00000E+00
13	5.82964E-03	6.76096E-04	-7.09264E-02	-3.12632E-01	1.00000E+00	1.00070E+00	1.00000E+00	1.00000E+00
14	6.64375E-03	7.66400E-04	-7.94740E-02	-3.50162E-01	1.00000E+00	1.00113E+00	1.00000E+00	1.00000E+00
15	7.53113E-03	8.64831E-04	-8.85498E-02	-3.89974E-01	1.00000E+00	1.00177E+00	1.00000E+00	1.00000E+00
16	8.49838E-03	9.72121E-04	-9.81588E-02	-4.32083E-01	1.00000E+00	1.00272E+00	1.00000E+00	1.00000E+00
17	9.55268E-03	1.08907E-03	-1.08300E-01	-4.76472E-01	1.00000E+00	1.00412E+00	1.00000E+00	1.00000E+00
18	1.07019E-02	1.21654E-03	-1.18962E-01	-5.23088E-01	1.00000E+00	1.00613E+00	1.00000E+00	1.00000E+00
19	1.19545E-02	1.35548E-03	-1.30125E-01	-5.71830E-01	1.00000E+00	1.00899E+00	1.00000E+00	1.00000E+00
20	1.33198E-02	1.50693E-03	-1.41757E-01	-6.22540E-01	1.00000E+00	1.01299E+00	1.00000E+00	1.00000E+00
21	1.48081E-02	1.67201E-03	-1.53807E-01	-6.74956E-01	1.00000E+00	1.01852E+00	1.00000E+00	1.00000E+00
22	1.64302E-02	1.85195E-03	-1.66211E-01	-7.28897E-01	1.00000E+00	1.02602E+00	1.00000E+00	1.00000E+00
23	1.81984E-02	2.04808E-03	-1.78882E-01	-7.83856E-01	1.00000E+00	1.03606E+00	1.00000E+00	1.00000E+00
24	2.01257E-02	2.26186E-03	-1.91713E-01	-8.39393E-01	1.00000E+00	1.04925E+00	1.00000E+00	1.00000E+00
25	2.22264E-02	2.49488E-03	-2.04573E-01	-8.94934E-01	1.00000E+00	1.06628E+00	1.00000E+00	1.00000E+00
26	2.45163E-02	2.74888E-03	-2.17311E-01	-9.49810E-01	1.00000E+00	1.08785E+00	1.00000E+00	1.00000E+00
27	2.70322E-02	3.02573E-03	-2.29753E-01	-1.00327E+00	1.00000E+00	1.11462E+00	1.00000E+00	1.00000E+00
28	2.97327E-02	3.32750E-03	-2.41712E-01	-1.05450E+00	1.00000E+00	1.14714E+00	1.00000E+00	1.00000E+00
29	3.26981E-02	3.65643E-03	-2.52984E-01	-1.10264E+00	1.00000E+00	1.18580E+00	1.00000E+00	1.00000E+00
30	3.59304E-02	4.01496E-03	-2.63359E-01	-1.14679E+00	1.00000E+00	1.23080E+00	1.00000E+00	1.00000E+00
31	3.94536E-02	4.40577E-03	-2.72615E-01	-1.18603E+00	1.00000E+00	1.28222E+00	1.00000E+00	1.00000E+00
32	4.32938E-02	4.83174E-03	-2.80522E-01	-1.21941E+00	1.00000E+00	1.34036E+00	1.00000E+00	1.00000E+00
33	4.74797E-02	5.29605E-03	-2.86831E-01	-1.24552E+00	1.00000E+00	1.40664E+00	1.00000E+00	1.00000E+00
34	5.20423E-02	5.80215E-03	-2.91259E-01	-1.26443E+00	1.00000E+00	1.48578E+00	1.00000E+00	1.00000E+00
35	5.70156E-02	6.35380E-03	-2.93486E-01	-1.27369E+00	1.00000E+00	1.59000E+00	1.00000E+00	1.00000E+00
36	6.24365E-02	6.95510E-03	-2.93181E-01	-1.27243E+00	1.00000E+00	1.74388E+00	1.00000E+00	1.00000E+00
37	6.83452E-02	7.61051E-03	-2.91021E-01	-1.25979E+00	1.00000E+00	1.92906E+00	1.00000E+00	1.00000E+00
38	7.47857E-02	8.32491E-03	-2.84422E-01	-1.23527E+00	1.00000E+00	2.24323E+00	1.00000E+00	1.00000E+00
39	8.18054E-02	9.10291E-03	-2.72922E-01	-1.19999E+00	1.00000E+00	2.69999E+00	1.00000E+00	1.00000E+00

40	8.94578E-02	9.10361E-03	-2.75743E-01	-1.20154E+00	1.00000E+00	2.85211E+00	1.00000E+00	1.00000E+00
41	9.77985E-02	9.95239E-03	-2.64980E-01	-1.15846E+00	1.00000E+00	3.53316E+00	1.00000E+00	1.00000E+00
42	1.06890E-01	1.08776E-02	-2.52251E-01	-1.10787E+00	1.00000E+00	4.41356E+00	1.00000E+00	1.00000E+00
43	1.16799E-01	1.18860E-02	-2.37825E-01	-1.05121E+00	1.00000E+00	5.52727E+00	1.00000E+00	1.00000E+00
44	1.27601E-01	1.29852E-02	-2.21905E-01	-9.89415E-01	1.00000E+00	6.91626E+00	1.00000E+00	1.00000E+00
45	1.39374E-01	1.41833E-02	-2.04637E-01	-9.23247E-01	1.00000E+00	8.63111E+00	1.00000E+00	1.00000E+00
46	1.52207E-01	1.54893E-02	-1.86119E-01	-8.53297E-01	1.00000E+00	1.07308E+01	1.00000E+00	1.00000E+00
47	1.66195E-01	1.69128E-02	-1.66409E-01	-7.80013E-01	1.00000E+00	1.32836E+01	1.00000E+00	1.00000E+00
48	1.81442E-01	1.84644E-02	-1.45533E-01	-7.03744E-01	1.00000E+00	1.63674E+01	1.00000E+00	1.00000E+00
49	1.98062E-01	2.01556E-02	-1.23490E-01	-6.24763E-01	1.00000E+00	2.00701E+01	1.00000E+00	1.00000E+00
50	2.16177E-01	2.19991E-02	-1.00256E-01	-5.43303E-01	1.00000E+00	2.44896E+01	1.00000E+00	1.00000E+00
51	2.35422E-01	2.40084E-02	-7.57907E-02	-4.59570E-01	1.00000E+00	2.97342E+01	1.00000E+00	1.00000E+00
52	2.57444E-01	2.61987E-02	-5.00349E-02	-3.73771E-01	1.00000E+00	3.59225E+01	1.00000E+00	1.00000E+00
53	2.86904E-01	2.85860E-02	-2.29182E-02	-2.86136E-01	1.00000E+00	4.31839E+01	1.00000E+00	1.00000E+00
54	3.06475E-01	3.11882E-02	5.64188E-03	-1.96932E-01	1.00000E+00	5.16520E+01	1.00000E+00	1.00000E+00
55	3.34347E-01	3.40246E-02	3.57285E-02	-1.06515E-01	1.00000E+00	6.14515E+01	1.00000E+00	1.00000E+00
56	3.64728E-01	3.71162E-02	6.73772E-02	-1.54810E-02	1.00000E+00	7.25846E+01	1.00000E+00	1.00000E+00
57	3.97842E-01	4.04862E-02	1.00660E-01	7.55809E-02	1.00000E+00	8.53759E+01	1.00000E+00	1.00000E+00
58	4.33938E-01	4.41594E-02	1.35678E-01	1.66021E-01	1.00000E+00	1.00043E+02	1.00000E+00	1.00000E+00
59	4.73282E-01	4.81632E-02	1.72562E-01	2.55100E-01	1.00000E+00	1.16899E+02	1.00000E+00	1.00000E+00
60	5.16166E-01	5.25273E-02	2.11470E-01	3.42086E-01	1.00000E+00	1.36318E+02	1.00000E+00	1.00000E+00
61	5.62911E-01	5.72842E-02	2.52584E-01	4.25803E-01	1.00000E+00	1.58769E+02	1.00000E+00	1.00000E+00
62	6.13862E-01	6.24692E-02	2.96116E-01	5.05040E-01	1.00000E+00	1.84798E+02	1.00000E+00	1.00000E+00
63	6.69399E-01	6.81209E-02	3.42298E-01	5.78226E-01	1.00000E+00	2.15200E+02	1.00000E+00	1.00000E+00
64	7.29935E-01	7.42813E-02	3.91416E-01	6.43400E-01	1.00000E+00	2.50836E+02	1.00000E+00	1.00000E+00
65	7.95918E-01	8.09960E-02	4.43775E-01	6.98351E-01	1.00000E+00	2.90964E+02	1.00000E+00	1.00000E+00
66	8.67840E-01	8.83151E-02	4.98959E-01	7.39377E-01	1.00000E+00	3.42094E+02	1.00000E+00	1.00000E+00
67	9.46235E-01	9.62930E-02	5.59212E-01	7.64147E-01	1.00000E+00	3.50149E+02	1.00000E+00	1.00000E+00
68	1.03169E+00	1.04989E-01	6.26188E-01	7.67416E-01	1.00000E+00	3.50149E+02	1.00000E+00	1.00000E+00
69	1.12483E+00	1.14467E-01	6.95473E-01	7.43440E-01	1.00000E+00	3.50149E+02	1.00000E+00	1.00000E+00
70	1.22635E+00	1.24799E-01	7.61027E-01	6.92538E-01	1.00000E+00	3.50149E+02	1.00000E+00	1.00000E+00
71	1.33701E+00	1.36060E-01	8.18371E-01	6.21110E-01	1.00000E+00	3.50149E+02	1.00000E+00	1.00000E+00
72	1.45763E+00	1.48335E-01	8.65614E-01	5.38104E-01	1.00000E+00	3.50149E+02	1.00000E+00	1.00000E+00
73	1.58911E+00	1.61715E-01	9.02855E-01	4.51913E-01	1.00000E+00	3.50149E+02	1.00000E+00	1.00000E+00
74	1.73242E+00	1.76298E-01	9.31217E-01	3.69042E-01	1.00000E+00	3.50149E+02	1.00000E+00	1.00000E+00
75	1.88863E+00	1.92195E-01	9.52212E-01	2.93789E-01	1.00000E+00	3.50149E+02	1.00000E+00	1.00000E+00
76	2.05889E+00	2.09522E-01	9.67384E-01	2.28461E-01	1.00000E+00	3.50149E+02	1.00000E+00	1.00000E+00
77	2.24448E+00	2.28408E-01	9.78112E-01	1.73821E-01	1.00000E+00	3.50149E+02	1.00000E+00	1.00000E+00
78	2.44677E+00	2.48994E-01	9.85550E-01	1.29565E-01	1.00000E+00	3.50149E+02	1.00000E+00	1.00000E+00
79	2.66727E+00	2.71433E-01	9.90608E-01	9.47354E-02	1.00000E+00	3.50149E+02	1.00000E+00	1.00000E+00
80	2.90762E+00	2.95892E-01	9.93986E-01	6.80328E-02	1.00000E+00	3.50149E+02	1.00000E+00	1.00000E+00
81	3.16959E+00	3.22551E-01	9.96203E-01	4.80529E-02	1.00000E+00	3.50149E+02	1.00000E+00	1.00000E+00
82	3.45514E+00	3.51610E-01	9.97633E-01	3.34252E-02	1.00000E+00	3.50149E+02	1.00000E+00	1.00000E+00
83	3.76640E+00	3.83285E-01	9.98541E-01	2.29401E-02	1.00000E+00	3.50149E+02	1.00000E+00	1.00000E+00
84	4.10566E+00	4.17810E-01	9.99110E-01	1.55518E-02	1.00000E+00	3.50149E+02	1.00000E+00	1.00000E+00
85	4.47546E+00	4.55442E-01	9.99462E-01	1.04310E-02	1.00000E+00	3.50149E+02	1.00000E+00	1.00000E+00
86	4.87854E+00	4.96461E-01	9.99678E-01	6.93208E-03	1.00000E+00	3.50149E+02	1.00000E+00	1.00000E+00
87	5.31790E+00	5.41172E-01	9.99808E-01	4.57072E-03	1.00000E+00	3.50149E+02	1.00000E+00	1.00000E+00
88	5.79680E+00	5.89907E-01	9.99886E-01	2.99388E-03	1.00000E+00	3.50149E+02	1.00000E+00	1.00000E+00
89	6.31880E+00	6.43028E-01	9.99933E-01	1.95028E-03	1.00000E+00	3.50149E+02	1.00000E+00	1.00000E+00
90	6.88778E+00	7.00930E-01	9.99960E-01	1.26471E-03	1.00000E+00	3.50149E+02	1.00000E+00	1.00000E+00
91	7.50797E+00	7.64043E-01	9.99977E-01	8.17064E-04	1.00000E+00	3.50149E+02	1.00000E+00	1.00000E+00
92	8.18398E+00	8.32937E-01	9.99986E-01	5.26166E-04	1.00000E+00	3.50149E+02	1.00000E+00	1.00000E+00
93	8.92083E+00	9.07822E-01	9.99992E-01	3.37800E-04	1.00000E+00	3.50149E+02	1.00000E+00	1.00000E+00
94	9.72349E+00	9.89555E-01	9.99995E-01	2.16240E-04	1.00000E+00	3.50149E+02	1.00000E+00	1.00000E+00
95	1.05944E+01	1.07864E+00	9.99997E-01	1.38173E-04	1.00000E+00	3.50149E+02	1.00000E+00	1.00000E+00
96	1.15537E+01	1.17575E+00	9.99998E-01	8.71891E-05	1.00000E+00	3.50149E+02	1.00000E+00	1.00000E+00
97	1.25938E+01	1.28160E+00	9.99999E-01	5.63636E-05	1.00000E+00	3.50149E+02	1.00000E+00	1.00000E+00
98	1.37275E+01	1.37647E+00	9.99999E-01	3.19236E-05	1.00000E+00	3.50149E+02	1.00000E+00	1.00000E+00
99	1.49633E+01	1.52273E+00	1.00000E+00	2.68853E-05	1.00000E+00	3.50149E+02	1.00000E+00	1.00000E+00
100	1.63103E+01	1.75990E+00	1.00000E+00	2.00000E-05	1.00000E+00	3.50149E+02	1.00000E+00	1.00000E+00

N	WZ(N)	BETZ(N)	ALPHZ(N)
1	.0C0C0E+00	-3.11681E+01	-1.22342E+01
2	2.12593E-03	-3.12111E+01	-1.22772E+01
3	4.44323E-03	-3.12583E+01	-1.23244E+01
4	6.96918E-03	-3.13101E+01	-1.23762E+01
5	9.72262E-03	-3.13671E+01	-1.24332E+01
6	1.27241E-02	-3.14297E+01	-1.24958E+01
7	1.59962E-02	-3.14986E+01	-1.25648E+01
8	1.95632E-02	-3.15745E+01	-1.26407E+01
9	2.34521E-02	-3.16582E+01	-1.27243E+01
10	2.76921E-02	-3.17504E+01	-1.28165E+01
11	3.23151E-02	-3.18522E+01	-1.29183E+01
12	3.73559E-02	-3.19645E+01	-1.30307E+01
13	4.28526E-02	-3.20888E+01	-1.31549E+01
14	4.88465E-02	-3.22262E+01	-1.32923E+01
15	5.53829E-02	-3.23782E+01	-1.34444E+01
16	6.25106E-02	-3.25467E+01	-1.36129E+01
17	7.02824E-02	-3.27335E+01	-1.37997E+01
18	7.87552E-02	-3.29408E+01	-1.40069E+01
19	8.79895E-02	-3.31708E+01	-1.42370E+01
20	9.80489E-02	-3.34263E+01	-1.44925E+01
21	1.09000E-01	-3.37102E+01	-1.47763E+01
22	1.20909E-01	-3.40256E+01	-1.50917E+01
23	1.33844E-01	-3.43759E+01	-1.54421E+01
24	1.47866E-01	-3.47650E+01	-1.58311E+01
25	1.63032E-01	-3.51968E+01	-1.62629E+01
26	1.79388E-01	-3.56755E+01	-1.67416E+01
27	1.96967E-01	-3.62056E+01	-1.72717E+01
28	2.15784E-01	-3.67918E+01	-1.78579E+01
29	2.35839E-01	-3.74394E+01	-1.85055E+01
30	2.57112E-01	-3.81542E+01	-1.92203E+01
31	2.79569E-01	-3.89431E+01	-2.00092E+01
32	3.03162E-01	-3.98145E+01	-2.08806E+01
33	3.27833E-01	-4.07793E+01	-2.18454E+01
34	3.53504E-01	-4.18513E+01	-2.29174E+01
35	3.80047E-01	-4.30476E+01	-2.41137E+01
36	4.07206E-01	-4.43863E+01	-2.54525E+01
37	4.34466E-01	-4.58804E+01	-2.69465E+01
38	4.60985E-01	-4.75288E+01	-2.85949E+01
39	4.85777E-01	-4.93169E+01	-3.03830E+01
40	5.08076E-01	-5.12296E+01	-3.22958E+01
41	5.27530E-01	-5.32643E+01	-3.43304E+01
42	5.44140E-01	-5.54345E+01	-3.65006E+01
43	5.58104E-01	-5.77682E+01	-3.88343E+01
44	5.69712E-01	-6.03044E+01	-4.13705E+01
45	5.79274E-01	-6.30924E+01	-4.41585E+01
46	5.87089E-01	-6.61912E+01	-4.72573E+01
47	5.93434E-01	-6.96695E+01	-5.07357E+01
48	5.98557E-01	-7.36055E+01	-5.46716E+01
49	6.02676E-01	-7.80833E+01	-5.91494E+01
50	6.05983E-01	-8.31863E+01	-6.42524E+01
51	6.08649E-01	-8.89830E+01	-7.00491E+01
52	6.10825E-01	-9.55038E+01	-7.65699E+01
53	6.12646E-01	-1.02710E+02	-8.37764E+01
54	6.14238E-01	6.95323E+01	8.84662E+01
55	6.15714E-01	6.14649E+01	8.03988E+01
56	6.17151E-01	5.34120E+01	7.23459E+01
57	6.18520E-01	4.56892E+01	6.46231E+01

58	6.2C191E-01	3.85390E+01	5.74729E+01
59	6.21445E-01	3.20996E+01	5.10335E+01
60	6.23985E-01	2.64133E+01	4.53474E+01
61	6.26462E-01	2.14575E+01	4.03913E+01
62	6.29609E-01	1.71721E+01	3.61060E+01
63	6.33817E-01	1.34893E+01	3.24231E+01
64	6.39852E-01	1.03484E+01	2.92823E+01
65	6.49232E-01	7.71612E+00	2.66500E+01
66	6.62973E-01	5.60212E+00	2.45360E+01
67	6.86708E-01	3.90925E+00	2.28431E+01
68	7.19544E-01	2.57946E+00	2.15133E+01
69	7.60903E-01	1.63774E+00	2.05716E+01
70	8.06444E-01	1.04280E+00	1.99767E+01
71	8.5C960E-01	6.97337E-01	1.96312E+01
72	8.90254E-01	4.99057E-01	1.94329E+01
73	9.22210E-01	3.76122E-01	1.93100E+01
74	9.46600E-01	2.90001E-01	1.92239E+01
75	9.64321E-01	2.23311E-01	1.91572E+01
76	9.76709E-01	1.69338E-01	1.91032E+01
77	9.85109E-01	1.25692E-01	1.90596E+01
78	9.9C663E-01	9.11868E-02	1.90251E+01
79	9.94254E-01	6.46994E-02	1.89986E+01
80	9.96528E-01	4.49520E-02	1.89788E+01
81	9.97938E-01	3.06219E-02	1.89645E+01
82	9.98795E-01	2.04782E-02	1.89544E+01
83	9.99306E-01	1.34621E-02	1.89473E+01
84	9.99606E-01	8.71273E-03	1.89426E+01
85	9.99778E-01	5.56051E-03	1.89394E+01
86	9.99877E-01	3.50495E-03	1.89374E+01
87	9.99932E-01	2.18532E-03	1.89361E+01
88	9.99963E-01	1.34976E-03	1.89352E+01
89	9.99980E-01	8.27027E-04	1.89347E+01
90	9.99989E-01	5.03329E-04	1.89344E+01
91	9.99994E-01	3.04610E-04	1.89342E+01
92	9.99997E-01	1.83499E-04	1.89341E+01
93	9.99998E-01	1.10149E-04	1.89340E+01
94	9.99999E-01	6.58845E-05	1.89340E+01
95	1.0C000E+00	3.94218E-05	1.89339E+01
96	1.0C000E+00	2.32994E-05	1.89339E+01
97	1.00000E+00	1.43125E-05	1.89339E+01
98	1.00000E+00	7.56914E-06	1.89339E+01
99	1.0C000E+00	6.42834E-06	1.89339E+01
100	1.0C000E+00	.00000E+00	1.89339E+01

ORIGINAL PAGE IS
OF POOR QUALITY

M XOCBL(M) NO PFM(M) PFMCHK(M) BETA(M) BETCHK UEP(M) AMACH(M) AH(M) CF(M) CFZ(M) ALPHW(M) NMCH RTHETA(M)

43 11.2C00 6 .1965E+02 .1965E+02 -.5966E+00 -.5970E+00 1.2070 .0000 .0000E+00 -.8065E-02 .3424E-02 -.2300E+02 70 1184.79

PROFILES AT M= 43 S(M)=R 1.12000E+01 INVRSE= 1 PFM(M)= 1.96542E+01 BETA(M)= -5.96617E-01

N	ETA(N)	YPL(N)	FZ(N)	SFZ(N)	GZ(N)	EPSBAR(N)	RHOMUR(N)	T(N)
1	.00000E+00		.00000E+00	.00000E+00	1.00000E+00	1.00000E+00	1.00000E+00	1.00000E+00
2	2.89445E-04	2.83072E-05	-2.61243E-03	-1.02488E-02	1.00000E+00	1.00000E+00	1.00000E+00	1.00000E+00
3	6.04741E-04	5.91620E-05	-5.43798E-03	-2.13304E-02	1.00000E+00	1.00000E+00	1.00000E+00	1.00000E+00
4	4.48830E-04	4.27937E-05	-8.49166E-03	-3.33027E-02	1.00000E+00	1.00000E+00	1.00000E+00	1.00000E+00
5	1.32367E-03	1.29452E-04	-1.17891E-02	-4.62260E-02	1.00000E+00	1.00000E+00	1.00000E+00	1.00000E+00
6	1.73225E-03	1.69410E-04	-1.53463E-02	-6.01620E-02	1.00000E+00	1.00000E+00	1.00000E+00	1.00000E+00
7	2.17759E-03	2.12964E-04	-1.91797E-02	-7.51736E-02	1.00000E+00	1.00000E+00	1.00000E+00	1.00000E+00
8	2.66302E-03	2.60438E-04	-2.33059E-02	-9.12243E-02	1.00000E+00	1.00000E+00	1.00000E+00	1.00000E+00
9	3.19214E-03	3.12185E-04	-2.77414E-02	-1.08677E-01	1.00000E+00	1.00000E+00	1.00000E+00	1.00000E+00
10	3.76088E-03	3.68589E-04	-3.26024E-02	-1.27792E-01	1.00000E+00	1.00000E+00	1.00000E+00	1.00000E+00

61	8.55732E-01	7.36546E+00	3.32675E+01
62	8.63381E-01	7.14215E+00	3.30442E+01
63	8.70735E-01	6.90994E+00	3.28120E+01
64	8.77810E-01	6.66902E+00	3.25711E+01
65	8.84623E-01	6.41972E+00	3.23218E+01
66	8.91187E-01	6.16245E+00	3.20645E+01
67	8.97516E-01	5.89775E+00	3.17998E+01
68	9.03624E-01	5.62629E+00	3.15283E+01
69	9.09525E-01	5.34881E+00	3.12508E+01
70	9.15230E-01	5.06617E+00	3.09682E+01
71	9.20752E-01	4.77931E+00	3.06813E+01
72	9.26103E-01	4.48924E+00	3.03913E+01
73	9.31296E-01	4.19703E+00	3.00991E+01
74	9.36342E-01	3.90380E+00	2.98058E+01
75	9.41249E-01	3.61071E+00	2.95127E+01
76	9.46028E-01	3.31900E+00	2.92210E+01
77	9.50685E-01	3.02989E+00	2.89319E+01
78	9.55224E-01	2.74468E+00	2.86467E+01
79	9.59648E-01	2.46471E+00	2.83667E+01
80	9.63958E-01	2.19123E+00	2.80933E+01
81	9.68140E-01	1.92619E+00	2.78282E+01
82	9.72228E-01	1.66835E+00	2.75704E+01
83	9.76314E-01	1.41282E+00	2.73149E+01
84	9.80391E-01	1.16090E+00	2.70629E+01
85	9.84334E-01	9.20842E-01	2.68229E+01
86	9.88004E-01	7.00935E-01	2.66030E+01
87	9.91265E-01	5.08481E-01	2.64105E+01
88	9.94008E-01	3.48776E-01	2.62508E+01
89	9.96168E-01	2.24221E-01	2.61263E+01
90	9.97742E-01	1.33852E-01	2.60359E+01
91	9.98789E-01	7.35376E-02	2.59756E+01
92	9.99415E-01	3.69279E-02	2.59390E+01
93	9.99749E-01	1.69210E-02	2.59190E+01
94	9.99904E-01	7.13255E-03	2.59092E+01
95	9.99967E-01	2.82755E-03	2.59049E+01
96	9.99990E-01	1.08706E-03	2.59031E+01
97	9.99997E-01	4.09043E-04	2.59024E+01
98	9.99999E-01	1.41667E-04	2.59022E+01
99	1.00000E+00	3.76019E-05	2.59021E+01
100	1.00000E+00	0.00000E+00	2.59020E+01

M XOCBL(M) NO PMF(M) PMFCHK(M) BETA(M) BETCHK UEP(M) AMAC(M) AH(M) CF(M) CFZ(M) ALPHW(M) NMCH RTHETA(M)

XC(M),M=1,MMAX (LEVY-LEES STREAMWISE COORDINATE)

.66912675E+01	.68183962E+01	.6947026CE+01	.70770230E+01	.72083816E+01	.73411038E+01	.74751989E+01	.76106798E+01
.77475512E+01	.78857949E+01	.80253579E+01	.81661515E+01	.83080633E+01	.84509733E+01	.85947632E+01	.87393110E+01
.88844790E+01	.90301045E+01	.91759984E+01	.93219520E+01	.94677451E+01	.96131532E+01	.97579554E+01	.99019521E+01
.10045007E+02	.10187101E+02	.10328356E+02	.10468977E+02	.10609166E+02	.10749072E+02	.10888792E+02	.11028386E+02
.11167892E+02	.11307334E+02	.11446731E+02	.11586096E+02	.11725448E+02	.11864823E+02	.12004316E+02	.12144175E+02
.12284756E+02	.12420311E+02	.12545698E+02	.12664189E+02	.12779421E+02	.12892951E+02	.13005292E+02	.13116602E+02
.13226934E+02	.13336303E+02	.13444714E+02	.13552173E+02	.13658694E+02	.13764295E+02	.13869001E+02	.13972843E+02
.14075855E+02	.14178071E+02	.14279531E+02	.14380272E+02	.14480333E+02	.14579755E+02	.14678577E+02	.14776837E+02
.14874574E+02	.14971825E+02	.15068626E+02	.15165011E+02	.15261099E+02	.15356646E+02	.15451946E+02	.15546929E+02
.15641613E+02	.15736015E+02	.15830150E+02	.15924034E+02	.16017682E+02	.16111110E+02	.16204336E+02	.16297378E+02
.16390254E+02	.16482983E+02	.16575580E+02	.16668059E+02	.16760431E+02	.16852707E+02	.16944895E+02	.17037005E+02
.17129042E+02	.17221020E+02	.17312938E+02					

*** INVERSE P.L. CALCULATIONS - SUMMARY CHART NO. 2 ***

M XLE S DT* THETA* (PCLRR) CPRL UEP STAN STPINT CFZ

1	7.00010	7.00010	1.99758	-1	-1.00016	-.80104	1.26568	-1	-1	.00000	1.10157
2	7.10000	7.10000	1.98222	.92611	-1.04389	-.83606	1.27944	.00000	.00000	.00000	1.11499
3	7.20000	7.20000	1.96865	.91914	-1.08795	-.87135	1.29316	.00000	.00000	.00000	1.12981
4	7.30000	7.30000	1.95687	.91284	-1.13218	-.90677	1.30678	.00000	.00000	.00000	1.14366
5	7.40000	7.40000	1.94586	.90697	-1.17682	-.94252	1.32039	.00000	.00000	.00000	1.15827
6	7.50000	7.50000	1.93500	.90133	-1.22210	-.97879	1.33405	.00000	.00000	.00000	1.17416
7	7.60000	7.60000	1.92379	.89577	-1.26830	-1.01579	1.34785	.00000	.00000	.00000	1.19181
8	7.70000	7.70000	1.91262	.89031	-1.31539	-1.05351	1.36177	.00000	.00000	.00000	1.20993
9	7.80000	7.80000	1.90303	.88526	-1.36287	-1.09153	1.37566	.00000	.00000	.00000	1.22533
10	7.90000	7.90000	1.89735	.88123	-1.40966	-1.12901	1.38921	.00000	.00000	.00000	1.23378
11	8.00000	8.00000	1.89791	.87886	-1.45438	-1.16482	1.40205	.00000	.00000	.00000	1.23180
12	8.10000	8.10000	1.90603	.87864	-1.49580	-1.19800	1.41383	.00000	.00000	.00000	1.21856
13	8.20000	8.20000	1.92146	.88065	-1.53330	-1.22803	1.42441	.00000	.00000	.00000	1.19639
14	8.30000	8.30000	1.94302	.88472	-1.56679	-1.25485	1.43379	.00000	.00000	.00000	1.16865
15	8.40000	8.40000	1.97011	.89067	-1.59627	-1.27847	1.44200	.00000	.00000	.00000	1.13658
16	8.50000	8.50000	2.00372	.89863	-1.62135	-1.29855	1.44895	.00000	.00000	.00000	1.09826
17	8.60000	8.60000	2.04631	.90905	-1.64113	-1.31435	1.45441	.00000	.00000	.00000	1.05018
18	8.70000	8.70000	2.10114	.92250	-1.65455	-1.32514	1.45810	.00000	.00000	.00000	.98935
19	8.80000	8.80000	2.17168	.93958	-1.66066	-1.33004	1.45978	.00000	.00000	.00000	.91442
20	8.90000	8.90000	2.26173	.96078	-1.65888	-1.32861	1.45929	.00000	.00000	.00000	.82543
21	9.00000	9.00000	2.37624	.98658	-1.64895	-1.32066	1.45656	.00000	.00000	.00000	.72275
22	9.10000	9.10000	2.52332	1.01756	-1.63087	-1.30617	1.45158	.00000	.00000	.00000	.60576
23	9.20000	9.20000	2.71683	1.05442	-1.60500	-1.28546	1.44442	.00000	.00000	.00000	.47323
24	9.30000	9.30000	2.97898	1.09767	-1.57272	-1.25960	1.43545	.00000	.00000	.00000	.32674
25	9.40000	9.40000	3.34048	1.14666	-1.53737	-1.23129	1.42555	.00000	.00000	.00000	.17685
26	9.50000	9.50000	3.83463	1.19857	-1.50421	-1.20473	1.41621	.00000	.00000	.00000	.04593
27	9.60000	9.60000	4.48289	1.24881	-1.47788	-1.18364	1.40874	.00000	.00000	.00000	-.04260
28	9.70000	9.70000	5.28297	1.29340	-1.45957	-1.16898	1.40353	.00000	.00000	.00000	-.08404
29	9.80000	9.80000	6.21508	1.33081	-1.44759	-1.15939	1.40010	.00000	.00000	.00000	-.09375
30	9.90000	9.90000	7.25455	1.36123	-1.43921	-1.15315	1.39788	.00000	.00000	.00000	-.08883
31	10.00000	10.00000	8.37655	1.38552	-1.43464	-1.14902	1.39640	.00000	.00000	.00000	-.07910
32	10.10000	10.10000	9.55636	1.40461	-1.43110	-1.14618	1.39538	.00000	.00000	.00000	-.06899
33	10.20000	10.20000	10.76956	1.41934	-1.42857	-1.14415	1.39465	.00000	.00000	.00000	-.06001
34	10.30000	10.30000	11.99084	1.43038	-1.42672	-1.14267	1.39412	.00000	.00000	.00000	-.05249
35	10.40000	10.40000	13.19500	1.43822	-1.42540	-1.14161	1.39374	.00000	.00000	.00000	-.04617
36	10.50000	10.50000	14.34734	1.44295	-1.42457	-1.14095	1.39351	.00000	.00000	.00000	-.04079
37	10.60000	10.60000	15.42031	1.44405	-1.42451	-1.14090	1.39349	.00000	.00000	.00000	-.03529
38	10.70000	10.70000	16.33297	1.43856	-1.42617	-1.14223	1.39397	.00000	.00000	.00000	-.02807
39	10.80000	10.80000	17.10876	1.41628	-1.43278	-1.14753	1.39586	.00000	.00000	.00000	-.01893
40	10.90000	10.90000	17.37967	1.35041	-1.45166	-1.16265	1.40127	.00000	.00000	.00000	-.05548
41	11.00000	11.00000	17.74242	1.21267	-1.48342	-1.18808	1.41031	.00000	.00000	.00000	-.35938
42	11.10000	11.10000	16.94429	3.57334	-1.11246	-.89098	1.30073	.00000	.00000	1.00000	-1.78398
43	11.20000	11.20000	16.28388	5.89543	-.81891	-.65587	1.20697	.00000	.00000	1.00000	-1.34292
44	11.30000	11.30000	15.60241	7.12998	-.68825	-.55122	1.16281	.00000	.00000	1.00000	-1.07090
45	11.40000	11.40000	15.14214	7.73352	-.62788	-.50287	1.14183	.00000	.00000	1.00000	-.15768
46	11.50000	11.50000	14.90784	8.11403	-.59075	-.47313	1.12873	.00000	.00000	1.00000	-.01909
47	11.60000	11.60000	14.86466	8.42815	-.56074	-.44910	1.11804	.00000	.00000	1.00000	.10483
48	11.70000	11.70000	14.96687	8.72464	-.53323	-.42707	1.10814	.00000	.00000	1.00000	.15192
49	11.80000	11.80000	15.17855	9.02224	-.50661	-.40575	1.09848	.00000	.00000	1.00000	.17811
50	11.90000	11.90000	15.47204	9.32792	-.48039	-.38475	1.08888	.00000	.00000	1.00000	.19255
51	12.00000	12.00000	15.82633	9.64334	-.45452	-.36403	1.07932	.00000	.00000	1.00000	.20037
52	12.10000	12.10000	16.22489	9.96780	-.42911	-.34368	1.06985	.00000	.00000	1.00000	.20467
53	12.20000	12.20000	16.65410	10.29944	-.40434	-.32384	1.06054	.00000	.00000	1.00000	.20747
54	12.30000	12.30000	17.10287	10.63582	-.38038	-.30465	1.05146	.00000	.00000	1.00000	.20989
55	12.40000	12.40000	17.56242	10.97457	-.35736	-.28622	1.04265	.00000	.00000	1.00000	.21250
56	12.50000	12.50000	18.02580	11.31354	-.33527	-.26860	1.03417	.00000	.00000	1.00000	.21562
57	12.60000	12.60000	18.48745	11.65074	-.31446	-.25185	1.02604	.00000	.00000	1.00000	.21935
58	12.70000	12.70000	18.94301	11.98445	-.29465	-.23598	1.01828	.00000	.00000	1.00000	.22368
59	12.80000	12.80000	19.38874	12.31317	-.27594	-.22100	1.01090	.00000	.00000	1.00000	.22864

60	12.90000	12.90000	19.82085	12.63519	-.25835	-.20691	1.00390	.00000	.00000	1.00000	.23432
61	13.00000	13.00000	20.23560	12.94863	-.24187	-.19372	.99731	.00000	.00000	1.00000	.24082
62	13.10000	13.10000	20.63069	13.25307	-.22649	-.18140	.99111	.00000	.00000	1.00000	.24795
63	13.20000	13.20000	21.00490	13.54675	-.21216	-.16992	.98531	.00000	.00000	1.00000	.25556
64	13.30000	13.30000	21.35703	13.82917	-.19886	-.15927	.97988	.00000	.00000	1.00000	.26357
65	13.40000	13.40000	21.68538	14.09937	-.18654	-.14940	.97484	.00000	.00000	1.00000	.27207
66	13.50000	13.50000	21.98890	14.35658	-.17519	-.14031	.97016	.00000	.00000	1.00000	.28099
67	13.60000	13.60000	22.26846	14.60075	-.16474	-.13194	.96584	.00000	.00000	1.00000	.29004
68	13.70000	13.70000	22.52688	14.83266	-.15510	-.12422	.96183	.00000	.00000	1.00000	.29884
69	13.80000	13.80000	22.76765	15.05358	-.14617	-.11707	.95811	.00000	.00000	1.00000	.30708
70	13.90000	13.90000	22.99387	15.26480	-.13785	-.11041	.95463	.00000	.00000	1.00000	.31470
71	14.00000	14.00000	23.20791	15.46741	-.13008	-.10418	.95136	.00000	.00000	1.00000	.32170
72	14.10000	14.10000	23.41141	15.66226	-.12278	-.09833	.94828	.00000	.00000	1.00000	.32816
73	14.20000	14.20000	23.60531	15.84953	-.11591	-.09284	.94538	.00000	.00000	1.00000	.33419
74	14.30000	14.30000	23.78995	16.03071	-.10945	-.08766	.94264	.00000	.00000	1.00000	.33990
75	14.40000	14.40000	23.96522	16.20468	-.10337	-.08279	.94005	.00000	.00000	1.00000	.34542
76	14.50000	14.50000	24.13062	16.37170	-.09766	-.07821	.93761	.00000	.00000	1.00000	.35086
77	14.60000	14.60000	24.28493	16.53129	-.09232	-.07394	.93533	.00000	.00000	1.00000	.35639
78	14.70000	14.70000	24.42609	16.68255	-.08739	-.06999	.93322	.00000	.00000	1.00000	.36221
79	14.80000	14.80000	24.55176	16.82435	-.08288	-.06638	.93128	.00000	.00000	1.00000	.36849
80	14.90000	14.90000	24.66043	16.95585	-.07882	-.06313	.92954	.00000	.00000	1.00000	.37522
81	15.00000	15.00000	24.75243	17.07696	-.07520	-.06023	.92797	.00000	.00000	1.00000	.38219
82	15.10000	15.10000	24.82967	17.18837	-.07198	-.05765	.92658	.00000	.00000	1.00000	.38913
83	15.20000	15.20000	24.89487	17.29125	-.06911	-.05535	.92534	.00000	.00000	1.00000	.39582
84	15.30000	15.30000	24.95075	17.38691	-.06653	-.05328	.92422	.00000	.00000	1.00000	.40212
85	15.40000	15.40000	24.99960	17.47650	-.06420	-.05142	.92321	.00000	.00000	1.00000	.40800
86	15.50000	15.50000	25.04266	17.56077	-.06208	-.04972	.92229	.00000	.00000	1.00000	.41354
87	15.60000	15.60000	25.08076	17.64026	-.06015	-.04818	.92146	.00000	.00000	1.00000	.41878
88	15.70000	15.70000	25.11227	17.71435	-.05844	-.04680	.92071	.00000	.00000	1.00000	.42410
89	15.80000	15.80000	25.14118	17.78490	-.05687	-.04554	.92003	.00000	.00000	1.00000	.42883
90	15.90000	15.90000	25.15088	17.84438	-.05570	-.04461	.91952	.00000	.00000	1.00000	.43363
91	16.00000	16.00000	25.19297	17.91642	-.05410	-.04333	.91882	.00000	.00000	1.00000	.43604

INTRAC=**DT(M), M=1,MMAX

.11997123E-01	.11904835E-01	.11823326E-01	.11752575E-01	.11686466E-01	.11621272E-01	.11553923E-01	.11486843E-01
.11429221E-01	.11395110E-01	.11398504E-01	.11447287E-01	.11539942E-01	.11669425E-01	.11832133E-01	.12033970E-01
.12289785E-01	.12619062E-01	.13042731E-01	.13583541E-01	.14271291E-01	.15154571E-01	.16316768E-01	.17891232E-01
.20062302E-01	.23030096E-01	.26923432E-01	.31728554E-01	.37326647E-01	.43569520E-01	.50308036E-01	.57393726E-01
.64680028E-01	.72014787E-01	.79246729E-01	.86167475E-01	.92611538E-01	.98092849E-01	.10275209E+00	.10437910E+00
.10655769E+00	.10176428E+00	.97797966E-01	.93705235E-01	.90940889E-01	.89533766E-01	.89274419E-01	.89888279E-01
.91159575E-01	.92922218E-01	.95050043E-01	.97443714E-01	.10002148E+00	.10271667E+00	.10547670E+00	.10825965E+00
.11103223E+00	.11376837E+00	.11644548E+00	.11904041E+00	.12153127E+00	.12390413E+00	.12615159E+00	.12826637E+00
.13023843E+00	.13206130E+00	.13374030E+00	.13529229E+00	.13673830E+00	.13809695E+00	.13938244E+00	.14060461E+00
.14176915E+00	.14287805E+00	.14393072E+00	.14492407E+00	.14585081E+00	.14669863E+00	.14745336E+00	.14810604E+00
.14865E56E+00	.14912246E+00	.14951400E+00	.14984964E+00	.15014301E+00	.15040161E+00	.15063042E+00	.15081968E+00
.15099332E+00	.15105160E+00	.15130433E+00					

OUTPUT QUANTITIES FROM SUBROUTINES INVI & PMFNW

VT DISTRIBUTION ON INVISCID MESH AT INTRAC=100

.35952428E-C2	.22893868E+00	.42765888E+00	.58163858E+00	.68745256E+00	.75313072E+00	.79141613E+00	.81400734E+00
.82880805E+00	.83987679E+00	.84878484E+00	.85E02368E+00	.86186490E+00	.86665864E+00	.87078713E+00	.87455646E+00
.87817497E+00	.88179777E+00	.88555472E+00	.88952594E+00	.89371041E+00	.89803761E+00	.90241068E+00	.90675128E+00
.91102450E+00	.91523545E+00	.91940895E+00	.92357076E+00	.92773966E+00	.93192947E+00	.93615418E+00	.94042881E+00
.94476417E+00	.94916245E+00	.953362150E+00	.95744348E+00	.96149377E+00	.96549133E+00	.96922113E+00	.97271553E+00
.98230368E+00	.98768801E+00	.99329446E+00	.99907119E+00	.10049686E+01	.10109639E+01	.10170775E+01	.10233855E+01
.10300245E+01	.10371529E+01	.104448630E+01	.10521139E+01	.10601764E+01	.1068621E+01	.10774108E+01	.10865261E+01
.10982145E+01	.11077993E+01	.11177514E+01	.11281444E+01	.11389688E+01	.11501670E+01	.11616913E+01	.11735337E+01
.11856840E+01	.11981416E+01	.12109259E+01	.12240760E+01	.12376007E+01	.12514290E+01	.12654327E+01	.12794396E+01

.12931573E+C1	.13067821E+01	.132039COE+01	.13340535E+01	.13478490E+01	.13617689E+01	.13756598E+01	.13892143E+01
.14C20460E+C1	.14138275E+C1	.14244078E+01	.14337935E+C1	.14420055E+01	.14489516E+01	.14544092E+01	.14581001E+01
.145978C4E+C1	.14592936E+01	.14565693E+01	.14515953E+01	.14444504E+01	.14354861E+01	.14256072E+01	.14162761E+01
.14088199E+C1	.14036036E+01	.14001757E+C1	.13979393E+01	.139645COE+01	.13954239E+01	.13946921E+01	.13941568E+01
.13937714E+C1	.13935304E+01	.13935084E+01	.13939856E+01	.13958820E+01	.14012880E+01	.14103330E+01	.13007452E+01
.12069855E+C1	.11628265E+C1	.11418453E+01	.11287473E+01	.11180491E+01	.11081527E+01	.10984912E+01	.10888895E+01
.10793310E+C1	.10698624E+C1	.10605507E+01	.10514648E+C1	.10426612E+01	.10341794E+01	.10260489E+01	.10182872E+C1
.10109041E+C1	.10C39115E+01	.99731677E+00	.99112112E+00	.98531565E+00	.97989229E+00	.97484641E+00	.97017122E+00
.96584747E+CC	.96184217E+CO	.95811696E+0C	.95463555E+0C	.95136818E+00	.94829111E+00	.94538708E+00	.94264476E+00
.94C05715E+CC	.93762154E+00	.93534117E+00	.93322622E+0C	.93129045E+00	.92954314E+00	.92798121E+00	.92659007E+00
.92534771E+CC	.92423111E+00	.92321989E+00	.92230094E+0C	.92146443E+00	.92071894E+00	.92003453E+00	.91952673E+00
.91883136E+CO							

INTRAC=100 PFF(M),M=1,MMAX							
.25283025E+01	.25361254E+01	.25457672E+01	.25571951E+01	.25692899E+01	.25813960E+01	.25929755E+01	.26045448E+01
.26179140E+01	.26358182E+01	.26609565E+01	.26948006E+01	.27369416E+01	.27858871E+01	.28409088E+01	.29032869E+01
.29761702E+01	.30636620E+01	.31701650E+01	.330C5051E+01	.34611269E+01	.36627701E+01	.39242185E+01	.42761188E+01
.47619367E+01	.54304931E+01	.63150589E+01	.74145811E+01	.87015471E+01	.10140753E+02	.11696771E+02	.13334526E+02
.15019611E+02	.16716525E+02	.18390254E+02	.19992923E+02	.21487823E+02	.22767441E+02	.23881332E+02	.24353436E+02
.25022228E+02	.22039718E+02	.19654042E+02	.18142531E+02	.17289649E+02	.16826886E+02	.16619139E+02	.16585312E+02
.16673249E+02	.16847089E+02	.17081606E+02	.17358159E+02	.17662280E+02	.17982873E+02	.18311421E+02	.18641673E+02
.18968788E+02	.19289207E+02	.1959961E+02	.19898141E+02	.20181055E+02	.20447266E+02	.20696214E+02	.20927338E+02
.21139671E+02	.21332750E+02	.21507690E+02	.21667052E+02	.21813818E+02	.21950514E+02	.22079016E+02	.22200580E+02
.223159C3E+02	.22425219E+02	.22528428E+02	.22625139E+02	.22714443E+02	.22794822E+02	.22864570E+02	.22922689E+02
.22969543E+02	.23006682E+02	.23036161E+02	.23060015E+02	.23079883E+02	.23096621E+02	.23110782E+02	.23121098E+02
.23130512E+02	.23126669E+02	.23147846E+02					

INTRAC=100 RHOU(E),M=1,MMAX							
.13756593E+01	.13892138E+01	.14020453E+01	.14138268E+01	.14244070E+01	.14337924E+01	.14420042E+01	.14489498E+01
.14544C68E+01	.14580967E+01	.14597856E+01	.14565585E+01	.14515786E+01	.14444248E+01	.14354477E+01	.14354477E+01
.14255526E+01	.14162058E+01	.14087411E+01	.14035259E+01	.14001048E+01	.13978775E+01	.13963971E+01	.13953790E+01
.13946540E+01	.13941242E+01	.13937434E+01	.13935059E+01	.13934865E+01	.13939656E+01	.13958632E+01	.14012693E+01
.141C3147E+01	.13007263E+01	.12069721E+01	.11628107E+01	.11418309E+01	.11287338E+01	.11180365E+01	.11081408E+01
.10984799E+01	.10888787E+01	.10793207E+01	.10698525E+01	.10605411E+01	.10514555E+01	.10426522E+01	.10341706E+01
.10260403E+01	.10182788E+01	.10108958E+01	.10039033E+01	.99730875E+00	.99111323E+00	.98530787E+00	.97988461E+00
.97483881E+00	.97016371E+0C	.96584003E+00	.96183408E+0C	.95810967E+00	.95462831E+00	.95136101E+00	.94828400E+00
.94538002E+00	.94263777E+0C	.94005021E+00	.93761464E+0C	.93533433E+00	.93321942E+00	.93128370E+00	.92953643E+00
.92747454E+0C	.92658343E+0C	.92534111E+0C	.92422454E+0C	.92321335E+00	.92229433E+00	.92145795E+00	.92071248E+0C
.920C281CE+0C	.91952032E+0C	.91882495E+0C					
VT DISTRIBUTION ON INVISCID MESH AT INTRAC=100							

.35952428E-C2	.22893877E+00	.42765896E+00	.58163865E+00	.68745262E+00	.75313078E+00	.79141619E+00	.81400739E+00
.82880810E+CO	.83987685E+00	.84878489E+0C	.85602373E+0C	.86186495E+00	.86665869E+00	.87078718E+00	.87455650E+00
.878175C2E+CO	.88179781E+00	.88555476E+00	.88952599E+00	.89271045E+00	.89603765E+00	.90241072E+00	.90675132E+00
.91102454E+CO	.91523548E+00	.91940899E+00	.92357080E+00	.92773970E+00	.93192951E+00	.93615422E+00	.94042884E+00
.94476421E+CO	.94916249E+00	.95362154E+0C	.95814351E+00	.96273779E+00	.96741917E+00	.97221136E+00	.97715556E+00
.98230372E+CC	.98768805E+00	.993294C7E+00	.99907123E+CC	.10049687E+01	.10109640E+01	.10170778E+01	.10233855E+01
.10300245E+C1	.10371529E+01	.10448630E+C1	.10531140E+01	.10617642E+01	.10706622E+01	.10797108E+01	.10888827E+01
.10982146E+C1	.11077993E+01	.11177516E+01	.11281445E+01	.11389689E+01	.11501670E+01	.11616933E+01	.11735337E+01
.11856840E+C1	.11981417E+C1	.12109259E+01	.12240476E+01	.12376008E+01	.12514292E+01	.12654393E+01	.12794396E+01
.12931574E+C1	.13067822E+C1	.13203900E+01	.13340536E+01	.13478491E+01	.13617691E+01	.13756600E+01	.13892145E+01
.14C20461E+C1	.14138278E+C1	.14244081E+01	.14337938E+01	.14420059E+01	.14489520E+01	.14544096E+01	.14581006E+01
.14597810E+C1	.14592943E+C1	.145657C2E+01	.14515963E+01	.14444514E+01	.14354870E+01	.14256075E+01	.14162756E+01
.14088185E+C1	.14036018E+01	.14001738E+01	.13979376E+01	.13964485E+01	.13954227E+01	.13946912E+01	.13941561E+01
.13937709E+C1	.13935301E+01	.13935082E+C1	.13939854E+01	.13958817E+01	.14012875E+01	.14103323E+01	.13007443E+01
.12069851E+C1	.11628265E+C1	.11418455E+C1	.11287475E+01	.11180493E+01	.11081530E+01	.10984914E+01	.10888897E+01
.10793312E+C1	.10698626E+C1	.106055C8E+C1	.10514649E+01	.10426613E+01	.10341795E+01	.10260490E+01	.10182873E+01
.10109041E+C1	.10C39115E+C1	.99731678E+CO	.99112113E+0C	.98531565E+00	.97989228E+00	.97484639E+00	.97017120E+01
.96584745E+CC	.96184214E+CO	.95811694E+00	.95463552E+0C	.95136816E+00	.94829108E+00	.94538705E+00	.94264474E+00
.94C05712E+CO	.93762151E+CO	.93534115E+00	.93322619E+0C	.93129042E+00	.92954312E+00	.92798114E+00	.92659004E+00

.92534768E+00 .92423109E+00 .92321987E+00 .92230082E+00 .92146441E+00 .92071892E+00 .92003452E+00 .91952672E+00
.91883136E+CC

INTRAC=100 PPF(M),M=1,MMAX

.25283025E+01	.25361246E+01	.25457665E+01	.25571945E+01	.25692893E+01	.25813954E+01	.25929749E+01	.26045442E+01
.26179134E+01	.26358175E+01	.26609557E+01	.26947997E+01	.27369405E+01	.27858858E+01	.28409071E+01	.29032848E+01
.29761673E+01	.30636579E+01	.31701591E+01	.33004962E+01	.34611130E+01	.36627479E+01	.39241824E+01	.42760602E+01
.47618448E+01	.54303593E+01	.63148854E+01	.74143807E+01	.87013328E+01	.10140535E+02	.11696556E+02	.13334317E+02
.15019411E+02	.16716335E+02	.18390072E+02	.19992749E+02	.21487656E+02	.22767279E+02	.23881174E+02	.24353278E+02
.25022072E+02	.22039565E+02	.19653904E+02	.18142407E+02	.17289538E+02	.16826784E+02	.16619043E+02	.16585221E+02
.16673158E+02	.16847004E+02	.17081523E+02	.17358077E+02	.17662199E+02	.17982742E+02	.18311340E+02	.18641592E+02
.18968708E+02	.19289127E+02	.19599880E+02	.19898060E+02	.20180974E+02	.20447185E+02	.20696132E+02	.20927256E+02
.21139589E+02	.21332668E+02	.21507607E+02	.21669699E+02	.21813735E+02	.21954331E+02	.22078933E+02	.22200497E+02
.22315820E+02	.22425136E+02	.22528345E+02	.22625056E+02	.22714366E+02	.22794739E+02	.22864888E+02	.22922607E+02
.22969461E+02	.23006608E+02	.23036079E+02	.23059934E+02	.23079801E+02	.23096539E+02	.23110701E+02	.23121017E+02
.23130432E+02	.23102650E+02	.23147766E+02					

INTRAC=100 RHOU(M),M=1,MMAX

.13756593E+01	.12794388E+01	.12931567E+01	.13047815E+01	.13203894E+01	.13340530E+01	.13478485E+01	.13617684E+01
.14544688E+01	.13892138E+01	.14020453E+01	.14138268E+01	.14244070E+01	.14337924E+01	.14420042E+01	.14489498E+01
.14255926E+01	.14580567E+01	.14597756E+01	.14592864E+01	.14565585E+01	.14515786E+01	.14444248E+01	.14354477E+01
.13946540E+01	.14162058E+01	.14087411E+01	.14035259E+01	.14001048E+01	.13978775E+01	.13963971E+01	.13953790E+01
.14103147E+01	.13941242E+01	.13937434E+01	.13935059E+01	.13934865E+01	.13939656E+01	.13958632E+01	.14012693E+01
.10984799E+01	.130007263E+01	.12069721E+01	.11628107E+01	.11418309E+01	.11287338E+01	.11180365E+01	.11081408E+01
.10260403E+01	.10888787E+01	.10793207E+01	.10698525E+01	.10605411E+01	.10514555E+01	.10426522E+01	.10341706E+01
.97483881E+00	.10182788E+01	.10108958E+01	.10039033E+01	.99730875E+00	.99111323E+00	.98530787E+00	.97988461E+00
.94538002E+00	.97016371E+00	.96584003E+00	.96183480E+00	.95810967E+00	.95462831E+00	.95136101E+00	.94828400E+00
.92797454E+00	.94263777E+00	.94005021E+00	.93741464E+00	.93533433E+00	.93321942E+00	.93128370E+00	.92953643E+00
.9202810E+00	.91952032E+00	.92534111E+00	.92422454E+00	.92321335E+00	.92229433E+00	.92145795E+00	.92071248E+00

VT DISTRIBUTION ON INVISCID MESH AT INTRAC=100

.35952428E-C2	.22893887E+00	.42765904E+00	.58163872E+00	.68745269E+00	.75313085E+00	.79141625E+00	.81400745E+00
.82880918E+00	.83987690E+00	.8488494E+00	.85602378E+00	.86186500E+00	.86665874E+00	.87078722E+00	.87455655E+00
.87817506E+00	.88179786E+00	.88555481E+00	.88952603E+00	.89371049E+00	.89803769E+00	.90241076E+00	.90675136E+00
.91102458E+00	.91523555E+00	.91940903E+00	.92357084E+00	.92773974E+00	.93192955E+00	.93615425E+00	.94042888E+00
.94476425E+00	.94916252E+00	.95362158E+00	.95814355E+00	.96273783E+00	.96741920E+00	.97221139E+00	.97715560E+00
.98223037E+00	.98768808E+00	.99329411E+00	.99907126E+00	.10049687E+01	.10109640E+01	.10170776E+01	.10233856E+01
.10300246E+C1	.10371530E+01	.10448631E+01	.10531140E+01	.10617642E+01	.10706622E+01	.10797109E+01	.10888827E+01
.10982146E+C1	.11077993E+01	.11177516E+01	.11281445E+01	.11389689E+01	.11501671E+01	.11616934E+01	.11735338E+01
.11856841E+C1	.11981417E+01	.12109260E+01	.12240761E+01	.12376008E+01	.12514293E+01	.12654394E+01	.12794397E+01
.12931574E+C1	.13067823E+01	.13203901E+01	.13340537E+01	.13478492E+01	.13617692E+01	.13756601E+01	.13892146E+01
.14020463E+C1	.14138280E+01	.14244083E+C1	.14337940E+01	.14420062E+01	.14489524E+01	.14544100E+01	.14581010E+01
.14597816E+C1	.14592950E+01	.14565710E+C1	.14515972E+01	.14444524E+01	.14354878E+01	.14256078E+01	.14162750E+01
.14088172E+C1	.14036000E+01	.14001719E+C1	.13979360E+01	.13964471E+01	.13954216E+01	.13946903E+01	.13941554E+01
.13937704E+C1	.13935297E+01	.13935079E+C1	.13939851E+01	.13958814E+01	.14012871E+01	.14103317E+01	.13007436E+01
.12069887E+C1	.11628265E+01	.11418457E+01	.11287477E+01	.11180496E+01	.11081532E+01	.10984916E+01	.10888988E+01
.10793313E+C1	.10698627E+01	.10605509E+01	.10514650E+01	.10426614E+01	.10341796E+01	.10260490E+01	.10182873E+01
.10109404E+C1	.10039115E+01	.99731679E+00	.99112113E+00	.98531565E+00	.97982288E+00	.97468438E+00	.97017119E+00
.96584743E+00	.96184212E+00	.95811692E+00	.95463550E+00	.95136813E+00	.94829106E+00	.94538702E+00	.94264711E+00
.94005710E+00	.93726214E+00	.93534112E+00	.93322616E+00	.93129039E+00	.92954309E+00	.92798115E+00	.92659002E+00
.92534766E+00	.92423107E+00	.92321985E+00	.92230080E+00	.92146439E+00	.92071890E+00	.92003450E+00	.91952671E+00
.91883135E+CC							

INTRAC=100 PPF(M),M=1,MMAX

.25283025E+01	.25361237E+01	.25457658E+01	.25571937E+01	.25692886E+01	.25813947E+01	.25929742E+01	.26045434E+01
.26179126E+01	.26358167E+01	.26609547E+01	.26947986E+01	.27369392E+01	.27858842E+01	.28409052E+01	.29032822E+01
.29761640E+01	.30636534E+01	.31701526E+01	.33004865E+01	.34611098E+01	.36627444E+01	.39241449E+01	.42760005E+01
.47617525E+01	.54302266E+01	.63147150E+01	.74141849E+01	.87011241E+01	.10140323E+02	.11696346E+02	.13334113E+02
.15019211E+02	.16716148E+02	.18390094E+02	.19992579E+02	.21487491E+02	.22767119E+02	.23881019E+02	.24353124E+02
.25021522E+02	.22039418E+02	.19653770E+02	.18142294E+02	.17289431E+02	.16826680E+02	.16618944E+02	.16585129E+02

.16673069E+02	.16846918E+02	.17081438E+02	.17357994E+02	.17662117E+02	.17982661E+02	.18311259E+02	.18641512E+02
.18968627E+02	.19289046E+02	.19599799E+02	.19857979E+02	.20180893E+02	.20447103E+02	.20696050E+02	.20927174E+02
.21139506E+02	.21332585E+02	.21507525E+02	.21666886E+02	.21813653E+02	.21950348E+02	.22078851E+02	.22200414E+02
.22315738E+02	.22425054E+02	.22528263E+02	.22624974E+02	.22714278E+02	.22794657E+02	.22864405E+02	.22922525E+02
.22964379E+02	.23006519E+02	.23035998E+02	.23059852E+02	.23079722E+02	.23096458E+02	.23110620E+02	.23120937E+02
.23130351E+02	.23126508E+02	.23147686E+02					

INTRAC=100 RHOUE(M),M=1,MMAX

.13756593E+01	.13892138E+01	.12931567E+01	.13067815E+01	.13203894E+01	.13340530E+01	.13478485E+01	.13617684E+01
.14544068E+01	.14580967E+01	.14020453E+01	.14138268E+01	.14244070E+01	.14337924E+01	.14420042E+01	.14489498E+01
.14255526E+01	.14162058E+01	.14597756E+01	.14552864E+01	.14565585E+01	.14515786E+01	.14444248E+01	.14354477E+01
.13946540E+01	.13941242E+01	.14087411E+01	.14035259E+01	.14001048E+01	.13978775E+01	.13963971E+01	.13953790E+01
.14103147E+01	.13007263E+01	.13937434E+01	.13935059E+01	.13934865E+01	.13939656E+01	.13958632E+01	.14012693E+01
.10984759E+01	.10888787E+01	.12069721E+01	.11628107E+01	.11418309E+01	.11287338E+01	.11180365E+01	.11081408E+01
.10260403E+01	.10182788E+01	.10793207E+01	.10698525E+01	.10605411E+01	.10514555E+01	.10426522E+01	.10341706E+01
.97483881E+00	.97016371E+00	.10108095E+01	.10039033E+01	.99730875E+00	.99111323E+00	.98530787E+00	.97988461E+00
.94538002E+00	.94263777E+00	.96584003E+00	.96183480E+00	.95810967E+00	.95462831E+00	.95136101E+00	.94828400E+00
.92797454E+00	.92658343E+00	.94005021E+00	.93761464E+00	.93533433E+00	.93321942E+00	.93128370E+00	.92953643E+00
.92002810E+00	.91952032E+00	.92534111E+00	.92422454E+00	.92321335E+00	.92229433E+00	.92145795E+00	.92071248E+00

*** SUMMARY OF CONVERGENCE HISTORY ***

INTRAC	DDTMAX	RMSDT	SMDT	DUEPAX	RMSUE	SMUE	DSFMAX	DFMAX	DGMAX
**	-.21223E-03	.10636E-04	.99000E+01	-.76023E-04	.23292E-05	.96000E+01	-I	-I	-I

*** SUMMARY OF CONVERGENCE HISTORY ***

INTRAC	DDTMAX	RMSDT	SMDT	DUEPAX	RMSUE	SMUE	DSFMAX	DFMAX	DGMAX
1	-.36126E+01	.22150E+00	.16000E+02	-.50202E+00	.36911E-01	.10300E+02	-I	-I	-I
2	-.11354E+01	.58411E-01	.16000E+02	-.31643E+00	.17793E-01	.92000E+01	-I	-I	-I
3	.10069E+01	.34470E-01	.12700E+02	-.20846E+00	.11374E-01	.91000E+01	-I	-I	-I
4	.16100E+01	.69307E-01	.12400E+02	.21601E+00	.11371E-01	.12200E+02	-I	-I	-I
5	.19658E+01	.95563E-01	.12000E+02	.24301E+00	.13023E-01	.11800E+02	-I	-I	-I
6	.18070E+01	.88620E-01	.11700E+02	.21789E+00	.11005E-01	.11400E+02	-I	-I	-I
7	.15874E+01	.79962E-01	.11500E+02	.18370E+00	.90156E-02	.11200E+02	-I	-I	-I
8	.13308E+01	.70375E-01	.11300E+02	.15465E+00	.73440E-02	.11000E+02	-I	-I	-I
9	.10997E+01	.58266E-01	.11200E+02	.13241E+00	.58984E-02	.10800E+02	-I	-I	-I
10	.90230E+00	.45410E-01	.11000E+02	.11449E+00	.47018E-02	.10600E+02	-I	-I	-I
11	.73054E+00	.32995E-01	.10900E+02	.10031E+00	.37329E-02	.10500E+02	-I	-I	-I
12	.58671E+00	.22876E-01	.10700E+02	.87468E-01	.30061E-02	.10400E+02	-I	-I	-I
13	.48057E+00	.15302E-01	.10600E+02	.76735E-01	.24622E-02	.10300E+02	-I	-I	-I
14	-.44127E+00	.15641E-01	.11400E+02	.66975E-01	.22387E-02	.10200E+02	-I	-I	-I
15	.31800E+00	.12700E-01	.10400E+02	.58102E-01	.18762E-02	.10200E+02	-I	-I	-I
16	.26230E+00	.10966E-01	.10300E+02	.51308E-01	.16153E-02	.10100E+02	-I	-I	-I
17	-.52058E+00	.14819E-01	.11300E+02	-.45390E-01	.17231E-02	.11300E+02	-I	-I	-I
18	-.30791E+00	.16008E-01	.11300E+02	.37837E-01	.15749E-02	.10000E+02	-I	-I	-I
19	-.21626E+00	.15484E-01	.11300E+02	.32356E-01	.14193E-02	.99000E+01	-I	-I	-I
20	-.17523E+00	.13671E-01	.15000E+02	.27679E-01	.12368E-02	.99000E+01	-I	-I	-I
21	-.14963E+00	.11588E-01	.14800E+02	.23623E-01	.10566E-02	.98000E+01	-I	-I	-I
22	-.12557E+00	.97244E-02	.14600E+02	.20392E-01	.89776E-03	.98000E+01	-I	-I	-I
23	-.10573E+00	.82043E-02	.14500E+02	.17335E-01	.76475E-03	.98000E+01	-I	-I	-I
24	-.89702E-01	.69773E-02	.14400E+02	.14635E-01	.65401E-03	.97000E+01	-I	-I	-I
25	-.77026E-01	.60055E-02	.14400E+02	.12559E-01	.56311E-03	.97000E+01	-I	-I	-I
26	-.67709E-01	.52354E-02	.14400E+02	.10638E-01	.48871E-03	.97000E+01	-I	-I	-I

27	.58938E-01	.46141E-02	.14400E+02	.88934E-02	.42727E-03	.97000E+01	-	-	-
28	.52403E-01	.41115E-02	.14400E+02	.73521E-02	.37673E-03	.96000E+01	-	-	-
29	.47068E-01	.36998E-02	.14500E+02	.61846E-02	.33501E-03	.96000E+01	-	-	-
30	.42637E-01	.33583E-02	.14500E+02	.51243E-02	.30053E-03	.96000E+01	-	-	-
31	.39074E-01	.30620E-02	.11200E+02	.41737E-02	.27139E-03	.96000E+01	-	-	-
32	.36268E-01	.28173E-02	.11200E+02	.37253E-02	.24763E-03	.11400E+02	-	-	-
33	.33799E-01	.26010E-02	.11200E+02	.34647E-02	.22743E-03	.11400E+02	-	-	-
34	.31528E-01	.24049E-02	.11200E+02	.32280E-02	.20990E-03	.11400E+02	-	-	-
35	.29488E-01	.22353E-02	.11200E+02	.30171E-02	.19521E-03	.11400E+02	-	-	-
36	.27594E-01	.20807E-02	.11200E+02	.28251E-02	.18232E-03	.11200E+02	-	-	-
37	.25843E-01	.19388E-02	.11200E+02	.26536E-02	.17083E-03	.11200E+02	-	-	-
38	.24166E-01	.18046E-02	.11200E+02	.24915E-02	.16024E-03	.11200E+02	-	-	-
39	.22647E-01	.16835E-02	.11200E+02	.23382E-02	.15079E-03	.11200E+02	-	-	-
40	.21156E-01	.15684E-02	.11200E+02	.21897E-02	.14187E-03	.11200E+02	-	-	-
41	.19750E-01	.14665E-02	.11200E+02	.20493E-02	.13390E-03	.11200E+02	-	-	-
42	.18438E-01	.13637E-02	.11200E+02	.19135E-02	.12589E-03	.11200E+02	-	-	-
43	.17129E-01	.12641E-02	.11200E+02	.17845E-02	.11807E-03	.11200E+02	-	-	-
44	.15918E-01	.11738E-02	.11200E+02	.16616E-02	.11081E-03	.11200E+02	-	-	-
45	.14771E-01	.10865E-02	.11200E+02	.15444E-02	.10374E-03	.11200E+02	-	-	-
46	.13684E-01	.10047E-02	.11200E+02	.14332E-02	.96981E-04	.11200E+02	-	-	-
47	.12655E-01	.92754E-03	.11200E+02	.13272E-02	.90494E-04	.11200E+02	-	-	-
48	.11677E-01	.85455E-03	.11200E+02	.12267E-02	.84253E-04	.11200E+02	-	-	-
49	.10755E-01	.78583E-03	.11200E+02	.11668E-02	.78283E-04	.99000E+01	-	-	-
50	.20223E+00	.13830E-01	.11200E+02	.21601E-01	.11857E-02	.11200E+02	-	-	-
51	.15733E+00	.11660E-01	.11100E+02	.17412E-01	.10376E-02	.11400E+02	-	-	-
52	.21030E+00	.13842E-01	.11100E+02	.22577E-01	.12619E-02	.11100E+02	-	-	-
53	.10895E+00	.82007E-02	.11300E+02	.13011E-01	.77251E-03	.11500E+02	-	-	-
54	.74466E-01	.51194E-02	.11300E+02	.88001E-02	.50584E-03	.11500E+02	-	-	-
55	.61171E-01	.39756E-02	.11100E+02	.69799E-02	.40343E-03	.11300E+02	-	-	-
56	.53331E-01	.34931E-02	.11100E+02	.59864E-02	.35869E-03	.11300E+02	-	-	-
57	.47222E-01	.31806E-02	.11100E+02	.52941E-02	.32968E-03	.11100E+02	-	-	-
58	.42260E-01	.28937E-02	.11100E+02	.47566E-02	.30342E-03	.11100E+02	-	-	-
59	.37871E-01	.26123E-02	.11100E+02	.42884E-02	.27768E-03	.11100E+02	-	-	-
60	.34034E-01	.23554E-02	.11100E+02	.38721E-02	.25384E-03	.11200E+02	-	-	-
61	.30636E-01	.21247E-02	.11100E+02	.34979E-02	.23203E-03	.11100E+02	-	-	-
62	.27479E-01	.18974E-02	.11100E+02	.31486E-02	.21048E-03	.11100E+02	-	-	-
63	.24657E-01	.16964E-02	.11100E+02	.28342E-02	.19107E-03	.11100E+02	-	-	-
64	.22117E-01	.15167E-02	.11100E+02	.26204E-02	.17342E-03	.99000E+01	-	-	-
65	.19876E-01	.13626E-02	.11100E+02	.24774E-02	.15789E-03	.99000E+01	-	-	-
66	.17860E-01	.12267E-02	.11100E+02	.23333E-02	.14392E-03	.98000E+01	-	-	-
67	.16039E-01	.10966E-02	.11100E+02	.21984E-02	.13050E-03	.98000E+01	-	-	-
68	.14373E-01	.97970E-03	.11100E+02	.20628E-02	.11826E-03	.98000E+01	-	-	-
69	.12888E-01	.87489E-03	.11100E+02	.19281E-02	.10708E-03	.98000E+01	-	-	-
70	.11512E-01	.78269E-03	.11100E+02	.17959E-02	.97005E-04	.98000E+01	-	-	-
71	.10290E-01	.69959E-03	.11100E+02	.16672E-02	.87784E-04	.98000E+01	-	-	-
72	.91863E-02	.62259E-03	.11100E+02	.15427E-02	.79200E-04	.98000E+01	-	-	-
73	.81921E-02	.55581E-03	.11100E+02	.14234E-02	.71531E-04	.98000E+01	-	-	-
74	.72290E-02	.48734E-03	.11100E+02	.13111E-02	.63904E-04	.97000E+01	-	-	-
75	.64335E-02	.43591E-03	.11100E+02	.12074E-02	.57689E-04	.97000E+01	-	-	-
76	.57192E-02	.38817E-03	.11100E+02	.11092E-02	.51930E-04	.97000E+01	-	-	-
77	.50764E-02	.34469E-03	.11100E+02	.10163E-02	.46643E-04	.97000E+01	-	-	-
78	.44979E-02	.30534E-03	.11100E+02	.92890E-03	.41812E-04	.97000E+01	-	-	-
79	.39777E-02	.26995E-03	.11100E+02	.84700E-03	.37416E-04	.97000E+01	-	-	-
80	.35100E-02	.23823E-03	.11100E+02	.77054E-03	.33427E-04	.97000E+01	-	-	-
81	.30924E-02	.20991E-03	.11100E+02	.69944E-03	.29818E-04	.97000E+01	-	-	-
82	.27183E-02	.18445E-03	.11100E+02	.63352E-03	.26547E-04	.97000E+01	-	-	-
83	.23845E-02	.16186E-03	.11100E+02	.57259E-03	.23600E-04	.97000E+01	-	-	-
84	.20870E-02	.14170E-03	.11100E+02	.51644E-03	.20943E-04	.97000E+01	-	-	-
85	.18222E-02	.12379E-03	.11100E+02	.46484E-03	.18552E-04	.97000E+01	-	-	-
86	.15870E-02	.10786E-03	.11100E+02	.41753E-03	.16404E-04	.97000E+01	-	-	-
87	.13784E-02	.93724E-04	.11100E+02	.37427E-03	.14474E-04	.97000E+01	-	-	-

88	--.11938E-02	.81247E-04	.11100E+02	--.33482E-03	.12751E-04	.97000E+01
89	--.10309E-02	.70222E-04	.11000E+02	--.29891E-03	.11209E-04	.97000E+01
90	--.88800E-03	.60502E-04	.11000E+02	--.26630E-03	.98338E-05	.97000E+01
91	--.78609E-03	.51952E-04	.10200E+02	--.23675E-03	.86086E-05	.97000E+01
92	--.66809E-03	.44448E-04	.10100E+02	--.21003E-03	.75195E-05	.97000E+01
93	--.58255E-03	.37877E-04	.10100E+02	--.18593E-03	.65532E-05	.97000E+01
94	--.50675E-03	.32138E-04	.10100E+02	--.16444E-03	.56976E-05	.96000E+01
95	--.44089E-03	.27139E-04	.10000E+02	--.14544E-03	.49415E-05	.96000E+01
96	--.38257E-03	.22797E-04	.10000E+02	--.12835E-03	.42747E-05	.96000E+01
97	--.33091E-03	.19038E-04	.10000E+02	--.11301E-03	.36880E-05	.96000E+01
98	--.28553E-03	.15800E-04	.99000E+01	--.99271E-04	.31735E-05	.96000E+01
99	--.24660E-03	.13016E-04	.99000E+01	--.86985E-04	.27228E-05	.96000E+01
**	--.21223E-03	.10636E-04	.99000E+01	--.76023E-04	.23292E-05	.96000E+01

***** JOB COMPLETE *****

ORIGINAL PAGE IS
OF POOR QUALITY

1 Report No NASA CR-178015	2 Government Accession No	3 Recipient's Catalog No
4 Title and Subtitle ALESEP: PART II - A Computer Program for the Analysis of Leading Edge Separation Bubbles on Infinite Swept Wings		5 Report Date February 3, 1986
		6 Performing Organization Code
7 Author(s) R.L. Davis,		8 Performing Organization Report No
		10 Work Unit No
9 Performing Organization Name and Address UNITED TECHNOLOGIES RESEARCH CENTER Silver Lane East Hartford, CT 06108 <i>UNW 89063</i>		11 Contract or Grant No NAS1-16585
		13 Type of Report and Period Covered CONTRACTOR REPORT
12 Sponsoring Agency Name and Address National Aeronautics and Space Administration Washington, D.C. 20546		14 Sponsoring Agency Code 505-60-21-01
15 Supplementary Notes Langley Technical Monitor: Joel L. Everhart		
16 Abstract A program called ALESEP is presented for the analysis of the inviscid-viscous interaction which occurs due to the presence of a closed laminar-transitional separation bubble on an airfoil or infinite swept wing. The ALESEP code provides an iterative solution of the boundary layer equations expressed in an inverse formulation coupled to a Cauchy integral representation of the inviscid flow. This interaction analysis is treated as a local perturbation to a known solution obtained from a global airfoil analysis; hence, part of the required input to the ALESEP code are the reference displacement thickness and tangential velocity distributions. Special windward differencing may be used in the reversed flow regions of the separation bubble to accurately account for the flow direction in the discretization of the streamwise convection of momentum. The ALESEP code contains a forced transition model based on a streamwise intermittency function, a natural transition model based on a solution of the integral form of the turbulent kinetic energy equation, and an empirical natural transition model. In addition, wall suction may be applied to the boundary layer to either control its growth or alleviate the separation bubble. Complete documentation of the two-dimensional code was originally given in NASA Contract Report 172310. An updated set of instructions for the input, output, and program usage for both two-dimensional airfoils and infinite swept wings is given herein along with a sample case.		
17 Key Words (Suggested by Author(s)) Interaction, separation bubble, viscous, transitional, airfoil and infinite swept wing separation	18 Distribution Statement Unclassified - Unlimited Subject Category 02	
19 Security Classif (of this report) Unclassified	20 Security Classif (of this page) Unclassified	21 No of Pages 74
		22 Price*

* For sale by the National Technical Information Service Springfield Virginia 22151