

NASA Technical Memorandum 87715

STRUCTURAL PERFORMANCE OF SPACE STATION TRUSSES WITH MISSING MEMBERS

JOHN T. DORSEY

MAY 1986

NASA

National Aeronautics and
Space Administration

Langley Research Center
Hampton, Virginia 23665

STRUCTURAL PERFORMANCE OF SPACE STATION TRUSSES
WITH MISSING MEMBERS

John T. Dorsey
NASA Langley Research Center
Hampton, VA 23665

INTRODUCTION

The United States has selected a space station as the next step required to establish a permanent presence in space. As currently envisioned, a space station with an operating life on the order of 20-30 years will achieve its Initial Operating Capability (IOC) sometime in the mid 1990's. An initial configuration chosen for study, the gravity gradient stabilized power tower described in reference 1, includes a truss structure which serves as the backbone of the station. The truss structure has many important functions, such as providing attachment locations for the many space station subsystems and payloads, and supporting the required power links between the power generation system and the manned modules. The truss also provides sufficient stiffness between sensors and reaction control thrusters and control moment gyros on the station to insure proper rigid and flexible body control.

Several recent studies have addressed important issues concerning the space station truss structure. In reference 2 for example, the issues of truss size and type are studied for three different gravity gradient stabilized space station concepts, and in reference 3, erectable and deployable methods for constructing the space station truss structure are examined. Space station structural dynamic studies have also been performed for the power tower configuration and are summarized for a station constructed with 9-foot square truss bays in reference 4, and for a station with 15-foot square truss bays in reference 5. Structural dynamic studies

have also been performed on the more recently defined space station dual keel reference configuration and are summarized in reference 6.

The type of truss currently being considered for the space station is a four longeron truss with square bays as described in references 2 and 3. A primary benefit of the four longeron truss is its inherent structural redundancy which prevents any catastrophic structural failures from occurring due to the loss of a single truss strut. This structural redundancy is especially important in helping to insure operational safety of the space station during its 20-30 year lifetime.

The studies described in references 4-6 have been important in defining space station structural dynamic characteristics as well as quantifying typical loads which will be encountered in the space station truss structure. However, none of the studies in references 4-6 address the issue of individual strut failures in the space station truss and the resulting effects on space station structural performance. One purpose of the studies described in this paper is to assess the degradation in strength and stiffness in four longeron space station trusses due to the failure of single struts. The studies described herein expand on those previously reported in reference 7 by examining; a truss beam with Warren-type diagonal lacing as well as the orthogonal tetrahedral truss, a power tower space station model, and truss platforms.

Although it is possible that the space station truss may lose a strut due to an accident, a more likely scenario involves purposely removing a truss strut during space station construction or normal operations. For example, the large internal volume available makes it attractive to store payloads and subsystems inside of the truss as described in reference 3.

This scenario requires the intentional removal of a truss strut, placement of the payload inside the truss bay and then replacement of the strut in the truss. Whenever a strut fails or is intentionally removed, the possibility exists of a length mismatch between the gap in the truss (where the strut was removed from) and the length of the truss strut which is to be placed in the truss. This mismatch may arise from manufacturing tolerances, as in the case of replacing a failed strut with a new one. In a more likely scenario, the mismatch would result from differences in thermal expansion, due to a removed strut being stored in shadow while the rest of the truss is in sunlight for example. Another purpose of this report is to assess the ease of strut replacement by determining the amount of resistance (i.e., stiffness) which the truss surrounding a gap offers to a strut being placed in the truss gap. This stiffness can be used to calculate the amount of force required to insert the strut into the gap.

FINITE ELEMENT MODEL DESCRIPTIONS

Truss Beams

The finite element model for the cantilevered space station transverse boom is shown in figure 1. The truss beam is a four longeron single laced orthogonal tetrahedral truss with 14' square bays. The truss struts are modeled with rod (axial stiffness only) elements and represent graphite epoxy tubes which have a 2 in. outer diameter and .06 in. thick walls. The tubes have a Young's modulus of 40×10^6 lbf/in², a density of .058 lbf/in³, and an area of .3657 in². The truss beam supports twelve deployable solar arrays (six on each side) and the arrays are sized to provide a total of 75kw of electrical power to the space station. A transition truss, composed of struts with the same cross-section described previously, connects the 14'

diameter rotary joint (see reference 8) to the truss beam and to the cantilever support. Nonstructural mass of the rotary joint (which includes drive mechanisms, power and thermal couplings, etc.) was assumed to be 2000 lbm. The mass of nodal joint clusters and the solar arrays were also included in the model.

Two other finite element models which consisted solely of bare truss beams (see figure 2) were also used for analysis. Both of these four longeron truss beams had 15' square bays, were simply supported, and were modeled with the same 2 in. diameter struts as described previously. The difference between the two truss beams was in the pattern of the diagonal members. The truss beam shown in figure 2a, an orthogonal tetrahedral configuration, has the advantage that only one type of nodal cluster is required to build the truss but a slight disadvantage due to stiffness coupling between bending/torsion and axial/shear. The diagonal pattern for the truss beam shown in figure 2b is of the Warren truss type for each face. An advantage of this truss is the lack of any stiffness coupling while a disadvantage is that two different types of nodal clusters are required to construct the truss. Both of these truss beam types are currently being considered for the space station truss structure.

Space Station Model

A model of the IOC power tower space station concept shown in figure 3 was also studied. An orthogonal tetrahedral truss with a bay size of 15' forms the basic support structure for the space station. The same 2 in. graphite epoxy tubes described previously were used in this model with the only difference being an increase in the material density to $.063 \text{ lbf/in}^3$ (which, compared to the $.058$ value, reflected updated information on the

tube material). This space station finite element model is described in detail in reference 5.

Truss Platforms

Two types of platforms were studied, an orthogonal tetrahedral truss (shown in figure 4) and a Warren-type truss (shown in figure 5). Both truss platforms had 15' square bays and the truss struts were 2 in. outer diameter tubes with the properties described previously.

ANALYSIS RESULTS

Vibration Modes and Frequencies

The first five vibration modes and frequencies for the cantilevered transverse boom model shown in figure 1 are summarized in the first column of Table I. The fundamental mode is 1st torsion about the X axis at a frequency of .599 hz. The two cantilever 1st bending modes follow at .671 hz and .735 hz, followed by 2nd and 3rd torsional modes at 1.21 hz and 1.38 hz respectively.

The first five modes and frequencies were recalculated for the case of a failed longeron near the root of the cantilever truss boom. The location of the failed longeron, denoted by the letter A in figure 6, is at the intersection of the truss beam and the rotary joint transition truss. The largest frequency reduction, from .599 hz to .464 hz (-22.5%), occurs in the first mode and the next larger reduction (-6.7%) occurs in the third mode. Frequency reductions in the other three modes were less than 1%.

For the simply supported orthogonal tetrahedral and Warren-type trusses, longerons were removed from a bay near the center of the truss beams and modes and frequencies calculated. Because of the structural redundancy in the truss beams and the diagonal strut patterns, load paths

around a failed strut could vary and, in turn, lead to differences in reduced stiffness depending on the particular strut removed. To examine this effect, two different longerons were removed from the truss beams and modes and frequencies calculated. For both beams, the two top longerons were removed (only one at a time) from the locations shown in figure 7a and 7b for the orthogonal tetrahedral truss and in figure 8 for the Warren-type truss. For the orthogonal tetrahedral truss, a case was also studied in which cantilever boundary conditions were assumed at one end and a face diagonal member removed from the root bay (see figure 7c). For this one case, a bay size of 5m rather than 15' was used. The tube properties however, remained the same.

Table II lists the first five modes and frequencies for: (1) the full orthogonal tetrahedral truss beam, (2) the truss with longeron A removed, and (3) the truss with longeron B removed. The fundamental mode for the full truss is 1st bending about the Y axis at 4.41 hz with 2nd bending about the Z axis occurring at 5.75 hz (the two bending frequencies differ due to the difference in boundary conditions in the two directions). The fundamental frequency is reduced by 13.8% when longeron A is removed and 12.7% when longeron B is removed. In both instances, the 1st mode shape changes from purely bending about the Y axis to a combination of bending about the Y axis plus bending about the Z axis. Smaller frequency reductions occur for the 2nd bending mode, -5.4% when longeron A is removed and -4.7% when longeron B is removed. All other frequency reductions are less than 1% except for the case of mode 4 with longeron A removed, which shows a reduction of 2.2%.

Similarly, table III shows the modes and frequencies for the Warren-type truss for: (1) the full truss, (2) when longeron A is removed, and (3) when longeron B is removed. The fundamental frequency, which is associated with 1st bending about the Y axis is reduced by 10.4% when longeron A is removed and by 11.5% when longeron B is removed. Frequency reductions for the 2nd mode are smaller, between 4% and 5%, when either longeron A or longeron B is removed.

In Table IV, modes and frequencies are shown for the full cantilever orthogonal tetrahedral truss and with diagonal D removed. The largest frequency reduction occurs in the first torsional mode (mode 3) and is 15.1% when the root diagonal is removed. Reductions in the first and second bending frequencies (modes 1 and 2, and 4 and 5 respectively) are all less than 0.4%.

Modes and frequencies were calculated for the space station model with the longeron at the keel/keel extension intersection removed (see figure 3). Of the first 100 vibration modes calculated for the space station, only the five modes listed in Table V had any significant reductions in frequency. The largest change occurred in mode 33, first keel bending about the Y axis, where the frequency for the station with the longeron removed (.4158 hz) was 16.0% less than the frequency for the full truss station (.4949 hz). Other modes which involved keel bending (modes 32, 34, and 35) had frequency reductions between 1.7% and 4.8%. The only torsional mode affected, mode 31, had a frequency decrease of 3.5% when the longeron was removed. For all of the other space station modes not listed in Table V, frequency reductions were less than 0.3%.

Modes and frequencies were also calculated for an orthogonal tetrahedral and Warren-type truss platform for the full truss and the case of a missing longeron. Both truss platforms were square with 12 bays on a side and the longeron was removed from the top face near the platform center (see figure 9). Frequencies for the first five elastic body modes (modes 7 - 11) are summarized for the orthogonal tetrahedral truss platform in table VI and for the Warren-type truss platform in table VII.

The full truss mode shapes show how the arrangement of truss diagonal members in the truss platform's upper and lower faces affects the truss bending stiffness. The orthogonal tetrahedral truss diagonal arrangement causes the platform to be more flexible in bending about an axis parallel to the face diagonals than about an axis perpendicular to the face diagonals. This difference in stiffness is not present in the Warren-type truss however because the face diagonals alternate directions from bay to bay. Because of the orthogonal tetrahedral truss's increased flexibility about an axis parallel to the face diagonals direction, its fundamental frequency (which is associated with the same mode shape for the two truss platforms) is 23.7% less than the Warren-type truss frequency. For the two other equivalent modes shown in tables VI and VII, the differences in frequency are much less severe being less than 3%. Additional modes (not found in the Warren-type truss) also occur for the orthogonal tetrahedral truss platform (modes 9 and 11) because of its face diagonal arrangement.

Removing longeron A from either of the truss platforms causes very little degradation in the truss frequencies. The largest reduction occurs in mode 8 for both truss platforms and is approximately 1% for each. The

frequency reduction in all other modes is less than 1% for both truss platforms.

Truss Stiffness With Struts Removed

In this section, study results are presented which quantify the stiffness of the truss surrounding a gap from which a strut has been removed. The truss stiffness which is calculated indicates how much resistance the truss structure offers to replacing a strut whose length may be different from that of the gap. The stiffness of the truss was calculated in the following manner. First a truss strut was removed from the beam or platform model (longeron A in figure 7a for example). Second, a unit load was applied at the gap along the line of action of the missing strut. This loading condition is represented by the two unit force vectors (labeled F) acting in the X direction at the locations shown in figure 7a. Third, the total displacements of points A and B were calculated and added vectorally to give the amount of gap closing due to the applied forces. Fourth, and finally, the stiffness of the truss surrounding the gap was calculated by dividing the unit force by the total displacement. When calculating the displacements, simply supported boundary conditions were assumed for both the truss beams and the truss platforms (the truss platforms were supported at the four bottom corner joints).

Truss beam stiffnesses for the cases when either longeron A or longeron B is removed are summarized for the orthogonal tetrahedral and Warren-type trusses in Table VIII. The static deflection shape with longeron A removed and unit loads applied at points A and B is shown for the orthogonal tetrahedral truss in figure 10a and for the Warren-type truss in figure 10b. The ratio of truss stiffness (calculated in the manner described in the

previous paragraph) to truss longeron axial stiffness (strut modulus x strut area / strut length = 8.13×10^4 lbf/in) is shown in the table. For both the orthogonal tetrahedral and the Warren-type trusses with either longeron A or B removed, the ratio of truss stiffness to strut stiffness is between .10 and .14. This means that the end fixity (ie. resistance to axial movement) that the truss offers to the strut being inserted in the gap is 10% to 14% of the strut stiffness. Thus, if a mismatch does exist between the length of the strut and the length of the gap, most of the deflection required to remove the mismatch and permit strut insertion will take place in the truss instead of the strut.

The stiffness of truss platforms with either a face longeron or a face diagonal removed (see figure 9) was also calculated for the orthogonal tetrahedral and Warren-type trusses. Figure 11 shows the variation in truss to strut stiffness ratio with the number of bays along the edge of the truss platform for the orthogonal tetrahedral and Warren-type trusses with longeron A removed. Initially, the stiffness ratio increases rapidly with increasing truss platform size because of increasing redundancy and decreasing boundary effects. When the number of bays along an edge reaches 12 (see figure 12), the stiffness ratio becomes essentially constant and a gap near the center of the truss behaves as if it is surrounded by an infinite truss.

In table IX, the truss to strut stiffness ratio is summarized for the two truss platforms (each 12 bays square) when either longeron A or diagonal D is removed. The axial end fixity offered to a missing longeron in either truss platform is approximately 45% of the strut axial stiffness. Thus, for a given length mismatch, replacing a longeron in a truss platform would

require applying an axial force to the truss on the order of 3 to 4 times that required to replace a longeron in a truss beam. For the case of replacing a face diagonal strut in a truss platform, the amount of axial end fixity offered by the truss is 9% greater than the strut stiffness for the Warren-type truss and 12% greater than the strut stiffness for the orthogonal tetrahedral truss. Thus, due to the approximately equal truss and strut stiffnesses, replacing a diagonal member in a truss platform where a length mismatch exists would result in approximately equal axial deformations in the diagonal strut and the surrounding truss.

Allowable Load In A Cantilevered Truss Beam

The reduction in load carrying capability (strength) was determined for a 15 bay cantilevered orthogonal tetrahedral truss beam in which a longeron was removed from the truss bay at the cantilever root (see figure 12). The ratio of the maximum allowable tip load, with the longeron removed, to the maximum allowable tip load for the full truss was based on Euler buckling and calculated as a function of the applied load direction in the following manner. For each value of θ at which the tip load was applied, forces were calculated in all of the truss members. The Euler buckling load, given by $P_{cr} = \pi^2 EI/L^2$ (where E is the strut modulus of elasticity, I is the strut moment of inertia, and L is the strut length), was compared to each strut in the truss which had a compressive load. Whichever member in the truss was closest to its buckling load (the critical member) was used to calculate an allowable tip load (the tip load which would buckle the strut) for load directions between 0° and 360° . The longeron at the root bay shown in figure 12, which was the critical member when the loading direction was 0° , was then removed from the truss. New allowable tip loads were calculated

for the truss for the full range of loading directions. For a given loading direction however, the critical member for the full truss was not necessarily the same as the critical member for the truss with the longeron removed.

The resulting ratio between maximum allowable tip loads is shown in figure 12 for the full range of loading directions. For the worst case (load direction of 190°), the truss with a failed longeron can still support 44% of the allowable full truss load. The figure also shows that for certain load directions, the truss with the failed strut can support a greater load than the full truss. This greater load carrying capability is attributed to changing load paths in the truss as the load direction is varied (due to the truss redundancy) as well as the effect of diagonal member orientation on possible load paths.

CONCLUDING REMARKS

Two types of four longeron truss beams and truss platforms (with two different diagonal patterns) which are being considered for space station construction were studied. In the orthogonal tetrahedral truss, all of the diagonals in a given plane run parallel to each other whereas in the Warren-type truss, diagonals in adjacent truss bays run perpendicular to each other. The diagonal pattern in the orthogonal tetrahedral truss results in bending/torsion and axial/shear coupling in the truss stiffnesses. This stiffness coupling is not present in the Warren-type truss.

For equivalent vibration modes, full truss frequencies for the Warren-type truss beam were slightly higher (2.1%-11.2%) than frequencies for the orthogonal tetrahedral truss because the coupling terms increased

the orthogonal tetrahedral truss flexibility. The fundamental frequency difference was much larger for the truss platforms, with the orthogonal tetrahedral truss frequency being 23% less than the Warren-type truss frequency. This large difference occurs because the orthogonal tetrahedral truss diagonal lacing pattern causes the platform to be more flexible in bending about an axis parallel to the face diagonals than about an axis perpendicular to the face diagonals.

For truss beams, removing a longeron caused the largest reductions in bending frequencies and removing a diagonal caused the largest reductions in torsional frequencies, with reductions limited to the lower modes (first few bending or torsional modes respectively). In general, the maximum frequency reduction due to removal of a longeron was slightly smaller for the Warren-type truss (approximately 2% to 3%) than for the orthogonal tetrahedral truss. Based on the truss models studied; simply supported beam with a missing longeron, cantilever beam with a missing diagonal, and power tower space station with a missing longeron, a maximum frequency reduction of 10% to 20% can be expected when one truss member is removed. Because of their increased structural redundancy however, maximum reductions in frequency of 1% or less are typical for a truss platform with a missing strut.

Replacing a longeron when there is a mismatch between the longeron length and the length of the gap in the truss was found to be easier for a truss beam than for a truss platform because the axial end fixity offered by the truss beam is 10% to 14% of the longeron axial stiffness, whereas the end fixity offered by the truss platform is 45% of the longeron axial stiffness. Replacing a face diagonal in a truss platform where a mismatch

exists is more difficult than replacing a longeron since the resistance offered by the truss in the diagonal direction is approximately 10% greater than the diagonal member axial stiffness. Thus, struts designed for easy replacement in a truss should have features which accommodate reasonable length mismatches (preferably without strut adjustment). This could be done for example, by designing struts which use lateral insertion forces to induce required axial forces. Insuring that a replacement strut is in thermal equilibrium with the surrounding truss will also help to reduce the amount of mismatch and thus the required axial forces.

Finally, based on an Euler buckling criteria, the load carrying capability of a cantilevered orthogonal tetrahedral truss beam was reduced by a maximum of 56% when a longeron at the truss root was removed. The amount of load reduction was found to be highly dependent on the applied loading direction.

REFERENCES

1. Space Station Reference Configuration Description. JSC 19989, August 1984.
2. Mikulas, Martin M: et. al.: Space Station Truss Structures and Construction Considerations. NASA TM 86338, January 1985.
3. Mikulas, Martin M.; et. al.: Deployable/Erectable Trade Study for Space Station Truss Structures. NASA TM 87573, July 1985.
4. Housner, Jerrold M.: Structural Dynamics Model and Response of the Deployable Reference Configuration Space Station. NASA TM 86386, May 1985.
5. Dorsey, John T.: Dynamic Characteristics of Power Tower Space Stations With 15-Foot Bays. NASA TM 87684, 1986.
6. Dorsey, John T.; Sutter, Thomas R.; Lake, Mark S.; Cooper, Paul A.: Dynamic Characteristics of Two 300 KW Class Dual Keel Space Station Concepts. NASA TM 87680, February 1986.
7. Dorsey, John T.: Structural Performance of Orthogonal Tetrahedral Truss Space-Station Configurations. NASA TM 86260, July 1984.
8. Lake, Mark S; Bush, Harold G.: An Analytical Investigation of a Conceptual Design for the Space Station Transverse Boom Rotary Joint Structure. NASA TM 87665, January 1986.

TABLE I.-CANTILEVER TRANSVERSE BOOM MODES AND FREQUENCIES

Mode	Frequency, hz		Mode Shape
	Full Truss	Longeron A Removed	
1	.599	.464	1st Torsion About X
2	.671	.667	1st Bending About Z + 1st Bending About Y
3	.735	.686	1st Bending About Y
4	1.21	1.20	2nd Torsion About X
5	1.38	1.37	3rd Torsion About X

TABLE II.-ORTHOGONAL TETRAHEDRAL TRUSS BEAM MODES AND FREQUENCIES

Mode	Frequency, hz			Mode Shape
	Full Truss	Longeron A Removed	Longeron B Removed	
1	4.41	3.80	3.85	1st Bending about Y (+1st Bending about Z) *
2	5.75	5.44	5.48	1st Bending about Z (+1st Bending about Y)
3	13.75	13.75	13.66	2nd Bending about Y +1st Torsion about X
4	16.10	15.75	16.09	2nd Bending about Z +2nd Bending about Y
5	17.62	17.62	17.57	1st Torsion about X +2nd Bending about Z

*Mode description includes part given in parentheses when either Longeron A or Longeron B is missing.

TABLE III.- WARREN-TYPE TRUSS BEAM MODES AND FREQUENCIES

Mode	Frequency, hz			Mode Shape
	Full Truss	Longeron A Removed	Longeron B Removed	
1	4.33	3.88	3.83	1st Bending about Y
2	5.92	5.68	5.63	1st Bending about Z (+1st Bending about Y)*
3	15.29	15.26	15.23	2nd Bending about Y
4	17.21	16.86	17.15	2nd Bending about Z
5	17.99	17.99	17.98	1st Torsion about X

*Mode description includes part given in parentheses when either Longeron A or Longeron B is missing.

TABLE IV.- ORTHOGONAL TETRAHEDRAL TRUSS MODES AND FREQUENCIES WITH MISSING DIAGONAL

Mode	Frequency, hz		Mode Shape
	Full Truss	Diagonal D Removed	
1	1.413	1.408	1st Bending
2	1.428	1.427	1st Bending
3	7.263	6.170	1st Torsion
4	7.924	7.907	2nd Bending
5	8.208	8.203	2nd Bending

TABLE V.- POWER TOWER SPACE STATION MODES AND FREQUENCIES

Mode	Frequency, hz		Mode Shape
	Full Truss	Missing Longerons	
31	.2699	.2604	1st Keel Torsion
32	.3365	.3308	1st Keel Bending about X
33	.4949	.4158	1st Keel Bending about Y
34	.7324	.6974	1st Transverse Boom Bending about X + Lower Keel Bending
35	.7620	.7348	Lower Keel Bending

TABLE VI.- ORTHOGONAL TETRAHEDRAL TRUSS PLATFORM MODES AND FREQUENCIES

Mode	Frequency, hz		Mode Shape (Nodal Pattern)
	Full Truss	Longeron A Removed	
7	12.20	12.14	
8	26.24	25.95	
9	29.34	29.34	
10	30.98	30.79	
11	38.54	38.51	

TABLE VII.- WARREN-TYPE TRUSS PLATFORM MODES AND FREQUENCIES

Mode	Frequency, hz		Mode Shape (Nodal Pattern)
	Full Truss	Longeron A Removed	
7	15.99	15.99	
8	26.95	26.72	
9	31.44	31.27	
10	38.81	38.81	
11	38.81	38.81	

TABLE VIII.-TRUSS BEAM SURROUNDING TRUSS STIFFNESS

Truss Beam	k_{truss}/k_{strut}^*	
	Longeron A Removed	Longeron B Removed
Orthogonal Tetrahedral	.098	.128
Warren-Type	.139	.135

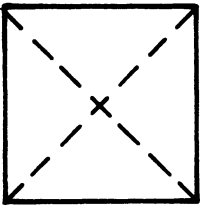
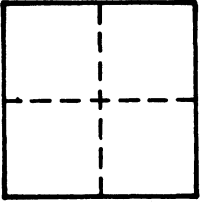
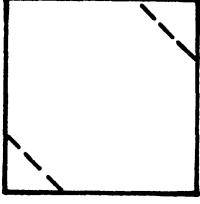
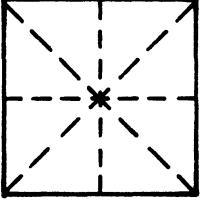
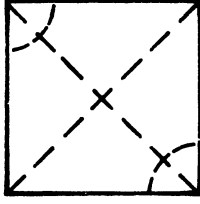
$$* k_{strut} = 8.13 \times 10^4 \text{ lb/in.}$$

TABLE IX.- TRUSS PLATFORM SURROUNDING TRUSS STIFFNESS

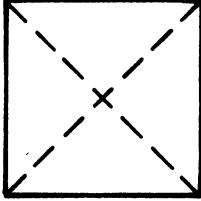
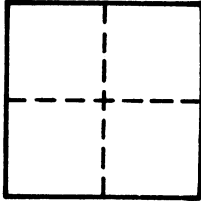
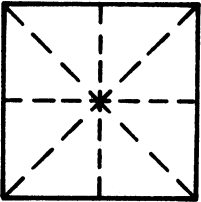
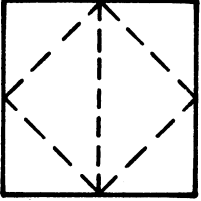
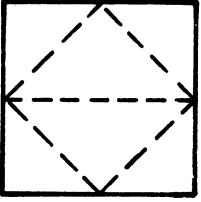
Truss Platform (12 bays x 12 bays)	k_{truss}/k_{strut}	
	Longeron A [*] Removed	Diagonal D ⁺ Removed
Orthogonal Tetrahedral	.440	1.119
Warren-type	.454	1.089

$$*k_{strut} = 8.13 \times 10^4 \text{ lb/in.}$$

$$+k_{strut} = 5.75 \times 10^4 \text{ lb/in.}$$

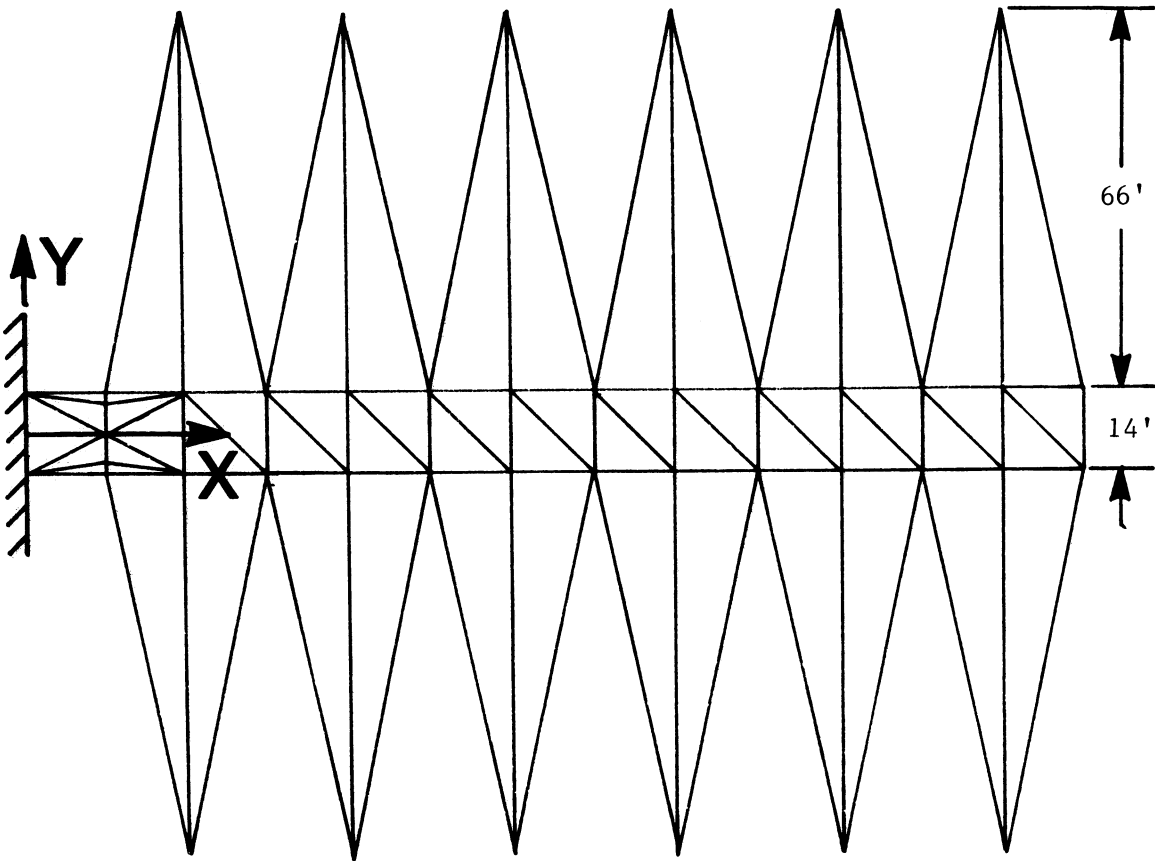

a. View of X-Y plane.

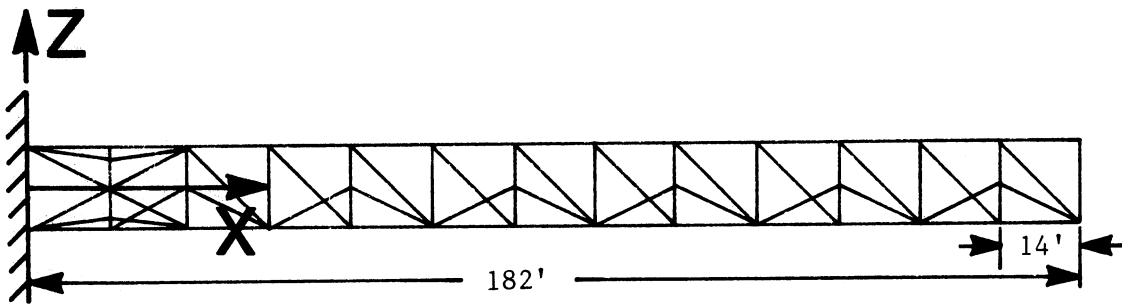

b. View of X-Z plane.

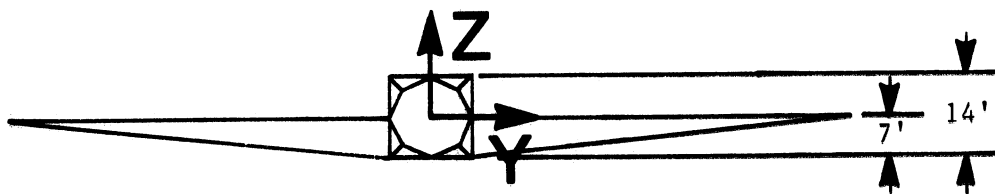

c. View of Y-Z plane.

Figure 1. - Space station transverse boom model.

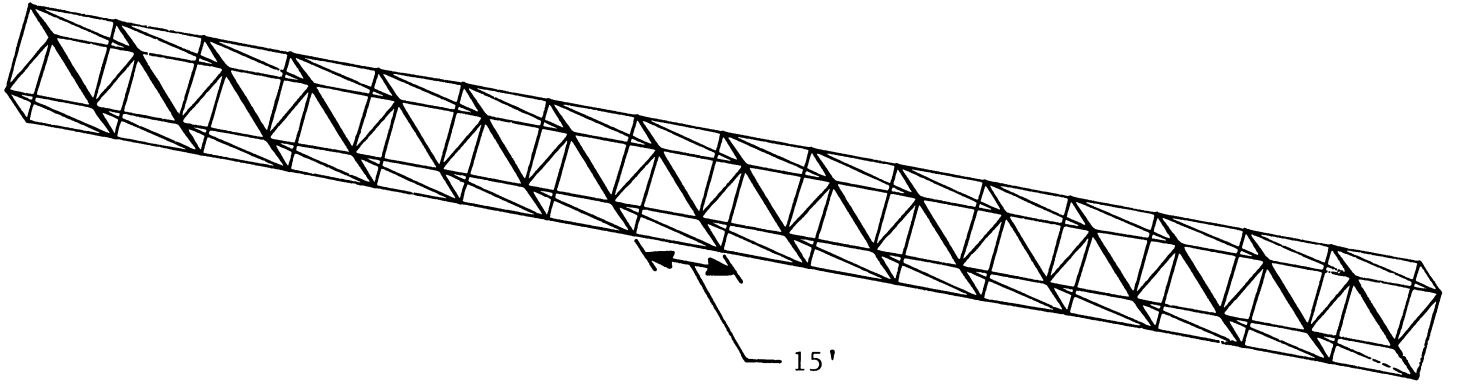

a. Orthogonal tetrahedral truss.

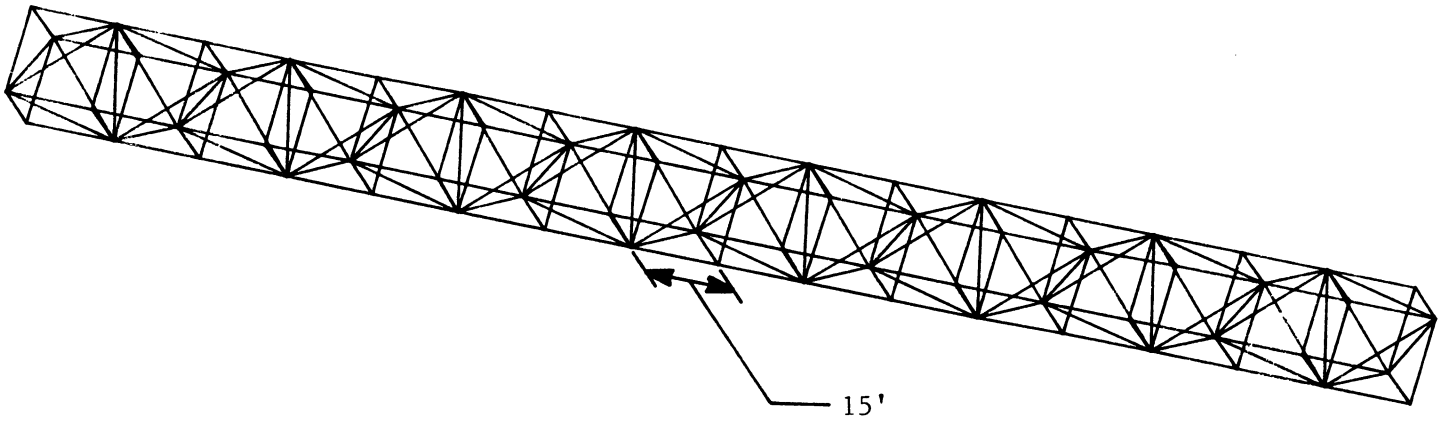

b. Warren-type truss.

Figure 2. - Truss beam models.

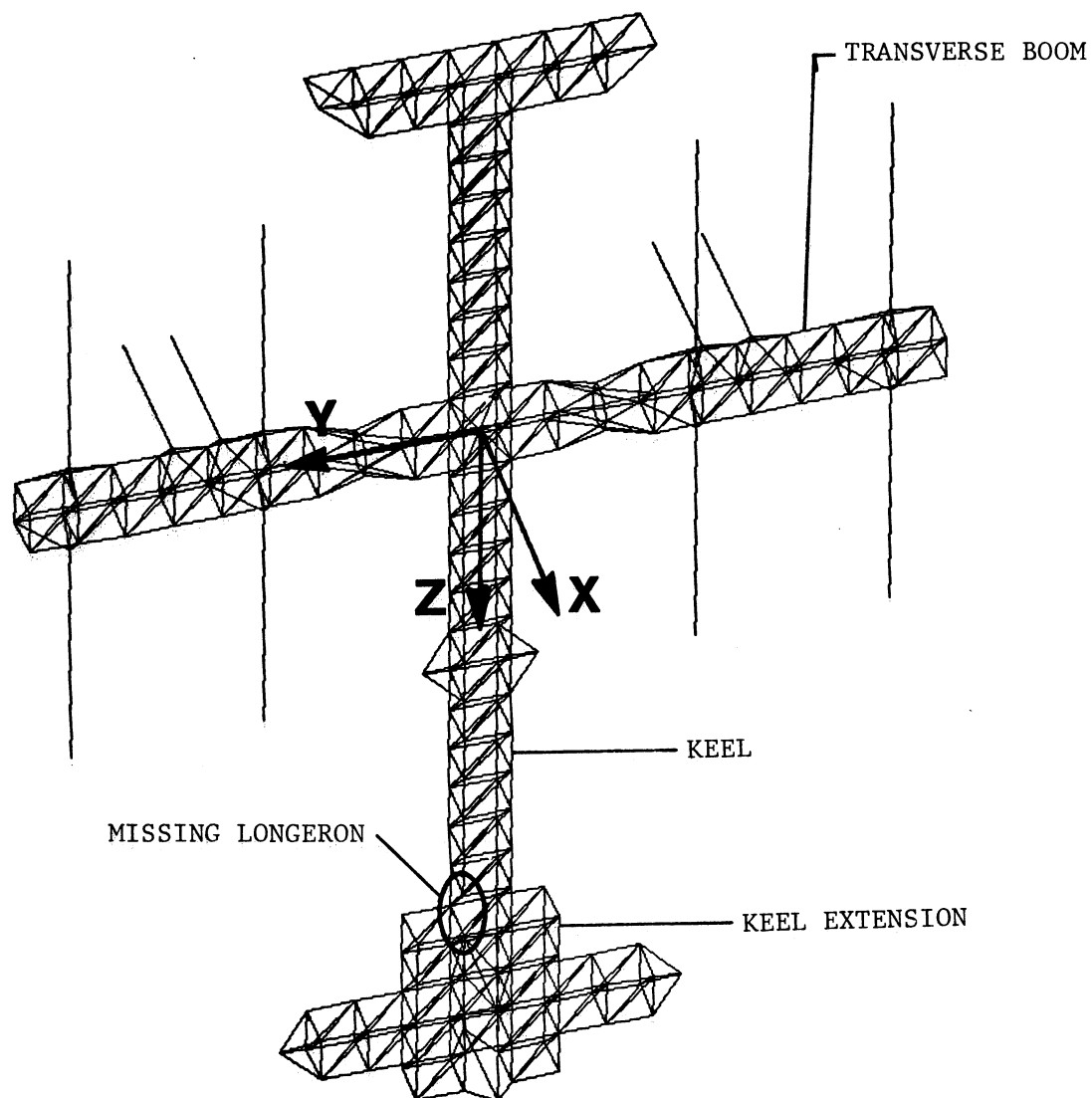

Figure 3. - Power tower space station model.

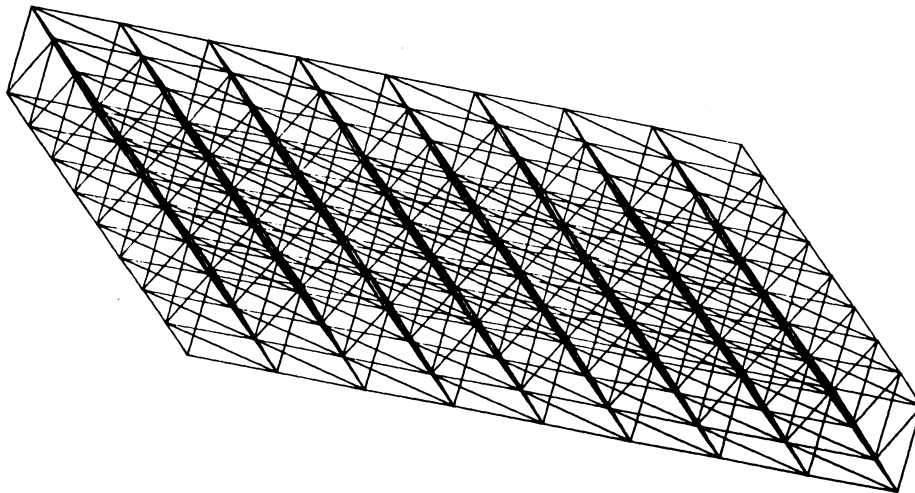
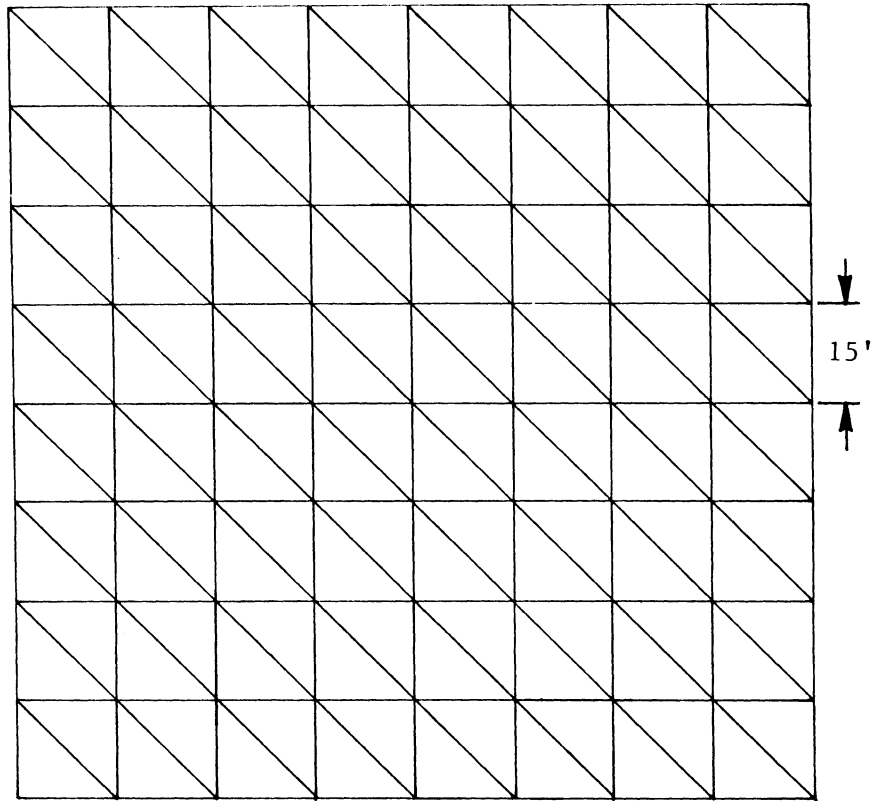

Figure 4. - Orthogonal tetrahedral truss platform model.

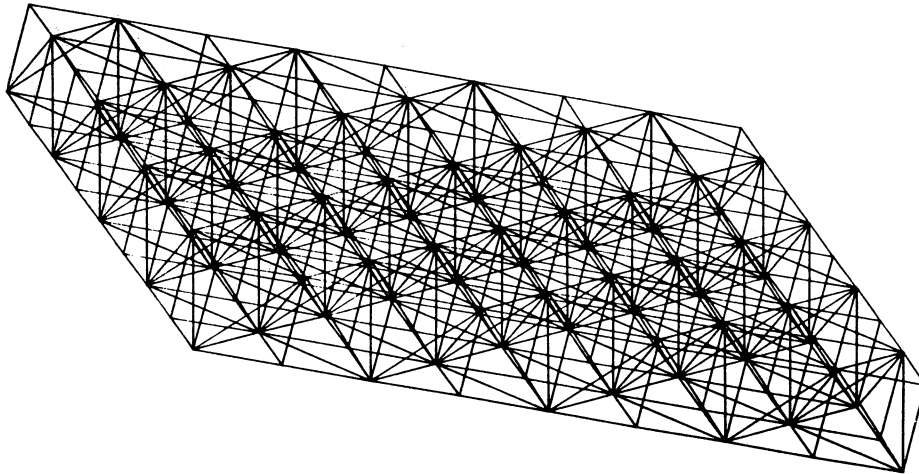
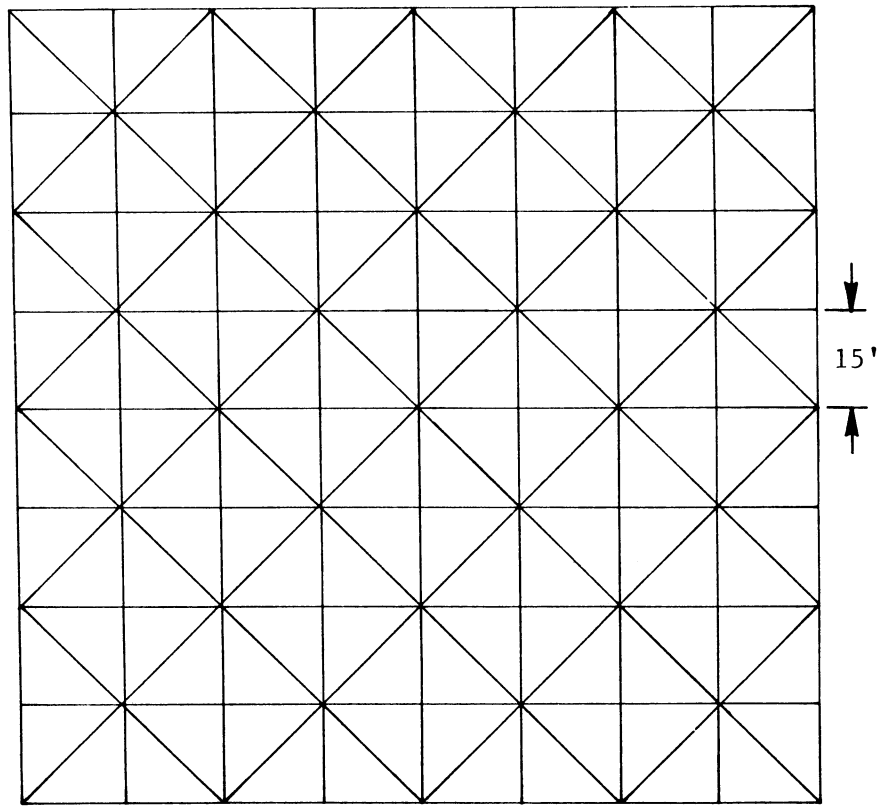

Figure 5. - Warren-type truss platform model.

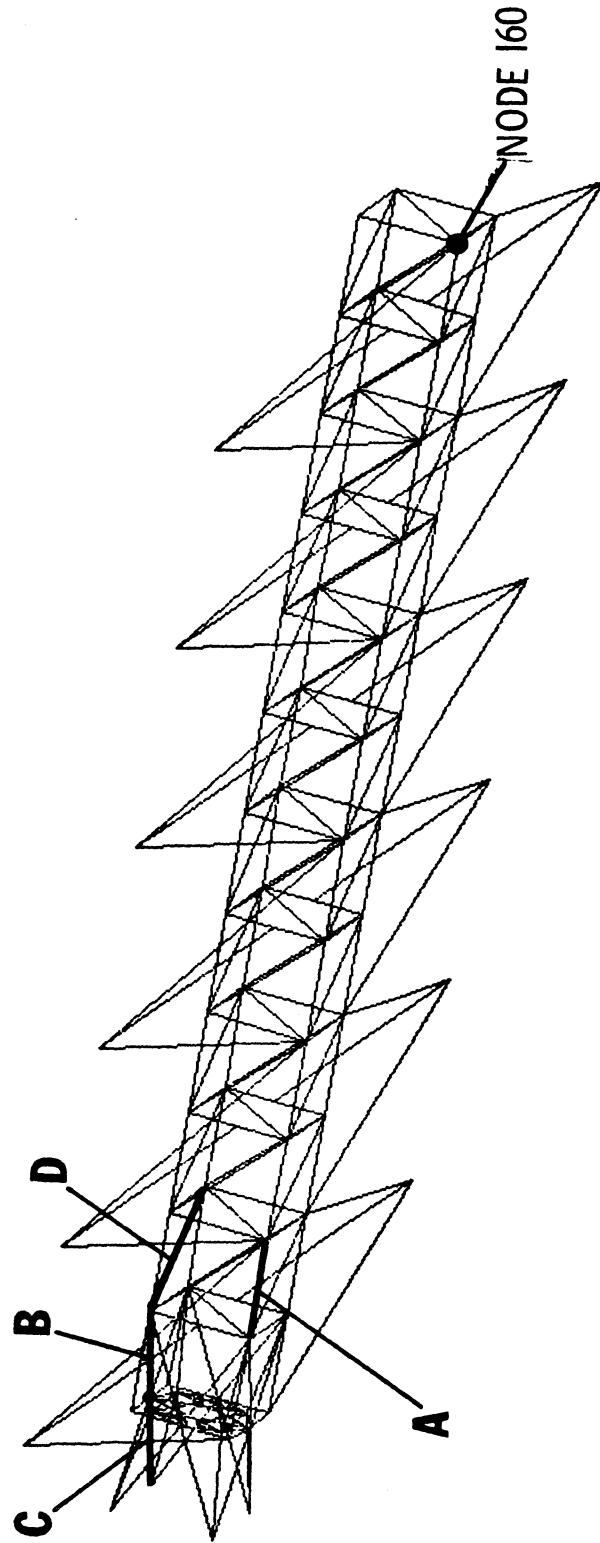
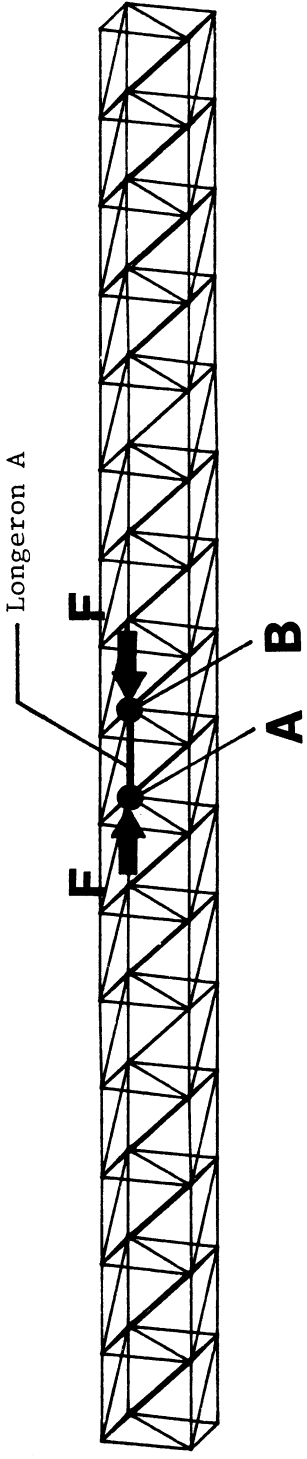
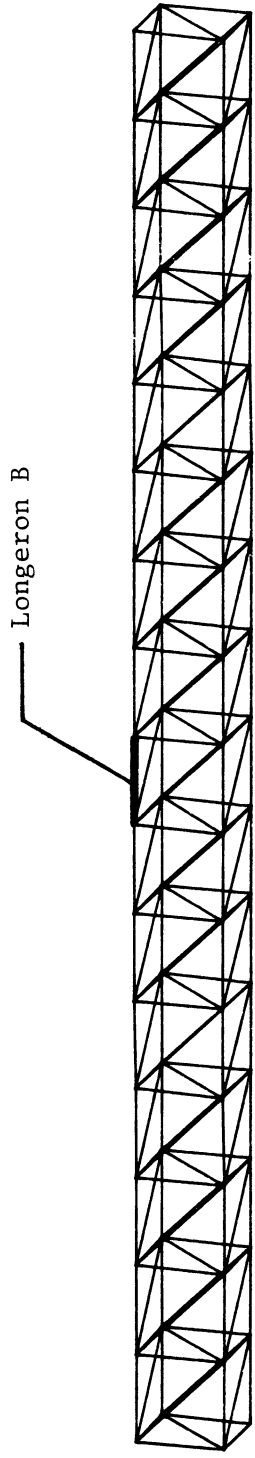

Figure 6. - Missing longeron (A) location on transverse boom model.



a. Longeron A with simple support truss boundary conditions.



b. Longeron B with simple support truss boundary conditions.

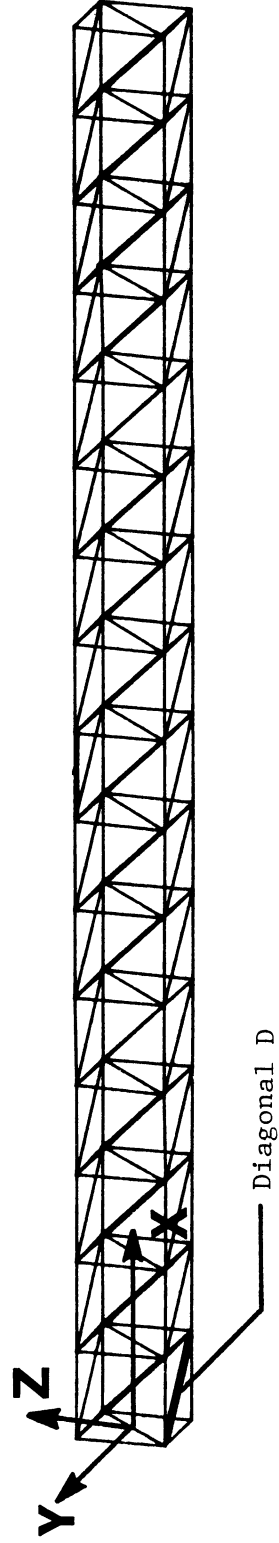

c. Diagonal D with truss cantilevered at $X=0$ end.

Figure 7. - Missing strut locations for the orthogonal tetrahedral truss beam.

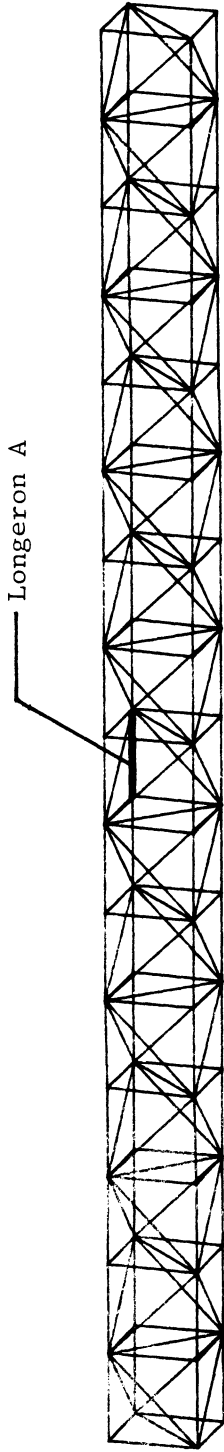

a. Longeron A with simple support truss boundary conditions.

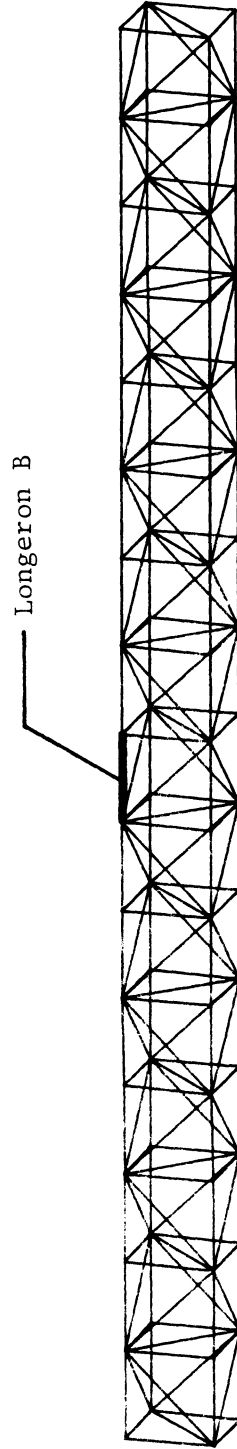

b. Longeron B with simple support truss boundary conditions.

Figure 8. - Missing strut locations for the Warren-type truss beam.

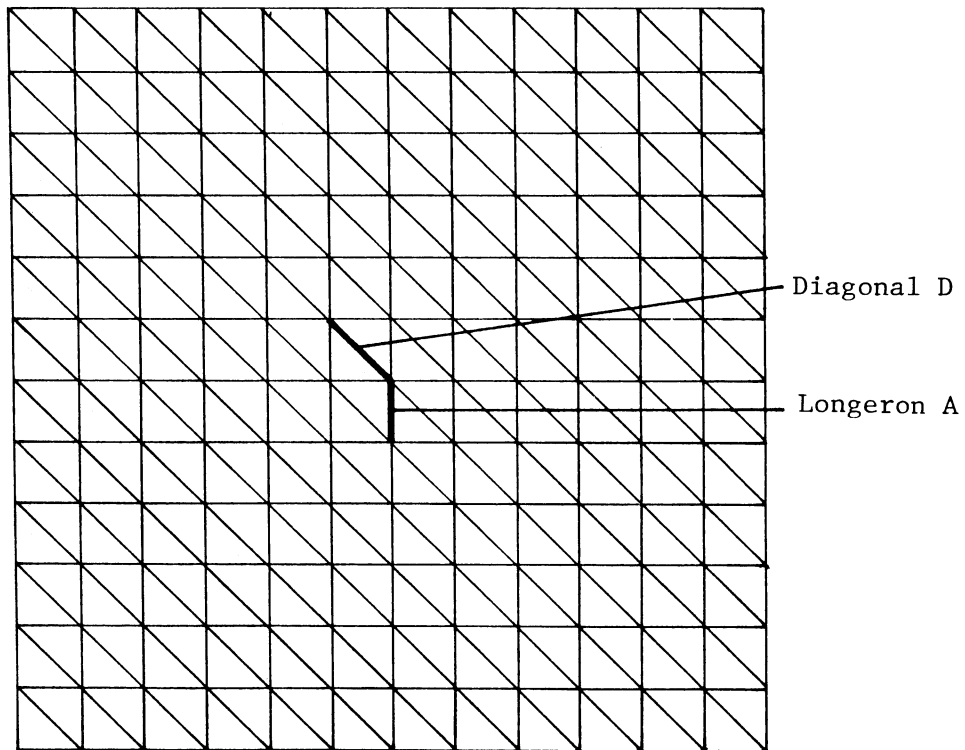

a. Orthogonal tetrahedral truss (top face).

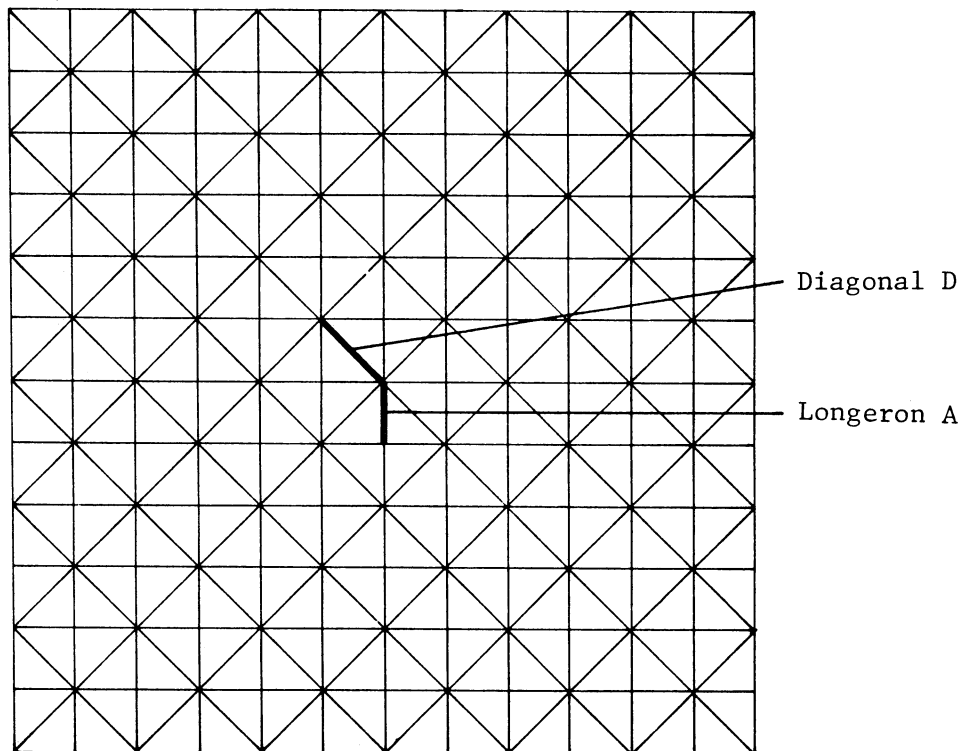

b. Warren-type truss (top face).

Figure 9. - Missing face strut locations for truss platforms.

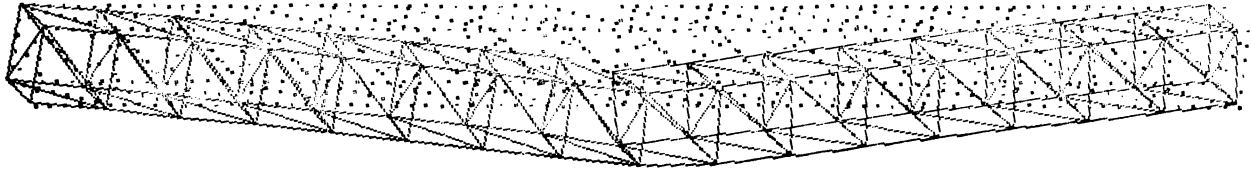

a. Orthogonal tetrahedral truss.

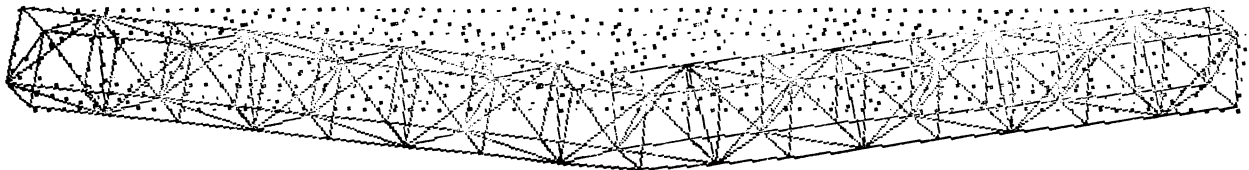

b. Warren-type truss.

Figure 10. - Truss beam deflection when load is applied at missing longeron (A) location.

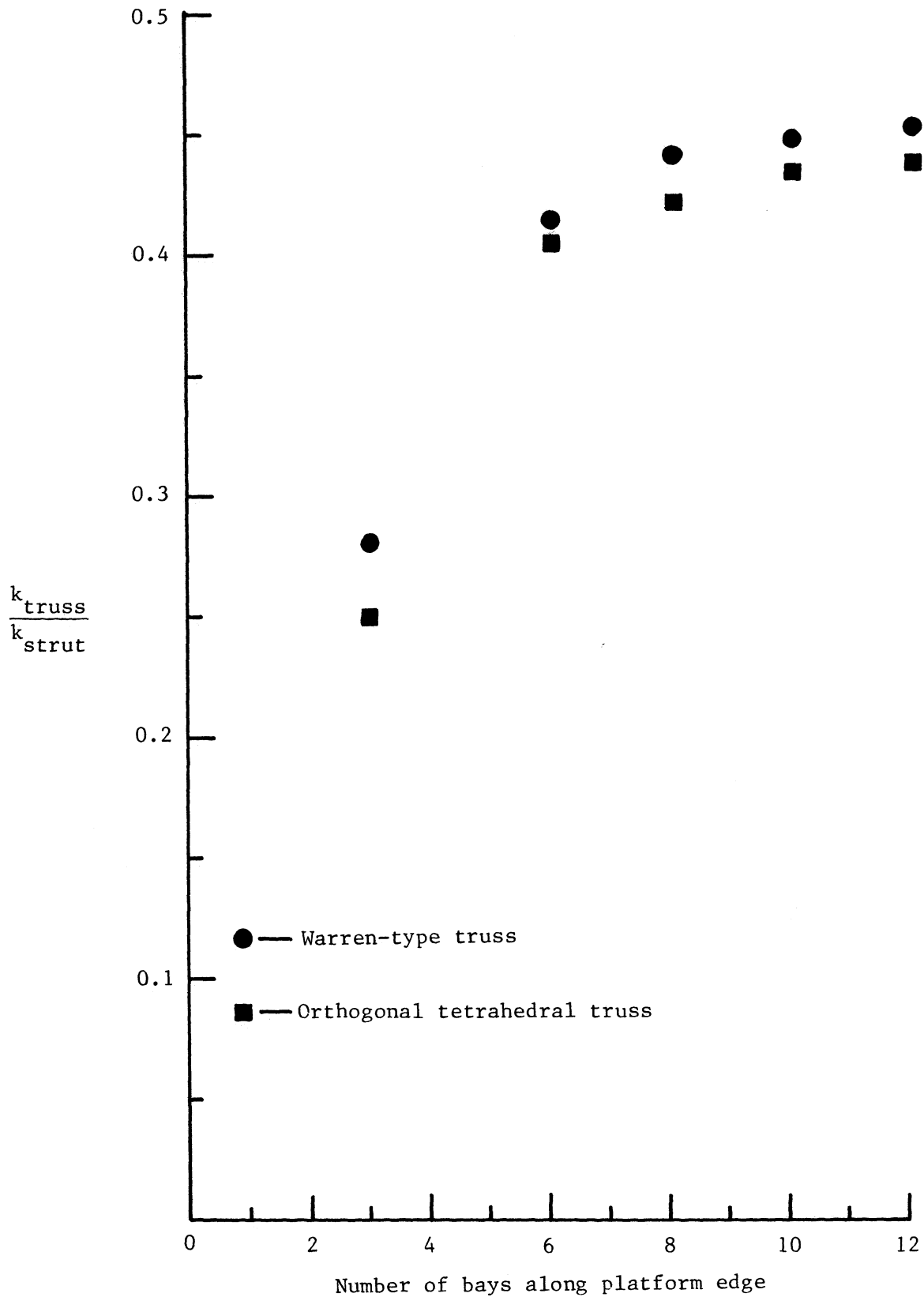

Figure 11. - Truss platform stiffness with longeron A removed versus the number of bays along a platform edge.

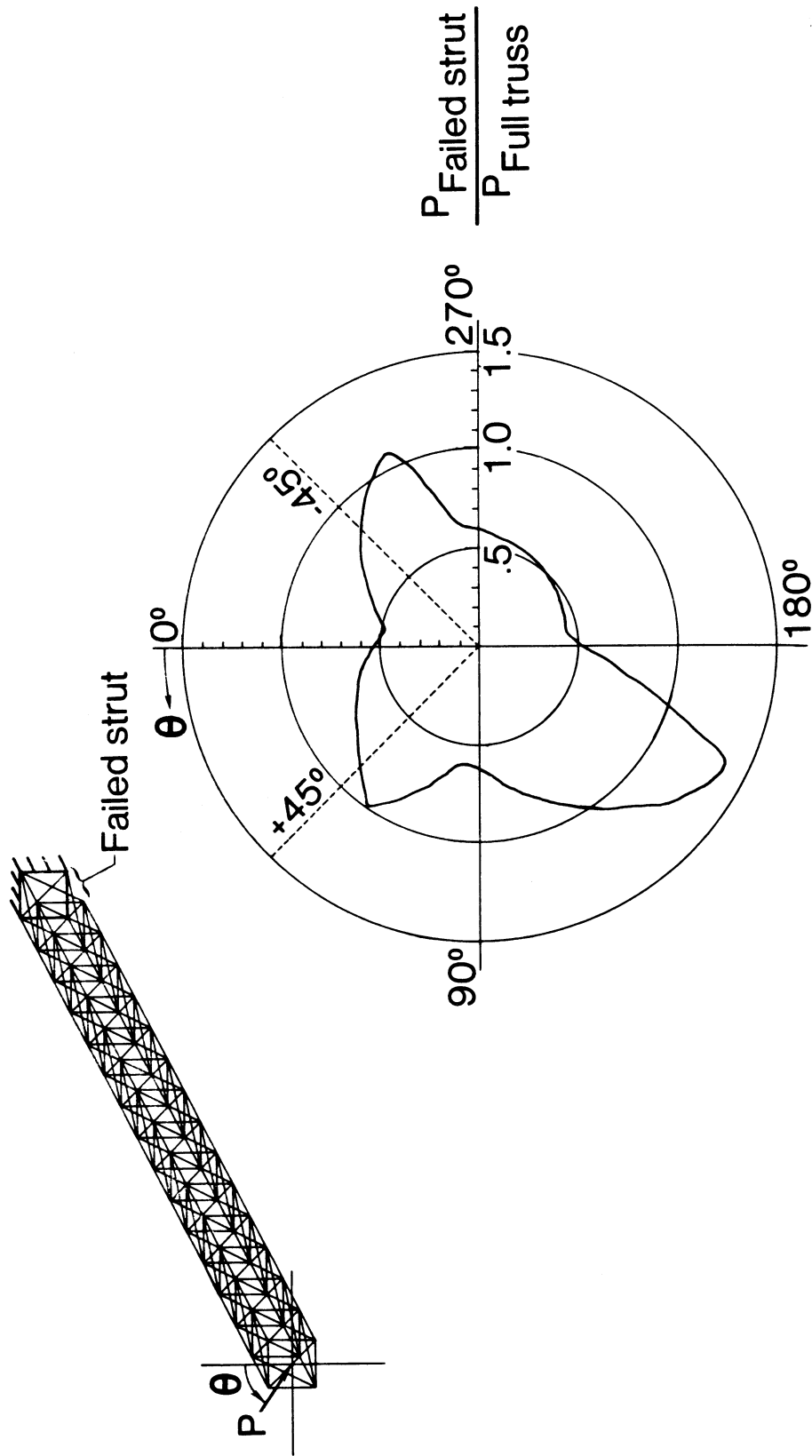

Figure 12. - Allowable load in cantilever truss beam.

Standard Bibliographic Page

1. Report No. NASA TM-87715	2. Government Accession No.	3. Recipient's Catalog No.	
4. Title and Subtitle Structural Performance of Space Station Trusses with Missing Members		5. Report Date May 1986	
		6. Performing Organization Code 506-43-41-02	
7. Author(s) John T. Dorsey		8. Performing Organization Report No.	
		10. Work Unit No.	
9. Performing Organization Name and Address NASA Langley Research Center Hampton, VA 23665-5225		11. Contract or Grant No.	
		13. Type of Report and Period Covered Technical Memorandum	
12. Sponsoring Agency Name and Address National Aeronautics and Space Administration Washington, DC 20546		14. Sponsoring Agency Code	
		15. Supplementary Notes	
16. Abstract Structural performance of orthogonal tetrahedral and Warren-type full truss beams and platforms are compared. In addition, degradation of truss structural performance is determined for beams, platforms and a space station when individual struts are removed from the trusses. The truss beam, space station, and truss platform analytical models used in the studies are described. Stiffness degradation of the trusses due to single strut failures is determined using flexible body vibration modes. Ease of strut replacement is assessed by removing a strut and examining the truss deflection at the resulting gap due to applied forces. Finally, the reduction in truss beam strength due to a missing longeron is determined for a space station transverse boom model.			
17. Key Words (Suggested by Authors(s)) Space Trusses, Structural Performance Strut Failure, Strut Replacement		18. Distribution Statement Unclassified - Unlimited Subject Category - 18	
19. Security Classif.(of this report) Unclassified	20. Security Classif.(of this page) Unclassified	21. No. of Pages 34	22. Price A03