

NASA Technical Memorandum 87738

NASA-TM-87738 19860017981

ADHESIVE EVALUATION OF THIN FILMS OF
LARC-TPI AND LARC-TPI WITH 5 MOL % ODA

DONALD J. PROGAR

FOR REFERENCE

NOT TO BE TAKEN FROM THIS ROOM

LIBRARY COPY

JUL 24 1986

LANGLEY RESEARCH CENTER
LIBRARY, NASA
HAMPTON, VIRGINIA

JUNE 1986

NASA

National Aeronautics and
Space Administration

Langley Research Center
Hampton, Virginia 23665



NF01624



INTRODUCTION

Recently, increased interest has been shown in the use of high temperature thermoplastic polyimides as matrices and adhesives for aircraft applications. A thermoplastic polyimide, LARC-TPI, was developed at NASA Langley Research Center in the late 1970's.¹⁻⁸ More recently, Mitsui Toatsu Chemicals, Incorporated (MTCI) of Japan was granted a nonexclusive license to manufacture LARC-TPI and market it commercially. Recently reported work on LARC-TPI material, supplied by MTCI in solution form, has further shown the potential of the LARC-TPI as a high temperature adhesive.⁹

The thermoplastic nature of this polymer has been attributed to the flexibility of a meta-linked, bridged, aromatic diamine, 3,3'-diaminobenzophenone (3,3'-DABP). This thermoplasticity affords the flow necessary to

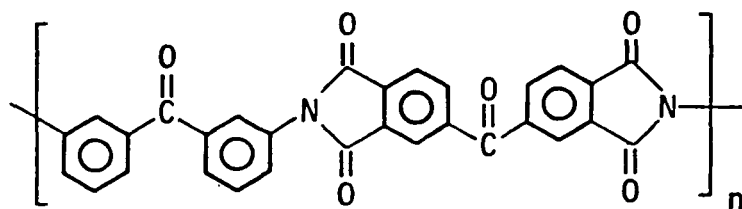

LARC-TPI

bond substrates. MTCI has shown that a modification of LARC-TPI by substituting a portion of the 3,3'-DABP with 4,4'-oxydianiline (ODA) provides more flow. This random copolymer with 5 mol % ODA, designated LARC-TPI/ODA in this report, has the following structure:

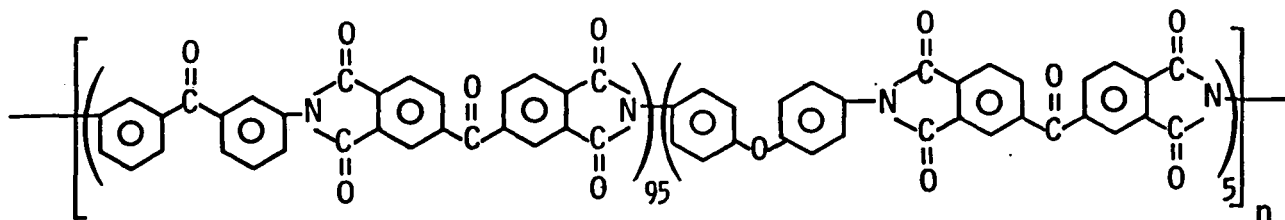

LARC-TPI/ODA

A study of the adhesive character of the random copolyimide, LARC-TPI/ODA, and LARC-TPI, both in the form of thin films, is the subject of this report.

EXPERIMENTAL

Materials. Thin films, 0.0046 cm (0.0018 in.), of LARC-TPI and LARC-TPI/ODA were supplied by Mitsui Toatsu Chemicals, Incorporated (MTCI) of Japan. The flexible films were originally processed to 300°C. The colors of the thin transparent films were yellow and amber for the LARC-TPI and LARC-TPI/ODA, respectively. The LARC-TPI is commercially available from MTCI whereas the LARC-TPI/ODA is an experimental random copolyimide film prepared by MTCI.

A 29.1 wt % solids polyamic-acid solution of LARC-TPI in (2-methoxyethyl)ether (diglyme) was manufactured and supplied by MTCI. The monomers used in the preparation of LARC-TPI were 3,3',4,4'-benzophenone tetracarboxylic dianhydride (BTDA) and 3,3'-diaminobenzophenone (3,3'-DABP).^{2,7} The solution, lot no. 26-001, had an inherent viscosity (η_{inh}) of 0.54 dl/g (35°C) and a Brookfield viscosity of 24,600 cps (23°C). The as-supplied solution was diluted to 7.5 wt % solids by adding diglyme and was

used to coat (prime) 104 E-glass cloth with an A1100 finish (γ -aminopropylsilane).

Characterization. Lap shear strength (LSS) was obtained according to ASTM D-1002 using a Model TT Instron universal testing machine. The lap shear strengths reported represent an average of four lap shear specimens per test condition except as noted in the tables. The range of LSS is indicated by dashed lines in the bar graph figures and is listed in the tables. Elevated temperature tests were conducted in a clam-shell, quartz-lamp oven with temperatures controlled to within $\pm 3^\circ\text{C}$ for all tests. Specimens were held 10 min at temperature prior to testing except for the water-boil test specimens for which the tests were conducted as soon as the test temperature was reached (approximately 1-2 min).

Bondline thickness was obtained as the difference between the total joint thickness measured with a micrometer and the sum of the adherend thicknesses. The average bondline thickness for the thermally aged and water-boil specimens was 0.012 cm (0.0048 in.).

Glass transition temperatures (T_g) of the adhesive from the fractured lap shear specimens and thin films were determined by thermomechanical analysis (TMA) on a DuPont 943 Analyser. TMA was run on the fractured lap shear specimens in static air at a heating rate of $5^\circ\text{C}/\text{min}$ using a hemispherical probe with a 15 g mass. Film samples were run at $5^\circ\text{C}/\text{min}$ in static air using film clamps and a 0 to 2 g load.¹⁰

Inherent viscosity (η_{inh}) was determined using a Cannon-Ubbelohde viscometer in a 35°C water bath controlled to within $\pm 0.01^\circ\text{C}$. A 10 ml solution of 0.5 wt % solids in N,N-dimethylacetamide (DMAC) was made and filtered. The average of three runs of the solution is reported.

Adhesive Bonding. The adhesive films were used to bond titanium adherends (Ti-6Al-4V, per Mil-T-9046E, Type III Comp.) with a nominal thickness of 0.13 cm (0.05 in.). The four-fingered Ti-6Al-4V panels were grit blasted with 120 grit aluminum oxide, washed with methanol, and treated with Pasa-Jell 107* to form a stable oxide on the surface. The adherends were washed with water and dried in a forced-air oven at 100°C for 5 min. The treated adherends were primed within two hours of the surface treatment by applying a thin coat of the LARC-TPI 24 wt % solids (diluted with diglyme from 29.1 wt % solids) solution on the surfaces to be bonded. They were air-dried under a fume hood for 0.5 hr then placed in a forced-air oven and heated for 15 min at 100°C and 15 min at 150°C. The primed adherends were placed in a sealed polyethylene bag and stored in a desiccator until needed. Lap shear specimens for thermal aging and water-boil were prepared by inserting LARC-TPI primed 104 E-glass cloth (A1100 finish) between two adhesive films which were then sandwiched between the primed adherends using a 1.27 cm (0.5 in.) overlap (ASTM D-1002), Figure 1, and applying pressure in a hydraulic press.

The following bond cycle used for this study was shown in previous studies with LARC-TPI adhesive to produce high lap shear strengths:

- (1) Apply 2.1 MPa (300 psi) pressure, heating rate $\approx 8^{\circ}\text{C}/\text{min}$, RT \rightarrow 343°C (650°F), hold 1 hr
- (2) Cool under pressure to $\approx 150^{\circ}\text{C}$ (302°F) and remove from bonding press

*Trade name for a titanium surface treatment available from Semco, Glendale, CA.

Thermal and Water-Boil Exposures. Lap shear specimens were prepared with LARC-TPI and LARC-TPI/ODA film and LARC-TPI (solution) as the primer and thermally exposed in a forced-air oven for 500 and 1000 hrs at 204°C (400°F). The forced-air oven was controlled to within $\pm 1\%$ of the exposure temperature. Lap shear strength tests were conducted at RT, 177°C (350°F), 204°C (400°F), and 232°F (450°F) before (controls) and after exposure.

A 72-hour water-boil test was conducted in laboratory glassware containing boiling distilled water. Lap shear specimens were immersed (above the bonded area) during the 72-hour period. Lap shear strengths were determined at RT, 177°C, 204°C, and 232°C.

RESULTS AND DISCUSSION

Bonding Scheme Evaluation. Determination of a bonding scheme which produced reasonable high lap shear strengths was necessary because the adhesive films evaluated were very thin, 0.0046 cm (0.0018 in.). Previous results reported with thicker 112 E-glass cloth supported LARC-TPI adhesive tape provided high lap shear strengths.⁹ The bonding conditions used in the reported reference were also initially used in this study, i.e., cycle 3: 8°C/min, 2.1 MPa bonding pressure, RT to 343°C, held 1 hr, cooled to 150°C and then removed from the press. Table I and Figure 2 give the lap shear test results where LARC-TPI film was used to bond Ti-6Al-4V. Some of the tests of bonded specimens were performed at temperatures up to 232°C. Initially, a single ply or film layer was used to determine the effect of bonding with or without a primer. Quite obviously, a primer improves the lap shear strength, i.e., RT (no primer), 7.9 MPa; RT (primer), 16.2 MPa.

Increasing the heat treatment of the primer from 150°C to 300°C showed no improvement in the lap shear strengths.

A scheme whereby a LARC-TPI "primed" 104 E-glass cloth was sandwiched between film layers provided a significant increase in lap shear strength: RT, 23.1 MPa; 177°C, 25.6 MPa; and 204°C, 20.7 MPa. Primary failure mode in all tests was cohesive.

Similar schemes and tests were conducted for LARC-TPI/ODA film bonding of Ti-6Al-4V (Table II and Figure 3). The LARC-TPI/ODA film was of the same thickness as the LARC-TPI film. The results of the tests were similar to that for the LARC-TPI film. Therefore, for evaluation of the effects of bonding pressure, the bonding scheme whereby 104 glass cloth is inserted between film layers and then inserted between the primed Ti-6Al-4V adherends, was used.

Bonding Pressure. Test results for 2.1 MPa and 3.4 MPa bonding pressures are given in Table III and Figure 4 for the LARC-TPI film and in Table IV and Figure 5 for the LARC-TPI/ODA film.

The differences in lap shear strength for the LARC-TPI film data are within 7.5% of each other for temperatures up to 204°C and are not considered significant. Failure mode was primarily cohesive except for that bonded at 3.4 MPa and tested at RT which was cohesive/adhesive. Therefore both bonding pressures gave similar results.

Although test results for LARC-TPI/ODA at RT and 177°C were about the same when bonded at either 2.1 MPa or 3.4 MPa, when tested at 204°C those bonded at 2.1 MPa were significantly lower (26%) than those bonded at 3.4

MPa. All failures were primarily cohesive. No differences in flow characteristics were noticed between LARC-TPI and LARC-TPI/ODA.

The Tg determined on the fractured lap shear specimens by TMA appear to be about the same for both adhesive films. The range of Tg for LARC-TPI was from 246°C to 256°C and for LARC-TPI/ODA from 251°C to 258°C. The Tg for the "as-received" films, as determined by TMA using film clamps, was 259°C for LARC-TPI film and 266°C for the LARC-TPI/ODA film.

Both bonding pressures produced about the same test results. However, because a slightly higher lap shear strength was obtained with the 3.4 MPa than with the 2.1 MPa pressure for the LARC-TPI/ODA adhesive at 204°C, the 3.4 MPa bonding pressure was selected for preparing the specimens for thermal aging and water-boil tests.

Thermal Exposure. Thermal exposure at 204°C for 500 and 1000 hrs was conducted in a forced-air oven controlled to within $\pm 2^\circ\text{C}$. Lap shear strength tests were performed at RT, 177°C, 204°C, and 232°C. Results are given in Table V and Figure 6 for LARC-TPI film-bonded specimens and Table VI and Figure 7 for LARC-TPI/ODA film-bonded specimens.

In general, no change in lap shear strength due to thermal exposure for up to 1000 hrs was shown for the LARC-TPI film system. However, a significant increase in lap shear strength was noted for the RT test after 500 hrs thermal aging which is characteristic of polyimides. The high lap shear strength, 18.9 MPa to 22.2 MPa, after 1000 hrs thermal exposure shows the adhesive potential for this material. The Tg varied randomly from 238°C to 250°C with no obvious trends observed.

As shown for LARC-TPI/ODA in Figure 7, a general decrease in lap shear strength with test temperature was observed regardless of the time of

thermal aging. A significant decrease at the 177°C test temperature (18%) between 500 and 1000 hrs exposure was noted. After 1000 hrs, lap shear strengths at 177°C, 204°C, and 232°C were 83%, 84%, and 85% of the control values, respectively. Again, no trends were obvious for the determined T_g values. The T_g ranged from 248°C to 263°C.

Comparing the results of thermal exposure for the two film systems indicates insignificant differences for the control tests except that the LARC-TPI/ODA tested at RT was 34% higher than the LARC-TPI lap shear strength. The test results for those exposed for 500 hrs show the two systems to be about the same since the lap shear strength values at any one test temperature fall within the scatter bands of each other. Test results for the 1000 hrs exposure show the LARC-TPI/ODA was 27% higher at RT than LARC-TPI lap shear strengths, whereas, LARC-TPI was 24% higher than LARC-TPI/ODA at 232°C. The T_g for the two film systems were about the same. Overall failure mode was primarily cohesive or cohesive/adhesive for both systems.

72-Hour Water-Boil. Lap shear strengths were determined at RT, 177°C, 204°C, and 232°C after immersion in boiling distilled water for a 72-hour period. Results are given in Table VII and Figure 8 for the LARC-TPI adhesive film system and in Table VIII and Figure 9 for the LARC-TPI/ODA adhesive film system. The reduction in lap shear strength for both adhesive film systems after water-boil at all test temperatures was quite evident. LARC-TPI lap shear strength retention after water-boil was: RT, 76%; 177°C, 59%; 204°C, 51%; and 232°C, 26% of the respective control value. For LARC-TPI/ODA, the lap shear strength retention after water-boil was: RT, 70%; 177°C, 57%; 204°C, 53%; and 232°C, 38% of the respective control value.

A general decrease in T_g after water-boil was evident for both the LARC-TPI and LARC-TPI/ODA adhesive film systems. The LARC-TPI/ODA adhesive film had the greater decrease in T_g , from approximately 254°C to an average of about 238°C ($\Delta 16^\circ\text{C}$), than the LARC-TPI film system ($\Delta 9^\circ\text{C}$). The failure mode, which was primarily cohesive for the controls, changes to cohesive/adhesive after water-boil for both adhesive systems.

SUMMARY

A commercially available LARC-TPI film and an experimentally prepared film of LARC-TPI with 5 mol % 4,4'-oxydianiline (ODA) were evaluated as thermoplastic adhesive films for bonding titanium alloy (Ti-6Al-4V). LARC-TPI polyimide had previously been shown to have good potential as an adhesive for applications in aircraft and spacecraft because of its toughness, flexibility, good thermal and thermooxidative stability. The LARC-TPI/ODA had been shown by the manufacturer (Mitsui Toatsu) to possess more flow than thermoplastic LARC-TPI.

Lap shear strength was used to screen the materials for adhesive potential. The materials were characterized after fracture by determining their glass transition temperatures (T_g). The mode of failure, cohesive and/or adhesive, was also noted.

Thermal exposure at 204°C for 500 and 1000 hrs and a 72-hour water-boil were conducted on lap shear specimens prepared with the two adhesive films. Lap shear tests were performed at RT, 177°C, 204°C, and 232°C before and after thermal exposure and after water-boil.

Results of the thermal exposure for the two film systems indicate insignificant differences for the control tests except that the RT lap shear strength for the LARC-TPI/ODA was 34% higher than the LARC-TPI. For 500 hrs at 204°C, the two film systems had about the same strength values. For 1000 hrs at 204°C, the LARC-TPI/ODA was 27% higher than LARC-TPI tested at RT, whereas, LARC-TPI was 24% higher than LARC-TPI/ODA at 232°C. The T_g determined for the two adhesive film systems were about the same. Overall failure mode was primarily cohesive or cohesive/adhesive for both systems.

Lap shear strengths were determined at RT, 177°C, 204°C, and 232°C before and after a 72-hour water-boil. A significant reduction in lap shear strengths was found for both adhesive film systems as well as a general decrease in T_g, approximately 16°C for the LARC-TPI/ODA and approximately 9°C for the LARC-TPI. The failure mode changed from primarily cohesive for the controls to cohesive/adhesive after water-boil for both adhesive film systems.

Both polymer materials, LARC-TPI and LARC-TPI/ODA in film form, appear promising as adhesives for structural applications in future aircraft and spacecraft.

REFERENCES

1. St. Clair, A. K.; and St. Clair, T. L.: A Multi-Purpose Thermoplastic Polyimide. Preprints, 26th National SAMPE Symposium, 26 165 (1981).
2. St. Clair, A. K.; and St. Clair, T. L.: LARC-TPI: A Multi-Purpose Thermoplastic Polyimide. NASA TM-84516, June 1982.

3. Progar, D. J.; and St. Clair, T. L.: Preliminary Evaluation of a Novel Polyimide Adhesive for Bonding Titanium and Reinforced Composites. Preprints, 7th National SAMPE Technical Conference, 7 53 (1975).
4. St. Clair, T. L.; and Progar, D. J.: Solvent and Structure Studies of Novel Polyimide Adhesives. Adhesion Science and Technology, 9A 187, Plenum Press, New York (1975).
5. Progar, D. J.; Bell, V. L.; and St. Clair, T. L.: Polyimide Adhesives. Patent No. 4,065,345 (1977).
6. Bell, V. L.: Process for Preparing Thermoplastic Aromatic Polyimides. Patent No. 4,094,862 (1978).
7. Hill, S. G.; Peters, P. D.; and Hendricks, C. L.: Evaluation of High Temperature Structural Adhesives for Extended Service. NASA Contractor Report 165944, July 1982.
8. Hendricks, C. L.; and Hale, J. H.: High Temperature Adhesive Development and Evaluation. Welding, Bonding, and Fastening - 1984, John D. Buckley and Bland A. Stein, eds., NASA CP-2387, 1985, pp. 351-390.
9. Progar, D. J.: Adhesive Evaluation of LARC-TPI and a Water-Soluble Version of LARC-TPI. Int. J. Adhesion and Adhesives, 6 No. 1, 12, January 1986.
10. Burks, H. D.: Thermomechanical Determination of Tg Using a Modified Film Sample-Mounting Method. J. of Appl. Polymer Sci., 18 627 (1974).

TABLE I. - LSS TEST RESULTS OF LARC-TPI FILM BONDED TI-6Al-4V

	Number of Specimens	Test Temperature, °C (°F)	Average LSS, MPa (psi)	Range of LSS, MPa (psi)	Primary Failure Mode ^a	Glass Transition Temperature, T _g ^b °C (°F)
1 Layer of film No primer	4	RT (RT)	7.9 (1150)	5.3-11.2 (770-1620)	Ad	--
1 Layer of film Primer ^c	4	RT (RT)	16.2 (2360)	14.2-17.0 (2060-2470)	Co	--
	4	177 (350)	19.1 (2780)	18.5-20.3 (2680-2950)	Co	--
	4	204 (400)	16.8 (2440)	15.9-17.3 (2310-2510)	Co	--
1 Layer of film Primer heated to 300°C (572°F)	3	RT (RT)	19.8 (2880)	18.5-21.9 (2680-3180)	Co	--
	2	177 (350)	19.2 (2800)	17.9-20.6 (2600-2990)	Co	--
	3	204 (400)	17.5 (2550)	14.2-19.6 (2060-2850)	Co	--
2 Layers of film with 104 glass cloth between Primer ^d	3	RT (RT)	23.1 (3350)	22.4-24.4 (3250-3540)	Co	253 (487)
	2	177 (350)	25.6 (3720)	24.5-26.7 (3360-3880)	Co	256 (493)
	3	204 (400)	20.7 (3010)	18.3-24.8 (2650-3600)	Co	248 (478)

Bonding conditions: 2.1 MPa (300 psi) pressure, heating rate of 8°C/min (14°F/min), RT to 343°C (650°F), held 1 hr

a Cohesive-Co, adhesive-Ad

b Single measurement

c LARC-TPI primer

d Glass cloth also primed with LARC-TPI

TABLE II. - LSS TEST RESULTS OF LARC-TPI/ODA FILM BONDED TI-6Al-4V

	Number of Specimens	Test Temperature, °C (°F)	Average LSS, MPa (psi)	Range of LSS, MPa (psi)	Primary Failure Mode ^a	Glass Transition Temperature, T _g ^b °C (°F)
1 Layer of film No primer	3	RT (RT)	5.4 (780)	3.5-8.5 (510-1240)	Ad	--
1 Layer of film Primer ^c	4	RT (RT)	20.6 (2980)	17.4-22.1 (2520-3200)	Co	--
	4	177 (350)	20.7 (3010)	19.5-22.3 (2830-3240)	Co	--
	4	204 (400)	16.7 (2430)	15.4-19.0 (2240-2750)	Co	--
2 Layers of film with 104 glass cloth between Primer ^d	3	RT (RT)	28.3 (4100)	25.4-31.4 (3680-4560)	Co	256 (493)
	3	177 (350)	21.9 (3180)	19.8-23.7 (2870-3440)	Co	258 (496)
	4	204 (400)	15.4 (2230)	11.5-23.7 (1660-3440)	Co	251 (484)

Bonding conditions: 2.1 MPa (300 psi) pressure, heating rate of 8°C/min (14°F/min), RT to 343°C (650°F), held 1 hr

a Cohesive-Co, adhesive-Ad

b Single measurement

c LARC-TPI primer

d Glass cloth also primed with LARC-TPI

TABLE III. - EFFECT OF BONDING PRESSURE ON LSS OF LARC-TPI FILM BONDED TI-6Al-4V

Bonding Pressure, MPa (psi)	Number of Specimens	Test Temperature, °C (°F)	Average LSS, MPa (psi)	Range of LSS, MPa (psi)	Primary Failure Mode ^a	Glass Transition Temperature, T _g ^b , °C (°F)
2.1 (300)	3	RT (RT)	23.1 (3350)	22.4-24.4 (3250-3540)	Co	253 (487)
	2	177 (350)	25.6 (3720)	24.5-26.7 (3560-3880)	Co	256 (493)
	3	204 (400)	20.7 (3010)	18.3-24.8 (2650-3600)	Co	248 (478)
3.4 (500)	4	RT (RT)	21.6 (3130)	19.7-24.1 (2860-3490)	Co/Ad	251 (484)
	4	177 (350)	23.8 (3450)	21.7-24.7 (3150-3580)	Co	254 (489)
	4	204 (400)	21.2 (3080)	19.9-23.2 (2890-3360)	Co	249 (480)
	4	232 (450)	18.1 (2620)	16.5-20.0 (2390-2900)	Co	246 (475)

Bonding conditions: heating rate of 8°C/min (14°F/min), RT to 343°C (650°F), held 1 hr

^a Cohesive-Co, adhesive-Ad

^b Single measurement

TABLE IV. - EFFECT OF BONDING PRESSURE ON LSS OF LARC-TPI/ODA FILM BONDED TI-6Al-4V

Bonding Pressure, MPa (psi)	Number of Specimens	Test Temperature, °C (°F)	Average LSS, MPa (psi)	Range of LSS, MPa (psi)	Primary Failure Mode ^a	Glass Transition Temperature, T _g ^b , °C (°F)
2.1 (300)	3	RT (RT)	28.3 (4100)	25.4-31.4 (3680-4560)	Co	256 (493)
	3	177 (350)	21.9 (3180)	19.8-23.7 (2870-3440)	Co	258 (496)
	4	204 (400)	15.4 (2230)	11.5-23.7 (1660-3440)	Co	251 (484)
3.4 (500)	4	RT (RT)	28.9 (4190)	25.8-32.4 (3740-4700)	Co	253 (487)
	4	177 (350)	22.3 (3230)	19.7-24.1 (2860-3490)	Co	254 (489)
	4	204 (400)	20.8 (3020)	18.6-22.7 (2700-3290)	Co	254 (489)
	4	232 (450)	18.1 (2630)	15.2-21.1 (2200-3060)	Co	254 (489)

Bonding conditions: heating rate of 8°C/min (14°F/min), RT to 343°C (650°F), held 1 hr

^a Cohesive-Co

^b Single measurement

TABLE V. - LSS TEST RESULTS OF THERMAL EXPOSURE AT 204°C FOR LARC-TPI FILM BONDED TI-6Al-4V

Time of Exposure at 204°C (400°F), hr	Number of Specimens	Test Temperature, °C (°F)	Average LSS, MPa (psi)	Range of LSS, MPa (psi)	Primary Failure Mode ^a	Glass Transition Temperature, T _g ^b °C (°F)
0 (Controls)	4	RT (RT)	21.6 (3130)	19.7-24.1 (2860-3490)	Co/Ad	251 (484)
	4	177 (350)	23.8 (3450)	21.7-24.7 (3150-3580)	Co	254 (489)
	4	204 (400)	21.2 (3080)	19.9-23.2 (2890-3360)	Co	249 (480)
	4	232 (450)	18.1 (2620)	16.5-20.0 (2390-2900)	Co	246 (475)
500	4	RT (RT)	28.2 (4080)	25.8-30.2 (3750-4380)	Co	258 (496)
	3	177 (350)	19.7 (2860)	17.8-23.1 (2580-3360)	Co/Ad	252 (486)
	4	204 (400)	18.0 (2620)	14.7-21.0 (2130-3050)	Co	256 (493)
	4	232 (450)	17.8 (2560)	14.6-20.3 (2120-2940)	Co	241 (466)
1000	4	RT (RT)	22.2 (3220)	20.4-26.9 (2960-3900)	Co	255 (491)
	4	177 (350)	20.8 (3020)	16.8-27.1 (2440-3930)	Co	252 (486)
	4	204 (400)	20.6 (3000)	16.2-22.8 (2350-3310)	Co	252 (486)
	4	232 (450)	18.9 (2740)	17.6-19.8 (2560-2880)	Co	238 (460)

Bonding conditions: 3.4 MPa (500 psi) pressure, heating rate of 8°C/min (14°F/min), RT to 343°C (650°F), held 1 hr

^a Cohesive-Co, adhesive-Ad

^b Single measurement

TABLE VI. - LSS TEST RESULTS OF THERMAL EXPOSURE AT 204°C FOR LARC-TPI/ODA FILM BONDED TI-6Al-4V

Time of Exposure at 204°C (400°F), hr	Number of Specimens	Test Temperature, °C (°F)	Average LSS, MPa (psi)	Range of LSS, MPa (psi)	Primary Failure Mode ^a	Glass Transition Temperature, T _g ^b °C (°F)
0 (Controls)	4	RT (RT)	28.9 (4190)	25.8-32.4 (3740-4700)	Co	253 (487)
	4	177 (350)	22.3 (3230)	19.7-24.1 (2860-3490)	Co	254 (489)
	4	204 (400)	20.8 (3020)	18.6-22.7 (2700-3290)	Co	254 (489)
	4	232 (450)	18.1 (2630)	15.2-21.1 (2200-3060)	Co	254 (489)
500	4	RT (RT)	25.0 (3620)	17.8-34.0 (2580-4920)	Co	258 (496)
	3	177 (350)	22.5 (3260)	21.1-23.9 (3060-3470)	Co	251 (484)
	3	204 (400)	22.1 (3210)	20.4-23.0 (2960-3340)	Co	248 (478)
	4	232 (450)	17.0 (2460)	15.1-19.0 (2190-2760)	Co/Ad	248 (478)
1000	4	RT (RT)	28.3 (4110)	26.3-29.6 (3810-4300)	Co	257 (495)
	3	177 (350)	18.4 (2670)	17.2-19.8 (2490-2880)	Co	263 (505)
	4	204 (400)	17.5 (2550)	16.0-19.2 (2320-2780)	Co	255 (491)
	3	232 (450)	15.3 (2220)	12.8-17.2 (1860-2500)	Co	254 (489)

Bonding conditions: 3.4 MPa (500 psi) pressure, heating rate of 8°C/min (14°F/min), RT to 343°C (650°F), held 1 hr

^a Cohesive-Co, adhesive-Ad

^b Single measurement

TABLE VII. - LSS TEST RESULTS OF A 72-HOUR WATER-BOIL FOR LARC-TPI FILM BONDED TI-6Al-4V

	Number of Specimens	Test Temperature, °C (°F)	Average LSS, MPa (psi)	Range of LSS, MPa (psi)	Primary Failure Mode ^a	Glass Transition Temperature, T _g ^b °C (°F)
Controls	4	RT (RT)	21.6 (3130)	19.7-24.1 (2860-3490)	Co/Ad	251 (484)
	4	177 (350)	23.8 (3450)	21.7-24.7 (3150-3580)	Co	254 (489)
	4	204 (400)	21.2 (3080)	19.9-23.2 (2890-3360)	Co	249 (480)
	4	232 (450)	18.1 (2620)	16.5-20.0 (2390-2900)	Co	246 (475)
72-Hour Water-Boil	6	RT (RT)	16.5 (2400)	14.8-19.1 (2140-2770)	Co/Ad	248 (478)
	4	177 (350)	14.1 (2050)	11.6-15.9 (1690-2310)	Co/Ad	244 (471)
	5	204 (400)	10.8 (1570)	9.3-14.5 (1360-2100)	Co/Ad	236 (457)
	4	232 (450)	4.7 (690)	4.1-5.2 (600-750)	--c	237 (459)

Bonding conditions: 3.4 MPa (500 psi) pressure, heating rate of 8°C/min (14°F/min), RT to 343°C (650°F), held 1 hr

a Cohesive-Co, adhesive-Ad

b Single measurement

c Thermoplastic failure

TABLE VIII. - LSS TEST RESULTS OF A 72-HOUR WATER-BOIL FOR LARC-TPI FILM BONDED TI-6Al-4V

	Number of Specimens	Test Temperature, °C (°F)	Average LSS, MPa (psi)	Range of LSS, MPa (psi)	Primary Failure Mode ^a	Glass Transition Temperature, T _g ^b °C (°F)
Controls	4	RT (RT)	28.9 (4190)	25.8-32.4 (3740-4700)	Co	253 (487)
	4	177 (350)	22.3 (3230)	19.7-24.1 (2860-3490)	Co	254 (489)
	4	204 (400)	20.8 (3020)	18.6-22.7 (2700-3290)	Co	254 (489)
	4	232 (450)	18.1 (2630)	15.2-21.1 (2200-3060)	Co	254 (489)
72-Hour Water-Boil	4	RT (RT)	20.2 (2930)	16.5-21.3 (2460-3080)	Co/Ad	238 (460)
	4	177 (350)	12.7 (1850)	10.7-14.8 (1560-2160)	Co/Ad	246 (475)
	4	204 (400)	11.1 (1620)	10.9-11.7 (1350-1700)	Co	233 (451)
	4	232 (450)	6.8 (980)	3.6-11.1 (520-1610)	--c	236 (456)

Bonding conditions: 3.4 MPa (500 psi) pressure, heating rate of 8°C/min (14°F/min), RT to 343°C (650°F), held 1 hr

^a Cohesive-Co, adhesive-Ad

^b Single measurement

^c Thermoplastic failure

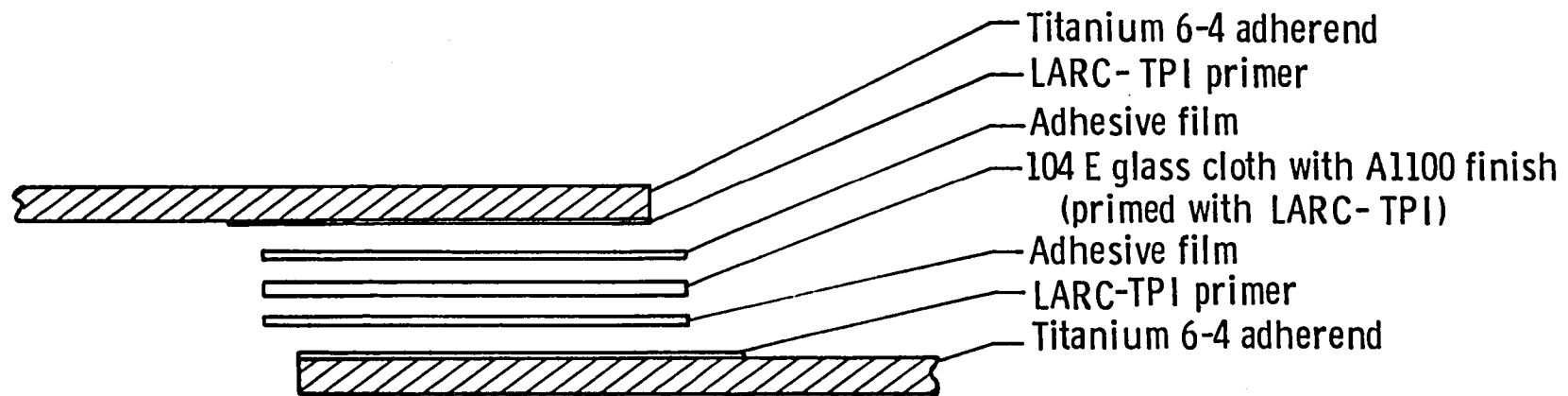

Figure 1. Sketch of the arrangement used to bond titanium adherends with a thin film adhesive.

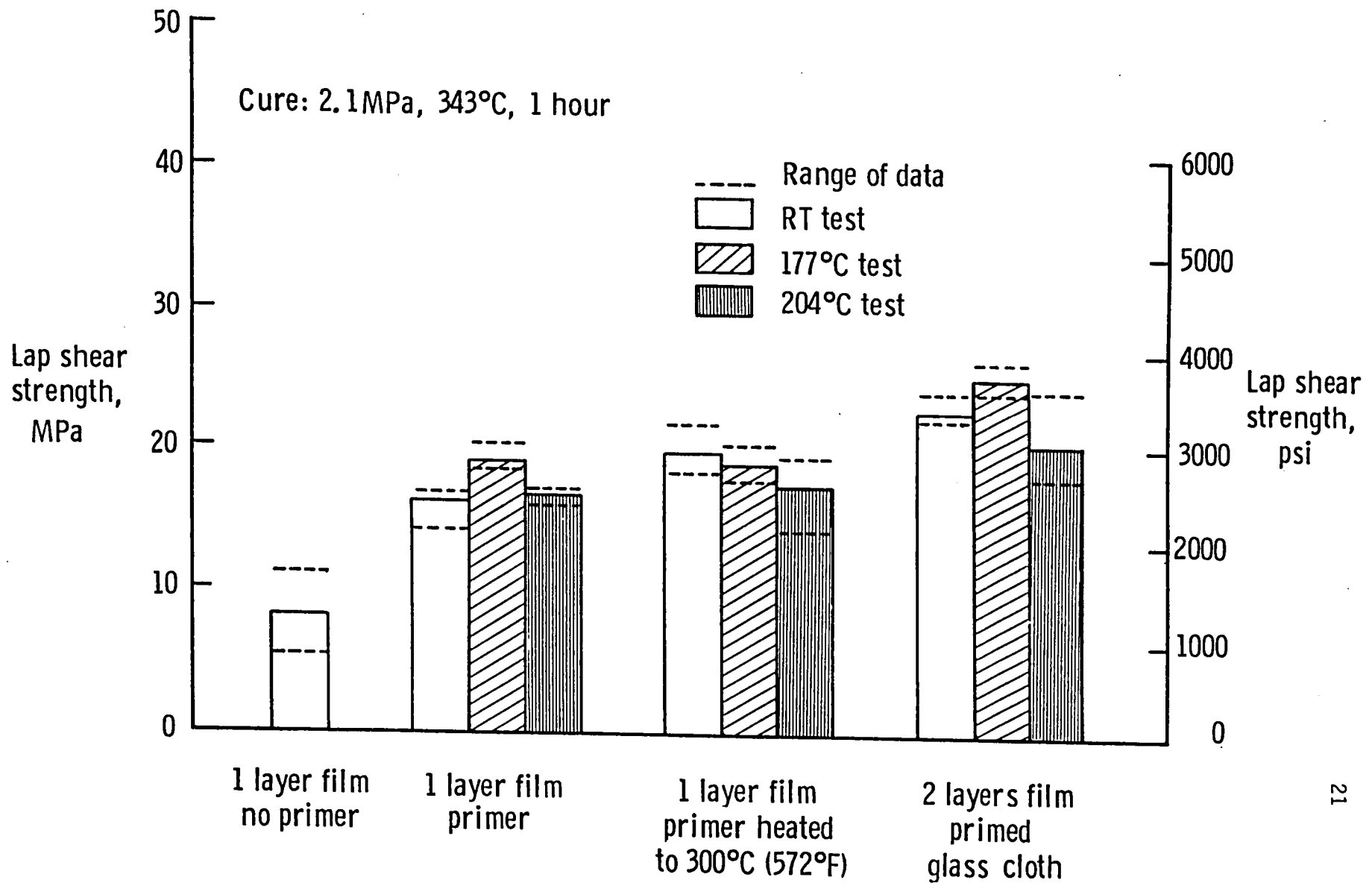

Figure 2. Effect of bonding schemes on lap shear strength for LARC-TPI film bonded Ti-6Al-4V.

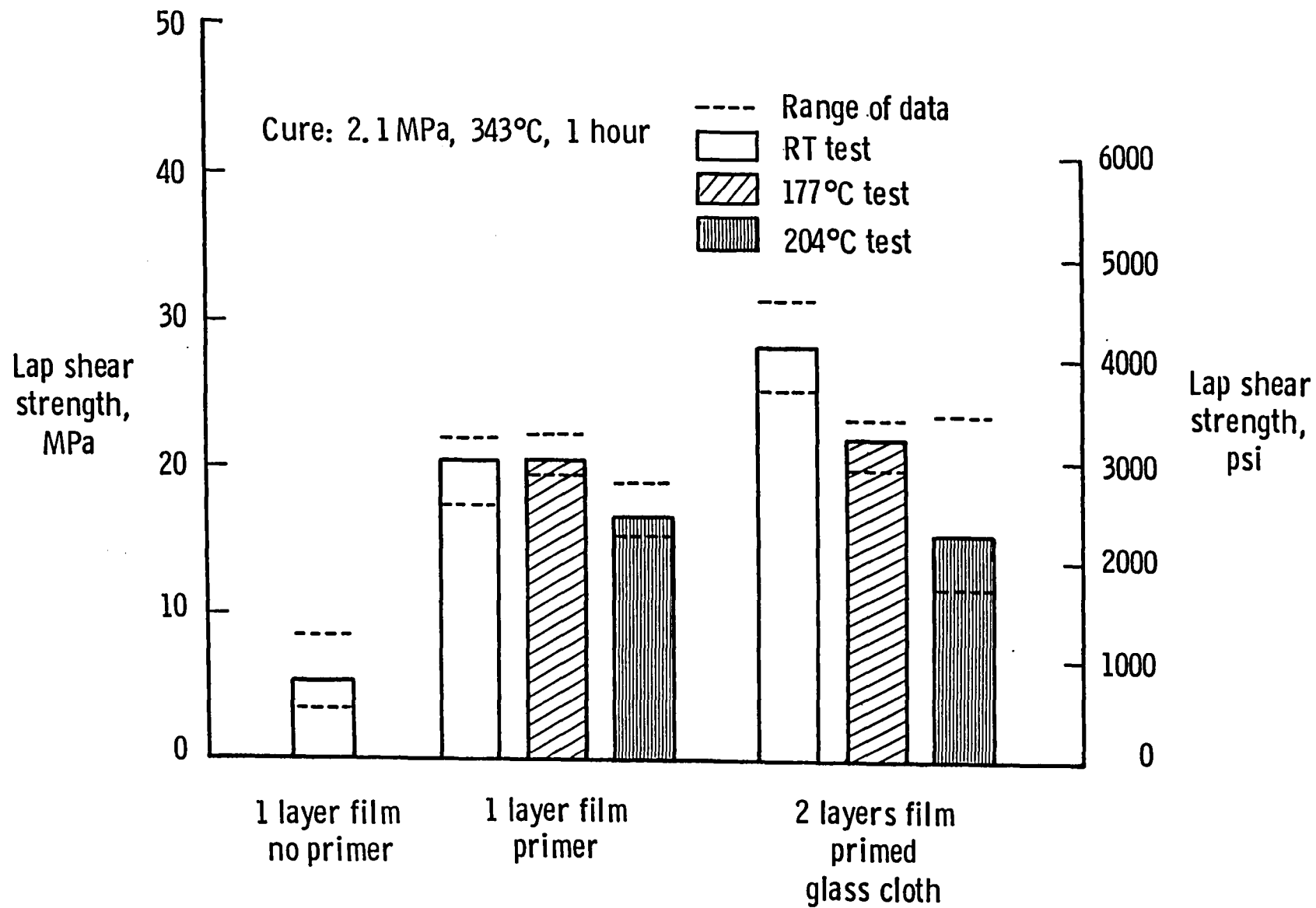

Figure 3. Effect of bonding scheme on lap shear strength for LARC-TPI/ODA film bonded Ti-6Al-4V.

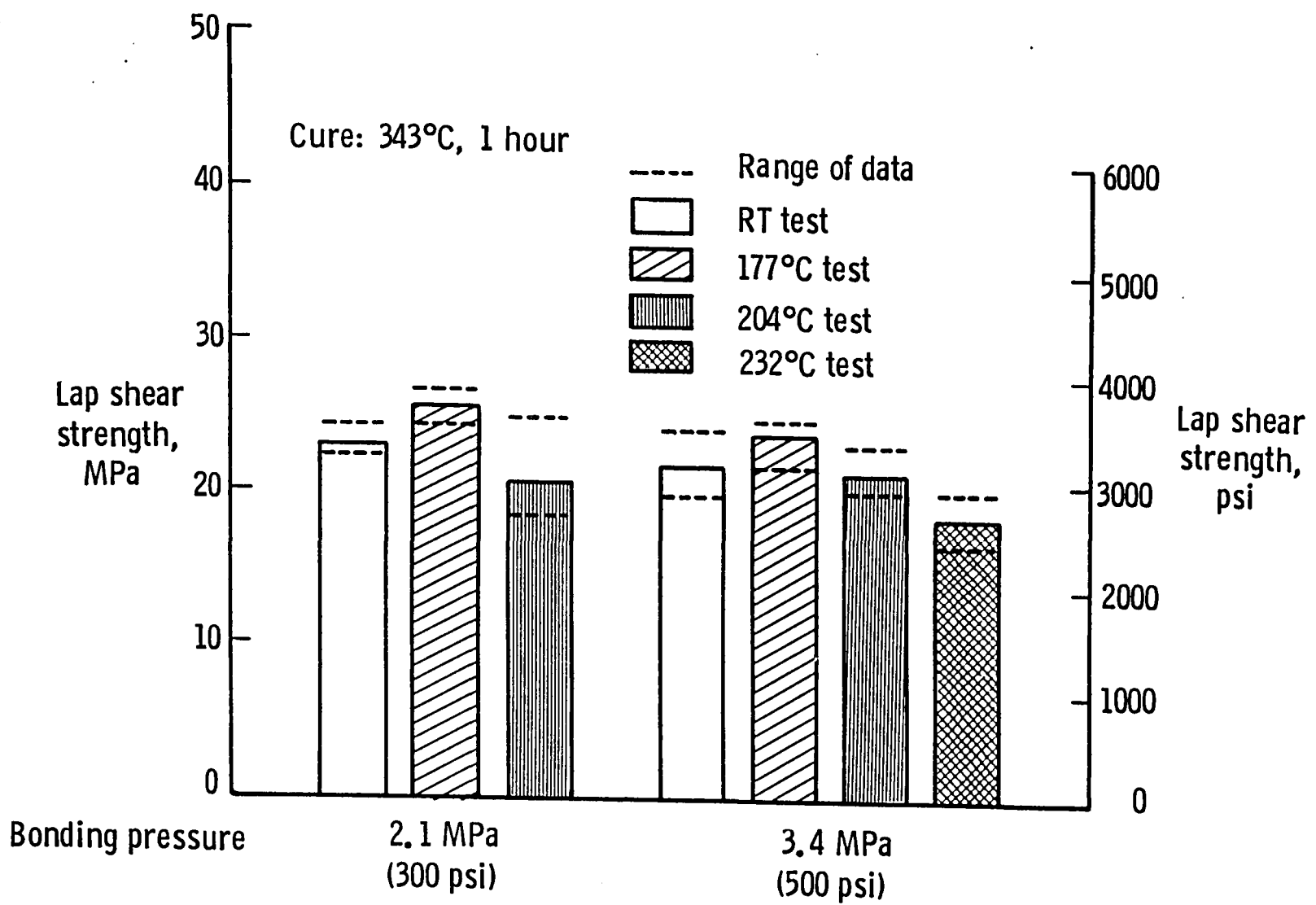

Figure 4. Effect of bonding pressure on lap shear strength for LARC-TPI film bonded Ti-6Al-4V.

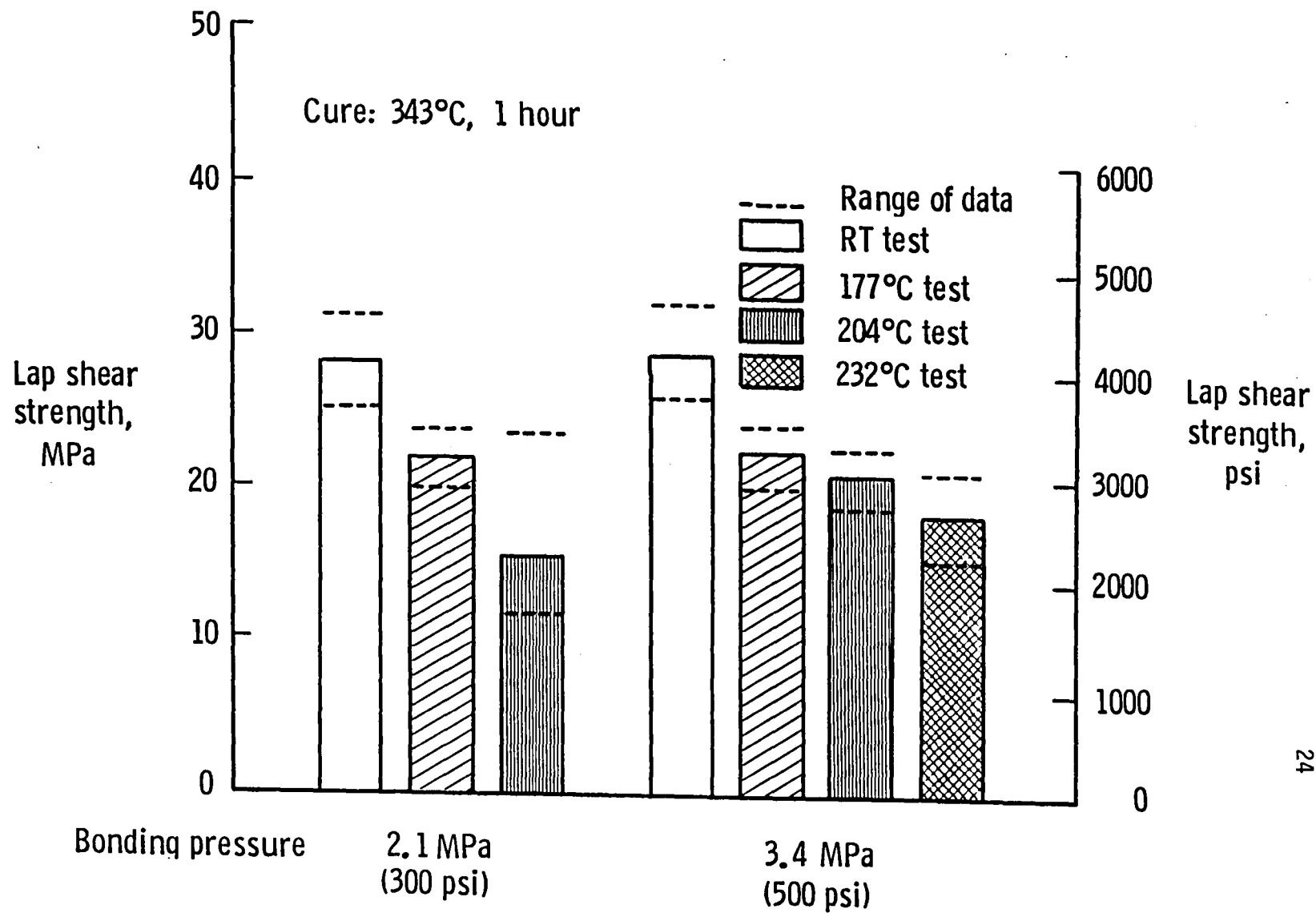

Figure 5. Effect of bonding pressure on lap shear strength for LARC-TPI/ODA film bonded Ti-6Al-4V.

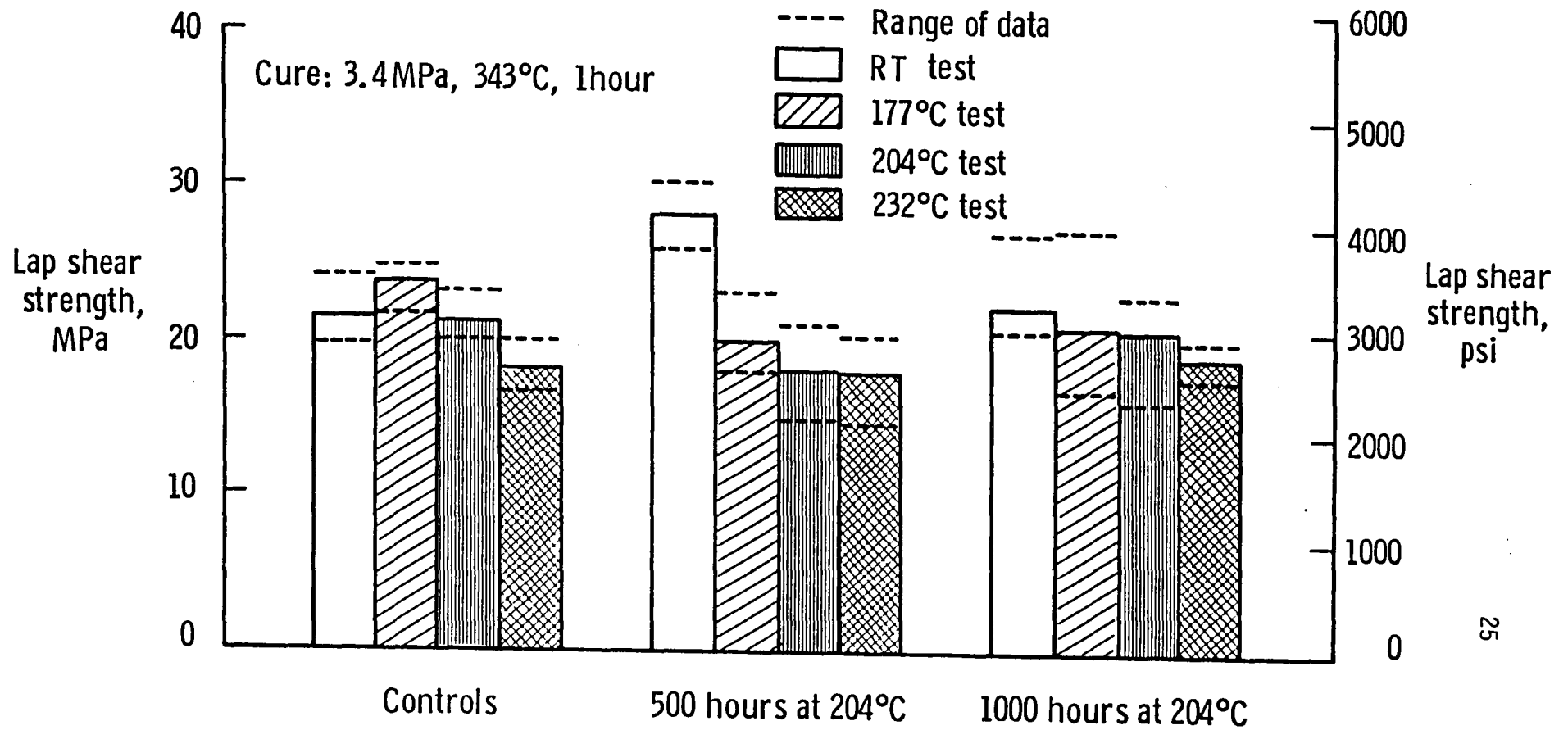

Figure 6. Effect of thermal exposure in air at 204°C for LARC-TPI film bonded Ti-6Al-4V.

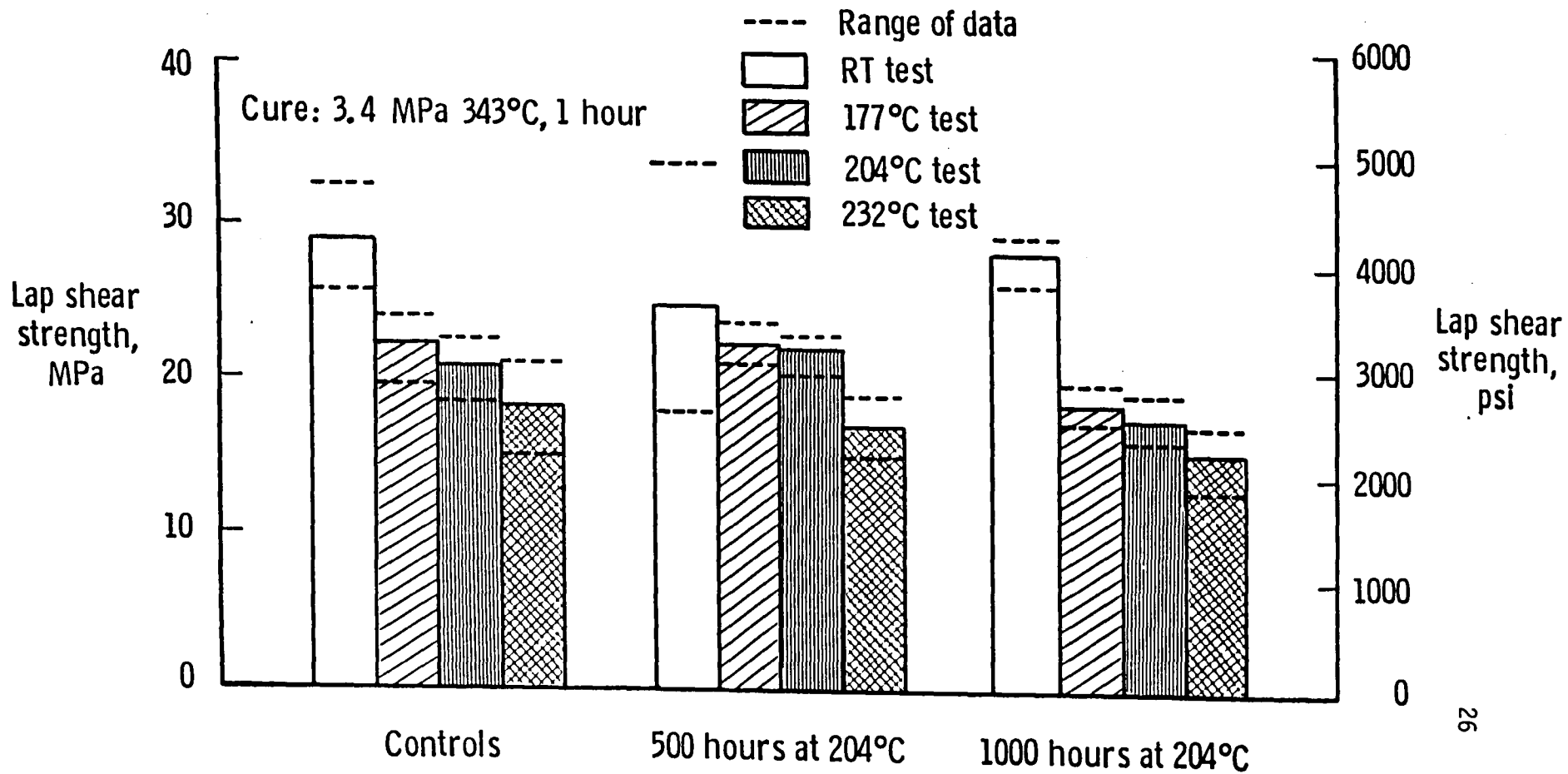

Figure 7. Effect of thermal exposure in air at 204°C for LARC-TPI/ODA film bonded Ti-6Al-4V.

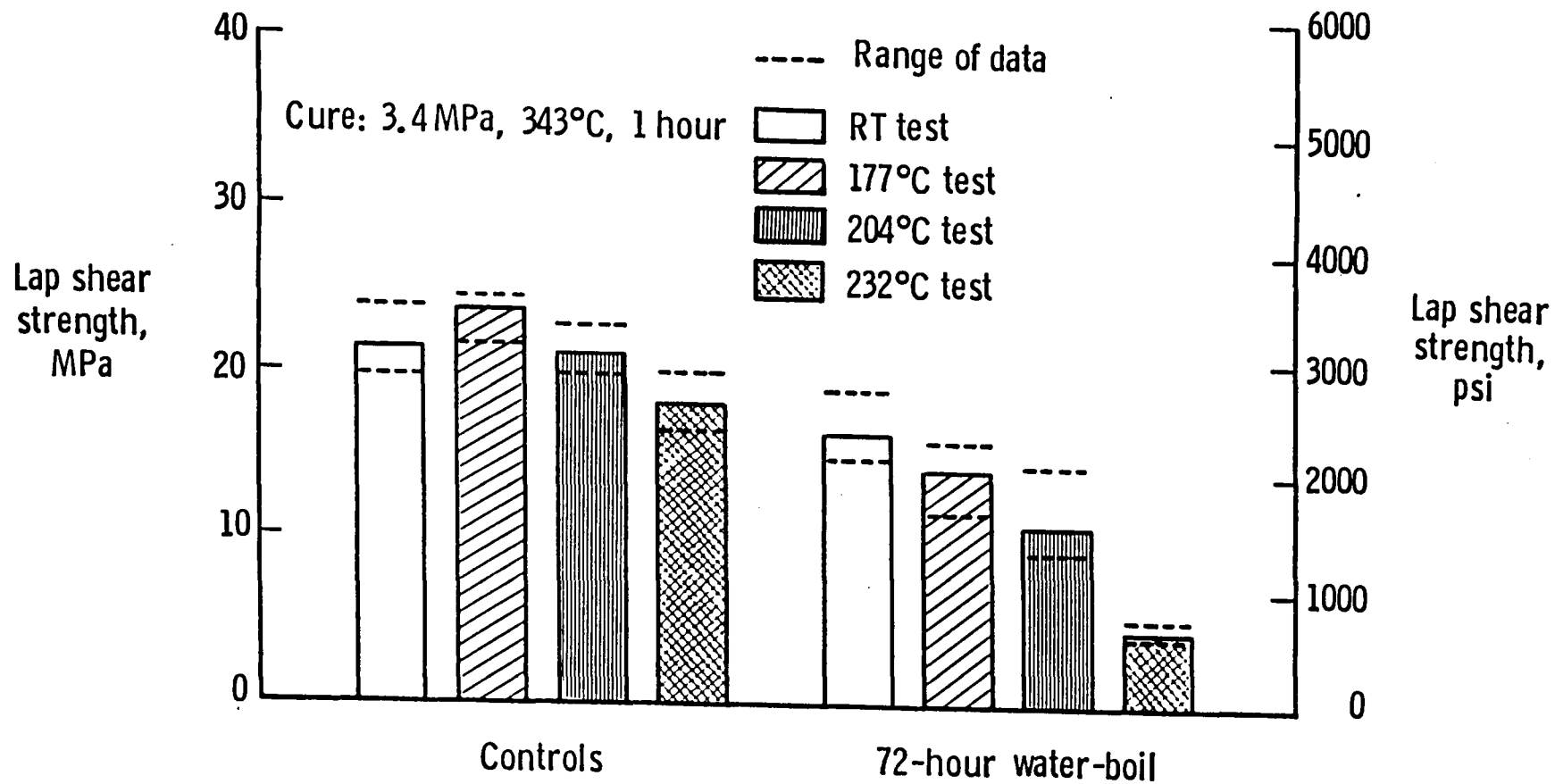

Figure 8. Effect of a 72-hour water-boil on lap shear strength for LARC-TPI film bonded Ti-6Al-4V.

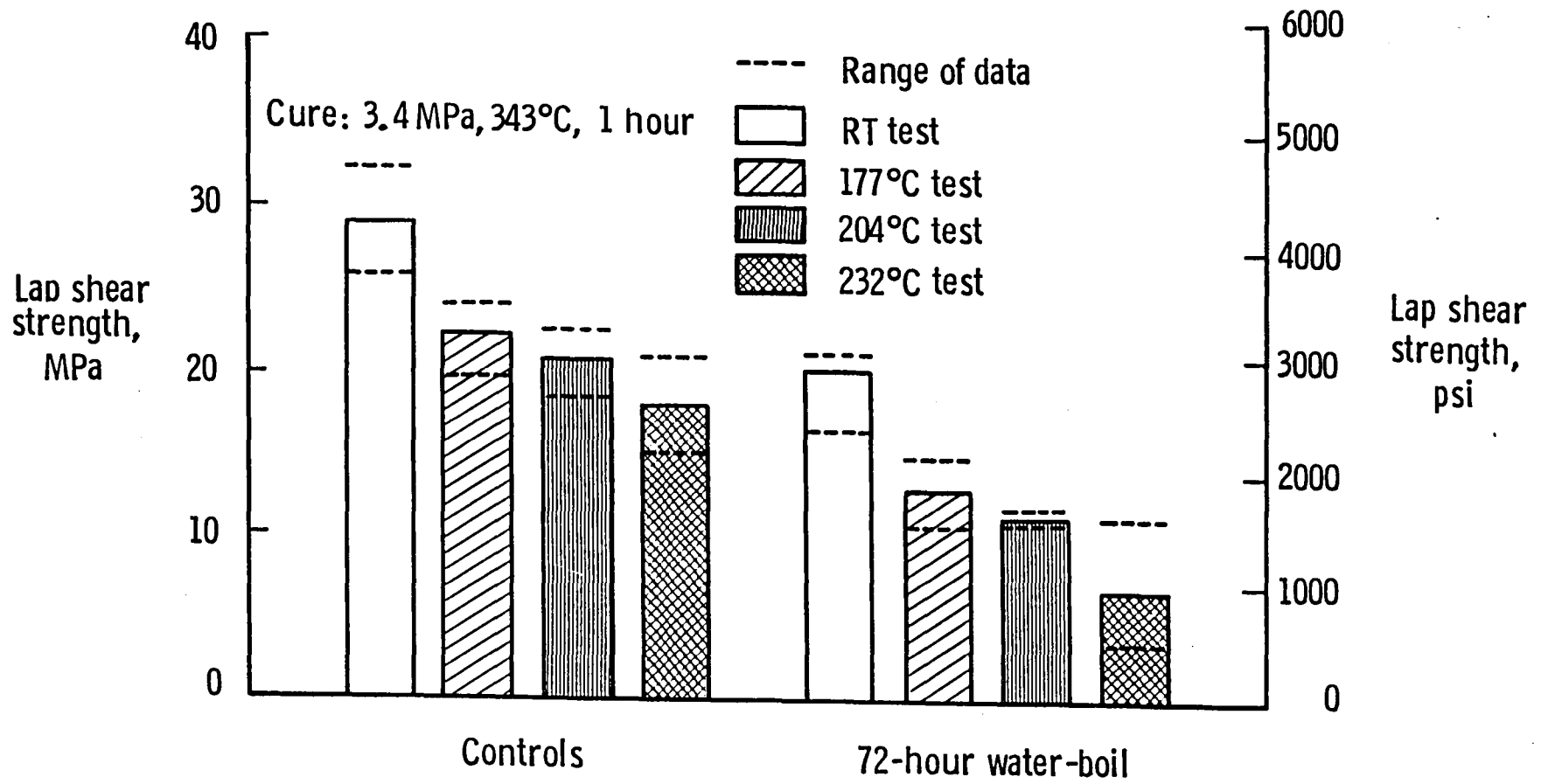

Figure 9. Effect of a 72-hour water-boil on lap shear strength for LARC-TPI/ODA film bonded Ti-6Al-4V.

Standard Bibliographic Page

1. Report No. NASA TM-87738	2. Government Accession No.	3. Recipient's Catalog No.	
4. Title and Subtitle Adhesive Evaluation of Thin Films of LARC-TPI and LARC-TPI with 5 Mol % ODA		5. Report Date June 1986	
		6. Performing Organization Code 506-43-11	
7. Author(s) Donald J. Progar		8. Performing Organization Report No.	
		10. Work Unit No.	
9. Performing Organization Name and Address NASA Langley Research Center Hampton, VA 23665-5225		11. Contract or Grant No.	
		13. Type of Report and Period Covered Technical Memorandum	
12. Sponsoring Agency Name and Address National Aeronautics and Space Administration Washington, DC 20546		14. Sponsoring Agency Code	
		15. Supplementary Notes Use of trade names or manufacturers does not constitute an official endorsement, either expressed or implied, by the National Aeronautics and Space Administration.	
16. Abstract A commercially available LARC-TPI film and an experimentally prepared film of LARC-TPI with 5 mol % of 4,4'-oxydianiline (ODA), designated as LARC-TPI/ODA in the report, supplied by Mitsui Toatsu Chemicals, Incorporated (MTCI), Japan, were evaluated as thermoplastic adhesive films for bonding Ti-6Al-4V. The LARC-TPI/ODA had been shown by MTCI to possess more flow than thermoplastic LARC-TPI and was, therefore, evaluated and compared to the LARC-TPI. Lap shear strength was used to evaluate the materials as adhesives. They were characterized after fracture by determining the glass transition temperature, T _g . The mode of failure was also reported. Thermal exposure at 204°C for 500 and 1000 hrs and a 72-hour water-boil were conducted on lap shear specimens prepared with the two adhesive films. Lap shear tests were conducted at RT, 177°C, 204°C, and 232°C before and after exposures.			
17. Key Words (Suggested by Authors(s)) Polyimide LARC-TPI Adhesive Thermoplastic Copolyimide		18. Distribution Statement Unclassified - Unlimited Subject Category 27	
19. Security Classif.(of this report) Unclassified	20. Security Classif.(of this page) Unclassified	21. No. of Pages 29	22. Price A03

End of Document