

NASA Contractor Report 3922(07)

USSR Space Life Sciences Digest

Issue 6

{NASA-CR-3922(07)} USSR SPACE LIFE SCIENCES N86-27864
DIGEST, ISSUE 6 {Management and Technical
Services Co.) 131 p HC A07/MF A01 CSCL 06C

Unclas

G3/51 43136

CONTRACT NASW-3676
JUNE 1986



NASA Contractor Report 3922(07)

USSR Space Life Sciences Digest

Issue 6

Edited by

Lydia Razran Hooke, Mike Radtke,
Ronald Teeter, and Joseph E. Rowe

*Management and Technical Services Company
Washington, D.C.*

Prepared for
NASA Office of Space Science and Applications
under Contract NASW-3676

NASA

National Aeronautics
and Space Administration

**Scientific and Technical
Information Branch**

1986

CONTENTS

Reader Feedback Form	v
FROM THE EDITORS	vi
SPECIAL FEATURE: SALYUT-7 MEDICAL RESEARCH.....	1
ADAPTATION ,.....	8
BIOSPHERICS	10
BODY FLUIDS	21
BOTANY.....	25
CARDIOVASCULAR AND RESPIRATORY SYSTEMS.....	29
DEVELOPMENTAL BIOLOGY*	41
ENDOCRINOLOGY	41
ENZYMولوجY	49
EXOBIولوجY	50
GENETICS*	56
HABITABILITY AND ENVIRONMENT EFFECTS	56
HEALTH AND MEDICAL TREATMENT	57
HEMATOLOGY	58
HUMAN PERFORMANCE	59
IMMUNOLOGY	62
LIFE SUPPORT SYSTEMS*	63
MATHEMATICAL MODELING*	63
METABOLISM	63
MICROBIOLOGY*	66

* Topics marked with * have no entries of their own, but refer readers to relevant abstracts included in other topic areas.

MORPHOLOGY AND CYTOLOGY	66
MUSCULOSKELETAL SYSTEM	68
NEUROPHYSIOLOGY	81
NUTRITION	90
PERCEPTION	94
PERSONNEL SELECTION*	95
PSYCHOLOGY	95
RADIOBIOLOGY	99
REPRODUCTIVE BIOLOGY	110
SPACE MEDICINE	113
SPECIAL FEATURE: EVAS BY SOVIET COSMONAUTS	120
CURRENT TRANSLATED SOVIET LIFE SCIENCE MATERIALS AVAILABLE TO OUR READERS	122
ENGLISH TRANSLATIONS OF SOVIET SPACE LIFE SCIENCES BOOKS AVAILABLE TO OUR READERS	124

* Topics marked with * have no entries of their own, but refer readers to relevant abstracts included in other topic areas.

USSR Space Life Sciences Digest: Number 1 Reader Feedback Form

To our readers: We are working in a large number of highly technical, specialized areas for which adequate Russian-English glossaries have yet to be compiled. We ask your help in improving the accuracy and specificity of our English terminology. Please fill out the form below whenever you encounter an incomprehensible, incongruous, awkward or otherwise inappropriate term. While we solicit all suggestions for improved renderings, the statement that a term is inappropriate provides us with useful information, even when no better alternative can be suggested. A copy of this form will appear in all future issues of the Digest. Thank you for your help.

Abstract #	Incorrect or contextually inappropriate word or phrase:	Suggested rendering: ("??" is an acceptable entry)

PLEASE RETURN TO: Dr. Lydia Hooke
Management and Technical Services Company
600 Maryland Ave. SW
Suite 209, West Wing
Washington, DC 20024

FROM THE EDITORS

This is the sixth issue of the USSR Space Life Sciences Digest. By this time readers on our mailing list will have received the index for Digest issues 1-4; any suggestions on improving index format and/or content would be most welcome. We would like to call your attention to the two special features included in this issue. The first, at the beginning of the abstract section, gives a relatively detailed overview of medical results for the "Salyut-7" -- "Soyuz-T" prime crew. The second feature, at the end of the abstract section, tabulates information about 20 years of Soviet EVAs. Information about two Soviet books highly relevant to NASA's life sciences concerns and available in English can be found on page 124.

Please address correspondence to:

Dr. Lydia Hooke
Management and Technical Services Company
600 Maryland Ave. SW
Suite 209, West Wing
Washington, DC 20024

SPECIAL FEATURE: SALYUT-7 MEDICAL RESEARCH

[This article was published in the March-April issue of Kosmicheskaya Biologiya i Aviakosmicheskaya Meditsina, the entire contents of which would ordinarily be covered in the next issue of the Digest. However, because of the extreme interest of the material for our readers and the importance of timeliness, we are including it here.]

P285(6/86)* Vorob'yev YeI, Gazenko OG, Shul'zhenko YeB, Grigor'yev AI, Barer AS, Egorov AD, Skiba IA.

Preliminary results of medical research performed on the 5-month space flight of the "Salyut-7" -- Soyuz-T" orbital complex.

Kosmicheskaya Biologiya i Aviakosmicheskaya Meditsina.
20(2): 27-34; 1986.

Abstract: The flight of the "Salyut-7" -- "Soyuz-T" complex lasted from 27 June to 23 November 1983. The two man crew consisted of V.A. Lyakhov (captain) and A.P. Aleksandrov (engineer). The medical goals of the flight included: performance of a broad range of medical, sanitary/hygienic and radiobiological investigations; gathering of information about changes induced by long-term exposure to microgravity; medical monitoring and preventive measures directed at maintenance of the cosmonauts' health and work capacity; medical monitoring during EVAs and use of physiologic data to regulate work performed outside the complex.

General flight conditions. The microclimate inside the spacecraft approximated Earth conditions and fluctuated only on days when operations such as EVAs were performed. The total radiation dose to which the crew was exposed was 1755 mrad. Examination of the automicroflora of the crew and the microflora on cabin surfaces revealed nothing new pertaining to the formation and behavior of microflora during space flight. The skin microflora showed no change from baseline levels during the flight. Staphylococcus bacteria in the nasal cavity of one cosmonaut developed resistance to an increased spectrum of antibiotics. Toward the end of the flight there was some increase in the total concentration of microorganisms in the air. The crew's diet was rotated on a 6-day cycle and contained all the essential nutrients. Mean caloric value was approximately 3100 calories and actual intake varied between 2530 and 3100 calories/day. Water intake was unrestricted and the crew preferred to drink hot water from which they made tea, coffee, fruit juice and freeze dried food. Total direct intake of hot water was 1.7 l/day per person and of cold water 0.12 l/day. Total water intake was 2.7 l/day per person, including 0.5 l in the solid rations and 0.4 l water of metabolism. Prophylactic measures included daily physical exercise, wearing of constant loading suits, wearing of LBNP suits late in the flight, and administration of fluid-electrolyte supplements before landing and in the immediate postflight period.

Inflight Studies

General state of the crew. Throughout the flight the crew reported that they felt well. During the first week, there were reports of sensations of blood rushing to the head, but these had virtually disappeared by day 9.

P285

The crew's appetites were consistently good and their sleep, lasting 6-8 hours, was deep and uninterrupted. Work capacity was adequate; at the end of a working day both crewmembers reported fatigue, but felt refreshed after a night's sleep. Body weight and calf volume decreased over the flight, by a mean of 9.9% for the captain and 13.7% for the engineer. During the flight, the captain's resting heart rate fluctuated within the range of 48-72 beats/minute (preflight baseline: 52-71) and the engineer's heart rate within the range of 58-70 beats/minute (baseline: 52-60). The captain's minimum and lateral systolic blood pressure showed a tendency to decrease during the flight, but there were no significant changes in end/systolic or mean pressure. The engineer's mean pressure increased somewhat during the first month of the flight but then gradually approached its baseline value. Some changes in bioelectric activity of the myocardia were noted in both cosmonauts, in particular, a decrease in the amplitude of some of the R and T waves.

Experiments using LBNP. The captain's heart rate during application of lower body negative pressure (LBNP) remained at preflight levels, while the engineer's showed a tendency to increase during months 2-5 of the flight. The captain's blood pressure during LBNP also remained at preflight value, while that of the engineer was lower than its preflight value during months 2-5 of the flight. Impedance plethysmography revealed a decrease in pulsed perfusion of the vessels of the brain during LBNP. In the flight engineer, who exhibited hypotonia of the cerebral vessels throughout the flight, these parameters approached their normal preflight levels under LBNP.

Experiments using graded physical exercise (Stress test). The captain's heart rate increased by approximately the same amount in response to exercise as it did on Earth. In the flight engineer, increase in heart rate in response to this test was somewhat elevated over its preflight level (117-131, as opposed to 121-123 beats/minute). For both cosmonauts, the ratio of heart rate to work performed, the time to reach a steady state and time required for heart rate to return to its baseline level remained within preflight limits. Increases in minute volume in response to exercise were within preflight limits for the captain, but dropped below baseline for the engineer. In the first minute after exercise the captain's systolic blood pressure increased over preflight levels during the first 3 months of the flight. During this same period, the flight engineer exhibited increases in minimum and terminal systolic pressure and stroke volume which were greater in the second minute after completion of exercise than in the first. Tolerance of exercise stress was rated as satisfactory for the captain during months 1-3 and for the flight engineer during months 1 and 2; for the remainder of the flight, tolerance was rated as good for both crewmembers.

Physiological and hygienic aspects of EVAs. The two EVAs, which lasted 170 and 175 minutes and were performed on days 128 (1 November) and 130 (3 November) of the flight, were devoted to installation of supplementary solar batteries on the spacecraft exterior. The duration of this work (5 hours and 45 minutes total) was not constrained by physiological or medical parameters. A semi-rigid suit was used, outfitted with an autonomous system designed to provide 5 hours of

P285

continuous life support. The suit was water cooled with a manual temperature control. Decompression sickness was prevented by denitrogenation in the air lock and maintenance of a pressure of 280-300 mm Hg in the suit. The atmosphere was close to pure oxygen with the partial pressure of CO₂ less than 10 mm Hg. The cosmonauts felt well throughout the operation but were somewhat tired afterward. During the EVAs, both cosmonauts showed increases in heart rate (maximum of 119 and 117 beats/minute for the captain and engineer, respectively), respiration rate (maximum of 48 and 36), and energy expenditure. These parameters showed greater increase during the first EVA than during the second (See Table). Mean energy expenditure in the course of EVA was 3.8 cal/min for the captain (first EVA) and 4.9 cal/min for the engineer (second EVA). The minimum value for this parameter, 2-3 cal/min, occurred during rest in the "shade." The maximum value occurred for the flight engineer during completion of the final tasks of the operation using the winch (6-7 cal/min) and for the captain during closing of the outer air lock (5 cal/min). The total amount of energy expended throughout the entire period a cosmonaut was in the suit (ca. 4.5 hours) was 1000 calories for the first EVA and 800-900 calories for the second. During the time outside the spacecraft, total oxygen consumption was 107 and 127 l (STPD) averaging 0.7 l/min. No signs of pronounced fatigue were noted after either operation and the astronauts claimed that the actual EVA was less taxing than its ground-based training simulation. Thermal regulation during the operation was successful and body temperature (measured behind the ear) varied within the "comfort" zone (35.2-36.8°C for the captain and 34.6-36.4°C for the engineer).

Biochemical studies. The "Plasma-01" apparatus (of Czechoslovakian manufacture) was used on this flight to store and transport urine samples to earth for biochemical laboratory analysis. One of the crewmembers (not specified which) collected urine over a period of 3 days starting on day 43 and again starting on day 86 of the flight. Samples were frozen and returned to Earth for analysis. Concentrations of sodium, potassium, magnesium, chlorine, phosphorous, other osmotically active substances, creatinine, urea, and a number of hormones and other biologically active substances were measured. It was found that the concentration of the majority of the electrolytes and also the concentration of creatinine and urea decreased throughout the flight. Diuresis was not measured, however, it was noted that concentration of antidiuretic hormone in the urine decreased. The ratio of sodium/potassium, an indirect indicator of mineralocorticoid activity increased on days 43-45 of the flight and then decreased on days 86-88, mainly due to decrease in concentration of sodium in the urine. The calcium/magnesium ratio also decreased over the flight. The total content of osmotically active substances in the urine was lower during the flight than preflight. One reason for the decreased amount of sodium may have been decreased dietary intake. On days 43-45 of flight, the concentrations of aldosterone, and hydrocortisone decreased in the urine, while the fraction of bound cortisone increased, suggesting an alteration in steroidogenesis. By day 88 the concentrations of aldosterone, hydrocortisone, and testosterone in diurnal and nocturnal urine had increased. Alteration in steroid metabolism, which in the initial flight period had been noted only with regard to glucocorticoids, was also noted on day 88 with respect to mineralocorticoids. Renal

P285

excretion of steroid hormones (hydrocortisone, testosterone and aldosterone) and antidiuretic hormone increased during the postflight period. Renal excretion of osmotically active substances, including sodium, decreased, while osmolarity and concentration of sodium in the blood increased.

Investigation of carbohydrate metabolism. (Performed with participation of French scientists.) On days 60 and 88 of the flight, a glucometer was used to measure the glucose content of the blood in one of the cosmonauts. These measurements were made first on an empty stomach and then every 30 minutes for 90-120 minutes after carbohydrate loading (28 g sugar + 28 g glucose). On day 60, glucose content at all measurement points was below preflight levels, and there was evidence of retarded utilization of glucose. On day 88, glucose level had risen at all measurement points, but glucose utilization was still further retarded. On day 25 postflight, the pattern of glucose utilization was analogous to that on day 88 inflight; by day 55 postflight, glucose utilization rate had returned to its preflight levels. The authors conclude that the changes occurring on day 60 indicate depression of hydrolytic processes in the digestive tract, and of carbohydrate transport, which has stabilized by day 88. Apparently, some changes in the insulin producing mechanism of the pancreas also occur accounting for the depressed rate of glucose utilization.

Results of Postflight Examinations

General. On landing, the cosmonauts reported that they felt relatively well. When lying down, they had no complaints, but experienced some dizziness when they attempted to assume a vertical position, and also reported a feeling of fatigue. At the landing site, the captain's heart rate was 82-110, while his blood pressure was 110/80; the parameters for the flight engineer were 72-102 and 115/70, respectively. After 7-8 hours, the cosmonauts reported that they were feeling well. Vesicular respiration was noted, and heart sounds were regular, muffled, and without murmur. Both cosmonauts had heart rates of 72, while their blood pressures were 120/90 and 120/80. One of the cosmonauts still experienced dizziness, discomfort and nausea when sitting or standing, but felt better when he assumed a horizontal position. Both cosmonauts noted rapid onset of fatigue when performing physical work, diminished work capacity and emotional lability. After landing, it was discovered that the captain had lost 3.5 kg and the flight engineer 5.7 kg. This weight had been regained by 8-9 days postflight.

Studies of vestibular function. After the flight, both cosmonauts showed evidence of statokinetic disturbance evidenced by altered gait and instability when standing with eyes closed (Romberg's sign). Head movements led to dizziness and feelings of discomfort, accompanied by stable rhythmic and undamped nystagmus. Study of the otolith function revealed hyperflexia and asymmetry of reactions. Similar symptoms, in addition to increased thresholds, were also characteristic of the disruption of the function of the semicircular canals. Errors in spatial orientation with respect to the gravitationally defined verticle were elevated relative to baseline. Signs of vestibular dysfunction persisted

P285

for 7 days postflight in the captain and for 3 days postflight in the engineer.

Motor studies. Dynamometry indicated moderate decreases in the strength of the anterior and posterior calf muscles. There was a slight decrease in the threshold of vibration sensitivity in the captain and a lowering of thresholds for muscular reception in both cosmonauts. In an upright position crewmembers showed greater numbers of shifts in center of gravity, high frequency fluctuations resembling tremors, and increased time to regain balance. These changes had disappeared or diminished markedly by day 11 postflight, although muscle strength in the calves was still impaired.

Cardiovascular studies. Postflight heart rate was elevated at rest. Electrocardiography revealed signs of metabolic changes in the myocardia (decrease in the amplitude of the T wave on all leads), a small amount of decrease in terminal systolic and diastolic volumes of the heart (by 10-15%), and orthostatic and physical deconditioning.

Biochemical studies. On the first day postflight the level of tissue metabolism was depressed in both cosmonauts, as demonstrated by a decrease in the content of the major substrates of intermediate products of carbohydrate metabolism (lactic and pyruvic acids), and in the activity of enzymes, especially malate dehydrogenase, in blood plasma. By day 8, most parameters had normalized to preflight levels. However, there was a substantial increase in total creatine kinase activity in the blood, accompanied by activation of muscle and myocardial isozymes in one cosmonaut, and of alanine aminotransferase in the other. The authors cite activation of tissue metabolism and changes in permeability of cell membranes as possible causes for these effects. By day 60 postflight enzymes levels had returned to normal.

Hematological studies. On day 1 postflight, the concentrations of erythrocytes and hemoglobin, as well as hematocrit value, were depressed. The Price-Jones curve suggested the presence of microcytosis in the blood. Later in the readaptation period a reticulocyte reaction was observed, reflecting erythropoiesis.

Studies of parameters of erythrocyte metabolism. As has been the case after other long-term flights, there was a decrease in concentration of ATP, a slight decrease in concentration of reduced glutathione, and increases in concentrations of lactate dehydrogenase, glucose-6-phosphate dehydrogenase, and 2,3-diphosphoglycerate compared to preflight values.

Studies of the functional status of the digestive system. No changes were observed in the activity of stomach and pancreatic enzymes on day 1 postflight. On day 5, there was a tendency for lipase activity in the urine to increase in both cosmonauts, indicating some changes in exocrine activity of the pancreas. On day 7 there was some increase in the activity of pancreatic amylases in the blood, which was twice as pronounced in the flight engineer. There was also an increase in invertase and maltase in the feces. On the basis of these results and

SPECIAL FEATURE: SALYUT-7 MEDICAL RESEARCH

P285

those involving reactions to glucose loading, the authors conclude that energy is provided under weightlessness mainly through the substrate of fatty acids.

Immunological studies. After the flight both cosmonauts exhibited a decrease in the activity of killer cells (by 60% on the average) and in the T-lymphocyte function. At the same time, the number of T-lymphocytes in the blood was depressed in the flight engineer. The captain showed increased sensitivity to Proteus, and the engineer showed some increase in IgM in the blood.

Tables and Figures:

Table: Results of medical monitoring during time in the air lock and on EVAs for two cosmonauts

Date	Day of Flight	Activity	Crew-member	Heart Rate per min.	Respiration Rate, per min.	Energy expended, cal/min
11/1/83	128	Work in suits in airlock	Capt.	106-132	10-20	3.0
			Eng.	75-116	16-24	2.6
		EVA	Capt.	81-119	36-48	3.8
			Eng.	78-117	24-36	4.9
11/3/83	130	Work in suits in airlock	Capt.	91-132	12-20	3.1
			Eng.	67-114	16-24	2.6
		EVA	Capt.	74-108	16-40	3.3
			Eng.	66-107	24-36	4.3

Figure 1: Changes over time in calf volume of crew members during a 150-day flight on "Salyut-7"- "Soyuz-T" orbital complex

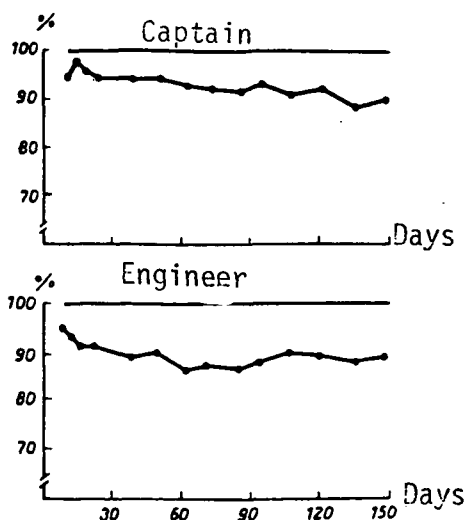

SPECIAL FEATURE: SALYUT-7 MEDICAL RESEARCH

P285

Figure 2. Changes in the mean values for resting heart rate before and during a 150-day flight.

Here and in Figure 3: 1, 2, and 3 -- mean values of parameter preflight and in months 2 and 5 of the flight, respectively

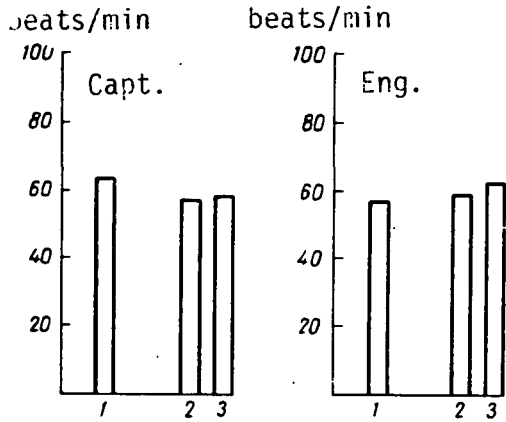
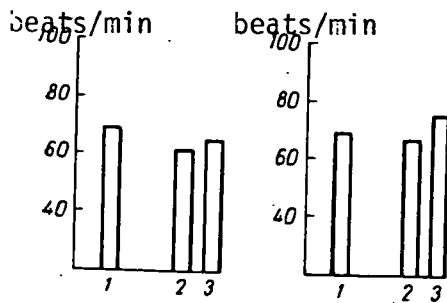

Figure 3. Changes in mean values for heart rate during LBNP (-35 mm Hg) test before and during a 150-day flight.



ADAPTATION

(See also: Endocrinology: P233; P272; Hematology: P275; Immunology: P236; Musculoskeletal System: P274)

PAPER:

P264(4/86) Sten'ko YuM, Vinogradov SA, Filatova TA.

The combined effects of climatic factors and ship conditions on psychophysiological functions in seamen of the Arctic fleet.

Gigiyena Truda i Professional'nyye Zabolevaniya.

1986(1): 28-31.

[8 references; none in English]

Scientific Research Institute for Hygiene in Shipping, USSR Ministry of Health, Moscow

Adaptation, Long-term Service, Seasonal Variations; Psychology, Social Adjustment, Information Processing; Thermal Regulation; Cardiovascular and Respiratory Systems, Functional Parameters

Humans, Seamen

Environmental Conditions, Long-term Cruise, Optimal Cruise Length, Arctic, Cold

Abstract: Individuals spending long periods in the Arctic are exposed to a set of extreme environmental conditions; sailors on longterm cruises are exposed to a different but overlapping set. The subjects of this experiment were seamen (n not specified) on year-round cruises in Arctic waters and the object of the investigation was the combined effects of the entire set of these extreme conditions on the following: personality traits, performance of information processing tasks, cardiovascular function, and thermal regulation. Changes in parameters indicative of the functioning of these systems were examined as a function of length of uninterrupted sea service and of season of the year. The MMPI (Minnesota Multiphasic Personality Inventory) test was used to assess personality factors. Test results clearly indicated a number of phases: in the first month, some amount of disruption and tension was noted, coinciding with the initial stages of adaptation. Between 1 and 3 months, emotional lability stabilized and positive psychological traits grew stronger. After 90 days at sea, symptoms of psychological maladjustment increased. These included interpersonal conflicts, irritability, tendency toward fatigue and failure to internalize social standards; self-control was observed to decrease. After 5 months at sea, MMPI results indicated that psychological disturbances had increased by a factor of more than three.

Information processing performance (e.g., short-term memory) reached optimal level in the second month of continuous sea service; after 3 months at sea, values of these parameters were significantly depressed. Cardiovascular parameters (e.g., heart rate and blood pressure) decreased from baseline value between days 30 and 60 of the cruise; subsequently these parameters increased, but not to a significant extent. These parameters decreased less in the winter months. A composite cardiac parameter (components not specified), purported to measure strain on cardiac regulatory mechanisms, showed different changes over time depending on navigation season. This parameter reached its lowest, optimal, value in the fall-summer navigation season between 61 and 90 days into the cruise; values increased between 90 and 120 days but were

still within normal range. In the winter navigation season, indicators showed a similar trend and phases, but decrease in tension between 61 and 90 days was less pronounced and remained above normal values. Thermal regulation was investigated as a function both of time at sea and of navigation season. In the summer-fall season subjects underwent the three phases of adaptation to cold identified in previous studies, however the onset of each of these phases was considerably delayed in comparison to cold adaptation on shore. For example, on shore, Phase III, (the normalization phase) typically occurs on day 23-30, but at sea its onset is delayed until day 50. Further delays of phase onset occur in the winter navigation season, "pathological" symptoms are evident in Phase II, and Phase III does not occur at all. The authors conclude that for the first 30 days of continuous service at sea, orienting reactions characteristic of the strain of initial adaptation of regulatory mechanisms are the predominant responses to environmental factors; subsequently, between days 30 and 90, the major systems stabilize at an optimum level. After 90 days of continuous service, changes indicative of the development of maladaptive disturbance can be observed. Therefore, it is recommended that uninterrupted service not exceed 90 days.

BIOSPHERICS

PAPERS:

P260(4/86) Sukhotin YuV, Kudryatsev VS.

Evaluation of the cost effectiveness of using remote sensing data in forest management

Issledovaniye zemli iz kosmosa.

1986(1): 57-63.

[3 references; none in English]

"Lesproyekt" All-Union Aerial Photography Forest Management Association, Moscow; Central Mathematical Economics Institute, USSR Academy of Sciences, Moscow

Biospherics, Remote Sensing Data
Forests, Forest Management
Cost Effectiveness Estimation

Abstract: This paper describes a number of cost effectiveness estimation procedures for assessing the utility of remote sensing data in performance of forest management. If the data produced by remote sensing is equivalent to that produced by an existing technology, then very simple cost estimation equations that only involve of the costs of the two technologies may be used. An instance where this procedure would be appropriate in forest management is performance of forest inventories. The authors state that forest inventories based on remote sensing data decrease expenditures of resources and money by a factor of 3 to 4 and increase the productivity of labor by an equivalent amount over existing methods which employ aerial photography. When information targeted for remote sensing differs substantially in content or quality from data obtained using an existing technology, then simple cost comparison is not appropriate. Instead, the authors suggest the following equation:

$$C-E = [B_n - (C_n^a + C_n^i)] - [B_e - C_e^a + C_e^i]$$

Where C-E = the cost effectiveness of utilizing the new technology; B_n and B_e = the benefits to be derived from the new and existing technology, and C_n^a & i and C_e^a & i are the administrative and information generation costs of each of the technologies.

The identification of ongoing changes in heavily wooded regions attributable to land use and natural disasters is one instance where the above equation is suitable. Where remote sensing produces forest management information which is not obtainable from other technologies, the appropriate equation is: $C-E = B_n - (C_n^a + C_n^i)$. An assessment of the cost-effectiveness of obtaining a new type of information must take account of all the major consequences -- ecological, sociological, economic -- of adopting that technology in the forest management sector directly affected, as well as indirect effects in other sectors.

Where the remote sensing data is to be utilized solely for purposes of obtaining information, benefits (productivity) may be associated with the information documents such as forest management plans, thematic maps, etc. Where processed information is to be used in actual production, benefits (productivity) may be surface in areas such as: timber, food

P260

products, raw material for industry and medicine, pelts, ecological benefits, etc. When estimating costs and benefits it is essential to take into account the period of time over which these will accrue.

P277(4/86) Kanevskiy VA, Ryazantsev VF, Perekrest ON, Il'in VP, Movchan YaI, Perekrest OI, Bekh LT, Dariy VP.

On the potential for using remote laser data to assess the state of agricultural crops on the basis of their luminescence.

Issledovaniye Zemli iz Kosmosa

1985(6): 37-39.

[3 references; none in English]

N.G. Kholodnyy Institute of Botany, Ukrainian Academy of Sciences, Kiev
Center for Automated Scientific Research and Meteorology, Moldavian
Academy of Sciences

Biospherics, Laser-induced Luminescence

Wheat, Rye

Chlorophyll Content, Fertilization, Biomass

Abstract: The goal of this experiment was to determine, for fields of wheat and rye, the relationship between the luminescence of plants and the amounts of chlorophyll, nitrogen, phosphorous and potassium in their leaves, as a function of fertilization and density of sowing. Experiments were performed from a helicopter, using a laser fluorometer. Luminescence was induced by fixing a laser on board with wavelength of 440 nm on wavelengths of 685 and 735 nm. Fields measured contained winter wheat in the milk-ripe stage and rye at various stages. A total of 100-150 measurements at the two wave lengths were obtained for 16 wheat fields differing in the amount of mineral fertilizer that had been applied. The results enabled the authors to derive the relationship between luminescence and such characteristics as total concentration of chlorophyll "a" and "b", content of phosphorous in the leaves, biomass and density of the crop. The mean intensity of luminescence was determined for each field, as was mean error which did not exceed 8%. These relationships are presented in Figures 1 and 2. Mean luminescence was observed to rise with increases in chlorophyll concentration, and phosphorous concentration, dry biomass, and density of sowing. Similar experiments with rye at different stages of development showed a decrease in luminescence for all levels of fertilization as the rye developed from the tillering phase to full flower. Increase in the amount of fertilizer applied to the soil increased the concentration of nitrogen, phosphorous and potassium in the leaves of the plant which was associated with increased mean luminescence.

Table and Figure Titles: Table: Change in intensity of luminescence of rye leaves as a function of the degree of assimilation of fertilizer

Figure 1: Mean luminescence (K) as a function of total concentration of chlorophyll "a" and "b" in a unit dry weight of leaves

Figure 2: Mean luminescence (K) as a function of concentration of phosphorous in the leaves of wheat

P277

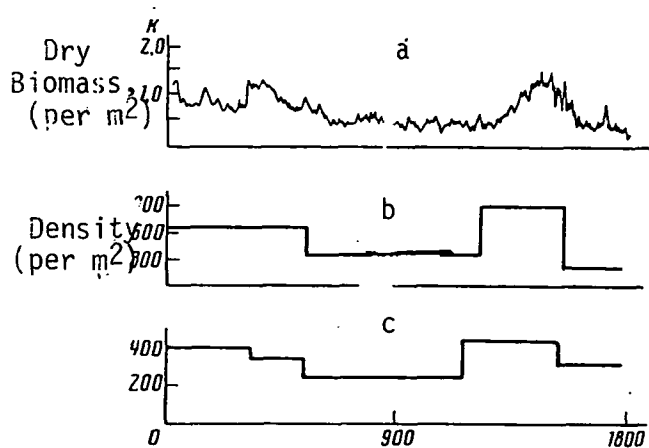

Figure 3: a - change in the parameter K along a test profile of sowing of winter wheat; b - change in dry biomass; c - change in sowing density.

MONOGRAPHS:

M69(4/86) Svirezhev YuM.

Matematicheskoye modelirovaniye biogeotsenoticheskikh protsessov [Mathematical modeling of ecological (literally, biogeocoenotic) processes].

Moscow: Nauka; 1985.

[126 pages]

Scientific Council on Problems in Ecology and Conservation and A.N. Severtsov Institute of Evolutionary Morphology and Animal Ecology, USSR Academy of Sciences.

Key Words: Biospherics, Ecological Processes and Prediction; Mathematical Modeling, Ecosystems; Oxygen Cycle, Forests, Swamps, Cotton

Annotation: This monograph applies a systems approach to the development of mathematical models of ecological processes at various levels of organization: specific ecosystems, interactions between ecosystems within a region, and the biosphere as a whole. The processes of transformation of matter and energy in ecosystems, the formation of the spatial structures of ecosystems, and also processes of species succession are examined. This monograph is intended for biologists, ecologists and geographers.

CONTENTS

(Numbers in parentheses refer to page numbers in the original.)

Svirezhev YuM, Krapivin VF, Vilkova LL, Tarko AM. A mathematical model of the oxygen cycle in the biosphere which takes account of the spatial distribution of land ecosystems (6)

Abstract: In order to estimate the potential consequences of the increase of CO₂ in the atmosphere, a model of the oxygen cycle in the atmosphere-vegetation-soil system was developed which models the spatial distribution of ecosystems. The detailed specification of the spatial distribution of ecosystems increases accuracy and reliability in predicting changes in the oxygen cycle resulting from human activity. [2 tables; 5 illustrations; 15 references]

Novichikhin YeP, Tarko AM. Modeling global oxygen and nitrogen cycles in the biosphere. (15)

Abstract: The work described in this paper used simulation methods to perform a theoretical study of global biogeochemical cycles of oxygen and nitrogen. For this purpose, two models of these cycles in the atmosphere-vegetation-soil system were constructed. In the first model the biosphere is treated as a single unified soil-vegetation formation and in the second model as a set of soil-vegetation formations. [1 table; 5 illustrations; 12 references]

M69

Logofet DO, Svirezhev YuM. Modeling the dynamics of biological populations and communities in nature preserves (25)

Abstract: Using a number of illustrative examples from the mathematical theory of populations and communities, this paper examines problems related to conservation. The dynamics of one isolated population exposed to random environmental fluctuations is described mathematically in such a way that it is possible to estimate the probability of the population dropping below a certain level as a function of the capacity of the environment to support that species. [4 illustrations; 21 references]

Chetverikov AN. Modeling forest ecosystems (37)

Abstract: This paper includes reviews of existing approaches to the modeling of forest ecosystems, an analysis of the trends within these approaches, and an evaluation of their potential for the future. [143 references]

Frey TE-A. Certain aspects of modeling the productivity of forest stands (51)

Abstract: This paper introduces a system of empirical equations, which are used to quantitatively describe the growth related changes in the weight ratios of certain structural subdivisions of the European spruce. These equations comprise a mathematical model of changes in the efficiency coefficient of a forest stand as a physiologically active system, with photosynthesis as input and respiration of living tissues as output. It is hypothesized that the main factor determining the high level of pure primary productivity, is the weight of the leaves (needles) per unit area of the forest stand. [1 table; 1 illustration; 3 references]

Galitskiy VV. The horizontal structure and dynamics of coeval plant communities: Digital modeling (59)

Abstract: This paper discusses the use of an approach, analogous to the method of "molecular dynamics," to analyze the effect of the horizontal geometric structure of a coeval plant community on its population dynamics. This type of approach is methodologically similar to a field experiment and makes analysis of the effects of computational procedures,, structures and parameters significantly simpler and more reliable. (5 illustration, 29 references)

Komarov AS. An experimental computer simulation of populations of vegetative-mobile(?) herbaceous plants (70)

Abstract: This paper cites the results of numerical statistical computer-based modeling of a sample population of vegetative-mobile herbaceous plants. Population size is discussed, as are the relationship of population size to the growth characteristics of plants and their spatial distribution in the population. The effect of random destructive factors on the behavior of population size is considered. The author discusses the possibilities and future potential for using numerical statistical modeling to analyze plant communities. [8 illustrations; 19 references]

M69

Aleksandrov GA, Logofet DO. A dynamic model of simultaneous cycles of organic matter and nitrogen in a mesotrophic bog (80)

Abstract: Using empirical information about the effect of C/N ratios on the productivity of phytogenesis and the rate decomposition of fallen leaves, the authors construct a dynamic model describing the biogenic aspects of succession in a mesotrophic bog. The results of applying this model to a transient bog are discussed with respect to the "Taiga Ravine" experimental area (Novgorod Oblast [Province], Valdayskiy Rayon [Region]). [10 illustrations; 11 references]

Pegov SA, Khomyakov PM. Utilization of index numbers as estimators(?) in modeling the development of ecosystems at the regional level (98)

Abstract: This paper presents a system for estimating the state of components of the environment. Changes in a component of natural environmental over time and the effects of pollution on these changes are treated as a law-governed process. This formulation serves as the basis for the construction of an ecological prediction model. [2 tables; 5 illustrations; 31 references]

Tarko AM, Sadyloyev RI. Construction and investigation of a dynamic model of growth and development of cotton (112)

Abstract: A mathematical model of the growth and development of cotton is derived. The principle of optimal control is used to determine the functions for the distribution of assimilators(?) in various organs of the cotton plant. The growth of cotton in the presence of various environmental conditions is studied. [5 illustrations; 9 references]

M72(4/86) Izrael' YuA, Bugrovskiy VV, Novikov YuV, editors.
Kosmicheskii monitoring biosfery
[Monitoring the biosphere from space].
Leningrad: Gidrometeoizdat; 1985.
[ca. 145 pages; 8 tables; 46 illustrations; 109 references]
Working Group on Monitoring of the Biosphere from Space, Monitoring
Section, Council on Biospheric Problems, USSR Academy of Sciences

Key Words: Biospherics, Remote Sensing, Ecological Monitoring,
Ecosystems, Anthropogenic Effects; Cybernetics and Data Processing,
Automated Remote Sensing Data Processing

Annotation: This book is a collection of papers from members of the Working Group on Monitoring the Biosphere from Space under the Monitoring Section, Council on Biospheric Problems USSR Academy of Sciences. It includes theoretical papers which describe issues related to various aspects of monitoring the biosphere from space, as well as [applied] papers devoted to specific experiments in this area. The contributors to this volume include leading authorities in geography, biology, and engineering who are concerned with solving problems related to monitoring the biosphere from space. This book will be useful to a wide range of scientists working in the areas of space monitoring and environmental conservation, and to interdisciplinary scientists, and students.

CONTENTS

(Numbers in parentheses refer to page numbers in the original.)

Foreword (3)

PART I: PROBLEMS AND THEORETICAL ASPECTS OF MONITORING THE BIOSPHERE
FROM SPACE

Yu.A. Izrael', Yu.V. Novikov. Ecological monitoring from space. (5)
Abstract: This paper examines the problem of ecological monitoring from space. The potential of this method for yielding information concerning man-caused changes in the atmosphere, land and water masses is demonstrated. A method for interactive processing of remote sensing information from space allows the construction of maps of man-caused changes in the environment, particularly with regard to the distribution of atmospheric pollution, man-caused changes in plant canopy and ground cover, oceans, seas and inland water masses. [9 illustrations; 2 references]

I.P. Gerasimov, L.N. Vasil'yev. Remote sensing methods in geography. State of the art and perspectives for future applications (16)
Abstract: Three of the major trends in space research in geography are: automated processing of remote sensing data from space, multiband surveys and remote identification of objects on earth. The authors discuss the potential for utilizing remote sensing data from space to identify three-dimensional structures, particularly, structures resulting from land use, and for studying geosystems and ecosystems and also for ecological monitoring. [4 illustrations]

M72

S.V. Viktorov. Using indicators in monitoring from space.

(24)

Abstract: This paper concerns future prospects for using terrain indicators in monitoring from space. One of the most effective methods for optimizing research is comparison of numerical ratings of various features of terrain over a number of years, as indications of various processes, predominantly man-caused. A summary is given of certain degenerative processes occurring in deserts, which may be identified using remote sensing. [1 table, 13 references]

Ye.A. Vostokova, Yu.G. Kel'ner. Cartographic monitoring of the environment using remote sensing data (29)

Abstract: Remote sensing data from space may be used to compile operational maps of the environment. Operational maps may be thematic or composite (complex). Such maps are especially important in the study of regions with high levels of anthropogenic impact, for example, the area near Lake Aral. Periodic compilation of operational maps make it possible to identify the dynamics of changes in natural features. The techniques for constructing operational maps are discussed.

D.V. Panfilov. The biogeographic structure of the territory of the USSR and the goals of monitoring from space. (33)

Abstract: A detailed analysis of the ecosystem and biogeosystem structures in the territory of the USSR is given. The types, classes and families of ecosystems are identified. All continental-insular biogeosystems of the USSR are divided into three groups according to drainage type: those with unified drainage, those with a number of divergent drainage paths and those with poor drainage. The amount of diversity in each biogeosystem is analyzed and a conclusion is drawn about the dependence of diversity on latitude. The overall state of contemporary biogeosystems within the USSR is evaluated in light of the changes that have resulted from anthropogenic effects. The major structural and functional parameters of specific ecosystems are defined. These must be considered in monitoring the environment from space. [1 table; 1 illustration; 1 reference]

M.D. Korzukhin, V.N. Sedykh. The tasks involved in regional reference monitoring of the forests of Western Siberia. (42)

Abstract: This article discusses the issue of the organization of an agency for monitoring forests, using the forests of Western Siberia as an illustration, and devotes particular attention to the goals of regional reference monitoring. It is demonstrated that the specific features of forest monitoring, considered as a component of overall ecological monitoring, are determined by the duration of the successions which occur and the infrequent confluence of climatic states. i.e., the dynamics of the area being monitored. The features proposed, which are observable, were chosen for the purpose of enabling identification of a set of baseline exogenous influences from the total set of influences on the forest and construction of a dynamic prediction model. The majority of the tasks involved in regional reference monitoring of a forest may be accomplished using remote sensing methods. [11 references]

PART II. SPECIFIC INVESTIGATIONS IN THE AREA OF BIOSPHERIC MONITORING
FROM SPACE

V.N. Khizhnichenko, S.A. Klepikov. Development of software for an image processing system for studying natural resources and monitoring the environment (52)

Abstract: This paper presents a description of software for an experimental digital processing system for increasing the effectiveness of problem solving in the study of natural resources and environmental monitoring, [1 Table; 1 illustration; 3 references]

V.Ye. Sokolov, B.V. Vinogradov, P.D. Gunin, A.M. Krasnitskiy. Space experiments in surveying nature preserves (60)

Abstract: This article describes the major methods and trends in aerospace monitoring of biospheric stations and preserves. These include the solution of the problem of providing calibration information in terms of polygonal coordinates for aerospace surveys and the inverse problem of recognizing the components of the state, structure, rhythmic changes and dynamics of a preserve center and buffer zone. [18 references]

V.V. Bugrovskiy, O.B. Butusov, Ye.B. Dudin, Ye.G. Melina, Ye.A. Vostokova. Automated processing of space images of Western Mongolia for topographical mapping of baseline(?) territories. (69)

Abstract: This paper presents the results of automated processing of photographs of Western Mongolia taken from space. It is demonstrated that utilization of an automated processing system extends the capabilities of topographical interpretation and furnishes objective material for quantitative descriptions of the interpretation scheme. It is concluded that it is expedient to use the reference? line algorithm in automated estimation of the area of various natural features. [8 illustrations; 4 references]

G.F. Krasnozhan. Biospheric monitoring from space and its relation to hydrospheric monitoring from space. (82)

Abstract: The use of modern methods of space monitoring to determine dynamic characteristics of water masses is described. Such methods may be utilized in the study of the basins of rivers, lakes and seas, of hydrological, morphological and hydrobiological characteristics and for compiling physical and economic maps. The potential for using satellite information for studying other features of water masses, particularly the mouths of rivers in the Northern Caspian region: the Ural, Volga and Terek, is explored. [3 illustrations, 7 references]

O.B. Butusov, A.M. Stepanov, T.V. Chernen'kova. Estimating the chemical pollution of buffer territories using modeling and sub-satellite experiments (93)

Descriptions are given of the fundamentals of the general methodology for performing subsatellite experiments in various natural geographic zones and of the mathematical modeling of atmospheric transport of polluting substances in foothills areas. The mean accumulation of pollutants is computed for a simulated

M72

region. A figure is presented which uses isolines to represent the field of pollution obtained. [2 illustrations; 5 references]

L.A. Kuzen'kov. A method and technology for automated interpretation of aerospace photographs in inventorying forests in the northeastern portion of the USSR (99)

Abstract: The technology used to interpret aerospace photographs for purposes of inventorying the forests of the northeastern portion of the USSR is discussed. [3 illustrations]

D.S. Orlov, N.I. Sukhanova. A case study in compiling large-scale cartograms of the spectral reflective capacity of the soil (108)

Abstracts: The basic methodology for compiling large-scale soil maps using remote echoes is described. The results of statistical processing of the coefficient of reflection at 750 nm for watershed and valley soils of a sod-podzolic zone (the territory of Moscow State University's Chashnikovo Agrobiological Station) are presented. A soil cartogram is compiled which indicates areas which are homogeneous with respect to reflectance of light with a wavelength of 750 nm. The spectral cartogram obtained shows satisfactory correspondence with a soil map of the same area. [1 table; 1 illustration; 15 references]

A.S. Samokhina, S.Ya. Vilenkin. A method for establishing a humidity profile at a given brightness temperature as a function of angle of observation and wavelength (116)

This paper demonstrates the construction of a profile of moisture and dielectric properties of soil on the basis of a profile of brightness temperature. An approximation method applicable to flat layered media, which utilizes signals with various wavelengths and angles of incidence is proposed. (6 references]

D.S. Orlov, O.V. Lopukhina. Use of spectral reflective capacity indices to characterize eroded soil (118)

Abstract: A laboratory methodology is described which utilizes spectrophotometric techniques for diagnosing eroded sod-podzolic soils. This methodology can form the basis for interpreting spectral band satellite and aircraft photographs. Experiments were performed on the territory around Moscow. [4 tables; 6 illus; 19 references]

V.V. Bugrovskiy, Ye.G. Mellina, Ye.V. Mikhaylenko, N.I. P'yavchenko. A model of a forest-swamp ecosystem for use in a system for monitoring the biosphere from space. (130)

Abstract: A model of a forest-swamp ecosystem, adapted for the utilization of remote sensing data from space is described. The major specifications of a mathematical model of plant communities which must be utilized in a system for monitoring the environment from space are discussed. The model is used to calculate growth in standing timber in a swampy forest area with atmospheric water supply. A conclusion is drawn that the given forest-swamp ecosystem is very sensitive to the amount of precipitation it receives. This model is proposed for use in a space monitoring system for predicting the status of territories with forest-swamp ecosystems. [8 illustrations; 5 references]

BODY FLUIDS

PAPERS:

P255(4/86) Kozlova VG, Aleksandrova YeA.

Change in electrical conductivity of blood under conditions of immersion.

Fiziologiya Cheloveka.

11(6): 1028-1030; 1985.

[10 references; 2 in English]

Body Fluids, Fluid-Electrolyte Balance

Humans, Males

Immersion, Dry

Abstract: In this paper, the authors evaluate a technique for measuring conductivity of small volumes in order to determine the electrical resistance of blood as an indicator of changes in extracellular fluid under conditions of immersion. Twelve healthy males, aged 25-35, participated as subjects, undergoing 7 days of "dry" immersion. The electrical resistance of their blood was measured: three times in a 3-day preliminary baseline period; 6 hours into immersion; on days 2 and 4, and 7 of immersion; and one day after treatment termination. Resistivity was determined using a portable conductometer and 0.1 ml of blood. Throughout the period the concentration of sodium and potassium in blood and urine was measured using flame photometry and fluid intake was recorded. In the baseline period, values for blood resistivity were stable for each individual and varied from 180 - 230 Ohm · cm across individuals. By the end of the first day of immersion, blood resistivity had increased for all subjects and substantial renal loss of fluid and sodium was noted. During the remainder of the period the level of blood resistivity paralleled changes in fluid loss with the maximum value of the former occurring at the end of day 7 when total cumulative loss was greatest. After immersion, both resistivity and hydration returned to normal. Measurement of blood conductivity or resistivity is recommended as a quick method for estimating the status of fluid electrolyte balance.

Table Title: Table: Concentration of electrolytes in plasma during a 7-day period of immersion

P255

Figure: Difference between consumption and renal excretion of fluid (a, ml) and sodium (b, m-equiv); electrical resistivity of blood (c, Ohm · cm) in various periods of the research.

1-7 = days of immersion;

RP = recovery period;

* -- $p < 0.05$ in comparison with baseline level;

+ -- $p < 0.05$ in comparison with resistivity at the end of immersion.

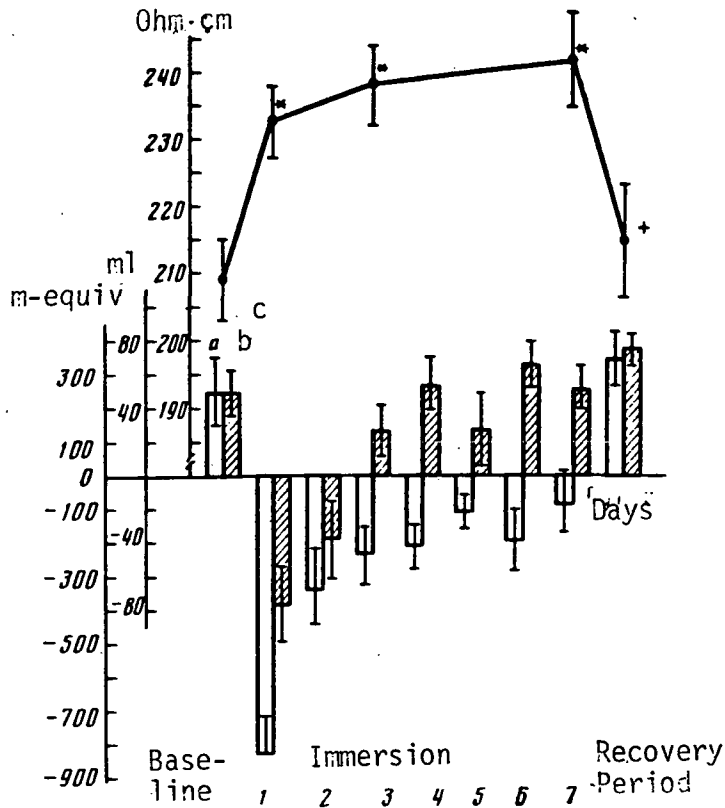

BODY FLUIDS

P265(4/86) Yakushev VS, Mironova YeV, Kuripka VI, Makoyed OB, Ryzhov AA.

Calcium balance during emotional stress due to pain.

Fiziologicheskii Zhurnal.

31(6): 683-688; 1985.

[18 references; 8 in English]

Zaporozhe Medical Institute

Body Fluids, Calcium Balance, Heart, Blood, Liver, Feces

Rats

Psychology, Emotional Stress, Pain

Abstract: Three groups of rats were studied. Group 1 (n=11) was the control group. Group 2 rats (n=29) were studied during the development of emotional stress due to pain (associated with elimination of efficacy of a learned response to escaping electric shock) 2, 4 and 6 hours after beginning of the stress inducing treatment. Group 3 rats (n=40) were studied 1, 2, 5, and 7 days after having been subjected to ethe stress-producing factor for 6 hours. The fact that the stress reaction had occurred was verified by the presence of stomach ulcers, thymus involution and adrenal hyperplasia. For all subjects, concentration of calcium and of ionized calcium was determined in blood serum. Calcium content in the left cardiac ventricle, liver, brain hemisphere, and aorta was also measured, as was calcium content in feces, by subjecting the material to mineralization at temperatures of 600°C, followed by processing with HCL. Calcium balance was further studied by injecting carmine red dye to serve as a fecal marker over a 3-day period. Calcium was found to be normal in control rats. Calcium content of blood serum was already diminished during the stress inducing treatment, to the greatest extent after 6 hours of the treatment. Serum calcium was also depressed after termination of the treatment but had normalized after 7 days. Serum ionized calcium also decreased as a result of the treatment. Changes in calcium concentration occurred in all the organs studied but showed different patterns for different organs. Calcium concentration in the heart decreased under stress, reaching its minimum at the period of maximum stress (6 hours). Calcium concentration in the liver, brain and aorta gradually increased during exposure to the stressor. Fecal excretion of calcium in stressed animals was 255% that of the controls. Effects of stress on calcium content of various organs persisted after stressor termination for a varying number of days in different organs.

P265

Figure and Table Titles: Table 1: Concentration of calcium in blood serum and tissues of albino rats at various periods in relation to induction of emotional stress due to pain

Control	Length of Exposure to Stressor			Time after Stress Induction			
	2 hours	4 hours	6 hours	1 day	2 days	5 days	7 days
	Blood serum (mmole/l)						
2.11	1.63**	1.88*	1.48**	1.72**	1.60**	1.19**	2.19
	Heart, (left ventricle) (mmole/kg tissue)						
1.87	1.35**	1.32**	1.10**	1.40**	1.36**	1.40**	0.84**
	Liver (mmole/kg tissue)						
2.77	3.89**	3.77**	3.95**	4.05**	3.80**	2.53**	2.86**
	Brain hemisphere (mmole/kg tissue)						
1.08	1.33**	1.31*	1.50**	1.56**	1.50**	1.30**	1.08
	Aorta						
1.58	1.77*	1.87**	2.02**	2.18**	1.97**	1.57	1.45

* - $p < 0.05$; ** - $p < 0.001$ in comparison to control animals.

Table 2: Concentration of ionized calcium in blood serum at various periods in relation to induction of emotional-pain stress

Figure 1: Excretion of calcium in healthy rats and rats subjected to the induction of emotional stress induced by pain

BOTANY

(See also: Biospherics: P277)

PAPERS:

P235(4/86)* Kostina LN, Anikeyeva ID, Vaulina EN.
Experiments with developing plants on the "Salyut-5," "Salyut-6" and
"Salyut-7" orbital space stations.

Kosmicheskaya Biologiya i Aviakosmicheskaya Meditsina.

20(1): 49-53; 1986.

[12 references; 3 in English]

Genetics, Chromosome Aberrations, Mutations

Botany, Crepis capillaris, Arabidopsis thaliana, Air-dried seeds, shoots

Space flight, Long-term, Salyut-5, Salyut-6, Salyut-7

Abstract: This paper describes work which investigated the following variables: frequency of chromosome rearrangement in sprouts from seeds exposed to space flight for varying periods of time before germination; and the viability and mutability of plants developing under space flight conditions. In the first experiment, air-dried seeds of Crepis capillaris (L) Wallr. were exposed to space flight for 3-234 days and then moistened, allowed to germinate, and fixed either while still in space or upon return to Earth. Parameters examined were frequency and range of chromosomal aberrations in the root meristem of the sprouts. Various controls were used. Exposure to flight slightly but significantly increased the tendency for chromosomal aberration; however, this tendency was virtually independent of exposure time. Seeds which had been germinated in space showed more aberrations than those germinated on Earth, suggesting that the actively developing system is more sensitive to the effects of space flight. The authors use this differential sensitivity to explain why mutation rate is independent of length of exposure to space. No matter how long the exposure, the sensitive period (from moistening the seeds to fixing the sprouts) was the same length for the experimental group (46-48 hours). No differences were found in the relative frequencies of different types of mutation.

In the second experiment, shoots with two cotyledon leaves of Arabidopsis thaliana were exposed to space flight conditions for 65 days. The plants were illuminated either for 12 or 14 hours per day for the first 16 days and continuously thereafter. After return to Earth, the plants were allowed to grow in the laboratory to the stage of fructification. They were then tested for fertility and frequency of recessive mutations [apparently in the sprouts growing from the next generation of seeds]. No differences were found in phototropic response or organ morphology between the control and experimental plants, although the experimental plants were somewhat retarded in their development. This retardation and the failure to bear fruit in space are attributed by the authors to insufficient light during the vegetative period. Analysis of the fruit of the plants grown in space showed a substantial increase in the frequency of recessive mutation and a slight decrease in fertility in comparison with control plants.

P235

In the third experiment, *Arabidopsis thaliana* seeds were cultivated in a nutritive medium in space for 69 days under continuous illumination and their seeds collected. The plants developing from these seeds were subsequently examined for fertility and recessive mutations. The germination rate of the seeds produced by these plants, and of the next generation, was compared to germination rate of a laboratory control and found to be reduced. The only morphological changes noted involved the size of the hypocotyl and cotyledon. The fertility of the next generation of plants did not differ from that of the control; however, the frequency of mutations was somewhat higher, indicating that chromosomal aberrations were eliminated, but not microaberrations and gene mutations. The authors conclude that space flight factors have a mutational effect on plant cells, leading to structural aberrations in chromosome and genetic mutation. Developing systems are more sensitive to this than air-dried seeds. Structural mutations surfacing in experimental plants themselves -- or in the initial stages of development of their immediate descendants are eliminated in the subsequent generation. Point mutations are retained after flight, although partial recovery occurs.

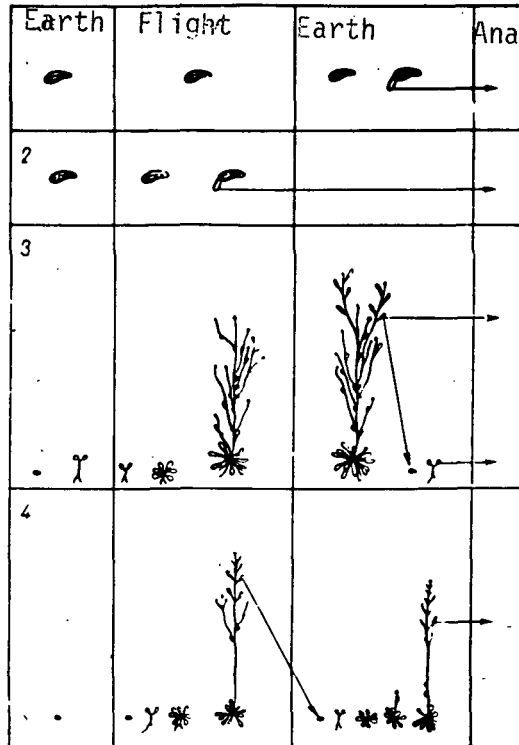

Figure 1: Diagram of experimental designs. 1- *C. capillaris* flight control; 2 - *C. capillaris* experimental group; 3 - *A. thaliana*, Experiment 2; 4 - *A. thaliana*, Experiment 3.

P235

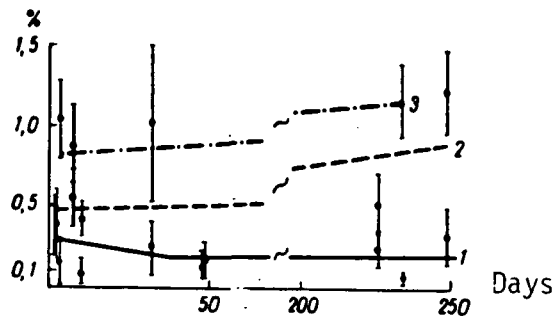

Figure 2. Frequency of aberrant cells in the root meristem of *C. capillaris*. Abscissa: flight duration in days. 1 - laboratory control; 2 - flight control; 3 - experimental group.

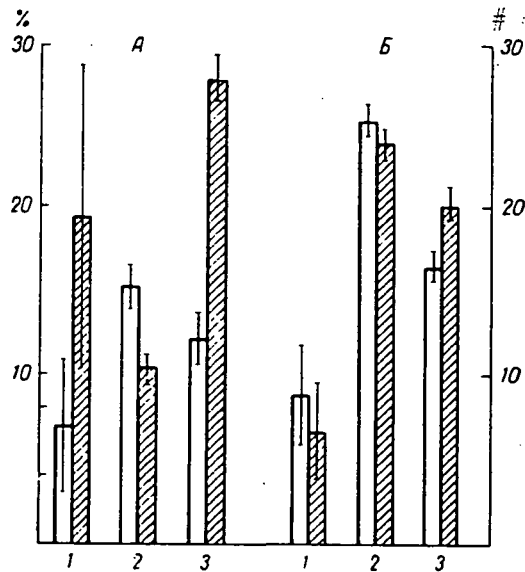

Figure 3. Fertility and frequency of mutants in *A. thaliana* plants grown in space (A) and their descendants (B). 1 - sterile fruit (in %); 2 - number of seeds per fruit; 3 - mutants (in %). White bars - control; Crosshatched bars- flight experiment.

P247(4/86)* Levinskikh MA.

Changes in photosynthesis rate of Closteriopsis acicularis var. africana Hind. as a function of concentration of oxygen in the atmosphere.

Kosmicheskaya Biologiya i Aviakosmicheskaya Meditsina.

20(1): 83-84; 1986.

[13 references; 11 in English]

Botany, Photosynthesis, Rate; Life Support Systems, CELSS

Seaweed, Closteriopsis acicularis

Oxygen Concentration

Abstract: This study tested the Warburg effect (decrease in rate of photosynthesis in seaweed with increase in concentration of oxygen in the atmosphere) as applied to Closteriopsis acicularis var. africana Hind. The seaweed was cultured either continuously or cumulatively. All cultivation conditions, with the exception of oxygen concentration, were optimal. Oxygen concentration was gradually increased from 4.5 to 50 percent, either as a result of the plants' own photosynthesis in a closed system or through introduction from an external source. Rate of growth was measured by absorption of atmospheric carbon dioxide by the seaweed cells and by the growth of dry matter. Maximum growth was achieved with the minimum oxygen concentration, and decreased regularly until oxygen constituted 19-19.5 percent of the atmosphere, at which point growth rate and photosynthesis stabilized and were not affected by further increases in oxygen concentration. No differences were found that could be attributed to any of the growth conditions tested.

Table Title: Rate of photosynthesis of Closteriopsis acicularis determined by absorption of carbon dioxide and growth of the biomass as a function of atmospheric oxygen concentration

CARDIOVASCULAR AND RESPIRATORY SYSTEMS

(See also: Adaptation: P264; Space Medicine: P251)

PAPERS:

P224(4/86)* Dořoshev VG, Kirillova ZA, Vanarshenko AP.

The nature of circulatory regulation in pilots.

Kosmicheskaya Biologiya i Aviakosmicheskaya Meditsina.

20(1): 12-15; 1986.

[8 references; none in English]

Cardiovascular and Respiratory Systems, Regulation of Circulation
Humans, Pilots
Human Performance, Job Demands

Abstract: This study investigated regulation of circulation in healthy pilots during job performance. Seventeen pilots (aged 27-33) were observed over a period of 3 months. On days that they were flying, measurements were made at rest 1 hour before beginning of their flights, while on days devoted to ground training, resting measurements were made 2 hours after the beginning of the working day. Measurements included heart rate, blood pressure, minimum blood pressure, mean blood pressure, final blood pressure, left ventricle ejection time, and time difference of pulse between carotid and femoral arteries. Values were computed for stroke and cardiac indices, as well as for specific actual and working peripheral resistance. Circulation parameter values were examined as a function of difficulty of flight tasks, which apparently increased in the second month and dropped again in the third (although this is not explicitly stated), and analyzed using Student's t.

For the first month, when flight demands remained relatively light, heart rate and blood pressure parameters were significantly higher on flight days than on ground training days. When demands were increased in the second month, these parameters were higher, but there were no significant differences between flight days and ground training days. In both these periods, increases in blood pressure values were accompanied by increases in peripheral resistance (ratio of actual resistance to working resistance). Ejection time, and cardiac and stroke indices remained relatively constant with different job demands. The authors conclude that circulatory homeostasis is being maintained through some degree of chronotropism and substantial increase in vascular tonus. In the third month, when flight demands dropped, lateral systolic blood pressure and heart ejection parameters decreased; peripheral resistance, however, remained at the previous elevated level. The authors attribute these results to gradual decrease in sympathetic effects on the heart and refer to the possibility of decrease in myocardial sensitivity to the influence of the sympathetic system. The authors describe the results of this study as indicative of successful adaptation to increased work loads.

Tables Titles: Table 1: Hemodynamic parameters in pilots over three months of observation.

Table 2: Changes in the hemodynamic parameters during in a working week

CARDIOVASCULAR AND RESPIRATORY SYSTEMS

P229(4/86)* Asyamolov BF, Panchenko VS, Karpusheva VA, Bondarenko RA, Vorob'yev OA, Zaritsky VV, Stupnitskiy VP, Popov IG, Lozinskiy PA, Ledovski SM.

Certain human reactions to a seven-day period of hypokinesia with head-down tilt.

Kosmicheskaya Biologiya i Aviakosmicheskaya Meditsina.

20(1): 29-32; 1986.

[19 references; 6 in English]

Cardiovascular and Respiratory Systems, Hemodynamics; Neurophysiology, Vestibular Tolerance, Acceleration Tolerance; Psychology, Cognitive Functioning, Emotional State
Humans, Males
Hypokinesia, Head-down Tilt

Abstract: Twenty male volunteers, aged 19-22, spent seven days under hypokinesia with head-down tilt (-10°). Hemodynamic function was assessed on days 2 and 3 in the morning and evening, and on days 1, 5 and 7 in the late afternoon. Blood pressure was recorded daily in the early morning and late evening; cardiac stroke volume was measured through plethysmography; EKG was recorded; and the condition of the vessels in the retina was assessed. Vestibular and autonomic tolerance was studied in the head-down position before and on days 2 and 5 of hypokinesia using a Coriolus acceleration test, with time before onset of symptoms of motion sickness as the parameter. Psychological parameters were assessed using an arithmetic task, Rorschach, Thematic Apperception Tests, another projective test, a personality trait survey, and other instruments. Nutritional status was assessed by measuring nitrogen metabolism and renal excretion of K^{+} and Na^{+} . Blood content measurements were taken for total proteins, albumin, chlorides, glucose K^{+} and Na^{+} , total lipids, beta-lipoproteins, chloesterol, triglycerides, alkaline phosphatases and other parameters. At initial exposure to head-down tilt subjects experienced the usual subjective symptoms and puffiness of the head and neck. These symptoms diminished as the experiment progressed. The experimental treatment led to changes in hemodynamic parameters, beginning 6 hours after the start of hypokinesia: pulse rate dropped; left ventricule ejection time dropped, stroke volume increased, while minute volume decreased only slightly; index of blood in the head increased, as did the tonus of small and intermediate caliber arteries of the brain. After day 3, some parameters (pulse, arterial tonus, stroke volume) began to return to normal. No changes were found in the tonus of retinal veins. Excretion of nitrogen increased throughout the hypokinesia period and excretion of potassium increased on the 7th day. No biochemical changes were detected in the blood. Although reproductive thinking decreased only insignificantly, performance on tests considered indicative of productive and heuristic thinking decreased substantially, as did indicators of mood and psychological well-being. Vestibular tolerance did not differ from baseline level on day 2, but it improved significantly by day 5. Diuresis increased substantially in the initial period of hypokinesia but dropped after day 3.

Table and Figure Titles: Table 1: Changes in blood pressure during a 7-day period of hypokinesia with head-down tilt

CARDIOVASCULAR AND RESPIRATORY SYSTEMS

P229

Table 2: Change in the caliber of veins and arteries and their ratio during hypokinesia with head-down tilt

Figure 1: Changes in mean values of cardiac stroke volume and minute circulatory volume during a 7-day period of hypokinesia with head-down tilt

Figure 2: Changes in the mean values of pulse rate and left ventricle ejection time during a 7-day period of hypokinesia

CARDIOVASCULAR AND RESPIRATORY SYSTEMS

P231(4/86)* Rumyantsev VV, Katkov VYe.

Human central hemodynamics during leg decompression.

Kosmicheskaya Biologiya i Aviakosmicheskaya Meditsina.

20(1): 35-37; 1986.

[5 references; 23 in English]

Cardiovascular and Respiratory Systems, Central Hemodynamics

Humans, Males

LBNP, Leg Decompression

Abstract: Subjects in this experiment were healthy males (average age 34, N not specified). The effects of leg decompression (called local negative pressure) on central hemodynamics were compared to the effects of lower body negative pressure (procedures not described). Central venous pressure and pressure in the pulmonary and brachial arteries were recorded by implanting catheters in these arteries. In addition cardiac minute volume, and parameters of blood acidity and oxygenation were recorded. Measurements were compared with baseline levels while subjects were in a head-down (-15°) position. Increasing negative pressure led to greater decreases in both local central venous pressure and pressure in the pulmonary artery when the treatment was lower body negative pressure than when it was local negative pressure. Within each treatment, effects (curves) for central venous pressure were parallel to effects for pulmonary artery pressure. However, values for arterial pressure were higher. A nomogram was developed which allows prediction of changes in central venous pressure and pressure in pulmonary artery for various types of decompression. Magnitude of effects of decompression on venous and arterial pressure are concluded to depend on the size of the body area undergoing decompression. The effects of local negative pressure on the lower extremities are concluded to be intermediate in magnitude between the effects of local decompression of both shins (and also head-down tilt position) and total lower body negative pressure.

Table and Figure Captions: Table: Changes in major circulatory parameters as a result of exposure to different types of negative pressure

Figure 1: Changes in pressure in pulmonary artery and central venous pressure during various types of decompression

Figure 2: Nomogram for determining changes in pressure in pulmonary artery and central venous pressure in response to various types of decompression

P240(4/86)* Vereshchagin VK, Gayevyy MD.

The effect of dibazol and its imidazoline analogs on tolerance of animals for hypergravity and on the development of post-ischemic cerebrovascular phenomena.

Kosmicheskaya Biologiya i Aviakosmicheskaya Meditsina.

20(1):67-70; 1986.

[20 references; 2 in English]

Cardiovascular and Respiratory Systems, Tolerance, Acceleration, Ischemia
Rats, Cats

Hypergravity, Centrifugation; Countermeasures, Dibazol, Imidazoline

Abstract: This paper describes the results of experiments on the effects of the drug dibazol and its newly developed imidazoline based analogs on tolerance to hypergravity and post-ischemic symptoms. Studies of tolerance for hypergravity were performed on 108 albino rats of both sexes using a centrifuge. The magnitude of induced hypergravity was selected to be the level at which 50% of the control group died. Accordingly, craniocaudal acceleration to 18 g in 10 minutes and caudocranial acceleration to 5-7 g over 5 minutes were used. In this and subsequent experiments, doses of the drugs were introduced intraperitoneally 30 to 60 minutes before the experimental treatment in doses of 2-3 mg/kg. In the hypergravity experiments, control rats died at a rate of 50% and 55.6% for the craniocaudal and caudocranial acceleration respectively. Administration of dibazol and AKS-87, one of the two imidazoline based drugs, substantially decreased mortality rate when acceleration was in the craniocaudal direction but increased it by 25 percent under caudocranial acceleration. Administration of the other imidazoline preparation, AKS-67, decreased mortality rate under both types of acceleration. [No statistical tests are cited.]

Hypothesizing that the main reason for mortality in response to craniocaudal acceleration is ischemia of the brain, the authors evaluated the operation of the tested drugs on the effects of experimentally induced ischemia. Ischemia was created through ligation of both carotid arteries in 63 white rats. In a control group of rats that had not been administered drugs, 40% of the ischemic subjects died in 12 hours, while 74 % died after 48 hours. Dibazol had no effect on this death rate. However, both AKS-87 and AKS-67 decreased mortality rate (to 18 and 17% after 48 hours respectively). In order to investigate the effects of these drugs on postischemic blood pressure and cerebral and peripheral vascular tonus, ischemia was experimentally created in 33 cats (using an unspecified procedure). Subgroups had received one of the three drugs in doses of 2-3 mg/kg, 90 minutes before induction of ischemia. Blood pressure and perfused pressure in the vessels and hind limbs were measured at various times after ischemia was created. In control cats, the first 20-30 minutes after treatment was characterized by a decrease in perfused pressure in cerebral vessels, followed by an increase in this pressure continuing for at least 120 minutes. Effects in the vessels of the hind limbs were similar but less pronounced and blood pressure fluctuated and tended to be hypotensive. Dibazol and its imidazoline analogs facilitated the development of reactive hyperemia and inhibited the development of postischemic hypoperfusia of the brain. Effects on blood pressure indicated that dibazol accelerated the appearance of postischemic hypotension, AKS-67

P240

inhibited it and AKS-87 virtually prevented its appearance. It is concluded that there are major qualitative differences among the effects of these three drugs and that AKS-67 may be of particular benefit to space medicine because it significantly increases acceleration tolerance and stabilizes post-ischemic blood pressure.

Table and Figure Titles: Table 1: Changes over time in perfused pressure in vessels of the brain and hind limbs and in blood pressure in the postischemic period in control animals and those to whom dibazol has been administered

Table 2: Changes over time in perfused pressure in vessels of the brain and hind limbs and in blood pressure in the postischemic period in animals administered AKS-67 and AKS-87

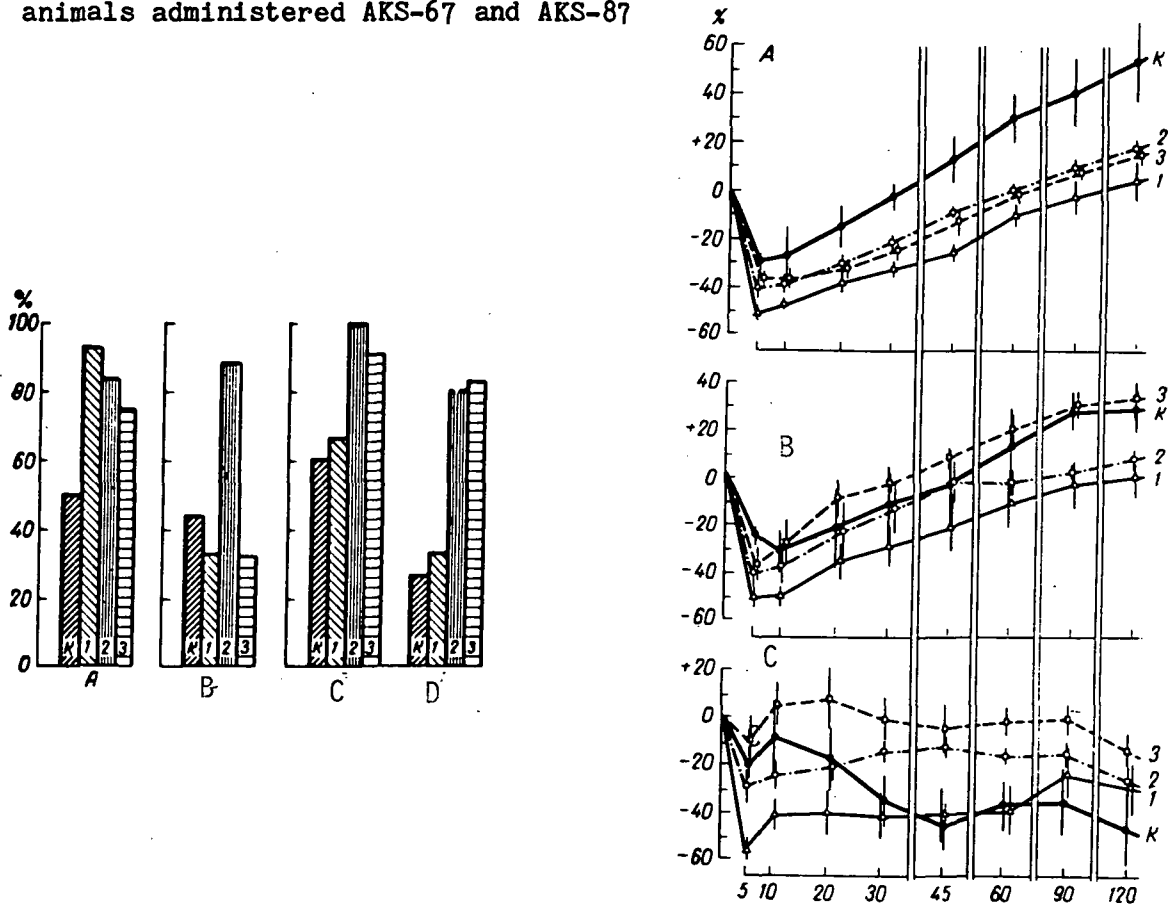

Figure 1: The effect of dibazol (1), AKS-67 (2) and AKS-87 (3) on survival rate of rats under conditions of hypergravity and ligation of both carotid arteries. K - control; A and B - respectively, craniocaudal and caudocranial acceleration. C and D - 12 and 48 hours after ligation, respectively.

Figure 2: Changes over time in perfused pressure in vessels of the brain (A) and hind limbs (B) and blood pressure (C) in the postischemic period of anaesthetized cats. Abscissa: time (in minutes). K - control; 1, 2, and 3 - after administration of dibazol, AKS-67 and AKS-87, respectively.

P250(4/86) Ulyatovskiy NV, Beregovoy GT, Beregovkin AV, Voronin LI, Yerebin AV, Yelizarov SYu.

On using acceleration to model the physiological effects of weightlessness.

In Kedrov BM and Kosmodem'yanskii AA, editors,
Nauchnoye tvorchestvo K.E. Tsiolkovskogo i sovremennoye razvitiye ego idey.

[The scientific work of K.E. Tsiolkovskiy and modern development of his ideas].

Moscow: Nauka; 1984: 64-66.

Cardiovascular and Respiratory Systems, Hemodynamic Effects
Humans; Personnel Selection, Cosmonauts
Weightlessness Simulations, G_x Acceleration

Abstract: This paper presents arguments in favor of using acceleration for modeling the hemodynamic effects of weightlessness, stating that this is an acceptable simulation of gravitational effects during all stages of space flight, including transitional states and the early readaptation period. In particular, it is argued that the use of $+G_x$ acceleration with the angle between the long axis of the trunk and the vector of acceleration equal to approximately 90° , reproduces the increase in intrathoracic blood volume and pressure in the right side of the heart, thus leading to accurate simulation of the compensatory shifts in neurohumoral regulation of hemodynamics which result from weightlessness.

Six apparently healthy individuals were exposed to 60 minutes of $+2.5G_x$ acceleration (angle= 90°), with thighs positioned at an angle of 90° to the trunk and shins at an angle of $95-115^\circ$ to the hips. Sensations and appearance in response to this treatment (e.g., sensation of rush of blood to head, coldness of feet and lower legs, facial edema) were analogous to those noted in the initial weightlessness period. Additionally, systolic pressure in the outer ear increased, there was a tendency to bradycardia, and increases in pulmonary hyperemia, and minimal and end systolic pressure in the brachial arteries, and in renal excretion and a decrease in lateral systolic pressure in the vessels of the leg. When subjects stood after centrifugation ceased they experienced heart pounding, dizziness, general weakness, paleness, and some orthostatic intolerance. These symptoms disappeared by 60-70 minutes after the centrifuge stopped. The authors argue that these symptoms, analogous to those of weightlessness, cannot simply be attributed to the debilitating effects of rotation, since symptoms were different (e.g., little orthostatic intolerance) when the angle of the body was changed to 80° decreasing flow of blood to the upper body. The authors conclude that, because of the relatively rapid occurrence and recovery from orthostatic symptoms analogous to those of weightlessness, $+G_x$ acceleration is appropriate for use in selecting and training cosmonauts.

P268(4/86) Toloknov AV, Bol'shakova TD, Vinnitskaya KB, Panteleymonov VA, Khitrov NK.

Characteristics of sympathetic and parasympathetic mechanisms of cardiac regulation in rats undergoing conditioning and deconditioning with respect to physical exercise.

Fiziologicheskiy Zhurnal SSSR imeni I.M. Sechenova.

LXXI(12): 1630-1634; 1985.

[13 references; 7 in English]

First Moscow Medical Research Institute, Moscow

Cardiovascular and Respiratory Systems, Cardiac Regulation;
Neurophysiology, Sympathetic and Parasympathetic Systems,
Mediators, Norepinephrine, Acetylcholine

Rats

Physical Exercise, Conditioning, Deconditioning

Abstract: Using the rat as a model, this work compares the nature and sequence of changes occurring in the mechanism underlying parasympathetic and sympathetic regulation of the heart during the development of physical conditioning through an exercise regimen and subsequent deconditioning. White male rats were compelled to swim with a weight equal to 7.5 percent of their body weights every day for 3 months for regularly increasing lengths of time. The criterion of physical work capacity, measured after every month of training, was the length of time animals could swim before they were unable to remain afloat. Measurements were made after 1, 2 and 3 months of training and 10 days after the conditioning procedure had been terminated (deconditioning). Parameters measured included: systolic pressure in the left ventricle before and after occlusion of the aorta, concentration of norepinephrine in the tissue of the left ventricle, and total level of acetylcholine in the tissue of the auricle. Maximum changes in systolic pressure and heart rate in response to injections of norepinephrine (5 mkg/kg) or acetylcholine (20 mkg/kg) were compared with baseline levels. The conditioning procedure led to a progressive increase in maximum work capacity, which almost doubled after 3 months. Moderate bradycardia at rest was noted after 2 months of conditioning; however, systolic blood pressure in the left ventricle before and after occlusion did not differ from control levels. After 3 months, bradycardia increased further, but the other parameters mentioned remained unchanged. However, the capacity of the myocardium to support maximum blood pressure while the aorta was being occluded increased.

After 2 months of conditioning there was insignificant increase in concentration of acetylcholine in tissue of the auricle; a larger and significant increase (by 57 percent, $p < 0.05$) occurred after 3 months. The degree to which heart rate decreased in response to acetylcholine exceeded baseline level somewhat after 2 months and exceeded it by a factor of three after 3 months. Throughout the experiment the concentration of norepinephrine in the left ventricle remained constant; however, after 3 months there was an increase in the positive isotropic effects of norepinephrine, as indicated by its effects on systolic pressure in the left ventricle. Immediately after exercise, the level of acetylcholine in the auricle decreased by 35% in control animals, but only by 20% after 2 and 3 months of conditioning. After 3 months, norepinephrine in the left ventricle decreased less than in control

CARDIOVASCULAR AND RESPIRATORY SYSTEMS

P268

animals directly after exercise. Ten days after the 2-month period of conditioning had terminated, heart rate and increased reactivity to acetylcholine had returned to baseline level. However, 10 days after the 3-month conditioning period a number of indicators of conditioning remained above baseline. These included: maximum work capacity, relative weight of the ventricles and capability of the myocardium to sustain maximum pressure in the left ventricle during occlusion of the auricle; baseline level of acetylcholine in the auricle and its stability after vigorous exercise. However, the effectiveness of acetylcholine on heart rhythm diminished sharply. Norepinephrine concentration was at normal level, but directly after physical exertion this level was as high as it had been immediately after training. The authors argue that these results show that adaptation (conditioning) to physical exertion facilitates the maintenance of the levels of the two mediators studied in the heart and increases the myocardium's reactivity to them. This is the mechanism through which conditioning of cardiac regulation by the sympathetic and parasympathetic nervous systems under exposure to extreme factors is facilitated. Comparison of sympathetic and parasympathetic regulation of the heart indicates that the changes observed in these systems during adaptation differ in temporal parameters. Parasympathetic changes (both due to conditioning and to deconditioning) occur earlier than sympathetic changes.

Tables and Figures: Table: Systolic pressure in left ventricle and changes in response to occlusion of the aorta at various times during and after a conditioning program (swimming)

P268

Figure 1: Concentration of acetylcholine in tissues of the auricle (upper portion) and changes in heart rate in response to exogenous acetylcholine (lower portion) in control rats and rats conditioned by swimming for 2 months (I), 3 months (II), and after completion of 3 months of conditioning (III)

White bars -- concentration of acetylcholine before physical exertion; hatched bars -- concentration of acetylcholine after physical exertion. Here and in Figure 2, vertical lines on the bars indicate mean error level; asterisks above a bar indicates parameter values significantly different ($p < 0.05$) from the control. a - control rats; b - conditioned rats.

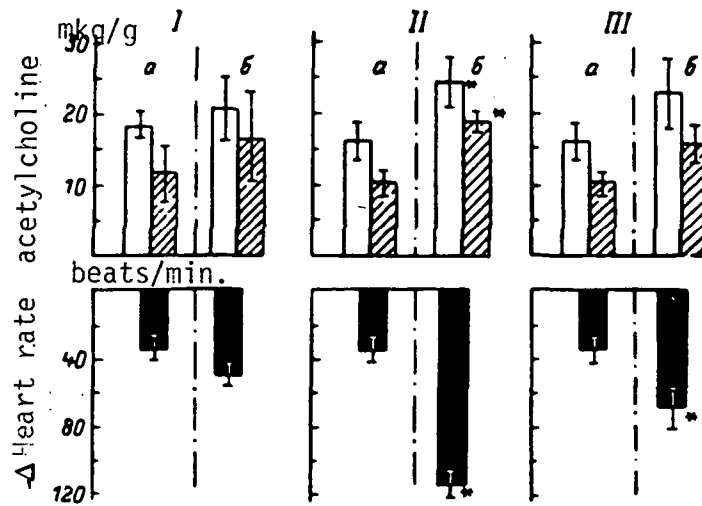
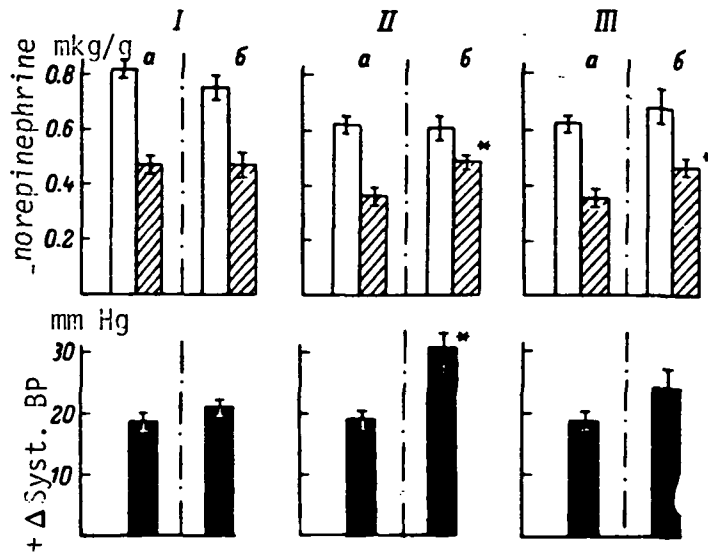

Figure 2. Concentration of norepinephrine in the tissue of the left ventricle of the heart (upper portion) and changes in systolic pressure in the left ventricle in response to exogenous norepinephrine (lower portion) in control rats and rats conditioned by swimming for 2 months (I), 3 months (II) and 10 days after completion of 3 months of conditioning (III).

Remaining symbols as in Figure 1.



CARDIOVASCULAR AND RESPIRATORY SYSTEMS

P269(4/86) Meyerson FZ, Katkova LS.

The effect of preliminary adaptation to short-term stress on resistance of spontaneous myocardial contractility to induced lipid peroxidation.

Byulleten' Eksperimental'noy Biologii i Meditsiny.

1985(12): 659-661.

[11 references; 3 in English]

Cardiovascular and Respiratory Systems, Myocardia, Auricle; Metabolism,
Lipid Peroxidation

Rats

Countermeasures, Pre-adaptation, Stress, Short-term

Abstract: Since preliminary adaptation to short-term stress increases myocardial resistance to the deleterious effects of long-term stress and since one of the mechanisms by which these effects disrupt contractility involves lipid peroxidation particularly of the cardiac muscle, it was hypothesized that the cardiac muscle of animals pre-adapted to short-term stress would show increased resistance to factors inducing lipid peroxidation. To test this hypothesis, experiments were performed on 36 male Wistar rats. The experimental group contained 18 rats which were adapted to short (15 minutes to 1 hour) periods of stress (immobilization on the back) for 13 days. Control animals were not pre-adapted. To evaluate peroxidation resistance of the myocardium of the auricle, the auricle of an isolated working heart was placed in a thermostatic bath with an oxygenated solution (95% O₂, 5% CO₂). The base of the auricle was fixed and the auricula atria was attached to a myograph. The isolated right auricle contracted spontaneously for 40-50 minutes and then it was gradually elongated so that maximum tension of isometric contraction developed. The following parameters were measured for the auricles of control and preadapted animals: frequency of spontaneous contractions (F), tension developed (T_d), tension at rest (T₀) and a composite indicator of contractile function (CF) equal to $F \cdot T_d / 1000$. Next H₂O₂ was introduced into the container holding the auricle until a concentration of 0.1 mM was attained. The number of rhythmically contracting, arrhythmically contracting and stopped auricles was counted for each group at intervals of one minute.

Auricles of control animals went through three phases in response to H₂O₂: Phase I was characterized by increased frequency and strength of contraction, but a decrease in isometric tension at rest. Phase II involved marked bradycardia and Phase III increased bradycardia and eventual stoppage of contractions. The same phases were observed in auricles of pre-adapted animals, but bradycardia in Phases II and III was attenuated and heart stoppage occurred in only a few cases. At minute 4, two control and zero pre-adapted auricles had stopped, while at minute 14, 12 control auricles and two pre-adapted auricles had stopped. Thus adaptation to short-term immobilization stress substantially increased the resistance of the auricle myocardium to the effects of lipid peroxidation induction. The authors conclude that the protective effects of pre-adaptation on resistance to long-term stress can not be attributed solely to adaptation of central regulatory mechanisms. The authors advance two possible mechanisms for the effects found. First, recurrent activation of lipid peroxidation and phospholipase may lead to changes in the phospholipid and fatty acid composition of the two-layer lipid membrane

P269

and thus limit lipid peroxidation. Second, recurrent activation of lipid peroxidation may induce the synthesis of antioxidative enzymes.

Table and Figure Titles: Table 1: Effects of preliminary adaptation to short-term stress on resistance of spontaneous contractions of the isolated right auricle to H_2O_2

Table 2: Effects of preliminary adaptation to short-term stress on resistance of the contractile function of an isolated right auricle to H_2O_2

Figure: Myographic recording of the functioning of an isolated right auricle in control (A) and pre-adapted (B) rats before and after the introduction of H_2O_2 into the incubation medium

Abscissa: time after introduction of H_2O_2 (in minutes); ordinate: developed tension (in mg); arrows: point of introduction of H_2O_2

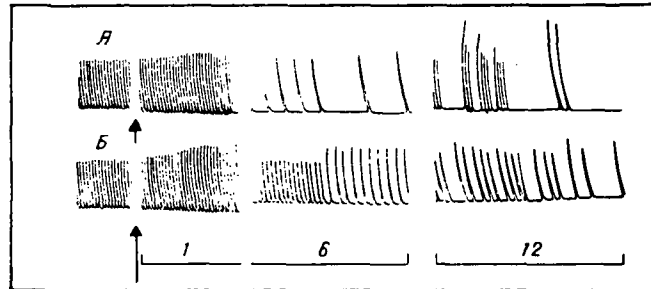

ENDOCRINOLOGY

(See also: Metabolism: P228; Musculoskeletal System P274; Neurophysiology: P253; Radiobiology: P270; Reproductive Biology: P266)

PAPERS:

P233(4/86)* Vorotnikova YeV, Zagorskaya YeA.

Morphological and biochemical investigation of the state of adrenal cortex of rats undergoing long-term hypokinesia.

Kosmicheskaya Biologiya i Aviakosmicheskaya Meditsina.

20(1): 41-45; 1986.

[26 references; 14 in English]

Endocrinology, Corticosterone; Morphology, Adrenal Cortex

Rats, Female

Hypokinesia, Long-term, Adaptation, Immobilization Stress

Abstract: This study used 250 female rats, divided into six groups. Group 1 (n=70) was the vivarous control; Group 2 (n=60) was a control group of rats exposed to acute immobilization stress (through being placed in restraints) for five hours; Group 3 (n=50) consisted of rats subjected to hypokinesia (through the use of immobilization cages) for 3 months; Group 4 (n=50) rats were exposed both to hypokinesia and immobilization stress; Group 5 (n=10) were animals studied after 1 month of readaption following hypokinesia; and Group 6 (n=10) contained animals exposed to acute immobilization stress during readaptation following hypokinesia. [Note: no specification is given as to how many and when acute stress sessions occurred.] Eight to ten members of each group were sacrificed and studied after 1 and 2 weeks, or 1, 2 and 3 months of hypokinesia or after 1 month of readaptation. Body weight and adrenal weight were measured. One adrenal gland was fixated, sliced and stained to reveal the relative numbers of functionally active and inactive cells. Another was frozen, sliced and stained for lipid identification. The concentration of corticosterone in blood plasma was determined through radioimmune assay.

Weight gains of animals exposed to hypokinesia lagged behind those for control animals, but the gap closed rapidly in the readaptation period. The absolute value of the weight of the adrenal glands did not differ significantly for the control and experimental animals, while the weight of the adrenal glands relative to body weight was 20%-40% higher for the experimental animals, indicating adrenal hypertrophy. Five hours of acute immobilization stress did not affect adrenal weight. Starting on day 7 of hypokinesia, histological analysis disclosed hypertrophy of the adrenal nodular zone and an increase in the number of functionally active cells the gland contained. At the same time, the activity of the reticulate zone was curtailed and the lower third of the nodular zone was depleted of lipids. Depletion of lipids was reversed after 30 days, and was at normal level on days 60 and 90. Acute immobilization stress led to no structural changes in the cortical material of the adrenal glands. On days 7, 14 and 30 of hypokinesia, such stress did lead to delipidization but to a lesser extent than for control animals. After 60 and 90 days of hypokinesia, acute immobilization no longer led to delipidization. After 30 days of readaptation, experimental animals responded to immobilization with delipidization in a manner indistinguishable from the controls. Corticosterone level in control

P233

rats was normal for female animals, 2.5 to 3 times that of males. On day 7 of hypokinesia the level of corticosterone was elevated in experimental animals to 47% above control. This level began to drop and was equal to control level on day 14 and below it on days 60 and 90. After 30 days of adaptation corticosterone concentration had returned to baseline. During most of the experimental period response of this parameter to acute stress was identical for hypokinetic and control animals. However, on day 90 of hypokinesia, corticosterone level of experimental animals in response to stress was 42% higher than that of controls. A similar effect, but of lower magnitude, occurred after 30 days of readaptation. The authors emphasize that after 90 days of hypokinesia the cortex of the adrenal gland retains its ability to react to acute stress by increasing secretion of corticosteroids, demonstrating that depletion of adrenal function has not occurred. Evidently, the reserve capacity of the steroid producing tissue of the cortex increases during the 90 days of hypokinesis, allowing the cells of the nodular zone to produce increased quantities of corticosterone without structural changes or delipidization. According to the authors this indicates that changes have occurred in regulating mechanisms.

Figure Titles: Figure 1: Changes in body weight, and absolute and relative weight of the adrenal gland of rats during and after long-term hypokinesia

Figure 2: Lipids and cortical material from the adrenal glands of rats at various stages of adaptation to hypokinesia

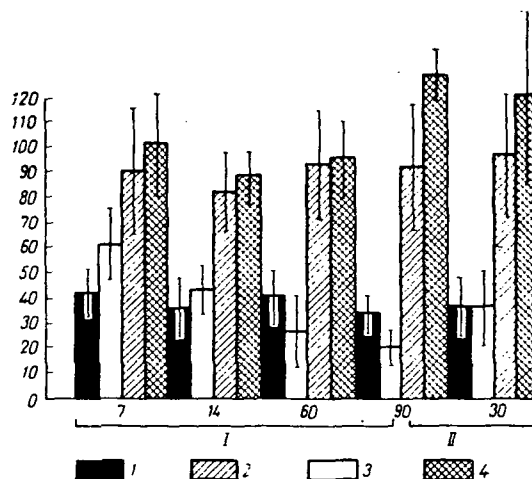

Figure 3. Concentration of corticosterone (in ug%) in blood plasma of rats. Bars 1-4 refer to groups 1-4 respectively.

P272(4/86) Kaplanskiy AS, Vorotnikova YeV.

Functional state of the adrenal glands in rats undergoing hypokinesia

Byulleten' Eksperimental'noy Biologii i Meditsiny.

1985 (12): 670-673.

[13 references; 4 in English]

Institute of Biomedical Problems, USSR Ministry of Health, Moscow

Editors' Note: Note the similarity between this study and P233, preceding, as well as the overlap in authors.

Endocrinology, Adrenal Glands, Corticosterone; Thymus; Morphology

Rats, Male

Hypokinesia, Longterm, Adaptation, Stress, Immobilization

Abstract: Subjects for this experiment were 250 white male rats divided into 4 groups. Group 1 was a vivarous control; Group 2 rats were subjected to acute stress induced by 5 hours of immobilization; Group 3 rats were subjected to hypokinesia in immobilization cages for varying periods of time; Group 4 rats were subjected to both hypokinesia and acute immobilization stress occurring at various points in the hypokinesia period. [Note: the authors do not specify how many times rats were subjected to acute stress, nor when this stress occurred in relation to their sacrifice.] Groups of 8-10 animals were sacrificed after 7, 14, 30, 60 and 90 days of hypokinesia, as well as 1 month after its termination. Blood plasma and adrenal and thymus glands were studied. Concentration of corticosterone in plasma was determined. The adrenals were weighed and sections stained which made it possible to distinguish functionally active and inactive cells in cortical matter. The thymus was weighed and sections fixed and stained.

For rats undergoing hypokinesia, level of corticosterone in the blood had increased by day 7 of the treatment, normalized by day 14 and dropped below control level on days 60 and 90, and returned to normal 30 days after treatment termination. Histologic examination of the adrenals of the hypokinetic rats indicated that during early stages of the treatment structural transformation of the cortex leads to hypertrophy of the steroidogenic tissue and to an increase in functionally active cells. Hypertrophy of the zona fasciculata continued throughout the hypokinesia period, even when corticosterone concentration in the blood was at or below normal levels. Delipidization of the cortex, which was observed in the early stages of hypokinesia, was followed by lipid accumulation after 1 month and eventual normalization after 2 and 3 months. One month after treatment termination, all indicators had normalized. The thymus decreased in weight and underwent involution throughout the hypokinetic period; however, degenerative process slowed after 30 days of the treatment and the thymus had returned to normal 30 days after treatment termination. Exposure of animals which had undergone long periods of hyperkinesia to additional acute immobilization stress was used to study the functions and reserve capabilities of the adrenals during hypokinesia. Acute stress led to greater increases in plasma corticosterone in hypokinetic (of 30 and 60-days duration) rats than in control rats. In the first month of hypokinesia, acute stress led to delipidization in hypokinetic rats, although to a lesser degree than in normal rats, but on days 60 and 90 of the treatment no such delipidization occurred in hypokinetic rats. The authors interpret the increased production of

P272

corticosterone in rats adapted to hypokinesia in response to acute stress, in the absence of morphological signs of increased activity of the cortex as evidence that there was a substantial increase in the reserve capabilities of the steroidogenic tissue and of its capacity to handle increased demands with ease. This hypothesis is consistent with effects noted in the thymus, viz., destruction of lymphocytes in response to acute stress was twice as great in hypokinetic than in control rats.

Figure 1: Concentration of corticosterone in blood plasma of rats. Abscissa: duration of experiment (in days). Abscissa: concentration of corticosterone (in ug %). Black bars: control; white bars: hypokinesia; single hatched bars: control + stress; cross-hatched bars: hypokinesia + stress.

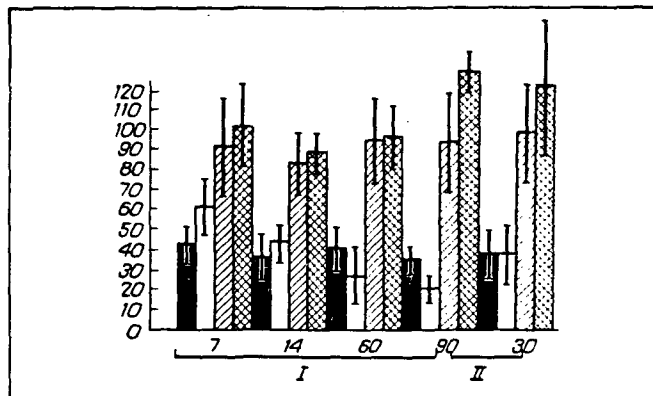

P272

ORIGINAL PAGE IS
OF POOR QUALITY

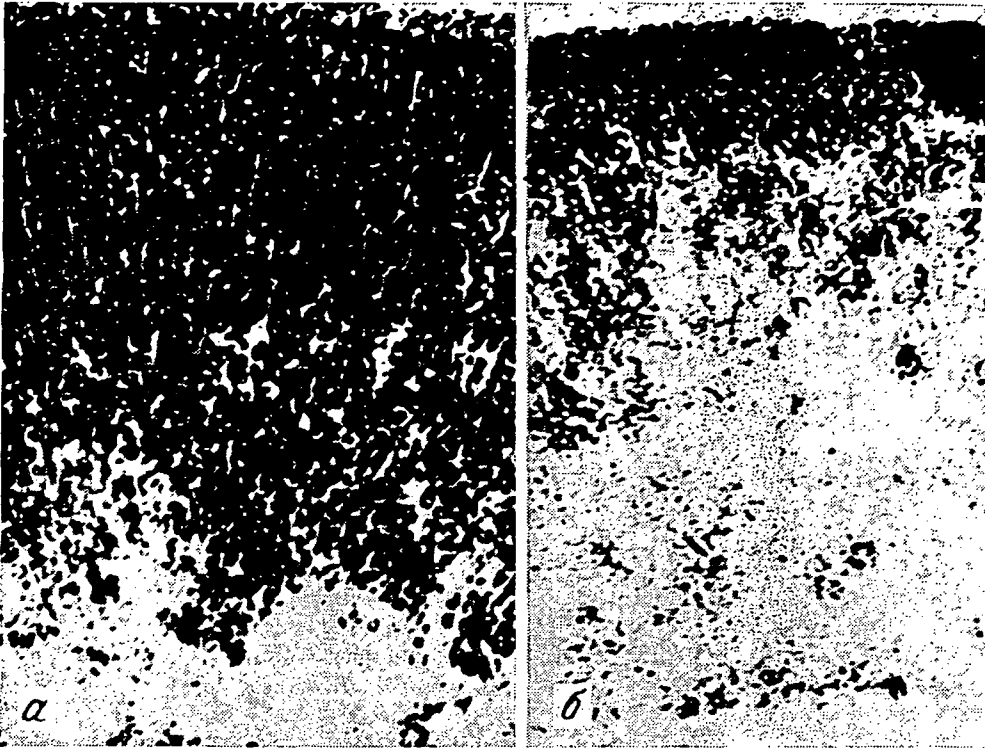

Figure 2: Reaction of the cortical substance of the adrenals of rats to 5 hours of stress.

a - absence of marked delipidization in the cortical substance of a rat after 90 days of hypokinesia. b - delipidization of the cortical substance of a control rat.

Figure 3 (not reproduced). Reactions of the thymus of control rats and rats adapted to hypokinesia, to 5 hours of acute stress.

P256(4/86) Neyzhmakova NA, Shafran LM.

Individual and typological characteristics of the functioning of the sympathetic adrenal system as prognostic indicators of the functional state of the body under complex environmental conditions.

Fiziologiya Cheloveka.

11(6): 903-909; 1985.

[26 references; 2 in English]

Affiliate of the Scientific Research Institute of Naval Hygiene, USSR Ministry of Health, Odessa.

Endocrinology, Sympathetic Adrenal System
 Humans, Sailors, Typology, Personnel Selection
 Human Performance, Stress, Monotony

Abstract: This experiment attempted to find indicators of sympathetic and adrenal functioning which would be predictive of functioning under conditions of sea voyages (monotony, noise, vibration, changes in temperature, air pollution). Subjects in this experiment were 137 healthy sailors, aged 20-40. Measurements were apparently made both between and during cruises. Measured parameters indicative of type of sympathetic adrenal system included: level of renal excretion of DOPA; catecholamines, such as epinephrine, norepinephrine, and dopamine; metabolites such as vanillylmandelic and homovanillic acids; catecholamine conjugates; and the relative activity of various links in the system. Heart rhythm was used to assess physiological effects of changes in the sympathetic adrenal system. Mental work capacity was measured using a variety of tests, and conditions on the ship at the time tests were made were also evaluated. Subjects were divided into three groups on the basis of sympathetic adrenal parameters. The two extreme groups differed from each other during shore leave, while performing ordinary (monotonous work) and while working under extreme conditions (not described) in level of free norepinephrine in urine and in ratios of norepinephrine to dopamine activity and epinephrine to norepinephrine activity. Under conditions of rest, Type I individuals secreted much more norepinephrine and had much lower epinephrine to norepinephrine ratios and higher norepinephrine to dopamine ratios than Type II subjects.

During stressful job performance conditions, individuals of the first type (11% of the total) exhibited increased excretion of DOPA, dopamine, epinephrine, norepinephrine, vanillylmandelic and homovanillic acids. Ratio of epinephrine to norepinephrine remained low, and ratio of norepinephrine to dopamine increased slightly. During a monotonous work period, DOPA excretion was higher than baseline by a factor of 10, excretion of dopamine, and norepinephrine remained high, while excretion of epinephrine dropped to baseline. Epinephrine: norepinephrine ratio remained at baseline level and ratio of norepinephrine to dopamine dropped to half baseline. Mental work capacity increased for these individuals under stress. However, these same people showed relatively early signs of fatigue during a monotonous work period. Cardiac phenomena under monotony were similar to those under stress but were less pronounced. Type II individuals (11.4% of the total) showed much lower baseline excretion of norepinephrine, and thus lower norepinephrine to dopamine ratio and higher epinephrine to norepinephrine ratios. Excretion of dopamine and DOPA was higher for Type II than for Type I subjects. Under extreme conditions

P256

(stress), DOPA and dopamine excretion increased much less markedly than for Type I, and norepinephrine increased to a more marked extent but remained much lower in absolute terms. Ratio of norepinephrine to dopamine increased by a factor of two but remained low and ratio of epinephrine to norepinephrine decreased but remained relatively high. During a monotonous work period, dopamine excretion was much higher than under stress and norepinephrine excretion was somewhat lower, epinephrine:norepinephrine ratio decreased marked from both baseline and stress (remaining much higher than for Type I individuals) and norepinephrine:dopamine ratio decreased slightly from stress level. These individuals exhibited lower parameters indicative of sympathetic adrenal activity and lower relative activity of biosynthetic processes. Type II individuals showed earlier signs of mental fatigue (deterioration of performance) than Type I counterparts under stress and considerable performance variability; cardiac parameters pointed to the risk of development of cardiovascular pathology under conditions of prolonged stress. Type II individuals developed signs of fatigue in response to monotony later than Type I subjects.

The authors conclude that individuals of the first type have advantages during periods of relaxation and in stressful situations, while those of the second type do better in monotonous work situations. The remaining 81.2% of the sailors could be characterized by whether Type I or Type II characteristics predominated in a given situation. According to the authors (specific data and criteria not cited), adaptation in subjects of this kind involves a shift from predominance of Type II characteristics to Type I characteristics, while fatigue involves the opposite shift. The authors conclude that: 1) type of functioning of the sympathetic adrenal system is an important physiological indicator characterizing not only individual differences in the activity of this regulatory system, but also individual differences in psychological functioning (in different situations); 2) the most informative criteria for determining the type of sympathetic adrenal functioning are the parameters of excretion of free norepinephrine and the ratios of epinephrine to norepinephrine and norepinephrine to dopamine; 3) individuals exhibiting mixed or intermediate types of sympathetic adrenal functioning adapt by shift from a predominantly Type II pattern to a predominantly Type I pattern, while fatigue leads to the reverse shift and "pure" types do not manifest analogous shifts; 4) study of the characteristics of sympathetic adrenal system functioning can be used in selection by modeling work conditions.

Table and Figure Titles: Table 1: Comparison of parameters of sympathetic adrenal system functioning for extreme types

Table 2: See following page.

Figure 1: Change in parameters of state of sympathetic adrenal system (%) under conditions of various levels of job demands compared with data during shore leave for two extreme types

Figure 2: Comparison of parameters of sympathetic adrenal system functioning during a cruise for individuals of intermediate and extreme types

P256

Figure 3: Changes in parameters for sailors during an ocean cruise juxtaposed to the characteristics of the extreme types

Figure 4: Parameters of sympathetic adrenal system functioning on a cruise and during performance of test tasks for two sailors

Table 2: Range of parameters of sympathetic adrenal system functioning for extreme types in situation representing varying degrees of stress

Type I			
Parameter:	Rest	Typical Work (Monotony)	Extreme Conditions
DOPA, ng/min	4.4-3.0	43.6-22.2	10.5-8.1
Dopamine, ng/min	89.2-53.6	320.4-190.0	199.9-79.9
Norepinephrine, ng/min	26.8-15.4	51.5-26.3	55.5-38.7
Epinephrine, ng/min	3.1-1.9	3.2-5.0[sic]	7.3-4.7
Norepinephrine/Dopamine	0.500-0.172	0.271-0.082	0.694-0.193
Epinephrine/Norepinephrine	0.201-0.070	0.190-0.062	0.189-0.084
Vanillylmandelic acid/ Epinephrine+Norepinephrine	75.1-30.1	170.0-38.9	57.6-27.0

Type II			
Parameter:	Rest	Typical Work (Monotony)	Extreme Conditions
DOPA, ng/min	9.1-5.5	13.3-8.7	17.9-7.1
Dopamine, ng/min	126.1-89.9	169.1-129.7	47.4-18.6
Norepinephrine, ng/min	0.38-0.22	0.96-0.66	1.6-0.4
Epinephrine, ng/min	9.9-5.5	7.3-5.9	13.0-7.2
Norepinephrine/Dopamine	0.0042-0.0017	0.0074-0.0039	0.086-0.008
Epinephrine/Norepinephrine	45.0-14.4	11.0-6.1	32.5-4.5
Vanillylmandelic acid/ Epinephrine+Norepinephrine	100.0-368.4	243.9-121.0	276.3-89.9

ENZYMOLGY

(See also: Nutrition: P252)

PAPER:

P247(4/86)* Drozdova TYe, Vetrova YeG.

Enzymes in blood serum in response to a 7-day period of immersion.

Kosmicheskoy Biologiya i Aviakosmicheskoy Meditsina.

20(1): 82-83; 1986.

[4 references; none in English]

Enzymology, Enzyme Activity

Humans, Males

Hypokinesia, Dry Immersion

Abstract: Six healthy males, aged 25-35, were subjected to a 7-day period of dry immersion. Blood was taken 5 and 2 days before immersion, on days 2, 4 and 7 of the immersion period, and on days 2 and 5 post-immersion. The activity of NAD-dependent malic dehydrogenase and its isozymes, NADP-dependent isocitrate dehydrogenase, alanine aminotransferase, aspartic aminotransferase, creatine phosphokinase and its isozymes was measured using standard tests. On day 2 of immersion, creatine phosphokinase isozyme MM activity increased significantly. On day 4 this level had dropped back to baseline, but isocitrate dehydrogenase and malic dehydrogenase activity had decreased below baseline level. On day 7 the latter two enzymes had further decreased, but no other significant effects were observed. On day 2 after immersion, alanine aminotransferase activity, which had been at baseline level during immersion, increased substantially; but this parameter began to return to normal by day 5 post-immersion. A similar pattern held for aspartic aminotransferase activity in the readaptation period. Creatine phosphokinase isozyme MM activity was substantially above baseline level after 7 days of immersion, and on both days 2 and day 5 post-immersion. By day 5 post-immersion, isocitrate dehydrogenase and malic dehydrogenase activity had risen above the low levels noted late in immersion to above baseline level. The authors attribute these effects to decrease in activity of enzymes in musculoskeletal tissues during immersion, as well as to overall decrease in metabolism through inhibition of intracellular activity of the Krebs cycle.

Table Title: Activity of malic dehydrogenase, isocitrate dehydrogenase, alanine aminotransferase, aspartate aminotransferase, and creatine phosphokinase and isoenzymes of malic dehydrogenase and creatine phosphokinase in blood serum

EXO BIOLOGY

MONOGRAPHS:

M68(4/86) Ratner VA, Zharkikh AA, Kolchanov NA, et al.

Problemy teorii molekulyarnoy evolyutsii

[Problems in the theory of molecular evolution].

Novosibirsk: Nauka; 1985.

[ca. 250 pages; 338 references]

Institute of Cytology and Genetics, Siberian Division, USSR Academy of Sciences

Key Words: Exobiology, Molecular Evolution; Genetics, Origin of Molecular-Genetic Systems; Mathematical Modeling

Annotation: The subject of this monograph is the modern theory of molecular evolution. An attempt is made to perform a creative synthesis of the concepts, factual data, methods, theoretical models, results, and interpretations relevant to the theory of the origin and subsequent evolution of molecular-genetic systems of control, their macromolecular components and subsystems. The most important issues addressed by this theory are examined: the origin of the principles of molecular-genetic organization, phylogenetic analysis methods, the evolution of genes and proteins, principles of macromolecule structure from the standpoint of their evolution, and the evolution of genomes. A substantial proportion of the theoretical results discussed were obtained by the authors themselves. This book is intended for researchers in the fields of mathematical biology, evolutionary theory, molecular biology, biophysics, biochemistry, genetic engineering, and also for students and graduate students.

CONTENTS

(Numbers in parentheses refer to page numbers in the original.)

Foreword (3)

1. Introduction: Approaches and problems (6)
 - 1.1 Molecular-genetic systems of control (6)
 - 1.2 Biological molecular evolution (10)
 - 1.3 Prebiological molecular evolution (13)
 - 1.4 Major problems in the theory of molecular evolution (14)
2. Theoretical analysis of dynamic characteristics of self-replicating molecular systems (16)
 - 2.1 Eigen kinetic models (16)
 - 2.2 Replication errors and stability of quasispecies (25)
 - 2.3 Multipurpose self-replicating systems -- sizers(?) (30)
 - 2.4 Dynamic characteristics of the evolution of sizers (35)
 - 2.4.1 Mini-sizers with two non-linked matrices (35)
 - 2.4.2 Mini-sizers with two linked matrices (36)
 - 2.4.3 A sizer with one matrix for > 2 proteins (40)

M68

3. Principles of the origin and evolution of genetic coding systems (43)
 - 3.1 Translation apparatus and the genetic code (43)
 - 3.2 Persistence of the genetic code and texts (48)
 - 3.3 "Scenarios" in the process of prebiological evolution (55)
 - 3.3.1 The origin of proteinoids and microspheres (56)
 - 3.3.2 Microspheres (protocells) (57)
 - 3.3.3 The connection between peptides and oligonucleotides (58)
 - 3.3.4 Modular assembly of polymers (60)
 - 3.3.5 The origin of the system of translation and sizers (61)
 - 3.4 Origin and evolution of the features of the genetic code (63)
4. Methods for studying the evolution of macromolecules (75)
 - 4.1 Genetic sequences (texts) (75)
 - 4.2 Methods for evaluating the similarity of sequences (77)
 - 4.2.1 Measures of the similarity of genetic texts
 - 4.2.2 Identifying related sequences (80)
 - 4.3 Optimal alignment of sequences (84)
 - 4.4 Methods of phylogenetic analysis (97)
5. Theoretical analysis of the evolution of genes and proteins (97)
 - 5.1 Phylogenetic analysis of genes and proteins (98)
 - 5.1.1 The globulin superfamily (98)
 - 5.1.2 The cytochrome c family (103)
 - 5.1.3 The trees of global evolution and taxonomy (104)
 - 5.2 Theory of evolution and variability of proteins (108)
 - 5.3 Evolutionary dynamics of the variability of proteins (114)
 - 5.4 Simulations of the dynamics of the microevolutionary process (117)
 - 5.4.1 Determined models of population dynamics (118)
 - 5.4.2 Stochastic models of population dynamics (119)
 - 5.4.3 Genetic load and Haldane's dilemma (121)
 - 5.4.4 The connection between the parameters of microevolution and the processes of macroevolution (123)
 - 5.4.5 The rate of macroevolution and the role of multicellularity (126)
 - 5.5 Synonymous macroevolutionary drift (127)
 - 5.5.1 Genetic drift of neutral alleles (130)
 - 5.5.2 Fundamentals of the unified theory (133)
 - 5.5.3 The evolution of isoacceptor t-RNA (138)
 - 5.6 Problems in molecular phyletic coevolution (142)
6. Structural organization and the evolution of macromolecules (149)
 - 6.1 Features of the structural organization of globular proteins (149)
 - 6.2 Principles of evolutionary transformation of structures of globular proteins (153)
 - 6.3 Mechanisms underlying mutational damage of spatial structures of globular proteins (162)
 - 6.4 Mechanisms underlying evolutionary transformation of genes and the products coded by them, related to the features of their structural organization (176)
 - 6.5 Structural organization and evolution of RNA (187)

M68

- 6.6 Identification of non-random inverted repetitions and complementary palindromes (191)
- 6.7 Structural principles and pathways of the origin and evolution of the macromolecules (200)

- 7. Principles underlying the origin and evolution of genomes (203)
 - 7.1 Dimensions of genomes and density of information coding (203)
 - 7.2 Factors in the evolution of genomes and plasmids (206)
 - 7.3 Evolutionary characteristics of semireplicated systems (209)
 - 7.4 Possible evolutionary pathways for the development of multi-operon systems in prokaryotes (219)
 - 7.5 Evolution of multigene families (223)
 - 7.6 A possible pathway for the evolution of genomes and molecular genetic control systems (237)

Conclusion (243)

References (247)

M73(4/86) Surkov YuA.

Kosmicheskiye issledovaniye planet i sputnikov

[Flight investigations of planets and /their/ satellites].

Moscow: Nauka; 1985.

[309 pages; 55 tables; 132 illustrations; 557 references]

V.I. Vernadskiy Institute of Geochemistry and Analytic Chemistry (Winner of the Order of Lenin), USSR Academy of Sciences

Key Words: Exobiology, Planetary Environments, Planetary Atmospheres, Planetary Surfaces, Mars, Jupiter, Saturn, Venus, Mercury, Planetary Satellites, Spectrometry

Annotation: This book outlines modern ideas about the planets of the solar system and the moon, which has been the focus of particular attention during the last two decades of space flight. Consideration is also given to the satellites of Mars, Jupiter, and Saturn, which, the author believes, will be targets of research in the near future. The major scientific problems related to planets and satellites awaiting further research are also discussed.

Major emphasis is placed on flight studies of planets and satellites from spacecraft. Scientific experiments; methods of research and onboard equipment are described, and the results of the experiments and their interpretations are considered. In addition, methods and equipment projected for use in future space flights are described.

CONTENTS

(Numbers in parentheses refer to page numbers in the original.)

Foreword (3)

PART I: MODERN IDEAS ABOUT THE PLANETS AND THEIR SATELLITES

Chapter 1. The origin and evolution of the bodies of the solar system (6)

Early history of the solar system (7)

Physical conditions and chemical composition of the solar corona (9)

Condensation of gases in dust particles (10)

Accumulation of dust particles and gases in planetary bodies (13)

The structure of the planets. Differentiation of substances (15)

The atmospheres of the planets and their satellites (18)

Prospects for future research (21)

Chapter 2. Mercury (22)

Major characteristics of the planet (22)

Geological features of the surface of Mercury (24)

The origin and structure of Mercury (27)

The atmosphere and volatile constituents on Mercury (29)

Prospects for future studies of Mercury (30)

Chapter 3. Venus (32)

Major characteristics of the planet (32)

The origin and evolution of the atmosphere (36)

The nature and history of the surface and crust (38)

M73

- Endogenous processes, differentiation of substance (50)
- The internal structure of Venus (52)
- Prospects for future studies of Venus (54)

Chapter 4. Mars (55)

- Major characteristics of the planet (55)
- Features of the geological structure on the surface (55)
- The composition and features of rocks on the surface of Mars (57)
- Substances on the mantle and core (61)
- The atmosphere and volatile constituents on Mars (63)
- Prospects for future studies of Mars (64)

Chapter 5. Planetary satellites (66)

- The Moon (68)
- Mars' satellites -- Phobos and Deimos (80)
- Jupiter's satellites -- Amalthea, Io, Europa, Ganymede and Callisto (83)
- Saturn's satellite -- Titan (88)
- Prospects for future studies of planetary satellites (92)

PART II. STUDIES OF THE PLANETS AND THEIR SATELLITES USING SPACECRAFT (93)

Chapter 1. Studies using gamma ray spectrometry (93)

- Gamma irradiation of the bodies of the Solar Systems (94)
- Gamma ray spectrometry apparatus for flight experiments (108)
- Studies using gamma irradiation of the Moon from the "Luna-10,-12" probes, and "Apollo-15, -16" spacecraft (140)

Chapter 2. X-ray spectrometry studies (181)

- Introduction (181)
- Fundamentals of the X-ray radiometry technique (182)
- X-ray radiometric analysis of Venusian rock from the "Venera-13" and "Venera-14" interplanetary space probes (188)
- Studies of the composition of Venusian rock from the "Vega-2" launch vehicle (210)
- X-ray radiometric analysis of the aerosol cloud layer of Venus from the "Venera-12" and "Venera-14" interplanetary space probes (211)
- X-ray radiometric analysis of Martian rock from the "Viking-1" and "Viking-2" spacecraft (217)
- X-ray spectrometric analysis of Moon rock (223)

Chapter 3. Neutron spectrometry (237)

- The method and equipment used for activation analysis of rock (237)
- Investigating the composition and features of rock using the activation method (244)
- Remote sensing investigation of the composition of rock using a neutron field (248)

M73

Chapter 4. Alpha particle spectrometry (251)

Analysis of Moon rock from the "Surveyor-5," "-6 "and "-7"
spacecraft using the alpha particle scatter method (251)

An apparatus for analyzing the composition of the Martian
atmosphere and surface using the alpha particle scatter method (256)

Chapter 5. Mass spectrometry studies (261)

Mass spectrometry of the atmosphere and clouds of Venus (261)

Mass spectrometry of the Martian atmosphere using the "Viking-1" and
"-2" spacecraft (273)

Mass spectrometry of the Lunar atmosphere from the "Apollo-17"
spacecraft (277)

A mass spectrometer for studying cloud aerosols (278)

A mass spectrometer for studying rocks (283)

Conclusion (287)

References (290)

GENETICS: See Botany P235; Exobiology: M68

HABITABILITY AND ENVIRONMENT EFFECTS

(See also: Adaptability: P264)

PAPER:

P241(4/86)² Novikova ND, Orlova MI, D'yachenko MB.

Investigation of the reproductive capacity of microflora on polymer materials used in hermetically sealed cabins.

Kosmicheskaya Biologiya i Aviakosmicheskaya Meditsina.

20(1): 71-73; 1986.

[6 references; 1 in English]

Habitability and Environment Effects, Microflora Growth

Microbiology, Bacteria

Polymer Materials, Environmental Moisture

Abstract: This study involved ten 5 X 5 cm samples of polymers of different chemical compositions widely used in hermetically sealed chambers. Ten strains of microbes isolated from the interior surfaces, equipment and integument of human residents of a hermetically sealed chamber served as test cultures. In the first condition the samples and test cultures were sealed in a container with a liquid medium consisting of a condensate of atmospheric moisture from a hermetically sealed inhabited chamber. In the second condition, a medium lacking a source of carbon was used. No polymer samples were used in the control condition. The test cultures were held for 30-60 days at various temperatures. At various times the number of test microbes was determined using traditional methods. Gram-negative and gram positive bacillaform flora (particularly of the genera Pseudomonas, Proteus and Bacillus) tended to show a higher rate of propagation on the polymer material than did coccaceous flora. The most active growth was shown by bacteria of the genus Pseudomonas aeruginosa. Among the different materials tested, the most growth occurred on a sample based on natural leather. Changes in the biochemical activity of the microbes occurred over the incubation period, (e.g., increase in the phosphatase and DNA-ase activity of Pseudomonas aeruginosa). Such changes might result in changes in pathogenicity to man. In this investigation the factor found to influence the propagation of microorganisms on polymers included temperature, the presence or lack of condensate, and the chemical composition of the condensate. The initial concentration of test microbes was not an important factor. Optimum temperature for microbe growth was 37°C. The polymer materials most conducive to microbe growth were heterogeneous, including compounds which contain not only carbon atoms, but also atoms of oxygen, nitrogen, sulphur and other elements typically occurring in organic compounds. Microbe growth was most pronounced on polymers based on cellulose and protein and least pronounced on fluoroplastic and polyurethane.

Figure Title: Growth of Pseudomonas aeruginosa on various types of polymer materials.

HEALTH AND MEDICAL TREATMENT

(See also: Radiobiology: P249; Space Medicine: P251)

PAPER:

P276(4/86) Kuznets YeI, Zinochkin VA, Opryshko AV, Utekhin BA, Chadov VI, Yakovleva EV.

Some conclusions and prospects for work in the area of thermal physiology applied to the performance of research on [man in] space.

In Kedrov BM and Kosmodem'yanskii AA, editors,
Nauchnoye tvorchestvo K.E. Tsiolkovskogo i sovremennoye razvitiye ego idey

[The scientific work of K.E. Tsiolkovskiy and modern development of his ideas].

Moscow: Nauka; 1984:73-76.

[6 references; none in English]

Health and Medical Treatment, Hyperthermia, Monitoring
Humans, Cosmonauts
Equipment and Instrumentation, Measurement Techniques

Abstract: This article describes techniques for monitoring the thermal status (particularly, overheating) of working cosmonauts. Researchers found that the best indicators predictive of dangerous states of hyperthermia involved rectal temperature in combination with heart rate. However, in manned space flights, particularly those requiring EVAs, use of rectal temperature is impractical. Oral and auricular temperatures also have major practical drawbacks for monitoring cosmonauts at work. The authors suggest the use of parotid temperature (presumably, with a thermocouple attached behind the ear), which is highly indicative of the mean body temperature under conditions of overheating, and lacks the major drawbacks of other techniques. To greatly enhance the diagnostic worth of these two indicators the authors suggest measurement of peripheral vascular tonus, particularly of the vessels of the brain, which can be accomplished through impedance plethysmography. They support this suggestion by arguing that a substantial decrease in vascular tonus, particularly when accompanied by dicrotic or asthenic pulse, testifies to excessive strain on the cardiovascular system and the approach of collapse, even if body temperature increases are minor. On the other hand, if tonus of regional vessels is maintained at a satisfactory level, this testifies to the presence of functional reserves, even if there is substantial hyperthermia or increased pulse rate. The next step in this applied research program is development of a method for continuous monitoring of the thermal status of cosmonauts which takes account of the degree of strain on the body's thermal regulation system, body temperature profiles, and level of physical exertion, as well as parameters reflecting the microclimate and emotional state of the cosmonaut.

HEMATOLOGY

(See also: Radiobiology: P248; Space Medicine: P251)

PAPERS:

P232(4/86)* Verigo VV, Gauzer F (Czechoslovakia).
[Modeling] cyclic processes in blood cell kinetics.
Kosmicheskaya Biologiya i Aviakosmicheskaya Meditsina.
20(1): 38-41; 1986.
[23 references; 15 in English]

Hematology, Erythropoiesis, Cyclic Processes; Metabolism
Humans
Mathematical Modeling

Abstract: Unlike investigations of other physiological processes, a large number of frequent measurements are impractical for hematological studies; thus, mathematical modeling becomes a particularly important technique. In order to model the effects of space flight on dynamic processes controlling the creation and aging of red blood cells, one must simulate processes which may be cyclical in nature, occurring in response to single triggering events or ongoing stimulation conditions. This paper develops such a model of erythropoiesis, based on an earlier model which simulated the age structure of red blood cells and reflected the rate of "aging" of circulating erythrocytes as a function of metabolism. In this previous model, the erythrocytes were destroyed when they reached a threshold age. The present model further simulates cyclic processes occurring in erythropoiesis, such as the changes in the age density of mature erythrocytes and reticulocytes as a function of physical time, biological time, maturity of the reticulocytes, hormonal stimulation and metabolic rate. Equations are derived for the mortality rate of cells in the functional pool, and proliferation rate of "young" cells in the population, which take account of the effects of chalone and erythropoietin. Production of erythropoietin is modeled as a function of the relationship of the current value of the hematocrit to its nominal value and the difference between the consumption of oxygen (proportional to metabolic level) and its transport. A distinctive feature of this model is its recognition of the cyclic nature of changes in the population of red blood cells of various kinds.

P275(4/86) Krichevskaya AA, Shugaley VS; Ananyan AA, Zigova IG.
Evaluation of the protective effects of arginine in cold stress.
 Voprosy Meditsinskoy Khimii.

31(6): 50-54; 1985.

[21 references; 7 in English]

Department of Biochemistry and Laboratory for Ecological Adaptation of
 Animals to Extreme Environmental Factors, Rostov University, Rostov-na-
 Donu.

Hematology, Erythrocyte Membrane, Permeability

Rats

Adaptation, Cold; Pharmacology, Countermeasures, Arginine

Abstract: This study investigated the efficacy of arginine in protecting the body against the detrimental effects of exposure to cold. Since one of these effects is destabilization of the erythrocyte membrane, the variables investigated include biochemical indicators of the stability of that membrane, i.e., concentration of hemoglobin, total peroxidase activity and activity of glucose-6-phosphate dehydrogenase (G-6-PD). The sensitivity of animals protected by arginine to another extreme factor, hyperbaric oxygenation was compared to that of animals not given arginine. Sensitivity was assessed by measuring length of exposure before onset of convulsions. Subjects in the experiment were white male rats. A control group (I) not exposed to cold was used. Experimental animals were placed in a refrigerated chamber with a constant temperature of 2-4° C. Rats in Group II were kept in the cold chamber for 3 days. Animals in group III were given arginine after 3 days in the cold and removed from the chamber 40 minutes later. Arginine was administered twice daily to Group IV rats, also exposed to cold. Group V contained animals given arginine but not exposed to cold. In all cases, the dose of arginine was 120 mg/kg body weight. The single dose of arginine did not alter the permeability of the erythrocyte membrane for animals in Group V. Three days of exposure to cold caused animals in Groups II, III and IV to show increases in concentration of hemoglobin, and in peroxidase and G-6-PD activity. The single dose of arginine administered at the end of the 3-day period did not normalize these indicators, although there was some tendency in that direction. However, repeated administration of arginine throughout cold exposure did lead to normalization of these parameters. Animals exposed to cold were more sensitive to breathing hyperbaric oxygen than control animals. A single dose of arginine increased tolerance of animals not exposed to cold, but not the resistance of Group III animals over that of Group II rats. Repeated doses of arginine increased resistance of rats exposed to cold (Group IV) to equal that of control animals. The authors recommend daily use of arginine to facilitate adaptation to cold and to minimize stress responses.

Table and Figure Titles: Table 1. The effect of arginine on concentration of hemoglobin, peroxidase and G-6-PD activity in blood serum and time to onset of convulsions in response to breathing of hyperbaric oxygen in rats exposed to cold

Table 2. Hemoglobin and peroxidase and G-6-PD activity in blood serum of rats given arginine during exposure to cold and hyperbaric oxygen.

HUMAN PERFORMANCE

(See also: Cardiovascular and Respiratory Systems: P224; Endocrinology: P256; Metabolism: P245; Musculoskeletal System: P263; Psychology: M67; Radiobiology: P238; Space Medicine: P251)

MONOGRAPH:

M76(4/86) Volkov VG, editor.

Metodika i tekhnika issledovaniy operatorskoy deyatel'nosti
[Methodology and technology in the study of operator performance].

Moscow: Nauka; 1985.

[102 pages; 2 tables 37 illustrations; 113 references]

Institute for Higher Nervous Activity and Neurophysiology, USSR Academy of Sciences

Key Words: Human Performance, Operator Performance, Operator Learning; Psychology, Psychophysics, Psychometrics, Stress, Biofeedback; Neurophysiology

Annotation: This collection contains material pertinent to the study of the characteristics of humans performing a variety of operators' job tasks, the methodology for evaluating the functional state of an operator, and a description of the relevant psychometric apparatus. This book is intended for specialists in the areas of psychophysiology and applied human physiology -- physiologists, psychologists, physicians and engineers.

CONTENTS

(Numbers in parentheses refer to page numbers in the original.)

The state of the art and characteristics of modeling biological systems. M.V. Frolov (3)

An integrated evaluation of the emotional state of a human being on the basis of autonomic functions. G.B. Milovanova (7)

Electroencephalographic correlates of the process of learning to drive an automobile. V. I. Bartel's (12)

The effects of delayed results of biofeedback training on job performance. V.A. Glazkova (20)

An experimental study of a formula in the information processing theory of emotions. Ye.A. Ivanov (24)

Characteristics and optimization of operator performance under monotonous conditions. A.K. Yepishkin, A.I. Skrypnikov (28)

Changes in functional state and work capacity parameters over the course of multiday operator performance. Ye.P. Sviridov (35)

Evaluation of the functional state of the human brain under various levels of emotional stress. V.A. Balabanova (40)

M76

On the existence of infralow frequency components in the speech signal. A.P. Belikov, V.P. Korolev, N.V. Mulyukin, O.A. Cherkasov (47)

An analysis of the effects of compensatory actions on the functional state of the body during a visual stress test. S.P. Kolpakov, A.G. Rummyantseva, A.M. Mamedov (50)

The effect of alcoholic intoxication on operator performance in driving motorized vehicles. V.I. Bartel's. A.L. Levchenko (56)

A device for simulating tasks in complex compensatory tracking with visual and oral displays. V.G. Volkov (62)

Eye movement reactions in humans in disorders of the central nervous system. V.M. Mashkova (66)

The potential of computers in verbal testing procedures. S.A. Varashevich, Ye.A. Cherenkova (73)

Changes in psychophysical parameters during automobile driving training. N.N. Lebedeva, O.P. Sel'tsovskiy, A.A. Shitikov (78)

Ways to increase the level of user communication with a computer in psychophysiological investigations. S.A. Varashkevich (83)

Use of feedback for optimizing test parameters in simulation of pursuit tracking tasks. V.G.Volkov, I.A.Smirnitskaya (90)

IMMUNOLOGY

PAPER:

P236(4/86)* Mirrakhimov MM, Kitayev MI, Khamzamulin RO, Tokhtabayev AG, Pogrebitskiy SM.

T- and B-lymphocyte types of immunity in acute altitude sickness.

Kosmicheskoy Biologiya i Aviakosmicheskoy Meditsina.

20(1): 53-56; 1986.

[19 references; 11 in English]

Immunology, T- and B-lymphocyte Immunity
Humans, Males, Typology
Adaptation, High Altitude, Altitude Sickness

Abstract: Fifty-seven healthy males spent 30 days at an altitude of 3600 m above sea level. Subjects were divided into two groups on the basis of tolerance of high altitude. Group 1 contained 25 men who adapted well. Group 2 contained 32 men showing mild or moderate altitude sickness, for at least 3 days. Immunological examination took place before ascent and on days 3 and 30 of adaptation to high altitude, and involved differential study of T- and B-lymphocyte types of immunity. Populations of T- and B-lymphocytes in peripheral blood were estimated. The status of the T-lymphocytes was associated with their ability to transform -- spontaneously and in the presence of phytohemagglutinin (PHA) and concanavalin A (Con A), and the status of B-lymphocytes with the concentration of immunoglobulin A, M and G in the blood as determined by immunodiffusion. Population of null cells was also estimated. In Group 1 subjects, exposure to high altitude was initially associated with decrease in the population of T-lymphocytes and with their capability to transform themselves into lymphoblasts in the presence of PHA. Immune indicators had returned to normal by day 30. Group 1 subjects showed no change in lymphocyte transformations in response to Con A at high altitude, but level of spontaneous transformation was depressed. There was a nonsignificant tendency for B-lymphocyte population to increase in the early portion of adaptation, while a significant increase in synthesis of immunoglobulin M was noted at day 30. In Group 2 decreases in T-cell population and activity were more marked, including decreases in response to Con A, and had not returned to baseline level by day 30. Initial(baseline) T-lymphocyte population was significantly lower for this group than for Group 1. On the third day of hypokinesia, concentration of B-lymphocytes was significantly lower for Group 2 than for Group 1, and the content of immunoglobulin M was substantially lower in Group 2 after 30 days. Concentration of null cells was lower in Group 2 individuals than in Group 1 individuals both initially and on days 3-5 of adaptation. The authors interpret these results as confirming that altitude sickness depresses thymus-linked immunity.

Table and Figure Titles: Table: T-lymphocyte type immunity in healthy men and those with altitude sickness during adaptation to high altitude

Figure: "Null" cells in apparently healthy individuals and those susceptible to altitude sickness

LIFE SUPPORT SYSTEMS: See Botany: P247

MATHEMATICAL MODELING: See Biospherics: M69; Exobiology: M68; Hematology: P232; Nutrition: P252

METABOLISM

(See also: Cardiovascular and Respiratory Systems: P269; Hematology: P232)

PAPERS:

P245(4/86)* Vlasova TF, Ushakov AS, Bychkov VP, Miroschnikova YeB.

Amino acids in blood of humans exposed to emotional stress.

Kosmicheskaya Biologiya i Aviakosmicheskaya Meditsina.

20(1): 80-81; 1986.

[8 references; 4 in English]

Metabolism, Amino Acid Level

Humans, Males

Psychology, Emotional Stress; Human Performance, Cognitive Demands

Abstract: Five healthy males (aged 23-41) participated in this study. Emotional stress was created in three ways: 1) simulation of ascent to 8000 m in a barochamber; 2) anticipation of acceleration to 8 G in a centrifuge (which apparently never took place); 3) performance of mental tasks under time pressure. Each subject was exposed to all three stress factors in the order presented above (possibly on three consecutive days) and was informed of the nature of each session the day before it took place (or was supposed to take place). Blood was taken in a baseline period, after anticipatory instructions and before exposure, as well as after exposure to each stress factor (exact time in relation to relevant, previous and subsequent stress factors and anticipatory information, not specified). Concentrations of 14 amino acids in the blood were determined using ion exchange chromatography. Simulated ascent caused a drop in total amino acids and in each individual acid studied, these effects occurred both before and after exposure. Anticipation of acceleration led to similar effects but to a lesser degree. Of the six acids significantly depressed in the anticipatory period, all remained depressed even when acceleration did not occur, suggesting the importance of the emotional factor. The mental task led to an increase in the total acid pool and in 10 and 7 individual acids (lysine, methionine, cysteine, aspartic acid, glutamic acid, glycine and alanine) in the anticipatory and post-task periods, respectively. The effect was particularly marked with the glutamic acids. Results suggest a distinction between emotional stress and mental strain (or anticipation thereof) in their physiological effects.

Table Title: Concentration of free amino acids in blood plasma of subjects exposed to emotional stress

P226(4/86)* Ivanova SM, Orlov ON, Brantova SS, Labetskaya OI, Davydova NA, Zezerov AYe, Ushakov AS.

The effects of performance of demanding operator tasks on human lipid peroxidation processes.

Kosmicheskaya Biologiya i Aviakosmicheskaya Meditsina.

20(1): 20-22; 1986.

[12 references; 5 in English]

Metabolism, Lipid Peroxidation; Endocrinology, Adrenergic System

Humans, Operators

Human Performance, Cognitive Demands; Psychology, Stress

Abstract: Twenty healthy subjects participated in this study of the effect of mental stress on lipid peroxidation. For 13 of these subjects stress was created by the requirement to solve 7 complicated mental problems under time pressure over the course of 2 hours. The other subjects apparently acted as controls. Lipid peroxidation was measured by determining concentration of products of lipid peroxidation in expired air and in the blood, using gas chromatography. In addition, catecholamine concentration in blood was measured as an index of the state of the adrenergic system. Measurement intervals are not specified directly. Analysis indicated that the concentration of pentane in expired air, and of epinephrine, norepinephrine and products of lipid peroxidation in the blood increased after the mental task session. While catecholamine content had decreased to baseline within 24 hours after the test, blood levels of primary and secondary lipid peroxidation products were still elevated after this period, and pentane in expired air remained high for 4 days. The authors conclude that in humans, stress which is not associated with physical harm increases the rate of lipid peroxidation. This implies the possibility of using antioxidants to protect against the harmful effects of stress. It is suggested that concentration of the products of lipid peroxidation in blood and expired air could be a useful indicator of the intensity of stress.

Figure 1. Chromatogram of expired air in humans before and after performance of operator task

Figure 2. Changes in concentration of products of lipid peroxidation and catecholamines in blood during the experiment

Figure 3. Concentration of pentane in expired air after the experiment

P228(4/86)* Kalandarov S, Bychkov VP, Frenkel' ID, Proskurova GI.
**Characteristics of humoral regulation of metabolism in simulations of
 spaceflight factors.**

Kosmicheskaya Biologiya i Aviakosmicheskay Meditsina.

20(1): 25-28; 1986.

[17 references; 2 in English]

Metabolism, Humoral Regulation; Endocrinology, Sympathetic-Adrenal System
 Humans, Age Groups
 Hypokinesia, Head-down Tilt; Nutrition, Diet Supplements; Psychology,
 Stress; Physical Exercise

Abstract: Subjects were divided into three groups according to age: Group 1 (N=10): 41-50; Group 2 (N=11): 50-57; Group 3 (N=6): 26-33. All groups were subjected to hypokinesia with head-down tilt (-8°) [described as long term, but no specific period given]. Groups 1 and 2 were further subjected to 3G_z linear acceleration lasting one minute and graded physical exercise of 450-1050 kg-m lasting a total of 15 minutes at unspecified times before and after hypokinesia. Group 3 was subjected to psychological stress created by the demand to perform mental tasks under time deficit before (twice), during (3 times) and after (once) hypokinesia. Functioning of the sympathetic-adrenal system was assessed by measuring excreted catecholamines using fluorometry. Functioning of the adrenal cortex was assessed by determining the amount of 17-oxycorticoid (17-ox) in daily urine and 11-oxycorticoid (11-ox) in blood plasma. Metabolic rate was assessed by measuring activity of lactate dehydrogenase (LDH), alanine aminotransferase (ALT), asparatate aminotransferase (AST), and creatine kinase (CK) in blood plasma, and the level of fatty acids in serum. Measurements were made before and after exposure to each of the stress factors. The subjects received a diet of 3000 calories per day, with Group 3 receiving an additional nutritional supplement (glucose, phosphatide concentrate, vitamins and minerals). Groups 1 and 2 showed increased excretion of epinephrine, norepinephrine and 17-ox, and increased 11-ox in the blood compared with the norm at all measurement points (apparently including the levels recorded before exposure to any stress). Linear acceleration was associated with significant increase of ALT in Group 1. Fatty acids in blood increased after exposure to the stress factors, most markedly after physical exercise. Subjects in Group 3 showed no increase in 17-ox attributable to psychological stress. On days 10 and 14 of hypokinesia only, level of 11-ox in the blood rose significantly in Group 3 subjects. During the hypokinesia period concentration of ALT dropped, while that of fatty acids increased for these subjects. Lack of any major effects in Group 3 subjects, compared to effects in Groups 1 and 2, is attributed to the nutritional supplement.

Table Titles: Table 1: Concentration of catecholamines and 17-oxycorticoid in daily urine for Groups 1 and 2

Table 2: Concentration of enzymes in blood serum of subjects in Groups 1 and 2

Table 3: Concentration of catecholamine and 17-oxycorticoid in daily urine (Group 3)

MICROBIOLOGY: See: Habitability and Environment Effects: P241

MORPHOLOGY AND CYTOLOGY

(See also: Endocrinology: P233; P272)

PAPER:

P261(4/86) Korzun YeI, Shakhbazov VG, Mailyan TV, Kolupayeva TV, Kovalenko YeA.

Electrokinetic properties of cell nuclei of the human buccal epithelium in response to hypoxia and motion sickness.

Patologicheskaya Fiziologiya i Eksperimental'naya Terapiya.

1985(6): 63-66.

[7 references; none in English]

Morphology and Cytology, Electronegativity, Cell Nuclei, Buccal Epithelium

Humans, Personnel Selection

Neurophysiology, Acceleration Tolerance; Adaptation, Hypoxia Tolerance, Physical Exercise

Abstract: This study investigated electrophoretic mobility of native cell nuclei of the buccal epithelium in humans who were exposed to acute hypoxia before and after conditioning in a barochamber, and who also experienced motion sickness induced by Coriolis and processional acceleration. Cells were scraped from the mucous membranes of the cheeks of 14 individuals and electrophoresis performed. Displacement of cell nuclei was determined using a microscope; electronegativity of the nuclei was expressed in terms of percentages with respect to 100 cells. Material for this procedure was taken before subjects entered the barochamber and 5 minutes after altitude tolerance had been tested in it and the subject returned to normal pressure. The amount by which the electronegativity index had dropped was determined for the subjects after they had been exposed to acute hypoxia before barochamber training, immediately after the completion of training, and 10, and 20 days afterward. Training involved a 3-day regimen of adaptation to hypoxia equivalent to 6100 m combined with physical exercise. Altitude tolerance was identified with duration of a subject's ability to tolerate hypoxia equivalent to an altitude above 7000 m. In addition, subjects were subjected to motion sickness induced by irregularly increasing Coriolis acceleration.

Exposure to hypoxia led to a reliable decrease in the electronegativity (EN) of cheek cell nuclei, both before and after the conditioning procedure. The authors conclude that parameters indicative of the electrokinetic properties of cell nuclei are highly sensitive to oxygen deficits. One day after conditioning, EN had decreased to somewhat below baseline, while post hypoxia EN remained unchanged from its pre-conditioning value. Because of this, the decrease in EN attributable to hypoxia was diminished after training, which the authors interpret as indicating that the training increases the stability of the nuclear genome. When individual values of EN were correlated with an individual's baseline (pre-training) tolerance time for hypoxia, a negative correlation of -0.59 was found, indicating that hypoxia affects the electrophoretic parameters of cells less in individuals who are more hypoxia tolerant. In addition, it was found that the small decreases in EN attributable to hypoxia

P261

which were characteristic of tolerant individuals were associated with smaller increases in tolerance time attributable to training. Thus, high baseline resistance was associated with less benefit attributable to training. Older (42-46) subjects tended to show higher initial tolerance. Like hypoxia, Coriolis acceleration was associated with a statistically significant decrease in value of EN. The authors recommend using electrophoretic properties of cells of the buccal epithelium as a good predictor of an individuals tolerance of hypoxia and/or motion sickness.

Table and Figure Titles: Table 1: The effect of acute hypoxia on EN% before and after training

Observation Time:	EN%		EO%
	Before Hypoxia	After Hypoxia	
Before Training (n=13)	56.8	43.6*	13.2
After Training			
Day 1 (n=10)	50.9	43.5**	7.4
Day 10 (n=5)	52.6	42.0	10.6
Day 20 (n=11)	51.5	42.5**	9.0

* P<0.001;

**P<0.05

Figure 1: Effects of irregularly increasing Coriolis acceleration on the EN% indicator

MUSCULOSKELETAL SYSTEM

(See also: Neurophysiology: P227; P254)

PAPERS:

P230(4/86)* Potapov PP.

Levels of collagen, lipids and glycogen in the skeletal muscles of rats in the recovery period after 15- and 30-day periods of hypokinesia.

Kosmicheskaya Biologiya i Aviakosmicheskaya Meditsina.

20(1): 33-35; 1986.

[10 references; 3 in English]

Musculoskeletal System, Collagen, Lipids, Glycogen

Rats

Hypokinesia, Long-term, Readaptation

Abstract: This experiment was performed on 111 albino rats, of which 55 served as controls. One experimental group of rats underwent 15 days of hypokinesia in a restraint cage, while the second group underwent a 30-day hypokinesia period. After the treatment the rats were returned to a normal group cage and were studied during the recovery period. Group 1 was studied during hypokinesia and on days 7, 15, and 30 of recovery and Group 2 during hypokinesia and on days 7, 15, 30 and 50 of the recovery period. After sacrifice skeletal muscle tissue was removed from the anterior group of femur muscles without the tendons, nerves and fasciae. Glycogen, total lipids, and triglycerides were isolated and measured. The concentration of oxyproline in hydrolysates of dried, defatted tissue was determined as a means of estimating the amount of collagen in the muscle.

Carcass weight measured immediately after the hypokinesia period was 22 to 25 percent below that of the control animals. By day 30 of the recovery period this parameter had returned to normal for both hypokinesia groups. The amount of collagen in the skeletal muscles was 30 and 32% higher than control level for the 15- and 30-day groups, respectively, directly after the hypokinesia period. Normalization of this parameter occurred by day 7 for the 15-day group and by day 15 for the 30-day group. Immediately after hypokinesia, glycogen content was depressed by 24 and 45% for the two groups. This parameter increased sharply to above baseline level by day 7 of recovery, but normalized by day 30 for the 15-day group and by day 60 for the 30-day group. Directly after hypokinesia, concentrations of total lipids and triglycerides were below control level for the 15-day group, but had returned to normal level for the 30-day group. During recovery, concentrations of these substances gradually increased for the 15-day group and were significantly above that of the control group on days 15 and 30; in the 30-day group the parameter increased on day 7, but had returned to control level by day 15. The authors conclude that in the first week of recovery from hypokinesia anabolic processes predominated and the synthesis of protein in the muscles increased. After the 30-day treatment period glycogen begins to accumulate in the muscles in substantial amounts by the 7-10th day of recovery. In the recovery period lipid synthesis apparently occurs faster than lipolysis. However, the accumulation of triglycerides dissipates rapidly. For the shorter period of hypokinesia analogous effects occur somewhat later in the recovery period and are less

P230

stable. The authors consider the fluctuations in glycogen and triglyceride levels which occur in the recovery periods to be adverse symptoms, indicative of disruption of the balance between synthesis and utilization of carbohydrates and lipids. It is of note that the readaption period required for normalization after hypokinesia is not positively associated with the length of the hypokinesia period itself.

Tables and Figures: Tables 1 and 2: Concentration of oxyproline (OP), total lipid (TL), glycogen (GG) and triglycerides (TG) in the skeletal muscles of rats during the recovery period after a 15-day (Table 1) and 30-day (Table 2) period of hypokinesia

Hypokinesia Length Parameter	Control	Hypokinesia	Recovery Period, Days			
			7	15	30	60
15 Days						
OP, ukmol/g	20.1	26.1*	21.5	20.9	20.2	
TL, g %	3.04	2.56*	3.13	3.43*	3.73*	
TG, ukmol/g	11.9	9.8*	13.0	14.5*	15.4*	
GG, mg%	407	308*	495*	274*	462	
30 Days						
OP, ukmol/g	20.9	27.6*	24.0*	20.3	20.4	20.6
TL, g %	3.05	3.30	3.36*	3.03	3.00	3.21
TG, ukmol/g	12.8	13.5	15.1*	12.9	12.2	14.2
GG, mg %	456	250*	1006*	883*	592*	489

*p < .05 (Note: it is not specified what values are being compared; presumably starred numbers are significantly different from control or baseline level.

Figure Title: Changes in carcass weight (in g) of rats during recovery from the effects of hypokinesia

P234(4/86)* Shvets VN, Pankova AS, Kabitskaya OYe, Vnukova ZE, Morukov BV.

The effects of diphosphonates on bone tissue of rats undergoing hypokinesia.

Kosmicheskaya Biologiya i Aviakosmicheskaya Meditsina.

20(1): 45-49; 1986.

[19 references; 16 in English]

Musculoskeletal System, Osteoporosis

Rats

Hypokinesia, Countermeasures, Diphosphonates

Abstract: Diphosphonates are synthetic pyrophosphates, which, unlike the latter, are resistant to enzymes, thus allowing them to be administered orally. These substances have been used in treating osteoporosis, but have not been tested for their capacity to prevent the development of osteoporosis induced by hypokinesia. This experiment used 39 male Wistar rats; one group was kept in immobilization cages (hypokinesia) for 60 days and the other served as a control. Every day a subgroup of the rats in each group was orally administered a 0.3 percent solution of 1-hydroxy-ethylene-1,1-diphosphonate (HEDP) containing 9 mg/kg phosphorus. The other rats were given a placebo. At the end of the period, the animals were sacrificed and the breastbone, pelvis bone, femur and humerus removed. Marrow was also extracted from the iliac bone and cultured *in vitro*. Frontal histological sections of the bones were prepared, stained and examined with an ocular microscope, using a test grid. Growth of long bones was evaluated. Parameters recorded included: total amount of spongy bone; amount of primary spongy bone; depth of penetration of the spongy bone into the medullary cavity; amount of cartilage tissue in total spongy bone; amount of cartilage tissue in primary spongy bone; width of the epiphyseal plate of growth; and number of osteoclasts in the primary spongy bone. Hypokinesia was associated with decreased rate of bone growth, and with a narrowing of the cortical plate of the diaphysis in experimental animals, while the medullary channel remained the same in width. This suggests that hypokinesia inhibits periostalic osteogenesis, rather than interfering with resorption of bone by the endosteum. In the humerus and femur, hypokinesia depressed the level of all parameters relative to the control. Administration of HEDP did not restore the levels of these parameters, but did compensate for the effect of hypokinesia on spongy bone, partially in the case of the sternum and completely for the pelvis. The mechanism underlying this effect is likely to be associated with the fact that administration of HEDP more than doubled the number of osteoblast precursor cells in marrow from iliac bone.

Table Titles: Table 1: Parameters of spongy bone in the proximal end of the diaphysis of the humerus bone

Table 2: Parameters of spongy bone in the distal end of the diaphysis of the femur

Table 3: Amount (in %) of spongy bone in the sternum and pelvis bones

Table 4: Number of stromal precursor cells in the marrow of the iliac bone per 10^6 explanted karyocytes

P243(4/86)* Zaychik VYe, Kondrashov AYe, Morukov BV.

A technique for determining the amount of calcium in the human foot by neutron activation.

Kosmicheskaya Biologiya i Aviakosmicheskaya Meditsina.

20(1): 75-74; 1986.

[11 references; 4 in English]

Musculoskeletal System, Calcium Level, Bone

Human

Technique Demonstration, Neutron Activation

Abstract: Using a special radiological research device which performs neutron-activated analysis in vivo, this study applied a technique for converting stable nuclide of calcium ^{48}Ca into the radionuclide ^{49}Ca , and subsequently registering the emitted gamma radiation, to measure the amount of Ca in the feet of 5 subjects. The transformation is achieved as a result of nuclear interactions, arising when the foot is irradiated with neutrons. Although the proportion of ^{48}Ca in the naturally occurring isotope is small, it forms a stable percentage of the calcium isotopes in human bone. Under constant conditions of radiation and spectrometry the magnitude of the recorded gamma radiation with energy of 3.08 MeV is strictly proportional to the amount of calcium in the foot. The apparatus is shown in Figures 1 and 2. The experiment was performed under conditions of error not to exceed 0.05 with an equivalent dose no greater than 3 rem. Conservatively calculated average equivalent dose in this procedure was 1 rem. This would permit three investigations of this type to occur in a year without exceeding safety standards. Maximum estimated error, computed on the basis of repeated measurements, did not exceed 4.82 percent. This method is recommended for use in space and clinical medicine.

Figure and Table Titles: Table: Results of in vivo neutron activated analysis of Ca in the foot.

P243

Figure 1: Device for irradiating the foot with neutrons.

1 - lithium containing screens; 2 - stainless steel tub filled with water; 3 - support for the foot, attached to bottom; 4 - cassettes with neutron sources; the arrows indicate the possible positions of the cassettes; 5 - concrete support ; 6 - ground.

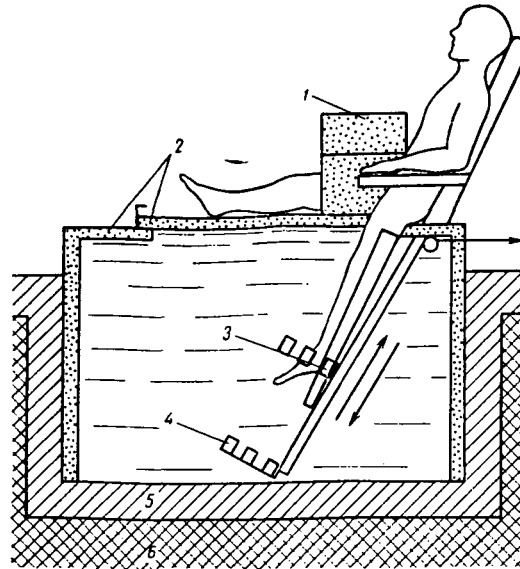

Figure 2: Position of foot support and cassettes with neutron sources while the foot is being irradiated. 1 - neutron sources in cylinders; 2 - U-shaped stainless steel plate, to which thin-walled containers for neutron sources are attached; 3 - heel rest; 4 - stop for the cassettes; 5 - removable rods, determining position of the foot; 6 - rubber yoke holding the foot to the plane of the support.

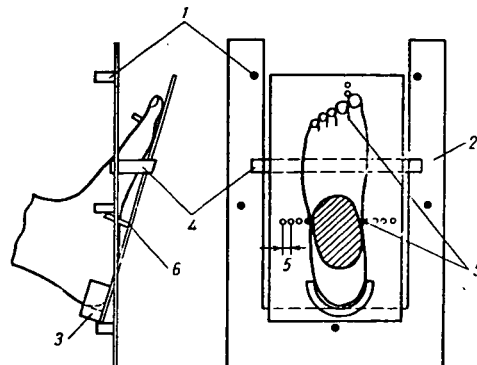

Figure 3: Diagram of the arrangement of the crystal of scintillation detectors in the spectrometric device (Not reproduced)

P259(4/86) Tambovtseva RV, Korniyenko IA.

The development of various types of fibers of the soleus muscle in postnatal ontogenesis in rats.

Arkhir anatomii, gistologii i embriologii.

90(1): 77-81; 1986.

[19 references; 14 in English]

Laboratory of Metabolism and Energy, Scientific Research Institute for the Physiology of Children and Adolescents, USSR Academy of Pedagogical Sciences, Moscow

Musculoskeletal System, Soleus Muscle, Fibers

Rats

Development, Muscle Development

Abstract: The soleus muscle of male and female Wistar rats in 20 age groups (n=10) ranging from 1 to 175 days were studied. The animals, which had been kept under standard laboratory conditions, were sacrificed and their muscles were isolated and frozen in liquid nitrogen and the ATPase myosin activity of a cryogenic cross section was determined after preincubation in an acid or basic medium. Three types of fibers can be identified in the acid medium -- oxidizing, oxidizing-glycolytic and glycolytic, and two types in the basic medium -- oxidizing-glycolytic and glycolytic. Activity of succinate dehydrogenase and lactate dehydrogenase were also determined. The relative content of muscle fibers of various types were determined using a micrometer. Results of the study indicated that the soleus muscle in rats goes through three developmental stages. In the first, lasting from birth to 7 days, there is no distinction among the different types of muscle fiber. In the second stage, lasting from day 7 until day 175 in males and until day 60-70 in females, two types of differentiated muscle fiber appear. Throughout this period glycolytic fibers are actively transformed into oxidizing-glycolytic fibers. This is followed by transformation of the latter into oxidizing fibers. In the third stage (male rats older than 175 days, female rats older than 60-70 days) the differentiation process is completed. The soleus muscle becomes homogeneous consisting only of oxidizing fibers.

Figure Title: Changes in muscle fibers of the soleus muscle of rats with age

P263(4/86) Strongina OM, Kuchma VR.

Use of ergometric parameters to predict fatigue of the neuromuscular system of the hands.

Gigiyena Truda i Professional'nyye Zabolevaniya.

1986(1): 49.

[3 references; none in English]

I.M. Sechenov Medical Institute, Moscow

Musculoskeletal System, Muscle Fatigue, Hands

Humans, Females

Human Performance, Ergometric Parameters

Abstract: This study attempted to determine the influence of individual components of static and dynamic work on the development of fatigue in female workers. The criterion selected for level of muscle fatigue was tolerance of static force. Since the recommended acceptable limit is a decrease of 20% in this parameter after 7-8 hours of work, exceeding this criterion was operationally defined as unacceptable fatigue. Occupations were studied in which job tasks were associated primarily with static components (e.g, machine tool operators) and in which dynamic physical demands predominated (e.g., mail sorters). Parameters of job tasks considered included, for static jobs: number of motions per shift, amount of force applied [presumably for each motion], length of time force had to be maintained; for dynamic jobs: number of motions, number of units processed, and magnitude of dynamic work per shift. Probability of hand fatigue as a function of these parameters was determined. Unacceptable levels of fatigue were predicted for women if static work involved more than 6000 motions per shift, and/or if the force which needed to be applied exceeded 4 kg and had to be maintained for longer than 3 seconds. For dynamic jobs it was determined that fatigue was likely to result if 3000 or more units weighing 10 kg or more were involved, and/or work performed was greater than 4,0000 kg per shift.

P274(4/86) Chaikovskii VS, Yevtinova IV, Basharina OB.

Concentration of steroids and androgen receptors in skeletal muscles during adaptation to physical exercise.

Voprosy Meditsinskoy Khimii.

31(6): 80-86; 1985.

[21 references; 16 in English]

Scientific Research Institute of Physical Culture, Leningrad

Musculoskeletal System, Skeletal Muscles, Endocrinology, Testosterone, Estradiol, Androstenedione, Receptor Binding
Rats, Males and Females; Reproductive Biology, Sex Differences
Adaptation, Physical Exercise

Abstract: The objective of this experiment was investigation of the effect of a single exposure to physical exertion on the concentration of steroid hormones in blood serum, skeletal muscles, and reception of androgens in the muscle cytosol. Male and female white rats served as subjects. Three experiments were performed. In the first two, the animals were divided into 10 groups of 10 rats each. In nine of these groups in a single session, the rats were compelled to swim in water at 30-32°C carrying weights 12% of their body weight for 6-7 one minute intervals with 1.5 minutes of rest between them. The tenth group of rats was a non-treated control. Animals were studied directly after the exercise session and 2, 4, 12, 24, 48, 72, 96 and 144 hours afterward. In Experiment I, concentrations of testosterone, androstenedione, and estradiol in the cytosol of the skeletal muscles, heart and blood serum were determined; in Experiment II, only testosterone and estradiol were measured. Radio immune assay methods were used. In Experiment III, rats were not subjected to exercise and were divided into 4 groups of 10 rats each. Three of the groups were given intraperitoneal doses of benzoate estradiol of 1.0, 0.1 or 0.05 mg per 1 kg body weight once a day for 3 days; the fourth group was a control. Twenty-four hours after the last dose, the concentrations of the listed hormones listed in the blood were measured. In Experiment I and III, the level of androgen receptors in the cytosol was determined by measuring receptor binding.

The effects of physical exercise on concentrations of the three hormones studied in male rats [Experiment I] were similar in the blood, heart and skeletal muscle. For each hormone, there were two major peaks in concentration compared to control levels. These occurred immediately after exercise for all three hormones, 48 hours later for androstenedione and estradiol, and 72 hours later for testosterone. Testosterone and androstenedione increased by 36 and 10 %, respectively; while estradiol increased by 430 %. Results with female rats [Experiment II] were generally analogous to those with males. Again there were two major peaks in the content of testosterone and estradiol in the blood and skeletal muscles, occurring immediately and 24-48 hours after exercise. There were also some significant differences; testosterone peaked in muscles after four hours of rest when its level in the blood had already started to decrease. In addition, increase in testosterone in skeletal muscles was substantially greater in terms of percentage of baseline level (277% vs. 36%) for females than for males; while estradiol increases were less (254% vs. 430%) for females. After 72 hours there was a sharp drop in levels of testosterone and estradiol in the blood and muscles of female rats to

P274

considerably below control levels, while at the same interval testosterone content in males was still elevated. The authors interpret these results as demonstration of the multiple function of the regulatory effects of sex hormones on metabolic process in response to physical exertion in males and females. These effects do not pertain only to support of anabolic processes, but are probably also relevant to supply of energy to muscle activity.

When androgen binding was studied in the cytosols of male and female rats at various interval after exercise, evidence was found for the cyclic nature of hormone regulation of metabolism in the skeletal muscles after exercise. The two major phases of this process were tentatively identified as: 1) anabolic phase or androgen satiation, marked by increase of content of both androgens and their specific receptors in the cells (48-72 hours after exercise for males; 48 hours for females); 2) androgen deficit marked by increases in androgen receptors in the cytosol with insufficient hormonal support (2 and 144 hours after exercise for males, 96 hours after for females). Comparison of time course for all the levels indicated that increases in the concentration of estradiol of rats of both sexes preceded increases in androgen receptor concentration, leading to the hypothesis that estradiol regulates the concentration and activity of cytoplasmic androgen receptors in target organs, increasing their sensitivity. This was confirmed by Experiment III where it was found that administration of estradiol decreased concentrations of testosterone and androstenedione in the blood, while increasing androgen binding in the muscles.

Table and Figure Captions: Table: Effect of estradiol on the content of steroids in the blood and binding of androgen by receptors in the muscles

P274

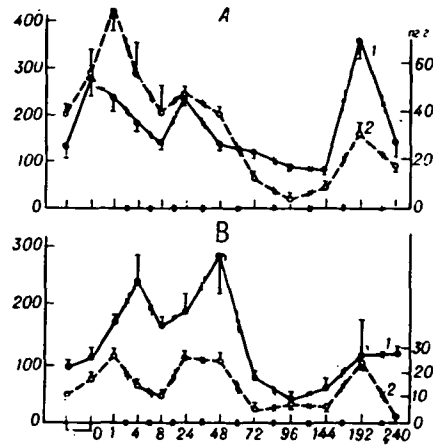
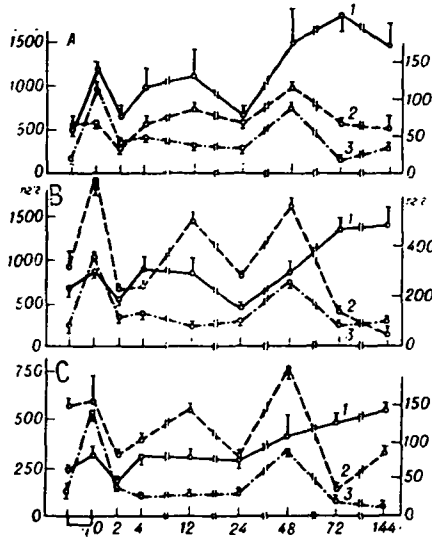

Figure 1. Effect of physical exercise on concentration of testosterone (1), androstenedione (2; scale on left) and estradiol (3; scale on right) in the blood (A), heart (B) and muscles (C) of male rats

Figure 2. Effects of physical exercise on concentration of testosterone (1) and estradiol (2) in the blood (A) and muscles (B) of female rats

Figure 3. Effect of physical exercise on specific binding of androgens in the cytosols of the muscles of male rats.

Figure 4. Effect of physical exercise on specific binding of androgens in the cytosols of the muscles of female rats.

P242(4/86)* Mel'nichenko VP, Gol'dovskaya MD, Krotov VP, Popov AG, Kondakova IS, Gorbatenkova NV.

A restraint system for use with conscious Macaca Mulatta monkeys in tilt tests.

Kosmicheskaya Biologiya i Aviakosmicheskaya Meditsina.

20(1): 73-74; 1986.

[2 references; none in English]

Musculoskeletal System, Equipment and Instrumentation, Restraint System
Monkeys
Gravitational Effects, Tilt Test

Abstract: Upright posture and phylogenetic similarity to humans are characteristics that make monkeys appropriate laboratory subjects for tilt tests intended to study various gravitational effects. However, when use of conscious animals is called for, measures must be taken to restrain motor activity. This paper describes a restraint system for use with Macaca Mulatta monkeys on a tilt table. This system consists of a restraint suit, a U-shaped "chin strap" to minimize head movement, and a "saddle" device to prevent the body from shifting in the upright position.

Figure Titles: Figure 1: Suit for restraining a monkey on a tilt table.

Figure 2: Overall view of the system for restraining a monkey on a tilt table.

MONOGRAPH:

M71(4/86) Person RS.

Spinal'nyye mekhanizmy upravleniya myshechnym sokrashcheniyem
[Spinal mechanisms for controlling muscle contraction].

Moscow: Nauka; 1985.

[ca. 185 pages; 4 tables; 60 illustration; 21 pages of references]
Institute for Problems of Information Transmission, USSR Academy of
Sciences

Key Words: Musculoskeletal System, Muscle Contraction, Electromyography;
Neurophysiology, Spinal Control, Motor Neurons

Annotation: This book synthesizes and summarizes the results of original research and data from the literature on the functioning of the motor neurons in the performance of different types of movements. With reference to data from experimental neurophysiology, and also to the results of studies of impulse activation in human motor units in voluntary muscle contraction, the following issues are explored: the performance of a single motor neuron (frequency of impulse propagation and discharge pattern, the controlling function of the motor neuron pool), recruitment of motor neurons and the possibility of their differentiated selection as a function of type of motor task, control of the motor neuron pool through inhibitory feedback and through the multisynapse reflex from the initial endings of the spindles, the role of presynaptic inhibition in control of this reflex, etc. This book is intended for scientists and teachers working in the areas of neurophysiology and motor physiology, and also for physicians dealing with motor disturbances and specialists in clinical electromyography.

CONTENTS

(Numbers in parentheses refer to page numbers in the original.)

Introduction (3)

Chapter 1: Research Methods (7)

- Research methods for studying impulse propagation of human motor neurons during voluntary motor contraction (7)
- Research methods for studying the response of human motor neurons to orthodromic and antidromic stimulation (13)

Chapter 2: Organization of the Functioning of the Motor Neuron Pool in Voluntary Muscle Contraction (15)

- The controlling functions of motor neurons and the motor neuron pool (15)
- Functional differentiation of motor units (17)
- The role of recruitment of motor units and changes in frequency of impulse propagation along them in control of muscle contractions (22)
- Differentiated control of motor units (56)
- Patterns of motor neuron discharge in different types of muscle contraction(78)
- Temporal parameters of motor neuron firing (96)

M71

Initiation of motor neuron pool activity (106)

Concluding remarks about the functioning of the motor pool (110)

Chapter 3: Some Spinal Mechanisms Controlling the Motor Neuron Pool (111)

Participation of inhibitory feedback in the organization of the functioning of the motor neuron pool (115)

Reflexes from the primary spindle endings (123)

Conclusion (162)

References (163)

NEUROPHYSIOLOGY

(See also: Cardiovascular and Respiratory Systems: P229, P268;
Musculoskeletal System: M71; Human Performance: M76)

PAPERS:

P227(4/86)* Petrenko YeT, Yermukhametova LA.

The effect of rhythmic visual noise (light flashes) on human encephalograms and efficiency of movements during task performance.

Kosmicheskaya Biologiya i Aviakosmicheskaya Meditsina.

20(1): 22-25; 1986.

[16 references; 3 in English]

Neurophysiology, EEG; Musculoskeletal System, Motor Control

Humans

Perception, Visual Noise

Abstract: Electorencephalography of 12 areas of the neocortex was recorded for 20 subjects, aged 19-22, as they tried to maintain their balance while standing on one foot. Oscillations of the body's center of gravity were recorded as an index of task performance success. Subjects either performed the task under normal conditions or in the presence of flickering light with intensity of 30,000 lux and frequency of 12 Hz. The flickering light was associated with significant decreases of the length of time balance was maintained and increases in the amplitude and frequency of shifts in center of gravity. These effects were associated with changes in the EEG. For example, the light increased the density of biopotentials at a frequency corresponding to rate of flickering. Density of maximum peaks also increased, most markedly in the visual, infraparietal, sensorimotor, left premotor areas and the areas of the motor muscles of the right leg and arm. The stimulation also increased bipolar coherence in the premotor, motor, and sensorimotor areas. On the basis of the data obtained, it is suggested that the light flashes interfere with motor task performance by disrupting the optimal spatial-temporal interactions among the centers of the neocortex functionally responsible for performance of motor acts. Some subjects were found to be resistant to the disruptive effects of the flickering light.

Table and Figure Titles: Figure 1: Autospectrogram of the left premotor area, motor representation of the muscles of the right arm, muscles of the right leg, left sensorimotor area of subject T

Figure 2. Coherence spectra of biopotentials of the neocortex of the left premotor area and motor representation of the muscles of the right leg, left sensorimotor area and motor representation of the muscles of the right leg and right arm for subject M.

P253(4/86) Grigor'yev AI, Nichiporuk IA, Arzamazov GS.

On the role of changes in hormonal status in the development of motion sickness in humans.

Fiziologiya Cheloveka.

12(1): 76-81; 1986.

[44 references; 16 in English]

Neurophysiology, Vestibular System, Motion Sickness, Tolerance Level
Humans, Males, Typology
Endocrinology, Hormones, ACTH, ADH, Aldosterone

Abstract: Eight healthy male non-pilots, aged 25 to 40, were divided into two groups on the basis of vestibular-autonomic tolerance. Motion sickness was induced by subjecting individuals to angular acceleration and linear acceleration varying in sign. Subjects were rotated on a stand in a prone position, around the long axis of the body until motion sickness occurred (intolerant group) or for a set period of time (tolerant group). Venous blood was taken a day before rotation (baseline) and again 10-15 minutes after treatment, while clinical symptoms of motion sickness persisted. The concentrations of adrenocorticotrophic hormone (ACTH), somatotrophic hormone (STH), antidiuretic hormone (ADH), prolactin, hydrocortisone, and aldosterone were determined by radioimmune assay. Results were analyzed using analysis of variance for small samples. There were no significant differences in hormone levels of the two groups during the baseline period, although ADH levels were elevated above the norm in both. After rotation, the only change in tolerant individuals was an insignificant increase in ACTH and a decrease in aldosterone. Levels of all measured hormones increased significantly in the non-tolerant individuals, all of whom demonstrated pronounced symptoms of motion sickness. The authors offer a hypothesis that increased hormonal activity during motion sickness is, first, the result of inclusion of the hypothalamo-pituitary system in the excitation locus of the central nervous system (which occurs during stimulation leading to motion sickness) and, secondly, of the development of an adaptive reaction to the provocative stimulus. They discuss the possible participation of endogenous morphine-like compounds in hormonal responses to vestibular stimulation as a connecting link between the nervous and endocrinological systems. They stress the importance of an integrated investigation of all levels of the neuroendocrine system during development of space motion sickness.

Table and Figure: Table: Individual differences in the concentration of hormones in blood plasma after rotation and in a baseline period

P253

Figure: Changes in concentration of hormones in blood plasma after vestibular stimulation in subjects with varying degrees of tolerance; Light bars: before treatment (n=8); hatched bars: after treatment; single hatched: low tolerance (n=5); cross-hatched: high tolerance (n=3).

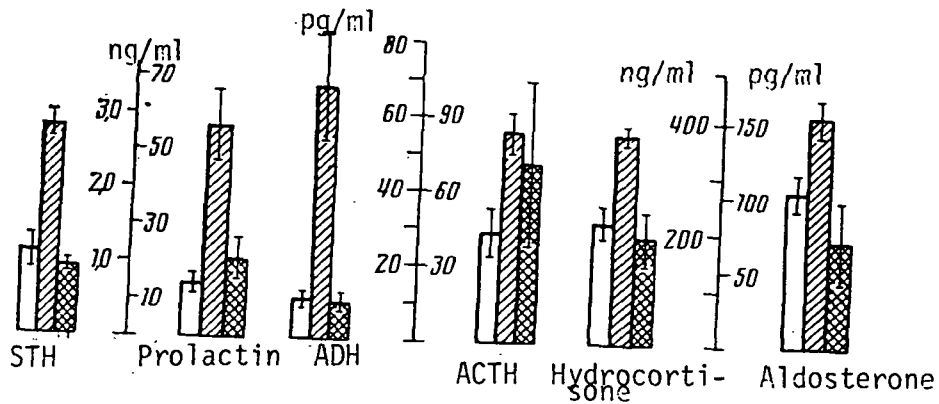

P254(4/86) Smetanin BN, Shlykov VYu, Kudinova MP.

Ameliorative effect of voluntary movements on the vestibular motor reaction.

Fiziologiya Cheloveka.

12(1): 133-140; 1986.

[12 references; 7 in English]

Institute for Problems in Information Transmission, USSR Academy of Sciences, Moscow.

Neurophysiology, Vestibular Stimulation

Humans

Musculoskeletal System, Voluntary Movements

Abstract: Fourteen individuals, aged 25-40, participated in this study. Subjects stood on a "stabilimeter" platform while the vestibular system was stimulated with electrodes, one placed on the right temple, the other on the left forearm. At the same time, subjects were required to make specified voluntary motions at the sound of a tone. These included some which destabilize vertical balance (e.g., rising to stand on the toes) and some (e.g., arm movements) with no appreciable effect on balance. During this treatment, electromyographic records were made of the muscles of the leg, pelvis, and trunk instrumental in maintaining balance. In addition, subjects were asked to describe their sensations. Electrical stimulation led to a pronounced deflection of the body to the right requiring compensatory movements to maintain balance. The magnitudes of the muscle movements were directly related to the strength of the electric current, which varied from 0.05 to 3.0 Ma. The requirement to stand on the toes enhanced the effects of the stimulation, so that a weaker signal evoked compensatory reactions. However, continuous stimulation with weak current, which led to deflection of the body throughout the entire stimulation period when the subject was standing still, caused only a short period of deflection when the subject simultaneously performed movements such as standing on the toes. Not all voluntary movements had the same effects on response to vestibular stimulation. Providing subjects with additional body support (hand holds) during stimulation and voluntary movements had no effect on the influence of the movements on vestibulomotor responses. The more pronounced the changes in body position associated with the movement, the greater the amplitude of the vestibulomotor reaction. Involuntary movements (evoked by direct stimulation of leg muscles) similar to the most effective voluntary ones had only a very weak effect on vestibulomotor reactions.

Figure Titles: Figure 1: Effect of monoaural electric stimulation of the vestibular apparatus on maintenance of balance in the frontal plane

Figure 2: Change in vestibulomotor reactions on simultaneous performance of voluntary movement of standing on the toes at various times after the beginning of vestibular stimulation

Figure 3: Rising to stand on the toes with and without concurrent vestibular stimulation

Figure 4: The effect of providing additional support while subject rises to stand on the toes on the magnitude of the vestibulomotor reaction

P257(4/86) Matsnev EI, Kuz'min MP, Zakharova LN.

Comparative evaluation of the effectiveness of vestibular, optokinetic and optovestibular stimulation in inducing experimental motion sickness.

Vestnik Otorino-Laringologii.

1986(1): 10-17.

[30 references; 23 in English]

Institute of Biomedical Problems, USSR Ministry of Health.

Neurophysiology, Motion Sickness Induction, Tolerance
Humans, Males, Individual Differences; Personnel Selection
Vestibular and Optokinetic Stimulation, Acceleration

Abstract: The goal of this experiment was to compare the effectiveness of vestibular, optokinetic and optovestibular stimulation in inducing experimental motion sickness. Twenty-nine healthy males participated as subjects. Of these, 17 (Group 1) displayed a high degree of vestibular tolerance; and 12 (Group 2) a low degree of such tolerance. The experiments utilized an electrically powered rotating chair and a drum with a screen with black and white vertical and diagonal stripes. In all conditions the subject was seated in the chair; in the vestibular condition only the chair was rotated (precessional left and right Coriolis acceleration, continuous Coriolis acceleration either to the right or left); in the optokinetic condition the drum was rotated (continuously to the right and left; discretely to the right and left; continuous to the right and left with subject required to bow his head in the frontal plane) and in the optovestibular condition both were rotated (Coriolis acceleration and tracking of vertical and diagonal stripes with chair rotating right and left, simultaneous vestibular stimulation and tracking of stripes moving in the same direction; simultaneous vestibular and stimulation and tracking of stripes moving in the opposite direction; gradually increasing Coriolis stimulation and simultaneous optokinetic stimulation in both same and opposite direction). Parameters measured included: nystagmometric parameters; rated severity and duration of motion sickness symptoms; ophthalmic diastolic pressure in the central retinal artery (before and after each type of stimulation); dark adaptation and visual acuity; and muscular equilibrium and tonus of the eye muscles.

For both groups of subjects, severity of induced motion sickness was greatest in response to Coriolis acceleration, and leftward acceleration led to more severe symptoms than rightward acceleration. Tolerant individuals showed no symptoms to optokinetic stimulation; while less tolerant subjects showed symptoms only under discrete stimulation and when stimulation was accompanied by pseudo-Coriolis acceleration. Of the optovestibular conditions, tolerant subjects showed symptoms of motion sickness only when leftward rotation of the chair was combined with tracking of motionless stripes. Less tolerant subjects showed symptoms of motion sickness in all optovestibular conditions, particularly when rotation was accompanied by tracking of motionless stripes. Frequency, amplitude and, particularly, slow phase speed of nystagmus in response to vestibular stimulation was greater in the less tolerant subjects. Optokinetic stimulation tended to be associated with increased nystagmic parameters for less tolerant subjects and this effect increased as a function of speed of stimulation. Examination of nystagmic gain under discrete and continuous optokinetic stimulation

P257

indicated that this coefficient decreased when the latter increased in speed, but, contrary to expectation, it was higher for people prone to motion sickness than for resistant individuals. Sick-prone individuals were more likely to show nystagmic dysrhythmia and reversion in response to optokinetic and optovestibular stimulation. These same individuals tended to show sensory symptoms, e.g., illusions, under all experimental conditions. No effects on blood pressure or heart or respiration rate were noted. Tendency toward motion sickness was associated with decreased rate of dark adaptation under the experimental conditions. No effects were found on diastolic pressure in the retina. Study of close vision in less tolerant subjects revealed increase in tonus in the internal musculus rectus of the eye. The authors conclude that autonomic/vestibular symptoms of experimental motion sickness are most likely to occur in response to vestibular stimulation, while illusions are most likely to occur under optokinetic stimulation. The most effective way to induce motion sickness in tolerant individuals is the combination of Coriolis acceleration and tracking of fixed visual stimuli. The differences in nystagmic parameters in tolerant and intolerant individuals in response to all types of stimulation studied indicates the utility of such parameters in predicting susceptibility.

Table and Figure Captions: Table 1: Experimental conditions

Table 2: Severity of autonomic/vestibular symptoms of motion sickness in individuals with varying degrees of tolerance in response to vestibular, optokinetic and optovestibular stimulation

Table 3: Parameters of postrotation nystagmus in tolerant and susceptible individuals in response to vestibular stimulation

Subject Group	Stimulation Condition	Duration, sec.	Frequency, Hz	Amplitude, degrees	Slow Phase Rate, deg/sec
1	I	28.1	2.2	3.9	39.2
	II	26.8	2.3	8.9	39.8
	III	28.5	2.3	6.8	33.1
2	I	30.7	2.8	12.0	63.9
	II	29.3	3.0	10.1	61.9
	III	28.8	3.3	10.3	76.0

1-tolerant; 2-less tolerant; I-Precessional Coriolis acceleration, rotation to right and left, 10 minutes; II - Continuous Coriolis acceleration to the right, 10 minutes; III - Continuous Coriolis acceleration to the left, 10 minutes

Figure 1: Main types of stimulation used to induce motion sickness vestibularly, optokinetically and optovestibularly

Figure 2: Severity of vestibular symptoms in vestibularly, optokinetically and optovestibularly induced motion sickness

P257

Figure 3: Typical electronystagmogram for vestibularly tolerant and intolerant individuals subjected to Coriolis acceleration ($20^\circ=20$ mm).

Figure 4: Ratio of rate of slow phase nystagmus and rate of optokinetic stimulation (gain)

P258(4/86) Gavrilin VK.

The otolithic reflex of ocular counterrolling in healthy individuals

Zhurnal ushnykh, nosovykh i gorlovykh bolezney

1986(1): 40-45.

[25 references; 9 in English]

Institute of Biomedical Problems, Moscow

Neurophysiology, Ocular Counterrolling

Humans, Males

Individual Differences, Normative Values

Abstract: This study investigated ocular counterrolling in 100 healthy men, aged 24-41. Subjects were placed in a dark room with 2-3 minutes of preliminary dark adaptation. The experimental method involved determining the angle of displacement of a visual afterimage after subjects shifted position from vertical to the horizontal. Estimates were made five times each for the right and left sides and averaged. Test sessions were repeated more than once at intervals of 20-40 days for 44 of the subjects. Maximum intraindividual variation in a given direction ranged over five trials between 0° and 4° indicating adequate reliability. Interindividual variability was much higher and allowed each individual to be classified as exhibiting a normal reflex (7 to 18°), hyporeflex ($< 7^{\circ}$) or hyperreflex ($> 18^{\circ}$ /maximum was 44°). The authors draw the following conclusions: 1. Healthy males, aged 24-41, exhibit ocular counterrolling averaging $12.84 \pm 0.81^{\circ}$ on the right side and $13.03 \pm 0.80^{\circ}$ for the left side using this experimental methodology. 2. Of the total group, 50 percent exhibited a normal reflex, 27 percent hyporeflexia and 23 percent hyperreflexia. Asymmetry (greater counterrolling on one side than on the other) of ocular counterrolling was observed in 50 of the 100 subjects and ranged from 0.2 to 26.2° , averaging 5.85° . Asymmetry occurred with equal frequency and magnitude in both directions. Changes occurred in one or another counterrolling parameter in 11 out of 44 individuals for whom repeated measurements were made.

MONOGRAPH:

M75(4/86) Kondrachuk AV, Sirenko SP.

Dinamika kupula v polikruzhnom kanale vestibulyarnogo analizatora
[The dynamics of the cupula in the semicircular canal of the vestibular system].

Kiev: Akademiya Nauk UkSSR; 1985.

[23 pages; 6 figures; 11 references; 4 in English]

Physics Institute, Ukrainian Academy of Sciences

Key Words: Neurophysiology, Vestibular System, Cupula; Mathematical Modeling, Angular Acceleration

Annotation: This pamphlet presents and examines a mathematical model of the cupula-endolymphic portion of the vestibular (afferent) system, as it responds to angular accelerations. The equation obtained to describe the motion of the cupula can be transformed into the well-known Shteinhausen equation when the assumptions are made that the torus is thin and the difference in the densities of the cupula and endolymph is zero. It is demonstrated that when there is even a small difference in these densities (more than 10^{-6} g/cm³), the dynamics of the cupula become substantially more complex, which may account for the deterioration of vestibular functioning under conditions of periodic provocative stimulation and altered gravity.

CONTENTS

(Numbers in parentheses refer to page numbers in the original.)

Introduction (3)

1. The structure of the semicircular canal system (4)

2. Statement of the problem (5)

3. A mathematical model. Derivation of equations of motion for the cupula endolymphic system (7)

4. Analysis of the equation of motion for the cupula (13)

5. Evaluation and discussion (18)

References (22)

NUTRITION

(See also: Metabolism: P228)

PAPER:

P237(4/86)* Belakovskiy MS, Yuzhanskaya MG, Panferova NYe, Pastushkova LKh, Pereverzeva OG, Smirnova AN, Sergeev IN, Spirichev VB.

The effects of various doses of ultraviolet radiation on levels of vitamins in the human body.

Kosmicheskay Biologiya i Aviakosmicheskaya Meditsina.

20(1): 56-61; 1986.

[15 references; 4 in English]

Nutrition, Vitamins

Humans, Males

Radiobiology, Ultraviolet

Abstract: Two groups of healthy men (N not specified) were given 20 sessions of ultraviolet radiation (dose rate 0.97 W/m^2 , wavelength ranging from 280 to 400 nm) over a period of 40 days. Group 1 received 0.75 minimal erythemic dose and Group 2 received from 0.5 to 3 erythemic doses in each session. After 10 sessions the mean total irradiation time per subject was 112 min for Group 1 and 93 for Group 2. Throughout the experiment the subjects received a standardized diet containing adequate amounts of vitamins. Before the experiment, after 10 and 20 ultraviolet sessions and during the recovery period, venous blood was taken from each subject and the concentrations of Vitamin A, carotenoids, Vitamin E, folic acid, Vitamin C, Vitamin B₁₂, and 25-hydroxy D in blood serum were determined. Concentrations of calcium, phosphorus, and activity of alkaline phosphatases were also measured, as was renal excretion of thiamine, riboflavin and N₁-methylnicotinamide. Changes in serum vitamin levels at various points in the experimental procedure can be seen in Table 1. The authors conclude that, for the values used in this experiment, the size of the dose of ultraviolet radiation does not influence the effects of this radiation if the time of irradiation per session and the number of sessions remains the same. The increased concentration of Vitamins A, E and D demonstrates the stimulating effect of ultraviolet radiation on vitamin metabolism. The decrease in ascorbic acid suggests that individuals undergoing ultraviolet irradiation require supplemental doses of Vitamin C. While Vitamin D levels continued to increase after 10 irradiation sessions and into the recovery period, this was not the case with the other vitamins indicating perhaps some degree of dietary overdose. Increased excretion of riboflavin and N₁-methylnicotinamide had similar implications.

Table and Figure Titles: Figure 1: Changes in the concentration of vitamins in blood serum after ultraviolet radiation.

Figure 2: Change in daily renal excretion of vitamins during exposure to ultraviolet radiation

P237

Table 1: Concentration of vitamins in the blood of subjects before, during and after ultraviolet radiation

Group Time	A, mkg/ 100 ml	Carotin- oids, mkg/ 100 ml	C, mg/ 100 ml	E, mg/ 100 ml	B ₁₂ , pg pg/ml	Folic acid ng/ml
Group 1						
Baseline	63.3	108.6	1.26	0.99	724	5.90
After 10 sessions	94.9	128.0	1.55	1.28	671	5.20
After 20 sessions	--	--	1.08	1.39	708	6.20
Recovery period	75.10	93.1	1.05	0.90	703	5.20
Group 2						
Baseline	55.7	149.6	1.29	1.11	562	4.4
After 10 sessions	74.7	185.8	1.05	0.90	703	3.8
After 20 sessions	--	--	1.04	1.20	620	5.2
Recovery period	82.2	156.10	1.12	1.16	663	5.3
Group Time	25-OH-D, ng/ml	Ca, mg/ 100 ml	Pi, mg/ 100 ml	Alkaline Phosphatase, mE/ml		
Group 1						
Baseline	42.30	9.9	4.1	50.9		
After 10 sessions	48.70	10.3	4.5	50.4		
After 20 sessions	57.00	10.3	4.7	50.7		
Recovery period	65.30	9.9	5.4	49.9		
Group 2						
Baseline	32.70	9.7	4.5	49.7		
After 10 sessions	45.70	10.2	4.7	50.2		
After 20 sessions	51.00	10.3	4.6	48.3		
Recovery period	77.30	10.4	5.3	51.3		

Table 2: Daily renal excretion of vitamins and their metabolites in subjects (N=3) receiving various doses of ultraviolet radiation (not reproduced)

P252(4/86) Koshkenbayev BKh, Tazhibayev ShS, Maksimenko VB,
Sisemaliyeva ZhS.

The effect of protein and vitamin deficiencies on lipolytic activity of enzymes and synthesis of cholesterol esters during exposure to hypokinesia.

Voprosy Pitaniya.

1985(6): 53-57.

[22 references; 9 in English]

Metabolism Laboratory, Kazakh Affiliate, Nutrition Institute, USSR
Academy of Sciences, Alma-Ata.

Nutrition, Protein and Vitamin Deficiencies; Enzymology; Metabolism,
Lipolysis, Cholesterol
Rats, Males
Hypokinesia

Abstract: Male August rats were divided into eight groups. Groups 1 to 4 (N for these groups cited as 8, not clear whether this is total for all 4 groups or for each one) were allowed normal physical activity. Group 1 was fed a balanced diet; Group 2 received a diet of wheat meal deficient in lysine, methionine, and threonine; Group 3 received a diet deficient in Vitamins A, E and C; Group 4 received a diet with both the above deficiencies. Groups 5 through 8 (n cited as 9) were kept under conditions of hypokinesia in an immobilization cage for 60 days; Group 5 received a balanced diet; Group 6 received the protein deficient diet; Group 7 received the vitamin deficient diet; Group 8 was given the vitamin and protein deficient diet. At the end of the 60-day period, blood serum was extracted from animals in all groups and activity of lipoprotein lipase and liver triglyceride lipase was determined. Thin layer chromatography was used to determine the concentration of lipid fractions and of cholesterol esters. Activity of lecithin cholesterol acyltransferase was also measured by combining blood samples for each group.

Hypokinesia decreased activity of lipoprotein lipase and liver triglyceride lipase for rats on all three diets, but to a significant degree only in those rats fed balanced diets. In terms of standardized units, lipoprotein lipase activity was greater than liver triglyceride lipase activity for all groups except for Group 8 rats (multiply deficient diet combined with hypokinesia), where the reverse was true, indicating an alteration of the lipolytic processes. Animals exposed to hypokinesia in combination with a balanced or multiply deficient diet showed a statistically significant increase in very low density serum lipids, and a decrease in high density lipoproteins. The groups exposed to hypokinesia and the singly deficient diets (as well as the group receiving protein deficient diet and normal activity) showed an increase over baseline of low density proteins. Concentration of serum phospholipids and triglycerides showed decreases under hypokinesia, to an extent varying with particular diet. Lowest levels of phospholipids were associated with balanced and multiply deficient diet and hypokinesia; while lowest levels of triglycerides were associated with the multiply unbalanced diet alone and in combination with hypokinesia. Results with lecithin cholesterol acyltransferase are described as paradoxical. The authors conclude that all the deficient diets modified the effects of hypokinesia on metabolism of serum lipids.

P252

Tables: Table 1: Effect of protein and vitamin deficiencies on lipoprotein lipase and liver triglyceride lipase in blood serum under conditions of hypokinesia

Table 2: Effect of protein and vitamin deficiencies on level of lipoproteins in blood serum under conditions of hypokinesia

Table 3: Effect of protein and vitamin deficiencies on concentration of total lipids in blood serum under conditions of hypokinesia

Experimental Treatment	Phospholipids	Free Fatty Acids	Triglycerides	Cholesterol Esters
Balanced Diet	3.73	0.64	0.80	1.89
Protein Deficit (Qualitative)	2.12*	0.05*	0.64	1.26
Vitamin Deficit (A, E & C)	1.71*	0.42	0.74	1.22
Multiple Deficit	2.19	1.73*	0.37*	1.36
Balanced & Hypokinesia	0.79*	1.35*	0.64	1.01
Protein Deficit & Hypokinesia	1.56	0.86	0.69	0.94
Vitamin Deficit & Hypokinesia	1.20*	0.92	0.38*	1.00
Multiple Deficit & Hypokinesia	0.98*	1.41*	0.55	1.46

Table 4: The effects of protein and vitamin deficiencies on concentrations of cholesterol esters in blood serum under conditions of hypokinesia

PERCEPTION

(See also: Neurophysiology: P227)

PAPER:

P262(4/86) Raushenbakh BV. (Interviewer: VN Artamanov)
Some psychological aspects of cosmonautics and aesthetics.

Psikhologicheskiy Zhurnal.

7(1): 77-82; 1986.

[No references]

Chair of Theoretical Mechanics, Moscow Physical Technical Institute;
Also USSR Academy of Sciences

Perception, Visual Geometry, Spatial Perception

Humans, Cosmonauts, Pilots

Psychology, Internal Representations; Space Flight, Soyuz Spacecraft

Abstract: In this interview, Academician B.V. Raushenbakh discusses how his work on the human engineering design of spacecraft led him to become interested in the psychology of perception and then in spatial representation in art. Since Soyuz space craft have no front windows, the pilots cannot see into space ahead of them, but must steer on the basis of a two-dimensional representation on a screen. It was found that such a representation did not provide adequate information to allow the pilot to create the veridical three-dimensional internal representation needed for his tasks. In order to determine what additional information was needed and how to present it, Raushenbakh examined the results of perceptual studies. He found that the study of the so-called perceptual constancies has been based almost exclusively on experiments performed indoors under idealized conditions, with the subject viewing an object at right angles. When Raushenbakh investigated these perceptual constancies outdoors under more natural conditions, he discovered that while the basic principles were the same, there were substantial quantitative differences between indoor and outdoor perception. Having established this, Raushenbakh proceeded to gather empirical perceptual data which was to be used to mathematically determine the geometrical properties of human three-dimensional perception, and thus to create a map of visual space. However, after closely examining this data, he concluded that this was not possible, i.e., that there is no single geometrical system capable of representing visual space without distortion. A representation attempting to avoid all distortions would entail superimposing images perceived as separate or having discontinuities in the visual space. However, [realistic] artists do not represent visual space this way but instead introduce one or another distortion which is perceptually accepted by the viewer. Raushenbakh went on to study the consciously or intuitively introduced distortions used by artists to represent what the brain sees.

PERSONNEL SELECTION: See Cardiovascular and Respiratory Systems: P250; Endocrinology: P256; Morphology and Cytology: P261; Neurophysiology: P257

PSYCHOLOGY

(See also: Adaptation: P264; Body Fluids: P265; Cardiovascular and Respiratory Systems: P229; Human Performance: M76; Metabolism: P245; P228; Perception: P262; Space Medicine: P251)

PAPERS:

P225(4/86)* Kozlovskiy AP, Kovalenko AF.

Psychological (emotional) stress in pilots awaiting ejection and its role in task performance.

Kosmicheskaya Biologiya i Aviakosmicheskaya Meditsina.

20(1): 16-19; 1986.

[3 references; none in English]

Psychology, Stress Symptoms; Human Factors, Task Performance
Humans, Pilots
Emotional Stress, Simulated Ejection

Abstract: Simulated ejection from an aircraft, using an ejection chair and an air stream was investigated in this study. Psychological stress was associated with values of parameters such as blood pressure, respiration rate, minute volume, oxygen consumption, and heat production. Subjects were also required to reproduce a given isometric tension at three second intervals. Performance parameters included reaction time, and accuracy in reproducing tension and time interval. Time between hearing the "Go" command and initiating ejection was also measured. Parameters were measured at unspecified intervals between 20-30 minutes before and 20-30 minutes after simulated ejection. Each of 21 flight certified pilots underwent between 2 and 40 simulated ejections. Heart rate increased from baseline as time of ejection approached, reaching a maximum between 5-10 seconds before and 5-10 seconds after ejection. Blood pressure behaved analogously, with the effect of stress on blood pressure extremely pronounced if subjects were concurrently required to breathe under elevated pressure. Minute volume, pulse rate, oxygen consumption and heat production also increased as ejection approached and continued to increase after the event, peaking at approximately two minutes post ejection. Task performance reaction time increased when subjects were seated in the ejection seat, and further increased when they heard the first hiss of the air stream. Reaction time between the "Go" command and the "ready to eject" signal was substantially longer than reaction times measured in isometric task performance. Delay in reaction time to eject increased with increases in velocity of the air stream. Performance on the isometric task worsened substantially when it was performed in temporal proximity to the simulated ejection. Error rate increases attributable to ejection did not depend on the parameters of the ejection simulation.

Table and Figure Titles: Table: Coefficient of the logistic functions of the type $y = \frac{100}{1 + 10^{a+bx}}$ for parameters of motor reactions

Figure 1: Values of indicators of emotional state of subjects at various times relative to time of simulated ejection

Figure 2: Change in motor reaction task performance parameters of subjects at various times relative to time of simulated ejection

P267(4/86) Yevstaf'yev VN, Netudykhatka OYu, Vigovskiy VI, Shayevich BK, Stoyanov AP.

Physiological and hygienic characteristics of work and rest schedules for seamen working under the brigade system.

Gigiyena i Sanitariya.

1986(2): 21-23.

[6 references; none in English]

Affiliate of the Scientific Research Institute for Hygiene in Water Transport, USSR Ministry of Health, Odessa

Psychology; Human Performance

Humans, Seamen

Work and Rest Schedules

Abstract: A number of new systems for structuring work on ships using labor brigades are being tried in the USSR. One of these new systems used on multipurpose cargo ships involves using brigades and a lengthened working day of 10-12 hours in transporting bulky cargos. This system was used on 3 ships for 10 cruises including 85 seaman. Seamen on ships of the same type working according to the old system were used as a control group. Hygiene and safety surveys of the ships indicated that, in general, health and safety standards were being followed, although some exceeding of recommended noise levels was noted. Under the brigade system ships' commanders and senior engineers worked one 4-hour watch per day. Other ship officers and engineers worked ten hours per day (2 four hour watches and 2 additional hours supervising); the remainder of the seamen worked 8 hours. When loading operations were occurring and at anchorage, most crew members worked 10 hours or more a day. This system allowed personnel to accumulate leave time sufficient to schedule 30 days of shore leave for every 30 days of work. Parameters measured in crewmembers working on both types of schedule included: reaction time for a simple acoustic-motor reaction, rate of visual information processing, critical flicker fusion, attention span, error rate in an information processing task, heart rate, systolic circulation/blood volume, minute circulation/blood volume, maximum inspiratory airflow, vital capacity on forced inspiration and expiration, and maximum hand strength. Measurements were made at the beginning and end of a 30-35 day cruise. On the basis of their results, the authors conclude that in general the brigade system schedule did not lead to significant changes in the parameters characterizing work capacity and physiological functions. Operators working on the brigade system showed higher values of parameters indicative of psychological functioning than those working on a traditional schedule, and seamen in jobs involving physical exertion showed higher physical work capacity under the brigade system. When seamen working on the brigade system were questioned, 75 % preferred the longer-day schedule, while an additional 15 % were indifferent or undecided.

MONOGRAPH:

M67(4/86) Kubasov VN, Taran VA, Maksimov SN.
 Professional'naya podgotovka kosmonavtov
[Professional Training of Cosmonauts.]
 Moscow: Mashinostroyeniye; 1985.
 [286 pages; illustrated; 100 references; 17 in English]

Key Words: Psychology, Cosmonaut Training, Human Performance, Man-Machine Systems, Performance Evaluation, Training Simulators

Annotation: This monograph describes the major methods and training devices used in the scientific and technical training of cosmonauts. The fundamentals of the theory of ergatic [Editors' note: apparently this word means "man-machine"] systems are presented. Existing ways of structuring the processes of instruction and [physical] training of cosmonauts and means of evaluating their performance are described. The design of instructional procedures is discussed. Instructional procedure development should be closely coordinated with the development of the technical systems with which the cosmonauts must interact as operators. This book is intended for engineers concerned with training operators of ergatic systems.

CONTENTS

(Numbers in parentheses refer to page numbers in the original.)

Foreword (3)

Chapter 1. Ergatic space systems (5)

- 1.1 The role and place of humans in space systems (5)
- 1.2 Ergatic systems and processes (14)
- 1.3 Ergatic processes on board spacecraft (26)
- 1.4 The working day of a cosmonaut on board a spacecraft (34)

Chapter 2. Requirements for professional training of cosmonauts as operators (55)

- 2.1 Tasks and functions of a cosmonaut-operator on board a spacecraft (55)
- 2.2 Control process requirements on a spacecraft (62)
- 2.3 Requirements for interaction between the cosmonaut-operator and the scientific and technological equipment on board the spacecraft (68)
- 2.4 General requirements for ergatic processes to deal with unforeseen (emergency) situations (71)
- 2.5 Some physiological, psychological and medical problems of spaceflight (84)

Chapter 3. Designing cosmonauts' jobs (96)

- 3.1 Psychological principles for designing human jobs in ergatic systems (96)
- 3.2 Analysis of the job of the cosmonaut-operator and crew of a spacecraft (99)
- 3.3 Interaction between the cosmonaut-operator and the equipment on board a spacecraft (109)
- 3.4 Group interactions within a spacecraft crew (118)

M67

Chapter 4. Scientific and technological training of cosmonaut-operators (129)

- 4.1 Principles for designing instructional methods and models for training specialists (129)
- 4.2 Development of job simulations (139)
- 4.3 Principles of scientific and technical training of cosmonaut-operators (158)
- 4.4 Methods and models for the job training of cosmonaut-operators (168)
- 4.5 Development of simulations of the job of cosmonaut-operators in emergency situations (173)

Chapter 5. Training devices for cosmonaut-operators (179)

- 5.1 A taxonomy of training devices for cosmonaut-operators (179)
- 5.2 Evaluating the appropriateness of training devices (187)
- 5.3 Adequacy of training devices (189)
- 5.4 Analysis of the effectiveness of training devices (197)
- 5.5 Problems in development of training devices for cosmonaut-operators on board spacecraft (199)

Chapter 6. Evaluating the scientific and technical training of cosmonaut-operators (206)

- 6.1 Fundamental concepts in the theory of evaluating job performance (206)
- 6.2 Stage by stage evaluation of the training of a cosmonaut-operator (212)
- 6.3 Practical evaluation of the level of preparation of an individual cosmonaut-operator (215)
- 6.4 Evaluating the level of theoretical and practical training of cosmonaut operators to perform in an emergency (222)

Chapter 7. Analyzing the efficiency of cosmonaut-operator job performance and job-performance training (233)

- 7.1 Analysing remarks made in the course of job performance by cosmonaut-operators (233)
- 7.2 A methodology for analyzing the efficiency of the scientific and technical performance of a cosmonaut-operator (242)
- 7.3 Determining length of training for a cosmonaut-operator (248)
- 7.4 Using competition to improve the efficiency of training of cosmonaut-operators (250)

Chapter 8. Prospects for the further development of jobs of cosmonaut-operators (262)

- 8.1 Issues for space research and structuring of the jobs of cosmonaut-operators (262)
- 8.2 Some problems in the development of procedures for training cosmonaut-operators to control a spacecraft (268)
- 8.3 Some problems in developing procedures for training cosmonaut operators to work with scientific instruments and apparatus (273)

References (280)

RADIOBIOLOGY
(See also: Nutrition: P237)

PAPERS:

P238(4/86)* Kokoreva LV.

On the physical endurance of rats repeatedly exposed to an intense constant magnetic field.

Kosmicheskaya Biologiya i Aviakosmicheskaya Meditsina.

20(1):61-63; 1986.

[9 references; 1 in English]

Radiobiology, Magnetic Fields, Repeated Exposure

Rats, Males

Human Performance, Endurance, Work Capacity

Abstract: Subjects in this experiment were 58 male outbred rats. The experimental group was exposed to a vertically directed constant magnetic field with inductance of 1.6 T every day for 3 hours. Rats' physical work capacity (endurance) was measured by the period of time they could swim while carrying a weight equal to 10 percent of their body weight. Endurance was measured on days 1, 6, 15 and 30 directly after exposure to the magnetic field. Performance was compared to that of control rats not exposed to the magnetic field, but otherwise treated identically. After a single exposure to the field, the endurance time for experimental rats was more than twice that of the controls. Subsequently endurance of the experimental group dropped gradually and was virtually identical to that of the controls by day 30. The authors relate these results to the temporal characteristics of effects of exposure to magnetic fields on the sympathetic adrenal system.

Figure 1: Physical endurance of rats over the course of exposure to 30 days of repeated exposure to a constant magnetic field of 1.6 T.

Abscissa: days of exposure to magnetic field; Ordinate: maximum endurance time (in % of control group).

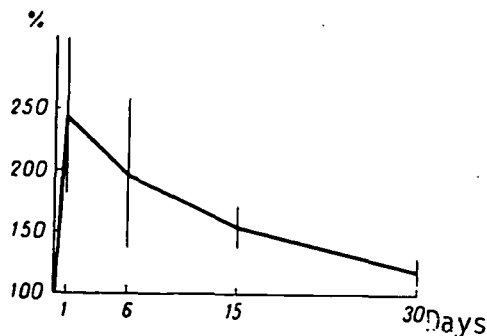

P239(4/86)* Ryzhov NI, Fedorenko BS.

Determining the radiobiological correlates of the quality factor for protons and helium ions.

Kosmicheskaya Biologiya i Aviakosmicheskaya Meditsina.

20(1): 63-66; 1986.

[12 references; 3 in English]

Radiobiology, Ionizing Radiation, Bioeffects

Review of Data

Quality Factor

Abstract: The quality factor has been suggested as an alternative to relative biological effectiveness (RBE) by the International Committee on Radiation Protection for use in studies of radiobiological effects. However, studies of ionizing radiation have shown that stipulated values for the quality factor and experimentally derived values for relative biological effectiveness may be very different for the same energy levels of protons. This paper reviews data on the radiobiological effects of prolonged exposure to protons of varying energy levels and to helium ions and suggests revised values for the quality factor, viz. 1.75 for 9 GeV protons and 1.30-1.45 for 100-730 MeV protons.

Table Titles: Table 1: Stipulated values of quality factor and (experimentally derived) values of the coefficient of relative biological effectiveness for protons

Table 2: Mean values of the coefficient of RBE for protons at different energy level

Subject	Proton Energy, MeV		
	100-240	250-490	500-730
Primates	1.00±0.10	1.00±0.10	1.15±0.10
Dogs	1.00±0.10	1.04±0.10	1.07±0.10
Human skin and tissues	0.95±0.10	--	0.98±0.04
Mean value	0.98±0.13	1.02±0.12	1.07±0.13

Table 3: Values for quality factor for protons of different energy levels

Proton energy, MeV	Mean RBE values	RBE derived from upper confidence interval (p=0.01)	Quality Factor
100-240	0.98±0.12	1.32	1.30
250-490	1.02±0.12	1.36	1.35
500-730	1.07±0.13	1.44	1.45

Table 4: Values for relative biological effectiveness coefficient for protons of 9 GeV and ions of 4 GeV/nucleon

P249(4/86)* Panferova NYe.

Potential for using ultraviolet radiation on long-term space flights.

Kosmicheskaya Biologiya i Aviakosmicheskaya Meditsina.

20(1):4-12; 1986.

[54 references; 19 in English]

Radiobiology, Ultraviolet Radiation, Deprivation, Long-term Space Flights
Humans, Cosmonauts; Theoretical Article
Health and Medical Treatment, Therapeutic Effects

Abstract: Since the light sources on spacecrafts are devoid of ultraviolet rays, ultraviolet deprivation must be considered as a possible adverse factor for cosmonauts on long-term flights. For this reason, the author reviews the literature pertaining to the biological effects of ultraviolet radiation. Effects reviewed with consideration of the influence of wavelength and dosage include: erythema, bacteriocidal, antirachitic, facilitation of nonspecific immunity and resorption of inflammations, acceleration of histamine production, facilitation of healing of infected muscles, and damage to the eyes. While a large amount of data exists on use of ultraviolet radiation for prophylactic and therapeutic purpose on Earth, these results cannot simply be extrapolated, without further study, to long-term space flight conditions. The author suggests the following possible purposes for use of ultraviolet radiation on long-term space flights: to sanitize the environment, to increase cosmonauts' resistance to the effects of adverse space flight factors, to prevent disruption of mineral metabolism, to facilitate healing of skin infections, and to desensitize to allergens. The role of UHF deficit in the development of disruption of Ca metabolism is particularly worthy of further study. Since shortwave UV radiation has a mutagenic effect, the issue of its effects on microorganisms likely to be present on a long-term space flight should also be considered, as should its chemical effects on volatile products of polymers and other spacecraft cabin materials.

Figure Titles: Title 1. Period of appearance and disappearance of erythemia on exposure to ultraviolet radiation

Figure 2: Erythemic response to ultraviolet radiation as a function of wavelength, based on data from various authors

Figure 3: Pigment forming effects of ultraviolet radiation

P248(4/86)* Chertkov KS, Gvozdeva NI, Fedorenko BS, Preobrazhenskiy YuYu.

The radioprotective and therapeutic efficacy of carrageenan in proton irradiation.

Kosmicheskaya Biologiya i Aviakosmicheskaya Meditsina.

20(1):84-86; 1986.

[8 references; 2 in English]

Radiobiology, Proton Irradiation

Mice, Male and Female

Countermeasures, Protective Effects, Carrageenan; Hematology, Hemapoiesis

Abstract: This experiment tested the radioprotective effects of carrageenan, which had already been tested with other types of radiation, against proton radiation. The experiment used 290 male and female hybrid mice, irradiated with protons with energy of 645 MeV and dose rate of 20-53 rad/sec. Control animals were irradiated at 5, 6, 7, and 8 Gy, while experimental animals, were given a dose of 6 mg/kg of carrageenan 15 minutes before irradiation or a dose of 2 mg/kg 6-7 hours post-irradiation. Carrageenan was obtained from Tichocarpus crinitius seaweed. Efficacy of the carrageenan was evaluated by consideration of 30-day survival rate, changes in body weight, cellular changes in bone marrow and number of endogenous colonies growing in the spleen on the ninth day after irradiation. Prophylactic administration of carrageenan increased survival rate for radiation doses of 6, 7 and 8 Gy but not for doses of 8.5 and 9 Gy. Carrageenan administered immediately after irradiation increased its toxicity. Prophylactic doses of carrageenan led to substantial increases in the nucleus containing cells in bone marrow over control levels for radiation doses of 6, 7 and 8 Gy. Protective effects were also found for endogenous colonies in the spleen and increases in body weight. No consistent effects of therapeutic doses of carrageenan were noted. The locus of carrageenan's prophylactic effects is considered to be protection of the hemopoietic system.

Table and Figure Titles: Table: The effect of carrageenan on the survival rate of mice irradiated with high energy (645 MeV.) protons.

Figure: Changes in the morphology of femoral bone marrow of mice after various doses of radiation on day 3 after exposure

P270(4/86) Minkina NA, Kuz'minskaya GN, Nikitina VN, Garina ChA.
**The effect of intermittent irradiation with a shortwave magnetic field
 on the state of the endocrine glands**

Radiobiologiya.

XXV(6): 756-761; 1985.

[19 references; 4 in English]

Scientific Research Institute for Labor Hygiene and Occupational
 Diseases, Leningrad; Pavlov Institute of Physiology, USSR Academy of
 Sciences, Leningrad

Radiobiology, Short-wave Magnetic Field, Intermittent Irradiation
 Rats, Male
 Endocrinology, Hypothalamus, Pituitary, Adrenal, Thyroid, Testes

Abstract: This experiment simulated conditions of radiation emanating from a short-wave radio on a ship. Outbred male rats were exposed 2 hours a day for 10 to 30 days to intermittent short wave irradiation with frequency of 13 MHz and output of 500 and 250 V/m. After the exposure period, animals were sacrificed and the neurosecretory nuclei of the hypothalamus were examined histologically. The activity of ACTH and gonadotropin in the pituitary was assessed. The content of ascorbic acid in the adrenal gland and the concentration of corticosterone in blood plasma were determined. The testes, adrenal gland and thyroid were weighted. The number of cells in the outer portion of the zona fasciculata of the cortical layer were counted. The height of the follicular epithelium, and the area of follicular cavities and their saturation with colloid were determined for the thyroid gland. In the testes, the number of ducts at the various stages of spermatogenesis and the number of spermatogonic types A and B per 1 mm of the duct in stages IV-VI of spermatogenesis were also determined.

In the hypothalamus, 10 days of exposure to short wave radiation at 500 V/m was associated with increased neurosecretory activity. Adrenocorticotropic activity in the pituitary gland and inhibition of the activity of the cortical layer of the adrenal glands in response to 10 days of the experimental treatment were also noted. After 30 days of treatment no changes were found, although the weight of the adrenals had decreased. Radiation at 250 V/m was not associated with changes in the pituitary of adrenal cortex, but the amount of corticosterone in blood plasma had decreased after 30 days of the treatment. The reactions of the thyroid to short-wave radiation depended on dose rate and duration of exposure. Ten days exposure to radiation at 500 V/m led to accumulation of colloids in the follicular cavities, without any signs of resorption. After 30 days, the height of the follicular epithelium increased and the size of the follicles decreased, indicating activation. Degenerative changes in the epithelium were also noted. On the other hand, with radiation of 250 V/m, there were symptoms of depression of the gland's activity which became more acute with increases in exposure duration, but there were few signs of dystrophy. With radiation of 500 V/m the luteotropic activity of the pituitary was depressed to an increasing degree with increasing exposure. With radiation of 250 V/m only activity of follicle stimulating hormone was attenuated. Examination of the testes showed disruption of spermatogenesis, degenerative changes, hyperemia in the vessels, and hemorrhaging. These symptoms varied in severity as a function of dose rate and length of exposure to radiation. The sexual system is described

P270

as the system most severely affected by shortwave electromagnetic radiation. Depression in the activity of the hypothalamic-adrenal system is described as an adaptive process which moderates the body's reaction to environmental factors.

Table and Figure Titles:

Table 1: Parameters of the state of the pituitary-adrenal system under exposure to an electromagnetic field

Table 2: Parameters of the state of the thyroid gland after exposure to an electromagnetic field

Table 3: Parameters of the state of the testes after exposure to an electromagnetic field

Figure 1: Percentage distribution of logarithms of volumes of nuclei of neurosecretory cells in supraoptic and paraventricular nuclei of the hypothalamus of rats after 100 days of irradiation with an electromagnetic field

Figure 2: Activity of luteinizing hormone of the pituitary of rats (concentration of ascorbic acid in the ovaries of recipient rats) after exposure to an electromagnetic field

P271(4/86) Vinogradov GI, Batanov GV, Haumenko GM, Levin AD, Trifonov SI.

The effects of nonionizing microwave radiation on autoimmune responses and the antigen structure of serum proteins.

Radiologiya

XX(6): 840-842; 1985

[7 references; none in English]

A.N. Murzeyev Scientific Research Institute of General and Communal Hygiene, Ukrainian Ministry of Health, Kiev

Radiobiology, Microwaves

Rats, Male, Females, Pregnant

Immunology, Autoimmune Responses; Development, Fetal Development

Abstract: The goals of this study were: 1) to investigate the antigen structure of serum proteins after exposure to low-level microwave radiation, which has been demonstrated to stimulate the development of autoimmune processes and 2) to identify the biological role of the antibodies which form. Male and female Wistar rats served as subjects in this study. These animals were irradiated with microwaves at intensities of 500, 50, or 10 $\mu\text{W}/\text{cm}^2$ in special echo-free chambers for 7 hours a day for 30 days. A control group of nonirradiated rats (otherwise treated identically) was used. After the irradiation, rats were sacrificed and blood serum obtained. Autoantibodies in the marrow were measured by observing reactions of complement fixation in the cold. Then the serum was divided into two parts. The first was subjected to immunochemical analysis and the second was administered intraperitoneally to female rats 10-days pregnant. The immunological analysis was accomplished through ultracentrifugation and electrophoresis. The results were analyzed on the basis of height and area of spectroscopic peaks and sedimentation constant of protein zones. Ultracentrifugation divided the serum into albumin (A) and three globulin fractions. Further analysis of the sedimentation constant suggested that protein fractions B and D were immunoglobulins, while fraction E was a globulin.

Irradiation of the rats led to shifts in the behavior of immunologically competent globulin fractions. While irradiation at 10 $\mu\text{W}/\text{cm}^2$ led to no significant change, irradiation at 50 $\mu\text{W}/\text{cm}^2$ led to a decrease in the density and displacement of peaks D and E. [This appears to be a misprint, table shows decrease in B not E.] After irradiation at 500 $\mu\text{W}/\text{cm}^2$, a new peak appeared (C) on the sedimentogram, which appeared to belong to the A gammaglobulin class. Results of immunoelectrophoresis showed a statistically significant decrease in heights of peaks obtained through electrophoresis. This may have resulted from a change in the structural specificity of the globulin or an inhibition of formation of immune complexes due to an excess of antigens or suppressive activity of the new humoral factor (associated with peak C). The authors argue that the changes in the antigen structure might lead to a situation where a subject's own proteins become immunologically foreign and stimulate the development of an autoimmune response. Fifty and 500 $\mu\text{W}/\text{cm}^2$ irradiation induced degranulation of the basophilic leukocytes in peripheral blood. When a salt-water extract of marrow tissues was used as an antigen, an indicator of damage to neutrophils using the same antigen increased significantly, and antimarrow complement fixing antibodies formed in blood serum. No such effects were observed with 10 $\mu\text{W}/\text{cm}^2$ irradiation.

P271

Study of blast transformation of lymphocytes in response to phytohemagglutinin showed that irradiation at 50 and 500 $\mu\text{W}/\text{cm}^2$ led to a significant decrease in transformation of blood lymphocytes into blasts. To investigate the actual biological effects of microwave induced autoimmune changes, serum from irradiated and nonirradiated animals was injected into pregnant females. Serum from control animals, and animals irradiated at 10 and 50 $\mu\text{W}/\text{cm}^2$ led to no changes in weight and length of fetus or in fetal death rate. Serum from rats irradiated at 500 $\mu\text{W}/\text{cm}^2$ led to a significant increases in fetal deaths, decrease in height and weights of fetuses, and increase in hemorrhaging in fetal internal organs. It can be concluded that these changes are attributable to the new protein developed by the donor animals.

Table 1. Sedimentation constants for blood serum globulin fractions of rats irradiated with microwaves at various intensities

Energy flux density, $\mu\text{W}/\text{cm}^2$	Sedimentation Peaks				
	A	B	C	D	E
Control	5.81	8.21	--	11.83	14.53
10	6.12	8.38	--	11.20	14.30
50	5.17	7.07	--	10.55	14.18
500	5.58	7.93	8.60	11.08	14.40

Table 2. Immuno-electrophoresis of serum globulin of rats irradiated with microwaves of varying intensities

Energy flux density, $\mu\text{W}/\text{cm}^2$	Height of peaks (v)
Control	34.0
10	31.7
50	32.4
500	29.1*

*Significantly different from control (no significance level cited)

MONOGRAPHS:

M74(4/86) Tigranyan RE. Fiziko-tekhnicheskaya praktika biologicheskogo eksperimenta s CVCh islucheniye
 [Technological support of /Literally: Physical-technological performance of/ biological experiments using super high frequency radiation].
 Pushchino: Scientific Center for Biological Research, USSR Academy of Sciences; 1985.
 [130 pages; 3 tables; 69 illustrations; 37 references]
 Institute of Biological Physics, Scientific Center for Biological Research, USSR Academy of Sciences

Key Words: Radiobiology, Electromagnetic waves, Super High Frequency Radiation, Bioeffects, Equipment and Instrumentation, Experimental Design

Annotation: This book examines a number of issues related to technological support for experiments to study the bioeffects of electromagnetic waves with wavelength in the decimeter band. The author condenses the major issues encountered in research on the effects of superhigh frequency radiation on biological subjects -- the generation, transmission and absorption of super high frequency waves, and the formation of a clear understanding of the nature of the magnetic field in the vicinity of the subject. The major emphasis in this book is placed on issues relating to construction of powerful super high frequency generators with impulse modulation, in a broad frequency band using existing laboratory models and clinical apparatus used for microwave therapy as a basis. The author describes the procedures and methods for constructing irradiation systems to record the electrophysical parameters of a biological subject during irradiation, as well as the equipment needed to create such systems in a research laboratory. Specific examples of the design of experiments to study the effects of super high frequency radiation on a number of biological subjects are cited. Design of these experiments is of great practical interest since measures must be included for protecting the experimenter from the harmful effects of radiation. This book contains fundamental information about how to construct small screened areas in order to shield laboratory staff. This book is intended for researchers working in the area of electromagnetic biology.

CONTENTS

(Numbers in parentheses refer to page numbers in the original.)

Introduction (3)

Chapter I. Some characteristics of the generation, transmission and absorption of super high frequency waves (6)

1. Characteristics of the design of super high frequency generators in the decimeter band (8)
2. Channelization, radiation and absorption of super high frequency electromagnetic energy (16)

M74

- Chapter II. Technological support of experiments on the bioeffects of super high frequencies (35)
1. The construction of modulated generators in the decimeter band for biological experiments (36)
 1. Basic specifications for the generator devices (37)
 2. Basic principles of construction for generator devices (41)
 2. Modulating devices (43)
 1. Linear modulators (45)
 - 1.1 The linear modulator without transformation using vacuum tubes (45)
 - 1.2 The linear modulator with signal transformation using vacuum tubes (47)
 2. Pulse modulators (48)
 - 2.1 Cathode pulse switch (48)
 - 2.2 Anode pulse switch (50)
 3. Tube generators of super high frequency radiation in the frequency range 150-160 MHz with wide band modulation
 1. GS-6 Base model (52)
 2. GSS-12 Base model (53)
 3. GSS-15A Base model (55)
 4. LMS series generators (63)
 - 4.1 LMS-541 Base model (63)
 - 4.2 LMS-551 Base model (up to 50 W) (66)
 - 4.3 LMS-551B Base model (up to 500 W) (67)
 4. Magnetron and tube super high frequency generators with fixed frequencies and wide band modulation (70)
 1. Magnetron generators at 2375 MHz with wide band pulse modulation (71)
 - 1.1 "Luch-3" Base model (72)
 - 1.2 "Luch-58-1" Base model (75)
 2. Tube generators at 460 MHz with wide band pulse modulation (79)
 - 2.1 "Romashka" Base model (80)
 - 2.2 "Volna-2" Base model (82)
 5. Irradiation conditions for biological subjects (84)
 1. Selection of type of transmitting lines for irradiating small biological subjects (88)
 2. Rereflected radiation in the irradiation container (88)
 6. Recording subject parameters during irradiation (90)
 1. An electrode system for recording electrophysical information (90)
 - 1.1 The principle of construction of artifact-free electrodes (90)
 - 1.2 The design of artifact-free electrodes (91)
 - 1.3 A system for transmitting the bioelectric activity potential to the recording apparatus (92)

M74

7. Methods for preparing biological subjects for irradiation by a super high frequency electromagnetic field (94)
 1. Long thin biological preparations (94)
 2. Preparations with small length to width ratios (96)
 3. Small laboratory animals (98)
 - 3.1 Warm blooded animals (98)
 - 3.2 Cold blooded animals (99)
 4. Liquid biological media (100)

Chapter III. Technology for building the components of waveguide equipments in the research laboratory (102)

1. General technological principles for building the components of waveguide equipment (102)
2. Development of the irradiating system (104)

Chapter IV. Methods for determining dose rate for a biological subject (110)

Chapter V. Examples of the assembly of equipment systems for studying the bioeffects of super high frequency radiation (113)

1. Recording an electrogram of a preparation of the heart of a frog (114)
2. Recording an electrogram of the heart of an intact frog (116)
3. Recording the parameters of the behavior of a nerve impulse (117)

Chapter VI. Conditions under which experiments on the bioeffects of super high frequency radiation are performed.

1. Norms for acceptable radiation and frequency standards (119)
2. The construction of screened areas (120)
3. Materials and design elements used in screened areas (122)

Conclusion (124)

References (125)

REPRODUCTIVE BIOLOGY

(See also: Endocrinology P233; P272; Musculoskeletal System: P274)

PAPER:

P266(4/86) Shekhova AN, Katsiya GV, Goncharov NP.

The effects of long-term hypokinesia on the functional activity of the sexual and adrenal glands of female hamadryas baboons.

Problemy endokrinologii.

XXXII (1): 71-73; 1986.

[12 references; 10 in English]

Laboratory of Experimental Endocrinology, Institute of Experimental Pathology and Therapy, USSR Academy of Medical Sciences, Sukhumi

Reproductive Biology, Menstrual Cycle; Endocrinology, Sexual and Adrenal Glands

Primates, Baboons, Female

Hypokinesia, Long-Term

Abstract: Hamadryas baboons were selected as subjects for this study of the effects of extreme factors on the menstrual cycle because of the similarity of their hormonal and sexual functions to humans. Subjects in this experiment were 10 sexually mature females weighing 12-16 kilograms with stable two-phase menstrual cycles. The primates' motor activity was restricted with immobilization suits attached to special beds; motion of the torso and hind limbs was totally restricted, head motion was partially restricted and the fore limbs were free. The duration of the hypokinesia was 26 days (animals' menstrual cycle was 28-35 days). The animals were separated into two groups: 5 animals were immobilized during the follicular phase of their menstrual cycle and 5 were immobilized during the luteal phase. Blood was taken from the veins of the animals before immobilization, after 1/2, 1, 2, 3, and 6 hours and on days 2, 3, 5, 7, 10, 14, 18, 22, and 26 of immobilization and every day for the four days of the hypothesized periovulatory period. Hormonal function of the adrenal and sexual glands was assessed by measuring the concentration of the steroid hormones estradiol, progesterone, testosterone, and hydrocortisone in peripheral blood plasma was determined using radioimmune assay.

In the follicular phase, level of estradiol was significantly decreased by day 2 and continued to decrease until it was less than half baseline by the end of the experiment. Concentration of progesterone, hydrocortisone, and testosterone all increased in the first two days of immobilization. Over the next two days, concentrations of progesterone and hydrocortisone dropped to baseline levels, while testosterone remained at near peak level. The similarity of pattern for hydrocortisone, progesterone and testosterone indicates that progesterone and testosterone are produced primarily by the adrenal gland during the follicular phase of the cycle. In weeks 2 to 4 of immobilization, concentration of hydrocortisone and testosterone remained at baseline level, while concentration of progesterone dropped gradually to 70 percent of baseline. These results testify to depression of the estrogenic functions of the ovaries of female animals immobilized during the follicular phase of their cycle; the absence of sequential fluctuation of estradiol and progesterone characteristic of normal menstruation demonstrate the establishment

P266

of an anovular cycle. Animals immobilized during the luteal portions of their cycle show a different pattern. A rapid and substantial decrease in progesterone levels occurs immediately, so that this level is half that of baseline by the second day, and by day 7-26 is only 8 percent of its baseline value. During the first 3 days of immobilization, estradiol level remains relatively constant; however, on day 5-7, which also marks the premature start of blood flow, estradiol concentration dropped significantly and remained at this level throughout the rest of the experiment. The similarity between the behavior of progesterone and estradiol suggests that estradiol is produced mainly by the ovaries in the luteal phase, while the drop in both concentrations suggests inhibition of the steroid producing functions of the gonads in long-term hypokinesia. The authors draw the following conclusions: 1. Long-term horizontal hypokinesia leads to a disruption of the menstrual cycle in primates. 2. Prolonged restriction of motor activity in female baboons depresses the hormonal functioning of the gonads: production of estradiol in the follicular period and production of progesterone in the luteal phase of the cycle. 3. Reactivity of the adrenal glands to acute immobilization stress depends on phase of menstrual cycle and is less pronounced during the luteal period.

Table and Figure Titles: Table: Change over time in the concentration of sex hormones and hydrocortisone (in nmole/l) in blood plasma of hamadryas baboons in the initial period of hypokinesia in various phases of the menstrual cycle

Figure 1. Changes over time in concentration of estradiol and progesterone in blood plasma of female baboons allowed free movement (1) and restricted motor activity in various phases of the menstrual cycle a -- follicular phase; b -- luteal phase; here and in Figure 2: ordinate -- concentration of the steroid in blood plasma (in nmole/l); abscissa -- (1) day of hypokinesia; (2) day of menstrual cycle

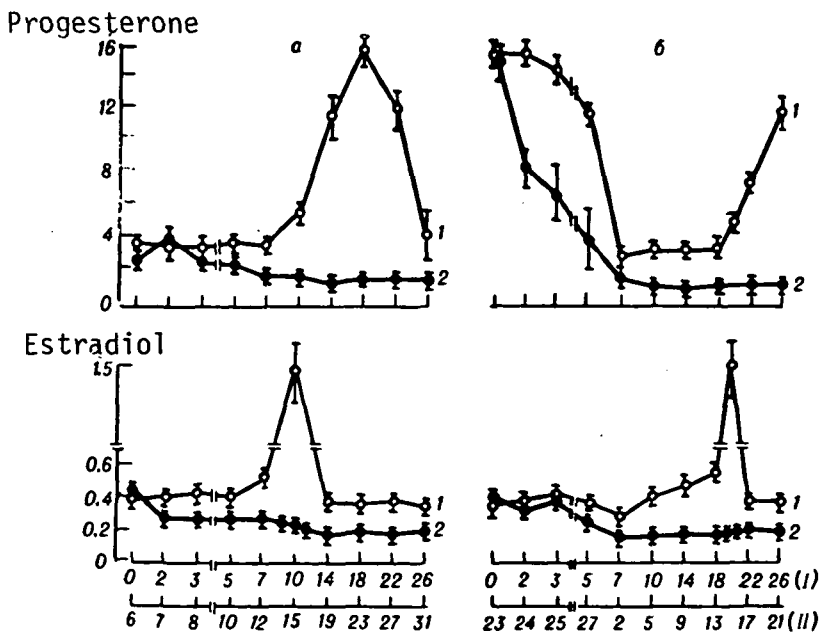

P266

Figure 2. Changes over time in concentration of hydrocortisone and testosterone in blood plasma of female baboons with restricted motor activity in the follicular (1) and luteal (2) phase of their cycles.

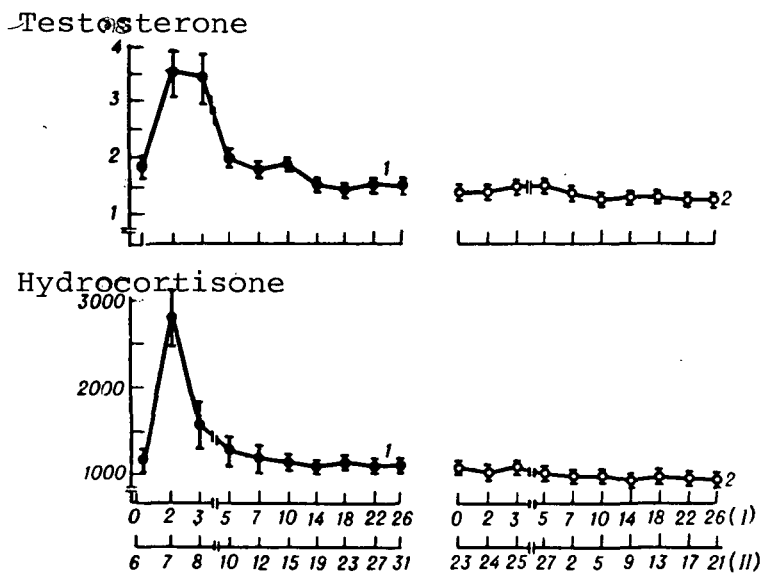

SPACE MEDICINE

(See also: Special Feature, page 1; All other medical topic categories)

PAPER:

P251(4/86) Vorob'yev YeI, Gazenko OG, Gurovskiy NN, Rudnyy NM, Degtyarev VA, Yegorov AD, YereMin AV.

Medical research performed in flight on the "Salyut-6" by the first prime crew

In: M (4/86):Kedrov BM, Kosmodem'yanski AA.

Nauchnoye tvorchestvo KE Tsiolkovskogo i sovremmennoye razvitiye ego idey [The scientific work of K. E. Tsiolkovskiy and Modern Development of His Ideas].

Moscow: Nauka; 1984: 56-60.

Space Medicine; Health and Medical Treatment; Cardiovascular and Respiratory Systems; Human Performance; Psychology; Hematology
Humans, Males, Cosmonauts
Spaceflight, "Salyut-6"; Countermeasures; Nutrition

[Note: Because of the brevity and unusual interest of this paper, we are translating it in its entirety.]

In 1977-78 a 96-day space flight was completed by a crew consisting of Yu.V. Romanenko (captain) and G.M. Grechko (flight engineer) of the Soviet Union on the "Salyut-6" orbital station.

During the flight, the prime crew performed an EVA to inspect the docking apparatus (on day 10), worked with two visiting crews (the first, consisting of V.A. Dzhanibekov and O.G. Makarov, from 11 to 16 January; the second, consisting of A.A. Gubarev and Vladimir Remek of Czechoslovakia, from 3 to 10 March) and with the cargo ship "Progress-1."

The manned flight medical problems addressed in the "Salyut-6" program involved the maintenance of crew health and high level of working capacity during and postflight, and the study of the phenomenology and mechanisms of adaptation to flight conditions and evaluation of the effectiveness of utilizing prophylactic countermeasures.

1. Description of flight conditions

The flight environment included a typical two-gas medium, the parameters of which were close to that of the Earth's atmosphere, an insignificant amount of exposure to radiation, and a terrestrial daily cycle of work and rest.

The flight diet consisted of a six-day menu of canned and freeze dried foods totaling 3100 calories per day. This diet corresponded to the projected amount of energy expenditure and was balanced for the basic nutrients. During the flight, the visiting crews and cargo ship brought fresh products, the selected according to the cosmonauts' preferences.

Water supply was maintained by treating water with silver ions and through a regeneration system that supplied the crew with hot water for showers and other uses. Catamine was used as a cleanser.

P251

Physical training occupied 2.5-3.0 hours per day, job performance approximately 8 hours, and the 4 meals totalled 2.5 hours. The crew got a day off every 5-6 days. Prophylactic therapeutic measures were utilized only by the prime crew.

As was the case with other "Salyut" orbital stations, prophylactic measures included training on a treadmill with a system of restraints and loading along the long axis of the body (approximately 50 kg), use of a bicycle ergometer, wearing "Penguin" (constant loading) suits for long periods, and Chilbis (lower body negative pressure) suits, myoelectric stimulation, a postflight prophylactic suit and electrolyte supplements.

A nutritional supplement consisting of 10 vitamins, methionine, and glutamic acid was taken by the crew over a 15-day flight period.

To prevent metabolic changes in the cardiac muscle during readaptation to Earth conditions they took the drugs: inoziya-f(?), panangin(?), and potassium orotat(?).

An on-board videotape system and radio contact with families, celebrities, and scientists provided psychological support and helped to structure leisure time.

2. General state of the cosmonauts

The cosmonaut's work capacity during flight was satisfactory.

The main phase of adaptation to weightlessness in all three crews was characterized by the appearance of spatial illusions ("sensation of tumbling backward"), gradual onset of the sensation of blood rushing to the head, stuffed nose, puffiness of the tissues of the face, decreased appetite, and also a sensation of discomfort which increased upon moving the head. The magnitude of these reactions varied among the cosmonauts; three of the cosmonauts vomited after eating.

Autonomic disturbances had virtually disappeared by day 4 of the flight. The sensation of blood rushing to the head, although diminishing by days 7-10, continued in an attenuated form in the primary crew throughout the flight, increasing on initiation of physical work, fatigue and also on consumption of large quantities of liquid.

In the first 10 days of the flight, and also in the last month, the prime crew noted the appearance of fatigue associated with loss of sleep at night.

The prime crew as a whole evaluated the presence of the visiting crew positively as a psychological factor. However, they also indicated that the presence of the visiting crew on board the station altered the established schedule and work rhythm.

P251

3. Results of flight research

During the flight the captain's heart rate, as a rule, was lower or no different from its mean preflight values, while the flight engineer's was higher than baseline value and tended to increase toward the end of the flight.

Blood pressure was measured using tachyoscillographic methods. In the captain, blood pressure parameters were initially higher than their mean preflight values, but then gradually decreased and on days 30-43 and 49 were lower than preflight values. Subsequently, the end systolic and mean pressures were virtually at preflight level.

Stroke and minute circulatory volume fluctuated in both cosmonauts, but on the whole were lower than preflight levels.

According to data obtained through impedance plethysmography, both cosmonauts showed an increase in pulse and minute blood volume in the vessels of the head. In the captain these phenomena were most pronounced on days 60 and 77 of the flight and were accompanied by a decrease in the tonus of the vessels (mainly those on the right), increasing toward the end of the flight. In the flight engineer the tonus of the major vessels increased somewhat, while the tonus of the arterioles and veins decreased markedly.

Pressure in the jugular vein, measured indirectly in both cosmonauts, was significantly elevated (See table.), as a result of fluid shifts.

Table: Changes over time in pressure in the jugular vein during flight (in Hg mm)

Crewmember	Preflight	Day of Flight				
		14	49	60	77	92
Captain	4.3-4.5	10.5	7.5	6.0	10.5	10.5
Flight engineer	3.2-3.3	9.9	11.9	11.2	10.9	13.2

By the end of the flight, leg volume had decreased by 16.8 % in the captain and by 9.2 percent in the flight engineer.

Electrocardiography (using 12 leads) revealed no pathologic changes.

In several instances, exercise stress tests using a bicycle ergometer (5 minutes with a loading of 750 kgm/min) indicated a more pronounced increase in the absolute and relative heart rates than had been observed on the ground.

On the whole, the responses of hemodynamic parameters were not substantially different from preflight levels. The relatively large increase in heart rate during several provocative tests may indicate a certain diminution of the functional capabilities of the cardiovascular system attributable to deconditioning under weightlessness and muscular

P251

inactivity. The influence of the latter factor may have been enhanced by the fact that the crew did not fully follow the recommended program of physical exercises.

Responses to a provocative test using LBNP indicated adequate response on the part of circulation parameters.

At the same time, there were several instances where the captain's blood pressure decreased to a more pronounced degree during flight. The increase in the flight engineer's heart rate in response to LBNP was more pronounced, although changes in blood pressure did not differ significantly from preflight levels.

Results of impedance plethysmography during LBNP showed marked vascular stenosis accompanied by decrease in blood perfusion in the head.

4. Results of postflight studies

The general state of the crew in the first few days postflight was characterized by some degree of fatigue and statokinetic changes. The cosmonauts mentioned sensations of increased heaviness of their bodies and other objects, and of downward displacement of their visceral organs.

The flight engineer experienced some vestibular discomfort during evacuation from the landing site. Body weight had decreased by 3.6 kg in the captain and 4.4 kg in the flight engineer. They did not experience thirst.

During the first day postflight, after a night's sleep, and in the following days, the general state and feeling of well-being of both cosmonauts progressively improved.

However, some symptoms of weakness were still evident. On day 10 postflight the cosmonauts felt completely well and had no complaints.

Recovery of orthostatic tolerance occurred over a postflight period of approximately three weeks.

Cardiovascular responses to an exercise stress test conducted on days 5 and 6 postflight showed deterioration from preflight levels. Recovery took longer than it had after previous long-term flights.

Echocardiography performed on the day of landing and the first few days postflight revealed marked decreases in left ventricle and stroke ejection volumes, and also some decrease in the weight of the left ventricle. The dimension of the left auricle were somewhat increased.

By day 4, the captain's weight had recovered by 50% and the flight engineer's by 70%. An increase in fluid consumption was noted. Sodium excretion, as with shorter flights, decreased in the first two days postflight. Potassium excretion was diminished on the day of landing, and then increased somewhat, probably because of increased intake of juices and foods. In the first 4 to 6 days postflight, calcium excretion was

P251

substantially greater than after previous long-term space flights. The concentration of calcium, sodium and osmotically active substances in blood serum had increased, while concentration of potassium had decreased. By day 7 these parameters had returned to normal.

In both cosmonauts the total weight of hemoglobin had decreased (by 23 and 26 percent); decreases were also noted in concentration of hemoglobin (by 1.5 and 2.65 percent), quantity of electrolytes (by 18 and 22 percent per ul), reticulocytes (by 33 and 37 percent) and thrombocytes (by 56 and 33 percent).

Fifteen to twenty percent of the erythrocytes examined were altered in size and shape (anisocytes and poikilocytes). The Price-Jones curve was bimodal postflight with predominance of spherocytes (smaller round erythrocytes) and a decrease in the number of normocytes.

The initial decrease in the number of reticulocytes was replaced by pronounced reticulocytosis. However, recovery of red blood cell parameters occurred slowly; poikilocytes and anisocytes could still be observed on day 12 postflight and the Price-Jones curve was still displaced to the left (spherocytes), with the number of normocytes depressed. All this apparently testifies to a retardation of the maturation of immature erythrocytes in the bone marrow.

Microbiological and immunological studies performed immediately after landing revealed an increased microbial concentration in the nasal cavity and decreased microbial concentration in the aural cavity in both cosmonauts.

No significant changes in humoral immunity were noted postflight.

Thus, during a 96-day period in orbit, the cosmonauts retained an adequate work capacity and successfully performed the planned flight program which involved a large number of complex work tasks (i.e., EVAs to inspect the docking apparatus, cooperative work with the two visiting crews, a large amount of work connected with the cargo ship and a variety of scientific experiments).

The extensive research program performed revealed no changes which would hinder further planned increases in the duration of space flights.

The results of this research demonstrate that humans can not only tolerate long-term space flights, but, as K.E. Tsiolkovskiy foresaw in his seminal works on cosmonautics, they can continue to perform a variety of intellectual and physical tasks while retaining adequate work capacity.

MONOGRAPH

M70(4/86) Kedrov BM, Kosmodem'yanskii AA, editors.

Nauchnoye tvorchestvo K. E. Tsiolkovskogo i sovremennoye razvitiye ego idey

[The scientific work of K. E. Tsiolkovskiy and Modern Development of His Ideas].

Moscow: Nauka; 1984.

[167 pages]

Commission on Development of the Scientific Heritage of K. E. Tsiolkovskiy, Institute of the History of Natural Science and Technology, USSR Academy of Sciences, K.E. Tsiolkovskiy State Museum of the History of Cosmonautics

Key Words: Health and Medical Treatment, Thermal Physiology; Cardiovascular and Respiratory Systems, Acceleration, Weightlessness Simulations; Botany, Weightlessness Effects; Exobiology, CETI; Spaceflight, Salyut-6

Annotation: This volume contains material from the XIIIth and XIVth K. E. Tsiolkovskiy Lecture Series. A wide range of issues related to the scientific work of K.E. Tsiolkovskiy and modern developments of his ideas in the areas of rocketry and space technology, the mechanics of space flight, space medicine and biology, aviation and aeronautics, and scientific forecasting are considered. The development of this scientist's ideas on staged rockets as applied to relative flight velocities is described. Questions relating to control of the motion of low thrust spacecraft, and further developments of Tsiolkovskiy's ideas on modeling the physiological effects of weightlessness as an acceleration effect are considered. The development of his ideas on aerodynamic studies of flight vehicles is also described. The future perspectives for the development of space industry is considered in light of this scholar's ideas. This collection is intended for readers interested in rocket and space science and technology, aviation and aeronautics, and also in the creative work of K.E. Tsiolkovskiy.

CONTENTS

(Numbers in parentheses refer to page numbers in the original.)

NOTE: Chapters marked * are further abstracted in this Digest issue.

From the Editors (3)

NOTE: Chapter titles in the first two sections are not cited because of lack of direct relevance to life sciences.

SECTION III: SPACE AND LIFE

Ye.I. Vorob'yev, O.G. Gazenko, N.N. Gurskiyy, N.M. Rudnyy, V.A. Degtyarev, A.D. Yegorov, A.V. Yerechin. Medical flight research performed by the prime crew of "Salyut-6" (56)* (translated in full)

Yu.V. Romanenko, D.K. Dedkov. Problems of long-term manned space flight (60)

M70

N.V. Ulyatovskiy, G.T. Beregovoy, A.V. Beregovkin, L.I. Voronin, A.V. Yeregin, S.Yu. Yelizarov. On the modeling of physiological effects of weightlessness as an acceleration effect (64)*

V.B. Malkin, T.A. Mikhailova. On the development of a science devoted to the effects of gravity on the growth and development of plants (67)

F.P. Kosmolinskiy. K.E. Tsiolkovskiy's "Mind and Passions" and the problem of functional state in humans (70)

Ye.I. Kuznets, V.A. Zinochkin, A.V. Opryshko, B.A. Utekhin, V.I. Chadov, E.V. Yakovleva. Some conclusions and perspectives for the future in the area of thermal physiology as applied to space research practice (73)*

S.A. Gozulov, I.D. Pestov. The further development of the creative heritage of K. E. Tsiolkovskiy in the area of control of the state of cosmonauts in flight (77)

NOTE: Section IV is omitted because of lack of direct relevance to life sciences.

SECTION V: TSIOLKOVSKIY AND PHILOSOPHICAL PROBLEMS IN THE CONQUEST OF SPACE

V.V. Kazutinskiy. A general scientific picture of the world and a strategy for searching for extraterrestrial civilizations (102)

M.I. Lazarev. International problems in the conquest of space (105)

A.M. Starostin. Some methodological problems in astrosociology (110)

K.Kh. Khayrullin. The "anthropocosmism" of K.E. Tsiolkovskiy and N.G. Kholodnyy (115)

SECTION VI: K.E. TSIOLKOVSKIY AND SCIENTIFIC PREDICTION

V.S. Avduyevskiy, S.D. Grishin, L.V. Leskov. Ten years of space technology (120)

S.D. Grishin, L.V. Leskov, Future prospects for space industry (commercialization) (124)

A.F. Romashenko, A. P. Kozlovtssev. Systems prediction and the problem of the conquest of space (128)

NOTE: Section VII is omitted because of lack of direct relevance to life sciences.

Reports published in the Proceedings of Lecture Series XIII-XIV (148)

Reports heard in Lecture Series XIII-XIV (not included in Proceedings) (155)

SPECIAL FEATURE: EVAS BY SOVIET COSMONAUTS

Date	Cosmonauts	EVA Duration	EVA Objective
3/18/65	A. Leonov	12 minutes	First EVA
1/16/69	Ye. Khrunov A. Yeliseyev	37 minutes	Interspacecraft transfer of cosmonauts in space
12/20/77	G. Grechko Yu. Romanenko	1 hour 28 min	Inspection and monitoring of the condition of the docking unit and exterior of the "Salyut-6" station
7/29/78	A. Ivanchenkov V. Kovalenok	2 hr 05 min	Disassembly and partial replacement of scientific apparatus attached to the space station exterior
8/15/79	V. Ryumin V. Lyakhov	1 hr 23 min	Separation and removal of antenna for KRT-10 radiotelescope, disassembly of scientific apparatus attached to space station exterior
7/30/82	V. Lebedev A. Berezovoy	2 hr 33 min	Disassembly and partial replacement of scientific apparatus attached to exterior of "Salyut-7"; exploration of capability for performing assembly operations using tools
11/1/83	A. Aleksandrov	2 hr 50 min	Mounting of an auxiliary section on the central panel of the solar battery
11/3/83	A. Aleksandrov V. Lyakhov	2 hr 55 min	Mounting of a second auxiliary section on the central panel of the solar battery
4/23/84	V. Solov'yev L. Kizim	4 hr 15 min	Setting up a work station on the connecting module of the station and beginning of repair of the reserve line of the integrated propulsion unit (IPU)
4/26/84	V. Solov'yev L. Kizim	5 hours	Adjustment of the unpressurized station and repair of the IPU
4/29/84	V. Solov'yev L. Kizim	2 hr 45 min	Mounting of an auxiliary IPU line
5/4/84	V. Solov'yev L. Kizim	2 hr 45 min	Mounting of a second auxiliary IPU line
5/18/84- 5/19/84	V. Solov'yev L. Kizim	3 hr 05 min	Mounting of two auxiliary sections on the side panel of the solar battery

SPECIAL FEATURE: EVAS BY SOVIET COSMONAUTS

Date	Cosmonauts	EVA Duration	EVA Objective
7/25/84	V. Dzhani­bekov S. Savitskaya	3 hr 35 min	Testing of the multipurpose portable cathode-ray device for cutting, welding, soldering and applying metal coating First EVA by a female cosmonaut
8/8/84	V. Solov'yev L. Kizim	5 hours	Completion of repair of IPU, recompression of the unpressurized line
8/2/85	V. Savinykh V. Dzhani­bekov	5 hours	Mounting of two auxiliary sections on the third and last panel of the solar battery of "Salyut-7"

CURRENT TRANSLATED SOVIET LIFE SCIENCE MATERIALS AVAILABLE TO OUR
READERS

Translations of recent Soviet publication, including those of interest to specialists in space life sciences, are published by Joint Publications Research Service (JPRS). JPRS publications may be ordered from the National Technical Information Service (NTIS), Springfield, Virginia 22161. The phone number of NTIS is (703)-487-4600 and telephone orders are encouraged. Each individual issue of a JPRS report must be ordered separately. Prices depend on number of pages; a recent issue of Space Biology and Aerospace Medicine, for example, cost \$16.00. When ordering, it is recommended that the JPRS number, title, date and author, if applicable, of publication be cited. An order takes 9-30 days to arrive. Rush orders are possible but involve an additional charge. There is a significant and variable lag period between the time a JPRS publication is completed and the time it is orderable from NTIS.

Two JPRS USSR Report Series appear of particular interest to NASA life scientists. These are: 1) Space, and 2) Life Sciences: Biomedical and Behavioral Sciences. In addition, JPRS translates the entire issue of the bimonthly Space Biology and Aerospace Medicine. As a service to our readers we will regularly provide publication information for these reports and cite the titles of articles selected as of particularly relevant to NASA. Translations of titles are those of JPRS. JPRS entries marked with * were previously abstracted in this Digest.

USSR REPORT: LIFE SCIENCES
BIOMEDICAL AND BEHAVIORAL SCIENCES

JPRS-UBB-86-003 29 January 1986

This report contains the Table of Contents from all USSR Report: Life Sciences: Biomedical and Behavioral Sciences, published between 7 January 1985 and 10 December 1985, a total of 25 reports.

USSR REPORT: LIFE SCIENCES
BIOMEDICAL AND BEHAVIORAL SCIENCES

JPRS-UBB-86-004 12 March 1986

Selected Contents:

Protein Hydrolysate from Microscopic Algae
(Bagmet GI; Journal Article Abstract; 1 page)

Change in Basic Kidney Functions Under Conditions of 30-Day Hypokinesia
(Umarova M; Journal Article Abstract: 1 page)

Influence of Complexity of Control Task on Level of Activation of Operators Physiological Functions when Working with Waiting
(Gritsevskiy MA & Zaytseva ZhI; Journal Article Abstract; 1 page)

Review of Book on Principles of Aviation Psychology
(Morozov A; Review Excerpt; 1 page)

USSR REPORT: LIFE SCIENCES
BIOMEDICAL AND BEHAVIORAL SCIENCES

JPRS-UBB-86-005 14 March 1986

Selected Contents:

Microbes and Grain Crop Harvests
(Lifanov V; Journal Article Abstract; 1 page)

Production and Processing of Microalgae
(Translation of Russian Pamphlet Abstract; 2 pages)

Amino Acid Production
(Translation of Russian Pamphlet Abstract; 2 pages)

Engineering Enzymology for Converting Cellulose to Glucose
(Andreyeva YeA; Translation of Russian Thesis Abstract; 1 page)

Use of Cells in Synthesis of Biologically Active Substances
(Frantsen O; Journal Article Abstract; 1 page)

Acoustic Spectroscopy of Lung Noises as Method of Illness Diagnosis
(Dzhurayev AD; Journal Article Abstract; 1 page)

Cholesterol Metabolism in Blood Cells of Irradiated Rats
(Novoselova YeG, et al.; Journal Article Abstract; 1 page)

Some Aspects of Biological and Clinical Effect of Small Doses of Ionizing Radiation on Human Body
(Deyeten P; Journal Article Abstract; 1 page)

ENGLISH TRANSLATIONS OF SOVIET SPACE LIFE SCIENCES BOOKS AVAILABLE TO OUR
READERS

We have recently learned two Russian Space Life Sciences Books translations of which are, or soon will be, available in English. For further information, NASA personnel should contact: NASA Headquarters, Scientific and Technical Information Branch (Code NIT-4), at (202) 453-2912. Other readers should direct inquires to:

Mrs. Ildiko Nowak, Chief
The National Translation Center
The John Crerar Library of the
University of Chicago
5730 South Ellis Avenue
Chicago, Illinois, 60637
(312) 962-7060

These books are:

Tigranyan RA.

Problems of Space Biology, Vol. 52

Metabolic Aspects of stress problems in space flight.

Original publication: Moscow: Nauka; 1985; 324 pages in English.

Abstracted in Issue # 5 of the Digest as M66(2/86).

Troitskii VS, Kardashev NS.

The problem of the search for extraterrestrial civilizations.

Original publication: Moscow: Nauka; 1982; 381 pages in English.

1. Report No. NASA CR-3922(07)		2. Government Accession No.		3. Recipient's Catalog No.	
4. Title and Subtitle USSR Space Life Sciences Digest - Issue 6				5. Report Date June 1986	
				6. Performing Organization Code	
7. Author(s) Lydia Razran Hooke, Mike Radtke, Ronald Teeter, and Joseph E. Rowe, Editors				8. Performing Organization Report No.	
				10. Work Unit No.	
9. Performing Organization Name and Address Management and Technical Services Company (MATSCO) 600 Maryland Avenue SW Suite 209, West Wing Washington, DC 20024				11. Contract or Grant No. NASW-3676	
				13. Type of Report and Period Covered Contractor Report	
12. Sponsoring Agency Name and Address Office of Space Science and Applications National Aeronautics and Space Administration Washington, DC 20546				14. Sponsoring Agency Code EBM	
				15. Supplementary Notes	
16. Abstract This is the sixth issue of NASA's USSR Space Life Sciences Digest. It contains abstracts of 54 papers recently published in Russian language periodicals and bound collections and of 10 new Soviet monographs. Selected abstracts are illustrated with figures and tables from the original. Additional features include a table of Soviet EVAs and information about English translations of Soviet materials available to readers. The topics covered in this issue have been identified as relevant to 26 areas of aerospace medicine and space biology. These areas are adaptation, biospherics, body fluids, botany, cardiovascular and respiratory systems, developmental biology, endocrinology, enzymology, exobiology, genetics, habitability and environment effects, health and medical treatment, hematology, human performance, immunology, life support systems, mathematical modeling, metabolism, microbiology, morphology and cytology, musculoskeletal system, neurophysiology, nutrition, perception, personnel selection, psychology, radiobiology, reproductive biology, and space medicine.					
17. Key Words (Suggested by Author(s)) space life sciences aerospace medicine space biology USSR space flight experiments space flight simulations			18. Distribution Statement Unclassified - Unlimited Subject Category 51		
19. Security Classif. (of this report) Unclassified	20. Security Classif. (of this page) Unclassified	21. No. of Pages 132	22. Price A07		

**National Aeronautics and
Space Administration
Code NIT-4**

**Washington, D.C.
20546-0001**

**Official Business
Penalty for Private Use, \$300**

**SPECIAL FOURTH-CLASS RATE
POSTAGE & FEES PAID
NASA
Permit No. G-27**

1 1 1U,F, 860624 S90569ASR
NASA
SCIEN & TECH INFO FACILITY
ATTN: ACCESSIONING DEPT
P O BOX 8757 BWI ARPRT
BALTIMORE MD 21240



**POSTMASTER: If Undeliverable (Section 158
Postal Manual) Do Not Return**
