

NASA Contractor Report 178305

INTEGRATED RESTRUCTURABLE FLIGHT CONTROL SYSTEM DEMONSTRATION RESULTS

(NASA-CR-178305)	INTEGRATED RESTRUCTURABLE	N87-22692
FLIGHT CONTROL SYSTEM DEMONSTRATION RESULTS		
(Alphatech) 134 p Avail: NTIS EC A07/MF		
AG1	CSCD 01C	Unclas

G3/08 0079000

Jerold L. Weiss, John Y. Hsu

ALPHATECH, Inc.
Burlington, Massachusetts

May 1987

Prepared For
NASA Langley Research Center
Under Contract NAS1-17411



National Aeronautics and
Space Administration

Langley Research Center
Hampton, Virginia 23665-5225

CONTENTS

	<u>Page</u>
FIGURES	iii
TABLES	iv
1. INTRODUCTION	1
1.1 BACKGROUND	2
1.2 SUMMARY	8
2. REVIEW OF RFCS TECHNOLOGY DEVELOPMENTS	11
2.1 FAILURE MODELS	12
2.2 FAILURE DETECTION AND IDENTIFICATION (FDI)	14
2.2.1 Aircraft-Path Subsystem	15
2.2.2 Actuator-Path Subsystem	16
2.3 AUTOMATIC CONTROL SYSTEM REDESIGN PROCEDURES	17
2.3.1 Auto Trim	18
2.3.2 Compensator Redesign	21
3. INTEGRATION ISSUES	23
3.1 PASSIVE ROBUST FEEDBACK COMPENSATION	24
3.2 FAILURE DETECTION	25
3.3 ACTIVE CONTROL SYSTEM CONFIGURATION	26
3.4 IDENTIFICATION	27
3.5 SUMMARY	29
4. INTERFACE ISSUES	33
4.1 ACTUATOR FAILURES	35
4.2 AIRCRAFT-PATH FAILURES	37
4.3 OVERALL RFCS OPERATION	44
5. APPLICATION TO A MODIFIED B-737 AIRCRAFT	49
5.1 DEMONSTRATION SYSTEM DETAILS	49
5.1.1 Operating Point	49
5.1.2 Flight Control System	52

CONTENTS (Continued)

	<u>Page</u>
5.1.3 Compensator Redesign Algorithm	56
5.1.4 Linear Trim Algorithm.	57
5.1.5 Failure Detection and Identification	58
5.2 DISCUSSION OF TEST CASE RESULTS	59
5.2.1 Baseline Maneuvers (R001 and R036)	63
5.2.2 Left Stabilizer Runaway (R034 and R035).	65
5.2.3 Missing Aileron Failure (R032, R033, R013, and R014).	66
5.2.4 Stuck Rudder (R030 and R031)	67
5.2.5 Missing Stabilizer Failure (R017 and R018)	68
5.3 SUMMARY	69
6. SUMMARY AND SUGGESTIONS FOR FUTURE WORK.	73
REFERENCES	77
APPENDIX A - RESPONSE DATA FOR IMPORTANT SIMULATION TRIALS	A-1

FIGURES

<u>Number</u>		<u>Page</u>
1-1	Failure Accommodation Decomposition	3
1-2	RFCS Component Decomposition.	4
1-3	Restructurable Control System	7
2-1	Measurement Configuration and Analytic Redundancy Implications.	13
4-1	RFCS State Transition Diagram	45
5-1	Command Following with LQ	53

TABLES

<u>Number</u>		<u>Page</u>
1-1	TASK BREAKDOWN FOR NASA CONTRACT NO. NAS1-17411	2
2-1	ACTUATOR-PATH FAILURE MODELS.	13
2-2	AIRCRAFT-PATH FAILURE MODES	13
5-1	ORIGINAL TEST PLAN.	60

SECTION 1
INTRODUCTION

This report presents the results of Task 8 of NASA contract NAS1-17411, "Automatic Control Design Procedures for Restructurable Aircraft Controls." The purpose of this task was to integrate the control redesign and automatic trim procedures which have been developed [1]* with the failure detection/identification (FDI) algorithms being developed under contract no. NAS1-18004, [2]. The output of this task was a Fortran program that implemented a complete restructurable flight control system (RFCS) on NASA's modified B-737 aircraft simulation for a single flight condition. This report documents the development of this prototype RFCS, discusses the results of simulations at NASA, and draws some conclusions. Table 1-1 shows the breakdown of the entire project by task.

Until now, the individual components of a prototype RFCS have been developed independently under two contracts (NAS1-17411 and NAS1-18004) to ALPHATECH, Inc. (see [1],[2]). While much interaction between these efforts has taken place, the details of integrating these components were not initially addressed. The independent work provided opportunity for greater depth in the research efforts and detailed analysis of the capabilities and limitations of the various subsystems. These initial efforts have been combined in

*References are indicated by numbers in square brackets, the list appears at the end of the main body of this report.

this effort in order to evaluate the overall system concept, and to determine the need for additional functionality.

TABLE 1-1. TASK BREAKDOWN FOR NASA CONTRACT NO. NAS1-17411

Task 1	Development of an Automatic Control Design Procedure for Restructurable Controls
Task 2	Flight Control Design Demonstration
Task 3	Application to an Aircraft with a Single Failure
Task 4	Reporting
Task 5	Perform a Complete Linearized Evaluation of the Automatic Design Algorithm
Task 6	Apply the Automatic Design Algorithm to a Nonlinear Simulation Model
Task 7	Extend the Restructuring Algorithm to Include Linear and Nonlinear Trim
Task 8	Integrated Automatic Control and FDI Designs

1.1 BACKGROUND

As aircraft become increasingly sophisticated, and as static stability is decreased in the interests of efficiency and maneuverability, the potential damage caused by unanticipated failure increases dramatically. Although pilots can be trained to react in the case of anticipated major failures, they cannot be expected to respond correctly, and in time, for all conceivable failures. This is particularly frustrating because modern aircraft, with complex controls, may remain controllable despite individual failures, as happened recently in two well publicized cases. In one case, (a Delta L-1011 flight [3]) the pilot was able to reconfigure his available controls

to save the plane. In another, (the Chicago DC-10 crash [4]) the pilot could not, although hindsight revealed the plane probably could have been saved.

The objective of a restructurable flight control system (RFCS) is to solve automatically and quickly the control problem facing a pilot during an emergency. The class of problems of interest includes those where the failure or failures are unanticipated, but excludes those unsolvable areas (total wing separation) where the plane cannot be saved.

The development of an automatic RFCS is best viewed as a problem in failure accommodation. That is, we wish to design a flight control system that is tolerant of those failure modes that cannot adequately be handled by the pilot in an emergency. As indicated in Fig. 1-1, this fault-tolerant operation can be achieved either passively (through the use of robust control laws) or actively (through FDI and control reconfiguration).

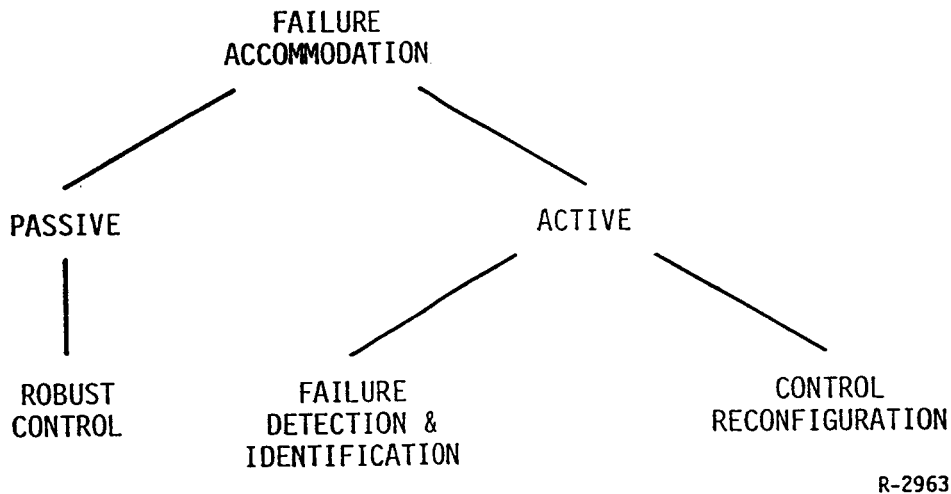
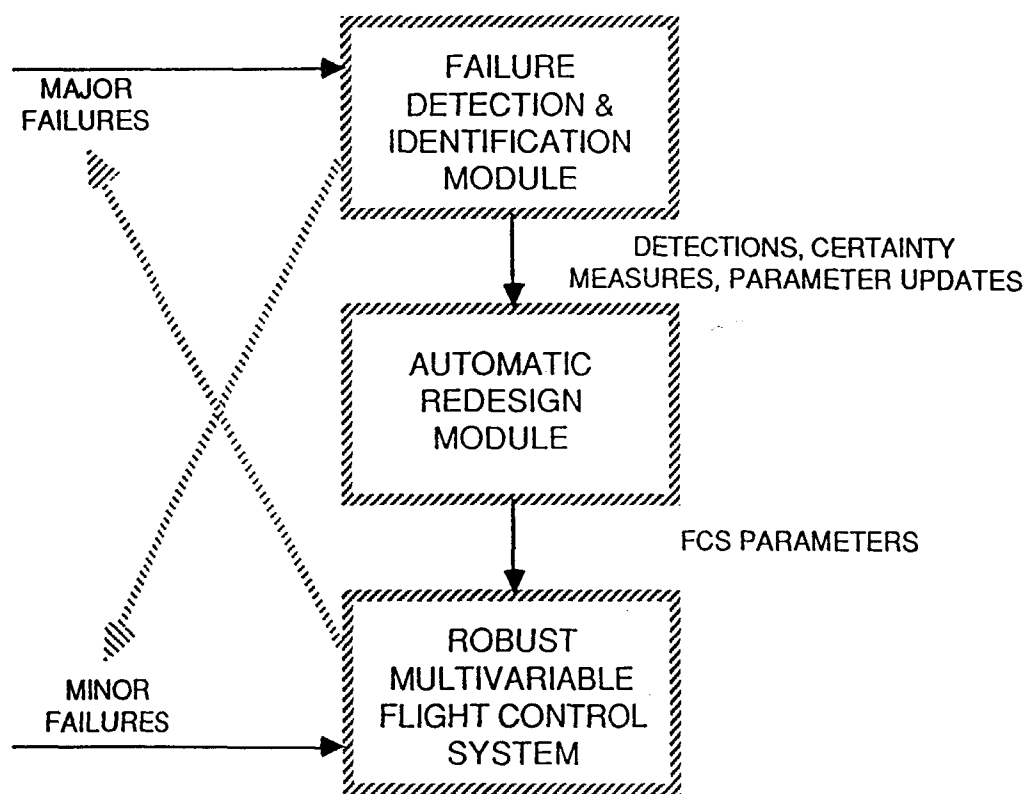

Figure 1-1. Failure Accommodation Decomposition

Passive fault tolerance can be thought of as robustness -- the aircraft with its normal flight control system (including the pilot) can tolerate

certain failures without modification. Other failures, however, may be too severe for the normal (i.e., any acceptable normal) controller to handle, and thus require active system modification. This modification involves (implicitly or explicitly) two processes: 1) failure detection and identification (including identification of a post-failure system model) and 2) control system reconfiguration in light of the identified failure.

Figure 1-2 provides a functional description of a RFCS which exploits both passive and active failure accommodation technologies. The system consists of a robust multivariable flight control system, a failure detection and identification algorithm and a procedure for automatic control system redesign.



R-4933

Figure 1-2. RFCS Component Decomposition

The robust multivariable flight control system is used in the RFCS to achieve a high degree of passive fault tolerance to "minor" failures, and to provide a safety margin for "major" failures so that the active components have time to operate. To achieve this, the control design must exploit the inherent control redundancy in the aircraft in order to minimize the effects of actuator failures and other damage. It is, however, unlikely that a robust control system alone will be sufficient to handle the wide range of failure/damage modes that must be accommodated. Even if possible, passive accommodation could require infeasibly high loop gains and bandwidths, might compromise the performance of the unfailed aircraft, or could require unnecessarily complex FCS hardware. Nonetheless, a properly designed robust flight control system applied to the unfailed aircraft will be able to handle the less severe failure/damage modes and will lengthen the time available for reconfiguring the FCS.

The more severe failure/damage modes will require a reconfiguration of the FCS. As indicated in Fig. 1-2, reconfiguration is initiated by a FDI system that must detect all conditions that may potentially lead to emergency conditions as well as identify the remaining control capability of the failed aircraft. The problems of false alarms and missed detections in the FDI system are minimized due to the existence of a robust nominal control system. As noted above, the nominal control system is designed to handle as many as possible of the failure/damage conditions. The FDI system is then required to handle only failure/damages that severely impact performance. As the severity of the impact of a failure on the aircraft performance increases, the urgency of reaction increases and the time available to reconfigure decreases. However, this trend is compensated by the corresponding increase

in the signature of the failure, which reduces the time needed by the FDI system to respond. This phenomenon, coupled with the effects of the robust control system and robust FDI design techniques, should allow a properly designed FDI system virtually to eliminate the problem of false alarms and missed detection.

The last component in Fig. 1-2, the automatic redesign module (ARM), uses the information about failures provided by the FDI system to modify the nominal robust FCS. To be effective, the new control system must be able to reconstruct the desired forces and moments as much as possible given the presence of large disturbances due to failures and, very importantly, constraints on the control system (e.g., actuation limits, bandwidth limits, etc.) Since control system constraints were important in the design of the nominal robust control system, the engineering tradeoffs that went into that design should be reflected in the new control design. Furthermore, the ARM should be tolerant of FDI limitations. Incorporation of FDI uncertainty into the redesign procedure will allow the new control system to hedge against imperfectly detected or isolated failures. Finally, graceful degradation of performance as the severity of failure increases should be a property of the ARM and can be obtained by ensuring that the nominal control system is recovered by the ARM when no failures are present.

Figure 1-3 presents the prototype RFCS that has been developed for this project with the above issues in mind. Control of the aircraft is effected through a dynamic feedback compensator that nominally provides command following, disturbance rejection, and stability augmentation for the unfailed aircraft without violating the constraints of the actuation mechanisms. In addition, a certain degree of passive fault tolerance is achieved by spreading

the control authority amongst many independent control elements. This results in the nonstandard use of standard control surfaces (e.g., collective aileron deflection) and implies a potential for increased safety from future development of nonstandard control surfaces.

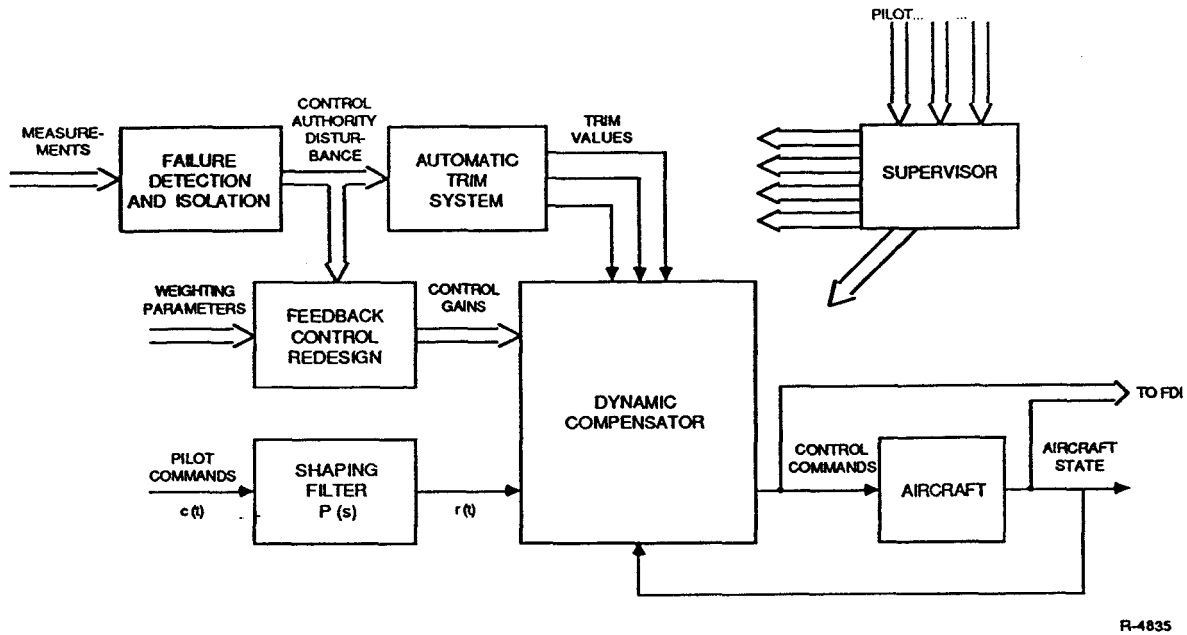

R-4835

Figure 1-3. Restructurable Control System

The purpose of the FDI system is to monitor the aircraft reliably and to indicate the presence of conditions which are beyond the capabilities of the normally configured system. Such a system must be general enough to respond to a variety of failure modes (including those that would not degrade system performance for maintenance purposes) yet be maximally sensitive to those failures that are of critical importance. In terms of flight-safety and overall aircraft survivability, it seems obvious that changes in the control authority of any control element are most important. However, since any FDI system must use sensors of some kind, the ability to respond to sensor

failures becomes critical in terms of the operational reliability of the FDI system. Thus, both control element failures and sensor failures should be handled explicitly in the FDI system to ensure maximal FDI performance during these failure conditions. Other failure modes may need to be detected (e.g., nonflight-critical equipment, small aerodynamic changes); however, less explicit information is needed in these cases in order to effect a useful control redesign.

Finally, redesign of the control system is accomplished through two functions that make maximal use of the information that is potentially available from a failure detection and identification algorithm. The feedback control redesign procedure discussed in [1] is based on the linear quadratic (LQ) design procedure and attempts to recover as much performance as possible (as measured by the return difference function) while maintaining the actuator bandwidth constraints that were present (either explicitly or implicitly) in the original feedback control design. The automatic trim system makes use of the observable parts of the disturbances that exist following a failure by feeding forward a control solution that is a function of the desired steady-state outputs and the observed disturbance. Since the disturbance must be observed/estimated after the failure occurs, and since it may take on a continuum of values, the automatic trim problem must be solved on-line.

1.2 SUMMARY

The purpose of this study was to examine the complementary capabilities of several restructurable flight control system (RFCS) concepts through the integration of these technologies into a complete system. Performance issues were addressed through a re-examination of RFCS functional requirements, and

through a qualitative analysis of the design issues that, if properly addressed during integration, will lead to the highest possible degree of fault-tolerant performance. Software developed under previous phases of this contract and under NAS1-18004 was modified and integrated into a complete RFCS subroutine for NASA's B-737 simulation. The integration of these modules involved the development of methods for dealing with the mismatch between the outputs of the failure detection module and the input requirements of the automatic control system redesign module. The performance of this demonstration system was examined through extensive simulation trials.

In Section 5 we present details of an RFCS design for a modified B-737 aircraft. This RFCS includes functional elements to detect and isolate aircraft-path and actuator-path control element failures, to redesign the feedback compensator after a failure has been detected, and to retrim the aircraft when significant measurable disturbances are present. The RFCS did not include any function to estimate remaining control effectiveness or to estimate (rather than measure) significant disturbances.

Extensive tests using NASA's nonlinear 6-DOF simulation were made. These tests were aimed at examining the impact of FDI delays and incomplete FDI decisions as well as examining the recovery capability of the compensator redesign and retrim algorithms. In all, over 40 simulation runs were made. A discussion of several specific runs is given in subsection 5.2. Subsection 5.3 provides a general summary of the results and Section 6 concludes with suggestions for further work. We believe that the key conclusions are:

1. Reconfiguration can provide a mechanism for failure recovery that fully utilizes the remaining (post-failure) control authority and achieves a high degree of fault-tolerance, even for major failures.

2. The RFCS demonstrated in this report performed quite well. Failure detection was accomplished with delays that were more than adequate for good failure recovery. Redesigned compensators provided improved stability augmentation and new trim solutions allowed recovery from the severest failures.
3. The automatic recovery procedures, especially in some of the severe failure cases, are sometimes contrary to traditional pilot training (e.g., reduce throttle at high pitch-up and slowing airspeed conditions). This is not unexpected since training cannot anticipate all types of failures, whereas the RFCS is designed to solve these previously-unanticipated problems. Note that the "expert-system" approach to reconfiguration is frequently based on pilot training, shown here to be an inadequate solution in some cases.
4. Proper design of the nominal flight control system can result in large degrees of passive fault tolerance and, thereby, make the FDI system design substantially easier (i.e., detection of "large" failures can be made with more reliability (higher detection and lower false alarm probabilities)).
5. Highly fault-tolerant RFCS design can be achieved only if the various functions (ARM, FCS, FDI) are complementary. Analysis methods that allow characterization of FCS failure-robustness in terms of FDI performance specifications, and other integrated design and analysis methods need to be developed.

SECTION 2

REVIEW OF RFCS TECHNOLOGY DEVELOPMENTS

The purpose of the work described in this report was to assess the capabilities of the RFCS technologies developed by ALPHATECH under contracts NAS1-18004 and NAS1-17411 by integrating them into a complete restructurable control system. This section briefly describes the technologies to be integrated. Further details are available in [1] and [5].

The overall RFCS shown in Fig. 1-2 is broken down into three functional elements; Failure Detection and Identification (FDI), a robust multivariable Flight Control System (FCS), and an Automatic (control system) Redesign Module (ARM). The ARM is composed of a feedback compensator redesign algorithm and a feedforward re-trim algorithm.

Robust multivariable flight control technology has been developed extensively over the last 20 years and will not be discussed in this section. However, it is important to note that for fault tolerance, both stability and performance robustness are important. Thus, the notion that one must trade-off nominal performance and robustness in the design of a FCS system is only partially true (it applies to stability robustness but not to performance). In addition, pilot-in-the loop concerns further modify this "classical" tradeoff notion (since large FCS stability margins sometimes adversely affect handling qualities). In this project we utilized the LQ methodology for the baseline FCS design (the compensator redesign algorithm is based on LQ ideas

also). Thus, the conclusions drawn about passive FCS fault-tolerance are all for LQ designs (known to have good theoretical stability margins). Exploration of fault tolerant capabilities of other design methods is a suggested area of further study.

The remainder of this section outlines the basic ideas and capabilities of the FDI system, the compensator redesign algorithm and the retrim algorithm. First, however, a brief description of the failure modes of interest is given.

2.1 FAILURE MODELS

The RFCS technologies described in this section are capable of dealing with a broad class of failures. We have limited this study to control element failures because of their criticality. In general, we can describe virtually any control element failure as follows. Let δ_c , δ_a , and δ_e be a commanded control value, an actuator output, and an effective control value, respectively (see Fig. 2-1). Both normal and failed operation of a control element are described by,

$$\delta_a(s) = A(s)\delta_c(s) + d_a(s) \quad (2-1)$$

$$\delta_e(s) = E(s)\delta_a(s) + d_e(s) \quad (2-2)$$

where s denotes the Laplace transformation variable. Under ideal no-failure circumstances $E(s) = 1$, $d_a(s) = d_e(s) = 0$ and $A(s)$ represents the unfailed dynamics of the actuator.

Specific actuator-path failures can be defined by different values for $A(s)$ and $d_a(s)$ as shown in Table 2-1.

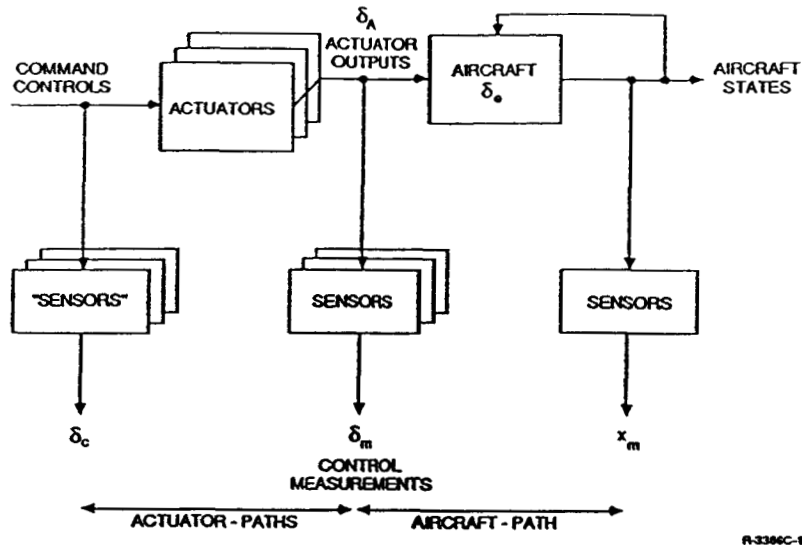

Figure 2-1. Measurement Configuration and Analytic Redundancy Implications

TABLE 2-1. ACTUATOR-PATH FAILURE MODELS

Stuck	$A = 0$	$d_a(t) = \text{constant}$
Floating	$A = 0$	$d_a(s) = K(s) * (\text{local angle of attack})$
Runaway	$A = 0$	$d_a(t) = \text{slewed to control limit}$

Specific aircraft-path failures can be defined by different values of $E(s)$ and $d_e(s)$. Common definitions of aircraft-path failures are shown in Table 2-2.

TABLE 2-2. AIRCRAFT-PATH FAILURE MODES

Stuck	$E = 0$	$d_e(t) = \text{constant}$
Floating	$E = 0$	$d_e(s) = K(s) * (\text{local angle of attack})$
Partial Loss	$E < 1$	$d_e = 0$ or, $d_e = (1-E)K(s) * (\text{local angle or attack})$

Note that most actuator path failures result in zero control authority ($A=0$) whereas some commonly discussed aircraft-path failures have nonzero effectiveness ($E \neq 0$). This situation will have an impact on how the FDI results are interpreted for use by the control redesign procedure.

2.2 FAILURE DETECTION AND IDENTIFICATION (FDI)

The FDI algorithm that was developed under contract no. NAS1-18004 focused on the general problem of detecting and identifying control element failures. This focus stems not only from the fact that such failures can result in emergency conditions, but also because any restructurable control system is limited in its ability to respond to emergency conditions by the amount of remaining control authority. Thus, the FDI system must detect such failures and identify the remaining control authority. The algorithm developed in NAS1-18004 (see [5]) maximizes the sensitivity to control element failures by explicitly including appropriate failure hypotheses in its operation.

Figure 2-1 describes the information flow which is available for FDI for an assumed measurement configuration. The figure first shows several parallel actuator paths in which failures of each actuator can be independently detected through the use of the analytical redundancy which is embedded in the independent actuator models. That is, "actuator-path" failures can be detected by comparing a predicted actuator output (based on the measured input, δ_c , and an actuator model) with the measured output, δ_m .

Although many control element failure modes are covered by such comparisons, there are other failures modes which are not. This is also illustrated in Fig. 2-1. In particular, when an effective control value (i.e., the

control value which actually moves the airplane) differs from the measured output of the actuator, then a control element failure also exists. These failures can be detected by the use of the analytical redundancy which is embedded in an aircraft model. That is, "aircraft-path" failures can be detected by comparing the measured motion variables (which are a function of the aircraft states) with a prediction of these variables based on the control measurements.

Clearly, from the figure, all control element failures could be detected using an aircraft model that includes the actuator models thereby eliminating the need for actuator output measurements and reducing the cost and weight associated with the sensor hardware and redundancy management. However, the parallel actuator-path FDI algorithms are very simple and reliable. As a result, the FDI system developed in [5] contains independent actuator-path and aircraft-path algorithms.

The structure of both actuator- and aircraft-path FDI systems developed in [5] involves a monitoring or trigger process and a verification and/or isolation process. The trigger process is used to reject the hypothesis of normal operation and to trigger the verification and isolation processes which reject false triggers and identify the source of a failure. This structure is used to achieve performance advantages which approach the performance of known onset-time algorithm without undue complexity. The advantages include greater failure sensitivity, lower false alarm rates, and shorter detection delays.

2.2.1 Aircraft-Path Subsystem

The aircraft-path trigger was designed to make the probability of missing a critical failure small. Thus, each failure mode has an explicit trigger

function that is optimized for triggering under the corresponding failure mode. Each trigger satisfies the condition that IF a particular "minimal" failure occurs, THEN the corresponding trigger test will "pass." Since the converse is not necessarily true and since false triggers are possible, verify and isolate tests are performed.

The verify and isolate tests are binary-hypothesis sequential tests, and are designed so that failures that are larger than some minimal value will be detected and isolated in shorter time periods. If these tests reach a maximal time limit, no decision (in favor of either hypothesis) is made.

The isolation process recognizes the fact that only the rejection of failure mode hypotheses is possible when detailed signature information is not used (as is the case in [5]). This fact results, in principle, in a matrix of isolation tests, each designed to reject a failure mode with maximal sensitivity to another failure mode. Although this structure appears complex, it guarantees optimal performance for every failure mode and allows detailed analysis and optimization of each part of the system. In practice, the off-diagonal tests in this isolation matrix were combined for efficiency. Also, in principle, only those failure modes which are in the "trigger-implied ambiguity group" need to be isolated, although in practice all failures were considered as possible following any trigger. To declare a failure, all isolation tests must "vote" in favor of that failure, although alternate decision mechanisms are described in Section 3.

2.2.2 Actuator-Path Subsystem

The character of the actuator residuals (all actuator failure directions are mutually orthogonal) resulted in one actuator-path subsystem for each

actuator failure. Thus, no isolation process was needed. These subsystems, like the aircraft-path subsystem, also used a trigger/verify structure to "solve" the unknown onset time problem. Two decision processes were created and tested; a fixed threshold and a varying threshold algorithm.

The fixed threshold algorithm was designed to accommodate the observed low frequency behavior in each residual, sensor noise, and other high frequency errors. The result of a trigger crossing its threshold is the initiation of a sequential verify test. If the verify test passes, the corresponding control element is declared as failed. If a verify fails, a "false trigger" is declared. Because fixed thresholds were used to accommodate low frequency errors, the sensitivity to actuator path failures was higher than originally expected (though by no means unacceptable).

The varying threshold algorithm was based on the concept derived in [5] for single-input, single-output systems with transfer function errors. It assumed that all transfer function errors were high frequency relative errors. Observations clearly indicated that this was not the case, and consequently, this decision process did not perform as well as expected. Further work in this area is needed before substantive conclusions can be drawn. For this study, the fixed threshold algorithm was used.

2.3 AUTOMATIC CONTROL SYSTEM REDESIGN PROCEDURES

The automatic redesign procedures (auto-trim and compensator redesign) developed in this project focused on incorporating all likely sources of information about the failed aircraft into the redesigned control system. The auto-trim algorithm utilizes information (linear models) about the desired (unfailed) operating point, the remaining control authority, and any

measurable disturbances (e.g., the effect of a stuck off-centered control surface) to re-solve for a new trim condition. The compensator redesign algorithm also uses linear models for the desired operating point and remaining control authority information. It also utilizes information about control bandwidths that is embedded in state and control weights for an LQ "basis-compensator" (i.e., the compensator resulting from execution of the redesign algorithm with an unfailed aircraft model). New control gains that ensure robust stability and maximize command following performance, are then output from the algorithm following a detected and isolated failure.

To be specific we assume, in both the feedback control redesign problem and the automatic trim problem, that a desired equilibrium point of the unfailed aircraft is given and a linear model of the failed aircraft at that operating point is available. That is, we assume that after a failure, the behavior of the aircraft is modeled by

$$\dot{x}_p = Ax_p + Bu_p + w_p + \zeta \quad (2-1)$$

where x_p is the perturbation of the state vector from the unfailed equilibrium value x_0 , u_p is the perturbation of the control vector from u_0 , w_p is a vector of known or measurable disturbances, and ζ is an unknown disturbance. The state transition and control effectiveness matrices (A,B) model the dynamics of the failed aircraft.

2.3.1 Auto Trim

For constant nonzero disturbances w_p (e.g., a stuck control surface), the trim solution $(x_p, u_p) = 0$ is clearly no longer an equilibrium point for Eq. 2-1. The trim problem is formulated to find a new desirable equilibrium

point for Eq. 2-1, subject to travel constraints on the control elements. In addition, we impose the constraint that the new equilibrium states be within the region of validity for the linear model, and that no other important state constraints are violated (e.g., minimum air speeds). When a solution to the problem does not exist, we wish to minimize the departure from some desirable conditions, subject to the same constraints.

Mathematically, the trim problem is formulated as follows. Let the desired conditions, y_d , be represented by,

$$Cx_p = y_d \quad (2-2)$$

Constraints on the controls and states can usually be given by simple bounds, viz.,

$$\begin{aligned} x_L &< x_p < x_U \\ u_L &< u_p < u_U \end{aligned} \quad (2-3)$$

Next, define the objective function,

$$J_2 = \|Ax_p + Bu_p + w_p\| + \|Cx_p - y_d\| \quad , \quad (2-4)$$

the feasible set,

$$F = \{x_p, u_p: \text{Eq. 2-3 holds}\} \quad (2-5)$$

and the optimizing set,

$$D = \{x_p, u_p: (x_p, u_p) = \arg \min J_2\} \quad . \quad (2-6)$$

The automatic trim problem is then compactly expressed by,

$$\min J_1 = \|x_p - x_p^0\| + \|u_p - u_p^0\| \quad (2-7)$$

subject to $(x_p, u_p) \in F$ and D

where x_p^0 and u_p^0 are some desired a priori perturbations from x_0, u_0 (usually zero).

When Euclidean norms are used in Eqs. 2-4 and 2-7, the trim problem is reduced to a form which can be solved using quadratic programming techniques (see [1] for details of the solution method).

The solution to the trim problem (x_p^*, u_p^*) is applied to the control elements as a feedforward term. In particular, if the LQ feedback gain matrix is G , then it can be shown ([1],[6]) that the application of $\delta_{\text{feedforward}} = Gx_p^* + u_p^*$ at $t = 0$ will change Eq. 2-1 to

$$\dot{x}_p = (A - BG)(x_p - x_p^*) + \zeta \quad (2-8)$$

Since $(A - BG)$ is stable, $\dot{x}_p \rightarrow 0$, and $x_p \rightarrow x_p^*$. Furthermore, for nonconstant disturbances, w_p , the solution to Eq. 2-7 can be obtained at each time that u_p is available. The feedforward control then serves to reduce the effect of w_p , dynamically (see [6] for theoretical justifications).

Of course, errors in the linear model of Eq. 2-1 will always exist and, therefore, the solution to Eq. 2-7 can only get us close to the desired conditions. The feedback control system, when properly designed, will ensure that when a feasible solution exists ($J_2 = 0$) the actual states will be driven close to the values selected by the trim problem. However, the performance of the feedback system (in terms of driving the aircraft to a new selected trim, as well as other disturbance rejection and command-following properties) is

degraded due to control element failures. Although this degradation may not be severe when sufficiently robust control laws are used, it is, nevertheless, of interest to explore methods of feedback compensator redesign.

2.3.2 Compensator Redesign

The goal of the feedback compensator redesign algorithm given in [1], is to recover, after failure, as much as possible of the desirable properties of some nominal control system (for the unfailed aircraft) subject to the constraint that the new compensator not violate any control-loop bandwidth constraints. The bandwidth constraints are imposed so that the stability robustness properties of the basic LQ compensator (which is used in the redesign procedure) are maintained. The problem is formulated in a probabilistic sense that includes the effects of model uncertainty. In order to acknowledge the increased potential of having inaccurate models after a failure occurs.

Mathematically, the compensator redesign problem is formulated as follows. The magnitude of the return difference matrix of the failed aircraft is a measure of feedback performance. The return difference is defined by

$$D(s) = I + G(sI-A)^{-1}B \quad (2-9)$$

where s is the Laplace transform variable and G is the gain matrix which defines the feedback compensator which we wish to determine (note, all compensator dynamics such as integrator states are included in A and B). Next, we assume that some nominal compensator satisfies bandwidth constraints of the form

$$\|P(j\omega_c I - A_0)^{-1} B_0 N_0\| < 1 \quad (2-10)$$

where (A_0, B_0) are the system and control matrices for the unfailed aircraft, N_0 is the square root of the inverse of some nominal control weighting matrix and P is a bandwidth scaling matrix. Next, we assume that B can be expanded as $B = B_f + \Delta B$, where B_f is the expected value of B and where ΔB is a random matrix with zero expected value and known second moments;

$$\beta_{ijkl} = E\{[\Delta B]_{ij} [\Delta B]_{kl}\} \quad (2-11)$$

The optimization problem we wish to solve is to maximize the expected "size" of $D(s)$ and minimize the expected size of the uncertainty about $D(s)$ while ensuring that the resultant control law satisfies bandwidth constraints of the form

$$\|P(j\omega_c I - A)^{-1} B_f N\| < 1 \quad (2-12)$$

where N is the square root of the inverse of the LQ control-weighting matrix which produces the new control law. The solution, G , is derived by solving the following problem.

$$\max \text{Tr} \int_0^{\infty} E\{\bar{D}^T(s) \bar{D}(s)\} - E\{[\bar{D}(s) - E\{\bar{D}(s)\}]^T [\bar{D}(s) - E\{\bar{D}(s)\}]\} ds$$

subject to Eq. 2-12

(2-13)

where $\bar{D}(s) = N^T D(s) N$. In [1] we describe how the use of the Kalman Equality, 2-7, to express $D(s)$ in terms of the control and state weights can be used to approximately solve Eq. 2-13. The solution is only valid for reduced effectiveness failures. When no uncertainty is present, the solution is trivial: simply solve the LQ design problem with the original weighting matrices and the new value of B .

SECTION 3
INTEGRATION ISSUES

In this section we discuss issues associated with the creation of a complete RFCS from the algorithms reviewed in Section 2 (robust flight control, FDI, compensator redesign and automatic trim). These issues can be roughly characterized as either performance or interface issues. For the performance issues, we discuss various engineering tradeoffs that occur when good unfailed-performance and high degrees of fault-tolerance are desired. This discussion looks at general functional requirements of restructurable flight control (with less regard to the algorithms already developed).

The overall performance goal of any RFCS is the development of a control system that allows the pilot, whenever it is physically possible, to adequately control the aircraft despite large changes to the dynamic input/output relationships of the aircraft and despite the presence of sometimes large force and moment disturbances. This goal requires adequate controllability (in the qualitative sense) for many possible failure modes including multiple simultaneous and sequential control element failures as well as failures that effect the basic aerodynamics of the aircraft.

In order to achieve this qualitative controllability goal, the RFCS must always be stable (this implies nominal stability and stability robustness for all failure modes), should have very good disturbance rejection properties, and should attempt to maximize command following performance. Furthermore,

these goals must be achieved without violating the physical constraints on the aircraft. As discussed in [1] and in Section 1, these goals can be achieved through a combination of passive and active fault-tolerant control functions. These functions are now discussed in detail in terms of how they can be used to satisfy the overall RFCS performance requirements and in terms of the design issues which need to be addressed for each function. Four general functions are discussed. They are:

1. Passive Robust Feedback Compensation,
2. Failure Detection,
3. Active Control System Reconfiguration,
4. Identification.

3.1 PASSIVE ROBUST FEEDBACK COMPENSATION

Much has been said about this function in past reports (see [1]). Feedback compensation is frequently used to achieve command-following performance goals for unfailed aircraft because it achieves the desired performance despite "small" modeling errors and disturbances. For RFCS's, we want to expand this capability as much as possible without sacrificing the stability robustness of the control law for the unfailed aircraft. To achieve an expanded tolerance to errors and disturbances, we would like to raise the loop gains and distribute control authority amongst independent control elements as much as possible. Limitations exist because of control element bandwidths and noise considerations.

The above discussion indicates that the process of creating a feedback compensator which is, as much as possible, tolerant or robust to failures,

is really no different in its goals than the process of creating a high-performance multivariable compensator for the unfailed aircraft. Perhaps the only difference is that one may wish to increase the stability robustness specifications to include larger errors due to the possibility of failures. It is this increased stability robustness specification which can give rise to a "tradeoff between nominal performance and failure robustness." However, closed-loop stability is only one requirement for good failure recovery performance. The large loop gains associated with a high performance compensator are also important for passive failure recovery. Therefore, it is more important to achieve nominal performance first, and to use any remaining degrees of freedom in the design to increase stability robustness in the presence of failures.

The design considerations discussed above, when properly addressed, can achieve a large degree of fault tolerance (see, e.g., [1]). Nevertheless, there may be failures which can only be handled by changing or reconfiguring the control system. This process requires various "active fault tolerance" technologies which are discussed below.

3.2 FAILURE DETECTION

Clearly, if active reconfiguration is necessary, we must first detect the fact that the aircraft is not operating normally. To define "normal" we need models of the aircraft, and since model errors will always exist, the detection system must use the best information while maintaining its sensitivity to important failure modes. The important failure modes should be determined by the capabilities of the passive compensator discussed above and considered explicitly in the design of the failure detection mechanism. (Note that it

may be possible to use one detection mechanism for many modes and still maintain adequate sensitivity. This is especially true for different types of control element failures like stuck, floating, partially missing, runaway, etc.). Typically, it is believed that the "size" of the important failure modes can be much greater than the size of the modeling error that defines normal operation. Thus, it should be easy to minimize false alarms in the process of detecting important failures.

In addition to detecting important failures explicitly, it may also be desirable to detect other unanticipated failures. Generic detection tests which use all information (an aircraft model) to its fullest are appropriate for this function; however, care must be taken to avoid false alarms.

Note that we have not considered any form of failure identification in this process. This is because the requirements of the identification function are dependent on the active reconfiguration strategy which is discussed next.

3.3 ACTIVE CONTROL SYSTEM RECONFIGURATION

The purpose of this function is to "reoptimize" the performance of the control system for the new failure conditions. This reoptimized performance includes the need to reject disturbances due to the failure, recover command following as much as possible, and ensure closed-loop stability (stability robustness).

In order to perform this reoptimization, any reconfiguration strategy requires some knowledge about the failed aircraft. More (and more accurate) information will allow any reconfiguration strategy to better reoptimize aircraft performance in the presence of failures. For example, if we knew only that some individual control element was inoperative, and that the failure was

inducing no disturbances on the aircraft, then the technique of simultaneous stabilization, [8], might be an appropriate reconfiguration strategy. This strategy would ensure closed-loop stability but does nothing to optimize command following or disturbance rejection performance. As another example, if a single control was stuck at a known position, the effectiveness of that control was known, and all controls had equivalent bandwidths, then a mixer-like strategy, [9], might be appropriate since it can recover the map from the unfailed control element commands to the forces and moments.

The LQ compensator redesign procedure and feedforward trim of [1] requires some knowledge of both control effectiveness and disturbances. More specifically, these procedures are implemented using estimates of the failed aircrafts linearized dynamics including estimates of uncertainty. Since this information covers nearly all failure modes, the performance of this strategy is only dependent on the quality of the estimates of the required information. The problem of providing accurate information is addressed in the following identification function.

3.4 IDENTIFICATION

In general, the question of what must be identified for adequate reconfiguration performance is still an open one. As discussed above, the most general information might consist of the selection of an operating point and the determination of the failed aircraft's linearized dynamics (including measurable/estimable portion of disturbances). The most important pieces of information for any strategy, however, are the failed aircrafts' control effectivenesses and an estimate of the disturbances. This is because failures of control elements can cause large disturbances, and redistribution

of control authority is only possible when the remaining authority is known. The failed aircraft's stability characteristics (if different from the unfailed aircraft) may be important in some cases, although this has not been investigated.

In order to maximize the quality of the identification procedure, it is typically necessary to "focus" the identification algorithm on the most important parameters for the particular failure mode. Focusing is important because it allows only the best information (i.e., that with the largest signal-to-noise ratio) to be selected. For example, if it is known that a particular control element is stuck at a particular position and that no other failures have occurred, then the estimation of the disturbance caused by this failure is trivial (see Section 5). Similarly, if an aircraft path failure (e.g., partially missing, etc.) can be isolated to a single control element, then the joint estimation of all control effectivenesses would not be necessary and the identification procedure could focus on only the failed control.

Because focusing can be extremely important for identification procedures, we see that a first step in identification is typically the isolation of failure modes. The isolation process answers the question Which failure mode occurred? The remaining step is one of estimation which then provides the detailed information needed for a reconfiguration strategy. An open question is the determination of what level of isolation is needed to obtain the focusing necessary to provide quality estimates.

Finally, although focusing of estimation algorithms on important parameters is important, it will only allow the best extraction of the information that is available. If this information is of low quality, then estimates will be poor. In order to ensure quality estimates, therefore, it is necessary to

ensure good signal-to-noise ratios in the signals being used for estimation. The only way this can be done is through the application of known control "probes" or (dither-like signals). These probes only need to be active during a brief identification period following a failure and would not interfere with normal flight. Furthermore, these probes can be designed to have minimal impact on the aircraft while enhancing the distinguishability of failures and improve estimation performance.

3.5 SUMMARY

The four basic functions needed to achieve high degrees of fault-tolerant control are

1. Feedback compensation during normal flight,
2. Failure detection,
3. Control system redesign procedures, and
4. Identification.

Each of these functions should be designed with the following concerns.

FEEDBACK COMPENSATION

1. If the nominal compensator has high loop-gains at low frequencies, then it will be able to passively accommodate many force and moment imbalances due to failures.
2. High loop-gains, however, may reduce stability robustness in the face of failures. However, this may not be important if detection, identification, and compensator redesign results in a robustly stable aircraft.
3. If the compensator can passively accommodate "large" failures, then failure detection thresholds can be set to values that significantly reduce false alarms. Thus, it is important to characterize the passive fault-tolerance of the nominal compensator.
4. If the failure detection system cannot detect some failures without sacrificing false-alarm performance, then the nominal compensator should be designed to passively accommodate those failures.

CONTROL SYSTEM REDESIGN

1. The redesigned feedback compensator must ensure stability and optimize disturbance rejection and command following performance without violating the control bandwidths that guarantee stability robustness.
2. To maximize performance, details of the failure condition are needed. Since many details are only available from identification procedures, on-line redesign is important.
3. Feedforward compensation (such as automatic trim) can be very useful in rejecting measurable disturbances. However, overly restrictive requirements (e.g., recover all forces and moments as in the mixer approach) can lead to control saturation.
4. When no failure exists, the redesigned control law should recover the nominal controller in order to minimize transients due to false alarms in which identification returns values close to the unfailed aircraft.
5. Assessment of the capabilities of redesigned control laws defines the overall limitations of the RFCS. These limitations can only be overcome by more "inherent redundancy."
6. Since identification procedures contain inaccuracies, the redesign procedures should incorporate measures of uncertainty about the parameters that drive the redesign.
7. The selection of a desired post-failure operating point can have a large impact on the RFCS's ability to recover from large failures.

IDENTIFICATION

1. Better estimates of critical parameters can be obtained if identification algorithms are focused. One method of focusing is to "isolate" the cause of an important failure, and then identify only the relevant parameters.
2. Estimates of identification accuracy are needed since the redesign procedure can maximize robustness if this estimate is available.
3. Estimation of post-failure control authority is the most important aspect of identification since it impacts how control power can be redistributed in the redesigned control law.
4. Probe or dither signals can be useful in improving identification accuracy. This can be done without affecting the overall stability of the unfailed aircraft since these signals only need to be applied after a failure is detected.

The issues discussed above are considered to be those that are most important in the development of an integrated RFCS in which the capabilities and limitations of each part of the RFCS are complemented by others. Further work in integrated RFCS design should include design and analysis methods that ensure such complimentary functionality. This is the only way to ensure and justify the high degree of fault tolerance that is claimed for restructurable flight control systems.

THIS PAGE INTENTIONALLY LEFT BLANK

SECTION 4
INTERFACE ISSUES

The interface issues that are discussed in this section are unique to the details of the algorithms that are being integrated. Methods for dealing with "mismatching" interfaces are derived and a description of the top-level control-logic for the demonstration system is developed. Much of the top-level operation is derived as a consequence of specific assumptions about detectable and isolatable failures and the expected results of reconfiguration.

In contrast to integration issues, the interface problem is particular to the algorithms that are being used for this project. The three basic functional blocks (FDI, ARM, and FCS; see Fig. 2-1) each have data input requirements and output capabilities that were derived somewhat independently. The result was a mismatch between the data that the FDI algorithm naturally provides and the information requirements of the ARM.

In particular, the FDI algorithm only provides "discrete" information about failures such as what failures have caused triggers, what failures could be verified and which failures are more likely than others (see [5]). When appropriate, flags are set to indicate that a particular control element failure has been detected and isolated or that a false trigger has occurred. Unfortunately, the automatic redesign module (trim and compensator redesign) needs a different set of information. The ARM module is based on the assumption that, after a failure occurs, the FDI system will provide an estimate of

the linear dynamics of the aircraft (at some desired flight condition), an estimate of any significant observable disturbances, and some characterization of the uncertainty of these estimates.

NOTATION

- β_{ijkl} = Uncertainty Tensor (see Section 2)
- B_0 = Unfailed Effectiveness Matrix
- w_p = Disturbance Vector (see Section 2)
- $[X]_{ij}$ = i, j -th Element of Matrix X
- B_f = Expected Value of Failed Effectiveness Matrix (see Section 2)
- E_j = Effectiveness of Control j
- $E\{ \}$ = Expected Value
- b_i^f = i -th Column of B_f
- δ_i^m = Measured Value of i -th Control "Position"
- δ_i^{trim} = Trim Value of i -th Control for the Desired Post-fail Operating Point
- $f(\cdot|\cdot)$ = Conditional Probability Distribution Function
- C = Confusion Set
- $\delta(\cdot)$ = Dirac Delta Function
- α_j^2 = Variance of E_j
- p_j = Probability of "Only the j -th Failure" Being True

Since the FDI algorithm is only concerned with control element failures, any stability effects due to failures must be ignored. Therefore, the state transition matrix (A) for the failed aircraft will be identical to its value for the unfailed aircraft and will be stored as data for the ARM. Note that

the value of A that is used in the ARM represents the linear dynamics of the unfailed aircraft about any desired operating point and need not correspond to the operating point of the aircraft just prior to reconfiguration.

Similarly, the elements of matrix B_f corresponding to unfailed control elements will be derived from the unfailed linear dynamics at the desired operating point.

The uncertainty characterization described in Section 2 (see [1] for more details) is a fourth order tensor involving the cross-covariances of elements in the uncertainty matrix ΔB . For simplicity, we will assume that β_{ijkl} is zero when $j \neq l$ (i.e., the effectiveness estimation errors for different controls are uncorrelated) and use the multiplicative model

$$[B]_{ij} = E_j [B_0]_{ij} \quad (4-1)$$

where E_j is a random variable representing the effectiveness of the j-th control. Thus, since B_f is the expected value of B, (see Section 2),

$$[B_f]_{ij} = E\{E_j\} [B_0]_{ij} \quad (4-2)$$

and

$$\beta_{ijkj} = [B_0]_{ij} [B_0]_{kj} \alpha_j^2 \quad (4-3)$$

where α_j is the standard deviation of E_j and would typically take on values between zero (no uncertainty) and one (100 percent uncertainty), although values exceeding one are not excluded.

4.1 ACTUATOR-PATH FAILURES

The FDI system has the capability of detecting and isolating multiple simultaneous and sequential actuator-path failures. When actuator failures

are detected and verified, reasonable values for B , w_p , and α_j can be determined by referring to the failure models described in Section 2. These models indicate that most failures result in zero authority and that the disturbances are governed by the actual position of the control element. Therefore, a wide range of actuator failures can be adequately handled by zeroing the column of the expected control effectiveness matrix (B_f) corresponding to failed actuators, and estimating the observable disturbances by

$$w_p = \sum_{i \in \{\text{Failed Actuators}\}} b_i^f (\delta_i - \delta_i^{\text{trim}}) \quad (4-4)$$

Although originally conceived for stuck surfaces in which w_p is constant, Eq. 4-1 can be executed at every time instance in order to allow the trim algorithm to properly handle floating and runaway failures. Also, note that by zeroing the columns of B corresponding to verified actuator failures, the ARM will eliminate their use in any reconfigured control law. Thus, the values assigned to the uncertainty parameters, α_j , is immaterial and can be left at its default (no-fail) value (typically zero).

The FDI system also has the capability to indicate when an actuator failure is suspected, but not clearly verified. Since the ARM is capable of dealing with uncertainty, it is superficially attractive to consider the possibility of utilizing the compensator redesign algorithm as an interim means of providing fault tolerance between the time that a failure has triggered and it is verified. There are two drawbacks to this idea, however. First, the FDI system is capable of identifying false triggers by failing to verify a failure after it has been triggered. In this case, the transition to an interim set of control gains and back to the originals when a false trigger

is identified could create undesirable transient control deflections. The second drawback to this idea lies in the fact that the use of a redesigned compensator will tend to de-emphasize the use of the suspected control element. This decreased use can frequently result in smaller failure signatures (refer to the failure models) and possibly cause false trigger indications. The overall result could then be a limit cycle of gain transitions caused by repeated triggers and false-trigger identifications. Since the actuator-path system is capable of detecting failures in a very short period of time (under one second) the lack of an interim robust control law during periods of suspected actuator failures will not severely impact overall aircraft performance. The problems cited above are then avoided by utilizing only the original control law until an actuator failure is triggered and verified.

4.2 AIRCRAFT-PATH FAILURES

The first thing to recognize in transforming aircraft-path FDI information into values of B_f , w_p , and α_j , is that, (unlike the actuator case) there is no directly measurable disturbance (w_p) estimate. Since most of the likely failure modes presented in Section 2 have no resulting disturbance associated with them, we will assume that aircraft-path failures as a whole have this property. As a result, the trim algorithm will not be executed for aircraft-path failures. Those failure modes that do have significant disturbances (e.g., runaway or stuck off-center) may, therefore, be problematic for this system.

In developing values for B_f and α , it is useful to recognize the four basic events that the aircraft-path FDI system can create. They are,

1. A single control element failure is isolated,

2. A trigger occurred, but all verify tests fail, indicating a false trigger,
3. A trigger occurred, some verify tests passed, but the isolation test results preclude isolation of a single control (unable-to-decide), and
4. A trigger occurred, but states 1, 2, or 3 have yet to be declared.

Event number 4 is similar to the "triggered but not yet verified" actuator case discussed above. The arguments for utilizing the original compensator in this state are equally valid here. Thus state 4 is handled by doing nothing.

Event number 3 (unable-to-decide) could occur either due to larger than anticipated model error effects, or due to a situation in which the size of a failure signature precludes the reliable isolation of two or more control elements. The first situation would indicate treatment of event 3 as a false trigger as appropriate. In the latter situation, however, substantial amounts of time might elapse before a correct identification of the failed control can be made (correct identification will never be made if failures are indistinguishable). Treating event 3 as a false trigger in this case could therefore be detrimental to failure recovery. Thus, compensator redesign should take place when event 3 is declared.

Event number 2 frequently occurs when no failure is present and therefore suggests that a return to a control law that assumes that there is no aircraft-path failure is appropriate (a "return" is necessary only if event 3 occurred previously; the occurrence of event 2 suggests that the previous state-3 occurrence was to model error).

Finally, in Event 1, when a single control can be isolated as failed, an estimate of B_f and α_j that somehow reflects the uncertainty about the post-failure control authority of the failed surface would be useful.

CONFUSION SET CREATION (EVENT 3)

The idea behind forming a confusion set comes from two aspects of the FDI system. First, in the design of the aircraft-path FDI system, it is possible to identify control elements that can not be isolated from each other. In this case, it is typical to treat all indistinguishable controls as a single fictitious control that will be detected and isolated upon the occurrence of any control failures within the indistinguishability or "confusion" set. The 737 application presented in Section 5, in fact, has such a situation. Force and moment imbalances by themselves are not sufficient for distinguishing same-side elevator and stabilizer controls and are therefore treated as single "horizontal-tail" controls (left and right) in the FDI algorithm [5]. In the demo RFCS system developed for this project, modifications to the FDI decision logic were made so that the isolation of a horizontal tail failure would result in event 3 with the only undecidable "test" being a fictitious elevator versus stabilizer test.

The second motivation for a confusion set is due to the occurrence of event 3 when marginally isolatable failures are present. Recall that in event 3 some or all of the verify tests may have passed but no unanimous verdict (declaring a single control to be failed) can be reached. When this occurs, we would like to examine the verify and isolate test results to determine what subset of failures could be indicated.

We approach the development of this set by determining the failures which are ruled out of consideration. First recall that each sequential (verify and isolate test) can be in one of three situations when event 3 occurs. Each sequential test statistic could have crossed its positive threshold, its negative threshold or be in between [5]. When a verify statistic crosses its

negative threshold, there is a clear indication that the corresponding failure should not be considered as part of the confusion set. Conversely, when it has crossed its positive threshold, there is, as yet, no reason to rule that control out of the confusion set. When the verify test statistic is in between, the situation is not as clear. However, the original data structures of the FDI algorithm did not permit distinguishing this case from the case where it crossed the negative threshold, thus we eliminate both "failed verify" and "unverified" controls from the confusion set.

The isolation test results are also used in the formation of a confusion set when event 3 occurs. To rule out a control from this set on the basis of isolation results, we require that some isolation test clearly indicates that the control to be ruled out is less likely than another control. That is, for every isolation test that crosses its positive or negative threshold before event 3 occurs, the control which is contra-indicated is ruled out of the confusion set.

Thus, the confusion set consists of those controls that have been verified, have been found to be more likely than another control, or have been involved in isolation tests which are unable to decide, but have not been found to be less likely than another control. This procedure produces the desired result in prototypical cases (e.g., two controls are more likely than all others, but the test distinguishing these two is unable to decide). However, other interesting possibilities for confusion sets arise. One possibility is that an empty confusion set could be created. Using the notation, $a > b$ to imply that the isolation test between a and b decides in favor of a, we would get an empty confusion set with, say a, b, c verified and $a > b$, $b > c$, and $c > a$. While this should not physically occur (especially when

a, b, or c is actually failed) there is no numerical guarantee that it will not occur. In the demo RFCS such a situation will be treated the same as event 2. Another property of this procedure is that a confusion set of size 1 occurs when a unanimous verdict is present. This is a pleasing result since it was our original requirement that isolation to a single control would be declared when a unanimous verdict was reached. However, it is also possible for a confusion set of size 1 to occur without a unanimous verdict. For example, a three control (a, b, and c) situation in which only a is verified and $a > b$, but a vs c is unable to decide, will result in a confusion set consisting of only a. This is an interesting result that sometimes makes sense, but has not been deeply explored in terms of consistency with actual physical failure scenarios. Note, however, that the decision logic implied by the confusion set would impact the FDI performance results reported in [5].

CREATING B_f AND α_j FOR EVENT 3

Having developed a confusion set consisting of all possible sources of failure when no unanimous decision can be reached (for a single control or for a false-trigger), we now present two methods for translating this type of uncertainty into values of B_f and α_j needed for the ARM.

Using the model of Eq. 4-1, we see that we need to transform the confusion set into a probability distribution for all the E_j .

Method 1

Let,

$$f(E_j | j \notin C) = \delta(E_j - 1) \quad (4-5)$$

$$f(E_j | j \in C) = p_j \delta(E_j) + (1 - p_j) \delta(E_j - 1) \quad (4-6)$$

It is then possible to show that

$$E\{E_j | j \notin C\} = 1 \quad (4-7)$$

$$E\{E_j | j \in C\} = 1 - p_j \quad (4-8)$$

and

$$\alpha_j^2 = \begin{cases} 0 & j \notin C \\ p_j (1-p_j) & j \in C \end{cases} \quad (4-9)$$

In the above, p_j represents the probability the "event" ($E_j = 0$ and $E_i = 1$, ($i \neq j$)). Thus, some measure of the magnitude of the relative likelihoods of each failure is desirable. While such measures are computable within the FDI system, it is felt that the extra effort in such computations is not worthwhile and we will use $p_j = |C|^{-1}$ for all j in C ($|C|$ denotes cardinality or number of members in the set, C).

Example

p_i = probability that $E_i = 0$, $E_j = 1$, $j \neq i$ with i, j in $\{1, 2, 3\}$.

$$\begin{aligned} E\{E_1\} &= p_1 \cdot 0 + p_2 \cdot 1 + p_3 \cdot 1 \\ &= 1 - p_1, \text{ since } (p_1 + p_2 + p_3) = 1 \end{aligned}$$

$$E\{E_1^2\} = p_1 \cdot 0^2 + p_2 \cdot 1^2 + p_3 \cdot 1^2 = 1 - p_1$$

$$\text{Var}(E_1) = \alpha_1^2 = (1-p_1) - (1-p_1)^2 = p_1(1-p_1) \quad (4-10)$$

and similarly for $i = 2$ and 3 .

Method 2

Let $f(E_j | j \notin C)$ be as in Eq. 4-5 and

$$f(E_j | j \in C) = p_j P_w(E_j) + (1-p_j) \delta(E_j-1) \quad (4-11)$$

where $P_w(E_j)$ is a uniform density on the interval $[0,1]$.

The statistics of E_j are then given by Eq. 4-7 and

$$E\{E_j | j \in C\} = 1 - p_j/2 \quad (4-12)$$

$$\alpha_j^2 = \begin{cases} 0 & j \notin C \\ p_j/12 (4 - 3 p_j) & j \in C \end{cases} \quad (4-13)$$

Again, p_j represents the likelihood that the j -th control has failed. However, in this method, we assume that E_j is uniformly distributed on $[0,1]$ under the hypothesis that j has failed and that it is equal to 1 under all other hypotheses.

SUMMARY OF AIRCRAFT-PATH INTERFACE

The demo system to be described in Section 5 employs the following logic upon the identification of the four FDI events described above (a detailed description of the software implementation is given in [10]).

Event 1 Use Eqs. 4-2, 4-3, and 4-7, 4-12, 4-13 with $p_j = 1$, where j is the index associated with the isolated control.

Event 2 Return (if event 3 previously declared; otherwise, no return necessary) to the nominal (unfailed) compensator when there are no actuator failures. When actuator

failures are present, return to α , B_f values set by actuator failure detection.

Event 3 Use Eqs. 4-2, 4-3, and 4-7, 4-8, 4-9 with $p_j = |C|^{-1}$.

Event 4 Make no change to the compensator.

4.3 OVERALL RFCS OPERATION

This subsection puts together the concepts discussed thusfar and fully describes the functional operation of the overall RFCS developed for this project. Details of the software implementation are provided in [10].

Figure 4-1 presents a state transition diagram (or finite-state machine description) for the overall RFCS algorithm. In this figure, there are eight types of events that cause transitions and two distinct types of states. The two types of states represent:

1. FCS operational states labeled F_0 , F' , F'' , and F''' ; State F_0 always corresponds to the baseline or nominal flight control law (gains and trim values); States F' , F'' , and F''' correspond to gains and trim values that have been redesigned.
2. Reconfiguration-method states labeled A_1 , A_2 , A_3 , A_4 ; in each of these states, the ARM parameters (B_f, α, w_p) are updated (differently for each state) and the compensator redesign and/or auto-trim algorithms are executed.

The system always starts in F_0 . The state transitions are due to seven FDI events (4 for the aircraft-path and 3 for the actuator-path subsystem) and an eighth event that accounts for the possibility of the formation of an empty confusion or ambiguity set when event 3 occurs (note events 1 through 4 correspond to the events discussed in subsection 4.2). The FDI transition events are:

1. AQI = Aircraft-path failure was successfully isolated,

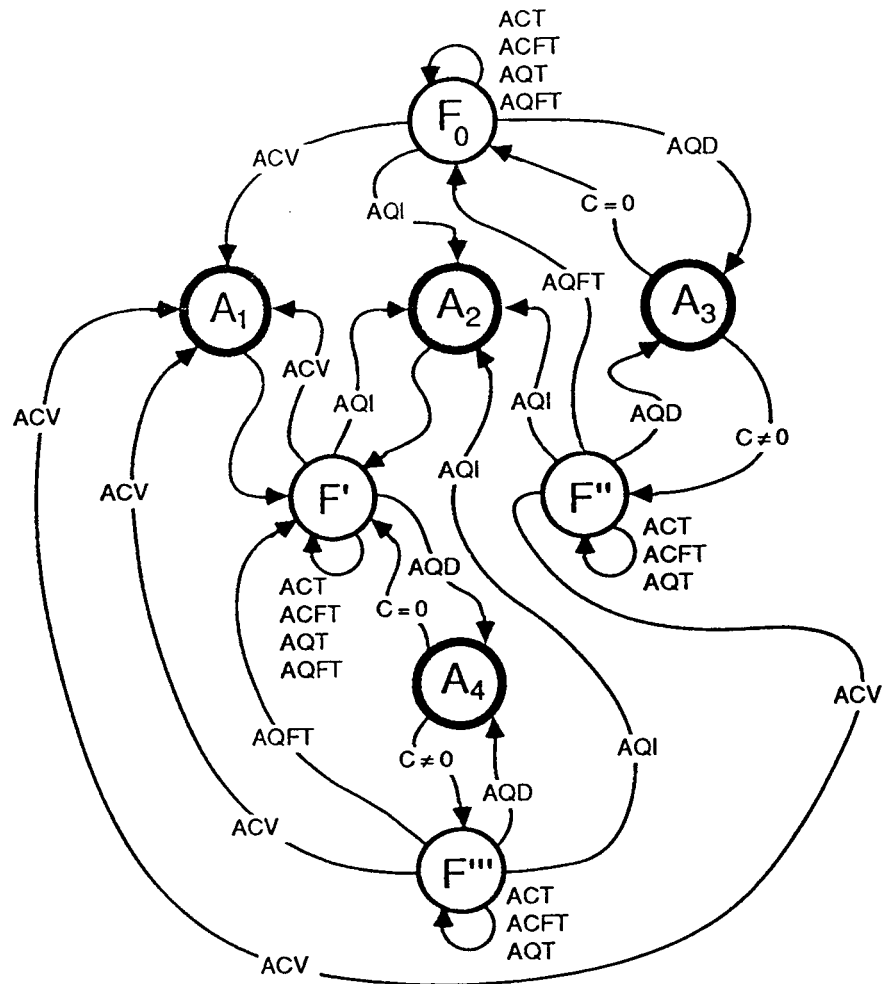

FDI TRANSITIONS:

ACT	ACTUATOR TRIGGER
ACV	ACTUATOR VERIFY
ACFT	ACTUATOR FALSE TRIGGER (RESET)
AQT	AIRCRAFT TRIGGER
AQI	AIRCRAFT VERIFY & ISOLATE
AQFT	AIRCRAFT FALSE TRIGGER (RESET)
AQD	AIRCRAFT UNABLE TO DECIDE (RESET)
C = 0	EMPTY AMBIGUITY/CONFUSION SET

FCS NODES:

F_0, F', F'', F''' , PARAMETER SETS USED IN FCS OPERATION

ARM NODES:

A_i , i^{th} PROCEDURE FOR UPDATING B_r, β, w_p & REDESIGN/RETRIM

R-4943-A

Figure 4-1. RFCs State Transition Diagram

2. AQFT = Aircraft-path false trigger occurred (all verifies fail),
3. AQD = Aircraft-path verify and isolation tests are unable to decide either 1 or 2,
4. AQT = Aircraft-path trigger, but 1 - 4 yet to occur,
5. ACV = Actuator-path failure successfully verified,
6. ACFT = Actuator-path false trigger occurred,
7. ACT = Actuator-path trigger, 5 or 6 yet to occur.

The empty confusion set event ($C=\phi$) occurs during calculations involved in two of the reconfiguration-method states (A_3 and A_4).

Transitions are always made within a single computational cycle until all FDI events that occurred in that cycle are taken into account. Transitions from one FCS state to another implies that the gains and trim values last created in the "target" state are to be used. Transitions without labels indicate that this transition occurs if no other FDI transition events are observed. When no unlabeled transitions are given, the state remains unchanged for the next cycle.

The RFCS described by Fig. 4-1 is capable of handling any combination of single aircraft-path and multiple actuator-path failures occurring sequentially or simultaneously. A small degree of "self-healing" is present in the return to previous FCS parameter sets when ACD is followed by $C=\phi$ in the same cycle or by AQFT in a subsequent cycle.

The reconfiguration-method states provide different means for updating the ARM parameters and subsequently calling the compensator redesign and auto-trim algorithm. Each of these states is now defined (note, the RFCS software implementation of [10] does not incorporate the exact logic of Fig. 4-1, though it is functionally equivalent).

Reconfiguration Method A₁

Method A₁ is used each time ACV occurs. The matrix B_f is computed using Eq. 4-2 with $E\{E_j\}$ updated to zero if actuator "j" was verified. E_j retains its previous value otherwise. The values of α_j are not updated, w_p is updated using Eq. 4-4. Finally, both the trim and compensator redesign algorithms are executed if B_f , w_p , or any α_j is significantly different than their "previous" values (note, "previous" here is used to indicate the values computed at the last time the algorithms were executed).

Reconfiguration Method A₂

This is used any time AQI occurs. The matrix B_f is computed using Eq. 4-2 with $E\{E_j\}$ updated using Eq. 4-12 with $p_j = 1$ for $j =$ the identified control only if it does not also have a verified actuator-path failure. It is left at zero (set previously by A₁) otherwise. Equation 4-3 is used to update α_j with $p_j = 1$ for $j =$ the identified control. Otherwise it is left at zero. w_p is unchanged. The compensator redesign algorithm is executed if B_f or α_j are significantly different than their "previous" values. The trim algorithm is not executed.

Reconfiguration Methods A₃ and A₄

The computations for these two states are the same. They are distinct states because their transitions under AQFT are different. This method is used when AQD occurs. The matrix B_f is computed using Eq. 4-2 with $E\{E_j\}$ updated using Eq. 4-8 with $p_j = \|C\|^{-1}$ for $j \in C$ only if control j does not also have a verified actuator-path failure. It is left at zero (set previously by A₁) otherwise. Equation 4-9 is used to update α_j with $p_j = \|C\|^{-1}$ for $j \in C$ only if control j does not also have a verified actuator-path failure.

Otherwise it is left at zero. w_p is unchanged. The compensator redesign algorithm is executed if B_f or any α_j are significantly different than their previous values. The trim algorithm is not executed.

Example

An example of the RFCS state transitions under multiple failures is now given. Physical justifications for some of the transition events are also given.

1. A severe maneuver is executed causing an AQD transition to A_3 (due to large model error excitation). A $C \neq \phi$ transition to F'' then occurs.
2. A small maneuver is executed causing an AQFT transition back to F_0 (small model errors are excited).
3. An aircraft-path failure on a marginally loaded surface occurs causing an AQD transition to A_3 followed by a $(C \neq \phi)$ transition to F'' . In the same cycle, an ACV event occurs causing a transition from F'' to A_1 and then to F' .
4. A maneuver occurs that excites the control having an aircraft-path failure causing an AQI transition from F' to A_2 and then back to F' with a new set of FCS parameters.
5. Some time later, another actuator-path failure occurs causing an ACV transition from F' to A_1 and then back to F' .

SECTION 5

APPLICATION TO A MODIFIED B-737 AIRCRAFT

In this section, the details of the integrated RFCS demonstration system are provided and results of extensive simulations resulting from embedding ALPHATECH's RFCS software in NASA's nonlinear 6-DOF simulation of a modified B-737 are described. Due to problems uncovered during software integration, several design deficiencies that were identified, remained unsolved. However, these deficiencies (mostly in the FCS) do not affect the more meaningful conclusions drawn from the simulation results. Plots of aircraft responses for various simulations are given in Appendix A.

5.1 DEMONSTRATION SYSTEM DETAILS

5.1.1 Operating Point

The choice of operating point for simulations was governed by the flight conditions for which the FDI system was designed [5]. The trim condition is defined by:

Velocity	= 160 knots
Altitude	= 3500 ft
Gear Up	
Flaps	= 15 degrees
Flight path angle	= 0 degrees

The state and control vectors are defined by

$$\mathbf{x} = \begin{bmatrix} \text{forward velocity, ft/sec} \\ \text{vertical velocity, ft/sec} \\ \text{pitch rate, rad/sec} \\ \text{pitch angle, rad} \\ \text{side velocity, ft/sec} \\ \text{roll rate, rad/sec} \\ \text{yaw rate, rad/sec} \\ \text{roll angle, rad} \end{bmatrix} \quad (5-1)$$

$$\mathbf{u} = \begin{bmatrix} \delta_{LT} \\ \delta_{RT} \\ \delta_{LS} \\ \delta_{RS} \\ \delta_R \\ \delta_{LE} \\ \delta_{RE} \\ \delta_{LA} \\ \delta_{RA} \\ \delta_{SPL} \\ \delta_{SPR} \end{bmatrix} = \begin{bmatrix} \text{left engine thrust, lbs} \\ \text{right engine thrust, lbs} \\ \text{left stabilator, deg} \\ \text{right stabilator, deg} \\ \text{rudder, deg} \\ \text{left elevator, deg} \\ \text{right elevator, deg} \\ \text{left aileron, deg} \\ \text{right aileron, deg} \\ \text{left spoiler, deg} \\ \text{right spoiler, deg} \end{bmatrix} \quad (5-2)$$

The trim values of \mathbf{x} and \mathbf{u} at this flight condition are

$$\mathbf{x}_0 = (283, 24, 0, .085, 0 \ 0 \ 0 \ 0) \quad (5-3)$$

$$u_0 = (3644, 3644, -3.1, -3.1, 0, 3.1, 3.1, 0, 0, 0, 0) \quad (5-4)$$

The linear model for perturbations to this trim condition when no failure exists is

$$\dot{x}_p = A_0 x_p + B_0 u_p \quad (5-5)$$

where $x_p = (x - x_0)$, $u_p = (u - u_0)$, and A_0 and B_0 are given by

$$A_0 = \begin{bmatrix} -.93131E-02 & .11586E+00 & -.24050E+02 & -.32052E+02 & 0.0 & 0.0 & .18601E-11 & 0.0 \\ -.16664E-00 & -.73932E+00 & .28319E+03 & -.27221E+01 & 0.0 & -.24609E-09 & 0.0 & 0.0 \\ .28753E-03 & -.65567E-02 & -.64142E+00 & .41310E-14 & .29057E-16 & 0.0 & -.86736E-18 & 0.0 \\ 0.0 & 0.0 & .10000E+01 & 0.0 & 0.0 & 0.0 & 0.0 & 0.0 \\ -.10902E-16 & -.30347E-17 & 0.0 & 0.0 & -.13295E+00 & .24811E-02 & -.28127E+03 & .32052E+02 \\ -.10588E-17 & -.35333E-17 & 0.0 & .57661E-19 & -.16636E-01 & -.19762E+01 & .70358E+00 & .56540E+03 \\ .34355E-18 & -.95285E-18 & 0.0 & -.36150E-18 & .31781E-02 & -.15293E-00 & -.17115E+00 & -.42975E-02 \\ 0.0 & 0.0 & 0.0 & 0.0 & 0.0 & .10000E+01 & .84927E-01 & 0.0 \end{bmatrix} \quad (5-6)$$

$$B_0 = \begin{bmatrix} .3419E-03 & .3419E-03 & .2110E-01 & .2110E-01 & 0.0 & .9895E-02 & .9895E-02 & .1132E-01 & .1132E-01 & -.1809E-01 & -.1809E-01 \\ .4740E-06 & -.4740E-06 & -.2485E+00 & -.2483E+00 & 0.0 & -.1165E+00 & -.1165E+00 & -.1332E+00 & -.1332E+00 & .1327E+00 & .1327E+00 \\ .6199E-05 & .6199E-05 & -.3600E-01 & -.3600E-01 & 0.0 & -.1675E+01 & -.1675E-02 & -.4728E-02 & -.4728E-02 & .1968E-02 & .1968E-02 \\ 0.0 & 0.0 & 0.0 & 0.0 & 0.0 & 0.0 & 0.0 & 0.0 & 0.0 & 0.0 & 0.0 \\ 0.0 & 0.0 & 0.0 & 0.0 & .2017E+00 & 0.0 & 0.0 & .1793E-02 & -.1793E-02 & .1847E-01 & -.1847E-01 \\ .2105E-05 & -.2105E-05 & .1190E-01 & -.1190E-01 & .1466E-01 & .5565E-02 & -.5565E-02 & .1182E-01 & -.1182E-01 & -.1370E-01 & .1370E-01 \\ .1245E-04 & -.1245E-04 & .8835E-03 & -.8835E-03 & -.1743E-01 & .5058E-03 & -.5058E-03 & .9593E-03 & -.9593E-03 & -.2369E-02 & .2369E-02 \\ 0.0 & 0.0 & 0.0 & 0.0 & 0.0 & 0.0 & 0.0 & 0.0 & 0.0 & 0.0 & 0.0 \end{bmatrix} \quad (5-7)$$

The open loop eigenvalues for the aircraft at this flight condition are

<u>Lateral Eigenvalues</u>		<u>Longitudinal Eigenvalues</u>	
Dutch Roll	-0.125 ± 1.23j	Short Period	-.690 ± 1.36j
Roll Subsidence	-.0051	Phugoid	-.00486 ± 1.33j
Spiral	-2.02		

5.1.2 Flight Control System

The baseline FCSs used for this demo are full state feedback LQ designs with integrator compensation for pitch and bank angles and for forward and side velocity (see [1] for details). Figure 5-1 shows the FCS implementation including the insertion of the trim values. Only primary control surfaces and the throttle were used for dynamic control (no spoilers). With compensation the linear model becomes

$$\dot{z}_p = Az_p + Bu_p \quad (5-9)$$

where

$$z_p = \begin{pmatrix} x_p \\ x_I \end{pmatrix}$$

$$x_I = C x_p$$

$$A = \begin{bmatrix} A_0 & 0 \\ C & 0 \end{bmatrix}$$

$$B = \begin{bmatrix} B_0 \\ 0 \end{bmatrix}$$

(5-10)

$$C = \begin{bmatrix} 0 & 0 & 0 & 1 & 0 & 0 & 0 & 0 \\ 0 & 0 & 0 & 0 & 1 & 0 & 0 & 0 \\ 0 & 0 & 0 & 0 & 0 & 0 & 0 & 1 \\ 1 & 0 & 0 & 0 & 0 & 0 & 0 & 0 \end{bmatrix}$$

(5-11)

$$G_y = [G_4 \ G_5 \ G_8 \ G_1] \quad (5-12)$$

$$G_r = [G_2 \ G_3 \ G_6 \ G_7] \quad (5-13)$$

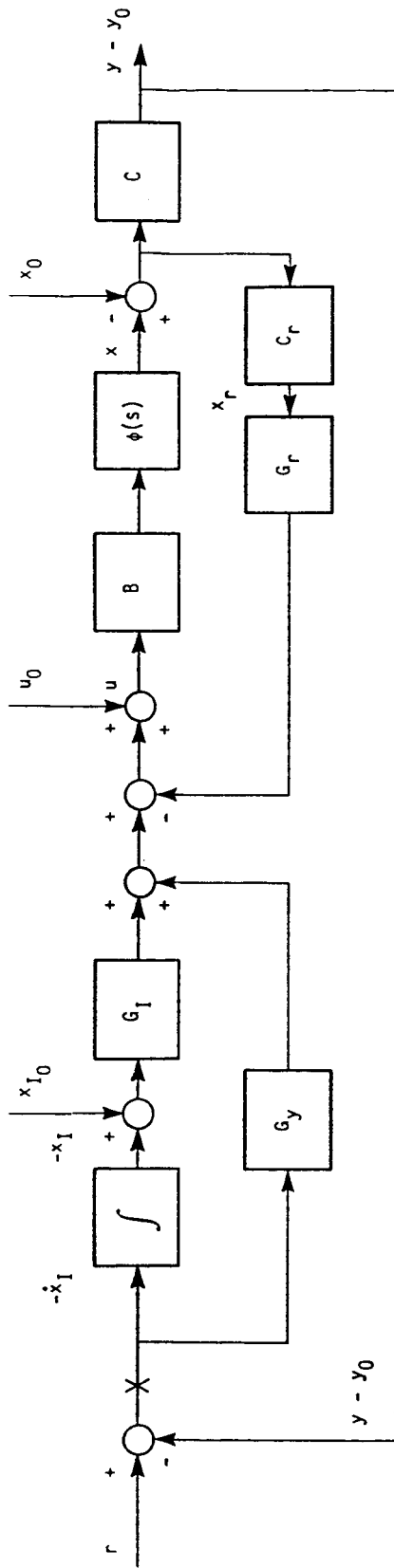

R-2829

Figure 5-1. Command Following with LQ

$$G_I = [G_9 \ G_{10} \ G_{11} \ G_{12}] \quad (5-14)$$

where G_i is the i th column of the compensator gain,

The equations of the compensator are:

$$\dot{x}_I = -r + Cx_p - Cx_o \quad (5-15)$$

$$u = u_o - G_r x_r - G_y Cx_p + G_y Cx_o + G_y r - G_I x_I \quad (5-16)$$

where

$$x_r = C_r x_a$$

$$C_r = \begin{bmatrix} 0 & 1 & 0 & 0 & 0 & 0 & 0 & 0 \\ 0 & 0 & 1 & 0 & 0 & 0 & 0 & 0 \\ 0 & 0 & 0 & 0 & 0 & 1 & 0 & 0 \\ 0 & 0 & 0 & 0 & 0 & 0 & 1 & 0 \end{bmatrix} \quad (5-17)$$

Two compensator gains (G) were used in the simulation results described in subsection 5.2. The first gain matrix is the one used in [1]. This gain made use of full independent individual control elements (referred to later as the full compensator). Unfortunately, it was designed for a different flight condition than the one being employed in this study. The gain matrix is

$$c = \begin{bmatrix} 1.3961E+02 & 1.9358E+01 & 7.4412E+02 & -2.0427E+03 & -2.7713E+00 & 2.0010E+02 & 5.0151E+02 & 4.2919E+02 & 5.0039E+03 & -6.5007E-01 & 2.2317E+02 & 1.2124E+01 \\ 1.3961E+02 & 1.9358E+01 & 7.4412E+02 & -2.0427E+03 & 2.7713E+00 & -2.0010E+02 & -5.0151E+02 & -4.2919E+02 & 5.0039E+03 & 6.5007E-01 & -2.2317E+02 & 1.2124E+01 \\ 7.0062E-02 & 7.3015E-02 & -3.4156E+01 & -5.8283E+01 & -5.6680E-02 & 1.1374E+01 & 1.1714E+01 & 2.2737E+01 & -3.1282E+01 & 4.2385E-02 & 1.1106E+01 & 9.7114E-03 \\ 7.0062E-02 & 7.3015E-02 & -3.4156E+01 & -5.8283E+01 & 5.6680E-02 & -1.1374E+01 & -1.1714E+01 & -2.2737E+01 & -3.1282E+01 & -4.2385E-02 & -1.1106E+01 & 9.7114E-03 \\ 1.2901E-15 & 2.9076E-16 & -3.5417E-14 & -5.2611E-14 & 1.6030E+00 & -1.7116E+01 & -2.5327E+02 & -5.7752E+01 & 1.0922E-14 & 1.1882E+00 & -4.3027E+01 & 2.0720E-16 \\ 1.3360E-01 & 1.3984E-01 & -6.5466E+01 & -1.1169E+02 & -1.1340E-01 & 2.2109E+01 & 2.3305E+01 & 4.4249E+01 & -5.9980E+01 & 7.9858E-02 & 2.1638E+01 & 1.8555E-02 \\ 1.3360E-01 & 1.3984E-01 & -6.5466E+01 & -1.1169E+02 & 1.1340E-01 & -2.2109E+01 & -2.3305E+01 & -4.4249E+01 & -5.9980E+01 & -7.9858E-02 & -2.1638E+01 & 1.8555E-02 \\ -8.0708E-02 & 1.1551E-02 & -1.6578E+01 & -2.4714E+01 & -2.6946E-01 & 5.1579E+01 & 5.5219E+01 & 1.0332E+02 & -1.9211E+01 & 1.8254E-01 & 5.0554E+01 & -4.0715E-03 \\ -8.0708E-02 & 1.1551E-02 & -1.6578E+01 & -2.4714E+01 & 2.6946E-01 & -5.1579E+01 & -5.5219E+01 & -1.0332E+02 & -1.9211E+01 & -1.8254E-01 & -5.0554E+01 & -4.0715E-03 \end{bmatrix}$$

$$(5-18)$$

The resulting closed loop eigenvalues are

<u>Lateral</u>	<u>Longitudinal</u>	
-.60 ± .59j	-.071 ± .065j	
-1.1	-.54	(5-19)
-2.1 ± 1.7j	-.84 ± .87j	
-2.6	-3.9	

An alternative gain was formulated using the control and state weights used to produce the G of Eq. 5-19 with A_0 and B_0 of Eqs. 5-6 and 5-7. This compensator did not have substantially different eigenvalues than those of Eq. 5-19. Time did not permit further investigation of alternative full compensators.

The second gain matrix utilized only standard B-737 control action. This eliminates all use of differential stabilizer, elevator, and throttle and collective aileron. Time did not permit a detailed design of this compensator. Therefore, we took the control and state weights used in the design of the gains in Eq. 5-18, generated a full LQ compensator from these weights, and set various terms to zero. The terms set to zero were 1) the lateral state feedback to the stabilizers, elevators, and throttles, 2) the longitudinal state feedback to the ailerons, all integrator state feedback except the integral of velocity to throttle terms. The resultant G is given by

G =	<table border="0" style="width: 100%; text-align: center;"> <tr> <td>1.7971D+02</td><td>2.6583D+01</td><td>3.5212D+02</td><td>-2.8567D+03</td><td>0.0000D+00</td><td>0.0000D+00</td><td>0.0000D+00</td><td>0.0000D+00</td><td>0.0000D+00</td><td>0.0000D+00</td><td>0.0000D+00</td><td>0.0000D+00</td><td>1.1891D+01</td> </tr> <tr> <td>1.7971D+02</td><td>2.6583D+01</td><td>3.5212D+02</td><td>-2.8567D+03</td><td>0.0000D+00</td><td>0.0000D+00</td><td>0.0000D+00</td><td>0.0000D+00</td><td>0.0000D+00</td><td>0.0000D+00</td><td>0.0000D+00</td><td>0.0000D+00</td><td>1.1891D+01</td> </tr> <tr> <td>9.8348D-02</td><td>5.6460D-02</td><td>-3.0408D+01</td><td>-5.5746D+01</td><td>0.0000D+00</td><td>0.0000D+00</td><td>0.0000D+00</td><td>0.0000D+00</td><td>0.0000D+00</td><td>0.0000D+00</td><td>0.0000D+00</td><td>0.0000D+00</td><td>0.0000D+00</td> </tr> <tr> <td>9.8348D-02</td><td>5.6460D-02</td><td>-3.0408D+01</td><td>-5.5746D+01</td><td>0.0000D+00</td><td>0.0000D+00</td><td>0.0000D+00</td><td>0.0000D+00</td><td>0.0000D+00</td><td>0.0000D+00</td><td>0.0000D+00</td><td>0.0000D+00</td><td>0.0000D+00</td> </tr> <tr> <td>1.9916D-14</td><td>8.3529D-15</td><td>2.0455D-12</td><td>-1.7896D-12</td><td>1.2642D+00</td><td>-3.1679D+00</td><td>-2.0196D+02</td><td>-4.9547D+01</td><td>0.0000D+00</td><td>0.0000D+00</td><td>0.0000D+00</td><td>0.0000D+00</td><td>0.0000D+00</td> </tr> <tr> <td>1.8183D-01</td><td>1.0483D-01</td><td>-5.6588D+01</td><td>-1.0370D+02</td><td>0.0000D+00</td><td>0.0000D+00</td><td>0.0000D+00</td><td>0.0000D+00</td><td>0.0000D+00</td><td>0.0000D+00</td><td>0.0000D+00</td><td>0.0000D+00</td><td>0.0000D+00</td> </tr> <tr> <td>1.8183D-01</td><td>1.0483D-01</td><td>-5.6588D+01</td><td>-1.0370D+02</td><td>0.0000D+00</td><td>0.0000D+00</td><td>0.0000D+00</td><td>0.0000D+00</td><td>0.0000D+00</td><td>0.0000D+00</td><td>0.0000D+00</td><td>0.0000D+00</td><td>0.0000D+00</td> </tr> <tr> <td>0.0000D+00</td><td>0.0000D+00</td><td>0.0000D+00</td><td>0.0000D+00</td><td>-1.4902D+01</td><td>4.0703D+01</td><td>3.9076D+01</td><td>9.5410D+01</td><td>0.0000D+00</td><td>0.0000D+00</td><td>0.0000D+00</td><td>0.0000D+00</td><td>0.0000D+00</td> </tr> <tr> <td>0.0000D+00</td><td>0.0000D+00</td><td>0.0000D+00</td><td>0.0000D+00</td><td>1.4902D-01</td><td>-4.0703D+01</td><td>-3.9076D+01</td><td>-9.5410D+01</td><td>0.0000D+00</td><td>0.0000D+00</td><td>0.0000D+00</td><td>0.0000D+00</td><td>0.0000D+00</td> </tr> </table>	1.7971D+02	2.6583D+01	3.5212D+02	-2.8567D+03	0.0000D+00	0.0000D+00	0.0000D+00	0.0000D+00	0.0000D+00	0.0000D+00	0.0000D+00	0.0000D+00	1.1891D+01	1.7971D+02	2.6583D+01	3.5212D+02	-2.8567D+03	0.0000D+00	0.0000D+00	0.0000D+00	0.0000D+00	0.0000D+00	0.0000D+00	0.0000D+00	0.0000D+00	1.1891D+01	9.8348D-02	5.6460D-02	-3.0408D+01	-5.5746D+01	0.0000D+00	0.0000D+00	0.0000D+00	0.0000D+00	0.0000D+00	0.0000D+00	0.0000D+00	0.0000D+00	0.0000D+00	9.8348D-02	5.6460D-02	-3.0408D+01	-5.5746D+01	0.0000D+00	0.0000D+00	0.0000D+00	0.0000D+00	0.0000D+00	0.0000D+00	0.0000D+00	0.0000D+00	0.0000D+00	1.9916D-14	8.3529D-15	2.0455D-12	-1.7896D-12	1.2642D+00	-3.1679D+00	-2.0196D+02	-4.9547D+01	0.0000D+00	0.0000D+00	0.0000D+00	0.0000D+00	0.0000D+00	1.8183D-01	1.0483D-01	-5.6588D+01	-1.0370D+02	0.0000D+00	0.0000D+00	0.0000D+00	0.0000D+00	0.0000D+00	0.0000D+00	0.0000D+00	0.0000D+00	0.0000D+00	1.8183D-01	1.0483D-01	-5.6588D+01	-1.0370D+02	0.0000D+00	0.0000D+00	0.0000D+00	0.0000D+00	0.0000D+00	0.0000D+00	0.0000D+00	0.0000D+00	0.0000D+00	0.0000D+00	0.0000D+00	0.0000D+00	0.0000D+00	-1.4902D+01	4.0703D+01	3.9076D+01	9.5410D+01	0.0000D+00	0.0000D+00	0.0000D+00	0.0000D+00	0.0000D+00	0.0000D+00	0.0000D+00	0.0000D+00	0.0000D+00	1.4902D-01	-4.0703D+01	-3.9076D+01	-9.5410D+01	0.0000D+00	0.0000D+00	0.0000D+00	0.0000D+00	0.0000D+00
1.7971D+02	2.6583D+01	3.5212D+02	-2.8567D+03	0.0000D+00	0.0000D+00	0.0000D+00	0.0000D+00	0.0000D+00	0.0000D+00	0.0000D+00	0.0000D+00	1.1891D+01																																																																																																										
1.7971D+02	2.6583D+01	3.5212D+02	-2.8567D+03	0.0000D+00	0.0000D+00	0.0000D+00	0.0000D+00	0.0000D+00	0.0000D+00	0.0000D+00	0.0000D+00	1.1891D+01																																																																																																										
9.8348D-02	5.6460D-02	-3.0408D+01	-5.5746D+01	0.0000D+00	0.0000D+00	0.0000D+00	0.0000D+00	0.0000D+00	0.0000D+00	0.0000D+00	0.0000D+00	0.0000D+00																																																																																																										
9.8348D-02	5.6460D-02	-3.0408D+01	-5.5746D+01	0.0000D+00	0.0000D+00	0.0000D+00	0.0000D+00	0.0000D+00	0.0000D+00	0.0000D+00	0.0000D+00	0.0000D+00																																																																																																										
1.9916D-14	8.3529D-15	2.0455D-12	-1.7896D-12	1.2642D+00	-3.1679D+00	-2.0196D+02	-4.9547D+01	0.0000D+00	0.0000D+00	0.0000D+00	0.0000D+00	0.0000D+00																																																																																																										
1.8183D-01	1.0483D-01	-5.6588D+01	-1.0370D+02	0.0000D+00	0.0000D+00	0.0000D+00	0.0000D+00	0.0000D+00	0.0000D+00	0.0000D+00	0.0000D+00	0.0000D+00																																																																																																										
1.8183D-01	1.0483D-01	-5.6588D+01	-1.0370D+02	0.0000D+00	0.0000D+00	0.0000D+00	0.0000D+00	0.0000D+00	0.0000D+00	0.0000D+00	0.0000D+00	0.0000D+00																																																																																																										
0.0000D+00	0.0000D+00	0.0000D+00	0.0000D+00	-1.4902D+01	4.0703D+01	3.9076D+01	9.5410D+01	0.0000D+00	0.0000D+00	0.0000D+00	0.0000D+00	0.0000D+00																																																																																																										
0.0000D+00	0.0000D+00	0.0000D+00	0.0000D+00	1.4902D-01	-4.0703D+01	-3.9076D+01	-9.5410D+01	0.0000D+00	0.0000D+00	0.0000D+00	0.0000D+00	0.0000D+00																																																																																																										

(5-20)

The resulting closed loop eigenvalues are

<u>Lateral</u>	<u>Longitudinal</u>	
-1.8 ± 2.0j	-2.4 ± 1.4j	
-1.7 ± 0.35j	-0.60	(5-21)
	-0.18	
	-0.048	

The FCS limits the control values at their maximum and minimum values and implements a nonminimal version of the FCS in order to prevent integrator windup when the controls reach these limits [10]. Unless specified otherwise in subsection 5.2, the control limits are

$$\Delta u_{\min} = (-2400, -2400, -10.8, -10.8, -10, -15, -15, -20, -20, 0, 0) \quad (5-22)$$

$$\Delta u_{\max} = (9800, 9800, 6.2, 6.2, 10, 15, 15, 20, 20, 8, 8) \quad (5-23)$$

5.1.3 Compensator Redesign Algorithm

The inputs to the compensator redesign algorithm are the control and state weighting matrices for a basis controller, the linear dynamics of the failed aircraft at some desired flight condition and some measure of uncertainty about the linear model. We will assume that the flight condition defined by Eqs. 5-3 to 5-7 is the desired post failure condition. Since no failure mode causes aerodynamic changes, the failed A matrix $A_f = A_0$. The failed B matrix, B_f and the uncertainty measure, β_{ijkl} , are derived in Section 3. For reference, the state and control weights used for redesign are (see [1])

$$R = \begin{bmatrix} 1.1000D-06 & -9.0000D-07 & 0.0000D+00 & 0.0000D+00 & 0.0000D+00 & 0.0000D+00 & 0.0000D+00 & 0.0000D+00 & 0.0000D+00 & 0.0000D+00 \\ -9.0000D-07 & 1.1000D-06 & 0.0000D+00 & 0.0000D+00 & 0.0000D+00 & 0.0000D+00 & 0.0000D+00 & 0.0000D+00 & 0.0000D+00 & 0.0000D+00 \\ 0.0000D+00 & 0.0000D+00 & 2.0000D-02 & 0.0000D+00 & 0.0000D+00 & 0.0000D+00 & 0.0000D+00 & 0.0000D+00 & 0.0000D+00 & 0.0000D+00 \\ 0.0000D+00 & 0.0000D+00 & 0.0000D+00 & 2.0000D-02 & 0.0000D+00 & 0.0000D+00 & 0.0000D+00 & 0.0000D+00 & 0.0000D+00 & 0.0000D+00 \\ 0.0000D+00 & 0.0000D+00 & 0.0000D+00 & 0.0000D+00 & 2.5000D-03 & 0.0000D+00 & 0.0000D+00 & 0.0000D+00 & 0.0000D+00 & 0.0000D+00 \\ 0.0000D+00 & 0.0000D+00 & 0.0000D+00 & 0.0000D+00 & 0.0000D+00 & 5.0000D-03 & 0.0000D+00 & 0.0000D+00 & 0.0000D+00 & 0.0000D+00 \\ 0.0000D+00 & 0.0000D+00 & 0.0000D+00 & 0.0000D+00 & 0.0000D+00 & 0.0000D+00 & 5.0000D-03 & 0.0000D+00 & 0.0000D+00 & 0.0000D+00 \\ 0.0000D+00 & 0.0000D+00 & 0.0000D+00 & 0.0000D+00 & 0.0000D+00 & 0.0000D+00 & 0.0000D+00 & 5.0000D-03 & 0.0000D+00 & 0.0000D+00 \\ 0.0000D+00 & 0.0000D+00 & 0.0000D+00 & 0.0000D+00 & 0.0000D+00 & 0.0000D+00 & 0.0000D+00 & 0.0000D+00 & 5.0000D-03 & 0.0000D+00 \end{bmatrix}$$

(5-24)

$$Q = \begin{bmatrix} 6.9753D-03 & 9.5838D-04 & -3.1061D-02 & -1.9725D-01 & 0.0000D+00 & 0.0000D+00 & 0.0000D+00 & 0.0000D+00 & 1.3663D-01 & 0.0000D+00 & 0.0000D+00 & 1.3749D-04 \\ 9.5838D-04 & 4.5349D-04 & -1.6185D-02 & -6.0149D-02 & 0.0000D+00 & 0.0000D+00 & 0.0000D+00 & 0.0000D+00 & 1.5320D-02 & 0.0000D+00 & 0.0000D+00 & 1.6616D-05 \\ -3.1061D-02 & -1.6185D-02 & 4.6256D+01 & 1.1136D+01 & 0.0000D+00 & 0.0000D+00 & 0.0000D+00 & 0.0000D+00 & 5.3199D+00 & 0.0000D+00 & 0.0000D+00 & -7.2934D-04 \\ -1.9725D-01 & -6.0149D-02 & 1.1136D+01 & 4.6206D+01 & 0.0000D+00 & 0.0000D+00 & 0.0000D+00 & 0.0000D+00 & 1.6804D+01 & 0.0000D+00 & 0.0000D+00 & -3.8571D-03 \\ 0.0000D+00 & 0.0000D+00 & 0.0000D+00 & 0.0000D+00 & 3.0000D+04 & 0.0000D+00 & 0.0000D+00 & 0.0000D+00 & 0.0000D+00 & 0.0000D+00 & 0.0000D+00 & 0.0000D+00 \\ 0.0000D+00 & 0.0000D+00 & 0.0000D+00 & 0.0000D+00 & 0.0000D+00 & 2.0000D+01 & 0.0000D+00 & 0.0000D+00 & 0.0000D+00 & 0.0000D+00 & 0.0000D+00 & 0.0000D+00 \\ 0.0000D+00 & 0.0000D+00 & 0.0000D+00 & 0.0000D+00 & 0.0000D+00 & 0.0000D+00 & 1.0000D+00 & 0.0000D+00 & 0.0000D+00 & 0.0000D+00 & 0.0000D+00 & 0.0000D+00 \\ 0.0000D+00 & 0.0000D+00 & 0.0000D+00 & 0.0000D+00 & 0.0000D+00 & 0.0000D+00 & 0.0000D+00 & 0.0000D+00 & 1.0000D+00 & 0.0000D+00 & 0.0000D+00 & 0.0000D+00 \\ 1.3663D-01 & 1.5320D-02 & 5.3199D+00 & 1.6804D+01 & 0.0000D+00 & 0.0000D+00 & 0.0000D+00 & 0.0000D+00 & 8.8826D+01 & 0.0000D+00 & 0.0000D+00 & 1.7688D-03 \\ 0.0000D+00 & 0.0000D+00 & 0.0000D+00 & 0.0000D+00 & 0.0000D+00 & 0.0000D+00 & 0.0000D+00 & 0.0000D+00 & 0.0000D+00 & 4.0000D-03 & 0.0000D+00 & 0.0000D+00 \\ 0.0000D+00 & 0.0000D+00 & 0.0000D+00 & 0.0000D+00 & 0.0000D+00 & 0.0000D+00 & 0.0000D+00 & 0.0000D+00 & 0.0000D+00 & 0.0000D+00 & 4.0000D+01 & 0.0000D+00 \\ 1.3749D-04 & 1.6616D-05 & -7.2934D-04 & -3.8571D-03 & 0.0000D+00 & 0.0000D+00 & 0.0000D+00 & 0.0000D+00 & 1.7688D-03 & 0.0000D+00 & 0.0000D+00 & 6.6181D-05 \end{bmatrix}$$

(5-25)

5.1.4 Linear Trim Algorithm

The trim algorithm utilizes the same linear model as the compensator redesign algorithm, plus; 1) a linear model relating the important variables to the states, 2) upper and lower bounds on allowable state and control perturbations, and 3) a weighting matrix to improve convergence of the quadratic programming algorithm.

The important variables are, as in previous reports, the flight path angle and angular rates. The angular rates are states (making the corresponding parts of the linear model for item 1 trivial) and the relationship between state perturbations and perturbations to flight path angle at this flight condition is

$$\Delta\gamma = 0.00030 \Delta u - 0.00353 \Delta w + \Delta\theta \quad (5-26)$$

The bounds on the state and control deviations were derived in the same manner as [1] and, unless specified otherwise in subsection 4.2, are given by,

$$\begin{aligned} \text{a) } \Delta u_{\min} &= (-2400, -2400, -10.8, -10.8, -10, -15, -15, -20, -20, 0, 0) \\ \text{b) } \Delta u_{\max} &= (9800, 9800, 6.2, 6.2, 10, 15, 15, 20, 20, 8, 8) \end{aligned} \quad (5-27)$$

$$\begin{aligned} \text{a) } \Delta x_{\min} &= (-30, -2.4, -3, -.26, -30, -3, -3, -.09) \\ \text{b) } \Delta x_{\max} &= (30, 20, 3, .088, 30, 3, 3, .09) \end{aligned} \quad (5-28)$$

Constraints on angular rates are meaningless since they are regulated as important variables.

5.1.5 Failure Detection and Identification

A complete description of the FDI software is given in [10]. Its design and performance characteristics are detailed in [5]. For this project, an interface module that translates FDI test results into appropriate flags for use in the RFCS logic was designed. The interface module also expands the isolation matrix to accommodate both horizontal tail surfaces (same side elevator and stabilizer surfaces are treated as a single control element in the FDI system since they are indistinguishable). For reference purposes, the FDI aircraft-path routine refers to the control elements in the following order;

1. Left Throttle
2. Right Throttle
3. Left Horizontal Tail

4. Right Horizontal Tail
5. Rudder
6. Left Aileron
7. Right Aileron

5.2 DISCUSSION OF TEST CASE RESULTS

This subsection provides a discussion of the simulation results. Plots of the temporal responses of important variables for several important test cases are given in Appendix A. This discussion includes notes on the performance of the aircraft during maneuvers, the operational characteristics (states) of the RFCS, comparisons between performance with and without the RFCS, the effects due to FDI decision errors and delays, and the fault tolerant capabilities of the two nominal control laws employed in the baseline FCS.

The original test plan is given in Table 5-1. It was formed to examine the following issues:

1. Comparison of earlier [1] (actuator failure) results which assumed perfect FDI with actual FDI results,
2. Examination of performance for correctly detected and isolated aircraft path failures,
3. Examination of degraded performance due to imperfect isolation of aircraft-path failures,
4. Effects on performance of aircraft-path false triggers.

Most simulations were run with sensor noise and no turbulence. The effects of turbulence were examined in a few examples near the end of the project. In addition, baseline runs (no failure) of two climbing turn maneuvers were made. In total, NASA performed 40 simulations and made substantial modifications to the original simulation and RFCS software in order to enable

TABLE 5-1. ORIGINAL TEST PLAN

Test Set 1 (Effects of Real Actuator FDI)

1.1.1	Maneuver:	Climbing Turn at 10 Seconds
	Failure:	Stuck Rudder at 5 seconds
	Environment:	No FDI or Recon
1.1.2	Maneuver:	Climbing Turn at 10 Seconds
	Failure:	Stuck Rudder at 5 seconds
	Environment:	Perfect FDI
1.1.3	Maneuver:	Climbing Turn at 10 Seconds
	Failure:	Stuck Rudder at 5 seconds
	Environment:	Real RDI
1.2.1	Maneuver:	None
	Failure:	Stabilator runaway of CR-178064 at 5 Seconds
	Environment:	No FDI or Recon, Travel limits of CR-178064
1.2.2	Maneuver:	None
	Failure:	Stabilator runaway of CR-178064 at 5 Seconds
	Environment:	Perfect FDI, Travel limits of CR-178064
1.2.3	Maneuver:	None
	Failure:	Stabilator runaway of CR-178064 at 5 Seconds
	Environment:	Real FDI, Travel limits of CR-178064

(Continued)

TABLE 5-1. ORIGINAL TEST PLAN (Continued)

Test Set 2 (Correctly Isolated Aircraft-Path Failures)

2.1.1 Maneuver: Climbing Turn at 10 Seconds
Failure: 100% missing left aileron at 5 seconds
Environment: No FDI or Recon

2.1.2 Maneuver: Climbing Turn at 10 Seconds
Failure: 100% missing left aileron at 5 seconds
Environment: Real FDI

2.2.1 Maneuver: Climbing Turn at 10 Seconds
Failure: 100% missing rudder at 5 seconds
Environment: No FDI or Recon

2.2.2 Maneuver: Climbing Turn at 10 Seconds
Failure: 100% missing rudder at 5 seconds
Environment: Real FDI

Test Set 3 (Imperfectly Isolated Aircraft-Path Failures)

Small Ambiguity Group (LE/LS)

3.1.1 Maneuver: Climbing Turn at 10 Seconds
Failure: 100% missing left stabilator at 5 seconds
Environment: No FDI

3.1.2 Maneuver: Climbing Turn at 10 Seconds
Failure: 100% missing left stabilator at 5 seconds
Environment: Real FDI

(Continued)

TABLE 5-1. ORIGINAL TEST PLAN (Continued)

Large Ambiguity Group (LE, LS, RE, RS)

- 3.2.1 Maneuver: Climbing Turn at 10 Seconds
 Failure: 100% missing left elevator at 5 seconds
 Environment: No FDI
- 3.2.2 Maneuver: Climbing Turn at 10 Seconds
 Failure: 100% missing left elevator at 5 seconds
 Environment: Real FDI

Test Set 4 (Aircraft-Path False Triggers)

- 4.1.1 Maneuver: Pitch Doublet at 10 Seconds
 Failure: None
 Environment: No FDI
- 4.1.2 Maneuver: Pitch Doublet at 10 Seconds
 Failure: None
 Environment: Real FDI
- 4.2.1 Maneuver: Roll Doublet at 10 Seconds
 Failure: None
 Environment: No FDI
- 4.2.2 Maneuver: Roll Doublet at 10 Seconds
 Failure: None
 Environment: Real FDI

batch operation on the CDC Cyber machine and to correct data and logical flaws in the RFCS design.

It should be mentioned again that certain deficiencies in the compensator designs were known to exist (see subsection 3.1.2). The results presented here should therefore be used for comparison purposes only. Actual performance of the aircraft under both failed and unfailed conditions would be different had these deficiencies been remedied. Nevertheless, the comparisons of performance made in this report are believed to be representative of the overall performance of the integrated restructurable flight control system.

The rest of this section is organized by groups of simulation runs.- For each group, a brief discussion of the characteristics of each run and a comparison of results is given.

5.2.1 Baseline Maneuvers (R001 and R036)

Appendix A defines the command profiles and shows the command response for these two runs. R001 uses the full FCS (i.e., nonstandard control action) and the original climbing turn maneuver (CT1) while R036 uses the limited FCS (only standard control action and no integrators on pitch, bank or sideslip) and a new maneuver (CT4).

Notes

1. The aircraft response in R001 is similar to that of [1] despite the fact that the compensator was designed for a different operating point.
2. The effects of the nonminimal realization (used to handle windup in the integrators) is seen in the fact that the controls do not return to their trim values after the maneuver.
3. The effects of the lack of sensor compensation is also seen in the high frequency actuator activity, although this does not affect the aircraft response.

4. The trim values used in the FCS are not correct. This is evidenced in the calibrated airspeed response before the maneuver occurs.
5. The altitude response for R036 is not very good (\dot{h} is not zero in steady state).
6. Bank and roll responses for R036 and R001 are similar, although R036 has a larger sideslip response.
7. The aileron response for R036 is smaller than for R001.
8. The speed response for R036 is slower than in R001, although a direct comparison is not possible since the maneuvers are different.

DUAL STABILIZER RUNAWAY (R006, R025, R026)

In each of these simulations, both left and right stabilizers ramp to their trailing-edge-up limit at 5 seconds. No maneuver is executed. The full FCS is used in each run. Run R006 has no reconfiguration, R025 executes the RFCS, and R026 executes the RFCS with a "perfect" FDI module (failure is detected at its onset time).

Notes

1. Run R006 exhibits severe departure from the nominal flight condition. Large phugoid oscillations are present for more than a minute after the failure time. The airspeed drops to a minimum of 137 fps (from a trim value of 289 fps), pitch angle reaches a maximum value of 40 degrees at about 15 seconds and 50 seconds, and the angle of attack reaches a maximum of 23.99 degrees (possibly a simulation limit) several times. The elevator saturates fairly quickly in response to the positive pitching moment caused by the failure, but this is insufficient for recovery/stabilization of the aircraft.
2. Run R025 exhibits superior recovery performance. This is believed to be largely due to the decrease in trim airspeed assigned by the RFCS. This causes the departure of the angle of attack to be arrested very quickly ($\delta \dot{w} / \delta u \Delta u$ is used to cancel the \dot{w} disturbance due to the failure). The altitude response is the only response in this run that could be considered worse than R006. In R025, airspeed drops only to a minimum of 184 fps, pitch angle

only reaches a maximum of 20 degrees and is nearly stabilized by 35 seconds (although some small phugoid oscillation or slow departure may exist) and the angle of attack reaches a maximum of 12.6 degrees at 24 seconds and is stabilized at about 10 degrees by 36 seconds. The elevator and throttle responses show the major control differences between this run and R006. Throttle is immediately reduced when the failure is detected (as in [1] in order to achieve the lower trim airspeed.

3. The failure is detected at 5.3 seconds (0.3 seconds after the runaway is initiated). New gains are computed at this time and at 32 seconds, when the aircraft-path FDI system triggers another redesign. This redesign is in response to an undetermined aircraft-path failure (LE, RE, or LA) that is declared because of the significant deviations of the aircraft from the operating point for which the FDI system was designed. The FDI results point to a software error in the implementation of the confusion set (see Section 4), however, the impact on aircraft performance is negligible (see note 4). The trim algorithm is executed almost every time step between 5.3 seconds and 8.5 seconds and never used again. This is due to the fact that the stabilizer runaway failure is implemented as a ramp at the actuator rate limit until the actuator reaches its position limit. The disturbances change as the ramp progresses and the trim algorithm is executed in response to these changes. The trim is not executed once the disturbances stop changing (stabilizers at their limits).
4. Run R026 looks nearly identical to R025 in all respects indicating that the effect of the small FDI delay is negligible.

5.2.2 Left Stabilizer Runaway (R034 and R035)

In both of these runs, the limited FCS is used. The failure occurs at the maneuver (CT1) time and is implemented by causing the left stabilizer to ramp to its limit. Run R034 does not utilize the RFCS and R035 uses the complete RFCS (real FDI).

Notes

1. In R035, the FDI system detects and verifies the actuator failure at 10.35 seconds (the failure and maneuver occur at 10.0 seconds). The trim algorithm is executed almost every time step between 10.35 and 12.45 seconds and then again at 34, 41, 47 and 49 seconds. The initial calls to TRIM are due to the changing disturbances caused by the ramp failure. The others are due to

noise in the sensors used to estimate the disturbance. The trim algorithm employs 8 degrees of left spoiler deflection to counteract the rolling moment due to the failure.

2. The altitude response for R035 is actually better than the response with no failure (R036). This is due to the fact that R036 utilizes a control law that is deficient in many ways as compared to the "basis-compensator" (i.e., the compensator resulting from computing new gains with no failure).
3. Comparing R034 and R035, we see that the altitude and bank angle responses are better with reconfiguration. The new trim airspeed is lowered by 26 fps for this case, which allows the maneuver to occur with, generally, smaller control deflections. R035 utilizes differential elevator, aileron, and increased use of the remaining stabilizer to return the bank angle to zero after the maneuver. Run R034 is only able to return to a significantly nonzero bank angle.
4. Run R034 has a surprisingly adequate recovery profile. The ailerons have sufficient authority to counteract the failure induced rolling moment, even without integrators on bank angle in the control law (see subsection 4.1).
5. This case would be an interesting one to investigate with a piloted simulation with a minimal stability augmentation system as the nominal FCS. This is not atypical of commercial transport aircraft and would serve to demonstrate the true severity of this failure.

5.2.3 Missing Aileron Failure (R032, R033, R013, and R014)

Runs R032 and R033 utilized the limited FCS and no and full reconfiguration, respectively. Runs R013 and R014 utilized the full FCS with no and full reconfiguration, respectively. All runs were made with CT1. The failure is a 100 percent reduction in the effectiveness of a single aileron.

Notes

1. In R014 the FDI system detects and isolates the aircraft path failure at 11.5 seconds, 1.5 seconds after the maneuver occurs and .7 seconds after the trigger occurs. New gains are calculated and no trim is necessary.
2. In R014, both the pitch and the bank responses are virtually identical to the no-failure case (R001).

3. Pitch and bank responses for R013 are also indistinguishable from R001. This verifies the conclusion in [1] that independent control of individual (left and right) control elements allows a properly designed FCS to possess much passive fault tolerance.
4. Even with the limited FCS (R032) a substantial degree of passive fault tolerance is observed. The bank response is expected to be different than R013 and R014 due to the differences in control laws. It is still very close to the no-failure case.
5. Improvements in R032 due to reconfiguration (seen in R033) are due to the fact that the basis-compensator is better than the limited FCS. The improved response, however, comes with increased use of some of the controls. This is due to the higher loop gains present in the basis-compensator.

5.2.4 Stuck Rudder (R030 and R031)

Runs R030 and R031 both use the limited FCS. The rudder was failed before the maneuver (CT1) occurred. Runs were made with the full FCS for this failure mode also; however, they are not discussed here (see [1], results were essentially the same). For R031, the state limits used in the trim algorithm were modified to require zero sideslip in steady state. This was done to highlight the differences between the two runs.

Notes

1. In R031, the FDI system detects the actuator failure at 5.75 seconds. The detection occurs before the maneuver because of the large rudder commands induced by sensor noise (the FCS deficiency helps detection in this case). Compensator redesign occurs immediately and, because the rudder failed off center (about 3 degrees), a new trim solution was obtained. The new trim includes substantial differential throttle as well as a few degrees of spoiler deflection. The noise associated with the rudder measurement causes enough change in the disturbance estimate to cause many retrimming operations throughout the run. A false trigger in the aircraft-path is subsequently identified as such at 18 seconds.
2. In both R030 and R031, the rudder failure excites a dutch roll mode. This mode is less damped without reconfiguration because the baseline FCS is less damped than the basis-compensator.

3. The bank responses are hard to compare because of the differences between the baseline FCS and the basis-compensator. However, the sideslip angle retains an offset from zero (-2 degrees) after the maneuver that is eliminated by the trim algorithm in R031.
4. The improvements to the altitude response when using the RFCS are attributable to the differences between the baseline FCS and the basis-compensator.
5. There is less use of differential aileron in R031 due to the differential throttle and spoiler deflections caused by the trim algorithm.
6. Comparison of runs R002 and R009 (real and perfect FDI for stuck-rudder failure using full FCS) shows no significant performance differences.

5.2.5 Missing Stabilizer Failure (R017 and R018)

Runs R017 and R018 both employed the full compensator and executed the CT1 maneuver. The failure was simulated by setting the left stabilizer effectiveness to zero before the maneuver (at $t = 5$ sec.). Run R017 did not utilize the RFCS and R018 implemented the full RFCS.

Notes

1. In R018, the FDI system detects and isolates a "fictitious" left horizontal tail failure at 6 seconds. Recall that the known indistinguishability of the left stabilizer and left elevator led us to the elimination of tests that would have tried to distinguish these two failures. The FDI system therefore declares an undetermined failure (LS or LE) and new gains are derived. A false trigger of the left aileron occurs at 8 seconds and is subsequently identified as such (unknown cause). No other reconfiguration events take place after this.
2. Both R017 and R018 have a small drop in altitude before the maneuver that is caused by the failure and is not present in the baseline (no-failure) case (R001).
3. Differences between control responses for R017 and R018 are significant. Run R018 (with reconfiguration) uses less elevator and right stabilizer during the maneuver. Noticeable but insignificant differences in the bank response between these runs is present. The same is true for the airspeed and pitch responses.

4. There is no substantial performance deterioration in either run as compared to the no failure case (R001).

OTHER RUNS

Many other simulations were run including a missing-elevator failure, a missing-rudder failure, roll and pitch doublets with no failure (to examine FDI false alarm performance) and several runs with turbulence. The results of these runs all support the conclusions drawn in subsection 5.3 and Section 6.

5.3 SUMMARY

In this section we presented details of an RFCS design for a modified B-737 aircraft. This RFCS included functional elements to detect and isolate aircraft-path and actuator-path control element failures, to redesign the feedback compensator after a failure has been detected, and to retrim the aircraft when significant measurable disturbances are present. The RFCS did not include any function to estimate remaining control effectiveness or to estimate (rather than measure) significant disturbances.

Extensive tests using NASA's nonlinear 6-DOF simulation were made. These tests were aimed at examining the impact of FDI delays and incomplete FDI decisions as well as examining the recovery capability of the compensator redesign and retrim algorithms.

Although the tests are extensive, they do not represent a detailed experimental paradigm. Therefore, any conclusions drawn from these results should be separately verified. Also, several design deficiencies were present in the final RFCS due to a lack of available time to correct them. These deficiencies included: 1) a nonminimal FCS realization that was implemented in order to handle windup of the integrators, 2) no filtering of the sensor

measurements, 3) control weights for the compensator redesign algorithm originated in [1], which used linear models of the aircraft at a different flight condition for tuning purposes, 4) the limited FCS was developed in a very ad hoc manner near the end of the project, and 5) the low bandwidth of the differential throttle loop used in [1] is still present in the full baseline compensator used in this study.

A general summary of the results described in subsection 5.2 is now given.

1. In general, the RFCS provided the most benefit during catastrophic failures such as a runaway failure. The retrim algorithm is believed responsible for this since it allows recovery methods that cannot be obtained in any other way. The use of changes in trim velocity appeared particularly useful for the runaway cases examined in this study. This was also observed in [1] and represents a failure recovery solution that is contrary to traditional pilot training for these cases.
2. RFCS performance was virtually indistinguishable in comparisons of real and perfect FDI cases. The FDI delays of up to several seconds for aircraft-path failures and up to 1 second for actuator path failures are therefore considered more than adequate. This was true for missing, stuck-at and runaway failures.
3. The baseline control law was sufficiently robust to adequately compensate for stuck-at and totally missing failures. This was true for the full compensator (utilizing nonstandard control action for the B-737) and for the limited compensator (utilizing only standard B-737 control action). In many cases, the effects of the failure were barely observable and in no case was the aircraft's maneuvering performance significantly affected. It is believed that the good low-frequency gains and the control of pitch and bank angles in both of the baseline compensators and the large stability margins of LQ designs are the major factors influencing this result. A further examination of the fault tolerant capabilities of other types of compensators (including a piloted simulation) would be very instructive.
4. The method used to handle uncertainty about the failure identity (confusion set operations) could not be accurately evaluated because of some undetermined implementation errors. However, the simulations resulting in incorrect confusion sets did not show any significant performance degradation. This again suggests that the stability and performance robustness of the

basis-compensator is substantial (resulting in even good robustness for an incorrectly redesigned compensator). Other support for this includes lack of any significant effect due to aircraft-path false alarms.

5. The more severe failures such as stabilizer runaways can cause enough of a departure from the nominal flight condition to generate aircraft-path false indications. This is due to the single-flight condition FDI design and the substantial modeling errors that are encountered during failure recovery. As mentioned above, such false indications never significantly impacted aircraft performance.
6. Some of the post-failure reconfigured responses to maneuver commands showed improvements over the no-failure response with the limited FCS. This is believed to be due to the deficiencies in the design of the limited FCS rather than the nonstandard control capability of the reconfigured FCS.

THIS PAGE INTENTIONALLY LEFT BLANK

SECTION 6

SUMMARY AND SUGGESTIONS FOR FUTURE WORK

The purpose of this study was to examine the complementary capabilities of several restructurable flight control system (RFCS) concepts through the integration of these technologies into a complete system. Performance issues were addressed through a re-examination of RFCS functional requirements, and though a qualitative analysis of the design issues that, if properly addressed during integration, will lead to the highest possible degree of fault-tolerant performance. Software developed under previous phases of this contract and under NAS1-18004 was modified and integrated into a complete RFCS subroutine for NASA's B-737 simulation. The integration of these modules involved the development of methods for dealing with the mismatch between the outputs of the failure detection module and the input requirements of the automatic control system redesign module. The performance of this demonstration system was examined through extensive simulation trials.

A general summary of the simulation results was given in subsection 5.3. The following suggestions for future efforts are derived from these results, from a qualitative analysis of the potential capabilities of the demonstration system for other types of aircraft, and from some of the results in [1].

1. The two LQ designs for the FCS both exhibited a great deal of passive fault tolerance. This result was observed in [1] and was therefore expected for the FCS that utilized full independent control action (nonstandard for the B-737). However, the degree of fault tolerance of the "standard" FCS (an LQ design

utilizing only standard B-737 control action) was surprising. The use of pitch and bank angles as reference commands may have been partially responsible for this result. A useful topic of future investigation would be the passive fault-tolerant capabilities of conventional and existing flight control systems and other FCS design methods.

2. A further investigation of the utility of the compensator redesign methodology would be useful. In this project and in [1], very little performance improvements due to redesigned gains were observed. This is due to the substantial fault tolerance of the baseline controllers and the stability of the B-737 aircraft. It is expected that compensator redesign would be more critical on unstable aircraft.
3. In this study, we selected a desired post-failure operating point arbitrarily. The operating point selection problem is one that needs to be developed. This problem involves deciding on the use of nondynamic controls (flaps, gear, weight redistribution), relaxation of the "model validity constraints" in the trim algorithm, selection of standard trim inputs (like flight path and velocity), and pilot interaction. The use of nondynamic controls in the trim algorithm may involve an extension of the quadratic optimization procedure to a mixed discrete-continuous procedure; branch-and-bound methods may be appropriate in this regard. Successive relaxation of model validity constraints is a powerful means of iteratively determining the best operating point. However, stability concerns need to be addressed in any such procedure.
4. Pilot interaction with a RFCS needs to be addressed in other areas besides operating point selection. The reference commands in the LQ FCS are generated by the pilot and, if the RFCS works well, would make the failure invisible to the pilot. If the pilot were allowed to select reconfiguration as an autopilot option, reconfiguration transients could be significant. The pilot reactions to such transients could have a large impact on failure recovery performance.
5. The logic of the RFCS system developed for this project is relatively straightforward. However, as FDI capabilities expand to include sensor and other equipment, more complex logic will be needed. It is possible that the use of a rule-based system for managing the potential variety of operational states would be effective.
6. An extension to the trim algorithm that incorporates known aerodynamic nonlinearities would be useful. In special cases (e.g., invertible control nonlinearities that appear identically in all axes) the extension may be straightforward.

7. While this study dealt with control element failures, it is likely that some failures of interest will include changes to the aircraft aerodynamics (e.g., partial loss of a horizontal vertical stabilizer or partial wing loss). The ARM can handle these cases when new linear models are available, but the development of such models is more difficult in these failure cases. Estimation methods and the effectiveness of the ARM in dealing with aerodynamic changes should be investigated.
8. The compensator redesign algorithm is based on the LQ method, which requires full-state feedback. Methods that require only output feedback would be of interest in further investigations. The capabilities of the trim algorithm would also be affected by the use of output feedback.
9. Performance issues in integration were discussed. Analytic methods for addressing these issues are highly important in developing early confidence in any RFCS design program, and would be a useful future effort.

THIS PAGE INTENTIONALLY LEFT BLANK

REFERENCES

1. Weiss, J.L., D.P. Looze, J.S. Eterno, and D.B. Grunberg, "Initial Design and Evaluation of Automatic Restructurable Flight Control System Concepts - NASA Contractor Report 178064," June 1986.
2. "Design and Evaluation of a Failure Detection and Isolation Algorithm for Restructurable Control Systems," ALPHATECH Technical Proposal P-2800-19-01, April 1985.
3. McMahan, J., "Flight 1080," Air Line Pilot, July 1978.
4. "National Transportation Safety Board Accident Report of the American Airlines DC10 Crash at Chicago - O'Hare International Airport, May 25, 1979, NTSB-AAR-79-17, December 21, 1979.
5. Weiss, J.L. and J.Y. Hsu, "Design and Evaluation of a Failure Detection and Isolation Algorithm for Restructurable Control Systems - NASA Contractor Report 178213," March 1987.
6. Smith, H.W. and E.J. Davison, "Design of Industrial Regulators," Automatica 1971, No. 7.
7. Kalman, R.E., "When is a Linear Control System Optimal?", Journal of Basic Engineering, Transactions of ASME, Series D. Vol. 86, March 1984.
8. Moerder, D., et al., "Reconfiguration in Stages, Part 2," Proceedings of the 1986 NAECON Conference, Dayton, OH, May 1986.
9. Huber, R. and B. McCullough, "Self-Repairing Flight Control Systems," Society of Auto. Engr., SAE-841552, Aerospace Congress and Exposition, Long Beach, CA, October 1984.
10. Weiss, J.L. and J.Y. Hsu, "Integrated Restructurable Flight Control System Development, Third Quarterly Report, Functional Software Description," ALPHATECH Technical Report TR-316, January 1987.

PRECEDING PAGE BLANK NOT FILMED

THIS PAGE INTENTIONALLY LEFT BLANK

APPENDIX A

RESPONSE DATA FOR IMPORTANT SIMULATION TRIALS

CONTENTS

A.1	COMMAND PROFILES.	A-2
A.2	UNFAILED CLIMBING TURN RESPONSES (R001, R036)	A-3
A.3	DUAL STABILIZER RUNAWAY FAILURE (R006, R025, R026).	A-11
A.4	SINGLE RIGHT STABILIZER RUNAWAY FAILURE (R034, R035).	A-23
A.5	MISSING LEFT AILERON FAILURE (R032, R033)	A-31
A.6	STUCK RUDDER FAILURE (R030, R031)	A-39
A.7	MISSING LEFT STABILIZER FAILURE (R017, R018).	A-47

A.1 COMMAND PROFILES

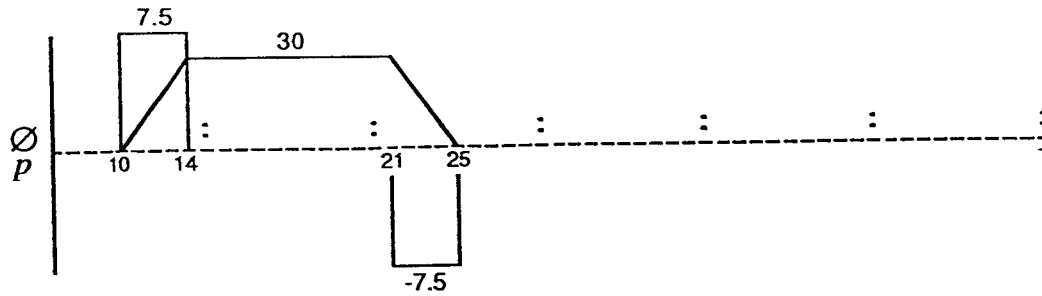
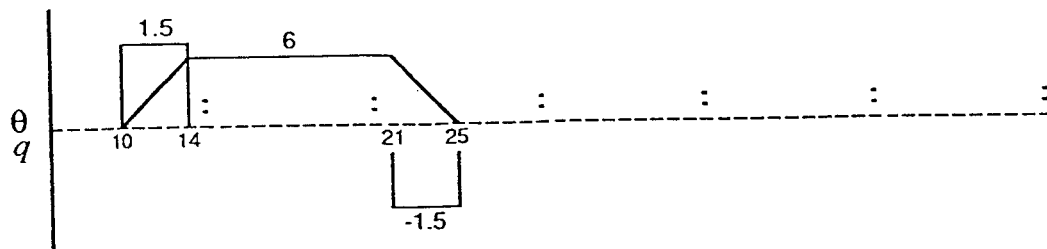

R-4779

Figure A.1-1. Original Climbing Turn (CT1)

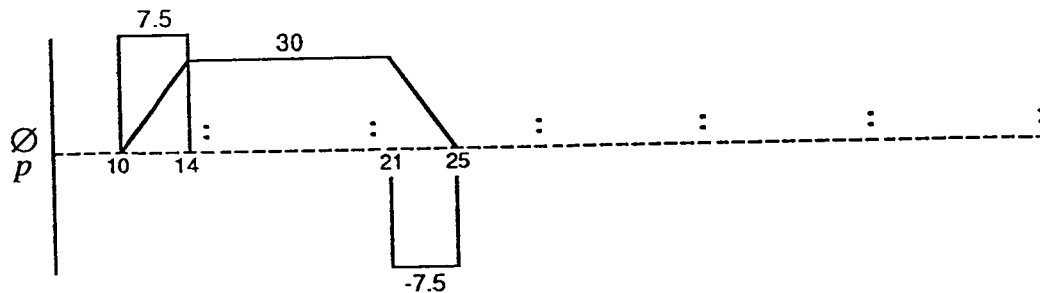
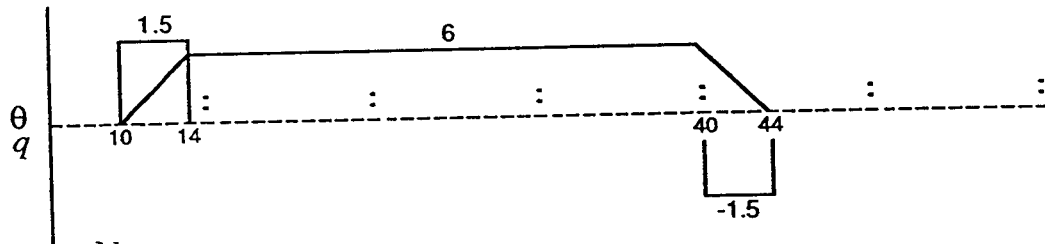

R-4780

Figure A.1-2. Modified Climbing Turn (CT4)

A.2 UNFAILED RESPONSES

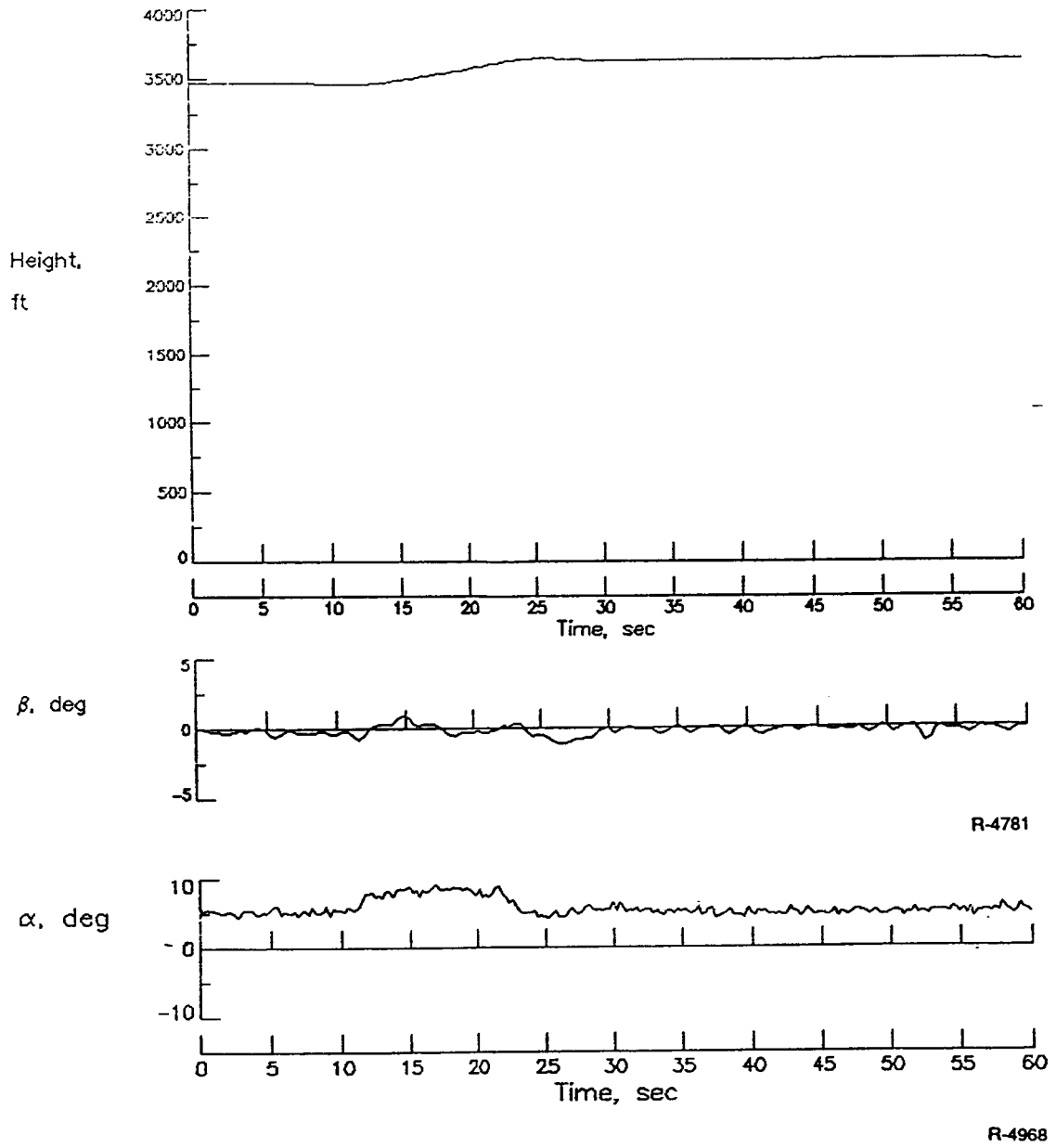
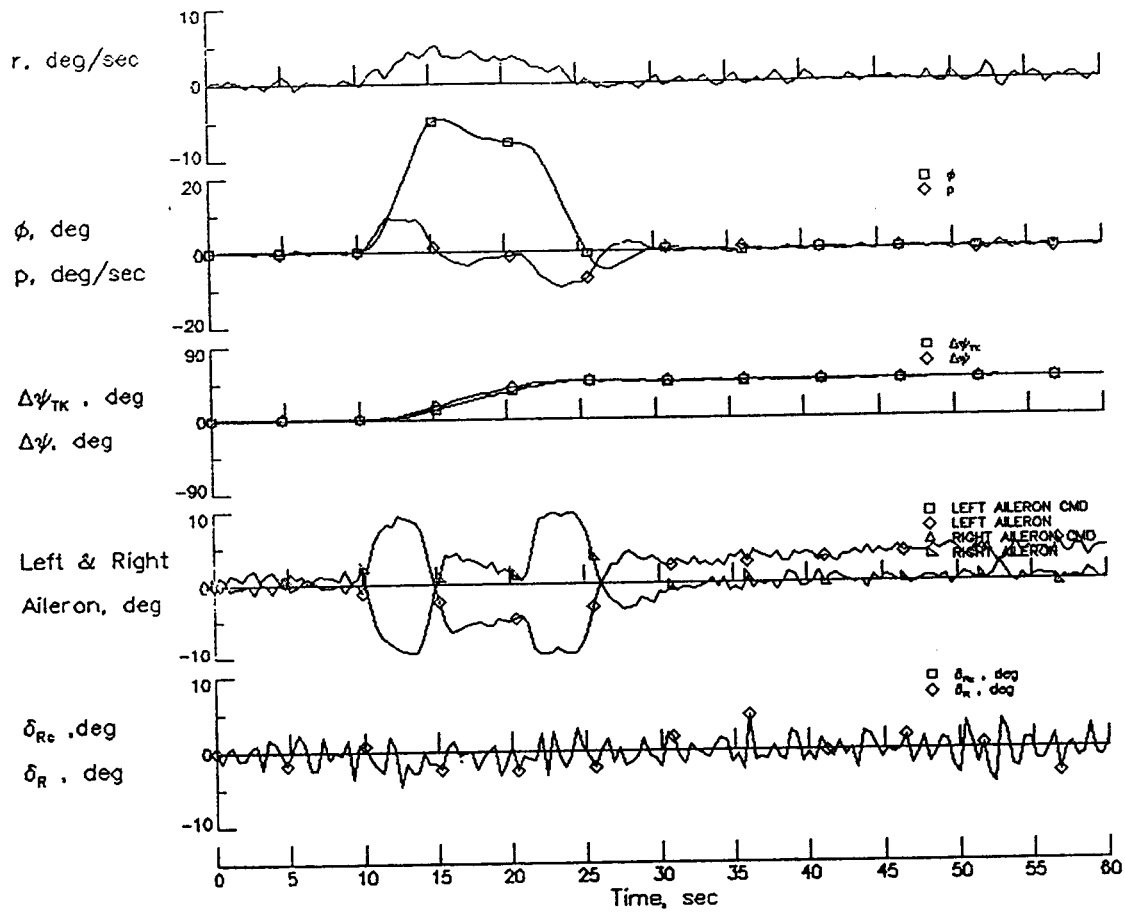
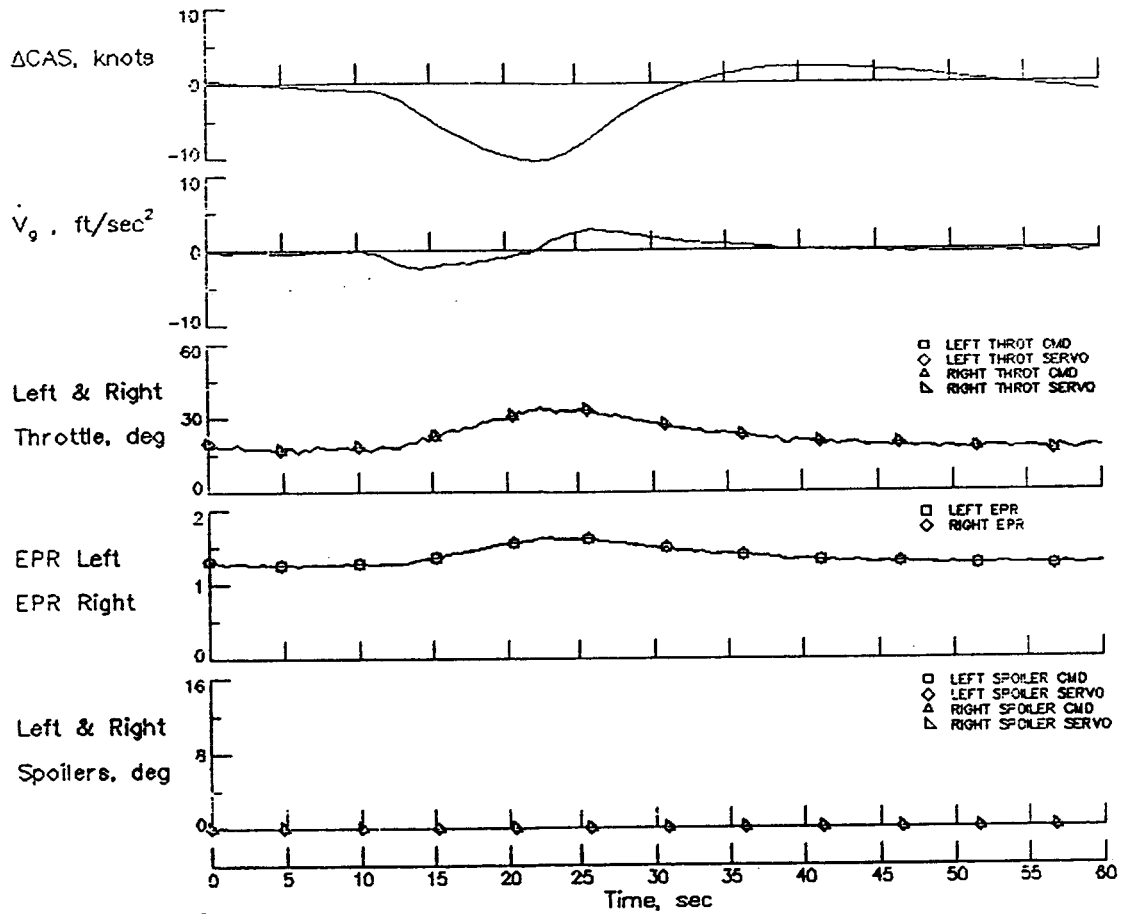

Figure A.2-1. R001, CT1, No Failure, Full FCS



R-4782

Figure A.2-1. R001, CT1, No Failure, Full FCS (Continued)



R-4783

Figure A.2-1. R001, CTL, No Failure, Full FCS (Continued)

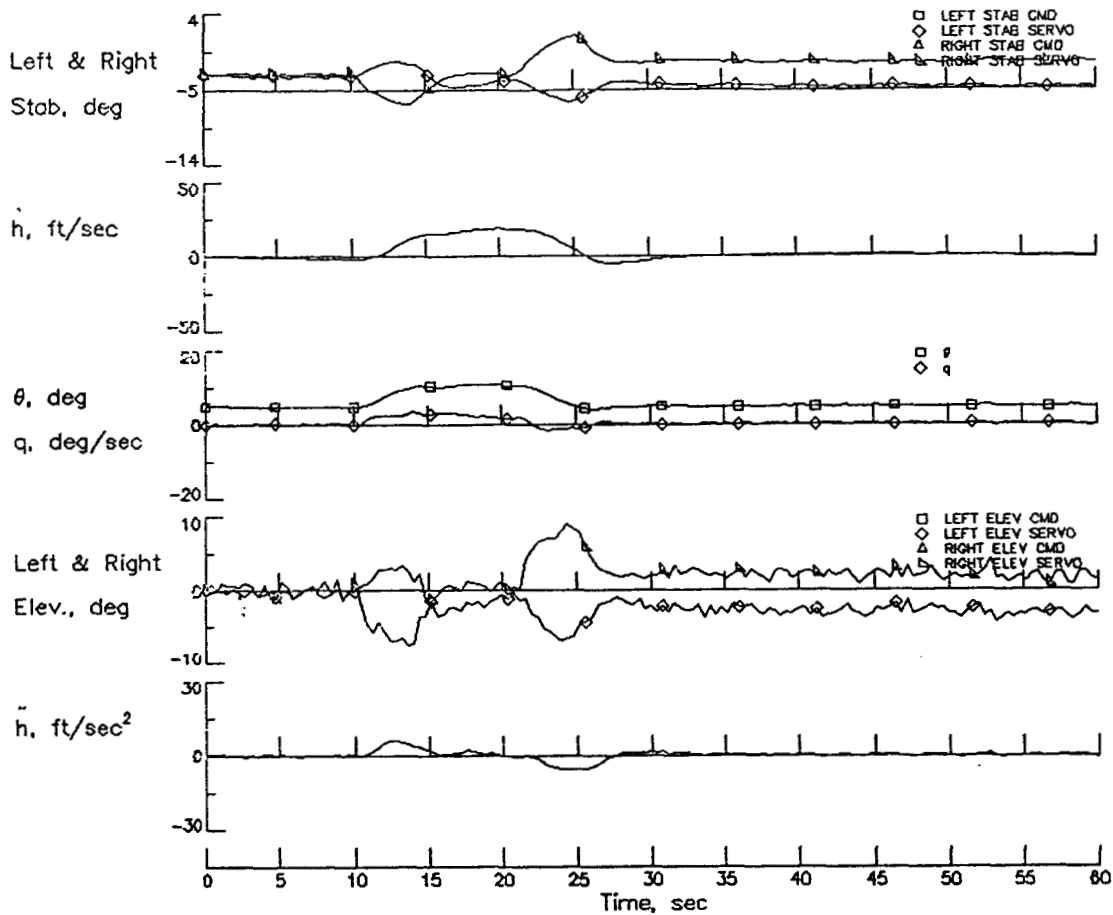

R-4784

Figure A.2-1. R001, CTL, No Failure, Full FCS (Concluded)

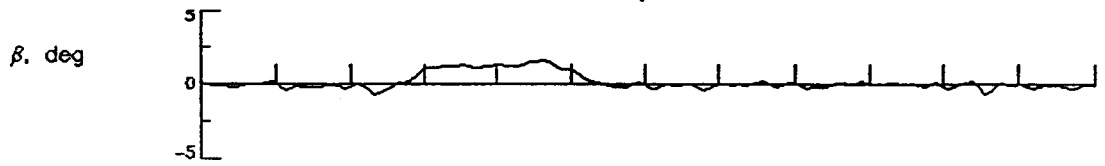
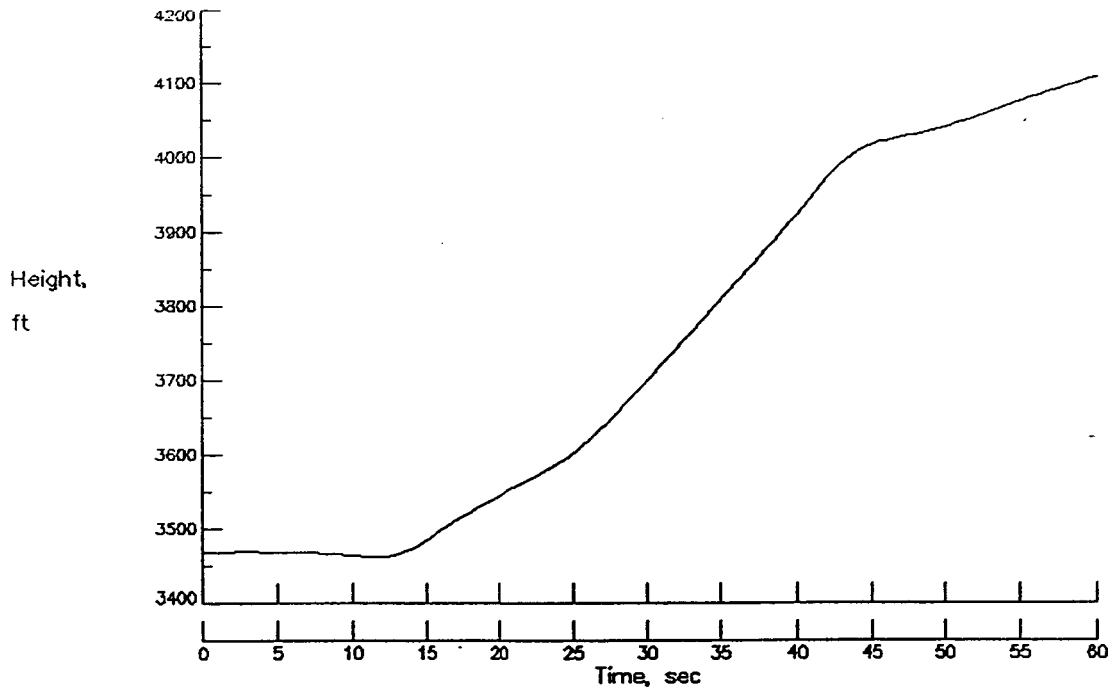

R-4785

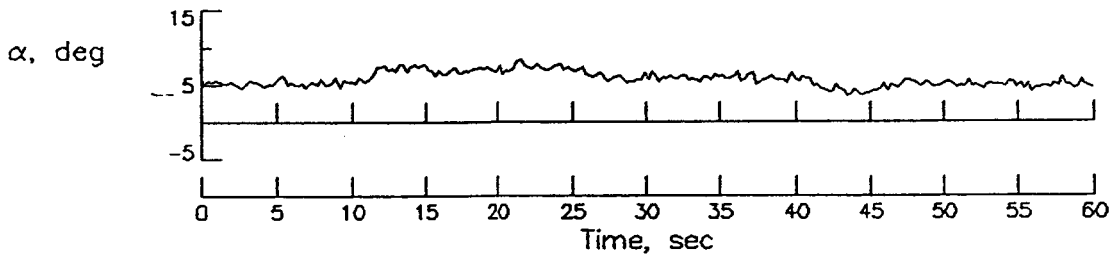

R-4969

Figure A.2-2. R036, CT4, No Failure, Limited FCS

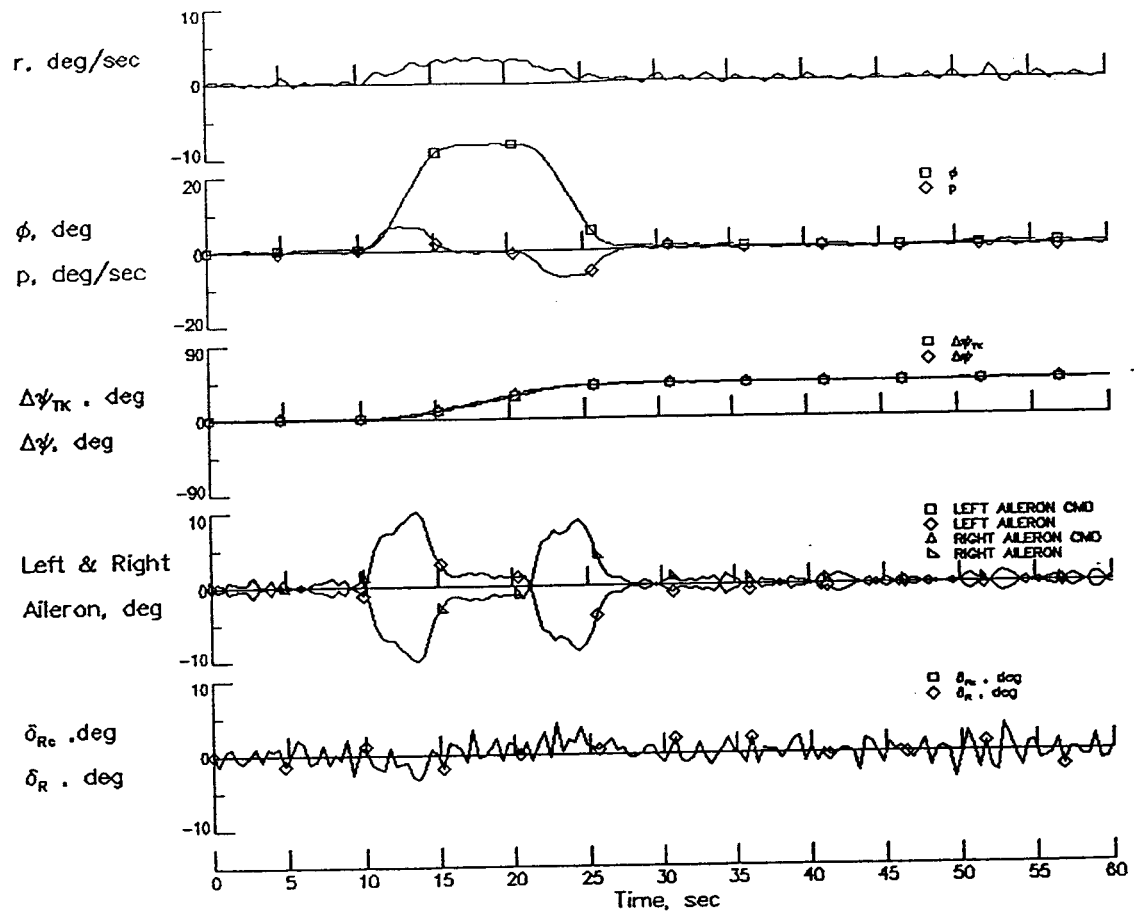

R-4786

Figure A.2-2. R036, CT4, No Failure, Limited FCS (Continued)

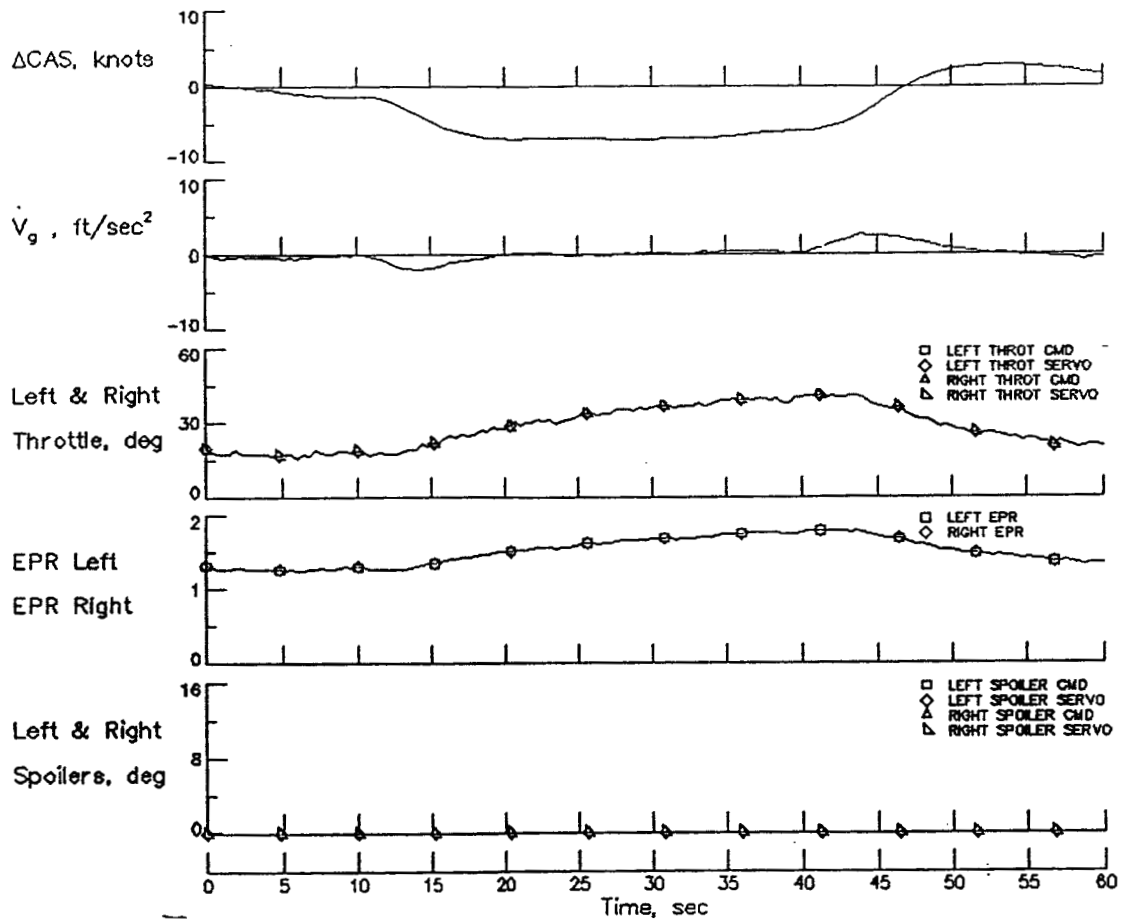

R-4787

Figure A.2-2. R036, CT4, No Failure, Limited FCS (Continued)

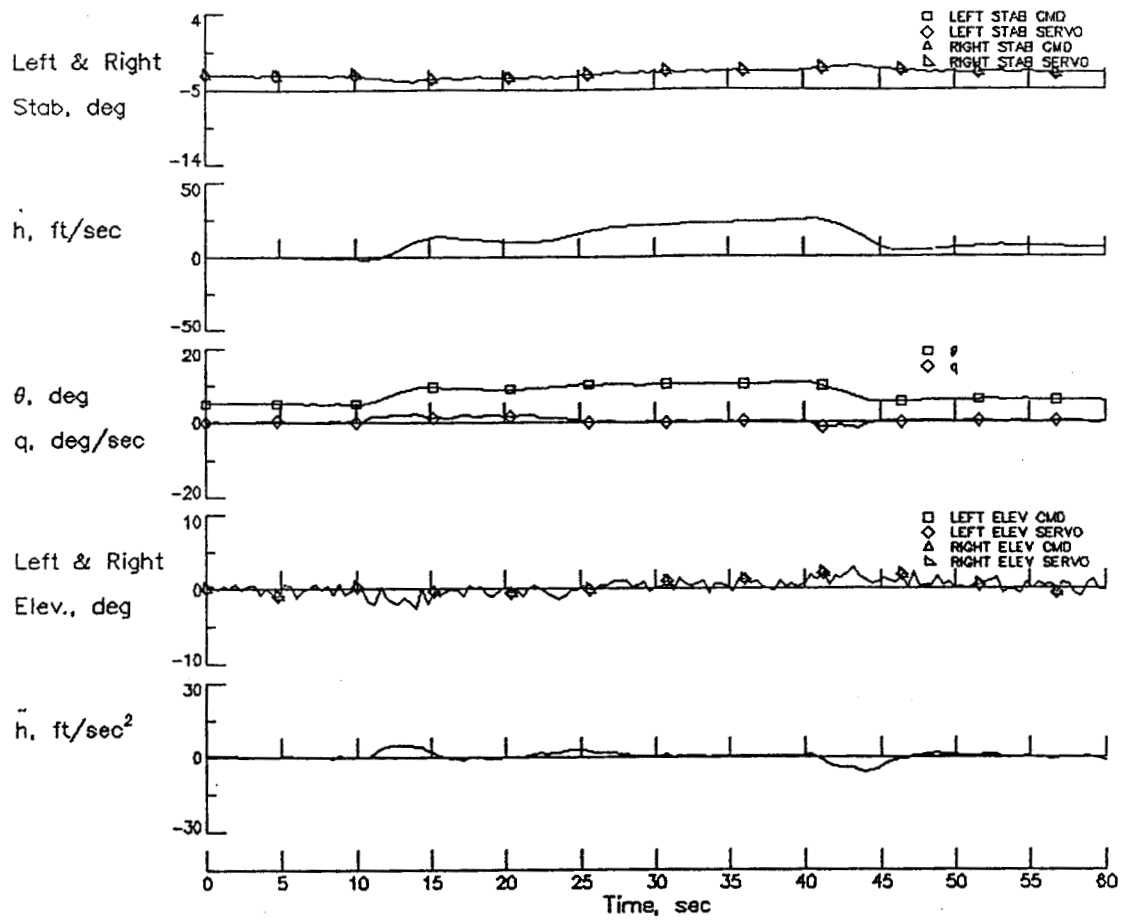

R-4788

Figure A.2-2. R036, CT4, No Failure, Limited FCS (Concluded)

A.3 DUAL STABILIZER RUNAWAY FAILURE

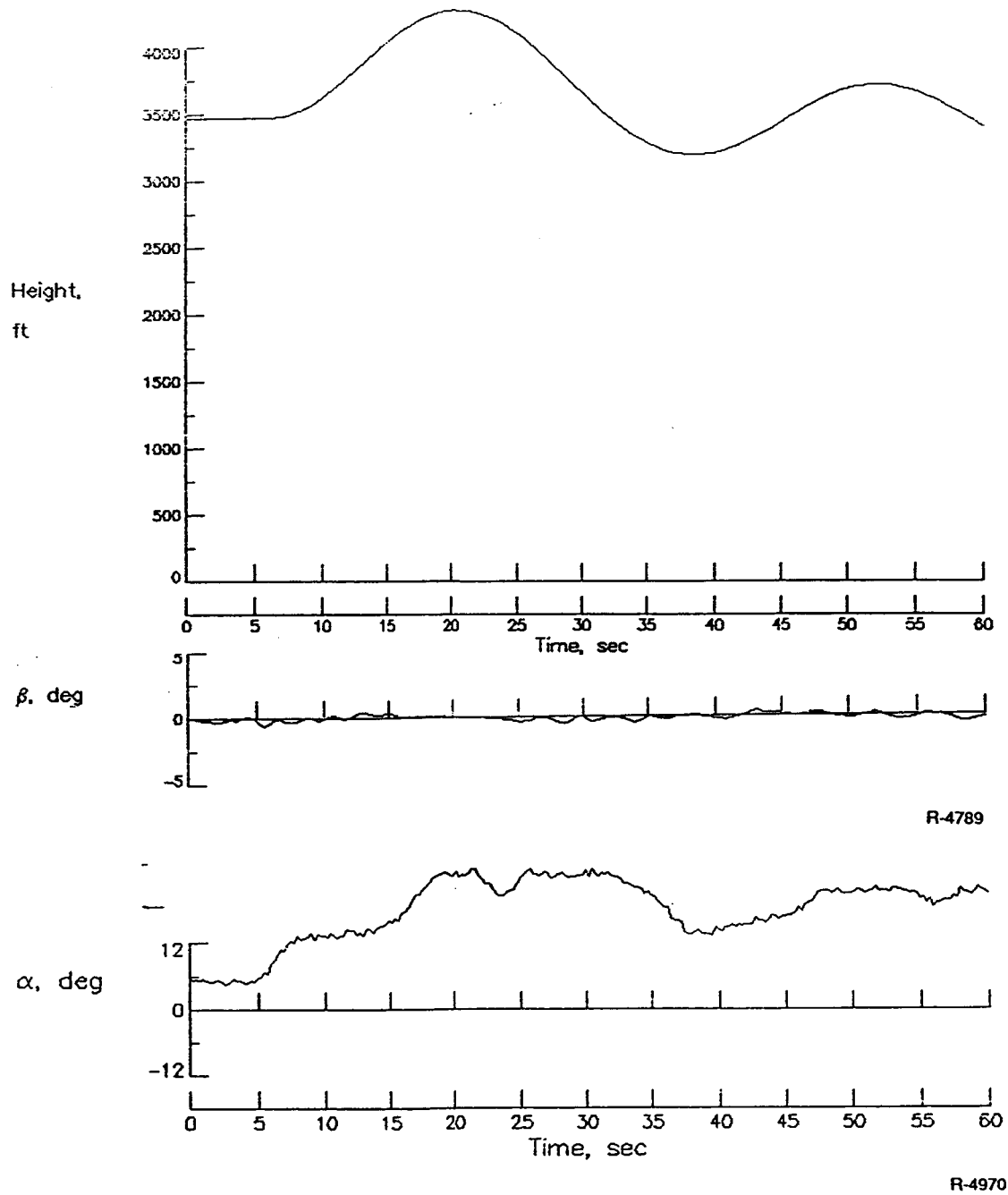

Figure A.3-1. R006, Full FCS, No Reconfiguration

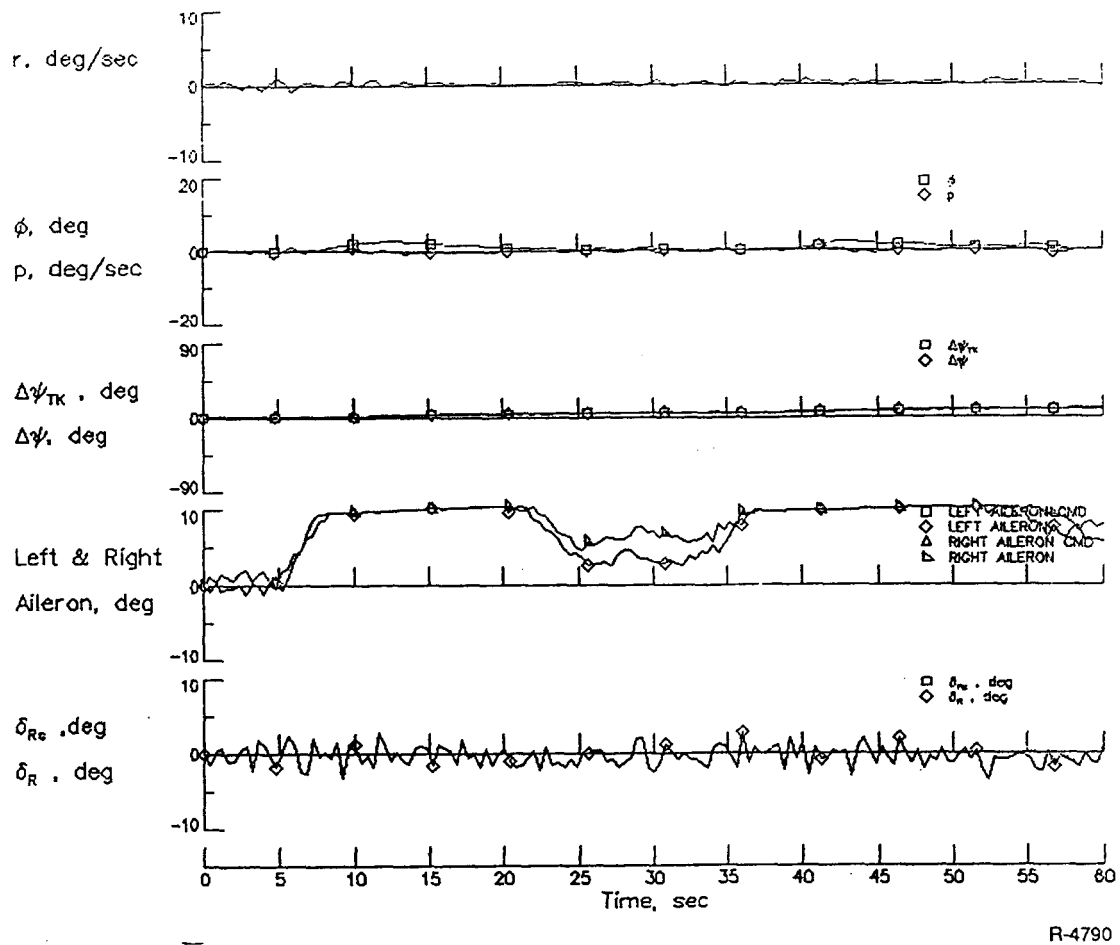
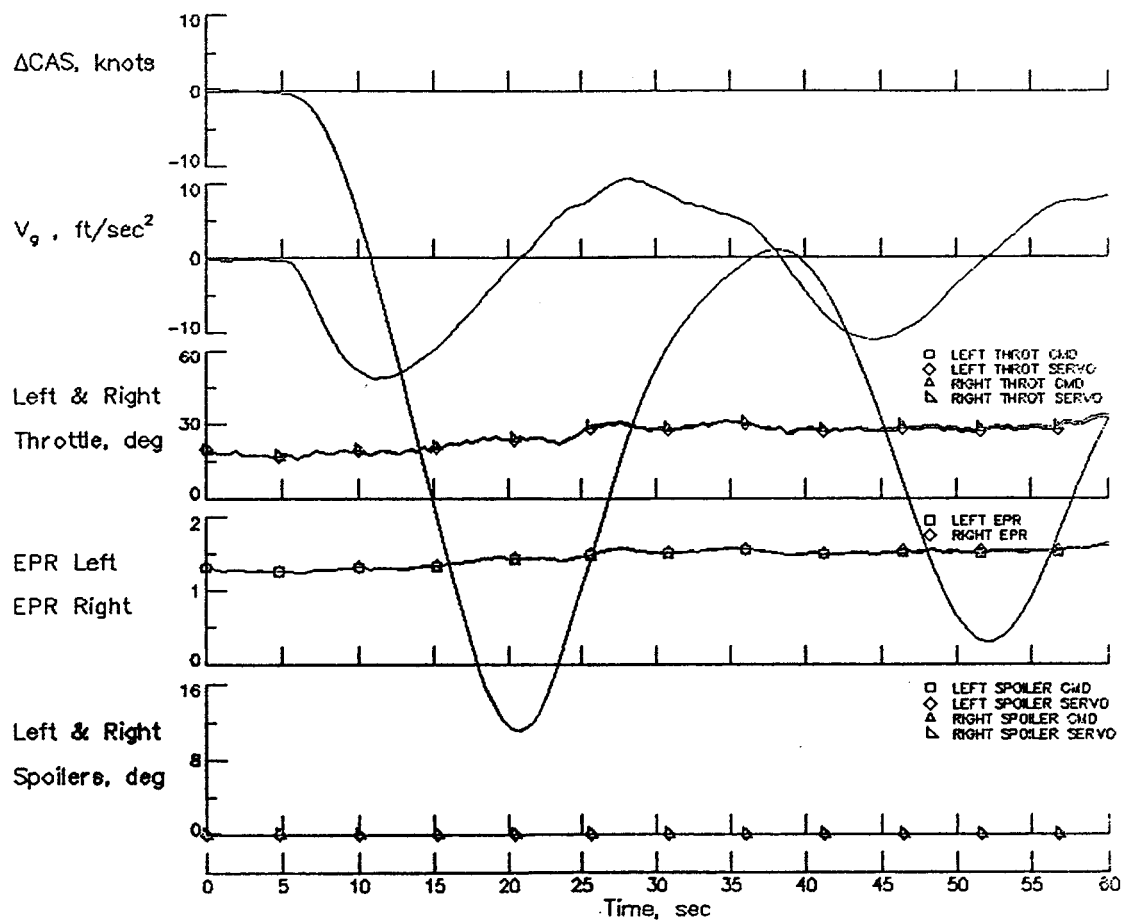
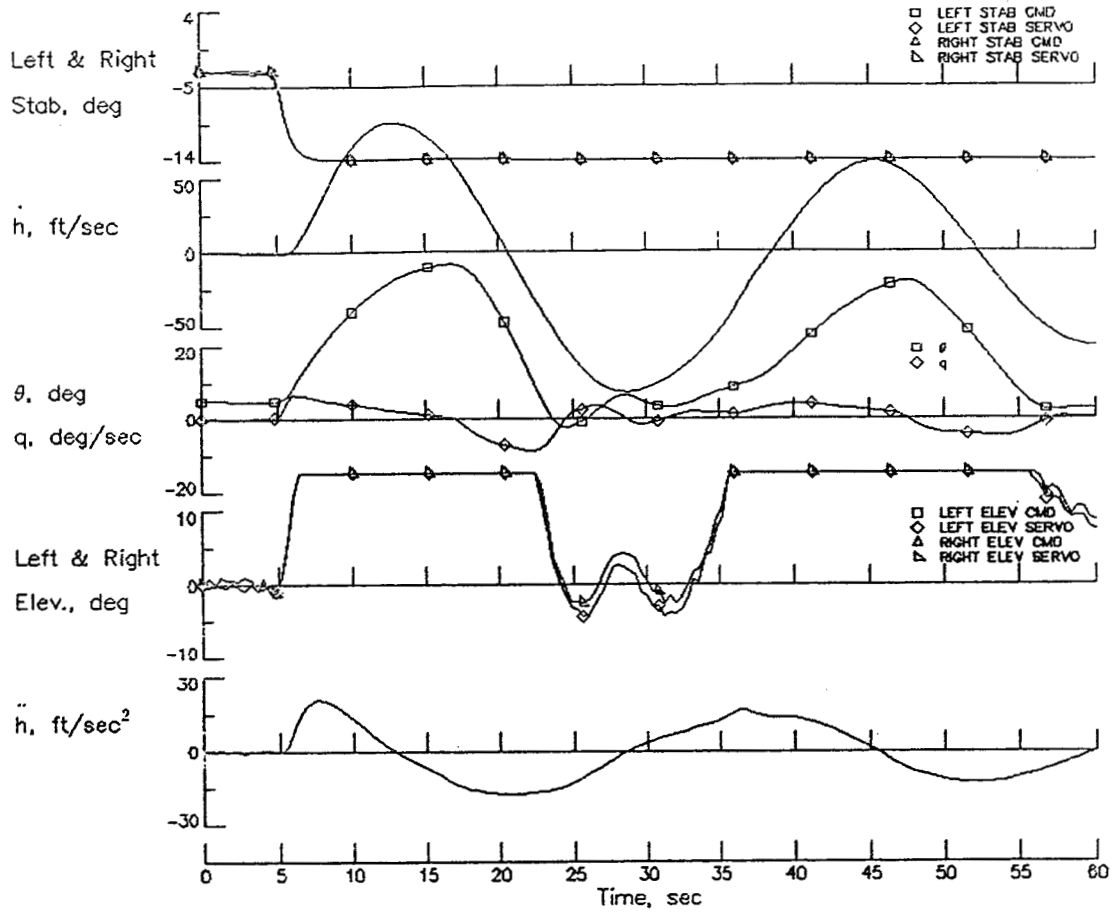

Figure A.3-1. R006, Full FCS, No Reconfiguration (Continued)



R-4791

Figure A.3-1. R006, Full FCS, No Reconfiguration (Continued)



R-4792

Figure A.3-1. R006, Full FCS, No Reconfiguration (Concluded)

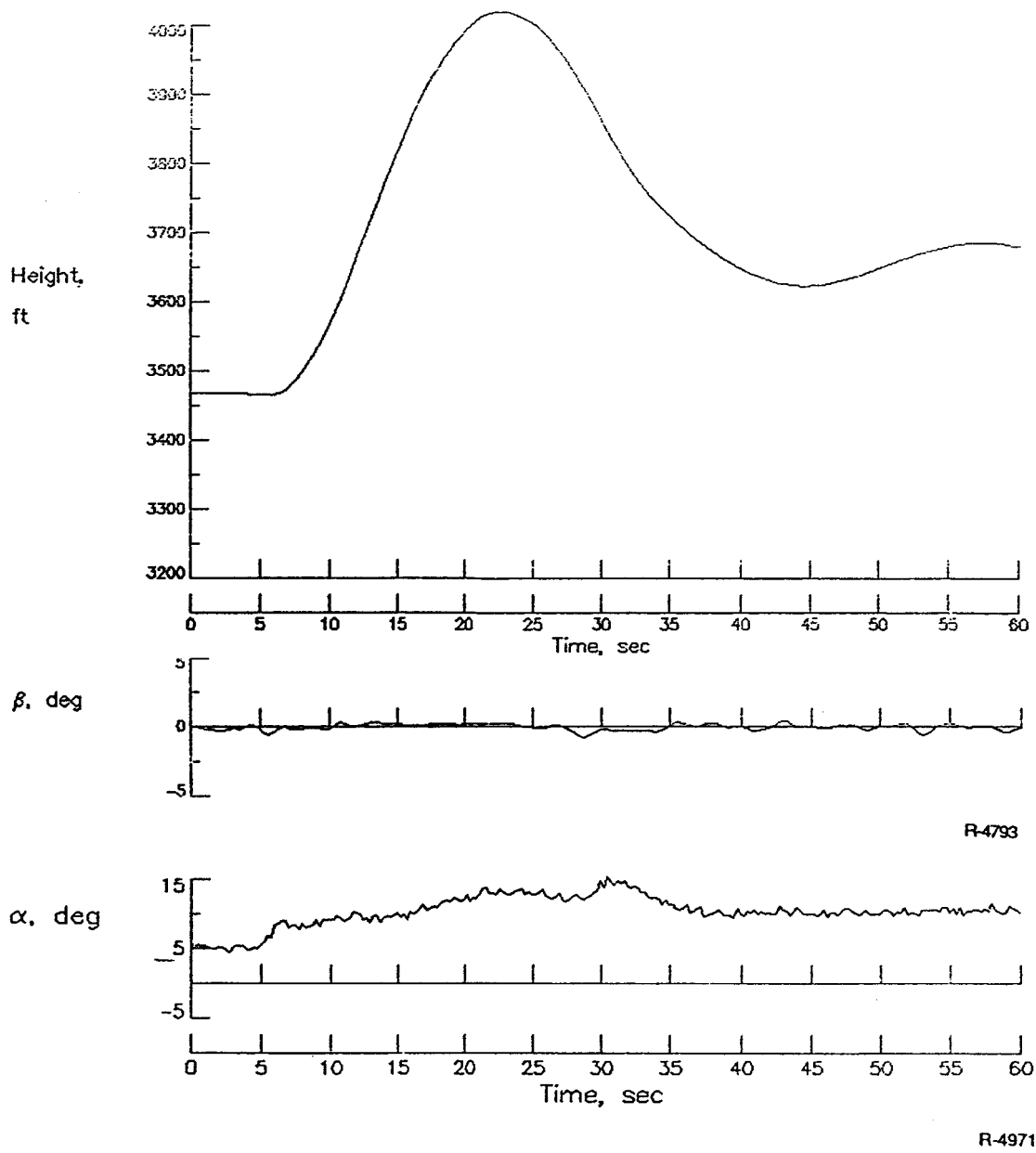
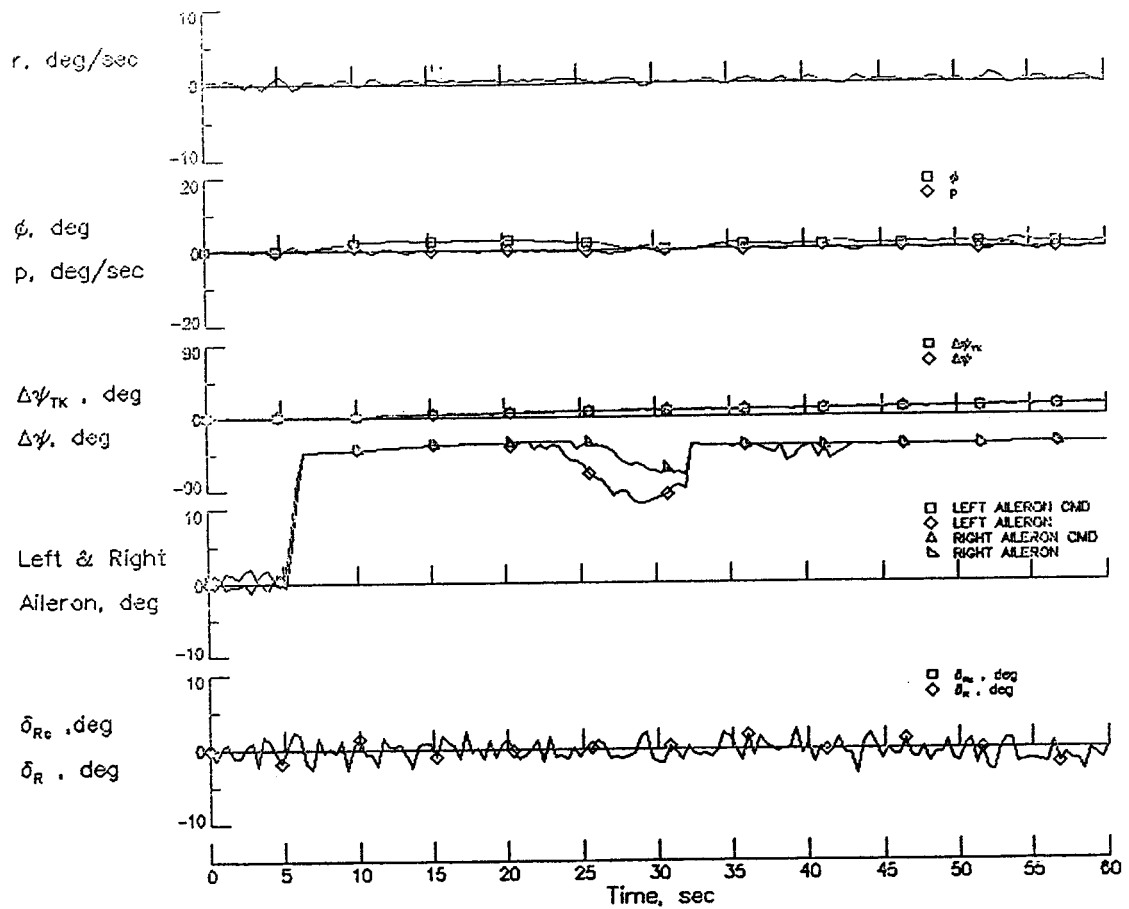
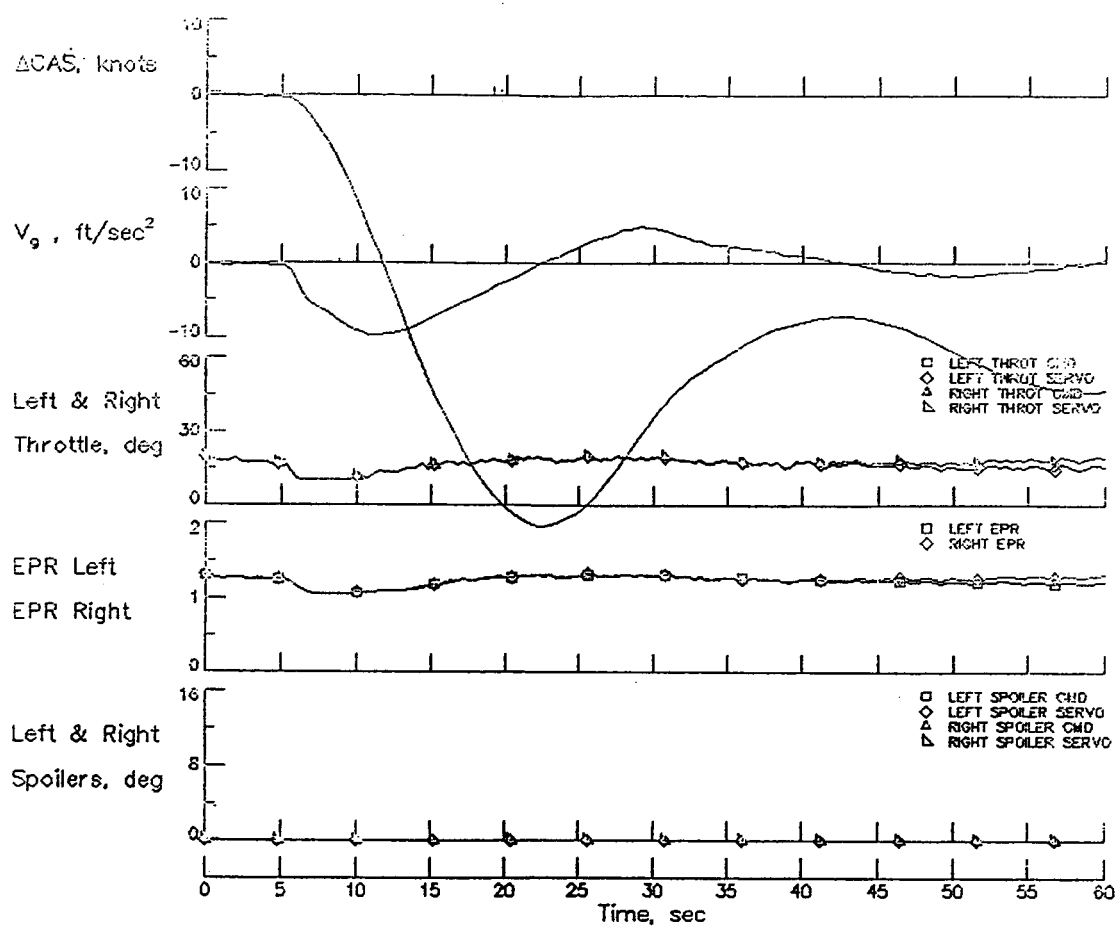

Figure A.3-2. R025, Full FCS, Reconfiguration, Real FDI



R-4794

Figure A.3-2. R025, Full FCS, Reconfiguration, Real FDI (Continued)



R-4795

Figure A.3-2. R025, Full FCS, Reconfiguration, Real FDI (Continued)

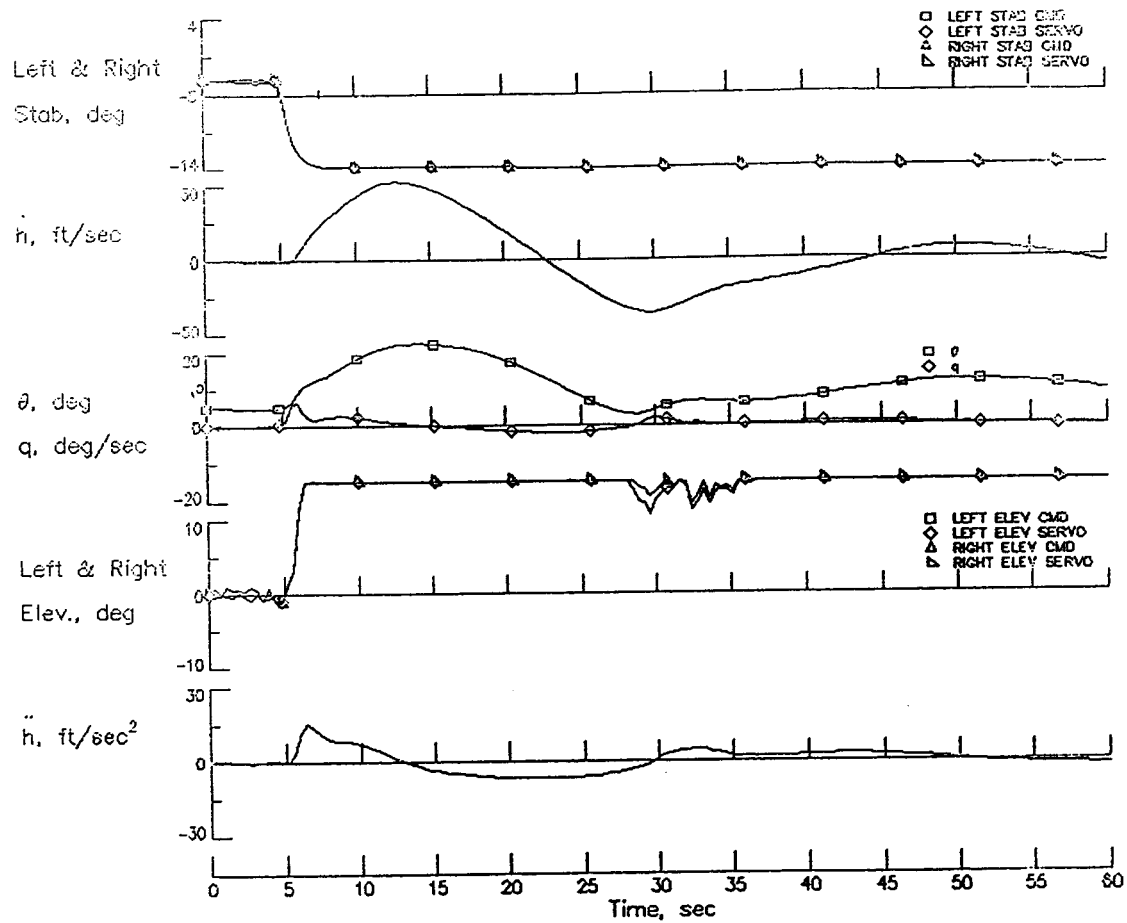

R-4796

Figure A.3-2. R025, Full FCS, Reconfiguration, Real FDI (Concluded)

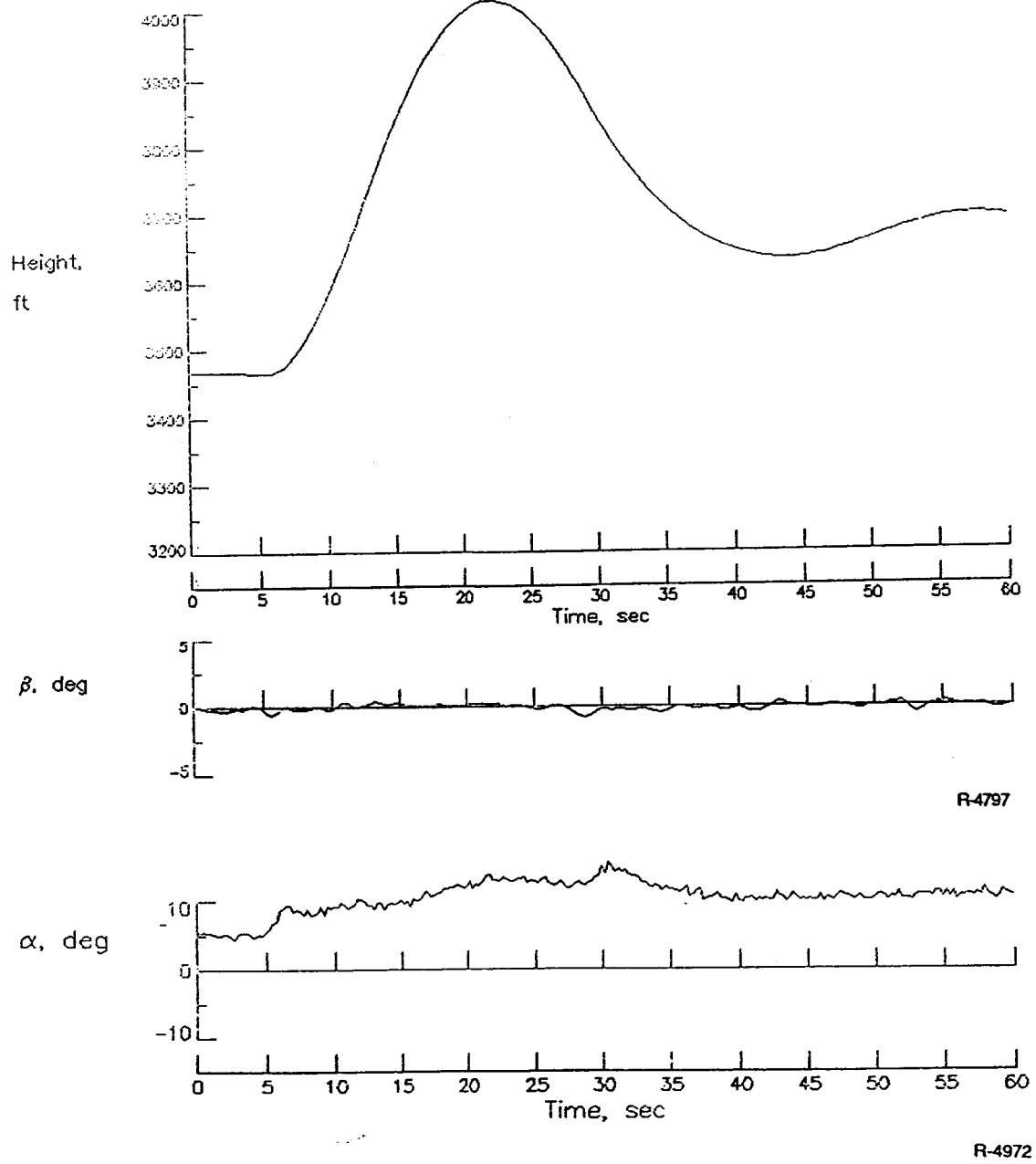
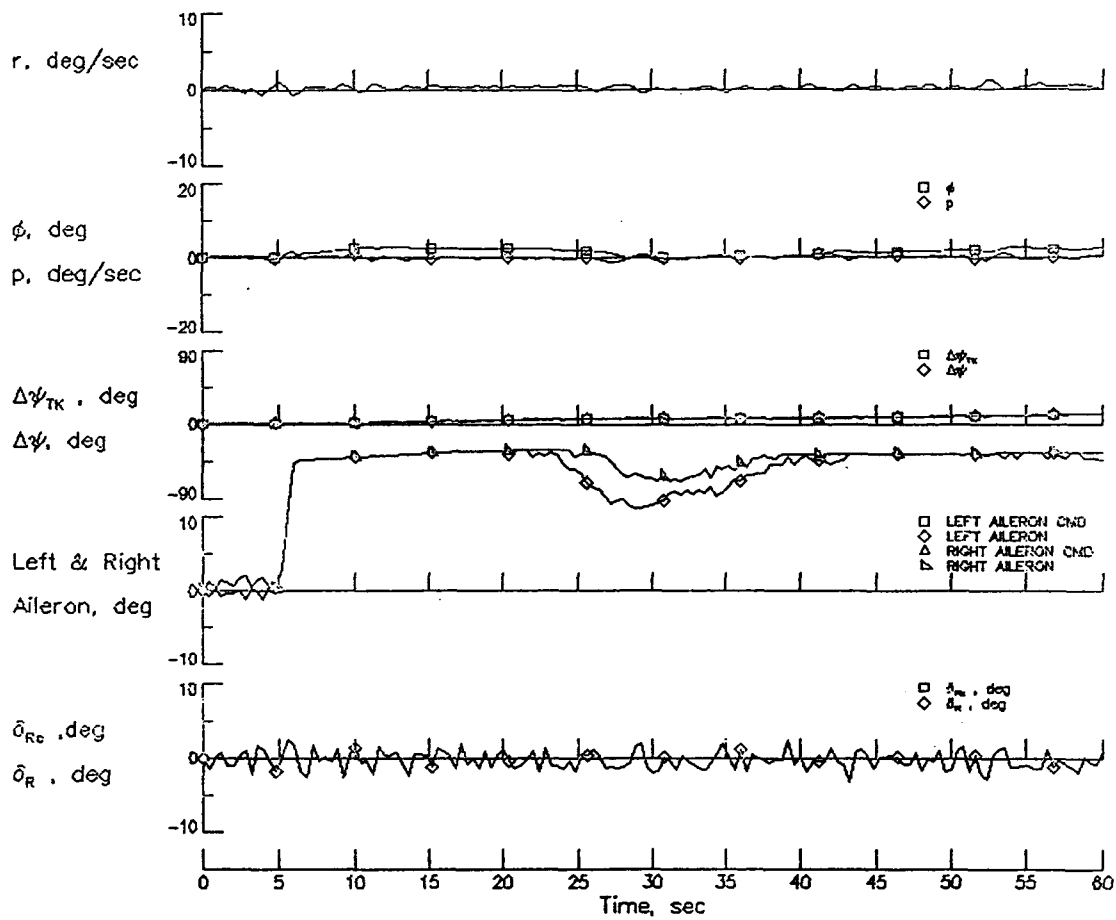

Figure A.3-3. R026, Full FCS, Reconfiguration, Perfect FDI

C-2



R-4798

Figure A.3-3. R026, Full FCS, Reconfiguration, Perfect FDI (Continued)

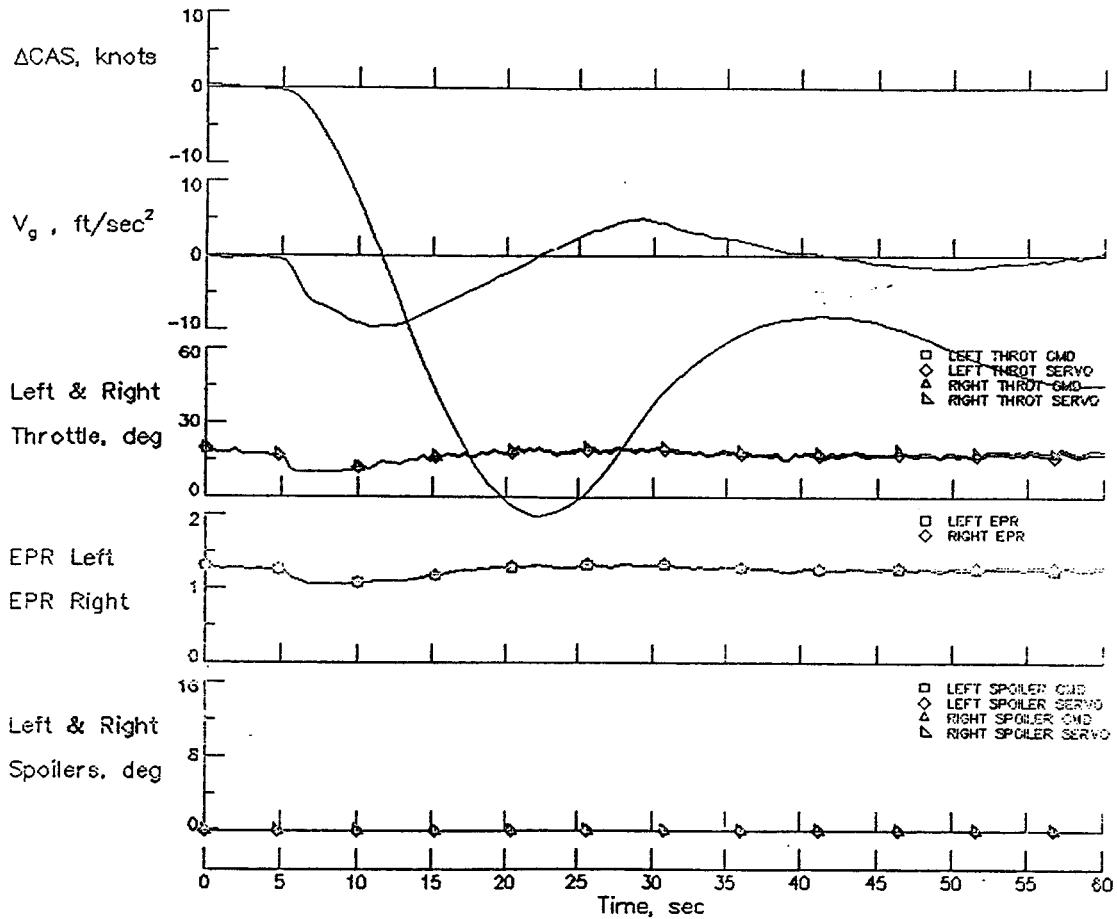

R-4799

Figure A.3-3. R026, Full FCS, Reconfiguration, Perfect FDI (Continued)

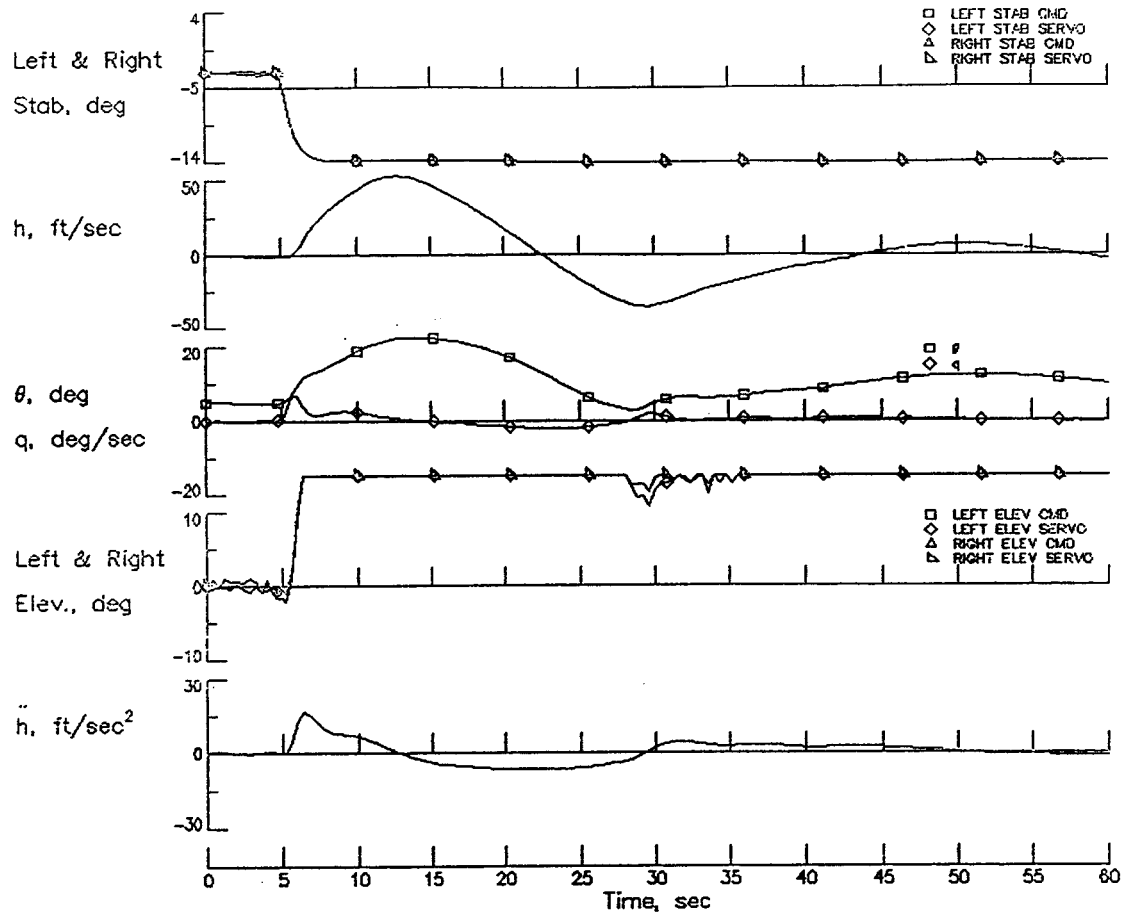

R-4800

Figure A.3-3. R026, Full FCS, Reconfiguration, Perfect FDI (Concluded)

A.4 SINGLE RIGHT STABILIZER RUNAWAY

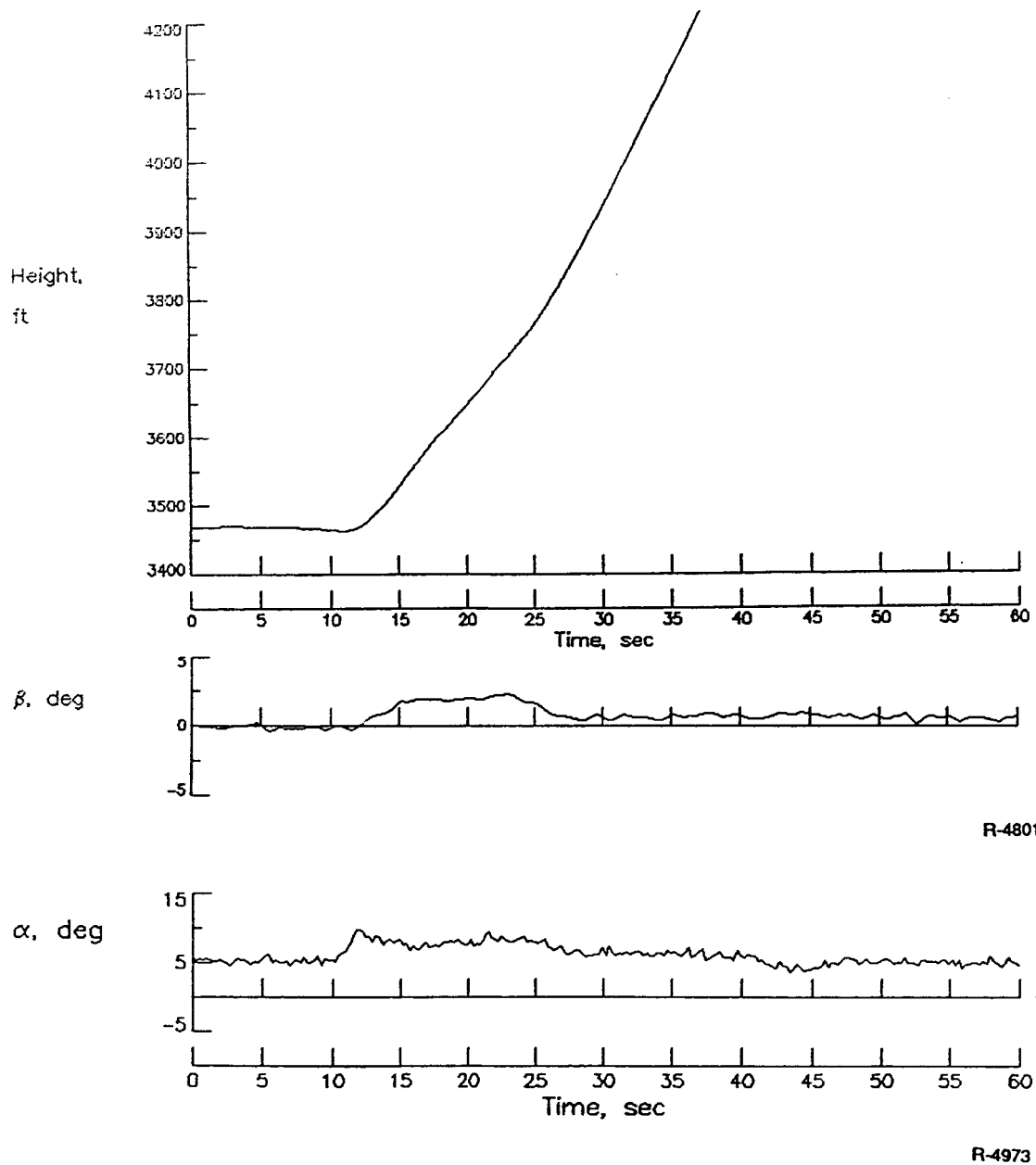
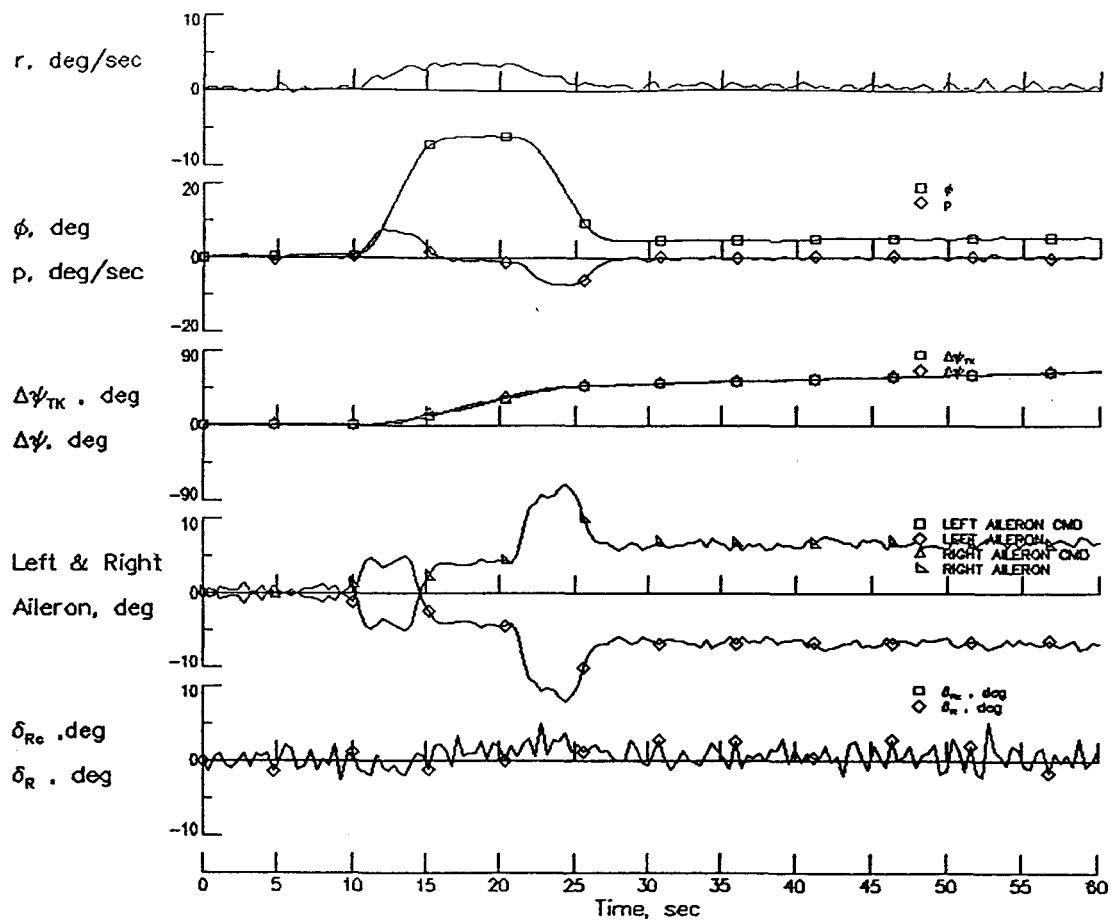
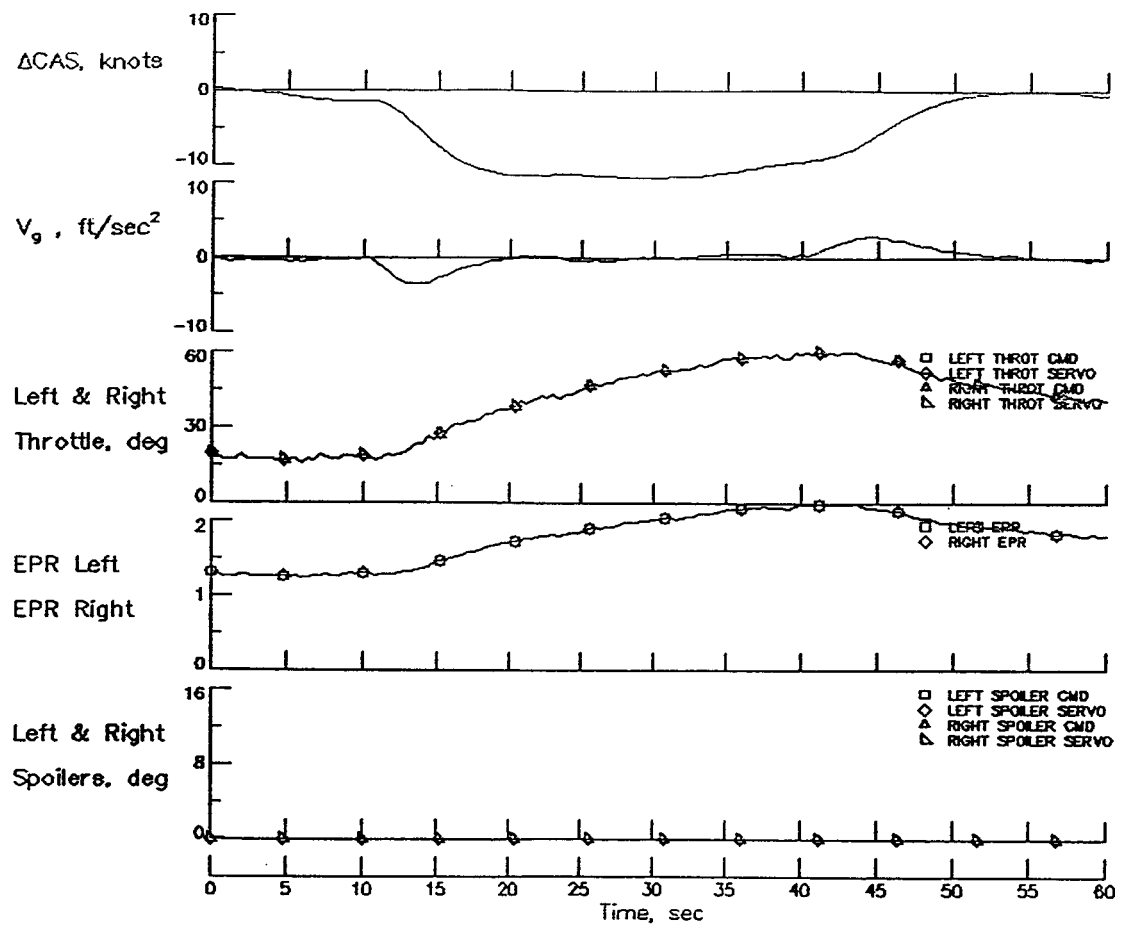

Figure A.4-1. R034, CT4, Limited FCS, No Reconfiguration



R-4802

Figure A.4-1. R034, CT4, Limited FCS, No Reconfiguration (Continued)



R-4803

Figure A.4-1. R034, CT4, Limited FCS, No Reconfiguration (Continued)

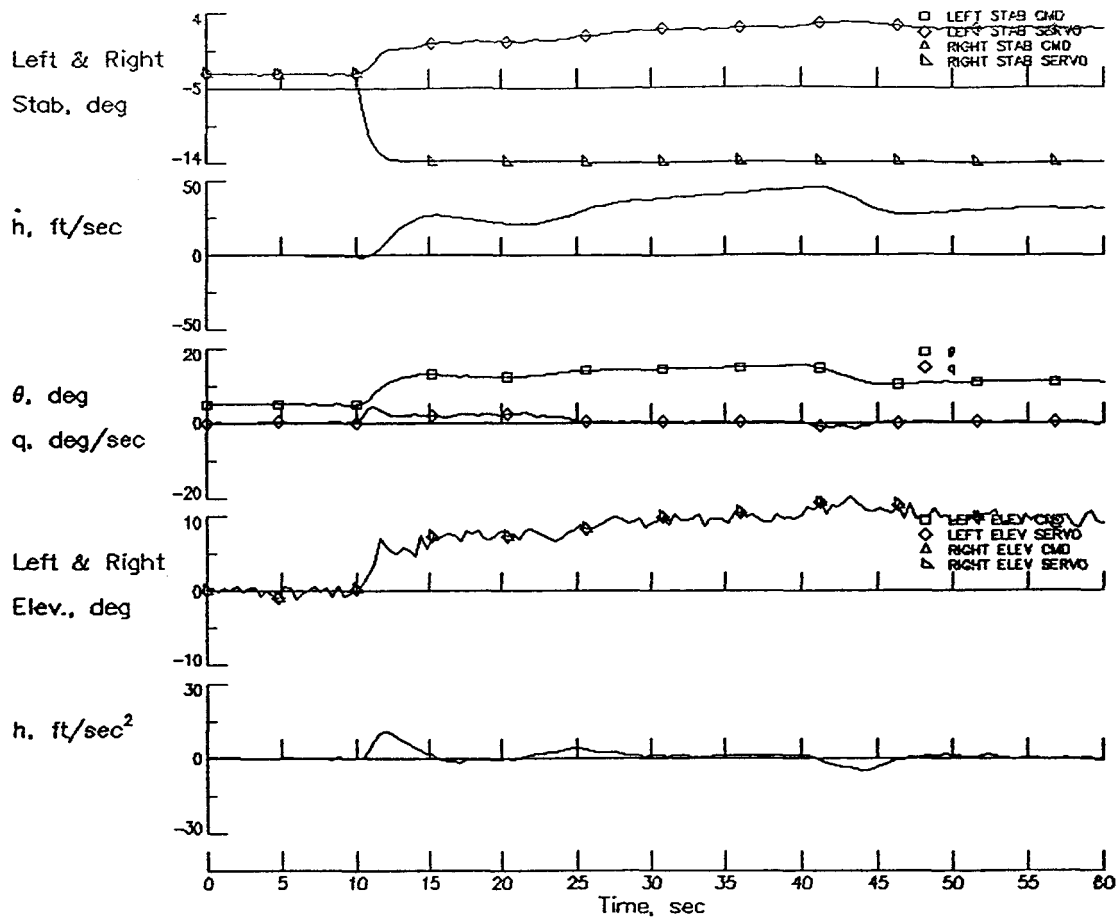

R-4804

Figure A.4-1. R034, CT4, Limited FCS, No Reconfiguration (Concluded)

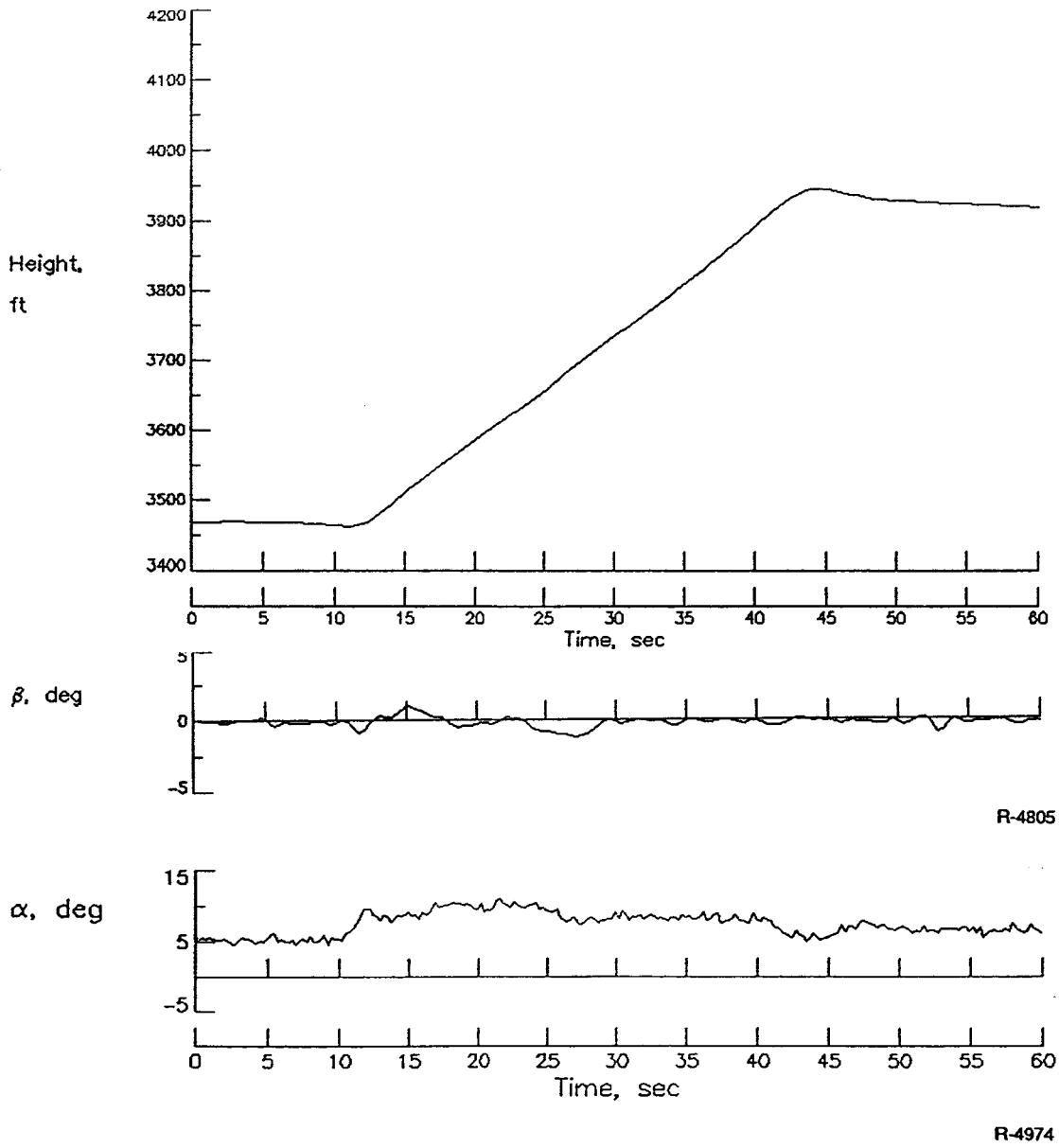
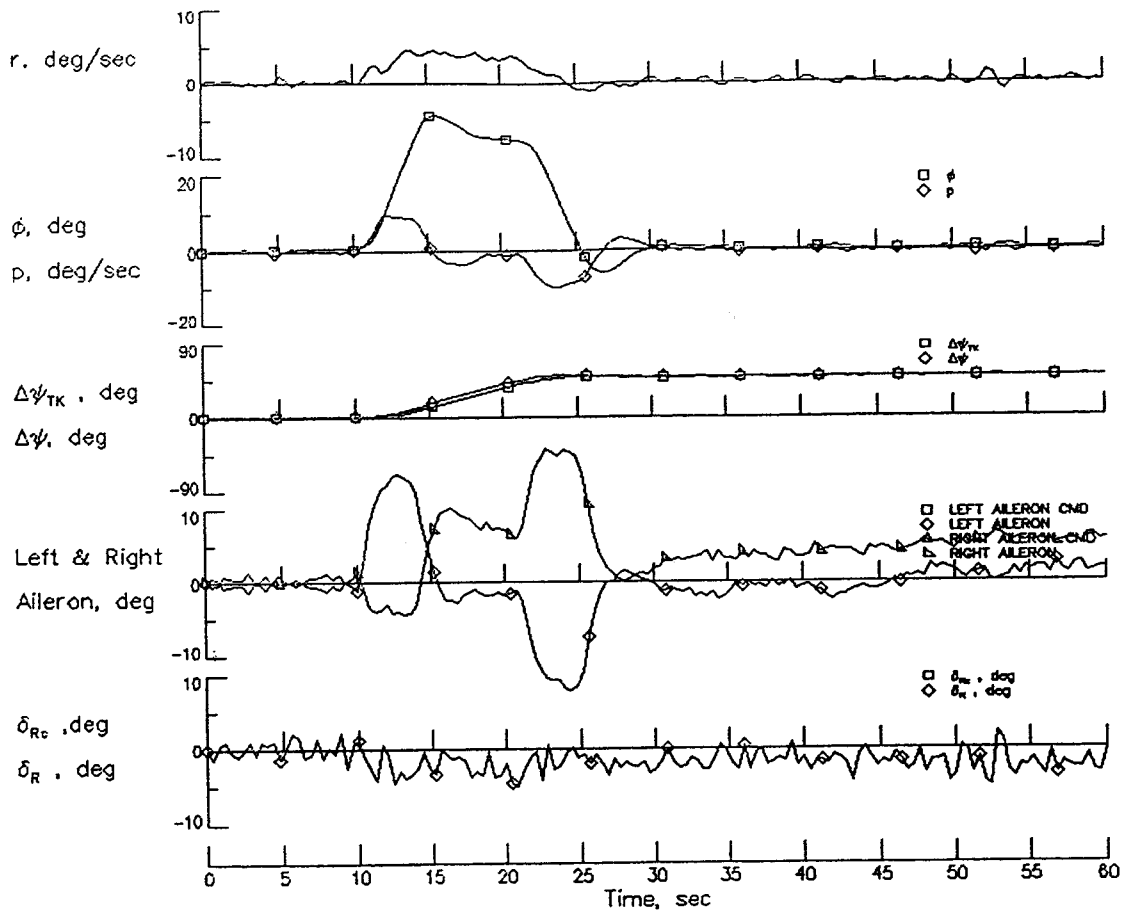
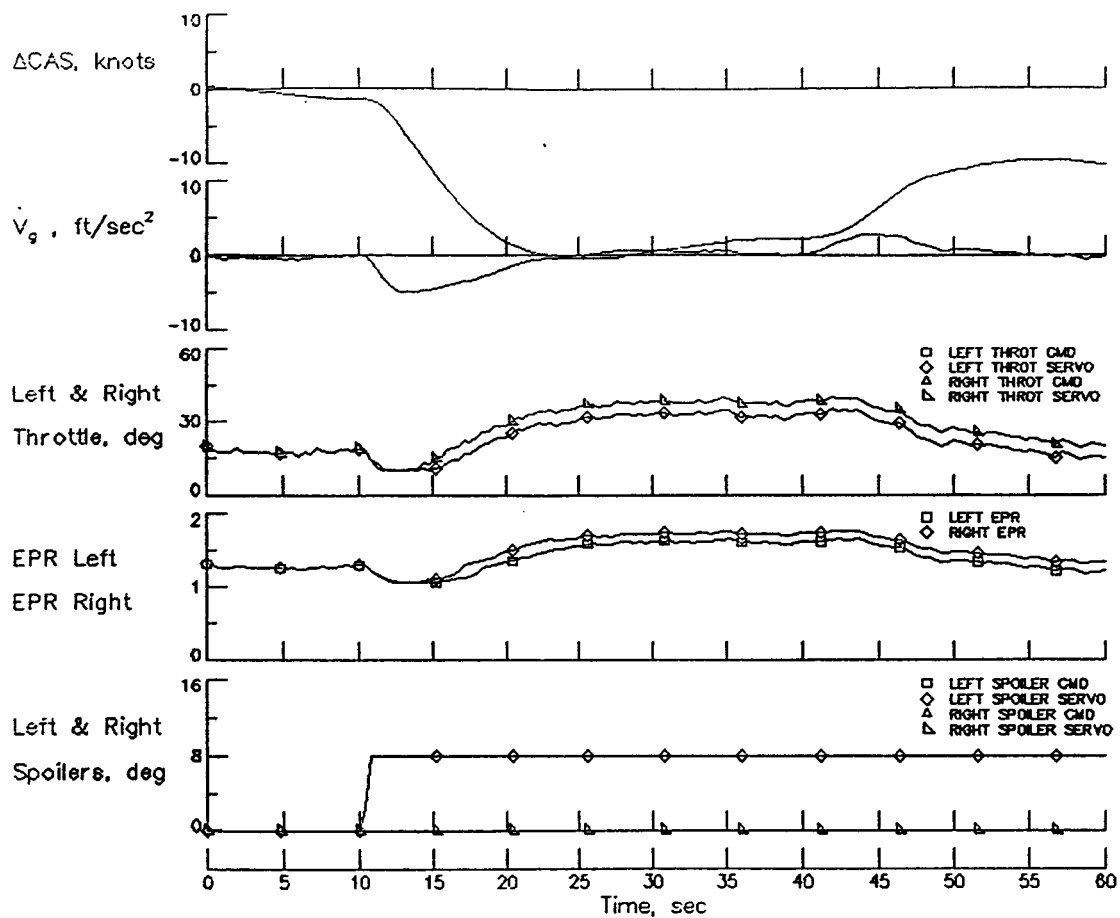

Figure A.4-2. R035, CT4, Limited FCS, Full Reconfiguration



R-4806

Figure A.4-2. R035, CT4, Limited FCS, Full Reconfiguration (Continued)



R-4807

Figure A.4-2. R035, CT4, Limited FCS, Full Reconfiguration (Continued)

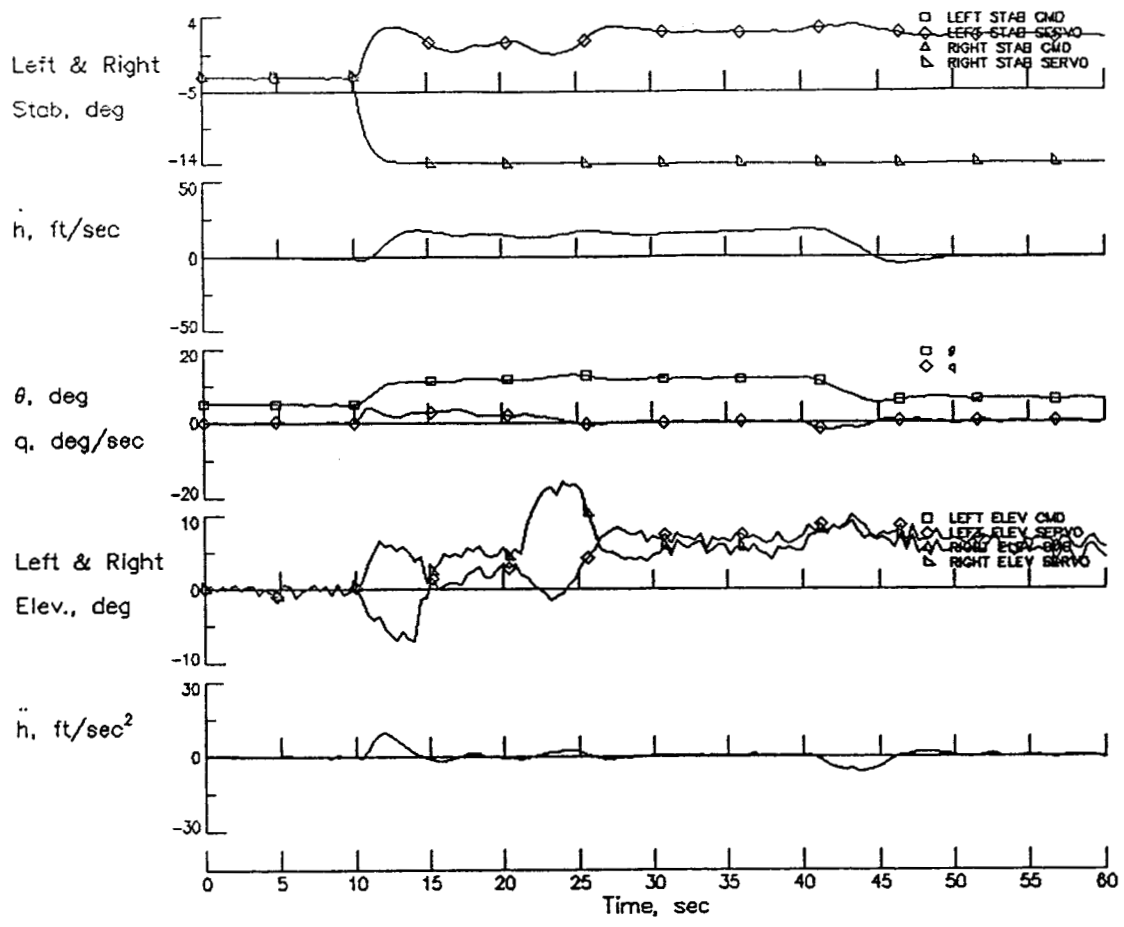

R-4808

Figure A-4-2. R035, CT4, Limited FCS, Full Reconfiguration (Concluded)

A.5 MISSING LEFT AILERON FAILURE

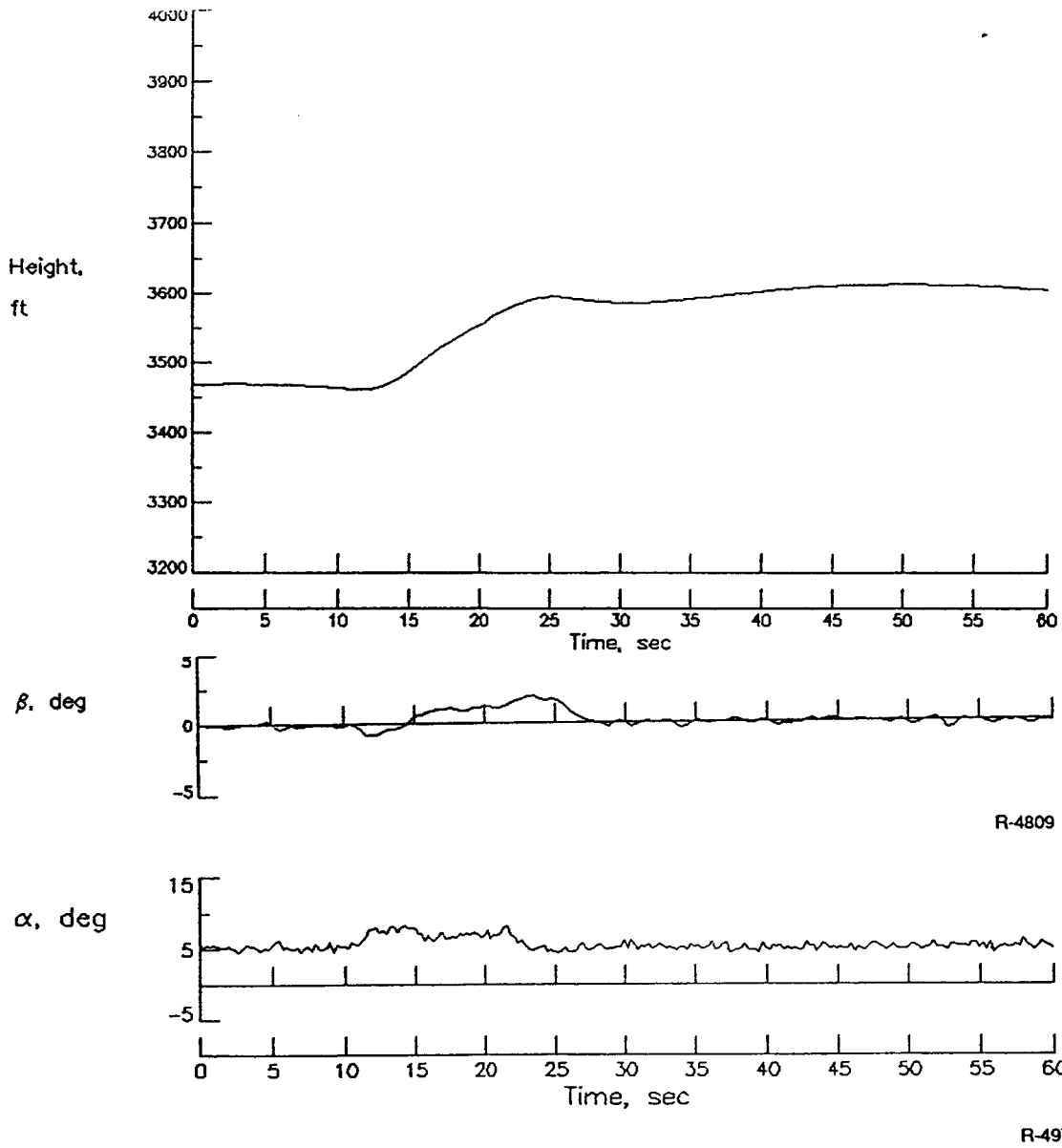
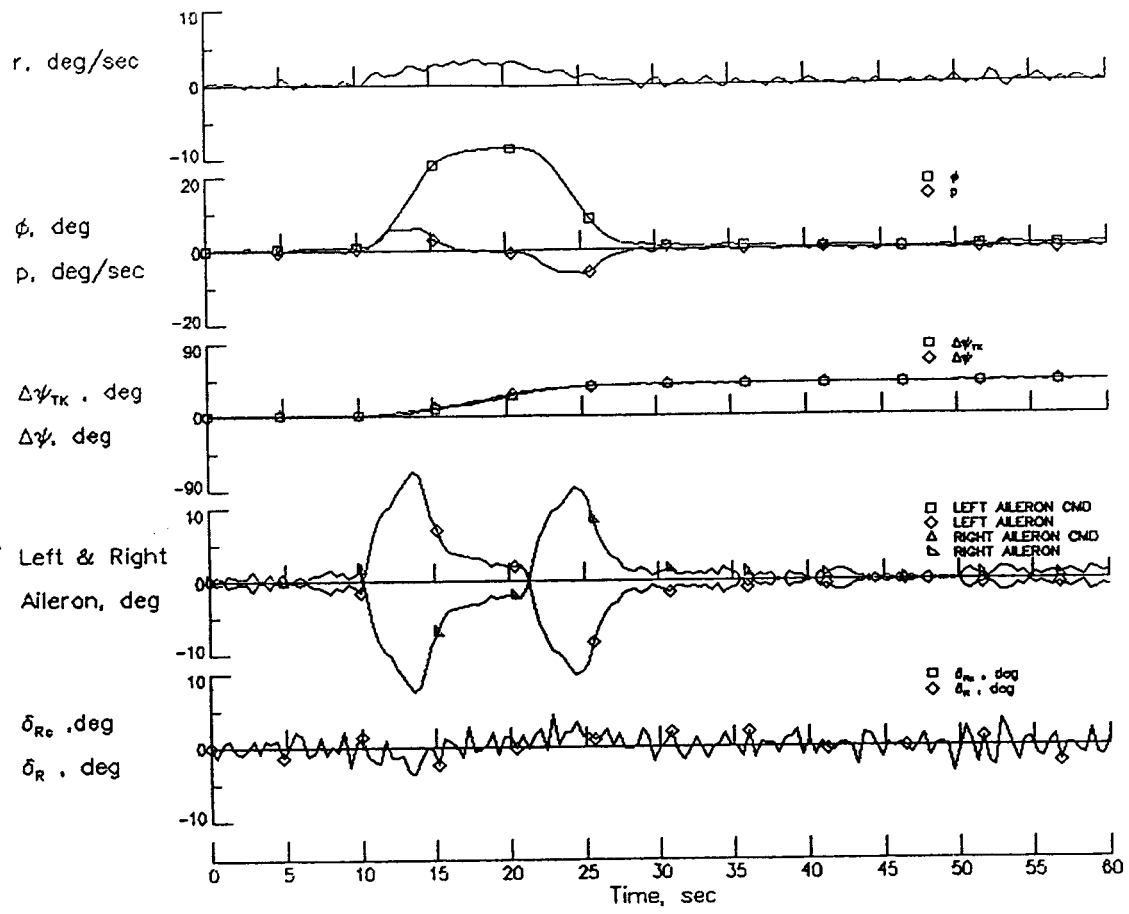
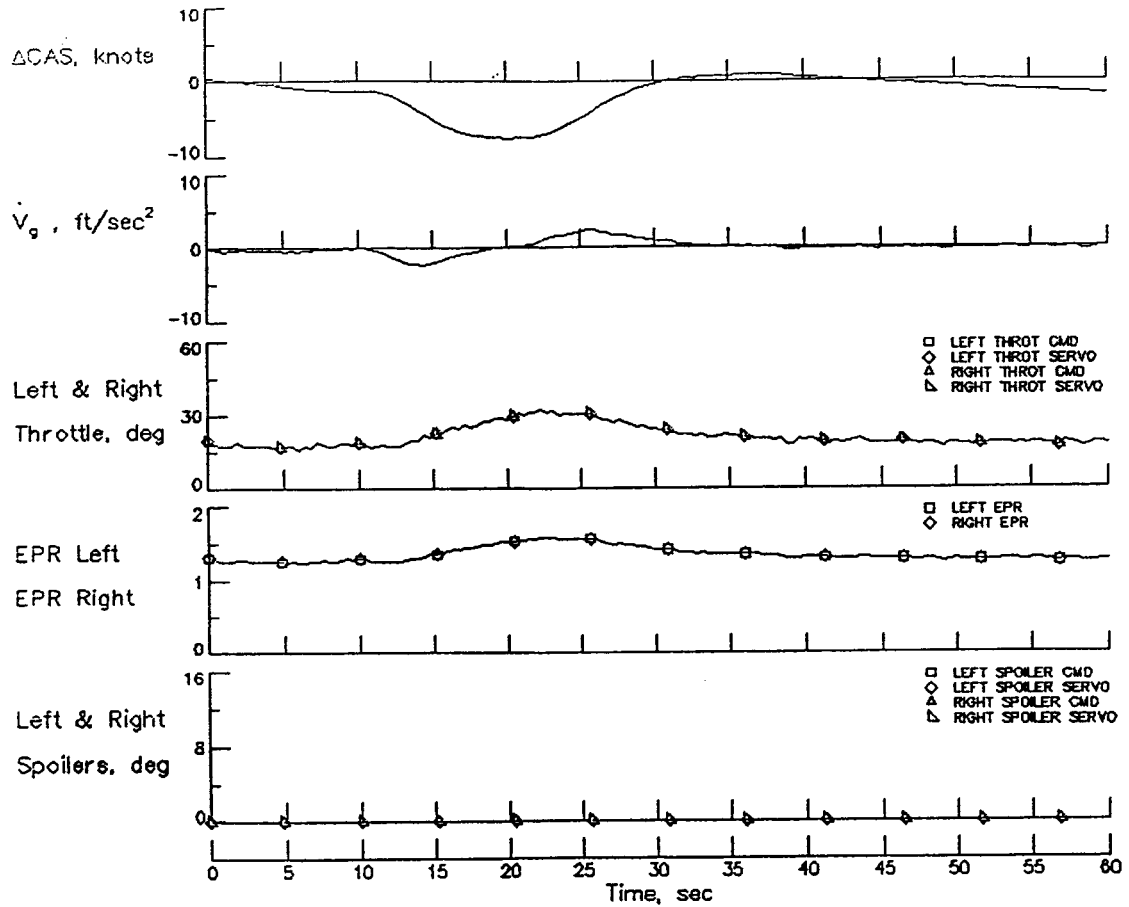

Figure A.5-1. R032, CT1, Limited FCS, No Reconfiguration



R-4810

Figure A.5-1. R032, CT1, Limited FCS, No Reconfiguration (Continued)



R-4811

Figure A.5-1. R032, CT1, Limited FCS, No Reconfiguration (Continued)

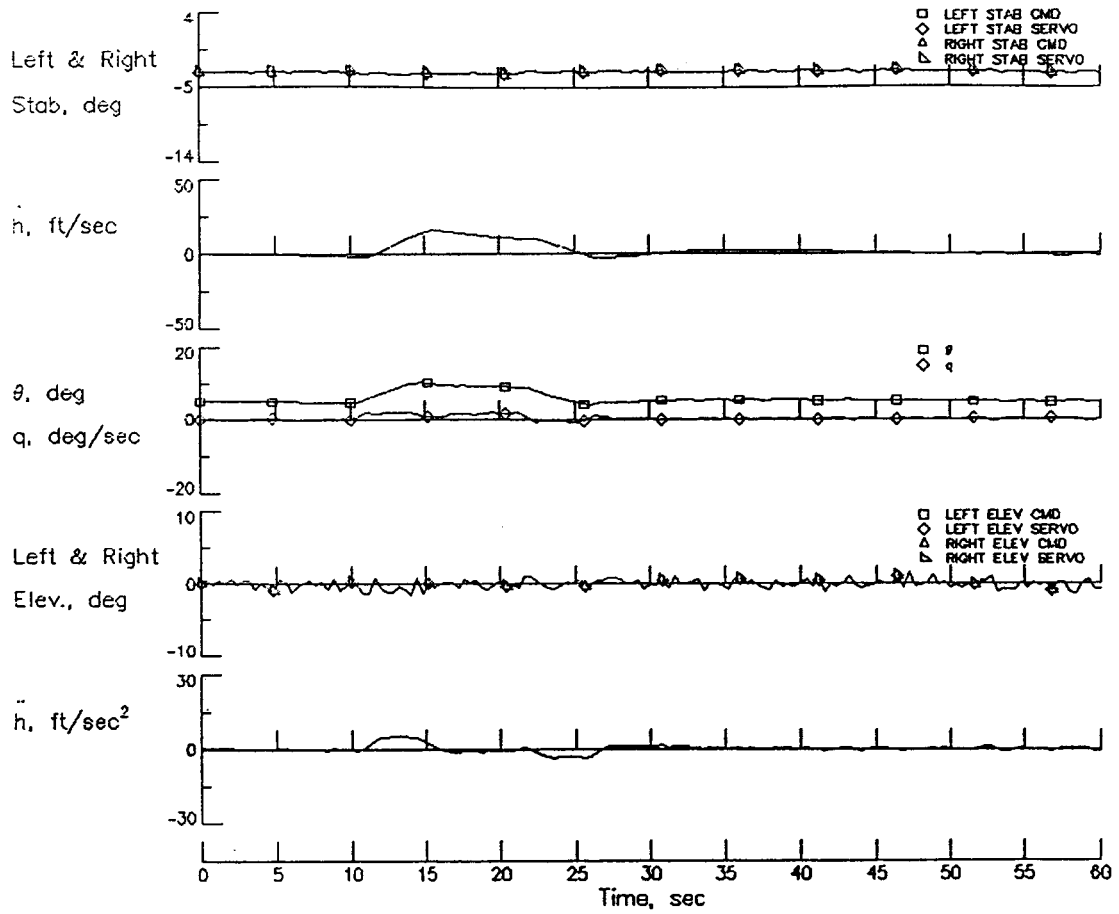

R-4812

Figure A.5-1. R032, CT1, Limited FCS, No Reconfiguration (Concluded)

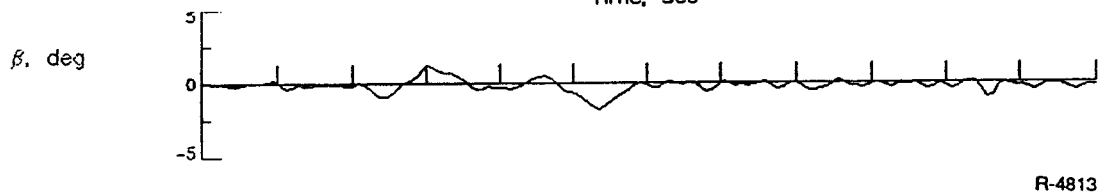
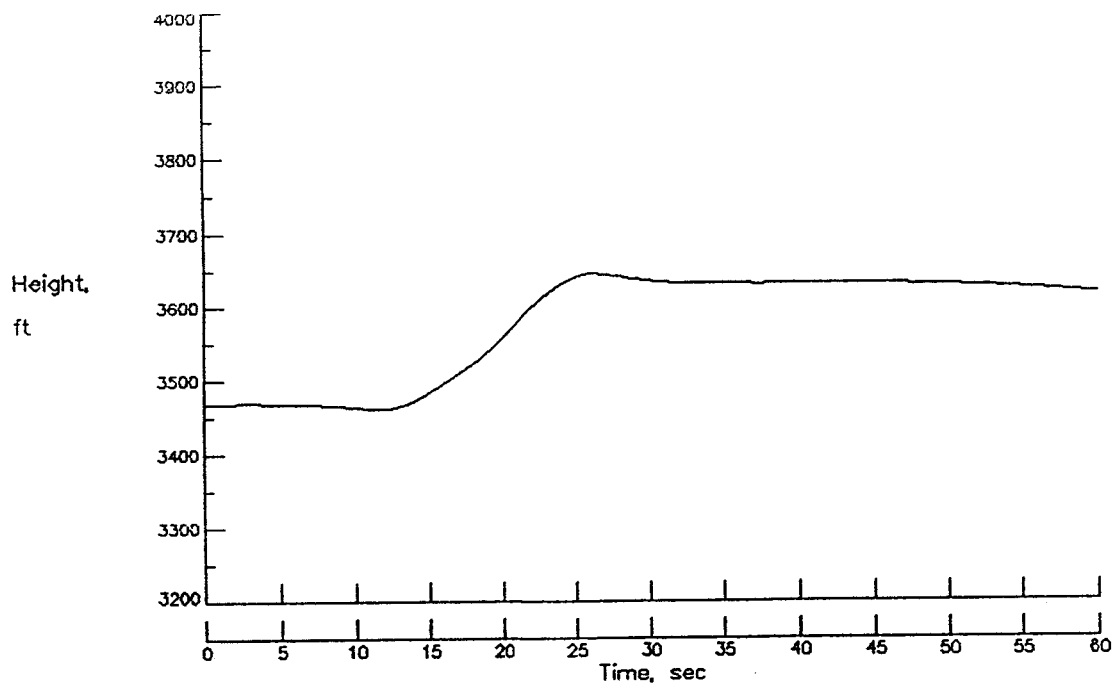

R-4813

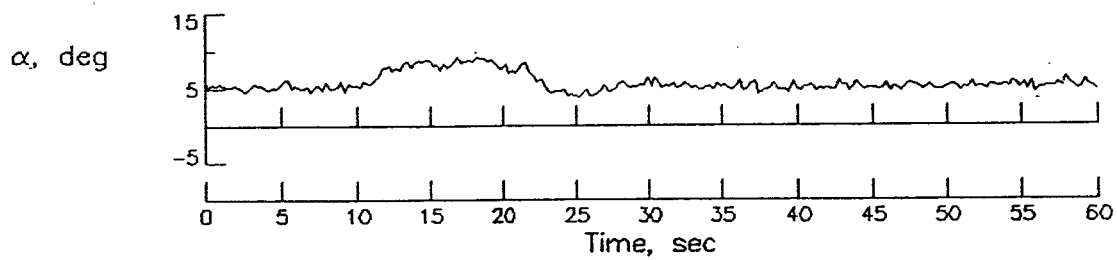

R-4976

Figure A.5-2. R033, CT1, Limited FCS, Full Reconfiguration

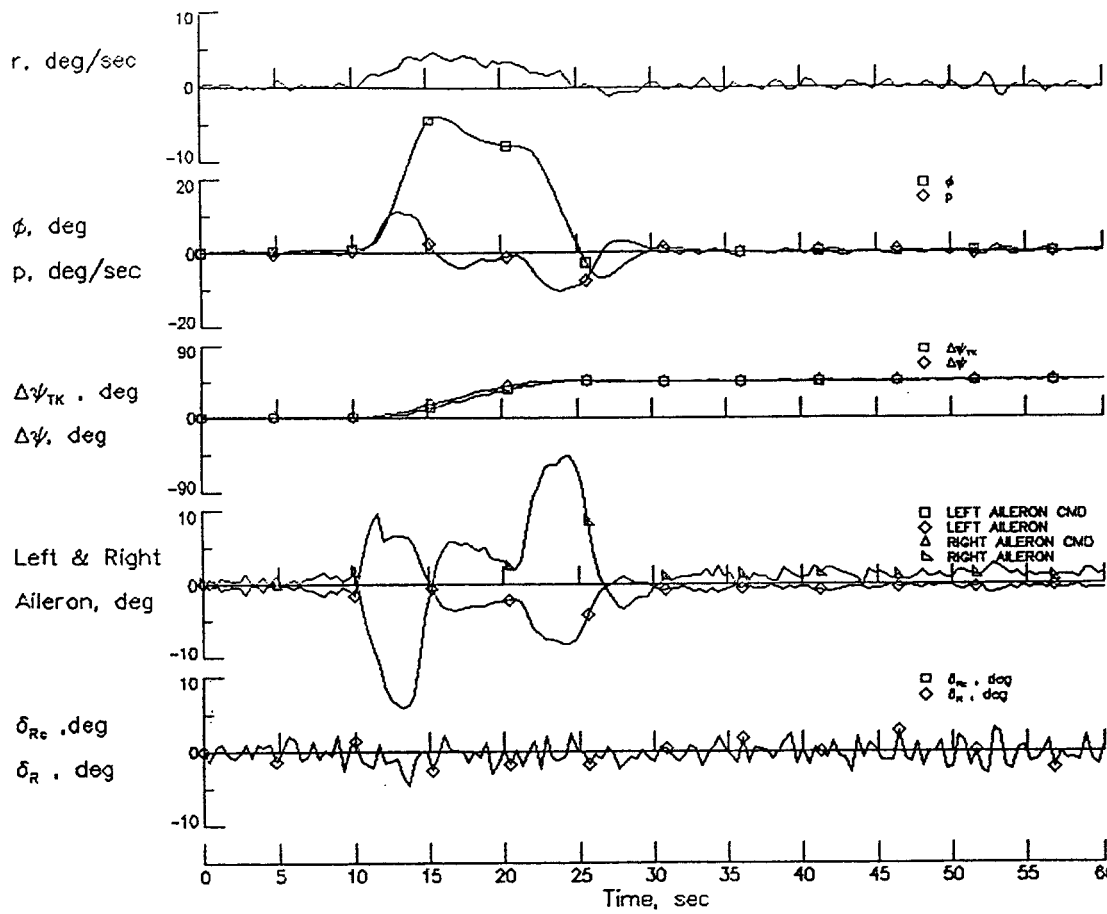

R-4814

Figure A.5-2. R033, CT1, Limited FCS, Full Reconfiguration (Continued)

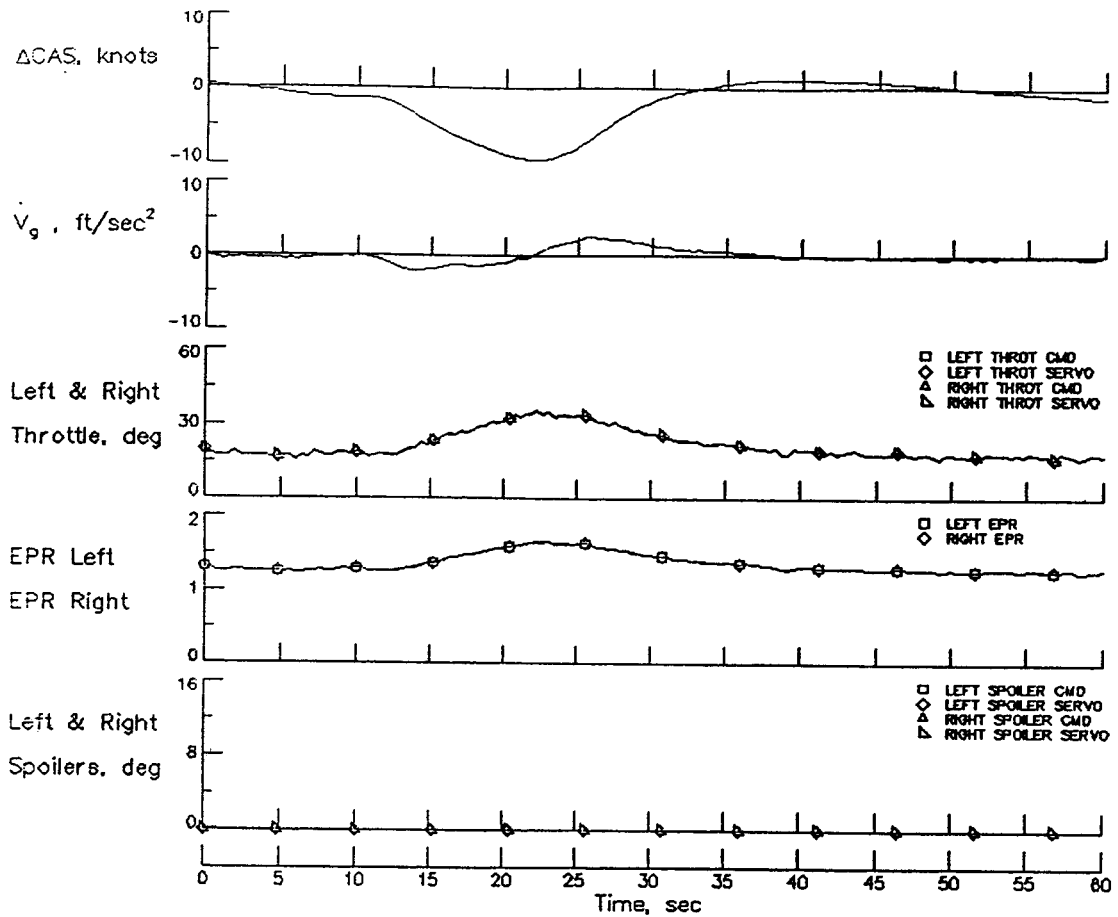

R-4815

Figure A.5-2. R033, CT1, Limited FCS, Full Reconfiguration (Continued)

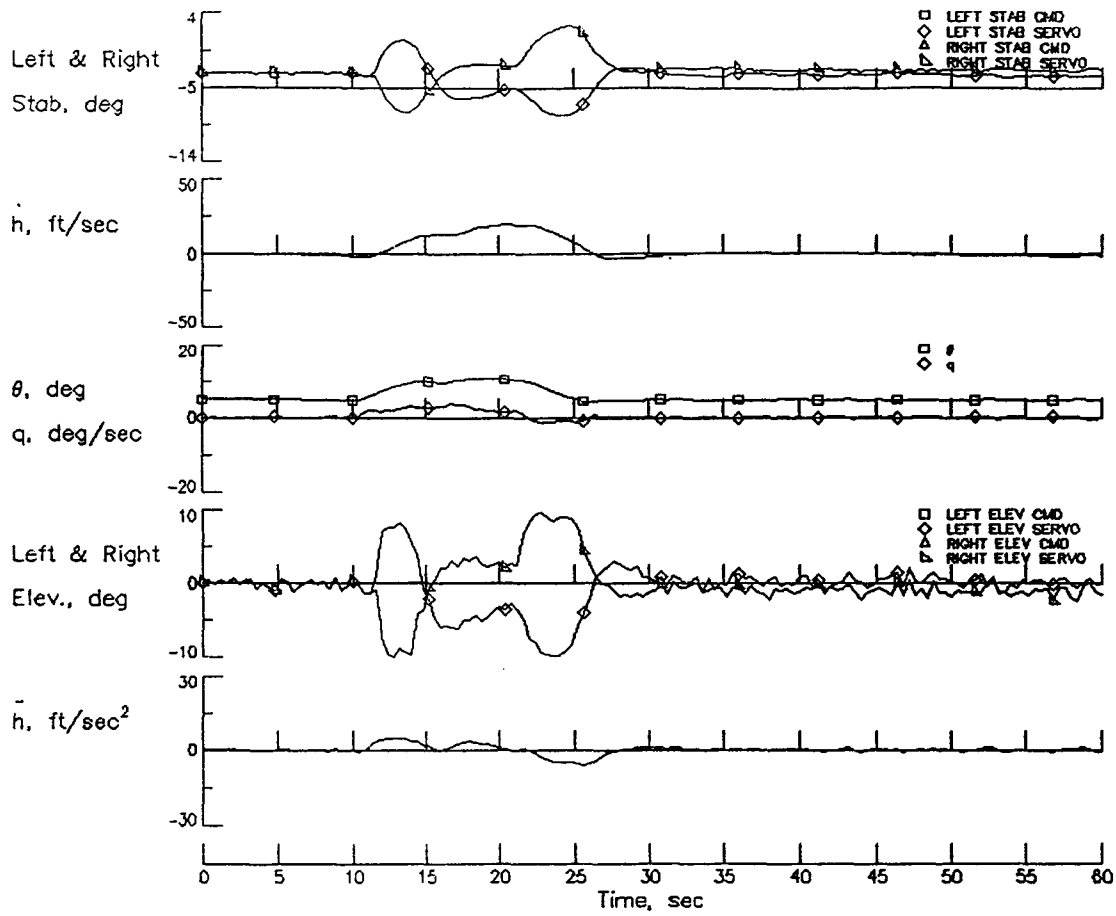

R-4816

Figure A.5-2. R033, CT1, Limited FCS, Full Reconfiguration (Concluded)

A.6 STUCK RUDDER FAILURE

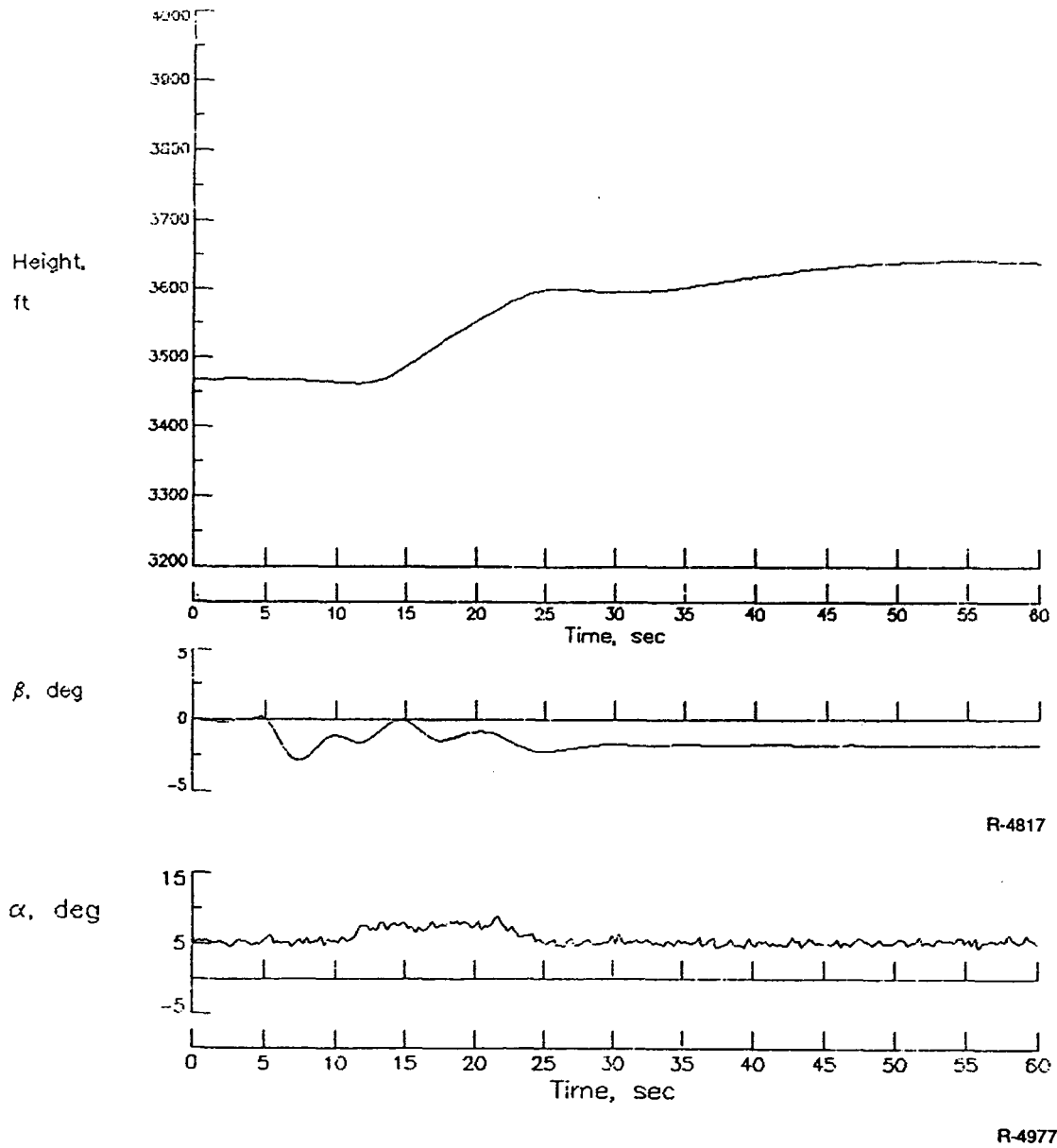
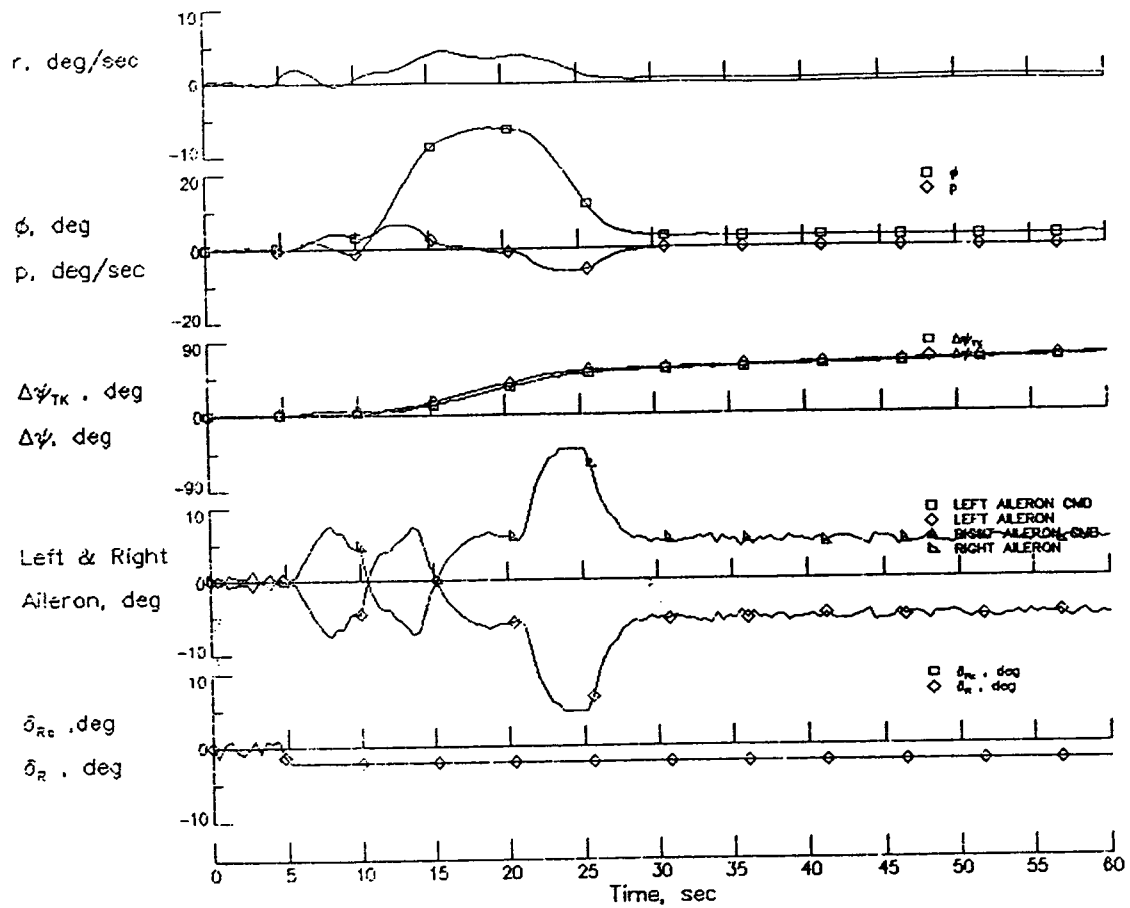
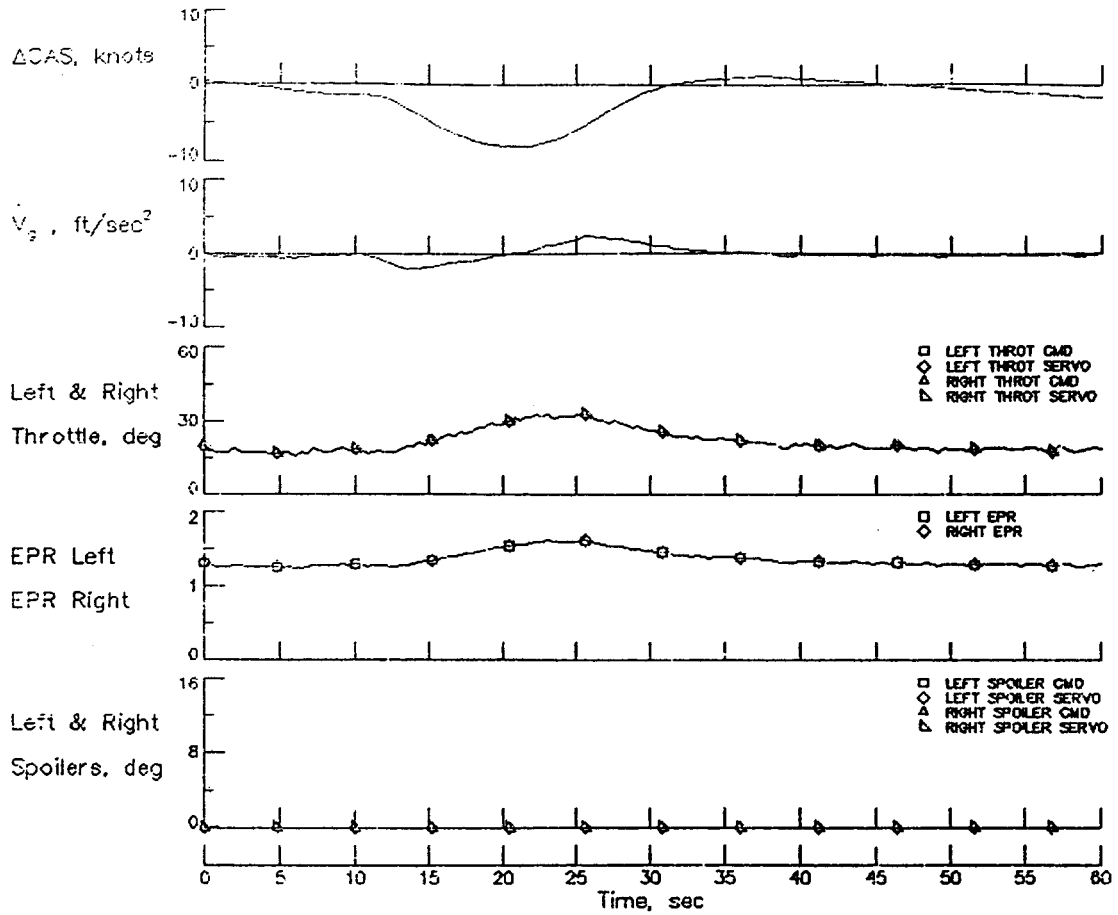

Figure A.6-1. R030, CT1, Limited FCS, No Reconfiguration



R-4818

Figure A.6-1. R030, CT1, Limited FCS, No Reconfiguration (Continued)



R-4819

Figure A.6-1. R030, CT1, Limited FCS, No Reconfiguration (Continued)

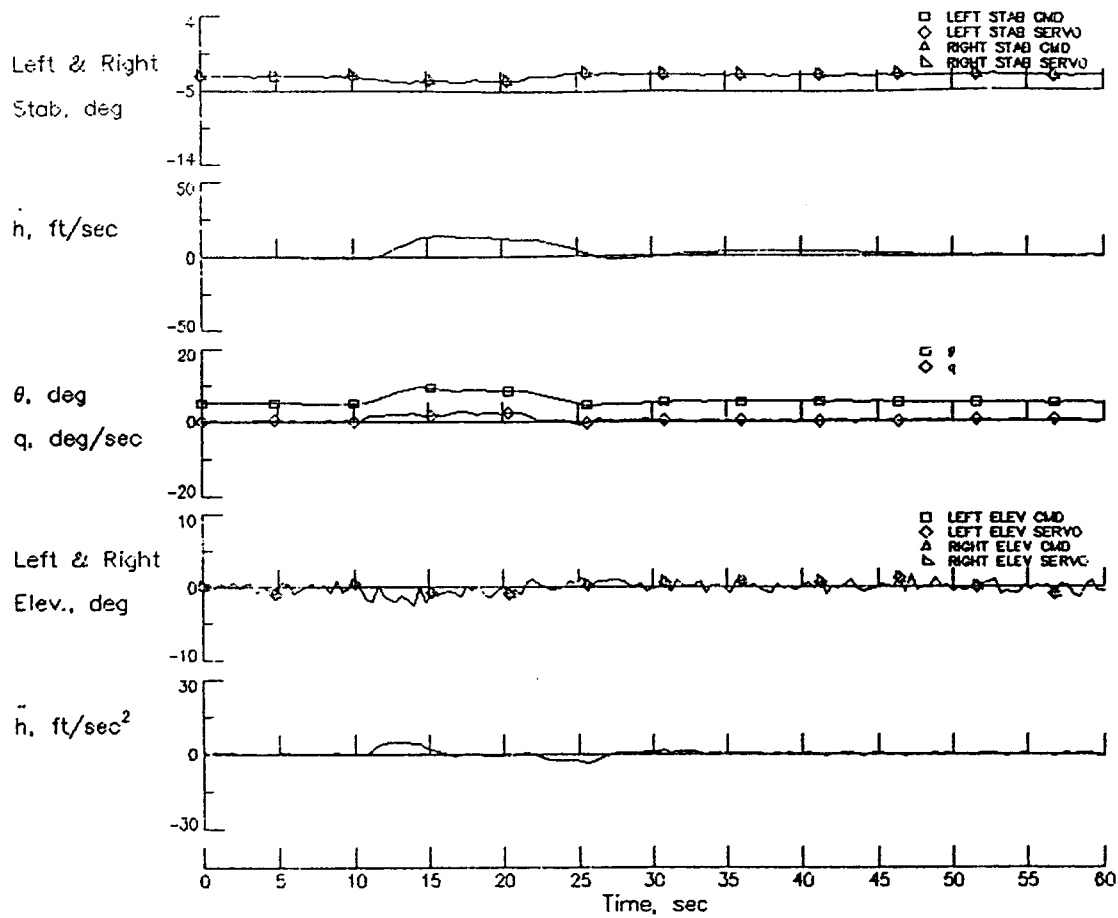

R-4820

Figure A.6-1. R030, CT1, Limited FCS, No Reconfiguration (Concluded)

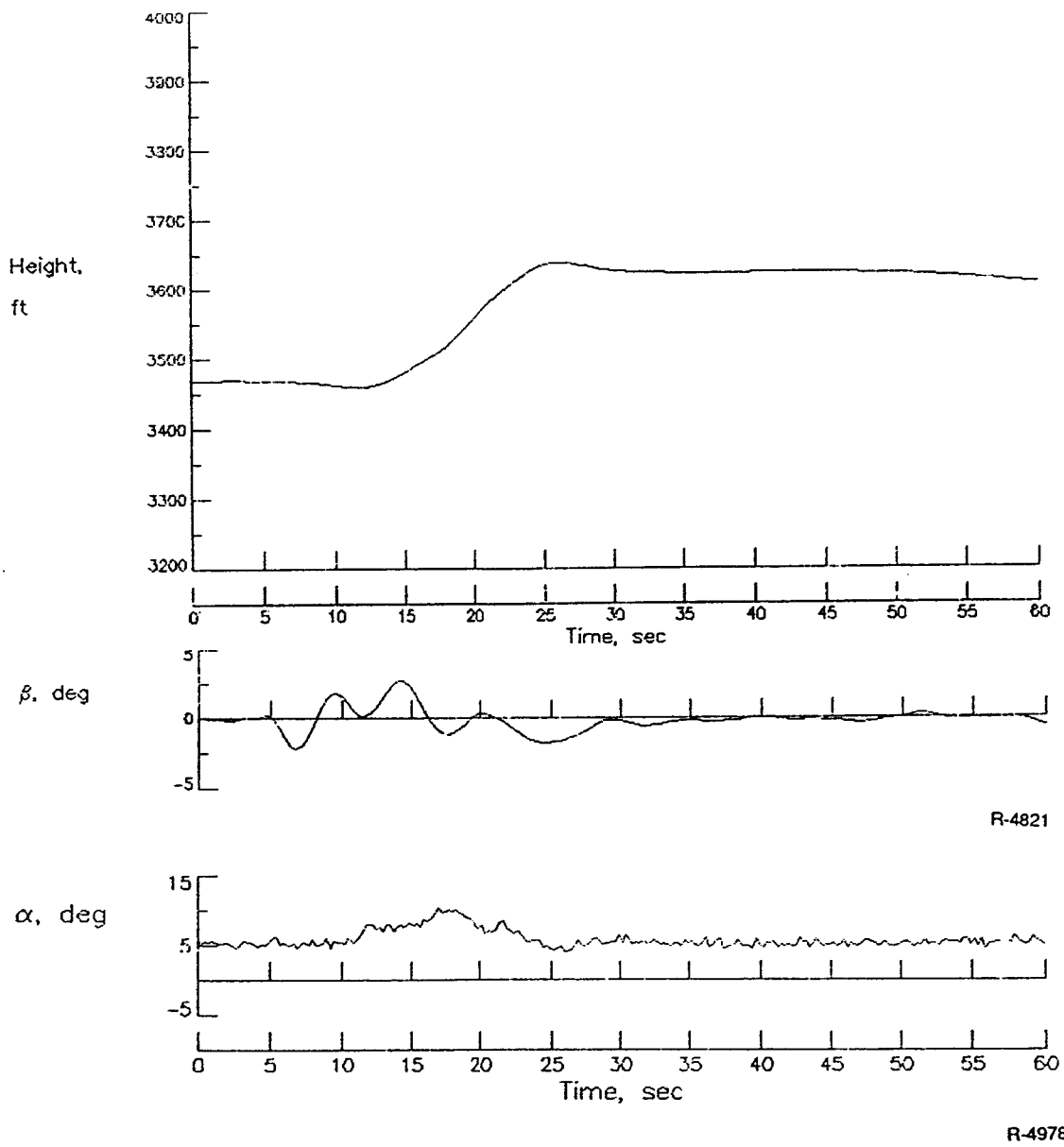
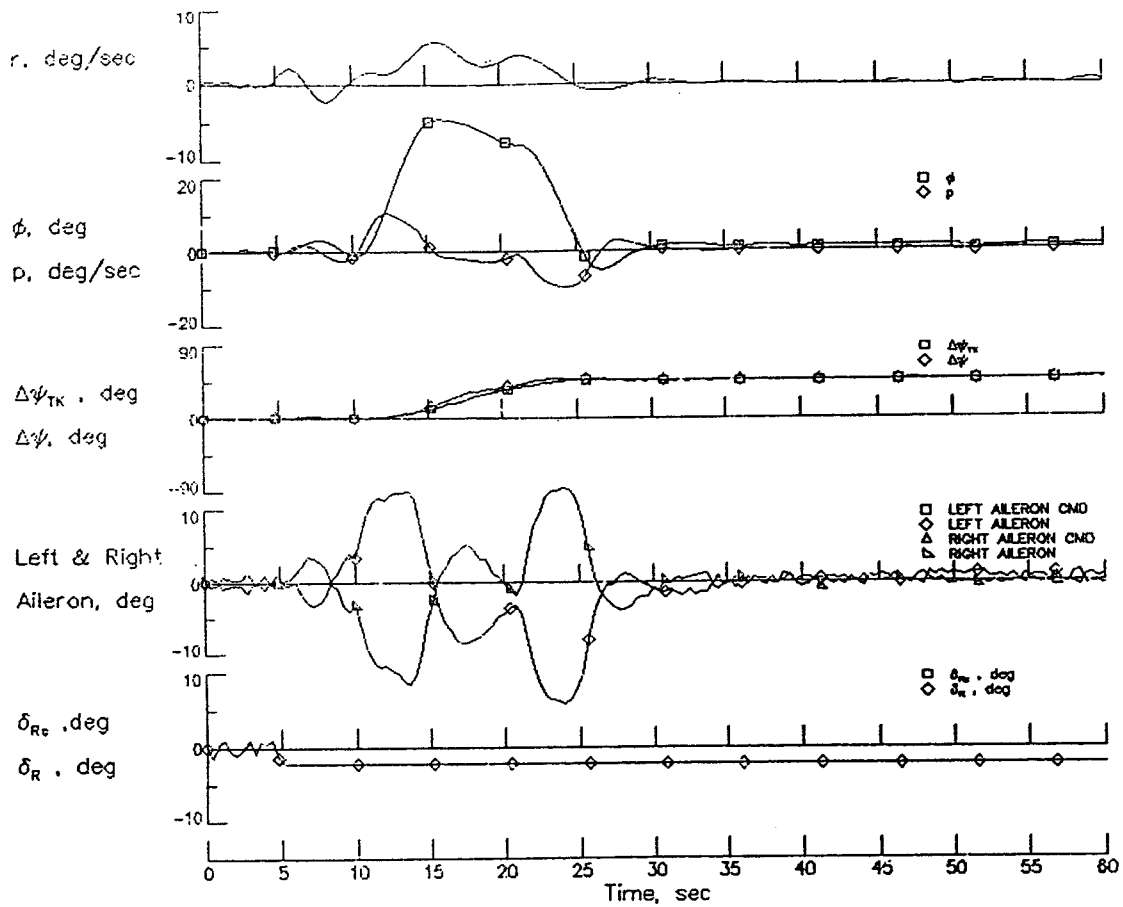
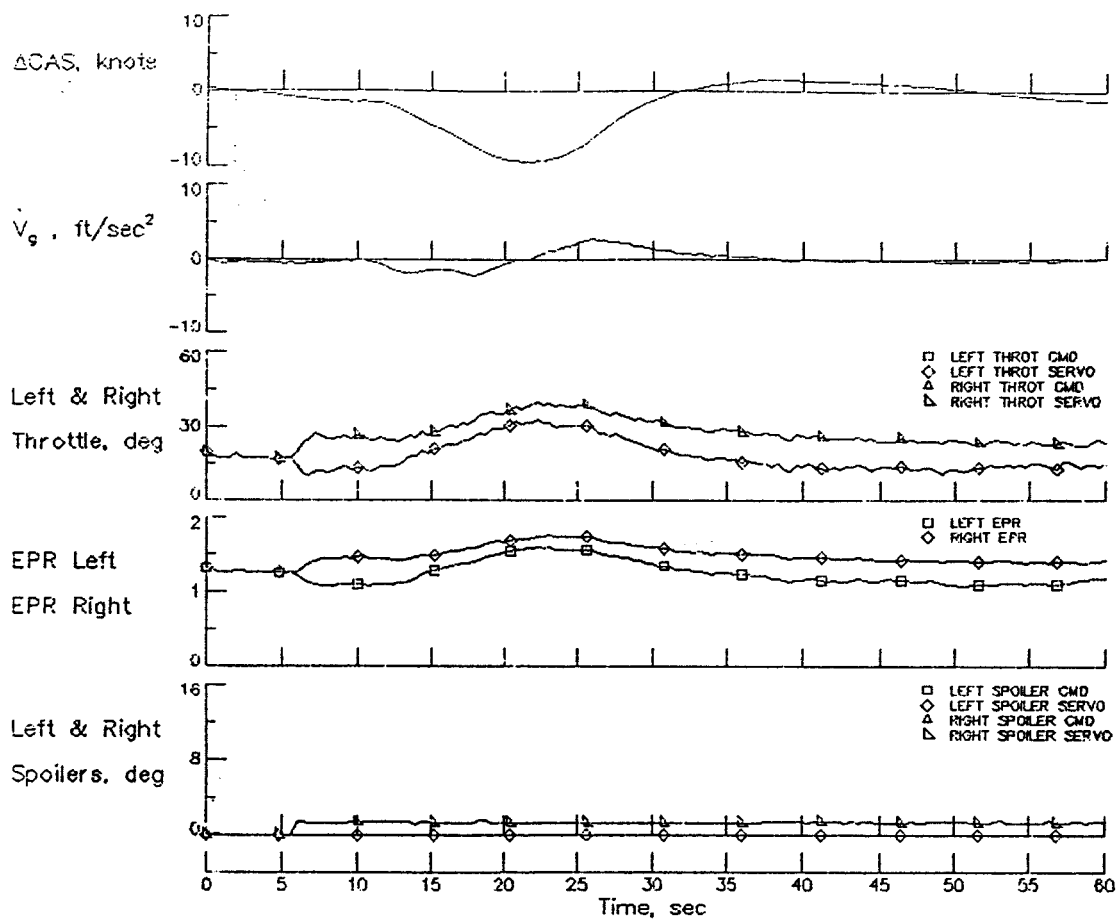

Figure A.6-2. R031, CT1, Limited FCS, Full Reconfiguration



R-4822

Figure A.6-2. R031, CT1, Limited FCS, Full Reconfiguration (Continued)



R-4823

Figure A.6-2. R031, CT1, Limited FCS, Full Reconfiguration (Continued)

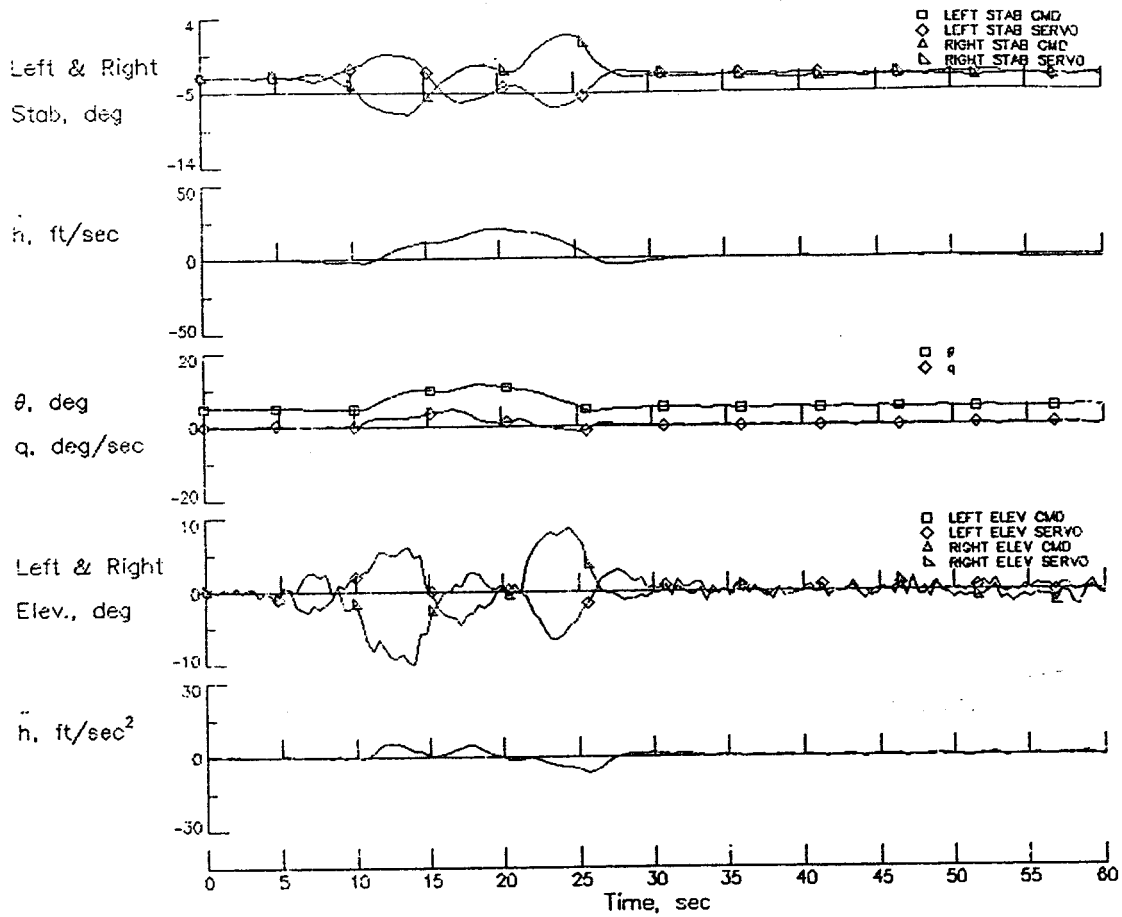

R-4824

Figure A.6-2. RO31, CTL, Limited FCS, Full Reconfiguration (Concluded)

A.7 MISSING LEFT STABILIZER FAILURE

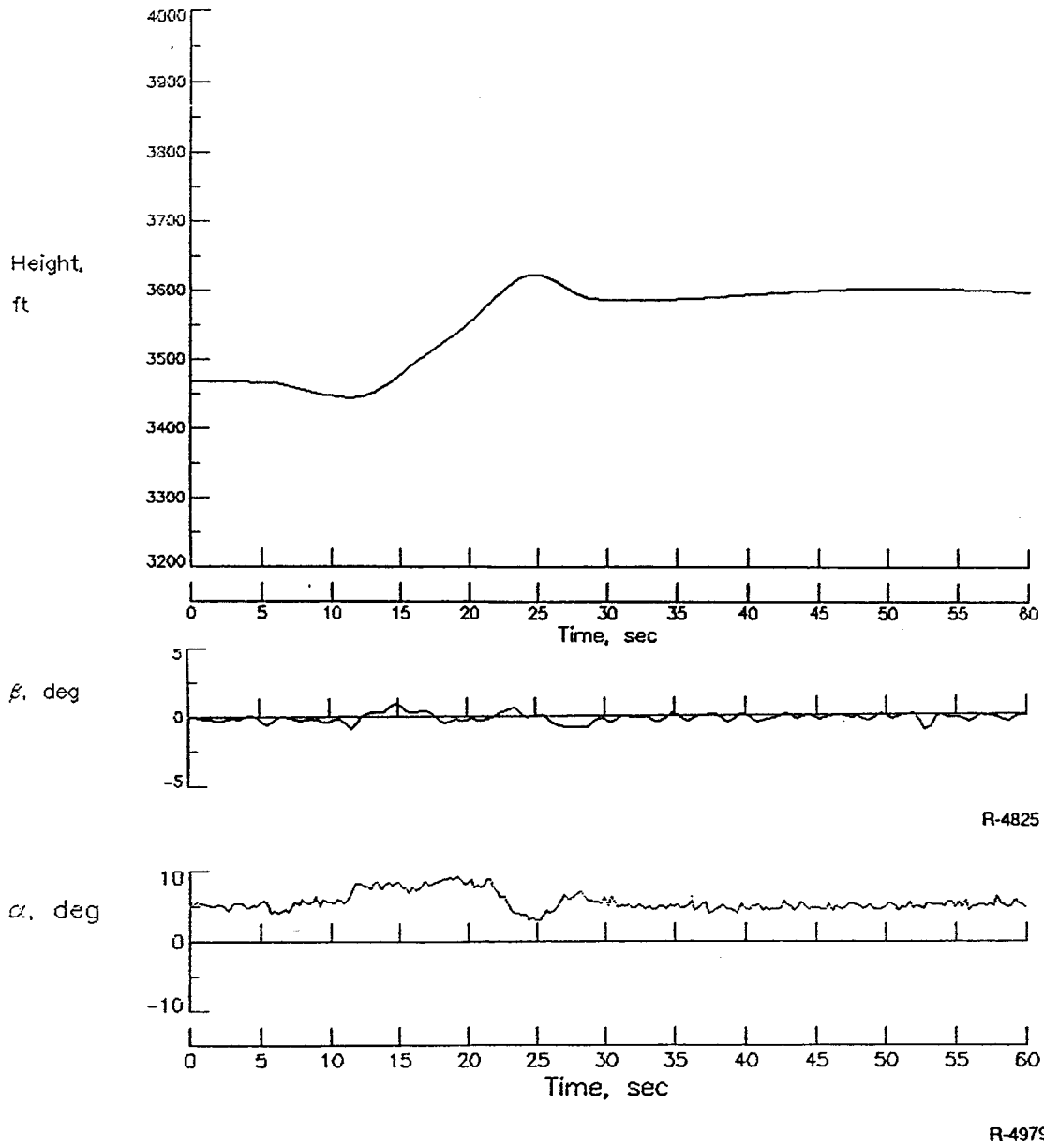
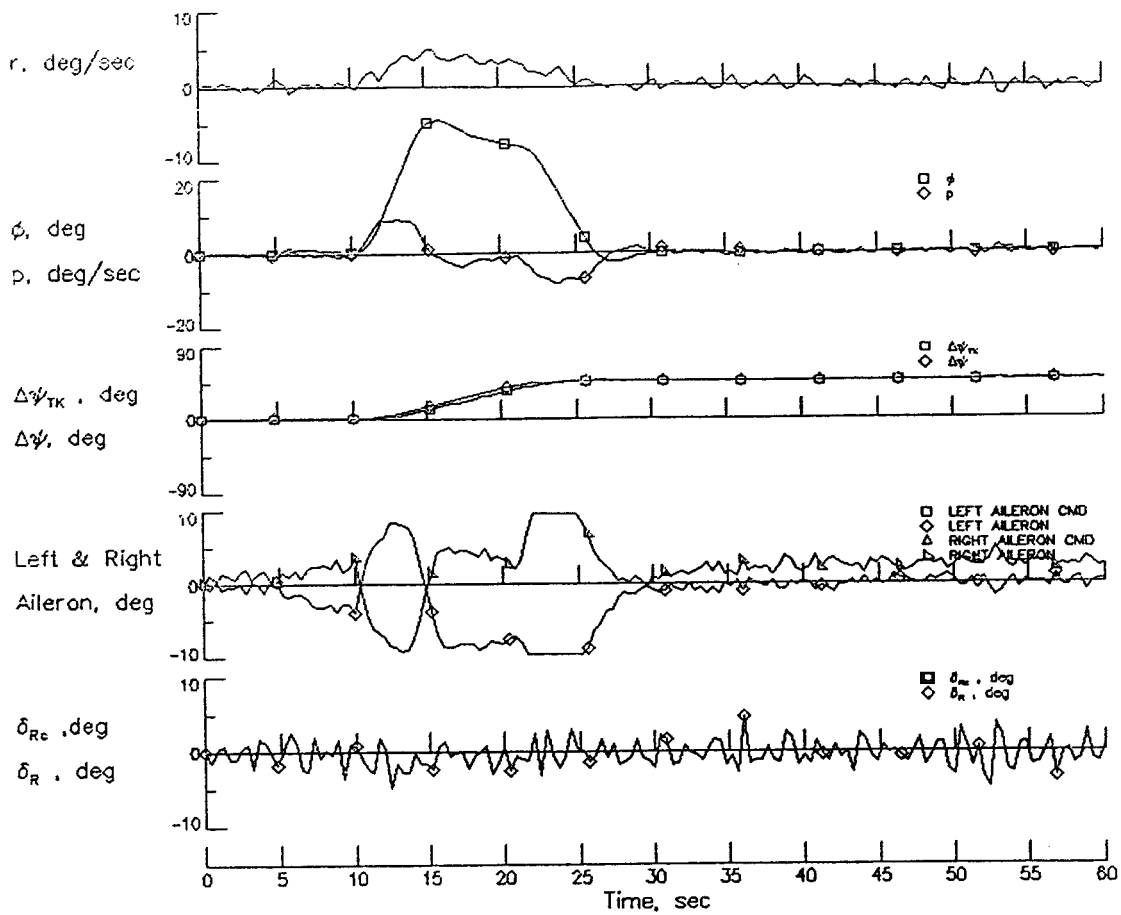
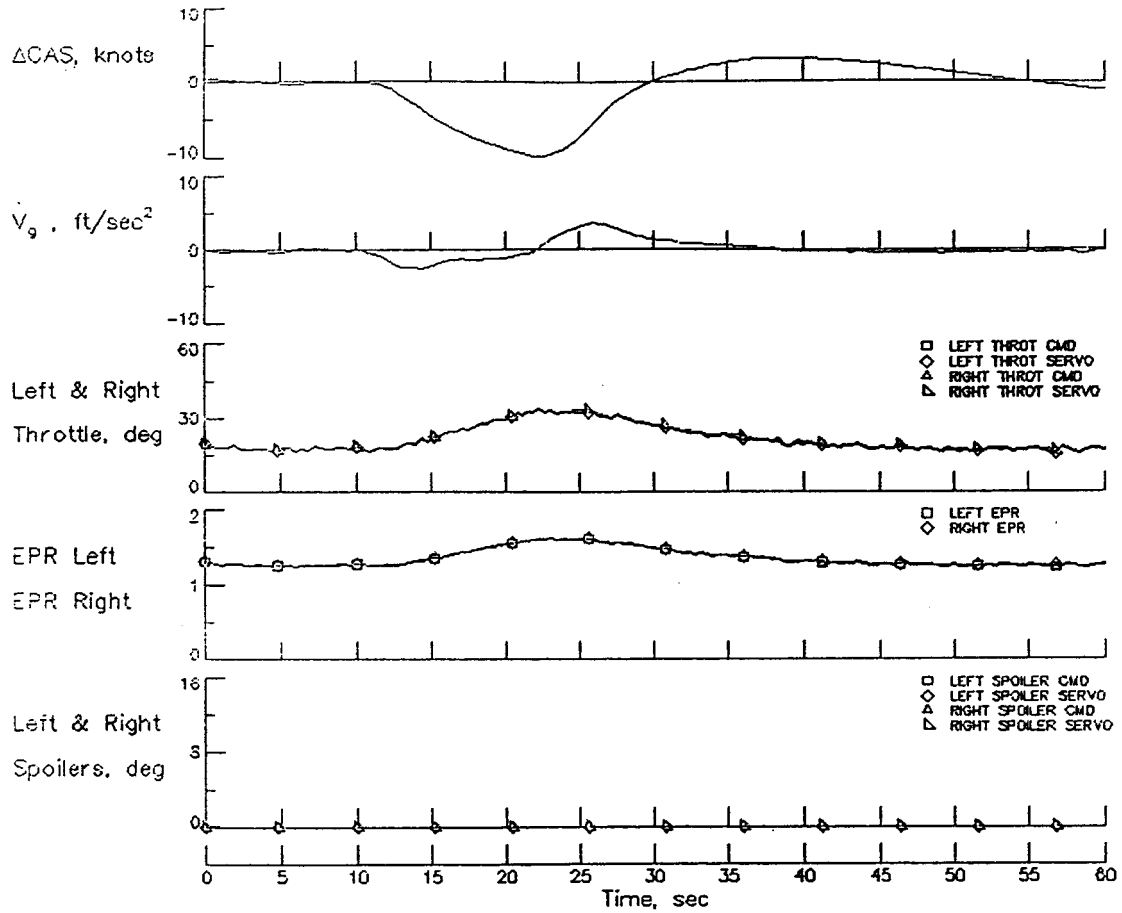

Figure A.7-1. R017, CTI, Full FCS, No Reconfiguration



R-4826

Figure A.7-1. R017, CT1, Full FCS, No Reconfiguration (Continued)



R-4827

Figure A.7-1. R017, CT1, Full FCS, No Reconfiguration (Continued)

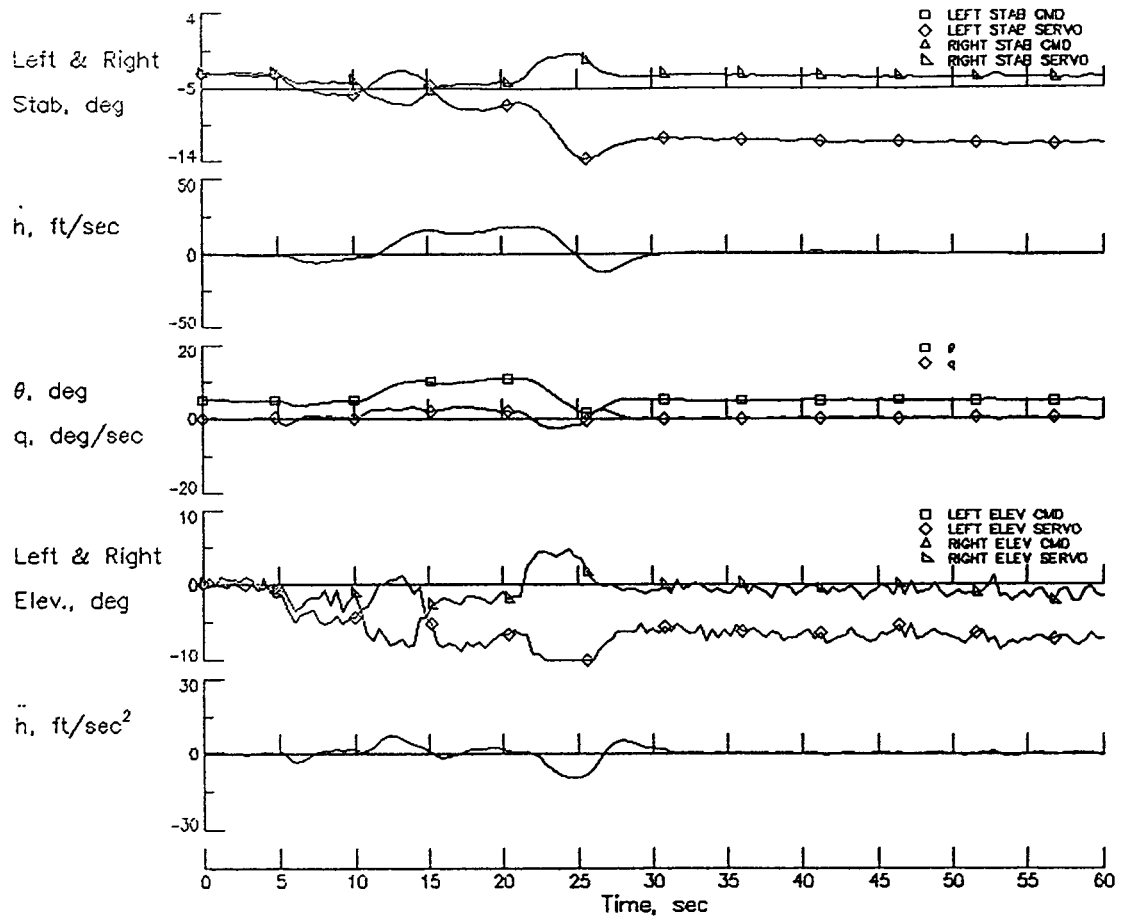

R-4828

Figure A.7-1. R017, CT1, Full FCS, No Reconfiguration (Concluded)

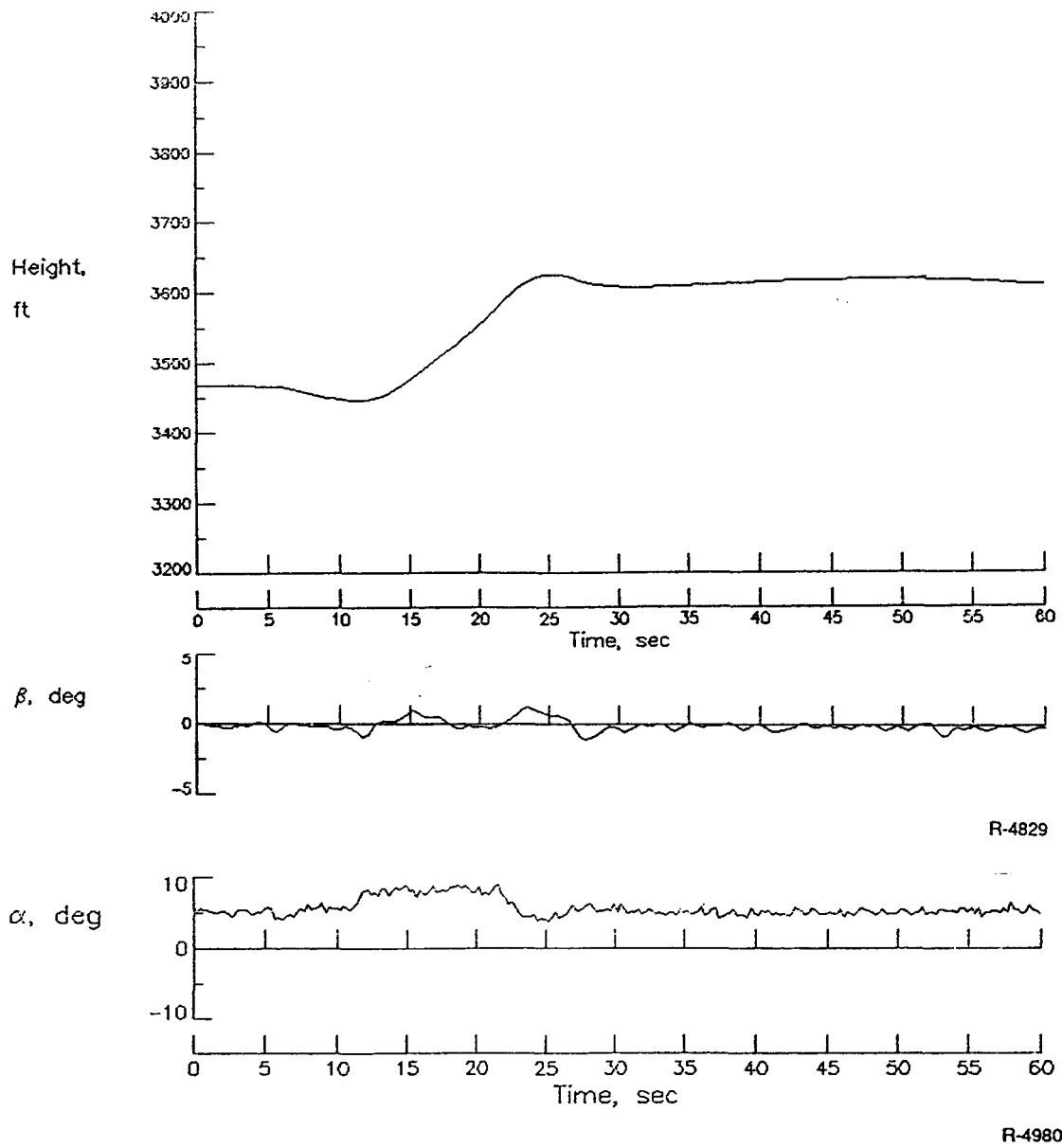
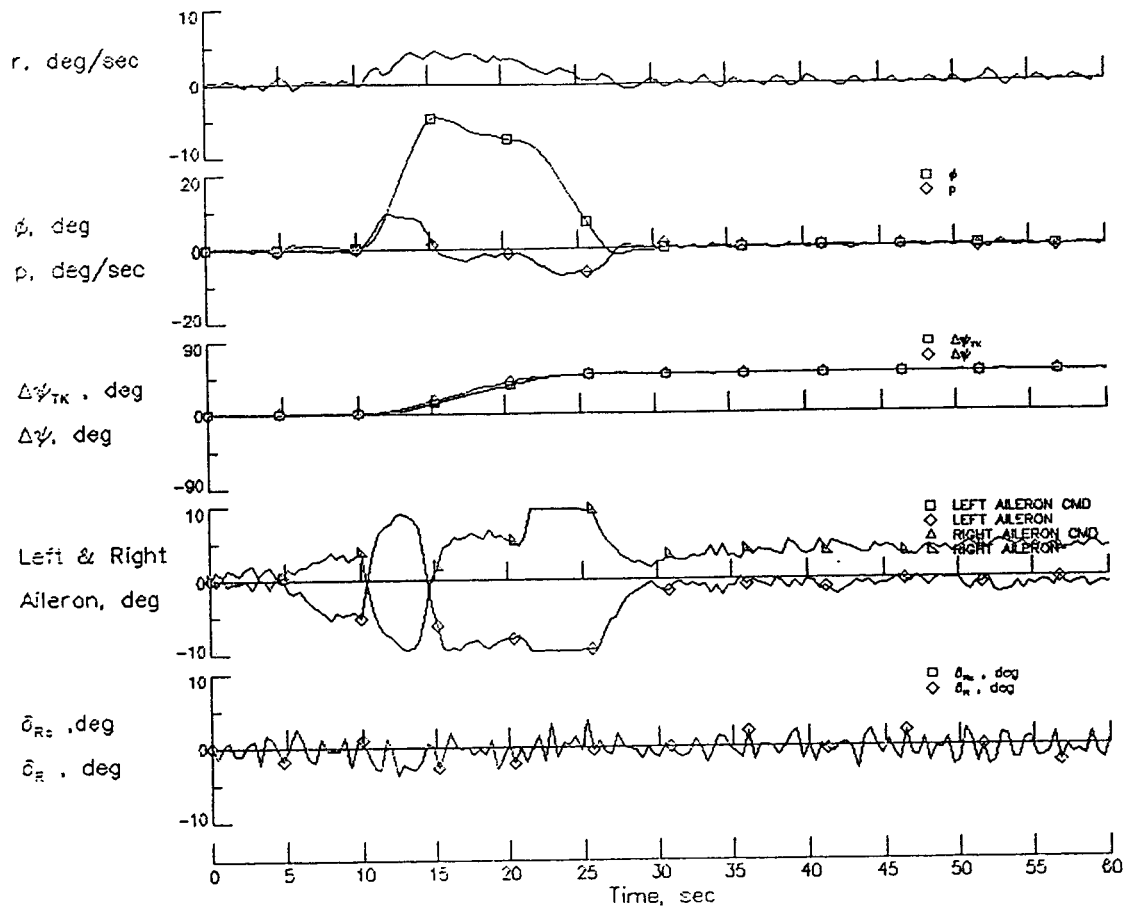
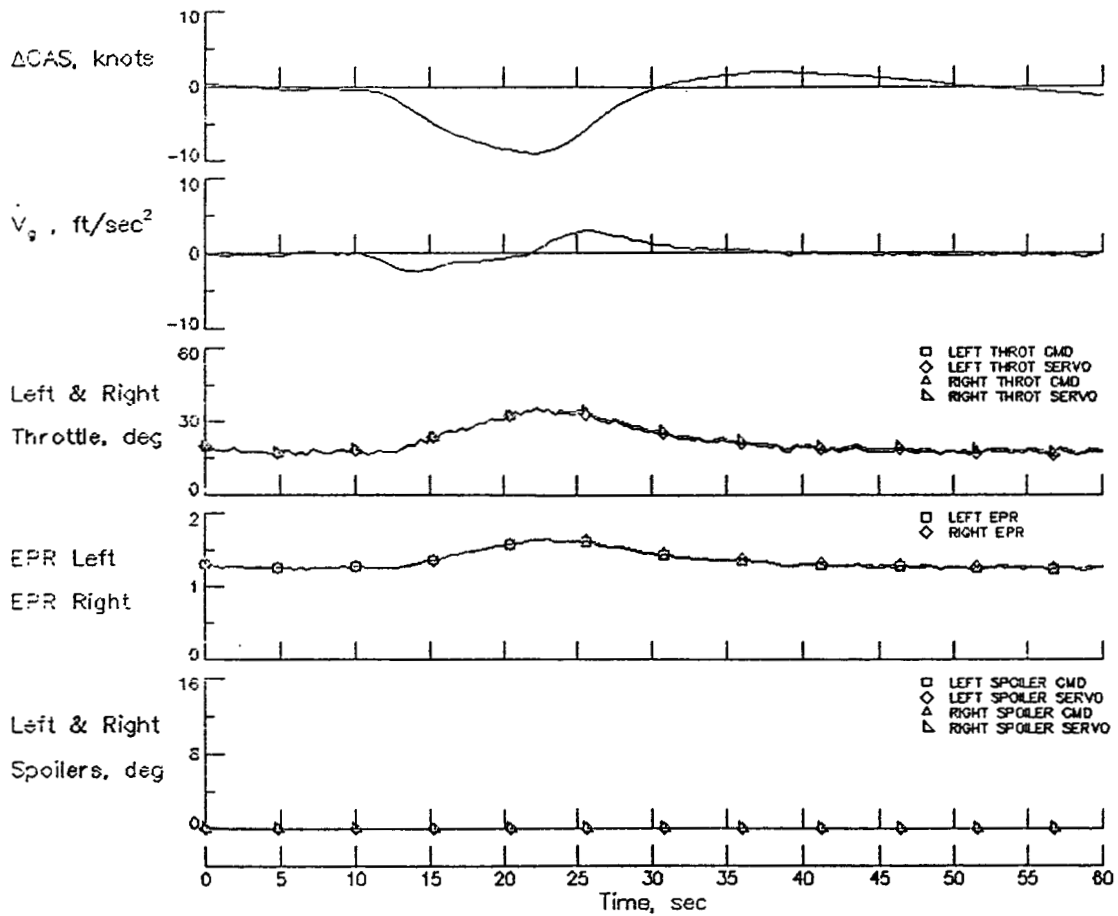

Figure A.7-2. R018, CT1, Full FCS, Full Reconfiguration



R-4830

Figure A.7-2. R018, CT1, Full FCS, Full Reconfiguration (Continued)



R-4831

Figure A.7-2. R018, CT1, Full FCS, Full Reconfiguration (Continued)

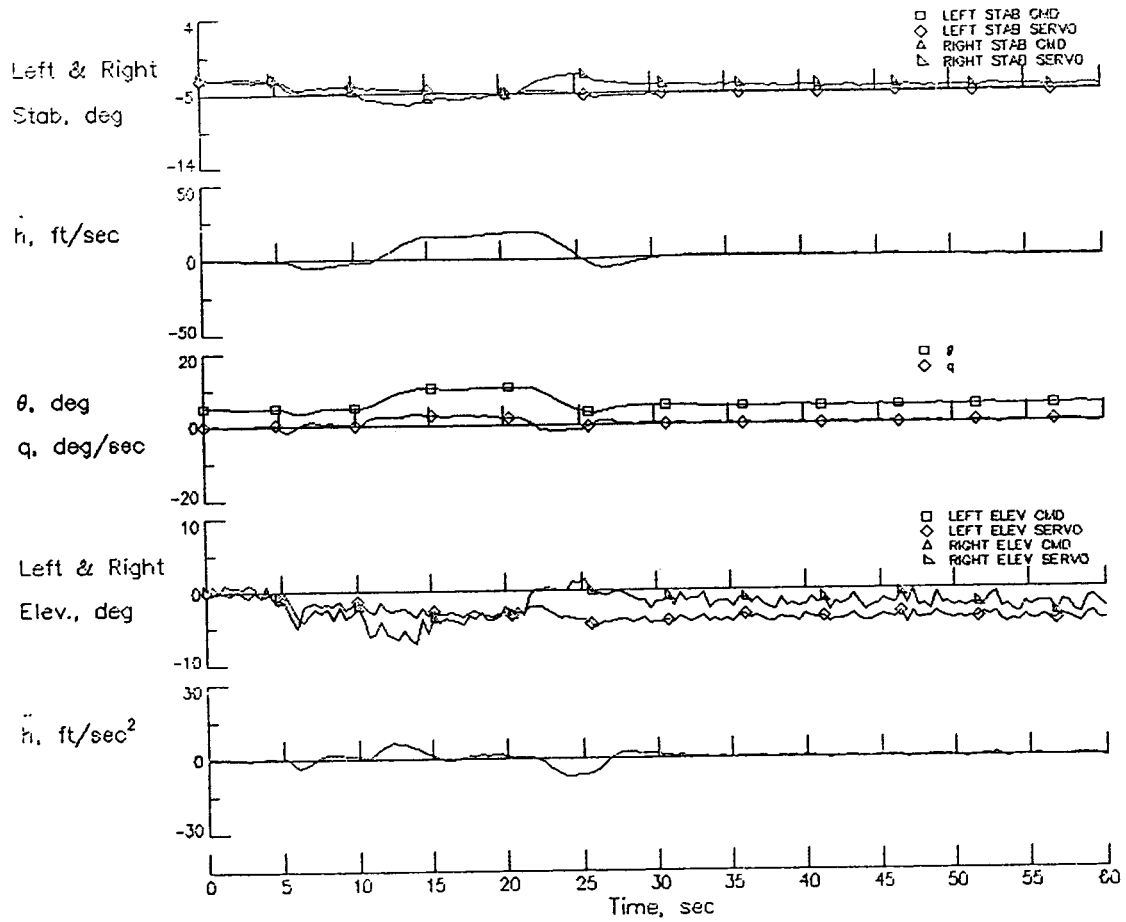

R-4832

Figure A.7-2. R018, CT1, Full FCS, Full Reconfiguration (Concluded)

Standard Bibliographic Page

1. Report No. NASA CR-178305	2. Government Accession No.	3. Recipient's Catalog No.	
4. Title and Subtitle INTEGRATED RESTRUCTURABLE FLIGHT CONTROL SYSTEM DEMONSTRATION RESULTS		5. Report Date May 1987	
		6. Performing Organization Code	
7. Author(s) Jerold L. Weiss John Y. Hsu		8. Performing Organization Report No. TR-335	
		10. Work Unit No.	
9. Performing Organization Name and Address ALPHATECH, Inc. 111 Middlesex Turnpike Burlington, MA 01803		11. Contract or Grant No. NAS1-17411	
		13. Type of Report and Period Covered Contractor Report	
12. Sponsoring Agency Name and Address NASA Langley Research Center Hampton, VA 23665		14. Sponsoring Agency Code	
		15. Supplementary Notes	
16. Abstract <p>The purpose of this study was to examine the complementary capabilities of several restructurable flight control system (RFCS) concepts through the integration of these technologies into a complete system. Performance issues were addressed through a re-examination of RFCS functional requirements, and though a qualitative analysis of the design issues that, if properly addressed during integration, will lead to the highest possible degree of fault-tolerant performance. Software developed under previous phases of this contract and under NAS1-18004 was modified and integrated into a complete RFCS subroutine for NASA's B-737 simulation. The integration of these modules involved the development of methods for dealing with the mismatch between the outputs of the failure detection module and the input requirements of the automatic control system redesign module. The performance of this demonstration system was examined through extensive simulation trials.</p>			
17. Key Words (Suggested by Authors(s)) Fault Tolerant Control Reconfiguration Failure Detection Aircraft Trim		18. Distribution Statement	
19. Security Classif.(of this report) Unclassified	20. Security Classif.(of this page) Unclassified	21. No. of Pages 136	22. Price

For sale by the National Technical Information Service, Springfield, Virginia 22161