

N87-22719

IMPROVING STABILITY MARGINS
IN DISCRETE-TIME LQG CONTROLLERS

B. Tarik Oranc and Charles L. Phillips

Electrical Engineering Department

Auburn University

Auburn, AL 36849

ABSTRACT

This paper discusses some of the problems encountered in the design of discrete-time stochastic controllers for problems that may adequately be described by the "LQG" assumptions; namely, the problems of obtaining acceptable relative stability, robustness, and disturbance rejection properties. The paper proposes a dynamic compensator to replace the optimal full state feedback regulator gains at steady state, provided that all states are measurable. The compensator increases the stability margins at the plant input, which may possibly be inadequate in practical applications. Though the optimal regulator has desirable properties the observer based controller as implemented with a Kalman filter, in a noisy environment, has inadequate stability margins. The proposed compensator is designed to match the return difference matrix at the plant input to that of the optimal regulator while maintaining the optimality of the state estimates as dictated by the measurement noise characteristics.

I. INTRODUCTION

The design of robust stochastic controllers for problems adequately described by the "LQG" assumptions has been a field of active research in recent years. Since Doyle's [1] and Doyle and Stein's [2] introductory papers different approaches have been taken in order to design various robust LQG controllers. It can be stated generally that the approaches taken were to increase the stability margins, namely the gain and phase margins at the plant input, sufficiently so that the closed loop system remained stable under large parameter changes in the plant and/or sensor failures. It is important to note at this point that most research has been on continuous time systems. The robustness problem may be more pronounced in discrete time controllers due to sampling rate limitations and the phase lag associated with sampling.

In order to have a better understanding of the problem it is necessary to briefly review the respective parts of the stochastic controller. The stochastic LQG controller is comprised of the LQ optimal feedback controller and the Kalman filter based current full state observer. It has been well established that the continuous time LQ controller based system has excellent guaranteed stability margins, namely a phase margin of at least 60° and an infinite gain margin. Unfortunately the discrete time equivalent doesn't have these guaranteed margins. However as the sampling period approaches zero the stability margins approach those that of the continuous time LQ controller. The Kalman filter will

show an excellent performance in estimating states and will also be stable. However when the Kalman filter is used to estimate the state variables for feedback to the LQ controller the robustness properties of the system will not be guaranteed. Doyle has given a simple example where a LQG controller-filter combination has very small gain margins, and hence is not robust. An investigation of the paper by Johnson [3] explains this behavior of the LQG controllers.

Consider the state space representation of a plant for which a LQG controller is to be designed.

$$\begin{aligned}x(k+1) &= Ax(k) + Bu(k) + Gw(k) \\y(k) &= Cx(k) + v(k)\end{aligned}\tag{1}$$

where

$$x(k) \in \mathbb{R}^n, u(k) \in \mathbb{R}^r, y(k) \in \mathbb{R}^m$$

and $w(k)$ and $v(k)$ are uncorrelated, zero mean white gaussian noise processes.

Denoting the constant Kalman filter gains by K_f and the constant LQ gains by K_c we consider the discrete time equivalent of Theorem 8.3 as stated in the monograph by O'Reilly [4].

Theorem : There exists a class of linear systems (1) such that one or more eigenvalues of $(I - K_f C)(A - BK_c)$ of the observer based feedback controller may lie outside of the unit circle in the complex plane though all eigenvalues of $(A - BK_c)$ and all the eigenvalues of $(A - K_f CA)$ are designed to lie within the unit circle, and even though the system pairs (A, B) , (A, C) are, respectively completely controllable and completely observable.

The significance of this theorem lies in the fact that although the closed loop eigenvalues of the LQG system are the union of the observer eigenvalues and optimal regulator eigenvalues, and hence result in a stable closed loop system, the eigenvalues of the controller may lie outside the unit circle, therefore causing the controller to be unstable. It may therefore be concluded that the LQG control system may not be robust.

There have been three major approaches in alleviating the robustness problem that may occur in LQG systems. In light of the theorem all three methods will be investigated in the same frame work. The first approach is that of Doyle and Stein [2]. They developed a robustness recovery procedure in which they added fictitious process noise at the plant input. By controlling the way the fictitious noise entered the plant input they recovered the loop transfer function (LTR) at the plant input asymptotically as the noise intensity is increased. This method has the drawback that the system has to be square. A recent paper by Madiwale and Williams [5] has extended the LTR procedure to minimum phase, non-square and left-invertible systems with full or reduced order observer based LQG designs. It is observed that the LTR method actually results in the Kalman filter gains being forced asymptotically into a region where all eigenvalues of the controller lie within the unit circle. The major problem in this method is that the Kalman filter is no longer optimal with respect to the true disturbances on the plant as its eigenvalues have been shifted via the effective adjustment on

the process noise . Another disadvantage is that the 40 dB/decade roll-off associated with the LQG design is pushed out into the high frequency range where unmodelled high frequency modes might be excited and cause instability.

The second approach which was initiated by Gupta [6], and by Moore et al [7] in separate papers was to achieve robustness in frequency bands where the problems occurred without changing the closed-loop characteristics outside those frequency bands. Gupta used frequency-shaped cost functionals to achieve robustness by reducing filter gain outside the model bandwidth. On the other hand Moore et al [7] essentially improvised on Doyle and Stein's LTR method by adding fictitious colored noise instead of white noise to the process input, thereby relocating both the Kalman filter eigenvalues and the controller eigenvalues. Recently Anderson et al [8] have investigated the relations between frequency dependent control and state weighting in LQG problems. Both of these procedures result in controller eigenvalues that lie within the unit circle, thereby overcoming the problems stated in the theorem.

The last approach is due to Okada et al [9]. Their approach is drastically different from the previous approaches. They have changed the structure of the LQG controller by introducing a feed-forward path from the controller input to the controller output. This is equivalent to introducing an additional feedback loop from the output to the input of the plant. The criteria for the selection of the gains in this path is to force the

controller to satisfy the circle criterion. This additional loop results in a robust controller with poor response properties. Therefore the response is improved by synthesizing an extended perfect model-following (EMPF) system [9]. This approach has the disadvantage that its statistical properties haven't been established. Furthermore it is not always applicable theoretically. However, in practice it outperforms Doyle and Stein's LTR method with some approximations as described in [9].

The approach taken in this paper is an extension of the LTR procedure. A dynamic compensator is proposed to replace the optimal feedback gains so as to recover the open loop transfer function at the plant input.

II. DERIVATION OF THE DYNAMIC COMPENSATOR

The LQ optimal controller can be designed for a system as described by equations (1) provided that all states are available for measurement. The resulting steady state controller which is depicted in Figure 1 will have excellent properties as mentioned previously.

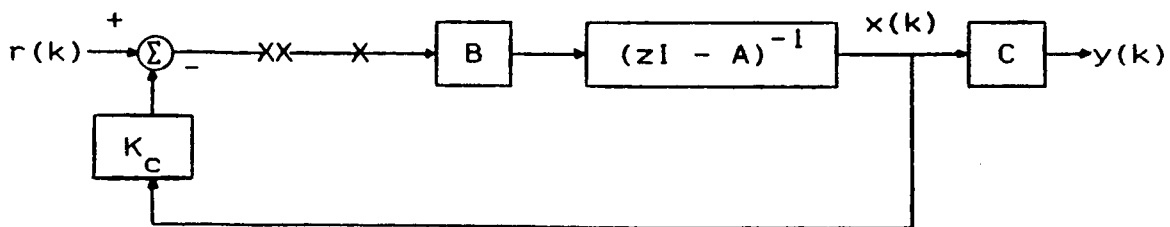

FIGURE 1. The LQ Based Optimal Controller

The optimal control for this system is described by the following equation.

$$u(k) = -K_C x(k) \quad (2)$$

In the case that the state measurements are corrupted by white gaussian noise an LQG controller can be designed in which the Kalman filter is used to estimate the states. The LQG design results in the following controller equations for the infinite horizon problem.

The Kalman filter is described by

$$\hat{x}(k+1) = A\hat{x}(k) + Bu(k) + K_f[y(k+1) - CA\hat{x}(k) - CBu(k)] \quad (3)$$

and the optimal control is described by

$$u(k) = -K_c \hat{x}(k) \quad (4)$$

Figure 2 depicts the LQG system.

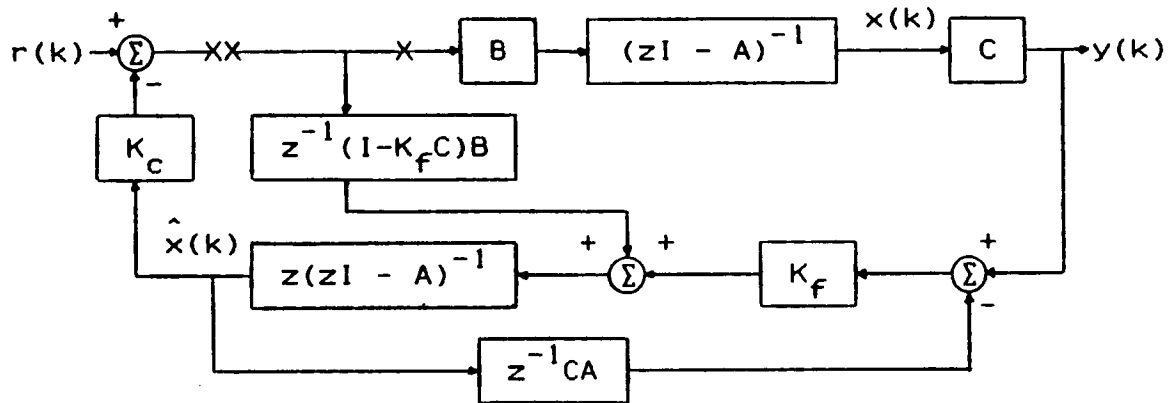

FIGURE 2. The LQG Based Optimal Controller/Observer

The following three properties of the system have been established :

P1: The closed loop transfer function matrices from $r(k)$ to $x(k)$ are identical in both the LQG and LQ systems.

P2: The loop transfer function matrices with the loops broken at XX are identical in both implementations.

P3: The loop transfer function matrices with the loops broken at X are generally different. Furthermore the LQG open-loop system might possibly have unstable poles.

The return difference ratios of the LQG and LQ systems are given by the following expressions.

$$T_{1qg}(z) = zK_c [zI - (I - K_f C)A + (I - K_f C)BK_c]^{-1} K_f C (zI - A)^{-1} B \quad (5)$$

$$T_{1q}(z) = K_c (zI - A)^{-1} B \quad (6)$$

Now define

$$\Delta(z) = T_{1qg}(z) - T_{1q}(z) \quad (7)$$

It is now proposed to replace the constant optimal feedback gains K_c by a dynamic system $\Psi(z)$ in the LQG system and solve for it as $\Delta(z)$ approaches zero pointwise in z .

$$\Delta(z) = T_{1qg}(z) \Big|_{K_c = \Psi(z)} - T_{1q}(z) = 0 \quad (8)$$

$$\Delta(z) = z\Psi(z) [zI - (I - K_f C)A + (I - K_f C)B\Psi(z)]^{-1} K_f C (zI - A)^{-1} B - K_c (zI - A)^{-1} B = 0 \quad (9)$$

$$\{z\Psi(z) [zI - (I - K_f C)A + (I - K_f C)B\Psi(z)]^{-1} K_f C - K_c\} (zI - A)^{-1} B = 0 \quad (10)$$

Since $(zI - A)^{-1} B \neq 0$ equation (9) becomes

$$z\Psi(z) [zI - (I - K_f C)A + (I - K_f C)B\Psi(z)]^{-1} K_f C - K_c = 0 \quad (11)$$

To solve for $\Psi(z)$ it is necessary to assume that $\det(K_f C) \neq 0$.

This implies that the number of outputs should be equal to the number of states i.e. $m = n$. Equation (10) then becomes

$$\{z\Psi(z) [zI - (I - K_f C)A + (I - K_f C)B\Psi(z)]^{-1} - K_c (K_f C)^{-1}\} K_f C = 0 \quad (12)$$

or

$$z\Psi(z) [zI - (I - K_f C)A + (I - K_f C)B\Psi(z)]^{-1} - K_c (K_f C)^{-1} = 0 \quad (13)$$

$$\{z\Psi(z) - K_c (K_f C)^{-1} [zI - (I - K_f C)A + (I - K_f C)B\Psi(z)]\} * [zI - (I - K_f C)A + (I - K_f C)B\Psi(z)]^{-1} = 0 \quad (14)$$

$$\{z\Psi(z) - K_C(K_f C)^{-1}[zI - (I - K_f C)A] - K_C(K_f C)^{-1}(I - K_f C)B\Psi(z)\} * \\ [zI - (I - K_f C)A + (I - K_f C)B\Psi(z)]^{-1} = 0 \quad (15)$$

$$\Delta(z) = \{[zI - K_C(K_f C)^{-1}(I - K_f C)B]\Psi(z) \\ - K_C(K_f C)^{-1}[zI - (I - K_f C)A]\} * \\ \{[zI - (I - K_f C)A + (I - K_f C)B\Psi(z)]^{-1}K_f C\} * \\ (zI - A)^{-1}b = 0 \quad (16)$$

Therefore, if

$$\Psi(z) = [zI - K_C(K_f C)^{-1}(I - K_f C)B]^{-1}K_C(K_f C)^{-1}[zI - (I - K_f C)A] \quad (17)$$

Then $\Delta(z) = 0$.

III. OBSERVATIONS

Before an example can be presented to demonstrate the effect of the dynamic compensator the following observations must be stated. Several problems are encountered in the design of the dynamic compensator. The major problem is the dependence of the compensator coefficients on the Kalman filter gains. Many of the problematic systems that were investigated, i.e. those with unstable controllers, result in extremely high compensator gains, and large, hence unstable, compensator poles. The reason for this behavior is observed to be the high condition numbers associated with K_f and $K_f C$. Because of this high condition number the matrix $(K_f C)^{-1}$ has extremely large entries, which in turn result in large poles and compensator gains.

A system similar to the one investigated by Doyle and Stein [2], chosen specifically to illustrate the unstable controller poles, resulted in extremely high compensator gains, and large unstable poles. Although the compensator

recovered the stability margins at the plant input of the LQG system it is not an acceptable compensator. In an attempt to find a physically realizable compensator several systems have been tested. Those that result in a realizable compensator have the properties that, the matrices mentioned previously have low condition numbers, and the controller eigenvalues are all within the unit circle. Since the controller is stable the low phase and gain margins associated with the problematic LQG systems are not observed, and the dynamic compensator does not have a pronounced effect to validate its use in practical systems.

IV. AN EXAMPLE

To illustrate the effects of the dynamic compensator on the stability margins of the open loop frequency response the following example was considered.

Let the plant be described by the following state equation :

$$x(k+1) = \begin{bmatrix} 1.0 & 0.005 \\ -0.015 & 0.98 \end{bmatrix} x(k) + \begin{bmatrix} 1.25E-5 \\ 0.005 \end{bmatrix} u(k) + \begin{bmatrix} 0.18 \\ -0.3 \end{bmatrix} w(k) \quad (18)$$

$$y(k) = \begin{bmatrix} 2.0 & 1.0 \\ 0.0 & 0.3648 \end{bmatrix} x(k) + \begin{bmatrix} 1.0 & 0.0 \\ 0.0 & 1.0 \end{bmatrix} v(k)$$

With $E\{w(k)\}=E\{v(k)\}=0$; $E\{w(i)w(j)\}=E\{v(i)v(j)\}=200\delta_{ij}$

The controller is :

$$u(k) = - [50.0 \quad 10.0] \hat{x}(k)$$

The state estimates are described by equation (3), where the

Kalman filter gains are given by,

$$K_f = \begin{bmatrix} 0.0827901406 & -0.13645879 \\ -0.13430101 & 0.223924574 \end{bmatrix} \quad (19)$$

The compensator as obtained from equation (17) is

$$\Psi(z) = \begin{bmatrix} 357.546 \frac{(z - 0.85914)}{(z - 0.125149)} \\ 34.2609 \frac{(z - 0.73884)}{(z - 0.125149)} \end{bmatrix} \quad (20)$$

To investigate the effect of the compensator on the system, the open loop frequency responses of the system are determined at both of the breakpoints defined previously. In Figure 3 the Nyquist plots of the system with the constant LQ gains are depicted. The Nyquist plots of Figure 4 are those of the system with the dynamic compensator. As seen, even though there is a slight increase in the phase margin the difference is not significant. Also the system exhibits an unexpected behavior at high frequencies which decreases the gain margin.

To observe the effect of the compensator on system robustness the plant was perturbed to be

$$\begin{aligned} x(k+1) = & \begin{bmatrix} 1.0 & 0.1 \\ -0.2 & 0.9 \end{bmatrix} x(k) + \begin{bmatrix} 1.25E-5 \\ 0.005 \end{bmatrix} u(k) \\ & + \begin{bmatrix} 0.18 \\ -0.3 \end{bmatrix} w(k) \quad (21) \\ y(k) = & \begin{bmatrix} 2.0 & 1.0 \\ 0.0 & 0.3648 \end{bmatrix} x(k) + \begin{bmatrix} 1.0 & 0.0 \\ 0.0 & 1.0 \end{bmatrix} v(k) \end{aligned}$$

The Nyquist plots of Figures 5 and 6 as obtained for the open loop responses of the system with and without the dynamic compensator indicate that the effect is not significant, but that there is definitely an improvement. As seen from Figure 6 there is an improvement in both the gain and phase margins, at the plant input, i.e., the loop breaking point XX. However at point X there is a decrease in the gain margin while a slight increase in the phase margin was noted.

The following example demonstrates the fact that although the compensator designed for the system is not practically acceptable it recovers the stability margins at the plant input of the LQG system. The plant is the same as the one given in (18) with the C matrix chosen to result in an unstable controller. The plant output is described by the following equation :

$$y(k) = \begin{bmatrix} 2.0 & 1.0 \\ 0.0 & 0.1 \end{bmatrix} x(k) + \begin{bmatrix} 1.0 & 0.0 \\ 0.0 & 1.0 \end{bmatrix} v(k) \quad (22)$$

The Kalman filter gains for this system are given by,

$$K_f = \begin{bmatrix} 0.143435809 & -0.0624081382 \\ -0.23095458 & 0.10172081836 \end{bmatrix} \quad (23)$$

The compensator is described by,

$$\Psi(z) = \begin{bmatrix} -181195.7489 \frac{(z - 0.99095002)}{(z + 565.52065)} \\ -112641.206 \frac{(z - 0.98813697)}{(z + 565.52065)} \end{bmatrix} \quad (20)$$

The Nyquist plots of the system, with and without the compensator are depicted in Figures 7 and 8. As seen from

Figure 8 the LQ open-loop frequency response is recovered at the plant input, i.e. at point X, when the compensator is used. However the extremely large gains of the compensator drastically change the frequency response of the system with the loop opened within the controller, at point XX.

V. CONCLUSION

As seen from the results described above, the dynamic compensator that was designed to mimic the return difference of the LQ system at the plant input of the LQG system did result in the anticipated improvement in the stability margins at the plant input. An appreciable improvement is observed for the LQG system with the unstable controller, though there is no longer any guaranteed stability margins at the loop opening point within the controller, i.e. at point XX. The same magnitude of improvement is not seen for systems with stable controllers. However, an increase in the phase margins is observed when the plant model is perturbed. Further research may be directed towards investigating why a realizable compensator can not be obtained for all systems which have unstable controllers, and hence low stability margins, especially for systems that do not have the same number of states and outputs. Also an investigation of the effects of the compensator on the time response of the system must be performed.

REFERENCES

- [1] Doyle, J.C., "Guaranteed Margins for LQG Regulators," IEEE Trans. Auto. Cont., Aug. 1978.
- [2] Doyle, J.C., Stein, G., "Robustness with Observers," IEEE Trans. Auto. Cont., Aug. 1979.
- [3] Johnson, C.D., "State-variable Design Methods May Produce Unstable Feedback Controllers," Int. Jour. Cont., April 1979.
- [4] O'Reilly, J., Observers for Linear Systems, Academic Press, N.Y. 1983.
- [5] Madiwale, A.N., Williams, D.E., "Some Extensions of Loop Transfer Recovery," ACC, 1985, pp 790-795.
- [6] Gupta, N.K., "Robust Control/Estimator Design by Frequency-shaped Functionals," IEEE Conf. on Dec. and Control (CDC), 1981, pp 1167-1172.
- [7] Moore, J.B., Gangsaas, D., Blight, J.D., "Performance and Robustness Trades in LQG Regulator Design," IEEE CDC, 1981, pp 1191-1200.
- [8] Anderson, B.D.O., Moore, J.B., Mingori, D.L. "Relations Between Frequency Dependent Control and State Weighting in LQG Problems," IEEE CDC, 1983, pp 612-617.
- [9] Okada, T., Kihara, M., Furihata, H., "Robust Control System with Observer," Int. Jour. Cont., May 1985.

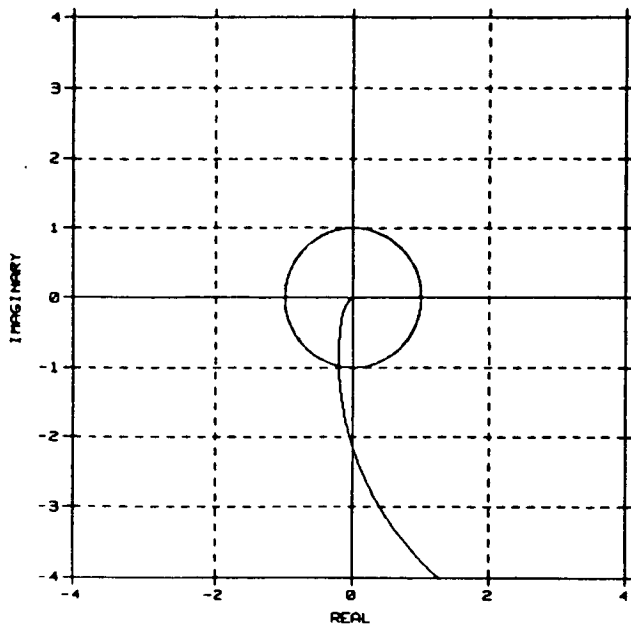

a) Loop point X

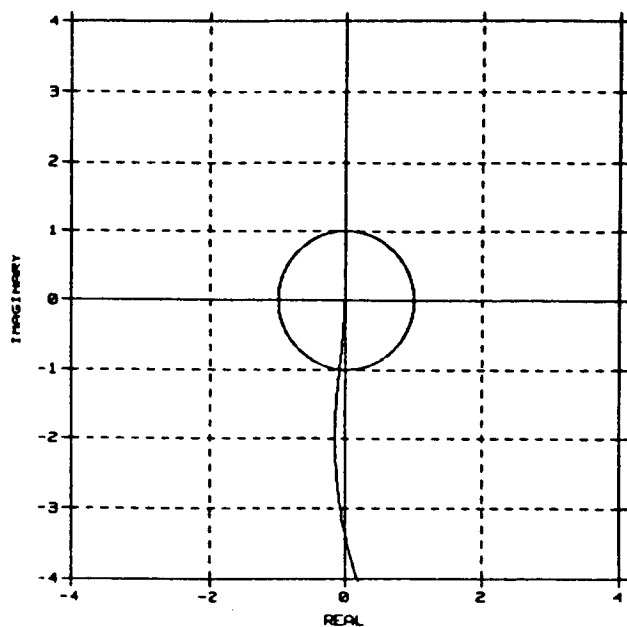

b) Loop point XX

Figure 3. LQG System Frequency Response With Constant Optimal LQ Gains

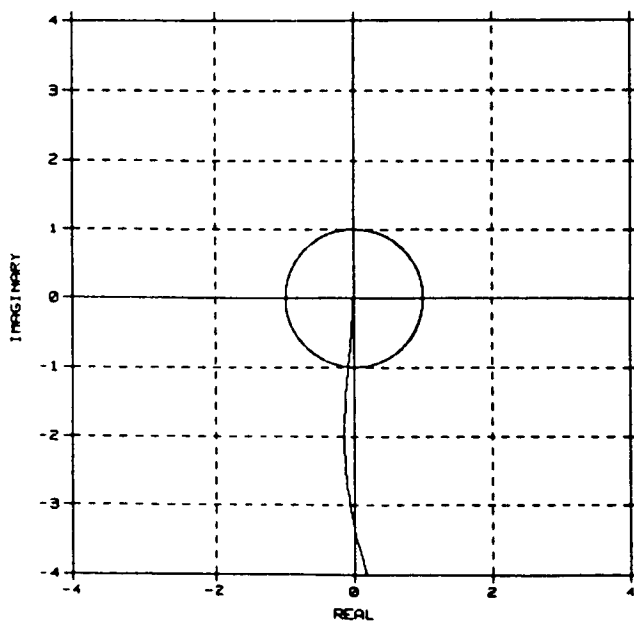

a) Loop point X

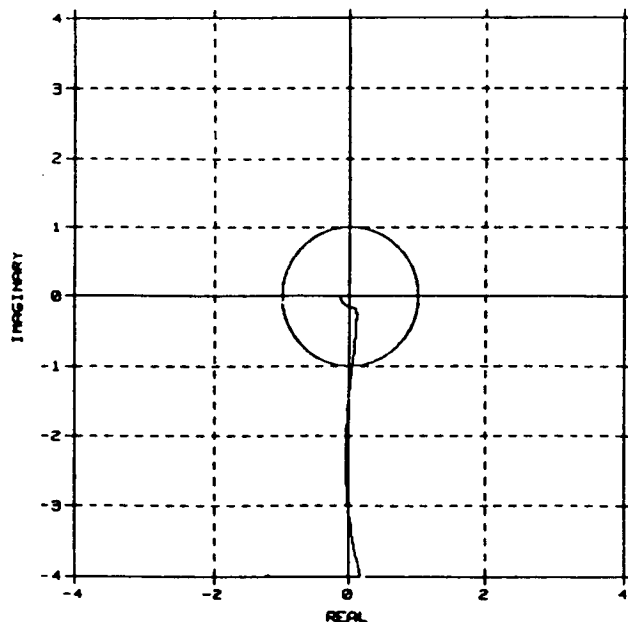

b) Loop point XX

Figure 4. LQG System Frequency Response With Dynamic Compensator

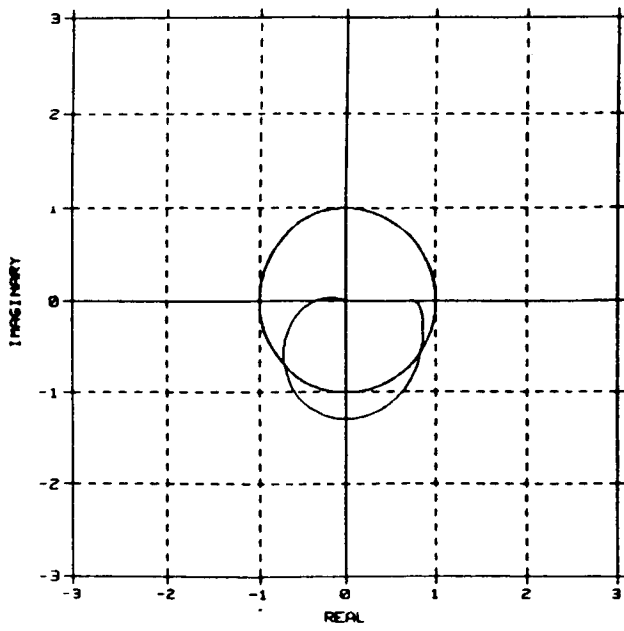

a) Loop point X

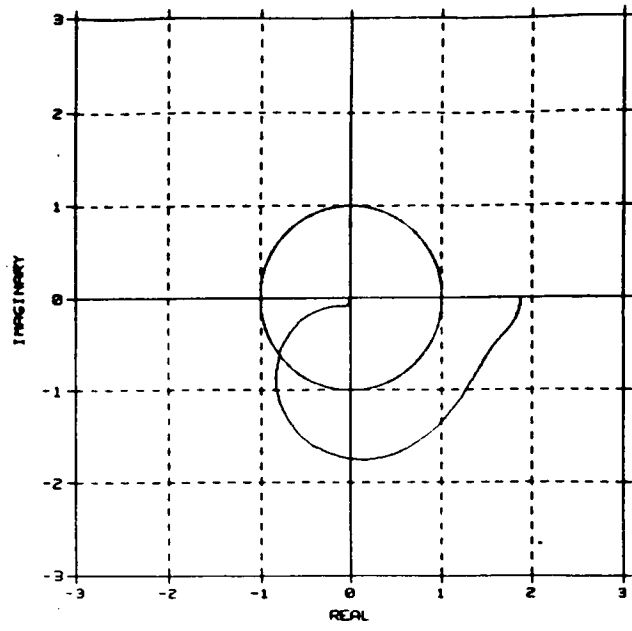

b) Loop point XX

Figure 5. Perturbed LQG System Frequency Response
With Constant Optimal LQ Gains

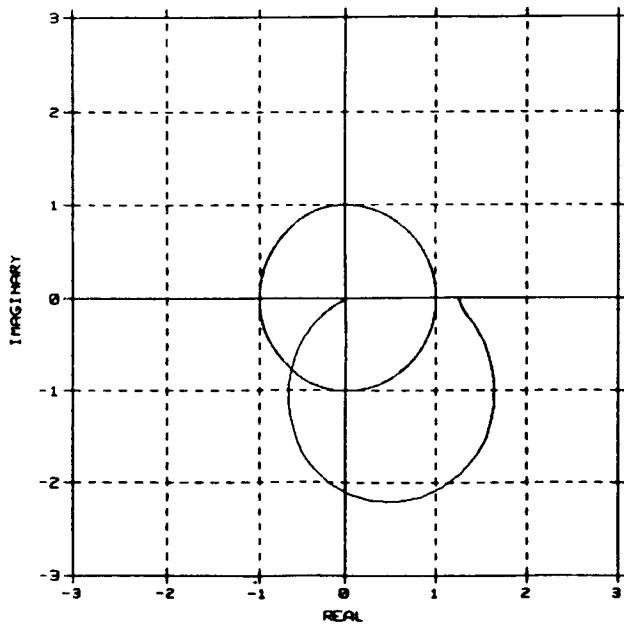

a) Loop point X

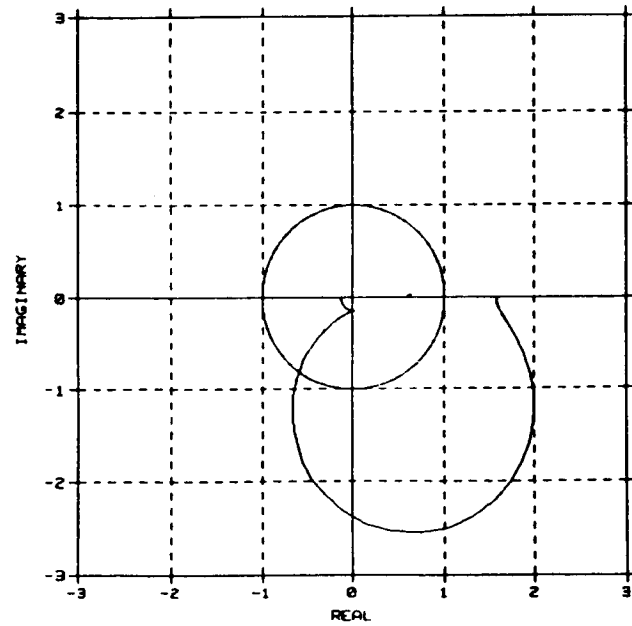

b) Loop point XX

Figure 6. Perturbed LQG System Frequency Response
With Dynamic Compensator

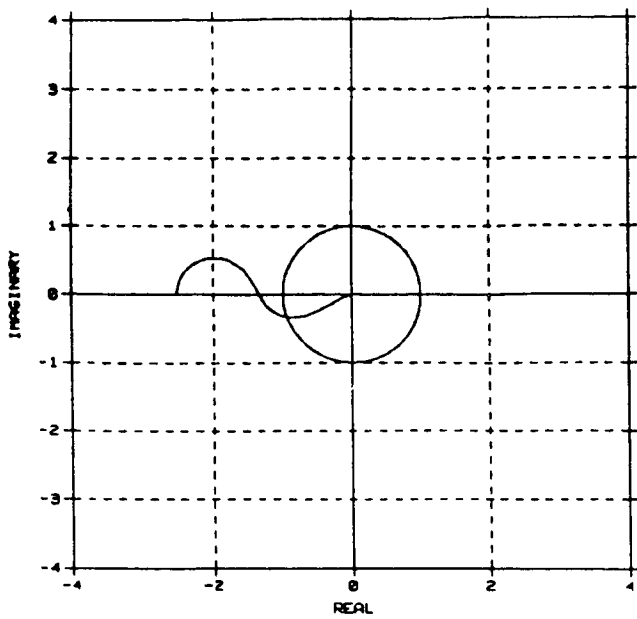

a) Loop point X

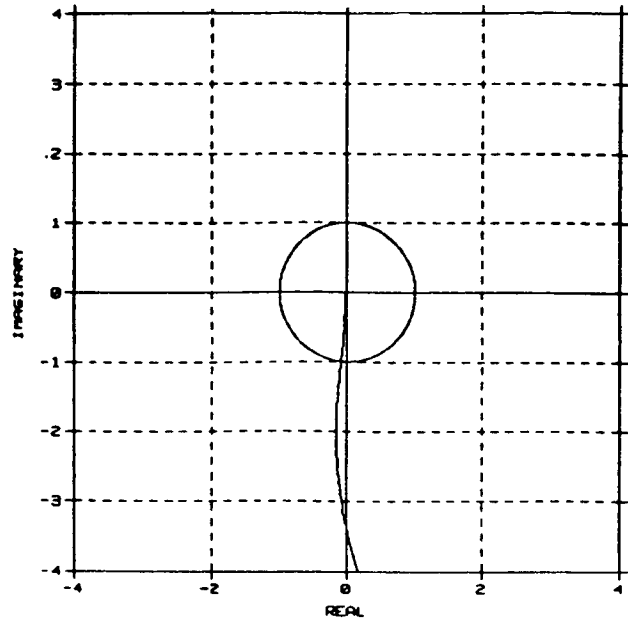

b) Loop point XX

Figure 7. LQG System Frequency Response With Constant Optimal LQ Gains. (Unstable Controller)

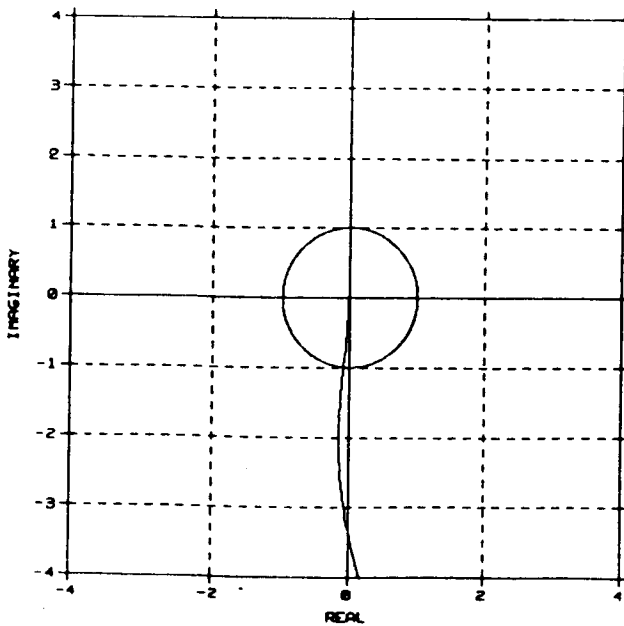

a) Loop point X

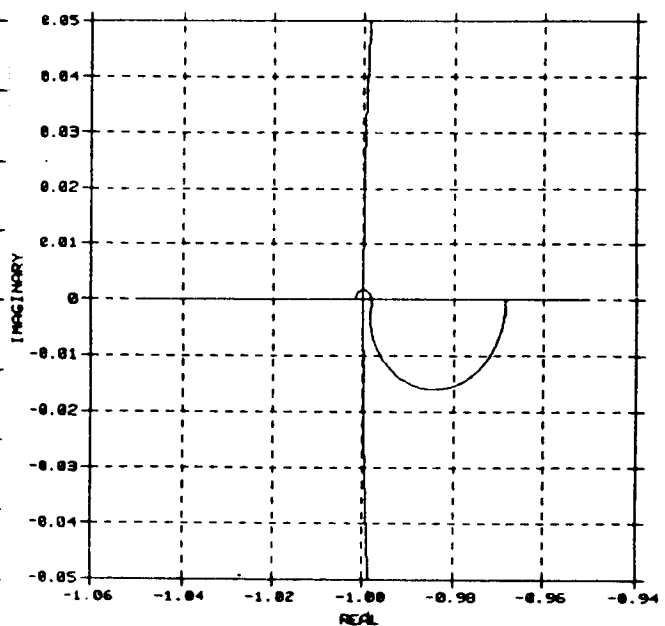

b) Loop point XX

Figure 8. LQG System Frequency Response With Dynamic Compensator. (Unstable Controller)