

NASA Technical Memorandum 89894

Effect of Gimbal Friction Modeling Technique on Control Stability and Performance for Centaur Upper-Stage

Ronald E. Graham
Lewis Research Center
Cleveland, Ohio

(NASA-TM-89894) EFFECT OF GIMBAL FRICTION
MODELING TECHNIQUE ON CONTROL STABILITY AND
PERFORMANCE FOR CENTAUR UPPER-STAGE (NASA)
10 p Avail: NTIS HC A02/MF A01 CSCL 22B

N87-22755

Unclas
83
84/15 0076848

Prepared for the
Guidance, Navigation and Control Conference
sponsored by the American Institute of Aeronautics and Astronautics
Monterey, California, August 17-19, 1987

NASA

EFFECT OF GIMBAL FRICTION MODELING TECHNIQUE ON CONTROL STABILITY
AND PERFORMANCE FOR CENTAUR UPPER STAGE

Ronald E. Graham
National Aeronautics and Space Administration
Lewis Research Center
Cleveland, Ohio 44135

Abstract

E-3582

The powered-phase autopilot for the Centaur upper stage rocket uses an autopilot forward loop gain scheduler that decreases the proportional gain as propellant mass is depleted. Nonlinear time response simulation studies revealed that Centaur vehicles with low-gain autopilots would have large attitude error limit cycles.

These limit cycles were due to the assumed presence of Coulomb friction in the engine gimbals. This situation could be corrected through the use of an harmonic "dither," programmed into the on-board digital computer and added to the engine command signal. This would introduce impending motion to the engines, allowing control of the engines even under small commands. Control authority was found to be restored when dither was used.

A concern arose that the Centaur could be unacceptably excited at resonances near the dither frequency, if the dither amplitude were excessive. Since the dither amplitude was to be chosen on the basis of friction level present, a test was conducted to measure this level. Dither characteristics were to be based on the test results.

The test results showed that the gimbal friction characteristic was actually hysteretic - a "bend and slide" phenomena - rather than the assumed Coulomb friction. This result had a tremendous effect on simulation results for low-gain autopilots. The simulation results showed that, using this new model of gimbal friction, dither would no longer be necessary.

Results of simulation studies in both the time and frequency domain are presented. It is recommended that autopilot simulation studies for future Centaur and similar upper-stage vehicles include a bend and slide engine gimbal friction model, with a small amount of Coulomb friction, modeled as part of the actuator dynamics, for a conservative stability analysis.

Introduction

The Centaur upper-stage rocket, shown in Fig. 1, has flown on over 60 missions atop Atlas rockets and several missions atop Titan rockets. Shuttle/Centaur was designed to fly in the Space Shuttle orbiter bay. The Shuttle/Centaur program was cancelled by NASA due to increased safety considerations arising after the Challenger accident. Although this analysis was performed prior to the program cancellation, the results are applicable to any Centaur or similar space flight vehicle.

The powered-phase autopilot of the Centaur, shown in Fig. 2, is used to maintain attitude control during full thrust operation. Control is maintained by using hydraulic actuators to gimbal the main engines. Linear stability analysis is per-

formed to estimate stability margins for the autopilot, but this analysis must be validated through time response simulation. This is due to the highly nonlinear nature of the autopilot¹ and plant models, and due to time-varying model parameters.

A basic assumption in Centaur autopilot simulation is that friction exists in the engine gimbals.² This phenomena has been modeled as classical Coulomb friction,³ as shown in Fig. 3, with the level of friction chosen from information gathered from test firings of the Pratt & Whitney RL10-A flight model engines.⁴ The effect of Coulomb friction has been documented for oscillating pendulums,⁵ which is how the Centaur engines have been modeled.

A plot of attitude error versus time for a typical Centaur with low-gain autopilot and no friction is shown in Fig. 4. Time responses showed that, for the level of Coulomb friction used in analysis, unacceptably large attitude error limit cycles were seen in simulation results, as shown in Fig. 5. These limit cycles could be attenuated through higher gain, at the expense of stability margins.

Coulomb friction will cause large limit cycles because the engines will stick in one position until the command signal is sufficient for them to overcome the frictional torque. This introduces phase lag to the system, which will decrease stability margins.⁶ Typical open-loop frequency responses for a Centaur with low-gain autopilot, with and without friction, are shown in Fig. 6.

Description of Analysis

An harmonic dither signal is widely used by manufacturers of control valves⁷ as a means of overcoming friction. For the case of gimbaling engines, dither may be added to the command signal as a means of introducing impending motion to the engines, so that they will not stick when subjected to small command signals.

The limitations on choice of dither frequency are as follows: first, the frequency could not fall within the controller bandwidth due to rigid body control performance considerations. Second, vehicle resonances near the dither frequency could not be unacceptably excited by the signal. Finally, the period had to be an even integer multiple of the digital autopilot sampling time, in order to achieve an even harmonic signal.

For the Centaur autopilot, the sampling time is 0.02 sec. Even integer multiples of this number were considered as possible candidates for the dither period. The period outside the controller bandwidth that moved the engines with the smallest amplitude was found to be 0.08 sec, for a frequency of 6.25 Hz.

A further analysis was performed to determine the best shape for the dither signal. A quantized sine wave and a square wave were tested. The square wave shown in Fig. 7 was chosen, because it required less amplitude than the sine wave to add the same amount of energy to the system. The square wave may be decomposed into harmonics that are integer multiples its frequency,⁸ and these harmonics contribute to the energy contained by the square wave. In this analysis, it was found that the harmonics did not themselves excite vehicle modes, but did contribute energy to the engines at the fundamental dither frequency, allowing them to be excited at a smaller amplitude than would a sine wave.

Having chosen the frequency, the dither amplitude must be such that the friction torque is broken, without forcing the engines against their stops. The dither amplitude may be calculated analytically either for a simple model of the engines or for a describing function approximation of the friction characteristic,⁹ but a prior knowledge of the amount of friction present is still necessary.

For this case, various amplitudes were tested, with the goal of finding the smallest amplitude that would break the friction torque. It was observed that amplitudes below a certain level would not excite the engines enough to break the friction, and that the level of dither necessary was a function of the friction level present. An example of this result is shown in Fig. 8, in which attitude error is plotted against time for two different dither amplitudes. One of the amplitudes is sufficient to break the friction; the other is not. These plots show the need to know the amount of friction present to prevent under-dithering the engines.

A test was performed¹⁰ to determine the amount of friction present in the engine gimbals, which would then be used to determine the required dither level. The results of this test showed the friction characteristic to be hysteretic rather than the assumed Coulomb friction. The characteristic is shown in Fig. 9. This result showed previous autopilot stability analyses to be more conservative than necessary.

The result of implementing this hysteretic damping characteristic in simulation was that it was no longer necessary to dither the engines to achieve control authority. Figure 10 shows a plot of attitude error versus time for a case in which the engine gimbal damping is hysteretic, and in which a smaller amount of Coulomb friction is still modeled, under the assumption that some Coulomb friction may exist in the hydraulic engine actuators. The two plots in Fig. 10 indicate that a small amount of dither, although not necessary to meet attitude error limit cycle requirements, may be used to further improve control performance.

Figure 11 shows an open-loop frequency response for the Centaur with this new friction character. The frequency response shows increased stability margins. A comparison of stability margins for the frequency response plots of Figs. 6 and 11 is shown in Table I. Although these stability margins are given for only one instant of flight, it can be easily shown that the effect of friction model on stability margins will be similar throughout flight.

Conclusions

For the case of a low-gain Centaur autopilot, the assumption of Coulomb friction existing in the engine gimbals will be seen in time response, as the sticking of the engines will cause unacceptably large attitude error limit cycles. This will also be reflected in open-loop frequency response, as the phase lag introduced by Coulomb friction reduces autopilot stability margins.

The problems introduced by Coulomb friction in dynamic simulation will be eliminated by the introduction of a dither signal, added to the engine command signal output of the control law. The judicious choice of dither type, frequency, and amplitude will eliminate engine sticking by introducing impending motion to the engines, thus returning control authority and stability margins to the autopilot, without excessively exciting other vehicle modes.

Since the dither amplitude necessary to break the Coulomb friction torque is a function of the amount of friction present, some knowledge of the actual friction characteristic is necessary to prevent over-dithering the engines. For this case, testing was necessary to determine this characteristic.

The test results showed the engine gimbal friction to actually be hysteretic in nature, rather than the assumed Coulomb friction. This "bend and slide" friction would require no dither to break. Although some sticking of the engines is still observed with hysteretic damping, engine commands can move the engines without dither.

The analysis here has shown that if coulomb friction were present in the engine gimbals, control authority could be maintained through the use of dither. However, modeling the engine with the more correct and test-verified hysteretic damping eliminates the need for dither. Future Centaur autopilot simulation studies should contain hysteretic gimbal damping, with a small amount of Coulomb friction also modeled (assumed to be present in the engine actuators) for a conservative stability analysis.

References

1. Graham, R.E. and Porada, T.W., "Linearization of Digital Derived Rate Algorithm for Use in Linear Stability Analysis," 1985 American Control Conference, Vol. 1, IEEE, New York, 1985, pp. 139-143. (Also, NASA TM-87000).
2. Schiller, M.L. and Stubblefield, W.O., "Flight Dynamics and Control Analyses of Centaur/Pioneer G," GDCA-BKM73-018, General Dynamics Convair Division, San Diego, CA, 1973.
3. Thomson, W.T., Theory of Vibration with Applications, Prentice-Hall, Englewood Cliffs, NJ, 1972.
4. Antl, R.J., Vincent, D.W., and Plews, L.D., "Static and Dynamic Characteristics of Centaur Gimbal System Under Thrust Load," NASA TM X-1205, 1966.

5. Dahl, P.R., "Solid Friction Damping of Spacecraft Oscillations," AIAA Paper 75-1104, Aug. 1975.
6. Hale, F.J., Introduction to Control System Analysis and Design, Prentice-Hall, Englewood Cliffs, NJ, 1973.
7. "Moog Series 62 Servovalve," Catalog No. 622477, Moog Inc., East Aurora, NY.
8. Stanley, W.D., Dougherty, G.R., and Dougherty, R. Digital Signal Processing, 2nd Edition, Reston Publishing Co., Reston, VA, 1984.
9. Greensite, A.L., Elements of Modern Control Theory, Spartan, New York, 1970.
10. Askew, J.W., "Centaur Engine Gimbal Friction Characteristics Under Simulated Thrust Load," NASA TM-87335, 1986.

TABLE I. - STABILITY MARGINS FOR THREE FRICTION MODELING CASES

	No friction	Coulomb friction only	Bend and slide friction
Upper gain margin, dB	11.1	2.6	7.1
Lower gain margin, dB	-19.6	-11.6	-18.7
Phase margin, deg	30.1	8.8	21.1

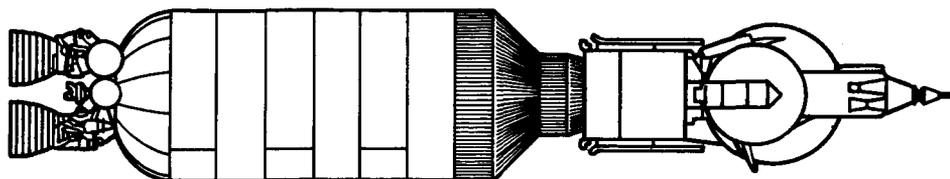
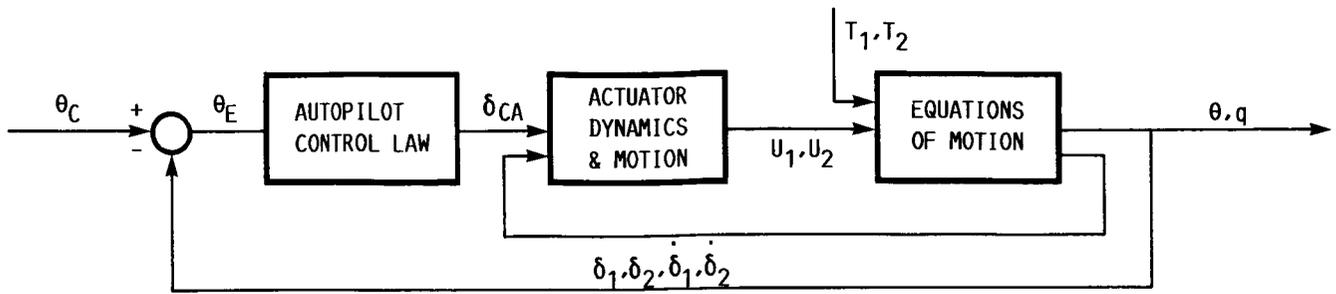
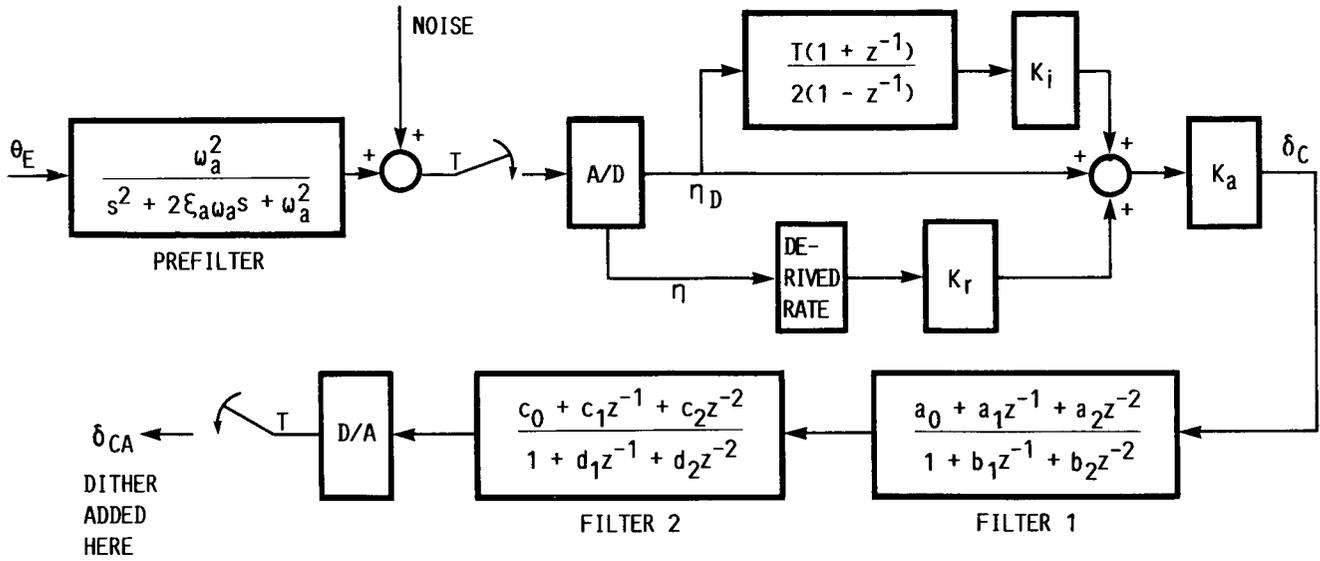

FIGURE 1. - CENTAUR UPPER STAGE.



(A) SIMULATION BLOCK DIAGRAM.



(B) AUTOPILOT BLOCK DIAGRAM.

FIGURE 2. - CENTAUR POWERED-PHASE AUTOPILOT.

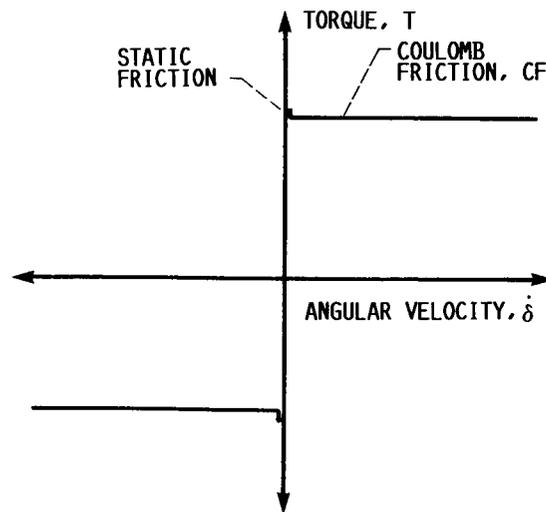

FIGURE 3. - COULOMB FRICTION MODEL.

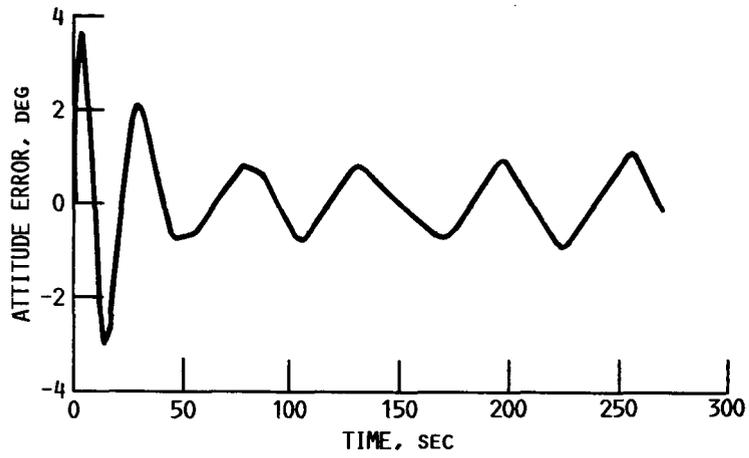

FIGURE 4. - ATTITUDE ERROR VERSUS TIME FOR CASE WITH NO FRICTION MODELED.

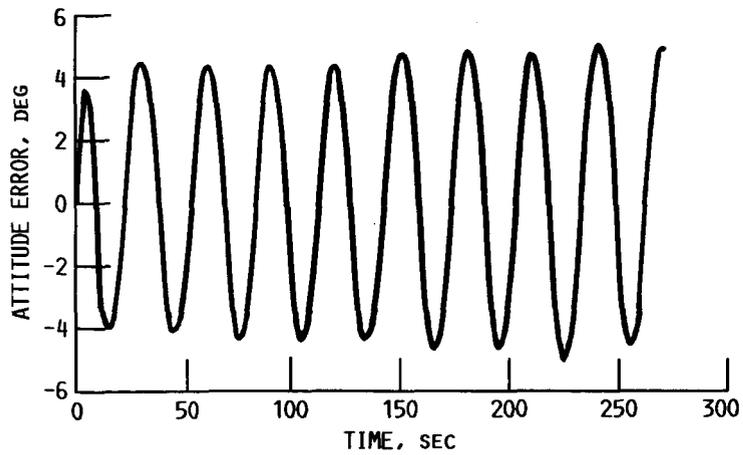

FIGURE 5. - ATTITUDE ERROR VERSUS TIME FOR CASE WITH COULOMB FRICTION AND NO DITHER.

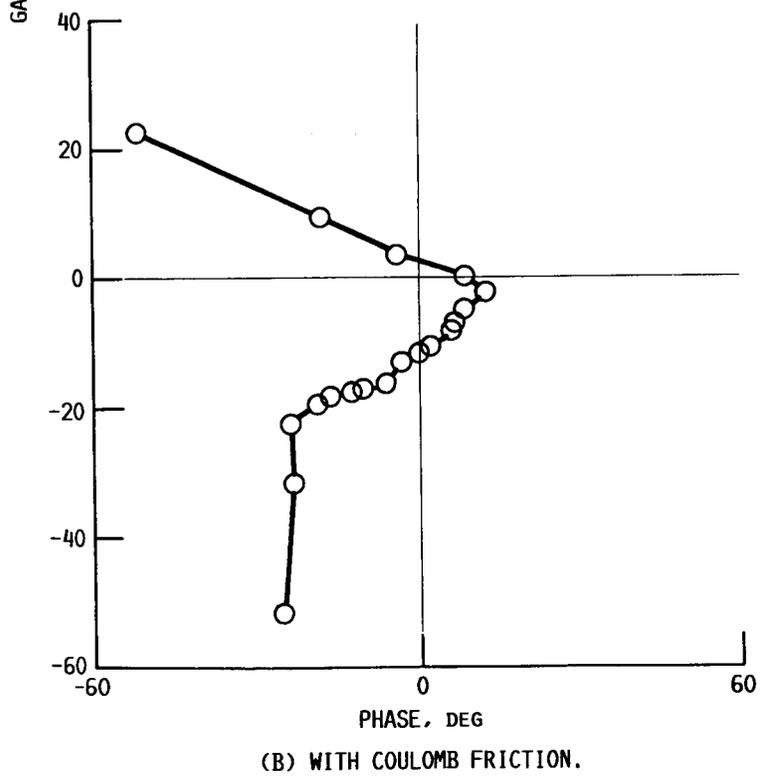
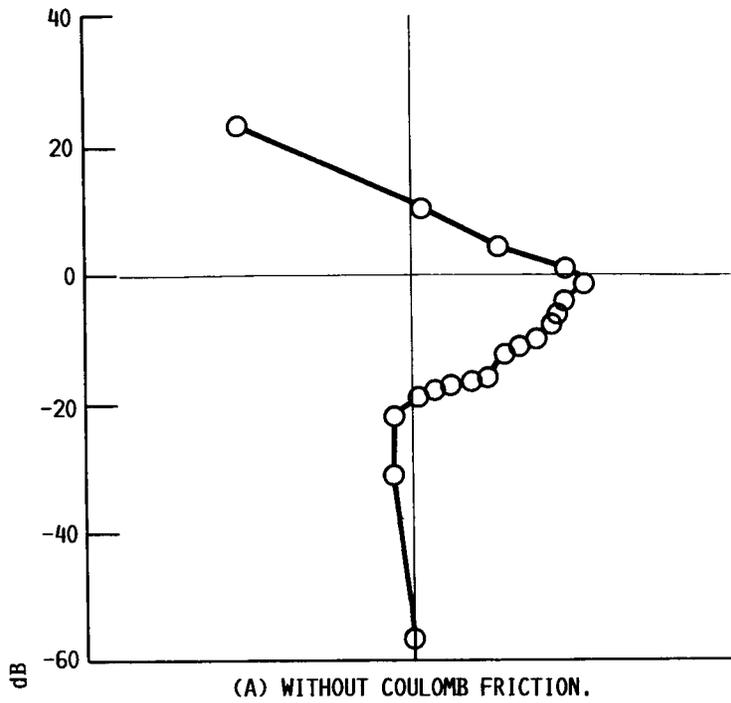

FIGURE 6. - FREQUENCY RESPONSES FOR CASES WITH NO DITHER.

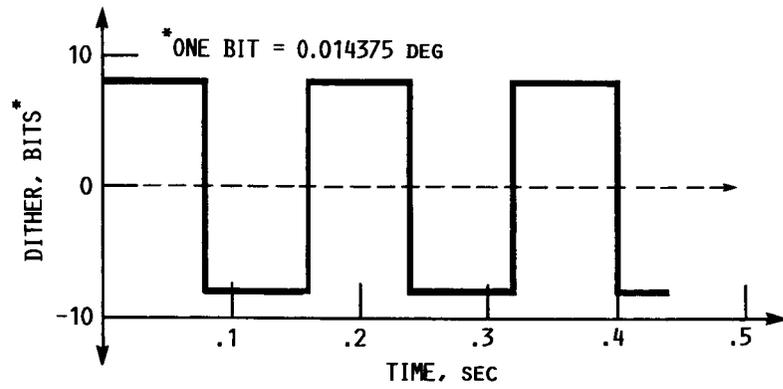

FIGURE 7. - DITHER SIGNAL.

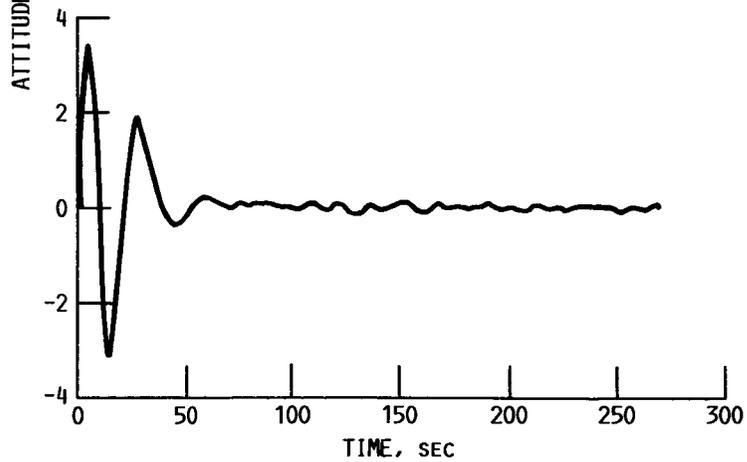
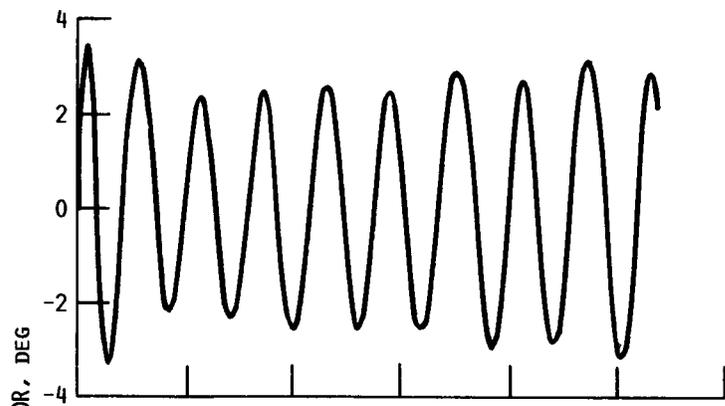

FIGURE 8. - ATTITUDE ERROR VERSUS TIME FOR CASES WITH COULOMB FRICTION AND TWO DITHER AMPLITUDES.

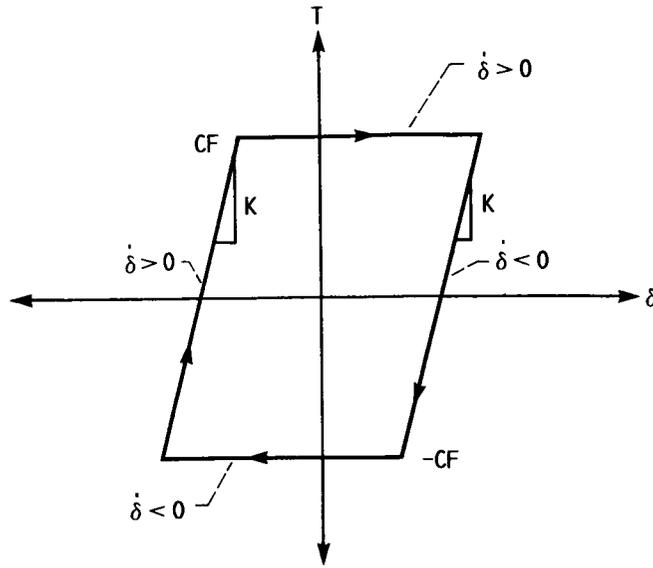

FIGURE 9. - HYSTERETIC FRICTION DAMPING MODEL.

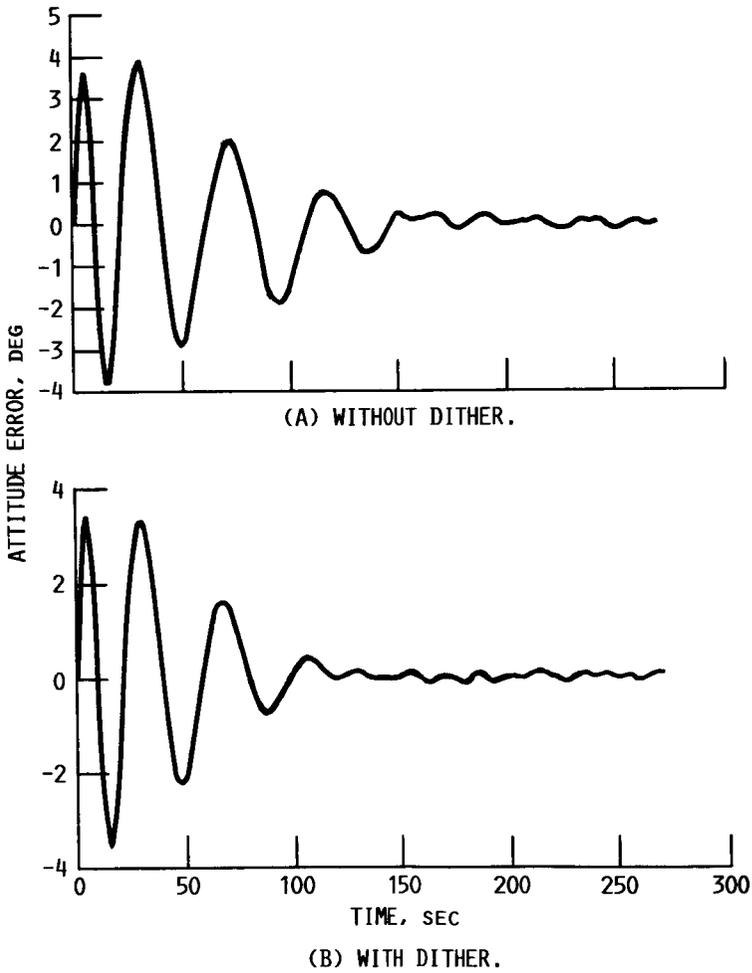

FIGURE 10. - ATTITUDE ERROR VERSUS TIME FOR CASES WITH HYSTERETIC FRICTION MODEL.

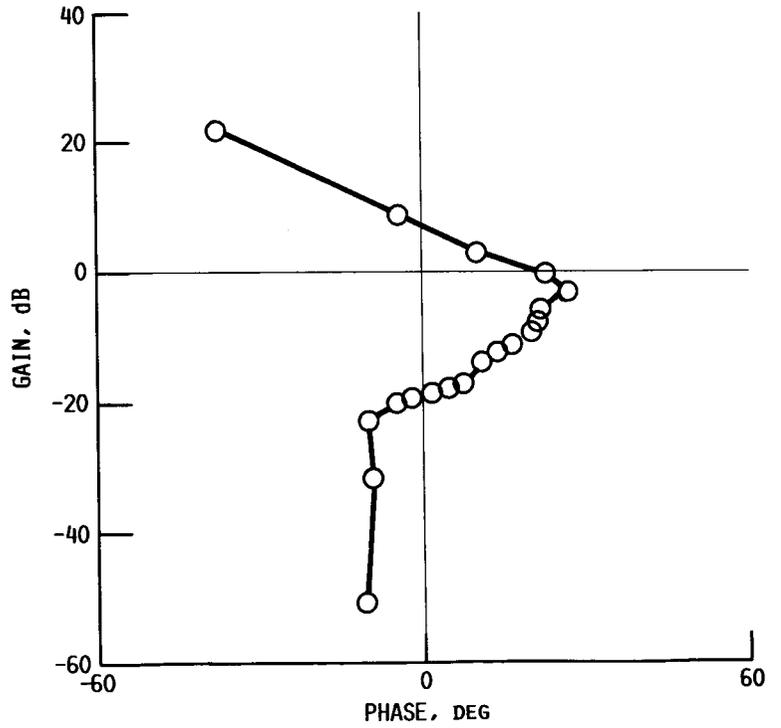

FIGURE 11. - FREQUENCY RESPONSE FOR CASE WITH HYSTERETIC FRICTION DAMPING.

1. Report No. NASA TM-89894		2. Government Accession No.		3. Recipient's Catalog No.	
4. Title and Subtitle Effect of Gimbal Friction Modeling Technique on Control Stability and Performance for Centaur Upper-Stage				5. Report Date	
				6. Performing Organization Code 927-60-00	
7. Author(s) Ronald E. Graham				8. Performing Organization Report No. E-3582	
				10. Work Unit No.	
9. Performing Organization Name and Address National Aeronautics and Space Administration Lewis Research Center Cleveland, Ohio 44135				11. Contract or Grant No.	
				13. Type of Report and Period Covered Technical Memorandum	
12. Sponsoring Agency Name and Address National Aeronautics and Space Administration Washington, D.C. 20546				14. Sponsoring Agency Code	
15. Supplementary Notes Prepared for the Guidance, Navigation and Control Conference sponsored by the American Institute of Aeronautics and Astronautics, Monterey, California, August 17-19, 1987.					
16. Abstract <p>The powered-phase autopilot for the Centaur upper stage rocket uses an autopilot forward loop gain scheduler that decreases the proportional gain as propellant mass is depleted. Nonlinear time response simulation studies revealed that Centaur vehicles with low-gain autopilots would have large attitude error limit cycles. These limit cycles were due to the assumed presence of Coulomb friction in the engine gimbals. This situation could be corrected through the use of an harmonic "dither," programmed into the on-board digital computer and added to the engine command signal. This would introduce impending motion to the engines, allowing control of the engines even under small commands. Control authority was found to be restored when dither was used. A concern arose that the Centaur could be unacceptably excited at resonances near the dither frequency, if the dither amplitude were excessive. Since the dither amplitude was to be chosen on the basis of friction level present, a test was conducted to measure this level. Dither characteristics were to be based on the test results. The test results showed that the gimbal friction characteristic was actually hysteretic - a "bend and slide" phenomena - rather than the assumed Coulomb friction. This result had a tremendous effect on simulation results for low-gain autopilots. The simulation results showed that, using this new model of gimbal friction, dither would no longer be necessary. Results of simulation studies in both the time and frequency domain are presented. It is recommended that autopilot simulation studies for future Centaur and similar upper-stage vehicles include a bend and slide engine gimbal friction model, with a small amount of Coulomb friction, modeled as part of the actuator dynamics, for a conservative stability analysis.</p>					
17. Key Words (Suggested by Author(s)) Control stability; Space flight (or launch) vehicles; Coulomb friction			18. Distribution Statement Unclassified - unlimited STAR Category 15		
19. Security Classif. (of this report) Unclassified		20. Security Classif. (of this page) Unclassified		21. No. of pages 9	22. Price* A02