

NASA Technical Memorandum 89440

---

# Flow Visualization Study of a Two-Dimensional Representation of the Space Shuttle Launch Pad Configuration

---

B. G. McLachlan, G. G. Zilliac, and S.S. Davis

---

(NASA-TM-89440) FLOW VISUALIZATION STUDY OF  
A TWO-DIMENSIONAL REPRESENTATION OF THE  
SPACE SHUTTLE LAUNCH PAD CONFIGURATION  
(NASA) 17 p Avail: NTIS HC A02/MF A01

N87-24643

CSCL 20D <sup>G3</sup> ~~H~~/34 Unclas  
0080333

June 1987

**NASA**  
National Aeronautics and  
Space Administration

---

# Flow Visualization Study of a Two-Dimensional Represen- tation of the Space Shuttle Launch Pad Configuration

---

B. G. McLachlan,  
G. G. Zilliac,  
S. S. Davis, Ames Research Center, Moffett Field, California

June 1987



National Aeronautics and  
Space Administration

**Ames Research Center**  
Moffett Field, California 94035

# Flow Visualization Study of a Two-Dimensional Representation of the Space Shuttle Launch Pad Configuration

B.G. McLachlan, G.G. Zilliac, and S.S. Davis

Ames Research Center

## Summary

The loss of the Space Shuttle Challenger was caused by the failure of the aft joint O-ring seals in its right solid rocket booster. It has been suggested by several sources that wind conditions, through a reduction in temperature of the right solid rocket booster caused by the wind blowing across the "cold" external tank, played a role in the O-ring failure. To check the plausibility of this "wind" theory, an experiment was carried out in a water towing tank to visualize the flow past a two-dimensional model representing a cross-section of the Space Shuttle launch configuration. The periodic formation of vortices was found to characterize the wake generated by the model. It is suggested that this organized motion in the flow is the dominant mechanism that accomplishes heat transfer from the external tank to the right solid rocket booster. Flow visualization results consisting of photographs that show instantaneous streamline patterns of the flow are presented.

## Symbols

|              |   |
|--------------|---|
| $d$          | characteristic length, external tank diameter             |
| $Re$         | Reynolds number, $U_{\infty}d/\nu$                        |
| $t$          | time from a specific instant in the vortex shedding cycle |
| $U_{\infty}$ | mean free stream velocity                                 |
| $\tau$       | normalized time, $U_{\infty}t/d$                          |
| $\nu$        | kinematic viscosity                                       |

## Introduction

Several sources (ref. 1) have reported that wind conditions on January 27/28, 1986, prior to the launch of the Space Shuttle Orbiter Challenger may have played a role in its catastrophic loss. The theory is that the wind blowing across the external tank (ET) reduced the temperature of the right solid rocket booster (SRB) and that this reduction in temperature was a factor in causing the booster's O-ring seals to fail.

For the "wind" theory to be correct, the wind-induced flow structure around the Shuttle launch configuration must be the primary determinant of the heat transfer from the external tank to the right SRB. In order to check the plausibility of this wind theory, a flow

visualization study of the Space Shuttle launch pad configuration was performed. Results of this study are presented in this report.

It is obvious that the flow generated by the actual Shuttle launch pad configuration (fig. 1) is both three-dimensional and turbulent. In the present study a two-dimensional representation of the Shuttle launch pad configuration was tested. This idealized configuration simplifies the testing and is believed to capture the essential flow features generated by the actual three-dimensional geometry. Further elaboration on this point will be made.

The authors would like to express their appreciation to Malyn Wells and Dane Smith for their timely construction of the Shuttle model; and, to Prof. D.P. Telionis for providing the particles used in the test.

### Background

It was reported (ref. 1) that the Challenger was oriented on its launch pad with its tail facing south ( $180^\circ$ ) the right SRB facing east ( $90^\circ$ ), and the left SRB facing west ( $270^\circ$ ). Additionally, it was reported that during the night of Jan 27/28, 1986, the winds were from  $250-300^\circ$ ; at three hours before launch the winds were from  $300^\circ$  at 8 knots with gusts to 16 knots; and during the night the ambient temperature dipped to  $24^\circ\text{F}$ , rising to  $38^\circ\text{F}$  at liftoff.

Infrared sensor readings of the Challenger's surface temperature were made ninety minutes before launch. Reports (ref. 1) just after the accident stated that the surface temperature of the aft lower portion of the right SRB was found to be  $7-9^\circ\text{F}$ ; surface temperatures of the left SRB and ET were found to be  $25^\circ\text{F}$  and  $2-8^\circ\text{F}$ , respectively. It is now known (ref. 2) that the original calibration of the infrared sensor was not correct, resulting in lower temperature readings than were actually the case. Yet, although the absolute temperature levels are suspect, the difference in temperature levels between the left and right SRB remains unaltered. This difference in the surface temperatures between the right and left SRB is interesting considering that the two SRBs are geometrically located symmetric with respect to the ET.

### Experimental Procedure

The flow visualization study was performed in a towing tank on a two-dimensional model representing a cross-section of the Space Shuttle launch configuration (fig. 2). Flow visualization was by means of a suspension of neutrally buoyant particles in water illuminated by a sheet of laser light. The model was moved through the water at a constant speed and short-time-exposure photographs of the induced particle motion were taken. The particle streak patterns recorded on each photograph correspond to instantaneous streamline patterns. The camera was moved with the model to produce the instantaneous streamline pattern as seen by an observer in the model's frame of reference. Information concerning

the velocity direction and magnitude can be obtained from the image by measuring the length and orientation of the individual streaks.

The particles used were made of Pliolite ACL<sup>1</sup> and ranged in diameter from 0.0035 to 0.0048 in. Pliolite has a specific gravity ranging from 1.02 to 1.04. In order to make the particles neutrally buoyant, a small amount of salt (0.0174 oz of salt/in<sup>3</sup> of water) was added to the water.

Two flow (wind) direction cases were tested, 270° and 300° (fig. 3). In the text these directions will be referred to as westerly and northwesterly, respectively. Taking the diameter of the model ET as the length scale the Reynolds number was 310.

### Scale Effect-Discussion

As noted, the approach used here was to test a two-dimensional model at Reynolds numbers that are lower than the actual full-scale Reynolds numbers. For wind conditions the day of the Shuttle Challenger's launch, the Reynolds number, based on the external tank diameter, ranged from 2.7 to 5.4 million. A question to be addressed is the influence that Reynolds number (scale effect) has on the flow structure. A brief discussion of this point follows.

Influence of Reynolds number on scale model testing has been a point of contention among aerodynamicists for years. However, it has been known for a long time that the wake produced by a bluff body is characterized by coherent vortex motion, i.e., vortex shedding—the production of vortices, or eddies, in a regular manner. This organized large scale motion in the wake has been shown to be Reynolds number invariant when the boundary layer is turbulent before separation. A graphic illustration of this invariance is provided by Cantwell (ref. 3) and Van Dyke (ref.4), both of whom compare photographs of the wake behind an inclined flat plate in a water channel (low Reynolds number) and the wake behind a grounded tankship (high Reynolds number) to show that the large scale wake structure is very similar. In the present study the Reynolds number is low enough ( $Re = 310$ ) that the boundary layer before separation and the resulting wake is laminar. It has been shown by Perry et al. (ref. 5) that the instantaneous streamline patterns of the laminar wake generated by a two-dimensional bluff body at low Reynolds numbers displays the same qualitative large scale features as the turbulent wake generated by the same body at higher Reynolds numbers. Hence, although the Reynolds number of the present test is orders of magnitude lower than full scale, the large scale features of the flow should be similar. The appendix provides further discussion on the effect of Reynolds number on vortex shedding.

### Two-Dimensional Idealization

The flow field generated by an actual Shuttle configuration is obviously three-dimensional. The question may therefore arise as to how the testing of a two-dimensional idealization of the Shuttle launch configuration can be justified.

---

<sup>1</sup>Pliolite is a trade name of the Goodyear Tire and Rubber Co.

Wind tunnel tests on a scaled Shuttle launch pad configuration have been reported by Porteiro et al. (ref. 6) for Reynolds numbers high enough to generate a turbulent wake. The results reported include surface oil flow visualization which indicates that the flow is two-dimensional over a significant portion of the external tank-booster configuration (over those regions where the geometry is two-dimensional). This two-dimensionality was indicated for flow directions relative to the launch pad configuration that correspond closely to those experienced by the Shuttle Challenger prior to launch (the same as used in the present test). On this basis the authors feel that the idealization of testing a two-dimensional configuration is justified.

### Discussion of Flow Visualization Results

The flow visualization showed that the model generates a wake that displays typical bluff body features: separation of the boundary layer on either side of the body; and, the periodic formation of vortices through the interaction of the resulting free shear layers. This process is illustrated in the photographs displayed in figures 4, 5, and 6. These photographs show the instantaneous streamline patterns of the flow past the model for the two flow directions tested: an overall view of the flow field, at a specific instant in the vortex shedding cycle, is shown in figure 4; a close-up view of the near wake region of the model, at various phases of the vortex shedding cycle, is provided in figures 5 and 6. Of mention, is that the streamline patterns are with respect to an observer in the model's frame of reference; therefore, the flow in the photographs can be viewed as going from left to right past a stationary model.

The discussion to follow will focus on the westerly ( $270^\circ$ ) wind direction case (fig. 5). However, the same argument applies in general to the northwesterly ( $300^\circ$ ) wind direction case (fig. 6).

It is significant that the photographs show the right SRB to lie in the wake region of the ET. The free shear layer that makes up the upper edge of the wake is made up of fluid that has come into contact with the "cold" ET. Also of note is the jet of fluid between the ET and the wing. In both wind direction cases tested, the free shear layer from the upper surface of the ET and the jet of fluid between the ET and the wing come into contact with the SRB individually or together during the vortex formation process. This aspect of the flow structure should induce heat transfer through forced convection: namely, the fluid elements that have come into contact with the ET are transported via the shear layer and the jet between the ET and wing to the aft region of the right SRB.

Another notable flow feature is the region of separated flow between the ET and right SRB. The velocity in this region is low, the flow slowly recirculating. This region exists because the SRB shields the space between itself and the ET from the dynamics of the vortex formation process. The "cold" free shear layer from the upper surface of the ET separates this recirculation zone from the "warm" outer flow and should have an insulating effect on the heat transfer from the outer flow to that zone. In this region heat transfer is most probably by conduction from the ET through the slowly recirculating fluid to the

SRB. For the actual three-dimensional geometry, free convective transport of "cold" fluid down the long axis of the ET through the recirculating region should occur.

For the actual full scale configuration the boundary layer and wake were turbulent. This is an element not captured in the present study. The addition of turbulence will enhance the heat transfer process of the flow elements noted above. However, it will not alter the dominant heat transfer mechanism: forced convection due to the organized motion of the flow—the vortex formation process.

### Conclusions

This study has examined the fluid dynamic aspects of the theory that wind conditions may explain the reduced temperature of the Space Shuttle Challenger's right solid rocket booster. The results demonstrate that the "wind" theory for the reduced temperature of the solid rocket booster is plausible. Based on the observed flow patterns, it is suggested that heat transfer is primarily accomplished through convective transport due to the organized motion of the flow—i.e., periodic vortex shedding. To prove that this theory is correct, further research should be performed that includes direct heat transfer measurements and three-dimensional effects.

## Appendix

### Further Observations Concerning Vortex Shedding

Due to the wind direction on the day of launch and the geometry of the Shuttle launch pad configuration one can make a comparison of its flow pattern to that of a circular cylinder. For the flow past a circular cylinder periodic vortex shedding occurs when the boundary layer is fully laminar (at Reynolds numbers greater than about 40) or fully turbulent before separation. Over Reynolds numbers ranging from approximately 200,000 to 3,500,000 this is not the case, a complicated laminar-transitional phenomena occurs, and at certain Reynolds numbers periodic vortex shedding may be suppressed (ref. 7, 8, 9). The reason for this discussion is that the lower values of the Reynolds number experienced by the full-scale Shuttle launch pad configuration may fall into the above vortex suppression range for a circular cylinder and raises the question as to whether periodic vortex shedding occurred continuously the night before the launch.

For a circular cylinder the lower end of the Reynolds number range where periodic vortex shedding is suppressed is known to be lowered by the introduction of turbulence into the free stream. The limited evidence available suggests that free stream turbulence should have a similiar effect on the upper end of the suppression Reynolds number range. The reader may refer to Morkovin (ref. 7) and Sarpkaya et al. (ref. 10) for a detailed discussion of this subject. If one keeps these points in mind, a noteworthy feature in the Shuttle problem that leads us to believe that vortex shedding did occur continuously is the presence of the launch tower upwind of the launch pad. The lattice like structure of the tower should have acted to increase the free stream turbulence approaching the launch configuration. This is in addition to the free stream turbulence present due to natural disturbances in the wind. The increased free stream turbulence level should have had an effect on the Shuttle launch pad configuration similiar to the effect on a circular cylinder and have resulted in vortex shedding characterizing the Shuttle wake for the lower Reynolds numbers experienced the night before launch.

As noted previously, it was reported that prior to launch the wind speed was 8 knots with gusts to 16 knots and the wind direction was from 250-300°. The effect of a time variation of the flow speed and direction on the flow structure is not addressed in the present study. From what is known about circular cylinder wake flows under unsteady free stream conditions (see, for example, ref. 10 and 11) we would still expect to find a wake dominated by the periodic formation process of large scale vortical structures.



## References

1. Wind Tunnel Data Indicated Potential for Frozen Seals. *Aviation Week and Space Technology*, vol. 124, no. 8, Feb. 24, 1986, pp. 22-25.
2. NASA Identifies Fixes for Booster Seal Problem. *Aviation Week and Space Technology*, vol. 124, no. 9, March 3, 1986, pp. 16-17.
3. Cantwell, B.J.: Organized Motion in Turbulent Flow. *Ann. Rev. Fluid Mech.*, vol. 13, 1981, pp 457-515.
4. Van Dyke, M.: *An Album of Fluid Motion*. Parabolic Press, Stanford, CA, 1982.
5. Perry, A.E.; Chong, M.S.; and Lim, T.T.: The vortex-shedding process behind two-dimensional bluff bodies. *J. Fluid Mech.*, vol. 116, 1982, pp. 77-90.
6. Porteiro, J.L.F.; Norton, D.J.; and Pollock, T.C.: *Space Shuttle Ice Suppression System Validation, Vol. II: Influence of Test Parameters on Flow Visualization Patterns*. Texas Engineering Experiment Station (TEES)-TR-4587-82-01, Texas A&M University, College Station, Texas, August 1982.
7. Morkovin, M.V.: *Flow Around Circular Cylinder - A Kaleidoscope of Challenging Fluid Phenomena*. ASME-Symposium on Fully Separated Flows, A.G. Hansen, ed., Philadelphia, PA., May 1964.
8. Roshko, A.: Experiments on the flow past a circular cylinder at very high Reynolds numbers. *J. Fluid Mech.*, vol. 10, 1961, pp. 345-356.
9. Schewe, G.: On the force fluctuations acting on a circular cylinder in crossflow from subcritical up to transcritical Reynolds numbers. *J. Fluid Mech.*, vol. 133, 1983, pp. 265-285.
10. Sarpkaya, T.; and Isaacson, M.: *Mechanics of Wave Forces on Offshore Structures*. Van Nostrand Reinhold Co., 1981, Chap. 3.
11. Williamson, C.H.K.: Sinusoidal flow relative to circular cylinders. *J. Fluid Mech.*, vol. 155, 1985, pp. 141-174.

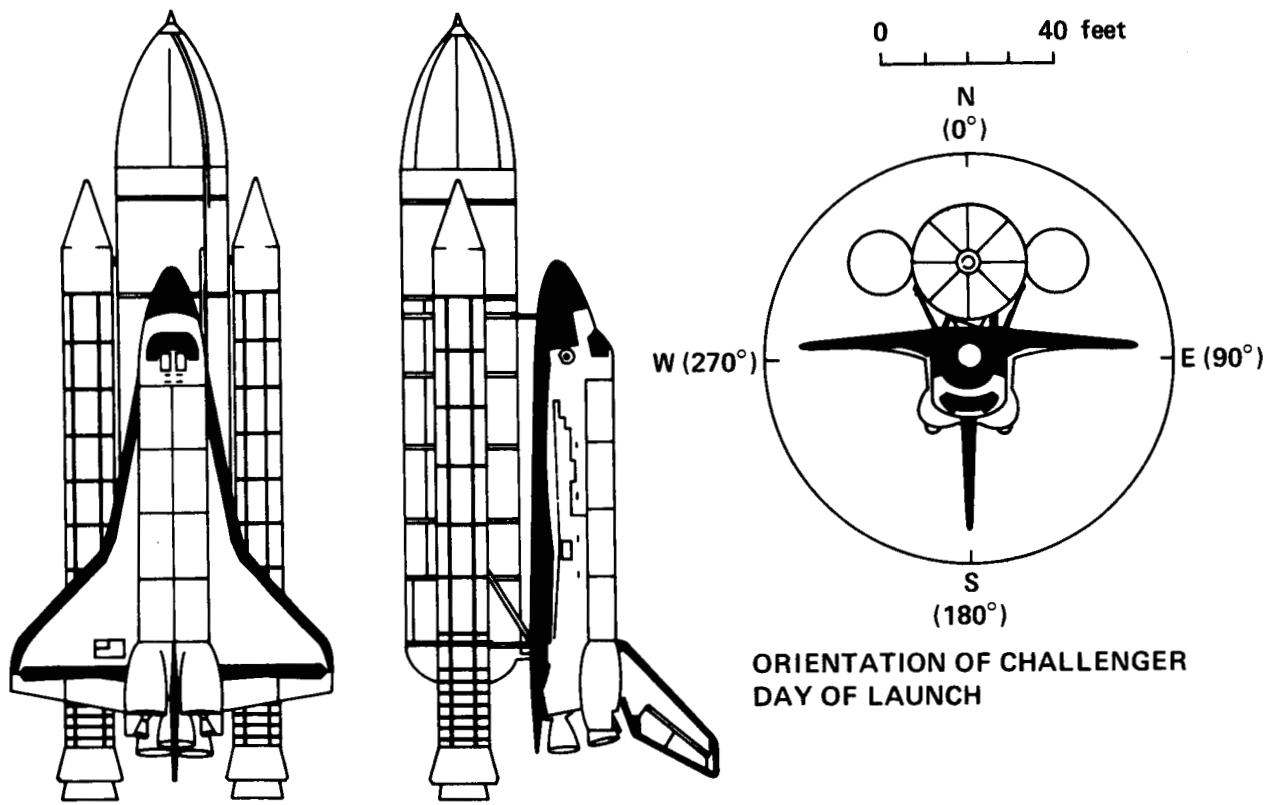

Figure 1. - Space Shuttle launch configuration.

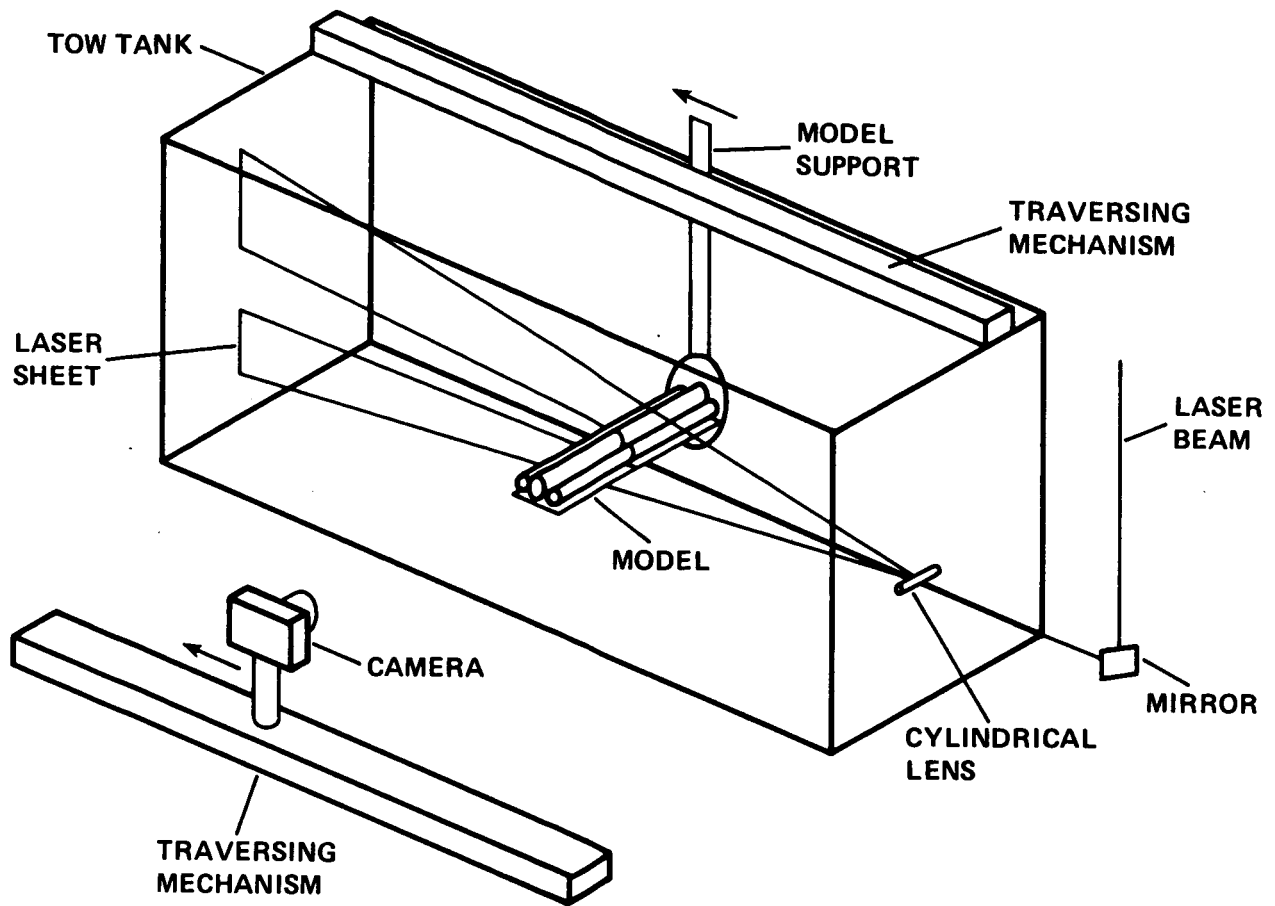

Figure 2. - Perspective view of the towing tank with model.

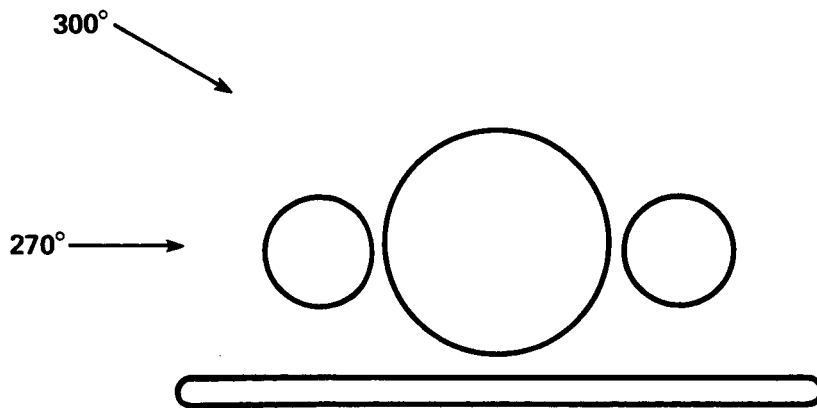
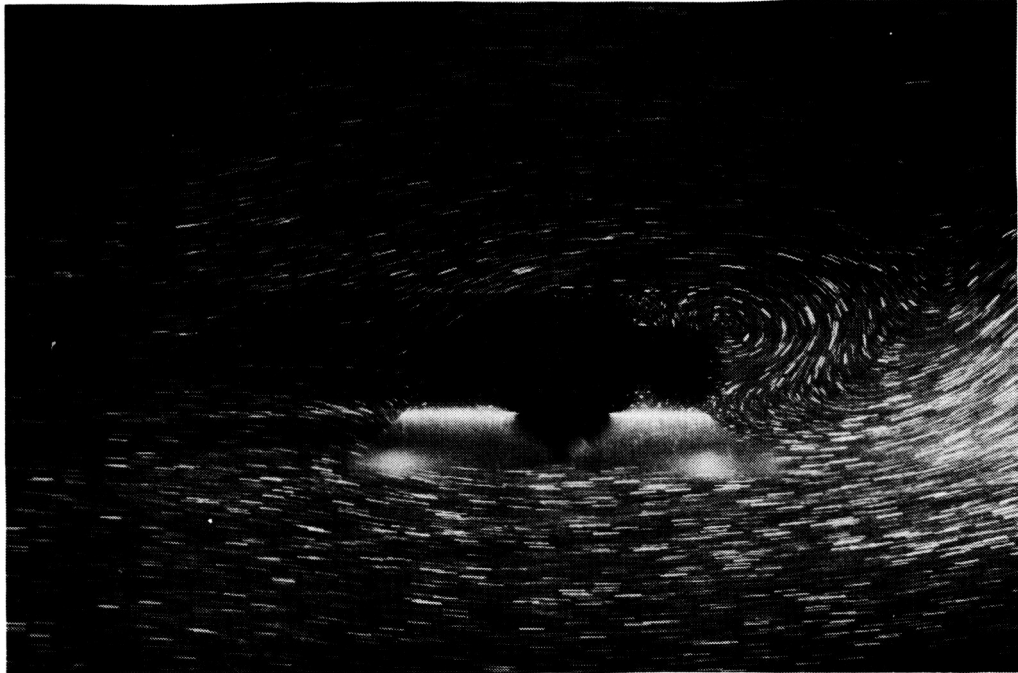
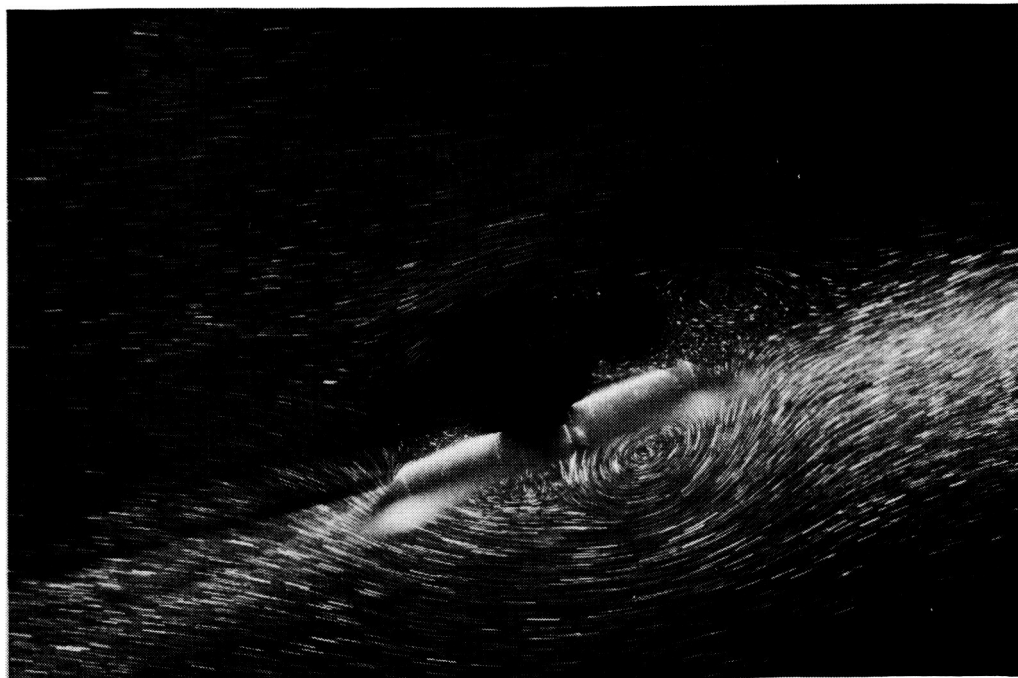

Figure 3. - Cross-section of the model (approximately to scale).



(a)



(b)

Figure 4. - Instantaneous streamlines of wake flow: (a) 270° case; (b) 300° case.

ORIGINAL PAGE IS  
OF POOR QUALITY

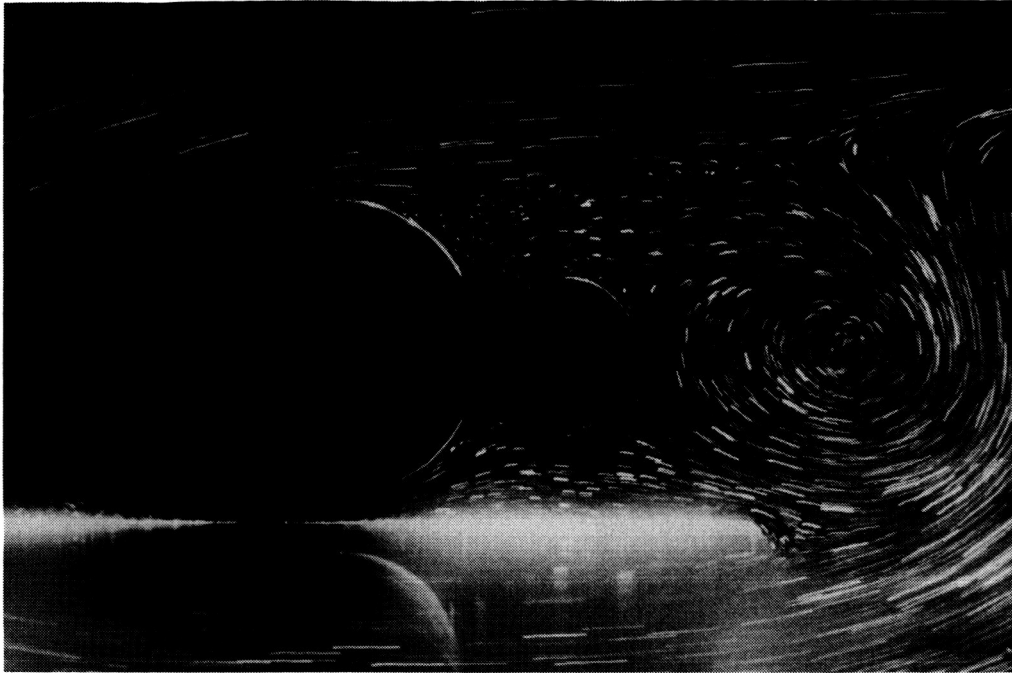

(a)

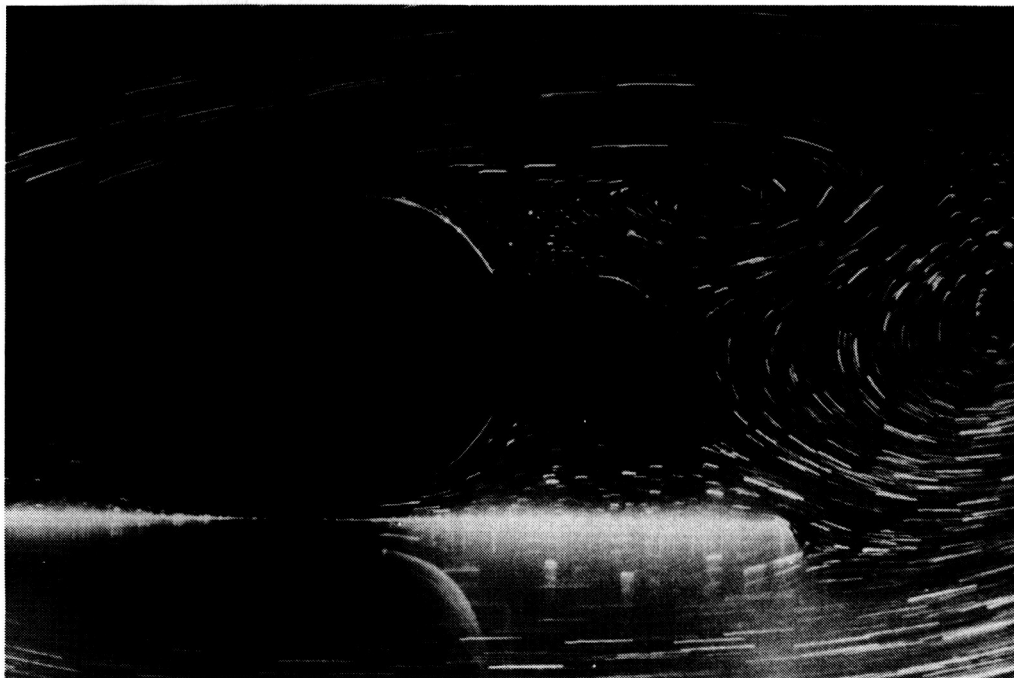

(b)

Figure 5. - Instantaneous streamlines of wake flow,  $270^\circ$  case: (a)  $\tau = 0$ ; (b)  $\tau = 0.85$ .

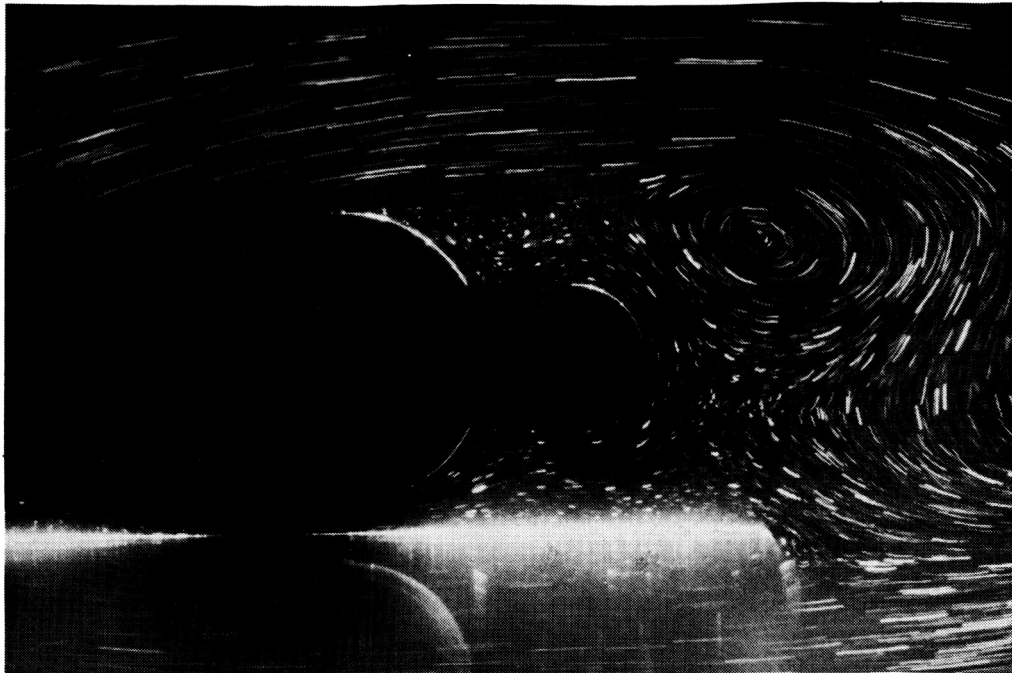

(c)

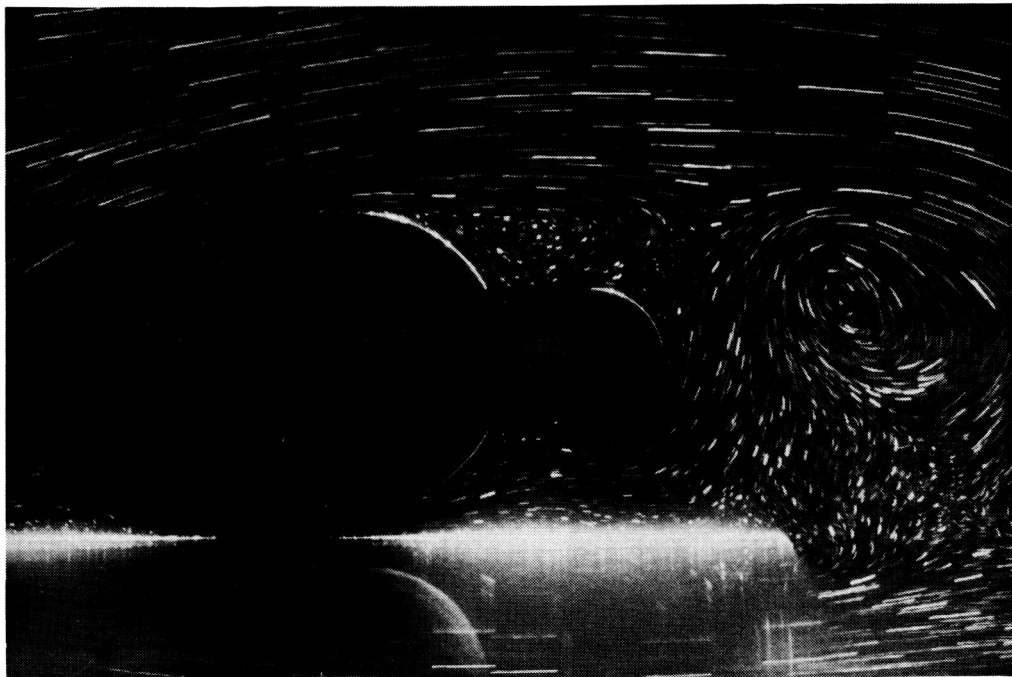

(d)

Figure 5. - Concluded. (c)  $\tau = 1.7$ ; (d)  $\tau = 2.5$ .

ORIGINAL PAGE IS  
OF POOR QUALITY.



(a)

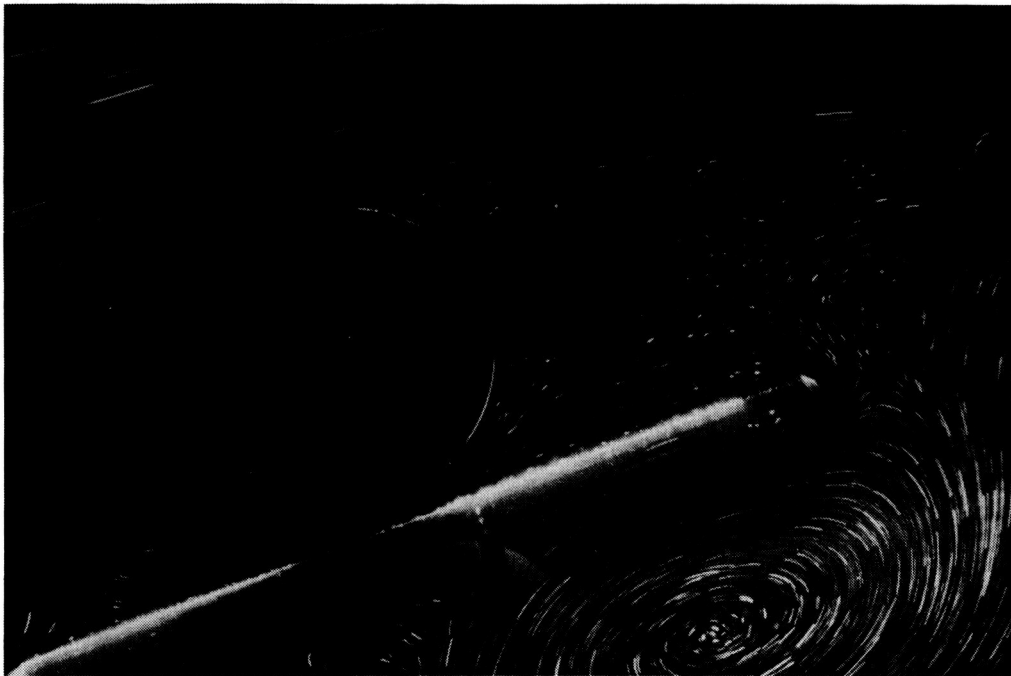

(b)

Figure 6. - Instantaneous streamlines of wake flow, 300° case: (a)  $\tau = 0$ ; (b)  $\tau = 0.85$ .

ORIGINAL PAGE IS  
OF POOR QUALITY

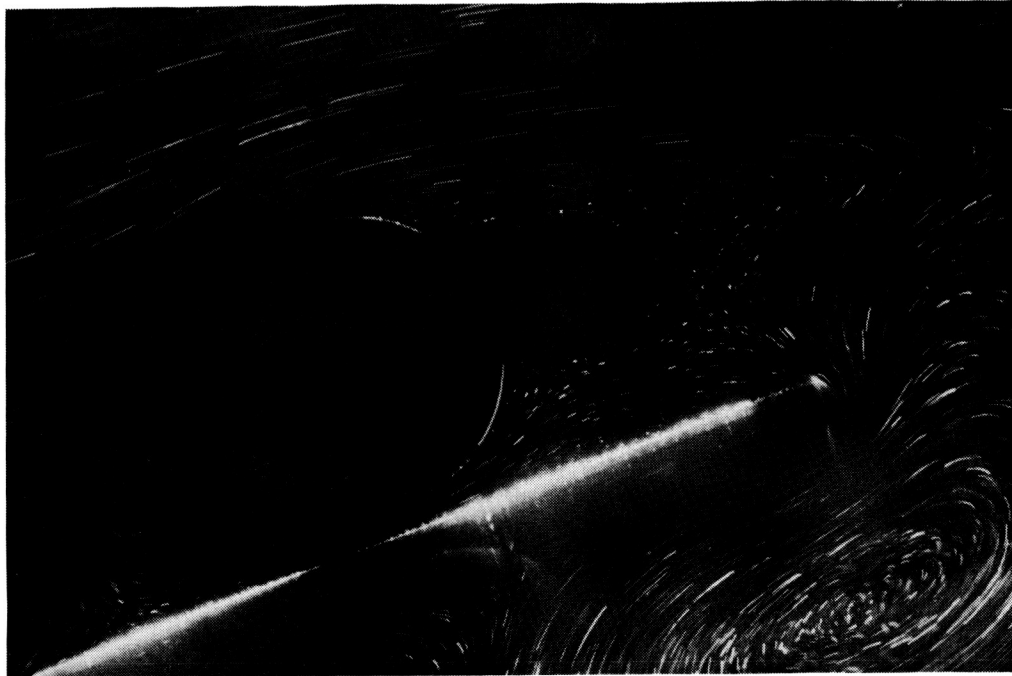

(c)

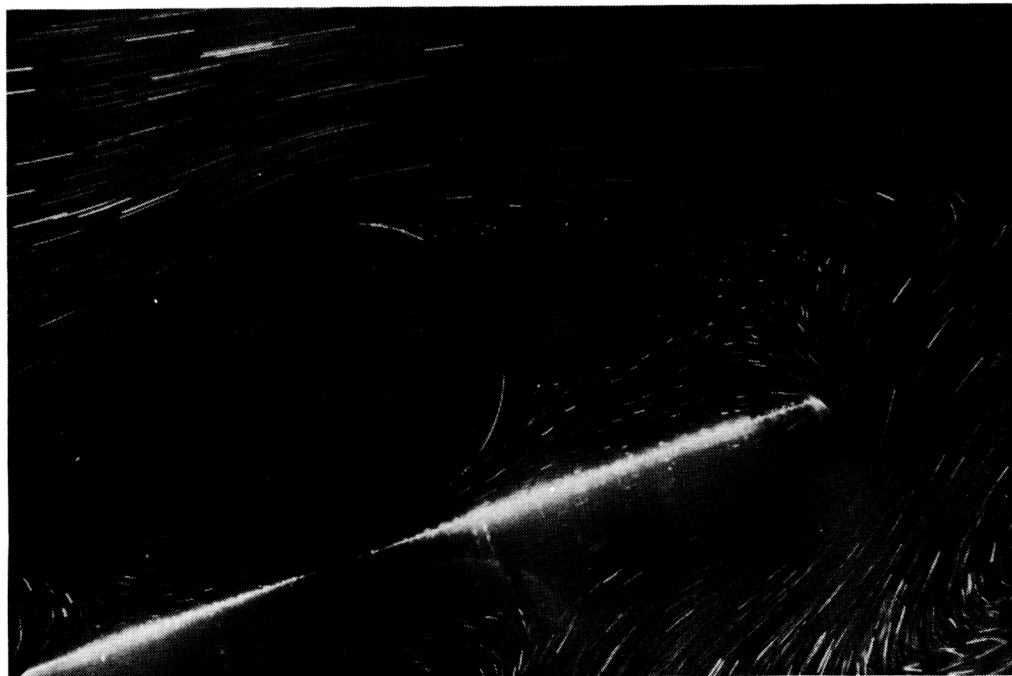

(d)

Figure 6. - Concluded. (c)  $\tau = 1.7$ ; (d)  $\tau = 2.5$ .

ORIGINAL PAGE IS  
OF POOR QUALITY





# Report Documentation Page

|   |  |   |  |   |                         |
|---|--|---|--|---|-------------------------|
| 1. Report No.<br><b>NASA TM-89440</b>   |  | 2. Government Accession No.                                 |  | 3. Recipient's Catalog No.  |                         |
| 4. Title and Subtitle<br><b>Flow Visualization Study of a Two-Dimensional Representation of the Space Shuttle Launch Pad Configuration</b>  |  |   |  | 5. Report Date<br><b>June 1987</b>  |                         |
|   |  |   |  | 6. Performing Organization Code   |                         |
| 7. Author(s)<br><b>B. G. McLachlan, G. G. Zilliac, and S. S. Davis</b>  |  |   |  | 8. Performing Organization Report No.<br><b>A-87151</b>   |                         |
|   |  |   |  | 10. Work Unit No.<br><b>505-60-31</b>   |                         |
| 9. Performing Organization Name and Address<br><b>Ames Research Center<br/>Moffett Field, CA 94035</b>  |  |   |  | 11. Contract or Grant No.   |                         |
|   |  |   |  | 13. Type of Report and Period Covered<br><b>Technical Memorandum</b>  |                         |
| 12. Sponsoring Agency Name and Address<br><b>National Aeronautics and Space Administration<br/>Washington, D.C. 20546</b>   |  |   |  | 14. Sponsoring Agency Code  |                         |
|   |  |   |  | 15. Supplementary Notes<br><b>Point of contact: B. G. McLachlan, Ames Research Center, MS 260-1, Moffett Field, CA 94035<br/>(415) 694-4142 or FTS 464-4142</b> |                         |
| 16. Abstract<br><p>The loss of the Space Shuttle Challenger was caused by the failure of the aft joint O-ring seals in its right solid rocket booster. It has been suggested by several sources that wind conditions, through a reduction in temperature of the right solid rocket booster caused by the wind blowing across the "cold" external tank, played a role in the O-ring failure. To check the plausibility of this "wind" theory, an experiment was carried out in a water towing tank to visualize the flow past a two-dimensional model representing a cross-section of the Space Shuttle launch configuration. The periodic formation of vortices was found to characterize the wake generated by the model. It is suggested that this organized motion in the flow is the dominant mechanism that accomplishes heat transfer from the external tank to the right solid rocket booster. Flow visualization results consisting of photographs that show instantaneous streamline patterns of the flow are presented.</p> |  |   |  |   |                         |
| 17. Key Words (Suggested by Author(s))<br><b>Space Shuttle<br/>Aerodynamic vortices</b>   |  |   | 18. Distribution Statement<br><b>Unclassified-Unlimited</b><br><br><b>Subject Category- 34</b> |   |                         |
| 19. Security Classif. (of this report)<br><b>Unclassified</b>   |  | 20. Security Classif. (of this page)<br><b>Unclassified</b> |  | 21. No. of pages<br><b>16</b>   | 22. Price<br><b>AO2</b> |