

LEWIS GRANT  
IN-32-CR

94530  
265?



**OPTIMIZATION OF ORBITAL ASSIGNMENT AND SPECIFICATION  
OF SERVICE AREAS IN SATELLITE COMMUNICATIONS**

**Cou-Way Wang  
Curt A. Levis  
O. Merih Buyukdura**

**The Ohio State University  
ElectroScience Laboratory**

**Department of Electrical Engineering  
Columbus, Ohio 43212**

**Technical Report 716548-7  
Contract NAG3-159  
February 1987**

**National Aeronautics and Space Administration  
Lewis Research Center  
21000 Brookpark Road  
Cleveland, Ohio 44135**

**(NASA-CR-181273) OPTIMIZATION OF ORBITAL  
ASSIGNMENT AND SPECIFICATION OF SERVICE  
AREAS IN SATELLITE COMMUNICATIONS (Ohio  
State Univ.) 265 p Avail: NTIS HC A12/MF  
A01**

**N87-27882**

**Unclas  
0094530**

**CSC 17B G3/32**

## NOTICES

When Government drawings, specifications, or other data are used for any purpose other than in connection with a definitely related Government procurement operation, the United States Government thereby incurs no responsibility nor any obligation whatsoever, and the fact that the Government may have formulated, furnished, or in any way supplied the said drawings, specifications, or other data, is not to be regarded by implication or otherwise as in any manner licensing the holder or any other person or corporation, or conveying any rights or permission to manufacture, use, or sell any patented invention that may in any way be related thereto.

<b>REPORT DOCUMENTATION PAGE</b>	<b>1. REPORT NO.</b>	<b>2.</b>	<b>3. Recipient's Accession No.</b>
<b>4. Title and Subtitle</b> Optimization of Orbital Assignment and Specification of Service Areas in Satellite Communications		<b>5. Report Date</b> February 1987	
<b>7. Author(s)</b> Cou-Way Wang, Curt A. Levis and O. Merih Buyukdura		<b>6.</b>	
<b>9. Performing Organization Name and Address</b> The Ohio State University ElectroScience Laboratory 1320 Kinnear Road Columbus, Ohio 43212		<b>8. Performing Organization Rept. No.</b> 716548-7	
<b>12. Sponsoring Organization Name and Address</b> National Aeronautics and Space Administration Lewis Research Center 21000 Brookpark Road, Cleveland, Ohio 44135		<b>10. Project/Task/Work Unit No.</b>	
		<b>11. Contract(C) or Grant(G) No</b> (C) (G) NAG3-159	
		<b>13. Type of Report &amp; Period Covered</b> Technical	
<b>15. Supplementary Notes</b>		<b>14.</b>	
<b>16. Abstract (Limit: 200 words)</b>  The mathematical nature of the orbital and frequency assignment problem for communications satellites is explored, and it is shown that choosing the correct permutations of the orbit locations and frequency assignments is an important step in arriving at values which satisfy the signal-quality requirements. Two methods are proposed to achieve better spectrum/orbit utilization. The first, called the $\Delta S$ concept, leads to orbital assignment solutions via either mixed-integer or restricted basis entry linear programming techniques; the method guarantees good single-entry carrier-to-interference ratio results. In the second, a basis for specifying service areas is proposed for the Fixed Satellite Service. It is suggested that service areas should be specified according to the communications-demand density in conjunction with the $\Delta S$ concept in order to enable the system planner to specify more satellites and provide more communications supply.			
<b>17. Document Analysis a. Descriptors</b>  Communication Satellites      Electromagnetic Interference Frequency Assignment      International Cooperation Orbit Spectrum Utilization			
<b>b. Identifiers/Open-Ended Terms</b>  Broadcast Satellite Service      Protection Ratio Fixed Satellite Service      Carrier/Interference Ratio Orbit/Frequency Assignment      Service Area Choices			
<b>c. COSATI Field/Group</b> 17B (Communications)			
<b>18. Availability Statement</b> A. Approved for public release; distribution is unlimited.		<b>19. Security Class (This Report)</b> Unclassified	<b>21. No. of Pages</b> 264
		<b>20. Security Class (This Page)</b> Unclassified	<b>22. Price</b>

## ACKNOWLEDGEMENT

This report constitutes the doctoral dissertation of Dr. Cou-Way Wang under the guidance of Prof. Curt A. Levis and Dr. O. Merih Buyukdura. The authors are greatly indebted to Profs. Charles H. Reilly and Clark A. Mount-Campbell and Mr. David J. Gonsalvez of the Department of Industrial and Systems Engineering for their ideas and many discussions relating to optimization in our joint pursuit of the objectives of this NASA Grant. We also are grateful to Ms. Ann Heyward and Dr. Edward F. Miller of the NASA Lewis Research Center for much useful information, advice, and criticism.

## TABLE OF CONTENTS

LIST OF TABLES	viii
LIST OF FIGURES	x
CHAPTER	PAGE
I. INTRODUCTION	1
II. DESCRIPTION OF PARAMETERS AND FACTORS IN C/I CALCULATIONS	10
A. Introduction	10
B. Satellite	11
C. Service area	13
D. Minimum elliptical beam	14
E. Antenna reference patterns and protection ratio	17
F. Received-power calculation	25
G. Signal quality requirement	33
III. THE OBJECTIVE FUNCTION OF THE EXTENDED-GRADIENT AND CYCLIC COORDINATE SEARCH METHODS	35
A. Introduction	35
B. General discussion of the gradient and cyclic-coordinate search methods and their objective function	36
1. Introduction	36
2. The gradient and cyclic-coordinate search methods	36
3. An objective function for satellite orbital/frequency assignments	39
4. Numerical exercise using the extended gradient search method	44
5. Numerical exercise using the cyclic coordinate search method	51
C. Empirical examination of the objective-function topography	51
1. The importance of the objective-function surface topography to the gradient and cyclic-coordinate search methods	51
2. Relation between variations of orbital/frequency separations and single-entry $C/I_e$ value	56

3.	Topographic features of the objective function	58
a)	Objective-function topography of three-satellite example, orbital variables only	58
b)	Objective-function topography of n-satellite case	68
c)	Possibility of one local minimum for a fixed permutation of orbital/frequency assignments	71
(1)	Introduction	71
(2)	Locations of global maximum and local minima of objective function	72
(3)	Topography of the worst single-entry C/I value	77
(4)	Numerical test	83
D.	Discussion and conclusion	84
IV.	OPTIMAL ORBITAL ASSIGNMENTS BY MEANS OF THE $\Delta S$ CONCEPT	86
A.	Introduction	86
B.	Relation between single-entry $C/I_e$ protection requirement and required satellite spacing	88
C.	Calculation of $\Delta s$ value	95
1.	Exact method	95
2.	Approximate method	97
3.	Validity of approximate method	103
4.	Relation between service-area adjacency and $\Delta s(1)$ value	104
D.	Relation between single-entry and total acceptable $C/I_e$ protection requirements	106
E.	Permutational aspect of the orbital-assignment problem	108
F.	Orbital assignment optimization formulations	111
1.	$\Delta s(1)$ constraint and objective function	111
2.	Mixed-integer and restricted-basis linear programming formulations	112
G.	Numerical examples	113
1.	Definition of the problem	113
2.	MIP and RBLP results	117
3.	Comparison between MIP and RBLP techniques	119
4.	Suggestions for future improvement	120
5.	Possible extensions of the method	123
H.	Conclusion and recommendation	124

V.	A SERVICE-AREA SPECIFICATION PROCEDURE	125
	A. Introduction	125
	B. Historical perspective	125
	1. service area assignment	125
	2. Insufficiency of communications supply from limited spectrum and orbit resources	127
	3. Relation between frequency re-use and service-area specification	131
	C. Service area specification by $\Delta S$ concept and communications-demand density	132
	1. Role of $\Delta S$ concept in service-area specification	132
	2. Role of communications-demand in service-area specification	133
	3. General consideration	134
	D. Application of service-area specification concept to a large administration or group of administrations	135
	1. General description	135
	2. Procedure of service-area specification and satellite assignment	136
	3. Traffic distribution between narrow-and wide-beam systems	138
	E. Numerical example	139
	1. Description of parameters	139
	2. Specifying four service areas according to $\Delta S$ consideration and traffic-demand density	146
	3. Improvement of traffic-supply matrix with service-area specification concept	156
	4. Discussion of numerical example	170
	F. Discussion and conclusion	171
VI.	CONCLUSION	173
APPENDICES		
A	STREAMLINED SOUP CODE	175
B	CONCAVE, QUASI-CONCAVE AND PSEUDO-CONCAVE FUNCTIONS	200
C	CONTOUR PLOTS OF OBJECTIVE-FUNCTION SURFACE	204

D	$\Delta S$ CALCULATION CODE	216
E	FORMULATIONS OF MIXED-INTEGER AND LINEAR PROGRAMS	225
	A. Algorithms	225
	B. Parameters and variables	227
	C. Formulation I	229
	D. Formulation II	231
	E. Formulation III	232
	F. Formulation IV	233
	G. Comparison between formulation III and IV	233
F	C/I CALCULATION OF MIXED INTEGER PROGRAM RESULT	237
	REFERENCES	244



## LIST OF TABLES

TABLE		PAGE
3.1	Test points of seven administrations	46
3.2	List of objective-function values	65
4.1	Example of $\Delta s(1)$ calculation procedure	99
4.2	$\Delta s(1)$ values of six South American administrations	101
4.3	C/I <sub>e</sub> results to show validity of approximate method	105
4.4	Satellite preferred locations of six administrations	116
4.5	$\Delta S$ parameters of six administrations	116
4.6	Mixed-integer and linear program results	118
5.1	U.S. domestic FSS communications demand in year 2000	128
5.2	Long distance telephone demand between top 28 cities in U.S. in year 2000	141
5.3	C/I results of two CONUS-beam satellites with 2.5-degree spacing	145
5.4	$\Delta S$ matrix of four regions	149
5.5	C/I results of collocating satellites serving East, West and South Central regions	150
5.6	C/I results of collocating satellites serving North Central, West and South Central regions	151
5.7	$\Delta s$ calculation for East and North Central regions	152
5.8	Telephone communications demand between major cities in four regions	154
5.9	Complete requirement matrix	155
5.10	Supply matrix without regional-beam satellites	157
5.11	Requirement matrix of four regions	159

	PAGE
5.12 Supply of regional beams to four regions	161
5.13 Percentage of satisfaction of demand by means of regional beams	162
5.14 Supply matrix adjustment	164
5.15 Supply matrix without regional beams	167
5.16 Supply matrix with regional beams	167
E.1 Satellite preferred locations of six administrations	234
E.2 $\Delta S$ parameters of six administrations	234
E.3 Mixed-integer and linear program results	236

## LIST OF FIGURES

FIGURE		PAGE
2.1	Minimum ellipse configuration	15
2.2	BSS satellite transmitting reference patterns	19
2.3	BSS ground receiving reference patterns	20
2.4	FSS satellite transmitting reference pattern	22
2.5	FSS ground receiving reference pattern	23
2.6	BSS frequency protection ratio	24
2.7	Configuration of received-power calculation	26
3.1	Geographic relation of seven South American administrations	45
3.2	Numerical example of the extended gradient search process	48
3.3	Numerical example of the cyclic coordinate search process	52
3.4	Configuration space of three-satellite case	60
3.5	Typical shape of objective function	62
3.6	Selected area to calculate objective-function value	64
3.7	Topography of objective function	66
3.8	Typical topography of objective function	67
3.9	Linear expansion of orbital assignments	75
3.10	Hypothetical case where two maxima occur in a linear trajectory	80
4.1	Configuration of received-power calculation	89
4.2	Configuration of $\Delta s(1)$ value calculation	96

	PAGE
4.3 Typical $\Delta s(1)$ value variation vs. mean satellite location	102
4.4 Geographic relation of four service areas	110
4.5 Geographic relation of six South American administrations	114
4.6 Satellite locations from mixed integer program result	122
5.1 Projected U.S. domestic FSS communications demand for the year 2000	129
5.2 Allocation of frequency channels in 6/4 GHz band	130
5.3 Locations of top 28 cities in U.S. with largest long-distance telephone demand in year 2000	144
5.4 Four selected regions with proper service-area separation and large communications demand	147
5.5 Possible beam arrangement for four regions	168
5.6 Possible communications distribution for four regions	169

## CHAPTER I

### INTRODUCTION

Since the launch of the first commercial communications satellite, the INTELSAT I, in April 1965, satellite communications have become more and more popular internationally [1,2,3]. Not only does the number of satellites continue to increase, but the demand for future satellite services is growing rapidly [3,4]. This situation creates a problem of how to provide enough satellite communications capacity to satisfy all the potential users. The study of this report is devoted to contributions toward solving this problem by developing methods that can efficiently utilize the spectrum and orbit resources.

The most popular satellite orbit for the civil communications services is the geostationary orbit [5,6]. The idea of using this orbit was proposed by Arthur C. Clarke [1]. However, the geostationary orbit can accommodate only a limited number of satellites for a given frequency channel because satellites that have the same frequency channel must be properly separated from one another in space for acceptable interference protection [6]. When the geostationary orbit is considered "crowded" with satellites, it is crowded in terms of electromagnetic compatibility. This requirement greatly limits the satellite capacity of the geostationary orbit.

A method of increasing the communications capacity is to increase the spectral band available for satellite communications use. The

spectral region of interest lies between the maximum usable frequency (MUF) for reflection by the ionosphere and the first oxygen absorption line (about 60 GHz) [7]. By international agreement, this spectral region is divided into many bands for various services, e.g., the broadcasting-satellite service (BSS), the fixed-satellite service (FSS), the military service, navigation, weather detection, etc [2,8]. As a result, only a limited number of spectral bands are available for the civil communications services.

As an example of the large demand for satellite communications, when the 11 to 12 GHz spectral band for civil satellite service was opened for use on an international basis, every administration requested some frequency channels [4]. Even those administrations that do not need, or cannot afford, a satellite at the present time requested channel assignments for future use. Therefore, lack of enough spectrum and orbit resources becomes a serious problem with regard to planning for future communications satellite traffic, i.e., orbital and frequency allocations.

The goal of the orbital and frequency planning task is to use the limited amount of resources to provide enough communications capacity to satisfy every potential user. The main concern of the planning task is to ensure that mutual interference between different satellite systems is acceptable; a poorly planned scenario would be likely to result in unacceptable carrier-to-interference ratios (C/I), and hence unacceptable signal quality, for at least some users. To avoid this, the satellite orbital locations and frequency channel allocations should

be carefully planned. This planning task becomes very difficult when the number of satellites and channels to be assigned becomes large.

Moreover, since the demand for present and future communications satellites is large, it is important to use the available spectrum and orbit resources efficiently. In other words, the objective is to achieve the maximum information-transfer capacity for the resources allocated.

In 1977, the spectral band 11.7 to 12.5 GHz was assigned to Region 1 and the band 11.7 to 12.2 GHz to regions 2 and 3 for the planning of the BSS. The administrations in Regions 1 and 3 completed the planning in the 1977 World Administrative Radio Conference (WARC-77) [9]. The plan was based generally on spacing the satellites uniformly at 6 degrees, when they are assigned the same frequency channel [10]. The administrations in Region 2 delayed the planning process in WARC-77, with the intention of making the most efficient use of the geostationary orbit and the spectral band [11,12]; then proposed a plan at the Regional Administrative Radio Conference in 1983 (RARC-83) [13,14]. Planning for the fixed-satellite communications service (FSS) has been deferred to conferences in 1988 or beyond. Therefore, a method is needed to solve the assignment problem in as near an optimal way with regard to this objective as possible.

Much work has been done on this problem. Several studies discuss some important factors that should be considered in the assignment problem. A study by D. J. Withers identifies three areas that should be exercised in order to achieve effective resource utilization [15]. The

first area is engineering for an interference-limited environment by properly using the antenna characteristics, signal modulation, and multiple-access techniques to minimize the interference power. The second area is effective inter-system coordination. It includes: 1) proper pairing of the up- and down-link bands, 2) a standard frequency translation between up- and down-link bands, 3) an agreed scale of permissible single-entry interference noise allocation, 4) maximization of the satellite service arc by easing the satellite elevation angle constraint. The third area is the reduction of inhomogeneity in orbit-spectrum sharing. Also in the Final Acts of the WARC-77, the importance of placing satellites as close as possible for efficient orbit utilization is expressed [16]: the satellite spacing should be small, while still keeping the mutual interference acceptable.

Some studies deal with the orbital assignment problem alone. A Japanese study tackles the problem of orbit utilization through a non-linear programming optimization procedure with the objective of minimizing the total orbital arc used for a scenario [17]. The basic approach is to relate the satellite geocentric angular separation to the interference power; the problem is formulated as a non-linear programming problem and the sequential unconstrained minimization technique is applied to solve it numerically. Another Japanese study modified the above program so that it can find the optimal orbital assignment for a new satellite when it is inserted into an existing scenario [18]. The result is optimal in the sense of finding the best location for the new satellite, while making some modification to the



existing scenario, such that the satellite separations or, equivalently, the interference powers still meet the requirements. The best location for inserting the new satellite is chosen so that the total orbital arc occupied by the final result is minimized. To carry out rigid planning of many satellites, an evolutionary model is used by repeatedly using the modified program to assign satellite locations one by one, and the ordering of insertion must first be chosen. It is not obvious, and appears unlikely, that the quality of the result is independent of this ordering.

Some studies deal with the frequency assignment problem alone. The methods of map-coloring and dot-linkage have been proposed to achieve the most conservational use of the spectrum resource [19,20,21,22]. A Japanese study tackles this problem by rearranging the frequency assignment of a given scenario that has an initial optimal orbital assignment [23]; e.g., orbital assignment is obtained from [17] with the frequency assignments assumed the same for all satellites. Therefore, in this Japanese study the frequency assignment, identified as a permutation problem, is handled independently of the orbital assignment; it is formulated as an integer program and the optimal permutation is obtained via the branch-and-bound method. When the new frequency assignments are made, the required satellite orbital separations may be reduced. The objective is the minimization of the total orbital arc occupied by the final scenario. Note that the combination of the two Japanese studies [17,23] becomes a complete package that solves the orbital and frequency assignments in two steps.

Some studies deal with both the orbital and frequency assignments. Some of these are aimed more at obtaining a better understanding of the problem than at actually solving it [24,25]. An application-oriented research group in Canada developed a software package for planning synthesis in connection with RARC-83 [26,27,28]. It is a multiple-stage process, and one of the objectives spelled out in the report is the minimization of the total orbital arc occupied by the scenario. First the minimum required orbital separations that meet the single-entry protection ratio are calculated for all pairs of satellites. These data are calculated in the following four cases: co-polarization and co-channel, co-polarization and adjacent channel, cross-polarization and co-channel, cross-polarization and adjacent channel. The initial scenario is an equal-spaced orbital assignment with co-channel, co-polarization frequency assignment. Then, the computer program can let the planner make changes both manually and automatically in the channel and/or polarization assignments, and manually in the orbital assignments. The program always produces a scenario, even if it turns out not to meet the required protection ratios. The result is a local optimum and not necessarily a global optimum.

Two methods have been proposed by a research group at the Ohio State University. The first method uses an extended gradient search technique to improve an existing scenario [29]. A sum of negative exponentials of the aggregate effective C/I ratios is used as the objective function to be minimized; therefore the procedure seeks to maximize the smallest of all such C/I ratios. The gradient direction of the objective function at the point representing the existing scenario

is calculated; then the objective function values at some discrete points along the negative of this direction are found. The point yielding the most favorable (minimum) objective function value is chosen as a new scenario to start another search process. The iterative process stops when a better scenario can not be found. The second method is called the cyclic coordinate search method [30]. In this method each orbital and frequency variable is varied in turn. Each time a set of points is examined, the point yielding the most favorable objective function value is selected as the new coordinate value for that variable. A cycle is completed when all the orbital and frequency variables have been varied once. The cyclic process is repeated with suitably adjusted step sizes until it reaches a solution where the improvement of C/I results halts. The detailed description of the two methods is given in Chapter III.

Transmission of a signal from the Earth terminal and its reception at a satellite constitutes an up-link; and transmission of a signal from a satellite and its reception at the Earth terminal constitutes a down-link. By international agreement, the up-link signals and the down-link signals are not in the same spectral band, so that the signals will not interfere with each other [31]. In this study only the regulation of the down-link traffic is considered. The up-link problem can be implemented similarly in another spectral band. Note that the above studies [17,26,27,28,29,30] also deal only with the down-link communications traffic regulation.

In Chapter II, some of the important factors and parameters involved in the carrier and interference power calculations are

discussed. Note that in this study an effective carrier-to-interference power ratio is used to evaluate the feasibility of a scenario; in Section II.F it will be shown that this is equivalent to the more usual margin calculation.

In Chapter III, the objective function to be minimized in the extended-gradient and cyclic-coordinate search techniques to improve a given scenario is analyzed [29]. It is shown that this function has large values when two (or more) orbital or frequency assignments are collocated; this indicates that both the signal quality requirement and the permutation of the orbital/frequency assignments need to be looked into in order to find the globally optimal scenario. Furthermore, some arguments are given which indicate that the objective function is likely to be a function with only one local minimum for a fixed permutation of orbital and frequency assignments; even though a definitive proof has eluded us, a set of numerical examples are presented which support these arguments. This suggests that a sufficient condition for obtaining the globally optimal solution by the extended-gradient search method is that it should terminate as an ordinary gradient search with the optimal permutation in orbital and frequency assignments.

In Chapter IV, a different approach, the  $\Delta S$  concept, is presented. It is shown that the single-entry C/I protection requirement is equivalent to a required minimum satellite separation; hence the highly non-linear C/I requirement can be viewed as constraints on the satellite locations. With this approach the orbital assignment can be formulated as a mixed-integer program and solved by the branch-and-bound method; or

it can be formulated as a linear program with non-linear side constraints and solved by a version of the simplex method for linear programming with restricted basis entry.

Chapter V intends to show that an important body of information for choosing FSS service areas is the communications-demand density. It is proposed that the service areas of an FSS system should be specified according to the communications-demand density in conjunction with the concept of small-beam design; the frequency re-use scheme can be implemented through small beams and well-separated service areas. A case study demonstrates that the communications supply for the United States could be significantly increased if the service areas are specified according to these principles. The  $\Delta S$  concept presented in Chapter IV is used in this case study.

## CHAPTER II

### DESCRIPTION OF PARAMETERS AND FACTORS IN C/I CALCULATIONS

#### A. INTRODUCTION

The feasibility of a scenario is evaluated according to the signal quality [32], which is usually expressed in terms of the signal-to-noise ratio (S/N) [33]. For instance, the unweighted signal quality requirement for 625-line, color-television signal is suggested to be a S/N ratio of 33 dB for 99% of the worst month [34]. The signal power (S) is measured in the baseband channel after modulation improvement and baseband processing [35,36]. For the purpose of planning the broadcasting-satellite service (BSS), the requirement is that the pre-detection carrier-to-noise ratio (C/N) at the receiver input should equal or exceed 14 dB for 99% of the worst month or 10 dB for 99.9% of the worst month [37,38].

The noise power includes the receiver thermal noise ( $N_t$ ) and all the interference powers from other communications systems [39]. In order that the interference powers from other communications systems will not further degrade the C/N level, the total (or aggregate) interference power level should be weak enough so that its contribution to the total noise power is negligible.

There are several criteria how weak the total interference power should be [40,41]; two which are commonly used are the interference-to-thermal noise ratio ( $I/N_t$ ) and the carrier-to-interference power ratio ( $C/I$ ) [40]. In this study the  $C/I$  criterion is used to evaluate the feasibility of a scenario, with a minor modification. Account must be taken of the fact that a given interference level at the same frequency as the desired carrier is more damaging than the same level of interference at a far removed frequency. This can be done by multiplying each interference power at a non-carrier frequency by a relative protection factor (less than unity) before adding the interference powers to obtain an effective ratio ( $C/I_e$ ). This is discussed in more detail in Section II.F, where it is also shown that this formulation is fully equivalent to the more usual, but less convenient, representation in terms of margins.

In the following sections some of the important factors and parameters involved in the  $C/I_e$  calculation are discussed.

## B. SATELLITE

A satellite is a relay terminal, its basic function is to receive signals from some Earth stations and to re-transmit them to other Earth stations. It has receiving and transmitting antennas, and a frequency translator [42,43] or, in some cases, more sophisticated signal-processing circuits which include frequency shifting.

A satellite may use any orbit to travel [2], but the geostationary orbit is the most popular orbit for civil communications. In this orbit

the satellite position is almost stationary with respect to any place on Earth; thus complicated satellite tracking systems at the Earth terminals may be avoided. This orbit is directly above the equator at a height of 37,165 kilometers above the Earth surface [2]. By international agreement this will be the main orbit for civil communications services [5,6]. Therefore, in this study only this orbit is considered.

Because the satellite is away from the Earth, it is possible to control its position and attitude only to a certain precision. A satellite drifts away from its designated orbital location and its position needs to be adjusted from time to time [44,45]. With present technology, a satellite orbital location may be maintained within 0.1 degree in the north-south and east-west directions, resulting in 0.14 degree of maximum excursion [44]. As for attitude control, the transmitting antenna pointing error may be kept within 0.1 degree, and the tolerance in the rotation about the beam axis is typically two degrees [44,45]. For the calculations of this report, the pointing error may be taken into account through the minimum elliptical beam calculation to be discussed in Section II.D, or through the antenna discrimination function to be discussed in Section II.E. The satellite rotational error may be taken into account through the minimum elliptical beam calculation to be discussed in Section II.D.



### C. SERVICE AREA

A service area is a designated area on the Earth surface to which a corresponding satellite directs its signals. Actually an antenna transmits its signal in all directions according to its pattern function, even though its target area is of limited size. By international agreement, a service area should be illuminated by its satellite main beam within the -3 dB contour of that beam [46,47]. This means that the received power density at any point in the service area should be within 3 dB of the power density at the antenna aim point.

For simplicity, a service area is represented by a set of test points at its boundary. To evaluate the  $C/I_e$  results of a scenario, one calculates the  $C/I_e$  values at all the test points of all the service areas, and compares them with the  $C/I_e$  requirement level. Because the interference is likely to be the worst on the service area boundaries, a scenario with satisfactory  $C/I_e$  values at all the test points should guarantee that the  $C/I_e$  values will be good at all the places inside all the service areas. The test points are also used to generate the minimum elliptical beam parameters to be discussed in Section II.D.

In this study a satellite and its corresponding service area(s) are viewed as a communications system. A service area may have several satellites, but all of these satellites are treated independently of one another.

#### D. MINIMUM ELLIPTICAL BEAM

The antenna main beam (-3 dB contour) of a satellite to its designated service area should be shaped, using available antenna technology, to fit the shape of the service area as suitably as possible [48]. However, a reference antenna pattern for shaped beams is still unavailable, i.e., there exists no internationally agreed method for predicting, for regulatory purposes, the discrimination to be expected from shaped beams outside their respective service areas. In order to analyze a scenario in terms of  $C/I_e$  results, the interference powers are therefore calculated by assuming that a service area is illuminated by a minimum elliptical beam from the satellite position that covers all the test points of that service area [47].

This minimum ellipse is specified by five parameters: the longitude and latitude of the beam aim point, the orientation angle, and the major- and minor-axis beam widths. In Figure 2.1, the aim point, which is on the Earth surface, is denoted as A. The antenna beam plane is a plane perpendicular to the satellite beam axis, SA, and passing through the aim point A. The vectors AM and AN denote the major and minor axes. The beam widths in the directions of these two axes, viewed from the satellite, are  $\psi_{max}$  and  $\psi_{min}$ , respectively. The orientation angle, which is not shown, is the angle measured anti-clockwise in the antenna beam plane from a line parallel to the equatorial plane to the major axis of the ellipse. The more detailed descriptions of these parameters can be found in a National Telecommunication and Information Administration (NTIA) document [49].

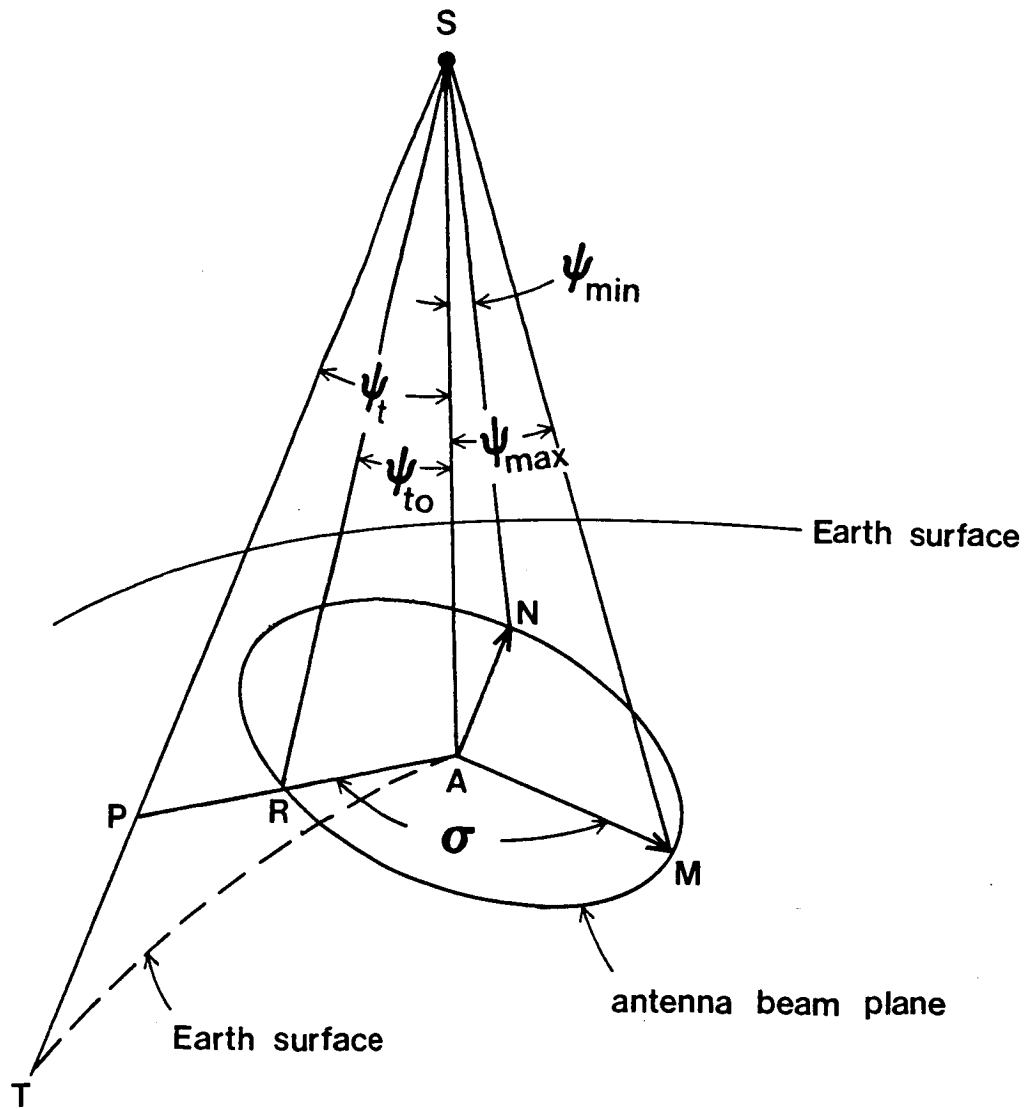

Figure 2.1. Minimum ellipse configuration.

To generate the ellipse data, one needs to specify the nominal satellite location and the locations of a set of test points; other parameters that can be specified are the minimum beam width, minimum elevation angle, satellite pointing error and rotational error. The resulting elliptical cone covers all the test points that are used to generate this ellipse; in a worst-case calculation that includes the specified satellite pointing error and rotational error. A computer program developed by Akima was used to generate the five ellipse parameters for the calculations of this report [49].

With these parameters, the half-power beam width (HPBW),  $\psi_{t0}$ , with respect to any test point, T, on the Earth surface can be calculated by means of a somewhat involved procedure. First the vector AP of Figure 2.1 is calculated, where P is the intersection of the line ST and the antenna beam plane. Then, the angle  $\sigma$  between the vector AP and the major axis AM is calculated. The length of AR is calculated from

$$AR = AM \cdot [\cos^2(\sigma) + A_r^2 \cdot \sin^2(\sigma)]^{-1/2}, \quad (2.1)$$

where  $A_r$ , called the axial ratio of the elliptical beam, is the ratio between AM and AN. Then it is assumed that the ratios between the angles  $\psi_{\max}$ ,  $\psi_{\min}$ ,  $\psi_{t0}$  and their corresponding arcs AM, AN, AR are the same; this is a very good approximation when the angles are not large. With this approximation, the angle  $\psi_{t0}$  is calculated from

$$\psi_{t0} = \psi_{\max} \cdot [\cos^2(\sigma) + A_r^2 \cdot \sin^2(\sigma)]^{-1/2}, \quad (2.2)$$

where  $A_r$  can be seen as the ratio between  $\psi_{\max}$  and  $\psi_{\min}$ .

The off-axis angle,  $\psi_t$ , toward the point T is calculated by the cosine law

$$\cos(\psi_t) = (ST^2 + SA^2 - AT^2)/(2 \cdot ST \cdot SA), \quad (2.3)$$

where ST, SA, AT denote distances in Figure 2.1.

The off-axis angle  $\psi_t$  and the corresponding HPBW  $\psi_{t0}$  will be used to calculate the directivity of the antenna toward the specific point, T. The antenna pattern envelopes used to calculate the directivity will be described in Section II.E.

The detailed description of all the parameters and the formulations of all the calculations can be found in the Spectrum Orbit Utilization Program (SOUP) manual [50]. A streamlined SOUP code is listed in Appendix A. It is much less complicated than the original SOUP code. The basic calculation is exactly the same, but with fewer options. For instance, the streamlined version does not consider propagation loss.

#### **E. ANTENNA REFERENCE PATTERNS AND PROTECTION RATIO**

Two sets of antenna reference patterns are used in the study. They are representations, adopted by the International Radio Consultative Committee (CCIR), of the envelopes of real antenna patterns. Their use therefore should result in a near worst-case interference power calculation. The first set includes the satellite transmitting antenna reference patterns and the ground receiving antenna reference patterns suggested in the International Radio Consultative Committee Conference

Preparatory Meeting in 1982 (CCIR-CPM-82) for the Regional Administration Radio Conference for Region 2 in 1983 (RARC-83) [10,51,52]. These are the BSS patterns. The gain, G, of the transmitting antenna is calculated from [53,54]

$$G = e \cdot [(\pi/\psi_{\max})/(180/223)]^2 \cdot A_r , \quad (2.4)$$

where the symbols mean

- e : the beam efficiency, taken as 0.6 in this study,
- $\psi_{\max}$  : the beam width of the major axis, in radians,
- $A_r$  : the axial ratio of the elliptical beam.

The ground receiving antenna gain in the BSS calculations is taken as 40.2 dB, corresponding to a circular-beam antenna of 1-meter diameter, 12 GHz carrier frequency and 0.6 beam efficiency. The reference patterns are shown in Figures 2.2 and 2.3, and are used in the calculation of the objective function values in Chapter III.

In Figures 2.2 and 2.3, both the transmitting and receiving antennas have two reference patterns with mutually orthogonal polarizations. The transmitting antenna transmits signals of the designated polarization according to the co-polarization pattern, at the same time it also transmits orthogonally polarized signals according to the cross-polarization pattern. The receiving antenna receives the wanted signals according to the co-polarization pattern by aligning its polarization parallel to that of the wanted signal. Any signal that is co-polarized with the wanted signal is received according to the

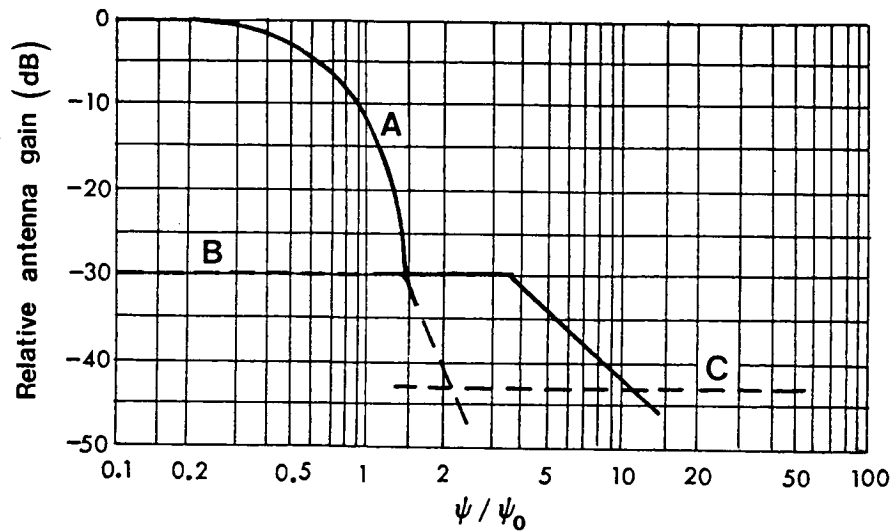

A: co-polar component (dB)

$$\begin{aligned}
 & -12(\psi/\psi_0)^2 && \text{for } 0 < \psi/\psi_0 < 1.58 \\
 & -30 && \text{for } 1.58 < \psi/\psi_0 < 3.16 \\
 & -17.5 - 25 \cdot \log(\psi/\psi_0) && \text{for } 3.16 < \psi/\psi_0 \\
 & \text{after intersection with curve C: as curve C}
 \end{aligned}$$

B: cross-polar component (dB)

$$\begin{aligned}
 & -30 && \text{for } 0 < \psi/\psi_0 < 1.56 \\
 & -40 - 40 \cdot \log[(\psi/\psi_0) - 1] && \text{for } 1.56 < \psi/\psi_0 \\
 & \text{after intersection with curve C: as curve C}
 \end{aligned}$$

C: minus the on-axis gain (dB), ( $G=42.5$  dB in this illustration)  
 $\psi$  : off-axis angle  
 $\psi_0$  : half-power beam width

Figure 2.2. BSS satellite transmitting reference patterns.

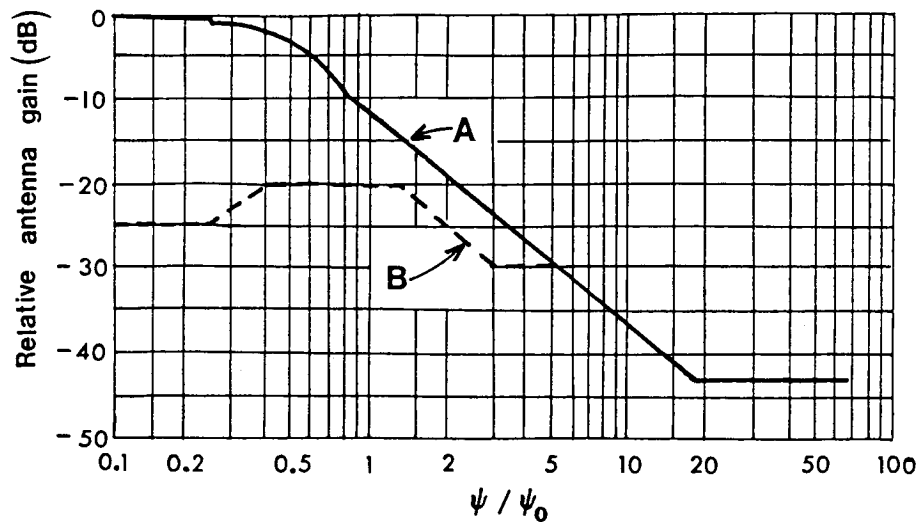

A: co-polar component without side-lobe suppression (dB)

0	for	$\psi/\psi_0 < 0.25$
$-12(\psi/\psi_0)^2$	for	$0.25 < \psi/\psi_0 < 0.94$
$-11.3 - 25 \cdot \log(\psi/\psi_0)$	for	$0.94 < \psi/\psi_0 < 18.88$
-43.2dB (-3dBi)	for	$18.88 < \psi/\psi_0$

B: cross-polar component (dB)

-25	for	$0 < \psi/\psi_0 < 0.25$
$-30 - 40 \cdot \log[1 - \log(\psi/\psi_0)]$	for	$0.25 < \psi/\psi_0 < 0.44$
-20	for	$0.44 < \psi/\psi_0 < 1.28$
$-17.3 - 25 \cdot \log(\psi/\psi_0)$	for	$1.28 < \psi/\psi_0 < 3.22$
-30 until intersection with co-polar component curve; then as for co-polar component		

$\psi$  : off-axis angle,

$\psi_0$  : half-power beam width

Half-power beam width = 1.8 degrees

Nominal on axis gain = 40.2 dB

Flat portion for  $\psi/\psi_0$  less than 0.25 takes account the antenna pointing error

Figure 2.3. BSS ground receiving reference patterns.



co-polarization pattern, and any signal that is cross-polarized with the wanted signal is received according to the cross-polarization pattern. These unwanted signals constitute the interference power at the receiver input.

In the second set of reference antenna patterns, intended for the fixed-satellite service (FSS) calculations, the satellite transmitting antenna reference pattern given in Figure 2.4 is a modified version of the fast fall-off reference pattern from CCIR-CPM-82/RARC-83 [55]. This modified reference pattern had been suggested as useful for the FSS systems [56,57]. The transmitting antenna gain is again calculated from Equation (2.4). The ground receiving antenna reference pattern, shown in Figure 2.5, is a modified version of the reference pattern from the International Radio Consultative Committee (CCIR-82) Report 391-4 [58]. The modification is suggested in a CCIR-82 Recommendation and in the CCIR-CPM-82/RARC-83 Report [59,60], and should become the standard in the year 1987. The receiving antenna gain is 43.2 dB, corresponding to a circular-beam antenna of 4.5-meter diameter, 4 GHz carrier frequency and 0.6 beam efficiency. Note that there is no cross-polarization pattern in Figure 2.4 because such a pattern has not been adopted by the international committee.

The relative protection ratio,  $PR(\text{dB})-PR_0(\text{dB})$ , used in Chapter III is taken from a CCIR-CPM-82 Report [61] and is shown in Figure 2.6. The value of  $PR_0$  is the co-channel protection ratio; the value of the actual protection ratio  $PR(\text{dB})-PR_0(\text{dB})$  depends on the carrier frequency offset between the wanted and unwanted signals as well as on the modulation

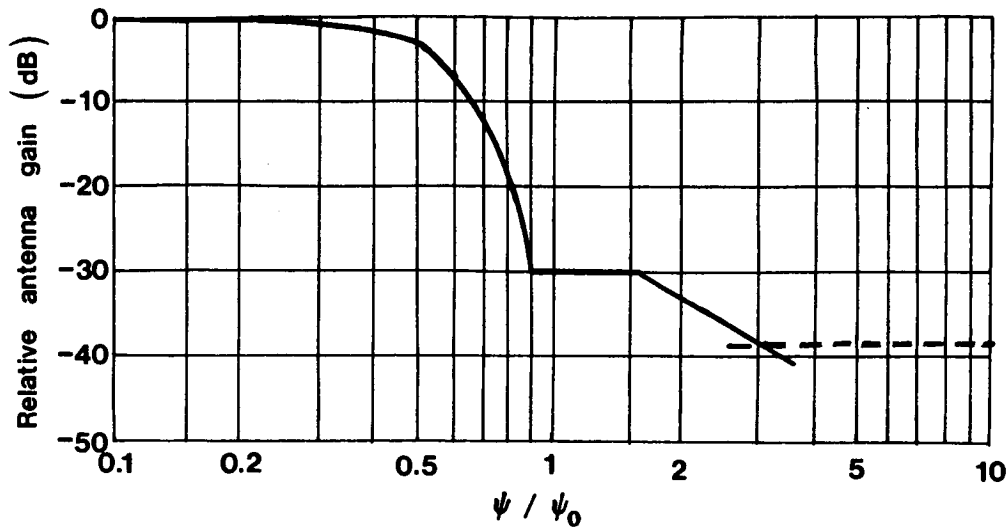

relative gain below on-axis gain (dB)

$$\begin{aligned}
 & -12(\psi/\psi_0)^2 && \text{for } 0 < \psi/\psi_0 < 0.5 \\
 & -18.75 \cdot \psi_0^2 \cdot [(\psi/\psi_0) - \alpha]^2 && \text{for } (0.4/\psi_0) + \alpha < \psi/\psi_0 < (1.265/\psi_0) + \alpha \\
 & -30 && \text{for } (1.265/\psi_0) + \alpha < \psi/\psi_0 < 1.585 \\
 & -24 - 30 \cdot \log(\psi/\psi_0) && \text{for } 1.585 < \psi/\psi_0 \\
 & \text{after intersection with } -G: \text{ as } -G
 \end{aligned}$$

$\psi$  : off-axis angle

$\psi_0$  : half-power beam width

$\alpha$  : by definition:  $\alpha = 0.5[1 - (0.8/\psi_0)]$

$G$  : on-axis gain

In the figure,  $G = 38.8$  dB,  $\psi_0 = 2$  degrees.

Figure 2.4. FSS satellite transmitting reference pattern.

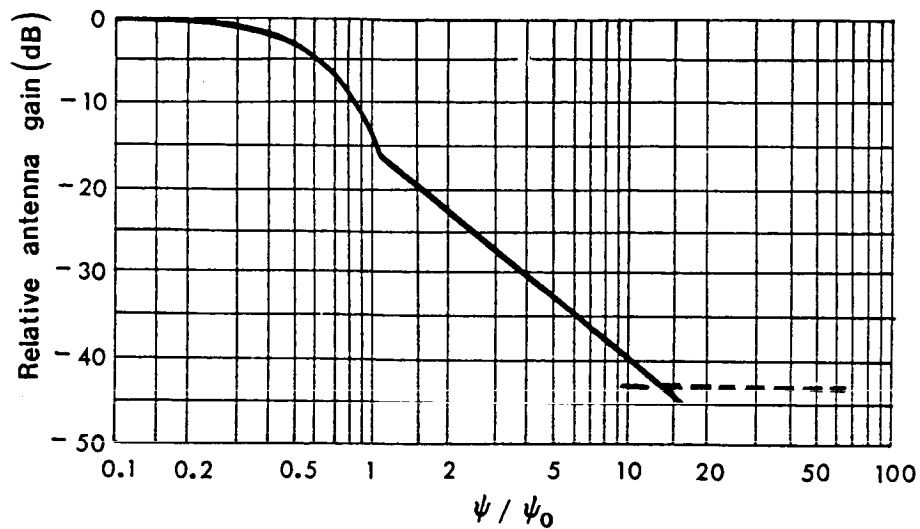

relative gain below on axis gain (dB)

$$\begin{array}{ll}
 -12(\psi/\psi_0)^2 & \text{for } 0 < \psi < \psi_1 \\
 (29-G)-25 \cdot \log(\psi) & \text{for } \psi_1 < \psi \\
 \text{after intersection with } -G-10: & \text{as } -G-10
 \end{array}$$

$\psi$  : off-axis angle  
 $\psi_0$  : half-power beam width  
 $G$  : on-axis gain  
 Half-power beam width = 1.17 degrees  
 $G$  : 43.2 dB

Figure 2.5. FSS ground receiving reference pattern.

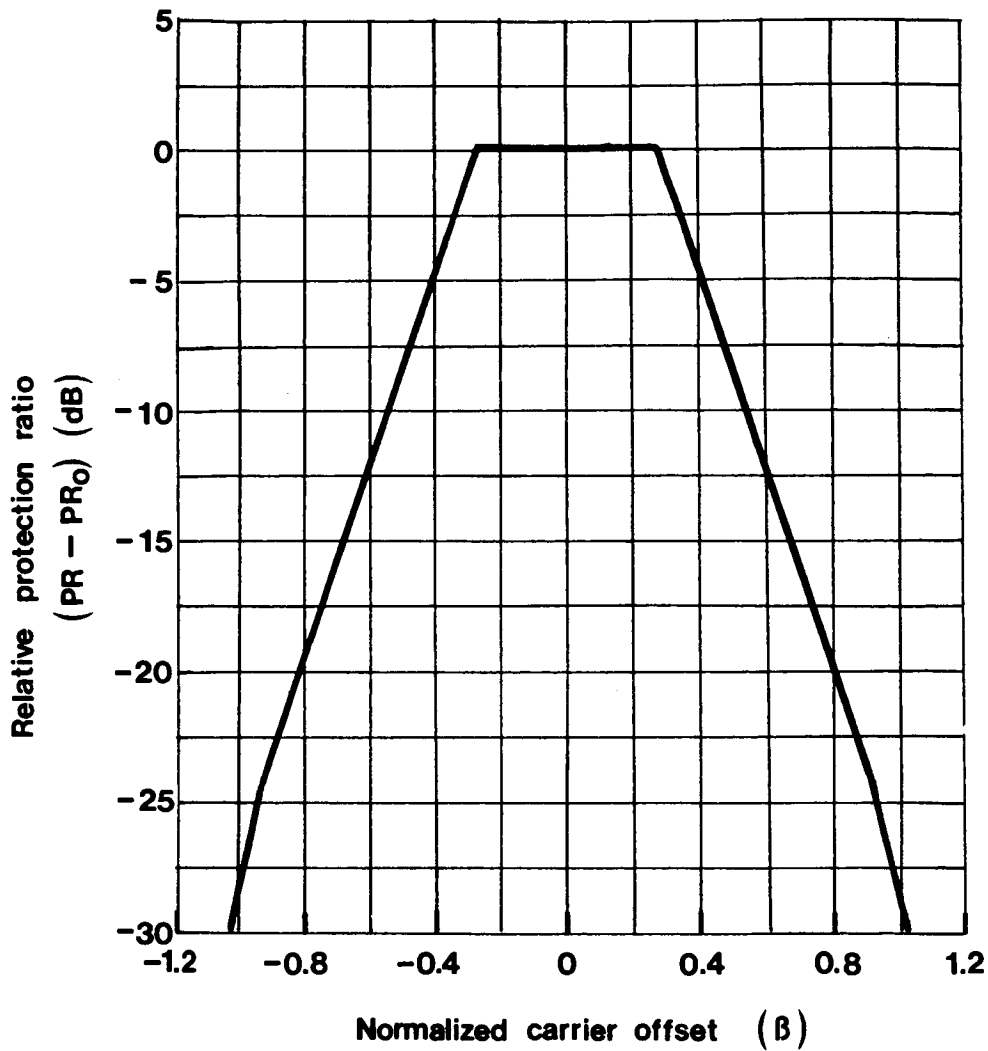

PR-PR<sub>0</sub> : relative protection ratio (dB)

$$\begin{array}{ll}
 0 & \text{for } |\beta| < 0.274 \\
 -35.6(|\beta| - 0.274) & \text{for } 0.274 < |\beta| < 0.92 \\
 -23.71(|\beta| - 0.92) & \text{for } 0.92 < |\beta|
 \end{array}$$

PR<sub>0</sub>: co-channel protection ratio  
 β : normalized frequency offset unit  
 = (f<sub>unwanted</sub> - f<sub>wanted</sub>) / (Carson's bandwidth)

Figure 2.6. BSS frequency protection ratio.

method of the signals [62]. The Carson bandwidth will be taken as 25.2 MHz, which is appropriate for the BSS TV/FM case.

#### F. RECEIVED-POWER CALCULATION

Refer to Figure 2.7 for the geometry, but note that the radius of the Earth relative to that of the geostationary orbit is exaggerated greatly for clarity. In this figure, the satellites assigned to service areas A, B are designated  $S_A$ ,  $S_B$ , respectively. The aim points of  $S_A$ ,  $S_B$  are the points a, b. The point d is one of the test points in A. The test points are normally chosen on the boundary of their service areas because interference is likely to be the worst there. The minimum ellipses of A, B from  $S_A$ ,  $S_B$  are labeled E(A), E(B). For the test point d, the off-axis angle of the  $S_A$  signal and the corresponding HRPBW in the direction toward d are  $\psi_{tc}$ ,  $\psi_{tco}$ ; the subscript c is meant as a mnemonic for carrier. The distance from  $S_A$  to d is x. These values are used to calculate the carrier power received from  $S_A$  at d. Also, for test point d, the off-axis angle of the  $S_B$  signal and the corresponding HRPBW are designated  $\psi_{ti}$ ,  $\psi_{tio}$ , respectively. Since the receiving antenna at the test point d is pointed at  $S_A$ , its off-axis angle toward  $S_B$  is  $\psi_{ri}$ . The distance from  $S_B$  to d is y. These values are used to calculate the interference power received from  $S_B$  at d.

Referring to Figure 2.7, the carrier power, C, at d is calculated by means of the Friis transmission equation [63,64]:

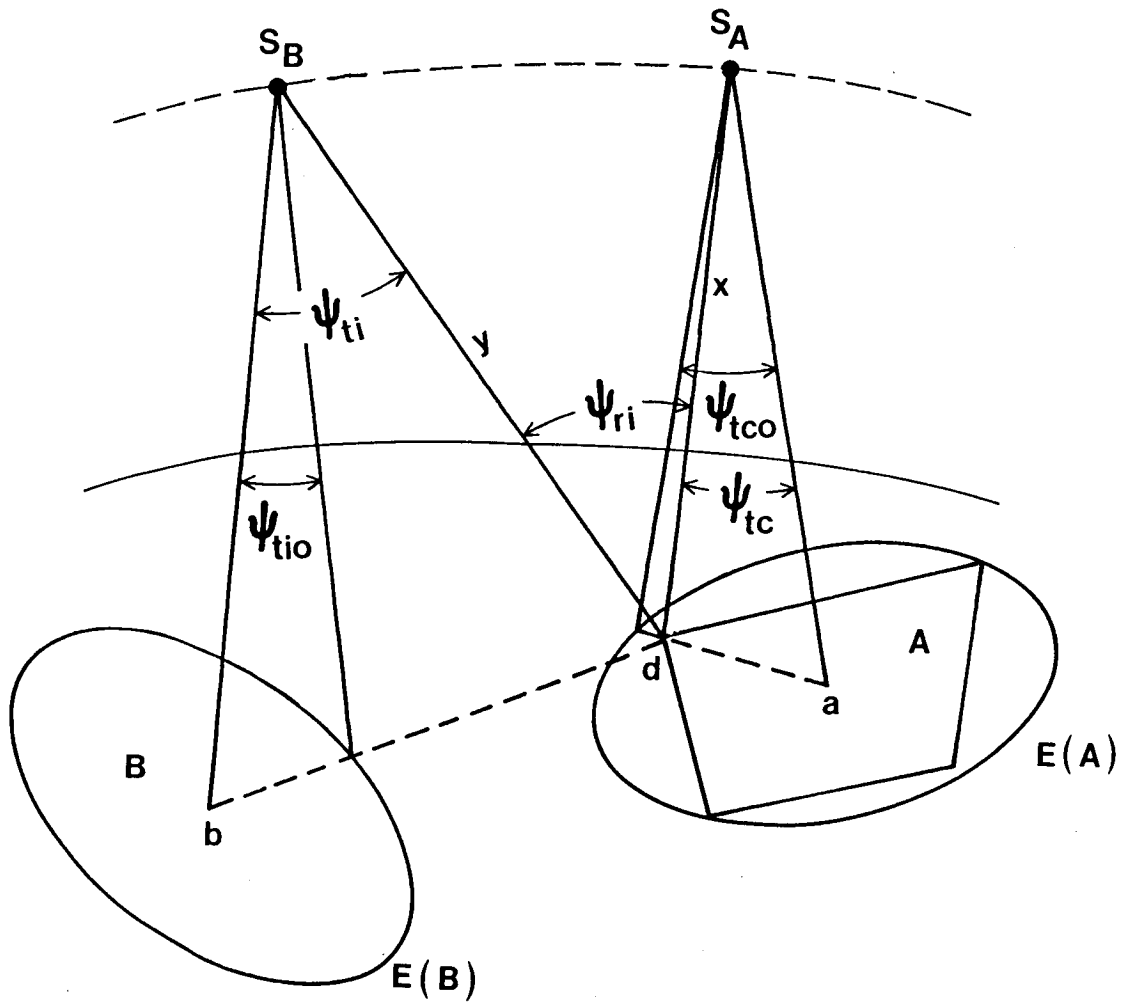

Figure 2.7. Configuration of received-power calculation.

$$C = \frac{P_A \cdot G_A \cdot D_A(\psi_{tc}) \cdot G_d \cdot c^2}{f_A^2 \cdot (4\pi)^2 \cdot x^2} \quad (2.5)$$

where the symbols mean

$P_A$  : the transmitting power of  $S_A$ ,

$G_A$  : the transmitting antenna gain of  $S_A$ ,

$D_A$  : the co-polarization transmitting antenna discrimination from  $S_A$  in the direction toward  $d$ ,

$G_d$  : the receiving antenna gain at  $d$ ,

$c$  : the velocity of light,

$f_A$  : the carrier frequency.

In Chapter III, the effective isotropic radiated powers are assumed constant for all the satellites. In Chapters IV and V, it is assumed that the carrier power densities at the aim points are equal for all the service areas [65]; therefore, all the satellite transmitting powers are adjusted to meet this requirement.

The interference power received at  $d$  must be calculated with care because there may be a polarization mismatch between the wanted and unwanted signals. Both of the orthogonally polarized signals transmitted from  $S_B$  must be decomposed into two components, one that is parallel to the wanted signal of the receiver and the other that is orthogonal. With the proper choice of the antenna reference patterns, the received interference power from each component is calculated from

$$I = \frac{P_B \cdot G_B \cdot D_B(\psi_{ti}) \cdot G_d \cdot D_d(\psi_{ri}) \cdot c^2}{f_B^2 \cdot (4\pi)^2 \cdot y^2} \quad (2.6)$$

where the symbols mean

$P_B$  : the transmitting power of  $S_B$ ,

$G_B$  : the transmitting antenna gain of  $S_B$ ,

$D_B$  : the transmitting discrimination from  $S_B$  to  $d$ ,

$G_d$  : the receiving antenna gain at  $d$ ,

$D_d$  : the receiving antenna discrimination from  $d$  in the  
direction toward  $S_B$  when the antenna is pointed at  $S_A$ ,

$f_B$  : the interference frequency.

The total interference power is the summation of all the components.

For instance when the signals of  $S_A$  and  $S_B$  are co-polarized, the

received interference power at  $d$  from  $S_B$  is calculated from [64,66]

$$I_{cp} = I_{tc,rc} + I_{tx,rx} + (I_{tc,rx} + I_{tx,rc}) \cdot D_x, \quad (2.7a)$$

when they are cross-polarized, the received interference power is

calculated from

$$I_{xp} = I_{tc,rx} + I_{tx,rc} + (I_{tc,rc} + I_{tx,rx}) \cdot D_x. \quad (2.7b)$$

Here the subscripts mean

cp : wanted and unwanted signals are co-polarized,

xp : wanted and unwanted signals are cross-polarized,

tc : signal transmitted according to the co-polarized reference  
pattern,

tx : signal transmitted according to the cross-polarized  
reference pattern,

rc : signal received according to the co-polarized reference  
pattern,



rx : signal received according to the cross-polarized reference pattern.

The term  $\Omega_x$  is the rain depolarization factor [66,67]. Since the propagation effect is not considered in this report, the term  $\Omega_x$  is taken to be zero. Also, Equation (2.7a) is further simplified as

$$I_{cp} = I_{tc,rc} \quad , \quad (2.7c)$$

because the cross-polarization component, which arises from the cross-polarized patterns of both the transmitting and receiving antennas, is negligible compared to the co-polarization component. Finally it should be noted that Equation (2.7b) is an approximation. In an actual case, these terms should add as phasors, not in a power sense; but to perform that calculation the relative phases of the tc, tx patterns and that of the rc, rx patterns would have to be known. So, without the term  $\Omega_x$ , a worst-case formula would be

$$I_{xp} = (\sqrt{I_{tc,rx}} + \sqrt{I_{tx,rc}})^2 \quad . \quad (2.7d)$$

When the carrier frequencies of the wanted and unwanted signals are different, a frequency filtering factor must be included in the effective interference power calculation. The proper expression for such a filtering factor can be easily obtained as follows. When evaluating the effect of the unwanted signal, the usual procedure is to calculate a term called the protection margin  $M_i$  from

$$M_i(\text{dB}) = (C/I_i)(\text{dB}) - PR_i(\text{dB}), \quad (2.8)$$

where the symbols mean

$i$  : index of frequency channel of the wanted signal,

$I_i$  : total interference power in channel  $i$ ,

$PR_i$  : protection ratio against interference power in channel  $i$ .

The interference power is acceptable when the value of  $M_i(\text{dB})$  is positive. (When there are several interference signals of the same carrier frequency, their total interference power is obtained by decomposing every polarized signal into parallel and orthogonal components with respect to the wanted signal, then calculating each interference power and summing them, as discussed above.) When there are several unwanted signals of different carrier frequencies, the equivalent protection margin,  $M$ , that evaluates the over-all effect of the interference power is calculated from [68,69]

$$M(\text{dB}) = -10 \cdot \log \left[ \sum_i 10^{-M_i(\text{dB})/10} \right], \quad (2.9)$$

where each term  $M_i$  is the protection margin in one frequency channel, and the summation is over all frequency channels. Equation (2.9) can be re-written as

$$\begin{aligned}
M(\text{dB}) &= -10 \cdot \log \left( \sum_i 10^{-\{(C/I_i)(\text{dB}) - PR_i(\text{dB})\}/10} \right) \\
&= -10 \cdot \log \left( \sum_i 10^{-\{(C/I_i)(\text{dB}) - [PR_i(\text{dB}) - PR_0(\text{dB})]\}/10} \cdot 10^{PR_0(\text{dB})/10} \right) \\
&= -10 \cdot \log \left( \sum_i 10^{-\{(C/I_i)(\text{dB}) - [PR_i(\text{dB}) - PR_0(\text{dB})]\}/10} \right) - PR_0(\text{dB}) \\
&= C(\text{dB}) - 10 \cdot \log \left( \sum_i 10^{\{I_i(\text{dB}) + [PR_i(\text{dB}) - PR_0(\text{dB})]\}/10} \right) - PR_0(\text{dB})
\end{aligned} \tag{2.10}$$

If the equivalent total, or aggregate effective interference power,  $I_e$ , is defined from the expression of the equivalent protection margin,  $M$ , as

$$\begin{aligned}
M(\text{dB}) &= (C/I_e)(\text{dB}) - PR_0(\text{dB}) \\
&= C(\text{dB}) - I_e(\text{dB}) - PR_0(\text{dB}) \quad ,
\end{aligned} \tag{2.11}$$

then the equivalent aggregate interference power can be expressed as

$$I_e(\text{dB}) = 10 \cdot \log \left( \sum_i 10^{\{I_i(\text{dB}) + [PR_i(\text{dB}) - PR_0(\text{dB})]\}/10} \right) \tag{2.12}$$

Therefore, the quantity  $[PR_i(\text{dB}) - PR_0(\text{dB})]$ , which is the relative protection ratio in Figure 2.6, can be interpreted as a filtering factor operating on the interference power when the carrier frequencies of the wanted and unwanted signals are different, and denoted as

$F(f_{\text{wanted}}, f_{\text{unwanted}})(\text{dB})$ . This approach will be taken throughout Chapter III. For a scenario of many satellites and where each satellite has many frequency channels, the aggregate effective interference power,

$I_{knj}^e$ , received in channel n at test point j in service area k is calculated from a power summation of terms of the type given in Equation (2.12),

$$I_{knj}^e \text{ (dB)} = 10 \cdot \log \left\{ \sum_{i \in K/k} \sum_{m \in N_i} 10^{[I_{im,knj} \text{ (dB)} + F(f_n, f_m) \text{ (dB)}] / 10} + \sum_{m \in N_k/n} 10^{[I_{km,knj} \text{ (dB)} + F(f_n, f_m) \text{ (dB)}] / 10} \right\} \quad (2.13a)$$

or

$$I_{knj}^e = \sum_{i \in K/k} \sum_{m \in N_i} I_{im,knj} F(f_n, f_m) + \sum_{m \in N_k/n} I_{km,knj} F(f_n, f_m) \quad (2.13b)$$

where the symbols mean

- $K/k$  : the index set of all the satellites, excluding satellite  $S_k$ ,
- $N_i$  : the index set of all the channels assigned to satellite  $i$ ,
- $I_{im,knj}$  : the single-entry interference power from channel  $m$  of  $S_i$ , received at channel  $n$  of test point  $j$  in service area  $k$ ,
- $F(f_n, f_m)$  : the relative protection ratio between the carrier frequency  $f_n$  and interference frequency  $f_m$ , as shown in Figure 2.6.

The aggregate  $(C/I_e)$  value in a channel at test point  $d$  is obtained by calculating the values of  $C$  using Equation (2.5) and  $I_e$  using Equation (2.13b) and dividing.

## G. SIGNAL QUALITY REQUIREMENT

When the signal quality requirement is stated as "S/N be no less than 30 dB for 99% of the worst month" [38], the main concern is to obtain satisfactory performance except during rare, large attenuation of signals due to heavy rains [70]. The prediction of statistical rain rate distributions as a function of geography will not be addressed in this study. In this study the carrier and interference powers are calculated without considering atmospheric absorption and rain attenuation. As for the assumption that the carrier power densities are the same at all satellite antenna aim points, the satellite transmitting powers can be adjusted to allow for these propagation effects so that the power density requirements are still satisfied; but this has not been done in the calculations which will be presented.

Most satellites function as a repeater [71]: they receive a signal, change the signal carrier frequency, and transmit it back to Earth. In such a design, any interference power generated on the up-link remains in the signal when re-transmitted in the down-link [72]. In this study, only the interference power generated in the down-link is considered; any interference power from the up-link is not included in the calculation. For BSS, it has been proposed in international telecommunication meetings that the  $C/I_e$  requirement value in the up-link be 10 dB higher (better) than that of the down-link [73,74,75]. Therefore for the BSS the interference power in the up-link should make an insignificant contribution to the overall interference power, and can be neglected. For FSS, the  $C/I_e$  requirement values for the up- and down-links may not differ much [76,77]. Therefore for the FSS case the

$C/I_e$  requirement value for each half link must be specified with care so that the total interference power does not degrade the signal quality excessively.

In evaluating the feasibility of a scenario, first one calculates the  $C/I_e$  values at all the test points; then compares them with the pre-determined  $C/I_e$  requirement value. A scenario is said to be good when all the resulting  $C/I_e$  values exceed the requirement value [78,79]. In Chapter III, a  $C/I_e$  requirement value of 30 dB will be used to evaluate the quality of the extended gradient search results; the precise required value depends on the modulations, but 30 dB is typical [78]. In Chapter IV, the requirement value is arbitrarily set at 25 dB in the numerical calculation; the precise value is relatively unimportant because the main goal of the numerical calculations in Chapter IV is to demonstrate the feasibility of the method. In Chapter V, the requirement value is set at 20 dB in the numerical calculation, where the U.S. is used as a case study, for the following reason. For the U.S. domestic satellite systems in the 6/4 GHz band, four-degree spacing between two satellites was used initially to regulate the orbital assignments. However, in order to better utilize the orbit resource, the Federal Communication Commission (FCC) has decided to adopt two-degree spacing in the satellite planning task in the 6/4 GHz band, to be effective beginning in 1987 [80]. Since the method proposed in Chapter V is not meant only for the U.S., the  $C/I_e$  requirement is set at 20 dB in the numerical calculations so that it could appear more reasonable on the international basis, and would be compatible with the assumed antenna parameters, as discussed in Section V.E.1.

**CHAPTER III**  
**THE OBJECTIVE FUNCTION OF THE EXTENDED-GRADIENT AND**  
**CYCLIC-COORDINATE SEARCH METHODS**

**A. INTRODUCTION**

The main purpose of the study in this chapter is to explore the mathematical nature of the orbital/frequency assignment problem by investigating an objective function used in the extended-gradient and cyclic-coordinate search methods to solve the satellite planning problem. It is shown that in order to find the global optimum solution one must deal with both the permutation of the orbital/frequency assignments and the signal quality requirement, e.g., the C/I ratio, in the optimization process. It is also shown that for a given set of scenarios with fixed orbital permutation (frequencies fixed) the function defined by the smallest single-entry C/I value has at most one local maximum. This strongly suggests that the objective function has only one local minimum for a given orbital permutation, as supported by some numerical evidence; this indicates that the extended gradient search process is highly likely to find the global optimal solution if it terminates as an ordinary gradient search with optimal orbital/frequency permutation.

## **B. GENERAL DISCUSSION OF THE GRADIENT AND CYCLIC-COORDINATE SEARCH METHODS AND THEIR OBJECTIVE FUNCTIONS**

### **1. Introduction**

The purpose of including this section is to introduce the basic principles of the gradient and cyclic-coordinate search methods, and to demonstrate how they perform for a particular objective function. Using the gradient search method for the assignment problem was proposed by Professor Clarence H. Martin of the Department of Industrial and Systems Engineering [29]; using the cyclic coordinate search method was proposed by Professor Clark A. Mount-Campbell of the Department of Industrial and Systems Engineering [30]; the objective function used in both methods was formulated by Professor Curt A. Levis of the Department of Electrical Engineering and Professor Clarence H. Martin of the Department of Industrial and Systems Engineering [29]; the numerical calculations discussed in Section III.B were performed by Professor Charles H. Reilly and Mr. David J. Gonsalvez of the Department of Industrial and Systems Engineering [30].

### **2. The Gradient and Cyclic-Coordinate Search Methods**

The gradient and cyclic-coordinate search methods are two techniques commonly used by systems engineers to find an optimal condition for system performance [81,82]. In applying either method, an objective function, which is a function of a set of decision variables, is constructed in order to rank candidate solutions. The decision



variables represent the controllable operating conditions of the system; in the present application, they are the satellite orbital location and frequency channel assignments. The objective function should be a measure of the performance of the system under the conditions specified by the values of the decision variables. For instance, one solution, or specification of values for the decision variables, should represent more attractive operating conditions than a second solution if the former solution yields a greater (smaller) value when evaluated in an objective function which is to be maximized (minimized). The optimal solution (operating conditions) should be that solution which provides the greatest (smallest) objective-function value, when the objective function is to be maximized (minimized).

With such an objective function, the gradient search is performed in the following way [29,81]. Assume that the function is concave (convex) and is to be maximized (minimized). First a point that represents an initial operating condition is located, and the gradient components of the objective function at that point are calculated. Then a proper step size is chosen in the gradient (negative-gradient) direction so as to reach another point representing another operating condition. Because the objective-function value predicts the system performance, a sufficiently small step in the gradient (negative-gradient) direction should always lead to a new condition that is better than the initial condition, at least according to the chosen objective function. Then, the same procedure is repeated with the improved operating condition as the new initial point and the search step size

properly adjusted according to the magnitude of the gradient: the smaller the gradient, the smaller the step size. This procedure should be repeated until a point is reached at which the gradient search does not yield improvement in system performance. This final solution will correspond to the optimal operating condition.

When the objective function is not concave (convex), global optimality of the solution is not guaranteed; instead the solution may converge to a local optimum, with the choice of the initial starting point influencing strongly which local optimum is selected. To reduce this influence and enhance the likelihood of finding a global or near-global optimum, a modified gradient search procedure, called an extended gradient search, was used in the present application [86]. Consider the objective function as one to be minimized. First, the gradient direction at the initial point is calculated. Then from this point a search line is extended in the negative-gradient direction to the boundary of the feasible region; the objective function is calculated at a set of ten equally-spaced points along that search line. The point with the most favorable objective-function value is chosen as the new starting point to do another calculation. If the starting solution is the most favorable solution, another ten equally-spaced points between the starting solution and the first tested point are examined, the point yielding the most favorable objective-function value is chosen as the new starting solution. The procedure stops when no solution can be found that yields a more favorable objective-function value.

Since the search line is extended, the method may allow the search process to go from a region with one local minimum to another region; this reduces the likelihood of the search being "trapped" at an undesirable minimum, i.e., one much greater than the global minimum.

The cyclic coordinate search method, with a given objective function, proceeds as follows [30,82]. First, an initial operating condition is assumed. Then the decision variables are varied in turn, one at a time. Each time a set of points, where the corresponding variable is varied along its feasible coordinate range, is examined; the point yielding the most favorable objective-function value is identified, and the search continues from this new solution with another decision variable and the same search process. A cycle is completed when every decision variable has been allowed to vary; once a cycle is completed, another cycle can begin. When there is no more improvement in the objective-function value, the process is repeated within a smaller region and with smaller step-sizes. The whole search process terminates when no more improvement is obtained with a step size commensurate with the accuracy to be obtained.

### **3. An Objective Function for Satellite Orbital/Frequency Assignments**

For the satellite planning problem, a suitable objective function is formulated as [29]

$$\begin{aligned}
Z &= \sum_{k \in K} \sum_{n \in N_k} \sum_{j \in J_k} Z_{knj} \\
&= \sum_{k \in K} \sum_{n \in N_k} \sum_{j \in J_k} \exp \{ a - [C_{knj}(\text{dB}) - I_{knj}^e(\text{dB})] \} , \quad (3.1)
\end{aligned}$$

where the symbols mean

- $K$  : the index set of all satellites,
- $N_k$  : the index set of all frequency channels assigned to satellite  $k$ ,
- $J_k$  : the index set of test points of service area  $k$ ,
- $a$  : arbitrary parameter used to avoid overflow in computer calculation,
- $C_{knj}$  : the carrier power at channel  $n$  of test point  $j$  in service area  $k$ , in dB,
- $I_{knj}^e$  : the effective interference power at channel  $n$  of test point  $j$  in service area  $k$ , in dB.

It is assumed that each satellite is associated with one service area; thus the index  $k$  that represents a satellite also represents its corresponding service area. Note that it is the satellites that are counted in the index set  $K$ ; one service area may be served by several satellites and each satellite is treated as an individual unit. The value of  $C_{knj}$  is calculated from Equation (2.5). The value of  $I_{knj}^e$  is calculated from Equation (2.13a), reproduced here

$$I_{knj}^e(\text{dB}) = 10 \cdot \log_{10} \left\{ \sum_{i \in K/k} \sum_{m \in N_j} 10^{[I_{im, knj}(\text{dB}) + F(f_n, f_m)(\text{dB})]/10} + \sum_{m \in N_k/n} 10^{[I_{km, knj}(\text{dB}) + F(f_n, f_m)(\text{dB})]/10} \right\}, \quad (3.2)$$

where  $I_{im, knj}$ , calculated from Equation (2.6), is the interference from channel  $m$  of satellite  $i$  into channel  $n$  of test point  $j$  in a service area served by satellite  $k$ . In Equation (3.1) the exponentially weighted summation is over all the frequency channels, at all the test points, in all the service areas. In Equation (3.2), the double-summation adds the interference from all other satellites, and the single-summation adds the interference from other channels of the same satellite.

The satellite locations, denoted by  $o_l$  for satellite  $l$ , and the carrier frequencies, denoted by  $f_{lh}$  for channel  $h$  of satellite  $l$ , are the decision variables. The limits of the orbital variables are usually determined by elevation angle constraints [83]; sometimes an eclipse-protection requirement may impose additional restrictions [84]. The limits of the frequency variables are determined by the limits of the available spectral band [4].

It is clear that the orbital variables are continuous variables; however, this is not necessarily true for the frequency variables. In past international conferences, generally the available spectral bands were each divided into channels of equal bandwidth, with each channel specified by its center frequency [85]. This is likely to be true for future conferences also; then the frequency variables will be discrete.

In the gradient search method, the derivatives with respect to all the decision variables need to be calculated; since it is impossible to differentiate with respect to a discrete variable, it is assumed here that in the frequency assignment the center frequencies of all the channels are allowed to vary continuously while each channel still has the same, fixed bandwidth. With this assumption, differentiation with respect to the frequency variables is allowed, and the frequency protection ratio of Figure 2.6 can be used. It is hoped, but cannot be guaranteed, that the optimization of the continuous-varying channel problem will lead to at least a near-optimum of the discrete channel problem.

Note in Figure 2.6 that there is a plateau in the frequency protection ratio. When two satellites are assigned frequencies with the frequency offset in this range, the gradient search method would find variation of these frequency assignments not useful because it would not change the objective-function value. This is definitely not the result the system planner wants, because separating the frequency assignments sufficiently could produce better  $C/I_e$  results. To avoid this problem, the plateau is deformed to form an isosceles triangle with small slopes ( $\pm 0.05$  dB/unit  $\beta$ ); this modification allows the frequency assignments to be separated if the frequency offset is located in the plateau region.

From Equation (3.1) it is clear that the value of  $Z_{knj}$  is small for large  $(C/I_e)_{knj}$ (dB) values. Since a good scenario should have large  $C/I_e$  at all test points, the global minimum of the objective function is likely to be a good solution for the assignment problem.

The gradient components of Z are

$$\nabla Z = \left( \frac{\partial}{\partial \alpha_1} Z, \frac{\partial}{\partial \alpha_2} Z, \dots, \frac{\partial}{\partial f_{11}} Z, \dots \right) \quad (3.3)$$

where the partial derivatives have been taken for all the decision variables; also

$$\frac{\partial}{\partial \alpha_1} Z = \sum_{k \in K} \sum_{n \in N_k} \sum_{j \in J_k} Z_{knj} \frac{-\alpha (C/I_e)_{knj} (\text{dB})}{\alpha \alpha_1}, \quad (3.4)$$

$$\frac{\partial}{\partial f_{1h}} Z = \sum_{k \in K} \sum_{n \in N_k} \sum_{j \in J_k} Z_{knj} \frac{-\alpha (C/I_e)_{knj} (\text{dB})}{\alpha f_{1h}}, \quad (3.5)$$

Referring to Figure 2.5 and Equations (2.5), (2.6), moving  $S_A$  clearly changes  $\psi_{tc}$ ,  $\psi_{ri}$ , and  $x$ , moving  $S_B$  changes also parameters  $\psi_{ti}$ ,  $\psi_{ri}$ , and  $y$ . Every satellite acts both as a desired and interfering source, so it affects the parameters associated with  $S_A$  in some terms, and those with  $S_B$  in others, and both in a few terms. As one moves  $S_A$  and  $S_B$ , the effective isotropic radiated powers, i.e., the products  $P_A \cdot G_A$ ,  $P_B \cdot G_B$  of satellites  $S_A$  and  $S_B$  respectively, are kept constant; but the carrier powers calculated from Equation (2.5) change somewhat at the test points, causing some contribution to  $\partial Z / \partial \alpha_1$ . Also, the minimum ellipses must be recomputed for new satellite locations; the change in ellipse changes  $\psi_{tco}$ ,  $\psi_{tio}$  and therefore  $D_A(\psi_{tc})$ ,  $D_B(\psi_{ti})$  since  $D_A$  depends on  $\psi_{tc} / \psi_{tco}$  and similarly for  $D_B$ .

Here one sees that in Equation (3.4) or (3.5),  $Z_{knj}$  is the weighting factor for the terms  $\partial / \partial \alpha_1 [(C/I_e)_{knj} (\text{dB})]$  and  $\partial / \partial f_{1h} [(C/I_e)_{knj} (\text{dB})]$ . Since the term  $Z_{knj}$  is a negative exponential function of  $(C/I_e)_{knj} (\text{dB})$ , it will be largest for the values  $k$ ,  $n$ , and  $j$

for which  $(C/I_e)_{knj}$ (dB) is smallest; so the weight serves to emphasize the contribution from those test points and channels which need improvement most urgently. With such an objective function, the gradient search method tends to relocate most strongly the orbital/frequency assignments that are responsible for the worst  $C/I_e$  terms, and the result is an increase of these  $C/I_e$  values. This, of course, was the rationale for choosing the exponential function. A numerical example, below, will illustrate this point.

#### **4. Numerical Exercise Using the Extended Gradient Search Method**

A numerical exercise will now be given to show that the properties associated with the objective function are indeed as discussed, and that the performance of the extended gradient search method with respect to this objective function is as predicted.

In this exercise seven administrations are under consideration; they are Argentina, Bolivia, Brazil, Chile, Paraguay, Peru and Uruguay (denoted as ARG, BOL, BRZ, CHL, PRG, PRU, and URG respectively) with the geographic relation shown in Figure 3.1 and the test points listed in Table 3.1. It is assumed that every administration has requested one orbital location and three contiguous frequency channels, with cross polarizations for adjacent channels, for its satellite; the orbital locations and the carrier frequencies of the leading (lowest) channels are the decision variables, and these leading channels all have the same polarization. The feasible orbital arc was taken from 90 to 110 degrees west, and the spectral band from 12,200 to 12,300 MHz, for all satellites; the bandwidth of each channel is assumed to be 12 MHz, with



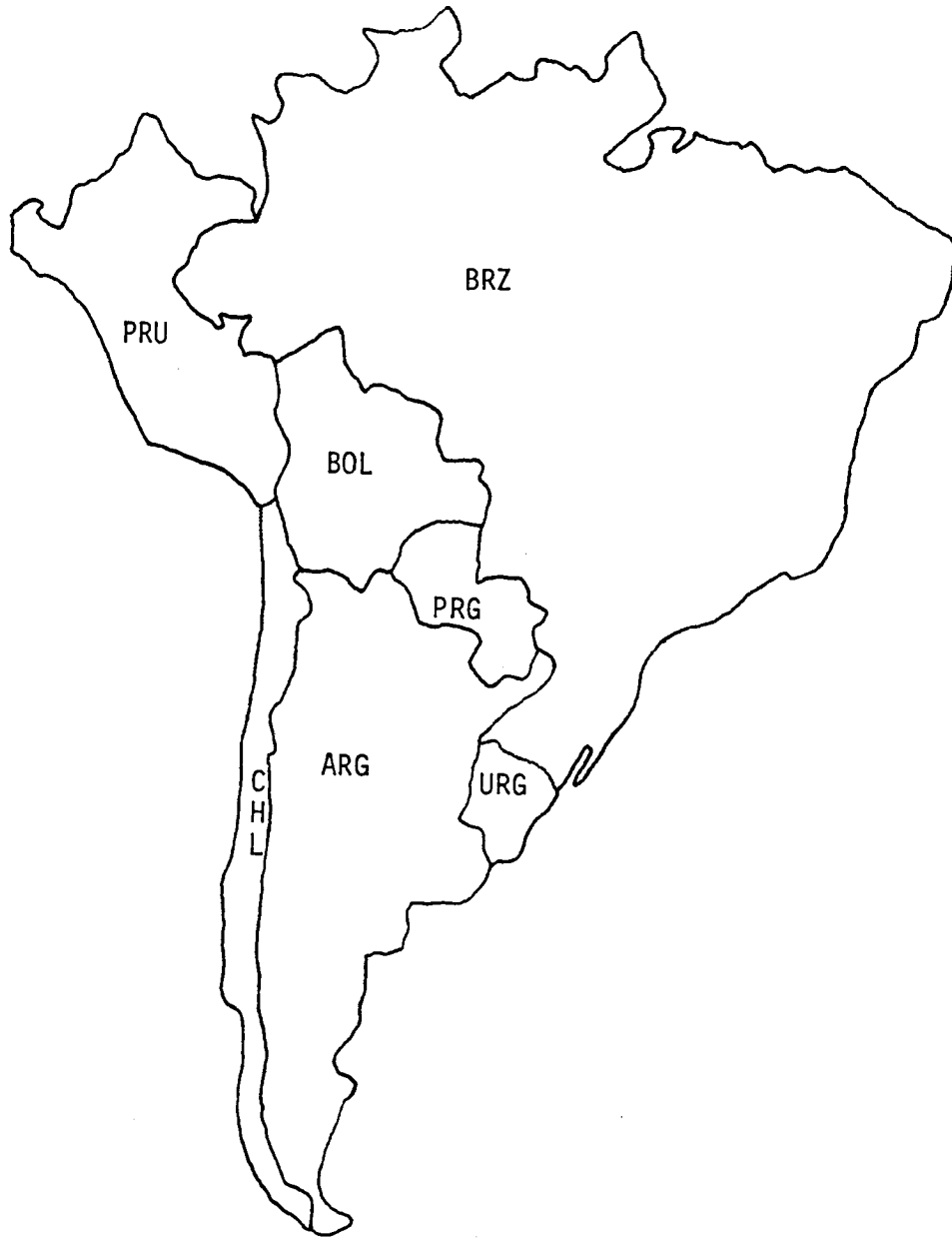

Figure 3.1. Geographic relation of the seven South American administrations.

Table 3.1

Test Points of Seven Administrations

ARGENTINA		PARAGUAY	
LON.	LAT.	LON.	LAT.
-66.2	-21.8	-57.6	-25.3
-62.8	-22.0	-58.6	-27.3
-53.8	-27.2	-56.2	-27.2
-56.7	-36.9	-54.7	-25.5
-63.8	-54.7	-54.2	-24.1
-68.3	-54.8	-58.1	-20.2
-73.2	-50.9	-59.1	-19.3
-71.4	-39.0	-62.2	-20.5
-70.5	-31.4	-62.7	-22.2
-68.6	-24.8	-58.7	-27.2
BOLIVIA		PERU	
-65.0	-12.2	-70.4	-18.3
-65.5	-9.8	-69.0	-12.3
-69.0	-11.2	-70.5	-9.4
-60.0	-16.1	-74.0	-7.6
-57.5	-18.0	-70.0	-2.7
-67.5	-22.7	-75.2	-0.0
		-80.3	-3.4
		-81.3	-4.4
		-81.2	-6.1
		-76.1	-13.4
BRAZIL		URUGUAY	
-60.5	4.5	-56.2	-34.9
-52.0	3.0	-54.9	-35.0
-46.0	-1.5	-53.5	-34.0
-35.0	-7.5	-53.2	-32.7
-42.0	-22.5	-55.6	-30.8
-53.0	-32.5	-56.9	-30.1
-56.3	-29.5	-57.6	-30.2
-70.8	-10.5	-58.2	-31.9
-73.0	-7.0	-58.4	-33.9
-69.0	1.0	-57.9	-34.5
CHILE			
-69.5	-17.5		
-67.1	-23.0		
-70.0	-34.2		
-71.7	-43.2		
-68.4	-52.3		
-72.8	-51.3		
-75.7	-46.8		
-74.0	-28.9		
-70.4	-18.3		

a 2.58 MHz guardband between two channels. The carrier and interference powers are calculated from Equations (2.5), (2.6) and (2.13a); the antenna reference patterns are from Figures 2.2 and 2.3; the frequency protection ratio is from Figure 2.6; the ellipse data are calculated from [49].

In this calculation the initial scenario is that all satellites are collocated at 110 degrees west, and the initial frequency assignments extend from 12,235 to 12,265 MHz in 5 MHz intervals. The intermediate solutions at all the search steps and the final solution after ten search processes are shown in Figure 3.2 to demonstrate how the search process proceeds. In Figure 3.2(c), only the worst aggregate  $C/I_e$  values for these administrations are shown. In these figures the administrations are denoted by numbers according to alphabetic order: 1 for Argentina, 2 for Bolivia, 3 for Brazil, 4 for Chile, 5 for Paraguay, 6 for Peru and 7 for Uruguay. The improvement of the  $C/I_e$  results is clearly seen as the iteration process proceeds. The orbital assignments are almost steady after iteration 7, and the frequency assignments are almost steady after iteration 5; this indicates that the search process may have reached the vicinity of a local minimum.

The improvement mechanism of the extended-gradient search method can be observed as follows. Note that the  $C/I_e$  results of administrations 3, 4, 6 and 7 are the worst after iteration 1; then at iteration 2, the orbital and frequency assignments of these four satellites make a very significant change, while that of the other three satellites are almost unchanged. This is exactly the purpose of the

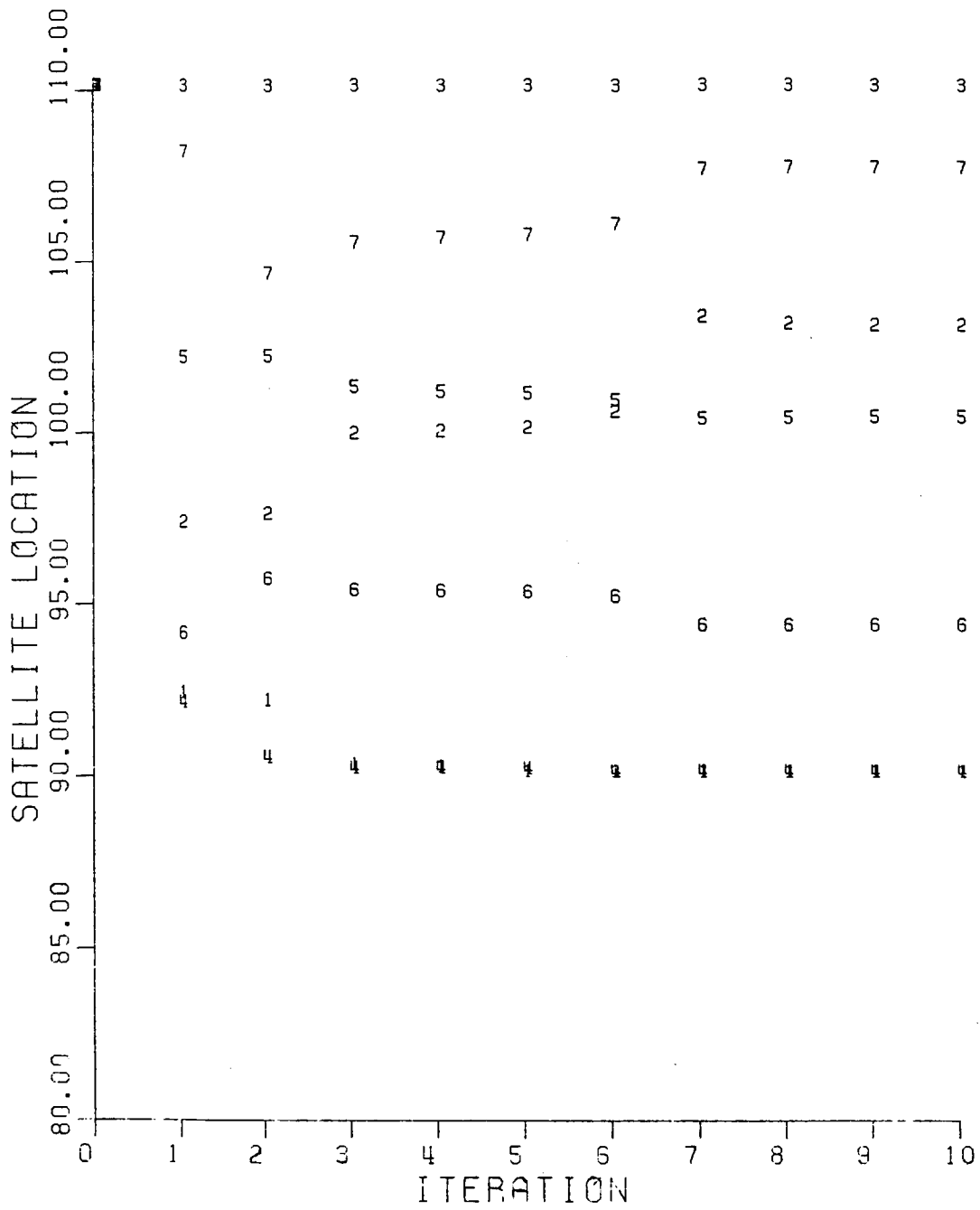

(a) Orbital assignment variation

Figure 3.2. Numerical example of the extended gradient search method.

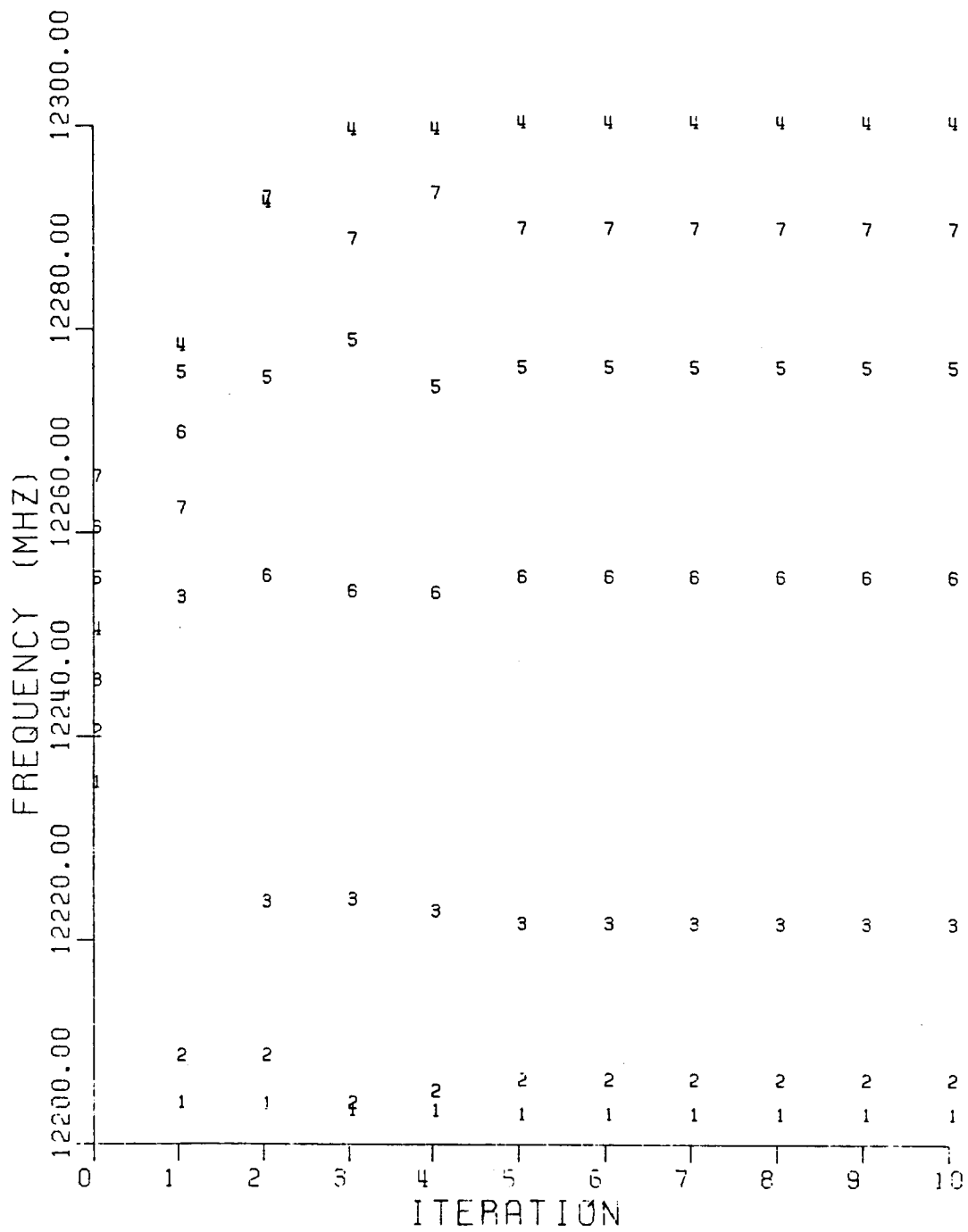

(b) Frequency assignment variation

Figure 3.2. Continued.

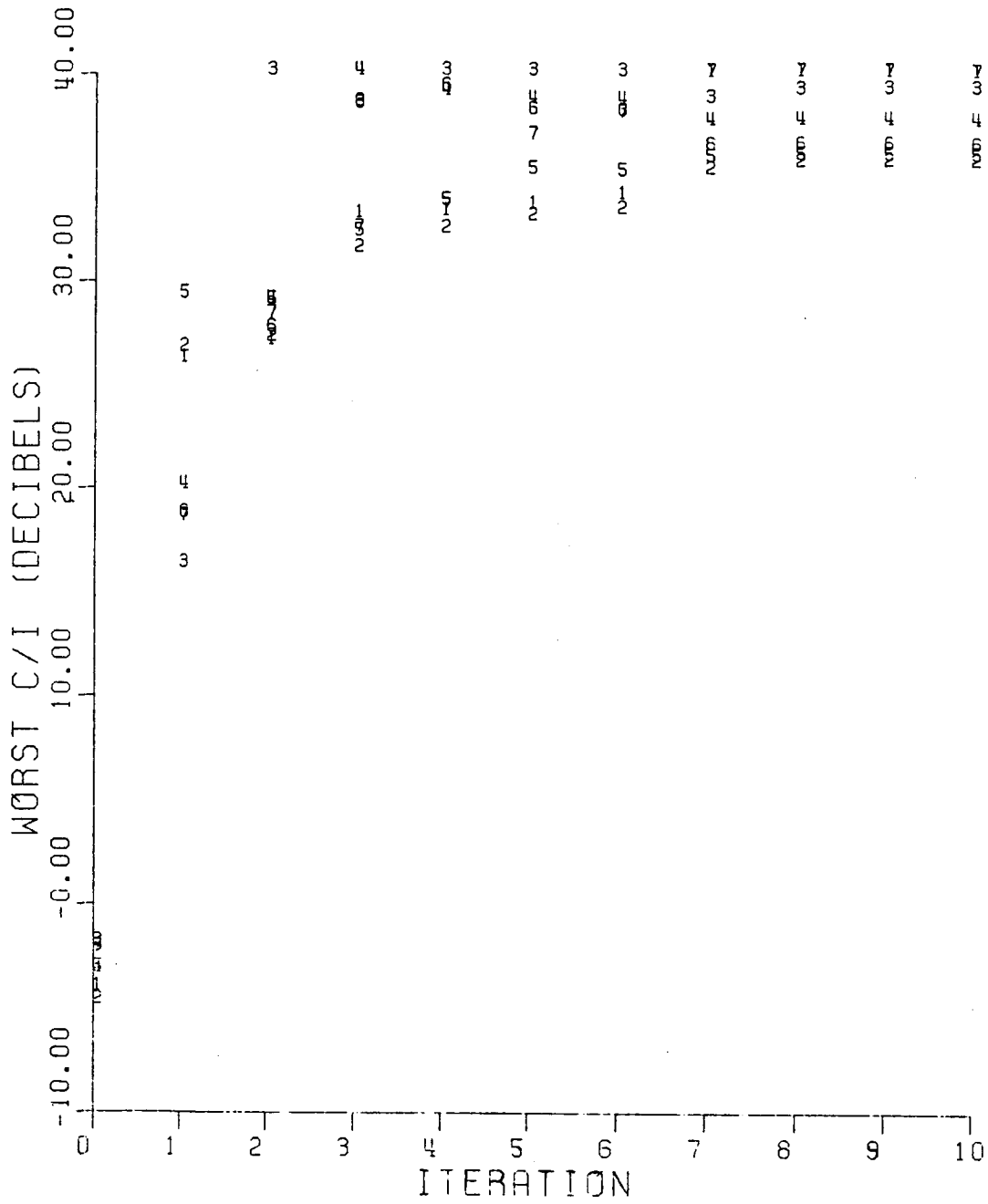

(c) C/I<sub>e</sub> variation

Figure 3.2. Continued.

exponentiation in the objective function as discussed in Section III.B.3.

The purpose of modifying the ordinary gradient search method can be seen as follows. It is known that the objective function takes on large values when some of the orbital and/or frequency assignments are identical (for reason to be explained in Section III.C); hence exchanging the position of two satellites means jumping over such a region. In Figure 3.2(a) the orbital order established in iteration 1 is disturbed by the extended search process: the order of satellites 2 and 5 is changed at iteration 7. Thus the extended gradient search method can move from a region with one local minimum to another region.

#### **5. Numerical Exercise Using the Cyclic Coordinate Search Method**

The performance of the cyclic coordinate search method is demonstrated here; the same objective function is used to solve the same assignment problem. The initial scenario is changed as follows: all satellites are at 110 degrees west and 12,250 MHz. The results are shown in Figure 3.3. The improvement in the  $C/I_e$  results is obvious.

### **C. EMPIRICAL EXAMINATION OF THE OBJECTIVE-FUNCTION TOPOGRAPHY**

#### **1. The Importance of the Objective-Function Surface Topography to the Gradient and Cyclic-Coordinate Search Methods**

The topography of the objective function greatly influences the outcome of the search methods. An objective function has only one

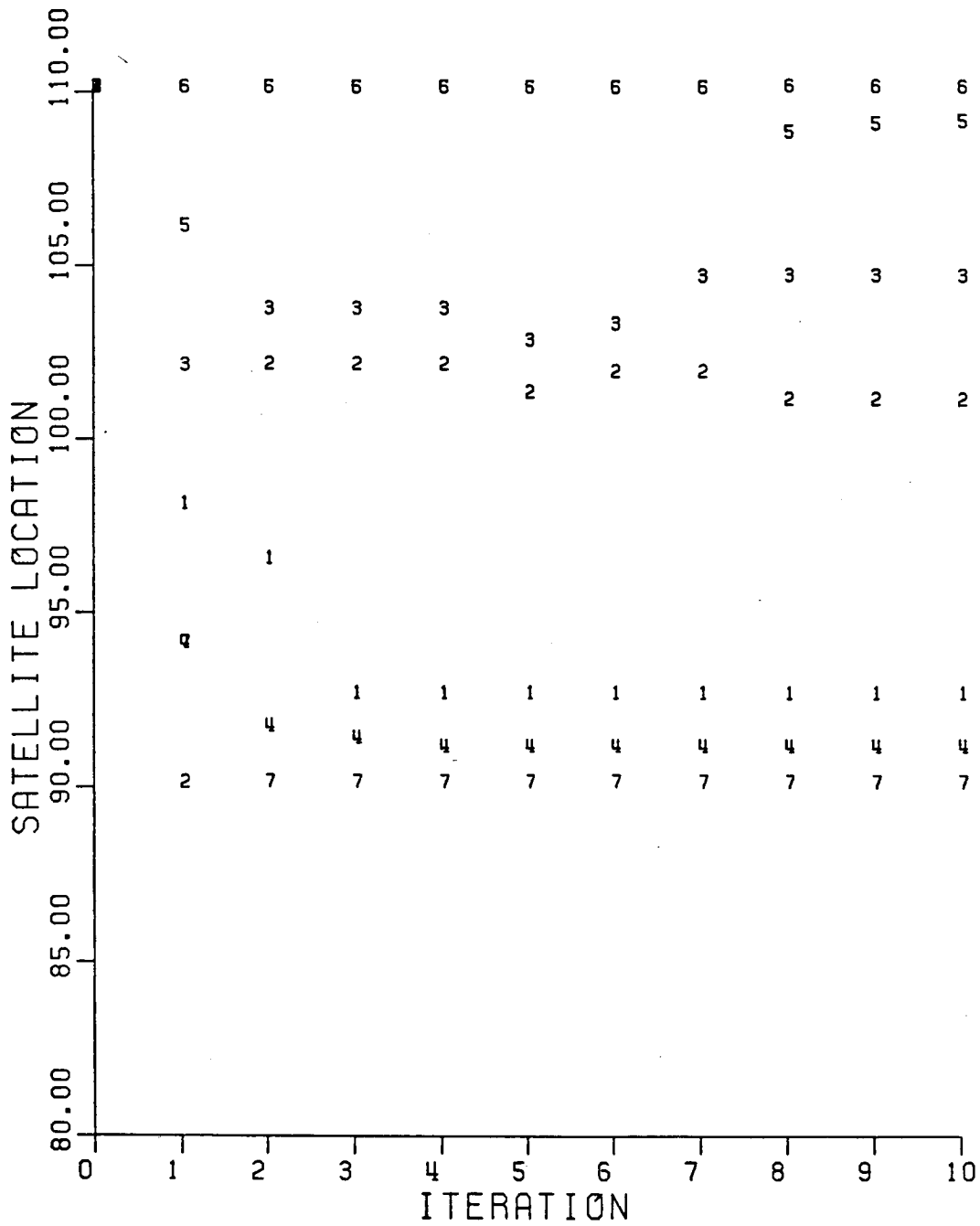

(a) Orbital assignment variation

Figure 3.3. Numerical example of the cyclic coordinate search method.



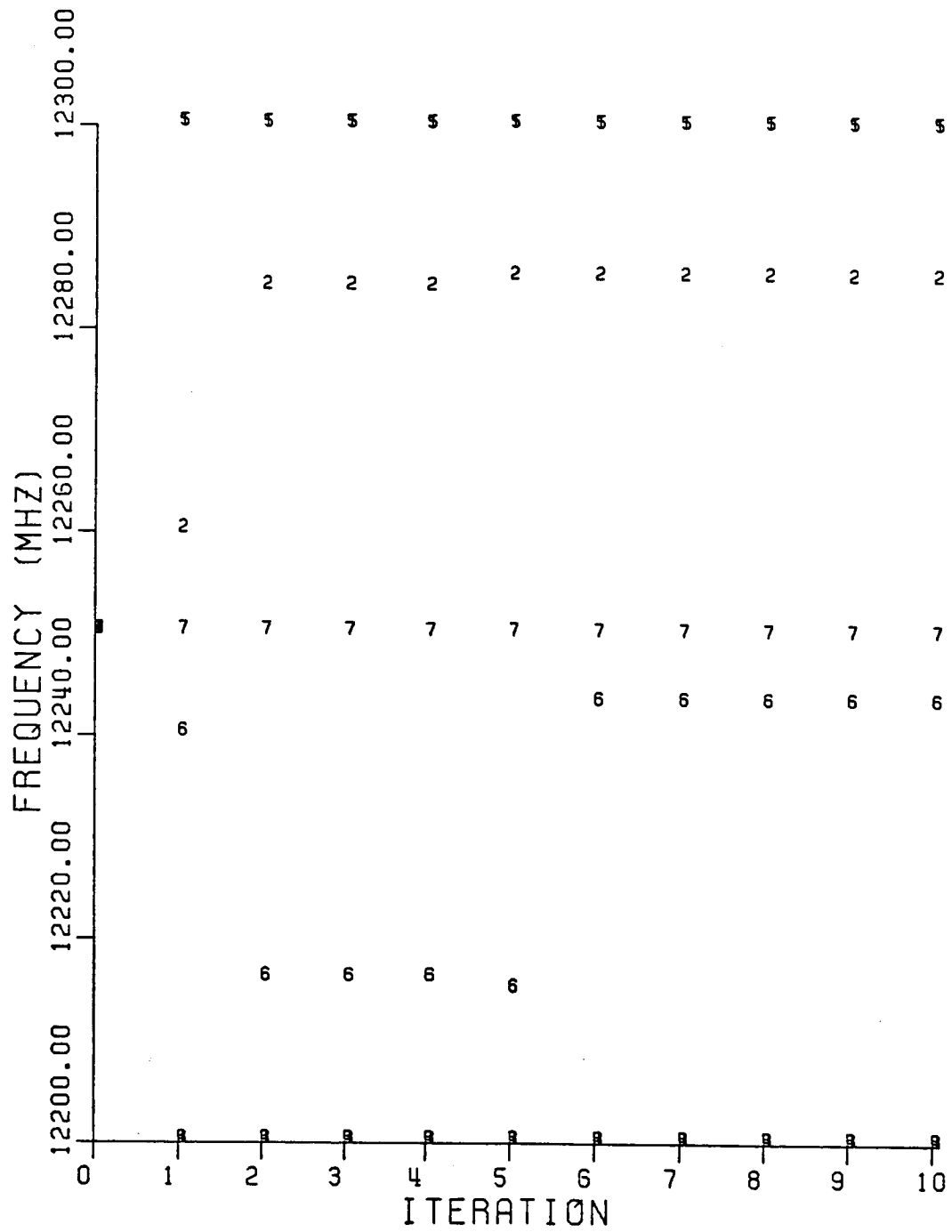

(b) Frequency assignment variation

Figure 3.3. Continued.

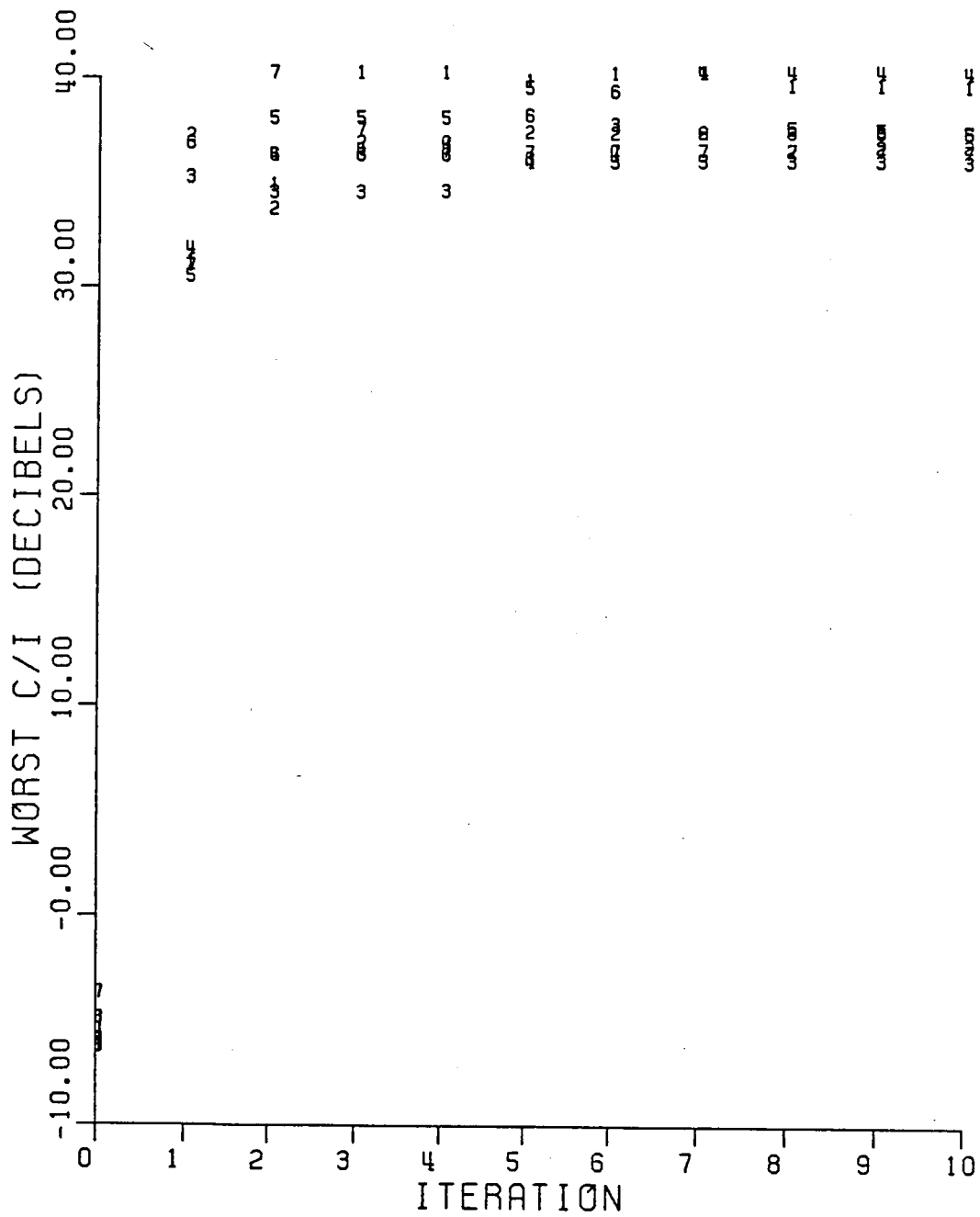

(c)  $C/I_e$  variation

Figure 3.3. Continued.

local maximum (minimum) if it is strictly concave (convex) or pseudo-concave (pseudo-convex). (See Appendix B for the definitions and properties of concave, strictly-concave and pseudo-concave functions.) The gradient and cyclic-coordinate search methods should lead one to a point very close to this maximum (minimum), if not directly locate it. If the objective function is not strictly concave, strictly convex, pseudo-concave, or pseudo-convex, it may have several local maxima or minima. The greatest maximum (least minimum) is called the global maximum (minimum), or simply maximum (minimum). The best operating conditions correspond to the global maximum (minimum), when the objective function is to be maximized (minimized). For such a function, both the gradient and the cyclic-coordinate search procedures will almost certainly give improvement to an initial operating conditions. However, both procedures may eventually be trapped at a local optimum instead of reaching the global optimum.

Therefore, knowledge of the mathematical properties of the objective function is important in determining whether the gradient and cyclic-coordinate search methods are to succeed. For instance, when the objective function has only one local maximum (minimum), or if the local maxima (minima) all correspond to nearly equal objective-function values, then it will be relatively easy to obtain a near-optimal solution by either method. If, on the other hand, there exist many local maxima (minima) at which the objective-function value is much smaller (greater) than its global maximum (minimum) value, then there is a greater likelihood of arriving at a solution which is much poorer than the true optimum.

Therefore, the topography of the objective function used for the satellite orbital and frequency assignment synthesis, i.e., Equation (3.1), will be examined next.

## **2. Relation Between Variations of Orbital/Frequency Separations and Single-Entry $C/I_e$ Value**

A very important concept should be pointed out first: for two satellites and their corresponding service areas, the single-entry  $C/I_e$  values at all the test points increase as the satellite orbital/frequency separations increase.

In the  $C/I_e$  calculation several terms are relatively invariant when satellite locations change. The received carrier powers are calculated from Equation (2.5), and the interference powers are calculated from Equations (2.6) and (2.13a). The satellite effective isotropic radiated powers (EIRP), defined as the product of the transmitting power and the transmitting antenna gain, are assumed the same for both satellites, regardless of orbital locations. Because the service areas are covered by the main beams within the -3 dB contour, the carrier transmitting discrimination factor at the test point is always larger than, and close to -3 dB. Because the geostationary orbit radius is 6.6 times the Earth radius, the propagation distances from the satellites to all the test points vary little when satellite locations are changed.

One factor that dominates the variations of the single-entry  $C/I_e$  values is the receiving discrimination term  $D_d(\psi_{rj})$  in the interference power, and that variation depends chiefly on the satellite spacing. Any relative change of the two satellite locations will change the ground antenna off-axis angles toward the interfering satellite. Through the reference pattern in Figure 2.3, this angular change induces a substantial change in the interference power. The further the two satellites are separated, the lower the discrimination factors, and thus the lower the interference. Another factor, the interference transmit discrimination term  $D_B(\psi_{tj})$ , also varies when the satellite locations are changed; however, the change of  $D_B(\psi_{tj})$  is much less than the change of  $D_d(\psi_{rj})$  because  $\psi_{tj}$  (seen from the geostationary satellite toward the Earth) changes much less than  $\psi_{rj}$  (seen from the ground upward to the sky) when the location of the interfering satellite is changed. The single-entry  $C/I_e$  values increase when the corresponding satellite spacing increases until the discrimination factor  $D_d(\psi_{rj})$  is in the far side-lobe of the reference pattern; then the  $C/I_e$  values become almost constant as the spacing keeps on increasing. This will be called "quasi-monotonic" variation:  $C/I_e$  values decrease (increase) continuously or remain constant when satellite spacing decreases (increases) continuously.

For a given service-area pair, the single-entry  $C/I_e$  value depends mainly on the magnitude of the satellite spacing, and slightly on the mean satellite orbital location. (It will be shown in Chapter IV that it varies only slightly for a large range of this mean satellite

location.) Therefore, for the purpose of the discussion in this section, an approximation is made by assuming that, for a given service-area pair, the single-entry  $C/I_e$  values at all the test points depend only on the magnitude of the satellite spacing and are independent of the mean satellite location.

Another factor that dominates the variation of the single-entry  $C/I_e$  values is the frequency offset in the frequency assignments. As explained in Section II.F, the frequency filtering factor of Figure 2.6 must be included in the effective interference calculation when the carrier frequencies of the wanted and unwanted signals are different. The larger the frequency offset, the lower the filtering factor, and the lower the interference. Therefore, the variations of the single-entry  $C/I_e$  values also depend strongly on the separation of the frequency assignments: for given orbital assignments, the further the frequency assignments are separated, the higher the single-entry  $C/I_e$  values.

### **3. Topographic features of the objective function**

#### **a) Objective-function topography of three-satellite example, orbital variables only**

For simplicity a three-satellite system will be used to demonstrate some key points. The three satellites are  $S_1$ ,  $S_2$ ,  $S_3$ , and these symbols will also be used to designate their orbital locations. A single channel will be considered so that no frequency variables are involved; in this case  $I$  and  $I_e$  are identical.

The configuration space for this example is described here. First one draws the three orbital variable axes and indicates the feasible region, as in Figure 3.4. The line segment HB measures the feasible range for  $S_1$ , HD for  $S_2$ , HF for  $S_3$ . In this figure the three satellites are assumed to have the same feasible orbital range, i.e.,  $HB = HD = HF$ ; therefore the feasible region is a cube. Any point in this cube represents an assignment scenario; its coordinates  $S_1, S_2, S_3$  are the satellite orbital locations of this assignment. For example, the point H represents the assignment in which all three satellites are collocated at one end of the orbital arc; the point A is for three satellites collocated at the other end; the point B is for  $S_1$  located at one end while  $S_2$  and  $S_3$  are collocated at the other. Note that associated with every point in the configuration space there is an objective-function value which can be calculated by Equation (3.1).

Several important features need to be mentioned. First, any point on the line AH indicates a three-satellite collocation. Then, all the points in the shaded plane ABHE correspond to  $S_2, S_3$  collocation; those in the plane ACHF to  $S_1, S_2$  collocation; those in the plane ADHG to  $S_1, S_3$  collocation. Points within any one of the six sub-regions separated by the three collocation planes have the same satellite permutation. For example within the sub-region bounded by the planes AHB, AHC, ABC and HBC, all the points have the satellite permutation  $S_1 > S_2 > S_3$ ; this is indicated by the notation 1-2-3 in Figure 3.4. Since the objective-function value is large when the C/I values are small, the objective function should have the highest values along the line AH because the

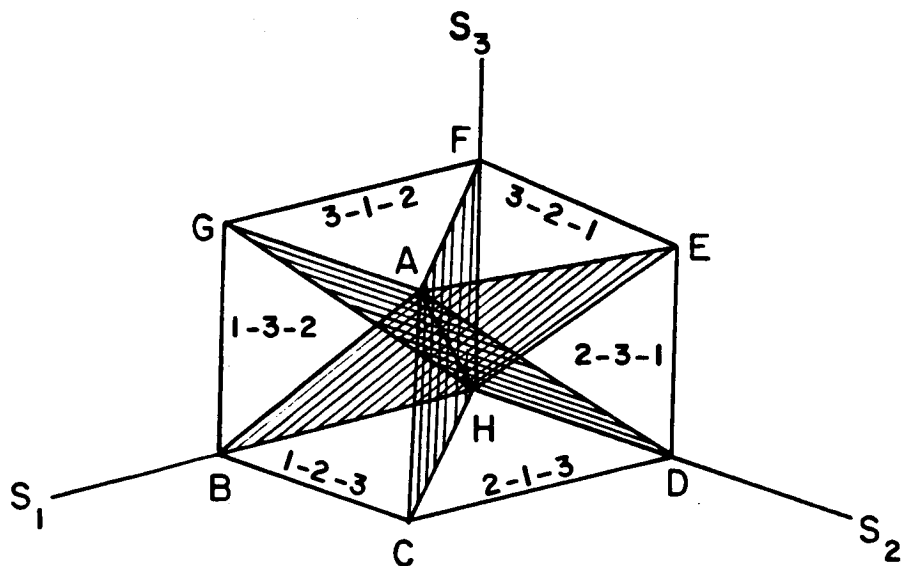

1-2-3: REPRESENTS ORDERING  $S_1 > S_2 > S_3$

Figure 3.4. Configuration space of three-satellite case.



C/I values are the smallest for collocated satellites. Near the pairwise collocation planes ABHE, ACHF, ADHG the objective function should be moderately high, while between these planes the objective function falls off to form valleys because all the satellites are spread out. Thus we can visualize the objective-function topography as dominated by a system of ridges corresponding to satellite collocations; these ridges are connected to each other at the line AH where three satellites are collocated. Of course, the ridges will be high if the service areas are close together and hence the transmitting discrimination factor  $D_B$  in Equation (2.6) is large; they will be small when the service areas are well separated.

An arbitrary plane in this cube may be chosen to show the objective-function values corresponding to points on this plane. The plane chosen here is the plane CJKLFMNP shown in Figure 3.5(a). The objective function might have the shape shown in Figure 3.5(b). The base plane is divided into six sub-regions by its intersection with the shaded planes in Figure 3.4. Each intersection line represents the collocation of two satellites, and each sub-region represents one permutation of the three satellites. The objective-function topography sketch shows these sub-regions separated by the ridges representing two-satellite collocation.

The objective-function values of a real set of scenarios will now be calculated here to confirm the above arguments. The three administrations are:  $S_1$  for Peru,  $S_2$  for Bolivia,  $S_3$  for Paraguay. The orbital locations chosen for the calculation constitute the shaded plane

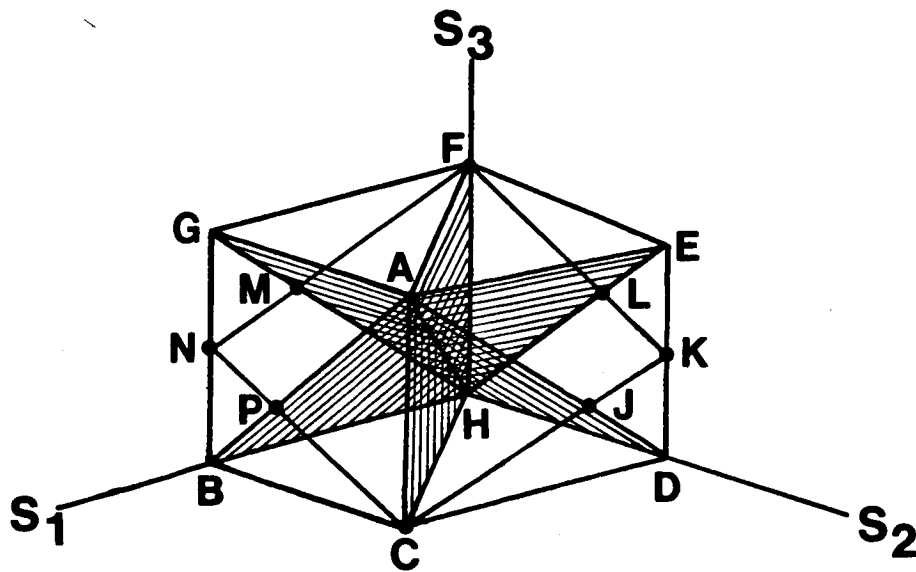

(a) an arbitrary plane.

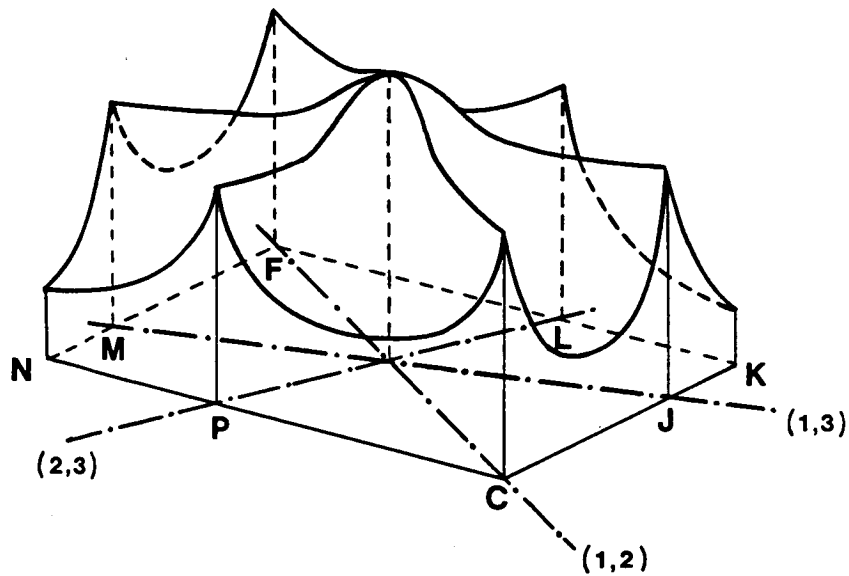

(AB) : REPRESENTS COLLOCATION OF  $S_A$  AND  $S_B$

(b) its objective-function surface.

Figure 3.5. Typical shape of objective function.

RSTU shown in Figure 3.6; it is inside the region of permutation  $S_1 > S_2 > S_3$ , and is a plane for which the value of  $S_2$  is constant at  $60^\circ\text{W}$ . The value of  $S_1$  ranges from 60 to 64 degrees west, while the value of  $S_3$  ranges from 57 to 60 degrees west. The objective-function value is calculated from Equation (3.1), the values of C and I are calculated from Equations (2.5), (2.6) and (2.13a), the antenna reference patterns are taken from Figures 2.2 and 2.3, the ellipse data are calculated from [49]; the test points are those given in Table 3.1 for these administrations. The results are listed in Table 3.2, and the topography is plotted in Figure 3.7. As predicted, the maximum of the objective function in this plane occurs at R, the three-satellite collocation, the objective function rises to apparent ridges above the lines RS and RU which lie in the planes ABH and ADH of two-satellite collocations, and away from the lines of satellite collocation the objective function falls off and forms a valley.

The typical topography of the objective-function surface for points lying on a plane inside any region of fixed permutation is shown in Figure 3.8. The point R' will be on the line AH, the lines R'S' and R'U' will be in the planes of two-satellite collocation, the points T' will be chosen in the R'S'U' plane. This figure illustrates the typical shape and locations of the tip, ridges and valley.

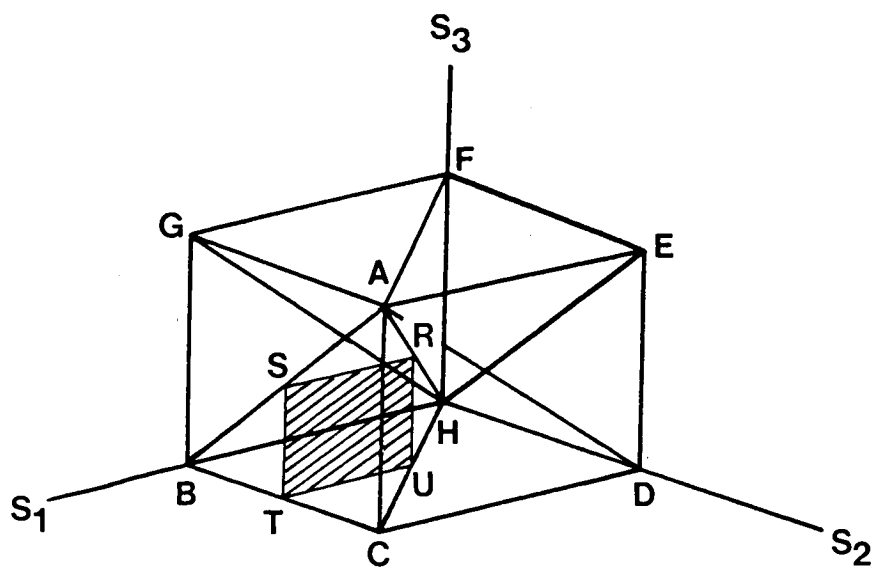

Figure 3.6. Selected area to calculate objective-function value.

Table 3.2

## List of Objective-function Values

$$z = \sum_K \sum_{J_k} \exp[a - (C/I)_{kj} \text{ (dB)}], \quad a = 5,$$

$S_2(\text{BOL}) = 60$  degrees,

$S_1(\text{PRU})$	$S_3(\text{PRG})$	$z$	$\ln(z)$
60.	60.	0.2625 E+4	7.873
	59.5	0.8918 E+3	6.793
	59.	0.7644 E+3	6.639
	58.	0.7606 E+3	6.634
	57.	0.7601 E+3	6.633
60.5	60.	0.1529 E+4	7.333
	59.5	0.1084 E+3	4.685
	59.	0.4488 E+2	3.804
	58.	0.4460 E+2	3.798
	57.	0.4455 E+2	3.797
61.	60.	0.1010 E+4	6.918
	59.5	0.5477 E+2	4.003
	59.	0.2781 E-1	-3.582
	58.	0.1111 E-1	-4.500
	57.	0.1104 E-1	-4.506
62.	60.	0.9673 E+3	6.874
	59.5	0.5322 E+2	3.974
	59.	0.1490 E-1	-4.206
	58.	0.1498 E-4	-11.109
	57.	0.6218 E-5	-11.989
63.	60.	0.9613 E+3	6.868
	59.5	0.5289 E+2	3.968
	59.	0.1454 E-1	-4.231
	58.	0.8250 E-5	-11.705
	57.	0.1852 E-6	-15.502
64.	60.	0.9596 E+3	6.867
	59.5	0.5277 E+2	3.966
	59.	0.1440 E-1	-4.241
	58.	0.7938 E-5	-11.744
	57.	0.1058 E-6	-16.062

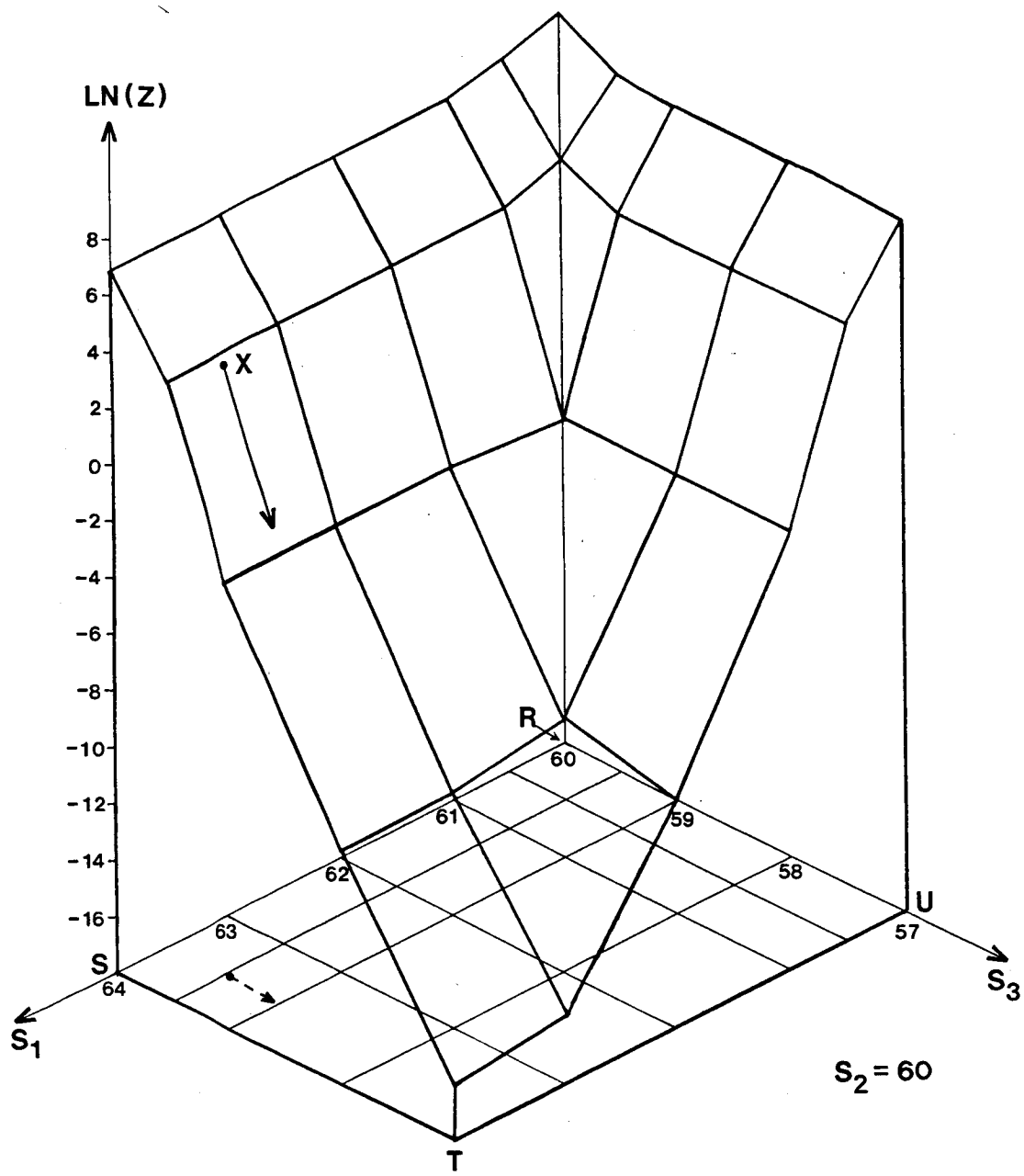

Figure 3.7. Topography of objective function.

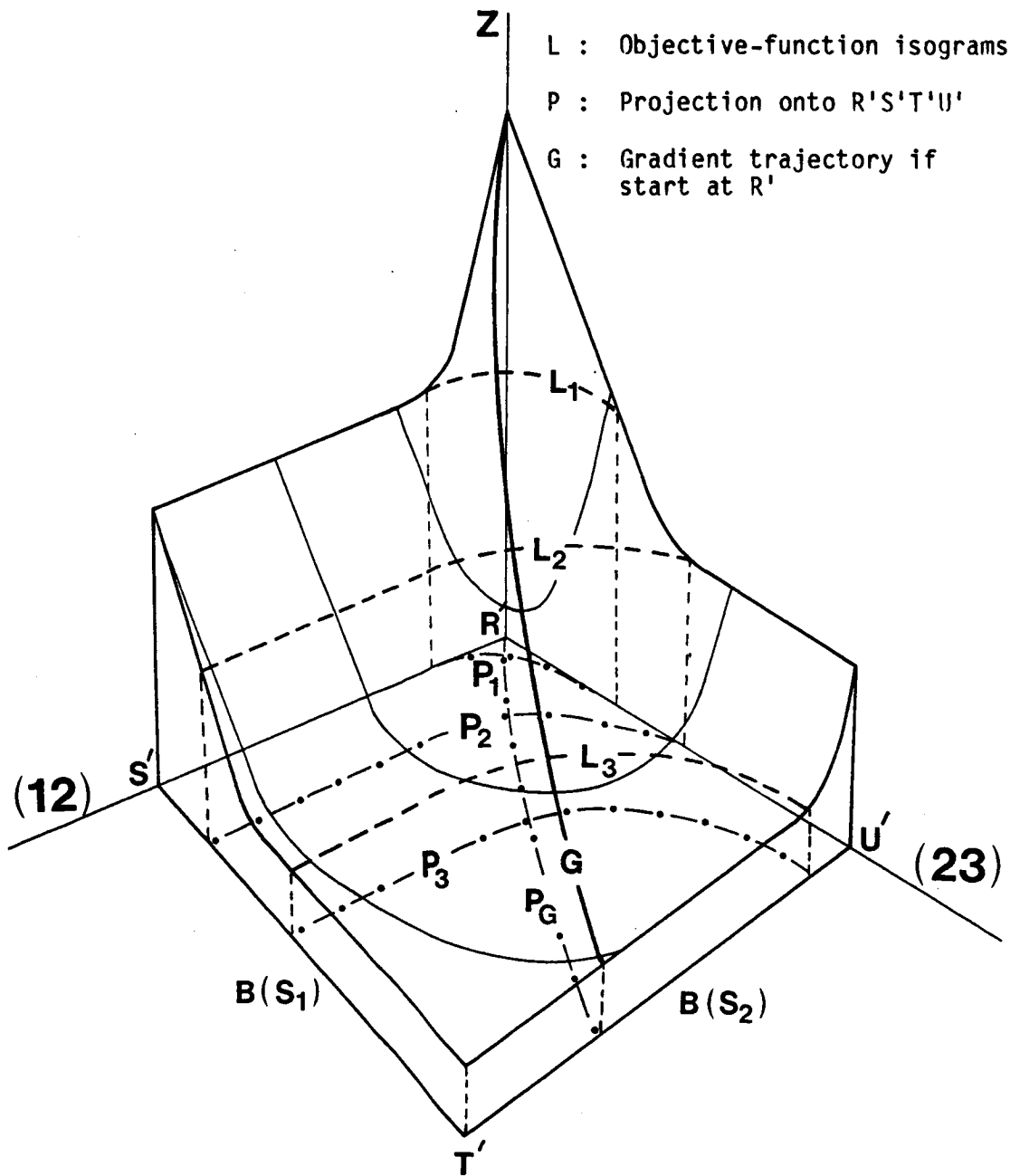

Figure 3.8. Typical topography of objective function.

A point made in Section III.B.3 can also be illustrated by referring to Figure 3.7. The gradient direction at the point  $x$  is almost perpendicular to the line  $RS$ . This means that when this gradient direction is followed, the orbital location of  $S_1$  is almost unchanged while  $S_3$  is placed further away from  $S_2$ . Note that points close to the line  $RS$  correspond to nearly collocating the satellites  $S_2$  and  $S_3$ ; when these satellites are close to each other, the test points of their service areas have low  $C/I$  values. This means that the corresponding weighting factors in Equation (3.4) are high, and the gradient search process will push the two responsible satellites  $S_2$  and  $S_3$  apart.

#### **b) Objective-function topography of $n$ -satellite case**

The general shape of the objective-function topography for an  $n$ -satellite case will now be addressed. Note that the orbital and frequency variables are two different classes of decision variables so that their effects on the objective-function topography should be discussed separately.

In the first step only the orbital variables are discussed; it is assumed that the frequency assignments are the same for all the satellites. For a case of  $n$  satellites to be assigned orbital locations, the  $n$  orbital variables constitute an  $n$ -dimensional configuration space, and it is divided into  $n!$  regions of different orbital permutations (i.e., satellite orderings) by  $n(n-1)/2$   $(n-1)$ -dimensional hyperplanes of two-satellite collocation. Each region of a fixed orbital permutation is surrounded by  $(n-1)$  hyperplanes of two-



satellite collocation and two  $(n-1)$ -dimensional boundary hyperplanes, each corresponding to one satellite at the boundary of its feasible orbital arc. The objective function has large values when satellites whose service areas are not well separated are collocated. For two neighbouring regions of different permutations, the corresponding permutations differ only in exchanging the relative positions of two satellites. Therefore the hyperplane between these two regions corresponds to the collocation of these two satellites, and the objective function may have large values in this hyperplane. All of these hyperplanes will connect at the line where all satellites are collocated; as a result the objective function has many local minima within the complete feasible region, and they can be characterized by their specific orbital permutations.

In general a satellite is associated with an orbital location and a set of frequency allocations. Basically, the effect of the frequency variables on the topography depends on the frequency protection ratio pattern shown in Figure 2.6. There is one important similarity between this pattern and the co-polarization antenna patterns: the relative protection ratio value is non-increasing as the frequency offset increases. So the spreading of the frequency assignments has the same effect on the objective-function value as the spreading of the orbital assignments: the further the frequency assignments are separated, the less the interference, and the smaller the objective-function value. Hence the objective function may have large values when the frequency assignments are collocated (or nearly collocated since the plateau in

Figure 2.6 has a certain bandwidth), and local minima may occur where frequency assignments are spread out.

The total number of local minima of the objective function in a case of  $n$  orbital and  $n$  frequency variables can be deduced as follows. Theoretically, the  $n$  orbital variables create  $n!$  regions with at least one local minimum in each region, then in each region the  $n$  frequency variables further create  $n!$  sub-regions with at least one local minimum in each sub-region. Therefore, there might be at least  $(n!)^2$  local minima in this case. However, in reality the number of local minima is likely to be smaller, e.g., the collocation of two satellites may not result in bad C/I values to produce a hyperridge of large objective-function values when the service areas are well separated.

Also, another important conclusion can be deduced from the above discussion: the local minima of the objective function may be characterized by the permutations of their orbital/frequency assignments.

**c) Possibility of one local minimum for a fixed permutation of orbital/frequency assignments**

**(1) Introduction**

Figures 3.6 and 3.7 also show that the objective function as a convex (or pseudo-convex) function with only one local minimum within a region of fixed orbital permutation. In this case this result should be obvious because, for a three-satellite example with only orbital variables, the objective function can be minimized by spreading the outside satellites as far as allowed by the feasible arc, i.e., until they reach the boundaries. It is interesting to speculate whether, for a general case of  $n$  satellites, there is only one local minimum in a region of fixed orbital/frequency permutation. If this conjecture could be shown to be true, or approximately true in the sense that all the minima for a fixed permutation have approximately equal objective-function values, then an ordinary (not extended) gradient search procedure would be sure to find an optimal, or at least near-optimal solution for a given orbital/frequency permutation. However, a definitive proof of the conjecture has eluded us. The remainder of this chapter presents evidence that it is likely to be true for the orbital variables. Therefore, in this section it is assumed that every satellite has been assigned the same frequency channel, and the discussion is confined to a region of fixed orbital permutation.

## (2) Locations of Global Maximum and Local Minima of Objective Function

First, it is shown that the global maximum of the objective function corresponds to a scenario of all-satellite collocation by showing that the objective-function value decreases quasi-monotonically along any linear trajectory starting from all-satellite collocation.

### Definition 1

For two scenarios  $x, y$  in the  $n$ -dimensional configuration space, the linear trajectory between them is specified by the set of scenarios  $z$  such that

$$z = ax + (1-a)y, \quad (3.6)$$

where  $a$  is a parameter with value  $0 < a < 1$ .

### Lemma 1

Assume that all the satellites have continuous feasible orbital arcs. Then given any two scenarios  $x, y$ , there exists a linear trajectory between them which is completely inside the feasible region; i.e., the feasible region is a convex set.

### Proof

A scenario  $z$  in the  $n$ -dimensional configuration space is expressed by a  $1 \times n$  row matrix  $z = (z_1, z_2, \dots, z_n)$ , where the components are the satellite locations of satellites 1, 2, ...  $n$  respectively.

Along a linear trajectory of starting scenario  $x$  and final scenario  $y$ , a scenario  $z$  satisfies

$$z = ax + (1-a)y , \quad (3.7a)$$

where  $0 < a < 1$ , or

$$(z_1, z_2, \dots, z_n) = a(x_1, x_2, \dots, x_n) + (1-a)(y_1, y_2, \dots, y_n) , \quad (3.7b)$$

or

$$z_i = ax_i + (1-a)y_i \quad \text{for } 1 < i < n. \quad (3.7c)$$

Since all the satellites have continuous feasible orbital arcs, one has  $z_i \in F_i$  if  $x_i, y_i \in F_i$  for  $1 < i < n$ , where  $F_i$  is the feasible arc for satellite  $i$ . Hence any scenario  $z$  along this linear trajectory is well defined, and the linear trajectory is completely inside the feasible region. So the feasible region is a convex set.

#### **Lemma 2**

Within a region of fixed orbital permutation in the  $n$ -dimensional configuration space all the pairwise satellite separations vary linearly along a linear trajectory.

#### **Proof**

From Lemma 1, for scenario  $z$  the pairwise satellite separation between satellites  $i, j$  is  $|z_i - z_j|$ . From Equation (3.7c) one has

$$(z_i - z_j) = a(x_i - x_j) + (1-a)(y_i - y_j) , \quad (3.8a)$$

where  $0 < a < 1$ . Since all the scenarios are of the same orbital permutation,  $(x_i - x_j)$  and  $(y_i - y_j)$  must have the same sign. Then, since

both  $a$  and  $(1-a)$  are positive,  $(z_i - z_j)$  will also have this same sign. Therefore, Equation (3.8a) can be rewritten as

$$|z_i - z_j| = a|x_i - x_j| + (1-a)|y_i - y_j| , \quad (3.8b)$$

i.e., all the pairwise satellite separations vary linearly when a scenario is varied along a linear trajectory.

### **Theorem 1**

The global maximum of the objective function is on the line of all-satellite collocation.

### **Proof**

A linear trajectory that starts with all-satellite collocation is illustrated in Figure 3.9, note that the ordering of the satellites remains the same. Since the initial pairwise spacings are all zero, from Lemma 2 all the satellite spacings increase linearly in the trajectory. As discussed in Section III.C.2, all the single-entry C/I values increase quasi-monotonically when the corresponding pairwise satellite spacings increase linearly. As a result, all the aggregate C/I values, which involve the summation of all their contributing single-entry interference powers, must also increase quasi-monotonically in the process. Thus the objective-function value, which is the summation of the exponential of the negative of the aggregate C/I values, must decrease quasi-monotonically. Hence, the global maximum of the objective function is on the line of all-satellite collocation.

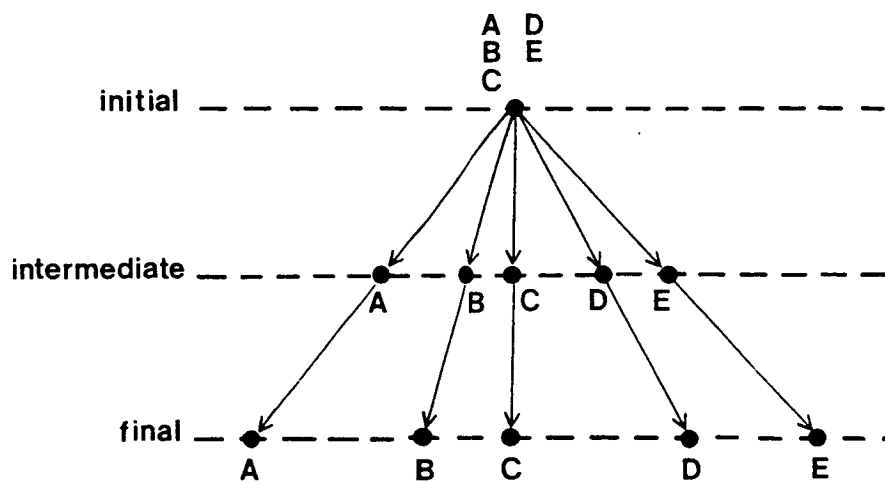

Figure 3.9. Linear expansion of orbital assignments.

## Theorem 2

Local minima of the objective function occur at boundaries of the feasible region such that all of the pairwise most widely separated satellites are at opposite limits of their respective feasible arcs.

### Proof

Let the satellites be numbered according to their orbital positions, so that  $x_1 < x_2 < \dots < x_n$ . Let the lower limits of their feasible arcs be denoted  $e_i$  ( $i=1,2,\dots,n$ ) and the upper limits  $\omega_i$  ( $i=1,2,\dots,n$ ).

Assume  $x_1 \neq e_1$ , i.e., satellite 1 is not at the lower limit of its feasible arc. Then

$$z = a(e_1, x_2, x_3, \dots, x_n) + (1-a)x, \quad 0 < a < 1 \quad (3.9)$$

defines a linear trajectory for which all the  $|z_1 - z_j|$  ( $j=2,3,\dots,n$ ) must increase continuously away from the other satellites. All other spacings remain unchanged on the trajectory. As discussed in Section III.C.2, this increases the single-entry C/I values involving satellite 1 quasi-monotonically while all other single-entry C/I values remain unchanged; therefore the objective-function value will decrease quasi-monotonically along the trajectory. Therefore it can not be a local minimum for the scenario  $x$  with  $x_1 \neq e_1$ . This proves the theorem.



### (3) Topography of the worst single-entry C/I value

In the following section the topography of an auxiliary function A, defined as the the worst (smallest) single-entry C/I value, will be investigated. Although it is not the objective function Z, it is hoped that these two functions may have sufficient resemblance that some of the properties about Z can be extrapolated from A. First the function is defined as

$$A = \min_{i \in K, k \in K, j \in J_k} [(C/I)_{i,kj}], \quad (3.10)$$

where the symbols mean

$(C/I)_{i,kj}$  : the single-entry C/I value at test point j of service area k and the single-entry interference power is from satellite i,

$J_k$  : index set of test points of service area k,

$K$  : index set of satellites in a scenario.

The value of A for a given scenario is obtained as follows. First all the single-entry interference from any one satellite to all the test points of other satellite systems are calculated using Equation (2.6), and these values are denoted as  $I_{i,kj}$  when i is the interfering satellite and j is the test point in service area k. The carrier power at any test point is calculated using Equation (2.5), and is denoted  $C_{kj}$  when j is the test point in service area k. The value of  $(C/I)_{i,kj}$  is calculated by taking the ratio of  $C_{kj}$  and  $I_{i,kj}$ . The value of A is obtained from choosing the smallest of all the  $(C/I)_{i,kj}$  terms for that scenario (note that a scenario is a point in the configuration space).

Note that, if this function is used as the objective function for the extended-gradient or cyclic-coordinate search method, then the most favorable assignment is that for which the objective function is the global maximum.

Considering only the orbital variables, we wish to show that this function has at most one local maximum (hence a global maximum when it exists) for each ordering (permutation) of the satellites, and that such a maximum must lie on a boundary of the feasible region. Some lemmas and definitions will be useful in the proof of this theorem.

### **Lemma 3**

Within a region of fixed permutation in the feasible region, all the  $(C/I)_{i,jk}$  terms are quasi-monotonic functions along any linear trajectory (orbital variables only).

### **Proof**

As discussed in Section III.C.2, for a service-area pair, the single-entry C/I values at all the test points vary quasi-monotonically as the satellite spacing varies. According to Lemma 2 all the pairwise satellite spacings either increase or decrease linearly, or remain constant along a linear trajectory within a region of fixed permutation. Therefore all the single-entry  $(C/I)_{i,kj}$  functions along that trajectory vary quasi-monotonically.

### **Definition 2**

For two curves that have a countable number of common points, a vertex of the two curves is a common point of the two curves.

Let a function  $Y(x)$  be defined from a set of quasi-monotonic functions  $Y_i(x)$ ,  $i \in I$  in a finite range as

$$Y(x) = \underset{i \in I}{\text{Min}} [Y_i(x)] . \quad (3.11)$$

**Lemma 4**

If the local maximum of  $Y(x)$  exists, it must occur at a vertex or at the boundary of the allowed range.

**Proof**

Assume that  $Y(x_0)$  is a local maximum (minimum) of  $Y(x)$ , and it is not a vertex of  $Y_i(x)$ ,  $i \in I$ , nor is it at the boundary. Then  $Y(x)$  is equal to one of the  $Y_i(x)$  in the vicinity of  $x_0$ ; hence  $Y(x)$  is monotonic in the vicinity of  $x_0$ . Being a local maximum (minimum) means that  $Y(x) < Y(x_0)$  ( $Y(x) > Y(x_0)$ ) for  $x$  in the vicinity of  $x_0$ , which contradicts the fact that  $Y(x)$  is monotonic in the vicinity of  $x_0$ . Hence the local maxima (minima) of  $Y(x)$  occur at the vertices or at the boundary.

**Lemma 5**

$Y(x)$  can not have more than one local maximum.

**Proof**

Suppose that, as shown in Figure 3.10, the function  $Y(x)$  has two separated local maxima at  $x_1$  and  $x_3$ , then there must exist a local minimum at some point  $x_2$  between  $x_1$  and  $x_3$ . By lemma 4, this local minimum must be at the vertex of two  $Y_i(x)$ , say  $Y_1(x)$  and  $Y_2(x)$ . The point  $x_2$  being a local minimum of  $Y(x)$  requires, in the vicinity of  $x_2$ ,

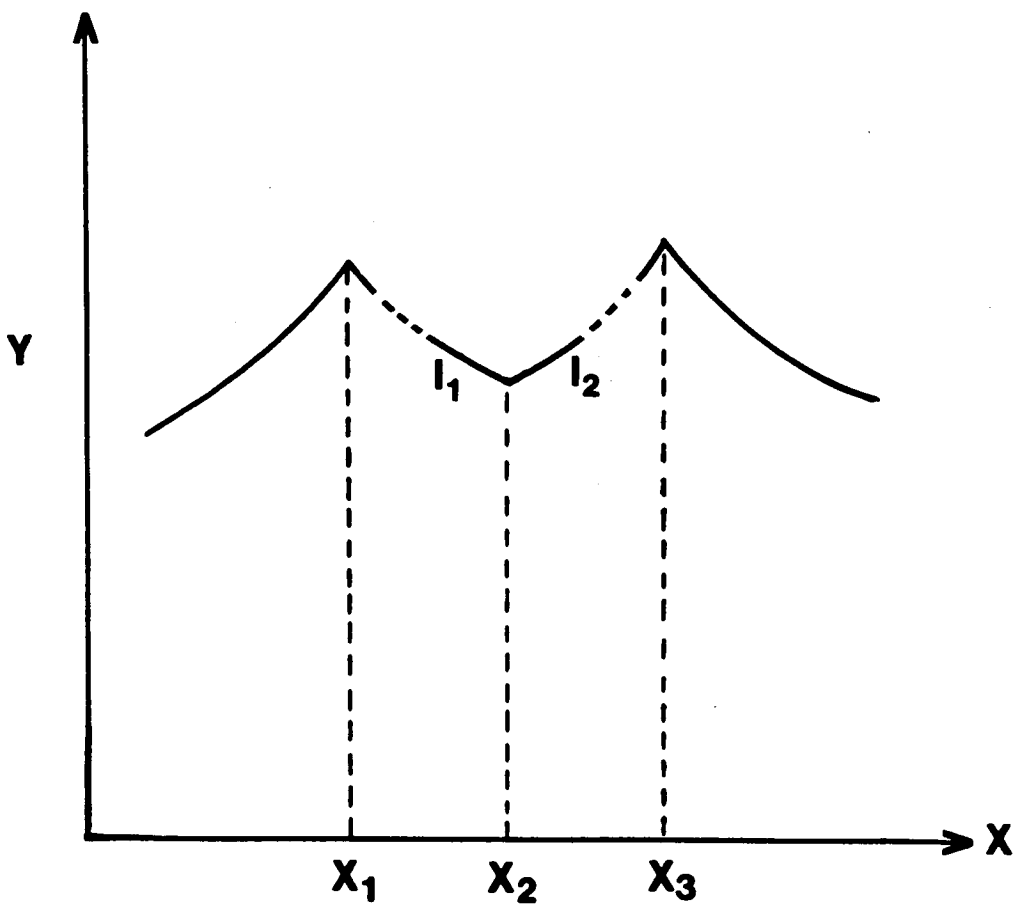

Figure 3.10. Hypothetical case where two maxima occur in a linear trajectory. (Proved impossible by contradiction)

$$Y(x) > Y(x_2) \quad \text{for } x > x_2 \quad \text{and } x < x_2 \quad (3.12)$$

Let  $Y_1(x)$  be the function which coincides with  $Y(x)$  for  $x < x_2$  (i.e., the curve  $l_1$ ) and  $Y_2(x)$  the function which coincides with  $Y(x)$  for  $x > x_2$  (i.e., the curve  $l_2$ ) in the vicinity of  $x_2$ , then one has

$$Y_1(x) > Y(x_2) \quad \text{for } x < x_2 . \quad (3.13)$$

$Y_1(x)$  being quasi-monotonic means that, from Equation (3.13),

$$Y_1(x) < Y(x_2) \quad \text{for } x > x_2 \quad (3.14)$$

in the vicinity of  $x_2$ . The same reasoning that led to these two equations, when applied to  $Y_2(x)$ , gives in the vicinity of  $x_2$ ,

$$Y_2(x) > Y(x_2) \quad \text{for } x > x_2 , \quad (3.15)$$

$$Y_2(x) < Y(x_2) \quad \text{for } x < x_2 . \quad (3.16)$$

Remembering that  $Y(x)$  coincides with  $Y_2(x)$  (by definition of  $Y_2(x)$  above) for  $x > x_2$ , Equation (3.15) can be rewritten

$$Y(x) > Y(x_2) \quad \text{for } x > x_2 , \quad (3.17)$$

and together with Equation (3.14) this gives

$$Y_1(x) < Y(x) \quad \text{for } x > x_2 \quad (3.18)$$

in the vicinity of  $x_2$ . This contradicts the definition of  $Y(x)$  in Equation (3.11). Thus  $Y(x)$  can have at most one local maximum.

### **Theorem 3**

Along any linear trajectory within a region of fixed permutation in the feasible region, the auxiliary function  $A$  has at most one local maximum (orbital variables only).

#### **Proof**

The discussion here is confined to a linear trajectory within a region of fixed permutation. From Lemma 3, all the single-entry C/I terms are quasi-monotonic functions on such a trajectory. The function  $A$  is defined as the minimum of all these C/I terms; thus the function  $A$  may be identified with  $Y(x)$  in Lemma 5 if the trajectory parameter  $a$  is identified with  $x$  in that lemma. Therefore, from Lemma 5, the function  $A$  has at most one local maximum (hence a global maximum when it exists) along a linear trajectory.

### **Theorem 4**

The auxiliary function  $A$  has at most one local maximum within a region of fixed permutation in the configuration space (orbital variables only).

#### **Proof**

The discussion here is still confined to a region of fixed permutation. It will be shown that Theorem 3 is contradicted if the function  $A$  has two local maxima within such a region. Suppose that the function  $A$  has two local maxima at  $x_1$  and  $x_2$ , then the linear trajectory that passes through both  $x_1$  and  $x_2$  will have two local maxima at  $x_1$  and  $x_2$ ; however, this is a clear contradiction of Theorem 3. Hence within

this region the function A has at most one local maximum; hence any maximum must be global in the region. Because the C/I variations are only quasi-monotonic, there may be sub-regions in which the value of A is constant; if this value is not exceeded elsewhere in this region, A will not have a distinct maximum in this region.

#### **Theorem 5**

The local maxima of the auxiliary function A are located at the boundary of the feasible region in the configuration space (orbital variables only).

#### **Proof**

By the same argument as in Theorem 2, a scenario located in the interior of a feasible region cannot be a local maximum because it is always possible to find a scenario located at the boundary that has better or equal single-entry C/I values. Thus any maximum of A has to be at the boundary.

#### **(4) Numerical test**

As discussed in Section III.B.3, the objective function Z is formulated to emphasize the worst aggregate  $C/I_e$  terms by exponentiating the negative of the aggregate  $C/I_e$  value; thus it is reasonable to say that there is a direct relationship between the function Z and the negative of the worst aggregate  $C/I_e$  term, or several such terms if they are of approximately equal value. In view of Theorem 4, this suggests that the function Z is likely to have only one local minimum within a region of fixed permutation. Since a rigorous proof has eluded us, a

numerical example of a four-administration model was calculated to investigate this feature: the four administrations are Argentina, Bolivia, Paraguay, and Peru; the feasible orbital range is from 62 to 68 degrees west. The objective-function value was calculated from Equation (3.1), the values of C and I were calculated from Equations (2.5), (2.6), and (2.13a); the antenna reference patterns are from Figures 2.2 and 2.3; the ellipse data were calculated from [49]. Since it is known from Theorem 2 that the local minima must be located at the boundaries of the feasible region in the configuration space, the objective function values at all the 24 boundary planes of this numerical example were calculated; the equal-height contour plots are shown in Appendix C, where Argentina, Bolivia, Paraguay and Peru are denoted as ARG, BOL, PRG, and PRU respectively. In each figure, two satellites are located at opposite ends of the feasible arc, and the (varying) orbital locations of the other two are indicated by the coordinates. The upper triangle represents one permutation and the lower triangle another permutation. Clearly there is only one local minimum for each permutation. The results suggests that for a general case (n satellites) it is likely that there is only one local minimum within a region of fixed orbital permutation.

#### **D. DISCUSSION AND CONCLUSION**

Even though the objective function in Equation (3.1) is not the only one that might be formulated to solve the orbital/frequency assignment problem, it still should be representative of objective functions designed to maximize low  $C/I_e$  ratios. Therefore many of the



mathematical features of the assignment problem can be inferred from this function.

Referring to Figures 3.4 and 3.5 and the discussions in Section III.C, the objective function of Equation (3.1) often has large values at points of either orbital or frequency assignment collocation, and the local minima can be characterized by the permutations of their orbital/frequency assignments. This feature indicates that there might be on the order of  $(n!)^2$  local optimum solutions for a  $n$ -satellite case of  $n$  orbital variables and  $n$  frequency variables; in reality the number of local optima is likely to be smaller because the collocation of two satellites may not result in bad  $C/I_e$  ratios when the service areas or their frequencies are well separated. Still, one thing is clear: permutation of the orbital/frequency assignments is an important part of the problem. Therefore a technique for finding the globally optimal (or a near-optimal) scenario must be able to choose the proper permutation of the orbital/frequency assignments, as an important step toward satisfying the  $C/I_e$  requirement.

Also, the discussion in Section III.C.3.c, which shows that the objective function is likely to have only one local minimum within a given orbital permutation, suggests that in order for an extended gradient search method to obtain the globally optimal solution, it should terminate as an ordinary gradient search with the optimal permutation in orbital/frequency assignments.

## CHAPTER IV

### OPTIMAL ORBITAL ASSIGNMENTS BY MEANS OF THE $\Delta S$ CONCEPT

#### A. INTRODUCTION

In this chapter a direct correspondence between the single-entry  $C/I_e$  protection requirements and the necessary satellite spacings is exhibited. This relationship is used to formulate linear constraints to enforce single-entry  $C/I_e$  protection requirements between all pairs of satellites. Two new formulations are then developed under the assumption that frequency assignments are the same for all the service areas. One is a mixed integer linear program, solved by a branch-and-bound procedure. The other is a linear program with both linear and nonlinear side constraints, the simplex method with restricted basis entry can be used to find an approximate solution when this formulation is used. As a consequence, the cumbersome nonlinear  $C/I_e$  expression used for the synthesis formulation in Chapter III is avoided.

The 1977 World Administrative Radio Conference (WARC-77) suggested that for maximum orbit utilization, space stations should be placed as close to each other as is consistent with keeping the mutual interference to acceptable levels [16]. This concept was explored by a Canadian study group by relating the single-entry  $C/I$  protection requirement to the satellite spacing [26,27,28]; they formulated a

orbital/frequency assignment program, for use at the 1983 Regional Administrative Radio Conference (RARC-83), based on the satellite spacing requirement. The concept of using this relationship in conjunction with linear optimization is original, to our best knowledge. The author is indebted to Professor Charles H. Reilly of the Department of Industrial and Systems Engineering for the mixed-integer and linear programming formulations and to Mr. David J. Gonsalvez for the actual programs.

The organization of the chapter is as follows. First the relationship between the single-entry  $C/I_e$  protection requirement and pairwise satellite spacing will be formulated, and the relative importance of system parameters will be discussed. Next, exact and approximate methods of calculating the required spacing will be presented. This will be followed by a heuristic discussion of the relationship between single-entry and total acceptable protection requirements, in order to establish single-entry requirements which are highly likely to lead to satisfaction of the total acceptable  $C/I_e$  protection requirement. Next the principle of the methods will be elucidated with a very simple hypothetical four-service area example to show how satellite ordering (permutation) enters into the linear optimization process. Finally the results of both the mixed integer program (MIP) and restricted-basis entry linear program (RBLP) formulations will be presented for a scenario of six South American administrations.

**B. RELATION BETWEEN SINGLE-ENTRY C/I<sub>e</sub> PROTECTION REQUIREMENT AND REQUIRED SATELLITE SPACING**

The relationship between a single-entry C/I<sub>e</sub> requirement and the required satellite spacing will now be derived. The general configuration of two service areas A, B and the locations of their satellites S<sub>A</sub>, S<sub>B</sub> is shown in Figure 4.1 which is identical to Figure 2.7. Refer to Section II.F for detailed description of all the parameters. It is assumed that frequency assignments are the same for both satellites. The received carrier power, C, in channel n (carrier frequency f<sub>n</sub>) at test point d is given in Equation (2.5) as

$$C = \frac{P_A \cdot G_A \cdot D_A(\psi_{tc}) \cdot G_d \cdot c^2}{f_n^2 \cdot (4\pi)^2 \cdot x^2} ; \quad (4.1)$$

the effective single-entry interference power, I<sub>n</sub><sup>e</sup>, from S<sub>B</sub> to channel n of test point d can be inferred from Equation (2.6) as

$$I_n^e = \sum_m \frac{P_B \cdot G_B \cdot D_B(\psi_{ti}) \cdot G_d \cdot D_d(\psi_{ri}) \cdot c^2 \cdot F(f_n, f_m)}{f_m^2 \cdot (4\pi)^2 \cdot y^2}$$

$$= \frac{P_B \cdot G_B \cdot D_B(\psi_{ti}) \cdot G_d \cdot D_d(\psi_{ri}) \cdot c^2}{(4\pi)^2 \cdot y^2} \cdot \sum_m \frac{F(f_n, f_m)}{f_m^2} , \quad (4.2)$$

where the summation is over all frequency channels assigned to S<sub>B</sub>. The term "single-entry" is defined as the aggregate of emissions from any

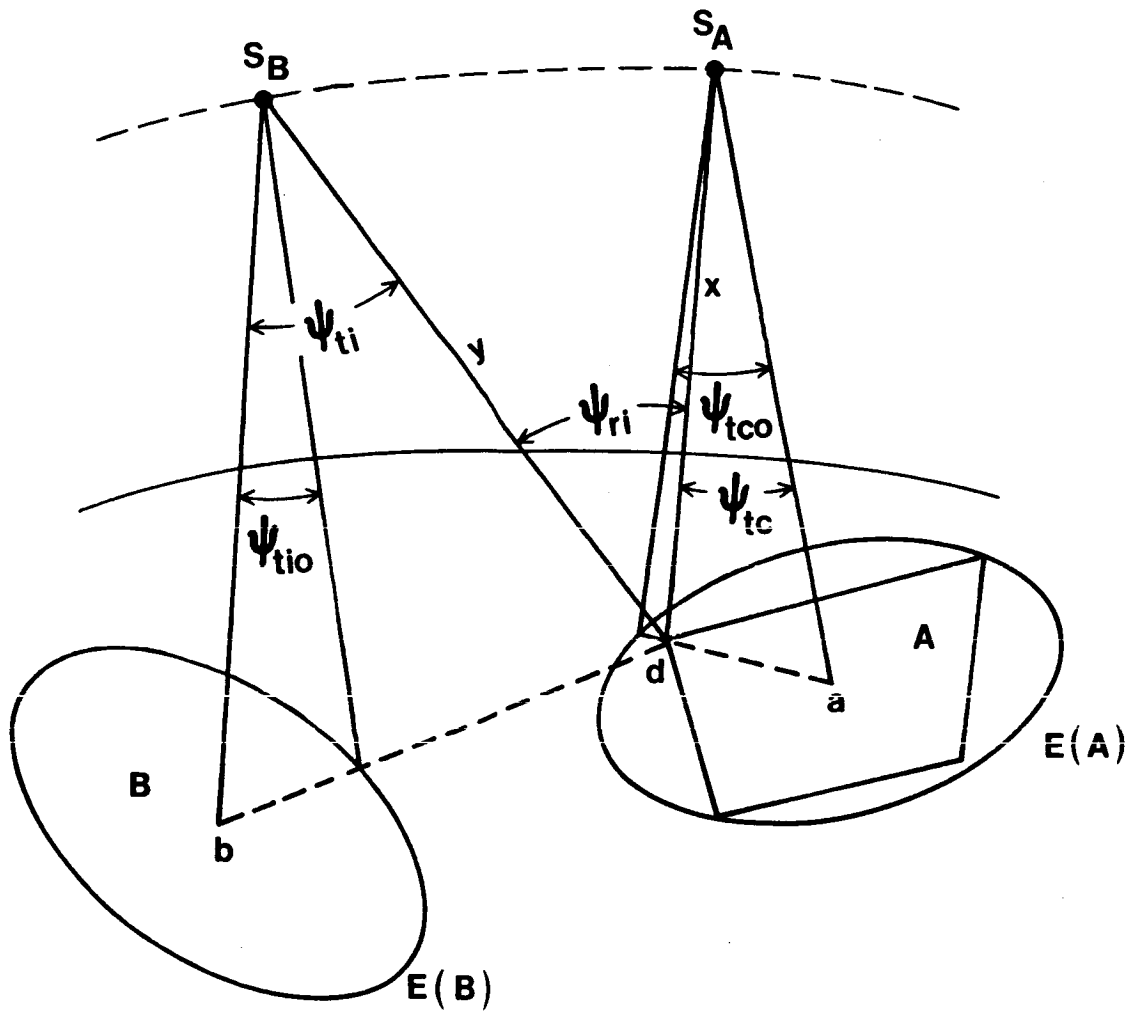

Figure 4.1. Configuration of received-power calculation.

one satellite entering any receiver in the wanted service within the channel to be protected [87]. The single-entry  $I_n^e$  values are different for different channels, and the worst one is in the channel at the center of the assigned band; it is denoted as  $I_e$ , and is used to evaluate the interference effect in this chapter.

The exact single-entry C/ $I_e$  ratio (in center channel  $n$ ) at test point  $d$  is therefore

$$\frac{C}{I_e} = \frac{P_A \cdot G_A / x^2}{P_B \cdot G_B / y^2} \cdot \frac{D_A(\psi_{tc})}{D_B(\psi_{ti}) \cdot D_d(\psi_{ri})} \cdot \frac{1}{f_n^2 \cdot [\sum_m (f_n, f_m) / f_m^2]} \quad (4.3)$$

Even though the only independent variables in Equation (4.3) are the satellite orbital locations, there are many hidden parameters and relationships. The minimum ellipse (its size, orientation, and aim point) for  $S_A$  is a function of satellite location. It is assumed in this chapter that the carrier power flux densities at the aim points are equal for all the satellite systems. For any ellipse size there is a corresponding  $G_A$  value, and the value of  $P_A$  must be adjusted to give the required power density at the aim point. As for  $D_A(\psi_{tc})$ , the value of  $\psi_{tc}$  depends on the satellite location, and there is also an implicit parameter  $\psi_{tc0}$  which is a function of the ellipse (refer to Figure 2.1). The same considerations apply to satellite  $S_B$ , and  $G_B$ ,  $P_B$ ,  $D_B$ . Strictly speaking, the values of  $G_d$ , and thus  $D_d$ , are different for different channels because they are functions of carrier frequencies; in this chapter the values of  $G_d$  for all channels are assumed the same, which is reasonable for a narrow band frequency assignment.

The exact calculation of Equation (4.3) is complicated, it is therefore worthwhile to seek an approximation to Equation (4.3). Because the geostationary orbit radius is 6.6 times the Earth radius, the propagation distances  $x$  and  $y$  are approximately equal. Then, since the power densities at the respective aim points are assumed equal [65], it follows that

$$\frac{P_A \cdot G_A}{x^2} \approx \frac{P_B \cdot G_B}{y^2} \quad (4.4)$$

When the service-area shape can be fitted reasonably with an ellipse, the test point  $d$  should be located on or near the  $-3$  dB contour [46,47], giving

$$D_A(\psi_{tc}) \approx 1/2 \quad (4.5)$$

Equation (4.3) can therefore be approximated as

$$\frac{C}{I_e} \approx \frac{1}{2 \cdot D_B(\psi_{ti}) \cdot D_d(\psi_{ri})} \cdot \frac{1}{f_n^2 \cdot \left[ \sum_m F(f_n, f_m) / f_m^2 \right]} \quad (4.6)$$

The factor  $1/[f_n^2 \cdot \sum_m F(f_n, f_m) / f_m^2]$  is a constant since it is assumed that the frequency assignments are the same for all satellites (note that  $f_n$  is at the center channel). An internationally agreed  $F(f_n, f_m)$  reference function exists only for the BSS, but not for the FSS which is the subject of the study in this chapter. However, it is known

that numerous U.S. FSS satellites have 24 transponders in the 6/4 GHz band occupying the whole 500 MHz bandwidth, each transponder channel is 36 MHz wide and the guard band between two channels is 4 MHz (cross-polarization discrimination allows frequency re-use in a satellite). In this chapter only the co-channel interference will be considered. Thus the value of  $1/\{f_n^2 \cdot [\sum_m F(f_n, f_m)/f_m^2]\}$  is taken to be one. Then Equation (4.6) can be approximated as

$$\frac{C}{I_e} \approx \frac{1}{2 \cdot D_B(\psi_{ti}) \cdot D_d(\psi_{ri})} \quad (4.7)$$

The variation of the  $C/I_e$  values with respect to the satellite orbital locations will now be discussed. Because the service areas are stationary and the satellite orbit radius is 6.6 times the earth radius, the value of  $\psi_{ti}$ , and hence the value of  $D_B(\psi_{ti})$ , changes little when the location of  $S_B$ , the interfering satellite, is changed by a small arc length. When the service-area pair and system parameters are given, the term  $\psi_{ri}$ , and thus  $D_d(\psi_{ri})$ , becomes the only factor that can significantly affect the  $C/I_e$  values; this is done by changing the satellite spacing to vary  $\psi_{ri}$ , and thus the  $D_d(\psi_{ri})$  value.



To have an acceptable single-entry  $C/I_e$  ratio, the main contributions are seen to come from the terms  $D_B(\psi_{ti})$  and  $D_d(\psi_{ri})$ . The term  $D_B(\psi_{ti})$  comes from the separation between the two service areas; the further they are separated, the less the value  $D_B(\psi_{ti})$ . The very fact that it comes from the geographic separation of the service areas makes it a valuable resource for the system planner. The term  $D_d(\psi_{ri})$  comes from the satellite spacing; the larger the spacing, the larger the value  $\psi_{ri}$ , and the smaller the value  $D_d(\psi_{ri})$ . The most important feature about the satellite spacing is that this quantity can be controlled by the system planner.

For a given single-entry  $C/I_e$  protection requirement, the system planner should first look for the term  $D_B(\psi_{ti})$  for its contribution to the margin between  $C$  and  $I_e$ ; when this is not enough, he then has to look for the term  $D_d(\psi_{ri})$  to make up the difference. For satellite  $S_A$  located at  $l$  and  $S_B$  located to the east of  $S_A$ , the threshold satellite spacing that lets the resulting worst single-entry  $C/I_e$  value equal the protection requirement is the local required spacing for the satellite pair, and is designated as  $\Delta s_{A(l),B(l+)}$ ; here the sign  $+$  means east of  $l$ . For  $S_B$  to the west of  $S_A$  it would be  $\Delta s_{A(l),B(l-)}$ . With any less spacing at least one of the test points would have an unacceptable single-entry  $C/I_e$  ratio, while with any more spacing all the single-entry  $C/I_e$  ratios would be better than the requirement. Thus, the  $\Delta s(l)$  function can be viewed as the reflection of the single-entry protection requirement, eg.,  $|S_A - S_B| > \Delta s_{AB}$  would guarantee satisfactory single-entry  $C/I_e$  ratios at all the test points in service areas A and B.

Since a satellite spacing requirement given by  $\Delta s(1)$  is equivalent to the equivalent single-entry protection requirement, it can be taken as a constraint on the relative locations of the corresponding satellites. So, instead of thinking about a scenario having satisfactory single-entry  $C/I_e$  values, one may think about the scenario satisfying all the  $\Delta s(1)$  constraints. One important feature about the  $\Delta s(1)$  value is that, in producing the margin between  $C$  and  $I_e$ , it fully utilizes the service-area separation to minimize the necessary satellite spacing. This approach corresponds directly to the idea proposed in WARC-77: for maximum orbit utilization satellites should be placed as close to each other as is consistent with keeping the mutual interference to acceptable levels [16]; hence the set of  $\Delta s(1)$  values is exactly what the system planner should use in order to achieve this goal. Using the  $\Delta s(1)$  value in the orbit planning task has a great advantage in terms of numerical calculations. While the  $C/I_e$  expression involves many geometric equations and is highly nonlinear with respect to the orbital variables, the  $\Delta s(1)$  set can be calculated once and for all for each service-area pair and then used as constraints. This greatly changes the aspect of the orbital assignment task, and the methods to solve it; this will be apparent in Section IV.F.

It is suggested in WARC-77 that single-entry protection requirements can be used as a guide for determining sharing criteria [87]; still the total interference from all sources must be calculated to evaluate the scenario definitively. In this chapter, satellite orbit planning methods are developed based on single-entry protection

requirements; it will be shown in Section IV.D that this is likely to lead to adequate aggregate protection when the single-entry  $C/I_e$  protection requirement is larger than the total acceptable protection requirement by 5 dB. First, one needs to turn one's attention to algorithms for calculating the  $\Delta s$  values just defined.

### C. CALCULATION OF $\Delta S$ VALUES

#### 1. Exact Method

An exact determination of the required satellite spacings requires solution of Equation (4.3) for  $\psi_{rj}$  for various locations of  $S_A$ . An explicit solution has not been found; still, a numerical value can be obtained by evaluating the right side of Equation (4.3) (or equivalently Equations (4.1) and (4.2)) for increasing separations until the required  $C/I_e$  value results. Specifically, the rigorous calculation of the threshold satellite spacing for two service areas A, B may be done by the following algorithm. (Refer to Figure 4.2 for the geometric relations.)

- (1) Set the location of satellite  $S_A$  at orbital location 1.
- (2) Move the location of satellite  $S_B$  incrementally from 1 toward the east. After each move, use the streamlined Spectrum/Orbit Utilization Program (SOUP) code in Appendix A to calculate the  $C/I_e$  values at all the test points of the two service areas.

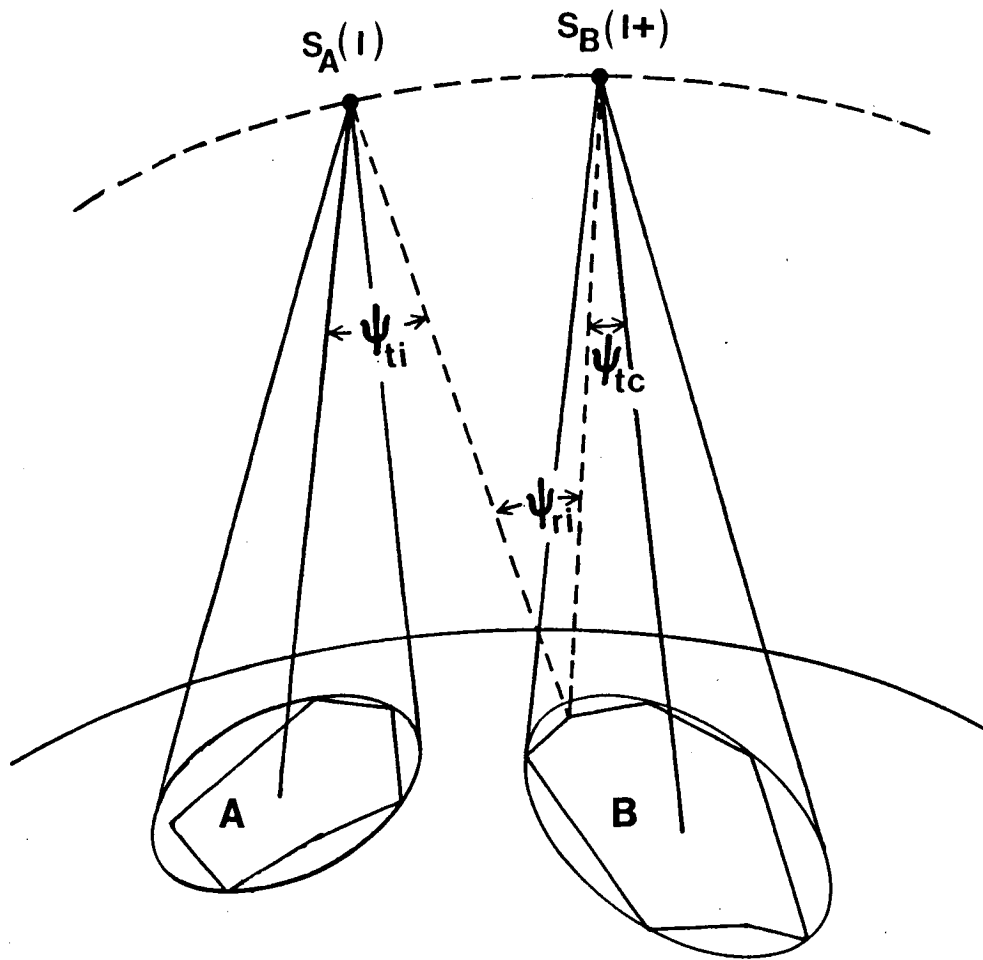

Figure 4.2. Configuration of  $\Delta s(l)$  value calculation.

- (3) There exists a satellite spacing beyond which all the  $C/I_e$  values exceed the single-entry protection requirement, and below which at least one  $C/I_e$  value is worse than the protection requirement. This is the satellite spacing for the two service areas at the prescribed locations and is denoted as  $\Delta S_{A(1),B(1+)}$ , where the sign + means east of 1.
- (4) Repeat procedures (1)-(3) for  $S_B$  west of  $S_A$ ; the resulting spacing is denoted as  $\Delta S_{A(1),B(1-)}$ , where the sign - means west of 1.
- (5) Repeat (1)-(4) with a set of new locations for satellite  $S_A$  until its feasible arc has been covered.

The above calculation is rather time consuming. For each test position, the minimum ellipse data of the service area has to be generated.

## 2. Approximate Method

To ease the computational burden, an approximate method was adopted. This method is based on the assumption that the power densities at the ground receiver locations do not change when the location of either satellite is moved away from 1 by a small arc length. The procedure is:

- (1) Collocate the two satellites at 1. Use the streamlined SOUP code in Appendix A to calculate all the ground receiver  $C/I_e$  values.

- (2) Pick out the test point with the worst  $C/I_e$  value, calculate the margin between this  $C/I_e$  value and the single-entry protection requirement. At this point the service-area separation factor has been accounted for, so this margin should be made up by separating the two satellites from collocation to produce the receiving discrimination loss  $D_d(\psi_{ri})$  toward the interfering satellite.
- (3) Use the receiving antenna reference pattern in Figure 2.5 to calculate the necessary off-axis angle that provides this margin; this is the topocentric angular separation (viewed from the test point with the worst  $C/I_e$  value) the two satellites should have.
- (4) Spread the satellites symmetrically apart from 1 step by step until the separation gives this necessary topocentric angle at this test point. The final geocentric separation is the approximate  $\Delta s(1)$  value when  $S_A$  and  $S_B$  are in the vicinity of orbital location 1.

The computer code for this calculation is listed in Appendix D.

An example of the  $\Delta s(1)$  calculation is shown in Table 4.1 with the two administrations being Bolivia (BOL) and Paraguay (PRG). The satellite transmitting and ground receiving reference patterns are given in Figures 2.4 and 2.5. Initially the satellites are located at 90 degrees west. The interference calculation is carried out, and the test point with the worst  $C/I_e$  value, -0.66 dB, is at 62.2 degrees west

Table 4.1

Example of  $\Delta s(1)$  Calculation Procedure

COUNTRY	SATELLITE (LON.)	FREQUENCY (MHz)
BOL	-90.00	4000.00
PRG	-90.00	4000.00

TEST COUNTRY : BOL      SATELLITE : -90.00

TEST POINT LON.	LAT.	INT. SAT.	C/I (dB)	MARGIN (dB)
-65.00	-12.20	PRG	28.86	-1.14
-65.50	-9.80	PRG	27.51	-2.49
-69.00	-11.20	PRG	27.78	-2.22
-60.00	-16.10	PRG	8.02	-21.98
-57.50	-18.00	PRG	2.58	-27.42
-67.50	-22.70	PRG	14.88	-15.12

TEST COUNTRY : PRG      SATELLITE : -90.00

TEST POINT LON.	LAT.	INT. SAT.	C/I (dB)	MARGIN (dB)
-57.60	-25.30	BOL	7.75	-22.25
-58.60	-27.30	BOL	10.58	-19.42
-56.20	-27.20	BOL	14.54	-15.46
-54.70	-25.50	BOL	13.22	-16.78
-54.20	-24.10	BOL	11.20	-18.80
-58.10	-20.20	BOL	1.15	-28.85
-59.10	-19.30	BOL	0.08	-29.92
-62.20	-20.50	BOL	-0.66	-30.66
-62.70	-22.20	BOL	-0.35	-30.35
-58.70	-27.20	BOL	10.15	-19.85

WORST MARGIN IS -30.66 dB AT PRG ( -62.20, -20.50)

REQUIRED SATELLITE SPACING : 4.00 AT -90.00 FOR C/I 30.0 dB

longitude, 20.5 degrees south latitude in Paraguay. The single-entry  $C/I_e$  protection requirement is chosen to be 30 dB, hence it requires 30.66 dB attenuation from the ground receiving discrimination to provide the necessary margin between C and  $I_e$ . Then the receiving reference pattern is used to calculate the required off-axis angle, i.e., the topocentric angle, of the two satellites as seen from the test point with the worst  $C/I_e$  value. The satellite geocentric spacing is obtained from step (4) of the approximate method, the result is shown in Table 4.1 which shows that, in the vicinity of 90 degrees west, the necessary satellite spacing for these two service areas is four degrees. This spacing should result in at least 30 dB single-entry  $C/I_e$  values at all test points, with the worst one at 30 dB. This result can not be guaranteed precisely, since the test point which was the worst for the original satellite locations may not be the worst for the new locations, and since new ellipses were not generated for the new satellite locations.

Using the same antenna parameters and 30 dB protection requirement, some of the  $\Delta s(l)$  values for several service-area pairs at different mean satellite locations are listed in Table 4.2. The calculation is made in 10- or 20-degree increments.

An example of the curve  $\Delta s(l)$  vs. mean satellite location  $l$  is shown in Figure 4.3, the two administrations are Paraguay and Uruguay. The  $\Delta s(l)$  value is fairly constant within a large range of satellite locations, and starts to increase when the satellite elevation angle is small.



Table 4.2

 $\Delta s(1)$  Values of Six South American Administrations

country pair	longitude	$\Delta S$	country pair	longitude	$\Delta S$	
ARG BOL	-70	4.00	CHL PRG	-20	3.05	
	-80	4.02		-30	2.45	
	-90	4.05		-40	1.69	
	-100	4.12		-50	1.35	
	-110	4.17		-60	1.14	
ARG CHL	-70	4.18		-70	1.08	
	-80	4.05		-80	1.14	
	-90	4.00		-90	1.25	
	-100	4.02		-100	1.46	
	-110	4.19		-110	2.00	
ARG PRG	-70	4.24		-120	3.32	
	-80	4.28		CHL PRU	-70	3.84
	-90	4.32	-80		3.83	
	-100	4.28	-90		3.85	
	-110	4.32	-100		3.89	
		-110	3.94			
ARG PRU	-70	0.94	CHL URG	-20	2.52	
	-80	1.04		-30	1.44	
	-90	1.15		-40	0.93	
	-100	1.25		-50	0.80	
	-110	1.41		-60	0.43	
ARG URG	-70	4.18		-70	0.42	
	-80	4.14		-80	0.41	
	-90	4.06		-90	1.03	
	-100	4.06		-100	1.28	
	-110	3.94		-110	1.59	
BOL CHL	-70	4.13		-120	2.10	
	-80	4.20		PRG PRU	-20	0.45
	-90	4.28	-40		0.47	
	-100	4.39	-60		0.48	
	-110	4.57	-70		0.49	
BOL PRG	-70	4.00	-80		0.49	
	-80	3.99	-90		0.50	
	-90	4.00	-100		0.85	
	-100	4.03	-110		1.10	
	-110	4.04	-120		1.76	
BOL PRU	-70	3.87	PRG URG		-20	2.35
	-80	3.95			-40	2.20
	-90	3.99			-60	2.13
	-100	4.10		-70	2.16	
	-110	4.26		-80	2.19	
BOL URG	-20	0.43		-90	2.20	
	-40	0.42		-100	2.34	
	-60	0.40		-110	2.46	
	-70	0.39		-120	2.64	
	-80	0.38		PRU URG	-20	0.45
	-90	0.38			-40	0.43
	-100	0.84			-60	0.41
	-110	0.94	-70		0.40	
	-120	1.09	-80		0.37	
			-90		0.37	
			-100		0.33	
			-110		0.32	
		-120	0.36			

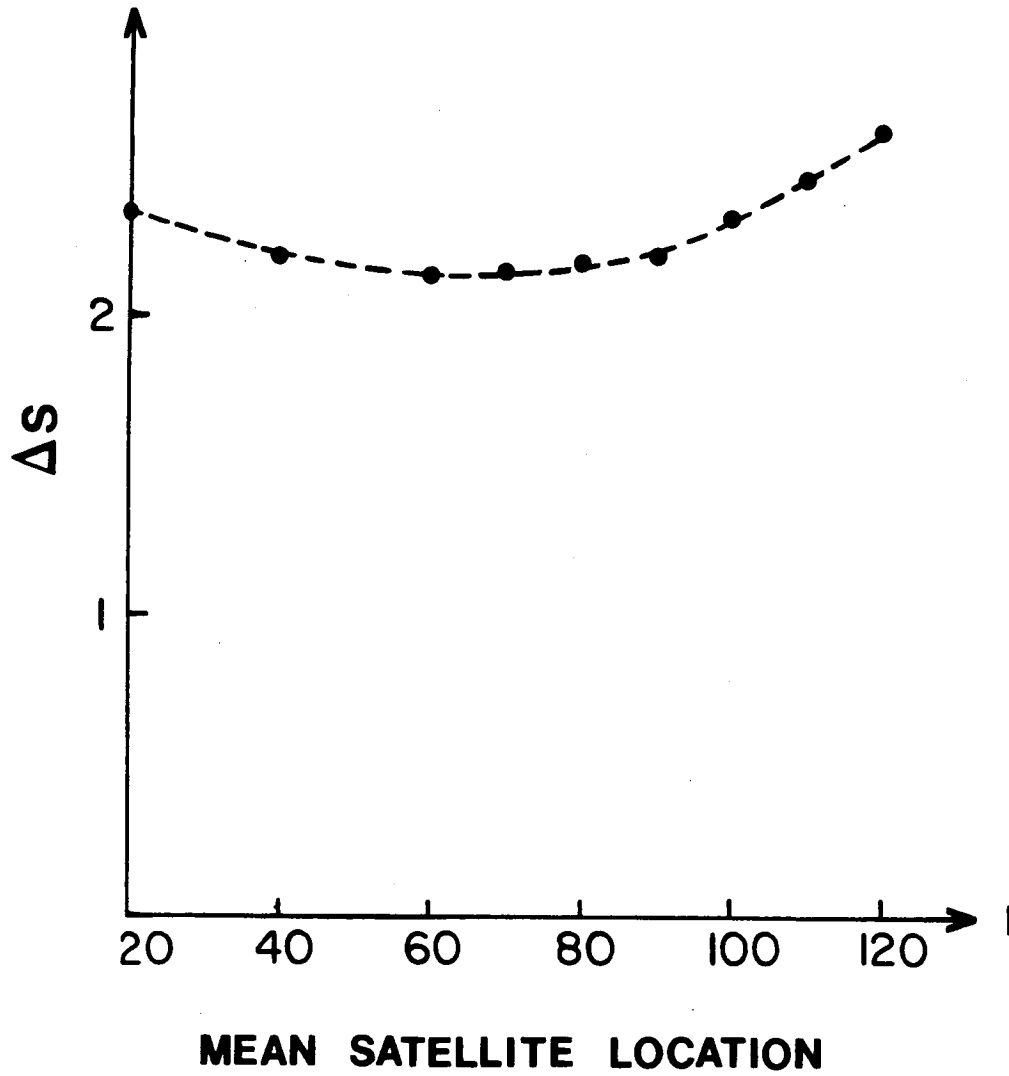

Figure 4.3. Typical  $\Delta s(1)$  value variation vs. mean satellite location.

Although the  $\Delta s(l)$  values are calculated up to two decimal fractions, in practical situations only the first decimal fraction is meaningful because the typical satellite station keeping inaccuracy is 0.1 degree [44]. The reason for keeping two decimal fractions is only to show their variations more precisely.

### 3. Validity of Approximate Method

The approximate method gives the correct result if the power densities at all the test points do not change when the satellites are moved by a small arc length. Strictly speaking, the power-density invariance assumption is not correct because the carrier power densities are designed to be constant only at the beam centers [65]. However, in practise, it is a highly acceptable assumption. To demonstrate this point more clearly, Equation (4.3) is written as

$$C/I_e = K(l_A, l_B) / D_d(\psi_{ri}) \quad , \quad (4.8)$$

where

$$K(l_A, l_B) = \frac{P_A \cdot G_A / x^2}{P_B \cdot G_B / y^2} \cdot \frac{D_A(\psi_{tc})}{D_B(\psi_{ti})} \cdot \frac{1}{f_n^2 \cdot \left[ \sum_m F(f_n, f_m) / f_m^2 \right]} \quad , \quad (4.9)$$

and  $l_A$  and  $l_B$  denote the orbital locations of  $S_A$  and  $S_B$ . The approximate method consists of calculating  $K$  for collocation, i.e.,  $K(l, l)$ , then assuming that this value remains constant as satellite locations are shifted a few degrees from  $l$ . The discussion in Section

IV.B (specifically, the paragraphs covering Equations (4.4) to (4.7) and the one immediately following Equation (4.7)) does indicate that this is a very good approximation.

Some examples support these arguments and show that the  $C/I_e$  values at the ground receivers do not change by more than 1 dB when the satellites are moved by two degrees; an example will now be given to demonstrate this point. In this example the Bolivia and Paraguay satellites are located at 92 and 88 degrees west, respectively, a four-degree separation as suggested from the result in Table 4.1. The  $C/I_e$  results from the streamlined SOUP calculation are given in Table 4.3. Note that the worst  $C/I_e$  value is very close to the 30 dB single-entry protection requirement, which indicates that the  $\Delta s(1)$  value of the approximate method is very close to that of the exact method.

#### **4. Relation Between Service-Area Adjacency and $\Delta s(1)$ Value**

For any adjacent service-area pairs the  $\Delta s(1)$  values for a given protection requirement are approximately independent of the sizes and shapes of the service areas. This can be seen best from Equation (4.7); for adjacent service areas A and B, the test point  $d$  in service area A with the worst  $C/I_e$  is on or near the common border with B, and its  $D_B(\psi_{ti})$  will be approximately 1/2 (-3dB). This determines the required  $D_d(\psi_{ri})$ , and  $\psi_{ri}$ , and hence  $\Delta s(1)$ . As another way of looking at it, the carrier and interference power densities along the common border are nearly equal because they are designed to be approximately 3 dB below the respective beam-center power densities, which are designed to be

Table 4.3

C/I<sub>e</sub> Results to Show Validity of Approximate Method

COUNTRY	SATELLITE (LON.)		FREQUENCY (MHz)		
BOL	-92.00		4000.00		
PRG	-88.00		4000.00		
TEST COUNTRY : BOL      SATELLITE : -92.00					
	TEST POINT		INT. SAT.	C/I (dB)	MARGIN (dB)
	LON.	LAT.			
	-65.00	-12.20	PRG	59.67	29.67
	-65.50	-9.80	PRG	58.32	28.32
	-69.00	-11.20	PRG	58.71	28.71
	-60.00	-16.10	PRG	38.82	8.82
	-57.50	-18.00	PRG	33.23	3.23
	-67.50	-22.70	PRG	46.03	16.03
TEST COUNTRY : PRG      SATELLITE : -88.00					
	TEST POINT		INT. SAT.	C/I (dB)	MARGIN (dB)
	LON.	LAT.			
	-57.60	-25.30	BOL	38.33	8.33
	-58.60	-27.30	BOL	41.27	11.27
	-56.20	-27.20	BOL	44.88	14.88
	-54.70	-25.50	BOL	43.33	13.33
	-54.20	-24.10	BOL	41.26	11.26
	-50.10	-20.20	BOL	31.79	1.79
	-59.10	-19.30	BOL	30.75	0.75
	-62.20	-20.50	BOL	30.06	0.06
	-62.70	-22.20	BOL	30.39	0.39
	-58.70	-27.20	BOL	40.86	10.86

equal. Therefore, the required margin between  $C$  and  $I_e$  is provided only by the satellite spacing. Since this is true for all adjacent service-area pairs, the required satellite spacings are nearly the same. For the receiving reference pattern in Figure 2.5 and a 30 dB single-entry  $C/I_e$  protection requirement, these  $\Delta s(1)$  values are approximately four degrees, as can be seen from several cases in Table 4.2.

The  $\Delta s(1)$  values for two non-adjacent service areas are likely to be smaller, and depend on their shapes, sizes and the separation between them. This is evident from Equation (4.7) since  $D_B(\psi_{ti})$  is likely to be smaller numerically (also in dB) in this case compared to the adjacent case. Heuristically, because of the service-area separation, the interference power densities in these two service areas are likely to have a deeper transmitting antenna discrimination loss relative to the carrier power densities. Therefore, the system needs less receiving antenna discrimination loss,  $D_d(\psi_{ri})$ , to achieve the required  $C/I_e$  ratio. This means that less satellite spacing, or a smaller  $\Delta s(1)$  value, is needed. This is shown in several cases in Table 4.2.

#### **D. RELATION BETWEEN SINGLE-ENTRY AND TOTAL ACCEPTABLE $C/I_e$ PROTECTION REQUIREMENTS**

In satellite communications, a scenario is evaluated by computing an equivalent margin (see Equations (2.8) and (2.9)), which takes into account all the interference, at all the test points. In Chapter II this was shown to be equivalent to comparing the aggregate  $C/I_e$  values with the total acceptable protection requirement. It is therefore

essential that an assignment algorithm is based ultimately on the total acceptable protection requirement. However, it was also suggested in WARC-77 that the single-entry protection requirement can be used as a guide for determining sharing criteria; of course the total interference from all sources still must be calculated to evaluate the scenario fully [87]. The extended-gradient and cyclic-coordinate search methods discussed in Chapter III are based on the aggregate  $C/I_e$  values. In contrast, the methods in this chapter, using the  $\Delta s$  concept, are based on single-entry  $C/I_e$  protection requirements. Clearly such an approach will be acceptable only if there exists some relationship between the single-entry and aggregate  $C/I_e$  values.

Although so far no such relationship has been established rigorously, it is generally felt that the single-entry  $C/I_e$  protection requirement does not need to exceed the total acceptable requirement by more than a few decibels. In order to ensure that a scenario made on the basis of single-entry  $C/I_e$  protection requirement would result in acceptable aggregate  $C/I_e$  values, WARC-77 suggested that the single-entry  $C/I_e$  protection requirement be higher by 5 dB than the total acceptable protection requirement [78]. Note that numerically 5 dB is equal to 3; this suggestion is therefore based on the assumption that at the test point which has the worst aggregate  $C/I_e$  value the aggregate interference will not exceed three times the strongest single-entry interference. This assumption is supported by the characteristics of the satellite transmitting and ground receiving antenna reference patterns. Referring to Figures 2.4, 2.5 and Equation

(2.6), because these two reference patterns are highly directional, among all the received single-entry interference powers only the few that come from the main or near side-lobe of the transmitting reference patterns and are received in the main or near side-lobe of the receiving reference pattern are relatively strong; the others are generally weak enough to be negligible. However, it is difficult to prove rigorously that 5 dB extra protection requirement is absolutely enough to cover the difference between the single-entry and aggregate  $C/I_e$  values; hence the aggregate  $C/I_e$  results must be calculated to evaluate the feasibility of a scenario. In the numerical examples in this chapter, 5 dB extra protection was used for all service areas.

In any case, the methods to be described below do not depend on the validity of 5 dB, or any universal number. If the final analysis by the streamlined SOUP program shows more than 5 dB extra protection is needed for some service areas, then a more appropriate value may be chosen to compute the  $\Delta s(1)$  values for an improved synthesis.

#### **E. PERMUTATIONAL ASPECT OF THE ORBITAL-ASSIGNMENT PROBLEM**

With a data base of  $\Delta s(1)$  values for all the service area pairs, conceptually the planning problem could be solved by choosing a proper ordering or permutation of the satellites and completing the scenario by locating every satellite in its feasible orbital range while making



sure that the  $\Delta s(1)$  constraints are satisfied. As an example, consider a four-service area case with the geographic relation as shown in Figure 4.4 with the objective of finding a scenario that uses the least orbit resource. The satellites are denoted as  $S_A$ ,  $S_B$ ,  $S_C$  and  $S_D$ . Assume that the values of  $\Delta_{S_B S_C}(1)$  and  $\Delta_{S_B S_D}(1)$ , the required satellite spacings for the non-adjacent service areas, are constant and are two degrees; similarly assume that the  $\Delta s(1)$  for all the adjacent service areas are constant and are four degrees. A scenario that meets this objective would be the ordering  $S_D-S_B-S_C-S_A$  with minimum required satellite spacing because it requires only eight degrees of orbital arc. Arrangements that do not include both the  $S_B-S_C$  and  $S_B-S_D$  satellite adjacencies would have to require at least a ten-degree arc. In this example, with the objective of conserving orbit resource, the basic concept is to have adjacent satellites serve non-adjacent service areas; here it utilizes the service-area separation to reduce the need for satellite spacing, and achieves the maximum orbit utilization suggested in reference [16].

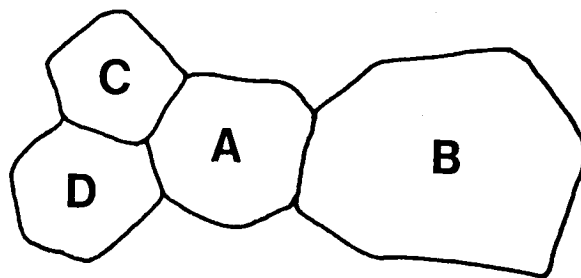

Figure 4.4. Geographic location of four service areas.

In such a brute-force procedure, it is likely that a feasible solution can not be found for a particular ordering. It could be that the available orbital arc for the task is used up before the allocation of all the satellites has been completed. Then, another ordering has to be tried.

Note that there are  $m!$  possible permutations for  $m$  satellites. This number becomes astronomical when  $m$  is large. If the goal is to find a scenario which is optimal by some criterion, in principle all the  $m!$  permutations have to be tested. Even if each test is simple and fast, the overall workload is still enormous.

## **F. ORBITAL ASSIGNMENT OPTIMIZATION FORMULATIONS**

### **1. $\Delta s(1)$ Constraint and Objective Function**

The orbital assignment problem can now be formulated as the optimization of a yet unspecified objective function, subject to the  $\Delta s(1)$  constraints on pairwise satellite spacings. The protection requirements will be satisfied because of the constraints. Also, it is highly desirable if the  $\Delta s(1)$  values are linear functions of the orbital variables so that a simple optimization technique, e.g., linear programming, can be used. This is apparently not true from Table 4.2 and Figure 4.3. Still, the  $\Delta s(1)$  values can be approximated by piecewise linear functions, or the maximum value of  $\Delta s(1)$  within a given orbital range, denoted as  $\Delta S$ , can be used as a constant parameter in the optimization formulation. The objective function is, in principle, entirely arbitrary, but we shall restrict it to a linear function of the

orbital locations since the whole purpose of this approach was to avoid the computational complexity of nonlinear optimization.

The objective function used in the numerical examples below is the sum of the absolute deviations of the assigned satellite positions from an arbitrary prescribed set of such positions, an "ideal" set. Such an "ideal" set might arise from requests of the user administrations. Alternatively, it may be specified as a tool for the synthesis, e.g., if the westernmost end of the available orbital arc is selected as the "ideal" location for all satellites, the resulting scenario is likely to allow the insertion of additional satellites at the eastern end at a later time with a minimum of readjustment.

Other objective functions which have been proposed for minimization are the length of the occupied orbital arc and the constant zero. The latter simply seeks to find a solution which satisfies the  $\Delta s(1)$  constraints.

## **2. Mixed-Integer and Restricted-Basis Linear Programming Formulations**

With the single-entry  $C/I_e$  protection requirement enforced by the  $\Delta s(1)$  constraints and a linear objective function, the problem can be formulated as a mixed integer program (MIP) [88]. Either the piecewise linear  $\Delta s$  functions or the constant  $\Delta S$  parameters might be used to formulate this program; in this chapter the constant  $\Delta S$  parameters will be used. The set of satellite locations which satisfy the  $\Delta S$  constraints and the feasible orbital range constraints constitutes the

feasible region. When the problem is solved via the branch-and-bound algorithm, the globally optimal solution is guaranteed [88]. However, the computational effort required to find this solution can be prohibitively long when the problem size, i.e., the number of satellites, is large.

To ease the burden on computational effort, the same problem can be formulated as a linear program (LP) with a set of nonlinear side constraints; only the constant  $\Delta S$  parameters can be used to formulate this program. A linear program is much more readily solvable than a nonlinear program or an integer program, and is most often solved by the simplex method [81]. However, in this problem, the nonlinear side constraints prevent one from using the simplex method in its most common form. The method can be modified to handle these nonlinear side constraints through the use of restricted basis entry. In doing so, one is certain to find a local, but not necessarily a global, optimum. The computational effort required by the LP technique should be acceptable when the problem size is large.

The MIP and the restricted-basis entry LP (RBLP) formulations are given in Appendix E as formulated by Professor Charles H. Reilly of the Department of Industrial and Systems Engineering for both of the non-trivial objective functions discussed above.

## **G. NUMERICAL EXAMPLES**

### **1. Definition of the Problem**

In this example, a model of six administrations in South America, as shown in Figure 4.5, is used; they are Argentina (ARG), Bolivia

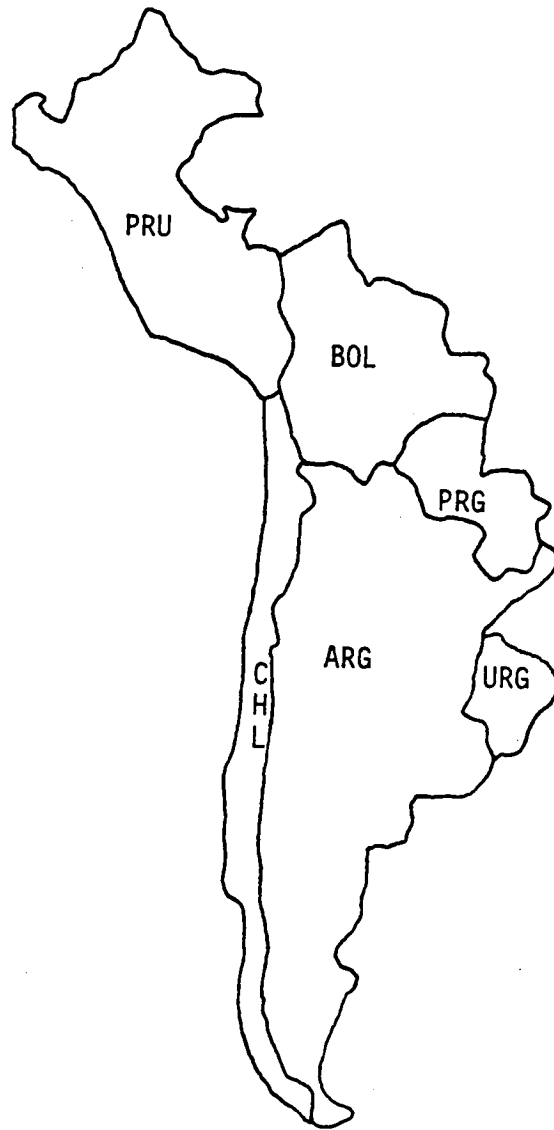

Figure 4.5. Geographic relation of six South American administrations.

(BOL), Chile (CHL), Paraguay (PRG), Peru (PRU), and Uruguay (URG). The feasible orbital ranges for all the administrations are taken to be from 80 to 110 degrees west. It is assumed that all satellites have the same frequency assignments. The antenna reference patterns are from Figures 2.4 and 2.5. The optimization requirement is to minimize the sum of the deviations of the actually assigned positions from the satellite preferred locations. Three sets of satellite preferred locations are considered, as listed in Table 4.4: in case 1, all the preferred satellite locations are at the center of the feasible range; in case 2, all the preferred satellite locations are at the western boundary; in case 3, every administration has its preferred satellite location at a longitude for which the azimuth angle of the satellite from the administration center is close to zero.

First, all the  $\Delta s(l)$  values must be calculated. They were calculated using a 30 dB single-entry protection requirement; the results are listed in Table 4.2. The  $\Delta S$  values of the six-administration problem, obtained from Table 4.2 by choosing the maximum  $\Delta s(l)$  values over the feasible range 80 to 110 degrees, are listed in Table 4.5. They are denoted as  $\Delta S_{ij}$  for satellite  $i$  and  $j$  in Appendix E. Using the  $\Delta S$  parameters instead of the approximate piecewise linear  $\Delta s$  functions results in a conservative design ( $C/I_e$  will tend to be larger), at the expense of possibly not using the orbit resource with maximum efficiency; but the alternative, i.e., using the  $\Delta s$  functions instead of the  $\Delta S$  parameters as constraints, would complicate the MIP formulations; note that the piecewise linear constraints can not be used in the RBLP formulation.

Table 4.4

Satellite preferred locations of six administrations

preferred	ARG	BOL	CHL	PRG	PRU	URG
case 1	95	95	95	95	95	95
case 2	110	110	110	110	110	110
case 3	87.5	92.5	97.5	87.5	102.5	82.5

Table 4.5

$\Delta S$  parameters of six administrations

$\Delta S$	ARG	BOL	CHL	PRG	PRU	URG
ARG	*	4.17	4.19	4.32	1.41	4.14
BOL		*	4.57	4.04	4.26	0.94
CHL			*	2.00	3.94	1.59
PRG				*	1.10	2.46
PRU					*	0.37
URG						*



## 2. MIP and RBLP Results

The solutions of the MIP and RBLP formulations for this objective function, i.e., Formulations III and IV in Appendix E, are listed in Table 4.6 together with the values of the total deviations, the occupied orbital arcs and the computer run times in seconds. These data were provided by Professor C. Reilly and Mr. D. Gonsalvez of the Department of Industrial and Systems Engineering.

Because of the  $\Delta S$  constraints, the solution is guaranteed to satisfy the single-entry  $C/I_e$  protection requirements; still the aggregate  $C/I_e$  values need to be checked. By assuming that the term  $1/\{f_n^2 \cdot [\sum_m [F(f_n, f_m)/f_m^2]]\}$  equals one in Equation (4.3), this becomes a co-channel interference calculation. The aggregate  $C/I_e$  results of the MIP solution of case 1 (which happens to be the most densely packed solution), calculated from the streamlined SOUP code in Appendix A, are listed in Appendix F. The results show that of the total 54 test points, only three places in Chile, three places in Paraguay and one place in Peru have aggregate  $C/I_e$  values between 27 to 30 dB while all the rest of the  $C/I_e$  values are above 30 dB. Note that the  $\Delta S$  values (Table 4.5) were calculated from single-entry  $C/I_e$  protection requirement of 30 dB, with the objective of guaranteeing that the aggregate  $C/I_e$  values be no less than 25 dB (see the discussion in Section IV.D). Clearly this objective has been achieved; in fact, the aggregate  $C/I_e$  results are better than expected.

A likely reason for the aggregate  $C/I_e$  values to be better than expected is the following. First note that in this example every

Table 4.6

## Mixed integer and linear program results

	case 1		case 2		case 3	
satellite	MIP	LP	MIP	LP	MIP	LP
ARG	88.68	105.74	101.35	110.00	88.76	101.26
BOL	99.57	101.57	97.18	104.33	92.93	92.50
CHL	95.00	97.00	105.54	99.76	97.50	97.07
PRG	93.00	95.00	107.54	97.76	84.44	87.50
PRU	91.06	93.06	109.63	108.59	102.50	102.67
URG	96.59	92.54	110.00	105.86	81.98	82.50
deviation	18.42	23.71	28.76	33.69	5.27	14.36
arc	10.89	13.20	12.82	12.24	20.52	20.17
cpu(sec)*	25.23	1.31	13.39	1.30	2.86	1.25

\* IBM-3081 computer

administration requires only one satellite. For a satellite and its corresponding service area, usually only the first adjacent satellites on both sides are close enough to produce significant interference, and these satellites do not usually influence the same test point; interference from far-away satellites are in general negligible because the actual satellite spacings are much larger than the required minimal spacings. This can be seen from the  $C/I_e$  results in Appendix F: among the seven test points with  $C/I_e$  less than 30 dB, only two receive two strong and almost equal signal, i.e., the two in Chile with  $C/I_e$  of 27.52 dB and 28.37 dB, and none receive more than two. Therefore the 5 dB margin between single-entry and total acceptable protection requirements is adequate for these sample problems; this confirms the argument made in Section IV.D.

### **3. Comparison Between MIP and RBLP Techniques**

Referring to Table 4.6, note that the total deviations in the MIP solutions are smaller than those of the RBLP solutions. This is not unexpected since the MIP solution guarantees a global optimum with respect to the objective function while the RBLP formulation does not. On the other hand, the computer run times for the MIP formulation are significantly longer, and they are known to increase more rapidly with problem size than is the case with the RBLP formulation. As stated in Section IV.F.2, the computer run time could be prohibitively long for the MIP formulation when the problem size, i.e., the number of satellites, is large. Therefore, the RBLP formulation becomes more

attractive as a practical method of solving a real-world problem. The MIP formulation is useful primarily for evaluating the performance of the RBLP formulation on small problems.

#### 4. Suggestions for Further Improvement

The  $C/I_e$  ratios in Appendix F suggest that a uniform 5 dB margin between the single-entry and total acceptable  $C/I_e$  protection requirements may result in over-protection. This raises the concern that, for a limited orbit resource and a large number of requests, a satisfactory scenario might never be found if the orbit resource barely allows every service area to have only the threshold aggregate  $C/I_e$  value.

When a feasible solution of the MIP or RBLP formulation does not exist for a given set of  $\Delta S$  constraints, the reason could be either that the  $\Delta S$  constraints are too high, or that there exists no solution that could satisfy the total acceptable  $C/I_e$  protection requirement. To find out which, a progressive testing process could be used by gradually decreasing the  $C/I_e$  requirement level in the  $\Delta s(1)$  calculation, and using these values in the MIP or RBLP calculation. Note that as the single-entry  $C/I_e$  requirement is gradually decreased, the first point at which a feasible solution (feasible in terms of the  $\Delta S$  requirements) exists may be such that the total acceptable  $C/I_e$  requirement is not satisfied at some test points. However, this does not mean that a feasible solution (feasible in terms of total acceptable  $C/I_e$  requirement) does not exist; this is because the margins between the

single-entry and total acceptable  $C/I_e$  protection requirements may not have to be the same for all satellite pairs. When this is the case it is proposed that the gradient search method be used to fine-tune the solution and improve those unacceptable aggregate  $C/I_e$  values; this approach is discussed below. If no solution is obtainable when the  $\Delta S(1)$  values are calculated using the total acceptable  $C/I_e$  protection requirement and the  $\Delta S$  parameters are the minimum (over 1) of the  $\Delta S(1)$  values, a feasible scenario definitely does not exist.

To demonstrate how the gradient search method can fix the worst  $C/I_e$  terms, the resulting satellite locations of the MIP solution of case 1 are laid out as shown in Figure 4.6; here B is for satellite of Bolivia, U of Uruguay, C of Chile, P of Paraguay, E of Peru, and A of Argentina. Indicated in the figure are the actual spacings (above the arrows) and the  $\Delta S$  values (below the arrows) between a satellite and its first and second adjacent satellites. The star (\*) sign means that the actual spacing is larger than the corresponding  $\Delta S$  value. First note that there is no star sign for the Chile satellite, while other satellites have at least one star. This means that the spacings between the Chile satellite and its first and second adjacent satellites are all at their minimal required values. This may explain why the  $C/I_e$  results for Chile are worse than the others. Then note that this scenario may be modified by moving the Peru satellite to the right (eastward) and moving the Uruguay satellite to the left (westward) by a small amount. Although this modification increases the sum of the absolute deviations from the "ideal" locations, it also improves the  $C/I_e$  results for Chile

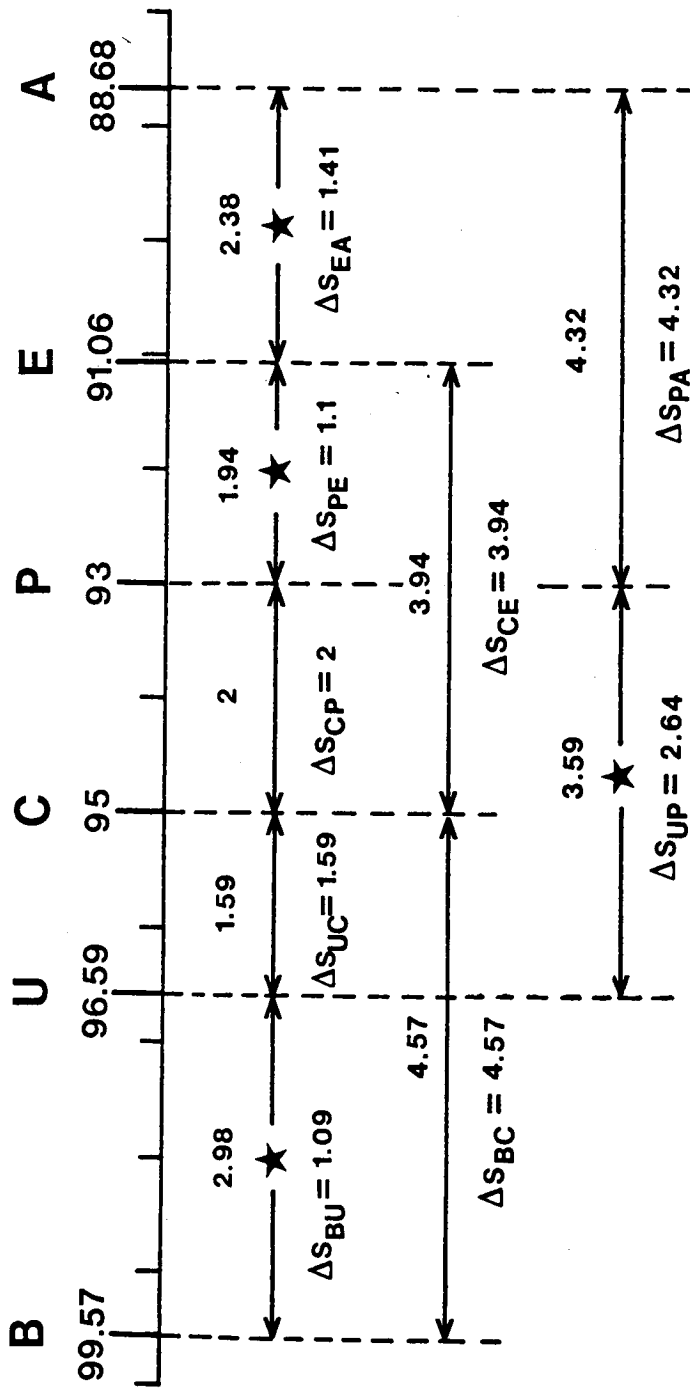

(★: Actual separation larger than required separation.)

Figure 4.6. Satellite locations from mixed integer program result.

by increasing the satellite spacings for the Chile satellite; note that the Peru and Uruguay satellites are its east and west adjacent satellites. This demonstrates that the gradient search technique can be used on the MIP or RBLP solution to improve the aggregate  $C/I_e$  results.

### 5. Possible Extensions of the Method

The  $\Delta S$  concept has many flexibilities. It was demonstrated here for elliptical satellite antenna beams, but it can also be applied to shaped beams if the shaped beam reference pattern is given. At present, such a pattern is not available. Also, to use the  $\Delta S$  approach the antenna reference patterns and the  $C/I_e$  protection requirement need not be the same for all administrations. Such non-uniformity merely changes the interference calculations, margin calculations, and the resulting  $\Delta S(l)$  values, but the same optimization procedures are still applicable.

The formulations may be useful when new satellites need to be added into an existing scenario in which the locations of existing satellites can not be changed. The computational burden of either technique depends greatly on the number of decision variables. For a task of adding more satellites, all the information about the existing scenario constitutes fixed parameters, and the only decision variables correspond to the new satellites. Therefore, the problem size is small, and the computational burden is reasonable.

This chapter has dealt only with the orbital assignment, not the frequency assignment. This is useful for the case that every satellite uses the full complement of the available spectral band. Still, the

same procedure should work if there is an a priori frequency assignment scenario; a considerable body of literature exists on such frequency assignments [19,20,21,22]. The only modification is to use the proper protection requirement value (by referring to the frequency assignments and protection ratio) in the  $\Delta s(1)$  calculation; the planning process will be exactly the same.

#### H. CONCLUSION AND RECOMMENDATION

In this chapter, two techniques are presented to solve the orbital assignment problem. The MIP technique guarantees to find the globally optimal solution, but may require prohibitively long computing time when the problem size is large. Still it is very useful for testing other methods on small problems and may be applicable when a few satellites are added into an existing scenario. The RBLP technique guarantees to find a locally, but not necessarily a globally optimal solution, but is more practical in terms of the computational effort.

Two approximations are used in these methods. The first one appears in the  $\Delta s(1)$  calculation; however, it is shown to be acceptable. The second one is to use maximum  $\Delta s(1)$  values,  $\Delta S$ , in the MIP and RBLP formulations; this decreases the efficiency of orbit use, but probably not seriously.

It is recommended that these methods be tried on larger scenarios, and that the extensions given in Section IV.G.5 be investigated.



**CHAPTER V**  
**A SERVICE-AREA SPECIFICATION PROCEDURE**

**A. INTRODUCTION**

In the previous chapters the optimization of orbital and frequency assignments was considered for communications satellites serving a given set of service areas defined by political boundaries. Now, procedures for choosing such service areas will be discussed in the fixed-satellite service (FSS) context, with the objective of increasing the communications capacity for all users. The need to study ways in which the concept of service areas should be defined was brought up in CCIR report 453-3 [89], and the study in this chapter is intended to give insight to that concept. By means of an illustrative example it will be shown that the considerations of traffic-demand density and of minimum allowable spacing ( $\Delta S$ , see Chapter IV) can serve as a basis for designing service areas for this objective.

**B. HISTORICAL PERSPECTIVE**

**1. Service Area Assignment**

In the broadcasting-satellite service (BSS) planning, a satellite service area is usually specified by the territories of an administration, a subdivision of an administration, or (in some cases) a

grouping of administrations [9,13]. Thus there appeared to be no need for a procedure for defining service areas for the WARC-77 and RARC-83 deliberations.

The situation is quite different with respect to FSS. The FSS satellites were initially used primarily for inter-administration communications. International consortia operated such satellites, with service areas chosen on the basis of demand (or market), technological considerations, and the composition of the consortium. The Intelsat satellites are examples of this type of operation. More recently, satellites have also been employed for intra-administration (Domsat) communications, e.g., satellite communications in U.S., Canada and the U.S.S.R. (if the latter is considered as a single entity; technically the International Telecommunication Union (ITU) regards each separate Soviet Republic as an administration) [90]. The simplest technology leads to large service areas; e.g., the whole contiguous continental U.S. (CONUS). While an experimental FSS satellite using regional and switched spot beams is at the heart of the NASA Advanced Communications Technology Satellite (ACTS) program [91], most civilian U.S. operational and planned systems are based on CONUS coverage. In current approaches to the orbital and frequency assignments for the FSS, the idea of specifying service areas by the territories of the administrations seems to be still prevalent.

## 2. Insufficiency of Communications Supply from Limited Spectrum and Orbit Resources

As FSS planning proceeds, it has become clear that the communications demand is very large [92,93]. As an example, the U.S. fixed-service communications supply appears to be in great mismatch with the demand [80,94]. The projected U.S. domestic FSS communications demand in the year 2000, as estimated in a COMSAT Laboratory report, is shown in Table 5.1, and is also shown as a "pie chart" in Figure 5.1 [94]; the total communications demand is equivalent to 2,474 transponders.

By international agreement the total bandwidth of the 6/4 GHz spectral band assigned to the FSS is 480 MHz [94,95] (note that at present this is the only band in the planning stage). This band is divided into 12 slots, each consisting of a frequency channel 36 MHz wide followed by a guard band of 4 MHz. Therefore, including the cross-polarization channels, there are 24 frequency channels in this band [94,95]; this is shown in Figure 5.2. A typical U.S. FSS satellite has 24 transponders transmitting the signals in these 24 channels. Therefore the total estimated demand of 2,474 transponders implies a need for 103 satellites to fulfill the demand with the 6/4 GHz band.

Because of interference between satellite systems, satellites must be separated from each other to have proper protection [16,96,97]. For the antenna technology available up to the year 1982, satellites with CONUS beams for systems proposed at that time needed to be separated by more than three degrees [98]. However, the amount of communications capacity so provided in the 6/4 GHz band is far from enough to satisfy

Table 5.1

U.S. Domestic FSS Communications Demand in the Year 2000

US Domestic  
TRAFFIC FORECAST SUMMARY - YEAR 2000

<u>SERVICE</u>	<u>TRAFFIC</u>	<u>BW EFFICIENCY</u>	<u>TRANSPONDERS (36 MHz)</u>
<b>TRUNKING</b>			
Voice	6816 x 10 <sup>3</sup> Channels	120 Channels/MHz	1578
Data	3348 Mbits/s	2.0 Mbits/MHz	41
Videoconf	7814 Channels	1.1 Channels/MHz	203
<b>CPS*</b>			
Voice	35 x 10 <sup>3</sup> Channels	60 Channels/MHz	16
Data	25038 Mbits/s	1.5 Mbits/MHz	477
Videoconf	411 Channels	0.68 Channels/MHz	17
<b>BROADCAST VIDEO</b>			
Distribution	233 Channels	0.069 Channels/MHz	92
DBS	50 Channels	0.028 Channels/MHz	50
		<b>TOTAL</b>	<b>2474</b>

\* CPS : Customer Premises Service

TRANSPONDER ALLOCATIONS

(US Domestic Traffic)

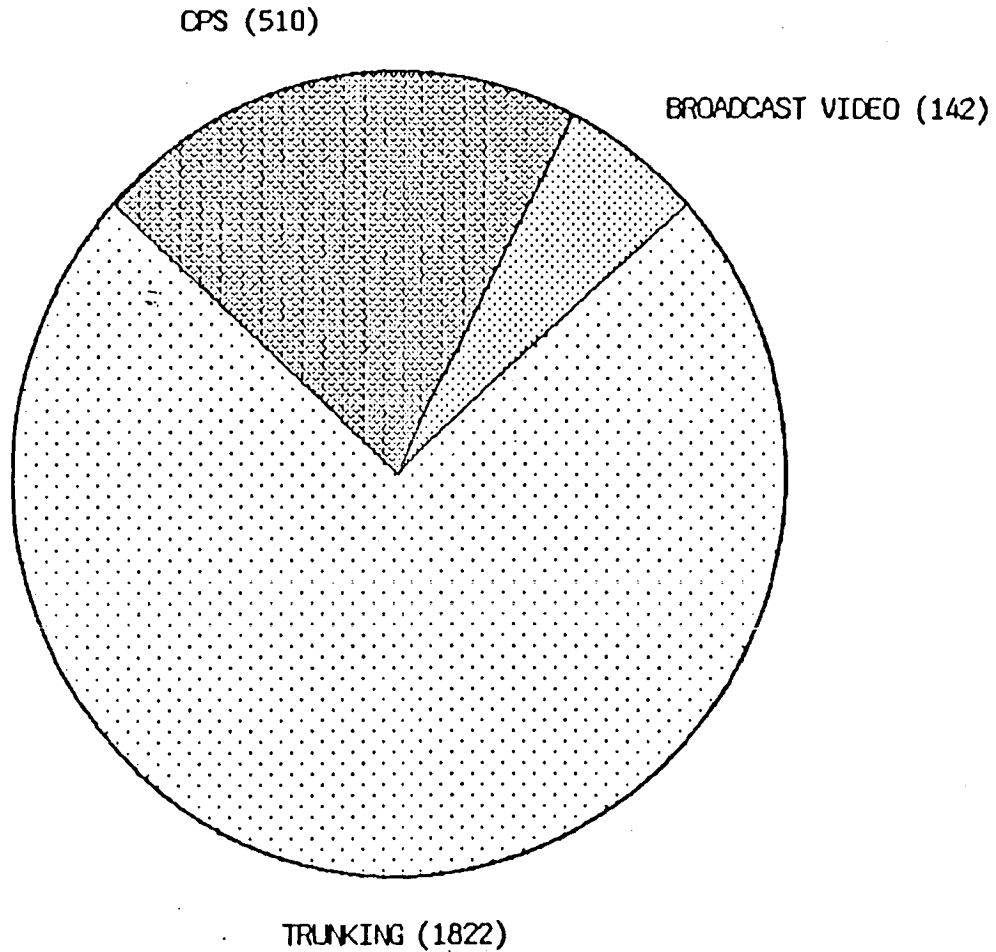

Figure 5.1. Projected U.S. Domestic FSS communications demand for the year 2000. CPS stands for Customer Premises Service. The number in parentheses indicates number of transponders.

Downlink Channelization CFDI

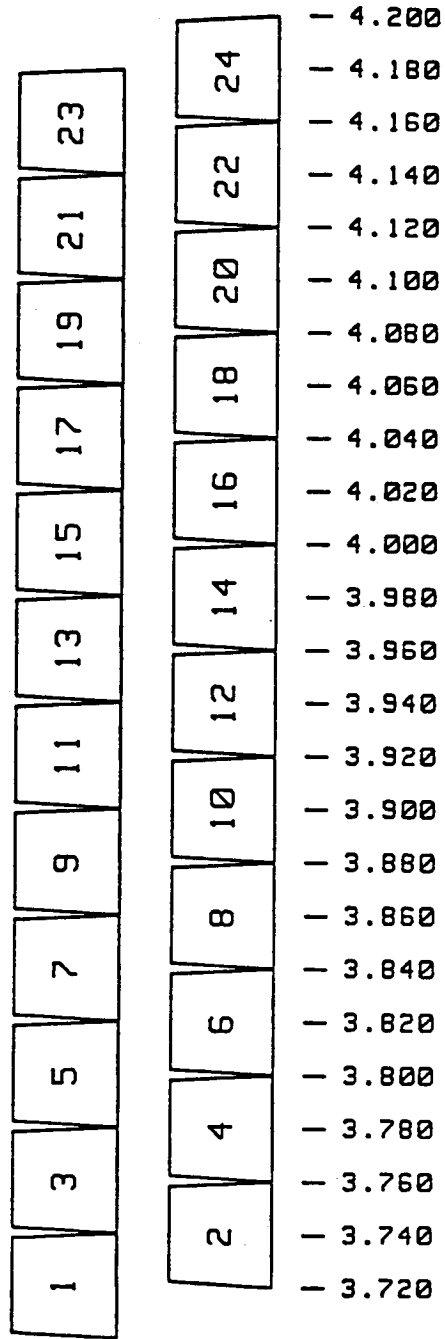

Figure 5.2. Allocation of frequency channels in 6/4 GHz band.

the FSS demand [99]. In order to increase the communications supply, the Federal Communication Commission (FCC) decided that the orbit resource should be more efficiently utilized and announced in the year 1984 that future antenna technology should allow two-degree spacing for U.S. FSS satellites, and satellite orbital planning should be based on two-degree spacing after the year 1987 (This also applies to the 14/12 GHz band) [80]. This will enable the U.S. to have about 25 geostationary satellites in the 6/4 GHz band. Clearly this still falls far short of the projected demand of 103 satellites!

Other spectral bands, e.g., the 14/12 GHz band, have been allocated to the FSS [31]. This should help increase the U.S. FSS communications supply. Still, it is apparent that the spectrum resource is limited, and that the orbit resource should be more efficiently utilized in order to maximally re-use the spectrum resource.

### **3. Relation Between Frequency Re-Use and Service-Area Specification**

The advantage of using narrow antenna beams to achieve frequency re-use has been recognized for some time [89,100]. Thus it was noted in CCIR report 453-3 that it is necessary to study ways in which the concept of coverage area should be defined [89]. Specifically, It was brought up in this report that under certain circumstances a satellite may transmit separate information on the same frequencies twice, or even a greater number of times, using antennas serving different parts of the world. This general idea has already found practical application with

the Intelsat series of satellites; while Intelsat IV satellites used global-coverage beams, Intelsat IV-A and V satellites employ hemispherically restricted beams to allow frequency re-use [101,102].

In view of the scarcity of the spectrum/orbit resources relative to demand, it becomes necessary to develop a method of specifying service areas such that the advantages of the narrow-beam concept can be fully utilized for efficient spectrum/orbit management.

### **C. SERVICE-AREA SPECIFICATION BY $\Delta S$ CONCEPT AND COMMUNICATIONS-DEMAND DENSITY**

#### **1. Role of $\Delta S$ Concept in Service-Area Specification**

In order to provide more traffic supply, the  $\Delta S$  concept discussed in Chapter IV suggests that the  $\Delta S$  values between satellite pairs should be as small as possible so that more satellites can be allocated in the orbit. As discussed in detail in Section IV.C, the margin between the carrier power,  $C$ , and the single-entry interference,  $I$ , comes mainly from the transmitting and receiving antenna discrimination factors in the interference power; the former comes from the separation between the two service areas, the latter from the separation between the two satellites. Also, as discussed in Section IV.C, for a given single-entry C/I protection requirement, the larger the transmitting discrimination loss, the less the receiving discrimination loss and thus the less satellite separation is needed. For the special case when the transmitting discrimination loss is enough for the protection



requirement to be met, the satellites can be collocated, or equivalently a satellite can have two beams serving two service areas simultaneously; this is exactly what CCIR report 453-3 means by using the same frequency band twice at one satellite [89].

Referring to Figure 2.4, the transmitting discrimination value depends on two factors: the half-power beam width (HPBW) and the off-axis angle. The value of HPBW depends on the size of the service area: the smaller the service area, the smaller the value of HPBW, and the narrower the beam; this is the narrow-beam idea stated in references [89,100]. The off-axis angle depends on the service-area separation. The combination of these two factors should be the key to the subject of service-area definition. If the system planner can control these two factors to reduce the  $\Delta S$  values between satellite pairs, more satellites can be assigned in the orbit and a larger communications supply; i.e., more circuits, can be provided. To achieve this purpose, basically the service areas should be specified as small as possible, and their separations should be as large as possible.

## **2. Role of Communications-Demand in Service-Area Specification**

The simple demand/supply concept implies that the supply should be used where the demand is; hence the communications-demand density must also be consulted in specifying service areas. There is precedent for using communications traffic-demand density quantitatively in the technical design of satellite systems. In time-division multiple access

(TDMA) system design, a simple rule is: the areas with heavy communications demand should be given more access to the communications system [103]. Similarly, service areas should specify regions with enough traffic demand to justify having satellite access as an area. Hence information about the communications traffic-demand density is an essential prerequisite to a reasonable choice of service areas.

### **3. General Consideration**

Hence, the  $\Delta S$  concept and the communications traffic-demand density should both be considered when specifying service areas. It is apparent that small and separated service areas allow the geostationary orbit to be used more efficiently; on the other hand, potential demand increases with the service-area size: a satellite which serves one metropolitan area (e.g., Boston) has less potential demand than one which serves a corresponding region (e.g., the Eastern U.S.) or the entire administration or a grouping of administrations. There has to be a compromise between these two factors. The overall rule is that the selected service areas must have enough communications demand to justify their own satellite beams.

There are, of course, other factors which need to be taken into account in a practical plan. For example, multiple-beam satellites, which may also be beam-switching, require more advanced technology and are likely to be more expensive than single-beam ones. Such economic and perhaps other operational matters will not be considered here; only the communications capacity will be addressed.

## **D. APPLICATION OF SERVICE-AREA SPECIFICATION CONCEPT TO A LARGE ADMINISTRATION OR GROUP OF ADMINISTRATIONS**

### **1. General Description**

The idea of service-area specification by the  $\Delta S$  concept and traffic-demand density may greatly benefit an administration, or a group of administrations, that has a large territory, when most of the traffic demand is between several small regions. When this idea is applied to such a situation, it is proposed to serve such administration(s) with a mixture of administration-coverage beams and intra-administration regional beams. The administration-coverage beams are intended to serve primarily areas of relatively low demand, while the majority of traffic demand from high-demand regions would be carried on the regional beams. The necessary separations between regional-beam satellites are usually smaller than those of the administration-coverage satellites. Thus if, instead of assigning the entire available orbital arc to administration-coverage satellites, a part is used to accommodate regional-beam satellites, then more satellites can be allocated in this arc and more communications supply can be provided.

Recall the scenario which has 25 CONUS beam satellites in the 6/4 GHz band with every satellite using the full spectral band (Section V.B.2). At first look it seems that this scheme uses the spectrum and orbit resources to their full extent for Earth station antenna technology which requires two-degree satellite spacing. However, if some of the service areas are changed from CONUS to smaller, separated

regions, the  $\Delta S$  values for their satellites will be smaller than two degrees, hence some orbit resource becomes available to allocate more satellites in the orbit.

## **2. Procedure of Service-Area Specification and Satellite Assignment**

When regional service areas are to be specified, first the traffic-demand density should be considered. Because of the population distribution or the commercial activities, usually there will exist some regions of relatively small size and large traffic demand. Often such regions include several large cities relatively close to each other. Such regions are good candidates for regional service areas within the administration(s). In selecting these service areas, three things should be considered simultaneously: the areas should be of small size, they should have large traffic demand, and the separations between these service areas should be large.

After the regional service areas have been selected tentatively, the  $\Delta S$  values between these service area pairs should be calculated by the method described in Chapter IV. Note that service areas for which the  $\Delta S$  values are zero can be served by a single satellite; this is the multiple-beam design described in CCIR report 453-3. Different from the multiple-beam TDMA design, in this case the two beams can be active simultaneously [104]. Also note that multiple-beam satellites can carry both inter- and intra-regional communications.

A traffic-demand matrix can be formulated for these tentative service areas. The elements in this matrix are traffic demand between

the regions that can be carried by the regional-beam satellites: the diagonal elements are the intra-regional traffic demand, the off-diagonal elements are the inter-regional traffic demand. The latter are non-zero only when the corresponding service areas can be served by multiple-beam satellites. A complete demand matrix consists of the above-described matrix plus one additional element: the traffic demand which cannot be carried by regional satellites and must be carried by administration-coverage satellites.

Examination of the  $\Delta S$  and demand matrices may suggest a revision of the regional service areas. For example, if many of the  $\Delta S$  values for a particular region are large (e.g., approaching the  $\Delta S$  value for administration-coverage satellites), this may indicate the region is too large, or too close to other regions, or both. On the other hand if many of the demand matrix elements corresponding to a region are very small, this may indicate the region is too small, or it is not a good candidate to be a regional service area. Thus a good choice of regional service areas becomes a compromise between achieving satisfactory  $\Delta S$  values and a satisfactory demand matrix, as will be evident from the example below.

A scenario including both regional and administration-coverage beams may, in principle, be constructed by any suitable method, e.g., by extensions of the methods of Chapters III and IV. Here a scenario will be generated by deassigning some of a series of equally spaced administration-coverage satellites and then allocating regional-beam satellites in this vacated orbital arc, consistent with the  $\Delta S$

requirement. The number of administration-coverage satellites to be deassigned and the number of regional beams to be assigned are determined by consulting the traffic-demand matrix. This procedure has the advantage of being compatible with a network of uniformly spaced administration-coverage satellites; the new scenario might even evolve out of such a system. It also has the advantage of demonstrating the important concepts without the computational complexity of optimization.

### **3. Traffic Distribution Between Narrow- and Wide-Beam Systems**

The traffic-demand problem is completely solved when the amount of traffic-supply is enough, or more than enough, to meet the demand. However, as stated earlier, the demand usually far exceeds the supply, and usually the adoption of the regional-service area idea can only improve, but not completely solve the demand/supply problem. Therefore, an important task of the procedure is to make sure all the demands have their proper share of the supply.

It will be assumed that the satellites serving the regional service areas are dedicated satellites which are not designed to provide administration-wide service. Therefore some satellites need to be preserved to provide administration-wide communications service, even though the traffic demand which can not be served on a regional basis may be small. Many criteria could be used to decide the distribution of satellite beams. It is known that, compared to a scenario with only administration-coverage beams, there will be a larger communications supply when the narrow-beam idea is implemented. Therefore, one

criterion might be that all the demands have an equal percentage of supply-increase, another criterion might be that the total communications supply has the maximum amount of increase and no one suffers any supply decrease. The latter is used to develop the scenario in Section V.E.

## **E. NUMERICAL EXAMPLE**

### **1. Description of Parameters**

Since the only available detailed traffic-demand density data available to the authors is the projected long-distance telephone traffic among major cities in the U.S., it will be used in an example to numerically explore the advantage of the service area specification concept. Because only the 6/4 GHz band is in the planning stage, this example considers the communications capacity only for this band. Also, only the down-link communications traffic regulation problem will be considered; the up-link problem can be implemented similarly in the up-link spectral band.

Of the total projected FSS communications demand shown in Table 5.1, more than 63% consists of long-distance telephone voice traffic [94]. The telephone voice demand will be taken as indicative of total demand. This assumption is justified in part because only telephone voice data is available to us, in part because it seems likely that the geographical distribution of other communications will be similar to that of telephone voice traffic, and in part because the objective here

is only to demonstrate a method, not to design a system. More detailed examination shows that a large portion of the voice long-distance telephone demand comes from major cities (or metropolitan areas), and there are 28 cities that share more than 75% of the voice long distance telephone demand. The list of these 28 cities, and the projected long distance voice telephone demand between them are shown in Table 5.2 [94]. The U.S. map in Figure 5.3 shows the locations of these 28 cities with their communications rankings: the cities indicated by triple circles are in the top 5 rankings, double circles are for rankings from 6 to 10, single circles for rankings from 11 to 15, and solid dots for rankings from 15 and up.

In order to arrive at  $\Delta S$  values and C/I ratios consistent with the antenna patterns shown in Figures 2.4 and 2.5, the C/I results of two CONUS beam satellites with 2.5-degree spacing were calculated and are listed in Table 5.3, and the worst single-entry C/I value is 25 dB. This value will be used as the single-entry C/I protection requirement for the U.S.; the total acceptable C/I protection requirement will then be 20 dB if 5 dB extra protection is needed to compensate for multiple interference. It is not implied here that 2.5-degree spacing or a 20 dB aggregate protection ratio is recommended. The purpose here is only to arrive at a consistent set of parameters for demonstrating a regional-coverage assignment procedure.

The calculations in this section are on a co-channel basis. Since adjacent channels in the scheme of Figure 5.2 are cross-polarized, it is assumed that there is enough polarization and frequency discrimination that this is a satisfactory approximation.



Table 5.2

Long Distance Voice Telephone Demand Between Top 28 Cities in U.S. in the Year 2000

US DOMESTIC VOICE TRAFFIC  
 TRAFFIC MATRIX  
 EARTH STATION TO EARTH STATION  
 TOTAL TRAFFIC FOR US IN 2000 IS 68146 CHANNELS.

CS NAME	NO.	NEW_YORK 1	LOS_ANGEL 2	CHICAGO 3	SAN_FRAN 4	BOSTON 5	DETROIT 6	WASHINGTON 7	CINCINNIA 8	PHILADEL 9	CLEVELAND 10
NEW_YORK	1	0	928	837	654	643	593	593	582	544	517
LOS_ANGEL	2	928	0	396	312	304	281	281	274	259	247
CHICAGO	3	837	396	0	281	274	251	251	247	232	221
SAN_FRAN	4	654	312	281	0	213	198	198	194	183	171
BOSTON	5	643	304	274	213	0	194	194	190	179	171
DETROIT	6	593	281	251	198	194	0	179	175	164	156
WASHINGTON	7	593	281	251	198	194	179	0	175	164	156
CINCINNIA	8	582	274	247	194	190	175	175	0	160	152
PHILADEL	9	544	259	232	183	179	164	164	160	0	145
CLEVELAND	10	517	247	221	171	171	156	156	152	145	0
DALLAS	11	434	205	183	145	141	129	129	126	118	114
ATLANTA	12	384	183	164	129	126	114	114	114	107	99
HOUSTON	13	346	164	148	114	114	103	103	103	95	91
ST_LOUIS	14	312	148	133	103	103	95	95	91	84	80
SYRACUSE	15	289	137	122	95	95	87	87	84	80	76
MIAMI	16	274	129	118	91	91	84	84	80	76	72
ST_LOUIS	17	262	126	110	87	87	80	80	76	72	68
RALEIGH	18	251	118	107	84	80	76	76	72	68	65
TAMPA	19	228	107	95	76	72	68	68	68	61	61
MIRREAPL	20	217	103	91	72	68	65	65	65	57	57
SEATTLE	21	217	103	91	72	68	65	65	65	57	57
KANSAS_C	22	194	91	84	65	61	57	57	57	53	49
DENVER	23	183	84	76	61	57	53	53	53	49	46
MILWAUKE	24	133	65	57	46	42	38	38	38	34	34
SAN_ANTO	25	122	57	53	42	38	38	38	34	34	30
PHOENIX	26	114	53	46	38	34	34	34	30	30	27
NEW_ORLE	27	114	53	46	38	34	34	34	30	30	27
SALT_LAK	28	76	34	30	27	23	23	23	23	19	19
TOTAL		10041	5242	4744	3789	3696	3434	3434	3358	3158	3011

Table 5.2 (Continued)

US DOMESTIC VOICE TRAFFIC  
 TRAFFIC MATRIX  
 EARTH STATION TO EARTH STATION  
 IN 2000 IS 68146 CHANNELS

TOTAL TRAFFIC FOR US

ES. NAME	NO.	DALLAS 11	AMARIEIM 12	ATLANTA 13	HOUSTON 14	SYRACUSE 15	MIAMI 16	ST. LOUIS 17	RALEIGH 18	TAMPA 19	MINNEAPL 20
NEW YORK	1	434	384	346	312	289	274	262	251	220	217
LOS ANGL	2	205	183	164	148	137	129	126	118	107	103
CHICAGO	3	183	164	148	133	122	118	110	107	95	91
SAN FRAN	4	145	129	114	103	95	91	87	84	76	72
BOSTON	5	141	126	114	103	95	91	87	80	72	68
DETROIT	6	129	114	103	95	87	84	80	76	68	65
WASHINGTON	7	129	114	103	95	87	84	80	76	68	65
CINCINNIA	8	126	114	103	91	84	80	76	72	68	65
PHILADEL	9	118	107	95	84	80	80	76	68	61	57
CLEVELND	10	114	99	91	80	76	72	68	65	61	57
DALLAS	11	0	84	76	68	61	61	57	53	49	46
AMARIEIM	12	84	0	68	61	53	53	49	49	42	42
ATLANTA	13	76	68	0	53	49	49	46	42	38	38
HOUSTON	14	68	61	53	0	46	42	42	38	34	34
SYRACUSE	15	61	53	49	46	0	38	38	34	30	30
MIAMI	16	61	53	49	42	38	0	34	34	30	30
ST. LOUIS	17	57	49	46	42	38	34	0	27	27	27
RALEIGH	18	53	49	42	38	34	34	34	0	27	27
TAMPA	19	49	42	38	34	30	30	27	27	0	23
MINNEAPL	20	46	42	38	34	30	30	27	27	23	0
SEATTLE	21	46	42	38	34	30	30	27	27	23	23
KANSAS_C	22	42	38	34	30	27	27	23	23	23	19
DENVER	23	38	34	30	27	27	23	23	23	19	19
MILWAUKE	24	27	27	23	19	19	19	15	15	15	15
SAN ANTO	25	27	23	19	19	15	15	15	15	11	11
PHOENIX	26	23	19	19	15	15	15	15	11	11	11
NEW ORLE	27	23	19	19	15	15	15	15	11	11	11
SALT_LAK	28	15	15	11	11	11	8	8	8	8	8
TOTAL		2520	2252	2033	1832	1690	1622	1546	1468	1328	1274

Table 5.2 (Continued)

US DOMESTIC VOICE TRAFFIC  
 TRAFFIC MATRIX  
 EARTH STATION TO EARTH STATION  
 IN 2000 IS 68146 CIRAMFELS

ES. NAME	HO. NO.	TOTAL TRAFFIC FOR US											SALT_LAK 28
		SEATTLE 21	KANSAS_C 22	DENVER 23	MILWAUKE 24	SAN_ANTO 25	PHOENIX 26	NEW_ORIE 27	76				
NEW_YORK	1	217	194	183	133	122	114	114	114	114	114	76	
LOS_ANGL	2	103	91	84	65	57	53	53	53	53	53	34	
CHICAGO	3	91	84	76	57	46	46	46	46	46	46	30	
SAN_FRAN	4	72	65	61	46	42	38	38	38	38	38	27	
BOSTON	5	68	61	57	42	38	34	34	34	34	34	23	
DETROIT	6	65	57	53	38	38	34	34	34	34	34	23	
WASHINGTON	7	65	57	53	38	38	34	34	34	34	34	23	
CINCINNIA	8	65	57	53	38	38	34	34	34	34	34	23	
PHILADEL	9	57	53	49	38	34	30	30	30	30	30	19	
CLEVELND	10	57	49	46	34	30	27	27	27	27	27	19	
DALLAS	11	46	42	38	27	27	23	23	23	23	23	15	
ANAHEIM	12	42	38	34	27	23	23	23	23	23	23	15	
ATLANTA	13	38	34	30	23	23	19	19	19	19	19	11	
HOUSTON	14	34	30	27	19	19	15	15	15	15	15	11	
SYRACUSE	15	30	27	27	19	15	15	15	15	15	15	11	
MIAMI	16	30	27	23	19	15	15	15	15	15	15	8	
ST_LOUIS	17	27	23	23	15	15	15	15	15	15	15	8	
RALEIGH	18	27	23	23	15	15	15	15	15	15	15	8	
TAMPA	19	23	23	19	15	11	11	11	11	11	11	8	
MINNEAPL	20	23	19	19	15	11	11	11	11	11	11	8	
SEATTLE	21	0	19	19	15	11	11	11	11	11	11	8	
KANSAS_C	22	19	0	15	11	11	11	11	11	11	11	8	
DIERVER	23	19	15	0	11	11	11	11	11	11	11	8	
MILWAUKE	24	15	11	11	0	8	8	8	8	8	8	4	
SAN_ANTO	25	11	11	11	8	0	0	0	0	0	0	4	
PHOENIX	26	11	8	8	8	8	8	8	8	8	8	4	
NEW_ORLE	27	11	8	8	8	8	8	8	8	8	8	4	
SALT_LAK	28	8	8	4	4	4	4	4	4	4	4	0	
TOTAL		1274	1134	1054	788	709	641	641	641	641	641	436	

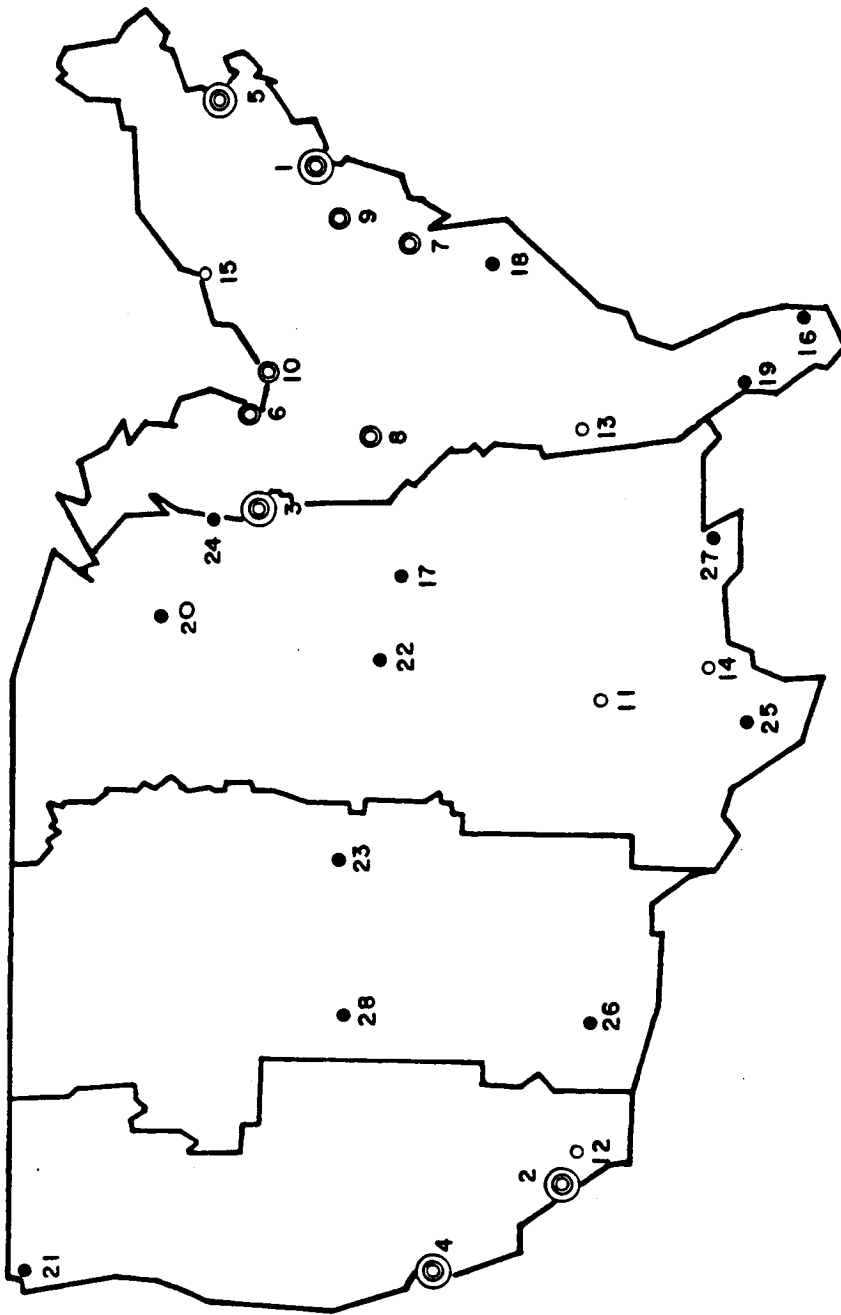

Figure 5.3. Locations of top 28 cities in U.S. with largest long-distance telephone demand in the year 2000.

Table 5.3

C/I Results of Two CONUS-beam satellites with  
2.5-degree spacing

COUNTRY	SATELLITE (LON.)	FREQUENCY (MHz)	
USA	-100.00	4000.00	
USA	-102.50	4000.00	
TEST COUNTRY : USA		SATELLITE : -100.00	
TEST POINT		INT. SAT.	C/I (dB)
LON.	LAT.		
-69.20	47.40	USA	-108.35
-66.90	44.80	USA	-108.29
-69.90	41.50	USA	-107.71
-81.80	24.40	USA	-108.44
-97.20	26.00	USA	-107.61
-117.10	32.30	USA	-108.47
-124.20	40.40	USA	-108.50
-122.80	49.00	USA	-108.39
-95.10	49.40	USA	-107.22
TEST COUNTRY : USA		SATELLITE : -102.50	
TEST POINT		INT. SAT.	C/I (dB)
LON.	LAT.		
-69.20	47.40	USA	-108.35
-66.90	44.80	USA	-108.30
-69.90	41.50	USA	-107.72
-81.80	24.40	USA	-108.41
-97.20	26.00	USA	-107.60
-117.10	32.30	USA	-108.51
-124.20	40.40	USA	-108.54
-122.80	49.00	USA	-108.41
-95.10	49.40	USA	-107.19

## 2. Specifying Four Service Areas According to $\Delta S$ Consideration and Traffic-Demand Density

Referring to Figure 5.3 about the communications traffic-demand density, four service areas that cover most of the top 28 cities may be specified as shown in Figure 5.4. The first service area, called the East region, covers the cities New York (1), Boston (5), Washington D.C. (7), Philadelphia (9), and Raleigh (18). The second service area, called North Central, covers Chicago (3), Detroit (6), Cincinnati (8) and Cleveland (10). The third service area, called West, covers Los Angeles (2), San Francisco (4) and Anaheim (12). The fourth service area, called South Central, covers Dallas (11), Houston (14), San Antonio (25) and New Orleans (27). These regional service areas were obtained by trial and error as reasonable compromises between the  $\Delta S$  matrix and demand matrix requirements. For example, the traffic demand for the North Central region could be increased by including Syracuse (15), St. Louis (17), Minneapolis (20), Kansas City (22), and Milwaukee (24); however, this would increase its size and reduce the separation between regions, thus it would increase  $\Delta S_{E,NC}$  and  $\Delta S_{NC,SC}$  sufficiently to prohibit sufficient frequency re-use. Even as it is,  $\Delta S_{E,NC}$  turns out too large to use a multiple-beam design. Its size could be reduced by eliminating Chicago (3) and Detroit (6) from this region, but then the traffic-demand might be too low to justify having its own satellite beams. This illustrates the compromise between  $\Delta S$  and traffic demand which must be the basis in specifying regional service areas.

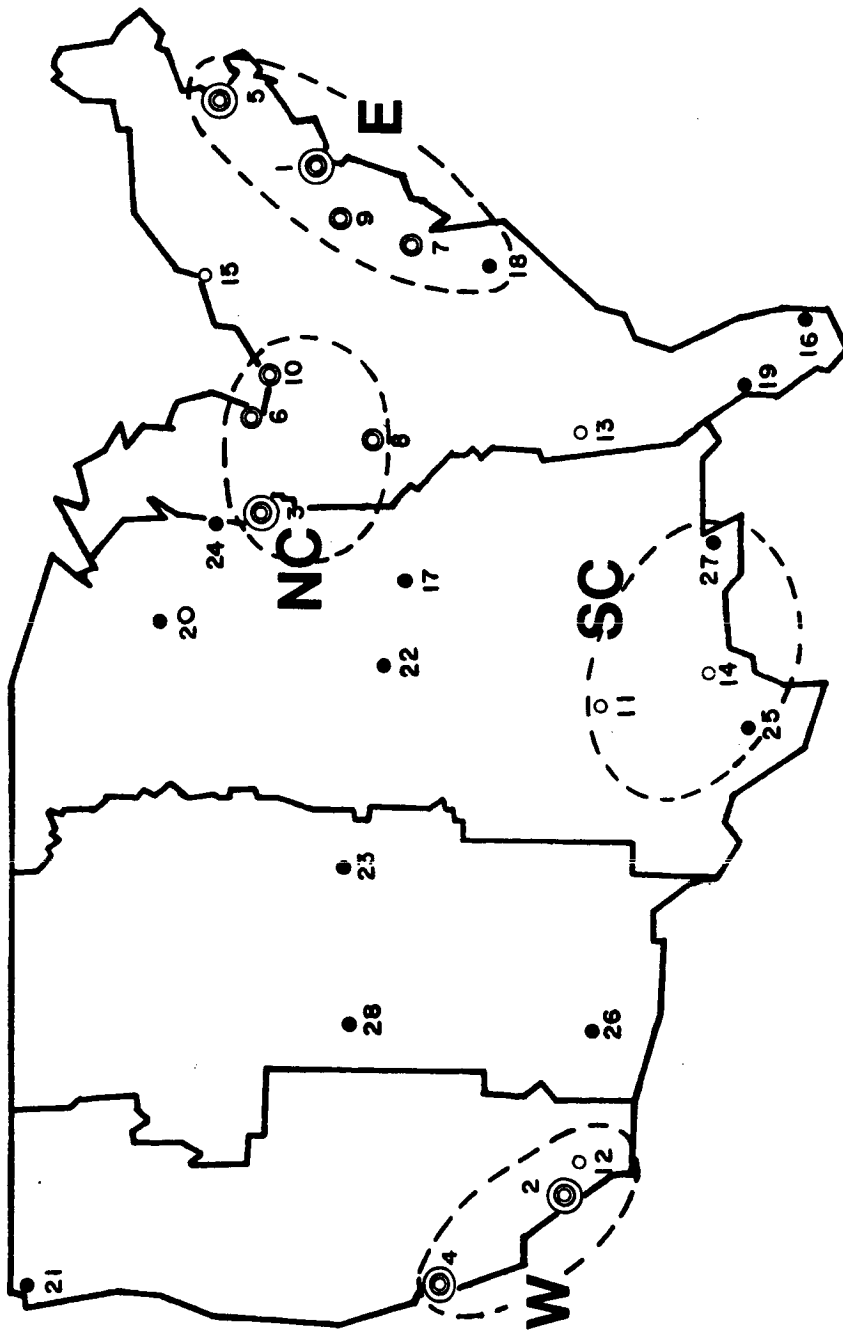

Figure 5.4. Four selected regions with proper service-area separation and large communications demand.

The  $\Delta S$  matrix of the four service areas is shown in Table 5.4: the  $\Delta S$  values between any two of the four service areas, except between East and North Central, are zero. To demonstrate that a multiple-beam scheme is feasible, the C/I ratio of a three-beam satellite serving East, West and South Central is shown in Table 5.5, and the C/I ratio of a three-beam satellite serving North Central, West and South Central is shown in Table 5.6; in both cases, the worst aggregate C/I values are larger than 25 dB. The  $\Delta S$  value between East and North Central is 1.24 degrees, as indicated in Table 5.7; however, for numerical convenience 1.25-degree spacing will be used for the East and North Central satellites.

With this  $\Delta S$  matrix, there can be two classes of regional-beam designs for satellites serving these four regions. In the first one the service areas East, West and South Central, or any combination of these, can use one multiple-beam satellite. In the second, the service areas North Central, West, and South Central, or any combination of them, can use one multiple-beam satellite. There are two overall restrictions: satellites serving the East and North Central regions respectively need to be separated by at least 1.25 degrees, and any two satellites that serve the same service area must be separated by no less than 2.5 degrees. Aside from these restrictions, a scenario can have any combination of the two regional-beam designs. For example, two adjacent satellites that serve the regions East and North Central, respectively, can also serve the service areas West and/or South Central.



Table 5.4

$\Delta S$  matrix of four regions

$\Delta S$	East	N. Central	West	S. Central
East	2.50	1.25	0	0
N. Central		2.50	0	0
West			2.50	0
S. Central				2.50

Table 5.5

C/I Results of collocating satellites serving  
East, West and South Central regions

REGION	SATELLITE (LON.)	FREQUENCY (MHz)
EAS	-100.00	4000.00
WES	-100.00	4000.00
SCR	-100.00	4000.00

TEST REGION : EAS		SATELLITE : -100.00		
TEST POINT	INT. SAT.	C/I (dB)	MARGIN (dB)	
LON.	LAT.			
-74.02	40.72	WES	44.30	
-74.02	40.72	SCR	34.35	
-74.02	40.72	TOTAL	33.93	8.93
-71.07	42.35	WES	42.97	
-71.07	42.35	SCR	34.43	
-71.07	42.35	TOTAL	33.86	8.86
-77.02	38.90	WES	44.29	
-77.02	38.90	SCR	32.49	
-77.02	38.90	TOTAL	32.21	7.21
-75.12	39.95	WES	44.54	
-75.12	39.95	SCR	33.90	
-75.12	39.95	TOTAL	33.54	8.54
-78.65	35.78	WES	43.28	
-78.65	35.78	SCR	28.91	
-78.65	35.78	TOTAL	28.76	3.76

TEST REGION : WES		SATELLITE : -100.00		
TEST POINT	INT. SAT.	C/I (dB)	MARGIN (dB)	
-118.25	34.05	EAS	44.13	
-118.25	34.05	SCR	32.33	
-118.25	34.05	TOTAL	32.05	7.05
-122.40	37.80	EAS	43.56	
-122.40	37.80	SCR	33.80	
-122.40	37.80	TOTAL	33.37	8.37
-117.95	33.85	EAS	43.97	
-117.95	33.85	SCR	32.02	
-117.95	33.85	TOTAL	31.75	6.75

TEST REGION : SCR		SATELLITE : -100.00		
TEST POINT	INT. SAT.	C/I (dB)	MARGIN (dB)	
-96.80	32.78	EAS	34.90	
-96.80	32.78	WES	37.02	
-96.80	32.78	TOTAL	32.82	7.82
-99.52	29.47	EAS	35.71	
-99.52	29.47	WES	35.22	
-99.52	29.47	TOTAL	32.45	7.45
-90.12	29.97	EAS	28.14	
-90.12	29.97	WES	39.74	
-90.12	29.97	TOTAL	27.85	2.85

Table 5.6

C/I results of collocating satellites serving  
North Central, West and South Central regions

REGION	SATELLITE (LON.)		FREQUENCY (MHz)	
WES	-100.00		4000.00	
NCR	-100.00		4000.00	
SCR	-100.00		4000.00	
TEST REGION : WES      SATELLITE : -100.00				
TEST POINT		INT. SAT.	C/I (dB)	MARGIN (dB)
LON.	LAT.			
-118.25	34.05	NCR	43.46	
-118.25	34.05	SCR	32.83	
-118.25	34.05	TOTAL	32.00	7.00
-122.40	37.80	NCR	43.47	
-122.40	37.80	SCR	33.80	
-122.40	37.80	TOTAL	33.36	6.36
-117.95	33.85	NCR	43.23	
-117.95	33.85	SCR	32.02	
-117.95	33.85	TOTAL	31.70	6.70
TEST REGION : NCR      SATELLITE : -100.00				
TEST POINT		INT. SAT.	C/I (dB)	MARGIN (dB)
LON.	LAT.			
-87.63	41.88	WES	42.72	
-87.63	41.88	SCR	30.48	
-87.63	41.88	TOTAL	30.23	5.23
-81.68	41.50	WES	43.22	
-81.68	41.50	SCR	31.60	
-81.68	41.50	TOTAL	31.50	6.50
-83.05	42.33	WES	43.97	
-83.05	42.33	SCR	32.64	
-83.05	42.33	TOTAL	32.52	7.52
-84.52	39.10	WES	43.73	
-84.52	39.10	SCR	29.55	
-84.52	39.10	TOTAL	29.39	4.39
TEST REGION : SCR      SATELLITE : -100.00				
TEST POINT		INT. SAT.	C/I (dB)	MARGIN (dB)
LON.	LAT.			
-96.80	32.78	WES	37.02	
-96.80	32.78	NCR	31.08	
-96.80	32.78	TOTAL	30.09	5.09
-95.37	29.77	WES	36.87	
-95.37	29.77	NCR	34.02	
-95.37	29.77	TOTAL	32.79	7.79
-98.52	29.47	WES	35.22	
-98.52	29.47	NCR	34.37	
-98.52	29.47	TOTAL	31.77	6.77
-90.12	29.97	WES	39.74	
-90.12	29.97	NCR	29.50	
-90.12	29.97	TOTAL	29.11	4.11

Table 5.7

Δs calculation for East and North Central regions

REGION	SATELLITE (LON.)		FREQUENCY (MHz)		
NCR	-70.00		4000.00		
EST	-70.00		4000.00		
TEST REGION : NCR      SATELLITE : -70.00					
	TEST POINT		INT. SAT.	C/I (dB)	MARGIN (dB)
	LON.	LAT.			
	-87.63	41.88	EST	28.66	3.66
	-83.05	42.33	EST	14.71	-10.29
	-84.52	39.10	EST	17.10	-7.90
	-81.68	41.50	EST	8.59	-16.41
TEST REGION : EST      SATELLITE : -70.00					
	TEST POINT		INT. SAT.	C/I (dB)	MARGIN (dB)
	LON.	LAT.			
	-71.07	42.35	NCR	29.00	4.00
	-75.12	39.95	NCR	22.11	-2.89
	-78.65	35.78	NCR	12.64	-12.36
	-74.02	40.72	NCR	29.50	4.50
	-74.02	40.72	NCR	29.50	4.50

WORST MARGIN IS -16.41 dB AT NCR ( -81.68, 41.50 )

REQUIRED SATELLITE SPACING : 1.24 AT -70.00 FOR C/I 25.0 dB

The projected long-distance telephone demand matrix between the major cities in these four areas is given in Table 5.8(a). When traffic demand for a region or between regions is computed below, we shall simply add matrix elements from Table 5.2. For instance, internal demand for the West region would be the demand from L.A. to San Francisco (2)-(4), San Francisco to L.A. (4)-(2), L.A. to Anaheim (2)-(12), Anaheim to L.A. (12)-(2), San Francisco to Anaheim (4)-(12), Anaheim to San Francisco (12)-(4). For demand from the West region to the North Central region, one would add the matrix elements corresponding to transmission from each of (2),(4),(12) to each of (3),(6),(8),(10). To make these numbers more applicable to the satellite planning task, they are converted to a corresponding number of satellite beams in the following way. From Figure 5.2, there are 24 frequency channels in the 6/4 GHz spectral band, and each channel is 36 MHz wide. Assuming that a high quality telephone channel occupies 8 KHz bandwidth, one MHz bandwidth can carry 120 telephone channels, and hence a full spectral band can carry 103,680 telephone channels. The number of satellite beams is therefore obtained from the number of telephone channels by dividing by 103,680. Table 5.8(a) is re-stated as satellite beam requirements in Table 5.8(b).

A complete requirement matrix, R, for the U.S. is shown in beam units in Table 5.9. In this matrix, the inter- and intra-regional communications demand of the four regions that can use the two regional-beam designs are listed individually, the rest of the demand, i.e., 73.15 beams, that must go through the CONUS-beam satellites is listed in one category. Note that the inter-regional demand between

Table 5.8

Telephone communications demand between major  
cities in four regions

(a) In channel units

channels	East	N. Central	West	S. Central
East	558400	514000	400200	198700
N. Central	514000	240400	253300	124300
West	400200	253300	124800	97800
S. Central	198700	124300	97800	31200

(b) In beam units

beams	East	N. Central	West	S. Central
East	5.38	4.95	3.85	1.91
N. Central	4.95	2.31	2.44	1.19
West	3.85	2.44	1.20	0.94
S. Central	1.91	1.19	0.94	0.30

Table 5.9

Complete requirement matrix

beams	East	N. Central	West	S. Central	CONUS
East	5.38	*	3.85	1.91	
N. Central	*	2.31	2.44	1.19	73.15
West	3.85	2.44	1.20	0.94	
S. Central	1.91	1.19	0.94	0.30	

East and North Central is included in the CONUS beam category because it can not use any of the two regional-beam designs.

### 3. Improvement of traffic-supply matrix with service-area specification

A supply matrix is used to express the traffic-supply arrangement; each element in this matrix is the amount of traffic supply from one region to another offered from a scenario, up to the maximum amount of demand from the corresponding regions.

If the communications demand is supported by 25 CONUS-beam satellites, the average percentage of satisfaction,  $s$ , is

$$\begin{aligned} s &= 25/103 \\ &= 24.27\% \end{aligned}$$

Assuming that each user in the continental U.S. has equal probability of accessing all satellites, then each user will have the same percentage of satisfaction and the corresponding supply matrix in beam numbers is given by

$$S = s \cdot R, \quad (5.1)$$

which is shown in Table 5.10. This represents the total supply expected from the all-CONUS system. While the origin and destination of traffic by regions East, N. Central, S. Central and West are not particularly meaningful with the all CONUS-beam design, the same partitioning as in Table 5.9 has been retained in Table 5.10; this will prove convenient when this scheme is compared to the multiple-beam designs to be discussed.



Table 5.10  
Supply matrix without regional-beam  
satellites

beams	East	N. Central	West	S. Central	CONUS
East	1.305	*	0.934	0.463	
N. Central	*	0.560	0.592	0.289	17.753
West	0.934	0.592	0.291	0.228	
S. Central	0.463	0.289	0.228	0.073	

When implementing the two regional-beam designs, some of the 25 CONUS beam satellites must be preserved; the criterion here is to have the maximum total increase of traffic supply and no loss for any individual. The projected total demand is 103 beams. The requirement matrix that can use the two regional-beam designs, which is simply the regionally served part of Table 5.9, is shown in Table 5.11; the regional sub-total requirement is found to be 29.85 beams. Suppose there are  $m$  CONUS satellites being replaced by the regional-beam designs. If the traffic which can be carried only by the CONUS beams does not suffer any loss after implementing the regional-beam designs, the number  $m$  must satisfy the requirement

$$(25-m)/(103-29.85) \geq (25/103).$$

The maximum value of  $m$ , denoted by  $M$ , is 7. Replacing  $M$  consecutive CONUS satellites with regional-beam satellites will lead to the maximum total increase of traffic supply. For a general case, the value of  $M$  is calculated from

$$M = \text{IFIX}[n-(n/t) \cdot (t-r)], \quad (5.2)$$

where the symbols are

IFIX : a function whose value is the largest integer equal to or less than the argument,

$n$  : number of satellites in a scenario before implementing regional-beam designs,

$t$  : total communications demand,

$r$  : communications demand that is to be satisfied by the regional-beam designs.

Table 5.11

Requirement matrix of four regions

beams	East	N. Central	West	S. Central	sub-total
East	5.38	*	3.85	1.91	11.14
N. Central	*	2.31	2.44	1.19	5.94
West	3.85	2.44	1.20	0.94	8.43
S. Central	1.91	1.19	0.94	0.30	4.34
				total	29.85

Reference to the  $\Delta S$  matrix in Table 5.4 shows the orbital arc that accommodates seven CONUS-beam satellites can support thirteen satellites with 1.25-degree spacing. Of these thirteen satellites, there could be maximally seven beams illuminating the region East since satellites serving the same service area must be separated by no less than 2.5 degrees. Then, because of the  $\Delta S$  restriction which does not allow collocation of East and North Central beams, there can be at most six beams illuminating North Central. (The reason that East has been allotted more beams than North Central is that it has more demand.) The maximum numbers of beams for West and South Central are both six. They can not be seven because the beam arrangement should allow inter-regional communications from East or North Central to West and South Central; the choice of seven West beams would result in beam-collocation of the East and West beams and no communications between West and North Central. (If these statements do not seem clear, the reader is encouraged to refer to Figure 5.5, which shows the sequence of the thirteen regional-beam satellites, and to experiment with other arrangements, keeping in mind both restrictions and regional-beam designs discussed in Section V.E.2.) With these beam assignments, the supply of regional beams to these four regions is listed in Table 5.12.

The corresponding percentages of satisfaction for the four regions are listed in Table 5.13; the corresponding supply matrix, obtained by multiplying elements of each row with the respective percentage of satisfaction, is shown in Table 5.14(a). It is assumed that the

Table 5.12

Supply of regional beams to four regions

region	beams
East	7
N. Central	6
West	6
S. Central	6
total	25

Table 5.13

Percentage of satisfaction of demand by  
means of regional beams

region	p. o. s.
East	$7/11.14 = 0.6283$
N. Central	1
West	$6/8.43 = 0.7117$
S. Central	1

satellite traffic is likely to be symmetrical, hence this matrix needs to be symmetrized. The adjustment should be dominated by the first row because the demand from/to East is the largest and the rate of successful connection depends therefore most strongly on the availability of the channels to the East. The first step is to symmetrize the first column and row, and the matrix should become as shown in Table 5.14(b). Next, the adjustment should be dominated by the third row because the communications from/to West is the second largest. Note that since the value of its first element has been decreased in step one, the available communications supply to the other three elements will increase. The total demand represented by the last three elements in row three can be seen from Table 5.9 to be 4.58 beam units. The beam supply corresponding to these elements are the six beams allotted to the West region (see Table 5.12) minus the 2.419 beam units assigned to the first element of row three in Table 5.14(b), or 3.581 beams. The percentage of satisfaction is therefore  $2.419/3.581$ , or 0.7818, which means the matrix is adjusted as shown in Table 5.14(c). This adjustment procedure continues, but is less complicated for the remaining two rows because the amount of beam supply for North Central and South Central is larger than the demand. The adjustment is completed by satisfying the demand, i.e., inserting the corresponding elements from Table 5.11, and the final result is shown in Table 5.14(d). At this point it should be recalled that the design began by converting seven of 25 satellites to regional-beam use, see discussion above Equation (5.2); thus 18 remain for CONUS coverage. For a clear

Table 5.14  
Supply matrix adjustment

(a) Step one

beams	East	N. Central	West	S. Central
East	3.380	*	2.419	1.200
N. Central	*	2.310	2.440	1.190
West	2.740	1.736	0.854	0.669
S. Central	1.910	1.190	0.940	0.300

(b) Step two

beams	East	N. Central	West	S. Central
East	3.380	*	2.419	1.200
N. Central	*			
West	2.419			
S. Central	1.200			



Table 5.14 (Continued)

(c) Step three

beams	East	N. Central	West	S. Central
East	3.380	*	2.419	1.200
N. Central	*		1.908	
West	2.419	1.908	0.938	0.735
S. Central	1.200		0.735	

(d) Final step

beams	East	N. Central	West	S. Central	sub-total
East	3.380	*	2.419	1.200	7
N. Central	*	2.310	1.908	1.190	5.408
West	2.419	1.908	0.938	0.735	6
S. Central	1.200	1.190	0.735	0.300	3.425

comparison of how the regional-beam designs increase the communications supply, the supply matrix without these regional-beam designs (as shown in Table 5.10) is re-listed in Table 5.15, and the supply matrix with regional-beam designs is given in Table 5.16. It is obvious that the design has accomplished its objective: increasing the communications supply (i.e., satellite availability) to the four regions while decreasing it for no user.

One possible beam arrangement that could provide the number of beams listed in Table 5.12 is shown in Figure 5.5. One possible communications traffic distribution that could provide the supply matrix as shown in Table 5.14(d) is shown in Figure 5.6, and is derived as follows. First, one should saturate the capacity of the one-beam satellites with intra-regional traffic supply, as in satellites  $S_2$ ,  $S_7$ , and  $S_{12}$ . Then one should try to saturate the capacity of the two-beam satellites with inter-regional traffic supply, as in  $S_3$ ,  $S_4$ ,  $S_5$ ,  $S_6$ ,  $S_8$ ,  $S_9$ ,  $S_{10}$ , and  $S_{11}$ ; because of the limited supply given in Table 5.14(d),  $S_5$ ,  $S_6$ , and  $S_8$  are not fully used by inter-regional traffic, and the remaining capacity in each is assigned to intra-regional traffic. The traffic of the three-beam satellites are then distributed to fulfill the remaining traffic supply quota in Table 5.14(d). Also note that as shown in Figure 5.6, additional intra-regional beams are available for North Central and South Central. Comparison of the supply matrix in Table 5.16, which is implemented by Figure 5.6, with the requirements in Table 5.9 show that this situation can be viewed as more than 100% satisfaction of the demand for these regions.

Table 5.15

Supply matrix without regional beams

beams	East	N. Central	West	S. Central	CONUS
East	1.305	*	0.934	0.463	
N. Central	*	0.560	0.592	0.289	17.753
West	0.934	0.592	0.291	0.228	
S. Central	0.463	0.289	0.228	0.073	

Table 5.16

Supply matrix with regional beams

beams	East	N. Central	West	S. Central	rest
East	3.380	*	2.419	1.200	
N. Central	*	2.310	1.908	1.190	18
West	2.419	1.908	0.938	0.735	
S. Central	1.200	1.190	0.735	0.300	

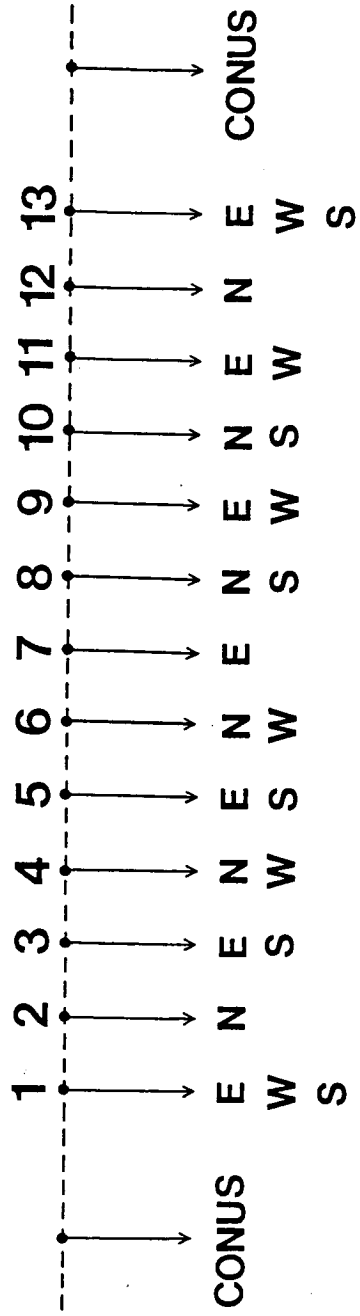

Figure 5.5. Possible beam arrangement for four regions.

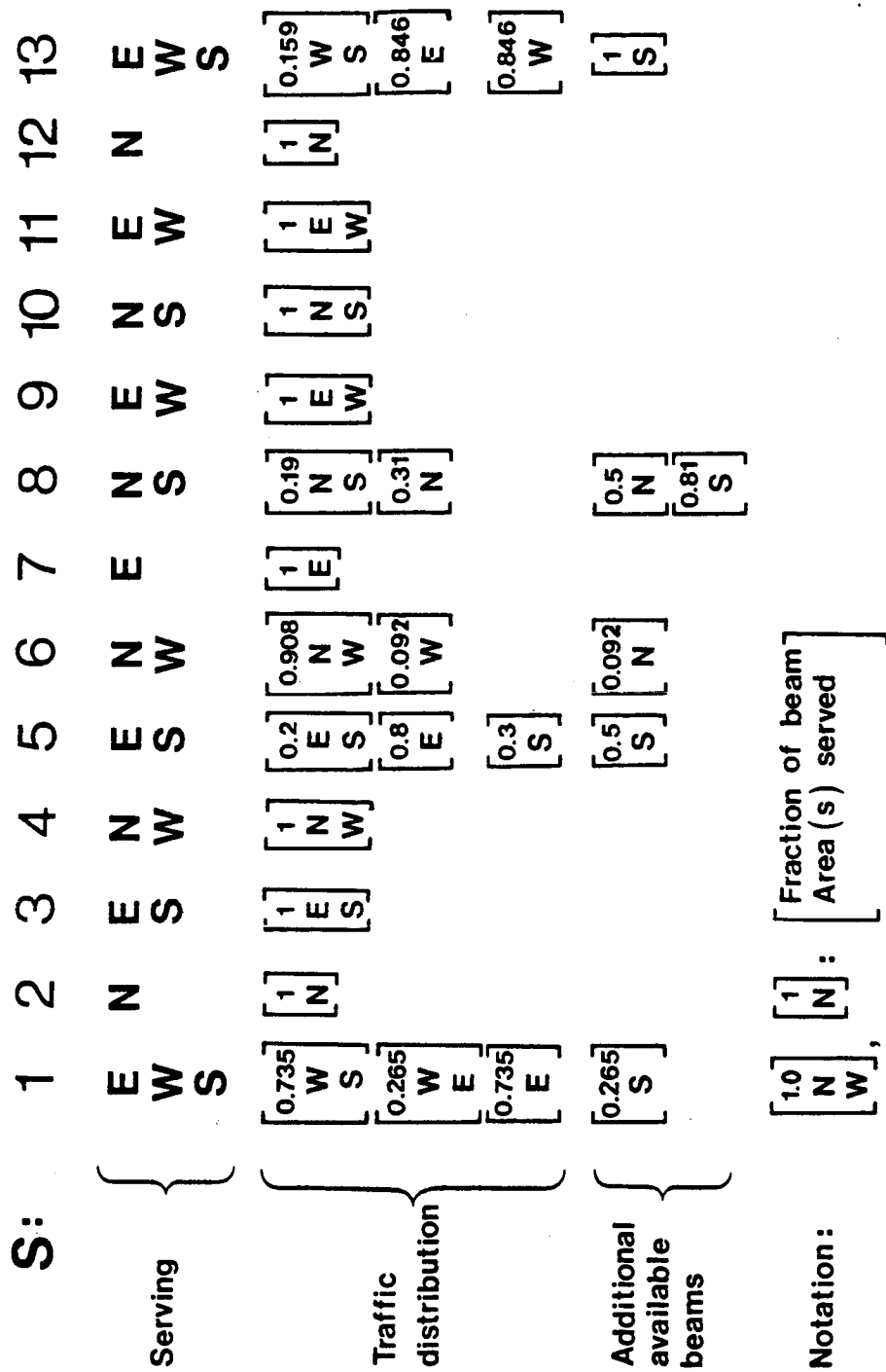

Figure 5.6. Possible communications distribution for four regions.

#### 4. Discussion of Numerical Example

The above example was formulated by observing the communications-demand density on a map and selecting service areas intuitively according to the following criteria: the communications demand within and between the service areas should be high, the service areas should be small, and the distance between these service areas should be large. To some extent these criteria conflict, and a compromise was necessary. Although the service areas were specified intuitively, there should be ways to automate this process. The ultimate criterion for the choice of service area specification is that it should result in the maximum communications supply. Intermediate criteria in terms of the  $\Delta S$  and demand matrix elements would be useful if they can be developed.

It was fortunate that the required spacing between the East and North Central satellites turned out slightly less than half the value for CONUS-beam satellites; this made the satellite "conversion" from CONUS to regional-beam particularly simple and straightforward. For other choices of service areas, the  $\Delta S$  matrix will be different, so will the beam arrangement and the resulting communications supply. Still the principle is the same: smaller  $\Delta S$  values means more satellites. It is hoped that this example will provide insight for generating more general and automated procedures.

The concept of replacing administration-coverage satellites with regional-beam ones may have great practical merit. At present, satellite planning work may take place many years before the actual satellite implantation. It is very difficult to make a plan that can

cope with the technologies available twenty years later; therefore, a good plan should be flexible so that the administrations will not be tied to old technologies. For example, if CONUS-beam designs are used in the U.S. planning process with the option of "converting" some to multiple-beam designs later, higher information capacity can be obtained within the framework of an existing scenario, i.e., without changes in the remaining satellites. Therefore, from the viewpoint of flexibility, the multiple-beam replacement option should be attractive as a component of the U.S. planning.

#### **F. DISCUSSION AND CONCLUSION**

It was suggested that service areas of the FSS system should be specified according to the communications traffic-demand density in conjunction with the  $\Delta S$  concept, because this could enable the system planner to specify more satellites and provide more communications supply. When applying this concept to specify satellites for an administration which has heavy traffic between several small and separated regions, it was shown that a mixture of administration coverage and intra-administration regional coverage can increase the communications capacity compared with only administration coverage. A numerical example was used to illustrate the design procedure for replacing several of a series of uniformly spaced administration-coverage satellites with regional-beam ones. It was shown that a substantial communications capacity increase could be obtained for many users without decreasing the capacity for any user. The procedure was

intuitive in part, and it is recommended that techniques for formalizing and automating it be investigated.

The regional service-area concept in this chapter is closely related to the  $\Delta S$  concept in Chapter IV. In Chapter IV, the specification of service areas is given and fixed and the focus of the study is allocating satellite locations in the orbit. The focus in Chapter V is the specification of service areas. It is found that consideration of  $\Delta S$  and traffic demand leads to useful techniques for this specification.

An important advantage in specifying smaller (i.e., regional as opposed to administration-coverage) service areas in the case of geographically large administrations is the reduction of interference to other communications systems. A smaller service area means a smaller beam, and hence a faster drop of the field strength away from the service area. Thus, the use of regional service areas can give better interference protection to other service areas, not only within but also outside the same administration.

In this chapter, the inter-satellite service (ISS) was not considered. The adoption of the ISS might affect this study significantly.



## CHAPTER VI

### CONCLUSION

The purpose of this study has been to explore orbit and frequency assignment methods with which the spectrum/orbit resources can be efficiently utilized for satellite communications.

In Chapter III, the mathematical nature of the orbital/frequency assignment problem is investigated by analyzing an objective function used by the extended-gradient and cyclic-coordinate search techniques. It is shown that the permutation of the orbital/frequency assignments is an important part of the problem. This indicates that a necessary condition for a technique to be able to find the globally optimal scenario is that it should be able to deal with both the continuous aspects of satisfying the signal quality requirement and with the permutation problem. It is also shown that, at least when the frequency variables are fixed, for a given orbital permutation this objective function is likely to have only one local minimum. This suggests that a sufficient condition to obtain the globally optimal solution by a extended gradient search method is that it should terminate as the ordinary gradient search procedure with the optimal permutation in orbital and frequency assignments.

In Chapter IV, a technique for obtaining the optimal orbital assignments is presented. The idea is to convert the signal quality requirement to minimum satellite spacing requirements and use them as constraints on the relative satellite locations. With a set of these

constraints, the assignment problem can be formulated as a mixed integer program (integer programming is often used to solve a permutation problem) and solved by the branch-and-bound method. The globally optimal solution is guaranteed; however, the required computational time may be prohibitively long when the problem size (number of satellites to be assigned) is large. To overcome this difficulty, the same problem is formulated as a linear program and solved by a version of the simplex method with restricted basis entry; only a locally optimal solution is guaranteed, but the method is more practical in terms of computational effort. The solutions of both programs are guaranteed to have satisfactory single-entry  $C/I_e$  (carrier-to-effective interference ratio) results.

In Chapter V, a basis of specifying service areas for the FSS system is proposed. It is suggested that while some satellites should cover large territories, some satellites should cover smaller regions where the communications demands are high. Smaller and separated service areas require smaller necessary satellite spacings, thus more satellites can be allocated in the orbit and higher communications supply can be obtained. The method involves simultaneous consideration of a requirement matrix and the  $\Delta S$  matrix for the proposed regions. A numerical example, in which projected voice telephone demand is used for the requirement matrix, demonstrates the validity of this approach.

## APPENDIX A

### STREAMLINED SOUP CODE

```

C*** >> MAIN PROGRAM <<
C   THIS IS A MINI SOUP PROGRAM
C*****
C
C   IMPLICIT INTEGER*4(I-N),REAL*8(A-H,O-Z)
C
C   CHARACTER*6 NAMESA
C
C   COMMON /CONSTS/ E,PI,RADIAN,DEGREE,GCR,ER,ERDB,EAP,
1   PFD,ALOG,ALN10,COIMIN,COISING
C
C   COMMON /PARAMS/ NUMSAR,NAMESA(10,2),NTPSA(10),CPHI0(10)
C
C   COMMON /VECTOR/ DSLON(10),RSLON(10),XO(10),YO(10),
1   ROAIKJ,
2   XOAC(10),YOAC(10),ZOAC(10),ROAC(10)
C
C   COMMON /VARBLS/ FREQ(10),IPOLAR(10),GAINR(10),GAINI(10),
1   EIRP(10),IPTNST(10),IPTNER(10)
C
C   COMMON /MINELL/ BCLAT(10),BCLON(10),DBCLAT(10),DBCLON(10),
1   REFLAT(10),REFLON(10),AXR(10),
1   ORIENT(10),AXMAJ(10)
C
C   COMMON /TPOINT/ RELON(10,20),RELAT(10,20),DELON(10,20),
1   DELAT(10,20),XE(10,20),YE(10,20),ZE(10,20)
C
C   COMMON /ANGLES/ YPHIT,YPHIR,PHITK,YPHI0
C
C   COMMON /REAL/   PIKJ,PKKJ,PWFQM,PWDRCK,YPWDRX,YPWDRX,
1   XOAKKJ,YOAKKJ,ZOAKKJ,ROAKKJ
C*****
C
C   OPEN (UNIT=20,FILE='INPUT0.DAT',TYPE='OLD')
C   OPEN (UNIT=6,FILE='NASAP.DAT',TYPE='NEW')
C
C   CALL ICONST
C   CALL INPUT0
C
C   ASSUME POWER DENSITIES AT ALL BEAM AIM POINTS ARE CONSTANT
C
C   DO 2 K = 1,NUMSAR
C     CALL GAINER(K)
C     EIRP(K) = PFD+10.*DLOG10(4.*PI*ROAC(K)*ROAC(K))-ERDB
2   CONTINUE
C
C   CALL ZFUNCT
C
C   STOP
C   END
C
C   SUBROUTINE ZFUNCT
C
C*** >> THIS ROUTINE IS THE OVERALL CONTROL ROUTINE AT EACH <<
C*** >> STEP IN THE LINE SEARCH PROCEDURE <<
C*****
C
C   IMPLICIT INTEGER*4(I-N),REAL*8(A-H,O-Z)

```

```

C
C CHARACTER*6 NAMESA
C
C COMMON /CONSTS/ E,PI,RADIAN,DEGREE,GCR,ER,ERDB,EAP,
1 PFD,ALOG,ALN10,COIMIN,COISING
C
C COMMON /PARAMS/ NUMSAR,NAMESA(10,2),NTPSA(10),CPH10(10)
C
C COMMON /VECTOR/ DSLON(10),RSLON(10),XO(10),YO(10),
1 ROAIKJ,
2 XOAC(10),YOAC(10),ZOAC(10),ROAC(10)
C
C COMMON /VARBLS/ FREQ(10),IPOLAR(10),GAINR(10),GAINI(10),
1 EIRP(10),IPTNST(10),IPTNER(10)
C
C COMMON /MINELL/ BCLAT(10),BCLON(10),DBCLAT(10),DBCLON(10),
1 REFLAT(10),REFLON(10),AXR(10),
1 ORIENT(10),AXMAJ(10)
C
C COMMON /TPOINT/ RELON(10,20),RELAT(10,20),DELON(10,20),
1 DELAT(10,20),XE(10,20),YE(10,20),ZE(10,20)
C
C COMMON /ANGLES/ YPHIT,YPHIR,PHITK,YPHIO
C
C COMMON /REAL/ PIKJ,PKKJ,FWFQM,FWDRCK,YPWDRC,YPWDRX,
1 XOAKKJ,YOAKKJ,ZOAKKJ,ROAKKJ
C
C*****
C
C*** >> INITIALIZE PARAMETER
C
C DO 10 I=1,NUMSAR
C CALL REPCAL(I)
C 10 CONTINUE
C
C*** >> OUTER SUMMATION (OVER K) FOR ALL SERVICE AREAS <<
C
C DO 1000 K = 1,NUMSAR
C JNTP = NTPSA(K)
C WRITE(6,705) NAMESA(K,1),DSLON(K)
C
C*** >> MIDDLE SUMMATION (OVER J) FOR ALL TEST POINTS IN AREA K <<
C
C DO 900 J = 1,JNTP
C CALL KPHI (K,J)
C CALL XPHIO (K,K,J)
C CALL KPWDRC (K,J)
C CALL XPWFQ (FREQ(K),FREQ(K))
C CALL XPOWER (K,K,J)
C
C
C*** >> CALCULATE INTERFERENCE POWER
C
C SUMP=0.
C DO 500 I = 1,NUMSAR
C IF (I.EQ.K) GO TO 500
C CALL ZPHI (I,K,J)
C CALL XPHIO (I,K,J)
C IF (IPOLAR(I).EQ.IPOLAR(K)) THEN
C CALL ZPWDRC (I,K,J)
C ELSE

```

```

          CALL ZPWDRX (I,K,J)
          END IF
          CALL XPWFQ (FREQ(K),FREQ(I))
          CALL XPOWER (I,K,J)
          COI = PKKJ-PIKJ
          DMGN = COI - COISING
C
          WRITE (6,706) DELON(K,J), DELAT(K,J), NAMESA(I,1), PIKJ, COI, DMGN
C
          IF (PIKJ .LT. -700.) PIKJ = -700.
C
          TEN1 = 10. ** (PIKJ/10.)
          SUMP = SUMP + TEN1
500      CONTINUE
C
          IF (NUMSAR.NE.2) THEN
          SUMPDB = 10.*DLOG10(SUMP)
          COIT = PKKJ-SUMPDB
          TDMGN = COIT-COIMIN
          WRITE (6,708) DELON(K,J), DELAT(K,J), SUMPDB, COIT, TDMGN
          END IF
C
          900      CONTINUE
          1000     CONTINUE
C
          705      FORMAT(//,12X,'TEST COUNTRY :',A6,5X,'SATELLITE :',F8.2,/,15X,
          1'TEST POINT',10X,'INT. SAT.',2X,'INT. PWR',3X,'C/I (dB)',
          25X,'MARGIN')
          706      FORMAT(15X,F7.2,2X,F7.2,5X,A6,4X,F8.2,4X,F6.2,6X,F6.2)
          708      FORMAT(13X,2(2X,F7.2),6X,'TOTAL',4X,F8.2,4X,F6.2,6X,F6.2,/)
          RETURN
          END
C
          SUBROUTINE ICONST
C
C***  >>  THIS ROUTINE INPUTS CONSTANTS THAT ARE USED IN THE PROGRAM <<
C
C*****
C
          IMPLICIT INTEGER*4(I-N), REAL*8(A-H,O-Z)
C
          COMMON /CONSTS/ E,PI,RADIAN,DEGREE,GCR,ER,ERDB,EAP,
          1 PFD,ALOG,ALN10,COIMIN,COISING
C
C*****
C
          E = 2.7182818285
          PI = 3.1415926536
          RADIAN = PI / 180.0
          DEGREE = 180.0 / PI
          GCR = 6.6134
          ER = 6.371E+06
          ALOG = 0.4342944819
          ALN10 = 2.3025850930
          ERDB = -20.0 * DLOG10(ER)
          PFD = -90.
          EAP = 0.6
C
          RETURN
          END

```

```

C
C      SUBROUTINE INPUTO
C
C***  >>  THIS ROUTINE INPUTS                                <<
C***  >>          - SERVICE AREA DATA                      <<
C***  >>          - INITIAL SATELLITE LOCATIONS             <<
C***  >>          - INITIAL FREQUENCY ASSIGNMENTS          <<
C***  >>          - INITIAL POLARISATIONS                  <<
C***  >>          - ANTENNA PATTERN TYPE                    <<
C
C*****
C      IMPLICIT INTEGER*4(I-N),REAL*8(A-H,O-Z)
C
C      CHARACTER*6 NAMESA
C
C      COMMON /CONSTS/ E,PI,RADIAN,DEGREE,GCR,ER,ERDB,EAP,
1      PFD,ALOG,ALN10,COIMIN,COISING
C
C      COMMON /PARAMS/ NUMSAR,NAMESA(10,2),NTPSA(10),CPHI0(10)
C
C      COMMON /VECTOR/ DSLON(10),RSLON(10),XO(10),YO(10),
1      ROAIKJ,
2      XOAC(10),YOAC(10),ZOAC(10),ROAC(10)
C
C      COMMON /VARBLS/ FREQ(10),IPOLAR(10),GAINR(10),GAINI(10),
1      EIRP(10),IPTNST(10),IPTNER(10)
C
C      COMMON /MINELL/ BCLAT(10),BCLON(10),DBCLAT(10),DBCLON(10),
1      REFLAT(10),REFLON(10),AXR(10),
1      ORIENT(10),AXMAJ(10)
C
C      COMMON /TPOINT/ RELON(10,20),RELAT(10,20),DELON(10,20),
1      DELAT(10,20),XE(10,20),YE(10,20),ZE(10,20)
C
C*****
C
C***  >>  INPUT DATA FOR SATELLITE, BEAM, EARTH STATION CHARACTERISTICS
C
C      READ(20,*) COISING
C      COIMIN = COISING - 5.
C      READ(20,*) NUMSAR
C      DO 10 N = 1,NUMSAR
C          READ(20,801) (NAMESA(N,I),I=1,2)
C          READ(20,*) DSLON(N),FREQ(N),IPOLAR(N),IPTNST(N),IPTNER(N)
C          READ(20,*) DBCLON(N),DBCLAT(N),ORIENT(N),AXMAJ(N),AXMIN
C          READ(20,*) NTP
C      DO 12 N1=1,NTP
C          READ(20,*) DELON(N,N1),DELAT(N,N1)
C
C          RELON(N,N1) = DELON(N,N1)*RADIAN
C          RELAT(N,N1) = DELAT(N,N1)*RADIAN
C
C      12  CONTINUE
C
C          NTPSA(N) = NTP
C          FREQ(N) = FREQ(N) * 1000.
C          RSLON(N) = DSLON(N) * RADIAN
C          AXR(N) = AXMAJ(N)/AXMIN
C          ORIENT(N) = ORIENT(N)*RADIAN
C          AXMAJ(N) = AXMAJ(N)*RADIAN

```

```

          BCLON(N) = DBCLON(N)*RADIAN
          BCLAT(N) = DBCLAT(N)*RADIAN
C
10  CONTINUE
C
C***  >>  REFLECT INPUT DATA  <<
C
      WRITE(6,901)
      DO 20  N = 1,NUMSAR
          WRITE(6,902)  NAMESA(N,1),DSLON(N),
$              FREQ(N),IPOLAR(N),IPTNST(N),IPTNER(N)
20  CONTINUE
C
801  FORMAT(2A6)
901  FORMAT(/12X,'COUNTRY',5X,'SATELLITE',5X,'FREQUENCY',3X,
$      'POLAR.',3X,'PTN(ST)',3X,'PTN(ER)',/)
902  FORMAT(13X,A6,5X,F9.2,5X,F9.2,5X,I2,7X,I2,8X,I2)
C
C***  >>  SET UP THE VECTORS FOR THE TEST POINTS  <<
C
      DO 30  K = 1,NUMSAR
C
          XOI = DCOS(RSLON(K))
          YOI = DSIN(RSLON(K))
          XO(K) = XOI
          YO(K) = YOI
C
          BCLT = BCLAT(K)
          BCLN = BCLON(K)
          COSBLT = DCOS(BCLT)
          CXE = COSBLT*DCOS(BCLN)
          CYE = COSBLT*DSIN(BCLN)
          CZE = DSIN(BCLT)
C
          XOACI = CXE-GCR*XOI
          YOACI = CYE-GCR*YOI
          ZOAC(K) = CZE
          ROACI = DSQRT(XOACI*XOACI + YOACI*YOACI + CZE*CZE)
C
          XOAC(K) = XOACI
          YOAC(K) = YOACI
          ROAC(K) = ROACI
C
          DO 30  J = 1,NTPSA(K)
              COSLAT = DCOS(RELAT(K,J))
              XE(K,J) = COSLAT * DCOS(RELON(K,J))
              YE(K,J) = COSLAT * DSIN(RELON(K,J))
              ZE(K,J) = DSIN(RELAT(K,J))
30  CONTINUE
C
      RETURN
      END
C
      SUBROUTINE GAINER(K)
C
C      THIS IS TO CALCULATE EARTH RECEIVER GAIN FROM ANTENNA
C      DIAMETER, AND TRANSMITTER GAIN FROM HPBW.
C
      IMPLICIT INTEGER*4(I-N),REAL*8(A-H,O-Z)
C

```

CHARACTER\*6 NAMESA

C  
COMMON /CONSTS/ E, PI, RADIANT, DEGREE, GCR, ER, ERDB, EAP,  
1 PFD, ALOGE, ALN10, COIMIN, COISING  
C  
COMMON /VARBLS/ FREQ(10), IPOLAR(10), GAINR(10), GAINI(10),  
1 EIRP(10), IPTNST(10), IPTNER(10)  
C  
COMMON /PARAMS/ NUMSAR, NAMESA(10,2), NTPSA(10), CPH10(10)  
C  
COMMON /MINELL/ BCLAT(10), BCLON(10), DBCLAT(10), DBCLON(10),  
1 REFLAT(10), REFLON(10), AXR(10),  
1 ORIENT(10), AXMAJ(10)  
C  
X0 = 223./180.  
GO TO (10,20,30,40,50), IPTNER(K)  
C  
C  
C FSS, DIAMETER 3 METERS  
C  
10 D = 3.  
WAVEL = 300. / FREQ(K)  
X1 = D/WAVEL  
GAINR(K) = 10.\*DLOG10(PI\*PI\*X1\*X1\*EAP)  
CPH10(K) = X0/X1  
GO TO 60  
C  
C  
C FSS, DIAMETER 3 METERS  
C  
20 D = 3.  
WAVEL = 300. / FREQ(K)  
X1 = D/WAVEL  
GAINR(K) = 10.\*DLOG10(PI\*PI\*X1\*X1\*EAP)  
CPH10(K) = X0/X1  
GO TO 60  
C  
C  
C FSS, DIAMETER 4.5 METERS  
C  
30 D = 4.5  
WAVEL = 300. / FREQ(K)  
X1 = D/WAVEL  
GAINR(K) = 10.\*DLOG10(PI\*PI\*X1\*X1\*EAP)  
CPH10(K) = X0/X1  
GO TO 60  
C  
C  
C FSS, DIAMETER 4.5 METERS  
C  
40 D = 4.5  
WAVEL = 300. / FREQ(K)  
X1 = D/WAVEL  
GAINR(K) = 10.\*DLOG10(PI\*PI\*X1\*X1\*EAP)  
CPH10(K) = X0/X1  
GO TO 60  
C  
C  
C BSS, DIAMETER 1 METER  
C  
50 D = 1.  
WAVEL = 300. / FREQ(K)  
X1 = D/WAVEL  
GAINR(K) = 10.\*DLOG10(PI\*PI\*X1\*X1\*EAP)  
CPH10(K) = X0/X1



```

C
C      CALCULATE TRANSMIT GAIN FROM HPBW
C
60    GAIN(K) = 10.*DLOG10(EAP*AXR(K)*(PI*XO/AXMAJ(K))**2)
C
      RETURN
      END
C
      SUBROUTINE KPHI (K,J)
C
C***  >>  THIS ROUTINE COMPUTES THE VECTOR COMPONENTS OF THE LINK <<
C***  >>  K-K-J , AND THE CORRESPONDING TRANSMITTING PHI ANGLE <<
C
C*****
C
      IMPLICIT INTEGER*4(I-N),REAL*8(A-H,O-Z)
C
      CHARACTER*6 NAMESA
C
      COMMON /CONSTS/  E,PI,RADIAN,DEGREE,GCR,ER,ERDB,EAP,
1      PFD,ALOG,ALN10,COIMIN,COISING
C
      COMMON /PARAMS/  NUMSAR,NAMESA(10,2),NTPSA(10),CPHI(10)
C
      COMMON /VECTOR/  DSLON(10),RSLON(10),XO(10),YO(10),
1      ROAIKJ,
2      XOAC(10),YOAC(10),ZOAC(10),ROAC(10)
C
      COMMON /VARBLS/  FREQ(10),IPOLAR(10),GAINR(10),GAIN(10),
1      EIRP(10),IPTNST(10),IPTNER(10)
C
      COMMON /MINELL/  BCLAT(10),BCLON(10),DBCLAT(10),DBCLON(10),
1      REFLAT(10),REFLON(10),AXR(10),
1      ORIENT(10),AXMAJ(10)
C
      COMMON /TPOINT/  RELON(10,20),RELAT(10,20),DELON(10,20),
1      DELAT(10,20),XE(10,20),YE(10,20),ZE(10,20)
C
      COMMON /ANGLES/  YPHIT,YPHIR,PHITK,YPHI0
C
      COMMON /REAL/    PIKJ,PKKJ,FWFQM,FWDRCK,YPWDRC,YPWDRX,
1      XOAKKJ,YOAKKJ,ZOAKKJ,ROAKKJ
C
C*****
C
      XOAKKJ = XE(K,J) - GCR * XO(K)
      YOAKKJ = YE(K,J) - GCR * YO(K)
      ZOAKKJ = ZE(K,J)
      ROAKKJ = DSQRT(XOAKKJ*XOAKKJ + YOAKKJ*YOAKKJ + ZOAKKJ*ZOAKKJ)
C
      COSPHI = (XOAC(K) * XOAKKJ + YOAC(K) * YOAKKJ + ZOAC(K) * ZOAKKJ)
      $      / (ROAC(K) * ROAKKJ)
      PHITK = DARCOS(COSPHI)
C
      RETURN
      END
C
      SUBROUTINE ZPHI (I,K,J)
C
C***  >>  THIS ROUTINE COMPUTES THE PHI ANGLES <<

```

```

C*** >> (FOR I INTERFERING WITH K TEST POINT J) <<
C
C*****
C
  IMPLICIT INTEGER*4(I-N),REAL*8(A-H,O-Z)
C
  CHARACTER*6 NAMESA
C
  COMMON /CONSTS/ E,PI,RADIAN,DEGREE,GCR,ER,ERDB,EAP,
1 PFD,ALOG,ALN10,COIMIN,COISING
C
  COMMON /PARAMS/ NUMSAR,NAMESA(10,2),NTPSA(10),CPHIO(10)
C
  COMMON /VECTOR/ DSLON(10),RSLON(10),XO(10),YO(10),
1 ROAIKJ,
2 XOAC(10),YOAC(10),ZOAC(10),ROAC(10)
C
  COMMON /VARBLS/ 1 FREQ(10),IPOLAR(10),GAINR(10),GAINI(10),
  EIRP(10),IPTNST(10),IPTNER(10)
C
  COMMON /MINELL/ 1 BCLAT(10),BCLON(10),DBCLAT(10),DBCLON(10),
  REFLAT(10),REFLON(10),AXR(10),
  1 ORIENT(10),AXMAJ(10)
C
  COMMON /TPOINT/ 1 RELON(10,20),RELAT(10,20),DELON(10,20),
  DELAT(10,20),XE(10,20),YE(10,20),ZE(10,20)
C
  COMMON /ANGLES/ YPHIT,YPHIR,PHITK,YPHIO
C
  COMMON /REAL/ 1 PIKJ,PKKJ,FWFQM,PWDRCK,YPWDRX,
  YOAKKJ,YOAKKJ,ZOAKKJ,ROAKKJ
C
C*****
C
C*** >> CALCULATE OFF AXIS VECTOR COMPONENTS (___IKJ) <<
C
  XOAIKJ = XE(K,J) - GCR * XO(I)
  YOAIKJ = YE(K,J) - GCR * YO(I)
  ZOAIKJ = ZE(K,J)
  ROAIKJ = DSQRT(XOAIKJ*XOAIKJ + YOAIKJ*YOAIKJ + ZOAIKJ*ZOAIKJ)
C
C*** >> COMPUTE DISCRIMINATION ANGLES <<
C*** >> FOR THE TRANSMITTING ANTENNA <<
C
  TNUMER = XOAC(I) * XOAIKJ + YOAC(I) * YOAIKJ + ZOAC(I) * ZOAIKJ
  TDENOM = ROAC(I) * ROAIKJ
  TEMPU = TNUMER / TDENOM
C
  YPHIT = 0.0
  IF (DABS(TEMPU) .LT. 1.0) YPHIT = DARCOS(TEMPU)
C
C*** >> COMPUTE DISCRIMINATION ANGLES <<
C*** >> FOR THE RECEIVING ANTENNA <<
C
  TNUMER = XOAKKJ * XOAIKJ + YOAKKJ * YOAIKJ + ZOAKKJ * ZOAIKJ
  TDENOM = ROAKKJ * ROAIKJ
  TEMPU = TNUMER / TDENOM
C
  YPHIR = 0.0
  IF (DABS(TEMPU) .LT. 1.0) YPHIR = DARCOS(TEMPU)

```



```

COSA = DCOS(A)
SINA = DSIN(A)
GO TO 3
1 CONTINUE
COSA = -1.
SINA = 0.
A = PI
IF (BCLAT(I).LT.RSLAT) GO TO 3
COSA = 1.
A = 0.
GO TO 3
2 CONTINUE
COSA = 0.
SINA = 1.
A = PI/2.
IF (BCLON(I).LT.RSLON(I)) GO TO 3
SINA = -1.
A = 1.5*PI
3 CONTINUE
C
TANT = SINW / (GCR - COSW)
TRAD = DATAN(TANT)
SINT = DSIN(TRAD)
COST = DCOS(TRAD)
C
A21 = - COSA * SINPHS
A22 =  COSA * COSPHS
A23 =  SINA
C
A31 = SINT * COSPHS + COST * SINA * SINPHS
A32 = SINT * SINPHS - COST * SINA * COSPHS
A33 = COST * COSA
C
FLAT = REFLAT(I)
FLON = REFLON(I)
CSFLAT = DCOS(FLAT)
VR1 = CSFLAT * DCOS(FLON)
VR2 = CSFLAT * DSIN(FLON)
VR3 = DSIN(FLAT)
C
BLAT = BCLAT(I)
BLON = BCLON(I)
CSBLAT = DCOS(BLAT)
VC1 = CSBLAT * DCOS(BLON)
VC2 = CSBLAT * DSIN(BLON)
VC3 = DSIN(BLAT)
C
PHIE = RELON(K,J)
THETAE = RELAT(K,J)
COSTE = DCOS(THETAE)
VE1 = COSTE * DCOS(PHIE)
VE2 = COSTE * DSIN(PHIE)
VE3 = DSIN(THETAE)
C
VS1 = GCR * COSPHS
VS2 = GCR * SINPHS
VS3 = 0.0
C
VRMVC1 = VR1 - VC1
VRMVC2 = VR2 - VC2

```

```

C      VRMVC3 = VR3 - VC3
C      VEMVS1 = VE1 - VS1
C      VEMVS2 = VE2 - VS2
C      VEMVS3 = VE3
C      S1NUMR = A31*VRMVC1 + A32*VRMVC2 + A33*VRMVC3
C      S1DENR = A21*VRMVC1 + A22*VRMVC2 + A23*VRMVC3
C      S2NUMR = A31*VEMVS1 + A32*VEMVS2 + A33*VEMVS3
C      S2DENR = A21*VEMVS1 + A22*VEMVS2 + A23*VEMVS3
C      IF (S1DENR. NE .0.0) GO TO 10
C      S1 = PI / 2.0
C      GO TO 15
10     S1 = DATAN(S1NUMR/S1DENR)
C      15 IF (S2DENR. NE .0.0) GO TO 20
C      S2 = PI / 2.0
C      GO TO 25
20     S2 = DATAN(S2NUMR/S2DENR)
C      25 SIGMA = S2 - S1
C      CS = DCOS(SIGMA)
C      SS = DSIN(SIGMA)
C      AR = AXR(I)
C      P0 = AXMAJ(I) / DSQRT(CS*CS + AR*AR * SS*SS)
C      YPHI0 = P0
C      RETURN
C      END
C      SUBROUTINE REFCAL(N)
C      C*** >> THIS ROUTINE CALCULATES THE REFERENCE POINT LAT. & LON. <<
C      C*** >> BASED ON THE ALGORITHM IN SOUP MANUAL 3.4, MAY 1983 <<
C      C*****
C      IMPLICIT INTEGER*4(I-N),REAL*8(A-H,O-Z)
C      CHARACTER*6 NAMESA
C      COMMON /CONSTS/ E,PI,RADIAN,DEGREE,GCR,ER,ERDB,EAP,
1     PFD,ALOG,ALN10,COIMIN,COISING
C      COMMON /PARAMS/ NUMSAR,NAMESA(10,2),NTPSA(10),CPHI0(10)
C      COMMON /VECTOR/ DSLON(10),RSLON(10),XO(10),YO(10),
1     ROAIKJ,
2     XOAC(10),YOAC(10),ZOAC(10),ROAC(10)
C      COMMON /VARBLS/ FREQ(10),IPOLAR(10),GAINR(10),GAINI(10),
1     EIRP(10),IPTNST(10),IPTNER(10)
C      COMMON /MINELL/ BCLAT(10),BCLON(10),DBCLAT(10),DBCLON(10),
1     REFLAT(10),REFLON(10),AXR(10),
1     ORIENT(10),AXMAJ(10)
C      COMMON /TPOINT/ RELON(10,20),RELAT(10,20),DELON(10,20),

```

```

1          DELAT(10,20),XE(10,20),YE(10,20),ZE(10,20)
C
COMMON /ANGLES/ YPHIT,YPHIR,PHITK,YPHI0
C
COMMON /REAL/   PIKJ,PKKJ,FWFQM,FWDRCK,YPWDRX,YPWDRX,
1             XOAKKJ,YOAKKJ,ZOAKKJ,ROAKKJ
C
C*****
C
PGMPS = BCLON(N) - RSLON(N)
COSTG = DCOS(BCLAT(N))
COSPP = DCOS(PGMPS)
Q1 = COSTG * DSIN(PGMPS)
Q2 = GCR - COSTG * COSPP
Q3 = DSQRT(Q1**2+Q2**2)
C
SX = DATAN2(Q1,Q2)
SY = DATAN2(DSIN(BCLAT(N)),Q3)
C
AMAJ2 = AXMAJ(N) * 0.5
SX2 = AMAJ2 * DCOS(ORIENT(N))
SY2 = AMAJ2 * DSIN(ORIENT(N))
C
X1 = SX + SX2
Y1 = SY + SY2
C
Q4 = DARCOS(DCOS(X1) * DCOS(Y1))
Q5 = DSIN(Q4)
T = GCR * Q5
IF (T .LE. 1.0) GO TO 10
C
X1 = SX - SX2
Y1 = SY - SY2
Q4 = DARCOS(DCOS(X1) * DCOS(Y1))
Q5 = DSIN(Q4)
T = GCR * Q5
IF (T .LE. 1.0 .AND. T .GE. -1.0) GO TO 10
IF (T .GT. 0.) T = 1.0
IF (T .LT. 0.) T = -1.0
C
WRITE(6,901) T
901 FORMAT(/10X,'***** POSSIBLE ERROR IN ELLIPSE SELECTION ',
$         F5.1)
C
10 PX = DARSIN(DSIN(Y1)/Q5)
IF (X1 .LT. 0.0) PX = PI - PX
D = DARSIN(T)
BLAM = D - Q4
REFLAT(N) = DARSIN(DSIN(BLAM) * DSIN(PX))
AL = DARCOS(DCOS(BLAM)/DCOS(REFLAT(N)))
IF (DABS(PX) .GT. PI/2.) AL = -AL
REFLON(N) = RSLON(N) + AL
C
RETURN
END
C
C
FUNCTION DARSIN(X)
C
IMPLICIT REAL*8(A-H,O-Z)

```

```

      DARSIN = DASIN(X)
      RETURN
      END
C
C      FUNCTION DARCOOS(X)
C
C      IMPLICIT REAL*8(A-H,O-Z)
      DARCOOS = DACOS(X)
      RETURN
      END
C
C      SUBROUTINE KPWDRC (K,J)
C
C**** >> THIS ROUTINE COMPUTES THE CARRIER SIGNAL DISCRIMINATING <<
C**** >> FACTOR (DESIRED POWER - CO-POLARISED ONLY - PHIR=0 ) <<
C
C*****
C
C      IMPLICIT INTEGER*4(I-N),REAL*8(A-H,O-Z)
C
C      CHARACTER*6 NAMESA
C
C      COMMON /CONSTS/  E,PI,RADIAN,DEGREE,GCR,ER,ERDB,EAP,
1      PFD,ALOG,ALN10,COIMIN,COISING
C
C      COMMON /PARAMS/  NUMSAR,NAMESA(10,2),NTPSA(10),CPHI0(10)
C
C      COMMON /VECTOR/  DSLON(10),RSLON(10),XO(10),YO(10),
1      ROAIKJ,
2      XOAC(10),YOAC(10),ZOAC(10),ROAC(10)
C
C      COMMON /VARBLS/  FREQ(10),IPOLAR(10),GAINR(10),GAINI(10),
1      EIRP(10),IPTNST(10),IPTNER(10)
C
C      COMMON /MINELL/  BCLAT(10),BCLON(10),DBCLAT(10),DBCLON(10),
1      REFLAT(10),REFLON(10),AXR(10),
1      ORIENT(10),AXMAJ(10)
C
C      COMMON /TPOINT/  RELON(10,20),RELAT(10,20),DELON(10,20),
1      DELAT(10,20),XE(10,20),YE(10,20),ZE(10,20)
C
C      COMMON /ANGLES/  YPHIT,YPHIR,PHITK,YPHI0
C
C      COMMON /REAL/    PIKJ,PKKJ,PWFQM,PWDRCK,YPWDRC,YPWDRX,
1      XOAKKJ,YOAKKJ,ZOAKKJ,ROAKKJ
C
C*****
C
C      PT = PHITK
C      P0 = YPHI0
C
C      GO TO(10,20,30,40,50),IPTNST(K)
C
C 10  CALL PTNST1 (PT,P0,GAINI(K),DISC)
      GOTO 60
C
C 20  CALL PTNST2 (PT,P0,GAINI(K),DISC)
      GOTO 60
C
C 30  CALL PTNST3 (PT,P0,GAINI(K),DISC)

```

```

      GOTO 60
C
C 40 CALL PTNST4 (PT, P0, GAIN(K), DISC)
      GOTO 60
C
C 50 CALL PTNST5 (PT, P0, GAIN(K), DISC)
C
C 60 YDSCT = DISC
C
C PREVENTING IMPERFECT MINIMUM ELLIPSE NOT COVERING ALL POINTS
C
C IF (YDSCT.LT.-3.) YDSCT=-3.
C*** >> COMPONENT OF DESIRED POWER DEPENDENT ON ORBIT LOCATION <<
C
C PWRCK = EIRP(K) + YDSCT + GAINR(K) - 20.0 * DLOG10(ROAKKJ)
      RETURN
C
      END
C
      SUBROUTINE ZPWDR (I, K, J)
C
C*** >> THIS ROUTINE COMPUTES THE INTERFERENCE SIGNAL <<
C*** >> TRANSMITTING AND RECEIVING DISCRIMINATIONS FOR <<
C*** >> THE CO-POLARISED CASE <<
C
C*****
C
      IMPLICIT INTEGER*4 (I-N), REAL*8 (A-H, O-Z)
C
      CHARACTER*6 NAMESA
C
      COMMON /CONSTS/ E, PI, RADIAN, DEGREE, GCR, ER, ERDB, EAP,
1 PFD, ALOGE, ALN10, COIMIN, COISING
C
      COMMON /PARAMS/ NUMSAR, NAMESA(10,2), NTPSA(10), CPHI0(10)
C
      COMMON /VECTOR/ DSLON(10), RSLON(10), XO(10), YO(10),
1 ROAIKJ,
2 XOAC(10), YOAC(10), ZOAC(10), ROAC(10)
C
      COMMON /VARBLS/ FREQ(10), IPOLAR(10), GAINR(10), GAIN(10),
1 EIRP(10), IPTNST(10), IPTNER(10)
C
      COMMON /MINELL/ BCLAT(10), BCLON(10), DBCLAT(10), DBCLON(10),
1 REFLAT(10), REFLON(10), AXR(10),
1 ORIENT(10), AXMAJ(10)
C
      COMMON /TPOINT/ RELON(10,20), RELAT(10,20), DELON(10,20),
1 DELAT(10,20), XE(10,20), YE(10,20), ZE(10,20)
C
      COMMON /ANGLES/ YPHIT, YPHIR, PHITK, YPHI0
C
      COMMON /REAL/ PIKJ, PKKJ, FWFQM, PWRCK, YPWDR, YPWDRX,
1 XOAKKJ, YOAKKJ, ZOAKKJ, ROAKKJ
C
C*****
C
C*** >> TRANSMITTING DISCRIMINATION <<
C

```



```

      PT = YPHIT
      PO = YPHIO
      GO TO (10,20,30,40,50),IPTNST(I)
C
  10 CALL PTNST1 (PT, PO, GAIN(I), DISC)
      GOTO 60
C
  20 CALL PTNST2 (PT, PO, GAIN(I), DISC)
      GOTO 60
C
  30 CALL PTNST3 (PT, PO, GAIN(I), DISC)
      GO TO 60
C
  40 CALL PTNST4 (PT, PO, GAIN(I), DISC)
      GO TO 60
C
  50 CALL PTNST5 (PT, PO, GAIN(I), DISC)
C
  60 YDSCT = DISC
C
C*** >> RECEIVING DISCRIMINATION <<
C
      PR = YPHIR
      PO = CPHIO(K)
C
      GO TO (110,120,130,140,150), IPTNER(K)
C
  110 CALL PTNER1 (PR, PO, FREQ(I), GAINR(K), DISC)
      GOTO 160
C
  120 CALL PTNER2 (PR, PO, FREQ(I), GAINR(K), DISC)
      GOTO 160
C
  130 CALL PTNER3 (PR, PO, FREQ(I), GAINR(K), DISC)
      GO TO 160
C
  140 CALL PTNER4 (PR, PO, FREQ(I), GAINR(K), DISC)
      GO TO 160
C
  150 CALL PTNER5 (PR, PO, FREQ(I), GAINR(K), DISC)
C
  160 YDSCR = DISC
C
C*** >> COMPONENT OF POWER DEPENDENT ON THE ORBIT LOCATION <<
C*** >> CO-POLARISED CASE <<
C
      YPWDRC = EIRP(I) + YDSCT + YDSCR
      $      - 20. * DLOG10(ROAIKJ)
C
      RETURN
      END
C
      SUBROUTINE ZPWDRX (I, K, J)
C
C*** >> THIS ROUTINE COMPUTES THE INTERFERENCE POWER <<
C*** >> TRANSMITTING AND RECEIVING DISCRIMINATIONS FOR <<
C*** >> THE CROSS-POLARISED CASE <<
C
C*****
C

```

```

C      IMPLICIT INTEGER*4(I-N),REAL*8(A-H,O-Z)
C
C      CHARACTER*6 NAMESA
C
C      COMMON /CONSTS/ E,PI,RADIAN,DEGREE,GCR,ER,ERDB,EAP,
1      PFD,ALOG,ALN10,COIMIN,COISING
C
C      COMMON /PARAMS/ NUMSAR,NAMESA(10,2),NTPSA(10),CPHI0(10)
C
C      COMMON /VECTOR/ DSLON(10),RSLON(10),XO(10),YO(10),
1      ROAIKJ,
2      XOAC(10),YOAC(10),ZOAC(10),ROAC(10)
C
C      COMMON /VARBLS/ FREQ(10),IPOLAR(10),GAINR(10),GAINI(10),
1      EIRP(10),IPTNST(10),IPTNER(10)
C
C      COMMON /MINELL/ BCLAT(10),BCLON(10),DBCLAT(10),DBCLON(10),
1      REFLAT(10),REFLON(10),AXR(10),
1      ORIENT(10),AXMAJ(10)
C
C      COMMON /TPOINT/ RELON(10,20),RELAT(10,20),DELON(10,20),
1      DELAT(10,20),XE(10,20),YE(10,20),ZE(10,20)
C
C      COMMON /ANGLES/ YPHIT,YPHIR,PHITK,YPHI0
C
C      COMMON /REAL/   PIKJ,PKKJ,PWFQM,PWDRCK,YPWDRC,YPWDRX,
1      XOAKKJ,YOAKKJ,ZOAKKJ,ROAKKJ
C
C*****
C
C***  >>  TRANSMITTING DISCRIMINATION  <<
C
C      PT = YPHIT
C      PO = YPHI0
C
C      GO TO (10,12,14,16,18),IPTNST(I)
C
C 10  CALL PTNST1(PT,PO,GAINI(I),DISC)
C      GO TO 20
C
C 12  CALL PTNST2(PT,PO,GAINI(I),DISC)
C      GO TO 20
C
C 14  CALL PTNST3(PT,PO,GAINI(I),DISC)
C      GO TO 20
C
C 16  CALL PTNST4(PT,PO,GAINI(I),DISC)
C      GO TO 20
C
C 18  CALL PTNST5(PT,PO,GAINI(I),DISC)
C
C 20  YDSCT = DISC
C
C***  >>  RECEIVING DIRECTIVITY  <<
C
C      PR = YPHIR
C      PO = CPHI0(K)
C
C      CALL XPTNER1(PR,PO,GAINR(K),DISC)
C      YDSXR = DISC

```

```

C
C*** >> COMPONENT OF POWER DEPENDENT ON THE ORBIT LOCATION <<
C*** >> CROSS-POLARISED CASE <<
C
100 YPWDRX = EIRP(I) + YDSCT + YDSXR
    $      - 20.0 * DLOG10(ROAIKJ)
C
    RETURN
    END
C
    SUBROUTINE XPWFQ (FQD,FQI)
C
C*** >> THIS ROUTINE COMPUTES THE FREQUENCY DEPENDENT PORTION <<
C*** >> IN THE POWER EQUATION <<
C
C*****
C
C      IMPLICIT INTEGER*4(I-N),REAL*8(A-H,O-Z)
C
C      CHARACTER*6 NAMESA
C
C      COMMON /CONSTS/ E,PI,RADIAN,DEGREE,GCR,ER,ERDB,EAP,
1      PFD,ALOG,ALN10,COIMIN,COISING
C
C      COMMON /PARAMS/ NUMSAR,NAMESA(10,2),NTPSA(10),CPH10(10)
C
C      COMMON /VECTOR/ DSLON(10),RSLON(10),XO(10),YO(10),
1      ROAIKJ,
2      XOAC(10),YOAC(10),ZOAC(10),ROAC(10)
C
C      COMMON /VARBLs/ FREQ(10),IPOLAR(10),GAINR(10),GAINI(10),
1      EIRP(10),IPTNST(10),IPTNER(10)
C
C      COMMON /MINELL/ BCLAT(10),BCLON(10),DBCLAT(10),DBCLON(10),
1      REFLAT(10),REFLON(10),AXR(10),
1      ORIENT(10),AXMAJ(10)
C
C      COMMON /TPOINT/ RELON(10,20),RELAT(10,20),DELON(10,20),
1      DELAT(10,20),XE(10,20),YE(10,20),ZE(10,20)
C
C      COMMON /ANGLES/ YPHIT,YPHIR,PHITK,YPHI0
C
C      COMMON /REAL/   PIKJ,PKKJ,PWFQM,FWDRCK,YPWDRC,YPWDRX,
1      XOAKKJ,YOAKKJ,ZOAKKJ,ROAKKJ
C
C*****
C
C*** >> POWER BEING CALCULATED IS INTERFERING POWER <<
C
C      X = (FQI - FQD)
C      ABSX = DABS(X)
C      IF(ABSX.LE.15.)THEN
C          FF = 0.
C      ELSE
C          FF = -(ABSX-15.)*1.6
C      END IF
C
C      PWFQM = FF - 20.0 * DLOG10(FQI)
C

```

```

RETURN
END
C
SUBROUTINE XPOWER (I,K,J)
C
C*** >> THIS ROUTINE CALCULATES ALL THE POWERS AFTER THE <<
C*** >> DIRECTIVITY AND FREQUENCY PORTIONS ARE COMPUTED <<
C
C*****
C
IMPLICIT INTEGER*4(I-N),REAL*8(A-H,O-Z)
C
CHARACTER*6 NAMESA
C
COMMON /CONSTS/ E,PI,RADIAN,DEGREE,GCR,ER,ERDB,EAP,
1 PFD,ALOG,ALN10,COIMIN,COISING
C
COMMON /PARAMS/ NUMSAR,NAMESA(10,2),NTPSA(10),CPH10(10)
C
COMMON /VECTOR/ DSLON(10),RSLON(10),XO(10),YO(10),
1 ROAIKJ,
2 XOAC(10),YOAC(10),ZOAC(10),ROAC(10)
C
COMMON /VARBLS/ FREQ(10),IPOLAR(10),GAINR(10),GAINI(10),
1 EIRP(10),IPTNST(10),IPTNER(10)
C
COMMON /MINELL/ BCLAT(10),BCLON(10),DBCLAT(10),DBCLON(10),
1 REFLAT(10),REFLON(10),AXR(10),
1 ORIENT(10),AXMAJ(10)
C
COMMON /TPOINT/ RELON(10,20),RELAT(10,20),DELON(10,20),
1 DELAT(10,20),XE(10,20),YE(10,20),ZE(10,20)
C
COMMON /ANGLES/ YPHIT,YPHIR,PHITK,YPH10
C
COMMON /REAL/ PIKJ,PKKJ,FWFQM,FWDRCK,YPWDRX,YPWDRY,
1 XOAKKJ,YOAKKJ,ZOAKKJ,ROAKKJ
C
C*****
C
IF (K.EQ.I) GO TO 100
C
C*** >> POWER BEING CALCULATED IS AN INTERFERING POWER <<
C
IF (IPOLAR(I).EQ.IPOLAR(K)) GO TO 50
C
C*** >> CROSS-POLARIZED <<
C
PIKJ = YPWDRX + FWFQM + ERDB + 27.56
RETURN
C
C*** >> CO-POLARIZED <<
C
50 PIKJ = YPWDRX + FWFQM + ERDB + 27.56
RETURN
C
C*** >> POWER BEING CALCULATED IS A DESIRED POWER <<
C
100 PKKJ = FWDRCK + FWFQM + ERDB + 27.56
RETURN

```

```

C      END
C
C      SUBROUTINE PTNST1 (PT, P0, G, DISC)
C
C      FSS SATELLITE TX PATTERN FROM CCIR REPORT 558-2
C
C      IMPLICIT INTEGER*4 (I-N), REAL*8 (A-H, O-Z)
C
C      COMMON /CONSTS/ E, PI, RADIANT, DEGREE, GCR, ER, ERDB, EAP,
1      PFD, ALOGE, ALN10, COIMIN, COISING
C
C      X=PT/P0
C      IF (X .LE. 1.3) GO TO 10
C      IF (X .LE. 3.15) GO TO 20
C
C      DISC = -(7.5 + 25.0 * DLOG10(X))
C      IF (DISC.LE.(-G-10.)) DISC = -G-10.
C      GO TO 40
C
C 10  DISC = -12.0 * X * X
C      GO TO 40
C
C 20  DISC = -20.0
C
C 40  RETURN
C      END
C
C      SUBROUTINE PTNST2 (PT, P0, G, DISC)
C
C      FSS SATELLITE TX PATTERN FROM RARC 83 § 5.1.10.1
C
C      IMPLICIT INTEGER*4 (I-N), REAL*8 (A-H, O-Z)
C
C      COMMON /CONSTS/ E, PI, RADIANT, DEGREE, GCR, ER, ERDB, EAP,
1      PFD, ALOGE, ALN10, COIMIN, COISING
C
C      DP0 =P0*DEGREE
C      X1 =PT/P0
C      X2 =DP0/0.8
C      X3 =.5*(1.-1./X2)
C
C      P1 =.4/DP0+X3
C      P2 =1.155/DP0 +X3
C      P3 =1.60/DP0+X3
C      P4 = 4.0/DP0+X3
C      P5 = 6.968/DP0 +X3
C      P6 = 10.**((G-11.5)/25.)/X2 + X3
C
C      IF (X1 .LE. 0.5) GO TO 10
C      IF (X1 .LE. P2) GO TO 12
C      IF (X1 .LE. P3) GO TO 14
C      IF (X1 .LE. P4) GO TO 16
C      IF (X1 .LE. P5) GO TO 18
C      IF (X1 .LE. P6) GO TO 20
C
C      DISC = -G
C      GO TO 40
C
C 10  DISC = -12.0 * X1 * X1

```

```

      GO TO 40
C
12  DISC = -18.75*DP0*DP0*(X1-X3)*(X1-X3)
      GO TO 40
C
14  DISC = -25
      GO TO 40
C
16  DISC = -17.5 - 25.*DLOG10((X1-X3)*X2)
      GO TO 40
C
18  DISC = -35.
      GO TO 40
C
20  DISC = -11.5 - 25.* DLOG10((X1-X3)*X2)
C
40  RETURN
      END
C
      SUBROUTINE PTNST3 (PT, P0, G, DISC)
C
C      FSS SATELLITE TX PATTERN FROM RARC 83 § 5.1.10.1
C      WITH MODIFICATION
C
      IMPLICIT INTEGER*4(I-N), REAL*8(A-H, O-Z)
C
      COMMON /CONSTS/ E, PI, RADIANT, DEGREE, GCR, ER, ERDB, EAP,
1      PFD, ALOGE, ALN10, COIMIN, COISING
C
      DP0 = P0*DEGREE
      X1 = PT/P0
      X2 = DP0/0.8
      X3 = .5*(1.-1./X2)
C
      IF (X1 .LE. 0.5) GO TO 10
      P2 = 1.265/DP0 +X3
      IF (X1 .LE. P2) GO TO 12
      P3 = 10.**((30.-24.)/30.)
      IF (X1 .LE. P3) GO TO 14
      P4 = 10.**((G-24.)/30.)
      IF (X1 .LE. P4) GO TO 16
C
      DISC = -G
      GO TO 40
C
10  DISC = -12.0 * X1 * X1
      GO TO 40
C
12  DISC = -18.75*DP0*DP0*(X1-X3)*(X1-X3)
      GO TO 40
C
14  DISC = -30.
      GO TO 40
C
16  DISC = -24.-30.*DLOG10(X1)
C
40  RETURN
      END
C
      SUBROUTINE PTNST4 (PT, P0, G, DISC)

```

```

C
C   FSS SATELLITE TX PATTERN FROM RARC 83 $5.10.1
C   WITH MODIFICATION
C
C   IMPLICIT INTEGER*4(I-N),REAL*8(A-H,O-Z)
C
C   COMMON /CONSTS/ E,PI,RADIAN,DEGREE,GCR,ER,ERDB,EAP,
1   PFD,ALOG,ALN10,COIMIN,COISING
C
C   DP0 = P0*DEGREE
C   X1 = PT/P0
C   X2 = DP0/0.8
C   X3 = .5*(1.-1./X2)
C
C   IF (X1 .LE. 0.5) GO TO 10
C   P2 = 1.265/DP0 +X3
C   IF (X1 .LE. P2) GO TO 12
C   P3 = 10.**((30.-24.)/30.)
C   IF (X1 .LE. P3) GO TO 14
C   P4 = 10.**((G-24.)/30.)
C   IF (X1 .LE. P4) GO TO 16
C
C   DISC = -G
C   GO TO 40
C
C 10  DISC = -12.0 * X1 * X1
C     GO TO 40
C
C 12  DISC = -18.75*DP0*DP0*(X1-X3)*(X1-X3)
C     GO TO 40
C
C 14  DISC = -30.
C     GO TO 40
C
C 16  DISC = -24.-30.*DLOG10(X1)
C
C 40  RETURN
C     END
C
C   SUBROUTINE PTNST5(PT,P0,G,DISC)
C
C   SATELLITE TX PATTERN FROM RARC 83 P.111,
C   BSS PATTERN
C
C   IMPLICIT INTEGER*4(I-N),REAL*8(A-H,O-Z)
C
C   COMMON /CONSTS/ E,PI,RADIAN,DEGREE,GCR,ER,ERDB,EAP,
1   PFD,ALOG,ALN10,COIMIN,COISING
C
C   X1 = PT/P0
C
C   IF (X1 .LE. 1.58) GO TO 10
C   IF (X1 .LE. 3.16) GO TO 12
C   IF (X1 .LE. 10.) GO TO 14
C
C   DISC = -42.5
C   GO TO 40
C
C 10  DISC = -12.0 * X1 * X1
C     GO TO 40

```

```

C
12 DISC = -30.
   GO TO 40
C
14 DISC = -17.5-25.*DLOG10(X1)
   GO TO 40
C
40 RETURN
   END
C
      SUBROUTINE PTNER1 (PR, P0, F, G, DISC)
C
C      FSS EARTH REVEIVER PATTERN FROM CCIR REPORT 391-4
C      ANTENNA DIAMETER 3 METERS, MAIN LOBE NOT GAUSSIAN
C
      IMPLICIT INTEGER*4(I-N), REAL*8(A-H, O-Z)
C
      COMMON /CONSTS/ E, PI, RADIANT, DEGREE, GCR, ER, ERDB, EAP,
1      PFD, ALOGE, ALN10, COIMIN, COISING
C
      DPR = PR*DEGREE
      DPO = P0 * DEGREE
      D = 3.
      WAVEL = 300./F
      X1 = D/WAVEL
      G1 = 2. + 15.* DLOG10(X1)
      PM = 20./X1* DSQRT(G-G1)
      PS = 15.85 / X1**0.6
C
      IF (DPR .LE. PM) GO TO 50
      IF (DPR .LE. PS) GO TO 60
      IF (DPR .LE. 48.) GO TO 70
C
      DISC = -10.
      GO TO 80
C
50 DISC = G- 2.5E-3 * X1*X1*DPR*DPR
   GO TO 80
C
60 DISC = G1
   GO TO 80
C
70 DISC = 32.-25.*DLOG10(DPR)
C
80 RETURN
   END
C
      SUBROUTINE PTNER2 (PR, P0, F, G, DISC)
C
C      FSS EARTH REVEIVER PATTERN FROM CCIR REPORT 391-4
C      MAIN LOBE GAUSSIAN, ANTENNA DIAMETER 3 METERS,
C      MODIFIED FOR NON US COUNTRIES
C
      IMPLICIT INTEGER*4(I-N), REAL*8(A-H, O-Z)
C
      COMMON /CONSTS/ E, PI, RADIANT, DEGREE, GCR, ER, ERDB, EAP,
1      PFD, ALOGE, ALN10, COIMIN, COISING
C
      DPR = PR*DEGREE
      X = PR/P0

```



```

C      P2 = 10.**((32.+10.)/25.)
C      IF (X.LE.0.5) THEN
C      DISC = G - 12.*X*X
C      GO TO 80
C      ELSE IF (DPR .GE. P2) THEN
C      DISC = -10.
C      GO TO 80
C      END IF
C
C      DISC = G - 12.*X*X
C      D1 = 32. - 25.*DLOG10(DPR)
C      IF (D1 .GE. DISC) DISC = D1
C
80    RETURN
C      END
C
C      SUBROUTINE PTNER3 (PR, P0, F, G, DISC)
C
C      FSS EARTH REVEIVER PATTERN FROM CCIR REPORT 391-4
C      MAIN LOBE GAUSSIAN, ANTENNA DIAMETER 4.5 METERS,
C      MODIFIED FOR US ONLY
C
C      IMPLICIT INTEGER*4(I-N), REAL*8(A-H, O-Z)
C
C      COMMON /CONSTS/ E, PI, RADIAN, DEGREE, GCR, ER, ERDB, EAP,
1      PFD, ALOGE, ALN10, COIMIN, COISING
C
C      DPR = PR*DEGREE
C      X = PR/P0
C      P2 = 10.**((29.+10.)/25.)
C
C      IF (X.LE.1.) THEN
C      DISC = G - 12.*X*X
C      GO TO 80
C      ELSE IF (DPR .GE. P2) THEN
C      DISC = -10.
C      GO TO 80
C      END IF
C
C      DISC = G - 12.*X*X
C      D1 = 29. - 25.*DLOG10(DPR)
C      IF (D1 .GE. DISC) DISC = D1
C
80    RETURN
C      END
C
C      SUBROUTINE PTNER4 (PR, P0, F, G, DISC)
C
C      FSS EARTH REVEIVER PATTERN FROM CCIR REPORT 391-4
C      MAIN LOBE GAUSSIAN, ANTENNA DIAMETER 4.5 METERS,
C      MODIFIED FOR US ONLY
C
C      IMPLICIT INTEGER*4(I-N), REAL*8(A-H, O-Z)
C
C      COMMON /CONSTS/ E, PI, RADIAN, DEGREE, GCR, ER, ERDB, EAP,
1      PFD, ALOGE, ALN10, COIMIN, COISING
C
C      DPR = PR*DEGREE
C      X = PR/P0

```

```

C      P2 = 10.**((29.+10.)/25.)
C
C      IF (X.LE.1.) THEN
C      DISC = G - 12.*X*X
C      GO TO 80
C      ELSE IF (DPR .GE. P2) THEN
C      DISC = -10.
C      GO TO 80
C      END IF
C
C      DISC = G - 12.*X*X
C      D1 = 29. - 25.*DLOG10(DPR)
C      IF (D1 .GE. DISC) DISC = D1
C
C 80   RETURN
C      END
C
C      SUBROUTINE PTNER5 (PR, P0, F, G, DISC)
C
C      EARTH REVEIVER PATTERN FROM RARC-83 P.115 CURVE B
C      BSS PATTERN
C
C      IMPLICIT INTEGER*4(I-N), REAL*8(A-H, O-Z)
C
C      COMMON /CONSTS/ E, PI, RADIAN, DEGREE, GCR, ER, ERDB, EAP,
C 1      PFD, ALOGE, ALN10, COIMIN, COISING
C
C      X = PR/P0
C
C      IF (X .LE. 0.25) GOTO 10
C      IF (X .LE. 0.94) GOTO 12
C      IF (X .LE. 18.88) GOTO 14
C
C      DISC = G -43.2
C      RETURN
C
C 10   DISC = G
C      RETURN
C
C 12   DISC = G -12. * X * X
C      RETURN
C
C 14   DISC = G -11.3 -25. * DLOG10(X)
C      RETURN
C
C      END
C
C      SUBROUTINE XPTNER1 (PR, P0, G, DISC)
C
C      CROSS POLARIZATION RECEIVER PATTERN, BSS
C
C      IMPLICIT REAL*8(A-H, O-Z)
C
C      X = PR/P0
C      IF (X.LE.0.25) GO TO 40
C      IF (X.LE.0.44) GO TO 50
C      IF (X.LE.1.28) GO TO 60
C      IF (X.LE.3.22) GO TO 70
C      IF (X.LE.5.60) GO TO 80
C      IF (X.LE.18.88) GO TO 90

```

```
C      DISC = G-43.2
      GO TO 100
C
40     DISC = G-25.
      GO TO 100
C
50     DISC = G-(30.+40.*DLOG10(1.0-X))
      GO TO 100
C
60     DISC = G-20.
      GO TO 100
C
70     DISC = G-(17.3+25.*DLOG10(X))
      GO TO 100
C
80     DISC = G-30.
      GO TO 100
C
90     DISC = G-(11.3+25.*DLOG10(X))
C
100    RETURN
      END
```

## APPENDIX B

### CONCAVE, QUASI-CONCAVE AND PSEUDO-CONCAVE FUNCTIONS

The content in this appendix is from the book "Nonlinear Programming" written by Olvi L. Mangasarian [105]. All the page numbers appearing in the content are referred to this book. Here only the concave functions are discussed; the same discussions apply to convex functions with obvious substitution.

#### Definition of convex set (p. 39)

A set  $I \subset \mathbb{R}^n$  is a convex set if, for  $x, y \in I$ ,  $a \in \mathbb{R}$ ,  $0 < a < 1$ , one has

$$(1-a)x + ay \in I, \quad (B.1)$$

here  $\mathbb{R}^n$  is the set of  $n$ -dimensional vector space,  $\mathbb{R}$  is the set of real numbers.

#### Definition of concave function (p. 56)

A numerical function  $f$  defined on a set  $I \subset \mathbb{R}^n$  is said to be concave at  $x \in I$  if, for  $y \in I$ ,  $0 < a < 1$ ,  $(1-a)x + ay \in I$ , one has

$$(1-a)f(x) + af(y) < f[(1-a)x + ay]; \quad (B.2)$$

$f$  is said to be concave on  $I$  if it is concave at each  $x \in I$ .

**Definition of strictly concave function (p. 57)**

A numerical function  $f$  defined on a set  $I \subset \mathbb{R}^n$  is said to be strictly concave at  $x \in I$  if, for  $y \in I$ ,  $x \neq y$ ,  $0 < a < 1$ ,  $(1-a)x + ay \in I$ , one has

$$(1-a)f(x) + af(y) < f[(1-a)x + ay] \quad ; \quad (\text{B.3})$$

$f$  is said to be strictly concave on  $I$  if it is strictly concave at each  $x \in I$ .

**Definition of quasi-concave function (p. 132)**

A numerical function  $f$  defined on a set  $I \subset \mathbb{R}^n$  is said to be quasi-concave at  $x \in I$  if, for  $y \in I$ ,  $f(x) < f(y)$ ,  $0 < a < 1$ ,  $(1-a)x + ay \in I$ , one has

$$f(x) < f[(1-a)x + ay] \quad ; \quad (\text{B.4})$$

$f$  is said to be quasi-concave on  $I$  if it is quasi-concave at each  $x \in I$ .

**Definition of strictly quasi-concave function (p. 137)**

A numerical function  $f$  defined on a set  $I \subset \mathbb{R}^n$  is said to be strictly quasi-concave at  $x \in I$  if, for  $y \in I$ ,  $f(x) < f(y)$ ,  $0 < a < 1$ ,  $(1-a)x + ay \in I$ , one has

$$f(x) < f[(1-a)x + ay] \quad ; \quad (\text{B.5})$$

$f$  is said to be strictly quasi-concave on  $I$  if it is strictly quasi-concave at each  $x \in I$ .

**Theorem 1** (p. 139)

Let  $f$  be a numerical function defined on the convex set  $I$  in  $R^n$ , and let  $x \in I$  be a local maximum. If  $f$  is strictly quasi-concave at  $x$ , then  $f(x)$  is a global maximum of  $f$  on  $I$ .

**Definition of pseudo-concave function** (p. 141)

Let  $f$  be a numerical function defined on some open set in  $R^n$  containing the set  $I$ .  $f$  is said to be pseudo-concave at  $x \in I$  if it is differentiable at  $x$ , and for  $y \in I$ ,  $\nabla f(x)(y-x) < 0$ , one has

$$f(y) < f(x) \quad ; \quad (B.6)$$

$f$  is said to be pseudo-concave on  $I$  if it is pseudo-concave at each  $x \in I$ .

**Theorem 2** (p. 143)

Let  $I$  be a convex set in  $R^n$ , and let  $f$  be a numerical function defined on some open set containing  $I$ . If  $f$  is pseudo-concave on  $I$ , then  $f$  is strictly quasi-concave on  $I$  and hence also quasi-concave on  $I$ . The converse is not true.

**Theorem 3** (p. 144)

Let  $f$  be a numerical function defined on some open set  $I$  in  $R^n$ , let  $x \in I$ , and let  $f$  be differentiable at  $x$ . If  $f$  is concave at  $x$ , then  $f$  is pseudo-concave at  $x$ , but not conversely.

**Theorem 4** (p. 145)

Let  $I$  be a convex set in  $R^n$ , and let  $f$  be a numerical function defined on some open set containing  $I$ . If  $f$  is pseudo-concave on  $I$ , then each local maximum of  $f$  on  $I$  is also a global maximum of  $f$  on  $I$ .

A final note: a function that is strictly concave is also concave, a function that is concave is also pseudo-concave, a function that is pseudo-concave is also strictly quasi-concave, a function that is strictly quasi-concave is also quasi-concave; the converse is not true.

APPENDIX C

CONTOUR PLOTS OF OBJECTIVE-FUNCTION SURFACE

ARG=62.

BOL=68.

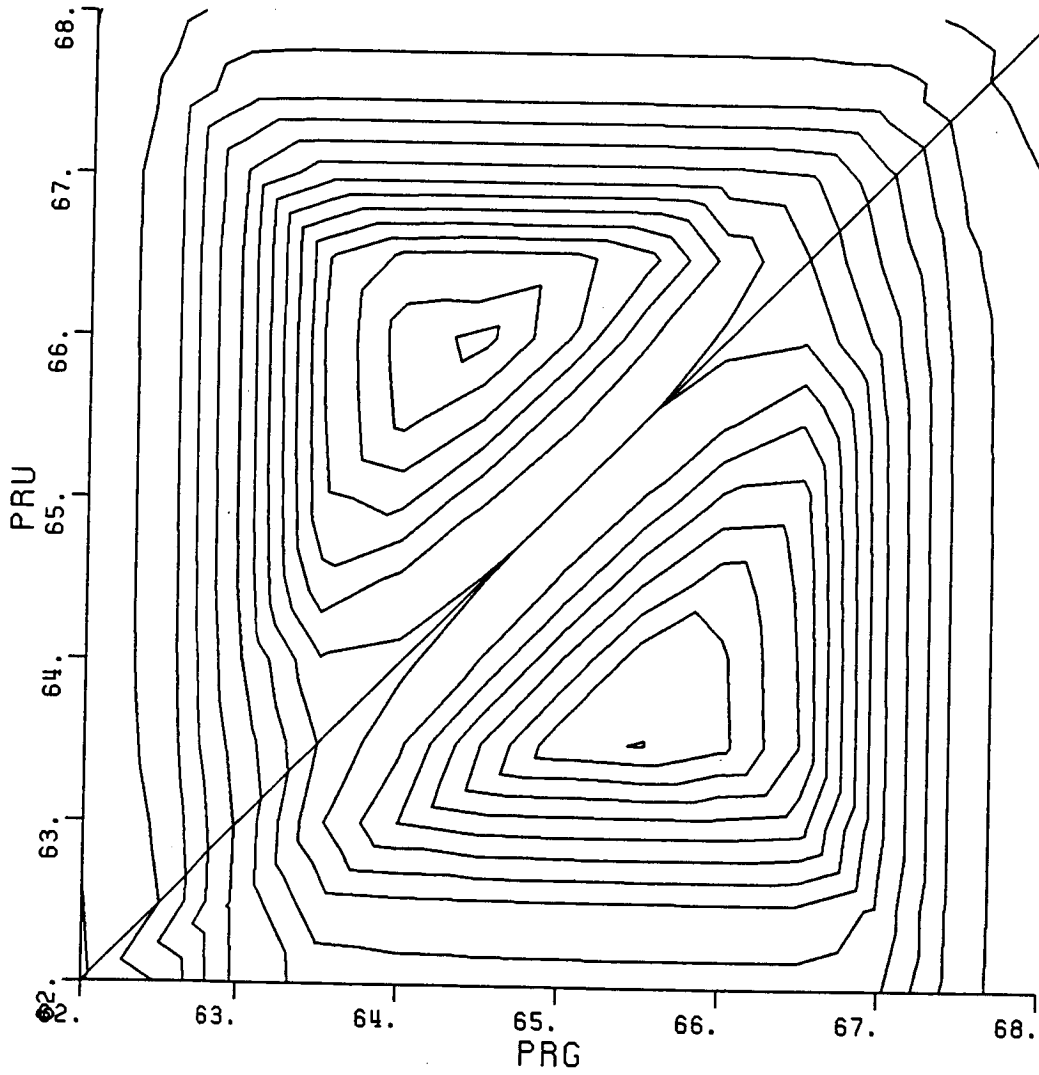



ARG=62.

PRG=68.

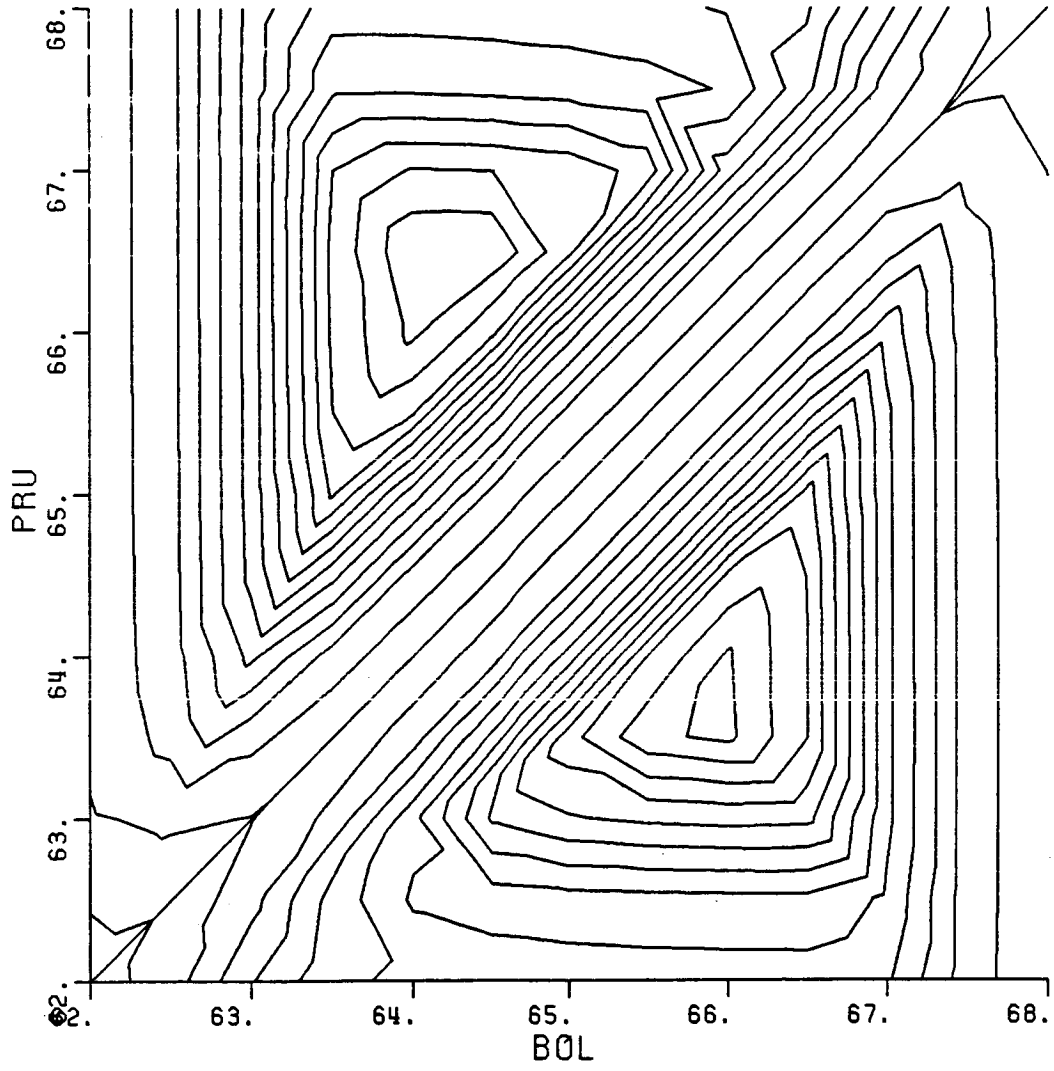

ARG=62.

PRU=68.

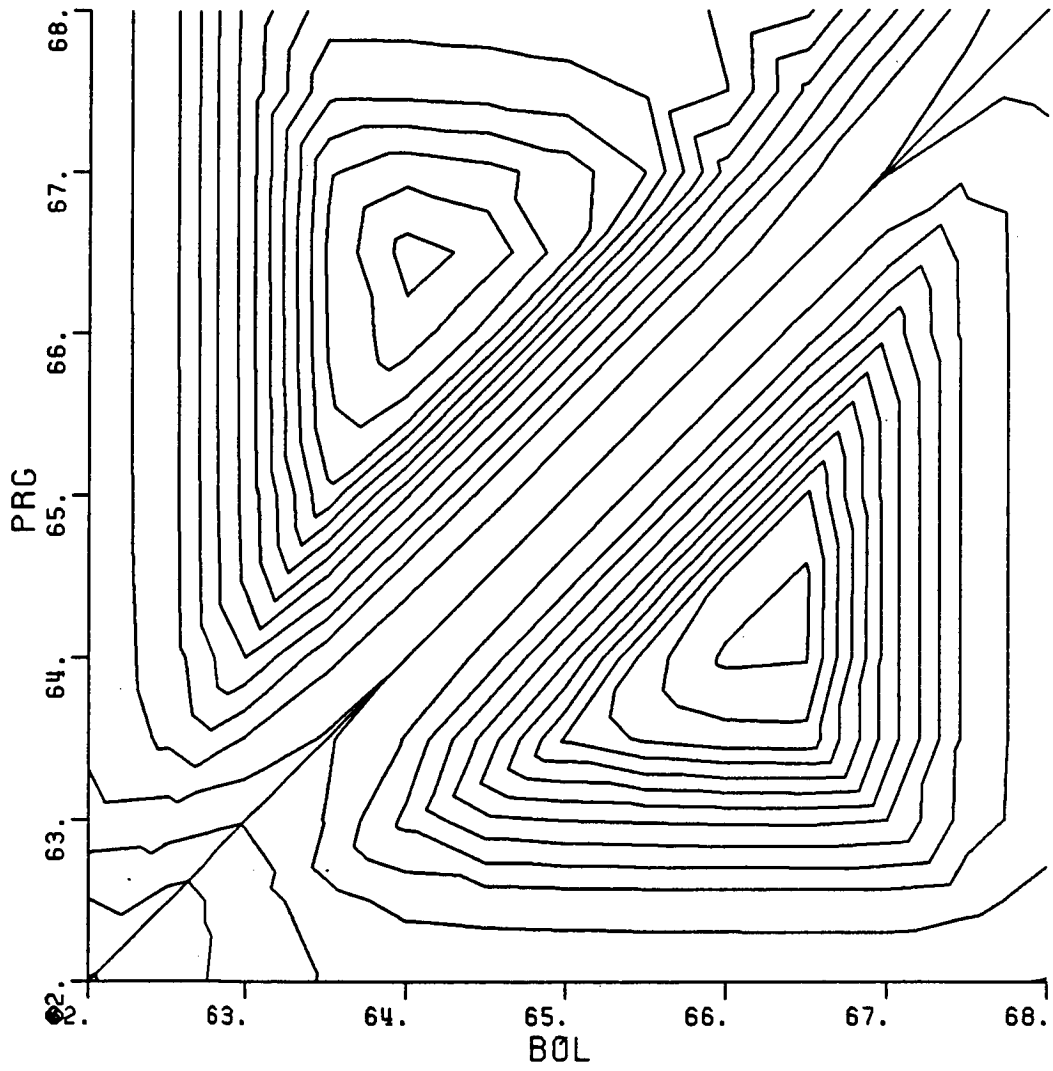

BOL=62.

ARG=68.

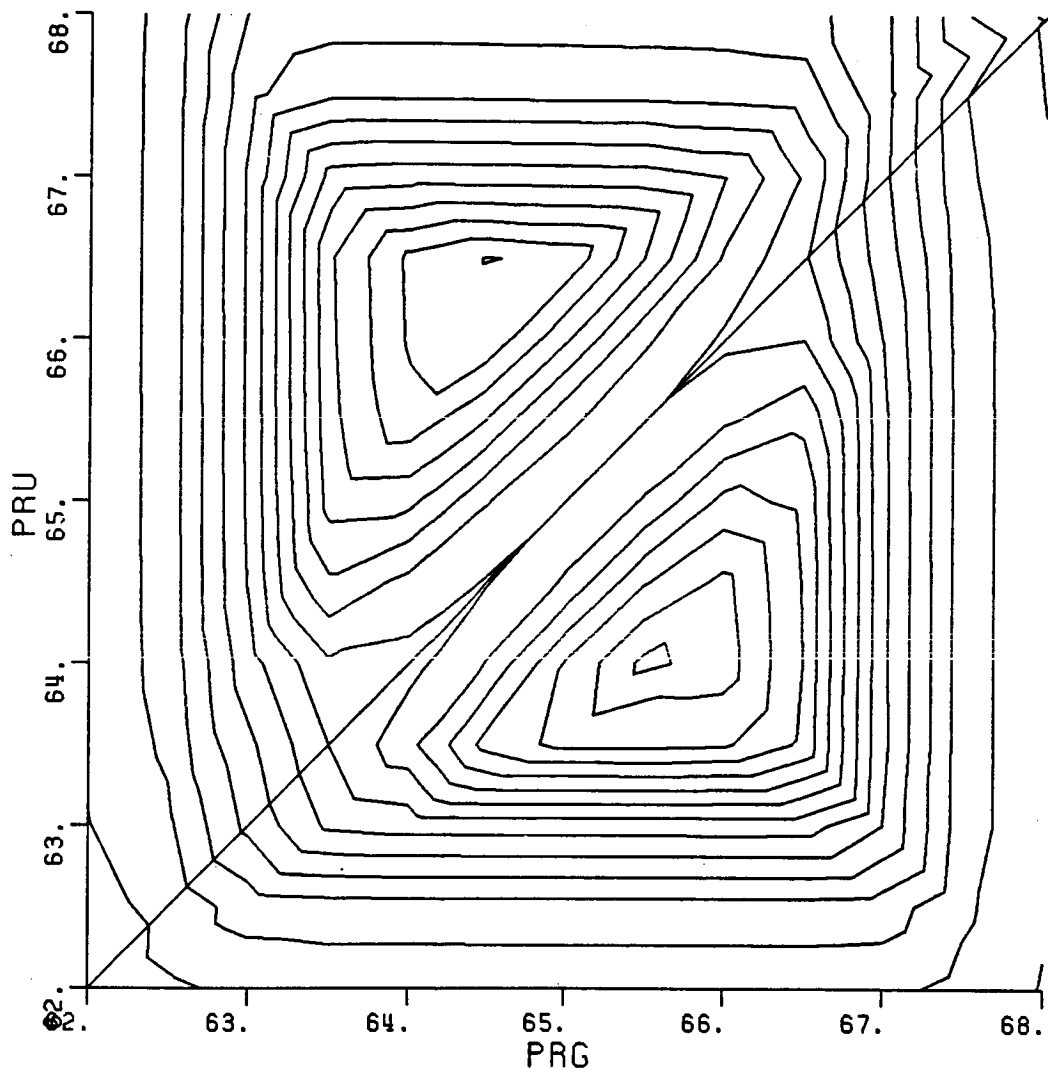

BOL=62.

PRG=68.

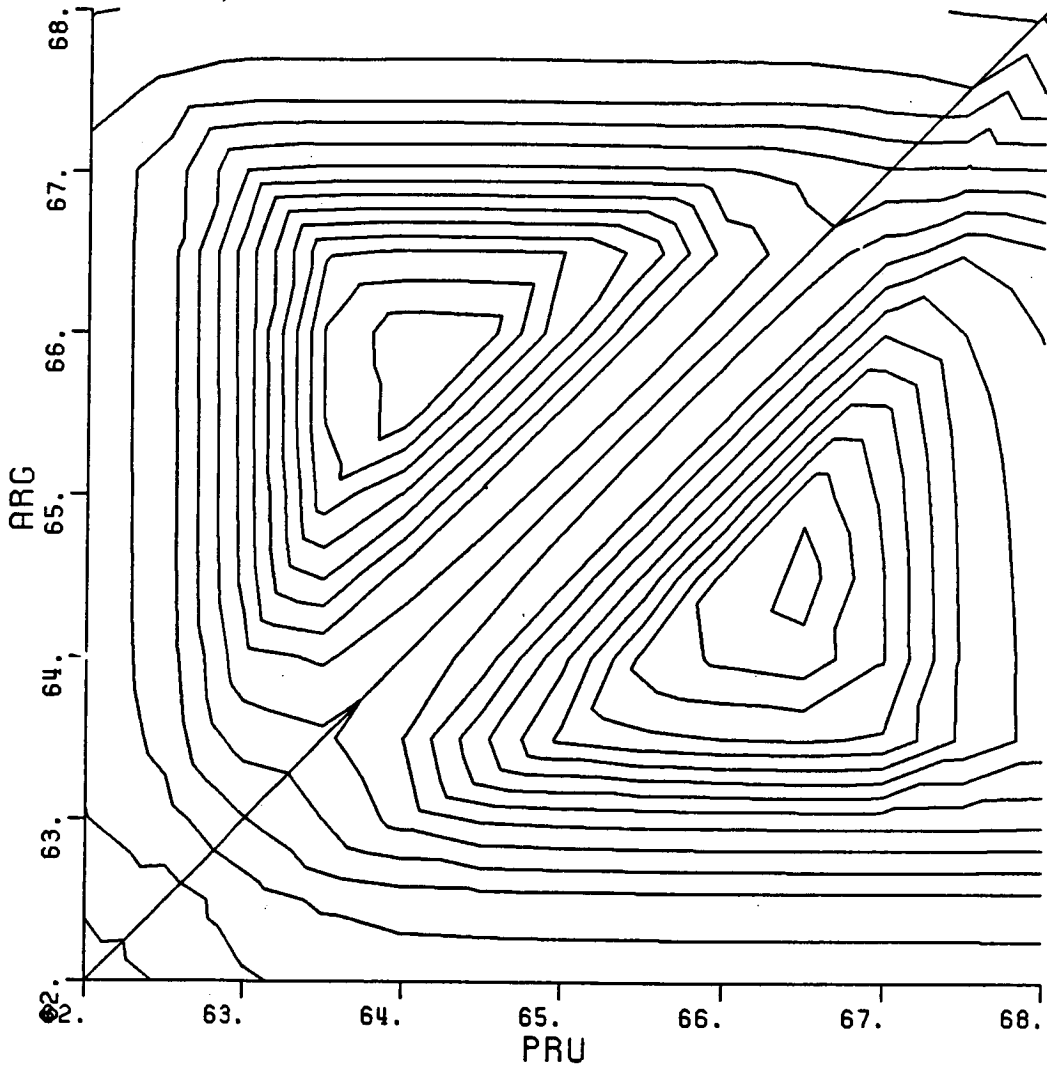

BOL=62.

PRU=68.

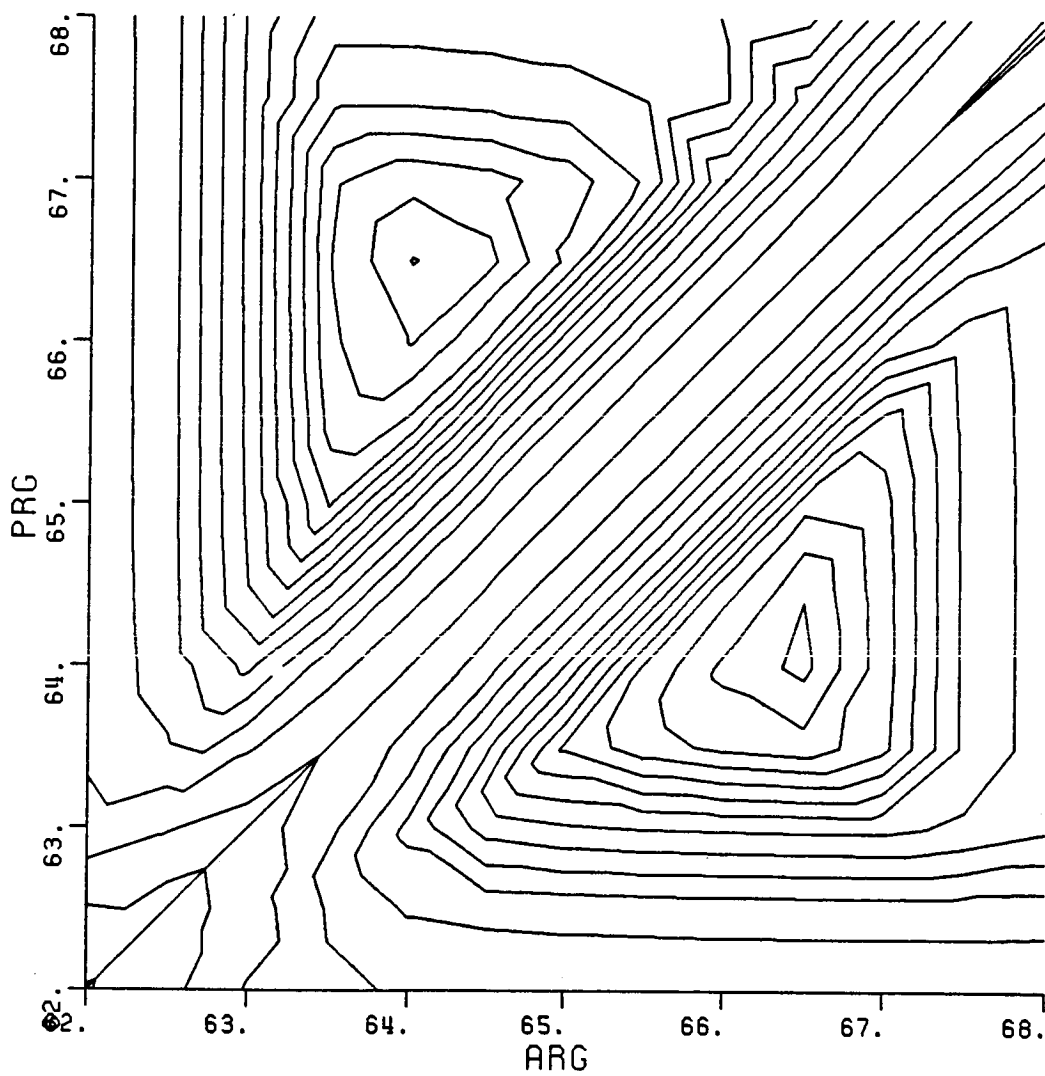

PRG=62.

ARG=68.

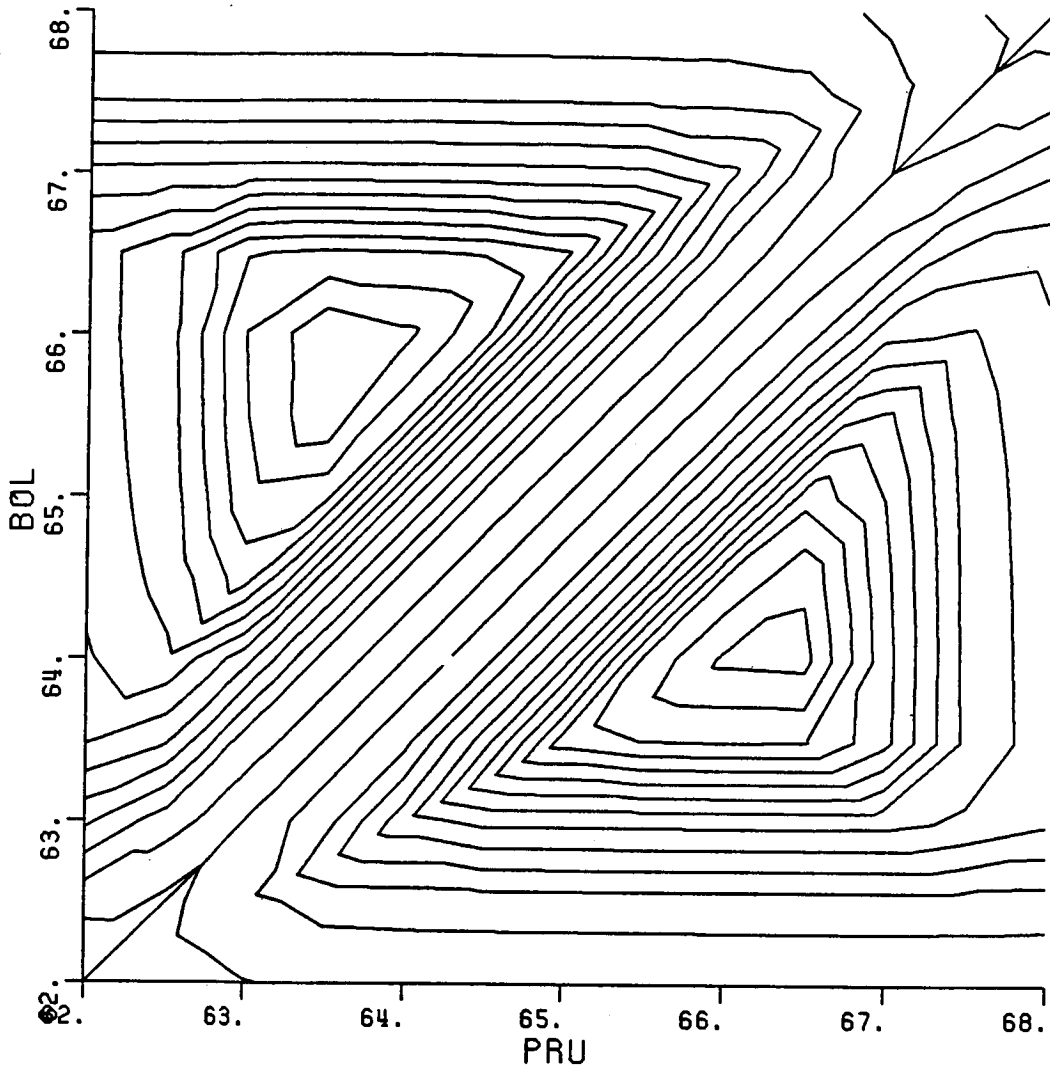

PRG=62.

BOL=68.

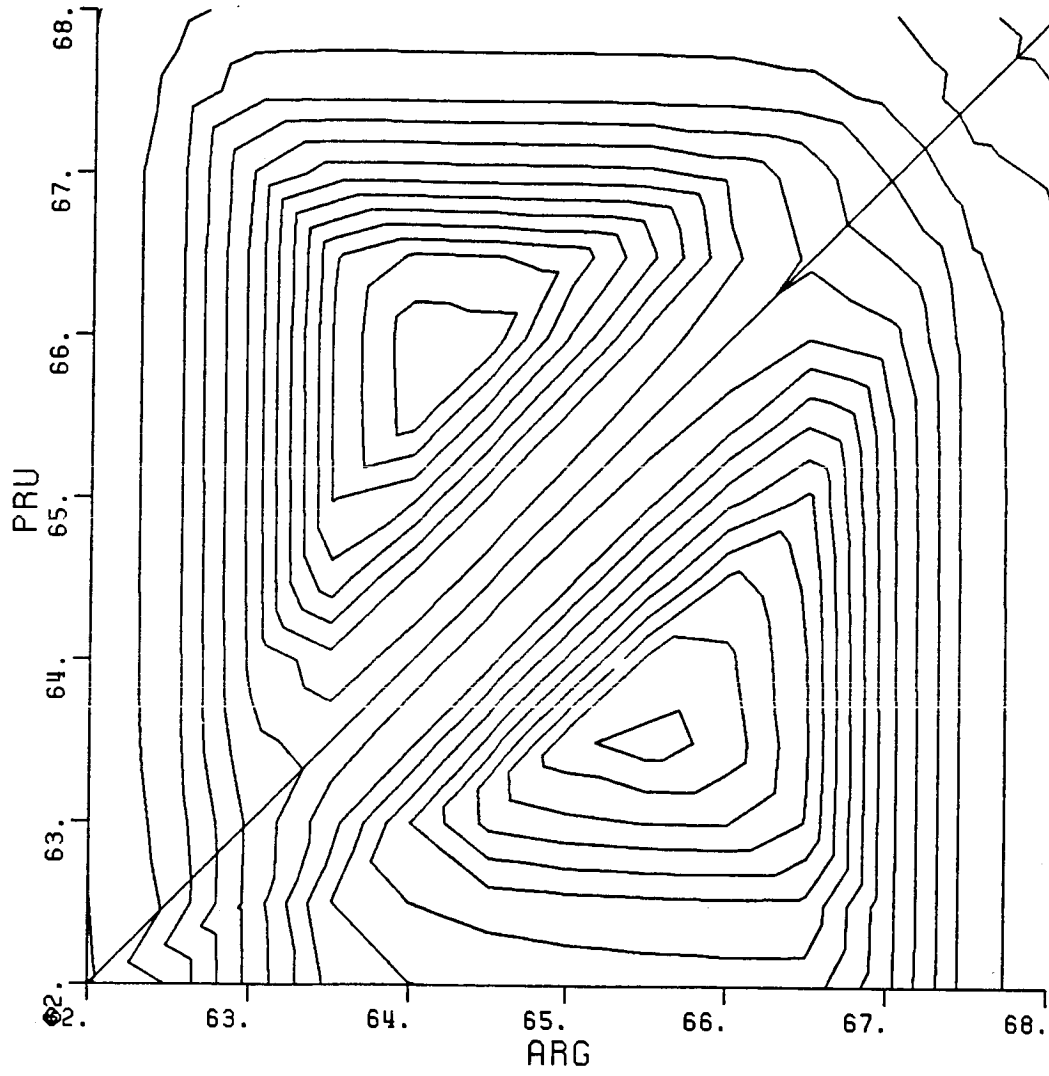

PRG=62.

PRU=68.

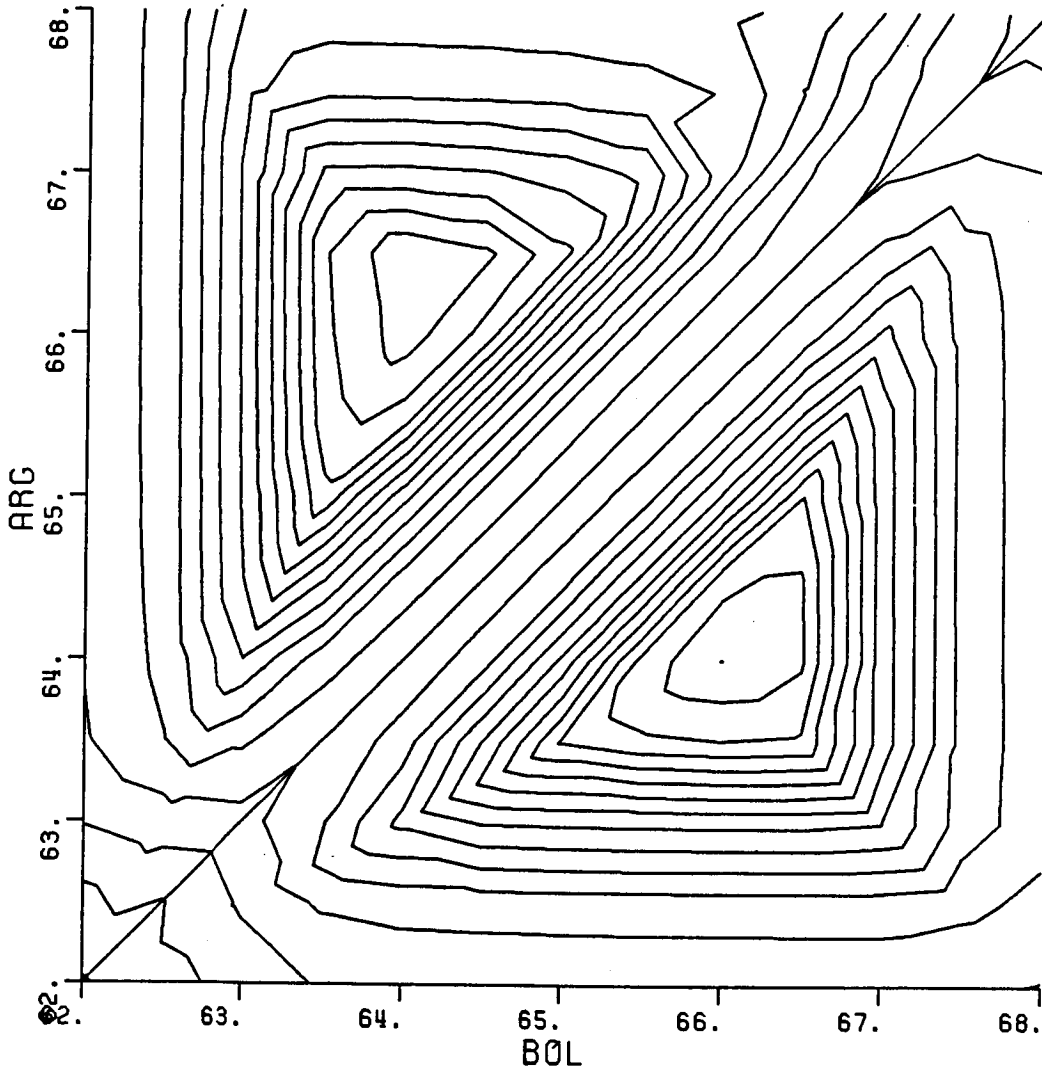



PRU=62.

ARG=68.

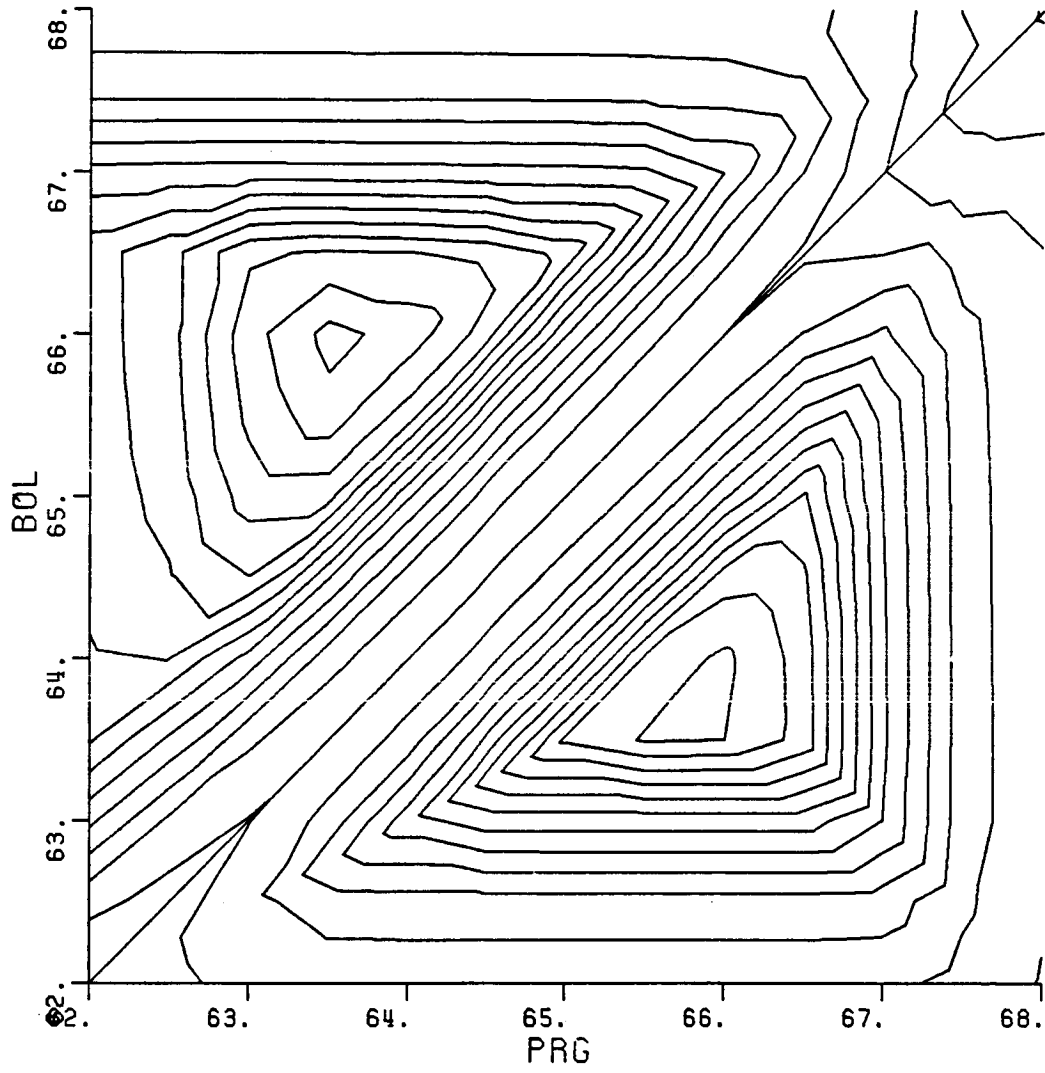

PRU=62.

BOL=68.

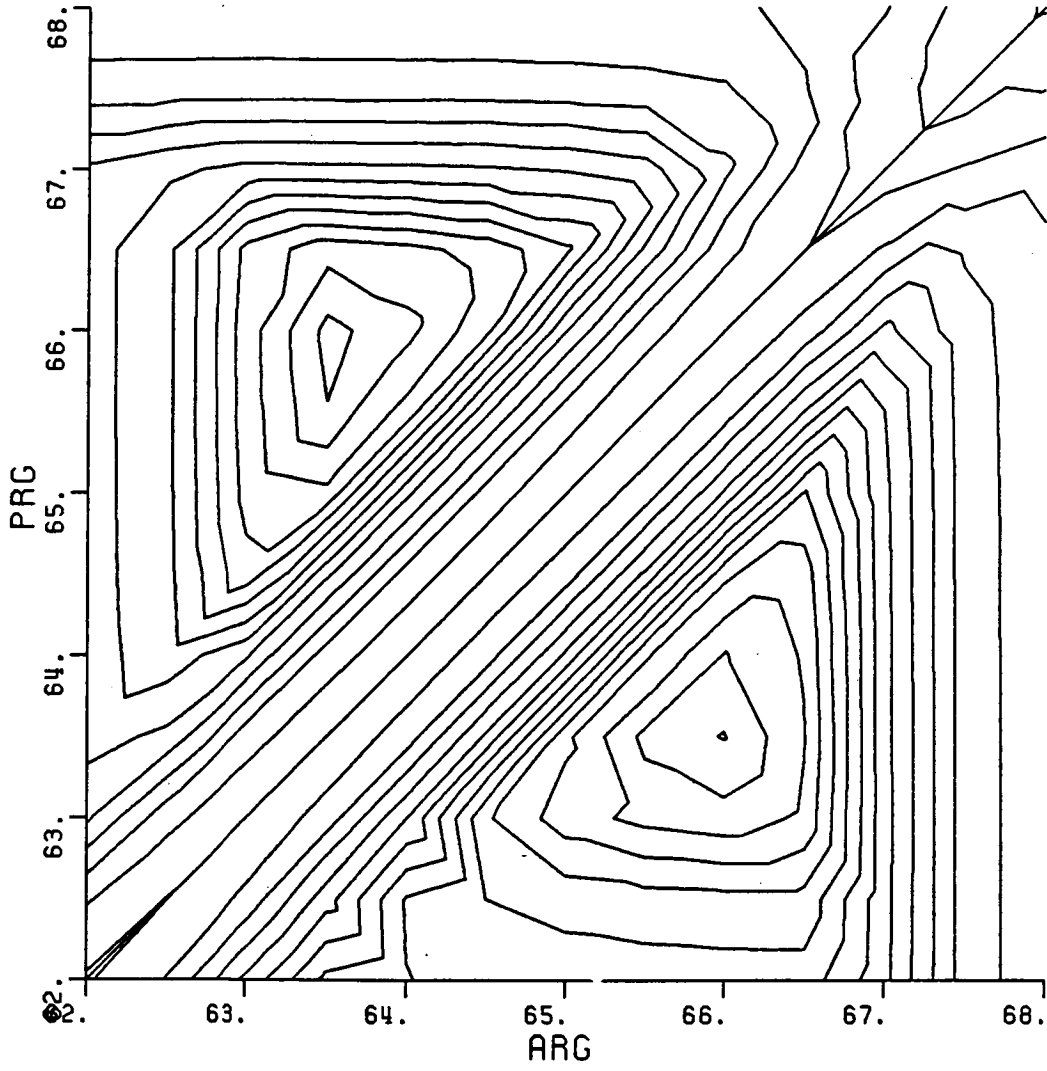

PRU=62.

PRG=68.

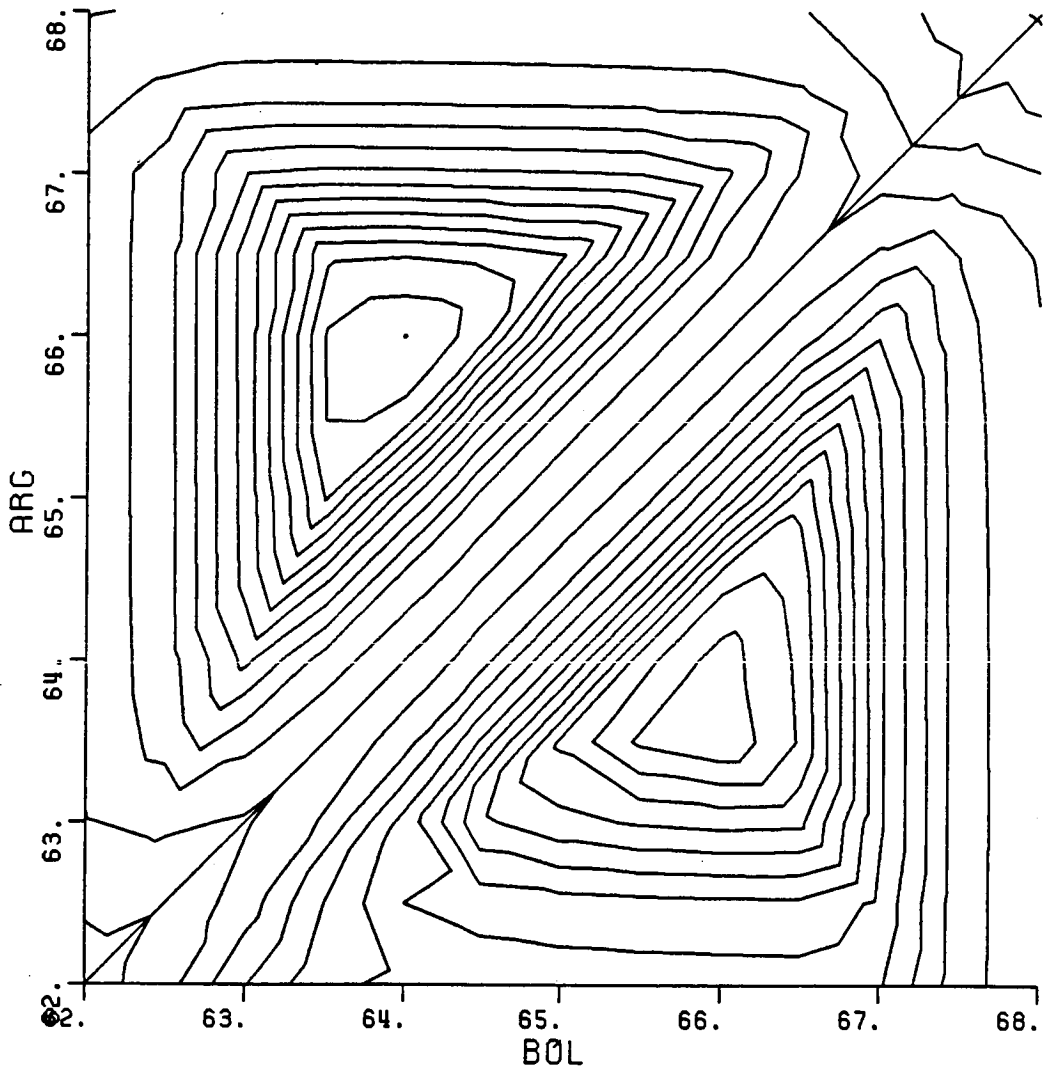

## APPENDIX D

### AS CALCULATION CODE

```

C*** >> MAIN PROGRAM <<
C THIS IS TO CALCULATE THE NECESSARY SATELLITE SPACING
C FOR TWO SERVICE AREAS.
C INITIAL SATELLITE LOCATIONS SHOULD BE THE SAME.
C SUBROUTINES SAME AS MINI-SOUP PROGRAM, EXCEPT DIMENSION OF
C SERVICE AREA IS TWO
C*****
C
C IMPLICIT REAL*8(A-H,O-Z)
C
C CHARACTER*6 NAMESA
C
C COMMON /CONSTS/ E,PI,RADIAN.DEGREE,GCR,ER,ERDB,EAP,
1 PFD,ALOG,ALN10,COIMIN,COISING
C
C COMMON /PARAMS/ NUMSAR,NAMESA(2,2),NTPSA(2),CPH10(2)
C
C COMMON /VECTOR/ DSLON(2),RSLON(2),XO(2),YO(2),
1 ROAIKJ,
2 XOAC(2),YOAC(2),ZOAC(2),ROAC(2)
C
C COMMON /VARBLS/ FREQ(2),IPOLAR(2),GAINR(2),GAINI(2),
1 EIRP(2),IPTNST(2),IPTNER(2)
C
C COMMON /MINELL/ BCLAT(2),BCLON(2),DBCLAT(2),DBCLON(2),
1 REFLAT(2),REFLON(2),AXR(2),
1 ORIENT(2),AXMAJ(2)
C
C COMMON /TPOINT/ RELON(2,20),RELAT(2,20),DELON(2,20),
1 DELAT(2,20),XE(2,20),YE(2,20),ZE(2,20)
C
C COMMON /ANGLES/ YPHIT,YPHIR,PHITK,YPHIO
C
C COMMON /REAL/ PIKJ,PKKJ,FWFQM,FWDRCK,YPWDRC,YPWDRX,
1 XOAKKJ,YOAKKJ,ZOAKKJ,ROAKKJ
C
C COMMON /SRCH/ DMGN(2,20)
C*****
C
C OPEN (UNIT=20,FILE='INPUT0.DAT',TYPE='OLD')
C OPEN (UNIT=6,FILE='DSOUT.DAT',TYPE='NEW')
C
C CALL ICONST
C CALL INPUT0
C
C DO 2 K = 1,NUMSAR
C CALL GAINER(K)
C EIRP(K) = PFD+10.*DLOG10(4.*PI*ROAC(K)*ROAC(K))-ERDB
2 CONTINUE
C
C CALL ZFUNCT
C CALL SEPAR
C
C STOP
C END
C
C SUBROUTINE ZFUNCT
C
C*** >> THIS ROUTINE IS THE OVERALL CONTROL ROUTINE FOR <<
C

```

```

C*****
C
C   IMPLICIT REAL*8(A-H,O-Z)
C
C   CHARACTER*6 NAMESA
C
C   COMMON /CONSTS/ E, PI, RADIAN, DEGREE, GCR, ER, ERDB, EAP,
1   PFD, ALOGE, ALN10, COIMIN, COISING
C
C   COMMON /PARAMS/ NUMSAR, NAMESA(2,2), NTPSA(2), CPHI0(2)
C
C   COMMON /VECTOR/ DSLON(2), RSLON(2), XO(2), YO(2),
1   ROAIKJ,
2   XOAC(2), YOAC(2), ZOAC(2), ROAC(2)
C
C   COMMON /VARBLS/ FREQ(2), IPOLAR(2), GAINR(2), GAINI(2),
1   EIRP(2), IPTNST(2), IPTNER(2)
C
C   COMMON /MINELL/ BCLAT(2), BCLON(2), DBCLAT(2), DBCLON(2),
1   REFLAT(2), REFLON(2), AXR(2),
1   ORIENT(2), AXMAJ(2)
C
C   COMMON /TPOINT/ RELON(2,20), RELAT(2,20), DELON(2,20),
1   DELAT(2,20), XE(2,20), YE(2,20), ZE(2,20)
C
C   COMMON /ANGLES/ YPHIT, YPHIR, PHITK, YPHI0
C
C   COMMON /REAL/ PIKJ, PKKJ, FWFQM, FWDRC, YPWDRC, YPWDRX,
1   XOAKJ, YOAKJ, ZOAKJ, ROAKJ
C
C   COMMON /SRCH/ DMGN(2,20)
C*****
C
C*** >> INITIALIZE PARAMETER
C
C   DO 10 I=1, NUMSAR
C     CALL REPCAL(I)
C   10 CONTINUE
C
C*** >> OUTER SUMMATION (OVER K) FOR ALL SERVICE AREAS <<
C
C   DO 1000 K = 1, NUMSAR
C     JNTP = NTPSA(K)
C     WRITE(6,705) NAMESA(K,1), DSLON(K)
C
C*** >> MIDDLE SUMMATION (OVER J) FOR ALL TEST POINTS IN AREA K <<
C
C   DO 900 J = 1, JNTP
C     CALL KPHI (K, J)
C     CALL XPHI0 (K, K, J)
C     CALL KPWDRC (K, J)
C     CALL XPWFQ (FREQ(K), FREQ(K))
C     CALL XPOWER (K, K, J)
C
C*** >> CALCULATE INTERFERENCE POWER
C
C   SUMP=0.
C   DO 500 I = 1, NUMSAR
C     IF (I.EQ.K) GO TO 500
C     CALL ZPHI (I, K, J)

```

```

CALL XPHIO (I,K,J)
IF (IPOLAR(I).EQ.IPOLAR(K)) THEN
  CALL ZPWRDC (I,K,J)
ELSE
  CALL ZPWDRX (I,K,J)
END IF
CALL XPWFQ (FREQ(K),FREQ(I))
CALL XPOWER (I,K,J)
COI = PKKJ-PIKJ
DMGN(K,J) = COI - COISING
C
WRITE(6,706) DELON(K,J), DELAT(K,J), NAMESA(I,1), PIKJ, COI, DMGN(K,J)
500 CONTINUE
C
900 CONTINUE
1000 CONTINUE
C
705 FORMAT(//,12X,'TEST COUNTRY :',A6,5X,'SATELLITE :',F8.2,/,15X,
1'TEST POINT',10X,'INT. SAT.',2X,'INT. PWR',3X,'C/I (dB)',
25X,'MARGIN')
706 FORMAT(/,15X,F7.2,2X,F7.2,5X,A6,4X,F8.2,4X,F6.2,6X,F6.2)
RETURN
END
C
C
SUBROUTINE SEPAR
C
THIS IS TO FIND THE MINIMAL REQUIRED SATELLITE SPACING FOR TWO
C SERVICE AREAS
C
*****
C
IMPLICIT REAL*8(A-H,O-Z)
C
CHARACTER*6 NAMESA
C
COMMON /CONSTS/ E,PI,RADIAN.DEGREE,GCR,ER,ERDB,EAP,
1 PFD,ALOG,ALN10,COIMIN.COISING
C
COMMON /PARAMS/ NUMSAR,NAMESA(2.2),NTPSA(2),CPHIO(2)
C
COMMON /VECTOR/ DSLON(2),RSLON(2),XO(2),YO(2),
1 ROAIKJ,
2 XOAC(2),YOAC(2),ZOAC(2),ROAC(2)
C
COMMON /VARBLS/ FREQ(2),IPOLAR(2),GAINR(2),GAINI(2),
1 EIRP(2),IPTNST(2),IPTNER(2)
C
COMMON /MINELL/ BCLAT(2),BCLON(2),DBCLAT(2),DBCLON(2),
1 REFLAT(2),REFLON(2),AXR(2),
1 ORIENT(2),AXMAJ(2)
C
COMMON /TPOINT/ RELON(2.20),RELAT(2.20),DELON(2.20),
1 DELAT(2.20),XE(2.20),YE(2.20),ZE(2.20)
C
COMMON /ANGLES/ YPHIT,YPHIR,PHITK,YPHIO
C
COMMON /REAL/ PIKJ,PKKJ,PWFQM,PWDRCK,YPWRDC,YPWDRX,
1 XOAKKJ,YOAKKJ,ZOAKKJ,ROAKKJ
C

```

```

COMMON /SRCH/  DMGN(2,20)
C
C *****
C
NTP1 = NTPSA(1)
NTP2 = NTPSA(2)
C
C SELECT WORST MARGIN AMONG ALL C/I VALUES AT ALL TEST POINTS
C
RMIN1 = DMGN(1,1)
DO J=2,NTP1
  RMIN1 = DMIN1(RMIN1,DMGN(1,J))
END DO
RMIN2 = DMGN(2,1)
DO J=2,NTP2
  RMIN2 = DMIN1(RMIN2,DMGN(2,J))
END DO
C
C NO SATELLITE SPACING REQUIRED
C
IF(RMIN1.GE.0..AND.RMIN2.GE.0.)THEN
  WRITE(6,1)
  1  FORMAT(//,11X,' **** SATELLITE SEPARATION NOT NEEDED ****')
  RETURN
END IF
C
C CALCULATE TOPOCENTRIC AND GEOCENTRIC ANGLE (SATELLITE SPACING)
C FROM WORST TEST POINT
C PRECAUTION MADE IF TWO SYSTEMS USE DIFFERENT RECEIVING PATTERNS
C
IF(IPTNER(1).EQ.IPTNER(2))THEN
  IF (RMIN1.LE.RMIN2) THEN
    CALL MINMGN(1,J1,RMIN1)
    WRITE (6,2) RMIN1,NAMESA(1,2),DELON(1,J1),DELAT(1,J1)
    CALL PTNANG(1,RMIN1,TOPOANG)
    CALL GEOANG(2,1,J1,TOPOANG,DELTAS)
  ELSE
    CALL MINMGN(2,J2,RMIN2)
    WRITE (6,2) RMIN2,NAMESA(2,2),DELON(2,J2),DELAT(2,J2)
    CALL PTNANG(2,RMIN2,TOPOANG)
    CALL GEOANG(1,2,J2,TOPOANG,DELTAS)
  END IF
ELSE
  CALL MINMGN(1,J1,RMIN1)
  WRITE (6,2) RMIN1,NAMESA(1,2),DELON(1,J1),DELAT(1,J1)
  CALL PTNANG(1,RMIN1,TOPOANG1)
  CALL GEOANG(2,1,J1,TOPOANG1,DELTAS1)
  CALL MINMGN(2,J2,RMIN2)
  WRITE (6,2) RMIN2,NAMESA(2,2),DELON(2,J2),DELAT(2,J2)
  CALL PTNANG(2,RMIN2,TOPOANG2)
  CALL GEOANG(1,2,J2,TOPOANG2,DELTAS2)
  DELTAS = DMAX1(DELTAS1,DELTAS2)
END IF
C
WRITE(6,100)DELTAS.DSLON(1),COISING
  2  FORMAT (//,11X,'WORST MARGIN IS ',F6.2,' AT ',A6,' ('
  1  F7.2,',',F7.2,') ')
  100 1  FORMAT(//,11X,'SATELLITE SEPARATION : ',F5.2,' AT ',
  1  F7.2,' FOR C/I ',F4.1,' dB')
C

```

```

RETURN
END
C
SUBROUTINE MINMGN(K1,J1,RMIN)
C
C THIS IS TO FIND THE MINIMUM MARGIN AMONG THE TEST POINTS
C
IMPLICIT REAL*8(A-H,O-Z)
C
CHARACTER*6 NAMESA
C
COMMON /CONSTS/ E,PI,RADIAN.DEGREE,GCR,ER,ERDB,EAP,
1 PFD,ALOG,ALN10,COIMIN,COISING
C
COMMON /PARAMS/ NUMSAR.NAMESA(2,2),NTPSA(2),CPH10(2)
C
COMMON /SRCH/ DMGN(2,20)
C
DO J=1,NTPSA(K1)
IF(DMGN(K1,J).LE.RMIN) THEN
J1 = J
RETURN
END IF
END DO
RETURN
END
C
SUBROUTINE PTNANG(K1,RMIN,TOPOANG)
C
C THIS IS TO CALCULATE THE TOPOCENTRIC ANGLE (FROM GROUND
C RECEIVING REFERENCE PATTERN) NECESSARY TO PROVIDE
C THE DISCRIMINATION
C
IMPLICIT REAL*8(A-H,O-Z)
C
CHARACTER*6 NAMESA
C
COMMON /CONSTS/ E,PI,RADIAN.DEGREE,GCR,ER,ERDB,EAP,
1 PFD,ALOG,ALN10,COIMIN,COISING
C
COMMON /PARAMS/ NUMSAR.NAMESA(2,2),NTPSA(2),CPH10(2)
C
COMMON /VARBLS/ FREQ(2),IPOLAR(2),GAINR(2),GAINI(2),
1 EIRP(2),IPTNST(2),IPTNER(2)
C
COMMON /SRCH/ DMGN(2,20)
C
IF (IPOLAR(1).NE.IPOLAR(2)) THEN
CALL XRPTNER1(PR,CPH10(K1),GAINR(K1),RMIN)
GO TO 60
END IF
C
GO TO (51,53,55,57,59),IPTNER(K1)
C
51 CALL RPTNER1(PR,CPH10(K1),FREQ(K1),GAINR(K1),RMIN)
GO TO 60
53 CALL RPTNER2(PR,CPH10(K1),FREQ(K1),GAINR(K1),RMIN)
GO TO 60
55 CALL RPTNER3(PR,CPH10(K1),FREQ(K1),GAINR(K1),RMIN)
GO TO 60

```



```

57 CALL RPTNER4(PR,CPHI0(K1),FREQ(K1),GAINR(K1),RMIN)
GO TO 60
59 CALL RPTNER5(PR,CPHI0(K1),FREQ(K1),GAINR(K1),RMIN)
C
60 TOPOANG = PR * DEGREE
RETURN
END

C
SUBROUTINE GEOANG(I,K,J,TOPOANG,DELTAS)
C
C THIS IS TO ITERATE TO CALCULATE THE NECESSARY GEOCENTRIC
C ANGLE FOR THE REQUIRED DISCRIMINATION
C
IMPLICIT REAL*8(A-H,O-Z)
C
CHARACTER*6 NAMESA
C
COMMON /CONSTS/ E,PI,RADIAN,DEGREE,GCR,ER,ERDB,EAP,
1 PFD,ALOG,ALN10,COIMIN,COISING
C
COMMON /PARAMS/ NUMSAR,NAMESA(2,2),NTPSA(2),CPHI0(2)
C
COMMON /VECTOR/ DSLON(2),RSLON(2),XO(2),YO(2),
1 ROAIKJ,
2 XOAC(2),YOAC(2),ZOAC(2),ROAC(2)
C
COMMON /MINELL/ BCLAT(2),BCLON(2),DBCLAT(2),DBCLON(2),
1 REFLAT(2),REFLON(2),AXR(2),
1 ORIENT(2),AXMAJ(2)
C
COMMON /TPOINT/ RELON(2,20),RELAT(2,20),DELON(2,20),
1 DELAT(2,20),XE(2,20),YE(2,20),ZE(2,20)
C
COMMON /SRCH/ DMGN(2,20)
C
DSLON = DSLON(I)
C
IF(DBCLON(K).GE.DBCLON(I)) THEN
DELTA = 0.01
DSK = DSLONG+TOPOANG/2.
DSI = DSLONG-TOPOANG/2.
ELSE
DELTA = -0.01
DSK = DSLONG-TOPOANG/2.
DSI = DSLONG+TOPOANG/2.
END IF
C
20 DSK = DSK-DELTA
DSI = DSI+DELTA
RSK = DSK*RADIAN
RSI = DSI*RADIAN
XOAK = XE(K,J)-GCR*DCOS(RSK)
YOAK = YE(K,J)-GCR*DSIN(RSK)
ZOAK = ZE(K,J)
ROAK = DSQRT(XOAK*XOAK+YOAK*YOAK+ZOAK*ZOAK)
XOAI = XE(K,J)-GCR*DCOS(RSI)
YOAI = YE(K,J)-GCR*DSIN(RSI)
ZOAI = ZE(K,J)
ROAI = DSQRT(XOAI*XOAI+YOAI*YOAI+ZOAI*ZOAI)
ARG = (XOAK*XOAI+YOAK*YOAI+ZOAK*ZOAI)/(ROAK*ROAI)

```

```

      TOPO = DACOS(ARG)*DEGREE
      IF(TOPO.GT.TOPOANG) GOTO 20
      DELTAS = DABS(DSK-DSI)+0.02
      RETURN
      END
C
      SUBROUTINE RPTNER1(PR,P0,F,G,DISC)
C
C      FSS EARTH RECEIVER REFERENCE PATTERN FROM CCIR REPORT 391-4
C      ANTENNA DIAMETER 3 METERS, MAIN LOBE NOT GAUSSIAN
C
      IMPLICIT REAL*8(A-H,O-Z)
C
      COMMON /CONSTS/ E,PI,RADIAN,DEGREE,GCR,ER,ERDB,EAP,
1      PFD,ALOG,ALN10,COIMIN,COISING
C
      D = 3.
      WAVEL = 300./F
      X1 = D/WAVEL
      G1 = 2. + 15.* DLOG10(X1)
C
      IF (DISC.GE.(G1-G)) GO TO 50
      IF (DISC.GE.(-G-10.)) GO TO 60
C
      PR = PI
      GO TO 80
C
50  PR = RADIAN * DSQRT(-DISC*400./(X1*X1))
      GO TO 80
C
60  PR = RADIAN*10.**(-(DISC+G-32.)/25.)
C
80  RETURN
      END
C
      SUBROUTINE RPTNER2(PR,P0,F,G,DISC)
C
C      FSS EARTH RECEIVER PATTERN FROM CCIR REPORT 391-4
C      MAIN LOBE GAUSSIAN, ANTENNA DIAMETER 3 METERS,
C      MODIFIED FOR NON US COUNTRIES
C
      IMPLICIT REAL*8(A-H,O-Z)
C
      COMMON /CONSTS/ E,PI,RADIAN,DEGREE,GCR,ER,ERDB,EAP,
1      PFD,ALOG,ALN10,COIMIN,COISING
C
      IF (DISC.GE.-3.) THEN
      PR = P0 * DSQRT(-DISC/12.)
      GO TO 80
      ELSE IF (DISC.LE.-(G+10.)) THEN
      PR = PI
      GO TO 80
      END IF
C
      PR1 = P0 * DSQRT(-DISC/12.)
      PR2 = RADIAN * 10.**(-(G+DISC-32.)/25.)
      PR = DMAX1(PR1,PR2)
C
80  RETURN
      END

```

```

C
SUBROUTINE RPTNER3 (PR, P0, F, G, DISC)
C
C
C FSS EARTH RECEIVER PATTERN FROM CCIR REPORT 391-4
C MAIN LOBE GAUSSIAN, ANTENNA DIAMETER 4.5 METERS,
C MODIFIED FOR US ONLY
C
IMPLICIT REAL*8(A-H, O-Z)
C
COMMON /CONSTS/ E, PI, RADIAN, DEGREE, GCR, ER, ERDB, EAP,
1 PFD, ALOGE, ALN10, COIMIN, COISING
C
IF (DISC.GE.-12.) THEN
PR = P0 * DSQRT(-DISC/12.)
GO TO 80
ELSE IF (DISC.LE.-(G+10.)) THEN
PR = PI
GO TO 80
END IF
C
PR1 = P0 * DSQRT(-DISC/12.)
PR2 = RADIAN * 10.**(-(G+DISC-29.)/25.)
PR = DMAX1(PR1, PR2)
C
80 RETURN
END
C
SUBROUTINE RPTNER4 (PR, P0, F, G, DISC)
C
C
C FSS EARTH RECEIVER PATTERN FROM CCIR REPORT 391-4
C MAIN LOBE GAUSSIAN, ANTENNA DIAMETER 4.5 METERS,
C MODIFIED FOR US ONLY
C
IMPLICIT REAL*8(A-H, O-Z)
C
COMMON /CONSTS/ E, PI, RADIAN, DEGREE, GCR, ER, ERDB, EAP,
1 PFD, ALOGE, ALN10, COIMIN, COISING
C
IF (DISC.GE.-12.) THEN
PR = P0 * DSQRT(-DISC/12.)
GO TO 80
ELSE IF (DISC.LE.-(G+10.)) THEN
PR = PI
GO TO 80
END IF
C
PR1 = P0 * DSQRT(-DISC/12.)
PR2 = RADIAN * 10.**(-(G+DISC-29.)/25.)
PR = DMAX1(PR1, PR2)
C
80 RETURN
END
C
SUBROUTINE RPTNER5 (PR, P0, F, G, DISC)
C
C
C BSS PATTERN, RARC-83.CPM, P.115 CURVE-B,
C ANTENNA DIAMETER 1 METER
C
IMPLICIT REAL*8(A-H, O-Z)
C

```

```

COMMON /CONSTS/ E, PI, RADIAN, DEGREE, GCR, ER, ERDB, EAP,
1 PFD, ALOGE, ALN10, COIMIN, COISING
C
IF (DISC.GE.-10.6032) THEN
PR = P0 * DSQRT(-DISC/12.)
GO TO 80
ELSE IF (DISC.LE.-43.2) THEN
PR = PI
GO TO 80
END IF
C
PR = P0 * 10.**(-(DISC+11.3)/25.)
C
80 RETURN
END
C
SUBROUTINE XRPTNER1 (PR, P0, G, DISC)
C
C CROSS POLARIZATION RECEIVER PATTERN
C
C IMPLICIT REAL*8(A-H, O-Z)
C
X = PR/P0
IF (DISC.GE.-20.) GO TO 60
IF (DISC.GE.-30.) GO TO 70
IF (DISC.GE.-43.2) GO TO 80
C
PR = PI
GO TO 100
C
60 PR = 0.
GO TO 100
C
70 PR = 10.**(-(17.3+DISC)/25.) * P0
GO TO 100
C
80 PR = 10.**(-(11.3+DISC)/25.) * P0
C
100 RETURN
END

```

**APPENDIX E**  
**FORMULATIONS OF MIXED-INTEGER AND LINEAR PROGRAMS**

**A. ALGORITHMS**

A mixed integer program (MIP) can be solved by a branch-and-bound algorithm [88]. In such an algorithm, a linear objective function is to be optimized; the constraints of the problem are expressed as linear equalities or inequalities. Some, but not necessarily all, of the decision variables are integers. The set of feasible solutions that satisfy the constraints constitutes the feasible region. For our purpose, we can assume that the integer variables are bounded. Because the integer variables have a finite number of feasible values, the number of feasible solutions is finite; therefore an enumerative approach can be used to theoretically test all the feasible solutions in order to find the globally optimal solution(s).

To perform the enumeration by the branch-and-bound algorithm, the set of feasible solutions can be structured as a tree, and every branch represents one possible value of a particular integer variable. For the branch-and-bound concept, "branching" means testing a path that leads to a subset of feasible solutions, "bounding" means calculating the upper and lower bounds of the objective function value associated with the tested path. In the enumerative process, the upper and lower bounds of the objective function value are updated whenever more favorable values

are found in the branch-and-bound process. In the branch-and-bound process a path is tested against the updated upper and lower bounds: it finds a more favorable upper or lower bound of the objective function value and updates it, or it terminates testing that path and all its associated feasible solutions once it determines that this path can not yield a more favorable upper or lower bound of the objective function value. The process terminates when the updated upper and lower bounds are equal, or when it determines that an optimal solution does not exist. All the feasible solutions will have been considered implicitly, but hopefully very few will have been examined explicitly. A globally optimal solution is guaranteed, if one exists, by this process.

The linear program (LP) is commonly solved by the simplex method [81]. In this program a linear objective function is to be optimized; the constraints of the problem are expressed as linear equalities or inequalities. All the decision variables are continuous variables, and they must have nonnegative values. The set of feasible solutions constitutes a feasible region that is a convex set; its boundaries are the hyperplanes representing the linear constraints and nonnegativity restrictions. Because the objective function and the constraints are all linear equations, a locally optimal solution is always at a vertex which is the intersection of the bounding hyperplanes. The simplex method examines a sequence of locally optimal feasible solutions of the linear program. Each solution examined shares at least one boundary with the previous one, and has an objective function value no less

favorable than that of the previous solution. The process terminates when it is determined that no improved solution can be found.

The simplex method can be modified to handle nonlinear complementarity constraints through the use of restricted basis entry: when a complementary variable enters the basis at a non-zero value, its complement is forced to be non-basic and cannot enter the basis (except when the variable leaves). The effect of this modification is that the continuous feasible region is divided into many distinct subregions. Although the simplex method can still work, it only guarantees a local, but not necessarily a global, optimum, provided a feasible solution is found.

As the number of satellites increases, the computational time needed to find a solution typically increases exponentially for the MIP technique, but only polynomially for the restricted basis LP (RBLP) technique. Therefore, the MIP technique may take a prohibitively long time to solve a large problem; and the RBLP technique becomes an acceptable alternative, even though sub-optimal, rather than globally-optimal, solutions may be found.

## **B. PARAMETERS AND VARIABLES**

The coordinate system here is in the reverse longitude direction of the common global system, hence the longitude values increase as one moves in the westerly direction. Or simply speaking, the new coordinate system uses the magnitude of west longitude; in this way, there are only non-negative variables in both of the new formulations.

The parameters in the formulations are:

$W_j(E_j)$  : westernmost(easternmost) feasible location for satellite  
j in degrees west,

$d_j$  : preferred location for satellite j relative to  $E_j$ ,

$\Delta S_{ij}$  : required satellite separation between satellites i and j,

$x_{ij} = \begin{cases} 1, & \text{if satellite } i \text{ is west of } j, \\ 0, & \text{otherwise,} \end{cases}$

m : number of satellites.

$E = \min_j \{E_j\}$ ,

$W = \max_j \{W_j\}$ .

The decision variables are:

$x_j$  : relative location of satellite j with respect to  $E_j$ ,

$p_{ij}(n_{ij})$  : degrees west(east) of satellite i that satellite j is  
located,

$x_j^+(x_j^-)$  : degrees west(east) of its preferred location that satellite  
j is located,

Y : length of the occupied orbital arc.



Note that the nonnegative variable  $p_{ij}$  alone can not represent the separation between satellites  $i$  and  $j$ , and another nonnegative variable,  $n_{ij}$ , is needed when  $i$  is east of  $j$ . Therefore when satellite  $i$  is west of  $j$ , the value of  $p_{ij}$  is positive, and  $n_{ij}$  should be set equal to zero; when satellite  $i$  is east of  $j$ ,  $n_{ij}$  is positive and  $p_{ij}$  should be zero. Also note from the definition of  $x_j$ , the coordinate system for every satellite is re-originated at the eastern-most bound,  $E_j$ .

### C. FORMULATION I

If the optimal criterion is to minimize the total amount of orbital arc occupied by the satellites to be synthesized, the MIP formulation is

$$\text{Minimize } f = Y \quad (\text{E.1})$$

subject to

$$x_i - x_j - p_{ij} + n_{ij} = 0, \quad \text{for } i < j \quad (\text{E.2})$$

$$p_{ij} + n_{ij} > \Delta S_{ij}, \quad \text{for } i < j \quad (\text{E.3})$$

$$x_j < W_j - E_j, \quad \text{for all } j \quad (\text{E.4})$$

$$p_{ij} + n_{ij} - Y < 0, \quad \text{for } i < j \quad (\text{E.5})$$

$$x_j > 0, \quad \text{for all } j \quad (\text{E.6})$$

$$p_{ij}, n_{ij} > 0, \quad \text{for } i < j \quad (\text{E.7})$$

$$Y > 0, \quad (\text{E.8})$$

$$(E - W) \cdot x_{ij} + p_{ij} < 0, \quad \text{for } i < j \quad (\text{E.9})$$

$$(W - E) \cdot x_{ij} + n_{ij} < (W - E), \quad \text{for } i < j \quad (\text{E.10})$$

$$x_{ij} \in \{0,1\}, \quad \text{for } i < j \quad (\text{E.11})$$

Equations (E.9) and (E.10) guarantee that

$$p_{ij} < 0, \text{ or } n_{ij} < 0. \quad (\text{E.12})$$

Together with Equation (E.7), one has

$$p_{ij} = 0, \text{ or } n_{ij} = 0. \quad (\text{E.13})$$

If the optimal solution can be found, the optimal values of the variables  $x_j$ 's specify the optimal orbital locations for the satellites. Otherwise, the code will tell the user that a feasible solution does not exist.

It is possible that the objective is only to have a feasible solution that satisfies the C/I protection requirements, as described in Chapter IV. Then one could reformulate the objective function of Equation (E.1) and ignore the variable  $Y$ , Equations (E.5) and (E.8). The calculation process will either stop when it finds a feasible solution, or determines that none exists.

Also, the same formulation (Equations (E.1) through (E.11)) is still applicable if the system requirement is to have the maximum C/I results for all the service areas, and there is no interest in the conservation of the orbit resource. One could progressively adjust the C/I protection requirement and repeat the  $\Delta S$  and MIP calculations until the resulting scenario uses up the whole feasible arc. This result is the scenario that offers the maximum C/I.

#### D. FORMULATION II

For the same objective as stated above, the LP formulation with the nonlinear side constraints is

$$\text{Minimize } f = Y \quad (\text{E.14})$$

subject to

$$x_i - x_j - p_{ij} + n_{ij} = 0, \quad \text{for } i < j \quad (\text{E.15})$$

$$p_{ij} + n_{ij} > \Delta S_{ij}, \quad \text{for } i < j \quad (\text{E.16})$$

$$x_j < W_j - E_j, \quad \text{for all } j \quad (\text{E.17})$$

$$p_{ij} + n_{ij} - Y < 0, \quad \text{for } i < j \quad (\text{E.18})$$

$$x_j > 0, \quad \text{for all } j \quad (\text{E.19})$$

$$p_{ij}, n_{ij} > 0, \quad \text{for } i < j \quad (\text{E.20})$$

$$Y > 0, \quad (\text{E.21})$$

$$p_{ij} \cdot n_{ij} = 0, \quad \text{for } i < j \quad (\text{E.22})$$

The solution to this problem is an orbital assignment.

In this formulation, Equation (E.22) is not a linear equation, thus the simplex method needs to be modified through the use of restricted basis entry: the variable  $p_{ij}$  can not be a basic variable if  $n_{ij}$  is a basic variable, and vice versa. Although the simplex method can still work, it only guarantees a locally optimal solution, provided a feasible solution is found.

### E. FORMULATION III

It is possible that every administration has a preferred satellite location and hopes the actual assigned location will be near the preferred location. Solutions become less and less attractive as the actual location becomes further and further removed from the preferred location. A suitable objective is to minimize the sum of the absolute deviations of the satellites' actual locations from their preferred locations, i.e., to minimize the total deviation. The MIP formulation is

$$\text{Minimize } f = \sum_j (x_j^+ + x_j^-) \quad (\text{E.23})$$

subject to

$$x_j - x_j^+ + x_j^- = d_j, \quad \text{for all } j \quad (\text{E.24})$$

$$x_i - x_j - p_{ij} + n_{ij} = 0, \quad \text{for } i < j \quad (\text{E.25})$$

$$p_{ij} + n_{ij} > \Delta S_{ij}, \quad \text{for } i < j \quad (\text{E.26})$$

$$x_j < W_j - E_j, \quad \text{for all } j \quad (\text{E.27})$$

$$x_j, x_j^+, x_j^- > 0, \quad \text{for all } j \quad (\text{E.28})$$

$$p_{ij}, n_{ij} > 0, \quad \text{for } i < j \quad (\text{E.29})$$

$$(E - W) \cdot x_{ij} + p_{ij} < 0, \quad \text{for } i < j \quad (\text{E.30})$$

$$(W - E) \cdot x_{ij} + n_{ij} < (W - E), \quad \text{for } i < j \quad (\text{E.31})$$

$$x_{ij} \in \{0,1\}, \quad \text{for } i < j \quad (\text{E.32})$$

The optimal values of the variables  $x_j$  prescribe optimal locations for the satellites which minimize the total deviation of the prescribed locations from the preferred locations.

Equations (E.9) and (E.10) guarantee that

$$p_{ij} < 0, \text{ or } n_{ij} < 0. \quad (\text{E.12})$$

Together with Equation (E.7), one has

$$p_{ij} = 0, \text{ or } n_{ij} = 0. \quad (\text{E.13})$$

If the optimal solution can be found, the optimal values of the variables  $x_j$  specify the optimal orbital locations for the satellites. Otherwise, the code will tell the user that a feasible solution does not exist.

It is possible that the objective is only to have a feasible solution that satisfies the C/I protection requirements, as described in Chapter IV. Then one could reformulate the objective function of Equation (E.1) and ignore the variable  $Y$ , Equations (E.5) and (E.8). The calculation process will either stop when it finds a feasible solution, or determines that none exists.

Also, the same formulation (Equations (E.1) through (E.11)) is still applicable if the system requirement is to have the maximum C/I results for all the service areas, and there is no interest in the conservation of the orbit resource. One could progressively adjust the C/I protection requirement and repeat the  $\Delta S$  and MIP calculations until the resulting scenario uses up the whole feasible arc. This result is the scenario that offers the maximum C/I.

Table E.1  
 Satellite preferred locations of six  
 administrations

country	ARG	BOL	CHL	PRG	PRU	URG
case 1	95	95	95	95	95	95
case 2	110	110	110	110	110	110
case 3	87.5	92.5	97.5	87.5	102.5	82.5

Table E.2  
 $\Delta S$  parameters of six administrations

$\Delta S$	ARG	BOL	CHL	PRG	PRU	URG
ARG	*	4.17	4.19	4.32	1.41	4.14
BOL		*	4.57	4.04	4.26	0.94
CHL			*	2.00	3.04	1.59
PRG				*	1.10	2.46
PRU					*	0.37
URG						*

The  $\Delta S$  matrix for these six countries is in Table E.2. The resulting assignments, together with the total occupied arc  $Y$ , the total deviation  $Z$  of the prescribed locations from the preferred locations, and the C.P.U. times in seconds are listed in Table E.3.

It is clear that the solutions obtained by solving the MIP formulation are better than those found by solving the LP formulation. The MIP solutions can never be worse than the corresponding LP solutions, but more computer time is required to solve the MIP formulation.

Table E.3

## Mixed-integer and linear program results

	case 1		case 2		case 3	
satellite	MIP	LP	MIP	LP	MIP	LP
ARG	88.68	105.74	101.35	110.00	88.76	101.26
BOL	99.57	101.57	97.18	104.33	92.93	92.50
CHL	95.00	97.00	105.54	99.76	97.50	97.07
PRG	93.00	95.00	107.54	97.76	84.44	87.50
PRU	91.06	93.06	109.63	108.59	102.50	102.67
URG	96.59	92.54	110.00	105.86	81.98	82.50
deviation	18.42	23.71	28.76	33.69	5.27	14.36
arc	10.89	13.20	12.82	12.24	20.52	20.17
cpu(sec)*	25.23	1.31	13.39	1.30	2.86	1.25

\* IBM-3081 computer



## APPENDIX F

### C/I CALCULATION OF MIXED INTEGER PROGRAM RESULT

COUNTRY	SATELLITE (LON.)	FREQUENCY (MHz)
ARG	-88.68	4000.00
BOL	-99.57	4000.00
CHL	-95.00	4000.00
FRG	-93.00	4000.00
PRU	-91.06	4000.00
URG	-96.59	4000.00

TEST COUNTRY : ARG      SATELLITE : -88.68

TEST POINT		INT. SAT.	C/I (dB)	MARGIN (dB)
LON.	LAT.			
-65.20	-21.80	BOL099	40.83	10.83
-65.20	-21.80	CHL095	37.25	7.25
-65.20	-21.80	PRG093	39.39	9.39
-65.20	-21.80	PRU091	41.47	11.47
-66.20	-21.80	URG096	68.02	38.02
-65.20	-21.80	TOTAL	33.39	8.39
-62.80	-22.00	BOL099	41.37	11.37
-62.80	-22.00	CHL095	51.35	21.35
-62.80	-22.00	PRG093	32.03	2.03
-62.80	-22.00	PRU091	53.86	23.86
-62.80	-22.00	URG096	67.24	37.24
-62.80	-22.00	TOTAL	31.48	6.48
-53.80	-27.20	BOL099	53.05	23.05
-53.80	-27.20	CHL095	63.14	33.14
-53.80	-27.20	PRG093	31.53	1.53
-53.80	-27.20	PRU091	52.74	22.74
-53.80	-27.20	URG096	49.37	19.37
-53.80	-27.20	TOTAL	31.39	6.39
-56.70	-36.90	BOL099	69.73	39.73
-56.70	-36.90	CHL095	55.57	25.57
-56.70	-36.90	PRG093	59.61	29.61
-56.70	-36.90	PRU091	53.45	23.45
-56.70	-36.90	URG096	41.77	11.77
-56.70	-36.90	TOTAL	41.25	16.25
-63.80	-54.70	BOL099	72.73	42.73
-63.80	-54.70	CHL095	42.01	12.01
-63.80	-54.70	PRG093	67.29	37.29
-63.80	-54.70	PRU091	52.85	22.85
-63.80	-54.70	URG096	74.65	44.65
-63.80	-54.70	TOTAL	41.65	16.65
-68.30	-54.80	BOL099	73.38	43.38
-68.30	-54.80	CHL095	39.26	9.26
-68.30	-54.80	PRG093	68.21	38.21
-68.30	-54.80	PRU091	53.16	23.16
-68.30	-54.80	URG096	75.74	45.74
-68.30	-54.80	TOTAL	39.08	14.08
-73.20	-50.90	BOL099	73.25	43.25
-73.20	-50.90	CHL095	35.44	5.44
-73.20	-50.90	PRG093	68.41	38.41
-73.20	-50.90	PRU091	52.91	22.91
-73.20	-50.90	URG096	75.82	45.82

ORIGINAL PAGE IS  
OF POOR QUALITY

-73.20	-50.90	TOTAL	35.36	10.36
-71.40	-39.00	BOL099	70.45	40.45
-71.40	-39.00	CHL095	35.45	5.45
-71.40	-39.00	PRG093	65.76	35.76
-71.40	-39.00	PRU091	54.18	24.18
-71.40	-39.00	URG096	71.26	41.26
-71.40	-39.00	TOTAL	35.38	10.38
-73.50	-31.40	BOL099	70.35	40.35
-73.50	-31.40	CHL095	35.10	5.10
-73.50	-31.40	PRG093	61.63	31.63
-73.50	-31.40	PRU091	54.08	24.08
-73.50	-31.40	URG096	63.29	33.29
-73.50	-31.40	TOTAL	35.03	10.03
-63.60	-24.80	BOL099	49.00	19.00
-63.60	-24.80	CHL095	35.23	5.23
-63.60	-24.80	PRG093	59.37	29.37
-63.60	-24.80	PRU091	53.21	23.21
-63.60	-24.80	URG096	67.38	37.38
-63.60	-24.80	TOTAL	34.96	9.96

TEST COUNTRY : BOL

SATELLITE : -99.57

TEST POINT	INT. SAT.	C/I (dB)	MARGIN (dB)
-65.00 -12.20	ARG088	70.32	40.32
-65.00 -12.20	CHL095	61.01	31.01
-65.00 -12.20	PRG093	64.85	34.85
-65.00 -12.20	PRU091	45.32	15.32
-65.00 -12.20	URG096	66.08	36.08
-65.00 -12.20	TOTAL	45.11	20.11
-65.50 -9.80	ARG088	69.00	39.00
-65.50 -9.80	CHL095	59.68	29.68
-65.50 -9.80	PRG093	63.52	33.52
-65.50 -9.80	PRU091	42.75	12.75
-65.50 -9.80	URG096	66.37	36.37
-65.50 -9.80	TOTAL	42.60	17.60
-69.00 -11.20	ARG088	69.81	39.81
-69.00 -11.20	CHL095	60.49	30.49
-69.00 -11.20	PRG093	64.34	34.34
-69.00 -11.20	PRU091	38.97	8.97
-69.00 -11.20	URG096	66.93	36.93
-69.00 -11.20	TOTAL	38.92	13.92
-60.00 -16.10	ARG088	47.93	17.93
-60.00 -16.10	CHL095	60.57	30.57
-60.00 -16.10	PRG093	43.69	13.69
-60.00 -16.10	PRU091	67.54	37.54
-60.00 -16.10	URG096	62.26	32.26
-60.00 -16.10	TOTAL	42.18	17.18
-57.50 -18.00	ARG088	41.71	11.71
-57.50 -18.00	CHL095	59.57	29.57
-57.50 -18.00	PRG093	38.56	8.56
-57.50 -18.00	PRU091	66.53	36.53
-57.50 -18.00	URG096	59.66	29.66
-57.50 -18.00	TOTAL	36.80	11.80

ORIGINAL PAGE IS  
OF POOR QUALITY

-67.50	-22.70	ARG068	41.44	11.44
-67.50	-22.70	CHL095	31.31	1.91
-67.50	-22.70	PRG093	49.15	19.85
-67.50	-22.70	PRU091	54.71	24.71
-67.50	-22.70	URG096	57.00	29.00
-67.50	-22.70	TOTAL	31.35	6.35

TEST COUNTRY : CHL      SATELLITE : -95.00

TEST POINT	INT. SAT.	C/I (dB)	MARGIN (dB)
-60.50	-17.50	ARG088	62.92
-60.50	-17.50	BOL099	30.58
-60.50	-17.50	PRG093	50.44
-60.50	-17.50	PRU091	30.53
-60.50	-17.50	URG096	55.17
-60.50	-17.50	TOTAL	27.52
-67.10	-23.00	ARG088	35.33
-67.10	-23.00	BOL099	32.18
-67.10	-23.00	PRG093	35.49
-67.10	-23.00	PRU091	48.86
-67.10	-23.00	URG096	49.75
-67.10	-23.00	TOTAL	29.19
-70.00	-34.20	ARG088	35.39
-70.00	-34.20	BOL099	61.16
-70.00	-34.20	PRG093	54.61
-70.00	-34.20	PRU091	59.79
-70.00	-34.20	URG096	51.30
-70.00	-34.20	TOTAL	35.20
-71.70	-43.20	ARG088	35.24
-71.70	-43.20	BOL099	62.26
-71.70	-43.20	PRG093	58.53
-71.70	-43.20	PRU091	59.09
-71.70	-43.20	URG096	56.00
-71.70	-43.20	TOTAL	35.15
-72.80	-51.30	ARG088	34.91
-72.80	-51.30	BOL099	63.54
-72.80	-51.30	PRG093	59.73
-72.80	-51.30	PRU091	58.11
-72.80	-51.30	URG096	58.10
-72.80	-51.30	TOTAL	34.85
-75.70	-46.80	ARG088	36.11
-75.70	-46.80	BOL099	63.76
-75.70	-46.80	PRG093	60.28
-75.70	-46.80	PRU091	58.44
-75.70	-46.80	URG096	58.50
-75.70	-46.80	TOTAL	36.04
-74.00	-28.90	ARG088	41.43
-74.00	-28.90	BOL099	62.06
-74.00	-28.90	PRG093	55.97
-74.00	-28.90	PRU091	60.69
-74.00	-28.90	URG096	55.35
-74.00	-28.90	TOTAL	41.03
-70.40	-18.30	ARG088	63.43
-70.40	-18.30	BOL099	31.80

-73.40	-18.30	PRG093	50.94	20.34
-73.40	-18.30	PRU091	31.37	1.07
-73.40	-18.30	URG096	55.51	25.51
-73.40	-18.30	TOTAL	26.37	3.37

TEST COUNTRY : PRG      SATELLITE : -93.00

TEST POINT	INT. SAT.	C/I (dB)	MARGIN (dB)	
-57.60	-25.30	ARG088	32.10	2.10
-57.60	-25.30	BOL099	40.41	10.41
-57.60	-25.30	CHL095	52.58	22.58
-57.60	-25.30	PRU091	52.47	22.47
-57.60	-25.30	URG096	46.66	16.66
-57.60	-25.30	TOTAL	31.31	6.31
-58.60	-27.30	ARG088	30.07	0.07
-58.60	-27.30	BOL099	43.33	13.33
-58.60	-27.30	CHL095	50.95	20.95
-58.60	-27.30	PRU091	50.84	20.84
-58.60	-27.30	URG096	35.20	5.20
-58.60	-27.30	TOTAL	28.70	3.70
-56.20	-27.20	ARG088	31.10	1.10
-56.20	-27.20	BOL099	45.13	15.13
-56.20	-27.20	CHL095	51.31	21.31
-56.20	-27.20	PRU091	51.20	21.20
-56.20	-27.20	URG096	37.50	7.50
-56.20	-27.20	TOTAL	30.00	5.00
-54.70	-25.50	ARG088	31.86	1.86
-54.70	-25.50	BOL099	43.23	13.23
-54.70	-25.50	CHL095	51.46	21.46
-54.70	-25.50	PRU091	51.34	21.34
-54.70	-25.50	URG096	49.09	19.09
-54.70	-25.50	TOTAL	31.39	6.39
-54.20	-24.10	ARG088	31.72	1.72
-54.20	-24.10	BOL099	41.60	11.60
-54.20	-24.10	CHL095	51.03	21.03
-54.20	-24.10	PRU091	50.91	20.91
-54.20	-24.10	URG096	57.11	27.11
-54.20	-24.10	TOTAL	31.19	6.19
-58.10	-20.20	ARG088	32.21	2.21
-58.10	-20.20	BOL099	36.69	6.69
-58.10	-20.20	CHL095	51.87	21.87
-58.10	-20.20	PRU091	51.75	21.75
-58.10	-20.20	URG096	60.60	30.60
-58.10	-20.20	TOTAL	30.81	5.81
-59.10	-19.30	ARG088	31.99	1.99
-59.10	-19.30	BOL099	35.81	5.81
-59.10	-19.30	CHL095	51.46	21.46
-59.10	-19.30	PRU091	51.35	21.35
-59.10	-19.30	URG096	61.11	31.11
-59.10	-19.30	TOTAL	30.41	5.41
-62.20	-20.50	ARG088	31.81	1.81
-62.20	-20.50	BOL099	35.22	5.22
-62.20	-20.50	CHL095	45.90	15.90
-62.20	-20.50	PRU091	51.45	21.45

-52.20	-20.50	URG096	60.07	30.07
-62.20	-20.50	TOTAL	30.02	5.02
-62.70	-22.20	ARG088	31.03	1.03
-62.70	-22.20	BOL099	35.50	5.50
-62.70	-22.20	CHL095	38.46	8.46
-62.70	-22.20	PRU091	51.18	21.18
-62.70	-22.20	URG096	57.93	27.93
-62.70	-22.20	TOTAL	29.13	4.13
-53.70	-27.20	ARG088	30.12	0.12
-53.70	-27.20	BOL099	43.01	13.01
-53.70	-27.20	CHL095	51.02	21.02
-53.70	-27.20	PRU091	50.90	20.90
-53.70	-27.20	URG096	35.62	5.62
-53.70	-27.20	TOTAL	28.82	3.82

TEST COUNTRY : PRU      SATELLITE : -91.06

TEST POINT	INT. SAT.	C/I (dB)	MARGIN (dB)
-70.40	-18.30	ARG088	22.44
-70.40	-18.30	BOL099	8.18
-70.40	-18.30	CHL095	0.25
-70.40	-18.30	PRG093	20.24
-70.40	-18.30	URG096	38.67
-70.40	-18.30	TOTAL	4.54
-69.00	-12.30	ARG088	23.36
-69.00	-12.30	BOL099	8.54
-69.00	-12.30	CHL095	18.79
-69.00	-12.30	PRG093	21.15
-69.00	-12.30	URG096	43.04
-69.00	-12.30	TOTAL	12.81
-70.50	-9.40	ARG088	24.10
-70.50	-9.40	BOL099	11.74
-70.50	-9.40	CHL095	29.68
-70.50	-9.40	PRG093	23.03
-70.50	-9.40	URG096	45.81
-70.50	-9.40	TOTAL	16.14
-74.00	-7.60	ARG088	24.91
-74.00	-7.60	BOL099	27.52
-74.00	-7.60	CHL095	30.49
-74.00	-7.60	PRG093	26.79
-74.00	-7.60	URG096	48.36
-74.00	-7.60	TOTAL	25.97
-70.00	-2.70	ARG088	22.37
-70.00	-2.70	BOL099	36.30
-70.00	-2.70	CHL095	27.95
-70.00	-2.70	PRG093	24.98
-70.00	-2.70	URG096	47.12
-70.00	-2.70	TOTAL	24.65
-75.20	0.00	ARG088	24.94
-75.20	0.00	BOL099	36.68
-75.20	0.00	CHL095	28.34
-75.20	0.00	PRG093	28.41
-75.20	0.00	URG096	47.50
-75.20	0.00	TOTAL	26.97

<del>-80.30</del>	<del>-3.40</del>	ARG088	55.74	25.84
<del>-80.30</del>	<del>-3.40</del>	BOL099	66.83	36.83
<del>-80.30</del>	<del>-3.40</del>	CHL095	58.49	28.49
<del>-80.30</del>	<del>-3.40</del>	PRG093	59.50	29.50
<del>-80.30</del>	<del>-3.40</del>	URG096	77.55	47.65
<del>-80.30</del>	<del>-3.40</del>	TOTAL	52.70	27.70
<del>-81.30</del>	<del>-4.40</del>	ARG088	55.54	25.54
<del>-81.30</del>	<del>-4.40</del>	BOL099	66.47	36.47
<del>-81.30</del>	<del>-4.40</del>	CHL095	58.13	28.13
<del>-81.30</del>	<del>-4.40</del>	PRG093	59.34	29.34
<del>-81.30</del>	<del>-4.40</del>	URG096	77.29	47.29
<del>-81.30</del>	<del>-4.40</del>	TOTAL	52.41	27.41
<del>-81.20</del>	<del>-6.10</del>	ARG088	55.26	25.26
<del>-81.20</del>	<del>-6.10</del>	BOL099	66.79	36.79
<del>-81.20</del>	<del>-6.10</del>	CHL095	58.45	28.45
<del>-81.20</del>	<del>-6.10</del>	PRG093	59.17	29.17
<del>-81.20</del>	<del>-6.10</del>	URG096	77.61	47.61
<del>-81.20</del>	<del>-6.10</del>	TOTAL	52.33	27.33
<del>-76.10</del>	<del>-13.40</del>	ARG088	54.34	24.34
<del>-76.10</del>	<del>-13.40</del>	BOL099	52.75	22.75
<del>-76.10</del>	<del>-13.40</del>	CHL095	36.94	6.94
<del>-76.10</del>	<del>-13.40</del>	PRG093	55.68	25.68
<del>-76.10</del>	<del>-13.40</del>	URG096	75.66	45.66
<del>-76.10</del>	<del>-13.40</del>	TOTAL	36.69	11.69

TEST COUNTRY : URG      SATELLITE : -96.59

TEST POINT	INT. SAT.	C/I (dB)	MARGIN (dB)	
<del>-56.20</del>	<del>-34.90</del>	ARG088	38.13	8.13
<del>-56.20</del>	<del>-34.90</del>	BOL099	55.95	25.95
<del>-56.20</del>	<del>-34.90</del>	CHL095	49.15	19.15
<del>-56.20</del>	<del>-34.90</del>	PRG093	57.89	27.89
<del>-56.20</del>	<del>-34.90</del>	PRU091	62.90	32.90
<del>-56.20</del>	<del>-34.90</del>	TOTAL	37.68	12.68
<del>-54.90</del>	<del>-35.00</del>	ARG088	38.70	8.70
<del>-54.90</del>	<del>-35.00</del>	BOL099	56.02	26.02
<del>-54.90</del>	<del>-35.00</del>	CHL095	49.21	19.21
<del>-54.90</del>	<del>-35.00</del>	PRG093	57.96	27.96
<del>-54.90</del>	<del>-35.00</del>	PRU091	62.96	32.96
<del>-54.90</del>	<del>-35.00</del>	TOTAL	38.19	13.19
<del>-53.50</del>	<del>-34.00</del>	ARG088	39.49	9.49
<del>-53.50</del>	<del>-34.00</del>	BOL099	56.28	26.28
<del>-53.50</del>	<del>-34.00</del>	CHL095	49.47	19.47
<del>-53.50</del>	<del>-34.00</del>	PRG093	51.23	21.23
<del>-53.50</del>	<del>-34.00</del>	PRU091	63.22	33.22
<del>-53.50</del>	<del>-34.00</del>	TOTAL	38.73	13.73
<del>-53.20</del>	<del>-32.70</del>	ARG088	39.27	9.27
<del>-53.20</del>	<del>-32.70</del>	BOL099	55.99	25.99
<del>-53.20</del>	<del>-32.70</del>	CHL095	49.18	19.18
<del>-53.20</del>	<del>-32.70</del>	PRG093	44.41	14.41
<del>-53.20</del>	<del>-32.70</del>	PRU091	62.93	32.93
<del>-53.20</del>	<del>-32.70</del>	TOTAL	37.71	12.71
<del>-55.60</del>	<del>-30.80</del>	ARG088	38.43	8.43

ORIGINAL PAGE IS  
OF POOR QUALITY

<del>-55.60</del>	<del>-30.80</del>	BOL099	56.21	26.21
<del>-55.60</del>	<del>-30.80</del>	CHL095	49.41	19.41
<del>-55.60</del>	<del>-30.80</del>	PRG093	37.26	7.26
<del>-55.60</del>	<del>-30.80</del>	PRU091	63.16	33.16
		TOTAL	34.61	9.61
<del>-56.90</del>	<del>-30.10</del>	ARG088	37.58	7.58
<del>-56.90</del>	<del>-30.10</del>	BOL099	47.68	17.88
<del>-56.90</del>	<del>-30.10</del>	CHL095	49.02	19.02
<del>-56.90</del>	<del>-30.10</del>	PRG093	35.10	5.10
<del>-56.90</del>	<del>-30.10</del>	PRU091	62.77	32.77
		TOTAL	32.90	7.90
<del>-57.60</del>	<del>-30.20</del>	ARG088	37.54	7.54
<del>-57.60</del>	<del>-30.20</del>	BOL099	48.42	18.42
<del>-57.60</del>	<del>-30.20</del>	CHL095	49.19	19.19
<del>-57.60</del>	<del>-30.20</del>	PRG093	36.30	6.30
<del>-57.60</del>	<del>-30.20</del>	PRU091	62.94	32.94
		TOTAL	33.59	8.59
<del>-58.20</del>	<del>-31.90</del>	ARG088	38.30	8.30
<del>-58.20</del>	<del>-31.90</del>	BOL099	56.91	26.91
<del>-58.20</del>	<del>-31.90</del>	CHL095	41.35	11.35
<del>-58.20</del>	<del>-31.90</del>	PRG093	45.82	15.82
<del>-58.20</del>	<del>-31.90</del>	PRU091	63.86	33.86
		TOTAL	36.03	11.03
<del>-58.40</del>	<del>-33.90</del>	ARG088	37.24	7.24
<del>-58.40</del>	<del>-33.90</del>	BOL099	55.83	25.83
<del>-58.40</del>	<del>-33.90</del>	CHL095	37.27	7.27
<del>-58.40</del>	<del>-33.90</del>	PRG093	57.77	27.77
<del>-58.40</del>	<del>-33.90</del>	PRU091	62.77	32.77
		TOTAL	34.19	9.19
<del>-57.90</del>	<del>-34.50</del>	ARG088	37.13	7.13
<del>-57.90</del>	<del>-34.50</del>	BOL099	55.54	25.54
<del>-57.90</del>	<del>-34.50</del>	CHL095	38.25	8.25
<del>-57.90</del>	<del>-34.50</del>	PRG093	57.48	27.48
<del>-57.90</del>	<del>-34.50</del>	PRU091	62.48	32.48
		TOTAL	34.58	9.58

## REFERENCES

- [1] W. L. Pritchard, "Satellite Communication-An Overview of the Problems and Programs", Proceedings of the IEEE, Vol. 65, No. 3, March 1977, pp. 294-307.
- [2] "What Is Up There?", IEEE Spectrum, Vol. 20, No. 9, Sep. 1983, p. 48. Referring from Space Log of TRW Electronics and Defense Sector, and from Telecommunications Journal.
- [3] W. L. Morgan, "Satellite Locations-1984", Proceedings of the IEEE, Vol. 72, NO. 11, Nov. 1984, pp. 1434-1444.
- [4] Final Acts of the World Administrative Radio Conference for the Planning of the Broadcasting-Satellite Service in Frequency Bands 11.7-12.2 GHz (in Regions 2 and 3) and 11.7-12.5 GHz (in Region 1), International Telecommunication Union, Geneva, 1977.
- [5] Report 633-1, "Orbit and Frequency Planning in the Broadcasting-Satellite Service", Recommendations and Reports of the CCIR, 1978, Vol. XI: Broadcasting Service (Television), International Telecommunication Union, Geneva 1978, pp. 216-228.
- [6] Report 206-4, "General Considerations Relating to the Choice of Orbit Parameters in the Fixed-Satellite Service", Recommendations and Reports of the CCIR, 1982, Vol. IV, Part 1: Fixed-Satellite Service, International Telecommunication Union, Geneva 1982, pp. 8-11.
- [7] Report 205-4, "Factors Affecting the Selection of Frequencies for Telecommunications with Space Stations in the Fixed-Satellite Service", Recommendations and Reports of the CCIR, 1982, Vol. IV, Part 1: Fixed-Satellite Service, International Telecommunication Union, Geneva 1982, pp. 5-8.
- [8] Final Acts of the World Administrative Radio Conference, International Telecommunication Union, Geneva.
- [9] Article 11, "The Plane for the Broadcasting-Satellite Service in the Frequency Bands 11.7-12.2 GHz in Region 3 and 11.7-12.5 GHz in Region 1", Final Acts of the World Administrative Radio Conference for the Planning of the Broadcasting-Satellite Service in Frequency Bands 11.7-12.2 GHz (in Regions 2 and 3) and 11.7-12.5 GHz (in Region 1), International Telecommunication Union, Geneva, 1977, pp. 31-72.



- [10] Annex 8, "Technical Data Used in Establishing the Provisions and Associated Plan and Which Should Be Used for Their Application", Final Acts of the World Administrative Radio Conference for the Planning of the Broadcasting-Satellite Service in Frequency Bands 11.7-12.2 GHz (in Regions 2 and 3) and 11.7-12.5 GHz (in Region 1), International Telecommunication Union, Geneva, 1977, pp. 90-104.
- [11] Article 12, "Provisions Governing the Broadcasting-Satellite Service in Region 2 Pending the Establishment of a Detailed Plan", Final Acts of the World Administrative Radio Conference for the Planning of the Broadcasting-Satellite Service in Frequency Bands 11.7-12.2 GHz (in Regions 2 and 3) and 11.7-12.5 GHz (in Region 1), International Telecommunication Union, Geneva, 1977, pp. 73-74.
- [12] Annex 6, "Planning Principles in Region 2", Final Acts of the World Administrative Radio Conference for the Planning of the Broadcasting-Satellite Service in Frequency Bands 11.7-12.2 GHz (in Regions 2 and 3) and 11.7-12.5 GHz (in Region 1), International Telecommunication Union, Geneva, 1977, p. 88.
- [13] "Final Acts of the Regional Administrative Conference for the Planning of the Broadcasting-Satellite Service in Region 2 (SAT-83), Geneva, 1983", International Telecommunication Union, Geneva, 1983.
- [14] Edward E. Reinhart, "An Introduction to the RARC '83 Plan for DBS Systems in the Western Hemisphere", Journal on Selected Areas in Communications, Vol. SAC-3, No. 1, Jan. 1985, pp. 13-19.
- [15] D. J. Withers, "Efficient Utilization of the Geostationary Orbit for Satellite Communication", Proceedings of the IEEE, Vol. 65, No. 3, March 1977, pp. 308-316.
- [16] Annex 7, "Use of the Spectrum/Orbit Resource", Final Acts of the World Administrative Radio Conference for the Planning of the Broadcasting-Satellite Service in Frequency Bands 11.7-12.2 GHz (in Regions 2 and 3) and 11.7-12.5 GHz (in Region 1), International Telecommunication Union, Geneva, 1977, pp. 89-90.
- [17] Y. Ito, T. Mizuno and T. Muratani, "Effective Utilization of Geostationary Orbit through Optimization", IEEE Transactions on Communications, Vol. Com-27, No. 10, Oct. 1979,
- [18] "The Orbit Spacing Minimizer (ORBIT-II) User's Manual", Kokusai Denshin Denwa Co. Ltd., Tokyo Japan, April 1984. pp. 1551-1558.

- [19] S. H. Cameron, "The Solution of the Graph-Coloring Problem as a Set-Covering Problem", IEEE Trans. Electromagnetic Compatibility, Vol. EMC-19, No. 3, Aug. 1977, pp. 320-322.
- [20] J.-F. Arnaud, "Frequency Planning for Broadcast Service in Europe", Proceedings of the IEEE, Vol. 68, No. 12, Dec. 1980, pp. 1515-1522.
- [21] J. A. Zoellner and C. L. Beall, "A Breakthrough in Spectrum Conserving Frequency Assignment Technology", IEEE Trans. Electromagnetic Compatibility, Vol. EMC-19, No. 3, Aug. 1977, pp. 313-319.
- [22] W. K. Hale, "Frequency Assignment: Theory and Applications" Proceedings of the IEEE, Vol. 68, No. 12, Dec. 1980, pp. 1497-1514.
- [23] T. Mizuike, Y. Ito and T. Muratani, "Optimization of Frequency Assignment", KDD Research and Development Laboratories, Tokyo 153, Japan. Also Presented in the International Conference on Communications, Amsterdam, The Netherland, May, 1984.
- [24] J. E. Maisel, "Investigation of the Eastern Satellite Arc for US Eastern Time Zone", Space Communications Division Internal Report, SCDIR 81-3, NASA Lewis Research Center, Sep. 1981.
- [25] H. J. Weiss, "Relating to the Efficiency of Utilization of the Geostationary Orbit/Spectrum in the Fixed-Satellite Service", Proceedings of the IEEE, Vol. 68, No. 12, Dec. 1980, pp. 1484-1496.
- [26] Robert R. Brown, Kenneth E. Brown, Harjit S. Hothi and Edward F. Miller, "Development and Use of the Computer Software Package for Planning the 12 GHz Broadcasting-Satellite service at RARC '83", Journal on Selected Areas in Communications, Vol. SAC-3, No. 1, Jan. 1985, pp. 36-43.
- [27] "Software Package for Planning the Region 2 12 GHz BSS", Inter-American Telecommunications Conference, Mexico, D. F., Mexico, Sep. 28, 1981.
- [28] J. Christensen, "BSS-CAPS, A System Description", Preparatory Seminar for RARC '83 on Broadcast Satellite Planning Principles and Methodology, May 4-8, 1981, Ottawa, Canada.

- [29] C. A. Levis, C. H. Martin, D. Gonsalvez and C. W. Wang, "Engineering Calculations for Communications Satellite Systems Planning", Second interim report 71-3533-3, NASA Grant No. NAG 3-159, NASA Lewis Research Center, June 1983.
- [30] C. H. Reilly, C. A. Mount-Campbell, D. J. Davis, C. H. Martin, C. A. Levis and C. W. Wang, "Broadcasting Satellite Service Synthesis Using Gradient and Cyclic Search Procedures", presented in the Eleventh American Institute of Aeronautics and Astronautics (AIAA) Communication Satellite Systems Conference, San Diego, March 1986.
- [31] Final Acts of the World Administrative Radio Conference, International Telecommunication Union, Geneva, 1979.
- [32] Report 215-4, "Systems for the Broadcasting-Satellite Service (Sound and Television)", Sec. 4, Recommendations and Reports of the CCIR, 1978, Vol. XI: Broadcasting Service (Television), International Telecommunication Union, Geneva 1978, P. 172.
- [33] Op. cit. [32], Sec. 4.2, p. 173.
- [34] Op. cit [32], Secs. 2.4 and 4.2.2, pp. 168 and 173.
- [35] Report 711-1, "Criteria of Efficiency of Use of the Geostationary-Satellite Orbit", Annex II, "Methodology for Relating An Orbit-Spectrum Utilization Measure to System Parameters", Sec. 2, Recommendations and Reports of the CCIR, 1982, Vol. IV, Part 1: Fixed-Satellite Service, International Telecommunication Union, Geneva 1982, p. 409.
- [36] Op. cit. [32], Sec. 3, p. 169.
- [37] Op. cit. [10], Sec. 3.3, p. 95.
- [38] Report 811, "Broadcasting-Satellite Service", Sec. 3.3, Recommendations and Reports of the CCIR, 1978, Vol. XI: Broadcasting Service (Television), International Telecommunication Union, Geneva 1978, p. 286.
- [39] Op. cit. [35], Annex II, Sec. 4, p. 410.
- [40] Report 870, "Technical Coordination Methods for Communications-Satellite Systems", Sec. 4.2, Recommendations and Reports of the CCIR, 1982, Vol. IV, Part 1: Fixed-Satellite Service, International Telecommunication Union, Geneva 1982, p. 313.

- [41] "Sharing between the Inter-Satellite Service and the Broadcasting-Satellite Service in the Vicinity of 23 GHz", Doc. 10-11S/26-E (U.S.A.), CCIR Document.
- [42] L. J. Ricardi, "Communication Satellite Antennas", Proceedings of the IEEE, Vol. 65, No. 3, March 1977, pp. 356-369.
- [43] R. W. Kreutel, Jr., D. F. DiFonzo, W. J. English and R. W. Gruner, "Antenna Technology for Frequency Reuse Satellite Communication", Proceedings of the IEEE, Vol. 65, No. 3, March 1977, pp. 370-378.
- [44] Report 811, "Broadcasting-Satellite Service", Recommendations and Reports of the CCIR, 1978, Vol. XI: Broadcasting Service (Television), International Telecommunication Union, Geneva 1978, pp. 285-290.
- [45] Sec. 5.1.11, "Satellite Station-Keeping and Antenna Pointing Accuracy", Technical Bases for the Regional Administrative Radio Conference 1983 for the Planning of the Broadcasting-Satellite Service in Region 2, Report of the CCIR Conference Preparatory Meeting, International Telecommunication Union, Geneva, 1982, p.118.
- [46] Sec. 1.3, "Beam area", op. cit. [10]
- [47] Recommendation 566, "Terminology Relative to the Use of Space Communication Techniques for Broadcasting", Recommendations and Reports of the CCIR, 1978, Vol. XI: Broadcasting Service (Television), International Telecommunication Union, Geneva 1978, pp. 161-162.
- [48] Report 558-2, "Satellite Antenna Patterns in the Fixed-Satellite Service", Recommendations and Reports of the CCIR, 1982, Vol. IV, Part 1: Fixed-Satellite Service, International Telecommunication Union, Geneva 1982, pp. 369-393.
- [49] H. Akima, "A Method for Determining the Minimum Elliptical Beam of a Satellite Antenna", NTIA Report 81-88, U.S. Department of Commerce, 1981.
- [50] J. Davidson and P. Sawitz, "Spectrum/Orbit Utilization Program. User and Programmer's Manual (SOUP-3)", Prepared by ORI, Silver Spring, MD 20910 Under Contract NAS 3-22884 for NASA/Lewis Research Center, 1981.

- [51] Sec. 5.1.10.3, "Earth-Station Receiving Antenna", Fig. 5-6, Curve B, Technical Bases for the Regional Administrative Radio Conference 1983 for the Planning of the Broadcasting-Satellite Service in Region 2, Report of the CCIR Conference Preparatory Meeting, International Telecommunication Union, Geneva, 1982, p. 115.
- [52] Sec. 5.1.10.1, "Spacecraft Transmitting Antenna Reference Pattern", Fig. 5-4, Technical Bases for the Regional Administrative Radio Conference 1983 for the Planning of the Broadcasting-Satellite Service in Region 2, Report of the CCIR Conference Preparatory Meeting, International Telecommunication Union, Geneva 1982, p. 111.
- [53] J. Davidson, H. R. Ottey, P. Sawitz and F.S. Zusman, "Spectrum Orbit Utilization Program Documentation: SOUP5 Version 3.8 Technical Manual", Eq. IV-B1, Prepared by ORI, Silver Spring, Maryland 20910 Under Contract NAS 3- 22885 for NASA Lewis Research Center, June 1984.
- [54] C. A. Balanis, Antenna Theory, Analysis and Design, Sec. 2.7, Harper & Row, Publishers, New, York.
- [55] Sec. 5.1.10.1, "Spacecraft Transmitting Antenna Reference Pattern", Fig. 5-5, Technical Bases for the Regional Administrative Radio Conference 1983 for the Planning of the Broadcasting-Satellite Service in Region 2, Report of the CCIR Conference Preparatory Meeting, International Telecommunication Union, Geneva, 1982, pp. 112-113.
- [56] NASA Lewis Research Center, Private Communication.
- [57] Op. cit. [48], Sec. 3.3, pp. 384-385.
- [58] Report 391-4, "Radiation Diagrams of Antennas for Earth Station in the Fixed-Satellite Service for Use in Interference Studies and for the Determination of a Design Objective", Recommendations and Reports of the CCIR, 1982, Vol. IV, Part 1: Fixed-Satellite Service, International Telecommunication Union, Geneva 1982, pp. 186-200.
- [59] Recommendation 580, "Radiation Diagrams for Use as Design Objectives for Antennas of Earth Stations Operating with Geostationary Satellites", Recommendations and Reports of the CCIR, 1982, Vol. IV, Part 1: Fixed-Satellite Service, International Telecommunication Union, Geneva 1982, pp. 184-185.

- [60] Sec. 5.2.5.1, "Earth Station Transmit Antenna Side Lobes", Technical Bases for the Regional Administrative Radio Conference 1983 for the Planning of the Broadcasting-Satellite Service in Region 2, Report of the CCIR Conference Preparatory Meeting, International Telecommunication Union, Geneva, 1982, p.137.
- [61] Sec. 5.1.7.2, "Adjacent Channel Protection Ratio (FMTV)", Technical Bases for the Regional Administrative Radio Conference 1983 for the Planning of the Broadcasting-Satellite Service in Region 2, Report of the CCIR Conference Preparatory Meeting, International Telecommunication Union, Geneva, 1982, p. 105.
- [62] Op. cit. [62], p. 104.
- [63] W. L. Stutzman and G. A. Thiele, Antenna Theory and Design, Chapter 1, John Wiley and Sons, Inc., New York, 1981.
- [64] Op. cit. [50], Sec. III, p. III.1.
- [65] Op. cit. [44], Sec. 7, "Power Flux-Density Required".
- [66] Op. cit. [5], Sec. 6, p. 222.
- [67] Report 564-1, "Propagation Data Required for Space Telecommunication Systems", Recommendations and Reports of the CCIR, 1978, Vol. V: Propagation in Non-ionized Media, International Telecommunication Union, Geneva 1978.
- [68] Op. cit. [5], Sec. 8.2, p. 224.
- [69] Op. cit. [10], Sec. 3, p. 96.
- [70] Op. cit. [10], Sec. 2, pp. 91-92.
- [71] H. A. Rosen, "Syncom and Its Successors", Proceedings of the IEEE, Vol. 72, NO. 11, Nov. 1984, pp. 1429-1434.
- [72] Op. cit. [5], Sec. 10, p. 225.
- [73] Op. cit. [38], Sec. 6, p. 288.
- [74] Op. cit. [36], Sec. 4.4, p. 175.
- [75] Sec. 5.1.5, "Carrier-to-Noise ratio", Technical Bases for the Regional Administrative Radio Conference 1983 for the Planning of the Broadcasting-Satellite Service in Region 2, Report of the CCIR Conference Preparatory Meeting, International Telecommunication Union, Geneva, 1982, p. 94.

- [76] Report 866, "Interference Allocations in Analogue FM Systems Operating at Frequencies Greater Than 10 GHz in the Fixed-Satellite Service", Sec. 3.4, Recommendations and Reports of the CCIR, 1982, Vol. IV, Part 1: Fixed-Satellite Service, International Telecommunication Union, Geneva 1982, pp. 67-69.
- [77] Op. cit. [35], Annex II, Sec. 3, p. 410.
- [78] Annex 9, "Criteria for Sharing between Services", Final Acts of the World Administrative Radio Conference for the Planning of the Broadcasting-Satellite Service in Frequency Bands 11.7-12.2 GHz (in Regions 2 and 3) and 11.7-12.5 GHz (in Region 1), International Telecommunication Union, Geneva, 1977, pp. 104-108.
- [79] Report 867, "Maximum Permissible Interference in Single-Channel-Per-Carrier Transmissions in Networks of the Fixed-Satellite Service", Recommendations and Reports of the CCIR, 1982, Vol. IV, Part 1: Fixed-Satellite Service, International Telecommunication Union, Geneva 1982, pp. 99-102.
- [80] "FCC Adopts Reduced Satellite Orbital Spacing Criteria for 4/6 GHz and 12/14 GHz Bands", FCC News, (CC Docket 81-704), Report No. 17459, April 27, 1983.
- [81] D. G. Luenberger, Introduction to Linear and Nonlinear Programming, Sec. 7.6, 2nd Ed., Addison-Wesley Pub. Co., Reading, Mass., 1973.
- [82] Op. cit. [81], Sec. 7.8.
- [83] Op. cit [10], Sec. 3.12, p.101.
- [84] Report 808, "Broadcasting-Satellite Service", Sec. 2.1, Recommendations and Reports of the CCIR, 1978, Vol. XI: Broadcasting Service (Television), International Telecommunication Union, Geneva 1978, p. 256.
- [85] Op. cit. [9], Sec. 11.3, p.32.
- [86] C. H. Martin, D. J. Gonsalvez, C. A. Levis and C. W. Wang, "Engineering Calculations for Communications Satellite Systems Planning", Interim report 71-3533-4, NASA Grant No. NAG 3-159, NASA Lewis Research Center, Dec. 1983.
- [87] Op. cit. [78], Sec. 1.2, p. 105.
- [88] R. Garfinkel and G. Nemhauser, Integer Programming, John Wiley & Sons, 1972.

- [89] Report 453-3, "Technical Factors Influencing the Efficiency of Use of the Geostationary-Satellite Orbit by Radiocommunication Satellites Sharing the Same Frequency bands", Sec. 2.3, Recommendations and Reports of the CCIR, 1982, Vol. IV, Part 1: Fixed-Satellite Service, International Telecommunication Union, Geneva 1982, p. 276.
- [90] Donald M. Jansky and Michel C. Jeruchim, Communication Satellites in the Geostationary Orbit, Chapter 1, Artech House Inc., Dedham MA, 1983.
- [91] Robert R. Lovell, "Communications Technology Development in NASA", Seminar on Domestic Satellite Communications, Shanghai, Oct. 5-12, 1983.
- [92] Report 711-1, "Criteria of Efficiency of Use of the Geostationary-Satellite Orbit", Recommendations and Reports of the CCIR, 1982, Vol. IV, Part 1: Fixed-Satellite Service, International Telecommunication Union, Geneva 1982, pp. 402-415.
- [93] W. L. Pritchard, "The History and Future of Commercial Satellite Communications", Fig. 9, IEEE Communications Magazine, Vol. 22, No. 5, May 1984, p. 35.
- [94] "Communications Platform Payload Definition Study; Task 1: Data Base Development", COMSAT Laboratories, RCA Astro-Electronics, Under Contract NAS 3-24236 for NASA Lewis Research Center, Oct. 11, 1984.
- [95] Report 555-2, "Discrimination by Means of Orthogonal Circular and Linear Polarizations", Recommendations and Reports of the CCIR, 1982, Vol. IV, Part 1: Fixed-Satellite Service, International Telecommunication Union, Geneva 1982, pp. 334-361.
- [96] Y. Yamamura, "Calculation of Allowable Orbital Spacings for the Fixed-Satellite Service", Thesis, Electrical Engineering Department, The Ohio State University, June 1985.
- [97] C. A. Levis and Y. Yamamura, "Calculation of Allowable Orbital Spacings for the Fixed-Satellite Service", Technical Report 716548-1, The ElectroScience Laboratory, The Ohio State University, on Grant No. NAG 3-159, for NASA Lewis Research Center.
- [98] Op. cit. [89], Sec. 8.2.2, p. 293.
- [99] Wilbur L. Pritchard, "The history and Future of Commercial Satellite Communications", IEEE Communications Magazine, Vol. 22, No. 5, May 1984.



- [100] Op. cit. [90], Sec. 5.7.
- [101] Op. cit. [48], Annex II, p. 389.
- [102] Op. cit. [90], p. 254.
- [103] F. A. Tobagi, R. Binder and B. Leiner, "Packet Radio and Satellite Networks", IEEE Communications Magazine, Vol. 22, NO. 11, Nov. 1984, PP. 24-40.
- [104] S. J. Campanella and J. V. Harrington, "Satellite Communications Networks", Proceedings of the IEEE, Vol. 72, NO. 11, Nov. 1984, pp. 1506-1519.
- [105] O. L. Mangasarian, Nonlinear Programming, McGraw-Hill Book Co.