

168-12703

# X-Band Uplink Ground Systems Development: Part II

C. E. Johns

Radio Frequency and Microwave Subsystems Section

*The prototype X-band exciter testing has been completed. Stability and single-sideband phase noise measurements have been made on the X-band exciter signal (7.145–7.235 GHz) and on the coherent X- and S-band receiver test signals (8.4–8.5 GHz and 2.29–2.3 GHz) generated within the exciter equipment. Outputs are well within error budgets.*

## I. Introduction

Previous performance tests made on the prototype exciter have been reported [1], but at that writing, stability measurements of the exciter and the X- and S-band test signals had not been performed. In [1], a brief description of the exciter mechanization and the method of generating its reference signals was given, and some measurement data on the exciter phase-correcting and command verification loops was presented. Since that report, exciter signal stability measurements have been made, and the test data is presented here.

## II. Exciter Output Functions

### A. Exciter Stability

The exciter stability measurements ( $\Delta F/F$ ) were made at JPL using the maser test facility. A simplified diagram of the test setup is shown in Fig. 1. The exciter signal was set to 7.2 GHz + 1 Hz, and phase was compared with a stable 7.2-GHz signal generated from a hydrogen maser. The 1-Hz difference signal at the phase comparator output was fed to the Allan variance computer. In addition, the 100 MHz from the

maser was supplied to the 100-MHz input ports on the exciter and to the reference input on the exciter synthesizer (Dana).

The results of the exciter stability measurements are shown in Fig. 2. The stability at the 1000-s integration period is about  $2.5 \times 10^{-16}$ , which is nearly an order of magnitude better than the stability budget allotted to the exciter alone ( $1.7 \times 10^{-15}$ ) for the overall X-band uplink system.

Also measured was the single-sideband phase noise density ( $S\phi$ ), measured in a 1-Hz bandwidth, for frequencies from 1 Hz to 20 kHz. The results are shown in Fig. 3. Shown on the graph is the measurement of the upper limit of the test system noise floor. For the X-band uplink system, the specified maximum noise density at the 1-Hz offset from the carrier is  $-50$  dBc, and at a 1000-Hz offset, the specified maximum is  $-70$  dBc. The measured data shown in Fig. 3 indicates that the exciter signal phase noise is far below the specified limits.

### B. X-Band Test Signal Stability

The stability of the 8.4-GHz coherent receiver test signal is shown in Fig. 4. The data shows the stability at the

1000-s integration period to be about  $2.5 \times 10^{-16}$ , the same as the exciter signal. This is to be expected, since the X-band test signal ( $F_{x-x}$ ) comprises about 85 percent of the exciter output signal ( $F_x$ ) and 15 percent of the coherent translator reference signal ( $131 F_x/749$ ). The stability specification for the X-band test signal in the X-band uplink system is  $\leq 2.75 \times 10^{-15}$  at 1000 s.

The single-sideband phase noise measurement of the X-band test signal is shown in Fig. 5. Also included is the upper limit of the test system noise floor. No specified limits exist for the X-band test signal phase noise in the X-band uplink system.

### C. S-Band Test Signal Stability

The frequency stability of the 2.3-GHz coherent test signal is shown in Fig. 6. At the 1000-s integration period, the stability of the signal is about  $7 \times 10^{-16}$ . This is also to be expected, since the S-band signal comprises only about 68 percent of the exciter signal and 32 percent of the coherent translator signal

( $509 F_x/749$ ) that is generated by a 8144/749 frequency shifter module followed by a  $\times 5$  frequency multiplier. Like the X-band test signal, the specified S-band stability is  $\leq 2.75 \times 10^{-15}$  at 1000 s for the X-band uplink system. The measured single-sideband phase noise of the S-band signal and the upper limit of the test system noise floor are shown in Fig. 7. As with the X-band test signal, there are no specified phase noise limits for the S-band test signal.

## III. Conclusions

The measured exciter output and the X- and S-band test signal stabilities show that the signals are well within their specified error budget for the Deep Space Network X-band uplink project. Also, stability measurements made on the original X-band exciter at DSS-13 have shown that the long-term stability, including the instability of the uncompensated 43-MHz cable from the control room to the antenna equipment, is within  $2.5 \times 10^{-15}$  [2].

## References

- [1] C. E. Johns, "Block III X-Band Receiver-Exciter," *TDA Progress Report 42-89*, vol. January-March 1987, Jet Propulsion Laboratory, Pasadena, California, pp. 83-93, May 15, 1987.
- [2] T. Y. Otoshi and M. M. Franco, "DSS-13 Stability Tests," *TDA Progress Report 42-89*, vol. January-March 1987, Jet Propulsion Laboratory, Pasadena, California, pp. 1-20, May 15, 1987.

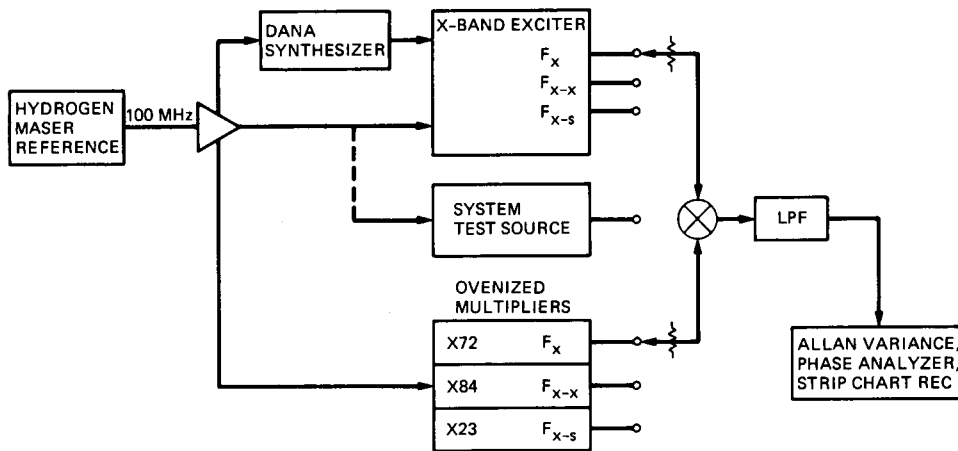

Fig. 1. Exciter test setup block diagram

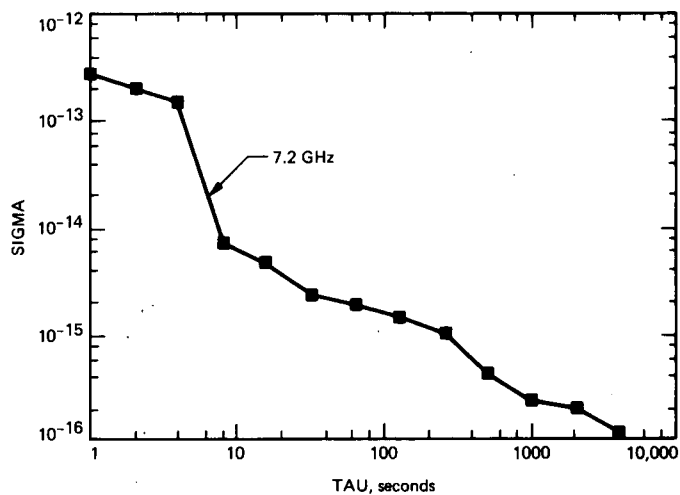

Fig. 2. Exciter output stability

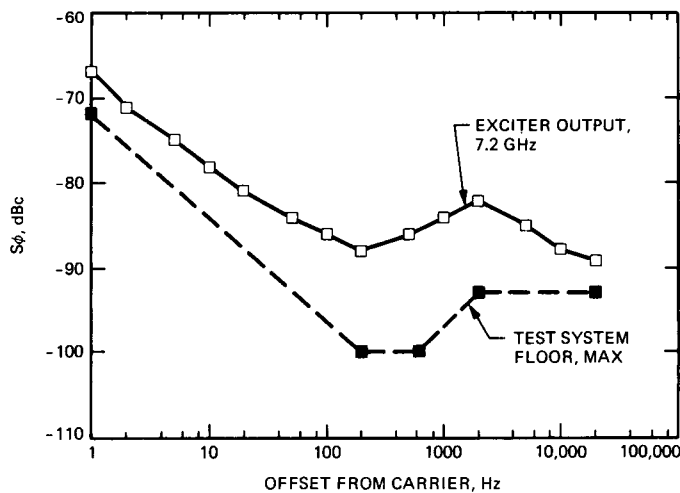

Fig. 3. Exciter phase noise

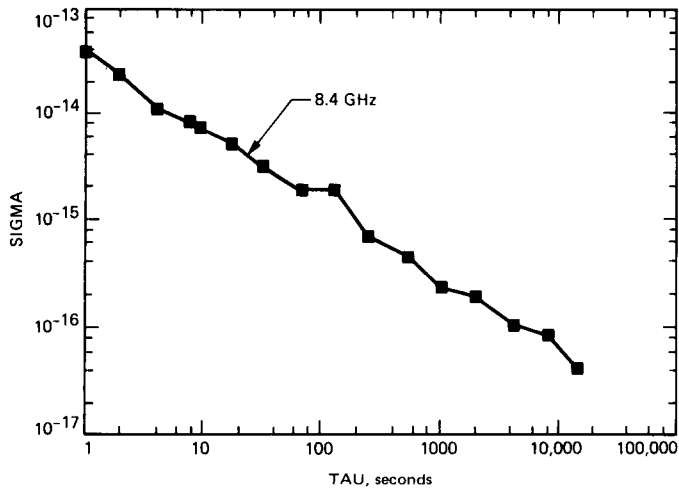

Fig. 4. X-band test signal stability

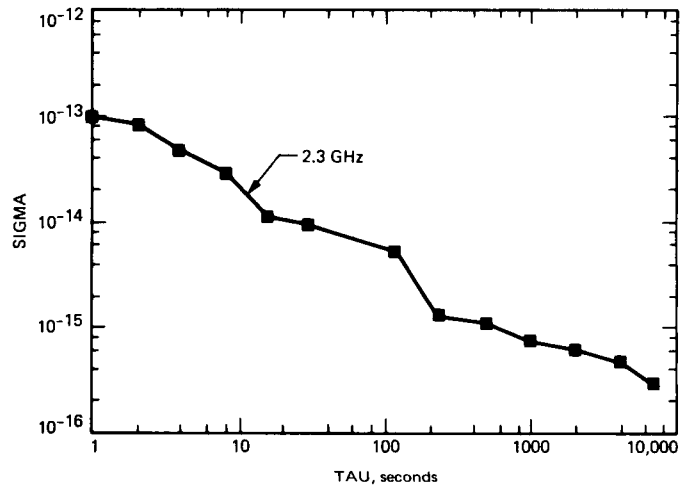

Fig. 6. S-band test signal stability

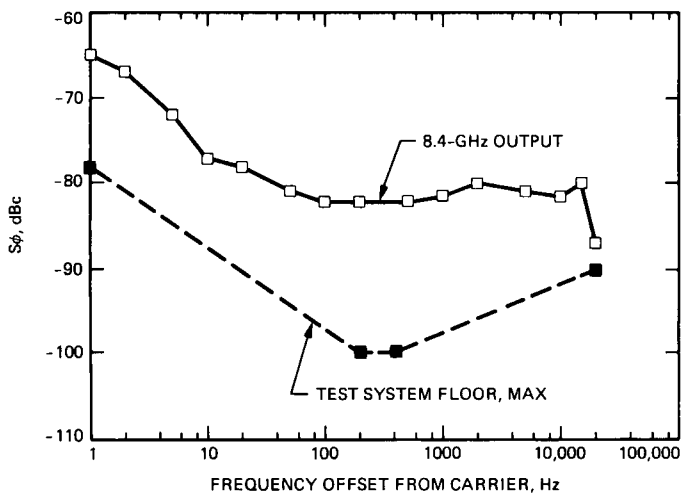

Fig. 5. X-band test signal phase noise

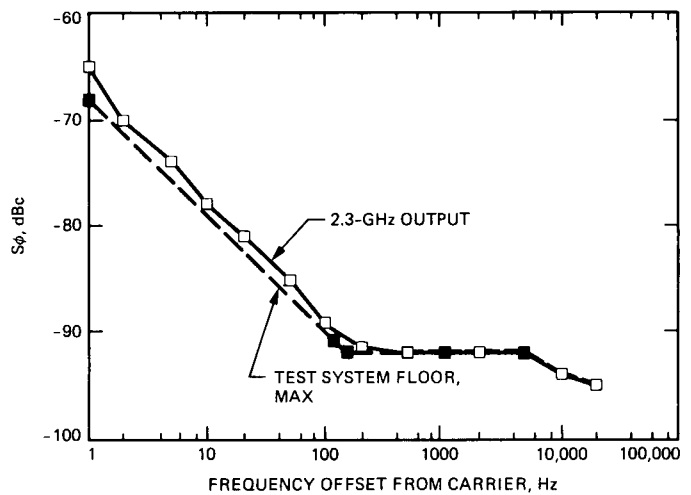

Fig. 7. S-band test signal phase noise