

46  
1

# NASA Contractor Report 172462

P-197

## Structural Tests and Development of a Laminar Flow Control Wing Surface Composite Chordwise Joint

IN-01  
117202

L. B. Lineberger

DATE  
OVERRIDE

LOCKHEED-GEORGIA COMPANY  
Marietta, Georgia 30063

CONTRACT NAS 1-17487  
December 1984

(NASA-CR-172462) STRUCTURAL TESTS AND  
DEVELOPMENT OF A LAMINAR FLOW CONTROL WING  
SURFACE COMPOSITE CHORDWISE JOINT Final  
Report (Lockheed-Georgia Co.) 197 p

N88-14066

Unclas  
CSCL 01A G3/01 0117202

marked on any reproduction of this document  
be three (3) years from date indicated on the document.



National Aeronautics and  
Space Administration

Langley Research Center  
Hampton, Virginia 23665

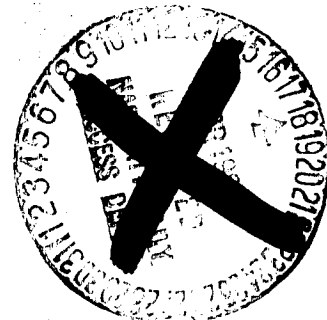

## FOREWORD

Contract NAS1-17487 between the National Aeronautics and Space Administration and the Lockheed-Georgia Company, effective August 8, 1983, provides under Task No. 3 for preparing a final NASA Contractor Report, documenting the test articles development and testing activities. The Contract is sponsored by the Aircraft Energy Efficiency (ACEE) Project Office of the Langley Research Center, with Dal V. Maddalon serving as Technical Monitor. This document, submitted in fulfillment of DRL-003-2 of the subject contract, constitutes the final report.

At the Lockheed-Georgia Company, the Contract was accomplished under the cognizance of R. H. Lange, Manager, Advanced Concepts Department, with L. B. Lineberger serving as Project Manager. Principal participants in this contract effort were as follows:

R. T. Beall	Manufacturing Development
G. J. Gilbert	Development Testing

This report is identified as LG84ER0113 by Lockheed-Georgia Company for internal control purposes.

PRECEDING PAGE BLANK NOT FILMED

I, II

## TABLE OF CONTENTS

<u>Section</u>	<u>Title</u>	<u>Page</u>
	FOREWORD	iii
	LIST OF FIGURES	ix
	LIST OF TABLES	xi
1.0	SUMMARY	1
2.0	INTRODUCTION	3
3.0	ABBREVIATIONS AND SYMBOLS	5
4.0	LFC WING STRUCTURAL CONFIGURATION AND DEVELOPMENT TEST PROGRAM	7
4.1	Wing Configuration	7
4.2	LFC Wing Structural Design	7
4.3	Wing Box Cover	8
4.4	Development Test Program	10
5.0	CV2 PANELS FABRICATION PROCESSES	11
5.1	Fabrication and Assembly	15
5.1.1	Materials	15
5.1.2	Layup and Cure - Hat Stiffener	15
5.1.3	Skin Layup and Cure	17
5.1.4	Surface Panel Assembly	22
5.1.5	Fabrication and Assembly of the Rib Cap Assembly	23
5.1.6	Chordwise Joint Assembly	25
5.2	Repair/Rework of Hat to Skin Attachment	27
6.0	CONCEPT VERIFICATION WING SURFACE SINGLE HAT/CHORDWISE JOINT TEST - CV2-1, TENSION STATIC	29
6.1	CV2-1 Test Objectives	29

PRECEDING PAGE BLANK NOT FILMED

TABLE OF CONTENTS Cont'd

<u>Section</u>	<u>Title</u>	<u>Page</u>
6.2	CV2-1 Test Specimen	29
6.3	CV2-1 Test Loads	29
6.4	CV2-1 Test Procedures and Instrumentation	29
6.4.1	CV2-1 Suction Flow Tests	29
6.4.2	CV2-1 Tension Tests	30
6.5	CV2-1 Summary of Test Results	30
6.5.1	CV2-1 Summary of Suction Flow Evaluation	30
6.5.2	CV2-1 Summary of Tension Static Test Results	34
7.0	CONCEPT VERIFICATION WING SURFACE SINGLE HAT/CHORDWISE JOINT TEST - CV2-2, FATIGUE/STATIC TENSION	43
7.1	CV2-2 Test Objectives	43
7.2	CV2-2 Test Specimen	43
7.3	CV2-2 Test Loads	43
7.4	CV2-2 Test Procedures and Instrumentation	43
7.4.1	CV2-2 Fatigue Tests	43
7.4.2	CV2-2 Tension Tests	52
7.5	CV2-2 Summary of Test Results	52
7.5.1	CV2-2 Summary of Fatigue Test Results	52
7.5.2	CV2-2 Summary of Residual Strength - Static Tension - Results	52
8.0	CONCLUDING REMARKS	57
	REFERENCES	59
APPENDIX A	Drawings LGA 124A-326 "WSSD CV-2 Specimen" -5 Sheets + Repair Bolts Installation	A-1
APPENDIX B	CV2-1 Loading Check Strain Gauge Readings	B-1
APPENDIX C	CV2-1 Loading Check With Ribs Attached Strain Gauge Readings	C-1

TABLE OF CONTENTS Cont'd

<u>Section</u>	<u>Title</u>	<u>Page</u>
APPENDIX D	CV2-1 Test Strain Gauge Readings	D-1
APPENDIX E	CV2-1 Test With Repair Bolts Strain Gauge Reading	E-1
APPENDIX F	CV2-2 Fatigue Test Strain Survey	F-1
APPENDIX G	CV2-2 Residual Strength Tension Test Strain Gauge Readings	G-1
APPENDIX H	CV2-2 Residual Strength Tension Test Strain Gauge Readings - Plots	H-1

## LIST OF FIGURES

<u>Figure</u>	<u>Title</u>	<u>Page</u>
1	LFC Wing Structural Design	7
2	Wing Structural Arrangement - 1993 LFC Transport	8
3	Wing Box Upper Cover - 1993 LFC Transport	8
4	Typical Hat Stiffener Wing Box Cover	9
5	Integrated Wing Surface Panel Development	10
6	Schematic of Hat Layup for Cure	11
7	Female Hat Tool Just Prior to Layup of Hat Plies	12
8	Hat Tool with all Details in Place	12
9	Skin Tool with Skin Layup	13
10	View of Open (Free) End of Tool with a Closeup View of First Two Titanium Skins in Place	14
11	View of Hat Ply Template and Prepreg Ply	14
12	Photograph Showing a Two-Ply Detail Being Formed into the Hat Tool	16
13	View of Hat Tool and Layup in Autoclave	16
14	Cured Hat Stiffener	17
15	Titanium Detail with Adhesive Applied	18
16	Skin Tool Showing First G/E Ply in Place and Titanium Detail Pinned to Locator Pins	18
17	End of Skin Tool Showing all Titanium Details in Place	19
18	Overall View of Skin Tool with Completed Skin Layup	19
19	Skin Layup Ready for Bagging for Cure	20
20	Exterior Side of Cured Skin	20
21	Interior Side of the Skin Panel after Removal from Tool	21
22	End of Skin Showing Titanium Detail Misfit	21

LIST OF FIGURES Cont'd

<u>Figure</u>	<u>Title</u>	<u>Page</u>
23	View of Hat and Skin Stiffener Being Prefitted Prior to Bonding	22
24	View of Rib Cap Assembly from Specimen End	23
25	View of Rib Cap Assembly from Center of Specimen	24
26	Overall View of CV2 Specimen with Rib Cap Assembly Installed	24
27	View of CV2 Specimen Showing Outer Surface	25
28	View of CV2 Specimen Showing Inner Surface	25
29	Overall View of Side of CV2 Specimen with Instrumentation Installed	26
30	View of Outer Surface with Instrumentation Installed	26
31	Flow vs. Pressure Loss	33
32	Slot Spanwise Flow Distribution	34
33	CV2-1 Test Setup	35
34	CV2-1 Test Setup	36
35	CV2-1 Specimen Damage-Skin	41
36	CV2-1 Specimen Damage - Bolt Bearing	42
37	CV2-2 Fatigue Test Setup	46
38	CV2-2 Fatigue Test Setup	46
39	CV2-2 Fatigue Test Setup with Environmental Chamber	48
40	CV2-2 Fatigue Test Temperature Cycles	49
41	CV2-2 Residual Strength Test Damage - Titanium Skin	54
42	CV2-2 Residual Strength Test Damage - Hat and Skin	54
43	CV2-2 Residual Strength Test Damage - Hat/Skin Side	55
44	CV2-2 Residual Strength Test Damage - Hat and Skin	55

## LIST OF TABLES

<u>Table</u>	<u>Title</u>	<u>Page</u>
1	Design and Predicted Loads	9
2	CV2-1 Strain Gauge Location	31
3	CV2 Dial Gauge Location	32
4	CV2-1 Loading Check-Dial Gauge Readings	35
5	CV2-1 Loading Check with Ribs Dial Gauge Readings	36
6	CV2-1 Test-Dial Gauge Readings	37
7	CV2-1 Panel Slot Widths Readings Before Testing	38
8	CV2-1 Test Slot Width Readings	39
9	CV2-1 Test with Bolts-Dial Gauge Readings	40
10	CV2-1 Test with Bolts Slot Width Readings	40
11	CV2-2 One Lifetime Load Spectrum	44
12	CV2-2 Strain Gauge Location	45
13	CV2-2 Thermocouple Map	48
14	CV2-2 Fatigue Test Slot Width Measurements, Load = 0.0 KIPS	49
15	CV2-2 Fatigue Test Slot Width Measurements, Load = 40.0 KIPS	50
16	CV2-2 Fatigue Test Slot Width Measurements, Load = 60.0 KIPS	51
17	CV2-2 Residual Strength Test Slot Width Measurements	53
18	CV2-2 Residual Strength Test-Dial Gauge Readings	53
19	Graphite-Epoxy Lamina Properties - Wet	56



## 1.0 SUMMARY

This report documents Lockheed's results in designing, fabricating, and testing under NASA Contract NAS1-17487, "Development of Laminar Flow Control Wing Surface Composite Structures," (WSCS) which continues the development of technology for the integrated LFC wing structural concept identified in Phase I, Reference 1. The ultimate objective is to permit incorporation of LFC into long-range commercial jet transports in the post--1990 period. The specific objectives of the WSCS project reported herein support this program objective and include; continue development of the integrated LFC wing structural concept identified in Phase I, and demonstrate that this concept can be efficiently applied to the surface of a future commercial transport.

In satisfying these objectives, the project was organized into three major tasks.

- 1) Preparation of a NASA Contractor Report documenting the NAS1-16235, "LFC Wing Panel Structural Design and Development" (WSSD) design, manufacturing and testing activities.
- 2) Fabricate two chordwise joint concept verification test panels (defined in Reference 2 as CV2).
- 3) Conduct tests on two CV2 panels to verify the static tension and fatigue strength of these LFC wing surface chordwise joints.

The results from the NAS1-16235 Program were documented in a NASA Contractor Report (CR172330) reference 2, during task 1.

In task 2 of the present study, two CV2 panels were fabricated. Structurally, the CV2 concept verification panels were designed to satisfy the requirements of the wing upper surface structure of the 1993 LFC transport wing at approximately 55 percent semi-span (reference 2). Both panels were fabricated using materials and processes established by the materials verification and concept selection tests previously conducted in reference 2.

The principal objectives of the two CV2 panel tests, task 3.0, were to verify the static tension and fatigue strength of the wing surface chordwise joints.

These principal objectives were achieved. The CV2 panel withstood four lifetimes of fatigue loading in a hot/wet environment without any failures. Also, of the two CV2 panels tested in static tension, one failed within 2 percent of the predicted allowable load.

## 2.0 INTRODUCTION

The recognition of potential long-term shortages of petroleum-based fuel, evidenced by dramatic increases in costs and periods where availability was limited, has since 1973, emphasized the need for improving the fuel efficiency of long-range transport aircraft. In 1976, in response to this need, the NASA established the Aircraft Energy Efficiency (ACEE) program with the objective of maintaining the U.S. competitive advantage through development of new technology for fuel efficiency. Of all advanced-technology concepts currently under consideration for application during the next two decades, Laminar Flow Control (LFC) offers the greatest potential for improving the fuel efficiency of transport aircraft. Consequently, LFC is one element of the ACEE program.

Both the theoretical methods and engineering and design techniques requisite to the application of LFC have been reasonably well-known since the mid-1940's. The validity of this background and the potential of LFC were partially evaluated in the 1960-1966 period by Northrop as a part of the X21A LFC Demonstration Program.

In the process of formulating the current LFC Program, the NASA sponsored a "Workshop on Laminar Flow Control," at the NASA Langley Research Center in April 1976. Attendees included representatives of the aircraft industry, the airlines, the Department of Defense, and the NASA. It was the general consensus of the workshop participants that the following tasks must be accomplished prior to the incorporation of LFC on an operational aircraft:

- (1) LFC structure and systems with acceptable weight and cost penalties must be developed.
- (2) Procedures for the economical manufacturing of LFC structure in a production environment are required.
- (3) The operational reliability of LFC in the airline environment must be demonstrated.

NASA formulated a three-phase program with the goal of developing LFC technology to permit application to aircraft in the 1990 period.

The Phase I effort, concluded in September 1978, resulted in the definition of candidate LFC systems for application to future production aircraft. Phase II, of which this contract is a part, involves the design and development of selected structural concepts, and initial development and testing of selected leading-edge subsystems. The final phase, Phase III, is envisioned as encompassing the design, fabrication, and flight demonstration of an integrated LFC system in a validator aircraft.

A central problem in the definition of a feasible production configuration for LFC transports is the development of LFC surface designs which satisfy aerodynamic requirements without imposing unacceptable structural weight penalties, manufacturing costs, and operational requirements. Consequently, during Phase I of the LFC program, extensive investigations were conducted in

the development of structural concepts for the wing-box region of the wing of an LFC transport. As a part of the development, alternative structural concepts were evaluated, detailed designs were developed for selected concepts, manufacturing procedures were established, and full-scale structural specimens were fabricated and tested.

The selected LFC surface design for the wing-box region is a structural skin and hat-section stiffener configuration with LFC ducting and metering integrated into the structure. The structural elements are fabricated of graphite/epoxy composites, with a titanium outer face sheet for lightning protection and resistance to erosion and corrosion. During Phase I, three 3 ft x 5 ft LFC surface panels were fabricated and subjected to extensive environmental and structural testing which validated the design concept.

The "Laminar Flow Control Wing Panel Structural Design and Development" project continued the development of the integrated LFC wing structural concept identified during Phase I of the LFC program sponsored by the ACEE Project Office of the Langley Research Center. NASA Contractor Report 172330, Reference 2 summarizes progress in the application of this concept to the wing of a 1993 LFC transport. Details of the LFC system and wing surface structure were developed by a preliminary design of the wing and verified by an ancillary test program. In Reference 2, Costs of the LFC transport were compared to those of an equivalent technology non-LFC transport designed for the same mission. Manufacturing processes were described and plans were outlined for the fabrication and testing of a large section of the wing surface to demonstrate that the integrated LFC wing surface structural concept can be efficiently applied to a future commercial transport.

The present work, reported on herein and conducted under a NASA Contract entitled "Development of Laminar Flow Control Wing Surface Composite Structures: project also continues the development of the integrated LFC wing structural concept identified during Phase I. This report summarizes progress in the application of this concept to the wing of a 1993 LFC transport. Whereas the WSSD project verified the static compression strength of the integrated LFC wing concept, (Reference 2) the present work verified the static tension and fatigue strengths of the wing surface chordwise joint.

Use of commercial products or names of manufacturers in this report does not constitute official endorsement of such products or manufacturers, either expressed or implied, by the National Aeronautics and Space Administration.

### 3.0 ABBREVIATIONS AND SYMBOLS

ACEE	AIRCRAFT ENERGY EFFICIENCY
AL/AL	ALUMINUM/ALUMINUM
ASSY	ASSEMBLY
C	CHORD, CRUISE
CL	CENTERLINE
CONT'D	CONTINUED
CS	CONCEPT SELECTION
CV	CONCEPT VERIFICATION
DIA	DIAMETER
DRL	DOCUMENTS REQUIREMENT LIST
FT	FEET
GR/EP, G/E	GRAPHITE/EPOXY
HZ	HERTZ - CYCLE PER SECOND
IN	INCHES
K	KIPS, 1000 POUNDS
KIPS/IN, K/IN	1000 POUNDS PER INCH
KSI	1000 POUNDS PER SQUARE INCH
L	LEFT
LB	POUNDS
LB/FT <sup>2</sup>	POUNDS PER SQUARE FOOT
LBM/SEC	POUND METER PER SECOND
LE	LEADING EDGE
LEFT	LEADING EDGE FLIGHT TEST
LFC	LAMINAR FLOW CONTROL
M	MACH NUMBER
MAX	MAXIMUM
MFG	MANUFACTURE
MI	MILE
MIN	MINUTE, MINIMUM
MV	MATERIAL VERIFICATION
N	NAUTICAL, LOADING
NAS	NATIONAL AIRCRAFT STANDARDS
NDI	NON DESTRUCTIVE INSPECTION
NO	NUMBER
NX	END LOAD
P	LOAD, POUNDS, PRESSURE
PSF	POUNDS PER SQUARE FOOT
PSI	POUNDS PER SQUARE INCH
R	RIGHT, RADIUS

SQ	SQUARE
STM	STANDARD MATERIAL
STP	STANDARD PROCESS
T	THICKNESS
TI	TITANIUM
TYP	TYPICAL
WS	WING STATION
WSCS	LAMINAR FLOW CONTROL WING SURFACE COMPOSITE STRUCTURE
WSSD	LAMINAR-FLOW CONTROL WING PANEL STRUCTURAL DESIGN AND DEVELOPMENT
X21A	NORTHROP LFC TEST AIRCRAFT (B-66)

SYMBOLS

&	AND
"	INCH
%	PERCENT
o	DEGREE
#	NUMBER
1st	FIRST
2nd	SECOND

**4.0 LFC WING STRUCTURAL CONFIGURATION  
AND DEVELOPMENT TEST PROGRAM**

**4.1 WING CONFIGURATION**

During Phase I, Lockheed conducted a comprehensive system study to evaluate the advantages of Laminar Flow Control (LFC) for future transport aircraft in the 1985-1995 time period. The study showed the use of LFC resulted in significant reductions of aircraft weight, fuel consumption, and direct operating costs.

Investigations were conducted to determine the optimum configuration for a 400-passenger long-range transport featuring LFC. The LFC aircraft configuration was optimized for a 84,800 lb payload, a range of 6500 n mi at cruise  $M = 0.80$  and 10,000 ft field length. This aircraft included advanced technology applications such as supercritical airfoil shapes, active controls, and composite primary and secondary structures (Reference 1).

**4.2 LFC WING STRUCTURAL DESIGN**

The baseline LFC wing concept developed during the LFC WSSD project is shown in Figure 1. Airflow from slots in the leading edge, upper surface, and lower surface into an internal system of ducts, to the main trunk ducts in the leading edge (shown by the arrows). Figure 2 shows the layouts of the basic structural geometry of the wing and the location of the principal structural members.

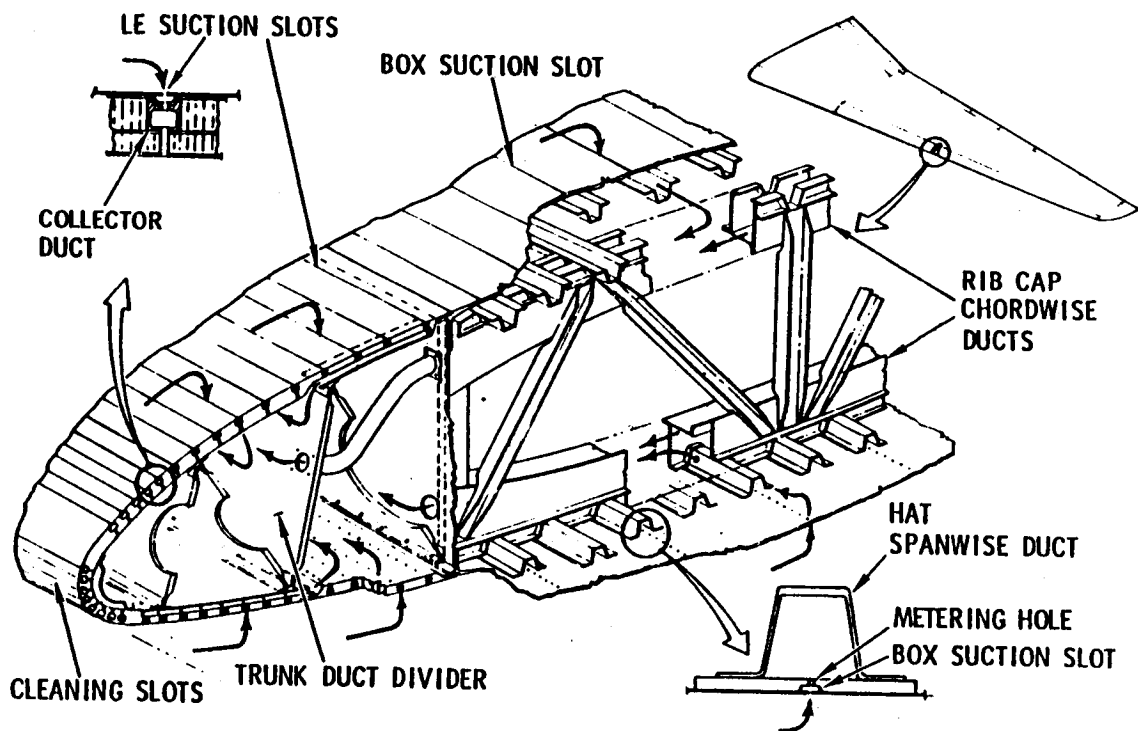

Figure 1. LFC Wing Structural Design

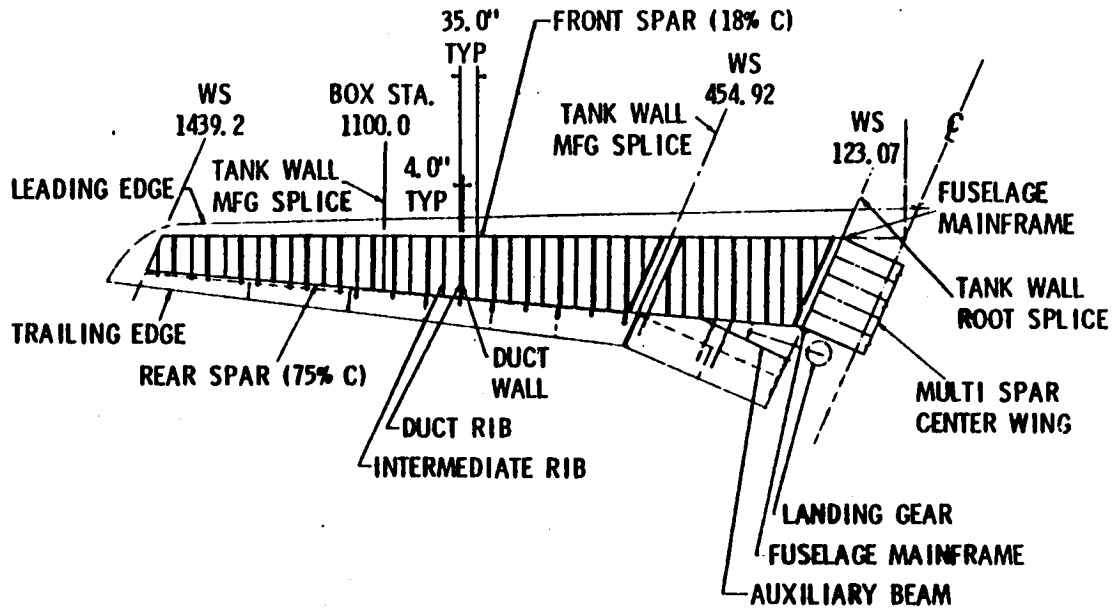

Figure 2. Wing Structural Arrangement - 1993 LFC Transport

#### 4.3 WING BOX COVER

The LFC wing box upper cover for the 1993 LFC transport is shown in Figure 3. The wing box upper surface extends from the WS 123 root splice to the W.S. 1439 tip. The cover is broken into three sections for manufacture and spliced at WS 454 and Box Sta. 1100. Each cover segment consists of a bonded assembly of titanium outer sheet, graphite/epoxy inner skin, spanwise hat stiffeners, rib caps, rib ducts, spar caps, and miscellaneous clips.

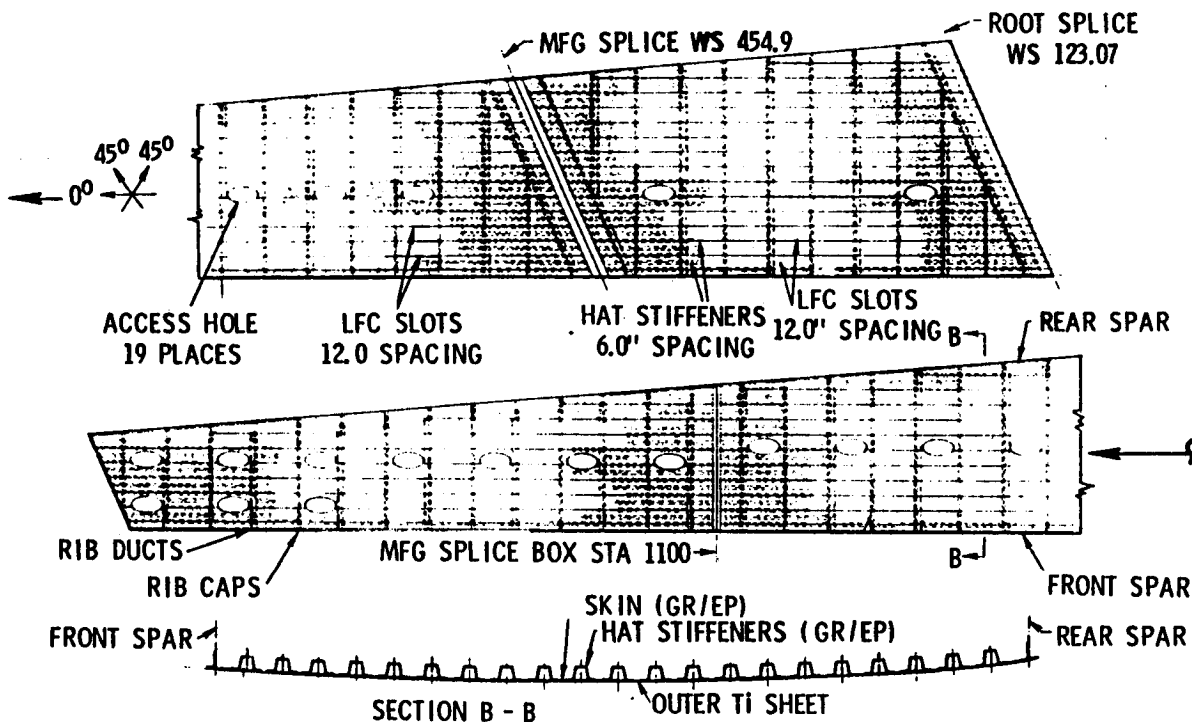

Figure 3. Wing Box Upper Cover - 1993 LFC Transport

Spanwise slots, spaced 6 inches apart, are cut through the titanium sheet. Slot ducts in the graphite/epoxy skin are located under each slot. Metering holes are drilled through the slot ducts to collect the air in the hat stiffeners. The surface slots and slot ducts are centered over spanwise hat-section stiffeners. The geometry of this configuration is depicted in Figure 4.

The wing ultimate design upper surface loads are -15.9 KIPS/in and +7.6 KIPS/in compression and tension respectively (see Table 1).

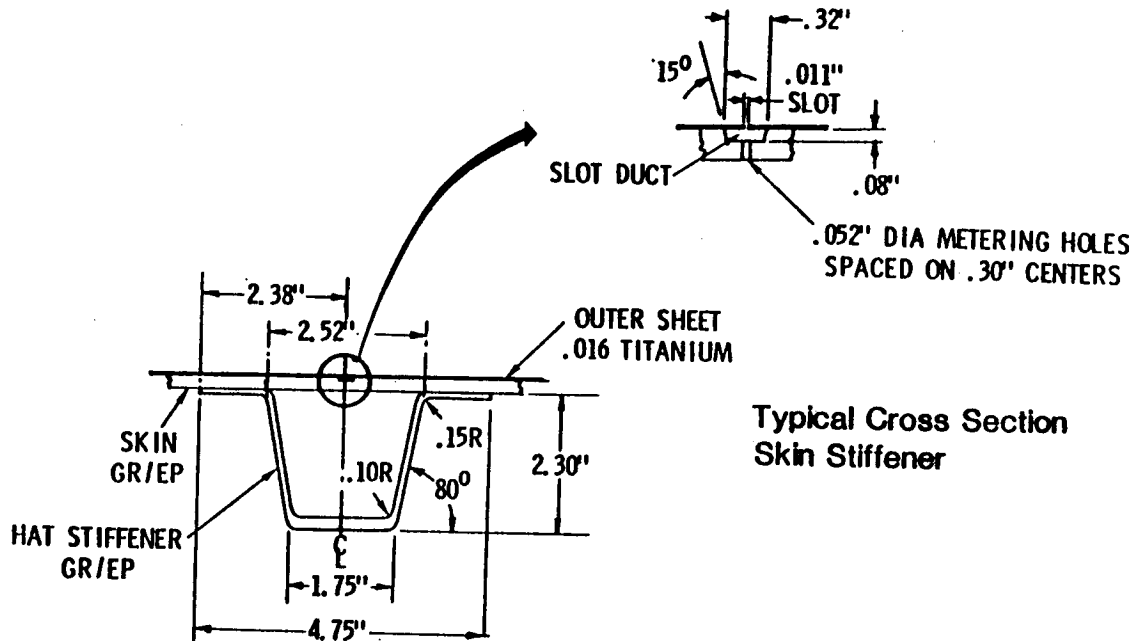

TABLE 1. DESIGN AND PREDICTED LOADS

TYPE OF LOAD	UNITS	UPBENDING COMPRESSION	DOWNBENDING TENSION
Design			
o NX (Ultimate)	KIPS/IN	- 15.9	+ 7.6
Design (7 IN)			
o Ultimate	KIPS	-111.3	+53.2
o 1g (LFC)	KIPS	- 29.7	+17.7
Predicted			
o Load	KIPS	-111.3	+154.0 Gross +133.0 Net
o Strain	IN/IN	-0.0065	+0.0084 Gross +0.0087 Net



#### 4.4 DEVELOPMENT TEST PROGRAM

The original long-range plan for developing the LFC wing surface is summarized in Figure 5. A series of material verification (MV) specimens were fabricated and tested to verify the materials and processes. Concept selection (CS) specimens were used to develop the critical design details, tools and manufacturing processes. Concept verification (CV) anticipates the manufacture and test of the large surface panel. The first panels made on the wing surface tool will be structurally tested to verify the design and the tool. These panels are identified as CV-1 and CV-2. The large panel assembly with ribs, rib ducts, chordwise joints and spar caps is identified as CV-4. CV-4 will be installed in a simulated wing box for testing the integrated LFC wing structure under simulated flight loads. The CV panels were not fabricated in the original WSSD program (reference 2). The present report summarizes the fabrication and test of the chordwise joint CV2 panel.

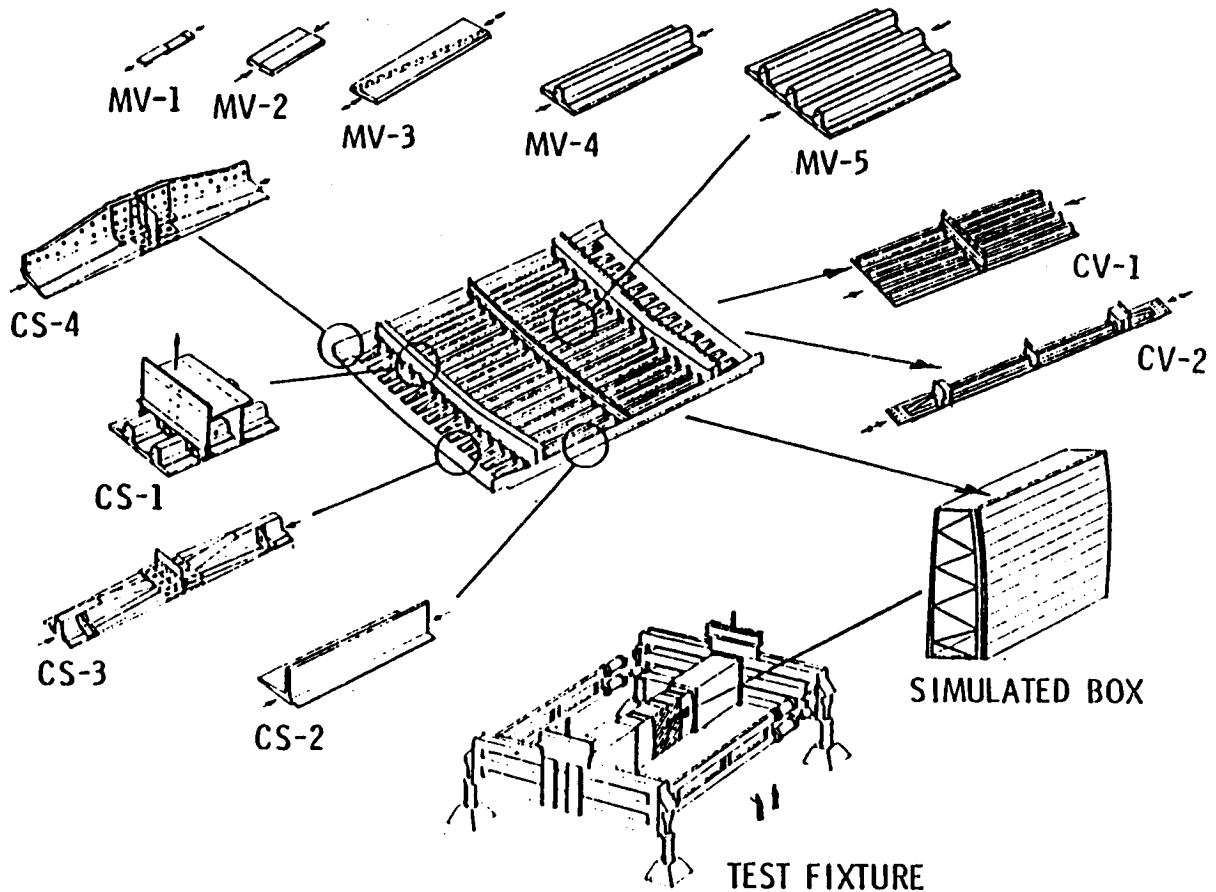

Figure 5. Integrated Wing Surface Panel Development

## 5.0 CV2 PANELS FABRICATION PROCESSES

Fabrication tooling for the CV-2 specimen was based on experience obtained from fabrication of earlier specimens.

The tool concepts used to make the hat stiffeners for CS-1 and CS-3 were combined for the design of the hat section tools. A female aluminum tool was machined to produce the outside contour of the hat section, and its dimensions were such as to produce a correct part after the graphite/epoxy was cured at 350°F. In order to ensure that the hat flanges mated with the skin, stepped aluminum caul plates were machined for each end of the tool. Flat aluminum caul plates were fabricated to be used as the stepped caul plates required for each end of the specimen.

The case rubber tool block used for the CS-3 hat section was used as a pattern, and a second rubber tool block was cast. Figure 6 shows a schematic of the hat layup and tool. Figure 7 shows the empty female hat, and Figure 8 shows the complete tool with all details in place prior to vacuum bagging for the autoclave.

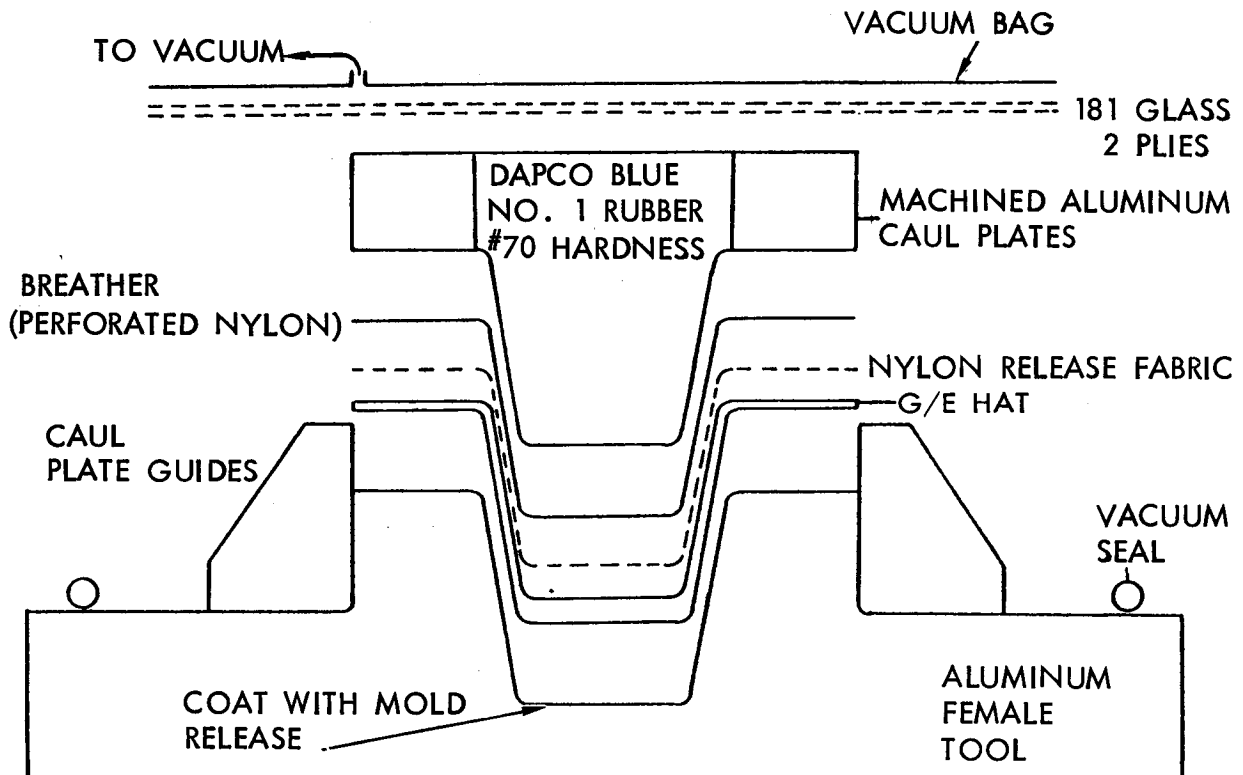

Figure 6. Schematic of Hat Layup for Cure

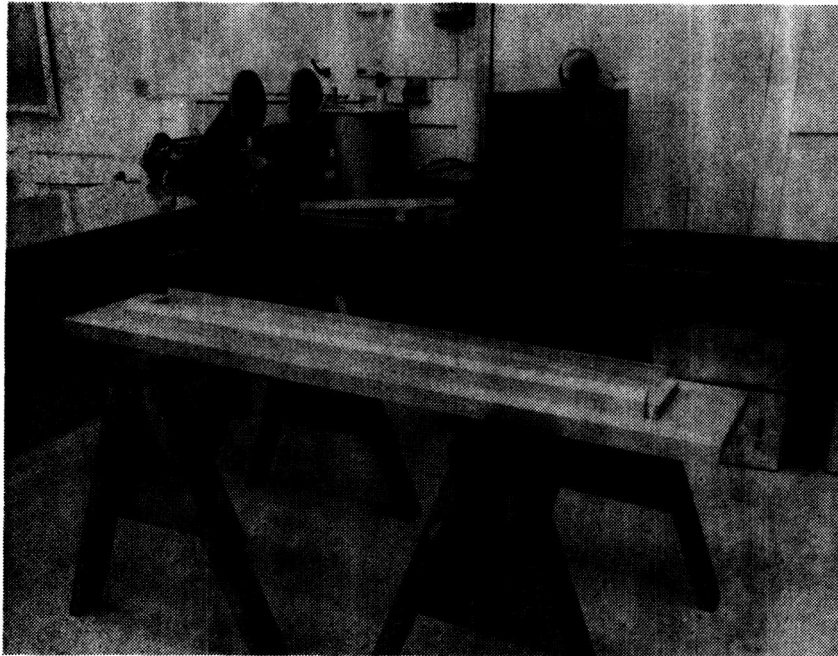

Figure 7. Female Hat Tool Just Prior to Layup of Hat Plies

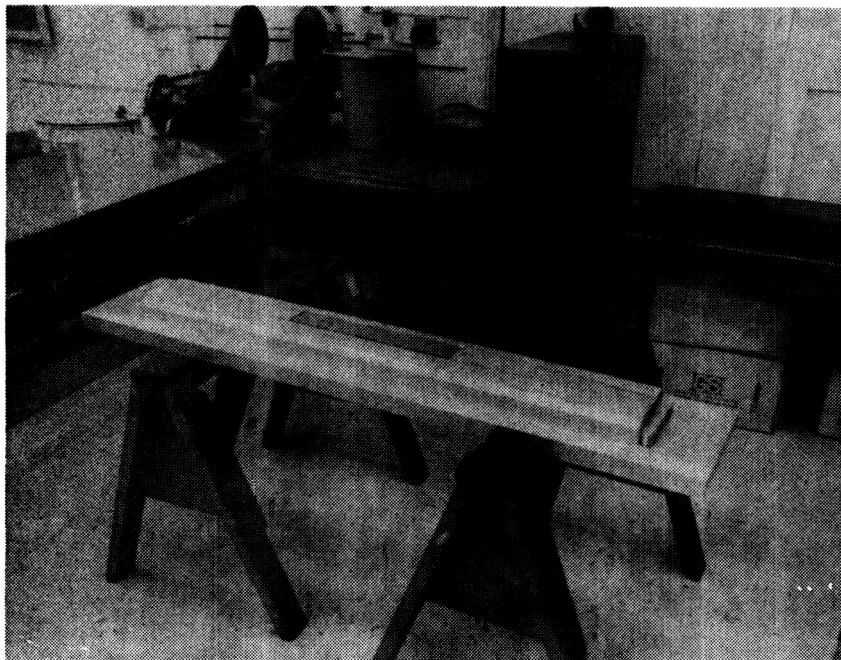

Figure 8. Hat Tool with All Details in Place

The tool concepts used for the skin panels of the CS-3 specimen were modified slightly for use on the skin panel. The basic tool was a 1/2-inch aluminum plate with aluminum dams attached for both sides and one end of the skin panel. Figure 9 shows an overall view of the skin tool and layup. The other end of the panel was open as shown in Figure 10. Two aluminum plates (one for each end) were machined to the proper thickness to provide the proper offset of the joint details from the exterior surfaces. Each plate had two holes drilled in them for aluminum dowel pins. On the open end of the tool these dowel pins extended into the basic 1/2-inch plate, firmly locating one end of the specimen. On the closed end, this end plate was pushed against the end dam to locate it during specimen layout. This detail permitted the end of the skin to slide differentially with the aluminum base plate during their thermal expansion in the cure cycle, and not displace any of the graphite/epoxy plies with respect to the titanium plies on each end.

Concepts for the tools used for the rib details were the same as those used for the CS-1 specimen. Male cast rubber tool blocks were used to lay up green clip details for the ribs. Ply templates were made and used to cut the plies for the hat section and rib clips. Figure 11 shows a pair of cut plies for the hat section. The skin tool was used as an assembly fixture to bond the hat to the skin. This assured that the outer surface would remain flat.

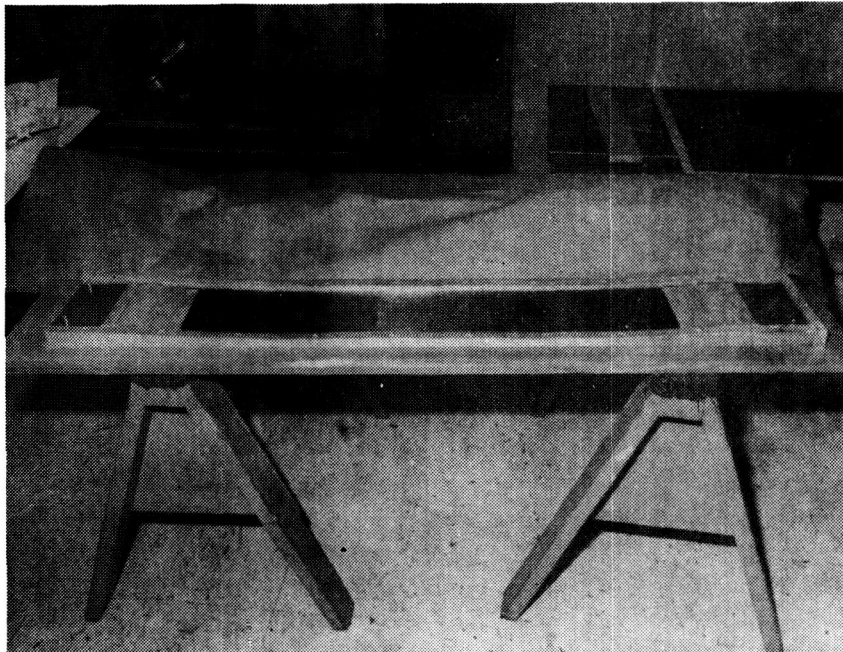

Figure 9. Skin Tool with Skin Layup

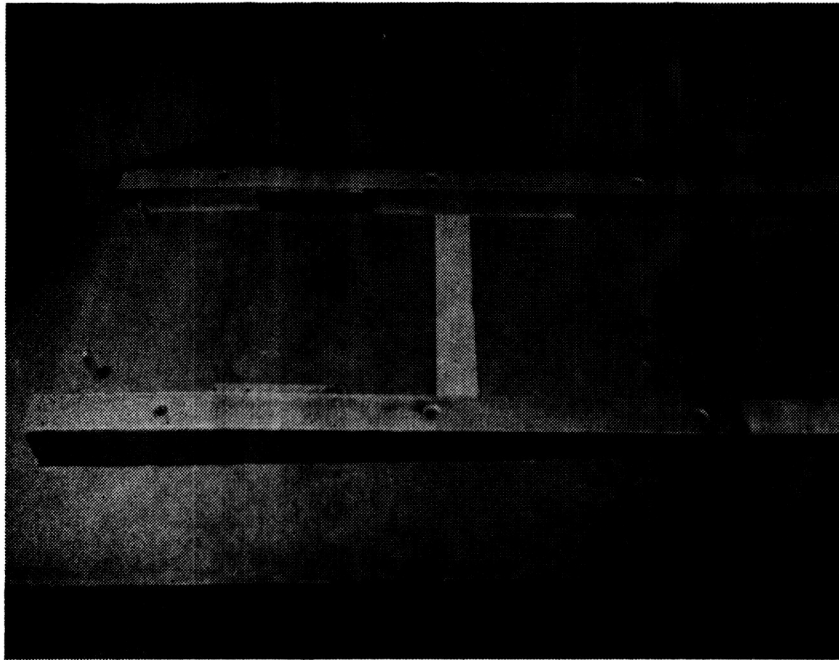

Figure 10. View of Open (Free) End of Tool with a Closeup View of First Two Titanium Skins in Place

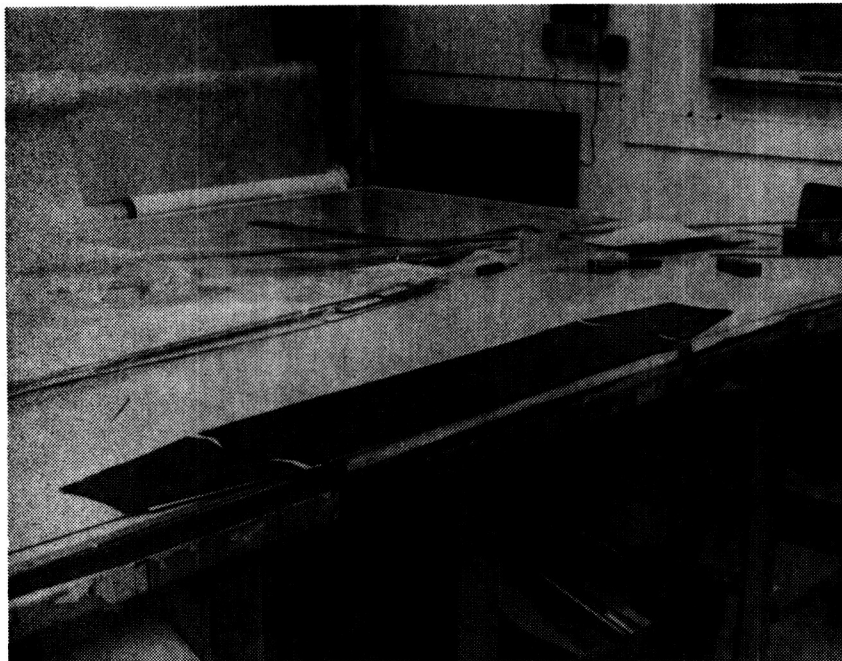

Figure 11. View of a Hat Ply Template and Prepreg Ply

## 5.1 FABRICATION AND ASSEMBLY

### 5.1.1 Materials

Graphite/Epoxy prepreg tape - Specification STM-22-805 - Hercules 3501/AS4  
- Lot 2683.

Adhesive Film, - Specification - MMM-A-132A. American Cyanamid FM300, .03  
pounds per square foot.

Adhesive Film - Specification - STM30-103. American Cyanamid FM73 - .06  
pounds per square foot.

Graphite/Epoxy prepreg fabric - Specification Commercial, Hercules  
A370-5H/1908.

Titanium Sheet - Specification STM07-306 Type III Comp C. (6Al-4V)  
annealed.

Fiberglass/Epoxy Laminate - MIL-P-18177

### 5.1.2 Layup and Cure - Hat Stiffener

Layup of the hat stiffener was accomplished by using a detailed ply layup sheet which specified each ply and its location. Prior to layup all of the hat plies were cut from Hercules 3502/AS4 12-inch-wide prepreg graphite/epoxy tape, using ply templates and stored in the freezer until needed. Processing of the composite details was in accordance with STP 61-220. Figure 11 shows a typical pair of plies that were notched to permit their installation without wrinkles at the bend locations. The plies were brought out of the freezer and allowed to warm up to room temperature. Each pair of plies was carefully placed into the tool and all the radii and edges were worked into position. Figure 12 shows a two-ply detail being laid into the tool. The part was vacuum debulked several times during layup. After all of the plies were in place, the rubber tool blocks and the machined caul plates were placed in the proper location as shown in Figure 8. A schematic of the tool with the layup inside is shown in Figure 6. The tool was vacuum bagged for cure in the autoclave. Figure 13 shows the tool and part in the autoclave ready for cure. New cure technology developed at Lockheed was used to assure that void-free details were produced. The cure cycle used is as follows:

1. Apply 100 psi to autoclave - Vent vacuum at 20 psi.
2. Heat to 290°F  $\pm$ 5°F
3. Dwell at 290°F for 3 hours.
4. Heat to 355°F.
5. Cure at 355°F  $\pm$ 5°F for 2 hours.
6. Cool to 160°F under pressure.



Figure 12. Photograph Showing a Two-Ply Detail  
Being Formed into the Hat Tool



Figure 13. View of Hat Tool and Layup in Autoclave

This cure cycle allows the resin to gel under isothermal conditions and well below the boiling point of water at 100 psi pressure. Therefore, water in solution in the prepreg resin stays and does not volatilize and form porosity. Two hat stiffeners were made. Both were free of porosity when inspected by C-scan ultrasonic procedure. While a no-bleed system was employed, it appears that the high degree of resin wetted surfaces inside the tool used more resin than anticipated as there was no exterior bleed of resin. Detail thickness was at the lower limits in accordance with STP 61-220 which specifies 0.0046 to 0.0054 inch per ply. Figure 14 shows a cured hat stiffener.

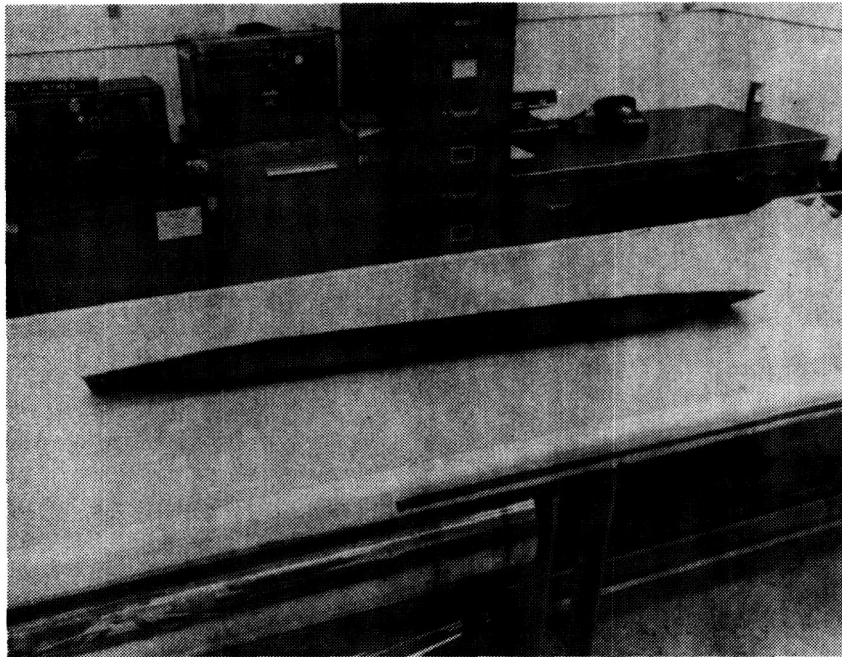

Figure 14. Cured Hat Stiffener

### 5.1.3 Skin Layup and Cure

Titanium end pieces were cut in accordance with the engineering drawing (Appendix A) and brake formed. Locator pin holes were jig drilled. The titanium details were then cleaned for bonding per STP 57-004 and primed with BR127 primer. Fiberglass fillers and the duct plate assembly were machined for fiberglass/epoxy stock per the drawing. FM300 adhesive film was applied to one surface of the primed titanium details. Figure 15 shows a titanium detail with adhesive applied.

Layup of the skin panel was accomplished using a detailed layup sheet which specified which ply, graphite/epoxy or titanium, where it was located, and where adhesive was required. No ply templates were used as all G/E plies were rectangular. White cotton gloves were used when handling all titanium plies. The basic tool was coated with mold release, and two machined fiberglass filler details were placed on each end per drawing. The fiberglass part nearest each end was wrapped with teflon tape to prevent it from being bonded to the assembly at this time. Titanium and graphite/epoxy plies were carefully laid up with a layer of FM300 adhesive being used to bond the titanium plies to each other and



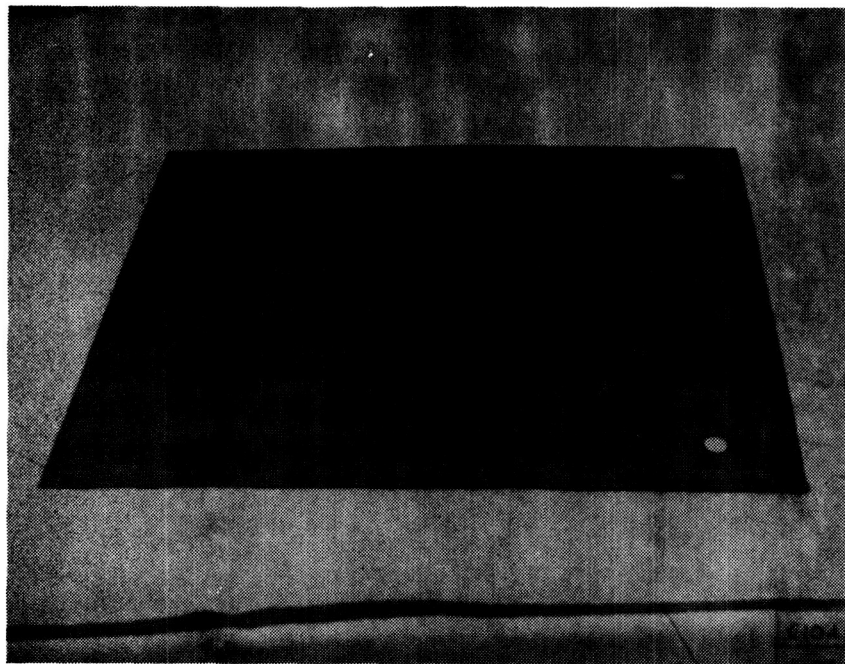

Figure 15. Titanium Detail with Adhesive Applied

to the graphite/epoxy plies. The skin panel was vacuum debulked several times during the layup sequence. Figures 16, 17, and 18 show the skin panel with the layup process nearly completed. Figure 19 shows the completed layup with rubber plate just prior to vacuum bagging for the autoclave. Figures 20 and 21 show the skin panel after removal from the autoclave. Figure 22 shows the end of the titanium plies where they are not completely bonded to each other. It was thought that this condition was caused by small differences in the forming of the titanium plies.

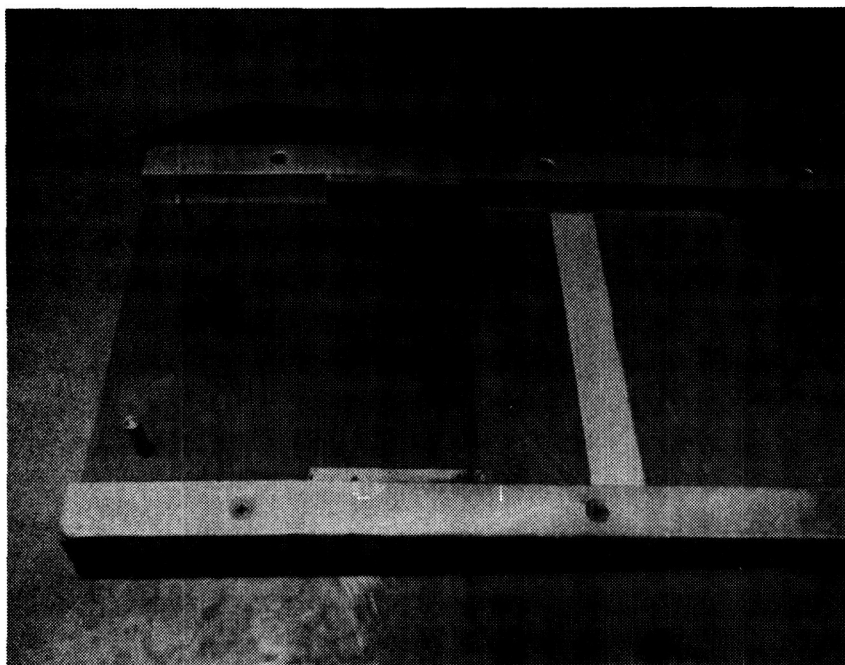

Figure 16. Skin Tool Showing First G/E Ply in Place and Titanium Detail Pinned to Locater Pins



Figure 17. End of Skin Tool Showing All Titanium Details in Place



Figure 18. Overall View of Skin Tool with Completed Skin Layup

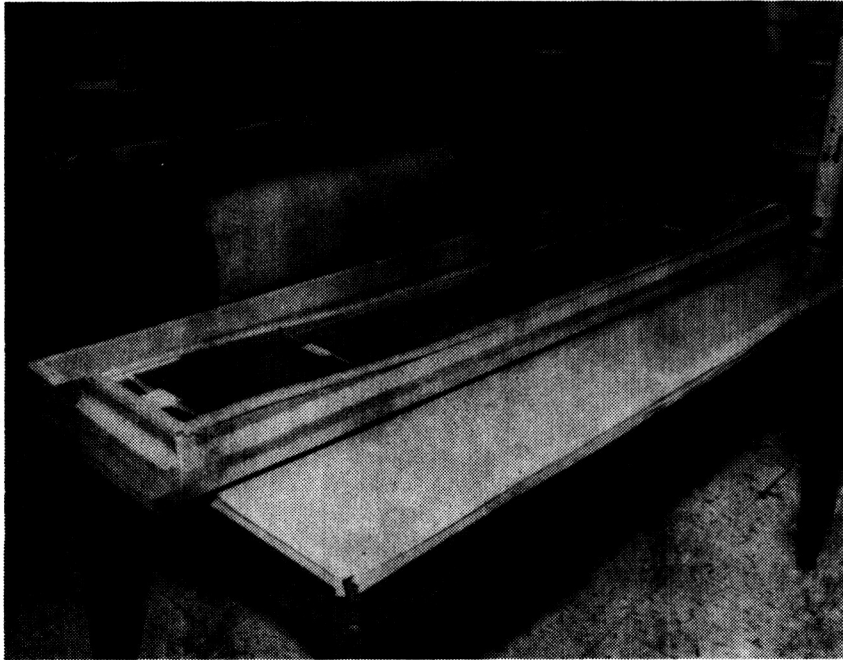

Figure 19. Skin Layup Ready for Bagging for Cure

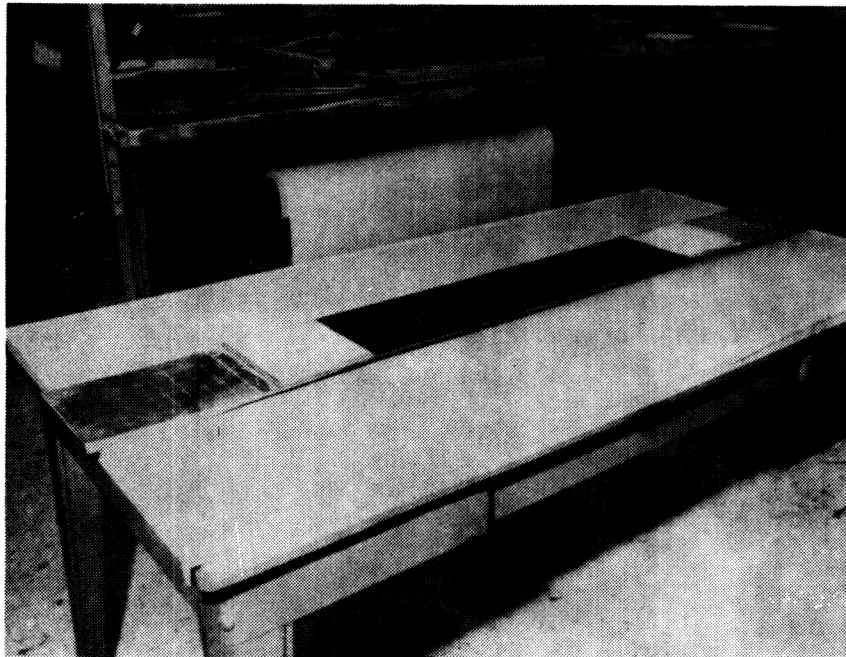

Figure 20. Exterior Side of Cured Skin

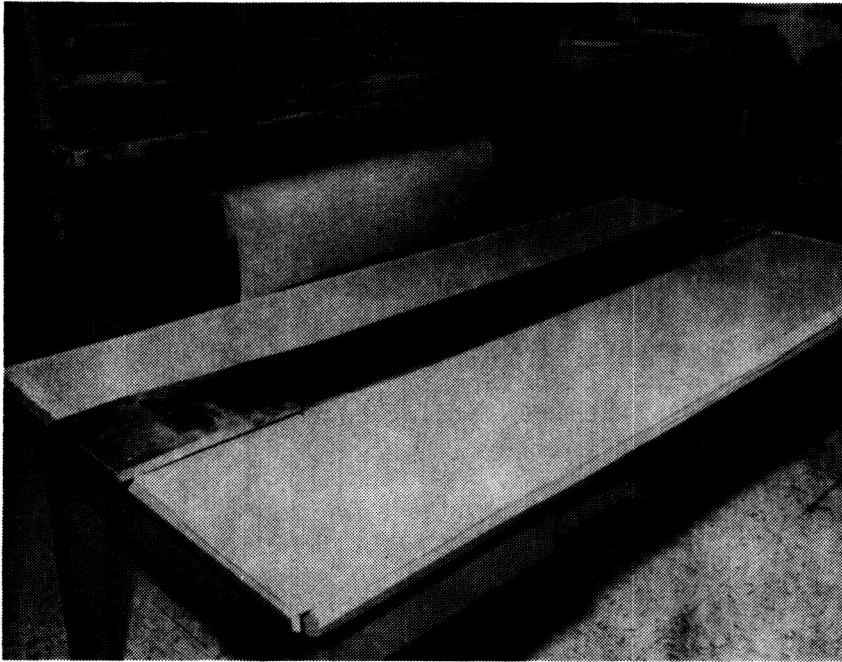

Figure 21. Interior Side of the Skin Panel After Removal from Tool

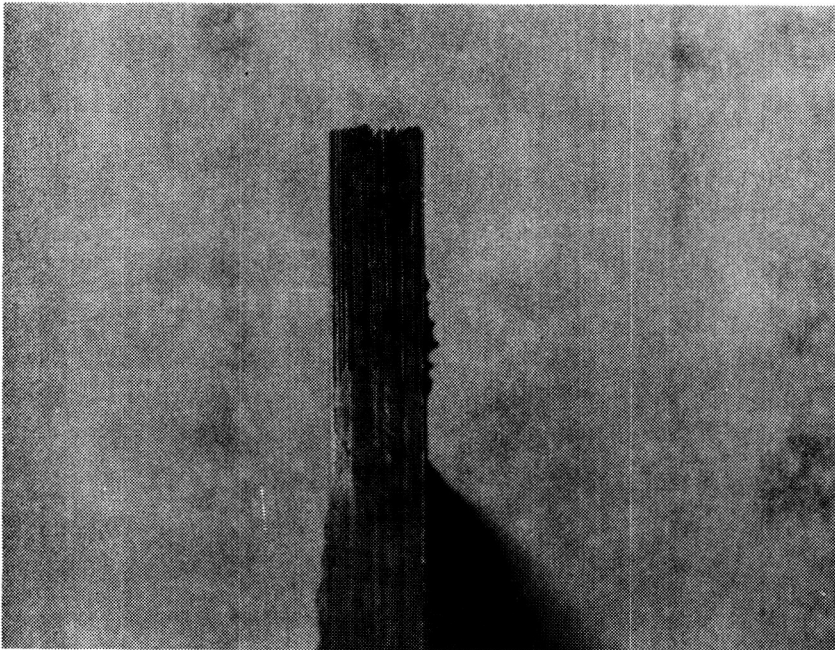

Figure 22. End of Skin Showing Titanium Detail Misfit

A total of three skin panels were made. One was scrapped due to slippage of the fiberglass wedge filler inboard. This was solved by pinning the filler to the titanium details. It could not be pinned to the aluminum tool due to thermal mismatch. The two skins were ultrasonic inspected and found to be clear of voids and porosity.

#### 5.1.4 Surface Panel Assembly

The slot duct was machined into the skin panel using a carbide milling cutter ground to the slot duct configuration. It was found that a better slot duct could be formed by machining rather than by the molding process used on previous programs. Metering holes were drilled using semi-automatic equipment and techniques developed on the LFC Leading-Edge Flight Test article reference 3). Hole quality was excellent.

After trimming the hats and skins to dimension, they were prefitted for bonding as shown in Figure 23. A verification bond cycle was conducted on both specimens. Two layers of FM73 adhesive -(0.06PSF), STM 30-102, was placed between one mil thick Teflon film and the hat and skin assemblies. The skin tool was used as the bond fixture. After curing the adhesive at 250°F and under 30 psi pressure, the details were separated and the teflon and cured adhesive film removed. Thickness of the adhesive film along the bond line was determined and low-pressure areas noted for additional layers of adhesives. Less than 5 percent of the bond needed an additional layer on either assembly. Fit of the

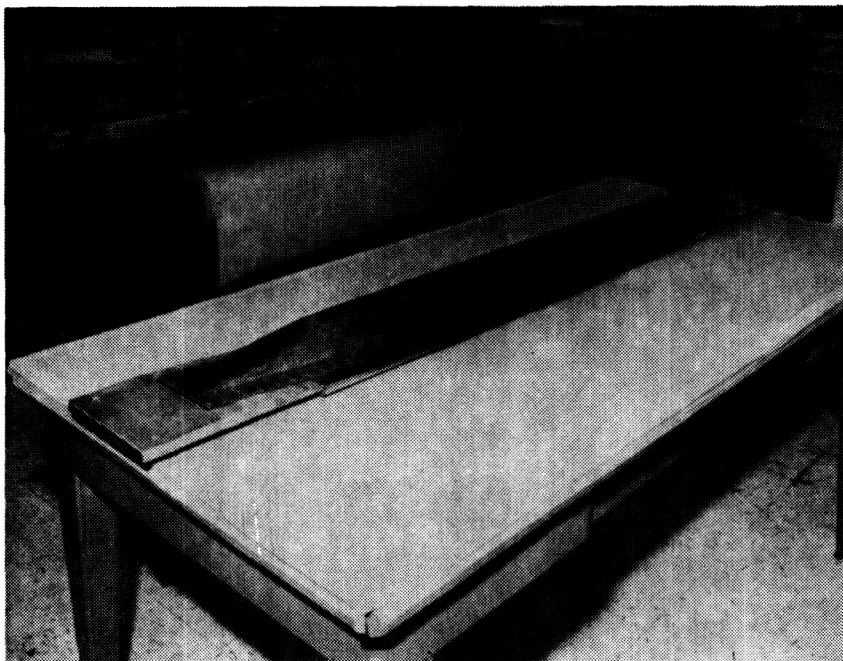

Figure 23. View of Hat and Skin Stiffener Being Prefitted Prior to Bonding

ORIGINAL PAGE IS  
OF POOR QUALITY

details was considered good and well within bonding tolerance. The details were then cleaned and adhesive applied in accordance with the verification results. Cure of the assembly was accomplished in an autoclave at 30 psi pressure and 250°F for 60 minutes. Following bonding of the assemblies, an ultrasonic nondestructive inspection was conducted. No disbonds were found in either the CV2-1 or CV2-2 specimens.

#### 5.1.5 Fabrication and Assembly of the Rib Cap Assembly.

The web and other flat details of the assembly were cut from precured details. They were then cleaned and adhesive applied to all mating surfaces. All formed details were laid up over rubber form blocks from G/E fabric. The details were then assembled and bagged for cure. Again the skin tool was used as a curing fixture, and cure was accomplished at 30 psi and 250°F. Following cure and cleanup, holes were drilled and the rib cap fasteners installed. Figures 24, 25, and 26 show different views of the rib cap assembly installation.

Titanium skins were cut to size, cleaned and primed in accordance with STP 57-004 and STP 60-005. The fiberglass duct plates were also prepared for bonding. FM123-4 adhesive was applied to the CV-2 composite surface and to the duct plate. The assembly was bonded at 30 psi and 200°F for 3 hours. NDI of the bond was by coin tapping. No delaminations were found. Following bonding, the suction slot was cut in the titanium skin using techniques and equipment developed on the LFC leading-edge program (reference 3).

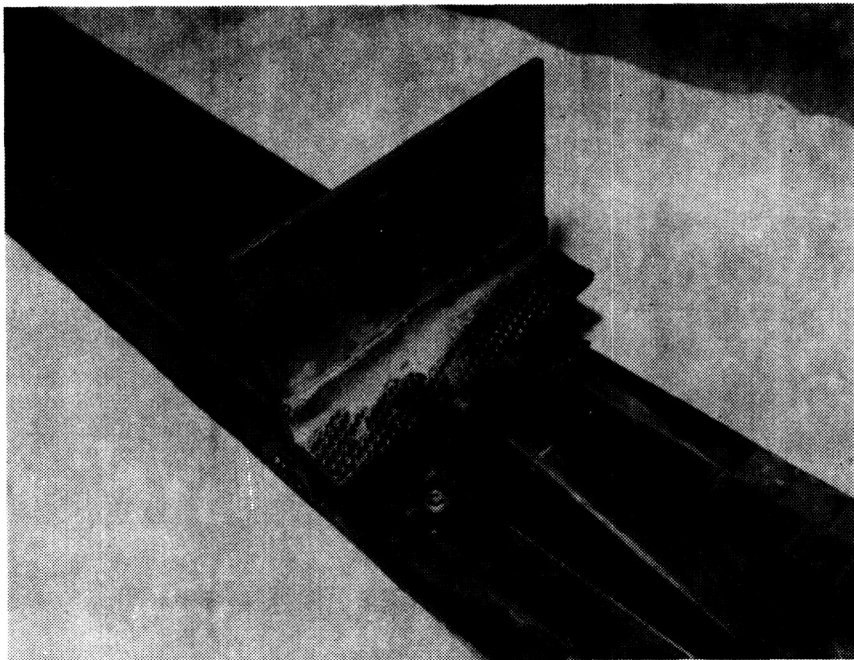

Figure 24. View of Rib Cap Assembly from Specimen End

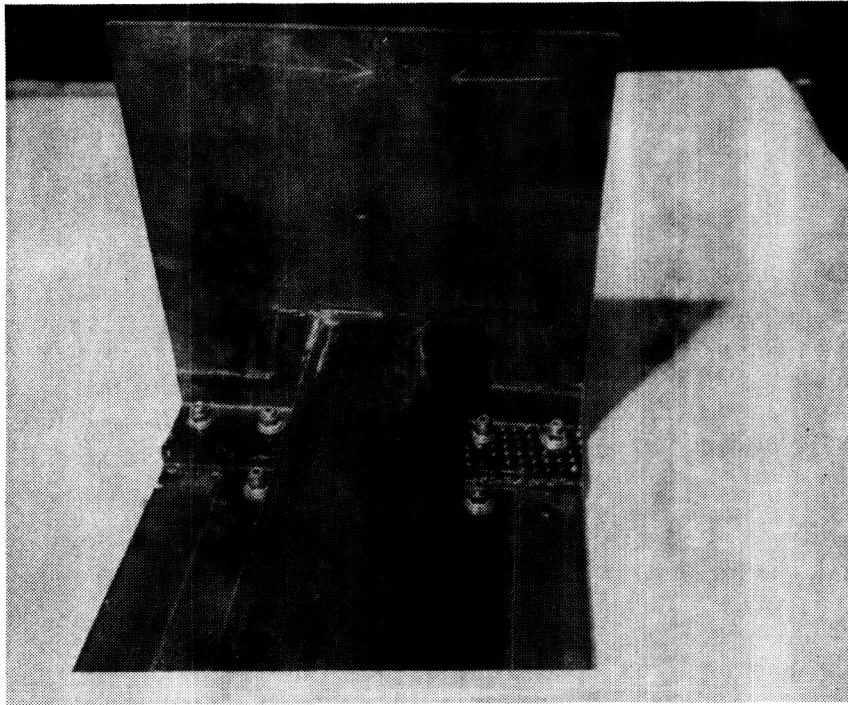

Figure 25. View of Rib Cap Assembly from Center of Specimen

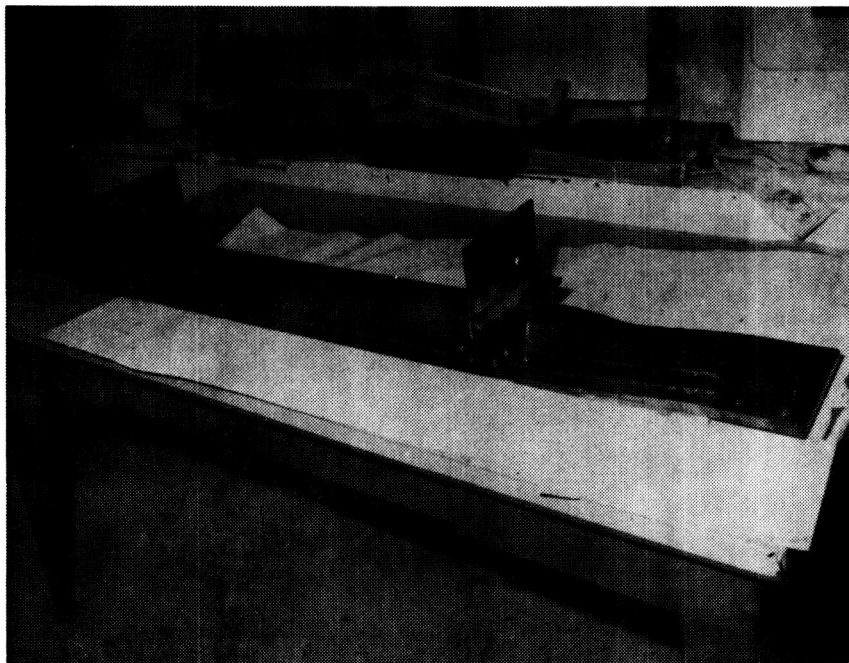

Figure 26. Overall View of CV2 Specimen with Rib Cap Assembly Installed

### 5.1.6 Chordwise Joint Assembly

Machined titanium splice plates were then fitted to the ends. Shimming was required to maintain alignment of the end fittings. After the specimen, end bolts were installed, the splice duct plate was bonded on. Holes were drilled through the duct plate and skin on the test machine side of the joints in order to allow the end fittings to be changed. Figures 27, 28, 29, and 30 show the completed specimen from different views.

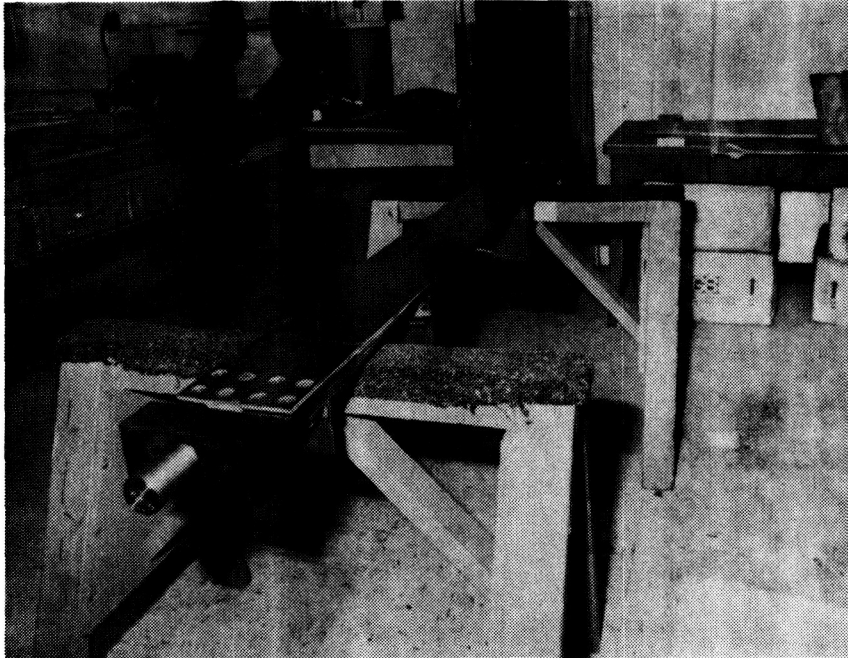

Figure 27. View of CV2 Specimen Showing Outer Surface

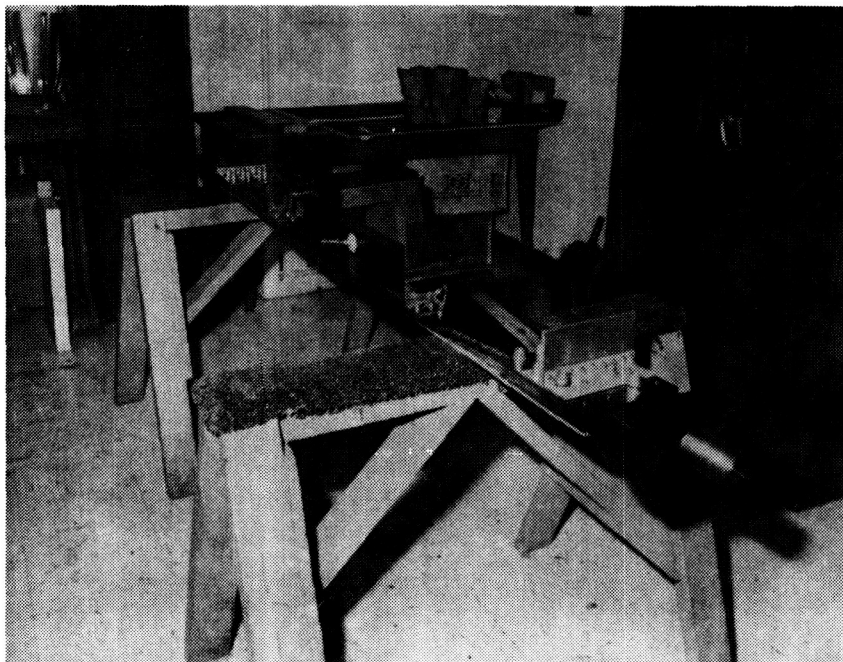

Figure 28. View of CV2 Specimen Showing Inner Surface



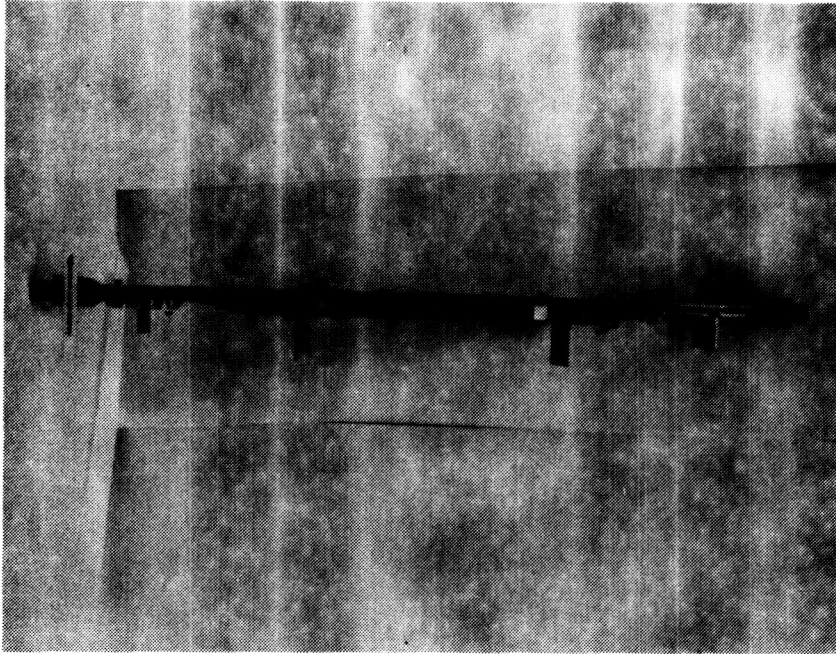

Figure 29. Overall View of Side of CV2 Specimen with Instrumentation Installed

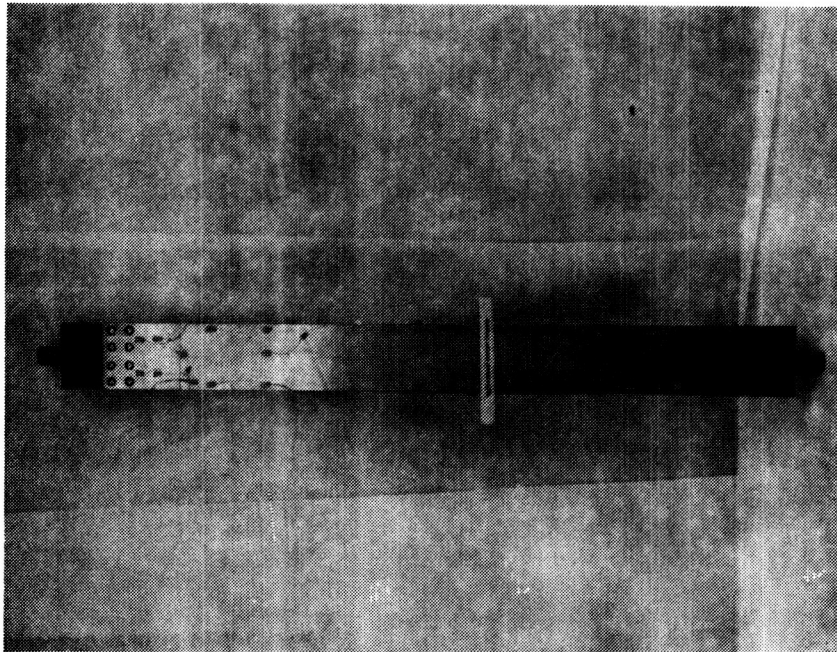

Figure 30. View of Outer Surface with Instrumentation Installed

## 5.2 REPAIR/REWORK OF HAT TO SKIN ATTACHMENT

During the initial static test on the first specimen, CV2-1 a disbond occurred at one end between the hat runout and the skin surface. Failure was in the first ply of graphite, not in the adhesive. This was repaired by injecting STM30-101 adhesive and clamping the joint together until the adhesive had cured. Holes were then carefully drilled through the hat flange and the skin panel in six places on each flange. Mist coolant was used to prevent overheating the titanium and causing a disbond. Two holes were also drilled through the hat crown. The procedure was also repeated on the unfailed end and additional 5/16-inch-diameter NAS 6205 fasteners were then wet installed and the specimen tested to failure. It was decided to rework CV2-2 likewise prior to test but to increase the fasteners to nine on each flange and six in the crown. During drilling of this specimen, disbonding was noted in the runout area. Whether it was caused by the moisture exposure or the drilling operation is not known. After all holes were drilled, the specimen was degreased, and the hat runout disbond wedged open slightly, and further cleaned with solvent. STM 30-101 adhesive was injected and the bolts installed and torqued to provide clamp up of the joint. The adhesive was allowed to cure prior to testing.

**6.0 CONCEPT VERIFICATION WING SURFACE SINGLE HAT/CHORDWISE JOINT TEST**  
**- CV2-1, TENSION STATIC**

**6.1 CV2-1 TEST OBJECTIVES**

The principal objectives of the CV2-1 panel tests were to verify the static tension strength and to measure the suction flow characteristics of the LFC wing surface chordwise joints.

**6.2 CV2-1 TEST SPECIMEN**

The CV2-1 test panel configuration, materials, and design requirements are presented on the engineering drawing entitled WSSD CV2 Specimen Panel Assembly, Dwg. No. LGA134A-326 (Appendix A). The test panel is 68.2 inches long (spanwise direction) and 7.00 inches wide. The panel is stiffened with a single hat-section stiffener, and there are joints on both ends of the panel. The panel side of both joints is similar to the CS3 chordwise joint specimen that was fabricated and tested in Reference 2. The opposite side of both joints is assembled with test adapter fittings to facilitate testing. The principal materials are titanium sheet, graphite-epoxy tape and fabric, film adhesives, and mechanical fasteners. The 350°F curing graphite-epoxy tape is used in fabrication of the hat-section stiffeners and surface skin laminates. The 250°F curing graphite-epoxy fabric is used in fabrication of the rib-cap clips, straps, and doublers. The FM123-4 film adhesive, cured at 200°F, is used to bond the titanium sheet to the outer surface of the panel skin laminates. The CV2-1 specimen is shown in Figures 27 - 30.

**6.3 CV2-1 TEST LOADS**

The CV2-1 panel was static tested to failure in a tensile mode. The predicted allowable net section tension load was 133 KIPS. Prior to conducting the tension test, suction flow tests was performed on the CV2-1 panel.

**6.4 CV2-1 TEST PROCEDURES AND INSTRUMENTATION**

**6.4.1 CV2-1 Suction Flow Tests**

A suction line was attached at the orifice in the leg of the hat-section stiffener at the panel mid-length location. Two orifices in the leg of the hat-section stiffener that are 18.15 inches from the chordwise joint centerlines of each end of the panel were blocked during the suction flow tests.

Three static pressure taps for recording duct pressures were installed in the leg of the hat-section stiffeners such that the end of each tap was flush with the inside surface of the stiffener leg. One pressure tap was located directly opposite the discharge orifice, and the remaining two taps were located in the same stiffener leg as the first tap and approximately 10 inches from the chordwise joint centerline of each end of the panel.

During the suction flow tests, hat-section stiffener duct pressures were recorded over a range of slot suction flows from 50 to 200 percent of the design

suction flow rate for a representative slot at the 55 percent semi-span location of the 1993 LFC transport. A small flowmeter was used to measure local slot flow at selected points along the slot to demonstrate uniformity of spanwise slot flow distribution. Suction flow measurements were made across the chordwise joints.

#### 6.4.2 CV2-1 Tension Tests

Upon completion of the suction flow tests, the CV2-1 panel was installed in a universal testing machine. Special test adapter fittings were attached to each end of the CV2-1 panel to facilitate the test. Tension load was applied to the panel in increments, and strain and deflection measurements were recorded. Also, slot width measurements were made at intervals along the entire length of CV2-1 panel at prescribed load levels.

The CV2-1 static tension panel was instrumented with 25 axial strain gauges and 4 rosette strain gauges. The axial and rosette strain gauges were located along the length of the panel test-section as shown in Table 2.

In addition, the CV2-1 panel was instrumented with 6 dial gauges to measure the deflection. The dial gauges were located on outer skin at three locations along the length of the panel (Table 3).

### 6.5 CV2-1 SUMMARY OF TEST RESULTS

#### 6.5.1 CV2-1 Summary of Suction Flow Evaluations

The suction flow test was carried out on the CV2-1 panel. The measured suction flow data consist of total slot flow, hat duct pressures (3), and spanwise flow distribution over a range of flows. The test plan called for suction levels from 50 percent to 200 percent of the design flow for a representative slot at the 55 percent semi-span location of the 1993 LFC transport. This design flow level corresponds to a slot Reynolds number of about 77, or a slot corrected flow rate of approximately 0.029 lbm/sec. This latter value was used as the 100 percent flow condition for the CV2-1 suction test.

Suction was applied to the orifice located at the panel mid-span in the side wall of the hat duct. The other two orifices in the hat duct were plugged. Three static pressure taps were installed in a side wall of the hat duct; one opposite the suction orifice and the other two located about 10 inches from either end of the active suction length. Each end of the active suction length or slot corresponds to the location of the simulated chordwise splice. Details of the test panel are given on Drawing LGA123A-326, Appendix A.

Flow versus pressure loss data for the CV2-1 panel are shown in Figure 31. The predicted data also shown is based upon equations used during the LFC Leading-Edge Flight Test (LEFT) contract design and performance work (reference 3). The measured data fall about 18 percent below predicted at the lowest flow rate and about 38 percent below predicted at the highest flow rate. This result is not surprising since previous data have shown the prediction equations generally underpredict test results.

TABLE 2. CV2-1 STRAIN GAUGE LOCATION

STRAIN GAUGE NUMBER	DISTANCE FROM LOWER SPLICE (IN)	DISTANCE FROM SLOT (IN)	LOCATION
1/2	0	3.5 R/L	Edge Inner Splice Doubler
3/4	0	1.75 R/L	Outer Skin
5/6	2.0	1.75 R/L	Outer Skin
7/8	2.0	1.75 R/L	Inside Inner Splice Doubler
9/10 (46/47)	8.0 (52)	3.0 R/L	Outer Skin
11/12 (48/49)	8.0 (52)	3.0 R/L	Inside Skin
13	8.0	0.0	Crown
14/15	14.0	3.0 R/L	Outer Skin
16/17	14.0	3.0 R/L	Inside Skin
18	14.0	0.5 L	Outer Skin
19	14.0	0.0	Crown
20/23	14.0	1.0 L/R	Leg (45°) (Crown-1.1)
21/24	14.0	1.0 L/R	Leg (Axial) (Crown-1.1)
22/25	14.0	1.0 L/R	Leg (Vertical) (Crown-1.1)
26/27	30.0	3.0 R/L	Outer Skin
28/29	30.0	3.0 R/L	Inner Skin
30	30.0	0.5 L	Outer Skin
31	30.0	0.0	Crown
32	30.0	1.0 R	Leg (45°) (Crown-1.1)
33	30.0	1.0 R	Leg (Axial) (Crown-1.1)
34	30.5	1.0 R	Leg (Vertical) (Crown-1.1)
35	27.5	1.0 L	Leg (45°) (Crown-1.1)
36	27.5	1.0 L	Leg (Axial) (Crown-1.1)
37	27.5	1.0 L	Leg (Vertical) (Crown-1.1)

NOTE: 1. (Upper)  
 2. R = Right; L = Left  
 3. 45° = 45° Leg of Rosette; Axial = Axial Leg of Rosette;  
 Vertical = Vertical Leg of Rosette

TABLE 3. CV2 DIAL GAUGE LOCATION

DIAL GAUGE NUMBER	DISTANCE FROM LOWER CENTER LINE OF SPLICE (IN)	DISTANCE FROM SLOT (IN)
1	16	3.25L
2	16	3.25R
3	30	3.25L
4	30	3.25R
5	44	3.25L
6	44	3.25R

As can be seen in Figure 31, the maximum flow obtainable with the test rig was about 123 percent of design flow, well short of the desired 200 percent. It appears that choked flow occurs in the fitting installed in the orifice of the hat duct as flow rate begins to exceed 123 percent of the design value.

Data are shown for the model "sealed" and "unsealed." Considerable leakage was found along the edges of the test piece and at the bolt hole openings in the surface skin at both ends of the panel. The model was sealed with duct tape and vacuum putty in an attempt to stop the leakage. It is suspected that some leakage still occurred after the model was sealed although use of an acoustic leak detector apparatus failed to locate any additional source of leaks. However, the results seem to indicate that leakage did not adversely impact the test results.

Figure 32 illustrates the results of spanwise local slot flow measurements made at three levels of suction total flow. The measurements were made using a small hand-held rotameter. Four regions are indicated on the figure which represent the four subsurface configurations which serve to interconnect the slot duct with the hat duct. Refer to Drawing LGA134A-326, Appendix A, for details of the subsurface geometry. The spanwise flow surveys indicate good flow distribution over all regions except D and the interfaces region between B and C. In region D, flow is routed from the slot duct through metering orifices to another larger duct which carries the flow spanwise to the plenum-like cavity of region C. Discounting blockages in these ducts or other fabrication anomalies, it appears that the duct geometry of region D may not provide the desired even flow distribution across the simulated chordwise joint. Further testing is required to identify the problem and a solution. Three hat duct pressures measured indicated less than a 1 percent variation in hat duct pressure from the center tap to the taps at either end of the panel.

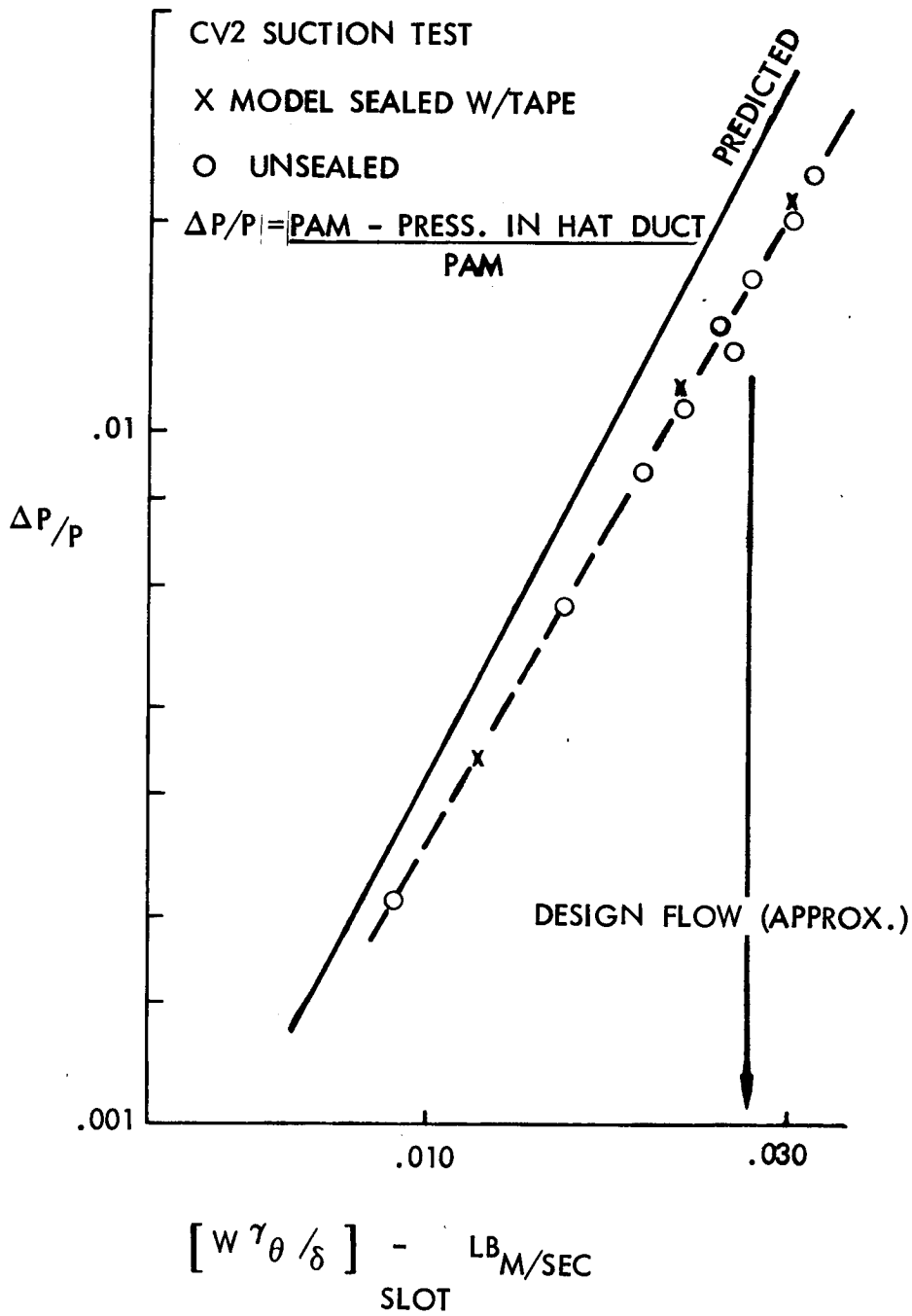

Figure 31. Flow vs. Pressure Loss

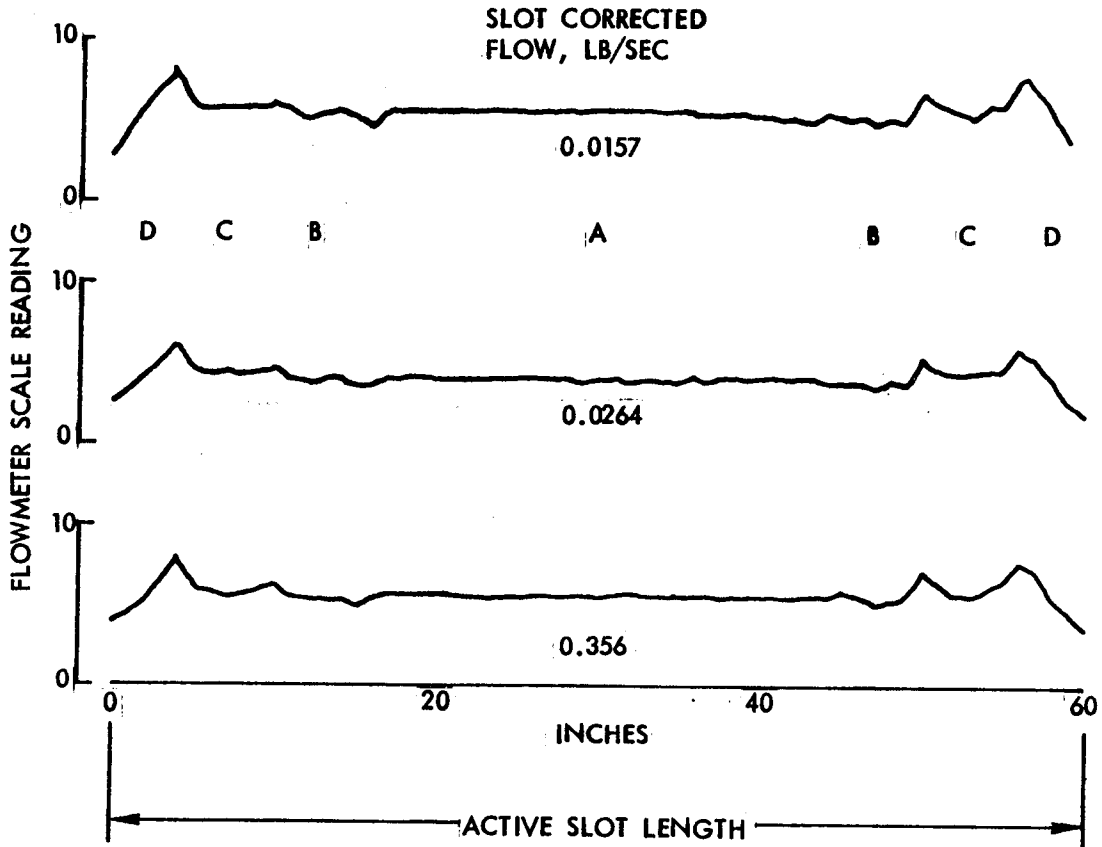

Figure 32. Slot Spanwise Flow Distribution

### 6.5.2 CV2-1 Summary of Tension Static Test Results

The CV2-1 panel was static-tested to failure in a tensile mode in a normal laboratory environment at room temperature in the universal test machine. A loading check to 40 KIPS was carried out as shown below. See Table 4 for dial gauge readings. An increasing dial gauge value shows a skin movement "away" from the hat direction.

During the loading check, "popping" noises were heard at 30 KIPS at the lower chordwise splice, and at 40 KIPS at the upper chordwise splice. No damage could be found with a visual inspection. Strain gauges were monitored during the check and the resulting data are reported in Appendix B. Strain gauge number 7 was replaced due to a large compressive offset which occurred after the first popping noise. As considerable lateral movement (dial gauge no. 1 = .037 in.) of the specimen was evident during the loading check, all four ribs were attached to a stiff side support frame (see Figures 33 and 34). Ribs were attached with approximately 4 KIPS tensile load applied. The loading check was re-run. Lateral deflections are shown in Table 5. Strain gauges were monitored and are reported in Appendix C. The slot widths were measured before and during the test and recorded in Tables 7 and 8 respectively. While tension loaded, the LFC slot opened over the center of the panel. Since the edges of skins (titanium and graphite) would be restrained by the adjacent skins, the slot



TABLE 4. CV2-1 LOADING CHECK-DIAL GAUGE READINGS

DIAL GAUGE NUMBER	LOAD-KIPS					
	3.5	10.0	20.0	30.0	40.0	0.0
1	0	11	13	18	37	207
2	0	12	14	19	36	202
3	0	9	11	15	28	196
4	0	9	11	13	25	180
5	0	9	10	14	24	167
6	0	8	9	13	20	166

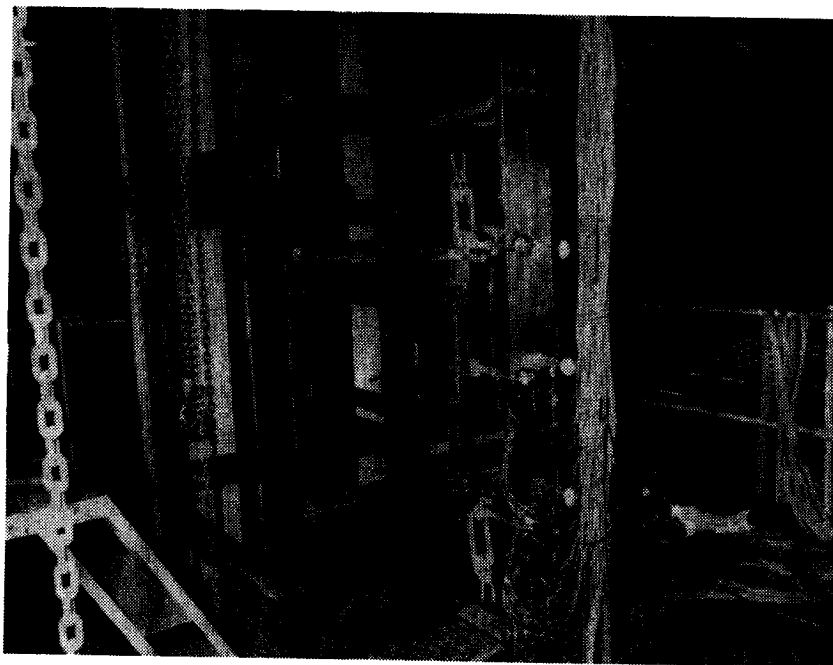

Figure 33. CV2-1 Test Setup

ORIGINAL PAGE IS  
OF POOR QUALITY

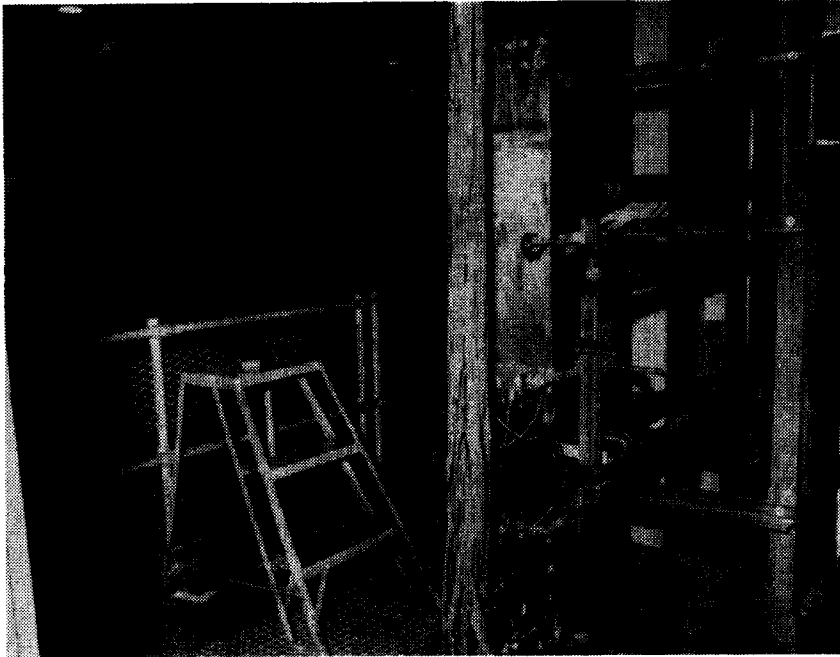

Figure 34. CV2-1 Test Setup

TABLE 5. CV2-1 LOADING CHECK WITH RIBS DIAL GAUGE READINGS

DIAL GAUGE NUMBER	LOAD-KIPS					
	3.5	10.0	20.0	30.0	40.0	0.0
1	0	0	1	2	1	1
2	0	1	3	5	6	1
3	0	0	0	1	1	2
4	0	0	2	3	4	2
5	0	1	3	4	6	1
6	0	1	3	5	7	1

TABLE 6. CV2-1 TEST-DIAL GAUGE READINGS

DIAL GAUGE NUMBER	LOAD-KIPS		
	3.5	20.0	40.0
1	0	2	3
2	0	5	8
3	0	1	2
4	0	2	4
5	0	3	6
6	0	4	8

movement is not considered a valid test. Previous tested multiple hat panels resulted in no noticeable slot movement.

Testing was conducted with the intent of loading to 100 KIPS tensile load. Strain gauges, dial gauges and Wilson airless gauge readings of the LFC slot width over its length were taken with 3.5 KIPS tension load applied. The procedure was repeated for 20 KIPS and 40 KIPS. Popping noises occurred while loading to 60 KIPS with the load dropping back to 52 KIPS after a loud "pop". Damage was discovered and the load reduced to zero.

The damage consisted of failure of the hat legs thru the laminate, resulting in separation of the hat section from the skin over a distance of approximately 9 in. from the lower end of the hat. Amount of hat "pop up" from the skin at the end of the hat was approximately 1/8 in. Also the suction orifice became disbonded and was not replaced. Strain gauges were monitored during this test and are recorded in Appendix D. Dial gauge readings are shown in Table 6.

The CV2-1 specimen was repaired by cold bonding the separated hat section and by adding 14 NAS 6205 bolts 5/16 in diameter at both ends (see Section 5.2). The CV2-1 specimen was reinstalled in the test machine and a satisfactory strain check to 40 KIPS tension load was conducted.

During testing, popping noises were heard while loading from 80 KIPS to 100 KIPS with a slight load drop-off to 98.6 KIPS, after holding 100 KIPS for the time needed to collect strain data. This drop-off occurred after another noise similar to the earlier noises. After unloading to make a visual inspection of the panel and then reapplying load, popping noises were heard from 100 KIPS to 110 KIPS. After holding 110 KIPS for approximately 5 seconds another popping sound occurred, dropping the load to 108.5 KIPS. An attempt was made to take the strain reading at this level but before these could be taken, total failure of the specimen occurred. Dial gauge readings are shown in Table 9. The strain gauges were monitored during the test to 110 KIPS and are reported in Appendix E. For this test, the slot widths were measured by feeler gauges and are recorded in Table 10.

TABLE 8. CV2-1 TEST SLOT WIDTH READINGS.

DISTANCE FROM LOWER SPLICE (IN)	LOAD-KIPS		
	3.5	20.0	40.0
3.0	10.8	10.8	10.9
6.0	10.5	10.7	10.7
9.0	10.6	10.8	10.6
12.0	10.5	10.9	10.8
15.0	10.8	10.9	10.8
18.0	11.0	11.1	10.8
21.0	11.2	11.1	11.1
24.0	11.2	11.2	11.1
27.0	11.1	10.9	10.6
30.0	11.1	11.1	11.0
33.0	11.1	11.0	11.0
36.0	11.2	11.1	11.2
39.0	11.1	11.1	11.0
42.0	11.0	10.8	11.0
45.0	10.5	10.8	10.7
48.0	10.8	10.5	10.3
51.0	9.8	10.2	10.3
54.0	10.2	10.0	10.5
57.0	10.8	10.8	10.8

TABLE 7. CV2-1 PANEL SLOT WIDTHS READINGS BEFORE TESTING

DISTANCE FROM LOWER SPLICE (IN)	NO LOAD
3.0	10.1
6.0	10.2
9.0	10.2
12.0	10.3
15.0	10.4
18.0	10.4
21.0	10.4
24.0	10.5
27.0	10.5
30.0	10.5
33.0	10.5
36.0	10.5
39.0	10.5
42.0	10.
45.0	10.
48.0	10.
51.0	10.
54.0	10.
57.0	10.

TABLE 9. CV2-1 TEST WITH BOLTS-DIAL GAUGE READINGS

DIAL GAUGE NUMBER	LOAD-KIPS					
	3.5	20.0	40.0	60.0	80.0	20.0
1	0	1	4	7	4	-5
2	0	3	6	8	6	-2
3	0	2	3	5	5	-1
4	0	1	3	6	7	2
5	0	6	12	17	22	7
6	0	5	11	16	22	7

TABLE 10. CV2-1 TEST WITH BOLTS SLOT WIDTH READINGS

DISTANCE FROM LOWER SPLICE (IN)	LOAD-KIPS					
	3.5	20.0	40.0	60.0	80.0	20.0
3.0	9	9	10	10	10	10
6.0	10	10	10	10	9	10
9.0	10	10	10	10	10	10
12.0	10	10	10	10	10	10
15.0	10	11	10	10	9	10
18.0	11	11	10	10	9	11
21.0	12	11	10	10	9	11
24.0	11	11	10	10	10	11
27.0	11	11	10	10	10	11
30.0	12	11	10	10	10	11
33.0	12	11	11	10	10	11
36.0	12	11	11	10	10	11
39.0	12	12	11	10	10	11
42.0	12	11	11	10	10	11
45.0	11	11	10	10	9	10
48.0	10	10	10	10	10	10
51.0	10	10	10	10	10	10
54.0	10	11	11	11	11	10

The CV2-1 specimen damage consisted of titanium skin and composite material failure in the region of the lower composite rib (Figure 35) plus combined failure of the hat section, and bearing failures around the lower 14 repair bolts (Figure 36). Panel measured width was 6.98 in.

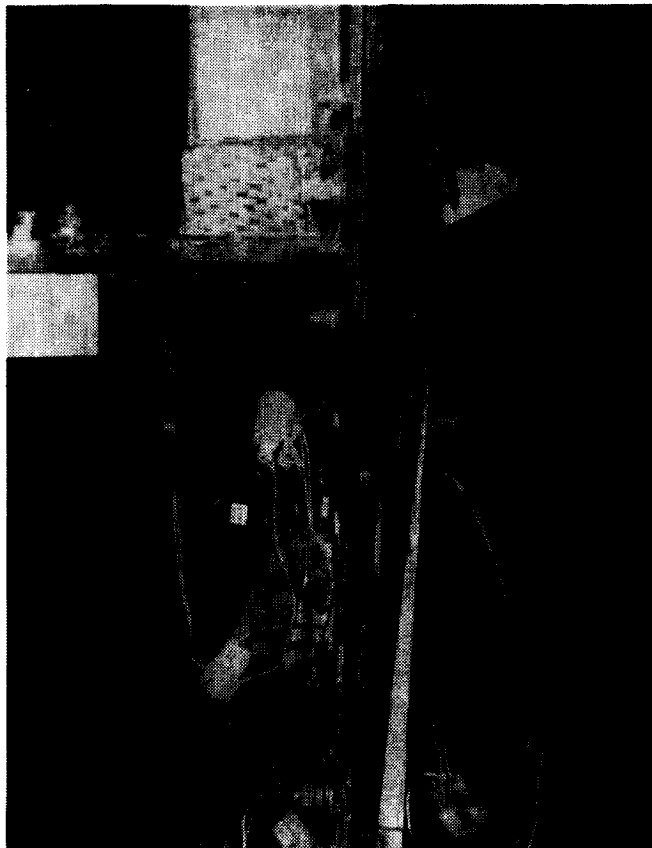

Figure 35. CV2-1 Specimen Damage - Skin

ORIGINAL PAGE IS  
OF POOR QUALITY

## 7.0 CONCEPT VERIFICATION WING SURFACE SINGLE HAT/CHORDWISE JOINT TEST - CV2-2, FATIGUE/STATIC TENSION

### 7.1 CV2-2 TEST OBJECTIVES

The principal objectives of the CV2-2 panel tests were to verify fatigue and residual tension strength of the LFC wing surface chordwise joints.

### 7.2 CV2-2 TEST SPECIMEN

Characteristics of CV2-2 fatigue specimen were the same as for the CV2-1 static tension specimen discussed in Section 6.2. However, because of the separation of the hat section from the composite skin during the static test of specimen CV2-1, 24 NAS 6205 bolts of 5/16 in. diameter were added to the CV2-2 panel (Appendix A). The bolts were added after the specimen was returned from the hot-wet moisture conditioning. The CV2-2 panel was moisture conditioned at 160°F and 95 to 100 percent humidity for a period of 121 days prior to conducting the fatigue test. Moisture level by weight was greater than one percent.

### 7.3 CV2-2 TEST LOADS

One lifetime load spectrum is shown in Table 11. Load No. 15 (Table 11) applies design limit compression load to the CV2-2 specimen. Four lifetimes of hot/wet/room temperature fatigue testing was completed. Then, the CV2-2 panel was also tested for residual tension strength.

### 7.4 CV2-2 TEST PROCEDURES AND INSTRUMENTATION

Forty four axial strain gauges and six rosette gauges were attached to the specimen and were located as shown in Table 12.

#### 7.4.1 CV2-2 Fatigue Tests

The specimen was installed in a computer controlled 100-KIP capacity (75-KIP capacity in fatigue) fatigue test machine using the same attachment end fittings which were used for the CV2-1 static specimen installation. Shims were used as necessary to obtain concentricity at both ends. The specimen was supported laterally at the chordwise joint centerlines and at the two rib caps. The supports were attached to one of the vertical columns of the test machine as shown in Figures 37 and 38. Prior to fatigue testing, lateral deflection of the specimen under load was checked at -40 KIPS using dial gauges attached to the vertical column of the test machine. Deflection was measured at the centerline of the chordwise joints, at the rib caps, and at the transverse centerline of the specimen. A maximum lateral deflection of 0.014 in. at a load of -40 KIPS occurred at the lower rib cap. All measured deflections were in a direction such that the lateral support members were loaded in tension. Deflection at the transverse centerline of the specimen was negligible.



ORIGINAL PAGE IS  
OF POOR QUALITY

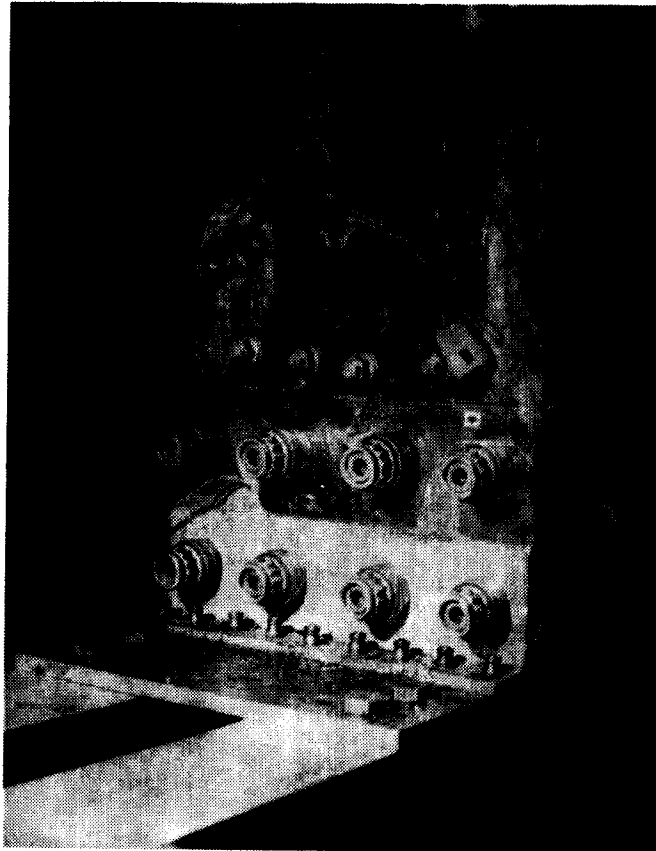

Figure 36. CV2-1 Specimen Damage - Bolt Bearing

TABLE 11. CV2-2 ONE LIFETIME LOAD SPECTRUM

LOAD LEVEL NO.	LOAD, POUNDS		CYCLES APPLIED AT						TOTAL CYCLES
	MEAN	VARY	1 FLIGHT	36 FLIGHTS	360 FLIGHTS	3600 FLIGHTS	9000 FLIGHTS	18000 FLIGHTS	
1	-25467	± 8989	6	33	25	21	19	19	121072
2	-25467	±11985	1	2	3	7	5	5	18570
3	-25467	±14982	0	10	17	24	20	22	5386
4	-25467	±17987	0	0	0	130	4	130	654
5	-25467	±20975	0	0	0	43	4	42	218
6	-25467	±23967	0	0	0	18	6	18	96
7	-25467	±26964	0	0	0	7	5	0	42
8	-25467	±29960	0	0	0	4	1	4	21
9	-25467	±33744	0	0	0	1	5	5	14
10	-25467	±35953	0	0	0	0	3	4	7
11	-25467	±38949	0	0	0	0	2	1	3
12	-25467	±41946	0	0	0	0	1	1	2
13	-25467	±44942	0	0	0	0	1	0	1
14	-25467	±47938	0	0	0	0	1	0	1
15	-25467	±50938	0	0	0	0	1	0	1
16	-29960	± 5993	0	34	36	34	32	32	17084
17	-29960	± 8989	0	11	22	24	24	22	6060
18	-29960	±12024	0	0	0	282	6	280	1414
19	-29960	±14982	0	0	0	79	10	78	404
20	-29960	±17978	0	0	0	22	8	24	120
21	-29960	±20975	0	0	0	6	5	8	37
22	-29960	±23967	0	0	0	1	3	6	13
23	-29960	±26964	0	0	0	0	3	2	5
24	-29960	±29960	0	0	0	0	1	1	2
25	-29960	±33311	0	0	0	0	1	0	1
26	-32957	± 8989	1	21	30	28	21	22	28425
27	-32957	±11985	0	0	0	251	7	251	1262
28	-32957	±14982	0	0	0	66	5	63	332
29	-32957	±17978	0	0	0	18	3	17	92
30	-32957	±20975	0	0	0	9	3	8	47
31	-32957	±23967	0	0	0	2	2	2	12
32	-32957	±26964	0	0	0	0	3	1	4
33	-32957	±29960	0	0	0	0	1	0	1
34	-32957	±32957	0	0	0	0	1	0	1
35	+ 2996	0	1	1	1	1	1	1	18000
TOTAL CYCLES/LIFETIME = 219,404									

TABLE 12. CV2-2 STRAIN GAUGE LOCATION

STRAIN GAUGE NUMBER	DISTANCE FROM UPPER SPLICE (IN)	DISTANCE FROM SLOT (IN)	LOCATION
1/2 (38/39)	0.0 (60.0)	3.5 R/L	Edge Inner Splice Doubler
3/4 (40/41)	0.0 (60.0)	1.75 R/L	Outer Skin
5/6 (42/43)	2.0 (58.0)	1.75 R/L	Outer Skin
7/8 (44/45)	2.0 (58.0)	1.75 R/L	Inside Inner Splice Doubler
9/10 (46/47)	8.0 (52.0)	3.0 R/L	Outer Skin
11/12 (48/49)	8.0 (52.0)	3.0 R/L	Inside Skin
13 (50)	8.0 (52.0)	0.0	Crown
14/15 (52/51)	14.0 (46.0)	3.0 R/L	Outer Skin
16/17 (54/53)	14.0 (46.0)	3.0 R/L	Inside Skin
18 (55)	14.0 (46.0)	0.5 L	Outer Skin
19 (56)	14.0 (46.0)	0.0	Crown
20/23 (57/60)	14.0 (46.0)	1.0 L/R	Leg (45°) (Crown-1.1)
21/24 (58/61)	14.0 (46.0)	1.0 L/R	Leg (Axial) (Crown-1.1)
22/25 (59/62)	14.0 (46.0)	1.0 L/R	Leg (Vertical) (Crown-1.1)
26/27	30.0	3.0 R/L	Outer Skin
28/29	30.0	3.0 R/L	Inner Skin
30	30.0	0.5 L	Outer Skin
31	30.0	0.0	Crown
32	30.0	1.0 R	Leg (45°) (Crown-1.1)
33	30.0	1.0 R	Leg (Axial) (Crown-1.1)
34	30.0	1.0 R	Leg (Vertical) (Crown-1.1)
35	27.5	1.0 L	Leg (45°) (Crown-1.1)
36	27.5	1.0 L	Leg (Axial) (Crown-1.1)
37	27.5	1.0 L	Leg (Vertical) (Crown-1.1)

- NOTE 1. (Lower End)  
 2. R = Right; L = Left  
 3. 45° = 45° Leg of Rosette; Axial = Axial Leg of Rosette  
 Vertical = Vertical Leg of Rosette

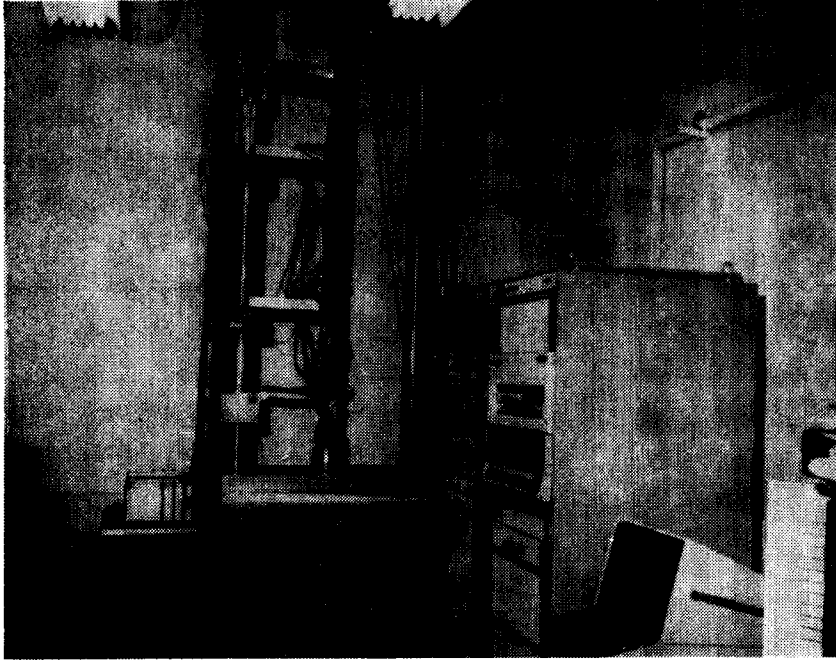

Figure 37. CV2-2 Fatigue Test Setup



Figure 38. CV2-2 Fatigue Test Setup

After 360 flights of the load spectrum, the vertical leg of the aluminum angle member of the lateral support at the lower chordwise splice was removed to reduce the stiffness of the support. In this final configuration, the deflection at the lower rib cap at -40 KIPS was 0.009 in.

All dial gauges were removed after 360 flights. Six copper-constantan thermocouples were installed on the specimen for the purpose of monitoring specimen temperature during the fatigue test. Thermocouple locations were as shown in Table 13.

Figure 39 shows the CV2-2 fatigue test setup after the installation of the environmental chamber.

Four lifetimes of the loads spectrum shown in Table 11 were applied. The loads were applied at the rate of approximately 950 flights per hour using a sine wave load form at a maximum frequency of 5 Hz. Each load condition was applied in the following sequence of load transients:

1. Mean Load
2. Max. Load (most positive)
3. Min. Load
4. Required number of repeats between 2 and 3 above
5. Return to Mean Load

Load level 15 of flight 9000 was not programmed for automatic application. This load was applied manually in order to accommodate the acquisition of strain data at peak load without exceeding the number of peak loads specified in the loads spectrum.

During application of the fatigue spectrum, part of the loads were applied with specimen temperature raised to 130°F. The temperature profile for the first lifetime is shown in Figure 40. The profile for lifetimes 2, 3, and 4 was the same.

The transient from room temperature (80°F) to 130°F required approximately 30 minutes. The transient from 130°F to room temperature required approximately 1.5 hours. The application of loads continued during the temperature transients except that on completion of flights 7199 and 17999, the loads spectrum was placed in hold until a temperature below 100°F was reached and then spectrum loading continued. The maximum compressive load applied at a temperature above 100°F was 41.9 KIPS at load level 26. Approximately 29 percent of the flights were applied at 130°F. Specimen temperature was monitored using six thermocouples shown in Table 13.

All thermocouples stabilized at 130°F  $\pm$ 5°F. The temperature cycle was computer controlled through a relay register located in the computer-test system interface. Strain surveys were made before and after the fatigue test and during the application of load level 15 at flights 9000, 27000, 45000, and 63000.

Slot duct width measurements were made at flight numbers 360, 9000, 27000, 45000, 63000, and after the fatigue test (Tables 14, 15, and 16). The measurements were made using a feeler gauge.

TABLE 13. CV2-2 THERMOCOUPLE MAP

THERMOCOUPLE NUMBER	DISTANCE FROM LOWER CENTER LINE OF SPLICE (IN)	DISTANCE FROM SLOT (IN)	LOCATION
Control	30.0	0.5L	Outer Skin
2	16.0	0.5R	Outer Skin
3	60.0	0.5R	Outer Skin
4	40.0	0.5L	Outer Skin
5	40.0	0.0	Crown
6	0	0.5L	Outer Skin

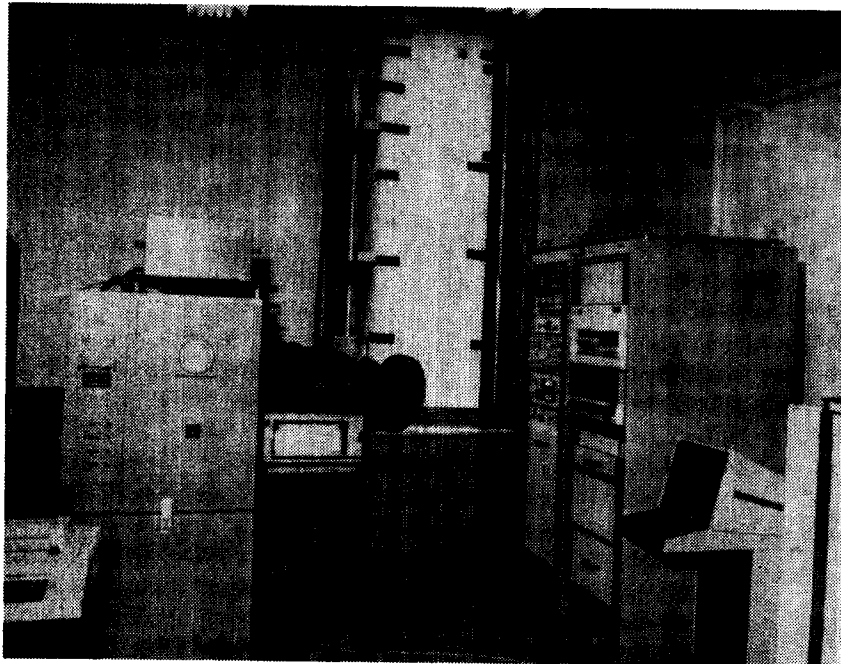

Figure 39. CV2-2 Fatigue Test Setup - With Environmental Chamber

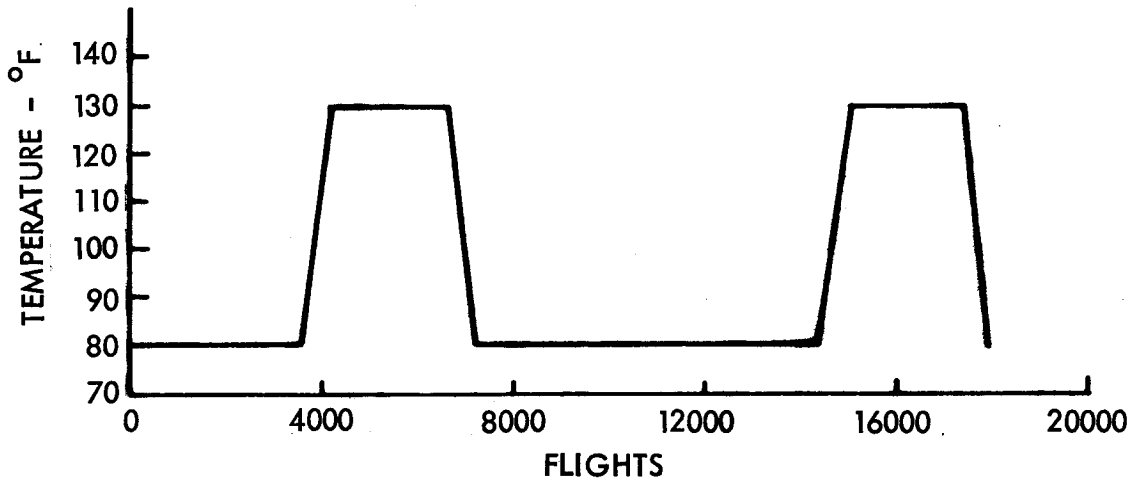

Figure 40. CV2-2 Fatigue Test Temperature Cycles

TABLE 14. CV2-2 FATIGUE TEST SLOT WIDTH MEASUREMENTS, LOAD = 0.0 KIPS

DISTANCE FROM LOWER SPLICE-IN	FLIGHTS					
	360	9000	27000	45000	63000	72000
3.0	10	10	10	10	10	10
6.0	10	11	11	11	11	11
9.0	10	10	10	10	10	10
12.0	11	11	11	11	11	11
15.0	12	12	12	12	13	13
18.0	13	13	13	13	13	13
21.0	13	13	13	13	14	13
24.0	13	13	13	13	14	14
27.0	13	14	14	14	14	14
30.0	13	15	15	15	15	15
33.0	13	15	15	15	16	16
36.0	13	15	16	15	16	16
39.0	13	16	16	16	17	16
42.0	13	15	16	16	16	16
45.0	13	14	14	14	14	14
48.0	11	11	10	11	11	11
51.0	9	10	10	10	10	10
54.0	8	10	10	10	10	10
57.0	10	10	10	10	10	10

TABLE 15. CV2-2 FATIGUE TEST SLOT WIDTH MEASUREMENTS,  
LOAD = 40.0 KIPS

DISTANCE FROM LOWER SPLICE-IN	FLIGHTS					
	360	9000	27000	45000	63000	72000
3.0	10	10	10	10	10	10
6.0	11	12	12	12	12	12
9.0	10	10	10	10	10	10
12.0	11	11	11	11	11	11
15.0	13	13	13	14	14	14
18.0	14	14	15	15	15	15
21.0	14	14	15	15	15	15
24.0	14	15	14	15	15	15
27.0	14	14	15	15	16	16
30.0	13	16	16	16	16	16
33.0	15	16	17	17	17	17
36.0	15	17	17	17	17	17
39.0	16	17	18	18	18	18
42.0	16	17	18	18	18	18
45.0	14	15	15	15	16	16
48.0	11	11	11	11	11	12
51.0	10	10	10	10	10	10
54.0	10	10	10	11	10	10
57.0	10	10	10	10	10	10



TABLE 16. CV2-2 FATIGUE TEST SLOT WIDTH MEASUREMENTS,  
LOAD = 60.0 KIPS

DISTANCE FROM LOWER SPLICE-IN	FLIGHTS			
	9000	27000	45000	63000
3.0	10	10	10	10
6.0	13	12	13	13
9.0	10	10	10	10
12.0	11	11	11	11
15.0	14	14	14	14
18.0	16	15	15	16
21.0	16	15	15	16
24.0	15	15	15	15
27.0	16	16	16	16
30.0	17	17	17	18
33.0	17	17	17	18
36.0	18	18	18	18
39.0	19	18	19	19
42.0	19	18	19	19
45.0	16	16	16	16
48.0	11	11	12	11
51.0	10	10	10	10
54.0	11	10	11	11
57.0	10	10	10	10

#### 7.4.2 CV2-2 Tension Test

After completion of four lifetimes of fatigue, a residual strength tensile static test of the CV2-2 specimen was conducted. The test set-up was essentially the same as for the previously tested CV2-1 tension static test (Figures 33 and 34). The strain gauges were located as shown on Table 12. The dial gauges were located as shown on Table 3.

The loading sequence was: 0 KIPS, 3.5 KIPS, 20 KIPS, 40 KIPS, 60 KIPS, 80 KIPS, 20 KIPS, 80 KIPS, 90 KIPS, 100 KIPS, 110 KIPS, 120 KIPS, and 130 KIPS.

### 7.5 CV2-2 SUMMARY OF TEST RESULTS

#### 7.5.1 CV2-2 Summary of Fatigue Test Results

After completing four lifetimes of hot/wet/room temperature fatigue strength cycle as discussed in Section 7.4, no damage was found by visual inspection. No disbond of titanium skin was found by "coin tap" test. The strain surveys data are contained in Appendix F. The LFC slot duct was measured and is recorded in Tables 14, 15, and 16.

#### 7.5.2 CV2-2 Summary of Residual Strength - Static Tension - Results

Four lifetimes of hot/wet fatigue testing was completed. Then, the CV2-2 panel was also residual tension strength tested. During the CV2-2 residual strength test, slot width measurements were taken every 3 inches from the lower end chordwise splice along the specimen length. A total of 19 locations were measured with the use of a feeler gauge. Table 17 presents these data. Dial gauges were monitored during the CV2-2 residual strength tension test and are recorded in Table 18.

The CV2-2 panel was installed in the universal testing machine with strain gauges attached (Table 12). The strain gauges were monitored during the CV2-2 residual strength test and the results are reported in Appendix G. Also, this strain data is plotted in Appendix H.

The CV2-2 residual strength test failing load was 130 KIPS. The failure mode was net section failure (including titanium outer skin), (Figures 41, 42, 43, and 44) at a point four inches above the upper composite rib cap. Note that the hat also failed in a net section failure mode, therefore the 24 bolts of 5/16 diameter prevented peel or shear tear out failure modes.

The section width was measured and recorded as 6.94 in. Using the 6.94 in. section width an allowable net section tension load of 133 KIPS was predicted. Note wet graphite composite material allowables (Table 19) were used. The failing load of 130 KIPS is two percent of the predicted tension load of 133 KIPS. Therefore, the static tension structure integrity strength was verified for the CV2-2 panel.

TABLE 17. CV2-2 RESIDUAL STRENGTH TEST SLOT WIDTH MEASUREMENTS

DISTANCE FROM LOWER SPLICE (IN)	LOAD IN KIPS						
	0	3.5	20	40	60	80	20
3.0	10	10	10	10	10	10	10
6.0	10	10	10	10	8	8	10
9.0	10	10	10	10	10	10	10
12.0	11	11	10	11	10	10	11
15.0	12	12	11	11	10	10	11
18.0	13	13	12	11	11	10	12
21.0	13	13	13	12	11	10	13
24.0	13	13	13	12	12	11	13
27.0	14	14	14	13	13	12	13
30.0	15	15	14	14	13	13	14
33.0	16	16	15	14	14	13	15
36.0	16	16	15	14	14	13	15
39.0	16	16	16	15	14	13	16
42.0	16	16	15	14	13	12	15
45.0	14	14	13	12	11	11	13
48.0	11	11	11	11	11	10	11
51.0	10	10	10	10	10	10	10
54.0	10	10	9	8	8	7	9
57.0	10	10	10	10	10	10	10

TABLE 18. CV2-2 RESIDUAL STRENGTH TEST-DIAL GAUGE READINGS

DIAL GAUGE NUMBER	LOAD-KIPS						
	0.0	3.5	20.0	40.0	60.0	80.0	20.0
1	0	0	-1	-1	-1	-1	-1.5
2	0	0	0	0	1	1	0
3	0	0	4.5	8	10	12	6
4	0	0	3.5	6.5	8	9	5.5
5	0	0	1	2	2.5	3	5
6	0	0	1	1	1.5	2	1

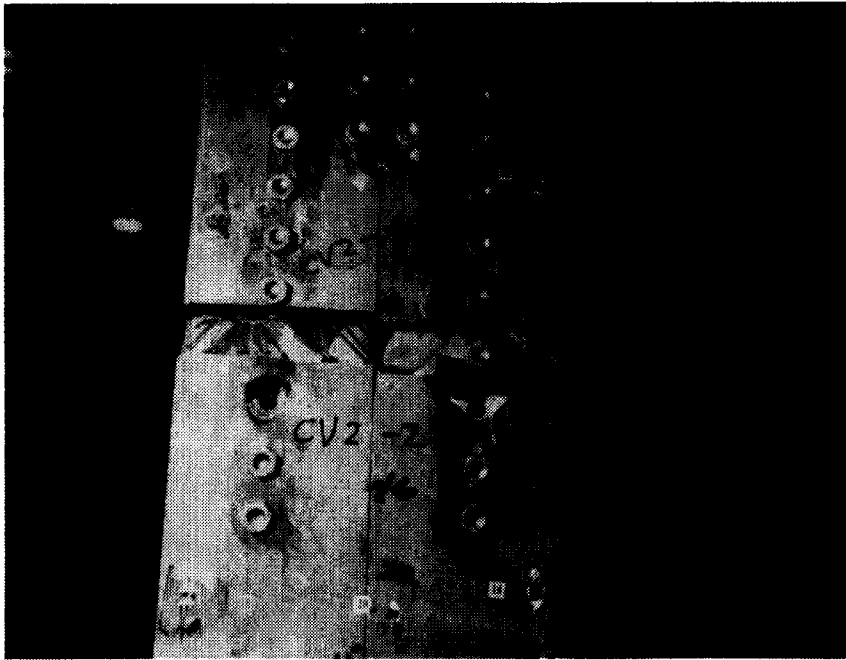

Figure 41. CV2-2 Residual Strength Test Damage - Titanium Skin

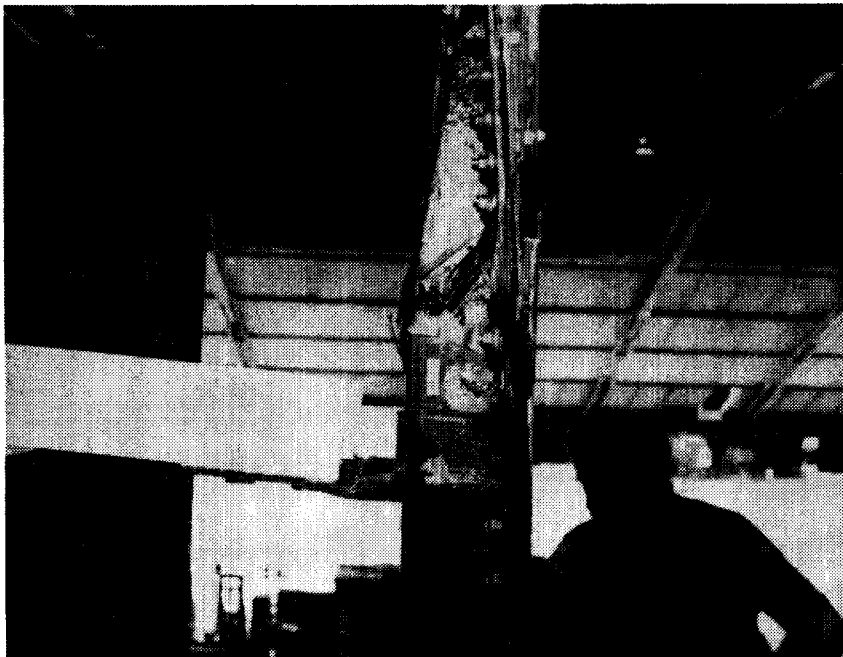

Figure 42. CV2-2 Residual Strength Test Damage - Hat and Skin

ORIGINAL PAGE IS  
OF POOR QUALITY.

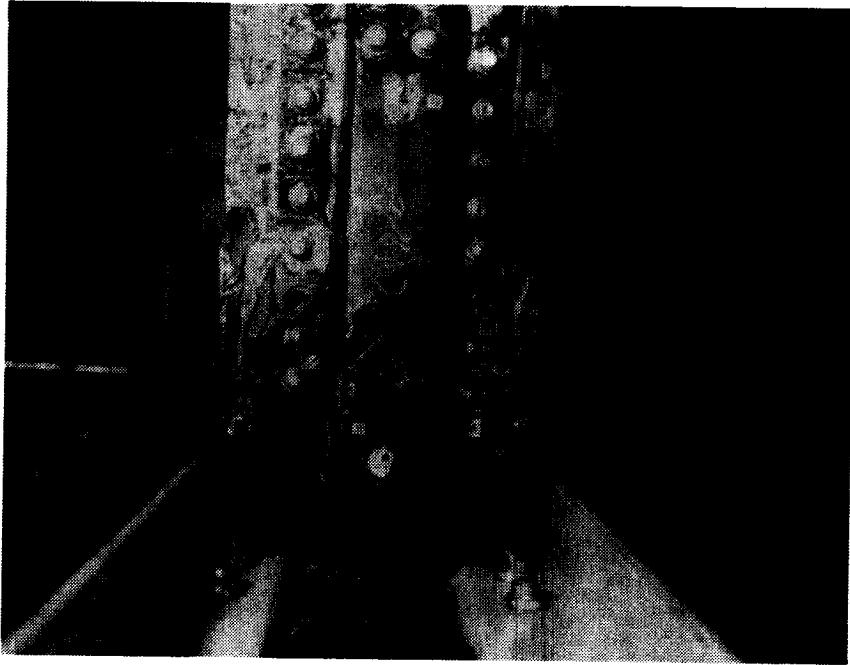

Figure 43. CV2-2 Residual Strength Test Damage - Hat/Skin Side

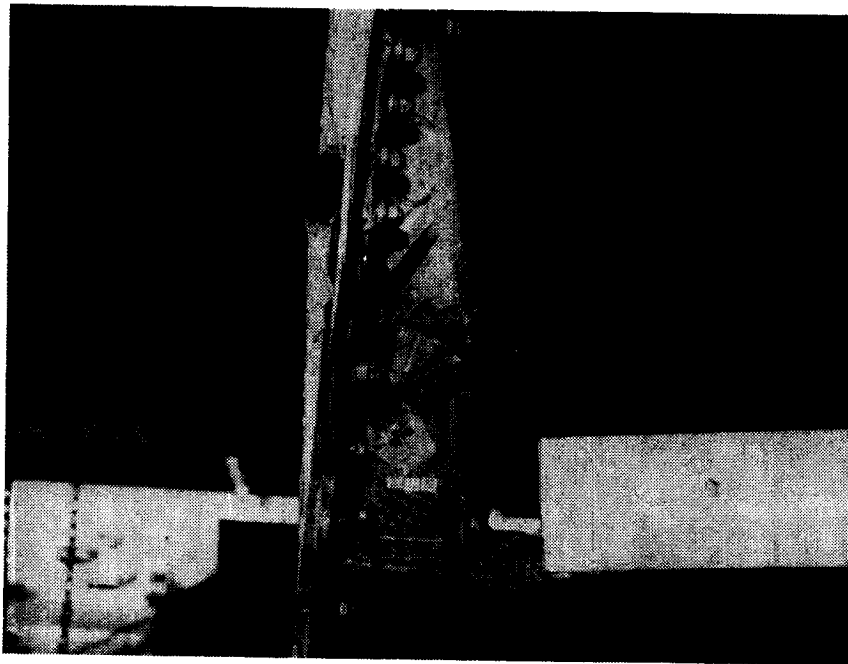

Figure 44. CV2-2 Residual Strength Test Damage - Hat and Skin

TABLE 19. GRAPHITE-EPOXY LAMINA PROPERTIES - WET

MODULUS (MILLION LB/IN <sup>2</sup> )	
FIBER DIRECTION	20.5
NORMAL TO FIBERS	1.35
SHEAR	0.60
MAJOR POISSON'S RATIO	0.30
DENSITY (LB/IN <sup>3</sup> )	0.057
THICKNESS, (IN/PLY)	0.005

## 8.0 CONCLUDING REMARKS

The graphite/epoxy integrated LFC wing structural concept has been sized for the LFC and structural system requirements. The concept has been shown by analysis to be structurally efficient and cost effective. Materials selected for the surface structure have been verified by material verification tests. Critical details of the surface and surface joints have been demonstrated by fabricating and testing complex, concept selection specimens.

Good progress was made toward the goal of developing the integrity of the LFC wing structural design. The major accomplishments were:

1. Two CV2 LFC chordwise joints were fabricated of a titanium - graphite composite structure.
2. Specimen strength was verified in static tension.
3. One specimen was tested in fatigue to four lifetimes in a hot/wet environment without failure.
4. Air suction flow characteristics were measured and found close to that predicted.

The next step would be to build the large surface panel described in Figure 5 and Section 6.10 of Reference 2.

REFERENCES

1. Sturgeon, R. F., et al.: "Evaluation of Laminar Flow Control System Concepts for Subsonic Commercial Transport Aircraft." NASA CR-159253, Prepared by Lockheed-Georgia Company under Contract NAS1-14631, September, 1980.
2. Lineberger, L. B., et al.: "Development of Laminar Flow Control Wing Surface Composite Structures.: NASA CR-172330, Prepared by Lockheed-Georgia Company under Contract NAS1-17487, May, 1984.
3. Etchberger, F. R., et al.: "LFC Leading Edge Glove Flight-Aircraft Modification Design, Test Article Development, and Systems Integration." NASA CR-172136, Prepared by Lockheed-Georgia Company under Contract NAS1-16219, November, 1983.

PRECEDING PAGE BLANK NOT FILMED





REV	DESCRIPTION	DATE
1	INITIAL	
2	DETAIL B MODIFIED, CHANGE S. HIGMAN	
3	LENGTH OF 11 SHEETS TO BE 110 IN. & 115.	

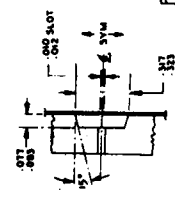

SECTION G-G SCALE 1/2  
(DETAIL OF SLOT & DUCT)

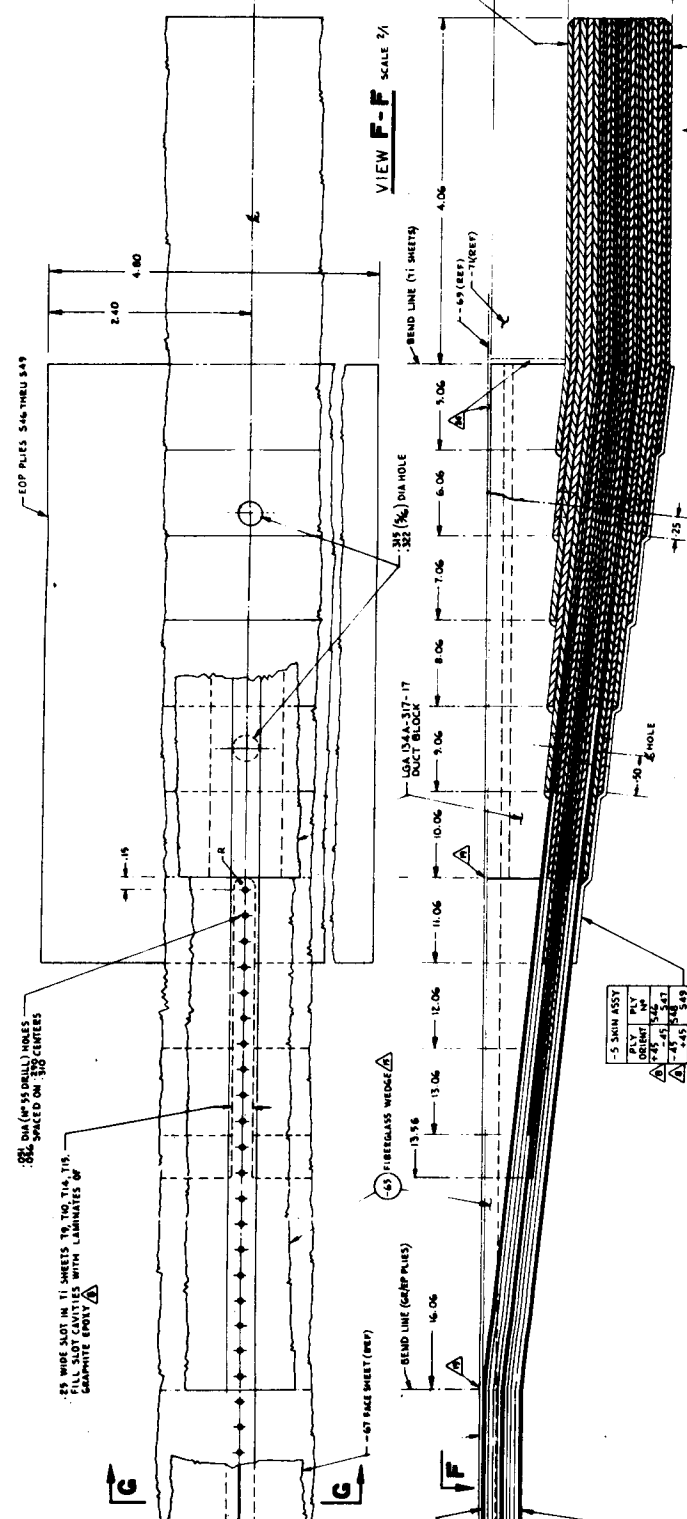

VIEW F-F SCALE 1/2

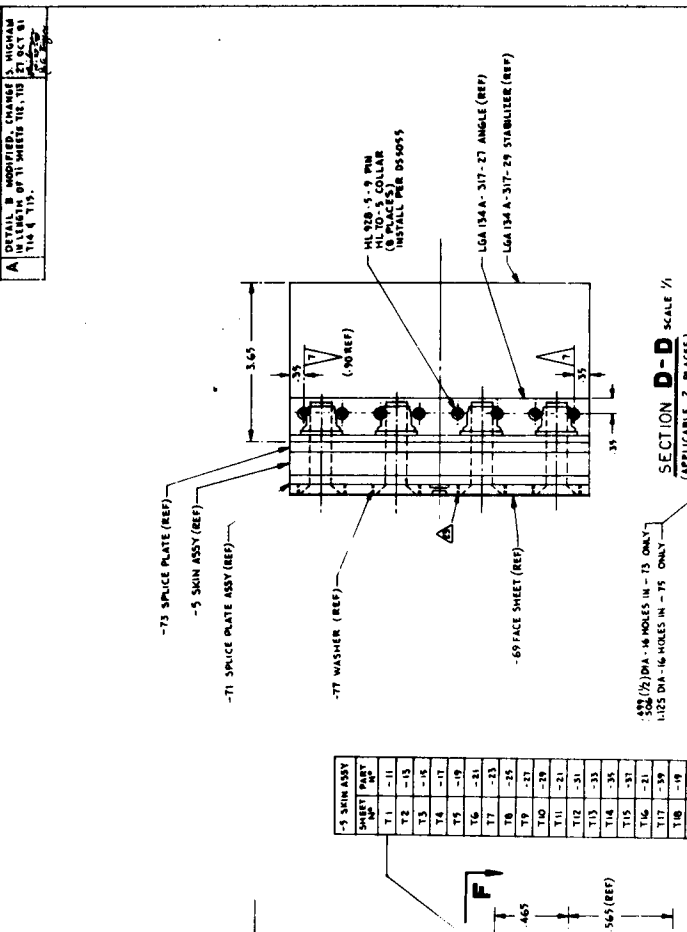

SECTION D-D SCALE 1/2  
(APPLICABLE 2 PLACES)

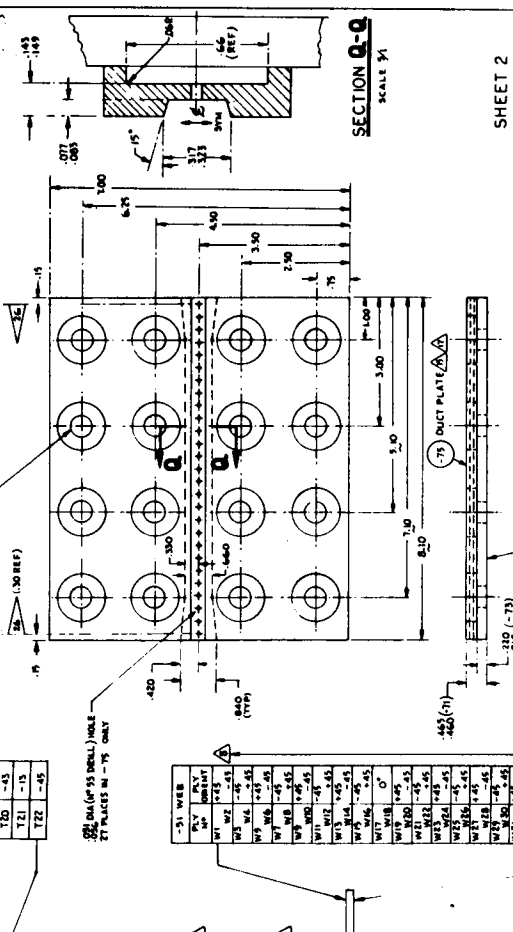

SECTION Q-Q SCALE 1/2

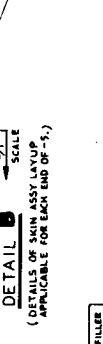

DETAIL B  
(DETAILS OF SKIN ASSY LAYOUT APPLICABLE FOR EACH END OF -5-)

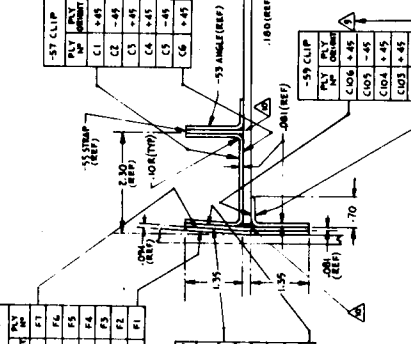

SECTION H-H SCALE 1/2

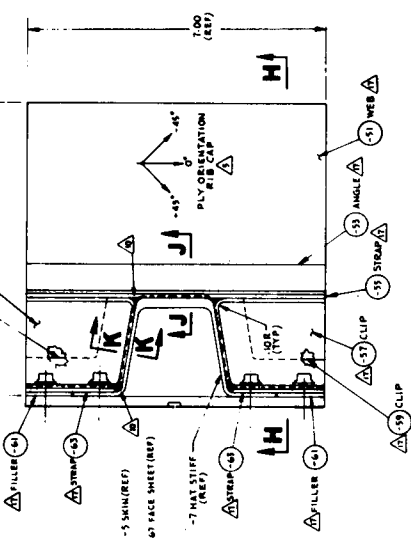

SECTION E-E SCALE 1/2  
(APPLICABLE 2 PLACES)

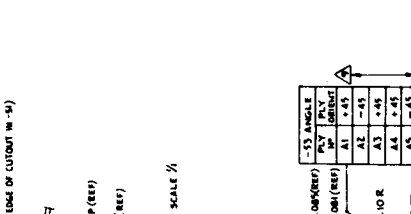

SECTION J-J SCALE 1/2

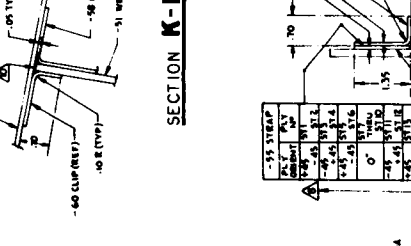

SECTION K-K SCALE 1/2

REV	DESCRIPTION	DATE
1	INITIAL	
2	DETAIL B MODIFIED, CHANGE S. HIGMAN	
3	LENGTH OF 11 SHEETS TO BE 110 IN. & 115.	

WSSD CV-2 SPECIMEN

LOCKHEED-BOEING

COMBUSTION

ENGINE

TEST CELL

TEST NO. 101141-315

DATE 11/15/78

BY J. S. HIGMAN

REVISED BY A

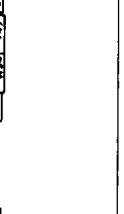

DETAIL-71 SPLICE PLATE ASSY (SCALE 1/2)

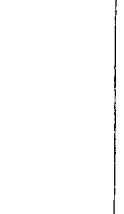

DETAIL-77 CSK WASHER (SCALE 1/2)

ORIGINAL LAYOUT IS OF POOR QUALITY

FOLDCUT FRAME

FOLDCUT FRAME

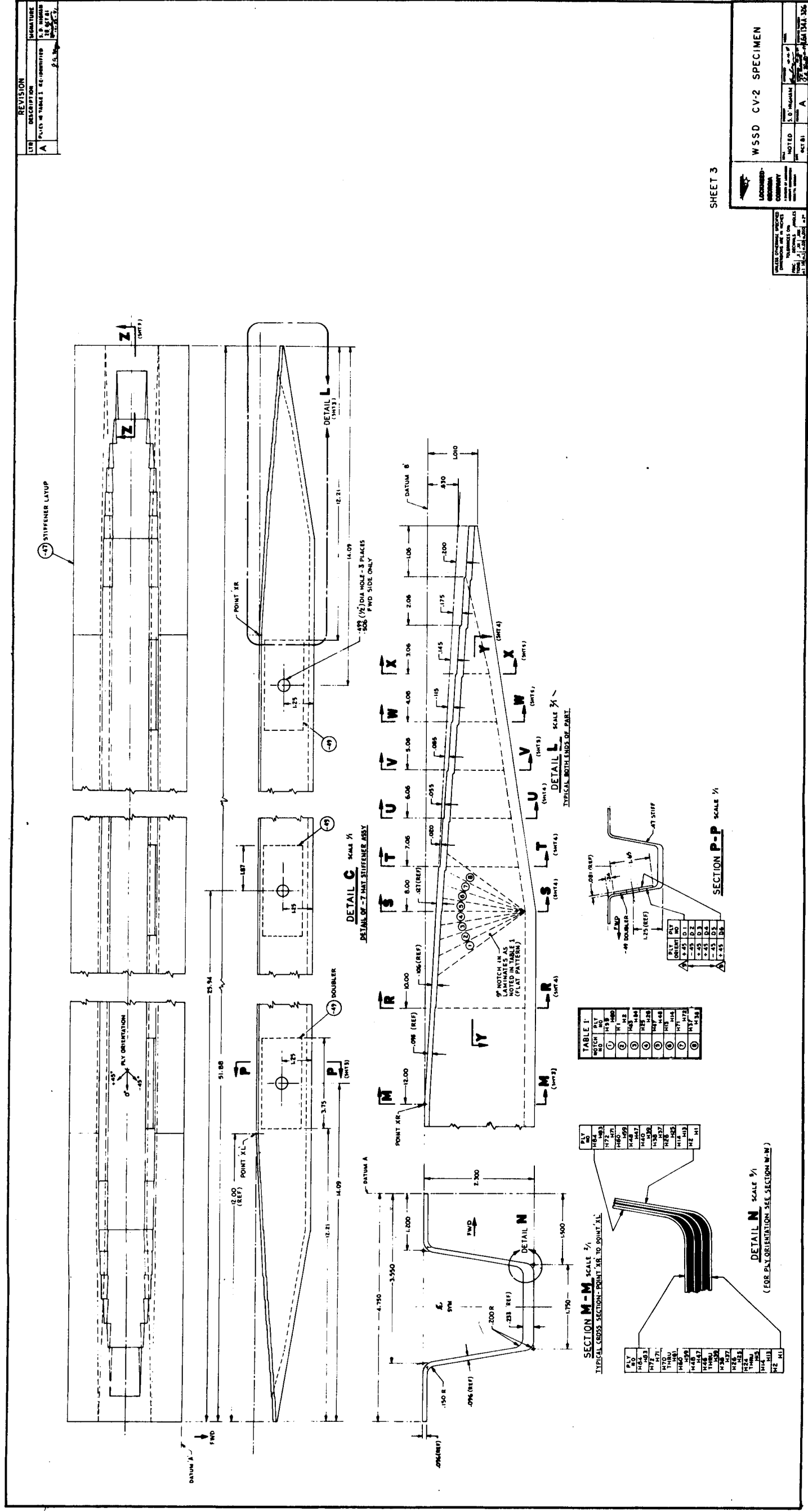

REVISION	
NO	DESCRIPTION
A	PLYS IN TABLE 1 RE-IDENTIFIED
SIGNATURE S.P. HUNTER 28 JUL 81 PROJECT	

SHEET 3

LOCKHEED CORPORATION	
WSSD CV-2 SPECIMEN	
DATE	28 JUL 81
BY	A
CHECKED BY	
DESIGNED BY	
DRAWN BY	
SCALE	
SHEET NO	
TOTAL SHEETS	

ORIGINAL PAGE IS  
OF POOR QUALITY

ORIGINAL PAGE IS  
OF POOR QUALITY

A-3

ORIGINAL PAGE IS  
OF POOR QUALITY

ORIGINAL PAGE IS  
OF POOR QUALITY

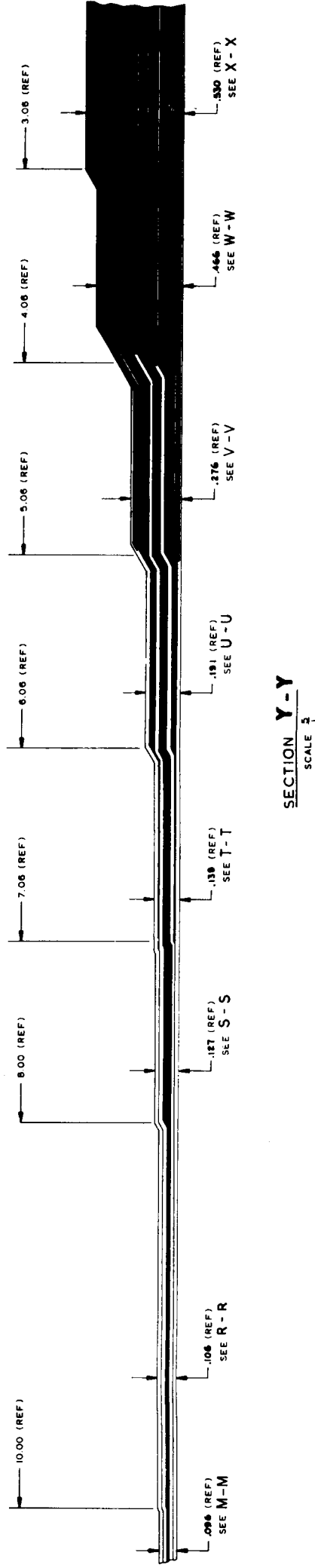
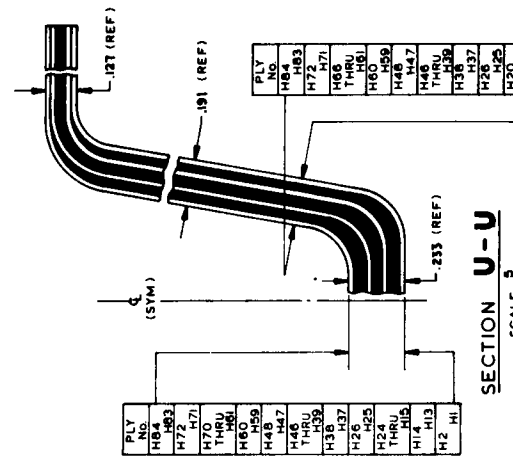
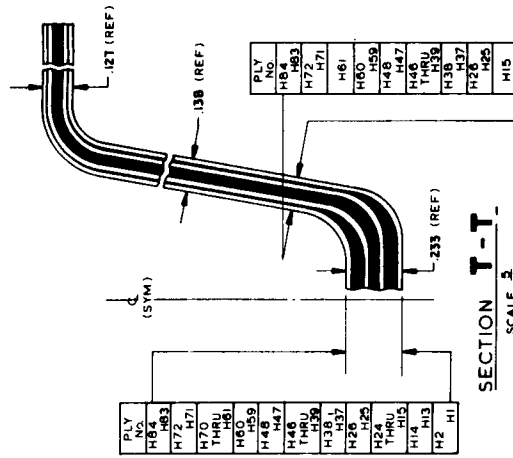
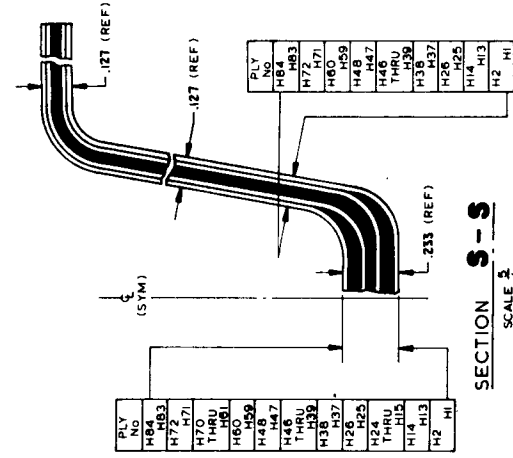
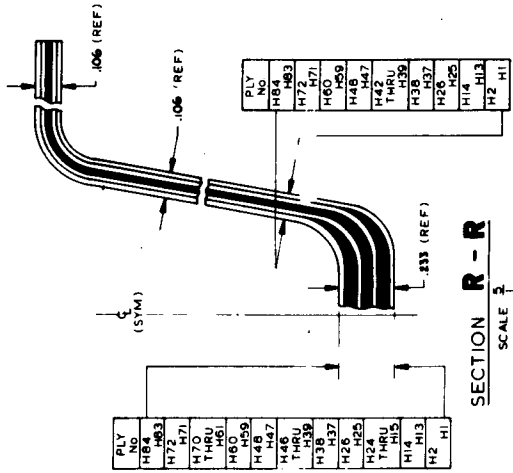

SHEET 4

LOCKHEED-  
CORPORATION  
CORPORATION

WSSD - CV-2 SPECIMEN

DATE: 11-1-68  
BY: J. B. HIGHAM  
CHECKED BY: J. B. HIGHAM  
DRAWN BY: J. B. HIGHAM  
SCALE: 1/2

FOLDOUT FRAME

A-4

FOLDOUT FRAME

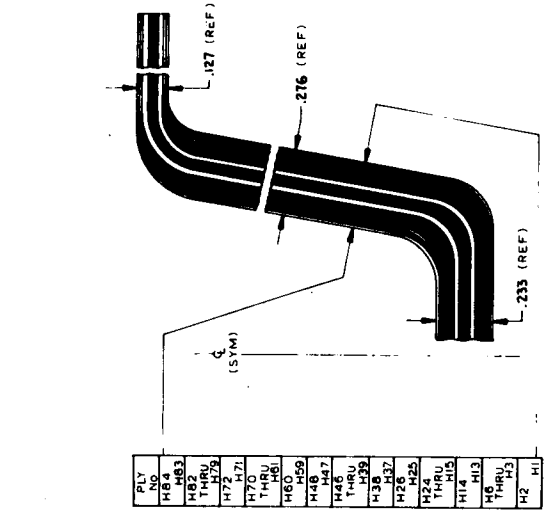

-47 MAT STIFF	
PLY NO	PLY ORIENT
H84	0°
H85	+45
H86	-45
H87	0°
H88	-45
H89	0°
H90	+45
H91	-45
H92	0°
H93	+45
H94	-45
H95	0°
H96	+45
H97	-45
H98	0°
H99	+45
H100	-45
H101	0°
H102	+45
H103	-45
H104	0°
H105	+45
H106	-45
H107	0°
H108	+45
H109	-45
H110	0°
H111	+45
H112	-45
H113	0°
H114	+45
H115	-45
H116	0°
H117	+45
H118	-45
H119	0°
H120	+45
H121	-45
H122	0°
H123	+45
H124	-45
H125	0°
H126	+45
H127	-45
H128	0°
H129	+45
H130	-45
H131	0°
H132	+45
H133	-45
H134	0°
H135	+45
H136	-45
H137	0°
H138	+45
H139	-45
H140	0°
H141	+45
H142	-45
H143	0°
H144	+45
H145	-45
H146	0°
H147	+45
H148	-45
H149	0°
H150	+45
H151	-45
H152	0°
H153	+45
H154	-45
H155	0°
H156	+45
H157	-45
H158	0°
H159	+45
H160	-45
H161	0°
H162	+45
H163	-45
H164	0°
H165	+45
H166	-45
H167	0°
H168	+45
H169	-45
H170	0°
H171	+45
H172	-45
H173	0°
H174	+45
H175	-45
H176	0°
H177	+45
H178	-45
H179	0°
H180	+45
H181	-45
H182	0°
H183	+45
H184	-45
H185	0°
H186	+45
H187	-45
H188	0°
H189	+45
H190	-45

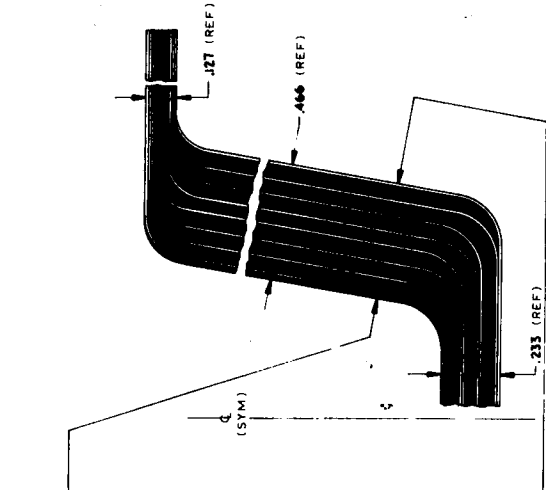

-47 MAT STIFF	
PLY NO	PLY ORIENT
H100	0°
H101	+45
H102	-45
H103	0°
H104	+45
H105	-45
H106	0°
H107	+45
H108	-45
H109	0°
H110	+45
H111	-45
H112	0°
H113	+45
H114	-45
H115	0°
H116	+45
H117	-45
H118	0°
H119	+45
H120	-45

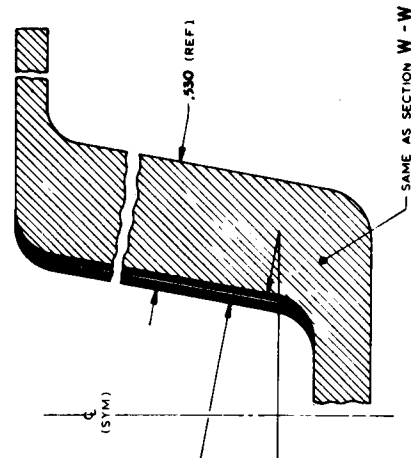

SECTION V-V SCALE 1/2

SECTION W-W SCALE 1/2

SECTION X-X SCALE 1/2

SAME AS SECTION W-W

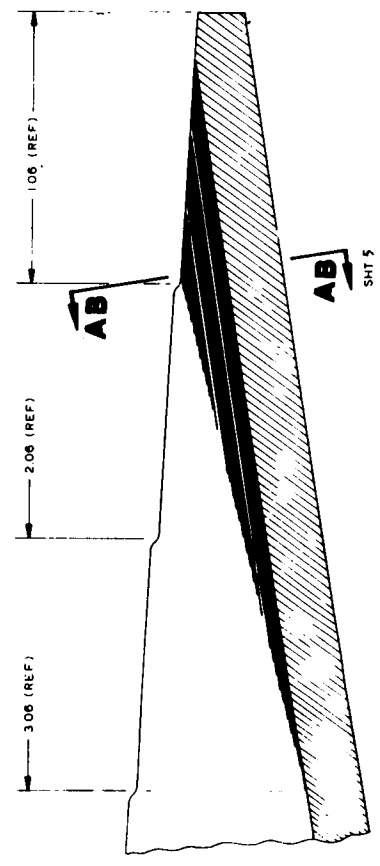

SECTION Z-Z SCALE 1/2

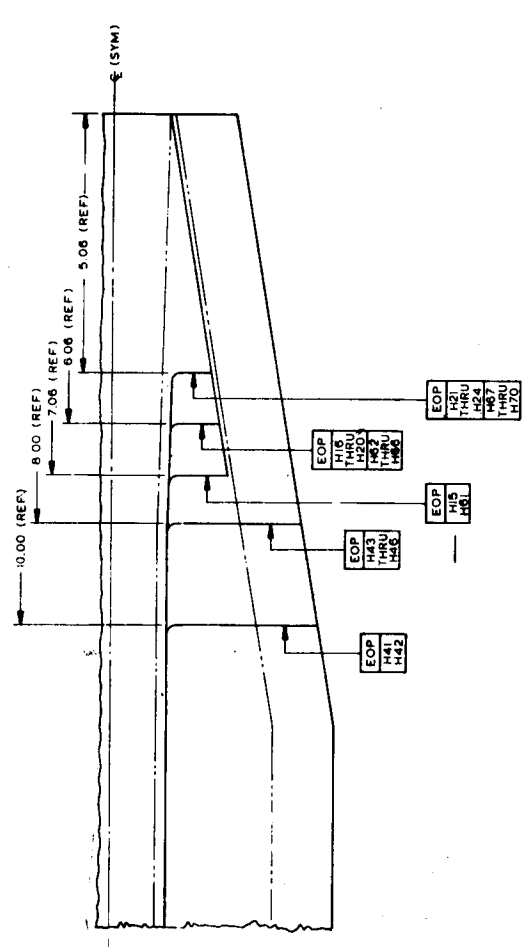

FLAT PATTERN SCHEMATIC OF NOTED PLIES NO SCALE

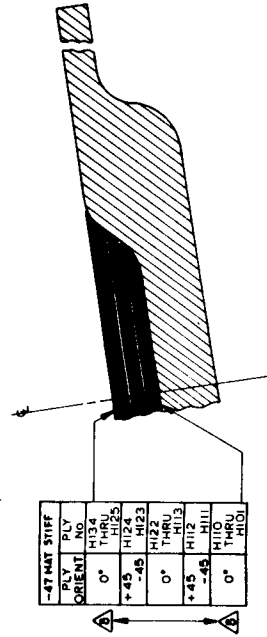

SECTION AB-AB SCALE 1/2

SHEET 5

LOCKHEED-BOEING COMPANY  
 WSSD-CV2 SPECIMEN  
 NOTED S. D. HIGHMAN  
 OCT 81  
 CALIFORNIA 326

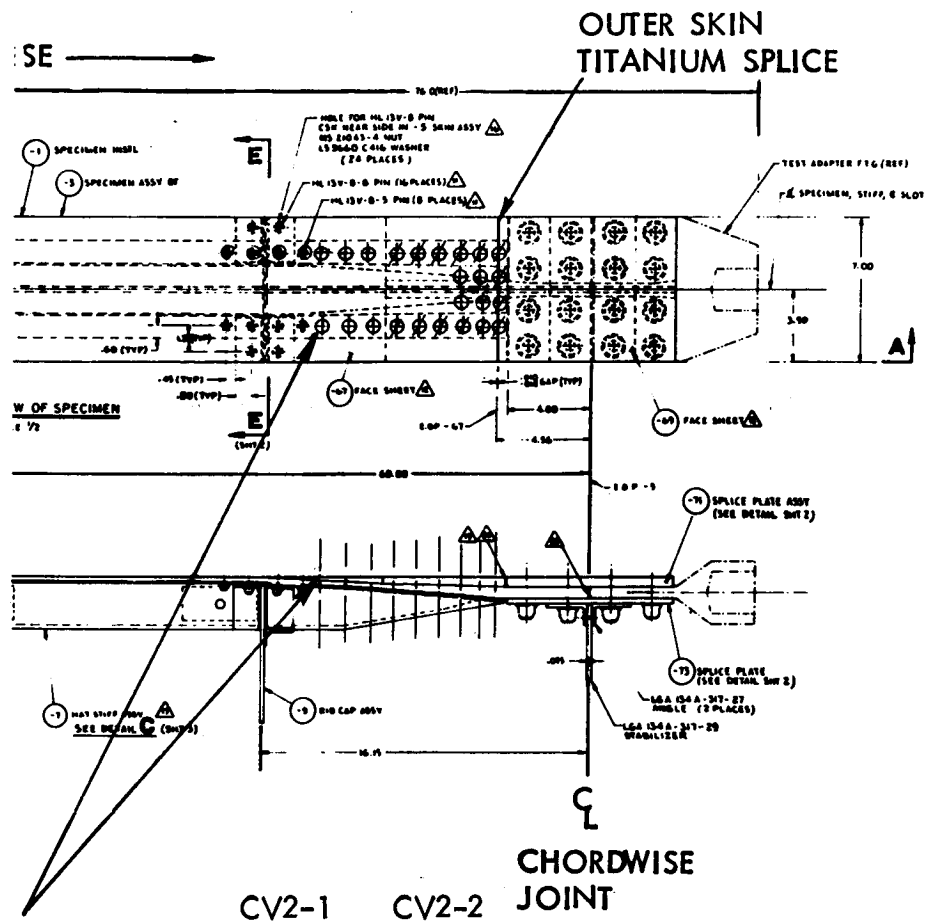

5/16" DIAMETER  
SPACING = 1.0"  
E/D = .50"  
NAS 6205  
NUT 68563  
WASHER LS9660

	CV2-1	CV2-2
5/16" DIAMETER	14	24
SPACING = 1.0"	∅	0
E/D = .50"		
NAS 6205		
NUT 68563		
WASHER LS9660		

Figure A-2. WSSD CV2 Specimen Rework

PRECEDING PAGE BLANK NOT FILLED

STRAIN DATA  
MICRO INCHES PER  
NEGATIVE SIGN INDICATES COMPRESSIVE STRAIN

LOAD INCREMENT	GAGE NO. 1A	GAGE NO. 2A	GAGE NO. 3A	GAGE NO. 4A	GAGE NO. 5A
0	0	0	0	0	0
10000	198	199	104	99	79
20000	648	597	263	248	183
30000	1179	1035	398	388	302
40000	1912	1354	597	607	446
0	9	4	24	44	-15

STRAIN DATA  
MICRO INCHES PER  
NEGATIVE SIGN INDICATES COMPRESSIVE STRAIN

LOAD INCREMENT	GAGE NO. 6A	GAGE NO. 7A	GAGE NO. 8A	GAGE NO. 9A	GAGE NO. 10A
0	0	0	0	0	0
10000	69	49	64	123	103
20000	164	114	184	306	267
30000	248	49	344	503	450
40000	402	-384	449	721	662
0	14	-469	-30	19	29

STRAIN DATA  
MICRO INCHES PER  
NEGATIVE SIGN INDICATES COMPRESSIVE STRAIN

LOAD INCREMENT	GAGE NO. 11A	GAGE NO. 12A	GAGE NO. 13A	GAGE NO. 14A	GAGE NO. 15A
0	0	0	0	0	0
10000	79	74	138	218	188
20000	213	188	356	547	487
30000	327	307	564	875	805
40000	446	402	733	1218	1113
0	0	-20	-25	24	4

Figure B-1. CV2-1 Loading Checks - Strain Gauge Readings (Continued)

~~PRECEDING PAGE BLANK NOT FILLED~~

STRAIN DATA  
MICRO INCHES PER  
NEGATIVE SIGN INDICATES COMPRESSIVE STRAIN

LOAD INCREMENT	GAGE NO. 16A	GAGE NO. 17A	GAGE NO. 18A	GAGE NO. 19A	GAGE NO. 26A
0	0	0	0	0	0
10000	362	377	237	262	331
20000	917	958	609	664	842
30000	1473	1559	985	1061	1352
40000	2028	2145	1367	1418	1882
0	29	4	19	-30	29

STRAIN DATA  
MICRO INCHES PER  
NEGATIVE SIGN INDICATES COMPRESSIVE STRAIN

LOAD INCREMENT	GAGE NO. 27A	GAGE NO. 28A	GAGE NO. 29A	GAGE NO. 30A	GAGE NO. 31A
0	0	0	0	0	0
10000	335	335	290	330	305
20000	852	842	744	842	792
30000	1379	1355	1192	1360	1264
40000	1892	1877	1631	1867	1707
0	4	29	4	14	-15

STRAIN DATA  
MICRO INCHES PER  
NEGATIVE SIGN INDICATES COMPRESSIVE STRAIN

LOAD INCREMENT	GAGE NO. 46A	GAGE NO. 47A	GAGE NO. 48A	GAGE NO. 49A
0	0	0	0	0
10000	119	105	78	72
20000	304	270	195	183
30000	494	451	307	309
40000	709	671	429	395
0	19	30	0	-25

Figure B-1. CV2-1 Loading Checks - Strain Gauge Readings (Continued)



STRAIN DATA  
MICRO INCHES PER  
NEGATIVE SIGN INDICATES COMPRESSIVE STRAIN

LOAD INCREMENT	GAGE NO. 20R	GAGE NO. 21R	GAGE NO. 22R	GAGE NO. 23R	GAGE NO. 24R
0	0	0	0	0	0
10000	-231	127	292	-200	98
20000	-573	309	752	-495	252
30000	-914	496	1212	-800	400
40000	-1265	678	1641	-1085	539
0	-26	-5	0	-10	0

STRAIN DATA  
MICRO INCHES PER  
NEGATIVE SIGN INDICATES COMPRESSIVE STRAIN

LOAD INCREMENT	GAGE NO. 25R	GAGE NO. 32R	GAGE NO. 33R	GAGE NO. 34R	GAGE NO. 35R
0	0	0	0	0	0
10000	309	-242	69	325	-246
20000	790	-603	183	823	-630
30000	1277	-965	297	1326	-1008
40000	1723	-1327	406	1799	-1382
0	-16	-26	-5	5	0

STRAIN DATA  
MICRO INCHES PER  
NEGATIVE SIGN INDICATES COMPRESSIVE STRAIN

LOAD INCREMENT	GAGE NO. 36R	GAGE NO. 37R
0	0	0
10000	74	341
20000	178	858
30000	293	1389
40000	392	1881
0	-5	-11

Figure B-1. CV2-1 Loading Checks - Strain Gauge Readings (Concluded)



STRAIN DATA  
MICRO INCHES PER INCH  
NEGATIVE SIGN INDICATES COMPRESSIVE STRAIN

LOAD INCREMENT	GAGE NO. 16A	GAGE NO. 17A	GAGE NO. 18A	GAGE NO. 19A	GAGE NO. 26A
0	0	0	0	0	0
10000	341	411	237	263	326
20000	856	1026	594	660	815
30000	1386	1631	965	1052	1319
40000	1926	2251	1337	1450	1823
0	39	29	4	-40	24

STRAIN DATA  
MICRO INCHES PER INCH  
NEGATIVE SIGN INDICATES COMPRESSIVE STRAIN

LOAD INCREMENT	GAGE NO. 27A	GAGE NO. 28A	GAGE NO. 29A	GAGE NO. 30A	GAGE NO. 31A
0	0	0	0	0	0
10000	330	315	290	335	314
20000	852	813	747	843	787
30000	1374	1310	1194	1361	1250
40000	1902	1823	1651	1875	1737
0	0	24	14	34	-15

STRAIN DATA  
MICRO INCHES PER INCH  
NEGATIVE SIGN INDICATES COMPRESSIVE STRAIN

LOAD INCREMENT	GAGE NO. 46A	GAGE NO. 47A	GAGE NO. 48A	GAGE NO. 49A
0	0	0	0	0
10000	109	105	78	81
20000	299	280	195	202
30000	498	451	312	317
40000	693	626	434	433
0	4	15	0	24

Figure C-1. CV2-1 Loading Check with Ribs Attached  
Strain Gauge Readings (Continued)

STRAIN DATA  
MICRO INCHES PER INCH  
NEGATIVE SIGN INDICATES COMPRESSIVE STRAIN

LOAD INCREMENT	GAGE NO. 20R	GAGE NO. 21R	GAGE NO. 22R	GAGE NO. 23R	GAGE NO. 24R
0	0	0	0	0	0
10000	-212	113	323	-200	113
20000	-534	305	782	-495	291
30000	-861	492	1232	-790	459
40000	-1203	689	1691	-1090	627
0	0	9	90	-15	24

STRAIN DATA  
MICRO INCHES PER INCH  
NEGATIVE SIGN INDICATES COMPRESSIVE STRAIN

LOAD INCREMENT	GAGE NO. 25R	GAGE NO. 32R	GAGE NO. 33R	GAGE NO. 34R	GAGE NO. 35R
0	0	0	0	0	0
10000	324	-226	74	315	-246
20000	806	-578	183	803	-625
30000	1292	-929	302	1301	-1008
40000	1779	-1295	417	1794	-1392
0	-6	-16	4	10	0

STRAIN DATA  
MICRO INCHES PER INCH  
NEGATIVE SIGN INDICATES COMPRESSIVE STRAIN

LOAD INCREMENT	GAGE NO. 36R	GAGE NO. 37R
0	0	0
10000	79	347
20000	204	870
30000	318	1398
40000	438	1926
0	24	10

Figure C-1. CV2-1 Loading Check with Ribs Attached  
Strain Gauge Readings (Concluded)

**STRAIN DATA**  
**MICRO INCHES PER INCH**  
**NEGATIVE SIGN INDICATES COMPRESSIVE STRAIN**

LOAD INCREMENT	GAGE NO. 20R	GAGE NO. 21R	GAGE NO. 22R	GAGE NO. 23R	GAGE NO. 24R
3500	0	0	0	0	0
20000	-536	330	751	-492	217
40000	-1203	710	1644	-1118	613
52000	-142	-119	-2481	-316	54
0	-112	-351	-3092	65	34
60000	-213	-104	-2386	-381	49
60000	-182	-104	-2366	-361	39

**STRAIN DATA**  
**MICRO INCHES PER INCH**  
**NEGATIVE SIGN INDICATES COMPRESSIVE STRAIN**

LOAD INCREMENT	GAGE NO. 25R	GAGE NO. 32R	GAGE NO. 33R	GAGE NO. 34R	GAGE NO. 35R
3500	0	0	0	0	0
20000	822	-588	228	830	-637
40000	1797	-1307	451	1814	-1398
52000	411	-1754	674	2059	-1788
0	-168	110	-20	-184	107
60000	426	-1739	659	2028	-1783
60000	426	-1724	649	2018	-1778

**STRAIN DATA**  
**MICRO INCHES PER INCH**  
**NEGATIVE SIGN INDICATES COMPRESSIVE STRAIN**

LOAD INCREMENT	GAGE NO. 36R	GAGE NO. 37R
3500	0	0
20000	193	875
40000	412	1921
52000	710	2163
0	-48	-197
60000	705	2138
60000	705	2123

Figure D-1. CV-1 Test Strain Gauge Readings (Continued)

STRAIN DATA  
MICRO INCHES PER INCH  
NEGATIVE SIGN INDICATES COMPRESSIVE STRAIN

LOAD INCREMENT	GAGE NO. 16A	GAGE NO. 17A	GAGE NO. 18A	GAGE NO. 19A	GAGE NO. 26A
3500	0	0	0	0	0
20000	867	1816	609	668	821
40000	1934	2241	1357	1372	1860
52000	4791	5024	1292	-248	2978
0	-318	-253	-228	-214	-169
60000	4632	4840	1312	-238	2923
60000	4662	4890	1248	-248	2918

STRAIN DATA  
MICRO INCHES PER INCH  
NEGATIVE SIGN INDICATES COMPRESSIVE STRAIN

LOAD INCREMENT	GAGE NO. 27A	GAGE NO. 28A	GAGE NO. 29A	GAGE NO. 30A	GAGE NO. 31A
3500	0	0	0	0	0
20000	873	827	761	850	791
40000	1914	1833	1656	1879	1741
52000	3059	2853	2413	3002	1306
0	-153	-178	-256	-164	-213
60000	3014	2818	2384	2948	1291
60000	3024	2799	2384	2938	1286

STRAIN DATA  
MICRO INCHES PER INCH  
NEGATIVE SIGN INDICATES COMPRESSIVE STRAIN

LOAD INCREMENT	GAGE NO. 46A	GAGE NO. 47A	GAGE NO. 48A	GAGE NO. 49A
3500	0	0	0	0
20000	319	350	190	188
40000	718	711	424	410
52000	1068	1017	536	536
0	-20	40	-69	-58
60000	1058	1002	531	536
60000	1058	987	531	536

Figure D-1. CV-1 Test Strain Gauge Readings (Continued)

**STRAIN DATA**  
MICRO INCHES PER INCH  
NEGATIVE SIGN INDICATES COMPRESSIVE STRAIN

LOAD INCREMENT	GAGE NO. 1A	GAGE NO. 2A	GAGE NO. 3A	GAGE NO. 4A	GAGE NO. 5A
3500	0	0	0	0	0
20000	438	743	254	258	199
40000	1439	1332	533	597	443
52000	1360	1457	932	866	861
0	325	-60	159	4	9
60000	2109	1577	897	990	796
60000	1636	1357	937	901	911

**STRAIN DATA**  
MICRO INCHES PER INCH  
NEGATIVE SIGN INDICATES COMPRESSIVE STRAIN

LOAD INCREMENT	GAGE NO. 6A	GAGE NO. 7A	GAGE NO. 8A	GAGE NO. 9A	GAGE NO. 10A
3500	0	0	0	0	0
20000	193	115	109	311	321
40000	447	385	374	706	727
52000	581	345	-1140	1324	1306
0	-224	-136	-1255	-25	-35
60000	726	690	644	1082	1053
60000	686	340	-1545	1304	1617

**STRAIN DATA**  
MICRO INCHES PER INCH  
NEGATIVE SIGN INDICATES COMPRESSIVE STRAIN

LOAD INCREMENT	GAGE NO. 11A	GAGE NO. 12A	GAGE NO. 13A	GAGE NO. 14A	GAGE NO. 15A
3500	0	0	0	0	0
20000	188	203	331	517	517
40000	422	442	713	1153	1209
52000	685	655	-55	1188	951
0	-125	-100	-124	-65	-15
60000	660	665	871	1193	995
60000	700	586	-55	1148	970

Figure D-1. CV-1 Test Strain Gauge Readings (Concluded)

**STRAIN DATA  
MICROINCHES PER INCH**

LOAD INCREMENT POUNDS	GAGE NO. 1A	GAGE NO. 2A	GAGE NO. 3A	GAGE NO. 4A	GAGE NO. 5A
3500	0	0	0	0	0
20000	344	499	214	198	173
40000	702	1048	468	461	396
60000	1056	1527	717	715	649
80000	1430	2041	1020	1052	892
100000	1853	2486	1314	1360	1101
20000	344	424	253	288	183
60000	1115	1517	811	794	664
100000	1912	2541	1369	1375	1125
110000	2118	2765	1513	1534	1244

LOAD INCREMENT POUNDS	GAGE NO. 6A	GAGE NO. 7A	GAGE NO. 8A	GAGE NO. 9A	GAGE NO. 10A
3500	0	0	0	0	0
20000	148	169	197	266	252
40000	367	432	369	567	554
60000	580	755	487	815	791
80000	843	1094	576	917	920
100000	1071	1427	670	1193	1217
20000	173	283	-119	63	108
60000	605	790	-301	669	687
100000	1081	1447	9	1203	1226
110000	1200	1611	78	1358	1370

LOAD INCREMENT POUNDS	GAGE NO. 11A	GAGE NO. 12A	GAGE NO. 13A	GAGE NO. 14A	GAGE NO. 15A
3500	0	0	0	0	0
20000	222	213	375	588	581
40000	504	476	731	1304	1312
60000	781	730	1116	2018	2028
80000	1029	1003	1457	2792	2779
100000	1147	1152	2060	3496	3456
20000	118	129	345	610	576
60000	643	640	1062	2033	1994
100000	1137	1137	1941	3526	3480
110000	1226	1231	2248	3898	3839

NEGATIVE SIGN INDICATES COMPRESSIVE STRAIN

Figure E-1. CV2-1 Test with Repair Bolts - Strain Gauge Readings (Continued)



STRAIN DATA  
MICROINCHES PER INCH

LOAD INCREMENT POUNDS	GAGE NO. 16A	GAGE NO. 17A	GAGE NO. 18A	GAGE NO. 19A	GAGE NO 26A
3500	0	0	0	0	0
20000	821	874	623	673	831
40000	1795	1931	1385	1461	1840
60000	2720	2950	2152	2268	2839
80000	3680	4042	2968	2848	3878
100000	4590	5150	3774	3497	4868
20000	895	1057	782	639	910
60000	2824	3084	2231	2080	2889
100000	4680	5214	3829	3541	4922
110000	5169	5850	4210	3878	5427

LOAD INCREMENT POUNDS	GAGE NO. 27A	GAGE NO. 28A	GAGE NO. 29A	GAGE NO. 30A	GAGE NO 31A
3500	0	0	0	0	0
20000	864	837	756	852	792
40000	1924	1848	1664	1877	1757
60000	2960	2853	2552	2892	2702
80000	4030	3893	3475	3942	3632
100000	5095	4908	4374	4972	4518
20000	1021	936	839	970	826
60000	3053	2917	2616	2976	2672
100000	5159	4982	4437	5051	4577
110000	5709	5509	4909	5593	5030

LOAD INCREMENT POUNDS	GAGE NO. 46A	GAGE NO. 47A	GAGE NO. 48A	GAGE NO. 49A
3500	0	0	0	0
20000	319	294	199	202
40000	734	654	433	432
60000	1154	1039	656	663
80000	1559	1399	856	878
100000	1574	1319	1123	1135
20000	179	94	136	163
60000	864	694	632	841
100000	1569	1269	1104	1303
110000	1734	1459	1206	1388

NEGATIVE SIGN INDICATES COMPRESSIVE STRAIN

Figure E-1. CV2-1 Test With Repair Bolts - Strain Gauge Readings (Continued)

**STRAIN DATA  
MICROINCHES PER INCH**

LOAD INCREMENT POUNDS	GAGE NO. 20R	GAGE NO. 21R	GAGE NO. 22R	GAGE NO. 23R	GAGE NO. 24R
3500	0	0	0	0	0
20000	-568	338	772	-585	301
40000	-1262	755	1696	-1124	666
60000	-1985	1163	2619	-1783	1002
80000	-2719	1624	3648	-2502	1407
100000	-3482	2041	4586	-3275	1738
20000	-714	358	883	-679	316
60000	-2061	1310	2714	-1938	1057
100000	-3553	2159	4626	-3365	1738
110000	-3965	2400	5108	-3778	1896

LOAD INCREMENT POUNDS	GAGE NO. 25R	GAGE NO. 32R	GAGE NO. 33R	GAGE NO. 34R	GAGE NO. 35R
3500	0	0	0	0	0
20000	852	-588	183	817	-624
40000	1868	-1315	396	1817	-1390
60000	2898	-2063	604	2807	-2157
80000	3980	-2831	803	3797	-2949
100000	4985	-3598	991	4746	-3741
20000	989	-723	158	898	-747
60000	3005	-2128	590	2827	-2239
100000	5051	-3669	996	4822	-3813
110000	5584	-4055	1095	5310	-4211

LOAD INCREMENT POUNDS	GAGE NO. 36R	GAGE NO. 37R
3500	0	0
20000	188	863
40000	407	1906
60000	620	2935
80000	839	3969
100000	1027	4957
20000	178	928
60000	610	2950
100000	1037	5012
110000	1141	5519

NEGATIVE SIGN INDICATES COMPRESSIVE STRAIN

Figure E-1. CV2-1 Test with Repair Bolts - Strain Gauge Readings (Concluded)

**STRAIN DATA  
MICROINCHES PER INCH**

LOAD INCREMENT POUNDS	GAGE NO. 1A	GAGE NO. 2A	GAGE NO. 3A	GAGE NO. 4A	GAGE NO. 5A
0	0	0	0	0	0
5000	39	110	84	89	64
10000	59	195	189	184	144
15300	68	260	284	278	169
0	-38	10	54	69	34
-10000	-128	-231	-170	-140	-40
-20000	-207	-406	-370	-329	-135
-20000	-197	-406	-370	-334	-135
-30000	-261	-511	-515	-488	-295
-40000	-311	-611	-659	-653	-469
-45800	-348	-681	-764	-767	-579
-45800	-348	-686	-794	-797	-604
0	29	-6	-50	-40	-45

LOAD INCREMENT POUNDS	GAGE NO. 6A	GAGE NO. 7A	GAGE NO. 8A	GAGE NO. 9A	GAGE NO. 10A
0	0	0	0	0	0
5000	61	57	159	77	69
10000	123	109	291	150	138
15300	185	125	578	218	252
0	17	15	-6	-5	-10
-10000	-53	-68	-359	-137	-119
-20000	-168	-178	-700	-273	-248
-20000	-168	-178	-656	-263	-248
-30000	-313	-283	-992	-414	-406
-40000	-463	-361	-1361	-580	-569
-45800	-556	-403	-1515	-672	-654
-45800	-569	-388	-1493	-657	-639
0	-27	0	49	14	9

NEGATIVE SIGN INDICATES COMPRESSIVE STRAIN

Figure F-1. CV2-2 Fatigue Test Strain Survey - Prior to First Lifetime (Continued)

STRAIN DATA  
MICROINCHES PER INCH

LOAD INCREMENT POUNDS	GAGE NO. 11A	GAGE NO. 12A	GAGE NO. 13A	GAGE NO. 14A	GAGE NO. 15A
0	0	0	0	0	0
5000	0	19	119	174	159
10000	4	19	233	344	319
15300	0	29	357	638	549
0	-5	-5	-10	0	-15
-10000	-15	-10	-253	-354	-370
-20000	-25	-35	-501	-694	-709
-20000	-25	-35	-501	-684	-694
-30000	-35	-60	-735	-1038	-1019
-40000	-40	-90	-973	-1382	-1358
-45800	-45	-100	-1112	-1566	-1548
-45800	-45	-90	-1112	-1461	-1543
0	-10	0	-10	114	19

LOAD INCREMENT POUNDS	GAGE NO. 16A	GAGE NO. 17A	GAGE NO. 18A	GAGE NO. 19A	GAGE NO. 26A
0	0	0	0	0	0
5000	368	280	198	228	261
10000	717	556	401	451	523
15300	1090	846	678	675	849
0	-20	10	4	-15	0
-10000	-767	-552	-412	-462	-539
-20000	-1514	-1128	-833	-919	-1083
-20000	-1499	-1133	-828	-924	-1078
-30000	-2251	-1735	-1229	-1391	-1636
-40000	-3038	-2356	-1645	-1873	-2214
-45800	-3496	-2722	-1883	-2156	-2550
-45800	-3501	-2737	-1888	-2156	-2555
0	24	-26	4	-10	9

NEGATIVE SIGN INDICATES COMPRESSIVE STRAIN

Figure F-1. CV2-2 Fatigue Test Strain Survey - Prior to First Lifetime (Continued)

STRAIN DATA  
MICROINCHES PER INCH

LOAD INCREMENT POUNDS	GAGE NO. 27A	GAGE NO. 28A	GAGE NO. 29A	GAGE NO. 30A	GAGE NO. 31A
0	0	0	0	0	0
5000	291	315	295	266	241
10000	558	630	575	527	463
15300	889	1010	900	833	740
0	19	-5	4	0	-5
-10000	-549	-646	-596	-548	-474
-20000	-1112	-1306	-1201	-1101	-953
-20000	-1127	-1311	-1206	-1101	-953
-30000	-1680	-1987	-1807	-1654	-1436
-40000	-2268	-2686	-2422	-2236	-1930
-45800	-2609	-3105	-2796	-2576	-2211
-45800	-2629	-3135	-2816	-2596	-2221
0	4	-5	-10	-18	-10

LOAD INCREMENT POUNDS	GAGE NO. 38A	GAGE NO. 39A	GAGE NO. 40A	GAGE NO. 41A	GAGE NO. 42A
0	0	0	0	0	0
5000	24	14	30	54	87
10000	38	0	82	94	189
15300	62	-20	190	238	379
0	-30	-25	5	-5	92
-10000	-63	-15	-98	-130	-49
-20000	-117	-15	-227	-264	-244
-20000	-117	-15	-227	-259	-244
-30000	-160	-10	-381	-398	-429
-40000	-209	24	-525	-517	-609
-45800	-233	39	-603	-596	-696
-45800	-209	39	-618	-577	-633
0	9	24	0	39	43

NEGATIVE SIGN INDICATES COMPRESSIVE STRAIN

Figure F-1. CV2-2 Fatigue Test Strain Survey - Prior to First Lifetime (Continued)

STRAIN DATA  
MICROINCHES PER INCH

LOAD INCREMENT POUNDS	GAGE NO. 43A	GAGE NO. 44A	GAGE NO. 45A	GAGE NO. 46A	GAGE NO. 47A
0	0	0	0	0	0
5000	68	34	60	89	90
10000	146	73	111	184	180
15300	303	93	151	289	290
0	48	24	30	9	20
-10000	-74	-30	-61	-165	-156
-20000	-216	-128	-183	-350	-326
-20000	-206	-133	-183	-350	-331
-30000	-363	-241	-320	-535	-496
-40000	-520	-335	-451	-725	-666
-45800	-617	-384	-587	-830	-756
-45800	-578	-379	-482	-810	-746
0	29	-10	5	0	0

LOAD INCREMENT POUNDS	GAGE NO. 48A	GAGE NO. 49A	GAGE NO. 50A	GAGE NO. 51A	GAGE NO. 52A
0	0	0	0	0	0
5000	0	24	98	167	246
10000	0	48	187	340	463
15300	-10	62	345	553	680
0	-10	0	-25	-10	24
-10000	0	-68	-248	-356	-410
-20000	0	-116	-490	-697	-799
-20000	0	-121	-475	-697	-819
-30000	0	-179	-727	-1033	-1208
-40000	0	-227	-989	-1379	-1587
-45800	4	-246	-1132	-1572	-1814
-45800	9	-232	-1137	-1582	-1814
0	0	9	0	0	24

NEGATIVE SIGN INDICATES COMPRESSIVE STRAIN

Figure F-1. CV2-2 Fatigue Test Strain Survey - Prior to First Lifetime (Continued)

**STRAIN DATA  
MICROINCHES PER INCH**

LOAD INCREMENT POUNDS	GAGE NO. 53A	GAGE NO. 54A	GAGE NO. 55A	GAGE NO. 56A
0	0	0	0	0
5000	386	227	207	222
10000	783	454	424	420
15300	1238	657	631	791
0	-15	14	0	-5
-10000	-818	-450	-410	-475
-20000	-1641	-905	-810	-955
-20000	-1646	-919	-820	-926
-30000	-2483	-1379	-1214	-1450
-40000	-3355	-1853	-1614	-1994
-45800	-3874	-2130	-1851	-2316
-45800	-3898	-2135	-1851	-2331
0	-15	-15	-10	54

**NEGATIVE SIGN INDICATES COMPRESSIVE STRAIN**

Figure F-1. CV2-2 Fatigue Test Strain Survey - Prior to First Lifetime (Continued)

STRAIN DATA  
MICROINCHES PER INCH

LOAD INCREMENT POUNDS	GAGE NO. 20R	GAGE NO. 21R	GAGE NO. 22R	GAGE NO. 23R	GAGE NO. 24R
0	0	0	0	0	0
5000	-167	0	246	-173	89
10000	-334	0	497	-355	184
15300	-485	0	759	-548	264
0	0	0	4	-10	-10
-10000	318	0	-493	369	-190
-20000	656	0	-986	744	-374
-20000	671	0	-996	749	-374
-30000	1010	0	-1499	1118	-568
-40000	1363	0	-2031	1513	-771
-45800	1585	0	-2342	1749	-889
-45800	1616	0	-2367	1779	-880
0	25	0	-15	19	-5

LOAD INCREMENT POUNDS	GAGE NO. 25R	GAGE NO. 32R	GAGE NO. 33R	GAGE NO. 34R	GAGE NO. 35R
0	0	0	0	0	0
5000	257	-191	19	249	-185
10000	510	-377	34	504	-369
15300	773	-583	59	805	-554
0	-10	0	0	-11	0
-10000	-540	381	-30	-536	394
-20000	-1065	768	-65	-1071	794
-20000	-1070	778	-65	-1071	794
-30000	-1610	1175	-100	-1611	1198
-40000	-2164	1587	-124	-2167	1624
-45800	-2495	1843	-134	-2493	1885
-45800	-2504	1859	-129	-2508	1911
0	-15	15	-5	-21	25

NEGATIVE SIGN INDICATES COMPRESSIVE STRAIN

Figure F-1. CV2-2 Fatigue Test Strain Survey - Prior to First Lifetime (Continued)



**STRAIN DATA  
MICROINCHES PER INCH**

LOAD INCREMENT POUNDS	GAGE NO. 36R	GAGE NO. 37R	GAGE NO. 57R	GAGE NO. 58R	GAGE NO. 59R
0	0	0	0	0	0
5000	9	258	-150	74	207
10000	24	505	-300	139	405
15300	49	774	-410	289	648
0	0	0	-5	4	0
-10000	-30	-533	314	-140	-426
-20000	-70	-1060	634	-300	-852
-20000	-55	-1060	663	-270	-852
-30000	-95	-1604	968	-445	-1283
-40000	-120	-2147	1288	-625	-1724
-45800	-135	-2477	1487	-730	-1983
-45800	-130	-2493	1512	-735	-1993
0	9	-22	74	44	0

LOAD INCREMENT POUNDS	GAGE NO. 60R	GAGE NO. 61R	GAGE NO. 62R
0	0	0	0
5000	-133	120	215
10000	-270	226	430
15300	-342	447	586
0	10	0	0
-10000	295	-242	-447
-20000	595	-484	-905
-20000	620	-473	-905
-30000	906	-740	-1368
-40000	1196	-1017	-1847
-45800	1379	-1178	-2117
-45800	1409	-1178	-2117
0	76	45	16

NEGATIVE SIGN INDICATES COMPRESSIVE STRAIN

Figure F-1. CV2-2 Fatigue Test Strain Survey - Prior to First Lifetime (Concluded)

**STRAIN DATA  
MICROINCHES PER INCH**

LOAD INCREMENT POUNDS	GAGE NO. 1A	GAGE NO. 2A	GAGE NO. 3A	GAGE NO. 4A	GAGE NO. 5A
0	0	0	0	0	0
-10000	-94	-190	-120	-110	-110
-20000	-173	-350	-270	-244	-219
-30000	-242	-510	-449	-414	-334
-40000	-330	-654	-629	-588	-453
0	0	0	0	0	0

LOAD INCREMENT POUNDS	GAGE NO. 6A	GAGE NO. 7A	GAGE NO. 8A	GAGE NO. 9A	GAGE NO. 10A
0	0	0	0	0	0
-10000	-106	-90	-333	-166	-153
-20000	-212	-174	-698	-317	-297
-30000	-318	-257	-1046	-458	-430
-40000	-424	-341	-1324	-599	-563
0	0	0	38	0	4

LOAD INCREMENT POUNDS	GAGE NO. 11A	GAGE NO. 12A	GAGE NO. 13A	GAGE NO. 14A	GAGE NO. 15A
0	0	0	0	0	0
-10000	-15	-20	-223	-359	-353
-20000	-25	-35	-459	-712	-701
-30000	-38	-50	-696	-1045	-1034
-40000	-45	-85	-948	-1373	-1356
0	0	0	0	29	9

**NEGATIVE SIGN INDICATES COMPRESSIVE STRAIN**

Figure F-2. CV2-2 Fatigue Test Strain Survey - First Lifetime After 360 Flights (Continued)

~~485~~ = 1360

**STRAIN DATA  
MICROINCHES PER INCH**

LOAD INCREMENT POUNDS	GAGE NO. 16A	GAGE NO. 17A	GAGE NO. 18A	GAGE NO. 19A	GAGE NO. 26A
0	0	0	0	0	0
-10000	-755	-570	-411	-452	-555
-20000	-1530	-1150	-832	-918	-1109
-30000	-2290	-1730	-1242	-1379	-1673
-40000	-3060	-2320	-1648	-1856	-2242
0	24	-18	4	-5	4

LOAD INCREMENT POUNDS	GAGE NO. 27A	GAGE NO. 28A	GAGE NO. 29A	GAGE NO. 30A	GAGE NO. 31A
0	0	0	0	0	0
-10000	-552	-656	-590	-538	-479
-20000	-1124	-1331	-1190	-1104	-957
-30000	-1691	-2001	-1795	-1661	-1430
-40000	-2272	-2696	-2419	-2233	-1903
0	-5	-10	-10	-5	-5

LOAD INCREMENT POUNDS	GAGE NO. 38A	GAGE NO. 39A	GAGE NO. 40A	GAGE NO. 41A	GAGE NO. 42A
0	0	0	0	0	0
-10000	-59	-15	-119	-129	-117
-20000	-112	-20	-237	-268	-244
-30000	-165	-15	-396	-426	-385
-40000	-223	-10	-560	-584	-517
0	4	19	-11	-5	0

NEGATIVE SIGN INDICATES COMPRESSIVE STRAIN

Figure F-2. CV2-2 Fatigue Test Strain Survey - First Lifetime After 360 Flights (Continued)

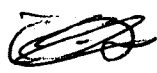

**STRAIN DATA  
MICROINCHES PER INCH**

LOAD INCREMENT POUNDS	GAGE NO. 43A	GAGE NO. 44A	GAGE NO. 45A	GAGE NO. 46A	GAGE NO. 47A
0	0	0	0	0	0
-10000	-118	-59	-86	-170	-165
-20000	-236	-128	-182	-335	-320
-30000	-363	-217	-298	-495	-460
-40000	-495	-315	-404	-654	-605
0	-5	0	0	0	4

LOAD INCREMENT POUNDS	GAGE NO. 48A	GAGE NO. 49A	GAGE NO. 50A	GAGE NO. 51A	GAGE NO. 52A
0	0	0	0	0	0
-10000	0	-63	-238	-353	-437
-20000	4	-121	-495	-710	-845
-30000	14	-178	-752	-1057	-1218
-40000	14	-231	-1018	-1404	-1606
0	9	0	0	-10	24

LOAD INCREMENT POUNDS	GAGE NO. 53A	GAGE NO. 54A	GAGE NO. 55A	GAGE NO. 56A
0	0	0	0	0
-10000	-814	-462	-405	-492
-20000	-1672	-913	-819	-1007
-30000	-2511	-1369	-1223	-1523
-40000	-3374	-1836	-1627	-2049
0	-15	-10	-5	0

NEGATIVE SIGN INDICATES COMPRESSIVE STRAIN

Figure F-2. CV2-2 Fatigue Test Strain Survey - First Lifetime After 360 Flights (Continued)

**STRAIN DATA  
MICROINCHES PER INCH**

LOAD INCREMENT POUNDS	GAGE NO. 20R	GAGE NO. 21R	GAGE NO. 22R	GAGE NO. 23R	GAGE NO. 24R
0	0	0	0	0	0
-10000	321	0	-494	364	-195
-20000	659	0	-1007	734	-393
-30000	996	0	-1511	1114	-583
-40000	1343	0	-2034	1503	-777
0	5	0	-5	9	4

LOAD INCREMENT POUNDS	GAGE NO. 25R	GAGE NO. 32R	GAGE NO. 33R	GAGE NO. 34R	GAGE NO. 35R
0	0	0	0	0	0
-10000	-530	385	-30	-534	389
-20000	-1075	781	-65	-1073	795
-30000	-1615	1177	-90	-1602	1190
-40000	-2169	1578	-120	-2146	1600
0	-5	15	0	-11	5

LOAD INCREMENT POUNDS	GAGE NO. 36R	GAGE NO. 37R	GAGE NO. 57R	GAGE NO. 58R	GAGE NO. 59R
0	0	0	0	0	0
-10000	-35	-526	305	-165	-431
-20000	-70	-1057	620	-330	-866
-30000	-95	-1594	930	-490	-1297
-40000	-125	-2136	1246	-655	-1727
0	0	-6	10	0	0

NEGATIVE SIGN INDICATES COMPRESSIVE STRAIN

Figure F-2. CV2-2 Fatigue Test Strain Survey - First Lifetime After 360 Flights (Continued)

C-2

**STRAIN DATA  
MICROINCHES PER INCH**

<b>LOAD INCREMENT POUNDS</b>	<b>GAGE NO. 60R</b>	<b>GAGE NO. 61R</b>	<b>GAGE NO. 62R</b>
0	0	0	0
-10000	269	-262	-461
-20000	554	-535	-927
-30000	839	-786	-1388
-40000	1140	-1048	-1869
0	5	0	-22

**NEGATIVE SIGN INDICATES COMPRESSIVE STRAIN**

**Figure F-2. CV2-2 Fatigue Test Strain Survey - First  
Lifetime After 360 Flights (Concluded)**

**STRAIN DATA  
MICROINCHES PER INCH**

LOAD INCREMENT POUNDS	GAGE NO. 1A	GAGE NO. 2A	GAGE NO. 3A	GAGE NO. 4A	GAGE NO. 5A
0	0	0	0	0	0
-10000	-15	-20	-10	-15	-15
-10000	-84	-180	-120	-115	-110
-20000	-163	-340	-264	-250	-219
-30000	-237	-500	-449	-414	-333
-40000	-316	-655	-633	-599	-452
0	4	9	-5	-10	0

LOAD INCREMENT POUNDS	GAGE NO. 6A	GAGE NO. 7A	GAGE NO. 8A	GAGE NO. 9A	GAGE NO. 10A
0	0	0	0	0	0
-10000	-14	-6	-50	-25	-30
-10000	-106	-90	-444	-156	-149
-20000	-212	-173	-751	-311	-293
-30000	-318	-257	-1014	-452	-427
-40000	-424	-341	-1364	-588	-560
0	0	10	21	0	0

LOAD INCREMENT POUNDS	GAGE NO. 11A	GAGE NO. 12A	GAGE NO. 13A	GAGE NO. 14A	GAGE NO. 15A
0	0	0	0	0	0
-10000	0	-15	-40	-55	-55
-10000	-5	-30	-223	-348	-344
-20000	-15	-45	-461	-696	-693
-30000	-25	-60	-708	-1024	-1026
-40000	-35	-95	-960	-1356	-1360
0	0	0	4	34	9

LOAD INCREMENT POUNDS	GAGE NO. 16A	GAGE NO. 17A	GAGE NO. 18A	GAGE NO. 19A	GAGE NO. 26A
0	0	0	0	0	0
-10000	-125	-101	-70	-80	-109
-10000	-742	-566	-417	-447	-545
-20000	-1514	-1142	-823	-914	-1099
-30000	-2281	-1727	-1234	-1381	-1663
-40000	-3073	-2338	-1650	-1868	-2247
0	14	-6	4	0	9

Figure F-3. CV2-2 Fatigue Test Strain Survey - First Lifetime After 360 Flights (2nd Survey) (Continued)

**STRAIN DATA  
MICROINCHES PER INCH**

LOAD INCREMENT POUNDS	GAGE NO. 27A	GAGE NO. 28A	GAGE NO. 29A	GAGE NO. 30A	GAGE NO. 31A
0	0	0	0	0	0
-10000	-104	-129	-119	-104	-104
-10000	-554	-656	-591	-538	-474
-20000	-1117	-1326	-1187	-1096	-957
-30000	-1695	-2001	-1792	-1658	-1435
-40000	-2283	-2706	-2427	-2241	-1918
0	-10	-10	-5	0	0

LOAD INCREMENT POUNDS	GAGE NO. 38A	GAGE NO. 39A	GAGE NO. 40A	GAGE NO. 41A	GAGE NO. 42A
0	0	0	0	0	0
-10000	-20	-5	-21	-25	-25
-10000	-59	0	-113	-129	-108
-20000	-107	-5	-247	-263	-239
-30000	-165	-5	-406	-427	-376
-40000	-214	-5	-575	-596	-517
0	4	14	-16	0	0

LOAD INCREMENT POUNDS	GAGE NO. 43A	GAGE NO. 44A	GAGE NO. 45A	GAGE NO. 46A	GAGE NO. 47A
0	0	0	0	0	0
-10000	-25	-15	-21	-46	-30
-10000	-103	-59	-86	-176	-160
-20000	-231	-123	-182	-336	-305
-30000	-358	-217	-293	-501	-450
-40000	-485	-320	-405	-661	-600
0	0	0	10	0	0

LOAD INCREMENT POUNDS	GAGE NO. 48A	GAGE NO. 49A	GAGE NO. 50A	GAGE NO. 51A	GAGE NO. 52A
0	0	0	0	0	0
-10000	0	-15	-60	-75	0
-10000	0	-63	-248	-337	0
-20000	0	-116	-504	-688	0
-30000	9	-169	-761	-1034	0
-40000	14	-222	-1038	-1386	0
0	0	0	-10	9	0

**NEGATIVE SIGN INDICATES COMPRESSIVE STRAIN**

Figure F-3. CV2-2 Fatigue Test Strain Survey - First Lifetime After 360 Flights (2nd Survey) (Continued)



**STRAIN DATA  
MICROINCHES PER INCH**

<b>LOAD INCREMENT POUNDS</b>	<b>GAGE NO. 53A</b>	<b>GAGE NO. 54A</b>	<b>GAGE NO. 55A</b>	<b>GAGE NO. 56A</b>
0	0	0	0	0
-10000	-181	-104	-99	-110
-10000	-816	-451	-410	-501
-20000	-1651	-896	-815	-1002
-30000	-2496	-1361	-1224	-1533
-40000	-3366	-1831	-1634	-2069
0	-15	-5	0	0

**NEGATIVE SIGN INDICATES COMPRESSIVE STRAIN**

Figure F-3. CV2-2 Fatigue Test Strain Survey - First Lifetime After 360 Flights (2nd Survey) (Continued)

STRAIN DATA  
MICROINCHES PER INCH

LOAD INCREMENT POUNDS	GAGE NO. 20R	GAGE NO. 21R	GAGE NO. 22R	GAGE NO. 23R	GAGE NO. 24R
0	0	0	0	0	0
-10000	55	0	-84	59	-34
-10000	327	0	-498	359	-195
-20000	659	0	-996	729	-393
-30000	996	0	-1509	1109	-587
-40000	1358	0	-2036	1508	-777
0	10	0	-5	4	0

LOAD INCREMENT POUNDS	GAGE NO. 25R	GAGE NO. 32R	GAGE NO. 33R	GAGE NO. 34R	GAGE NO. 35R
0	0	0	0	0	0
-10000	-103	75	-10	-112	81
-10000	-530	381	-30	-534	388
-20000	-1065	778	-65	-1068	793
-30000	-1615	1180	-90	-1597	1197
-40000	-2179	1587	-120	-2151	1611
0	0	5	0	0	5

LOAD INCREMENT POUNDS	GAGE NO. 36R	GAGE NO. 37R	GAGE NO. 57R	GAGE NO. 58R	GAGE NO. 59R
0	0	0	0	0	0
-10000	-10	-110	65	-36	-97
-10000	-35	-526	305	-161	-436
-20000	-65	-1057	610	-326	-861
-30000	-95	-1594	930	-491	-1302
-40000	-125	-2141	1251	-661	-1747
0	0	-6	10	-6	-6

LOAD INCREMENT POUNDS	GAGE NO. 60R	GAGE NO. 61R	GAGE NO. 62R
0	0	0	0
-10000	116	-56	-102
-10000	330	-262	-455
-20000	620	-524	-920
-30000	904	-785	-1386
-40000	1199	-1047	-1856
0	61	0	5

NEGATIVE SIGN INDICATES COMPRESSIVE STRAIN

Figure F-3. CV2-2 Fatigue Test Strain Survey - First Lifetime After 360 Flights (2nd Survey) (Concluded)

STRAIN DATA  
MICROINCHES PER INCH

LOAD INCREMENT POUNDS	GAGE NO. 1A	GAGE NO. 2A	GAGE NO. 3A	GAGE NO. 4A	GAGE NO. 5A
0	0	0	0	0	0
10000	72	150	195	215	140
20000	115	344	415	441	267
25470	153	461	477	537	343
0	-111	-83	171	225	131
-20000	-241	-398	-187	-173	-43
-40000	-370	-641	-593	-600	-315
-60000	-462	-874	-951	-984	-569
-76400	-548	-1063	-1275	-1311	-771
0	-255	-20	-129	-29	-19

LOAD INCREMENT POUNDS	GAGE NO. 6A	GAGE NO. 7A	GAGE NO. 8A	GAGE NO. 9A	GAGE NO. 10A
0	0	0	0	0	0
10000	154	62	24	119	139
20000	346	163	101	215	313
25470	447	216	168	277	409
0	163	9	-49	-63	38
-20000	-106	-145	-213	-278	-256
-40000	-424	-318	-324	-494	-535
-60000	-718	-463	-410	-743	-800
-76400	-969	-569	-468	-911	-964
0	38	-10	0	14	207

LOAD INCREMENT POUNDS	GAGE NO. 11A	GAGE NO. 12A	GAGE NO. 13A	GAGE NO. 14A	GAGE NO. 15A
0	0	0	0	0	0
10000	14	9	216	375	342
20000	29	29	428	771	660
25470	39	34	542	969	844
0	9	4	-35	34	-55
-20000	-10	-20	-503	-708	-726
-40000	-25	-45	-996	-1435	-1391
-60000	-40	-75	-1513	-2108	-2067
-76400	-60	-95	-1962	-2642	-2613
0	14	9	4	138	501

NEGATIVE SIGN INDICATES COMPRESSIVE STRAIN

Figure F-4. CV2-2 Fatigue Test Strain Survey - First Lifetime After 9000 Flights (Continued)

STRAIN DATA  
MICROINCHES PER INCH

LOAD INCREMENT POUNDS	GAGE NO. 16A	GAGE NO. 17A	GAGE NO. 18A	GAGE NO. 19A	GAGE NO. 26A
0	0	0	0	0	0
10000	725	584	419	415	539
20000	1420	1219	869	831	1118
25470	1802	1559	1101	1063	1424
0	-90	119	24	-45	39
-20000	-1565	-1070	-831	-936	-1084
-40000	-3080	-2285	-1675	-1851	-2251
-60000	-4689	-3510	-2505	-2820	-3454
-76400	-6069	-4534	-3197	-3666	-4488
0	44	-360	39	14	29

LOAD INCREMENT POUNDS	GAGE NO. 27A	GAGE NO. 28A	GAGE NO. 29A	GAGE NO. 30A	GAGE NO. 31A
0	0	0	0	0	0
10000	540	650	578	532	457
20000	1081	1335	1147	1090	929
25470	1381	1710	1461	1386	1189
0	4	68	-10	19	0
-20000	-1141	-1292	-1212	-1106	-944
-40000	-2296	-2701	-2437	-2260	-1898
-60000	-3500	-4145	-3722	-3450	-2851
-76400	-4552	-5407	-4850	-4481	-3633
0	-99	-25	-25	29	0

LOAD INCREMENT POUNDS	GAGE NO. 38A	GAGE NO. 39A	GAGE NO. 40A	GAGE NO. 41A	GAGE NO. 42A
0	0	0	0	0	0
10000	4	-15	123	128	116
20000	19	-25	236	222	311
25470	28	-25	323	302	394
0	-73	-45	46	-35	155
-20000	-78	-40	-257	-387	-156
-40000	-126	-15	-550	-654	-326
-60000	-165	19	-811	-912	-531
-76400	-208	53	-1012	-1100	-711
0	19	63	-6	14	0

NEGATIVE SIGN INDICATES COMPRESSIVE STRAIN

Figure F-4. CV2-2 Fatigue Test Strain Survey - First Lifetime After 9000 Flights (Continued)

**STRAIN DATA  
MICROINCHES PER INCH**

LOAD INCREMENT POUNDS	GAGE NO. 43A	GAGE NO. 44A	GAGE NO. 45A	GAGE NO. 46A	GAGE NO. 47A
0	0	0	0	0	0
10000	151	68	70	154	169
20000	346	137	161	309	329
25470	454	210	211	384	408
0	146	68	25	4	44
-20000	-186	-74	-162	-285	-270
-40000	-508	-289	-338	-595	-589
-60000	-806	-485	-589	-899	-888
-76400	-797	-578	-715	-1149	-1057
0	4	0	0	4	9

LOAD INCREMENT POUNDS	GAGE NO. 48A	GAGE NO. 49A	GAGE NO. 50A	GAGE NO. 51A	GAGE NO. 52A
0	0	0	0	0	0
10000	-15	33	202	340	441
20000	-25	76	419	686	854
25470	-30	100	532	889	1075
0	0	4	-35	-20	14
-20000	24	-87	-494	-692	-928
-40000	63	-159	-1012	-1374	-1748
-60000	92	-221	-1589	-2046	-2494
-76400	126	-274	-2093	-2589	-3093
0	14	28	0	-45	29

LOAD INCREMENT POUNDS	GAGE NO. 53A	GAGE NO. 54A	GAGE NO. 55A	GAGE NO. 56A
0	0	0	0	0
10000	783	444	417	469
20000	1606	889	835	944
25470	2061	1126	1071	1207
0	29	14	0	14
-20000	-1602	-915	-831	-990
-40000	-3296	-1853	-1642	-2049
-60000	-5069	-2812	-2434	-3177
-76400	-6611	-3632	-3083	-4171
0	-25	-10	9	-5

NEGATIVE SIGN INDICATES COMPRESSIVE STRAIN

Figure F-4. CV2-2 Fatigue Test Strain Survey - First Lifetime After 9000 Flights (Continued)

**STRAIN DATA  
MICROINCHES PER INCH**

LOAD INCREMENT POUNDS	GAGE NO. 20R	GAGE NO. 21R	GAGE NO. 22R	GAGE NO. 23R	GAGE NO. 24R
0	0	0	0	0	0
10000	-331	0	502	-365	169
20000	-676	0	1024	-749	334
25470	-861	0	1304	-965	433
0	-31	0	64	-25	-34
-20000	655	0	-970	743	-392
-40000	1371	0	-2029	1526	-760
-60000	2107	0	-3112	2353	-1146
-76400	2802	0	-4028	3126	-1467
0	85	0	39	73	9

LOAD INCREMENT POUNDS	GAGE NO. 25R	GAGE NO. 32R	GAGE NO. 33R	GAGE NO. 34R	GAGE NO. 35R
0	0	0	0	0	0
10000	503	-377	34	522	-383
20000	1002	-778	74	1066	-781
25470	1278	-1009	88	1365	-1011
0	-34	-36	0	25	-21
-20000	-1090	752	-60	-1046	780
-40000	-2185	1550	-124	-2138	1597
-60000	-3338	2368	-178	-3239	2454
-76400	-4365	3050	-203	-4174	3240
0	0	40	9	-21	56

LOAD INCREMENT POUNDS	GAGE NO. 36R	GAGE NO. 37R	GAGE NO. 57R	GAGE NO. 58R	GAGE NO. 59R
0	0	0	0	0	0
10000	34	507	-305	183	445
20000	54	1031	-640	353	901
25470	69	1315	-834	437	1149
0	-5	5	-20	34	20
-20000	-65	-1060	634	-309	-892
-40000	-125	-2130	1283	-662	-1803
-60000	-185	-3249	1976	-1005	-2720
-76400	-215	-4205	2615	-1259	-3504
0	9	-22	49	4	-6

NEGATIVE SIGN INDICATES COMPRESSIVE STRAIN

Figure F-4. CV2-2 Fatigue Test Strain Survey - First Lifetime after 9000 Flights (Continued)

**STRAIN DATA  
MICROINCHES PER INCH**

<b>LOAD INCREMENT POUNDS</b>	<b>GAGE NO. 60R</b>	<b>GAGE NO. 61R</b>	<b>GAGE NO. 62R</b>
0	0	0	0
10000	0	251	464
20000	0	523	923
25470	0	659	1190
0	0	20	16
-20000	0	-514	-930
-40000	0	-1057	-1907
-60000	0	-1606	-2890
-76400	0	-2073	-3739
0	0	0	0

**NEGATIVE SIGN INDICATES COMPRESSIVE STRAIN**

Figure F-4. CV2-2 Fatigue Test Strain Survey - First Lifetime after 9000 Flights (Concluded)

**STRAIN DATA  
MICROINCHES PER INCH**

LOAD INCREMENT POUNDS	GAGE NO. 1A	GAGE NO. 2A	GAGE NO. 3A	GAGE NO. 4A	GAGE NO. 5A
0	0	0	0	0	0
10000	67	155	215	235	115
20000	120	349	459	471	254
25470	154	490	526	562	307
0	-92	-64	220	264	105
-20000	-246	-423	-144	-130	-48
-40000	-362	-676	-565	-559	-279
-60000	-439	-914	-910	-953	-461
-76400	-516	-1089	-1216	-1256	-634
0	62	0	23	-5	14

LOAD INCREMENT POUNDS	GAGE NO. 6A	GAGE NO. 7A	GAGE NO. 8A	GAGE NO. 9A	GAGE NO. 10A
0	0	0	0	0	0
10000	168	65	24	103	139
20000	342	151	101	187	279
25470	405	216	163	248	356
0	130	5	-53	-75	9
-20000	-140	-152	-227	-272	-237
-40000	-430	-326	-323	-474	-483
-60000	-690	-456	-410	-699	-671
-76400	-898	-548	-477	-872	-772
0	14	10	14	9	115

LOAD INCREMENT POUNDS	GAGE NO. 11A	GAGE NO. 12A	GAGE NO. 13A	GAGE NO. 14A	GAGE NO. 15A
0	0	0	0	0	0
10000	4	14	217	367	343
20000	19	24	435	764	672
25470	24	29	554	963	846
0	0	4	-20	39	-40
-20000	-20	-15	-500	-706	-732
-40000	-30	-35	-1010	-1421	-1400
-60000	-35	-50	-1529	-2067	-2062
-76400	-50	-55	-1979	-2578	-2595
0	4	19	14	89	44

NEGATIVE SIGN INDICATES COMPRESSIVE STRAIN

Figure F-5. CV2-2 Fatigue Test Strain Survey - First Lifetime After 9000 Flights (1st Page)



**STRAIN DATA  
MICROINCHES PER INCH**

LOAD INCREMENT POUNDS	GAGE NO. 16A	GAGE NO. 17A	GAGE NO. 18A	GAGE NO. 19A	GAGE NO. 26A
0	0	0	0	0	0
10000	720	448	435	411	549
20000	1415	1066	880	817	1123
25470	1787	1396	1113	1050	1429
0	-55	-30	39	-55	54
-20000	-1540	-1227	-827	-937	-1089
-40000	-3090	-2483	-1678	-1863	-2266
-60000	-4743	-4084	-2494	-2819	-3439
-76400	-6119	-5201	-3167	-3661	-4458
0	74	-614	34	9	34

LOAD INCREMENT POUNDS	GAGE NO. 27A	GAGE NO. 28A	GAGE NO. 29A	GAGE NO. 30A	GAGE NO. 31A
0	0	0	0	0	0
10000	566	664	580	542	453
20000	1113	1353	1156	1100	926
25470	1414	1732	1471	1406	1192
0	24	78	4	39	0
-20000	-1129	-1290	-1221	-1096	-952
-40000	-2297	-2712	-2456	-2265	-1898
-60000	-3598	-4154	-3741	-3484	-2844
-76400	-4653	-5390	-4858	-4501	-3613
0	-99	9	0	-30	0

LOAD INCREMENT POUNDS	GAGE NO. 38A	GAGE NO. 39A	GAGE NO. 40A	GAGE NO. 41A	GAGE NO. 42A
0	0	0	0	0	0
10000	9	-5	107	119	77
20000	14	-20	205	188	243
25470	19	-25	287	252	321
0	-68	-30	46	-35	141
-20000	-73	-25	-206	-313	-127
-40000	-97	-5	-509	-561	-254
-60000	-126	39	-761	-809	-453
-76400	-160	68	-987	-1042	-662
0	33	73	0	-10	9

NEGATIVE SIGN INDICATES COMPRESSIVE STRAIN

Figure F-5. CV2-2 Fatigue Test Strain Survey - First Lifetime after 9000 Flights (Continued)

**STRAIN DATA  
MICROINCHES PER INCH**

LOAD INCREMENT POUNDS	GAGE NO. 43A	GAGE NO. 44A	GAGE NO. 45A	GAGE NO. 46A	GAGE NO. 47A
0	0	0	0	0	0
10000	83	58	75	139	119
20000	200	137	146	274	254
25470	264	201	196	354	319
0	83	58	15	0	4
-20000	-137	-74	-162	-270	-255
-40000	-265	-271	-323	-555	-519
-60000	-421	-463	-545	-844	-768
-76400	-582	-571	-671	-1084	-953
0	4	4	0	9	19

LOAD INCREMENT POUNDS	GAGE NO. 48A	GAGE NO. 49A	GAGE NO. 50A	GAGE NO. 51A	GAGE NO. 52A
0	0	0	0	0	0
10000	-10	24	211	331	417
20000	-15	48	433	677	839
25470	-20	67	556	875	1060
0	0	0	-15	-15	0
-20000	14	-73	-488	-698	-904
-40000	38	-130	-1026	-1386	-1773
-60000	72	-183	-1607	-2024	-2534
-76400	97	-231	-2100	-2608	-3133
0	9	9	14	-15	29

LOAD INCREMENT POUNDS	GAGE NO. 53A	GAGE NO. 54A	GAGE NO. 55A	GAGE NO. 56A
0	0	0	0	0
10000	788	697	413	471
20000	1625	964	831	952
25470	2095	939	1058	1210
0	48	-218	0	29
-20000	-1602	-1326	-832	-983
-40000	-3325	-2410	-1649	-2049
-60000	-5088	-3493	-2432	-3175
-76400	-6787	-4324	-3072	-4127
0	19	-475	14	0

NEGATIVE SIGN INDICATES COMPRESSIVE STRAIN

Figure F-5. CV2-2 Fatigue Test Strain Survey - First Lifetime after 9000 Flights (Continued)

STRAIN DATA  
MICROINCHES PER INCH

LOAD INCREMENT POUNDS	GAGE NO. 20R	GAGE NO. 21R	GAGE NO. 22R	GAGE NO. 23R	GAGE NO. 24R
0	0	0	0	0	0
10000	-337	-1098	502	-376	184
20000	-704	-2601	1004	-771	339
25470	-905	-2610	1289	-989	434
0	-61	-2737	39	-35	-24
-20000	643	255	-995	751	-388
-40000	1371	-1189	-2068	1561	-756
-60000	2105	-2159	-3151	2391	-1124
-76400	2778	-4454	-4067	3133	-1445
0	30	-1521	14	39	23

LOAD INCREMENT POUNDS	GAGE NO. 25R	GAGE NO. 32R	GAGE NO. 33R	GAGE NO. 34R	GAGE NO. 35R
0	0	0	0	0	0
10000	514	-387	39	514	-390
20000	1019	-789	64	1065	-800
25470	1296	-1020	79	1360	-1030
0	-15	-41	0	25	-31
-20000	-1088	748	-55	-1066	773
-40000	-2186	1552	-119	-2161	1608
-60000	-3332	2356	-174	-3257	2469
-76400	-4342	3024	-213	-4170	3222
0	24	25	14	0	35

LOAD INCREMENT POUNDS	GAGE NO. 36R	GAGE NO. 37R	GAGE NO. 57R	GAGE NO. 58R	GAGE NO. 59R
0	0	0	0	0	0
10000	34	514	-330	169	465
20000	54	1034	-674	334	926
25470	69	1319	-873	413	1179
0	0	5	-35	29	40
-20000	-60	-1052	643	-305	-892
-40000	-120	-2141	1321	-649	-1828
-60000	-175	-3242	2024	-978	-2745
-76400	-210	-4184	2652	-1237	-3515
0	19	0	39	14	30

NEGATIVE SIGN INDICATES COMPRESSIVE STRAIN

Figure F-5. CV2-2 Fatigue Test Strain Survey - First Lifetime after 9000 Flights (Continued)

STRAIN DATA  
MICROINCHES PER INCH

LOAD INCREMENT POUNDS	GAGE NO. 60R	GAGE NO. 61R	GAGE NO. 62R
0	0	0	0
10000	0	261	411
20000	0	527	893
25470	0	668	1149
0	0	30	-33
-20000	0	-513	-1006
-40000	0	-1051	-1990
-60000	0	-1598	-2990
-76400	0	-2051	-3819
0	0	25	-33

NEGATIVE SIGN INDICATES COMPRESSIVE STRAIN

Figure F-5. CV2-2 Fatigue Test Strain Survey - First  
Lifetime after 9000 Flights (Concluded)

**STRAIN DATA  
MICROINCHES PER INCH**

LOAD INCREMENT POUNDS	GAGE NO. 1A	GAGE NO. 2A	GAGE NO. 3A	GAGE NO. 4A	GAGE NO. 5A
0	0	0	0	0	0
10000	67	175	196	206	119
20000	110	384	446	432	263
25470	144	525	503	514	321
0	-107	-54	225	245	110
-20000	-261	-424	-125	-97	-58
-40000	-367	-691	-538	-491	-288
-60000	-463	-940	-907	-846	-480
-76400	-459	-940	-907	-846	-480
0	33	-5	-236	9	4

LOAD INCREMENT POUNDS	GAGE NO. 6A	GAGE NO. 7A	GAGE NO. 8A	GAGE NO. 9A	GAGE NO. 10A
0	0	0	0	0	0
10000	115	48	236	84	87
20000	245	141	511	159	236
25470	293	201	695	234	319
0	91	-11	-107	-85	-54
-20000	-97	-175	-725	-282	-213
-40000	-318	-338	-1290	-479	-416
-60000	-516	-468	-1889	-714	-644
-76400	-516	-457	-445	-709	-653
0	33	-22	-10	-15	-131

LOAD INCREMENT POUNDS	GAGE NO. 11A	GAGE NO. 12A	GAGE NO. 13A	GAGE NO. 14A	GAGE NO. 15A
0	0	0	0	0	0
10000	14	9	212	362	338
20000	24	24	434	753	671
25470	29	29	553	967	845
0	0	0	-20	39	-45
-20000	-10	-20	-514	-700	-736
-40000	-25	-40	-1028	-1409	-1398
-60000	-45	-55	-1562	-2094	-2084
-76400	-45	-55	-1567	-2084	-2074
0	0	9	-10	109	34

**NEGATIVE SIGN INDICATES COMPRESSIVE STRAIN**

Figure F-6. CV2-2 Fatigue Test Strain Survey - Third Lifetime after 9000 Flights (Continued)

STRAIN DATA  
MICROINCHES PER INCH

LOAD INCREMENT POUNDS	GAGE NO. 16A	GAGE NO. 17A	GAGE NO. 18A	GAGE NO. 19A	GAGE NO. 26A
0	0	0	0	0	0
10000	701	0	420	401	539
20000	1392	0	870	823	1114
25470	1770	0	1113	1051	1416
0	-80	0	39	-50	44
-20000	-1597	0	-832	-948	-1095
-40000	-3069	0	-1678	-1870	-2264
-60000	-4809	0	-2519	-2852	-3468
-76400	-4804	0	-2519	-2857	-3473
0	54	0	19	-10	19

LOAD INCREMENT POUNDS	GAGE NO. 27A	GAGE NO. 28A	GAGE NO. 29A	GAGE NO. 30A	GAGE NO. 31A
0	0	0	0	0	0
10000	542	655	570	532	452
20000	1098	1360	1161	1100	929
25470	1394	1719	1476	1401	1189
0	9	73	4	29	4
-20000	-1144	-1287	-1216	-1096	-939
-40000	-2297	-2706	-2447	-2246	-1883
-60000	-3519	-4155	-3751	-3430	-2837
-76400	-3529	-4175	-3761	-3440	-2837
0	14	-25	-35	9	-5

LOAD INCREMENT POUNDS	GAGE NO. 38A	GAGE NO. 39A	GAGE NO. 40A	GAGE NO. 41A	GAGE NO. 42A
0	0	0	0	0	0
10000	4	-15	102	109	68
20000	4	-25	195	183	233
25470	14	-25	267	247	316
0	-78	-45	30	-40	126
-20000	-68	-40	-201	-308	-122
-40000	-97	-25	-504	-556	-258
-60000	-136	-15	-751	-799	-468
-76400	-136	-15	-756	-799	-468
0	4	29	-11	-15	-15

NEGATIVE SIGN INDICATES COMPRESSIVE STRAIN

Figure F-6. CV2-2 Fatigue Test Strain Survey - Third Lifetime after 9000 Flights (Continued)

STRAIN DATA  
MICROINCHES PER INCH

LOAD INCREMENT POUNDS	GAGE NO. 43A	GAGE NO. 44A	GAGE NO. 45A	GAGE NO. 46A	GAGE NO. 47A
0	0	0	0	0	0
10000	68	58	75	130	134
20000	181	147	156	270	259
25470	245	201	196	350	334
0	63	53	15	0	19
-20000	-148	-74	-147	-271	-235
-40000	-260	-265	-308	-541	-490
-60000	-422	-452	-529	-846	-744
-76400	-422	-452	-519	-841	-744
0	-10	-5	0	0	0

LOAD INCREMENT POUNDS	GAGE NO. 48A	GAGE NO. 49A	GAGE NO. 50A	GAGE NO. 51A	GAGE NO. 52A
0	0	0	0	0	0
10000	0	28	216	341	422
20000	0	52	443	688	849
25470	0	72	566	881	1075
0	4	0	-15	-15	-45
-20000	4	-63	-488	-699	-909
-40000	19	-116	-1016	-1383	-1787
-60000	34	-169	-1617	-2051	-2578
-76400	34	-169	-1617	-2031	-2573
0	0	0	-15	79	29

LOAD INCREMENT POUNDS	GAGE NO. 53A	GAGE NO. 54A	GAGE NO. 55A	GAGE NO. 56A
0	0	0	0	0
10000	0	0	414	445
20000	0	0	828	921
25470	0	0	1055	1173
0	0	0	-15	9
-20000	0	0	-844	-942
-40000	0	0	-1658	-1972
-60000	0	0	-2458	-3082
-76400	0	0	-2458	-3087
0	0	0	-10	-30

NEGATIVE SIGN INDICATES COMPRESSIVE STRAIN

Figure F-6. CV2-2 Fatigue Test Strain Survey - Third Lifetime after 9000 Flights (Continued)

STRAIN DATA  
MICROINCHES PER INCH

LOAD INCREMENT POUNDS	GAGE NO. 20R	GAGE NO. 21R	GAGE NO. 22R	GAGE NO. 23R	GAGE NO. 24R
0	0	0	0	0	0
10000	-338	847	486	-370	170
20000	-715	689	1012	-769	330
25470	-901	798	1283	-977	430
0	-71	-316	29	-35	-34
-20000	638	-582	-1004	744	-402
-40000	1373	-966	-2071	1542	-766
-60000	2118	-1434	-3162	2375	-1149
-76400	2133	-1434	-3172	2390	-1144
0	25	-198	-15	29	4

LOAD INCREMENT POUNDS	GAGE NO. 25R	GAGE NO. 32R	GAGE NO. 33R	GAGE NO. 34R	GAGE NO. 35R
0	0	0	0	0	0
10000	502	-382	34	508	-379
20000	1019	-799	64	1072	-804
25470	1290	-1015	79	1362	-1024
0	-20	-41	-5	25	-36
-20000	-1092	748	-60	-1053	777
-40000	-2189	1537	-124	-2135	1591
-60000	-3359	2336	-179	-3244	2455
-76400	-3363	2346	-179	-3254	2471
0	-15	10	-5	-26	15

LOAD INCREMENT POUNDS	GAGE NO. 36R	GAGE NO. 37R	GAGE NO. 57R	GAGE NO. 58R	GAGE NO. 59R
0	0	0	0	0	0
10000	29	503	-332	164	446
20000	49	1027	-693	339	922
25470	69	1312	-874	424	1176
0	-5	0	-51	29	40
-20000	-60	-1061	637	-315	-908
-40000	-125	-2133	1309	-659	-1836
-60000	-185	-3259	2017	-994	-2779
-76400	-185	-3270	2032	-994	-2779
0	-5	-61	10	0	-6

NEGATIVE SIGN INDICATES COMPRESSIVE STRAIN

Figure F-6. CV2-2 Fatigue Test Strain Survey - Third Lifetime after 9000 Flights (Continued)



**STRAIN DATA  
MICROINCHES PER INCH**

<b>LOAD INCREMENT POUNDS</b>	<b>GAGE NO. 60R</b>	<b>GAGE NO. 61R</b>	<b>GAGE NO. 62R</b>
0	0	0	0
10000	-275	261	460
20000	-581	532	947
25470	-739	678	1215
0	-21	30	16
-20000	559	-523	-959
-40000	1160	-1061	-1939
-60000	1786	-1629	-2967
-76400	1791	-1629	-2967
0	20	-6	0

**NEGATIVE SIGN INDICATES COMPRESSIVE STRAIN**

Figure F-6. CV2-2 Fatigue Test Strain Survey - Third Lifetime after 9000 Flights (Concluded)

STRAIN DATA  
MICROINCHES PER INCH

LOAD INCREMENT POUNDS	GAGE NO. 1A	GAGE NO. 2A	GAGE NO. 3A	GAGE NO. 4A	GAGE NO. 5A
0	0	0	0	0	0
10000	62	159	210	202	107
20000	105	372	453	423	249
25470	125	425	477	452	264
0	-106	-54	243	254	92
-20000	-260	-426	-115	-82	-64
-40000	-371	-711	-516	-462	-294
-60000	-438	-866	-764	-693	-416
-76400	-554	-1122	-1199	-1121	-656
0	48	14	-354	-39	-5

LOAD INCREMENT POUNDS	GAGE NO. 6A	GAGE NO. 7A	GAGE NO. 8A	GAGE NO. 9A	GAGE NO. 10A
0	0	0	0	0	0
10000	105	37	309	98	101
20000	230	124	609	173	197
25470	250	145	669	201	216
0	76	-22	-35	-75	-25
-20000	-106	-178	-650	-276	-212
-40000	-313	-340	-1250	-463	-400
-60000	-433	-426	-1640	-613	-515
-76400	-664	-561	-2365	-861	-708
0	9	-49	109	.4	-409

LOAD INCREMENT POUNDS	GAGE NO. 11A	GAGE NO. 12A	GAGE NO. 13A	GAGE NO. 14A	GAGE NO. 15A
0	0	0	0	0	0
10000	14	9	220	375	346
20000	19	24	441	750	668
25470	29	34	490	814	738
0	9	9	-15	39	-30
-20000	-10	-10	-501	-686	-724
-40000	-25	-30	-1006	-1377	-1373
-60000	-35	-30	-1334	-1792	-1794
-76400	-60	-55	-2021	-2561	-2591
0	14	9	14	187	74

NEGATIVE SIGN INDICATES COMPRESSIVE STRAIN

Figure F-7. CV2-2 Fatigue Test Strain Survey Fourth Lifetime after 9000 Flights (Continued)

**STRAIN DATA  
MICROINCHES PER INCH**

LOAD INCREMENT POUNDS	GAGE NO. 16A	GAGE NO. 17A	GAGE NO. 18A	GAGE NO. 19A	GAGE NO. 26A
0	0	0	0	0	0
10000	705	0	439	419	554
20000	1390	0	883	828	1123
25470	1529	0	967	922	1236
0	-80	0	44	-40	59
-20000	-1560	0	-815	-933	-1079
-40000	-3005	0	-1639	-1831	-2207
-60000	-4053	0	-2162	-2433	-2954
-76400	-6129	0	-3178	-3687	-4483
0	64	0	78	29	79

LOAD INCREMENT POUNDS	GAGE NO. 27A	GAGE NO. 28A	GAGE NO. 29A	GAGE NO. 30A	GAGE NO. 31A
0	0	0	0	0	0
10000	561	671	588	552	462
20000	1108	1363	1171	1110	919
25470	1211	1516	1289	1223	1022
0	34	103	34	49	4
-20000	-1119	-1295	-1216	-1081	-939
-40000	-2252	-3143	-2457	-2211	-1849
-60000	-3009	-4111	-3246	-2961	-2458
-76400	-4557	-6009	-4903	-4461	-3594
0	78	14	9	34	24

LOAD INCREMENT POUNDS	GAGE NO. 38A	GAGE NO. 39A	GAGE NO. 40A	GAGE NO. 41A	GAGE NO. 42A
0	0	0	0	0	0
10000	-10	-20	113	128	68
20000	0	-35	195	207	209
25470	4	-40	220	231	253
0	-78	-59	46	-15	111
-20000	-73	-49	-196	-282	-132
-40000	-92	-40	-494	-528	-263
-60000	-121	-30	-658	-677	-395
-76400	-170	-30	-982	-997	-691
0	9	19	-11	24	0

NEGATIVE SIGN INDICATES COMPRESSIVE STRAIN

Figure F-7. CV2-2 Fatigue Test Strain Survey Fourth Lifetime after 9000 Flights (Continued)

STRAIN DATA  
MICROINCHES PER INCH

LOAD INCREMENT POUNDS	GAGE NO. 43A	GAGE NO. 44A	GAGE NO. 45A	GAGE NO. 46A	GAGE NO. 47A
0	0	0	0	0	0
10000	73	53	80	129	124
20000	176	122	160	274	248
25470	205	151	180	304	278
0	68	53	25	0	9
-20000	-128	-79	-131	-260	-235
-40000	-236	-251	-292	-535	-483
-60000	-338	-378	-442	-720	-643
-76400	-573	-550	-618	-1055	-932
0	4	9	15	14	-35

LOAD INCREMENT POUNDS	GAGE NO. 48A	GAGE NO. 49A	GAGE NO. 50A	GAGE NO. 51A	GAGE NO. 52A
0	0	0	0	0	0
10000	0	23	216	302	435
20000	4	47	438	581	847
25470	9	52	487	635	940
0	0	4	-10	-145	-59
-20000	0	-58	-478	-860	-1019
-40000	-10	-116	-1005	-1540	-1876
-60000	-5	-144	-1388	-1962	-2400
-76400	0	-207	-2107	-2702	-3262
0	4	9	14	-120	39

LOAD INCREMENT POUNDS	GAGE NO. 53A	GAGE NO. 54A	GAGE NO. 55A	GAGE NO. 56A
0	0	0	0	0
10000	0	0	423	455
20000	0	0	831	905
25470	0	0	920	999
0	0	0	4	34
-20000	0	0	-822	-906
-40000	0	0	-1635	-1905
-60000	0	0	-2156	-2613
-76400	0	0	-3082	-3933
0	0	0	29	14

NEGATIVE SIGN INDICATES COMPRESSIVE STRAIN

Figure F-7. CV2-2 Fatigue Test Strain Survey Fourth Lifetime after 9000 Flights (Continued)

**STRAIN DATA  
MICROINCHES PER INCH**

LOAD INCREMENT POUNDS	GAGE NO. 20R	GAGE NO. 21R	GAGE NO. 22R	GAGE NO. 23R	GAGE NO. 24R
0	0	0	0	0	0
10000	-336	1109	501	-374	183
20000	-696	1056	1003	-771	338
25470	-771	977	1116	-845	385
0	-76	-10	39	-50	-29
-20000	645	-397	-1004	741	-391
-40000	1351	-646	-2046	1522	-748
-60000	1821	-1008	-2724	2033	-988
-76400	2802	-1487	-4116	3142	-1459
0	45	34	4	44	23

LOAD INCREMENT POUNDS	GAGE NO. 25R	GAGE NO. 32R	GAGE NO. 33R	GAGE NO. 34R	GAGE NO. 35R
0	0	0	0	0	0
10000	494	-376	39	533	-383
20000	989	-772	74	1072	-776
25470	1076	-852	79	1189	-873
0	-78	-26	4	45	-31
-20000	-1189	761	-55	-1032	785
-40000	-2280	1538	-114	-2105	1592
-60000	-3017	2039	-154	-2801	2128
-76400	-4516	3006	-208	-4148	3225
0	-122	50	19	20	51

LOAD INCREMENT POUNDS	GAGE NO. 36R	GAGE NO. 37R	GAGE NO. 57R	GAGE NO. 58R	GAGE NO. 59R
0	0	0	0	0	0
10000	34	513	-335	174	459
20000	59	1037	-695	333	924
25470	64	1141	-770	363	1025
0	9	21	-55	19	50
-20000	-45	-1043	644	-314	-910
-40000	-105	-2092	1329	-662	-1839
-60000	-145	-2791	1784	-876	-2445
-76400	-205	-4139	2709	-1259	-3576
0	34	76	9	-10	10

NEGATIVE SIGN INDICATES COMPRESSIVE STRAIN

Figure F-7. CV2-2 Fatigue Test Strain Survey Fourth Lifetime after 9000 Flights (Continued)

**STRAIN DATA  
MICROINCHES PER INCH**

<b>LOAD INCREMENT POUNDS</b>	<b>GAGE NO. 60R</b>	<b>GAGE NO. 61R</b>	<b>GAGE NO. 62R</b>
0	0	0	0
10000	-279	270	480
20000	-568	541	961
25470	-629	602	1062
0	-21	30	26
-20000	552	-522	-946
-40000	1140	-1069	-1939
-60000	1546	-1431	-2591
-76400	2332	-2113	-3803
0	35	15	26

**NEGATIVE SIGN INDICATES COMPRESSIVE STRAIN**

Figure F-7. CV2-2 Fatigue Test Strain Survey  
Fourth Lifetime after 9000 Flights (Concluded)

**STRAIN DATA  
MICROINCHES PER INCH**

LOAD INCREMENT POUNDS	GAGE NO. 1A	GAGE NO. 2A	GAGE NO. 3A	GAGE NO. 4A	GAGE NO. 5A
0	0	0	0	0	0
5000	38	87	85	57	29
10000	57	140	148	120	54
15300	100	280	391	336	183
0	-39	-39	238	192	64
-10000	-116	-223	105	62	-10
-20000	-197	-451	-82	-111	-100
-30000	-264	-581	-244	-265	-169
-40000	-336	-702	-464	-458	-288
-45800	-351	-765	-578	-573	-343
0	14	9	47	4	19

LOAD INCREMENT POUNDS	GAGE NO. 6A	GAGE NO. 7A	GAGE NO. 8A	GAGE NO. 9A	GAGE NO. 10A
0	0	0	0	0	0
5000	38	32	159	42	57
10000	72	37	241	65	81
15300	182	86	509	135	115
0	67	-33	0	-52	-82
-10000	-10	-103	-335	-164	-111
-20000	-87	-162	-675	-267	-227
-30000	-173	-222	-963	-365	-357
-40000	-294	-297	-1308	-477	-434
-45800	-346	-351	-1472	-534	-458
0	14	10	41	0	-44

LOAD INCREMENT POUNDS	GAGE NO. 11A	GAGE NO. 12A	GAGE NO. 13A	GAGE NO. 14A	GAGE NO. 15A
0	0	0	0	0	0
5000	0	0	102	152	148
10000	4	4	166	251	247
15300	9	14	353	556	534
0	0	0	0	4	0
-10000	-10	-10	-241	-355	-357
-20000	-15	-20	-491	-690	-714
-30000	-25	-25	-741	-1026	-1036
-40000	-30	-30	-1011	-1385	-1387
-45800	-30	-25	-1167	-1543	-1571
0	9	14	19	68	39

**NEGATIVE SIGN INDICATES COMPRESSIVE STRAIN**

Figure F-8. CV2-2 Fatigue Test Strain Survey  
End of Fourth Lifetime (Continued)

STRAIN DATA  
MICROINCHES PER INCH

LOAD INCREMENT POUNDS	GAGE NO. 16A	GAGE NO. 17A	GAGE NO. 18A	GAGE NO. 19A	GAGE NO. 26A
0	0	0	0	0	0
5000	302	0	192	197	241
10000	510	0	325	315	409
15300	1084	0	680	640	862
0	-5	0	34	-25	24
-10000	-748	0	-400	-474	-528
-20000	-1487	0	-814	-922	-1085
-30000	-2185	0	-1213	-1366	-1622
-40000	-2963	0	-1656	-1853	-2243
-45800	-3389	0	-1878	-2129	-2573
0	44	0	59	24	34

LOAD INCREMENT POUNDS	GAGE NO. 27A	GAGE NO. 28A	GAGE NO. 29A	GAGE NO. 30A	GAGE NO. 31A
0	0	0	0	0	0
5000	243	0	255	251	206
10000	414	0	442	418	339
15300	858	0	929	866	708
0	34	0	49	39	-10
-10000	-537	0	-566	-517	-478
-20000	-1127	0	-1210	-1073	-945
-30000	-1679	0	-2099	-1615	-1393
-40000	-2308	0	-2675	-2230	-1890
-45800	-2654	0	-2979	-2560	-2156
0	0	0	9	39	9

LOAD INCREMENT POUNDS	GAGE NO. 38A	GAGE NO. 39A	GAGE NO. 40A	GAGE NO. 41A	GAGE NO. 42A
0	0	0	0	0	0
5000	24	4	51	69	48
10000	14	4	97	103	77
15300	14	-10	184	187	160
0	-44	-10	46	24	58
-10000	-63	-10	-62	-104	-30
-20000	-68	-10	-185	-237	-117
-30000	-68	-10	-313	-371	-171
-40000	-87	0	-477	-514	-249
-45800	-87	14	-564	-578	-302
0	33	29	-6	19	19

NEGATIVE SIGN INDICATES COMPRESSIVE STRAIN

Figure F-8. CV2-2 Fatigue Test Strain Survey  
End of Fourth Lifetime (Continued)



STRAIN DATA  
MICROINCHES PER INCH

LOAD INCREMENT POUNDS	GAGE NO. 43A	GAGE NO. 44A	GAGE NO. 45A	GAGE NO. 46A	GAGE NO. 47A
0	0	0	0	0	0
5000	48	29	35	49	59
10000	73	53	70	84	89
15300	131	102	125	189	188
0	19	29	10	-20	-5
-10000	-64	-10	-51	-145	-115
-20000	-127	-64	-111	-280	-239
-30000	-181	-133	-176	-404	-363
-40000	-244	-240	-266	-544	-492
-45800	-273	-299	-331	-619	-547
0	24	14	20	0	-5

LOAD INCREMENT POUNDS	GAGE NO. 48A	GAGE NO. 49A	GAGE NO. 50A	GAGE NO. 51A	GAGE NO. 52A
0	0	0	0	0	0
5000	0	14	108	128	195
10000	4	19	172	237	323
15300	4	43	344	499	636
0	4	4	-5	-45	0
-10000	-10	-29	-232	-396	-471
-20000	-10	-53	-473	-738	-980
-30000	-10	-82	-724	-1059	-1504
-40000	-10	-106	-1009	-1420	-1979
-45800	0	-120	-1172	-1593	-2184
0	4	9	19	24	9

LOAD INCREMENT POUNDS	GAGE NO. 53A	GAGE NO. 54A	GAGE NO. 55A	GAGE NO. 56A
0	0	0	0	0
5000	0	0	211	197
10000	0	0	333	336
15300	0	0	652	672
0	0	0	14	-30
-10000	0	0	-408	-495
-20000	0	0	-811	-940
-30000	0	0	-1218	-1415
-40000	0	0	-1650	-1960
-45800	0	0	-1866	-2271
0	0	0	34	0

NEGATIVE SIGN INDICATES COMPRESSIVE STRAIN

Figure F-8. CV2-2 Fatigue Test Strain Survey  
End of Fourth Lifetime (Continued)

STRAIN DATA  
MICROINCHES PER INCH

LOAD INCREMENT POUNDS	GAGE NO. 20R	GAGE NO. 21R	GAGE NO. 22R	GAGE NO. 23R	GAGE NO. 24R
0	0	0	0	0	0
5000	-131	273	225	-158	84
10000	-231	537	373	-271	136
15300	-521	1417	770	-590	267
0	-21	-5	9	-25	-15
-10000	320	-201	-496	368	-203
-20000	680	-392	-1007	766	-386
-30000	1006	-573	-1503	1139	-564
-40000	1401	-641	-2073	1561	-757
-45800	1636	-876	-2387	1826	-856
0	40	39	19	39	28

LOAD INCREMENT POUNDS	GAGE NO. 25R	GAGE NO. 32R	GAGE NO. 33R	GAGE NO. 34R	GAGE NO. 35R
0	0	0	0	0	0
5000	152	-161	14	233	-163
10000	285	-282	29	406	-286
15300	679	-598	54	812	-606
0	-173	-16	0	15	-11
-10000	-749	376	-25	-518	381
-20000	-1330	762	-55	-1051	788
-30000	-1886	1129	-84	-1559	1170
-40000	-2536	1550	-119	-2138	1608
-45800	-3023	1781	-129	-2453	1857
0	-503	25	14	15	25

LOAD INCREMENT POUNDS	GAGE NO. 36R	GAGE NO. 37R	GAGE NO. 57R	GAGE NO. 58R	GAGE NO. 59R
0	0	0	0	0	0
5000	19	239	-150	74	217
10000	19	398	-250	124	348
15300	44	801	-524	253	707
0	4	21	-25	19	15
-10000	-25	-513	319	-150	-456
-20000	-55	-1042	668	-314	-916
-30000	-85	-1549	997	-483	-1381
-40000	-115	-2127	1371	-663	-1877
-45800	-125	-2443	1580	-757	-2145
0	19	10	14	-5	0

NEGATIVE SIGN INDICATES COMPRESSIVE STRAIN

Figure F-8. CV2-2 Fatigue Test Strain Survey  
End of Fourth Lifetime (Continued)

**STRAIN DATA  
MICROINCHES PER INCH**

<b>LOAD INCREMENT POUNDS</b>	<b>GAGE NO. 60R</b>	<b>GAGE NO. 61R</b>	<b>GAGE NO. 62R</b>
0	0	0	0
5000	-137	110	213
10000	-219	190	357
15300	-447	390	725
0	-26	-11	0
-10000	268	-276	-486
-20000	552	-557	-976
-30000	836	-822	-1456
-40000	1145	-1108	-1968
-45800	1338	-1253	-2246
0	10	-11	0

**NEGATIVE SIGN INDICATES COMPRESSIVE STRAIN**

Figure F-8. CV2-2 Fatigue Test Strain Survey  
End of Fourth Lifetime (Concluded)

**STRAIN DATA  
MICROINCHES PER INCH**

LOAD INCREMENT POUNDS	GAGE NO. 1A	GAGE NO. 2A	GAGE NO. 3A	GAGE NO. 4A	GAGE NO. 5A
0	0	0	0	0	0
3500	28	56	38	38	44
20000	163	324	263	187	169
40000	323	500	359	370	338
60000	491	801	603	592	567
80000	655	1063	920	862	781
20000	130	238	210	202	248
80000	655	1074	872	886	801
90000	708	1211	1006	982	886
100000	795	1376	1155	1112	985
110000	887	1569	1294	1233	1085
120000	964	1757	1442	1363	1185
130000	1032	1882	1567	1478	1259

LOAD INCREMENT POUNDS	GAGE NO. 6A	GAGE NO. 7A	GAGE NO. 8A	GAGE NO. 9A	GAGE NO. 10A
0	0	0	0	0	0
3500	38	54	43	56	33
20000	144	185	188	234	245
40000	284	315	381	498	477
60000	452	577	676	686	655
80000	655	816	985	883	887
20000	168	266	313	75	168
80000	708	827	989	916	863
90000	799	942	1125	1033	979
100000	900	1056	1270	1160	1085
110000	1011	1170	1410	1287	1191
120000	1107	1290	1550	1395	1282
130000	1194	1394	1665	1503	1374

**NEGATIVE SIGN INDICATES COMPRESSIVE STRAIN**

Figure G-1. CV2-2 Residual Strength Tension  
Test-Strain Gauge Readings (Continued)

STRAIN DATA  
MICROINCHES PER INCH

LOAD INCREMENT POUNDS	GAGE NO. 11A	GAGE NO. 12A	GAGE NO. 13A	GAGE NO. 14A	GAGE NO. 15A
0	0	0	0	0	0
3500	.9	114	79	119	104
20000	29	0	445	596	637
40000	49	59	885	1233	1319
60000	54	19	1306	1725	1961
80000	79	59	1756	2212	2614
20000	34	-5	445	44	482
80000	79	44	1726	2188	2579
90000	84	79	1954	2282	2873
100000	94	84	2176	2521	3216
110000	99	79	2399	2784	3575
120000	108	79	2626	3003	4028
130000	118	94	2839	3277	4356

LOAD INCREMENT POUNDS	GAGE NO. 16A	GAGE NO. 17A	GAGE NO. 18A	GAGE NO. 19A	GAGE NO. 26A
0	0	0	0	0	0
3500	263	209	114	234	178
20000	1397	1126	789	956	1060
40000	2829	2243	1638	1797	2149
60000	4261	3345	2463	2599	3195
80000	5708	4327	3362	3450	4274
20000	1526	1126	804	1000	1069
80000	5728	4327	3307	3500	4265
90000	6385	4751	3729	3923	4770
100000	7126	5284	4122	4326	5305
110000	10174	5793	4554	4725	5845
120000	10174	6257	5016	5123	6419
130000	10174	6576	5428	5492	6920

NEGATIVE SIGN INDICATES COMPRESSIVE STRAIN

Figure G-1. CV2-2 Residual Strength Tension  
Test-Strain Gauge Readings (Continued)

STRAIN DATA  
MICROINCHES PER INCH

LOAD INCREMENT POUNDS	GAGE NO. 28A	GAGE NO. 29A	GAGE NO. 30A	GAGE NO. 31A
0	0	0	0	0
3500	221	196	187	157
20000	1340	1156	1067	893
40000	2695	2421	2159	1815
60000	4070	4075	3241	2748
80000	5475	6167	4338	3710
20000	1512	1776	1161	917
80000	5460	9641	4338	3705
90000	6165	9951	4876	4184
100000	6859	9951	5415	4667
110000	7569	9951	5958	5156
120000	8308	9951	6511	5669
130000	8944	9951	6996	6118

LOAD INCREMENT POUNDS	GAGE NO. 38A	GAGE NO. 39A	GAGE NO. 40A	GAGE NO. 41A	GAGE NO. 42A
0	0	0	0	0	0
3500	9	9	10	24	14
20000	24	29	190	198	121
40000	24	29	448	476	350
60000	24	-69	783	794	545
80000	24	-128	1102	1137	745
20000	-15	-109	314	322	233
80000	14	-94	1123	1142	760
90000	14	-109	1283	1301	852
100000	14	-94	1432	1455	945
110000	4	-69	1576	1614	1027
120000	0	-69	1721	1772	1115
130000	0	-55	1849	1892	1198

NEGATIVE SIGN INDICATES COMPRESSIVE STRAIN

Figure G-1. CV2-2 Residual Strength Tension Test-Strain Gauge Readings (Continued)

STRAIN DATA  
MICROINCHES PER INCH

LOAD INCREMENT POUNDS	GAGE NO. 43A	GAGE NO. 44A	GAGE NO. 45A	GAGE NO. 46A	GAGE NO. 47A
0	0	0	0	0	0
3500	14	24	40	39	24
20000	132	103	136	264	219
40000	293	310	307	574	449
60000	489	531	534	864	719
80000	661	753	792	1174	929
20000	195	236	257	224	174
80000	631	767	822	1159	924
90000	719	876	953	1314	1099
100000	798	984	1094	1479	1224
110000	881	1087	1235	1614	1344
120000	954	1191	1377	1744	1444
130000	1023	1284	1498	1849	1549

LOAD INCREMENT POUNDS	GAGE NO. 48A	GAGE NO. 49A	GAGE NO. 50A	GAGE NO. 51A	GAGE NO. 52A
0	0	0	0	0	0
3500	0	14	74	108	152
20000	14	52	414	709	822
40000	24	100	848	1458	1636
60000	9	139	1282	2217	2454
80000	-15	153	1727	3020	3306
20000	-10	24	453	798	882
80000	-15	153	1727	3020	3306
90000	-5	153	1978	3425	3705
100000	-10	153	2205	3848	4134
110000	0	168	2447	4307	4573
120000	24	172	2689	5051	4962
130000	38	172	2891	5504	5332

NEGATIVE SIGN INDICATES COMPRESSIVE STRAIN

Figure G-1. CV2-2 Residual Strength Tension Test-Strain Gauge Readings (Continued)

**STRAIN DATA  
MICROINCHES PER INCH**

<b>LOAD INCREMENT POUNDS</b>	<b>GAGE NO. 53A</b>	<b>GAGE NO. 54A</b>	<b>GAGE NO. 55A</b>	<b>GAGE NO. 56A</b>
0	0	0	0	0
3500	244	178	148	173
20000	1483	926	838	861
40000	3026	1882	1707	1684
60000	4617	2833	2575	2491
80000	6267	3744	3380	3304
20000	1708	946	848	847
80000	6262	3749	3365	3304
90000	7100	4220	3769	3715
100000	7908	4695	4218	4121
110000	8632	5112	4667	4532
120000	9058	5429	5195	4953
130000	9685	5780	5645	5310

**NEGATIVE SIGN INDICATES COMPRESSIVE STRAIN**

Figure G-1. CV2-2 Residual Strength Tension  
Test-Strain Gauge Readings (Continued)



STRAIN DATA  
MICROINCHES PER INCH

LOAD INCREMENT POUNDS	GAGE NO. 20R	GAGE NO. 21R	GAGE NO. 22R	GAGE NO. 23R	GAGE NO. 24R
0	0	0	0	0	0
3500	-141	54	167	-134	52
20000	-690	359	985	-751	350
40000	-1369	733	1966	-1526	700
60000	-2103	1092	2967	-2345	1012
80000	-2833	1569	3973	-3204	1329
20000	-816	354	1054	-923	312
80000	-2858	1417	3958	-3228	1320
90000	-3230	1604	4480	-3653	1481
100000	-3598	1776	4978	-4097	1623
110000	-3985	1948	5471	-4541	1770
120000	-4403	2120	5979	-5030	1888
130000	-4760	2283	6452	-5430	1978

LOAD INCREMENT POUNDS	GAGE NO. 25R	GAGE NO. 32R	GAGE NO. 33R	GAGE NO. 34R	GAGE NO. 35R
0	0	0	0	0	0
3500	169	-141	0	174	-159
20000	1013	-783	39	1034	-800
40000	2041	-1586	93	2100	-1614
60000	3050	-2414	128	3166	-2465
80000	4078	-3252	183	4262	-3326
20000	1086	-879	19	1116	-918
80000	4088	-3262	168	4247	-3351
90000	4602	-3689	197	4795	-3787
100000	5106	-4115	217	5338	-4238
110000	5601	-4552	227	5886	-4704
120000	6081	-5003	237	6445	-5180
130000	6493	-5395	252	6937	-5600

NEGATIVE SIGN INDICATES COMPRESSIVE STRAIN

Figure G-1. CV2-2 Residual Strength Tension Test-Strain Gauge Readings (Continued)

**STRAIN DATA  
MICROINCHES PER INCH**

LOAD INCREMENT POUNDS	GAGE NO.	GAGE NO.	GAGE NO.	GAGE NO.	GAGE NO.
	36R	37R	57R	58R	59R
0	0	0	0	0	0
3500	4	175	-126	39	147
20000	44	1003	-677	274	836
40000	84	2039	-1369	544	1693
60000	104	3065	-2115	743	2565
80000	129	4117	-2912	1023	3457
20000	0	1074	-862	224	892
80000	129	4117	-2937	1008	3457
90000	129	4644	-3348	1123	3904
100000	144	5170	-3754	1223	4334
110000	144	5696	-4180	1317	4770
120000	144	6250	-4656	1412	5257
130000	134	6727	-5097	1502	5663

LOAD INCREMENT POUNDS	GAGE NO.	GAGE NO.	GAGE NO.
	60R	61R	62R
0	0	0	0
3500	-97	85	160
20000	-581	482	883
40000	-1181	954	1783
60000	-1833	1411	2688
80000	-2510	1874	3620
20000	-718	462	915
80000	-2515	1884	3630
90000	-2861	2110	4086
100000	-3212	2336	4573
110000	-3599	2557	5060
120000	-4078	2773	5623
130000	-4424	2974	6056

NEGATIVE SIGN INDICATES COMPRESSIVE STRAIN

Figure G-1. CV2-2 Residual Strength Tension  
Test-Strain Gauge Readings (Concluded)

GAGE: 1A  
SPECIMEN: CV2-2  
CONDITION: RESIDUAL STRENGTH

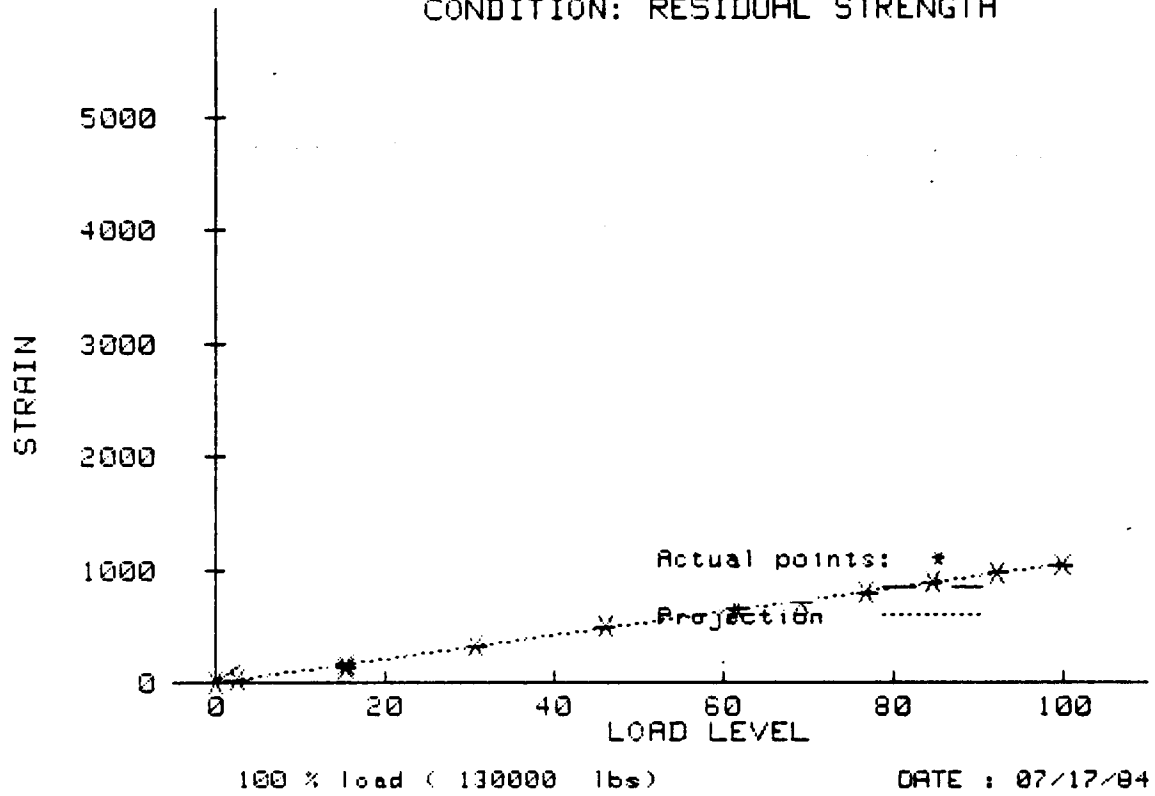

Figure H-1. CV2-2 Residual Strength Tension Test -  
Strain Gauge Readings - Plot Gage 1

GAGE: 2A  
SPECIMEN: CV2-2  
CONDITION: RESIDUAL STRENGTH

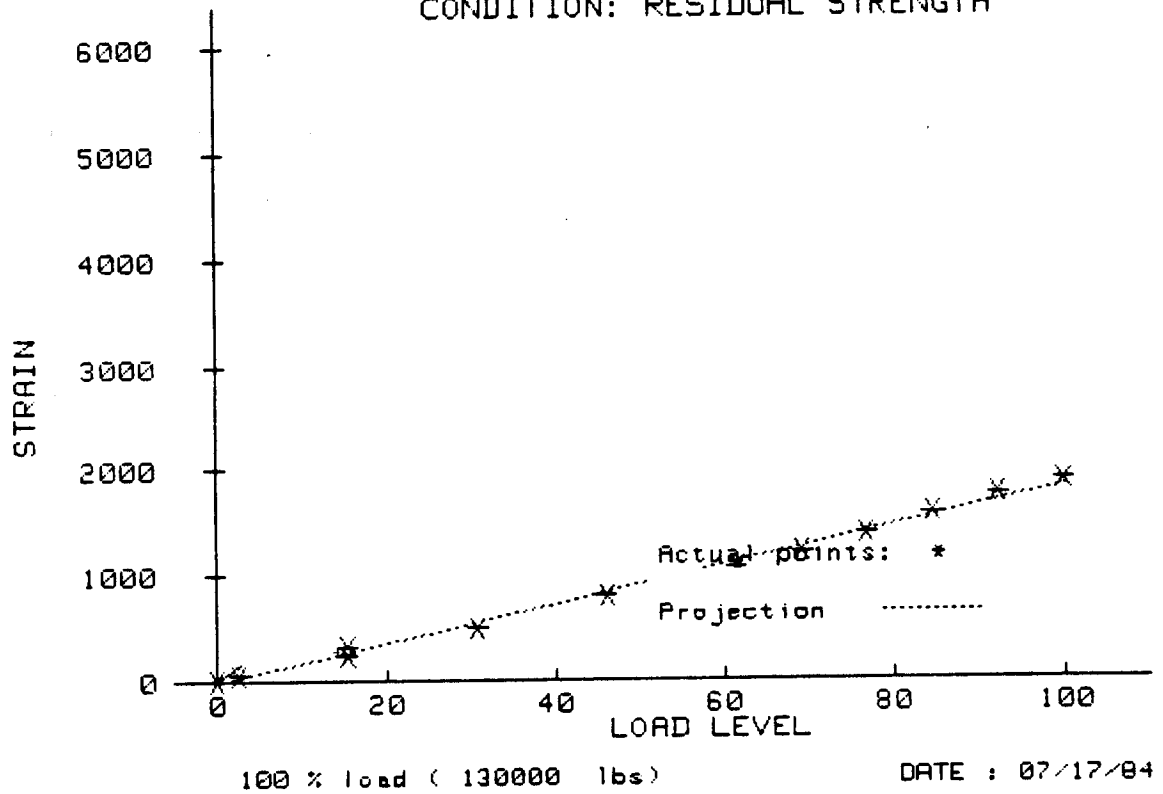

Figure H-2. CV2-2 Residual Strength Tension Test - Strain Gauge Readings - Plot Gage 2

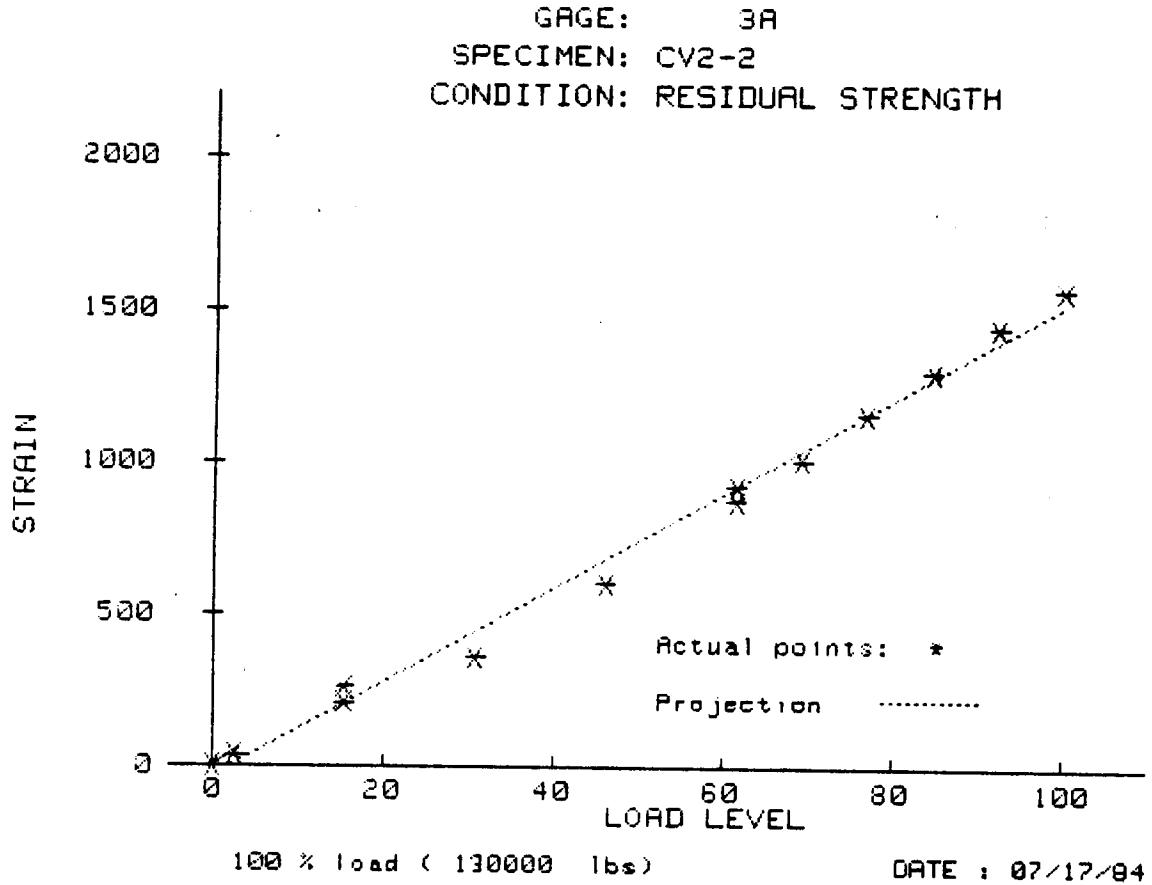

Figure H-3. CV2-2 Residual Strength Tension Test -  
Strain Gauge Readings - Plot Gage 3

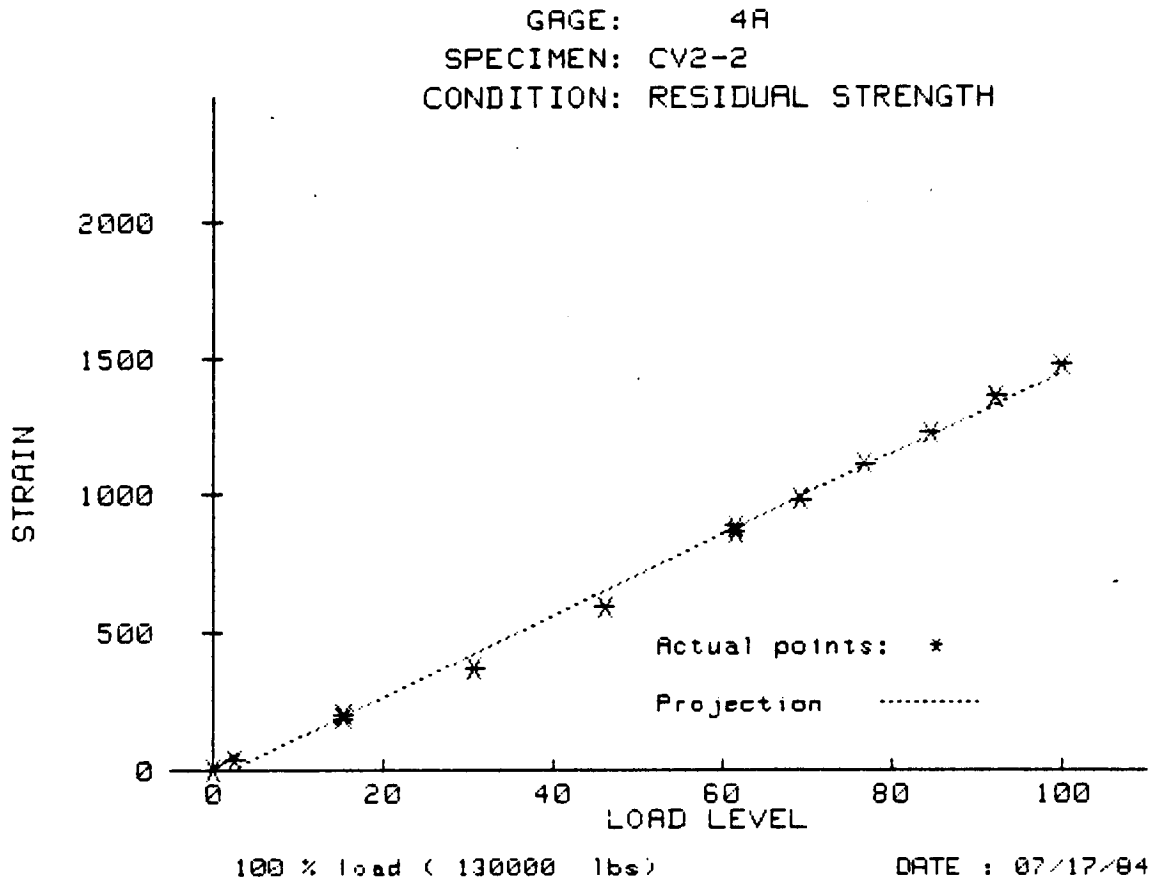

Figure H-4. CV2-2 Residual Strength Tension Test - Strain Gauge Readings - Plot Gage 4

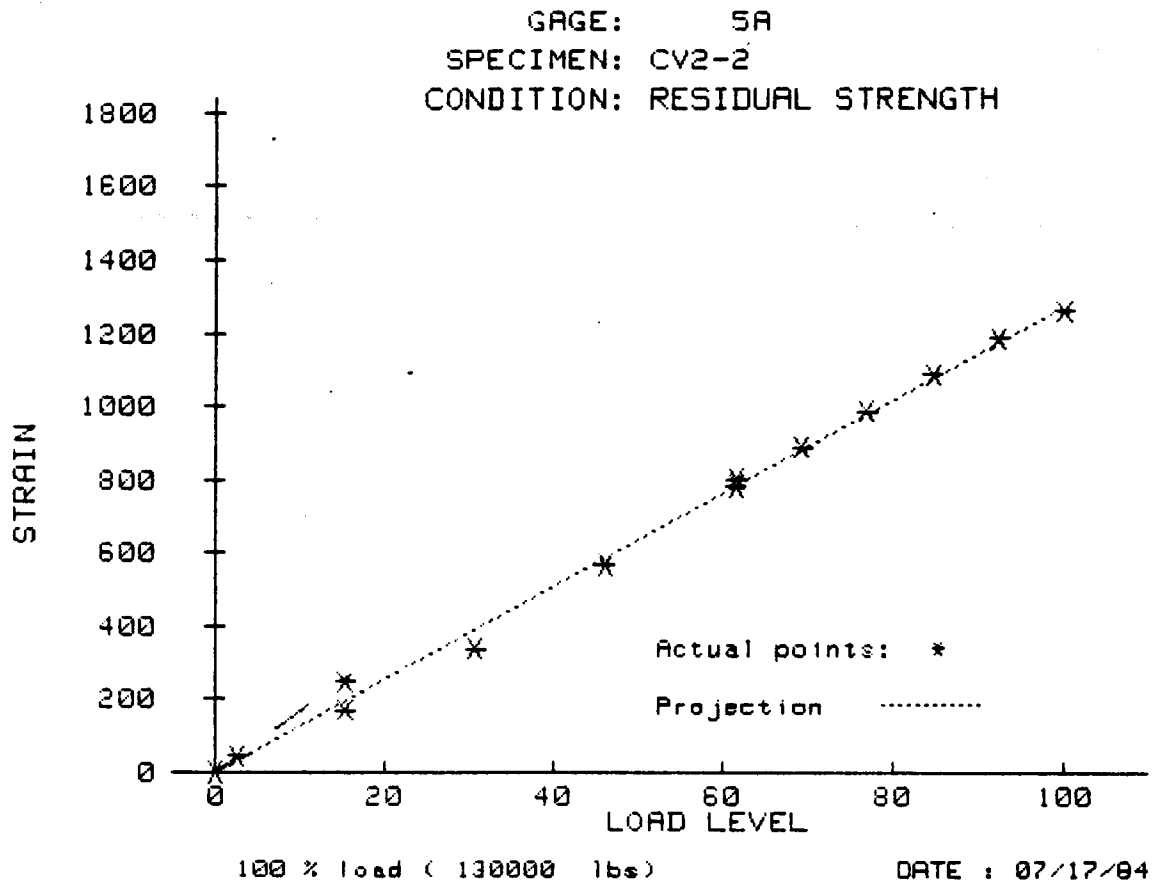

Figure H-5. CV2-2 Residual Strength Tension Test -  
Strain Gauge Readings - Plot Gage 5

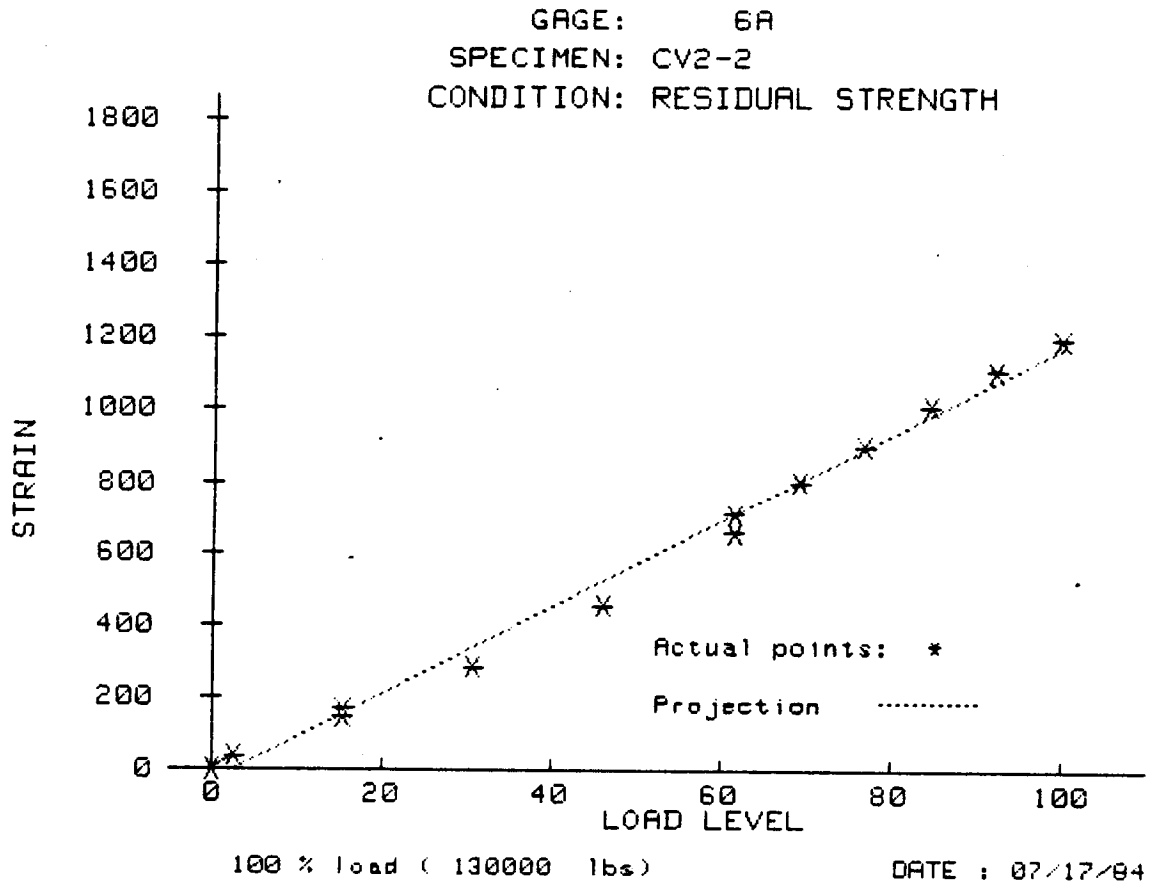

Figure H-6. CV2-2 Residual Strength Tension Test - Strain Gauge Readings - Plot Gage 6



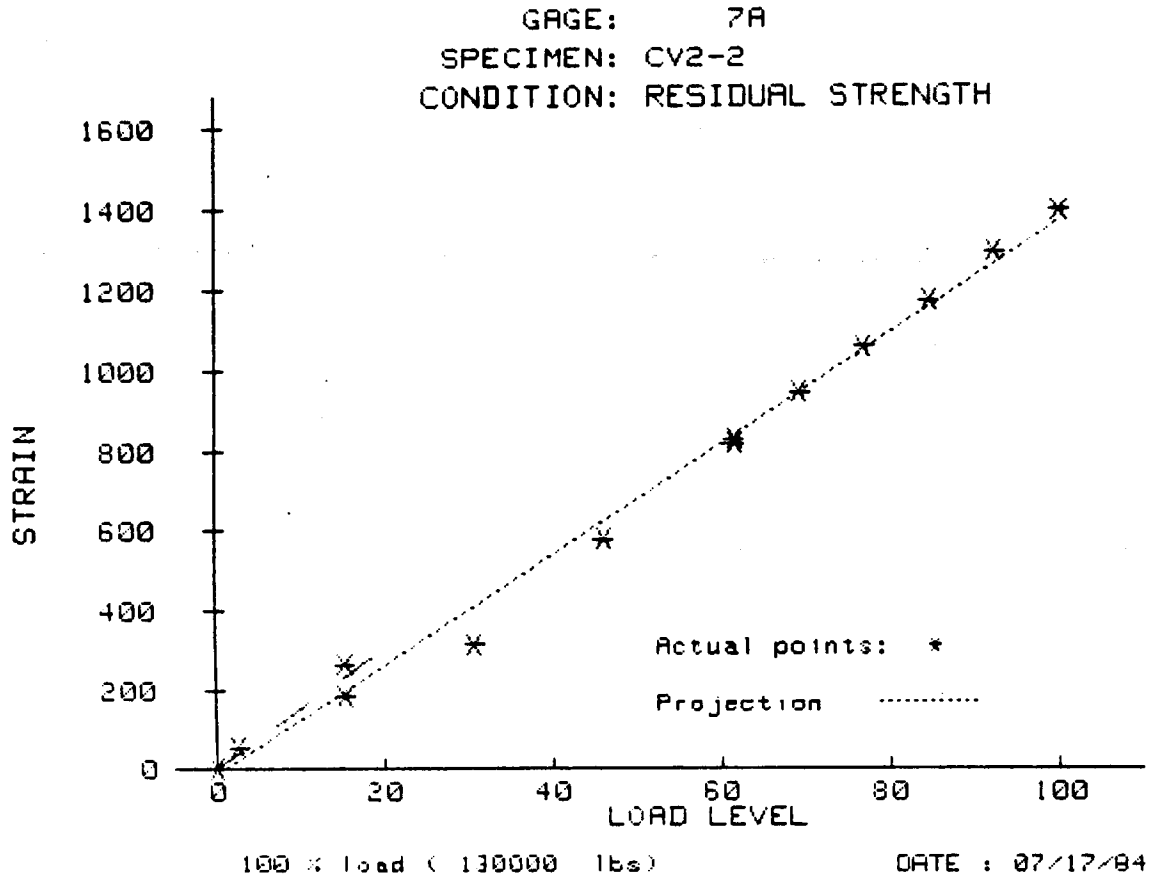

Figure H-7. CV2-2 Residual Strength Tension Test - Strain Gauge Readings - Plot Gage 7

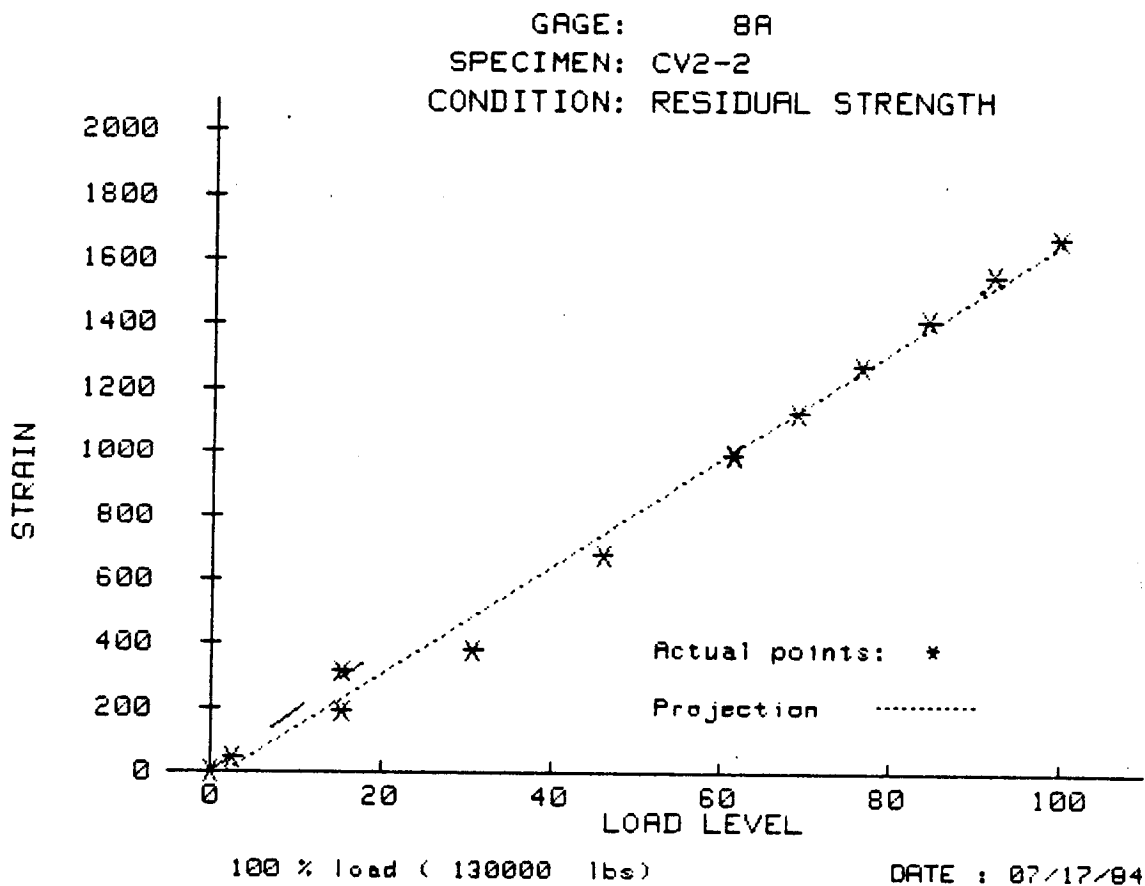

Figure H-8. CV2-2 Residual Strength Tension Test -  
Strain Gauge Readings - Plot Gage 8

GAGE: 9A  
SPECIMEN: CV2-2  
CONDITION: RESIDUAL STRENGTH

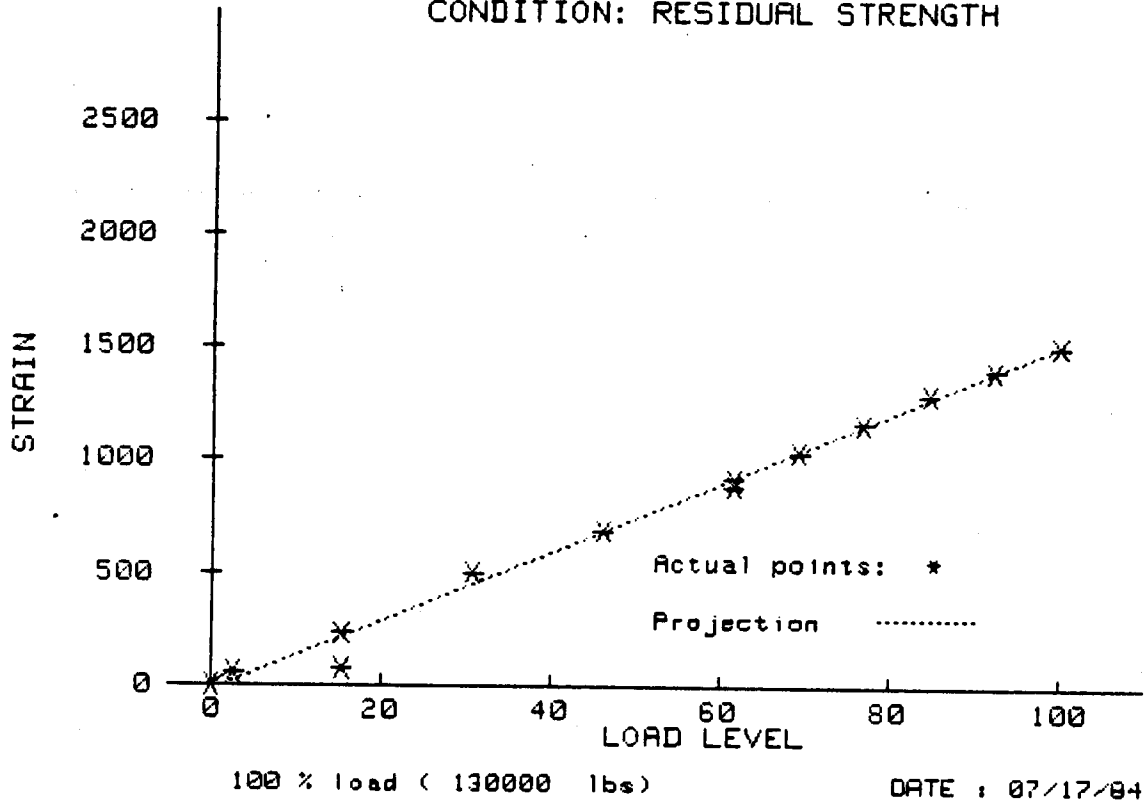

Figure H-9. CV2-2 Residual Strength Tension Test - Strain Gauge Readings - Plot Gage 9

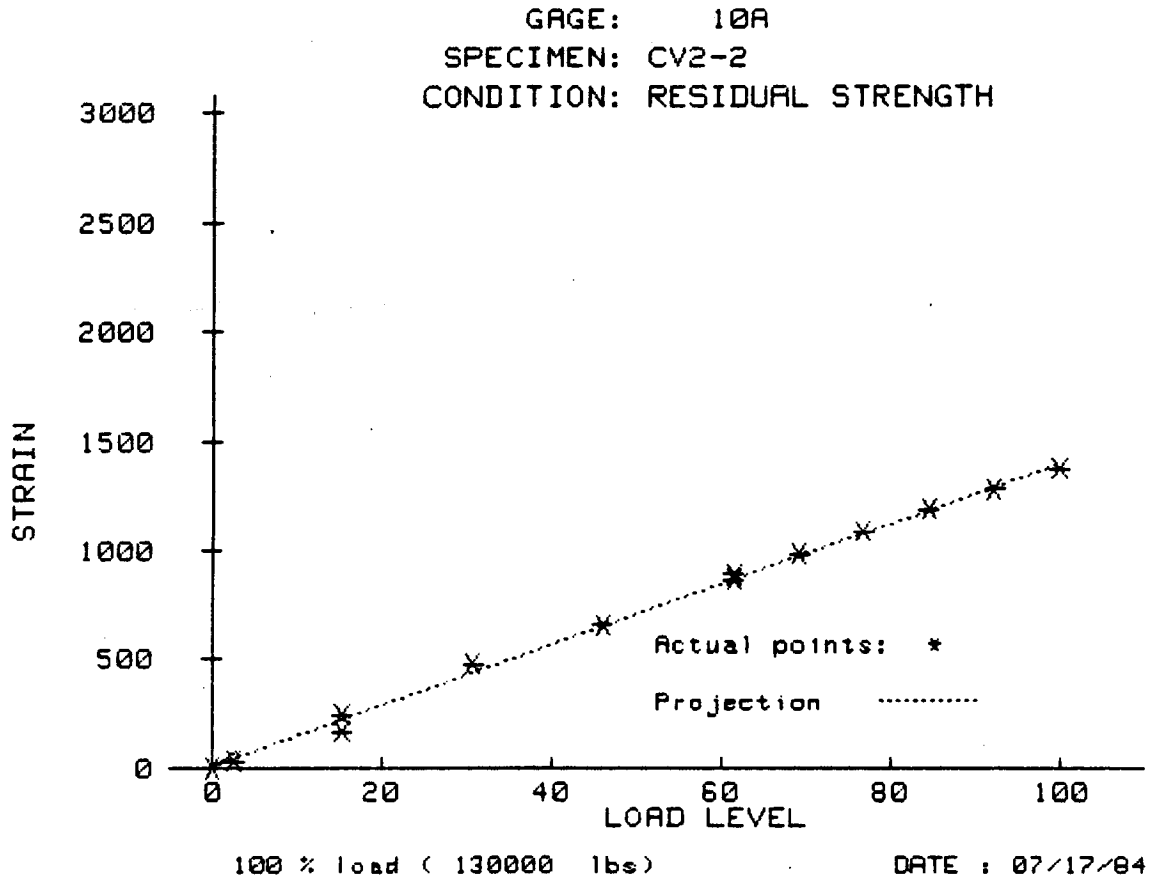

Figure H-10. CV2-2 Residual Strength Tension Test - Strain Gauge Readings - Plot Gage 10

GAGE: 11A  
SPECIMEN: CV2-2  
CONDITION: RESIDUAL STRENGTH

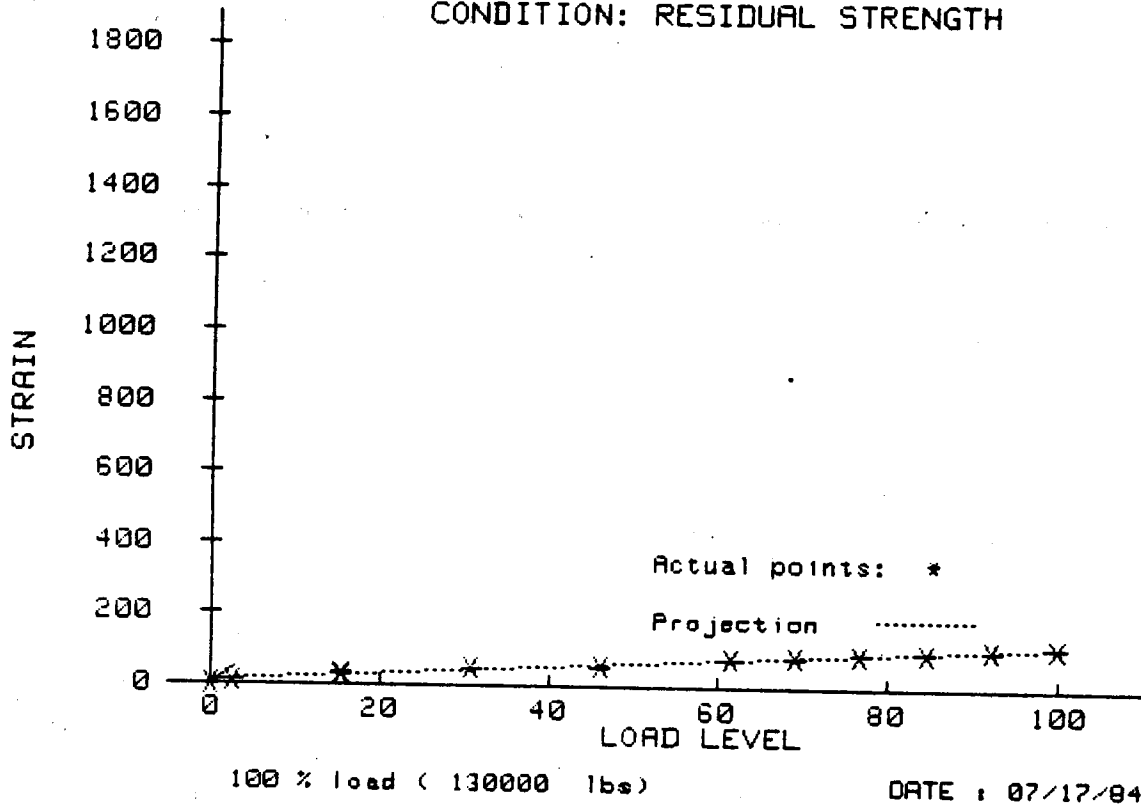

Figure H-11. CV2-2 Residual Strength Tension Test - Strain Gauge Readings - Plot Gage 11

GAGE: 12A  
SPECIMEN: CV2-2  
CONDITION: RESIDUAL STRENGTH

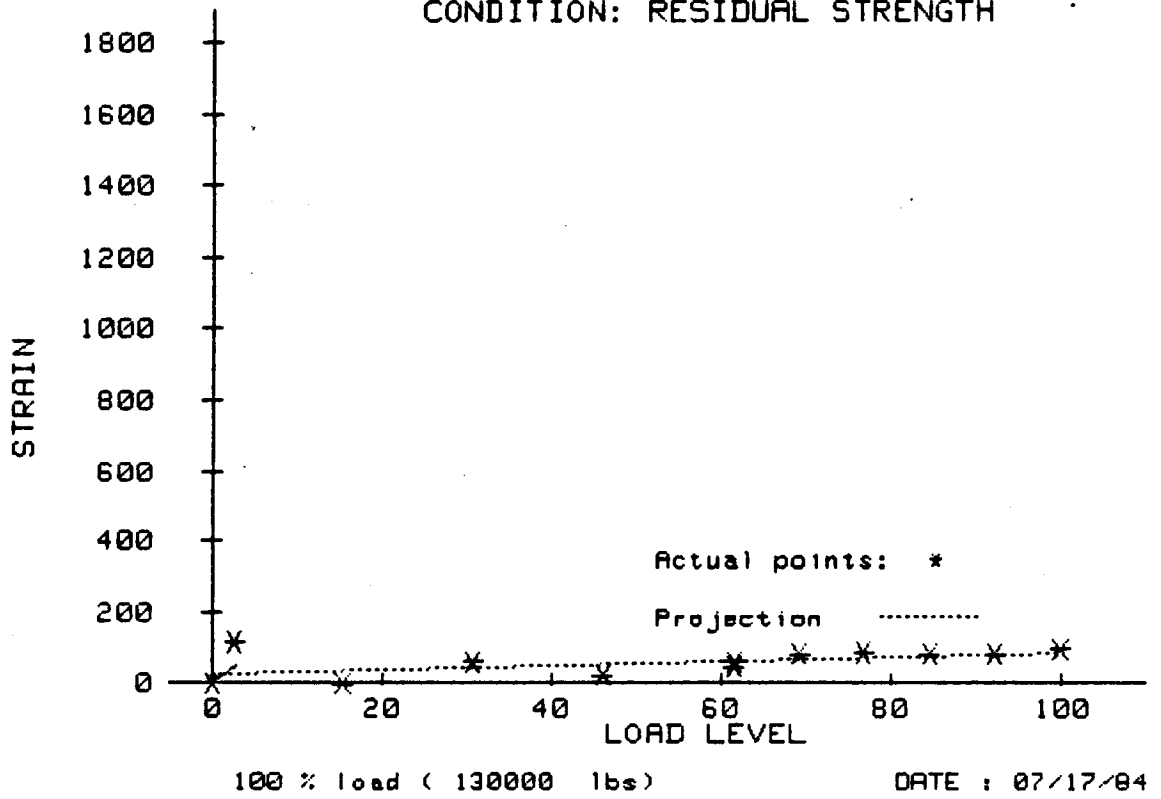

Figure H-12. CV2-2 Residual Strength Tension Test - Strain Gauge Readings - Plot Gage 12

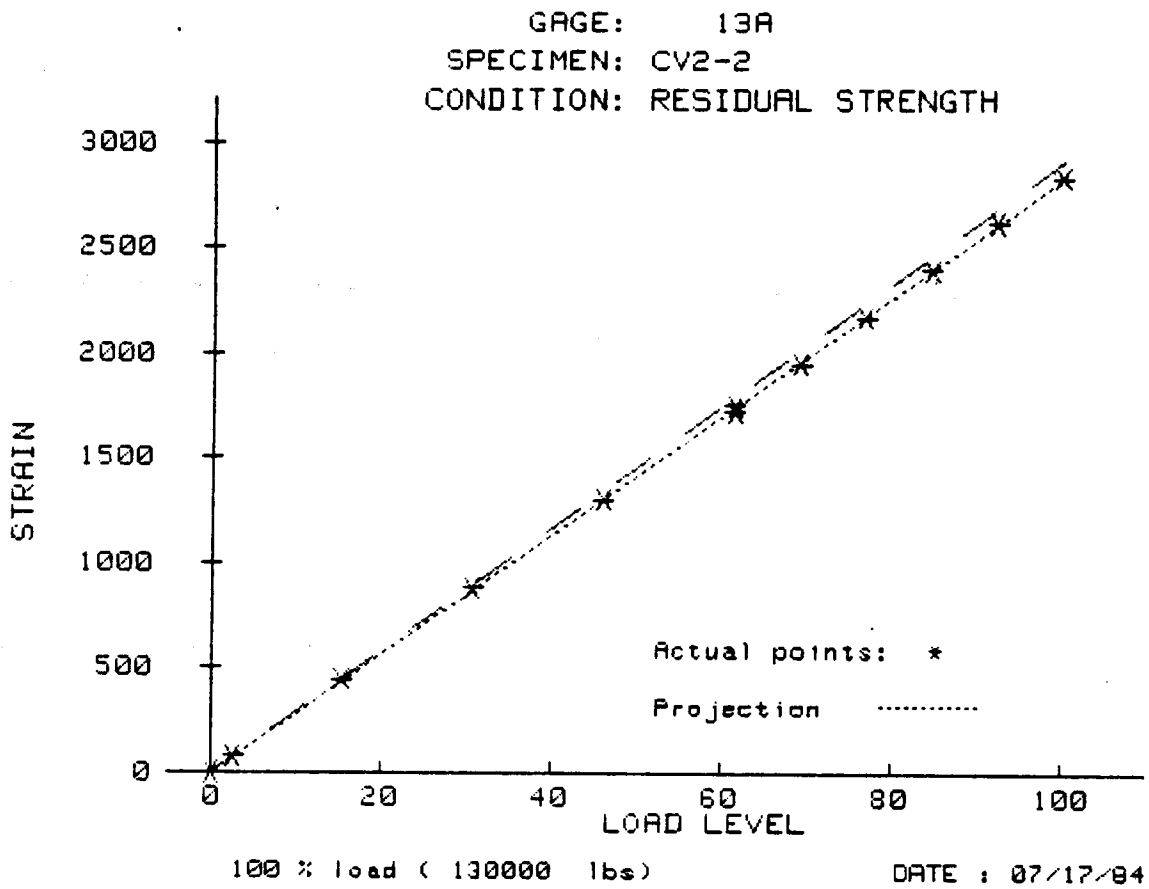

Figure H-13. CV2-2 Residual Strength Tension Test - Strain Gauge Readings - Plot Gage 13

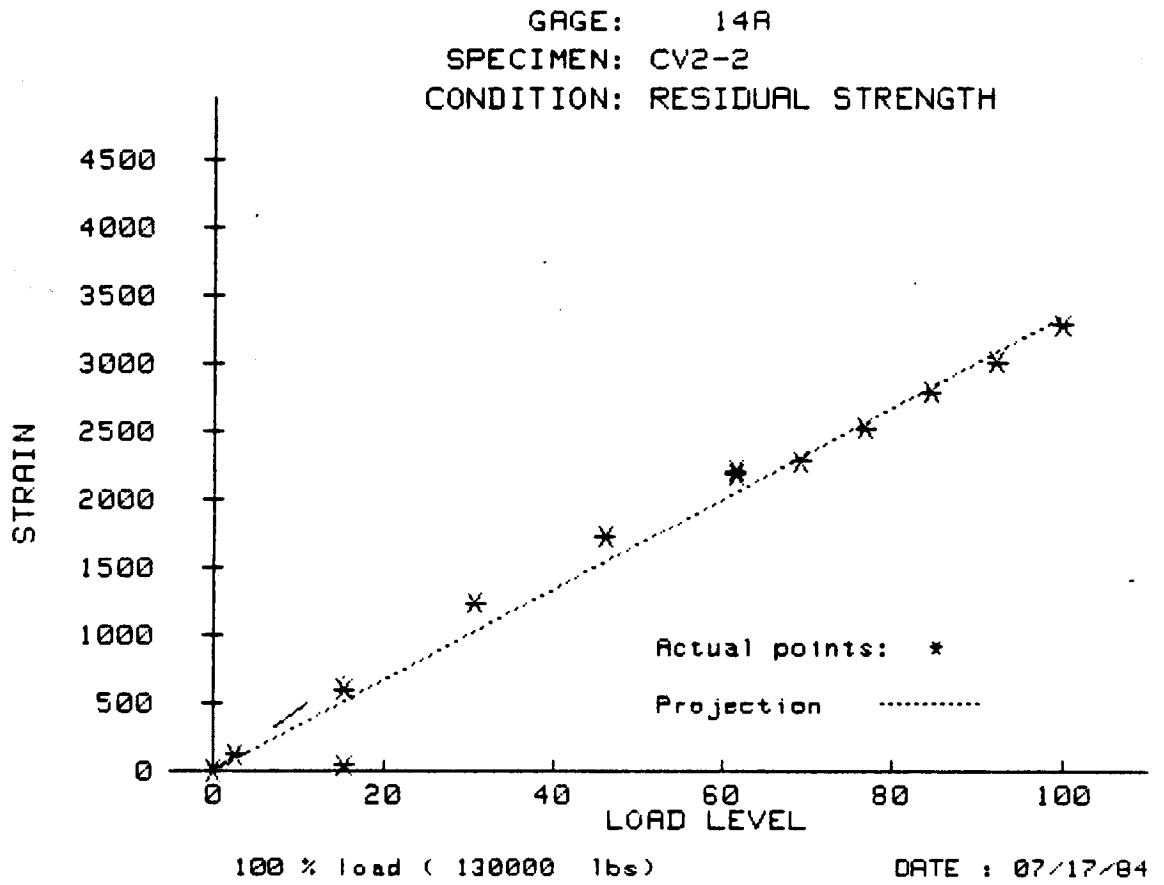

Figure 14. CV2-2 Residual Strength Tension Test - Strain Gauge Readings - Plot Gage 14



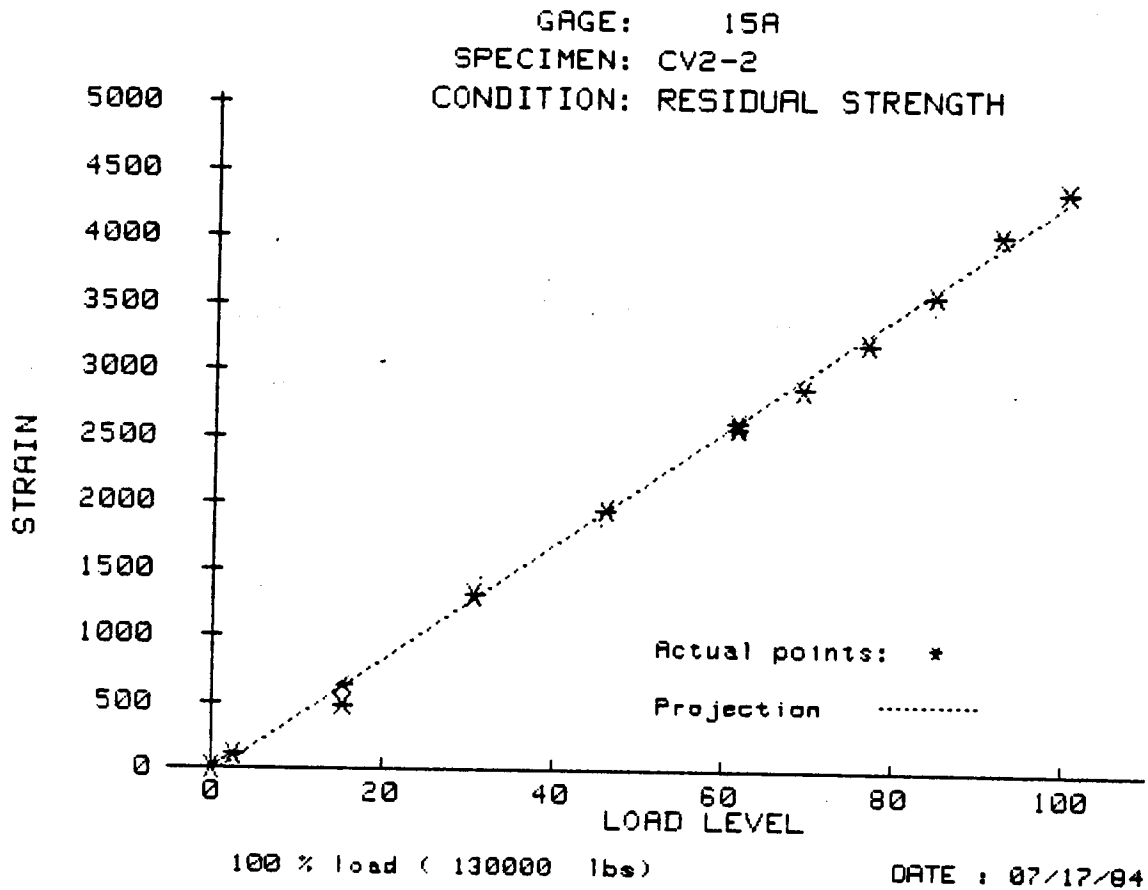

Figure H-15. CV2-2 Residual Strength Tension Test -  
Strain Gauge Readings - Plot Gage 15

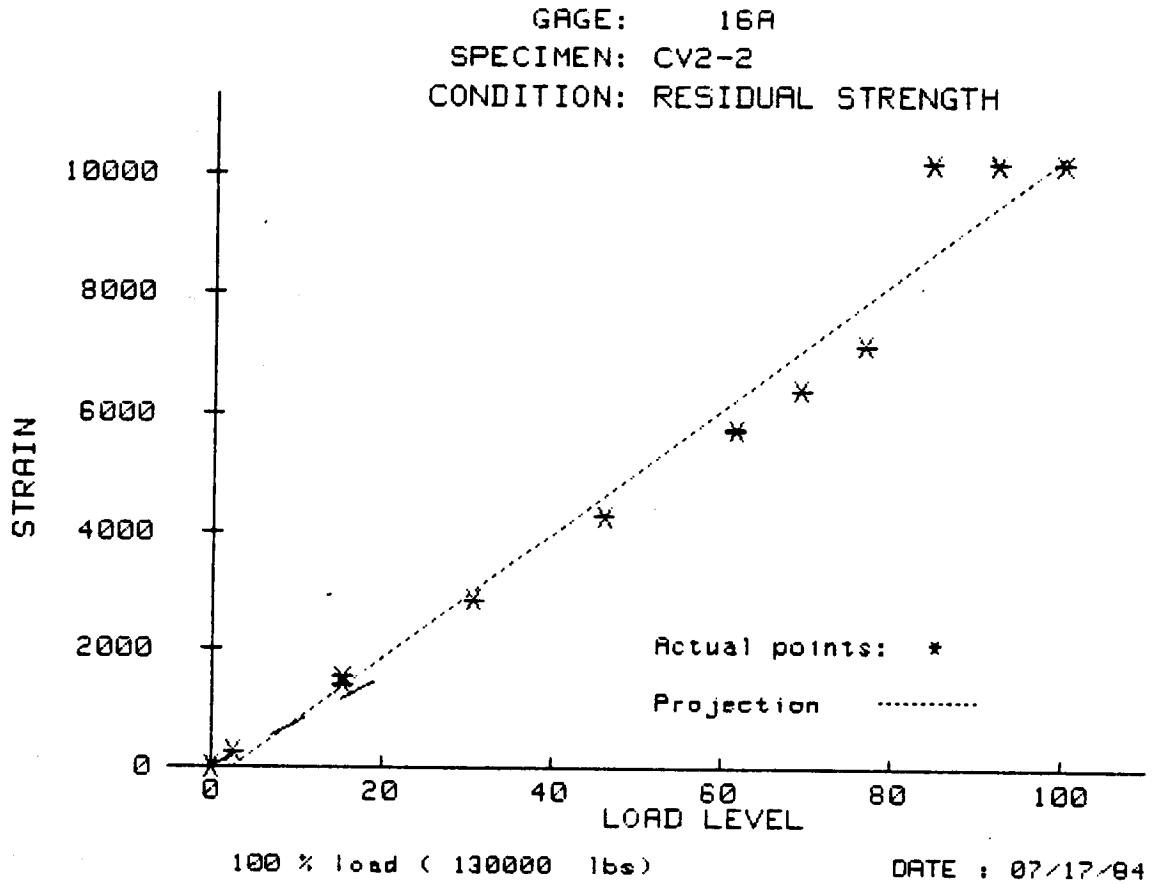

Figure H-16. CV2-2 Residual Strength Tension Test - Strain Gauge Readings - Plot Gage 16

GAGE: 17A  
SPECIMEN: CV2-2  
CONDITION: RESIDUAL STRENGTH

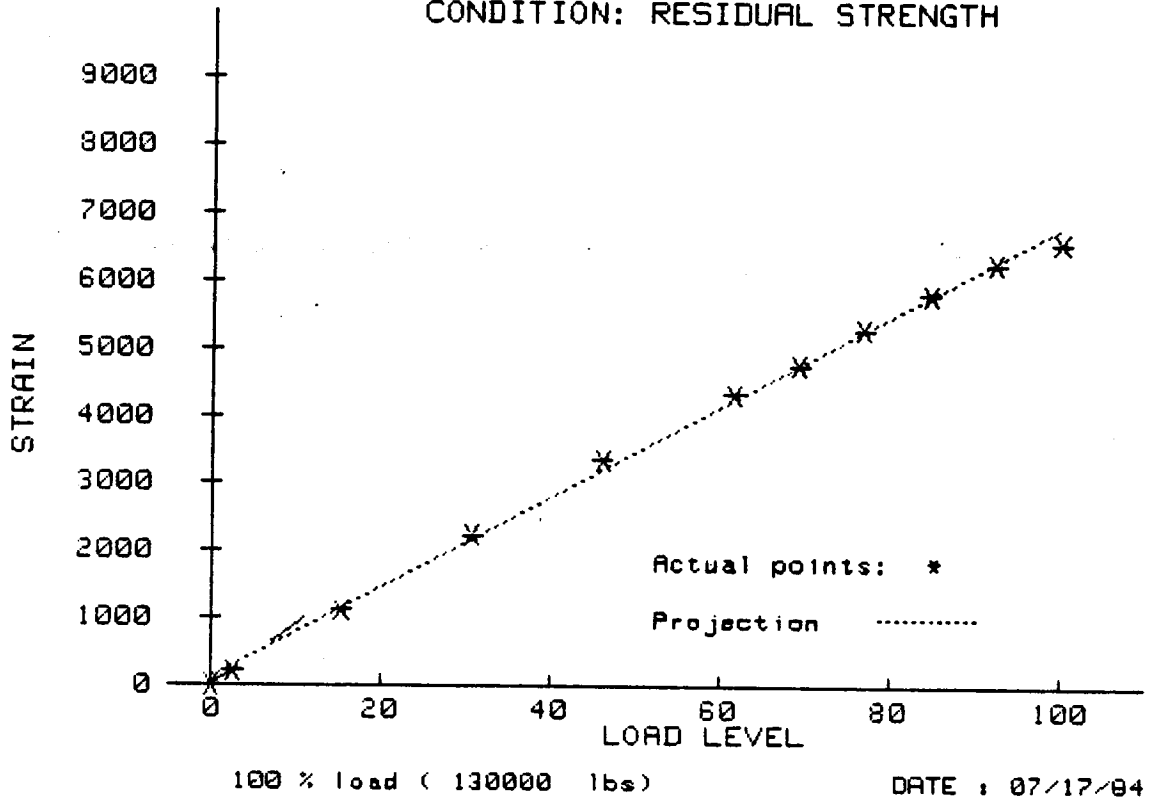

Figure H-17. CV2-2 Residual Strength Tension Test - Strain Gauge Readings - Plot Gage 17

GAGE: 18A  
SPECIMEN: CV2-2  
CONDITION: RESIDUAL STRENGTH

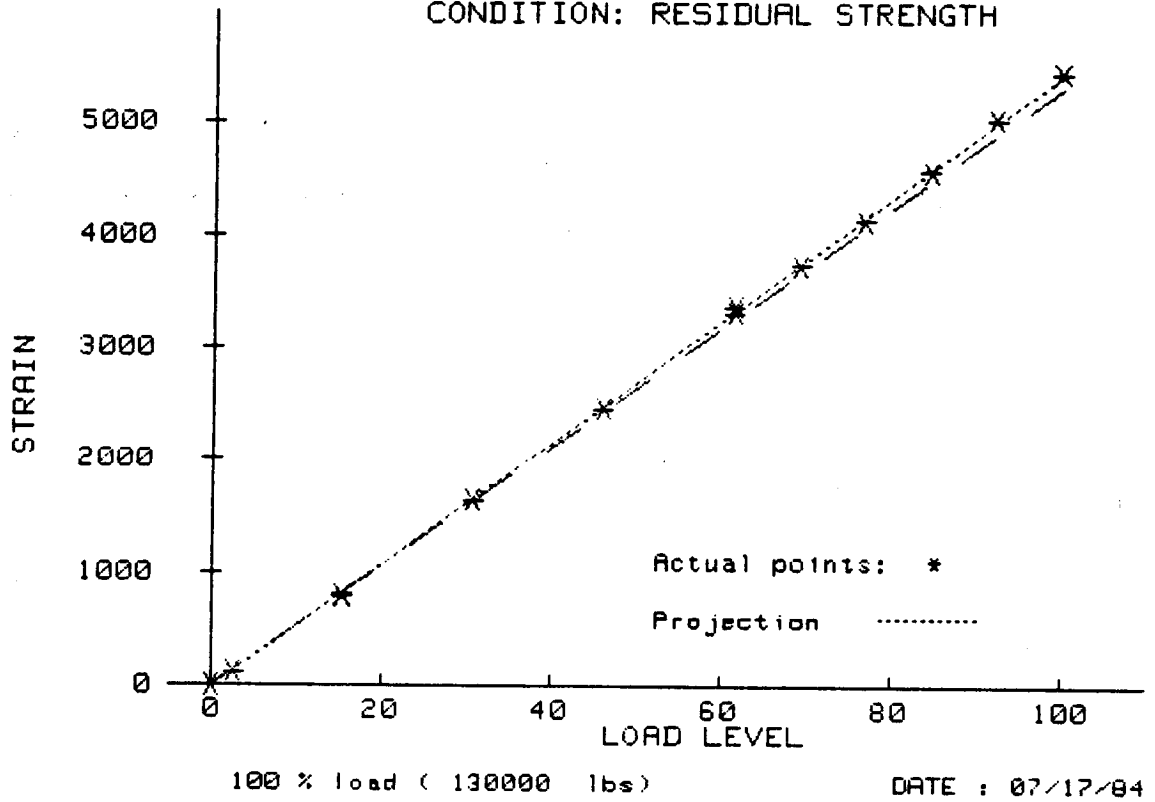

Figure H-18. CV2-2 Residual Strength Tension Test -  
Strain Gauge Readings - Plot Gage 18

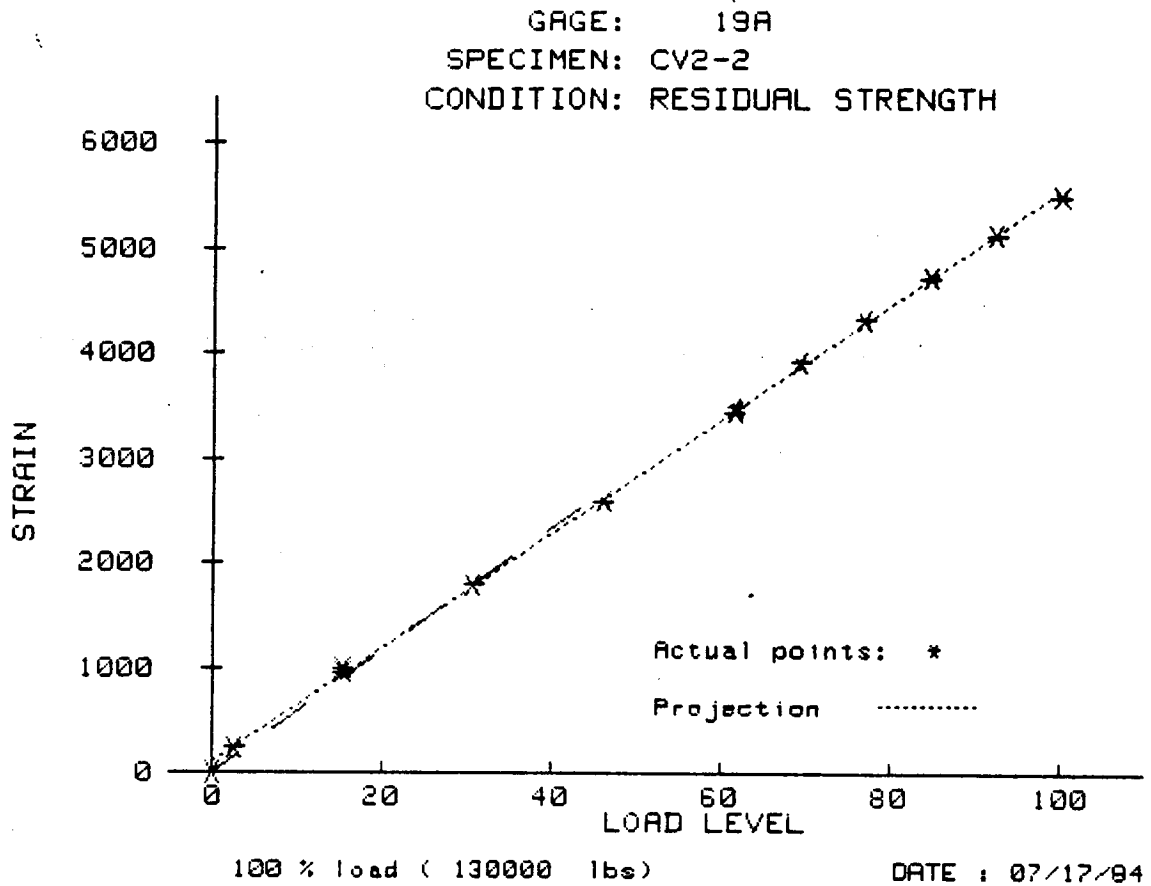

Figure H-19. CV2-2 Residual Strength Tension Test - Strain Gauge Readings - Plot Gage 19

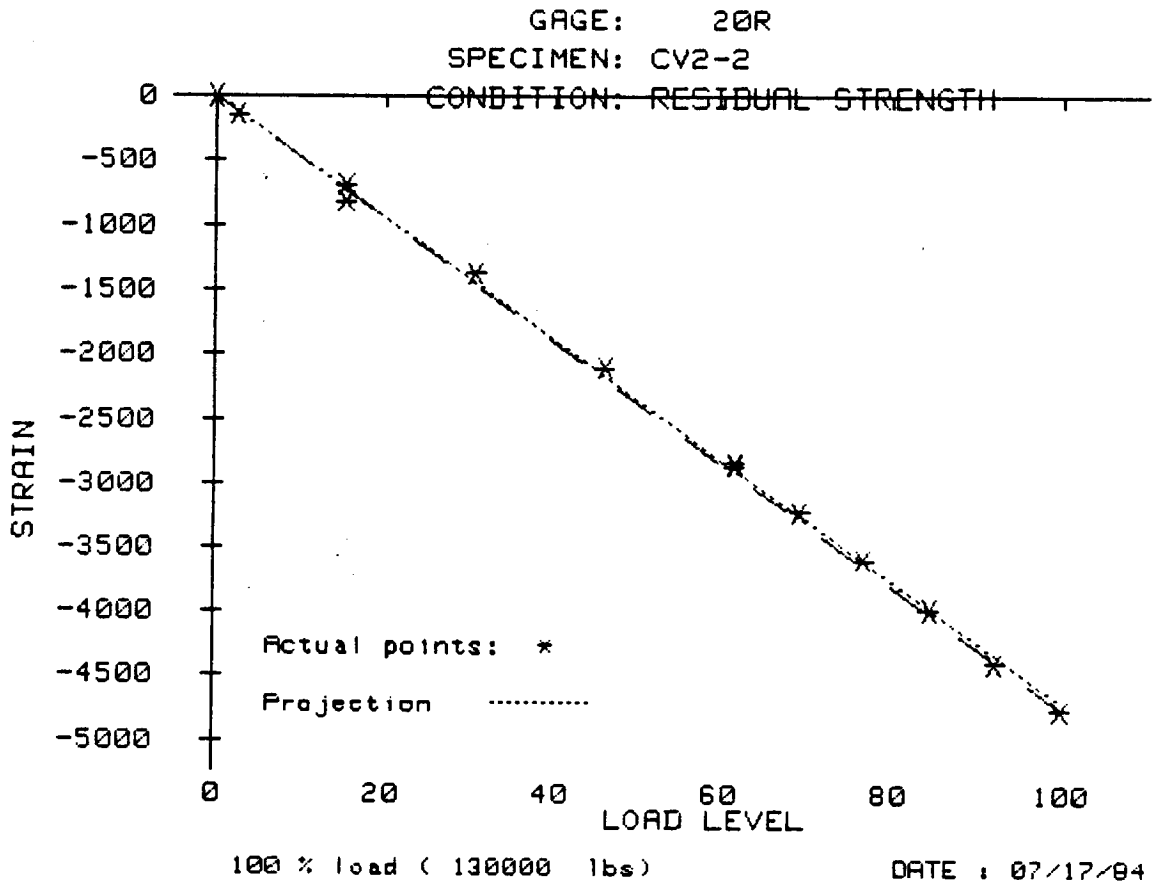

Figure H-20. CV2-2 Residual Strength Tension Test - Strain Gauge Readings - Plot Gage 20

GAGE: 21R  
SPECIMEN: CV2-2  
CONDITION: RESIDUAL STRENGTH

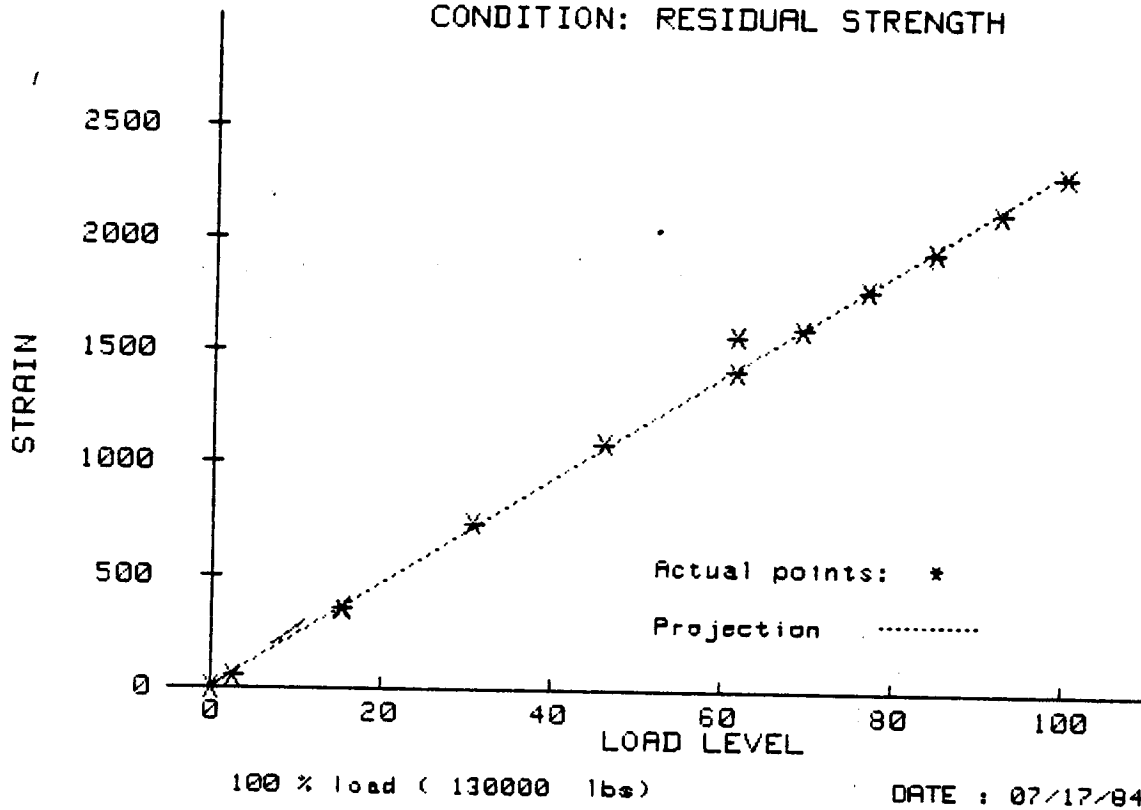

Figure H-21. CV2-2 Residual Strength Tension Test - Strain Gauge Readings - Plot Gage 21

GAGE: 22R  
SPECIMEN: CV2-2  
CONDITION: RESIDUAL STRENGTH

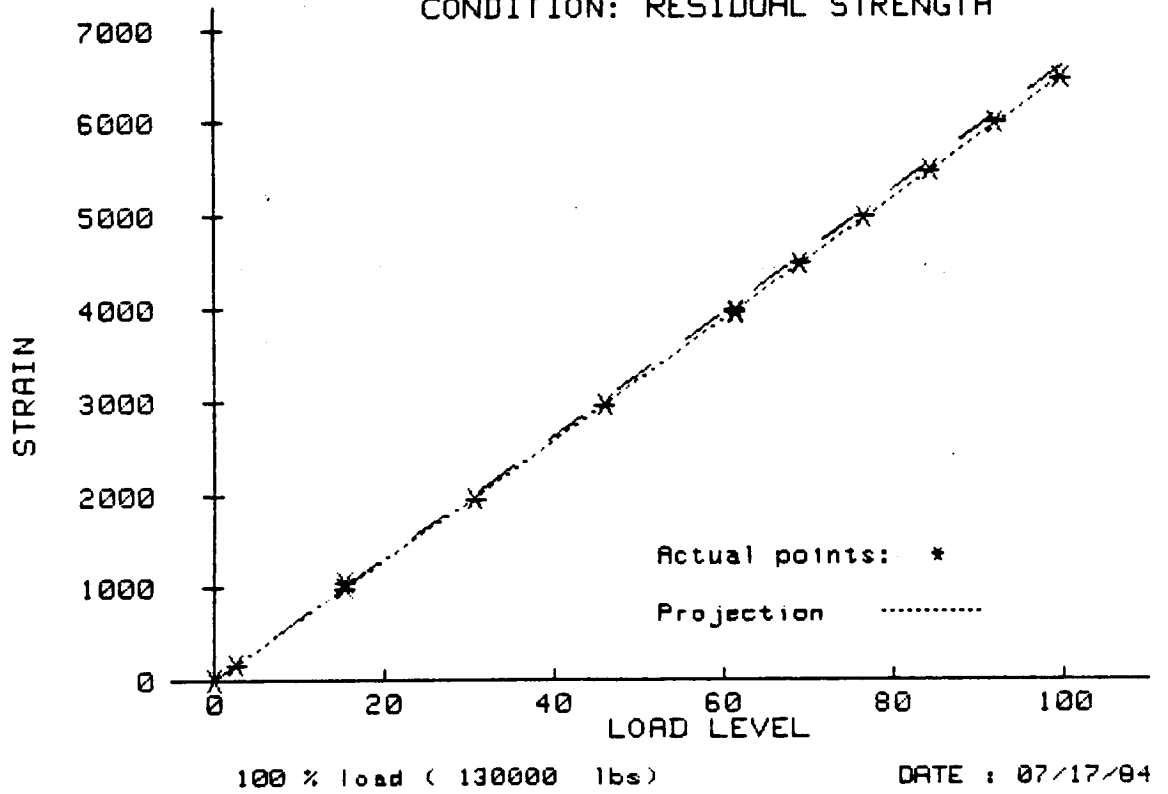

Figure H-22. CV2-2 Residual Strength Tension Test - Strain Gauge Readings - Plot Gage 22



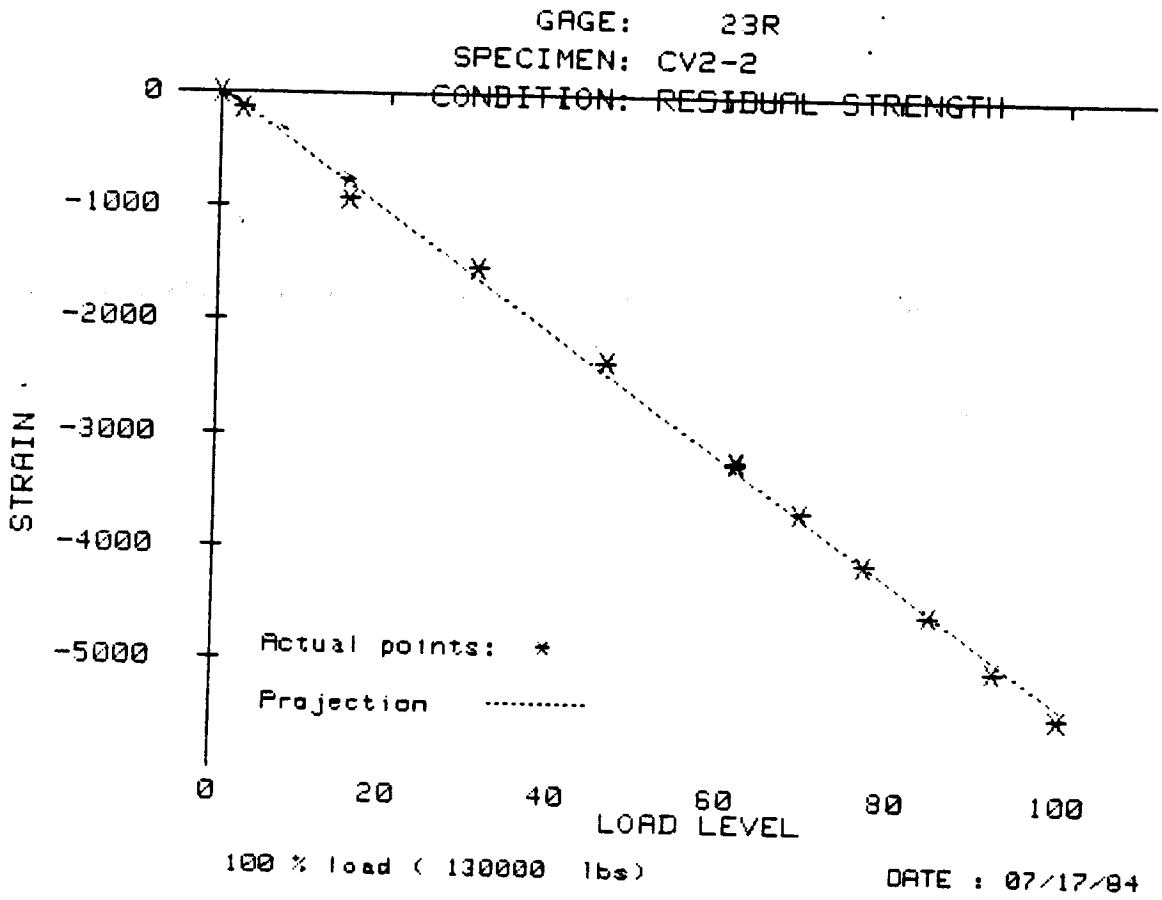
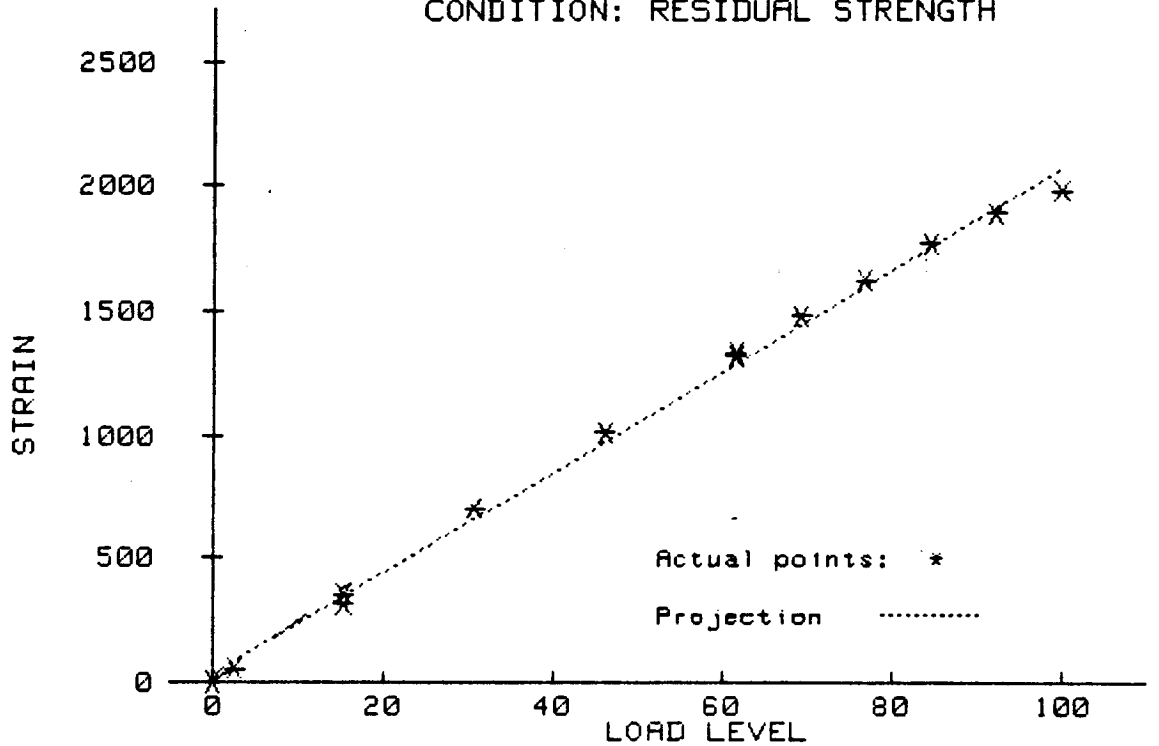

Figure H-23. CV2-2 Residual Strength Tension Test - Strain Gauge Readings - Plot Gage 23

GAGE: 24R  
SPECIMEN: CV2-2  
CONDITION: RESIDUAL STRENGTH



100 % load ( 130000 lbs)

DATE : 07/17/84

Figure H-24. CV2-2 Residual Strength Tension Test - Strain Gauge Readings - Plot Gage 24

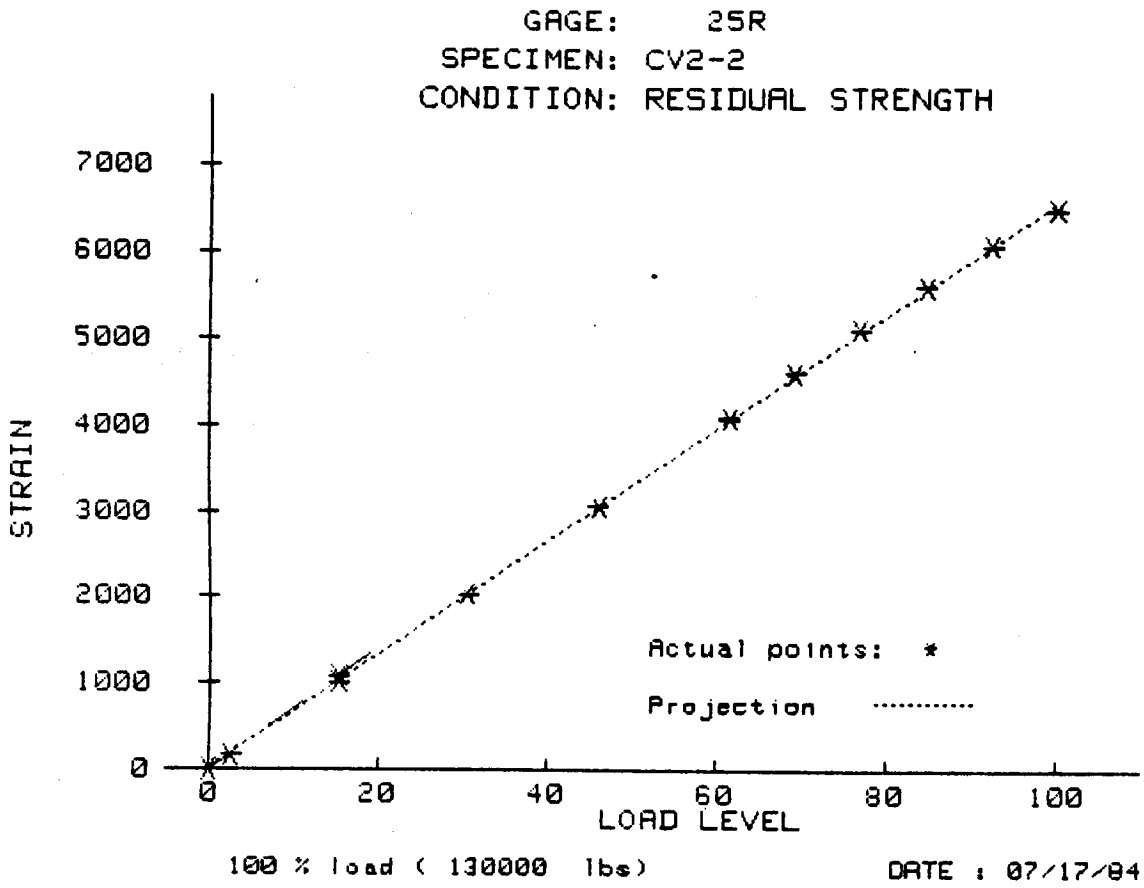

Figure H-25. CV2-2 Residual Strength Tension Test - Strain Gauge Readings - Plot Gage 25

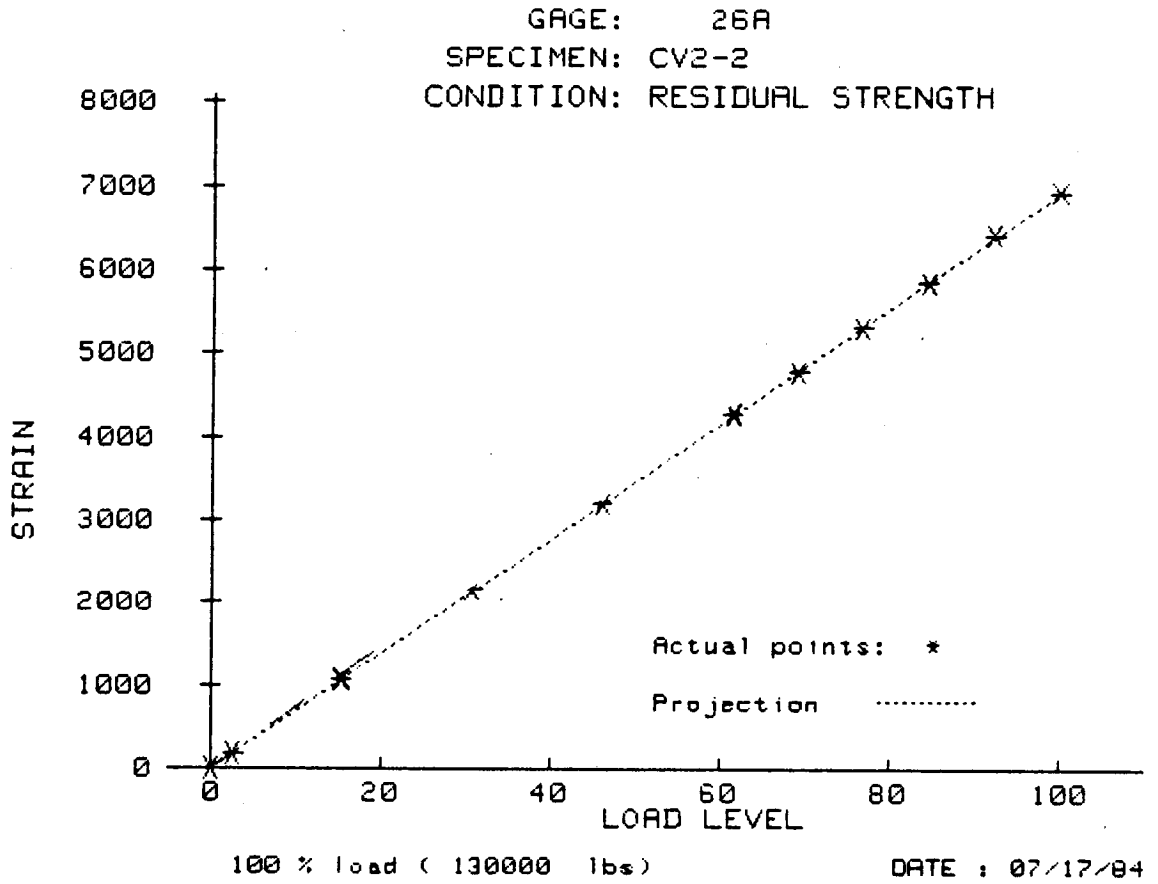

Figure H-26. CV2-2 Residual Strength Tension Test - Strain Gauge Readings - Plot Gage 26

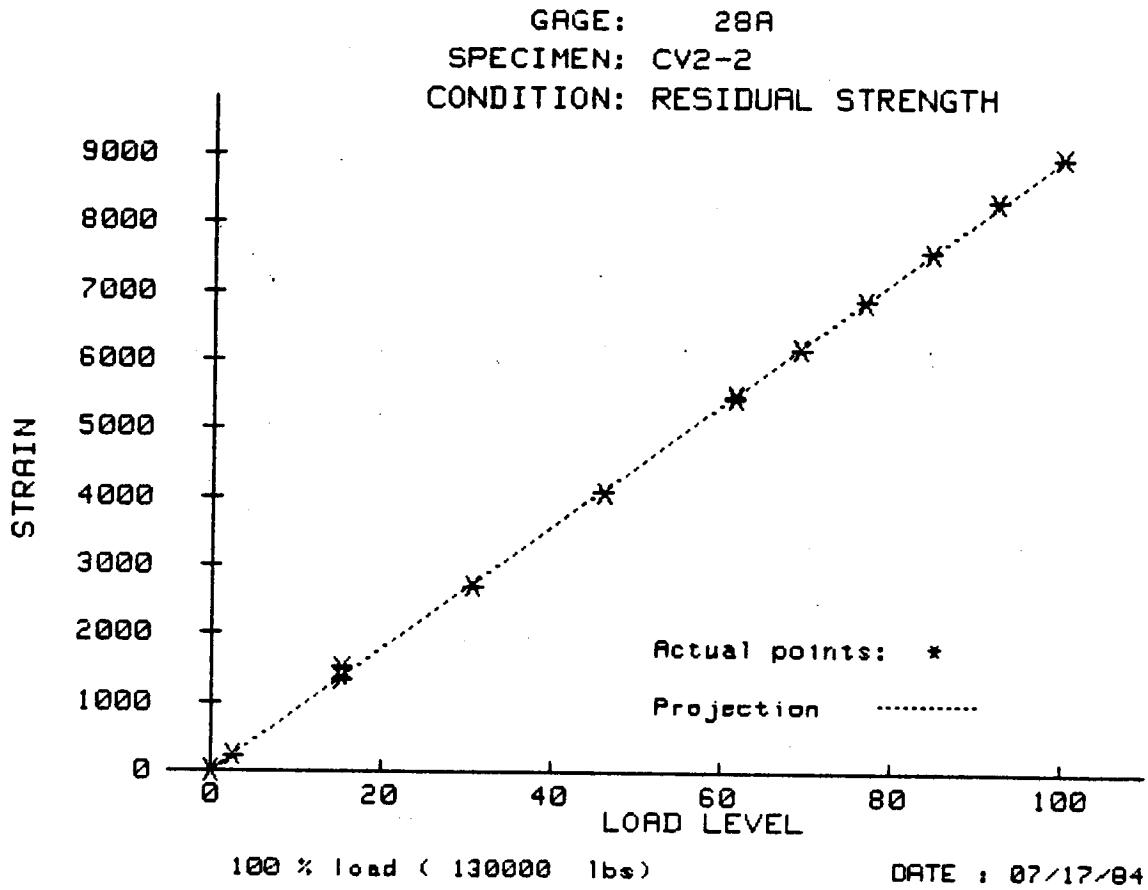

Figure H-28. CV2-2 Residual Strength Tension Test - Strain Gauge Readings - Plot Gage 28

GAGE: 29A  
SPECIMEN: CV2-2  
CONDITION: RESIDUAL STRENGTH

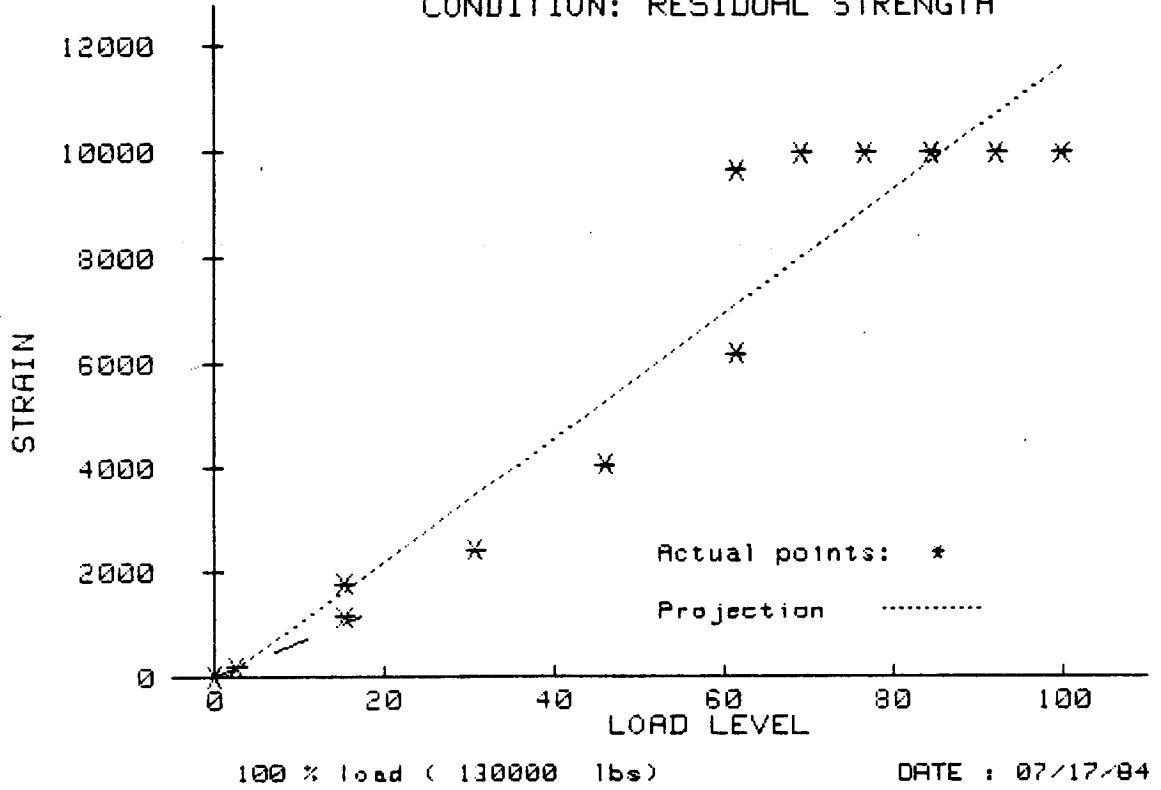

Figure H-29. CV2-2 Residual Strength Tension Test - Strain Gauge Readings - Plot Gage 29

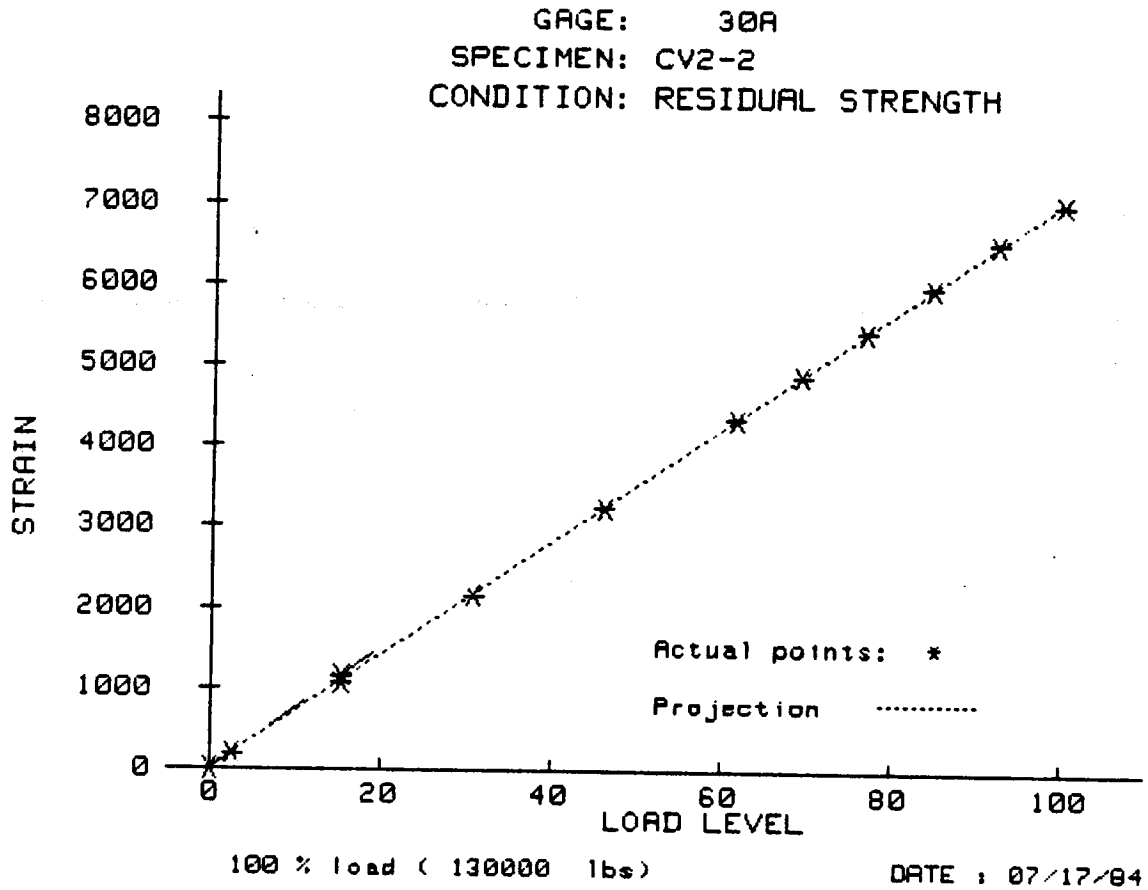

Figure H-30. CV2-2 Residual Strength Tension Test - Strain Gauge Readings - Plot Gage 30

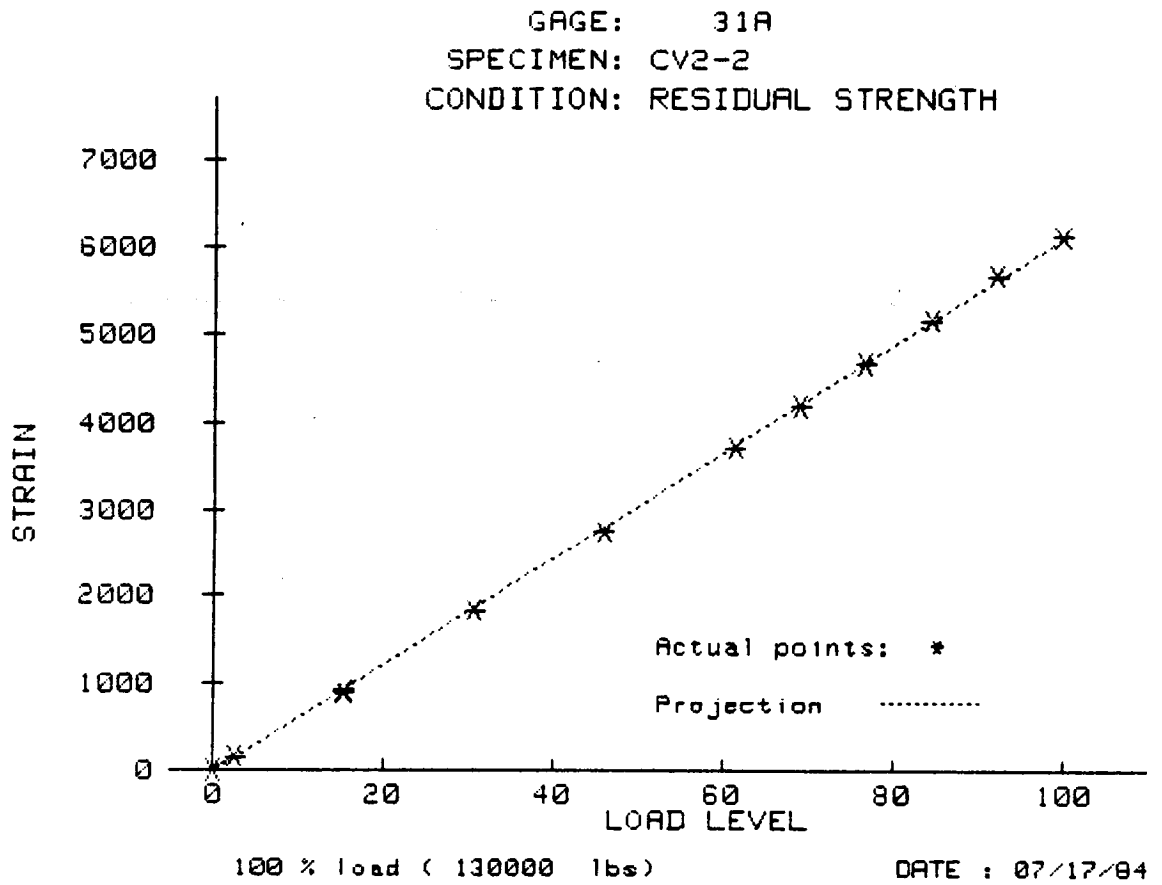

Figure H-31. CV2-2 Residual Strength Tension Test - Strain Gauge Readings - Plot Gage 31



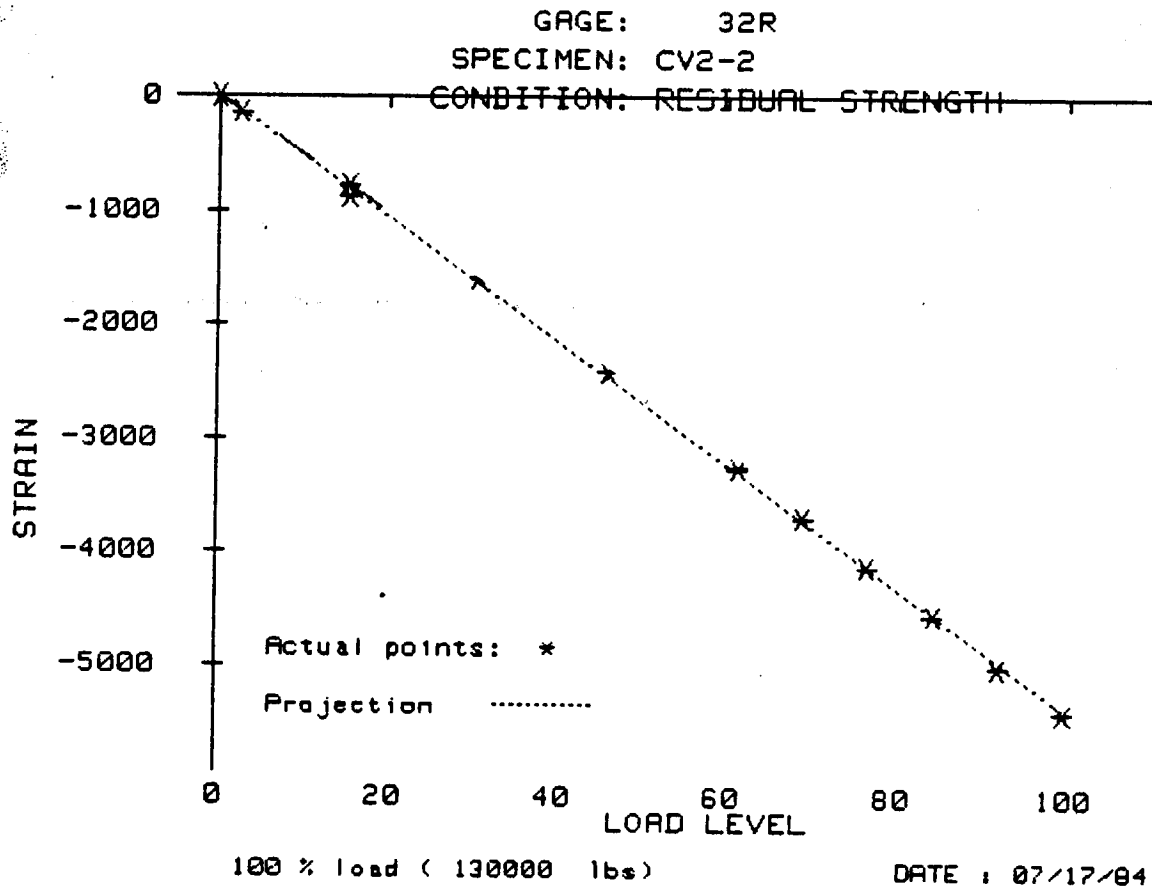

Figure H-32. CV2-2 Residual Strength Tension Test - Strain Gauge Readings - Plot Gage 32

GAGE: 33R  
SPECIMEN: CV2-2  
CONDITION: RESIDUAL STRENGTH

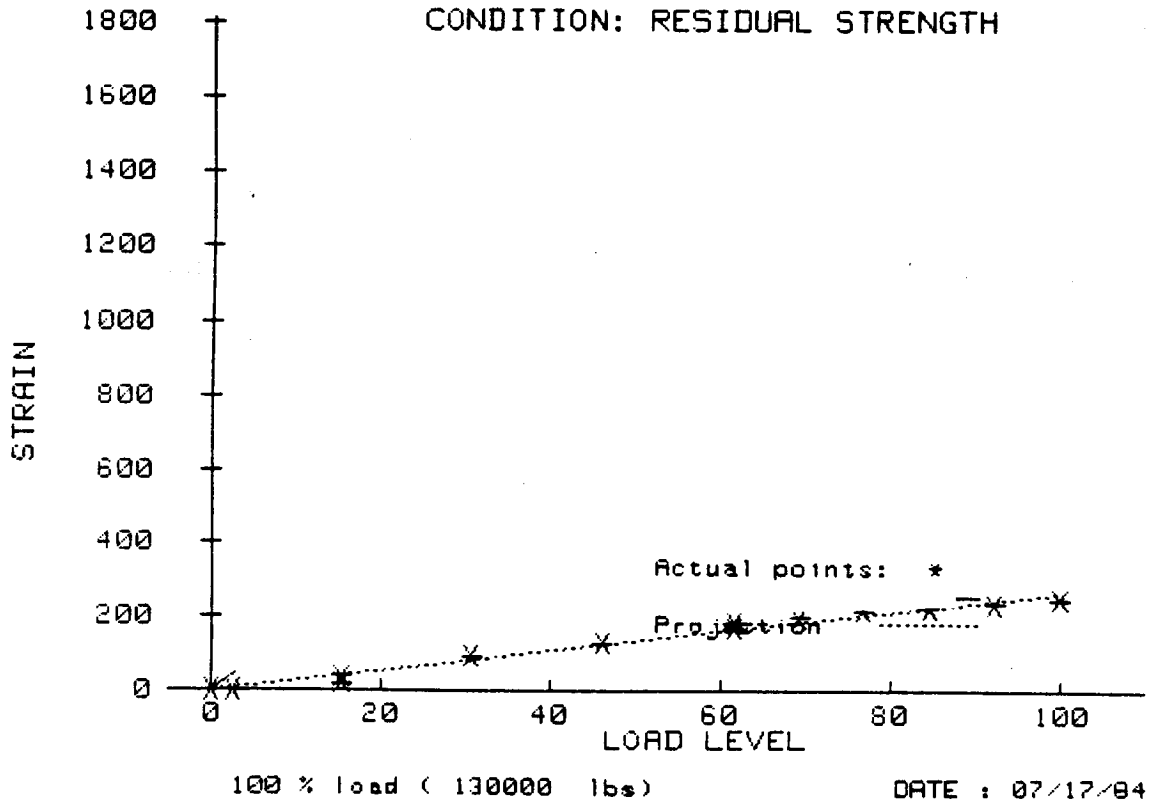

Figure H-33. CV2-2 Residual Strength Tension Test -  
Strain Gauge Readings - Plot Gage 33

GAGE: 34R  
SPECIMEN: CV2-2  
CONDITION: RESIDUAL STRENGTH

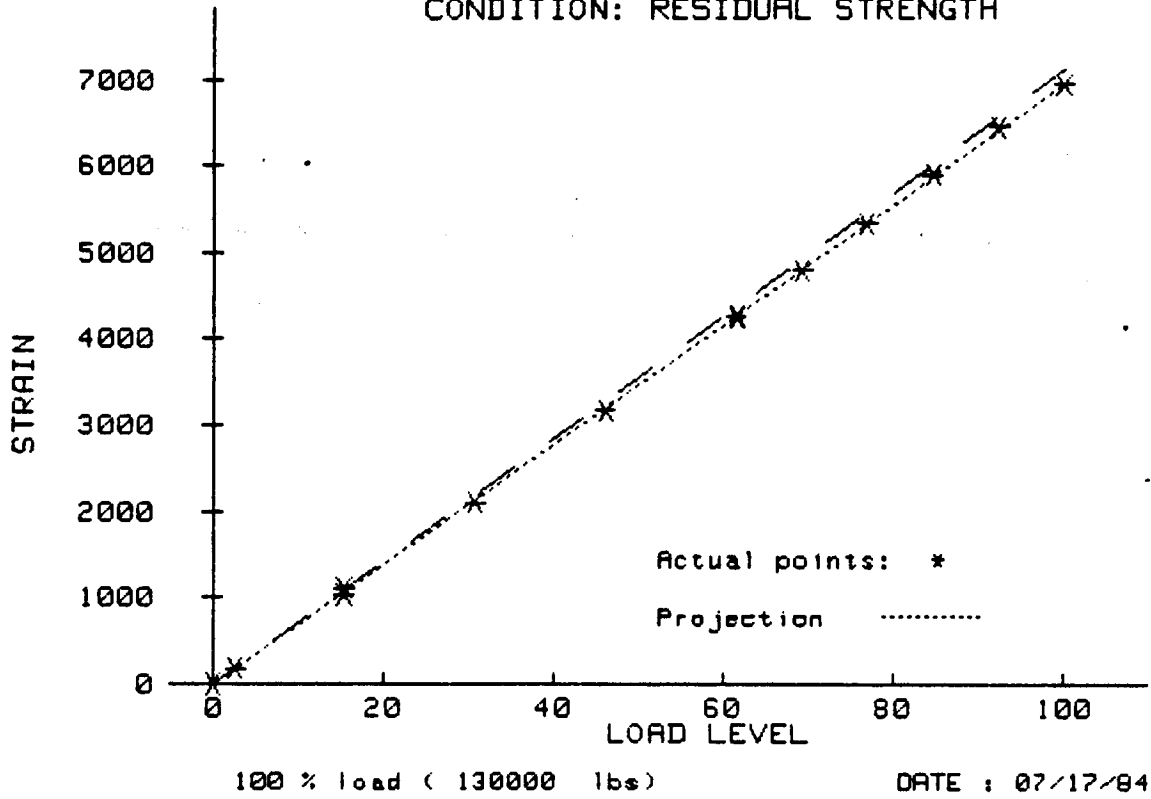

Figure H-34. CV2-2 Residual Strength Tension Test - Strain Gauge Readings - Plot Gage 34

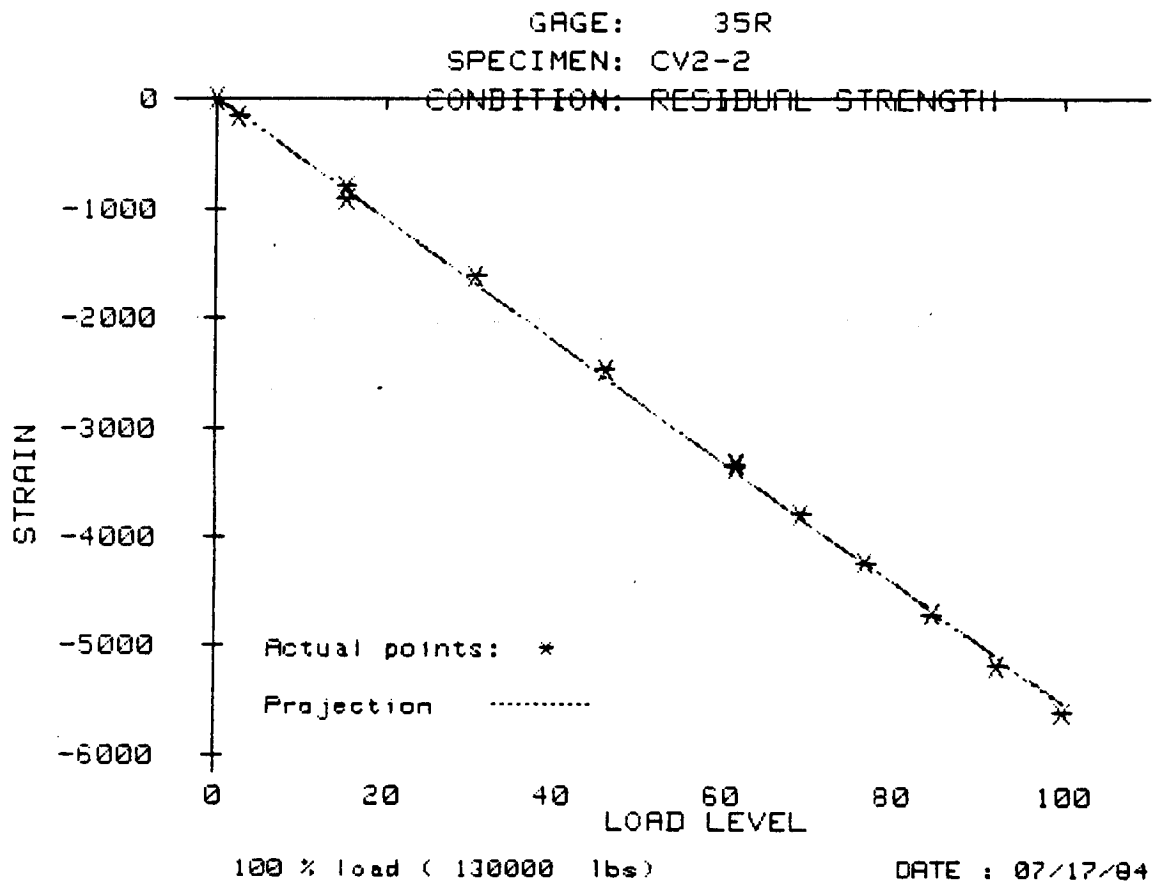

Figure H-35. CV2-2 Residual Strength Tension Test - Strain Gauge Readings - Plot Gage 35

GAGE: 36R  
SPECIMEN: CV2-2  
CONDITION: RESIDUAL STRENGTH

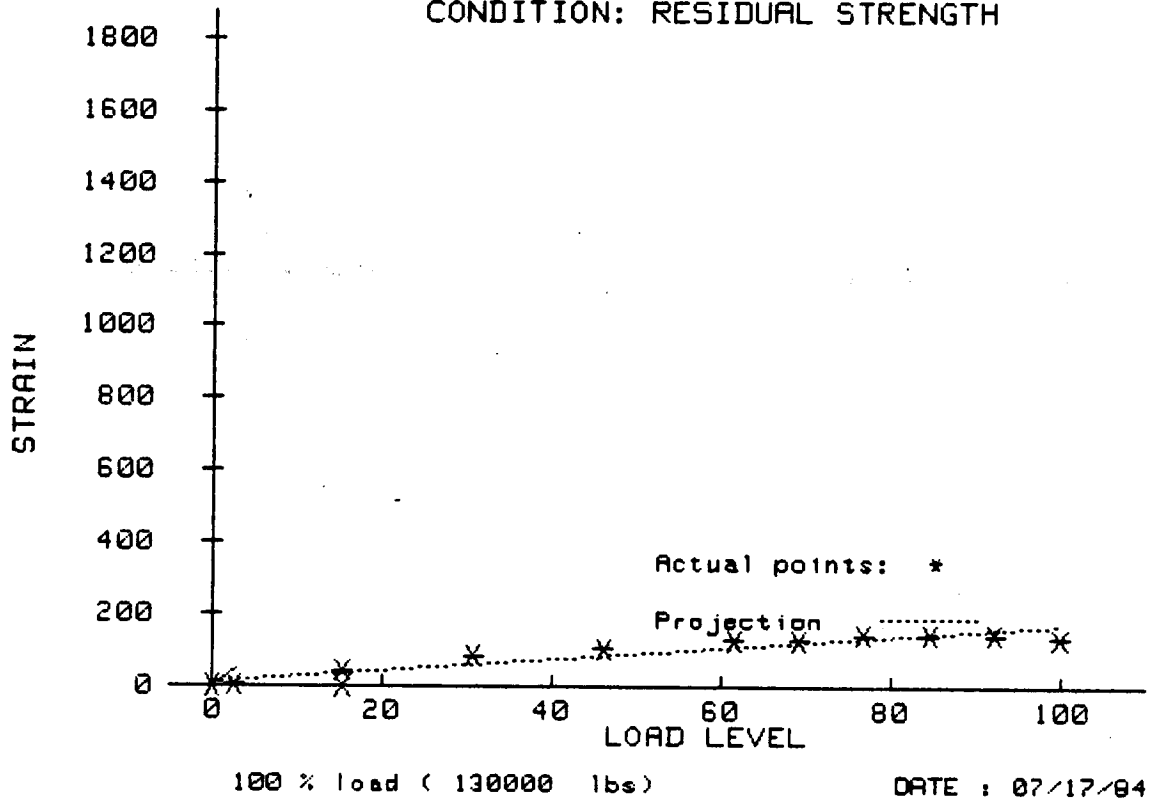

Figure H-36. CV2-2 Residual Strength Tension Test -  
Strain Gauge Readings - Plot Gage 36

GAGE: 37R  
SPECIMEN: CV2-2  
CONDITION: RESIDUAL STRENGTH

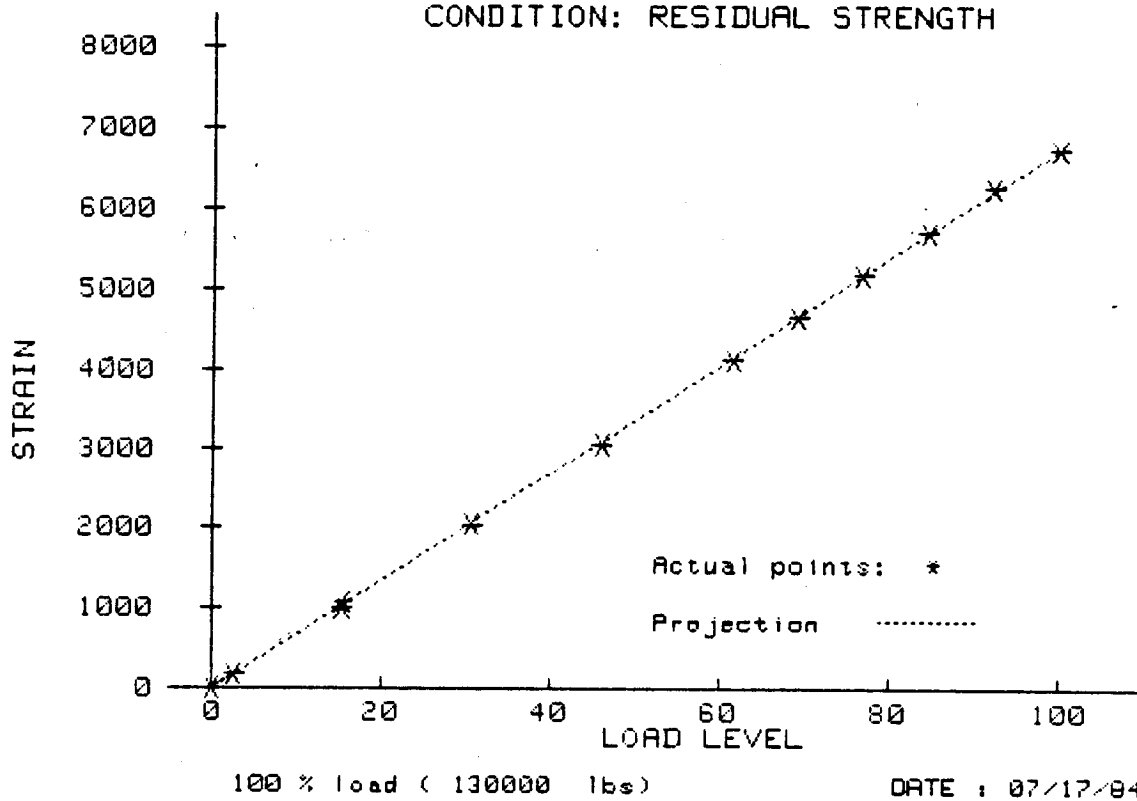

Figure H-37. CV2-2 Residual Strength Tension Test - Strain Gauge Readings - Plot Gage 37

GAGE: 38A  
SPECIMEN: CV2-2  
CONDITION: RESIDUAL STRENGTH

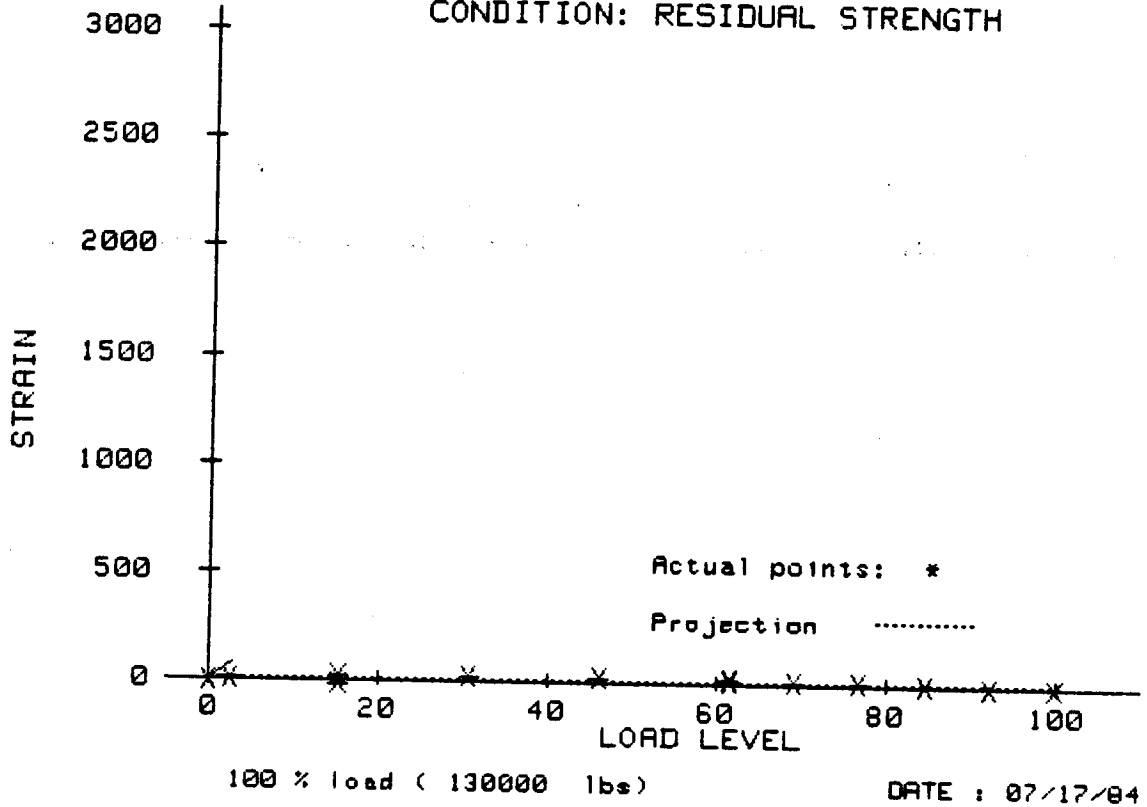

Figure H-38. CV2-2 Residual Strength Tension Test - Strain Gauge Readings - Plot Gage 38

GAGE: 39A  
SPECIMEN: CV2-2  
CONDITION: RESIDUAL STRENGTH

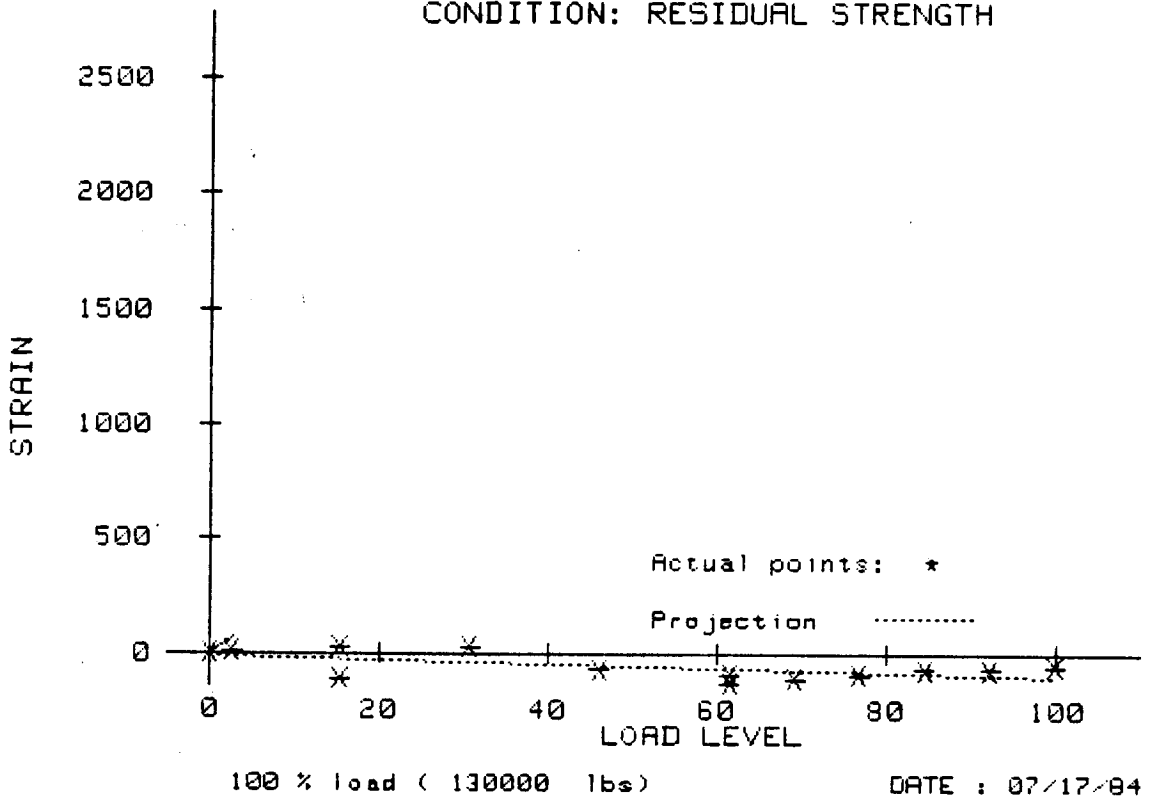

Figure H-39. CV2-2 Residual Strength Tension Test - Strain Gauge Readings - Plot Gage 39



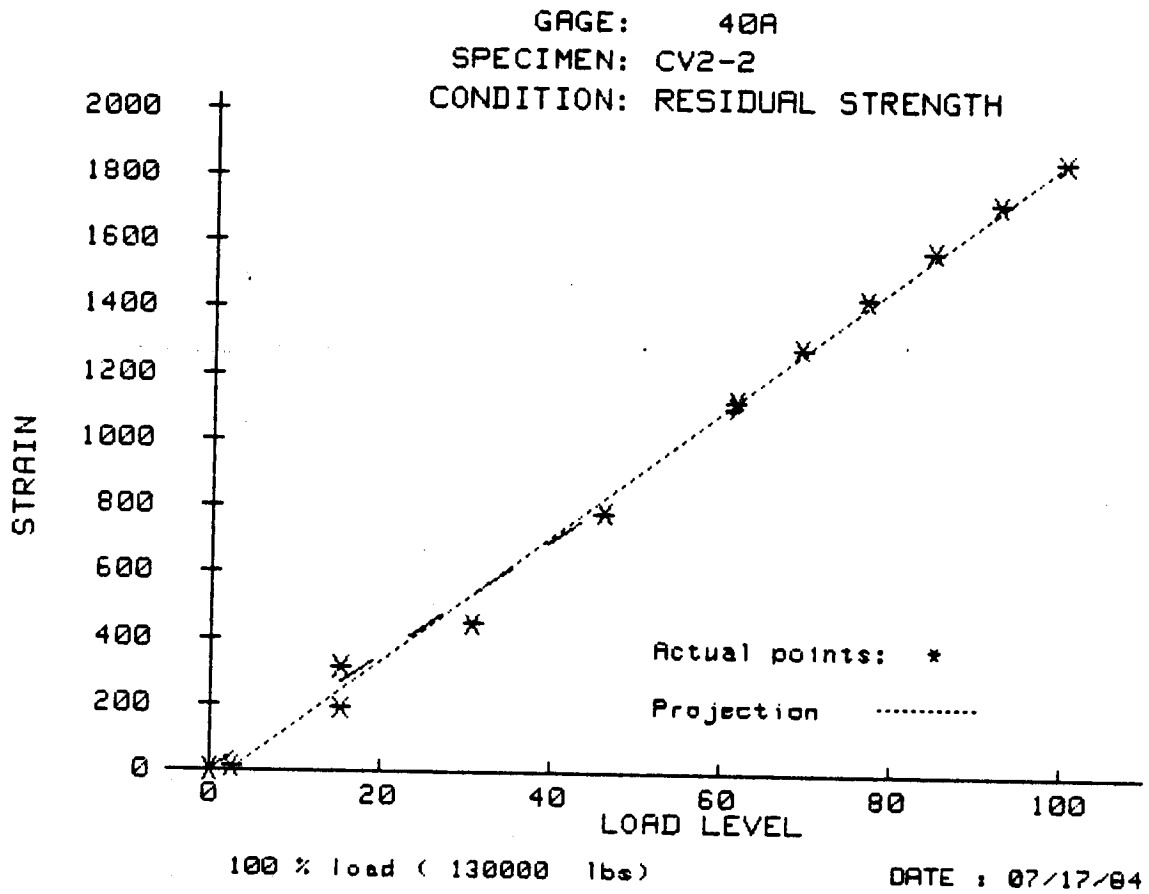

Figure H-40. CV2-2 Residual Strength Tension Test - Strain Gauge Readings - Plot Gage 40

GAGE: 41A  
SPECIMEN: CV2-2  
CONDITION: RESIDUAL STRENGTH

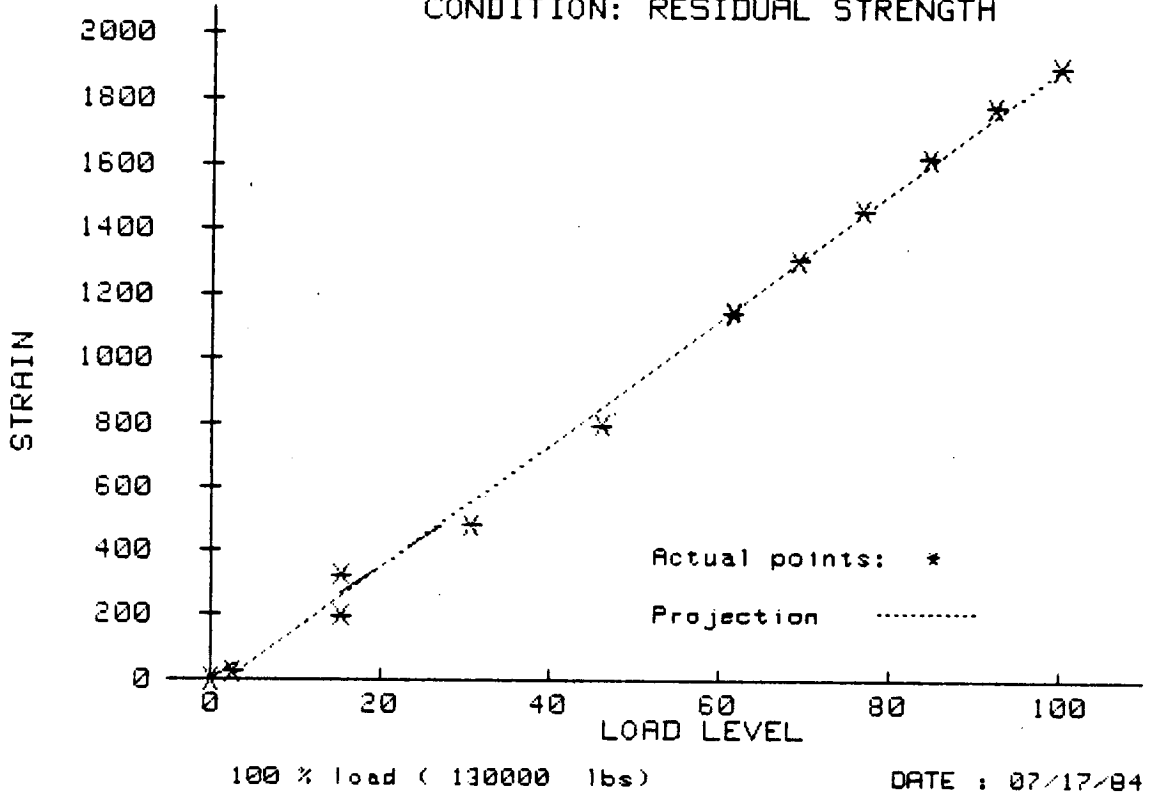

Figure H-41. CV2-2 Residual Strength Tension Test - Strain Gauge Readings - Plot Gage 41

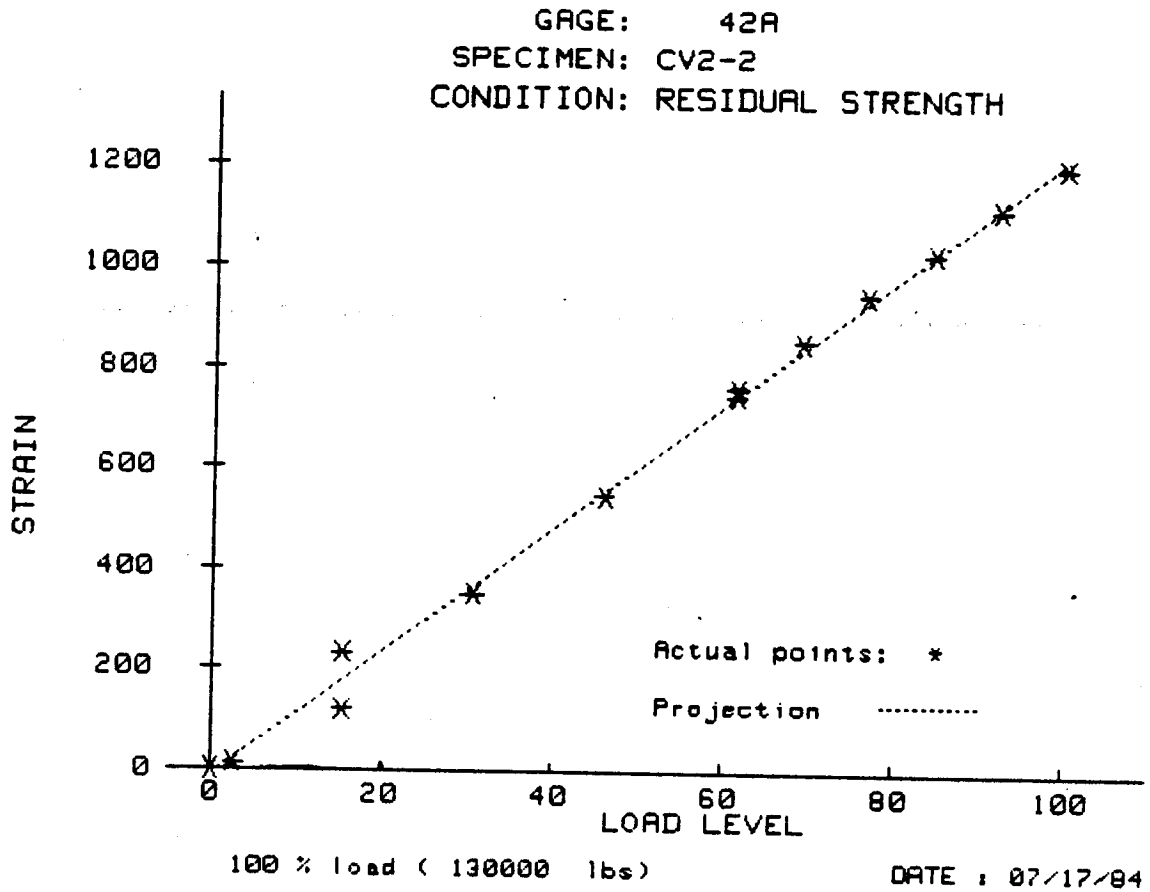

Figure H-42. CV2-2 Residual Strength Tension Test - Strain Gauge Readings - Plot Gage 42

GAGE: 43A  
SPECIMEN: CV2-2  
CONDITION: RESIDUAL STRENGTH

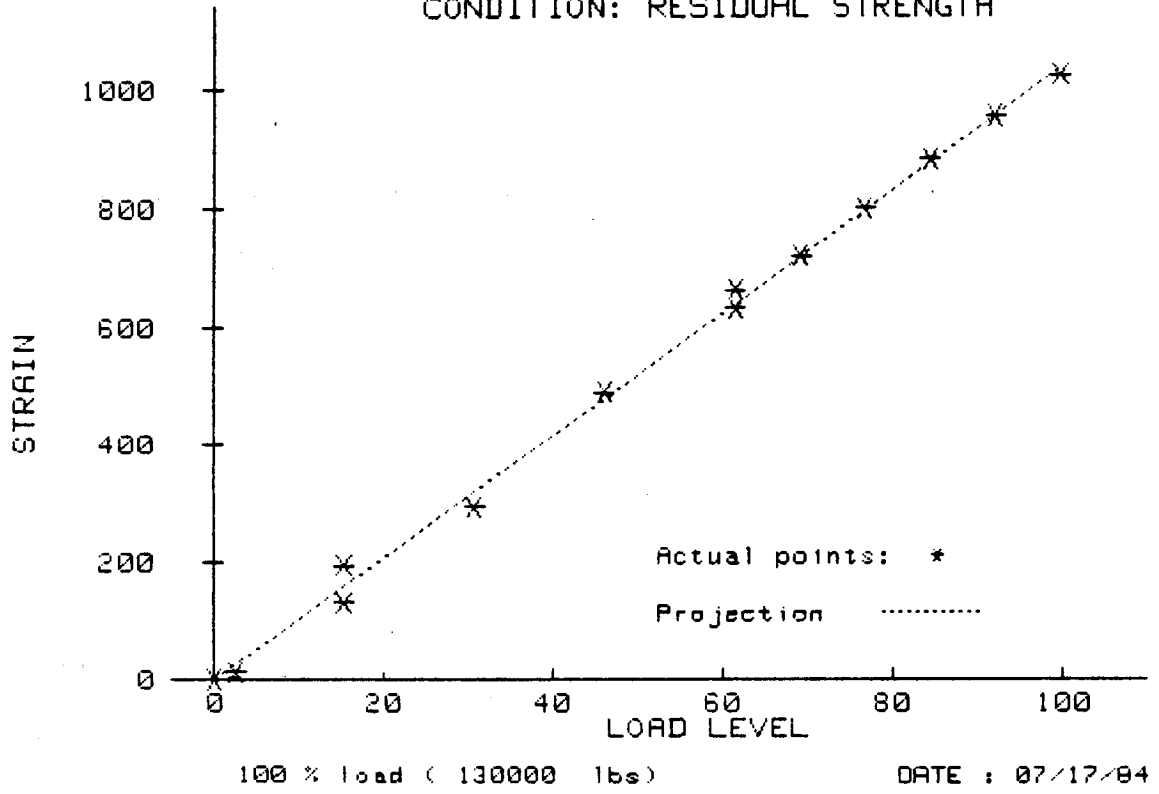

Figure H-43. CV2-2 Residual Strength Tension Test - Strain Gauge Readings - Plot Gage 43

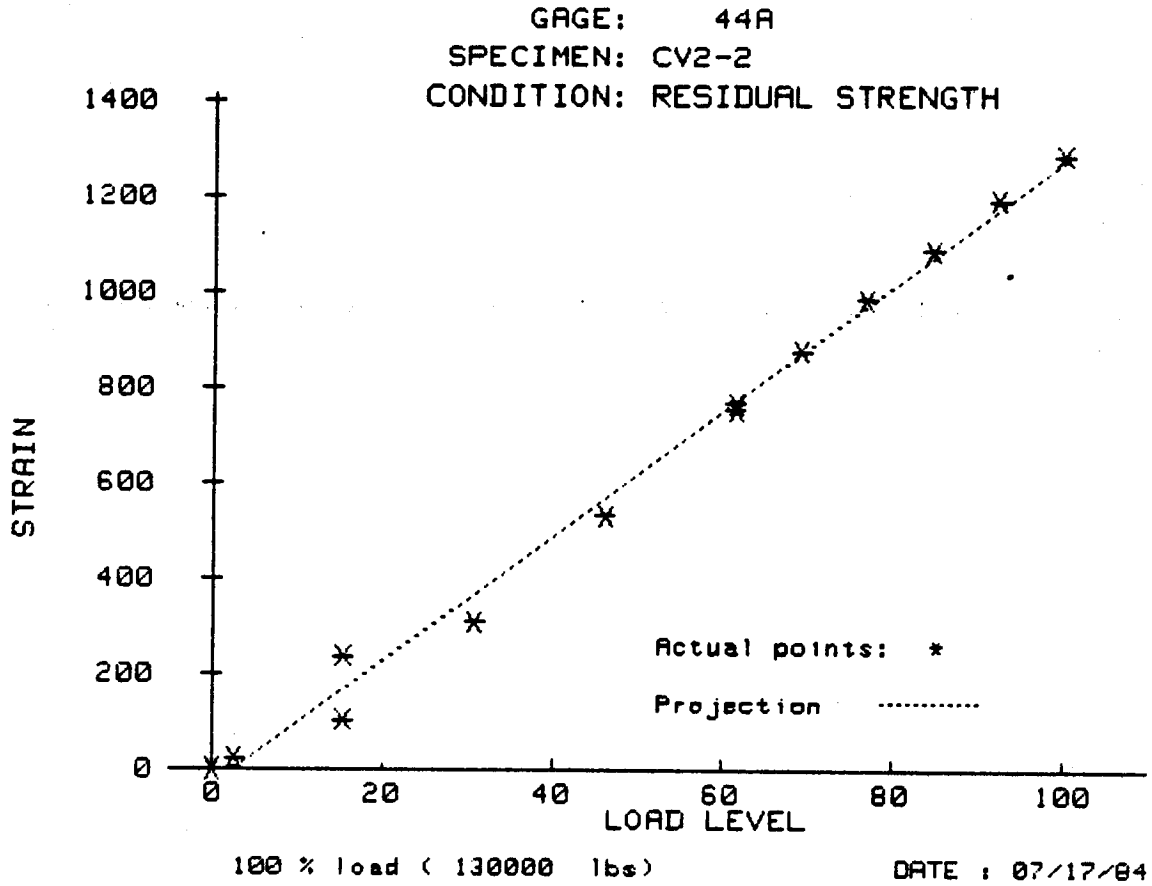

Figure H-44. CV2-2 Residual Strength Tension Test - Strain Gauge Readings - Plot Gage 44

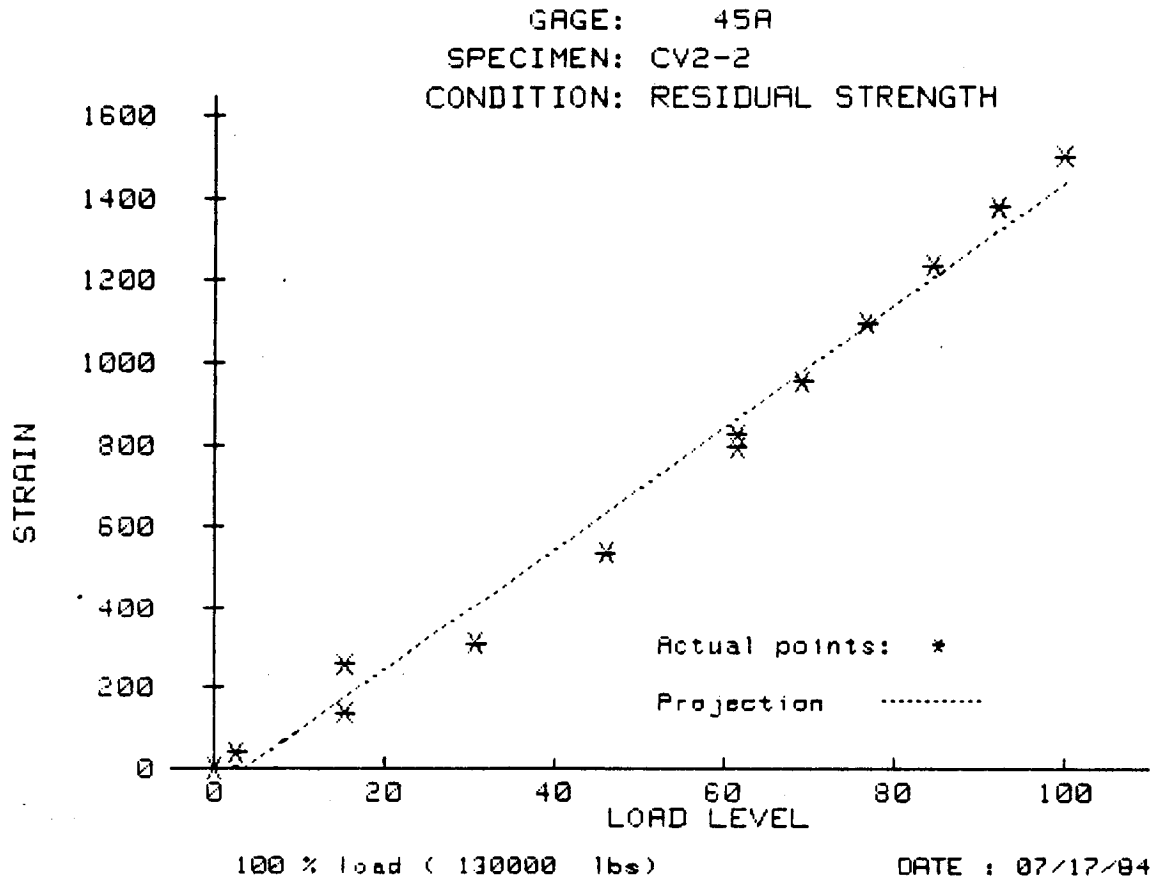

Figure H-45. CV2-2 Residual Strength Tension Test - Strain Gauge Readings - Plot Gage 45

GAGE: 46A  
SPECIMEN: CV2-2  
CONDITION: RESIDUAL STRENGTH

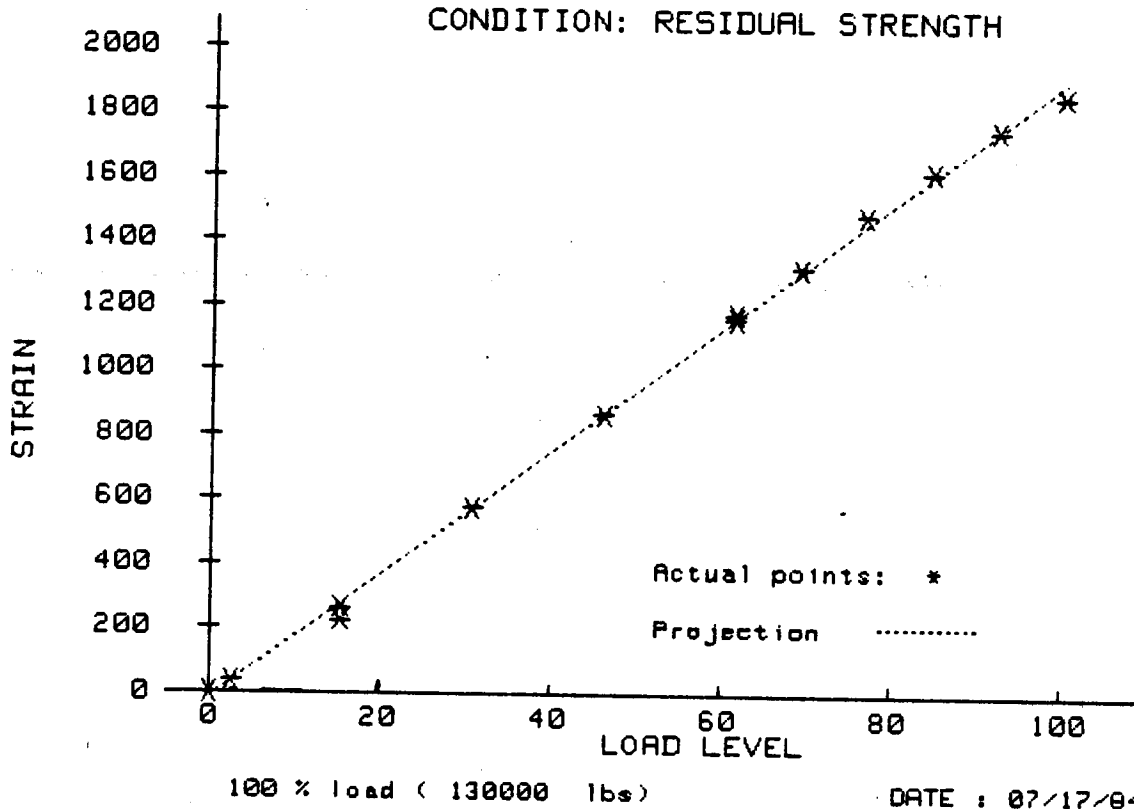

Figure H-46. CV2-2 Residual Strength Tension Test - Strain Gauge Readings - Plot Gage 46

GAGE: 47A  
SPECIMEN: CV2-2  
CONDITION: RESIDUAL STRENGTH

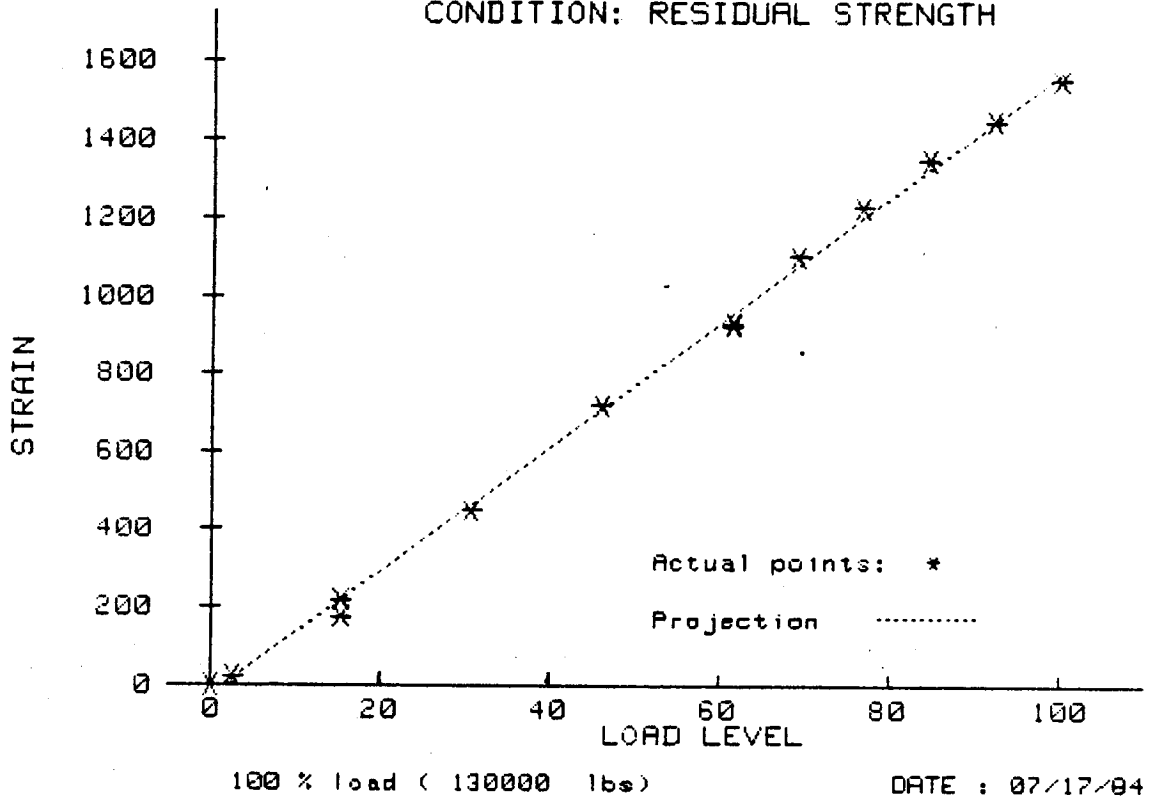

Figure H-47. CV2-2 Residual Strength Tension Test -  
Strain Gauge Readings - Plot Gage 47



GAGE: 48A  
SPECIMEN: CV2-2  
CONDITION: RESIDUAL STRENGTH

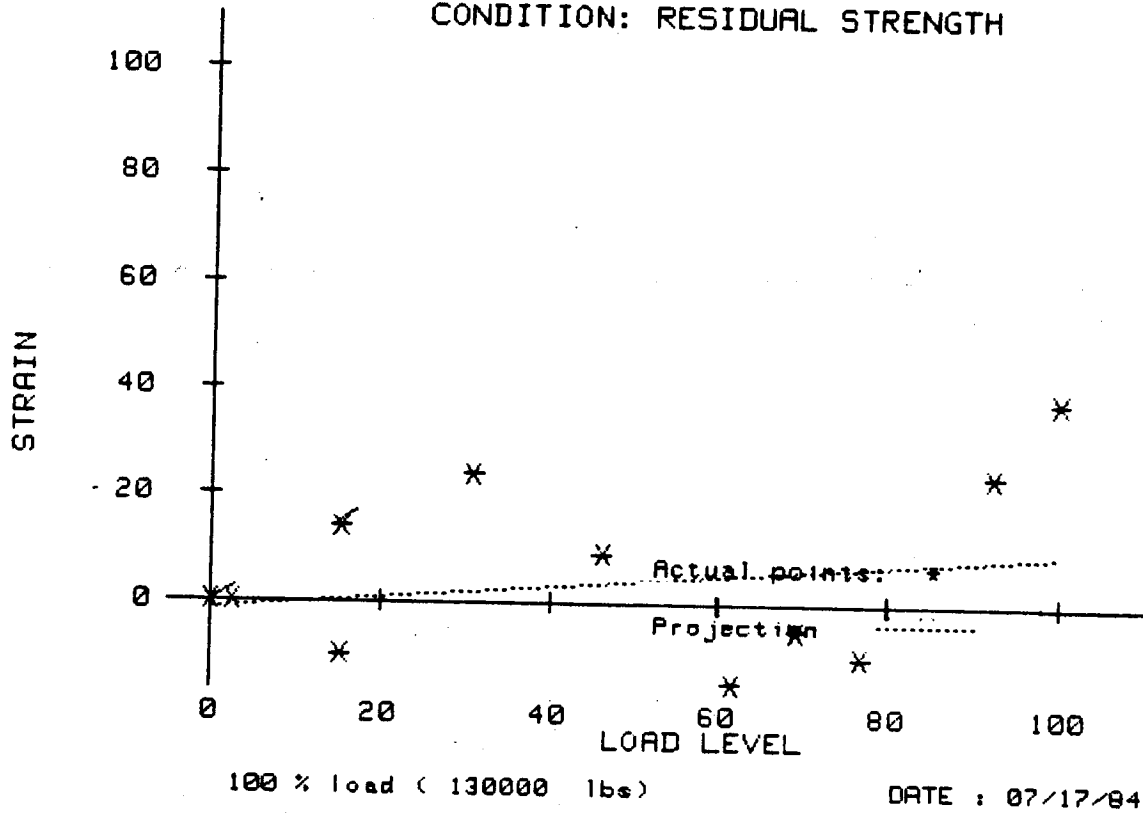

Figure H-48. CV2-2 Residual Strength Tension Test - Strain Gauge Readings - Plot Gage 48

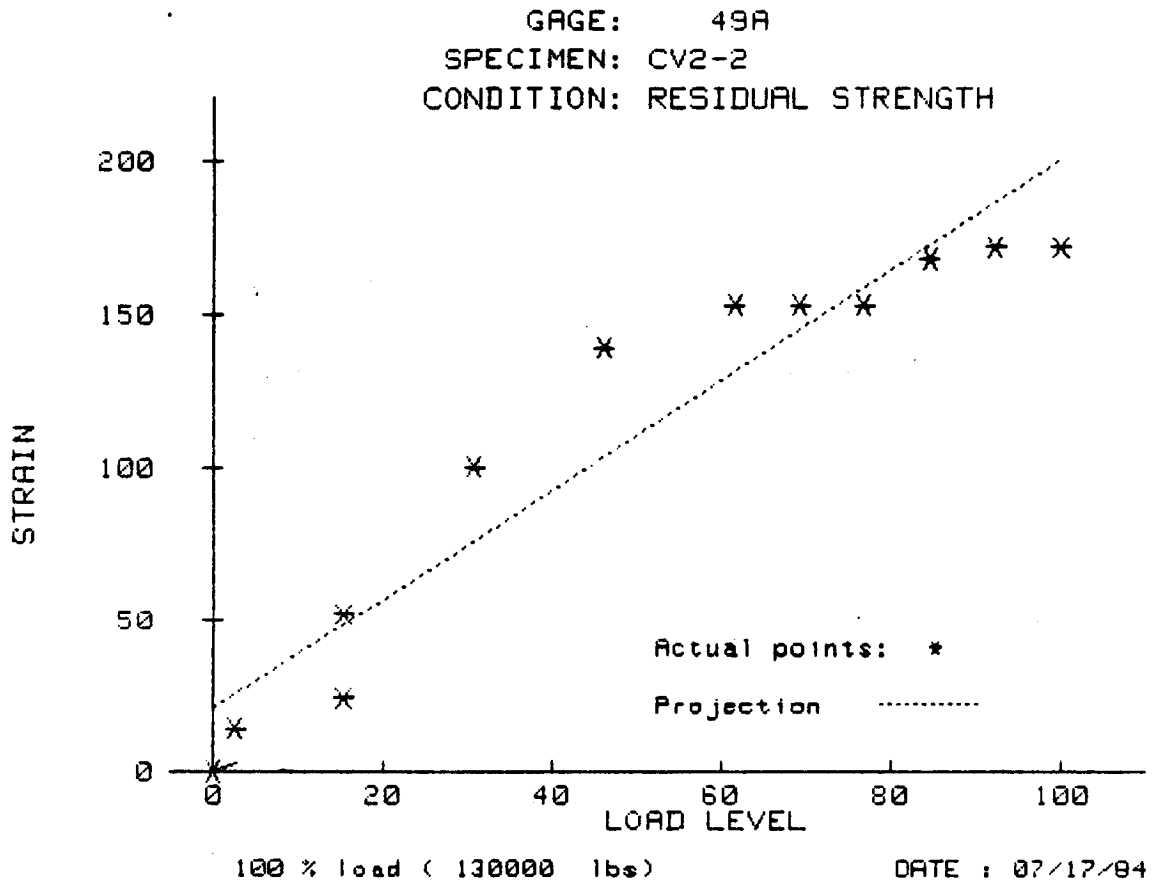

Figure H-49. CV2-2 Residual Strength Tension Test - Strain Gauge Readings - Plot Gage 49

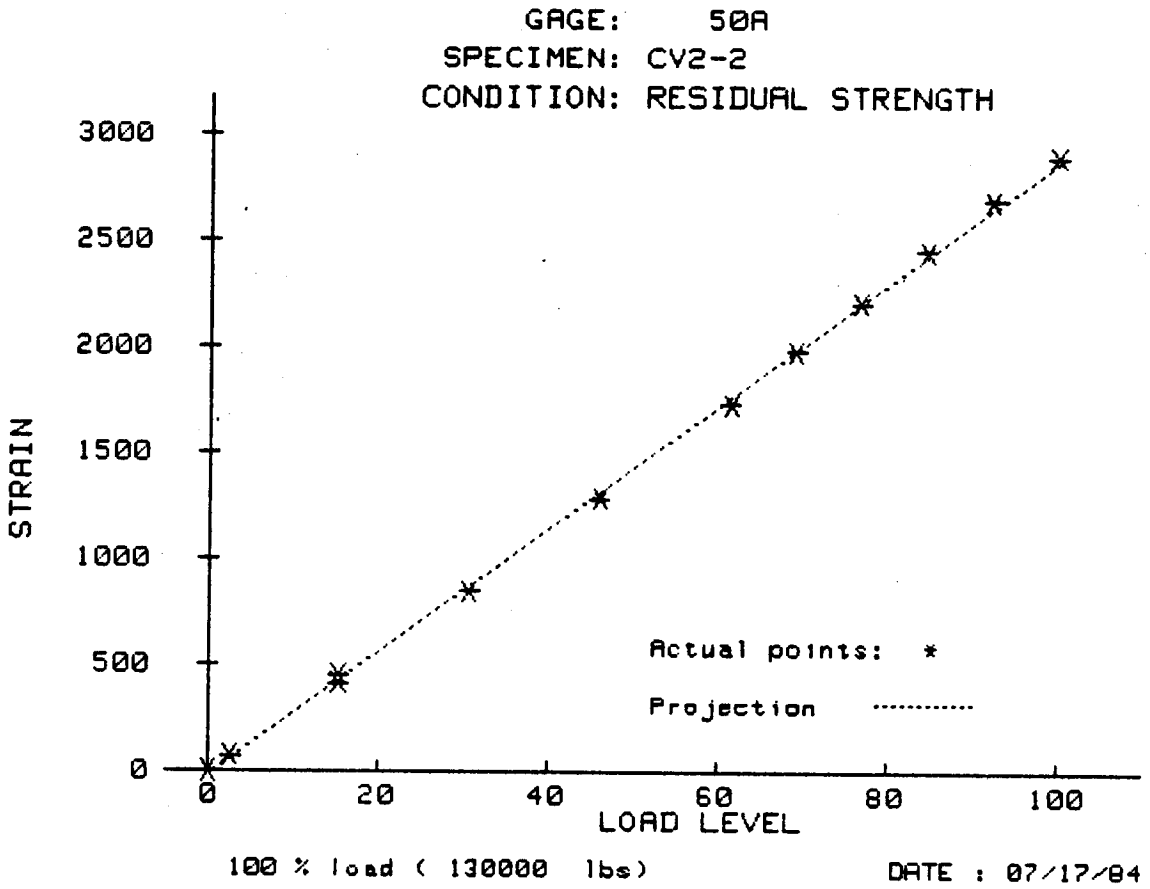

Figure H-50. CV2-2 Residual Strength Tension Test - Strain Gauge Readings - Plot Gage 50

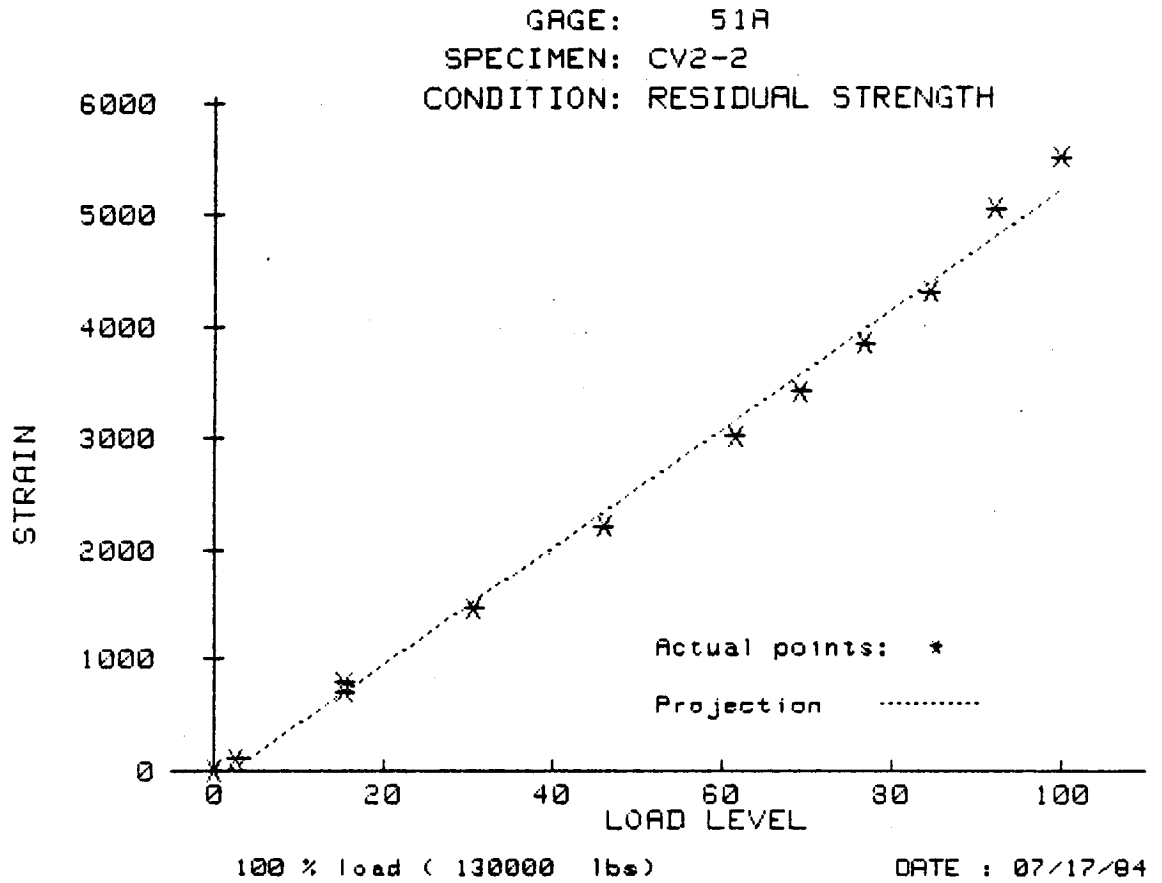

Figure H-51. CV2-2 Residual Strength Tension Test - Strain Gauge Readings - Plot Gage 51

GAGE: 52A  
SPECIMEN: CV2-2  
CONDITION: RESIDUAL STRENGTH

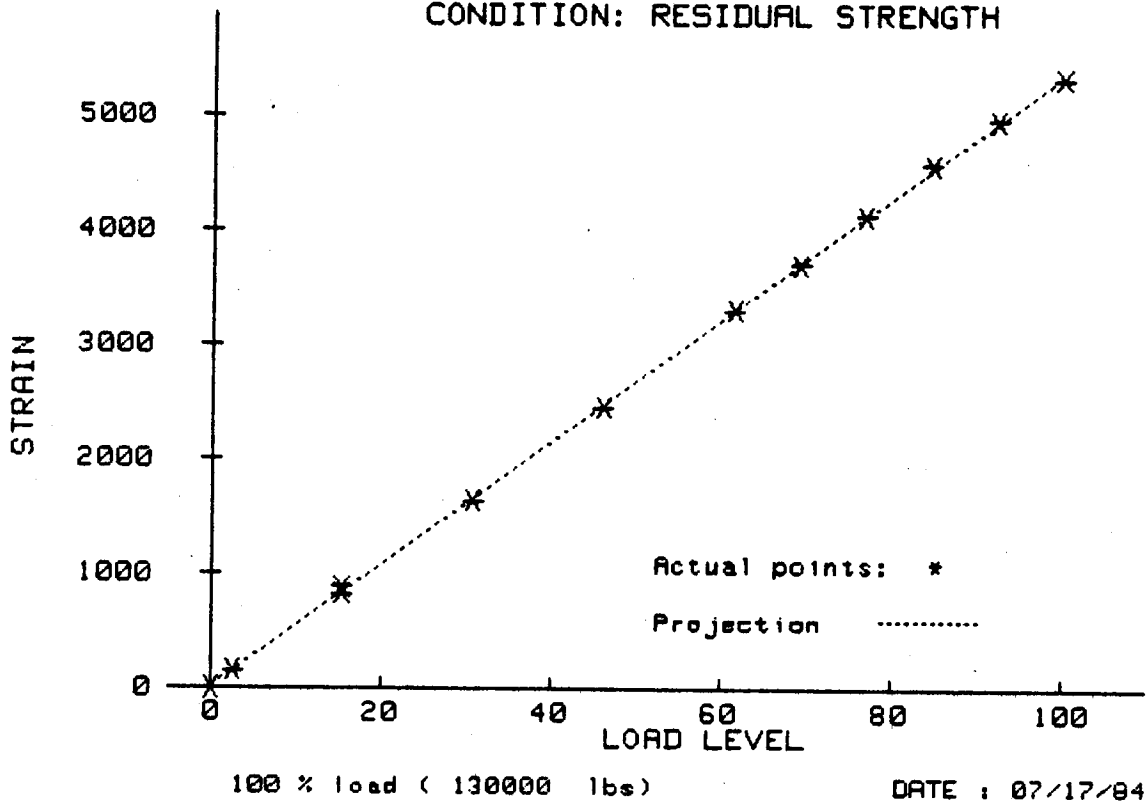

Figure H-52. CV2-2 Residual Strength Tension Test - Strain Gauge Readings - Plot Gage 52

GAGE: 53A  
SPECIMEN: CV2-2  
CONDITION: RESIDUAL STRENGTH

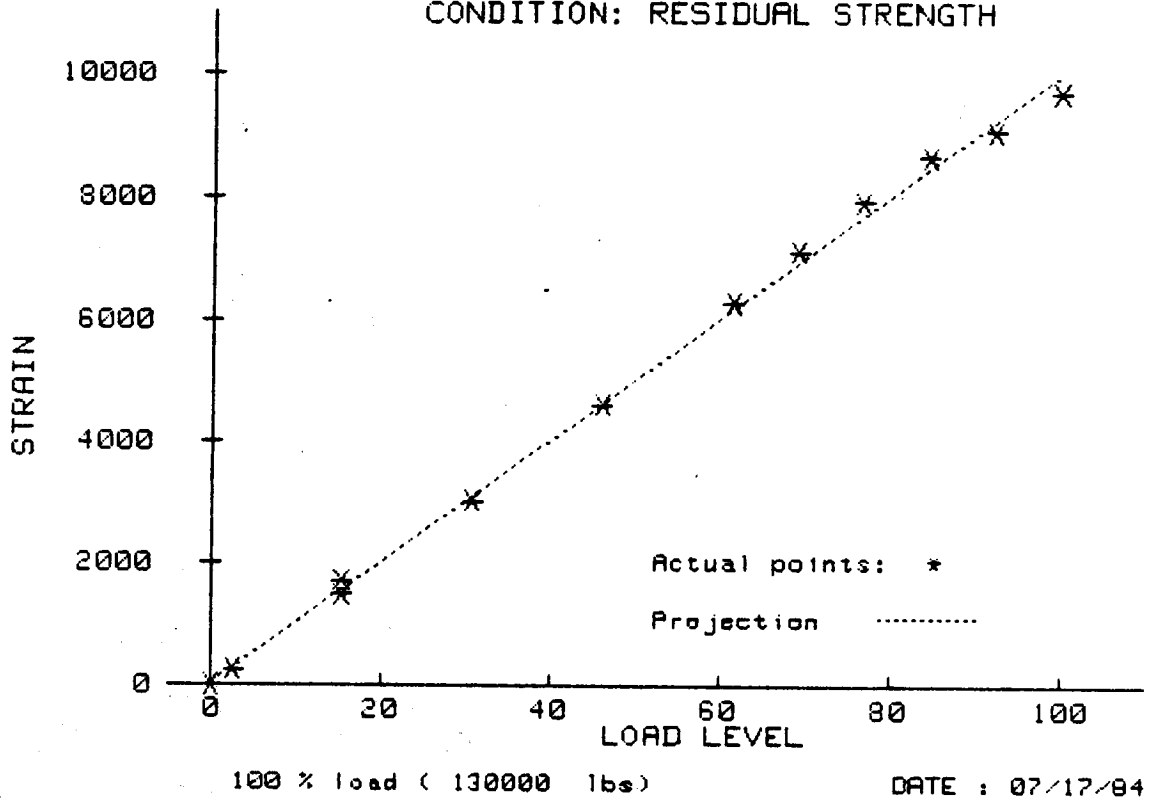

Figure H-53. CV2-2 Residual Strength Tension Test - Strain Gauge Readings - Plot Gage 53

GAGE: 54A  
SPECIMEN: CV2-2  
CONDITION: RESIDUAL STRENGTH

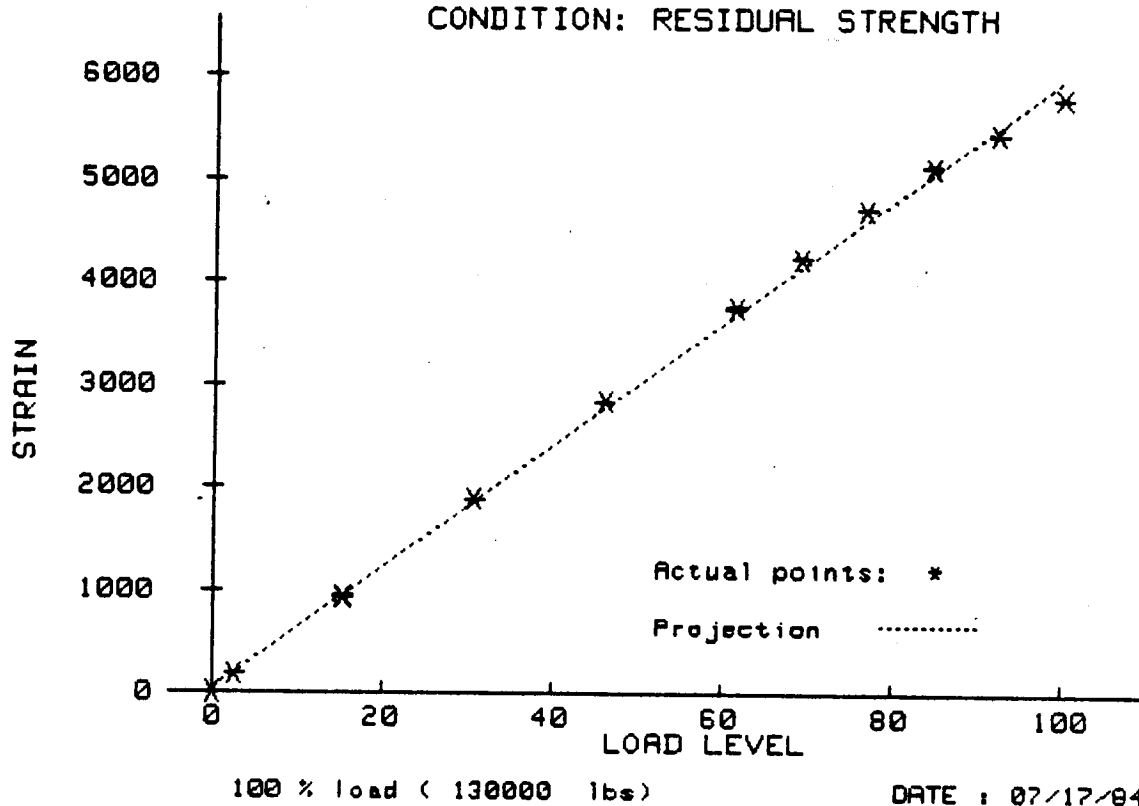

Figure H-54. CV2-2 Residual Strength Tension Test - Strain Gauge Readings - Plot Gage 54

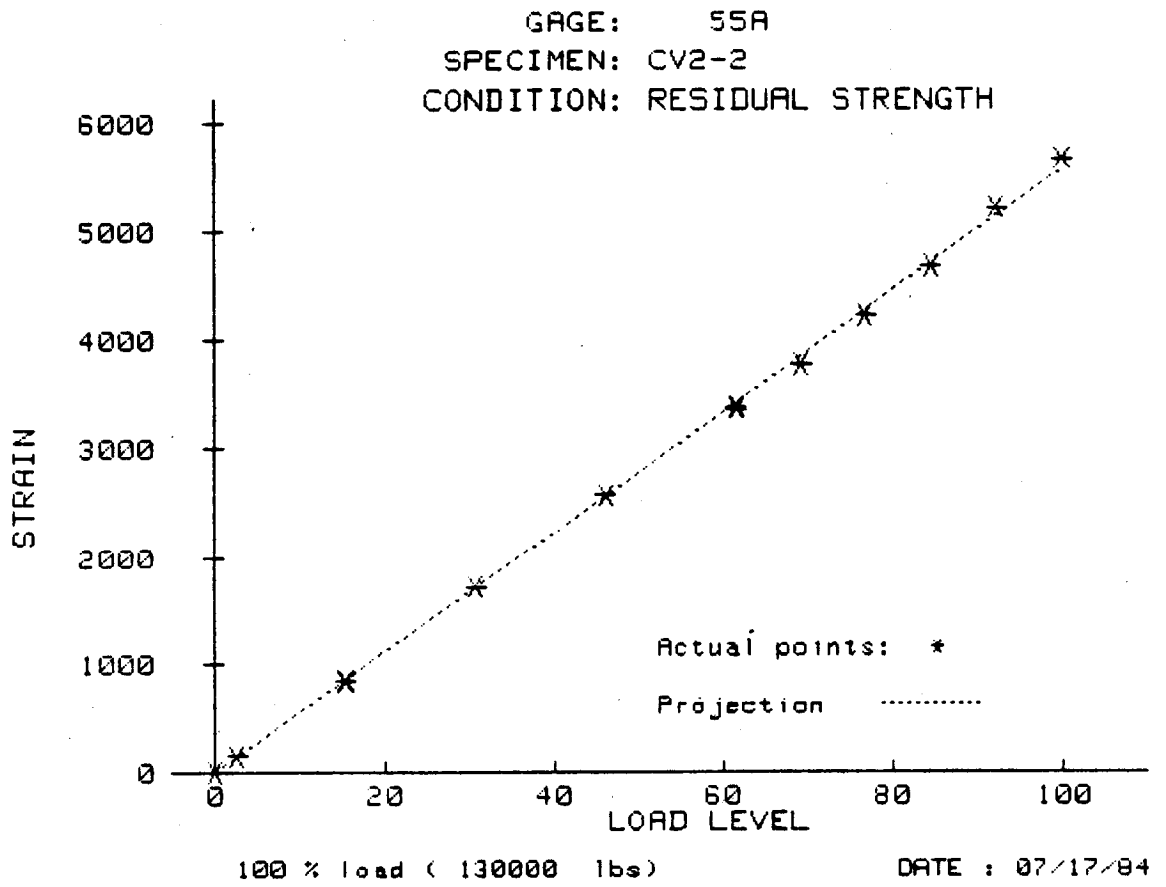
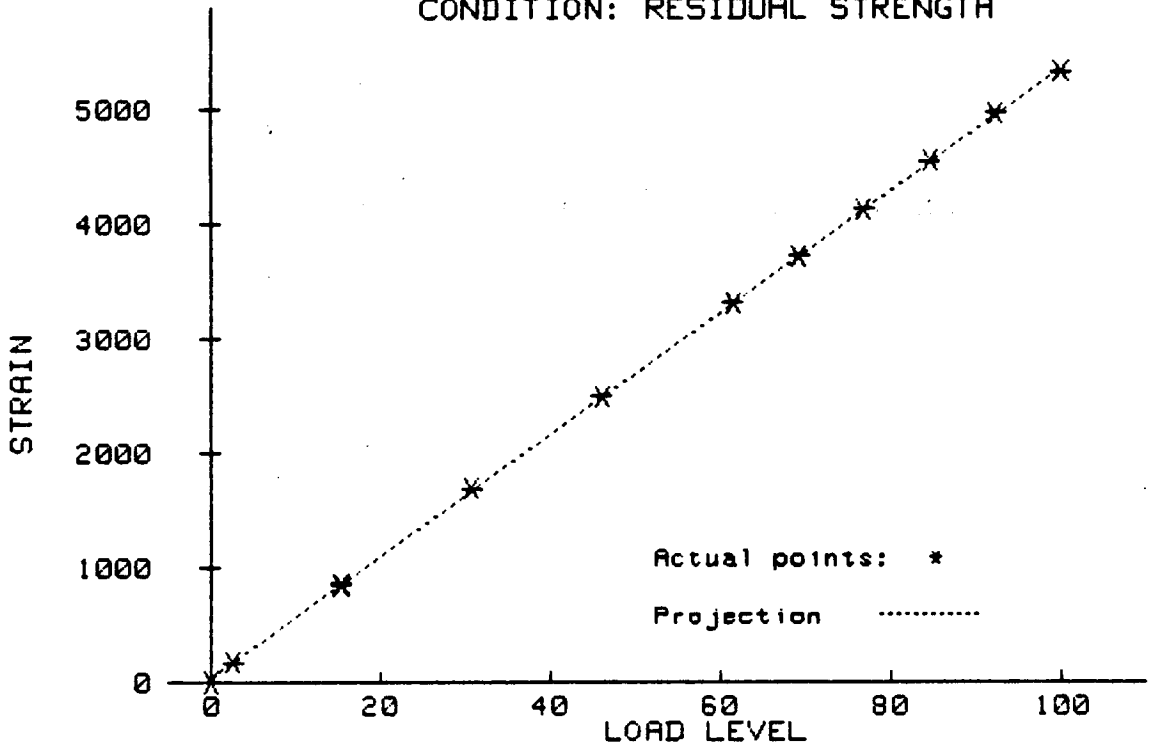

Figure H-55. CV2-2 Residual Strength Tension Test - Strain Gauge Readings - Plot Gage 55



GAGE: 56A  
SPECIMEN: CV2-2  
CONDITION: RESIDUAL STRENGTH



100 % load ( 130000 lbs)

DATE : 07/17/84

Figure H-56. CV2-2 Residual Strength Tension Test -  
Strain Gauge Readings - Plot Gage 56

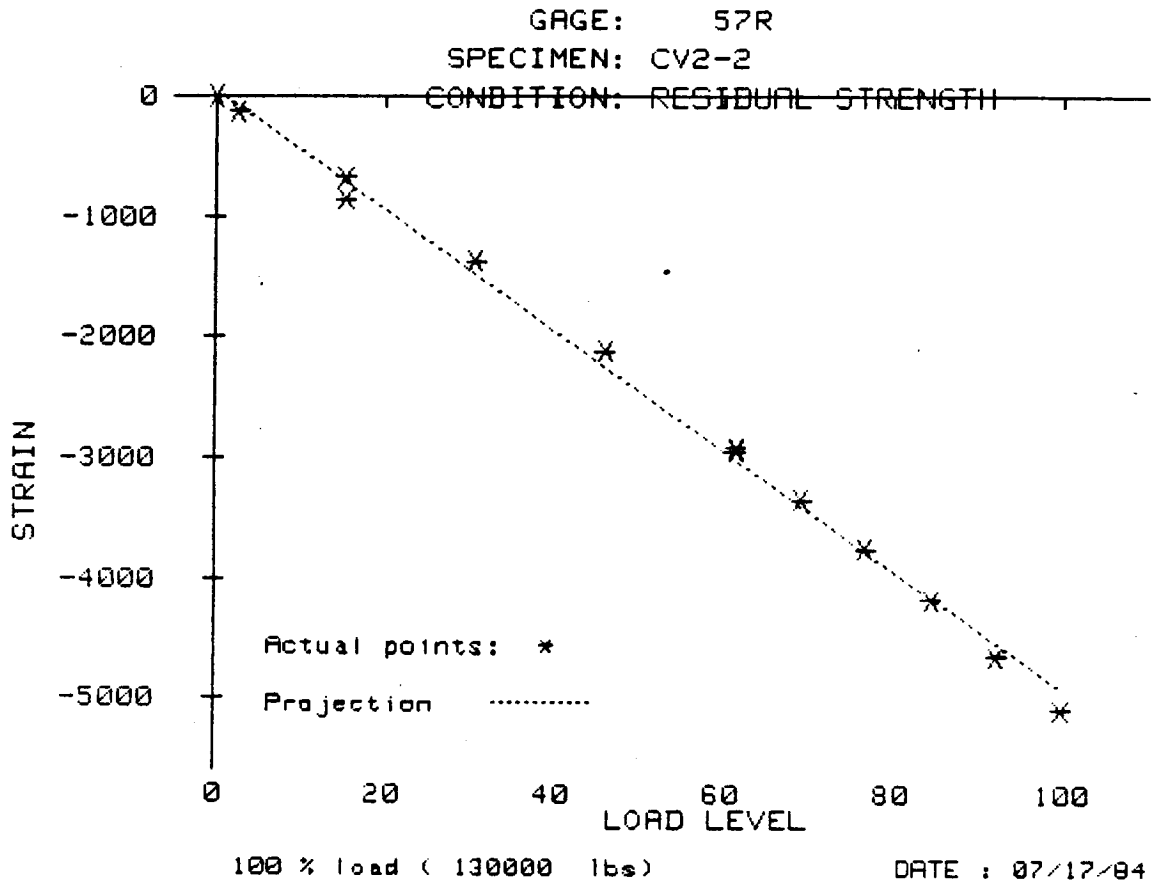

Figure H-57. CV2-2 Residual Strength Tension Test - Strain Gauge Readings - Plot Gage 57

GAGE: 58R  
SPECIMEN: CV2-2  
CONDITION: RESIDUAL STRENGTH

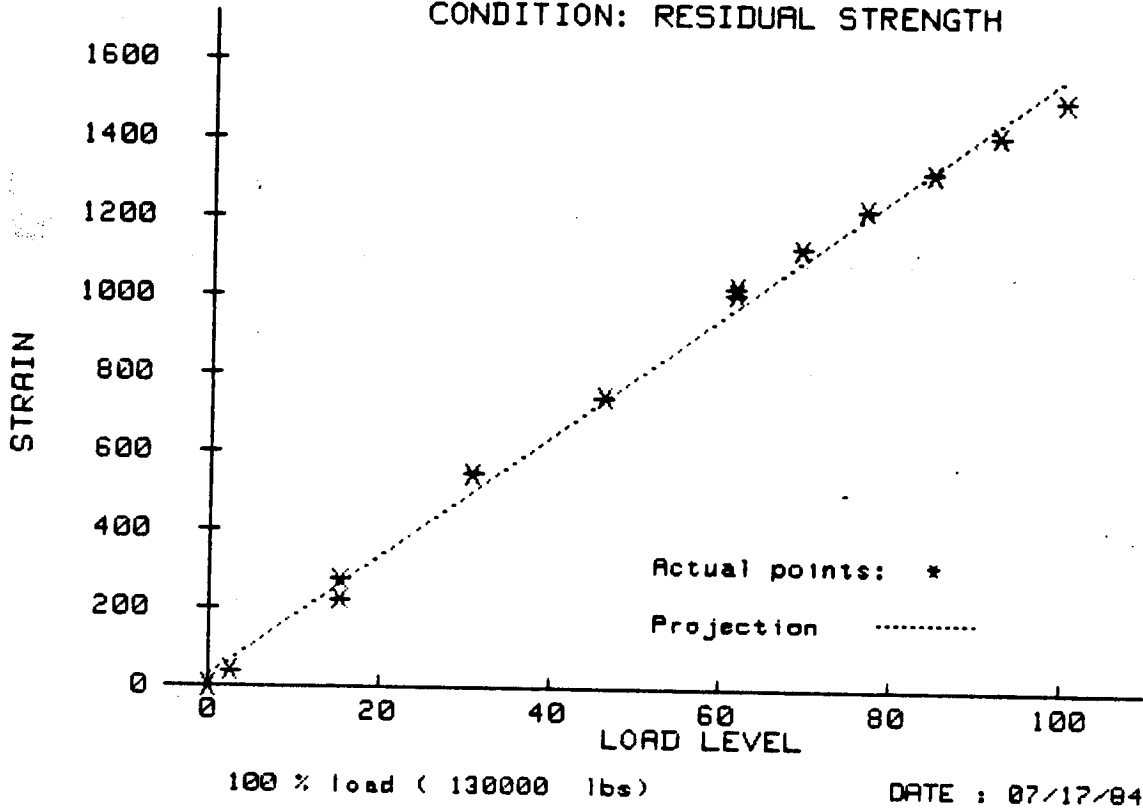

Figure H-58. CV2-2 Residual Strength Tension Test - Strain Gauge Readings - Plot Gage 58

GAGE: 59R  
SPECIMEN: CV2-2  
CONDITION: RESIDUAL STRENGTH

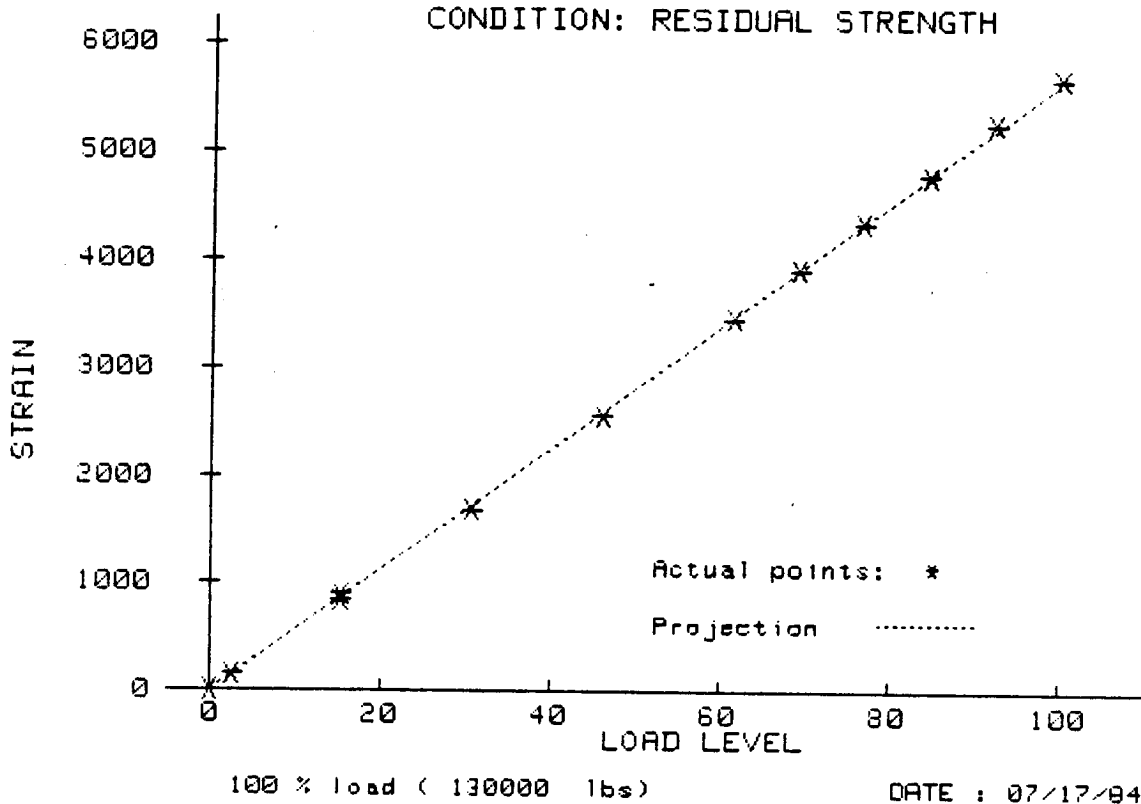

Figure H-59. CV2-2 Residual Strength Tension Test - Strain Gauge Readings - Plot Gage 59

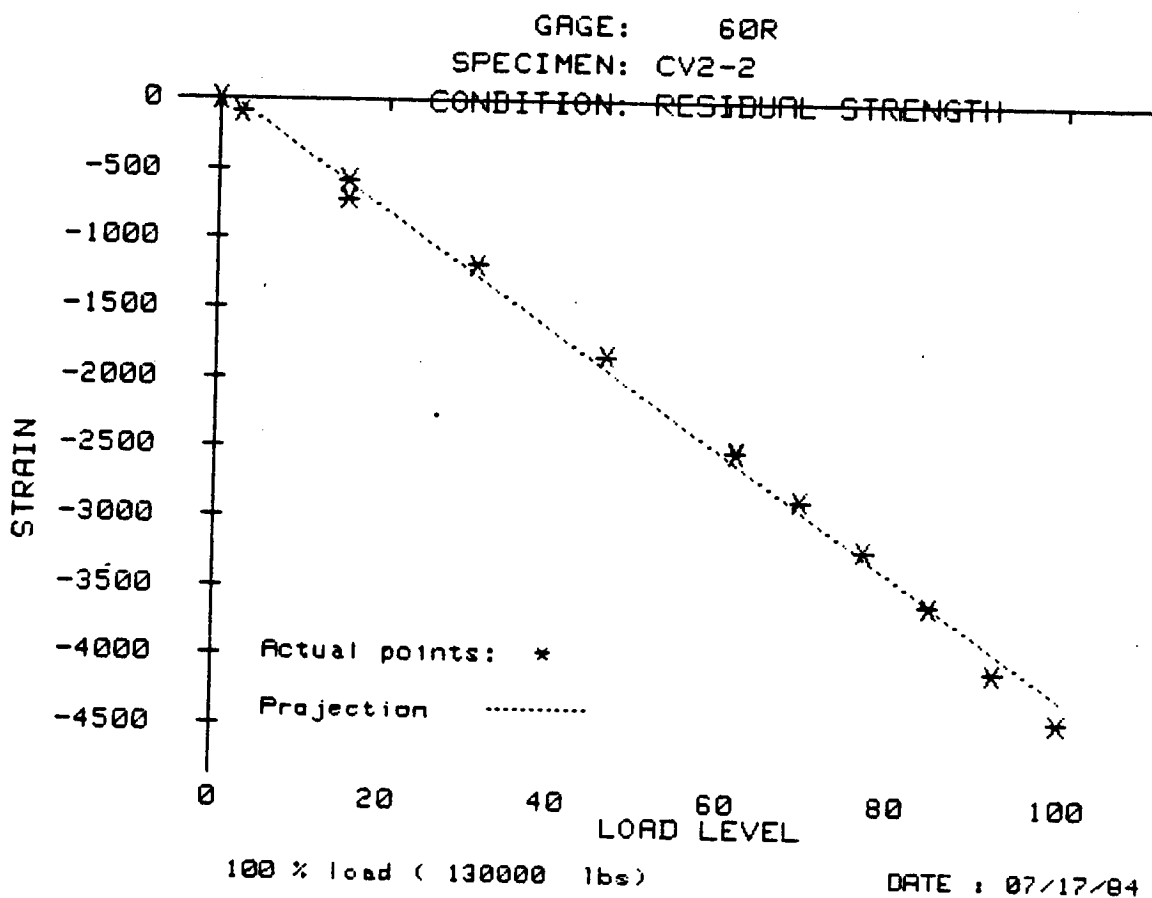

Figure H-60. CV2-2 Residual Strength Tension Test -  
Strain Gauge Readings - Plot Gage 60

GAGE: 61R  
SPECIMEN: CV2-2  
CONDITION: RESIDUAL STRENGTH

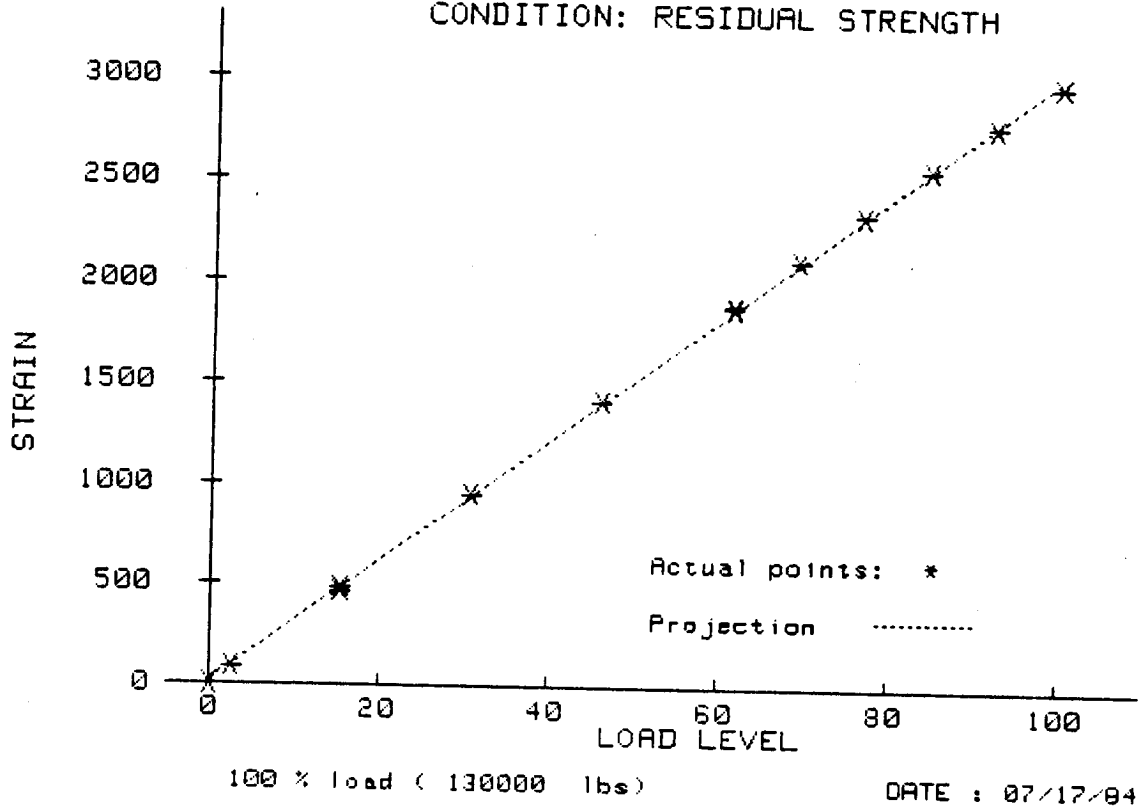

Figure H-61. CV2-2 Residual Strength Tension Test - Strain Gauge Readings - Plot Gage 61

C-3

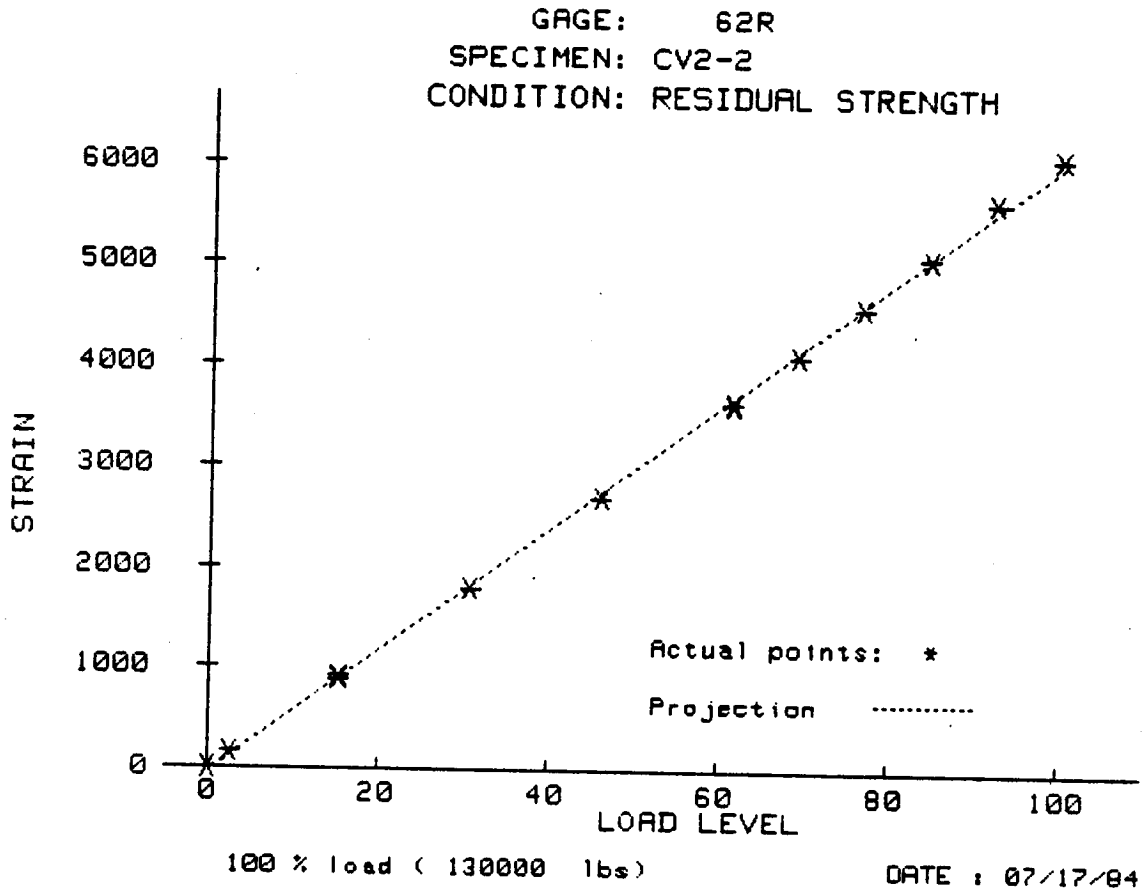



Figure H-62. CV2-2 Residual Strength Tension Test - Strain Gauge Readings - Plot Gage 62

1. Report No. NASA CR-172462		2. Government Accession No.		3. Recipient's Catalog No.	
4. Title and Subtitle STRUCTURAL TESTS AND DEVELOPMENT OF A LAMINAR FLOW CONTROL WING SURFACE COMPOSITE CHORDWISE JOINT				5. Report Date December 1984	
				6. Performing Organization Code	
7. Author(s) L. B. Lineberger				8. Performing Organization Report No. LG84ER0113	
9. Performing Organization Name and Address Lockheed-Georgia Company 86 South Cobb Drive Marietta, GA 30063				10. Work Unit No.	
				11. Contract or Grant No. NAS1-17487	
12. Sponsoring Agency Name and Address National Aeronautics and Space Administration Washington, DC 20546				13. Type of Report and Period Covered Contractor Report	
				14. Sponsoring Agency Code	
15. Supplementary Notes Langley Contract Monitor: Dal V. Maddalon Final Report					
16. Abstract <p>The dramatic increases in fuel costs and the potential for periods of limited fuel availability provided the impetus to explore technologies to reduce transport aircraft fuel consumption. NASA sponsored the Aircraft Energy Efficiency (ACEE) program beginning in 1976 to develop technologies to improve fuel efficiency. The Lockheed-Georgia Company accomplished under NAS1-16235 LFC Lamina-Flow-Control Wing Panel Structural Design and Development (WSSD); design, manufacturing, and testing activities. An in-depth preliminary design of the baseline 1993 LFC wing was accomplished. A surface panel using the Lockheed graphite/epoxy integrated LFC wing box structural concept was designed. The concept was shown by analysis to be structurally efficient and cost effective. Critical details of the surface and surface joints were demonstrated by fabricating and testing complex, concept selection specimens.</p> <p>This report documents the Lockheed-Georgia Company accomplishments under NAS1-17487, Development of LFC Wing Surface Composite Structures (WSCS). Tests were conducted on two CV2 panels to verify the static tension and fatigue strength of LFC wing surface chordwise joints.</p>					
17. Key Words (Suggested by Author(s)) Laminar Flow Control (LFC) Composite Chordwise Joint Structural Tests				18. Distribution Statement  Subject Category 01	
19. Security Classif. (of this report) Unclassified		20. Security Classif. (of this page) Unclassified		21. No. of Pages 199	22. Price

