

NASA Technical Memorandum 100781

# Status of 20 kHz Space Station Power Distribution Technology

(NASA-TM-100781) STATUS OF 20 kHz SPACE  
STATION POWER DISTRIBUTION TECHNOLOGY  
(NASA) 12 p CSCI 10B

N88-15838

g3/20 Unclas  
0121852

Irving G. Hansen  
*Lewis Research Center*  
*Cleveland, Ohio*

Prepared for the  
Applied Power Electronics Conference and Exposition—APEC '88  
sponsored by The Institute of Electrical and Electronics Engineers  
New Orleans, Louisiana, February 1-5, 1988

**NASA**

# STATUS OF 20 KHZ SPACE STATION POWER DISTRIBUTION TECHNOLOGY

Irving G. Hansen  
National Aeronautics and Space Administration  
Lewis Research Center  
Cleveland, Ohio 44135

## SUMMARY

Power Distribution on the NASA Space Station will be accomplished by a 20 kHz sinusoidal, 440 VRMS, single phase system. In order to minimize both system complexity and the total power conversion steps required, high frequency power will be distributed end-to-end in the system. To support the final design of flight power system hardware, advanced development and demonstrations have been made on key system technologies and components. This paper will discuss the current status of this effort.

## BACKGROUND

An isometric view of a complete Space Station is shown in Fig. 1. The central portion remains fixed relative to earth, while the solar receiving elements remain fixed relative to the sun, a rotary joint (B joint) connects these two elements. All generation is performed outside the B-joint on the solar fixed elements.

Energy storage for the photovoltaic sources will be accomplished with nickle hydrogen batteries. Energy storage for the solar dynamic sources will be done thermally. Present plans call for the initial station to be only solar powered, and for the solar dynamic elements to be added later as a "growth" phase.

All the electrical energy is converted to 20 kHz, 440 V, single phase power and delivered across the rotary joint.

The power distribution system is comprised of two separate independent systems, each "side" supplying one system. This results in redundant power being available in a manner similar to the port and starboard systems used on aircraft.

Distribution voltages are 208 VRMS inside pressurized volumes Fig. 2. Transformers are used to both step down the voltage and provide the common mode isolation required for single point grounding. This is a distributed power system, with sufficient initial versatility to provide a proper foundation for automation and growth over its intended 30-year life. A more detailed description of the Space Station Power System and its technical rationale is given in Ref. 1. To support the final design of flight power system hardware, advanced development and demonstrations have been made on key system technologies and components.

## Developments Resonant Power Conversion

Resonant Conversion will be used to generate the 20 kHz system power. Parallel resonant circuits have been implemented, since they provide the low

source impedance required for voltage regulation and are easily paralleled. System regulation is provided by varying the phase angle between series connected converters. This "phasor" regulation allows control of the compliance range of the input regulation. When controlable limits are placed upon regulator compliance, an interesting input impedance characteristic is obtained Fig. 3. This characteristic basically allows control of the range over which the converter exhibits negative input impedance. This in turn allows additional control regarding system stabilities and operation from nonlinear sources. Resonant power conversion has been under development by Lewis Research Center and our contractors for over 15 years. Some of the extent of this effort is shown in Fig. 4. Of particular interest has been the bi-directional capabilities of some of the circuit topologies. This capability of controlling energy flow in either direction has formed the basis of our ac motor control work. This converter is a bi-directional, high frequency to low frequency, variable voltage, variable frequency, converter.<sup>2-4</sup>

The converter (or motor driver) uses wave form synthesis (pulse population density) to create a lower frequency wave form. The salient feature of this modulation scheme is that the frequency (wave pattern) may be controlled independently of the voltage (pattern density). This in turn allows a wide range of motor operation, free of the effects of harmonic distortion of the applied voltage, Fig 5.

#### POWER CABLES

Multikilowatt power distribution cables operating at 20 kHz require particular attention in minimizing their inductive reactance. Low inductance is required for two reasons; not only to reduce voltage drops and the resulting cross talk between loads, but also to reduce the external magnetic field of the cable.

Low inductance was achieved by configuring the cable as a double-sided stripline. Low series resistance at 20 kHz was also important to maximize efficiency/weight trade-offs. To prove the configuration concept electrically, while holding down development costs, the line was initially fabricated using easily available material.

The conductors were "straps" woven of individually insulated copper wires. This "litz" wire type of construction afforded flexibility and low ac resistance.<sup>5</sup>

This cable was designed to deliver 25 kW over a distance of 50 m with a real power loss of 2 percent. As manufactured the cable parameters were: resistance: 0.83 m $\Omega$ /m, inductance: 0.035 mH/m, capacitance: 0.00137 mF/m, and weight: 1 kg/m.

Subsequent testing of this cable at full power verified that such a configuration could easily meet the electrical requirements. However, two concerns arose concerning the braided conductors. The dimensions were not entirely stable; they would change under fabrication and subsequent handling stress, thus changing the electrical parameters. Also, it was recognized that considerable time would be required to outgass long braided conductors in space. Therefore, second generation cable is under development at Gore and Associates, Fig. 6. In this cable low ac resistance and dimensional stability are provided by the flat foil conductor. Each conductor will have a solid

dielectric coating, and outgassing will be enhanced by using a gas permeable dielectric for filler and jacket material. Electrically the solid cable is very similar to the braided cable except that additional shielding will be provided inside the outer jacket. This particular cable is scheduled to be delivered for testing in April 1988.<sup>6</sup>

#### REMOTE POWER CONTROLLER (RPC)

The RPC provides a direct link in a distributed power system between the system management computer and individual loads. This device provides individual load control current limiting, fault protection, and provides inputs to system status indicators.<sup>7</sup>

The RPC accepts on/off and current set point commands. A serial data word displays the load current, the load voltage, and the sign of the volt-ampere product. Once the RPC is tripped, the display holds the last current reading to allow for system failure analysis.

The source converters for the Space Station are parallel resonant (mapham) converters. As a result the system is energy limited and responds very rapidly to overloads.

In the case of the Space Station Power System the integrated system transient response is over an order of magnitude faster than the regulator loop response. To prevent any individual overload from causing transient cross talk with other system loads, the RPC provides rapid current limiting. Limiting of hard faults occurs in about 2  $\mu$ s and the switched reactance limiting allows a maximum pass through current of 300 percent of the RPC rating. Full limiting is obtained by the end of first half cycle of operation (25  $\mu$ s).

#### SEMICONDUCTOR PACKAGE

A new hi-power semiconductor package has been developed for NASA by Power Technology Components.<sup>8</sup> This package provides an electrically isolated case with a low inductance lead configuration.

The hermetic sealing of the case is backed-up by applying a post assembly internal coating of parylene\* Figs. 7 and 8. Among the advantages of this package is the reduced area being driven by common mode voltages when applied in a bridge circuit. This minimizes the leakage currents coupled into the heat sinking.

This package is intended for general application on the Space Station. A commercial version without the parylene coating will be marketed by PTC as their "power mode" series.

#### MOS CONTROLLED THYRISTOR (MCT)

One of the most rewarding advanced developments is the MCT work of Dr. Temple at The General Electric Corporate Research Development Laboratories.<sup>9</sup>

---

\*Union Carbide Corporation Trademark.

This device combines the ruggedness of an S.C.R. with the controlability of MOS circuitry. Using dedicated driver chips, which also provide "smart" circuitry such as status and protection, multikilowatt loads may be driven directly from logic power.

Conceptually, the MCT consists of a thyristor with one of its "transistor equivalent" base emitter junctions shorted by a field effect transistor to allow turn-off, Fig. 9. Turn on may be accomplished by a second field effect transistor to the second "base." Under these conditions the device will turn on with one polarity applied to the gate, and turn off with the reverse polarity.

The development of the MCT has been jointly sponsored by NASA (LeRC), AFWAL, and the Electric Power Research Insititute (EPRI). As presently configured the MCT is unilaterally conducting and bilaterally blocking. One part of the work done for NASA addresses the construction of a bilaterally conducting device. This would represent the ultimate device for ac circuitry, in particular those requiring four quadrant operation of the switching devices.

Three categories of devices are being fabricated:

	VOLTAGE	CURRENT	TURN-OFF TIME
AIR FORCE	900	150 A	≈1 μsec
NASA	1200 V	40-60 A	<1 μsec
DOD *	2500 V	1500 A	>1 μsec

#### CONCLUDING REMARKS

Although resonant power components and conversion technology have been under development by NASA Lewis for over 15 years, the application of high frequency to power distribution caused some anxiety. The advanced development program has demonstrated that an adequate technology base exists to allow a successful development of the Space Station power distribution system.

#### REFERENCES

1. F. Teren, "Space Station Electrical Power Systems Requirements and Design," NASA Lewis Research Center, NASA TM-89889, 1987. (AIAA paper 87-9003.)
2. F. Schwartz, "Bi-directional Four Quadrant (BD3Q) Power Converter Development," NASA Lewis Research Center, NASA CR-159660, 1979.

**ORIGINAL PAGE IS  
OF POOR QUALITY**

3. T. Lipo, "Study of the Generator/motor Operation of Induction Machines in a High Frequency Link Space Power System," University of Wisconsin, Madison, WI, NASA CR-179600, 1987, p. 5001.
4. T. Lipo, and S. Sul, "Design and Test of Bi-directional Speed and Torque Control of Induction Machines Operating From High Frequency Link Converter," University of Wisconsin, Madison, WI, NASA CR-180860, 1987.
5. M. Patel, "High Frequency Power Distribution System," Induction General, Inc., Pittsburgh, PA, NASA CR-175071, 1986
6. J. Mildice, "AC Power System Testbed," General Dynamics Space Systems, NASA CR-175068, 1986.
7. F. Tofigh, "208 VAC, 20 Khz Hybrid Remote Power Controller," in 22nd Inter-society Energy Conversion Engineering Conference, paper 879250, 1987.
8. V. Balodis, A. Berman, D. Devance, G. Ludlow and L. Wagner "Space Station Power Semiconductor Package Development," Power Technology Components, Microsemi Corp., Torrence, CA, NASA CR-180829, 1987,
9. V.A.K. Temple, "MOS Controlled Thyristors in Energy Conversion Systems," in 22nd Inter-society Energy Conversion Engineering Conference, paper 879252, 1987.

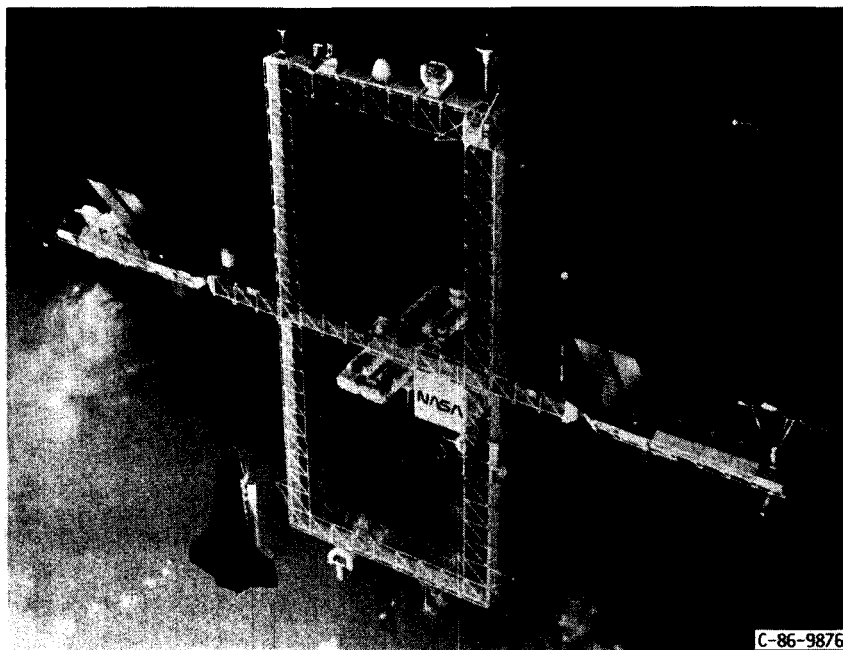

FIGURE 1. - SPACE STATION: DUAL KEEL DESIGN.

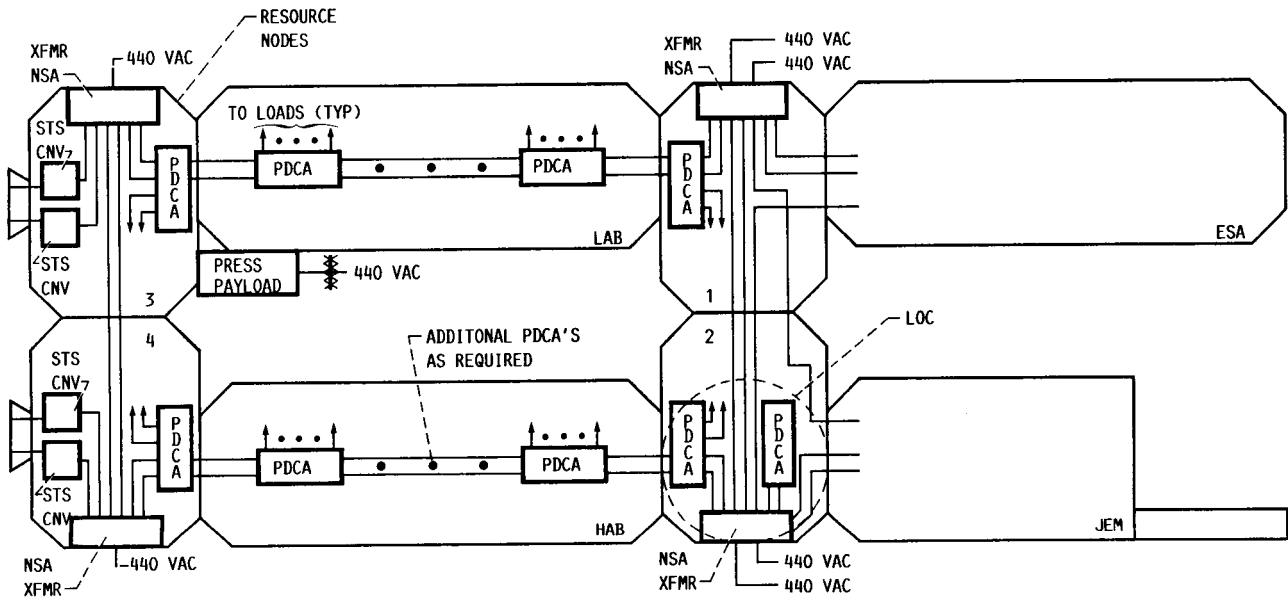

FIGURE 2. - MODULE PRIMARY DISTRIBUTION ARCHITECTURE.

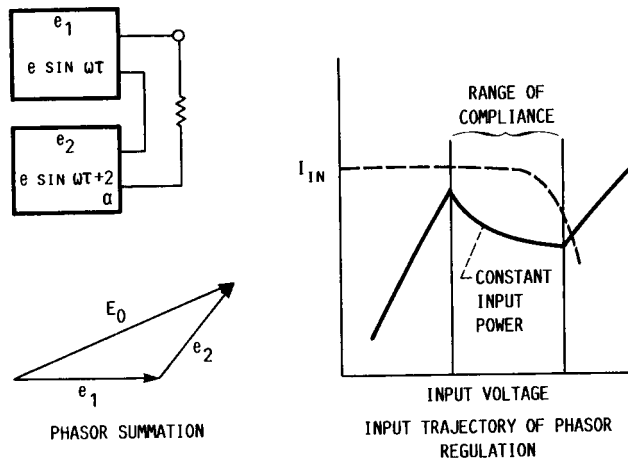

FIGURE 3. - PHASOR REGULATION CONCEPTS.

ORIGINAL PAGE IS  
OF POOR QUALITY

		OUTPUT			FORM	CONTRACTOR	NOTES
		DC	LOW FREQUENCY	HIGH FREQUENCY			
INPUT	DC	⊗		⊗	DC/DC	DR. FRANCIS C. SCHWARTZ TRW HUGHES	SERIES RESONANT
	LOW FREQUENCY			⊗	DC/HIGH FREQUENCY (MAIN CONVERTERS)	GDC (BD)* MARTIN MARIETTA	(IRAD)
	HIGH FREQUENCY	⊗	⊗		LOW FREQUENCY/ HIGH FREQUENCY AC SOURCE	TRW* GDC FRANCIS C. SCHWARTZ/ SERIES RESONANT	BI-DIRECTIONAL
	LOW FREQUENCY			⊗	HIGH FREQUENCY/ LOW FREQUENCY LOAD CONVERTERS	GDC* TRW* HUGHES AEROSPACE AVIONICS	
	HIGH FREQUENCY	⊗	⊗		HIGH FREQUENCY/ LOW FREQUENCY SYNTHESIS	GDC* TRW* UNIVERSITY OF WISCONSIN* FRANCIS C. SCHWARTZ	(10 KHZ (BD)* SERIES RESONANT)

⊗ TECHNOLOGY DEMONSTRATED

\* (BD) BI-DIRECTIONAL OPERATION DEMONSTRATION

FIGURE 4. - RESONANT POWER CONVERSION DEVELOPMENT STATUS.

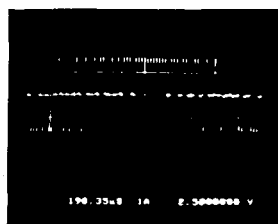
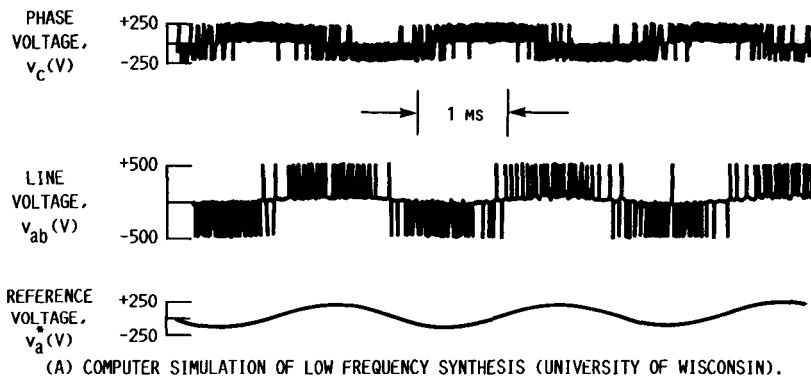

(B) OUTPUT OF BREADBOARD SYNTHESIZER (UNIVERSITY OF WISCONSIN).

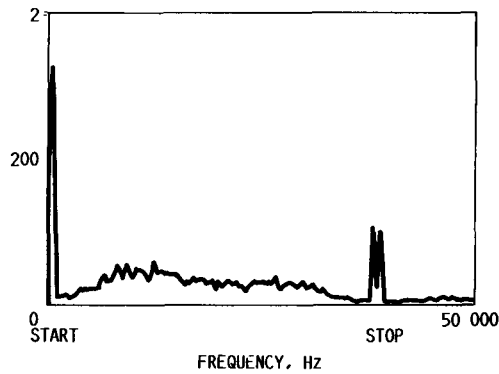

(C) SPECTRUM OF BREADBOARD SYNTHESIZER (UNIVERSITY OF WISCONSIN) (1st SIDEBAND SET).

FIGURE 5. - WAVEFORM SYNTHESIS.



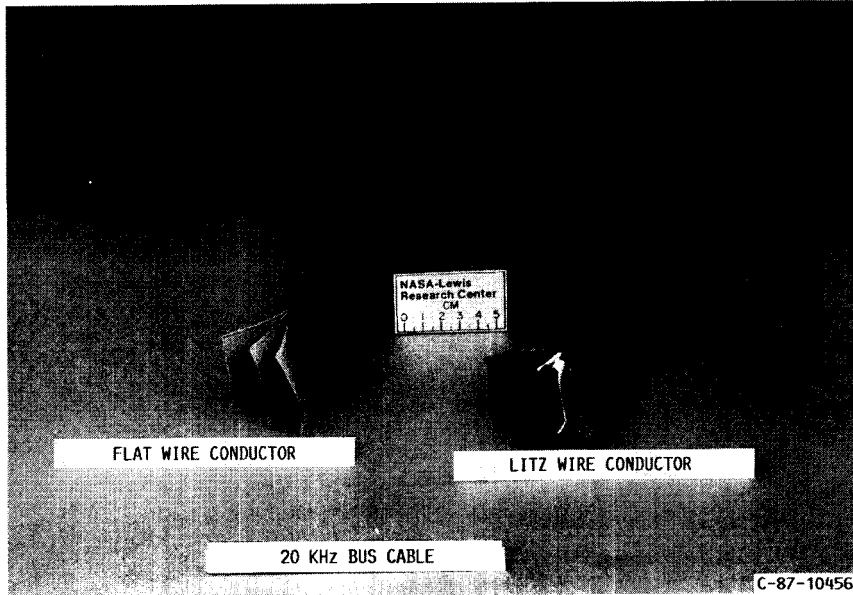

FIGURE 6. - TWO 20 KHZ CABLE CONFIGURATIONS.

ORIGINAL PAGE IS  
OF POOR QUALITY

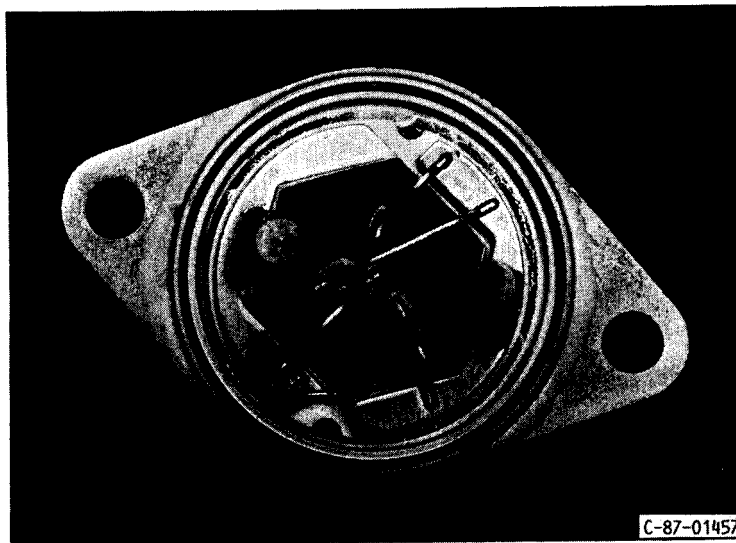

FIGURE 7. - HERMETIC, HIGH POWER SEMI-CONDUCTOR PACKAGE.

ORIGINAL PAGE IS  
OF POOR QUALITY

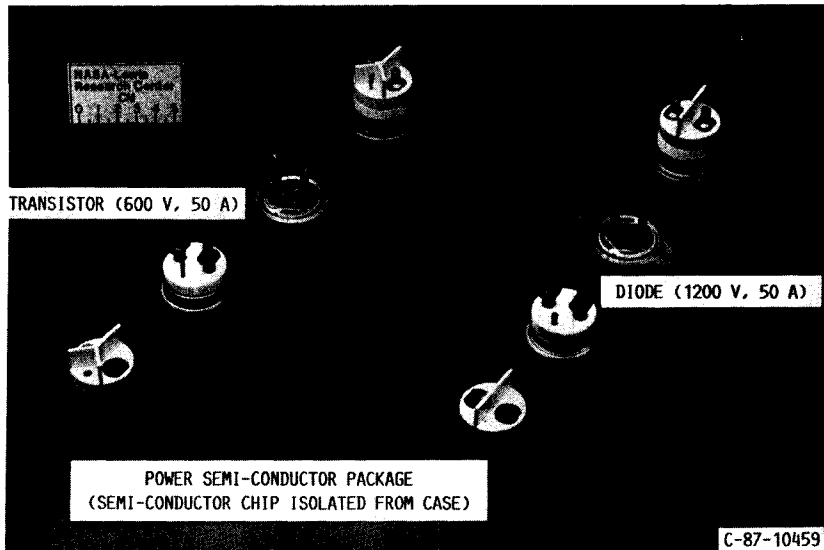

FIGURE 8. - POWER SEMI-CONDUCTOR PACKAGE ASSEMBLIES.

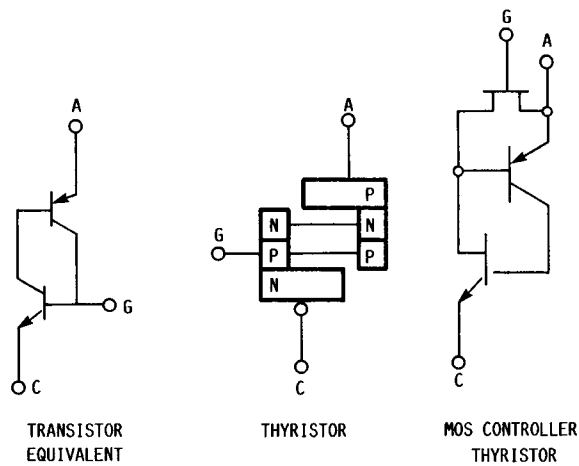

FIGURE 9. - REPRESENTATIVE SEMICONDUCTOR SCHEMATICS.



National Aeronautics and  
Space Administration

# Report Documentation Page

1. Report No. NASA TM-100781	2. Government Accession No.	3. Recipient's Catalog No.	
4. Title and Subtitle Status of 20 kHz Space Station Power Distribution Technology		5. Report Date January 1988	
		6. Performing Organization Code	
7. Author(s) Irving G. Hansen		8. Performing Organization Report No. E-3951	
		10. Work Unit No. 481-54-02	
9. Performing Organization Name and Address National Aeronautics and Space Administration Lewis Research Center Cleveland, Ohio 44135-3191		11. Contract or Grant No.	
		13. Type of Report and Period Covered Technical Memorandum	
12. Sponsoring Agency Name and Address National Aeronautics and Space Administration Washington, D.C. 20546-0001		14. Sponsoring Agency Code	
		15. Supplementary Notes Prepared for the Applied Power Electronics Conference and Exposition - APEC '88, sponsored by the Institute of Electrical and Electronics Engineers, New Orleans, Louisiana, February 1-5, 1988.	
16. Abstract Power Distribution on the NASA Space Station will be accomplished by a 20 kHz sinusoidal, 440 VRMS, single phase system. In order to minimize both system complexity and the total power conversion steps required, high frequency power will be distributed end-to-end in the system. To support the final design of flight power system hardware, advanced development and demonstrations have been made on key system technologies and components. This paper will discuss the current status of this effort.			
17. Key Words (Suggested by Author(s)) Aerospace power systems		18. Distribution Statement Unclassified - Unlimited Subject Category 20	
19. Security Classif. (of this report) Unclassified	20. Security Classif. (of this page) Unclassified	21. No of pages 10	22. Price* A02