

N88-17619

Investigation of the Influence of Wind Shear on the Aerodynamic Characteristics of Aircraft Using a Vortex-Lattice Method

October 22, 1987

Dan D. Vicroy

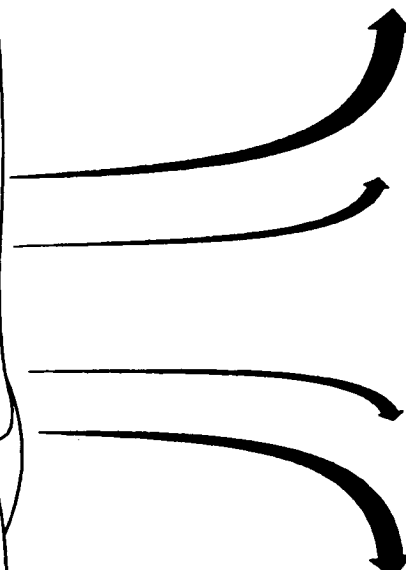

PRECEDING PAGE BLANK NOT FILMED

Abstract

Wind shear is considered by many in the aviation community to be one of the major safety issues facing their industry. The Federal Aviation Administration has addressed this problem through an Integrated Wind Shear Program Plan which incorporates the expertise of industry, universities, and various government agencies such as the National Aeronautics and Space Administration, the National Oceanic and Atmospheric Administration and the Department of Defense. The plan is aimed at reducing the hazard of low-level wind shear through improved training and operating procedures, wind shear detection systems and flight guidance systems.

The flight simulator is an important tool used to address the airborne aspects of the wind shear program. The fidelity of the analytical models which represent the airplane and the atmosphere within the flight simulators is therefore of critical importance. The bulk of the simulation and analytical studies conducted to date have concentrated on determining the effect of the changing free-stream velocity vector on the airplane performance, and on developing higher fidelity wind shear models. Very little work has been done to determine the effect of the spatial variation of the wind field about the airplane on the airplane's aerodynamic characteristics. It is important that these aerodynamic effects are characterized and presented in a form which can be incorporated into research and training simulators. The research presented in this paper is a preliminary effort to address this need.

The objective of this study was to investigate and characterize the aerodynamic effect of shear flow through a series of sensitivity studies of the wind velocity gradients and wing planform geometry parameters. The wind shear effect was computed using a modified vortex-lattice computer program and characterized through the formulation of wind shear aerodynamic coefficients. The magnitude of the aerodynamic effect was demonstrated by computing the resultant change in the aerodynamics of a conventional wing and tail combination on a fixed flight path through

a simulated microburst.

The results of this study indicate that a significant amount of the control authority of the airplane may be required to counteract the wind shear induced forces and moments in the microburst environment. It is important to note that the forces and moments presented in this report are only due to the spatial variation of the wind field, and are not currently accounted for in today's research and training simulators.

Outline

- Introduction
- Modification of Vortex-Lattice Algorithm
 - Spatially Varying Wind Field
 - Boundary Condition
 - Force and Moment Equations
- Program Checkout and Validation
- Shear Coefficient Development
- Sensitivity Studies
 - Vortex-Lattice Distribution
 - Planform Geometry
 - Wing and Stabilizer Combination
- Concluding Remarks

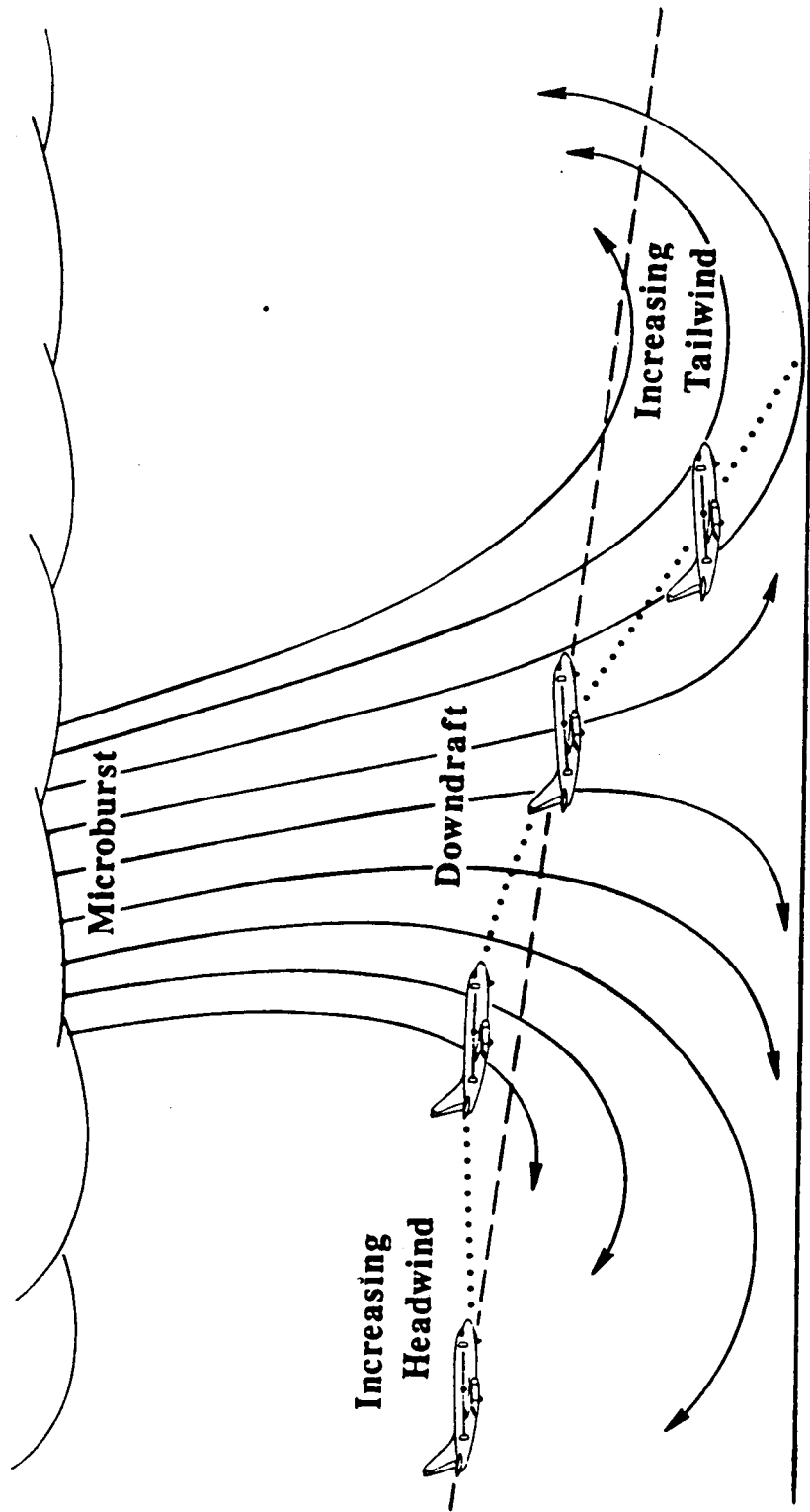

Research Objective

Investigate and characterize the aerodynamic effect of shear flow through a series of sensitivity studies of the spatial wind velocity gradients and wing planform geometry parameters

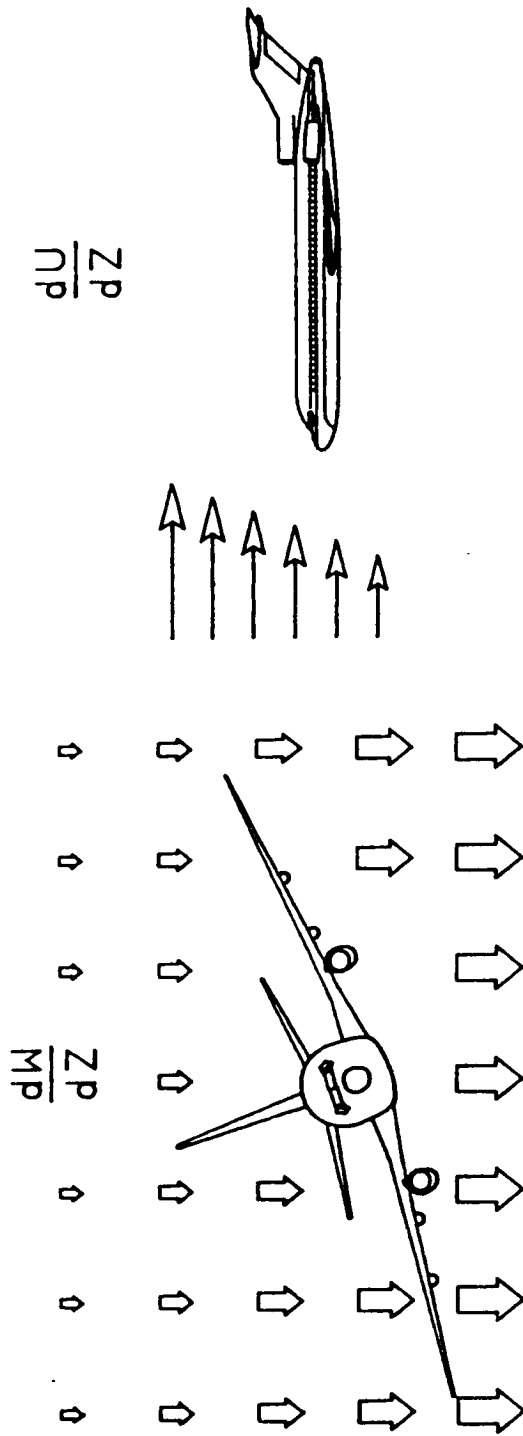

Outline

- Introduction
- Modification of Vortex-Lattice Algorithm
 - Spatially Varying Wind Field
 - Boundary Condition
 - Force and Moment Equations
- Program Checkout and Validation
- Shear Coefficient Development
- Sensitivity Studies
 - Vortex-Lattice Distribution
 - Planform Geometry
 - Wing and Stabilizer Combination
- Concluding Remarks

Defining Wind Field

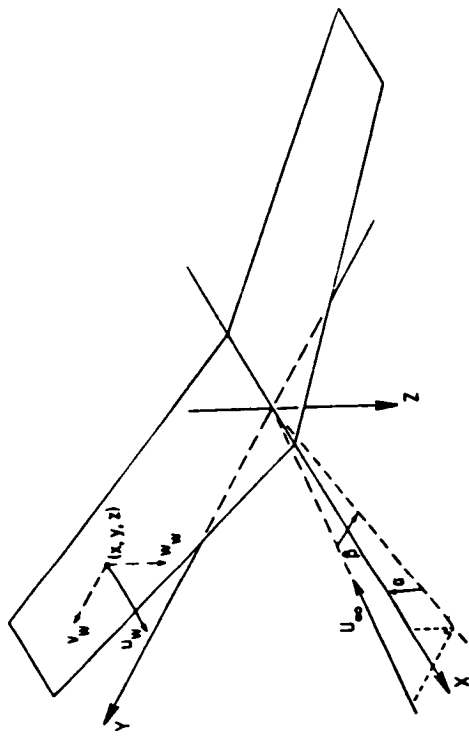

Uniform Flow

$$\begin{pmatrix} u_w \\ v_w \\ w_w \end{pmatrix} = -U_\infty \begin{pmatrix} \cos \alpha \cos \beta \\ \sin \beta \\ \sin \alpha \cos \beta \end{pmatrix}$$

Nonuniform Flow

$$\begin{pmatrix} u_w \\ v_w \\ w_w \end{pmatrix} = \begin{pmatrix} u_s \\ v_s \\ w_s \end{pmatrix} - U_\infty \begin{pmatrix} \cos \alpha \cos \beta \\ \sin \beta \\ \sin \alpha \cos \beta \end{pmatrix}$$

where:

$$\begin{pmatrix} u_s \\ v_s \\ w_s \end{pmatrix} \equiv \begin{pmatrix} \frac{\partial u_s}{\partial x} & \frac{\partial u_s}{\partial y} & \frac{\partial u_s}{\partial z} \\ \frac{\partial v_s}{\partial x} & \frac{\partial v_s}{\partial y} & \frac{\partial v_s}{\partial z} \\ \frac{\partial w_s}{\partial x} & \frac{\partial w_s}{\partial y} & \frac{\partial w_s}{\partial z} \end{pmatrix} \begin{pmatrix} x \\ y \\ z \end{pmatrix}$$

Boundary Condition

Boundary Condition:

No flow through the panel

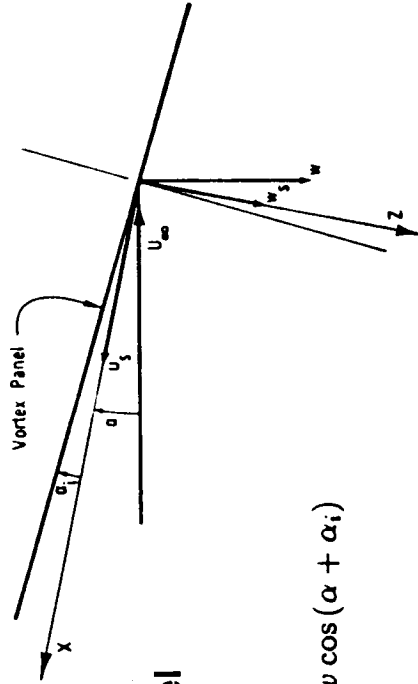

$$U_{\infty} \sin(\alpha + \alpha_i) - u_s \sin \alpha_i = w_s \cos \alpha_i + w \cos(\alpha + \alpha_i)$$

Force and Moment Equations

Lift of line vortex element per unit span

$$\tilde{l} = \rho V \Gamma$$

Spanwise bound vortex element

$$l_s = F_z \sin \alpha - F_x \cos \alpha$$

$$d_s = -F_z \cos \alpha - F_x \sin \alpha$$

where

$$F_z = \rho \Gamma 2s \cos \phi [U_\infty \sin \alpha - u \sin \alpha - w \cos \alpha - \omega_s - k(v + v_s) \tan \phi]$$

$$F_x = \rho \Gamma 2s \cos \phi [(U_\infty \cos \alpha - u \cos \alpha - v_s + w \sin \alpha) \tan \phi + k(v + v_s) \tan \psi]$$

and $k = +1$ (right side); -1 (left side)

Sideforce

$$F_z = \rho \Gamma 2s \cos \phi [-U_\infty \cos \alpha + u \cos \alpha - w \sin \alpha + u_s + (-U_\infty \sin \alpha + u \sin \alpha + w_s + w \cos \alpha) \tan \psi]$$

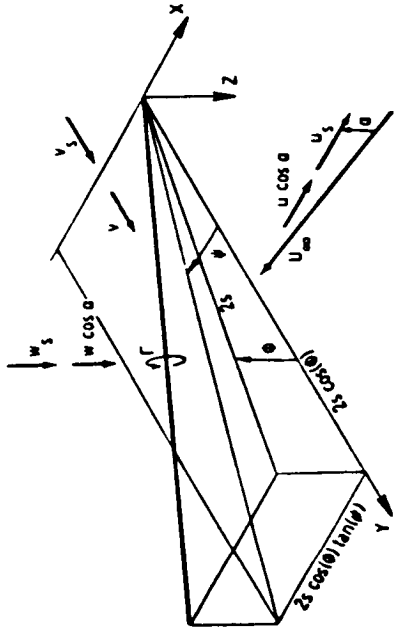

Outline

Introduction

Modification of Vortex-Lattice Algorithm

- Spatially Varying Wind Field

- Boundary Condition

- Force and Moment Equations

Program Checkout and Validation

Shear Coefficient Development

Sensitivity Studies

- Vortex-Lattice Distribution

- Planform Geometry

- Wing and Stabilizer Combination

Concluding Remarks

ORIGINAL PAGE IS
OF POOR QUALITY

Rotary Motion

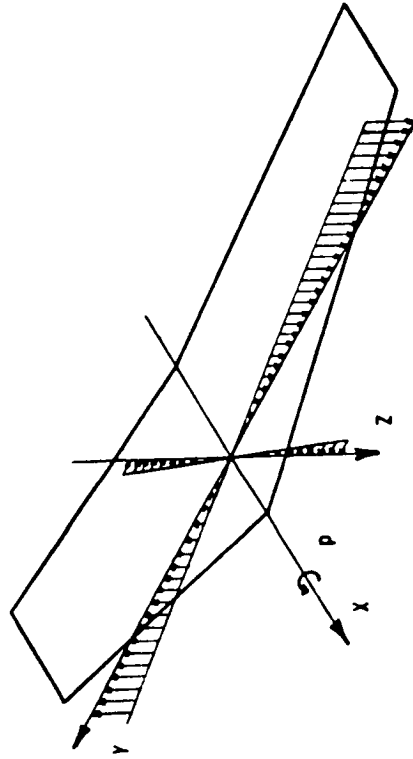

Rolling

$$p = \frac{1}{2} \left(\frac{\partial v_s}{\partial z} - \frac{\partial w_s}{\partial y} \right)$$

Pitching

$$q = \frac{1}{2} \left(\frac{\partial w_s}{\partial x} - \frac{\partial u_s}{\partial z} \right)$$

Yawing

$$r = \frac{1}{2} \left(\frac{\partial u_s}{\partial y} - \frac{\partial v_s}{\partial x} \right)$$

ORIGINAL PAGE IS
OF POOR QUALITY

ORIGINAL PAGE IS
OF POOR QUALITY

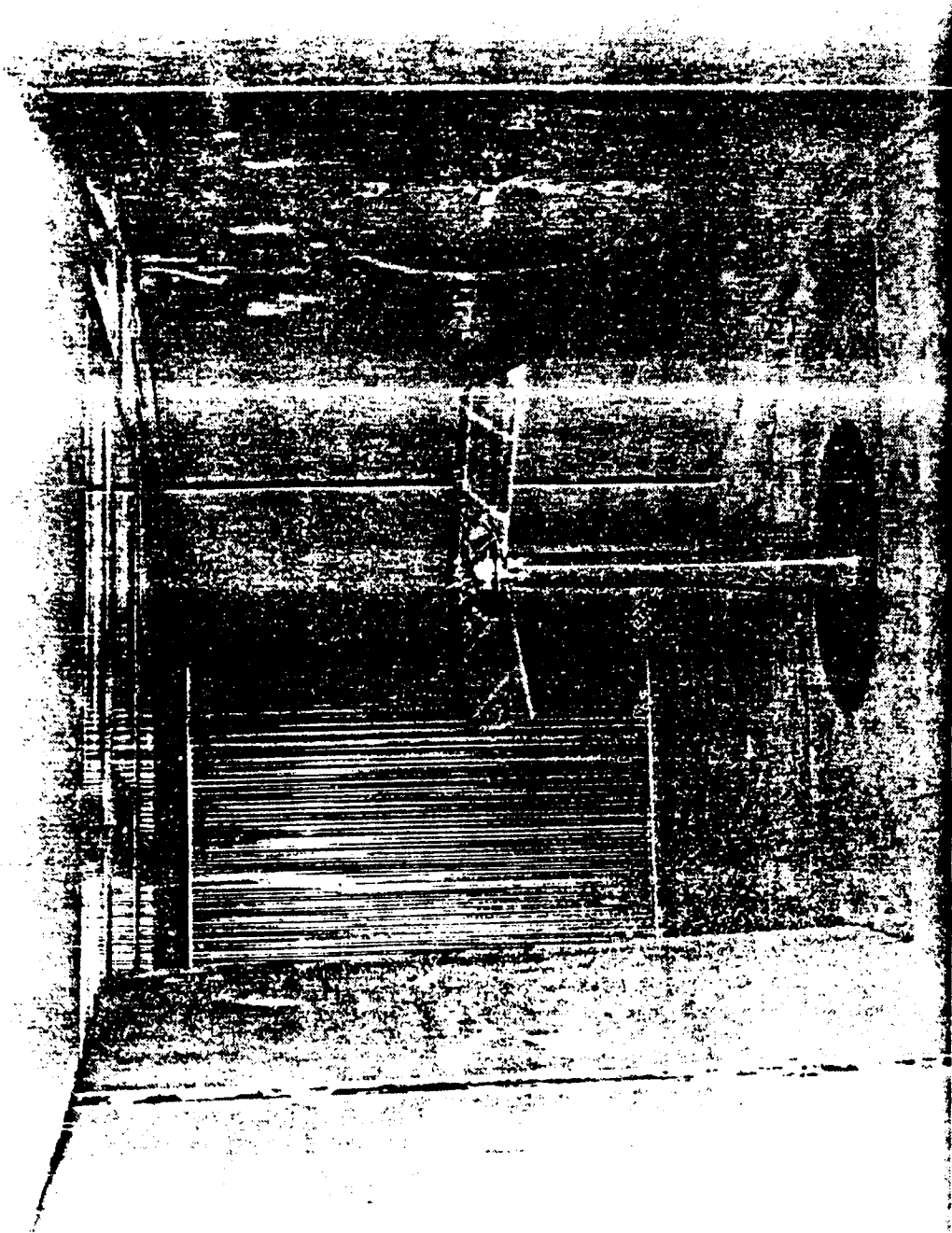

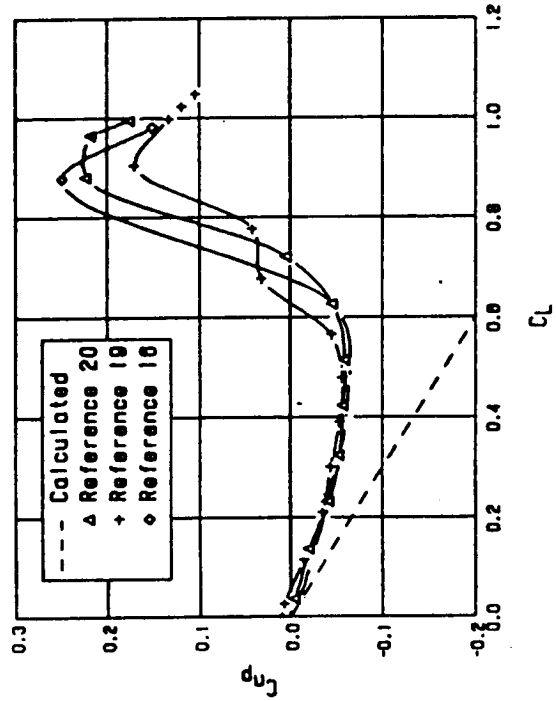
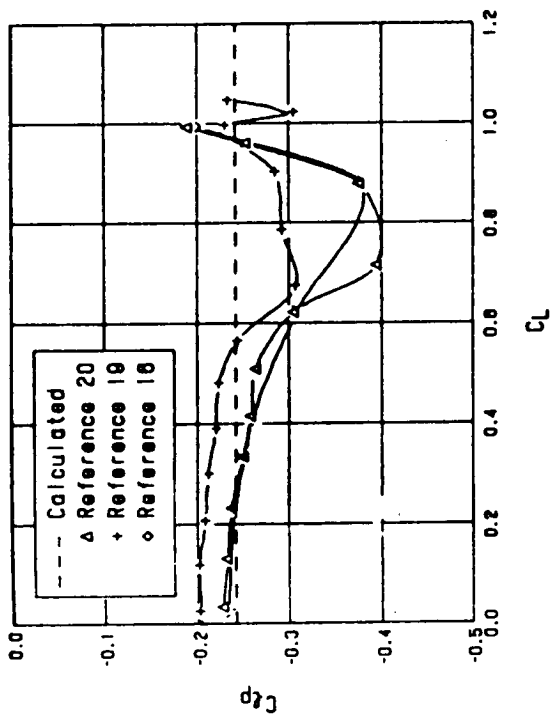
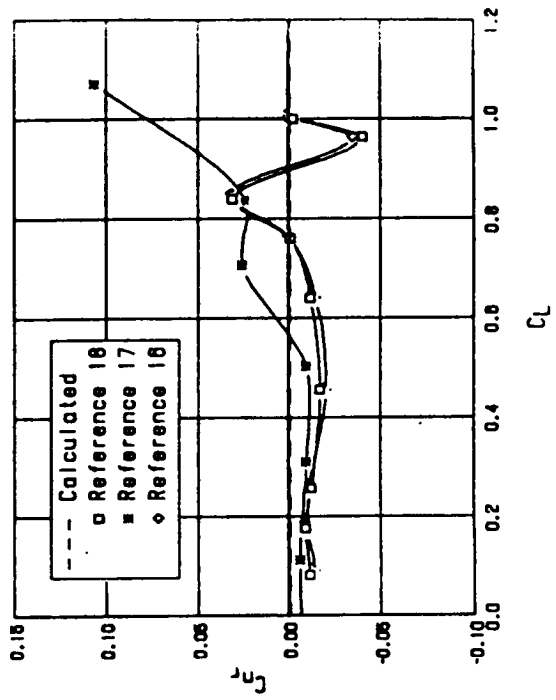
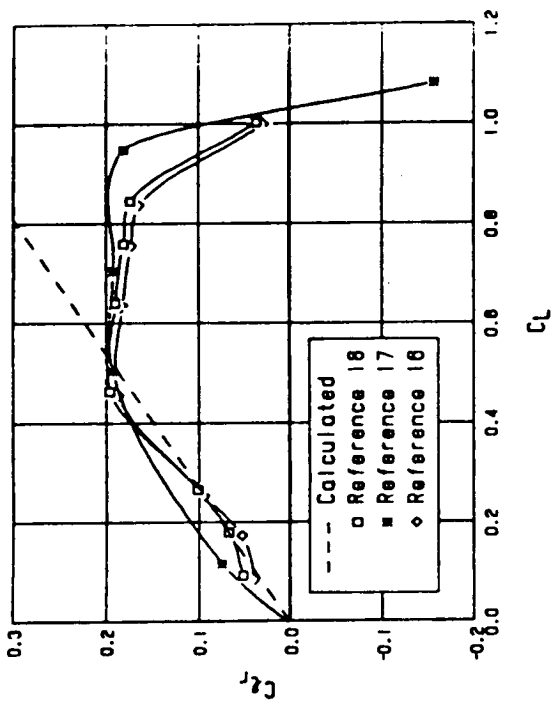

ORIGINAL PAGE IS
OF POOR QUALITY

Outline

- Introduction
- Modification of Vortex-Lattice Algorithm
 - Spatially Varying Wind Field
 - Boundary Condition
 - Force and Moment Equations
- Program Checkout and Validation
- Shear Coefficient Development
- Sensitivity Studies
 - Vortex-Lattice Distribution
 - Planform Geometry
 - Wing and Stabilizer Combination
- Concluding Remarks

ORIGINAL PAGE IS
OF POOR QUALITY

Shear Coefficient Development

Shear lift coefficient as defined by Campos:

$$C_{L_s} = \frac{\partial C_L}{\partial \left(\frac{S\bar{c}}{2U_\infty} \right)}$$

Total lift coefficient now becomes:

$$C_L = C_{L_o} \alpha + C_{L_s} \frac{S\bar{c}}{2U_\infty}$$

Change in force and moment coefficients due to shear

$$\begin{bmatrix} \Delta C_L (2U_\infty/\bar{c}) \\ \Delta C_D (2U_\infty/\bar{c}) \\ \Delta C_Y (2U_\infty/b) \\ \Delta C_l (2U_\infty/b) \\ \Delta C_m (2U_\infty/\bar{c}) \\ \Delta C_n (2U_\infty/b) \end{bmatrix} = [\alpha A + B] \begin{bmatrix} \partial u_s/\partial x \\ \partial u_s/\partial y \\ \partial u_s/\partial z \\ \partial v_s/\partial x \\ \partial v_s/\partial y \\ \partial v_s/\partial z \\ \partial w_s/\partial x \\ \partial w_s/\partial y \\ \partial w_s/\partial z \end{bmatrix}$$

ORIGINAL PAGE IS
OF POOR QUALITY.

$$A = \begin{pmatrix} C_{L_{ous}} & C_{L_{ouy}} & C_{L_{ouz}} & C_{L_{ous}} & \dots & C_{L_{ous}} \\ C_{D_{ous}} & C_{D_{ouy}} & C_{D_{ouz}} & \dots & \dots & \dots \\ C_{Y_{ous}} & C_{Y_{ouy}} & \dots & \dots & \dots & \dots \\ C_{l_{ous}} & \dots & \dots & \dots & \dots & \dots \\ C_{m_{ous}} & \dots & \dots & \dots & \dots & \dots \\ C_{n_{ous}} & \dots & \dots & \dots & \dots & \dots \end{pmatrix}$$

$$B = \begin{pmatrix} C_{L_{us}} & C_{L_{uy}} & C_{L_{uz}} & C_{L_{us}} & \dots & C_{L_{us}} \\ C_{D_{us}} & C_{D_{uy}} & C_{D_{uz}} & \dots & \dots & \dots \\ C_{Y_{us}} & C_{Y_{uy}} & \dots & \dots & \dots & \dots \\ C_{l_{us}} & \dots & \dots & \dots & \dots & \dots \\ C_{m_{us}} & \dots & \dots & \dots & \dots & \dots \\ C_{n_{us}} & \dots & \dots & \dots & \dots & C_{n_{us}} \end{pmatrix}$$

Outline

- Introduction
- Modification of Vortex-Lattice Algorithm
 - Spatially Varying Wind Field
 - Boundary Condition
 - Force and Moment Equations
- Program Checkout and Validation
- Shear Coefficient Development
- Sensitivity Studies
 - Vortex-Lattice Distribution
 - Planform Geometry
 - Wing and Stabilizer Combination
- Concluding Remarks

ORIGINAL PAGE IS
OF POOR QUALITY

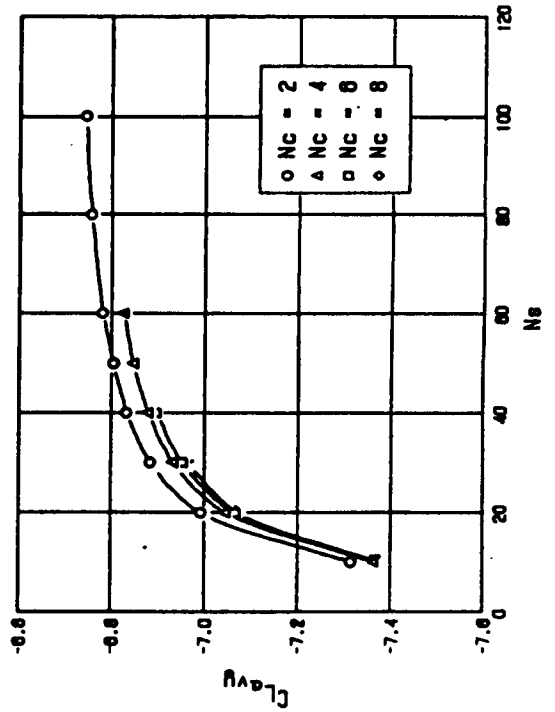
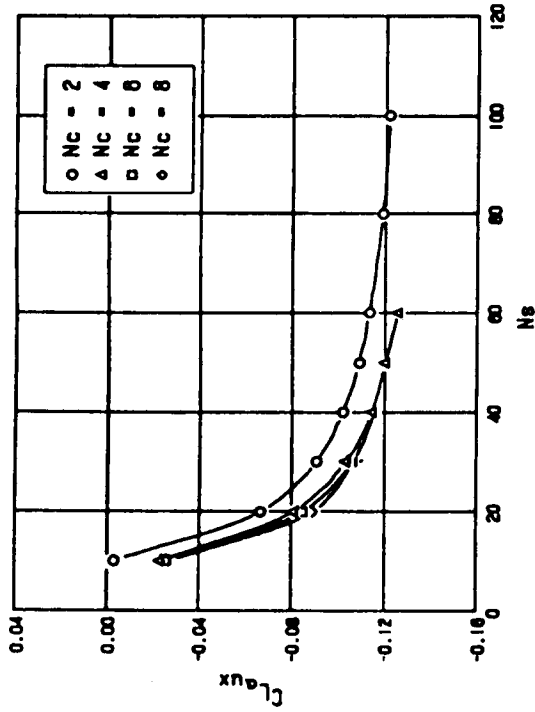
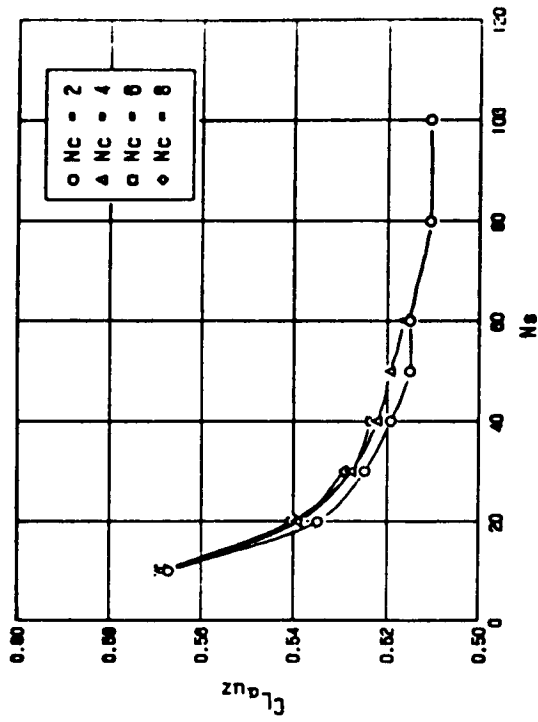







Sensitivity Study Results

Vortex-Lattice Distribution

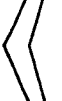
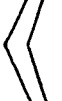
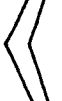
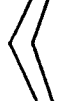
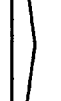
- ▶ Increasing N_s and N_c resulted in asymptotic convergence of shear coefficient values
- ▶ $N_s < 30$ and $N_c < 4$ resulted in significant variations in computed values
- ▶ $N_s = 40$ and $N_c = 4$ selected for remaining sensitivity studies

ORIGINAL PAGE IS
OF POOR QUALITY

Configuration	Aspect Ratio	Sweep (deg)	Taper Ratio	Dihedral (deg)
1 	2.61	45	1.0	0
2 	2.61	45	1.0	10
3 	4.0	25	0.6	10
4 	6.0	25	0.6	10
5 	8.0	25	0.6	10
6 	8.0	25	0.6	0
7 	8.0	25	0.6	5
8 	8.0	0	0.6	10
9 	8.0	45	0.6	10
10 	8.0	25	0.3	10
11 	8.0	25	1.0	10

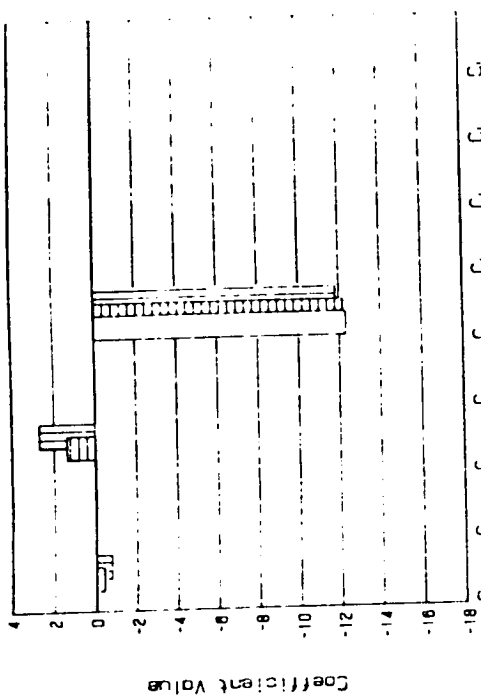

Dihedral = 0

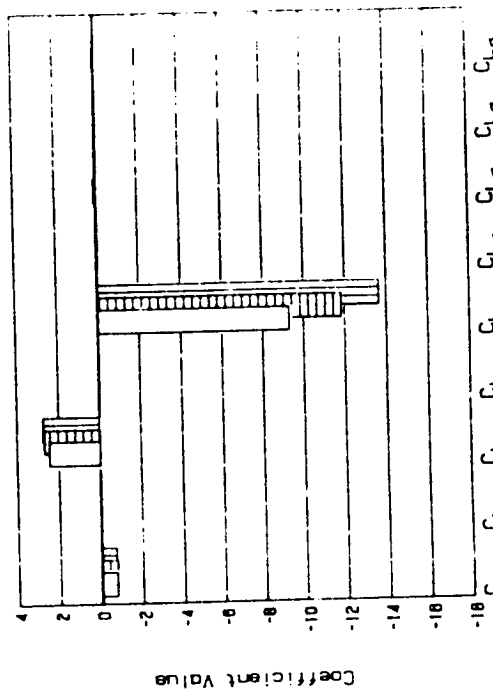

Taper = 1.0

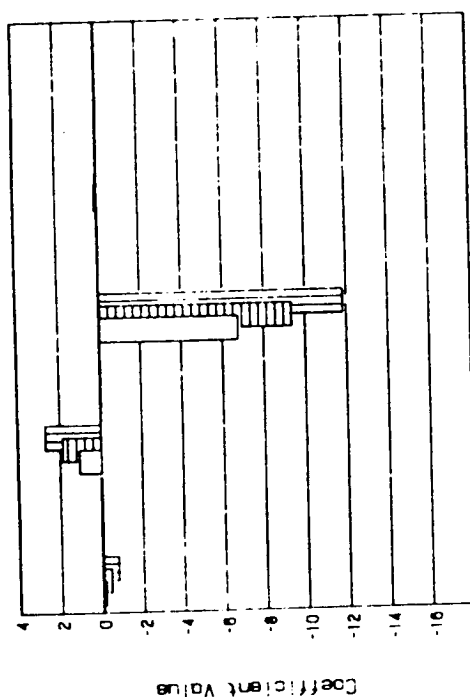

PR = 8

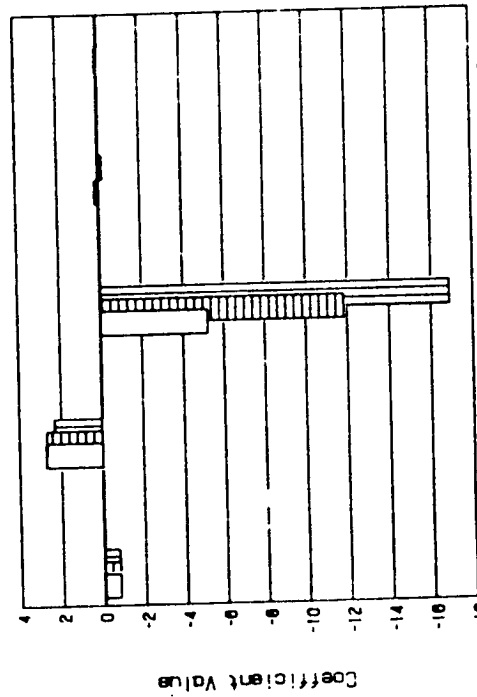

Sweep = 45

ORIGINAL PAGE IS
OF POOR QUALITY

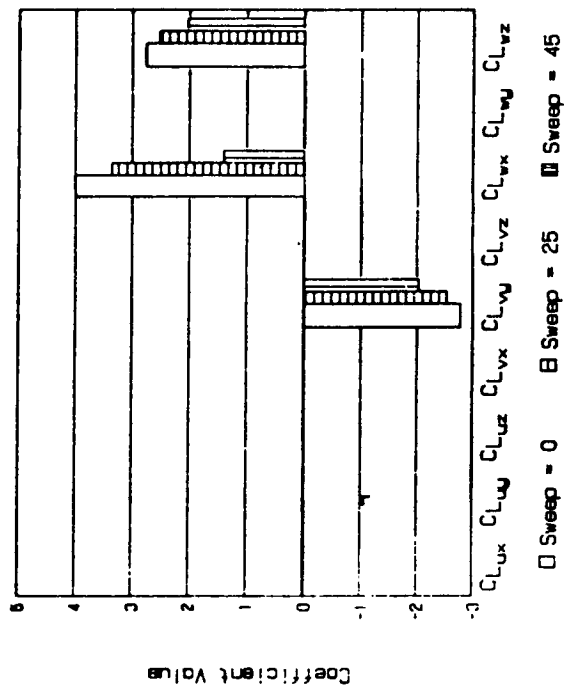
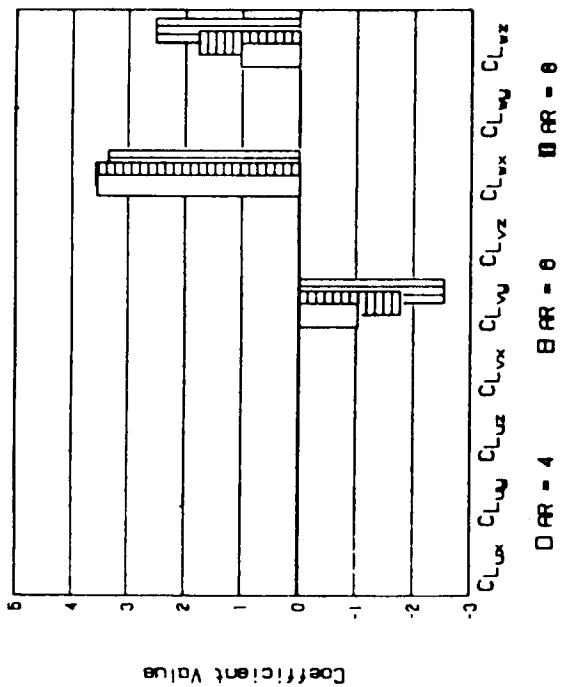
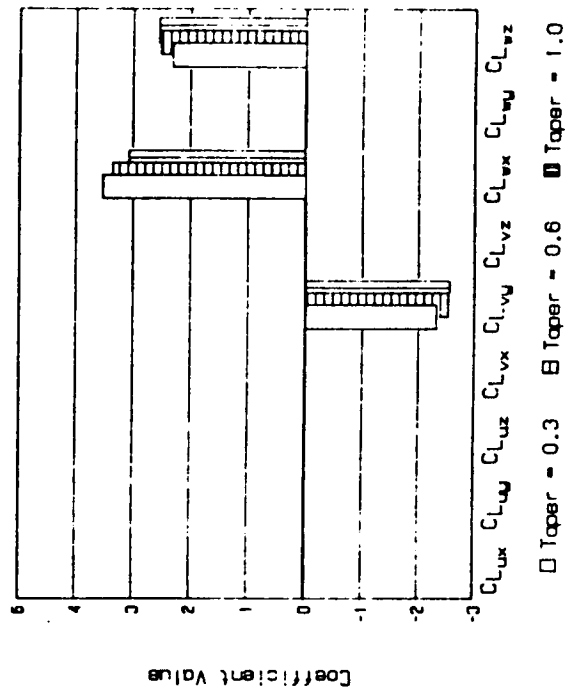
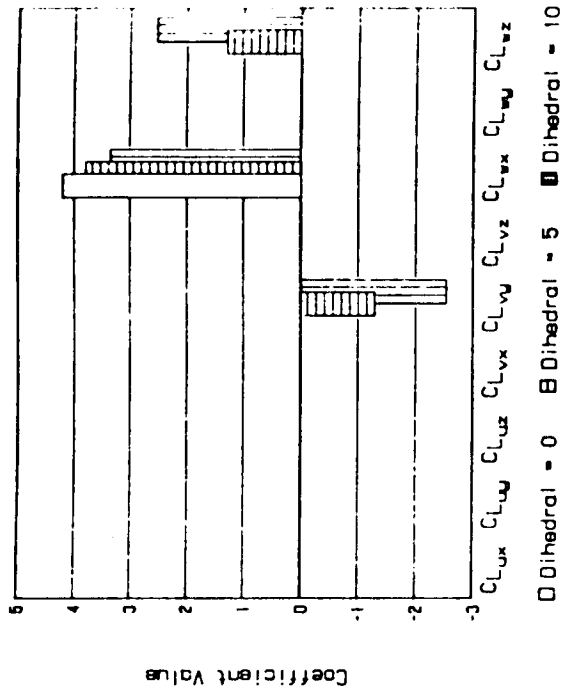

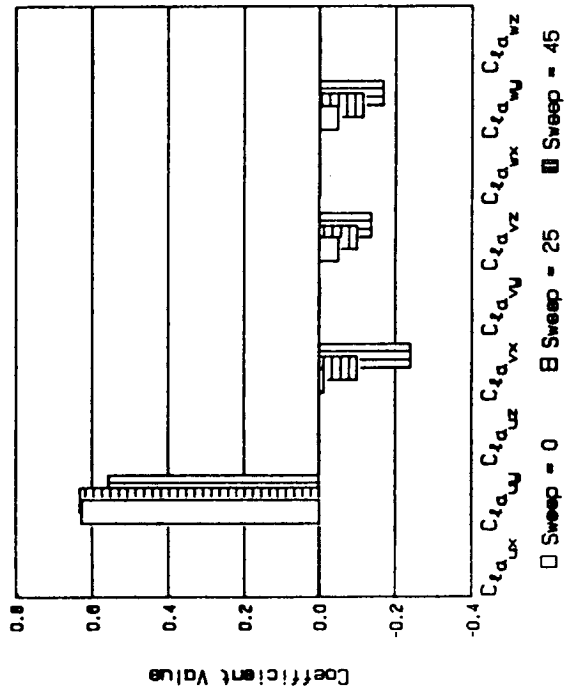
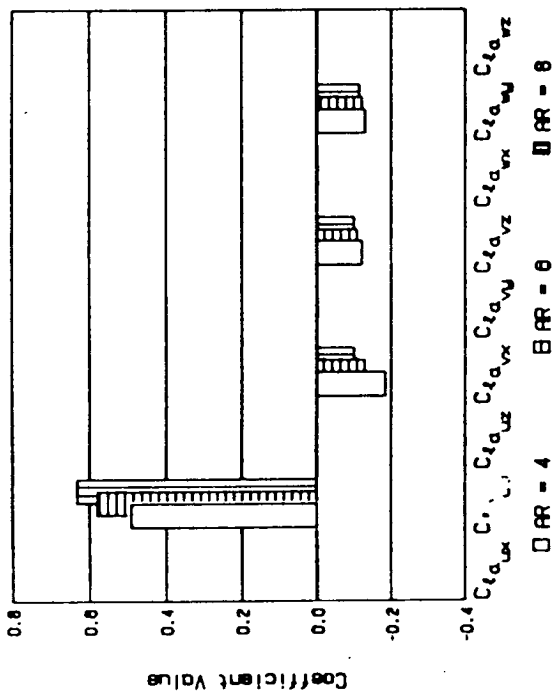
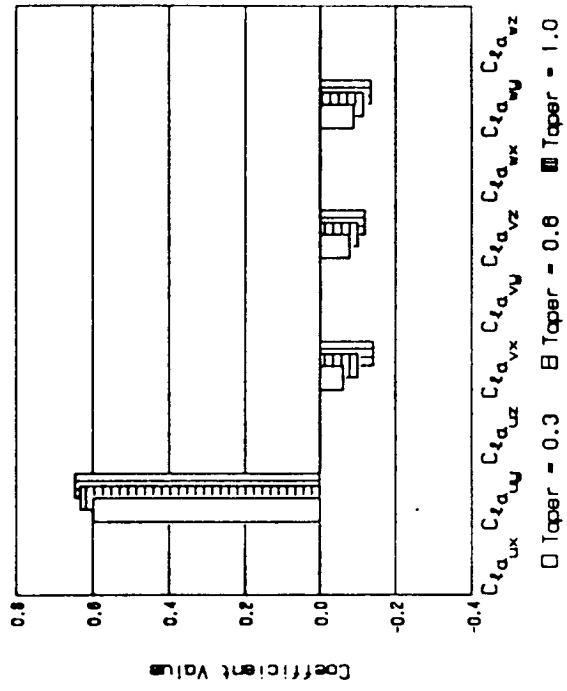
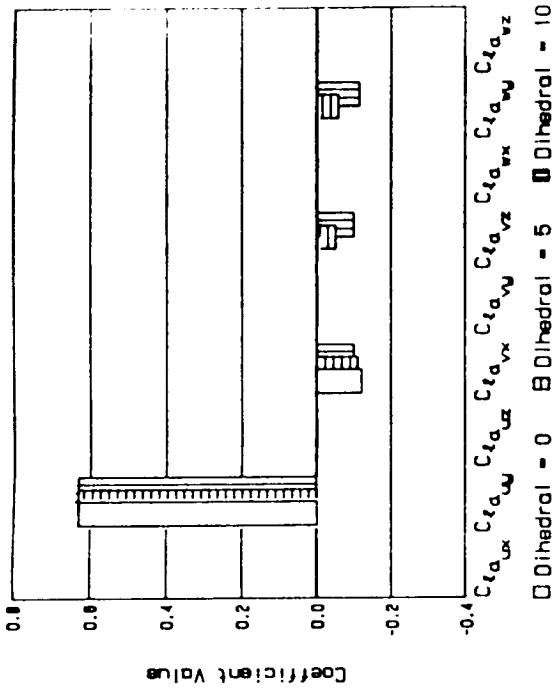

ORIGINAL PAGE IS
OF POOR QUALITY

ORIGINAL PAGE IS
OF POOR QUALITY

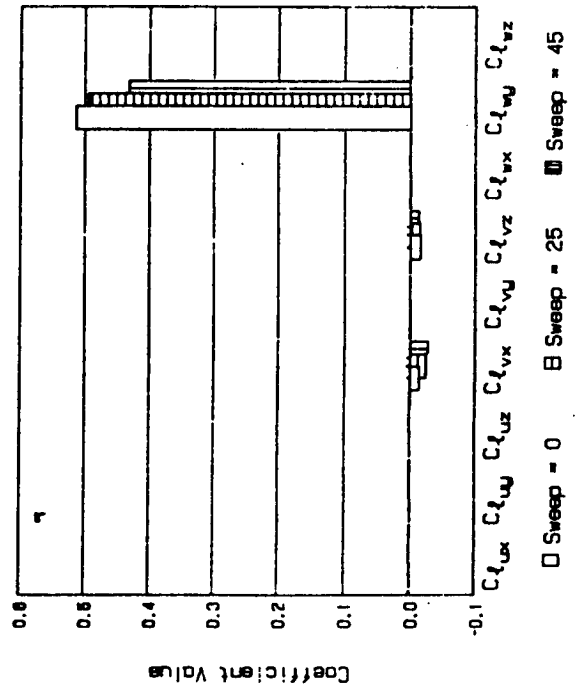
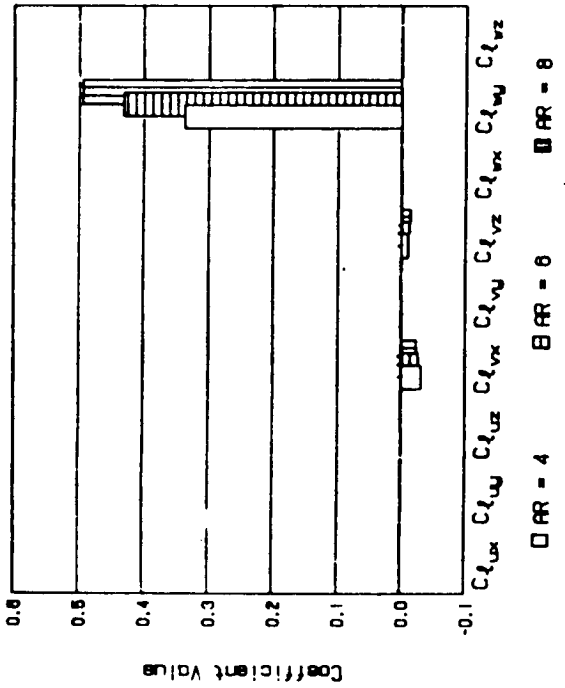
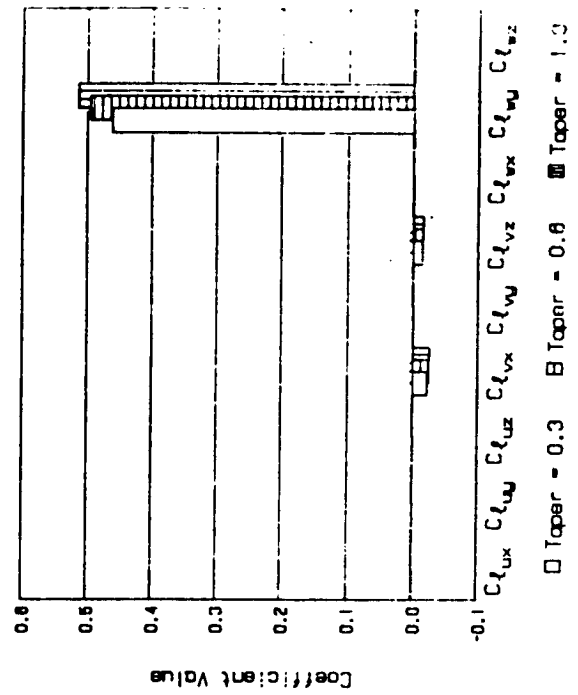
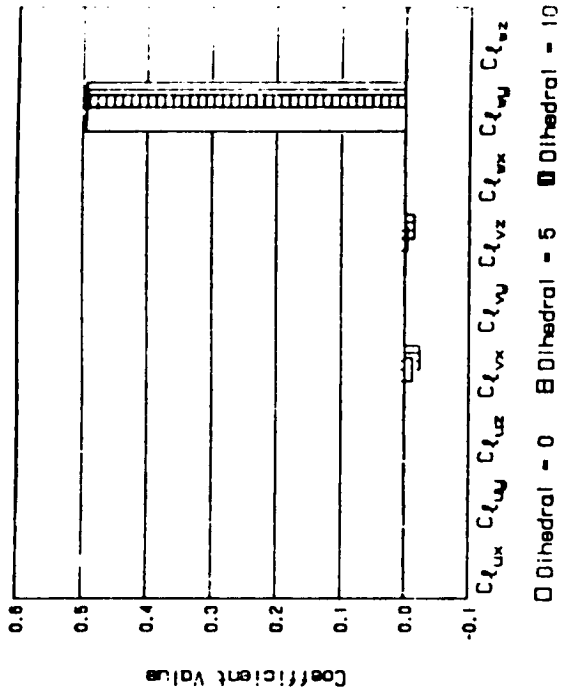

Sensitivity Study Results

Platform Geometry Effect

- ▶ Separation of gradient effects into longitudinal and lateral categories
- ▶ In general, sweep had the largest effect on the shear coefficients
- ▶ Taper ratio had the smallest effect

ORIGINAL PAGE IS
OF POOR QUALITY

LANGLEY RESEARCH CENTER



NAS 515

515

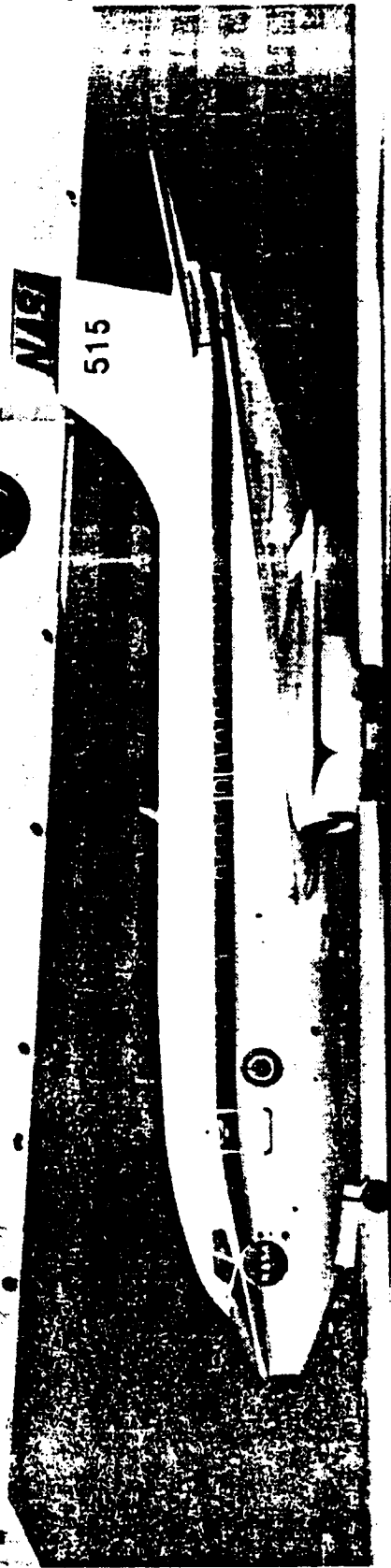

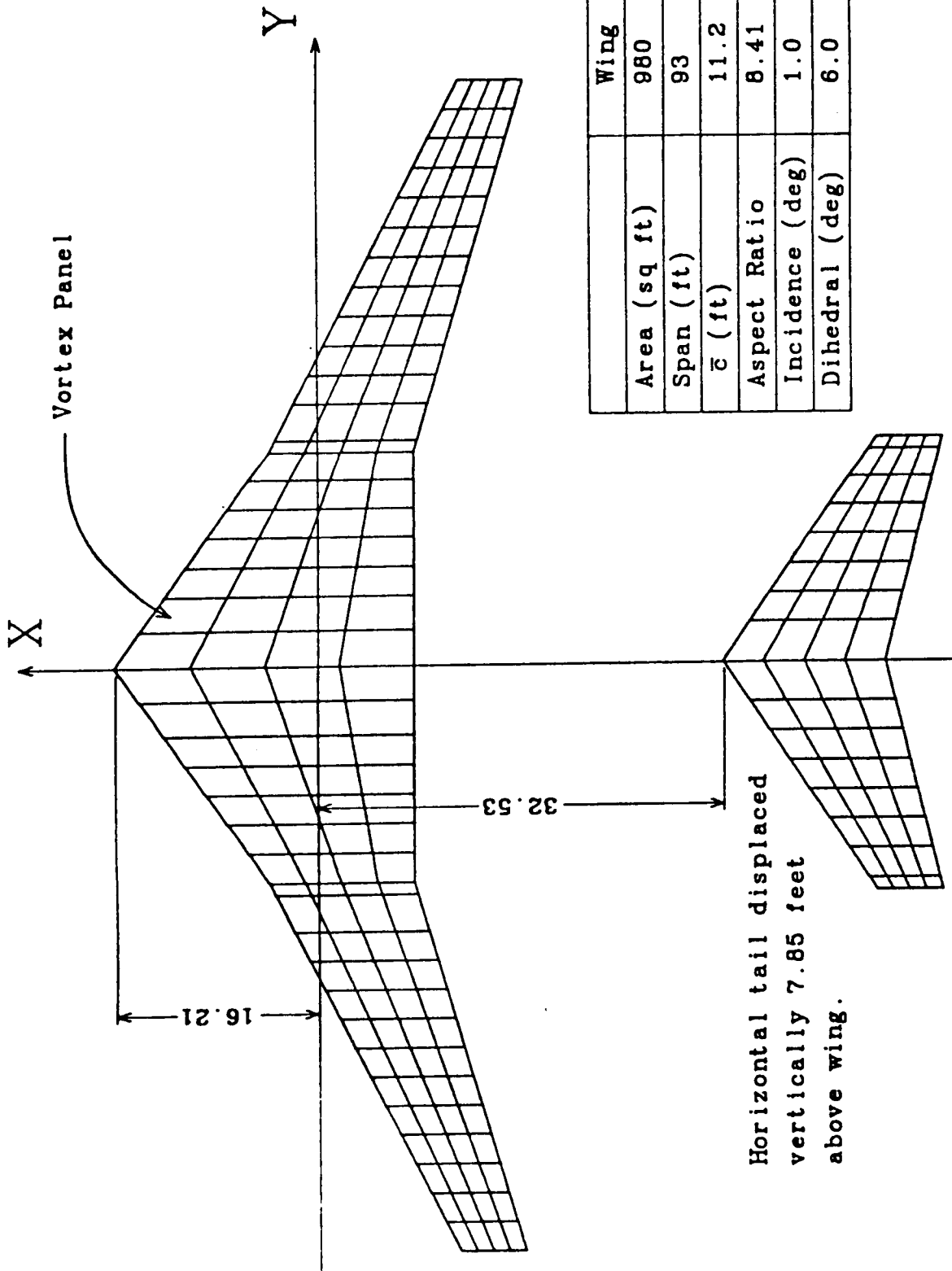

	Wing	Tail
Area (sq ft)	980	312
Span (ft)	93	36
\bar{c} (ft)	11.2	9.6
Aspect Ratio	8.41	4.0
Incidence (deg)	1.0	0
Dihedral (deg)	6.0	7.0

Horizontal tail displaced vertically 7.85 feet above wing.

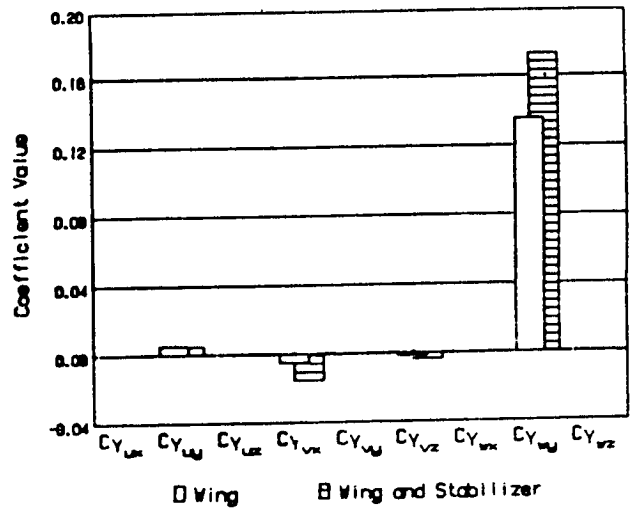
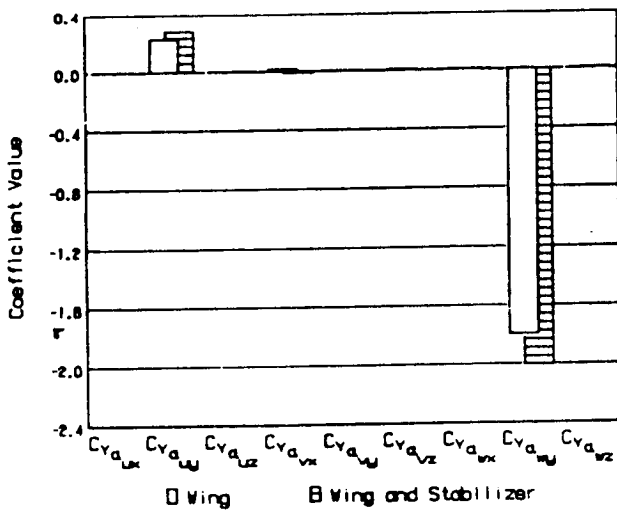
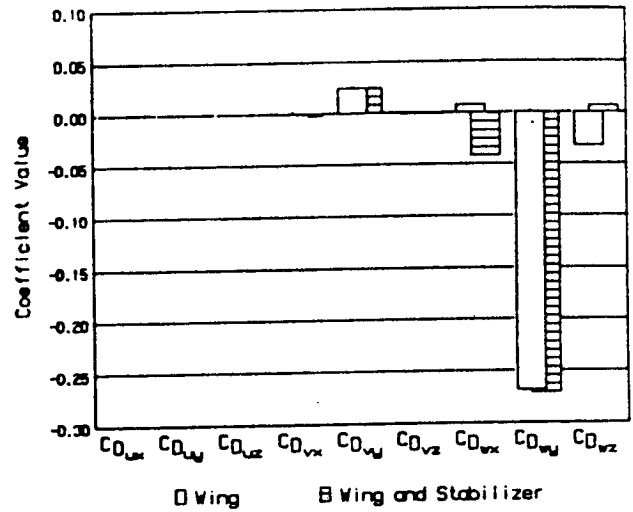
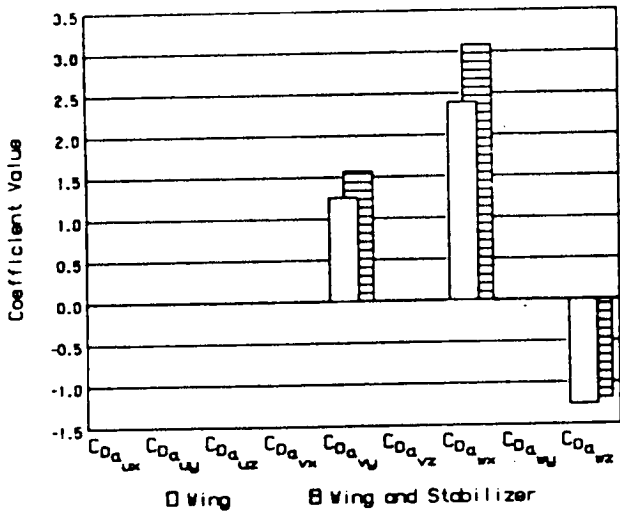
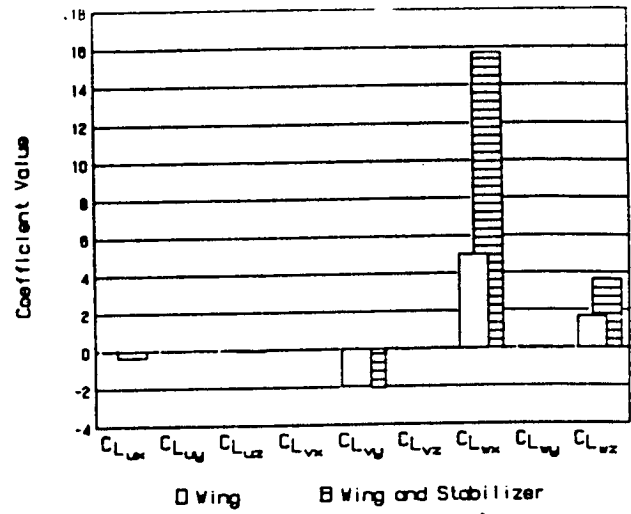
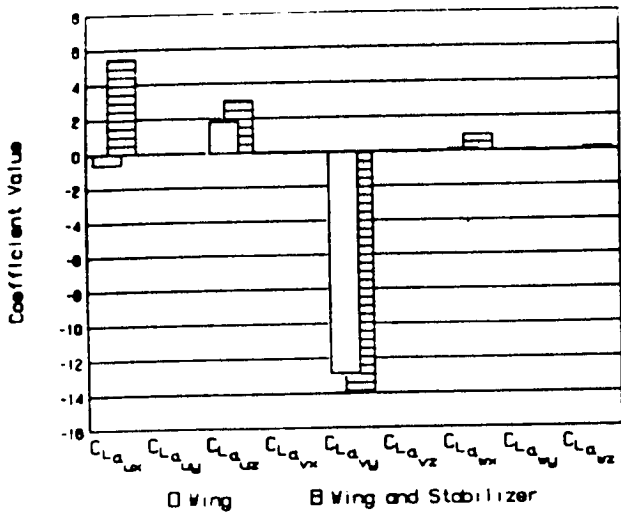

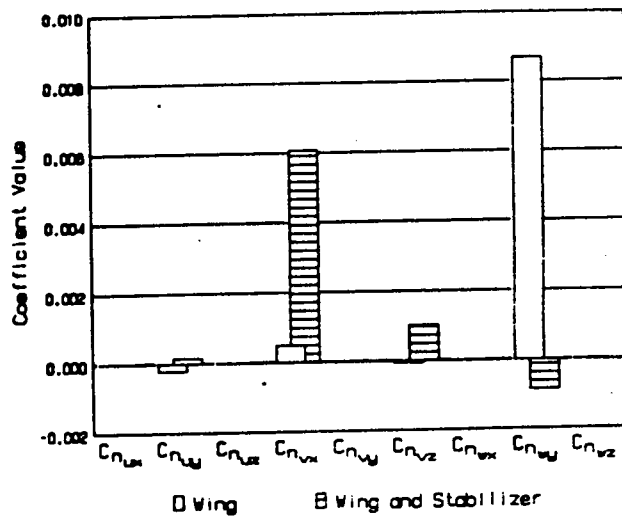
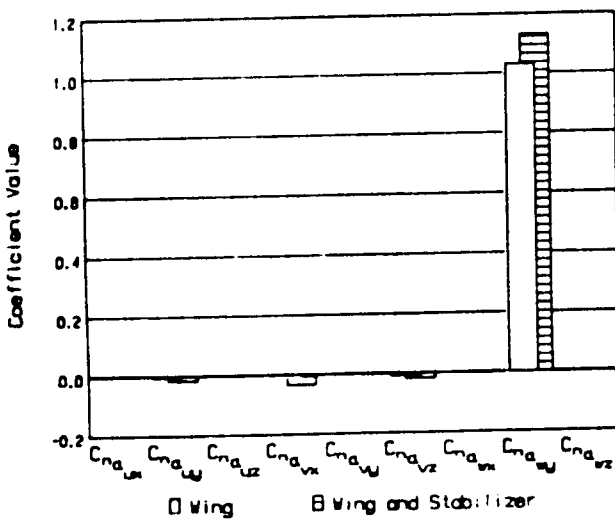
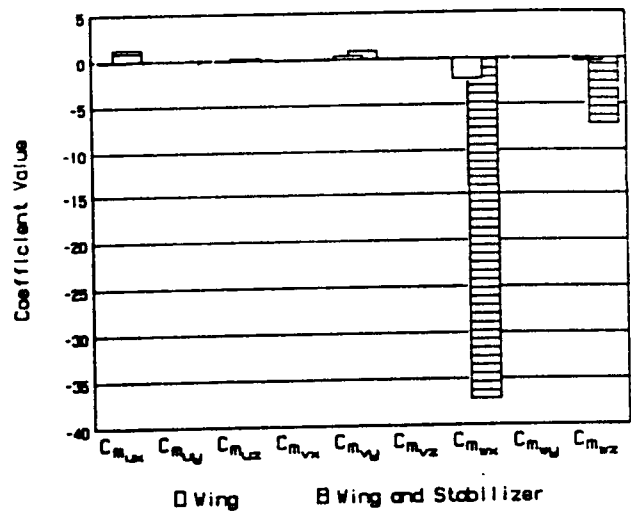
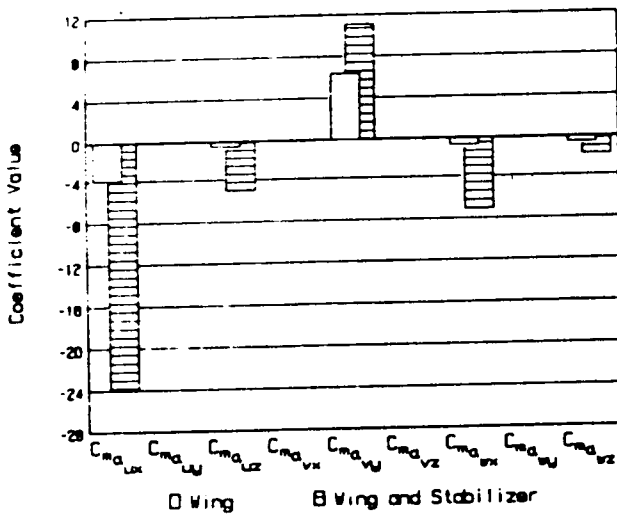
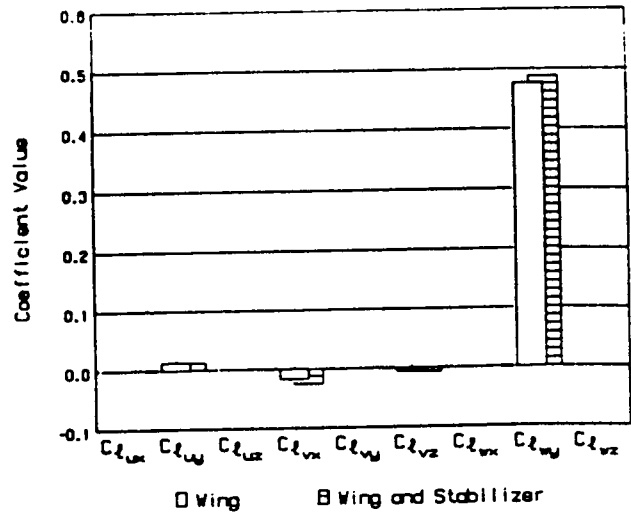
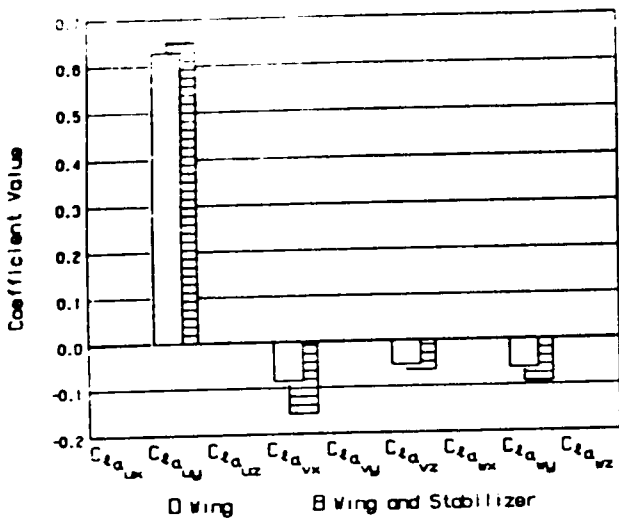

Sensitivity Study Results

Wing and Stabilizer

- ▶ **Addition of stabilizer increased the magnitude of the shear coefficient in nearly every case**
- ▶ **Primarily a longitudinal effect**
- ▶ **Horizontal and vertical displacement of stabilizer led to large increases in x and z shear coefficients**

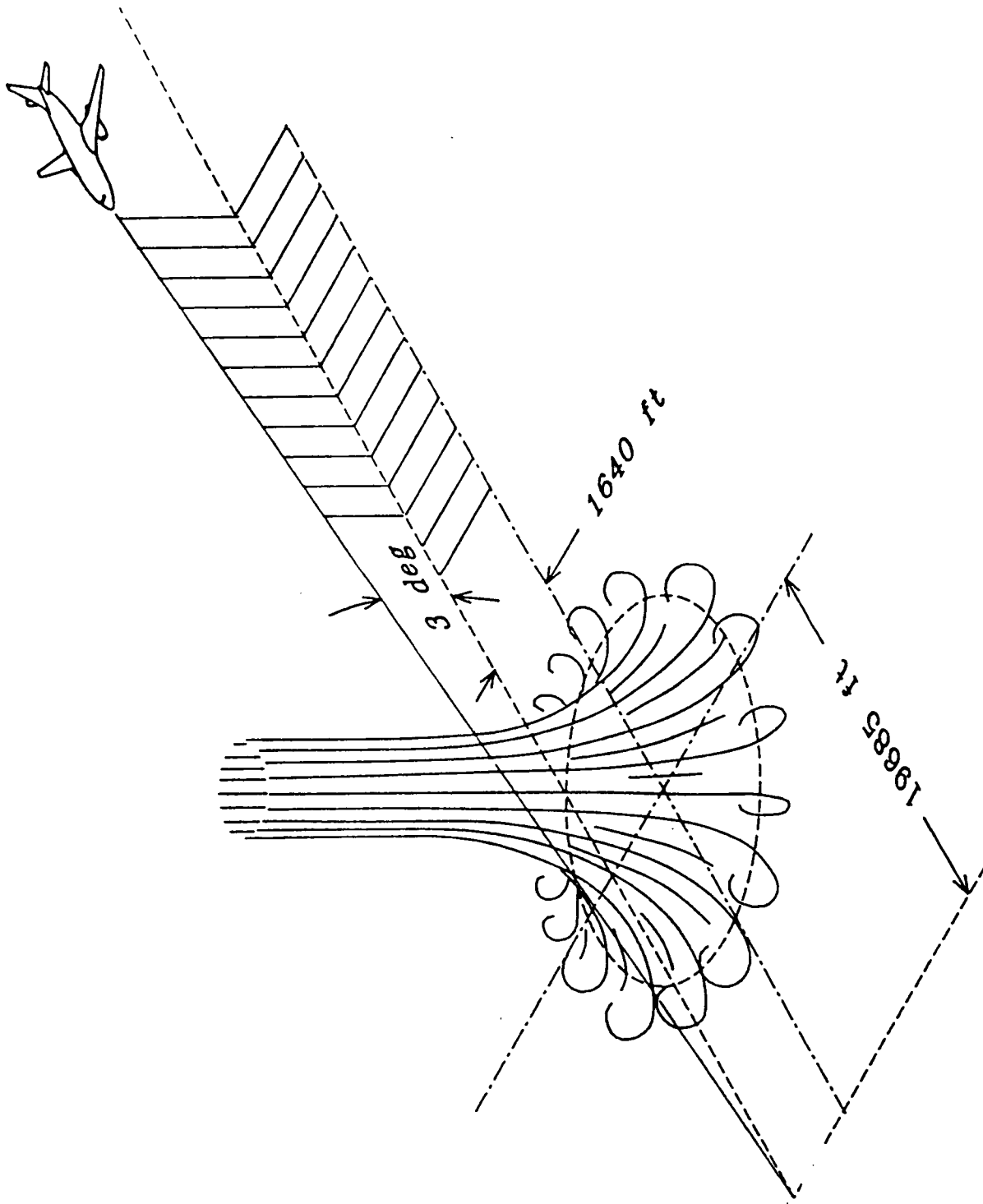

ORIGINAL PAGE IS
OF POOR QUALITY

ORIGINAL PAGE IS
OF POOR QUALITY

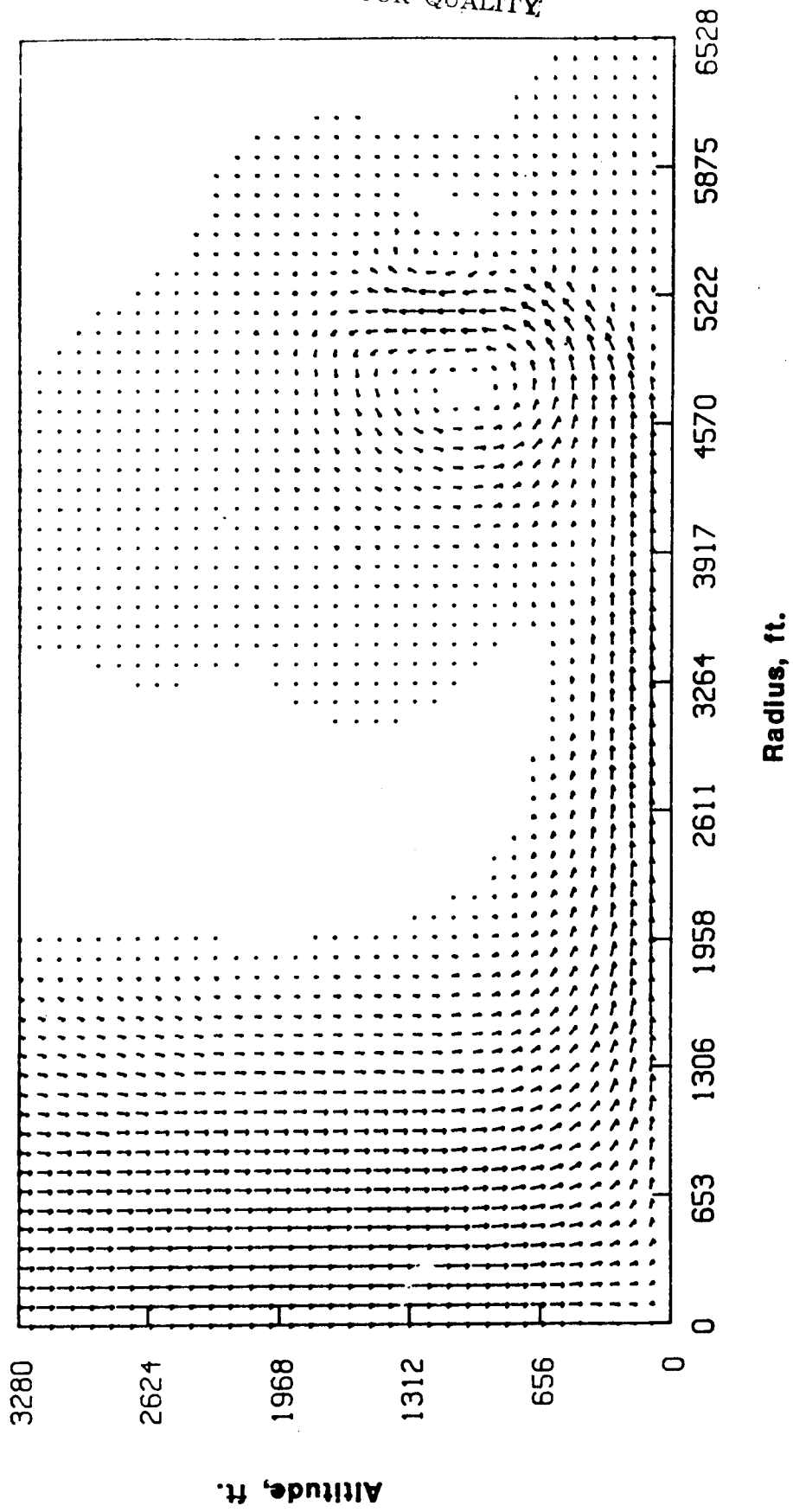

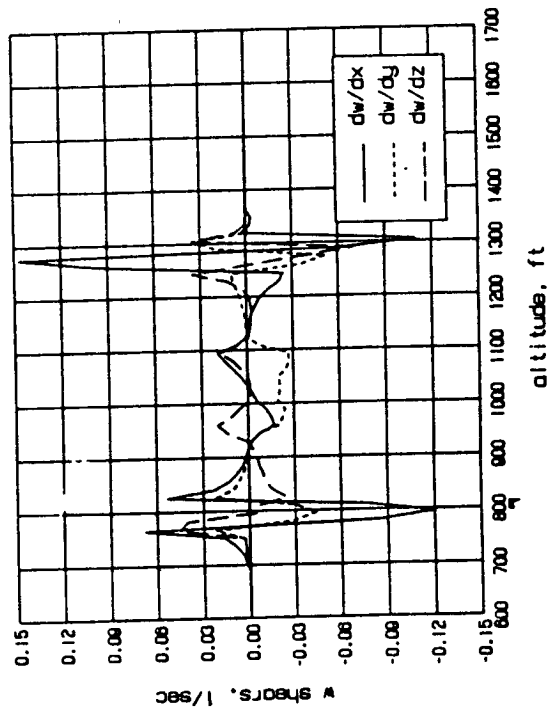
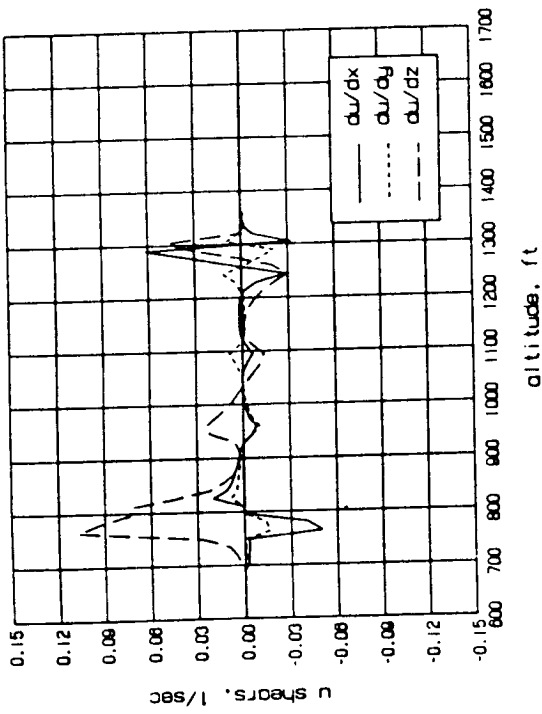
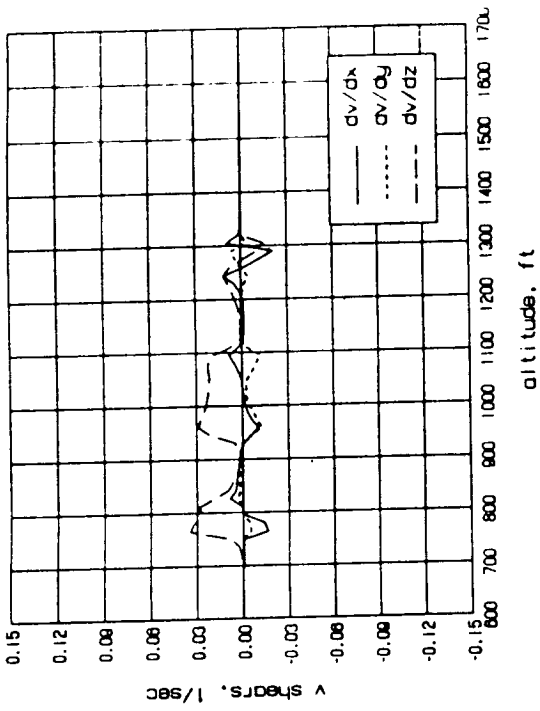

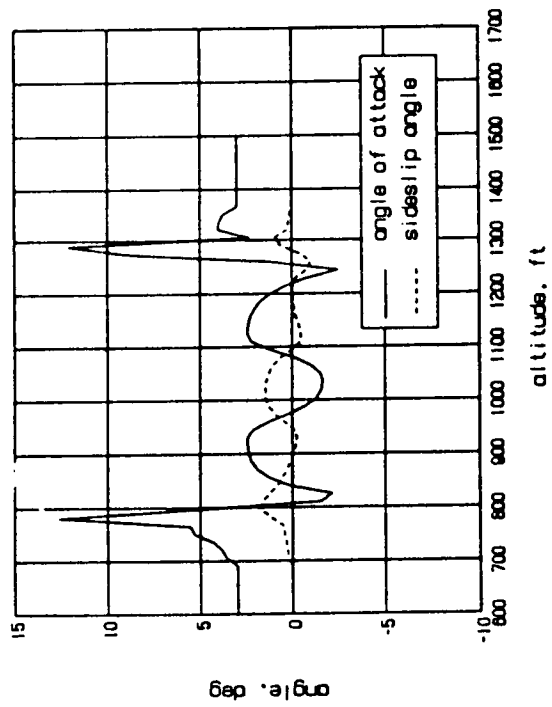
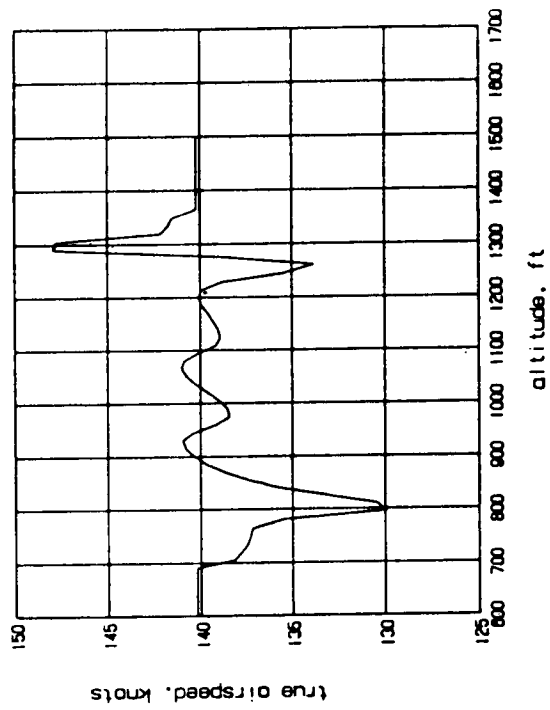

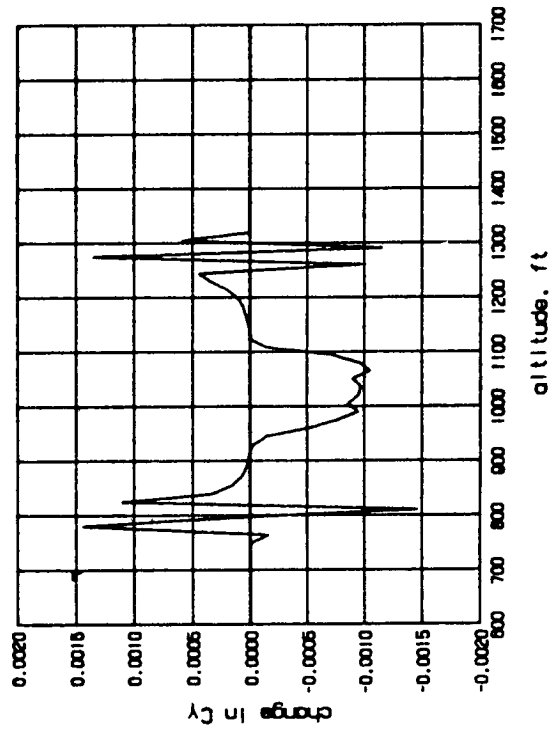
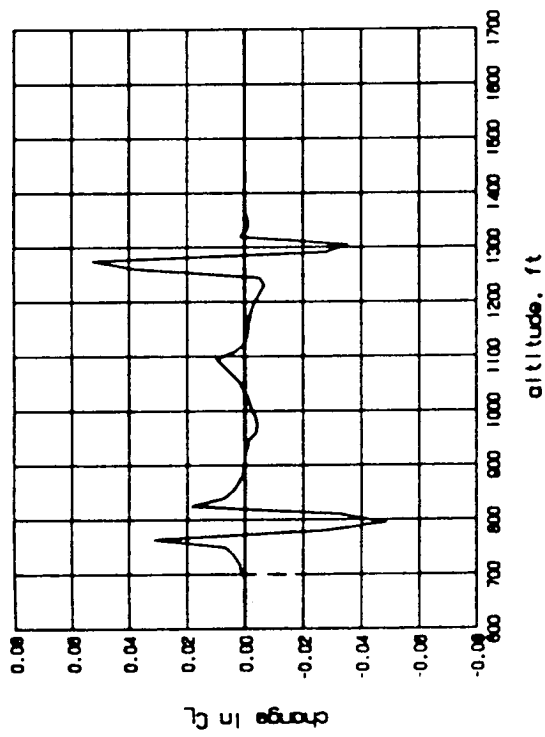
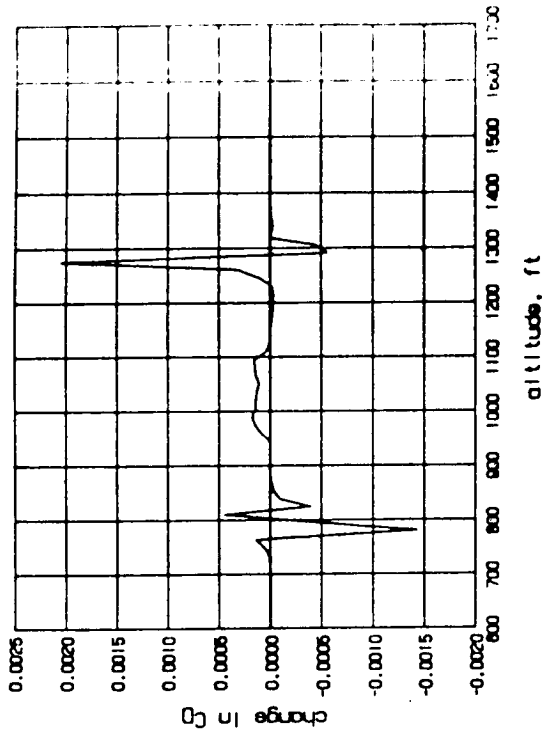

ORIGINAL PAGE IS
OF POOR QUALITY

ORIGINAL PAGE IS
OF POOR QUALITY

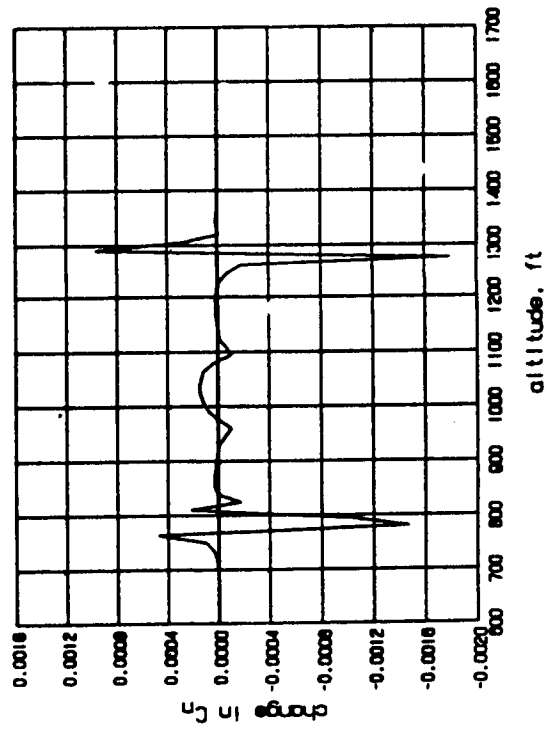
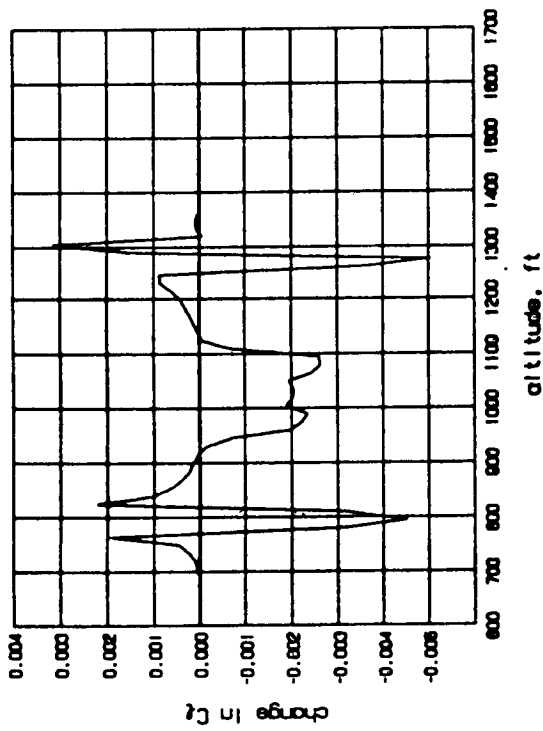
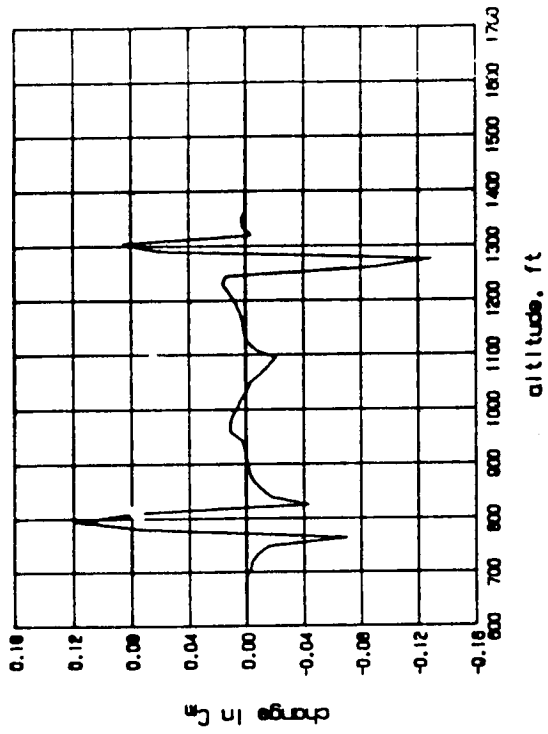

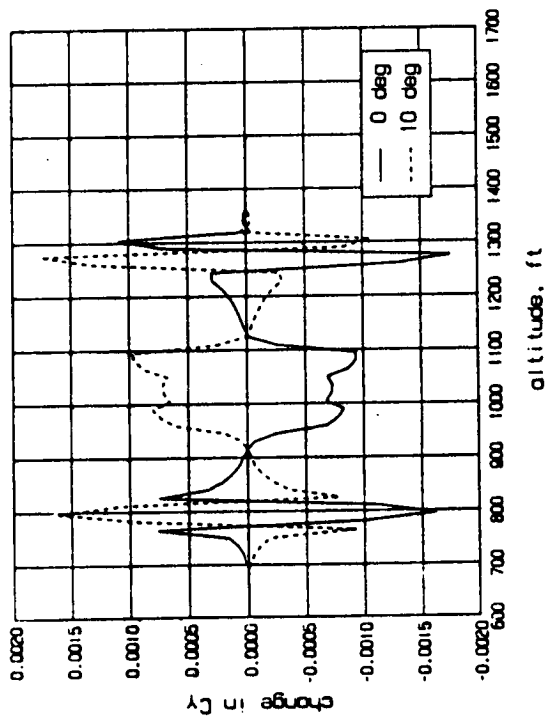
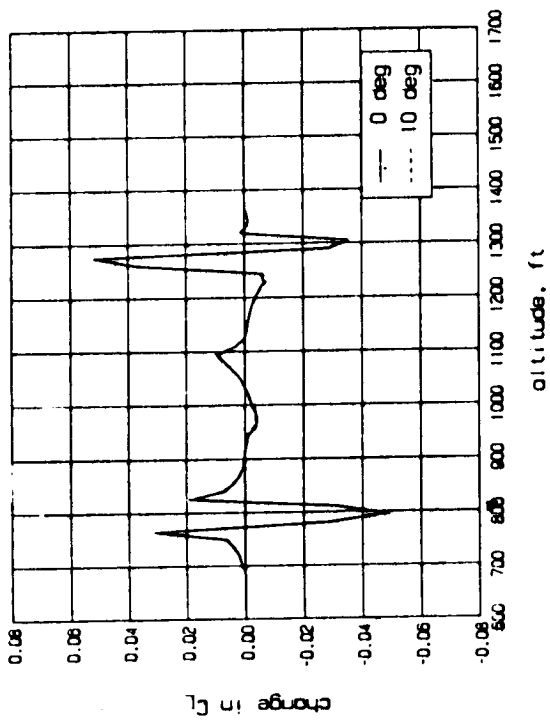
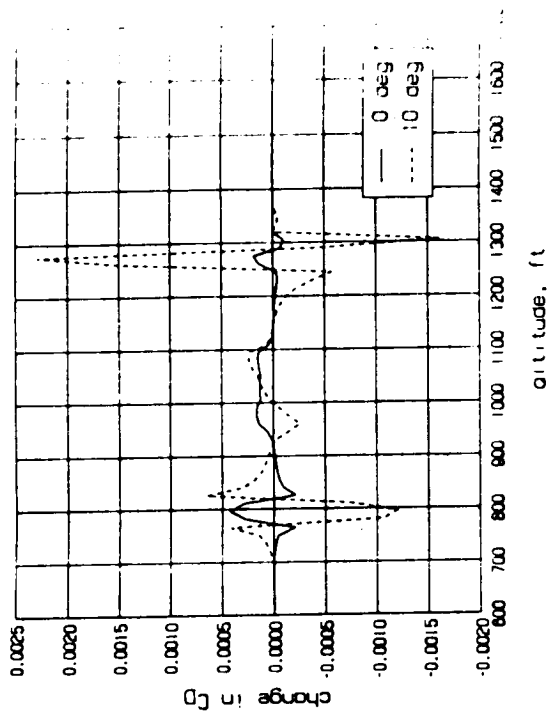

ORIGINAL PAGE IS
OF POOR QUALITY

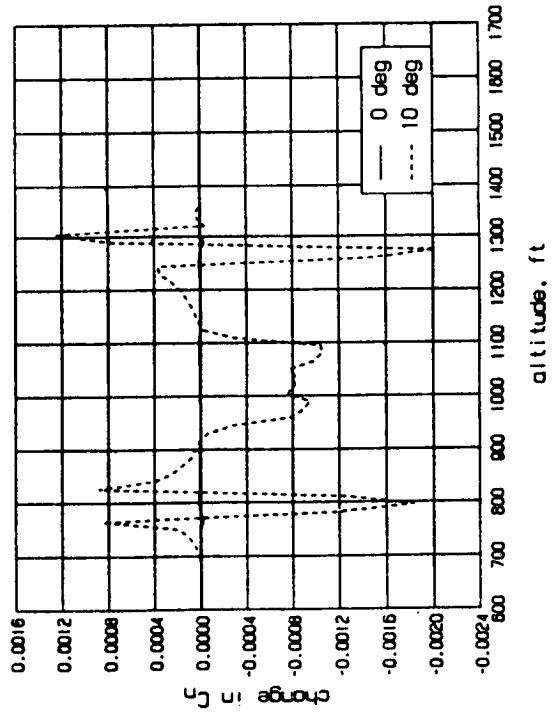
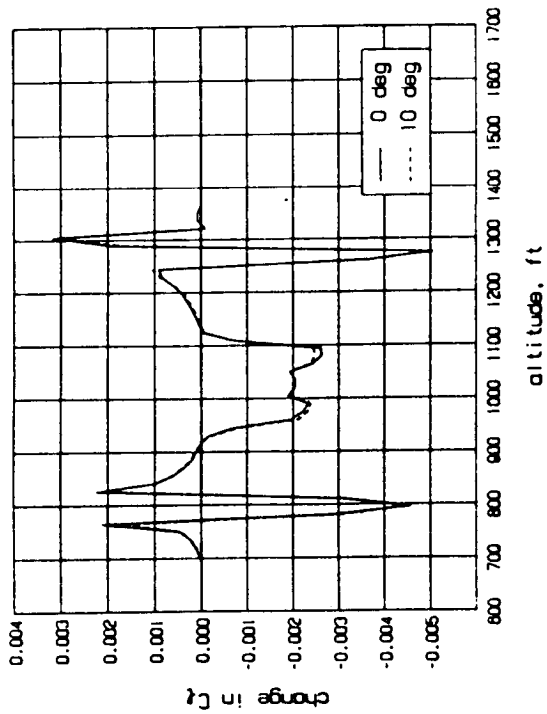
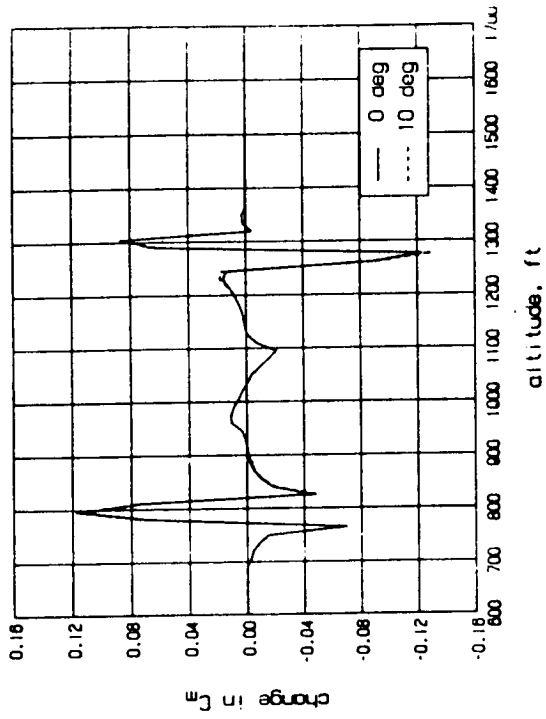

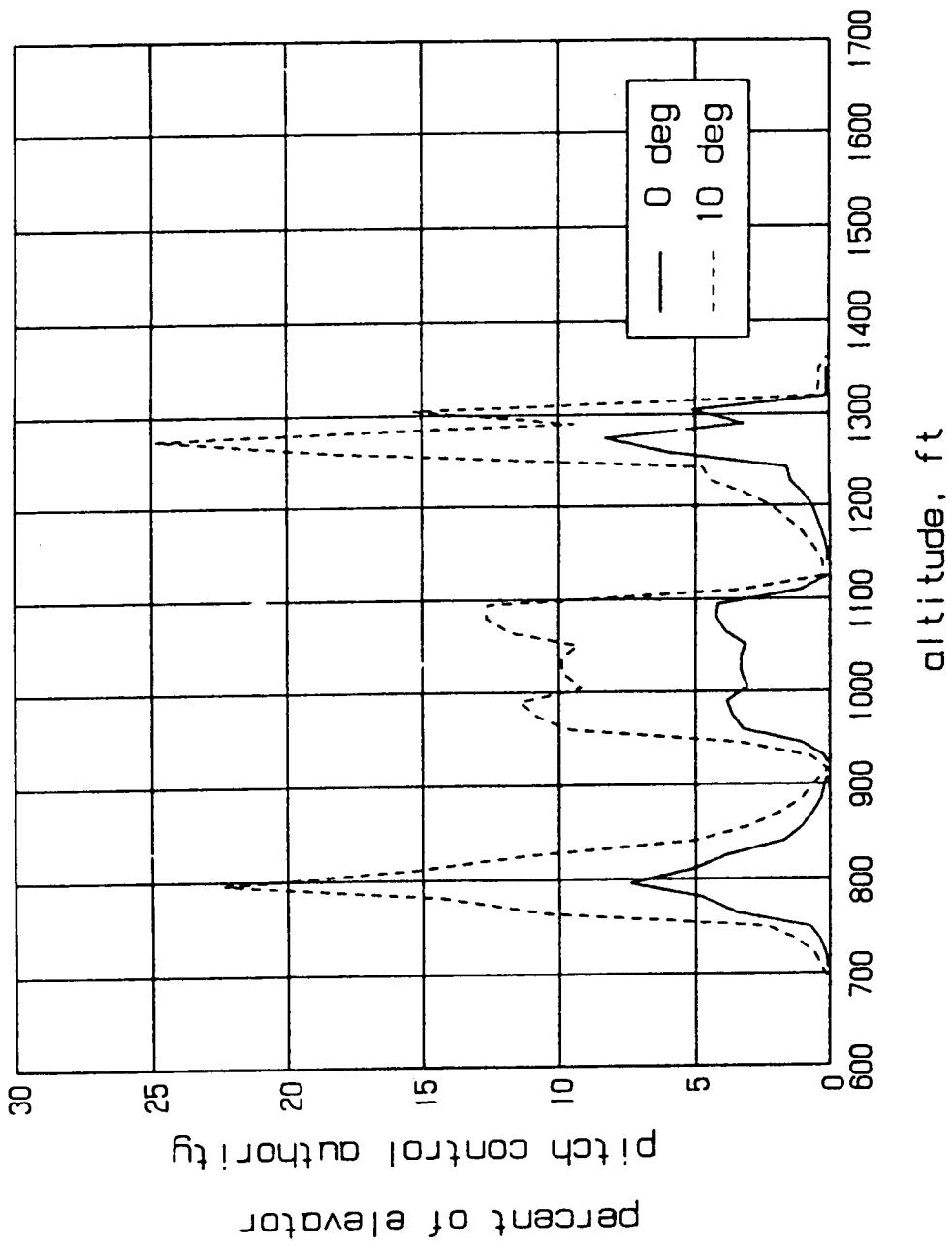

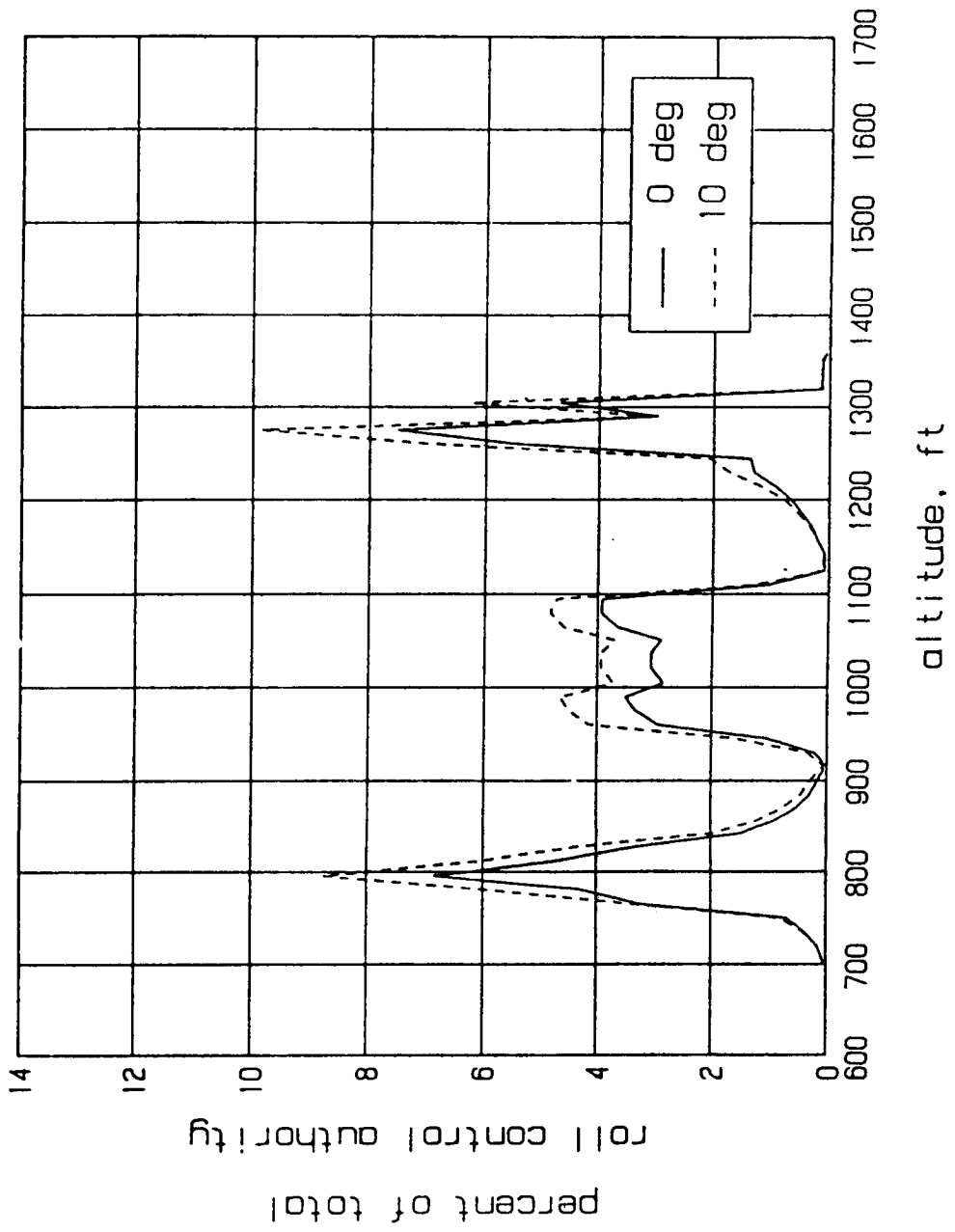

Outline

- Introduction
- Modification of Vortex-Lattice Algorithm
 - Spatially Varying Wind Field
 - Boundary Condition
 - Force and Moment Equations
- Program Checkout and Validation
- Shear Coefficient Development
- Sensitivity Studies
 - Vortex-Lattice Distribution
 - Planform Geometry
 - Wing and Stabilizer Combination
- Concluding Remarks

Concluding Remarks

Study Limitations

- ▶ Limited to small angle of attack range and thin airfoil approximation
- ▶ Effect of sideslip was not investigated
- ▶ Fuselage and vertical surface effects were not accounted for

Concluding Remarks

Pertinent Results of Study

- ▶ A method of characterizing the aerodynamic effect of wind shear in the form of wind shear aerodynamic coefficients was formulated
- ▶ A method of modifying a vortex-lattice algorithm to compute the aerodynamic effect of wind shear was demonstrated
- ▶ An example of the magnitude of the wind shear aerodynamic effect was computed for a conventional wing and stabilizer configuration on a fixed flight path through a microburst

Concluding Remarks

Recommendations for Future Research

- ▶ **Adaptation of more sophisticated aerodynamic codes to compute wind shear effect on complete configuration**
- ▶ **Simulation studies of pilots ability to manage the flight path with the wind shear induced aerodynamic effects**
- ▶ **Wind tunnel studies to confirm analytical results and explore high angle of attack effects**

QUESTIONS AND ANSWERS

RICK PAGE (FAA Technical Center) - Do you intend to do any research work into asymmetrical microbursts and also multiple glidepaths?

DAN VICROY (NASA LaRC) - We used a symmetrical microburst in this case but flew off to the side of it about 1500 ft. so that we would get asymmetrical effects. The shears are transformed into the body axes yielding asymmetrical shear gradients as we penetrated the microburst. So, we essentially did take into account that effect. Certainly this is just one example. I plan to look at more complex aerodynamic codes to compute the shear coefficients of complete airplane configurations. Another study that could be done is to do more of a statistical analysis of what kind of changes you are going to see with a variety of different kinds of microbursts. I don't plan to do that myself, but that work certainly could be done.