

N88-23912

Laser Diagnostics for Combustion Temperature and Species Measurements

Alan C. Eckbreth
United Technologies Research Center
Silver Lane
East Hartford, Connecticut 06108
(203) 727-7269

Introduction

Up to this point the workshop has focused primarily on surface or volume thermometry using radiative emission techniques. In this presentation, we will shift direction and focus on measurements that can be made in the gaseous phase of temperature and/or species concentrations. Laser optical diagnostic techniques will be emphasized [Refs. 1-4]. As shown in Panel 1, there are many advantages of using lasers to diagnose combustion processes. Many of these are, of course, self explanatory. Among the more important capabilities is the absence of an upper temperature limit due to the fact that nothing of a physical nature needs to be inserted in the combustion process under examination. The techniques, that will be described, are all sufficiently fast that measurements are possible under single pulse excitation, with a single pulse typically lasting on the order of a microsecond or less. The techniques are also concurrently spatially precise, that is these are pointwise measurements. And the techniques are unambiguous in that they provide in-situ measurements. For example, measurements do not have to be corrected as in the case of a thermocouple for radiation or conduction effects. Among the chief disadvantages is the fact that optical access is

LASER DIAGNOSIS OF COMBUSTION

- **Advantages**
- **Remote**
- **Non perturbing**
- **High temperature capability**
- **Fast**
- **Spatially precise**
- **Unambiguous**
- **Disadvantages**
- **Optical access**
- **Expensive**
- **Signal strength**
- **Interferences**

required. In practical devices this is often a major disadvantage in that such access may be difficult to provide. Another disadvantage, certainly compared with the radiation pyrometric techniques that have been discussed, is that these techniques are expensive. In addition to detection equipment somewhat similar to that used in radiation techniques, these methods also require one or more sophisticated laser sources. Another disadvantage resides in signal strength. The most ubiquitous technique, spontaneous Raman scattering, tends to be the most generic, but due to its weakness, it's typically constrained to look at only the major constituents. Stronger techniques, such as fluorescence, are suited only to examining a few species whose optical absorptions are spectrally accessible. In practical combustion environments, interferences may severely limit the applicability of certain of the techniques. In general, no single technique can provide temperature and species measurements of all of the constituents and a combination of complementary techniques needs to be applied. The techniques to be described derive information of temperature and concentration by interrogating individual rotational-vibrational states of the target molecules.

As a review, Panel 2 demonstrates that molecules are free to rotate with energies prescribed by the rotational quantum number J , molecules are free to vibrate with energies prescribed by the vibrational quantum number v , and molecules may have varying degrees of electronic excitation. However, at temperatures typical of most combustion processes, the degree of electronic excitation is relatively weak and most of the molecules reside in the ground electronic state as shown in the Panel 3. Also shown in the panel is the manner in which the vibrational and rotational state populations are

MOLECULAR ENERGY LEVELS

Rotation

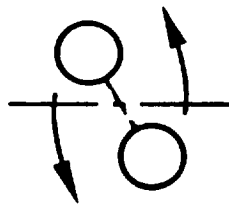

$$E_r = hcB J(J + 1)$$

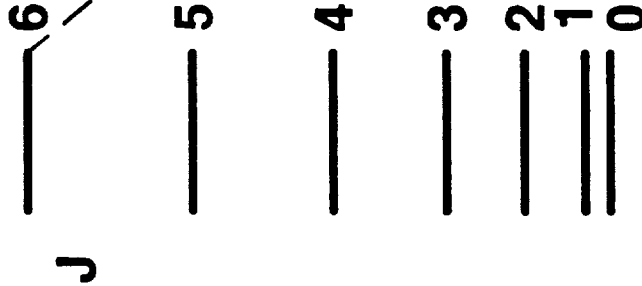

Vibration

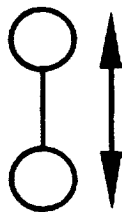

$$E_v = hc\omega_e (v + 1/2)$$

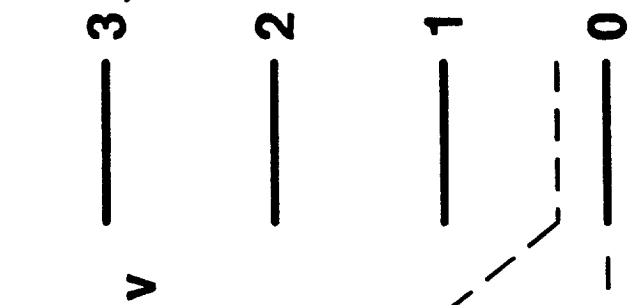

Electronic

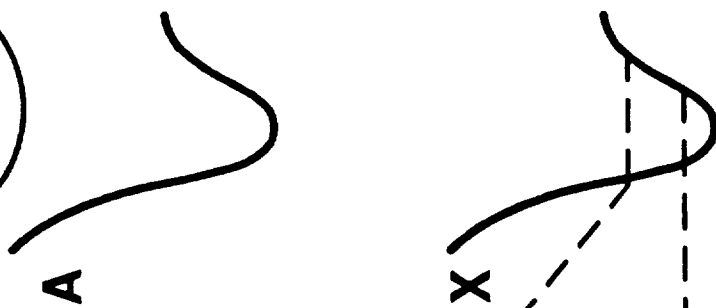
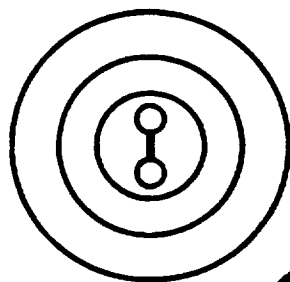

MOLECULAR POPULATION PARTITIONING

- Electronic state population

$$n_n = \frac{n}{Q_n} g_n e^{-\epsilon_n/kT} \quad \text{generally } \epsilon_n/kT \gg 1$$

$$\therefore n_0 = n$$

- Vibrational state population

$$n_v = \frac{n}{Q_v} g_v e^{-\epsilon_v/kT}$$

- Rotational state population

$$n_j = \frac{n_v}{Q_j} g_j e^{-\epsilon_j/kT}$$

- Individual vibration-rotation state population

$$n_{vj} = n \frac{g_v}{Q_v} \frac{g_j}{Q_j} e^{-(\epsilon_v + \epsilon_j)/kT}$$

PANEL 3

distributed in accordance with Boltzmann statistics. Putting these expressions together, one sees that the distribution over the individual vibrational-rotational states is highly temperature dependent. This then forms the basis for diagnostic utilization. By measuring the relative populations in several of the vibrational-rotational states, one can deduce the temperature. By making an absolute measurement of the population in any one given state, and knowing the temperature, one can then deduce the total species concentration.

The techniques to be covered in this review fall into two major classes. There are the incoherent approaches and the coherent techniques as outlined in Panel 4. We will begin by considering three incoherent techniques: Rayleigh scattering, spontaneous Raman scattering and laser-induced fluorescence spectroscopy (LIFS). The one coherent technique to be examined is termed coherent anti-Stokes Raman spectroscopy which goes by the acronym CARS. The various incoherent scattering approaches are explained in Panel 5. In the panel, ground and upper electronic states are indicated by the parabolic-shaped potential energy diagrams. The curves represent the variation of potential energy with internuclear separation. The horizontal lines indicate various vibrational levels of excitation in each electronic state and, for simplicity, the rotational splitting within each vibrational level is not shown.

Rayleigh scattering is the elastic scattering of light by molecules. By elastic is meant that there is no energy exchange between the incoming photons and the molecules. Consequently, the scattering is unshifted from the incident wavelength and occurs at the same wavelength as the incoming light. This phenomenon is responsible for the blue color of the sky and was

SPATIALLY-PRECISE LASER DIAGNOSTICS FOR COMBUSTION TEMPERATURE AND SPECIES

- **Incoherent approaches**
 - **Rayleigh scattering**
 - **Spontaneous Raman scattering**
 - **Laser induced fluorescence spectroscopy (LIFS)**
- **Coherent techniques**
 - **Coherent anti-Stokes Raman spectroscopy (CARS)**

SCATTERING PROCESSES

Rayleigh (elastic)

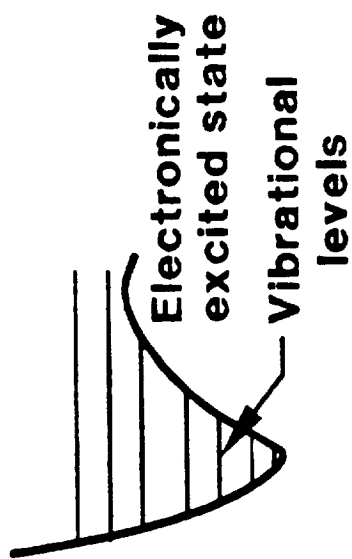

Raman (inelastic)

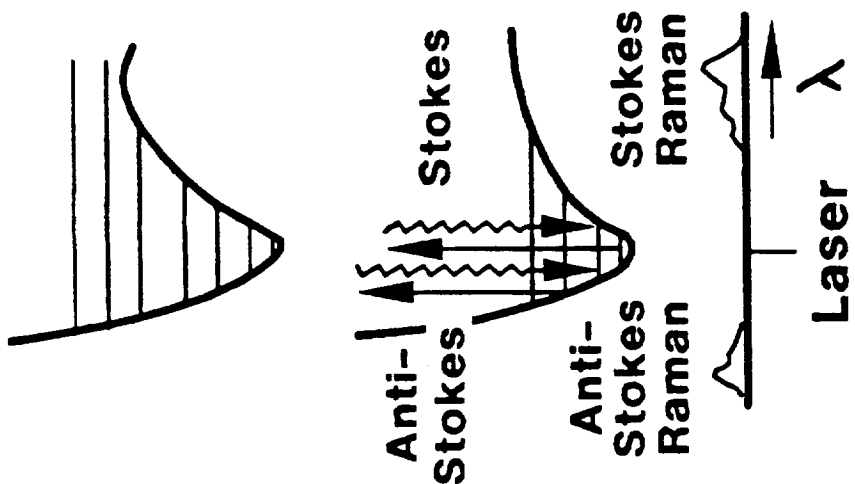

Fluorescence

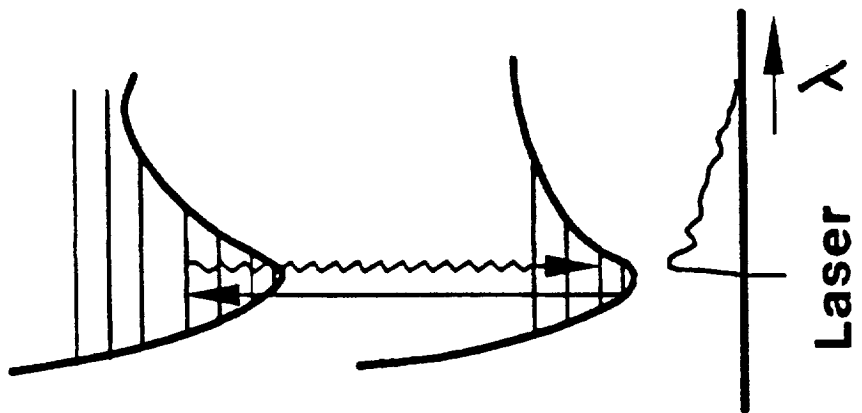

understood by Lord Rayleigh in his investigations over a century ago. Spontaneous Raman scattering is the inelastic scattering of light and was discovered by C. V. Raman in 1928 for which he received the Nobel Prize in 1931. In Raman scattering, energy exchange does occur between the incoming photons of light and the molecules with which the light is interacting. Recall that the frequency of a lightwave quantum is directly related to the energy of that quantum. When the photon gives up energy to the molecule, the photon is downshifted in frequency or scattered to a longer wavelength. Because of the similarity of this long wavelength scattering to fluorescence, this Raman process is often termed the Stokes branch. If the molecules are excited prior to the interaction, they may give up energy to the photons upshifting the photon frequency and scattering them to a lower wavelength. This process, for historical reasons, is called an anti-Stokes process. Both Raman and Rayleigh scattering are essentially instantaneous processes occurring on the time scale of 10^{-12} seconds or less. Also note that, in spontaneous Raman scattering and Rayleigh scattering, the incident wavelength can be arbitrarily selected; there is no input wavelength requirement. Incident laser frequencies in the visible and ultraviolet, however, are favored because the scattering scales as the fourth power of the scattered frequency in accord with dipole radiation laws. In laser-induced fluorescence, the laser is tuned into an actual absorbing electronic transition of the molecule. Following promotion to the electronically-excited state, the molecule, after some period of time, may spontaneously radiate the energy which one monitors as the fluorescence signal. In addition to radiating the excited energy away, the molecule may lose its energy by any number of collisional channels, a

process termed collisional quenching. Quenching often complicates species concentration measurements but can generally be cancelled out in thermometric investigations.

The typical experimental arrangement for a laser light scattering system is shown in Panel 6. The beam from the laser is introduced through the medium under investigation. Scattering occurs nominally into 4π steradians in accord with dipole radiation laws. Spatial resolution is obtained by triangulation of the detection system, consisting of a field lens and an appropriate spectrometer, with the illuminating laser beam. Scattering is collected over some solid angle Ω at some angle θ to the incident laser beam. The spatial resolution l is determined by the field stop in the spectrometer or an iris in the optical detection chain. Although many experiments are performed with the scattering being collected at 90 deg., these techniques can be implemented in backscattering and, thus, are amenable to implementation as single-ported optical approaches. The laser beam is generally focussed into the measurement volume to enhance the spatial resolution. Typical focal diameters are on the order of 200 microns or less and the axial spatial resolution along the beam can vary from submillimeter to several millimeters.

Rayleigh Scattering

Beginning with Rayleigh scattering, Panel 7 displays both the advantages and disadvantages of this technique. This most important advantage is that it is very strong and, as we will see in the next panel, can provide high time resolution even with continuous wave lasers. It is a very simple technique,

LASER LIGHT SCATTERING

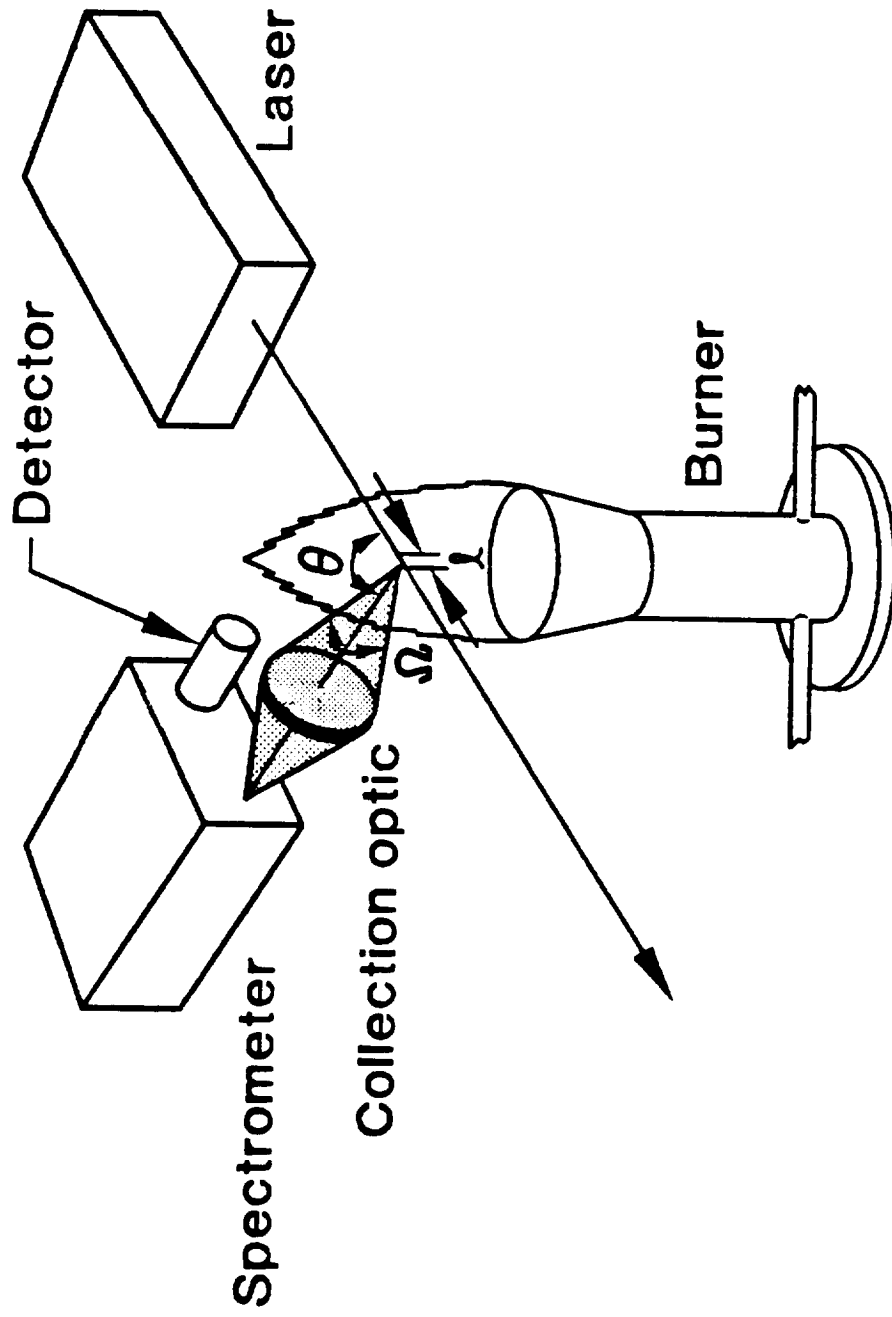

RAYLEIGH SCATTERING

Advantages

- Strong
- Simple
- Quantitative
- Spatially - precise

Disadvantages

- Not species specific
- Particle interferences
- Composition dependent

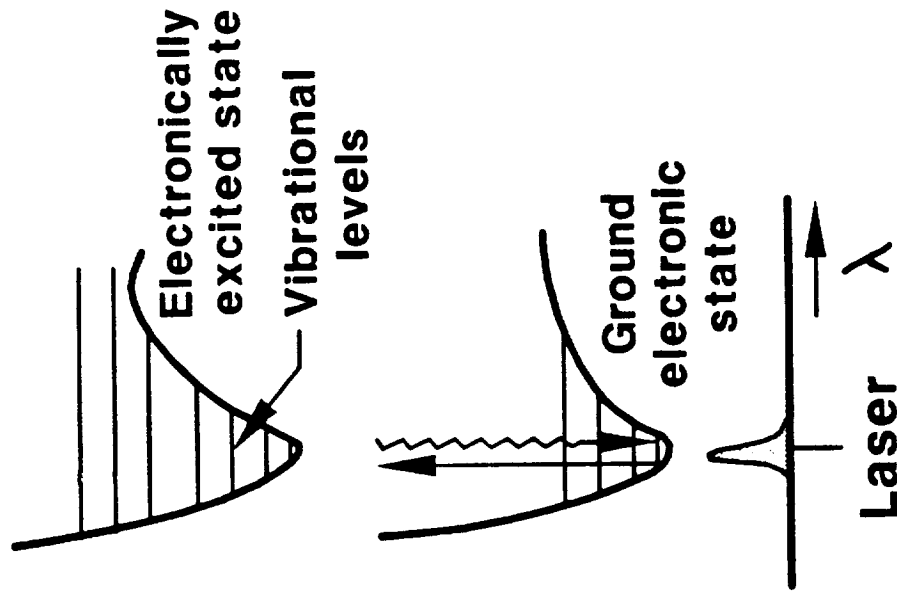

is quantitative and, with the proper optics, is spatially precise. Its major disadvantage is the fact that it is not species specific. Since the scattering is not shifted in wavelength, there is no way to distinguish the scattering, for example, from a carbon dioxide molecule or from a water vapor molecule. So the technique looks primarily at the total gas density. Although the technique is composition dependent, by judicious tailoring of the reactant mixture of gases, one can arrange the Rayleigh cross section to be nearly invariant with reaction extent. Thus, as reaction proceeds from the reactants to the products, the total cross section can remain nearly constant solely tracking the density. Since the signal is not shifted in wavelength, it is subject to strong Mie scattering interferences from particles whose cross sections are typically much stronger than those for molecules. Thus, Rayleigh scattering is restricted to particle free environments. However, because of its signal strength, it is a very powerful technique as illustrated in Panel 8. There we present a feasibility calculation for a five Watt, continuous wave argon ion laser interrogating a one atmosphere pressure, 2000 K flame using an F3 optical collection system with a spatial resolution of one millimeter. Assuming an overall collection efficiency of 20 percent, one sees that the Rayleigh photon flux is nearly 10^8 photons per second. If one is sampling at a one kilohertz sampling rate, i.e. an aperture time of a millisecond, one gathers nearly 100,000 photons. If these are detected by a photomultiplier with a 20 percent quantum efficiency, the signal can be observed with a signal/noise greater than 100 resulting in an absolute accuracy to better than 1 percent. Since most combustion processes occur at very low Mach numbers, the pressure is essentially constant throughout. Application of the ideal gas

CW LASER RAYLEIGH FREQUENCY RESPONSE IN FLAMES

- Rayleigh cross section
$$\frac{\partial \sigma}{\partial \Omega} = \frac{2\pi^2(\mu-1)^2}{N_0^2 \lambda^4}$$

- Mixture Rayleigh cross section
$$\frac{\partial \sigma}{\partial \Omega} \Big|_{\text{mix}} = \sum_i \chi_i \left(\frac{\partial \sigma}{\partial \Omega} \right)_i$$

 $\approx 8.6 (10^{-28}) \text{ cm}^2/\text{sr postflame}$

- Rayleigh signal
$$P_{\text{Ray}} = P_i n \frac{\partial \sigma}{\partial \Omega} \Big|_{\text{mix}} \Omega \ell \epsilon$$

→ 2.4 (10⁻¹¹) W for 5W @ 5145Å, 1atm, 2000°K, f/3, 1mm, 20%

- Rayleigh photon flux $\dot{n}_{\text{Ray}} = P_{\text{Ray}}/\epsilon_p \rightarrow 6.2 (10^7) \text{ photons/sec}$

- Rayleigh photons at 1 kHz $n_{\text{Ray}} = 6.2 (10^4) \text{ photons}$

- S/N at 20% Q.E. $S/N = \sqrt{\eta} n_{\text{Ray}} \rightarrow 112$

law then allows one to make a temperature measurement by measuring the density.

An example of Rayleigh scattering used in the foregoing manner is illustrated in Panel 9. There one views probability density functions of temperature in a turbulent premixed methane/air flame. In this flame, hydrogen was added and the stoichiometry was adjusted in such a way that the total Rayleigh cross section remained invariant as the reaction proceeded. Low in the flame one sees very narrow pdf's typical of the cold core flow, very high in the flame one sees a broader, but hot, distribution typical of gases leaving the flame. In the intermediate zones, where the flame fluctuates, bimodal pdf's are seen typical of sampling alternately hot and cold pockets of gas. Rayleigh scattering can also be nicely integrated with laser Doppler velocimeters to add a temperature measuring capability. In these instances the particle seeding rate is kept low enough so that one can make the Rayleigh temperature measurements in between the various velocity realizations. Despite its limitations Rayleigh scattering is a very powerful technique when properly applied.

Spontaneous Raman Scattering

As seen in Panel 10, one advantage of spontaneous Raman scattering is that it is applicable to all molecules. All molecules have at least one vibrational-rotational mode which is Raman active. The technique is

RAYLEIGH TEMPERATURE PDF'S IN A TURBULENT METHANE FLAME

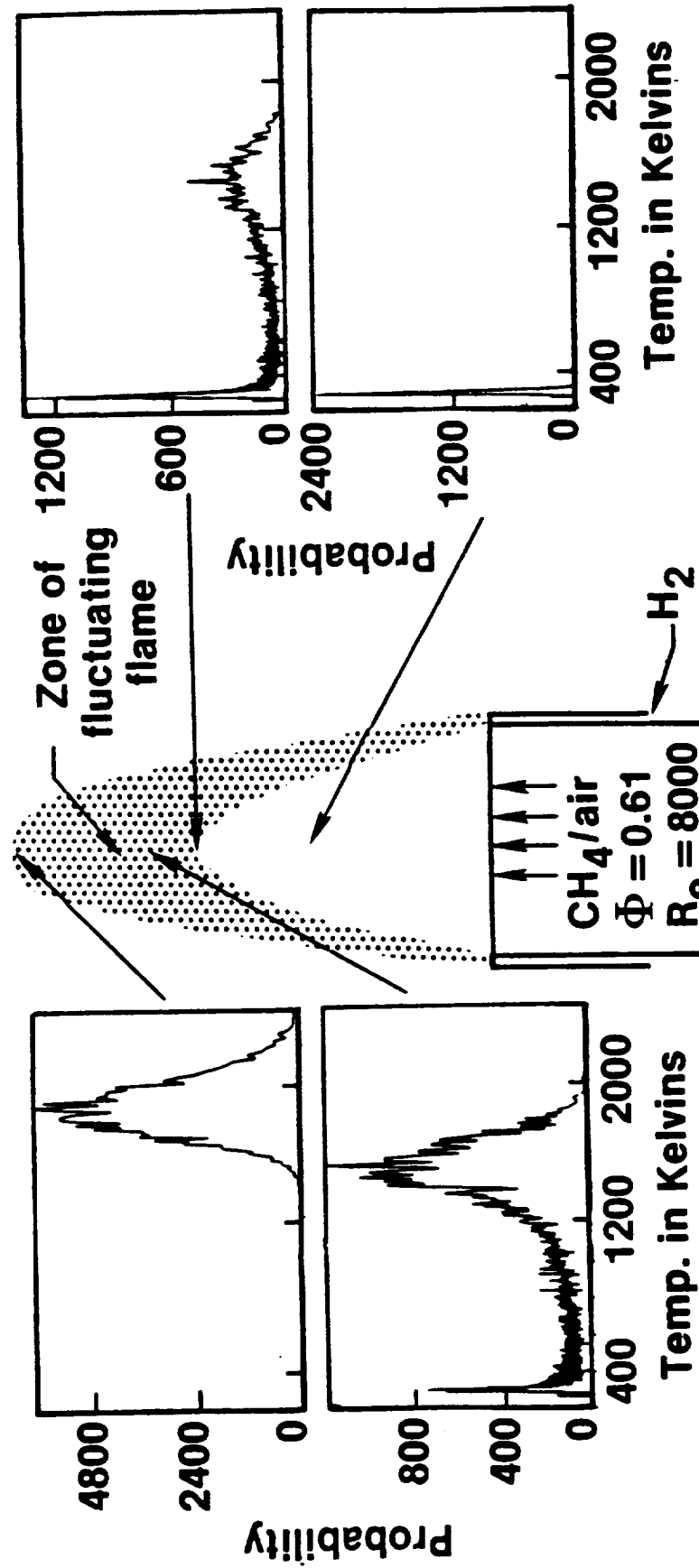

From: R.W. Dibble and R.E. Hollenbach: Laser Rayleigh Thermometry in Turbulent Flames.
Proc. 18th Symp. on Combustion, pp. 1489-1499, 1981.

SPONTANEOUS RAMAN SCATTERING

Advantages

Applicable to all molecules

Quantitative

Simple

Spatially - precise

Disadvantages

Very weak

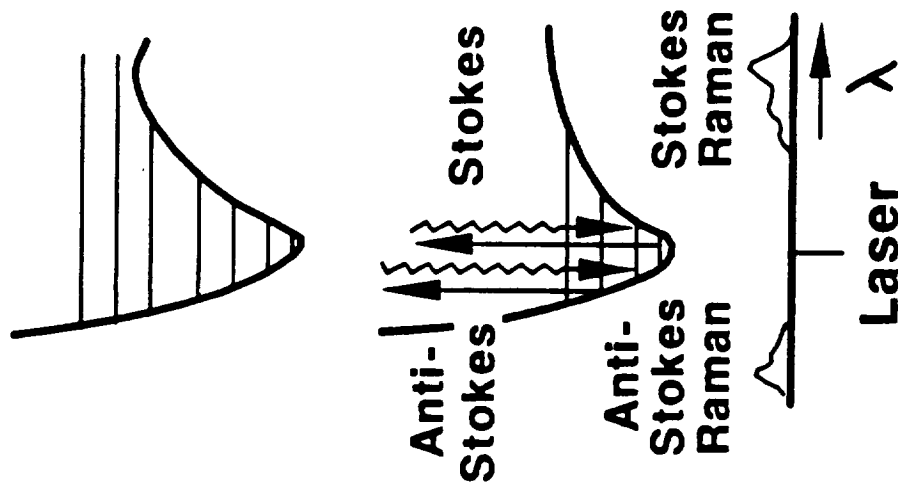

quantitative, simple and, as with all the incoherent scattering techniques, it can be made spatially precise. The major disadvantage of spontaneous Raman is that it is a very weak process. For example, in atmospheric pressure flame situations, the Raman signal is about 14 orders of magnitude less than the input energy.

The basis for thermometry using Raman scattering is illustrated in Panel 11 and stems from the interrogation of individual vibrational-rotational states as alluded to earlier. Here the focus is just on two individual vibrational-rotational states M and N. In the Stokes process, the molecules are taken from state M to N with energy being "absorbed" by the gas and the photon is down shifted in energy. In the anti-Stokes process, one has the converse process. Conservation of energy applies in these scattering processes and, since the energy levels of most combustion molecules are very well known, the scattered frequencies can be calculated precisely. The Raman scattering intensities vary linearly with the number density in the initial vibrational-rotational state from which scattering is observed. The frequency to the fourth scaling originates from the dipole radiation nature of the Raman scattering. For a gas in thermal equilibrium, the respective state populations are given by Boltzmann statistics. If one measures the anti-Stokes to Stokes intensities, by simple rearrangement of the equations it is observed that a temperature measurement can be made. In reality, one observes the spontaneous Raman scattering from an ensemble of vibrational-rotational modes. However this can be easily calculated with computer codes and, as seen in Panel 12, one can calculate the anti-Stokes to Stokes Raman scattering over temperature

RAMAN THERMOMETRY PRINCIPLE

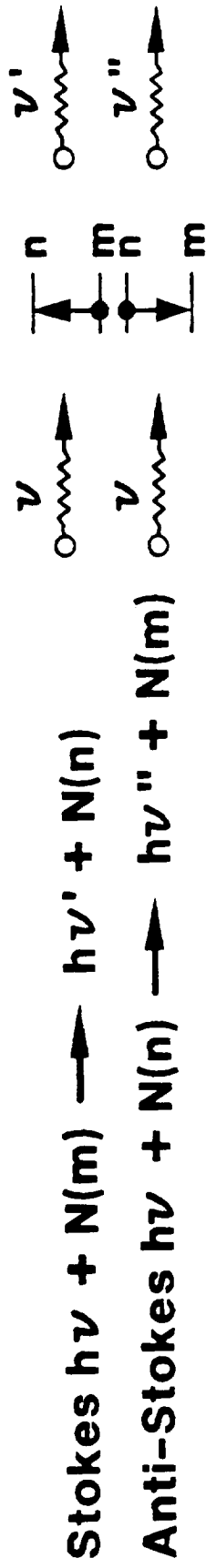

Conservation of energy

$$h(\nu - \nu') = E(n) - E(m)$$

$$h(\nu'' - \nu) = E(n) - E(m)$$

Scattering intensities

$$I_S(\nu') \sim \nu'^4 N(m)$$

$$I_A(\nu'') \sim \nu''^4 N(n)$$

Thermal equilibrium $\frac{N(n)}{N(m)} = e^{-[E(n)-E(m)]/kT}$

Temperature measurement

$$T = \frac{E(n) - E(m)}{k \ln I_A(\nu'')/I_S(\nu') + 4k \ln \nu'/\nu''}$$

TEMPERATURE VARIATION OF AS/S RAMAN RATIO

Visible excitation of nitrogen

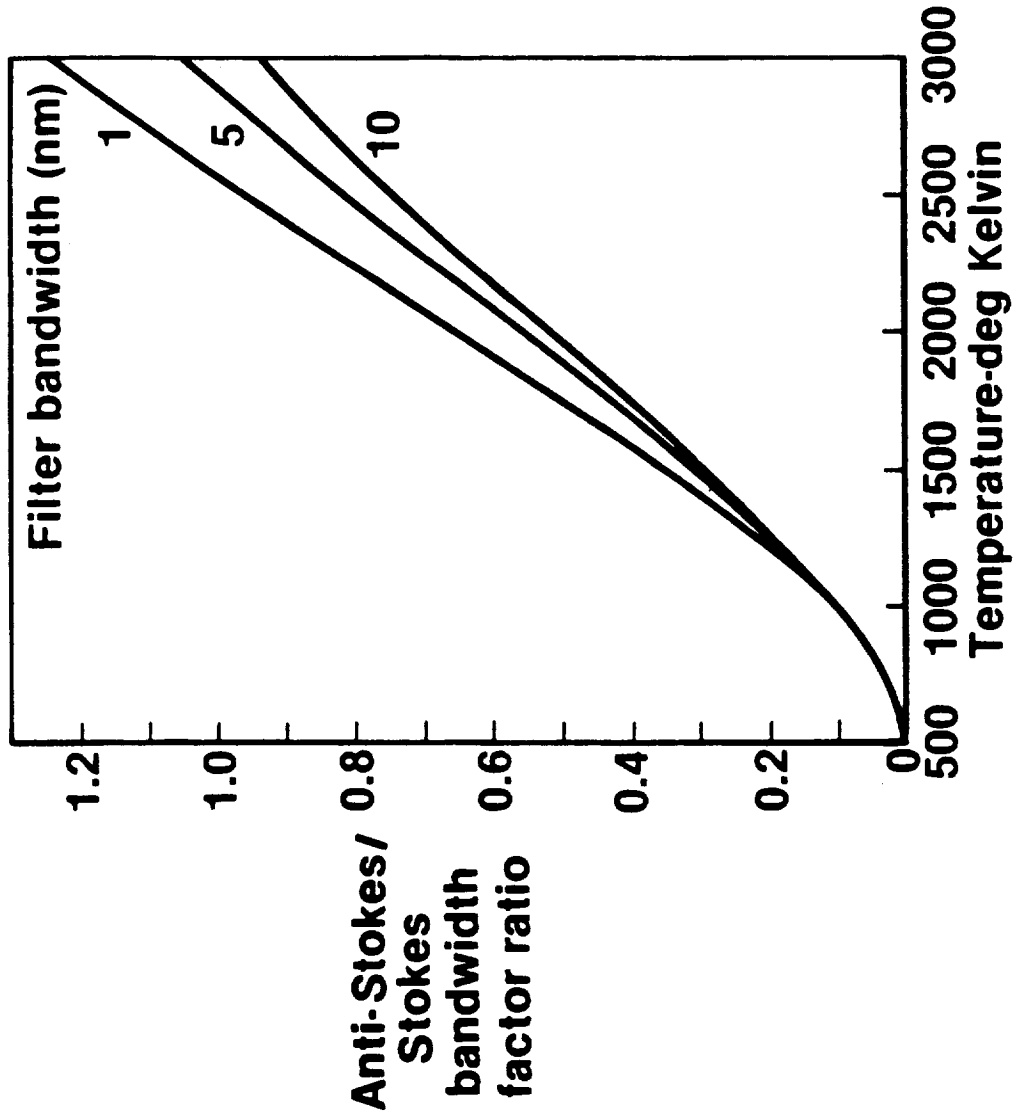

as a function of detection bandwidths. This anti-Stokes to Stokes method works quite nicely at temperatures above 600 or 700 K and results in a nearly linear behavior up to temperatures near 3000 K. At lower temperatures this particular approach does not work since there is very little vibrational excitation and, thus, not much of an anti-Stokes signal to detect.

Another approach to thermometry using Raman scattering is to spectrally resolve the Stokes Q-branch. The Q-branch is a spectrum in which the vibrational quantum number changes but the rotational quantum number does not. As can be seen in Panel 13, the vibrational Q-branch spectrum of nitrogen is quite temperature sensitive. At low temperatures, one sees a very narrow band made up of low lying rotational transitions. As the temperature increases and population shifts to higher rotational levels, the band broadens and smears. At still higher temperatures, one begins to see Stokes contributions from vibrationally-excited states. Since a typical Raman spectrum may only contain a few thousand photons at best, temperature measurements made by resolving these bands must be performed by time consuming scans and are not amenable to single pulse measurements under most low pressure applications.

An exception to this rule is illustrated by work that UTRC is currently performing for the NASA Marshall Space Flight Center in which Raman scattering is being applied to make measurements in the fuel preburner of the space shuttle main engine (SSME) [5]. The overall instrument concept is illustrated in Panel 14 and uses fiber optics to pipe a high power argon ion laser to an instrument package bolted to the preburner. Raman scattering is collected in a separate fiber and piped to a spectrograph and optical multichannel detector

TEMPERATURE DEPENDENCE OF N₂ Q-BRANCH STOKES RAMAN SPECTRUM

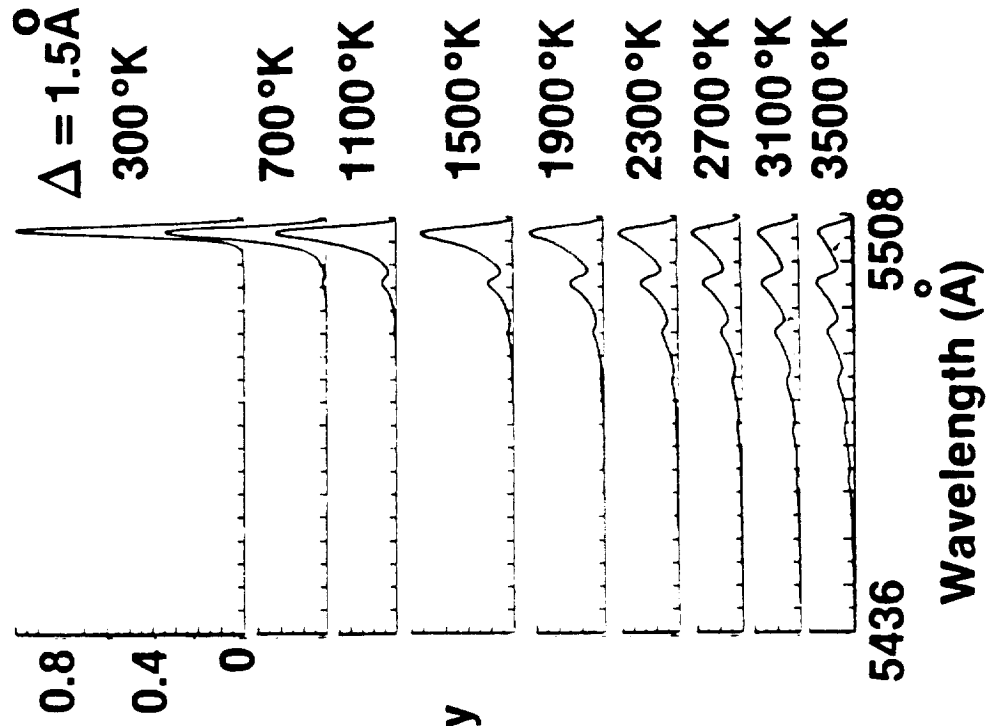

From: M. Lapp, et al.: Laser Raman Probe for Flame Temperature.
 Project SQUID Technical Report GE-1-PU, April 1973.

SSME FIBER OPTIC RAMAN THERMOMETER DIAGNOSTICS

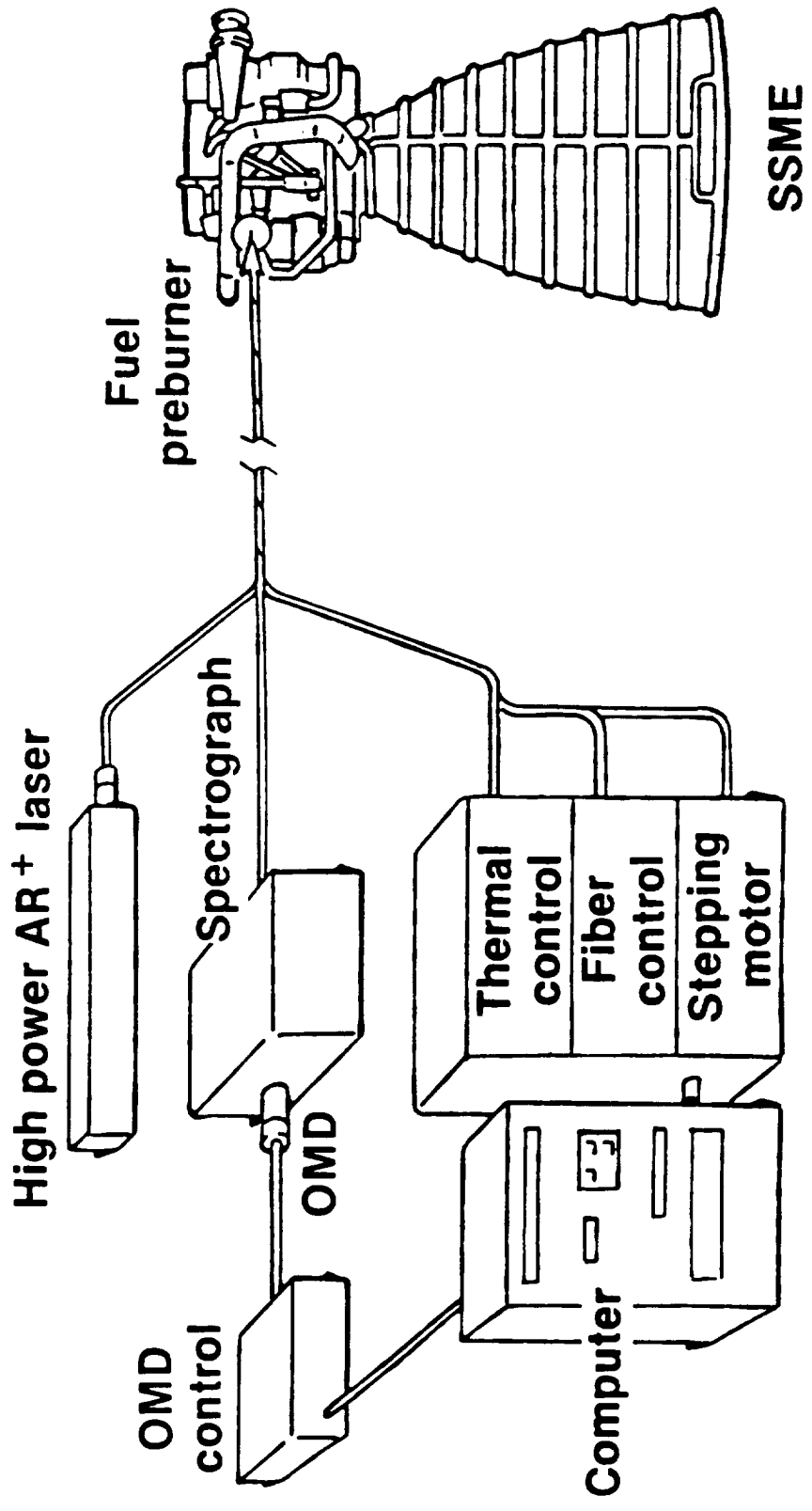

for recording and subsequent data analysis. The SSME preburner operates at pressures in excess of 300 atmospheres thus permitting use of a continuous wave laser with signal arrival rates high enough to permit measurements every 10^{-2} seconds. Details of the interior of the optical head, which bolts to the fuel preburner, are shown in Panel 15. The laser ray emanating from the transmitter fiber is recollimated and then directed by means of optics down the central axis of the instrument for focusing into the fuel preburner. The Raman scattered radiation is collected in backscattering and separately focused into a receiver fiber. The central portion of the receiving lens is purposely obscured to enhance the spatial resolution of the measurement in this coaxial backscattering arrangement [6]. Not surprising, as shown in Panel 16, the hydrogen spontaneous Raman spectrum is quite temperature sensitive and reflects the changing distribution of population over the various rotational states in the ground vibrational level. With hydrogen, due to its very large vibrational anharmonicity, the higher vibrational levels lead to Raman scattering far displaced from that produced by the ground vibrational state and they are usually not observed. Due to large rotational-vibrational interaction, the individual Q-branch transitions in the ground vibrational state are well separated permitting them to be easily resolved as the calculation suggests. Panel 17 displays as dots the spontaneous Raman spectrum obtained from a high pressure cell at 1000 K and over 300 atmospheres of pressure [3]. The solid line is the theoretical best fit to the data points read directly off of the optical multichannel detector. Plotting the integrated strength of each one of these rotational transitions against the

OPTICAL HEAD CONCEPTUAL DESIGN

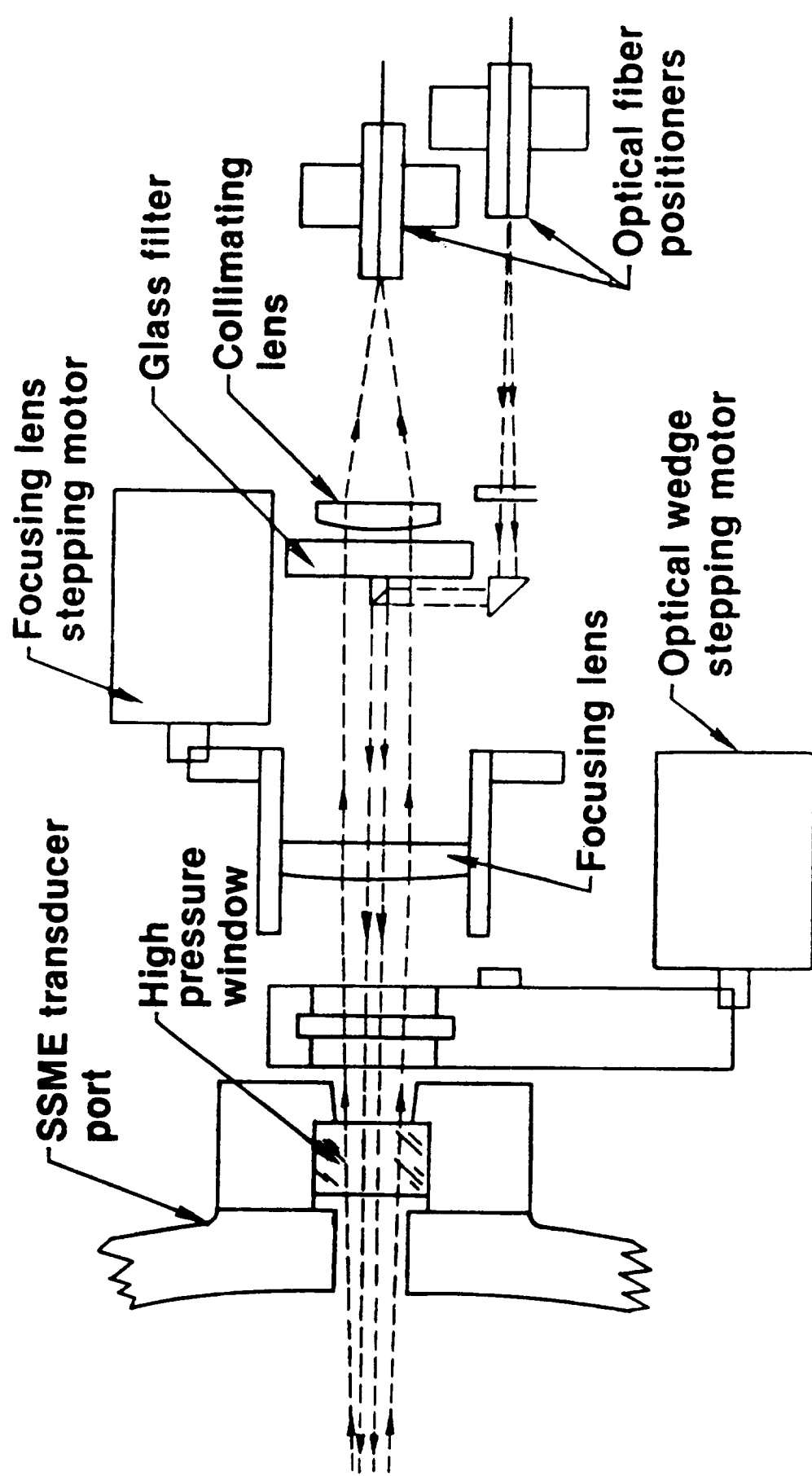

PANEL 15

CALCULATED H₂ SPONTANEOUS RAMAN SPECTRA

p = 380 atm, slitwidth 2 cm⁻¹

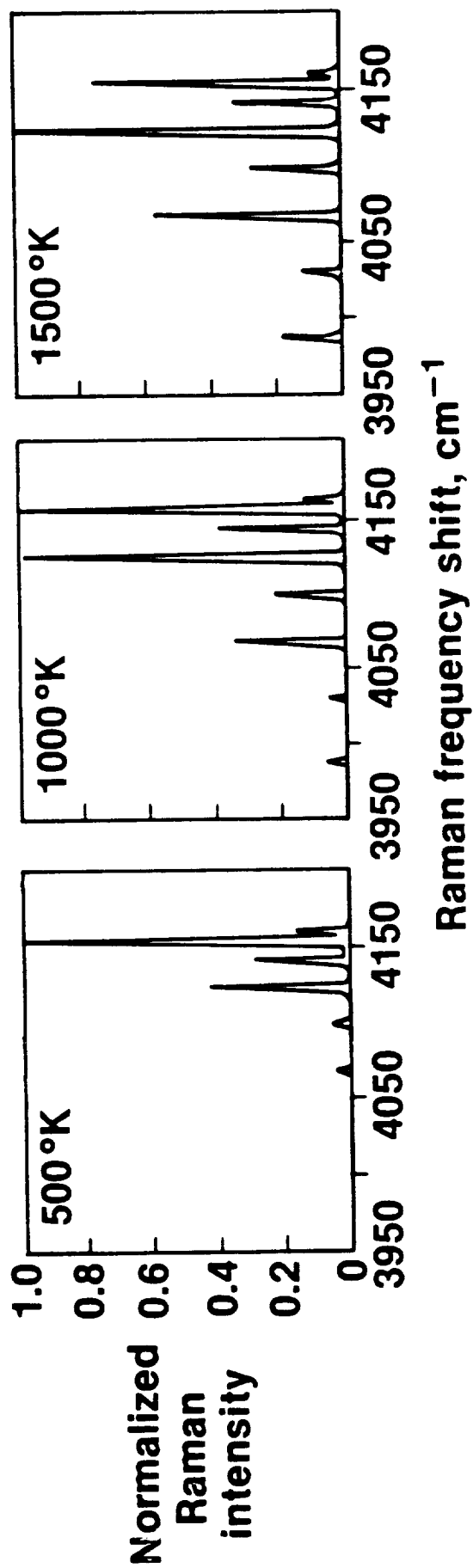

HYDROGEN Q-BRANCH RAMAN SPECTRUM

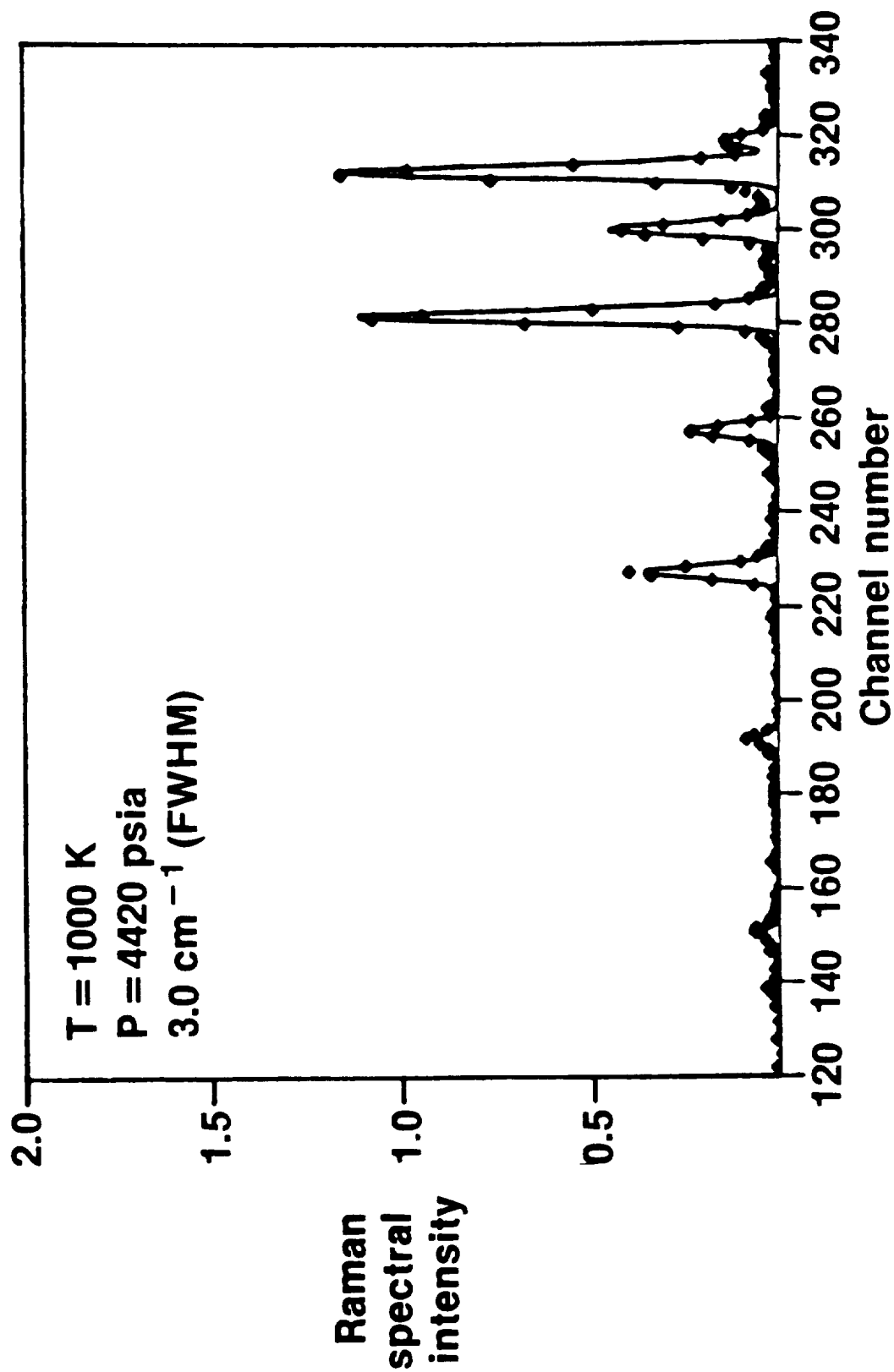

PANEL 17

respective state energy, as shown in Panel 18, leads to a typical Boltzmann plot from whose slope the temperature derives. This instrument is typically capable of making such measurements every 10 milliseconds with accuracies on the order of ± 3 percent. This is a highly favorable situation since it involves very high pressures and hydrogen combustion is characterized by very low luminosity and lack of particulate formation typical of hydrocarbon-fueled flames.

Hydrocarbon flames pose quite a challenge and a limitation to spontaneous Raman scattering. Practical flames, typically nonpremixed, lead to large amounts of soot formation in fuel-rich regions leading to very high luminosity levels. The high luminosity typically precludes use of a continuous wave laser, rather a pulsed laser is used to induce Raman scattering in a time period short enough to minimize collection of a significant amount of the background radiation. However, as illustrated in Panel 19, the use of pulsed lasers with the spatial resolutions typically employed, leads to very high laser fluxes in the focal volume. This results in laser heating of the soot particles which occur in the combustion process. These soot particles are heated into the 3000-5000 K range. Because of the strong dependence of the Planck function on temperature, this results in greatly enhanced amounts of laser modulated soot incandescence. As shown in Panel 20, this laser modulated soot incandescence can approach or in many instances exceed the spontaneous Raman scattering signal leading to very poor signal to interference ratios. Shown in the panel are signal to interference ratios calculated over soot number density/soot particle diameter parameter space.

H₂ RAMAN TEMPERATURE ANALYSIS

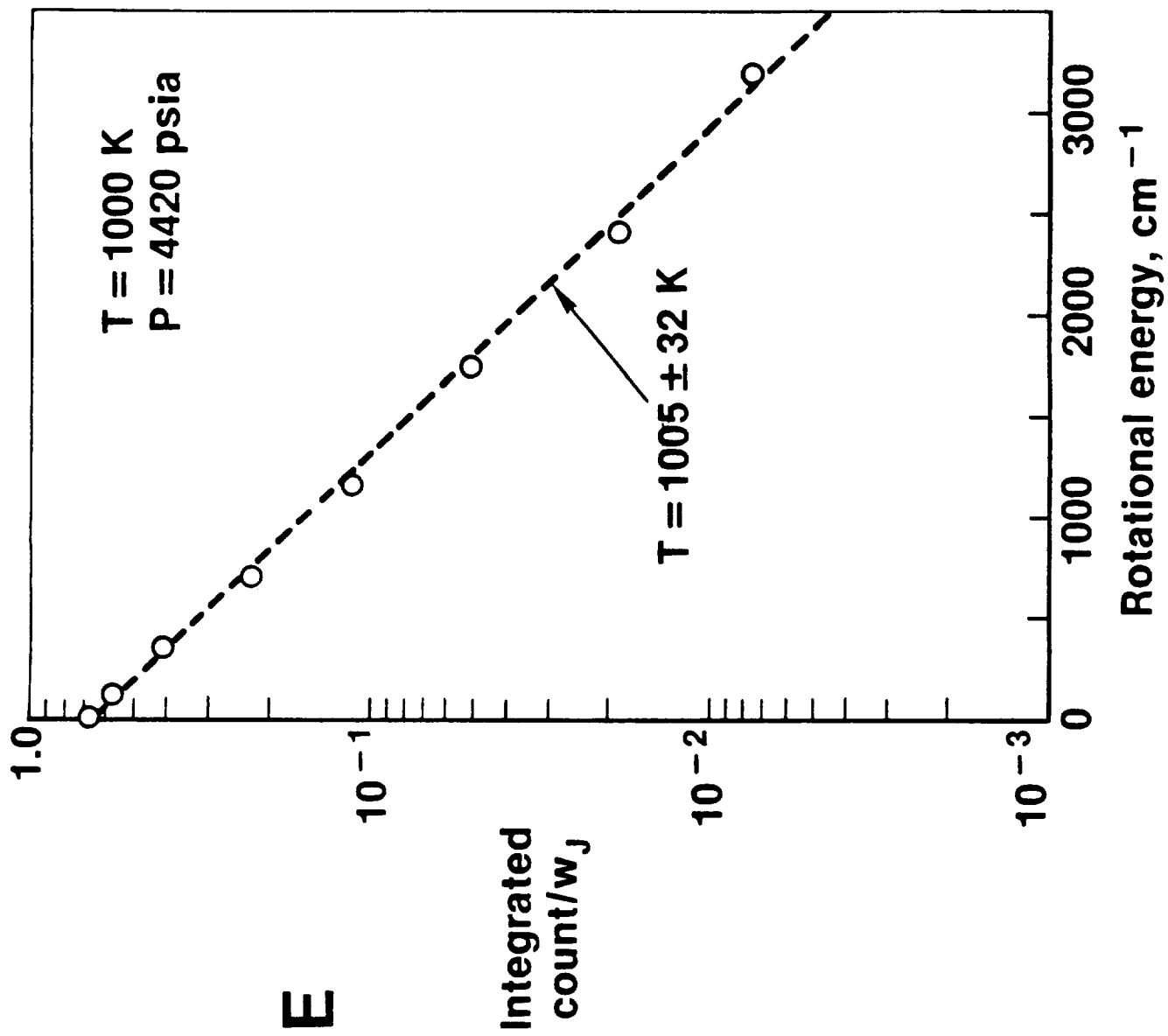

PANEL 18

Laser Irradiated Particle Temperatures

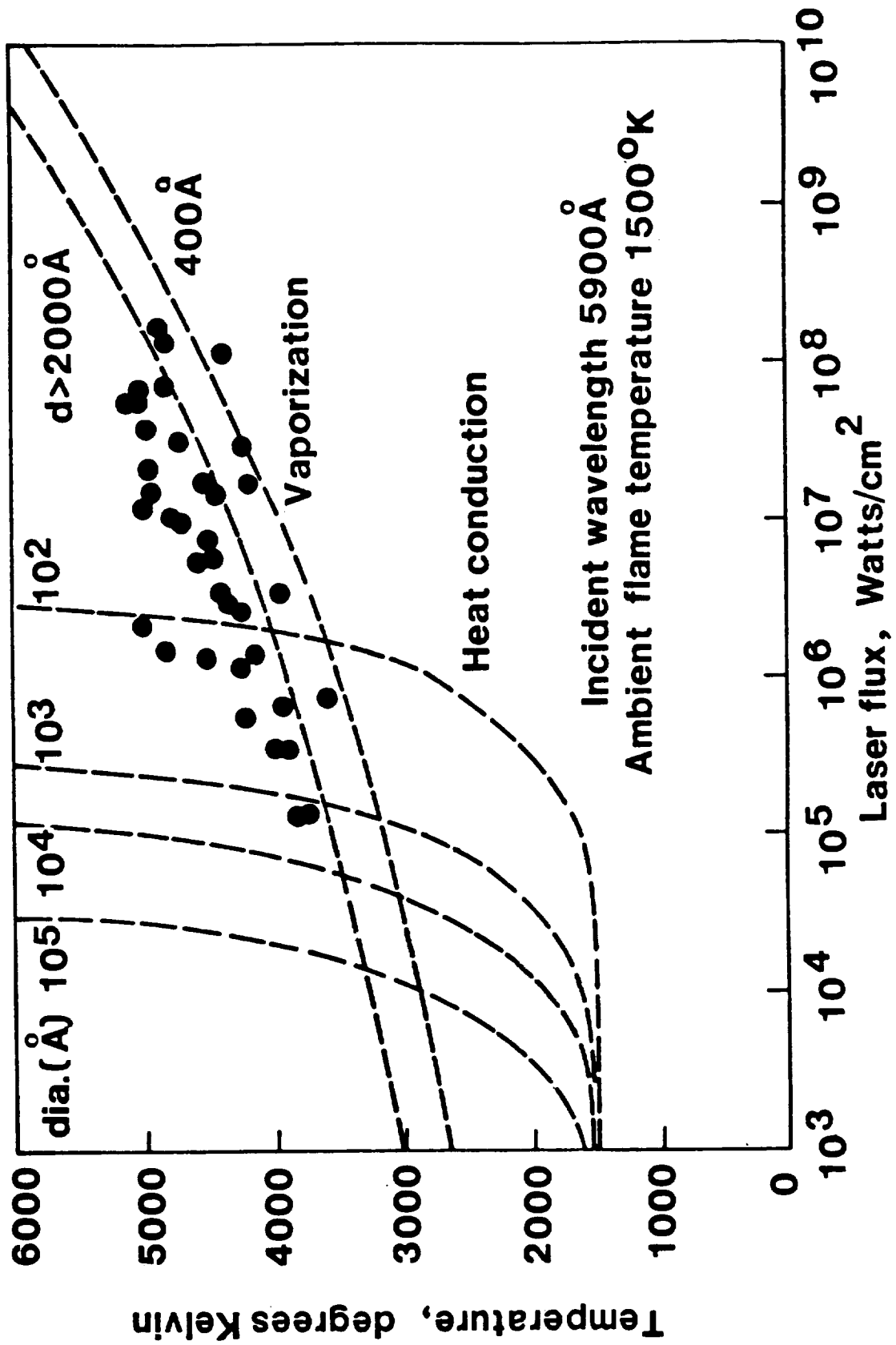

PANEL 19

RAMAN S/I MAP

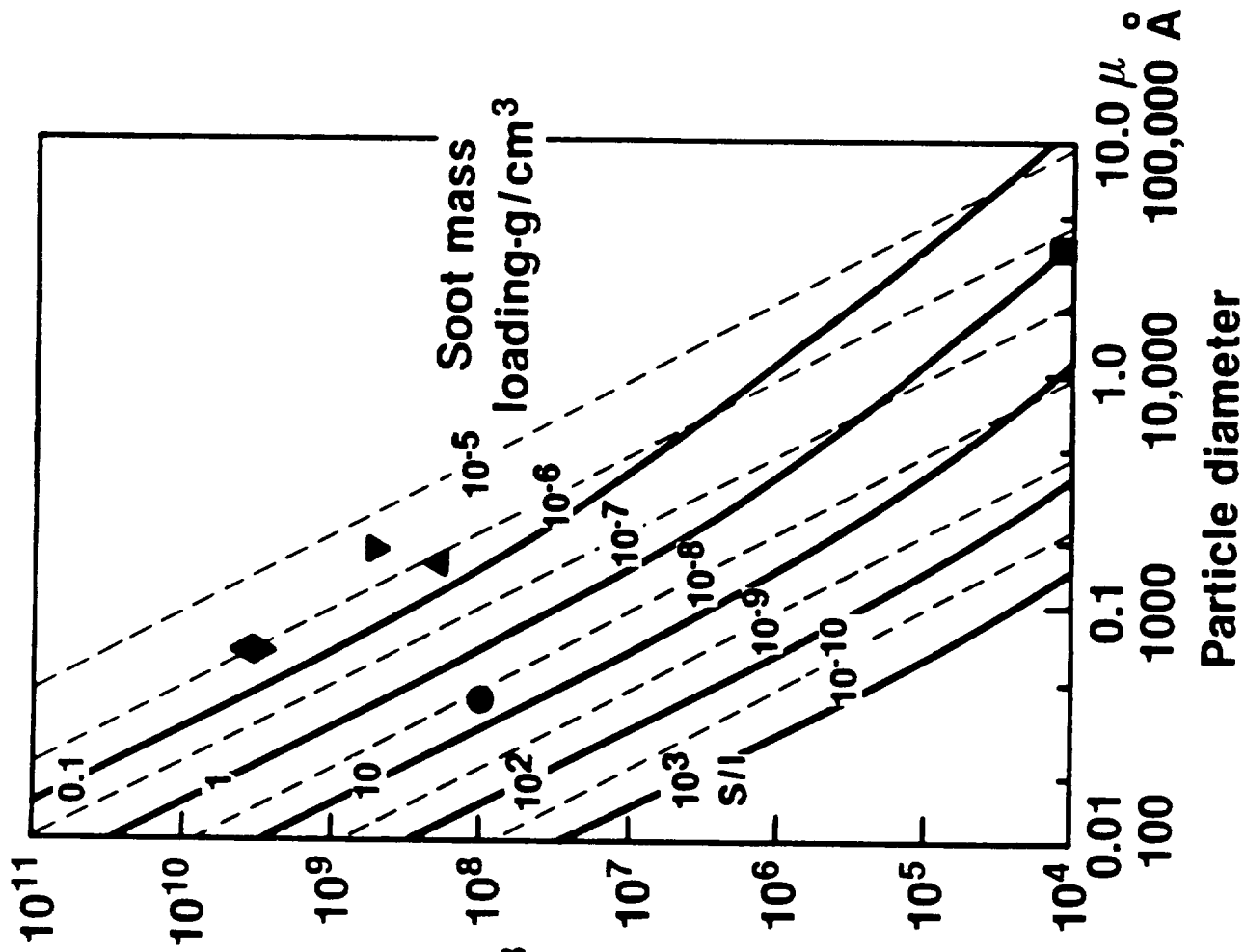

<p>Laser: 0.5J, 532nm, 10^{-8} sec</p> <p>Raman: N_2, 2000 K, 1atm</p>
<ul style="list-style-type: none"> ■ Combustor JP-4 ◆ $\text{CH}_4:\text{O}_2$ premixed flame ▲ C_4H_{10} diffusion flame ● Combustor C_3H_8 (g) ▼ C_3H_8 diffusion flame

The dashed lines are soot mass loadings and the solid points are soot conditions typically found in practical combustors.

Because of these severe interferences, spontaneous Raman scattering has seen very little practical utility in devices typical of the real world, i.e. gas turbines, furnaces, internal combustion engines. This conclusion is certainly valid for pulsed lasers which operate in the visible region of the spectrum and was the motivation for the development of the much stronger coherent techniques nearly a decade ago. However, in the past few years, highly energetic and reliable pulsed ultraviolet lasers have emerged. With these sources, a reexamination of spontaneous Raman scattering is merited even for practical utilization. For example, the Raman scattering from a pulsed krypton fluoride laser operating at 248 nanometers is nearly twenty times stronger than that from a laser operating at 532 nanometers, the wavelength of frequency-doubled neodymium:YAG lasers. Furthermore, as one operates deeper into the ultraviolet, the incandescence from the laser heated soot particles diminishes resulting in much larger signal to interference ratios for Raman excitation in the ultraviolet. Calculations that I've made recently indicate that pulsed uv Raman scattering appears to be potentially applicable to practical combustors having modest particulate loadings. However, there are other interference effects such as laser-induced fluorescences from fuel fragments and/or photodissociation of target molecules that also have to be considered before one can comment definitively on the practical utility of uv spontaneous Raman scattering. Further experimentation is clearly needed to examine the applicability of spontaneous Raman scattering in the ultraviolet.

However a decade ago when conclusions about the practical utility of Raman scattering were first being reached, such high power and reliable ultraviolet lasers did not exist.

Coherent Anti-Stokes Raman Spectroscopy (CARS)

Consequently, to be able to make measurements in flames of practical interest, one searched for much stronger techniques than spontaneous Raman scattering. The technique which emerged is depicted in Panel 21 and is a coherent form of Raman spectroscopy known as CARS. It is a very strong technique with signal levels being anywhere from 4 to 6 orders of magnitude stronger than spontaneous Raman scattering. It is a coherent technique which means that the signal emerges as a laserlike beam. This has two important implications. One is that all of the signal can be collected. This is in contrast to an incoherent scattering process where, even with fast optics, for example F3, only about one percent of the total signal can be collected. In addition, because the signal is coherent, one can collect it with extremely small solid angle collection optics greatly minimizing the collection of interfering radiations. With CARS, the interferences do not go away; it is simply that one can operate with much higher signal to interference ratios, perhaps 10 orders of magnitude greater, than those commonly available with spontaneous Raman scattering. The technique is spatially precise depending on the beam crossing geometries which are employed and, like all Raman techniques, it is applicable to all molecules. One of its major disadvantages

COHERENT ANTI-STOKES RAMAN SPECTROSCOPY (CARS)

Advantages

- Strong
- Coherent
- Spatially - precise
- Applicable to molecules

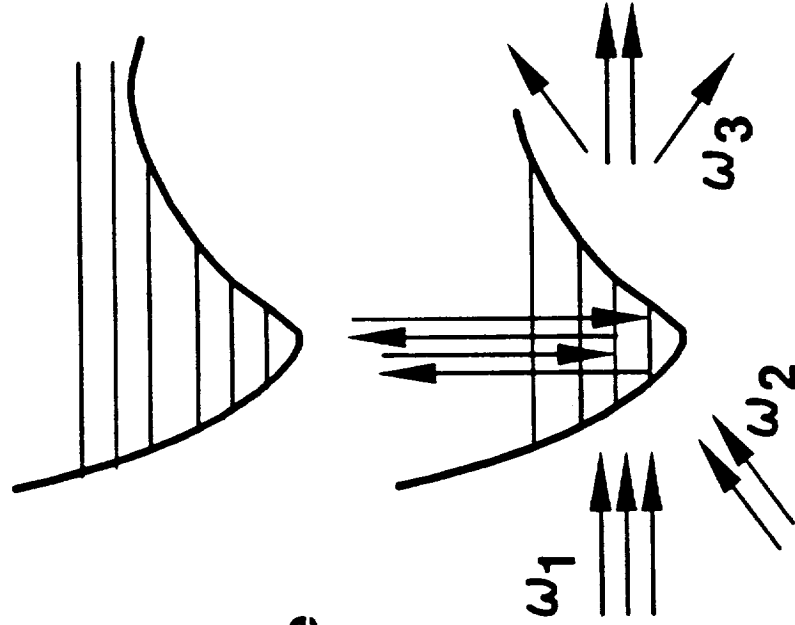

Disadvantages

- Double - ended
- Complex
- Refractive sensitive

is that it is double ended. Although it is a spatially precise technique, line of sight optical access is generally required. This makes it very difficult to employ in some situations, e.g., to annularly-shaped gas turbine combustors. It is a much more complex technique than spontaneous Raman scattering and it can be sensitive to refractive index gradients in the medium. However, even in these instances there are special beam geometries which minimize these sensitivities.

As shown in Panel 22, CARS occurs when laser beams at frequencies ω_1 , the pump, and ω_2 , the Stokes, are mixed in an appropriate fashion. Mixing involves focusing and orientation of the laser beams in accordance with so-called phase-matching considerations. Phase matching ensures that the signal generated at one point will be in phase with the signal generated at subsequent points so that the signal builds up in a constructive manner and does not destructively interfere. There are many geometries to achieve phase matching and, in practice, this is an easy requirement to fulfill. The CARS signal always occurs at $2\omega_1 - \omega_2$. What is key in the process is the frequency difference between ω_1 and ω_2 . When it coincides with a Raman active rotational-vibrational resonance in the gas, the CARS signal becomes resonantly enhanced and uniquely characteristic of the constituent being interrogated. Although the spectrum can be generated at very high resolution by scanning the Stokes laser sequentially over the transitions of interest, diagnostically this is generally unacceptable. Rather, for fast pulse diagnostics, the Stokes laser is made broadband accessing simultaneously all of the vibrational-rotational transitions in a given band region and leads to

COHERENT ANTI-STOKES RAMAN SPECTROSCOPY (CARS)

- Approach

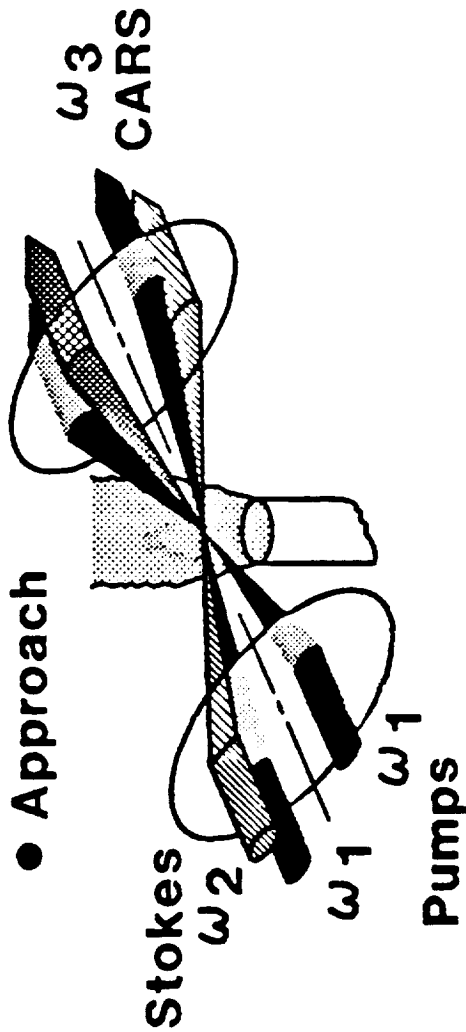

- Phase matching

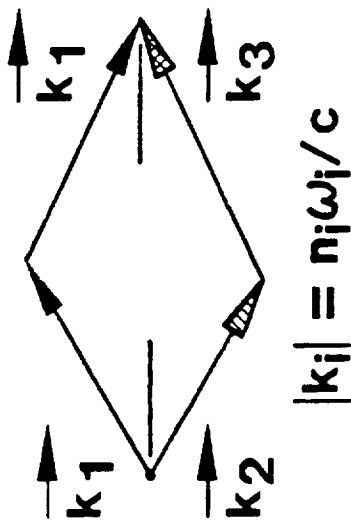

- Energy level diagram

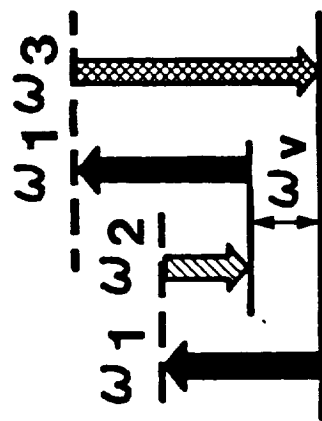

- Spectrum

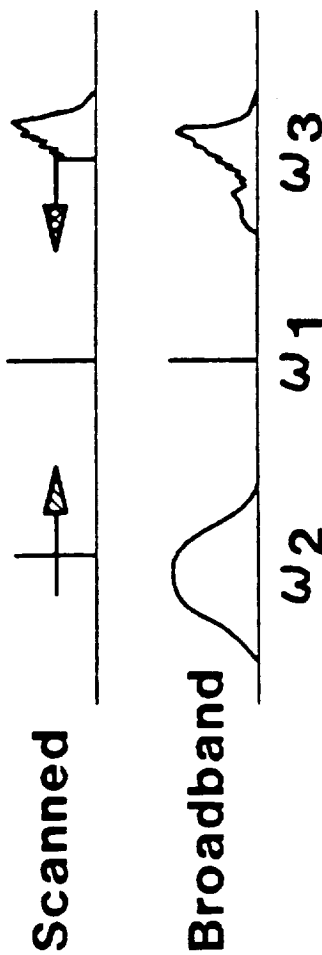

generation of the entire CARS spectrum with each pulse. Capture of the spectrum then permits instantaneous temperature and density measurements to be made. One of the disadvantages of CARS also becomes apparent in this diagram; one nominally can only interrogate one constituent at a time, i.e., the constituents whose Raman resonances coincide with the frequency difference $\omega_1 - \omega_2$. This is in contrast to spontaneous Raman scattering where, with one laser beam, all species Raman scatter and can be monitored. There are advanced multicolor CARS techniques emerging [Ref. 8] which overcome this limitation but they are even more complicated than the straightforward CARS process outlined here.

Panel 23 summarizes the measurement capabilities of CARS for combustion processes. With CARS, because of the higher photon yields, one can simultaneously capture the entire spectral signature and obtain temperature from it analogous to what we saw earlier with spontaneous Raman scattering. At atmospheric pressure, the typical accuracies are about $\pm 1\%$ time averaged and about $\pm 3\%$ for a single 10^{-8} sec pulse. Species concentrations are gathered from the strength of the signal in general, although CARS is a unique spectroscopy in that, in certain concentration ranges, its signatures are also concentration sensitive. This is a very important advantage when one is making measurements in practical media where attenuation by particulates and fuel droplets may be significant or where windows are subject to fouling after a period of time. Due to a number of reasons, CARS is typically restricted to viewing only the major constituents, i.e. species concentrations on the order of 1/2% or greater. For a variety of reasons, the accuracy is not as good on

CARS MEASUREMENT CAPABILITIES - COMBUSTION

- **Temperature**
 - **From spectral signatures**
 - **Accuracy at flame temperatures**
± 1% time averaged ± 3% single pulse
- **Species concentrations**
 - **From signal strength in general**
 - **From spectral signatures in certain ranges**
 - **Sensitivity restricted to major constituents, > 0.5%, for**
either broadband or narrowband background suppressed
 - **Relative accuracy to within ± 5%**

concentration as it is with temperature. Species concentration measurements are typically accurate within about $\pm 5\%$.

Panel 24 displays the temperature variation of the nitrogen CARS spectrum. It is conceptually similar to those spectra seen earlier from spontaneous Raman scattering but differs in the actual spectroscopic details. Basically, one again is looking at rotational and vibrational state population distributions. Temperature measurements are performed by capturing such spectra and then using computer codes to deduce which of a library of spectra produces the best fit to that particular experimentally-captured spectrum.

CARS has been successfully applied to a wide range of practical combustion devices as summarized in Ref. 9. It is capable of making temperature measurements under extremely high soot loadings as evidenced by the measurements in Panel 25 performed in laminar ethylene air diffusion flames [Ref. 10]. In these small-scale laboratory flames, the measurement volume was roughly cylindrical with a diameter on the order of 100 microns and an axial extent of 700 microns. Contrast these measurements with the application of CARS to actual afterburning jet engine exhausts [Ref. 11]. In that particular application, a hardened CARS instrument was mounted about an afterburning Pratt & Whitney F-100 jet engine, which, at full thrust, creates an acoustic environment on the order of 150 decibels. Spatially-resolved temperature and species concentration measurements were made throughout the one meter diameter exhaust flow. The CARS signal is piped out of the hostile environment using fiber optics and sent to remotely located spectrographic and detection equipment. The CARS instrument was operated completely remotely due

TEMPERATURE SENSITIVITY OF N₂ CARS SPECTRUM

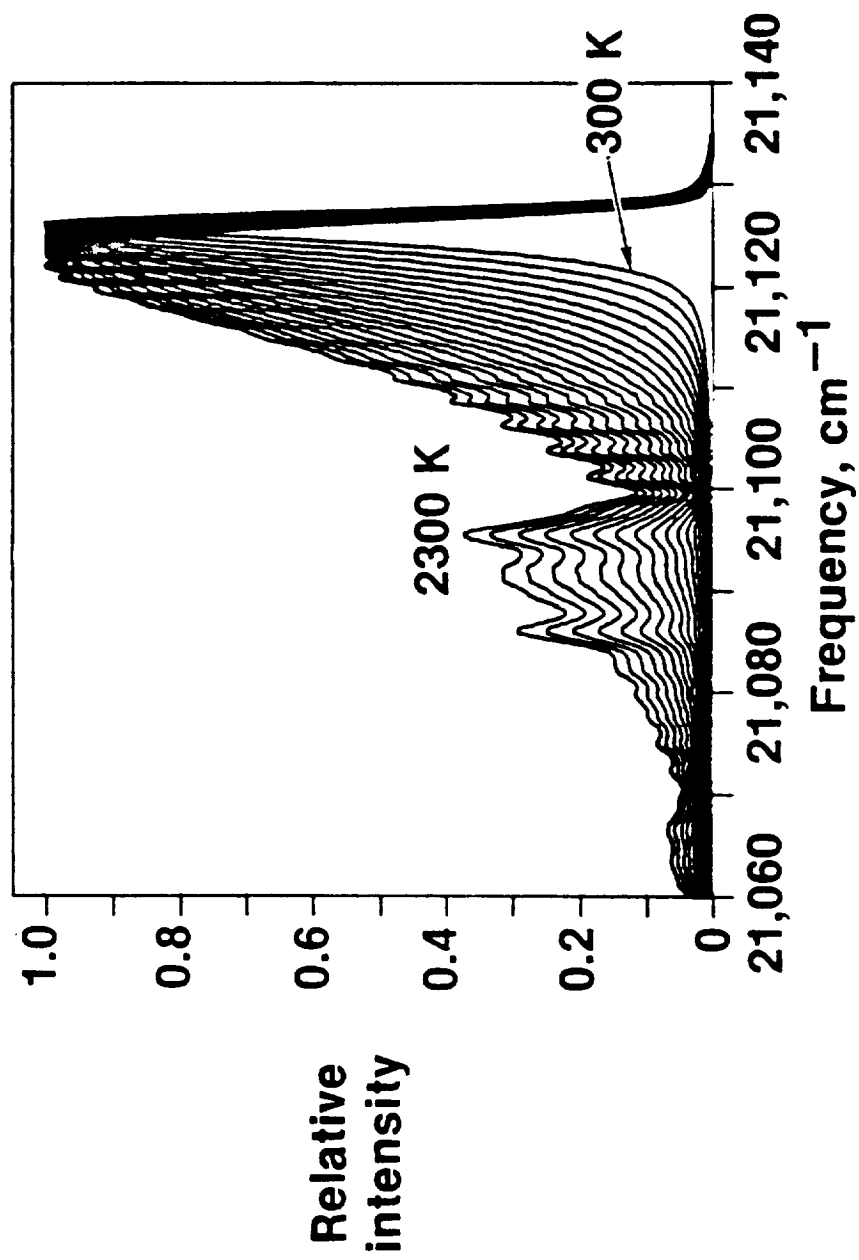

EFFECT OF DILUENT N₂ ON A LAMINAR ETHYLENE/AIR DIFFUSION FLAME

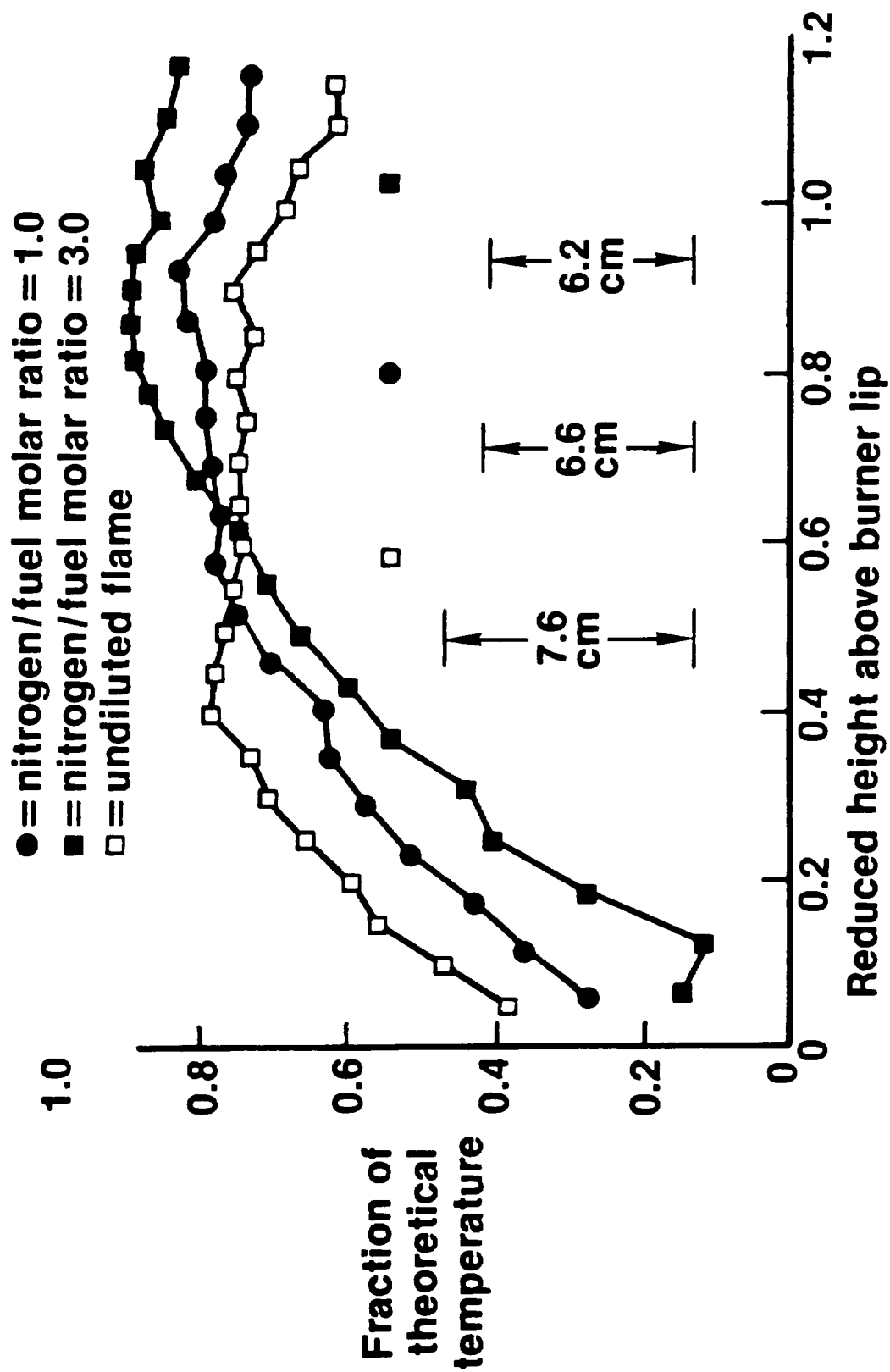

to the hostility of such jet engine environments. This illustrates that, despite the sophistication of these laser techniques, they can be engineered for hostile real world environments. The CARS instrument operates at 20 pulses per sec and therefore, in a 20 sec measurement period, gathers about 400 single shot temperature measurements as illustrated by the histogram displayed in Panel 26. From the histogram one can deduce the average temperature in the medium as well as deduce the magnitude of the turbulent temperature fluctuations. One can also display the time history of the measurements as they occurred.

Laser-Induced Fluorescence Spectroscopy (LIFS)

Laser-induced fluorescence spectroscopy has received much attention due to its very good sensitivity, i.e., it is capable of detecting constituents in trace levels at either the part per million or occasionally the part per billion type levels. Its primary utilization is in detecting trace quantities of constituents. However, because it interrogates individual vibrational-rotational states, it can be used for thermometry although it is hardly ever the method of first choice for thermometric utilization. It is a very sensitive technique because one probes an actual allowed electronic absorption in the constituent being observed as illustrated in Panel 27. Indeed fluorescence may be viewed as a very sensitive method of monitoring absorptions in a spatially precise manner. Following promotion to the upper

SINGLE PULSE CARS TEMPERATURES IN AUGMENTED JET EXHAUST

Center: 1398 K RMS deviation: 163 K
Total count: 347 Spread test: 200 K

Histogram

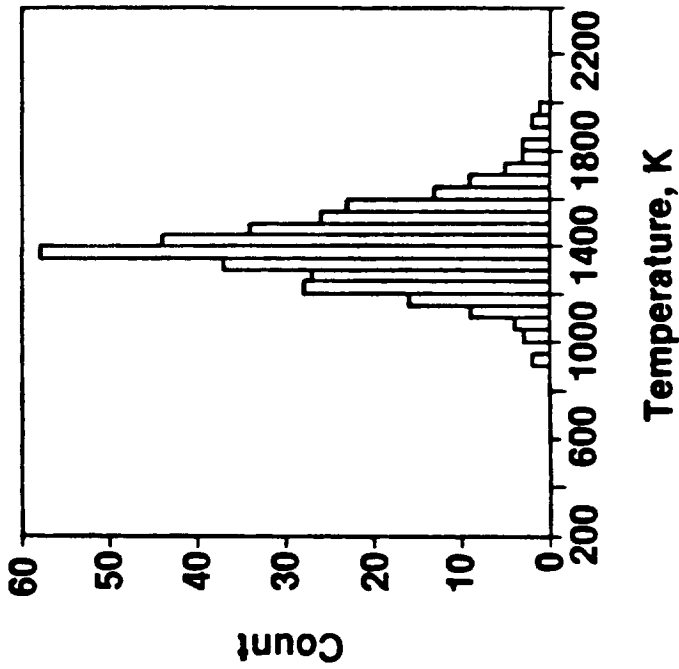

Time history

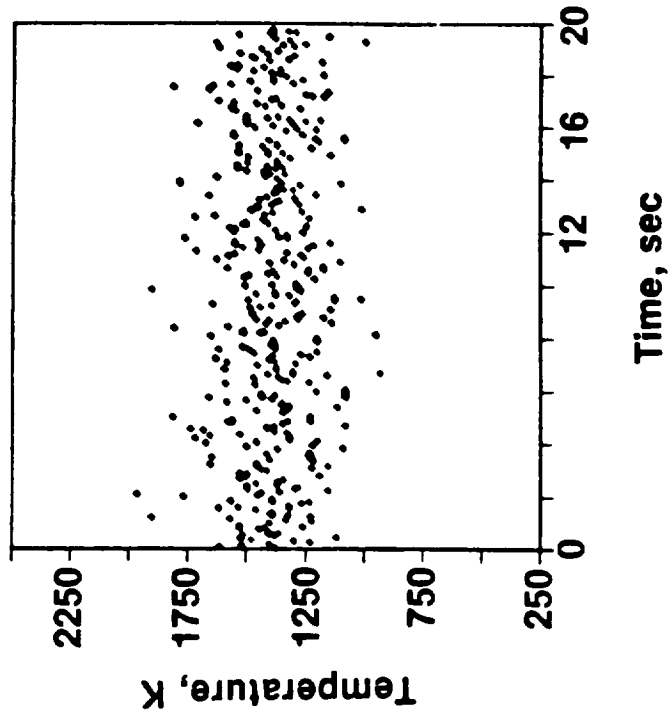

LASER-INDUCED FLUORESCENCE SPECTROSCOPY (LIFS)

Advantages

- Simple
- Spatially precise
- Semi-quantitative
- Ground state observed
- Sensitive

Disadvantages

- Limited species
- Fluorescence efficiency
 - Collisional quenching
 - Photodissociation
 - Chemical reaction

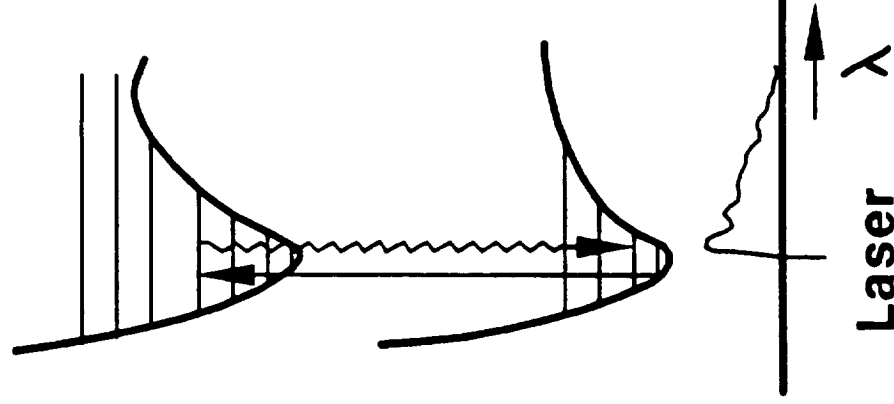

state by absorption, the fluorescence signal results from the spontaneously-emitted photons from the upper level. This is not an instantaneous process since the promoted electronic state has a finite lifetime. In addition to spontaneously radiating, there are a number of mechanisms by which this upper state can be deactivated, for example, by collisions with other molecules, the molecule may fly apart or photodissociate upon being excited, or it may disappear by a chemical reaction because the excited state may have an enhanced reactivity. These processes all diminish the efficiency of the fluorescence process and have to be taken into account in order for the measurements to be quantitatively precise. This is often difficult to do with great accuracy, so, in some respects, laser-induced fluorescence spectroscopy is often a semiquantitative technique.

The general approaches for using laser-induced fluorescence for thermometry are summarized in Panel 28. The first approach involves excitation scans. Here the laser is tuned over the various absorption transitions of the ground electronic state and the fluorescence from the entire upper manifold is typically monitored. This, in essence, allows the various rotational-vibrational states of the ground electronic state to be monitored from whence a temperature can be deduced. The difficulty with this approach is that one requires a tunable laser with a large tuning range and the technique is time consuming which precludes instantaneous measurements. A simplified extension of this approach is the two line technique. Here just two individual vibrational-rotational states in the ground electronic state are monitored. By exciting to the same upper state, the fluorescence

LASER INDUCED FLUORESCENCE THERMOMETRY APPROACHES

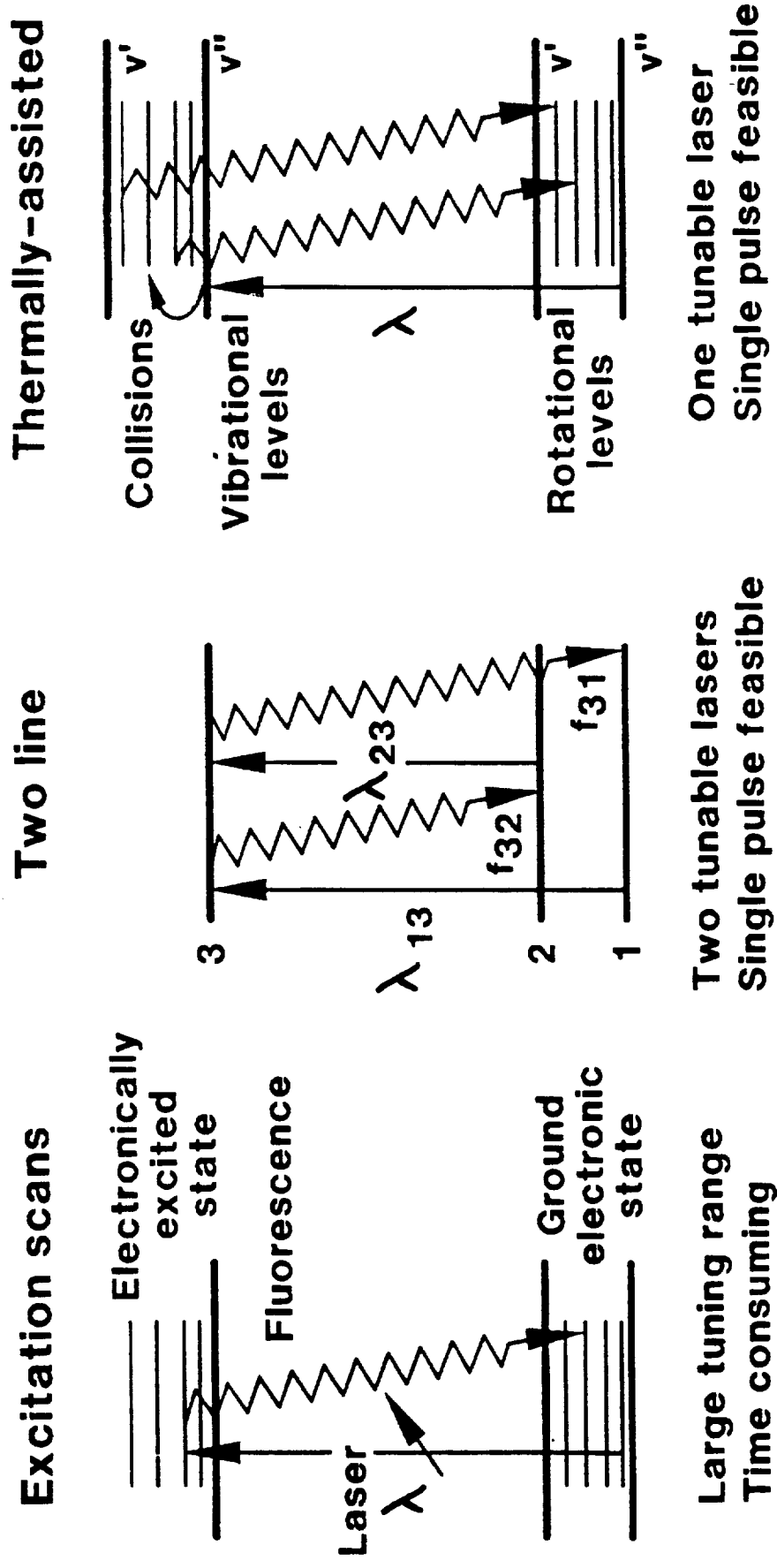

Large tuning range
Time consuming

Two tunable lasers
Single pulse feasible

One tunable laser
Single pulse feasible

efficiency cancels out in the relative population determination making this a temperature measurement technique which is completely insensitive to quenching effects. Furthermore, if the two pulsed lasers are sequenced within a characteristic time for the medium to change, single pulse measurements become feasible. Such techniques have seen widespread utilization using atomic species such as thalium, indium, tin or lead seeded into the flames to perform highly accurate temperature determinations [Ref. 12]. One can also use this technique with naturally-occurring flame constituents and it has been employed, for example, with the hydroxyl radical to make temperature measurements in flames [Ref. 13]. However, the OH radical is present in sufficiently high concentrations only at high temperatures and so this approach is restricted to elevated temperature thermometry.

The third class of approaches is the so-called thermally assisted where one laser is used to promote excitation to a single vibrational-rotational level in the electronically excited state. Collisions with that state then redistribute population over the manifold of vibrational-rotational states and the resulting fluorescent distribution is a function of temperature. By monitoring the distribution of the fluorescence, the temperature can be deduced. This technique has also been demonstrated on seeded atomic species and on naturally occurring molecular species. In the latter instance, detailed computer modeling is required to predict the resulting fluorescence intensity distribution. With atomic seeds in flames, excellent results have been obtained with thermally-assisted laser-induced fluorescence thermometry. Panel 29 shows one such example of measurements from thalium in an acetylene/

oxygen/air flame. The temperature was independently measured to be 2465 K. Single-shot thermally-assisted fluorescence thermometry was demonstrated with a histogram mean at 2470 deg. Furthermore, the width of the resulting histogram was quite narrow as seen in Panel 29. However, as stated earlier, because of the need for a tunable laser, often in the ultraviolet, and the requirement to introduce seeds to achieve measurements at low temperatures, fluorescence thermometry is generally not the method of first choice.

Two-Dimensional Field Techniques

To this juncture we have concentrated on measurements made at a single point. However the incoherent techniques lend themselves readily to extensions of simultaneous measurements in one and or two dimensions. Two dimensional laser imaging [Ref. 14] is illustrated in Panel 30. Rather than illuminating the medium with a single ray or pencil of laser light, the laser is formed by various means into a sheet of light which intersects the medium under study. The scattering from various points along the sheet is then imaged onto a two-dimensional array detector which can spatially resolve the fluorescence emanating from each point along the illuminated sheet. The motivation for two dimensional imaging is summarized in Panel 31 and stems from the fact that it permits entire fields to be mapped at a single instant of time. This not only expedites data collection but, quite importantly, permits spatial correlations to be developed between various points. Such correlations enable one to gain phenomenological insight into the fundamental

SINGLE PULSE THERMALLY-ASSISTED LIFS THERMOMETRY IN FLAMES

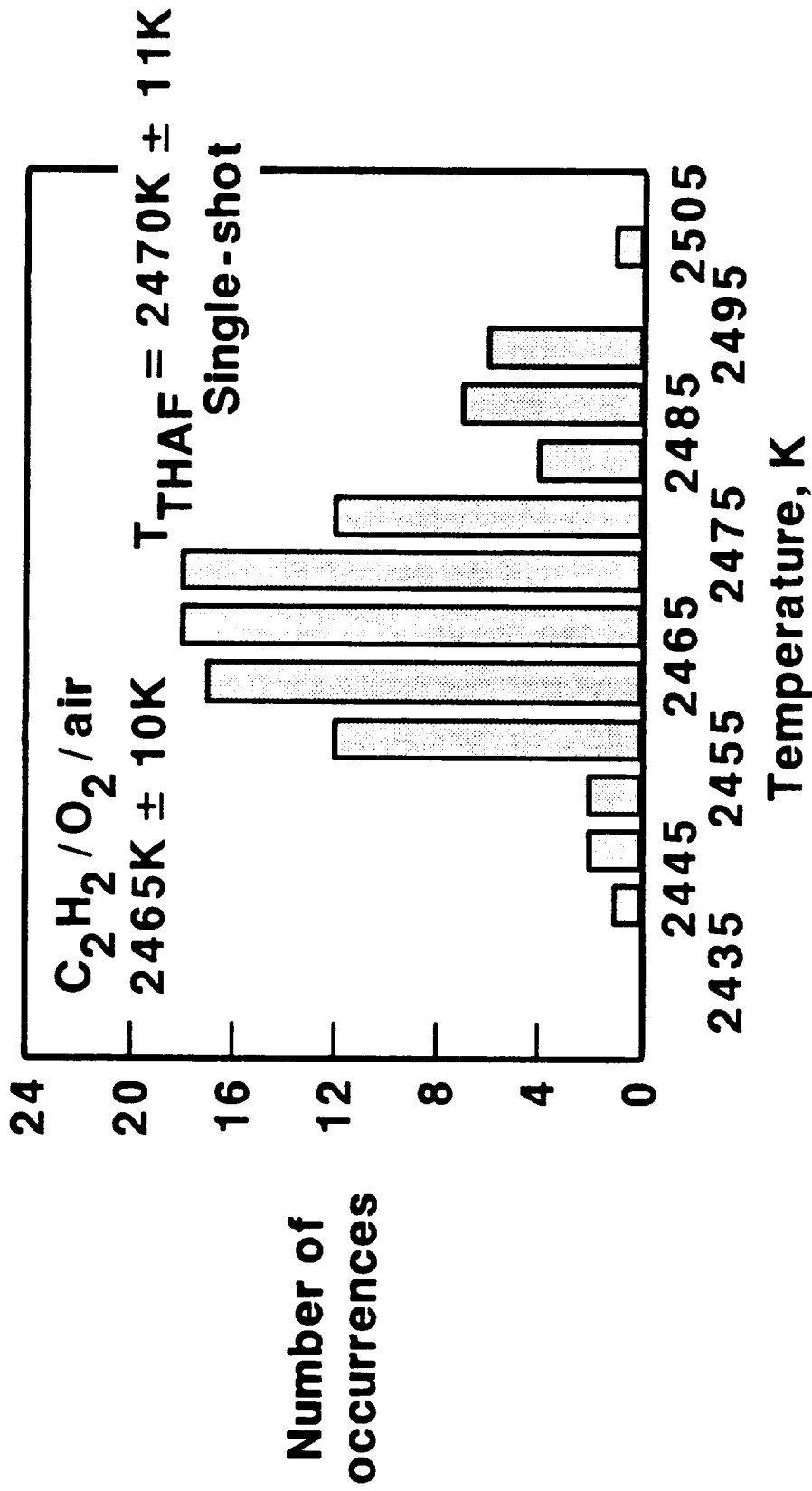

Ref: M.L. Elder, et al., Appl. Spect. 38, 113 (1984)

2-D LASER IMAGING

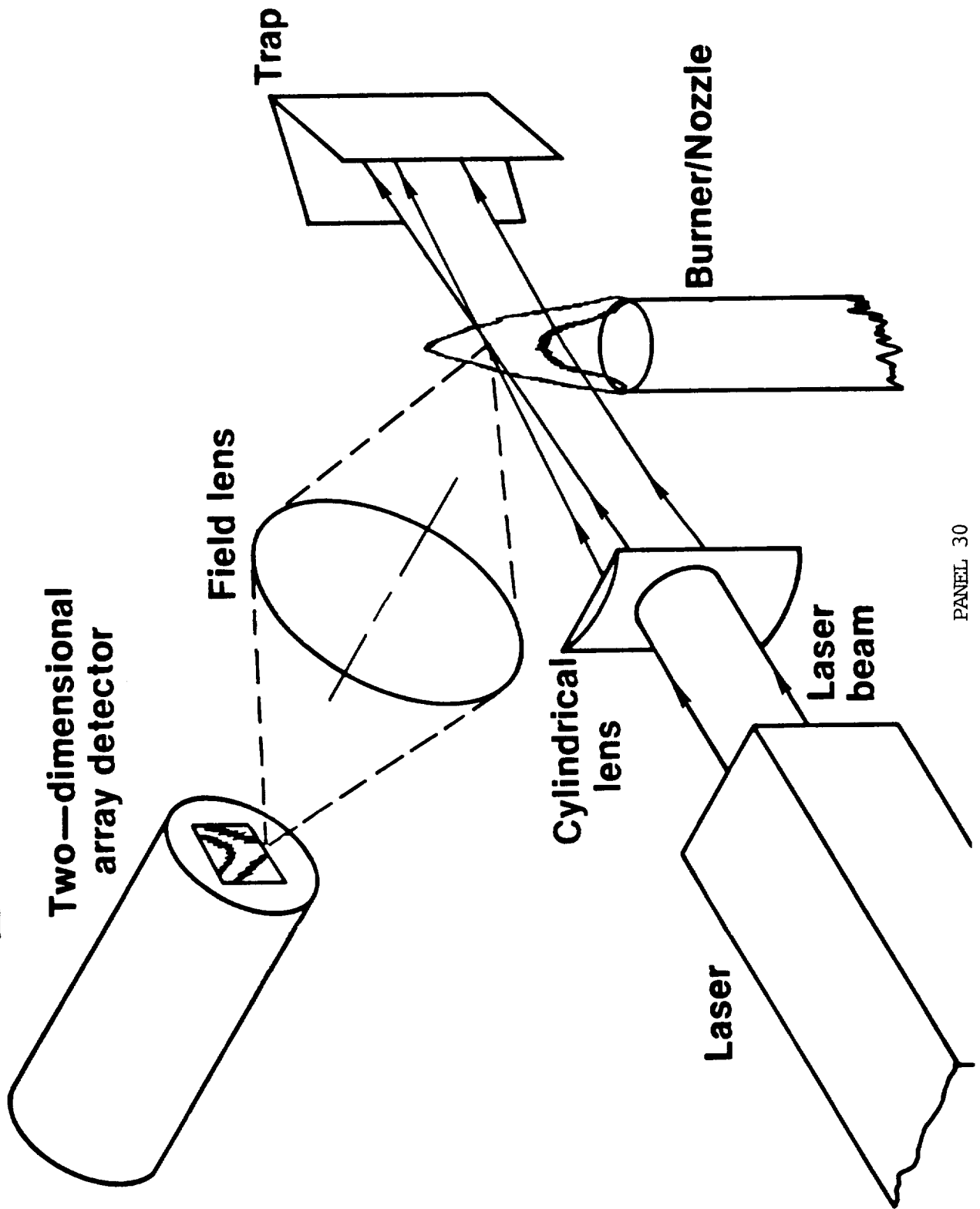

2-D IMAGING

MOTIVATION

- **Laser based**
- **Field mapping**
 - **Spatial correlations**
 - **Phenomenological insight**
- **High repetition rates**
- **Temporal correlations**

processes which are occurring. Such insight is often very difficult to glean from a series of statistically-uncorrelated single point measurements. Two dimensional imaging today can be done at very high repetition rates as lasers and cameras push into the hundreds of Hertz range. Such disadvantages as computer storage capabilities and computational speeds are rapidly diminishing with advances in the computer state of the art.

As summarized in Panel 32, all of the scattering processes previously considered can be potentially used for 2-D laser imaging. Mie scattering, i.e., the elastic scattering of light from particles, and laser-induced fluorescence have actually seen the most utilization in this regard due to the strength of the respective processes. Rayleigh scattering is fairly strong but its utility is restricted to total density measurements in particle-free situations as discussed earlier. Raman scattering, due to its weakness, is very difficult to implement in atmospheric pressure, two-dimensional situations unless one has very powerful one-of-a kind pulsed lasers [Ref. 15].

Imaging techniques have actually seen the most use for species concentrations measurements although they can be implemented to make temperature measurements as well. In our laboratory we have used linear Rayleigh imaging in a turbulent flow to measure flame thicknesses. In this particular application, Rayleigh scattering from along a line of laser light was imaged onto a linear diode array to observe the density variation through the flame front. Since the Mach number was low and since the composition dependence of the total Rayleigh cross section was also very small, temperature could be obtained from the density measurement through the perfect

SCATTERING PROCESSES FOR IMAGING

- **Mie Scattering**
Seeding required
Fractional concentration measurement
- **Rayleigh Scattering**
Total density measurement
Temperature from gas law, $M < 1$
- **Raman Scattering**
Very weak
Temperature, species mapping difficult
in atmospheric pressure flames
- **Fluorescence**
Species mapping (limited)
Seeding possibly required
Temperature measurements awkward
Velocity mapping possible

gas law. Panel 33 shows one such measurement example obtained with a single 10^{-8} sec laser pulse. Fluorescence has seen the most use for two-dimensional flame temperature mapping and most work to date has employed two line fluorescence approaches to perform the two dimensional temperature measurements [Ref. 16]. However such approaches require not only two lasers but also two detectors and one has to register very carefully the two spatial fields in order to get accurate temperature measurements. Thus this approach is quite cumbersome and is not easy to implement. The simplest approach demonstrated to date involves seeding the flame with an inert constituent at constant mole fraction. By picking the correct transition in the molecular seed, one can achieve a fluorescence intensity which displays a peak behavior relative to temperature as shown in Panel 34 by the $Q_1(22)$ transition in NO . Upon illuminating a flame or field whose temperature is to be measured, the area of maximum fluorescence intensity then corresponds to the temperature at which the peak in the fluorescence occurs. The temperature at other points in the field can then be deduced from this peak temperature by moving sequentially away from this self-calibration point as it were. An example of using this approach is shown in the temperature contours obtained in a rod stabilized flame shown in the right hand portion of Panel 34. For this technique to work, the seed must be chemically inert and must be uniformly dispersed throughout the entire medium.

Panel 35 presents a summary of the various spatially precise laser diagnostics that have been considered here for species and temperature measurements in the gas phase. Rayleigh scattering, because it is not species

RAYLEIGH IMAGING IN A TURBULENT FLAME

Single 10^{-8} sec pulse; CH_4 --air

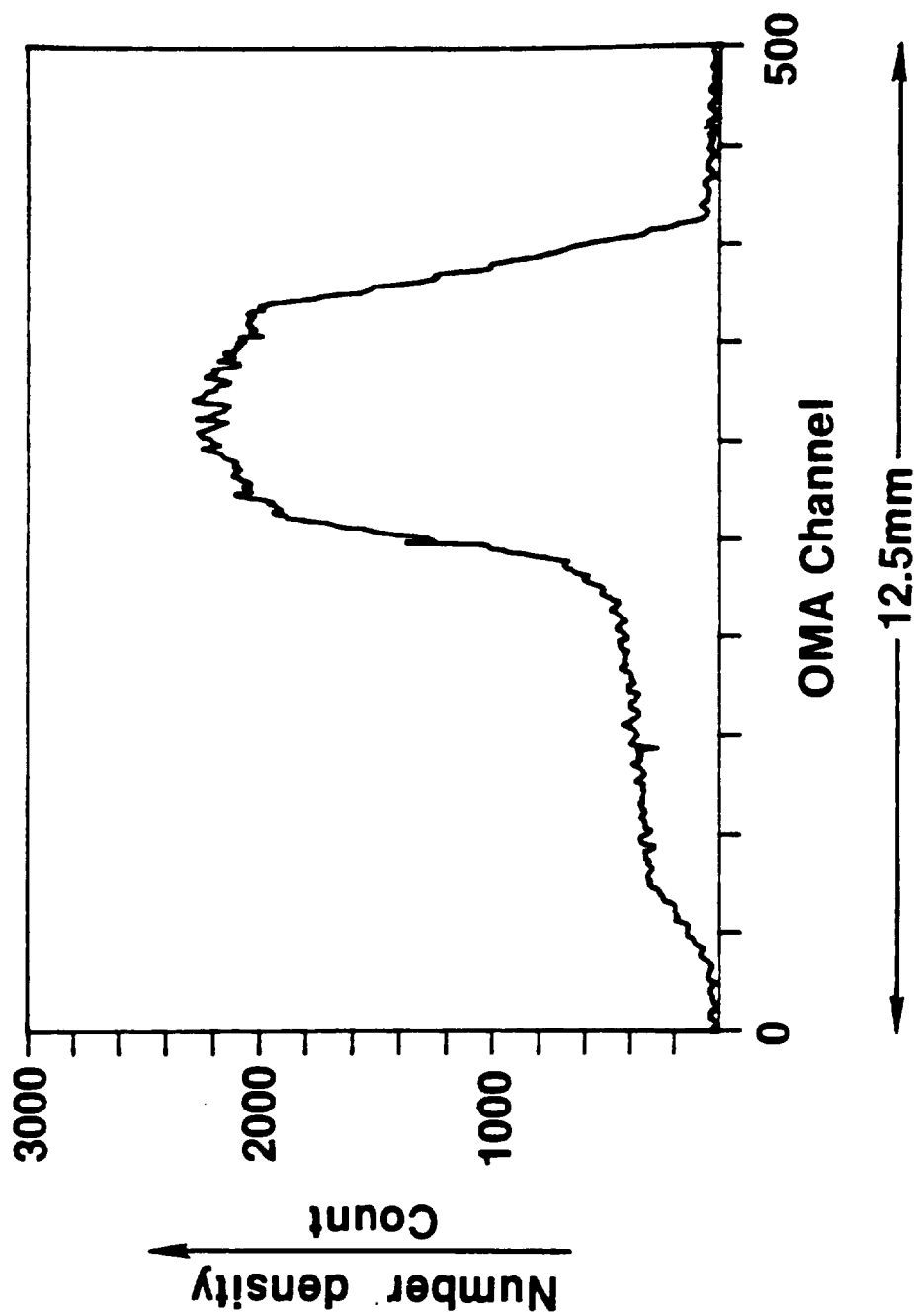

PANEL 33

TWO-DIMENSIONAL LIFS TEMPERATURE IMAGING IN FLAMES

NO seeded at constant mole fraction

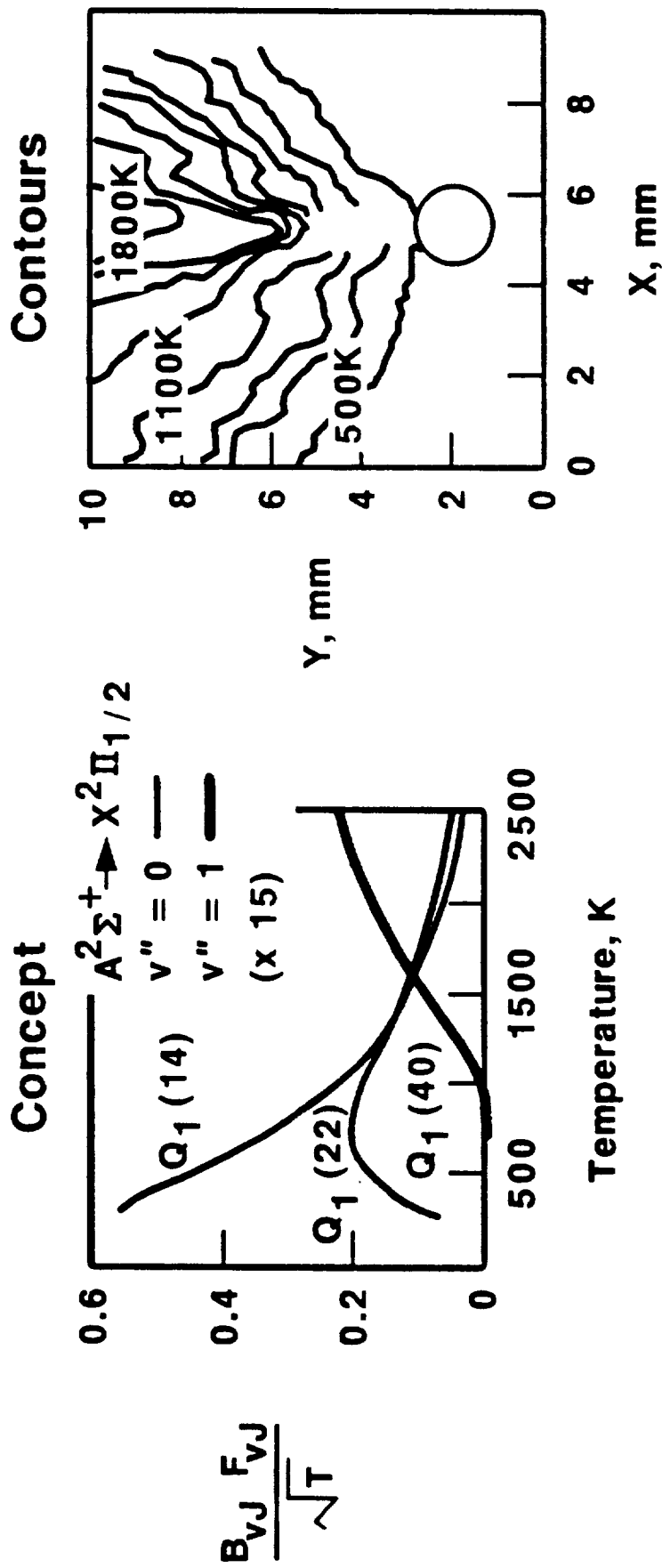

Ref: J.M. Seltzman, et al., Optics Letters 10, 439 (1985)

SPATIALLY-PRECISE LASER COMBUSTION DIAGNOSTICS

Summary

- **Rayleigh scattering**
 - Total number density, temperature (gas law)
 - Applicable only to particle-free situations
- **Spontaneous Raman scattering**
 - Thermometry, major species (>0.1%) measurements
 - Restricted to relatively clean flames and flows
- **Laser induced fluorescence**
 - Flame radicals, atomic species
 - Thermometry
- **CARS**
 - Thermometry, major species
 - Broadly applicable

specific, can only be used to measure the total number density from which temperature can be derived if one has a constant pressure situation. Furthermore Rayleigh scattering is applicable only to particle free situations. However it is extremely strong and can be a very powerful technique with carefully chosen flames. Spontaneous Raman scattering is species specific. However, it is extremely weak technique and therefore is capable of measuring only the major species in combustion systems. Furthermore its utilization is restricted to flames that are relatively clean, that is whose luminosity levels are not too high and whose soot particle loadings are relatively low. Also due to its weakness it is very difficult to implement in two-dimensional imaging situations. Laser-induced fluorescence is an extremely sensitive technique for looking at flame radicals and atomic species, and because of its strength, lends itself readily to two-dimensional imaging. However its utilization for thermometry is generally somewhat cumbersome and, therefore, it is generally not the thermometric method of choice. CARS is capable of temperature and major species concentrations measurements in combustion systems. Because of its signal strength and coherence, it is a technique that is broadly applicable to many practical combustion systems and devices. CARS can also be implemented in a linear imaging mode but has not seen widespread attention in this regard.

References

1. A. C. Eckbreth, P. A. Bonczyk and J. F. Verdick: Prog. Energy Combust. Sci. 5, 253 (1979).
2. A. C. Eckbreth: Proceedings 18th Symposium (International) on Combustion, p. 1471, The Combustion Institute, Pittsburgh, PA, 1981.
3. A. C. Eckbreth: AIAA Paper No. 86-0138 (1986); to be published in the J. Propulsion and Power (1987).
4. A. C. Eckbreth: Laser Diagnostics for Combustion Temperature and Species. Abacus Press, Kent U.K., 1987.
5. J. A. Shirley: pp. 603-617, NASA Conference Publication 2372 (1985).
6. A. C. Eckbreth and J. W. Davis: Appl. Opt. 16, 804 (1977).
7. J. A. Shirley: pp. 107-123, NASA Conference Publication 2436 (1986).
8. A. C. Eckbreth and T. J. Anderson: SPIE Paper 742-07 (1987).
9. A. C. Eckbreth: SPIE Proceedings 621, 116 (1986).
10. L. R. Boedeker and G. M. Dobbs: Comb. Sci. Tech. 46, 301 (1985).
11. A. C. Eckbreth, G. M. Dobbs, J. H. Stufflebeam and P. A. Tellex: Appl. Opt. 23, 1328 (1984).
12. G. Zizak, N. Omenetto and J. D. Winefordner: Opt. Eng. 23, 749 (1984).
13. R. Cattolica: Appl. Opt. 20, 1156 (1981).
14. R. K. Hanson, Proceedings 21st Symposium on Combustion, The Combustion Institute, Pittsburgh, PA, 1987, in press.

15. M. B. Long, D. C. Fourquette, M. C. Escoda and C. B. Layne: *Opt. Lett.* 8, 244 (1983).
16. R. J. Cattolica and D. A. Stephenson: pp. 714-721 in J. R. Bowen, N. Manson, A. K. Oppenheim and R. I. Soloukhin, Eds.: Dynamics of Flames and Reactive Systems, AIAA, New York, 1984.