

NASA Technical Memorandum 100876

NASA-TM-100876 19880015463

Characterization of a 30-GHz IMPATT Solid State Amplifier

Lawrence W. Wald
Lewis Research Center
Cleveland, Ohio

July 1988

LIBRARY COPY

AUG 26 1988

LANGLEY RESEARCH CENTER
LIBRARY W-2
HAMPTON, VIRGINIA

NASA

Trade names or manufacturers' names are used in this report for identification only. This usage does not constitute an official endorsement, either expressed or implied, by the National Aeronautics and Space Administration.

CHARACTERIZATION OF A 30-GHz IMPATT SOLID STATE AMPLIFIER

Lawrence W. Wald
National Aeronautics and Space Administration
Lewis Research Center
Cleveland, Ohio 44135

SUMMARY

This memorandum describes the characterization and testing of a 20-W solid state amplifier operating in the Ka band to be used in low cost experimental ground terminals. The amplifier was developed by the TRW Electronic Systems Group under NASA Contract NAS3-23266 as a proof-of-concept (POC) device in support of the Advanced Communications Technology Satellite (ACTS) program. Additional goals were development of high-power IMPATT devices and circulators, and multistage diode circuits, which are an integral part of the amplifier.

The amplifier underwent acceptance testing at the NASA Lewis Research Center, Cleveland, Ohio. Characteristics measured include an output power of 42 dBm, gain of 30 dB, an injection-locking RF bandwidth of 260 MHz, and an overall direct current-to-radiofrequency (dc-to-RF) efficiency of 6.7 percent.

INTRODUCTION

Advanced communications system development at NASA Lewis has centered on the 30-GHz uplink and 20-GHz downlink technology that will be used for future geosynchronous communication satellites. One element of this effort has been the development of solid state RF amplifiers using a variety of state-of-the-art devices such as the IMPATT and the GaAs FET. Advanced amplifiers will be used in transmitters for both space and ground applications. The amplifier described herein is based on IMPATT diode technology. This prototype amplifier was slated for further development and possible use in a low cost experimental ground terminal for the ACTS program.

This memorandum summarizes the amplifier development and provides characterization data from tests performed at the NASA Lewis Research Center.

System Design

The amplifier requirements are shown in table I. The amplifier uses double-drift silicon IMPATT diodes. Details on the development effort and construction of the diodes are given in reference 1. The goals set for diode development were a diode output power of at least 2.5 W with a dc-to-RF efficiency of 12 percent.

The amplifier is a two-stage design, composed of a driver and a power amplifier. The driver stage uses a single diode, and the main amplifier/combiner section uses 12 diodes in a Kurokawa configuration for power combining (ref. 1). A block diagram of the design is shown in figure 1. The amplifier operates in an injection-locked, cw mode. An injection-locked amplifier will be free-running, that is, RF output is present even if the RF input is

E-4110

N88-24847

zero; for an RF input of f_c GHz, the amplifier will lock-up on the input frequency and track the frequency as long as it is both within the operating bandwidth of the amplifier and above a certain power level.

One essential component found in injection-locking oscillators or reflection amplifiers employing IMPATT diodes is the three-port circulator. The circulator decouples the diode input circuit from the diode output circuit and, in effect, transforms a one-port network into a two-port network. Since both the input and output signals are transmitted through the circulator, the electrical characteristics of the device have a profound effect on circuit performance. The circulators must be capable of handling the signal power, have wide bandwidth with low VSWR, and have adequate isolation for input/output decoupling. Insertion loss must be low, less than 0.5 dB, to minimize any effect on the already low efficiency of the IMPATT devices. TRW engaged in a program of circulator development; from this program, circulators with adequate RF characteristics were developed and used in the IMPATT amplifier. The circulators in the amplifier have a VSWR of 1.2, with a passband from 27 to 35 GHz. Passband insertion loss is typically 0.2 dB.

Interface Requirements

The following interface requirements are specified by the contractor in reference 1. Radio frequency input and output connections are made with standard WR-28 waveguide with a UG 599/U flange. The source and load VSWR should not exceed 1.3. The RF input signal should be between 28.675 and 28.94 GHz, and the signal level should not exceed 64 mW cw (18 dBm). Nominal input power is 13 dBm. Direct current supply requirements are 62 V at 1.0 A, 58 V at 4.0 A, and 12 V at 1.0 A. Since the dc-to-RF efficiency of the amplifier is low, the amplifier requires forced-air cooling. A large heat sink is attached to the baseplate of the amplifier, and an integral cooling fan is provided. A photograph of the amplifier is shown in figure 2.

TEST DISCUSSION

Scalar tests were performed along with bit-error-rate (BER) measurements. The scalar tests included RF power output as a function of RF power input, RF power output as a function of frequency, dc-to-RF efficiency, and injection-locking bandwidth as a function of power input. The BER measurements were made at two power levels for a number of different frequencies within the passband of the amplifier.

Scalar Tests

The test and measurement configuration for the power and gain measurements is shown in figure 3. The Hewlett Packard (HP) 8690A signal generator was used to generate a signal in a range from 28.5 to 29.5 GHz. A HP wavemeter was used to determine the frequency of the signal, and a Hughes 8001H amplifier boosted the signal level to the 8 to 18 dBm range needed to test the IMPATT amplifier. The 8001H is a TWT-based amplifier with an approximate 45-dB gain in the 30-GHz region. A power meter was used to measure the output of the Hughes amplifier, and a variable vane attenuator was adjusted to obtain the desired input level to the IMPATT amplifier. Power output from the IMPATT amplifier was then measured using another HP power meter.

Power and gain measurements. - The amplifier is a dual-stage design comprised of a single-diode driver and a power amplifier. The power amplifier is composed of 12 diodes arranged in a Kurokawa configuration. Table II lists the amplifier output power and gain with respect to frequency and input level. Figures 4, 5, and 6 show the data of table II plotted for input power levels of 8, 13, and 18 dBm, respectively. Note in the figures the change in abscissa (frequency) caused by the increase in operating bandwidth as the input power is increased. The gain variation and gain slope were within the contractual design requirements of 0.5 dB per 50 MHz interval and 0.15 dB per MHz for the 8-dBm drive level. At the nominal input level of 13 dBm the gain requirements are met, up to a frequency of 28.90 GHz. Above this point the gain drops severely, although operation is still within the injection-locking bandwidth. For the overdrive condition the gain requirements are attained, up to 29.05 GHz; as with the nominal input level case, the output power falls off severely at the upper end of the injection-locking bandwidth (above 29.05 GHz).

The operating bandwidth was determined using an HP 8566A spectrum analyzer. At the loss of injection lock the output spectrum changes from a cw signal to a "picket fence" spectrum (i.e., multiple carriers). The operating bandwidth increased from 200 MHz for an input level of 8 dBm to 260 MHz for the overdrive condition of 18-dBm input.

VSWR. - The amplifier was tested for input VSWR by using the configuration shown in figure 7. Three input power levels were used: 8, 13, and 18 dBm. The results appear in table III and figure 8. As expected, the input VSWR flattens out with increasing input power; that is, the amplifier approaches saturation.

Efficiency. - One goal of the proof-of-concept (POC) effort was to develop silicon double-drift IMPATT diodes capable of producing at least 2.5 W of output power at 12 percent dc-to-RF efficiency. For testing the amplifier, two dc power supplies were used: one at 62 V and the other at 58 V. During operation the 62-V source provided 331 mA, and the 58-V source provided 3700 mA; which agrees with the values shown in figure 1. Total dc input power was 235 W. RF output power of the amplifier was approximately 42 dBm or 15.8 W. The dc-to-RF efficiency was about 6.7 percent.

Scalar test summary. - The measured amplifier characteristics are shown in table IV. The measured characteristics are quite close to the requirements listed in table I. Phase linearity, harmonic output, and spurious output were not measured.

Bit-Error-Rate Measurements

The amplifier was originally developed as an experimental POC device to be used in a Ka-band satellite earth terminal. The 30/20 communication satellites use a 30-GHz uplink and a 20-GHz downlink frequency. The NASA Lewis Research Center has developed an end-to-end 30/20 satellite link simulation (ref. 2) known as the System Integration and Test Evaluation (SITE) Laboratory to allow simulation and experimentation in a controlled environment. The SITE Laboratory includes a data generation and checking subsystem, an uplink and downlink terminal, the satellite transponder system, and a control and performance monitoring computer.

The IMPATT amplifier was designed to function as the power amplifier for a small ground terminal. The SITE Laboratory has the capability to generate

pseudorandom digital data for use in end-to-end communications system testing. Various components can be placed within the system, and BER measurements are made as a function of signal energy per bit to noise power density (E_b/N_0). The IMPATT amplifier was placed in the simulation loop as the uplink amplifier, and BER measurement tests were performed. A data rate of 220 Mbps was used for the tests.

Test results. - The amplifier was placed in the system, and a set of BER measurements was made for changes in amplifier drive level, input frequency, and downlink TWT operation. Input drive levels to the IMPATT amplifier of 13 and 16 dBm were used, at frequencies from 28.775 to 28.90 GHz; this data is shown in table V. Information in this table includes the frequency of operation, the input power level, and the measured BER as a function of E_b/N_0 . Figures 9 and 10 show the data in graphical form for input levels of 13 and 16 dBm, respectively; also shown in each figure is the E_b/N_0 curve for the ideal case. The BER data tracks to within 1 dB of the ideal case for both the 13- and 16-dBm cases until higher levels of E_b/N_0 are used (above an E_b/N_0 level of 10 dB). The data becomes more dispersed for higher values of E_b/N_0 and also degrades from the ideal curve for both cases. The 20-GHz downlink TWT was operated in a saturated mode to give the best overall system performance.

The operating point of the 20-GHz downlink TWT was varied to determine the effect on the IMPATT amplifier. The downlink tube was operated at the 1-dB compression point and in the linear regime. The input frequency was fixed at 28.825 GHz, and IMPATT amplifier drive levels of 13 and 16 dBm were used. The BER data as a function of drive level is listed in table VI and shown graphically in figure 11. The data indicates better overall system performance is attained in operating the downlink TWT at the 1-dB compression point. Note however, the lowest BER is achieved with the 20-GHz TWT operating in saturation. This is evident from comparing the data of figures 9 and 10, with the TWT in saturation, to the data in figure 11.

CONCLUSION

The 30-GHz IMPATT Amplifier developed by TRW as a POC device for the ACTS program met its development requirements. The measured RF characteristics allow its use in a low cost, portable ground terminal.

The BER tests indicate acceptable performance for the transmission of digital data. The BER tests were performed using a 220-Mbps signal, although for portable operation a lower bit rate would likely be used. The successful operation at 220 Mbps indicates the amplifier should function properly at a lower bit rate. For actual use as part of the ACTS system, further development would be necessary to alter the frequency of operation to that of the ACTS uplink frequency.

REFERENCES

1. Ngan, Y.C.; and Quijije, M.A.: 30 GHz Solid State Amplifier for Low Cost Low Data Rate Ground Terminals. (REPT-4-9-T-10-F, TRW Electronic Systems Group; NASA Contract NAS3-23266) NASA CR-174795, 1984.
2. Kerczewski, R.J.: A Study of the Effect of Group Delay Distortion on an SMSK Satellite Communications Channel. NASA TM-89835, 1987.

TABLE I. - IMPATT AMPLIFIER REQUIREMENTS

Power output, W cw	20
Operating band, GHz	28.5 to 29.0
RF bandwidth, ^a MHz	50
Gain at RF bandwidth, dB	30±1
Gain variation, dB	≤0.5
Gain slope, dB/MHz	≤0.15
RF overdrive capability, dB	5
Phase linearity, deg p-p	<10
Harmonic response, dBc	≤ -50 dBc
Spurious response, dBc	≤ -60 dBc

^aFlat response, 1 dB.

TABLE II. - IMPATT AMPLIFIER

OUTPUT POWER AND GAIN AS A

FUNCTION OF FREQUENCY

Frequency, GHz	Output power, dBm	Gain, dB
Input power, 8 dBm		
28.70	42.13	34.13
28.75	42.09	34.09
28.80	42.01	34.01
28.85	41.78	33.78
28.90	42.02	34.02
Input power, 13 dBm		
28.70	42.13	29.13
28.75	42.11	29.11
28.80	42.04	29.04
28.85	41.97	28.97
28.90	41.78	28.78
28.95	41.18	28.18
29.00	40.77	27.77
Input power, 18 dBm		
28.70	42.16	24.16
28.75	42.11	24.11
28.80	42.05	24.05
28.85	41.86	23.86
28.90	41.50	23.50
28.95	41.27	23.27
29.00	41.04	23.04
29.05	40.48	22.48
29.10	33.89	15.89
29.15	32.78	14.78

TABLE III. - VSWR MEASUREMENTS

AS A FUNCTION OF FREQUENCY

Frequency, GHz	Reflected power, dBm	VSWR
Forward power, 8 dBm		
28.4	2.23	3.10
28.5	4.32	3.05
28.6	.83	2.55
28.7	-1.80	1.94
28.8	3.59	4.00
28.9	-1.28	2.04
29.0	2.02	3.00
Forward power, 13 dBm		
28.5	1.39	1.70
28.6	-.10	1.56
28.7	3.58	2.03
28.8	4.62	2.22
28.9	.49	1.63
29.0	6.04	2.65
Forward power, 18 dBm		
28.5	3.28	1.44
28.6	3.32	1.44
28.7	1.58	1.36
28.8	8.09	1.94
28.9	1.53	1.35
29.0	6.10	1.66

TABLE IV. - MEASURED AMPLIFIER CHARACTERISTICS

RF output power, W cw	15.8
Operating band, GHz	28.7 to 29.0
RF bandwidth, MHz	200 to 260
Gain, dB	29 ± 1
Gain variation, dB	<0.5
Gain slope dB/MHz	<0.15
RF overdrive capacity, dB	5

TABLE V. - BIT-ERROR-RATE DATA FOR THE IMPATT AMPLIFIER

Dataset, IMPATT number	Frequency, GHz	Signal power per bit to noise density ratio, E_b/N_0 , dB						
		6.06	7.06	7.98	8.96	10.07	11.06	11.99
Input power, 13 dBm								
1	28.8	5.3×10^{-3}	2.1×10^{-3}	8.9×10^{-4}	2.5×10^{-4}	4.8×10^{-5}	1.1×10^{-5}	1.6×10^{-6}
6	28.9	4.7	1.9	7.2	1.8	3.9	1.1	7.1
10	28.775	5.3	2.2	8.6	2.5	5.6	1.1	2.9
11	28.875	4.6	1.7	5.9	1.6	3.1	4.0×10^{-6}	1.3
Input power, 16 dBm								
3	28.8	5.3×10^{-3}	2.2×10^{-3}	7.1×10^{-4}	2.0×10^{-4}	4.1×10^{-5}	9.5×10^{-6}	2.8×10^{-6}
4	28.85	4.9	1.9	6.4	1.5	2.7	6.1	2.2
5	28.875	4.5	1.8	6.1	1.6	3.0	5.7	2.1
7	28.825	4.5	1.8	6.0	1.7	3.3	5.4	1.1
8	28.775	5.8	2.4	9.2	2.8	6.7	1.3×10^{-5}	5.5

TABLE VI. - BIT-ERROR-RATE DATA FOR DOWNLINK VARIATION

[Frequency, 28.825 GHz.]

Dataset, IMPATT number	Downlink	Signal power per bit to noise density ratio, E_b/N_0 , dB						
		6.06	7.06	7.98	8.96	10.07	11.06	11.99
Input power, 13 dBm								
20	1-dB compression	6.3×10^{-3}	2.9×10^{-3}	1.1×10^{-3}	3.4×10^{-4}	9.3×10^{-5}	1.6×10^{-5}	2.5×10^{-6}
21	Linear operation	7.9	3.7	1.6	6.5	2.0×10^{-4}	5.1	1.3×10^{-5}
Input power, 16 dBm								
31	1-dB compression	5.8×10^{-3}	2.6×10^{-3}	9.3×10^{-4}	3.1×10^{-4}	8.0×10^{-5}	1.5×10^{-5}	2.1×10^{-6}
30	Linear compression	9.7	4.9	2.1×10^{-3}	7.5	2.6×10^{-4}	6.9	1.3×10^{-5}

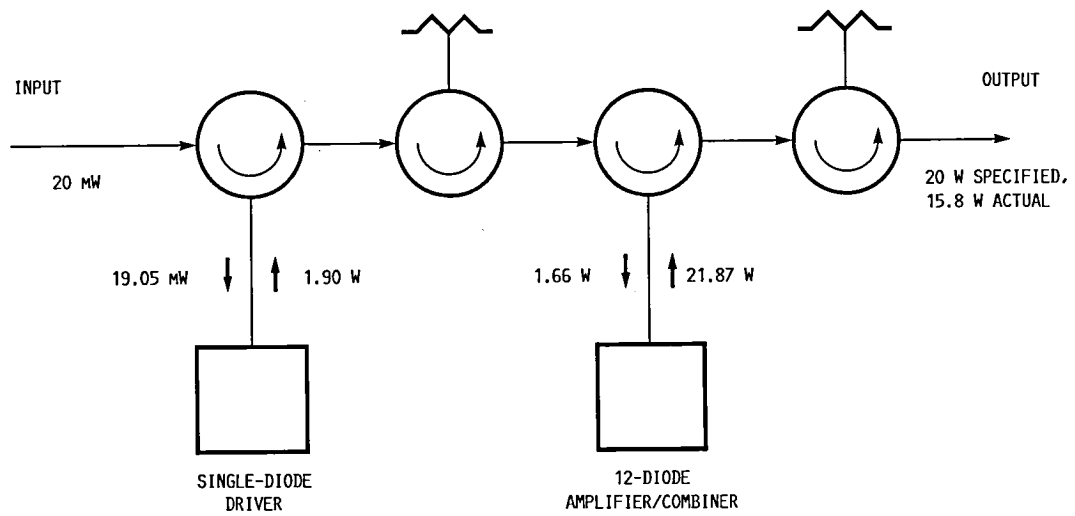
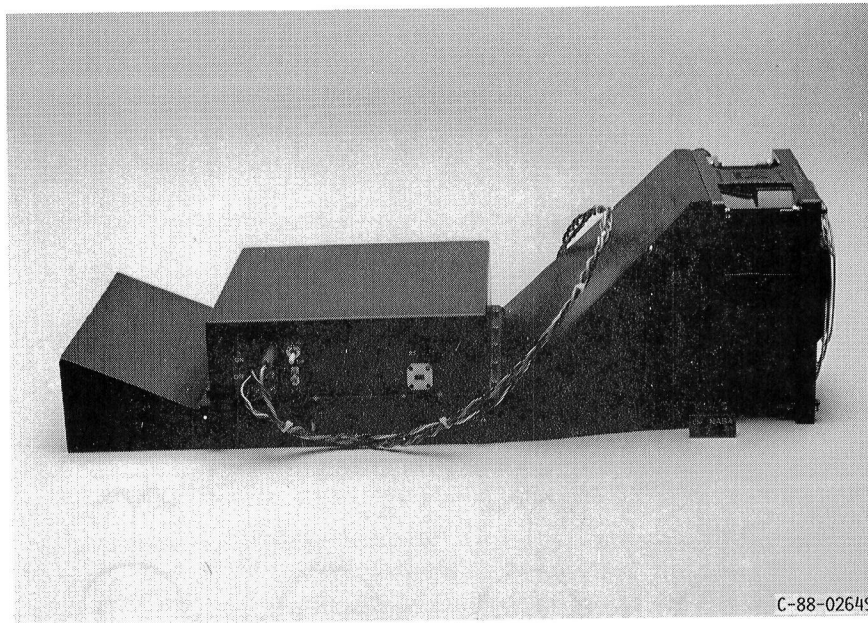
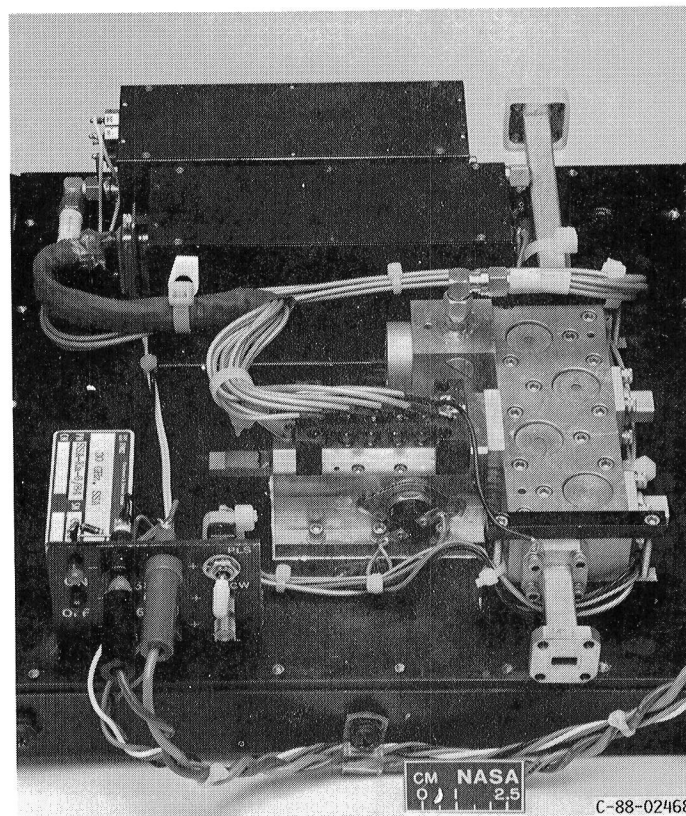

FIGURE 1. - 30-GHz IMPATT AMPLIFIER BLOCK DIAGRAM.



(A) PHOTOGRAPH OF COMPLETED AMPLIFIER.



(B) INTERNAL CIRCUITRY OF AMPLIFIER.
FIGURE 2. - 30-GHZ IMPATT AMPLIFIER.

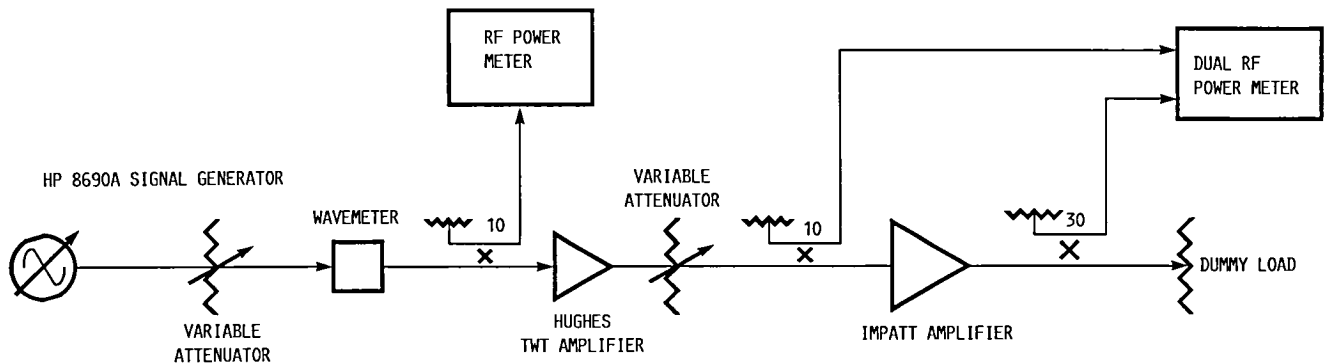

FIGURE 3. - POWER AND GAIN MEASUREMENT TEST CONFIGURATION.

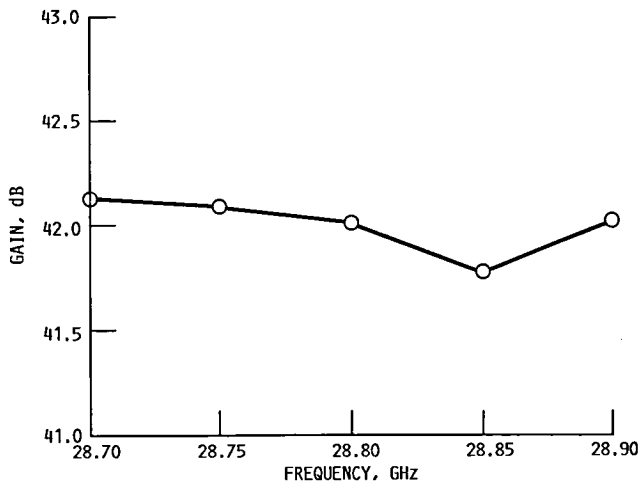

FIGURE 4. - GAIN AS FUNCTION OF FREQUENCY AT INPUT POWER OF 8 dBm.

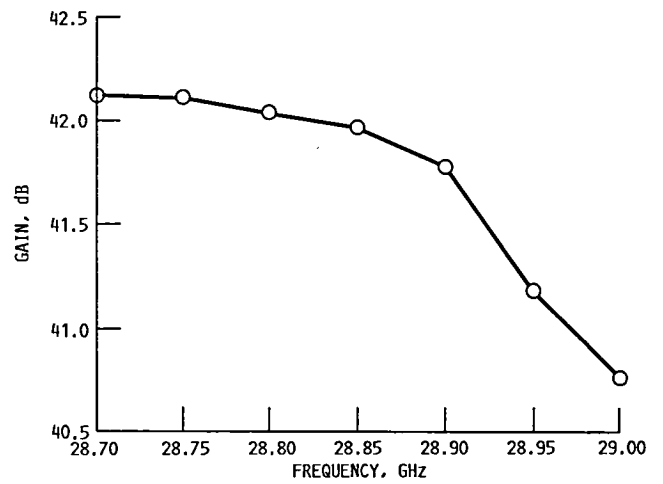

FIGURE 5. - GAIN AS FUNCTION OF FREQUENCY AT INPUT POWER OF 13 dBm.

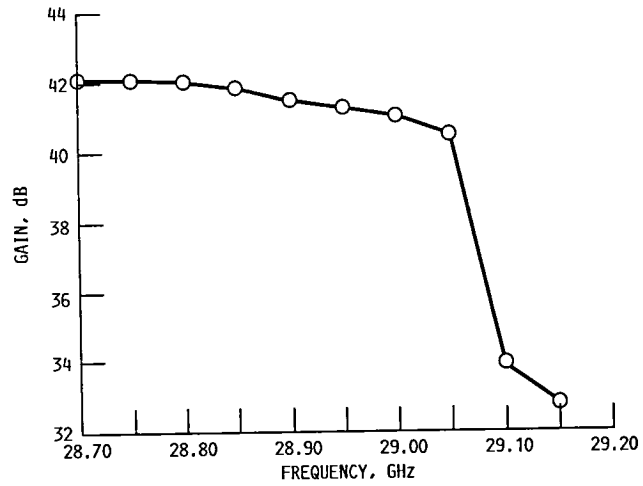

FIGURE 6. - GAIN AS FUNCTION OF FREQUENCY AT INPUT POWER OF 18 dBm.

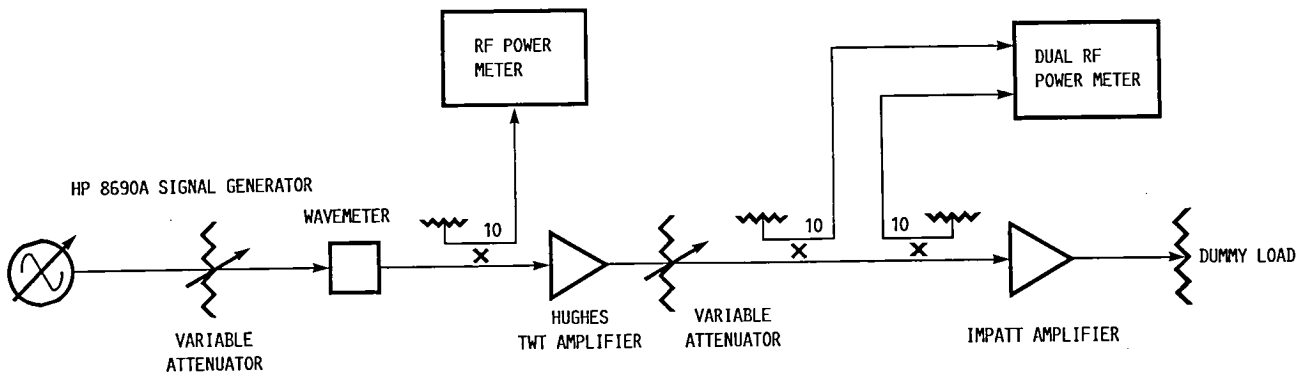

FIGURE 7. - VSWR TEST SETUP.

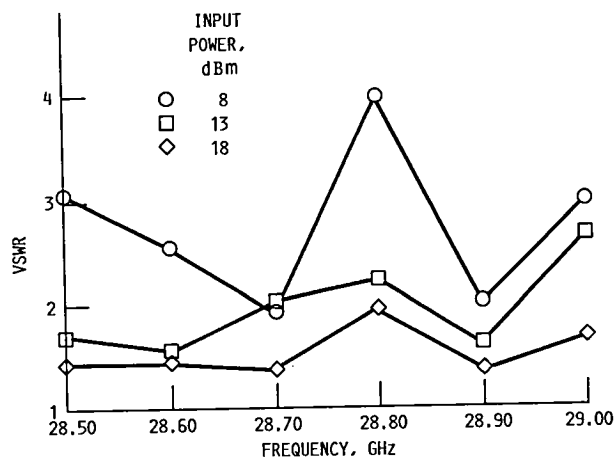

FIGURE 8. - VSWR AS A FUNCTION OF FREQUENCY AT THREE INPUT POWER LEVELS.

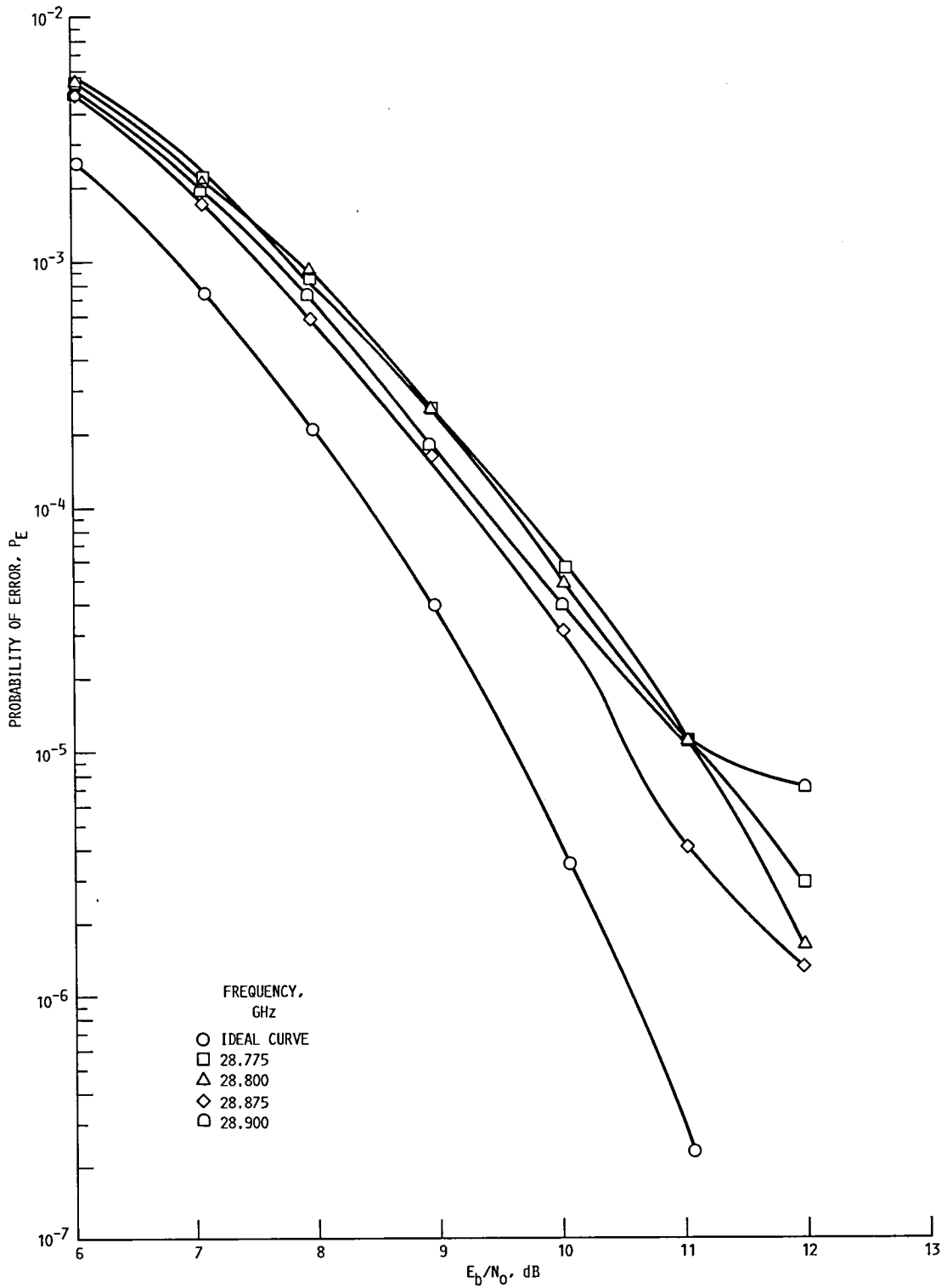

FIGURE 9. - BIT ERROR RATE AS A FUNCTION OF SIGNAL POWER TO NOISE DENSITY RATIO, E_b/N_0 , FOR INPUT POWER OF 13 dBm.

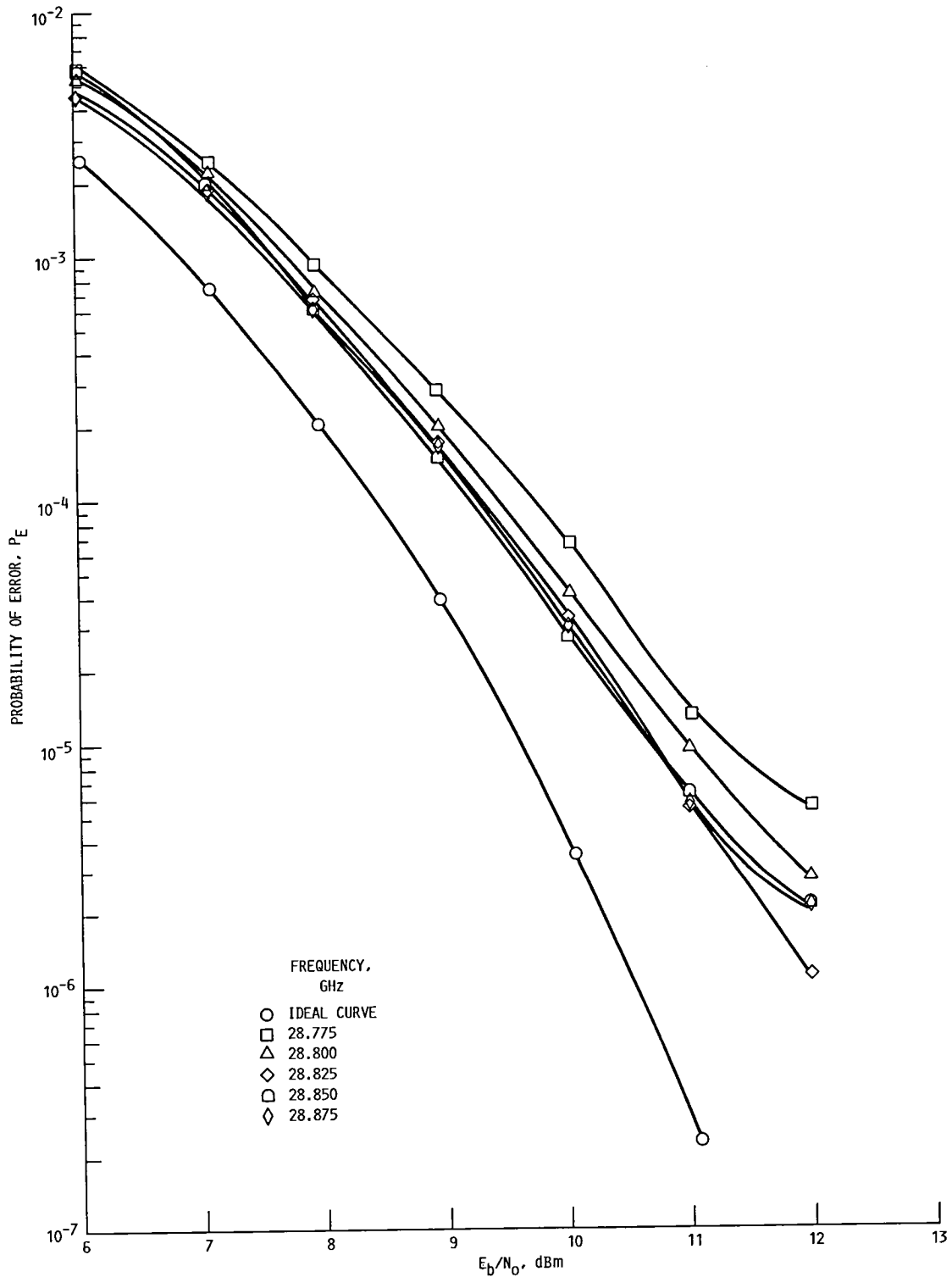

FIGURE 10. - BIT ERROR RATE AS A FUNCTION OF SIGNAL POWER TO NOISE DENSITY RATIO, E_b/N_0 , FOR INPUT POWER OF 16 dBm.

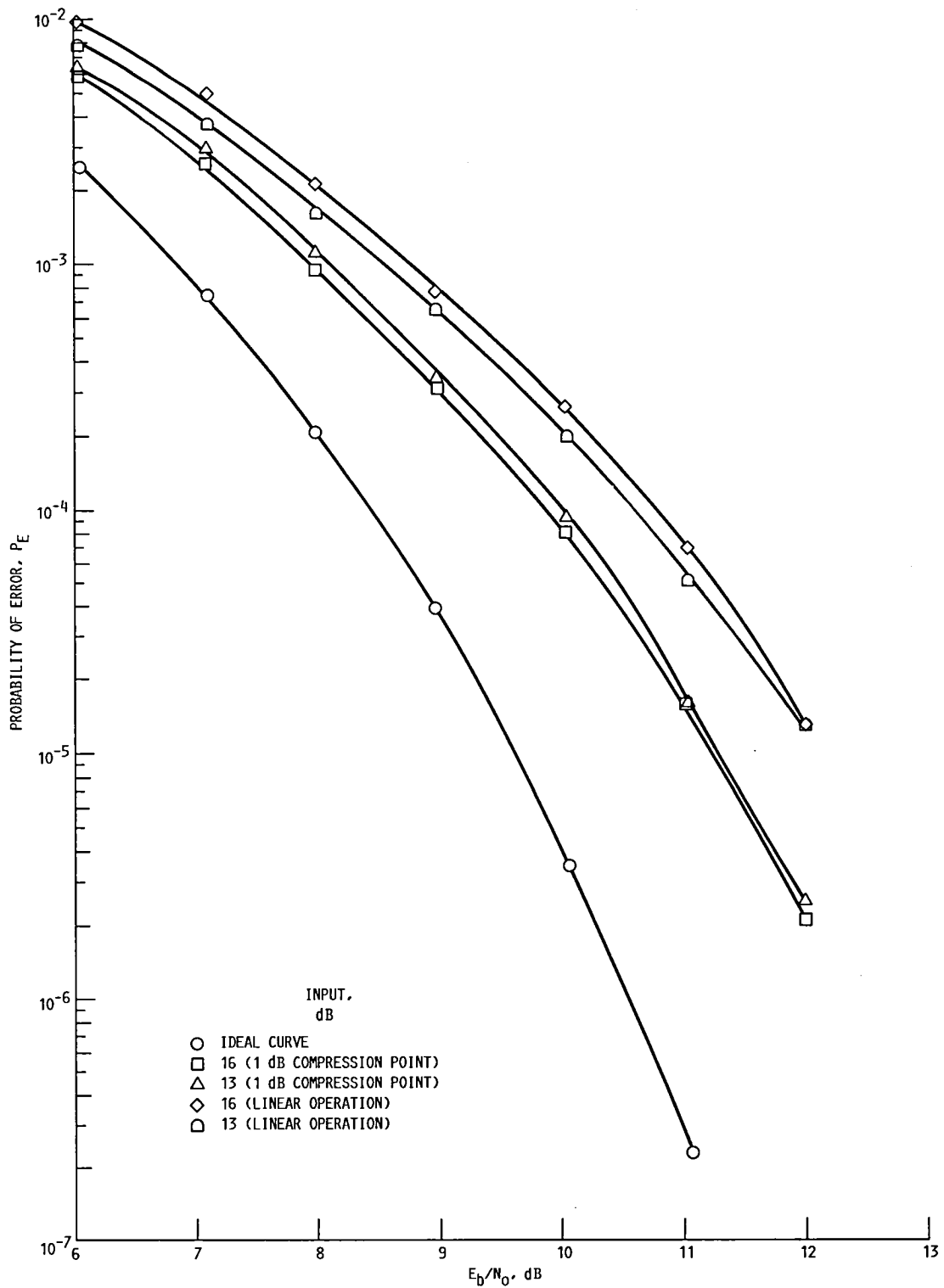

FIGURE 11. - BIT ERROR RATE AS A FUNCTION OF SIGNAL POWER TO NOISE DENSITY RATIO, E_b/N_0 FOR DOWNLINK TWT VARIATION.

1. Report No. NASA TM-100876		2. Government Accession No.		3. Recipient's Catalog No.	
4. Title and Subtitle Characterization of a 30-GHz IMPATT Solid State Amplifier				5. Report Date July 1988	
				6. Performing Organization Code	
7. Author(s) Lawrence W. Wald				8. Performing Organization Report No. E-4110	
				10. Work Unit No. 650-60-23	
9. Performing Organization Name and Address National Aeronautics and Space Administration Lewis Research Center Cleveland, Ohio 44135-3191				11. Contract or Grant No.	
				13. Type of Report and Period Covered Technical Memorandum	
12. Sponsoring Agency Name and Address National Aeronautics and Space Administration Washington, D.C. 20546-0001				14. Sponsoring Agency Code	
15. Supplementary Notes					
16. Abstract This memorandum describes the characterization and testing of a 20-W solid state amplifier operating in the Ka band to be used in low cost experimental ground terminals. The amplifier was developed by the TRW Electronic Systems Group under NASA Contract NAS3-23266 as a proof-of-concept (POC) device in support of the Advanced Communications Technology Satellite (ACTS) program. Additional goals were development of high-power IMPATT devices and circulators, and multistage diode circuits, which are an integral part of the amplifier. The amplifier underwent acceptance testing at the NASA Lewis Research Center, Cleveland, Ohio. Characteristics measured include an output power of 42 dBm, gain of 30 dB, an injection-locking RF bandwidth of 260 MHz, and an overall direct current-to-radiofrequency (dc-to-RF) efficiency of 6.7 percent.					
17. Key Words (Suggested by Author(s)) IMPATT; Ka band; Ground terminal; IMPATT amplifier; IMPATT diodes; Solid state amplifier			18. Distribution Statement Unclassified - Unlimited Subject Category 32		
19. Security Classif. (of this report) Unclassified		20. Security Classif. (of this page) Unclassified		21. No of pages 14	22. Price* A02

National Aeronautics and
Space Administration

Lewis Research Center
Cleveland, Ohio 44135

Official Business
Penalty for Private Use \$300

SECOND CLASS MAIL

ADDRESS CORRECTION REQUESTED



Postage and Fees Paid
National Aeronautics and
Space Administration
NASA-451

NASA
