

N89-12881

HOST STRUCTURAL ANALYSIS PROGRAM OVERVIEW

R.L. Thompson
NASA Lewis Research Center
Cleveland, Ohio

Hot-section components of aircraft gas-turbine engines are subjected to severe thermal-structural loading conditions, especially during the startup and takeoff portions of the engine cycle. The most severe and damaging stresses and strains are those induced by the steep thermal gradients induced during the startup transient. These transient stresses and strains are also the most difficult to predict, in part because the temperature gradients and distributions are not well known or readily predictable and, in part, because the cyclic elastic-viscoplastic behavior of the materials at these extremes of temperature and strain are not well known or readily predictable.

A broad spectrum of structures-related technology programs is underway to address these deficiencies at the basic as well as the applied level, with participation by industry and universities, as well as in-house at NASA Lewis. The three key program elements in the HOST structural analysis program are computations, constitutive modeling, and experiments for each research activity. Also shown are tables summarizing each of the activities. These elements are shown in the accompanying schedule and figures.

The computations element of the structures program focuses on developing improved time-varying thermal-mechanical load models for the entire engine mission cycle from startup to shutdown. The thermal model refinements will be consistent with those required by the structural code, including considerations of mesh-point density, strain concentrations, and thermal gradients. Models will be developed for the engine hot section components namely, the burner liner, turbine vane, and turbine blade. An automated component-specific geometric modeling capability, which will produce three-dimensional finite-element models of the components, is another part of this element. Self-adaptive solution strategies will be developed and included to facilitate the selection of appropriate elements, mesh sizes, etc. The development of new and improved, nonlinear, three-dimensional finite elements and associated structural analysis programs, including the development of temporal elements with time-dependent properties to account for creep effects in the materials and component, is another major part of this element.

The second element of the structures program is the development of constitutive models and their implementations in structural analysis codes. Improved constitutive modeling methods to improve the prediction of cyclic thermomechanical viscoplastic material behavior are being developed for both isotropic and anisotropic materials. The models are being incorporated in nonlinear, finite-element structural analysis computer programs and will be exercised on combustor liners, and turbine blades and vanes.

The third element of the structures program is experimentation. Experimental facilities to aid in developing and verifying theories and models as well as to aid

in evaluating advanced instrumentation have been constructed at Lewis. These include the high temperature structures laboratory for testing tubular specimens and the structural component response test facility for testing plates, cylinders, and combustor liner segments. Large quality data bases have been generated in the test facilities. Advanced strain measurement systems have also been evaluated.

Further explanation and details about the three elements in the structures program mentioned above are given in the Structural Analysis section of this publication.

STRUCTURAL ANALYSIS... IT'S ROLE IN HOST

GOAL:

TO DEVELOP AND VALIDATE INTEGRATED TIME-VARYING THERMAL/MECHANICAL LOAD MODELS, COMPONENT-SPECIFIC AUTOMATED GEOMETRIC MODELING AND SOLUTION STRATEGY CAPABILITIES, AND ADVANCED INELASTIC ANALYSIS METHODS AND CONSTITUTIVE MODELS, INCLUDING PLASTICITY AND CREEP EFFECTS, FOR NONLINEAR, ANISOTROPIC, FINITE ELEMENT STRUCTURAL ANALYSIS AND DESIGN COMPUTER CODES.

PROGRAM INTEGRATION

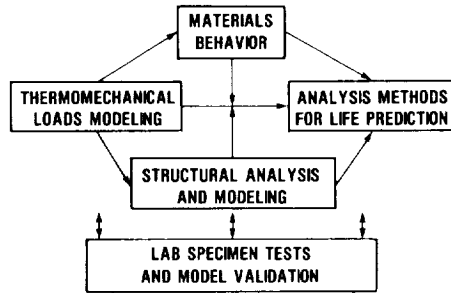

PROGRAM ELEMENTS:

- THERMAL/STRUCTURAL DATA TRANSFER MODULE
- THERMAL/MECHANICAL LOAD/MISSION AND COMPONENT-SPECIFIC STRUCTURAL MODELS
- 3-D INELASTIC ANALYSIS METHODS
- CONSTITUTIVE MODELING
- STRUCTURAL COMPONENT RESPONSE RIG
- HIGH TEMPERATURE STRUCTURES LABORATORY

CS-85-3351

Figure 1

STRUCTURAL ANALYSIS

PROGRAM ELEMENT	FISCAL YEAR							EXPECTED RESULT
	82	83	84	85	86	87	88	
THERMAL DATA TRANSFER	(C)							COMPUTER MODULE LINKING THERMAL AND STRUCTURAL ANALYSES
COMPONENT SPECIFIC MODELING		(C)			▼			COMPONENT-RELATED, TIME VARYING, THERMAL-MECHANICAL LOAD HISTORY AND GEOMETRIC MODELS
3-D INELASTIC ANALYSIS		(C)	▼					ADVANCED 3-D INELASTIC STRUCTURAL STRESS ANALYSIS METHODS AND SOLUTION STRATEGIES
ISOTROPIC MODEL DEVELOPMENT		(C)						CYCLIC STRUCTURAL ANALYSIS
STRUCTURAL COMPONENT RESPONSE		(IH)						BURNER STRUCTURAL LIFE EXPERIMENTS
HIGH-TEMPERATURE STRUCTURES LAB			(IH)					INTEGRATED EXPERIMENTAL AND ANALYTICAL RESEARCH
MATERIAL BEHAVIOR TECHNOLOGY			(IH and G)					CONSTITUTIVE THEORY AND MODELING METHODS

CD-86-22258

Figure 2

HOT SECTION COMPONENTS REQUIRING 3-D INELASTIC ANALYSIS

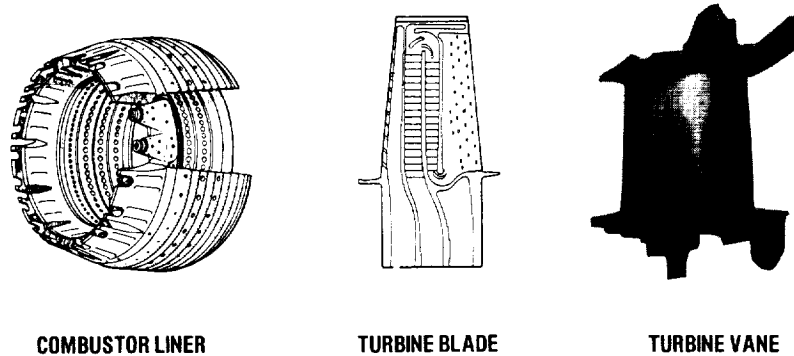

Figure 3

CS-85-3293

BIAXIAL CONSTITUTIVE EQUATION DEVELOPMENT FOR SINGLE CRYSTALS

OBJECTIVE:

DEVELOP AND VERIFY TWO NEW TYPES OF CONSTITUTIVE MODELS IN MULTIAXIAL FORM FOR A REALISTIC AIRCRAFT ENGINE SINGLE CRYSTAL ALLOY.

GRANT:

UNIVERSITY OF CONNECTICUT (NAG3-512).

APPROACH:

DEVELOPMENT IS DIRECTED TOWARD ANISOTROPIC NICKEL BASE SUPERALLOYS FOR TURBINE BLADES AND VANES.

- BIAXIAL CLASSIFICATION EXPERIMENTS, INCLUDING PROPORTIONAL AND NONPROPORTIONAL LOADS, WILL BE PERFORMED TO DETERMINE QUALIFICATIONS MATERIAL BEHAVIOR FOR PWA 1480.
- MODEL DEVELOPMENT WILL BE BASED ON A CRYSTALLOGRAPHIC SLIP SYSTEM VIEWPOINT AS WELL AS A MACROSCOPIC CONTINUUM APPROACH.
- HIGH TEMPERATURE BIAXIAL EXPERIMENTS WILL BE CONDUCTED TO DETERMINE FUNCTIONAL FORMS AND MATERIAL CONSTANTS.
- COMPLEX MODEL VERIFICATION TESTS, INCLUDING THERMOMECHANICAL TESTS, WILL BE CONDUCTED.
- THE SINGLE CRYSTAL CONSTITUTIVE MODELS WILL BE INCORPORATED IN A FINITE-ELEMENT PROGRAM.

STATUS:

THIRD YEAR OF GRANT.

ACCOMPLISHMENTS:

TWO ANISOTROPIC CONSTITUTIVE MODELS FOR PWA 1480 HAVE BEEN DEVELOPED AND INCORPORATED IN A FINITE ELEMENT CODE.

A HIGH-TEMPERATURE BIAXIAL COMPUTER CONTROLLED TEST CAPABILITY EXISTS AT THE UNIVERSITY OF CONNECTICUT.

A DATA BASE ON PWA 1480 IS BEING GENERATED.

COMPLEX BIAXIAL VERIFICATION TESTS HAVE BEEN INITIATED.

CD-86-22331

Figure 4

CONSTITUTIVE MODELING OF INELASTIC ANISOTROPIC MATERIAL RESPONSES

OBJECTIVE:
DEVELOP A WORKABLE CONSTITUTIVE MODEL THAT PREDICTS THE INELASTIC STRUCTURAL RESPONSES OF SINGLE-CRYSTAL ALLOYS USED IN GAS TURBINE ENGINE BLADES AND VANES.

GRANT:
UNIVERSITY OF CINCINNATI (NAG3-511).

APPROACH:

- DEVELOPMENT DIRECTED TOWARD ANISOTROPIC, NICKEL-BASE SUPER ALLOYS FOR TURBINE BLADES AND VANES.
- A DATA BASE OF ISOTHERMAL CYCLES UNIAXIAL BEHAVIOR WILL BE OBTAINED FOR RENE N4.
- AN AUTOMATED PROCEDURE (CODE) FOR OBTAINING MATERIAL CONSTANTS WILL BE DEVELOPED.
- THE MODEL WILL BE INCORPORATED IN A NONLINEAR FINITE ELEMENT CODE AND EXERCISED ON A TURBINE BLADE PROBLEM.

STATUS:
THIRD YEAR OF GRANT.

ACCOMPLISHMENTS:

- AN ANISOTROPIC CONSTITUTIVE MODEL FOR RENE N4 HAS BEEN DEVELOPED AND INCORPORATED IN A FINITE-ELEMENT CODE.
- A CODE TO DETERMINE THE MATERIAL CONSTANTS FROM EXPERIMENTAL DATA HAS BEEN DEVELOPED.
- A HIGH-TEMPERATURE UNIAXIAL COMPUTER CONTROLLED TEST CAPABILITY EXISTS AT THE UNIVERSITY OF CINCINNATI.
- TESTING TO ESTABLISH A LARGE QUALITY DATA BASE FOR RENE N4 AT TEMPERATURES OF 1400, 1600, AND 1800 °F HAS BEEN INITIATED.

CD-86-22324

Figure 5

MULTIAXIAL TEST PROGRAM TO DETERMINE SURFACES OF CONSTANT INELASTIC STRAIN RATE AT ELEVATED TEMPERATURE

OBJECTIVE:
PROVIDE HIGH-TEMPERATURE BIAxIAL EXPERIMENTAL DATA TO ASSIST IN THE FORMULATION OF NONLINEAR CONSTITUTIVE MODELS FOR STRUCTURAL ALLOYS USED IN TURBINE ENGINE HOT-SECTION COMPONENTS.

INTERAGENCY AGREEMENT:
OAK RIDGE NATIONAL LABORATORY.

APPROACH:

- COMPUTER CONTROLLED BIAxIAL (TENSION TORSION) TESTS AT A TEMPERATURE OF 650 °C ON A REFERENCE HEAT OF TYPE 316 STAINLESS STEEL WILL BE CONDUCTED.
- REFERENCE TESTS ON INCONEL 718 WILL BE CARRIED ON AT 950 °C.
- SURFACES OF CONSTANT INELASTIC STRAIN RATE WILL BE GENERATED AND DATA STORED IN A COMPUTER.
- A HIGH TEMPERATURE BIAxIAL EXTENSOMETER WILL BE EVALUATED.

STATUS:
SECOND YEAR OF AGREEMENT.

ACCOMPLISHMENT:

- EVALUATION OF A HIGH-TEMPERATURE EXTENSOMETER HAS BEEN COMPLETED.
- SURFACES OF CONSTANT INELASTIC STRAIN RATE ARE BEING GENERATED. SOFTWARE FOR STORAGE, TRANSFER, REDUCTION, AND ANALYSIS OF DATA HAS BEEN DEVELOPED.

CD-86-22323

Figure 6

ORIGINAL PAGE IS
OF POOR QUALITY

HIGH-TEMPERATURE STRUCTURES LABORATORY

OBJECTIVE:

PROVIDE HIGH-TEMPERATURE UNIAXIAL AND BIAXIAL EXPERIMENTAL DATA ON CYLINDRICAL SPECIMENS TO ASSIST IN THE FORMULATION, DEVELOPMENT, AND VERIFICATION OF NEW AND IMPROVED CONSTITUTIVE MODELS AND TO EVALUATE ADVANCED INSTRUMENTATION ISOTROPIC AND ANISOTROPIC.

IN HOUSE

APPROACH:

- COMPUTER CONTROLLED UNIAXIAL AND BIAXIAL (TENSION/TORSION) TEST MACHINES WILL BE USED TO PROVIDE EXPERIMENTAL DATA.
- RADIOFREQUENCY AND AUDIOFREQUENCY INDUCTION HEATERS WILL BE USED TO HEAT SPECIMENS TO DESIRED TEMPERATURES.
- DATA WILL BE STORED ON COMPUTERS FOR FUTURE DATA REDUCTION, ANALYSIS, AND DISPLAY.
- LARGE QUALITY DATA BASES, BOTH ISOTHERMAL AND NONISOTHERMAL, WILL BE OBTAINED AND HIGH-TEMPERATURE BIAXIAL EXTENSOMETERS WILL BE EVALUATED.

STATUS:

COMPLETED FOURTH YEAR.

ACCOMPLISHMENTS:

- GENERATED LARGE QUALITY UNIAXIAL DATA BASE, BOTH CYCLIC ISOTHERMAL AND NONISOTHERMAL, FOR HASTALLOY-X.
- DEVELOPED SOFTWARE FOR DETAILED ANALYSIS OF DATA.
- DEMONSTRATED THAT COMPUTER CONTROLLED BIAXIAL TEST MACHINES FOR HIGH-TEMPERATURE TESTING ARE OPERATIONAL.
- EVALUATION OF A HIGH-TEMPERATURE BIAXIAL EXTENSOMETER HAS BEEN COMPLETED.
- HIGH-TEMPERATURE TORSIONAL TESTING IN UNDERWAY.

CD-86-22326

HIGH TEMPERATURE FATIGUE & STRUCTURES LABORATORY

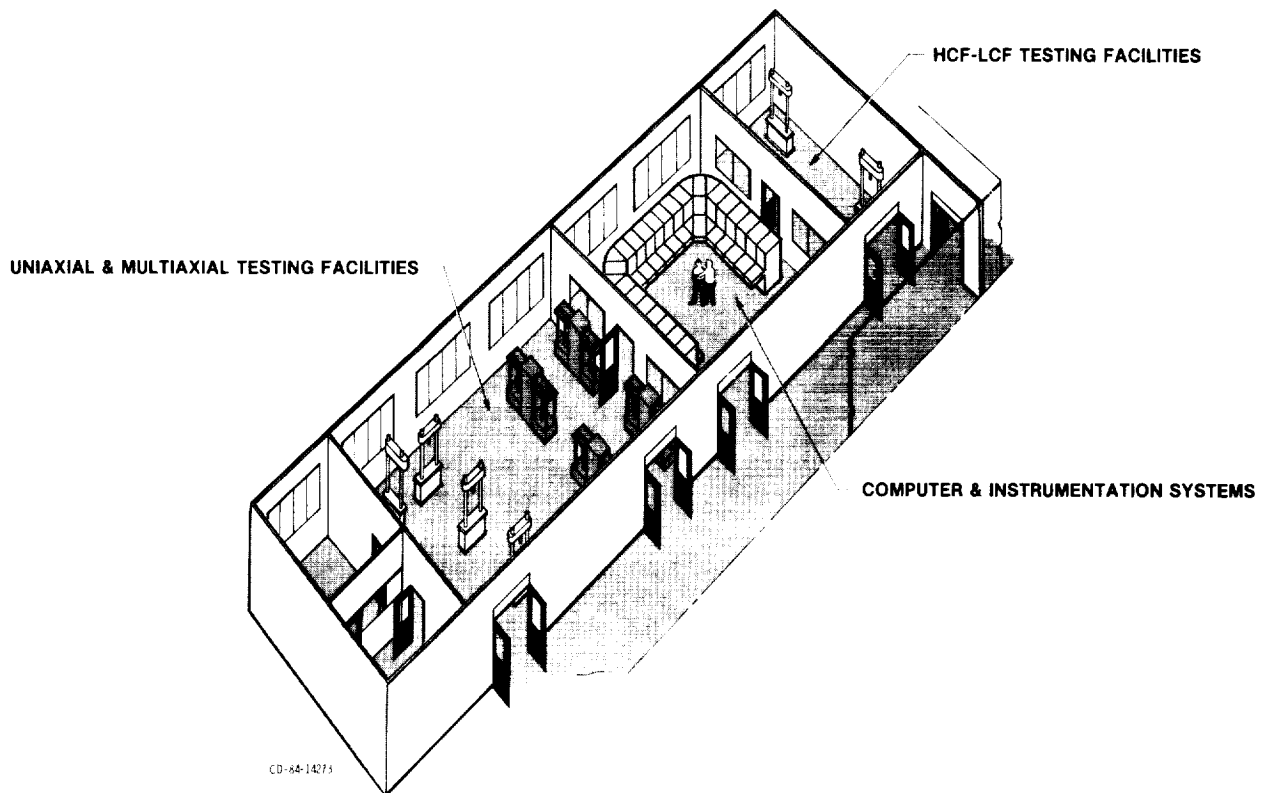

Figure 8

BENCH TOP RIG

OBJECTIVE:

PROVIDE HIGH-TEMPERATURE EXPERIMENTAL DATA ON FLAT PLATES TO ASSIST IN THE DEVELOPMENT AND VERIFICATION OF NEW AND IMPROVED STRUCTURAL ANALYSIS AND LIFE PREDICTION TOOLS AND TO EVALUATE ADVANCED INSTRUMENTATION.

IN HOUSE

APPROACH:

- A QUARTZ LAMP HEATING SYSTEM IS USED TO IMPROVE METAL TEMPERATURES SIMILAR TO AN IN-SERVICE LINER ON 5 BY 8 IN. FLAT PLATES.
- A 2-3 MIN. THERMOANALYSIS SIMULATES A 3-4 HR ENGINE MISSION CYCLE.
- POWER SETTINGS, COOLING AIR FLOW RATES, AND COOLING TEMPERATURES ARE VARIED TO MATCH A DESIRED TEMPERATURE HISTORY ON A LIST PLATE.
- ADVANCED TEMPERATURE, DEVELOPMENT AND STRAIN MEASUREMENT SYSTEMS ARE EVALUATED.
- AN AUTOMATED DATA ACQUISITION SYSTEM IS USED TO STORE, REDUCE, AND DISPLAY THE DATA.

STATUS:

COMPLETED FOURTH YEAR.

ACCOMPLISHMENTS:

- DEMONSTRATED THAT TEST RIG IS A VIABLE STRUCTURAL COMPONENT EXPERIMENTAL TOOL.
- INFRARED THERMOVISION SYSTEM HAS PROVIDED TEMPERATURE MAPS OF COOL SURFACE OF TEST PLATE.
- EVALUATED A UTRC LASER SPECKLEGRAM SYSTEM TO MEASURE STRAINS.
EVALUATED A HIGH-RESOLUTION CAMERA SYSTEM TO MEASURE DISPLACEMENTS.
- PLATE TEMPERATURES WERE REPEATABLE FROM CYCLE TO CYCLE.
- THERMAL/STRUCTURAL ANALYSIS OF PLATES HAVE BEEN PERFORMED.

CD-86-22328

Figure 9

BENCH-TOP RIG

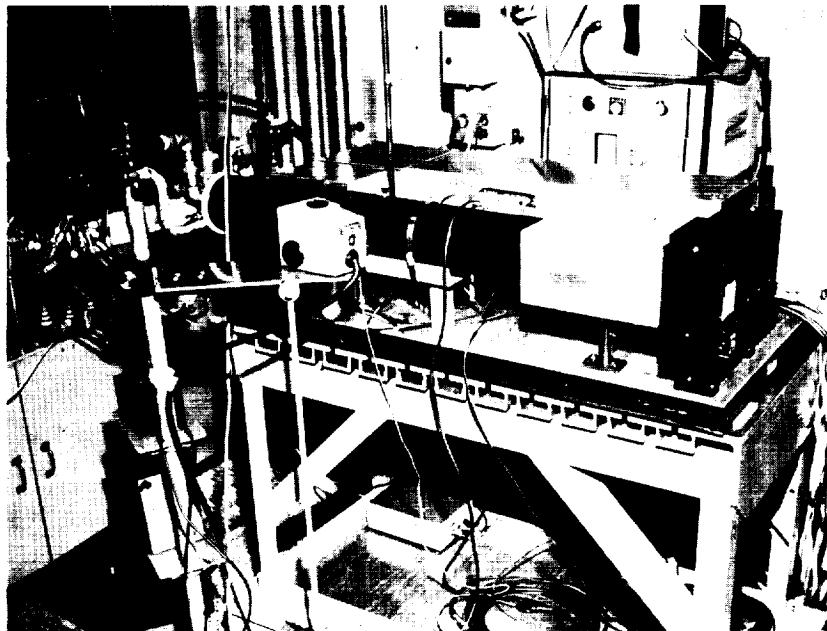

CD-86-22226

Figure 10

STRUCTURAL COMPONENT RESPONSE RIG

OBJECTIVE:

PROVIDE HIGH-TEMPERATURE EXPERIMENTAL DATA ON COMBUSTOR LINER SEGMENTS TO ASSIST IN THE DEVELOPMENT AND VERIFICATION OF NEW AND IMPROVED STRUCTURAL ANALYSIS AND LIFE-PREDICTION TOOLS, AND TO EVALUATE ADVANCED INSTRUMENTATION.

COOPERATIVE NASA LEWIS AND PRATT & WHITNEY EFFORT.

APPROACH:

- A QUARTZ LAMP HEATING SYSTEM IS USED TO IMPOSE METAL TEMPERATURES ON A 20 IN. DIAMETER TEST LINER SIMILAR TO AN IN-SERVICE LINER.
- A 2-3 MIN. THERMAL CYCLE SIMULATES THE TAKEOFF, CRUISE, LANDING, AND TAXI MODES OF A 3-4 HR ENGINE MISSION CYCLE.
- POWER SETTINGS, COOLING AIRFLOW RATES, AND COOLING AIR TEMPERATURES ARE VARIED TO MATCH A DESIRED TEMPERATURE HISTORY OF A POINT ON THE TEST LINER.
- BOTH THERMOCOUPLES AND AN INFRARED CAMERA SYSTEM ARE USED TO MEASURE SURFACE METAL TEMPERATURES.
- DISPLACEMENT MEASUREMENTS AT CRITICAL LOCATIONS ON THE TEST LINER ARE OBTAINED.
- AN AUTOMATED DATA ACQUISITION SYSTEM IS USED TO STORE, REDUCE AND DISPLAY THE DATA.

STATUS:

COMPLETED FOURTH YEAR.

ACCOMPLISHMENTS:

- DEMONSTRATED THAT TEST RIG IS A VIABLE STRUCTURAL COMPONENT EXPERIMENTAL TOOL.
- COMPLETED LISTING OF A CONVENTIONAL COMBUSTOR LINER SEGMENT.
- LINER CRACKING AT THE SEAM WELD WAS OBSERVED AFTER 1600 THERMAL CYCLES.
- TESTING WAS STOPPED AFTER 1800 THERMAL CYCLES DUE TO LARGE LINER DISTORTION.
- RAISING LINER MAXIMUM TEMPERATURE BY 1000F ACCELERATED DAMAGE.
- LINER TEMPERATURES WERE REPEATABLE FROM CYCLE TO CYCLE.
- LARGE QUALITY DATA BASE INCLUDING TEMPERATURE DISPLACEMENT MEASUREMENTS WAS OBTAINED.
- THERMAL STRUCTURAL ANALYSIS OF THE LINER HAS BEEN PERFORMED.

CD-86-22330

Figure 11

STRUCTURAL COMPONENT RESPONSE RIG

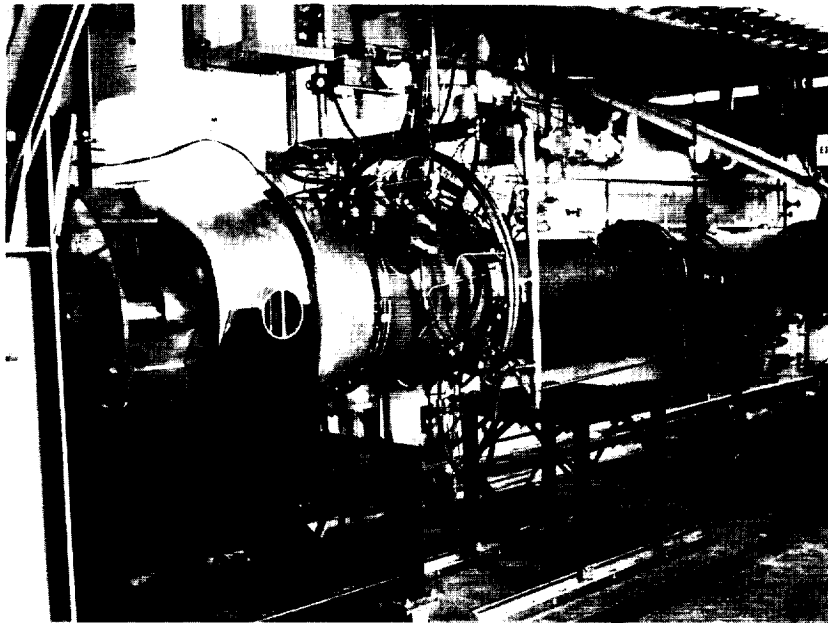

CD-86-22225

Figure 12

ORIGINAL PAGE IS
OF POOR QUALITY

COMBUSTOR TEST LINER AFTER 1280 THERMAL CYCLES

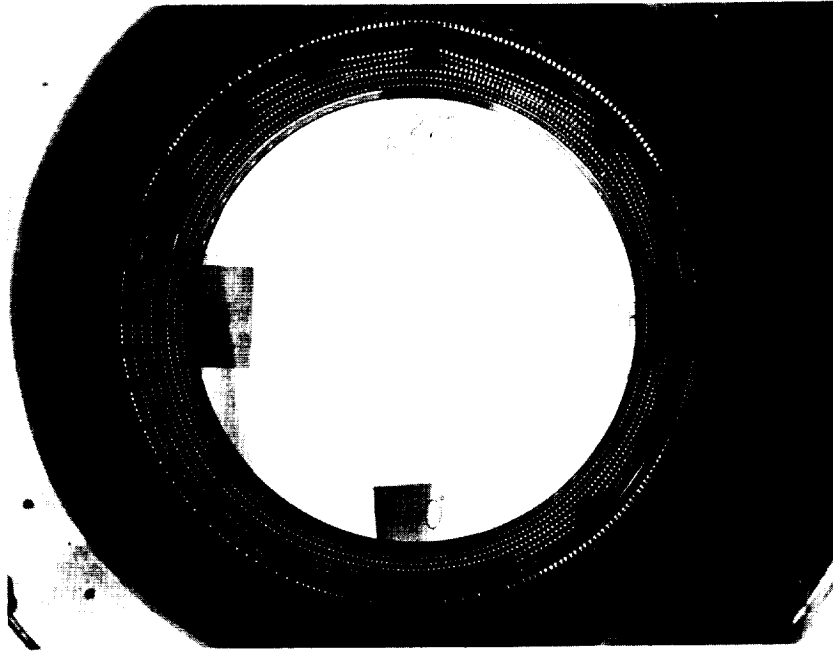

CD 86-22259

Figure 13

THERMAL-TO-STANDARD DATA TRANSFER MODULE

OBJECTIVE:

DEVELOP AN AUTOMATED PROCEDURE FOR EFFICIENT AND ACCURATE TRANSFER OF TEMPERATURES FROM A HEAT TRANSFER CODE TO A STRUCTURAL ANALYSIS CODE.

CONTRACT:

GENERAL ELECTRIC (NAS3-23272).

APPROACH:

DEVELOP A CODE WITH THE FOLLOWING FEATURES AND CAPABILITIES: MODULAR, USER FRIENDLY, DIFFERENT 3D MESH DENSITIES, BOTH FINITE-ELEMENT AND FINITE DIFFERENCE HEAT TRANSFER CODES, EFFICIENT 3D SEARCH AND WEIGHTING ROUTINES, HARD-WIRED THERMAL AND STRUCTURAL CODES, FILES TO EASILY ACCESS OTHER CODES WINDOWING, ALIGNMENT OF HEAT TRANSFER AND STRESS MODES, EXTERIOR STRESS POINT BY AN OUTSIDE HEAT TRANSFER MODEL, AND ABILITY TO SELECT A TIME SLIP FROM A LARGE TRANSIENT THERMAL ANALYSIS.

STATUS:

COMPLETED.

ACCOMPLISHMENTS:

- FINAL REPORTS HAVE BEEN COMPLETED.
- OVER 30 USERS HAVE A COPY OF THE CODE FOR USE AND EVALUATION.
- CODE HAS BEEN SENT TO COSMIC.

CD-86-22322

Figure 14

OVERALL PROGRAM SCHEMATIC FOR 3-DIMENSIONAL TRANCITS (HOST)

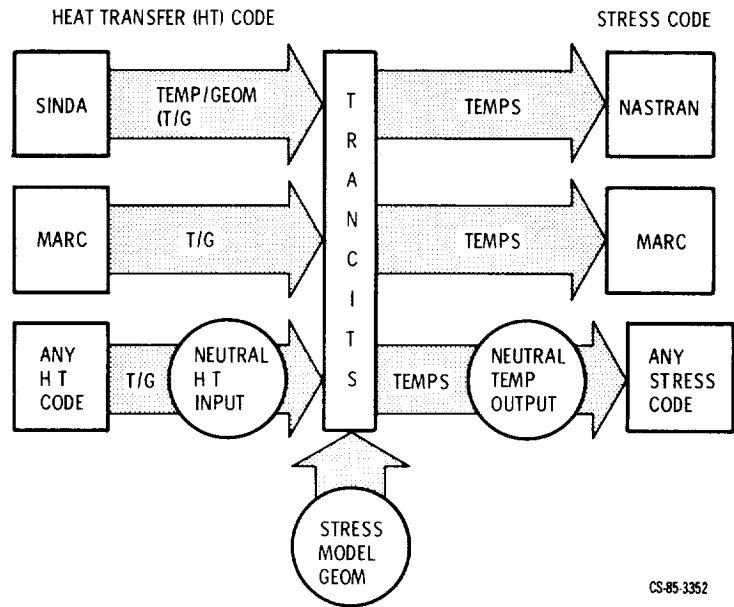

Figure 15

COMPONENT-SPECIFIC MODELING (HOST)

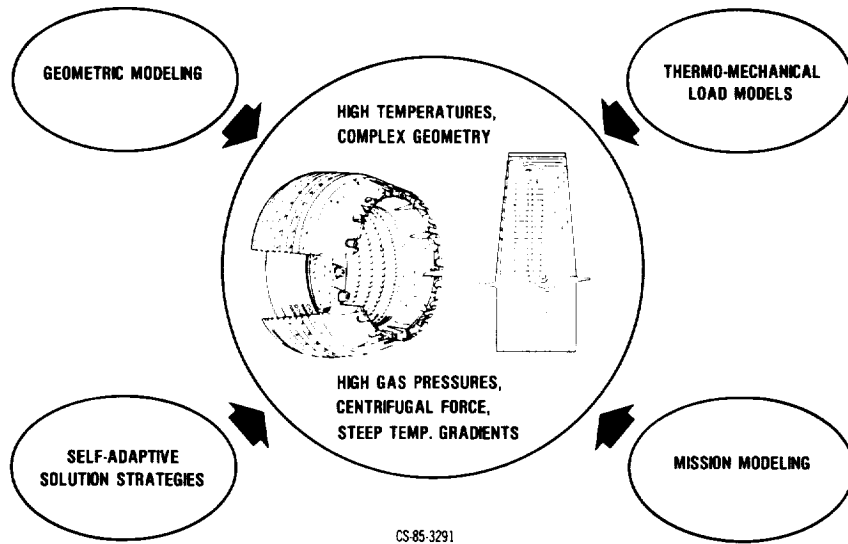

Figure 16

COMPONENT'S SPECIFIC MODELING (COSMO)

OBJECTIVE:

DEVELOP/VERIFY INTERDISCIPLINARY MODELING ANALYSIS METHODS AND REQUISITE COMPUTER CODES STREAMLINED FOR THREE HOT-SECTION COMPONENTS.

CONTRACTOR:

GENERAL ELECTRIC BUSINESS GROUP (NAS3-23687).

APPROACH:

- AVAILABLE METHODS FOR GAS DYNAMICS, HEAT TRANSFER 3D INELASTIC.
- ANALYSES AND MODELING TECHNIQUES REQUIRED TO COMPUTATIONALLY VALIDATE HOT-SECTION COMPONENT DESIGNS WILL BE MODIFIED.
- EXTENDED AND INTEGRATED INTO A MODULAR COMPUTER CODE (COSMO) VIA A TWO-PHASE INCREMENTALLY FUNDED CONTRACT.

STATUS:

THE FIRST PHASE (BASE PROGRAM) OF COSMO IS NEAR COMPLETION.

ACCOMPLISHMENTS:

THE THERMODYNAMIC, THERMOCHEMICAL LOAD TRANSFER, AND EXECUTIVE MODULES ARE OPERATIONAL ON THE LEWIS CRAY COMPUTER.

CD-86-22332

Figure 17

CONSTITUTIVE MODELING FOR ISOTROPIC MATERIALS

OBJECTIVE:

TO DEVELOP UNIFIED CONSTITUTIVE MODEL FOR FINITE-ELEMENT STRUCTURAL ANALYSES OF TURBINE-ENGINE HOT-SECTION COMPONENTS.

CONTRACTOR:

SOUTHWEST RESEARCH INSTITUTE (NAS3-23925.)

APPROACH:

- DEVELOPMENT IS DIRECTED TOWARD ISOTROPIC, CAST NICKEL-BASE ALLOYS FOR AIR-COOLED TURBINE BLADES AND VANES.
- A DATA BASE OF CYCLIC UNIAXIAL AND MULTIAXIAL BEHAVIOR WILL BE OBTAINED FOR A BASE MATERIAL (B1900) AND AN ALTERNATE MATERIAL (MAR M247).
- EFFICIENT METHODS FOR OBTAINING MODEL CONSTANTS WILL BE DEVELOPED.
- MODELS WILL BE INCORPORATED IN FINITE-ELEMENT CODE AND EXERCISED ON A BLADE AIRFOIL PROBLEM.

STATUS:

- THE BASE PROGRAM HAS BEEN COMPLETED.
- AN OPTIONAL PHASE OF THE PROGRAM IS UNDERWAY IN WHICH THE ALTERNATE MATERIAL WILL BE STUDIED AND MODEL DEVELOPMENT WILL BE EXTENDED TO INCLUDE COATING, GRAN SIZE, AND THERMAL HISTORY EFFECTS, IF NECESSARY.

ACCOMPLISHMENTS:

- UPDATED VERSIONS OF THE BODNER AND WALKER MODELS, WITH COMPATIBLE NUMERICAL INTEGRATION SCHEMES WERE INCORPORATED IN THE MARC CODE.
- THESE WERE EXERCISED IN SIMULATIONS OF A LARGE NUMBER OF CYCLIC TESTS WITH GENERALLY GOOD RESULTS.
- FOR THE FIRST TIME UNIFIED CONSTITUTIVE MODELS HAVE BEEN APPLIED TO THE CYCLIC STRUCTURAL ANALYSIS OF AN ENGINE HOT SECTION COMPONENT.

CD-86-22329

Figure 18

3-D INELASTIC ANALYSIS (HOST)

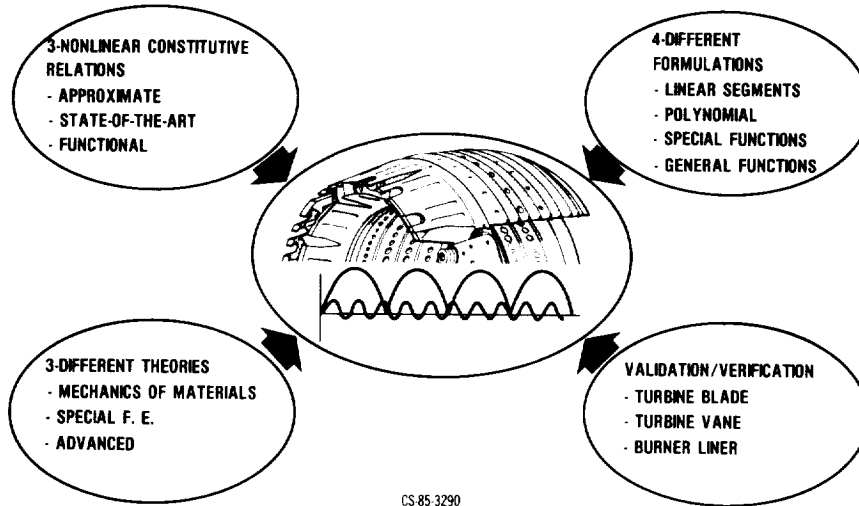

Figure 19

THREE-DIMENSIONAL INELASTIC ANALYSIS METHODS FOR HOT-SECTION COMPONENTS-I

OBJECTIVE:

DEVELOP NEW ANALYTICAL METHODS THAT PERMIT MORE ACCURATE AND EFFICIENT STRUCTURAL ANALYSIS FOR COMBUSTER LINERS, TURBINE BLADES AND VANES.

CONTRACTOR:

PRATT & WHITNEY.

APPROACH:

PROVIDE A SERIES OF NEW COMPUTER CODES THAT EMBODY PROGRESSIVELY MORE SOPHISTICATED ANALYSIS CAPABILITIES BASED ON:

- AN APPROXIMATE MECHANICS OF MATERIALS FORMULATION (MOMM)
- A STATE-OF-THE-ART, SPECIAL FINITE-ELEMENT FORMULATION (MHOST)
- AN ADVANCED TECHNOLOGY BOUNDARY-ELEMENT FORMULATION (BEST3D).

STATUS:

PROGRAM IN FOURTH YEAR.

ACCOMPLISHMENTS:

- COMPUTER CODES GENERATING WIDESPREAD INTEREST IN GOVERNMENT/INDUSTRY/UNIVERSITY SECTORS.
- FIRST USERS WORKSHOP HELD IN JUNE 1985.
- PRELIMINARY VERSIONS DISTRIBUTED FOR EARLY EVALUATION.
- SECOND USERS WORKSHOP ANTICIPATED FOR LATE 1987.

CD-96-22327

Figure 20

THREE-DIMENSIONAL INELASTIC ANALYSIS METHODS FOR HOT SECTION COMPONENTS-II

OBJECTIVE:

DEVELOP IMPROVED ANALYSIS TOOLS THAT ALLOW MORE ACCURATE AND EFFICIENT CHARACTERIZATION OF THE CYCLIC TIME DEPENDENT PLASTICITY OCCURRING IN HOT-SECTION COMPONENTS.

CONTRACTOR:

GENERAL ELECTRIC.

APPROACH:

PROVIDE A MATRIX OF FINITE-ELEMENT-BASED CODES WITH VARYING SOPHISITICATION RELATIVE TO

- ELEMENT TYPE FORMULATION
- MATERIAL CONSTITUTIVE MODEL REPRESENTATION SHARING A COMMON EMPHASIS ON EFFICIENT SOLUTION ALGORITHMS.

STATUS:

PROGRAM COMPLETED.

ACCOMPLISHMENTS:

- CODE EVALUATION UNDERWAY AT LEWIS.
- USERS WORKSHOP ANTICIPATED FOR LATE 1986.
- CODE DISTRIBUTION THROUGH COSMIC ANTICIPATED IN EARLY 1987.

Figure 21

—