

N89 - 15856

Full-Disk Magnetograms Obtained with a Na Magneto-Optical Filter at
the Mount Wilson Observatory

Edward J. Rhodes, Jr. (USC and JPL)
Alessandro Cacciani (University of Rome and JPL)
Glenn Garneau (JPL)
Tony Misch (Lick Observatory)
Dusan Progovac (USC)
Tom Shieber (UCLA)
Steve Tomczyk (UCLA)
Roger K. Ulrich (UCLA)

We report here on the first full-disk magnetograms to be obtained with the Na Magneto-Optical Filter (MOF) which is located at the 60-foot solar tower of the Mount Wilson Observatory. This MOF was employed as a longitudinal magnetograph on June 18, 19, and July 1, 1987. On those three days the MOF was combined with a large format (1024x1024 pixel) virtual phase charge coupled device camera and a high-speed data acquisition system. The combined system was used to record both line-of-sight magnetograms and Dopplergrams which covered the entire visible solar hemisphere. The pixel size of these magnetograms and Dopplergrams was $2.3 \hat{n}$. On each of the three days a time series of nine pairs of magnetograms and Dopplergrams was obtained at the rate of one pair every two minutes. On the same three days longitudinal magnetograms having one arcsecond pixels were obtained with the vacuum telescope at Kitt Peak and provided to us by T. Duvall. We have compared the MOF and vacuum tower magnetograms both at JPL's Multi-Mission Image Processing Laboratory and at USC and have found the two sets of images to be well correlated both in spatial distribution and strength of the measured magnetic field. We have also employed the simultaneously-obtained MOF Dopplergrams to remove the cross-talk which was present between the Doppler and Zeeman shifts of the NaD lines from the magnetograms from all three days and will also describe recent improvements to the system which allow us to obtain full-disk magnetograms as rapidly as once every 25 seconds. This work was supported by NASA grant NASW-13 and by NSF grant INT 84-00213 to USC. A portion of the research was also performed by the Jet Propulsion Laboratory, California Institute of Technology, under contract with the National Aeronautics and Space Administration.

COMPONENTS OF MAGNETO—OPTICAL FILTER IN MAGNETOGRAPH MODE AND WITH Na D1/D2 SEPARATOR (IMAGING LENSES OMITTED)

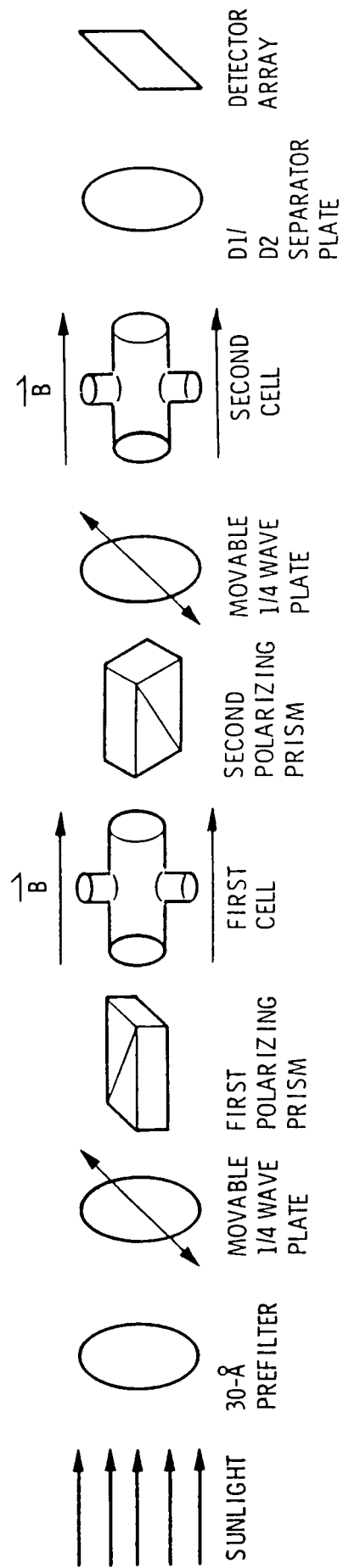
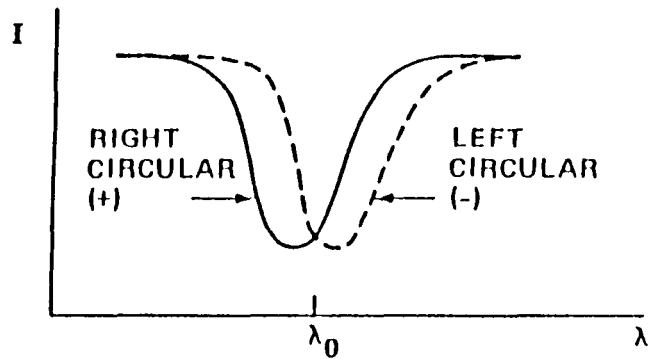

Figure 1. Schematic diagram of the MOF in the longitudinal magneto-graph/Dopplergraph mode. In actual operation on objective lens, field lens, and a reimaging lens are added to the elements shown here. The first 1/4 wave plate is for the magnetograph, while the second is for the Dopplergraph.

- ~ MAGNETIC FIELD SPLITS SPECTRAL LINE:
TWO COMPONENTS
OPPOSITE POLARIZATIONS



- ~ LINE DISPLACEMENT DEPENDS ON FIELD STRENGTH:

$$\Delta\lambda (+) = -aH$$

$$\Delta\lambda (-) = +aH$$

$$a \cong 10 \text{ m}\text{\AA}/\text{kg} = 0.01 \text{ m}\text{\AA}/\text{g}$$

- ~ DOPPLER SHIFT DISPLACES BOTH COMPONENTS:

$$\Delta\lambda = bV$$

$$b \cong 20 \text{ m}\text{\AA}/(\text{km/s}) = 0.02 \text{ m}\text{\AA}/(\text{m/s})$$

- ~ H, V CAN BE DERIVED:

MEASURE INTENSITY (I)

IN TWO WINGS (R = RED, B = BLUE)

IN TWO POLARIZATIONS (+, -).

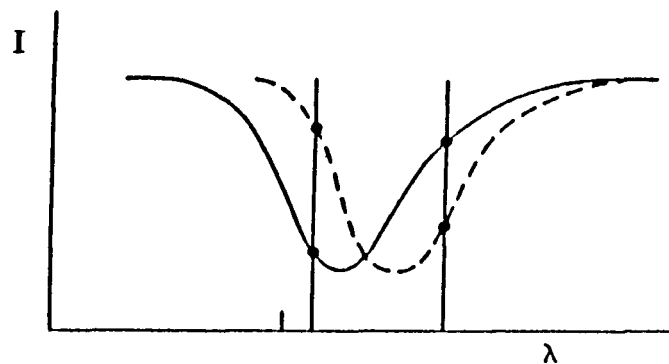

Figure 2. Schematic illustration of the method by which the simultaneous Zeeman splittings and Dopplers shifts of a solar spectral line can be determined separately.

$$B_- = I_0 + (aH + bV) (dI/d\lambda)$$

$$B_+ = I_0 + (-aH + bV) (dI/d\lambda)$$

$$R_+ = I_0 + (-aH - bV) (dI/d\lambda)$$

$$R_- = I_0 + (aH - bV) (dI/d\lambda)$$

- $\Sigma = B_- + B_+ + R_+ + R_- = 4I_0$,

RED - BLUE GIVES V,

RIGHT - LEFT GIVES H:

$$V = \frac{(R_+ - B_+) + (R_- - B_-)}{\Sigma}$$

$$H = \frac{(R_+ - R_-) + (B_+ - B_-)}{\Sigma}$$

Figure 3. Formulae used for the conversion of four filtergrams into one magnetogram (H) and one Dopplergram (V).

ORIGINAL PAGE IS
OF POOR QUALITY

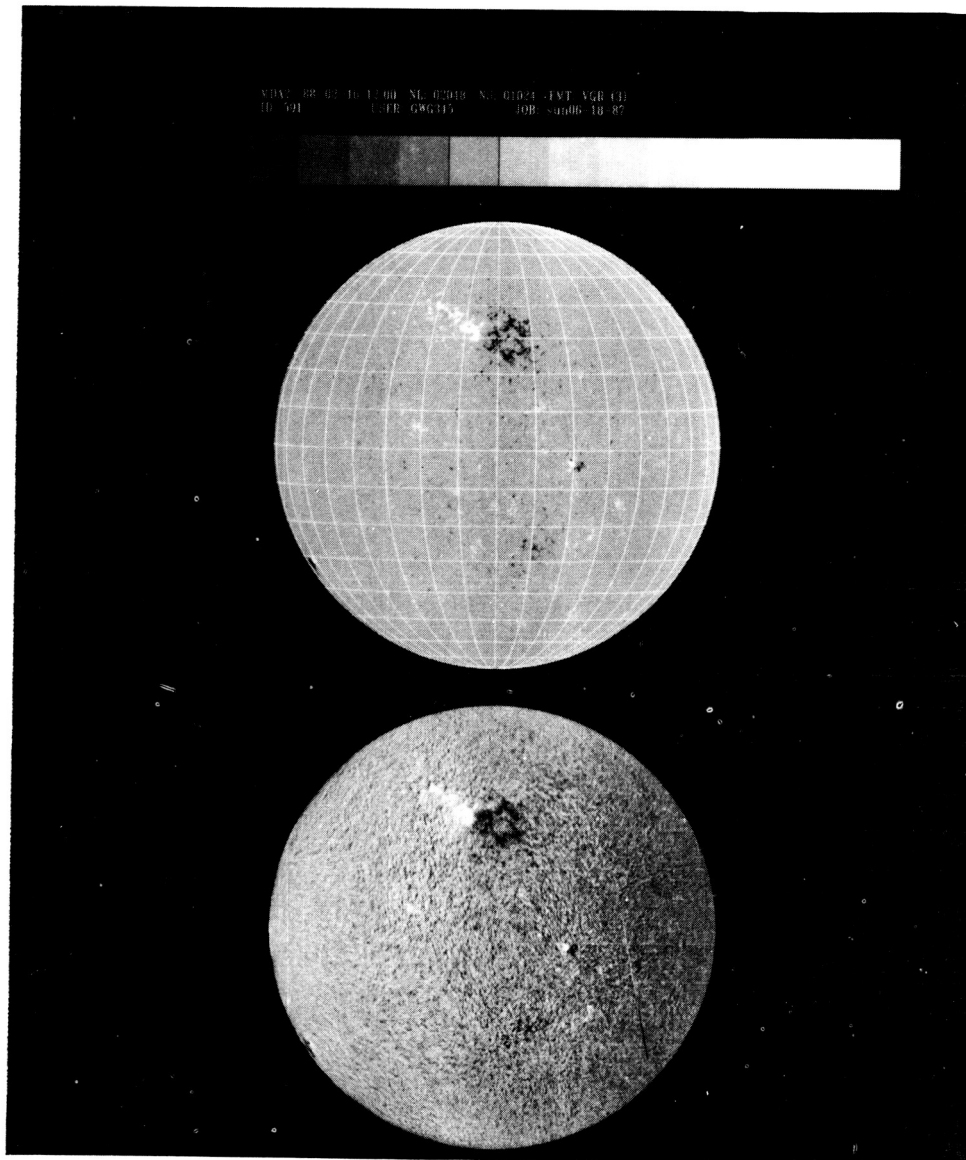

- Figure 4. KPNO magnetogram for 6/18/87 (top).
Single Mt. Wilson MOF magnetogram for 6/18/87 (bottom).

ORIGINAL PAGE IS
OF POOR QUALITY

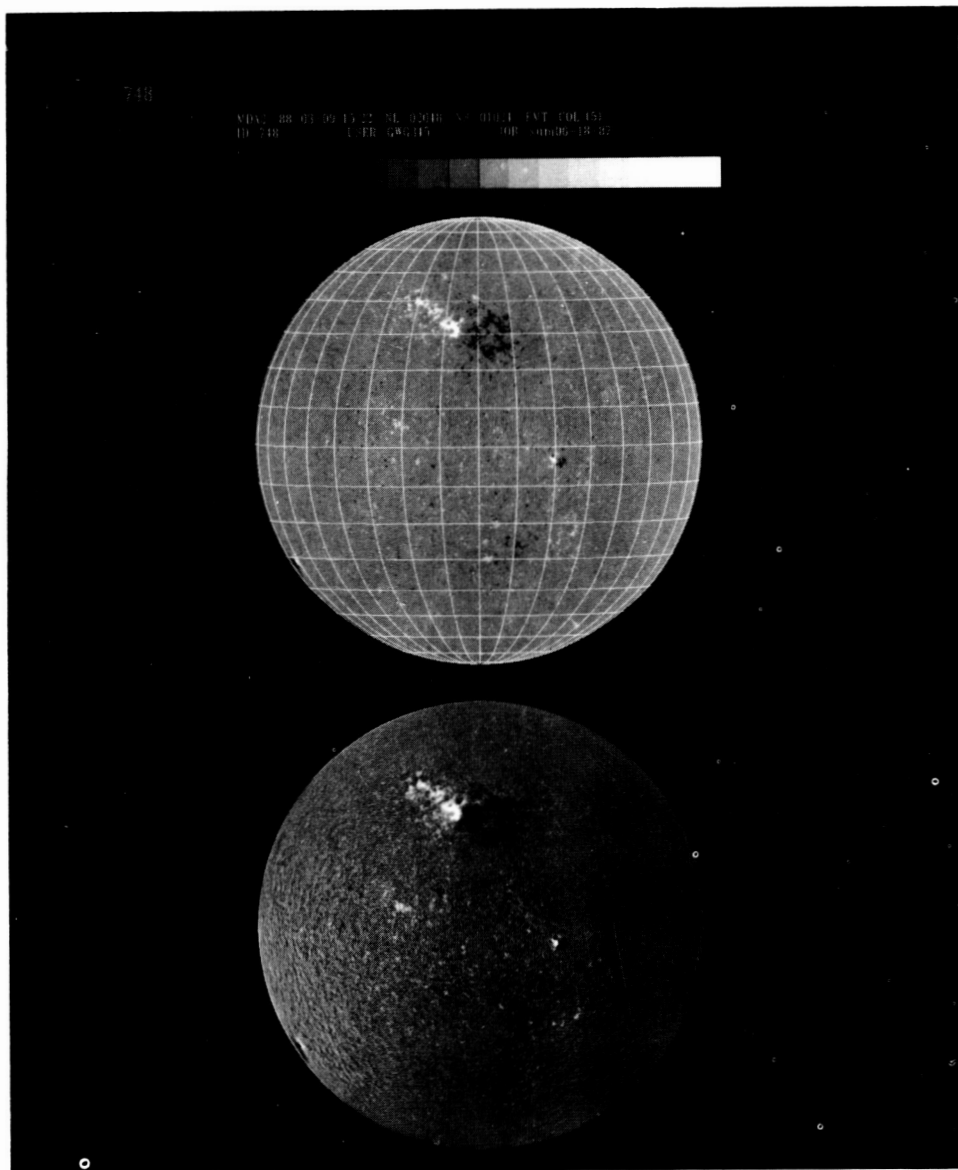

- Figure 5. KPNO magnetogram for 6/18/87 (top).
Average of nine individual MOF magnetograms for 6/18/87 (bottom).

ORIGINAL PAGE IS
OF POOR QUALITY

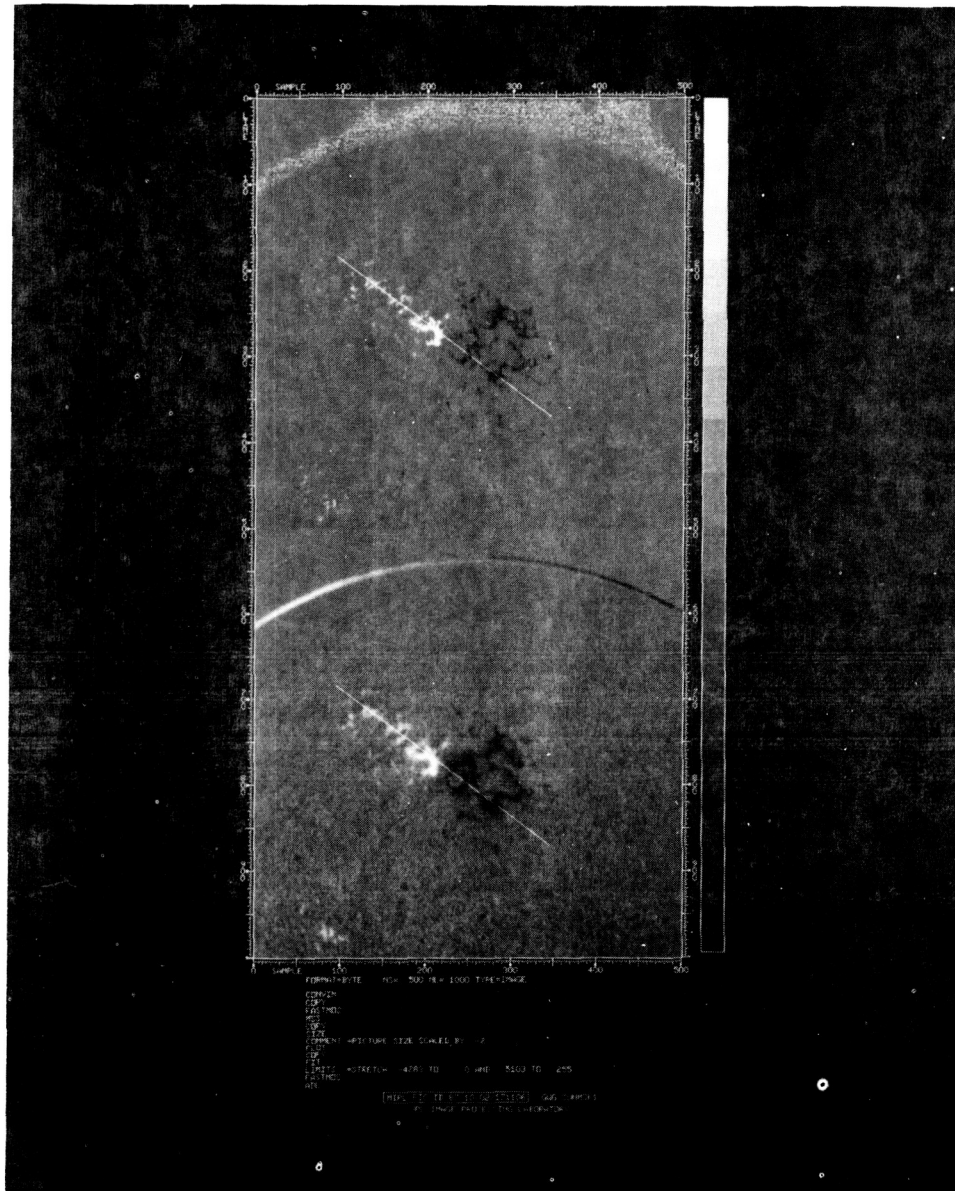

- Figure 6. Enlargement of active region located at 30° N in Figures 4 and 5. KPNO magnetogram is shown at the top. The average of the nine MOF magnetograms is shown below. The white line is a scan line through the active region along which the magnetic field strengths are compared in Figures 7 and 8.

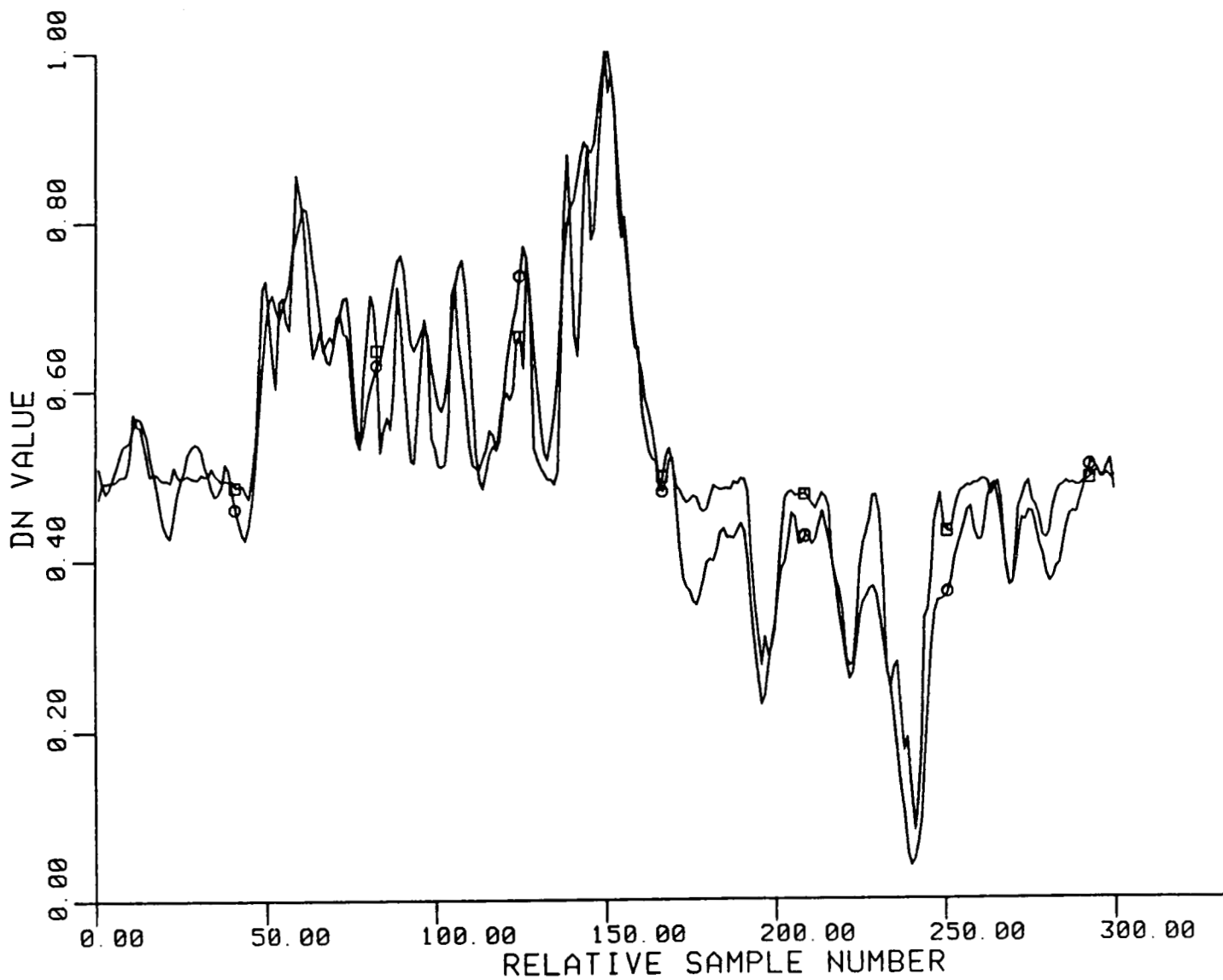
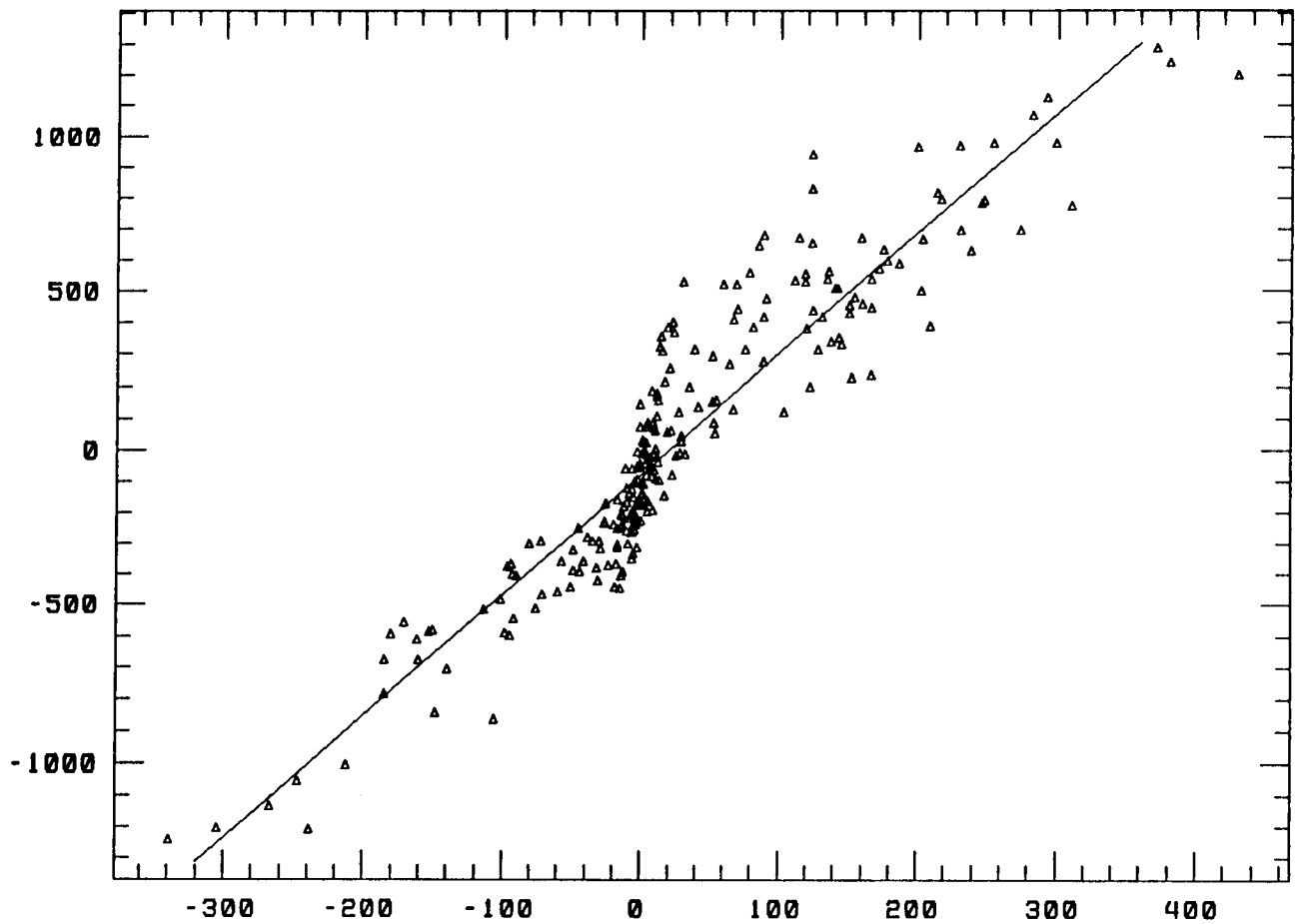
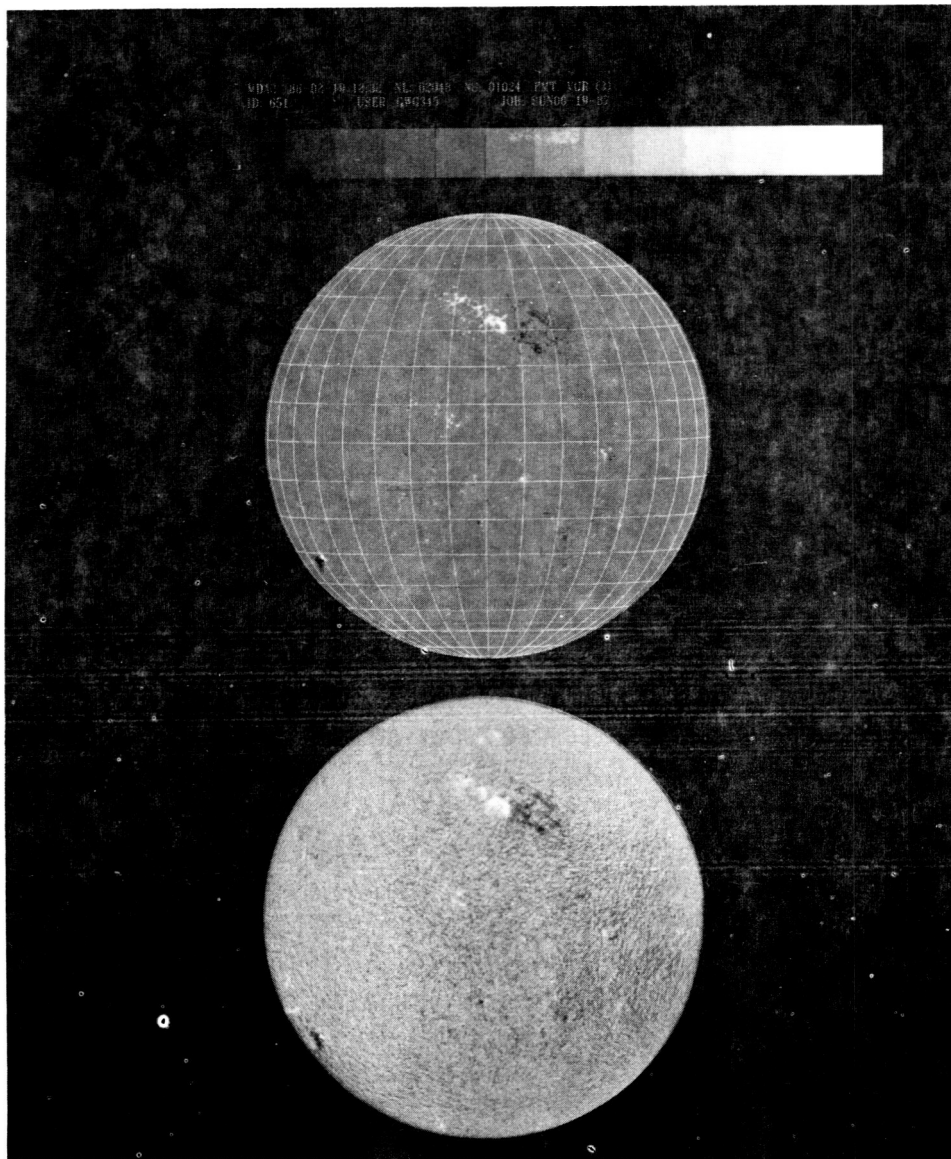

Figure 7. Comparison of measured magnetic field strengths along the scan line through the active region shown in Figure 6. The MOF data points are labeled with the open circles, while the corresponding KPNO data points are labeled with the squares.



- Figure 8. Scatterplot of measured magnetic field strengths along scanline shown in Figure 6. KPNO values are plotted horizontally in gauss while corresponding values from the average MOF magnetogram shown in Figure 5 are plotted vertically. The least squares fit to the points is shown as the straight line. The correlation coefficient for this fit was 0.93.



- Figure 9. Comparison of KPNO magnetogram for 6/19/87 (top) with corresponding single Mt. Wilson MOF magnetogram (bottom). The active regions shown in Figures 4 and 5 have all rotated to the west in these images.

ORIGINAL PAGE IS
OF POOR QUALITY

ORIGINAL PAGE IS
OF POOR QUALITY

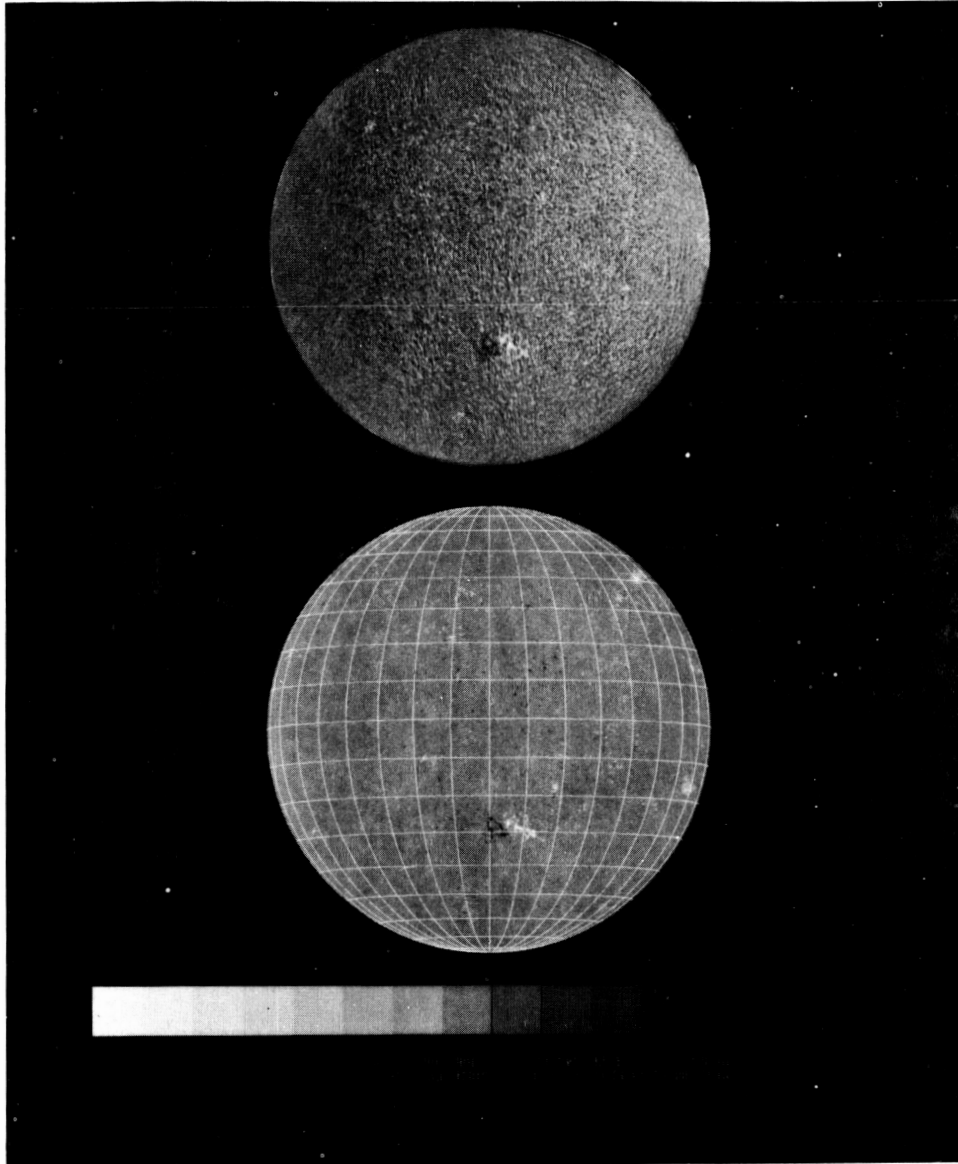

• Figure 10. Comparison of KPNO (top) and single Mt. Wilson MOF magnetogram for 7/1/87 (bottom).

ORIGINAL PAGE IS
OF POOR QUALITY

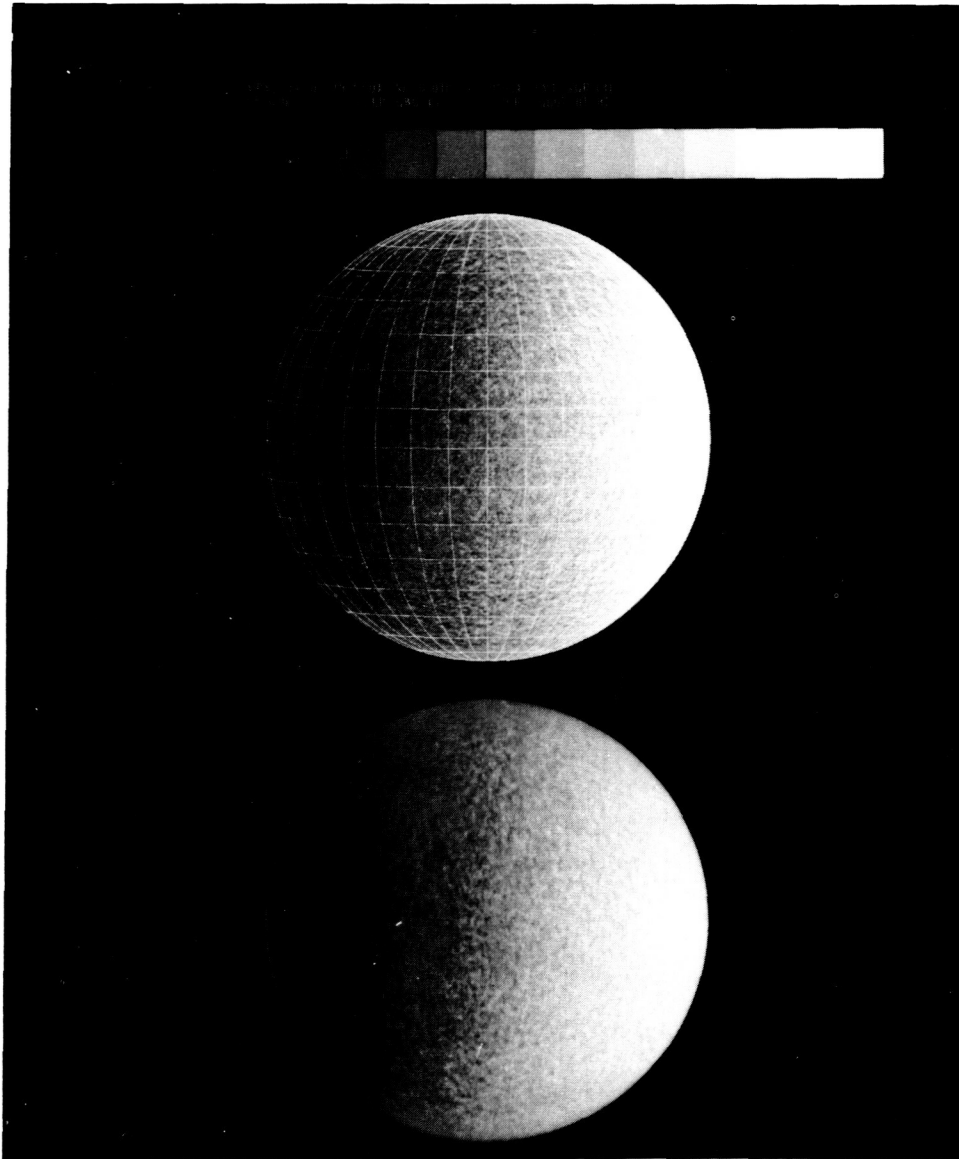

- Figure 11. Comparison of KPNO (top) and Mt. Wilson MOF Dopplergram (bottom) for 7/1/87. Solar rotation is visible in both images as is the supergranulation. Because the two images were not obtained simultaneously, the oscillatory velocity patterns are not in phase. The Mt. Wilson Dopplergram was obtained in 1 minute while the KPNO Dopplergram required 40 minutes.

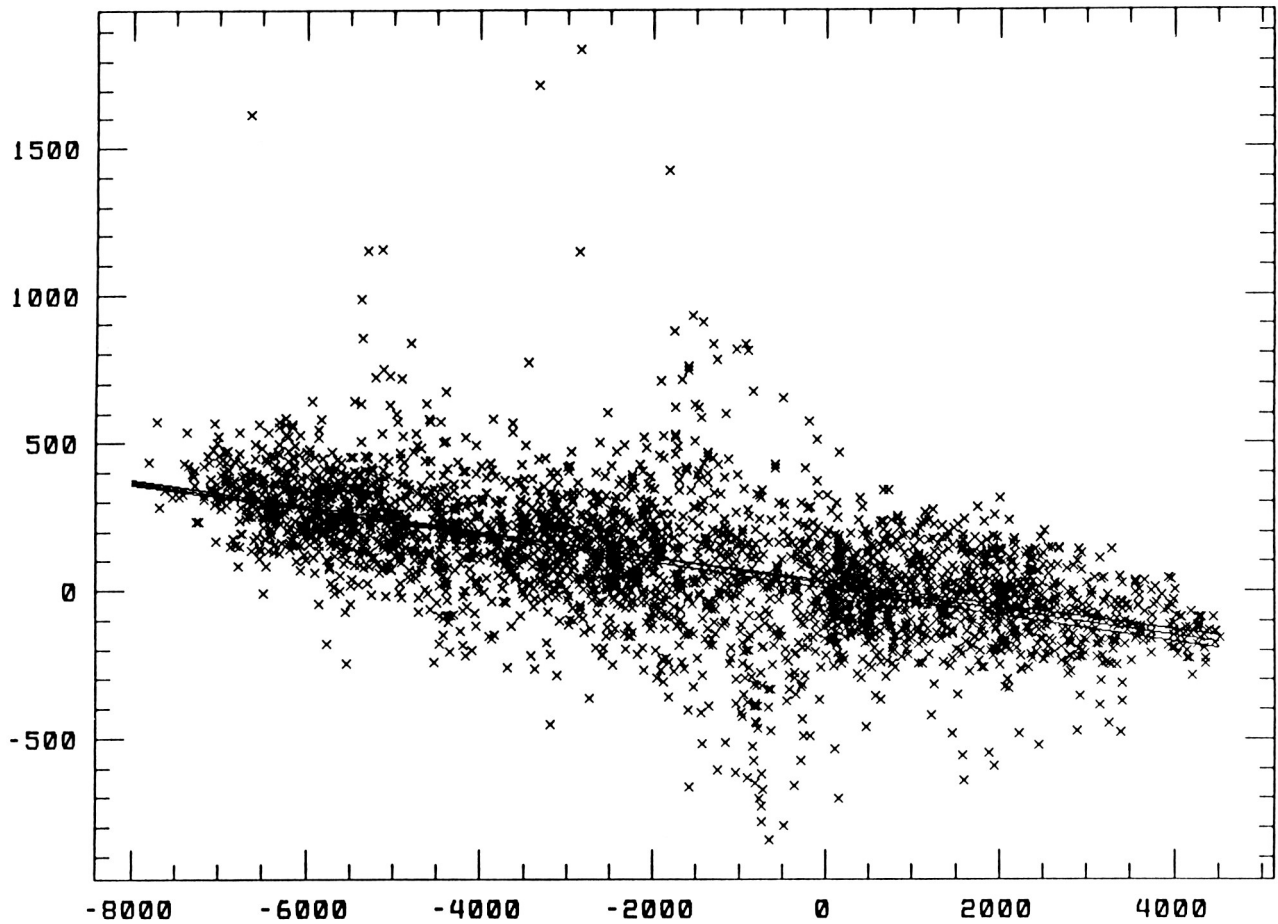

• Figure 12. Comparison of magnetic and Doppler signals from 6/18/87 raw images. Values were compared for three narrow (three-pixel high) bands which were oriented parallel to the equator. One band was in the Northern Hemisphere, one in the Southern Hemisphere, and the third was along the equator itself. The overall correlation between the two signals is evident as is a large amount of scatter. There are 3072 pairs of points included in this figure. The three straight lines are the least-squares regression fits to the 1024 pairs of points within each zone. The nearly identical regression fits indicate that a single trend is valid over the entire image (except in the active regions). The largest deviations from the regression fits correspond to the large magnetic field strengths recorded in the large active region of Figures 4 and 6. The simple correlation between the Doppler velocities and the weak magnetic background signal is masked by the large field strengths in this active region.

MDA1 88-03-23 12:42 NL 01189 NS: 01120 FMT: FF (1)
ID: 1303 USER: GWG345 JOB: 06-18-87 mag'

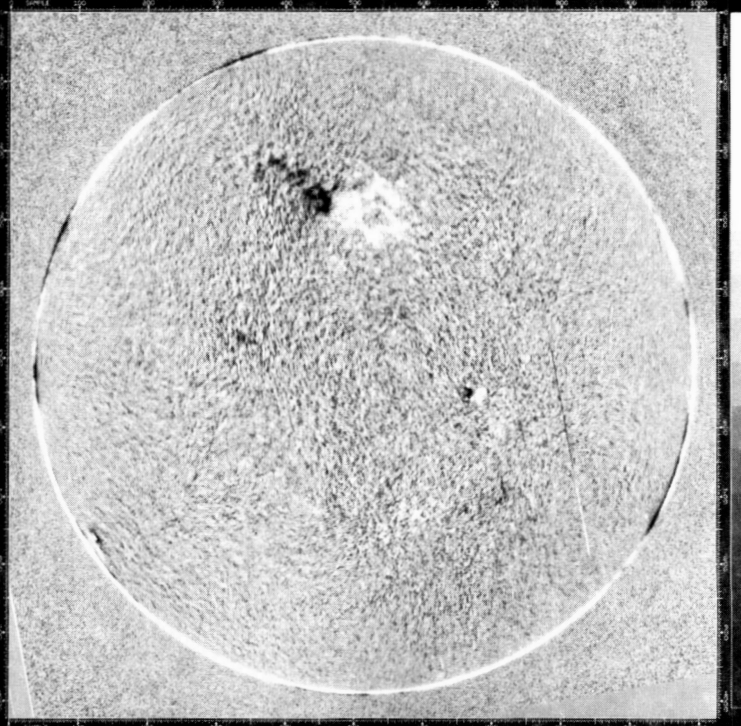

- Figure 13. A single “cleaned” magnetogram for 6/18/87. This magnetogram is the result of the removal of the Doppler-shift-induced cross-talk from the raw magnetogram of Figure 4. This cross-talk was removed using the empirical fit for the 6/18/87 magnetogram and Dopplergram which was found in Figure 12 above. This fit ($MAGNETIC = 26.94 - 0.04362 \times DOPPLER$) was calculated for each pixel of the raw magnetogram and then subtracted from that image. The east-west trend which was evident in Figures 4 and 5 is absent in this “cleaned” magnetogram.

ORIGINAL PAGE IS
OF POOR QUALITY

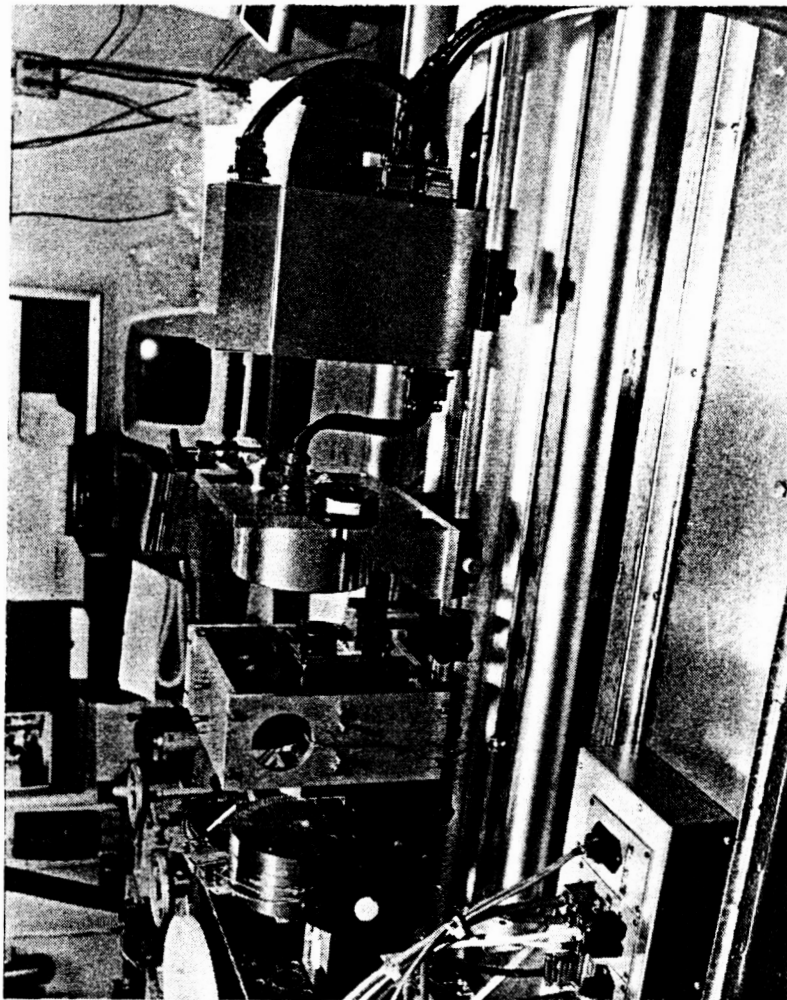
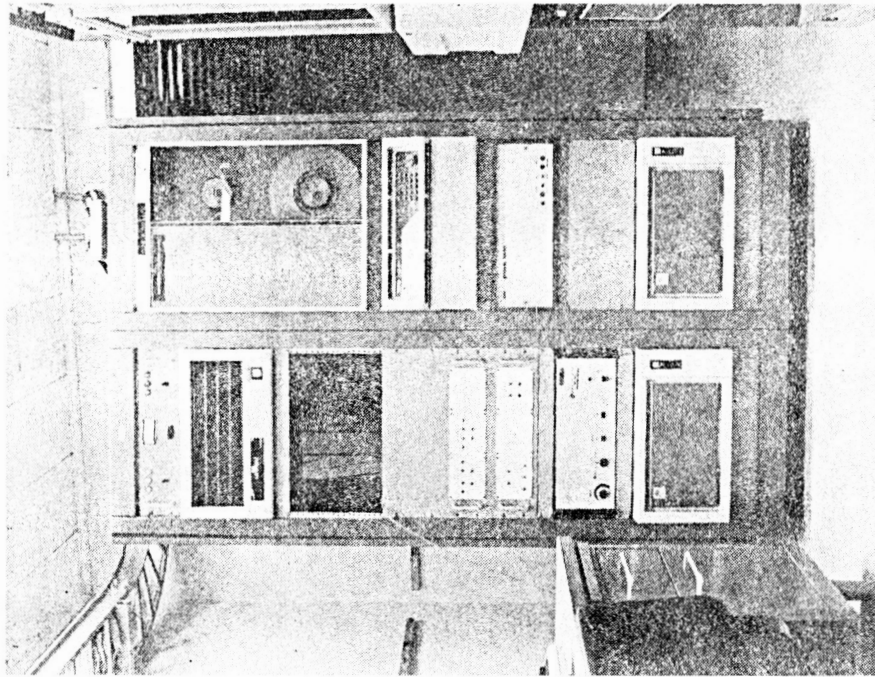

• Figure 14. (left) Photograph of the MOF (the two magnet assemblies at the left) and the CCD camera (the aluminum cylinder at the center and the electronics box at the right) as they are currently installed at Mt. Wilson. (right) The 60-foot tower CCD Data Acquisition Computer.

MT. WILSON HELIOSEISMOLOGY DATA ACQUISITION FACILITY

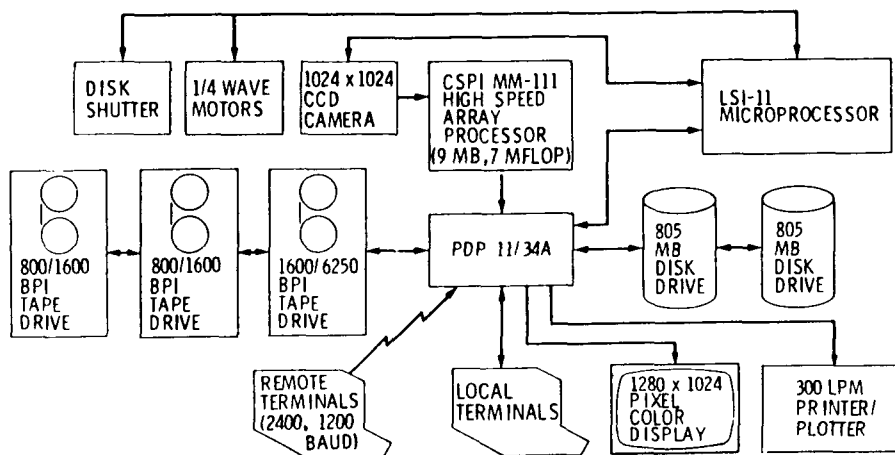

- Figure 15. Schematic diagram of the data acquisition system at the 60-foot tower which will be used for the magnetogram development. Since the figure was prepared an additional 800 MB of disk storage has been added at to the system. In addition to the shown here, analysis will also be conducted on the USC ALLIANT FX/8 system.

Improvements Implemented Since June 1987

- Data Acquisition Rate Sped Up to 4 frames in 66 seconds
- Guider Has Been Renovated
- Wide Acceptance Angle Polarizers Have Been Installed
- Images can be Numerically Integrated in Real Time
- Faster Disk Drives Installed

Planned Improvements for 1988

- 2x Magnification Optics to be Installed
- Efforts underway to Improve "Seeing" of 60-Foot Tower
- All-Refractive Optic System May be Implemented
- Vector Magnetograph Mode to be Tested
 - Additional Mount to be Installed for Extra Waveplates
 - Additional Array Processor Memory will Allow Rapid Acquisition of Six-Filtergram Sequence