

NASA Technical Memorandum 4110

Geometrical and Structural Properties of an Aeroelastic Research Wing (ARW-2)

Maynard C. Sandford, David A. Seidel,
and Clinton V. Eckstrom
*Langley Research Center
Hampton, Virginia*

Charles V. Spain
*PRC Kentron, Inc.
Aerospace Technologies Division
Hampton, Virginia*



National Aeronautics and
Space Administration
Office of Management
Scientific and Technical
Information Division

1989

Summary

Transonic steady and unsteady pressure tests have been conducted on the right panel of a large elastic wing known as the DAST ARW-2. The wing has a supercritical airfoil, an aspect ratio of 10.3, and a leading-edge sweepback angle of 28.8° and is equipped with two inboard and one outboard trailing-edge control surfaces. Only the outboard control surface was deflected to generate steady and unsteady flow over the wing. Currently, the measured surface pressure data acquired on this elastic wing are being processed for publication. This report presents the geometrical and structural characteristics of this elastic wing, in terms of a combination of measured and calculated data, to permit future analysts to compare the experimental surface pressure data with theoretical predictions.

Introduction

At NASA Langley Research Center, progress continues on a program to measure unsteady pressures on several wing configurations (refs. 1, 2, and 3). The goal of this program is to generate an extensive data base of measured unsteady pressures for use in evaluating the accuracy of theoretical computational transonic aerodynamic programs. Initially, all wing models tested were made as rigid as possible to minimize wing structural deformations and thereby maintain simple basic comparisons with the transonic aerodynamic programs. Recently, a flexible wing configuration was tested as part of this pressure measurement program. The wing construction is similar to that of actual aircraft wings and should provide more realistic measured data for comparison with results from advanced transonic aerodynamic programs that include the effects of aeroelastic deformations in the computational process.

Funding constraints and subsequent cancellation of the NASA program Drones for Aerodynamics and Structural Testing (DAST) (ref. 4) made available the second in a series of aeroelastic research wings (ARW-2) for unsteady pressure testing in the Langley Transonic Dynamics Tunnel (TDT). This elastic wing configuration, known as DAST ARW-2, has an aspect ratio of 10.3, a leading-edge sweepback angle of 28.8° , and a supercritical airfoil. The wing has a hydraulically driven outboard trailing-edge control surface and was instrumented with unsteady pressure gages. Therefore it was extremely useful to the present unsteady pressure measurements program (ref. 5).

The purpose of the present paper is to provide the physical properties of this elastic wing model. Geometrical and structural properties of the wing are

presented in detail along with mode shape data from a mathematical model of the wing for use by analysts in their computational transonic aerodynamic code development. A combination of design data, measured data from the wind tunnel model, and calculated data from a finite element model are presented.

Symbols

c	local chord, in.
dx	displacement in x -direction, in.
dy	displacement in y -direction, in.
dz	displacement in z -direction, in.
f	frequency of oscillating control surface, Hz
R	radius of fuselage sections, in.
x	streamwise coordinate, in.
X	streamwise coordinate measured from the wing local leading edge, in.
y	spanwise coordinate, in.
z	vertical coordinate, in.
Z	vertical distance from the wing reference plane ($z = 59.50$ in.), in.

Wind Tunnel Model

General

These tests were conducted in the Langley Transonic Dynamics Tunnel (TDT). The TDT is a closed-circuit continuous-flow tunnel which has a 16-foot square test section with slots in all four walls. An elastic semispan wing model is described herein. This model consisted of the right wing panel from the DAST ARW-2 drone flight vehicle and a rigid half-body fuselage. Both the fuselage and the wing were mounted on a remotely controlled turntable mechanism located on the tunnel sidewall. The turntable was used to adjust the model angle of attack. A photograph of the complete model mounted in the tunnel is shown in figure 1. The location of the sidewall turntable and its relationship to the wing and fuselage is shown in figure 2.

Instrumentation

The locations of the wing instrumentation are shown in figure 3. The primary instrumentation consisted of 182 pressure transducers and 10 accelerometers. In addition, strain gages were located near the wing root to measure bending moments. A differential pressure gage was mounted in each supply line to the hydraulic actuator of each control surface to measure hinge moments. Small potentiometers were used to measure the control surface angular displacement.

The model angle of attack was measured by a servo accelerometer that was mounted near the wing root. Both steady and unsteady pressures were obtained with differential pressure transducers referenced to the tunnel's static pressure. Streamwise rows of upper and lower surface pressure orifices were located at six span stations. The wing location of these orifices are tabulated in table 1. Surface orifices were connected to pressure transducers by matched tubes having an inner diameter of 0.040 inch and a length of 18 inches. To determine the wind-on tube transfer functions, needed to correct the unsteady pressure data from these matched-tube transducers, simultaneous measurements were also obtained from a row of in situ transducers mounted on the wing upper surface parallel to the fifth row of surface orifices. The 10 accelerometers were used to determine the wing dynamic deflections. The accelerometer locations are shown in figure 3 and presented in table 2. The accelerometers were embedded in the wing approximately halfway between the upper and lower surface.

Fuselage Geometry and Construction

The half-body fuselage was used primarily to place the wing outside the wind tunnel wall boundary layer. The fuselage had a semicircular cross section. The nose and tail fuselage sections were made shorter than the actual flight fuselage. However, the center section of the fuselage was made very similar to the flight fuselage in both diameter and wing location to provide flow around the inboard section of the wing similar to that expected to occur on the flight vehicle. This fuselage shape represents those found on transport aircraft. The geometric properties of the fuselage are shown in figure 2 and the fuselage coordinates are presented in table 3.

The rigid half-body fuselage structure consisted of a backplate and several bulkheads to which the exterior shell was fastened. The exterior shell was made of 1/4-inch-thick fiberglass in four sections as shown in figure 2. The nearly full length backplate and the two end bulkheads were fabricated of 1/2-inch-thick aluminum plate. The middle three bulkheads were fabricated of 1-inch-thick aluminum plate and were located at the joint locations of the fiberglass sections. The fiberglass shell sections were attached to the backplate and the bulkheads with screw fasteners along all edges. The half-body fuselage backplate was fastened directly to the wind tunnel turntable before the exterior shell sections were installed. The backplate and bulkhead masses were reduced considerably by cutting circular holes out of the material to conveniently handle the pieces.

Wing Geometry and Construction

The elastic wing had an aspect ratio of 10.3 with a leading-edge sweep angle of 28.8°. The planform geometry of the wing is presented in figure 3. The wing was equipped with three hydraulically driven control surfaces, two inboard and one outboard, and their locations are shown also in figure 3. Only the outboard surface was deflected statically and dynamically during the pressure measurement tests while both inboard surfaces were held fixed at 0° in relation to the wing surface. The outboard surface hinge line was located at 77 percent of the local chord.

Originally, the wing contour was formed from three supercritical airfoil shapes with different thickness-to-chord ratios (ref. 6). Straight-line interpolation along constant percent chords was used to define the area between the three airfoil shapes. This wing contour was the desired shape for a loaded wing associated with straight and level flight at a cruise Mach number of 0.8 and at an altitude of 46 800 feet. However, an elastic wing deforms to a different shape, known as the "jig" shape, if all aerodynamic loads and vehicle weight loads are removed. The present wing configuration was fabricated according to a set of calculated jig shape coordinates, which are hereafter referred to as the design airfoil coordinates. Design coordinates and the measured coordinates from the actual wing cantilevered at the root chord are presented in table 4. The design and measured coordinates are compared in figure 4. Overall, the comparison is good at all 10 span stations shown, but the differences are exaggerated by the enlarged vertical scales. On the lower surface, the largest difference is 0.077 inch at $y = 60$ inches in the trailing-edge region. On the upper surface, the largest difference is 0.065 inch at $y = 110$ inches in the leading-edge region.

The semispan wing consisted of a carry-through section which attached to the sidewall turntable and a wing panel which attached to the carry-through section near the edge of the fuselage shell. The carry-through section was machined from a 4-inch-thick block of aluminum. Two diagonal aluminum beams were located below the carry-through section, from the outer edge of the section back to the turntable, to provide additional wing root stiffness. The wing panel was constructed of two main aluminum spars connected with ribs and covered with honeycomb filled fiberglass skins. The forward spar is located at 25 percent of the local chord and the rear spar is located at 62 percent of the local chord. The upper and lower fiberglass skins between the front and rear spars were fastened permanently with both adhesives

and rivets (ref. 7). This type of construction formed a center box beam which provided the primary structural strength and stiffness requirement of the wing. The leading-edge and trailing-edge fiberglass sections were attached to the center section with removable screw fasteners. A more detailed description of the wing construction and how the jig shape was calculated are found in reference 5.

Wing Measured Structural Properties

The measured total wing weight was 156.25 pounds with the center of gravity located at $x = 27.266$ inches and $y = 14.643$ inches. No measured mass distribution data are available for this wing. Measured bending and torsion stiffness distributions of the wing are presented in figure 5. The stiffness data were calculated from angular deflections of the loaded wing. The deflections were measured with a laser light source and set of mirrors mounted on the wing along the centerline of the wing box beam (43.5 percent chord). These loading tests and corresponding deflection measurements also demonstrated that the 43.5-percent-chord line was the actual elastic axis of the wing.

The measured frequency data for the model are presented in figure 6. In figure 6(a), the data were acquired with the model mounted on a rigid backstop in the laboratory, whereas in figure 6(b), the data were acquired with the model mounted on the turntable in the tunnel. The first three mode frequencies for these two sets of data differ slightly. This is not unreasonable, because the turntable is not believed to be as stiff as the rigid backstop. The fourth and fifth modes compare well except for the node line of the fourth mode. One explanation for this discrepancy is that the node line is exceptionally sensitive to several factors, such as the shaker location and amplitude and the relationship of the frequency to the exact peak of the amplitude. This difference in the fourth mode was not pursued further, because at the time the test was intended to be a pressure model test and not a flutter model test.

Wing Analytical Structural Model

Neither the mass distribution data nor the mode shape and generalized mass data were measured for this elastic wing model because of time constraints imposed by either the wind tunnel or the flight test schedule. Without these measured data to define completely the structural properties of this elastic wing, a mathematical model was used to calculate the wing frequencies, mode shapes, and generalized masses. A finite element program known as SPAR (Structural Performance and Resizing) was used to

generate this mathematical model and is described in reference 8. The finite element model was developed while the wing was being constructed and was continuously updated by comparison with the measured static loads, vibration, weight, and balance test data. To the extent practical, the analytical model reflects the actual construction of the wing, as opposed to an elastic axis or flat plate representation. A variety of isotropic elements were used to represent the ribs, spars, center section, and the sidewall turntable. Instrumentation and system weights were represented as point masses. The fiberglass skins were modeled as composite bending plate and membrane elements based on the actual layup. The finite element model contained a total of 452 joints and approximately 900 elements and 2700 degrees of freedom. The geometric mesh is illustrated in figure 7.

The data from 100 joint locations were selected for inclusion in this report: a 6×15 array of joints located on the wing panel and 10 joints located on the carry-through section. These 100 joint locations are listed in table 5 and shown in figure 8. The calculated modal deflections, rotations, and frequencies for the first six modes are tabulated in table 6. The sixth mode is given for completeness and convenience of knowing where the next mode frequency is located. The modal deflections are scaled so that the generalized mass values are normalized to 1.0 for each of the modes. The quality of a mathematical model simulation can be determined by comparing calculated and measured properties. Therefore, calculated frequencies and node lines of the first five modes are presented in figure 9 for comparison with the measured results given in figure 6(b). The comparison is reasonably good except for the frequency of the third mode and the node line of the fourth mode. These differences appear significant now; however at the time that the measurements were taken, the higher modes were not considered important for a high-aspect-ratio model pressure test. Although not presented in this paper, the measured data for the sixth mode ($f = 90.0$ Hz) compared well with the calculated data. Also, measured and calculated bending and torsion stiffness distributions are compared in figure 10. Both the bending and the torsion stiffness comparisons are good except for the most outboard tip region.

Concluding Remarks

Physical properties of an elastic wing are presented herein for use by analysts in making calculations for comparison with experimental data. The elastic wing has an aspect ratio of 10.3, a sweepback angle of 28.8° , and a supercritical airfoil and was

tested to measure unsteady pressures due to an oscillating outboard trailing-edge control surface. Tests were conducted in the Langley Transonic Dynamics Tunnel as part of a comprehensive unsteady pressure measurement program. A combination of measured, design, and calculated data are presented.

The measured coordinates of the supercritical airfoil at several span stations compare well overall with the design airfoil values. Also, the measured and calculated stiffness distributions compare well, while the modal frequencies and node lines are in reasonably good agreement. Overall, the finite element model is considered a reasonably good representation of the actual wind tunnel model.

NASA Langley Research Center
Hampton, VA 23665-5225
February 22, 1989

References

1. Sandford, M. C.; Ricketts, R. H.; Cazier, F. W., Jr.; and Cunningham, H. J.: Transonic Unsteady Airloads on an Energy Efficient Transport Wing With Oscillating Control Surfaces. *J. Aircr.*, vol. 18, no. 7, July 1981, pp. 557-561.
2. Hess, R. W.; Wynne, E. C.; and Cazier, F. W., Jr.: *Static and Unsteady Pressure Measurements on a 50 Degree Clipped Delta Wing at $M = 0.9$* . NASA TM-83297, 1982.
3. Ricketts, Rodney H.; Sandford, Maynard C.; Seidel, David A.; and Watson, Judith J.: Transonic Pressure Distributions on a Rectangular Supercritical Wing Oscillating in Pitch. *J. Aircr.*, vol. 21, no. 8, Aug. 1984, pp. 576-582. (Also available as NASA TM-84616.)
4. Murrow, H. N.; and Eckstrom, C. V.: Drones for Aerodynamic and Structural Testing (DAST)—A Status Report. *J. Aircr.*, vol. 16, no. 8, Aug. 1979, pp. 521-526.
5. Seidel, David A.; Sandford, Maynard C.; and Eckstrom, Clinton V.: Measured Unsteady Transonic Aerodynamic Characteristics of an Elastic Supercritical Wing. *J. Aircr.*, vol. 24, no. 4, Apr. 1987, pp. 225-230.
6. Byrdsong, Thomas A.; and Brooks, Cuyler W., Jr.: *Wind-Tunnel Investigation of Longitudinal and Lateral-Directional Stability and Control Characteristics of a 0.237-Scale Model of a Remotely Piloted Research Vehicle With a Thick, High-Aspect-Ratio Supercritical Wing*. NASA TM-81790, 1980.
7. Eckstrom, Clinton V.; and Spain, Charles V.: Experiences in the Use of Composite Material for a Wing Skin. *J. Aircr.*, vol. 20, no. 11, Nov. 1983, pp. 913-919.
8. Whetstone, W. D.: *EISI/SPAR Reference Manual—System Level 103*. Engineering Information Systems, Inc., Jan. 1979.

Table 1. Location of Static and Dynamic Pressure Orifices and In Situ Transducers

Chord number	1	2	3	a ⁴	a ⁵	a ⁶	b ⁷
Semispans, in.	31.25	54.25	68.25	80.50	99.20	110.75	99.70
Percent of semispans	27.4	47.6	59.9	70.7	87.1	97.2	87.5
Local chord, in.	30.900	22.571	20.241	18.202	15.090	13.167	15.006
x value at leading edge, in.	17.172	29.811	37.505	44.236	54.512	60.859	54.787
Upper chordwise location: X/c (Distance from local leading edge, in.)							
	0.025 (0.773)	0.025 (0.565)	0.025 (0.506)	0.025 (0.455)	0.025 (0.377)	0.025 (0.329)	0.143 (2.146)
	.078 (2.411)	.088 (1.987)	.088 (1.781)	.087 (1.584)	.084 (1.268)	.092 (1.211)	.202 (3.031)
	.131 (4.048)	.151 (3.409)	.151 (3.056)	.148 (2.694)	.143 (2.158)	.162 (2.107)	.301 (4.517)
	.184 (5.686)	.215 (4.853)	.214 (4.331)	.209 (3.804)	.202 (3.048)	.227 (2.989)	.407 (6.108)
	.247 (7.633)	.292 (6.591)	.290 (5.869)	.294 (5.352)	.301 (4.542)	.294 (3.871)	.513 (7.698)
	.331 (10.228)	.351 (7.923)	.348 (7.043)	.350 (6.371)	.354 (5.342)	.362 (4.767)	.680 (10.204)
	.415 (12.824)	.409 (9.232)	.406 (8.217)	.407 (7.408)	.407 (6.142)	.430 (5.662)	.830 (12.455)
	.499 (15.419)	.468 (10.564)	.464 (9.391)	.463 (8.428)	.460 (6.941)	.497 (6.544)	
	.621 (19.189)	.526 (11.873)	.522 (10.565)	.519 (9.447)	.513 (7.741)	.565 (7.440)	
	.682 (21.074)	.585 (13.204)	.581 (11.759)	.579 (10.539)	.566 (8.541)	.632 (8.322)	
	.736 (22.743)	.658 (14.852)	.654 (13.237)	.659 (11.995)	.680 (10.261)	.700 (9.217)	
	.809 (24.998)	.739 (16.680)	.735 (14.877)	.739 (13.451)	.742 (11.197)	.767 (10.099)	
	.884 (27.316)	.821 (18.531)	.817 (16.536)	.819 (14.908)	.830 (12.525)	.835 (10.995)	
	.930 (28.737)	.902 (20.359)	.899 (18.196)	.899 (16.364)	.910 (13.732)	.902 (11.877)	
	.990 (30.591)	.990 (22.346)	.990 (20.038)	.990 (18.020)	.990 (14.939)	.990 (13.036)	
Lower chordwise location: X/c (Distance from local leading edge, in.)							
	0.025 (0.773)	0.025 (0.565)	0.025 (0.506)	0.025 (0.455)	0.025 (0.377)	0.025 (0.329)	
	.078 (2.411)	.088 (1.987)	.088 (1.781)	.087 (1.584)	.084 (1.268)	.092 (1.211)	
	.131 (4.048)	.151 (3.409)	.151 (3.056)	.148 (2.694)	.143 (2.158)	.126 (1.659)	
	.184 (5.686)	.215 (4.853)	.214 (4.331)	.209 (3.804)	.202 (3.048)	.227 (2.989)	
	.247 (7.633)	.292 (6.591)	.290 (5.869)	.294 (5.352)	.301 (4.542)	.294 (3.871)	
	.331 (10.228)	.351 (7.923)	.348 (7.043)	.350 (6.371)	.354 (5.342)	.362 (4.767)	
	.415 (12.824)	.409 (9.232)	.406 (8.217)	.407 (7.408)	.407 (6.142)	.430 (5.662)	
	.499 (15.419)	.468 (10.564)	.464 (9.391)	.463 (8.428)	.460 (6.941)	.497 (6.544)	
	.621 (19.189)	.526 (11.873)	.522 (10.565)	.519 (9.447)	.513 (7.741)	.565 (7.440)	
	.682 (21.074)	.585 (13.204)	.581 (11.759)	.579 (10.539)	.566 (8.541)	.632 (8.322)	
	.736 (22.743)	.658 (14.852)	.654 (13.237)	.659 (11.995)	.680 (10.261)	.700 (9.217)	
	.809 (24.998)	.739 (16.680)	.735 (14.877)	.739 (13.451)	.742 (11.197)	.767 (10.099)	
	.884 (27.316)	.821 (18.531)	.817 (16.536)	.819 (14.908)	.830 (12.525)	.835 (10.995)	
	.930 (28.737)	.902 (20.359)	.899 (18.196)	.899 (16.364)	.910 (13.732)	.902 (11.877)	
	.990 (30.128)	.990 (22.052)	.990 (19.694)	.990 (17.729)	.990 (14.713)	.990 (12.812)	

^aDynamic pressure data obtained for these three outboard chords.

^bIn situ transducers used for calibration.

^cDifferent from the corresponding orifice on upper surface.

Table 2. Location of Wing Accelerometers

Accelerometer number	x , in.	y , in.
1	19.17	22.78
2	30.06	22.78
3	38.85	61.52
4	47.35	61.52
5	49.25	82.00
6	57.43	84.10
7	54.19	91.72
8	60.96	92.00
9	61.95	107.00
10	67.65	107.00

Table 3. Model Half-Body Fuselage Coordinates
 [R values measured from $z = 49.98$ in. and $y = 0$ in.]

x , in.	R , in.	x , in.	R , in.
^a - 85.63	0	59.37	12.202
-84.63	2.506	61.37	12.090
-83.63	3.520	63.37	11.956
-82.63	4.282	65.37	11.797
-81.63	4.910	67.37	11.611
-80.63	5.452	69.37	11.395
-79.63	5.930	71.37	11.148
-78.63	6.361	73.37	10.868
-77.63	6.752	74.37	10.715
-76.63	7.111	75.37	10.554
-75.63	7.443	76.37	10.385
-74.63	7.750	77.37	10.208
-73.63	8.037	78.37	10.023
-72.63	8.305	79.37	9.832
-71.63	8.556	80.37	9.633
-70.63	8.792	81.37	9.427
-69.63	9.014	82.37	9.214
-68.63	9.223	83.37	8.995
-67.63	9.420	84.37	8.769
-66.63	9.607	85.37	8.536
-65.63	9.783	86.37	8.296
-63.63	10.107	87.37	8.049
-61.63	10.397	88.37	7.795
-59.63	10.657	89.37	7.533
-57.63	10.890	90.37	7.263
-55.63	11.100	91.37	6.985
-53.63	11.288	92.37	6.697
-51.63	11.456	93.37	6.398
-49.63	11.607	94.37	6.087
-47.63	11.743	95.37	5.762
-45.63	11.865	96.37	5.421
-40.63	12.118	97.37	5.059
-35.63	12.315	98.37	4.673
-30.63	12.457	99.37	4.256
-25.63	12.500	100.37	3.797
^b - 25.13	12.500	101.37	3.280
^c 4.87	12.500	102.37	2.672
^d 48.87	12.500	103.37	1.885
49.37	12.500	104.37	0
54.37	12.400		

^aStart of section 1.
^bStart of section 2.
^cStart of section 3.
^dStart of section 4.

Table 4. Measured and Design Airfoil Coordinates

[Z values measured from $z = 59.50$ in. (wing reference plane)]

(a) $y = 20.0$ in.; $c = 35.702$ in.

X/c	Design Z/c		Measured Z/c	
	Upper Surface	Lower Surface	Upper Surface	Lower Surface
.000	-.004289	-.004289	-.003951	-.003951
.005	.012919	-.021792	.013808	-.019616
.010	.019192	-.028053	.019989	-.026428
.020	.027160	-.036041	.027697	-.034973
.030	.032553	-.041574	.032878	-.040857
.040	.036520	-.045903	.036851	-.045495
.050	.039624	-.049498	.039938	-.049235
.060	.042227	-.052613	.042505	-.052516
.070	.044457	-.055392	.044634	-.055447
.080	.046337	-.058102	.046489	-.058182
.090	.047937	-.060609	.048019	-.060757
.100	.049313	-.062932	.049328	-.063107
.120	.051551	-.067073	.051575	-.067389
.140	.053299	-.070608	.053290	-.070950
.160	.054683	-.073612	.054564	-.074013
.180	.055751	-.076147	.055517	-.076599
.200	.056502	-.078274	.056290	-.078790
.220	.056919	-.080044	.056778	-.080622
.240	.057023	-.081501	.056974	-.082138
.260	.056890	-.082684	.056988	-.083368
.280	.056701	-.083617	.056775	-.084335
.300	.056199	-.084328	.056290	-.085108
.320	.055572	-.084830	.055654	-.085705
.340	.054835	-.085107	.054861	-.086058
.360	.053977	-.085230	.053934	-.086279
.380	.052991	-.085163	.052872	-.086209
.400	.051865	-.084886	.051777	-.085909
.420	.050599	-.084384	.050541	-.085400
.440	.049189	-.083645	.049123	-.084615
.460	.047634	-.082644	.047506	-.083553
.480	.045934	-.081350	.045738	-.082194
.500	.044093	-.079731	.043864	-.080563
.520	.042112	-.077862	.041897	-.078678
.540	.039997	-.075567	.039857	-.076498
.560	.037753	-.072950	.037705	-.074043
.580	.035371	-.070082	.035346	-.071340
.600	.032892	-.067168	.032914	-.068442
.620	.030286	-.064033	.030364	-.065315
.640	.027571	-.060744	.027725	-.062130
.660	.024750	-.057477	.024985	-.058851
.680	.021825	-.054325	.022118	-.055699
.700	.018783	-.051170	.019143	-.052648
.720	.015631	-.048312	.016069	-.049790
.740	.012353	-.045662	.012900	-.046988
.760	.008943	-.043188	.009605	-.044595
.780	.005404	-.040874	.006279	-.042169
.800	.001751	-.038913	.002833	-.040017
.820	-.002006	-.037282	-.000723	-.038232
.840	-.005839	-.036019	-.004455	-.036848
.860	-.009736	-.035153	-.008582	-.035657
.880	-.013669	-.034735	-.012477	-.035139
.900	-.017631	-.034800	-.016206	-.034912
.920	-.021607	-.035394	-.019961	-.035080
.940	-.025605	-.036565	-.023771	-.035836
.960	-.029631	-.038364	-.027616	-.037095
.980	-.033713	-.040851	-.031491	-.039182
.990	-.035794	-.042370	-.033483	-.040353
1.000	-.037884	-.044101	-.035999	-.042158

Table 4. Continued

(b) $y = 30.0$ in.; $c = 31.433$ in.

X/c	Design Z/c		Measured Z/c	
	Upper Surface	Lower Surface	Upper Surface	Lower Surface
.000	-.007854	-.007854	-.007864	-.007864
.005	.008459	-.024158	-.007985	-.022814
.010	.014496	-.030199	.014071	-.029761
.020	.022039	-.037846	.021604	-.037982
.030	.027121	-.043142	.026623	-.043482
.040	.030768	-.047088	.030404	-.047626
.050	.033948	-.050535	.033460	-.050984
.060	.036487	-.053348	.036047	-.053788
.070	.038651	-.055897	.038205	-.056420
.080	.040516	-.058281	.040105	-.058899
.090	.042139	-.060550	.041744	-.061238
.100	.043562	-.062704	.043192	-.063294
.120	.045930	-.066568	.045579	-.067142
.140	.047788	-.069645	.047464	-.070248
.160	.049249	-.072083	.048975	-.072865
.180	.050433	-.074505	.050239	-.075373
.200	.051388	-.076478	.051241	-.076999
.220	.052107	-.078140	.052008	-.079147
.240	.052571	-.079505	.052537	-.080599
.260	.052785	-.080606	.052817	-.081703
.280	.052762	-.081465	.052922	-.082690
.300	.052533	-.082105	.052839	-.083368
.320	.052129	-.082550	.052537	-.083870
.340	.051588	-.082815	.052085	-.084214
.360	.050939	-.082913	.051528	-.084367
.380	.050213	-.082843	.050856	-.084402
.400	.049418	-.082605	.050099	-.084186
.420	.048549	-.082178	.049230	-.083759
.440	.047578	-.081538	.048234	-.083062
.460	.046448	-.080644	.047088	-.082145
.480	.045077	-.079441	.045729	-.081038
.500	.043454	-.077933	.044189	-.079660
.520	.041738	-.076135	.042492	-.077963
.540	.039889	-.073999	.040716	-.075844
.560	.037916	-.071571	.038784	-.073466
.580	.035809	-.068904	.036652	-.070895
.600	.033578	-.066037	.034500	-.068046
.620	.031220	-.063016	.032113	-.064981
.640	.028735	-.059898	.029532	-.061878
.660	.026122	-.056725	.026875	-.058689
.680	.023385	-.053558	.024033	-.055452
.700	.020524	-.050461	.021127	-.052314
.720	.017542	-.047495	.018090	-.049392
.740	.014436	-.044539	.014955	-.046483
.760	.011212	-.041544	.011779	-.043520
.780	.007867	-.038966	.008670	-.040242
.800	.004411	-.036755	.005376	-.037871
.820	.000840	-.034886	.001957	-.036034
.840	-.002839	-.033384	-.001770	-.034303
.860	-.006623	-.032293	-.005659	-.032594
.880	-.010505	-.031666	-.008654	-.031865
.900	-.014483	-.031586	-.012483	-.031388
.920	-.018544	-.032111	-.016684	-.031556
.940	.022688	-.033346	-.021159	-.032553
.960	-.026898	.034931	-.025751	.034408
.980	-.031176	-.038075	-.030446	-.037085
.990	-.033330	-.039752	-.032683	-.038714
1.000	-.035501	-.041627	-.035041	-.039605

Table 4. Continued

(c) $y = 40.0$ in.; $c = 27.164$ in.

X/c	Design Z/c		Measured Z/c	
	Upper Surface	Lower Surface	Upper Surface	Lower Surface
.000	-.015341	-.015341	-.014186	-.014186
.005	-.000048	-.030328	.000155	-.030733
.010	.005499	-.035875	.005715	-.036411
.020	.012464	-.043065	.012686	-.043445
.030	.017275	-.048089	.017414	-.048265
.040	.020825	-.051824	.020903	-.051880
.050	.023606	-.054767	.023766	-.054849
.060	.025934	-.057253	.026157	-.057418
.070	.027993	-.059492	.028187	-.059720
.080	.029857	-.061595	.029952	-.061835
.090	.031536	-.063599	.031614	-.063858
.100	.032998	-.065485	.033025	-.065439
.120	.035256	-.068778	.035446	-.069046
.140	.037160	-.071404	.037425	-.071740
.160	.038925	-.073728	.038998	-.074043
.180	.040361	-.075757	.040358	-.076139
.200	.041603	-.077492	.041448	-.077989
.220	.042608	-.078966	.042440	-.079577
.240	.043370	-.080211	.043224	-.080903
.260	.043901	-.081246	.043762	-.082016
.280	.044218	-.082089	.044087	-.082886
.300	.044358	-.082752	.044245	-.083538
.320	.044347	-.083242	.044260	-.084050
.340	.044214	-.083555	.044127	-.084455
.360	.043978	-.083691	.043902	-.084662
.380	.043654	-.083647	.043541	-.084702
.400	.043245	-.083408	.043084	-.084584
.420	.042744	-.082966	.042546	-.084201
.440	.042137	-.082303	.041913	-.083512
.460	.041407	-.081408	.041157	-.082679
.480	.040527	-.080258	.040273	-.081570
.500	.039481	-.078840	.039197	-.080192
.520	.038254	-.077135	.037988	-.078696
.540	.036855	-.075120	.036625	-.076334
.560	.035304	-.072785	.035096	-.074039
.580	.033658	-.070107	.033412	-.071482
.600	.031904	-.067238	.031592	-.068634
.620	.029963	-.064163	.029672	-.065612
.640	.027912	-.060907	.027660	-.062675
.660	.025735	-.057603	.025509	-.059801
.680	.023418	-.054306	.023209	-.056574
.700	.020965	-.051021	.020774	-.053250
.720	.018361	-.047743	.018176	-.049842
.740	.015610	-.044464	.015509	-.046209
.760	.012711	-.041212	.012878	-.042668
.780	.009661	-.038085	.010063	-.039153
.800	.006472	-.035267	.007045	-.036975
.820	.003142	-.033057	.003810	-.034451
.840	-.000328	-.031190	.000571	-.032134
.860	-.003937	-.029669	-.003290	-.031684
.880	-.007680	-.028726	-.007270	-.031235
.900	-.011562	-.028442	-.011603	-.030881
.920	-.015584	-.028895	-.016153	-.030995
.940	-.019757	-.030144	-.020792	-.031913
.960	-.024089	-.032254	-.025439	-.033784
.980	-.028590	-.035275	-.030125	-.036655
.990	-.030914	-.037142	-.032480	-.038523
1.000	-.033286	-.039253	-.034897	-.040568

Table 4. Continued

(d) $y = 50.0$ in.; $c = 23.278$ in.

X/c	Design Z/c		Measured Z/c	
	Upper Surface	Lower Surface	Upper Surface	Lower Surface
.000	-.029155	-.029155	-.027246	-.027246
.005	-.015109	-.042805	-.014223	-.042747
.010	-.010137	.047777	-.009228	-.047780
.020	-.003690	-.054344	-.002466	-.054419
.030	.000637	-.058822	.001742	-.058593
.040	.003806	-.062090	.004974	-.061740
.050	.006395	-.064688	.007670	-.064478
.060	.008683	-.066928	.009820	-.066731
.070	.010739	-.068928	.011715	-.068732
.080	.012550	-.070722	.013410	-.070559
.090	.014076	-.072309	.014896	-.072203
.100	.015384	-.073715	.016293	-.073877
.120	.018089	-.076446	.018712	-.076547
.140	.020265	-.078618	.020786	-.078740
.160	.022166	-.080510	.022506	-.080677
.180	.023826	-.082149	.023984	-.082283
.200	.025267	-.083564	.025249	-.083684
.220	.026514	-.084772	.026433	-.084872
.240	.027589	-.085800	.027544	-.085890
.260	.028501	-.086665	.028413	-.086831
.280	.029267	-.087374	.029158	-.087598
.300	.029890	-.087951	.029763	-.088164
.320	.030381	-.088389	.030184	-.088543
.340	.030738	-.088695	.030461	-.088756
.360	.030974	-.088867	.030683	-.088922
.380	.031082	-.088892	.030768	-.088973
.400	.031077	-.088755	.030789	-.088952
.420	.030953	-.088437	.030695	-.088764
.440	.030725	-.087912	.030508	-.088390
.460	.030393	-.087138	.030218	-.087755
.480	.029976	-.086080	.029814	-.086886
.500	.029417	-.084781	.029286	-.085783
.520	.028738	-.083138	.028643	-.084221
.540	.027929	-.081173	.027846	-.082428
.560	.026983	-.078919	.026854	-.080341
.580	.025891	-.076416	.025743	-.078037
.600	.024648	-.073685	.024508	-.075324
.620	.023250	-.070743	.023098	-.072139
.640	.021684	-.067608	.021531	-.068945
.660	.019951	-.064296	.019777	-.065509
.680	.018050	-.060839	.017847	-.061961
.700	.015977	-.057265	.015786	-.058354
.720	.013732	-.053622	.013487	-.054807
.740	.011307	-.049975	.010987	-.051404
.760	.008705	-.046397	.008372	-.048070
.780	.005922	-.042995	.005566	-.044953
.800	.002959	-.039890	.002640	-.042117
.820	-.000176	-.037180	-.000405	-.039579
.840	-.003475	-.034780	-.003662	-.037402
.860	-.006954	-.032888	-.007014	-.035580
.880	-.010601	-.031636	-.010582	-.034353
.900	-.014433	-.031146	-.014296	-.033791
.920	-.018463	-.031516	-.018282	-.034128
.940	-.022717	-.032828	-.022425	-.035516
.960	-.027224	-.035150	-.026799	-.037862
.980	-.032032	-.038522	-.031394	-.041056
.990	-.034565	-.040612	-.033813	-.042772
1.000	-.037193	-.042973	-.036342	-.043833

Table 4. Continued

(e) $y = 60.0$ in.; $c = 21.614$ in.

X/c	Design Z/c		Measured Z/c	
	Upper Surface	Lower Surface	Upper Surface	Lower Surface
.000	-.048763	-.048763	-.048246	-.048244
.005	-.034936	-.062193	-.032883	-.063105
.010	-.030019	-.067143	-.027635	-.067650
.020	-.023801	-.073564	-.021499	-.073712
.030	-.019517	-.078084	-.017728	-.078071
.040	-.016386	-.081391	-.014609	-.081176
.050	-.013887	-.083977	-.012133	-.083735
.060	-.011727	-.086161	-.010000	-.085868
.070	-.009766	-.088122	-.008140	-.087937
.080	-.007971	-.089936	-.006451	-.089732
.090	-.006375	-.091629	-.004998	-.091426
.100	-.005005	-.093174	-.003674	-.092944
.120	-.002790	-.095825	-.001305	-.095669
.140	-.000472	-.098156	.000740	-.098029
.160	.001346	-.100136	.002480	-.100144
.180	.002933	-.101880	.003952	-.102069
.200	.004307	-.103407	.005298	-.103730
.220	.005487	-.104734	.006432	-.105156
.240	.006472	-.105872	.007473	-.106359
.260	.007286	-.106835	.008330	-.107367
.280	.007938	-.107626	.008996	-.108228
.300	.008443	-.108259	.009496	-.108844
.320	.008813	-.108741	.009833	-.109385
.340	.009053	-.109069	.010037	-.109746
.360	.009183	-.109249	.010130	-.110014
.380	.009197	-.109273	.010134	-.110112
.400	.009109	-.109134	.010000	-.110093
.420	.008924	-.108828	.009778	-.109829
.440	.008637	-.108338	.009403	-.109422
.460	.008248	-.107649	.008982	-.108677
.480	.007749	-.106742	.008427	-.107830
.500	.007133	-.105586	.007779	-.106636
.520	.006389	-.104156	.006904	-.105193
.540	.005500	-.202421	.006053	-.103397
.560	.004436	-.100340	.004993	-.101407
.580	.003243	-.097878	.003785	-.099135
.600	.001901	-.095223	.002453	-.096622
.620	.000398	-.092397	.000944	-.093813
.640	-.001258	-.089385	-.000713	-.090750
.660	-.003081	-.086202	-.002601	-.087627
.680	-.005066	-.082858	-.004632	-.084346
.700	-.007212	-.079402	-.006807	-.081009
.720	-.009525	-.075877	-.009116	-.077714
.740	-.012005	-.072356	-.011647	-.074420
.760	-.014655	-.068905	-.013873	-.071166
.780	-.017473	-.065612	-.016733	-.068048
.800	-.020466	-.062568	-.020278	-.065165
.820	-.023635	-.059866	-.023586	-.062564
.840	-.026979	-.057604	-.027099	-.060370
.860	-.030514	-.055883	-.030736	-.058816
.880	-.034238	-.054805	-.034554	-.057858
.900	-.038160	-.054467	-.038501	-.057622
.920	-.042292	-.054962	-.042703	-.058237
.940	-.046631	-.056378	-.047164	-.059922
.960	-.051229	-.058802	-.051911	-.062726
.980	-.056059	-.062299	-.056909	-.066608
.990	-.058575	-.064474	-.059362	-.068834
1.000	-.061161	-.066888	-.061870	-.070380

Table 4. Continued

(f) $y = 70.0$ in.; $c = 19.950$ in.

X/c	Design Z/c		Measured Z/c	
	Upper Surface	Lower Surface	Upper Surface	Lower Surface
.000	-.077946	-.077946	-.076320	-.076320
.005	-.064302	-.091179	-.063916	-.091124
.010	-.059460	-.096117	-.059247	-.095924
.020	-.053358	-.102460	-.053449	-.102149
.030	-.049167	-.106906	-.049247	-.106707
.040	-.046116	-.110268	-.045959	-.110100
.050	-.043693	-.112918	-.043258	-.112922
.060	-.041600	-.115126	-.041109	-.115126
.070	-.039698	-.117078	-.039413	-.117134
.080	-.037962	-.118869	-.037380	-.118981
.090	-.036416	-.120555	-.035843	-.120783
.100	-.035097	-.122151	-.034503	-.122420
.120	-.032989	-.124971	-.032164	-.125291
.140	-.030776	-.127234	-.030899	-.127575
.160	-.029060	-.129227	-.028338	-.129573
.180	-.027565	-.131073	-.026767	-.131511
.200	-.026280	-.132689	-.025462	-.133153
.220	-.025201	-.134099	-.024342	-.134704
.240	-.024303	-.135313	-.023464	-.135994
.260	-.023580	-.136347	-.022696	-.137129
.280	-.023023	-.137210	-.022174	-.137997
.300	-.022607	-.137923	-.021832	-.138820
.320	-.022326	-.138485	-.021576	-.139312
.340	-.022165	-.138901	-.021496	-.139784
.360	-.022120	-.139172	-.021456	-.140095
.380	-.022180	-.139288	-.021496	-.140276
.400	-.022336	-.139248	-.021657	-.140326
.420	-.022587	-.139037	-.021943	-.140246
.440	-.022933	-.138635	-.022334	-.139990
.460	-.023379	-.138028	-.022836	-.139478
.480	-.023931	-.137195	-.023444	-.138624
.500	-.024599	-.236121	-.024192	-.137535
.520	-.025402	-.134782	-.025040	-.136190
.540	-.026360	-.133166	-.026044	-.134603
.560	-.027504	-.131269	-.027209	-.132746
.580	-.028769	-.129076	-.028514	-.130522
.600	-.030189	-.126597	-.030000	-.127927
.620	-.031765	-.123852	-.031642	-.125402
.640	-.033501	-.120871	-.033479	-.122676
.660	-.035393	-.117695	-.035397	-.119588
.680	-.037430	-.114403	-.037460	-.116461
.700	-.039633	-.111076	-.039639	-.113148
.720	-.041987	-.107714	-.041913	-.109910
.740	-.044496	-.104307	-.044423	-.106586
.760	-.047170	-.101020	-.047214	-.103333
.780	-.050011	-.097898	-.049940	-.100402
.800	-.053021	-.094993	-.053007	-.097545
.820	-.056208	-.092394	-.056265	-.095020
.840	-.059585	-.090201	-.059734	-.092801
.860	-.063148	-.088530	-.063389	-.091114
.880	-.066917	-.087491	-.067204	-.090120
.900	-.070891	-.087200	-.071180	-.089834
.920	-.075081	-.087762	-.075351	-.090356
.940	-.079502	-.089257	-.079799	-.091842
.960	-.084154	-.091756	-.084578	-.094393
.980	-.089056	-.095299	-.089629	-.098318
.990	-.091601	-.097462	-.092234	-.100597
1.000	-.094220	-.099881	-.094839	-.102877

Table 4. Continued

(g) $y = 80.0$ in.; $c = 18.285$ in.

X/c	Design Z/c		Measured Z/c	
	Upper Surface	Lower Surface	Upper Surface	Lower Surface
.000	-.119055	-.119055	-.115460	-.115460
.005	-.105634	-.132022	-.103631	-.130712
.010	-.100897	-.136961	-.097897	-.135570
.020	-.094923	-.143171	-.092377	-.141796
.030	-.090849	-.147749	-.088532	-.146046
.040	-.087892	-.150941	-.085712	-.149409
.050	-.085549	-.153515	-.083483	-.152141
.060	-.083528	-.155804	-.081555	-.154419
.070	-.081694	-.157857	-.079803	-.156484
.080	-.080018	-.159708	-.078198	-.158341
.090	-.078534	-.161394	-.076676	-.160131
.100	-.077280	-.162944	-.075394	-.161791
.120	-.075287	-.165709	-.073111	-.164628
.140	-.073179	-.168124	-.071287	-.167048
.160	-.071558	-.170249	-.069874	-.169085
.180	-.070167	-.172105	-.068631	-.170980
.200	-.068990	-.173715	-.067519	-.172716
.220	-.068010	-.175117	-.066648	-.174304
.240	-.067216	-.176382	-.065706	-.175734
.260	-.066597	-.177647	-.064929	-.176889
.280	-.066131	-.178649	-.064436	-.177853
.300	-.065814	-.179421	-.064189	-.178757
.320	-.065403	-.180029	-.063992	-.179452
.340	-.065551	-.180500	-.063872	-.179989
.360	-.065589	-.180828	-.063834	-.180378
.380	-.065726	-.181025	-.063888	-.180635
.400	-.065962	-.181069	-.064102	-.180756
.420	-.066285	-.180959	-.064430	-.180761
.440	-.066696	-.180669	-.064890	-.180487
.460	-.067210	-.180182	-.065520	-.179869
.480	-.067824	-.179465	-.066254	-.179250
.500	-.068557	-.178512	-.067092	-.178297
.520	-.069433	-.177291	-.068018	-.176900
.540	-.070463	-.175790	-.069135	-.175438
.560	-.071684	-.174000	-.070356	-.173450
.580	-.073015	-.171924	-.071731	-.171495
.600	-.074504	-.169570	-.073286	-.169020
.620	-.076152	-.166947	-.074934	-.166325
.640	-.077959	-.164094	-.076785	-.163625
.660	-.079914	-.161055	-.078740	-.160756
.680	-.082011	-.157890	-.080843	-.157788
.700	-.084256	-.154676	-.083067	-.154693
.720	-.086649	-.151396	-.085416	-.151692
.740	-.089190	-.148099	-.087831	-.148697
.760	-.091890	-.144956	-.090433	-.145734
.780	-.094754	-.141972	-.093176	-.142744
.800	-.097787	-.139201	-.096090	-.140263
.820	-.101007	-.136726	-.099288	-.138039
.840	-.104407	-.134639	-.102623	-.135865
.860	-.108011	-.133062	-.106249	-.134228
.880	-.111822	-.132115	-.110000	-.133319
.900	-.115846	-.131913	-.113943	-.133133
.920	-.120096	-.132564	-.118111	-.133746
.940	-.124569	-.134158	-.122552	-.135356
.960	-.129279	-.136748	-.127317	-.138089
.980	-.134223	-.140362	-.132202	-.141878
.990	-.136781	-.142552	-.134726	-.144157
1.000	-.139409	-.144989	-.137426	-.144841

Table 4. Continued

(h) $y = 90.0$ in.; $c = 16.621$ in.

X/c	Design Z/c		Measured Z/c	
	Upper Surface	Lower Surface	Upper Surface	Lower Surface
.000	-.175371	-.175371	-.172261	-.172261
.005	-.162220	-.188064	-.161285	-.181936
.010	-.157575	-.192914	-.156041	-.188386
.020	-.151767	-.199023	-.149868	-.195830
.030	-.147803	-.203547	-.145697	-.200646
.040	-.144936	-.206704	-.142876	-.204191
.050	-.142676	-.209258	-.140549	-.207102
.060	-.140724	-.211542	-.138590	-.209537
.070	-.138965	-.213596	-.136878	-.211695
.080	-.127357	-.215457	-.135372	-.213654
.090	-.135935	-.217156	-.134009	-.215511
.100	-.134730	-.218723	-.132743	-.217162
.120	-.132820	-.221512	-.130658	-.220122
.140	-.130826	-.223946	-.129133	-.222654
.160	-.129302	-.226091	-.127541	-.224811
.180	-.128001	-.227982	-.126215	-.226758
.200	-.126917	-.229645	-.125203	-.228597
.220	-.126031	-.231115	-.124238	-.230194
.240	-.125326	-.232446	-.123509	-.231731
.260	-.124790	-.233754	-.122810	-.233112
.280	-.124410	-.234826	-.122448	-.234305
.300	-.124163	-.235663	-.122207	-.235354
.320	-.124049	-.236332	-.122122	-.236083
.340	-.124043	-.236850	-.122110	-.236686
.360	-.124145	-.237242	-.122159	-.237162
.380	-.124338	-.237495	-.122364	-.237434
.400	-.124627	-.237603	-.122623	-.237614
.420	-.125001	-.237561	-.122942	-.237699
.440	-.125465	-.237350	-.123382	-.237711
.460	-.126025	-.236941	-.123967	-.237488
.480	-.126688	-.236320	-.124642	-.237006
.500	-.127465	-.235459	-.125474	-.236192
.520	-.128380	-.234338	-.126487	-.235071
.540	-.129453	-.232940	-.127650	-.233751
.560	-.130718	-.231260	-.128892	-.232165
.580	-.132085	-.229296	-.130206	-.230291
.600	-.133610	-.227042	-.131719	-.228326
.620	-.135296	-.224530	-.133479	-.225866
.640	-.137128	-.221789	-.135275	-.223618
.660	-.139104	-.218861	-.137222	-.221044
.680	-.141225	-.215807	-.139278	-.217928
.700	-.143478	-.212704	-.141345	-.214890
.720	-.145869	-.209517	-.143684	-.211195
.740	-.148412	-.206306	-.146438	-.207042
.760	-.151111	-.203252	-.149073	-.204070
.780	-.153966	-.200372	-.154257	-.201605
.800	-.156996	-.197697	-.156035	-.199193
.820	-.160207	-.195312	-.159748	-.196475
.840	-.163611	-.193312	-.163455	-.194287
.860	-.167220	-.191812	-.167186	-.192913
.880	-.171033	-.190932	-.171014	-.191978
.900	-.175070	-.190800	-.175137	-.191611
.920	-.179329	-.191516	-.179434	-.191954
.940	-.183817	-.193173	-.183853	-.193503
.960	-.188534	-.195824	-.188235	-.195981
.980	-.193474	-.199487	-.192491	-.199224
.990	-.196029	-.201698	-.194594	-.201026
1.000	-.198649	-.204144	-.196463	-.202864

Table 4. Continued

(i) $y = 100.0$ in.; $c = 14.957$ in.

X/c	Design Z/c		Measured Z/c	
	Upper Surface	Lower Surface	Upper Surface	Lower Surface
.000	-.249920	-.249920	-.247857	-.247857
.005	-.237593	-.262876	-.236315	-.260632
.010	-.233085	-.267532	-.231422	-.265860
.020	-.227437	-.273554	-.225437	-.272133
.030	-.223592	-.277815	-.221758	-.276396
.040	-.220812	-.281064	-.219070	-.279573
.050	-.218621	-.283657	-.216509	-.282153
.060	-.216732	-.285847	-.214660	-.284466
.070	-.215024	-.287797	-.213038	-.286483
.080	-.213469	-.289592	-.211717	-.288300
.090	-.212089	-.291294	-.210491	-.289989
.100	-.210930	-.292902	-.209432	-.291597
.120	-.209095	-.295769	-.207341	-.294472
.140	-.207159	-.298100	-.205759	-.296952
.160	-.205685	-.300150	-.204532	-.299050
.180	-.204446	-.301972	-.203332	-.300960
.200	-.203421	-.303714	-.202324	-.302710
.220	-.202590	-.305315	-.201456	-.304285
.240	-.201940	-.306735	-.200879	-.305699
.260	-.201451	-.307961	-.200430	-.307100
.280	-.201116	-.309000	-.200189	-.308233
.300	-.200908	-.309850	-.199954	-.309151
.320	-.200828	-.310547	-.199934	-.309928
.340	-.200848	-.311083	-.199975	-.310431
.360	-.200975	-.311485	-.200176	-.310699
.380	-.201190	-.311762	-.200403	-.311155
.400	-.201491	-.311894	-.200564	-.311369
.420	-.201886	-.311894	-.201047	-.311450
.440	-.202362	-.311733	-.201637	-.311436
.460	-.202932	-.311398	-.202394	-.311115
.480	-.203608	-.310849	-.203145	-.310538
.500	-.204392	-.310065	-.203983	-.309553
.520	-.205303	-.309020	-.205008	-.308641
.540	-.206375	-.307680	-.206161	-.307395
.560	-.207614	-.306039	-.207387	-.305934
.580	-.208968	-.304103	-.208916	-.304178
.600	-.210475	-.301899	-.210585	-.302180
.620	-.212123	-.299480	-.212267	-.299982
.640	-.213912	-.296861	-.214304	-.297180
.660	-.215841	-.294081	-.216349	-.294285
.680	-.217911	-.291166	-.218406	-.291282
.700	-.220115	-.288145	-.220913	-.288474
.720	-.222460	-.285037	-.223373	-.285813
.740	-.224952	-.281928	-.225859	-.282978
.760	-.227598	-.278880	-.227743	-.280491
.780	-.230412	-.275973	-.230491	-.276537
.800	-.233393	-.273293	-.233768	-.273967
.820	-.236555	-.270935	-.236811	-.271651
.840	-.239904	-.268992	-.239901	-.269982
.860	-.243455	-.267565	-.243252	-.268802
.880	-.247220	-.266761	-.246845	-.268132
.900	-.251199	-.266668	-.250618	-.267978
.920	-.255400	-.267384	-.254801	-.268500
.940	-.259828	-.268992	-.259224	-.269841
.960	-.264497	-.271585	-.263856	-.271925
.980	-.269394	-.275216	-.268802	-.275143
.990	-.271933	-.277467	-.271369	-.276852
1.000	-.274539	-.279912	-.275491	-.279057

Table 4. Concluded

(j) $y = 110.0$ in.; $c = 13.292$ in.

X/c	Design Z/c		Measured Z/c	
	Upper Surface	Lower Surface	Upper Surface	Lower Surface
.000	-.348955	-.348955	-.343688	-.343688
.005	-.336456	-.360986	-.332540	-.359081
.010	-.332108	-.365462	-.327397	-.363130
.020	-.326643	-.371244	-.321030	-.368711
.030	-.322915	-.375335	-.317865	-.372684
.040	-.320220	-.378482	-.315184	-.375562
.050	-.318084	-.381003	-.313061	-.377752
.060	-.316242	-.383139	-.311309	-.379791
.070	-.314582	-.385034	-.309851	-.381710
.080	-.313072	-.386785	-.308454	-.383341
.090	-.311729	-.388438	-.307087	-.384973
.100	-.310589	-.389985	-.305977	-.386513
.120	-.308770	-.392763	-.303877	-.389187
.140	-.306860	-.395027	-.302155	-.391514
.160	-.305396	-.397050	-.300727	-.393568
.180	-.304181	-.398809	-.299610	-.395517
.200	-.303177	-.400485	-.298733	-.397322
.220	-.302369	-.402017	-.298091	-.398976
.240	-.301735	-.403383	-.297646	-.400366
.260	-.301252	-.404560	-.297351	-.401431
.280	-.300913	-.405557	-.297215	-.402518
.300	-.300701	-.406379	-.297140	-.403417
.320	-.300603	-.407044	-.297125	-.404066
.340	-.300611	-.407565	-.297125	-.404724
.360	-.300709	-.407949	-.297193	-.405207
.380	-.300897	-.408206	-.297419	-.405547
.400	-.301177	-.408334	-.297767	-.405683
.420	-.301539	-.408327	-.297872	-.405857
.440	-.301984	-.408168	-.298288	-.405819
.460	-.302528	-.407836	-.298937	-.405554
.480	-.303169	-.407300	-.299844	-.405101
.500	-.303917	-.406546	-.300780	-.404429
.520	-.304785	-.405527	-.301800	-.403462
.540	-.305796	-.404228	-.303076	-.402231
.560	-.306958	-.402636	-.304353	-.400758
.580	-.308234	-.400756	-.305788	-.398908
.600	-.309645	-.398605	-.307276	-.396785
.620	-.311178	-.396228	-.308817	-.394353
.640	-.312853	-.393654	-.310501	-.391672
.660	-.314665	-.390936	-.312321	-.388847
.680	-.316612	-.388091	-.314451	-.386015
.700	-.318695	-.385125	-.316596	-.383213
.720	-.320937	-.382083	-.319021	-.380252
.740	-.323322	-.379011	-.321536	-.377450
.760	-.325873	-.375992	-.324270	-.374655
.780	-.328583	-.373093	-.327110	-.371883
.800	-.331466	-.370414	-.330108	-.369444
.820	-.334523	-.368044	-.333333	-.367284
.840	-.337769	-.366089	-.336649	-.365607
.860	-.341211	-.364647	-.340025	-.364436
.880	-.344856	-.363824	-.343620	-.363817
.900	-.348706	-.363711	-.347352	-.363983
.920	-.352782	-.364398	-.351264	-.364874
.940	-.357084	-.365983	-.355229	-.366574
.960	-.361628	-.368527	-.359466	-.369474
.980	-.366421	-.372104	-.363840	-.373545
.990	-.368919	-.374286	-.366007	-.375456
1.000	-.371493	-.376724	-.367964	-.379557

**ORIGINAL PAGE IS
OF POOR QUALITY**

Table 5. Finite-Element Model Joint Locations

Joint	Location, inches			Joint	Location, inches		
	x	y	z		x	y	z
1	.1581000E+02	0.	.5903700E+02	51	.5301507E+02	.6396879E+02	.5865509E+02
2	.1965000E+02	0.	.5903700E+02	52	.5570457E+02	.6277002E+02	.5803616E+02
3	.3171000E+02	0.	.5903700E+02	53	.4195737E+02	.7612333E+02	.5783599E+02
4	.3946000E+02	0.	.5903700E+02	54	.4574158E+02	.7443663E+02	.5860845E+02
5	.1149000E+02	.9000000E+01	.5903700E+02	55	.5167591E+02	.7179159E+02	.5863820E+02
6	.1744000E+02	.9000000E+01	.5903700E+02	56	.5416055E+02	.7068414E+02	.5848253E+02
7	.2362000E+02	.9000000E+01	.5903700E+02	57	.5550499E+02	.7008490E+02	.5827214E+02
8	.2718000E+02	.9000000E+01	.5903700E+02	58	.5806289E+02	.6894479E+02	.5768668E+02
9	.3171000E+02	.9000000E+01	.5903700E+02	59	.4514431E+02	.8192876E+02	.5743213E+02
10	.3946000E+02	.9000000E+01	.5903700E+02	60	.4873383E+02	.8032885E+02	.5815379E+02
11	.1008313E+02	.1805973E+02	.5992475E+02	61	.5436284E+02	.7781989E+02	.5818255E+02
12	.1579403E+02	.1550497E+02	.6145593E+02	62	.5671964E+02	.7676942E+02	.5804246E+02
13	.2474312E+02	.1150159E+02	.6104819E+02	63	.5799491E+02	.7620101E+02	.5784526E+02
14	.3739096E+02	.1210015E+02	.5950913E+02	64	.6042121E+02	.7511956E+02	.5729251E+02
15	.3988457E+02	.1210010E+02	.5902270E+02	65	.4833126E+02	.8773420E+02	.5698932E+02
16	.4574724E+02	.1209997E+02	.5787255E+02	66	.5172608E+02	.8622106E+02	.5766012E+02
17	.1645622E+02	.2966934E+02	.5973124E+02	67	.5704977E+02	.8384819E+02	.5768931E+02
18	.2178400E+02	.2728596E+02	.6107060E+02	68	.5927874E+02	.8285470E+02	.5756528E+02
19	.3013336E+02	.2355087E+02	.6083860E+02	69	.6048484E+02	.8231712E+02	.5738096E+02
20	.3879841E+02	.1967456E+02	.5968589E+02	70	.6277953E+02	.8129433E+02	.5686080E+02
21	.4111324E+02	.1863902E+02	.5919398E+02	71	.5151820E+02	.9353963E+02	.5651355E+02
22	.4655831E+02	.1863895E+02	.5809966E+02	72	.5471833E+02	.9211328E+02	.5713425E+02
23	.2282931E+02	.4127895E+02	.5944222E+02	73	.5973669E+02	.8987649E+02	.5716471E+02
24	.2777397E+02	.3906696E+02	.6056670E+02	74	.6183783E+02	.8893998E+02	.5705716E+02
25	.3552361E+02	.3560015E+02	.6046106E+02	75	.6318029E+02	.8893808E+02	.5684051E+02
26	.4127922E+02	.3302538E+02	.5982510E+02	76	.6569880E+02	.8893782E+02	.5628244E+02
27	.4361972E+02	.3197836E+02	.5937266E+02	77	.5470515E+02	.9934507E+02	.5601143E+02
28	.4821283E+02	.3197791E+02	.5842562E+02	78	.5771057E+02	.9800549E+02	.5658249E+02
29	.2920959E+02	.5290159E+02	.5904020E+02	79	.6242362E+02	.9590480E+02	.5661598E+02
30	.3377259E+02	.5086777E+02	.5997904E+02	80	.6439692E+02	.9502526E+02	.5652605E+02
31	.4091386E+02	.4764944E+02	.5999929E+02	81	.6565744E+02	.9502282E+02	.5632198E+02
32	.4376002E+02	.4637621E+02	.5983316E+02	82	.6802274E+02	.9502258E+02	.5580046E+02
33	.4612620E+02	.4531770E+02	.5944321E+02	83	.5789209E+02	.1051505E+03	.5548942E+02
34	.4986748E+02	.4531788E+02	.5864793E+02	84	.6070282E+02	.1038977E+03	.5601206E+02
35	.3239654E+02	.5870702E+02	.5880318E+02	85	.6511055E+02	.1019331E+03	.5605076E+02
36	.3676484E+02	.5675999E+02	.5969116E+02	86	.6695602E+02	.1011105E+03	.5597939E+02
37	.4361513E+02	.5370669E+02	.5971417E+02	87	.6813480E+02	.1011081E+03	.5579433E+02
38	.4648327E+02	.5242830E+02	.5954195E+02	88	.7034688E+02	.1011078E+03	.5531066E+02
39	.4803522E+02	.5173657E+02	.5928672E+02	89	.6000443E+02	.1089984E+03	.5513545E+02
40	.5098793E+02	.5042049E+02	.5860321E+02	90	.6329294E+02	.1089981E+03	.5550744E+02
41	.3558348E+02	.6451246E+02	.5852326E+02	91	.6825932E+02	.1089976E+03	.5537431E+02
42	.3975709E+02	.6265220E+02	.5937653E+02	92	.7027273E+02	.1089974E+03	.5525616E+02
43	.4630206E+02	.5973499E+02	.5940229E+02	93	.7134655E+02	.1089972E+03	.5509277E+02
44	.4904236E+02	.5851358E+02	.5923208E+02	94	.7335998E+02	.1089970E+03	.5466151E+02
45	.5052514E+02	.5785268E+02	.5899175E+02	95	.6270516E+02	.1139181E+03	.5467585E+02
46	.5334625E+02	.5659526E+02	.5833879E+02	96	.6579134E+02	.1139178E+03	.5501359E+02
47	.3877043E+02	.7031789E+02	.5819995E+02	97	.7045215E+02	.1139173E+03	.5489666E+02
48	.4274934E+02	.6854442E+02	.5900618E+02	98	.7234169E+02	.1139171E+03	.5479890E+02
49	.4898898E+02	.6576329E+02	.5903522E+02	99	.7334945E+02	.1139170E+03	.5464890E+02
50	.5160145E+02	.6459886E+02	.5887992E+02	100	.7523900E+02	.1139169E+03	.5425149E+02

ORIGINAL PAGE IS
OF POOR QUALITY

Table 6. Finite-Element Model Mode Shape Data

(a) Mode 1, $f = 8.0935$ Hz

Joint	Deflection, Inches				Rotation	
	dx	dy	dz	dz/dy	dz/dx	dx/dy
1	.1124169E-02	.1302405E-02	.2857602E-02	-.2985195E-03	.2565329E-03	.5347967E-06
2	.1124165E-02	.1305912E-02	.1872644E-02	-.2986432E-03	.2565156E-03	.4031621E-06
3	.1123905E-02	.1310654E-02	-.1220718E-02	-.2985277E-03	.2564539E-03	.4911721E-06
4	.1115333E-02	-.3155874E-03	-.2868712E-02	-.1054746E-02	.2081494E-03	-.2797908E-04
5	-.4031931E-03	.3020104E-03	-.1716960E-03	-.1384704E-02	.7701640E-03	.1882214E-03
6	-.3613731E-03	.1349830E-02	-.4323886E-02	-.1580482E-02	.4999327E-03	.2425685E-03
7	-.3692285E-03	.2230828E-02	.7162530E-02	-.193395E-02	.4606462E-03	.2237943E-03
8	-.3527176E-03	.3224684E-02	-.8494265E-02	-.2195125E-02	.4048046E-03	.1579315E-03
9	-.3402251E-03	.3748144E-03	-.1202297E-01	-.1633889E-02	.4476145E-03	-.2432158E-03
10	-.3380059E-03	-.6826759E-03	-.1512659E-01	-.1433283E-02	.4478125E-03	-.1231957E-03
11	-.7775258E-03	.2952351E-02	-.1615631E-01	-.3357154E-02	.1304159E-02	.1848252E-03
12	.5836698E-03	.6551019E-02	-.1591109E-01	-.2247725E-02	.8640113E-03	.1461762E-03
13	.4567339E-03	.7611862E-02	-.1323161E-01	-.2478001E-02	.6767137E-03	.2303887E-03
14	-.9546859E-03	.9941207E-02	-.1973302E-01	-.5557061E-02	.5800118E-03	.7664614E-04
15	-.1138899E-02	.7412854E-02	-.2079615E-01	-.7310547E-02	.2888560E-03	.3122904E-03
16	-.1850834E-02	-.3946552E-03	-.2426262E-01	-.7794374E-02	.6763051E-03	.1292016E-03
17	-.2554343E-02	.5115585E-02	-.7219522E-01	-.6031814E-02	.3179804E-02	.2403841E-03
18	.1901540E-02	.1487290E-01	-.7385338E-01	-.4835026E-02	.2309290E-02	.3184035E-03
19	.1485640E-02	.1608221E-01	-.7360876E-01	-.5366590E-02	.2127054E-02	.1477143E-03
20	-.3855330E-03	.1229008E-01	-.7219600E-01	-.8335292E-02	.2920893E-02	.1727279E-03
21	-.1874069E-02	.9525376E-02	-.7205207E-01	-.8152671E-02	.1617944E-02	.3588443E-03
22	-.3767079E-02	.1957706E-02	-.8131079E-01	-.9019311E-02	-.1017990E-02	.1740748E-03
23	-.5715003E-02	.8024793E-02	-.2215737E+00	-.1400227E-01	.7945910E-02	.3199045E-03
24	.4006662E-02	.2741527E-01	-.2288805E+00	-.1493360E-01	.7774030E-02	.2707402E-03
25	.3842108E-02	.2984286E-01	-.2339993E+00	-.1593193E-01	.7476367E-02	.4099173E-03
26	-.4793857E-03	.2201934E-01	-.2349942E+00	-.1567015E-01	.6391486E-02	.9434329E-04
27	-.4225339E-02	.1590977E-01	-.2364972E+00	-.1647887E-01	.3701849E-02	.1050207E-03
28	-.7440535E-02	.2729745E-03	-.2516919E+00	-.1753651E-01	.5033353E-03	.7179609E-03
29	-.1201892E-01	.7149077E-02	-.5509924E+00	-.2966768E-01	.1596959E-01	.1283864E-03
30	.2647743E-02	.3725072E-01	-.5616548E+00	-.3014598E-01	.1516311E-01	.4611053E-03
31	.1834490E-02	.4054303E-01	-.5643244E+00	-.3001777E-01	.1313821E-01	.2173861E-03
32	-.1837414E-02	.3342184E-01	-.5622281E+00	-.3035808E-01	.1242832E-01	.8293893E-04
33	-.7072848E-02	.2387213E-01	-.5585998E+00	-.2976675E-01	.1089127E-01	-.3421196E-04
34	-.1590659E-01	-.3751640E-02	-.6012889E+00	-.3357144E-01	.1158796E-01	-.2619606E-02
35	-.1441152E-01	.2193982E-02	-.8144108E+00	-.3948677E-01	.2320870E-01	.1247054E-03
36	.3246161E-02	.3828671E-01	-.8277201E+00	-.4110104E-01	.2032131E-01	.5783609E-03
37	.1438582E-02	.4076085E-01	-.8326710E+00	-.4302027E-01	.1857696E-01	-.7452311E-04
38	-.2144524E-02	.3442328E-01	-.8298190E+00	-.4328771E-01	.1775835E-01	.3493190E-02
39	-.6913437E-02	.2319211E-01	-.8266877E+00	-.4407609E-01	.1715395E-01	-.1240581E-03
40	-.1740707E-01	-.6839340E-02	-.8146876E+00	-.4546287E-01	.1509750E-01	.1001992E-02
41	-.1834952E-01	-.7835748E-02	-.1153780E+01	-.5092146E-01	.2695367E-01	-.6655621E-03
42	.2820821E-02	.3458437E-01	-.1169351E+01	-.5319209E-01	.2665167E-01	.9588232E-04
43	.1114720E-02	.3580968E-01	-.1180914E+01	-.5482410E-01	.2496342E-01	-.3839368E-03
44	-.4009767E-02	.2619293E-01	-.1181453E+01	-.5586945E-01	.2425132E-01	-.5008056E-02
45	.9958185E-02	.1322485E-01	-.1180440E+01	-.5559175E-01	.2363431E-01	-.2456716E-03
46	-.2447354E-01	-.2291699E-01	-.1171695E+01	-.5517412E-01	.2285346E-01	.2330290E-04
47	-.2258145E-01	-.2448066E-01	-.1573114E+01	-.6022129E-01	.3434357E-01	-.5594591E-03
48	.1822273E-02	.2333881E-01	-.1592412E+01	-.6087456E-01	.3122875E-01	-.2279982E-03
49	.9515526E-03	.2313493E-01	-.1612361E+01	-.6374576E-01	.2937713E-01	-.7504442E-03
50	-.6704856E-02	.1177702E-01	-.1615539E+01	-.6470104E-01	.2982379E-01	.1184929E-02
51	-.1376958E-01	-.3264423E-02	-.1616445E+01	-.6561595E-01	.2945772E-01	-.7546776E-03
52	-.3299547E-01	-.4583470E-01	-.1614541E+01	-.6731381E-01	.2638650E-01	-.5490330E-03
53	-.285410E-01	-.4849416E-01	-.2077800E+01	-.7186723E-01	.3867979E-01	-.1471718E-02
54	-.7951779E-03	.4844249E-02	-.2102028E+01	-.7321022E-01	.3830182E-01	-.5093085E-02
55	.3456842E-02	.2592436E-02	-.2120374E+01	-.7534904E-01	.3727624E-01	-.1266906E-02
56	-.1090565E-01	-.1155724E-01	-.2139057E+01	-.7642442E-01	.3722672E-01	.2061037E-02
57	-.1921808E-01	-.2842963E-01	-.2142555E+01	-.7758048E-01	.3687289E-01	-.1084850E-02
58	-.4106315E-01	-.7620602E-01	-.2143838E+01	-.7847268E-01	.3637555E-01	-.6263926E-03
59	-.3630191E-01	-.8130261E-01	-.2667970E+01	-.8378033E-01	.4741208E-01	-.1359598E-02
60	-.6254854E-02	.25211465E-01	-.2697575E+01	-.8569426E-01	.4550401E-01	-.9810710E-03
61	-.9341492E-02	.2923058E-01	-.2734996E+01	-.8778933E-01	.4462862E-01	-.1646215E-02
62	-.1721342E-01	-.4419377E-01	-.2748235E+01	-.8878762E-01	.4485514E-01	-.3384901E-02
63	-.2675010E-01	-.6293527E-01	-.2754756E+01	-.8917309E-01	.4445374E-01	-.1478243E-02
64	-.5231209E-01	-.1154472E+00	-.2763706E+01	-.8991168E-01	.4246521E-01	-.1174120E-02
65	-.4695824E-01	-.1235666E+00	-.3338569E+01	-.9187357E-01	.5068375E-01	-.2128311E-02
66	-.1527706E-01	-.6636172E-01	-.3371540E+01	-.9319814E-01	.5083869E-01	-.1368316E-02
67	-.1818733E-01	-.7174993E-01	-.3418887E+01	-.9532625E-01	.5083221E-01	-.2034164E-02
68	-.2662097E-01	-.8770378E-01	-.3436892E+01	-.9623737E-01	.5063644E-01	-.2038559E-02
69	-.3684374E-01	-.1072044E+00	-.3445941E+01	-.9670949E-01	.5047676E-01	-.1932565E-02
70	-.6493902E-01	-.1622485E+00	-.3461119E+01	-.9676102E-01	.4870912E-01	-.1633504E-02
71	-.5946086E-01	-.1743208E+00	-.4075019E+01	-.1012531E+00	.5823081E-01	-.2252949E-02
72	-.2722052E-01	-.1179906E+00	-.4113844E+01	-.1027738E+00	.5753764E-01	-.1766645E-02
73	-.3067802E-01	-.1244540E+00	-.4173445E+01	-.1054599E+00	.5745475E-01	-.2488640E-02
74	-.3898211E-01	-.1398231E+00	-.4195626E+01	-.1057847E+00	.5788770E-01	.5880016E-02
75	-.5129282E-01	-.1651943E+00	-.4272481E+01	-.1078968E+00	.5769590E-01	-.2098648E-02
76	-.8347616E-01	-.2317034E+00	-.4418249E+01	-.1092351E+00	.5850151E-01	-.3058994E-02
77	-.7436476E-01	-.2327154E+00	-.4869241E+01	-.1068816E+00	.6212645E-01	-.2712362E-02
78	-.4247630E-01	-.1789927E+00	-.4910922E+01	-.1079728E+00	.6196742E-01	-.2072622E-02
79	-.4595762E-01	-.1872445E+00	-.4976986E+01	-.1080006E+00	.6273605E-01	-.2876655E-02
80	-.5391104E-01	-.2015830E+00	-.5007131E+01	-.1069766E+00	.6493171E-01	-.1440968E-01
81	-.6659728E-01	-.2271895E+00	-.5085892E+01	-.1113262E+00	.6058318E-01	-.2635516E-02
82	-.9817037E-01	-.2909751E+00	-.5229312E+01	-.1123956E+00	.6016254E-01	-.4595055E-02
83	-.9090302E-01	-.2973639E+00	-.5702423E+01	-.1101518E+00	.6498767E-01	-.3121564E-02
84	-.6047402E-01	-.2471916E+00	-.5746084E+01	-.1112945E+00	.6478309E-01	-.2468432E-02
85	-.6358614E-01	-.2548705E+00	-.5813249E+01	-.1116313E+00	.6535124E-01	-.3018646E-02
86	-.7097279E-01	-.2687357E+00	-.5844368E+01	-.1103218E+00	.6784955E-01	.9819461E-02
87	-.8279779E-01	-.2922072E+00	-.5921619E+01	-.1139469E+00	.6367869E-01	-.3142625E-02
88	-.1134059E+00	-.3526762E+00	-.6062958E+01	-.1146956E+00	.6369725E-01	-.3162700E-02
89	-.1025984E+00	-.3425115E+00	-.6268971E+01	-.1122427E+00	.6673174E-01	-.2935551E-02
90	-.7784028E-01	-.3104890E+00	-.6487432E+01	-.1123236E+00	.6650336E-01	-.2969941E-02
91	-.8649627E-01	-.3399332E+00	-.6818634E+01	-.1131806E+00	.6686587E-01	-.2968565E-02
92	-.9429486E-01	-.3592093E+00	-.6953569E+01	-.1135514E+00	.6710713E-01	-.2996205E-02
93	-.1052415E+00	-.3809976E+00	-.7025659E+01	-.1135339E+00	.6725318E-01	-.3047507E-02
94	-.1340543E+00	-.4359088E+00	-.7161198E+01	-.1141468E+00	.6714333E-01	-.3409242E-02
95	-.1181843E+00	-.4026552E+00	-.7080000E+01	-.1145453E+00	.6938703E-01	-.2554281E-02
96	-.9596382E-01	-.3748310E+00	-.7215271E+01	-.1126602E+00	.6603611E-01	-.3232414E-02
97	-.1036062E+00	-.4019091E+00	-.7525911E+01	-.1123120E+00	.6633930E-01	-.2561387E-02
98	-.1086283E+00	-.4179222E+00	-.7652272E+01	-.1134757E+00	.6640143E-01	-.3151694E-02
99	-.1195972E+00	-.4378546E+00	-.7720548E+01	-.1134081E+00	.6819730E-01	-.2800178E-02
100	-.1466039E+00	-.4889656E+00	-.7849540E+01	-.1135914E+00	.6861789E-01	-.2796484E-02

Table 6. Continued

(b) Mode 2, $f = 29.2299$ Hz

Joint	Deflection, Inches			Rotation		
	dx	dy	dz	dz/dy	dz/dx	dx/dy
1	.3200688E-03	-.4419857E-01	.8122809E-03	-.8004057E-03	.7307535E-04	.4283268E-02
2	.3161244E-03	-.2771563E-01	.5276221E-03	-.8029983E-03	.7238407E-04	.4279242E-02
3	.3170718E-03	.2388614E-01	-.3445834E-03	-.8019147E-03	.7238429E-04	.4279673E-02
4	.3653427E-04	.2674124E-01	-.9289060E-02	-.8776237E-02	.1705523E-02	.7536009E-02
5	-.1231674E+00	-.1230107E+00	.2163682E-02	-.3091543E-02	.3413310E-02	.1268025E-01
6	-.1199080E+00	-.5325230E-01	-.1790751E-01	-.4274475E-02	.3038714E-02	.1250084E-01
7	-.1178502E+00	.2763598E-01	-.4028265E-01	-.6050653E-02	.4019884E-02	.1248353E-01
8	-.1191527E+00	.6057398E-01	-.5580072E-01	-.6507737E-02	.4219327E-02	.5224273E-02
9	-.1187136E+00	.1980838E-01	-.8320075E-01	-.8936078E-02	.2884311E-02	-.5179771E-03
10	-.1186458E+00	.3608160E-01	-.1020020E+00	-.9412072E-02	.2895406E-02	.3342388E-02
11	-.2574235E+00	-.2232743E+00	-.2988142E-01	-.6532372E-02	.4179160E-02	.1414551E-01
12	-.1823096E+00	-.5866279E-01	-.4392030E-01	-.5264593E-02	.4379068E-02	.1225324E-01
13	-.1319609E+00	.5475643E-01	-.6144992E-01	-.7112347E-02	.5043144E-02	.1184386E-01
14	-.1382818E+00	.4495615E+00	-.1434397E+00	.3056508E-03	.1193784E-01	.2575594E-01
15	-.1400721E+00	.5086985E+00	-.1645197E+00	-.2329733E-01	.7098765E-02	.2648511E-01
16	-.1492150E+00	.6246154E+00	-.2183216E+00	-.3091483E-01	.1017915E-01	.2465685E-01
17	-.5426883E+00	-.1058684E+00	-.1414278E+00	-.6790442E-02	.1151460E-01	.2695583E-01
18	-.4576844E+00	.5362286E-01	-.1829435E+00	-.5059548E-02	.8724406E-02	.2465556E-01
19	-.3925121E+00	.2198992E+00	-.2479317E+00	-.9896553E-02	.1207550E-01	.2655899E-01
20	-.2991767E+00	.4901192E+00	-.3174502E+00	-.3244399E-01	.2251932E-01	.2259428E-01
21	-.2880837E+00	.5468510E+00	-.3452814E+00	-.3215089E-01	.1302761E-01	.2313762E-01
22	-.3080830E+00	.6549698E+00	-.4211763E+00	-.2855282E-01	.2762274E-02	.2523102E-01
23	-.9138506E+00	.2168300E-01	-.3677239E+00	-.1344292E-01	.2567309E-01	.2703416E-01
24	-.8129897E+00	.1935847E+00	-.4608465E+00	-.1350909E-01	.2412530E-01	.3042433E-01
25	-.7190614E+00	.4149946E+00	-.6070777E+00	-.2170324E-01	.2886211E-01	.3003892E-01
26	-.6609815E+00	.5876585E+00	-.7192171E+00	-.2756939E-01	.3035846E-01	.2970859E-01
27	-.6491554E+00	.6508219E+00	-.7764411E+00	-.3325854E-01	.2285114E-01	.3121119E-01
28	-.6771505E+00	.7674372E+00	-.8916695E+00	-.3665766E-01	.7982730E-02	.3079181E-01
29	-.1340590E+01	.1683717E+00	-.7132552E+00	-.1304015E-01	.3899059E-01	.3455874E-01
30	-.1225847E+01	.3472535E+00	-.8611496E+00	-.1387134E-01	.3884576E-01	.3588165E-01
31	-.1105898E+01	.5984846E+00	-.1107348E+01	-.2223614E-01	.4433093E-01	.3503672E-01
32	-.1067737E+01	.6913594E+00	-.1208047E+01	-.2838673E-01	.4871510E-01	.3111194E-01
33	-.1049985E+01	.7659910E+00	-.1318753E+01	-.2477119E-01	.3679547E-01	.3438515E-01
34	-.1070264E+01	.9337309E+00	-.1462357E+01	-.4145593E-01	.5886988E-01	.6579031E-01
35	-.1594484E+01	.2564198E+00	-.8971069E+00	-.8300423E-02	.3955840E-01	.4012389E-01
36	-.1473532E+01	.4396950E+00	-.1063298E+01	-.1089141E-01	.4521880E-01	.3946069E-01
37	-.1352021E+01	.7019406E+00	-.1349187E+01	-.1488058E-01	.4751488E-01	.4086186E-01
38	-.1311034E+01	.8130938E+00	-.1469060E+01	-.1936879E-01	.5169120E-01	.6907682E-02
39	-.1296796E+01	.8746660E+00	-.1536388E+01	-.1927399E-01	.5290924E-01	.4117595E-01
40	-.1290383E+01	.9838625E+00	-.1677577E+01	-.2061008E-01	.3557420E-01	.3432846E-01
41	-.1868567E+01	.3577416E+00	-.1051042E+01	.3310678E-02	.4207857E-01	.4930113E-01
42	-.1746741E+01	.5394010E+00	-.1231866E+01	.4145190E-02	.4299505E-01	.4396130E-01
43	-.1620582E+01	.8140857E+00	-.1536491E+01	-.3878803E-02	.4872910E-01	.4373372E-01
44	-.1576173E+01	.9326818E+00	-.1666048E+01	-.5110668E-02	.5122159E-01	.5394421E-01
45	-.1559819E+01	.9963299E+00	-.1737709E+01	-.8742117E-02	.5262545E-01	.4406546E-01
46	-.1547011E+01	.1116175E+01	-.1892444E+01	-.1645923E-01	.4516325E-01	.4566604E-01
47	-.2171393E+01	.4756293E+00	-.1141277E+01	.1194030E-01	.3710929E-01	.4612227E-01
48	-.2049728E+01	.6525182E+00	-.1328306E+01	.1104289E-01	.4412062E-01	.4782233E-01
49	-.1916550E+01	.9369279E+00	-.1647735E+01	.1042687E-01	.4818871E-01	.4823240E-01
50	-.1869801E+01	.1059999E+01	-.1785424E+01	.9313653E-02	.4932978E-01	.3940958E-01
51	-.1851685E+01	.1128544E+01	-.1861869E+01	.9702587E-02	.5020238E-01	.4832001E-01
52	-.1834842E+01	.1265419E+01	-.2026119E+01	-.5246377E-02	.4366741E-01	.4875512E-01
53	-.2496907E+01	.6110272E+00	-.1129211E+01	.2870761E-01	.3798698E-01	.5160208E-01
54	-.2378789E+01	.7813024E+00	-.1320329E+01	.2949378E-01	.3807118E-01	.5229549E-01
55	-.2242604E+01	.1074903E+01	-.1642729E+01	.3014389E-01	.4257881E-01	.5291040E-01
56	-.2192823E+01	.1205026E+01	-.1783781E+01	.2962946E-01	.4445605E-01	.4170379E-01
57	-.2171745E+01	.1280139E+01	-.1862619E+01	.3091956E-01	.4532496E-01	.5257555E-01
58	-.2148262E+01	.1431645E+01	-.2032985E+01	.3447175E-01	.3642256E-01	.5305782E-01
59	-.2850751E+01	.7704735E+00	-.9900843E+00	.5307185E-01	.2343531E-01	.5888617E-01
60	-.2736018E+01	.9336876E+00	-.1174834E+01	.5392724E-01	.3056790E-01	.5617407E-01
61	-.2596930E+01	.1233446E+01	-.1491719E+01	.5408881E-01	.3372290E-01	.5754486E-01
62	-.2544129E+01	.1368952E+01	-.1628572E+01	.5588278E-01	.3542036E-01	.6581456E-01
63	-.2519817E+01	.1449789E+01	-.1704417E+01	.5479811E-01	.3563683E-01	.5758966E-01
64	-.2486704E+01	.1618603E+01	-.1868732E+01	.4534283E-01	.2731628E-01	.5737198E-01
65	-.3219016E+01	.9591251E+00	-.6974185E+00	.6732549E-01	.2299957E-01	.5643283E-01
66	-.3113221E+01	.1111281E+01	-.8759320E+00	.7163643E-01	.2133513E-01	.6032392E-01
67	-.2975004E+01	.1414982E+01	-.1171691E+01	.7535373E-01	.2340791E-01	.6123197E-01
68	-.2919218E+01	.1555804E+01	-.1299222E+01	.7806384E-01	.2405610E-01	.6272008E-01
69	-.2892663E+01	.1639863E+01	-.1370506E+01	.7908914E-01	.2496297E-01	.6121914E-01
70	-.2849407E+01	.1822704E+01	-.1524798E+01	.5887934E-01	.1809750E-01	.6244799E-01
71	-.3608657E+01	.1176517E+01	-.2538394E+00	.9645969E-01	.2986787E-02	.6902055E-01
72	-.3510598E+01	.1322453E+01	-.4107810E+00	.9892260E-01	.7998204E-02	.6320158E-01
73	-.3370411E+01	.1620312E+01	-.6713344E+00	.1026818E+00	.9483080E-02	.6622597E-01
74	-.3310869E+01	.1762893E+01	-.8030751E+00	.1095113E+00	.1872701E-01	.9103035E-01
75	-.3312795E+01	.1872617E+01	-.8162315E+00	.1076875E+00	.5507725E-02	.6408160E-01
76	-.3314784E+01	.2109408E+01	-.8292717E+00	.1136545E+00	.5477718E-02	.7502579E-01
77	-.4004259E+01	.1424802E+01	.3488646E+00	.1140702E+00	-.3989430E-02	.6867447E-01
78	-.3916255E+01	.1560428E+01	.2081371E+00	.1173241E+00	-.4981816E-02	.6527080E-01
79	-.3782926E+01	.1854788E+01	-.1891145E-01	.1172775E+00	-.3602455E-02	.6830650E-01
80	-.3725389E+01	.1993562E+01	-.1135295E+00	.1188087E+00	-.2777309E-02	.8989698E-01
81	-.3725711E+01	.2102980E+01	-.1109810E+00	.1198878E+00	-.9542544E-03	.6947390E-01
82	-.3725775E+01	.2207139E+01	-.1038215E+00	.1212707E+00	-.4182246E-03	.6181941E-01
83	-.4399855E+01	.1606192E+01	.1074244E+01	.1263023E+00	.1414026E-01	.7036578E-01
84	-.4321033E+01	.1820407E+01	.9517263E+00	.1295918E+00	-.1208702E-01	.6643823E-01
85	-.4193132E+01	.2101627E+01	.7513384E+00	.1303499E+00	-.1364578E-01	.6866523E-01
86	-.4136494E+01	.2235723E+01	.6743162E+00	.1273581E+00	-.1865480E-01	.3749219E-01
87	-.4134455E+01	.2338261E+01	.6901200E+00	.1361244E+00	-.9367145E-02	.6848027E-01
88	-.4130109E+01	.2552452E+01	.7109729E+00	.1378657E+00	-.8730972E-02	.6879432E-01
89	-.4659753E+01	.1885346E+01	.1604693E+01	.1334603E+00	-.1854049E-01	.6784559E-01
90	-.4666417E+01	.2058430E+01	.1662319E+01	.1332240E+00	-.1799448E-01	.6705398E-01
91	-.4665095E+01	.2405567E+01	.1754393E+01	.1365524E+00	-.1909919E-01	.6704106E-01
92	-.4663021E+01	.2556849E+01	.1793417E+01	.1380037E+00	-.1935003E-01	.6752811E-01
93	-.4659893E+01	.2651972E+01	.1814218E+01	.1382216E+00	-.1967888E-01	.6770091E-01
94	-.4651582E+01	.2846838E+01	.1853292E+01	.1393093E+00	-.1901550E-01	.6761801E-01
95	-.4983093E+01	.2130453E+01	.2325269E+01	.1393314E+00	-.2607886E-01	.6758346E-01
96	-.4989137E+01	.2293110E+01	.2389269E+01	.1354491E+00	-.1802470E-01	.6721022E-01
97	-.4987042E+01	.2621168E+01	.2478970E+01	.1358021E+00	-.1834552E-01	.6631801E-01
98	-.4985794E+01	.2760526E+01	.2516071E+01	.1384851E+00	-.1870218E-01	.6737842E-01
99	-.4983014E+01	.2848541E+01	.2536799E+01	.1381633E+00	-.2174359E-01	.6599465E-01
100	-.4974658E+01	.3031125E+01	.2576773E+01	.1396520E+00	-.2098615E-01	.6677934E-01

ORIGINAL PAGE IS
OF POOR QUALITY

Table 6. Continued

(c) Mode 3, $f = 32.7980$ Hz

Joint	Deflection, Inches			Rotation		
	dx	dy	dz	dz/dy	dz/dx	dx/dy
1	-.5643928E-02	-.3386357E-01	-.1434740E-01	.2131641E-02	-.1287931E-02	.2201591E-02
2	-.5646014E-02	-.2540340E-01	-.9404805E-02	.2131310E-02	-.1288206E-02	.2200620E-02
3	-.5643732E-02	-.1134234E-02	.6129793E-02	.2130847E-02	-.1287778E-02	.2200118E-02
4	-.5718557E-02	.1590334E-01	.9751275E-02	.4029354E-02	-.1829149E-03	.4101917E-02
5	-.5662864E-01	-.6616450E-01	.1970856E-01	.9684082E-02	-.3213456E-02	.4979903E-02
6	-.5531229E-01	-.3889439E-01	.3505937E-01	.1046443E-01	-.1438338E-02	.4429111E-02
7	-.5420233E-01	-.4575542E-02	.4094013E-01	.1196535E-01	-.7706979E-03	.4608232E-02
8	-.5500034E-01	.4387557E-02	.4068781E-01	.1364109E-01	-.2223727E-03	.1426990E-02
9	-.5487747E-01	.6679135E-02	.4817760E-01	.8303459E-02	-.1385996E-02	.1721305E-02
10	-.5486110E-01	.2372556E-01	.5869441E-01	.6570993E-02	-.1539827E-02	.2732599E-02
11	-.1203837E+00	-.1371867E+00	.1337209E+00	.2604651E-01	-.6934276E-02	.9717327E-02
12	-.9133745E-01	-.8206983E-01	.1152485E+00	.1479658E-01	-.3263054E-02	.5090219E-02
13	-.6586665E-01	-.3184973E-01	.7626355E-01	.1529171E-01	-.1761349E-02	.4218459E-02
14	-.6251577E-01	.1522596E+00	.9918969E-01	.4053670E-01	-.4811087E-02	.1153908E-01
15	-.6092332E-01	.1987903E+00	.1041906E+00	.4159313E-01	-.1327304E-02	.1053271E-01
16	-.5735643E-01	.3113059E+00	.1184585E+00	.4313433E-01	-.2602207E-02	.1076418E-01
17	-.2487080E+00	-.9044625E-01	.4887079E+00	.3702845E-01	-.1295733E-01	.1155862E-01
18	-.2330380E+00	-.7497254E-01	.4645373E+00	.3264934E-01	-.1060824E-01	.9229358E-02
19	-.2015622E+00	.1494504E-02	.4180472E+00	.3207788E-01	-.8659693E-02	.1235047E-01
20	-.1452421E+00	.1586928E+00	.3859433E+00	.3822380E-01	-.9705832E-02	.1034595E-01
21	-.1272371E+00	.2037349E+00	.3858400E+00	.3692490E-01	-.3267124E-02	.9391684E-02
22	-.1240797E+00	.3109042E+00	.4126307E+00	.4634825E-01	-.6171100E-02	.1149389E-01
23	-.4098126E+00	-.3824864E-01	.1233545E+01	.6601346E-01	-.2474233E-01	.1116155E-01
24	-.4058643E+00	-.4882914E-01	.1207068E+01	.6957740E-01	-.2592089E-01	.1082327E-01
25	-.3635229E+00	.4832117E-01	.1149073E+01	.6618773E-01	-.2285635E-01	.1312481E-01
26	-.3158324E+00	.1696979E+00	.1118501E+01	.6234205E-01	-.2044627E-01	.1386558E-01
27	-.2875592E+00	.2279912E+00	.1133439E+01	.6827372E-01	-.6338658E-02	.1426908E-01
28	-.2819651E+00	.3570614E+00	.1173732E+01	.6665330E-01	-.8573286E-02	.1108811E-01
29	-.5806789E+00	.4776153E-01	.2394635E+01	.9169957E-01	-.2988523E-01	.1481323E-01
30	-.5729221E+00	.3575296E-01	.2342836E+01	.9100270E-01	-.2968706E-01	.1201149E-01
31	-.5215527E+00	.1419516E+00	.2248051E+01	.8759588E-01	-.2644505E-01	.1549126E-01
32	-.4972413E+00	.1989831E+00	.2209751E+01	.8804888E-01	-.2625148E-01	.1397108E-01
33	-.4701241E+00	.2661467E+00	.2181620E+01	.8590072E-01	-.2585962E-01	.1575234E-01
34	-.4458190E+00	.4211112E+00	.2280480E+01	.8831824E-01	-.3249745E-01	.2871390E-01
35	-.6812751E+00	.1085723E+00	.3032677E+01	.9294450E-01	-.2770209E-01	.1795186E-01
36	-.6673898E+00	.1064067E+00	.2966384E+01	.9189924E-01	-.2533955E-01	.1398261E-01
37	-.6179399E+00	.2203206E+00	.2867600E+01	.8911933E-01	-.2714338E-01	.1857403E-01
38	-.5922807E+00	.2848797E+00	.2834358E+01	.8964029E-01	-.2787841E-01	.8966007E-02
39	-.5749235E+00	.3335092E+00	.2814777E+01	.8964029E-01	-.2791092E-01	.1828997E-01
40	-.5364563E+00	.4463606E+00	.2783205E+01	.9027671E-01	-.2402556E-01	.1466357E-01
41	-.7874537E+00	.1804381E+00	.3605696E+01	.7900250E-01	-.1596753E-01	.2071075E-01
42	-.7656536E+00	.1947256E+00	.3528762E+01	.7436174E-01	-.1610164E-01	.1492264E-01
43	-.7157450E+00	.3145301E+00	.3427818E+01	.6866573E-01	-.1774482E-01	.1942655E-01
44	-.6910112E+00	.3795903E+00	.3397279E+01	.6863246E-01	-.2092260E-01	.1621938E-01
45	-.6748325E+00	.4232582E+00	.3383043E+01	.6912800E-01	-.2182400E-01	.1973360E-01
46	-.6359125E+00	.5250125E+00	.3368620E+01	.7003264E-01	-.2423253E-01	.1933428E-01
47	-.9031680E+00	.2581067E+00	.4024843E+01	.5495343E-01	-.4512092E-02	.2023256E-01
48	-.8668702E+00	.2981888E+00	.3933178E+01	.5255897E-01	-.6189937E-03	.1658956E-01
49	-.8190190E+00	.4225113E+00	.3820086E+01	.4426599E-01	-.6719729E-02	.2074438E-01
50	-.7964492E+00	.4811518E+00	.3789715E+01	.4297823E-01	-.8332590E-02	.1796670E-01
51	-.7833005E+00	.5181756E+00	.3774700E+01	.4217258E-01	-.9811668E-02	.2045273E-01
52	-.7510677E+00	.5986950E+00	.3777761E+01	.5097571E-01	-.6750451E-02	.2168619E-01
53	-.1029157E+01	.3328983E+00	.4177039E+01	.1513714E-01	.2408912E-01	.1828364E-01
54	-.9752489E+00	.4068195E+00	.4063827E+01	.1167095E-01	.2073908E-01	.1841030E-01
55	-.9272319E+00	.5306109E+00	.3929701E+01	.2280361E-02	.1603804E-01	.2100022E-01
56	-.9102109E+00	.5812475E+00	.3891238E+01	.1037645E-02	.1460413E-01	.4316535E-01
57	-.9019706E+00	.6086094E+00	.3874448E+01	-.4091323E-02	.1323068E-01	.2188504E-01
58	-.8845018E+00	.6603537E+00	.3864916E+01	-.4349438E-02	.9545472E-02	.2074906E-01
59	-.1166258E+01	.3943034E+00	.3960834E+01	-.4294700E-01	.6717327E-01	.2312621E-01
60	-.1091913E+01	.5038068E+00	.3815425E+01	-.5246923E-01	.6041688E-01	.1927825E-01
61	-.1046035E+01	.6248977E+00	.3650154E+01	-.6511518E-01	.5390316E-01	.2056688E-01
62	-.1032940E+01	.6675786E+00	.3595527E+01	-.6884041E-01	.5251540E-01	.1789905E-01
63	-.1031845E+01	.6821162E+00	.3568662E+01	-.7141395E-01	.5006604E-01	.2116037E-01
64	-.1031133E+01	.6962473E+00	.3561487E+01	-.6565691E-01	.6019804E-01	.2281485E-01
65	-.1318054E+01	.4315866E+00	.3283786E+01	-.9553481E-01	.9105421E-01	.1562220E-01
66	-.1224052E+01	.5743326E+00	.3118695E+01	-.1013275E+00	.8967502E-01	.1972815E-01
67	-.1177668E+01	.6890460E+00	.2897018E+01	-.1154462E+00	.8891894E-01	.1975286E-01
68	-.1172099E+01	.7176704E+00	.2818633E+01	-.1213145E+00	.8544351E-01	.3402340E-02
69	-.1177978E+01	.7204328E+00	.2780997E+01	-.1217588E+00	.8432160E-01	.2053190E-01
70	-.1201103E+01	.7002583E+00	.2730179E+01	-.1070916E+00	.7501159E-01	.2207616E-01
71	-.1482604E+01	.4361233E+00	.2149039E+01	-.1622214E+00	.1470667E+00	.2088106E-01
72	-.1368223E+01	.6031723E+00	.1928626E+01	-.1755392E+00	.1419482E+00	.2030375E-01
73	-.1329052E+01	.7085856E+00	.1612536E+01	-.1993363E+00	.1415736E+00	.1715796E-01
74	-.1327653E+01	.7304920E+00	.1510191E+01	-.2042626E+00	.1386877E+00	.6748853E-01
75	-.1356880E+01	.7175728E+00	.1324140E+01	-.2167432E+00	.1438309E+00	.2075269E-01
76	-.1437321E+01	.6389743E+00	.9562157E+00	-.2283754E+00	.1505774E+00	.1445821E-01
77	-.1660732E+01	.4057413E+00	.5233117E+00	-.2190440E+00	.1828042E+00	.1422523E-01
78	-.1534777E+01	.5826677E+00	.2696346E+00	-.2268823E+00	.1844237E+00	.1928001E-01
79	-.1498873E+01	.6636168E+00	-.1141253E+00	-.2314731E+00	.1859756E+00	.1437738E-01
80	-.1501407E+01	.6795205E+00	-.2824939E+00	-.2244313E+00	.1989807E+00	.1570754E+00
81	-.1539292E+01	.6506587E+00	-.5171225E+00	-.2577385E+00	.1762039E+00	.1567253E-01
82	-.1630907E+01	.5565996E+00	-.9327147E+00	-.2675829E+00	.1722697E+00	.9208183E-02
83	-.1847956E+01	.3343737E+00	-.1492715E+01	-.2539540E+00	.2162576E+00	.1315213E-01
84	-.1716974E+01	.5129114E+00	-.1774007E+01	-.2648553E+00	.2143604E+00	.1747773E-01
85	-.1683913E+01	.5858022E+00	-.2192121E+01	-.2732744E+00	.2190179E+00	.1255394E-01
86	-.1690801E+01	.5886702E+00	-.2388806E+01	-.2631799E+00	.2384507E+00	.1216355E+00
87	-.1730120E+01	.5566806E+00	-.2649530E+01	-.2937460E+00	.2074180E+00	.1128414E-01
88	-.1829839E+01	.4505943E+00	-.3113361E+01	-.3026841E+00	.2082605E+00	.2875561E-02
89	-.1975373E+01	.2735117E+00	-.2988885E+01	-.2794648E+00	.2359610E+00	.1255128E-01
90	-.1888451E+01	.4178011E+00	-.3754079E+01	-.2795555E+00	.2338243E+00	.1189389E-01
91	-.1917879E+01	.4419950E+00	-.4926198E+01	-.2897937E+00	.2380008E+00	.1196362E-01
92	-.1945350E+01	.4324085E+00	-.5408201E+01	-.2932607E+00	.2399067E+00	.1169523E-01
93	-.1984493E+01	.3969732E+00	-.5666209E+01	-.2934693E+00	.2416048E+00	.1132456E-01
94	-.2087707E+01	.2931611E+00	-.6152906E+01	-.2954299E+00	.2419599E+00	.8595796E-02
95	-.2139475E+01	.1747361E+00	-.5041097E+01	-.2962538E+00	.2632748E+00	.1397692E-01
96	-.2060372E+01	.3016223E+00	-.5792167E+01	-.2858317E+00	.2342252E+00	.9659798E-02
97	-.2088316E+01	.3243465E+00	-.6903138E+01	-.2881721E+00	.2362593E+00	.1417330E-01
98	-.2109481E+01	.3199922E+00	-.7356823E+01	-.2946563E+00	.2386683E+00	.1045575E-01
99	-.2145145E+01	.2879936E+00	-.7603234E+01	-.2933732E+00	.2485769E+00	.1452955E-01
100	-.2242958E+01	.1913869E+00	-.8071015E+01	-.2954962E+00	.2477416E+00	.1359012E-01

Table 6. Continued

ORIGINAL PAGE IS
OF POOR QUALITY

(d) Mode 4, $f = 60.8920$ Hz

Joint	Deflection, Inches				Rotation	
	dx	dy	dz	dz/dy	dz/dx	dx/dy
1	-.1696948E-01	-.2467761E-01	-.4313599E-01	.1819857E-03	-.3872311E-02	.2143812E-02
2	-.1697040E-01	-.1643774E-01	-.2826736E-01	.1818929E-03	-.3872298E-02	.2142673E-02
3	-.1696872E-01	.9399690E-02	.1843039E-01	.1822736E-03	-.3871921E-02	.2142495E-02
4	-.1704479E-01	.2483264E-01	.6223570E-01	.6588352E-02	-.6555652E-02	.4067477E-02
5	-.6571440E-01	-.5526633E-01	-.9724175E-01	-.4201089E-02	-.6682622E-02	.4913165E-02
6	-.6468210E-01	-.2710273E-01	-.5092998E-01	-.2963388E-02	-.7057369E-02	.5033688E-02
7	-.6419920E-01	.4007004E-02	-.6265785E-02	.1432997E-02	-.8107576E-02	.4292381E-02
8	-.6508149E-01	.1287130E-01	.2357657E-01	.2106240E-02	-.8684530E-02	.1488299E-02
9	-.6498945E-01	.1515481E-01	.9130980E-01	.5168087E-02	-.8134263E-02	.1813444E-02
10	-.6498311E-01	.3299684E-01	.1473545E+00	.6225305E-02	-.8154710E-02	.2854623E-02
11	-.1284976E+00	-.8959023E-01	-.1701166E+00	-.4025264E-01	-.6109898E-03	.1774920E-01
12	-.1139785E+00	-.2127689E-01	-.9201167E-01	-.5550201E-02	-.8669080E-02	.5033911E-02
13	-.9632439E-01	.2610922E-02	.8367372E-02	.2494132E-02	-.1163728E-01	.4151451E-02
14	-.9814143E-01	.1311737E+00	.2856502E+00	.4157178E-01	-.3305095E-01	.7853468E-02
15	-.8233135E-01	.1752800E+00	.3840274E+00	.7114804E-01	-.3439036E-01	.6155999E-02
16	-.3995381E-01	.3112830E+00	.6369925E+00	.9967742E-01	-.4989044E-01	.6085535E-02
17	-.2759860E+00	-.1964257E-01	-.4981342E+00	-.5279889E-01	-.2838823E-01	.1499721E-01
18	-.3030990E+00	.7993763E-01	-.2027174E+00	-.2994067E-01	-.3990556E-01	.1986068E-01
19	-.2981340E+00	.7746840E-01	.2251504E+00	-.2585697E-03	-.5541273E-01	.2000139E-01
20	-.2085796E+00	.1410433E+00	.7375441E+00	.4646229E-01	-.7483814E-01	.1415003E-01
21	-.1525497E+00	.1752315E+00	.9196824E+00	.5374348E-01	-.4893141E-01	.9313274E-02
22	-.8653761E-01	.2987243E+00	.1269657E+01	.8779347E-01	-.3304830E-01	.1118329E-01
23	-.4345622E+00	.5968920E-01	-.1155377E+01	-.1174230E+00	-.8399319E-01	.1508066E-01
24	-.5315798E+00	.1992619E+00	-.4645322E+00	-.8256670E-01	-.1030334E+00	.2267232E-01
25	-.5310018E+00	.1755293E+00	.6242972E+00	-.2478778E-01	-.1338087E+00	.2215547E-01
26	-.4265419E+00	.1928357E+00	.1476348E+01	.1366051E-01	-.1481677E+00	.1705142E-01
27	-.3288323E+00	.2152465E+00	.1928469E+01	.5235660E-01	-.1099578E+00	.1471870E-01
28	-.2094753E+00	.3001920E+00	.2530824E+01	.5195646E-01	-.4992086E-01	.3970324E-02
29	-.5380474E+00	.1039307E+00	-.2183443E+01	-.2030686E+00	-.1753503E+00	.1310597E-01
30	-.7144113E+00	.2891939E+00	-.9407768E+00	-.1537995E-01	-.2037894E+00	.2455279E-01
31	-.7202209E+00	.2809377E+00	.1050055E+01	-.7440625E-01	-.2425968E+00	.2501152E-01
32	-.6739363E+00	.2742997E+00	.1826552E+01	-.3708678E-01	-.2566873E+00	.2268717E-01
33	-.5553811E+00	.2803504E+00	.2518259E+01	-.3331839E-01	-.2379521E+00	.1988106E-01
34	-.3638760E+00	.3229309E+00	.3465698E+01	.3032008E-01	-.3197408E+00	.1273984E-01
35	-.5673905E+00	.9962790E-01	-.2856466E-01	-.2483871E+00	-.2218889E+00	.1608846E-01
36	-.7887788E+00	.3220738E+00	-.1291905E+01	-.2055566E+00	-.2754660E+00	.2677865E-01
37	-.7987708E+00	.3311297E+00	.1217701E+01	-.1167234E+00	-.3105568E+00	.2780047E-01
38	-.7318578E+00	.3413955E+00	.2268387E+01	-.8480153E-01	-.3298877E+00	-.1984178E-01
39	-.6435715E+00	.3291164E+00	.2836481E+01	-.5506696E-01	-.3398083E+00	.2102114E-01
40	-.3883383E+00	.3329301E+00	.3923742E+01	-.2104517E-01	-.3084372E+00	.8805095E-02
41	-.5896604E+00	.8026545E-01	-.3601737E+01	-.3057138E+00	-.3083647E+00	.1730626E-01
42	-.5891899E+00	.3494267E+00	-.1716605E+01	-.2539728E+00	-.3404583E+00	.3104964E-01
43	-.8666163E+00	.3739736E+00	.1319656E+01	-.1603389E+00	-.3910824E+00	.3137766E-01
44	-.7838594E+00	.3820582E+00	.2588883E+01	-.1188215E+00	-.4055369E+00	.6316680E-01
45	-.6774069E+00	.3715154E+00	.3272750E+01	-.1009329E+00	-.4128648E+00	.2604200E-01
46	-.3732976E+00	.3607353E+00	.4615286E+01	-.5036170E-01	-.4015325E+00	.1539869E-01
47	-.5885671E+00	.4173375E-01	-.4452424E+01	-.3637136E+00	-.3642250E+00	.2362413E-01
48	-.9006180E+00	.3513945E+00	-.2232013E+01	-.3119631E+00	-.4352639E+00	.3924915E-01
49	-.9105614E+00	.4019548E+00	.1394687E+01	-.2010339E+00	-.4740596E+00	.3775671E-01
50	-.8185484E+00	.4152613E+00	.2879877E+01	-.1579348E+00	-.4937948E+00	.4237209E-01
51	-.6983659E+00	.3995089E+00	.3683606E+01	-.1343722E+00	-.5050634E+00	.3154789E-01
52	-.3419230E+00	.3814580E+00	.5276978E+01	-.2710617E-01	-.4641575E+00	.2000361E-01
53	-.5836594E+00	-.1782896E-01	-.5449007E+01	-.4419383E+00	-.4971404E+00	.2632693E-01
54	-.9642821E+00	.3522781E+00	-.2796391E-01	-.3671280E+00	-.5370084E+00	.4702314E-01
55	-.9583989E+00	.4284688E+00	.1431662E+01	-.2578397E+00	-.5949844E+00	.4694076E-01
56	-.8407821E+00	.4441569E+00	.3204839E+01	-.2144733E+00	-.6192664E+00	-.1085259E-01
57	-.6996091E+00	.4239141E+00	.4163052E+01	-.1779269E+00	-.6296933E+00	.4007627E-01
58	-.2828846E+00	.4002360E+00	.6030009E+01	-.7960521E-01	-.6043969E+00	.1987387E-01
59	-.5457648E+00	-.1036394E+00	-.6454599E+01	-.5028400E+00	-.5996449E+00	.4035906E-01
60	-.9783999E+00	.3150280E+00	-.3384277E+01	-.4422133E+00	-.6727172E+00	.5284641E-01
61	-.9636454E+00	.4312190E+00	.1462852E+01	-.3133010E+00	-.7198562E+00	.5377719E-01
62	-.8303188E+00	.4586586E+00	.3506817E+01	-.2695248E+00	-.7469510E+00	.2914405E-01
63	-.6660118E+00	.4447736E+00	.4609976E+01	-.2389057E+00	-.7559348E+00	.4371034E-01
64	-.1855586E+00	.4006635E+00	.6802603E+01	-.1548157E+00	-.6814605E+00	.2886561E-01
65	-.4851346E+00	-.2074866E+00	-.7397390E+01	-.5652503E+00	-.7569784E+00	.3810330E-01
66	-.9615012E+00	.2580433E+00	-.3950779E+01	-.4938690E+00	-.7937218E+00	.6321186E-01
67	-.9306266E+00	.4118589E+00	.1510229E+01	-.3692959E+00	-.8614886E+00	.6396696E-01
68	-.7851721E+00	.4568202E+00	.3809004E+01	-.3377683E+00	-.8905604E+00	-.8115101E-01
69	-.6027590E+00	.4411270E+00	.5053042E+01	-.2918005E+00	-.9000589E+00	.5817921E-01
70	-.6043645E-01	.4057112E+00	.7524034E+01	-.1183502E+00	-.8332005E+00	.4162973E-01
71	-.3785168E+00	-.3309057E+00	-.8301639E+01	-.6396212E+00	-.8745943E+00	.6160576E-01
72	-.8992041E+00	.1715240E+00	-.4474421E+01	-.5719460E+00	-.9559074E+00	.7265865E-01
73	-.8598504E+00	.3832018E+00	.1600987E+01	-.4359450E+00	-.1034998E+00	.7577437E-01
74	-.7032532E+00	.4430265E+00	.4269974E+01	-.4481117E+00	-.1116654E-01	-.4876730E+00
75	-.4851736E+00	.4314681E+00	.5695322E-01	-.3395148E+00	-.1055132E-01	.6957264E-01
76	-.1033465E+00	.3949425E+00	.8382307E-01	-.3384428E+00	-.1127800E-01	.4797270E-01
77	-.2502194E+00	-.4746253E+00	-.9026854E+01	-.6752976E+00	-.1079648E-01	.5808608E-01
78	-.7980891E+00	.6735361E-01	-.4883604E+01	-.6197000E+00	-.1108008E+01	.8256295E-01
79	-.7292782E+00	.3343507E+00	.1670280E+01	-.5299653E+00	-.1204676E-01	.8543089E-01
80	-.5601318E+00	.4185039E+00	.4623403E+01	-.6057482E-01	-.1357401E-02	-.9948250E+00
81	-.3197792E+00	.4152927E+00	.6161002E+01	-.3795822E+00	-.1118435E-01	.6528611E-01
82	-.2727125E+00	.3550318E+00	.8876702E+01	-.3561479E+00	-.1110009E-01	.2950748E+00
83	-.7131570E-01	-.6103028E+00	-.9413484E+01	-.7022891E+00	-.1161622E-01	.8873612E-01
84	-.6209367E+00	-.6946144E-01	-.5135598E+01	-.6602946E+00	-.1239007E+01	.8996744E-01
85	-.5419177E+00	.2620851E+00	.1666388E+01	-.6004484E+00	-.1274730E-01	.8951545E-01
86	-.3837549E+00	.3732924E+00	.4635257E+01	-.7079968E+00	-.1442115E-01	-.1108753E-01
87	-.1494602E+00	.3687395E+00	.6194530E+01	-.4609638E+00	-.1231470E-01	.9106299E-01
88	.4448690E+00	.2778630E+00	.8967563E+01	-.4231590E+00	-.1244359E-01	.1832300E+00
89	.4438362E-01	-.6983650E+00	-.9464006E+01	-.6577735E+00	-.1335455E-01	.8204326E-01
90	-.4467954E+00	-.1846847E+00	-.5142340E+01	-.6510234E+00	-.1319153E-01	.8319663E-01
91	-.2814224E+00	.1417045E+00	.1477699E+01	-.6363193E+00	-.1339204E-01	.8588414E-01
92	-.1275374E+00	.2426653E+00	.4189214E+01	-.6408830E+00	-.1350800E-01	.8746358E-01
93	.9221110E-01	.2328807E+00	.5643844E+01	-.6465143E+00	-.1363582E-01	.8862849E-01
94	.6735106E+00	.1318872E+00	.8390943E+01	-.6628548E+00	-.1375300E-01	.9544523E-01
95	-.2407705E+00	-.7753105E+00	-.9158542E+01	-.6206467E+00	-.1436080E-01	.6385480E-01
96	-.2087086E+00	-.3012410E+00	-.5021847E+01	-.6220377E+00	-.1334674E-01	.8327991E-01
97	-.5811221E-01	.1833749E-01	.1232606E+01	-.6436093E+00	-.1349204E-01	.8623868E-01
98	.6498154E-01	.1256753E+00	.3790178E+01	-.6447732E+00	-.1366625E-01	.8809298E-01
99	.2683281E+00	.1173470E+00	.5169070E+01	-.6511224E+00	-.1380460E-01	.7552871E-01
100	.8113417E+00	.2370106E-01	.7763881E+01	-.6680446E+00	-.1372841E-01	.8128129E-01

Table 6. Continued

(e) Mode 5, $f = 66.6051$ Hz

Joint	Deflection, Inches				Rotation	
	dx	dy	dz	dz/dy	dz/dx	dx/dy
1	.6080133E-02	.3295221E-01	.1545585E-01	-.6040053E-02	.1387560E-02	-.5818038E-03
2	.6080710E-02	.3074225E-01	.1012987E-01	-.6042121E-02	.1387557E-02	-.5839062E-03
3	.6077408E-02	.2369780E-01	-.6600966E-02	-.6039733E-02	.1386759E-02	-.5822701E-03
4	.5941751E-02	-.9549580E-02	-.1814822E-01	-.2036709E-01	.1843896E-02	-.1471642E-02
5	-.9387933E-02	.2259645E-01	-.7582188E-01	-.2468959E-01	.8430557E-02	.2196994E-02
6	-.8964401E-02	.3463411E-01	-.1170210E+00	-.2740304E-01	.4679067E-02	.3199241E-02
7	-.9341937E-02	.4235222E-01	-.1455275E+00	-.3215188E-01	.4839999E-02	.2856049E-02
8	-.8918028E-02	.5718585E-01	-.1579770E+00	-.3599032E-01	.3990760E-02	.2317932E-02
9	-.8728152E-02	.5448309E-02	-.1987068E+00	-.2866144E-01	.6231405E-02	-.4841515E-02
10	-.8693742E-02	-.1835097E-01	-.2444688E+00	-.2602770E-01	.6748214E-02	-.2987215E-02
11	-.1013109E-01	.7472718E-01	-.3590162E+00	-.6470711E-01	.1627324E-01	.4869202E-02
12	-.1243272E-04	.1204695E+00	-.3192762E+00	-.3640254E-01	.9344020E-02	.1378766E-02
13	-.1732436E-03	.1273090E+00	-.2422592E+00	-.3951408E-01	.8040776E-02	.3022993E-02
14	-.3879507E-02	.1156201E+00	-.4522101E+00	-.8527671E-01	.2400189E-01	.4201441E-02
15	-.1464293E-01	.8249272E-01	-.5199496E+00	-.1144705E+00	.2200587E-01	.6574077E-02
16	-.4553772E-01	-.3475053E-01	-.6776691E+00	-.1398318E+00	.2788042E-01	.5476662E-02
17	-.2248391E-01	.8404276E-01	-.1127889E+01	-.6465732E-01	.2864313E-01	.2175745E-02
18	.1719879E-01	.1793689E+00	-.1113660E+01	-.6425409E-01	.2841803E-01	.5162862E-02
19	.2652271E-01	.1811826E+00	-.1102778E+01	-.6829945E-01	.3297317E-01	-.6677207E-03
20	.4342347E-02	.1318058E+00	-.1202500E+01	-.9306441E-01	.4778048E-01	-.1695051E-02
21	-.3623236E-01	.1077925E+00	-.1329052E+01	-.8354267E-01	.8233344E-02	.3016226E-02
22	-.6646674E-01	-.7498124E-02	-.1485132E+01	-.1129557E+00	-.3795011E-01	.5403401E-03
23	-.4244132E-01	.8704608E-01	-.2227944E+01	-.7164178E-01	.3565333E-01	.2819072E-02
24	-.1972703E-02	.1641055E+00	-.2240374E+01	-.7235699E-01	.3926882E-01	.6862365E-02
25	-.7945526E-02	.1605251E+00	-.2297976E+01	-.6375732E-01	.4260076E-01	-.9679596E-04
26	-.1307757E-01	.1191073E+00	-.2438447E+01	-.5522579E-01	.5066767E-01	.7588174E-03
27	-.6712501E-01	.1323291E+00	-.2711091E+01	-.3757488E-01	.7413932E-02	.6487862E-03
28	-.8130866E-01	.4735185E-01	-.2809453E+01	-.4821591E-01	.7652436E-01	.3818796E-02
29	-.6100562E-01	.6302061E-01	-.2882946E+01	-.5057192E-02	.5979390E-02	.1994692E-02
30	-.6857961E-01	.5590671E-01	-.2831259E+01	-.2709907E-02	-.6182364E-02	.2540245E-02
31	-.5785437E-01	.3951750E-01	-.2859478E+01	-.1179038E-01	.5197936E-02	.1762678E-02
32	-.4635192E-01	.5776191E-01	-.2909682E+01	.2003111E-01	.1373333E-01	.2218091E-02
33	-.5231424E-01	.5128934E-01	-.3009464E+01	.3380781E-01	.5189946E-02	-.1538681E-04
34	-.5417337E-01	.9835275E-01	-.3011972E+01	.3122107E-01	.2567294E-01	.1825666E-01
35	-.6945830E-01	.6189703E-01	-.2648159E+01	.5087653E-01	-.6063670E-01	.6639376E-03
36	-.1140532E+00	.8150855E-02	-.2517910E+01	.7068208E-01	-.5089304E-01	-.2055654E-02
37	-.1011794E+00	-.1170834E-01	-.2448311E+01	.9897732E-01	-.4708365E-01	.3689916E-02
38	-.9023502E-01	-.3248980E-02	-.2459989E+01	.1100490E+00	-.3781134E-01	-.2323874E-01
39	-.7784541E-01	.2476803E-01	-.2476690E+01	.1147689E+00	-.3629736E-01	.3756013E-02
40	-.5939652E-01	.1082753E+00	-.2566393E+01	.1362773E+00	-.5395127E-01	-.4028887E-02
41	-.6710913E-01	.8327203E-01	-.1924247E+01	.1109678E+00	-.1002267E+00	.2371188E-02
42	-.1468008E+00	-.1127701E-01	-.1719292E+01	.1328648E+00	-.1033974E+00	-.3531726E-02
43	-.1421364E+00	-.2805416E-01	-.1473169E+01	.1652389E+00	-.1032026E+00	.6253252E-02
44	-.1190642E+00	.1060734E-02	-.1399361E+01	.1799963E+00	-.1029067E+00	-.3482563E-02
45	-.9564395E-01	.3606430E-01	-.1367024E+01	.1889529E+00	-.1016711E+00	.4452484E-02
46	-.3773772E-01	.1625070E+00	-.1386227E+01	.1678124E+00	-.1180605E+00	-.3528136E-02
47	-.5039281E-01	.1331328E+00	-.8046468E+00	.1575748E+00	-.1380902E+00	.5282726E-02
48	-.1624265E-00	.1753785E-01	-.4937356E+01	.1535178E+00	-.1404081E+00	-.5849854E-02
49	-.1605660E+00	.9256566E-02	-.2768223E-01	.1896515E+00	-.1490097E+00	.8789596E-02
50	-.1329923E+00	.4469075E-01	.1355283E+00	.2070683E+00	-.1526936E+00	-.3052277E-01
51	-.9865090E-01	.8918851E-01	.2195707E+00	.2226662E+00	-.1564134E+00	.6196870E-02
52	-.8957410E-02	.2354761E+00	.3968894E+00	.2448469E+00	-.1223862E+00	.5304871E-02
53	-.1597308E-01	.2074417E+00	.5423123E+00	.1451874E+00	-.1765015E+00	.3869928E-02
54	-.1517424E+00	.1024783E+00	.9667754E+00	.1669218E+00	-.1881648E+00	-.7203282E-02
55	-.1580327E+00	.1031894E+00	.1661455E+01	.1958561E+00	-.2045787E+00	.1082532E-01
56	-.1230046E+00	.1411580E+00	.1956396E+01	.2092902E+00	-.2154195E+00	-.2719202E-01
57	-.8134351E-01	.1778333E+00	.2116912E+01	.2263765E+00	-.2188732E+00	.9416192E-02
58	.5655985E-01	.3246381E+00	.2419085E+01	.2219080E+00	-.2146772E+00	-.4009256E-02
59	.4467678E-01	.2910143E+00	.1812659E+01	.8604437E-01	-.1677943E+00	.6083927E-02
60	-.9328803E-01	.2292972E+00	.2325165E+01	.1008794E+00	-.1899833E+00	-.7402308E-02
61	-.1067678E+00	.2389089E+00	.3234097E+01	.1226571E+00	-.2160101E+00	.8914077E-02
62	-.7272449E-01	.2691076E+00	.3628893E+01	.1311190E+00	-.2294401E+00	-.9721230E-02
63	-.2771158E-01	.2981556E+00	.3843403E+01	.1408486E+00	-.2341154E+00	.4996486E-02
64	-.1331442E+00	.3872475E+00	.4382748E+01	.1722935E+00	-.1393717E+00	.2316296E-02
65	-.1217784E+00	.3510886E+00	.2574726E+01	.2706480E-03	-.1770927E+00	-.7115944E-03
66	-.2506431E-02	.3648907E+00	.3172273E+01	.1078112E-01	-.1894888E+00	-.7555149E-02
67	-.1229876E-01	.3767299E+00	.4215140E+01	.1990926E-01	-.2136336E+00	.7574513E-02
68	-.1018066E-01	.3808899E+00	.4683570E+01	.6037934E-02	-.2331232E+00	-.1750014E+00
69	.4903081E-01	.3833458E+00	.4947371E+01	.3475651E-01	-.2391630E+00	.6225088E-02
70	-.1959487E+00	.4018347E+00	.5563939E+01	.1737504E+00	-.1945040E+00	.6441172E-03
71	-.2259217E+00	.3449221E+00	.2507145E+01	-.1644015E+00	-.8191978E-01	-.3987765E-02
72	-.1490382E+00	.4374933E+00	.3057291E+01	-.1766417E+00	-.1183970E+00	-.2186792E-02
73	-.1101922E+00	.4582447E+00	.4090119E+01	-.2009739E+00	-.1440346E+00	-.3302463E-02
74	-.1176929E+00	.4408885E+00	.4696665E+01	-.2396560E+00	-.2144192E+00	-.1673137E+00
75	-.1494876E+00	.4044262E+00	.4914458E+01	-.2132129E+00	-.1295826E+00	.7302639E-02
76	-.2181608E+00	.2402887E+00	.5228563E+01	-.2459299E+00	-.1457639E+00	-.3738655E-01
77	.3260098E+00	.2410623E+00	.1228217E+01	-.3454440E+00	-.3908682E-01	.2309913E-01
78	.2875075E+00	.4025761E+00	.1755853E+01	-.3505566E+00	-.2689955E-01	-.2991664E-02
79	.2593451E+00	.3766062E+00	.2717676E+01	-.3577190E+00	-.7258357E-01	-.1036515E-01
80	.2635340E+00	.3479689E+00	.3217994E+01	-.3815309E+00	-.1141166E+00	-.1351570E+00
81	.2769364E+00	.2633089E+00	.3308775E+01	-.3660633E+00	-.3667487E-01	-.1945575E-01
82	.3020123E+00	.3268898E-01	.3426721E+01	-.3815424E+00	-.4322565E-01	-.1127064E+00
83	.4226406E+00	.8047194E-02	-.1191822E+01	-.4705316E+00	-.6514288E-01	-.1823627E-01
84	.4283141E+00	.2196839E+00	-.7411097E+00	-.4955750E+00	.4153080E-01	-.2084204E-02
85	.3951492E+00	.1943999E+00	.1127014E+00	-.5243298E+00	.4313995E-01	-.1785322E-01
86	.3758180E+00	.1311281E+00	.4705971E+00	-.5426450E+00	.3166819E-01	-.1272529E+00
87	.372982E+00	.2780715E-01	-.4337519E+00	-.5421727E+00	.473084E-01	-.208596E-01
88	.3551518E+00	-.2735709E+00	.3497283E+00	-.5651302E+00	.3706489E-01	.3706489E-01
89	.4760009E+00	-.1938033E+00	-.3316487E+01	-.5555937E+00	.1009435E+00	-.1900108E-01
90	.5112216E+00	-.5274079E-01	-.3621025E+01	-.5520608E+00	.9634186E-01	-.191408E-01
91	.5040409E+00	-.2047694E+00	-.4126745E+01	-.5920501E+00	.1085982E+00	-.1821711E-01
92	.4926535E+00	-.3089757E+00	-.4352226E+01	-.6094661E+00	.1129172E+00	-.1997902E-01
93	.4743365E+00	-.4299372E+00	-.4474179E+01	-.6135368E+00	.1156872E+00	-.2075323E-01
94	.4248244E+00	-.7371923E+00	-.4709311E+01	-.6234848E+00	.1167914E+00	-.2656219E-01
95	.5347652E+00	-.5127087E+00	-.6475898E+01	-.6091289E+00	.1867179E+00	-.1988487E-01
96	.5697141E+00	-.3964114E+00	-.6887952E+01	-.5822861E+00	.9986497E-01	-.2666705E-01
97	.5538742E+00	-.5476798E+00	-.7416699E+01	-.5953680E+00	.1033954E+00	-.1141504E-01
98	.5470478E+00	-.6376942E+00	-.7639013E+01	-.6178495E+00	.1107659E+00	-.2335389E-01
99	.5308771E+00	-.7480498E+00	-.7767357E+01	-.6149846E+00	.1391503E+00	-.1079804E-01
100	.4773622E+00	-.1036299E+01	-.8026211E+01	-.6307693E+00	.1354449E+00	-.1452681E-01

Table 6. Concluded

(f) Mode 6, $f = 96.7594$ Hz

Joint	Deflection, Inches			Rotation		
	dx	dy	dz	dz/dy	dz/dx	dx/dy
1	.4959872E-01	.1168126E+00	.1260782E+00	.1973587E-02	.1131763E-01	-.1126405E-01
2	.4960996E-01	.7349478E-01	.8263055E-01	.1978001E-02	.1131912E-01	-.1125641E-01
3	.4960083E-01	-.6223884E-01	-.5387295E-01	.1975423E-02	.1131785E-01	-.1125631E-01
4	.5029088E-01	-.1085255E+00	-.1554518E+00	.1015584E-01	.1384288E-01	-.2359136E-01
5	.3782673E+00	.3209571E+00	.2490422E+00	.1353343E-01	.9610473E-02	-.3411442E-01
6	.3730514E+00	.1364141E+00	.1769402E+00	.1384311E-01	.1051886E-01	-.3247675E-01
7	.3708882E+00	-.6486594E-01	-.1193215E+00	.1062673E-01	.9567859E-02	-.3256155E-01
8	.3757271E+00	-.1467505E+00	.8679138E-01	.1038672E-01	.9950451E-02	-.1366001E-01
9	.3751174E+00	-.6867538E-01	-.5556268E-02	.1171935E-01	.1214053E-01	-.3909912E-02
10	.3751241E+00	-.1487519E+00	-.9259370E-01	.1159785E-01	.1277657E-01	-.1424672E-01
11	.7170327E+00	.4868251E+00	.4309639E+00	.7106466E-01	-.2255414E-03	-.6834746E-01
12	.5877928E+00	.1351265E+00	.3035683E+00	.1843787E-01	.1074024E-01	-.3065479E-01
13	.4637660E+00	-.1159996E+00	-.1353336E+00	.1048107E-01	.1299719E-01	-.3002674E-01
14	.5064267E+00	-.7270112E+00	-.1716574E+00	-.1230383E-01	.3907718E-01	-.5274985E-01
15	.4900530E+00	-.8743921E+00	-.2863272E+00	-.6567745E-01	.3835886E-01	-.5131403E-01
16	.4366059E+00	-.1292007E+01	-.5669916E+00	-.1113882E+00	.5227859E-01	-.5352465E-01
17	.1412536E+01	.1192043E+00	.9779514E+00	.6814064E-01	.3233823E-01	-.6317920E-01
18	.1336545E+01	-.2415968E+00	.6262913E+00	.4663469E-01	.4198589E-01	-.6988829E-01
19	.1236925E+01	-.4636578E+00	.1100006E+00	.1391060E-01	.6079008E-01	-.7273581E-01
20	.1010886E+01	-.8067748E+00	-.5204150E+00	-.3458131E-01	.8410797E-01	-.6744404E-01
21	.8822654E+00	-.9276571E+00	-.8209853E+00	-.3138357E-01	.3233221E-01	-.6196453E-01
22	.8117744E+00	-.1322737E+01	-.1170047E+01	-.7486124E-01	-.2839422E-01	-.6066712E-01
23	.2068739E+01	-.3242082E+00	.1668497E+01	.9971281E-01	.9457018E-01	-.6148236E-01
24	.2096656E+01	-.6300125E+00	.9822394E+00	.7925526E-01	.1025933E+00	-.5709125E-01
25	.2019284E+01	-.7806628E+00	-.1262600E+00	.3179827E-01	.1326601E+00	-.5683071E-01
26	.1833507E+01	-.9484199E+00	-.1016952E+01	.1018194E-01	.1458072E+00	-.5371893E-01
27	.1667360E+01	-.103367E+01	-.1630811E+01	-.4639081E-01	.6400213E-01	-.4967886E-01
28	.1564338E+01	-.1253136E+01	-.2092618E+01	-.1044460E-01	-.6188508E-01	-.4549100E-01
29	.2392297E+01	-.7244032E+00	.2035177E+01	.9105842E-01	.1710016E+00	-.2983482E-01
30	.2524661E+01	-.9002857E+00	.1086894E+01	.8429259E-01	.1714133E+00	-.2484530E-01
31	.2522464E+01	-.9772268E+00	-.4917616E+00	.5946013E-01	.1934113E+00	-.2964974E-01
32	.2472931E+01	-.1030620E+01	-.1144383E+01	.4250257E-01	.7131424E+00	-.4594568E-01
33	.2356882E+01	-.1071796E+01	-.1838939E+01	-.7601107E-01	.1454064E+00	-.3345184E-01
34	.2281422E+01	-.8927623E+00	-.2391205E+01	-.3173134E-01	.2578754E+00	-.9965672E-01
35	.2352473E+01	-.8644888E+00	.1986969E+01	.7272781E-01	.1739861E+00	-.7119141E-02
36	.2521593E+01	-.9565459E+00	.1025856E+01	.7521016E-01	.1928091E+00	-.5693169E-02
37	.2536325E+01	-.9681733E+00	-.5915959E+00	.8292583E-01	.1865517E+00	-.1031368E-02
38	.2497633E+01	-.9623966E+00	-.1250729E+01	.7758458E-01	.2047512E+00	-.1530983E+00
39	.2444204E+01	-.9294562E+00	-.1620342E+01	.8210561E-01	.2074114E+00	-.6719981E-03
40	.2248493E+01	-.8641952E+00	-.2419675E+01	.9392305E-01	.8802607E-01	-.2972134E-01
41	.2201000E+01	-.9616960E+00	.1764368E+01	.5920703E-01	.1923913E+00	-.3865961E-01
42	.2392474E+01	-.9650588E+00	.8803575E+00	.7825383E-01	.1853916E+00	-.1867310E-01
43	.2435891E+01	-.8894992E+00	-.5571139E+00	.8537253E-01	.1816989E+00	-.1910766E-01
44	.2423758E+01	-.8257140E+00	-.1153209E+01	.9749996E-01	.1814301E+00	-.4407487E-01
45	.2388685E+01	-.7804324E+00	-.1480266E+01	.9432091E-01	.1819941E+00	-.1992024E-01
46	.2249989E+01	-.6576249E+00	-.2213764E+01	.5456624E-01	.1131242E+00	-.2110495E-01
47	.1895476E+01	-.1001659E+01	.1383362E+01	.9052860E-02	.1713480E+00	-.3168320E-01
48	.2096433E+01	-.9074660E+00	.6797951E+00	.3340965E-01	.1582620E+00	-.4421852E-01
49	.2186310E+01	-.7275794E+00	-.4446370E+00	.8986361E-01	.1385368E+00	-.4917950E-01
50	.2202844E+01	-.6253889E+00	-.9143244E+00	.1129800E+00	.1378605E+00	-.1049897E-01
51	.2190753E+01	-.5540458E+00	-.1177798E+01	.1285699E+00	.1326649E+00	-.4453524E-01
52	.2107779E+01	-.3573255E+00	-.1765237E+01	-.6192187E-01	.7702562E-01	-.4373758E-01
53	.1437470E+01	-.9987896E+00	-.7803638E+00	-.5632238E-01	.1387490E+00	-.5565508E-01
54	.1624629E+01	-.7735568E+00	.3894888E+00	.2596985E-02	.1039041E+00	-.8020572E-01
55	.1763292E+01	-.4765551E+00	-.2316174E+00	.8088367E-01	.7128877E-01	-.8343286E-01
56	.1815590E+01	-.3172552E+00	-.4870574E+00	.1063369E+00	.5758628E-01	-.1381244E-01
57	.1834772E+01	-.2183449E+00	-.6322078E+00	.1394887E+00	.5098423E-01	-.7789028E-01
58	.1833910E+01	.4431779E-01	-.1004908E+01	.5222780E-01	-.2306089E-01	-.7073243E-01
59	.7898774E+00	-.9277482E+00	-.1135185E-01	-.1135096E+00	.5506905E-01	.1215735E+00
60	.9642282E+00	-.5536500E+00	.1969077E-01	-.7105844E-01	.1897493E-01	.1111111E+00
61	.1151465E+01	-.1255886E+00	.3714593E-01	.3359077E-01	-.2595462E-01	.1218852E+00
62	.1248402E+01	.8806748E-01	.7784616E-01	.7988252E-01	-.4059080E-01	.1429046E+00
63	.1308102E+01	.2207530E+00	.9217984E-01	.9845967E-01	-.5365037E-01	.1132194E+00
64	.1416982E+01	.5371297E+00	.1033608E+00	.8085560E-01	-.6900549E-01	.1026984E+00
65	.3606286E-02	-.7683642E+00	-.9766815E+00	-.2262752E+00	-.3704025E-01	.8855281E-01
66	.1404230E+00	-.2470004E+00	-.4715051E+00	-.1342194E+00	-.8896838E-01	.1538919E+00
67	.3716203E+00	.3035685E+00	.3541272E+00	-.4444678E-03	-.1535342E+00	.1572224E+00
68	.5051970E+00	.5764454E+00	.7251808E+00	.3564406E-01	-.1917888E+00	-.4505678E-01
69	.5950139E+00	.7186998E+00	.9229798E+00	.9593165E-01	-.1985769E+00	.1532510E+00
70	.8239293E+00	.1108222E+01	.1298753E+01	.1270756E+00	-.2134020E+00	.1501561E+00
71	-.9455440E+00	-.5323206E+00	-.2167081E+01	-.3074832E+00	-.1608239E+00	.2112129E+00
72	-.8486963E+00	.1352550E+00	-.1095576E+01	-.2418646E+00	-.2388871E+00	.1896120E+00
73	-.5678619E+00	.8017038E+00	.6335860E+00	-.1035285E+00	-.3275534E+00	.2059963E+00
74	-.3771071E+00	.1130098E+01	.1420742E+01	-.7722198E-01	-.3596903E+00	-.1420622E+00
75	-.3081481E+00	.1373284E+01	.1912052E+01	.2193799E-02	-.3796421E+00	.1882455E+00
76	-.8777663E-01	.1924636E+01	.2893556E+01	.3277338E-01	-.4625614E+00	.2315358E+00
77	-.1996478E+01	-.2014399E+00	-.3432694E+01	-.3927118E+00	-.3665876E+00	.1978314E+00
78	-.1957774E+01	.5778994E+00	-.1810435E+01	-.3195703E+00	-.4025368E+00	.2208889E+00
79	-.1646827E+01	.1336176E+01	.8008405E+00	-.2074940E+00	-.5182511E+00	.2302430E+00
80	-.1432103E+01	.1703839E+01	.2149492E+01	-.2716007E+00	-.6722777E+00	-.5505208E+00
81	-.1341248E+01	.1945606E+01	.2812111E+01	-.7548147E-01	-.4152948E+00	.2200442E+00
82	-.1115034E+01	.2395737E+01	.3896961E+01	-.6592127E-01	-.4143834E+00	.4017322E+00
83	-.3049942E+01	.2056003E+00	-.4544233E+01	-.4462778E+00	-.4537183E+00	.2532171E+00
84	-.3055272E+01	.1013040E+01	-.2533340E+01	-.3973157E+00	-.5494414E+00	.2381064E+00
85	-.2720360E+01	.1861490E+01	.7450669E+00	-.3291177E+00	-.5980660E+00	.2395362E+00
86	-.2500765E+01	.2245356E+01	.2268159E+01	-.4704940E+00	-.8070111E+00	-.1372389E+01
87	-.2390936E+01	.2457566E+01	.3040851E+01	-.1517410E+00	-.5425024E+00	.2351263E+00
88	-.2129708E+01	.2817209E+01	.4280850E+01	-.9827406E-01	-.5396739E+00	.3987478E+00
89	-.3758853E+01	.5143954E+00	-.5110917E+01	-.4070410E+00	-.6687642E+00	.2236921E+00
90	-.4001099E+01	.1395109E+01	-.3001932E+01	-.4015592E+00	-.6502717E+00	.2175294E+00
91	-.3931515E+01	.2399963E+01	.3068403E+00	-.3837855E+00	-.6738135E+00	.2209761E+00
92	-.3856378E+01	.2805899E+01	.1678344E+01	-.3868646E+00	-.6833910E+00	.2258723E+00
93	-.3745921E+01	.2986886E+01	.2416531E+01	-.3933504E+00	-.6973961E+00	.2291058E+00
94	-.3451250E+01	.3265984E+01	.3812070E+01	-.4086656E+00	-.6983745E+00	.2290535E+00
95	-.4539669E+01	.9285657E+00	-.5405934E+01	-.3557587E+00	-.7773048E+00	.2080932E+00
96	-.4766475E+01	.1725123E+01	-.3342045E+01	-.4045339E+00	-.6706716E+00	.2118662E+00
97	-.4697673E+01	.2705025E+01	-.1804404E+00	-.3998834E+00	-.6885435E+00	.2222479E+00
98	-.4638254E+01	.3092242E+01	.1126823E+01	-.3962874E+00	-.7040909E+00	.2224963E+00
99	-.4534630E+01	.3255891E+01	.1833628E+01	-.4034958E+00	-.7142227E+00	.2073274E+00
100	-.4257205E+01	.3517809E+01	.3161504E+01	-.4153889E+00	-.6991241E+00	.2173753E+00

ORIGINAL PAGE IS
OF POOR QUALITY



L-83-9881

Figure 1. DAST ARW-2 model mounted in wind tunnel.

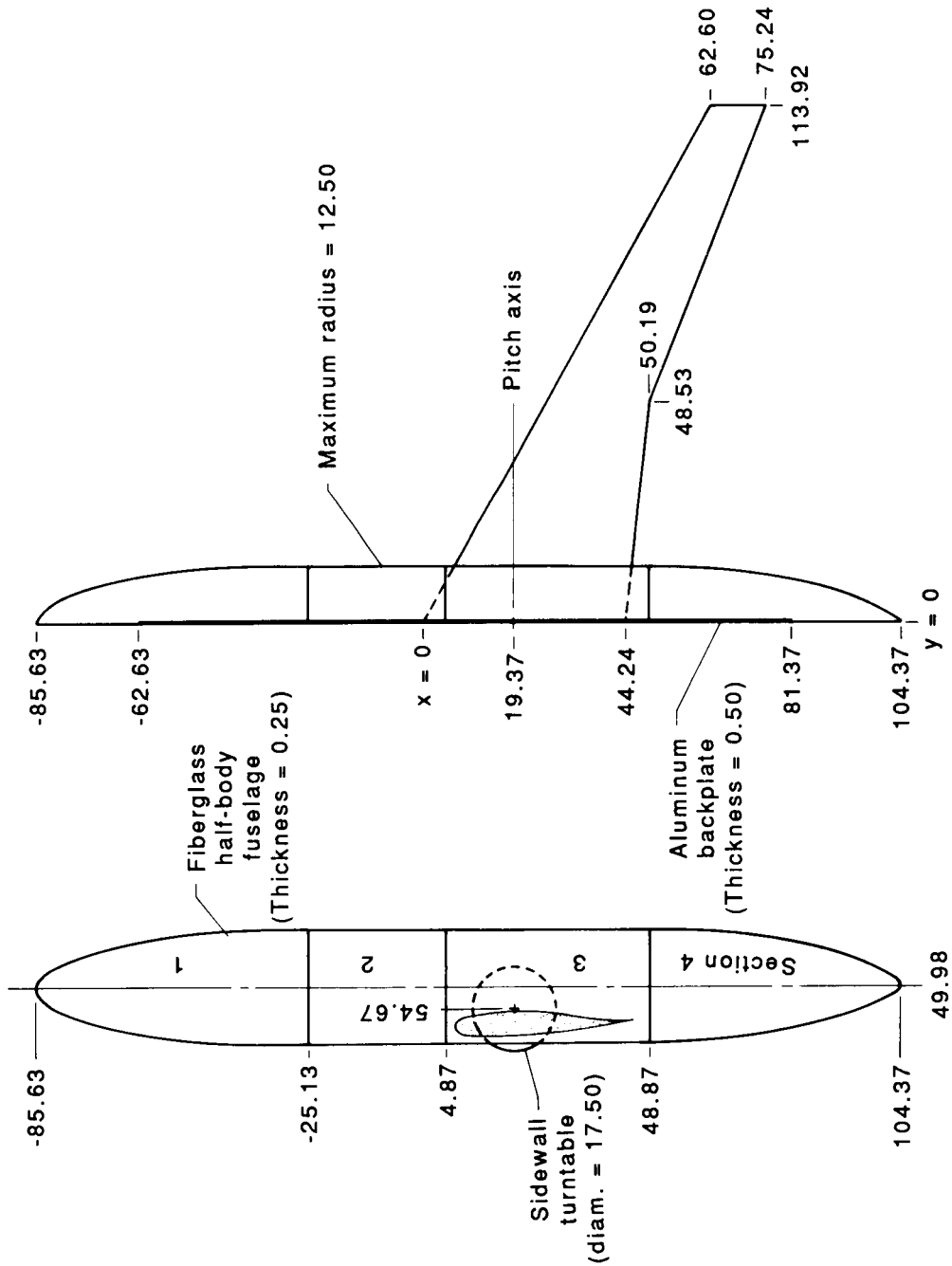

RIGHT SIDE VIEW TOP VIEW

Figure 2. Sketch of complete wind tunnel model. All dimensions are in inches.

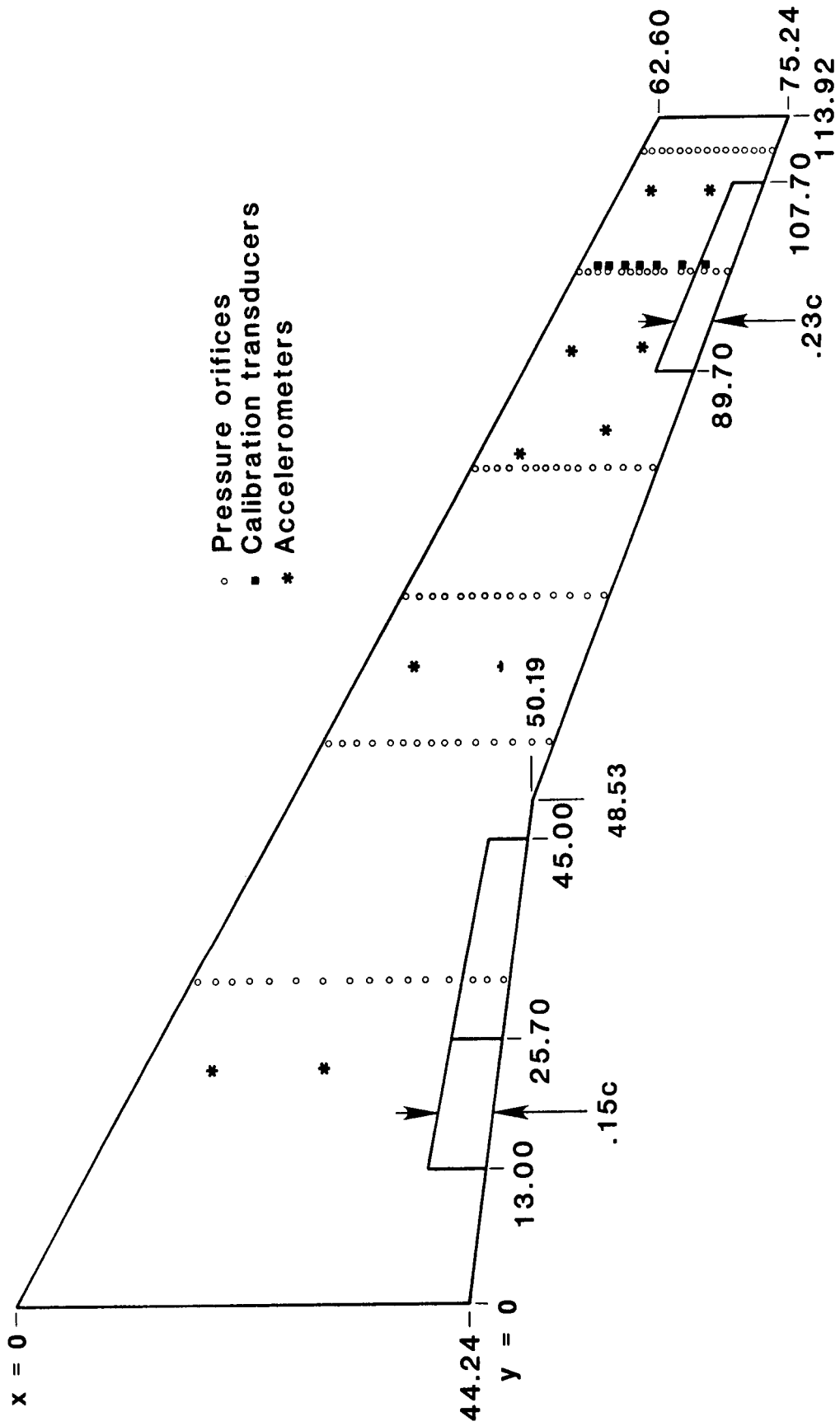
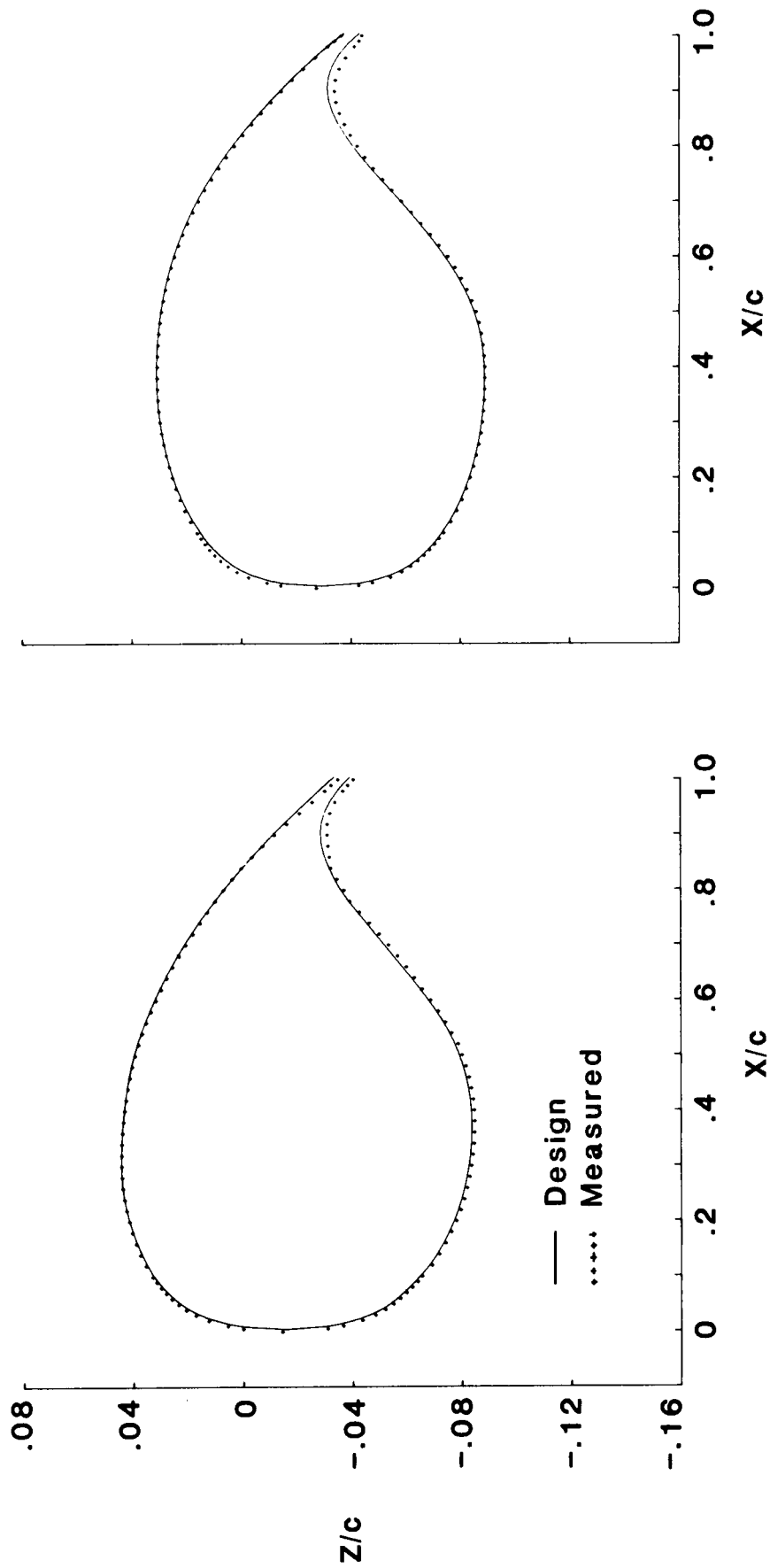

Figure 3. Sketch of wing planform. All dimensions are in inches.



(b) $y = 30.0$ in.; $c = 31.433$ in.

(a) $y = 20.0$ in.; $c = 35.702$ in.

Figure 4. Measured and design airfoil coordinates.

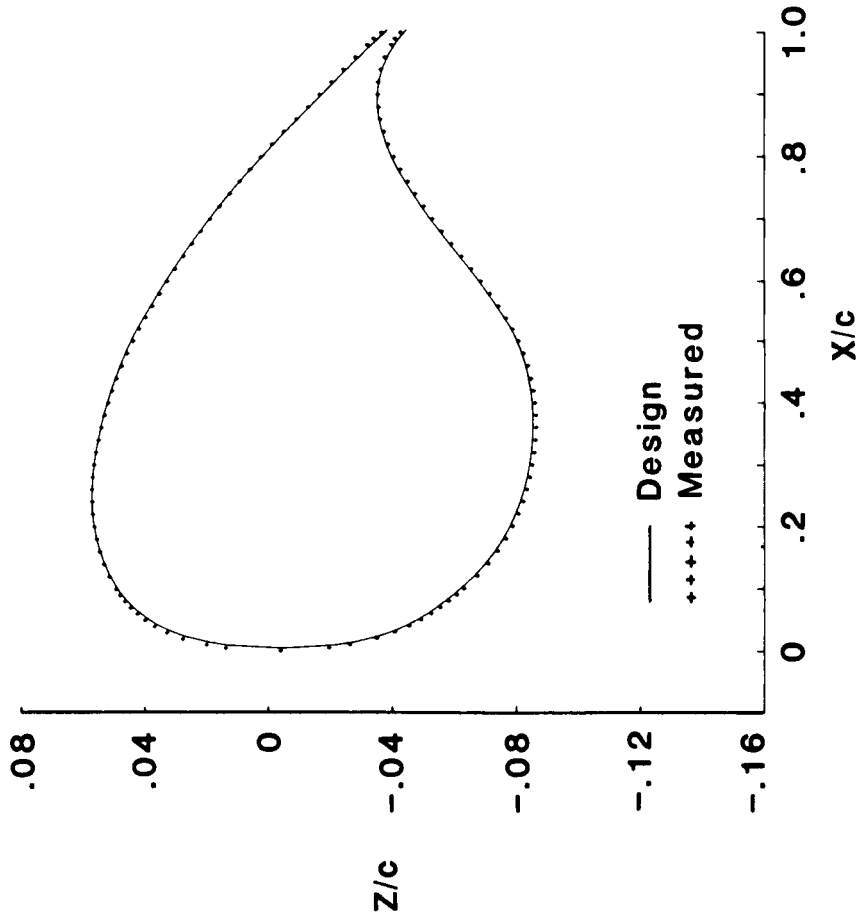

(c) $y = 40.0$ in.; $c = 27.164$ in.

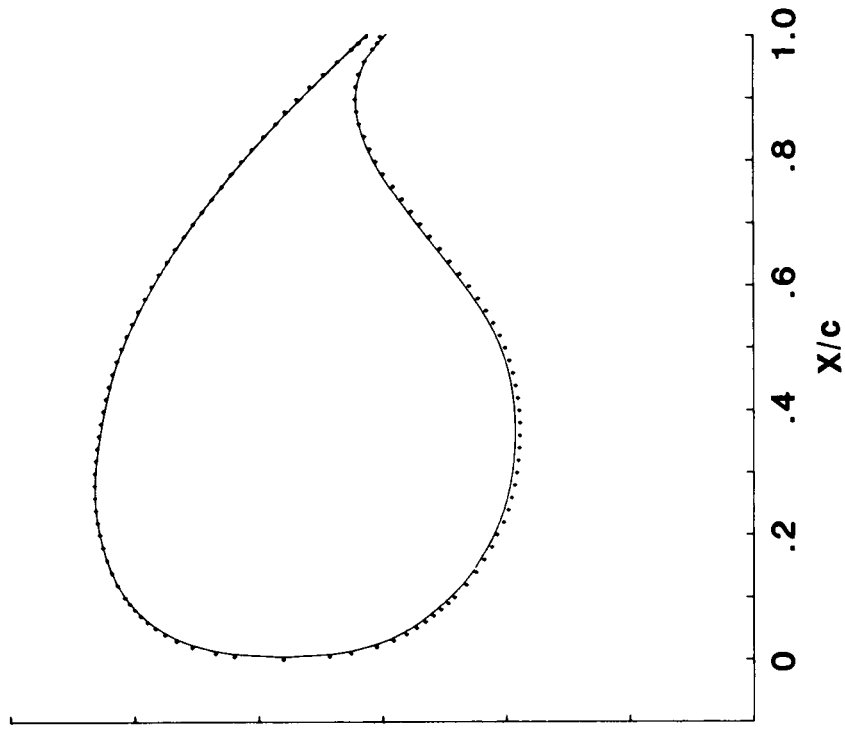

(d) $y = 50.0$ in.; $c = 23.278$ in.

Figure 4. Continued.

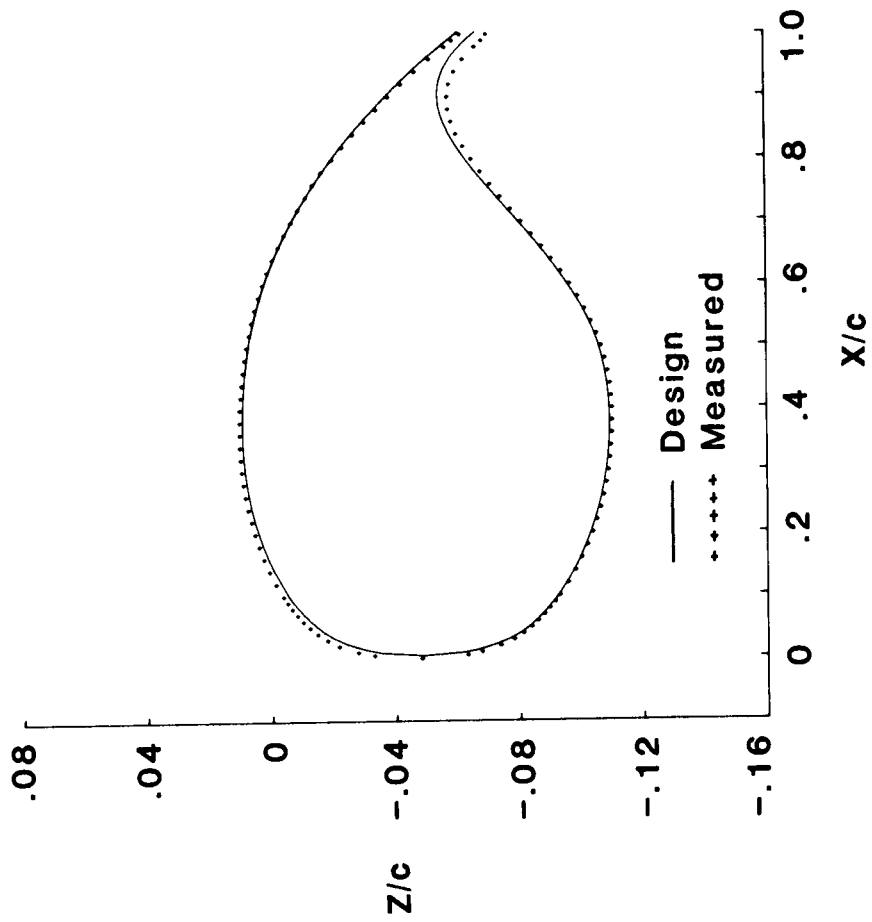

(e) $y = 60.0$ in.; $c = 21.614$ in.

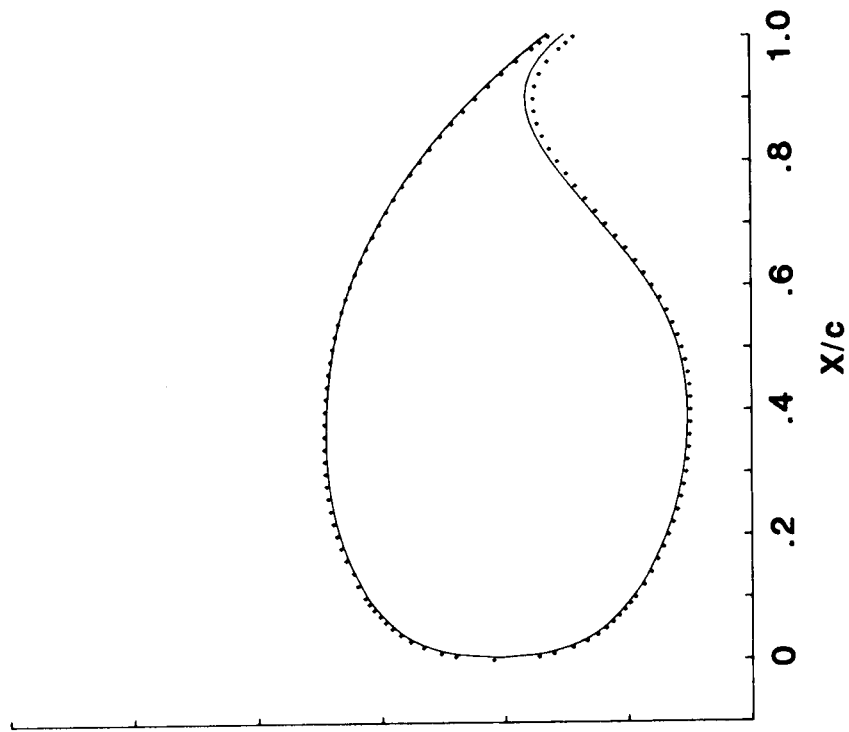

(f) $y = 70.0$ in.; $c = 19.950$ in.

Figure 4. Continued.

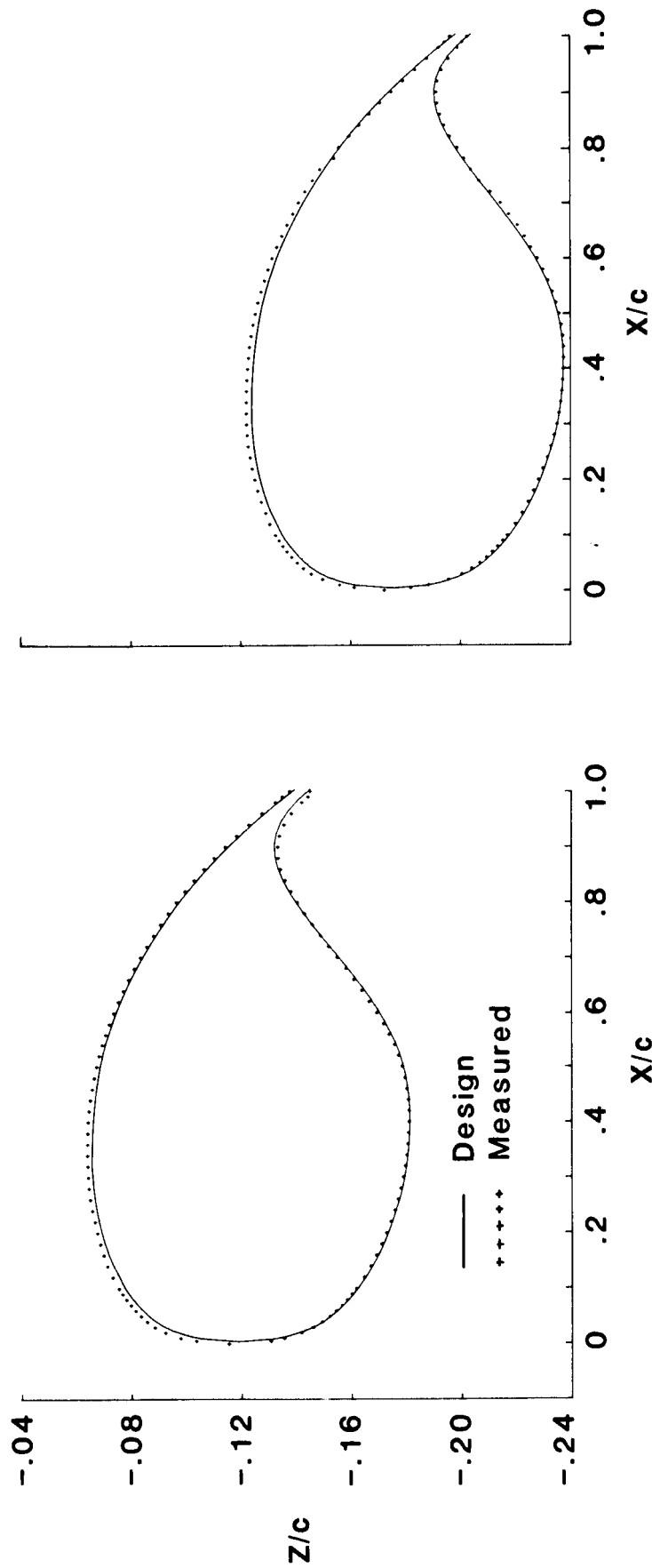

(h) $y = 90.0$ in.; $c = 16.621$ in.

(g) $y = 80.0$ in.; $c = 18.285$ in.

Figure 4. Continued.

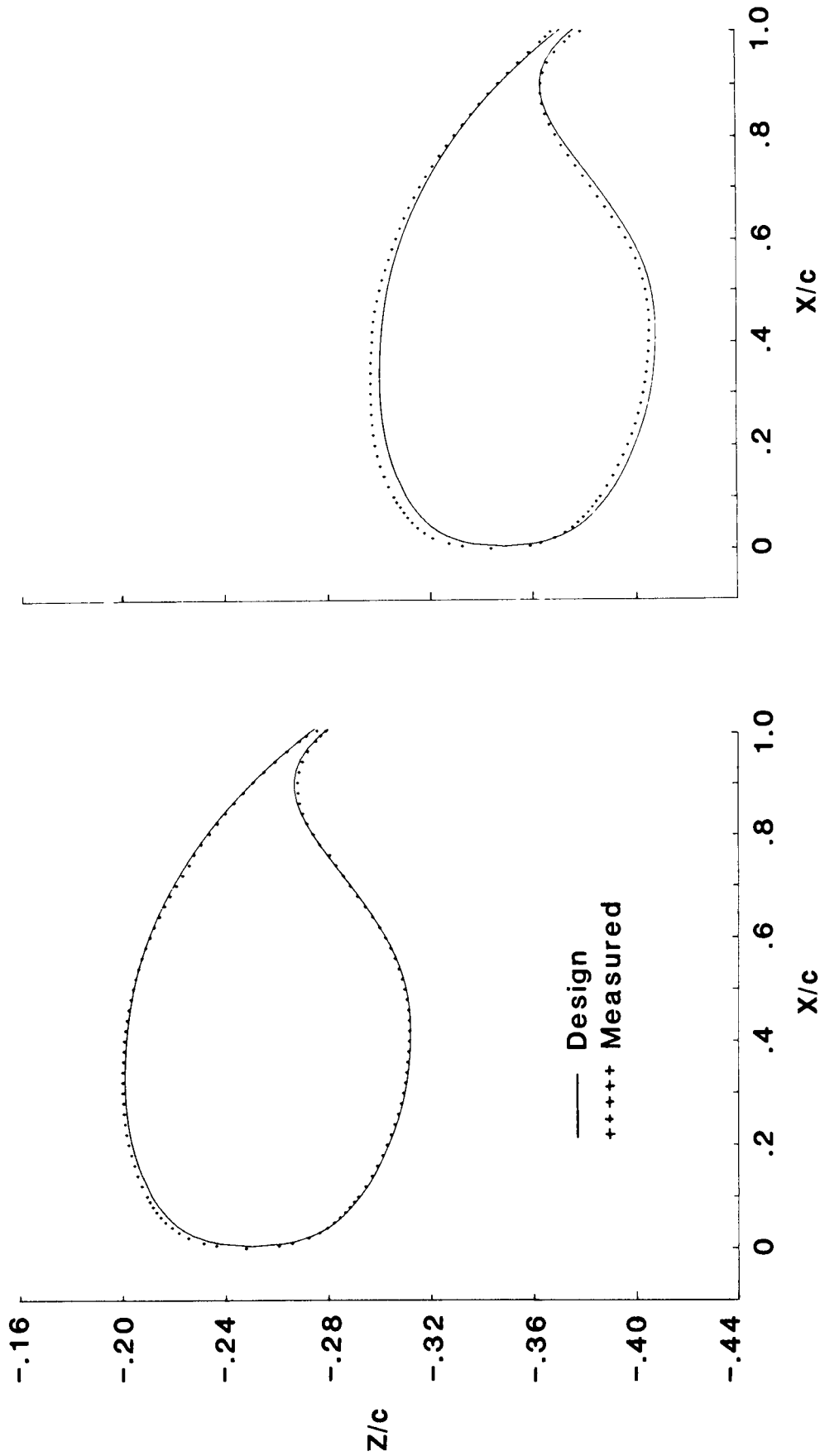

(j) $y = 110.0$ in.; $c = 13.292$ in.

(i) $y = 100.0$ in.; $c = 14.957$ in.

Figure 4. Concluded.

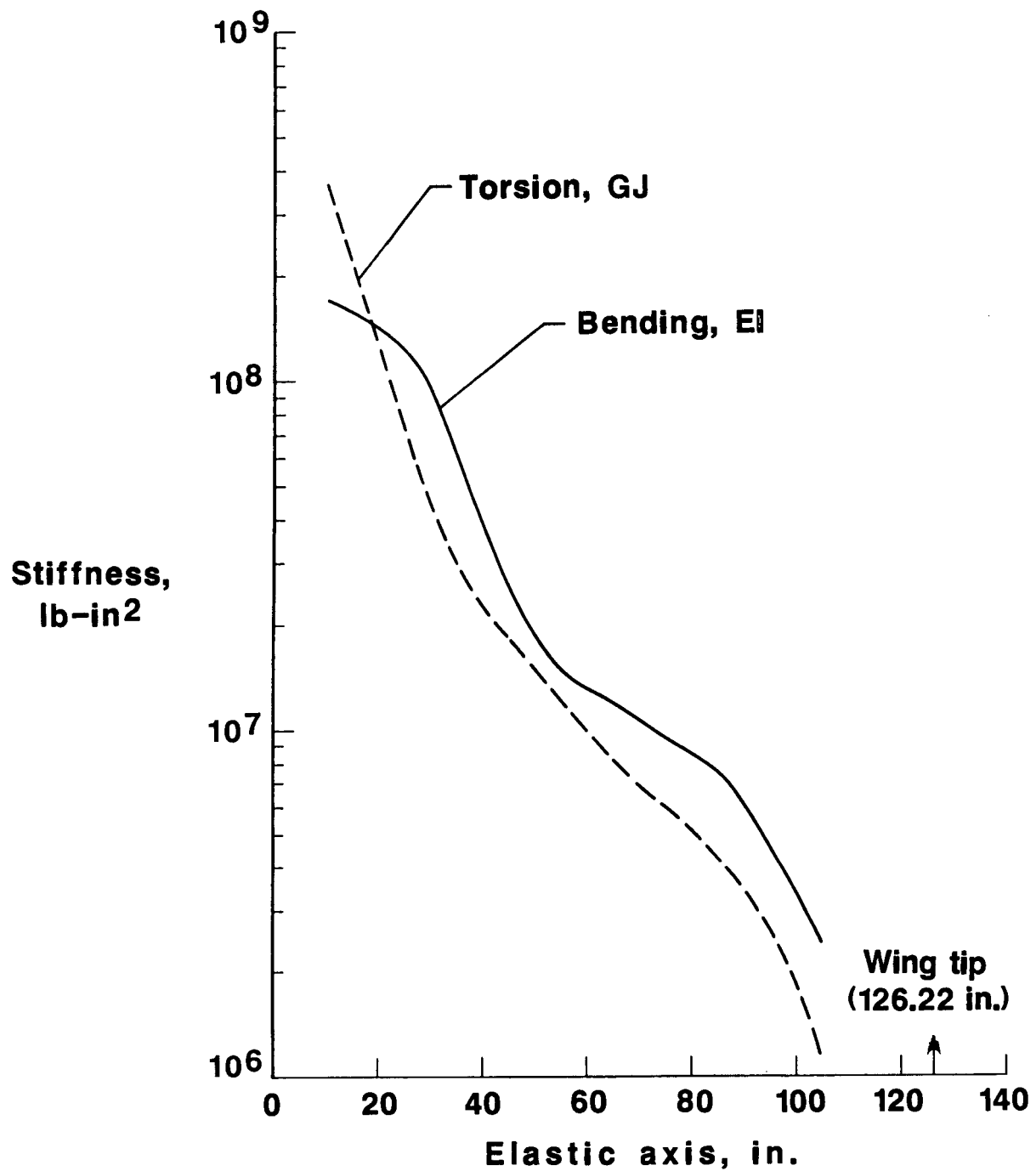
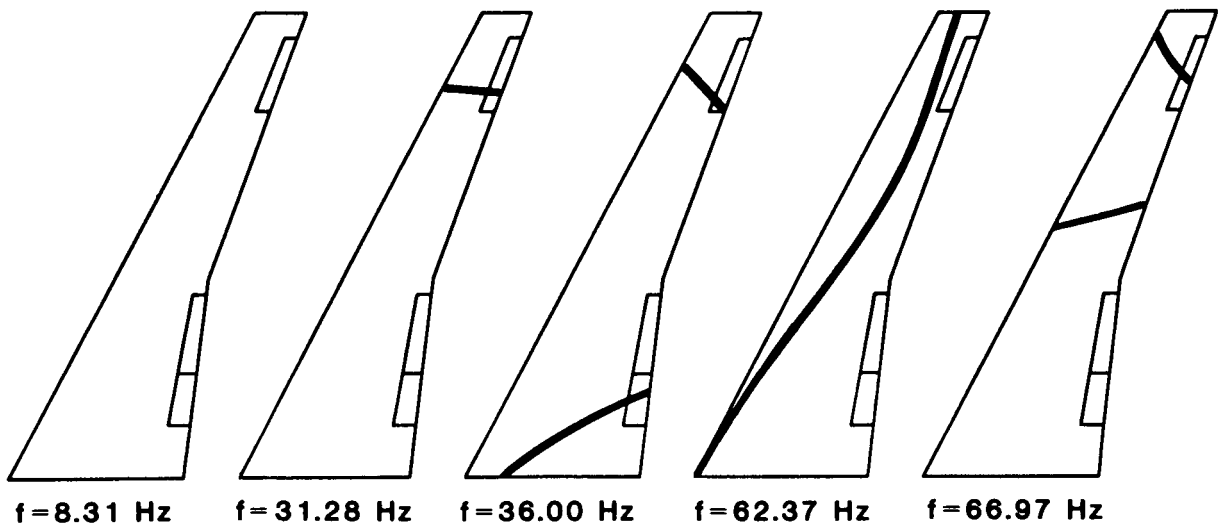
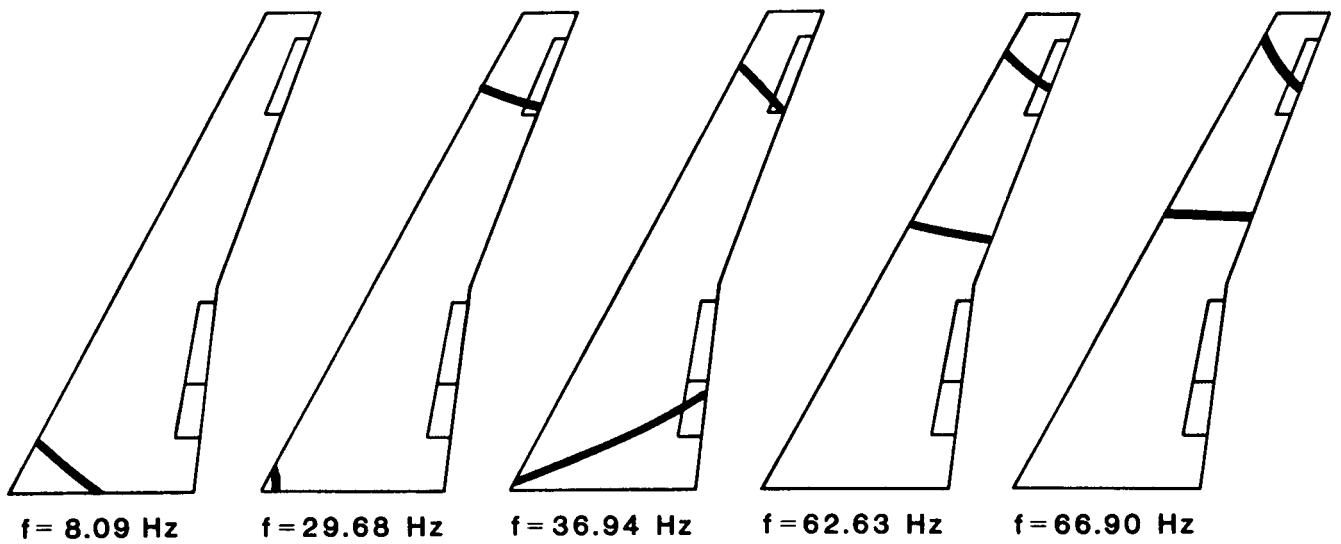

Figure 5. Measured wing stiffness characteristics.



(a) Wing mounted on rigid backstop in laboratory.



(b) Wing mounted on turntable in tunnel.

Figure 6. Measured wing frequencies and node lines.

ORIGINAL PAGE IS
OF POOR QUALITY

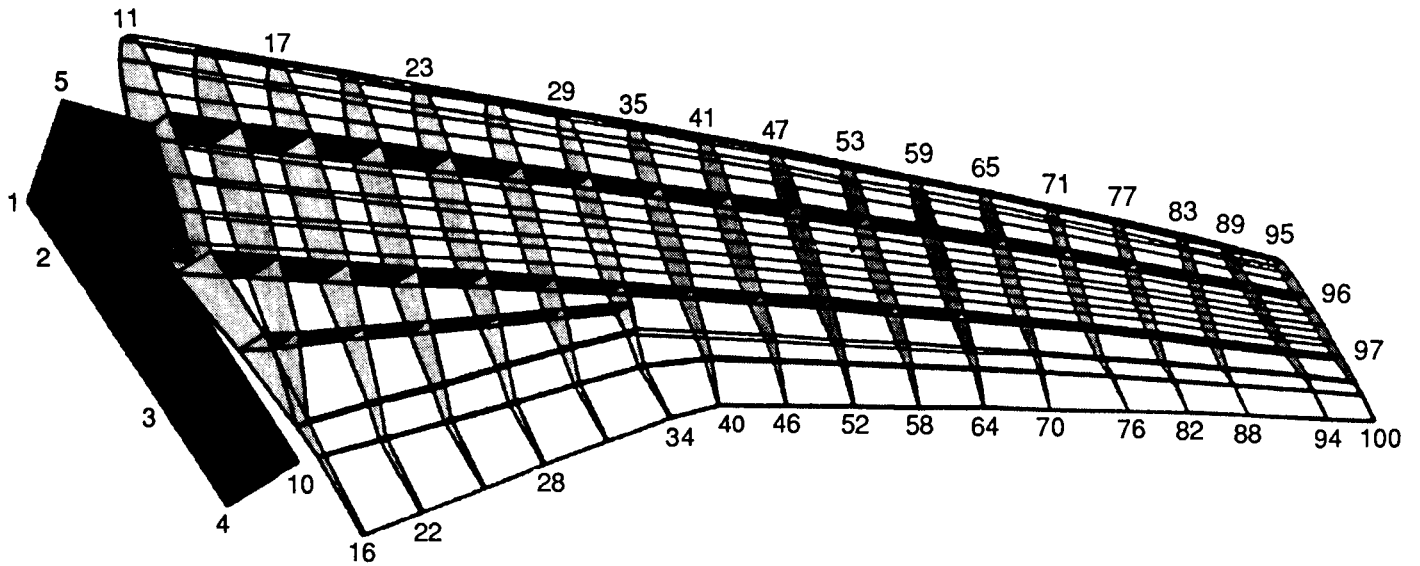

Figure 7. Sketch of finite-element model used in SPAR program. Shading used only to clarify viewing of figure. Numbers indicate joint locations given in table 5 and figure 8.

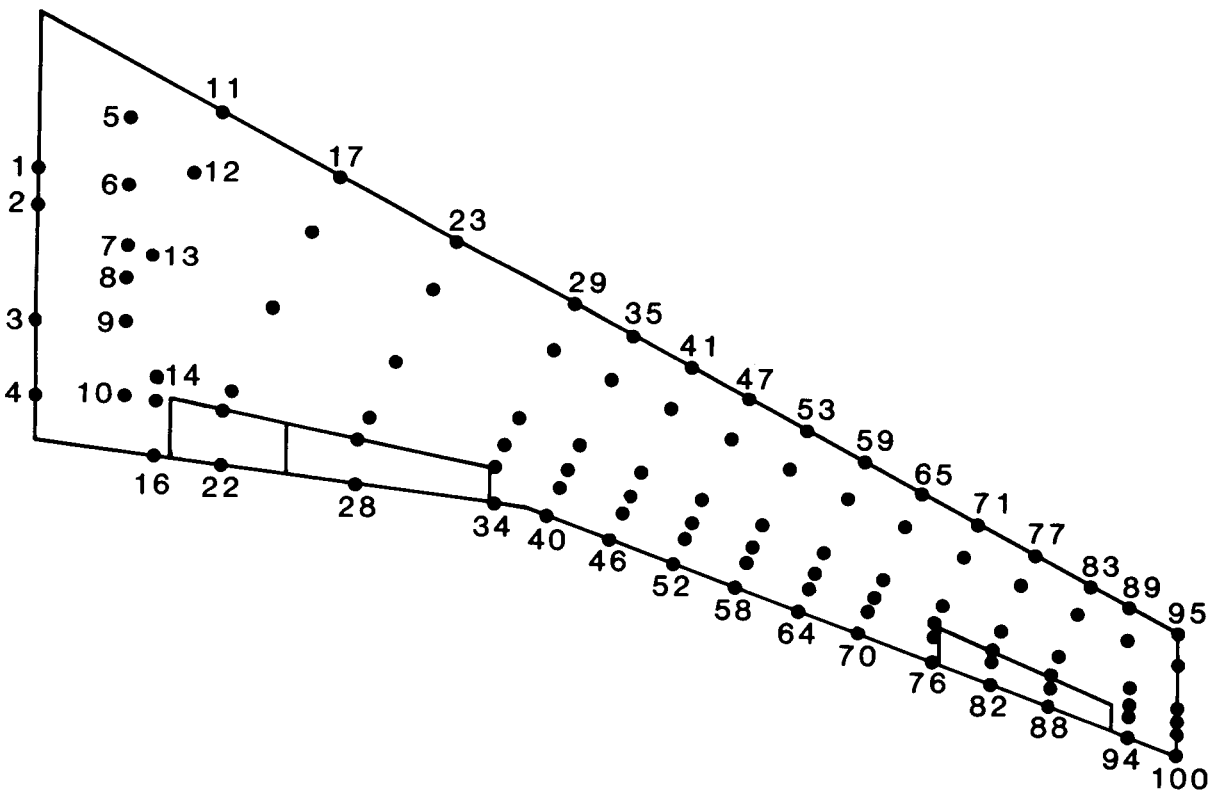

Figure 8. Finite-element joint locations where mode shape deflection data were obtained.

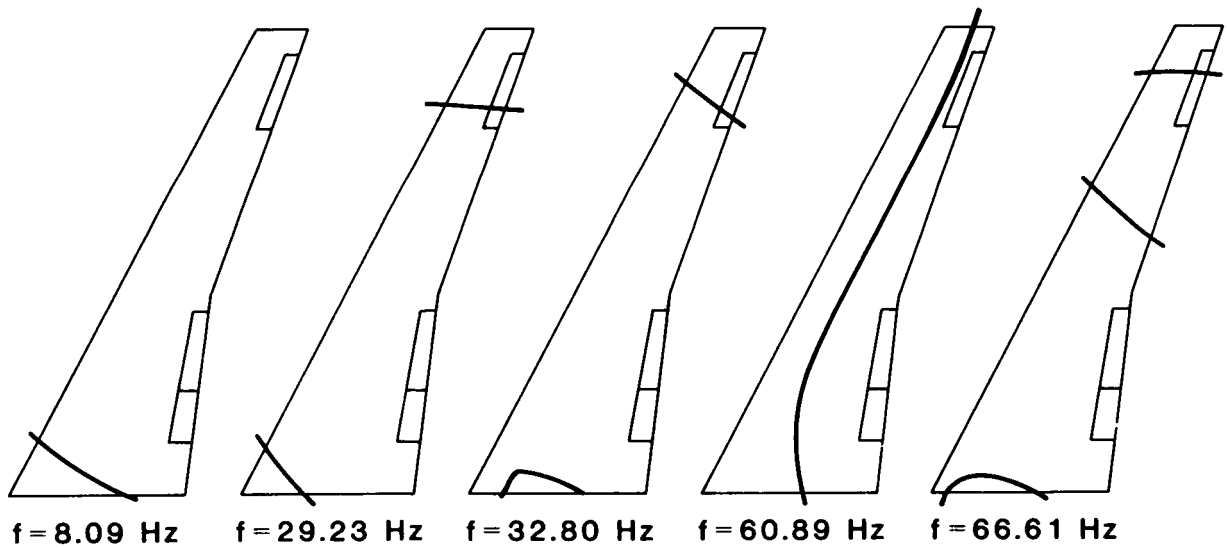

Figure 9. Calculated wing frequencies and node lines for SPAR analytical model with simulated turntable mounting.

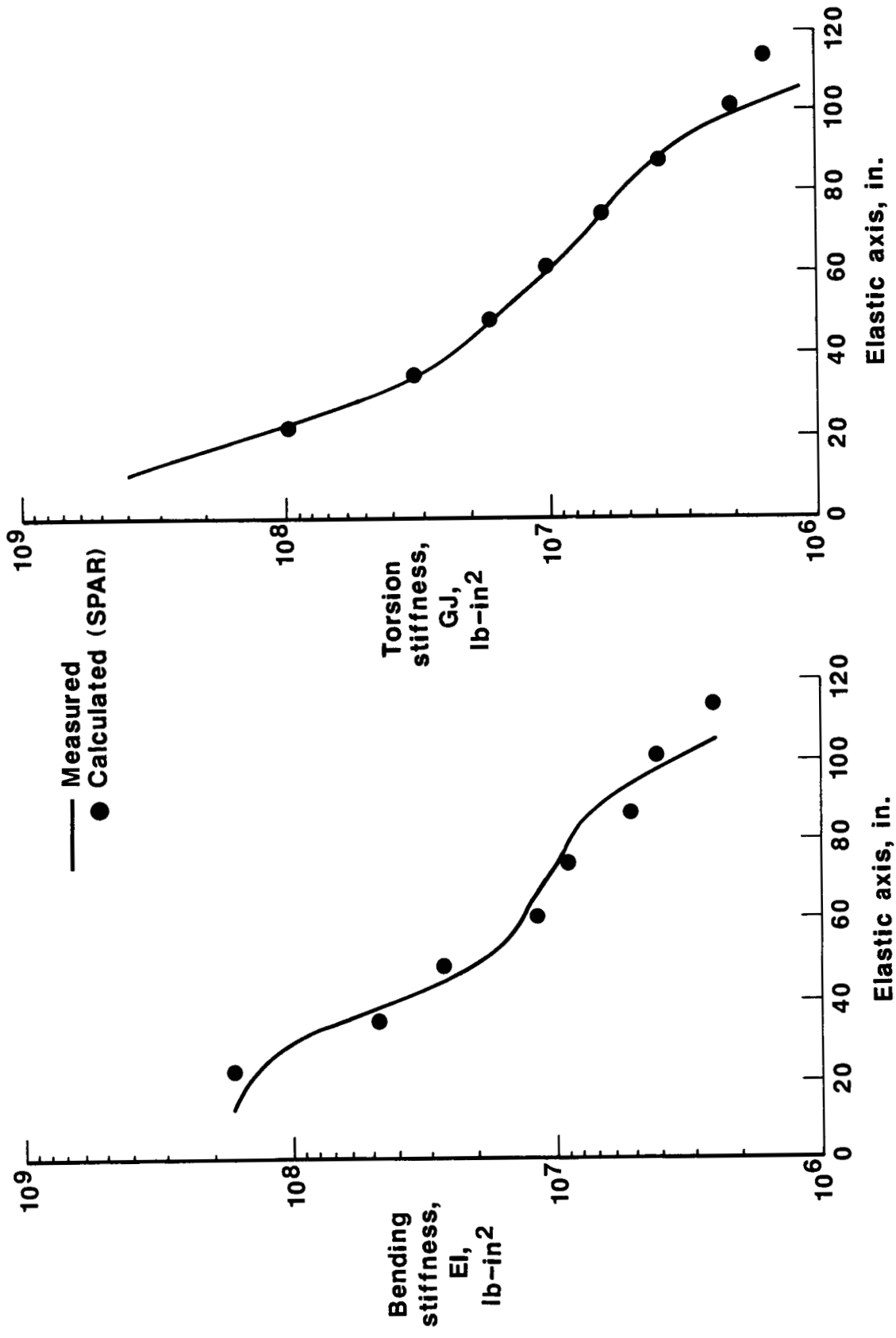

Figure 10. Measured and calculated stiffness distribution.



Report Documentation Page

1. Report No. NASA TM-4110		2. Government Accession No.		3. Recipient's Catalog No.	
4. Title and Subtitle Geometrical and Structural Properties of an Aeroelastic Research Wing (ARW-2)			5. Report Date April 1989		
			6. Performing Organization Code		
7. Author(s) Maynard C. Sandford, David A. Seidel, Clinton V. Eckstrom, and Charles V. Spain			8. Performing Organization Report No. L-16545		
9. Performing Organization Name and Address NASA Langley Research Center Hampton, VA 23665-5225			10. Work Unit No. 505-63-21-02		
			11. Contract or Grant No.		
12. Sponsoring Agency Name and Address National Aeronautics and Space Administration Washington, DC 20546-0001			13. Type of Report and Period Covered Technical Memorandum		
			14. Sponsoring Agency Code		
15. Supplementary Notes Maynard C. Sandford, David A. Seidel, and Clinton V. Eckstrom: Langley Research Center, Hampton, Virginia. Charles V. Spain: PRC Kentron, Inc., Aerospace Technologies Division, Hampton, Virginia.					
16. Abstract Transonic steady and unsteady pressure tests have been conducted on the right panel of a large elastic wing known as DAST ARW-2. The wing has a supercritical airfoil, an aspect ratio of 10.3, and a leading-edge sweepback angle of 28.8° and is equipped with two inboard and one outboard trailing-edge control surfaces. This report presents the geometrical and structural characteristics of this elastic wing, in terms of a combination of measured and calculated data, to permit future analysts to compare the experimental surface pressure data with theoretical predictions.					
17. Key Words (Suggested by Authors(s)) Elastic wing Structural modelling Transonic flow Supercritical airfoil			18. Distribution Statement Unclassified—Unlimited Subject Category 02		
19. Security Classif. (of this report) Unclassified		20. Security Classif. (of this page) Unclassified		21. No. of Pages 38	22. Price A03