

# NASA Technical Memorandum 101632

## Some Effects of Aerodynamic Spoilers on Wing Flutter

Robert V. Doggett, Jr.

July 1989

(NASA-TM-101632) SOME EFFECTS OF  
AERODYNAMIC SPOILERS ON WING FLUTTER (NASA.  
Langley Research Center) 18 p CSCL 01A

N89-29324

Unclas  
H1/02 0233941



National Aeronautics and  
Space Administration

Langley Research Center  
Hampton, Virginia 23665-5225

# **SOME EFFECTS OF AERODYNAMIC SPOILERS ON WING FLUTTER**

By

Robert V. Doggett, Jr.

## **SUMMARY**

The effects of deployment angle and size of symmetrically mounted upper-surface and lower-surface spoilers on the flutter characteristics of a simple, paddle-like, low-aspect-ratio, rectangular wing model that was tested at Mach number 0.80 in the Langley Transonic Dynamics Tunnel are presented. The results show that the flutter dynamic pressure is increased by increasing either spoiler deployment angle or spoiler size. For the configurations studied spoiler size was more effective than deployment angle in increasing the flutter dynamic pressure.

## **INTRODUCTION**

There are a number of means that have been developed over the years for use in flutter research and development wind-tunnel tests to minimize the risk of structural damage to models. These means include subcritical response techniques wherein vibration response measurements are made at conditions below the flutter boundary and are then used to extrapolate to flutter conditions, mechanical devices that grasp the structure when flutter is encountered to prevent excessive vibrations, and methods for decelerating the wind-tunnel flow so that the flow conditions are changed quickly when flutter is encountered. Although all of these methods are effective in certain situations, no single means has been developed that works effectively in all cases. For a given situation there are advantages and disadvantages to each of the available methods. Consequently, there is a need for additional methods.

Because the flutter instability is produced by an unfavorable coupling of unsteady aerodynamic forces with structural inertia and stiffness forces to produce an oscillatory vibration, the dynamic pressure at which flutter occurs can be increased if this unfavorable coupling can be modified. The present study was undertaken to determine if aerodynamic

spoilers could be used to change this coupling in a favorable way to increase the flutter dynamic pressure. If effective, spoilers would be particularly attractive for wind-tunnel flutter-model applications where it is usually desirable to test the model to conditions very close to, or in many instances to, the flutter boundary because it is necessary to accurately define the flow conditions at which flutter occurs. Because the spoiler could be deployed rapidly, the violent increase in vibration amplitude that usually occurs at flutter might be prevented.

An examination of the literature, both a computerized search for recent publications and a manual search of the card catalogues at the NASA Langley Research Center library for older publications, showed that spoilers, speed brakes and other devices that are extended from an airplane wing to alter aerodynamic characteristics have been used effectively in many stability and control applications in aeronautics, but that they have not been used as a flutter stopper or suppressor. There has been, however, some research into the unsteady aerodynamic characteristics of spoilers (ref. 1) for their possible use in active control systems for controlling aeroelastic response. As an initial step in evaluating the effectiveness of spoilers in increasing flutter dynamic pressure, the present study was undertaken to determine the effects of spoiler size and deployment angle on wing flutter for a simple spoiler arrangement. A relatively simple, rectangular-planform, paddle-type flutter model was equipped with upper-surface and lower-surface-mounted "flutter spoilers" that could be deployed over a range of angles by adjusting a mechanical mechanism. Three different size spoilers were provided. The spoiler-equipped model was flutter tested in the NASA Langley Research Center Transonic Dynamic Tunnel at Mach number 0.80, a transonic condition that is of interest in many flutter studies, to determine the effects of spoiler deployment angle and size on wing flutter.

## SYMBOLS

$A_s$	planform area of spoiler
$A_w$	planform area of wing
$f_f$	flutter frequency
$f_{h1}$	natural frequency of first bending mode
$f_{h2}$	natural frequency of second bending mode
$f_{fa}$	natural frequency of first fore-and-aft mode

$f_{\alpha}$	natural frequency of first torsion mode
$q$	dynamic pressure, $1/2 \rho V^2$
$q_{ref}$	reference dynamic pressure
$V$	velocity
$M$	Mach number
$\rho$	fluid density
$\delta$	deployment angle of spoiler

## APPARATUS AND PROCEDURE

### Wind Tunnel

The wind-tunnel tests were conducted in the Langley Transonic Dynamics Tunnel. This wind tunnel is used almost exclusively for aeroelastic testing. It is of the single return type, and is powered by a motor driven fan. Its speed and stagnation pressure are continuously controllable over a range of Mach numbers from near zero to 1.2 and a range of pressures from near vacuum to about one atmosphere. Either air or a heavy gas (R-12) can be used as the test medium. Only R-12 gas was used for the present study.

### Model

Wing geometry and construction.- The model wing used in the present study was similar to the one described by Cole in reference 2. The wing planform and construction details are shown in figure 1. This model was in effect a "rigid" rectangular wing that was attached to a flexible support shaft centered at 30-percent of the root chord. The wing portion of the model was a 0.25-inch-thick aluminum alloy plate that was covered with balsa wood to provide a NACA 64A010 airfoil section. Some lightening holes were drilled in the aluminum alloy plate aft of about the 60-percent chord section. The flexible support shaft consisted of an extension of the plate to form a "panhandle." Aluminum alloy doublers were riveted to both sides of the panhandle to produce the desired total stiffness of the panhandle. The panhandle was instrumented with two four-arm resistance-wire strain-gage bridges. One bridge was orientated to be primarily sensitive to bending strains; the other bridge was orientated to be primarily sensitive to torsional strains.

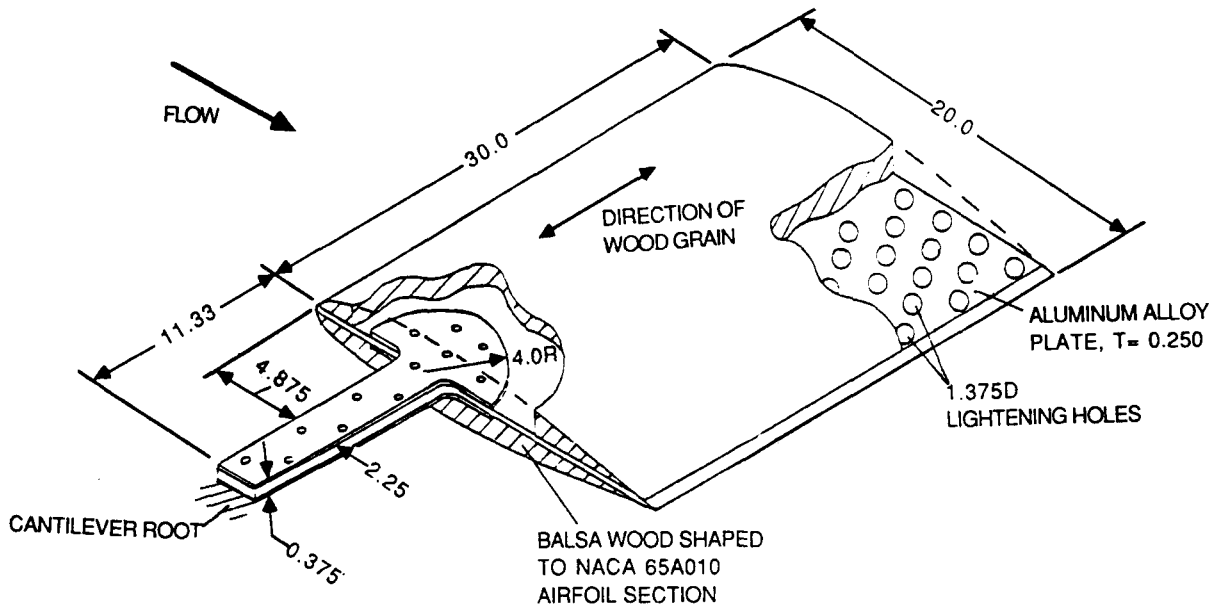

Figure 1. - Sketch showing wing geometry and construction details. Dimension are in inches.

Spoiler geometry and construction.- For the present study the wing was modified to provide a means for incorporating upper-surface and lower-surface mounted spoilers. These spoilers were 0.020-inch-thick-steel plates that were hinged along their leading edges to the aluminum core of the model wing. The leading edge of each spoiler was at the wing midchord. The spanwise centerline of the spoilers was at two-thirds of the wing span. Aluminum angles were installed on the underside of each spoiler for stiffening purposes. A prop rod which was bolted to the aluminum angle on the spoiler and to an aluminum angle attached to the aluminum core of the wing was used to fix the spoilers at preset angles. Index holes were drilled in the aluminum angles to facilitate adjusting the spoiler angle to 20, 30, 40, 50, and 60 degrees. The deployment angles of the upper-surface and lower-surface-mounted spoilers were always set to the same value. Some of the details of this arrangement can be seen in the photograph shown in figure 2 which is a view looking forward from behind the model. Three pairs of spoilers were provided. The geometry of these spoilers is shown in figure 3. The area of a single spoiler in each set of two was 4.7, 9.5, and 14.2 percent of the wing area, respectively.

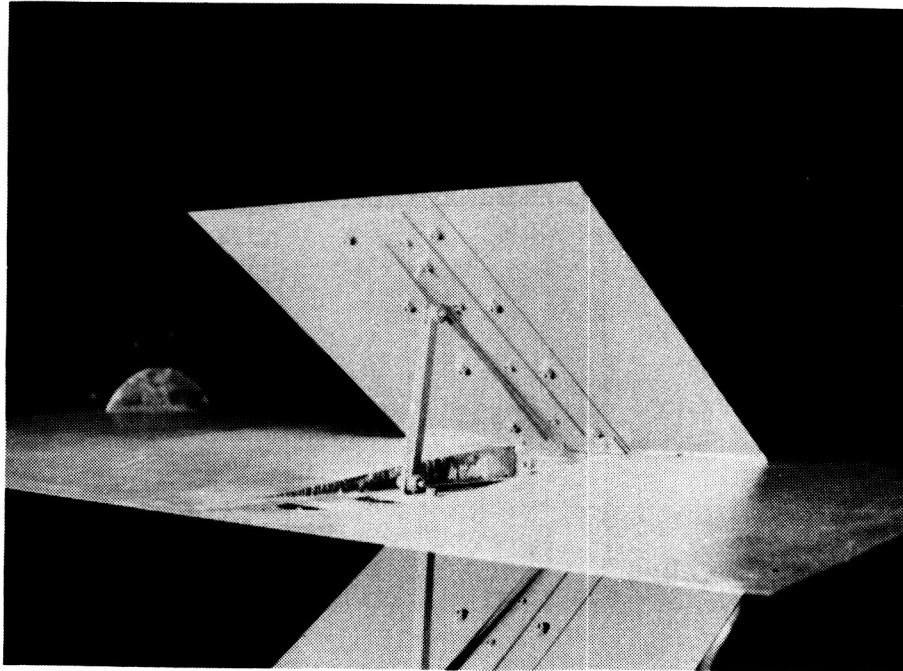

Figure 2. - Photograph showing spoiler construction and mounting arrangement.

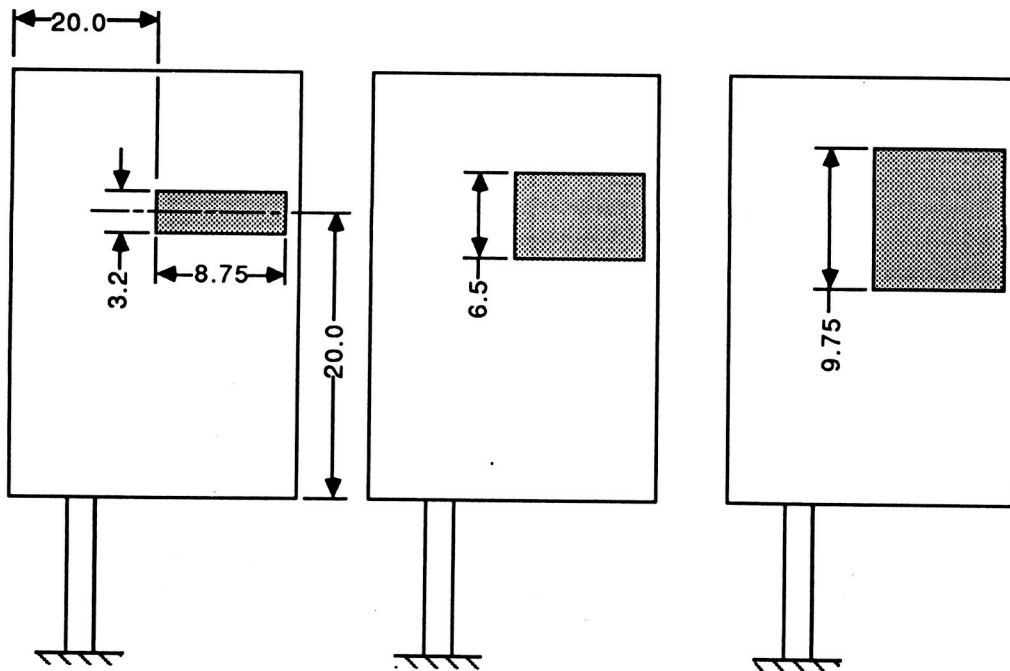
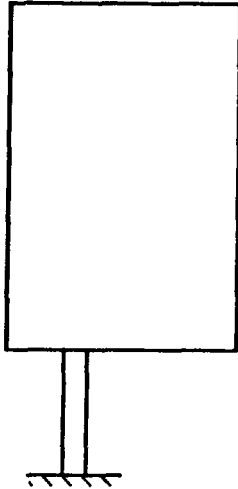

Figure 3. - Sketches of speed brake configurations.  
Dimensions are in inches.

Natural Frequencies, Hz

$A_S/A_W$	$f_h$	$f_\alpha$	$f_{fa}$	$f_{h2}$
0.047	2.9	12.9	16.7	24.8
.095	2.8	12.5	16.2	24.6
.142	2.7	12.3	16.0	24.2



**Mode 1, First bending.**  
(Flapping motion out of plane of paper. Node line at cantilever root.)

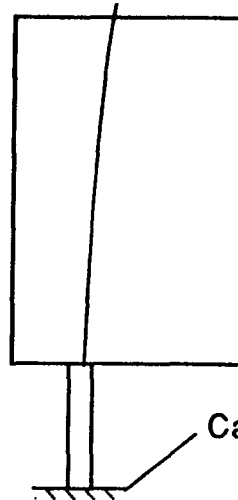

Cantilever root

**Mode 2, First torsion.**

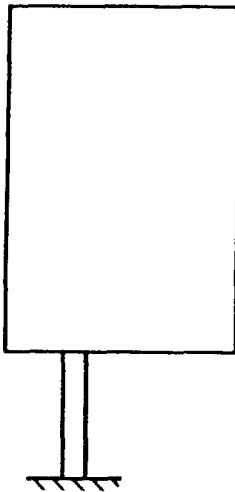

**Mode 3, First fore and aft.**  
(Motion in plane of paper. Node line at cantilever root.)

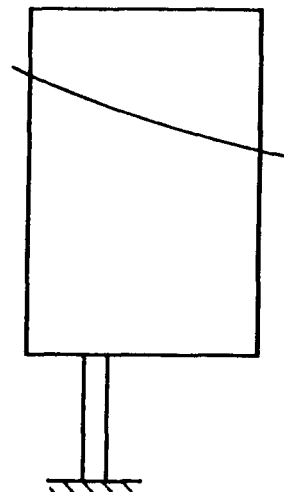

**Mode 4, Second bending**

Figure 4.- Natural frequencies and node lines.

Vibration characteristics.- Some measured natural frequencies and node lines are presented in figure 4 for the model configurations tested. The first mode was essentially a bending of the panhandle which produced a flapping mode of the wing. The second mode was primarily a twisting of the panhandle which produced a wing torsion mode that was essentially a rigid rotation of the wing about the center line of the panhandle. The third mode was primarily an in-plane bending of the panhandle. The fourth mode was a second bending mode with a node line outboard on the wing and "perpendicular" to the leading edge of the wing. The vibration characteristics are similar to those presented in reference 1 except that the present frequencies are lower because the addition of the spoilers increased the wing mass and pitching moment of inertia.

### Test Procedure

A photograph of one of the model configurations mounted in the wind tunnel is shown in figure 5. For testing the inboard end of the panhandle was cantilever mounted to a remotely controlled turntable that could be used to vary model angle of attack. A splitter plate that was attached to the wind-tunnel wall was mounted at the wing root. The panhandle passed through a circular hole in the splitter plate. The gap between the panhan-

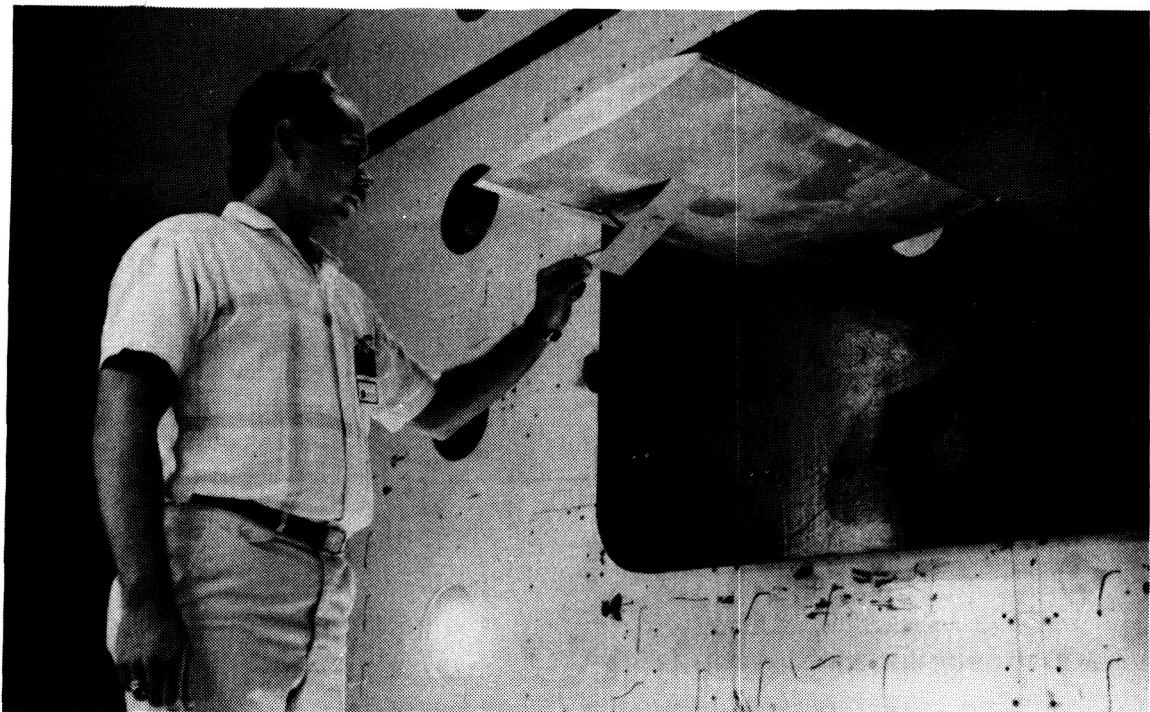

Figure 5. - Photograph of model mounted in wind tunnel.



dle and the splitter plate hole was shielded against flow through the splitter plate by a small disk attached to the panhandle. That portion of the panhandle between the inboard edge of the splitter plate and the wind-tunnel wall was shielded from the flow by using a fairing so that there were no aerodynamic forces on the panhandle. This mounting arrangement placed the model root about eleven inches off the wind-tunnel wall, well outside the wall boundary layer.

The present experiments were conducted at  $M=0.80$  only. The determination of a flutter point proceeded as follows. With the tunnel stagnation pressure set to a low value the fan rpm was increased until  $M=0.80$  flow was obtained. The Mach number was then held constant at  $M=0.80$  as the stagnation pressure was increased by gradually adding R-12 gas to the tunnel. While the pressure was being increased the model response was monitored and the angle of attack was adjusted so that the model lift was kept near zero. Mean values of the output signals from the strain gages (proportional to static load) were displayed and used to trim the model to zero lift. In addition, dynamic response time histories from the strain gages were displayed on a recording oscillograph and were continuously monitored. Further, the frequency response of the model was displayed as an autospectrum by using a spectrum analyzer so that the frequency content of the response could be determined as flutter was approached. When these observations indicated that a flutter condition had been reached, the wind-tunnel flow conditions were recorded after which the tunnel speed was reduced rapidly. The tunnel was then stopped, and the model checked for damage. No model damage was detected during the test. Next a configuration change made, for example, setting the spoiler deployment angle to a new value, and the process just described was repeated for the new configuration, and so on until all the configurations had been tested.

## RESULTS AND DISCUSSION

### Experimental Results

Deployment angle effects.- The flutter results obtained at  $M=0.80$  by varying spoiler deployment angle  $\delta$  for a constant ratio of spoiler area to total wing area ( $A_s/A_w=0.047$ ) are presented in figure 6. Flutter

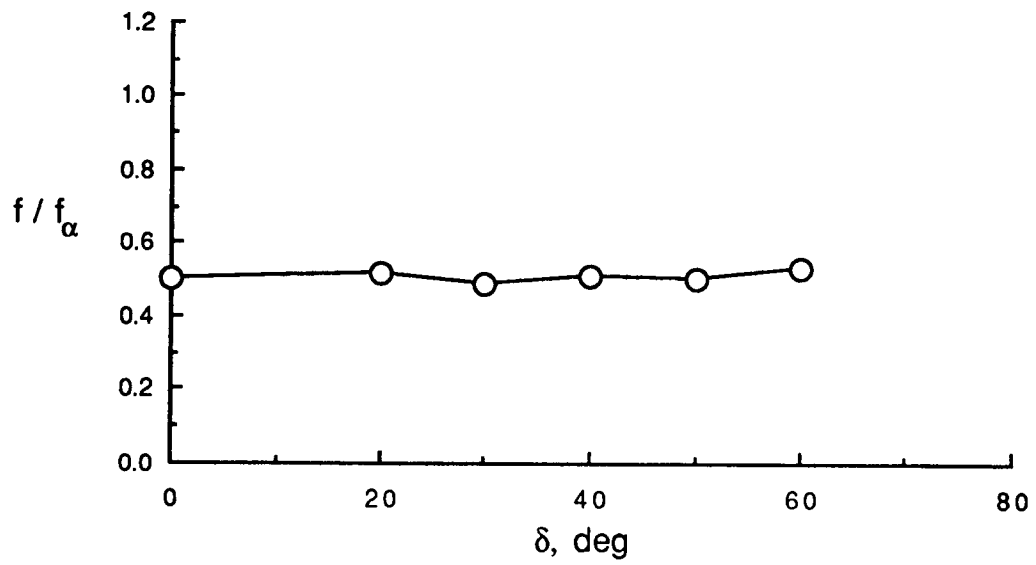

(a) Frequency results

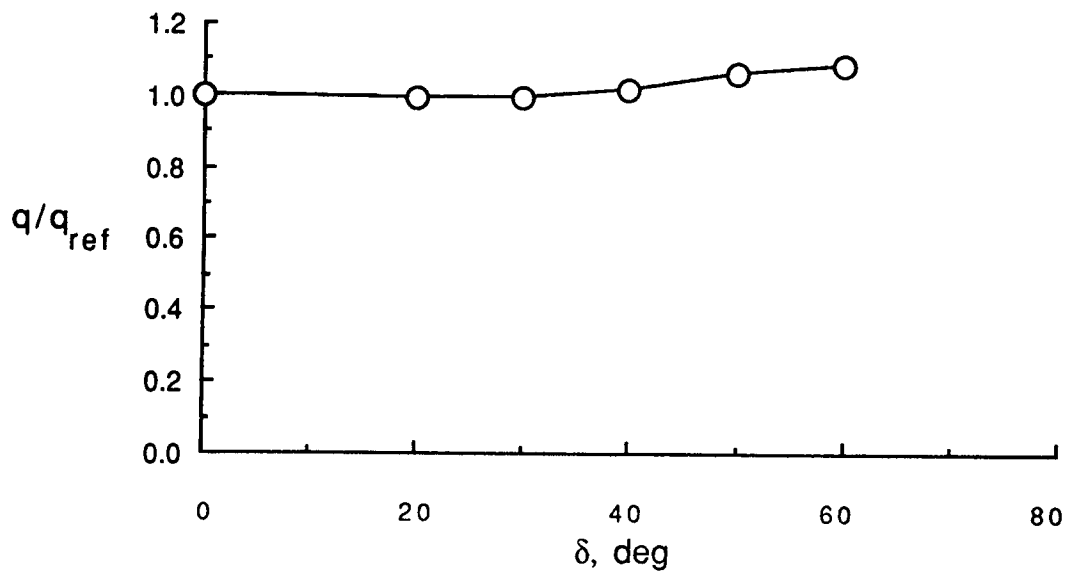

(b) Dynamic pressure results

Figure 6.- Spoiler deployment angle effects on flutter,  $A_S/A_W=0.047$ .

frequency results are presented at the top in the figure as the variation of the ratio of flutter frequency to first torsion frequency  $f_f/f_\alpha$  with  $\delta$ . Flutter dynamic pressure results are presented in the lower portion of the figure as the variation of the ratio of flutter dynamic pressure  $q$  to a reference dynamic pressure  $q_{ref}$  with  $\delta$ . The reference dynamic pressure value was 94.9 psf which was the flutter dynamic pressure of the wing with the spoiler not deployed,  $\delta=0^\circ$ . The frequency data show that the flutter frequency remained nearly constant at about 50 percent of the first torsion frequency. The autospectra data showed that the model responded primarily in the first bending and first torsion modes. The dynamic pressure data show that the flutter dynamic pressure increased as the deployment angle was increased. The observed increase in flutter  $q$  was not very large over the range of angles studied. The flutter  $q$  for the spoilers deployed at both 20 and 30 degrees was essentially the same as the value for the undeployed spoilers. The dynamic pressure increased by only about eight percent when the spoilers were deployed to 60 degrees. Although this deployment angle effect is small, changes of this magnitude would be effective in wind-tunnel flutter model applications as long as the change could be affected quickly.

Size effects.- The flutter results obtained at  $M=0.80$  by varying spoiler size for a constant value of deployment angle  $\delta=40^\circ$  are presented in figure 7. Flutter frequency results are presented at the top in the figure as the variation of  $f_f/f_\alpha$  with relative spoiler size ratio  $A_s/A_w$  which ranged from zero (no spoiler) to 0.142. Flutter dynamic pressure results are presented in the lower portion of the figure as the variation of  $q/q_{ref}$  with  $A_s/A_w$ . These frequency data also show that the flutter frequency remained constant at about 50 percent of the first torsion frequency, although there is a consistent decrease in flutter frequency ratio with increasing spoiler size. The autospectra showed that most of the response was in the first bending and first torsion modes. The dynamic pressure data show that the flutter  $q$  increases with increasing spoiler size. The largest spoilers had the effect of increasing the flutter dynamic pressure by about 15 percent.

#### Experiment and Analysis Correlation

Although a non-linear unsteady aerodynamic theory would be required to accurately calculate the effects of either spoiler deployment

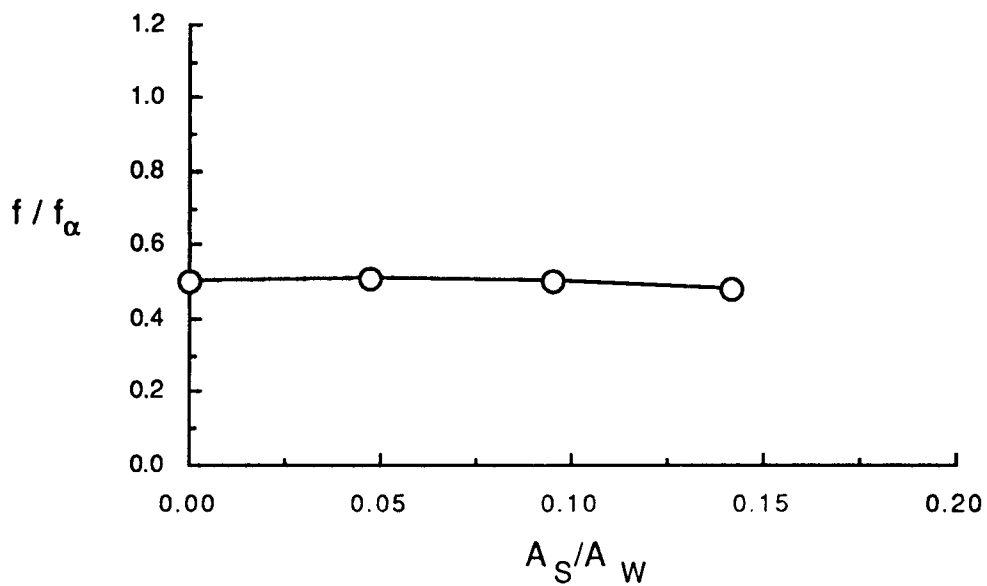

(a) Frequency results

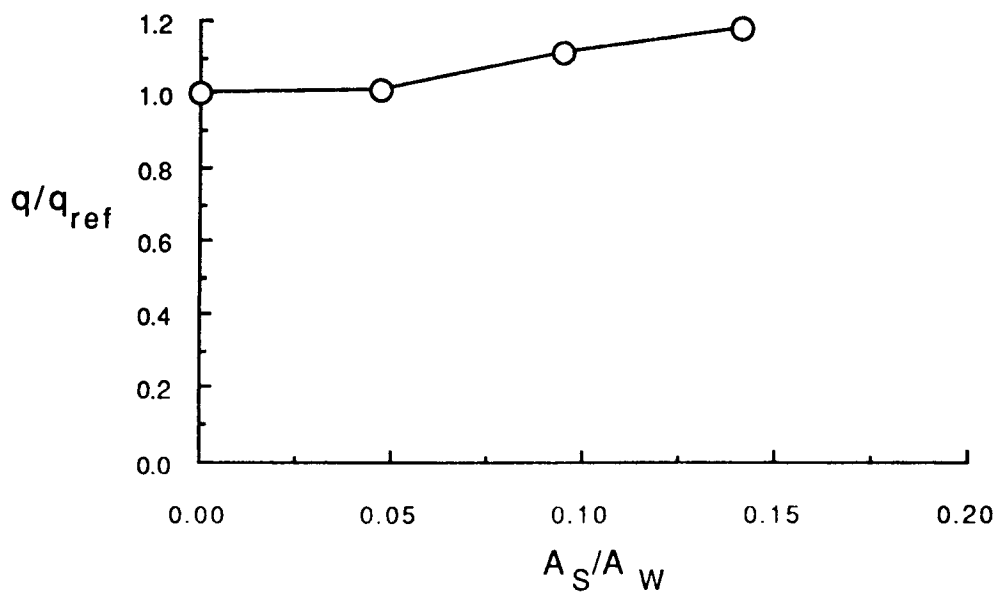

(b) Dynamic pressure results

Figure 7.- Spoiler size effects on flutter,  $\delta=40^\circ$ .

angle or size on wing flutter characteristics,<sup>1</sup> it does seem reasonable, however, that it may be possible to develop a correction factor that, when used as a multiplier on the flutter dynamic pressure obtained by using linear unsteady aerodynamic theory for the wing without spoilers, would yield a reasonable estimate of the flutter dynamic pressure of the wing with spoilers. A correction factor of the form

$$[ 1.0 + f(\text{area}) g(\delta) ]$$

is suggested where  $f(\text{area})$  is a function of spoiler size and  $g(\delta)$  is a function of spoiler deployment angle. For application in this study twice the ratio  $A_s/A_w$  was chosen for  $f(\text{area})$  and the function  $\sin(\delta)$  was chosen for  $g(\delta)$ . Thus the factor becomes

$$[ 1.0 + 2.0 (A_s/A_w) \sin(\delta) ].$$

A few comments concerning the rationale in selecting the form of the factor and the expressions for the specific functions are in order. Obviously the factor should be a function of both spoiler size and deployment angle, an increase in either reducing the unsteady aerodynamic forces and/or unfavorable coupling with an increase in flutter dynamic pressure resulting. It seems very reasonable that the factor should vary linearly with spoiler size, at least to a first order, thus suggesting twice the area ratio for  $f(\text{area})$ -twice the area ratio because there were both upper-surface and lower-surface-mounted spoilers. Finally, it can be argued that the effect of deployment angle is most likely a non-linear one. For small deployment angles a more or less linear effect might be expected, but it appears that once the deflection angle becomes large the flow becomes "totally spoiled," so to speak, and further increases in deployment angle would have little effect, thus suggesting the choice of  $\sin(\delta)$  for  $g(\delta)$ .

Presented in figure 8 are some comparisons between measured flutter dynamic pressures and calculated flutter dynamic pressures obtained

---

<sup>1</sup> The linear doublet-lattice unsteady aerodynamic theory could be used in symmetric applications (both upper-surface and lower-surface-mounted spoilers) to represent spoiler size effects by modeling the spoilers as a hole in the wing.

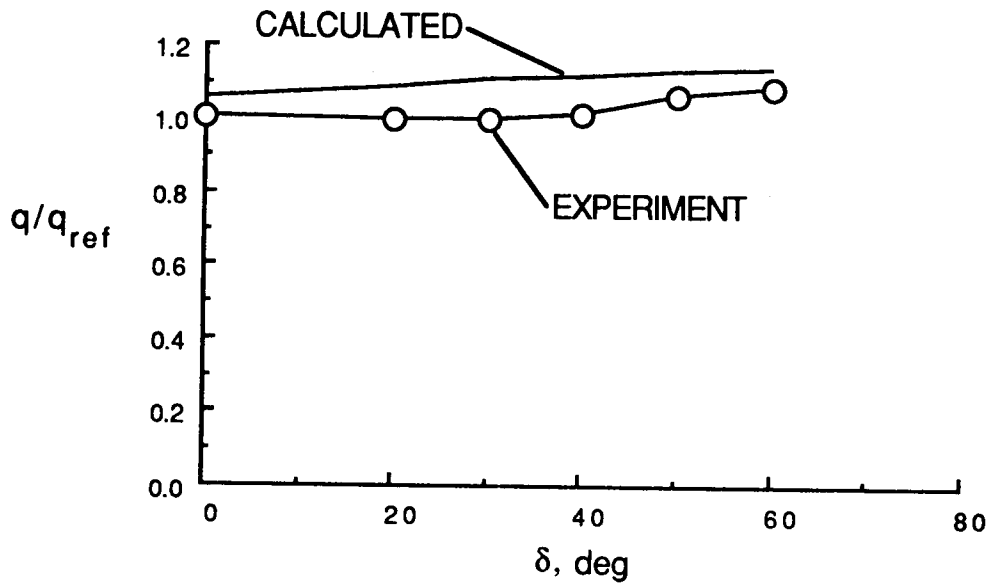

(a) Deployment angle effects

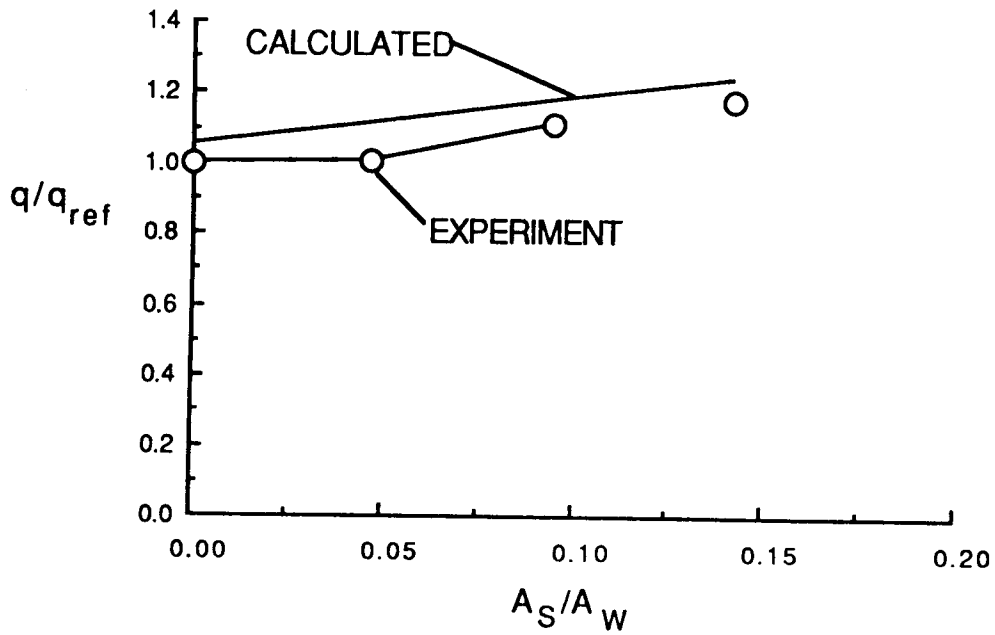

(b) Area effects

Figure 8.- Comparison of experimental and calculated flutter results.

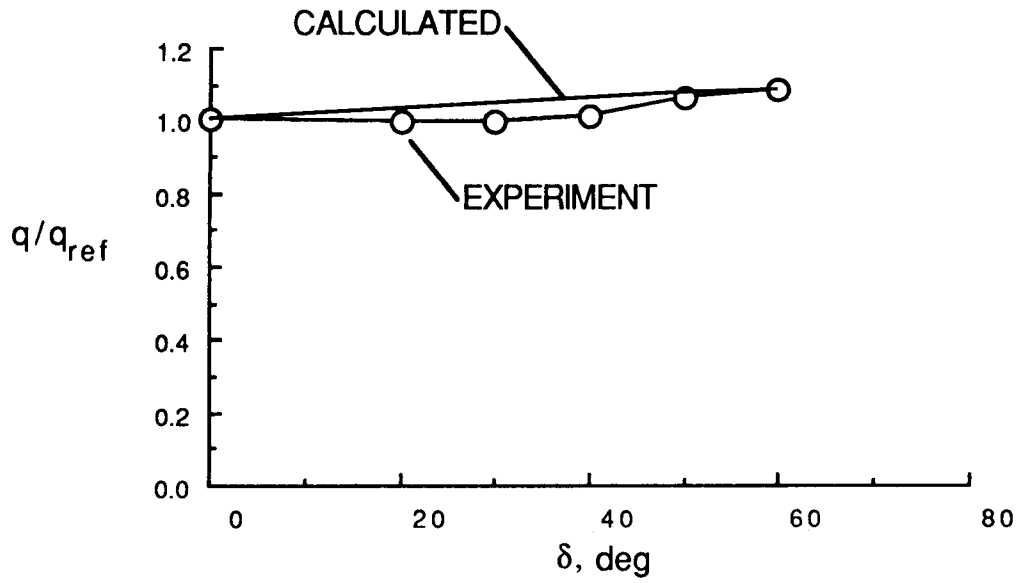

(a) Deployment angle effects

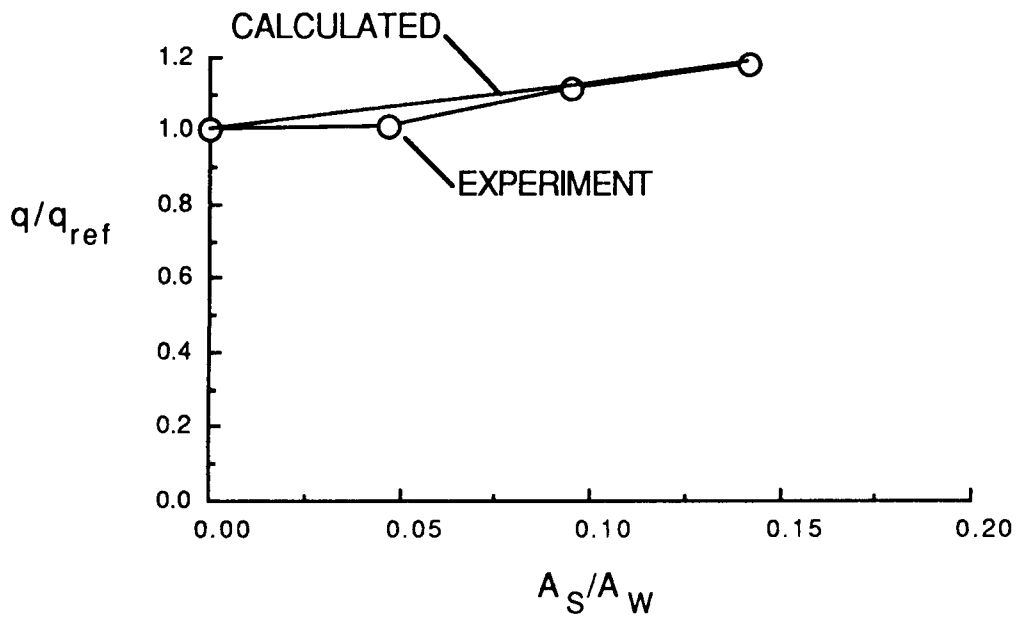

(b) Area effects

Figure 9.- Comparison of experimental and calculated flutter results with offset removed.

by applying the correction factor. Deployment angle effects are shown at the top in the figure; size effects are shown at the bottom in the figure. The experimental data are repeated from figures 6 and 7. The calculated results were obtained by multiplying flutter results for the wing without a spoiler by the appropriate correction factor, taking into account spoiler size and deployment angle. The basic calculated result was based on results obtained by Cole (ref. 2) using linear subsonic lifting surface theory. For use here Cole's result<sup>2</sup> was adjusted to account for differences in torsion frequency between his configuration and the present model. The resulting value of flutter dynamic pressure was 99.9 psf which is in good agreement with the experimental value of 94.9 psf, the value used for  $q_{ref}$ . A comparison of the experimental data and calculated results obtained by applying the relatively simple correction factor agree reasonably well with the experimental data in a qualitative sense. If the offset that exists between the two sets of data because the experiment and theory do not agree exactly for the no-spoiler case were removed, the agreement is quite good as shown by the data presented in figure 9. For presentation in figure 9 the calculated results were normalized by  $q_{ref}=99.9$  psf, the calculated value for no spoiler. The  $q_{ref}$  value for the experimental data was left unchanged at 94.9 psf.

It is recognized, of course, that the simple means suggested here for adjusting calculated results to account for spoiler effects on wing flutter is not precise. It does appear, however, that it may be possible to gain some insight into qualitative effects of spoiler effects on flutter by applying relatively simple correction factors to no-spoiler flutter results obtained by using linear unsteady aerodynamic theory. Experimental trend data from other configurations are needed to develop and refine such correction factors.

#### CONCLUDING REMARKS

Experimental flutter results at  $M=0.80$  for a simple, paddle-like, rectangular planform model equipped with symmetrically mounted upper-surface and lower-surface aerodynamic spoilers showed that the flutter

---

<sup>2</sup> Mr. Cole graciously made available to the author some details of his analytical results not presented in reference 2. The author's appreciation is acknowledged.



dynamic pressure is increased by increasing either spoiler size or spoiler deployment angle. Further, the data showed that increasing the size was more effective than increasing the deployment angle for the particular configurations studied here. A means for adjusting calculated flutter dynamic pressure results obtained for a wing without spoilers to account for spoiler effects on flutter was suggested. The use of the suggested correction factor gave reasonable qualitative results for the configurations studied here, but additional parametric experimental studies are needed to develop and refine such factors before they can be applied with confidence in general applications.

#### REFERENCES

1. Costes, M; Gravelle, A.; Philippe, J. J.; Vogel, S.; and Triebstein, H.: Steady and Unsteady Investigations of Spoiler and Flap Aerodynamics in Two Dimensional Subsonic Flows. Proceeding of the 15th Congress of the International Council of the Aeronautical Sciences, Vol. 2, pp. 1243-53, Sept. 1986.
2. Cole, Stanley R.: Flutter of a Low-Aspect Ratio Rectangular Wing. NASA TM-4116, 1989.



# Report Documentation Page

1. Report No. <b>NASA TM-101632</b>		2. Government Accession No.		3. Recipient's Catalog No.	
4. Title and Subtitle <b>Some Effects of Aerodynamic Spoilers on Wing Flutter</b>			5. Report Date <b>July 1989</b>		
			6. Performing Organization Code		
7. Author(s) <b>Robert V. Doggett, Jr.</b>			8. Performing Organization Report No.		
			10. Work Unit No. <b>505-63-21-02</b>		
9. Performing Organization Name and Address <b>NASA Langley Research Center Hampton, VA 23665-5225</b>			11. Contract or Grant No.		
			13. Type of Report and Period Covered <b>Technical Memorandum</b>		
12. Sponsoring Agency Name and Address <b>National Aeronautics and Space Administration Washington, DC 20546-0001</b>			14. Sponsoring Agency Code		
			15. Supplementary Notes		
16. Abstract <p>The effects of deployment angle and size of symmetrically mounted upper-surface and lower-surface spoilers on the flutter characteristics of a simple, paddle-like, low-aspect-ratio, rectangular wing model that was tested at Mach number 0.80 in the Langley Transonic Dynamics Tunnel are presented. The results show that the flutter dynamic pressure is increased by increasing either spoiler deployment angle or spoiler size. For the configurations studied spoiler size was more effective than deployment angle in increasing the flutter dynamic pressure.</p>					
17. Key Words (Suggested by Author(s)) <b>Aerelasticity Flutter Speed brakes Rectangular wing</b>			18. Distribution Statement <b>Unclassified - Unlimited Subject Category 02</b>		
19. Security Classif. (of this report) <b>Unclassified</b>		20. Security Classif. (of this page) <b>Unclassified</b>		21. No. of pages <b>17</b>	22. Price <b>A03</b>