

NASA Conference Publication 3037

Second Beamed Space-Power Workshop

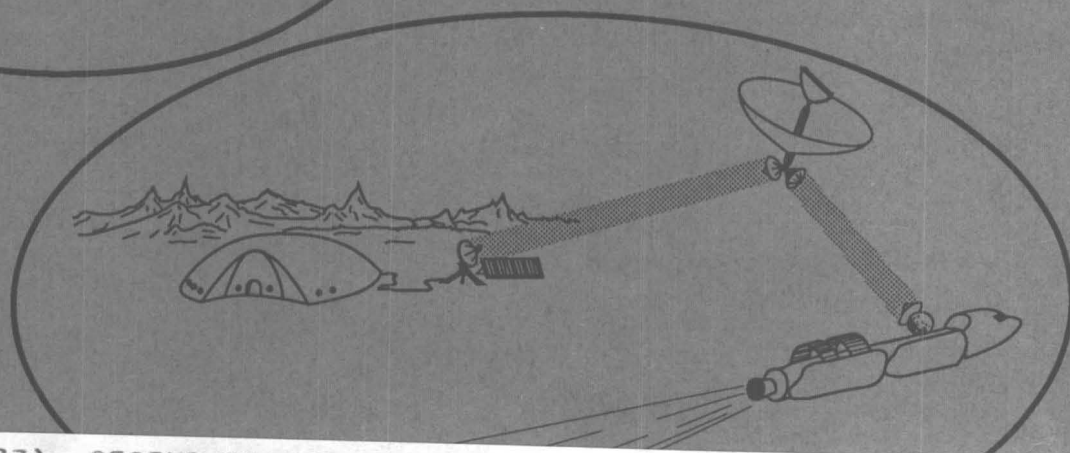
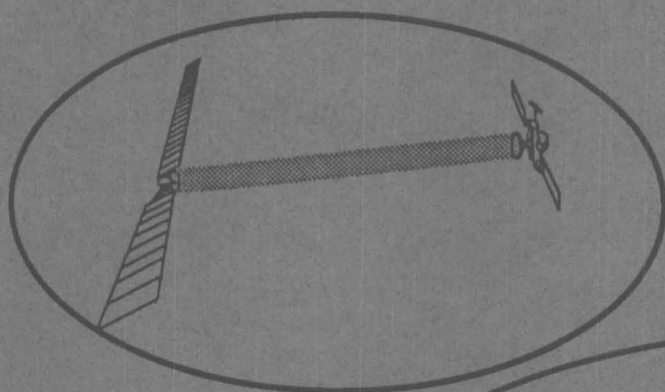

(NASA-CP-3037) SECOND BEAMED SPACE-POWER
WORKSHOP (NASA. Langley Research Center)
439 p

CSCL 10B

N90-10140

--THRU--

N90-10167

Unclas

H1/20 0216764

*Proceedings of a workshop held at
NASA Langley Research Center
Hampton, Virginia
February 28-March 2, 1989*

NASA

NASA Conference Publication 3037

Second Beamed Space-Power Workshop

Russell J. De Young, Editor
NASA Langley Research Center
Hampton, Virginia

**Proceedings of a workshop sponsored by
the National Aeronautics and Space
Administration and held at
NASA Langley Research Center
Hampton, Virginia
February 28–March 2, 1989**

NASA

National Aeronautics and
Space Administration
Office of Management
Scientific and Technical
Information Division

1989

PREFACE

The Second Beamed-Power Workshop held at the NASA Langley Research Center on February 28 - March 2, 1989, brought together mission specialists and technologists from NASA and universities to evaluate potential missions for microwave and laser power beaming in space. These power-beaming missions could have a substantial impact on future research programs within the Office of Aeronautics and Space Technology and mission scenarios within the Office of Exploration. These two NASA offices sponsored the workshop, and the results contained in this proceeding will hopefully impact future space technologies and missions.

The High Energy Science Branch of the NASA Langley Research Center focused on laser-powered missions while the Power Technology Division of NASA Lewis Research Center focused on microwave-powered missions. There was close cooperation between these two groups in presenting power-beaming mission scenarios with potentially high payoff in the areas of space propulsion, planetary power, and near-Earth applications. These missions studies are hopefully the first step toward future studies which will demonstrate the enabling character of power beaming for future NASA missions.

We thank the workshop participants for their enthusiasm and cooperation in critiquing the mission presentations and for their desire to support this emerging, new technology.

R. J. De Young
NASA Langley Research Center

PRECEDING PAGE BLANK NOT FILMED

CONTENTS

Preface	iii
Contents	v
Executive Summary	1 <i>omit</i>
Office of Exploration Overview	3 <i>51</i>
John Alred	

BEAM POWER MISSIONS AND APPLICATIONS

Power Beaming Options	21 <i>52</i>
John D. G. Rather	
Laser Propulsion to Earth Orbit - Has Its Time Come?	41 <i>53</i>
Arthur Kantrowitz	
Power From Space for Use on Earth: An Emerging Global Option	57 <i>54</i>
Peter E. Glaser	
New Energy Conversion Techniques in Space, Applicable to Propulsion	69 <i>55</i>
A. Hertzberg and K. C. Sun	

MILLIMETER-WAVE TECHNOLOGY BACKGROUND

Vacuum Microelectronics for Beam Power and Rectennas	107 <i>56</i>
Henry F. Gray	
Millimeter-Wave/Infrared Rectenna Development at Georgia Tech	127 <i>57</i>
Mark A. Gouker	
Gyrotron Development for Space Power Beaming	139 <i>58</i>
Wallace M. Manheimer	
Antenna Technology for Beamed Space-Power	159 <i>59</i>
W. S. Gregorwich	
History and Status of Beamed Power Technology and Applications at 2.45 Gigahertz	171 <i>50</i>
William C. Brown	

LASER TECHNOLOGY BACKGROUND

Laser Technology and Background: Introduction	189 <i>omit</i>
E. J. Conway	
Technical Options for High Average Power Free Electron Millimeter-Wave and Laser Devices	191 <i>91</i>
James C. Swingle	

Laser Energy Conversion	221
N. W. Jalufka	522
Structural Concepts for Very Large (400-Meter-Diameter) Solar Concentrators	239
Martin M. Mikulas, Jr. and John M. Hedgepeth	513

MINIWORKSHOP MISSION STUDIES

Overview of Laser Concepts	261
Edmund J. Conway	510
Overview of Microwave Concepts	287
Karl Faymon	515

PLANETARY POWER APPLICATIONS MINIWORKSHOP

Laser-Powered Lunar Base	293
Reference Mission - Nuclear Reactor Power for Lunar Base	295
Robert C. Costen and Donald H. Humes	
Laser-to-Electric Lunar Base Converter	299
Gilbert H. Walker	516
Diode Array and Iodine Lasers	309
M. Williams, and R. De Young	
Laser-Powered Martian Rover	317
W. L. Harries, W. E. Meador, G. A. Miner, G. L. Schuster, G. H. Walker, and M. D. Williams	517
Power for the Moon: Is Microwave Power Beaming an Option?	329
Ronald C. Cull	518
Applicability of the Beamed Power Concept to Lunar Rovers, Construction, Mining, Explorers and Other Mobile Equipment	343
Jose L. Christian, Jr.	519
Planetary Power Applications--Discussion Summary	357
R. C. Costen	520

SPACE PROPULSION APPLICATIONS MINIWORKSHOP

Low-Earth-Orbit To Low-Lunar-Orbit Laser Freighter	363
Russell J. De Young	520
Laser Propulsion Option	365
Donald H. Humes	521
Earth Orbit Laser Systems	377
Ja H. Lee	522
Laser Diode Array and Transmission Optics	383
Jin H. Kwon	523

Laser Thruster	391	24
N. W. Jalufka		
LEO to GEO and Return Transport: Microwave Beam Power	397	5
Karl Faymon		
Space Propulsion Applications--Discussion Summary	405	mtt
Ja H. Lee		

NEAR-EARTH APPLICATIONS MINIWORKSHOP

Central Electrical Utility Power For a Satellite Ring City in Low Earth Orbit Space	409	6
Ira T. Myers, Karl A. Faymon, and A. D. Patton		
Beamed Laser Power in Support of Near-Earth Missions	419	27
Edmund Conway, Gregory Schuster, Willard Weaver, and Donald Humes		
Near-Earth Applications--Discussion Summary	443	mtt
Willard R. Weaver		

CHAIRPERSON REPORTS

PLANETARY POWER APPLICATION MINIWORKSHOP	447
SPACE PROPULSION APPLICATION MINIWORKSHOP	449
NEAR-EARTH APPLICATIONS MINIWORKSHOP	451
.....PANEL DISCUSSION SUMMARY.....	453

APPENDIX

Non-NASA Participants	455
NASA Participants	459
Miniworkshop Participants	463

2nd BEAMED SPACE POWER WORKSHOP

Executive Summary

The 2nd Beamed Space Power Workshop held at NASA Langley Research Center from February 28 to March 2, 1989, began development of the case for increasing NASA's commitment to beamed power technology as a power option for advanced NASA missions. The workshop participants were NASA Headquarters managers, systems study specialists from several NASA centers, and managers, technologists, and professors from national laboratories, industry, government, and universities. Applications of beamed power in the areas of space defense and in the commercial field of beaming solar-derived power to the earth for distribution as electrical energy were discussed; however, these non-NASA applications were not the focus of this workshop. The workshop emphasized the similarities and complementary nature of laser and microwave power beaming for NASA missions. The question before the meeting was not "laser versus microwave," but rather "will NASA require beamed power?"

The two and a half-day meeting consisted of 1) a tutorial day designed to acquaint the participants with NASA's studies of exploratory missions, advanced space, and commercial beamed power applications not within the current NASA mission set; 2) three miniworkshops to review applications of beamed power within the NASA mission; and 3) a session devoted to critique of the miniworkshop presentations and a panel discussion of broader issues.

Three parallel miniworkshop sessions were devoted, respectively, to a) planetary power, b) space transportation, and c) near-earth applications of beamed power. The results of several preliminary conceptual studies were presented at each session. Although these studies were the most coherent set of arguments yet made for NASA's need for beamed power, the presentations were found uniformly to be lacking some element of completeness, coherence, or reality.

The session chairmen, while critical of the preliminary character of the studies, offered guidelines and suggestions for improved studies. The criteria were to emphasize a) enabling missions, b) enhancing missions when building on existing technology, and c) reducing risk to the mission. A panel of five experts discussed issues including synergism with Strategic Defense Initiative (SDI) technologies, system reliability, the need for credible technology demonstrations, and the difficulties of getting new technology adopted by project managers. The panelists and the moderator expressed the belief that, based on this meeting, beamed power would be enabling for future NASA missions.

Since the panel discussion members and moderator believed that beamed power would enable NASA missions, it must be concluded that significant progress had been made toward establishing the need for power transmission in NASA's future. However, the preliminary and incomplete nature of the concepts presented at the miniworkshops suggested that a final case for increasing NASA's commitment to beamed power technology as an option for advanced NASA missions must await more complete studies.

N90-10141

S1-20
216765
185

OFFICE OF EXPLORATION OVERVIEW

John Alred
National Aeronautics and Space Administration
Lyndon B. Johnson Space Center
Houston, TX

ND 185600

Abstract

The NASA Office of Exploration case studies for FY 89 are reviewed with regard to study groundrules and constraints. Three study scenarios are presented: lunar evolution, Mars evolution, and Mars expedition with emphasis on the key mission objectives.

PRECEDING PAGE BLANK NOT FILMED

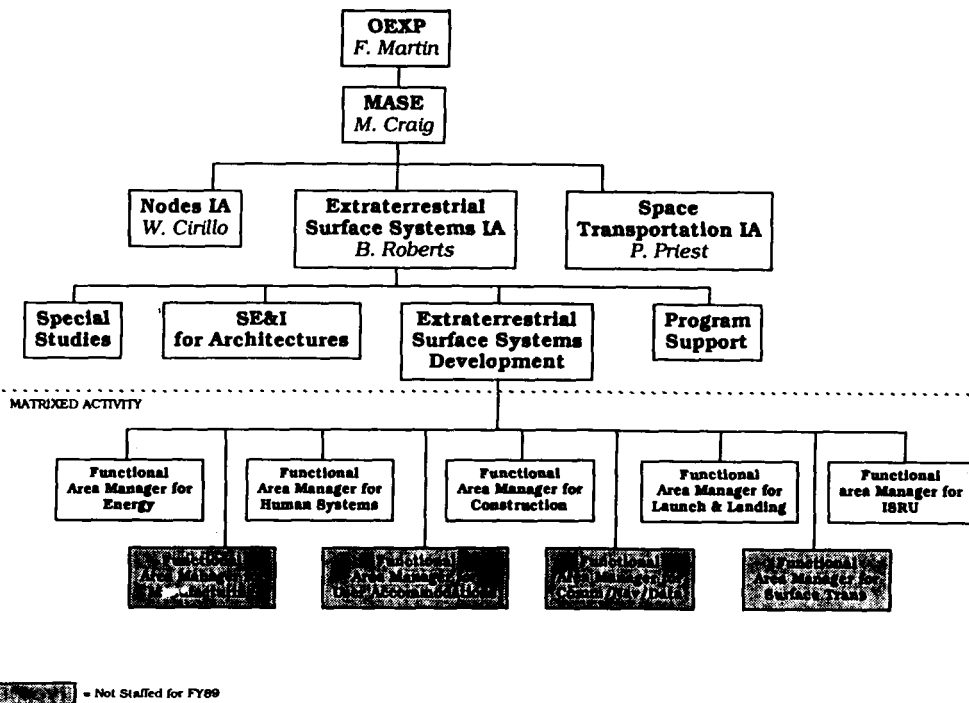

**Specific Exploration Studies Goals and Objectives
for FY 1989**

Primary Goal

- Develop knowledge base for FY 91 "decision Year" Budget

Objectives

- Update and refine exploration cases
- Obtain a detailed understanding of prerequisite requirements

- Continue building exploration team capability
- Develop effective external interactions
- Conduct first relative cost estimate

ORIGINAL PAGE IS
OF POOR QUALITY

Objective: Update and Refine Exploration Cases

Strategy for Case Study Additions and Modifications

- Do an in-depth penetration of technologies, systems, and operations capabilities required to conduct a "bare bones" trip to Mars
- Investigate the potential for Mars evolution capability using scaled down vehicles and systems (relative to FY 88 studies) and constant annual investment (i.e., mass-to-LEO)
- Using the same constant annual investment strategy as in the Mars evolution case study, investigate the potential for a lunar evolution capability characterized by robust objectives for scientific achievement, technical research and development, operations support, and human acclimation

Objective: Update and Refine Exploration Cases

Strategy for Case Studies Analysis

- Conduct systematic evaluations to ensure determination of cause and effect. Emphasize parametric analyses of capabilities and configurations, and conduct broad trade studies
- Identify enabling technology areas and special exploration opportunities along with their associated systems alternatives
- Conduct trade studies in technology and operations areas having potential for high yield relative to reduced mass-to-LEO, reduced dependency to a LEO node, improved systems performance and operation, and reduced cost
- Evaluate the impact of using an artificial-g transfer vehicle and a conjunction trajectory on a mission to Mars/Phobos
- Augment understanding of the effect of constant annual investment (using mass-to-LEO as the investment constraint) on lunar and Mars evolution strategy

Objective: Update and Refine Exploration Cases

Strategy for Program Planning

- **Formulate an advanced development plan and identify candidate case study technologies**
- **Conduct technical studies of international participation implications**

Objective: Obtain a Detailed Understanding of Prerequisite Requirements

Areas

- **Earth-to orbit transportation**
- **Life sciences**
- **Scientific precursors**
- **Space Station Freedom**
- **Technology**

Strategy

- **Seek to understand truly enabling vs. enhancing prerequisites**
- **Iterate plans with appropriate program offices**
- **Initiate (with Code E) science studies and user requirement and opportunity development**
- **Develop artificial gravity research facility feasibility and concepts**
- **Emphasize exploiting the systems and infrastructures that will be in place in the late 1990s for initiating exploration**

Generic Groundrules and Constraints for Studies

- All case studies shall be evaluated to answer the question "why send humans?"
- All case studies shall be evaluated for the potential of maximizing science return
- All case studies shall be unconstrained by budget
- Relative, not absolute, cost estimates will be made for the FY 1989 case studies
- Evolutionary case studies shall be evaluated for the potential suitability of extraterrestrial resources
- All case studies shall be evaluated for the potential of international cooperation

FY89 Focused Case Studies

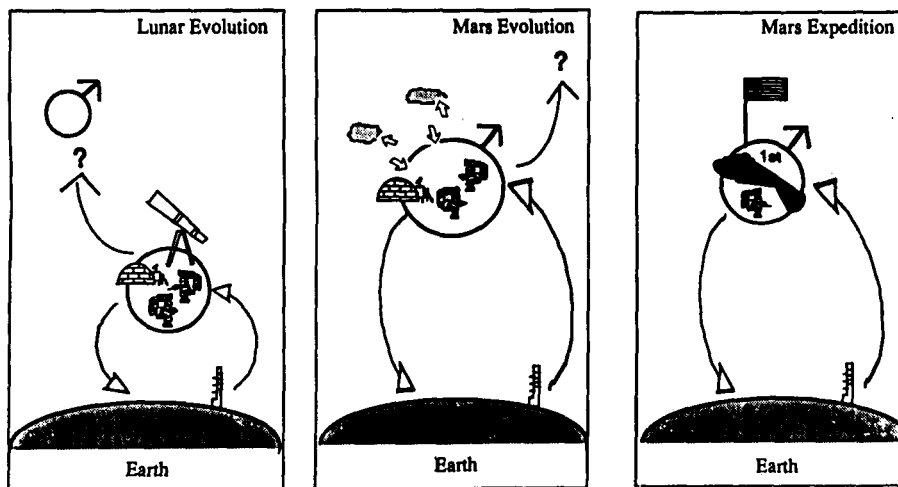

Study Parameters Spread

	Lunar Evolution Case Study	Mars Evolution Case Study	Mars Expedition Case Study
Destination	Moon	Mars	Mars
Exploration Approach	Permanent Base	Permanent Base	Expeditionary
Vehicle Gravity Environment	Zero-G	Artificial-G	Zero-G
Trajectory Type	Minimum Energy	Minimum Energy	Sprint
On-orbit Assembly	In LEO	In LEO	None
Reusability vs. Expendability **	All Reusable	Reusable/Expendable	All Expendable
Aerobrake L/D	None Specified	None Specified	0.9-1.2

** To Be Studied

Mars Expedition

- **Split Mission Concept**
- **Outbound cargo consists of crew sortie vehicle for descent and ascent at Mars and supporting infrastructure**
- **Outbound piloted vehicle carries trans-Earth injection stage**

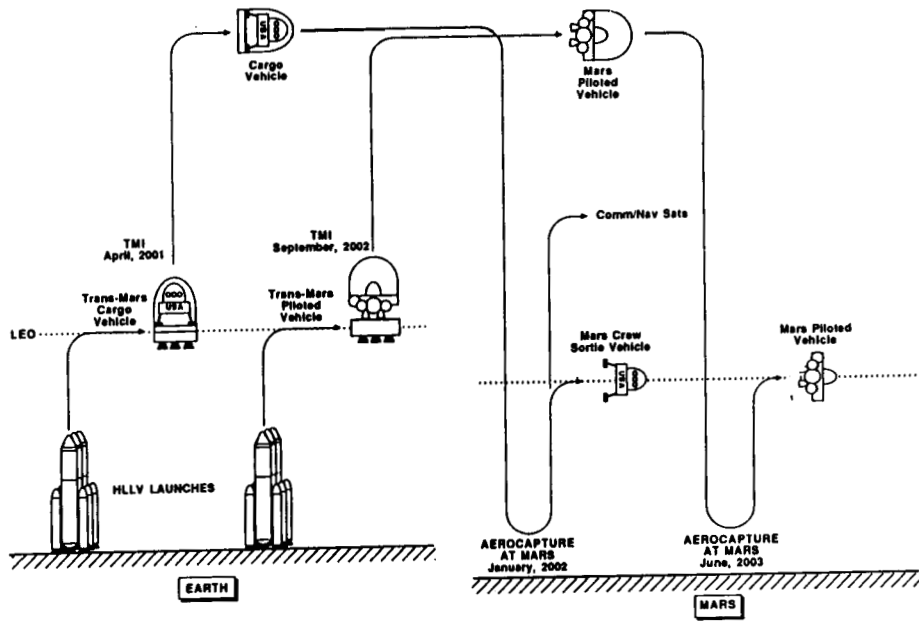

MARS EXPEDITION CASE STUDY -- flight profile.

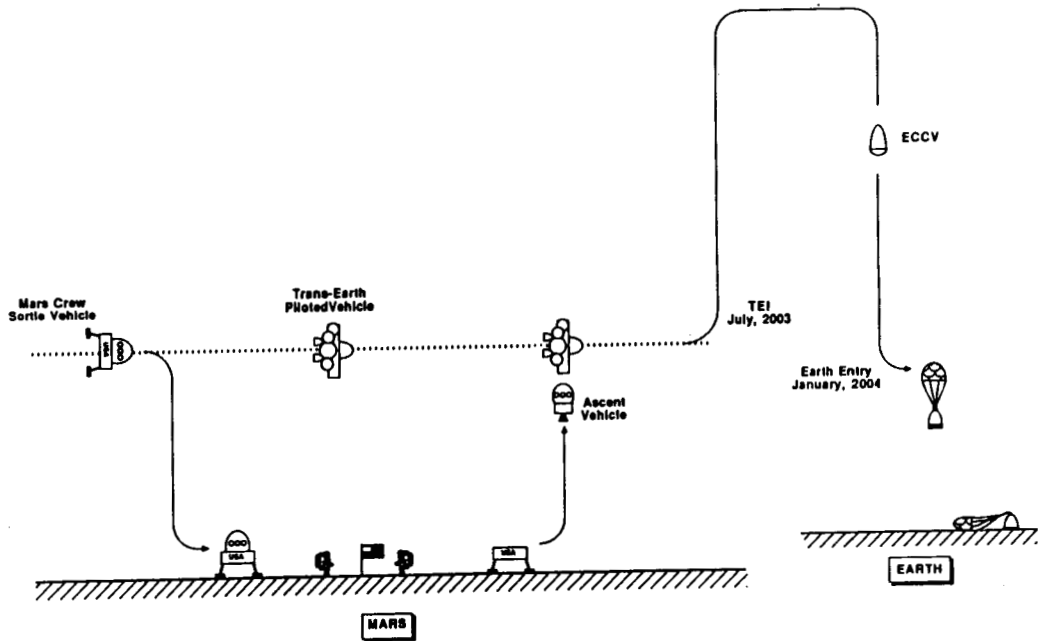

MARS EXPEDITION CASE STUDY -- flight profile.

Mars Evolution Case Study

Exploration Objectives

- the emplacement of a permanent, self-sufficient base on Mars, and the establishment of early leadership in manned exploration of the Mars system

Mars Evolution Case Study

Key Features

- Annual limit on mass to low Earth orbit
- Advanced technology
- Establishment of an initial manned habitat on Mars
- Early emphasis on a martian moon gateway to produce water and cryogenic propellants
- Utilization of in situ resources
- Varied classes of missions using varied trajectories
- Block I reference
 - Initial flight uses opposition-class trajectory
 - all other flights use conjunction-class or opposition-class
 - advanced chemical propulsion
 - aerobraking at Mars and Earth
 - reusable vehicles
 - propellant production from indigenous resources
- Block II update

Mars Evolution

- **BASE SITE LOCATION**

- **Simund Valley (Chryse Basin) in Hydrates Complex**
- **0 deg latitude, 33.5 deg west longitude**

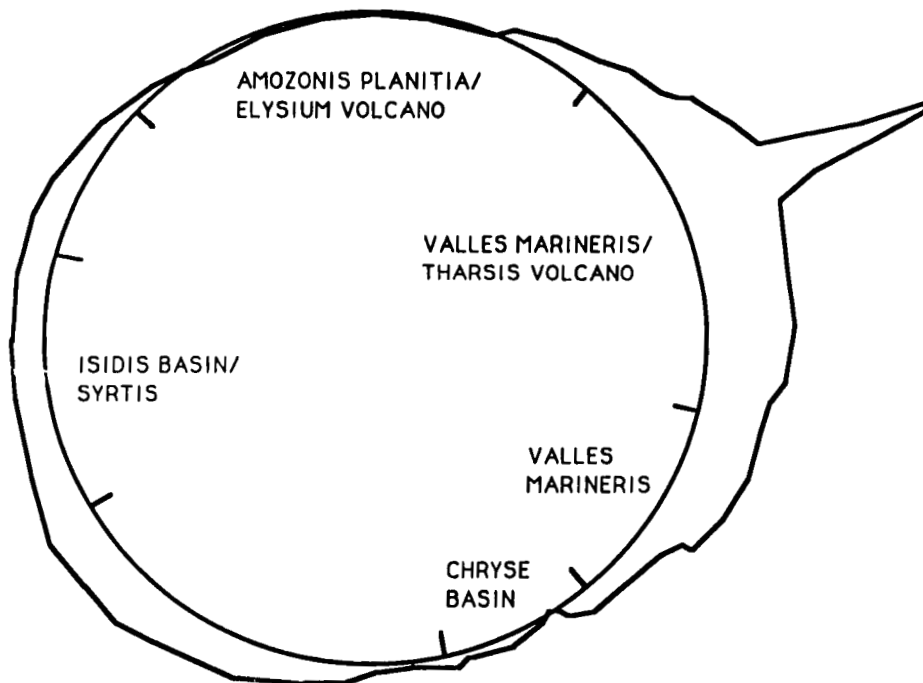

MARS EVOLUTION CASE STUDY

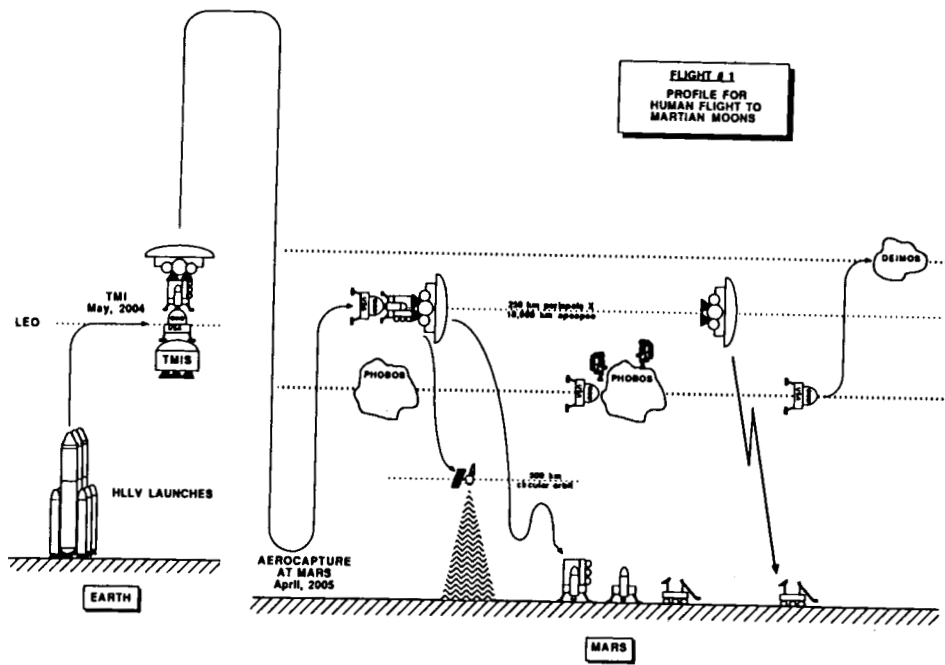
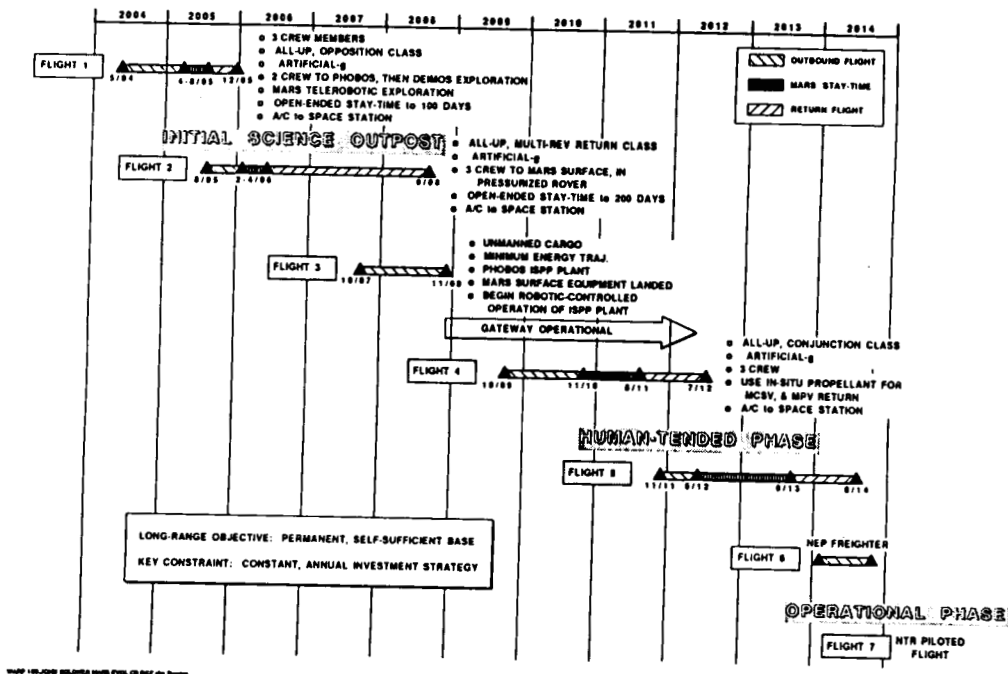

MARS EVOLUTION CASE STUDY -- flight 1 profile.

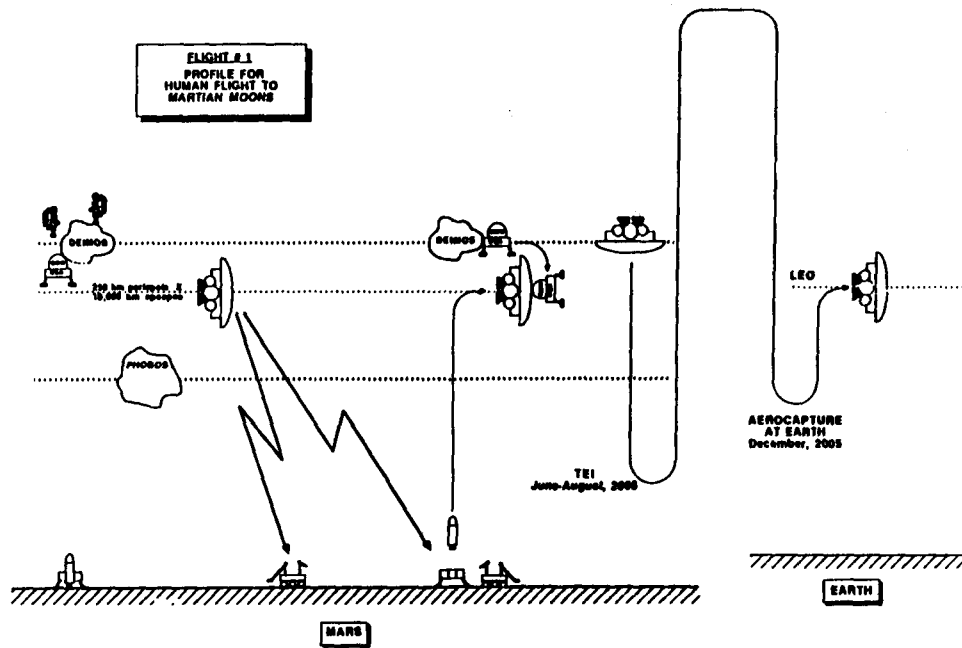

MARS EVOLUTION CASE STUDY -- flight 1 profile.

Lunar Evolution Case Study

Exploration Objectives

- Long range objective
 - establishment of a permanent facility on the lunar surface with a significant capability for self support
- Evolutionary objectives
 - provision of test bed and learning center for long duration planetary missions
 - cut the tie to Earth by development of the lunar resource potential including propellant production and exploitation of resources
 - development of a significant science research capability for astronomy, planetary science, life sciences, and other fields
 - development of a gateway both inward for lunar base expansion and outward to support expansion of human presence into the solar system

Lunar Evolution Case Study

Key Features

- Lunar base evolves through three phases: human-tended, experimental, and operational
- Annual limit on mass to low Earth orbit
- Use of advanced technology
- Emphasis on early development of a human-tended outpost
- Utilization of in situ resources
- Lunar facility has a variety of scientific, technological, and operational objectives
- Block I reference
 - advanced chemical propulsion
 - aerobraking
 - reusable vehicles
 - propellant production from indigenous resources
- Block II update
 - additional mass-to-LEO allocation, and/or
 - new technology

Lunar Evolution

• BASE SITE LOCATION

- North of crater Moltke in southern region of Mare Tranquillitatis
- 0 deg latitude, 24 deg east longitude

• FAR-SIDE ASTRONOMY SITE

- 0 deg latitude, 141 deg longitude

LUNAR SITE DIAGRAM

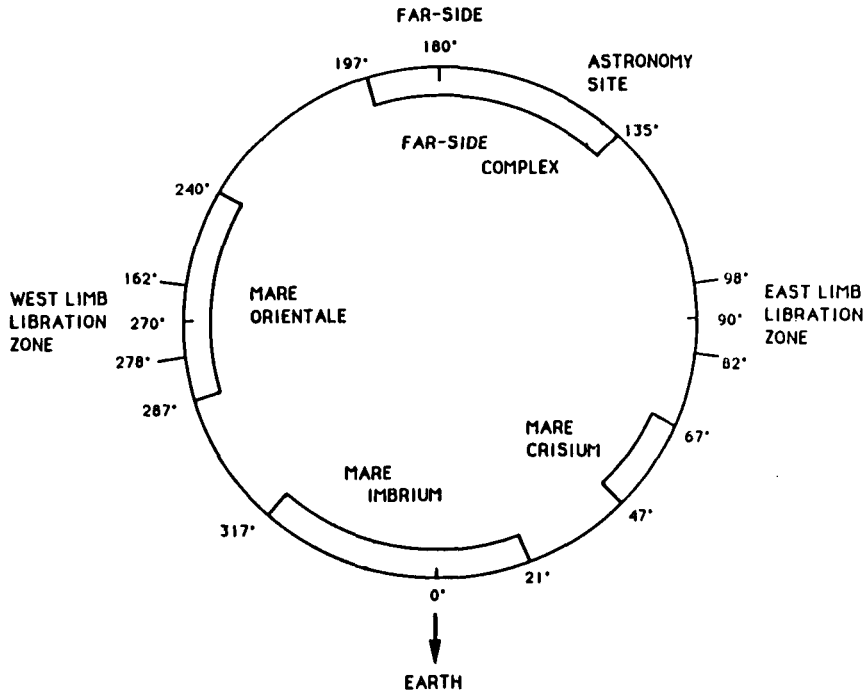

LUNAR EVOLUTION CASE STUDY

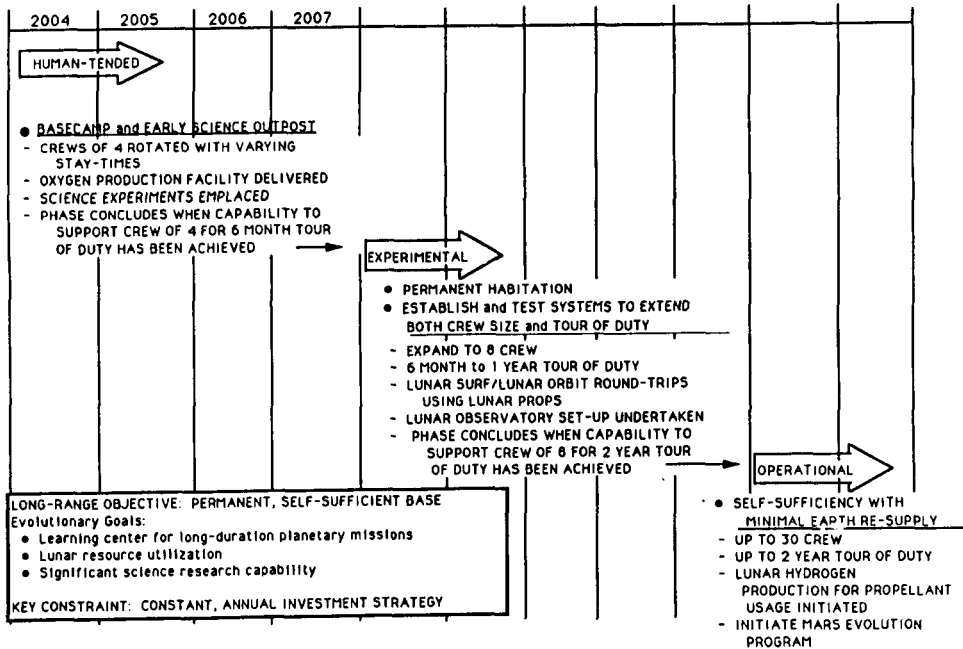

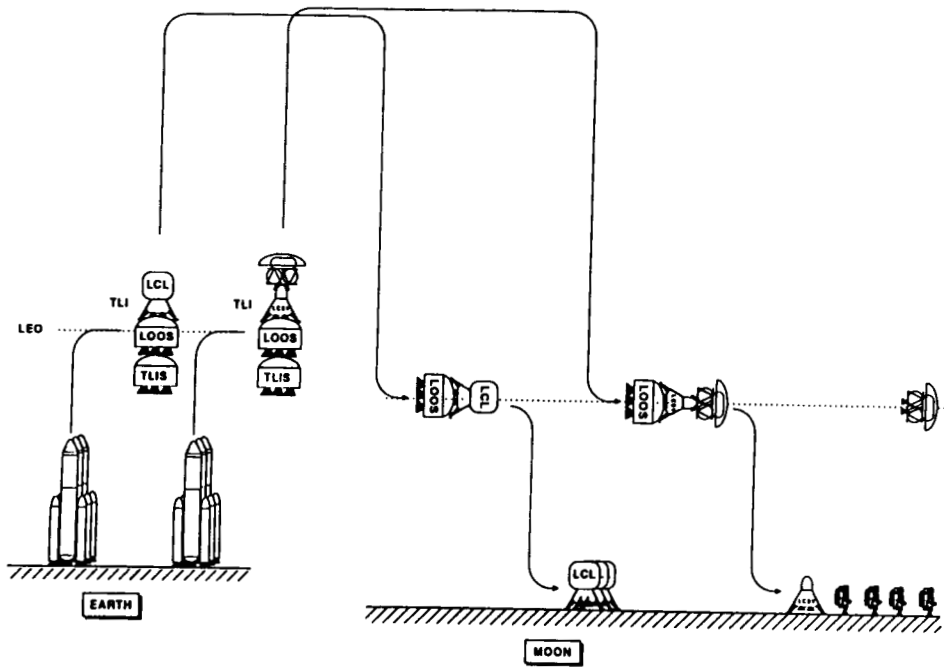

LUNAR EVOLUTION CASE STUDY -- science outpost/human-tended phases.

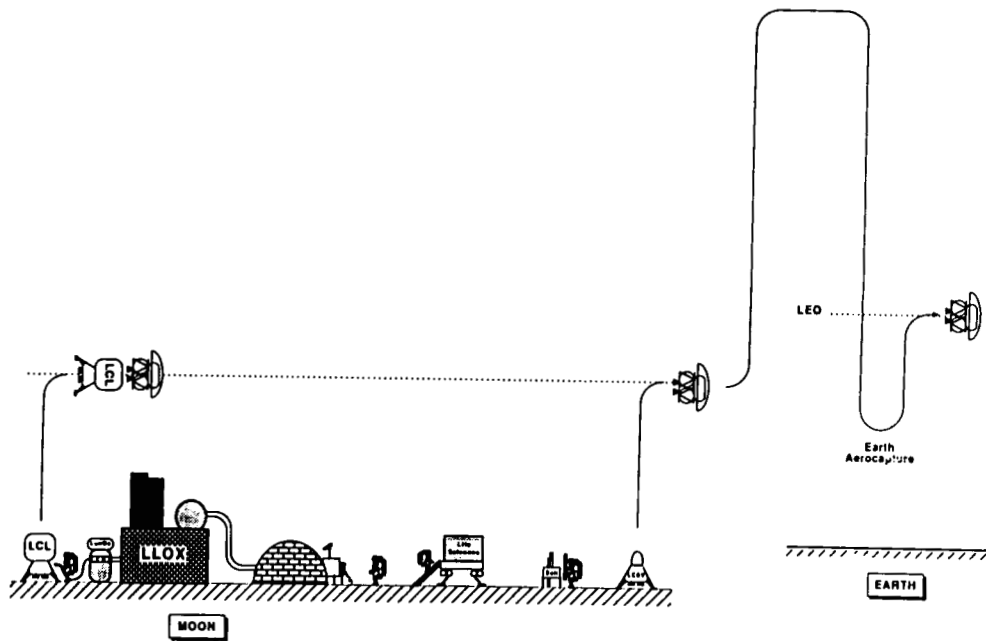

LUNAR EVOLUTION CASE STUDY -- science outpost/human-tended phases.

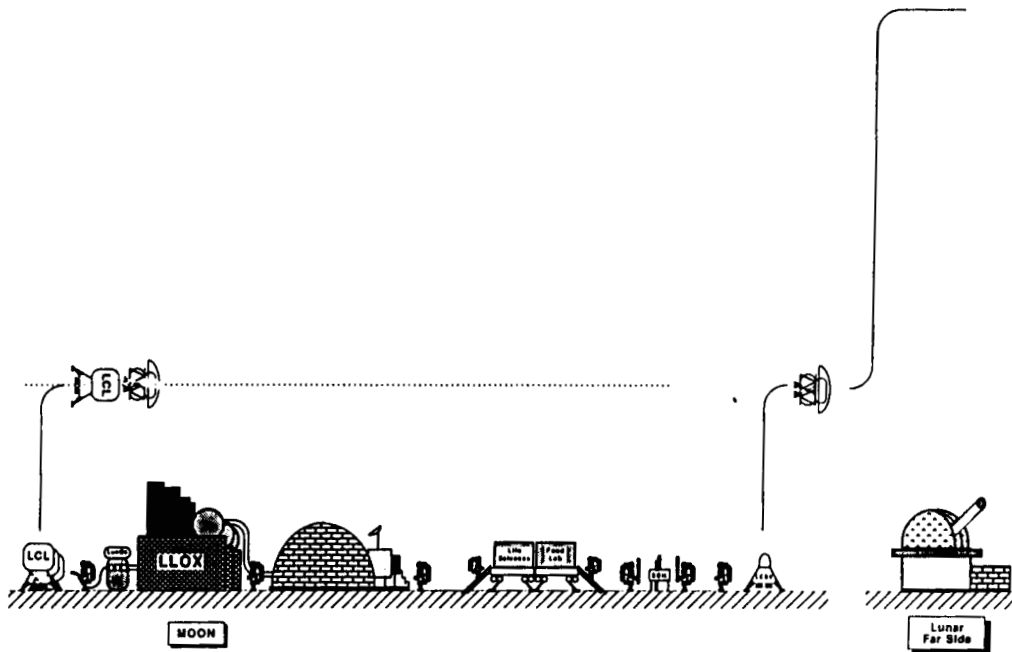

LUNAR EVOLUTION CASE STUDY -- experimental phase.

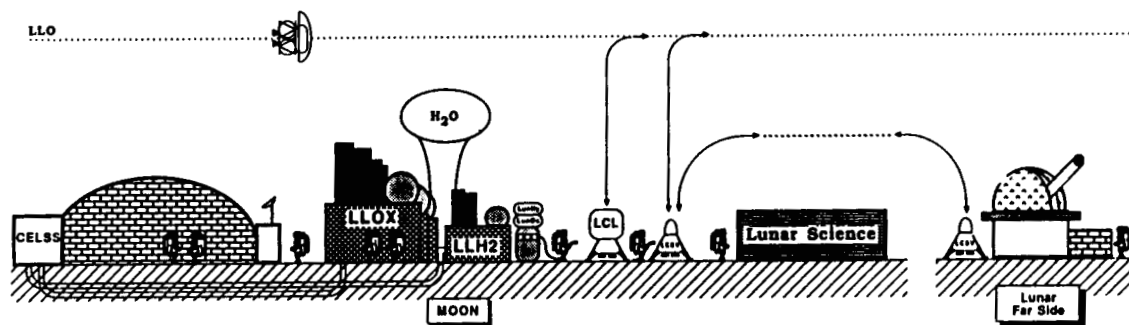

LUNAR EVOLUTION CASE STUDY -- operational phase.

FY 89 Emerging Case Studies

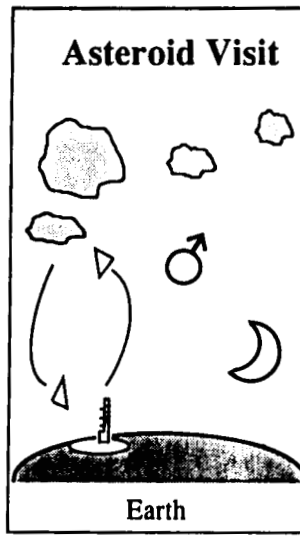
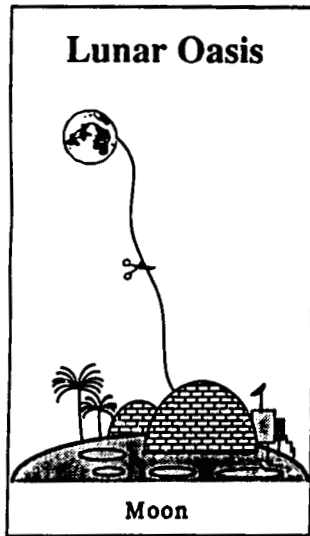

BEAM POWER MISSIONS AND
APPLICATIONS

52-20
2/27-6
2/27

POWER BEAMING OPTIONS

N90-10142

John D. G. Rather
Vice President for Research and Technology Innovation
Kaman Aerospace Corporation KC 590 112

PRECEDING PAGE BLANK NOT FILMED

~~PAGE 20~~ INTENTIONALLY BLANK

Successful taming of beamed power would be a monumental jump in technological capabilities. I think history provides some lessons about such transformations that are worth pondering as we begin this workshop.

When we examine major technological revolutions, they all have a common thread. I think there have been four outstanding examples in the last 50 years. The first was the Manhattan project. The second was the development of the nuclear submarine/nuclear missile fleet. The third was the ICBMs. And the fourth was the Apollo program. Every one of these major revolutions in technology had the common thread that, at the outset, an important mission or application was recognized, but there was no existing technology base or master plan for getting to the desired operational capability. First, the people in charge of the government decision-making process had to be convinced that the new effort was worth doing. They, in turn, convinced the President, Congress, and the public. Having done that, enough organized support was mustered so that the programs could be launched. Then, the engineers were challenged to find the best way to reach the desired goals. Challenged with the question of how to get to the required performance criteria in the shortest time and most economical way, engineers have a wonderful record for coming up with workable solutions.

It's remarkable how little was known at the outset of these programs. Just think of Apollo: (1) no one had ever thought of rendezvous in lunar orbit; (2) hydrogen propulsion hadn't been harnessed except for a few Centaur experiments which were scaled far below what was needed for Apollo; (3) the required computer technology was not even on the drawing boards. Given the challenge, NASA achieved all the needed innovations successfully in eight years. You can go through the same ritual for the other examples, and the story is the same: You can't take existing technologies and expand them to serve some mission; what you must do first is to define the mission and then create the technology to do the job.

What we have to do here at Langley in order to make this conference yield high payoffs is to seek uniquely important missions and applications that justify power beaming: things that can't be done well by any other method, or that become cheaper, better, or quicker through this revolutionary technology. So the primary question becomes; "Does power beaming make sense when compared to other options?" The second question is, "If it does make sense, what kind of power beaming? Microwave? Laser?" The third question is, "How do we get there from here?"

To stimulate discussion, I will propose some large scale power beaming applications, bearing in mind all three of these foregoing questions. Let's start with really large-scale stuff in the tradition of the hugh microwave power satellites considered in the 1970s.

The United States would like to reverse the balance of trade. We do have an asset we can export: One thing we have that isn't being capitalized upon is 1.7 billion kilowatt hours per day of unused electrical capacity. At night, it isn't efficient to cool down the steam power plants or necessary to stop the flow of water in the dams. There is a large amount of existing generating capacity that just isn't used. Figure 1 shows the typical day to night electrical load swing for the United States as a whole. Most of it is in the Central and Eastern time zones because, even though there's a large population on the Pacific coast, they have more benign weather. There are eight or ten hours in the middle of the night when the U.S. has a lot of power available, and there are a few hours in the middle of a summer afternoon when there's a great demand that almost exceeds our abilities to supply it. For the latter demand, we build huge power resources that often are not used.

People started thinking about the microwave power source in orbit back when there was a perceived energy crisis. I would suggest that, since we are no longer building new power plants with such frequency, maybe we should think about using in better ways what we already have. One approach that could undoubtedly be realized more quickly than a major power satellite in orbit might be a large microwave phased array on the ground near our own power resources or near other countries' resources on the other side of the ocean, as shown in Figure 2. A passive reflector a kilometer in diameter up in geostationary orbit could be used to reflect the power back down to the earth near to places where there is a demand. This could work both ways, giving us the ability to import power across eight or ten time zones when needed. A single-dish, relatively low power transmitter at the receiving end would provide the phase reference for the transmitter and would enable controlling all the beam steering electronically, making the link fail-safe by constantly controlling the phase at the transmitter. But, in order for this to make any sense, the overall efficiency must be reasonably high, and the cost must be competitive with other methods of energy export.

At the bottom of Figure 2, it can be seen that nearly 50% transfer efficiency (electric to electric) could be achieved by a microwave relay system. This raises further interesting possibilities because, if inexpensive amorphous solar cell arrays can be built, why not deploy them on the earth's surface in Nevada, the Australian desert and the Sahara desert, and beam the energy around the world without bothering with the great difficulties of assembling a power plant 10 kilometers

long in geostationary orbit? At least, this may be a first step to eventual power plants in orbit.

The fundamental question that should be addressed first is, "Is there a cheaper way to do it?" It's easy to see from Figure 3 that, on land, transferring power over distances of a thousand miles gets quite expensive. It's expensive to acquire real estate and to build power lines. The cheapest way of shipping energy across land turns out to be by natural gas pipelines. This motivated me years ago to look at some estimates for a laser relay system; and, of course, the microwave one just proposed might be even cheaper.

So we need to look at the questions of a) feasibility, and b) cost, in order to see whether the concept of power beaming makes any sense. The one thing that isn't on the chart shown in Figure 3 is the cost of moving oil in tanker ships, which is so cheap that it probably falls off the bottom of the chart. The arguments against fossil fuels must be couched in different areas such as (1) exhaustion of limited resources, (2) environmental pollution, and (3) vulnerability to supply-side blackmail. These matters are extremely important and have their own costs which must be added to the cost of cheap oil.

Now let's shift the discussion to lasers. A lot of attention was given in the 70s to microwave solar power. I would like to look at the laser alternative in some depth. I contend that it can be shown to be environmentally very acceptable. I believe that a near-term demonstration of considerable note can be achieved more easily with lasers than with microwaves. Also, possibilities do exist for direct conversion of solar photons to laser photons; and it's been proven that efficient re-conversion to useful energy can be achieved.

Lasers can perform two principal functions: propulsion and space power beaming. I think that, since we have to walk before we can run, the earliest reasonable opportunities that should be considered involve beaming power from the ground to space. Some examples of ground to space power beaming are shown in Table 1. Some of the associated applications include K-band wide coverage radar for air traffic monitoring and identification, which even gains current significance in the international attempt to control drugs. Then there is ship traffic monitoring, the same thing that the Soviets are doing with their unpopular nuclear reactor powered RORSATS except more so. Even clear air turbulence mapping can be done with millimeter wave radar; and then, of course, there are many defense applications. Electric propulsion for economical orbit raising from LEO to GEO, and direct broadcast TV transmission from GEO are other important applications that, I think, have definite merit. Then there are many other active remote sensing applications that we might consider in this workshop, plus industrial processes and life support.

Back in the 70s, the chart shown in Figure 4 was prepared by NASA as an index of some of the applications that they were considering at the time. Propulsion applications are shown in the shaded envelope, but the most interesting things for us at this workshop are the arrows that I have added to indicate 10 kilowatts per year and 1 megawatt per year. These show that even modest amounts of beamed power from lasers currently available can lead to a plethora of applications, including propulsion applications. So, even extrapolating from things that were being considered a decade ago, we begin to see the utility of power beaming.

Let's look at some possibilities augmenting the Space Shuttle usefulness with laser propulsion from LEO to GEO using ground-based lasers. Leik Myrabo, whom some of you know, has authored a book called "The Future of Flight", which expresses boundless zeal for laser propulsion. I worked with Leik for several years back in the late '70s and early '80s. We looked at several possibilities, particularly with regard to saving and using the Shuttle main tank by making use of the ullage fuel that's contained in it upon reaching orbit as a laser-heated monopropellant. We examined three possibilities in detail: (1) an autonomous tugboat taken up in the Shuttle bay, which had its own monopropellant; (2) a rendezvous of the Shuttle with a permanent tugboat in orbit where the tug is refueled with the residual ullage fuel from the Shuttle main tank and then used to boost the main tank or a large Shuttle payload up to GEO and; (3) raising the entire Shuttle to GEO and returning personnel.

I don't have time to go through all the details of this. The summary (see Table 2) is that; for that analysis, the typical amount of ullage fuel was taken to be 520 kg of hydrogen, and 3000 kg of oxygen. The total required energy to perform a typical mission is 4,500 gigajoules. That translates to 10 megawatts of laser power for 5.2 days, which isn't too bad!

The details of this mission were worked out in considerable depth by Leik Myrabo in a study contract supported by NASA Marshall Space Flight Center, from which several points in the present talk originated. Figures 5 and 6 show two walk-around charts which parameterize the various tradeoffs. Explanations of each chart are given on the page following. There are many factors that have to be looked at carefully to really appreciate the pros and cons of this sort of mission.

One possible motivation to consider for laser propulsion as we contemplate expanding major space activities from LEO to GEO and beyond is the fact that the radiation dose in the inner and outer Van Allen belts is quite considerable. As you traverse the belts, you integrate a large dose particularly in the outer belt if you don't make a fast trip. So if you consider solar-thermal or ion propulsion as alternatives, the payload had better be pretty immune to radiation because it will take ten or more days to get across the belt. This implies a dose of about

10^4 rad, as can be seen in Figure 7. So, depending on what you're trying to do, you might not want to expose even unmanned vehicles to radiation fluences like that, and this provides a persuasive reason supporting what we're trying to do at this meeting.

Now some thoughts about large mass in orbit. First, I want to affirm my belief that the real payoffs from many commercial endeavors -- even building power stations on the surface of the earth -- come when you scale to large size. The economies of large engineering efforts can become very significant, and this provides a challenge for us to find out how the scaling goes and where the payoffs come for the things we're considering at this meeting. Looking at the question of how we get large mass into high orbit, an old mnemonic that goes back to Professor Kantrowitz in the '60s is that approximately a gigawatt of laser power on the ground should be able to deliver a ton of payload to low earth orbit every four minutes. Even if the Shuttle were flying once a week, as people said it would at the beginning of the program, one ton per four minutes would equal the entire Shuttle fleet payload every three days. Of course, the way things are now, it would take a small fraction of one day. But the thing that interests me is that, if you look at the integrated amount of mass that you can get into orbit, piecemeal, 2000 lbs at a time, by a continuous stream going up from the surface, you find that you can do monumental works in very reasonable times. Figure 8 shows the estimated total electrical energy consumption in the United States to the year 2000 and beyond. At the bottom of the chart, it can be seen that a very small fraction of the total electrical energy of the United States would be required to build the first space colony for a few thousand people (e.g. the so-called Bernal Sphere).

Now let's come back to the same sort of picture that I showed earlier for microwave power beaming, but this time for huge lasers (Figure 9). Assuming we can build propulsion class lasers, then isn't it reasonable to think in terms of what else we can do with them -- like intercontinental power transfer? An early application could utilize a ground-based transmitter with a relay mirror in orbit sending power back to airplanes. (Abe Hertzberg will delight us with some details of laser air flight later in this session.)

The efficiencies of a laser relay scheme will probably be lower than those of a microwave scheme for the foreseeable future, but efficiency is not the whole story. Since the wavelength is about 10,000 times shorter for lasers than microwaves, the transmitter and receiver apertures can be 10,000 times smaller in diameter. Even with a realistic assessment of what the laser conversion efficiency will be, the numbers are not too daunting. I believe strongly in the free electron laser, which I'll discuss later, and it appears that 35% "wallplug" conversion efficiency is not unreasonable for the FEL*. So if we go through all of the losses associated with the full relay process to the user by this method, we'd probably be down to 15% instead of the 50% overall efficiency that we found for microwaves. However, the laser

*Free Electron Laser

relay may still render possible things that can't be done otherwise, and therefore it's worth examining. Efficiency is not the bottom line. Cost is the bottom line.

Turning to possibilities for solar power satellites, we have to look first at the question of what's the most cost effective way to convert solar power to electricity for the user. (It may be that the simplest approach will be to build amorphous solar cells for direct use on the ground, and forget about space altogether!) However, there is an alternative, shown in Figure 10 that I looked at in quite a bit of detail back in 1974. I named it STAG, for the Solar Tracking Adaptive Geometry. (Some of you might enjoy the fact that it started out being called STAG because it was first conceived as grown-up BAMBI, but that is an in-joke with a different motive!)

The STAG idea basically is to eliminate waste heat by using a big, very low-weight (possibly inflatable) light collector and designing it as a reflective filter so that you use only the part of the solar spectrum that you need to pump the laser and let the unwanted black body radiation simply pass through. We did a detailed examination of a strawman concept using iodine as the lasant. The light collector focuses the sun to a large plenum in which most of the waste heat is accountable only to the photon efficiency of the lasing process, which is quite high. The emerging 1.3 micron wavelength photons are then focused on the adaptive optics array, which transmits the beam to the ground or to users elsewhere in space.

We compared this method with another strawman, an indirectly pumped Brayton cycle carbon-monoxide electric discharge laser, and we found that the direct pumping iodine laser compared favorably. Even though the iodine STAG device is very big, its weight would be quite reasonable for a 100 MW unit. This suggests the possibility of building piecemeal power plants of about a hundred megawatts apiece and beaming the power to local users on the ground, in the air, or in space. It's about the same amount of power produced by a typical power plant on the ground. So the idea would be to bring the power down to a low cost collector just adjacent to the user facility on the ground or to other large users in space. One laser could access many users in the course of a day.

Objections to laser power beaming to the earth have often been based upon weather factors. If you're bringing the power down to collectors that are local to existing power plants for the purpose of feeding the national grid, the statistical coverage of the clouds is not too bad. A lot of the country is accessible all the time, as you can easily see from pictures taken from space. This is substantiated by the data in Figure 11 taken, I think, from an old Lockheed study.

One other point I want to make is that lasers for NASA applications would have to operate more or less continuously at very high power levels. Lasers for DoD applications have traditionally been conceived

for short run times at very high power. The free electron laser emerges as a prime candidate for both of these classes. This will be a comfort to the electrical engineers in the audience who may be worried because I'm not harping on microwaves. It's really just a question of wavelength! The FEL works just as well for microwaves as it does for lasers, and, in fact, it's demonstrated the highest and most efficient power generation at millimeter wavelengths ever achieved. Figure 12 shows the basic principles of an FEL.

Finally, a plug for my company, Kaman Corporation. I decided long ago that one of the most taxing problems standing in the way of beamed power is the fact that we don't know how to build very large optics cheaply enough to achieve the things that we dream of. Kaman has invested a substantial amount of IR&D money to solve this problem, and we now have a glorious new technology that we're going to reveal at the SPIE meeting in Orlando at the end of March. This will be a totally new approach to building very large optical apertures. Basically, we know how to produce phased arrays for optical wavelengths. The approach makes full use of the economies of the silicon microprocessor industry, and I think it can greatly reduce scaling difficulties and costs. We have named her PAMELA, which means "Phased Array Mirror, Extendable Large Aperture". She is represented crudely by Figure 13, which shows that she is composed of thousands of small "smart" segments, each a precision machine carrying two microprocessors, edge sensors capable of measuring position to $\lambda/40$ at visible wavelengths, and long-throw actuators that can conjugate disturbances in the atmosphere or in the optical system.

Table 1

HIGH POWER SPACE APPLICATIONS

- **K-BAND WIDE-COVERAGE RADAR**
 - AIR TRAFFIC MONITORING AND IDENTIFICATION
 - SHIP TRAFFIC MONITORING AND IDENTIFICATION
 - CLEAR AIR TURBULENCE MAPPING
 - DEFENSE
- **ELECTRIC PROPULSION FOR ECONOMICAL ORBIT RAISING (LEO TO GEO, ETC.)**
- **DIRECT-BROADCAST TV TRANSMISSION**
- **ADVANCED REMOTE SENSING**
- **INDUSTRIAL PROCESSES**
- **LIFE SUPPORT FOR LARGE MANNED SPACE STATIONS**

Table 2

SHUTTLE RENDEZVOUS WITH TUGBOAT IN LEO. RESIDUAL SHUTTLE MAIN TANK FUEL IS TRANSFERRED TO TUG. TUG THEN BOOSTS MAIN TANK OR FULL SHUTTLE PAYLOAD TO GEO.

- $I_{SP} = 1,500$ SECONDS
- $\Delta V = 5,630$ METERS/SEC (EACH WAY)
- TUG SPACECRAFT DRY MASS = 4,400 Kg.
- AVAILABLE FUEL MASS \geq 3,640 Kg.*
- MAIN TANK DRY MASS (OR ALT. PAYLOAD) = 32,300 Kg.

- TOTAL REQUIRED ENERGY = 4,500 GJ.
- MINIMUM ONE WAY MISSION DURATION = 5.2 DAYS
- MINIMUM REQUIRED LASER POWER = 10.2 MW

* 520 Kg. H₂ + 3,120 Kg. Lox

ESTIMATED TYPICAL DAILY ELECTRIC LOAD VARIATIONS FOR THE U.S. IN 1985

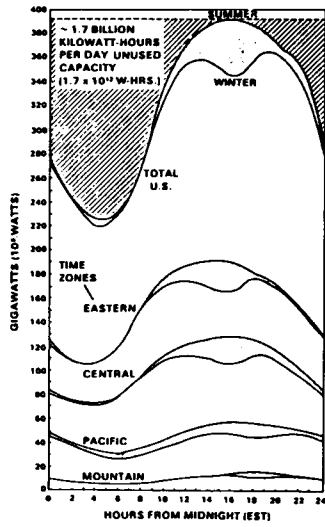

ESTIMATED TYPICAL DAILY ELECTRIC LOAD VARIATIONS FOR THE UNITED STATES IN 1985. STIPPLED AREAS INDICATE SEASONAL RANGE. LINED AREA REPRESENTS UNUSED OFF-LOAD CAPACITY.*

*DEVELOPED FROM DATA SUPPLIED BY EDISON ELECTRIC INSTITUTES, NY, NY

Figure 1

INTERCONTINENTAL POWER RELAY VIA MICROWAVES

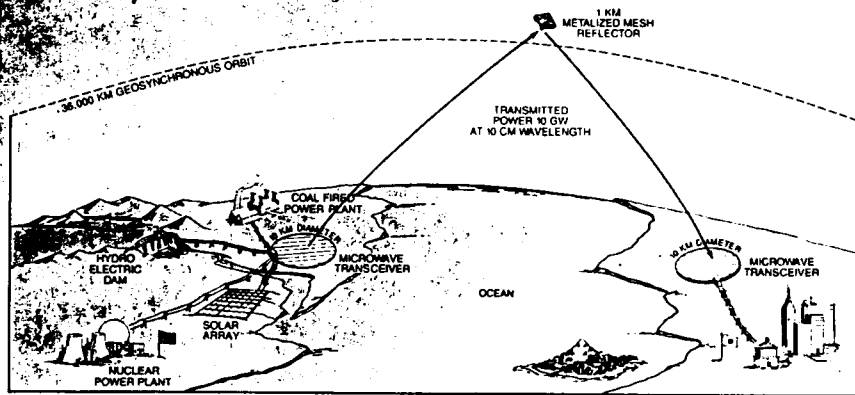

EFFICIENCIES

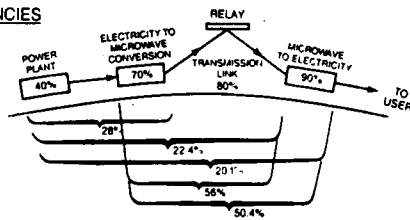

Figure 2

ORIGINAL PAGE IS OF POOR QUALITY

(U) COST OF ENERGY TRANSMISSION FACILITIES (1979 \$)

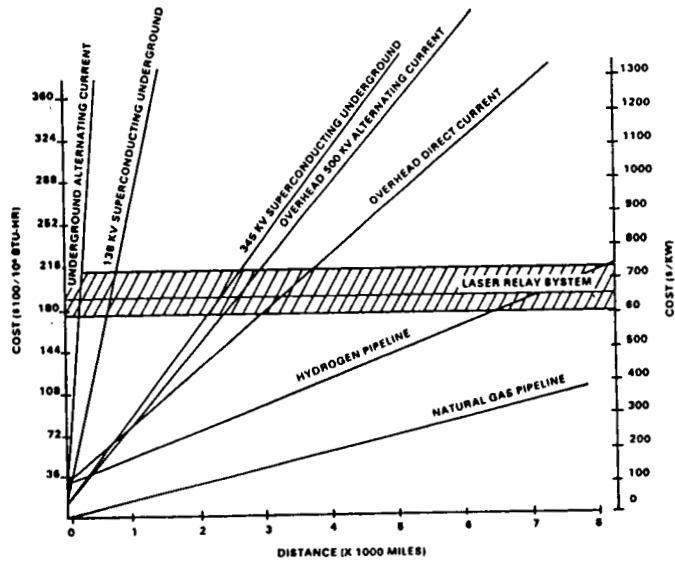
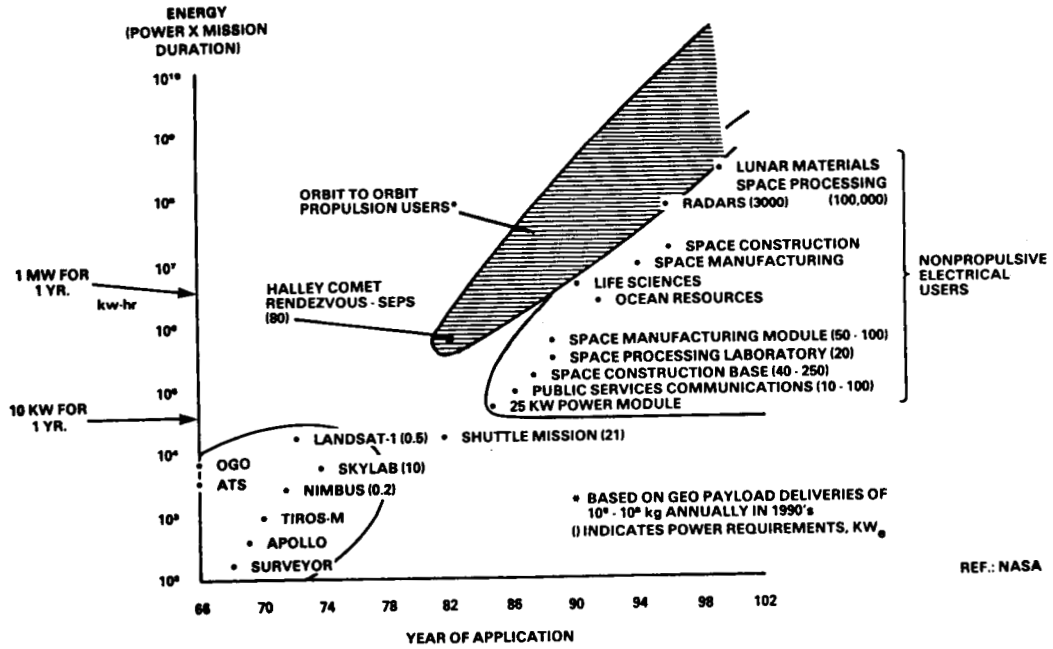

Figure 3

FUTURE NEAR EARTH SPACE ENERGY NEEDS



REF.: NASA

Figure 4

LASER PROPULSION APPLICATIONS *
PARAMETERS FOR ORBIT RAISING FROM 185 KILOMETERS

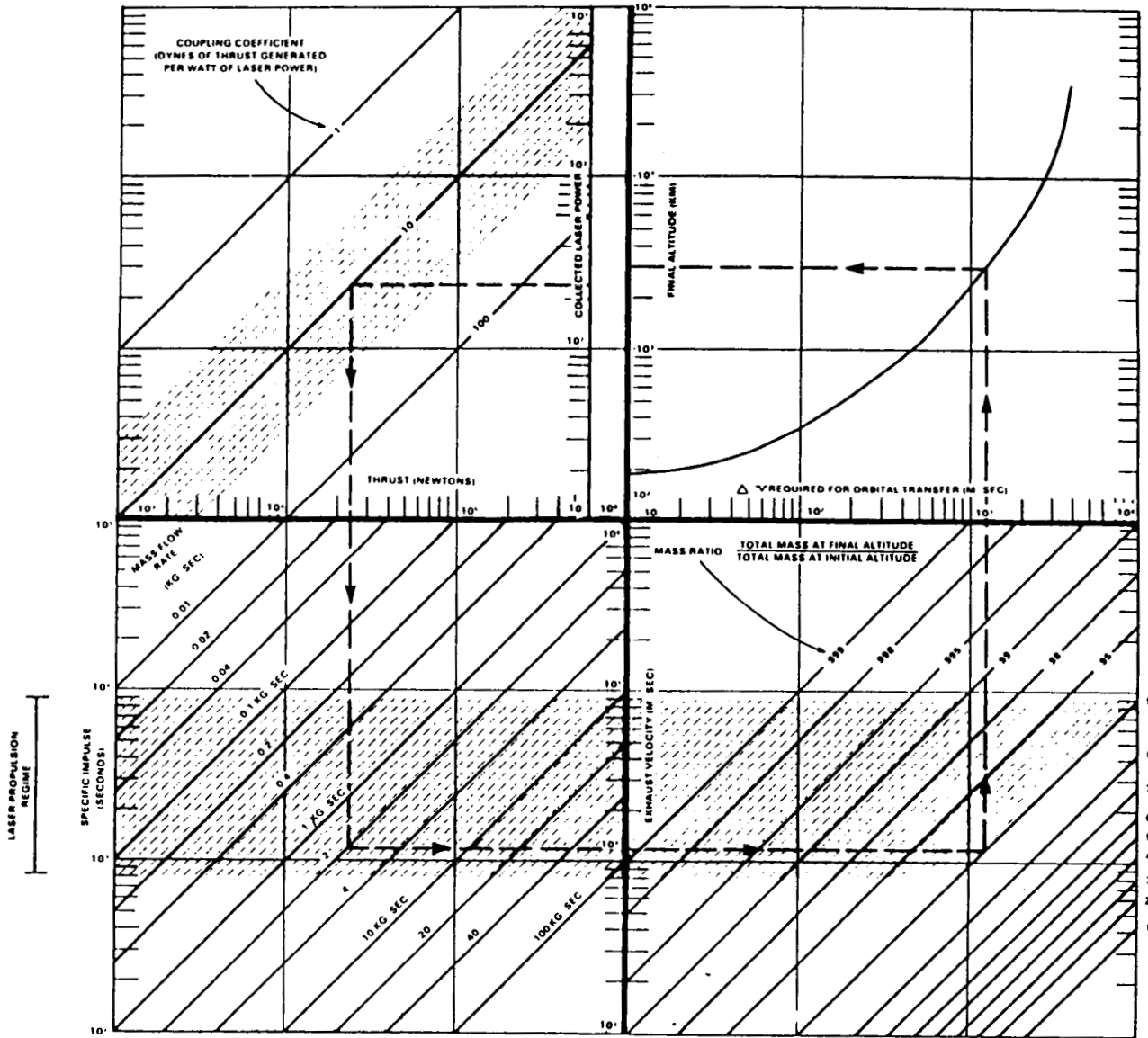

*Figure legend on next page.

Figure 5

NASA LASER PROPULSION APPLICATIONS

Long running high energy lasers provide an exciting option for propulsion systems to perform orbital transfer. Significant payloads can be raised to long-term parking orbits using moderate size laser systems with run times of less than a day.

As previously mentioned, there are many ways to group and plot intersecting system parameters to serve as mission analysis tools. The "first estimate" charts shown on the next two pages show the logical relationships among all of the principal parameters of laser propulsion for orbit changing. The first chart relates laser power to achievable orbital height for specified performance of the laser propulsion engine. The second chart uses a plausible tug model to find the duration of operation to raise a given payload to a given orbital height using the laser power found from the first chart.

In the upper right hand quadrant, the facing graphic plots the key mission parameter of a given increase in orbital velocity (total Δv) required to deliver any payload from a 185 kilometer orbit to any selected orbital altitude. The remaining curves represent parametric assumptions to describe particular propulsion system options that lead to required laser power (upper left hand quadrant). The significant engine performance parameters are specific impulse, I_{sp} , and the energy coupling coefficient, C , which relates rocket thrust to collected laser power. The chosen combination of C and I_{sp} defines the required fuel flow rate. Knowing what altitude is desired then defines the mass fraction (final-total-mass/initial-total-mass) required to get there. Alternatively, for a specified mass fraction, the chart shows what altitude can be reached.

An example of how to use this plot is shown for the mission of raising a 32 metric ton payload (approximate weight of the expended shuttle main tank) from 185 kilometers to 3000 kilometer orbit using 3.6 metric tons of residual hydrogen and a range of tug-like propulsion systems weighing between 1 and 5 metric tons (i.e., mass fraction approximately 0.9). Exhaust velocity for this example is selected as 10,000 meters per second, corresponding to a thrust of 23,000 Newtons, and the coupling coefficient is chosen to be $C=12$ dynes per watt. If these assumptions comprise a valid propulsion system, then the total power required is approximately 200 megawatts.

Stippled areas have been added to the chart to designate areas of validity or plausibility. The chart may not be accurate to within 10 percent for mass ratios lower than 0.9 because the fuel mass is sufficiently large that it will affect optimum mission parameters (see next chart). The other boundaries of the stippled areas indicate a plausible regime vis-à-vis achievable physics.

To go further, we must adopt a model of the laser tugboat. The mass of the tug is primarily related to the thrust, both because of the size of the engine and pumps and because of the required stress bearing components of the system as a whole. (Interestingly, the laser light collectors will have the same diameter regardless of the thrust for a specified laser wavelength.)

(Figure 5)

PERFORMANCE PARAMETERS OF LASER ORBITAL TRANSFER VEHICLE

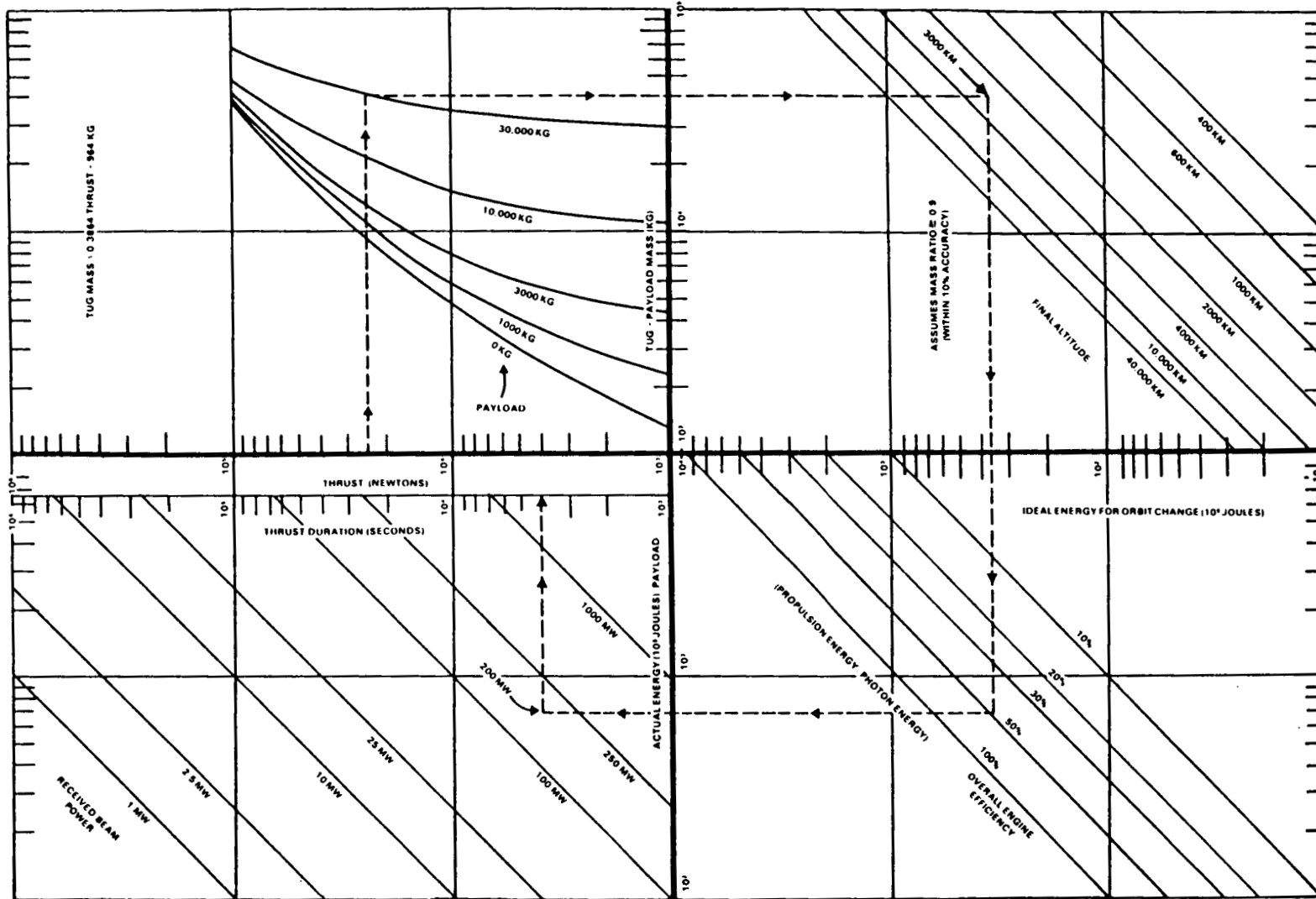

Figure 6 (Figure legend on next page.)

NASA LASER PROPULSION APPLICATIONS (CONTINUED)

TRW* has modelled a laser propelled tug which seems to have plausible and justifiable characteristics. For our purposes here, we have adopted the TRW tug model as expressed by the equation on the facing chart. We also assume that the fuel mass will, in general, be a small fraction of the tug plus payload mass (<10%).

It is important to understand that this chart is "slaved" to the chart on the previous page. The same thrust, altitude, and laser power must be used here that were chosen on the previous chart. In addition, the laser engine conversion efficiency is closely related to the coupling coefficient on the previous chart for a given engine design. Fifty percent efficiency is regarded as a reasonable value. With these constraints we can then find the total thrust time to perform the mission.

The dashed line applies to the mission of raising the Space Shuttle main tank to a 3000 kilometer orbit from 185 kilometers. It can be seen that this mission can be accomplished in ~3500 seconds of thrust time with 200 megawatts of delivered laser power. Or, retracing all of the steps, we find that the same mission can be performed in ~26,000 seconds (7.2 hours) with 20 megawatts of laser power.

* Reference: M. Huberman et.al., "Investigation of Beamed Energy Concepts for Propulsion", Volume 1, by TRW Defense and Space Systems Group, prepared for AFWL, Edwards AFB, CA, October 1976.

(Figure 6)

NATURAL RADIATION DOSE

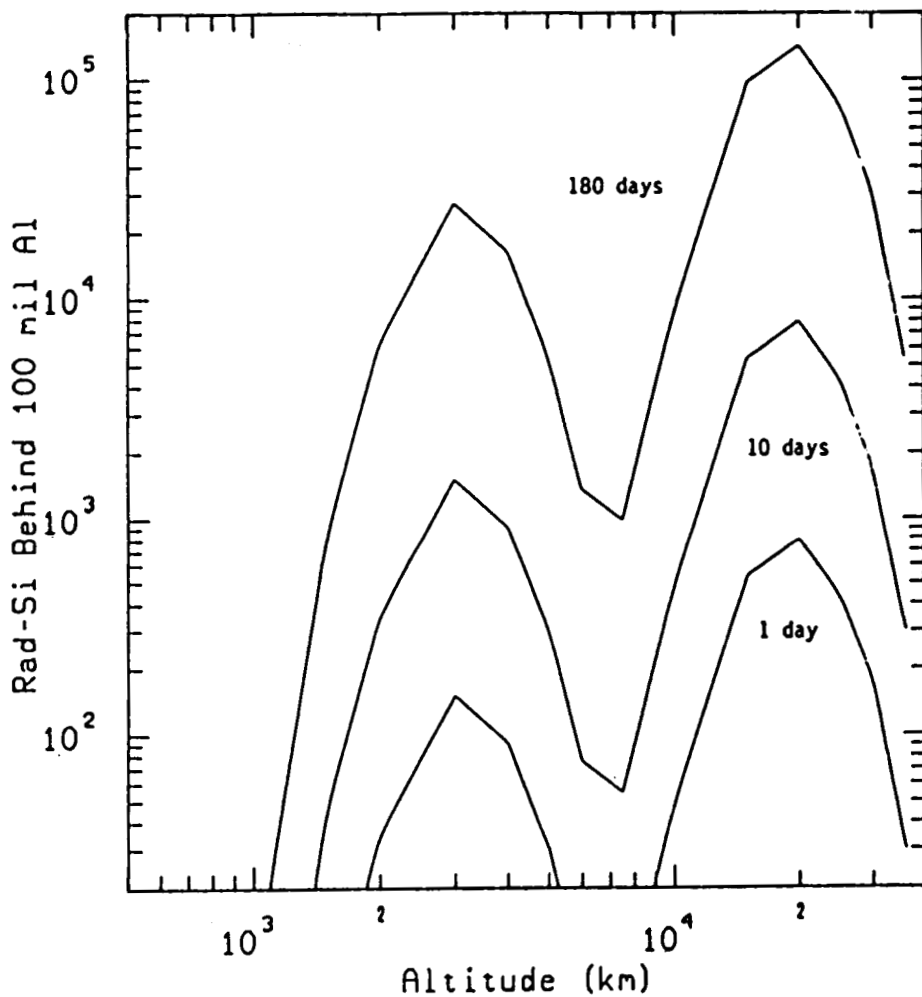
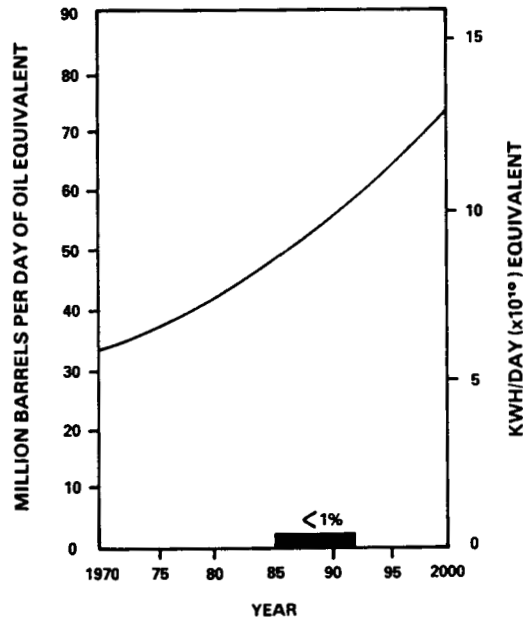

Figure 7

FRACTION OF U.S. TOTAL ELECTRICAL ENERGY NEEDED TO BUILD A SPACE COLONY



ORIGINAL PAGE IS OF POOR QUALITY

Figure 8

INTERCONTINENTAL POWER RELAY VIA LASER BEAMS

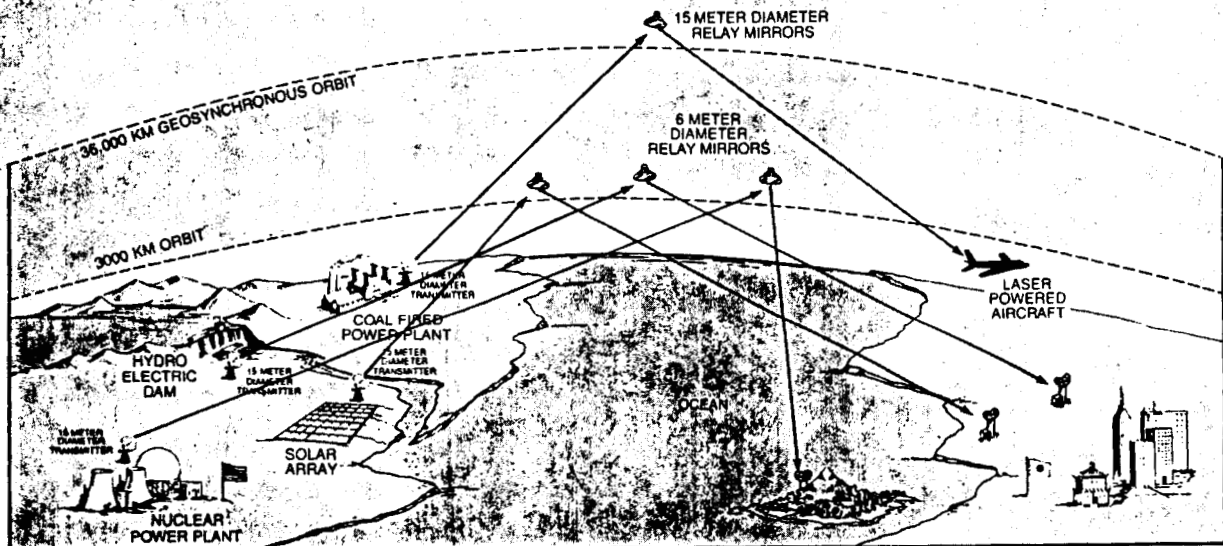

Note: Optics diameters assume 2.2 micron wavelength

EFFICIENCIES

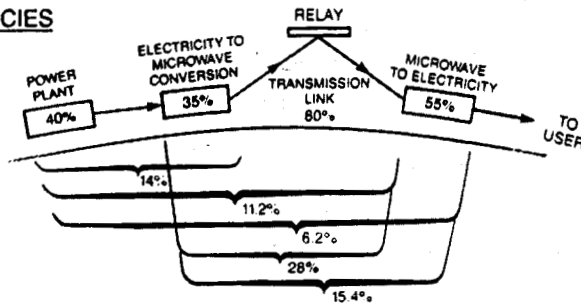
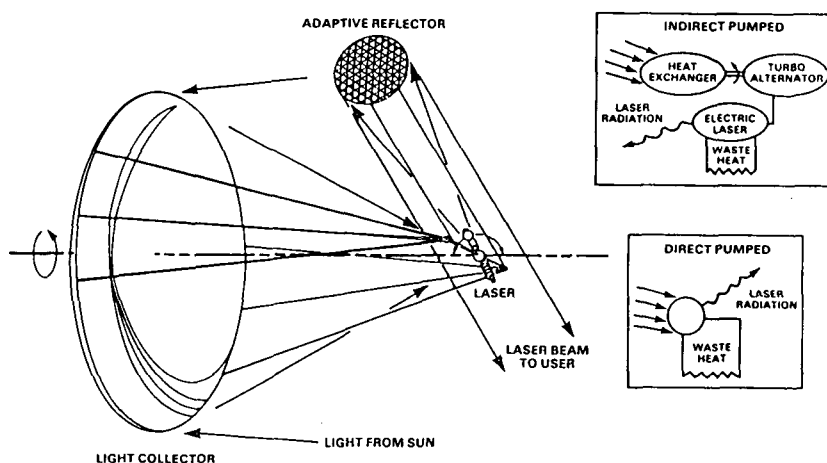

Figure 9

SOLAR POWERED LASERS IN SPACE



There are several plausible concepts for solar powered lasers in space. Direct solar-pumped lasers may be particularly interesting because of their simplicity, provided that they can be made sufficiently efficient and cost effective.

The "hammer-and-tongs" approach to building a continuously operating high laser system in space would involve the use of some sort of solar powered electrical generator to run a conventional electric discharge laser (EDL) or a free electron laser (FEL). Indeed, this may prove to be a straightforward method if high overall efficiencies can be achieved by such lasers as the FEL (/50%), the CO EDL (/50%), or the Excimer (/15% at short wavelengths). A baseline case CO EDL concept developed by W. J. Schafer Associates has an estimated system mass, of 131,000 Kg for a 100 MW laser*. The four major contributors to the mass of this system are the sunlight collector, the adaptive projector optics, the laser (with its power generator), and the waste heat radiator. In electrical laser systems, the latter two components dominate because the solar concentrator can be of very light construction and the projector optics are relatively minor components of the entire system.

Directly pumped solar lasers are very different in conception. The sun is a large angular source (/0.5 degree) so that the image at the focus of a large concentrator is still large even for very short focal lengths. (A 1 Km diameter concentrator intercepts 1 GW of solar power. A focal ratio of 0.4 yields an image approximately 4 meters in diameter.) Hence, the lasing volume must be large also. This necessitates development of a new class of laser especially suitable for use in space. Interestingly, the power scales with volume of the laser and thus increases as the cube of the linear diameter, while the mass scales with the wall areas which increases only as the square. (The lasing medium is a gas of negligible weight.) Hence, larger devices have better specific weight per megawatt transmitted.

The biggest problem with direct-pumped lasers is that the solar spectrum is very broad, while the absorption lines of most lasing gases are very narrow. Hence, only a small fraction of the available sunlight can be utilized. This equates to low overall efficiency, which seems fatal to the concept at first glance. It is possible, however, to use clever filtering at the primary collector and/or a "black-body Chamber" pumping cavity to improve the effectiveness markedly.

New and important progress is being made in the area of waste heat rejection by A. Hertzberg at the University of Washington. Laboratory experiments have proven the feasibility to reducing the heat radiator mass by a factor of at least ten by allowing the heat to melt a material which can be broken into thousands of tiny droplets to achieve very large surface radiation area. This breakthrough should profoundly affect the feasibility of high energy systems in space.

*For an extensive discussion of the physics and engineering of solar powered lasers in space see for example the paper "New Candidate Lasers for Power Beaming and Discussion of their Applications" by John D. G. Rather in Radiation Energy Conversion in Space, V. 61 of AIAA Progress in Astronautics and Aeronautics (1978).

Figure 10

**(U) LOCATION OF GROUND SITES DEPENDS
PRIMARILY UPON AVERAGE ANNUAL NUMBER
OF CLEAR DAYS**

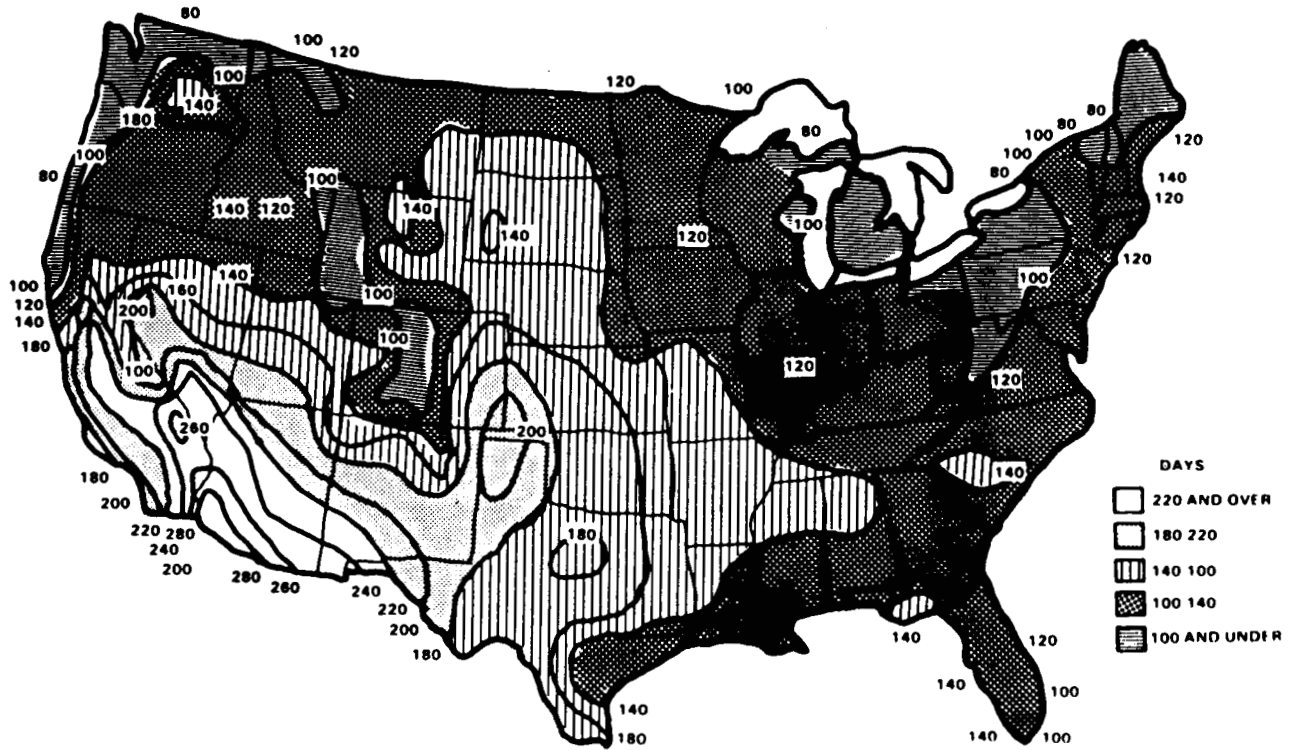

(UNCLASSIFIED)

Figure 11

BASIC ELEMENTS OF A COMPTON-REGIME FREE ELECTRON LASER

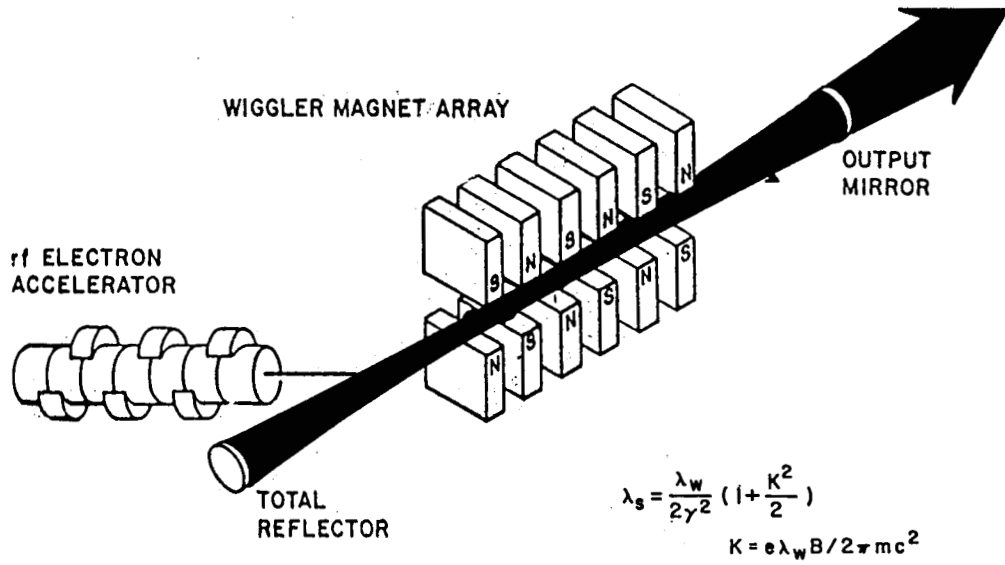

Figure 12

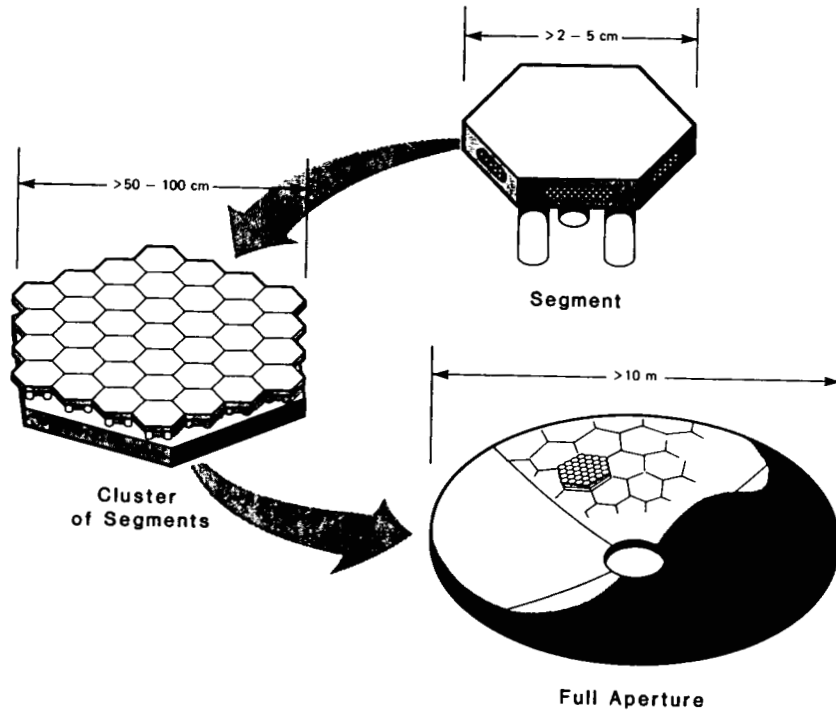

Figure 13

N90-10143

S3-20

LASER PROPULSION TO EARTH ORBIT
HAS ITS TIME COME?

Arthur Kantrowitz
Dartmouth College
Hanover, New Hampshire

DB608495

Abstract

Recent developments in high energy lasers, adaptive optics, and atmospheric transmission bring laser propulsion much closer to realization. Perhaps more important, the need to transport much greater tonnages to orbit for commercial purposes, Space Station Freedom and for military purposes is now clear. A part (e.g. half the space station supplies) of this traffic could be orbited in small packages. Accordingly a workshop on this possibility was held at Livermore National Laboratory in July 1986 and this paper leans heavily on its results.

Proposed vehicle
This paper proposes a reference vehicle for study which consists of payload and solid propellant (e.g. ice). A suitable laser pulse is proposed for using a Laser Supported Detonation wave to produce thrust efficiently.

It seems likely that a minimum system (10 Mw CO2 laser & 10m dia. mirror) could be constructed for about \$150 M. This minimum system could launch payloads of about 13 kg to a 400 km orbit every 10 minutes. The annual launch capability would be about 683 tonnes times the duty factor. Laser propulsion would be an order of magnitude cheaper than chemical rockets if the duty factor was 20% (10,000 launches/yr.) and launches beyond that would be even cheaper.

The chief problem which needs to be addressed before these possibilities could be realized is the design of a propellant to turn laser energy into thrust efficiently and to withstand the launch environment.

INTRODUCTION

The key cost which determines the magnitude of realistic possibilities in space is the cost of transportation to low Earth orbit (LEO). One of the great disappointments in the utilization of space is that in the 29

years since Sputnik this key cost has not declined.

One opportunity for dramatic improvement is to transmit the orbital energy from a laser on the ground to the ascending vehicle. Lasers can easily vaporize any material and it is possible to transfer energies to the vapor which are large compared to chemical energies. The evaporated material produces a jet which propels the vehicle, and the kinetic energy of the propulsive jet can be a large fraction of the energy absorbed from the laser. If the vapor is heated to very high temperatures, correspondingly high jet velocities can be achieved so that the amount of propulsive material (and the lift-off weight) required to launch a given payload can be about an order of magnitude less than that required for a chemical rocket. The laser which is the dominant component remains on the ground so that laser propulsion systems are, in principle capable of launching a payload every few minutes.

When this system was first proposed fifteen years ago (Refs. 1 and 2) four major extrapolations of existing technology were required for its implementation:

1. Laser average powers had to be extended by several orders of magnitude.
2. Atmospheric transmission problems needed to be explored.
3. Collimating mirrors larger than conventional dimensions needed to be developed.
4. Technology for efficiently converting laser energy into the kinetic energy of a jet with speeds up to about 10^6 cm/sec (specific impulse 1000) and with thrust vectors considerably off the laser beam axis needed to be developed.

While none of these extrapolations seemed difficult enough to prevent development of laser propulsion, taken together at a time when the decision had been made to develop and to depend on the Shuttle for the nation's space transportation needs, it is not surprising that no major program was undertaken in the early seventies.

At this time the first three extrapolations are being vigorously pursued largely under SDI programs. There are strong indications that lasers of any required power can be built. Combining modules of molecular e.g. CO₂ lasers or constructing very large free electron lasers are two avenues which now seem open. The problems involved in transmitting many megawatts through the atmosphere are being addressed. While some of these may be somewhat different for laser propulsion than they are for other SDI* purposes, there are persuasive indications that these beams can be transmitted through the atmosphere with the aid of adaptive optics. Adaptive optics also has made it possible to build very large mirrors, e.g., the 10 meter Keck telescope.

The development of thruster technology has not been vigorously pursued and such work as has been carried out seems more adapted to the task of changing the orbit of a satellite (which needs much smaller laser power).

*Strategic Defense Initiative

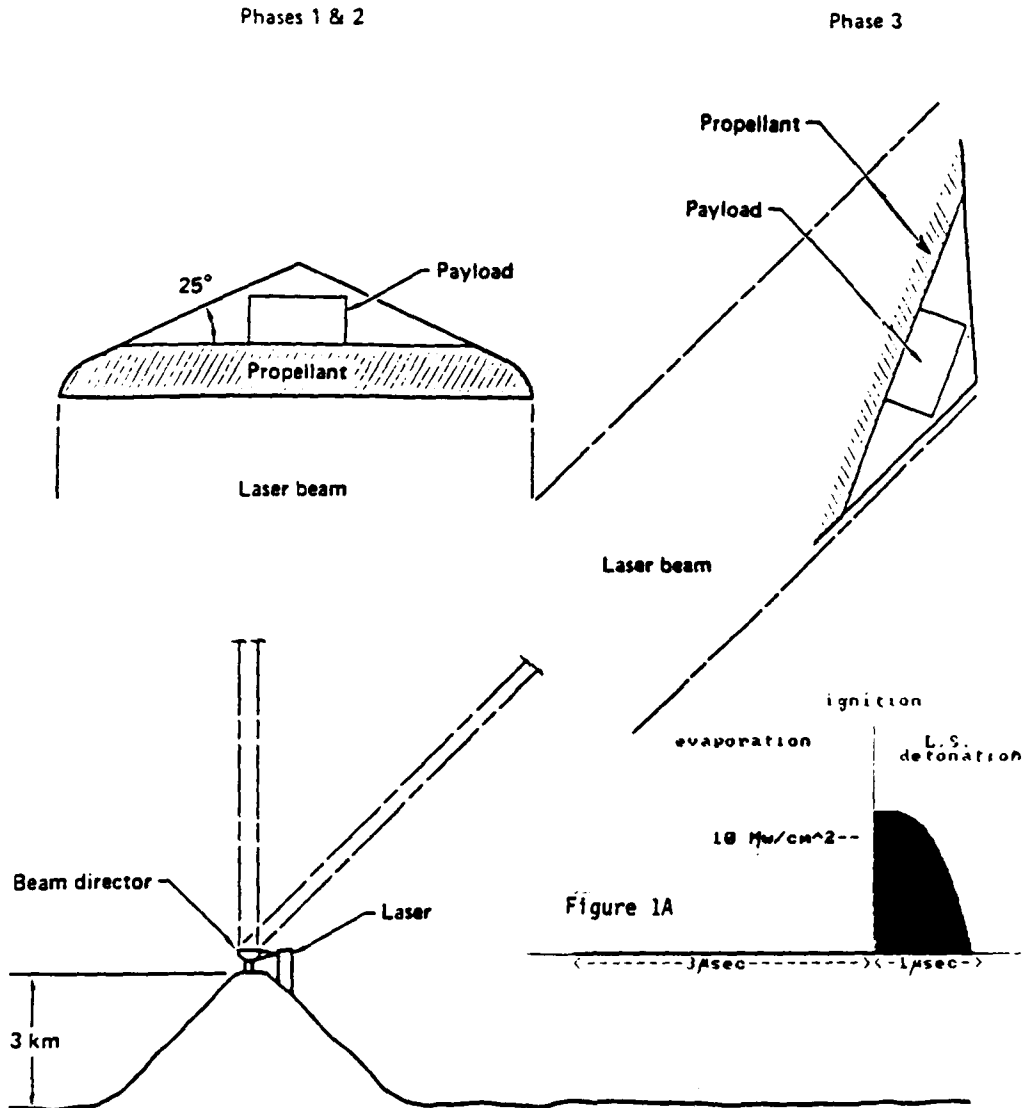

Figure 1. A very schematic rendition of the principle of laser propulsion and the reference vehicle. The ground-based laser generates a double pulse: the first evaporates a designed amount of propellant, and the second heats the vapor to a temperature high enough to produce the desired specific impulse. The propellant (about 7.7 times the payload weight at lift-off) is a solid of low molecular weight. The conic shape allows the laser to illuminate the base at an angle of incidence up to 1 radian without damaging the payload. The reference vehicle is shown at launch and in the exoatmospheric phase 3. The thrust is vertical for the ascent through the atmosphere (phases 1 & 2), and the propellant can be cylindrical. For phase 3, the large angle of incidence of the laser necessary to produce a thrust component perpendicular to the laser beam requires a conical payload bay to keep the payload in the shadow of the propellant. A large part of the propellant is consumed in the ascent through the atmosphere.

Figure 1A. The three phase pulse. The evaporation phase controls the density distribution which is acted upon by the high power Laser Supported Detonation (LSD) phase. The ignition phase uses the highest instantaneous power available from the laser system to ignite the gas close to the surface as rapidly as possible. The plasma formed will then shield the propellant from the LSD phase which follows.

I would like to propose the modification of this two pulse system illustrated in Fig. 1A. Here the pulse is divided into three phases with the addition of an "ignition spike." The evaporation energy is typically one to two orders of magnitude smaller than the energy needed to drive the LSD. The specific energy deposited in an element of gas by the LSD is proportional to the 2/3 power of the ratio of the flux to the density (Ref. 3). Thus the deposited energy can be controlled either by controlling the density or the flux during the LSD phase. It is clearly more economical to control the density distribution which depends only on the flux as a function of time during the evaporation phase. It is therefore proposed that the flux during the evaporation be an adjustable function of time chosen to produce a density distribution designed to achieve the desired specific impulse with maximum efficiency.

The ignition phase consists of a spike, perhaps a gain switched spike, intended to ionize the vapor close to the propellant surface sufficiently to make it opaque to the laser radiation. It is important that this process be accomplished rapidly to avoid evaporating too much propellant at this stage. It will be seen that the highest attainable flux will lead to minimum evaporation (see reference 4). It is therefore proposed that the flux in the ignition spike be as large as can be delivered. The limitation will probably be imposed by surface breakdown in the laser. Required duration of the ignition spike will depend on the nature of the propellant e.g. for lithium hydride calculated that, at a flux of 25 Mw/cm^2 , the time required was 7.5 nsec and thus a fluence of less than $.2 \text{ joules/cm}^2$ to achieve unit optical depth.

The third LSD phase involves most of the energy and the cost of creating it controls the system cost. The objective of this pulse shape design has been to prepare the vapor to efficiently utilize whatever pulse shape minimizes this laser cost.

ESTIMATES OF THE CAPABILITY OF THE REFERENCE SYSTEM

It will be useful to start by attempting an estimate of the losses which are foreseen for this process.

First there are the losses in the laser itself. Assuming electrically driven lasers, the "wall plug" efficiency EL gives the ratio of the power in the collimated laser beam to the power drawn from the utility lines. For example for a 10 micron free electron laser Briggs (LLNL) informed us that an appropriate EL would be about 20%. For the CO₂ laser Daugherty (AVCO) suggested 16%.

Second there are losses in the atmosphere. Among these are scattering due to Thermal Blooming, Stimulated Raman Scattering, and Atmospheric Turbulence, and there is absorption chiefly due to water vapor. We assumed that at the intensities to be used (for the sample trajectory 10^5 w/sq cm at the collimator) and noting that we have a cooperative target, that the beam would be essentially diffraction limited. Starting from a mountain top about 10,000 ft high we took the transmission through the remainder of the atmosphere, EA , to be $.9/\cos(\theta)$ where θ is the zenith angle.

The third set of losses occurs in converting the laser energy arriving at the vehicle into thrust. An ideal thruster would convert the laser energy arriving at the vehicle into kinetic energy $MDOT \cdot VJ^2/2$ where MDOT is the propellant used per second and VJ is the designed jet velocity. (Note that in the double pulse system, the propellant mass and the propulsive energy can be chosen independently; VJ can be chosen to optimize overall performance.) Losses in this conversion which result in a thruster efficiency, ETH, include:

- A. The latent heat of the evaporated propellant.
- B. Chemical or internal molecular energy remaining in the jet following the one dimensional expansion. These losses will be reduced by the use of the longest duration pulses which still allow essentially one dimensional expansion (1 microsecond for a 1 meter dia vehicle).
- C. Losses due to non-homogeneities in gas velocity in the jet.

These losses are estimated in reference 5 by Rod Hyde for lithium as a propellant. (Lithium was chosen simply for ease of calculation.)

The uncertainties in the value of ETH are presently the leading uncertainty in the efficiency of laser propulsion. At the present state of the art the workshop saw no reason to change the guess that ETH would be about 40% (which was made in Ref. 1).

Finally the kinetic and potential energy in the payload is of course smaller than the kinetic energy in the propulsive jet integrated over the trajectory. We will call the ratio of these energies the trajectory efficiency, ETR. For the sample trajectory ETR was 27%.

ESTIMATE OF THE MASS LAUNCHING CAPABILITY, M_o , OF A PULSED LASER

The range to orbit, D, will be dominated by the acceleration during the high velocity (V) portions of the trajectory. If we take this acceleration, VDOT, as constant, using the final acceleration and taking $VJ = V$,

$$VDOT \cdot M_o = MDOT \cdot VJ = 2 \cdot ETH \cdot P' / V, \quad (1)$$

we get

$$D = \frac{V^2}{2 \cdot VDOT} = \frac{M_o \cdot V^3}{4 \cdot ETH \cdot P'}, \quad (2)$$

where P' is the average laser power at the vehicle, and M_o is the mass launched.

The radius, r_v of a vehicle base which can be illuminated with a flux ϕ with peak power PP from the laser is

$$r_v = (PP / \pi \cdot \phi)^{.5}.$$

We have assumed a "flat top" distribution of intensity. Actually D will be limited by diffraction to approximately

$$D_{max} = r_m * r_v / .3 * \lambda \quad (3)$$

where r_m is the radius of the collimating mirror, λ is the laser wavelength and the constant .3 is chosen to correspond to a value of r_v halfway to the first dark ring. For $\lambda = 10$ microns, $r_v = 50$ cm, and $r_m = 5$ m we get $D_{max} = 833$ km.

Setting $D = D_{max}$ (eq. 2&3) we get

$$M_0 = \frac{7.5 * r_m * E_{TH} * P' * (PP / \phi)^{.5}}{\lambda * v^3} \quad (4)$$

Allowing for atmospheric absorption as discussed above we take for our model 10 MW laser, $P' = 8$ MW, $PP = P' * 10^4$, $\phi = 10^7$ watts/cm² and the above values of r_m , r_v , E_{TH} , and λ , the mass which can be accelerated to orbital velocity is 18 kg. The agreement of this estimate with the sample trajectory result calculated below (13.79 kg.) is as good as might be expected since in that case the acceleration was not constant.

A SAMPLE TRAJECTORY*

When we consider the practical applications of laser propulsion an important consideration is the minimum** scale of an initial trial.

To illuminate the choice for this minimum scale we will attempt to calculate the payload which can be launched with a 10 MW laser, making the guess that this will be within one order of magnitude of the practical minimum. It was assumed that the pulse duration was $10^{(-4)}$ of the time between pulses so that the flux on the 1 sq meter vehicle base would be 10 MW/sq cm. Note that the mass which can be launched varies inversely with the square root of the minimum flux sufficient to sustain an efficient LSD. The achievement LSDs at low flux will be one of the most important objectives of propellant research.

After several trials it was found possible to launch 13.79 kg into a 411 km circular orbit making the assumptions listed in Table 1.

* In Ref. 5 Jordin Kare gives a more complete modelling of the laser launching. Close agreement between his results and those presented here provides some confidence that the remaining bugs are not too important.

** We will not consider here the utility of small satellites other than to note that Freeman Dyson* proposes that satellites as small as 1 kg would be useful for space science purposes.

*Dyson F., see his March 26, 1986 talk at Analog Devices, Norwood, MA.

TABLE 1

ASSUMPTIONS FOR SAMPLE 10 MW LASER LAUNCH MODELLING

- A. Initial mass (propellant + payload) = 120 kg.
- B. The base area of the propellant = 1 sq. meter
- C. The coefficient of atmospheric drag = .4
(note that this assumes that the vehicle will be streamlined as well as a sphere.)
- D. The trajectory starts at the laser which is on a mountaintop 3 km above sea level.
- E. The jet velocity, VJ, can be adjusted in magnitude between 3.6 and 10 km/sec by varying the energy ratio in the two pulses.
- F. The thruster efficiency will be $ETH = 40\%$ for any VJ in this range. This assumes that a propellant can be found which will perform as well as the Lithium in Hydes calculation while avoiding environmental and cost impacts of Lithium.
- G. The direction of the thrust, which is normal to the vehicle base, can be adjusted by tilting the vehicle. It was assumed that the vehicle attitude would be continuously measured from the ground and controlled by moving the laser pulses off center. A short simulation indicated that, if the vehicle was spinning at a few rps, it would be possible to control the thrust axis to within about 5 degrees.
- H. Vehicle design was assumed to allow an angle of incidence between the laser and the base up to 65 degrees without exposing the payload to damaging laser radiation (see Fig. 1).
- I. It was assumed that the beam director mirror would be 10 meters in dia. allowing the 10 micron beam to be focussed on the 1 meter dia. vehicle base out to a range of about 800 km. This implies performance not very far from the diffraction limit. More work is needed to specify tolerances on optical performance.

The program used to calculate the trajectory is to be found in Appendix 1. A sample result is shown in Fig. 2 and the numerical results are given in Table 2. The ascent to orbit is divided into four phases.

1. Phase 1 starts with a liftoff close to the laser and with a vehicle weight (propellant plus payload) of 120 kg which was close to the largest load the laser could lift with $VJ=3.6$ km/sec. VJ was varied to make the best compromise between gravity and drag so as to minimize the mass loss per unit altitude gain. Phase 1 was terminated (somewhat arbitrarily) when the acceleration reached 1 g. At the end of phase 1 the mass was 57 kg.
2. In phase 2, continuing the vertical ascent to 130 km, the vertical acceleration was maintained at 1 g and VJ varied from 5 to 10 km/sec, the mass ended up at 38 kg and the vertical velocity was 1.45 km/sec.
3. At the beginning of the extraatmospheric acceleration, phase 3, the vehicle was tilted so that the angle of incidence of the laser on the vehicle base was 1 radian. The thrust, which is normal to the base, was at the beginning of phase 3, 33° up from the horizontal. The vehicle was maintained at this angle of incidence to the laser as it

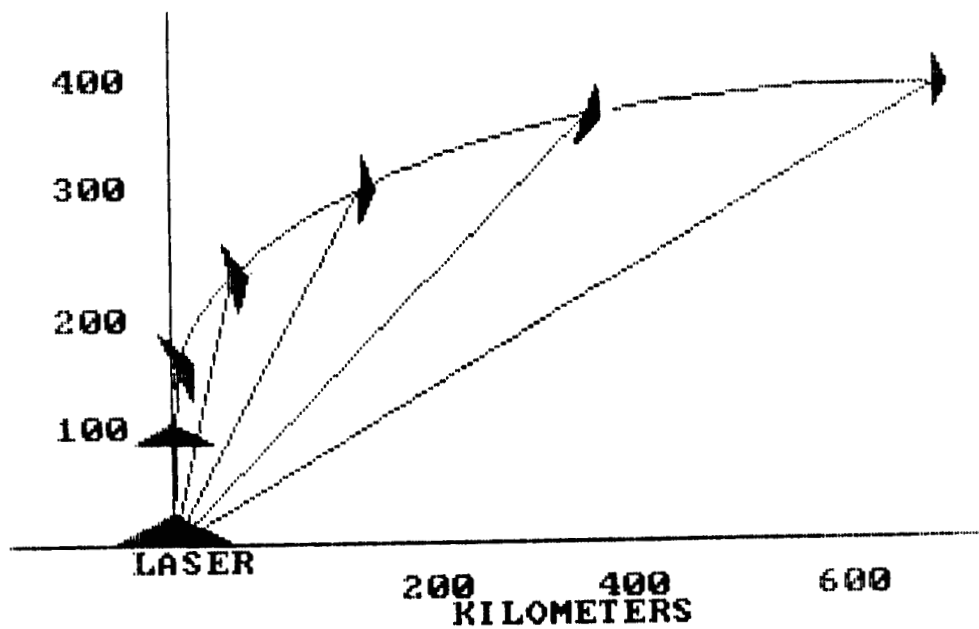
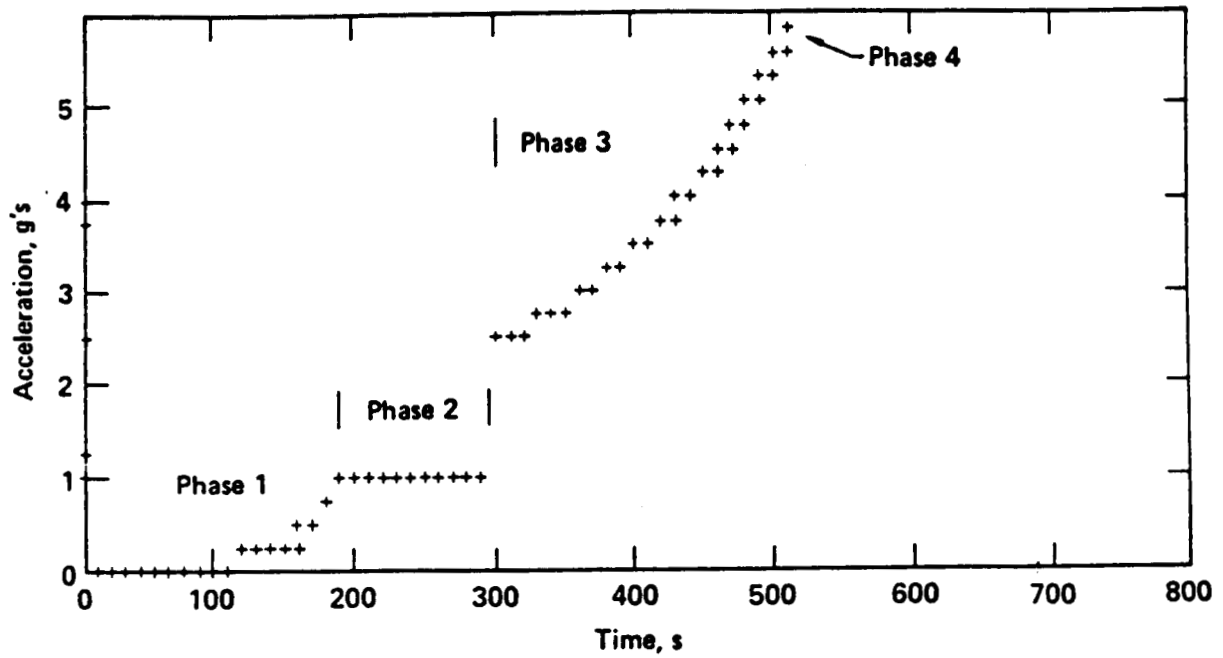

Figure 2. The sample trajectory. Beginning at a 3-km mountaintop, the launch is divided into four phases and reaches a 411-km orbit after 502 s. The vehicle coordinates and the angle (not scalable) to the laser are shown in the lower graph, and the vehicle acceleration is shown in the upper graph.

accelerated horizontally until after about 360 sec into the flight the zenith angle between the laser beam and the vertical reached .5 radians. Then the thrust became horizontal and afterward had a downward component which was continued until the vertical velocity was cancelled.

4. When the vertical velocity became negative near the end of acceleration the vehicle was tilted in phase 4 to maintain the vertical velocity close to 0. Phase 4 ended 502 seconds into the flight when orbital velocity was reached.

TABLE 2

TIME	MASS	HOR.DIST.	SAMPLE 10 HEIGHT	MW LAUNCH VJ PHASE 1&2	VERT.VELOC.
PHASE 1					
0	120	0	3	3.6	.085
20	107.09	0	4.7	3.648	.091
40	96.4	0	6.6	3.958	.099
60	87.45	0	8.7	4.268	.11
80	79.77	0	11.1	4.573	.124
100	73.13	0	13.8	4.862	.144
120	67.25	0	17	5.111	.173
140	61.87	0	20.9	5.261	.218
160	56.59	0	26	5.155	.3
173	PHASE 2				
180	50.62	0	33.6	4.973	.468
200	46.17	0	45	6.575	.664
220	43.53	0	60.4	8.055	.861
240	41.52	0	79.7	8.761	1.058
260	39.74	0	102.9	9.192	1.254
280	38.11	0	130.1	9.588	1.451
280	PHASE 3		HORIZONTAL VELOCITY		
300	35.86	4.2	159.8	.412	1.514
320	33.61	17.1	190.7	.863	1.575
340	31.36	39.6	222.7	1.36	1.619
360	29.12	72.7	255.3	1.924	1.633
380	26.89	117.6	287.8	2.545	1.605
400	24.66	175.6	319.1	3.231	1.523
430	22.46	248	348.2	3.982	1.377
440	2028	336.1	373.5	4.795	1.157
460	18.13	441.1	393.7	5.672	.855
480	16.03	564.3	406.8	6.608	.465
500	13.99	706.8	411.2	7.605	-.02
500	PHASE 4				
502	13.79	722.2	411.2	7.71	-.003

END RESULTS

INITIAL MASS, KG 120 FINAL MASS 13.79
 RANGE= 831 FINAL ZENITH ANGLE = 60 ACC. = 5.75
 ELEC. BILL/KG IN LEO = \$ 10.1 PROPELLANT = \$ 15.39

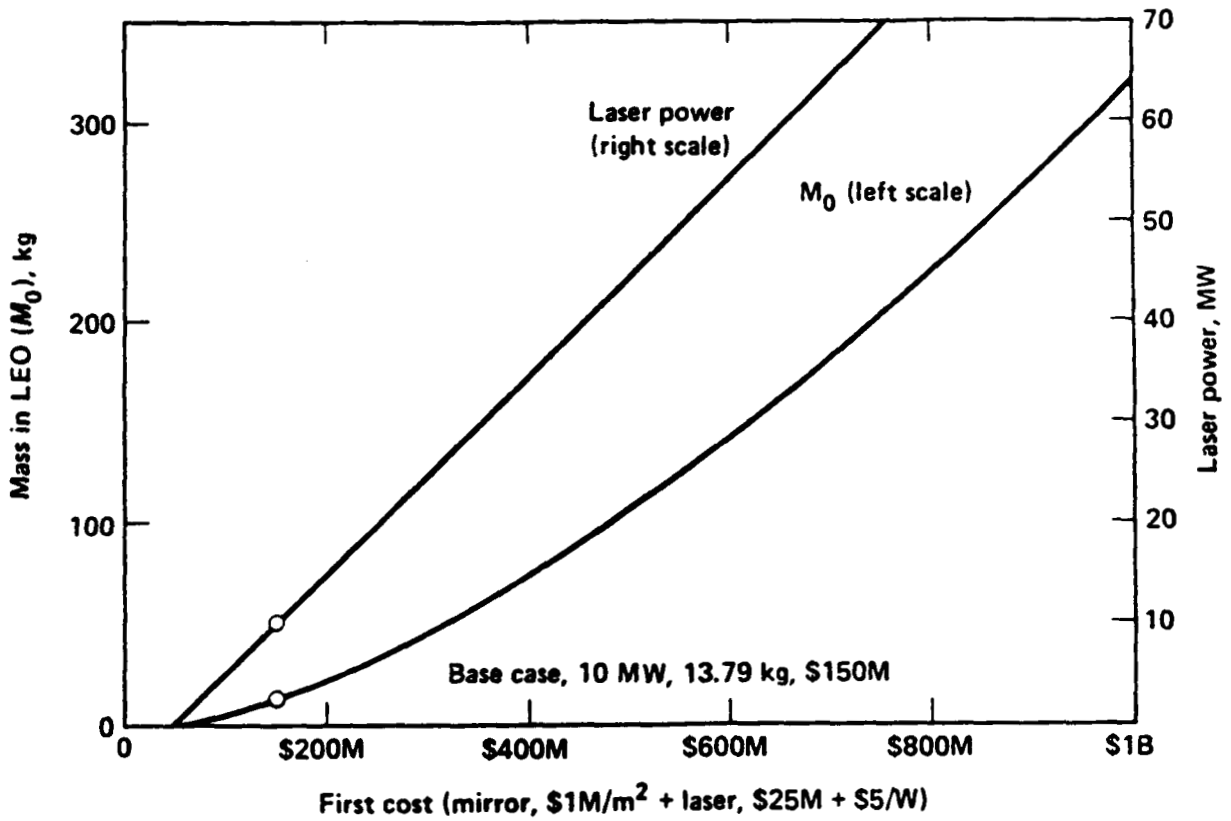

Figure 3. Estimates from Eq. (5) of laser launching capability to LEO (~400 km). Costs are based on estimates from Avco for CO₂ lasers and from Itek for adaptive optics.

ECONOMICS OF THE 10 MW LAUNCHER

What can we say now of the costs of transportation to LEO by this small scale laser propulsion?

The electricity used in the sample trajectory was about 505 kw hrs per kg of payload. Even though this is more than 50 times the ideal energy requirement, the cost of this electricity will not dominate transportation costs. This parallels the situation in chemical rockets where the fuel costs are also not dominant. For the calculations below and for Table 2, the U.S. Govt rate of \$.02/kw hr was used.

It is harder to estimate propellant costs since a realistic propellant is still to be found. The mass of propellant, about 7.7 pounds per pound of payload, is small enough so that it would be expected that a propellant can be found which is cheap enough so that propellant costs probably will not have an important impact on overall launch costs. For the calculations below and for Table 2, \$2/kg of propellant was assumed. It must be remembered that the choice of propellant will have a large impact on the thruster efficiency and thus a direct impact on the launching capability of a laser and on the economics of laser propulsion.

The important costs for laser propulsion are the capital and the operating costs of the ground laser installation. Eq. 4 can be used to optimize the distribution of costs between mirrors and lasers and to provide a rough estimate of the capital cost of a laser launching installation to launch M_0 grams. If for example we take the cost of mirrors made with adaptive optics to be proportional to the mirror area (\$1 M/m² was suggested by Itek) and we take laser costs to be proportional to average (not peak) power, we get that the costs should be distributed equally between laser and mirror. If also we take a laser cost \$25M + \$ 5 per watt (estimated by Jack Daugherty of Avco for CO₂ lasers), and correcting eq. 4 by a factor 13.79/18 to agree with the result of the sample trajectory, we get

$$M_0 = 11.5*(C - 50)*C^{.5} \quad (5)$$

where C is the capital cost in millions of dollars.

Eq. 5 is plotted in fig. 3. The Department of Energy uses a rule of thumb for estimating the operating costs of large experimental installations of 20% of the capital cost per year. If we add amortization of the capital costs in 5 years then the costs of the ground installation comes to 40% per year. The 10 MW installation would have a capital cost of \$150 M and an operating cost of \$60 M/yr.

From the sample calculation, a 10 MW laser could launch 13.79 kg (30.4 lbs) in 502 secs. If the laser were used with a duty factor of 1 (62,821 launches/yr), it would then launch 866 tonnes/yr. Allotting the \$60M/yr costs to the payload launched gives for the 10 MW laser

$$\begin{aligned} \text{Launch cost/lb} &= \$32/\text{duty factor} \\ &+ \$12 \text{ (Electricity \& Propellant)} \end{aligned} \quad (6)$$

The \$1000/lb, estimated (Ref. 6) for the mid 1990s chemical rocket, would be bettered if the duty factor were greater than .032 (2000 launches/yr). The break-even point in eq. 6 will change quite rapidly with laser power. Neglecting the favorable variation of the launch time and the electricity and propellant costs with laser power, eq. 5 gives that a 20MW laser installation costing \$250 M would launch 36 kg. The break-even point would then occur at a duty factor of .02 (1300 launches/yr).

The primary uncertainty in these estimates comes from a lack of knowledge of what can be done to produce an efficient thruster without introducing too much flight hardware which has added so much to the cost of chemical rockets. In the same trajectory it was assumed that the 40% thruster efficiency would be maintained down to a flux of 10 MW/sq cm. Propellants will need to be developed to achieve high thruster efficiency at low flux to make laser propulsion a serious contender for space transportation to LEO. In view of the fact that almost no effort has been devoted to this requirement it should be evident that a great opportunity exists to creatively design materials.

It is a pleasure to acknowledge stimulating discussions of this subject with participants at the Livermore Workshop, especially Jordin Kare, Dennis Reilly and Rod Hyde. I am indebted to Freeman Dyson and Lowell Wood for the important suggestion that primary emphasis be placed on finding the minimum system for an initial trial of laser propulsion to orbit.

REFERENCES

1. Kantrowitz, A., "Propulsion to Orbit by Ground Based Lasers", May 1972, *Astronautics and Aeronautics*.
2. D.H. Douglas-Hamilton, A. Kantrowitz, and D.A. Reilly, "Laser Assisted Propulsion Research", Vol 61 of *Progress in Astronautics and Aeronautics*.
3. Raizer, N.P., *Sov. Physics*. 12, 33 (1979).
4. Hyde, Roderick A., One Dimensional Modelling of a Two-Pulse LSD Thruster. *Proceedings of the Laser Propulsion Workshop, Lawrence Livermore Laboratory 1986*.
5. Kare, Jordin "Trajectory Simulation for Laser Launching", *Proc. Workshop on Laser Propulsion, Lawrence Livermore National Laboratory, 7-18 July 1986*.
6. Report of the National Commission on Space, *Pioneering the Space Frontier*, pg. 115. Bantam Books.

Appendix

A Sample Trajectory Using a 10-MW Laser

```
!LASERPROP TRAJECTORY (USING THRUSTER EFF THEFF = .4)
! USE 10 MW LASER
!"LASPRP15" 12/31/86

! INITIALIZATION

OPEN #1:PRINTER
OPEN #2:NAME "OUTFILE"
ERASE #2
LET M = 120E3           ! MASS
LET M0 = M
LET CD = .4            ! ASSUMES DRAG LIKE A SPHERE
LET B = 0              ! ACTIVATES PHASE 1
LET AREA = 1E4         ! BASE AREA
LET THEFF = .4
LET Y = 3E5            ! ALTITUDE, MOUNTAIN
LET Y0 = Y
LET LPWR = 1E14*(1-.1*(1-EXP((Y0-Y)/7E5))/COS(TH)) ! 10 MW, 10% VERT ATM LOSS
LET VX = 0             ! HORIZONTAL VEL.
LET RHO = (1.225E-3)*EXP(-Y/7E5) ! EXPONENTIAL ATMOSPHERE
LET VY = SQR(2*M*983/(RHO*AREA*CD)) ! INITIAL VY TO MINIMIZE MDOT/VY
LET VJ = 3.6E5        ! INITIAL JET VELOCITY, PHASE 1
PRINT #1: , "TABLE 2, SAMPLE 10 MW LAUNCH"
PRINT #1:
PRINT #1: "TIME"; "MASS", "HOR. DIST.", "HEIGHT", "VJ PHASE
1&2", "VERT. VELOC."
PRINT #1:
PRINT #1: , "PHASE 1"

! TRAJECTORY

FOR T = 0 TO 2000
  IF T/20 = INT (T/20) THEN
    PRINT #1: T; INT (M/10)/100,
    PRINT #1: INT (X/1E4)/10, INT (Y/1E4)/10,
    IF B = 0 OR C = 0 THEN
      PRINT #1: INT (VJ/100)/1E3,
    ELSE
      PRINT #1: INT (VX/100)/1E3,
    END IF
    PRINT #1: INT (VY/1E2)/1000
  END IF
  IF T/5 = INT (T/5) THEN ! OUTPUT TO PLOTTER
    ! PRINT #1: #2:INT (X/1E4)/10;"",INT (Y/1E4)/10
    ! IF T>1 THEN PRINT #1: #2: T;"", VDOT
  END IF
  IF (VX^2/(6.371E8 + Y))>983*(1 + Y/6.371E8)^(-2) THEN ! ORBIT REACHED
    SOUND 500,1
    PRINT #1: T;INT (M/10)/100,
    PRINT #1: INT (X/1E4)/10,INT(Y/1E4)/10,INT (VX/1E3)/100,INT (VY/1E2)/1000
```



```

EXIT FOR
END IF
!

IF Y<1.30E7 THEN      ! VERTICAL ASCENT THRU THE ATMOS.
  LET A = 0
  LET RHO = (1.225E-3) *EXP (-Y/7E5)
  LET DRAG = CD*.5*RHO*(VX^2 + VY^2)*AREA
  LET THRUST = (M*V DOT + M*983 + DRAG)
  LET VJ = 2* LPWR*THEFF/THRUST
  LET MDOT = THRUST/VJ
  ! PHASE 1 USE LOW VJ FOR HIGH THRUST
  IF B = 0 THEN      ! TO MINIMIZE MDOT/VY
    LET V DOT = SQR(2*M*983/ (RHO*AREA*CD)) - VY
    IF V DOT>983 THEN      ! GO TO PHASE 2
      LET B = 1
      PRINT #1: T, "PHASE 2"
      EXIT IF
    END IF      SET V DOT = 983 PHASE 2
  ELSE IF B = 1 THEN      ! SET V DOT = 983 PHASE 2
    LET V DOT = 983
  END IF
  LET VY = VY + V DOT
  ! OUT OF THE ATMOSPHERE      PHASE 3
ELSE IF VY>0 THEN      ! TILT VEHICLE 1 RADIAN FOR HOR AND DOWN THRUST
  LET A = 1
  IF C=0 THEN
    PRINT #1: T,"PHASE 3      HORIZONTAL VELOCITY"
    LET C=1
  END IF
  LET VJ = 8E5
  LET MDOT = LPWR*2*THEFF/VJ^2
  LET V DOT = MDOT*VJ/M
  LET VX = VX + V DOT*SIN(TH + 1)
  LET VY = VY + V DOT*COS(TH + 1)-983 + ((VX)^2)/6.371E8
ELSE IF VY<0 THEN      !      PHASE 4
  IF D = 0 THEN
    PRINT #1: T, "PHASE 4"
    LET D = 1
  END IF
  LET A = 2      ! HOLD VY NEAR 0
  LET VJ = 8E5
  LET MDOT = LPWR*2*THEFF/VJ^2
  LET V DOT = VJ*MDOT/M
  LET VY DOT = -983 + ((VX)^2) /6.371E8
  LET VX = VX + V DOT*SQR(1-(VY DOT/V DOT0^2))
  LET VY = VY -983 + ((VX)^2)/6.371E8 + VY DOT
END IF
LET X = X + VX
LET Y = Y + VY
LET M = M - MDOT
LET TH = ATN(X/Y)      ! ZENITH ANGLE

LET LPWR = 1E14*(1-.1*(1-EXP( (YO-Y)/7E5) )/COS(TH))      ! 10MW, 10% VERT ATM

```

```

LOSS
NEXT T
LET D = 1E-5*SQR(X^2 + Y^2)          ! RANGE IN KM

PRINT #1:
PRINT #1: "          END RESULTS"
PRINT #1:
PRINT #1: "INITIAL MASS, KG": INT (MO/1E3),
PRINT #1: "FINAL MASS": INT (M/10)/100
LET AC = INT (.1*VDOT)/100
PRINT #1: "RANGE = ";INT(D),"FINAL ZENITH ANGLE = ";INT(57.3*TH);
PRINT #1: "    ACC. = ";AC
LET EB = INT(100*T*5E4*.02/((3600)*(M/1E3)))/100  ! $.02/KWHR,LASER = 20% EFF
LET PB = INT(100*((MO-M)/M^2)/100  ! $2/KG
PRINT #1: "ELEC. BILL/KG IN LEO  = $";EB,
PRINT #1: "PROPELLANT  = $";PB
END

```

N90-10144

54-20

216768

POWER FROM SPACE FOR USE ON EARTH: AN EMERGING GLOBAL OPTION

LW 086 419

Peter E. Glaser
Vice President
Arthur D. Little, Inc.
Cambridge, Massachusetts, U.S.A.

Abstract

The concept of the Earth as a closed ecological system is addressed from the point of view of the availability and use of energy from space and its potential influence on the economies of both developed and developing countries. The results of past studies of the solar power satellite (SPS) are reviewed, and the current international activities exploring various aspects of an SPS are mentioned.

The functions of an SPS, including collection of solar energy in orbit, conversion to an intermediate form of energy, transmission of energy from orbit to Earth, and conversion to useful energy in the most appropriate form, are discussed, and directions for future developments are indicated, including a suggested planning framework.

Salient aspects of SPS technologies are presented, and the potential benefits of the uses of lunar materials for the SPS construction are outlined. Scenarios within the context of international participation in a global SPS system are presented.

The conclusion is drawn that an SPS system is one of the few promising, globally applicable power generation options that has the potential to meet energy demands in the 21st Century and to achieve the inevitable transition to inexhaustible and renewable energy sources.

Introduction

The time horizon for the development of energy technologies that may be the key to meeting future global energy need encompasses a period well beyond 2000. Although there is no dearth of projections on how these energy needs may be met, the dynamic changes taking place in the scientific and technical fields, the increasing role of developing countries on the international scene, and the mounting threats of present energy resource utilization to the Earth's ecology, e.g. global warming, require that all worthwhile options for energy production be explored. To achieve the inevitable transition to inexhaustible and renewable resources, the potential of power generated in space for use on Earth is receiving renewed attention.

A major study of space power was performed over a decade ago by the U.S. Department of Energy and NASA (1). Its participants concluded that solar energy converted in space and beamed to Earth via laser or microwaves was technically feasible, and they could not identify any insurmountable economic or environmental obstacles.

The rationale for a transition to new energy sources is presented in the light of current information on energy projections. Advances in technology and economic considerations of their significance to space power applications provide a new dimension to the expansion of the space infrastructure and the opening of new resources beyond the surface of the Earth that could benefit all humanity.

Background

Technological advances during the 20th Century in all fields of human endeavors have occurred at a dizzying pace. Within one lifetime, events of such significance have occurred that it is hard to grasp their implications when considered in isolation. Seemingly there is a discontinuity in societal development with consequences that were unthinkable at the beginning of this century. This generation of scientists has shed the shackles of gravity and explored the outer reaches of the solar system, unlocked the forces within the atom, and devised methods of electronic communication that have created the "global village". The threads of life have been recombined and the uniqueness of planet Earth has entered human consciousness. The illusion that man has unlimited capabilities to control nature and fashion the environment based on scientific understanding and technological prowess has engendered a naive belief that man can control nature and exploit energy and material resources with impunity to meet his immediate needs. Only scant regard is paid to the reality that these resources are irreplaceable assets, and that their profligate use may threaten the global environment and even the conditions under which future generations may have to live.

Future Global Energy Demands

One of the major challenges facing contemporary society is the development of technologies that will meet future global energy demands. Even if one assumes that energy efficiency improvements and energy-conserving paths are being pursued with all possible vigor, and that economic success and well-being is no longer measured only by per capita energy consumption, the trend in electrical power demand growth to meet global economic advancement will continue, e.g., in the United States at a rate of 2.6 percent per year to the year 2000 (2). Projections of electric demand tend to underestimate the actual increase in electric end-use intensity, because the increased demand will be in response to uses of advanced process equipment that ranges from microwave ovens, computer-driven operations, and communication systems to electric arc furnaces for steel-making and semiconductor production processes.

Electric demand in developing countries will increase during the next decades at a much greater rate than in developed countries. The availability of adequate supplies of electricity, along with technical advances, will be required to achieve the economic growth desired and to meet the unfulfilled expectations of growing populations of these countries. Currently U.S. per capita annual energy use runs about 10,000 kWh, as compared to 250-370 kWh in lower-income developing countries (3). This enormous disparity in energy consumption will effect a greatly increased demand for electricity in developing countries--one that is projected to increase at an annual demand growth of 7 percent and even higher in countries that are industrializing rapidly.

The lag in improvements in electricity generation and distribution infrastructure results in demands that far outstrip supply. They range from 10 percent in India to 25 percent in Pakistan. If developing countries were to industrialize with an energy intensity that approached that of the developed countries, an unsustainable five-fold increase in world energy demand is projected (4).

Transition to New Energy Sources

To meet the global energy demands of the civilization of planet Earth in the 21st Century, transition to an energy economy that is based on inexhaustible and renewable energy sources will have to be made. Fusion and solar energy are the major options that, in suitable combinations, may be able to sustain the energy requirements of an interdependent global energy economy. Although fusion is a potential option, a practical controlled fusion reactor has yet to be demonstrated. The conversion of solar energy for a wide range of distributed and centralized applications can provide nearly unlimited amounts of energy to meet all conceivable future global needs.

There are two primary approaches to the conversion of solar energy :

1. Terrestrial solar energy conversion technologies, such as water heaters, passive heating, industrial process heat, biomass, photovoltaics, solar dynamic, wind, and hydroelectric generation. Except for hydro-electric generation, the conversion of solar energy into electricity requires suitable energy storage methods to compensate for diurnal and seasonal variations in insolation and interruptions of solar rays by unfavorable weather conditions. Energy storage not only reduces the efficiency of the conversion process, but it also contributes to system costs, especially if large-scale or base-load (continuous) conversion systems are required.
2. Solar energy conversion in space for use on Earth, was proposed in 1968 (5) to overcome the drawbacks of terrestrial solar energy conversion systems for the generation of base-load electricity, and is being increasingly considered by several countries.

The Solar Power Satellite (SPS) Concept

The proposal for an SPS was motivated by the following considerations:

The average solar ratio (SR) for the land areas of the Earth, that is, the ratio of total solar insolation for a year on a given area to the total energy use in that area, is currently about 3,000 and will decrease as world energy consumption rises. For the industrialized countries, the mean SR is about 80. These low SR values mean that industrialized countries, even if the highest conversion efficiencies conceivable were assumed, could not obtain more than a small part of their energy needs from the sun unless highly-efficient and moderate-cost systems are available to transport energy from the sunny under-populated area of the world or from high-Earth orbit locations, e.g.: geosynchronous orbit (GEO), where solar energy is consistent and available except for very short-term and precisely predictable interruptions during eclipses around equinoxes.

The SPS concept can meet the requirements for base-load electricity of both developed and developing countries, providing a wide range of design options with generation capacities ranging from a few 100 MW to 5 GW or more.

When an SPS is located in GEO, 36,000 km above the equator, the insolation level -- 1.35 kW/m² - is higher than it is at the Earth's surface and it is constant during the year (except during very short eclipse periods). In this orbit, the solar energy collected can be converted into electricity and transmitted to Earth locations via a microwave or laser

beam, -- where it can be converted back to electricity. A microwave-receiving antenna on Earth was demonstrated at Goldstone, CA, to have an efficiency of 82 percent in 1975. A microwave beam would suffer an attenuation of only a few percent as it passed through the Earth's atmosphere, even under unfavorable weather conditions.

The annual capacity factor of an SPS would be nearly 100 percent (compared with 20-30 percent for most terrestrial solar power plants without energy storage.) The SPS would be a continuous source of renewable energy, and there would be only limited siting constraints for receiving antennas either on land or in the oceans. Even a very large-area SPS in GEO, such as a 5-GW SPS, would not cast a shadow on the Earth because its angular size is much less than that of the Sun.

SPS Technical Features

As originally conceived, an SPS could utilize various approaches to the conversion of solar energy, such as photovoltaic and solar dynamic. Among these conversion processes, photovoltaic conversion was selected as a useful starting point because solar cells were already in wide use in communication, Earth observation, and meteorological satellites. An added incentive was the substantial progress being made in the development of advanced photovoltaic materials and the increasing confidence in the achievement of significant cost reductions.

High-efficiency solar cells are being developed. Both single- and multiple-band gap solar cells are being used for solar concentrators and flat solar arrays, and they are exhibiting increased resistance to the space radiation environment. In the development of space solar cells, at first scientists relied on single-crystal silicon, the mainstay of current satellite power systems. Silicon solar cells presently achieve efficiencies in the 15 percent range and show a power density of about 50 W/kg. A significant increase in both range and power density can be achieved when concentrator arrays are used. Gallium arsenide solar cells have already been developed for use with light-weight concentrators. With small attitude corrections, they will always face the sun. Advanced photovoltaic materials, such as gallium arsenide and indium phosphide, will most likely supercede silicon cells for use in space. Gallium arsenide solar cells have achieved a demonstrated efficiency of about 24 percent, while indium phosphide has reached a 19 percent level and attained a specific power density of 100 W/kg with a solar concentrator.

Solar dynamic conversion has been considered as an alternative to photovoltaic conversion because conversion efficiencies with this technology are expected to be higher than those achieved with solar cells developed earlier. Solar dynamic conversion, although promising, has not yet been demonstrated in space applications, but it is currently being considered for use in powerplants in space in both low- and high- Earth orbits.

The area of a solar collector required for energy conversion by the SPS is about one sixth to one third the area of a collector located on Earth at a comparable conversion efficiency. When a microwave beam is used, the diameter of the receiving antenna is a function of the diameter of the transmitting antenna, the wavelength used, and the distance between the two antennas. For example, to provide 5 GW of power on Earth to

a transmission grid would require a receiving antenna that was about 8 km in diameter. If an infrared laser were used, the receiving site would be less than 1 km in diameter; however, the transmission efficiency in unfavorable weather would decrease.

The launch costs to low-Earth orbit (LEO) fall in the \$2,000-\$4,000 per kg range when using either expendable launch vehicles or a space shuttle: LEO-to-GEO transportation of major SPS components assembled at a LEO space station can be accomplished with solar electric propulsion (ion thrusters). About 80 percent of the transportation costs are for transportation from Earth to LEO.

Although advanced launch systems using chemical fuels are expected to reduce transportation costs, it is unlikely that they will approach the goal of about \$100 per kg in the foreseeable future. Most of the materials that would be required for constructing an SPS are commodity materials; therefore, obtaining as much as 60 to 90 percent of such materials from the moon is being seriously considered because transportation costs are expected to be reduced by about an order of magnitude, and the Moon's gravity is but a sixth that of the Earth.(6)

SPS Economic Considerations

The objective of the SPS is to generate base-load electricity for use on Earth. Economic justification for SPS development must acknowledge that it is not possible to know now the cost of a technology that will not be developed for at least 10 years, or commercialized in less than 20 years. The decision regarding development of an SPS will depend on the global demand for electricity, the timing for the commercialization of a SPS in competition with other alternative energy technologies, the limits placed on the use of fuels that contribute to the atmospheric warming trend, and the stage of development of the space infrastructure.

An SPS reference system design developed by NASA and the U.S. Department of Energy in the late 1970s (1) would deliver 5 GW of power to the Earth using a 1.6-km diameter transmitting antenna in an SPS and a 8-km diameter receiving antenna on Earth. A rough estimate of the cost of a complete SPS system is \$3,000-5000 per kW.

Although it is very difficult to project costs per kW for an SPS at the concept development stage, a number of developments tend to make this project more feasible today. They include: buildup of the space infrastructure consisting of space transportation systems, space stations, and platforms, thin film and high-concentration solar cells, solar dynamic conversion, large space structures, automated assembly, high frequency microwave transmission and advanced lasers. Furthermore, funding for space activities by several countries, which globally is approaching \$50 billion per year, is increasing. Specifically, Europe, Japan and the Soviet Union are planning significant programs with the objective of developing space power systems during the next 30 years.

The significance of space power development was recognized at the planning conference for the International Space Year (ISY). An international space power test program was

recommended for performance within the framework of the ISY with the objectives: "to evaluate the feasibility of collecting and converting solar energy, and transmitting energy at levels necessary to facilitate industrial applications in orbit or on Earth." (7)

Applications of SPS in Developing Countries

An SPS could be of particular interest to those developing countries that lack conventional energy sources. They could bypass the 'smoke stack' era that characterized energy development following the industrial revolution, while providing for their own specific growing energy needs. Laser beams transmitting about 100 to 500 MW of power from space to selected sites on Earth would be attractive because smaller additions to power-generating capacity could be more easily integrated in an evolving transmission grid as compared with a 1- to 5-GW SPS using a microwave beam.

An SPS can be designed that will beam power to more than one receiving site to meet peak energy needs in several time zones to supplement terrestrial electricity generation capacity. An SPS system consisting of a number of satellites with different outputs and capacities can be organized to take into account technical, economic, and societal issues and be capable of meeting the needs of both developing and developed countries. The Intelsat organizational structure has already been successful in operating a global communication satellite system, and has been a model for the International Maritime Satellite (Inmarsat) organization. Proceeding with a U.S. effort akin to Comsat, leading to the creation of an international organization for developing and operating a global SPS system may achieve "international cooperation in an area of high national stakes and strongly-held differences in views"(8), can be a means to maintain significant U.S. industry involvement.

SPS Growth Path

An implicit assumption in any large-scale project is that the decision-making process is fraught with uncertainties associated with projected system performance, costs, and environmental effects. Furthermore, the need for the continuing support of public and private investors over an extended time period is also required. This was the case with NASA's Apollo program that was conceived and executed with a definite start date and agreed-upon performance objectives, budgets, and schedules, and with an identifiable management structure that was made responsible for landing man on the moon. That is to say, it was a "monolithic" project. The time needed to complete such projects makes them vulnerable to changes in the regulatory environment, and if they should extend over a decade or more, they become vulnerable to changing economic and political conditions as well. A continuing consensus of both public and private investors, as well as the support of appropriate interest groups and government agencies, is required until the project is completed.

An approach can be followed in the development of the SPS that identifies essential generic technologies, pursues intermediate applications of these technologies with near-term returns on investment, e.g., space power for use in space shuttles, space stations, free-flying platforms, electric propulsion lunar and planetary bases, and on Earth. This "terracing" approach to large space projects (9) can reduce the risks associated with a "monolithic" project. As part of this approach, essential generic technologies will have been demonstrated in other applications, that are justified on their intrinsic economic benefits. The growing generic technology data base can then be incorporated into the ongoing SPS planning and R&D efforts. Figure 1 shows a power beaming growth path with intermediate objectives designed to support "Our Ambition: Opening New Resources to Benefit Humanity" (10).

In parallel, assessments of economic, regulatory, legal and societal issues will influence decisions that pertain to the growth path for the SPS, leading to a broad consensus with respect to the overall technical, economic, and political feasibility within the framework of international activities that pertain to the implementation of a global SPS system.

The commercialization of space power -- at first for use in space and subsequently for use on Earth -- will permit participating organizations to obtain returns on investments without a long-term commitment to a global SPS system implementation.

An SPS has the characteristics of an ideal space enterprise. Such an enterprise "would have a stable, predictable, very large market on Earth and, once established, would not be dependent on Earth-to-orbit transportation costs to generate continuing revenues" (11).

Conclusions

The expansion of the space infrastructure is a strategic goal for an increasing number of countries that are expanding their technological capabilities to participate in commercial space activities. These activities are increasingly being recognized as the key to future economic growth, industrial expansion, and space market penetration. The commercial potential of space markets is so large that space industry endeavors could be among the fastest growing and important industrial activities in the 21st Century.

The development of space power can provide a critical dimension to the growing efforts of mankind to move beyond the surface of the Earth and to benefit from the limitless energy and materials resources of the solar system. Now is the time for taking a positive view of the achievable economic returns from space endeavors. There is little doubt that the future uses of space resources will have the most profound effects on the civilization of planet Earth and that new knowledge, increased understanding, and enhanced scientific and technical capabilities will be essential to confront the challenges that must be overcome to achieve the inevitable transition to inexhaustible and renewable energy resources. Moving towards this goal, a truly global civilization that will benefit all humanity may be created.

POWER BEAMING GROWTH PATH

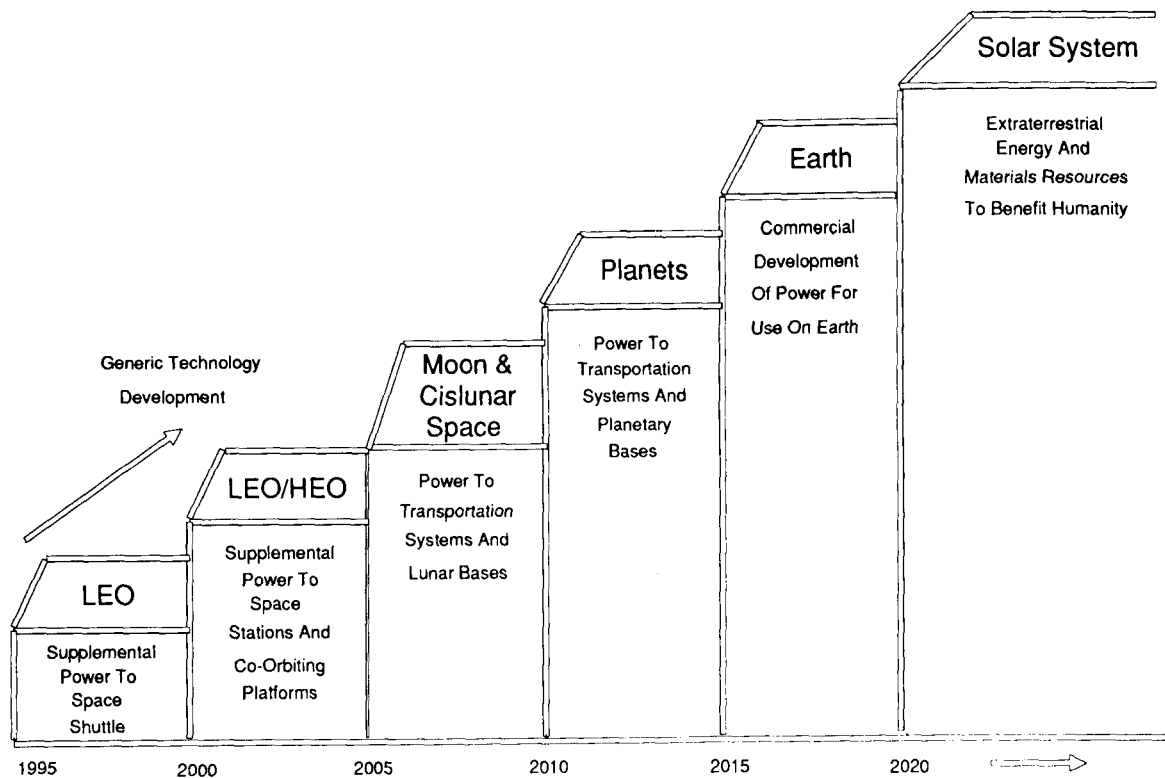

Figure 1

REFERENCES

1. U.S. Department of Energy, Satellite Power System Concept Development and Evaluation Program System Definition Technical Assessment Report, DOE/ER/10035-03, Dec. 1980, NTIS, Springfield, VA 22161.
2. U.S. Department of Energy, Annual Outlook for U.S. Electric Power 1987, Projections through 2000, DOE/EIA-0474(87), Energy Information Administration, Washington, DC, 1987, p.8.
3. H.C. Bailly, "U.S. Energy Association Seminar on the Third World Power Crisis," presented in Washington, D.C., February 1968.
4. Ibid.
5. P.E. Glaser, "Power from the Sun: Its Future", Science, Vol. 162, 1968, p. 857-886.
6. P. Du Bose, "Solar Power Satellite Built of Lunar Materials", Space Power, Vol. 6, 1986, pp. 1-98.
7. Report on the Pacific ISY Conference, August 19-21, 1987, Kona, Hawaii,--Th. B. McCord, editor, University of Hawaii at Manoa, Hawaii Institute of Geophysics, February 1988.
8. J.M. Logsdon, "Solar Power Satellites: The Institutional Challenge", Space Power, Vol. 4, 1983, p. 26.
9. P.E. Glaser, "The Solar Power Satellite -- A Goal for the Economic Development of Space", Space Power, Vol. 5, pp. 83-90, 1985.
10. National Commission on Space, Pioneering the Space Frontier, Bantam Books, Inc., New York, May 1986, p. 3.
11. Ibid., p. 82.

N90-10145

S5-20

275707

NEW ENERGY CONVERSION TECHNIQUES IN SPACE,
APPLICABLE TO PROPULSION*†

A. Hertzberg and K.C. Sun

WF 8 3515 9

RIP
OTA

L 1535 057

ABSTRACT

The powering of aircraft with laser energy from a solar power satellite may be a promising new approach to the critical problem of the rising cost of fuel for aircraft transportation systems. The result is a nearly fuelless, pollution-free flight transportation system which is cost-competitive with the fuel-conservative airplane of the future. The major components of this flight system include a laser power satellite, relay satellites, laser-powered turbofans and a conventional airframe. The relay satellites are orbiting optical systems which intercept the beam from a power satellite and refocus and redirect the beam to its next target.

INTRODUCTION

The dramatic, nearly prohibitive increase in the cost of aviation kerosene illustrates one of the major problems currently facing aircraft designers. This new design constraint has become a dominating factor in the consideration of future aircraft transportation systems. Even with the advanced technology projected for future aircraft, substantial amounts of fossil fuels must be consumed and, as these fuels become even more scarce, the operating costs of conventional flight transportation systems may very well rise to forbidding levels.¹

The powering of an aircraft with laser energy beamed from a solar power satellite may be a promising new solution to the aircraft transportation fuel requirement, creating the possibility of a virtually pollution-free global air transportation system based on an inexhaustible energy resource. This

*The concept of laser-powered aircraft propulsion has been previously discussed by the author. Papers were presented at the AIAA Aircraft Systems & Technology Conference (AIAA 78-1484), Los Angeles, CA, August 1978; the GCL Symposium, Brussels, Belgium, September 1978; the Delft University of Technology, Delft, The Netherlands, September 1978; and the AAS 25th Anniversary Conference, October-November 1978, Houston, TX. A similar paper was published in Astronautics & Aeronautics (17:41-49, 1979).

† AIAA paper No. 79-1338 © Reprinted with permission.

paper will examine the potential of the laser-powered air transportation system as an approach which nearly eliminates fossil fuel requirements in aircraft transportation.

The system, described in the following sections, largely confines itself, as a first step, to near-term technology. For example, existing laser concepts and solar energy conversion systems are employed in conjunction with a modified conventional aircraft and propulsion system flying a standard flight profile. It is apparent that the cost of kerosene will rise in the near future to levels where such a system will become competitive even under these constraints. Moreover, the authors feel that these results invite continued studies in which the introduction of new technology and special design approaches are employed. Such studies offer the potential of making the laser-powered aircraft flight system economically superior as a major transportation system.

A laser-powered flight transportation system (Fig. 1) would involve beaming infrared laser energy from a solar power satellite, via a relay satellite, to a flying aircraft in which the laser energy is collected and converted into thermal energy for use by the aircraft propulsion system. Since laser-powered aircraft would be indirectly energized by solar energy, a laser flight system has the potential of saving significant amounts of fuel. For a 5500 km transcontinental range and a payload of 196 passengers (18,140 kg), a transonic laser airplane would require 40 MW of laser power and in each flight would save 31,400 liters (8300 gallons) over a similar fuel efficient kerosene airplane. Advances in laser aircraft propulsion may result in vehicles capable of hypersonic velocities which could serve as Air Breathing Launch Vehicles (ABLV). Several different laser aircraft concepts have already been proposed, as indicated in Table I.

An important part of laser aircraft systems is the Space Laser Power System, i.e., the laser power satellites and relay satellites.^{2,3} The laser power satellites resemble microwave solar power satellites, except that a closed-cycle laser system is used instead of a microwave generator system. The relay satellites are orbiting optical systems which intercept the beam from the power satellite, correct beam distortions and refocus and redirect the beam to a flying laser aircraft or another receiver. Since the mass and the cost of a Space Laser Power System overshadow those of the aircraft, an analysis of any laser-powered flight transportation system must include an assessment of the Space Laser Power System.

Laser-powered flight transportation is an excellent example of the multi-mission capability of the Space Laser Power System. Because of its short wavelength, a laser beam can be focused to small spot sizes at very long transmission ranges. Small spot sizes result in small, high power density receivers that can be mirrors for a relay network, high temperature engines for electrical power generation, or compact propulsion units that can be integrated into an airframe. A relay network would enable the heavy laser power satellites to be deployed in a low Earth sun-synchronous orbit, avoiding the transportation costs to geosynchronous orbit, while still retaining a worldwide distribution capability.

In this article laser-powered ABLV's are introduced and then followed by a discussion of laser-powered commercial jet transports.

AIR BREATHING LAUNCH VEHICLES

The laser-powered ABLV combines the high specific impulse of an air breathing propulsion system with the high temperature potential of a laser

heat engine. The projected kerosene and hydrogen fueled ramjets have a specific impulse on the order of 1000 seconds, approximately the same as a laser rocket. A. Kantrowitz and R. Rosa proposed that focused laser radiation be used to heat the ingested air to extremely high temperatures, resulting in a ramjet with even higher specific impulses.⁴ An ABLV teamed with a Space Laser Power System, i.e., a space-borne energy source, results in a more flexible boost trajectory and a more gradual acceleration than the rigid rectilinear trajectory with a 10 g acceleration of the proposed laser rocket and the ground based laser system.⁵ Unfortunately, ramjets cannot produce static thrust and an alternative engine cycle may be needed. L. Myrabo's laser-driven rotary pulse jet is one of several interesting and clever possibilities.⁶ Myrabo's device is a pulsed system made quasi-steady by rotating a set of propulsion units.

An extensive system study is needed to fully assess the potential of these concepts. The relatively advanced technology requirements of ABLV's do not permit such an analysis at this time. The laser-powered commercial jet transportation system, however, is based on near-term technology, and hence is described in much greater detail, with a particular emphasis on the system cost.

LASER-POWERED FLIGHT TRANSPORTATION SYSTEM

This particular laser-powered flight transportation system involves a Space Laser Power System and a fleet of conventional aircraft, each equipped with laser driven turbofans (Figs. 1 and 2). In the Space Laser Power System, the laser power satellite is deployed in a low earth, sun-synchronous orbit and converts solar radiation into infra-red laser energy which is beamed to a relay satellite. The relay satellite is deployed in an elliptical orbit and redirects the beam towards

the next target which is either a cruising airplane or another relay. At the airplane, the laser energy is converted into thermal energy, which is used to drive the engines. The aircraft engines are modified kerosene burning turbofans with a laser powered heat exchanger placed ahead of the combustor so that either kerosene or laser radiation can be used as an energy source. The airframe is a modification of a Boeing design for a fuel conservative air transport --the "Terminal Area Compatible/Energy" (TAC/E) airplane.⁷

It must be emphasized that untried technology is avoided as far as possible in this analysis. This laser-powered flight transportation system is based on available and near-term projected technology, and the major subsystems are direct modifications of existing designs:

The flight profile chosen for the laser-powered airplane (Fig. 3) is the same as that of a conventional kerosene burning airplane. The laser flight system is completely compatible with existing airports and air traffic control systems. The laser airplane will take off and climb to an altitude of 9 kilometers using kerosene power alone. Upon reaching cruising altitude, the laser power satellite and relay satellites will begin tracking the airplane. When a secure tracking lock is achieved, the laser will be activated and the beam will be directed to the receptor area of the airplane. At this point the airplane will fly on laser power alone with the kerosene flow shut off. Using only laser power, the airplane will continue to cruise to its destination. Prior to descent, the kerosene flow will be turned on. When full kerosene power is restored, the laser will be diverted away to another waiting laser airplane. Using only kerosene, the laser aircraft will descend and land in a conventional manner. In the case of an interruption of laser power, the airplane will have an emergency kerosene reserve for a 930 kilometer cruising range.

The practicality of a laser-powered flight transportation system is measured by its system cost and depends heavily on whether or not the fuel savings will offset the high capital cost of the Space Laser Power System. These costs are a reflection of the particular configuration that we have chosen: power satellites, relay satellites, and a specific laser airplane design. This configuration evolved from a consideration of the available technology and a rough optimization of the spacecraft deployment strategy. Within this system framework, each subsystem (i.e., components of the power satellite, relays, and airplanes) was in turn designed for minimum cost.

The following sections of this paper will discuss the important aspects of each major component of the laser-powered flight transportation system, with an emphasis on obtaining a realistic cost estimate. The analysis is initiated by the preliminary design of a laser-powered turbofan and the suggested modification of a Boeing TAC/E airframe. Next, the laser power satellite and relay satellites are designed to meet the airplane laser power and receiver area requirements. The total laser flight system cost is then calculated using these component costs and compared against an advanced kerosene flight system.

LASER TURBOFAN

The laser turbofan is comprised of two major components: a heat exchanger which converts laser radiation into useful thermal energy, and conventional turbomachinery (Fig. 4). The laser turbofans are installed in a common housing or propulsion pod. Mounted on top of the propulsion pod is a 15 meter diameter receiver which focuses and directs the laser beam into a heat exchanger placed inside a blackbody cavity with a 5 meter diameter opening. Once inside the cavity, the laser beam is processed by a system of mirrors and light pipes into an intensity

distribution that illuminates the interior of the heat exchanger tubes. Reflection and re-radiative losses are held to 3 MW because of the blackbody cavity design. Compressor air passing over the outside of these thin circular tubes is heated by cross flow convection and passed to the turbine. In order to keep the heat exchanger pressure drop small, the inlet flow Mach number is kept low, $M = 0.05$.

The laser receiver must be covered with a thin transparent window in order to minimize skin friction and prevent the establishment of convective flows inside the blackbody cavity and concentrator. Such a laser receiver window could be fabricated by mounting a set of window elements in a mosaic frame with the air pressure behind the window approximately equal to that of the external air flow. Sapphire-like substances are suitable window materials due to their good infrared transmission, high mechanical strength, thermal stability and insensitivity to thermal shock.

The resulting heat exchanger is relatively light, amounting to only 45% of the uninstalled gas turbine weight. Relatively compact heat exchangers can be designed because the laser energy can be focused in a manner leading to almost constant (high) wall temperature throughout the entire length of the heat exchanger. The heat exchanger weight was estimated as the total tube weight. This, however, ignores headers and other miscellaneous equipment which should not increase the airplane weight by more than few percent. The material chosen for this heat exchanger design is a nickel-chromium iron alloy.⁸

The laser turbofan is equipped with a combustor in tandem with the heat exchanger to facilitate the two modes of operation, kerosene and laser. Under

kerosene power, the turbine inlet temperature ranges from 1560°K at sea level static to 1420°K at high altitudes, similar to those of the conventional Boeing TAC/E airplane. Under laser power the turbine inlet temperature is 1100°K. Higher turbine inlet temperatures could be obtained by increasing the heat exchanger size; however, the additional thrust gained by these higher temperatures is offset by the weight penalty of a larger heat exchanger. Material limitations restrict the wall temperature to less than 1300°K.

MODIFIED AIRCRAFT

The basic airframe used in this report is an example of Boeing's design for a fuel conservative aircraft, the TAC/E airplane (Fig. 5). In order to share the same laser receiver the laser turbofans are grouped together in a common propulsion pod. The three engine propulsion pod is placed above the center of the fuselage in a manner resembling Boeing's AWACS design (Fig. 6) requiring, of course, a substantial structural re-design. The calculated laser airplane cruise lift to drag ratio is 14.6. Applying this same method to the baseline Boeing TAC/E airplane, the resulting lift to drag ratio is 17.4, which agrees with Boeing's estimate of 17.5.⁷ Due to the large laser receiver, a more optimal aircraft configuration might integrate the laser receiver completely into the airframe.

The airplane costs, i.e., the manufacturing costs, crew pay and maintenance costs, were derived from Boeing's analysis of the TAC/E airplane.⁷ Since the heat exchanger mass is small in comparison to the airframe mass, the manufacturing costs of the laser airplane and kerosene airplane are similar.

LASER POWER SATELLITE

One possible design for a 42 MW output laser power satellite is shown in

Fig. 7. A solar-powered thermal engine generates electrical power for the closed-cycle supersonic electric discharge CO laser. An adaptive optical system employing active controls to remove beam aberrations aims and focuses the laser radiation. The three major satellite subsystems, the Electrical Power Supply, the Closed-Cycle Laser and the Optics, are detailed in the following sections. The mass and cost estimates of the resulting laser power satellite are also described in later sections.

ELECTRICAL POWER SUPPLY

Electrical power is generated using a regenerative Brayton cycle thermal engine with a cycle efficiency of 38%. More advanced thermal engines, such as the Potassium Rankine Cycle^{9,10} and the Energy Exchanger Cycle¹¹, may be used in the future. Photovoltaic power cells are probably unacceptable in low earth sun-synchronous orbits due to the severe radiation degradation from exposure to the Van Allen Belts.

LASER SYSTEMS

Both the CO and CO₂ lasers were considered in this study. However, optical considerations favored the shorter wavelength of CO radiation. Due to beam diffraction, a CO laser ($\lambda = 5 \mu\text{m}$) requires a 30m diameter transmitter aperture for a 10m diameter spot at a 20,000 kilometer range, whereas a CO₂ laser ($\lambda = 10.6 \mu\text{m}$) requires a 60m diameter aperture. As suggested by Mann,¹² an electric to laser open-cycle conversion efficiency of 60% was used. After taking into account the energy needs of the refrigeration and recirculation equipment, the final closed-cycle conversion efficiency reduces to 25%.

The heaviest components of a closed cycle CO laser are the heat exchangers,

radiators, the supersonic diffuser and ducting, which collectively amount to 85% of the total subsystem mass. Since most of the laser components are similar to those used in existing thermal engines, the manufacturing cost of a closed cycle laser device should correspond to that of these same thermal engines. Consequently, the manufacturing cost of the laser subsystem is adjusted to be \$500/kg, which is about 35% higher than the cost of a high bypass turbofan (\$368/kg)⁷.

OPTICS

Using Coherent Optical Adaptive Techniques (COAT)¹³, a sophisticated optical system directs the laser radiation to the proper receiver and maintains beam coherence. The transmitting aperture expands the narrow beam from the laser device and corrects for any beam distortions. In this design a Cassegrain aperture configuration using a large concave primary mirror and a small convex secondary mirror is employed (Fig. 8). On the secondary mirror, error sensors measure beam distortions and instruct the primary mirror to change its shape in order to provide the necessary phase corrections. The primary mirror surface is composed of small mirror plates supported by fine actuators on a reaction structure which in turn is supported on a truss structure by coarse actuators. The combination of these actuators and mirror segments conforms the primary mirror to the desired shape.

The primary mirror has a 30m diameter and the secondary mirror has a 0.6m diameter. The technical feasibility of a 30m diameter lightweight adaptive mirror for space has already been explored by R. Berggren and G. Lenertz of Itek Corporation.¹⁴ Allowing for diffraction, 0.05 microradian beam jitter and $\lambda/20$ wavefront error, a 30m diameter transmitter can focus the 5 micron CO laser radiation to an 8.5m diameter spot size at a range of 20,000 kilometers. This results

in a 15m aircraft receiver diameter which is large enough to capture the beam, including jitter.

In order to center the laser spot on the receiver area, submicroradian pointing and tracking accuracies are needed. For a receiver diameter D of 15 meters and a range R of 20,000 kilometers, a tracking resolution $\delta\theta < D/2R = 0.4$ microradians is required. With active interaction between the transmitter and receiver units this requirement can be met. Each receiver unit will be equipped with a feedback telemetry system to communicate positioning and beam quality information back to the transmitter. Experiments at Lockheed have already demonstrated a beam stabilization of better than 1 microradian.² Conventional space systems already achieve 0.10 to 0.01 microradian tracking accuracies.¹⁵

Only 5 percent of the laser beam is lost during propagation. Due to the lack of CO and H_2O at high altitudes, the vertical atmospheric transmission of CO laser radiation from space to an airplane at a 9 km altitude is calculated to be 99%, using the atmospheric absorption coefficients from McClatchey.¹⁶ Besides atmospheric absorption and scattering, other losses occur in imperfect relay mirrors and in the truncation of a Hermite Gaussian beam by a finite receiver size.

The heaviest optical components are the primary mirror, the transmitter structure and the control moment gyroscopes, totaling approximately 95% of the optical system mass. Since production models of large scale space optics do not exist, the first unit manufacturing costs were parametrized for \$1,000 to \$3,000 per kilogram, comparable to the cost of similar complex equipment.

POWER SATELLITE MASS AND COST SUMMARY

The laser power satellite mass and cost distribution are shown in Fig. 9. The

total power satellite mass is 671,500 kg. The thermal engine electrical power supply is the heaviest subsystem at 74% of the total satellite mass. The closed cycle laser and the optical system are respectively 18% and 8% of the total satellite mass.

The cost analysis includes DDT&E costs (Development, Design, Testing & Engineering), manufacturing costs, space transportation costs, space assembly costs and maintenance costs. The DDT&E costs average \$3,500/kg. The first unit manufacturing costs were calculated, using the cost structure described in the previous sections. Then, in order to find the mass production costs, an 85% learning curve was applied to the first unit power satellite cost. Using a Heavy Lift Launch Vehicle, the space transportation cost to a low sun-synchronous orbit is \$47/kg.² P. Glaser has suggested a space assembly cost of \$30/kg.¹⁷ The maintenance cost is calculated on the assumption that during its 30 year lifetime, 10% of the laser power satellite will be replaced. An interest rate of 6% per year was applied to the initial procurement costs (DDT&E, manufacturing, space transportation and space assembly costs), to account for the penalties of such a large capital investment. Interest rates for large tax-free capital investments are currently 6% per year for tax-free systems over a thirty year life. (Taxable import-export investments handled by the U.S. World Bank are charged an interest between 8% and 9% per year.) The initial procurement costs were assumed to be repaid over the entire lifetime of the power satellite in a series of equal annual payments. All costs are in constant 1978 dollars.

In spite of its relatively small mass, the transmitting optical system is the most expensive subsystem of the power satellite because of its high technology

and precision design requirements. Due to its low Earth orbit, the space transportation costs are only 20% of the initial procurement costs as opposed to 45% for geosynchronous deployment. The total cost of each power satellite is \$170 million, assuming a \$2,000/kg optics cost.

RELAY SATELLITES

Relay satellites intercept the beam from a space laser power satellite, correct outgoing beam aberrations, refocus the beam and direct it to the next target. Lockheed's concept of a relay satellite with two Cassegrain optical systems, one for receiving and another for transmitting, is shown in Fig. 10. The primary receiver mirror captures the incoming beam and directs it to transfer mirrors where beam jitter is removed. Inside the spacecraft, these transfer mirrors guide the beam to the primary transmitter mirror which corrects beam distortions, focuses and redirects the beam. The relay's optical systems are designed to be very similar to those of the laser power satellite. The transmitter and receiver primary mirrors and secondary mirrors have the same respective dimensions as the Cassegrain transmitter on the laser power satellite. Almost 90% of the relay satellite's total mass is involved with optics; the remainder is associated with spacecraft housekeeping functions.

The relay satellite cost analysis is very similar to that of the laser power satellite. Due to the different orbital requirements (elliptical rather than sun-synchronous), the space transportation cost was assumed to be \$97/kg. Since each relay could be launched as a completed unit from earth, space assembly costs were ignored. As with the power satellite, the first unit manufacturing cost of optics were paramitized from \$1,000/kg to \$3,000/kg.

In spite of their small size and mass (each relay weighs only 12% of the power satellite weight), relay satellites are inherently very expensive due to the high cost of optics. Depending on the cost of optics, the relay costs range from 25% to 50% of the power satellite cost. A mass and cost summary of a relay satellite is displayed in Fig. 11. The total mass and cost of each relay are 77,500 kg and \$66 million respectively, assuming a \$2,000/kg optics cost.

SPACECRAFT DEPLOYMENT

Past studies by Lockheed^{2,3} indicate that space laser systems are very effective when teamed with relay satellites. For example, in applications requiring small near-earth laser receivers, a geosynchronous laser power satellite requires large transmitter apertures, excessive space transportation costs and very demanding pointing and tracking accuracies. For a laser-powered flight system, a more suitable, though not necessarily optimal, spacecraft deployment strategy would be to place the laser power satellites in a low sun-synchronous orbit and to place the relays in an elliptical orbit. The low sun-synchronous orbit is a nearly polar orbit that avoids the earth's shadow and leads to significant reductions in space transportation costs compared to those of geosynchronous deployment. The large angular inclination and very high apogee over the northern hemisphere of the relay elliptical orbit result in long loiter times over the northern hemisphere.

For example, power satellites in a 1500 km altitude circular sun-synchronous orbit at a 97° inclination to the equator would beam laser energy to relay

satellites in a 4 hour elliptical orbit with a 500 km perigee and a 12,300 km apogee at a 63.4° inclination (Fig. 2). Each relay is over the northern hemisphere from 0.5 until 3.5 hours past its perigee. The relays can be used effectively in the northern hemisphere for 75% of its orbital period. Eight relays in this same orbit spaced 45° apart can provide full time coverage of the northern hemisphere. However, only six of the eight relays would be over the northern hemisphere at any given moment. For simplicity, a strategy of one power satellite and one relay per flying airplane was chosen. Thus, if an airplane flies 3 times per day and averages 8 hours per flight, then 6 power satellites, 8 relay satellites and 6 airplanes can handle 18 flights per day. Boeing's analysis of the TAC/E airplane assumed a fleet of 300 airplanes. Following Boeing's example, a fleet of 300 airplanes was selected for this study. Consequently, 300 power satellites and 400 relay satellites are also needed.

FLIGHT SYSTEM COST ANALYSIS

In this cost analysis a control group, the kerosene airplane fleet, and an experimental group, the laser airplane fleet, are both subjected to the same mission models. This technique minimizes the need to make an absolute determination of the actual system cost. Instead, relative costs determine the system's effectiveness.

The standard mission models are an 18,140 kg payload for each airplane to be delivered over ranges of 5500 km and 7500 km. The laser flight system consists of a fleet of 300 laser power transmitters, 400 relay satellites and 300 airplanes. The kerosene flight system consists of a fleet of only 300 airplanes. Each airplane

flies 3 times a day with each flight lasting approximately 8 hours. A 30 year lifetime is assumed for the aircraft and spacecraft. Since the actual future cost of kerosene is unknown, the fuel costs were parametrized from 26¢/liter to \$1.05/liter.

The cost effectiveness of the laser flight system is measured by the break-even fuel cost which is the cost of kerosene at which the annual cost of the laser airplane fleet equals the annual cost of the kerosene airplane system. If the manufacturing cost of optics is \$2,000/kg, then the break-even fuel cost is 52¢/liter (\$2/gal) for a 5500 kilometer range. For a 7500 kilometer range the break-even fuel cost is 36¢/liter (\$1.40 gal). The anticipated cost of synthetic kerosene is expected to be about 40¢/liter (\$1.50/gal). Despite the large amounts of rocket propellant consumed in delivering the power satellites and relays to orbit, the energy content of the kerosene saved by the laser airplane system will equal the total energy cost of the space system in a little more than a year of operation.

Fig. 12 depicts the subsystem cost distribution for both the laser and kerosene airplane systems at a fuel cost of 40¢/liter and a range of 7500 km. The spacecraft costs, which include those of both the relays and power satellites, are the dominant cost of the laser flight system. The fuel costs dominate the kerosene flight system. In a laser-powered transportation system the fuel costs are traded for spacecraft costs. This high percentage of spacecraft costs is due primarily to the interest on the large capital investments and the high manufacturing cost of optics. Even at a 6% per year interest rate, the spacecraft costs are nearly twice those without interest.

The above analysis indicates that a laser-powered flight transportation is cost effective in comparison to tomorrow's advanced kerosene airplanes. This conclusion is very dependent on the following assumptions: high fuel costs, advancements in technology, a mature space industry and system operation at very high utilization rates. Without these assumptions, a laser flight system would probably be economically unjustified.

IMPACT OF INCREASED FUEL COSTS

A laser flight system becomes economically competitive with a kerosene flight system only when the cost of the fuel saved is comparable to the initial procurement cost (including interest) of a Space Laser Power System. The competitive edge occurs at fuel prices of about 40¢/liter. Oil price increases are inevitable and the actual future cost of kerosene will probably depend on the price of synthetic oil which is estimated by DOE to be about 40¢/liter. Improvements in laser and optics technology will make laser propulsion economically competitive at a lower kerosene cost.

ADVANCEMENTS IN TECHNOLOGY

The cost effectiveness of the laser flight system also hinges on the required advancements in technology. The technology required for the airplane is well within reach. The technology required for the laser power satellites and relay satellites is far more demanding.

The amount of new technology incorporated into the airplane is minimal. Both the airframe and rotating turbomachinery are of conventional design. The only new components are the heat exchanger and the receiving optics. However, as

previously shown, such a laser to fluid heat exchanger can be fabricated in a conventional manner. The most difficult problem is that of designing compact receiver optics small enough to fit inside an aerodynamically streamlined container but big enough to intercept a 10 meter diameter laser beam.

Most of the new technology is designed into the laser power satellites and relay satellites. Many of the important spacecraft components have yet to be built. Even though high power lasers and optics are already in existence, none of these devices have a sufficiently high performance which would permit the construction of a low cost Space Laser Power System. Each of the laser and optical components is based on small scale laboratory experiments, prototypes and paper designs.

A low cost Space Laser Power System requires a high efficiency laser which is capable of continuous operation and is scalable to high power levels. The electrically excited CO laser and CO₂ laser are both capable of continuous operation at high power levels. The laser used in this report is a 42 megawatt CO laser with an open-cycle electric to laser efficiency of 60%. Small scale experimental CO lasers have reached 63% open cycle conversion efficiency¹², but an efficient, continuous wave, megawatt size CO laser still does not exist at this early date. The CO₂ laser which is the most developed high power gas laser has already reached megawatt sizes and promises an open cycle efficiency of 30%.¹⁸

The development of inexpensive high power optics is anticipated; however, this task is far from easy. For example, laser windows and the small mirrors must withstand continuous exposure to high power laser fluxes, often necessitating active cooling mechanisms. Large mirrors are needed for long range focusing to the

desired small spot sizes. Adaptive optics, employing error sensors and mirror surface actuators, should provide phase correction and survive the harsh high power laser environment. The transmitting optical system is required to point and track a small target at very long ranges. Furthermore, all these requirements must be accompanied by high reliability.

In addition to these stringent technical requirements, these optical systems would have to be manufactured at a reasonable cost, probably as low as \$2,000/kg. Even if these devices exist today, using present day manufacturing techniques, the cost of optics would be prohibitively expensive. The successful manufacture of low cost, high power optics depends on the development of advanced mass production techniques which in turn will form the basis of a mature optics industry.

Since this flight system features a laser power transmission system, particular emphasis is placed on the technology of lasers and optics. This does not mean that the technology requirements for the other spacecraft components are trivial. Questions pertaining to the technical feasibility of large scale space structures and space transportation systems have been already addressed by the various studies on microwave solar power satellites available in the literature.

A MATURE SPACE INDUSTRY

The spacecraft manufacturing, transportation and assembly costs were derived from recent microwave solar power satellite studies which assume fleet sizes (50 or more power satellites) and a mature space industry. Current projections call for the deployment of at least sixty 10 GW microwave solar power satellites at a rate of 1 to 4 each year.^{9,10} For a laser flight system, a fleet of 300 laser power satellites and 400 relays is proposed. In order to build a fleet of laser

and/or microwave power satellites, a mature space industry is needed. Such an industry will be capable of constructing large quantities of spacecraft components at low cost by using advanced manufacturing techniques, mass production techniques, learning curves, economies to scale, etc. This industry would also include an armada of boosters, space tugs and space assembly facilities in addition to the ground based factories. (The spacecraft components will be manufactured in ground based factories and the final assembly will occur in space.)

The size of such a mature space industry should not be underestimated. The Space Laser Power System needed for a commercial jet transportation system requires the production and delivery into orbit of approximately 230 million kilograms of spacecraft within a 1 to 2 year period, which is equivalent to the mass of 3500 kerosene powered jet transports. A fleet of 10 GW microwave solar power satellites (80 million kg/satellite) has the mass equivalent of 75,000 jet transports. In comparison, the existing American aerospace industry is capable of producing less than 1,000 jet transports a year.

While the size of a mature space industry seems forbidding, any new alternative energy source will require a massive industry of its own. For example, if coal-derived synthetic oil becomes a new energy source, then the size of the coal gasification industry, i.e., gasification plants, additional mining facilities, railroads, etc., may equal or exceed the size and cost of a mature space industry.

Furthermore, any new energy source is capital intensive and consequently must be operated at a very high utilization rate. Unlike ground solar systems, space solar power systems can operate continuously round the clock. Here, we have assumed that the laser-powered airplanes are flying almost 24 hours each day of

the year, resulting in the nearly continuous use of the Space Laser Power System. The proposed microwave solar power satellites for electrical power generation would be deployed in a geosynchronous orbit and would operate 99% of the year. Lockheed's laser power satellites for electrical power generation would be deployed in a sun-synchronous orbit and would operate continuously.

SYSTEM SAFETY

While the radiation intensity at the aircraft receiver is less than 30 watts per cm^2 , a protective system must be provided both for the airplane and terrestrial inhabitants. This protection requires a system which permits the laser power to be switched on only when a secure tracking lock onto the heat exchanger receptor of the airplane exists. Thus, any failure to properly track the aircraft would automatically shut down the laser, and the aircraft would revert to kerosene power until a secure lock is re-established. Since the signal travel time to the relay satellite is only about 40 milliseconds at the farthest tracking distance, it should be possible to terminate the laser beam in less than 100 milliseconds if tracking is disrupted. The upper surface of the airplane can be easily designed to withstand this brief exposure to moderate intensities. Moreover, standard airplane window materials are opaque to both CO_2 and CO laser radiation so that the crew and passengers are never exposed to radiation.

Flight paths would be arranged so that no airplane would fly into a laser beam. In the event when another airplane accidentally intrudes into the beam path, the interruption of the beam will automatically trip a laser cutoff mechanism.

Since corresponding protection for terrestrial inhabitants is not possible, there still exists the rare possibility that someone may be so positioned as to

C 2

look in the direction of the laser transmitter at the moment of a tracking lock failure. In clear weather conditions much of the radiation may reach the ground. Since the beam (15m in diameter) sweeps the ground at roughly 960 km/hr, the maximum energy deposited near the beam center is about 1 Joule/cm². While this is considerably less than the threshold for skin burns (6 Joules/cm²), it is twice the dose tolerable for corneal eye damage.¹⁹ The brief exposure allowed by the feedback safety system minimizes the possibility of contact. The large scale transportation network considered here would expose less than 10⁻⁸ of the Earth's surface each year to radiation doses about the threshold for eye damage, assuming as high as 1 miss per 100 missions. In addition, flight paths can be selected that will avoid populated areas. Taking into account the rarity of tracking failure, the rarity of perfect optical transmission conditions, and the additional rarity of someone looking directly into the laser beam, the probability of eye damage is reduced to an infinitesimal level.

The use of a power satellite-relay combination also enhances the overall system reliability. For example, the failure of any given power satellite or relay would not require an additional margin of fuel reserve since laser power could be restored by switching to another operating unit. Collateral safety effects, such as reduced fuel load on take-off, enhances the aircraft's safety.

ENVIRONMENTAL EFFECTS

A laser-powered aircraft is a long range transportation system with a minimal pollution impact on the atmosphere. The turbofan involves an engine in which heat is transferred to the engine airflow by convection instead of combustion.

Consequently, the usual combustion products, such as nitric oxides, water vapor and carbon dioxide, are absent from the laser turbofan exhaust. Moreover, at the CO and CO₂ laser frequencies and at power levels on the order of 30 W/cm², there is no interaction with the ionosphere and thus no effect on the ozone level. Launch effluents are small when compared to the emissions from a whole fleet of kerosene airplanes. Rocket engines also burn relatively clean; exhaust products are normally only CO₂ and H₂O.

PROGRAM DEVELOPMENT

The high capital investment requirements of this flight system demand that the technology and associated risks be assessed in a step by step research and development program. In the beginning a small RPV could be energized by a system of existing welding lasers and tracking systems stationed on the ground. This would be the first free flight demonstration of laser propulsion and would also be the first fuelless airplane. The next step may involve space shuttle deployed relay satellites and a ground based laser, probably located on top of a mountain, such as Mauna Loa in Hawaii, allowing relatively efficient atmospheric beam transmission from ground to relays. This laser system would be used to power small jet aircraft. The large scale prototype spacecrafts and jet transport could then follow with confidence.

FUTURE POTENTIAL

In the above studies the authors, in order to make a preliminary economic assessment, have confined themselves to technology which they feel can be justified as a reasonable extension of existing or near-term technology. This may be an unduly severe constraint considering the time-span for the introduction

of such a program, and serves only as the basis for illustrating the technical viability of such a scheme.

Research and development programs are active in the area of new concepts in both laser development and solar energy conversion. For example, there is a significant effort in much shorter ($\approx 2 \mu\text{m}$) lasers of high efficiency. An outstanding example is the "free electron laser," which promises, in principle, high efficiency conversion from electrical energy to laser energy at wavelengths which could be optimized for such a flight system.²⁰ In examining the cost structure of our satellites, it can be seen that reducing the wavelength from about 5 microns to 2 microns would have a first order impact in reducing the cost. Other approaches to high efficiency lasing systems are also being studied. For example, the solar pumped laser concept offers the potential of a large increase in efficiency of the conversion of solar radiation into laser energy.²¹ Studies are under way at the University of Washington which indicate that the efficiency of energy conversion in space using proper advanced technology may be significantly increased.¹¹ Therefore, the authors feel that there are a number of technical approaches which would permit the utilization of a satellite strategy which can dramatically reduce the operating cost of the system.

In limiting themselves to existing aircraft and engine technology, the authors again penalized the system unnecessarily. An optimal airplane flying in optimal strategy for laser propulsion could significantly reduce the laser power requirements. For example, since the airplane is not burdened by a large parasitic mass of fuel during take-off, a new flight strategy should be introduced which would allow aircraft to climb more rapidly. The altitude constraints, which were optimized for a kerosene airplane, certainly do not represent an

optimal flight strategy for such an aircraft. With an aircraft and engine designed around such a transportation system, there is little reason to believe that the operating altitude of this aircraft could approach that of the SST, resulting again in further cruise economies.

The very existence of laser power satellites suggests that these systems can be used also as part of a space transportation system, acting in a synergistic way to reduce the boost cost of such systems.²²

These are but a few of the options that should be examined to determine the ultimate potential of this system. This paper, therefore, represents only an introductory examination of the general feasibility and appears in itself to be encouraging enough to warrant such explorations.

CONCLUSIONS

A laser-powered flight transportation system is only one of many possible uses of a Space Laser Power System. This article has explored the possibility of using laser propulsion for an air-breathing booster and a commercial jet transport. If all the assumptions made here are true, then a laser-powered commercial jet transportation system will be cost competitive with an advanced fuel efficient kerosene flight system.

As pointed out earlier, the economic justification of any solar power satellite depends primarily on the establishment of a very large and mature space industry. Such an industry can only be sustained by a correspondingly large market. Due to its multi-mission capability, the Space Laser Power System has the potential for a market that includes air and space transportation, electrical power generation, high temperature chemical processing (such as coal gasification), hydrogen production, and material processing. Once the mature space industry

is established for the construction of small power satellites for a laser flight system, these same industrial facilities could also be used, for example, for the construction of larger laser power satellites for electrical power generation and space propulsion.

The laser flight system, like many other space laser concepts, can be incorporated directly into our existing technology base. As shown, laser airplanes are incorporated with existing airport systems. A laser heat engine may even replace a coal-fired boiler of an electrical power plant, while still retaining the same turbomachinery and power distribution lines.

In the long run, advancements in technology will result in high efficiency, low cost Space Laser Power Systems. These advanced space laser systems combined with the unique advantages of relay capability and multi-mission capability will then play a vital role in the development of solar power satellites and solar-powered flight transportation systems.

ACKNOWLEDGMENTS

The authors wish to thank Mr. W.S. Jones, Project Leader for Space Laser Systems at Lockheed Palo Alto Research Laboratory for his contributions, particularly in the development of a deployment strategy for the laser-powered satellite system. In addition, the authors wish to thank M.A. Lunsford of the University of California, Davis for his Brayton cycle design. Special thanks are due to A.P. Bruckner of the Aerospace and Energetics Research Program at the University of Washington for his useful comments in preparing this article.

This research was supported by NASA Grant No. NGL 48-002-044 S-12.

REFERENCES

1. L.M. Nicolai, "Changing Requirements in Aircraft Design," Aeronautics & Astronautics, 17:22-31 (1979).
2. "Laser Power Conversion Systems Analysis," Lockheed Missiles and Space Company, NAS3-21132 (LRC).
3. "Laser Rocket Systems Analysis Study," Lockheed Missiles and Space Company, LMSC-D564671 (October 1977).
4. A.R. Kantrowitz and R.J. Rosa, "Ram Jet Powered by Laser Beam," U.S. Patent No. 3,818,700.
5. A. Kantrowitz, "Propulsion to Orbit by Ground-Based Lasers," Aeronautics & Astronautics, Vol. 10 (May 1972).
6. L.N. Myrabo, "Solar Powered Global Aerospace Transportation," AIAA Paper 78-689, IAAA/DGLR 13th International Electric Propulsion Conference.
7. Fuel Conservation Possibilities for Terminal Area Compatible Aircraft, Boeing Commercial Airplane Co., NASA-CR-132608 (March 1975).
8. "Inconel Alloy 601," International Nickel Inc. (1973).
9. "Systems Definition: Space Based Power Conversion Systems," Boeing Aerospace Company, NAS8-31628 (MSFC).
10. "Solar Power Satellite: Systems Definition Part II," Boeing Aerospace Company, NAS9-15196 (JSC).
11. A.T. Mattick, A. Hertzberg, R. Decher and C.V. Lau, "High Temperature Solar Photon Engines," J. Energy, 17:16-17 (1979).
12. M.M. Mann, "CO Electric Discharge Lasers," AIAA Journal, 14:549-567 (1976).
13. J.W. Hardy, "Active Optics: A New Technology for the Control of Light," Proceedings of the IEEE, Vol. 66 (June 1978).
14. R.R. Berggren and G.E. Lenertz, Feasibility of a 30 Meter Space Based Laser Transmitter, Itek Corp., NASA-CR-134903, NAS3-19400.
15. C.F. Hansen and G. Lee, "Laser Power Stations In Orbit," Aeronautics & Astronautics, 15:30-42 (1977).
16. R.A. McClatchey, Atmospheric Attenuation of CO Laser Radiation, Environmental Research Paper No. 359, AFCRL-71-0370.

17. P.E. Glaser, "Perspectives on Satellite Solar Power," AIAA Journal of Energy (March-April 1977).
18. J.P. Reilly, "High Power Electric Discharge Lasers," Astronautics & Aeronautics, pp. 52-63 (March 1975).
19. J.F. Ready, Effects of High Power Laser Radiation, Academic Press (1971).
20. E.T. Gerry and J.D.G. Rather, "The Laser Future," Astronautics & Aeronautics, 17:60-67 (1979).
21. W.H. Christiansen, "A New Concept for Solar Pumped Lasers," in Radiation Energy Conversion in Space, K.W. Billman, ed., Vol. 61 of Progress in Astronautics and Aeronautics, pp. 346-356.
22. R.F. Weiss, A.N. Pirri and N.H. Kemp, "Laser Propulsion," Astronautics & Aeronautics, 17:50-58 (1979).
23. A.I. Barchukov, F.V. Bunkin, V.I. Konov and A.M. Prokhorov, "Laser Air-Jet Engine," JETP Letters, 23:213-215 (1976).
24. I. Bekey, H. Mayer and M. Wolfe, Advanced Space System Concepts and Their Orbital Support Needs (1980-2000), Aerospace Corporation, December 1976, Contract No. NASW-2727.
25. R. Weber, "Laser Powered Propulsion for Aircraft," Memorandum to NASA Headquarters, Research Division, dated June 11, 1976.

TABLE I - LASER-POWERED AIRCRAFT CONCEPTS

<u>AUTHOR</u>	<u>YEAR</u>	<u>VEHICLE</u>	<u>PROPULSION</u>	<u>CONVERSION SYSTEM</u>
KANTROWITZ & ROSA ⁴	1974	HYPERSONIC AIRFRAME	RAMJET	ALKALI SEED/INVERSE BREMSSTRAHLUNG
L.N. MYRABO ⁶	1976	LAUNCH VEHICLE	MHD FANJET	BREAKDOWN/INVERSE BREMSSTRAHLUNG
BARCHUKOV, et al. ²³	1976	LAUNCH VEHICLE	LASER AIRJET	BREAKDOWN/SHOCK WAVE
BEKEY, et al. ²⁴	1976	JET TRANSPORTS	TURBOFAN	FOCUSED LASER RADIATION
R.J. WEBER ²⁵	1976	JET TRANSPORTS	TURBOFAN	LIQUID METAL HEAT EXCHANGER
L.N. MYRABO ⁶	1978	LAUNCH VEHICLE	ROTARY PULSE JET	BREAKDOWN/INVERSE BREMSSTRAHLUNG
HERTZBERG, et al. ¹	1978	JET TRANSPORT	TURBOFAN	LASER TO AIR HEAT EXCHANGER

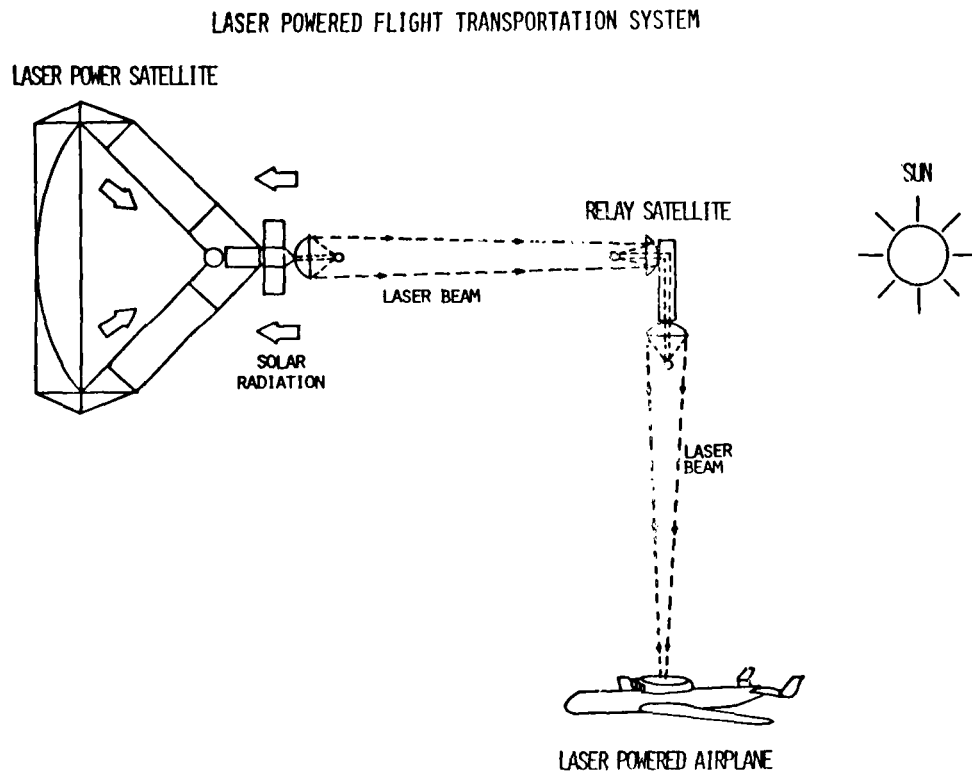

FIGURE 1

SPACECRAFT DEPLOYMENT STRATEGY

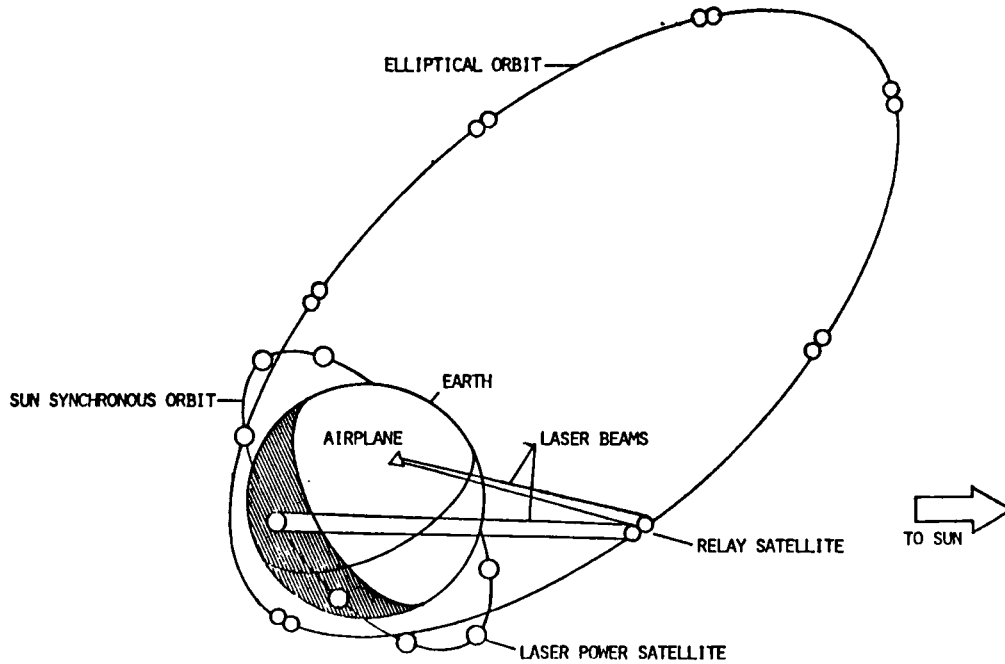

FIGURE 2

LASER POWERED AIRPLANE FLIGHT PROFILE

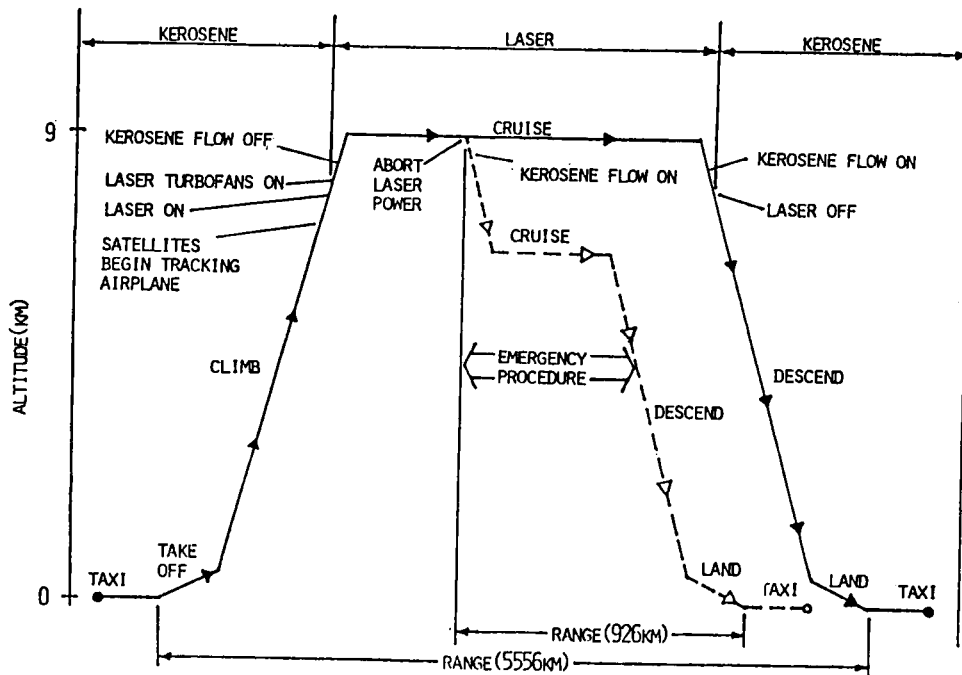

FIGURE 3

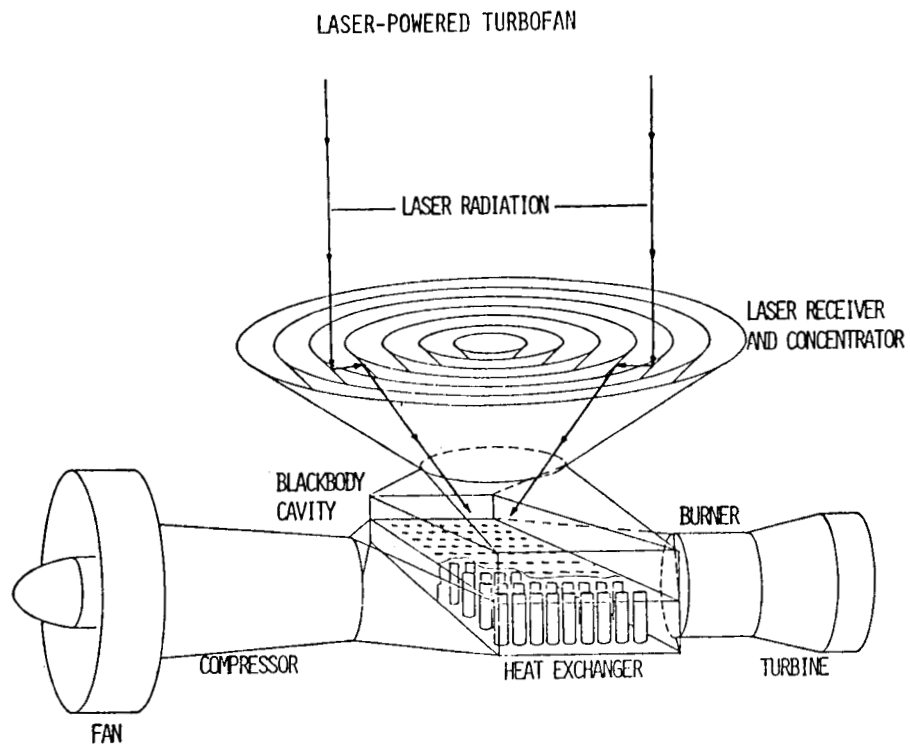

FIGURE 4

KEROSENE POWERED AIRPLANE (BOEING TAC/E AIRPLANE)

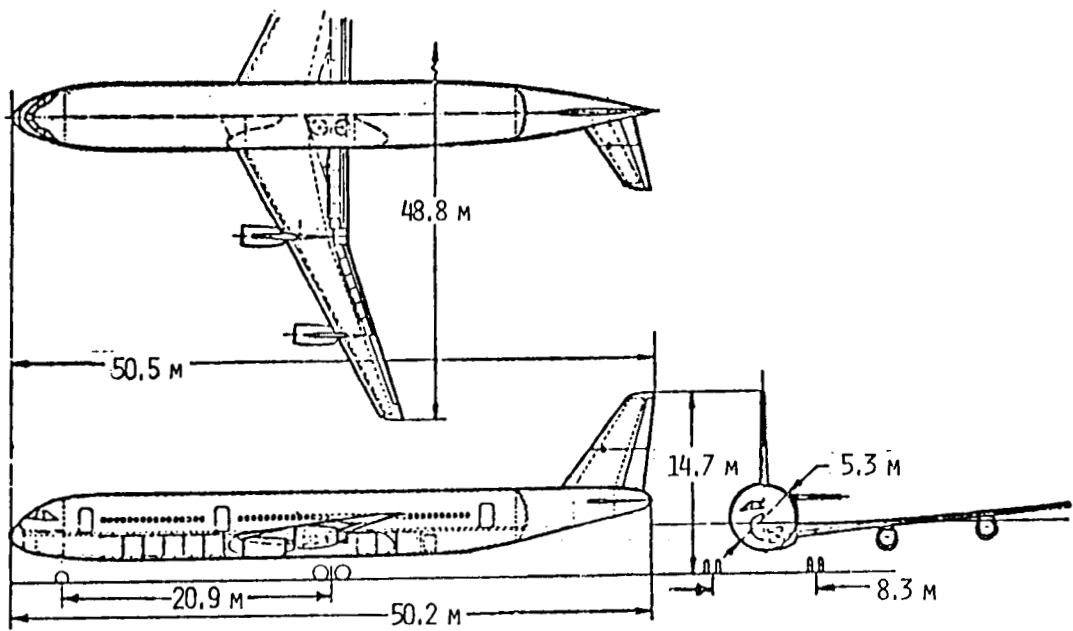

FIGURE 5

LASER POWERED AIRPLANE - BASELINE CONFIGURATION

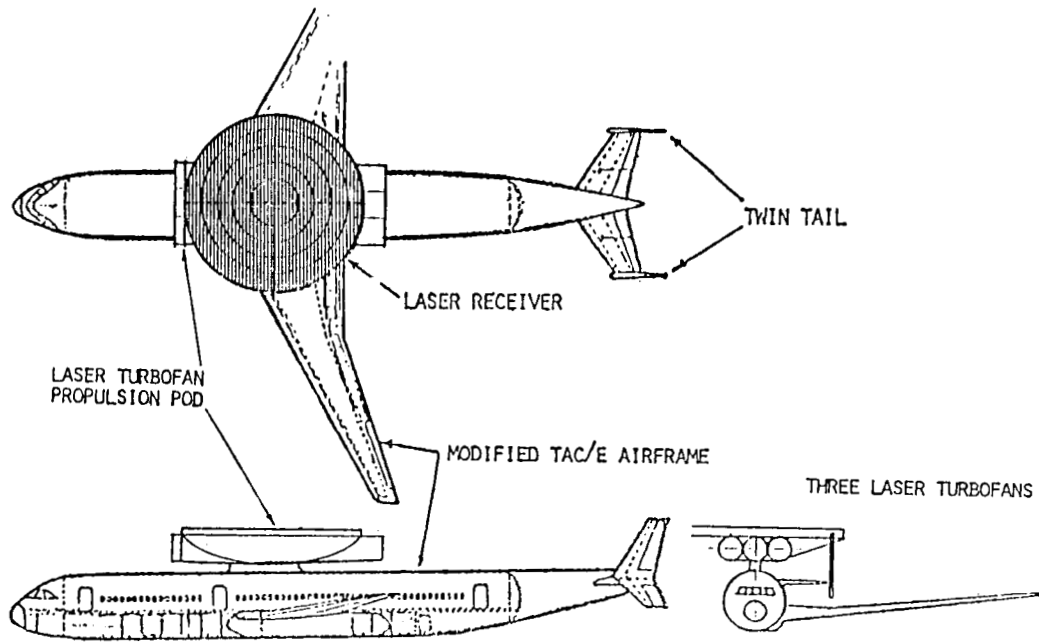

FIGURE 6

CARBON MONOXIDE LASER POWER SATELLITE - 42 MW OUTPUT POWER

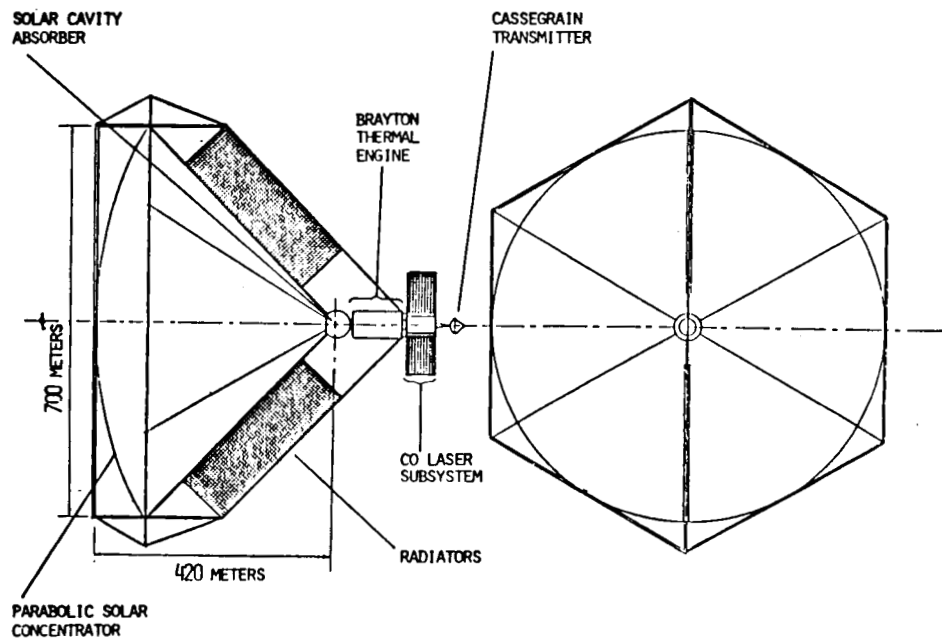

FIGURE 7

CASSEGRAIN TRANSMITTER SUBSYSTEM

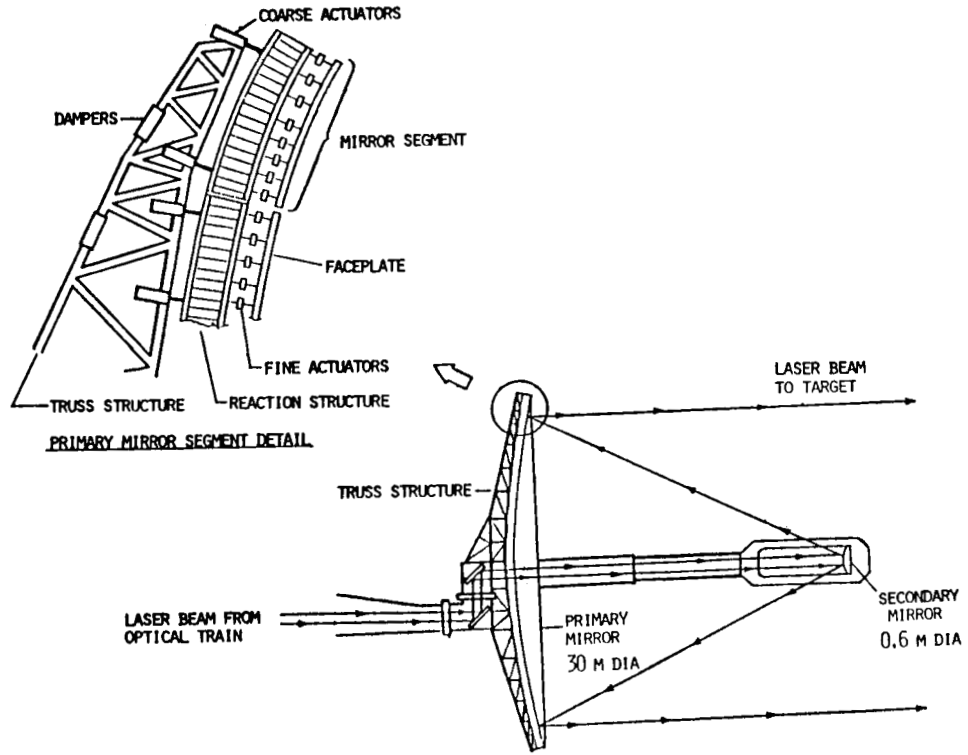

FIGURE 8

LASER POWER SATELLITE MASS AND COST DISTRIBUTION

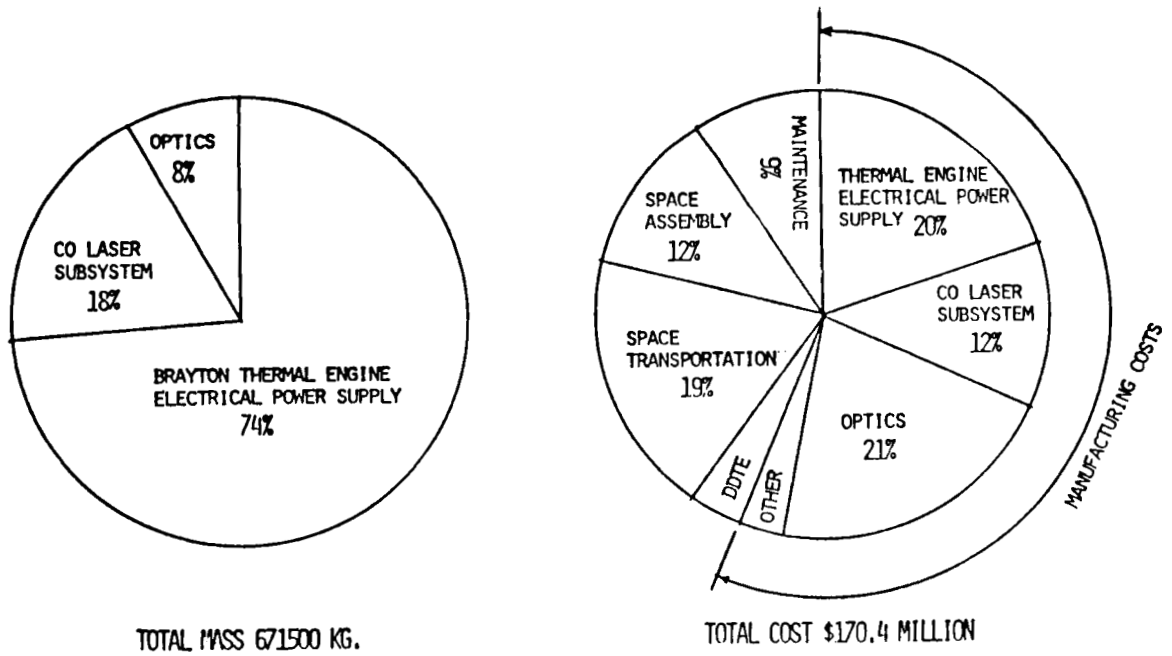

FIGURE 9

RELAY SATELLITE CONFIGURATION

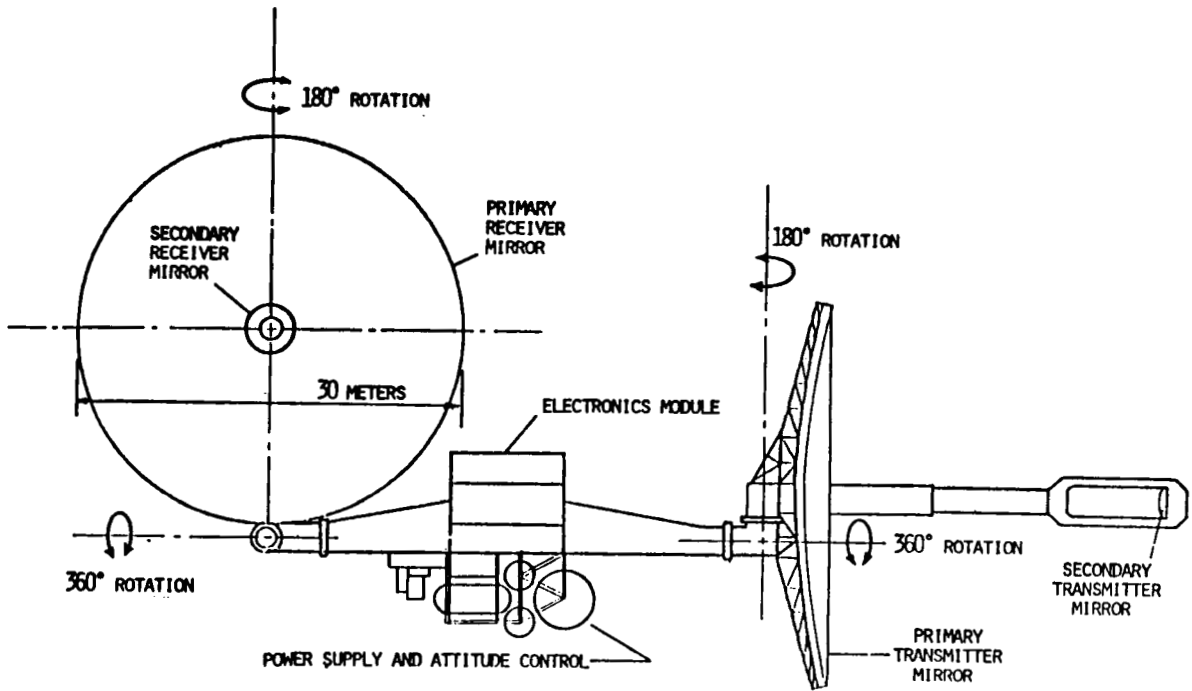

FIGURE 10

RELAY SATELLITE MASS AND COST DISTRIBUTION

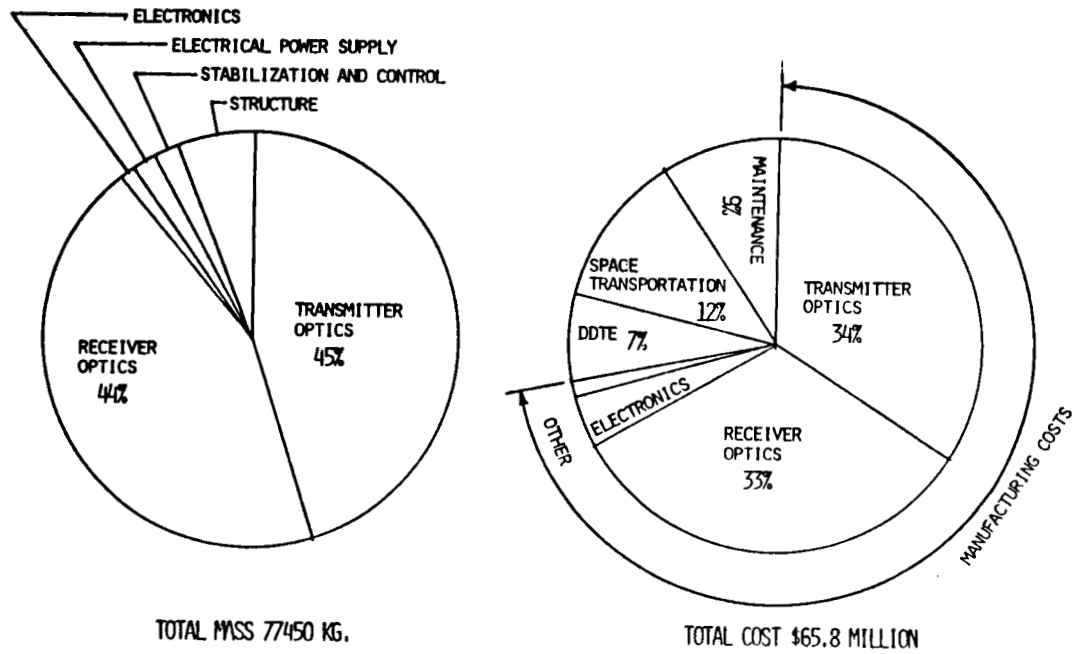
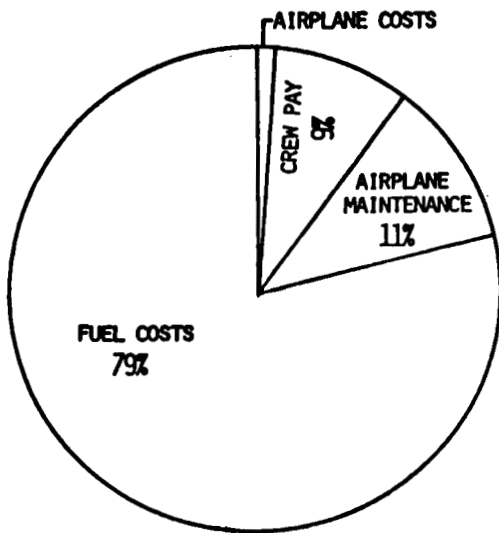
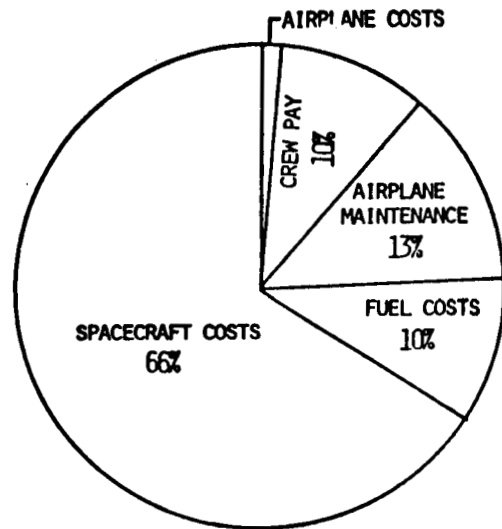

FIGURE 11

KEROSENE FLIGHT SYSTEM AND LASER FLIGHT SYSTEM COST DISTRIBUTION AT 40¢/LITER FUEL COST AND A 7500 KM RANGE



KEROSENE FLIGHT SYSTEM COST \$1.43/KG-PAYLOAD



LASER FLIGHT SYSTEM COST \$1.36/KG-PAYLOAD

FIGURE 12

MILLIMETER-WAVE TECHNOLOGY
BACKGROUND

PRECEDING PAGE BLANK NOT FILMED

PAGE 104 INTENTIONALLY BLANK

N90-10146

56-20

Vacuum Microelectronics

216710

for

Beam Power and Rectennas

NS999791

**Henry F. Gray
Naval Research Laboratory
Washington, DC 20375**

PRECEDING PAGE BLANK NOT FILMED

SUMMARY

VACUUM MICROELECTRONICS FOR BEAM POWER AND RECTENNAS

Both solid-state and vacuum electronics have serious limitations and weaknesses with respect to applications in space, particularly for beaming and receiving microwave and millimeter wave power. For example, solid-state devices are limited in speed due to velocity saturation of charge carriers in the transport channel of FETs. This saturation is due to the generation of optical and acoustic mode phonons which occurs in all materials. In order to increase the speed of solid-state devices, the transport channel length is decreased. However, as the length is decreased, the voltage across the channel must also decrease to prevent voltage breakdown of the device. The consequence is that significant power cannot be obtained in a single device, and power combining is difficult, if not technically or economically impractical. Vacuum electronics also have significant problems, the greatest of which is the size and weight of vacuum tubes. There is also the extremely high cost which is determined to a great extent by the machine shop manufacturing methods used. In addition, they cannot be integrated into high density circuits. Vacuum microelectronics, which is presently based on field emitter arrays, promises to eliminate many of the problems experienced in both solid-state and vacuum electronics. It takes advantage of the fabrication and processing methods of solid-state and the ballistic electron advantage of vacuum electronics. Vacuum Microelectronic devices can be described as vacuum transistors or micro-miniature vacuum tubes, as one chooses. The fundamental reason behind this new technology is the very large current densities available from field emitters, namely as high as 10^8 A/cm². Array current densities as high as 1000 A/cm² have been measured. Total electron transit times from source to drain for 1 micron feature size devices have been predicted to be about 150fs. This very short transit time implies the possibility of submillimeter wave transmitters and rectennas in devices which can operate with reasonably high voltages and which are small in size and are lightweight. In addition, they are expected to be extremely radiation hard and very temperature insensitive. That is, they are expected to have radiation hardness characteristics similar to vacuum tubes, and both the high temperature and low temperature limits should be determined by the package. That is, there should be no practical intrinsic temperature or carrier freezeout problems for devices based on metals or composites. But the technology is difficult to implement at the present time because it is based on 300-500 angstrom radius field emitters which must be relatively uniform. There is also the need to understand the non-equilibrium transport physics in the near-surface regions of the field emitters (both in the solid and in the vacuum). It appears, nevertheless, that this technology would be very attractive for future space beam power and rectenna applications.

Field Emitter Array Electronics

Technical Promise

- **High Current Density: $> 1000 \text{ A/cm}^2$**
- **Very Radiation Hard: "Vacuum Tube" Hardness**
- **Temperature Insensitive: -100C to $+1000\text{C}$**
- **Long Operational Life: No known wearout mechanism**
- **Ultra-high Speed: $> 100 \text{ Ghz}$ for medium power mm wave amplification**
- **$< 150 \text{ fs}$ for signal processing**

Vacuum Microelectronics

Outline

- **Can't Solid State Hack It?**
- **Classical Field Emission**
- **Field Emitter Arrays**
- **Beam Power**
- **Rectennas**

What Is "Vacuum Microelectronics" ?

Vacuum Microelectronics is a new electronics technology that combines solid state microelectronics fabrication and processing with vacuum electron ballistic transport. It promises to extend the present limits of both solid state and vacuum electronics. The basis for vacuum microelectronics at the present time is the Field Emitter Array, where the active charge transport structure is a miniature electron field emitter of 500 angstrom radius, and the fundamental cell dimension is one micrometer or smaller; that is, as small as, or smaller than, VLSI active cells.



Vacuum Microelectronics Based on Field Emitter Arrays

Weaknesses of Solid State Electronics

- **Temperature Sensitive**
 - High Temperature Limit - Intrinsic Temperature
 - Low Temperature Limit - Carrier Freeze-out
- **Radiation Sensitive**
 - Bulk and Surface Charges
 - Lattice Damage
 - Electron-Hole Pair Generation
- **Voltage Breakdown**
 - High Electric Fields in One-Dimension
 - Thin Dielectric Layers
- **Finite Carrier Velocity**
 - $< 5 \times 10^7$ cm/s in all solids
 - Acoustic and Optical Phonon Generation

Classical Field Emission

3,000 - 10,000 volts

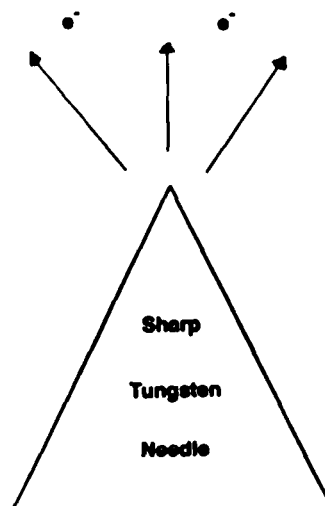

FIELD EMISSION

- FIRST REPORTED IN 1897 (R. W. WOOD)
- THEORY DEVELOPED IN 1928 (FOWLER, NORDHEIM)

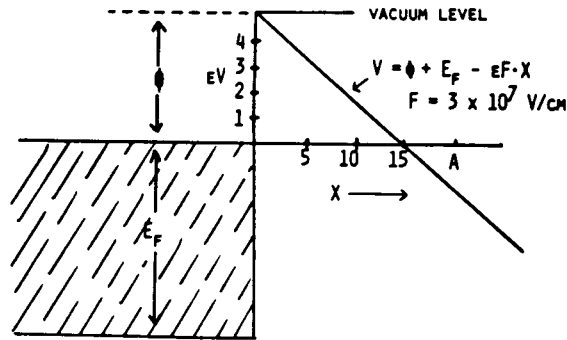

$$V_B(E_x) = \phi + E_F - E_x - eF \cdot X$$

$$X_0 \text{ (THICKNESS AT FERMI LEVEL)} = \frac{\phi}{eF}$$

INTEGRAL GRIDDED SINGLE CRYSTAL SILICON FEAs

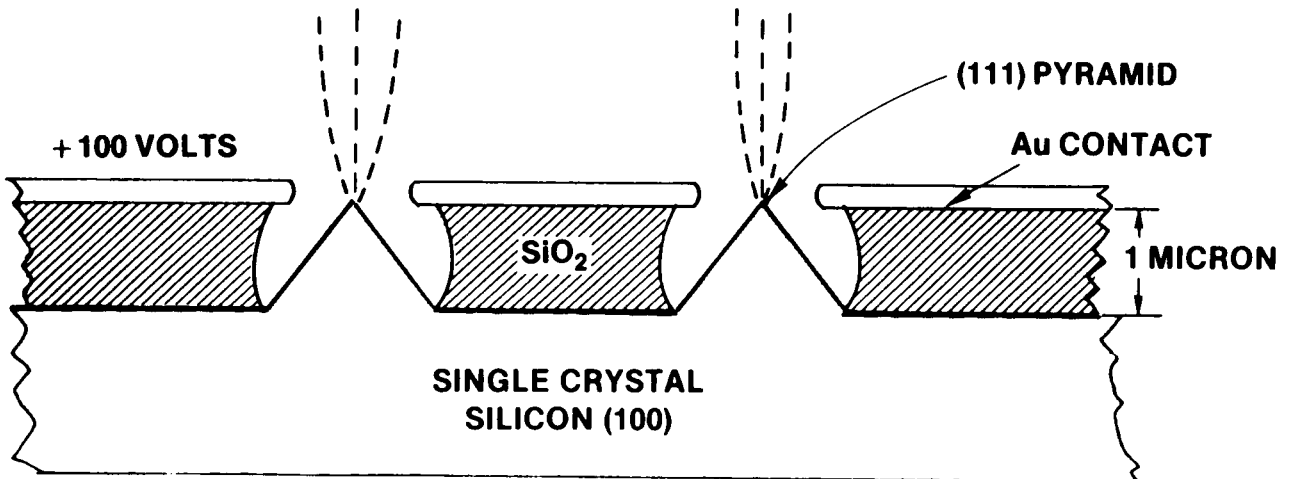

POTENTIAL DISTRIBUTION

GATE = 100 Volts
COLLECTOR = 200 Volts
APERTURE = 1.50 μm

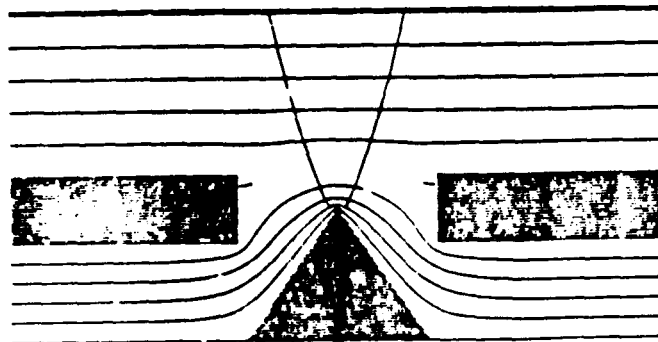

Ion Bombardment Effects

Conventional Electron Field Emission

+ (3-10) KV

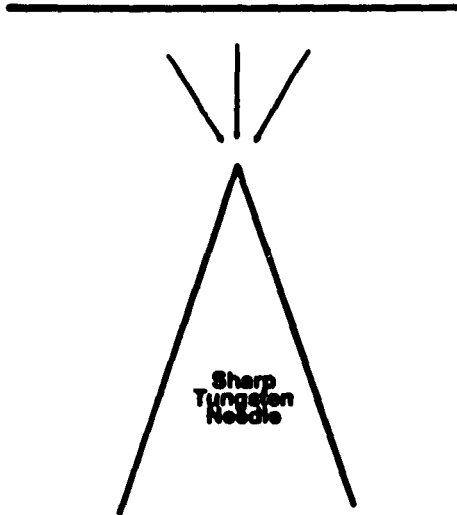

Field Emitter Arrays

+ 1 KV

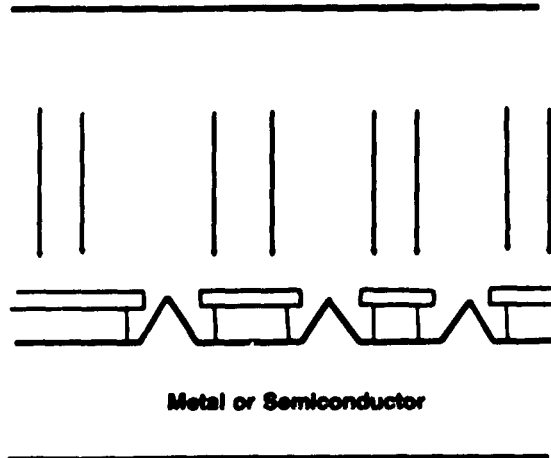

PHYSICS OF SPEED LIMITATIONS IN ELECTRONIC DEVICES

o Saturation Velocity

Solid State Devices

$< 3 \times 10^7$ cm/s

Due to optical and acoustic
phonon scattering

Field Emitter Arrays

$< 3 \times 10^{10}$ cm/s

Practical value (at 100V):

6×10^8 cm/s

o Acceleration

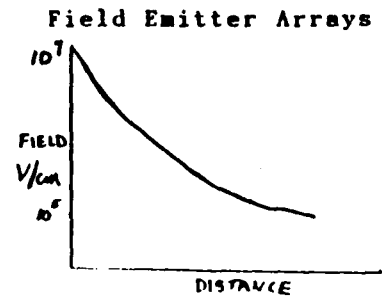
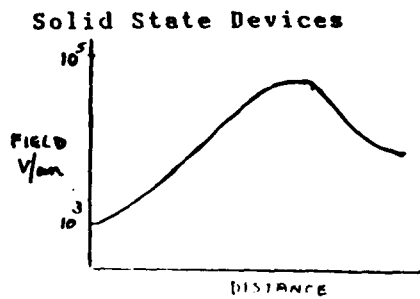

Field Emitter Array Electronics

Comparison of Electronics Technologies

- **Vacuum Tubes (1950 Vintage)**
 - Current Density 1 A/cm^2
 - Large Device Structures
- **Transistors**
 - Current Density 1000 A/cm^2
 - Small Device Structures
- **Field Emitter Arrays**
 - Current Density $10^7 - 10^8 \text{ A/cm}^2$
 - True Submicron and Nanostructure Devices

FIELD EMITTER ARRAY SWITCH

- ULTRA FAST • NO LATCH-UP • PLANAR OR 3-D

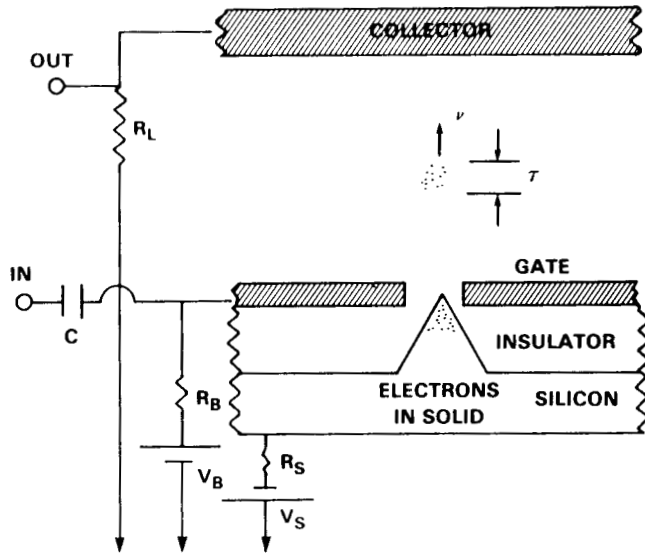

FEATRON FABRICATION OF THE NRL FEA

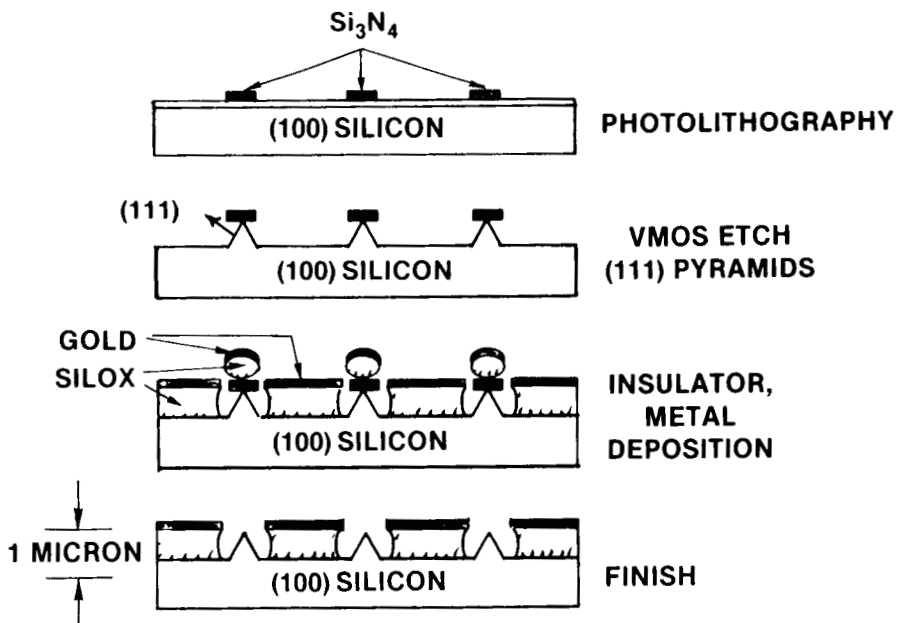

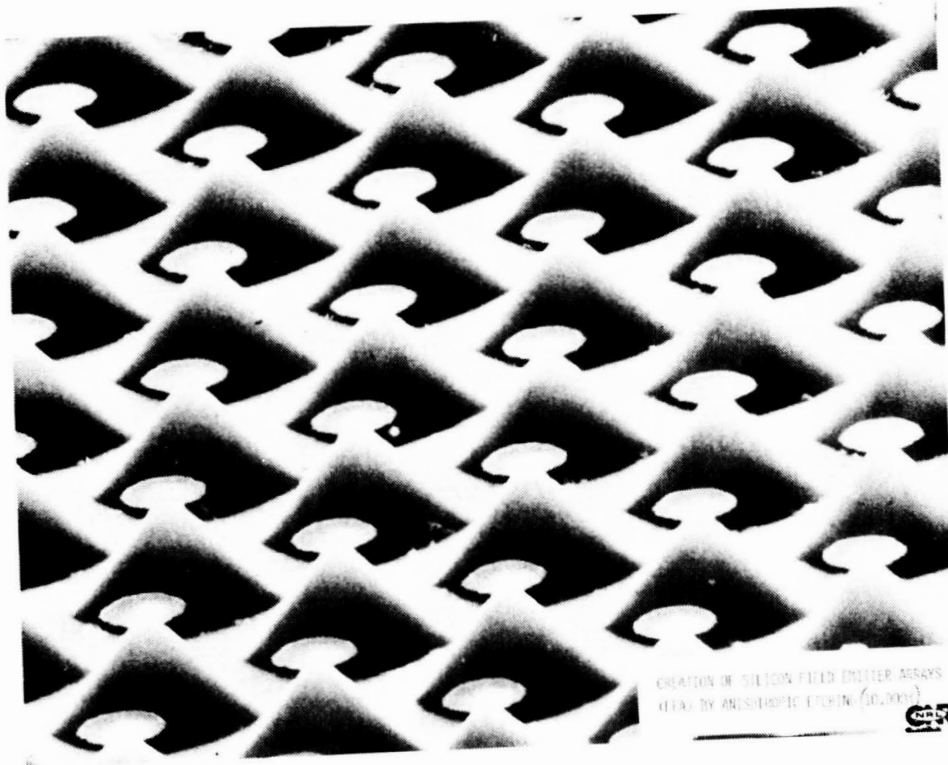

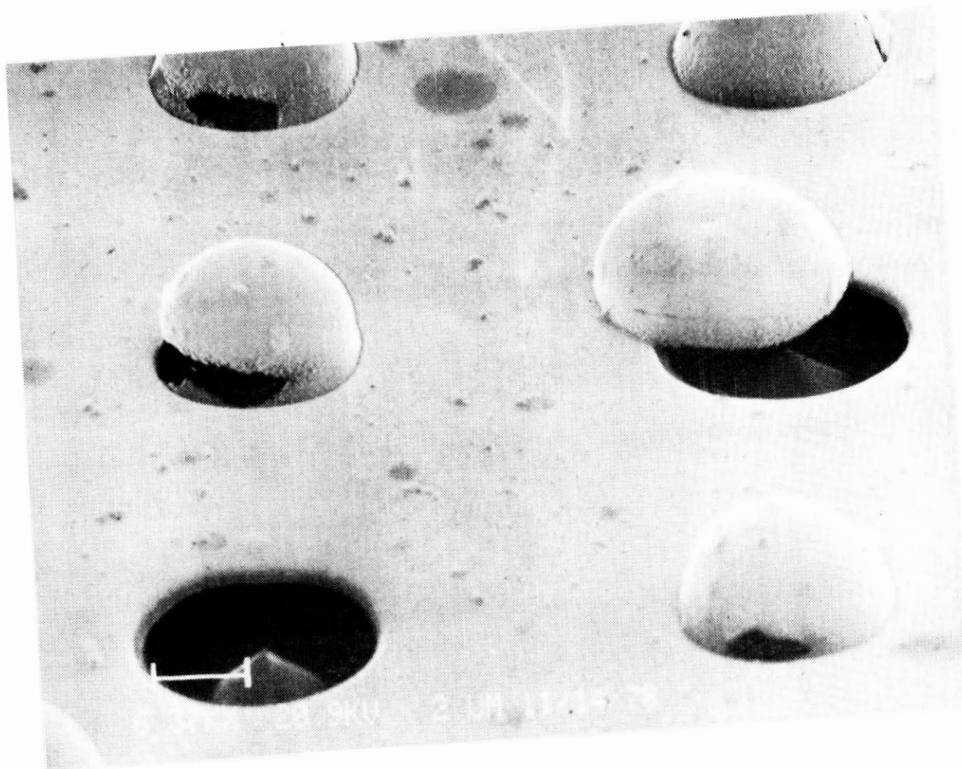
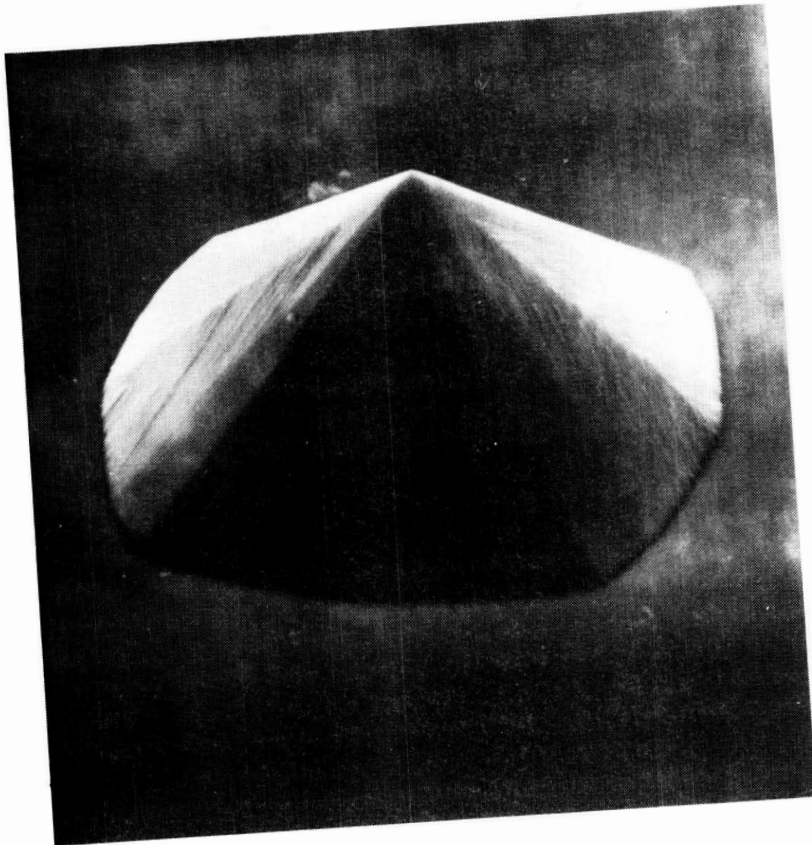

ORIGINAL PAGE
BLACK AND WHITE PHOTOGRAPH

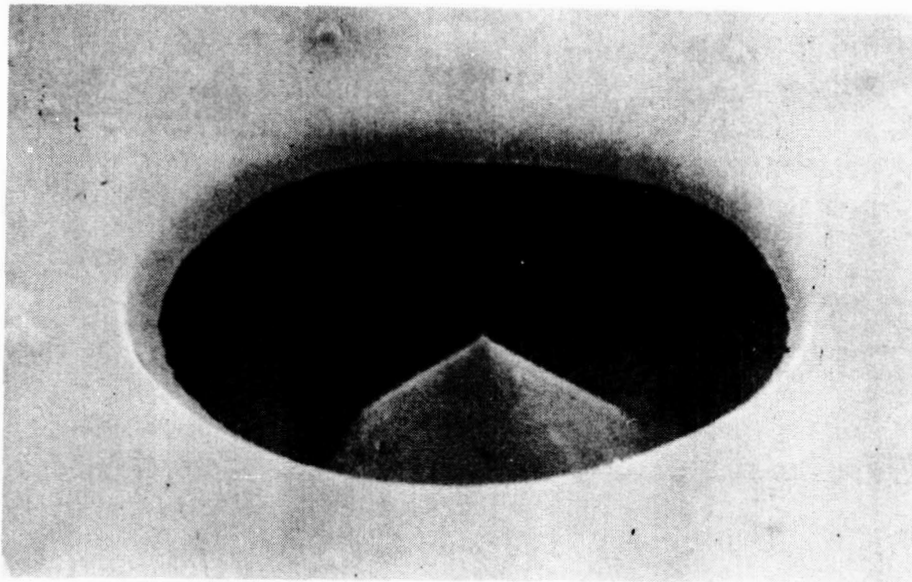
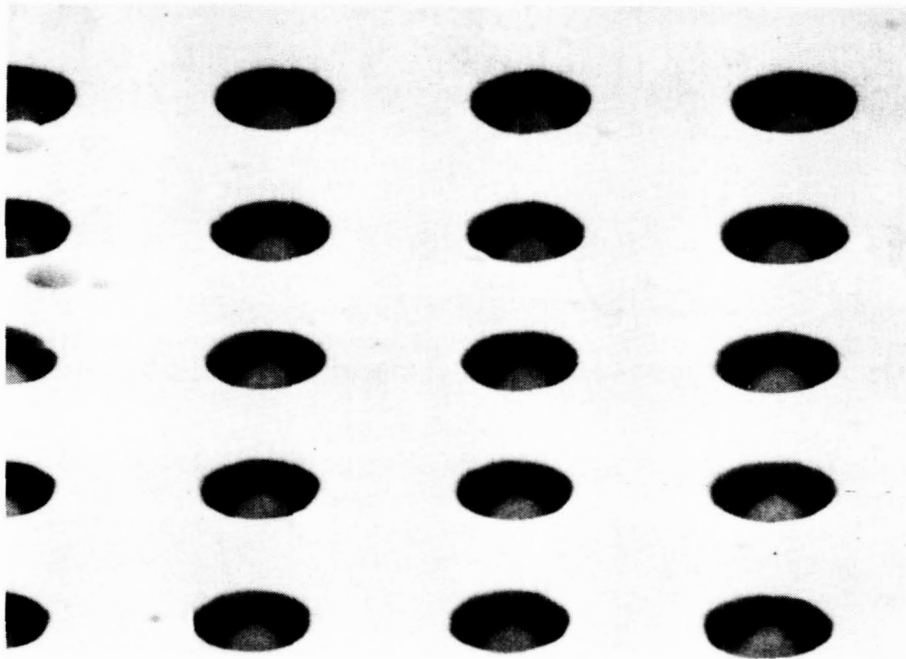

ORIGINAL PAGE
BLACK AND WHITE PHOTOGRAPH

SILICON PLANAR FIELD EMITTER ARRAY VACUUM FET

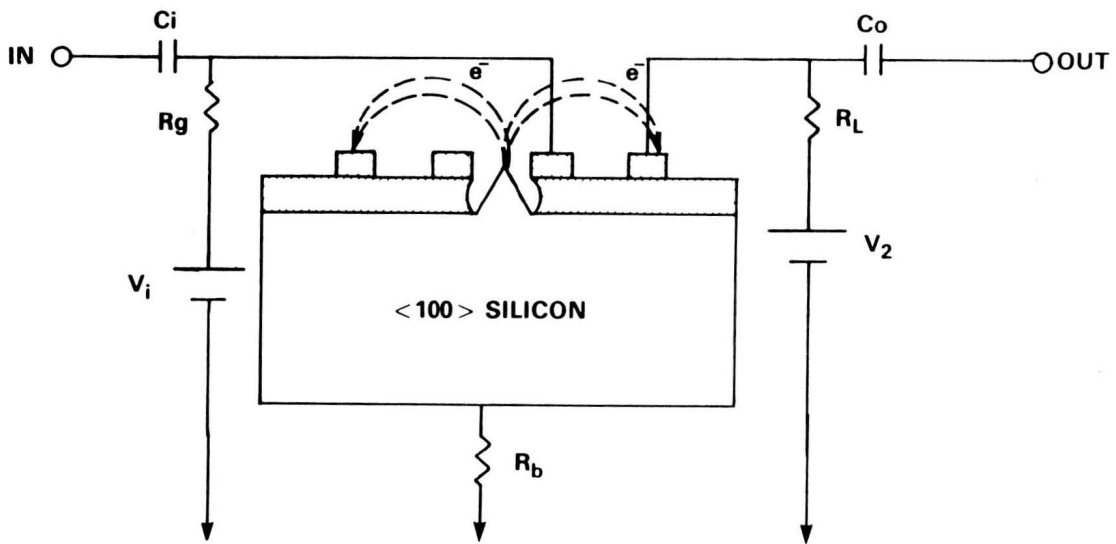

INTERDIGITATED SILICON PLANAR FIELD EMITTER ARRAY VACUUM FET

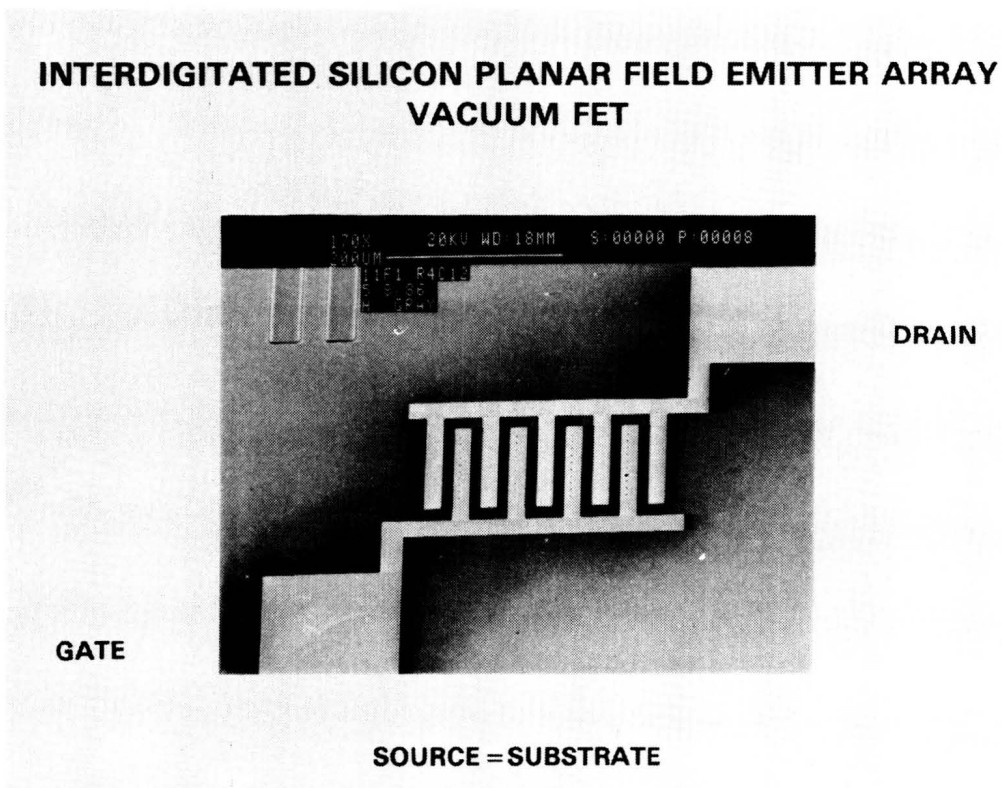

GATE MODULATION OF SILICON PLANAR VACUUM FIELD EMITTER ARRAY FET

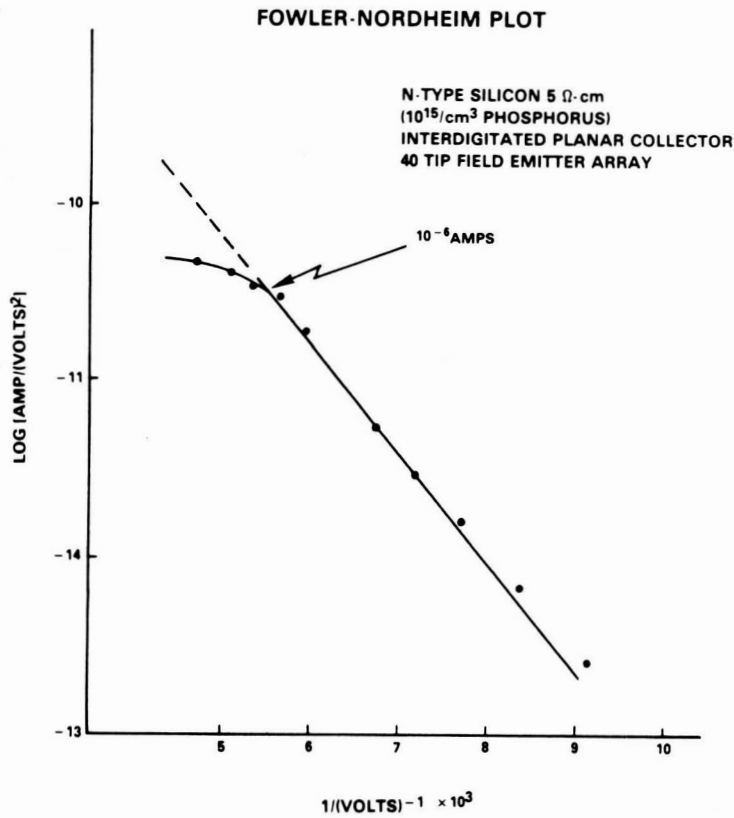
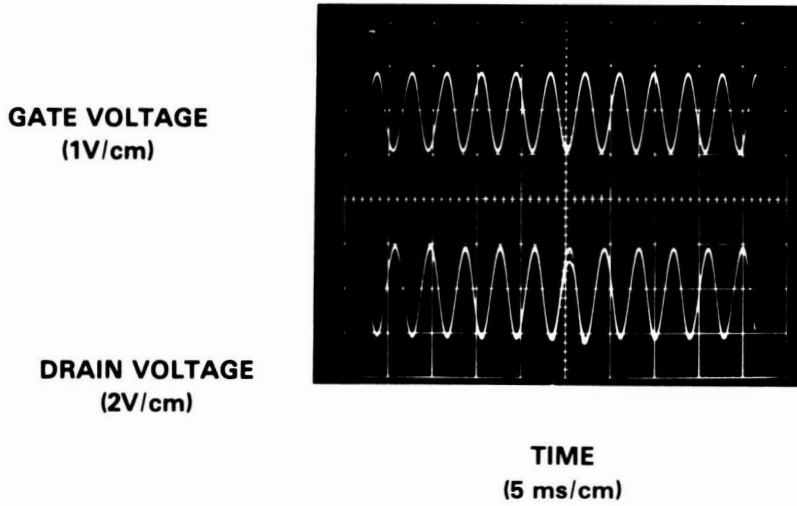

Current Saturation in n-Type Semiconductors

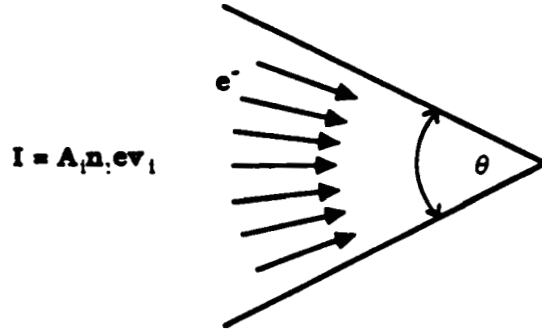

$v_s =$ constant in saturated regime
 current is not sufficient to support an arc

Non-equilibrium: velocity saturation

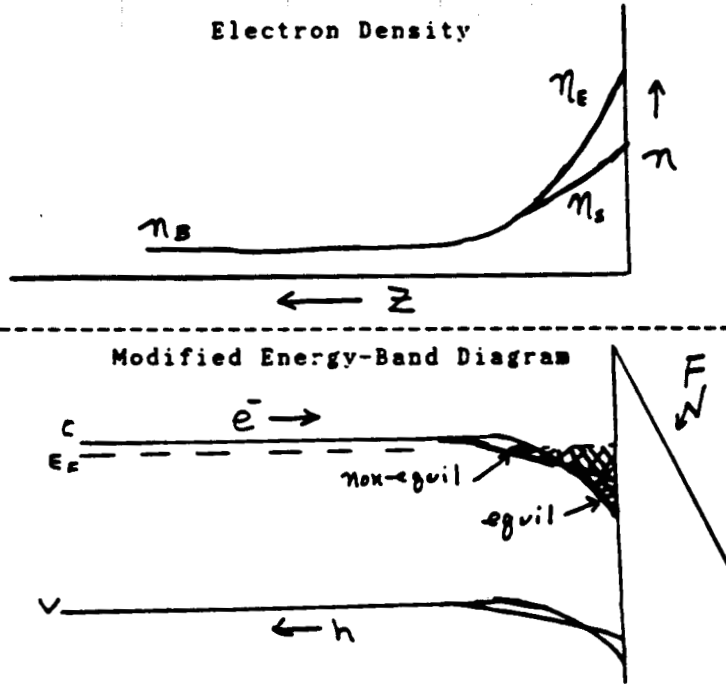

Surface charge depletion and increased field penetration

Device: 69
Vdr = 200.00 V
Vg = 100.00 V

STEP 1002

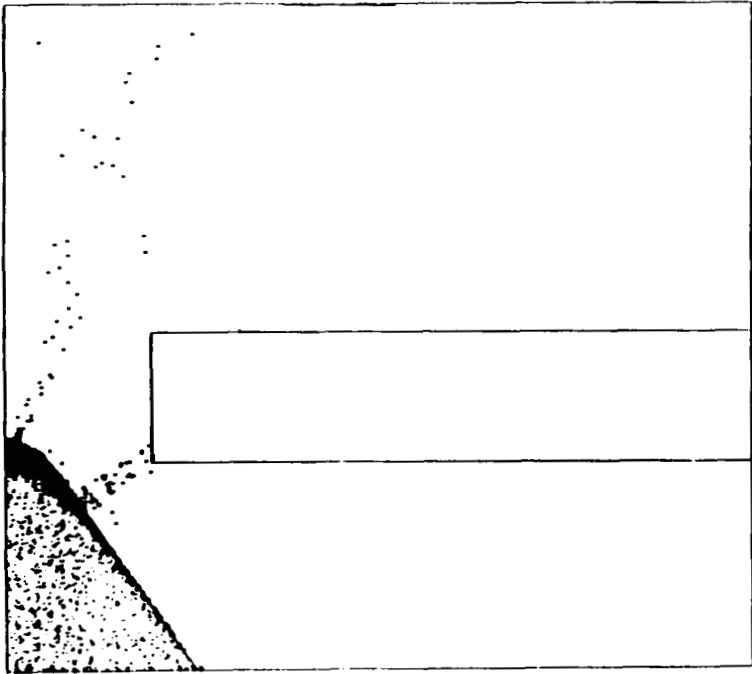

Field Emitter Array Embedded Stripline Triode

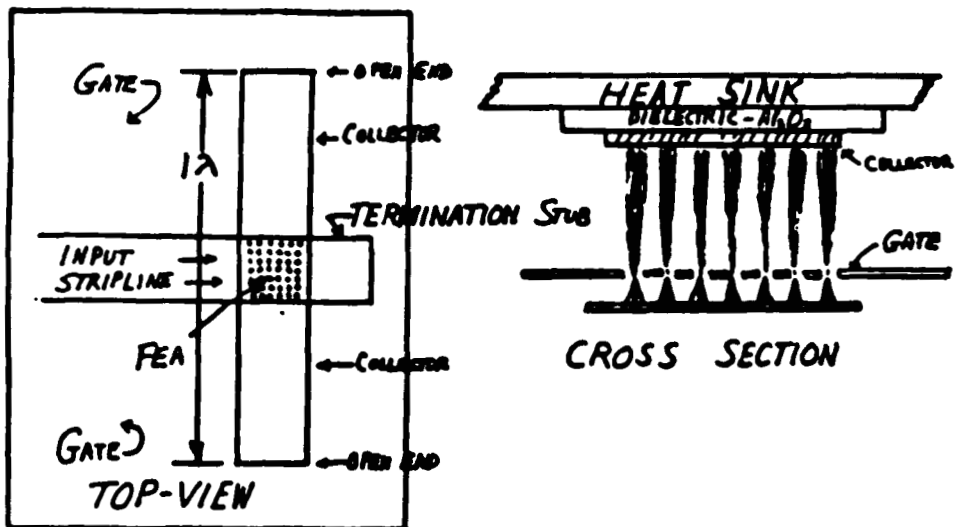

Not to Scale

Field Emitter Array Triode Space-Charge Limit

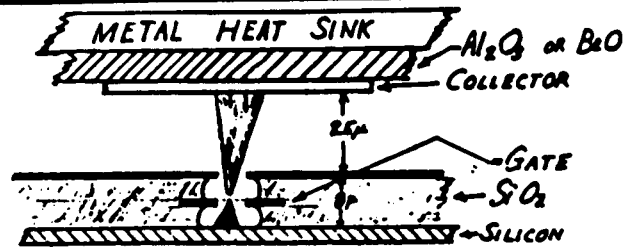

MINIMUM COLLECTOR VOLTAGE (Volts)	MAXIMUM "SCREEN"-COLLECTOR SPACING (micrometers)
16.0	25.0
50.0	44.3
75.0	54.5
100.0	63.0
200.0	88.7
300.0	109.0
400.0	128.0

$$J_m = \frac{2.3 \times 10^{-6} \times (V_s^k + V_c^k)^k}{D^2} \quad \frac{\text{Amps}}{\text{cm}^2}$$

FIELD EMITTER ARRAY DISTRIBUTED AMPLIFIER for MICROWAVE AND MILLIMETER WAVE FREQUENCIES

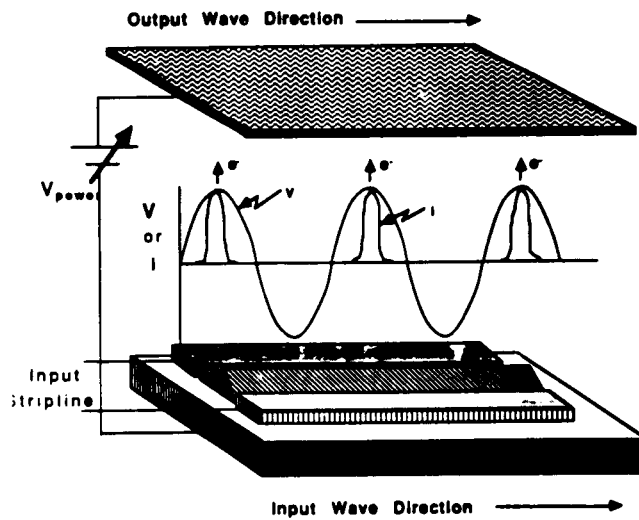

**INTEGRAL GRIDDED SINGLE CRYSTAL
SILICON FEA
WITH SECOND FOCUS GRID**

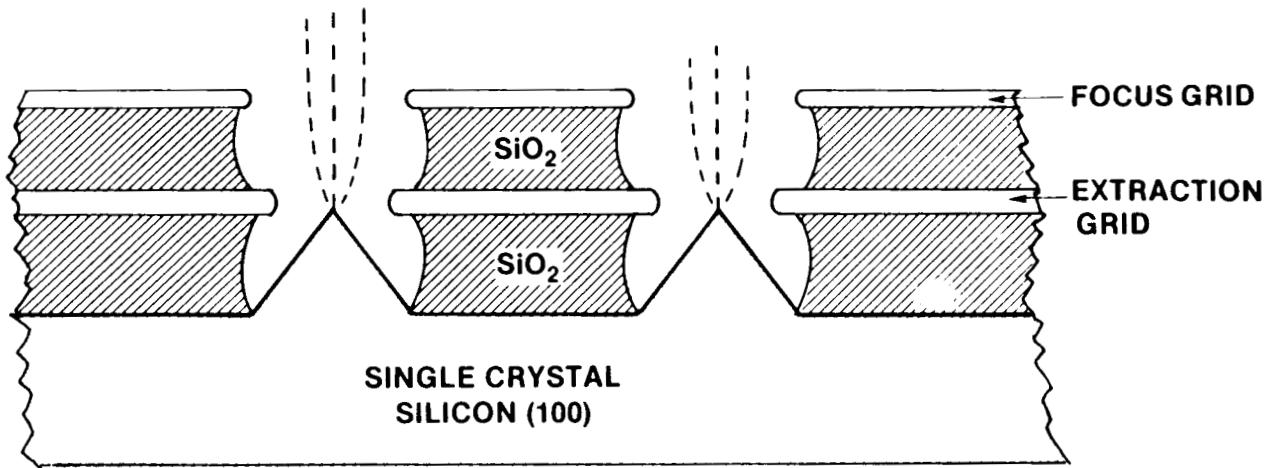

Vacuum Microelectronics

Photo-Excited Field Emitter Arrays

Photo-Excited Field Emitter Array

Voltage Modulated Field Emitter Array

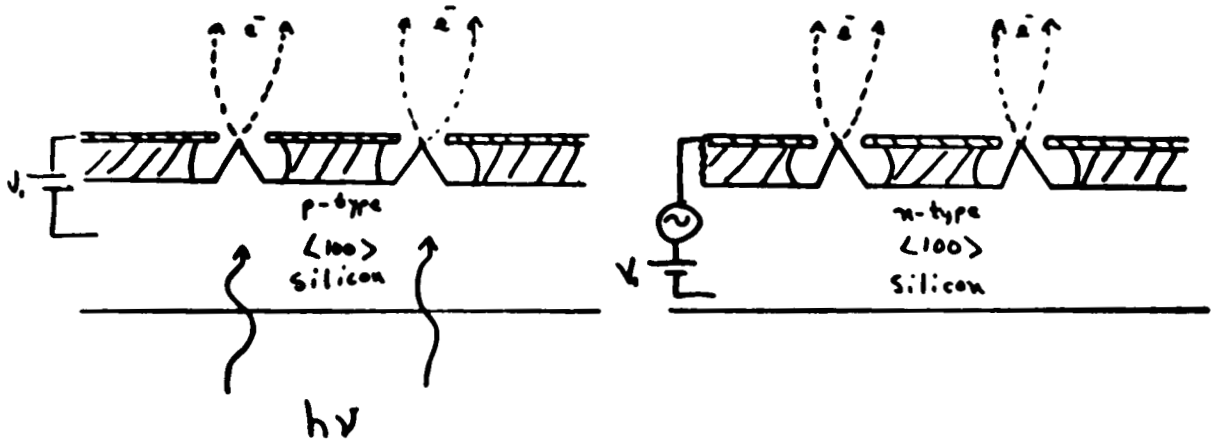

Vacuum Microelectronics Based on Field Emitter Arrays

Research and Development

- **3-D Fabrication and Processing in the 300-500 Angstrom Regime**
- **3-D Microstrip Transmission Line Theory and Calculations**
- **Field Emitter Array Physics - Theory and Experiment**
- **Device and Circuit Design**

**MILLIMETER-WAVE / INFRARED
RECTENNA DEVELOPMENT AT
GEORGIA TECH**

Mark A. Gouker
Georgia Tech Research Institute
Atlanta, Georgia

GW 16 758

SPONSORED BY
NASA under Grant No. NAG 3-202
and
Georgia Tech Research Institute

ABSTRACT

*millimeter wave / infrared Rectenna
(mmw/IR)*

The key design issues of the MMW/IR monolithic rectenna have been resolved. The work at Georgia Tech, in the last year, has focused and has been concentrated on increasing the power received by the physically small MMW rectennas in order to increase the rectification efficiency. The solution to this problem is to place a focusing element on the back side of the substrate. The size of the focusing element can be adjusted to help maintain the optimum input power density not only for different power densities called for in various mission scenarios, but also for the nonuniform power density profile of a narrow EM-beam.

- Underlying Technologies for the MMW Rectenna are in place.
- A key element in the rectenna design is an integrated focusing element.
 - Aids in optimizing the rectification efficiency
 - Can compensate power density variations of different mission scenarios.
 - Can compensate for the power density profile of a narrow EM beam.

Why go to higher frequencies?

Reduce the size of the transmit and receive apertures of point to point beamed power systems.

Take advantage of readily available sources at higher frequencies.

- D/He-3 fusion reactors emit synchrotron radiation that peaks at about 1000 GHz [1].
- Black body radiation from the Earth that peaks wave lengths in the 10 - 15 μm ranges [2].

EARLY EXPERIMENTAL WORK

In the early work at Georgia Tech metal-oxide-metal diodes (MOM) were investigated as a rectifying element for the MMW/IR rectennas. While MOM diodes have been reported to show diode behavior up to optical frequencies, they do not appear to be suitable candidates for the rectenna elements.

Summary of Experimental Work

Metal-Oxide - Metal Diodes

- Originally proposed for the infrared rectennas; however, do not appear to be viable for rectifying element.
- Thin oxide layers are very susceptible to shorts.
- I-V characteristics are not suitable for efficient rectifications.

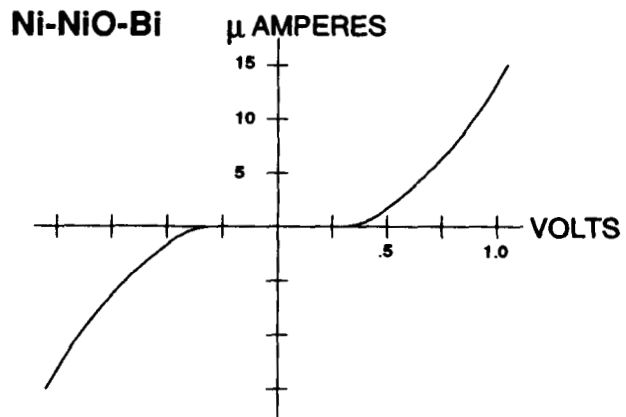
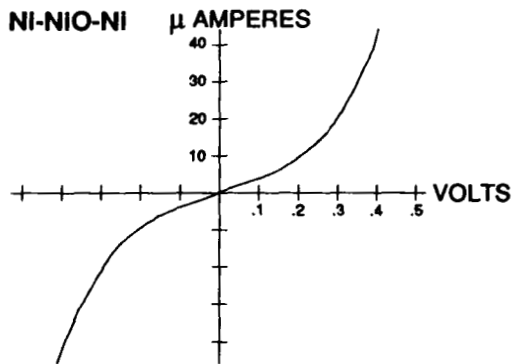

ANTENNA MEASUREMENTS AT 230 GHz

More recent experimental work includes measurements of substrate mounted dipole antennas at 230 GHz. The antennas at this frequency are 400 microns long and 10 microns wide. These antennas are physically much smaller than the dielectric slab on which they are mounted. In essence the antenna acts as a miniature field probe that detects how the EM-wave passes through the dielectric slab; therefore, the problem can be viewed as optics-like, and a focusing element can be used to increase the field strength in the vicinity of the antenna.

MMW Substrate Mounted Antenna Measurements

- Measured dipole antenna patterns at 230 GHz.
- The measured field pattern shapes are in agreement with a simple super position model of the antenna reception.
- In essence, the antenna receives the local field at the surface of the substrate.

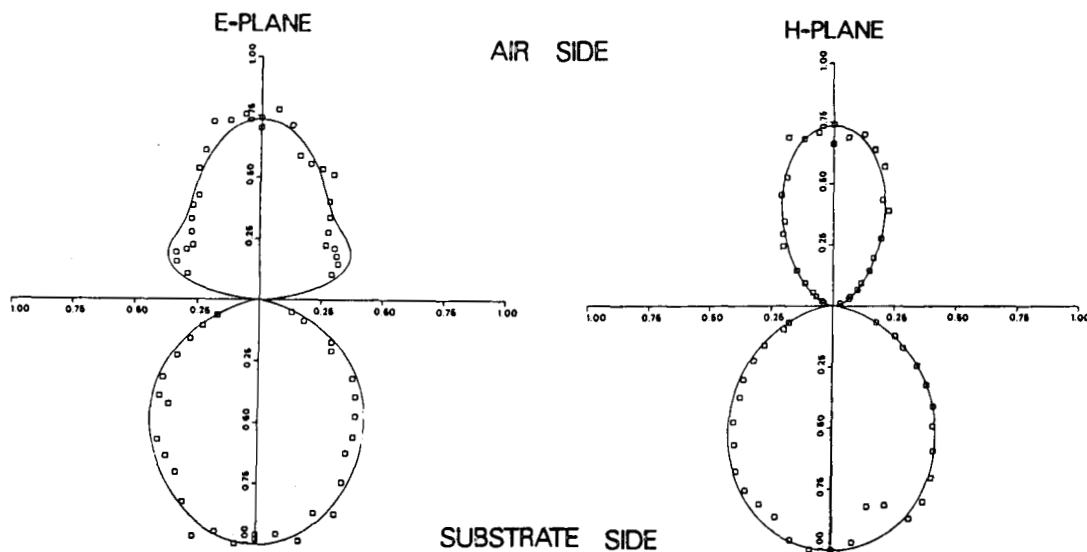

MMW-IR RECTENNA DESIGN

The MMW/IR rectenna will have the same subcomponents as the 2.45 GHz rectenna (antenna, low-pass filters, and rectifying element); however, the large number of rectennas needed at these higher frequencies will make it necessary to use monolithic IC fabrication technics. The appropriate frequency range to begin the MMW/IR development is 100 GHz to 300 GHz, but the design should be able to easily scale to higher frequencies when suitable rectifiers become available.

MMW / Infrared Rectenna Design

An antenna feeding a rectifying element is still the most efficient conversion scheme.

- Conversion from EM wave to dc power will require a large number of conversion elements.
- The design should be monolithic using high throughput IC processing techniques.

Appropriate frequency range to begin development is 100 - 300 GHz.

- Significant decrease in the size of the transmit and receive apertures.
- GaAs diode characteristics are known at these frequencies.

Note: There are some problems with GaAs diodes, but they are the best viable option at this time.

The rectenna design should scale throughout the MMW and infrared regions.

- Low-pass filters and impedance matching sections are proportional to wavelength.

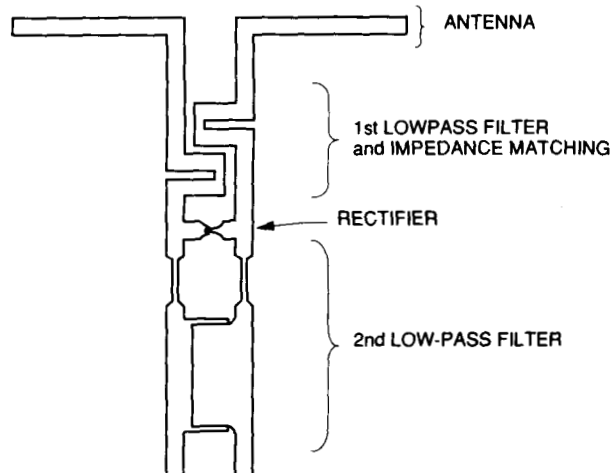

INTEGRATED CIRCUIT ANTENNAS

Among the antennas that should be considered for the MMW/IR rectenna are the microstrip and substrate mounted type antennas. The microstrip type antenna has metalization on both sides of the substrate while the substrate mounted type antennas have metalization only on one side of the substrate.

A. MICROSTRIP PATCH

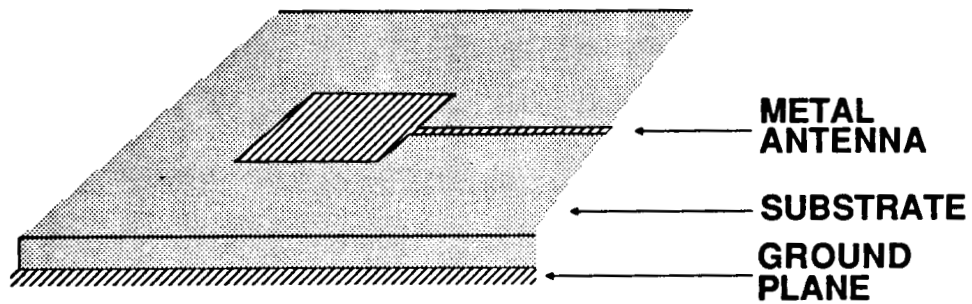

B. SUBSTRATE MOUNTED COPLANAR STRIPS DIPOLE

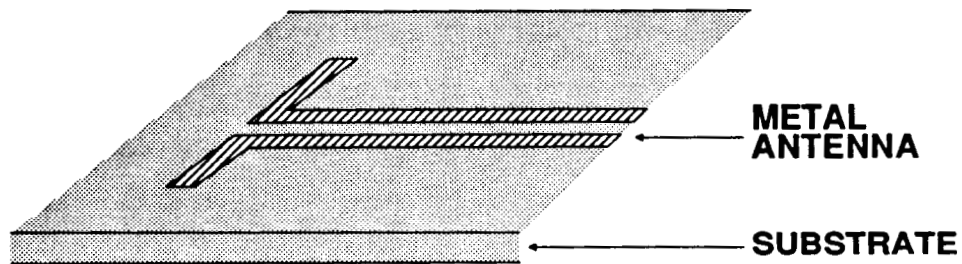

C. SUBSTRATE MOUNTED SLOT DIPOLE

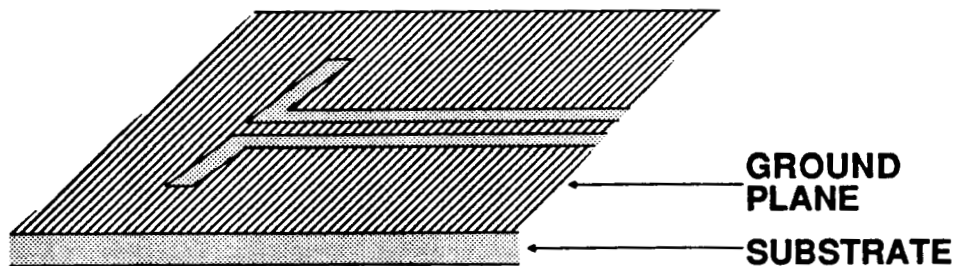

RADIATION EFFICIENCY

Microstrip antennas become inefficient in the millimeter wave region. At 300 GHz with a 2 mil GaAs substrate (thinnest practical substrate height for mechanical stability), the radiation efficiency is only 40%. These surface wave losses can be reduced in the substrate mounted antennas by placing a focusing element on the back side of the substrate.

- Microstrip antennas become inefficient in the MMW region [3].

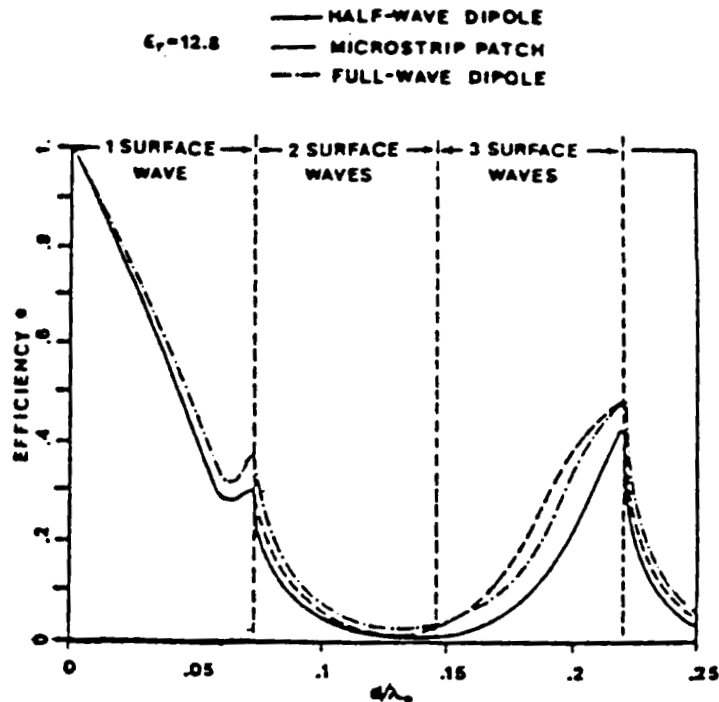

- A substrate mounted (coplanar type) antenna can be designed to maintain high radiation efficiency.
 - No ground plane on the back side of the substrate
 - A focusing element can be placed on the back side of the substrate:
 - discourage the propagation of the surface waves
 - adjust the power received by each antenna

Integrated Focusing Element - A Method to Optimize the Efficiency

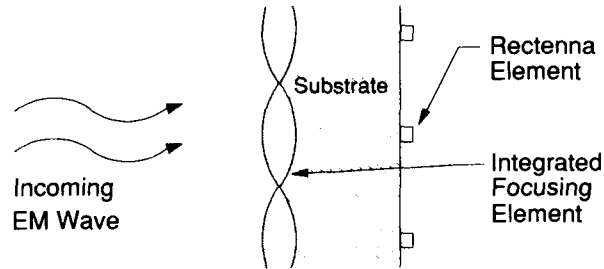

The integrated focusing element will reduce the loss to surface waves

- The surface wave modes will be discouraged by the irregular boundary condition of the focusing element
- The focusing of the incoming wave will make it more difficult for surface waves to be launched

The integrated focusing element can be used to adjust the power received by the antenna.

- Resonant antennas at MMW or IR frequencies have small physical size and thus small effective height.
- The focusing element can control the voltage levels developed at the terminals of the antenna.
- The voltage levels across the rectifier can be selected for the most efficient conversion.
- Rectenna performance can be optimized independent of the EM wave power density.
- Integrated focusing element serves as an adjustable interface between different power densities called for in various mission scenarios and the optimized power input to the rectenna element.

Various size focusing elements can be used to handle the changing power density of a beamed EM wave.

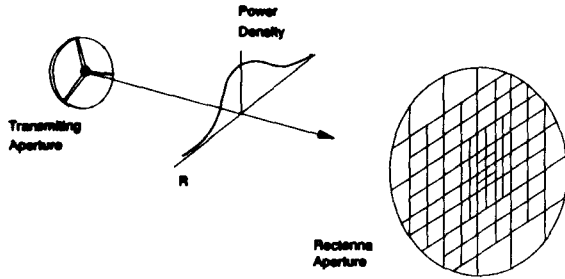

The focusing elements in the center of the rectenna array are smaller.

Integrated focusing elements take advantage of higher frequency instead of fighting it.

Efficiency

The EM capture efficiency should be very high with the integrated focusing elements

Transmission Line Loss [4]:

$$\alpha_{conductor} \propto f(\sigma, \text{geometry}) \frac{1}{\sqrt{\lambda}}$$

$$\alpha_{dielectric} \propto f(\epsilon, \text{loss tangent}) \frac{1}{\lambda_0}$$

Filter size scales with wave-length, transmission line losses should remain reasonable - well into the submillimeter/far-infrared regions.

Rectification efficiency should remain high in the MMW region with GaAs diodes. Above these frequencies advances in semiconductor devices or new rectification technologies are needed.

Time Scale for Implementation of MMW Rectennas

A program to develop a monolithic, 100 GHz rectenna array could be accomplished within 3 years.

- 1st year Develop hybrid rectenna elements with integrated focusing elements.
- 2nd year Develop hybrid rectenna arrays.
- 3rd year Develop monolithic rectenna arrays.

SUMMARY

MMW/IR rectenna elements will be made from monolithic construction of antenna and rectifier. An integrated focusing element increases the efficiency of the beamed power conversion, maintains voltage levels for optimum rectenna performance and adjusts for EM beam power density profile and for different mission scenarios.

Efficiency should remain high throughout the MMW region, and if higher frequency rectifiers are developed, well into the far-infrared region.

A monolithic, 100 GHz rectenna array could be realized within three years.

ACKNOWLEDGMENTS

Georgia Tech started working on MMW/IR rectennas with a grant from NASA Lewis Research Center. For the past several years this work has been supported by internal grants from the Georgia Tech Research Institute.

REFERENCES

1. J. F. Santarius, "Strategy for D/He-3 Fusion Development," Proceedings of the Lunar He-3 Fusion Power Workshop, Sponsored by NASA Lewis Research Center, Cleveland, Ohio, April 25-26, 1988.
2. M. A. Gouker, D. P. Campbell and J. J. Gallagher, "Technology for Satellite Power Conversion," Final Technical Report, NASA Grant No. NAG3-282, June 1987.
3. D. M. Pozar, "Considerations for Millimeter Wave Printed Antennas," IEEE Trans, vol. AP-31, pp. 740-747, 1983.
4. K. C. Gupta, R. Garg and I. J. Bahl, Microstrip Lines and Slot Lines, Chapter 7, Artech house, Inc., Norwood, MA, 1979.

N90-10148

58-35

GYROTRON DEVELOPMENT FOR SPACE
POWER BEAMING

216772

NSA999771

Wallace M. Manheimer
High Power Electromagnetic Radiation Branch
Plasma Physics Division
Naval Research Laboratory
Washington, D.C.

PRECEDING PAGE BLANK NOT FILMED

PAGE 138 INTENTIONALLY BLANK

Gyrotron has, up to now, generated by far the highest average power at millimeter wavelength. Also, the beam voltage is relatively low ($V_b < 100$ kV) so it can be more easily used in a space based environment.

Consider a 50 element phased array, each element is 400 kW.

Advantages of Phased Array

- * A 30 M antenna for 2 mm radiation is extremely difficult**
- * A single 20 MW tube would be very difficult**
- * A phased array allows some electronic steering of the beam**
- * A 50 element phased array at 400 kW each requires 4 meter dishes at 140 GHz and 2.8 meter dishes at 300 GHz**
- * A phased array allows for graceful degradation**

140 GHz PHASED ARRAY SPACE POWER BEAMING FOR LUNAR MISSION AT A RANGE OF 1000 km

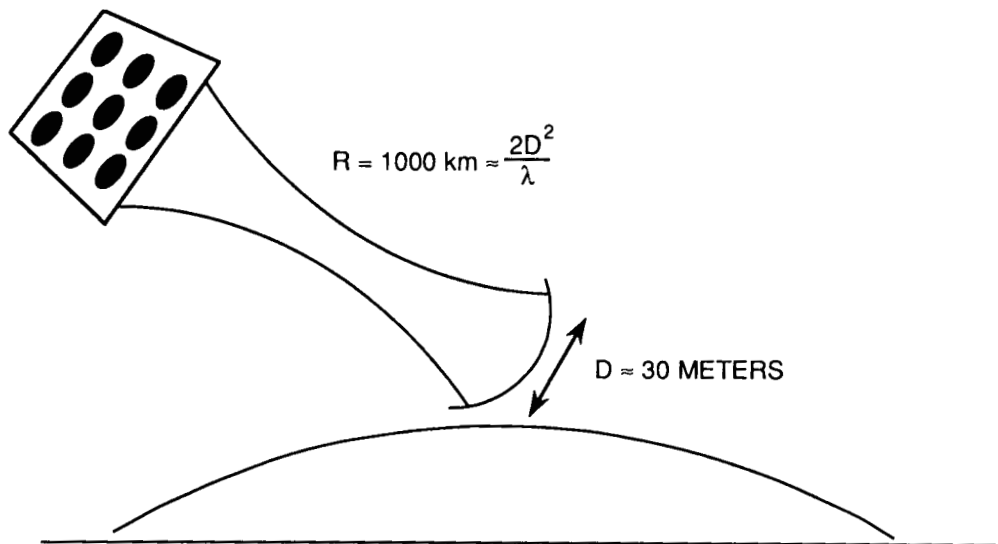

There are two crucial elements to the NASA application from the point of view of the millimeter wave source:

- * Generating the Power**
- * Phase locking the tube**

A commercially available gyrotron is the 140 GHz gyrotron manufactured by Varian. This operates in the $TE_{0,3}$ mode and has generated a power of 100 kW in CW operation. The graph shows a plot of rf power as a function of beam Voltage. At 60 kV, a power of 100 kW was achieved (ref 1).

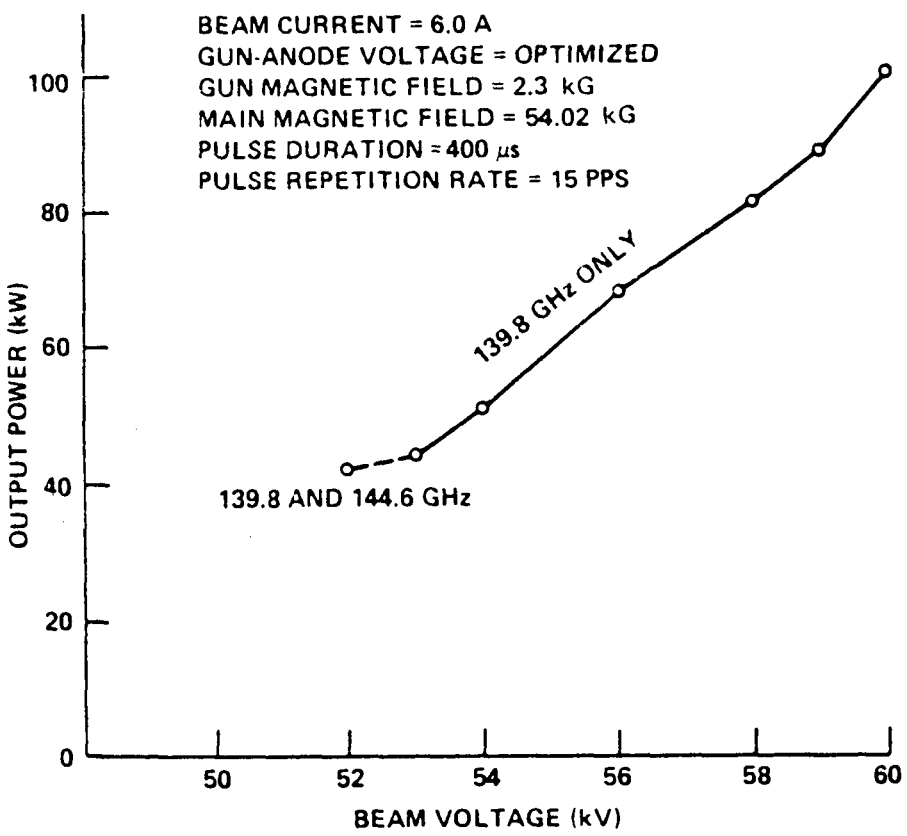

Output power versus beam voltage in pulse tests on the first experimental 140 GHz gyrotron for a beam current of 6 A.

A schematic of the MIT 140 GHz gyrotron. This gyrotron operates in high order whispering gallery modes, and at optimum performance has achieved a power of more than half a Megawatt. It operates in a pulsed mode with pulses about 4 μ sec long (ref 2).

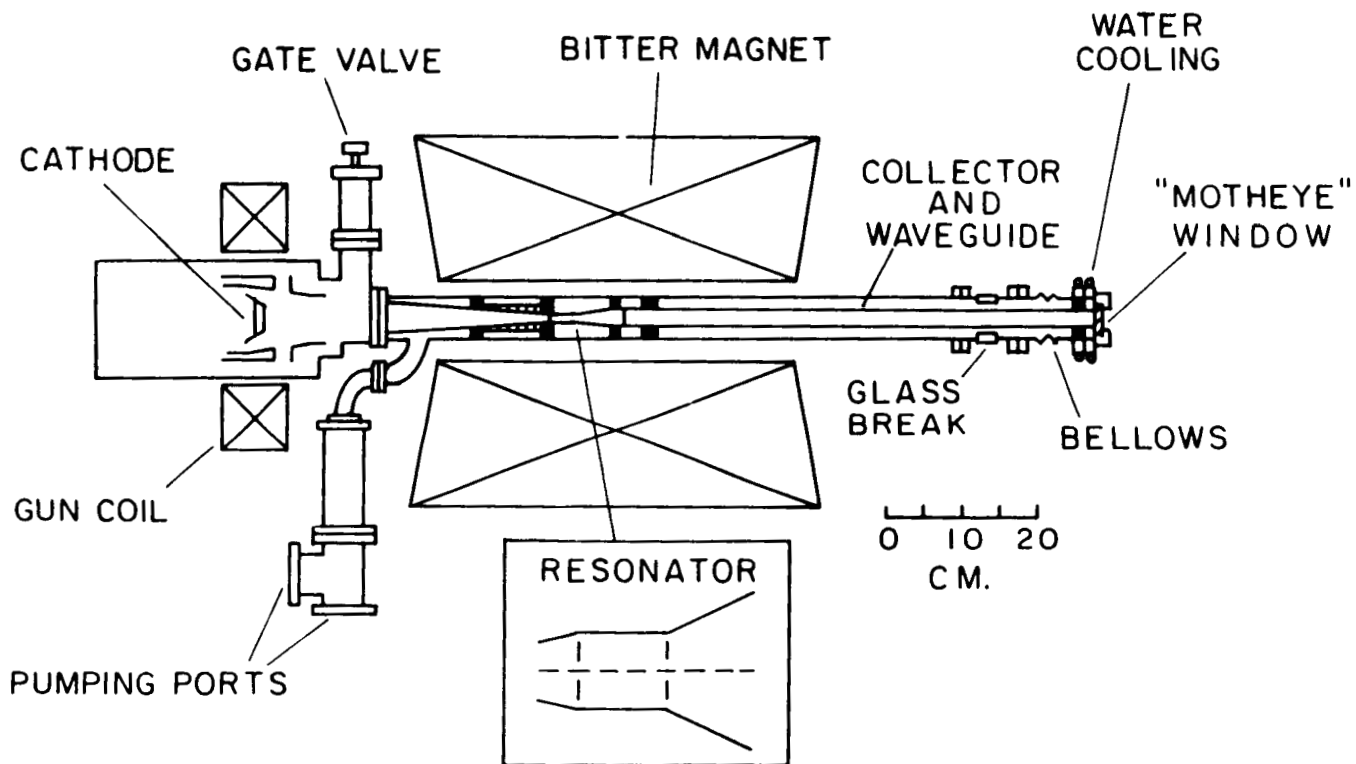

A plot of the power as a function of frequency for the MIT gyrotron. As the magnetic field increases, the gyrotron hops first along a series of TE_{m_2} modes, then along a series of TE_{m_3} modes, and finally along a series of TE_{m_4} modes.

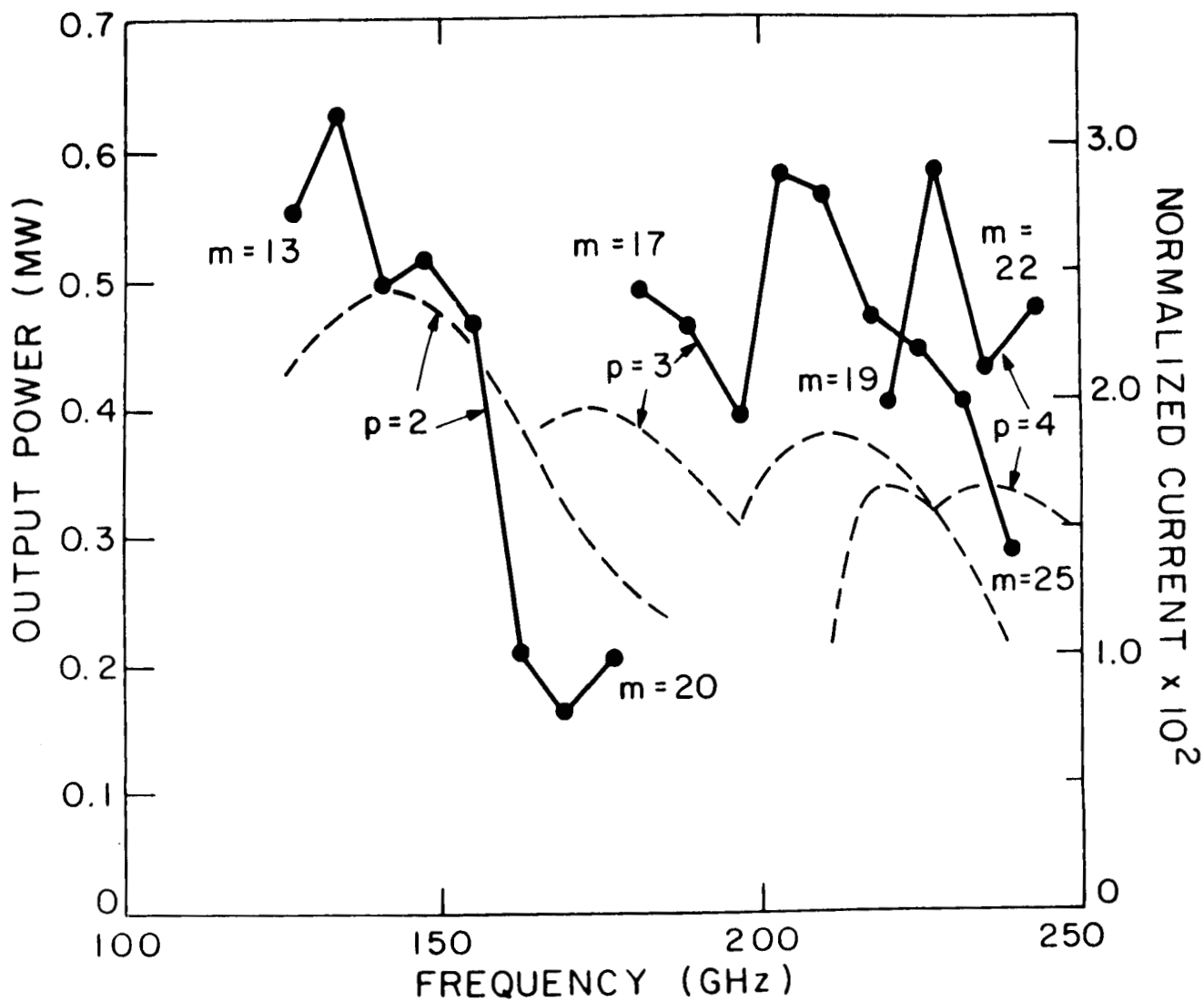

A schematic of the NRL quasi-optical gyrotron. The radiation is confined by a series of resonator mirrors aligned horizontally. The electron gun injects a beam vertically, and when it traverses the resonator, it gives up some of its power to modes in the resonator at the cyclotron frequency or its harmonics. The radiation is extracted by diffraction around the edges of the resonator mirrors. NRL contends that as the frequency of the radiation increases, optical rather than microwave techniques will become more and more important. The quasi-optical gyrotron is a first step in that direction (ref 3).

NRL HIGH POWER QUASI-OPTICAL GYROTRON

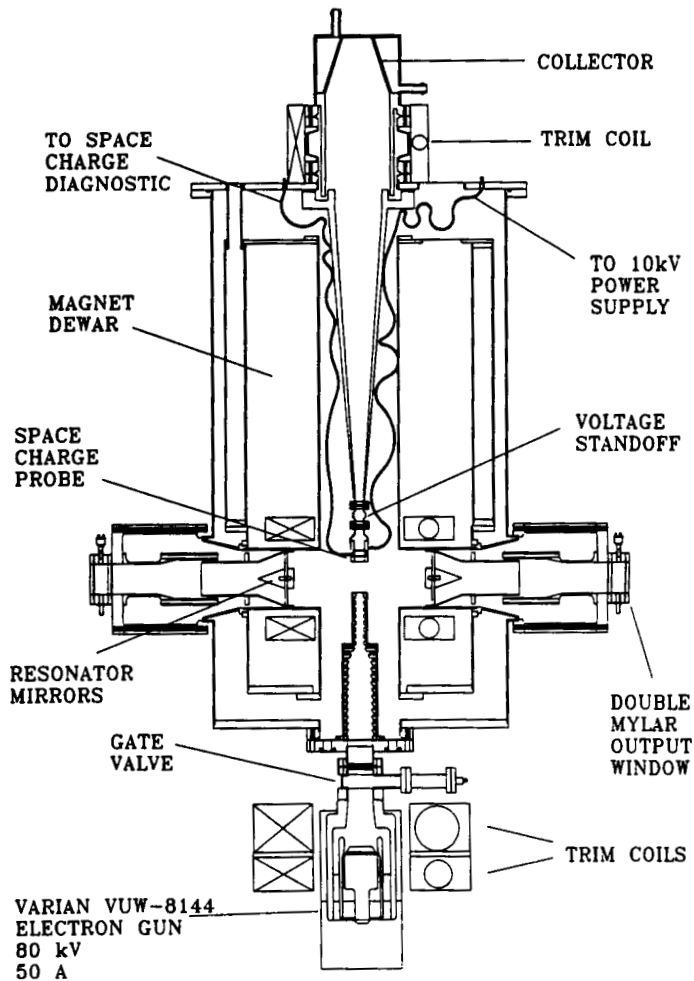

Advantages of the QOG for Megawatt CW operation at 100-300 GHz

- Resonator and interaction volumes are large ($\gg \lambda^3$).
- Low resonator mirror losses (ohmic).
- Low electron beam energy (~ 100 keV).
- Effective transverse mode selection.
- Moderately insensitive to electron beam temperature.
- Radiation output coupling is independent of interaction length.
- Radiation output and e-beam collection are separated.
- Tunable output frequency.
- Allows use of dc electric field for efficiency enhancement and space-charge cancellation.

The power and efficiency of the NRL Quasi optical gyrotron as a function of cathode current. The operating frequency is 130 GHz.

QOG Output Power & Efficiency @ 50 kG

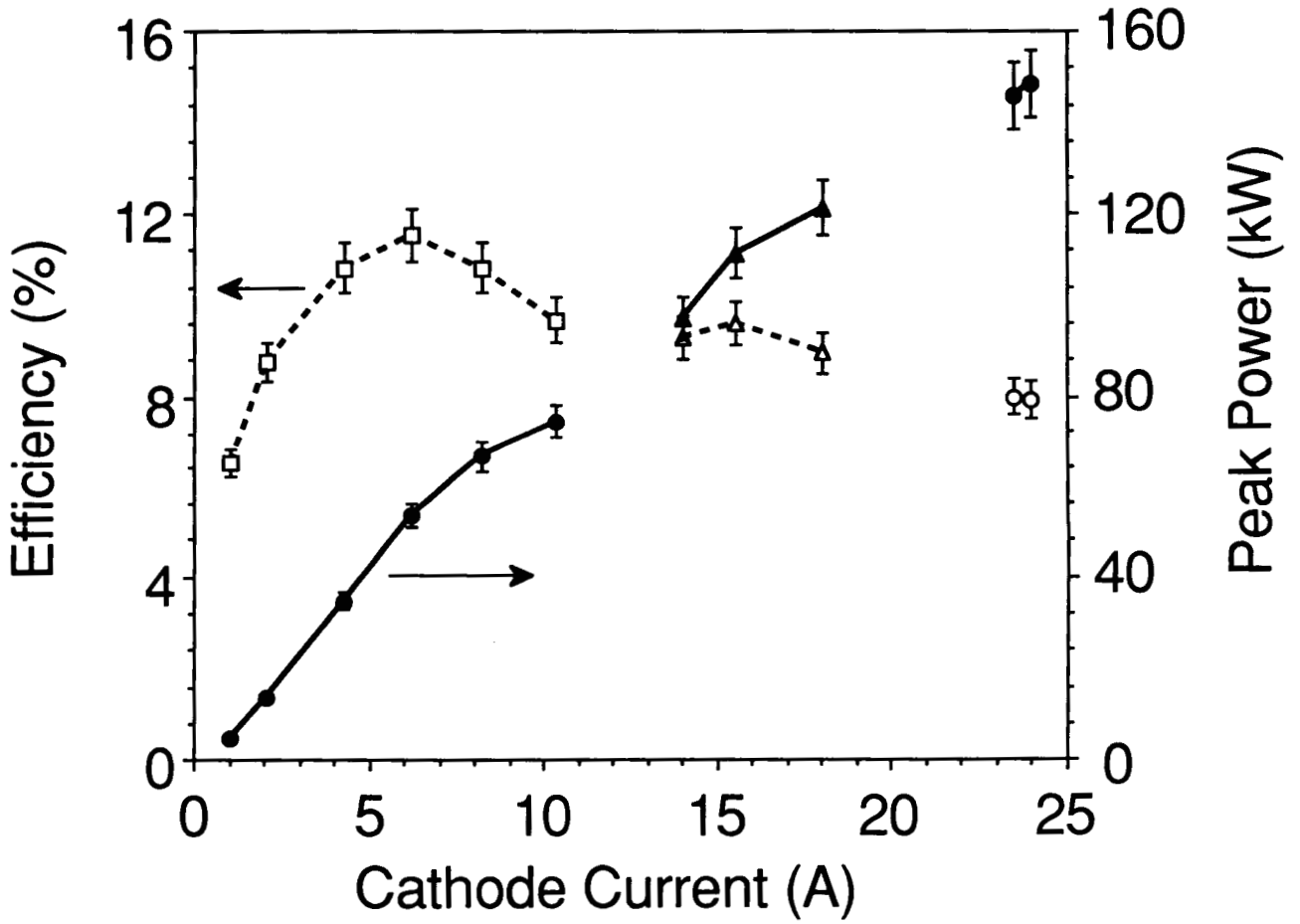

Phase control can be achieved either by running in an amplifier or phase locked oscillator mode. In either case a source is needed to drive the system. Currently available sources are extended interaction oscillators (EIO's) and extended interaction amplifiers (EIA's), manufactured by Varian, Canada. Their output powers are about the same, but so far, EIO's exist at higher frequencies. EIA's have gains of about 30 dB.

Available CW EIA's

VKB 2463T 95 GHz 50 W

Electronic tuning range = 0.15%

Available CW EIO's

VKB-2426L,M 95 GHz 50 W

VKB-2438L,M 140 GHz 20 W

KKY-2432L,M 300 GHz 1 W

Electronic tuning range = 0.15%

Mechanical tuning range = 2 GHz

The amplifier can be driven by an impatt diode at 20 mW. All phase control can be done at 20 mW power level.

Amplifier would require more than 40 dB gain at 140 GHz, and more than 55 dB at 300 GHz.

Adler's relation for phase locking bandwidth of an injection locked oscillator:

$$\Delta f/f = 1/Q (P_{in}/P_{out})^{1/2}$$

Large gain can be achieved, but operation must be very near the natural frequency.

A schematic of the NRL 35 GHz phase locked gyrotron oscillator experiment. The gyrotron ran in a low order (TE_{01}) mode. The locking signal was injected through a circulator into the output waveguide. The gyrotron operated at about 20 kW. The locking bandwidth was measured as a function of the magnetron power. The relative phase of the two signals was measured with a magic Tee hybrid coupler. Also the power spectrum was measured for the free running oscillator as well as the locked oscillator (ref 4).

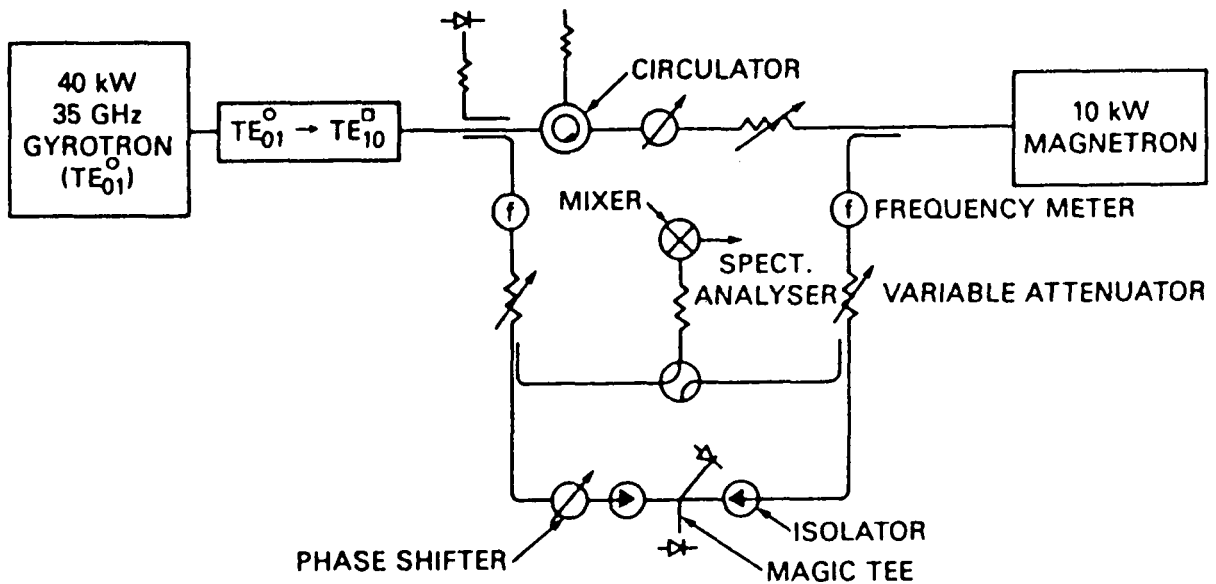

Line drawing of the experiment.

An experimental measurement of the region of phase locked operation of the NRL phase locked gyrotron compared with the relative power of the gyrotron and magnetron. The solid line is Adler's theory. Notice that the agreement is reasonably good.

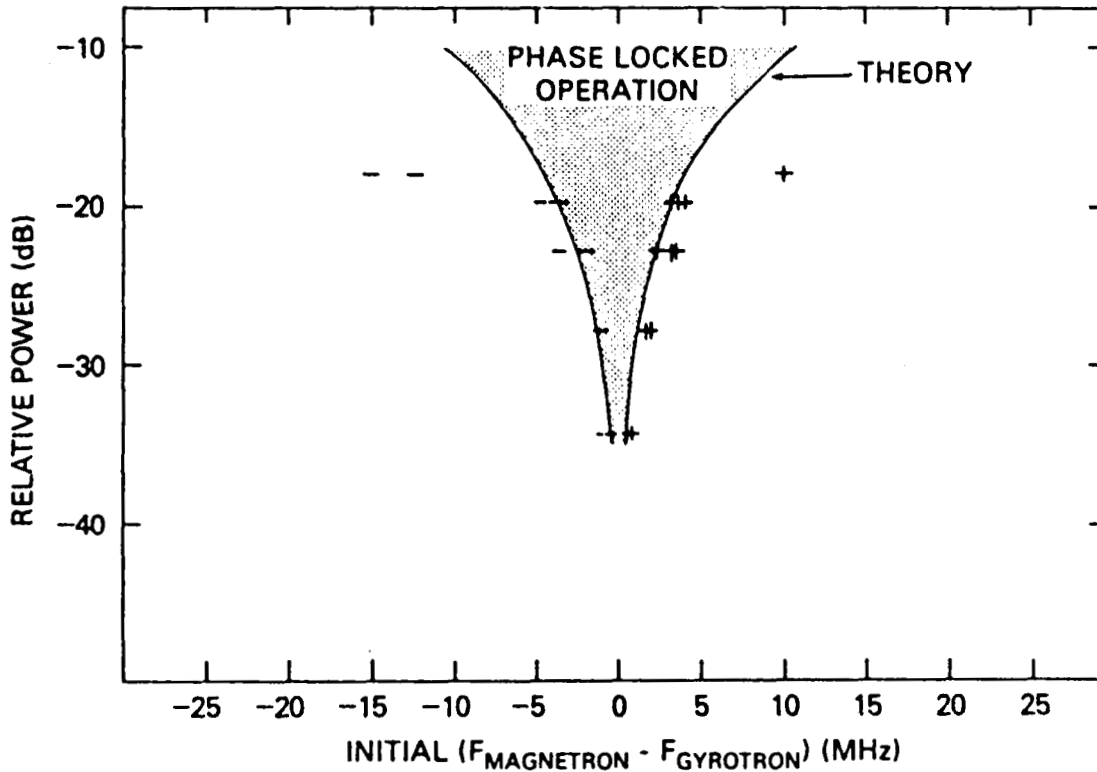

Maximum frequency separations over which phase locking was observed as a function of relative drive power. The gyrotron and magnetron powers were those in the TE_{01} (circular) mode at the output window of the gyrotron.

To be sure that the magnetron was locking the gyrotron and not visa versa, the spectrum of the gyrotron and magnetron in the free running mode was taken. Notice that they are quite different. When the gyrotron runs in the phase locked mode, its spectrum matches that of the magnetron.

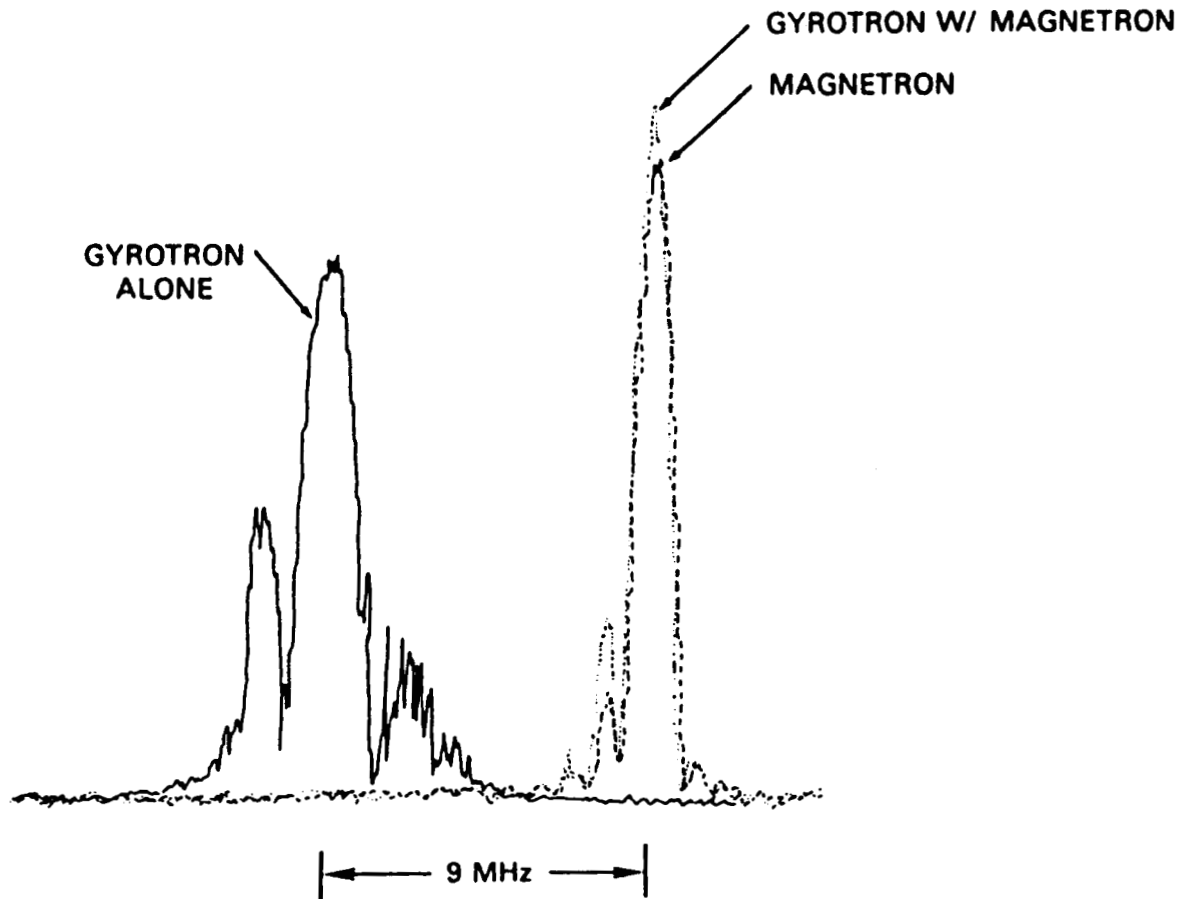

Spectra of the gyrotron, in locked and unlocked operation, as compared to the magnetron spectrum. The magnetron power was 15.5 dB below that of the gyrotron.

The locking bandwidth can be considerably increased by utilizing one or more prebunching cavities to prebunch the beam instead of utilizing direction through the output. Shown is a schematic of another NRL experiment of a phase locked gyrotron utilizing a prebunched beam. This oscillator ran in fundamental mode at 4.5 GHz and at power levels of 1-2 kW (ref 5).

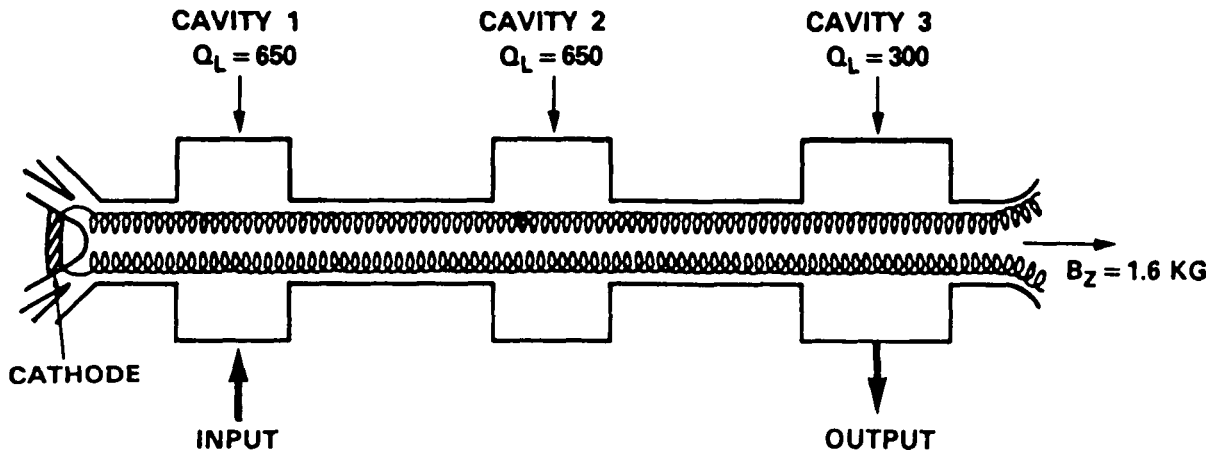

Three-cavity gyrokystron configuration. The first two cavities are 6.06 cm in length, and the third is 7.4 cm. The connecting drift spaces are 10.1 cm long.

Plot of locking bandwidth for direct injection from Ref 5 is shown on top. It agrees well with Adler's theory. Shown on the bottom is the locking bandwidth for the case of a prebunched beam. Notice that the locking bandwidth is considerably larger than that predicted by Adlers theory.

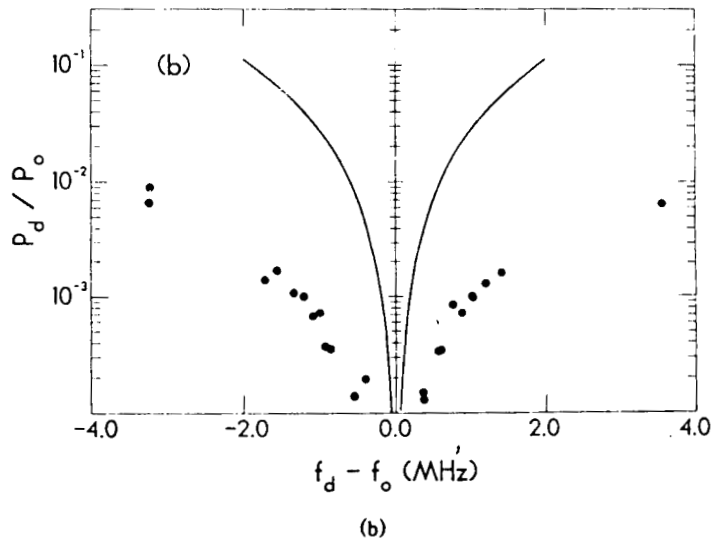
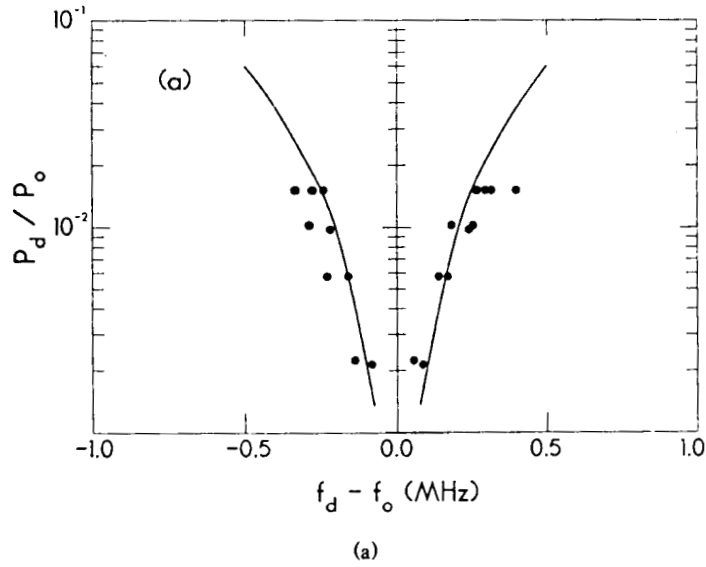

Phase locking bandwidths for (a) direct injection of cavity 1 with $Q_e = 1100$ and (b) three cavity configuration with $Q_e = 375$ in cavity 3. Note that the locking bandwidth exceeds the theoretical prediction (solid curves), in the multicavity case.

As the frequency and power get larger, one must ultimately deal with overmoded or optical systems. A TE_{13} phase locked gyrokystron has been designed and partially constructed at NRL, but has not yet run (ref 6).

PHASE-LOCKED GYROKLYSTRON OSCILLATOR

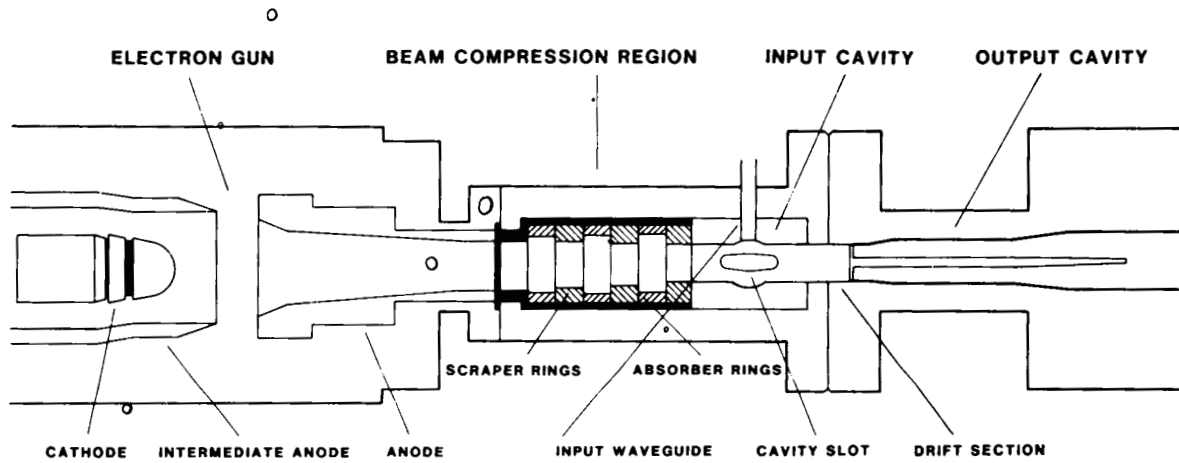

A prebunching cavity can be mated to the NRL quasi-optical gyrotron. This will allow investigation of phase locking the quasi-optical gyrotron. This experiment is in the planning stage.

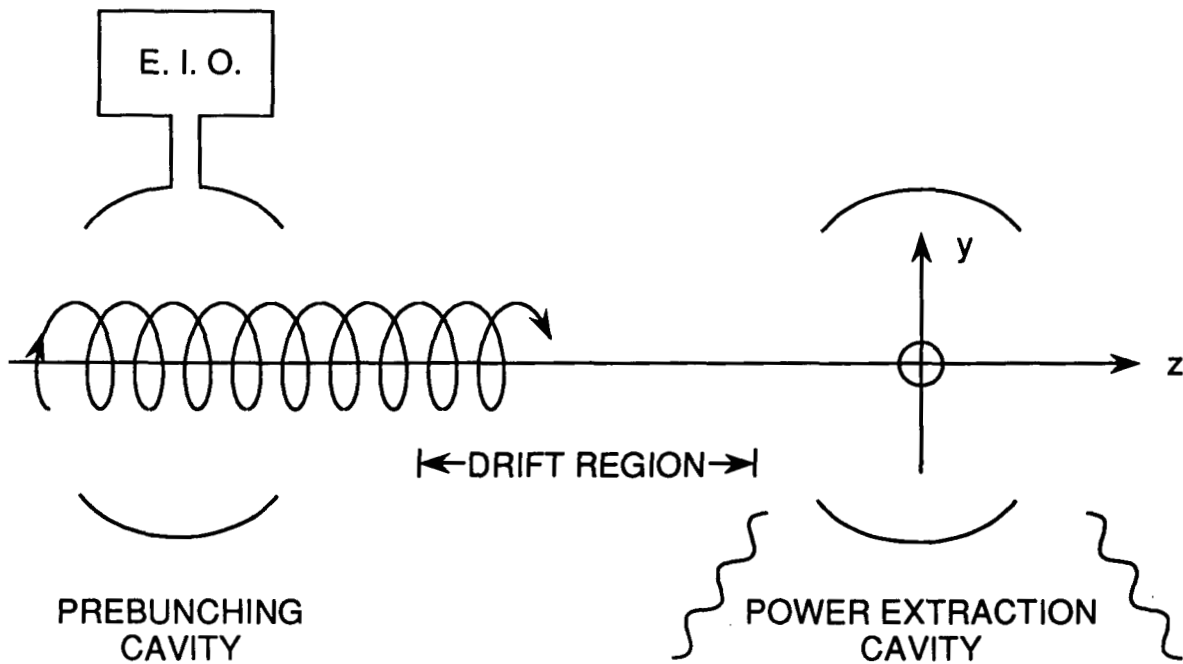

References

1. K. Felch, R. Bier, L. Cragi, H. Huey, L. Ives, H. Jory, n. Lopez, and S. Spang, Int. J. Electronics, 61, 701, (1986)
2. K. Kreischer and R. Temkin, Phys. Rev. Lett. 59, 547 (1987)
3. A. Fliflet, T. Hargreaves, W. Manheimer, R. Fischer, and M. Barsanti, Submitted to Phys. Rev. Lett., also see NRL Memorandum Report 6422
4. M. Read, R. Seeley and W. Manheimer, IEEE Trans. Plasma Sci. PS-13, 398, (1985)
5. A. McCurdy, C. Armstrong, W. Bollen, R. Parker and V. Granatstein, Phys. Rev. Lett. 57, 2379 (1986)
6. J. Burke, W. Manheimer, and M. Czarnaski, NRL Memorandum Report 6434.

N90-10149

Sy-32

ANTENNA TECHNOLOGY FOR
BEAMED SPACE-POWER

216773

100

L1533051

W. S. GREGORWICH
LOCKHEED RESEARCH LABORATORIES
PALO ALTO, CALIFORNIA

See p. 170

PROPAGATION CONSIDERATIONS

To obtain maximum energy transfer (i.e., >90% efficiency) it is necessary to operate within the Rayleigh range (R) for both the transmit and receive antennas with both antennas having the same size aperture (ref. 1). Radiation travels as a collimated, tubular beam for $R < D^2/2\lambda$ (where D is the antenna diameter and λ is the free space wavelength) and then diverges to form an angular beam. See Figure 1. It can be seen from the figure that D must be very large and λ very small which suggests that a millimeter wave system is the best candidate for energy transfer.

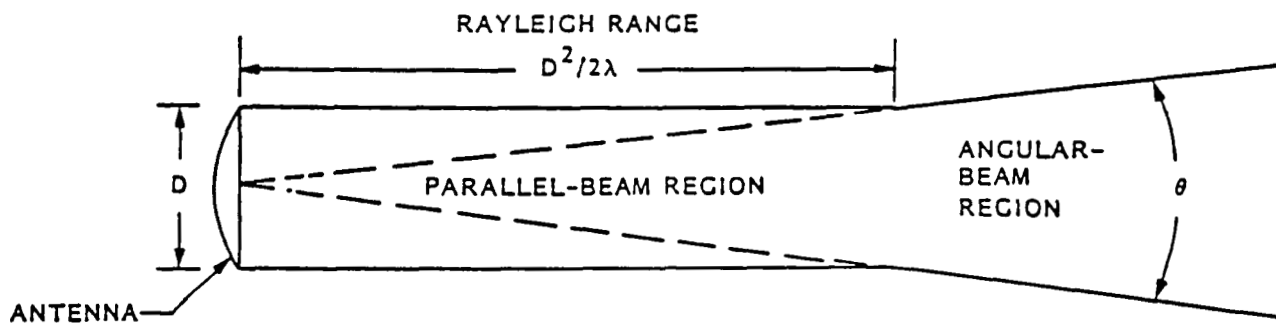

Figure 1. RADIATION TRAVELS AS A PARALLEL BEAM ALONG THE RAYLEIGH RANGE, THEN DIVERGES TO FORM AN ANGULAR BEAM

NEAR ZONE AND SIDELOBE CONSIDERATIONS

In the millimeter wave regime, dish antennas appear to be the most practical configuration. To avoid power breakdown and loss at millimeter wavelengths, the transmission lines and feed must operate in the oversized circular waveguide (i.e., ten times larger diameter) in the TE_{01} and TE_{11} modes respectively. High power gyrotrons normally operate in the TE_{01} mode and high efficiency corrugated horns utilize the TE_{11} mode. AT 140 GHz and 200KW, a TE_{01} to TE_{11} mode converter has been tested with 95% efficiency (ref. 2).

High concentrations of power on the dish and subreflector in the near zone must also be considered in the design (ref. 3). Blockage from the subreflector will cause undesired high sidelobes and degradation of efficiency. It is possible to considerably reduce subreflector blockage by employing the polarization twist reflector technique shown in Figure 2. The subreflector is comprised of a horizontal grating which reflects the parallel E-field from the feed back to the dish. The main reflector then 'twists' the reflected horizontal polarization to vertical, which now passes through the horizontally grated subreflector essentially unaffected (ref. 4).

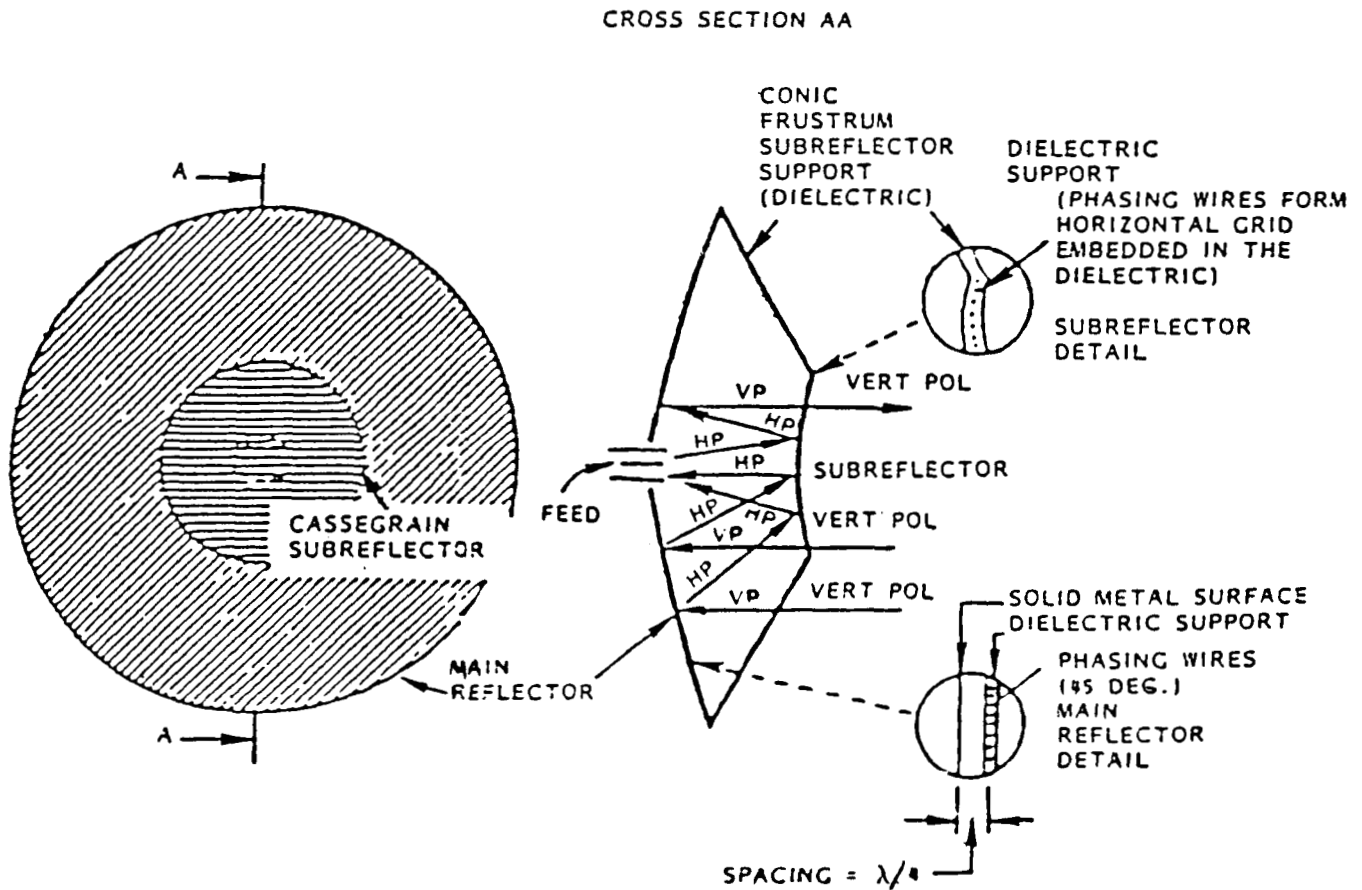

Figure 2. Detail of Cassegrain Antenna

DEPLOYMENT CONCEPTS

Operating at millimeter wavelengths requires a high precision surface $\leq \lambda/50$ rms. A technique to achieve this precision for very large dishes is the electrostatic membrane reflector (ref. 5). As seen in the schematic of Figure 3, a classical wrapped rib is deployed as the rigid command surface to support the membrane reflector at its periphery and hold the associated controlling electrodes. By means of bias and control voltages between the membrane and command surface electrodes, the metallized reflector membrane is distended into the desired shape and can almost instantaneously adapt to compensate for localized beam or solar distortion. The reflector can be quickly changed from parabolic to spherical to allow off axis scan.

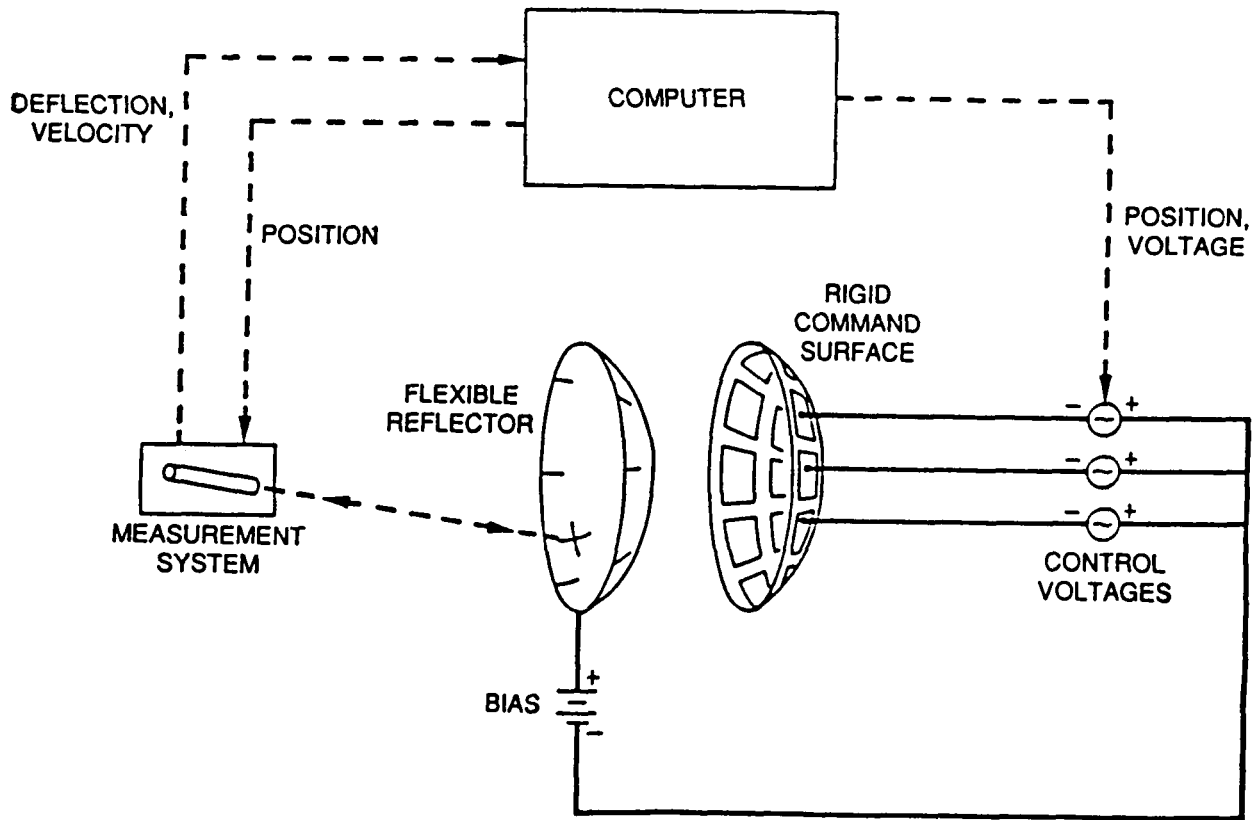

Figure 3.

MEASUREMENT SYSTEM

An optical laser system that senses the slope of the membrane, or for that matter, any dish is depicted in Figure 4. It is located on the feed support boom above the array feed. A two-axis scanning mirror scans the slope measurement beam over the membrane surface. A continuous scan in a spiral pattern from the outer edge to the center and continuing in the same direction from the center to the outer edge avoids vibration producing accelerations, minimizes cost, and maximizes reliability. Strong signals are received only when the beam scans over selected sample points where reflective material has been deposited on the membrane. The locations of sample points can be determined from angle resolvers in the scanner or, alternatively, bar codes similar to those used with point-of-sale scanners in supermarkets can be placed adjacent to the sample points.

ELECTRONIC BEAM SCAN

Rather than attempt to mechanically scan the large dishes, one can electronically beam steer by means of spherical reflectors. Parabolic apertures only allow 10- beamwidth scan for 90% main-lobe efficiency. The sphere instead is the simplest of all three-dimensional surfaces because its radius of curvature is constant. To scan a spherical reflector, the prime focus feed must be either a line source linear array or a hemispherical cluster array (ref. 6) as shown in Figure 4.

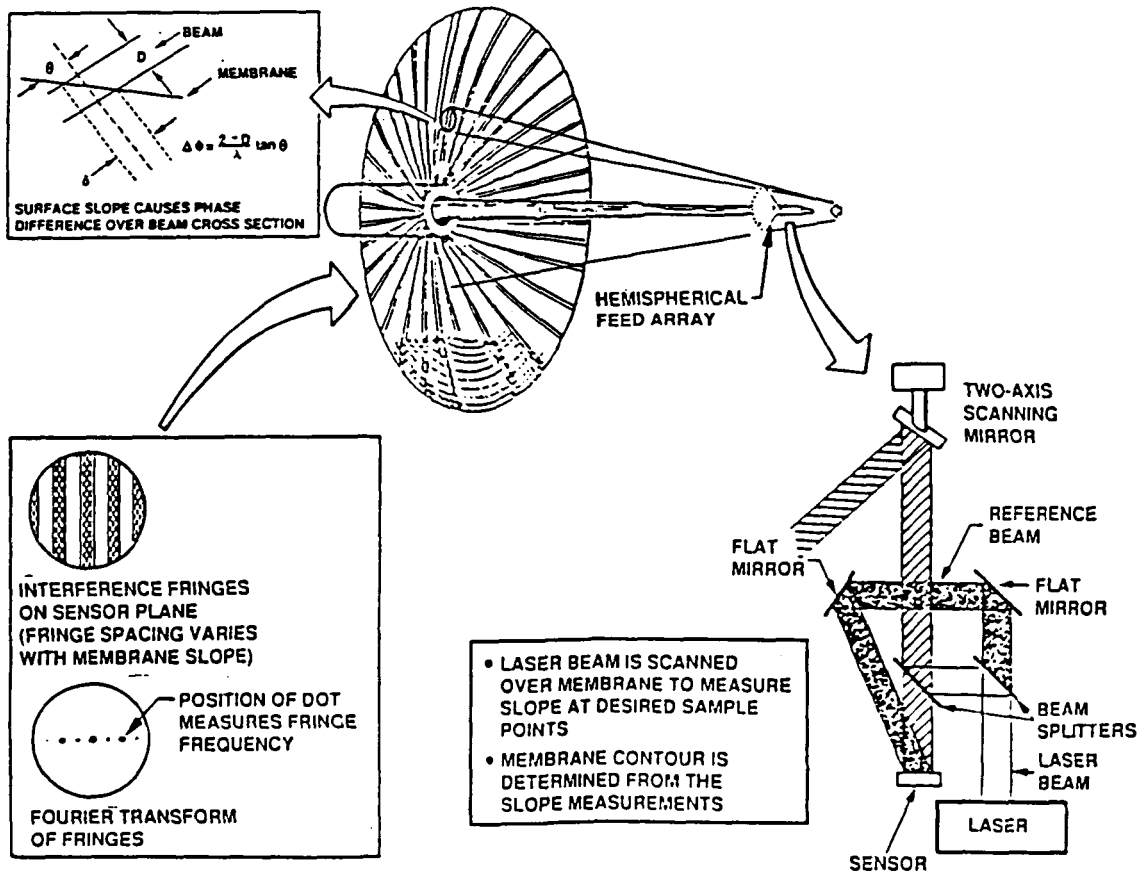

Figure 4. DEPLOYED DISH WITH OPTICAL SENSOR AND HEMISPHERICAL FEED

RIGID REFLECTORS

As an alternative high precision reflector, shuttle tile can be employed to fabricate a rigid, thermally stable, 4.4m diameter dish that can withstand very high concentrations of RF power with no distortion. The diameter of 4.4m is the maximum size that can fit within the launch vehicle without deployment. A large rigid reflector made of hexagonal shuttle tile panels and assembled from the Space shuttle is depicted in Figure 5. A 60 to 90 GHz dish fabricated from third generation shuttle tile is shown in Figure 6.

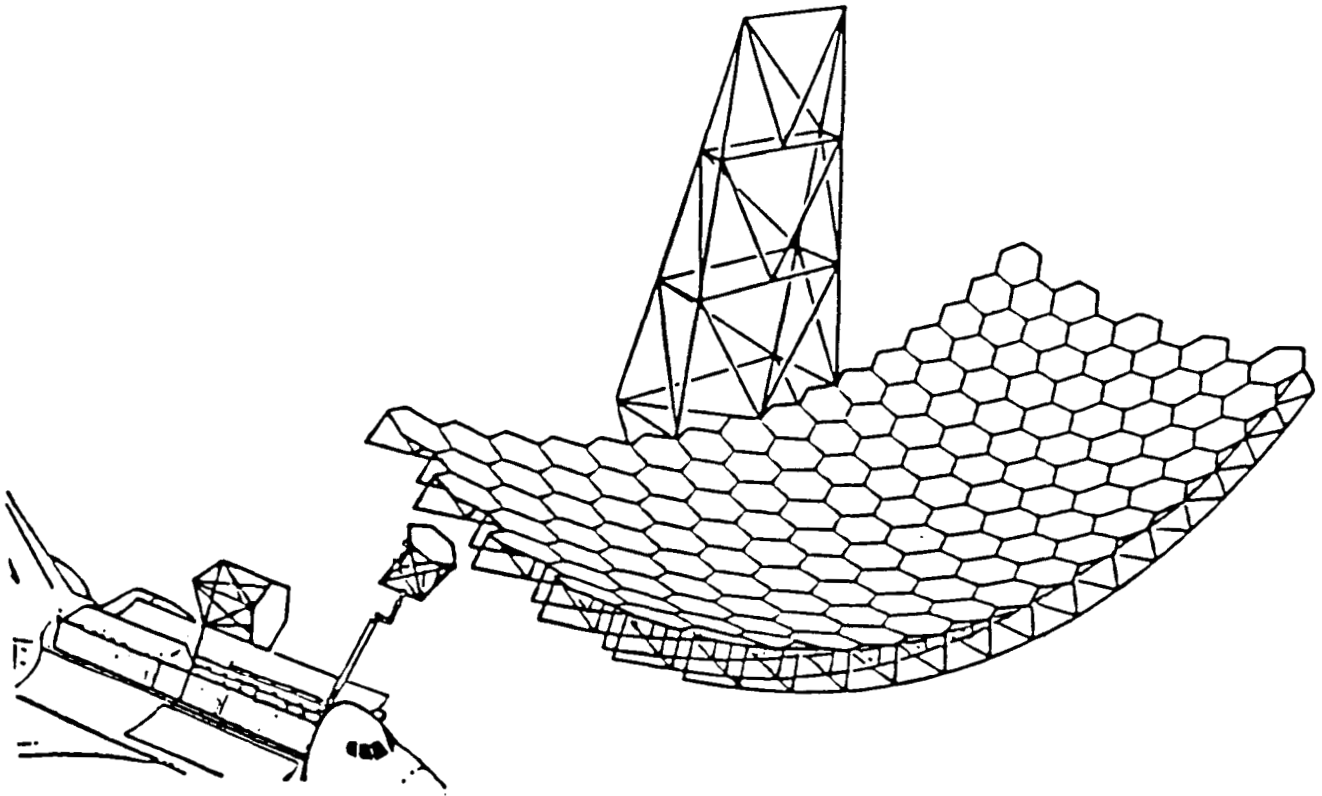

Figure 5.

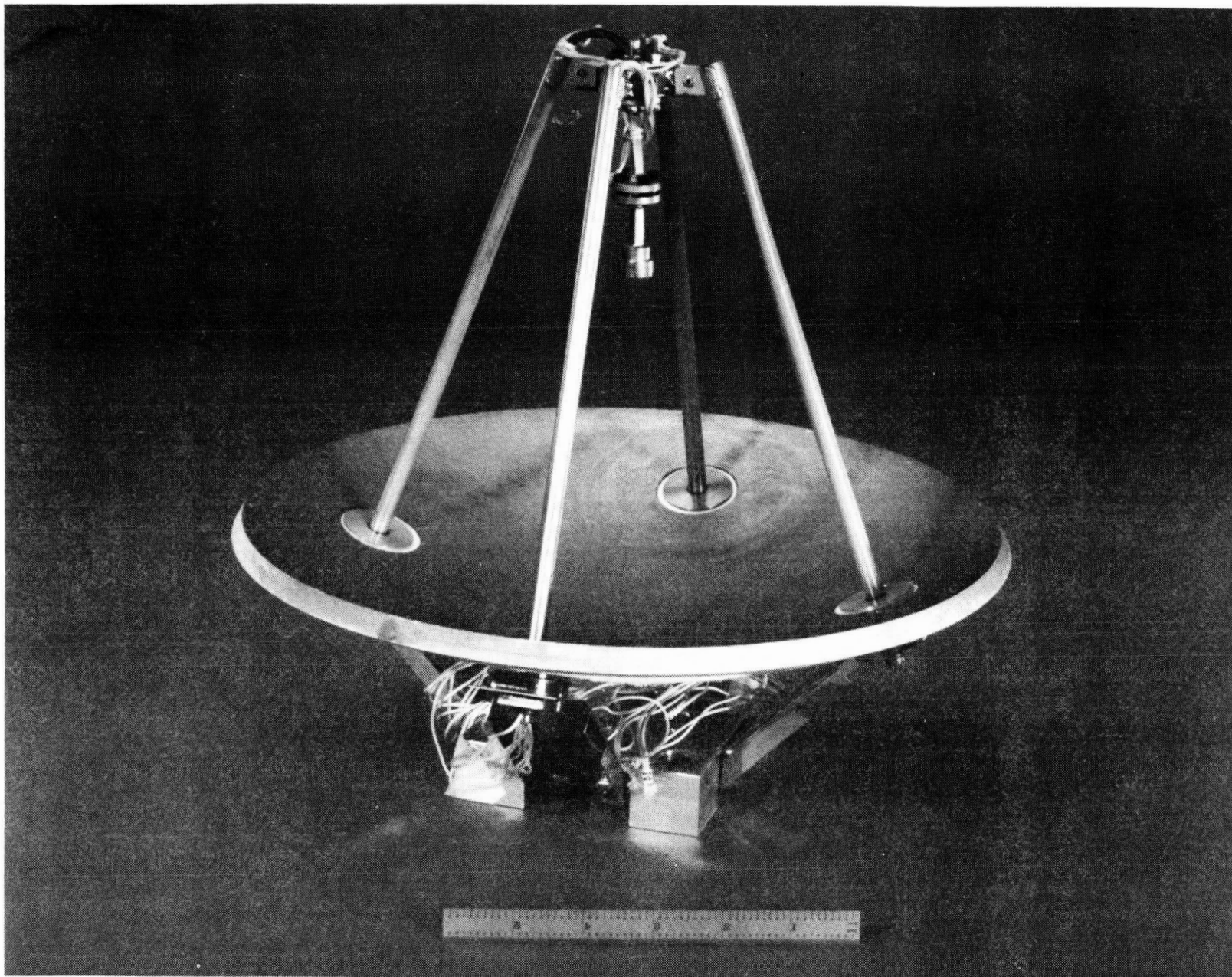

Figure 6. 60 to 90 GHz DISH FABRICATED FROM THIRD GENERATION SHUTTLE TILE

COLLECTION SYSTEMS

The energy collecting feed of the receiving dish could consist of an array of open-ended waveguides attached to parallel-plate, radial line, high-power combiners. Diode rectifiers placed across the inside of the waveguides can be used to convert the millimeter wave power to DC. Once the power is converted to DC, sodium sulfur or nickel hydrogen batteries can store the energy. A ton of batteries are needed to store 1 MW of power over a 7 minute interval.

As an alternative to collecting dishes, rectennas can be employed to gather and rectify the RF energy. A further increase in efficiency may be achieved by cascading rectenna panels as shown in Figure 7. Selecting the proper panel spacings will help to tune the rectennas to free space, thereby increasing energy transfer and at the same time providing a large area for dumping waste heat. The rectenna dipoles can be photo etched on shuttle tile substrate to reduce thermal distortion and dielectric losses.

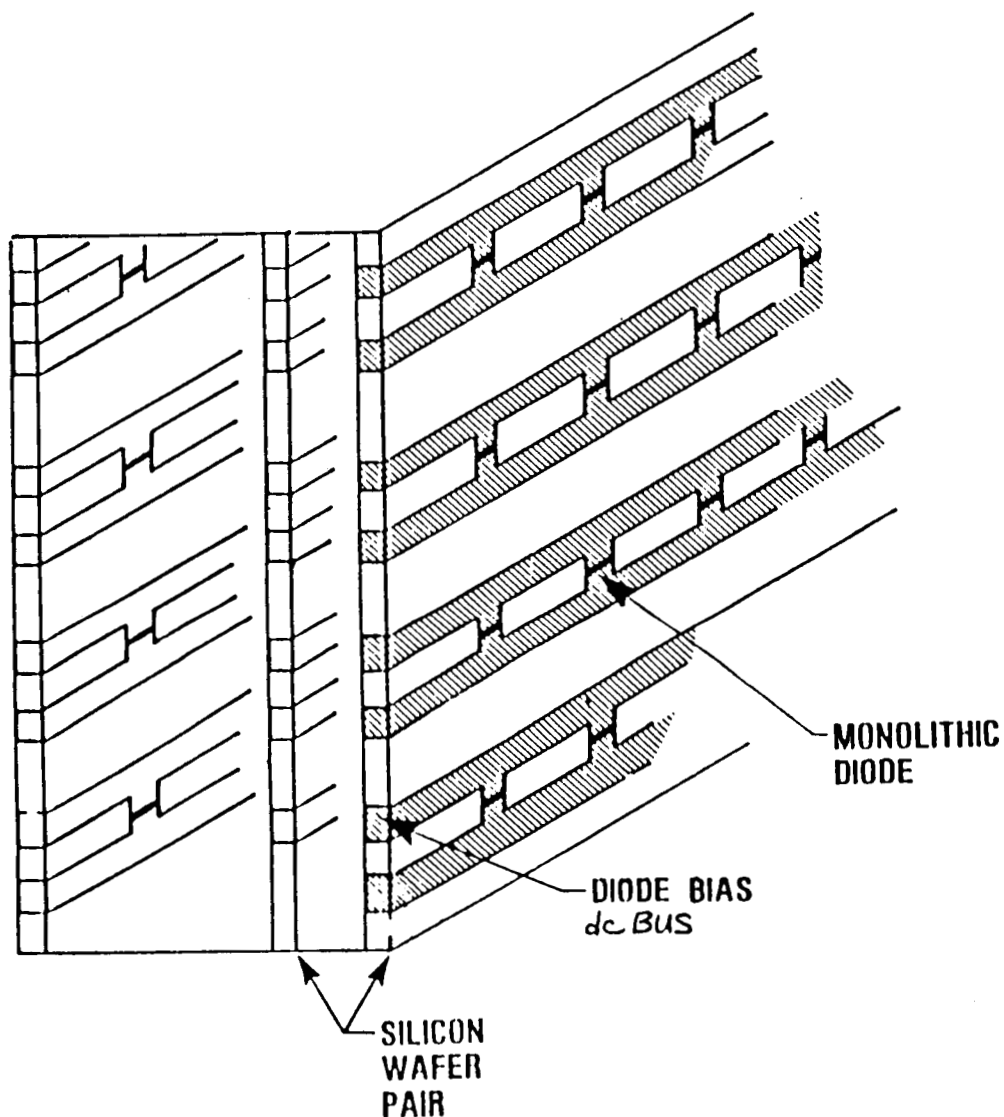

Figure 7

RECTENNA DIODE SELECTION

The maximum power density for rectennas is just over 1 KW/m². To keep the rectenna area to a minimum, each diode should receive a nominal 4 watts of millimeter wave power, see Figure 8. The diodes must meet EMI requirements and have greater than 30 K hours of life.

<u>CRITERIA</u>	<u>COMMENTS</u>
POWER LEVEL	4 W NOMINAL - TO KEEP RECTENNA AREA MINIMUM
RELIABILITY	>30,000 HRS MIN - FAIL SAFE DESIGN - SHORTS DO NOT DOMINO
SPURIOUS	MUST MEET EMI REQUIREMENTS

AVAILABLE

	<u>POWER</u>	<u>COST</u>
GALLIUM ARSENIDE (GAAs)	UP TO 8 W	\$20 PER DIODE
SILICON	1/4 W	\$1 PER DIODE

Figure 8.

RECTENNA DEPLOYMENT

Simple space deployment of the flat rectenna panels from the shuttle bay (4.4 m diameter) or a launch vehicle is depicted in Figure 9.

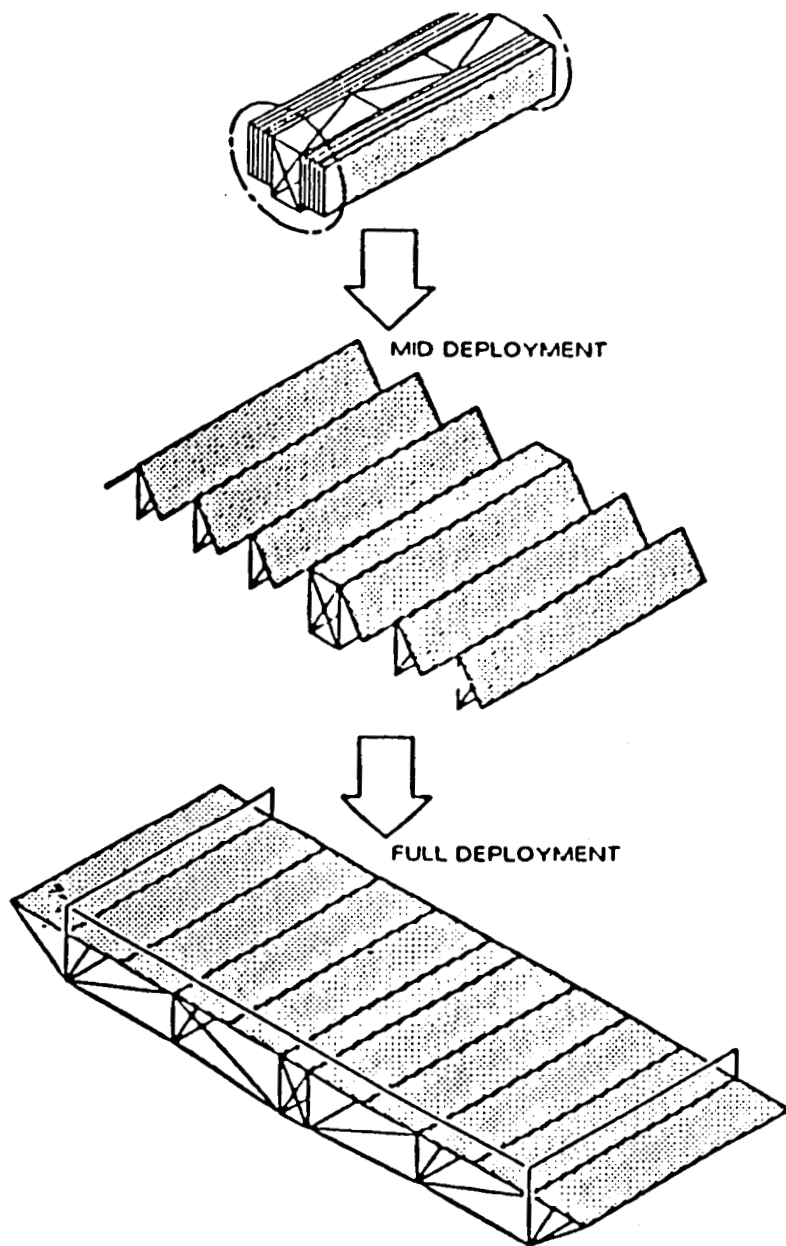

Figure 9. Deployment Sequence

CONCLUSIONS

Based on present technology, the efficient transfer of RF power in space is feasible. However, many parameters must be taken into consideration when designing the system and the interrelationships of these parameters must also be considered. Once the distance between the orbiting spacecraft is specified and the transmit frequency is chosen, then the maximum size for the transmit and receive antennas is fixed (i.e., Rayleigh Range). Once the level of transmit power and transmit time is specified, then the minimum amount of spacecraft batteries is determined. High power RF transmission allows the satellite designer another option in the design of spacecraft power systems.

REFERENCES

1. W. S. Gregorwich, "Microwave Power Beaming from Earth-to-Space," 1988 IEEE Aerospace Applications Conference, Feb. 7-12, 1988.
2. M. Thumm et al. "Very High Power mm-Wave Components in Oversized Waveguides," Microwave Journal, November 1986, pp 103-120.
3. R. L. Lewis and A. C. Newell, "Efficient and Accurate Method for Calculating and Representing Power Density in the Near Zone of Microwave Antennas," IEEE Trans. on Antennas & Propagation, Vol. 36, No. 6, June 1988, pp 890-901.
4. P.W. Hannan, "Microwave Antennas Derived from the Cassegrain Telescope," IRE Trans. on Antennas & Propagation, Vol. 9, No. 3, March 1961, pp 140-153.
5. W. S. Gregorwich and H. A. Malliot, "Large Aperture Antenna Concepts for Millimeter Wave Applications," 1989 IEEE Aerospace Applications Conference, February 12-17, 1989.
6. B. Popovich et al, "Synthesis of an Aberration Correction Feed Array for Spherical Reflector Antennas," 1983 IEEE International Antennas & Propagation Symposium, pp 574-577.

N90-10150

510-20
510774
147

HISTORY AND STATUS OF
BEAMED POWER TECHNOLOGY AND APPLICATIONS
AT 2.45 GIGAHERTZ

RK 190060

William C. Brown, Consultant
Raytheon Company
Microwave and Power Tube Division
190 Willow Street
Waltham, MA

THE FIRST PROPOSED APPLICATION OF BEAMED MICROWAVE POWER TRANSMISSION

A reciting of history begins at some point in time. In the case of beamed power transmission it could begin with Heinrich Hertz who first used parabolic reflectors or it could be with Tesla's unsuccessful endeavors.⁽¹⁾ But we will begin at the time when there were microwave power generators large enough to combine with large transmitting apertures to provide enough power at the receiving end for significant power applications.⁽²⁾

The first seriously proposed application made in 1959 was a microwave powered helicopter platform flying at 50,000 feet altitude that could communicate with another platform 700 miles away. The proposed platform was named RAMP, an acronym for Raytheon Airborne Microwave Platform* Although its development was never actively pursued, the interest attending its proposal was responsible for the Air Force starting significant developments to improve the technology base.

One of the shortcomings of the proposed helicopter was that there was no technology at that time to convert microwave power directly and efficiently into electric power for motors. The RAMP concept depended upon using the microwave power to indirectly heat air which was then ejected from the rotor tips for propulsion purposes.

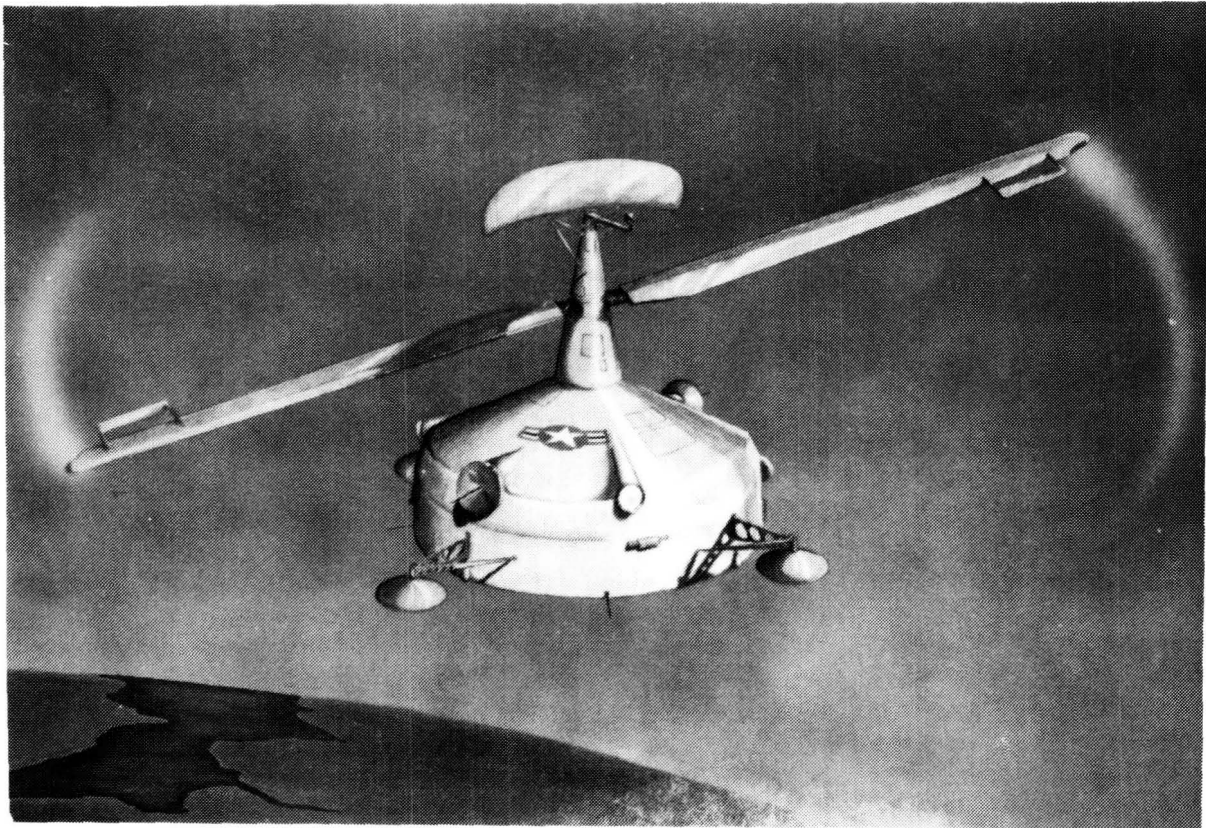

E59-10573

*There is no readily available reference.

AN EXPERIMENTAL MICROWAVE POWERED HELICOPTER

The Air Force had sponsored a program at Purdue University under Professor Roscoe George to investigate solid state rectifiers to convert microwave power into DC power. (3) Out of this effort and a need for a nondirectional receiving antenna for aircraft use came the invention of the "rectenna" a term contracted from the words "rectifier" and "antenna". (4)

The rectenna looked like a phased array but because each receiving element was terminated in a diode rectifier circuit, it was "non-directive" and ideal for airborne vehicles that roll and pitch.

In 1964 such a rectenna was used with a small tethered helicopter to successfully demonstrate for ten continuous hours the flight of an aircraft powered only with a microwave beam. (5,6)

A non-tethered, beam riding helicopter, but not microwave powered, was successfully demonstrated in 1967. (6) With 400 kilowatts of continuous microwave power available (2), the technology was basically available for a high altitude helicopter platform. In the meantime, communication satellites were coming into use and it was not until the early 1980s that the need for such platforms was again acknowledged.

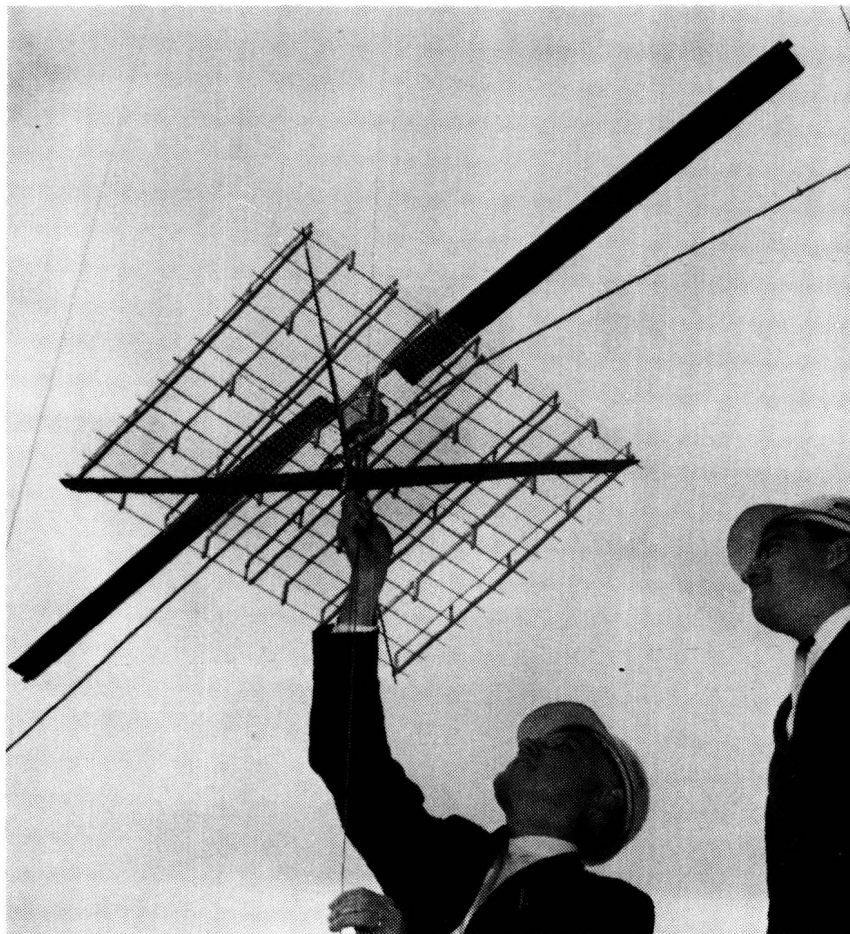

64-24256C

ORIGINAL PAGE
BLACK AND WHITE PHOTOGRAPH

INTO SPACE WITH MICROWAVE BEAMS

The next beamed power technology development support was motivated by the Space Station application. That activity, sponsored by MSFC in the 1969 to 1964 time period and carried out in the ISM (Industrial, Scientific, Medical) band of 2.4 to 2.5 GHz because of the cost effectiveness of using the technology already existing there, was responsible for great improvements in all parts of the technology, but particularly in rectenna technology. Ultimately, all of the advancements were put together in a demonstration of overall DC to DC efficiency of 48% in 1964. In 1965, the overall efficiency was raised to 54% and validated by the Quality Control Department of JPL at Raytheon. In this latter demonstration, the microwave generator efficiency was measured at 69%, the transmitted beam efficiency at 95%, and the rectenna overall capture and rectification efficiency at 82%. (7)

This demonstration at Raytheon and verification by JPL was essential to the acceptance of the technology by the scientific and engineering communities. For example, the antenna community is accustomed to capture efficiencies of uniformly illuminated apertures of not more than 80%. By adding the rectification function to each individual dipole antenna in the array, however, its capture efficiency increases to 100%. The array also becomes desirably non-directive and its overall capture and rectification efficiency is typically over 80% where most of the inefficiency is caused by diode and skin losses in the rectifier.

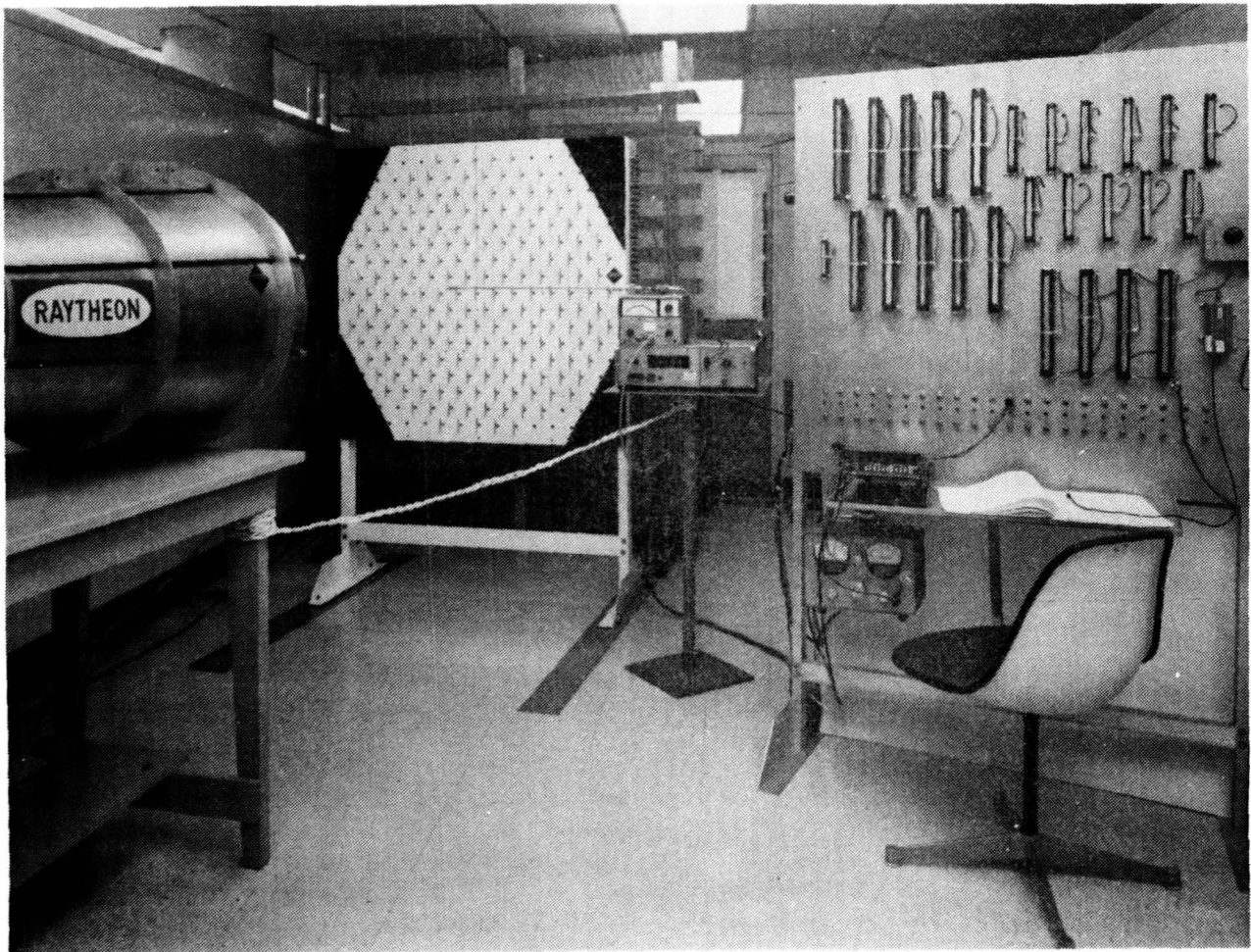

75-74306

INTO SPACE WITH MICROWAVE BEAMS (Cont.)

Circa 1970, following a briefing by Dr. Peter Glaser and others to a Congressional Committee on the SPS, NASA's Office of Applications became interested in further development and demonstration of microwave technology with the SPS application in mind. It initiated responsibility to carry out its sponsorship through JPL and Lewis Research Center.

Four activities of importance came from this support. One was a study of the complete microwave subsystem including satellite and ground rectenna(8), one was a study and technology development dealing with rectenna for the SPS application(9), a third was a demonstration of beaming significant amounts of power over a significant distance(10,11), and a fourth was productive studies dealing with microwave power generation and antennas.(12)

Of all of these efforts, the 1985 JPL Goldstone demonstration of transmitting power over a distance of one mile and converting the incident microwave power at 84% efficiency to produce over 30 kilowatts of DC power was the most visible. A large 18 x 24 foot rectenna composed of 18 subarrays was designed and built by the Raytheon Company for the demonstration. The efficiency and success with which the demonstration was carried out attests to the soundness and reliability of the rectenna technology involved. The rectenna survived and was operable after a direct lightning strike on the tower in 1980, and which destroyed equipment on the ground.

The success of this demonstration was possibly essential to provide the credibility necessary to later undertake the joint DOE/NASA study of the Solar Power Satellite concept.

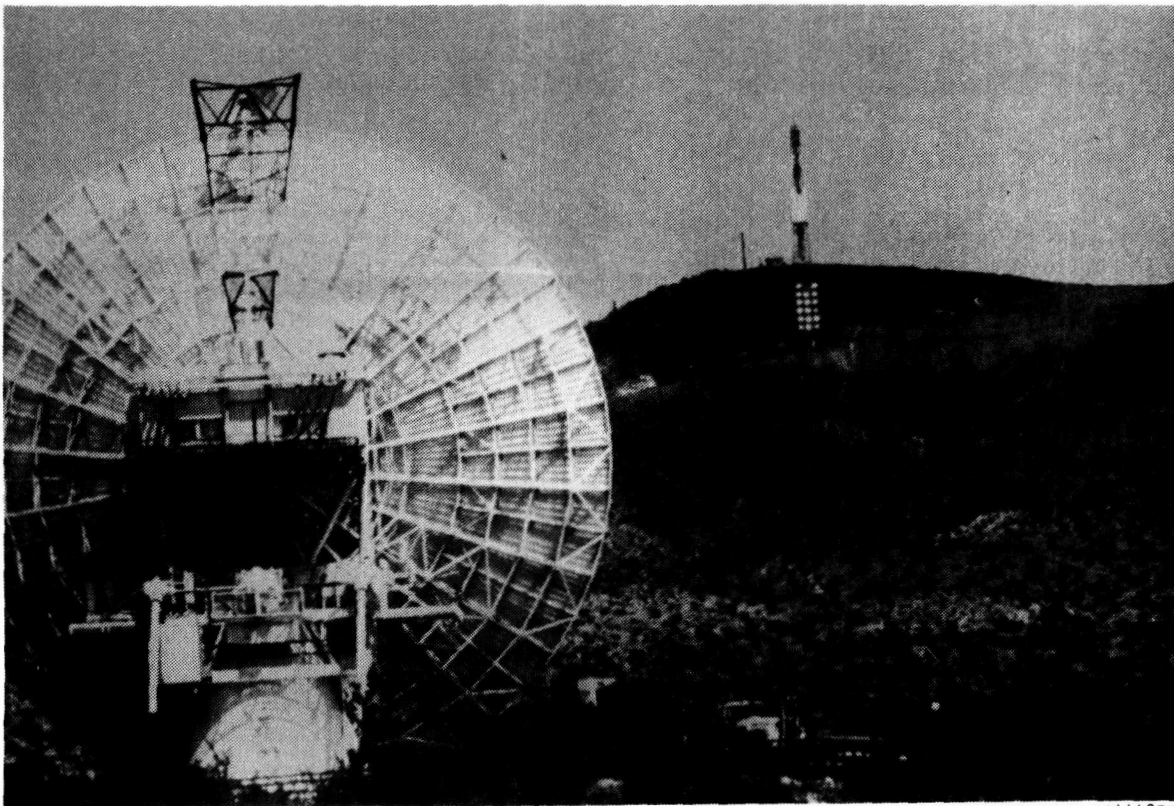

G444872

ORIGINAL PAGE
BLACK AND WHITE PHOTOGRAPH

THE SOLAR POWER SATELLITE AND BEAMED POWER TRANSMISSION

The introduction of the concept of the Solar Power Satellite in 1968 by Dr. Peter Glaser of Arthur D. Little, Inc. had an enormous impact upon the direction of beamed power transmission.(13) The very large physical and electrical size of the beamed power system presented a tremendous challenge to engineers to solve the many problems involved.

The first organized activity to study the technical and economic feasibility of the Solar Power Satellite as a system was that of a four-company team comprised of Arthur D. Little, Inc., Raytheon Company, Grumman Aerospace Corp., and Textron, Inc. The results of this six month study carried out in 1971 were sufficiently favorable to encourage the management of the four companies to jointly send a letter to the Director of NASA recommending the support and study of this concept by NASA.

The first general recognition within NASA of the SPS as an important potential program grew out of NASA's comprehensive study entitled "Outlook for Space in the Year 2000". By this time, however, spurred on by the oil embargo of 1973, the government had created ERDA (Energy Research and Development Agency) and given it the charter for the development of all sources of energy to be used on the earth's surface in the United States. ERDA established a task group to study the SPS. This group recommended a detailed assessment of SPS covering technical feasibility, economic viability, environmental and societal acceptability, and the merits of SPS when compared with other future alternatives.

The recommendations evolved into a three-year study program termed the "DOE/NASA Satellite Power System Concept Development and Evaluation Program". The many detailed studies undertaken during this study, including important system studies by Rockwell International and Boeing Aerospace Company, were completed in the summer of 1980. A 670 page document summarizing the results of these studies was published.(14)

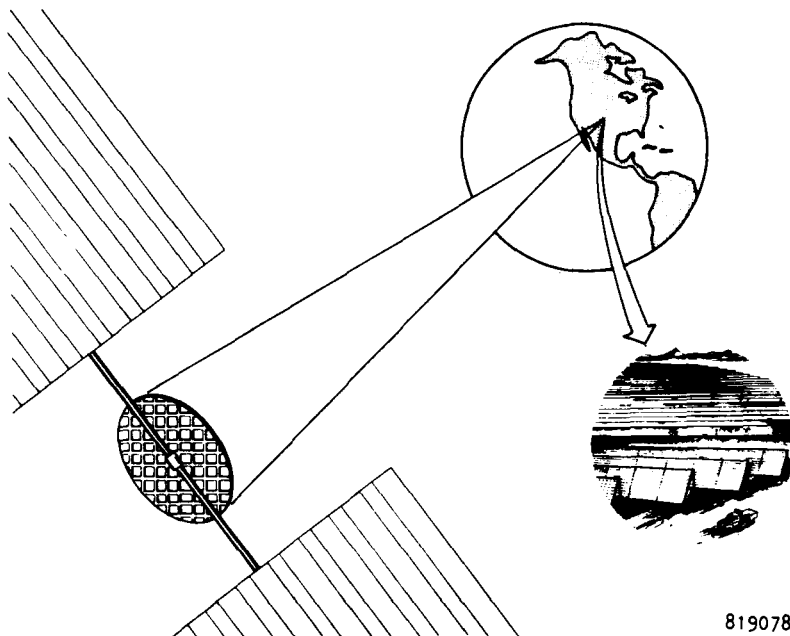

819078

BEAMED MICROWAVE POWER TRANSMISSION IN THE SPS

A portion of the funding for the three year SPS study, administered by NASA, was used for engineering studies. The particularly difficult problem of building a high power transmitter in space was addressed by several companies, including Boeing, Raytheon, North American Rockwell, and Grumman Aerospace. In the writer's opinion it was the contribution of R.M. Dickinson of JPL that pointed the design in the proper direction. The concept, as shown below, was an electronically steerable array composed of modules comprised of two magnetrons acting in conjunction with a passive combiner to excite a section of slotted waveguide array.

Dickinson's concept motivated an intensive evaluation of the magnetron directional amplifier as a generator for the SPS. (13) The evaluations used the common microwave oven magnetron for experimental data. It was determined that this tube generated very little extraneous noise, was highly efficient, and had an internal feedback mechanism to regulate its cathode temperature to achieve the longest possible life. (12) A subsequent study from MSFC designed a specific magnetron for the SPS application with projected 50 year life, 85% efficiency, and an external control loop to eliminate interfacing power conditioning with the photo voltaic array. (15)

The magnetron in combination with the slotted waveguide array became a radiation module that was combined with other modules to form a subarray of the large, one kilometer diameter, SPS transmitting array as shown below. The SPS magnetron application was recently updated with new technology. (16)

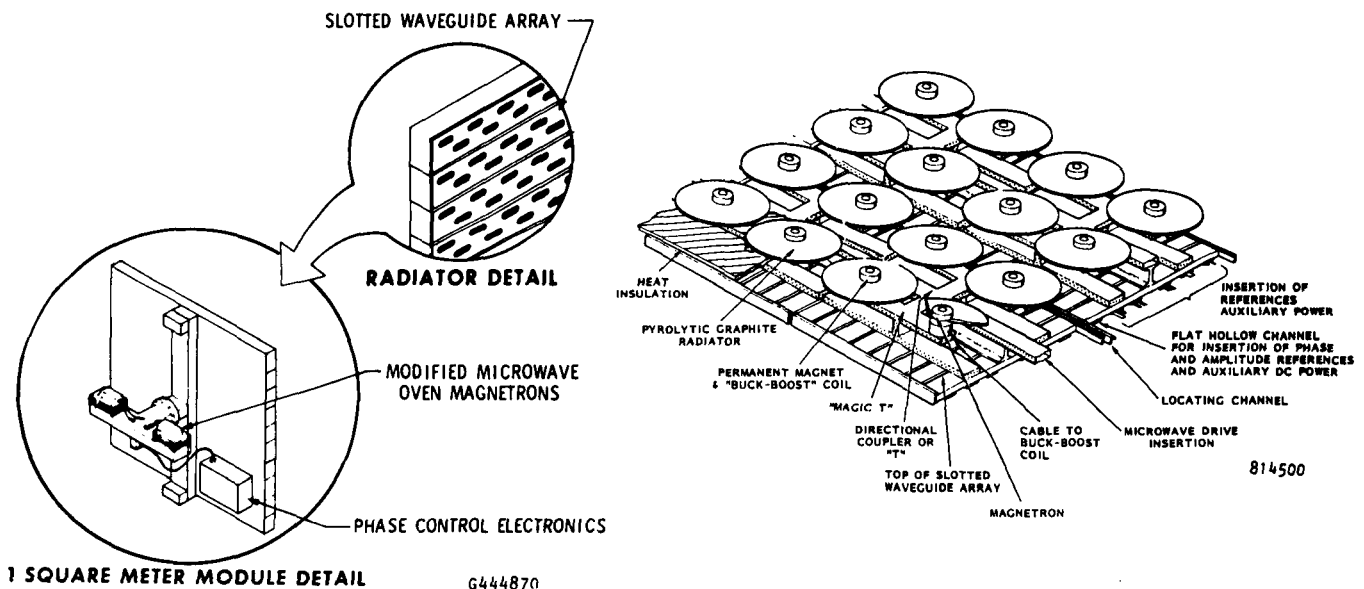

REINTRODUCTION OF MICROWAVE POWERED AIRCRAFT

Generic improvements in beamed microwave technology and the standing need for a long endurance high altitude platform led to a revival of interest within NASA in microwave powered platforms in 1978. Out of this interest came two microwave powered airship studies from Wallops Flight Facility. (17,18) These studies produced two outstanding technology advances.

The first of these was a new thin-film, printed circuit rectenna format which made its use in both air and space vehicles very attractive. (18) This format was later greatly improved upon and made ready for space use with the use of discretionary funding at LeRC. (19)

The second contribution was the conceptual design of an electronically steerable phased array composed of radiation modules similar to those for the SPS. (18) It was determined that a combination of an off-the-shelf microwave oven magnetron, a ferrite circulator, and a section of slotted waveguide array could become a building block for Earth-based transmitters for both space applications and for microwave powered aircraft.

It was subsequently found that the design could be greatly simplified by adding additional external circuitry to the microwave oven magnetron to greatly increase its gain while locking its output phase to the phase of the driver. (20)

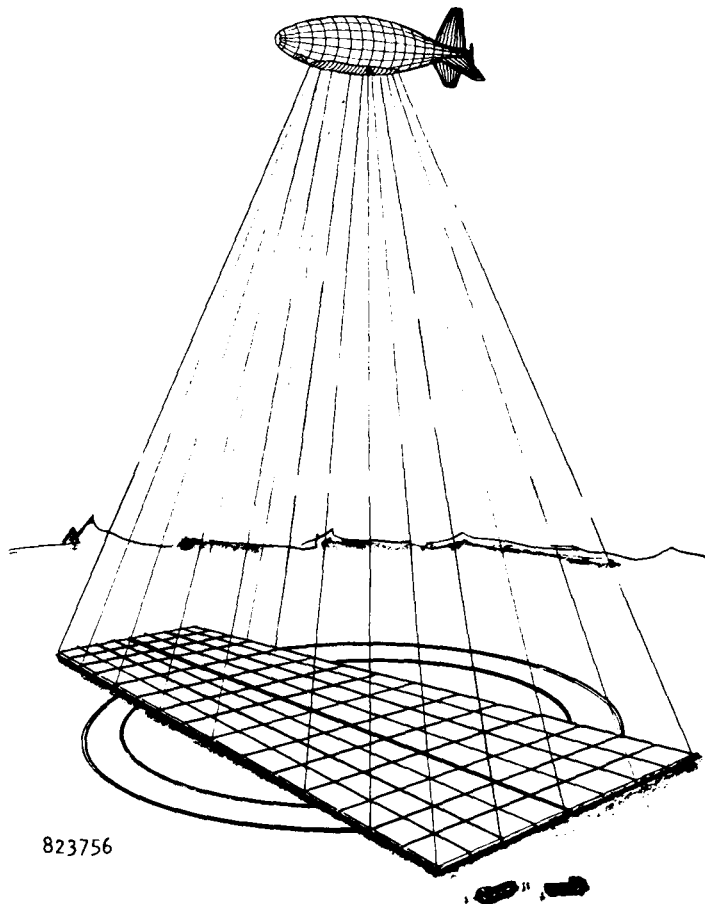

THE CANADIAN SHARP PROGRAM

The development of the new rectenna format remained unexploited experimentally in the USA, although it was studied in the context of a microwave powered airplane for atmospheric surveillance.(21) In 1981, however, the Canadian government embarked on the SHARP (Stationary High Altitude Relay Platform) program that in 1987 produced the first successful demonstration of the free flight of a microwave powered aircraft, in this case an airplane, shown below.(22) The Canadian team was successful in adding its own improvement to rectenna technology, a crossed polarized rectenna that would remain efficient regardless of the angular position of the airplane.

The SHARP program is projected to go through an intermediate stage of development before the final system which will support an airplane flying at 65,000 feet for months at a time, performing useful communication and surveillance functions.

The SHARP program today represents the cutting edge of active application of 2.45 GHz technology, and represents a logical step on the learning curve toward a space application. An electronically steered array for a microwave powered airplane flying at 65,000 feet could also be used experimentally to beam small amounts of power to a low Earth orbit satellite with a rectenna designed for low power density to explore the importance of refraction and attenuation in the Earth's atmosphere under a variety of weather conditions.

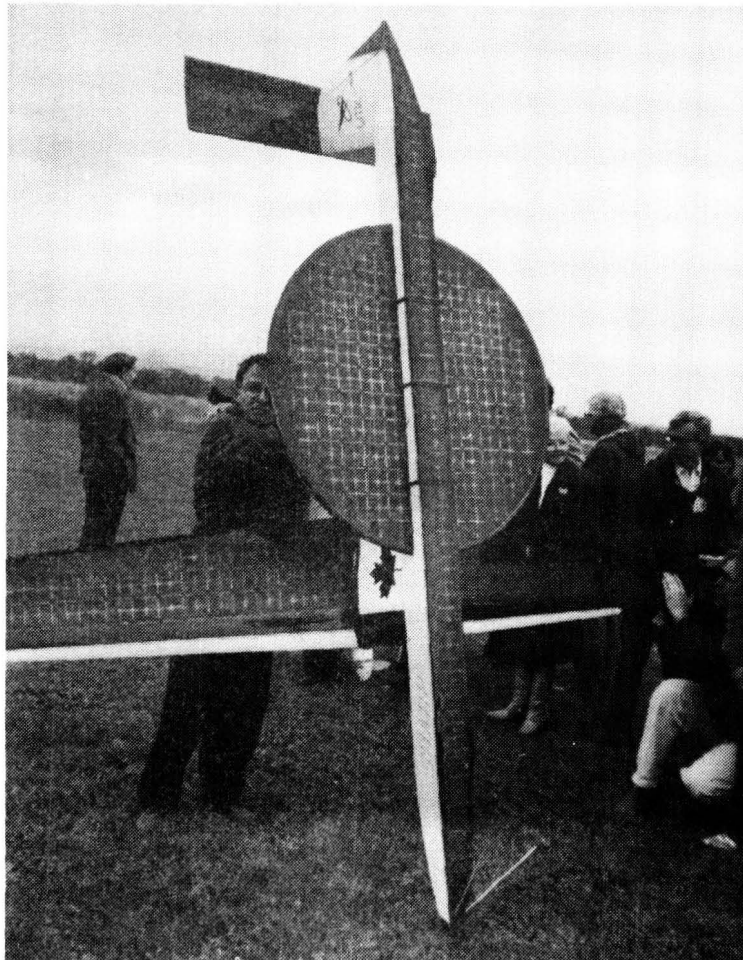

G-350758

ORIGINAL PAGE
BLACK AND WHITE PHOTOGRAPH

THE RECTENNA FOR SPACE USE

The well developed rectenna at 2.45 GHz has many desirable qualities as a source of power in space where a microwave beam can be made available. These desirable qualities and other characteristics are

- | | |
|-----------------------------------|---|
| • State of Development | Substantially completed |
| • Specific Mass | Low, 1 kg/kW |
| • Efficiency | High, 85% overall |
| • Typical DC Power Density Output | 500 W/m ² |
| • Dissipation of Inefficiencies | Direct radiation to space |
| • Life | Very long, rectifiers can be shielded |
| • Incident Angle Tolerance | Efficiency nearly constant over 60° |
| • Critical Material Use | Negligible |
| • Reliability | Excellent |
| • Ease of Manufacture | Uses Existing Facilities |
| • Cost | Potentially low but dependent upon diode cost |
| • Transportability | Excellent |
| • Negative Factors | Current design radiates harmonics -
new design would not |

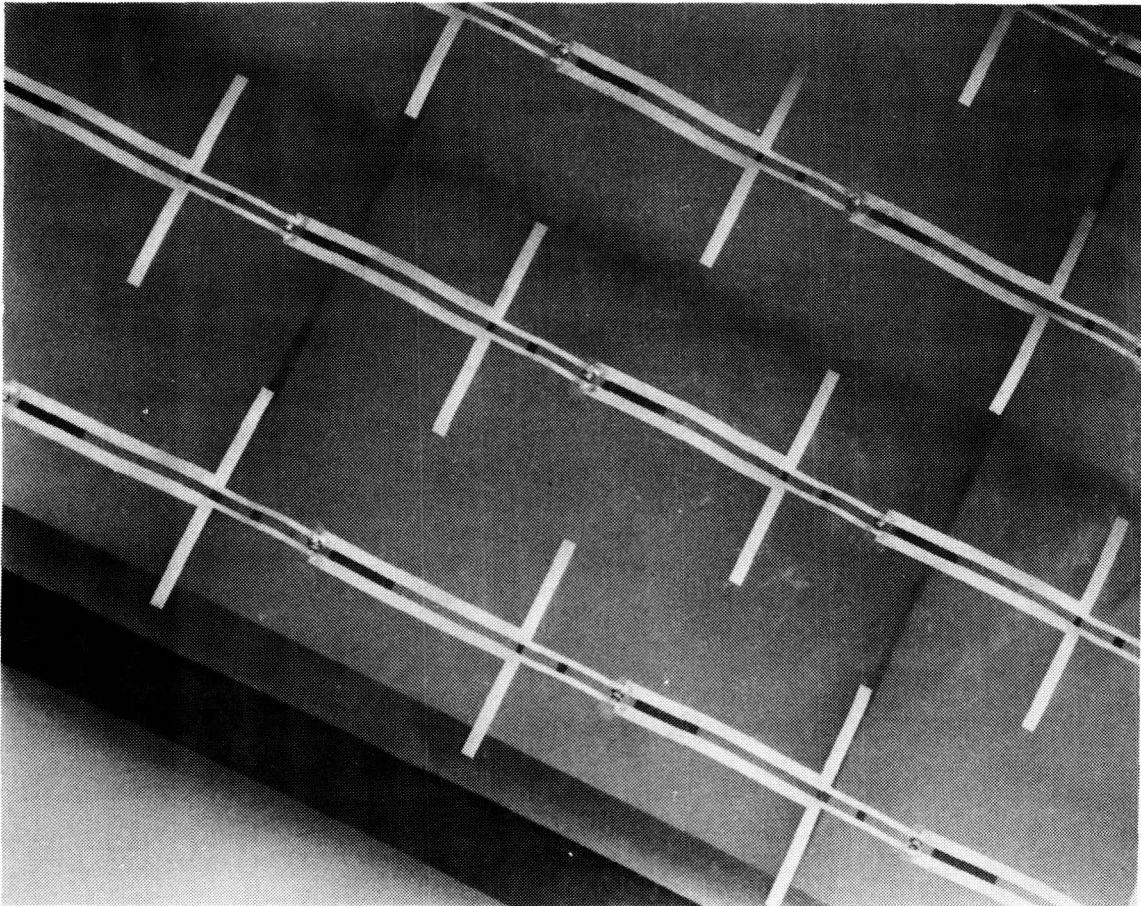

83-0337C

ORIGINAL PAGE
BLACK AND WHITE PHOTOGRAPH

AN EQUATORIALLY BASED BEAMED POWER TRANSMISSION SYSTEM

Any beamed power transmission from Earth to low Earth orbit for peaceful purposes, whether by laser or microwave, should (must) be based in the equatorial plane to take advantage of a time of contact with the space vehicle that is at least 16 times that available from any other geographical location. The full exploitation of beamed power transmission system to space is an international project!

As shown below, a fully mature land-based system consists of four high power transmitters equally spaced around the Earth to interact with an all-electronic LEO-to-GEO transportation system, and 10 low power transmitters for use with orbiting industrial parks or other satellites in LEO. All transmitters use electronically steerable beams that sweep over a 90° total angle in the west to east direction.

A mature system is not necessary to achieve economic payback. Single transmitters are effective for both low Earth orbit use, and for the LEO to GEO transportation system. But as the system grows and matures, it allows higher duty cycle for both transmitters and satellites and the economics become very favorable.

The international geopolitical aspect of the use of the equatorial plane is particularly interesting from the commercialization of space viewpoint. The ownership of the ground based portion of the system could be modelled after Intelsat, and the various space vehicles could then purchase transmitted power from it, analogous to the domestic practice of buying power from the electric utilities. The financial investment in such a system would be relatively modest by business standards. The physical system is firmly based upon well developed technology at 2.45 GHz. Because of this, studies have shown that the first low power transmitter should be well under \$100,000,000.⁽²³⁾ Such a transmitter would provide 16,000 kilowatts of rectified DC power to a 200 meter diameter industrial park, with an efficiency of greater than 20% from 60~ Earth power to satellite DC power. Average power to one satellite with one Earth transmitter is 240 kilowatts, and three 400 kilowatts with all 14 ground based transmitters.

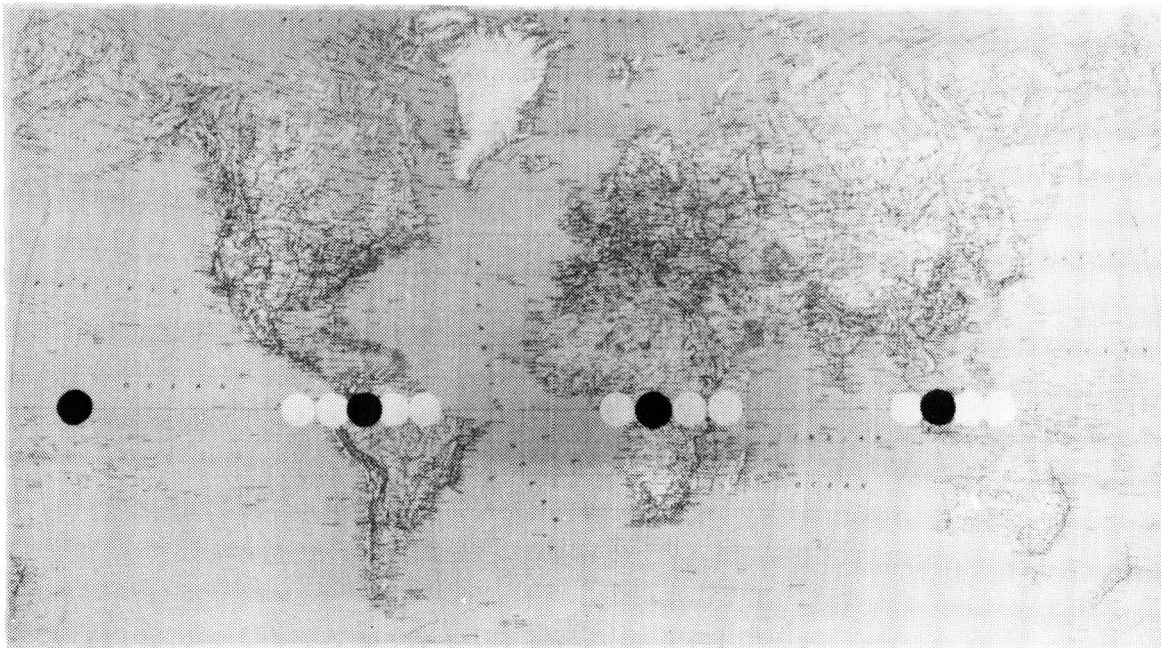

ORIGINAL PAGE
BLACK AND WHITE PHOTOGRAPH

AN ALL-ELECTRONIC LEO TO GEO TRANSPORTATION SYSTEM

It is well known that a much better transportation system from LEO to GEO than now exists with conventional chemical rocket propulsion will be necessary to develop space beyond LEO and to make large scale projects such as the SPS feasible. This is true even if a substantial portion of the material needed for SPS construction comes from the moon.

Electric propulsion with its much higher specific impulse could solve the LEO to GEO transportation problem if there were a suitable source of low mass electric power for the electric thrusters. Fortunately, there is. The thin film format for the rectenna developed by NASA can produce almost any needed amount of power at a mass penalty of only one kilogram for each kilowatt of DC power output. Further, the rectenna sections can be interconnected to make the power available at the high voltage required by such high specific impulse thrusters as the ion thruster and can eliminate much of the current power conditioning with other sources.

An all electronic propulsion system that combines the rectenna and microwave beam source with the thruster has been under study for some time. (24) It has gradually matured to the point where projections of its performance and cost can be made. (25) The vehicles for economic operation of the system are large by current standards but will be needed for such large scale operations as constructing solar power satellites. An artist's concept, guided by engineering input, is shown below. Such a vehicle could transport 50,000 kilograms representing a payload fraction of 51% to GEO and return to LEO in 35 days with four Earth based beams and in 140 days with one Earth beam. A fleet of such vehicles, going in convoy, could move very large amounts of material at low cost. In addition express trips to GEO with minimum payload could be made in a matter of 10 days with four beams.

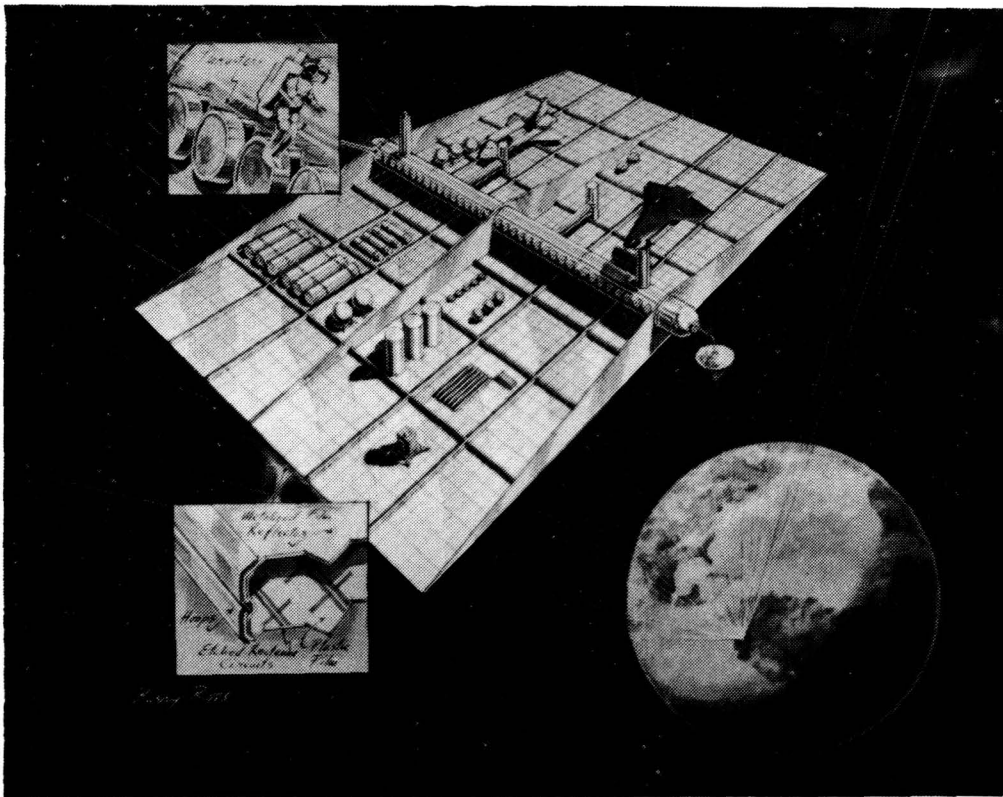

8CE90933

AN ORBITING INDUSTRIAL PARK SYSTEM

The President's Commission on Space referred to Orbiting Industrial Parks in their published report. Such "industrial parks" will be very much dependent upon large amounts and low cost electric energy. However, they will quite likely be in low Earth orbit and not concerned with the geography beneath them. Hence, the industrial parks could be constructed in the equatorial plane and jointly use and buy electric energy from a land based complex of beamed power transmitters. (23) Such a complex viewed to scale from the North Pole, is shown below. The view includes four high power transmitters for LEO to GEO use.

A table showing the projected cost of electric energy from such a complex in terms of several scenarios of the stage of maturity of the system is given below. Cost of electric energy is seen to vary from a maximum of \$8.00/KWH for a single transmitter and park down to \$0.36/KWH for a fully mature system. The costs include amortization costs of both transmitters and rectennas over a ten year period. Learning experience in constructing the units is reflected in reduced cost of equipment built downstream. Initial costs do not include the cost of constructing the space park. The maximum duty cycle from land-based sites is 21%.

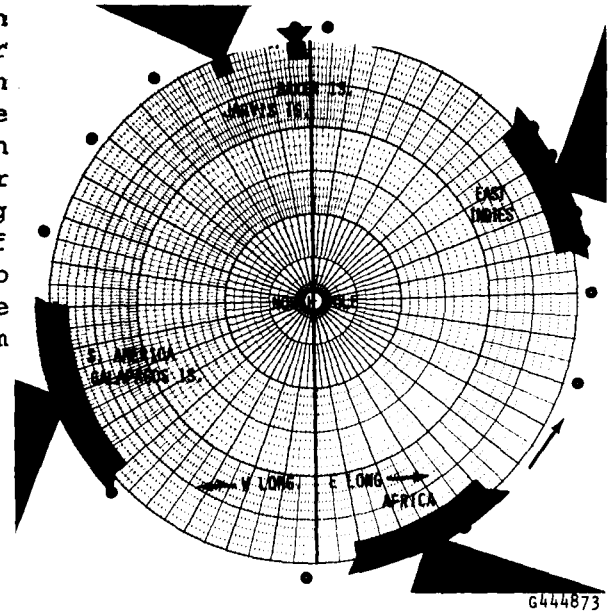

6444873

SCENARIO	GROUND BASED TRANSMITTER			INDUS. PARK BASED RECTENNA			ANNUAL KW HR ENERGY DELIVERED 10 ⁶ KW HR	EQUIPMENT COST PER KW HR \$	60 CYCLE KW HR** CHARGE \$	TOTAL KW HR CHARGE \$
	Q'TY	INITIAL COST 10 ⁶ \$	YEARLY* COST 10 ⁶ \$	Q'TY	INITIAL COST 10 ⁶ \$	YEARLY* COST 10 ⁶ \$				
A	1	80	8	1	80	8	2.1	7.61	0.20	7.83
B	14	560	56	67	2.680	268	1.970.0	0.16	0.20	0.36
C	14	560	56	1	80	8	29.4	2.17	0.20	2.37
D	1	80	8	14	560	56	29.4	2.17	0.20	2.37
E	4	240	24	4	240	24	33.6	1.42	0.20	1.62

* INITIAL COST IS CHARGED OFF EQUALLY OVER 10 YEAR PERIOD

** ASSUMES 25% OVERALL EFFICIENCY AND 60 CYCLE ENERGY COST OF 5¢/KW HR

6444871

ORIGINAL PAGE IS
OF POOR QUALITY

REFERENCES

1. W. C. Brown, "The History of Power Transmission by Radio Waves," Trans. on Microwave Theory and Techniques, Vol. MTT-32 No. 9, September, 1984 Special Centennial Historical Issue.
2. W. C. Brown, "A Survey of the Elements of Power Transmission by Microwave Beam," in 1961 IRE Int. Conv. Rec., Vol. 9, Part 3, pp. 93-105.
3. R. H. George, "Solid State Power Rectifications" in Okress, Microwave Power Engineering, Vol. I. New York: Academic, 1968, pp. 275-294.
4. W. C. Brown et al., U.S. Patent 3434678, March 25, 1969.
5. W. C. Brown, "Experimental Airborne Microwave Supported Platform, Tech. Rep. RADC-TR-65-188, Contract AF30 (602) 3481, Dec. 1965.
6. W. C. Brown, "Experiments Involving a Microwave Beam to Power and Position a Helicopter," IEEE Trans. Aerosp. Electron. Systems, Vol. AES-5, No. 5, pp. 692-702, Sept. 1969.
7. R. M. Dickinson and W. C. Brown, "Radiated Microwave Power Transmission System Efficiency Measurements," Tech. Memo 33-727, Jet Propulsion Lab., Cal. Inst. Technol., March 15, 1975.
8. "Microwave Power Transmission System Studies," Raytheon Contractor Rep. ER 75-4368, NASA CR-134886, Dec. 1975.
9. W. C. Brown, "Electronic and Mechanical Improvement of the Receiving Terminal of a Free-Space Microwave Power Transmission System," Raytheon Contractor Rept. PT-4964, NASA CR-135194, Aug. 1977.
10. R. M. Dickinson, "Evaluation of a Microwave High-Power Reception-Conversion Array for Wireless Power Transmission," Tech. Memo 33-741, Jet Propulsion Lab., Cal. Inst. Technol., Sept. 1, 1975.
11. "Reception-Conversion Subsystem (RXCV) Transmission System," Raytheon Final Rep. Microwave Power, ER75-4386, JPL Contract 953968 NASA Contract NAS7-100, Sept. 1975.
12. W. C. Brown, "Microwave Beamed Power Technology Improvement," Final Rep., JPL Contract 955104, Raytheon Rep. PT-5613, May 15, 1960.
13. P. E. Glaser, "Power From the Sun; Its Future", Science, Vol. 162, pp. 957-861, Nov. 22, 1968.
14. Final Proc. Solar Power Satellite Program Rev. DOE/NASA Satellite Power System Concept Develop. Evaluation Program, Conf. 800491, July 1980.

REFERENCES (Cont.)

15. W. C. Brown, "Satellite Power System (SPS) Magnetron Tube Assessment Study," NASA Contractor Rep. 3383, Contract NAS8-33157, Feb. 1981.
16. W. C. Brown, "Update on the Solar Power Satellite Transmitter Design", Space Power Vol. 6, pp. 123-135, 1986.
17. W. C. Brown, "Design Definition of a Microwave Power Reception and Conversion System for Use on a High Altitude Powered Platform," NASA Contractor Rep. CR-15866, Contract NAS6-3006, Wallops Flight Facility.
18. W. C. Brown, "Design Study for a Ground Microwave Power Transmission System for Use with a High-Altitude Powered Platform," NASA Contractor Rep. 168344, June, 1983, Raytheon Rep. PT-6052, Contract NAS6-3200, May, 1982.
19. "Rectenna Technology Program - Ultra Light 2.45 GHz Rectenna" NASA Report CR179558, March 11, 1987. NASA Lewis Research Center Contract NAS3-22764.
20. W. C. Brown, U.S. Patent No. 4,571,552-1986.
21. D. L. Douquet, D. W. Hall, R.P. McElveen, "Feasibility Study of a Carbon Dioxide Observational Platform System," Final Report Contract NAS8-3660, Dec. 1988, Lockheed Georgia Co.
22. "Beam-Power Plane", Arthur Fisher, Popular Science, Jan. 1988, pp. 62-6's.
23. W. C. Brown, "A Microwave Powered Orbiting Industrial Park System", Proceedings of 8th Princeton/AIAA/SSI Conference May 6-9, 1987. Published by AIAA, Washington, DC.
24. W. C. Brown and P. E. Glaser, "An Electric Propulsion Transportation System from Low-Earth Orbit to Geostationary Orbit Utilizing Beamed Microwave Power," Space Solar Power Rev., Vol. 4, pp. 119-129, 1983.
25. W. C. Brown, "All Electronic Propulsion - Key to Future Space Ship Design" Paper AIAA 88-3170 at AIAA/ASME/SAE/ASEE Joint Propulsion Conference, July 11-13, 1988, Boston, MA.

omit

LASER TECHNOLOGY BACKGROUND

PRECEDING PAGE BLANK NOT FILMED

PAGE 186 INTENTIONALLY BLANK

LASER TECHNOLOGY AND BACKGROUND

Introduction

E. J. Conway

Current laser technology was not developed for the transmission and conversion of useful amounts of power. Instead, a variety of laser applications have evolved, including optical spectroscopy, laser fusion, remote sensing, communications, cutting and welding, and others. For each, specific lasers have been developed. Now, we find ourselves with many available or developable lasers, but still with little experience in the maturation of high-average-power lasers with the beam quality necessary for power transmission in space. One of the few laser systems with the credentials of high power and good beam quality is the Free Electron Laser. Although not primarily an in-space laser, the Free Electron Laser has lessons to teach us. It is for this purpose that we have a paper on this topic. It will be given by Jim Swingle, of Lawrence Livermore Laboratory, as the first paper after this introduction.

Conversion from laser power to electric power is an area largely neglected for other laser applications. Converters are characterized first by their efficiency and second by the bandwidth or wavelength range over which they are efficient. Converters have been proposed which work on purely thermal effects, photon effects, and electromagnetic effects. However, for laser power transmission, laser-to-electric converters have a very special role in the program, and a paper surveying the types and characteristics of these devices is especially appropriate as background for a meeting such as this. It will be the second paper, to be given by Nelson Jalufka of Hampton University, after this introduction.

An in-space laser power station will probably be a large space structure. The large size may come from solar collectors, laser transmission optics, thermal radiators, or other diverse requirements. NASA has spent approximately two decades investigating the concepts and materials which appear to be useful for building large structures for use in space. To understand space power stations, we must have a grasp on its structure. This subject will be discussed by Martin Mikulas, of NASA's Langley Research Center, in the third paper after this introduction.

N90-10151

511-26
216775

**Technical Options for High Average Power
Free Electron Millimeter-Wave
and Laser Devices**

James C. Swingle
Lawrence Livermore National Laboratory

L110756

PRECEDING PAGE BLANK NOT FILMED

Technical Options for High Average Power Free Electron
Millimeter-Wave and Laser Devices

Many of the potential space power beaming applications require the generation of directed energy beams with respectable amounts of average power (MWs). A somewhat tutorial summary is provided here on recent advances in the laboratory aimed at producing direct conversion of electrical energy to electromagnetic radiation over a wide spectral regime from microwaves to the ultraviolet.

The space power beaming problem

A broad range of wavelength options is needed to thoroughly investigate power beaming scenarios over characteristic ranges for NASA's missions spanning at least 5 orders of magnitude. A simple calculation of the size of the Airy disk produced in the focal plane of a uniformly illuminated transmitter aperture motivates the need to push toward shorter wavelength as the characteristic range increases. The microwave and mm-wave beams suitable for beaming to low earth orbit (LEO) and requiring apertures with sizes of order hundreds of meters become impractical for beaming to geosynchronous orbit (GEO) or to the earth's moon. Infrared or visible beams allow aperture sizes in the tens of meters over these distances. At ranges associated with beaming to Mars from the earth (or its moon), even shorter wavelengths would appear to be worth examining.

It is important to remember that the benefits of reduced aperture size at shorter wavelength are accompanied by the need to maintain surface figure and jitter at levels permitting nearly diffraction-limited performance for the design wavelength. The sophistication and cost of the transmitter technology (at least on a per unit area basis) increases as the wavelength is reduced. Detailed trades must therefore be performed for any particular application.

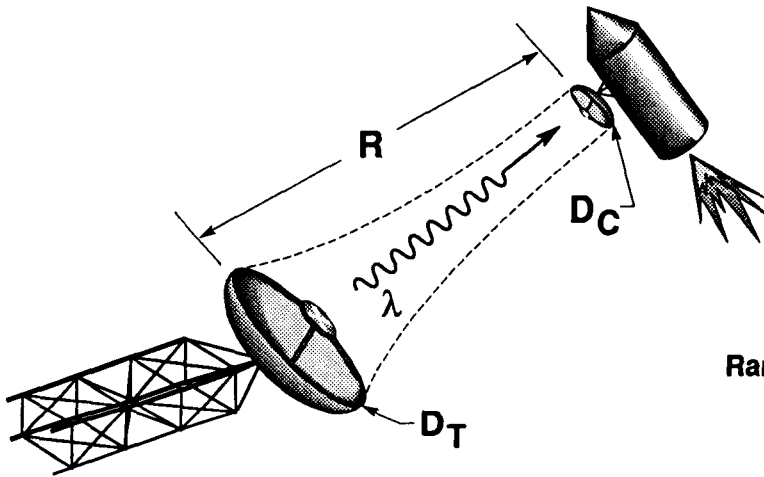

$$D_T D_C = 2.44 \lambda R$$

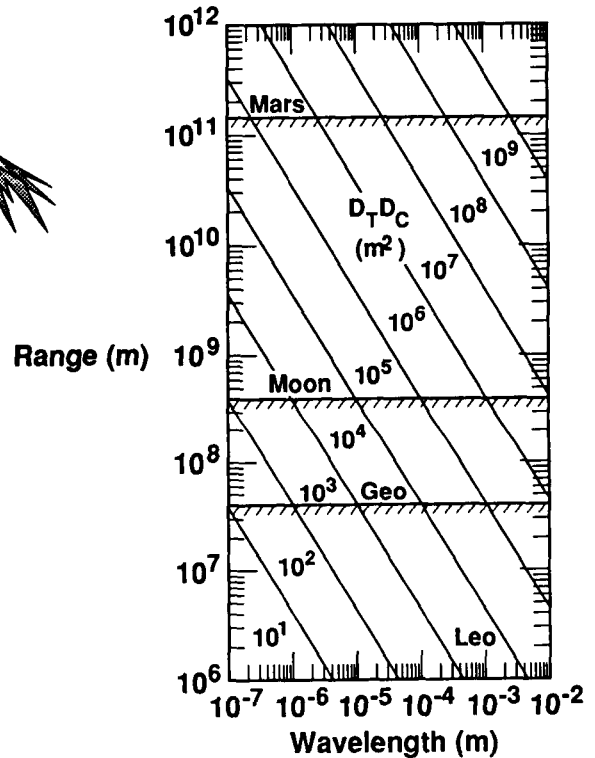

Energy and directed energy weapons programs have extended technical options

Programs aimed at inertial fusion, magnetic fusion, and directed energy weapons have advanced the technologies that may contribute to the generation of very high power beams with good mode quality. For example, the tokamak programs around the world have begun to focus on the use of high average power mm-wave sources (140 - 250 GHz) to drive electron cyclotron heating in confined plasmas. This technique is seen as a way to promote stabilization of the plasma and to enhance the fusion energy gain of these devices.

The inertial fusion and laser weapons programs have produced advances in the technologies of carbon dioxide, chemical (HF, DF, iodine), excimer (ArF, KrF, XeF, etc.), and free electron lasers. The free electron devices are newcomers in the high energy laser business, and thus will be the focus of this brief tutorial summary.

- **Multi-MW microwave and mm-wave sources**
 - Gyrotrons
 - Free electron masers

- **Infrared, visible, and ultraviolet lasers scalable to high average power**
 - Carbon dioxide (10.6 μm)
 - Chemical lasers (1.3 — 4 μm)
 - Excimer (.2 — .4 μm)
 - Free electron lasers (.1 — 100 μm)

Compton FELs in the near infrared have been envisioned as oscillators and MOPAs.

The majority of the free electron laser work performed around the world has been done in regimes of electron energy and current density where collective effects do not dominate the electron interaction with the electromagnetic field: the so-called Compton regime. A high quality electron beam is injected into a wiggler which produces an alternating magnetic field along the direction of propagation. Since the electrons are relativistic, this field undulation that occurs on scale lengths of many centimeters in the laboratory reference frame becomes equivalent to optical wavelengths in the electron frame of reference, thus allowing for conditions of resonance between the wiggler field and an electromagnetic field. Depending on the gain of the electromagnetic field in a single pass through the wiggler (which depends on many variables including the peak current of the e-beam, the e-beam quality, and the detailed configuration of the wiggler), the FEL can be configured as an oscillator or a single pass amplifier. In the oscillator configuration, which is typical of devices using low peak current accelerators (10s to 100s of Amperes), a resonator cavity is established around the wiggler to allow the build-up of the electromagnetic field as many electron pulses propagate through the device. In the single pass schemes typical of high peak current accelerators (100s to 1000s of Amperes), efficient extraction of energy occurs in a single pass through the wiggler without the use of optics. A master oscillator pulse at the appropriate wavelength is usually injected into the wiggler with the electron pulse in order to facilitate initial coupling of the electrons to the electromagnetic field.

Oscillator

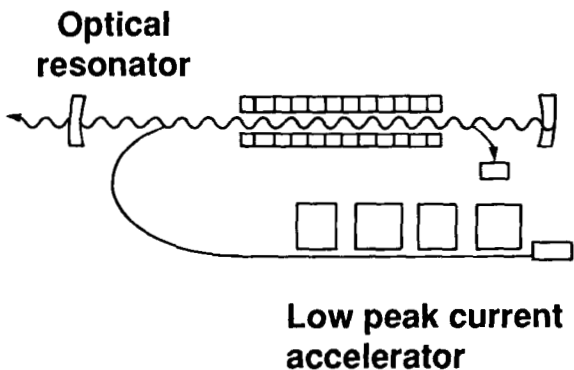

Master oscillator/power amplifier

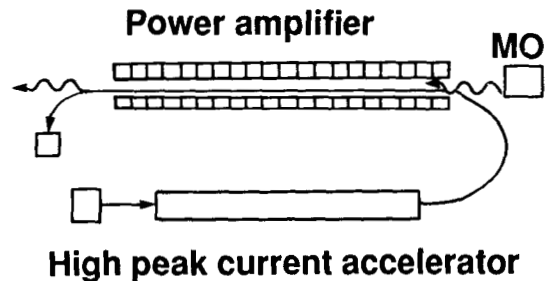

Wavelength scaling

The condition for resonance between the magnetic field of the wiggler and the electromagnetic radiation produced by the electrons is established through the Lorentz contraction of the wiggler period into the frame of reference of the electron and the Doppler shift of the radiation. If the resonance condition is not met for an FEL design at a given wavelength, it is possible (even likely) that no net energy will be extracted from the electron beam or that the electron beam will actually extract energy from the injected signal applied to the wiggler. In general, a wiggler of a given period and magnetic field will be resonant with shorter wavelengths as the energy of the electrons is increased, scaling as the inverse square of the energy.

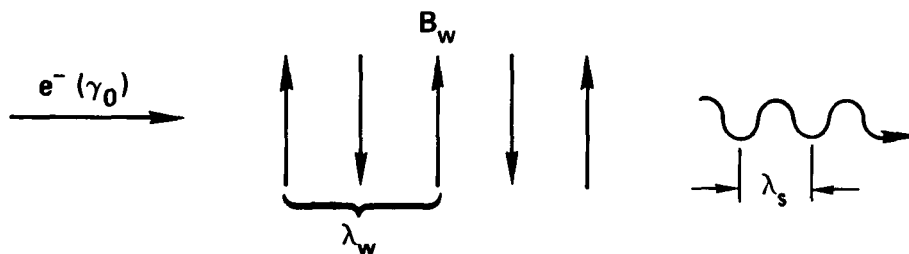

The output frequency of the FEL is the result of a Lorentz contraction (of the wiggler period) followed by a Doppler shift.

$$\lambda_s = \frac{\lambda_w}{2 \gamma_{\parallel}^2} = \frac{\lambda_w}{2 \gamma_0^2} \left[1 + \frac{1}{2} \left(\frac{e B_w \lambda_w}{2 \pi m c} \right)^2 \right]$$

FEL resonance condition in the near infrared

Design trades are illustrated in this figure for a wavelength of 1 μm . Current state of the art on wiggler technology for the near infrared makes use of wiggler periods in the range 4 - 10 cm and peak fields in the range 2 - 5 kG. Permanent magnet, electromagnet, and hybrid designs have been constructed. It can be seen that e-beam energies in the range 100 - 200 MeV are prescribed by the resonance condition. Other constraints must be applied to the choice of wiggler parameters. The Halbach limit deals with constraints on delivering the requisite peak field to the wiggler axis as the wiggler takes on different values of period and gap between the pole tips.

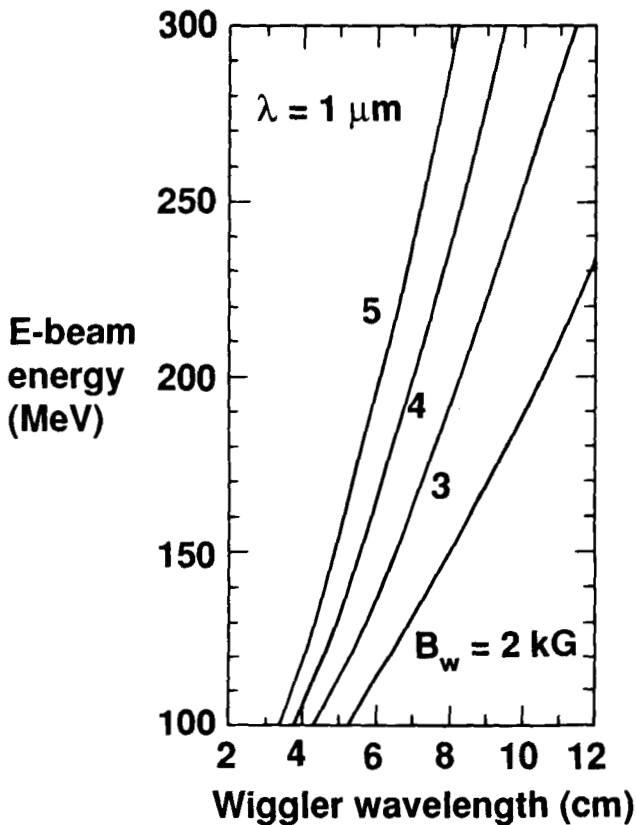

Resonance condition

$$\lambda = \frac{\lambda_w}{2 \gamma^2} (1 + a_w^2)$$

$$\gamma = \frac{E \text{ (MeV)}}{0.511}$$

$$a_w \approx 0.0661 B_w \text{ (kG)} \lambda_w \text{ (cm)}$$

Halbach limit*

$$B_w \leq 33.4 \exp \left[-\frac{g}{\lambda_w} \left(5.47 - 1.8 \frac{g}{\lambda_w} \right) \right]$$

g = gap between poles

* hybrid undulator, electromagnet with steel core assisted by permanent magnets

Electron capture and deceleration

Establishing conditions for the initial resonance is only part of the problem associated with achieving high extraction efficiency from the FEL. Resonance between the electromagnetic field and wiggler motion must be considered for the ensemble of electrons making up the beam. These electrons are spread out uniformly along the axis and have some instantaneous energy distribution for a real beam. The phase space plot on the left illustrates the initial conditions, where the vertical axis is electron energy and the horizontal axis is equivalent to axial position expressed as a relative phase angle between some idealized single resonant electron and every other electron in the beam. Initial conditions at the entrance to the wiggler promote axial bunching of the electrons on scale lengths of the wavelength of the electromagnetic field injected at the entrance to the wiggler. For a MOPA configuration, this initial EM field would be that of the master oscillator. A region of the electron phase space is defined (a ponderomotive well) such that electrons confined to this region will be decelerated. Electrons that are not trapped in this well remain relatively unaffected by the FEL interaction. The schematic at right illustrates the situation after propagation through some portion of the wiggler, where the phase space viewed is now associated with one electron bunch of spatial extent equal to the wavelength of the light. The trapped particles have now been decelerated by some amount, producing gain in the light wave. In order to maintain resonance as the deceleration takes place, adjustment of wiggler parameters must occur. The magnetic field or the wiggler period can be reduced to maintain resonance as the electrons lose energy. This technique is called tapering. Several real world effects can cause electrons to spill out of the ponderomotive well (often called a "bucket") as propagation proceeds down the wiggler. Field errors in the wiggler can provide discreet kicks to the beam that destroy resonance or the electron beam may be misaligned with respect to the magnetic axis of the wiggler so that its betatron motion eventually results in partial decoupling of the electron distribution in the transverse plane from the propagating EM spatial mode.

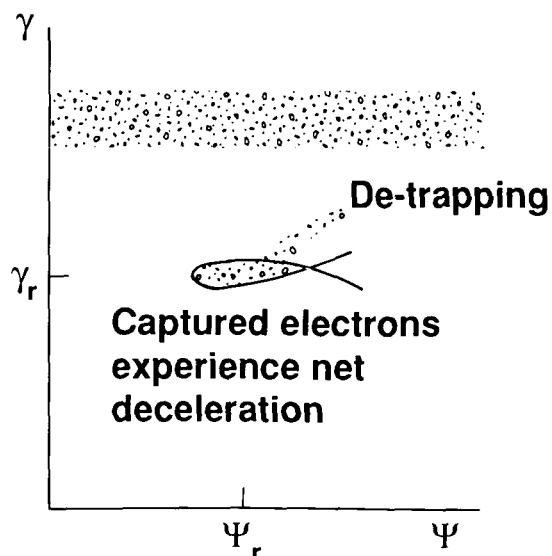
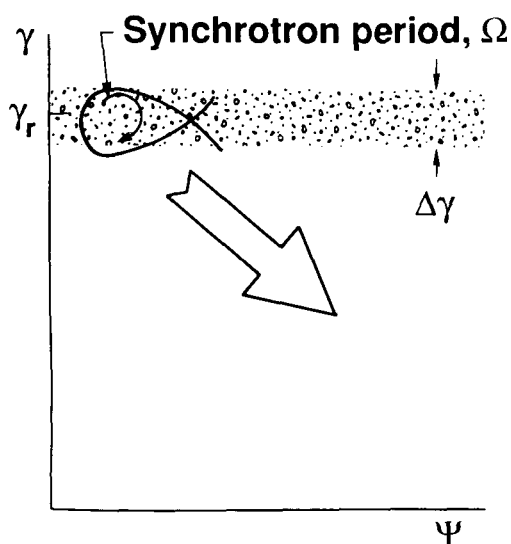

- Ponderomotive well defines stable phase space orbits

- De-trapping mechanisms reduce gain

Typical FEL amplifier performance and B-field tapering in the near-infrared

For a high gain (typically high peak current) FEL amplifier, a typical tapered wiggler B-field profile along the axial coordinate of the wiggler is shown. The corresponding laser intensity as a function of position is shown at left. The amplifier produces extremely high exponential gain in the initial stages until saturation occurs. At this point, significant tapering must begin in order to maintain resonance. Beyond saturation, significant energy extraction occurs from the electron beam.

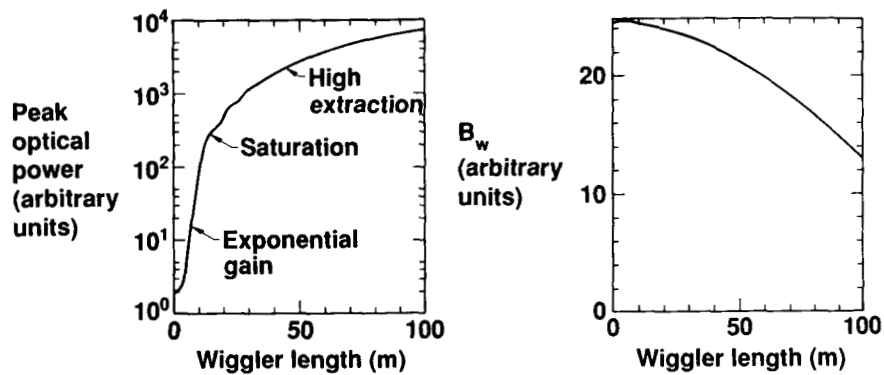

Induction FEL technology will provide sources over a broad spectrum

The possibility of producing FEL design concepts over a large region of the electromagnetic spectrum has prompted FEL research groups around the world to study and propose a multitude of experiments. Many of these experiments are now underway and some have achieved remarkable success. As an example of the wide range of technology options that any given program may be pursuing, the array of FEL devices under study at Livermore is illustrated. The Electron Laser Facility (ELF) was used to conduct an experiment at a wavelength of 8 mm that showed high extraction efficiency in a MOPA configuration. The Microwave Tokamak Experiment (MTX) is now under construction and will supply mm-waves and multi-megawatts of average power to the Alcator-C tokamak. The PALADIN experiment is currently operating at a wavelength of 10.6 um using a 25 meter long hybrid wiggler with extremely low field errors. High single pass gain has been observed on this experiment. Detailed computational studies have been conducted over the last two years on a 1 um FEL which is being offered to the U.S. Army Strategic Defense Command as an option for use in its Technology Integration Experiment at the White Sands Missile Range. Finally, some high gradient accelerator research being conducted in collaboration with LBL and SLAC has produced encouraging results on a relativistic klystron that could be used to drive traveling wave accelerators at average gradients of order 100 MeV/meter. Access to the high e-beam energy regime with a compact accelerator has spawned computational studies of single pass vacuum ultraviolet and soft x-ray FELs for a variety of applications (e.g. holography and x-ray lithography).

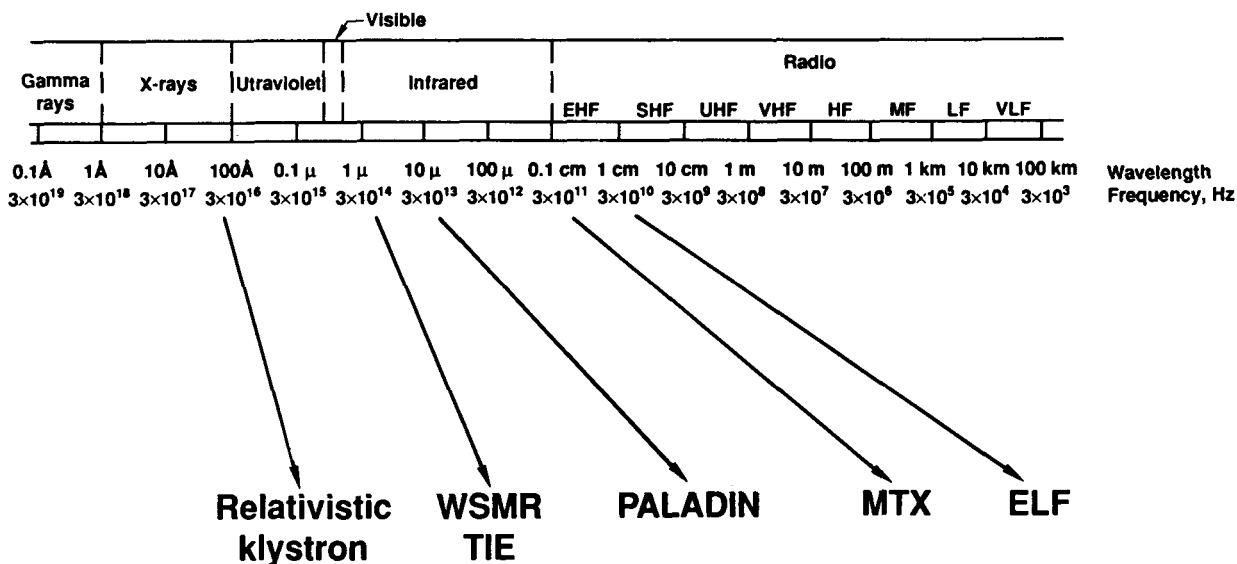

Experiments at the Electron Laser Facility (ELF) produced
1 GW of peak power at 35 GHz

High single pass extraction efficiency in an FEL device was first observed at Livermore in 1984. The ELF device made use of the existing Experimental Test Accelerator, a 3.5 MeV induction accelerator. The multi-kA beam of the accelerator was passed through an emittance filter to obtain a beam of sufficient quality for an FEL experiment. Typical peak currents delivered to the wiggler were in the range 800 - 1000 Amperes in a pulse lasting 15 - 20 ns. The wiggler was a pulsed electromagnet and was assembled from 1 meter long modules. Experiments involved wiggler lengths of 3 - 4 meters. A conventional magnetron was used as the master oscillator source, producing 40 - 50 kW of peak power. The experiment typically ran at repetition rates of 0.5 - 1 Hz. A schematic diagram is shown of the experimental layout. Experimental results are shown at right. It can be seen that exponential gain of ~ 30 dB/meter was observed in the front end of the wiggler. Upon gain saturation, the performance of an untapered wiggler was observed to degrade rapidly, in good agreement with the predictions of a particle simulation code that treated the electron motion in 3 dimensions and the electromagnetic field in two dimensions (upgraded since then to 3-D). The tapered wiggler continued to extract energy from the e-beam, producing 1 GW of peak power at a single pass extraction efficiency of 35 - 40 %.

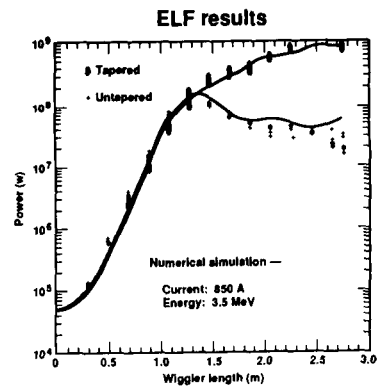
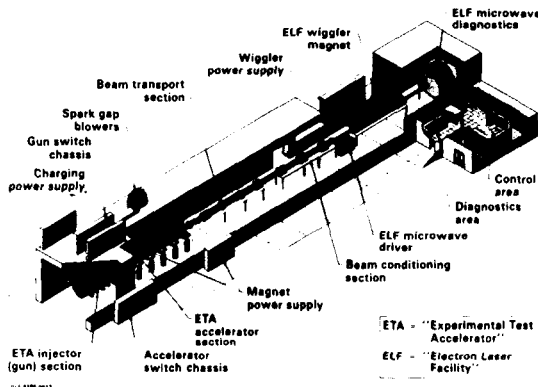

IMP is designed to deliver high peak and high average power radiation

Since 1986, the accelerator used on ELF has been upgraded to produce a much higher quality e-beam at high repetition rate (5 kHz). The new accelerator is undergoing initial activation and testing this year. By 1991, the goal is to couple the output of this accelerator to a new wiggler based on the parameters shown in this chart. The device will operate at 250 GHz and will produce peak power of 12 GW and average power of 2 MW for delivery to the Alcator C tokamak located adjacent to the facility. The extraction efficiency in the mm-wave regime is calculated to be quite high. Typical of these MOPA devices, the mm-wave beam quality is expected to be very good, featuring virtually single transverse mode operation. This device, and others of its generation, will begin the demonstration of efficient, high average power mm-wave operation in the laboratory during the 1990s, with mode quality suitable for convenient phased array operation for power beaming applications.

IMP design parameters:

E_{beam}	10 MeV
I_{beam}	3 kA
f	250 GHz
P (peak)	12 GW
% extraction	40%
P (ave)	2 MW
PRF	5 kHz

IMP wiggler

L_w	5.5 m
λ_w	0.1 m
B_w (max)	4.5 kG

Experimental Test Accelerator II (ELF II/IMP microwave facility)

A schematic of the IMP facility is shown in this chart. The induction accelerator is shown in the shielded tunnel with the pulse power units located directly above. Magnetic modulators are used for pulse compression on this system, thus avoiding the use of spark gaps for operation at 5 kHz. These devices have been operated into dummy loads at this repetition frequency. The FEL beamline is shown extending to the right. In initial tests this year, the ELF wiggler will be driven by the beam to produce 140 GHz pulses in short bursts for initial tokamak experiments. The facility will reach full high average power capability at 250 GHz in 1991.

Experimental Test Accelerator II (ELFII/IMP microwave facility)

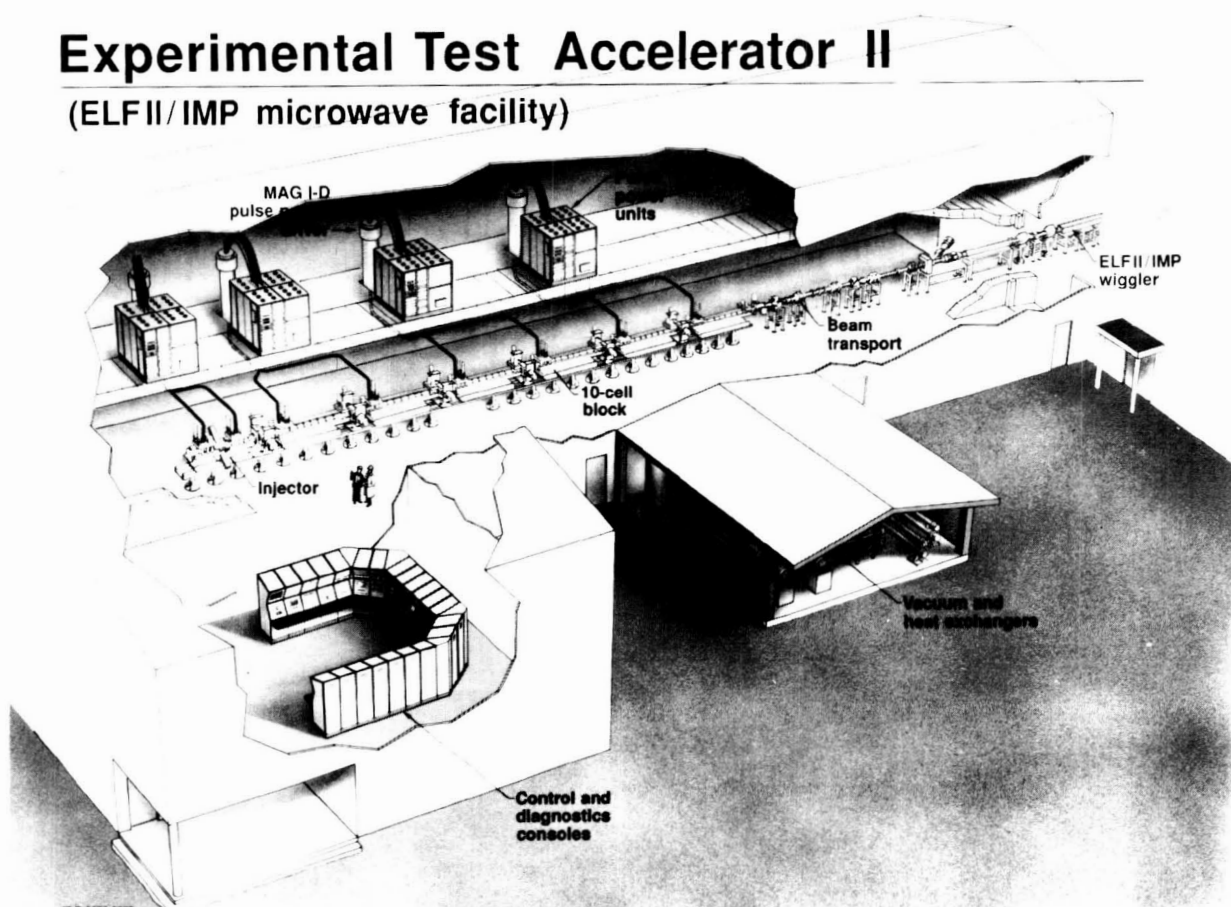

ORIGINAL PAGE
BLACK AND WHITE PHOTOGRAPH

Photo of ETA II induction accelerator

The existing configuration of the ETA II accelerator that will be used to drive IMP is shown. The electron injector is seen in the foreground. It currently produces a 1.5 MeV, 1.6 kA beam with a pulse length of 70 ns FWHM at a brightness of $> 3 \times 10^9$ A/(m-rad)², which greatly exceeds the brightness requirement for the IMP experiment. The output of the injector is currently being accelerated in the modules extending to the left up to an energy of ~ 5 MeV.

(See figure on next page.)

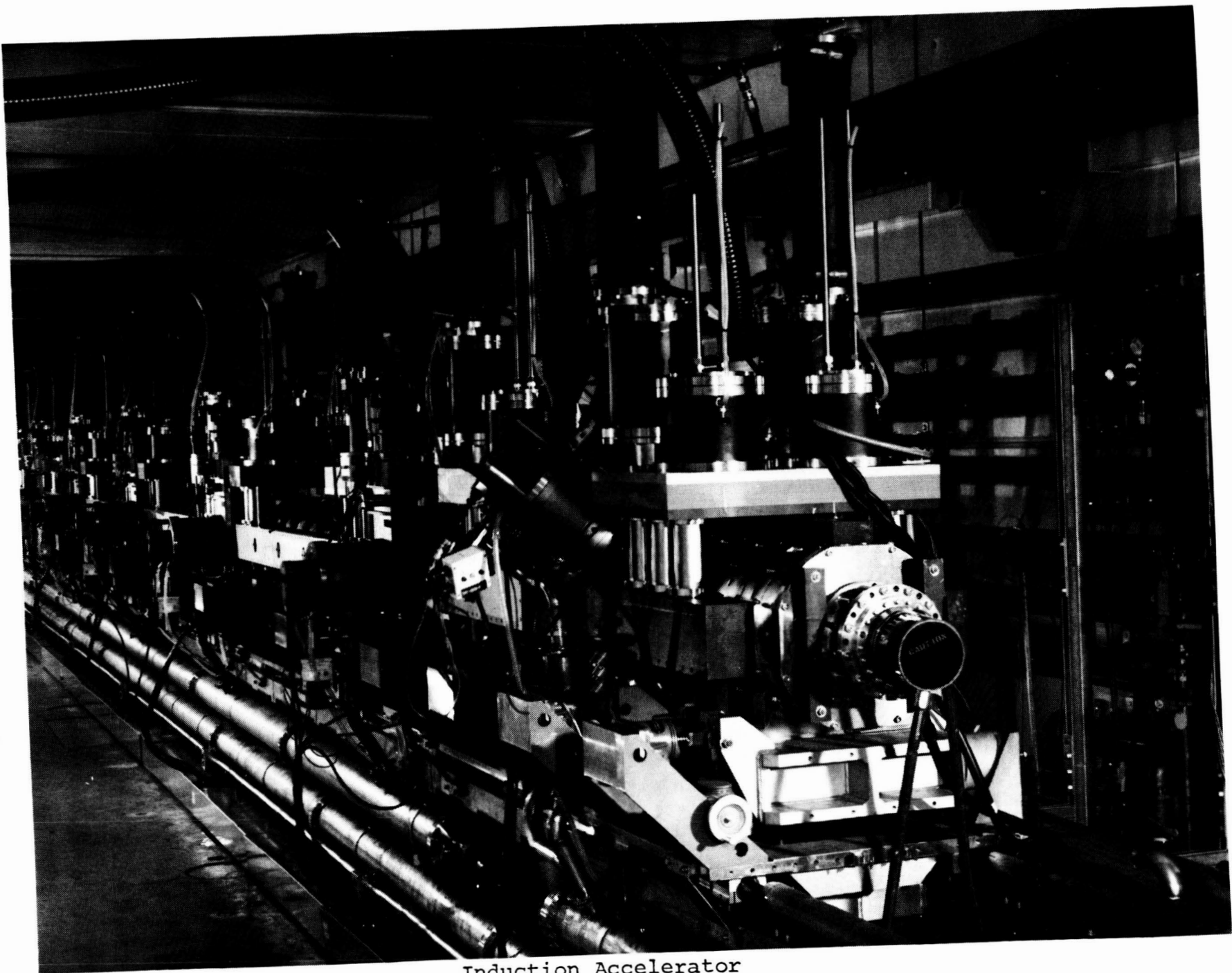

Induction Accelerator

ORIGINAL PAGE
BLACK AND WHITE PHOTOGRAPH

Photo of the PALADIN wiggler

As a representative example of the maturity of wiggler technology being fielded in laboratories around the world, this photo shows a view of the 25 meter long wiggler operating as part of the 10.6 um FEL experiment underway at Livermore. The 45 MeV, 500 Ampere beam from the Advanced Test accelerator makes a single pass through this device. Very high single pass gain has been observed to date with the wiggler being seeded by a conventional CO₂ laser located above the tunnel. The PALADIN wiggler has a period of 8 cm and a peak field of ~ 3 kG. It is a DC electromagnet that is operated for many hours at a time and has field errors of 2 parts in 1000. The electron beam has been routinely propagated through this device without application of external steering.

(See figure on next page.)

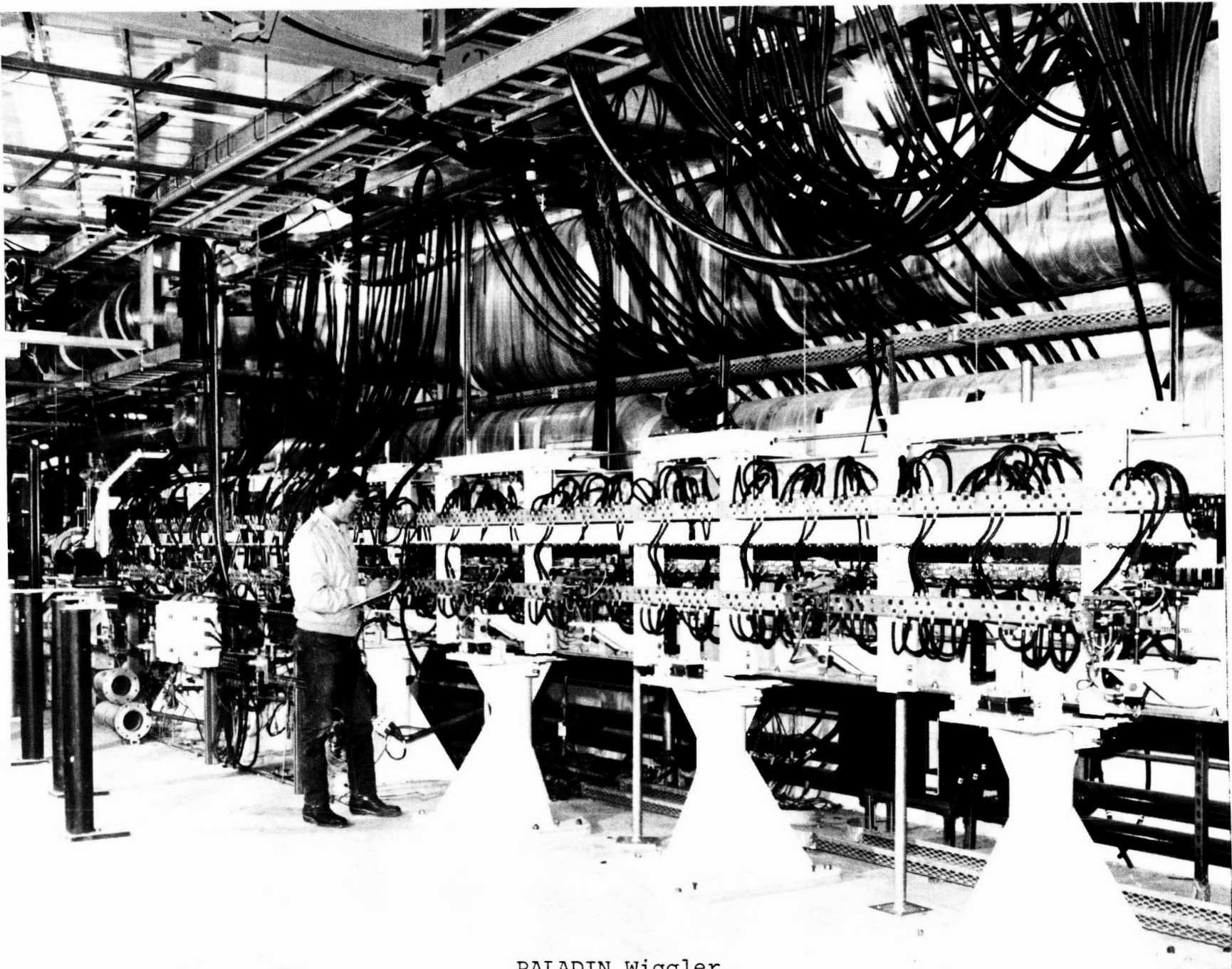

PALADIN Wiggler

ORIGINAL PAGE
BLACK AND WHITE PHOTOGRAPH

PALADIN Wiggler Schematic

The PALADIN wiggler is a hybrid wiggler in the sense that it is an electromagnetic device with permanent magnet assist. The wiggler is segmented into 5 meter long modules and is currently operating at a total length of 25 meters. Each module separates into top and bottom halves, where each side consists of cast iron pole pieces that are precisely machined on the tips after attachment to rigid structural beams. The curved shape produced on the pole tips provides gentle focusing of the e-beam in the horizontal plane. A water cooled coil is fitted over each pole piece to provide excitation and permanent magnets are attached to the sides of each pole piece to retard saturation in the iron, especially near the roots of each pole piece. The top half of each module is lowered onto the bottom half after assembly and the gap between pole pieces in the vertical direction is precisely controlled via gage blocks.

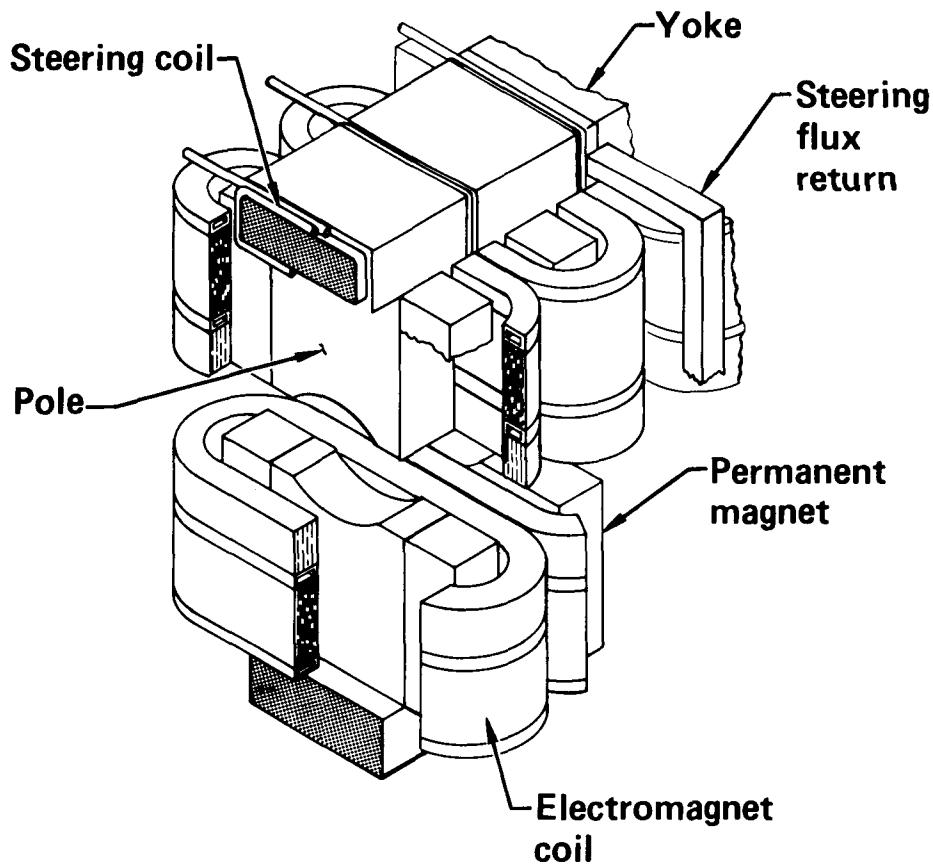

Artist's rendering of the Army's Technology Integration
Experiment site at the White Sands Missile Range

Significant focus in the optical FEL program has been on the development of design concepts for a moderate power free electron laser which would be integrated with an optical transmitter at the White Sands Missile Range in the mid-1990s at a wavelength near 1 um. The U.S. Army Strategic Defense Command is conducting a technology selection process for the type of FEL to be incorporated in the facility. FELs driven by RF linacs and induction machines are being offered by Boeing and TRW, respectively.

(See figure on next page.)

ORIGINAL PAGE
BLACK AND WHITE PHOTOGRAPH

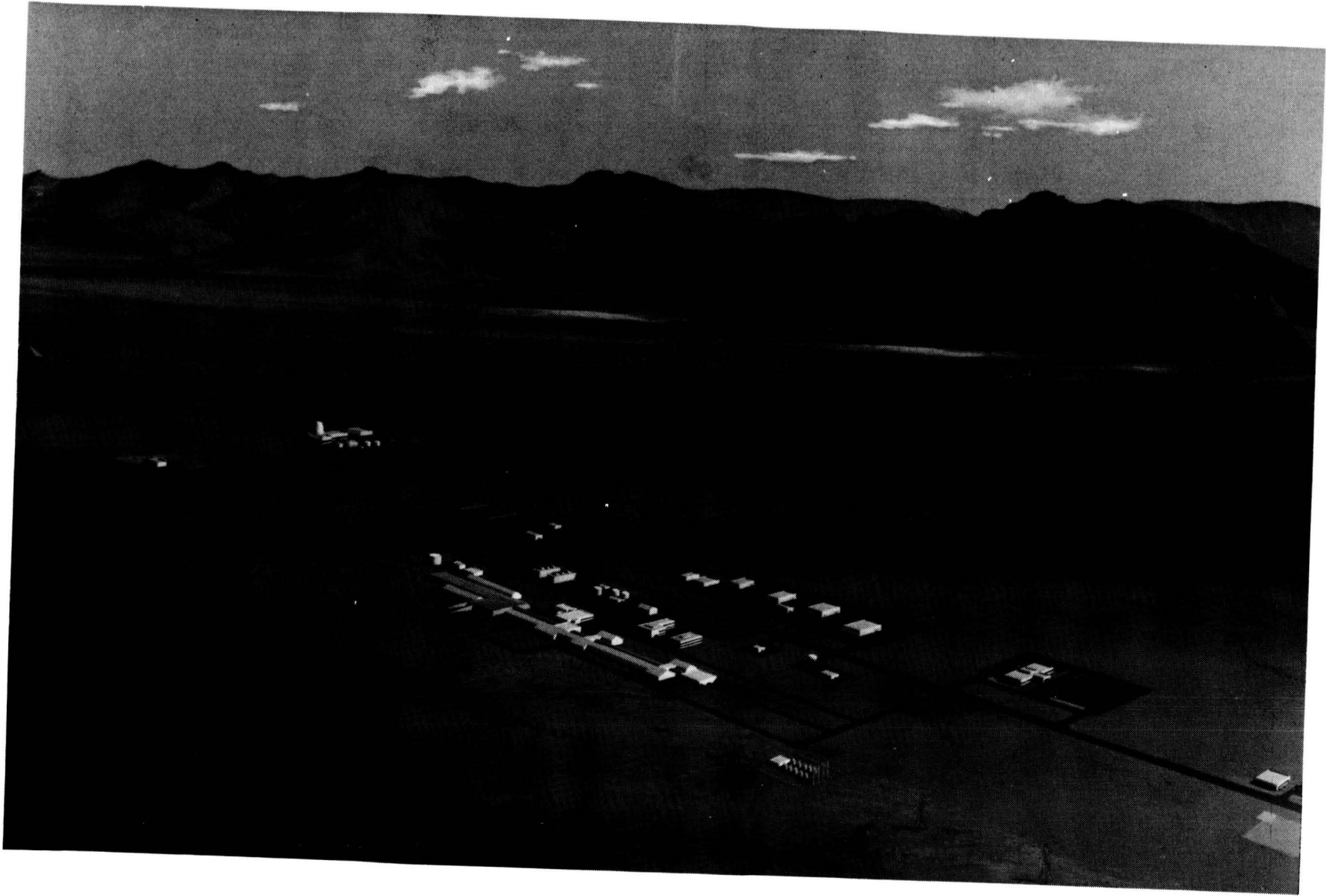

Artist's rendering of the Army's Technology Integration
Experiment site at the White Sands Missile Range

Schematic of a relativistic klystron

Various research groups around the world are examining advanced concepts for high gradient accelerators that could be used for TeV colliders and short wavelength FELs. The FEL resonance condition requires that the e-beam energy be increased as the design wavelength is reduced. Operation of FELs in the wavelength regime from the vacuum ultraviolet to soft x-rays requires 500 - 1500 MeV beams. In order to have reasonable overall size for these accelerators, the average gradient must be increased by an order of magnitude compared to the state-of-the-art. In this schematic, one approach being studied at Livermore is shown. A low energy induction accelerator is used to drive a series of relativistic klystron cavities that produce high peak power microwave pulses for insertion into a traveling wave high gradient beamline. The high peak power, short pulse and somewhat higher frequency of the relativistic klystron drive compared to conventional microwave tubes allow the high gradient beamline to sustain electric fields on its surfaces that are well above those used in conventional RF accelerators (10s to 100s of MV/m). Klystron tests at Livermore have demonstrated efficient conversion (~50%) of induction accelerator beam power to microwaves at 11.4 GHz. Peak power of 200 MW has been observed from a single extraction cavity. This microwave power was used to drive a prototype traveling wave structure (built by SLAC) up to field levels near 100 MV/m without observation of dark current or breakdown. The possibility of compact .5 - 1 GeV accelerators operating at peak currents of kiloamps could, in the future, allow the development of efficient single pass vacuum ultraviolet lasers that could be used for power beaming over very large distances within the solar system.

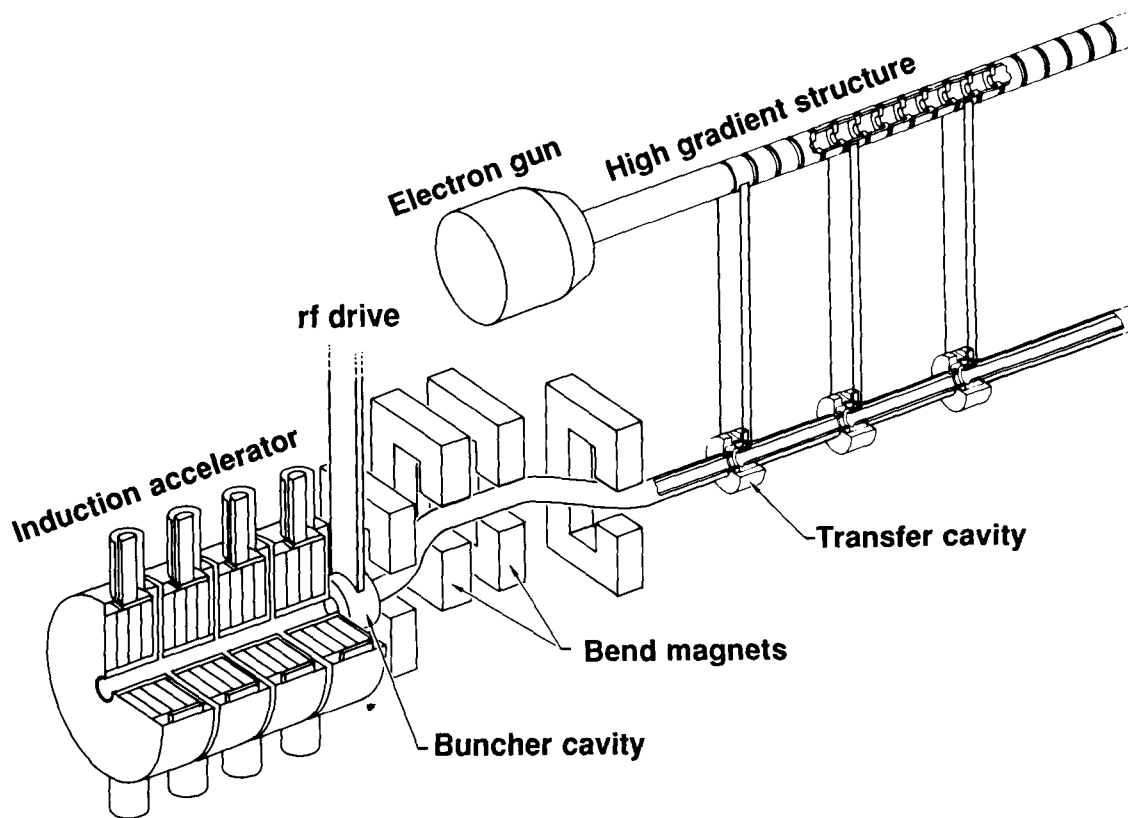

Photograph of relativistic klystron experiment

A 1.5 MeV induction accelerator shown in the foreground is used to drive the relativistic klystron device at the top of the picture. Peak power in the range 200 MW at 11.4 GHz has been observed at this facility. The length of this apparatus is approximately 4 meters.

(See figure on next page.)

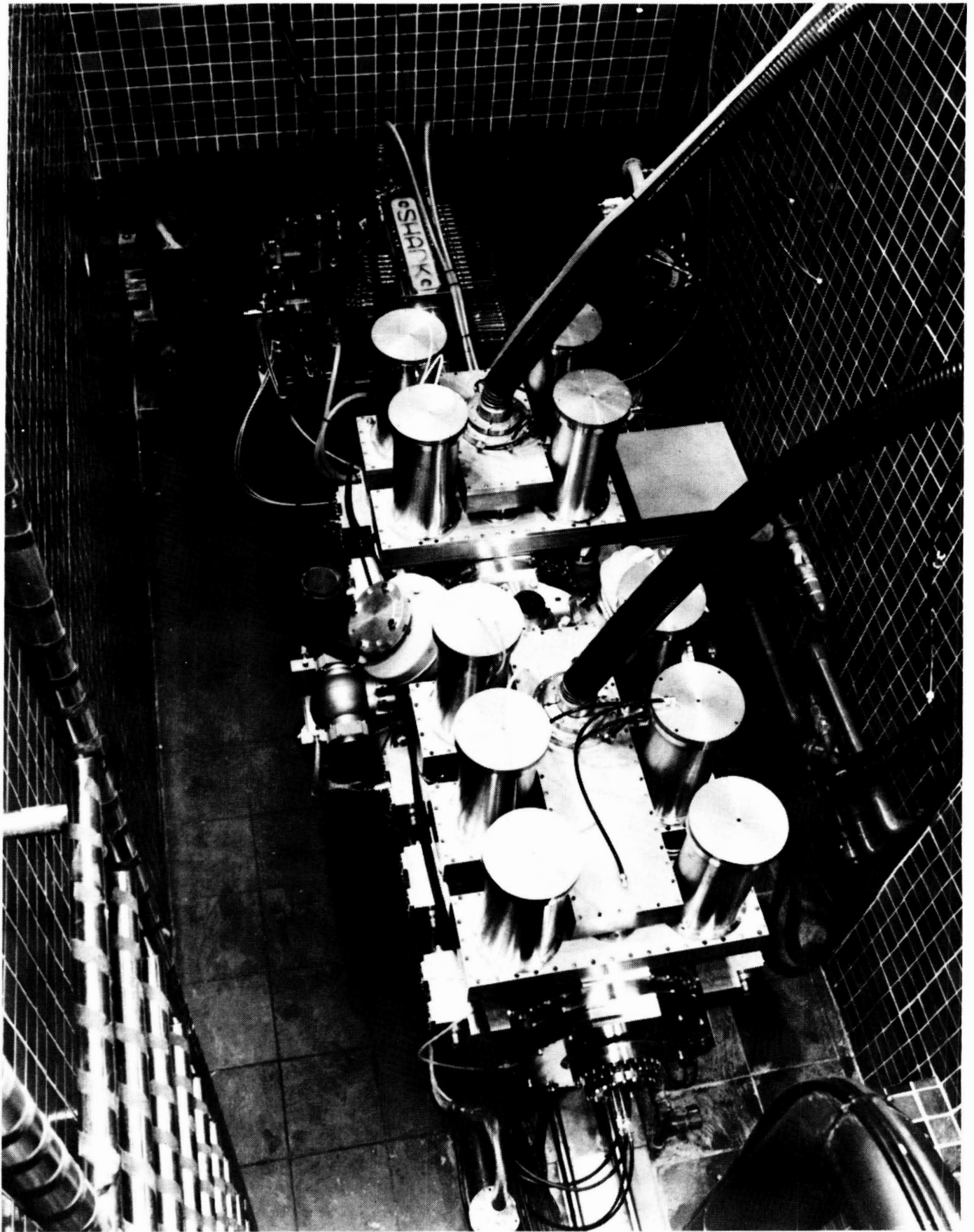

Photograph of a Relativistic Klystron Experiment

ORIGINAL PAGE
BLACK AND WHITE PHOTOGRAPH

Photograph of relativistic klystron tube

This 11.4 GHz tube is driven subharmonically through the larger waveguide at 5.7 GHz. The electron beam propagates from right to left in the picture. The subharmonic drive initiates bunching of the electron beam. In some of the designs tested, several bunching cavities are used to increase the gain of the device until extraction of the high power microwaves is performed in a cavity coupled to the smaller waveguide. These devices operate as wideband amplifiers which can be configured as injection-locked arrays.

(See figure on next page.)

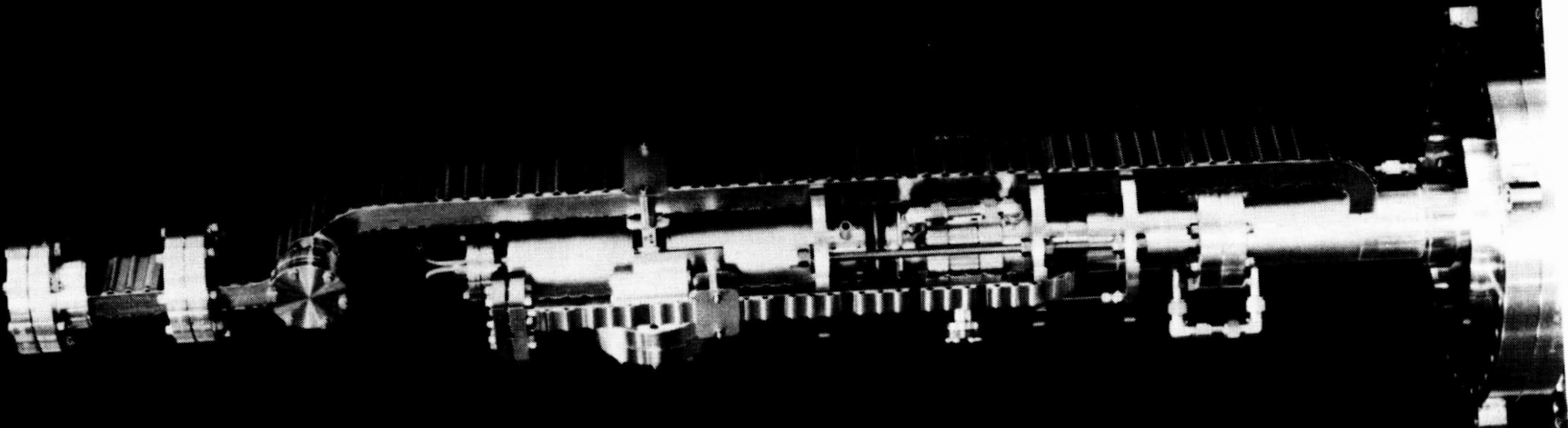

Photograph of Relativistic Klystron Tube

ORIGINAL PAGE
BLACK AND WHITE PHOTOGRAPH

Soft x-ray FELs, if they work, will exceed competing sources in peak spectral brilliance.

Particle simulation codes are now being used to estimate the conditions under which soft x-ray FELs can be made to work. Preliminary results indicate that it is possible to obtain coherent x-ray beams from single pass amplifiers. For applications such as semiconductor lithography and holography of biological materials, these sources could substantially increase the peak spectral brilliance of the source compared to conventional undulators and synchrotrons. In order to obtain this result, it will be necessary to improve the brightness of electron beams by 1 to 2 orders of magnitude while still maintaining high peak current. Wiggler technology will also need to be advanced in order to obtain very short wavelengths. Uncorrelated pole-to-pole wiggler field errors will have to be reduced by a factor of 10 compared to the current state-of-the-art. MOPA configurations are desirable in the very short wavelength regime because of the lack of suitable optics. In general, extraction efficiency will be quite low in the soft x-ray regime (perhaps 1% at best). Therefore, recirculation of the e-beam energy will be required for efficient operation. At Los Alamos, experiments have shown that the e-beam energy emerging from the wiggler can be converted into microwaves and delivered through bridge couplers back into the RF accelerating structure. At very low extraction efficiency, direct electron recirculation may be possible in ring geometries.

Key Issues

1. **Bright electron beams**
($10^{11} - 10^{12} \text{ A}/(\text{m-rad})^2$)
2. **High peak current**
(300 - 1000A)
3. **Accurate wigglers**
($\delta a_w/a_w < 10^{-4}$)

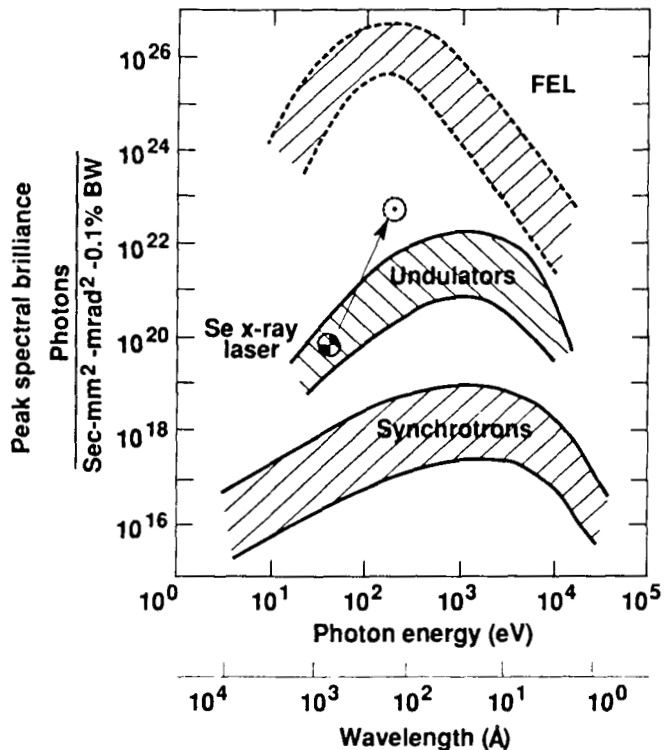

Key questions for short wavelength FEL technology development

Much of the practical experience in operating FELs in the world exists in the infrared and microwave regimes. Highly developed particle simulation codes, which have been validated at these longer wavelengths, are being used to predict the design requirements for shorter wavelength devices. It is important to remember that some key physics issues remain to be resolved for short wavelength operation. One example concerns the propagation of the electromagnetic wave through long wigglers as it interacts with the electron beam. As the wavelength becomes short, the wiggler can be many Rayleigh ranges long. (The Rayleigh range is the scale length over which diffraction is expanding the beam). Two processes tend to work against diffraction to confine the power in the optical mode to a transverse dimension comparable to the e-beam size. The first is gain guiding, which puts the power where gain exists (i.e. near the electron beam). This effect has been easily observed on PALADIN. The second effect is that of refractive guiding, where the non-uniform refractive index of the electron beam provides gentle focusing of the optical mode. Tentative indications of this effect have been seen in some experiments and computational studies have indicated that the effect should be present. Further validation is needed.

The drive toward shorter wavelength must also be accompanied by large improvements in e-beam quality in terms of brightness, energy uniformity (both instantaneous and throughout the electron pulse), and spatial jitter with respect to the axis of the magnetic transport system. Furthermore, these conditions must be reproducible at high repetition rate as the device is driven up in average power. The accelerator must be able to meet the requirements for high FEL extraction efficiency while coming to steady state conditions both electrically and thermally. Component reliability must be extremely high under these conditions.

- **Can the short wavelength FELs be made to work at all?**
 - Are we modeling the right physics?
 - Do computational models compare well with experiment?

- **Can high quality electron beams be produced (and reproduced)?**
 - High brightness
 - Low energy sweep
 - Small transverse jitter

E-beam requirements become more stressing as wavelength becomes shorter.

This chart illustrates the general trend toward more advanced accelerator capabilities as wavelength is reduced. The electron energy requirements prescribed by the resonance condition increase. Technical options supporting higher gradient accelerators become important as one proceeds to shorter wavelength. Brightness requirements, which can currently be met down into the near infrared, must be improved by factors of 10 to 100 in order to produce efficient FELs in the visible and ultraviolet. Finally, the tolerances on the variation of electron energy become much tighter.

Wavelength Parameter	Millimeter Wave	Mid- Infrared	Near IR/ Visible	Ultraviolet
Electron beam energy (MeV)	2 — 10	30 — 70	15 — 400	400 — 1000
E-beam brightness (A/(m-rad) ²)	1 — 10 x 10 ⁷	1 — 10 x 10 ⁸	1 — 10 x 10 ⁹	1 — 10 x 10 ¹⁰
E-beam energy sweep (%)	5 — 10	1 — 3	.3 — 1	.1 — .3

Summary

A brief update was presented on the current trends in the development of FEL technology that could potentially support future power beaming applications. Concepts exist at this time that could allow efficient conversion of electrical power to directed energy beams over an extremely large spectral range. Component technology is beginning to mature to the point where high average power operation is possible, although the current generation of prototype devices is rather large and expensive. Realization of the need for compactness, light weight, and affordability has begun to spawn some advanced concepts that could move the technology toward practical applications over the next decade.

- **Concepts for efficient conversion to directed energy are being developed over a broad spectral range**
- **Some schemes are beginning to address need for compactness and light weight**
 - **must maintain favorable high power scaling**
- **In general, current generation of technology is inadequate**
 - **too large**
 - **too expensive**

N 9 0 - 1 0 1 5 2 512-36

LASER ENERGY CONVERSION

216776

N. W. Jalufka
Physics Department
Hampton University
Hampton, Virginia

HD 608674

PRECEDING PAGE BLANK NOT FILMED

INTRODUCTION

The conversion of laser energy to other, more useful, forms is an important element of any space power transmission system employing lasers. In general the user, at the receiving sight, will require the energy in a form other than laser radiation. In particular, conversion to rocket power and electricity are considered to be two major areas where one must consider various conversion techniques.

Colson 3/8
P.

REQUIREMENTS FOR A SPACE-BASED LASER ENERGY CONVERTER

The major requirements for a laser energy converter are listed below. These requirements are justified by the following:

High Conversion Efficiency - One wants to convert as much of the laser radiation as possible since laser energy not converted to useful energy will be converted to heat which must be rejected from the system by radiators.

Wavelength Independent - One does not know at this time which laser systems will be employed in a space-based power transmission system. One would like for the converter to be able to operate on any available laser.

High Power-to-Weight Ratio - Initial cost of launching the system into space may constitute a major portion of the mission cost.

High Reliability - Repair to space-based equipment is not only costly but also equipment failure could jeopardize a mission.

Minimum Maintenance - One does not want to spend a large portion of his time in space carrying out routine maintenance. It would appear that a static system might have an advantage in meeting this requirement.

- High Conversion Efficiency
- Wavelength Independent
- High Power-to-Weight Ratio
- High Reliability
- Minimum Maintenance

LASER PROPULSION

Conversion of laser energy to Rocket thrust can be achieved with the thruster shown below. The laser energy is absorbed by the plasma ($T = 15,000$ to $20,000\text{K}$) and a portion of the energy is converted to heat. The heated plasma expands through the nozzle producing thrust. Such a device should have an efficiency in excess of 50%. The remaining energy is lost in molecular disassociation, ionization and excitation of molecular and atom. Heat and radiative losses to the wall may be partially recovered and used to preheat the incoming gas which should raise the overall efficiency and reduce the waste heat which must be removed from the sytem by radiators.

LASER ROCKET THRUSTER

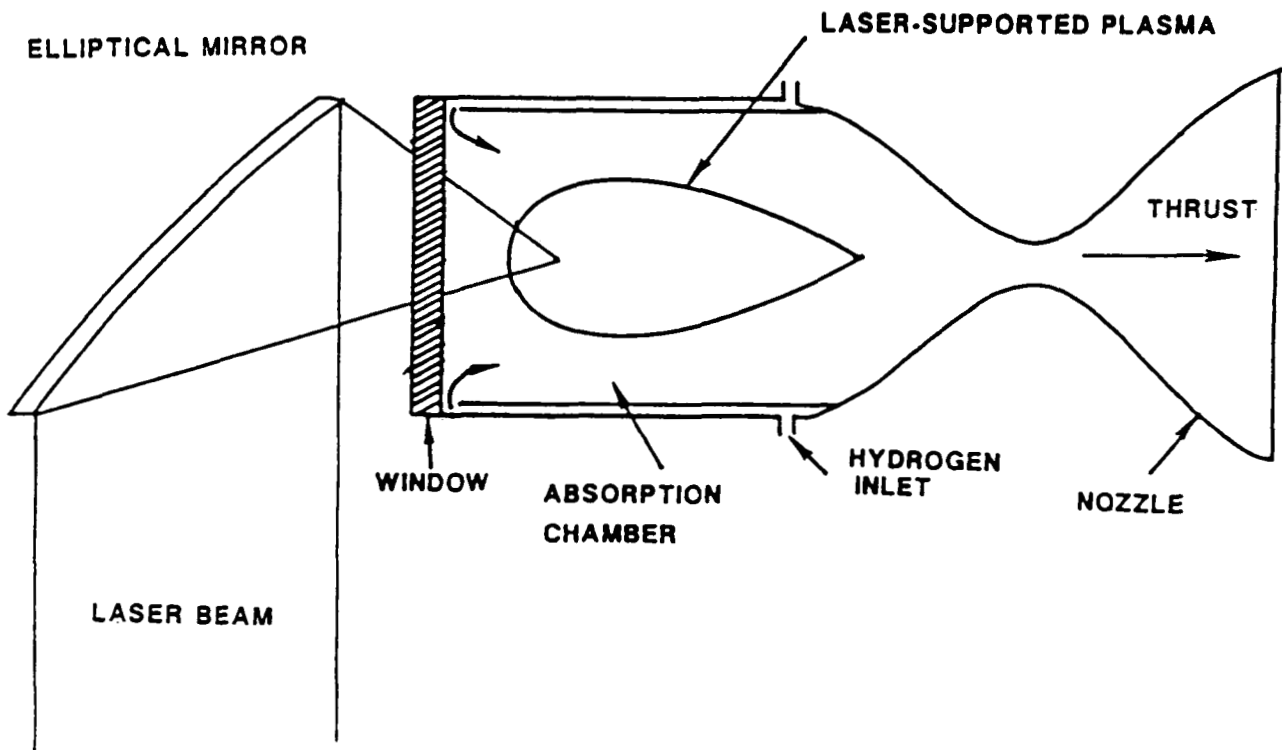

PRINCIPAL ENERGY CONVERSION TECHNIQUE

The chart lists the principal technique for converting laser energy to electricity. Only those techniques which have a good technology base are considered.

Direct Conversion

Photovoltaic Cells

Dynamic Conversion

Gas Turbine

MHD Generators

LASER ENERGY-SEMICONDUCTOR BAND GAP ENERGY COMPARISON

The chart shows the energy band gap of various semiconductors and the photon energy for several different lasers. When the semiconductor absorbs photons from the laser, beam electrons are raised into the conduction band of the semiconductor allowing a current to flow. For a particular laser, one would choose the semiconductor having an energy band gap closest to the photon energy in the laser beam. The closer this match, the higher the efficiency.

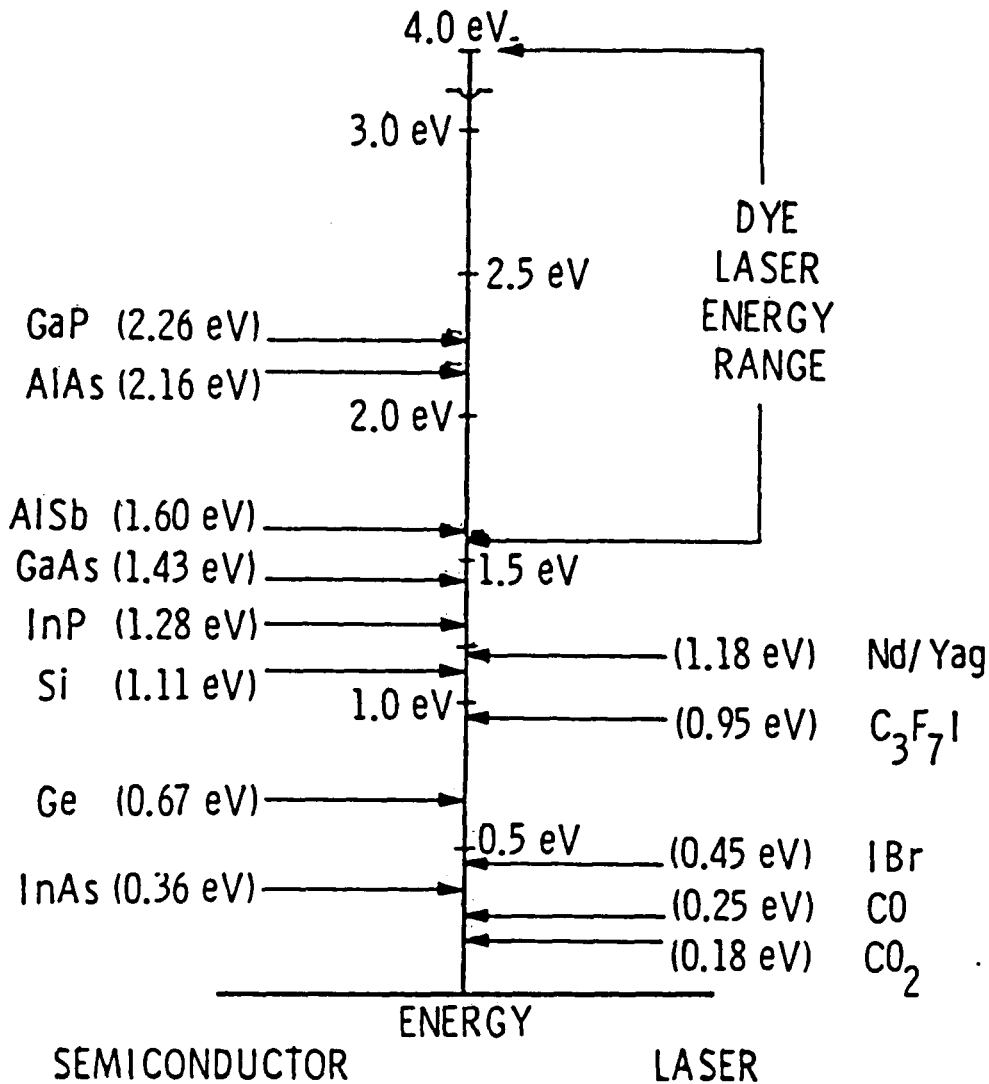

TYPES OF PHOTOVOLTAIC CONVERTERS

This figure shows the construction of three different types of photovoltaic converters. The Schottky Barrier converter uses a thin metal barrier which results in a large series resistance and has the lowest efficiency of the three.

The conventional p-n junction converter is the standard solar cell construction. A limiting feature of this type of cell is that charge carriers diffuse laterally resulting in a high series resistance.

The vertical p-n junction converter is best suited for high intensities and has the lowest series resistance. This converter has the highest efficiency of the three with efficiencies of about 50%.

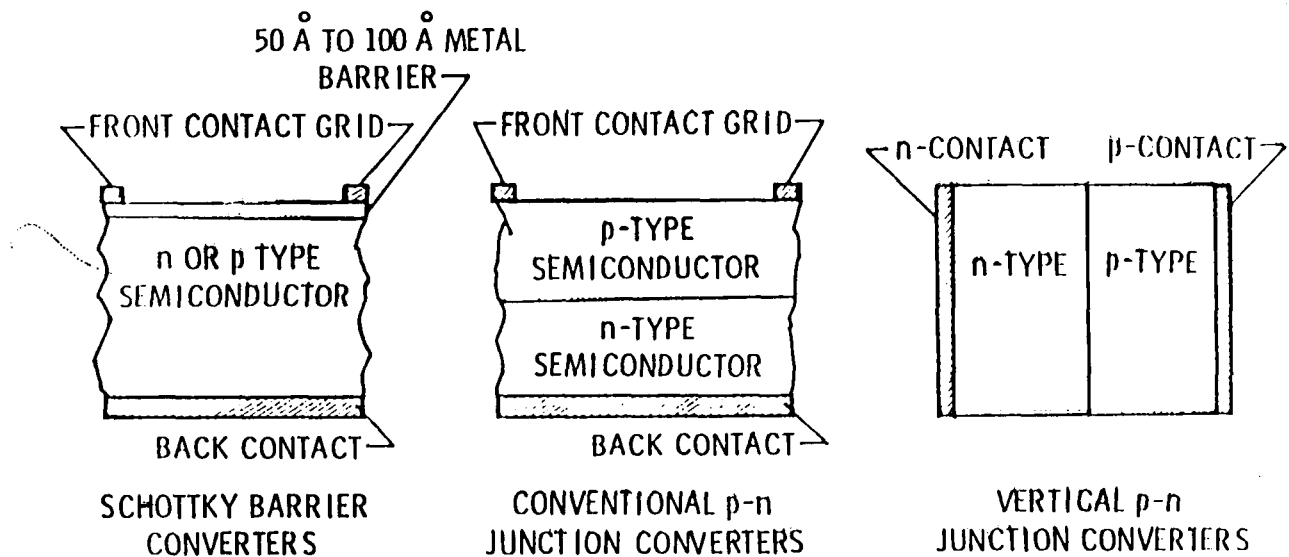

SERIES-CONNECTED, VERTICAL-MULTIJUNCTION PHOTOVOLTAIC CONVERTER

This figure shows the construction of the series-connected, vertical-multijunction photovoltaic converter. This is just a stack of vertical p-n junction converters. As constructed, the device has a low series resistance and high efficiency.

M - metal
n - n-type semiconductor
p - p-type semiconductor

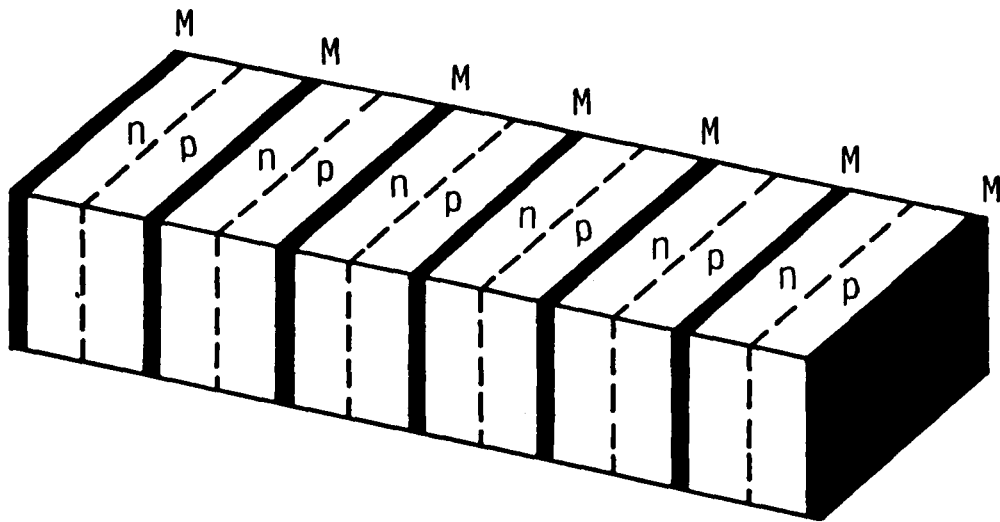

PHOTOVOLTAIC CELLS

This table lists the advantages and disadvantages of photovoltaic cells as space-based laser energy converters.

Advantages

- Proven Technology
- High Conversion Efficiency > 40%
- High Power Density
- Low Maintenance

Disadvantages

- Low Temperature Operation
- High Intensity Effects Not Well Understood
- Restricted Wavelength Coverage

MHD GENERATOR

This figure shows a Schematic of a simple MHD generator. Power is generated when a plasma moves with velocity \vec{v} through the magnetic field \vec{B} . The resulting $\vec{v} \times \vec{B}$ force causes a current to flow between the electrodes. To use this system for laser energy conversion, the laser energy either creates and heats the plasma which flows through the generator, or it may be used to heat an existing plasma prior to its introduction into the MHD generator.

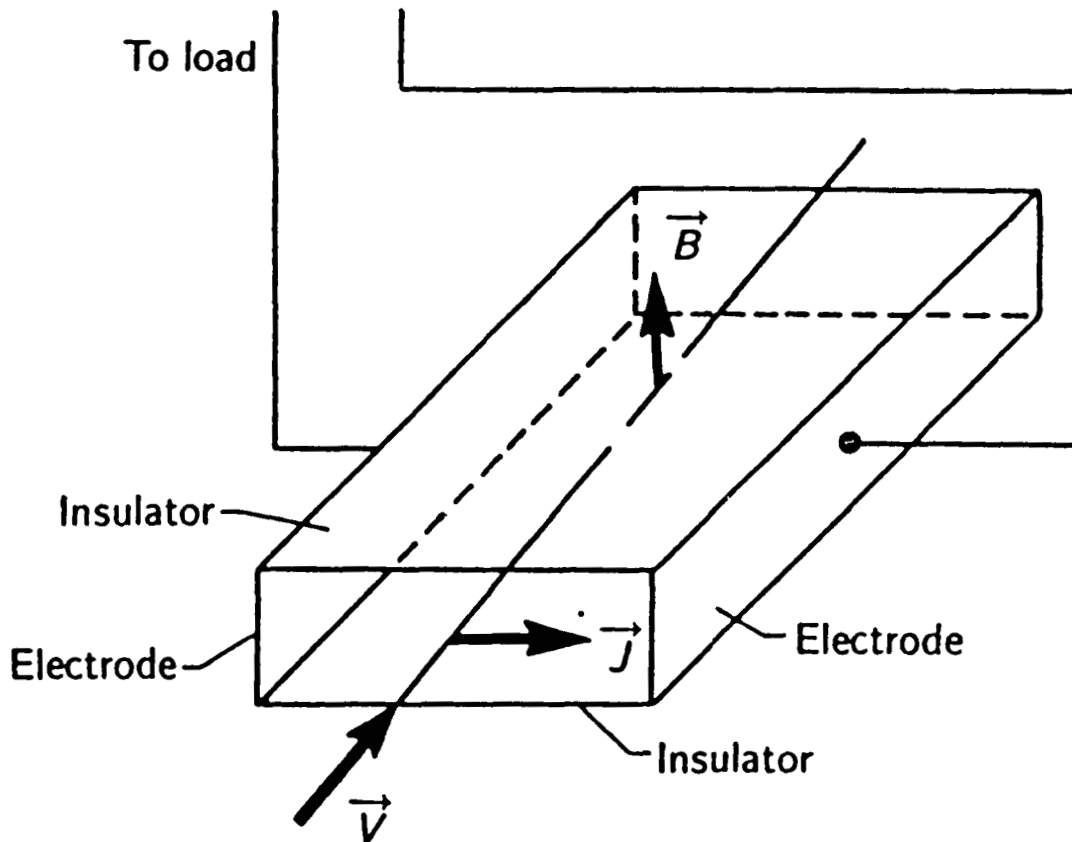

PULSED MHD SYSTEM

Focussing of the laser beam at the rear of the generator creates a breakdown in the gaseous medium resulting in a high temperature, dense plasma. As the plasma density increases the plasma becomes optically thick to the laser radiation (the laser cannot penetrate into the plasma) and a laser supported detonation wave is formed. The wave propagates to the left along the laser beam and as the wave passes through the MHD generator power is produced. Conversion efficiencies in excess of 50% are theoretically possible.

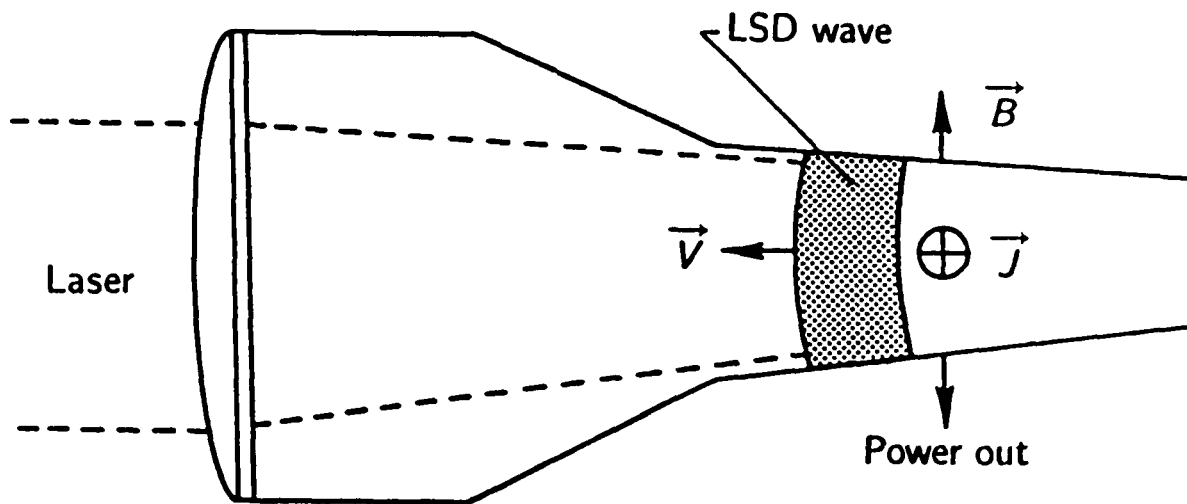

LIQUID-METAL MHD SYSTEM

A schematic of a liquid metal MHD, Brayton cycle space based system. The incoming laser radiation is used to heat the liquid-metal which is then mixed with the carrier gas. After passing through the MHD generator the flow is expanded through a nozzle into the separator where the liquid metal is separated from the carrier gas. Liquid metal and carrier gas are then recycled to the system. Conversion efficiencies of 70% are theoretically possible for the generator giving an overall system efficiency of 25-30%.

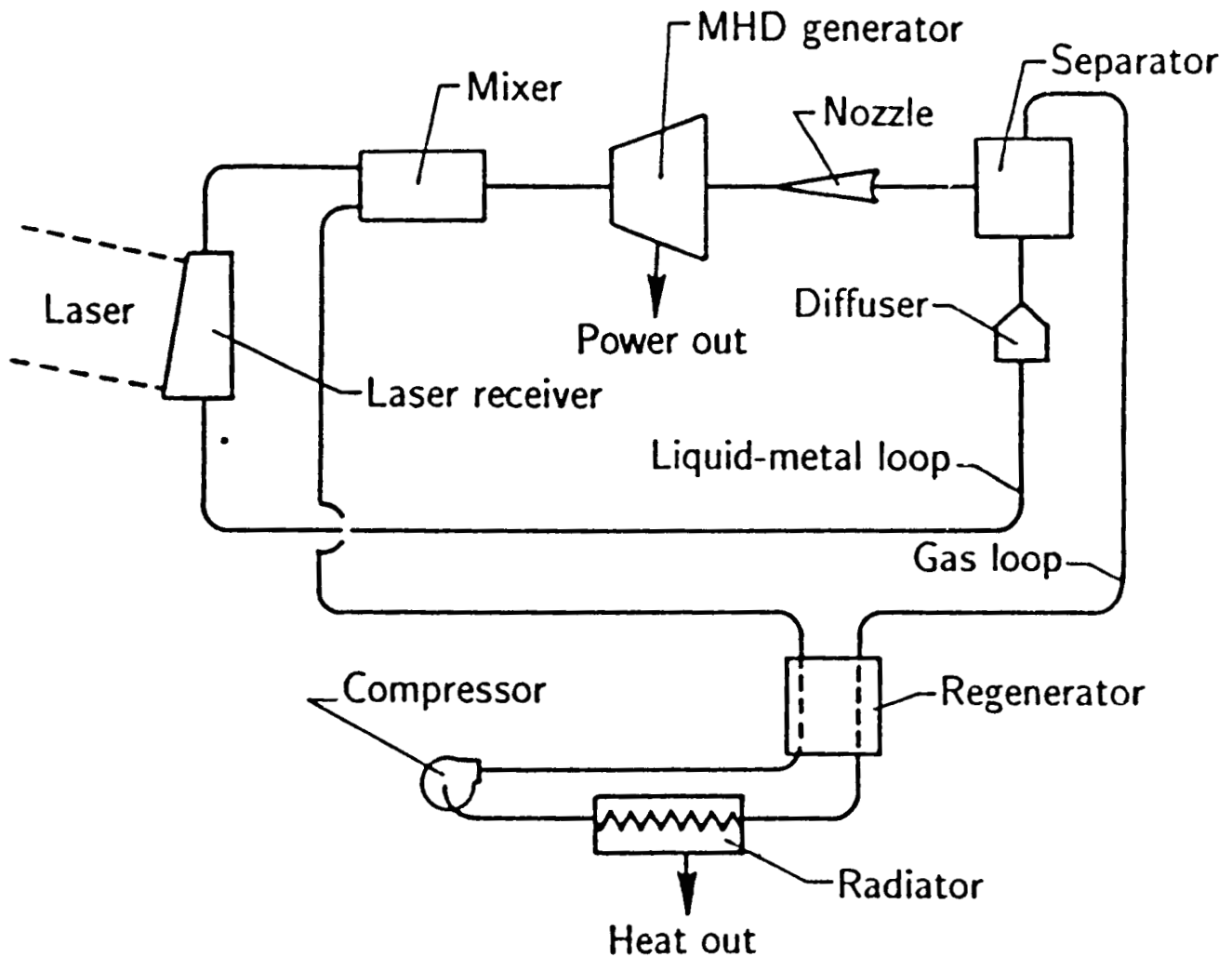

MHD GENERATORS

The table lists the advantages and disadvantages of MHD generators for space application.

Advantages

- **Large Existing Technology Base from Terrestrial Applications**
- **Proven Technology**
- **High Overall System Efficiency**
- **High Power Density**
- **Closed Cycle Operation**
- **Low Maintenance (few or no moving parts)**
- **Operation Over a Broad Wavelength Range**

Disadvantages

- **Not Flight Proven**
- **Weight**

LASER BRAYTON CYCLE TURBINE SYSTEM

Below is a schematic of a laser powered Brayton Cycle turbine system. The incoming laser energy is used to heat helium which is then expanded through a gas turbine. The turbine shaft drives a compressor to recycle the helium and a generator to produce electrical power. Overall efficiencies of 30% are predicted for this system.

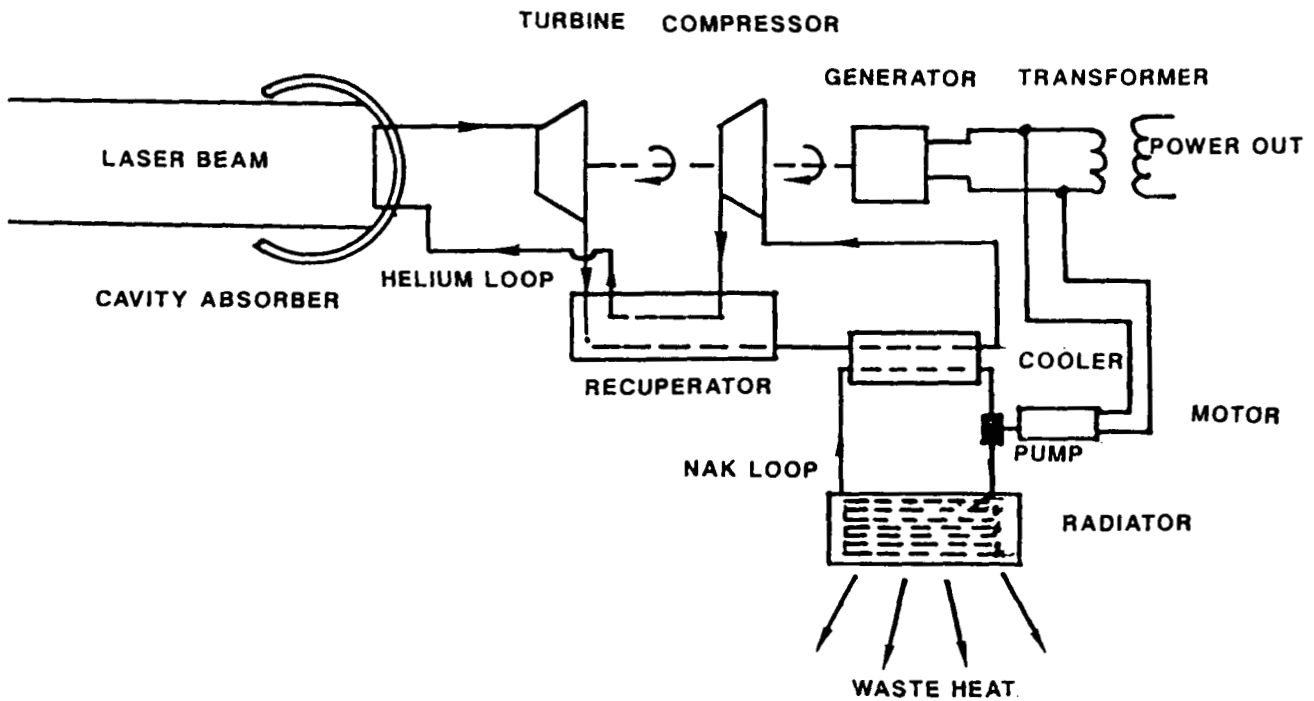

GAS TURBINES

The table lists the advantages and disadvantages of gas turbines for space power application. Conversion of laser energy to heat in the helium loop should be very efficient.

Advantages

- Proven Technology
- High Reliability
- Good Efficiency (~ 30%)

Disadvantages

- Rotating System (high maintenance)
- Materials (high temperature operation)

OPTICAL RECTIFICATION

The figure shows the concept of optical rectification as an energy converter. Not well developed, this method does, however, show much promise as an efficient laser energy converter with conversion efficiencies in excess of 50% being predicted. This system has not been developed to a point that all of its advantages and disadvantages are known.

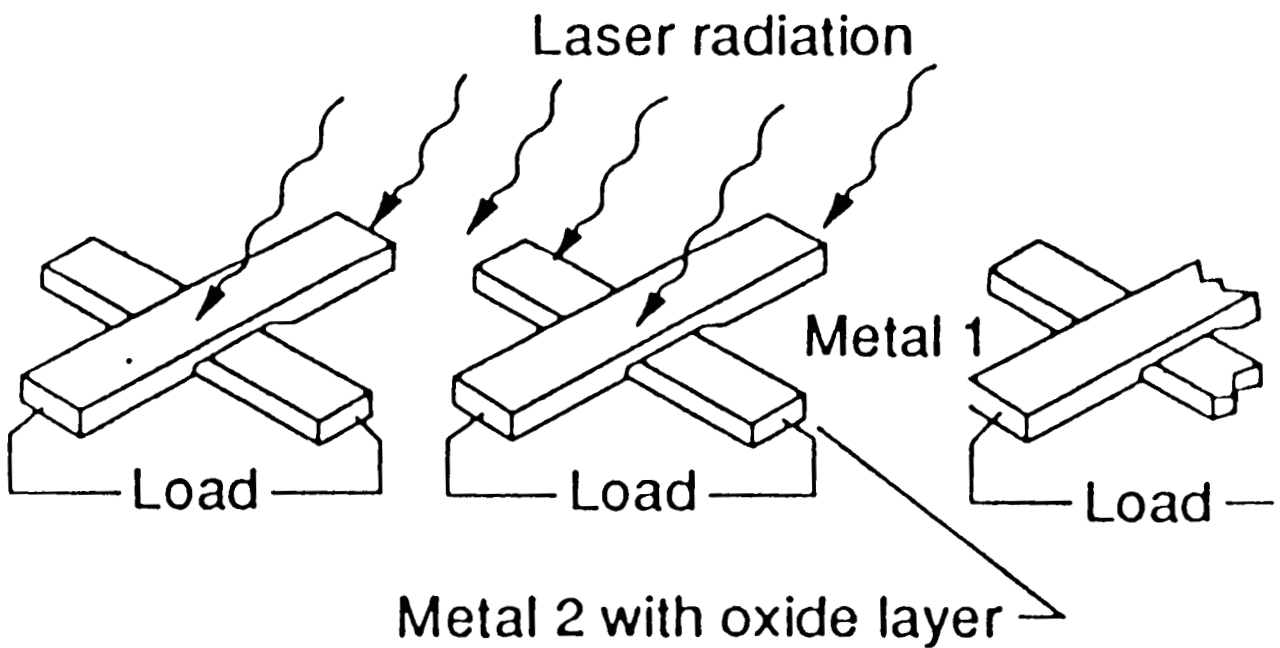

REVERSE FREE-ELECTRON LASER

The free-electron laser may be used in a reverse cycle absorbing laser energy and producing electrical power. This concept is not well developed but theoretically is very promising due to its large theoretical conversion efficiency ($> 50\%$).

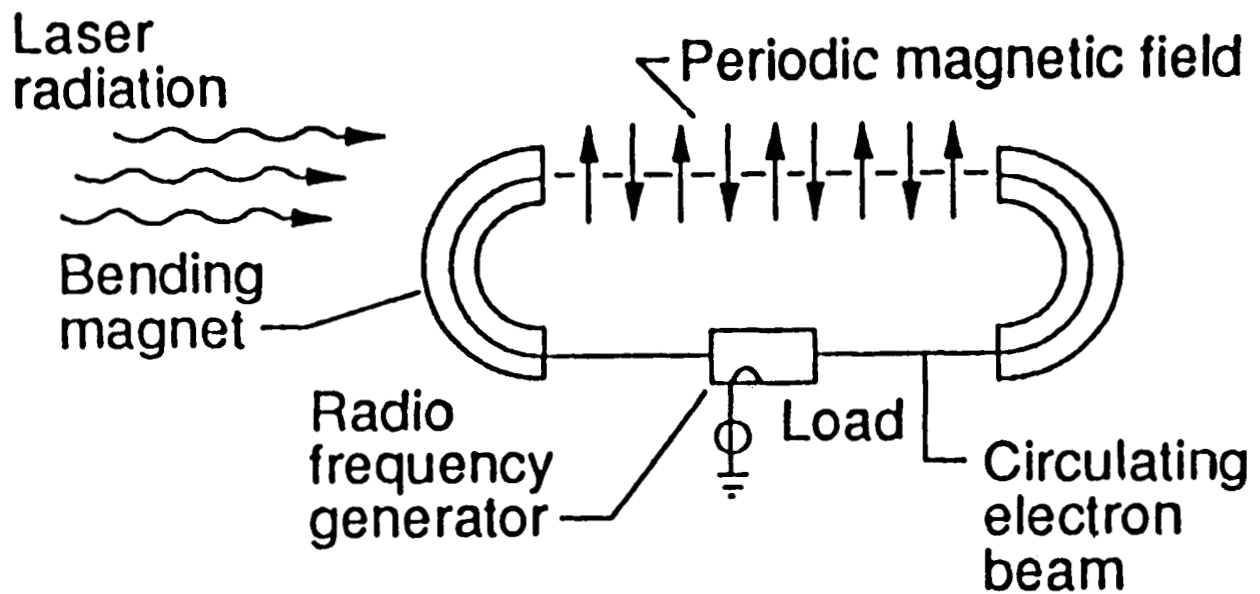

SUMMARY AND CONCLUSIONS

Three systems (photovoltaic cells, MHD generators, and gas turbines) have been identified as the laser-to-electricity conversion systems that appear to meet most of the criteria for a space-based system. The laser thruster also shows considerable promise as a space propulsion system.

At this time one cannot predict which of the three laser-to-electric converters will be best suited to particular mission needs. All three systems have some particular advantages, as well as disadvantages. It would be prudent to continue research on all three systems, as well as the laser rocket thruster.

Research on novel energy conversion systems, such as the optical rectenna and the reverse free-electron laser, should continue due to their potential for high payoff.

N90-10153

513-44

**STRUCTURAL CONCEPTS FOR VERY LARGE
(400-METER-DIAMETER) SOLAR
CONCENTRATORS**

016777
110

**Martin M. Mikulas, Jr.
NASA Langley Research Center
Hampton, VA**

ND 2103191

and

**John M. Hedgepeth
ASTRO Aerospace Corporation
Carpinteria, CA**

A 4738104

INTRODUCTION

Since the beginning of the space age in the late 1950's, there has been considerable interest in placing large structures in orbit. Most of the applications for these large structures are associated with the reflection of electromagnetic waves. Typical applications include communication antennas, a wide range of telescopes, and reflection of solar rays. Another application for large space structures involves platforms which are used as a common base for mounting many experiments or other devices which share utilities such as power and communications. The Space Station Freedom is an example of the latter category.

In this paper, a general discussion of various types of large space structures is presented. A brief overview of the history of space structures is presented to provide insight into the current state-of-the art. Finally, the results of a structural study to assess the viability of very large solar concentrators are presented. These results include weight, stiffness, part count, and in-space construction time.

ORIGINAL PAGE IS
OF POOR QUALITY

SPACE STRUCTURES HISTORY

In the 1960's, the only access to space was through the use of expendable launch vehicles. This required that all spacecraft be automatically deployed once in orbit. This requirement led to the development of novel and ingenious structures which could be packaged very compactly for launch, yet be deployed to very large dimensions. Perceived applications at that time included low frequency radio astronomy, solar sails for interplanetary propulsion and large flat surfaces for reflecting solar rays either for illumination purposes or to provide increased energy to solar collector farms (references 1, 2, 3, and 4). Requirements for these structures are discussed in reference 5.

During an energy crisis in the 1970's, attention was given to the possibility of collecting solar energy in space and microwaving it back to Earth. Such solar power systems were very large and required the use of reusable launch vehicles to reduce cost as well as to enable in-space construction. Thus a new class of space structures, commonly referred to as erectable structures were conceived to accommodate the construction of these very large systems. During the same time period, considerable interest developed in large (5 meter to 100 meter) low frequency communication antennas (references 6 and 7). This application was best served through the use of umbrella-like structures which could automatically deploy large parabolic mesh reflector surfaces.

In the 1980's, the Space Shuttle has enabled the practical consideration of astronauts constructing large structures in space. This capability opens the door to structures that are larger, more versatile, more accurate, and stiffer than could be accomplished through only the use of deployable structures. The Space Station Freedom support truss is an example where this new capability is being utilized to construct a structure with features which could not be accomplished by other means. This new capability for constructing structures in space has also led to the consideration of constructing large solar concentrators for use on the Space Station as well as constructing very precise and stiff segmented reflectors for large telescopes. (See figure 1.)

1960's

- **Small Deployables from ELV's (~ 20 meters)**
- **Extremely Large Deployable Membrane Surfaces (~ 1 - 2 km)**
 - **Solar Sails**
 - **Solar Reflectors**

1970's

- **Very Large Erectables**
 - **Solar Energy, Space-To-Earth Power Stations (~ 5 - 10 km)**
- **Deployable Mesh Reflectors (~ 5 - 100 m)**

1980's

- **Moderate Size Erectables**
 - **Space Station (~ 100 m)**
 - **Solar Concentrators (20 - 30 m)**
 - **Precision Segmented Reflectors (~ 10 - 40 m)**

Figure 1

LARGE SPACE STRUCTURES

Two major categories have been identified for large space structures, deployable and erectable. Figure 2 shows examples of truss structures of each type. The erectable truss shown is one that was developed for very large structures such as would be required for a solar power station. This particular truss was developed specifically to be rapidly assembled by astronauts in orbit and is presented in reference 8 and 9. These studies demonstrated that large erectable trusses could be assembled in space by astronauts at the rapid rate of one strut every 40 seconds.

The deployable truss shown is a tetrahedral geometry such as presented in references 10 and 11. This truss was built and tested at Langley Research Center. As can be seen in the figure, the truss packages very compactly, yet deploys into a deep truss. The truss shown was successfully deployed in a simulated 0-g test by free-fall dropping it in a vacuum chamber. Although this deployment test was successful, such structures have not been demonstrated in large multiple ring configurations. The lack of experience with the deployable trusses in large configurations is the primary barrier to the acceptance of this technology for space missions.

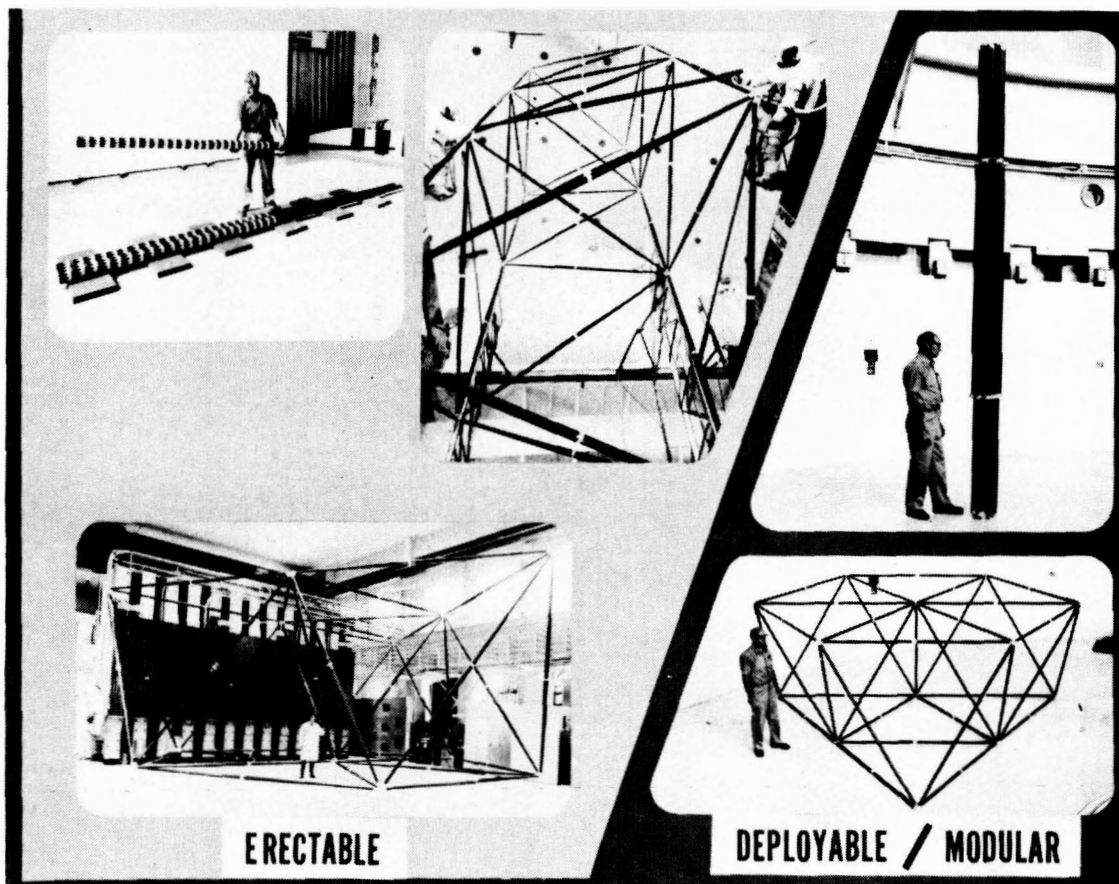

Figure 2

ERECTABLE LARGE SPACE STRUCTURES

Considerable experience has accrued over the past 10 years with erectable structures as indicated in figure 3. This experience has culminated in the development of the erectable backbone truss structure for the Space Station Freedom. Details of the research in erectable structures is presented in references 8 and 9, and in references 12 through 17. These references describe research on hardware design, development, and testing, on dynamic analysis, and on underwater simulated 0-g construction tests.

The results of the highly successful ACCESS in-space construction experiment are presented in reference 18. This research has provided the basis for the reliable in-space construction of a wide class of large space truss structures. However, as will be discussed subsequently, there is a limit to the size of such structures that can be constructed by astronauts.

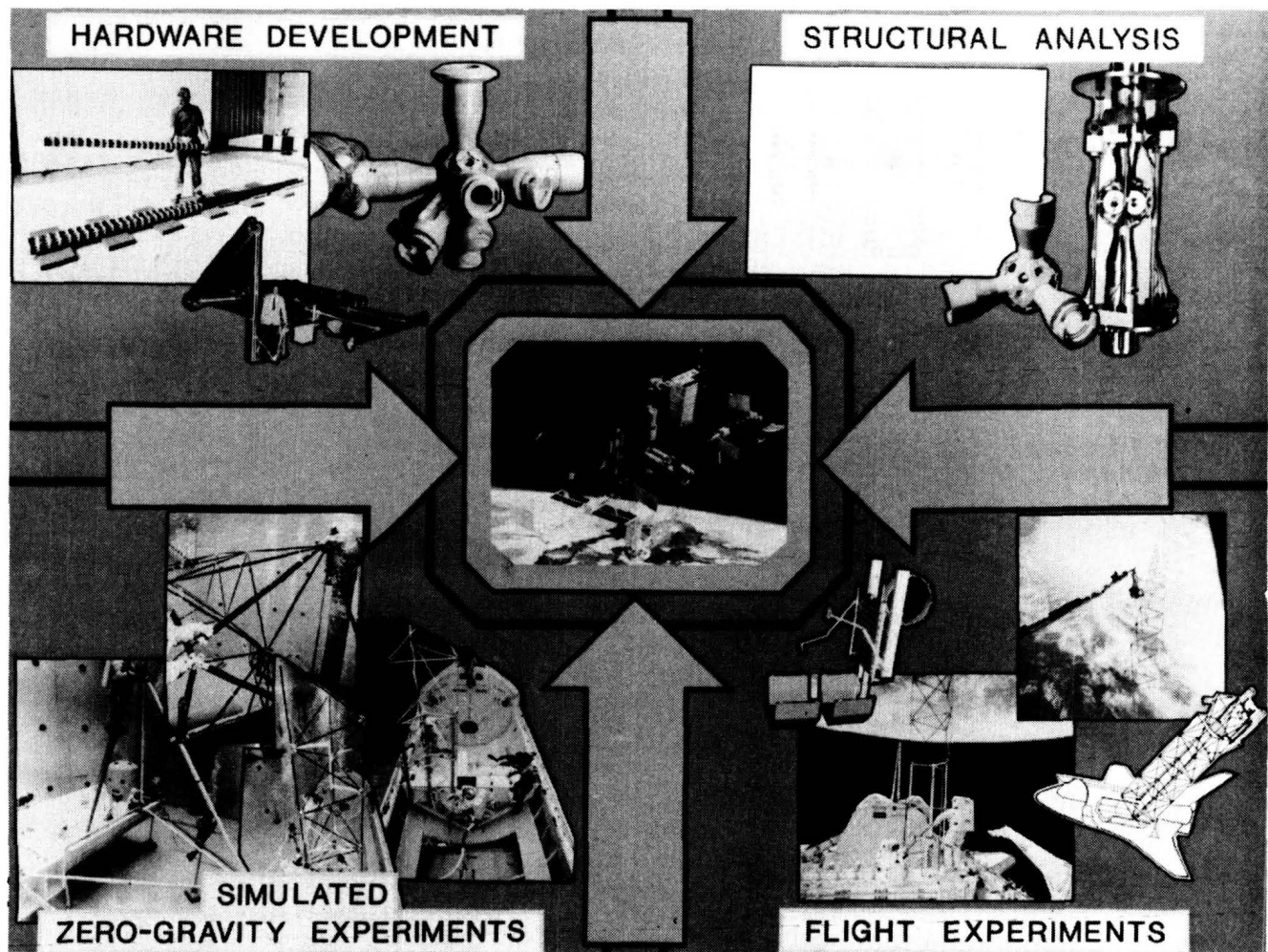

Figure 3

ORIGINAL PAGE
BLACK AND WHITE PHOTOGRAPH

SPACE STATION MOBILE TRANSPORTER

Erectable structures offer great versatility in packaging for launch and the geometries of structures that can be constructed in space. However, these advantages are somewhat offset by the fact that structures must be assembled in space piece by piece. Experiments and studies over the past 10 years have shown that assembling structures piece by piece can be accomplished very efficiently if an appropriate construction aid is provided. One such construction aid was developed and demonstrated for very large space platforms and is shown in the upper center photograph of figure 2 (reference 9). This aid provided mobile foot restraints which could position astronauts for rapid assembly of the truss. A similar device was developed for the Space Station Freedom and is shown in figure 4. This aid, which is called the Mobile Transporter, has astronaut positioning arms on both sides of the truss and, in addition, is able to move over the truss. This transporter has been demonstrated in 1-g and in neutral-buoyancy-simulated 0-g tests (reference 18). The results of the tests showed that these structures could be assembled at the rate of 1 strut every 30 or 40 seconds. With such a construction rate, two astronauts could assemble about 500 struts per 6 hour EVA allowing some time for resting. This means that structures with only a few thousand struts will not represent a major construction challenge. For reference, the Space Station Freedom has about 600 struts. The major challenge in assembling a large space system is the installation and integration of all the utilities and subsystems. Again, however, the mobile transporter or assembly aid provides a mechanism for accomplishing the integration in an efficient and orderly fashion. For extremely large structures which may have hundreds of thousands of struts, it is likely that this assembly process will have to be automated to be practical.

SPACE STATION TRUSS ASSEMBLY WITH MOBILE TRANSPORTER DEMONSTRATED IN 1-G TESTS

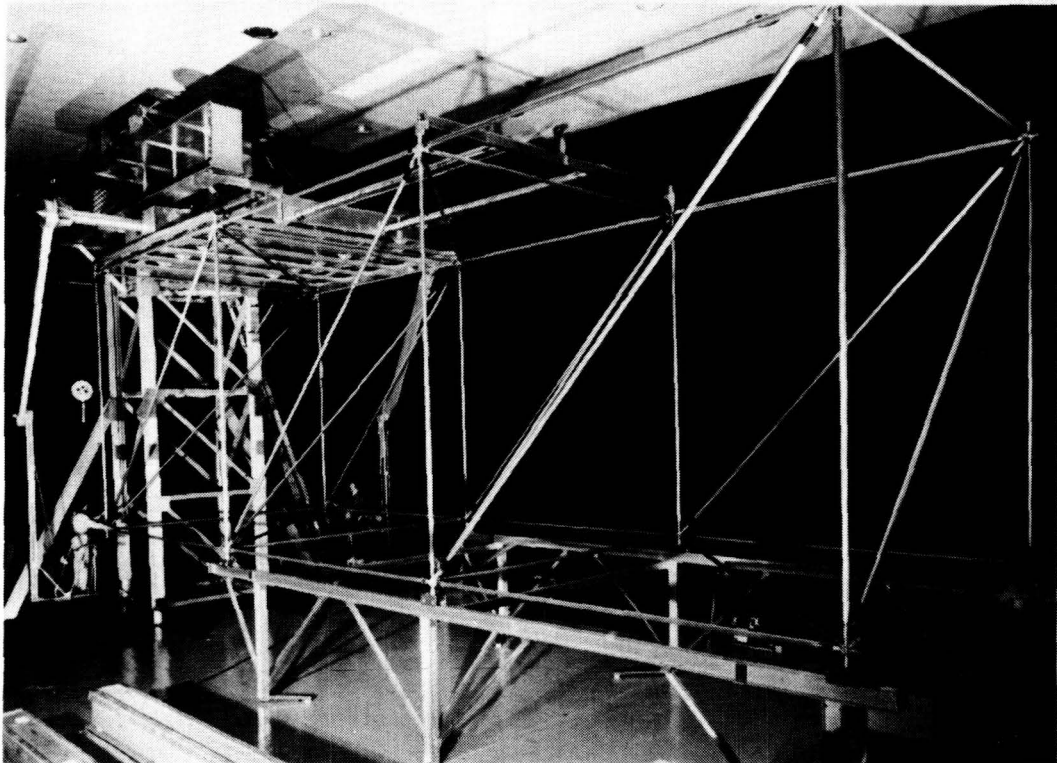

Figure 4

REFLECTOR ANTENNA CONCEPTS

Figure 5 shows three concepts for deployable reflector antennas. The state-of-the-art of these and other deployable antennas is presented in reference 19. Because of the delicate nature of the mesh surfaces of such antennas, it is highly desirable to have these systems prebuilt on the ground and automatically deployed in orbit. An alternate approach for achieving very large antennas is to deploy modules and assemble them in space (reference 20).

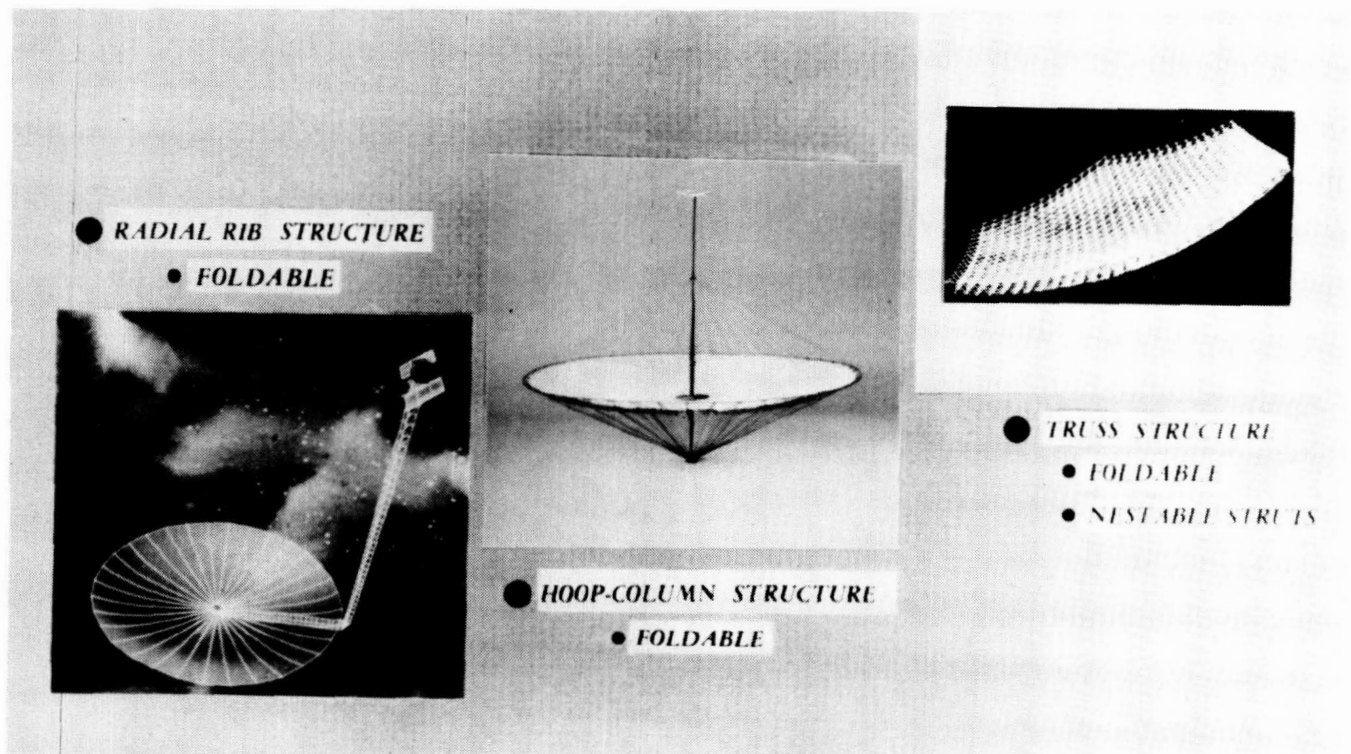

Figure 5

ORIGINAL PAGE
BLACK AND WHITE PHOTOGRAPH

ONE KILOMETER FLAT SOLAR COLLECTOR

In the past, large orbiting flat solar reflectors have been considered for applications such as illuminating cities, extending growing seasons, and increasing power to solar collector farms (references 2 and 3). A sketch of a one kilometer version of such a reflector is shown in figure 6. This particular concept is well suited for deployable structures. This concept consists of a central telescoping mast and an outer deployable torus which is laterally supported by guy wires. As can be seen in the figure, the flat membrane is stretched inside the torus to form the reflecting surface. There are no major technical barriers to achieving this type of reflector. The deployable torus would require the most development. Areal density for these structures would be quite low (on the order of 0.1 kg per square meter).

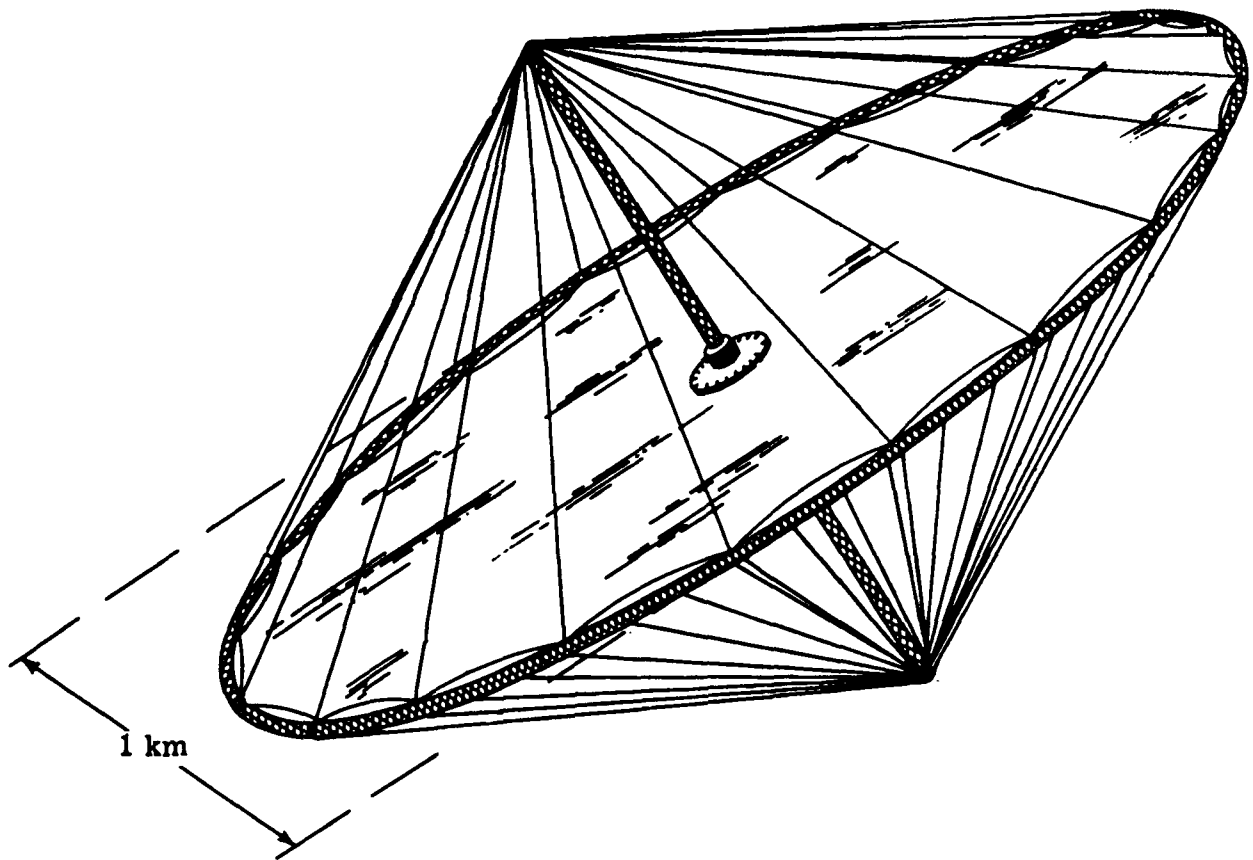

Figure 6

POSSIBLE MEMBRANE SHAPES

As shown in figure 6, stretched membranes result in very lightweight reflectors, thus, making them attractive for space applications. However, high performance solar concentrators require a dish-like shaped doubly curved surface to focus the solar rays. The equation which governs the equilibrium of a membrane is presented in figure 7 for two possible cases. The first case considered is one in which the membrane is loaded with a lateral pressure. In this case the loading is equilibrated by inplane loads as shown at the lower left hand side of the figure. Since a membrane has no bending stiffness the inplane loads must be positive or equal to zero. Experiments in the past have shown that a membrane surface must be stretched to eliminate wrinkles and develop a high performance reflecting surface. Thus for a membrane to achieve high quality dish-like shape, it must be loaded with a lateral pressure. This is difficult to achieve in space, however, in a subsequent section inflatable concentrators are discussed. The second case considered is one in which there is no lateral pressure. In this case there are two possible ways to satisfy the equilibrium equation. Either the membrane is flat (both radii are infinite), or one radius is positive and the other is negative. The later case results in a saddle shaped membrane as shown in the lower right. In subsequent figures, solar concentrator concepts which utilize these different membrane shapes will be discussed.

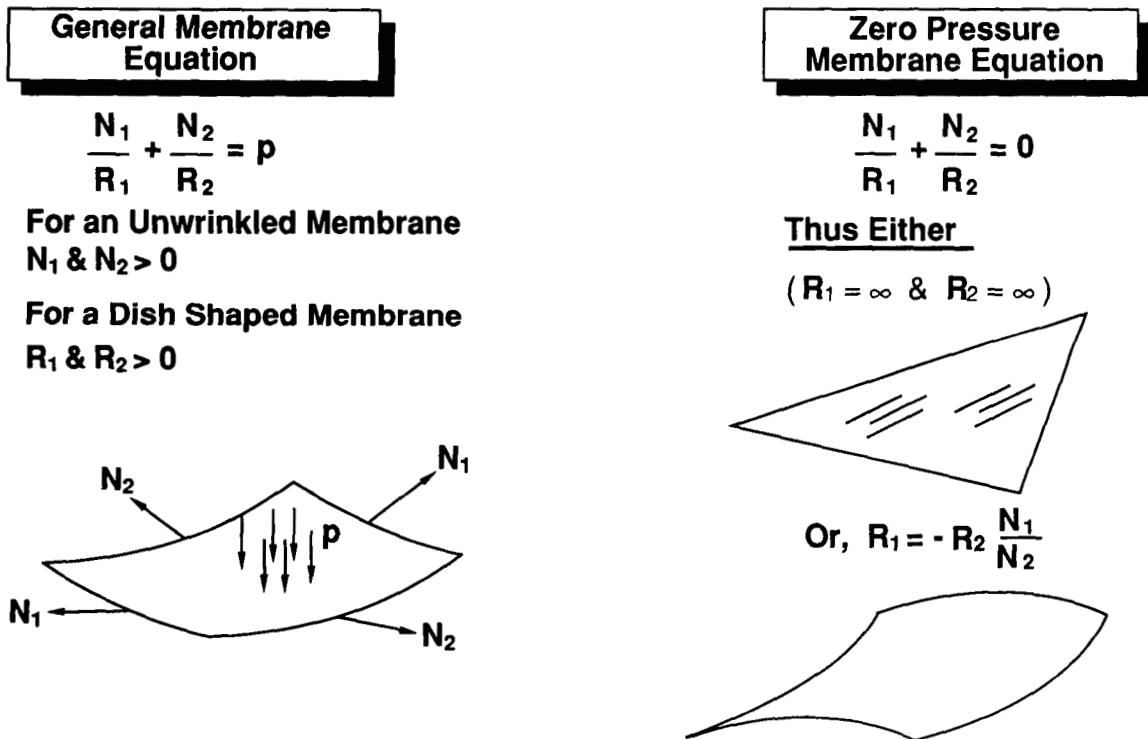

Figure 7

DOUBLY CURVED MESH REFLECTORS

Doubly curved mesh reflectors have proven to be quite valuable for low frequency radio communications applications as discussed in reference 18. An example of one mesh reflector concept is shown in figure 8. This concept is known as the hoop column antenna and is discussed in detail in reference 21. The hoop column antenna is very similar to the flat reflector shown in figure 6. The major difference being that the reflector surface is pulled into a doubly curved shape by many radial catenary-like cords. The resulting doubly curved surface is composed of numerous radial sectors, each of which is saddle shaped as discussed in figure 7. Such a locally saddled surface has been shown to be adequate for radio antennas where rms surface errors control the performance. This type of membrane shaping system is not suited for solar concentrators for two reasons. First, locally pillowed surfaces have large local slope errors which produce unsatisfactory scattering of the solar rays. Second, the membrane films required to reflect solar rays are not as forgiving as double knit meshes in forming a wrinkle-free doubly curved surface.

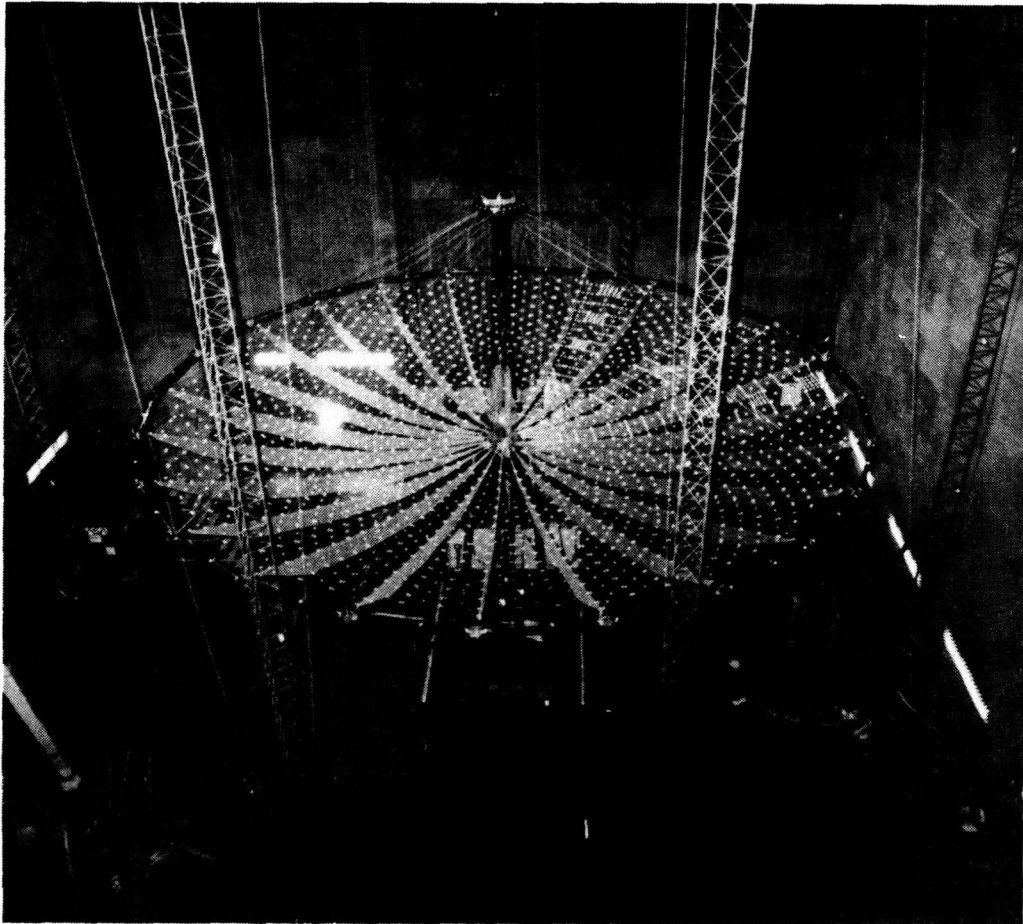

Figure 8

INFLATABLE SOLAR CONCENTRATOR

Inflatable solar concentrators have been under consideration for many years. Until recently, inflatable reflectors were not given serious consideration due to pressure leakage through micrometeoroid penetrations of the membrane film surface. However, in reference 22 it has been shown that for very large diameter concentrators (> 100 meters), the required inflation pressures are so low that leakage is very small. Thus, inflatable reflectors are legitimate contenders for the large solar concentrators. Figure 9 shows an artist concept of an inflatable concentrator. The concentrator is lenticular in shape with a clear membrane forming the front of the lens and a pressurized torus at the intersection of the front and rear surfaces to maintain radial equilibrium. Weight curves are presented in reference 21 for large inflatable solar concentrators and the results show that this concept is extremely lightweight. There are two main problems that remain unresolved with inflatable solar concentrators. First, the thin film surfaces must be formed from several meter-wide strips of thin plastic films. The seams between strips represent discontinuities in the film which results in local wrinkles which degrade reflector performance. Increasing pressure to remove these wrinkles, results in heavier concentrators. Second, the thin films used for these reflectors are some form of plastic, all of which have very high coefficients of thermal expansion. This high coefficient of thermal expansion inhibits making a stable, high precision solar concentrator. Although the inflatable concept has some drawbacks, it is clearly worth continued research because of the potentially low resultant weight.

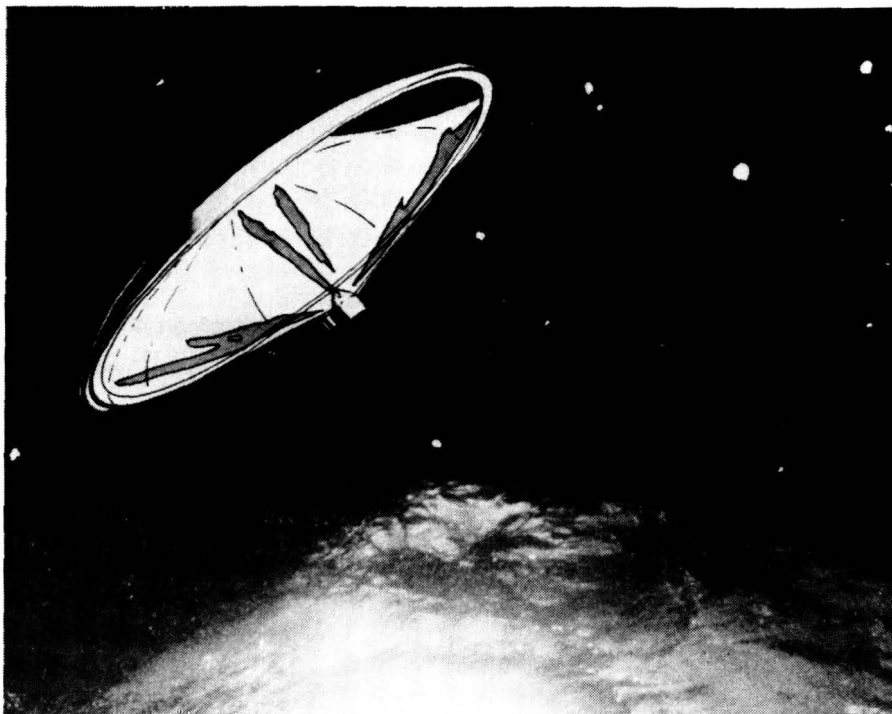

Figure 9

SOLAR DYNAMIC CONCENTRATOR

A solar dynamic power system is currently being considered for a growth version of Space Station Freedom. The concentrator required for this application is about 18 meters in diameter and is discussed in detail in reference 23. A photograph of a partly assembled concentrator is shown in figure 10. The concentrator is formed from 4-meter-diameter hexagonal panels. These hexagonal panels were sized to fit in the Space Shuttle cargo bay for launch. Once in orbit, the panels would be assembled by astronauts to form the 18-meter-diameter reflector. This approach is limited to small (about 20 meters) concentrators because of the low inherent stiffness of the resulting thin configuration. However, this approach could prove to be of value for larger concentrators by providing numerous subreflectors to be mounted on a very large support truss.

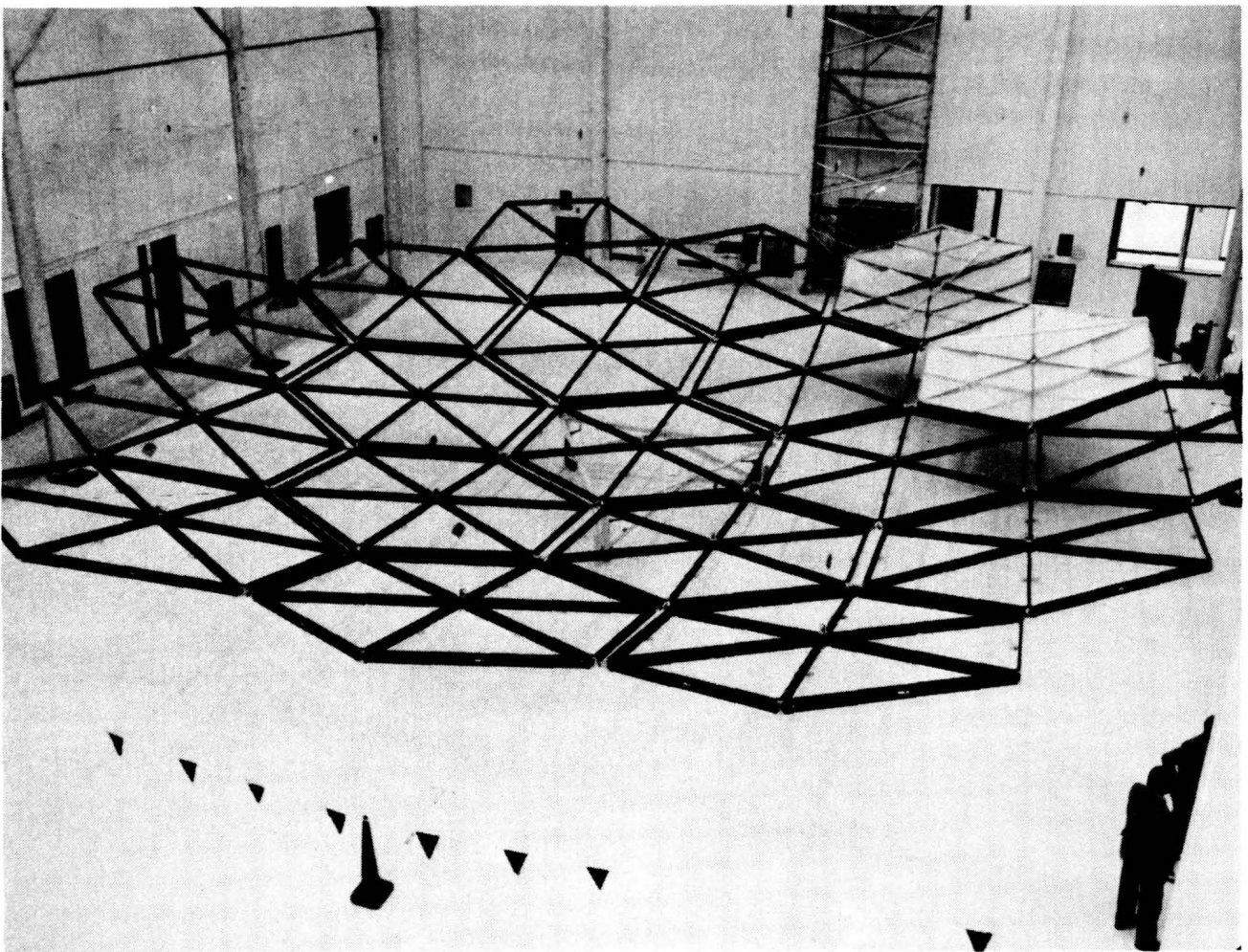

Figure 10

ORIGINAL PAGE
BLACK AND WHITE PHOTOGRAPH

TRUSS SOLAR CONCENTRATOR

It is well known that trusses form very stiff, lightweight structures for many applications. In order to assess their applicability to large solar concentrators, the truss/concentrator configuration shown in figure 11 was studied. In this concept, a flat triangular membrane facet is stretched between the intersections of three struts on the truss surface to form the concentrator. In order to reduce part count and to minimize truss mass, the individual truss struts should be as long as possible. However, the size of the membrane flats is dictated by the concentration ratio desired. If the sun's rays were exactly parallel, each facet could be no larger than the receiving collector. However, since the sun's rays are not exactly parallel, there must be a correction for that fact which makes each flat slightly smaller. The details of this correction are presented in reference 24. To assess the applicability of trusses to very large solar concentrators, a 400-meter-diameter concentrator is presented in the next figure.

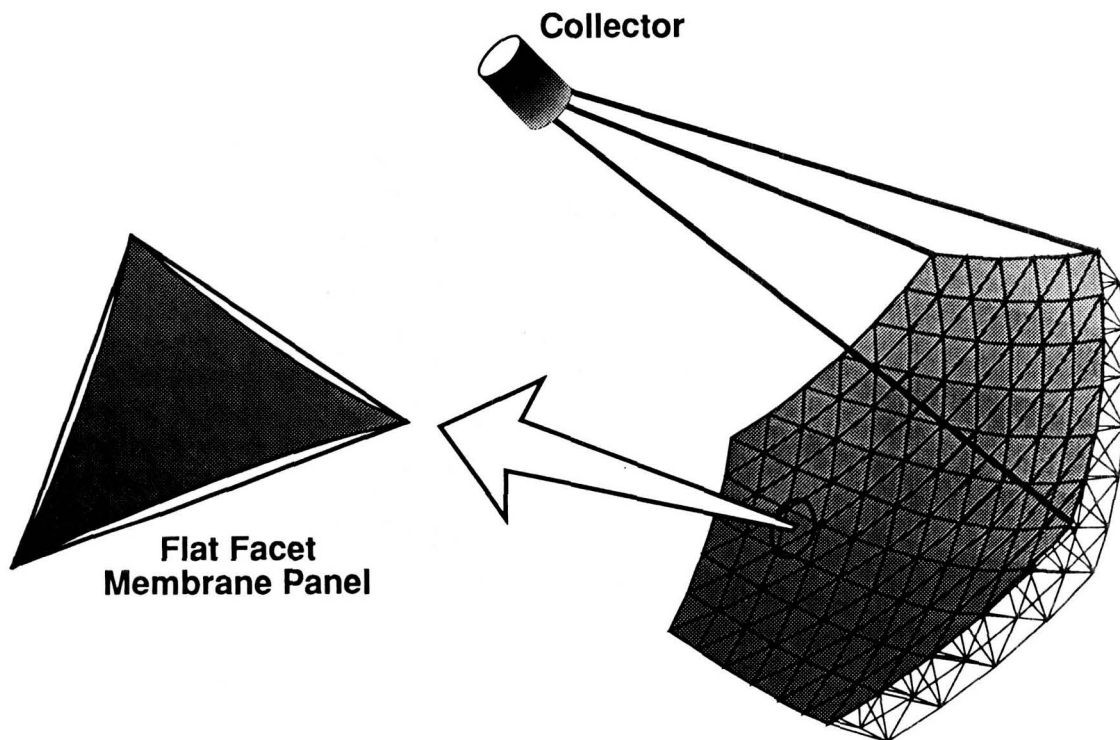

Figure 11

400-METER FACETED SOLAR CONCENTRATOR

Figure 12 shows a flat projected sketch of a 400-meter effective diameter, faceted solar concentrator. The concentration ratio selected for this point design was 2000 to 1. This results in a maximum flat facet size of 5 meters as determined from reference 24. A typical facet is shown in the upper right with an astronaut for comparison. As indicated in the figure, this geometry would require 18,000 triangular facets and 52,000 struts. The next two figures show the weight and assembly time for such large solar concentrators.

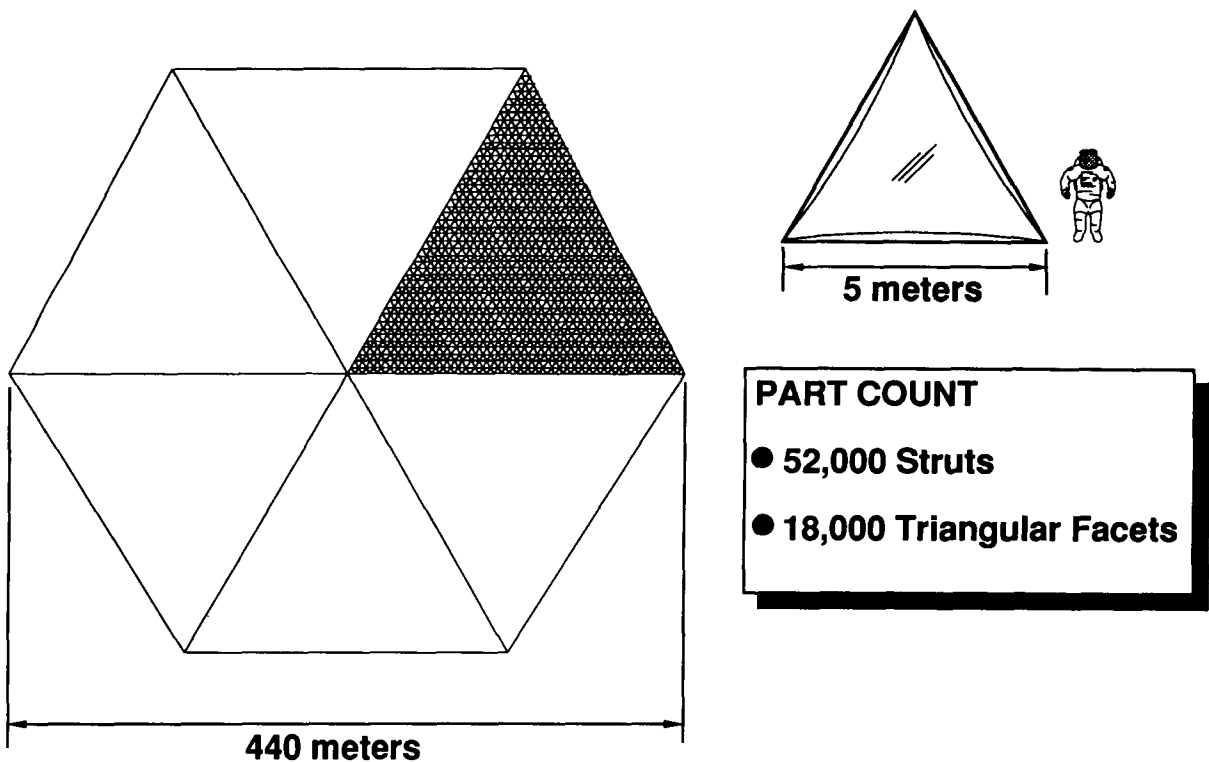

Figure 12

WEIGHT OF LARGE SOLAR CONCENTRATORS

In figure 13 the weight of flat faceted truss and inflatable concentrators is presented. The circular symbol at the upper right of the figure indicates the weight of the 400 meter concentrator shown in the previous figure. For these weight calculations the membrane facets were 0.25 mil kapton and the struts were 1.2 inches in diameter, 0.015-inch-thick walled graphite/epoxy tubes. A factor of two was applied to the total strut weight to account for truss joints. As can be seen in the figure, the truss concentrator weighs about 75,000 lbs. as compared to about 8,000 lbs. for the inflatable. The shaded lines are included to provide a means for comparison with other concepts. For example the flat solar reflectors of reference 3 have an areal density of about 0.1 kg/m². This was the areal density chosen for a system level study of solar concentrators in reference 25. Although the flat solar reflectors are very lightweight, there is no known means for adapting this concept into a high performance reflecting concentrator. Thus, at this time it appears that the choices for large solar concentrators are the relatively heavy truss type or the very lightweight inflatable. The truss type concentrator, although heavy, has the advantage of being technically straightforward to develop. The inflatable, although lightweight, has the disadvantages of wrinkles from the seams, high coefficient of thermal expansion and low natural frequencies. Further development work is required on both concepts before a rational selection can be made.

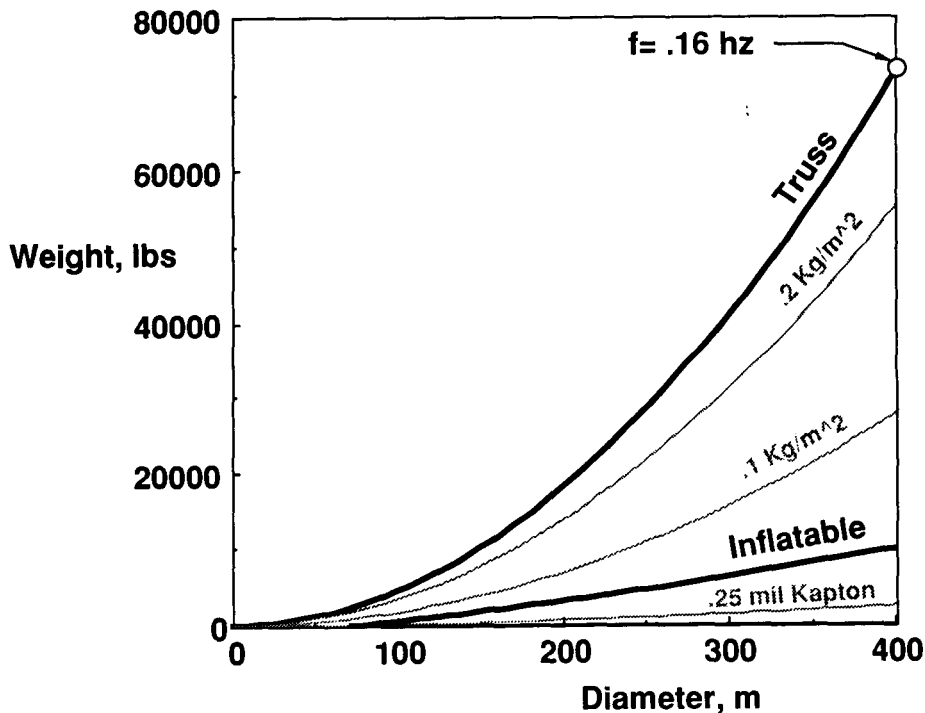

Figure 13

PART COUNT AND ASSEMBLY TIME FOR LARGE TRUSS SOLAR CONCENTRATORS

Figure 14 shows the number of struts and corresponding assembly time for truss solar concentrators. As can be seen, a 400-meter-diameter concentrator would require over 400 hours of assembly time at the rate of 0.5 minutes per strut. This would correspond to astronauts working 72 6-hour EVA's to complete the construction. This is probably not a feasible approach for constructing these large reflectors. The alternate approach for assembling the erectable concentrator is through the use of robots. The use of robotic construction on such a large scale is currently being studied; however, the feasibility of such an approach has not yet been determined. Deployable truss structures have been studied in the 10- to 20-meter-diameter range, however, this very large scale has not been given serious consideration. Again, much development work would be required to establish feasibility.

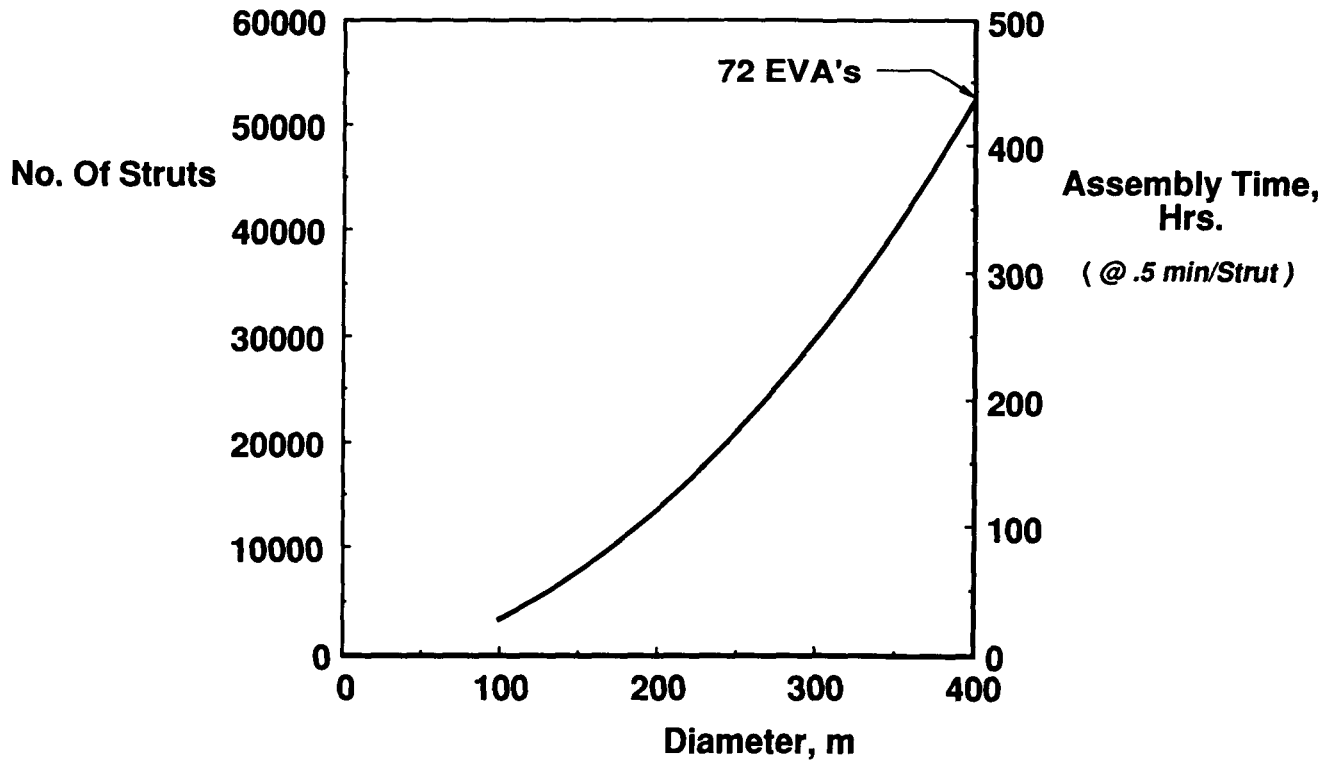

Figure 14

CONCLUDING REMARKS

In this paper an overview was given of large space structures technology and an assessment was made of the applicability of various structural concepts to very large solar concentrators and is summarized in figure 15. There does not appear to be any technical barrier to developing very large ultra-lightweight deployable membrane surfaces such as solar sails or flat reflectors. However, achieving very large high performance solar concentrators for space applications is a challenge. For all the structural concepts considered for large solar concentrators, each one had several major perceived disadvantages that need to be resolved. The major conclusion of the current study was that several years of development would be required on a couple of selected structural concepts before a feasible approach could be identified for very large (400-meter-class) solar concentrators.

- **Large Ultra-Lightweight Deployable Membrane Surfaces Appear Achievable For Applications Such As Solar Sails Or Flat Solar Reflectors**
- **For Large Solar Concentrators Several Years Of Research And Development Required Before A Satisfactory Concept Can Be Identified**

Figure 15

REFERENCES

1. NASA Task Group: Outlook for Space. NASA SP-386, January 1976.
2. Hedgepeth, John M.; Miller, Richard K.; and Knapp, Karl: Conceptual Design Studies for Large Free-Flying Solar-Reflector Spacecraft. NASA CR-3438, 1981.
3. Canady, John E., Jr. and Allen, John L., Jr.: Illumination from Space with Orbiting Solar-Reflector Spacecraft. NASA TP-2065, September 1982.
4. MacNeal, Richard H.: Comparison of the Solar Sail with Electric Propulsion Systems. NASA CR-1986, February 1972.
5. Hedgepeth, John M.: Critical Requirements for the Design of Large Space Structures. NASA CR-3484, November 1981.
6. Large Space Systems Technology - 1979 Technology Review, Hampton, VA, NASA CP-2118, November 1979.
7. Large Space Antenna Systems Technology - 1982, Parts 1 and 2. NASA CP-2269, November 30-December 3, 1982, pp. 257-283.
8. Bush, Harold G. and Heard, Walter L., Jr.: General Description of Nestable Column Structural and Assembly Technology. NASA TM-83255, December 1981.
9. Heard, Walter L., Jr.; Bush, Harold G.; Wallsom, Richard E.; and Jensen, J. Kermit: A Mobile Work Station Concept for Mechanically Aided Astronaut Assembly of Large Space Trusses. NASA TP-2108, March 1983.
10. Mikulas, Martin M., Jr.; Bush, Harold G.; and Card, Michael F.: Structural Stiffness, Strength and Dynamic Characteristics of Large Tetrahedral Space Truss Structures, NASA TM X-74001, March 1977.
11. Bush, Harold G.; Heard, Walter L., Jr.; Walz, J. E.; and Rehder, J. J.: Deployable and Erectable Concepts for Large Spacecraft. NASA TM-81904, October 1980.
12. Mikulas, Martin M., Jr., et al.: Space Station Truss Structures and Construction Considerations. NASA TM-86338, 1985.
13. Mikulas, Martin M., Jr., et al.: Deployable/Erectable Trade Study for Space Station Truss Structures. NASA TM-87573, 1985.
14. Mikulas, Martin M., Jr.; Bush, Harold G.; Wallsom, Richard E.; Dorsey, John T.; and Rhodes, Marvin D.: A Manned-Machine Space Station Construction Concept. NASA TM-85762, February 1984.

15. Bush, Harold G.; Mikulas, Martin M., Jr.; Wallsom, Richard E.; and Jensen, J. Kermit: Conceptual Design of a Mobile Remote Manipulator System. NASA TM-86262, July 1984.
16. Young, John W.; Lallman, Frederick J.; Cooper, Paul A.; and Giesy, Daniel P.: Control/Structures Interaction Study of Two 300 KW Dual-Keel Space Station Concepts. NASA TM-87679, 1986.
17. Heard, Walter L., Jr. and Watson, Judith J.: ;Results of the ACCESS Space Construction Shuttle Flight Experiment. AIAA Paper No. 86-1186-CP, Presented at the AIAA Space Systems Technology Conference, San Diego, CA, June 9-12, 1986, 1986.
18. Watson, J. J.; et al: Results of EVA/Mobile Transporter Space Station Truss Assembly Tests. NASA TM 100661, November 1988.
19. Large Space Antenna Systems Technology 1984. NASA Conf. Pub. 2368, Part 2. Conference Proceedings held in Hampton, VA, December 4-6, 1984.
20. Vaughan, D. H.: Modular Reflector Concept Study. NASA CR-3411, March 1981.
21. Campbell, T. G.; Butler, D. H.; Belvin, K.; and Allen, B. B.: Development of the 15-Meter Hoop/Column Antenna System. Large Space Antenna Systems Technology 1984. NASA Conf. Pub. 2368, Part 2. Conference Proceedings, Hampton, VA, December 4-6, 1984, pp. 167-212.
22. Friese, G. J.; Bilyeu, G. D.; and Thomas, M.: Initial '80's Development of Inflated Antennas. NASA CR-166060, January 1983.
23. Corrigan, Robert D. and Ehresman, Derik T.: Solar Concentration Advanced Development Project. Proceedings from the 22nd AIAA/Intersociety Energy Conversion Engineering Conference. Philadelphia, PA, August 10-14, 1987, pp. 156-161.
24. Hedgepeth, John M. and Miller, Richard K.: Structural Concepts for Large Solar Concentrators. NASA CR-4075, June 1987.
25. DeYoung, R. J.; Walker, G. H.; Williams, M. D.; Schuster, G. L.; and Conway, E. J.: Preliminary Design and Cost of a 1-Megawatt Solar-Pumped Iodide Laser Space-to-Space Transmission Station. NASA TM-4002, September 1987.

MINIWORKSHOP MISSION STUDIES

PRECEDING PAGE BLANK NOT FILMED

N90-10154

54-36
216778

OVERVIEW OF LASER CONCEPTS

Edmund J. Conway
NASA Langley Research Center
Hampton, VA

ND210491

Abstract

A number of laser-power transmission applications are overviewed. Some will be expanded in the miniworkshops to follow, and other applications mentioned here are given to provide some breadth to the potential use of laser-power transmission in space.

See 286

PRECEDING PAGE BLANK NOT FILMED

PAGE 260 INTENTIONALLY BLANK

SOLAR-PUMPED LASER APPLICATIONS

Space-laser power stations have been discussed for many years. This figure shows eight applications which have received some consideration. They range from terrestrial power to aerospace uses, such as spacecraft propulsion.

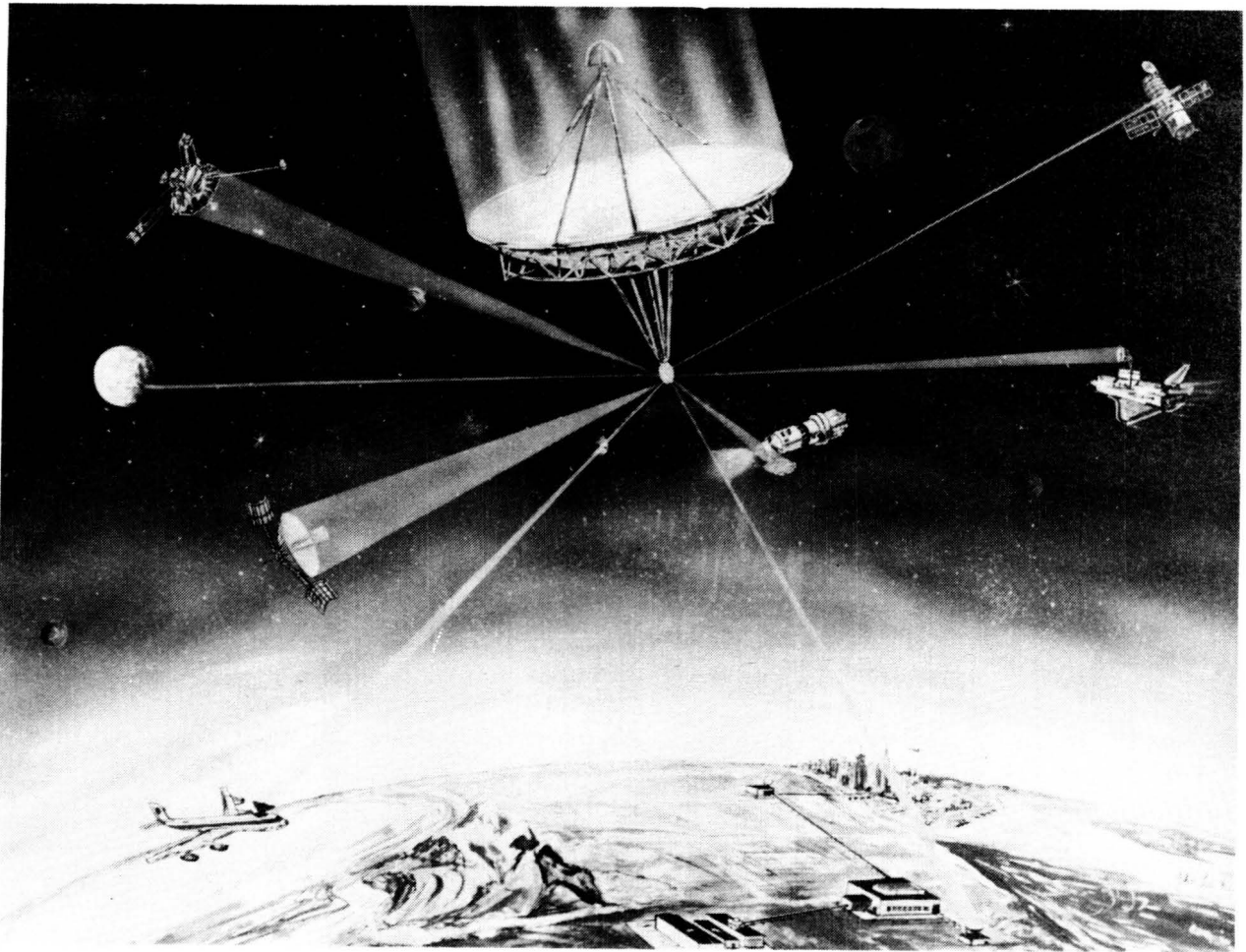

ORIGINAL PAGE
BLACK AND WHITE PHOTOGRAPH

APPROACH

One of the purposes of this workshop is to identify beamed-power applications which offer a high payoff for NASA missions. These NASA missions are (1) lunar and planetary exploration, (2) transportation from Earth to the Moon or planet, and (3) near-Earth operations. Thus, the miniworkshop is broken up into three areas: planetary power, propulsion, and near-Earth applications. The approach to this overview is to identify a broad set of applications for laser planetary power, for laser propulsion, and for near-Earth uses. However, this overview will touch about equally on concepts to be presented at this workshop and on concepts which have been passed over. The overview will close with a discussion of the lasers that have been considered in this miniworkshop study.

LASERS FOR PLANETARY POWER

We will be reviewing in turn briefly power to a Mars base, Martian geophysical analysis, a Mars pipeline heater, lunar base power, and power for an advanced rover.

ORIGINAL PAGE
BLACK AND WHITE PHOTOGRAPH

A MARS BASE

This figure shows an example of power to a base on Mars. A number of activities are in view around the base, but the primary element is the power arriving at this base from distant orbiting power station. The power is being collected by a fairly small laser-to-electric converter shown in the figure. Because a manned base on Mars is included in the studies of the Office of Exploration (Coze Z), this is a concept to be reviewed at this workshop.



GEOPHYSICAL ANALYSIS

This figure shows a remote geophysical analysis of Martian soil in progress. A number of spectrophotometers have landed, and they have their microwave antennae pointed toward the orbiting power station. The laser beam for the power station strikes the ground, producing a plasma which emits light. This light is spectrophotometrically analyzed by the nearby robot spectrophotometers to determine the elemental composition of the surface and to transmit the results to the power station. Since geophysics is not a primary agency interest, this concept was not prepared for the workshop.



ORIGINAL PAGE
BLACK AND WHITE PHOTOGRAPH

THE MARS PIPELINE HEATER

Manned landings on Mars are almost certain to be close to the equator of the planet for orbital mechanics reasons, yet later when a permanent presence on Mars is developed, people will need a variety of resources--among them--water. There is a good deal of water in the polar regions of Mars in the form of solid ice. The figure shows a laser heating a pipe in which liquid water is flowing, but the pipe must be kept warm to keep the water from freezing and the pipe from blocking. This is one application for laser power for advanced, permanently inhabited Mars bases. This application, beamed power providing water for a manned Mars base, is so far in the future that it is of little importance in 1989.

ORIGINAL PAGE
BLACK AND WHITE PHOTOGRAPH



A LUNAR OUTPOST

Here the setup is less permanent than those that were shown on Mars. This lunar outpost is far from the main base which might be either laser or fission powered. However, the outpost will be laser powered because it is a temporary base which must be picked up and moved every few months and cannot justify a permanent nuclear power system. This outpost supports prospecting in a particular area, so it is not quite as large-scale nor as permanent as in the Mars base concepts. Both lunar and Mars bases are included in our preparation on planetary power for the workshop.

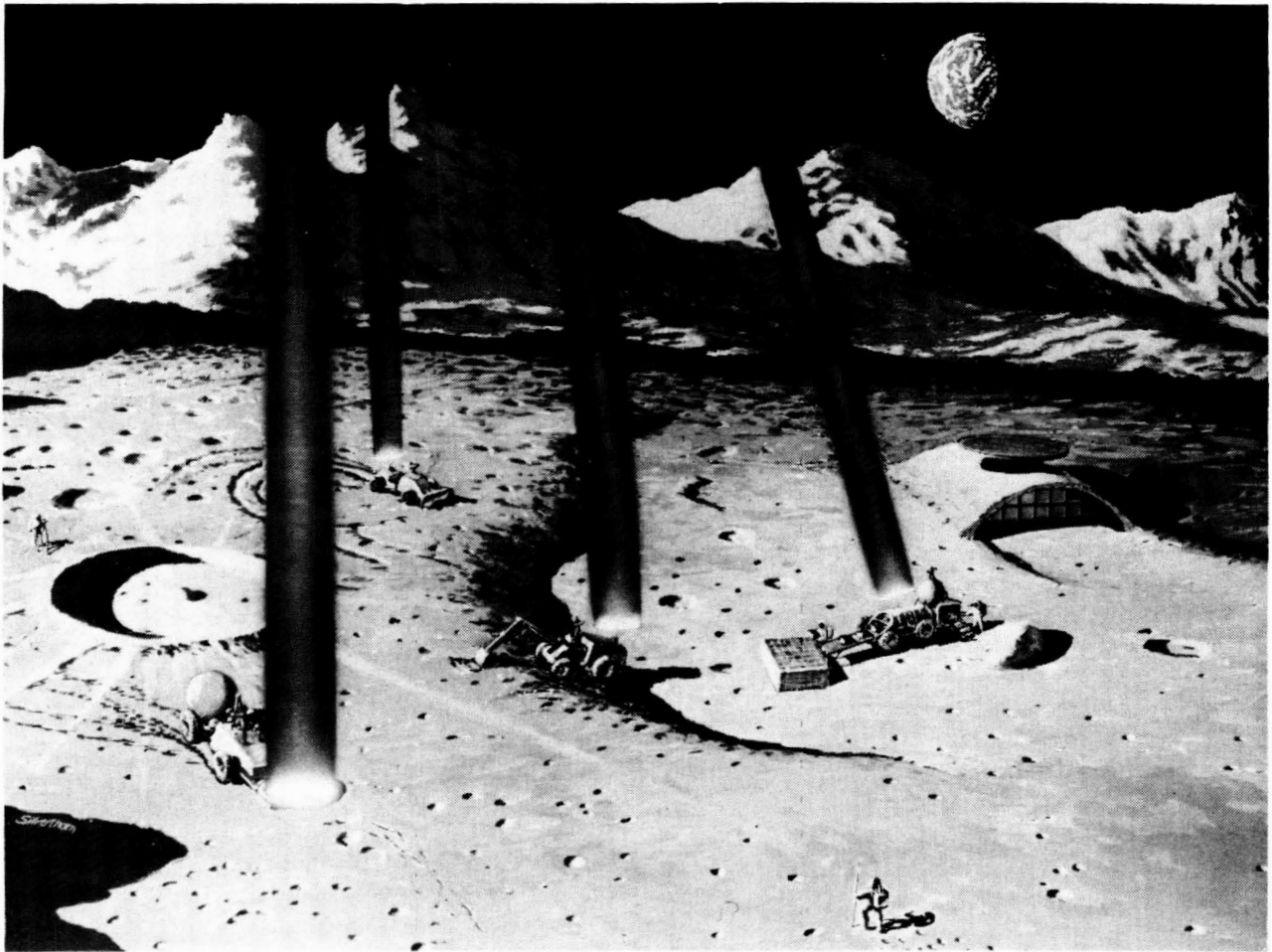

ORIGINAL PAGE
BLACK AND WHITE PHOTOGRAPH

AN ADVANCED ROVER

ORIGINAL PAGE
BLACK AND WHITE PHOTOGRAPH

This figure shows the laser power beamed to an advanced rover, with the power being collected by a laser photovoltaic converter which is approximately two meters in diameter, smaller than the width of the rover itself. The rover has a capability of locomotion, of coring, of pushing soil, communications, chemical analyses, and a number of other uses. The power for all of this is provided by the laser beam. A beamed-power rover is part of our workshop preparation.

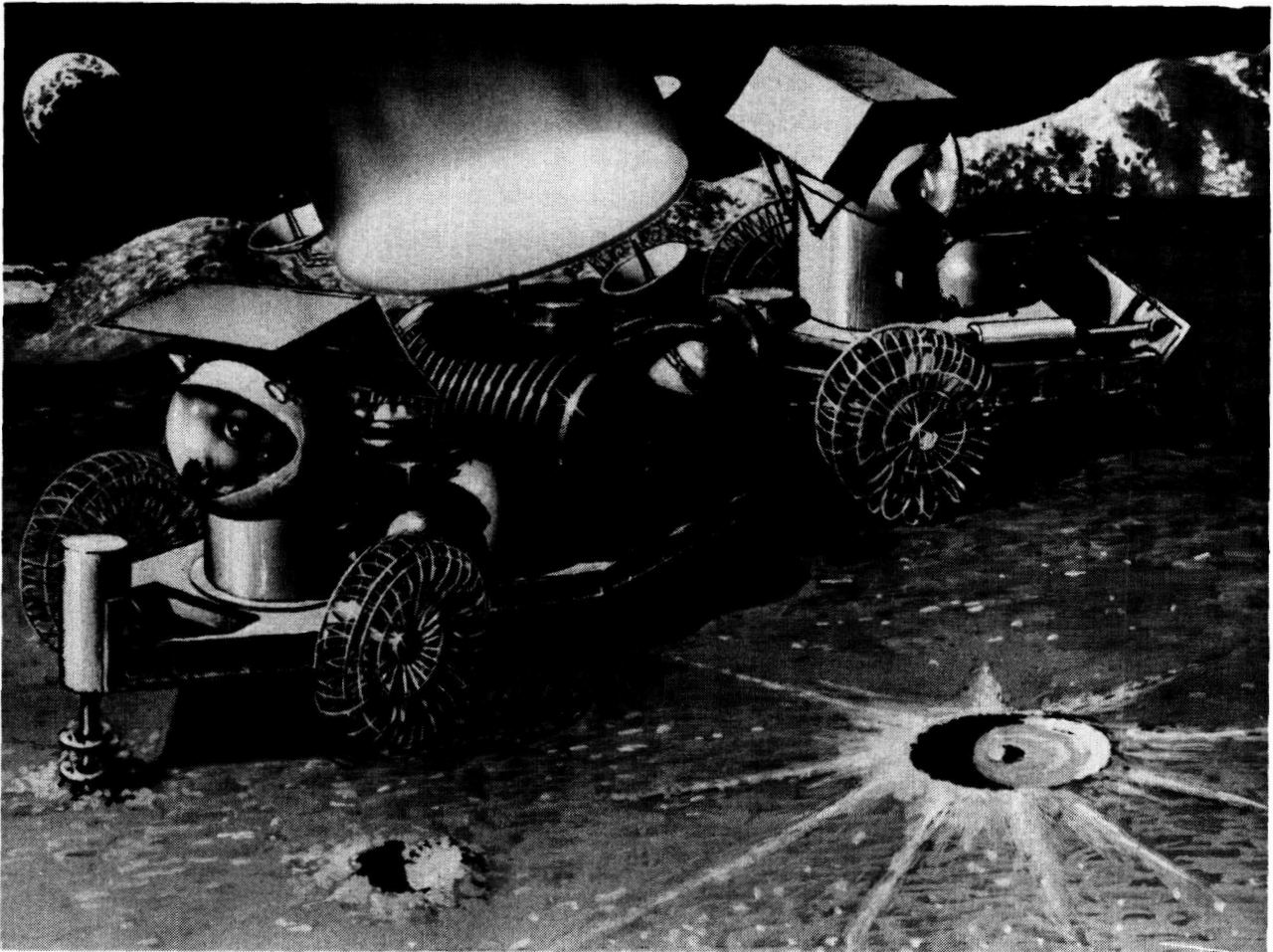

LASER PROPULSION

Let's change the topic from planetary exploration to how you travel from Earth to the neighborhood of a planet. Lasers have been considered for Earth-to-orbit propulsion and for propulsion involved in orbit raising. There has been consideration given to laser light sails, to laser electrical propulsion for low altitude satellites in high-drag orbits, and laser thermal propulsion for transfer from low-Earth orbit to low-lunar orbit. We will discuss these on the following figures.

LASER-SUPPORTED PURE HYDROGEN ROCKET

This is a concept for a laser thermal rocket in which the laser beam comes in through a focusing window or lens, heating gaseous hydrogen to a very high temperature, approximately 20,000° kelvin, and the hot gas escapes through a rocket nozzle, producing thrust. This particular concept was developed by Marshall Space Flight Center, and it is the engine for the propulsion concept which Langley is presenting in this workshop.

THE S-1 LASER OTV

This is an artist's conception of a laser thermal orbit transfer vehicle. It shows the orbit transfer vehicle receiving power from a distant laser after it has been placed in orbit by the space shuttle. The cargo looks like tubes or pipes off to the right in the figure.

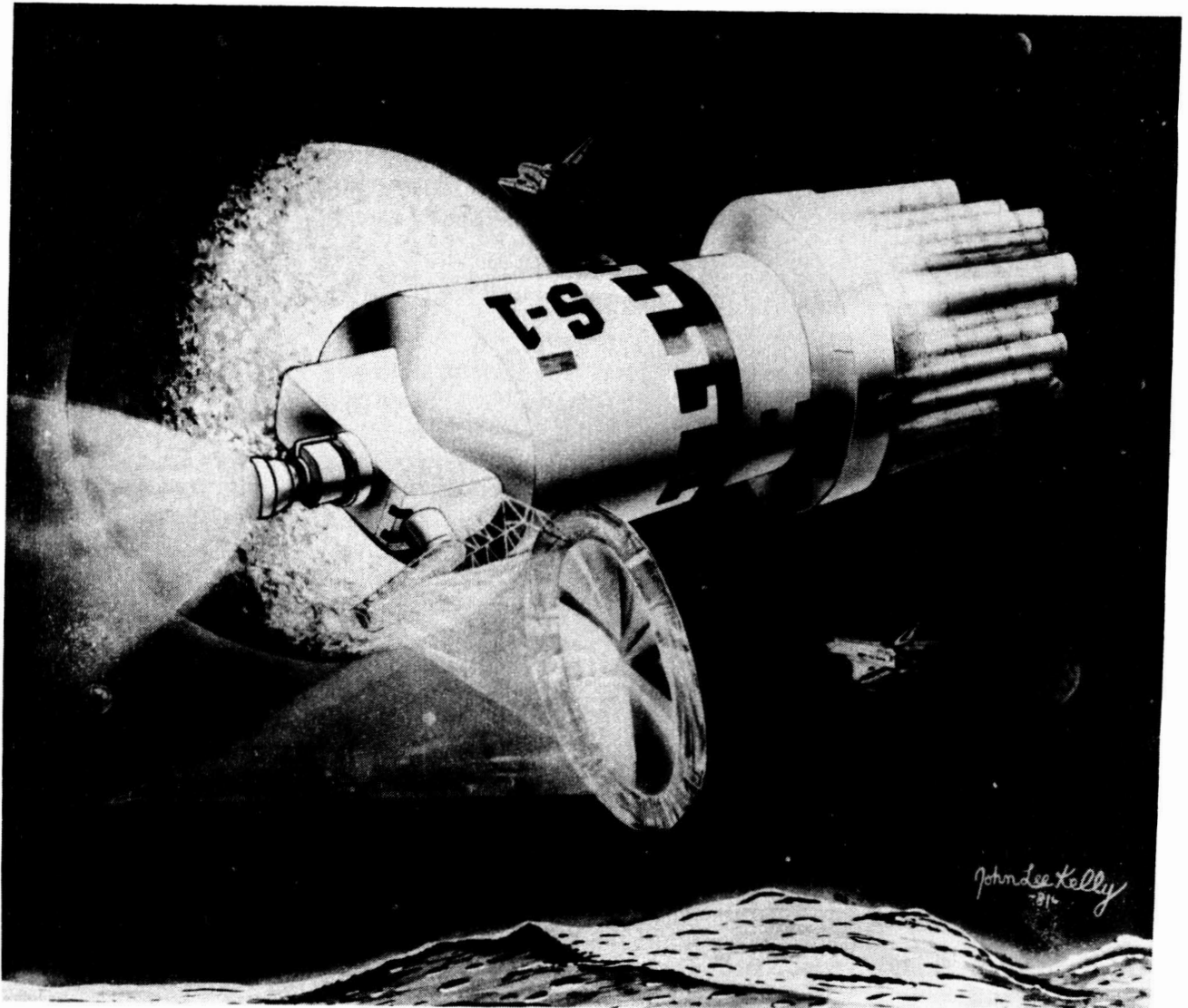

ORIGINAL PAGE
BLACK AND WHITE PHOTOGRAPH

LLTS./LUNAR LASER TRANSPORTATION SYSTEM

This figure is an artist's conception of a laser thermal rocket during liftoff from the surface of the Moon. The launch point is not far from a permanent lunar base which appears to the left in the figure. This is the concept for a transfer system from the lunar surface to low-lunar orbit. To complete the laser transportation catalog, shortly we will be talking about an orbit transfer vehicle from low-lunar orbit to low-Earth orbit. This LLTS system did not offer high enough value to NASA for presentation in this workshop.

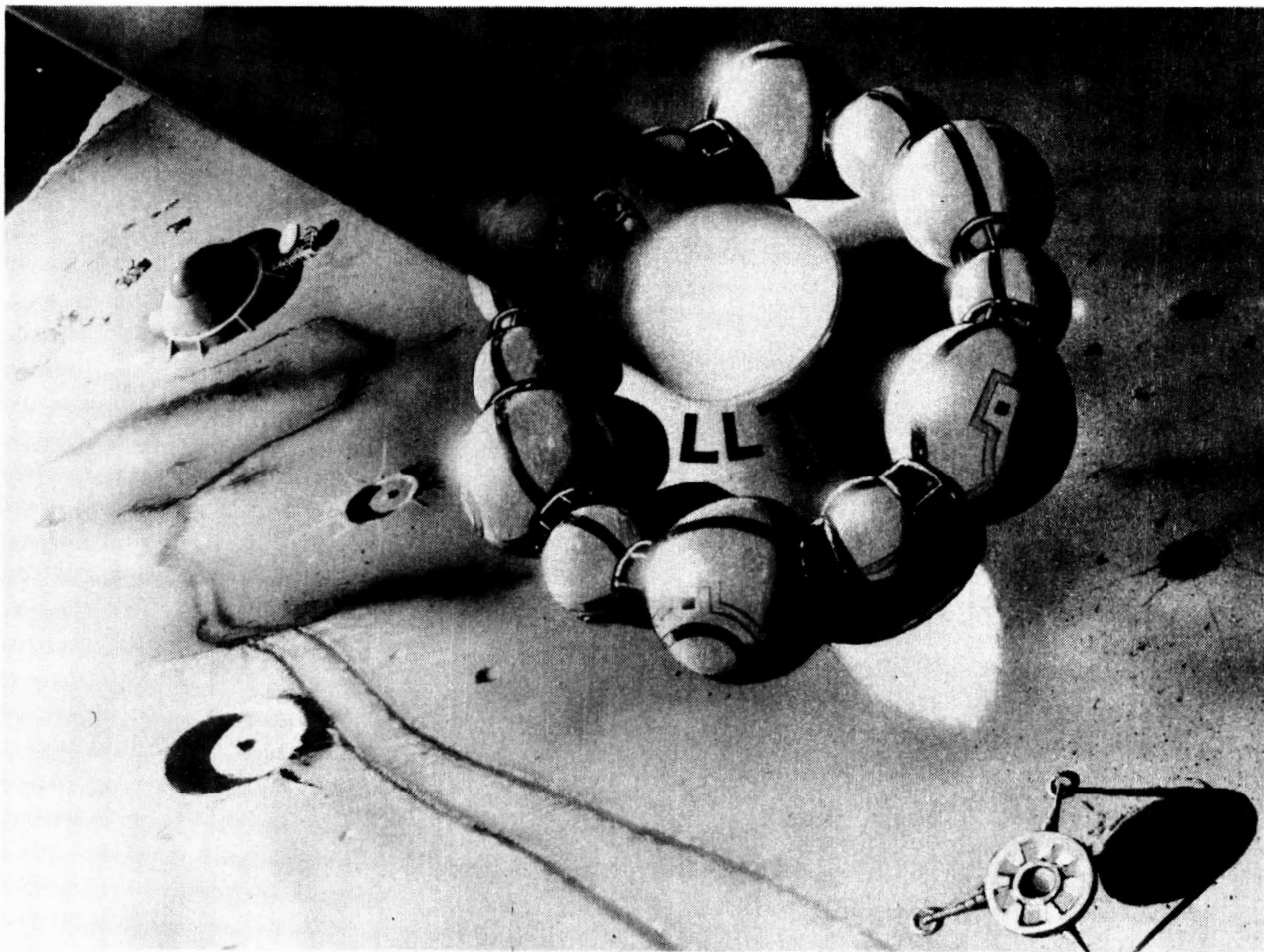

ORIGINAL PAGE
BLACK AND WHITE PHOTOGRAPH

ENABLING SPACE MISSIONS BY LASER-POWER TRANSMISSION

This figure shows two possible uses for lasers. In one case, a laser in high orbit transmits power to an electric propulsion system in a low-altitude, high-drag orbit. The small area for the laser-to-electric converter permits large amounts of power to be generated without much drag. (Large amounts of drag are associated with solar photovoltaic arrays which provide the same power level.) This system could remain in orbit at altitudes significantly lower than 200 kilometers for as long as the fuel would last. The other option in this figure is to use a blackbody laser, in high orbit to transmit power to a spacecraft in orbit that received a great deal of radiation. The critical subsystem is a radiation insensitive laser-to-electric converter, such as the MHD converter shown in this figure. Neither of these concepts offer as high a payoff to NASA and are not among the concepts which we have prepared for this workshop.

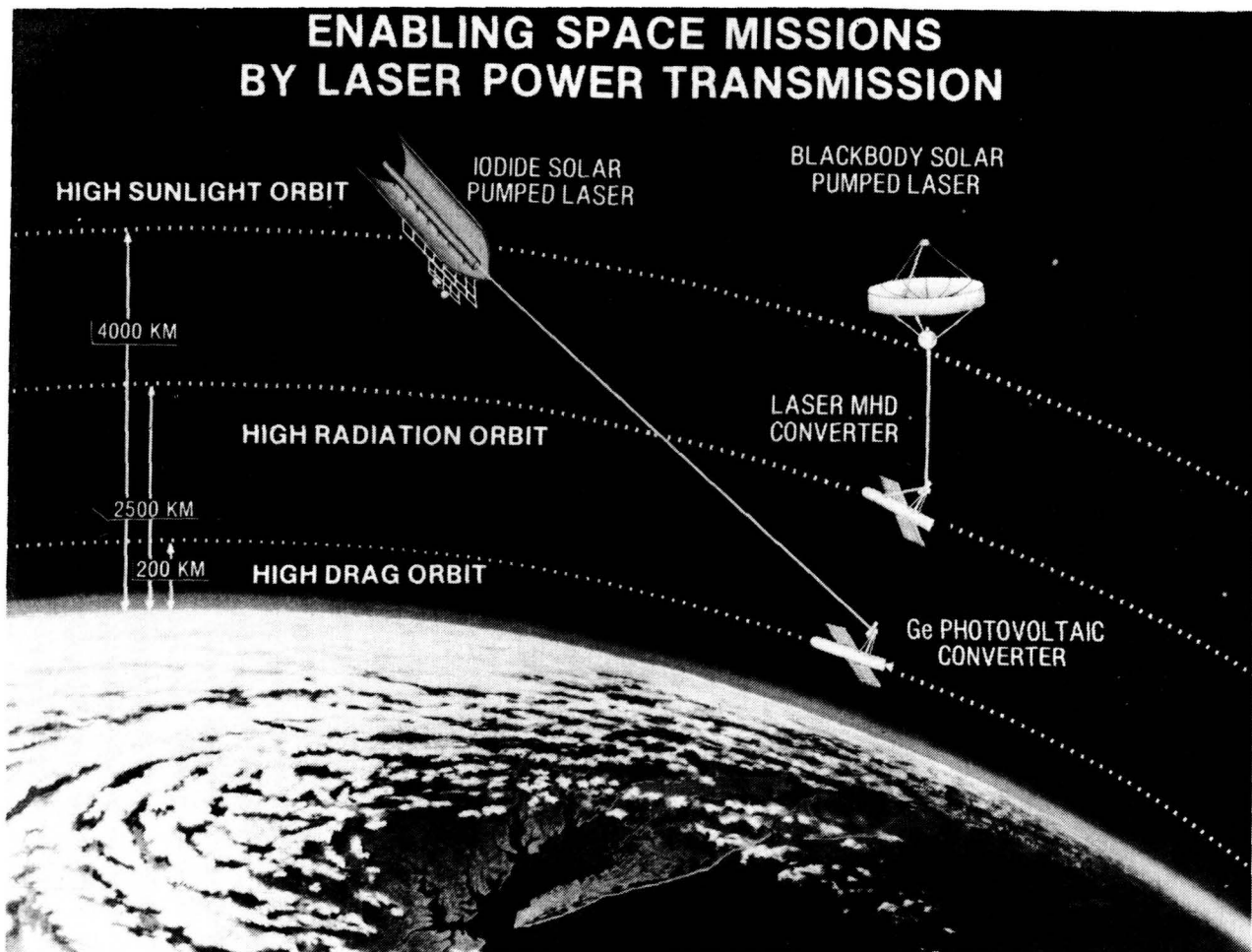

HYBRID LASER/CHEMICAL OTV

This figure shows the hybrid laser/chemical orbital transfer vehicle for low-earth orbit to low-lunar orbit operations. The interesting feature about this concept is that only one laser power station is required. The power station is in a high earth orbit, and it provides power only for acceleration to escape the earth's gravity-well. Small amounts of chemical power are used to circularize the orbit around the Moon and for thrust to begin the return from the Moon. An aerobrake is used to decelerate the spacecraft for Earth capture. There will be more presented on this concept in the propulsion session of the workshop.

FOR LEO-LLO OPERATIONS

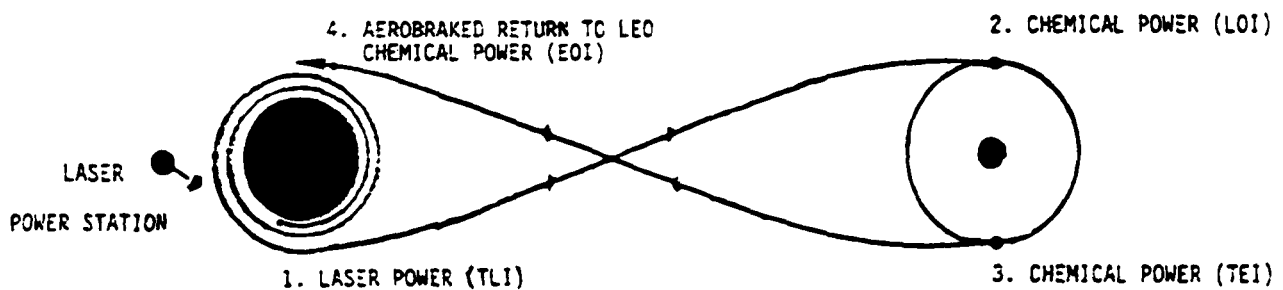

NEAR-EARTH APPLICATIONS OF LASER POWER

We will touch on four topics: (1) power transmitted from space to Earth, (2) power for a space industrial complex , (3) power for GEO satellites, and (4) power for Space Station Freedom.

NUCLEAR-PUMPED LASER PROVIDING POWER TO EARTH

Here you see a nuclear-pumped laser providing power for four users and having several other beams emitted also. The beam of primary interest here is the one that goes to the ground. As you can see, this beam is directed to a large power station near some unidentified city, west of but near the northern end of the Chesapeake Bay on the East Coast of the United States. One can only wonder what city is important enough to receive the first power transmitted from space.

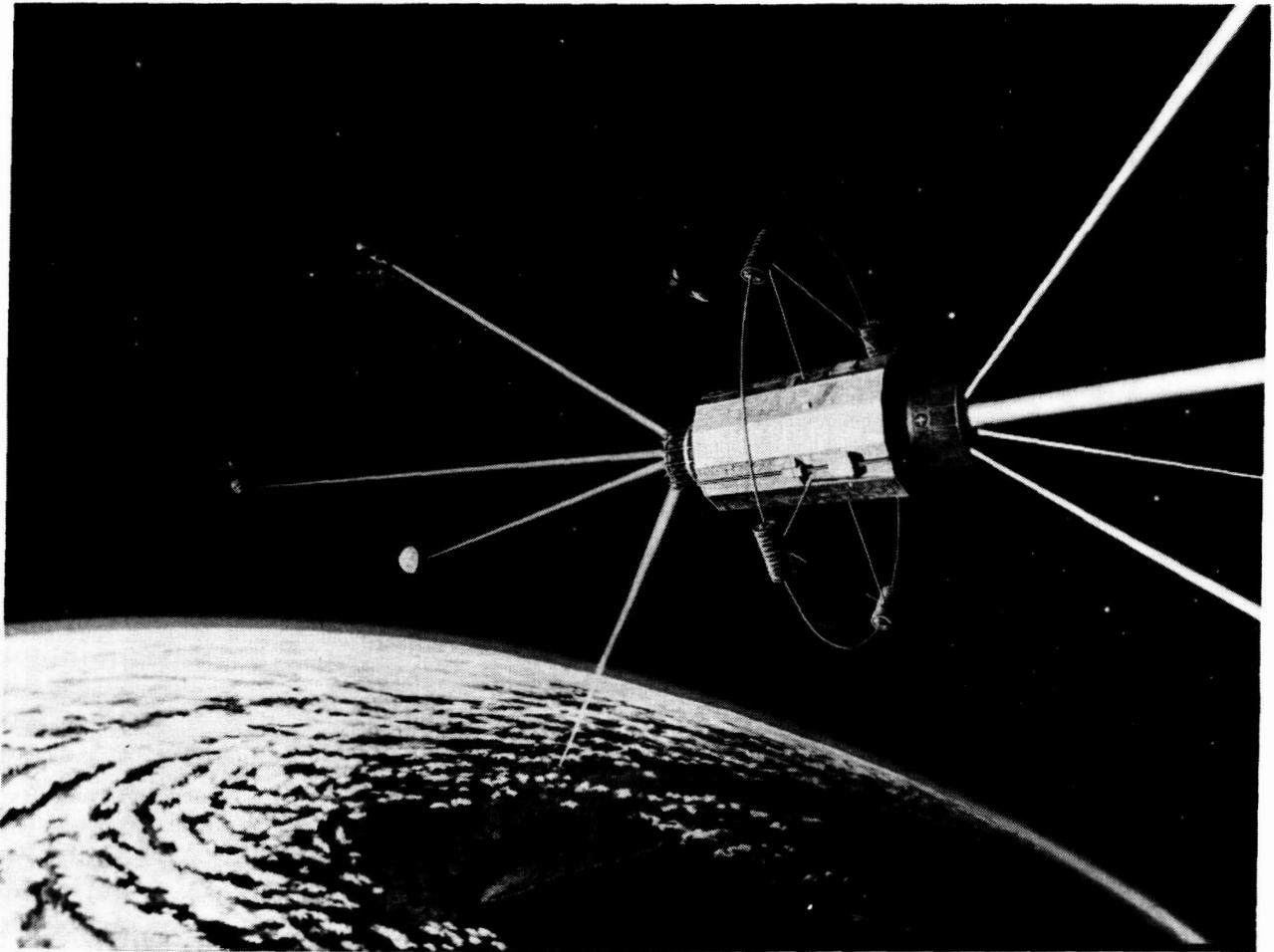

ORIGINAL PAGE
BLACK AND WHITE PHOTOGRAPH

LASER-POWER APPLICATIONS

This figure shows three areas of application. One is a lunar base and we won't discuss that any further. The second application is a space industrial complex which might be in low-Earth orbit or in geostationary orbit. The third application is power beamed from Earth to a spacecraft, (probably a communications satellite) in geostationary orbit. The idea is to use the relatively cheap electrical power on Earth so that a spacecraft in geostationary orbit (therefore always in view) need not carry solar arrays, batteries, etc. We will discuss power beamed from Earth to GEO in our workshop presentations but will not go into powering a space industrial complex, since that is more likely to be an industry than a NASA project.

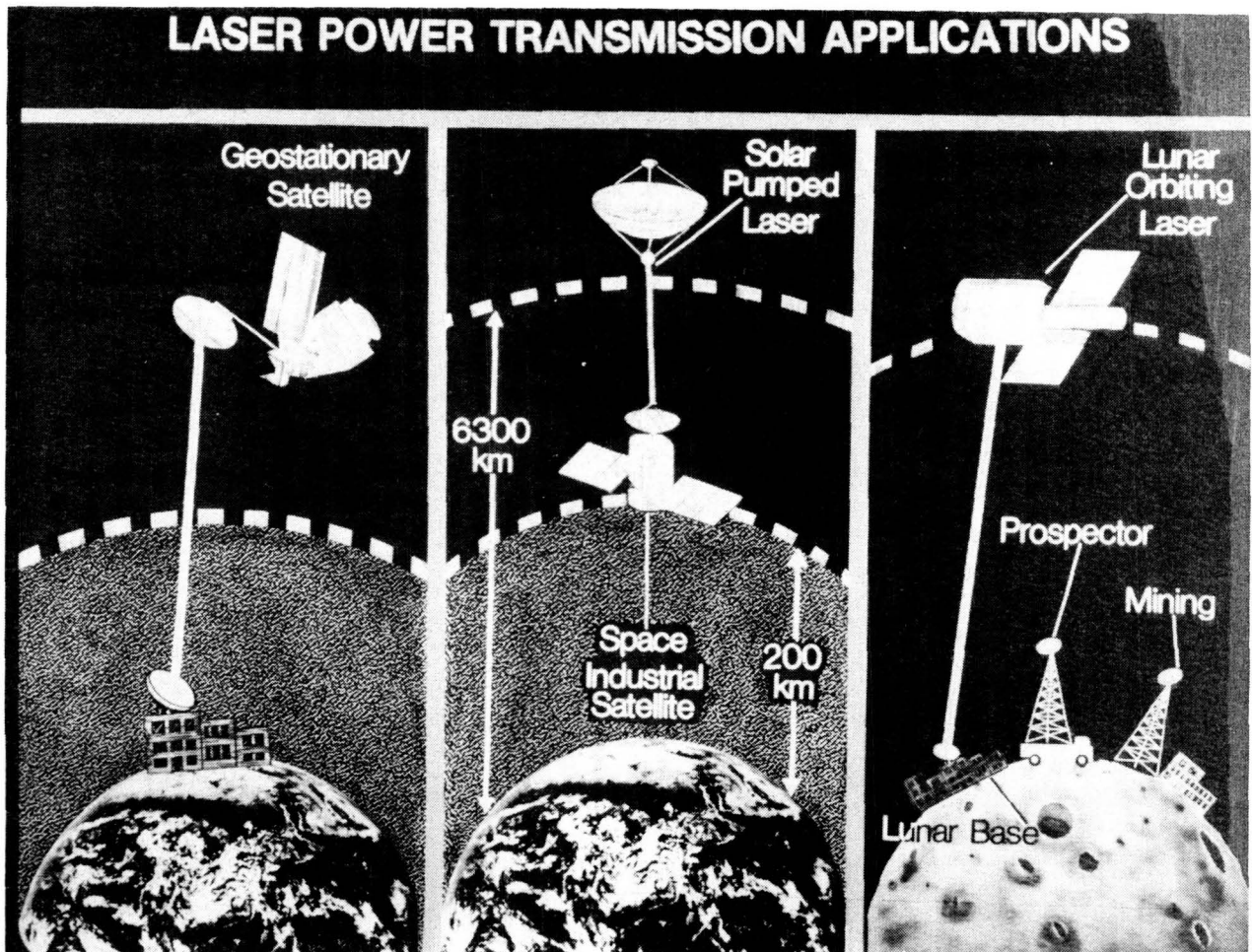

ORIGINAL PAGE
BLACK AND WHITE PHOTOGRAPH

PRELIMINARY CONCEPT STUDY OF SOLAR-PUMPED LASER POWER BEAMED TO SPACE STATION FREEDOM

This figure shows a laser-power station in high-Earth orbit beaming power to a power relay satellite which is co-orbiting with the Space Station Freedom. The power is re-transmitted from the power relay satellite to the Space Station Freedom providing the power needed there. The advantage of this concept is that drag induced by the large solar arrays can be avoided, since solar photovoltaic power need not be carried on Space Station Freedom. This reduction in frontal area (removal of the solar arrays) not only reduces the drag, it reduces the mass of the Space Station Freedom, as well. Combined, this reduces the number of reboosts necessary to keep the Space Station Freedom in orbit over a long period of time. This concept will be discussed from slightly different points of view in the near-Earth workshop.

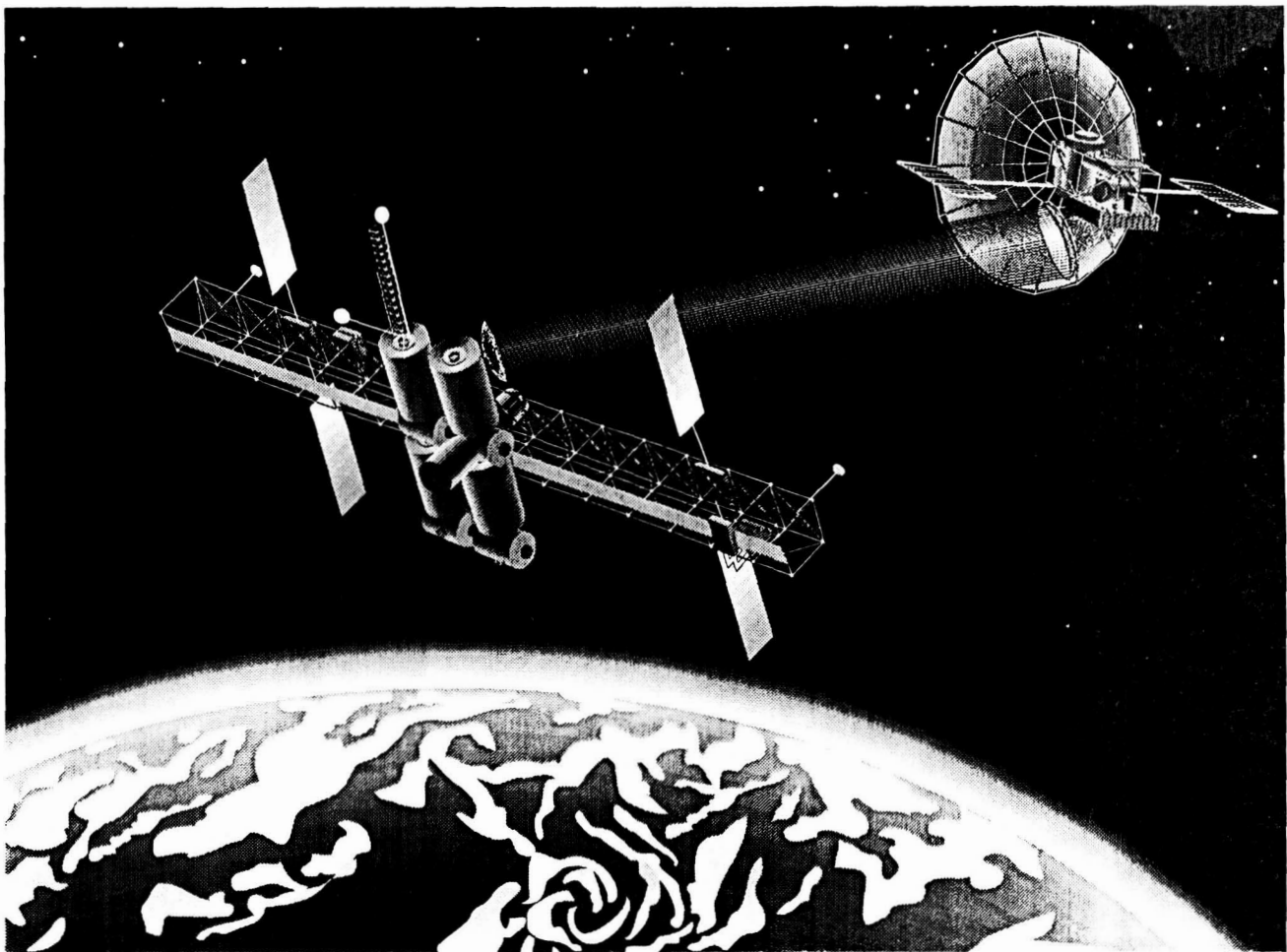

LASERS IN THE MINIWORKSHOP STUDIES

In this session, we discussed the solar-pumped iodine laser, the optically pumped neodymium ion laser, and the electrically pumped diode lasers.

IODINE PHOTODISSOCIATION LASER

This figure shows (1) the absorption spectrum of two iodide lasants superimposed on the air mass zero solar spectrum and (2) an energy level diagram for the lasing process. The iodides absorb at wavelengths less than 300 nanometers, so they are absorbing in a region where the solar radiance is not very strong. The energy diagram for C_3F_7I shows this lasant absorbing radiation at 270 nanometers, being excited to $C_3F_7I^*$, dissociating into I^* and the C_3F_7 radical. The I^* then lases and ultimately recombines into C_3F_7I . A very small fraction of the iodine becomes molecular iodine I_2 , and a very small fraction of the C_3F_7 radical dimerizes to become $(C_3F_7)_2$.

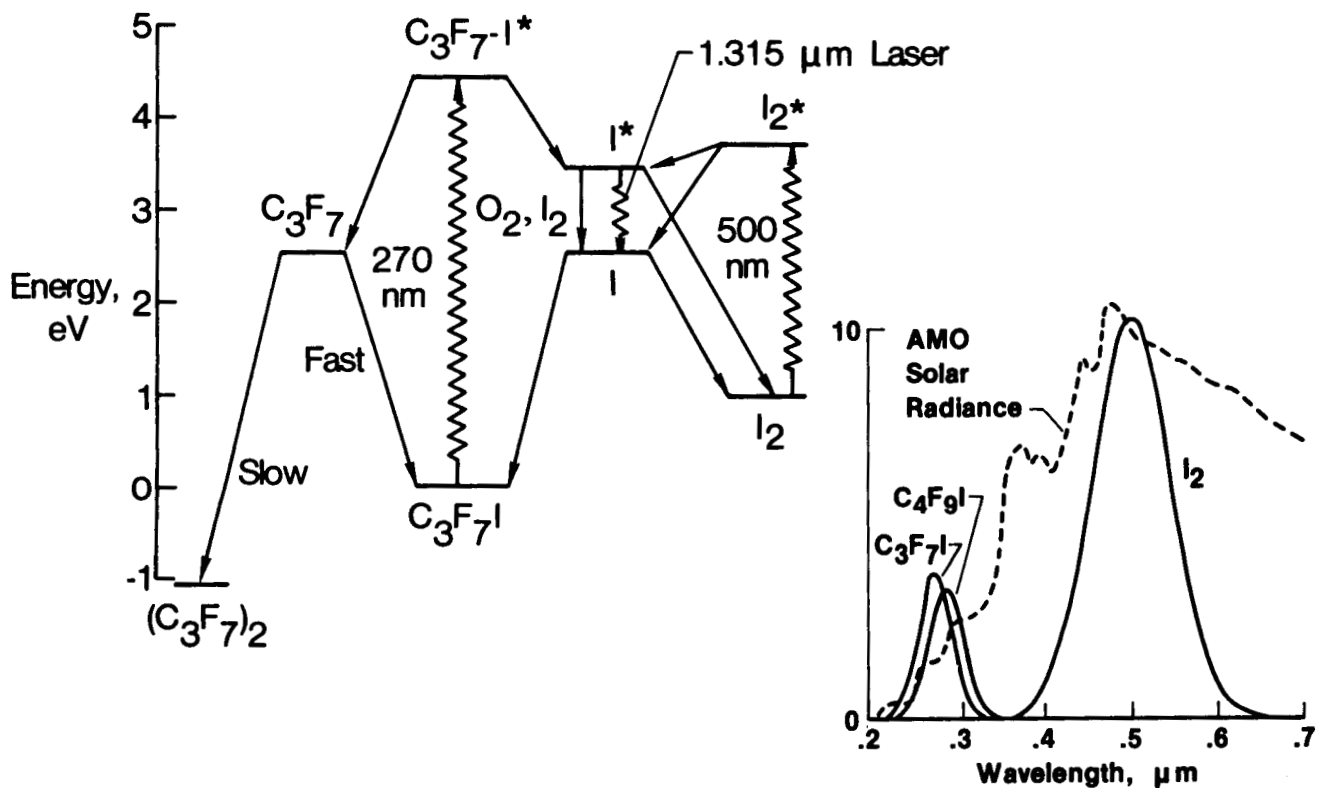

EXPERIMENTAL SOLAR-PUMPED LASER

This figure shows several people working on a solar-pumped laser experiment in our lab. A large solar-simulating arc lamp is encased in an elliptical concentrator (beneath the aluminum foil on the right side of the figure). The laser is at one focus of this ellipse and the arc lamp is at the other. Radiation from the laser is emitted toward the left. Experimenters there are involved in adjusting some of the measuring instruments for characterizing the radiation while a technician in the foreground is adjusting the flow rate of the lasant through the laser.

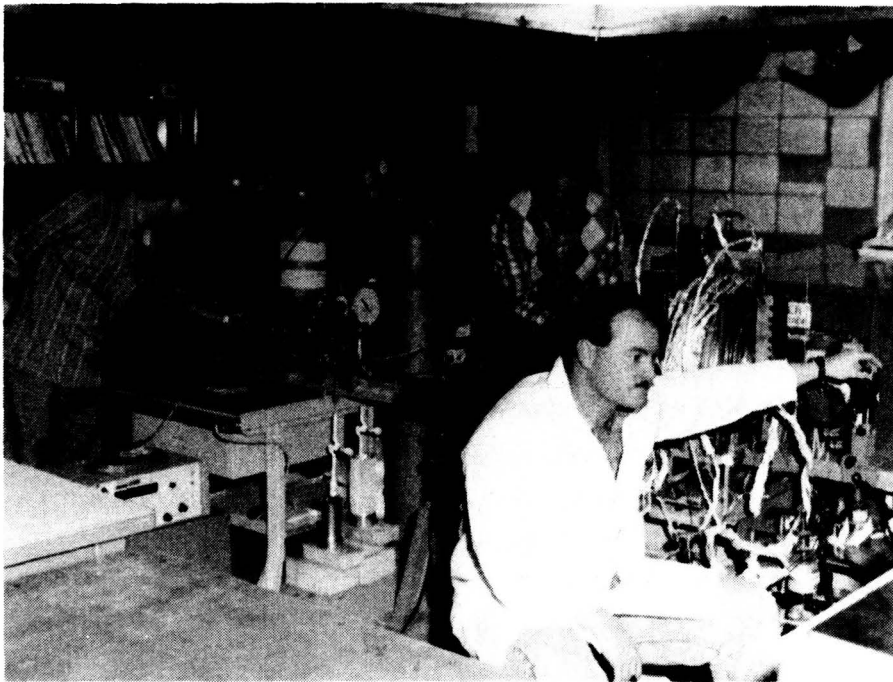

ORIGINAL PAGE
BLACK AND WHITE PHOTOGRAPH

NEODYMIUM THREE PLUS SPACE-BASED LIQUID LASER

This concept shows a large parabolic collector capturing sunlight and concentrating it with a complex concentrator. The second element of this concentrator is called a reconcentrator. The concentrated solar power is focused onto a small laser. The Nd:POCl₃ lasant is being circulated to provide cooling and to remove the hot lasant from the cavity. The 10-megawatt coherent CW beam is emitted from this laser and is transmitted by a reflecting mirror shown on the right side of the figure. The back of the parabolic concentrator is a large radiator with approximately 4×10^5 meters of radiating area.

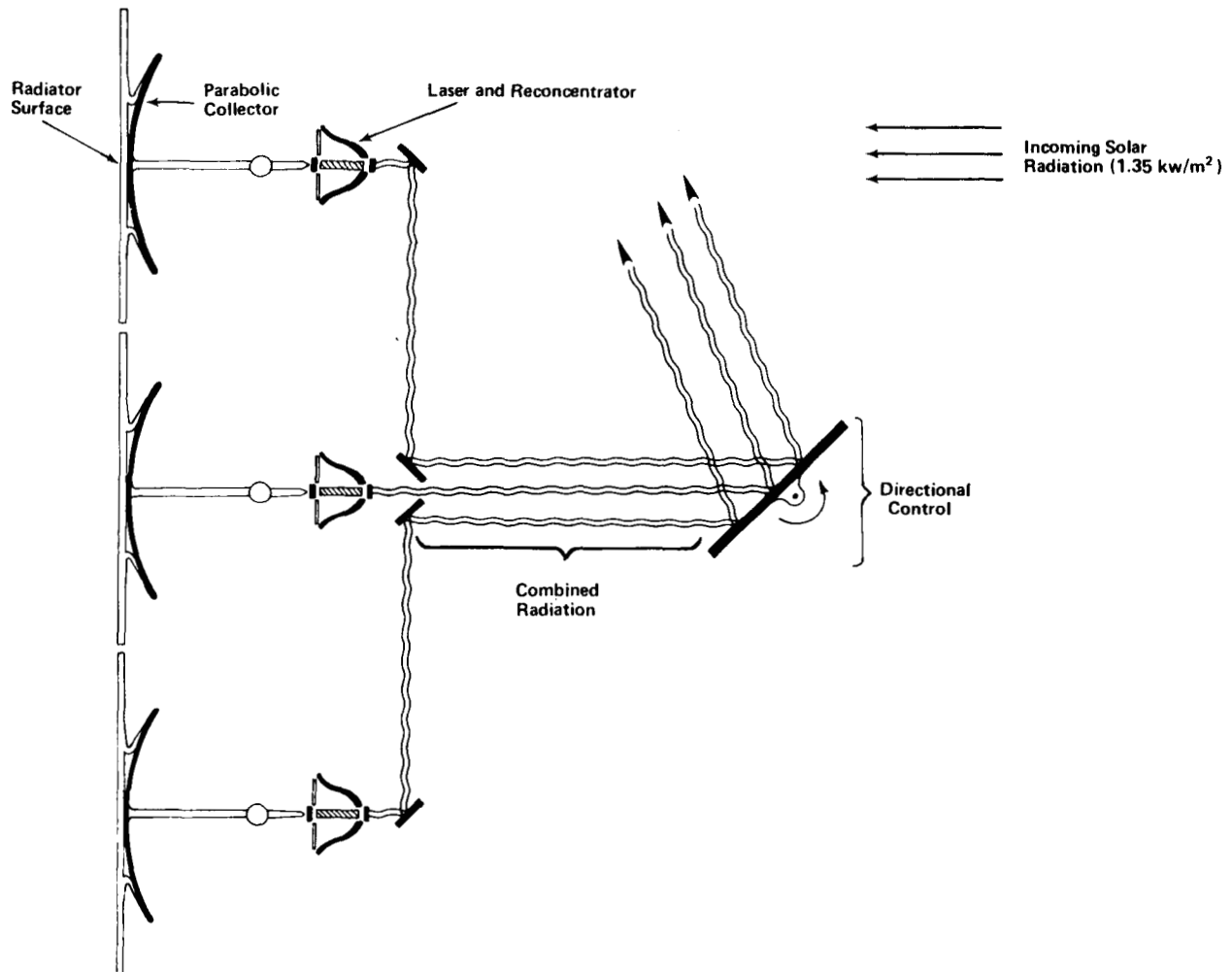

THE FIBER BUNDLE NEODYMIUM GLASS LASER

One of the reasons that glass lasers are not generally used for solar pumping is that glass has a tendency to fracture where sharp temperature gradients exist. In an attempt to avoid this problem, we have done some experimental laser research with neodymium fibers in a bundle. Water flows through the fiber bundle along the axis to provide cooling. The figure shows laser output power in watts as a function of the simulator input power for a mirror with 90 percent reflectivity acting as the transmitting mirror. This laser, as you can see, produces about 23 or 24 watts.

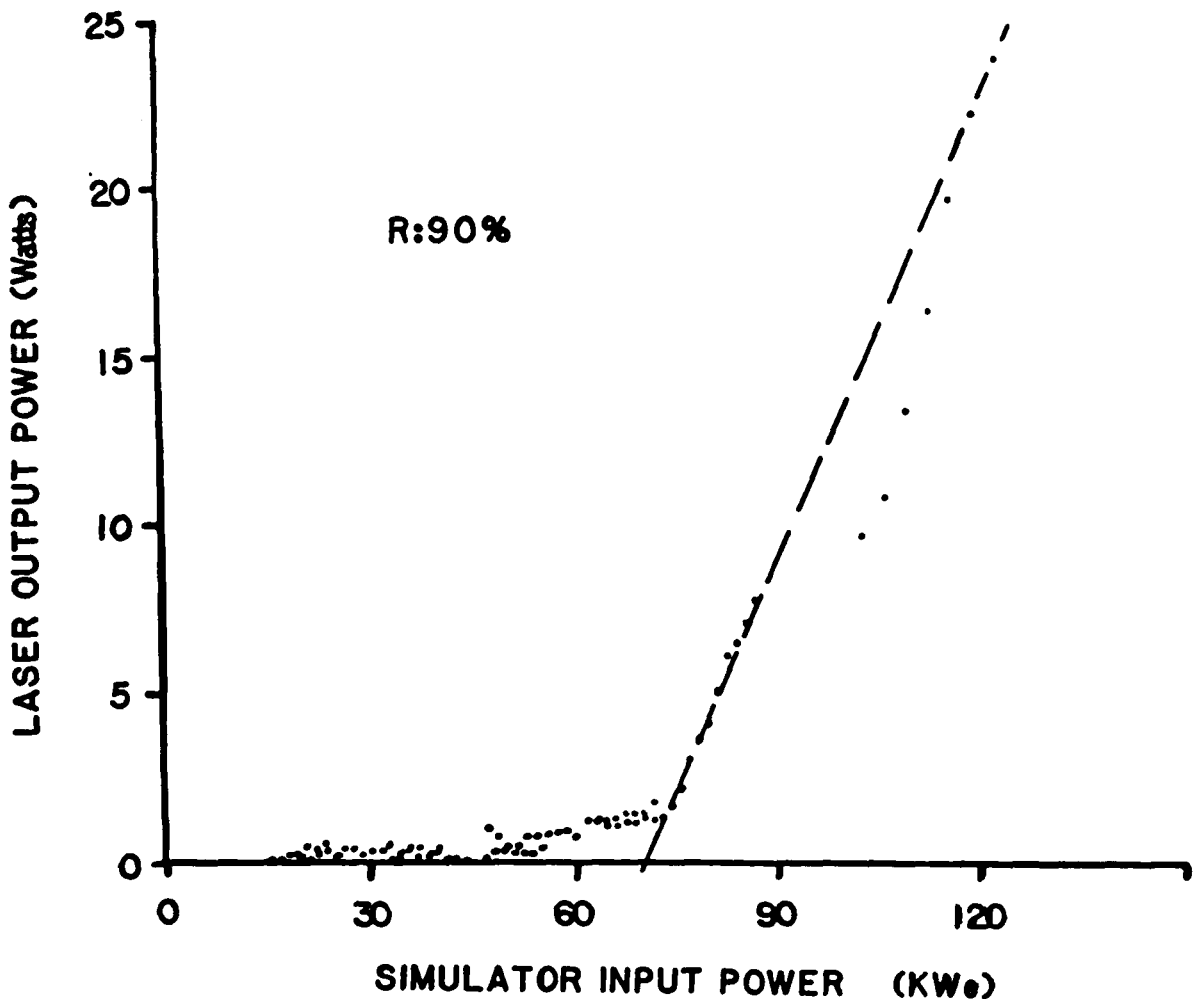

DIODE ARRAY EXPERIMENT

In this figure we see a researcher adjusting one of the mirrors in an experiment to measure the coherence that can be established between several independent diodes. This experiment tests techniques to gang diodes into arrays which provide large amounts of coherent power.



ORIGINAL PAGE
BLACK AND WHITE PHOTOGRAPH

Plk reviewed

SUMMARY

~~In this presentation, we reviewed the concepts of laser power-beaming applicable to advanced NASA missions. This review covered many concepts not developed for this workshop, and it was intended to give you a broader view of what is possible. We identified some specific concepts to be presented at the miniworkshops, and we've briefly discussed the types of lasers (the iodine lasers and the diode lasers) which are central to the laser miniworkshop presentations.~~ *are discussed.*

N90-10155 515-32

216779

OVERVIEW OF MICROWAVE CONCEPTS

ND 315753

Karl Faymon
NASA Lewis Research Center

LEO TO GEO AND RETURN TRANSPORT

POSSIBLE APPLICATION SCENARIOS FOR BEAMED POWER

SPACE BASED APPLICATIONS

- SPACE-TO-SPACE
- SPACE-TO-PLANETARY SURFACE

PLANETARY SURFACE BASED OPERATIONS

- SURFACE-TO-SURFACE
- SURFACE-TO-ORBIT

• ————— •

THE SCENARIOS PRESENTED HERE ARE NOT THE RESULT OF ANY "DETAILED" ANALYSIS. THEY REPRESENT "ZERO TH ORDER" ESTIMATIONS AND ARE PRESENTED TO FOSTER DISCUSSION ON THE VIABILITY OF BEAMED POWER TRANSMISSION.

BEAM POWER TRANSMISSION

APPLICATIONS: SPACE BASED OPERATIONS - SPACE-TO-SPACE.

Concept	Ref. Technology	Pow. Level	Attributes	Benefits	Comments
<u>Non-propulsive</u>					
• Central sta. power for space complexes.		Multi-MW.	Isolation of nuclear power source from inhabited stations. Multiple users served from single source.	Reduced costs - Econ. of scale. - Reduced operat. costs. • Power costs in space reduced by one-half.	Space operations more complex; - Avoidance of beam paths. - May need relay stations. - Requires siting of facilities. Simplified station/satellite design; - Eliminates solar panels and storage for solar power systems.
• Power trans. to operational satellites.		100's to MW's.	Isolation of nuclear power source from user satellites. Higher payload mass fractions on satellites.	Reduced costs - Econ. of scale. - Reduced oper. costs. • Satellite payload increased by 20 percent.	Complex space operations; - Avoidance of beam paths. - Requires multiple power satellites for coverage. • Handover operations as satellites pass from one power source to another. Simplifies satellite design; - Same reason as above.
<u>Propulsive</u>					
• Orbit raising/ orbit operations.		Multi-MW.	Centralized power system/systems for LEO-GEO/orbital ops. electric propulsion vehicles. Increased payload mass fractions for transit vehicles.	Reduced costs - Econ. of scale. - Reduced oper. costs. • Vehicle payload increased by factor of 2.	Use of electrical propulsion for Earth-moon space orbit operations. - May extend trip time; questionable for manned operations. - May require multiple power sources for viable op's scenarios. • Roving power sources required? Simplified vehicle design; - Same reason as above.

KAF: BEAM POWER; JSP (166), 9/4/88.

BEAM POWER TRANSMISSION

APPLICATIONS: SPACE BASED OPERATIONS - SPACE-TO-PLANETARY SURFACE.

Concept	Ref. Technology	Pow./Level	Attributes	Benefits	Comments
<u>Non-propulsive</u>					
• Power for exploratory/initial manned landing on Mars.		10's KWs.	No need to land power system for initial Mars landing team. • Uses excess power from Earth-Mars transit vehicle while in Mars "holding orbit".	Reduced mass of Earth-Mars transit vehicle. - Separate power system not required for surface op's. • No estimate.	Requires electric propulsion Earth-Mars transit vehicle. - Multi-MW required for transit not needed at planet. Surface operations requires 10's KWs only. Cannot est. ben'fts at this time.
• Lunar/planetary outpost power.		10's KWs.- 100's KWs.	Temporary/permanent power sources to support exploration activities. Power supply for a distributed surface infrastructure.	No need to land separate power system to support temporary outpost or exploration activities. • Reduce power costs by 1/2.	Requires "orbiting/stationary" power satellite. - Specialized orbit requirements. - May be attractive for low-power activities on surface. • Could use solar based power. - Could cover wide surface area.
• Space Power Satellite for terrestrial power.		GW's.	Solar power supply for terrestrial needs. Renewable energy resource its atmosph. intrusion.	Environmentally attractive system. • Protects the Earth's atmosphere	High initial cost. Transportation to orbit; - Launch system atmospheric effects. Environ. effects of power beam? Siting may be a problem.
<u>Propulsive</u>					
• Planetary rovers/sample collectors.		KW's.	Reduced mass of rover system. Could service any number of rovers. - Rovers could be widely spread.	Higher rover payload mass fraction - Greater mobility for rover. • Could increase rover P/L by 1/2.	Power to be supplied by orbiting satellite/station. - Specialized orbit requirements for orbiting station. - Rover must have provision for loss of beam (shadowing).
• Mars airplane.		10's KWs.	Could make Mars airplane a viable concept for Mars exploration. - Extremely flexible exploration system.	Mars airplane does not need its own power source. - Increase in range for plane. • No estimate of benefits.	Power to be supplied by orbiting satellite/station. - Specialized orbit requirements for orbiting station. - Could require a number of orbiting stations for vast surface coverage.

KAF: BEAM POWER: JSF (167) 9/4/88.

BEAM POWER TRANSMISSION

APPLICATIONS: PLANETARY SURFACE BASED OPERATIONS.

SURFACE-TO-SURFACE

Concept	Ref. Technology	Pow./Level	Attributes	Benefits	Comments
<p><u>Non-propulsive</u></p> <ul style="list-style-type: none"> • Central sta. power for surface complexes. 		Multi-MW.	Isolation of nuclear power source from inhabited stations. Multiple users served from a single source.	<p>Reduced costs</p> <ul style="list-style-type: none"> - Econ. of scale. - Reduced operat. costs. - Eliminate land lines across hostile terr. <ul style="list-style-type: none"> • Reduce power costs by 2/3. 	<p>Requires some clustering of op's.</p> <ul style="list-style-type: none"> - Could use fixed relay stations for widely spaced complexes. • Incurs additional transmission losses. - Eliminate maintenance of transmission/distribution system for "conventional" utility on planetary surface.
<p><u>Propulsive</u></p> <ul style="list-style-type: none"> • Planetary surface exploration vehicles. (Surface/Air) 		10-100 KW's.	Reduced mass of transportation systems. Could service any of trans. systems.	<p>Higher transport system payload mass fractions.</p> <ul style="list-style-type: none"> • Increase payload mass fraction by 50 percent 	<p>Power from fixed station may have to be augmented by relay stations.</p> <ul style="list-style-type: none"> - Incurs additional transmission losses. <p>Could result in a highly flexible transportation/exploration system with supporting infrastructure.</p>

SURFACE-TO-ORBIT

Concept	Ref. Technology	Pow./Level	Attributes	Benefits	Comments
<p><u>Non-propulsive</u></p> <ul style="list-style-type: none"> • LEO-GEO orbit raising. 		100's KW's. Multi-MW's.	Increased payload mass fraction of transport vehicle with electric propulsion.	<p>Reduced cost of delivering mass to orbit.</p> <ul style="list-style-type: none"> • Increase payload mass fraction by factor of 2. 	<p>Power system located on Earth surface. Operational complexity:</p> <ul style="list-style-type: none"> - Requires LEO staging point. - Ascent in equatorial plane, <ul style="list-style-type: none"> • Plane change with electric propulsion impractical. - Power Station siting difficult. <ul style="list-style-type: none"> • Vehicle in-sight of station small portion of orbit. • Longer trip times. - Multiple stations may be needed to make this concept viable.

KAF: BEAM POWER: JSF (168), 9/5/88.

PLANETARY POWER APPLICATIONS MINIWORKSHOP

LASER-POWERED LUNAR BASE

N 90-10156

76-36

~~SECRET~~
516780

R. Costen, D. Humes — Nuclear Reactor Reference Mission

23

ND 210441

G. Walker — Laser-to-Electric Lunar Base Converter

M. Williams, R. De Young — Diode Array and Iodine Lasers

R. De Young — Mission Payoff Summary

Introduction

The objective of ~~this study~~ was to compare a nuclear reactor-driven Sterling engine lunar base power source to a laser-to-electric converter with orbiting laser power station, each providing 1 MW of electricity to the lunar base. The comparison was made on the basis of total mass required in low-Earth-orbit for each system. This total mass includes transportation mass required to place systems in low-lunar orbit or on the lunar surface.

The nuclear reactor with Sterling engines is considered the reference mission for lunar base power and is described first. The details of the laser-to-electric converter and mass are discussed. The next two solar-driven high-power laser concepts, the diode array laser or the iodine laser system, are discussed with associated masses in low-lunar-orbit. Finally, the payoff for laser-power beaming is summarized.

PRECEDING PAGE BLANK NOT FILMED

**REFERENCE MISSION -
NUCLEAR REACTOR POWER FOR LUNAR BASE**

ROBERT C. COSTEN

DONALD H. HUMES

NASA LANGLEY RESEARCH CENTER

PRECEDING PAGE BLANK NOT FILMED

PAGE 294 INTENTIONALLY BLANK

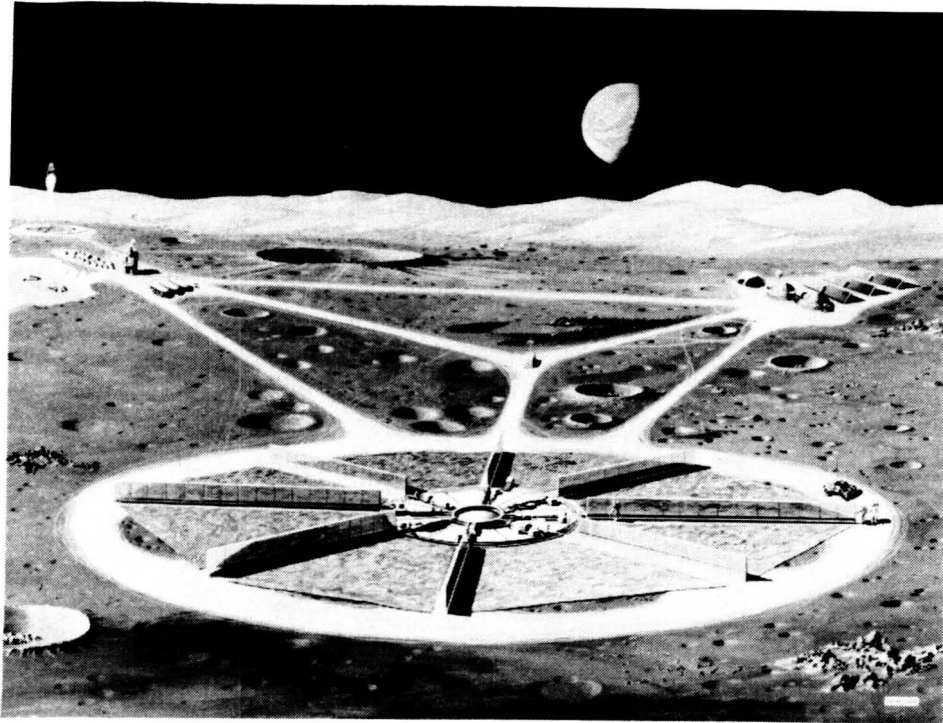

Nuclear Power System Layout

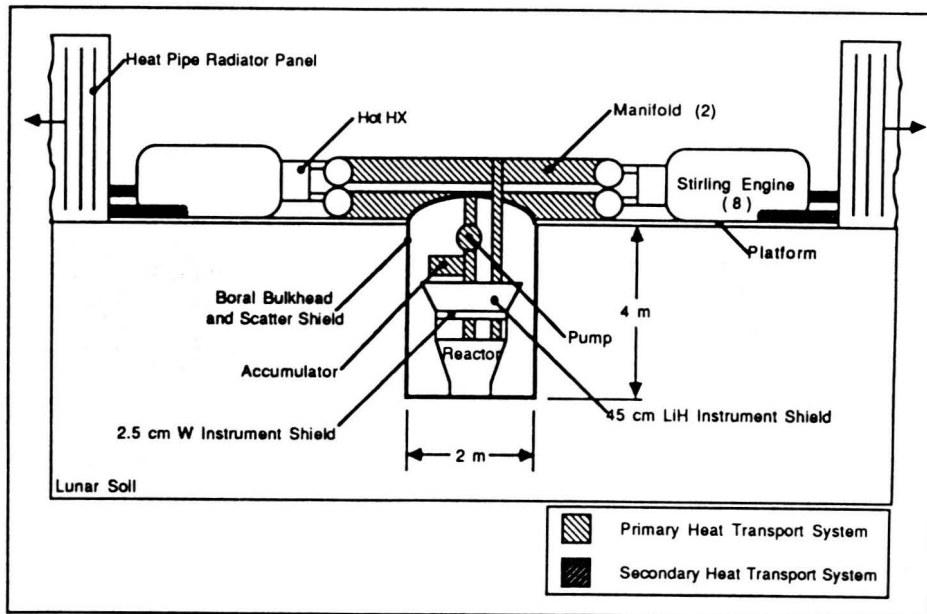

ORIGINAL PAGE
BLACK AND WHITE PHOTOGRAPH

POWER AND MASS

Power Rating:

Reactor Thermal Power	2500 kWt
Electrical Power Output	825 kWe

Nuclear Power Plant Mass:

Reactor/Instrument Shielding	3489 kg
Converter	6876 kg
Power Conditioning	2567 kg
Radiator	<u>7072 kg</u>
	20,004 kg
Vehicle and Propellant Mass (LEO to Lunar Surface)	<u>83,017 kg</u>
Total Mass in LEO	103,021 kg

ADDITIONAL CONSIDERATIONS

Advantages of Nuclear Power for Lunar Base:

Continuous Power (7 Years)
Existing Technology

SP-100 Reactor (Scaled Up)
Stirling Engines

Disadvantages:

Fixed and Permanent Location on Lunar Surface
Radiation Safety

Location Away from Habitat

- Impractical for Heating Habitat with Waste Thermal Energy
- Long Electric Cables

Maintenance Requires Robotics Technology

- No Containment Vessel
- Micrometeoroids
- Embrittlement

REFERENCE DOCUMENTS

Nuclear Power Plant Configuration and Specifications:

Office of Exploration (Code Z) Case Study 4

NASA TM 4075, October 1988

Masses of Power Plant Components:

"SP-100 Power System Conceptual Design for Lunar Base Applications," by Lee S. Mason and Harvey S. Bloomfield (NASA Lewis Research Center) and Donald C. Hainley (Sverdrup Technology, Inc.), Transactions of the Sixth Symposium on Space Nuclear Power Systems, Albuquerque, NM, January 8-12, 1989, pp. 9-12.

Mases of OTV, Lunar Lander, and Propellant:

"Conceptual Analysis of a Lunar Base Transportation System," by Tevor D. Hoy and Lloyd B. Johnson, III, (USAF), Mark B. Persons (George Washington University), and Robert L. Wright (NASA Langley Research Center), Paper No. LBS-88-233, Lunar Bases & Space Activities in the 21st Century, Houston, TX, April 5-7, 1988.

LASER-TO-ELECTRIC LUNAR BASE CONVERTER

Gilbert H. Walker

ND 2-10491

PHOTOVOLTAIC CONVERSION OF LASER TO ELECTRICAL POWER

- HIGH INTENSITY
- BANDGAP MATCH
- SELECTION OF SEMICONDUCTOR
- TYPES OF PHOTOVOLTAIC CONVERTERS
- MAXIMUM EFFICIENCY

CONSIDERATIONS FOR PHOTOVOLTAIC CONVERTERS

- ENERGY OF PHOTONS
- BANDGAP ENERGY OF SEMICONDUCTOR
- INCIDENT POWER DENSITY OF PHOTONS
- POWER CONVERSION EFFICIENCY
- CURRENT DENSITY
- SERIES RESISTANCE
- TYPE OF CONVERTER

PHOTOVOLTAIC CONVERTERS

Requirements

Convert iodine ($1.315\mu\text{m}$) or diode ($0.85\mu\text{m}$) laser radiation to electricity

Converter output fixed at 1 MWe

TYPES OF PHOTOVOLTAIC CONVERTERS

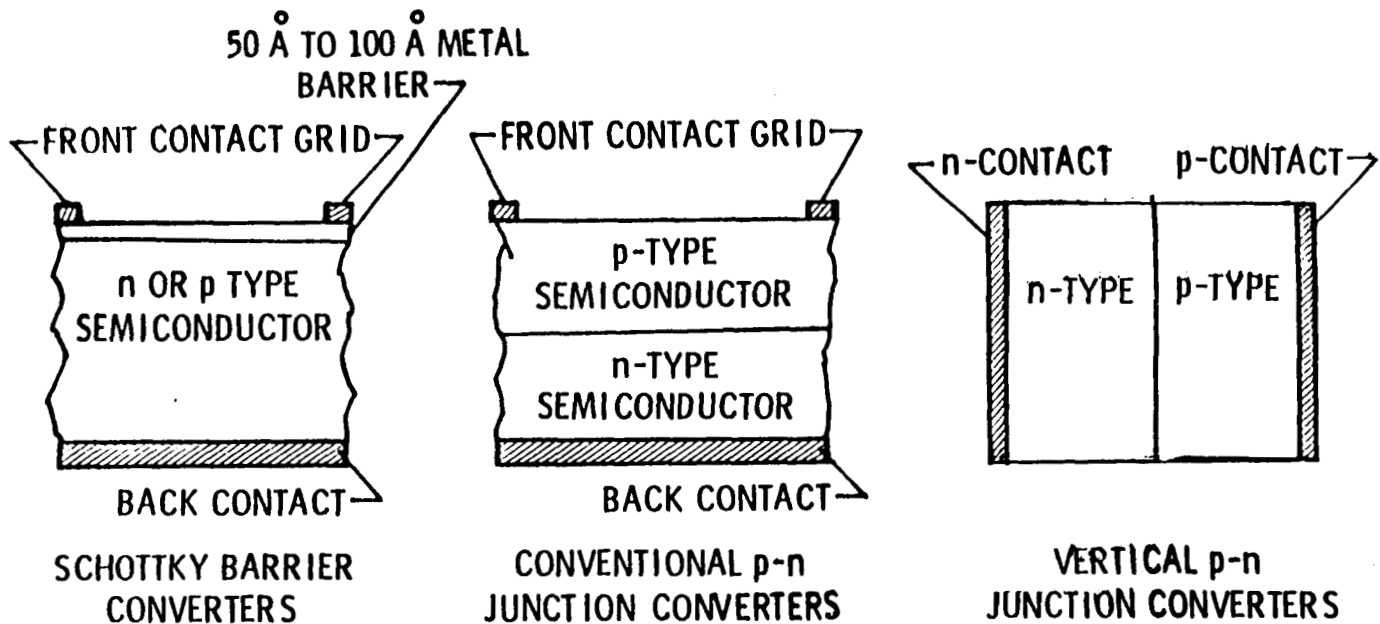

SERIES-CONNECTED, VERTICAL-MULTIJUNCTION PHOTOVOLTAIC CONVERTER

M - metal
n - n-type semiconductor
p - p-type semiconductor

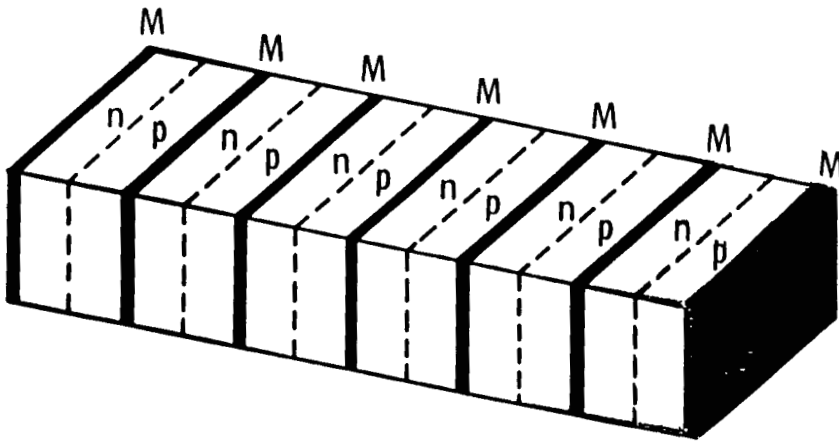

OPTIMUM PHOTOVOLTAIC CONVERTERS

For iodine laser ($1.315\mu\text{m}$) radiation:

Use $\text{Ga}_{.53}\text{In}_{.47}\text{As}$

For diode array laser ($0.85\mu\text{m}$) radiation:

Use $\text{Ga}_{.971}\text{Al}_{.029}\text{As}$

SCHEMATIC DIAGRAM OF CONVERTER LASER BEAM

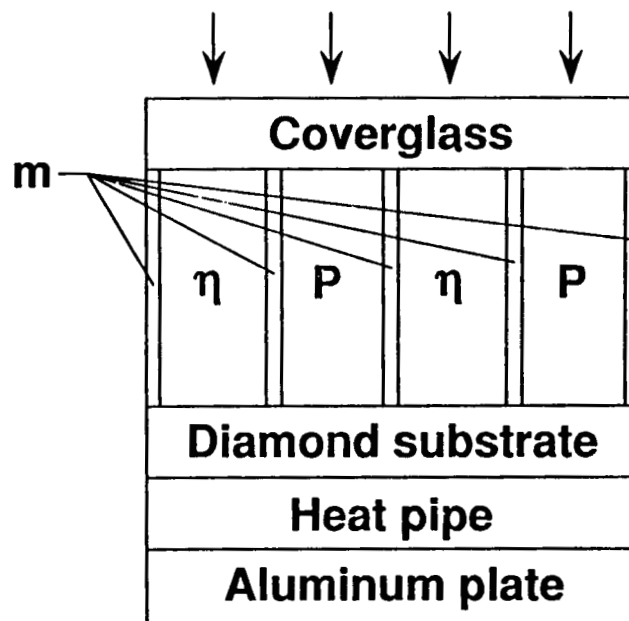

CHARACTERISTICS OF Ga_{0.971}In_{0.029} As AND Ga_{0.53}Al_{0.47} As converter

Number of junctions	500
Temperature	300 K
Recombination velocity	$1 \times 10^4 \text{ cm sec}^{-1}$
Laser wavelength	$1.315 \mu\text{m}, 0.85 \mu\text{m}$
Converter thickness	$3 \times 10^{-3} \text{ cm}$
Converter width	$3 \times 10^{-4} \text{ cm}$
Converter length	1 cm
Width of p-region	$2.5 \times 10^{-4} \text{ cm}^{-3}$
Carrier concentration	$1 \times 10^{17} \text{ cm}^{-3}$
Reflection coefficient	0.05

**CURRENT - VOLTAGE CHARACTERISTICS OF A
Ga_{0.53}In_{0.47}As IODINE LASER CONVERTER**

T = 320 K

$\eta = 48\%$

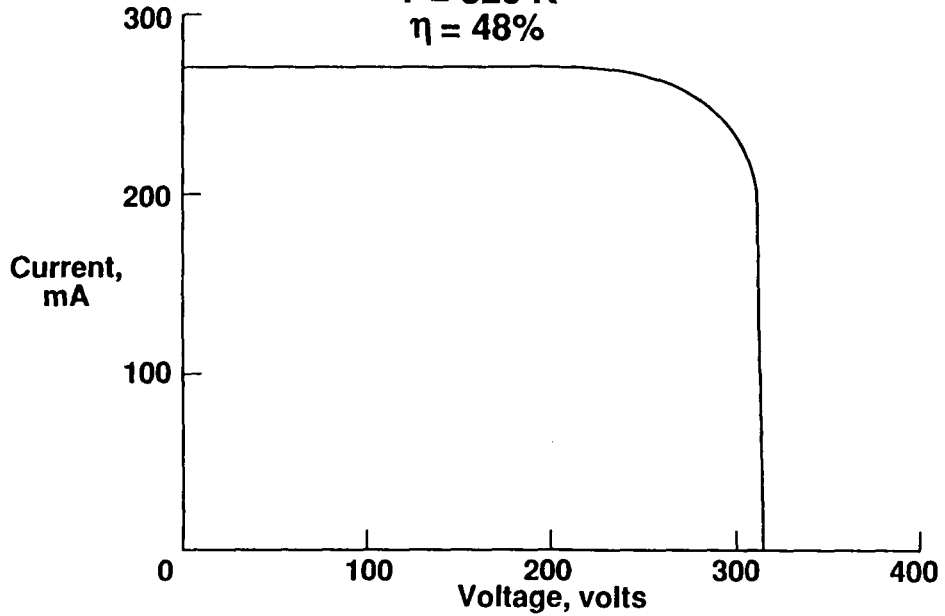

**CURRENT - VOLTAGE CHARACTERISTICS OF A
Ga_{0.971}Al_{0.029}As DIODE LASER CONVERTER**

T = 320 K

$\eta = 46\%$

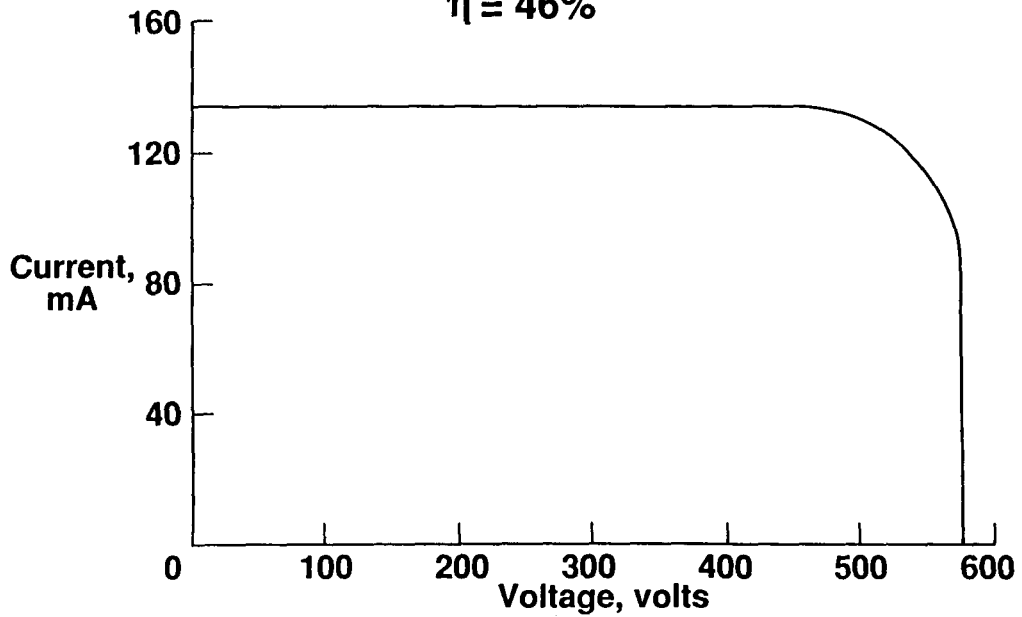

MASS BREAKDOWN FOR CONVERTER SYSTEM

<u>Converter</u>	<u>0.85 μm</u>	<u>1.315 μm</u>
A. Semiconductor	$6.59 \times 10^{-2} \text{ Kg}$	$6.88 \times 10^{-2} \text{ Kg}$
B. Coverglass	$3.31 \times 10^{-1} \text{ Kg}$	$3.31 \times 10^{-1} \text{ Kg}$
C. Diamond substrate	4.35 Kg	4.35 Kg
D. Supporting blanket	3.38 Kg	3.38 Kg
Total mass converter	8.12 Kg	8.13 Kg

MASS OF IODINE LASER-PHOTOVOLTAIC CONVERTER COMPONENTS

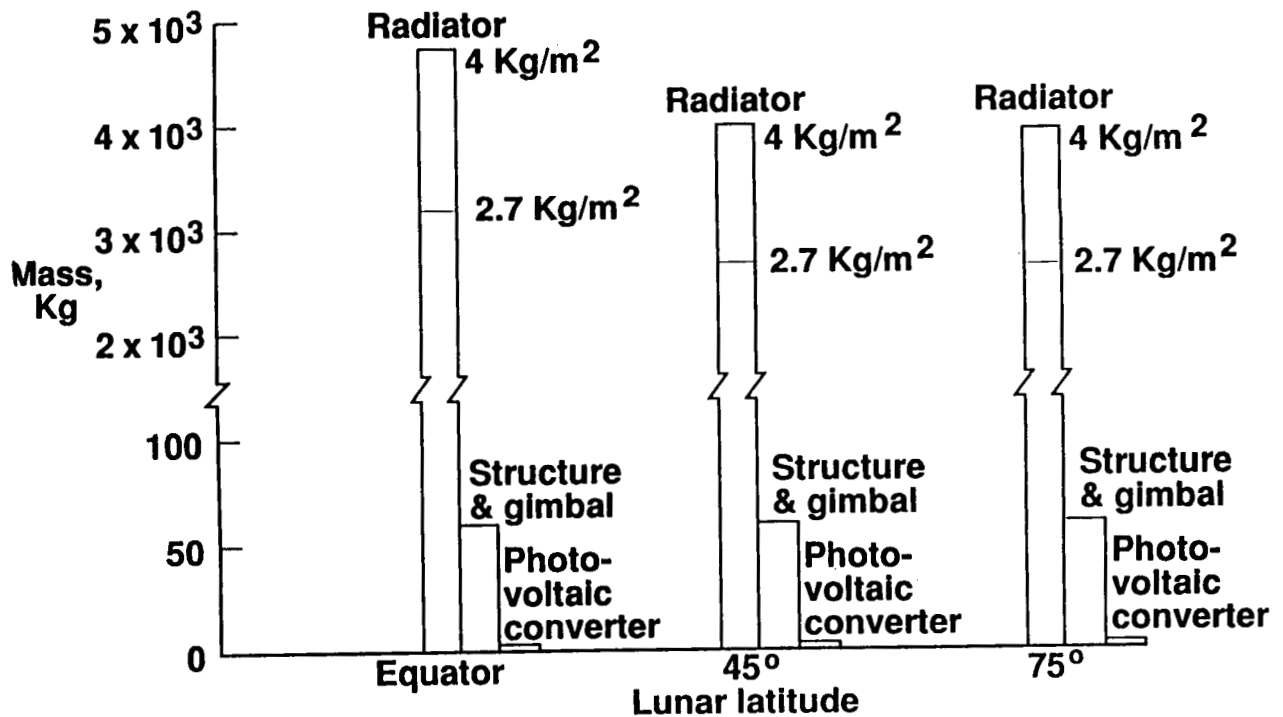

MASS OF DIODE LASER-PHOTOVOLTAIC CONVERTER COMPONENTS

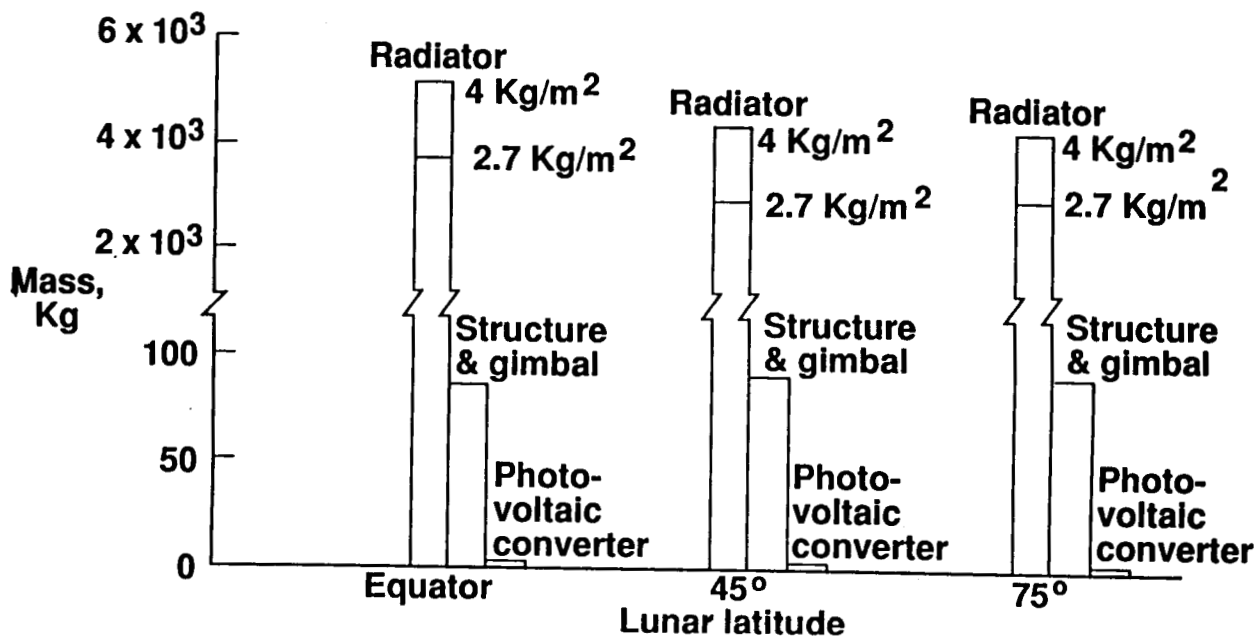

BLOCK DIAGRAM OF LASER-TO-ELECTRIC CONVERSION

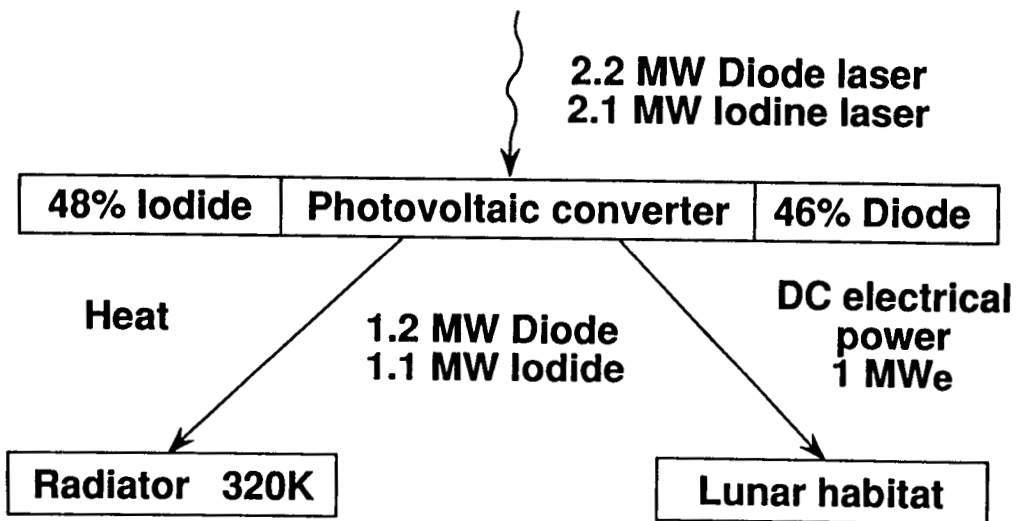

LEO CONVERTER MASS SUMMARY

	IODINE LASER CONVERTER (1.3 μm)	DIODE LASER CONVERTER (0.85 μm)
Converter Mass (Equator)	$7.11 \times 10^3 \text{ Kg}$	$7.70 \times 10^3 \text{ Kg}$
OTV and Fuel	$29.4 \times 10^3 \text{ Kg}$	$31.9 \times 10^3 \text{ Kg}$
Total LEO Mass	$36.6 \times 10^3 \text{ Kg}$	$39.7 \times 10^3 \text{ Kg}$

LASER POWERED LUNAR BASE

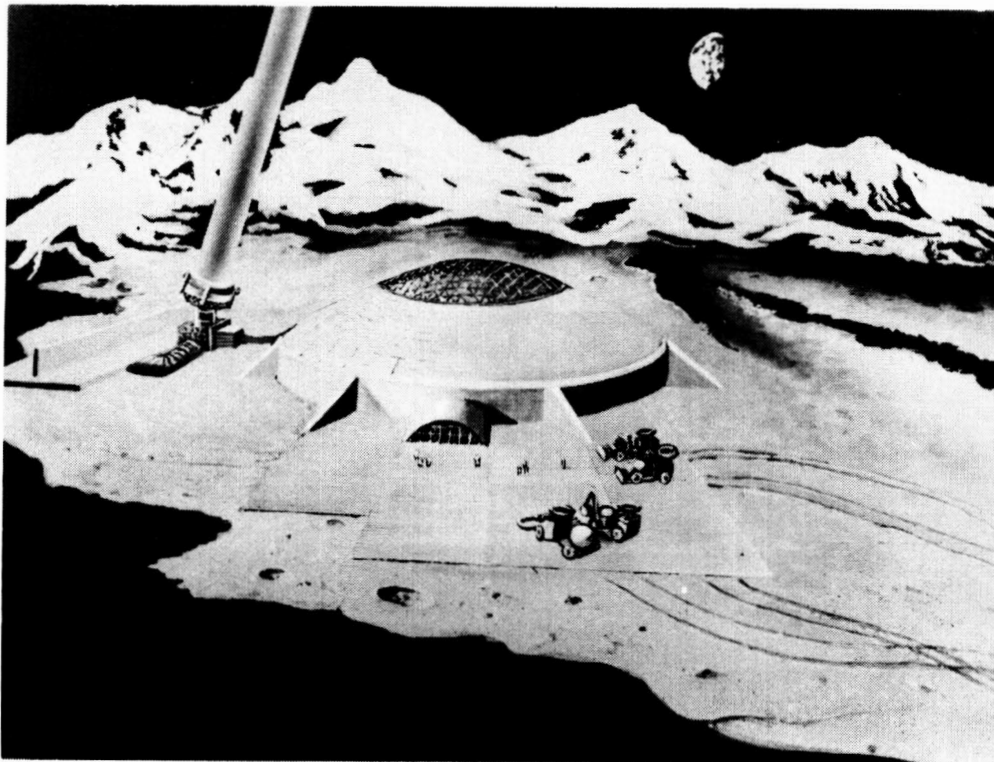

ORIGINAL PAGE
BLACK AND WHITE PHOTOGRAPH

SUMMARY

- Converter mass on lunar surface - 7000 kg.
- Radiator dominant mass component.
- Transportation costs to lunar surface - 30,000 kg.
- Converter approaching 50% laser-to-electric feasible.

DIODE ARRAY AND IODINE LASERS

M. Williams and R. De Young

NV 10491

1. Design a 2.35 MW solar-pumped iodine laser system
2. Design a 2.56 MW solar-electric laser diode array

LUNAR ORBIT DATA

75% coverage of moon surface

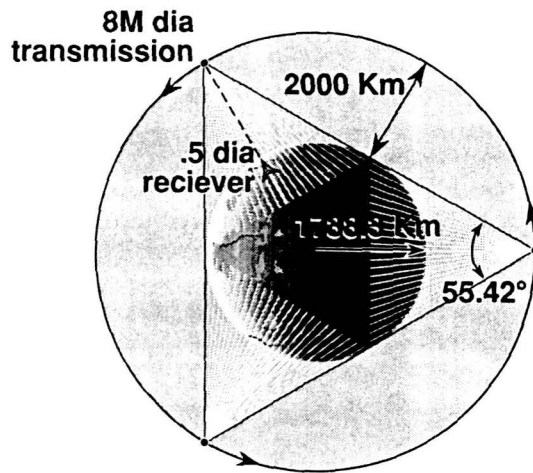

Orbital velocity	1146 m/sec
Orbital period	5.7 hrs
Time in view	1.97 hrs
Two satellites in view	4 min 20.8 sec (in orbital plane)

Iodine Solar - Pumped Laser

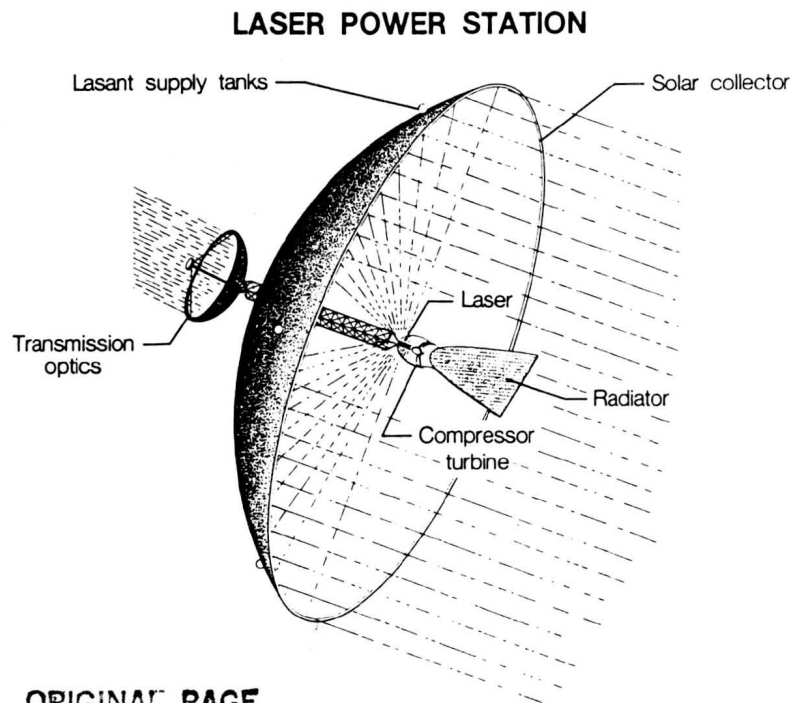

ORIGINAL PAGE
BLACK AND WHITE PHOTOGRAPH

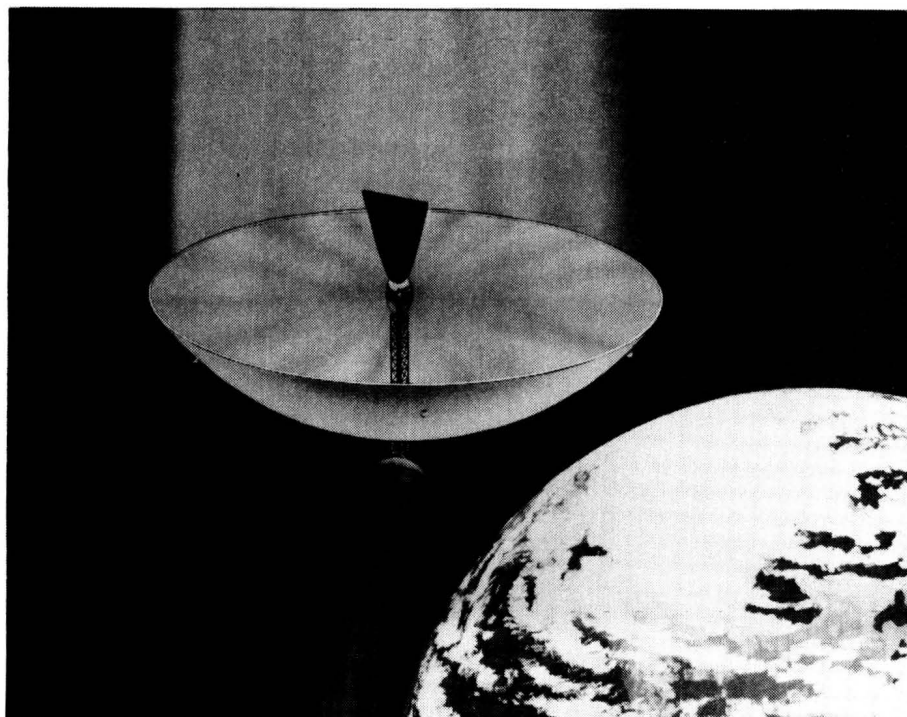

**SOLAR PUMPED IODINE LASER
POWER STATION IN LUNAR ORBIT**

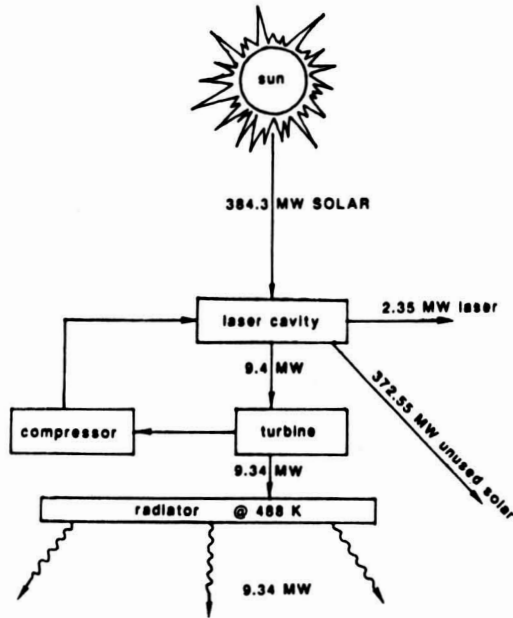

Iodine Solar-Pumped Laser 2.35 MW Laser Output

Laser System Components

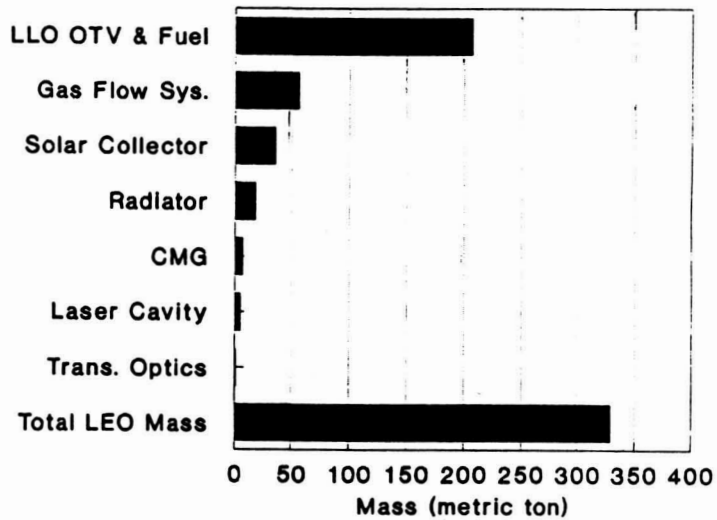

Solar-Electric Laser Diode Array

DIODE LASER SATELLITE

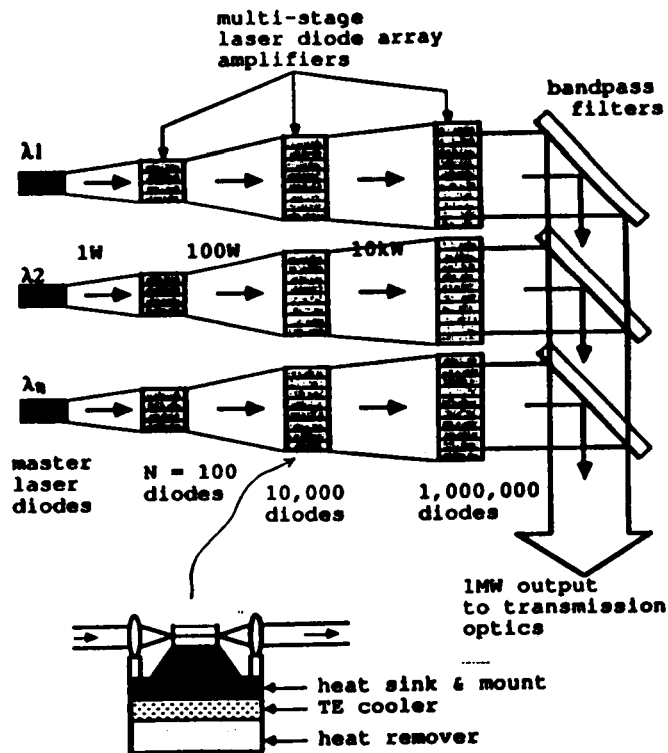
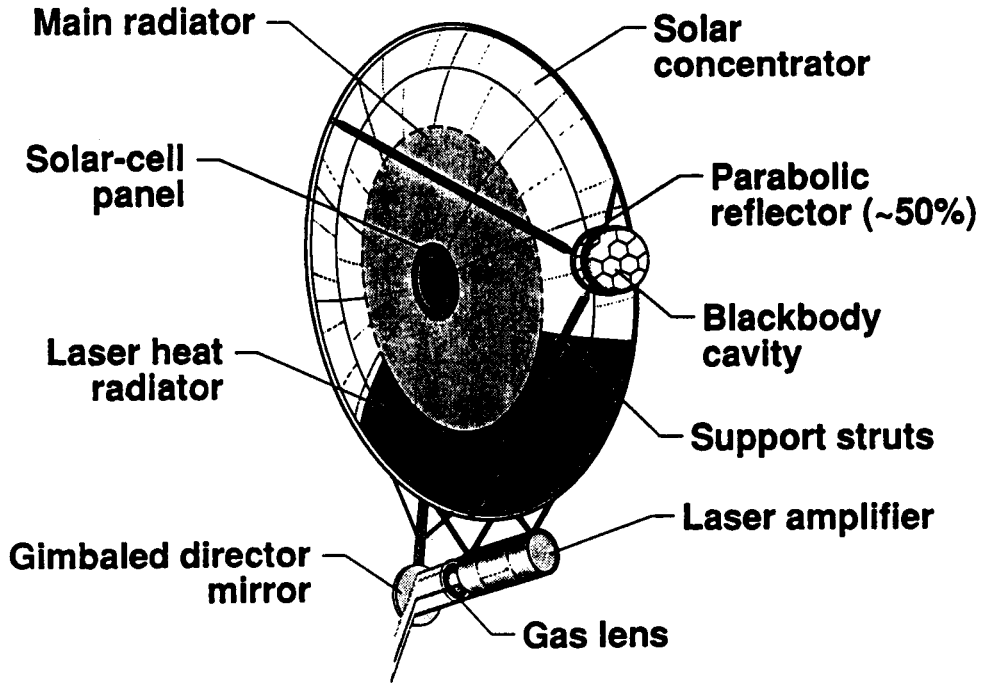

LUNAR SATELLITE POWER FLOW

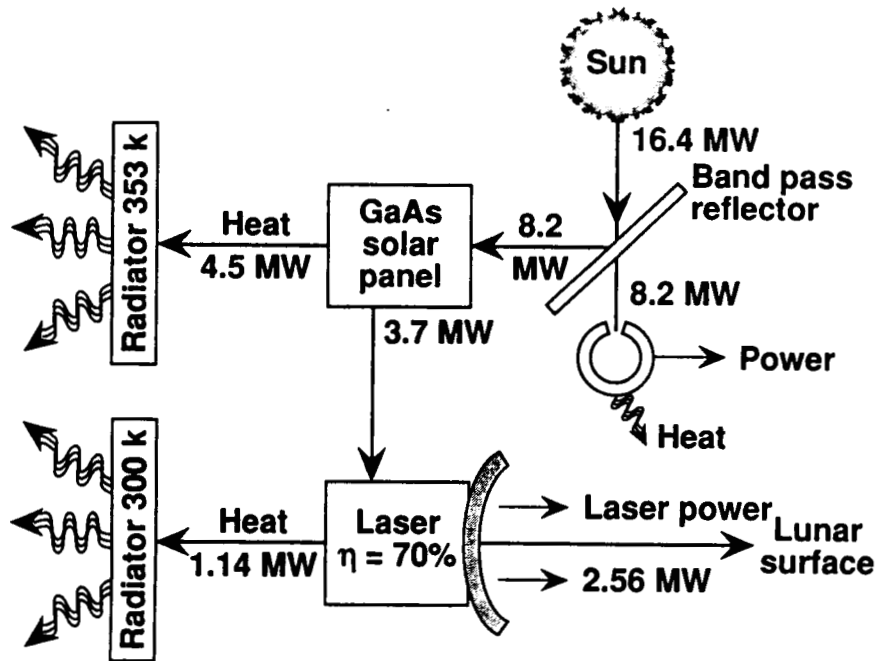

Laser Diode Array System 2.56 MW Laser Output

Laser Systems Components

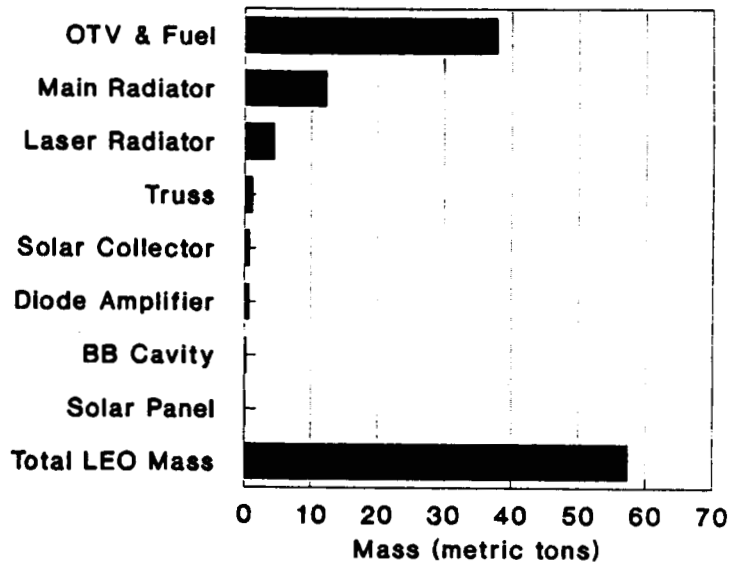

Summary

- 2000 km lunar orbit laser with 8m transmission aperture has 0.5m lunar surface spot size.
- Iodine laser system with OTV and fuel has mass of 329 metric tons.
- Laser diode array with OTV and fuel has mass of 57.4 metric tons.
- OTV and Fuel dominant system mass component.

Lunar Base Power Mass Summary

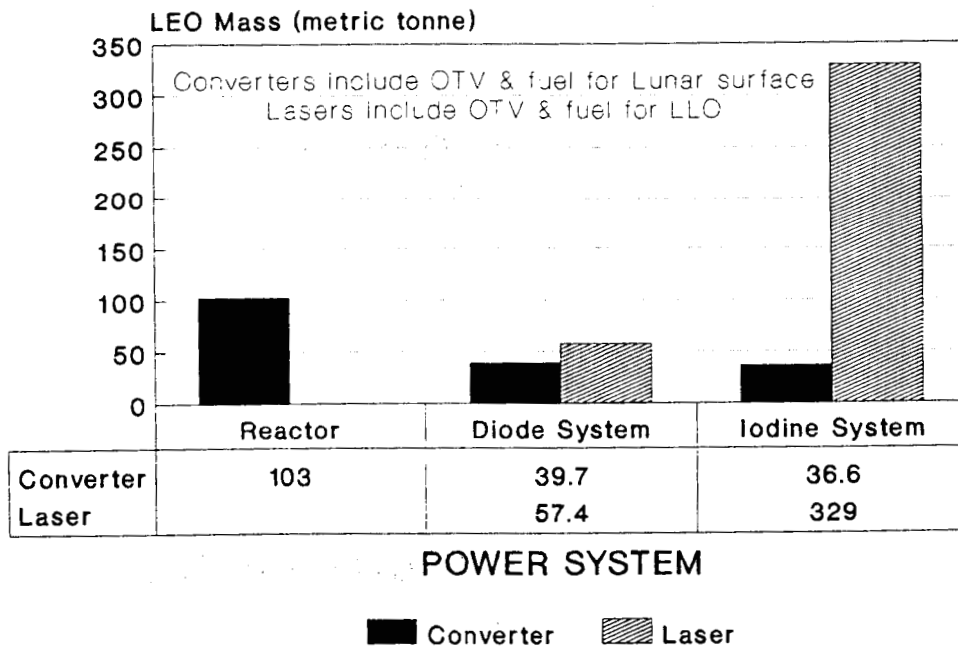

Mission Payoff Summary

Lunar Base Power

- Laser-to-electric converter can be mobile and located near human habitats.
- Laser-to-electric converter mass at 39 t is factor of 2.6 lighter than reactor system.
- Diode converter and laser mass at 97 t is near reactor mass of 103 t.
- Advanced low mass radiators could substantially reduce converter mass.

N90-10157 . 517-36

LASER-POWERED MARTIAN ROVER

ND 2 10491

W. L. Harries
W. E. Meador
G. A. Miner
G. L. Schuster
G. H. Walker
M. D. Williams

LASER-POWERED MARTIAN ROVER

by W. E. Meador

Two rover concepts were considered: an unpressurized skeleton vehicle having available 4.5 kW of electrical power and limited to a range of about 10 km from a temporary Martian base and a much larger surface exploration vehicle (SEV) operating on a maximum 75-kW power level and essentially unrestricted in range or mission. The only baseline reference system was a battery-operated skeleton vehicle with very limited mission capability and range and which would repeatedly return to its temporary base for battery recharging. It was quickly concluded that laser powering would be an uneconomical overkill for this concept.

The SEV, on the other hand, is a new rover concept that is especially suited for powering by orbiting solar or electrically pumped lasers. Such vehicles are visualized as mobile habitats with full life-support systems onboard, having unlimited range over the Martian surface, and having extensive mission capability (e.g., core drilling and sampling, construction of shelters for protection from solar flares and dust storms, etc.). Laser power beaming to SEV's was shown to have the following advantages: (1) continuous energy supply by three orbiting lasers at 2000 km (no storage requirements as during Martian night with direct solar powering); (2) long-term supply without replacement; (3) very high power available (MW level possible); (4) greatly enhanced mission enabling capability beyond anything currently conceived. Pointing and tracking of rovers are not problems for laser power stations at 2000 km altitudes, nor are the sizes of transmitter and receiver dishes (3 m and 1 m diameters, respectively). An electrically pumped laser diode array, with the sun as the prime energy source, was selected for special study. The total LEO mass, including OTV and fuel, for a 192-kW laser array is 7.5×10^6 g. By far the largest contributor to the mass of the photovoltaic converter (to 75 kW electric on the rover) of the laser beam is the 240 kg radiator for rejection of waste heat. Some of these weights can no doubt be alleviated by novel engineering schemes, including use of waste converter energy to run Stirling engines and use of energy stored in the blackbody collector on the laser system for propulsion. Moreover, cooling by the constant Martian winds might be more effective than presently contemplated.

In summary, laser power beaming to large Martian rovers is a potentially revolutionary new concept for enhancing mission capability, removing range limitations, and generally and very significantly broadening the scope of mission planning.

ORIGINAL PAGE IS
OF POOR QUALITY

CONTENTS

- Advantages of power beaming
- Rover concepts: unpressurized skeleton; Winnebago
- Power beaming alternatives
- Pointing and tracking
- Laser satellite
- Masses to LEO
- PV conversion; heat use (e.g., Stirling engine at 500° K; decrease radiator size) and rejection

POWER BEAMING ADVANTAGES

- Primary OEXP Issue: How to power rover
 - Batteries, fuel cells run down; need gas stations
- Laser power beaming to rover
 - Long life without replacement
 - Unlimited range from base; Winnebago rover is moving habitat
 - Very high power available
 - Greatly enhanced mission enabling capability; rover becomes mobile power source.

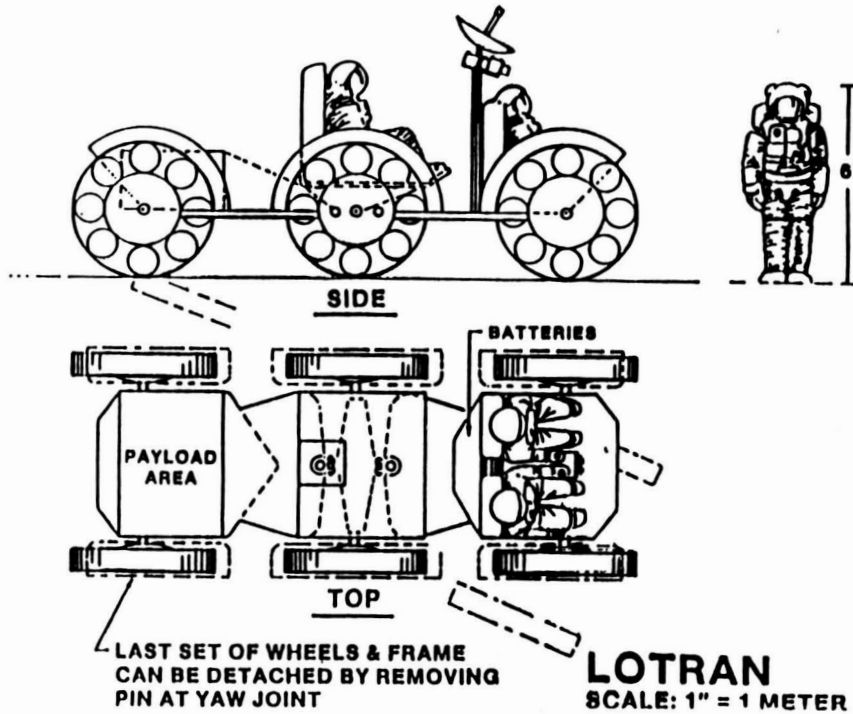

HIGH POWERED MARTIAN ROVER

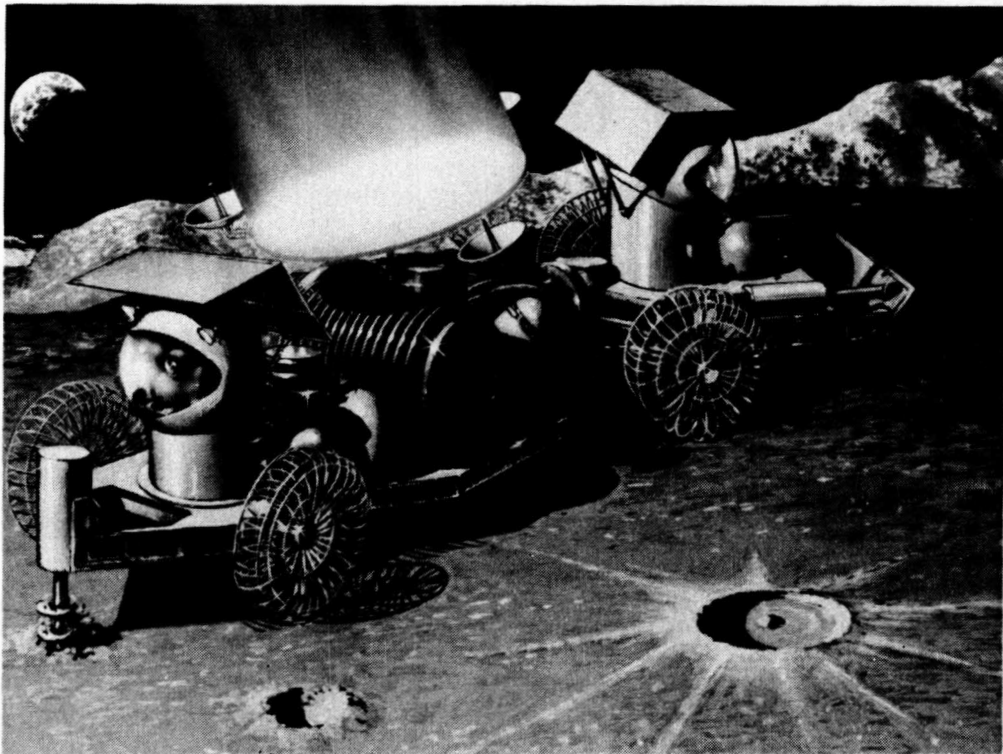

ORIGINAL PAGE
BLACK AND WHITE PHOTOGRAPH

SPECIFICATION FOR MARS SURFACE EXPLORATION VEHICLE

Total Weight	8000 (Kg) inc 25% for power system
Crew	5 persons
Speed	10 Km/hr.
Slope climbing	30° for 50 Km

	POWER REQUIREMENTS	(KW)
1	Rolling resistance at 10 Km/hr;	10.5
2	Hill climbing 30° at 10 Km/hr:	37
3	Housekeeping requirements	4.5
4	Externally mounted core drill	10
5	External power tools	2
	Max. power (1 + 2 + 3)	52
	Need ~ 50% reserve	
	Max. power including reserve	75

SIZE OF TRANSMITTING AND RECEIVING DISHES DIFFRACTION LIMITED

D_t = diameter transmitter dish

D_r = diameter receiver dish

λ = wavelength of signal = 1 μ m

z = distance apart

$$D_t D_r = \frac{4}{\pi} \lambda z = 1.27 \times 10^{-6} z$$

e.g., if $z = 2 \times 10^7$ m-geosynchronous orbit on Mars, and $D_r = 2$ m, then $D_t = 13$ m

If $z = 2 \times 10^6$ m, and $D_r = 1$ m, then $D_t \approx 3$ m

PROVIDING POWER TO A MARS ROVER

	METHOD	ADVANTAGES	DISADVANTAGES
Directly from orbiting satellite via laser beam	1. Nuclear-electric-laser 2. Direct solar-pumped laser 3. Solar panel-diode laser 4. Solar concentrator-solar panel-diode laser	a) 4 satellites cover most of Mars b) energy storage not required c) unlimited range	
From orbiting satellite to ground station. Energy stored, rover returns to recharge	1-4 above - store energy	d) large receiving dishes secure on ground	f) limited range ~ 100 Km for rover, g) need storage at ground station and on rover.
Ground station collects directly from sun. Energy stored, rover returns to recharge.	5. Solar panel - store energy 6. Solar concentrator - solar panel - store energy	(d) above e) eliminates laser	(f), (g) above h) collects for only 6 hrs. a day.

POINTING TO A STATIONARY VEHICLE ON MARS

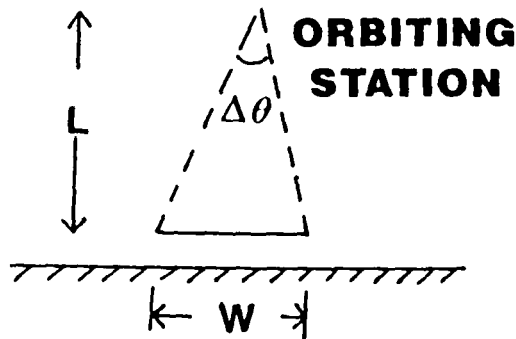

Maximum attainable accuracy $\Delta\theta = 0.2'' \text{ arc} = 10^{-6}$ radian

If $W = 2\text{m}$, and $L = 2 \times 10^7\text{m}$ -geosynchronous orbit

$$\Delta\theta = 10^{-7}\text{radians--impossible}$$

Reduce L to 2×10^6 m or 2000 Km--then possible

TRACKING A MOVING VEHICLE ON SURFACE OF MARS

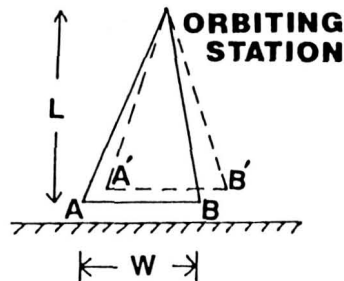

Vehicle motion random—cannot anticipate. Signal from position AB takes time $t = L/c$ to station. Laser beam takes similar time; total = $2L/c$, $c =$ velocity of light.

Vehicle with vel v moves $2Lv/c$ in this time.

Require $2Lv/c < BB' = \alpha W$; α is precision factor

If $v = 10 \text{ Km/hr} = 2.8 \text{ ms}^{-1}$, $c = 3 \times 10^8 \text{ ms}^{-1}$, $\alpha = 0.1$, $W = 2\text{m}$

For $L = 2 \times 10^7 \text{m}$, geosynchronous orbit

$2Lv/c = 0.37\text{m}$; $\alpha W = 0.2$ - not satisfied.

Would be satisfied for $L = 2 \times 10^6 \text{m}$ or 2000 Km.

MARTIAN ORBIT DATA

Surface area covered 55.76%

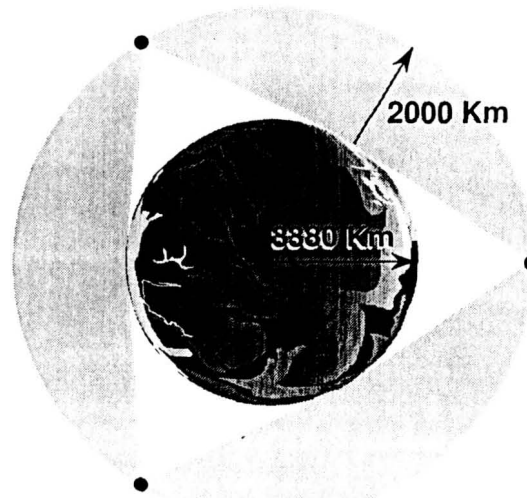

Orbit height	2000 Km	View time	56 min 39.8 sec
Period	3 hrs 19 min 40.8 sec	Dead time	9 min 53.8 sec
Velocity	2821.47 m/sec		

ORIGINAL PAGE
BLACK AND WHITE PHOTOGRAPH

DIODE LASER SATELLITE

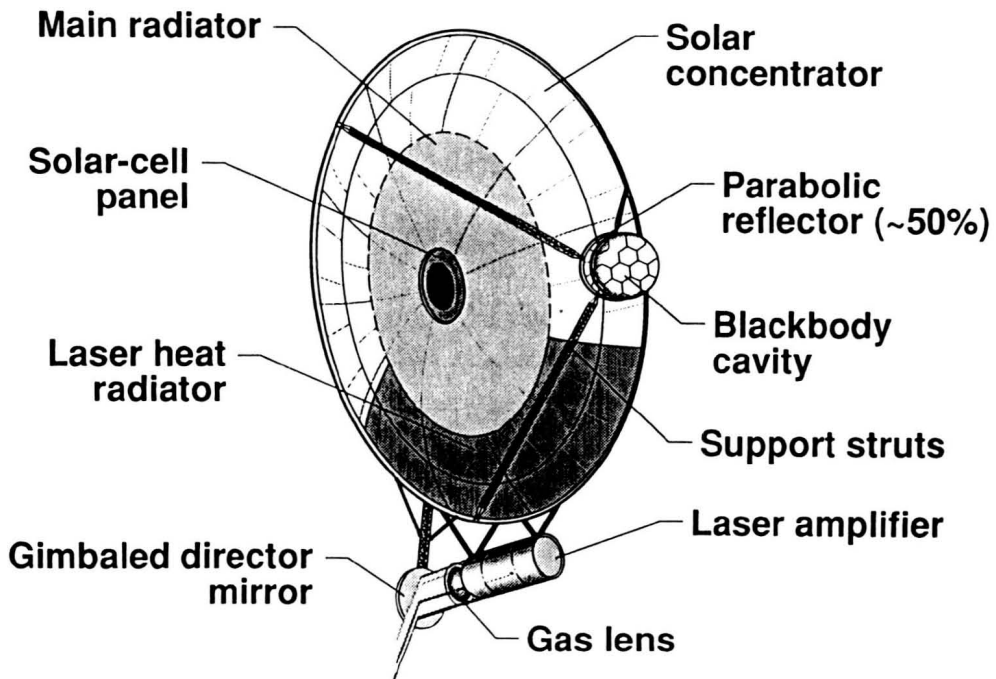

MARTIAN SATELLITE POWER FLOW

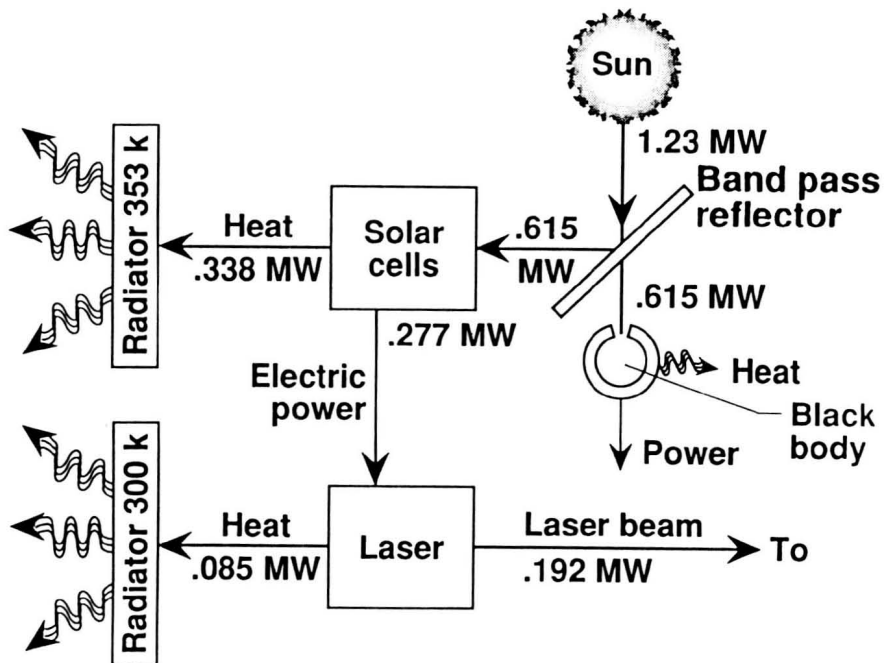

Laser Diode Array For Mars Rover

12.3 kW Laser Output

Laser Systems Components

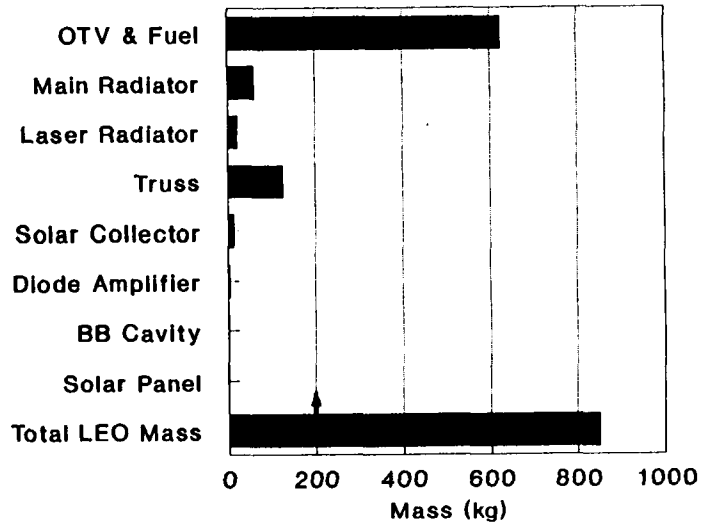

Laser Diode Array For Mars Rover

192 kW Laser Output

Laser Systems Components

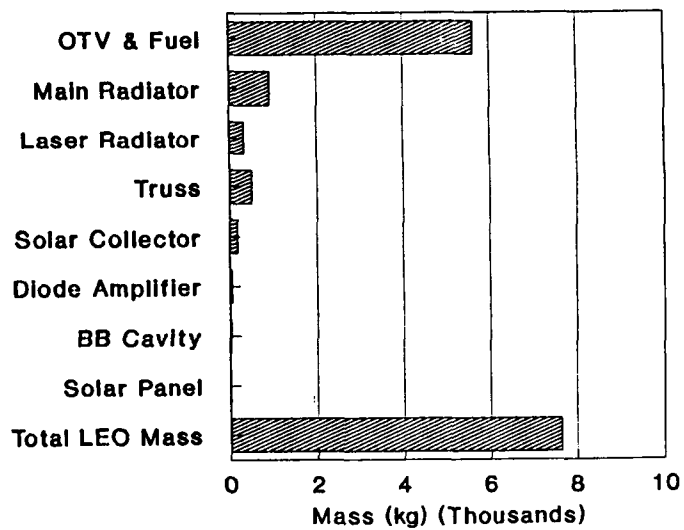

ROVER POWER SYSTEM MASSES

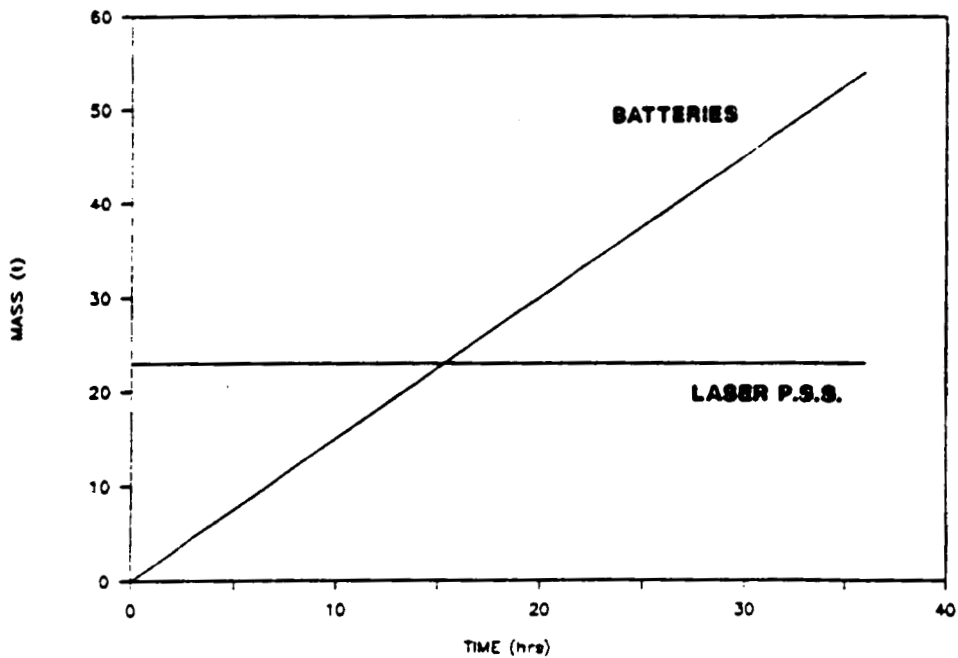

PHOTOVOLTAIC CONVERTER FOR MARS ROVER

- Diode laser ($0.85\mu\text{m}$)
- $\text{Ga}_{.971}\text{Al}_{.029}\text{As}$ converter
- 75 KW_e system
- 4.5 KW_e system

PHOTOVOLTAIC CONVERTER FOR MARS ROVER

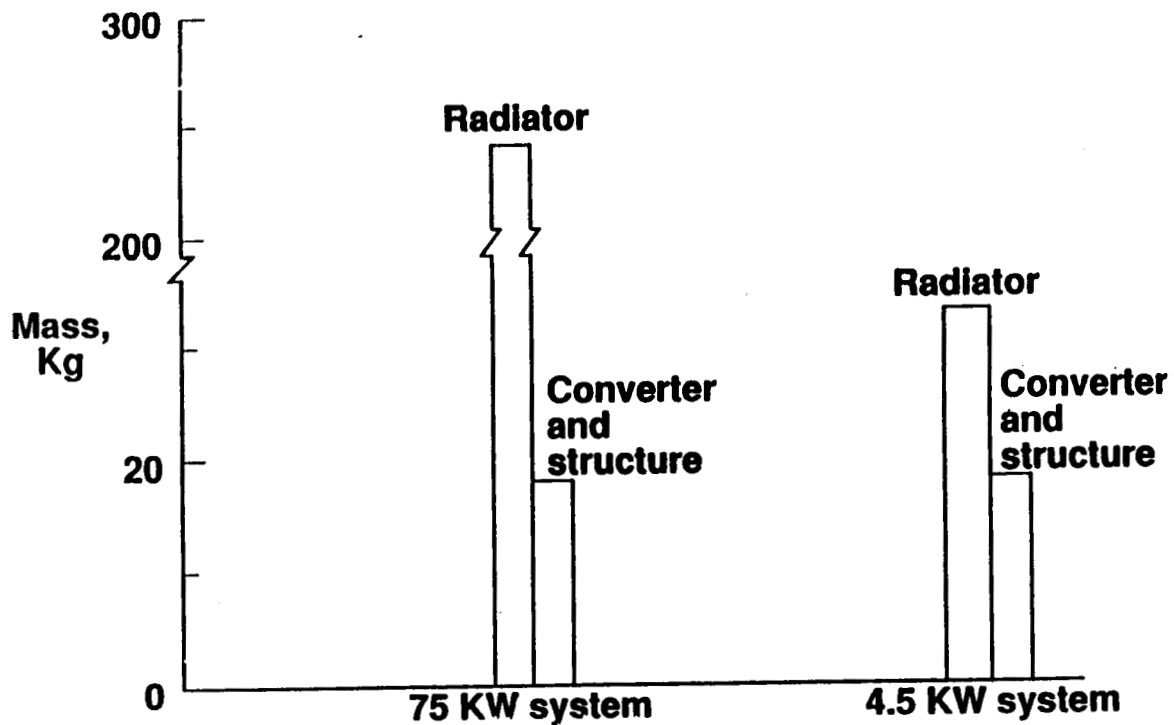

CONCLUSIONS

- Laser power beaming overkill for skeleton rover with limited range and mission capability.
- Laser power beaming to Winnebago rovers potentially revolutionary new concept.
 - Mission enabling
 - Unlimited range; circumnavigation
 - No pointing or tracking problems for lasers at 2000 km altitude
 - Reasonable weights, with substantial reduction possible via novel uses of waste energy

N 90 - 10158

9-18-70

516785

**POWER FOR THE MOON:
IS MICROWAVE POWER BEAMING AN OPTION?**

**RONALD C. CULL
NASA LEWIS RESEARCH CENTER**

ND315753

PRECEDING PAGE BLANK NOT FILMED

PAGE 328 INTENTIONALLY BLANK

PROBLEM:

SURFACE POWER APPROACHES SUFFER FROM:

SOLAR:

- HIGH MASS DUE TO 14 DAY ENERGY STORAGE REQUIREMENT

NUCLEAR:

- POLITICAL & ENVIRONMENTAL QUESTIONS OF PLACING A REACTOR ON THE MOON

POSSIBLE SOLUTION:

POWER BEAMING MAY ALLOW THE POWER SUPPLY (NUCLEAR OR SOLAR) TO BE PUT IN ORBIT AROUND THE MOON AND SUPPLY POWER TO MULTIPLE ASSETS

QUESTIONS NEEDING ANSWERS

- ① **COST (MASS) COMPARISON TO SURFACE POWER TECHNOLOGY**
- ② **TECHNICAL FEASIBILITY OF OPTIONS**

OBJECTIVE:

PERFORM 0th ORDER ANALYSIS OF ALTERNATE POWER SYSTEM ARCHITECTURES USING POWER BEAMING:

- SYSTEM MASS DRIVERS
- APPLICATIONS ISSUES
- TECHNOLOGY ISSUES
- IDENTIFY SYNERGISTIC OPTIONS

SCENARIOS POSTULATED

LUNAR BASE

SURFACE POWER

SOLAR

NUCLEAR

BEAMED POWER

LOW ORBIT (STORAGE)

LOW ORBIT (MULTIPLE SAT.)

STATIONARY ORBIT

LEVELS OF TECHNOLOGY

SOA

PATHFINDER

ADVANCED

MULTIPLE LUNAR LOCATIONS

BASES

OUTPOSTS

VEHICLES

POWER BEAMING SYSTEM (UNIVERSAL DIAGRAM)

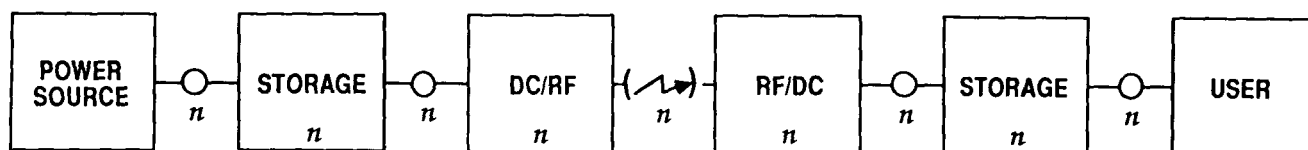

—○— PMAD

↗ BEAMED POWER LINK

POWER BEAMING ANALYSIS APPROACH

ASSUMPTIONS:

- CIRCULAR, EQUATORIAL ORBITS
- VIEW ANGLE TO 10° ABOVE HORIZONS
- ENERGY FLOW
 - DIRECTLY FROM SOURCE TO LOAD WHILE IN VIEW
 - TRANSMITTED TO SURFACE STORAGE WHILE IN VIEW FOR USE WHEN OUT OF VIEW
 - STORED ON SATELLITE WHILE OUT OF VIEW (PV ONLY, NUCLEAR CASE MORE MASS EFFICIENT TO ELIMINATE SATELLITE STORAGE AND ENLARGE NUCLEAR SOURCE)

POWER BEAMING ANALYSIS APPROACH

ASSUMPTIONS (Cont.):

$$\text{TOTAL MASS} = \text{POWER DEPENDENT MASS} + \text{POWER INDEPENDENT MASS}$$

POWER DEPENDENT MASS:

SOURCE
PMAD
STORAGE
TUBE

POWER INDEPENDENT MASS:

SPACECRAFT BUS
TUBE SUPPORT EQUIP.
ANTENNA
RECTENNA

POWER DEPENDENT SYSTEM MASSES

(Kg/Kw CONTINUOUSLY TO LOAD)

$$\text{POWER DEPENDENT SYSTEM MASS} = \text{EFFECTIVE SURFACE MASS} + \text{EFFECTIVE ORBITER MASS}$$

$$\text{ASSUME: } \frac{\text{MASS ON SURFACE}}{\text{MASS IN ORBIT}} = 1/2 \text{ - DUE TO PROPELLENT REQUIREMENTS}$$

NORMALIZE TO SURFACE SYSTEM:

$$\text{PDSM} = \text{SURFACE MASS} + 1/2 (\text{ORBITER MASS})$$

$$\begin{aligned} \text{PDSM} = & \text{PMAD} + \text{STORAGE} \cdot (T) \cdot (1-\text{DC}) + \text{PMADs} \cdot \left(\frac{1}{\text{DC}} - 1\right) + \text{PMAD} \\ & 1/2 [\text{TRANSMITTERs} \cdot \left(\frac{1}{\text{DC}} - 1\right) + \text{TRANSMITTER} + \text{PMADs} \cdot \left(\frac{1}{\text{DC}} - 1\right) + \\ & \text{PMAD} + \text{STORAGE} \cdot (T) \cdot (1-\text{DC}) + \text{PMAD} \cdot (1-\text{DC}) + \text{SOURCE}] \end{aligned}$$

$$\begin{aligned} \text{WHERE: DUTY CYCLE (DC)} &= f (\text{ALTITUDE}) \\ \text{ORBIT TIME (T)} &= f (\text{ALTITUDE}) \end{aligned}$$

S. O. A. TECHNOLOGY

(ORBITER)	EFF. (%)	MASS (Kg/Kw or Kg/Kw hr)	POWER MULTIPLIER		MASS (Kg/Kw DELIVERED)	
			STORAGE	NO STOR.	STORAGE	NO STOR.
PV (OAST-1)	-	15	14.00	6.25	210.0	93.8
PMAD	98	10	13.72	-	137.2 (1-DC)	-
STORAGE (Ni H ₂)	67	20	9.26	-	185.2 (T) (1-DC)	-
PMAD	98	10	9.07	6.12	90.7 ($\frac{1}{DC} - 1$)	61.2
TRANSMITTER	40	1	3.63	2.45	3.6 ($\frac{1}{DC} - 1$)	2.5
TRANSMISSION LINK	85					
(BASE)						
RECEIVER (RECTENNA)	50		1.54	1.04		
PMAD	98	10	1.51	1.02	15.1 ($\frac{1}{DC} - 1$)	10.2
STORAGE	67	20	1.02	-	20.4 (T) (1-DC)	-
PMAD (S.S.F.)	98	100	1.00	1.00	100.0	100.0

S.O.A. MICROWAVE LINK PATHFINDER GENERATION/STORAGE TECHNOLOGY

(ORBITER)	EFF. (%)	MASS (Kg/Kw or Kg/Kw hr)	POWER MULTIPLIER		MASS (Kg/Kw DELIVERED)	
			STORAGE	NO STOR.	STORAGE	NO STOR.
NUCLEAR (SP-100)	-	20.0	9.81	6.25	196.2	125.0
PV (AMORP. Si)	-	3.3	15.09	6.25	49.8	20.6
PMAD	98	1.0	14.80	-	14.8 (1-DC)	-
STORAGE (REG. FUEL CELL)	65	.8	9.61	-	7.7 (T) (1-DC)	-
PMAD	98	1.0	9.42	6.12	9.4 ($\frac{1}{DC} - 1$)	6.1
TRANSMITTER	40	1.0	3.77	2.45	3.8 ($\frac{1}{DC} - 1$)	2.5
TRANSMISSION LINK	85					
(BASE)						
RECEIVER (RECTENNA)	50		1.60	1.04		
PMAD	98	5.0	1.56	1.02	7.8 ($\frac{1}{DC} - 1$)	5.1
STORAGE	65	.8	1.02	-	.8 (T) (1-DC)	-
PMAD (S.S.F.)	98	45.0	1.00	1.00	45.0	45.0

ADVANCED MICROWAVE TECHNOLOGY PATHFINDER GENERATION/STORAGE TECHNOLOGY

(ORBITER)	EFF. (%)	MASS (Kg/Kw or Kg/Kw hr)	POWER STORAGE	MULTIPLIER NO STOR.	MASS (Kg/Kw DELIVERED) STORAGE	NO STOR.
NUCLEAR (SP-100)	-	20.0	2.62	1.68	52.40	33.60
PV (AMORP. Si)	-	3.3	4.02	1.68	13.25	5.56
PMAD	99	1.0	3.98	-	3.98 (1-DC)	-
STORAGE (REG. FUEL CELL)	65	.8	2.59	-	2.07 (T) (1-DC)	-
PMAD	99	1.0	2.56	1.67	$2.56 \left(\frac{1}{DC} - 1\right)$	1.67
TRANSMITTER	80	1.0	2.05	1.33	$2.05 \left(\frac{1}{DC} - 1\right)$	1.33
TRANSMISSION LINK	85					
(BASE)						
RECEIVER (RECTENNA)	85		1.57	1.02		
PMAD	99	1.0	1.55	1.01	$1.55 \left(\frac{1}{DC} - 1\right)$	1.01
STORAGE	65	.8	1.01	-	.81 (T) (1-DC)	-
PMAD (S.S.F.)	99	45.0	1.00	1.00	45.00	45.00

SOLAR SOURCE BEAM POWER SYSTEM

(Power Dependent System Masses Only)

(1MW Cont. Delivered)
(Pathfinder PV/RFC)
(55 kg/kW Surface PMAD)
(S.O.A. Microwave)

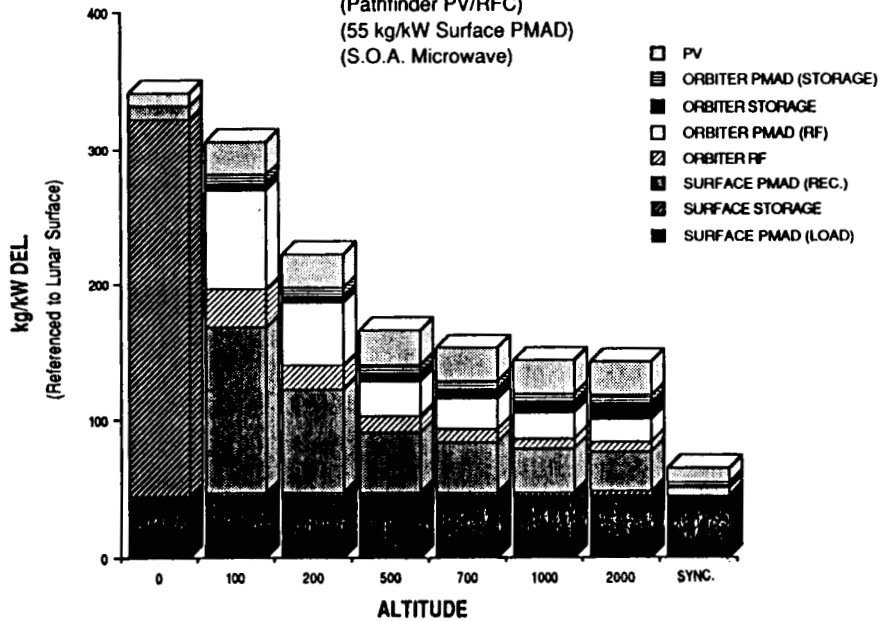

NUCLEAR SOURCE BEAM POWER SYSTEM

(Power Dependent System Masses Only)

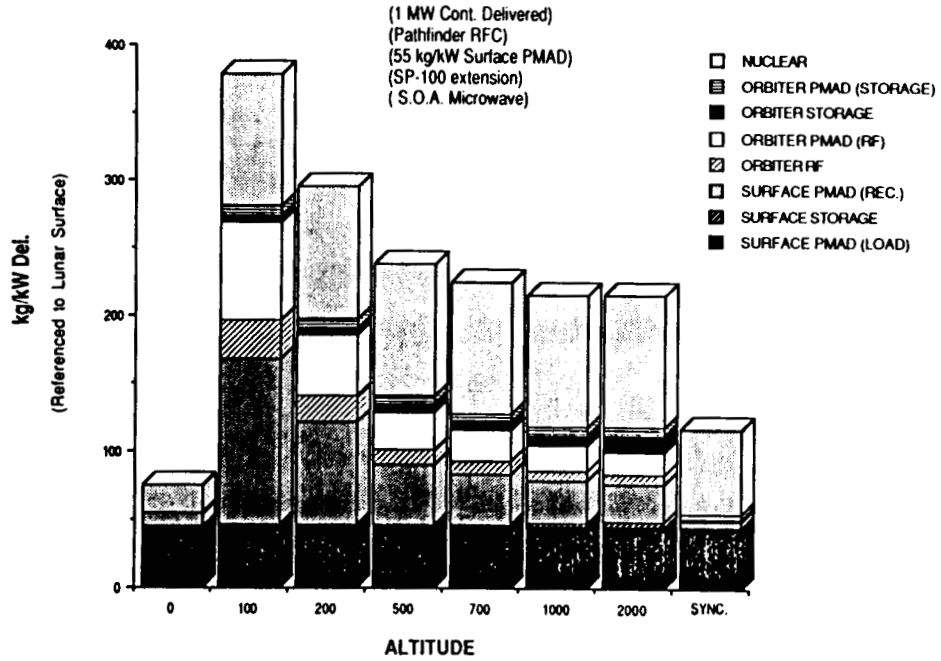

TRANSMISSION SYSTEM

MASS

(@ 94 GHz)

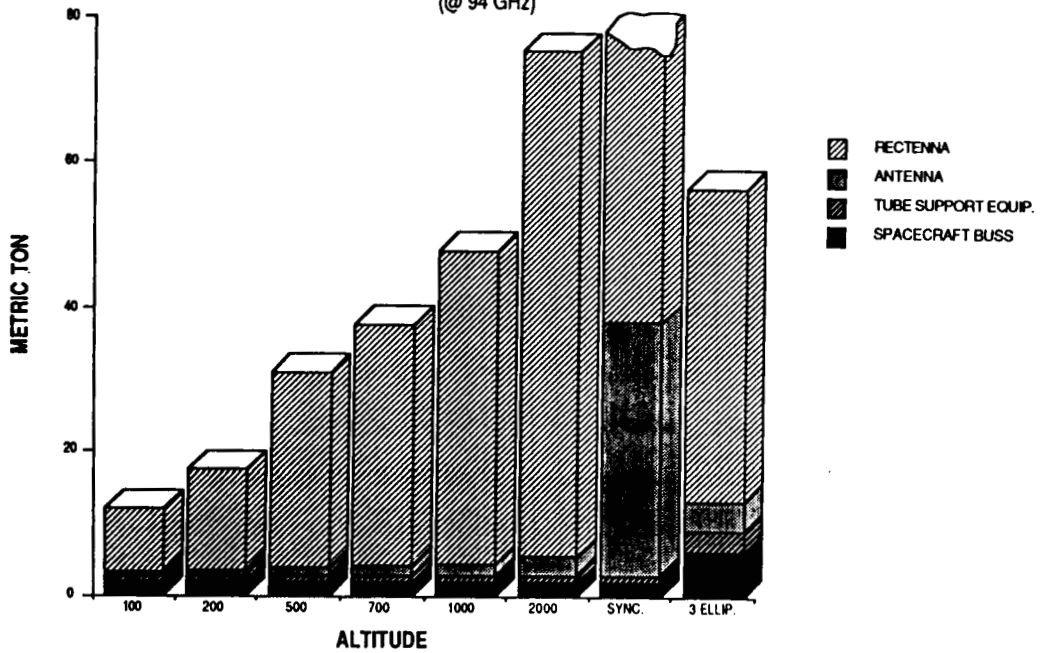

THREE SATELLITE BEAM POWER SYSTEM

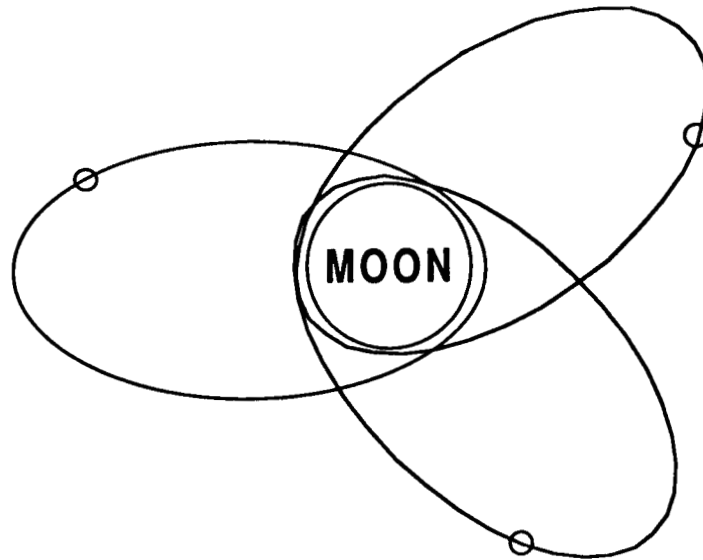

SOLAR SOURCE BEAMED POWER SYSTEM

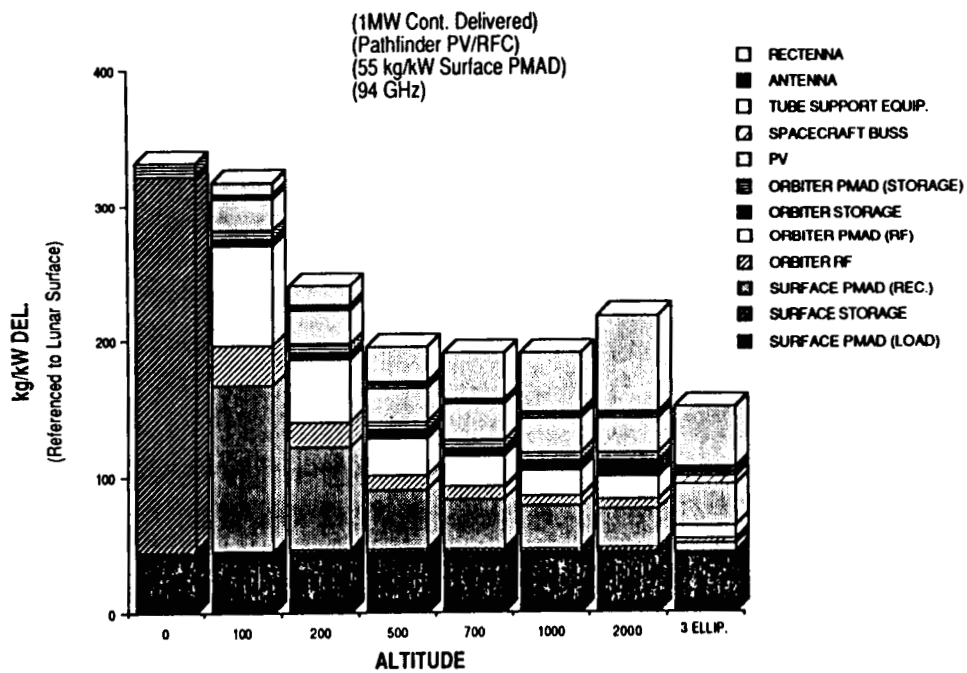

NUCLEAR SOURCE BEAMED POWER SYSTEM

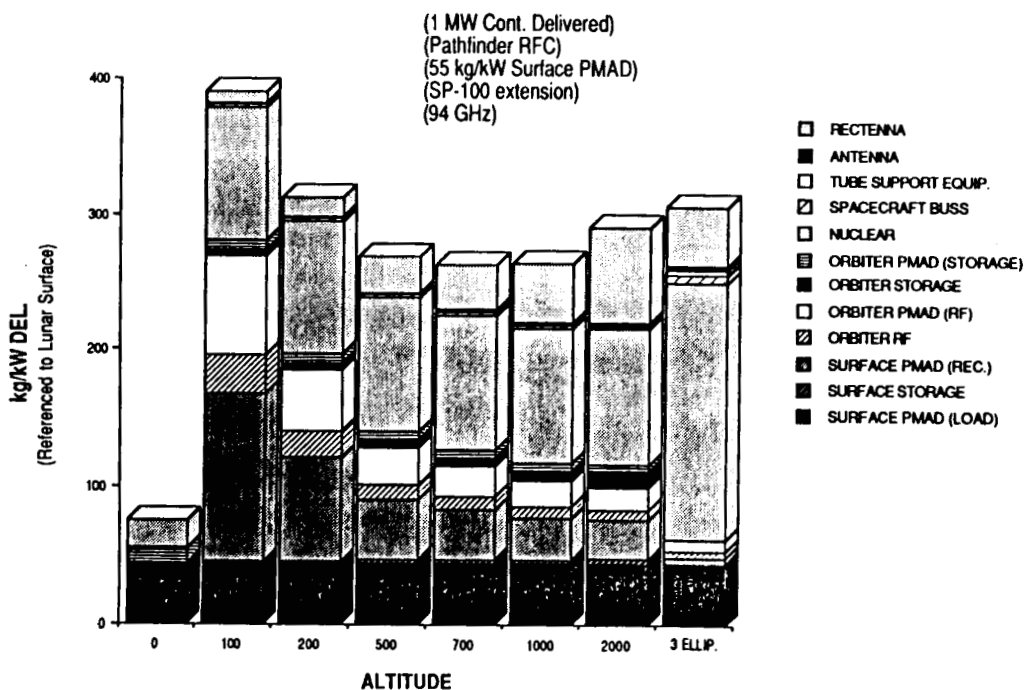

LUNAR BASE POWER

<u>METHOD</u>	POWER TRANS.	<u>TECHNOLOGY LEVEL</u>		
		S.O.A S.O.A	PATHFINDER S.O.A.	PATHFINDER ADVANCED
SURFACE				
SOLAR		9,984 (9,874) *	341 (286)	336 (286)
SOLAR (14 DAY ONLY)		155 (45)	63 (8)	58 (8)
NUCLEAR		--	75 (20)	70 (20)
BEAM				
SOLAR (500 km Circular)		889 (779)	194 (139)	189 (39)
NUCLEAR (500 km Circular)		--	267 (212)	109 (59)
SOLAR (3; elliptical orbits)		396 (286)	144 (89)	78 (28)
NUCLEAR (3; elliptical orbits)		--	301 (246)	120 (70)

* WITH PMAD (WITHOUT PMAD)

ADDITIONAL LUNAR ASSETS POWER

<u>METHOD</u>	POWER TRANS.	<u>TECHNOLOGY LEVEL</u>			
		S.O.A S.O.A	PATHFINDER S.O.A.	PATHFINDER ADVANCED	
SURFACE					
SOLAR		9,984 (9,874)*	341 (286)	336 (286)	
SOLAR (14 DAY ONLY)		155 (45)	63 (8)	58 (8)	
NUCLEAR		--	75 - 300 (20-245)	75 - 300 (20-245)	
BEAM					
SOLAR (500 km Circular)		361 - 887 (251-777)	143 - 192 (88-137)	71 - 88 (21-38)	
NUCLEAR (500 km Circular)		--	216 - 265 (161-210)	90 - 107 (40-57)	
SOLAR (3; elliptical orbits)		154 - 390 (44-280)	94 - 137 (39-82)	60 - 72 (10-22)	
NUCLEAR (3; elliptical orbits)		--	250 - 294 (195-239)	102 - 115 (52-65)	

* WITH PMAD (WITHOUT PMAD)

TEN ANTENNA CONFIGURATION

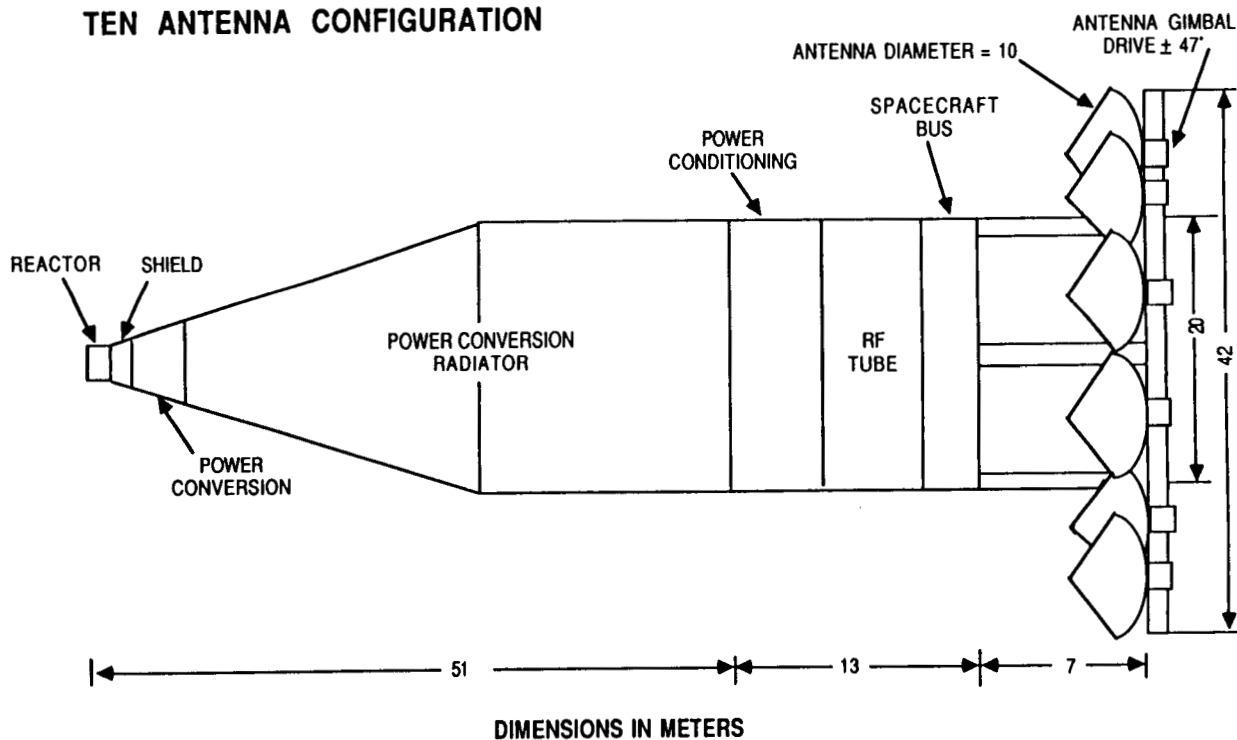

TEN ANTENNA CONFIGURATION

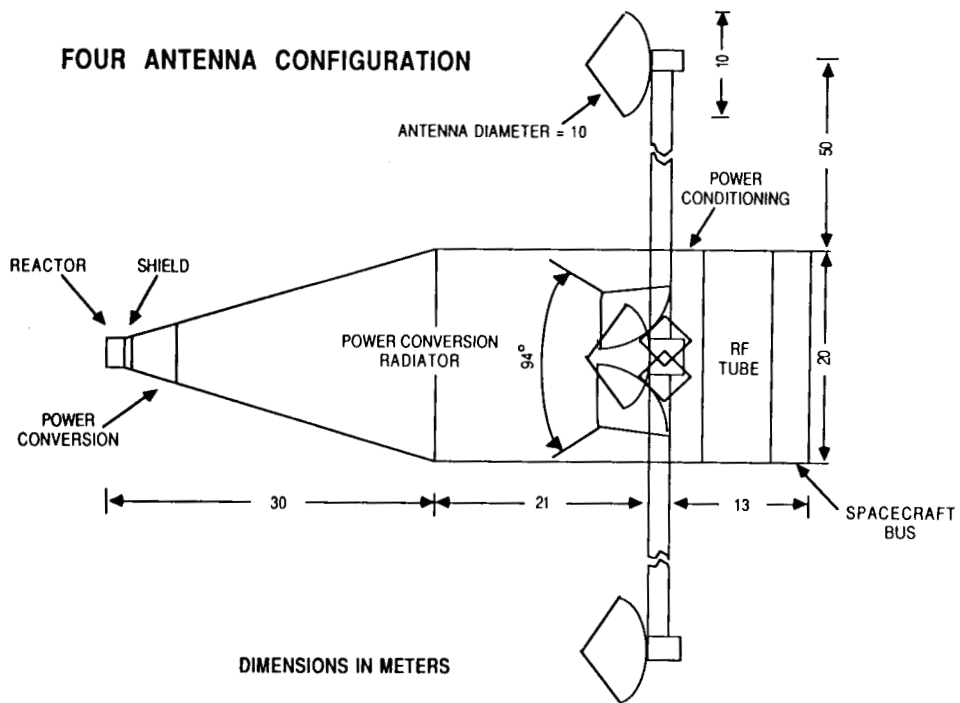
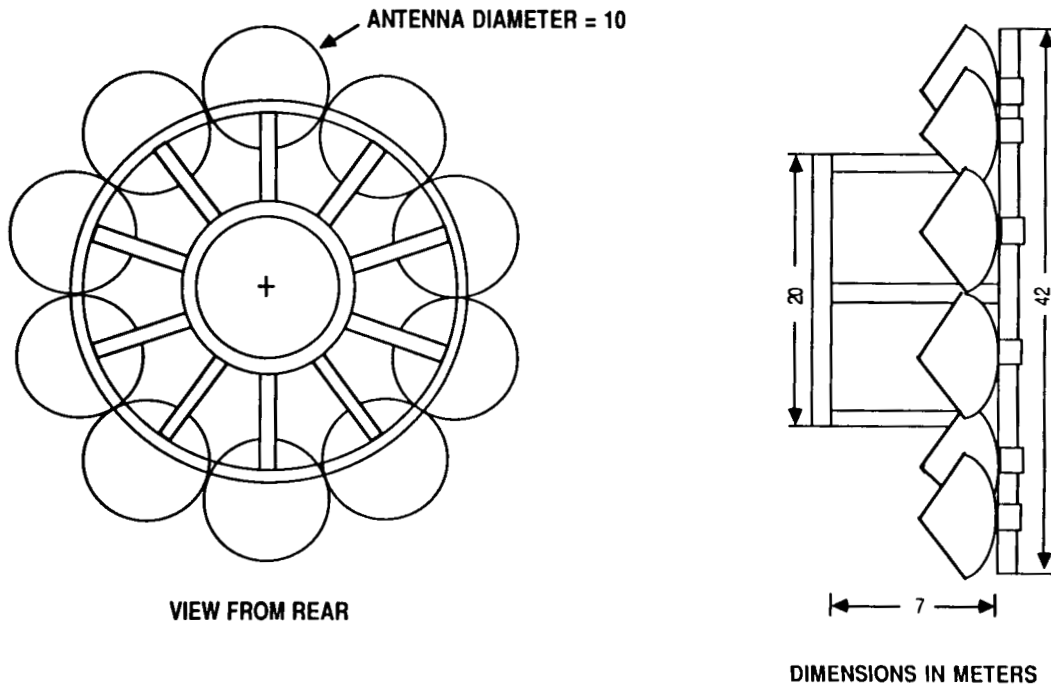

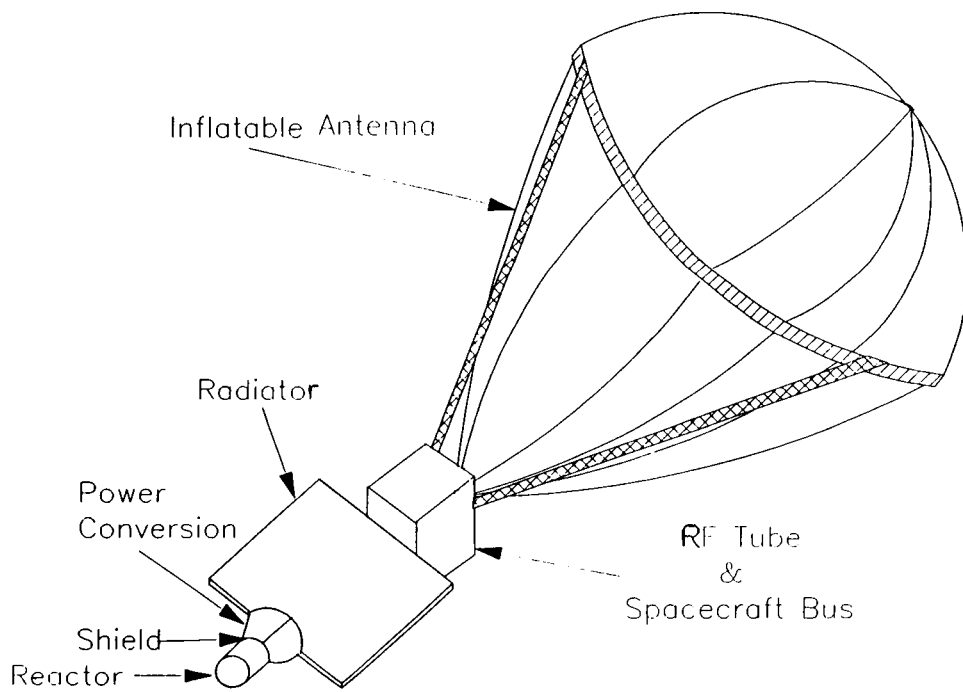
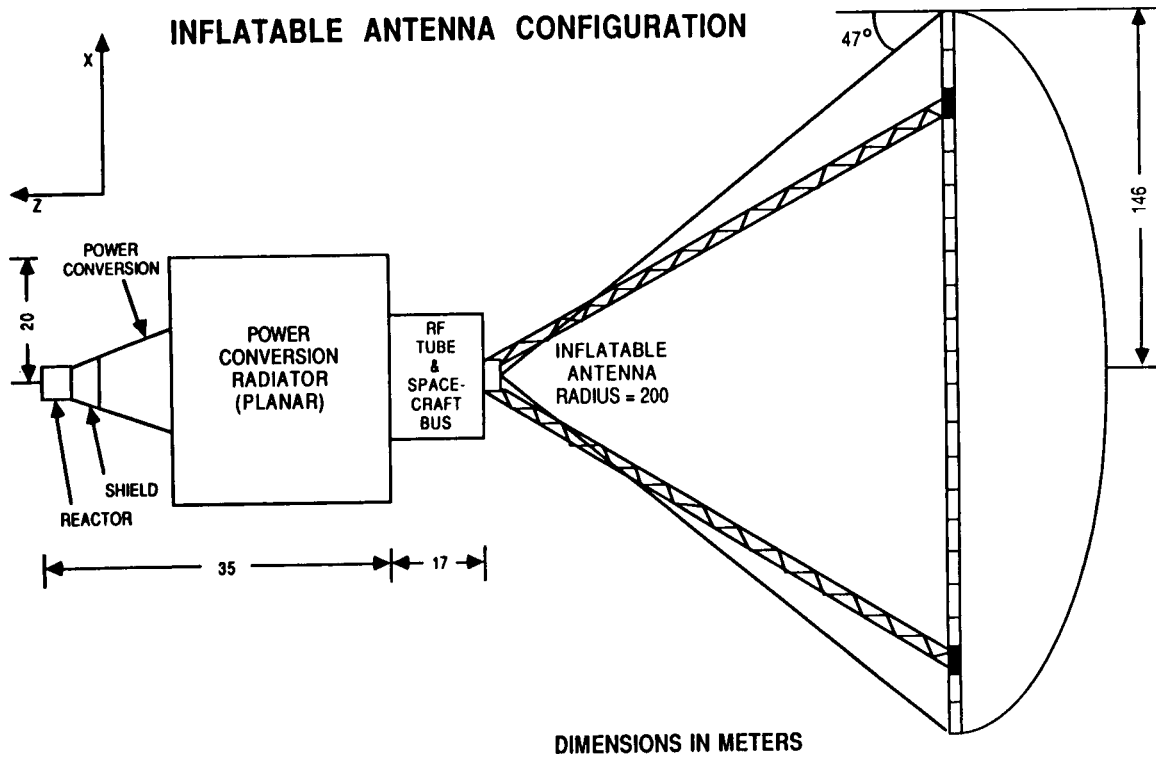

ISSUES & CONCERNS

ANTENNA SYSTEM

POINTING ACCURACY

SURFACE ACCURACY

RF SOURCE

EFFICIENCY

WEIGHT

FREQUENCY

COOLING

CRYOGENICS

RECTENNA

EFFICIENCY

WEIGHT

FREQUENCY

SUMMARY

- **0th ORDER ANALYSIS INDICATES MICROWAVE BEAM POWER SYSTEM MASS FALLS BETWEEN SOLAR AND NUCLEAR SURFACE POWER SYSTEMS**
- **MANY TRADES - MORE INTENSIVE STUDY NEEDS TO BE PERFORMED**
- **A NUMBER OF TECHNICAL & APPLICATIONS QUESTIONS NEED TO BE ANSWERED**

N 9 0 - 1 0 1 5 9 ; 59-20

APPLICABILITY OF THE BEAMED POWER CONCEPT
TO LUNAR ROVERS, CONSTRUCTION, MINING, EXPLORERS
AND OTHER MOBILE EQUIPMENT

216786

Jose L. Christian, Jr.
NASA Lewis Research Center
Cleveland, OH

ND 315 7/1/72

INTRODUCTION:

~~This paper will address~~ some of the technical issues dealing with the feasibility of high power (10 Kw - 100 Kw) mobile manned equipment for settlement, exploration and exploitation of Lunar resources *are addressed.*

~~This study has divided~~ this problem into three categories:

- * Short range mining/construction equipment, *a*
- * Moderate range (50 Km) exploration vehicle *and an*
- * Unlimited range explorer *are addressed.*

The following are some general assumptions made through the analysis:

PV array systems (including structure)	22 kg/kw
Advanced PV concepts (including structures)	3 kg/kw
Multimegawatt Nuclear	12 kg/kw or 80 w/kg
Regenerative Fuel Cells (includes cooling)	100 W-hr/kg 65% efficiency

CASE STUDY I: SHORT RANGE MINING/CONSTRUCTION EQUIPMENT

It is supposed that :

- * All vehicles should have enough stored energy to make the trip back home. In this example we are going to assume that the trip is 5 km on a 15° slope, with roughness (friction coefficient) of 0.32.
- * It is supposed that 25% of the power capability of the vehicle is for housekeeping and life support. For the beamed powered vehicles, enough of this power should be stored for emergencies. If the beam goes down, the vehicle should be able to return home with the crew.
- * This trip should be made in 15 min., which is equivalent to 20 Km/hr.
- * For these design specifications we will consider three vehicles: 25 Kw (4,000 Kg), 50 Kw (8,000 Kg) and 100 Kw (16,000 Kg).

MINING VEHICLES OPERATED WITH REGENERATIVE FUEL CELLS

	Vehicle Power		
	25 Kw	50 Kw	100 KW
5 Km trip storage	127 Kg	253 Kg	486 Kg
Pmad	500 Kg	1,000 Kg	2,000 Kg
work storage			
1 hr	385 Kg	770 Kg	1,540 Kg
2 hr	769 Kg	1,538 Kg	3,076 Kg
3 hr	1,154 Kg	2,308 Kg	4,615 Kg

MINING VEHICLES OPERATED WITH REGENERATIVE FUEL CELLS

	Vehicle Power		
	25 Kw	50 Kw	100 KW
total masses			
1 hr	1,011 Kg	2,023 Kg	3,419 Kg
	24.7 w/kg 25%		
2 hr	1,395 Kg	2,791 Kg	4,958 Kg
	17.9 w/kg 35%		
3 hr	1,780 Kg	3,561 Kg	6,494 Kg
	14 w/kg 45%		

Beam Power System Description:

RF source: Gyrotron 5 Kg/kw

50 % efficiency

collector temperature 800 K

no window used

cryo-cooling for magnets included

radiator mass for collector based on 450 K ambient temp.

operation frequency 289 GHz

support structure 1/4 of the mass of the tube

Optics: Monolithic parabolic reflector

2 m in diameter

1.4 kg/m²

losses less 2%

surface temperature 800 K

Rectenna: 60% efficiency

> 770 K operating temperature (vacuum microelectronics)

REQUIRED INFRA-STRUCTURE TO SUPPORT BEAMED POWER VEHICLES

	Vehicle Power		
	25 Kw	50 Kw	100 KW
TRANSMITTER:	84 Kw	167 Kw	334 Kw
antenna	4.5 Kg	4.5 Kg	4.5 Kg
gyrotron	540 Kg	1,080 Kg	2,160 Kg
Pmad *	1680 Kg	3,360 Kg	6,720 Kg
structure	130 Kg	260 Kg	520 Kg
totals:	2,354 Kg	4,704 Kg	9,404 Kg

* This might or might not be included in the beam power infra-structure, since it might be part of the base/outpost power system.

BEAMED POWER SYSTEM AT THE VEHICLE END

	Vehicle Power		
	25 Kw	50 Kw	100 KW
RECEIVER:			
rectenna	22 Kg	22 Kg	22 Kg
Pmad	500 Kg	1000 Kg	2000 Kg
energy storage	96 Kg	192 Kg	384 Kg
totals:	618 Kg	1192 Kg	2384 Kg
40 w/kg	15% power system mass		

This architecture provides an almost unlimited amount of power to the user.

CONCLUDING REMARKS ABOUT MINING/CONSTRUCTION VEHICLES

Mining/construction operation:	Effective time utilization:	
8 hrs . working day	1 hr . 45%	7 hr . 83% power system mass
1 hr . lunch	2 hr . 51%	7 . 5 w/kg
two 15 min . breaks	3 hr . 53%	100% time utilization
effective time 7 hrs .		

beamed power vehicle = 100% time utilization
40 w/kg
15 % power system mass

This time utilization efficiency takes into account the time invested by the worker on traveling back and forth (5 Km) to recharge his batteries and the time invested on charging the batteries . The power supply utilized to do this is the same power supply for the beam power example .

CASE 2: MODERATE RANGE (50 Km) EXPLORATION VEHICLE

- * 100 Kw continuous power vehicle
- * 25% of total power capacity dedicated to housekeeping and life support
- * The system should have enough power storage for return trip if beam is down . Also should have an extra hour storage in case of beam blockage due to geological features .
- * Two types of vehicles will be analyzed . A 29 tonne (10 Km/hr) and a 14 . 5 tonne (20 Km/hr) .
- * The analysis considers also two possible frequencies .
One is 140 GHz for which an optics of 8 . 86m is used and 280 GHz for which an optics of 6 . 27 m is used . If an optics at the receiver is to be 4m, then the minimum interception efficiencies are 20% for 140 GHz and 41% for 280 GHz, assuming that the maximum distance between receiver and transmitter is 50 Km .

SOLAR/RFC LUNAR EXPLORER FOR DAYTIME OPERATION ONLY

	10 Km/hr	20 Km/hr
mobility (round trip)	11,334 Kg	5,666 Kg
P _{mad}	2,000 Kg	2,000 Kg
PV system		
(conventional)	2,200 Kg	2,000 Kg
(advanced)	300 Kg	300 Kg
totals:		
(conventional)	15,484 Kg	9,866 Kg
sp	6.5 w/kg	10 w/kg
%	53%	68%
(advanced)	13,634 Kg	7,966 Kg
sp	7.3 w/kg	13 W/kg
%	47%	55%

RFC EXPLORER FOR NIGHTTIME OPERATIONS

	10 Km/hr	20 Km/hr
mobility (round trip)	11,334 Kg	5,666 Kg
P _{mad}	2,000 Kg	2,000 Kg
Life support and operations		
1 hr.	1,538 Kg	1,538 Kg
3 hr.	4,615 Kg	4,615 Kg
5 hr.	7,690 Kg	7,690 Kg
1 hr.	51% 7 w/kg	63% 11 w/kg
3 hr.	61% 6 w/kg	84% 8 w/kg
5 hr.	72% 5 w/kg	106% 6.5 w/kg

RANGE ACHIEVED BY A COLLIMATED BEAM

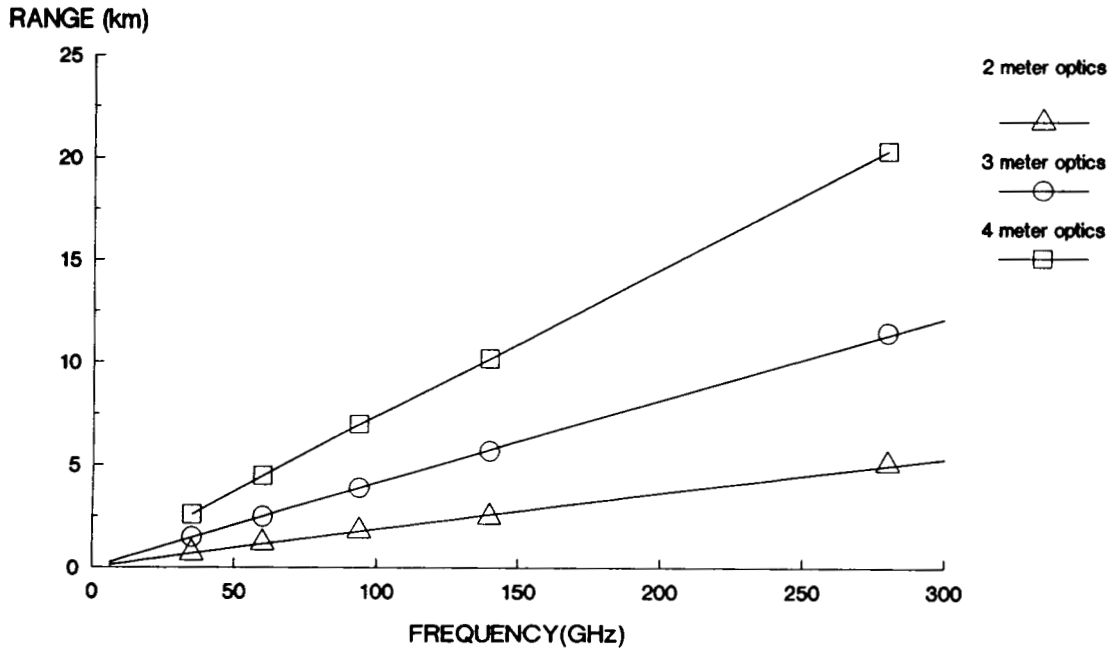

VISUAL RANGE ABOVE THE HORIZON ON LUNAR SURFACE ASSUMING NO GEOLOGICAL OBSTACLES

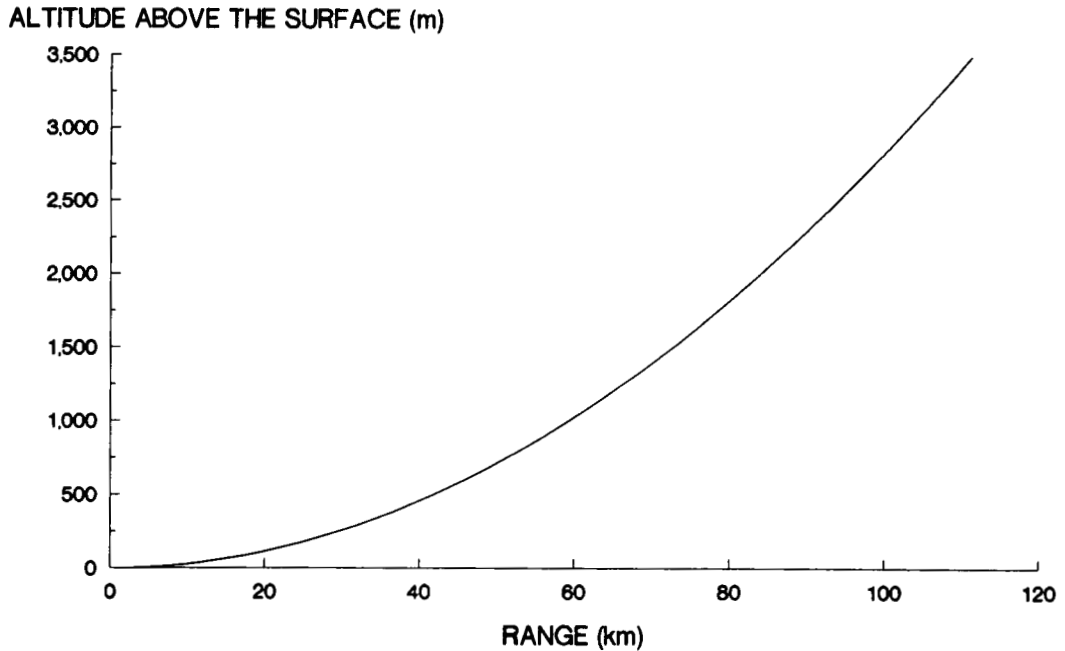

SUPPORT INFRA-STRUCTURE TO BEAMED POWER EXPLORER

	140 GHz	280 GHz
Transmitter characteristics	1,865 Kw	900 Kw
gyrotron (50 % eff.) (1 kg/kw)	2,390 Kg	1,114 Kg
antenna (1.4 kg/m ²)	86.3 Kg	43 Kg
Pmad (95% eff) (20 Kg/kw)	37,000 Kg	18,000 Kg
structure (1/4 tube)	466 Kg	225 Kg
totals	39,861 Kg	19,382 Kg
RF system	2,861 Kg	1,382 Kg

ANALYSIS OF THE WORST PERFORMANCE OF EXPLORER VEHICLE OBTAINED WITH A BEAMED POWER SYSTEM.

Receiver:	10 Km/hr	20 Km/hr
rectenna	62.8 Kg	62.8 Kg
Pmad	2,000 Kg	2,000 Kg
"shadowing" 1 hr. supply	1,538 Kg	1,538 Kg
return emergency storage	5,667 Kg	2,833 Kg
totals:	9,267 Kg	6,434 Kg
power plant fraction	32%	44%
specific power	11 w/kg	15 w/kg

CASE 3: UNLIMITED RANGE EXPLORER

This vehicle has the capability of sustaining missions of very long duration (several days) with journeys up to hundreds of kilometers . This differs from the previous case since there is not any mountaintop on the surface of the Moon that could meet this kind of requirements .

This case assumes the existence of an orbiting beam power infrastructure, capable of providing power to any ground mobile vehicle (or any surface facility) virtually any where on the planet .

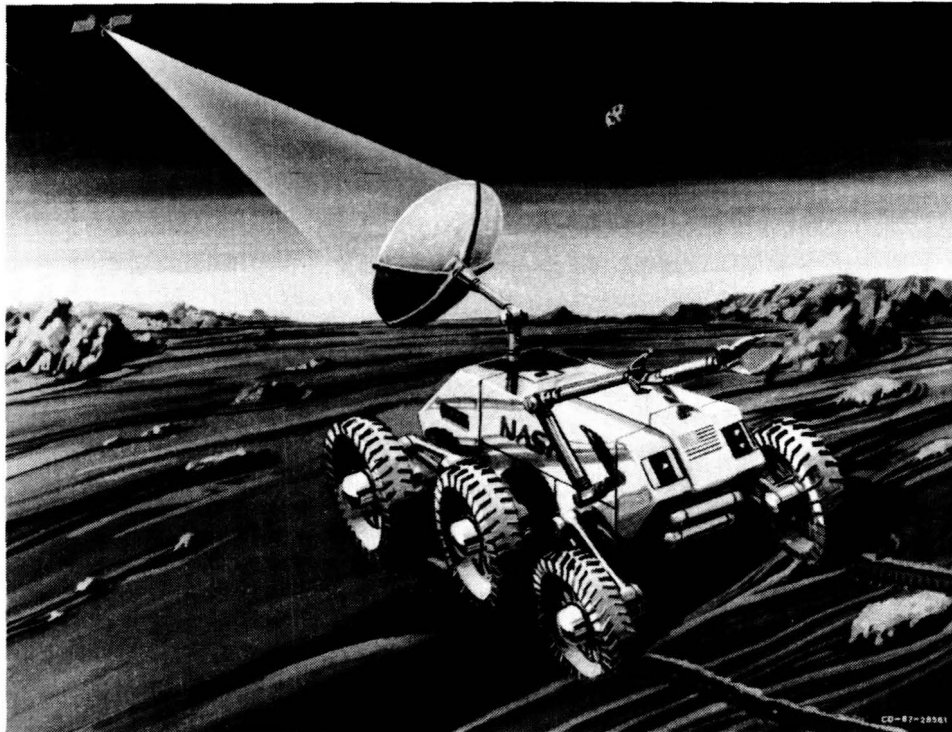

ORIGINAL PAGE
BLACK AND WHITE PHOTOGRAPH

RANGE OF RFC ON LUNAR SURFACE FOR ROVER APPLICATION

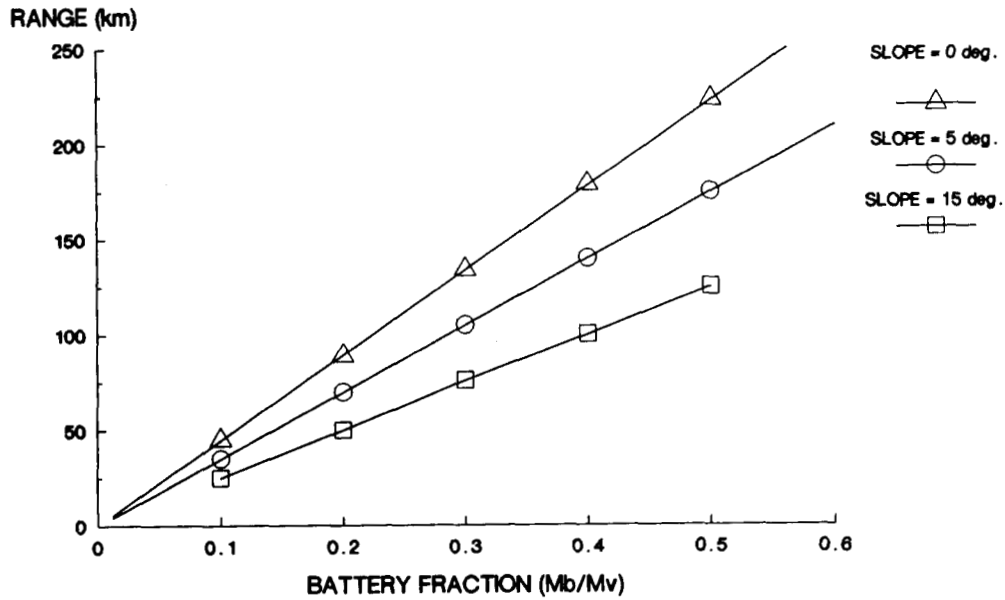

The system used is a RFC
100 W-hr/kg and 65% efficiency

NOMENCLATURE

n_{depth} = Depth of discharge

SSC = specific storage capacity (W-hr/kg)

P = period of the orbit

n_a = interception efficiency

DC = duty cycle (fraction of the time that the orbiter is visible)

n_o = overall electronics efficiency

n_{ch} = charge efficiency

n_{dis} = discharge efficiency

The following expression relates the power required at the transmitter with the power demanded by the receiver as a function of the duty cycle and system's efficiencies .

$$P_d = n_a n_o \left\{ \frac{1-DC}{n_{\text{depth}} n_{\text{ch}} n_{\text{ds}} DC} + 1 \right\}^{-1} P_t$$

The mass of the battery at the receiving end is also determined by the demanded power at the receiver P_d (watts) and the period of the orbit P (seconds).

$$M_b = \frac{P_d (1-DC)P}{\{ n_{\text{depth}} n_{\text{ch}} n_{\text{ds}} SSC (3600) \}} \quad (\text{KG})$$

LUNAR BEAM POWER ORBITING STATION DUTY CYCLES FOR DIFFERENT ORBITAL TRAJECTORIES

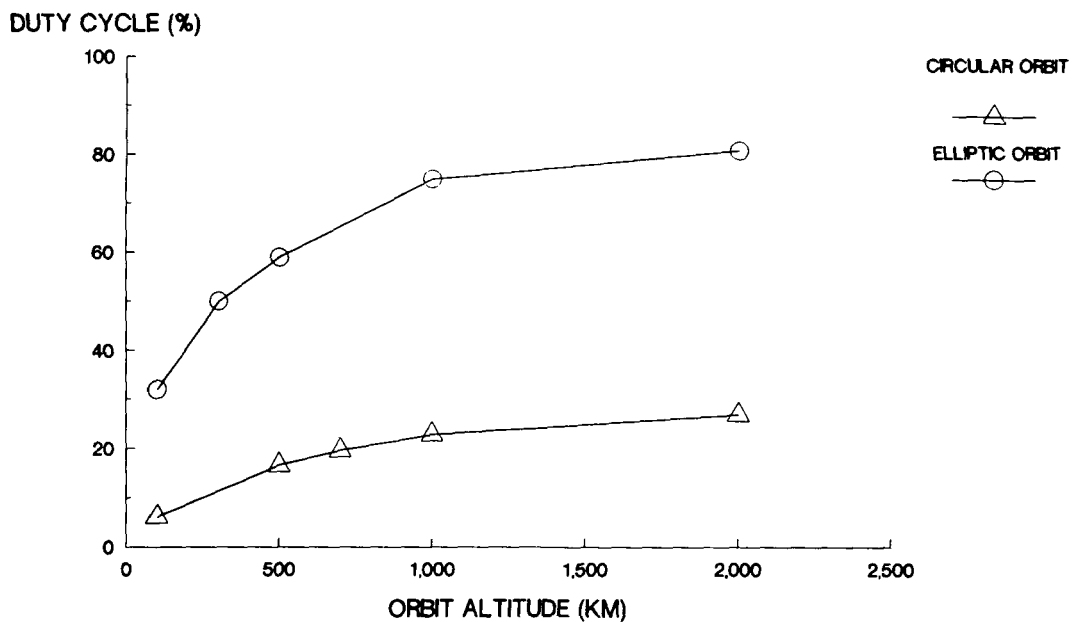

PERFORMANCE OF A HYPOTHETICAL VEHICLE POWERED BY AN ORBIT BEAMED POWER STATION

rectenna

10.6 μm rectenna
 60% efficiency
 MOM structure
 4 m optics
 mass 15.7 Kg (5 kg/m^2)
 passive cooling (617 K)

power level = 100 Kw
 speed = 20 Km/hr
 total mass = 14,500 Kg

storage

20% of the cycle 1,101 Kg
 1 hr shadow 1,538 Kg

Orbiter:
 elliptic orbit
 80% duty cycle
 2,000 Km apog .
 3hr . 34min . 45sec .
 (period)

P_{rad} 2,000 Kg

18% mass power fraction
 37 w/kg

LUNAR BEAM POWER ORBITING STATIONS FOR COMPLETE COVERAGE

NUMBER OF STATIONS

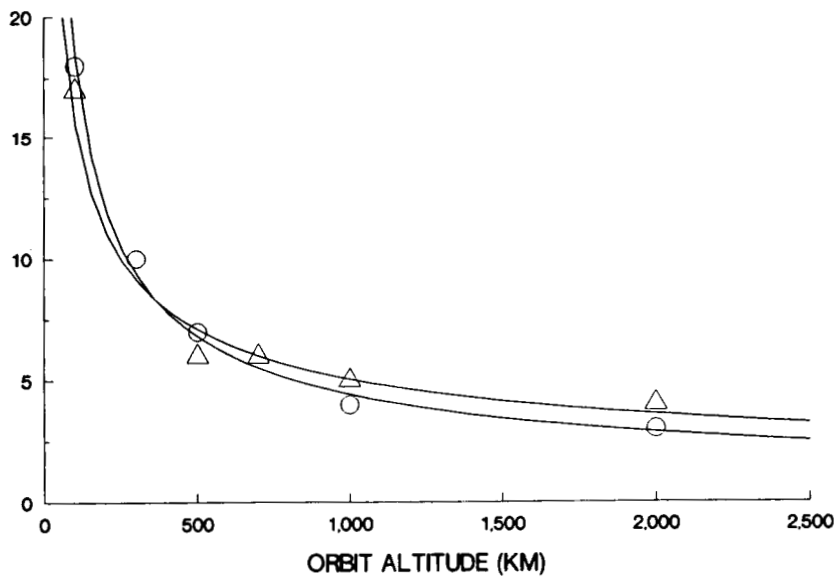

ORBITER'S POWER REQUIREMENTS

The major concern at this point is to conceive an efficient way to generate and beam the power such that the power requirements on the orbiter are not unrealistic .

$$P_d = n_a n_e \left\{ \frac{1-DC}{n_{\text{depth}} n_{\text{ch}} n_{\text{ds}} DC} + 1 \right\}^{-1} P_t$$

$$n_a = .8$$

$$n_e = .1$$

$$DC = 80\%$$

For these assumptions, the power requirements at the transmitter are about 31 times higher than at the user . This is due to the inefficiencies of the system .

A 3.1 Mw orbit transmitter might be reasonable if its existence could be justified in relation to other activities . A stand alone infra-structure of this magnitude might reduce all the benefits of a beamed power very long range explorer vehicle .

CONCLUSIONS:

Based on the assumptions made in this preliminary analysis, the beamed power concept might not be a too unreasonable alternative .

A more in depth analysis should follow, addressing some technology feasibility issues in regard to antenna, RF generation and rectenna concepts . An objective assessment is appropriate at this point in order to evaluate the merits of state-of-the-art technology, and its predicted evolution in the future in regard to its applicability to beamed power .

omit

PLANETARY POWER APPLICATIONS -- DISCUSSION SUMMARY

By R. C. Costen

A number of issues were raised during discussion of the specific mission presentations. A summary is given here of the various related mission issues discussed.

Political. Some environmental and political issues were raised. In space there are only two prime power sources: solar or nuclear. There is political resistance to placing nuclear reactors in Earth orbit lower than geosynchronous. There may also be political resistance to placing a reactor on the surface of the moon. A possible alternative would be to place the reactor in lunar orbit and beam the power down to the lunar surface. However, we must avoid interference with the observatory planned for location on the far side of the moon.

Missions. A paramount mission was an early demonstration of power beaming. One suggestion was that we obtain a solar concentrator and beam across 30 terrestrial miles at a power level much lower than 1 megawatt. For a demonstration of power beaming in space, we need not try to append power beaming to an existing mission. Instead, we could dedicate a new mission to such a demonstration. In addition to demonstrating power beaming, we need to emphasize its mission-enabling capabilities -- what does power beaming allow us to do in space that is impractical any other way? The technological priorities in space will probably be determined by near Earth studies and by the first mission to Mars. However, the case studies performed by NASA's Office of Exploration are not yet clear about exactly what is to be done on Mars. How would these studies change if power beaming were an option?

The SP-100 nuclear reactor, which is rated at 100 kilowatts, is being developed partly through NASA funding for application to an electric power plant for a manned lunar base. This power system will include a small photovoltaic power and storage system for life support and communications in the event of a major power failure. The power plant will also have multiple reactors for increased reliability. A version of the SP-100 reactor, scaled up to 10 megawatts and combined with electric propulsion, is being considered for a cargo transporter to Mars. Instead of returning to Earth, this unit could remain in Martian orbit and beam power to the surface. The combination of nuclear power, electric propulsion, and power beaming could also be used as a self propelled power station in space. The nuclear power source could alternatively be used to energize the thruster, the power beam, or both. Such a power station might also utilize a nuclear-pumped laser. An advantage of this power-beaming system is that it would enable the shielding mass for the nuclear reactor to be minimized because the reactor would remain a long distance away from the power user.

Instead of beaming power from a lunar orbit of 2000 kilometers altitude, we could beam power from libration points L1 and L2 at about 35,000 miles lunar altitude and compensate for the increase in beam

jitter by using a low-grade concentrator on the lunar surface. Since L1 and L2 are above fixed points on the lunar surface, the slew rate would be much less than in a 2000 kilometer orbit, and a pointing system similar to that of the Hubble telescope could be used. The pointing accuracy could also be improved by utilizing a cooperative system between the transmitter and receiver, such as a homing beam or feedback system at the receiver.

Other missions were also considered. Surface to surface power beaming on the moon could utilize orbiting relay stations. With such stations, a photovoltaic installation could receive nearly continuous sunlight at one of the lunar poles and beam power to other lunar sites. Such a relay system could also be used with a free electron laser (FEL), which is tunable and could be used to beam megawatts of power from the surface of the earth to the surface of the moon. At 1 micron wavelength, a FEL could transmit from a 10 meter dish on the earth's surface to a 100 meter dish on the moon with about a 50 percent loss in the earth's atmosphere. The beam would be free of sideband frequencies; however, some radiative backscatter could occur. The moon may also be a good source of helium-3, a rare isotope on the earth which is an important ingredient of proposed clean nuclear fusion systems. A beam powered thruster could use oxygen, obtained from the moon, as a monopropellant to transport payloads of helium-3 from the moon to the earth.

Technology. Some comments on technology concerned energy storage. Fuel cells are excellent for large storage because it is relatively easy to store large volumes of hydrogen and oxygen and realize an economy of scale. Alternatively, one could take advantage of the lunar environment and store energy in a molten lake. An advantage of beamed power is that it can reduce the energy storage needed on a rover. The first Martian rover, designed for returning soil samples, will probably use regenerative fuel cells. Various rover configurations could be optimized. For example, a photovoltaic powered rover could be designed with large solar cell panels mounted on trailers. Also, a rover could take on hydrogen and oxygen for its fuel cells at large storage stations.

Reliability and maintainability were also discussed. It is difficult to make a nuclear reactor that will last for ten years. Also, the maintenance problems for a reactor in orbit are probably triple those on the surface. Some power-beaming systems, such as those employing master oscillator power amplifier (MOPA) systems, have a string of failure points. A solution is to use redundancy in each MOPA system and also to have multiple power-beaming stations in orbit. Small inflatable lenses and mirrors are vulnerable to deflation by micrometeoroids; large inflatable lenses and mirrors, although less vulnerable to deflation, are subject to thermal distortions. Millimeter wave power-beaming can be very efficient for short paths, such as from a planetary surface to low orbit. Power management and distribution (PMAD), which includes electric power supplies, switches, cable, etc., is a more significant part of the mass of millimeter-wave systems than of laser systems. Superconductivity would help reduce PMAD mass. The design of output windows is challenging for megawatt level gyrotron tubes, which

generate millimeter waves. Also challenging is the fabrication of megawatt level diode laser arrays. A Japanese-based company is developing diode lasers. Faceted windows could be used on some types of laser electric converter cells to reduce reflections from the wires and to decrease the series resistance. The mass of thermal radiators, which is significant for all high power systems in space, could be halved by the use of liquid droplet radiators.

00117

SPACE PROPULSION APPLICATIONS MINIWORKSHOP

PRECEDING PAGE BLANK NOT FILMED

~~FRAME~~ 360 INTENTIONALLY BLANK

N90-10160

520-20

100
50-1

**LOW-EARTH-ORBIT TO LOW-LUNAR-ORBIT
LASER FREIGHTER**

216787

Russell J. De Young
NASA Langley Research Center

ND210491

PRECEDING PAGE BLANK NOT FILMED

PAGE 362 INTENTIONALLY BLANK

LOW-EARTH-ORBIT TO LOW-LUNAR-ORBIT LASER FREIGHTER

Russell J. De Young

The objective of this mission study was to compare laser propulsion to chemical LOX/H₂ and nuclear electric propulsion for the specific mission of delivering a 144-metric ton lunar base from low-Earth-orbit to low-lunar-orbit. The basis of comparison was total mass in low-Earth-orbit needed to accomplish this mission. The Office of Exploration approach to establishing the lunar base was to use two vehicles: a nuclear electric propulsion (NEP) vehicle to deliver cargo and a chemical vehicle to deliver humans. The NEP vehicle was reactor driven with a vehicle dry mass of 125 metric tons. The Office of Exploration study did not use chemical propulsion for cargo, but in the present study it was used for cargo for comparison to laser propulsion.

This mission study assumes a high-power laser, either nuclear or solar electric-driven diode laser, is in orbit around Earth, beaming power to a laser propulsion vehicle. Laser power is only used for the LEO escape burn, other much lower-power burns are done with LOX/H₂.

Nuclear Electric Propulsion

Vehicle Dry- 125 t
Payload- 620 t
Fuel- 180 t

Chemical Propulsion

Vehicle Dry- 7.9 t
Payload- 1.0 t
Fuel- 18.5 t

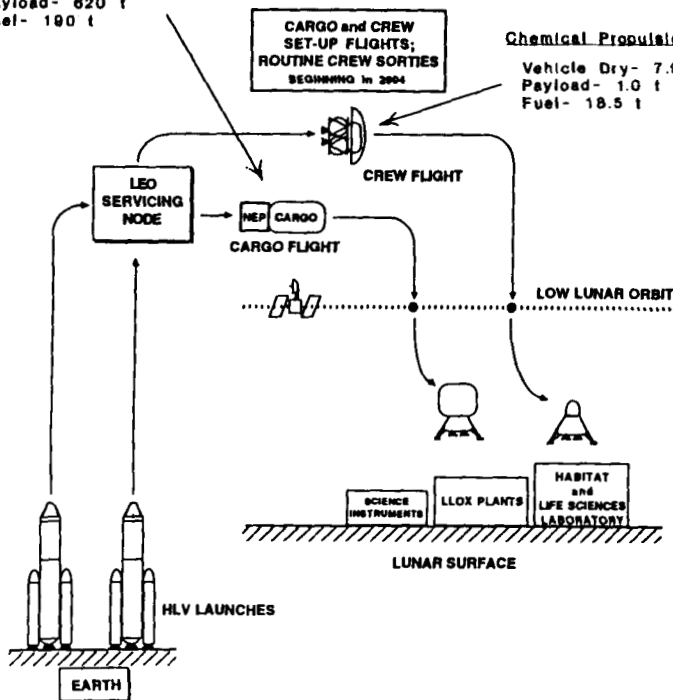

Laser Propulsion Option

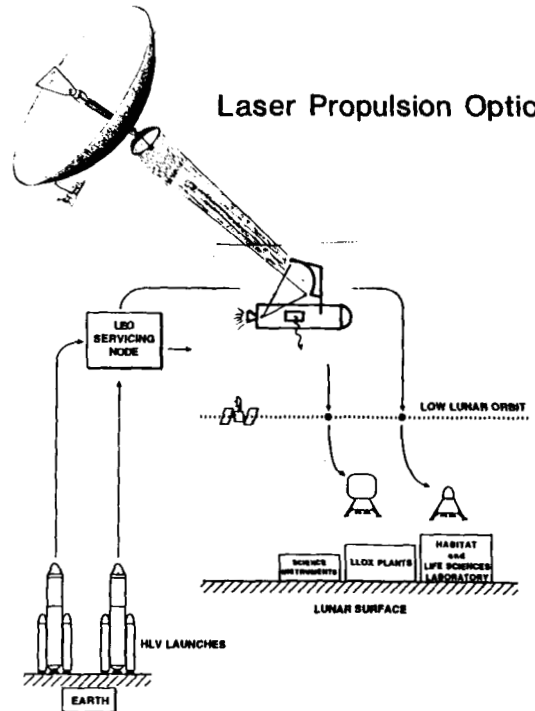

N90-10161

51-36
216788

LASER PROPULSION OPTION

See
p. 375

ND 2 10491

Donald H. Humes

LEO TO LLO TRANSPORTATION VEHICLES

LUNAR TRANSFER VEHICLE

Dry Mass (engines, structure, etc.)	7.9 t
Propellant Type	LOX/LH2
Mixture Ratio	7/1
Specific Impulse	470 s
Payload Capacity (includes crew)	1.0 t
Crew Capacity	6
Propellant Capacity	18.5 t

ELECTRIC CARGO VEHICLE

Dry Mass		125.0 t
5 MWe Reactor, Engines	(75.0 t)	
Tanks, Propellant Reserves	(19.0 t)	
(10% Propellant)		
Payload Adaptor/Structure	(31.0 t)	
(5% Payload Capacity)		
Propellant Type		Argon
Mixture Ratio		NA
Specific Impulse		6000 s
Payload Capacity		620
Crew Capacity		Unmanned
Propellant Capacity		190

CHEMICAL PROPULSION ΔV SUMMARY

from T.D. HOY LBS-88-233

ΔV (EOI) (W/ Aerobrake) = 94 m/s
(W/O Aerobrake) = 3155 m/s

ΔV (LOI) = 875 m/s

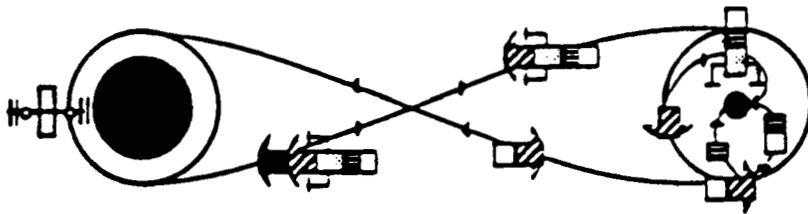

ΔV (TLI) = 3155 m/s

ΔV (TEI) = 875 m/s

EOI - Earth Orbit Insertion

LOI - Lunar Orbit Insertion

TLI - Trans Lunar Burn

TEI - Trans Earth Injection Burn

LOW-THRUST EARTH-ESCAPE TRAJECTORY

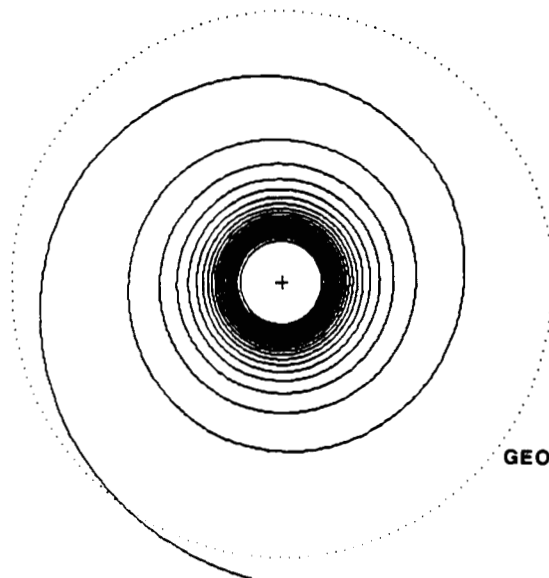

COMPARISON OF CHEMICAL OTV AND ELECTRIC OTV

FOR LEO-LLO OPERATIONS

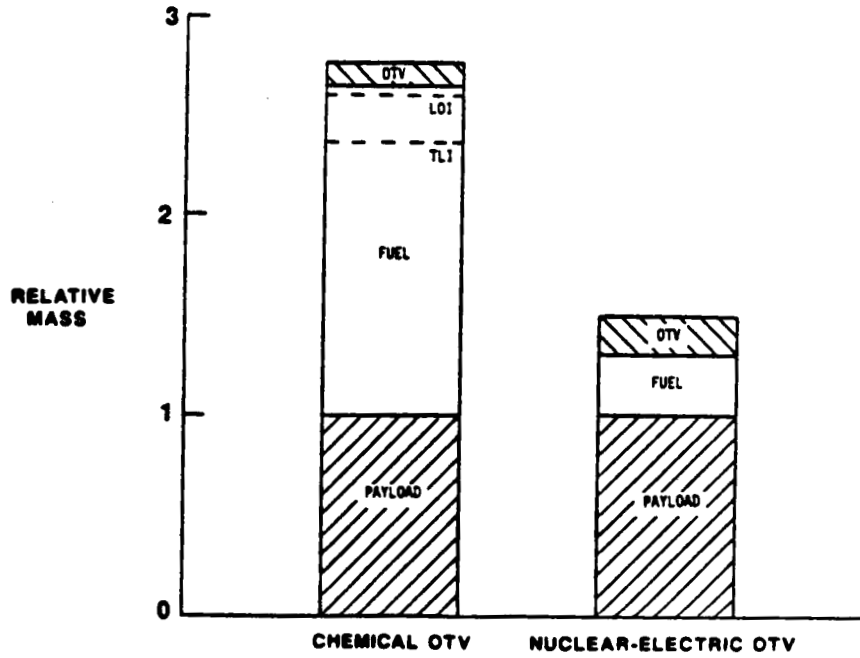

COMPARISON OF CHEMICAL OTV AND ELECTRIC OTV

FOR LEO-LLO OPERATIONS

<u>OTV</u>	TIME, days (OUTGOING)	
	<u>LEO-GEO</u>	<u>LEO-LLO</u>
CHEMICAL	.091	2.3
NUCLEAR-ELECTRIC	277.	401.
NUCLEAR-ELECTRIC *	90.	130.

* with 144000 kg payload (oneway)

RADIATION FLUX VERSUS ALTITUDE

NASA CONTRACTOR REPORT 3536

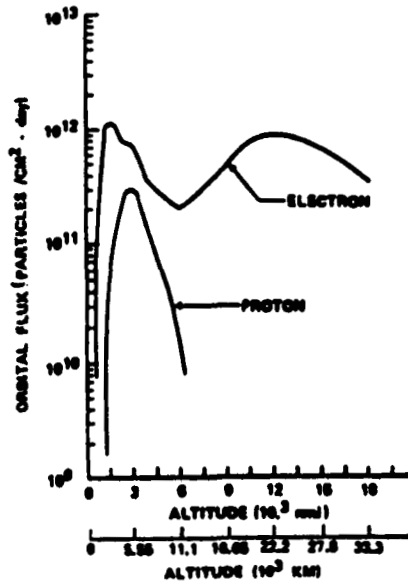

COMPARISON OF CHEMICAL OTV AND ELECTRIC OTV FOR LEO-LLO OPERATIONS

OTV	RELATIVE RADIATION FLUENCE	
	ELECTRONS	PROTONS
CHEMICAL	1	1
NUCLEAR-ELECTRIC	2970	6570
NUCLEAR-ELECTRIC *	958	2120

* with 144000 kg payload (oneway)

NASA EVOLUTIONARY EXPANSION TRANSPORTATION PLAN

TWO OTVs ARE REQUIRED BECAUSE

- CHEMICAL OTVs ARE TOO EXPENSIVE TO DELIVER CARGO (IN TERMS OF FUEL MASS DELIVERED TO LEO)
- NUCLEAR-ELECTRIC OTVs ARE TOO SLOW FOR MANNED FLIGHTS

PURPOSE OF TALK

THE PURPOSE OF THIS TALK IS TO SHOW THAT THE ADDITION OF A LASER THRUSTER TO A CHEMICAL OTV, MAKING IT A HYBRID LASER/CHEMICAL OTV, WOULD RESULT IN THE FUEL SAVINGS NEEDED WHILE STILL PROVIDING FAST TRIP TIMES, THUS ELIMINATING THE NEED FOR NUCLEAR-ELECTRIC OTVs IN THE EARTH/MOON REGION

ADVANTAGES OF LASER PROPULSION

- FUEL EFFICIENT COMPARED TO CHEMICAL THRUSTERS BECAUSE LASER THRUSTERS HAVE A SPECIFIC IMPULSE OF ABOUT 1500 s COMPARED TO ABOUT 480 s FOR CHEMICAL THRUSTERS
- HIGH THRUST COMPARED TO NUCLEAR-ELECTRIC THRUSTERS MAKING TRIP TIMES MUCH SHORTER, ESPECIALLY THROUGH THE VAN ALLEN RADIATION BELTS
- LASER PROPULSION IS A HAPPY COMPROMISE BETWEEN CHEMICAL AND NUCLEAR-ELECTRIC PROPULSION HAVING THE ADVANTAGES OF BOTH

HYBRID LASER/CHEMICAL OTV

FOR LEO-LLO OPERATIONS

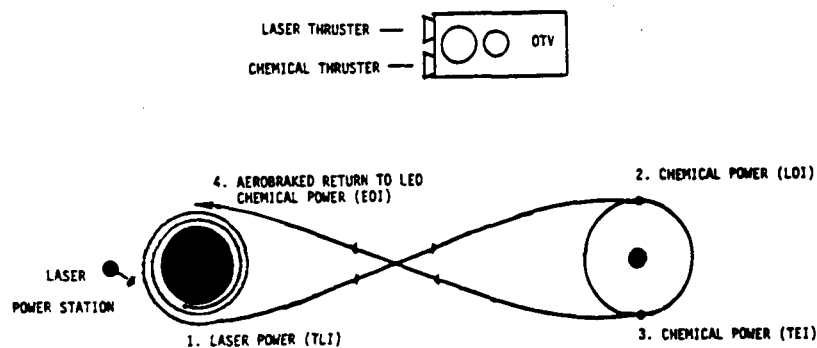

ONLY TL1 (BURN #1) IS LASER POWERED BECAUSE

- 84% OF FUEL IS USED DURING TL1 FOR CHEMICAL OTV
- LASER CAN BE PLACED NEAR THE EARTH
- LASER TRANSMISSION DISTANCE IS SMALL

LOW-THRUST EARTH-ESCAPE TRAJECTORIES

HYBRID LASER/CHEMICAL OTV

MASS (OTV) = 8790 kg

$I_{sp} = 1500$ s

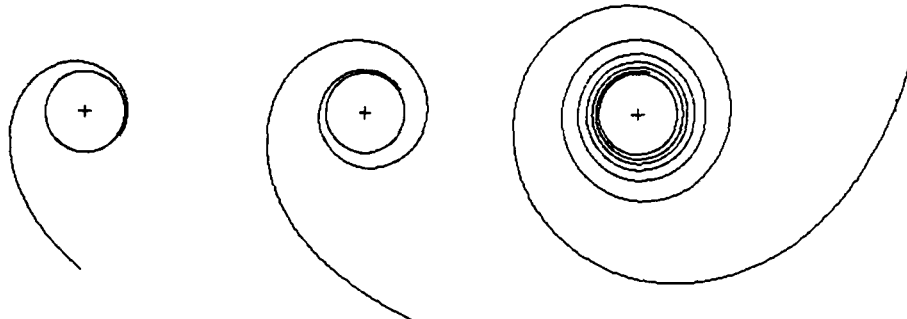

$P_{exhaust} = 250$ MW

Payload = 36000 kg

$P_{exhaust} = 100$ MW

Payload = 28800 kg

$P_{exhaust} = 25$ MW

Payload = 24000 kg

PERFORMANCE OF HYBRID LASER /CHEMICAL OTV

FOR DELIVERY OF 144000 kg TO LLO FROM LEO

MASS (OTV) = 8790 kg

$I_{sp} = 1500$ s (laser)

$I_{sp} = 465$ s (chemical)

POWER (exhaust)	THRUST	PAYLOAD/TRIP	TRIPS	MASS FUEL*	LASER	
					ON TIME	MAXIMUM RANGE*
250 MW	34000 N	36000 kg	4	133600 kg	2.55 hr	24700 km
150	20400	28800	5	147800	3.81	27200
100	13600	28800	5	154000	6.05	34500
50	6800	28800	5	163400	13.2	47300
25	3400	24000	6	181600	24.7	63400

* Total fuel required to deliver 144000 kg to LLO
(all four burns, all trips) with return to LEO

* Range of OTV from center of Earth when laser power discontinued

**PERFORMANCE OF HYBRID LASER/CHEMICAL OTV
FOR LEO-LLO OPERATIONS**

MASS (OTV) = 8790 kg

$I_{sp} = 1500$ s (laser)

$I_{sp} = 465$ s (chemical)

POWER(exhaust)	RELATIVE RADIATION FLUENCE PER TRIP	
	ELECTRON FLUENCE	PROTON FLUENCE
250 MW	1.61	2.54
150	2.08	4.10
100	3.04	6.65
50	5.43	11.6
25	9.27	20.5
Chemical	1.	1.
NEP*	2970.	6570.
NEP*	958.	2120.

* With 144000 kg payload

* Relative to that of chemical OTV

LEO MASS TO DELIVER LUNAR BASE

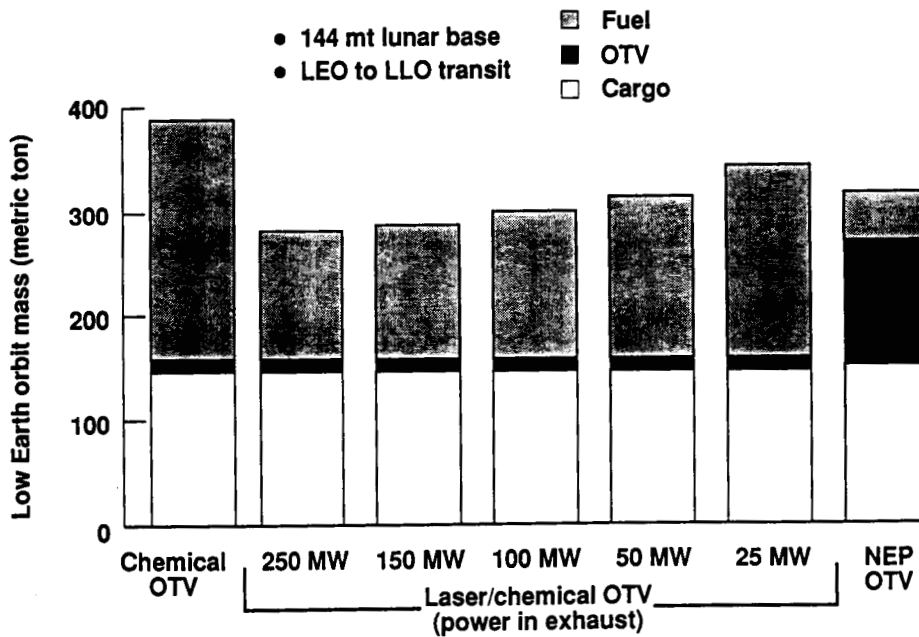

TIME IN VAN ALLEN RADIATION BELTS

(LEO-GEO)

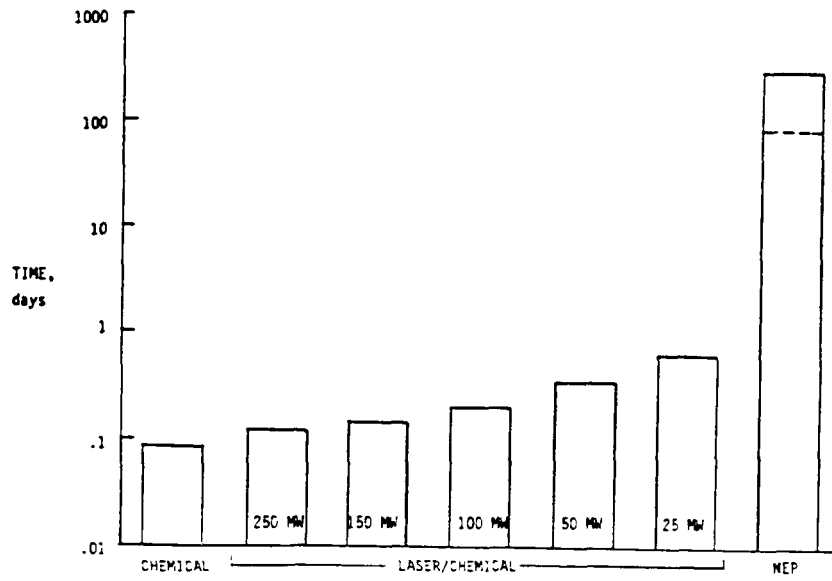

TIME FOR LEO TO LLO TRANSFER

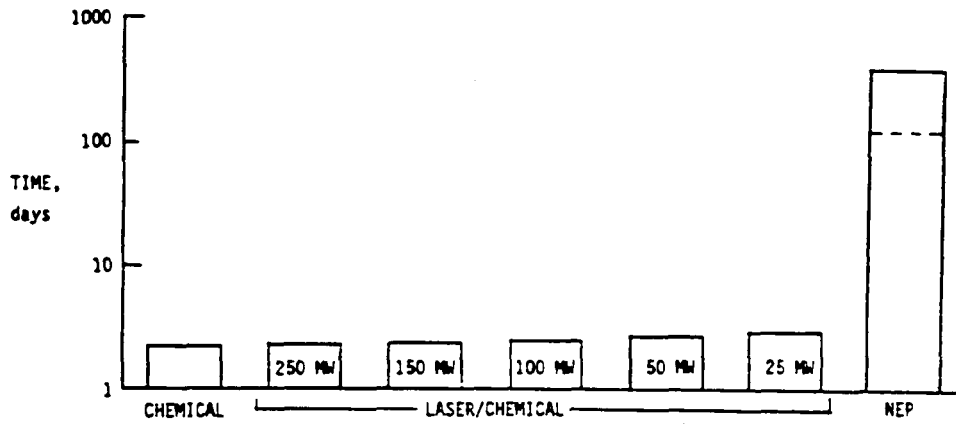

SUMMARY

THE USE OF LASER THRUSTERS WITH EXHAUST POWERS IN THE 25 MW TO 250 MW RANGE CAN REDUCE THE FUEL THAT WOULD BE NEEDED TO TRANSPORT THE LUNAR OUTPOST EQUIPMENT TO LOW-LUNAR ORBIT WITH A CHEMICAL OTV BY 57000 KG TO 105000 KG WITH NO SIGNIFICANT PENALTY IN TRIP TIME. THIS WOULD SAVE ONE OR TWO LAUNCHES OF THE HEAVY-LOAD LAUNCH VEHICLE.

NUCLEAR-ELECTRIC OTVs WOULD TAKE 40 TO 120 TIMES AS LONG TO GET TO THE MOON AND WOULD SPEND 100 TO 1700 TIMES AS LONG IN THE VAN ALLEN RADIATION BELTS AS OTVs THAT HAVE LASER THRUSTERS.

EARTH ORBIT LASER SYSTEMS

216789

Ja H. Lee

LaRC

ND210091

35

PRECEDING PAGE BLANK NOT FILMED

- Provide 50 ~ 500-MW laser powers for 25 ~ 250-MW thrusters
- Placed on 6,300-km earth orbit for power beaming to laser OTV's
- Laser system options
 - a) Electrically pumped lasers
 - Nuclear reactor driven diode laser amplifier array
 - Solar panel driven diode laser amplifier array
 - Other electric discharge lasers are considered but discarded a priori
 - b) Direct solar-pumped lasers
 - Iodine photodissociation laser
 - Solid-state lasers
 - Liquid lasers

REACTOR DRIVEN LASER POWER TRANSMITTER FOR LEO-TO-LLO OTV

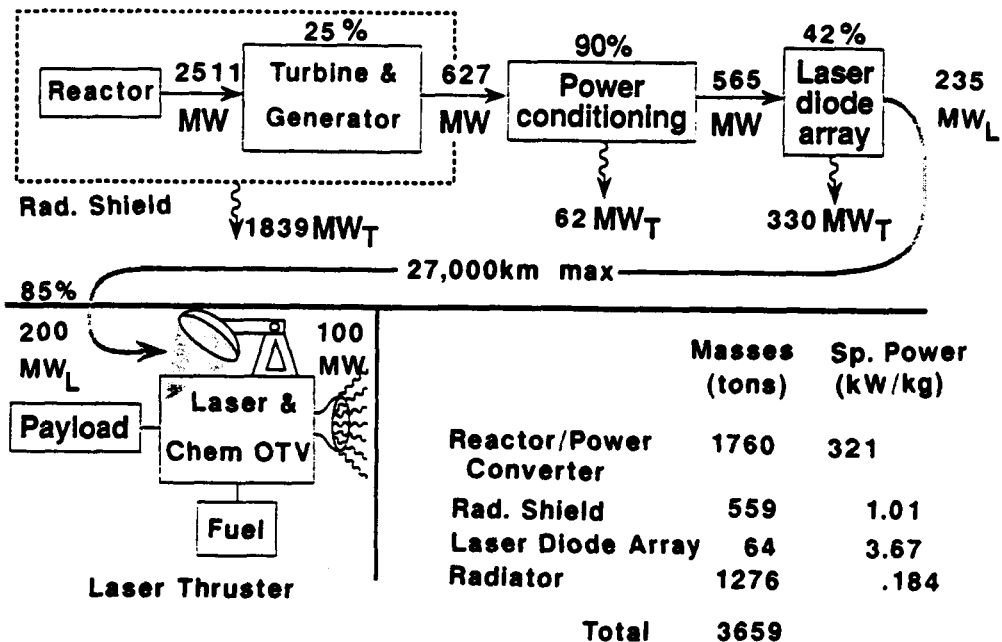

SOLAR DRIVEN LASER POWER TRANSMITTER FOR LEO-TO-LLO OTV

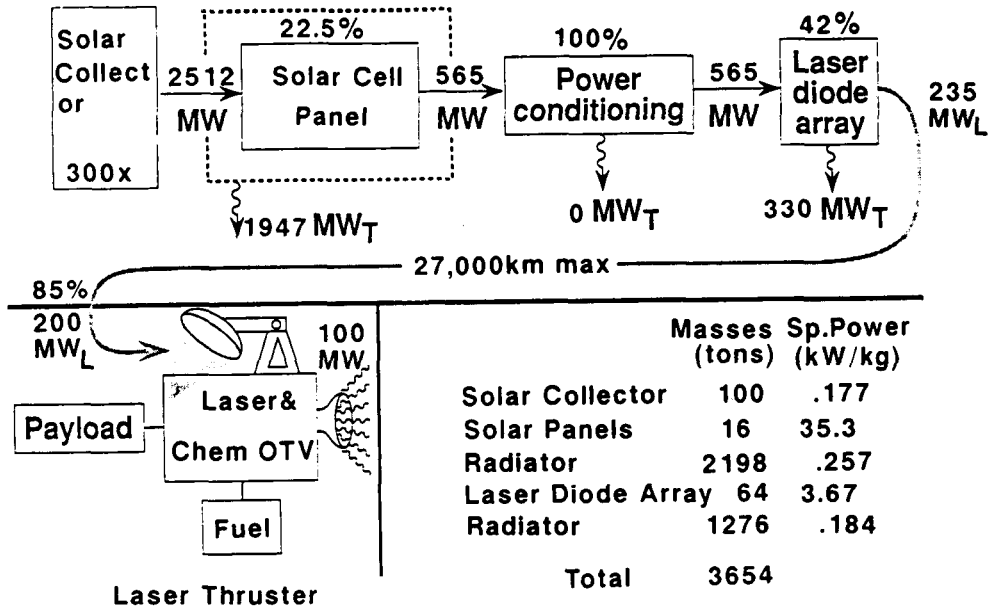

LASER SYSTEMS FOR PROPULSION

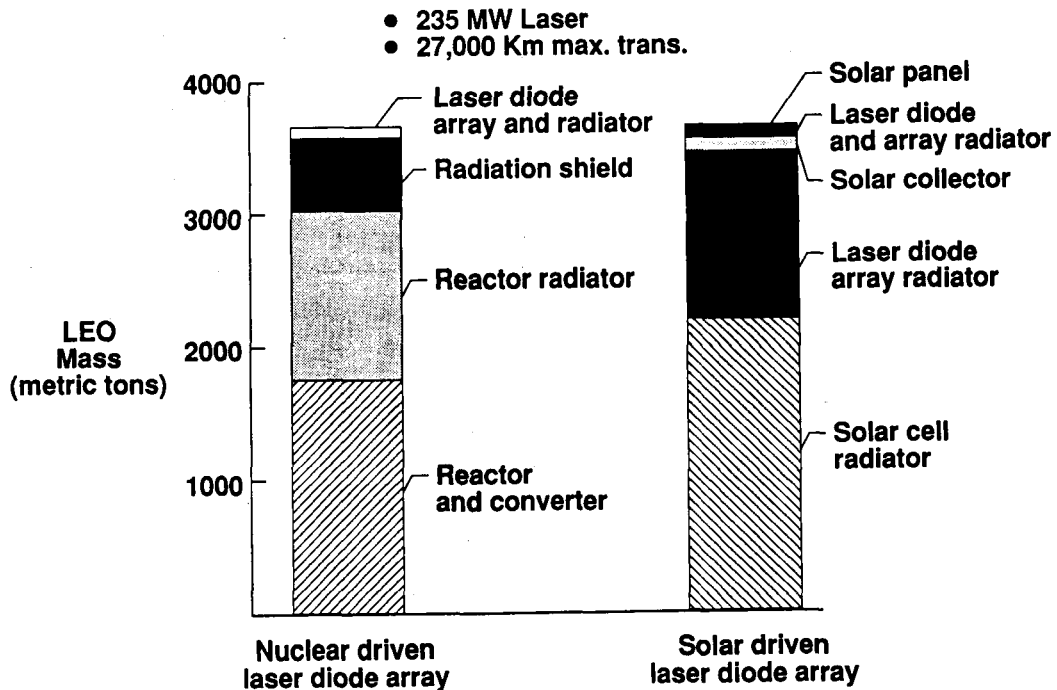

C-5

TRANSMITTER MASS VS LASER POWER

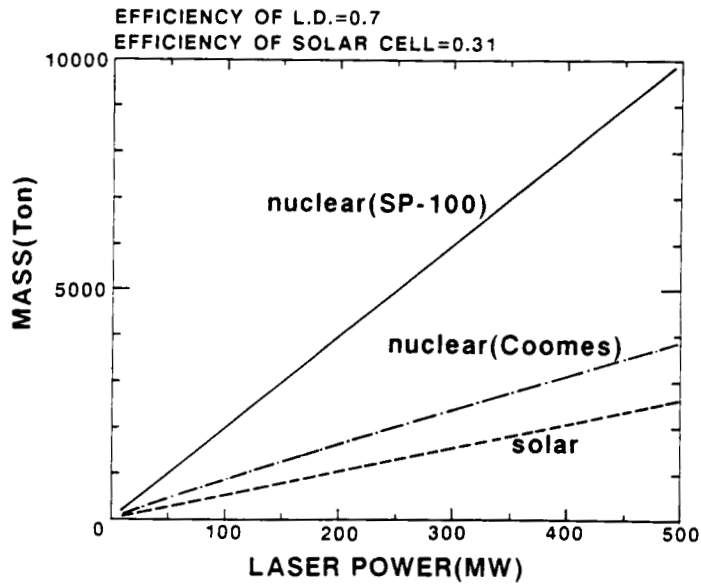
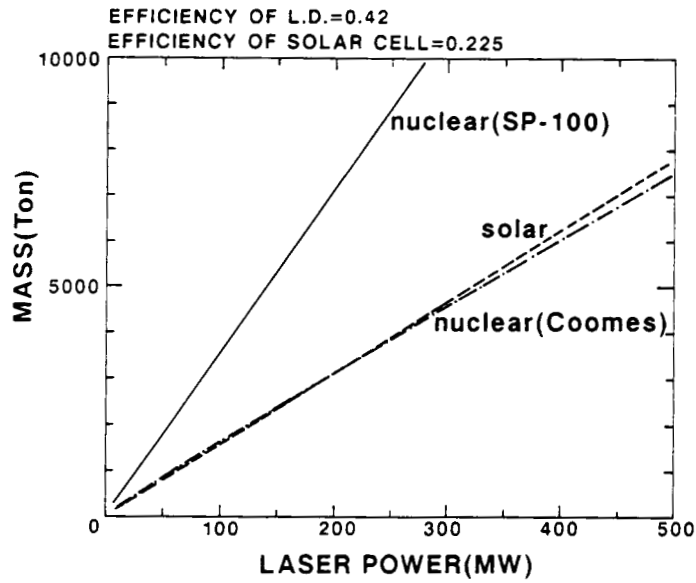

SOLAR DRIVEN LASER POWER TRANSMITTER

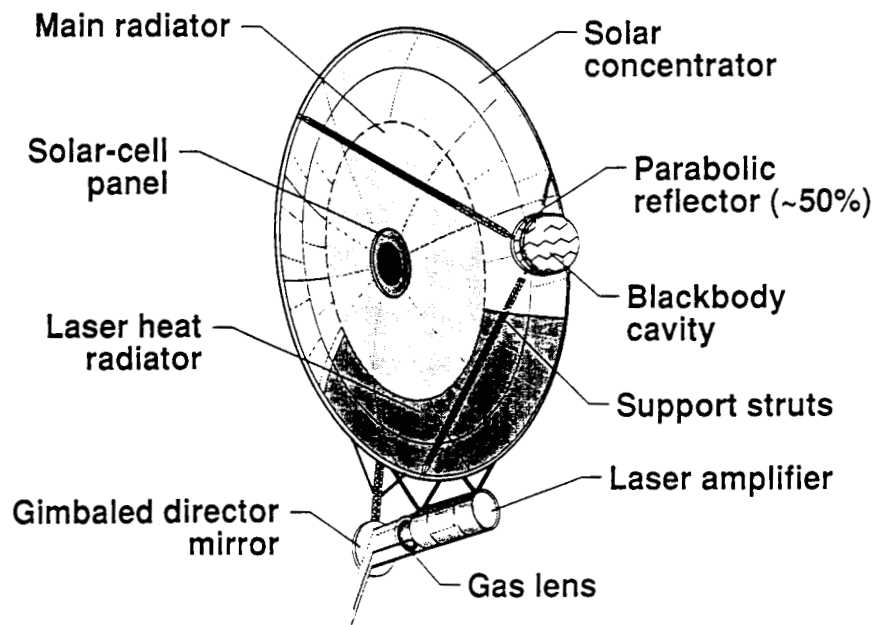

SUMMARY

- ✗ At the state-of-the-art efficiencies, both nuclear and solar-driven systems require equal masses for the same laser powers in the 50-500 MW range, typically 3,700 tons for a 100-MW thruster.
- Future efficiency improvement of solar panel and laser diode array will realize significant reduction (by a factor of 3) in system masses.
- Beaming time for laser propulsion is relatively short and other missions should be considered for increasing the system duty cycle.

N90-10163 53-36

516790
71

**LASER DIODE ARRAY
AND TRANSMISSION OPTICS**

Jin H. Kwon

MW 597822

MIAMI UNIVERSITY OHIO

PRECEDING PAGE BLANK NOT FILMED

LASER DIODE ARRAY AND TRANSMISSION OPTICS

LASER TYPE	AlGaAs Semiconductor Laser
WAVELENGTH	830 nm
POWER PER LASER DIODE	5 Watts
ELECTRICAL-TO-OPTICAL EFFICIENCY	42 %
LASER SYSTEM	Parallel Array Amplification

Coherent Combining of Laser Diode Arrays

1. Injection-Locking

locking bandwidth	5 GHz(0.1Å)
temperature control	±0.1 C
near threshold operation	
power gain	17 dB

2. Travelling-wave Amplification

amplification bandwidth	THz(20Å)
temperature control	±5 C
power gain	18.6 dB

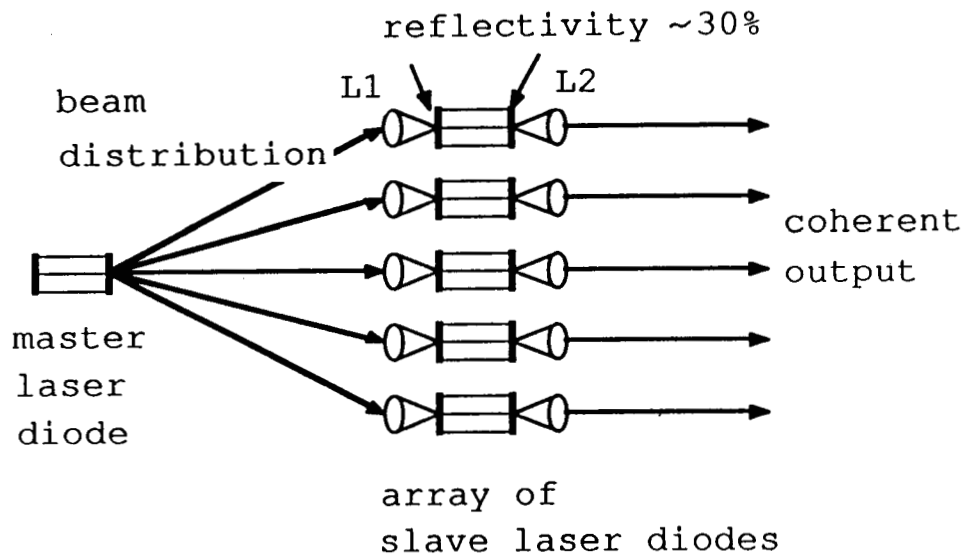

Injection-locking of laser diodes.

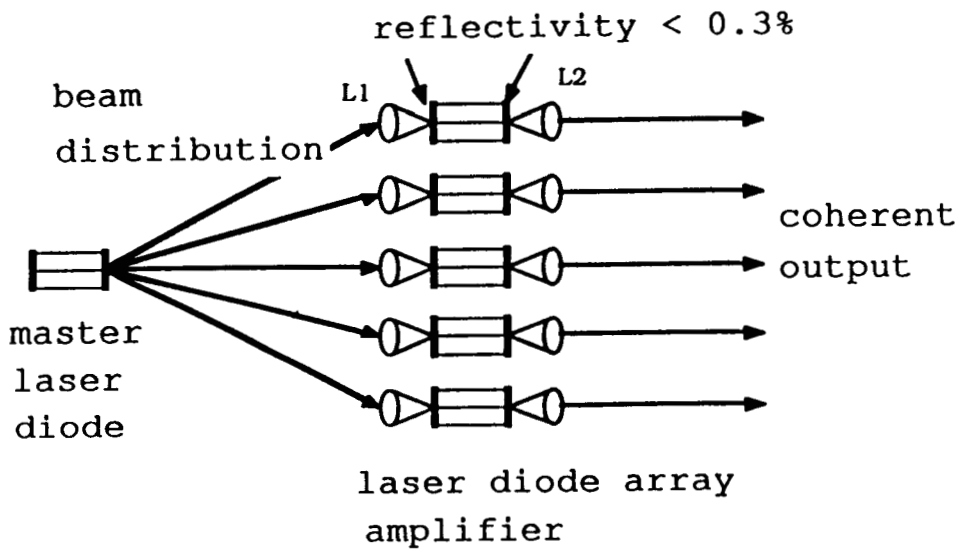

L1, L2 Input and Output Microlens Arrays

Amplification through laser diode array.

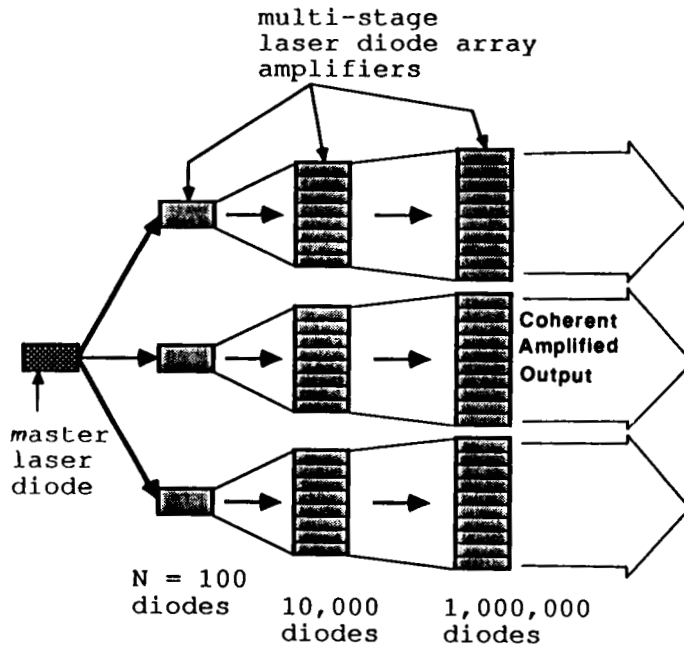

Multi-stage beam-combining and amplification.

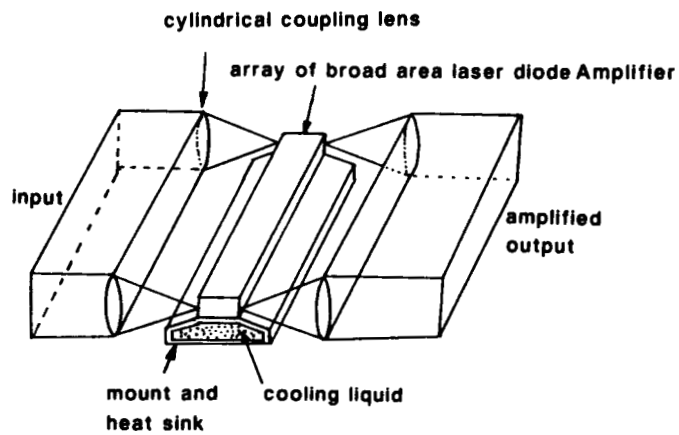

Basic Building Block of LD Array System
made with Broad Area Laser Diode Amplifier

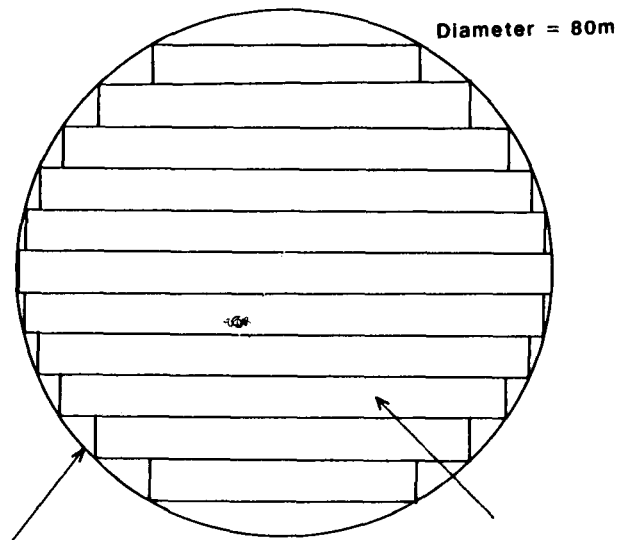

Laser System Output Aperture
made of 4,000 strips for 235 MW Output

Shape of Laser Diode Transmitter
at the Final Amplification Stage

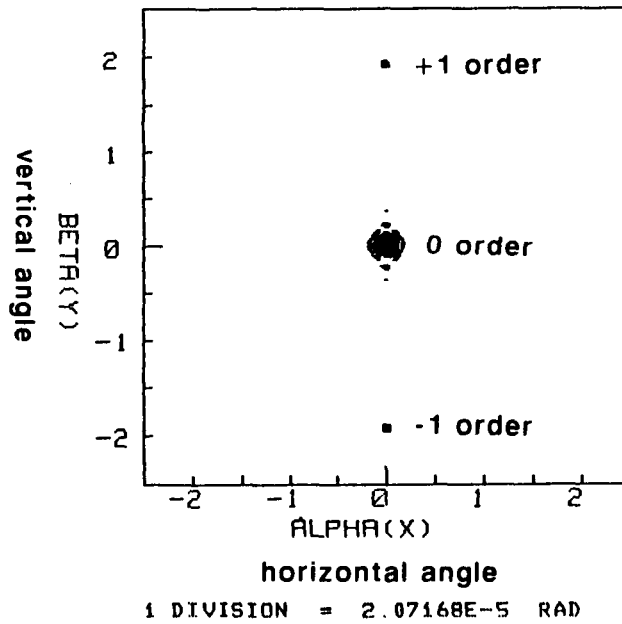

Far Field Pattern of Laser Diode Array Transmitter

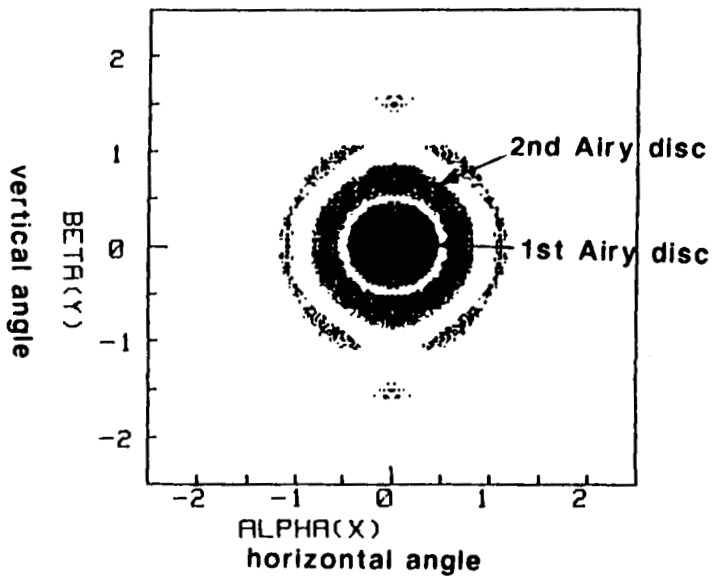

1 DIVISION = 1.90607058824E-6 RAD

Power inside 1st Airy disc = 84 %

Power inside 2nd Airy disc = 91 %

Detailed Structure of 0th order BeamPattern

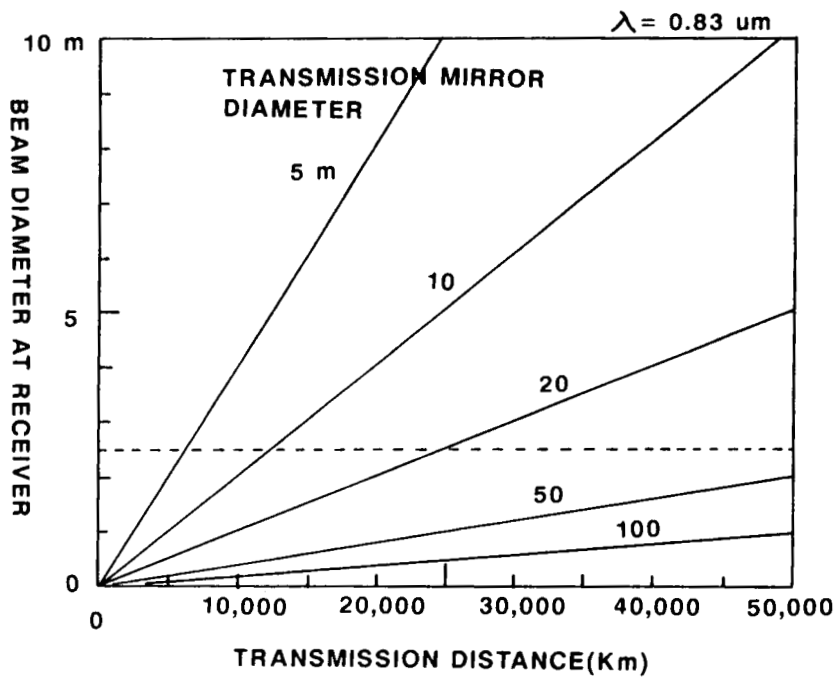

Beam Diameter at Receiver vs. Transmission Distance.

CONCLUSION

Laser System: Parallel Diode Array Amplifier (500MW)

**Power Collection Efficiency
at Receiver** **85 %**

Transmitter Diameter **80 m**

Receiver Diameter **3 m**

Transmission Distance **50,000 Km**

N 9 0 - 1 0 1 6 4

524-36

312781

LASER THRUSTER

524-36

HD 608674

N. W. Jalufka
Physics Department
Hampton University
Hampton, Virginia

PRECEDING PAGE BLANK NOT FILMED

PAGE 390 INTENTIONALLY BLANK

Artist's Concept of Laser Thruster

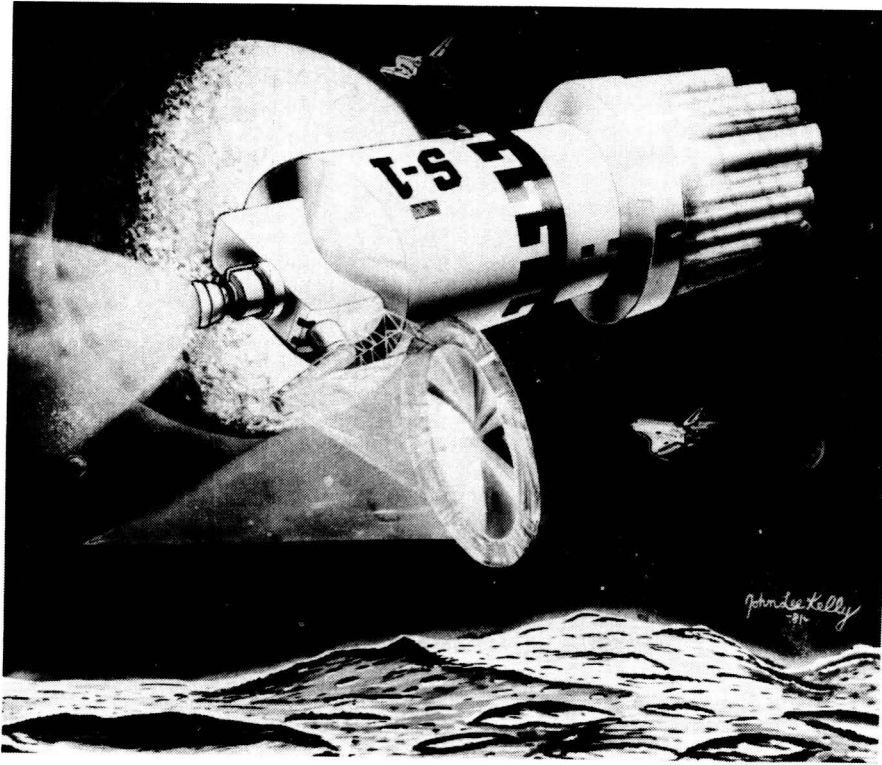

LASER ROCKET THRUSTER

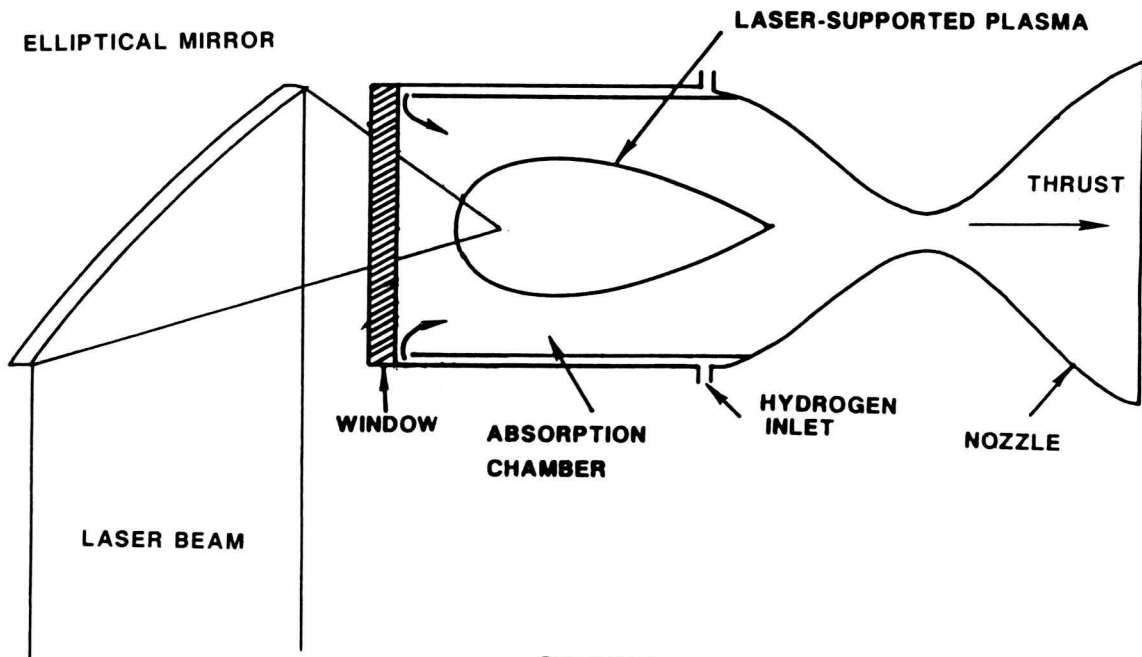

ORIGINAL PAGE
BLACK AND WHITE PHOTOGRAPH

DESIGN OF LASER THRUSTER

- Laser Power - 50 to 500 Mwatts
- Specific impulse - 1500 sec.
- Thrust ~ 35000 N - Maximum
- Fuel - H₂
- 60% efficiency (for calculations)
- Maximum Transmission Distance - 50,000 km

BASIS FOR WEIGHT DETERMINATION

- Thruster not any heavier than a chemical rocket engine.
- Addition of absorption chamber should not increase weight more than a factor of 2.
- Weight of thruster plus optics chosen for system - 279 kg.

*Agrees with value given in:

Glumb, Ronald J., "Laser Propulsion for Earth-Moon Transportation Systems," presented at the Symposium on Lunar Bases and Space Activities in the 21st Century, Houston, TX, 1988, Paper No. LBS-88-086.

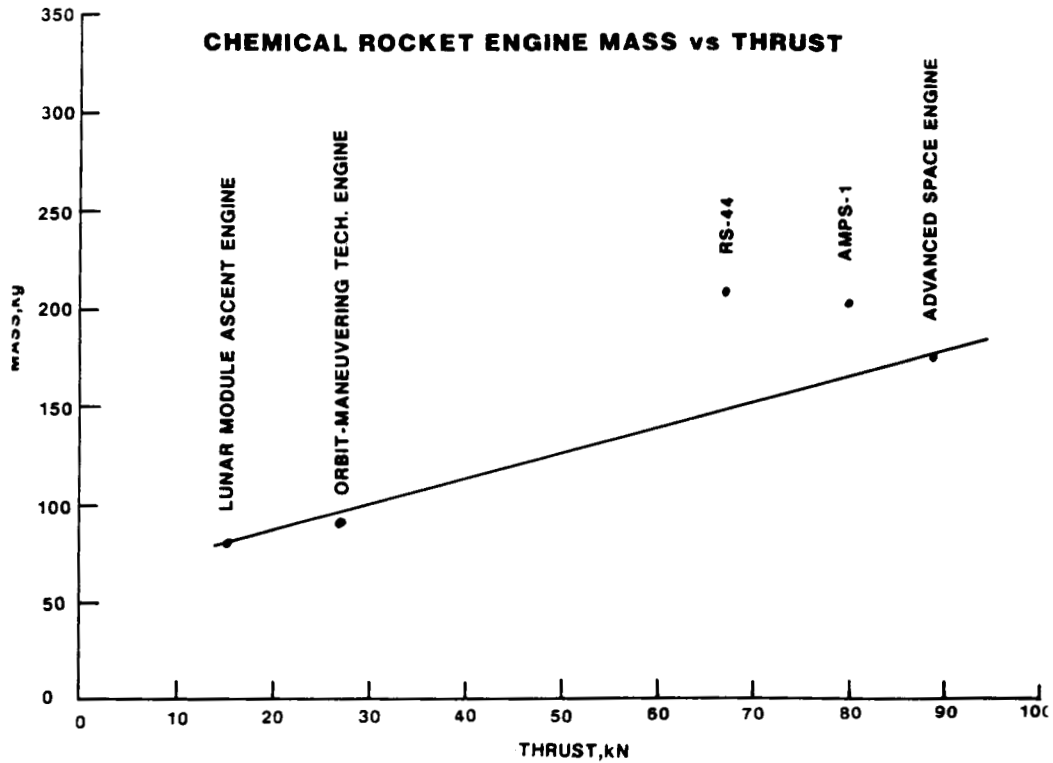

COLLECTOR-FOCUSSING MIRROR WEIGHT*

- Adaptive Optics - 30 kg/m²
- Non-adaptive Optics - 2 kg/m²
- For 3 meter by 4.25 meter elliptical mirror
 - + Adaptive Optics - 300 kg.
 - + Non-adaptive Optics - 20 kg.

*Values taken from:

Frisbee, R. H., Horvath, J. C. and Sercel, J. C., "Space-Based Laser Propulsion for Optical Transfer," JPL Report D-1919, December 1984.

OTV VEHICLE MASS*

Structure	2303 kg.
Tanks	1614 kg.
Propulsion Systems-Chemical	1419 kg.
Thermal Control Systems	242 kg.
GN & C	68 kg.
Electrical Systems	252 kg.
Aerobrake	<u>1042 kg.</u>
Residuals	1571 kg.
	8511 kg.
Laser Thruster & Collecting Optics	<u>279 kg.</u>
	8790 kg.

*Hoy, D., Johnson, III, L. B., Persons, M. B., & Wright, R. L.: Conceptual Analysis of a Lunar Base Transportation System, Symposium on Lunar Bases & Space Activity in the 21st Century, Houston, TX, 1988, Paper LBS-88-233.

The Laser Propulsion Vehicle Used in This Study Has The Following Characteristics:

- Thruster Efficiency - 60%
- Thruster Weight - 259 kg.
- Collection Mirror Weight - 20 kg.
- Total Vehicle Dry Weight - 8790 k

Laser Propulsion Payoff Summary

- Laser propulsion can reduce fuel by 57 t to 105 t over chemical propulsion for 144 t Lunar base, with no significant increase in trip time.
- Laser Propulsion reduces trip time by a factor of 40 to 120 over nuclear electric propulsion and time in radiation belts by a factor of 100 to 1700.
- Either solar or nuclear driven laser diode arrays could produce multimegawatt beams, typically 3,700 t for a 235 MW laser system.
- Laser diode arrays have high payoff due to short wavelength (850nm) and high diode efficiency (70%).
- A dry laser OTV of 8790 kg and 60% efficiency can transport 144 t lunar base.
- Laser Propulsion could carry both personnel and cargo safely to the lunar base.
- Large power beaming infrastructure required thus powering multiple missions essential.

N90-10165 55-20

LED TO GEO AND RETURN TRANSPORT

5167-2

MICROWAVE BEAM POWER

KARL FAYMON

ND 315 333

NASA LEWIS RESEARCH CENTER

LEO TO GEO AND RETURN TRANSPORT

CHARACTERISTICS OF LOW THRUST PROPULSION

- ORBIT RAISING:

- REQUIRES INCREASED " ΔV " OVER IMPULSIVE HOHMANN TRANSFER BECAUSE OF THRUSTING THROUGH PLANETARY "POTENTIAL WELL".

- PLANE CHANGE MANEUVERS DURING ASCENT

- NON-OPTIMAL PLANE CHANGE-INCREMENTAL PLANE CHANGES MUST BE DONE INITIALLY AT HIGH ORBIT VELOCITIES WHICH REQUIRE GREATER IMPULSE FOR A GIVEN $\Delta\theta$.

- LOW THRUST PROBABLY NOT ADEQUATE FOR ORBIT RENDEZVOUS. VEHICLE NEEDS AN ORBITAL MANEUVERING SYSTEM FOR BOTH ORBIT INSERTION AND DOCKING.

LEO TO GEO AND RETURN TRANSPORT

LEO-TO-GEO ORBIT TRANSFER PROPULSION
(ONE WAY)

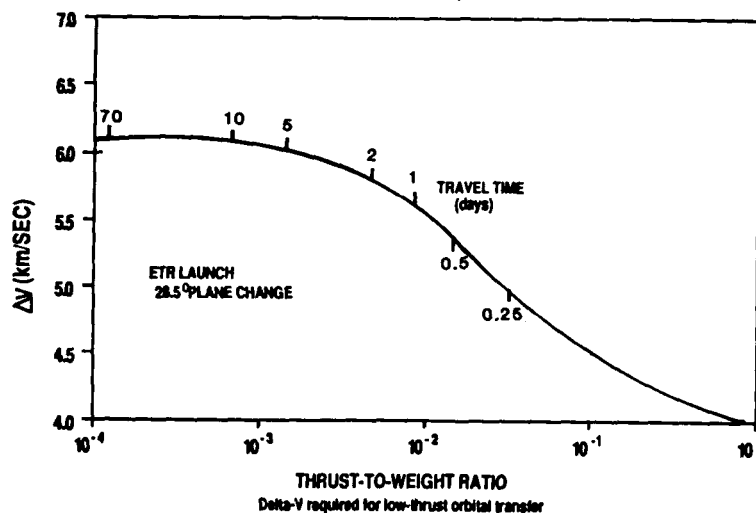

REFERENCE: P.W. GARRISON, J.F. STUCKY, FUTURE SPACECRAFT PROPULSION, JPL, PASADENA, CA
JET PROPULSION, NO. 4, VOL. 6, 1987.

LEO TO GEO AND RETURN TRANSPORT

ASSUMPTIONS:

- POWER BEAMED TO VEHICLE
 - TERRESTRIAL LOCATION
 - ORBITING POWER STATION

- ELECTRIC PROPULSION VEHICLE
 - 90,000 KG MAX. WEIGHT IN LEO
 - 10,000 KW RECTENNA: 50,000 SQUARE METERS AREA
 - TOTAL THRUST AVAILABLE 370 NEWTONS
 - * 1000 30 CM ION THRUSTERS
 - * XENON PROPELLANT

- LAUNCH TO LEO RENDEZVOUS FROM KSC
 - 28.5° PARKING ORBIT INCLINATION
 - 300 KM ORBIT ALTITUDE
 - PAYLOAD RETURN GEO TO LEO - 25% OF MAXIMUM PAYLOAD

BEAM POWER APPLICATIONS: LEO TO GEO AND RETURN TRANSPORT

Reference/Baseline: Brown, Wm. C., "LEO to GEO Transportation System Combining Electric Propulsion With Beamed MicroWave Power From Earth", 25th Goddard Memorial Symposium, Visions of Tomorrow: A Focus on National Transportation Issues; Volume 59, Science and Technology Series, American Astronautical Society Publication.

Baseline Vehicle/Mission		Revised Vehicle/Mission - I		Revised Vehicle/Mission - II	
Total Mass in LEO-(300 KM)	90,000 kg.	Total Mass in LEO-(300 KM)	90,000 Kg.	Total Mass in LEO-(300 KM)	90,000 Kg.
Propellants	14,000	Propellants	17,000	Propellants	19,000
Ascent	9,900	Ascent	11,000	Ascent	12,000
Return	4,100	Return	6,000	Return	7,000
Thrusters	10,000	Thrusters	10,000	Thrusters	10,000
Rectenna	10,000	Rectenna	10,000	Rectenna	500
Structure and PMAD	10,000	Rectenna Structure: (1)	5,000	Rectenna Structure: (1)	200
Loaded Veh. Wt. (less P/L)	44,000 Kg.	Structure and PMAD	10,000	Structure and PMAD	10,000
Payload (51%)	46,000 Kg.	Orb. Maneuver. Syst.: (2)	1,000	Orb. Maneuver. Syst.: (3)	800
		Propulsion and tankage	13,000	Propulsion and tankage	2,000
		Propellants		Propellants	
		Loaded Veh. Wt. (less P/L)	66,000 Kg.	Loaded Veh. Wt. (less P/L)	42,500 Kg.
		Payload (27%)	24,000 Kg.	Payload (53%)	47,500 Kg.
<p>Notes:</p> <p>Thrusters: Isp = 4500 sec. Equatorial ascent from 300 Km altitude; Delta V (one way) to GEO - 4500 m/s. Single microwave beam transmission from terrestrial equatorial station. No payload return to LEO. Microwave beam frequency: 2.45 Ghz.</p>		<p>Notes:</p> <p>Thrusters: Isp = 4500 sec. Launch azimuth 28.5 deg. (300 Km); Delta V (one way) to GEO - 6100 m/s. Single microwave beam transmission from terrestrial equatorial station Orbital maneuvering system raises LEO orbit from 300 Km to 1000 Km prior to start of beam power phase. This is required for equatorial power station to "see" vehicle. 25% of maximum payload returned to LEO. Microwave beam frequency: 2.45 Ghz.</p>		<p>Notes:</p> <p>Thrusters: Isp = 4500 sec. Launch azimuth 28.5 deg. (300 Km); Delta V (one way) to GEO - 6100 m/s. Single microwave beam transmission from orbiting power station in 28.5 degree orbit at 300 Km. altitude. 25% of maximum payload returned to LEO. Microwave beam frequency: 100 Ghz.</p>	
<p>(1): Rectenna weight of 0.2 Kg/m² is interpreted as weight only of rectenna blanket. Additional structure is required to ensure adequate separation of rectenna nodes and vehicle structural and control nodes.</p>		<p>(2): Orbital maneuvering system is required for rendezvous at LEO and GEO. Space shuttle system with 800 m/s delta V total capability is assumed; Isp = 313 seconds, Propellants: N2O4-MMH.</p>		<p>(3): Orbital maneuvering system is required for rendezvous at LEO and GEO. Requirements are less than CASE I since GEO injection point can always be "seen" by orbiting power station. Space shuttle system is also assumed.</p>	

BEAM POWER APPLICATIONS: LEO TO GEO AND RETURN TRANSPORT

Reference/Baseline: Brown, Wm. C., "LEO to GEO Transportation System Combining Electric Propulsion With Beamed MicroWave Power From Earth", 25th Goddard Memorial Symposium, Visions of Tomorrow: A Focus on National Transportation Issues; Volume 69, Science and Technology Series, American Astronautical Society Publication.

Revised Vehicle/Mission - III		Chemically Propelled Vehicle	
Total Mass in LEO-(300 Km)	90,000 Kg.	Total Mass in LEO-(300 Km)	90,000 Kg.
Propellants	12,000	Propellants	70,000
Ascent 12,000		Ascent 52,000	
Return -----		Return 17,500	
Thrusters	10,000	Orb. Man. 500	
Rectenna	500	Structure and OMS	<u>10,000</u>
Rectenna Structure: (1)	400	Loaded Veh. Wt. (less P/L)	80,000 Kg.
Structure and PMAD	10,000	Payload (11%)	<u>10,000</u>
Orb. Maneuver. Syst.: (2)			
Propulsion and tankage	1,000	Notes:	
Propellants	3,200	Launch azimuth 28.5 deg. (300) Km.	
Heat shield	<u>1,000</u>	Hohmann transfer ellipse.	
Loaded Veh. Wt. (less P/L)	37,100 Kg.	Delta V (one way) 4.2 Km/sec. with	
Payload (59%)	<u>52,900 Kg.</u>	plane change at apogee.	
		Advanced H2-O2 propulsion system.	
Notes:		Isp = 500 seconds.	
Thrusters; Isp = 4500 sec.		25% of maximum payload returned to LEO.	
Launch azimuth 28.5 deg. (300 Km);			
Delta V (one way) to GEO - 8100 m/s.			
Single microwave beam transmission from			
orbiting power station in 28.5 degree			
orbit at 300 Km. altitude.			
Aerobraking reentry on return to 300 Km.			
LEO rendezvous.			
25% of maximum payload returned to LEO.			
Microwave beam frequency: 100 Ghz.			

(1): Additional structure is required to protect rectenna during aerobraking reentry and LEO rendezvous.	(2): Orbital maneuvering system will inject into Hohmann transfer ellipse for LEO reentry and LEO rendezvous.
--	---

LEO TO GEO AND RETURN TRANSPORT

FIGURE OF MERIT COMPARISION OF MISSION VERSIONS

- **FIGURE-OF-MERIT:**
 - PAYLOAD MASS/SUPPORT MASS DELIVERED TO LEO
- **SUPPORT MASS DELIVERED TO LEO**
 - PROPELLANTS FOR LEO TO GEO AND RETURN
 - PROPELLANTS FOR ORBITAL MANEUVERING SYSTEM
 - SPECIAL TRANSFER VEHICLE REFURBISHMENT HARDWARE
 - TRANSFER VEHICLE REPAIR AND MAINTENANCE HARDWARE
 - PRORATED (150 MISSIONS - 30 YR LIFE) POWER STATION MASS
 - PRORATED OPERATIONS SUPPORT MASS IN LEO
- **THIS IS NOT A TRUE "COST" FIGURE-OF-MERIT: THESE ENTITIES HAVE A VARYING "COST OF DELIVERY" TO LEO.**
 - CAPTIAL COST OF SUPPORT ENTITIES/FUNCTIONS IS NOT ACCOUNTED FOR.

LEO TO GEO AND RETURN TRANSPORT
ORBITING POWER STATION - MISSION SUPPORT ASSUMPTIONS

- 50,000 kW REQUIRED: (20% END TO END EFFICIENCY)
- 100 W/kg FOR NUCLEAR POWER SYSTEM (UNMANNED STATION)
- STATION IS MULTIPLE USE - PROVIDES OTHER FUNCTIONS
 - 250,000 kg CHARGEABLE TO ORBIT RAISING FUNCTION
- 30 YR LIFETIME: 5 LAUNCHES/YR, - 150 TOTAL LAUNCHES

POWER SYSTEM MASS: 500,000 kg
 STATION MASS - CHARGEABLE 250,000
 OPERATIONS & MAINT. (30 YRS) 300,000

TOTAL MASS OF ORBITING STATION CHARGEABLE TO ORBIT RAISING FUNCTION 1,050,00 kg

STATION CHARGEABLE MASS/MISSION 7,000 kg

BEAM POWER APPLICATIONS; LEO TO GEO AND RETURN TRANSPORT

MISSION VERSION COMPARISONS: Support mass/payload delivered to LEO to support a mission.

Mission Version	I.	II.	III.	IV.
Propellants/Mission	30,000 kg.	21,000 kg.	15,200 kg.	70,000 kg.
Special Maint. Items/Miss.	---	---	1,000	---
Total Mission Support; Mass delivered to LEO For Direct Miss. Support.	30,000 kg.	21,000 kg.	16,200 kg.	70,000 kg.
Prorated Op's Support: Mass/Mission.	5,000	10,000	10,000	5,000
PAYLOAD	24,000 kg.	47,500 kg.	52,900 kg.	10,000 kg.
PL/Dir.Sup. Mass, (kg/kg)	.686 kg/kg	1.532 kg/kg	1.941 kg/kg	.1334 kg/kg
Pow. Stat. Sup. Mass/Miss.	?	7,000 kg.	7,000 kg.	7,000 kg.
Veh. Repair & Maint. Sup.	1,000 kg.	1,000 kg.	1,000 kg.	1,000 kg.
DELIVERED PAYLOAD MASS. kg TOTAL SUPPORT MASS kg	.667 kg/kg	1.21 kg/kg	1.50 kg/kg	.120 kg/kg

LEO TO GEO AND RETURN TRANSPORT

SUMMARY

- BEAM POWER SHOWS ADVANTAGES IN REDUCED MASS DELIVERED TO LEO TO SUPPORT MISSION
 - ARE TECHNOLOGY ASSUMPTIONS VALID?
 - FURTHER WORK NEEDS TO TRANSLATE MISSION COMPARISONS TO "TRUE DOLLARS" PER kg OF PAYLOAD
- IF ASSUMPTIONS HAVE "ANY" VALIDITY-BEAM POWER ORBIT RAISING FOR LEO-TO-GEO AND RETURN TRANSPORT HAS SIGNIFICANT POTENTIAL

1988 COST OF DELIVERING 1 kg PAYLOAD TO ORBIT (ADVANCED LAUNCH SYSTEM NOT INCLUDED)

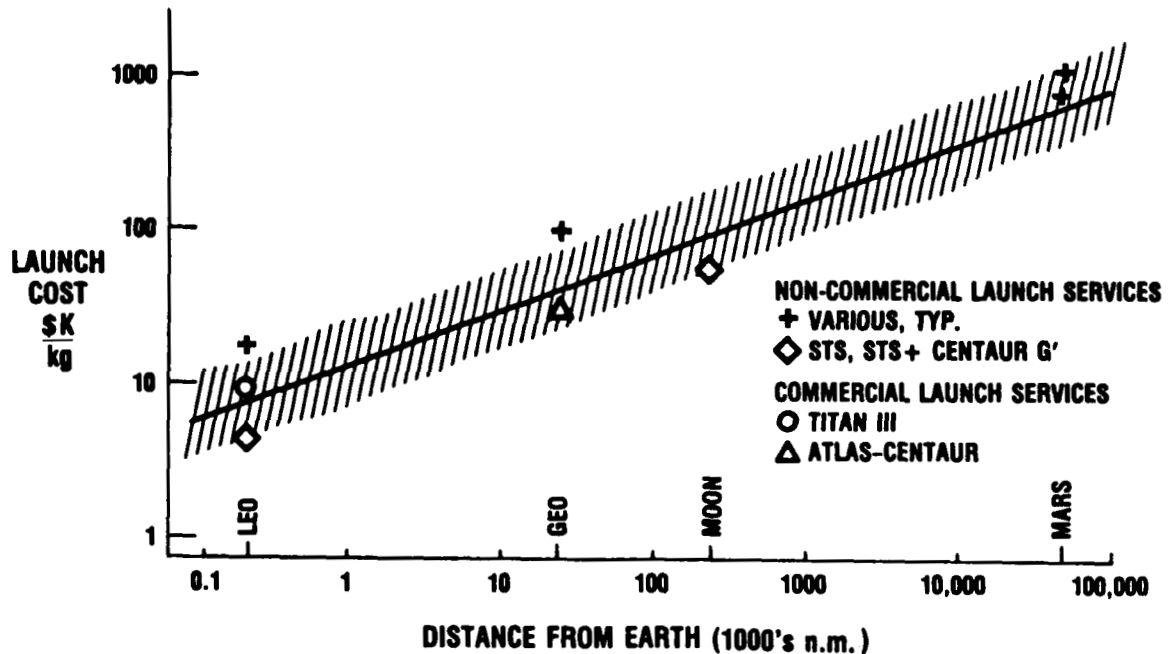

COST OF DELIVERING 100 kWe OF USABLE POWER

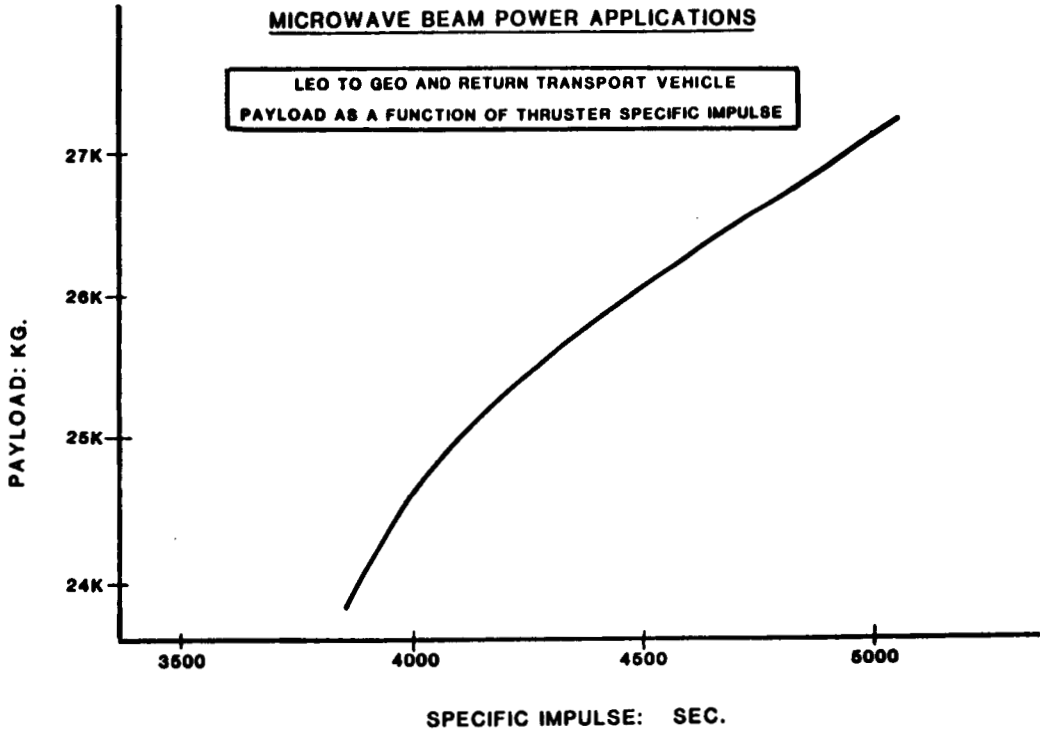
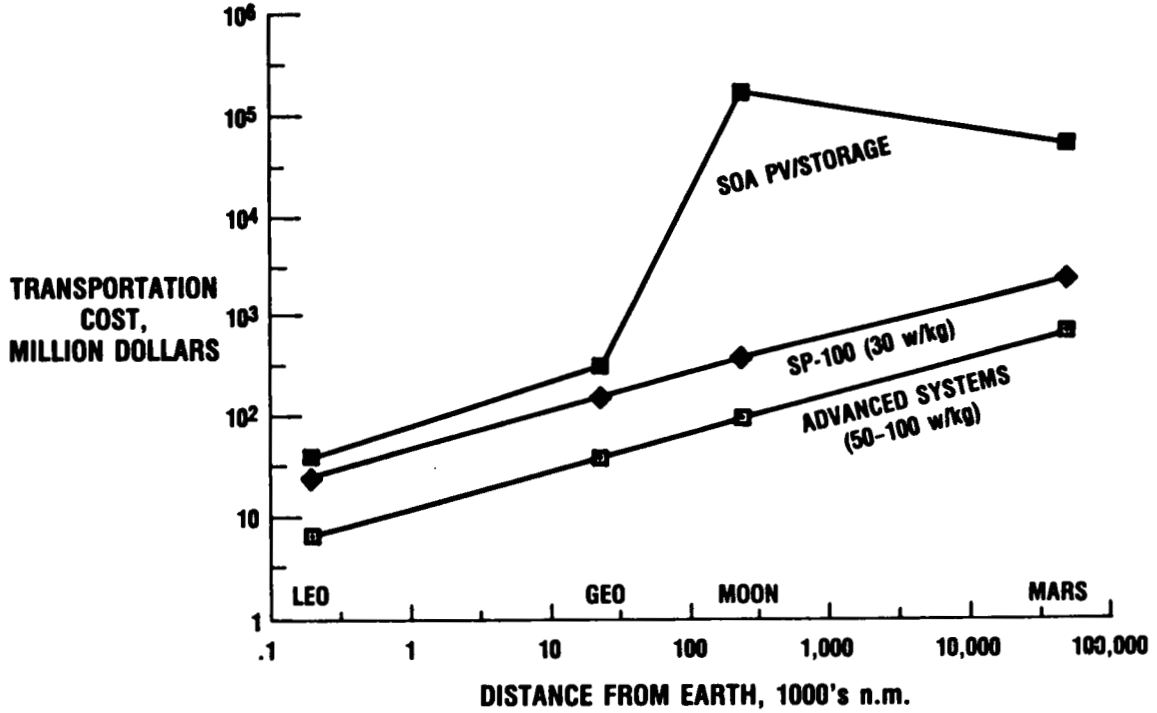

SPACE PROPULSION APPLICATIONS--DISCUSSION SUMMARY

by Ja H. Lee

This miniworkshop dealt with both microwave LEO → GEO propulsion and laser LEO → low lunar orbit propulsion. Laser propulsion was compared with chemical and nuclear reference propulsion missions already established by the Pathfinder program. A difficulty encountered immediately was that the reference missions had two separate scenarios: chemical propulsion for transportation of men and nuclear propulsion for freight-only missions to lunar base and then to Mars.

The laser propulsion option did not closely follow these two separate missions but took an intermediate size to accomplish the lunar mission by a series of repetitive trips to the moon. However, this approach left the comparison indirect; therefore, the conclusions that were favorable for the laser option were criticized for being ambiguous, at best, by the session chairperson.

The microwave option presented was for LEO-to-GEO propulsion only. The GEO to the moon base was not addressed, and a study of different schemes of propulsion for such long distance beyond GEO has to be made. Perhaps the microwave option is entirely out of the question for a distance >5,000 Km, and its application may be limited to near-Earth missions due to the large receiver size.

Placing the nuclear reactor in near-Earth orbit below GEO is obviously a sensitive issue related to the radiation safety of the earth. Therefore, the solar-driven laser propulsion then becomes a more desirable option. However, this issue is not confined to technical issues but depends upon the national and international policies on space nuclear power. Future studies may find suitable multi-missions that the space laser station can accommodate for its cost-effective operation. The duty cycle of the laser station for LEO-LLO propulsion is extremely low, and the high capital invested in the laser station cannot be justified by a single laser propulsion mission.

PRECEDING PAGE BLANK NOT FILMED

PAGE 404 INTENTIONALLY BLANK

**NEAR-EARTH APPLICATIONS
MINIWORKSHOP**

PRECEDING PAGE BLANK NOT FILMED

PAGE 406 INTENTIONALLY BLANK

N90-10166

5633

**CENTRAL ELECTRICAL UTILITY POWER
FOR A SATELLITE RING CITY IN
LOW EARTH ORBIT SPACE**

216793

**IRA T. MYERS and KARL A. FAYMON
NASA LEWIS RESEARCH CENTER**

AND

**A. D. PATTON
TEXAS A&M UNIVERSITY**

ND 315753

TQ 431621

PRECEDING PAGE BLANK NOT FILMED

INTRODUCTION

- CIVILIZED NATIONS REQUIRE CENTRAL ELECTRIC POWER
- COLONIES AND LARGE SPACE MANUFACTURING OR SCIENTIFIC ENDEAVORS WILL ALSO NEED CENTRAL, UTILITY POWER
- THIS PAPER TALKS ABOUT ONE SUCH CONFIGURATION - THE RING CITY - IN LOW EARTH ORBIT SPACE

WHAT IS A RING CITY?

- A GROUP OF LARGE FREE FLYERS - 10 TO 20 UNITS
- PERHAPS 100 PEOPLE IN EACH UNIT
- ORGANIZED IN A CIRCLE (OR SPHERE) SO THAT POWER CAN BE FED FROM A CENTRAL LOCATION
- LOCATED AT 300 TO 700 MILES ALTITUDE
- FREE FLYERS ("BUILDINGS") SPACED ABOUT A KILOMETER APART

POTENTIAL ACTIVITIES OF A RING CITY

• ELECTROPHORETIC SEPARATION OF PHARMACEUTICALS	\$ 1-5 B/YR
• SEMICONDUCTOR DEVICES AND SENSORS	\$ 1 B/YR
• UNUSUAL ALLOYS AND FABRICATIONS (DELICATE COLD WELD ASSEMBLIES)	\$ 1-2 B/YR
• REDUCED GRAVITY MEDICAL CENTER	\$ 1 B/YR
• HOTEL - LUXURY ACCOMMODATIONS \$5000/DAY X 360 X 300	\$ 600 M/YR
• ZERO GRAVITY RESEARCH & DEVELOPMENT INSTITUTE 100 RESEARCHERS	\$ 1 B/YR
• ULTRA HIGH VACUUM FACILITY AND RESEARCH INSTITUTE	\$ 1 B/YR
• OUTER SPACE OBSERVATIONS	\$ 1 B/YR
• EARTH OBSERVATIONS	\$ 1 B/YR
• ADMINISTRATION	\$ 500 M/YR
• LAUNCH FACILITY & WAY STATION	\$ 1-3 B/YR

ELECTRICAL POWER NEEDS OF A RING CITY

• LIFE SUPPORT - 1500 PEOPLE @ 10 KW	15 MEGAWATTS
• MANUFACTURING, RESEARCH	10 MEGAWATTS
TOTAL	25 MEGAWATTS

COST OF POWER IN SPACE

- SPACE STATION - \$ 1 B FOR 75 kW FOR 10 YEARS \$ 130/kW hr
- SPACE STATION - ESTIMATED ADD-ON POWER \$ 30-50/kW hr
- LARGE REACTOR - 1 MW FOR 10 YEARS, \$ 1 B \$ 10/kW hr
- VERY ADVANCED SYSTEM ~ \$ 1/kW hr

MAGNITUDE OF UTILITY POWER COSTS

- TAKE POWER COSTS AT \$10/kW hr (INDIVIDUAL 1-2 MW PLANTS ON EACH FREE FLYER)
- 25 MW IS 2.5×10^8 kW HRS FOR TOTAL RING CITY
- POWER COST AT \$10/kW hr \$ 2.5 B/YR
- THIS IS HIGH, BUT FOR A RING CITY CITY, BUT NOT IMPOSSIBLE, SINCE THE TOTAL GROSS VALUE PROJECTED FOR THE RING CITY IS \$ 10-18 B
- DESIREABLE TO REDUCE COSTS
- WILL INVESTIGATE CENTRALIZED POWER

PARAMETERS USED FOR COMPARISON

• SOLAR ARRAY SPECIFIC WEIGHT	5 kg/kW
• NUCLEAR REACTOR SPECIFIC WEIGHT	
100 kW	30 kg/kW
1 MW	10 kg/kW
10 MW	3 kg/kW
100 MW	2 kg/kW
1000 MW	1 kg/kW
• BEAM POWER SYSTEM SPECIFIC WEIGHT	3 kg/kW
• BEAM POWER LINK EFFICIENCY	0.50
• STORAGE SPECIFIC WEIGHT	100 W hr/kg (10 kg/kW hr)
• RING CITY RADIUS	1 km
• NUMBER OF FREE FLYERS	10
• POWER, AVERAGE, PER FREE FLYER	1 MEGAWATT
• 2 HOUR ORBIT, 1 HOUR STORAGE	
• MAX POWER FACTOR FOR 1 FF	2.0
• MAX POWER FACTOR FOR 10 FF	1.2
• SOLAR ARRAY - STORAGE CHARGING FACTOR	2.5

NUCLEAR REACTOR SYSTEM SPECIFIC WEIGHT vs POWER

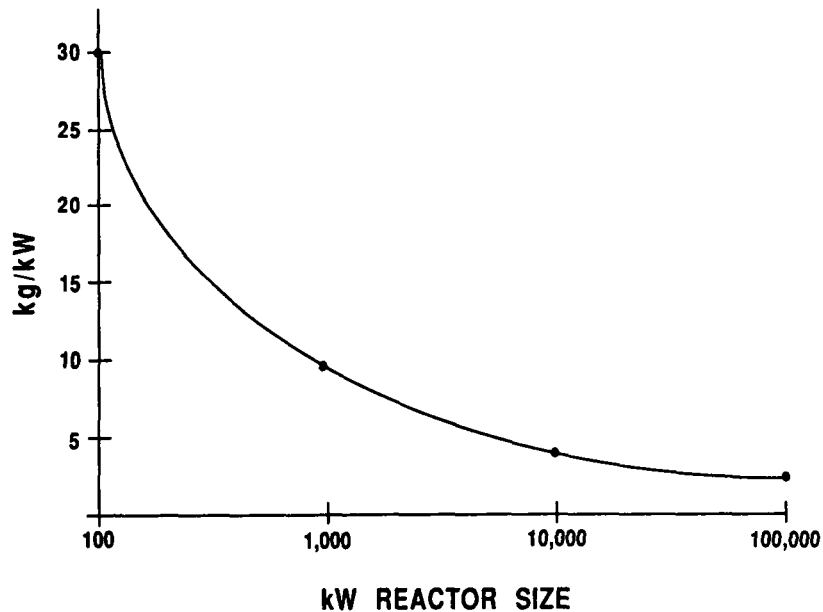

COMPARISON OF WEIGHTS OF DIFFERENT POWER SYSTEM CONFIGURATIONS

CASE I. INDIVIDUAL SOLAR

CASE II. CENTRALIZED SOLAR

CASE III. INDIVIDUAL NUCLEAR

CASE IV. CENTRALIZED NUCLEAR

CASE I. INDIVIDUAL SOLAR ARRAYS

WEIGHT OF SOLAR ARRAY FOR 1 F.F. (2.5) 5 kg/hr x 1000 kW x 2 (max. power)	25,000 kgms
TOTAL WEIGHT FOR 10 F.F.	250,000 kgms
ENERGY STORAGE FOR 1 F.F. 10 kg/kW hr x 1 HR x 1000 kW	20,000 kgms
ENERGY STORAGE FOR 10 F.F.	200,000 kgms
POWER MANAGEMENT & DISTRIBUTION FOR 1 F.F. 10 kg/kW x 1000 kW	20,000 kgms
POWER MANAGEMENT & DISTRIBUTION FOR 10 F.F.	200,000 kgms
TOTAL WEIGHT FOR 1 FREE FLYER	65,000 kgms
TOTAL WEIGHT FOR 10 FREE FLYERS	650,000 kgms

SPECIFIC WEIGHT = 650 kg/kW

CASE II. CENTRALIZED SOLAR ARRAY

POWER REQUIRED (2.5) (10,000 kW) (1.2) (2)	60,000 kW
SOLAR ARRAY WEIGHT 60,000 kW x 5 kg/kW	300,000 kgms
PMAD WEIGHT	200,000 kgms
ENERGY STORAGE 10 kg/kW x 60,000 kW	600,000 kgms
BEAM POWER SYSTEM WEIGHT 3 kg/kW x 60,000 kW	180,000 kgms
TOTAL CENTRALIZED POWER SYSTEM WEIGHT	1,280,000 kgms

SPECIFIC WEIGHT = 1,280 kg/kW

CASE III. INDIVIDUAL NUCLEAR UNITS

POWER REQUIRED PER F.F. 1000 kW x 2 (peak factor)	2000 kW
NUCLEAR REACTOR WEIGHT PER F.F. 2000 kW x 7 kg/kW	14,000 kgms
POWER MANAGEMENT & DISTRIBUTION 2000 kW x 10 kg/kW	20,000 kgms
TOTAL FOR 1 FREE FLYER	34,000 kgms
TOTAL FOR 10 FREE FLYERS	340,000 kgms

SPECIFIC WEIGHT = 340 kg/kW

CASE IV. CENTRALIZED NUCLEAR UNIT

POWER REQUIRED 10,000 kW x 1.2 (2)	24,000 kW
NUCLEAR REACTOR WEIGHT 24,000 KW 2.5	60,000 kgms
BEAM POWER SYSTEM WEIGHT 24,000 kW x 3 kg/kW	72,000 kgms
PMAD WEIGHT 10000 kW x 10 kg/kW	100,000 kgms
TOTAL WEIGHT	232,000 kgms

SPECIFIC WEIGHT = 232 kg/kW

SUMMARY OF WEIGHTS

<u>CASE</u>	<u>TOTAL POWER SYSTEM WEIGHT kgs</u>	<u>SPECIFIC WEIGHT kg/kW</u>
INDIVIDUAL SOLAR ARRAYS	650,000	650
CENTRAL SOLAR ARRAY PLUS MICROWAVE BEAM	1,280,000	1280
INDIVIDUAL NUCLEAR REACTORS	340,000	340
CENTRALIZED NUCLEAR REACTOR	232,000	232

ROUGH ESTIMATE OF COST OF ELECTRICAL ENERGY IN SPACE

ASSUME

- PRESENT LAUNCH COSTS IN SHUTTLE \$ 10,000/kg
- EXPECTED FUTURE LAUNCH COSTS \$ 2000/kg
- LAUNCH COSTS 1/3 OF TOTAL SYSTEM
- COST IN ORBIT \$6000/kg
- SYSTEM LIFE 10 YEARS 10⁵ HOURS
- TOTAL ENERGY IN 10 YEARS FOR 10 MW 10⁹ KW HRS

SUMMARY OF COSTS

<u>CASE</u>	<u>TOTAL POWER SYSTEM WEIGHT (A)</u>	<u>TOTAL POWER SYSTEM COST 63000 A</u>	<u>COST PER KW HR \$</u>
INDIVIDUAL SOLAR ARRAYS	650,000 kgm	\$ 4 B	\$ 4
CENTRAL SOLAR ARRAY PLUS MICROWAVE BEAM	1,280,000 kgm	\$ 8 B	\$ 8
INDIVIDUAL NUCLEAR REACTORS	340,000 kgm	\$ 2 B	\$ 2
CENTRALIZED NUCLEAR REACTOR	232,000 kgm	\$ 1.4 B	\$1.40

CONCLUSIONS

- COST OF ELECTRIC POWER IN SPACE IS ABOUT \$ 1 - 10 PER KW HR.
- CENTRALIZED NUCLEAR POWER IS PROBABLY LIGHTEST WEIGHT AND LOWEST COST FOR LARGE MULTIPLE SYSTEMS OF THE FUTURE.

N90-10167

527-36

Beamed Laser Power in Support of Near-Earth Missions

SC- J. 4/10

ND 2 10491

Edmund Conway
Gregory Schuster
Willard Weaver
Donald Humes

NASA Langley Research Center

Reference Missions

BEAMED LASER POWER IN SUPPORT OF NEAR EARTH MISSIONS Reference Missions

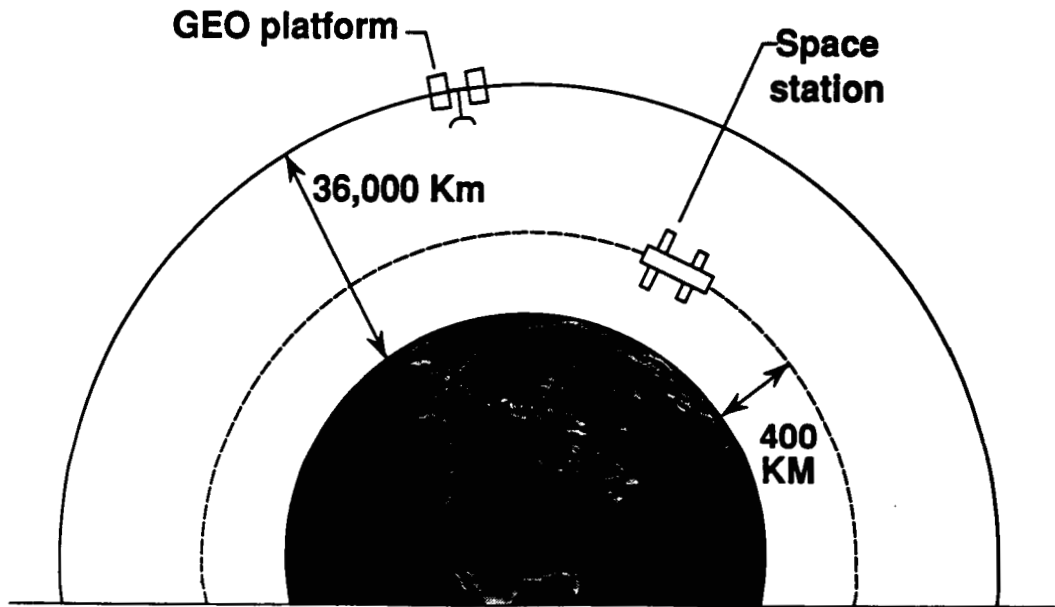

ORIGINAL PAGE
BLACK AND WHITE PHOTOGRAPH

125 KW SPACE STATION
(Lunar Observatory Accomodation)
(75 KW PV +50 KW SD)
(NASA TM-4750)

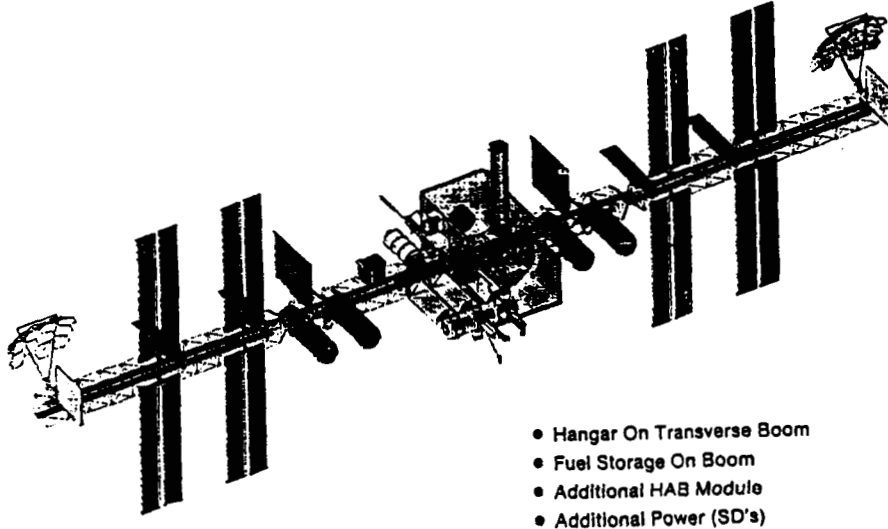

LASER-BEAMED POWER VS. CONVENTIONAL POWER

Conventional Technologies

- Photovoltaic power generators (including batteries) add mass and produce atmospheric drag. This drag requires space station to be reboosted.
- Solar Dynamic power generators produce less atmospheric drag than PV.

Approach

- Remove conventional power generators and do not carry to LEO reboost fuel.
- Place laser converter, radiator and batteries on space station.
- Provide laser power.
- Since earth-to-orbit launch is very costly (\$/Kg), we will compare power options in terms of total mass taken over 10 years to LEO (TMLEO/10 yrs.) to meet the space station's power requirements.

Comparison

- Is beamed power (a) better than conventional, (b) competitive, or (c) not competitive?
- If beamed power is better, we will know what could have been gained if the technology had been developed earlier.

ORIGINAL PAGE
BLACK AND WHITE PHOTOGRAPH

SPACE STATION POWER SYSTEM MASSES

(10 years, on-board power generation)

1. All Photovoltaic Power

$$P_{ss_1} (N) = N * 75: \text{KWe}$$

$$M_1 = N * M (75 \text{ KW PV}) + M (\text{FUEL}_1): \text{Kg}$$

2. 75 KW PV + Solar Dynamic

$$P_{ss_2} (N) = 75 + N * 25: \text{KWe}$$

$$M_2 (N) = M (75 \text{ KW PV}) + N * M (25 \text{ KW SD}) + M (\text{FUEL 2}): \text{Kg}$$

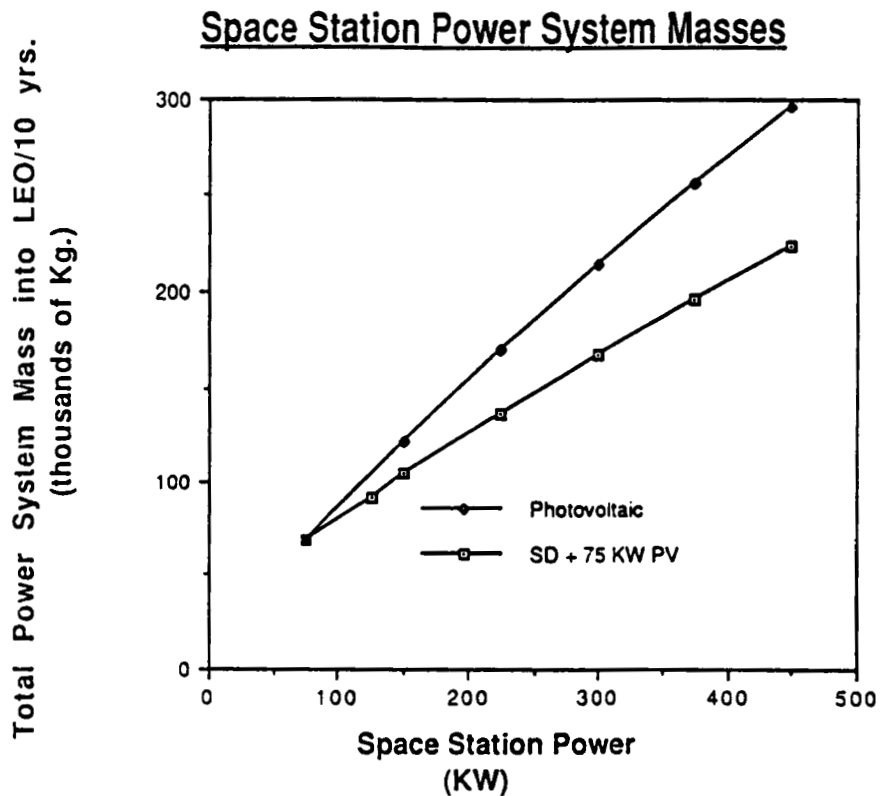

SPACE STATION POWERED BY SOLAR-PUMPED LASER

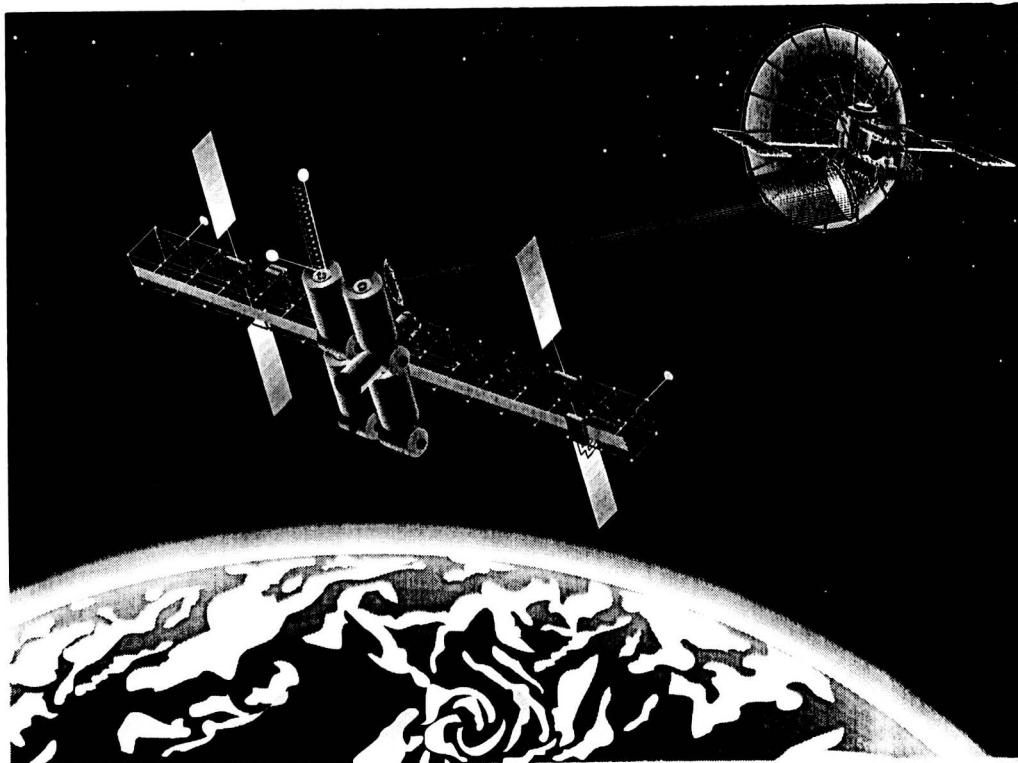

PRELIMINARY CONCEPT STUDY
OF
SOLAR-PUMPED LASER POWER
BEAMED TO SPACE STATION

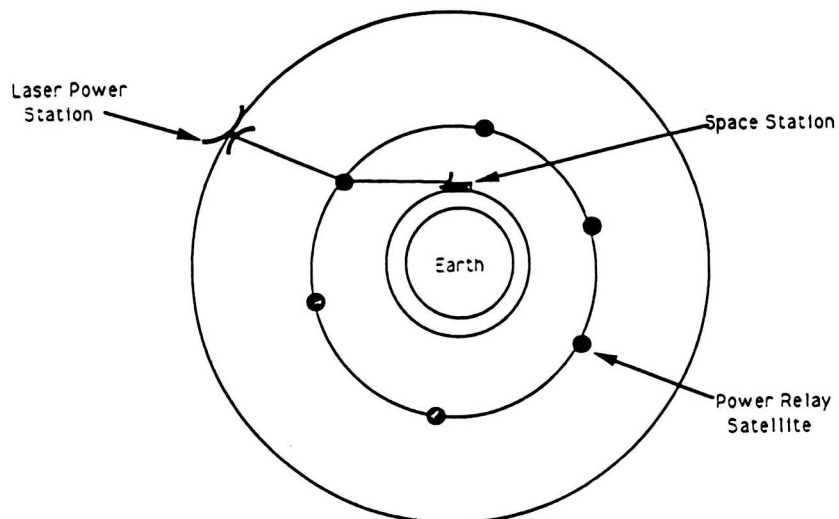

ORIGINAL PAGE
BLACK AND WHITE PHOTOGRAPH

ONE MEGAWATT IODINE SOLAR PUMPED LASER POWER STATION

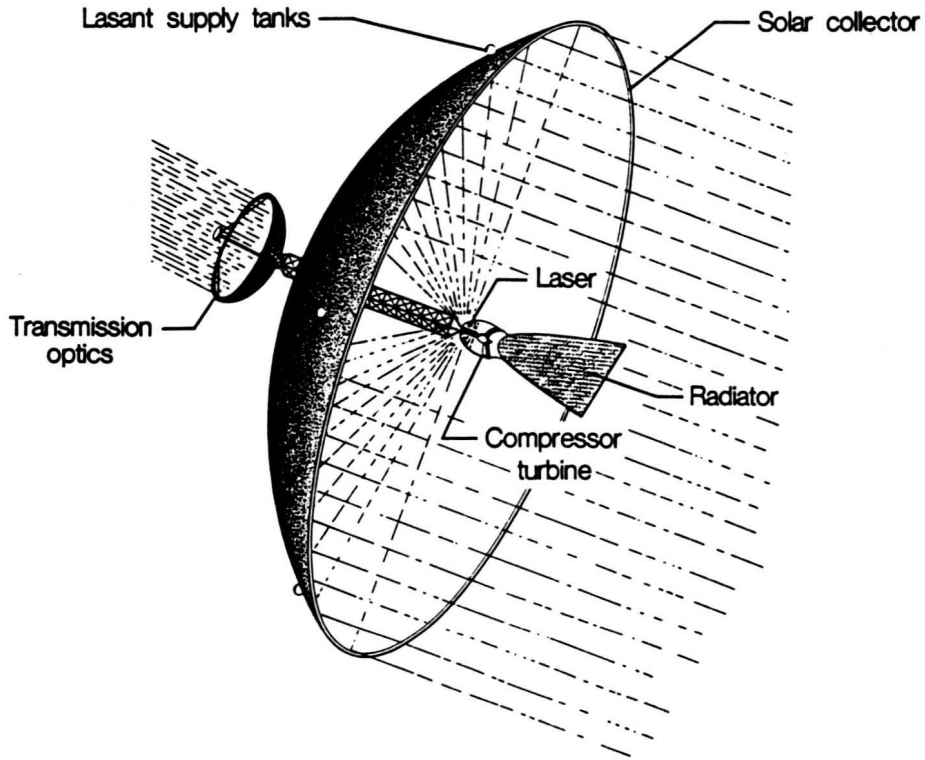

POWER RELAY SATELLITE (JPL D-1919)

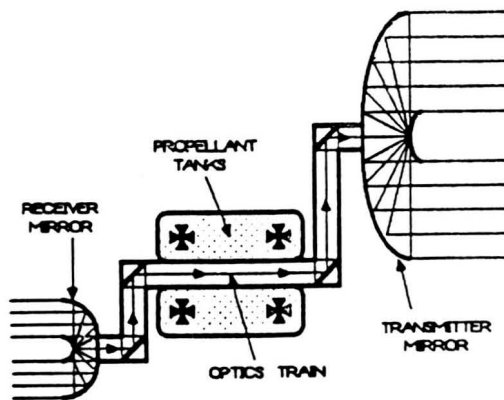

ACTIVE COOLING

ACS SIZED FOR
10 YEARS

ADAPTIVE OPTICS
(30 kg/m²)

LASER ENERGY-SEMICONDUCTOR BAND GAP ENERGY COMPARISON

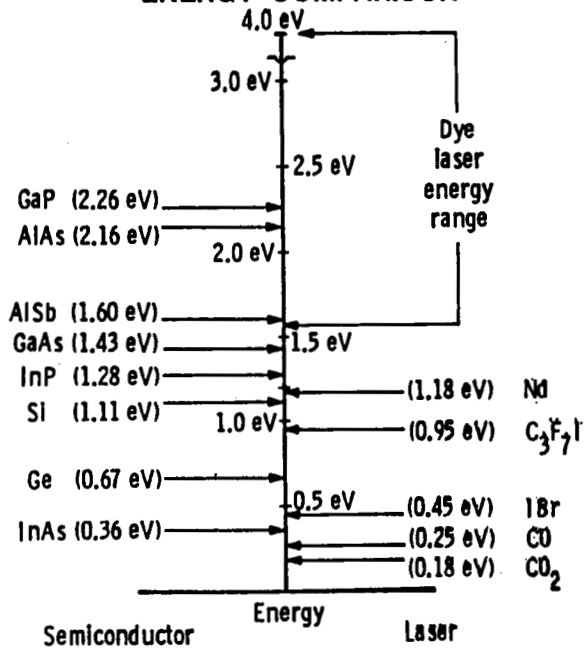

SCHEMATIC DIAGRAM OF CONVERTER LASER BEAM

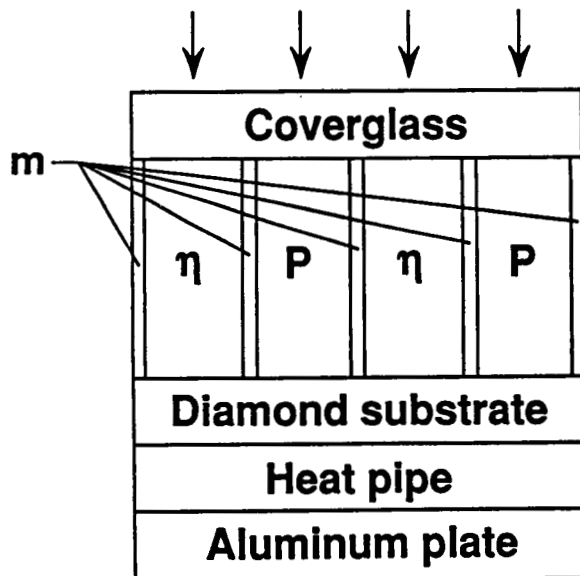

LASER PHOTOVOLTAIC CONVERSION SYSTEM

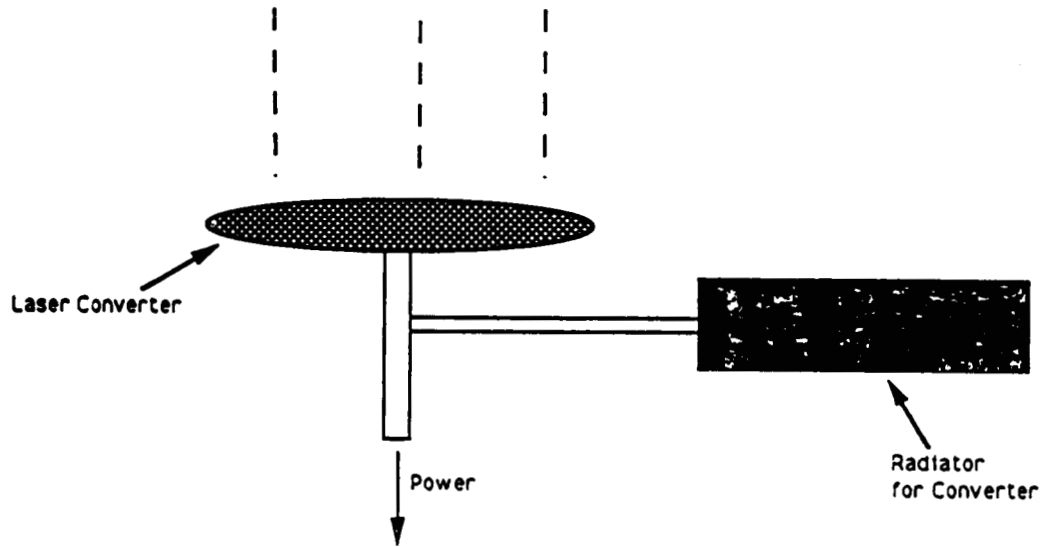

**Relative Subsystem Masses
for
Laser Power Beamed to Space Station**

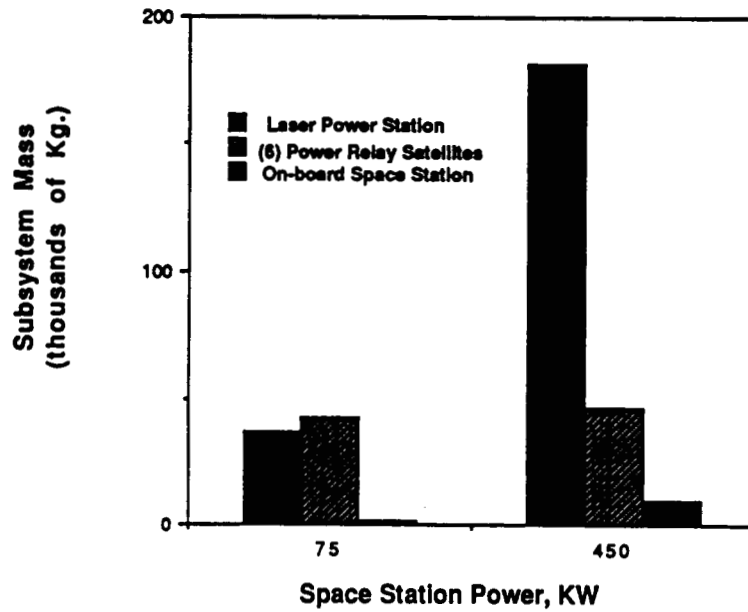

Space Station Beamed-Power-System Mass

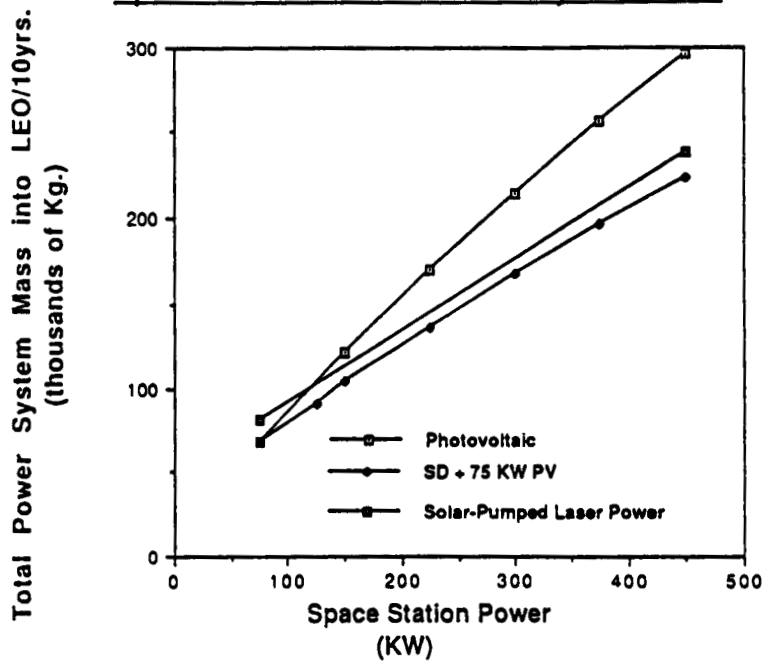

TWO CONVENTIONALLY POWERED SPACE STATIONS

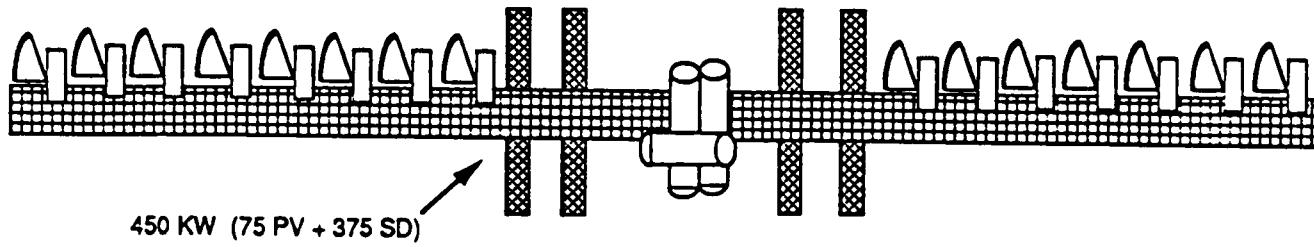
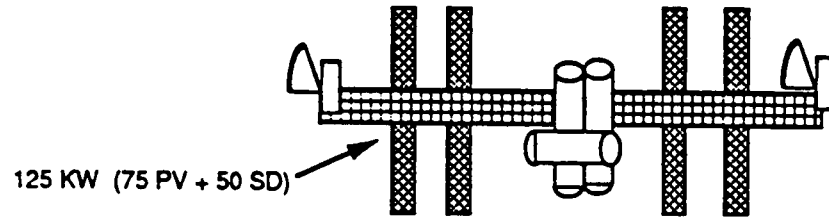

A Laser Supported Space Station Concept

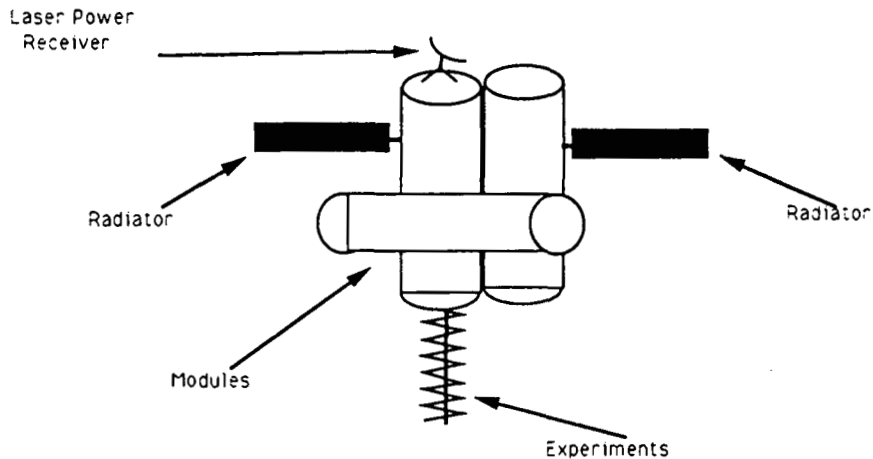

SUMMARY

• Solar-pumped laser-beamed power:

- ^{is} Lighter than photovoltaic for power requirements of 150 KWe and above; *and is*
- Competitive with combined photovoltaic/solar-dynamic over the entire power range investigated.

• ^A Space Station supported by laser-beamed power:

- Can be a lower-g facility (reduced drag) than with PV or PV + SD power;
- Has greater freedom of orientation (small receiver moves rather than large arrays or concentrators); *and*
- Requires less structure (arrays, alpha joints, booms) permitting easier control and fewer vibrational modes.

CONCLUSION

- Laser power beaming offers a revolutionary concept for planing, designing, and powering large orbiting spacecraft.

**SPACE STATION POWERED
BY A NUCLEAR ELECTRIC DIODE LASER**

*01111
15
END*

GREG SCHUSTER

PRECEDING PAGE BLANK NOT FILMED

PAGE 430 INTENTIONALLY BLANK

NUCLEAR ELECTRIC DIODE LASERS

High Orbit System
with Power Relay Stations

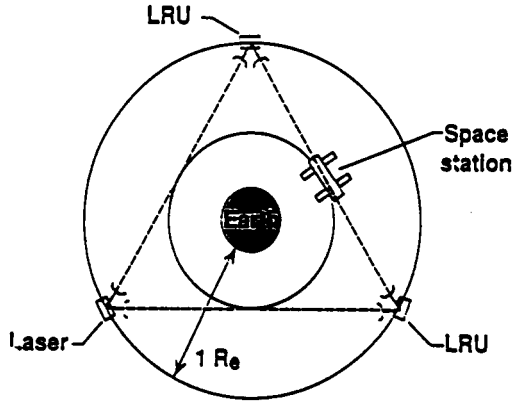

Co-Orbiting System at LEO

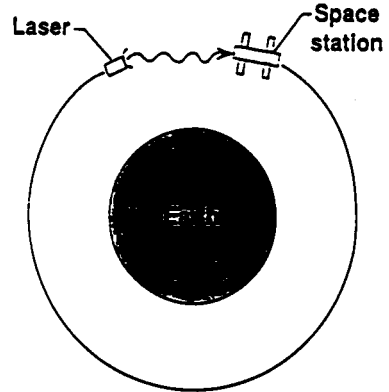

REACTOR DRIVEN 1 MW LASER POWER STATION

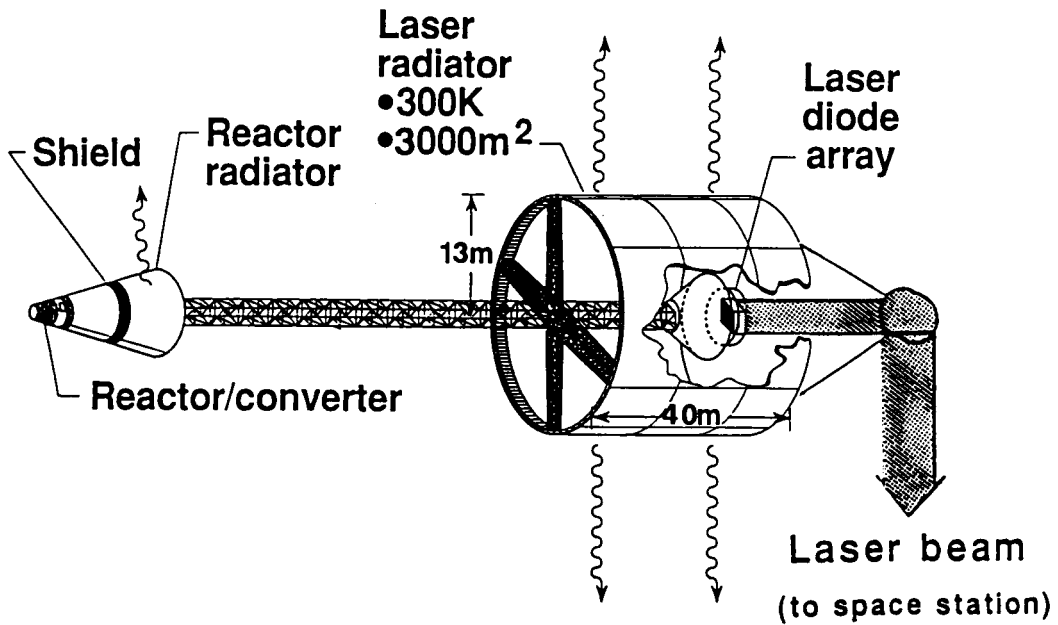

COMPONENT MASSES FOR CO-ORBITING LASER POWER SYSTEM

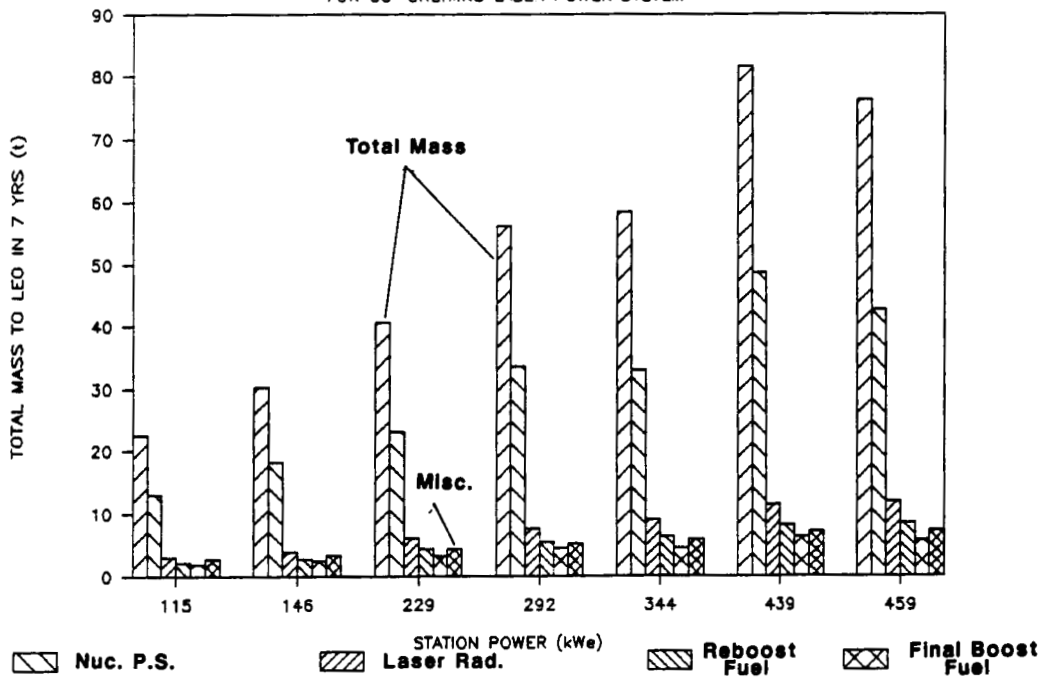

Power System Masses for Various Space Station Requirements

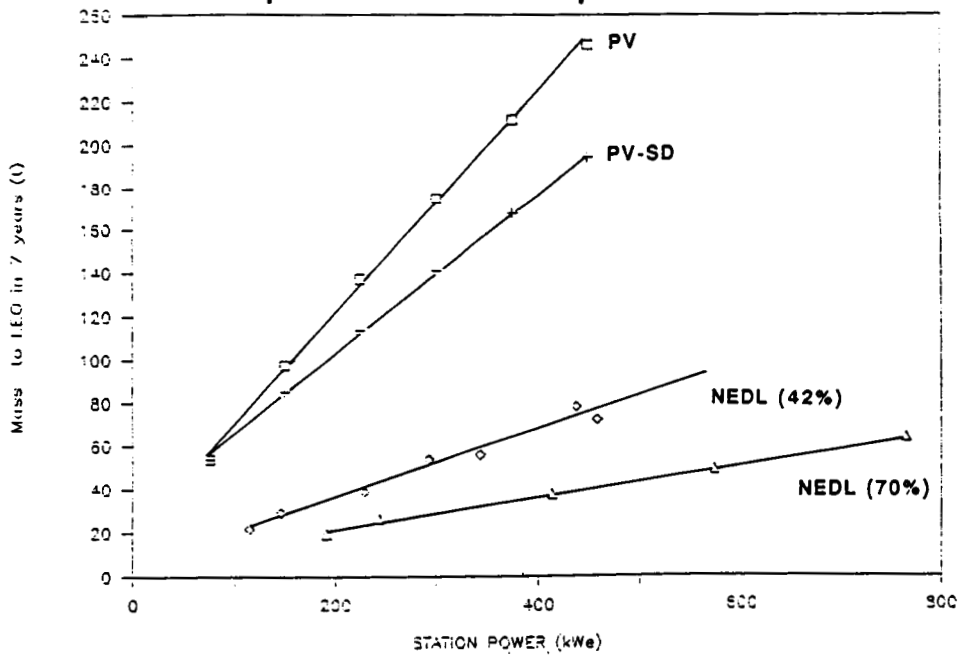

CONCLUSION

- The co-orbiting Nuclear Electric Diode Laser requires less total mass to LEO than the baseline P.V. - S.D. system over the entire power range.
- This mass advantage increases as the power requirement increases.

LASER-POWERED GEO MISSION

W. R. WEAVER

LASER-POWERED GEO MISSION

CONCEPT

Earth-based laser transmitter beams power to an advanced platform in geosynchronous orbit

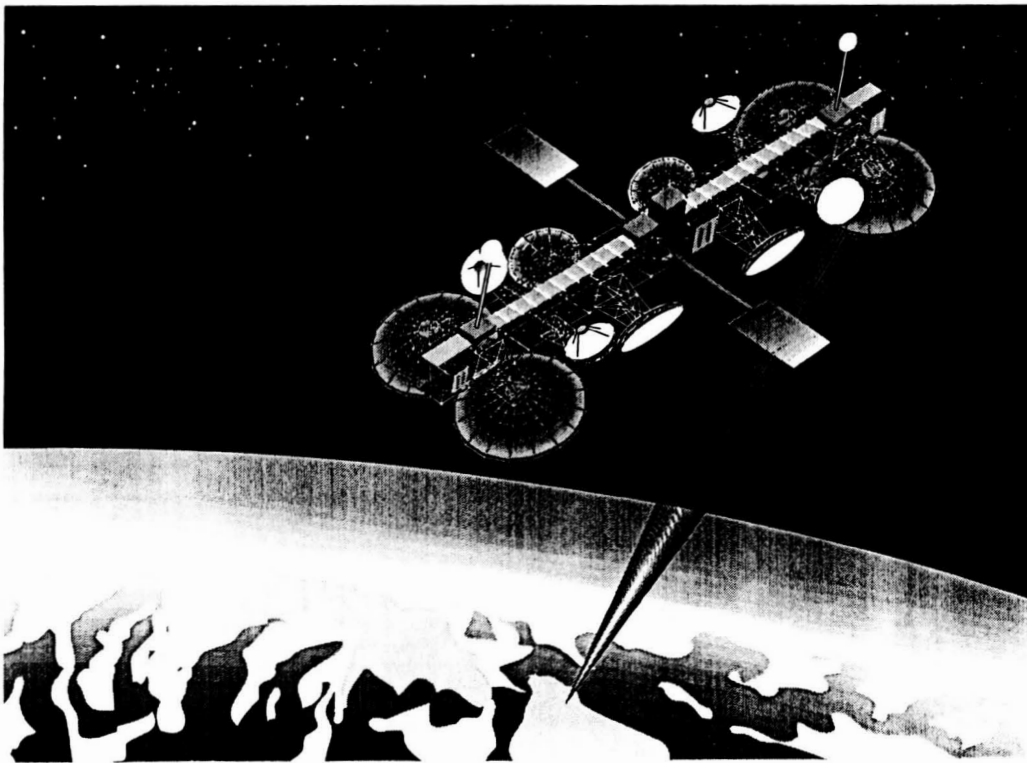

ORIGINAL PAGE
BLACK AND WHITE PHOTOGRAPH

LASER-POWERED GEO MISSION

RATIONALE

- Larger, more sophisticated GEO platforms have large projected power requirements
- 1 to 10 x 10³ kg platforms may need 1 to 10 kW_e
- 10 to 100 x 10³ kg advanced platforms may need 10 to 100 kW_e

COMPONENTS

- Earth-based laser transmitter nearby an electrical power generating station
- Geostationary orbiting platform consisting of multiple scientific and communications payloads
- Advanced laser-to-electric converter power system on platform

LASER-POWERED GEO MISSION

ADVANTAGES

- Earth-to-GEO transmission eliminates the complexity of an orbiting transmitter
- Geosynchronism minimizes receiver and transmitter pointing error requirements
- Mass of electrical power system components in space minimized
- Earth-generated electricity to power laser transmitter "cheap" relative to space generated electricity
- Earth-basing of transmitter gives greater flexibility in choice of laser type
 - Free-electron laser for tunability?
 - Liquid neodymium for high power?

CONCERNS

- Atmospheric absorption and scattering effects
- Environmental effects, such as aircraft safety

LASER-POWERED GEO MISSION

ANALYSIS

- Obtain from literature projected mass and power requirements of advanced platforms
- Determine mass M_{conv} of conventional on-board electrical power system
- Determine mass M_{laser} of comparable laser converter power system
- Compare M_{conv} to M_{laser}

PARAMETERS

- Sum of OTV and fuel masses = 2.6 times mass in GEO
- Waste-heat radiator temperature = 350 K
- Radiator specific mass = $2.7 \text{ kg} / \text{m}^2$
- Laser-to-electric converter specific mass = $40 \text{ kg} / \text{m}^2$
- Converter efficiency = 50 percent
- Converter power density = $1000 \text{ W} / \text{cm}^2$
- Tracking error = 10^{-6} radians
- Collector specific mass = $0.1 \text{ kg} / \text{m}^2$

LASER-POWERED GEO MISSION

RESULTS

- Mass of conventional electric power system on GEO platform is approximately 15 percent of GEO payload mass
- Primary mass component is sum of OTV and OTV fuel masses
- Mass of laser receiver determined by minimum tracking error
- Mass of waste-heat radiator for laser receiver not a major factor

GEO PLATFORM ELECTRICAL SYSTEM MASS

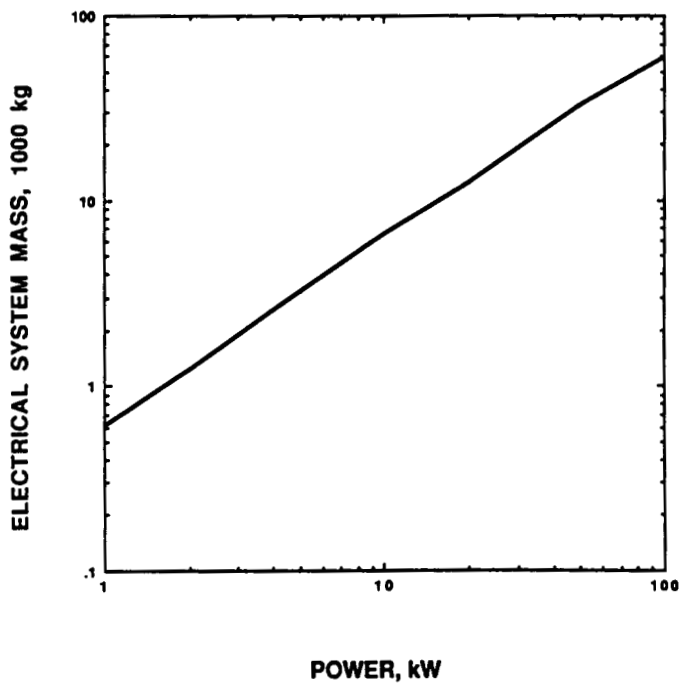

GEO PLATFORM POWER SYSTEM MASS

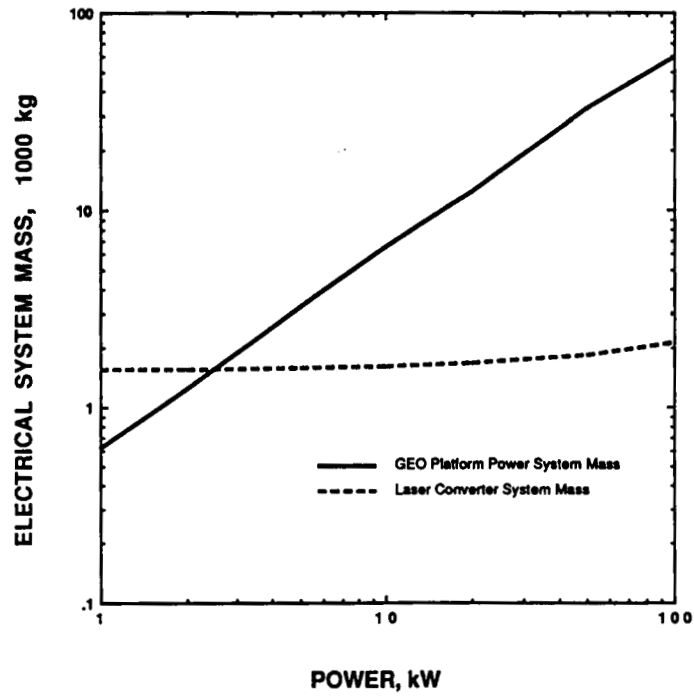

LASER-POWERED GEO MISSION

CONCLUSION

Laser-powered GEO mission has **high potential payoff** for advanced platforms with power requirements in excess of 5 kW_e

NEAR-EARTH APPLICATIONS--DISCUSSION SUMMARY

UNIT
TO
END

Willard R. Weaver

MICROWAVE BEAMING — Presented as a "\$100 Study", the "ringed-city" exemplifies the need for distributive power. The user does not care about the how or the where from of utility power. His only concern is its plentifulness, availability, and reliability. The concept is an example of the need to expand civilization's horizons beyond those of today (individual solar/nuclear) to distributed power for the advantages of economies of scale and the need for isolation of individual platforms. Don't anticipate power needs of ringed-city modules to approximate those of an average user in Cleveland (used as a basis to compare power costs) since these platforms will probably be unique, heavy-duty, industrial-type consumers in order to amortize high front-end costs. Don't overlook the necessary, and expensive replacement reactor since SP-100 technology is based on a 7-year lifetime at full power. Interest raised in tethering power source to user. Analysis needs to include more detail about orbital mechanics of ringed-city concept, stability of free-flyers, EMI tolerance of users. Concern arose over nuclear-safe orbits — society may define no orbit as nuclear-safe except possibly GEO. GEO may be excluded because of radiation hazard to platforms due to congest that region of space. Bottom line is that no LEO is completely nuclear-safe — alternatives increase transmission distances, complicate orbits, may force a hybrid concept of laser transmission to city modules and microwave transmission between the modules and within the ring.

LEO-GEO power beaming — Presented numerous generalized options (not in handout), then focussed on mass and cost of most attractive. Transmitting and receiving antenna areas are about 2 km² with phased array. Its important to minimize radiation-belt transit time, boost cannot be too leisurely. The high-voltage capability of the rectenna minimizes IR losses and matches well that requirement of the ion thrusters. Best payoff is with multiple (14) transmitters and (67) vehicles for \$0.36 / kW hr compared to a AA alkaline Duracell battery at \$150 / kW hr.

Microwave-powered airplane — Unscheduled presentation by researcher noted that Canada is moving ahead unilaterally with rectenna application but almost prevented test flight out of concern over microwave EMI. Expensive (\$40 each) GaAs diodes replaced with silicon Schottky diodes from Hewlett Packard off-the-shelf at \$.50 each. The rectenna was designed to be aerodynamically neutral,

and the wing was detached from the fuselage to improve banking and minimize transmission angle from the vertical. A special two-layer rectenna had to be developed to overcome linear polarization as the airplane circled above the transmitter. The rectenna was noisy (intermodulation, parasitic oscillations) and subject to spurious signal amplification and re-emission.

LASER TRANSMISSION —

Laser beaming to a space station — Reference mission presentation caused some difficulty in understanding the meaning of the baseline space station mass data. Radiators on viewgraph of modified space station were scaled, but only approximately. Radiator drag could be reduced by integrating over sun-angle for full revolution. Size of collector requested and incorrect placement of metal strip in vertical junction diode viewgraph noted. Lower competitiveness at higher power levels predicated on a very incomplete and crude understanding of components in the laser system which should firm-up in time as needed technologies and components become better defined. Consider adding GaInAs data to bandgap figure.

Nuclear-powered diode laser — Again, concern about nuclear-safe orbit acceptance by society raised; consider fleshing-out the scenario with the reactor in GEO. Separation distances used are more than adequate for proper shieldin.

Earth to GEO — Similarities to Lewis concept noted in which the SPS concept is turned upside down with transmitter on the Earth. Interest shown in details of receiver/transmitter sizes and power densities.

CHAIRPERSON REPORTS

PLANETARY POWER APPLICATION MINIWORKSHOP

Chairperson Report

The Planetary Power Miniworkshop was chaired by Jim Early of Lawrence Livermore National Laboratory. After giving an overview of the missions presented during the miniworkshop, he made several general comments and suggestions.

Under general comments, he stated that beamed-power technology is clearly emerging but is still in the technology push mode. There is a need to find a mission where diode lasers are an enabling technology and also a need to perform small-scale demonstrations of some beam-power technologies.

He had several suggestions on areas to cover in future system studies which are listed below:

1. Examine lasers at L1 with concentrators at the lunar receivers.
2. Look at polar site missions.
3. Look at use of lunar materials or used tanks for fabrication of laser receiver radiators, since radiator mass is dominant converter mass component.
4. The solar cell option on the rovers seems too conservative; oversized panels may be possible.
5. Look at storage concepts using lunar materials (Al, O₂, Fe, H₂O).
6. Need to evaluate impacts on cost and mission reliability in next studies.
7. Look at 1 μm-laser beamed from Earth surface to power lunar base.
8. How do pointing accuracies depend on slew rate?
9. Look at oversized receiver to deal with jitter and beam quality.
10. Can laser power for lunar base be used for propulsion or multi-mission applications?
11. Better mission definition is needed for the rover mission, especially with regard to how much excess power is available in orbit. How does the mission restrict power station orbits? What are the rover mission requirements, and how does the laser affect system reliability?

The laser system could be driven by either nuclear or solar prime power, but there was concern that the nuclear option may not materialize for political reasons, thus, the solar option becomes important. For the millimeterwave missions, the vacuum micro-electronics technology may make some missions enabling by impacting the receiver and transmitter sizes and masses.

SPACE PROPULSION APPLICATION MINIWORKSHOP

Chairperson Report

The Space Propulsion Applications miniworkshop was chaired by Ed Gabris from NASA Headquarters. He reviewed the LEO → LLO laser freighter mission and the LEO → GEO and return microwave transporter.

For the laser freighter mission, three propulsion vehicles were compared: a chemical OTV, a nuclear electric propulsion vehicle, and a laser propulsion vehicle, each transporting 144 metric tons (lunar base) to low lunar orbit. The study attempted to determine payoff in terms of mass savings in LEO of the laser propulsion over the other two vehicles. A criticism of the study was that the comparison was not done with enough fidelity to allow a direct comparison of the three vehicles, and a better presentation of the payoff data needed to be made.

Major issues that surfaced were the absolute comparison of weight advantage in LEO, if nuclear propulsion will be allowed in LEO, the large transmitter size, waste heat cooling, reliability of 10^6 laser diodes, and the laser propulsion vehicle laser window material.

Recommendations for further study included a better one-to-one comparison of the propulsion vehicles, determine the impact of placing the laser-power station on the Earth and beam the power up to the laser propulsion vehicle, and determine the impact of no nuclear in LEO.

The microwave LEO-GEO transporter clearly showed advantages in terms of payload mass/total support mass over the chemical reference system. The dominant issues for this system were the use of nuclear power in LEO, the large antenna sizes needed, and the low LEO-GEO traffic made up primarily of high-value cargo, where the loss of use during transit time becomes a significant economic loss.

The recommendations for this study were to look into a LEO to LLO transport mission and determine if there is payoff with regard to the Code Z reference missions. Also, determine the impact of no nuclear in LEO scenario.

PRECEDING PAGE BLANK NOT FILMED

PAGE 448 INTENTIONALLY BLANK

NEAR-EARTH APPLICATIONS MINIWORKSHOP

Chairperson Report

The Near-Earth Applications miniworkshop was chaired by A. D. Patton from Texas A & M University. He stated that near-Earth missions and applications for beamed power could impact four general classes of missions: industrial, including microgravity platforms in low Earth orbit (LEO), co-orbiting platform (colonies) in LEO all being powered by a central power station, stationary high altitude relay platforms and power for platforms in GEO. The benefits that power beaming could realize would be economics of scale, load factor improvement, improved power capacity utilization, reduced required levels of power system redundancy, reduced platform drag in LEO, reduction in vibration and outgassing by not having the prime power source on the platform, and enabling incremental generic power system additions.

The miniworkshop presentations were preliminary in nature, and better figures of merit need to be derived to compare differing power options. Nevertheless, many of the beamed power near-Earth missions are attainable in the near term with significant economic payoff.

The microwave power-beaming option was most suitable for short-range applications primarily in LEO. For space-to-space transmission distances less than 10 km, 2.45 GHz technology is desirable and easily attainable, whereas for distances up to about 100 km, 20-40 GHz is most applicable. For ranges beyond 100 km, lasers are the most practical when driven by either nuclear or solar prime power sources. In the presentation, the solar laser option was less advantageous in terms of mass compared to the nuclear-driven laser option.

Problem areas that need to be addressed include nuclear reactors in LEO which might not be allowed for political reasons. In this case, laser-power beaming would allow the reactor-driven laser to be in a high altitude, low-drag orbit, whereas the user would be in LEO (higher drag). Atmospheric penetration by beam power raises environmental concerns that need to be addressed. Finally, power-beaming options which require a large initial investment are at a significant disadvantage as compared to options which permit incremental investments as needs for power develop through time.

PRECEDING PAGE BLANK NOT FILMED

PANEL DISCUSSION SUMMARY

A panel discussion was held which attempted to bring focus to the many issues of technology, missions, politics, and program justification. The panel moderator was Ed Gabris of NASA Headquarters, and the panelists were Ed Coomes (Battelle), A. D. Patton (Texas A & M University), Jim Early (Lawrence Livermore Lab), John Rather (Kaman Aerospace) and Abraham Hertzberg (University of Washington). A summary is presented here of highlights of the panel discussion.

NASA should spend more effort in this technology, but because the beam power infrastructure could be quite expensive, cheap ways of getting started should be investigated, such as ground-based laser-power beaming, placing the expensive massive laser component on the ground. Applications that exploit near-term missions at low initial investment and allow an incremental building block approach to the beam-power infrastructure should be emphasized. The total power infrastructure should be investigated for mission synergisms. What commonality of power system can beam powered exploit?

Good mission studies with unique cases need to be continued. Such studies might include surface-to-surface power distribution as well as direct Earth-to-moon power distribution of lunar bases.

Missions should be studies that both enhance and enable missions, with the greater emphasis on enabling missions with power beaming. Single clear-cut enabling missions need to be identified.

A problem area was discussed which became variously known as the "Faymon Effect" that is "not on my mission you won't." The difficulty of convincing missions people to allow new technology, such as beamed power on their spacecraft, was a significant barrier. This effect might be overcome by developing several small-scale demonstration experiments that would increase the confidence level toward beam-power technology.

Specific technology areas that had potential high payoff for beamed power were vacuum microelectronics, laser diode arrays, and free-electron lasers (FEL). Other technologies, especially those being developed by SDI, should be incorporated into the NASA beamed-power program.

When asked from the floor if beamed power was mission enabling, the panel responded unanimously in the affirmative that this technology was enabling and should be supported for future NASA missions.

APPENDIX

NON-NASA PARTICIPANTS

2nd BEAMED SPACE-POWER WORKSHOP

William C. Brown
Raytheon Co.
Microwave & Power Tube Division
Foundry Avenue
Waltham, MA 02254
(617) 642-4423

Adrian Alden
Canadian Communication Research Center
11400 Station H
K2H8S2
Ottawa, Canada
(613) 998-2444

Peter Glaser
Arthur D. Little, Inc.
Acorn Park
Cambridge, MA 02140
(617) 864-5770

W. S. Gregorwich
Lockheed Missiles & Space Co.
Research and Development Division
3251 Hanover Street
Palo Alto, CA 94304-1187
(415) 424-2633

Kai Chang
Department of Electrical Engineering
Texas A & M University
College Station, TX 77843
(409) 845-5425

Henry F. Gray
Code 6844
Naval Research Laboratory
4555 Overlook Avenue, S.W.
Washington, D.C. 20375-5000
(202) 767-2812

Bill Gus
MIT/NWI6/166
Plasma Fusion Center
167 Albany Street
Cambridge, MA 02139
(617) 253-8656

Wallace Manheimer
Code 4740
Naval Research Laboratories
4455 Overlook Avenue, S.W.
Washington, D.C. 20375-5000
(202) 767-3128

Robert Berry
Varian Microwave Tube Div.
Bldg. #4
611 Hansen Way
Palo Alto, CA 94393-1731
(415) 424-5665

Y. M. Eyssa
Applied Superconductivity Center
University of Wisconsin-Madison
Madison, WI 53706
(608) 263-1580

Mark Gouker
Georgia Institute of Technology
GTRI/EML
Atlanta, GA 30332
(404) 894-3503

E. P. Coomes
Battelle/PNL
Battelle Boulevard
Richland, WA 99352
(509) 375-2549

Alton D. Patton
Center for Space Power
Texas A & M University
College Station, TX 77843-3118
(409) 845-8768

Don R. Segna
U.S. DOE
P.O. Box 550
MS 85-90
Richland, WA 99352
(509) 376-8989

Murali Kadiramangalam
Department of Applied Sciences
New York University
26-36 Stuyvesant Street
New York, NY 10003
(212) 998-8995

Walter H. Christiansen
Aerospace & Engr. Res. Program
Building FL-10
University of Washington
Seattle, WA 98195
(206) 543-6224

Abraham Hertzberg, Director
Aerospace & Energetics Res. Program
FL-10
University of Washington
Seattle, WA 98195
(206) 543-6321

Ronald J. Glumb
TRW Space & Technology Group
Building RI, Room 1044
One Space Park
Redondo Beach, CA 90278
(213) 812-0465

Peter Iles
Applied Solar Energy Corp.
15251 East Don Julian Road
City of Industry, CA 91749
(818) 968-6581

Richard Statler
Naval Research Lab
Code 6629
Washington, D.C. 20375
(202) 767-2446

H. Paul Muruska
GE Electro Optics Engineering
Astro-Space Division
P.O. Box 8555
Philadelphia, PA 19101
(215) 354-1989

Robert Frisbee
Jet Propulsion Lab
4800 Oak Grove Drive
MS 125-224
Pasadena, CA 91109
88-792-9276

John Rather
Vice President for Research
Kaman Aerospace Corp.
1600 Wilson Boulevard
Suite 1200
Arlington, VA 22209
(703) 522-5616

Nelson Jalufka
Hampton University
NASA Langley Research Center
Mail Stop 493
Hampton, VA 23665-5225
(804) 864-1487

James C. Swingle
MS L-626
Lawrence Livermore National Lab
P.O. Box 5511
Livermore, CA 94550
(415) 423-1045

Jim Early
L-466
Lawrence Livermore National Lab
Livermore, CA 94550
(415) 422-6221

Arthur Kantrowitz
Dartmouth College
Thayer School of Engineering
Hanover, NH 03755
(603) 646-2611

Wynn Harries
Old Dominion University
NASA Langley Research Center
Hampton, VA 23665-5225
(804) 864-1409

Jin Kwon
Miami University
NASA Langley Research Center
Mail Stop 493
Hampton, VA 23665-5225
(804) 864-1480

NASA PARTICIPANTS

2nd BEAMED SPACE-POWER WORKSHOP

Robert J. Acosta
Mail Stop 54-8
National Aeronautics and Space Admin.
NASA Lewis Research Center
2100 Brookpark Road
Cleveland, OH 44135
FTS 297-3491

Jose L. Christian, Jr.
Mail Stop 301-3
National Aeronautics and Space Admin.
NASA Lewis Research Center
2100 Brookpark Road
Cleveland, OH 44135
FTS 297-5519

Karl A. Faymon
Mail Stop 301-3
National Aeronautics and Space Admin.
NASA Lewis Research Center
2100 Brookpark Road
Cleveland, OH 44135
FTS 297-6150

Bernie Garrett
Mail Stop 364
National Aeronautics and Space Admin.
NASA Langley Research Center
Spacecraft Analysis Branch
Hampton, VA 23665-5225
(804) 864-4425

Robert L. Cataldo
Mail Stop 501-6
National Aeronautics and Space Admin.
NASA Lewis Research Center
2100 Brookfield Road
Cleveland, OH 44135
FTS 297-5254

Ronald C. Cull
Mail Stop 301-5
National Aeronautics and Space Admin.
NASA Lewis Research Center
2100 Brookpark Road
Cleveland, OH 44135
FTS 297-3948

Ira T. Myers
Mail Stop 301-3
National Aeronautics and Space Admin.
NASA Lewis Research Center
2100 Brookpark Road
Cleveland, OH 44135
FTS 297-6116

Ed Gabris
Code R
National Aeronautics and Space Admin.
Washington, D.C. 20546
(202) 453-2742

PRECEDING PAGE BLANK NOT FILMED

~~PAGE 458~~ INTENTIONALLY BLANK

Dr. John Alred
Mail Stop IZ2
National Aeronautics and Space Admin.
Johnson Space Center
Lunar and Mars Exploration Office
Houston, TX 77058
(713) 282-1875

Dr. Gary Bennett
Code RP
National Aeronautics and Space Admin.
Washington, D.C. 2054
(202) 453-9111

Earl Van Landingham
Code RP
National Aeronautics and Space Admin.
Washington, D.C. 20546
453-2847

Martin M. Mikulas
Mail Stop 190
National Aeronautics and Space Admin.
NASA Langley Research Center
Hampton, VA 23665-5225
(804) 864-3102

Dr. William L. Grantham
Mail Stop 161
National Aeronautics and Space Admin.
NASA Langley Research Center
Hampton, VA 23665-5225
(804) 864-6494

Edmund J. Conway
Mail Stop 493
National Aeronautics and Space Admin.
NASA Langley Research Center
Hampton, VA 23665-5225
(804) 864-1435

Willard E. Meador
Mail Stop 493
National Aeronautics and Space Admin.
NASA Langley Research Center
Hampton, VA
(804) 864-1434

Russell J. De Young
Mail Stop 493
National Aeronautics and Space Admin.
NASA Langley Research Center
Hampton, VA 23665-5225
(804) 864-1472

Robert C. Costen
Mail Stop 493
National Aeronautics and Space Admin.
NASA Langley Research Center
Hampton, VA 23665-5225
(804) 864-1413

Gilbert H. Walker
Mail Stop 493
National Aeronautics and Space Admin.
NASA Langley Research Center
Hampton, VA 23665-5225
(804) 864-1411

Willard R. Weaver
Mail Stop 493
National Aeronautics and Space Admin.
NASA Langley Research Center
Hampton, VA 23665-5225
(804) 864-1408

Donald H. Humes
Mail Stop 493
National Aeronautics and Space Admin.
NASA Langley Research Center
Hampton, VA 23665-5225
(804) 864-1484

Ja H. Lee
Mail Stop 493
National Aeronautics and Space Admin.
NASA Langley Research Center
Hampton, VA 23665-5225
(804) 864-1473

Gregory L. Schuster
Mail Stop 493
National Aeronautics and Space Admin.
NASA Langley Research Center
Hampton, VA 23665-5225
(804) 864-1486

Michael Piszczor
Code RP
National Aeronautics and Space Admin.
Washington, D.C. 20546
(202) 453-9112

MiniWorkshop Participants

Planetary Power

Jim Early (Chair)
John Rather
Peter Iles
Robert Cataldo
Abraham Hertzberg
Murali Kadiramangalam
Wallace Manheimer
Y.M. Eyssa
W.S. Gregorwich
Robert Acosta

Space Propulsion

Ed Gabris (Chair)
Arthur Kantrowitz
Robert Frisbee
Ron Glumb
Paul Maruska
William Brown
Robert Berry
William Grantham
Mark Gouker
Adrian Alden
Bernie Garrett

Near Earth

Alton Patton(Chair)
Ed Coomes
Bill Gus
W. Christiansen
Gary Bennett
Henry Gray
Don Segna
Richard Statler
James Swingle
Kai Chang

PRECEDING PAGE BLANK NOT FILMED



Report Documentation Page

1. Report No. NASA CP-3037	2. Government Accession No.	3. Recipient's Catalog No.	
4. Title and Subtitle Second Beamed Space-Power Workshop		5. Report Date July 1989	
		6. Performing Organization Code	
7. Author(s) Russell J. De Young, Editor		8. Performing Organization Report No. L-16590	
		10. Work Unit No. 906-85-44-50	
9. Performing Organization Name and Address NASA Langley Research Center Hampton, Virginia 23665-5225		11. Contract or Grant No.	
		13. Type of Report and Period Covered Conference Publication	
12. Sponsoring Agency Name and Address National Aeronautics and Space Administration Washington, DC 20546-1001		14. Sponsoring Agency Code	
		15. Supplementary Notes	
16. Abstract <p>The Second Beamed Space-Power Workshop was held at NASA Langley Research Center on February 28 - March 2, 1989. The workshop proceedings contain an overview of laser and microwave space-power transmission technologies. Major emphasis was placed on potential beamed power missions, especially with reference to the NASA Office of Exploration case studies. Three groups of potential missions were presented where beamed power could have substantial payoff: near-Earth applications, space propulsion, and planetary power. Beam power payoff was quantified in each group. It was found that beamed power to a high power planetary rover was unique and mission enabling.</p>			
17. Key Words (Suggested by Author(s)) Space power Laser power transmission Microwave power transmission Propulsion		18. Distribution Statement Unclassified - Unlimited Subject Category: 20	
19. Security Classif. (of this report) Unclassified	20. Security Classif. (of this page) Unclassified	21. No. of pages 469	22. Price A20