

NASA Technical Memorandum TM 102153

Debris/Ice/TPS Assessment And Photographic Analysis For Shuttle Mission STS-34

November 1989

(NASA-TM-102153) DEBRIS/ICE/TPS ASSESSMENT
AND PHOTOGRAPHIC ANALYSIS FOR SHUTTLE
MISSION STS-34 (NASA) 235 p CSCL 22A

N90-13447

Unclass
G3/16 0243194



National Aeronautics and
Space Administration



Debris/Ice/TPS Assessment And Photographic Analysis For Shuttle Mission STS-34

Charles G. Stevenson
NASA/Kennedy Space Center

Gregory N. Katnik
NASA/Kennedy Space Center

Scott A. Higginbotham
NASA/Kennedy Space Center

November 1989

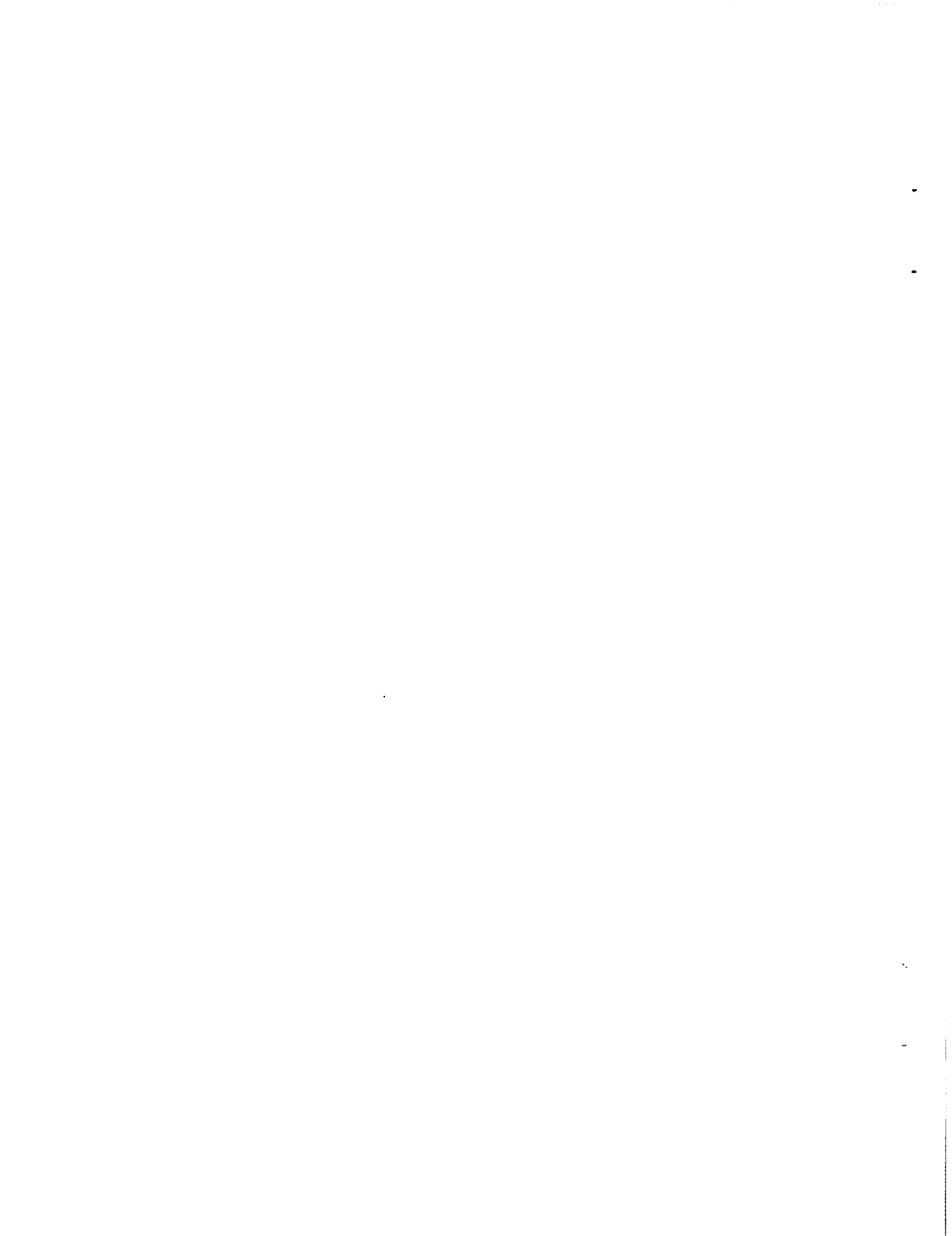

DEBRIS/ICE/TPS ASSESSMENT
AND
PHOTOGRAPHIC ANALYSIS
OF
SHUTTLE MISSION STS-34

October 18, 1989

Prepared By:

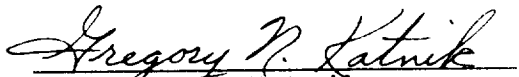
Gregory N. Katnik
NASA/Kennedy Space Center
TV-MSD-22

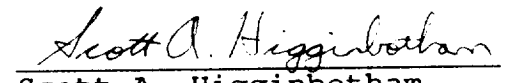
Scott A. Higginbotham
NASA/Kennedy Space Center
TV-MSD-22

Approved:
November 16, 1989



Charles G. Stevenson
Lead, Ice/Debris Assessment Team
Chief, ET Mechanical Systems
TV-MSD-22



TABLE OF CONTENTS

1.0	Summary	2
2.0	KSC Ice/Frost/Debris Team Activities . .	6
3.0	Pre-Test Briefing	11
3.1	Pre-Launch SSV/Pad Debris Inspection . .	12
4.0	Scrub	18
4.1	Ice/Frost Inspection	18
4.2	Orbiter	18
4.3	Solid Rocket Boosters	18
4.4	External Tank	21
4.5	Facility	25
4.6	Post Drain Inspection	48
5.0	Launch	51
5.1	Ice/Frost Inspection	51
5.2	Orbiter	51
5.3	Solid Rocket Boosters	51
5.4	External Tank	54
5.5	Facility	58
6.0	Post Launch Pad Debris Inspection . . .	72
7.0	Film Review Summary/Problem Reports. . .	76
7.1	Launch Film and Video Data Review . . .	93
7.2	On-Orbit Film Data Review.	129
7.3	Landing Film and Data Review	130
8.0	SRB Post Flight/Retrieval Assessment . .	133
8.1	RH SRB Debris Inspection	133
8.2	LH SRB Debris Inspection	138
8.3	Recovered SRB Disassembly Findings . . .	143
9.0	Orbiter Post Landing Debris Assessment .	163
10.0	Debris Sample Lab Reports	197
11.0	Post Launch Anomalies	201
11.1	Post Launch Pad Inspection	201
11.2	Film Review	201
11.3	Solid Rocket Booster Inspection	202
11.4	Orbiter Inspection	203

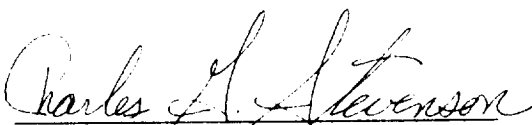
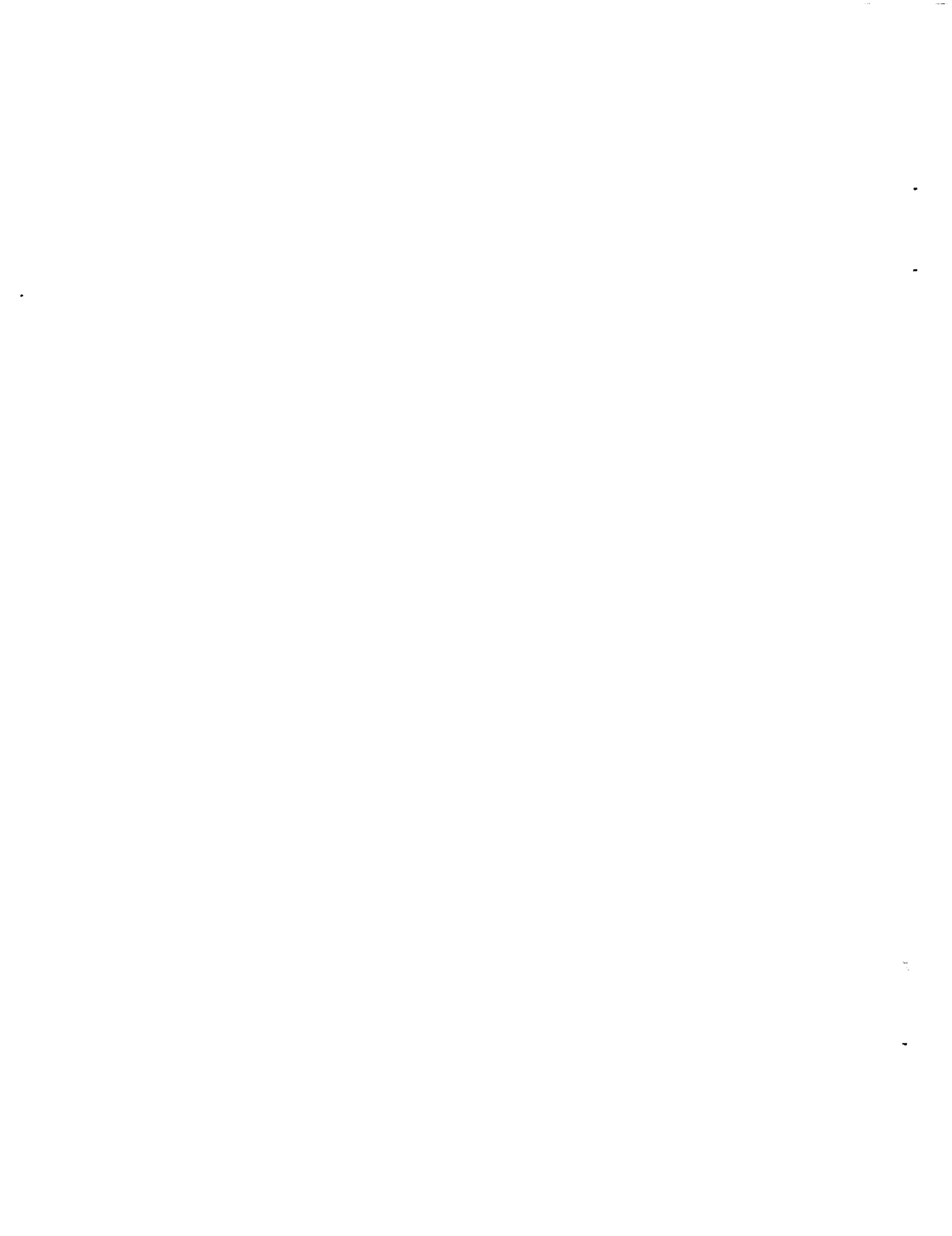

FORWARD

The Debris Team is continuing its effort to develop and implement measures to control damage from debris in the Shuttle operational environment and to make the control measures a part of routine processing and operations.

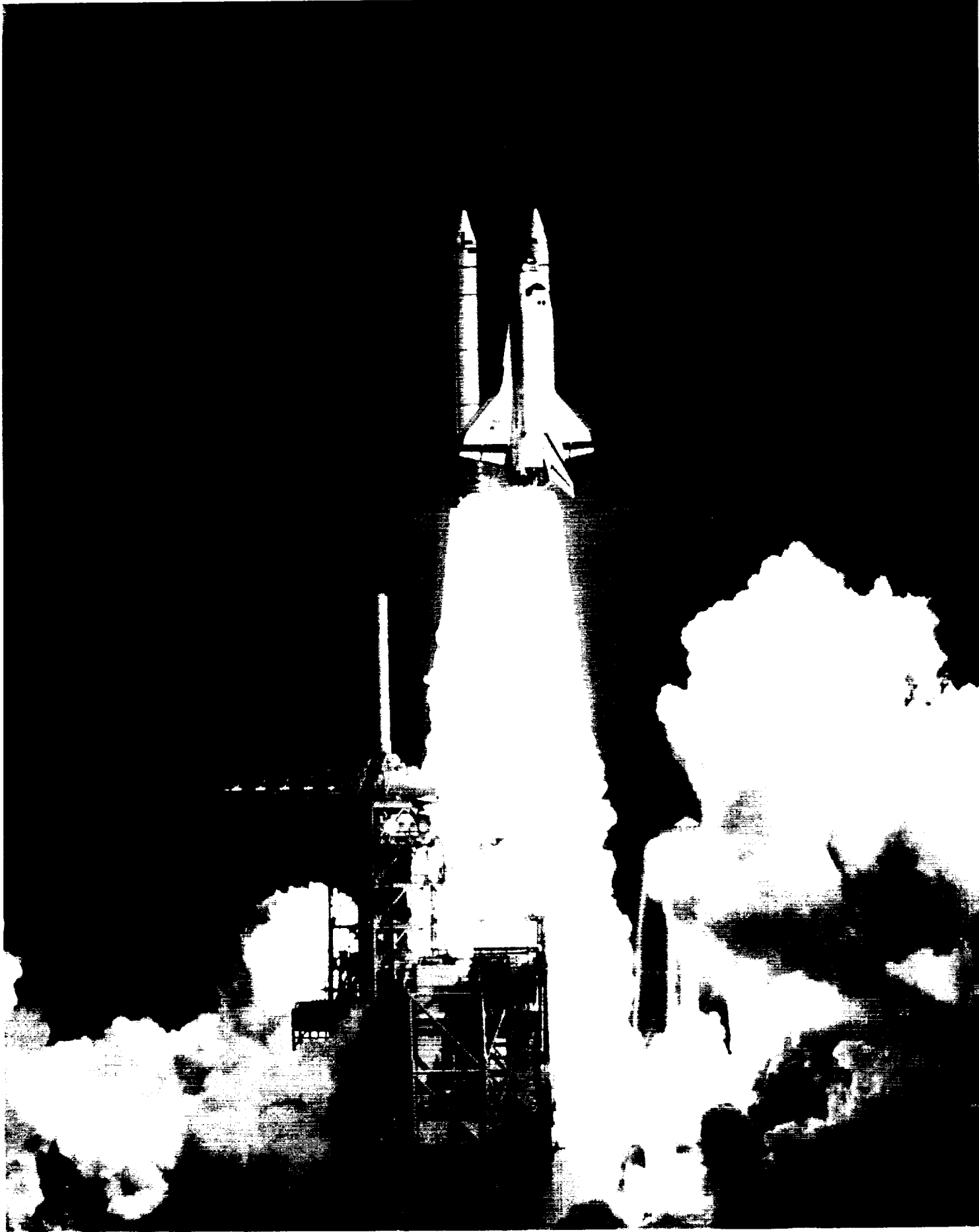

Launch of Shuttle Mission STS-34 on 10/18/89 at 12:53 p.m. EST

1.0 Summary

Debris and Photo Analysis Team activities for Mission STS-34 began with the pre-launch debris inspection of the launch pad and Shuttle vehicle on 16 October 1989. No major anomalies were observed on OV-104 Atlantis, BIO-32, or ET-27. Minor facility discrepancies, which included loose MLP deck bolts and loose debris items under the raised deck surrounding the SSME exhaust hole, were corrected prior to cryo loading the vehicle.

No Orbiter or SRB anomalies were detected during the Ice Inspection. Condensate, but no ice or frost, was present on all acreage areas of the External Tank. There were no ET anomalies with the exception of liquid air dripping from the -Y bipod strut DFI box vent hole. Liquid air formation at this location should not occur by design. Examination of closeout photographs revealed that this area had not been closed out properly at MAF. When KSC closed out the DFI box, missing insulation was not recognized. Consequently, the area again escaped proper closeout. This resulted in a near LH2-temperature inside the DFI box, which produced liquid air from contact with the atmosphere. An IPR on this condition was dispositioned to use-as-is by MRB approval. Seven Ice/Frost console anomalies were documented and found acceptable for launch per the LCC and NSTS-08303. The hydrogen umbilical leak sensor detected no significant hydrogen during the cryo load and was removed by the Ice Inspection Team during the T-3 hour hold.

The launch was scrubbed due to RTLS weather violations. A post drain inspection was performed six hours after the scrub decision. No TPS damage, such as divots or cracks on the tank acreage, were visible except for a 2-1/2" diameter PDL closeout missing on the LH2 aft dome. This condition was dispositioned on an IPR to use-as-is since underlying ablator is adequate for ascent heating protection. The -Y bipod strut DFI closeout showed no visible TPS damage.

The vehicle was again cryo loaded after a 24 hour scrub/turnaround. No Orbiter or SRB anomalies were detected during the Ice Inspection. Condensate, but no ice or frost, was present on all acreage areas of the External Tank. The 2-1/2" divot on the aft dome apex was 2/3 full of ice. Hard ice was present in the LO2 feedline bellows and support brackets. Light accumulations of frost on the LO2 ET/Orbiter umbilical were typical. The top and sides of the LH2 ET/Orbiter umbilical were covered by heavy, but typical, ice/frost. There were no unusual vapors emanating from the umbilicals or any evidence of leakage. Liquid air drops and vapors continued to emanate from the -Y bipod DFI box vent hole in a manner similar to that observed during the launch attempt the previous day. This condition was considered acceptable for launch. Six Ice/Frost console anomalies were documented and found acceptable for launch per the LCC and NSTS-08303. At launch, the ET ice condition was well within the data base for ice formation.

A post launch debris inspection of Pad 39B was performed after the successful launch. No significant flight hardware or TPS material was found, except for 5 Orbiter Q-felt plugs. Launch damage to the holddown posts was minimal. No signs indicative of stud hang-up were visible. No fragments from HDP debris containers were found. The GH2 vent line had latched properly, but excessive slack in the lanyard caused cable impressions on the 7-inch QD. Overall, the facility sustained minimal damage.

A total of 129 film and video items were analyzed as part of the post launch data review. No major vehicle damage or lost flight hardware was observed that would have affected the success of the mission. However, a stud 'hang-up' occurred on holddown post #2. The momentary drag caused by this condition was detectable in the Orbiter yaw accelerometer data. Film item E-8 showed that HDP #2 shoe lifted 2.4 inches with the SRB aft skirt as the vehicle ascended. As the shoe and the aft skirt foot separated, the shoe pulled back onto the spherical bearing momentarily exposing the extended stud. Numerous pieces of debris fell from the vehicle during ascent. Most have been identified as ice/frost particles from the ET/Orbiter umbilicals, RCS paper covers, and instafoam particles from the SRB aft skirts. The particles falling from the vehicle after Max Q are either pieces of SRB propellant or aft skirt instafoam. Objects in the SRB plumes prior to and just after separation from the External Tank are chunks of SRB propellant slag. Movement of the Orbiter body flap was visible after the roll maneuver and through most of the ascent. The motion appears to have an amplitude and frequency similar to that observed on OV-102 during STS-28R. Review of on-orbit photos of the separated ET revealed divots in the intertank flanges.

The Solid Rocket Boosters were inspected at Hanger AF after retrieval. Both forward skirts and frustums exhibited a total of 11 debonds and five areas of TPS lost during descent. Over 500 gallons of seawater were present in the retrieved RH forward skirt due to an unplugged bolt hole on the forward dome. A systems tunnel cover on the RH forward case segment was missing a 30" x 8" area of MSA-1 to substrate. Review of splashdown film ruled out water impact as the probable cause. The K5NA closeout on the trailing edge of the forward center field joint was debonded from both the case wall and the cork trailing edge at approximately 320 degrees radial location and measured 7 inches in length. Two of the factory joints exhibited debonds of the vulcanized EPDM moisture seals. The first, at station 531.5, 225 to 248 degrees radial location, was on the leading edge of the LH forward dome joint seal and was approximately 30 inches in length. The second, at station 1011.5, 45 degrees radial location, was on the trailing edge of the LH forward center segment and was approximately 7 inches in length.

Holddown post #2 aft skirt foot hole showed evidence of stud hang-up. Thread marks from the Inconel stud were impressed around 1/3 of the inner aluminum surface of the hole. The stud abraded a 1/2-inch deep chamfer inclined 45 degrees on the outboard edge of the hole and 3/4 of the paint from the aft inner surface was removed by the broaching. Some evidence of the stud contact was found in all aft skirt stud holes except for HDP #5.

Stud hang-ups have occurred on five previous flights (STS-2, 4, 51-I, 51-J, and 61-A). Broaching similar to that experienced on STS-34 occurred on three of those flights. Minor broaching and thread impressions have occurred on 46 holddown posts of ten previous flights. Holddown post shoes have been lifted on STS-2 and 29. Further investigation revealed HDP #2 stud preload limits and shoe dimensions were within specification just prior to launch. The raised inner web on the frangible nut fracture plane exhibited evidence of ductile, tensile failure, which indicates this web separated before its pyrotechnic detonated. The web on the frangible nut and the embedded booster cartridge metal on the holddown post stud were the most significant contributors to the stud hang-up and were caused by the non-simultaneous firing of the pyrotechnics.

A post landing inspection of OV-104 was performed on Runway 23. The Orbiter TPS sustained a total of 53 hits, of which 18 had a major dimension of one inch or greater. The Orbiter lower surface had a total of 51 hits, of which 17 had a major dimension of one inch or greater. Based on these numbers and comparison to statistics from previous missions of similar configuration, the number of hits on the lower surface is less than average. Also, based on the severity of damage as indicated by surface area and depth, this flight is better than average.

The largest damage tile damage site, measuring 3"x5"x3/4", occurred on the outboard aft lower corner of the LH OMS pod stinger. Damage of this magnitude in this location has not been previously observed. A bolt washer and retainer insert were missing from SSME #2 carrier panel.

A #10 washer, 1/2-inch in diameter, was embedded in a lower surface tile forward of the LH2 ET/ORB umbilical area. Half of the washer protruded into the aerodynamic flow and showed signs of heating. Laboratory analysis determined that the washer was subjected to a temperature between 2678 to 2849 degrees F. However, based on the absence of severe slumping at the tile damage site, that temperature range could not have occurred at this location. The uncertainty of specific local temperature could indicate heating of the washer prior to tile impact.

A second washer, 1/4-inch in diameter, fell onto the runway from the LO2 ET/ORB umbilical cavity when the door was opened. Although the origin of the washer has not been determined yet, preliminary research shows the washer was not part of the EO-3 ordnance device. Dimensional analysis of the washer is continuing.

White streaks/deposits were present on both wing leading edge RCC panels. Lab analysis revealed the streaks were caused by TPS materials, SRB separation products, and landing site earth minerals. The lower surface Orbiter tile samples indicated localized heating from re-entry, but the only materials recovered from the damage sites were tile TPS elements. Window #3 was heavily hazed; window #4 was lightly hazed.

During pyro removal, a stop-bolt from the forward attach point EO-1 bolt's centering mechanism was found to be compressed and bent. The damaged assembly was removed for analysis. Fragments from the EO-3 ordnance device fell onto the runway when the LO2 ET/ORB umbilical door was opened. The debris was a result of the ball fitting ordnance plunger failing to seat properly.

No flight hardware was found during the runway walkdown after landing. A survey marker/concrete post protruded 3/4-inch above runway 23 surface. It was located 1500 feet past the threshold on the runway centerline 371 feet away from the Orbiter touchdown point. The marker has since been removed. Two other markers located on each threshold will also be removed. A live round of ammunition was found approximately 0.3 miles from the runway threshold and 33 feet east of the centerline.

A total of 39 Post Launch Anomalies were observed during this mission assessment.

2.0 KSC ICE/FROST/DEBRIS TEAM ACTIVITIES

Team Composition: NASA KSC, NASA MSFC, NASA JSC,
LSOC SPC, RI - DOWNEY, MMMSS - MAF,
USBI - BPC, MTI - UTAH

Team Activities:

1) Prelaunch Pad Debris Inspection

Objective: Identify and evaluate potential debris material/sources. Baseline debris and debris sources existing from previous launches.

Areas: MLP deck, ORB and SRB flame exhaust holes, FSS, Shuttle vehicle external surfaces

Time: L - 1 day

Requirements: OMRSD S00U00.030 - An engineering debris inspection team shall inspect the shuttle and launch pad to identify/resolve potential debris sources. The prelaunch vehicle/pad configuration shall be documented/photographed.

Documents: OMI S6444

Report: Generate PR's and recommend corrective actions to pad managers.

2) Launch Countdown Firing Room 2

Objective: Evaluate ice/frost accumulation on the shuttle vehicle and/or any observed debris utilizing OTV cameras.

Areas: MLP deck, FSS, Shuttle vehicle external surfaces

Time: T - 6 hours to Launch + 1 hour or propellant drainback

Requirements: OMRSD S00FB0.005 - Monitor and video tape record ET TPS surfaces during loading through prepressurization.

Documents: OMI S0007, OMI S6444

Report: OIS call to NTD, Launch Director, and Shuttle managers. Generate IPR's.

3) Ice/Frost TPS and Debris Inspection

Objective: Evaluate any ice formation as potential debris material. Identify and evaluate any ORB, ET, or SRB TPS anomaly which may be a debris source or safety of flight concern. Identify and evaluate any other possible facility or vehicle anomaly.

Areas: MLP deck, FSS, Shuttle vehicle external surfaces

Time: T - 3 hours (during 2 hour BIH)

Requirements: OMRSD S00U00.020 - An engineering debris inspection team shall inspect the shuttle for ice/frost, TPS, and debris anomalies after cryo propellant loading. Evaluate, document, and photograph all anomalies. During shuttle walkdown inspect orbiter aft engine compartment (externally) for water condensation and/or ice formation in or between aft compartment tiles. An IR scan is required during the shuttle inspection to verify ET surface temperatures. During shuttle walkdown, inspect ET TPS areas which cannot be observed by the OTV system.

Documents: OMI S0007, OMI S6444

Report: Briefing to NTD, Launch Director, Shuttle management; generate IPR's.

4) Post Launch Pad Debris Inspection

Objectives: Locate and identify debris that could have damaged the Shuttle vehicle during launch.

Areas: MLP deck, flame exhaust holes and trenches, FSS, pad surfaces and slopes, extension of trenches to perimeter fence, walkdown of the beach from Playlinda to Complex 40, aerial overview of inaccessible areas.

Time: Launch + 3 hours (after pad safing, before washdown)

Requirements: OMRSD S00U00.010 - An engineering debris inspection team shall perform a post launch pad/area inspection to identify any lost flight or ground systems hardware

and resultant debris sources. The post launch pad/area configuration shall be documented/photographed.

Documents: OMI S0007, OMI S6444
Report: Initial report to LTD and verbal briefing to Level II at L+8 hours; generate PR's.

5) Launch Data Review

Objective: Detailed review of high speed films video tapes, and photographs from pad cameras, range trackers, aircraft and vehicle onboard cameras to determine possible launch damage to the flight vehicle. Identify debris and debris sources.

Time: Launch + 1 day to Launch + 6 days

Requirements: OMRSD S00U00.011 - An engineering film review and analysis shall be performed on all engineering launch film as soon as possible to identify any debris damage to the space shuttle vehicle. Identify flight vehicle or ground system damage that could affect orbiter flight operations or future SSV launches.

Documents: OMI S6444
Report: Daily reports to Level II Mission Management Team starting on L+1 day through landing; generate PR's.

6) SRB Post Flight/Retrieval Inspection

Objective: Evaluate potential SRB debris sources. Data will be correlated with observed Orbiter post landing TPS damage.

Areas: SRB external surfaces (Hangar AF, CCAFS)

Time: Launch + 24 hours (after on-dock, before hydrolasing)

Requirements: OMRSD S00U00.013 - An engineering debris damage inspection team shall perform a post retrieval inspection of the SRB's to identify any damage caused by launch debris. Any anomalies must be documented/photographed and coordinated with the results of the post launch shuttle/pad area debris inspection.

Documents: OMI B8001
Report: Daily reports to Level II Mission Management Team. Preliminary report to SRB Disassembly Evaluation Team. Generate PR's.

7) Orbiter Post Landing Debris Damage Assessment

Objective: Identify and evaluate areas of damage to Orbiter TPS due to debris and correlate, if possible, source and time of occurrence.

Additionally, runways are inspected for debris and sources of debris.

Areas: Orbiter TPS surfaces, runways

Time: After vehicle safing on runway, before towing

Requirements: OMRSD S00U00.040 - An engineering debris inspection team shall perform a prelanding runway inspection to identify, document, and collect debris that could result in orbiter damage. Runway debris and any facility anomalies which cannot be removed/corrected by the Team shall be documented and photographed; the proper management authority shall be notified and corrective actions taken.

Requirements: OMRSD S00U00.050 - An engineering debris inspection team shall perform a post landing runway inspection to identify and resolve potential debris sources that may have caused vehicle damage but was not present or was not identified during pre-launch runway inspection. Obtain photographic documentation of any debris, debris sources, or flight hardware that may have been lost on landing.

Requirements: OMRSD S00U00.060 - An engineering debris inspection team shall map, document, and photograph debris-related Orbiter TPS damage and debris sources.

Requirements: OMRSD S00U00.012 - An engineering debris damage inspection team shall perform a post landing inspection of the orbiter vehicle to identify any damage caused by launch debris. Any anomalies must be documented/

photographed and coordinated with the results of the post launch shuttle/pad area debris inspection.

Requirements: OMRSD V09AJ0.095 - An engineering debris inspection team shall perform temperature measurements of RCC Nose Cap and RCC RH Wing Leading Edge Panels 9 and 17.

Documents: OMI S0026, OMI S0027, OMI S0028

Report: Briefing to NASA Convoy Commander and generate PR's. Preliminary report to Level II on the day of landing followed by a preliminary update the next day.

8) Level II report

Objective: Compile and correlate data from all inspections and analyses. Results of the debris assessment, along with recommendations for corrective actions, are presented directly to Level II via SIR and PRCB. Paper copy of complete report follows in 3 to 4 weeks. (Ref NASA Technical Memorandum series).

3.0 PRE-TEST BRIEFING

The Ice/Frost/Debris Team briefing for launch activities was conducted on 16 October 1989 at 0830 hours with the following key personnel present:

C. Stevenson	NASA - KSC	Chief, ET Mechanical Systems Lead, Ice/Debris Assess Team
G. Katnik	NASA - KSC	ET Mech/TPS, Ice/Debris Assessment, STI
S. Higginbotham	NASA - KSC	STI, Debris Assessment
B. Speece	NASA - KSC	ET Processing, Ice Assess
B. Bowen	NASA - KSC	ET Processing, "SURFICE"
J. Rivera	NASA - KSC	ET Processing, Debris Assess
A. Oliu	NASA - KSC	"SURFICE", Debris Assess
M. Bassignani	NASA - KSC	ET Processing, Ice Assess
B. Davis	NASA - KSC	STI, Debris Assessment
K. Tenbusch	NASA - KSC	"SURFICE", Debris Assess
J. Hoffman	LSOC - SPC	ET Processing, Ice Assess
M. Young	LSOC - SPC	ET Processing, Ice Assess
M. Jaime	LSOC - SPC	ET Processing, Ice Assess
J. Blue	LSOC - SPC	ET Processing, Ice Assess
F. Huneidi	NASA - MSFC	TPS & Ice Assessment
D. Andrews	NASA - MSFC	Debris Assessment
Z. Byrns	NASA - JSC	Level II Integration
C. Gray	MMC - MAF	ET TPS & Materials Design
S. Copsey	MMC - MAF	ET TPS Testing/Certif
K. Ely	MMC - KSC	ET Processing, LSS
J. McClymonds	RI - Downey	Debris Assess, LVL II Integ
G. Tamagno	RI - Downey	Debris Assess, LVL II Integ
H. Novak	USBI - PSE	SRB Processing
H. Huppi	MTI - Utah	SRM Plant Representative

These personnel participated in various team activities, assisted in the collection and evaluation of data, and wrote reports contained in this document.

3.1 PRE-LAUNCH SSV/PAD DEBRIS INSPECTION

The pre-launch debris inspection of the pad and Shuttle vehicle was conducted on 16 October 1989 from 1300 - 1530 hours. The detailed walkdown of Launch Pad 39B and MLP-1 also included the primary flight elements OV-104 Atlantis (5th flight), ET-27 (LWT-20), and BI-032. Documentary photographs were taken of facility anomalies, potential sources of vehicle damaging debris, and new vehicle configurations.

There were no major vehicle anomalies. However, one piece of hydrogen fire detector system butcher paper was missing from the ET thrust strut. A PR had been generated earlier and the condition was accepted for flight based on the proximity of 4 other paper locations near the ET/ORB LH2 umbilical.

Due to the continued concern over potential hydrogen leakage from the ET/ORB LH2 umbilical interface area during the cryoload/launch of STS-28R, a temporary hydrogen detector was installed at the ET/ORB LH2 umbilical until a permanent sensor can be designed and installed. The temporary detector consists of two tygon tubes that run from the LH2 umbilical area to the hazardous gas detection equipment located on the FSS. The tubes were attached to the vehicle by three velcro strap assemblies. A length of parachute cord attached to these assemblies enable the entire apparatus to be quickly removed from the vehicle without causing TPS damage. The hydrogen sensor is intended to remain in place during cryo loading and be removed by the Ice Inspection Team during the T-3 hour hold.

A recurring problem is loose MLP deck bolts. This inspection revealed loose deck bolts west of the LH SRB, adjacent to the SSME exhaust hole, in the access plate east of the RH SRB (total of 4), and in the raised decks adjacent to both SRB's. Grounding strap bolts were also loose around the SRB exhaust holes.

Other discrepancies included loose nuts on the water spray pipe north of the SSME exhaust hole, a pipe cap on the raised deck north of the RH SRB exhaust hole, a loose vent pipe elbow next to the north MLP stairs, and a loose shim in the sound suppression water pipe bracket adjacent to the RH SRB HDP #4.

Trash and debris was visible in several areas. A paper tag lay in the HDP #5 well area. A piece of wire, a short length of cord, and a 1-1/2"x1" piece of shim or deck scale lay in the HDP #3 well area. A piece of wire was also found in the HDP #4 well area. Loose debris items were visible under the raised deck surrounding the SSME exhaust hole: a red tag near the LH2 TSM and a dust mask and tag adjacent to the LO2 TSM.

Excessive RTV was again applied to the instrumentation bands at the base of the SRB holddown posts. This condition was accepted for this launch, but will not be acceptable for subsequent launches. The two MLP's in the VAB were inspected and excessive RTV had been applied to the holddown posts. The RTV was removed and procedures will be changed to apply the minimal amount necessary for protecting the instrumentation with no RTV exposed.

Cleanup of the MLP deck and pad surface was almost complete at the time of the inspection. The facility discrepancies were transferred to the pad leader for resolution prior to vehicle tanking.

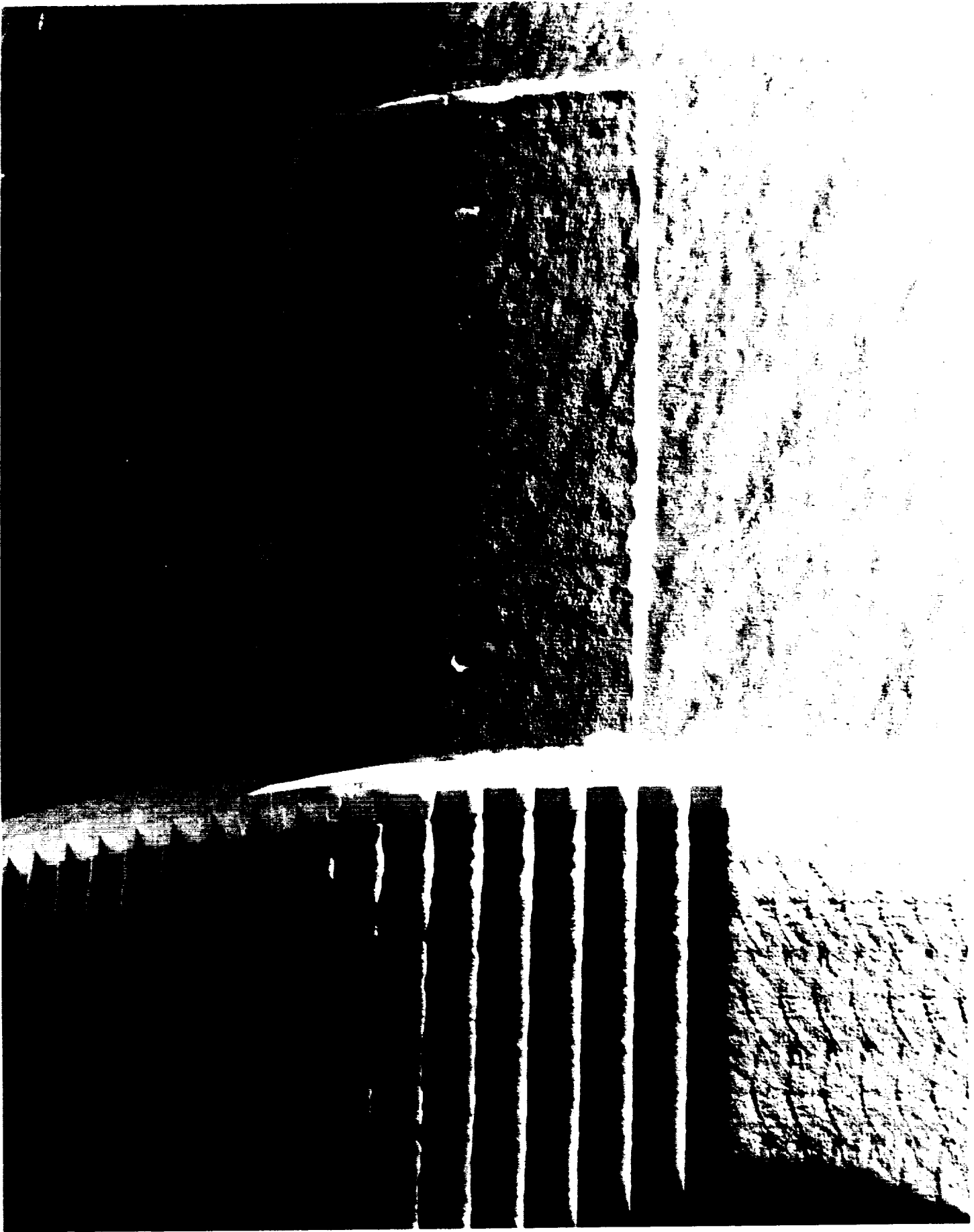

TPS repair performed at the factory after the LO2 tank barrel
section was joined to the intertank section

14

ORIGINAL PAGE
COLOR PHOTOGRAPH



Excessive application of RTV to the SRB holddown posts



Dust mask and red tag debris under the raised deck adjacent to
the SSME exhaust hole



Untorqued MLP deck access plate bolts (removed for clarity)



4.0 SCRUB

The launch countdown for STS-34 was scrubbed at 1315 EST on 17 October 1989 due to RTLS weather LCC violations.

4.1 ICE/FROST INSPECTION

The Ice/Frost Inspection of the cryoloaded vehicle was performed on 17 October 1989 from 0700 to 0900 hours during the two hour built-in-hold at T-3 hours in the countdown. There were no violations of NSTS-08303 or the Launch Commit Criteria. Ambient weather conditions at the time of the inspection were:

Temperature:	78.7 F
Relative Humidity:	72.9 %
Wind Speed:	4.7 Knots
Wind Direction:	118 Degrees

The portable STI infrared scanner was utilized to obtain surface temperature measurements for an overall thermal assessment of the vehicle, as shown in Figure 1 and 2.

4.2 ORBITER OBSERVATIONS

No Orbiter tile anomalies were observed. The average Orbiter surface temperature was recorded as 80 degrees F. The average surface temperatures of the SSME engine mounted heat shields were measured at 53 degrees F for SSME #1, 52 degrees F for SSME #2, and 61 degrees F for SSME #3. SSME #2 had a small amount of ice at the nozzle to heatshield interface 3 o'clock position. Condensate, but no ice or frost, was present on all three heatshields.

4.3 SRB OBSERVATIONS

No SRB anomalies or loose ablator/cork were observed. The STI portable infrared scanner recorded RH and LH SRB case surface temperatures between 79 to 81 degrees F. Temperatures in the area of the SRB field joint heaters averaged 84 degrees F. The predicted Propellant Mean Bulk Temperature (PMBT) supplied by MTI was 82 degrees F.



FIGURE 1. INFRA RED SCANNER SSV SUMMARY DATA

TIME: 0700 - 0900
 DATE: 10/17/89
 VEH. STS: 34

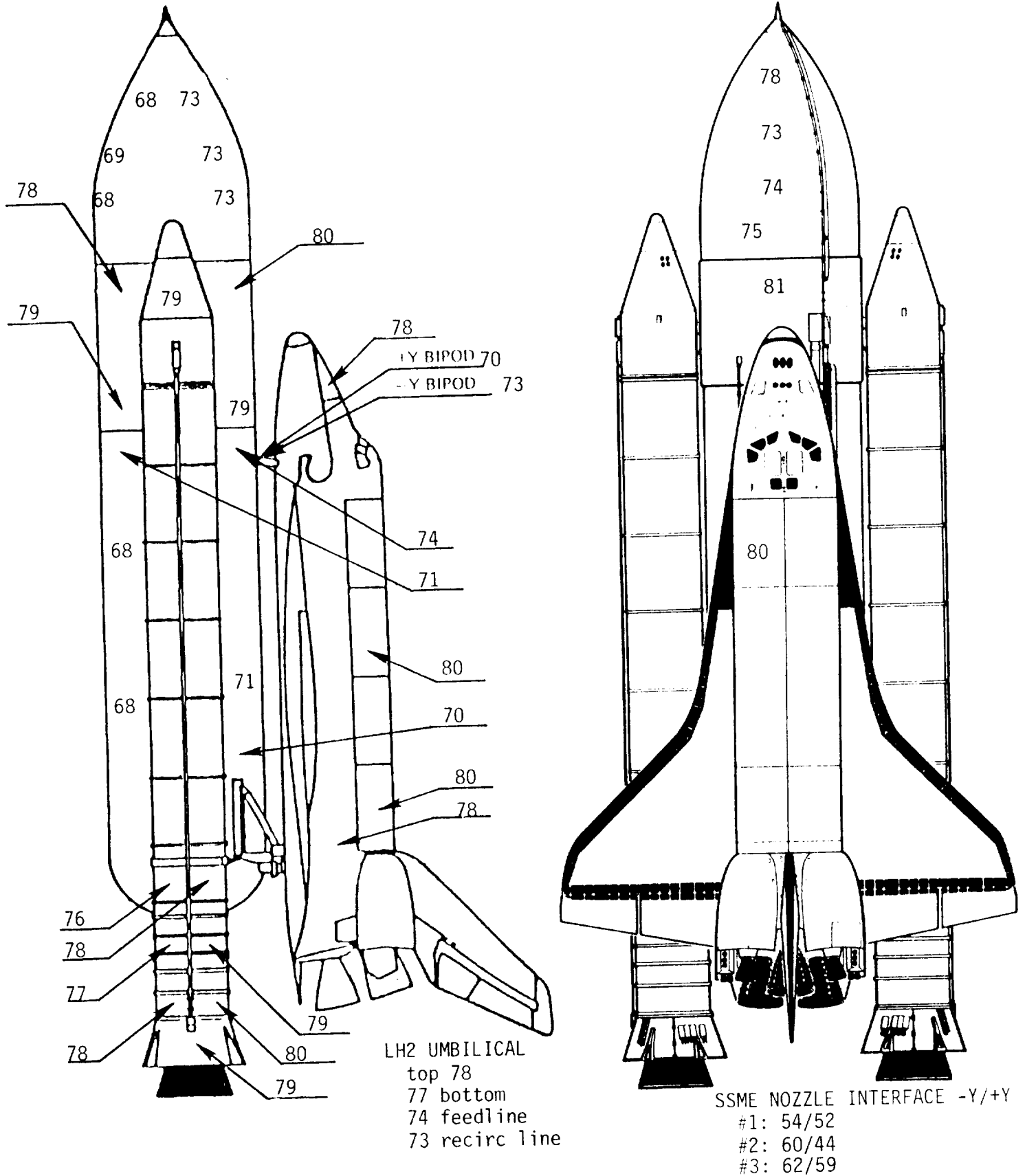
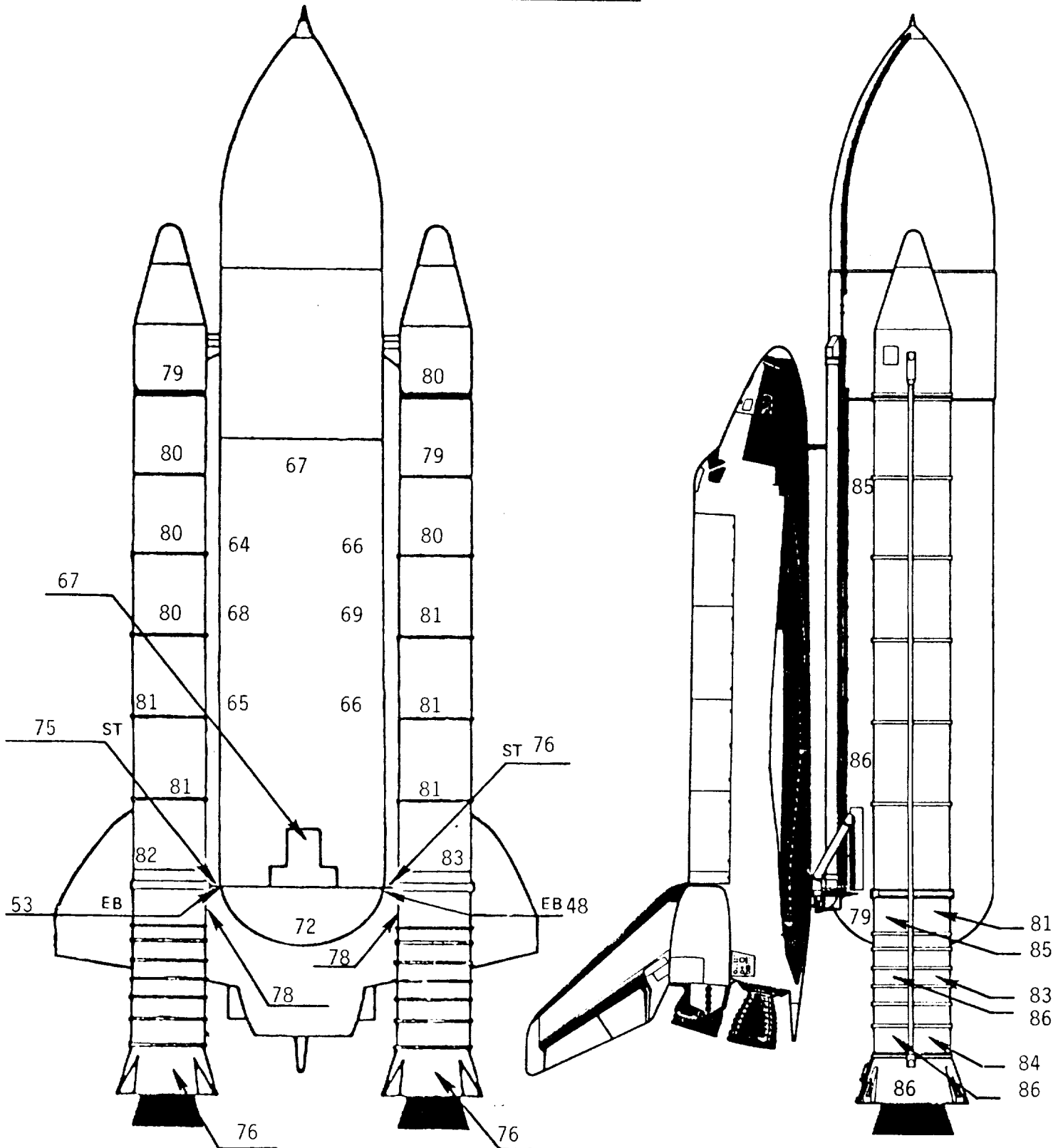

FIGURE 2. INFRA RED SCANNER SSV SUMMARY DATA

TIME: 0700 - 0900
 DATE: 10/17/89
 VEH. STS- 34



4.4 EXTERNAL TANK OBSERVATIONS

The ice/frost prediction computer program was run from 0400 to 1315 hours and the results tabulated in Figures 3, 4, and 5. The program predicted condensate with no ice accumulation on all TPS acreage surfaces.

Acreage condensate, but no ice or frost, was present on the L02 tank, Intertank (run on), and LH2 tank. The IR scanner measured an average surface temperature of 72 degrees F on the L02 tank, 79 degrees F on the Intertank, and 69 degrees F on the upper and lower LH2 tank.

A moderate amount of condensate trickled down the LH2 tank and ran off the aft dome. There was no acreage ice or frost.

Ice/Frost covered the lower EB fittings outboard to the strut pin hole with condensate on the rest of the fitting. The struts were dry and were not covered by ice.

Heavier than normal amounts of ice were present in all L02 feedline bellows. Normal amounts of ice/frost were present in the L02 feedline support brackets. These conditions are acceptable per NSTS-08303.

There was very little ice in the LH2 feedline bellows. A normal amount of ice had formed in the LH2 recirculation line bellows.

The LH2 ET/ORB umbilical exhibited less ice but slightly more than normal accumulations of frost. The L02 ET/ORB umbilical exhibited typical (light) ice/frost accumulations. Frost fingers had formed on the purge vents and normal venting was occurring. There were no unusual vapors emanating from the umbilicals nor any evidence of leakage.

Minor frost had formed around the GUCP, but there was no sign of leakage.

Liquid air dripped from the -Y bipod strut DFI box vent hole. Liquid air formation at this location exceeds the design intent and is not desirable. Examination of closeout photographs revealed the area had not been closed out properly at MAF. When KSC closed out the DFI box, the missing insulation was not recognized. Consequently, the area again escaped proper closeout. This resulted in a near LH2-temperature inside the DFI box which produced liquid air from contact with the atmosphere. IPR-34RV-023 was generated to document this condition and was dispositioned to use-as-is per MRB approval. An area of ice/frost approximately 5"x1"x1/2" had formed at the -Y bipod ramp to intertank interface. This condition was acceptable per NSTS-08303.

The tumble valve cover was properly installed and intact.

STS-34		TEST: S0057 Scrub (Weather)				DATE		T-O TIME																	
ORBITER	ET	SRB	MLP	PAD	LO2	LO2	DATE	DATE																	
OV-104	27	B1032	1	39B	CHILDCDN TIME: 0348 SLOW FILL TIME: 0423	CHILDCDN TIME: 0348 SLOW FILL TIME: 0355	10/17/89	10/17/89																	
LOCAL TIME		CONDITONS		LO2 TANK STA 370 TO 540		LO2 TANK STA 550 TO 852		LO2 TANK STA 1130 TO 1380		LO2 TANK STA 1380 TO 2058															
TEMP OF	REL HUM %	DEW PT OF	WIND VEL KNTS	WIND DIR DEG	REGION	LOCAL VEL KNTS	SOFI TEMP OF	COND RATE IN/HR	ICE RATE IN/HR	REGION	LOCAL VEL KNTS	SOFI TEMP OF	COND RATE IN/HR	ICE RATE IN/HR	REGION	LOCAL VEL KNTS	SOFI TEMP OF	COND RATE IN/HR	ICE RATE IN/HR						
0400	77.4	76	69.59	6	113	II	3.54	64.64	.0020	.1594	II	3.54	59.71	.0033	.1292	II	1.92	52.23	.0035	.0759	II	8.34	65.04	.0041	.2867
0415	77.6	75	69.42	8	109	II	4.72	66.14	.0019	.2002	II	4.72	61.97	.0033	.1691	II	4.40	60.58	.0041	.1524	II	9.76	65.81	.0037	.3332
0430	77.2	74	66.64	6	112	II	3.54	64.17	.0019	.1539	II	3.54	59.96	.0036	.1239	II	1.92	51.48	.0034	.0727	II	8.31	64.30	.0038	.2782
0445	76.9	75	68.73	6	120	II	3.54	64.09	.0019	.1535	II	3.54	59.87	.0037	.1234	II	1.92	51.36	.0034	.0724	II	8.34	64.24	.0039	.2776
0500	77.2	76	69.40	5	116	II	2.95	63.75	.0020	.1358	II	2.95	57.85	.0035	.1060	II	1.60	51.20	.0034	.0748	II	6.95	63.74	.0042	.2378
0515	76.8	77	69.37	5	114	II	2.95	63.57	.0021	.1347	II	2.95	57.62	.0037	.1049	II	1.60	50.92	.0035	.0735	II	6.95	63.57	.0043	.2369
0530	76.9	77	69.47	6	113	II	3.54	64.50	.0021	.1566	II	3.54	59.33	.0033	.1264	II	1.92	51.95	.0036	.0741	II	8.34	64.76	.0041	.2837
0545	76.8	76	69.00	6	110	II	3.54	64.23	.0020	.1544	II	3.54	59.01	.0037	.1243	II	3.30	57.30	.0040	.1103	II	7.32	63.83	.0041	.2459
0600	77.3	76	69.40	6	108	II	3.54	64.66	.0020	.1573	II	3.54	59.48	.0038	.1266	II	3.30	57.78	.0040	.1127	II	7.32	64.06	.0041	.2502
0615	77.4	76	69.59	6	117	II	3.54	64.88	.0020	.1584	II	3.54	59.71	.0033	.1282	II	1.92	52.23	.0035	.0759	II	8.34	65.04	.0040	.2867
0630	76.8	77	69.37	9	118	II	5.31	66.24	.0020	.2191	II	5.31	62.43	.0039	.1866	II	2.88	56.21	.0040	.0969	II	12.51	66.62	.0036	.4191
0715	76.6	75	68.43	4	120	II	2.36	61.63	.0020	.1098	II	2.36	54.72	.0037	.0808	II	1.28	50.27	.0033	.0705	II	5.56	61.29	.0041	.1895
0745	76.8	77	69.37	3	127	II	1.77	60.61	.0020	.1038	II	1.77	52.43	.0032	.0792	II	0.96	50.92	.0035	.0735	II	4.17	59.72	.0043	.1427
0800	77.6	76	69.79	4	126	II	2.36	62.99	.0020	.1161	II	2.38	56.18	.0035	.0868	II	1.28	51.69	.0035	.0770	II	5.56	62.67	.0042	.1945
0815	78.8	74	70.22	3	131	II	1.77	62.22	.0019	.1120	II	1.77	54.17	.0034	.0873	II	0.96	52.73	.0034	.0817	II	4.17	61.24	.0041	.1514

EGGV-340

FIGURE 3. Ice/Frost Computer Predictions

STS - 34		TEST: S0007 Scrub (Weather)				DATE: 10/17/89		T-O TIME: DATE 10/17/89																	
ORBITER	ET	SRB	MLP	PAD	LO2		LM2																		
OV-104	27	B1032	1	39B	CHILDDOWN TIME: 0348	FAST FILL TIME: 0435	CHILDDOWN TIME: 0348	FAST FILL TIME: 0425																	
					REPLENISH TIME: 0640	REPLENISH TIME: 0630	REPLENISH TIME: 0630	REPLENISH TIME: 0630																	
LOCAL TIME	CONDITIONS				LO2 TANK STA 370 TO 540				LM2 TANK STA 1130 TO 1380				LM2 TANK STA 1380 TO 2099												
	TEMP OF	REL HUM %	DEW PT OF	WIND VEL KNTS	WIND DIR DEG	REGION	LOCAL VEL KNTS	SOFT TEMP OF	COND RATE IN/HR	ICE RATE IN/HR	REGION	LOCAL VEL KNTS	SOFT TEMP OF	COND RATE IN/HR	ICE RATE IN/HR	REGION	LOCAL VEL KNTS	SOFT TEMP OF	COND RATE IN/HR	ICE RATE IN/HR					
0830	80.1	72	70.72	3	113	II	1.77	63.22	.0018	.1172	II	1.77	55.26	.0031	.0926	II	0.96	53.86	.0034	.0370	II	4.17	62.13	.0039	.1574
0845	80.8	69	70.20	9	103	II	5.31	68.35	.0012	.2357	II	5.31	64.67	.0033	.2039	II	4.95	63.45	.0037	.1854	II	10.93	69.03	.0026	.3976
0900	80.5	67	69.08	7	106	II	4.13	66.55	.0013	.1859	II	4.13	62.05	.0032	.1552	II	3.85	60.56	.0035	.1397	II	8.54	65.96	.0023	.3020
0915	80.6	70	70.42	7	87	II	4.13	67.45	.0015	.1926	II	4.13	62.98	.0035	.1616	II	3.85	61.52	.0038	.1457	II	8.54	66.92	.0033	.3137
0930	79.7	72	70.33	6	90	II	3.54	66.36	.0018	.1676	II	3.54	61.30	.0039	.1227	II	3.30	59.68	.0038	.1227	II	7.32	65.58	.0038	.2666
0945	82.6	67	71.14	7	112	II	4.13	68.75	.0013	.2018	II	4.13	64.35	.0033	.1706	II	3.85	62.93	.0036	.1543	II	8.54	68.14	.0029	.3283
1000	82.3	64	69.55	6	117	II	3.54	66.97	.0011	.1711	II	3.54	61.99	.0030	.1407	II	1.92	55.08	.0031	.0902	II	8.34	66.32	.0025	.3064
1015	83.0	62	69.33	6	110	II	3.54	67.14	.0009	.1721	II	3.54	62.17	.0028	.1417	II	3.30	60.61	.0031	.1274	II	7.32	66.24	.0025	.2717
1030	82.2	65	69.89	7	121	II	4.13	67.77	.0010	.1945	II	4.13	63.31	.0030	.1636	II	2.24	56.87	.0032	.0903	II	9.73	67.76	.0023	.3574
1045	82.4	62	68.75	9	115	II	5.31	68.02	.0004	.2324	II	5.31	64.33	.0025	.2008	II	2.88	58.70	.0031	.1084	II	12.51	68.16	.0008	.4416
1100	82.8	61	68.68	9	115	II	5.31	68.13	.0003	.2332	II	5.31	64.45	.0024	.2017	II	2.88	58.86	.0031	.2091	II	12.51	68.16	.0006	.4420
1115	83.0	61	68.87	8	115	II	4.72	67.93	.0005	.2136	II	4.72	63.91	.0026	.1824	II	2.56	57.98	.0030	.0983	II	11.12	67.92	.0011	.3991
1130	82.8	62	69.14	13	105	I	7.67	70.08	.0000	.3203	II	7.67	66.79	.0019	.2872	II	7.15	65.90	.0025	.2636	I	15.86	69.54	.0009	.5617
1145	82.8	63	69.59	10	111	II	5.90	69.05	.0003	.2600	II	5.90	65.69	.0026	.2279	II	5.50	64.61	.0030	.2081	II	12.20	68.74	.0002	.4429
1200	83.0	63	69.79	11	104	II	6.49	69.54	.0001	.2836	II	6.49	66.44	.0024	.2509	II	6.05	65.43	.0029	.2236	II	13.42	69.25	.0007	.4884

ORIGINAL PAGE IS OF POOR QUALITY

ORIGINAL PAGE COLOR PHOTOGRAPH

FIGURE 4. Ice/Frost Computer Predictions

EGGV-140

TEST:		S0007 Scrub (Weather)				DATE		T-0 TIME																																
STS - 3+						10/17/89		DATE 10/17/89																																
ORBITER		SRB		MLP		PAD		LH ₂																																
OV- 104		B1032		1		39B		CHILLDOWN TIME 0348																																
								FAST FILL TIME 0425																																
								SLOW FILL TIME 0630																																
								REPLENISH TIME 0630																																
								LO ₂ TANK STA 550 TO 852																																
								LO ₂ TANK STA 1130 TO 1380																																
								LO ₂ TANK STA 1380 TO 2058																																
CONDITIONS																																								
LOC'L TIME	TEMP OF	REL HUM %	DEW PT OF	WIND VEL KNTS	WIND DIR DEG	REGION	LOCAL VEL KNTS	SOFT TEMP OF	COND RATE IN/HR	ICE RATE IN/HR	REGION	LOCAL VEL KNTS	SOFT TEMP OF	COND RATE IN/HR	ICE RATE IN/HR	REGION	LOCAL VEL KNTS	SOFT TEMP OF	COND RATE IN/HR	ICE RATE IN/HR																				
1215	83.3	62	69.63	11	103	II	6.49	69.54	0.001	0.2335	II	6.49	66.45	0.0023	0.2510	II	6.05	65.45	0.0028	0.2297	II	13.42	59.24	0.0006	0.4881															
1230	83.2	64	70.43	9	112	II	5.31	69.41	0.0007	0.2447	II	5.31	65.79	0.0028	0.2128	II	4.95	64.61	0.0033	0.1939	II	10.98	68.99	0.0018	0.4116															
1245	83.2	61	69.07	12	103	I	7.08	69.88	0	0.3004	II	7.08	66.50	0.0020	0.2677	II	6.60	65.56	0.0025	0.2433	I	14.64	69.17	0	0.5220															
1300	83.3	59	68.71	11	107	I	6.49	69.76	0	0.2791	II	6.49	66.03	0.0019	0.2467	II	6.05	65.03	0.0024	0.2258	I	13.42	63.88	0	0.4795															
1315	83.7	59	65.62	13	106	I	7.67	70.90	0	0.3199	II	7.67	66.78	0.0015	0.2868	II	7.15	65.90	0.0021	0.2634	I	15.86	70.39	0	0.5599															
AVG.	80.1	69	69.61	7	SE			66.39					66.34					58.04					66.06																	

EGGV-240

FIGURE 5. Ice/Frost Computer Predictions

ORIGINAL PAGE IS OF POOR QUALITY

The ET/ORB hydrogen detection sensor tygon tubing was removed with no damage to the vehicle.

The summary of ice/frost team observation anomalies consists of 7 OTV recorded items:

Anomaly 001 recorded ice/frost formations along the bond line of the -Y bipod strut DFI box closeout. Liquid air dripped from the box drain hole. The anomaly was upgraded to PR ET-27-TS-0065, which was dispositioned to use-as-is per MRB acceptance.

Anomaly 002 documented ice/frost in the LO2 feedline bellows and on the LO2 umbilical cavity purge vents. This condition was acceptable per NSTS-08303.

Ice/frost formations on the LH2 umbilical purge vents, in the LH2 recirculation line bellows, and on the LH2 umbilical-to-orbiter interface were documented on Anomaly 003. These formations were acceptable per NSTS-08303.

Anomaly 004 recorded ice/frost accumulations on the EB-7 and EB-8 fittings. This ice/frost is acceptable per NSTS-08303.

Anomaly 005 documented a piece of hydrogen detection system butcher paper on the vertical strut 'wet' with condensate. This condition is not a debris concern and does not affect the function of the butcher paper.

A large ice finger on the LH2 cable tray vent hole was recorded on Anomaly 006. It is acceptable per NSTS-08303.

Anomaly 007 recorded vapors venting from the closeout of the LH2 recirculation line-to-tank interface. The venting stopped at GMT 17:33:36. The condition is acceptable per NSTS-08303.

4.5 FACILITY OBSERVATIONS

All debris concerns previously identified had been resolved prior to cryoloading and no new items were noted during the walkdown. No leaks were observed on either the LO2 or LH2 ORB T-0 umbilicals, though small amounts of ice had formed. Some condensate dripped from the LO2 TSM umbilical. There was no apparent leakage anywhere on the GH2 vent line or GUCP. The modification to the GH2 vent line prevented ice from forming but some ice/frost, which was expected, had accumulated on the GUCP legs. Visual and infrared observations of the GOX seals confirmed no leakage. The ends of the GOX vent ducts exhibited no frost or icicles.

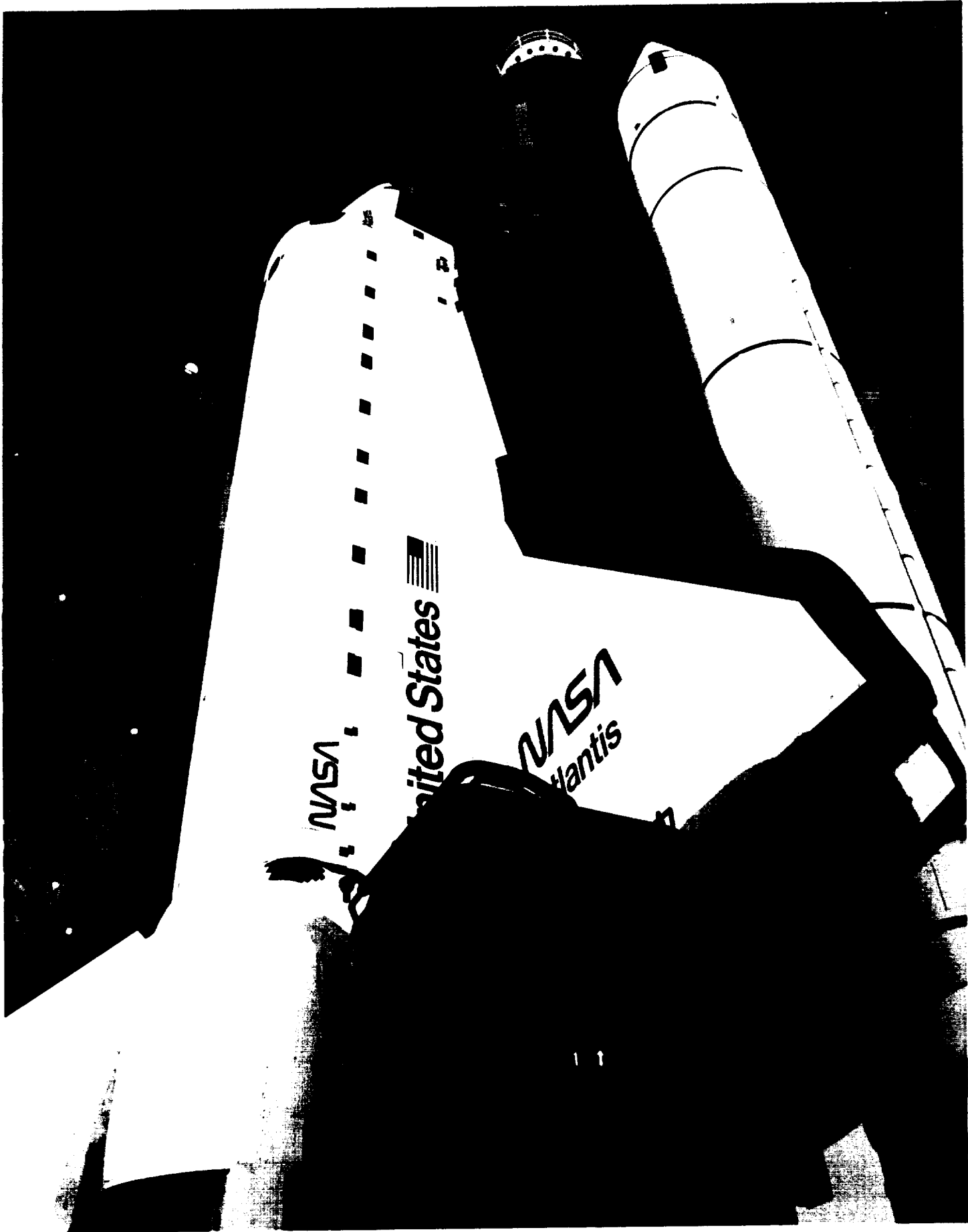

Overall view of OV-104, ET-27 (LWT 20), and BI-032

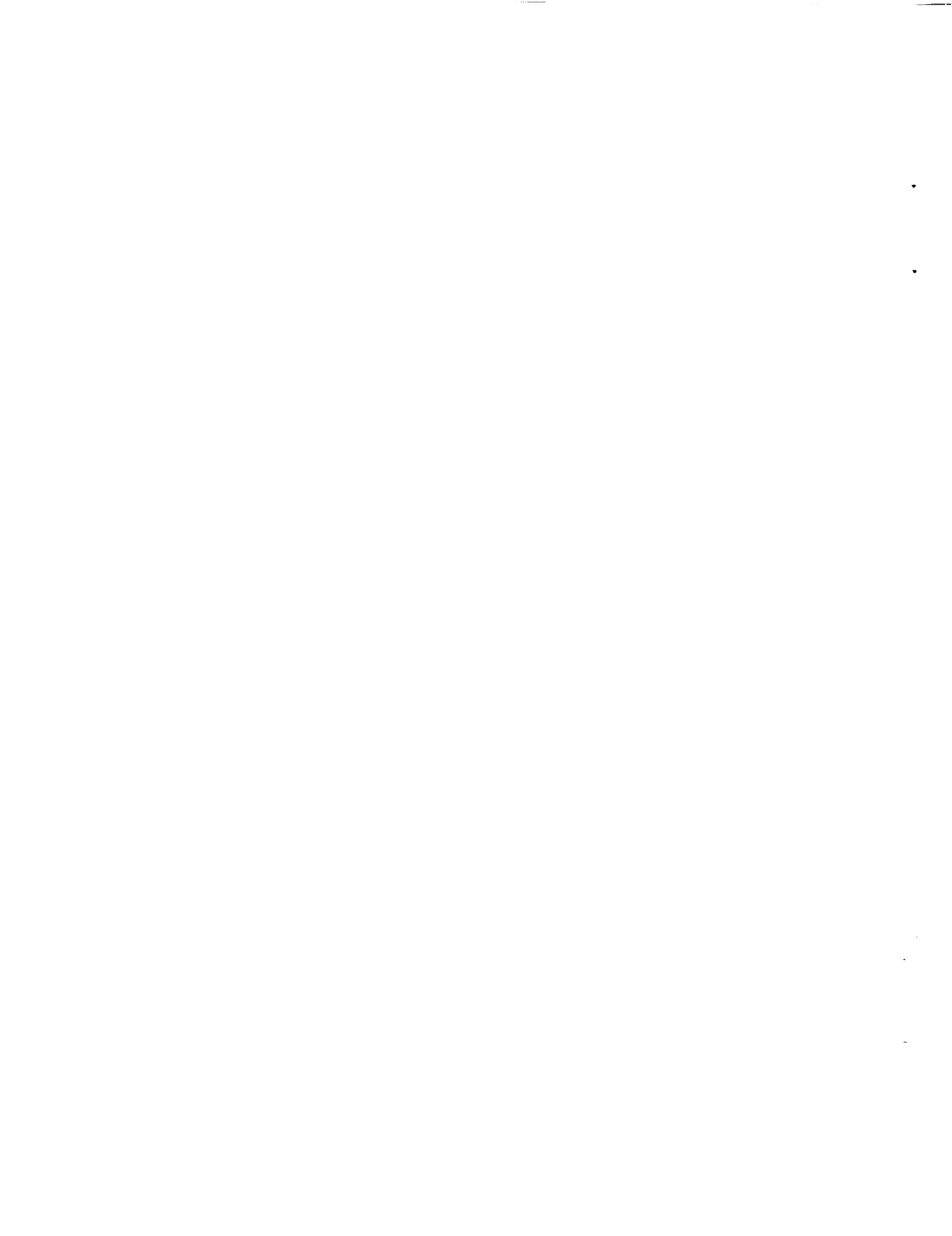

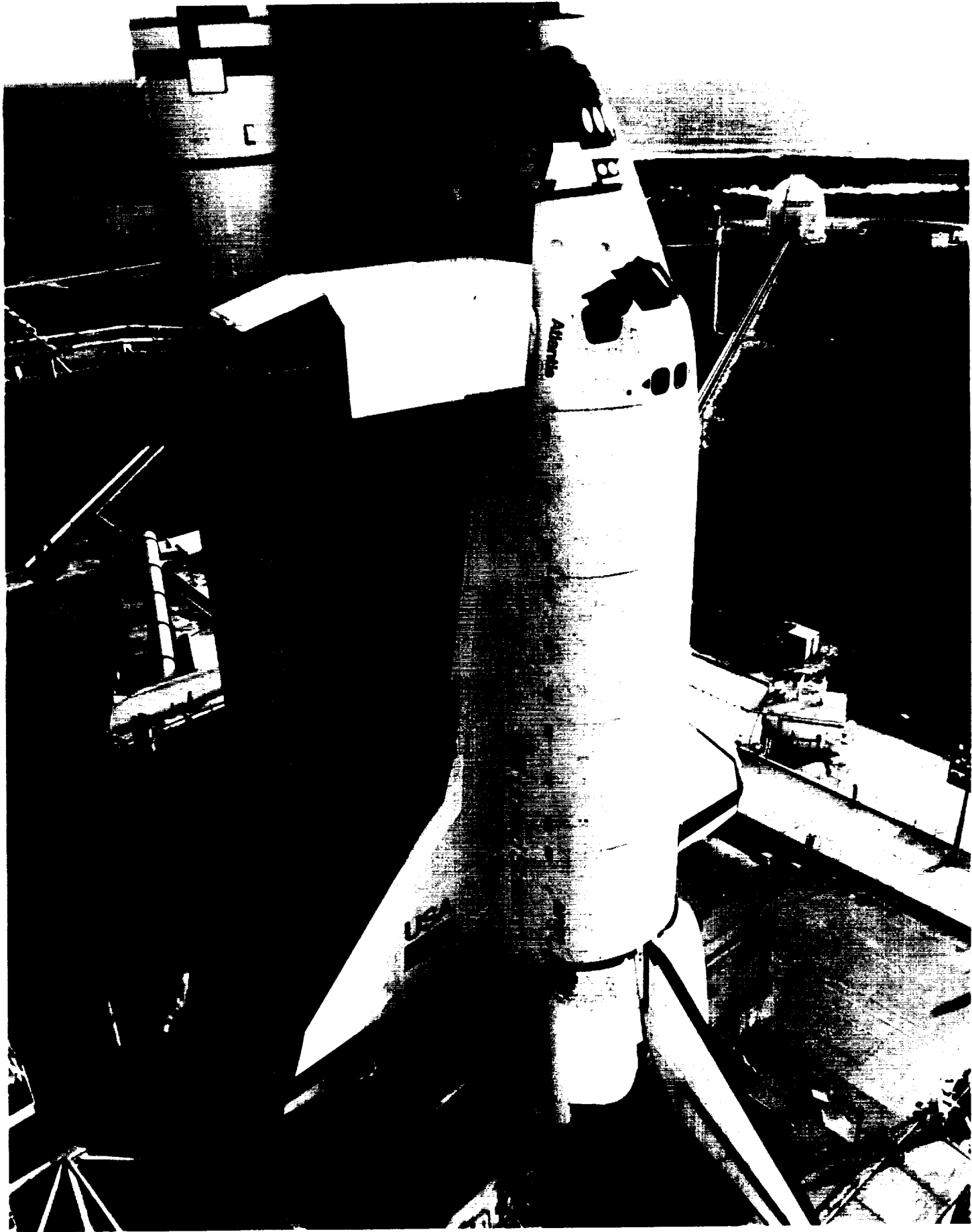

Overall view of the Orbiter Atlantis





Overall view of the ET intertank and LO2 tank acreage TPS
Southerly winds blew GOX vapors away from the vehicle



Overall view of the Solid Rocket Boosters/External Tank -Z side
Note reflection of condensate on aft hardpoint TPS closeout





Overall view of Shuttle Main Engines. Ice/frost accumulated at
SSME #2 nozzle-to-heat shield interface 3 o'clock position

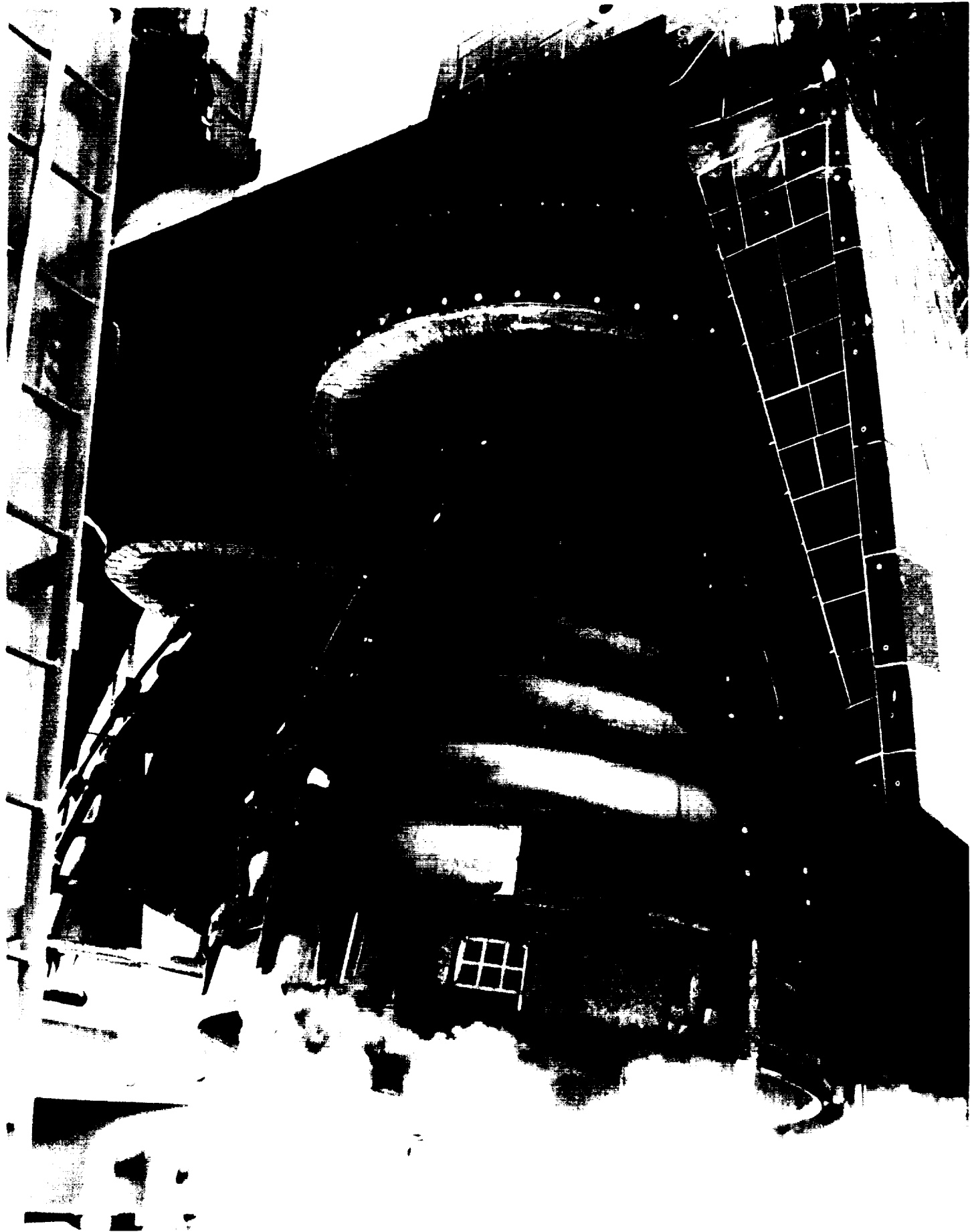

SSME #1 and #3 exhibit condensate on the engine mounted heat shields. Carrier panel Q-felt plugs show white-capped ends.



Moderate amount of condensate is visible on SSME #2 heatshield
Minimal ice/frost has formed on the Orbiter LH2 T-0 umbilical
32

ORIGINAL PAGE
COLOR PHOTOGRAPH

ORIGINAL PAGE
COLOR PHOTOGRAPH



Discolored RCS thruster paper cover may indicate presence of oxidizer vapors



Overall view of L02 tank ogive and barrel section. Sanded areas indicate location of previously installed instrumentation

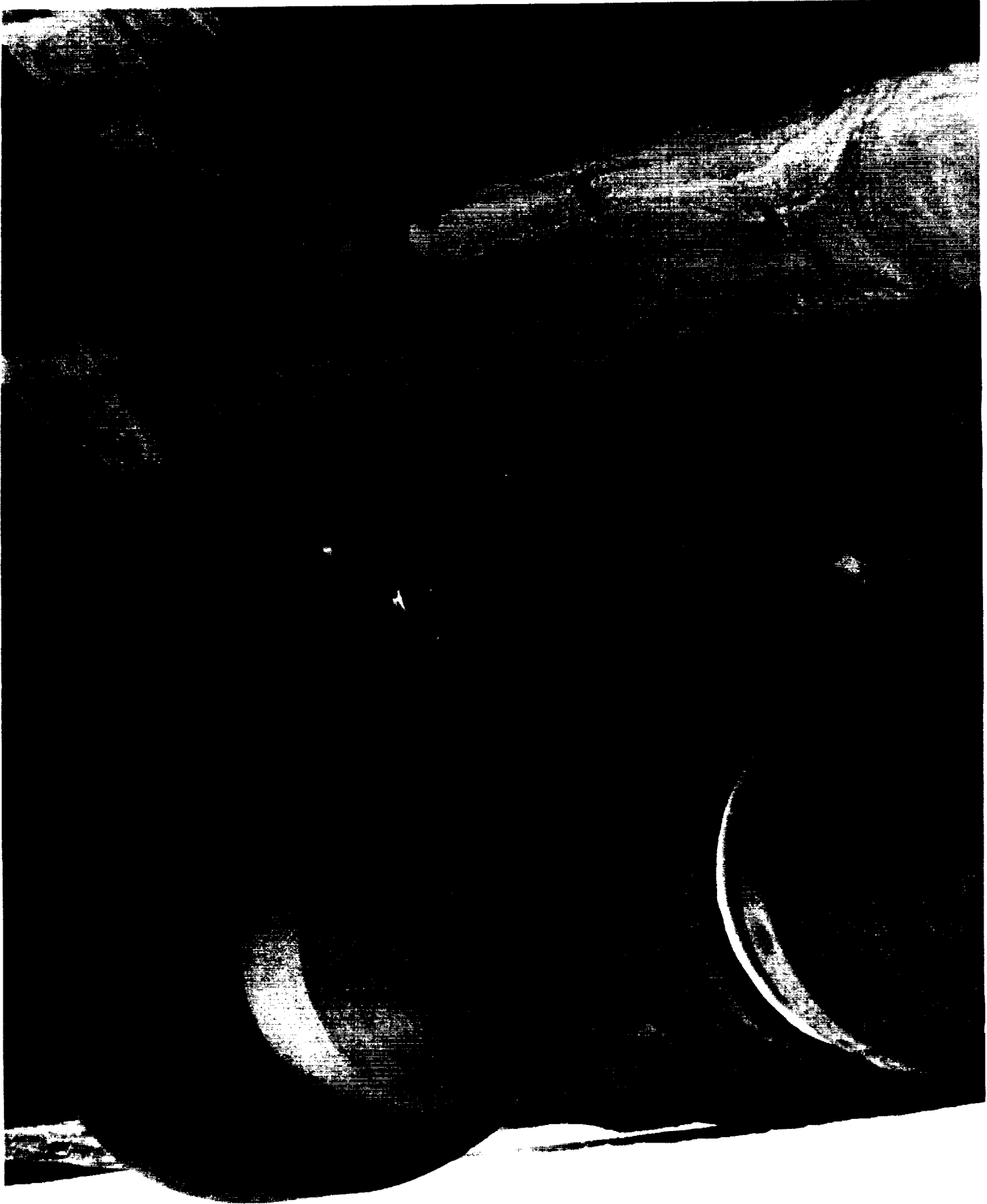

ORIGINAL PAGE
COLOR PHOTOGRAPH

Typical accumulation of ice/frost in LO2 feedline bellows
and support brackets





Typical formation of ice/frost in LO2 feedline support bracket



Frost-covered hard ice has formed in the L02 feedline bellows

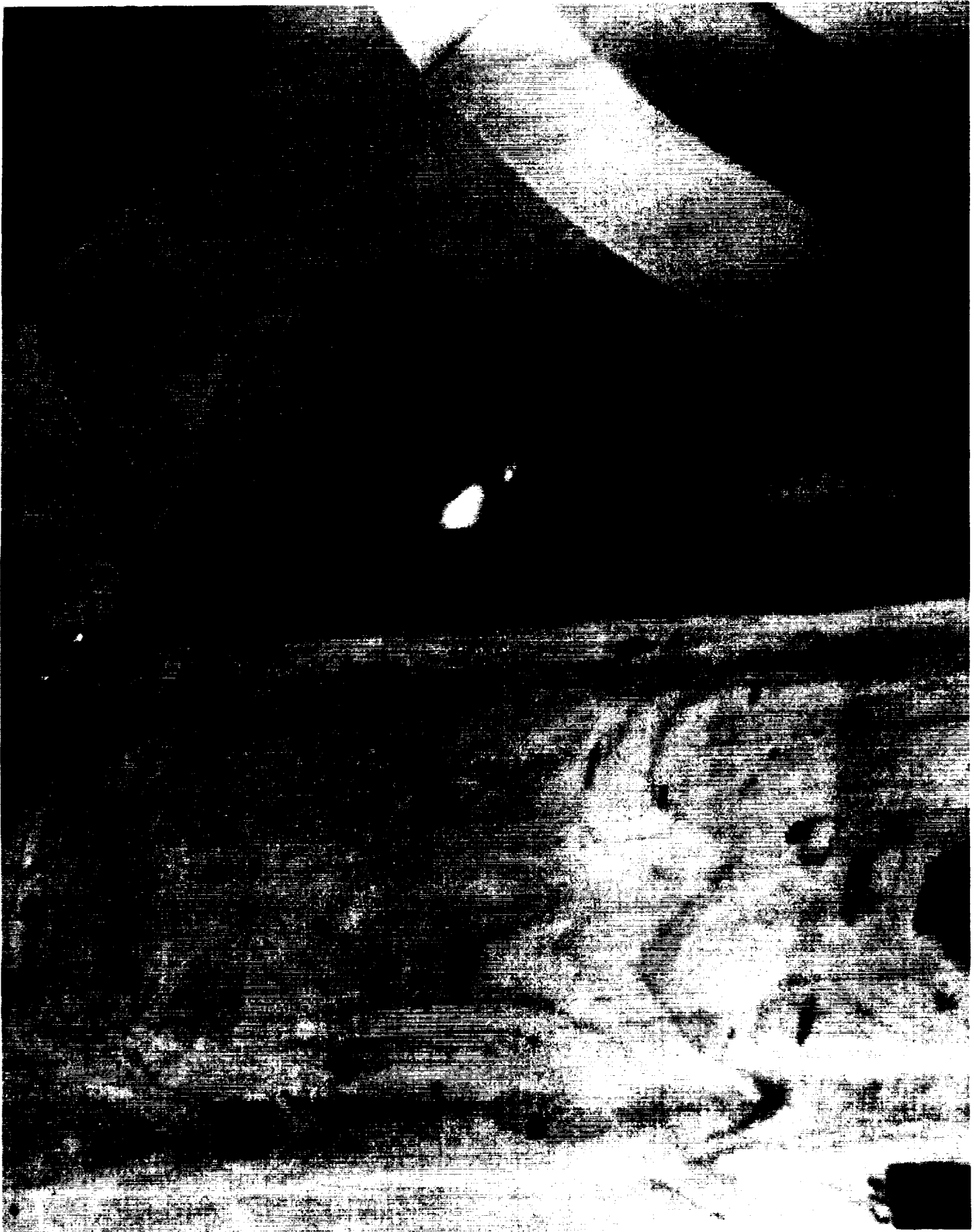

Frost marks location of TPS crack between ET thrust strut
and longeron

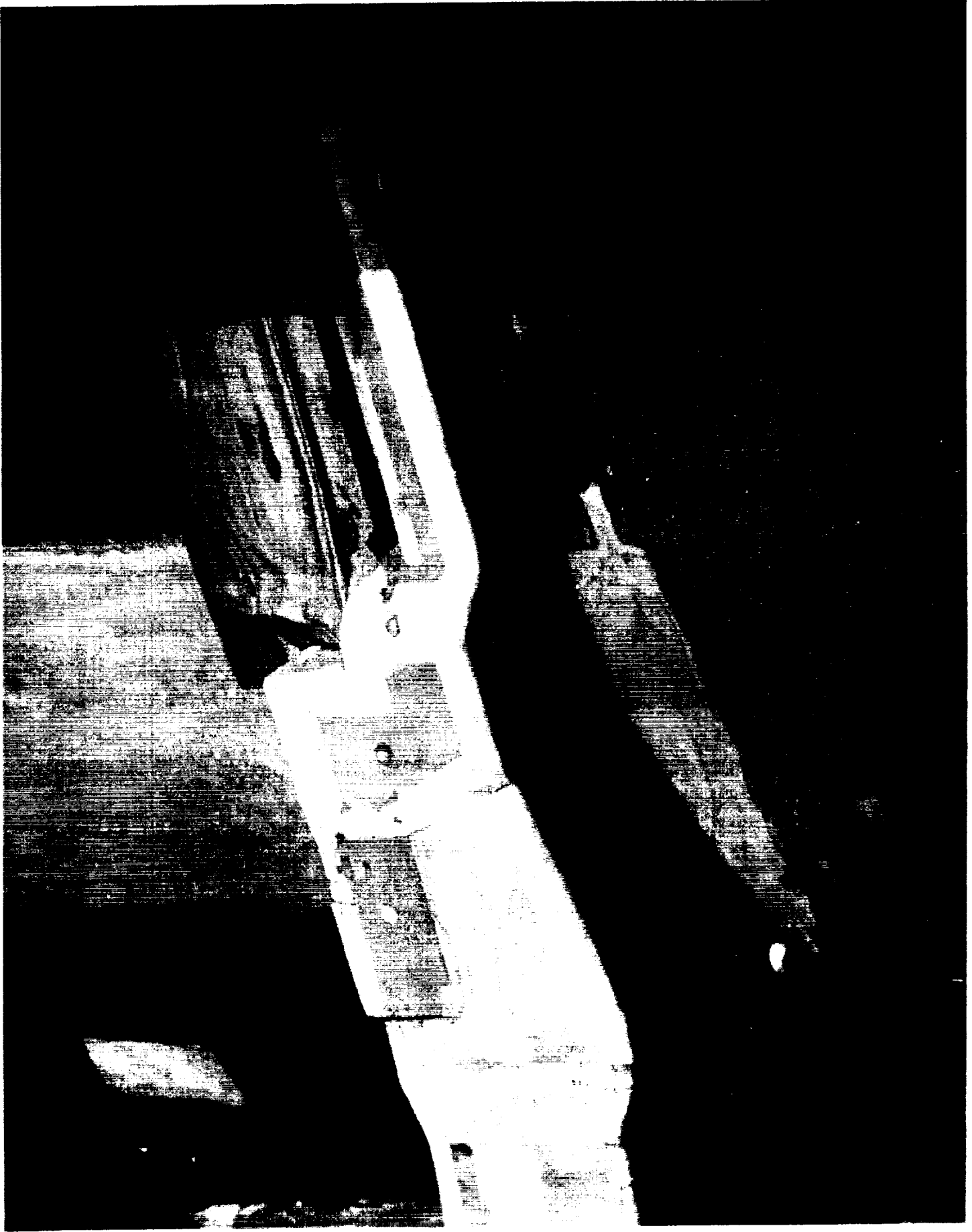

Frost areas mark location of unused instrumentation island
and small TPS crack

ORIGINAL PAGE
CGO 100 0000124

ORIGINAL PAGE
COLOR PHOTOGRAPH

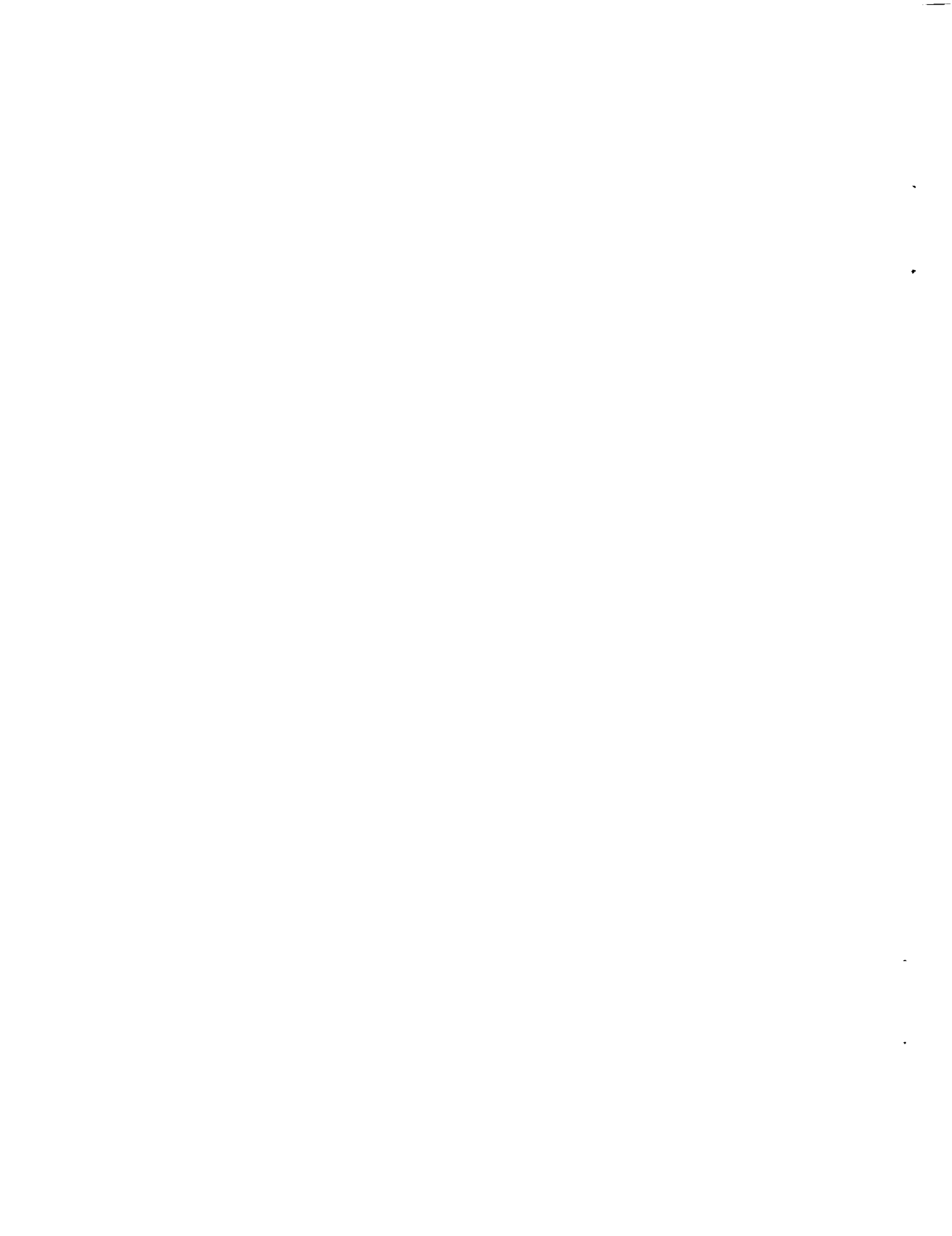



Typical ice/frost accumulation on LO2 ET/ORB umbilical
baggie and purge vent



ORIGINAL PAGE
COLOR PHOTOGRAPH

Overall view of ET/ORB umbilicals. Note missing piece of fire detector paper on thrust strut; small frost-covered TPS crack

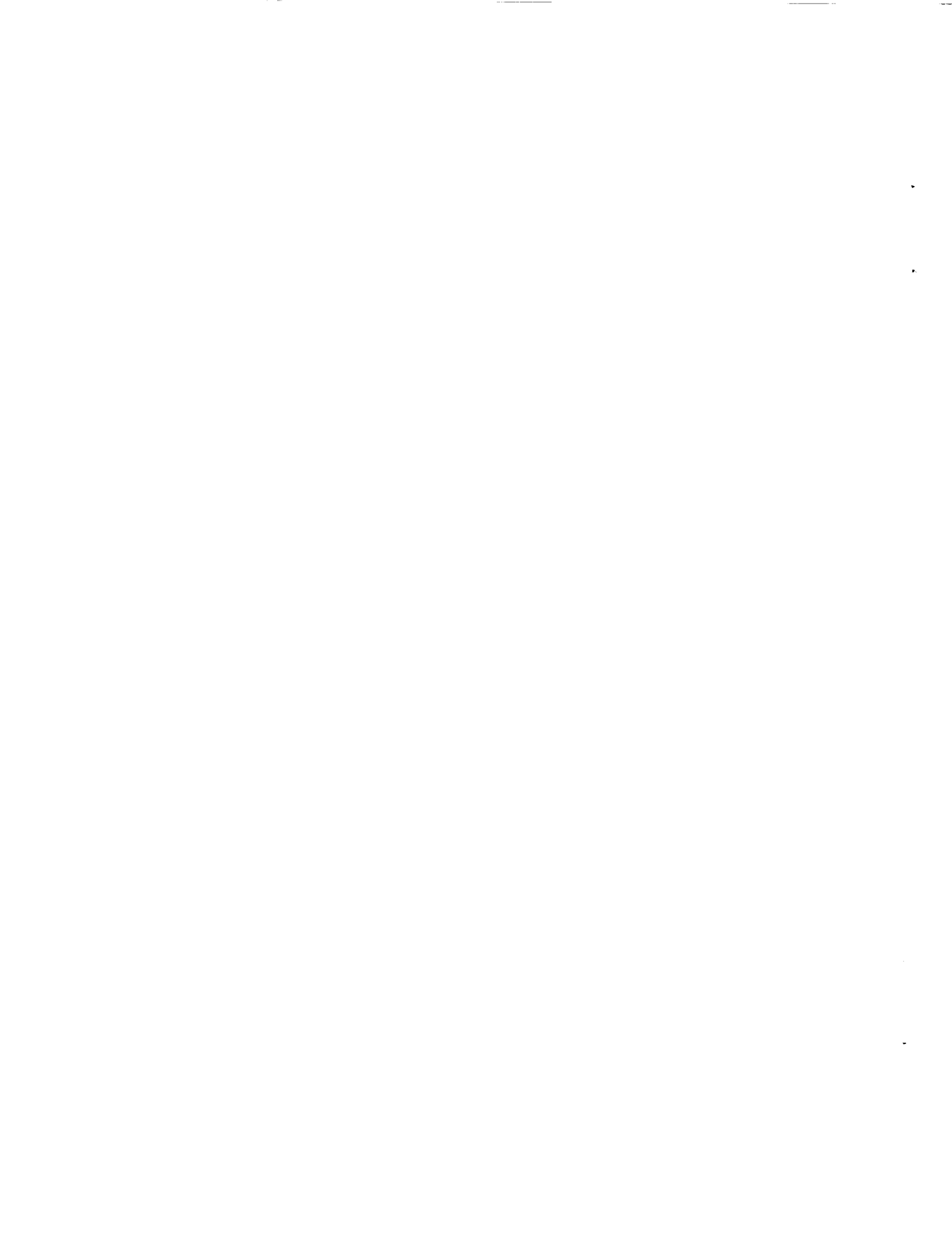



Heavy ice/frost formation on all sides of LH2 ET/ORB umbilical.
However, no frost accumulation in LH2 feedline bellows.

42

ORIGINAL PAGE
COLOR PHOTOGRAPH

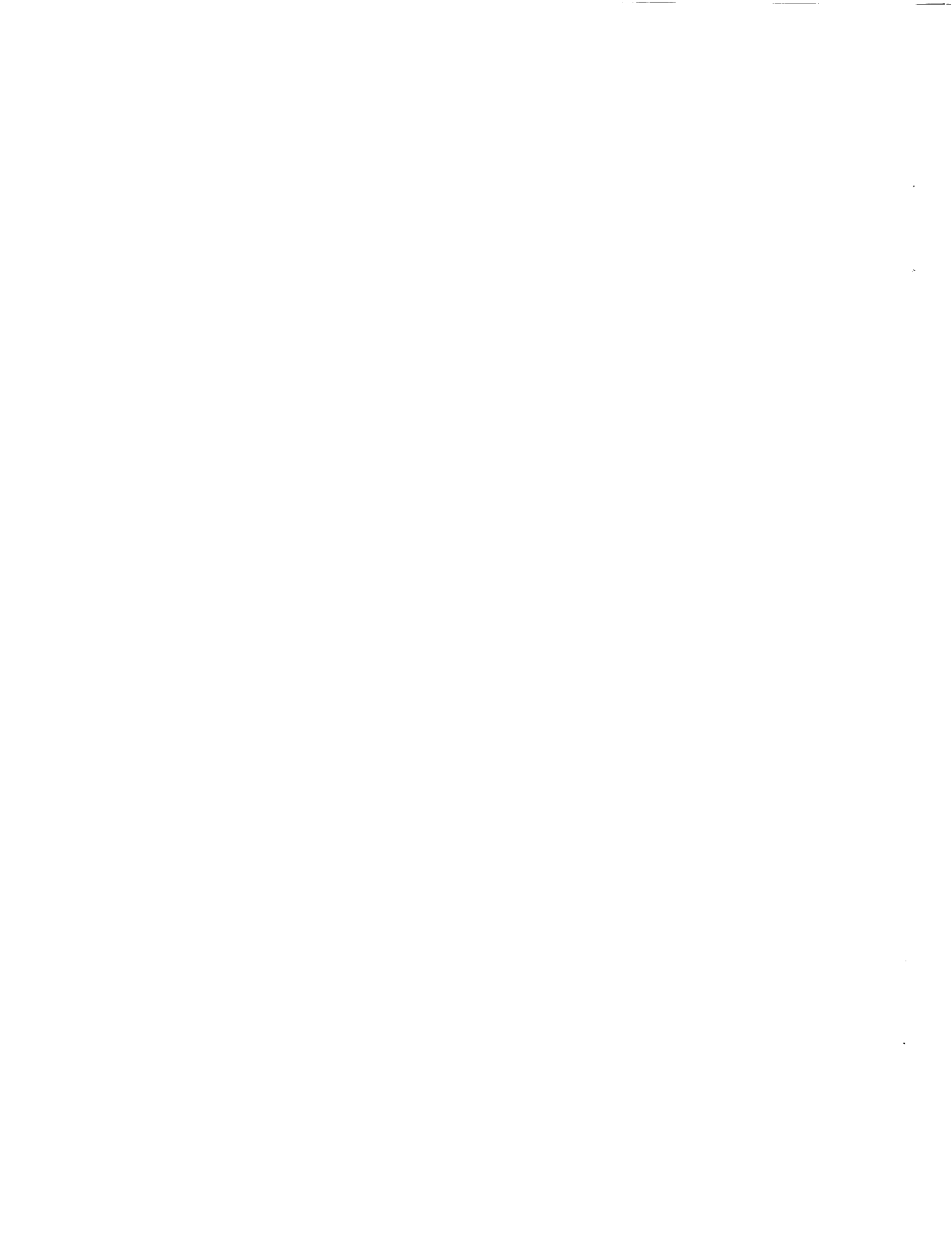



Frost marks location of square-shaped TPS repair on
LH2 feedline-to-umbilical interface



Vapors and liquid air drops fall from -Y bipod DFI box vent hole. Frost has formed along ramp closeout bond line.

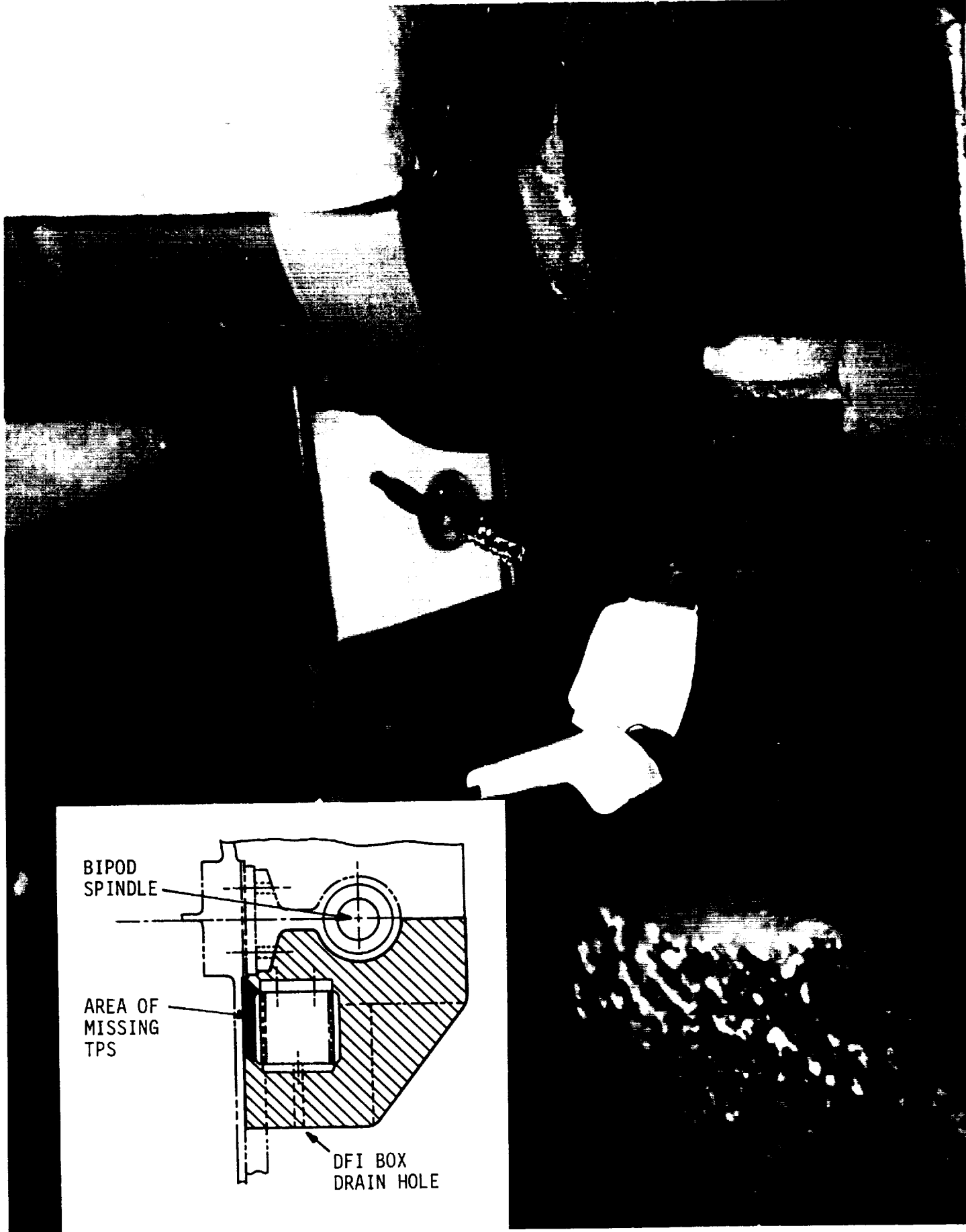

-Y bipod DFI connector box prior to closeout. Area of missing TPS caused liquid air to form after the ET was cryo-loaded.



GOX vapors vent equally from both exhaust ducts and are blown
away from vehicle by southerly winds



Several SRB primary sound suppression water troughs were low

4.6 POST DRAIN INSPECTION

The STS-34 launch was scrubbed due to weather constraints at the RTLS abort site. Both the LH2 and LO2 tanks had been filled to 100 percent. A post-drain inspection was performed from 1905 to 2130 hours on 17 October 1989. Since a 24-hour Scrub Turnaround was initiated, an examination of the MLP/pad was included along with the vehicle. The post drain inspection and the preflight pad debris inspection were combined.

The tumble valve cover exhibited no anomalies.

The -Y nosecone footprint area was missing topcoat and two sections of the grid mark. IPR-34RV-0238 was generated with disposition to use-as-is.

No TPS damage, such as divots or cracks on the tank acreage, were visible except for a 2-1/2 inch diameter PDL closeout missing on the LH2 aft dome. IPR-34RV-0237 was generated with disposition to use-as-is since underlying ablator is adequate for ascent heating protection.

The -Y bipod strut DFI box closeout had no visible TPS damage.

A solid, 2-1/2 inch diameter by 1 inch thick ice ball had formed on the aft face of the +Y vertical cable tray instrumentation island. This island was utilized for VAFB DFI, is not currently used by KSC, and will not be flown on later tanks.

A crack, 12 inches in length, was visible in the +Y LH2 longeron TPS. This has typically occurred after detanking other vehicles and is acceptable per NSTS-08303.

A small amount of solid ice still remained in the LH2 feedline bellows and LH2 recirculation line bellows. Solid ice was attached to five of the LH2 umbilical purge vents. Ice 1 inch thick still covered EB-7 and EB-8. All of this ice has occurred previously on other vehicles and is acceptable per NSTS-08303.

There were no Orbiter or SRB TPS anomalies.



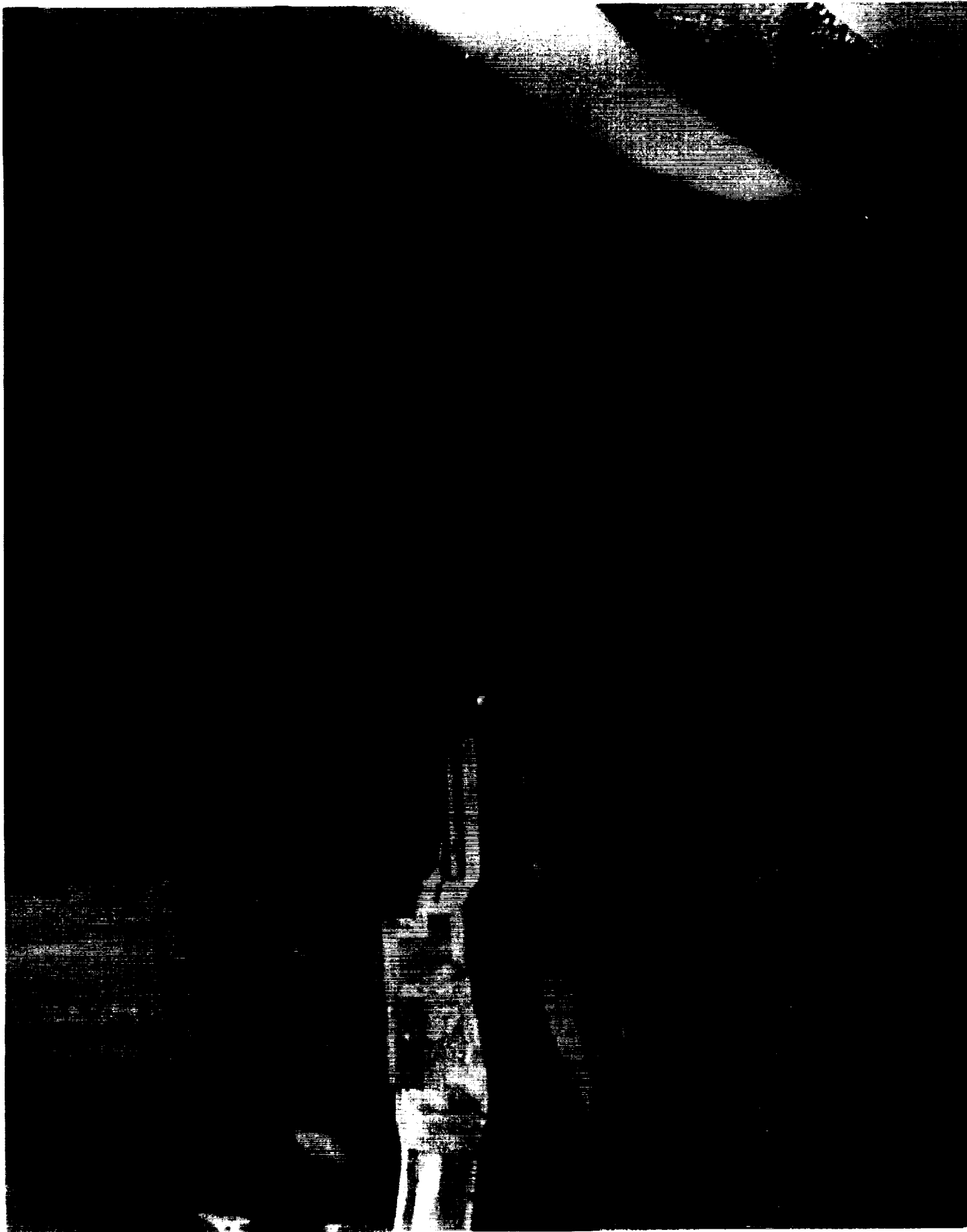

Hard ice still remained on unused ET instrumentation island

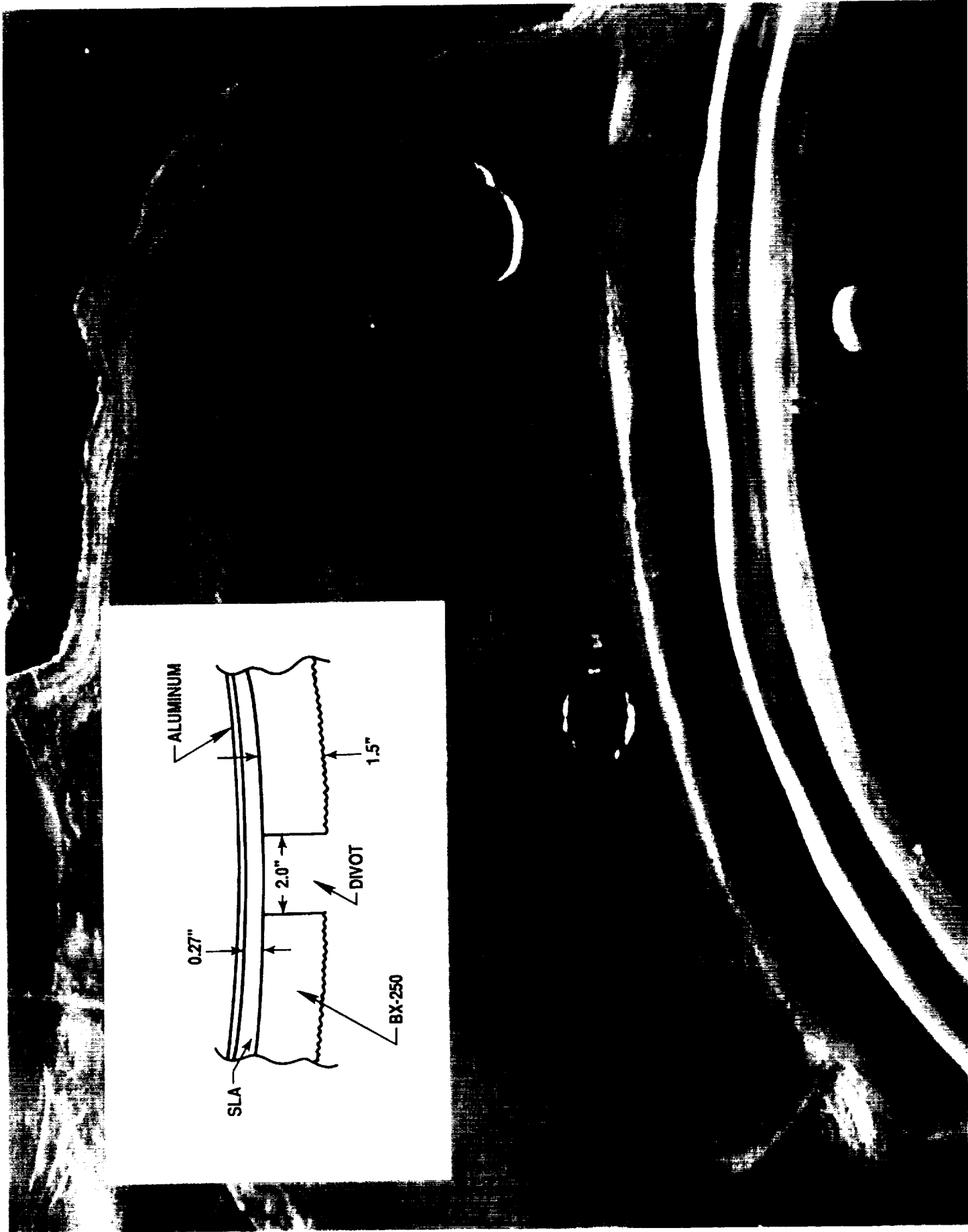

FT post drain inspection revealed at 2.5 inch divot on the aft dome apex. Nearby repair shows frost on isochem bondline.

5.0 LAUNCH

STS-34 was launched at 1253 EST on 18 October 1989.

5.1 ICE/FROST INSPECTION

The Ice/Frost Inspection of the cryoloaded vehicle was performed on 18 October 1989 from 0715 to 0900 hours during the two hour built-in-hold at T-3 hours in the countdown. There were no violations of NSTS-08303 or the Launch Commit Criteria. Ambient weather conditions at the time of the inspection were:

Temperature:	75.5 F
Relative Humidity:	81.3 %
Wind Speed:	5 Knots
Wind Direction:	203 Degrees

The portable STI infrared scanner was utilized to obtain surface temperature measurements for an overall thermal assessment of the vehicle, as shown in Figure 6 and 7.

5.2 ORBITER OBSERVATIONS

No Orbiter tile anomalies were observed. The average Orbiter surface temperature was recorded as 76 degrees F. The average surface temperatures of the SSME engine mounted heat shields were measured at 64 degrees F for SSME #1, 49 degrees F for SSME #2, and 62 degrees F for SSME #3. A small amount of ice was visible on the nozzle to heat shield interface of SSME #2. Condensate, but no ice or frost, was present on all of the SSME heat shields.

5.3 SRB OBSERVATIONS

No SRB anomalies or loose ablator/cork were observed. The STI portable infrared scanner recorded RH and LH SRB case surface temperatures between 78 and 81 degrees F. Temperatures in the area of the SRB field joint heaters ranged from 84 to 86 degrees F. The predicted Propellant Mean Bulk Temperature (PMBT) supplied by MTI was 82 degrees F.

FIGURE 6. INFRA RED SCANNER SSV SUMMARY DATA

TIME: 0700 - 0900
 DATE: 10/18/89
 VEH. STS 34

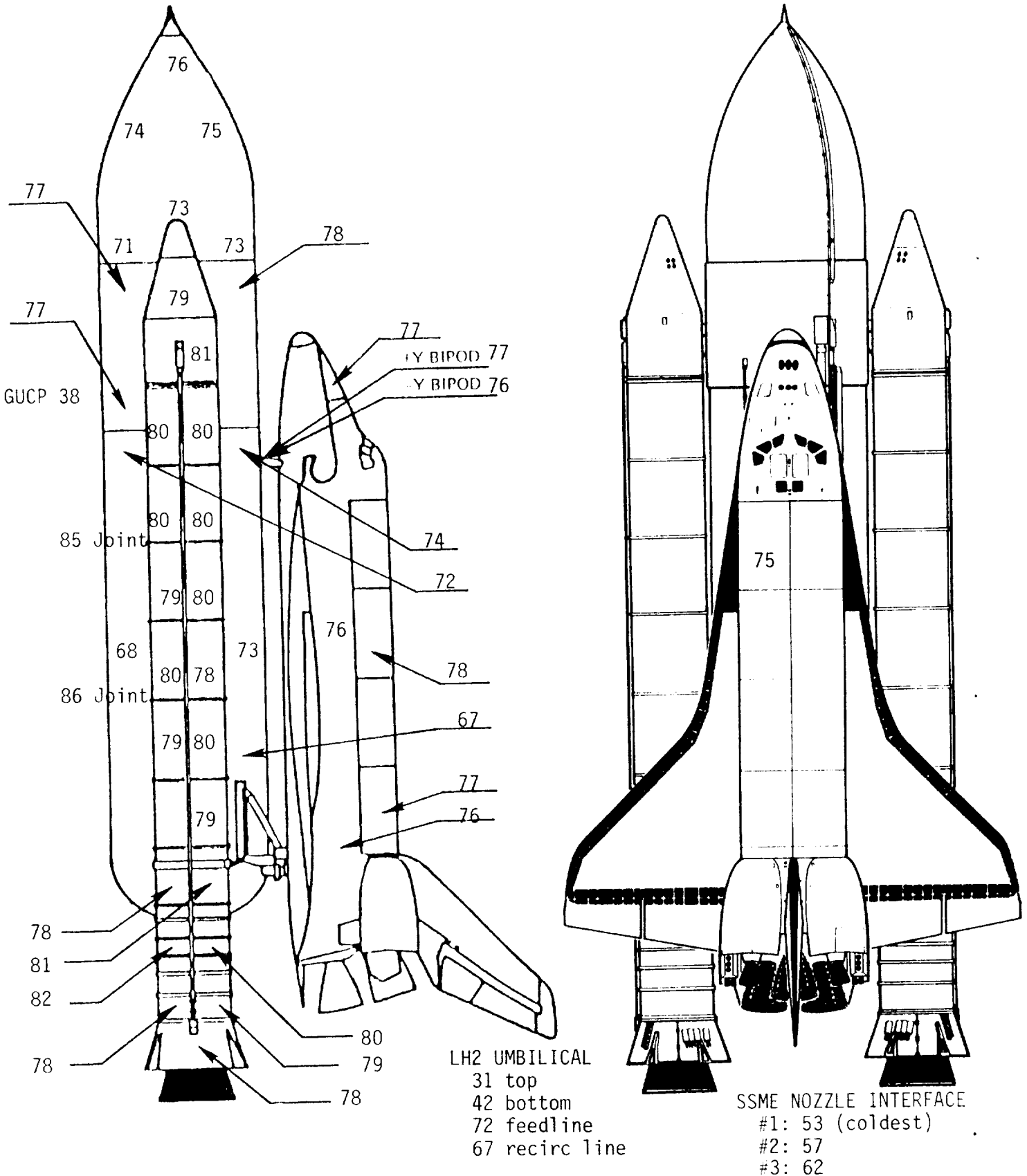
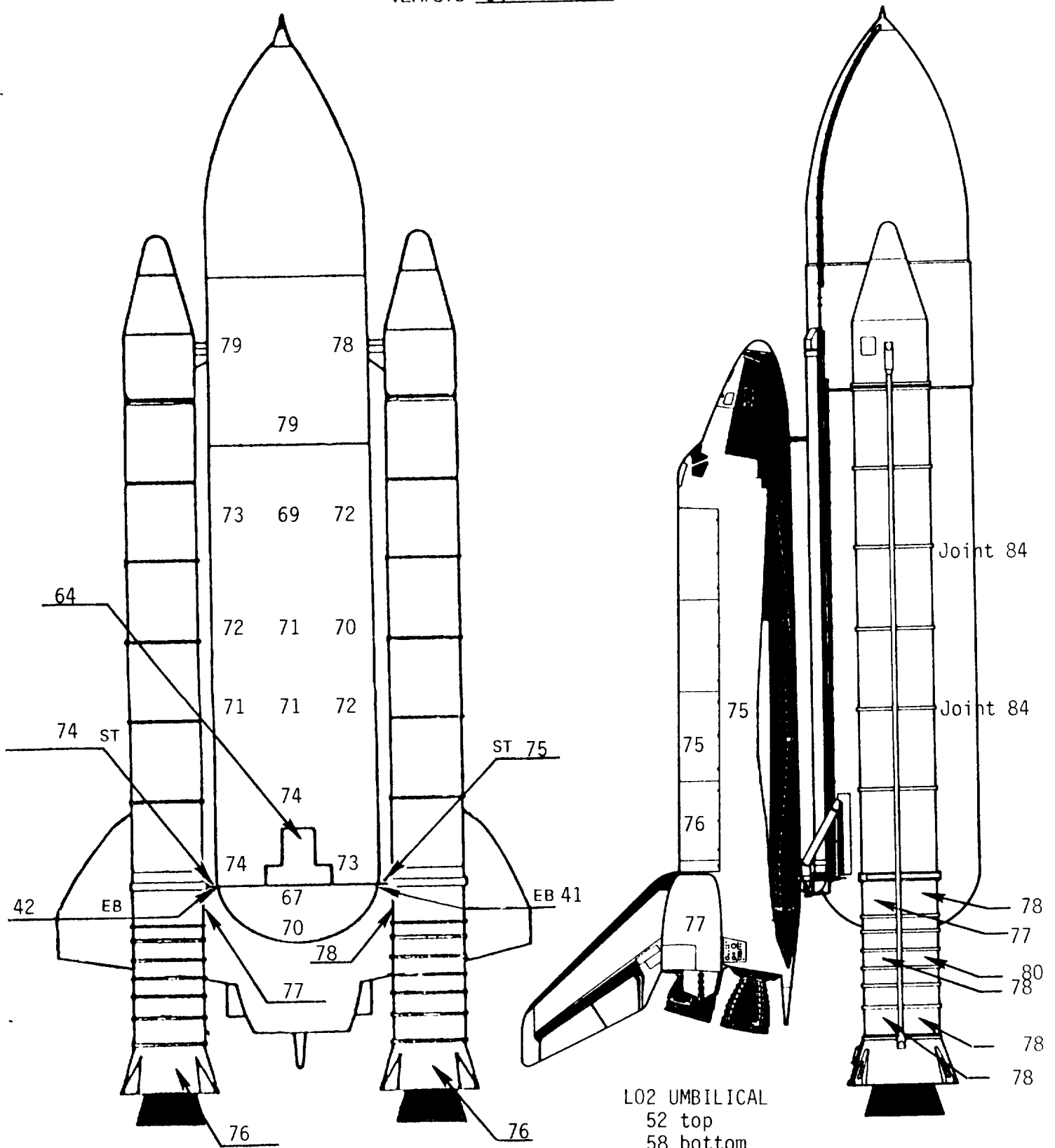

FIGURE 7. INFRA RED SCANNER SSV SUMMARY DATA

TIME: 0700 - 0900
 DATE: 10/18/89
 VEH. STS- 34



SSME NOZZLE-TO-H/S INTERFACE

- #1: 71 (51 on eyeball)
- #2: 40 (coldest)
- #3: 62

L02 UMBILICAL
 52 top
 58 bottom
 68 F/L elbow

5.4 EXTERNAL TANK OBSERVATIONS

The ice/frost prediction computer program was run from 0415 to 1253 hours and the results tabulated in Figures 8, 9, and 10. The program predicted condensate with no ice accumulation on all TPS acreage surfaces.

Acreage condensate, but no ice or frost, was present on the LO2 tank, Intertank (run on), and LH2 tank. The IR scanner measured an average surface temperature of 74 degrees F on the LO2 tank, 78 degrees F on the Intertank, and 71 degrees F on the upper and lower LH2 tank.

An average amount of condensate trickled down the LH2 tank and ran off the aft dome. There was no acreage ice or frost. A 2.5 inch divot on the aft dome apex, which had been discovered during the post drain inspection, was 2/3 full of ice. An adjacent repair exhibited a frost ring on the isochem bond line. These were acceptable per NSTS-08303.

Small cracks filled with frost were present in the areas between the thrust struts and LH2 tank longerons (both sides). Some vapors were emitted from the -Y side while some loose foam was visible on the +Y side. These cracks formed during ET detank and were acceptable per NSTS-08303. Three small frost areas had formed on the aft faces of both ET/SRB cable trays.

Ice/Frost covered the lower EB fittings outboard to the strut pin hole with condensate on the rest of the fitting. The struts were dry and were not covered by ice.

The LO2 ET/ORB umbilical exhibited light accumulations of frost on both the inboard and outboard sides. Frost fingers had formed on the purge vents and normal venting was occurring.

There was minor frost, but no ice, in the LH2 feedline bellows. Heavy ice had formed in the LH2 recirculation line bellows, but this was acceptable per NSTS-08303. The top and sides of the LH2 ET/ORB umbilical were covered by heavy, but typical, ice/frost. This coverage is acceptable per NSTS-08303. There were no unusual vapors emanating from the umbilicals or any evidence of leakage.

Hard ice was present in the LO2 feedline bellows and support brackets. Several pressurization line ice/frost ramps had ice on the trailing edges. These conditions are acceptable per NSTS-08303.

Run-on condensate from the LO2 tank was present on the inter-tank. Minor frost had formed around the GUCP, but there was no sign of leakage.

The tumble valve cover, which was not replaced during the recycle, remained intact with no sign of degradation.

TEST: S0007 Launch													DATE		T-0 TIME		DATE																		
STS-34													10/18/89		10/18/89																				
ORBITER	ET	SRB	MLP	PAD	LO2				LO2				LO2				LO2				LO2				LM2										
OV-104	27	B1032	1	39B	CHILDDOWN TIME 0413	SLOW FILL TIME 0413	FAST FILL TIME 0427	REPLENISH TIME 0702	CHILDDOWN TIME 0316	SLOW FILL TIME 0347	FAST FILL TIME 0412	REPLENISH TIME 0626	CHILDDOWN TIME 0352	SLOW FILL TIME 0746	FAST FILL TIME 0746	REPLENISH TIME 0746	CHILDDOWN TIME 0746	SLOW FILL TIME 0746	FAST FILL TIME 0746	REPLENISH TIME 0746	CHILDDOWN TIME 0746	SLOW FILL TIME 0746	FAST FILL TIME 0746	REPLENISH TIME 0746	CHILDDOWN TIME 0746	SLOW FILL TIME 0746	FAST FILL TIME 0746	REPLENISH TIME 0746	CHILDDOWN TIME 0746	SLOW FILL TIME 0746	FAST FILL TIME 0746	REPLENISH TIME 0746			
LOCAL TIME	TEMP. OF	REL. HUM. %	DEW PT. OF	WIND VEL. KNTS	WIND DIR. DEG.	CONDITIONS					REGION	LOCAL VEL. KNTS	SOFT TEMP. OF	COND. RATE IN/HR	ICE RATE IN/HR	REGION	LOCAL VEL. KNTS	SOFT TEMP. OF	COND. RATE IN/HR	ICE RATE IN/HR	REGION	LOCAL VEL. KNTS	SOFT TEMP. OF	COND. RATE IN/HR	ICE RATE IN/HR	REGION	LOCAL VEL. KNTS	SOFT TEMP. OF	COND. RATE IN/HR	ICE RATE IN/HR	REGION	LOCAL VEL. KNTS	SOFT TEMP. OF	COND. RATE IN/HR	ICE RATE IN/HR
						LO2 TANK STA 370 TO 543	LO2 TANK STA 550 TO B52	LO2 TANK STA 1130 TO 1380	LO2 TANK STA 1380 TO 2058																										
0415	75.8	78	63.75	3	162	1.77	59.68	.0019	.0992	II	1.77	51.42	.0032	.0746	II	1.26	49.90	.0034	.0689	II	1.14	49.90	.0034	.0689	II	1.14	49.90	.0034	.0689	II	1.14	49.90	.0034	.0689	
0430	75.1	80	68.77	4	163	2.36	61.09	.0021	.1075	II	2.36	54.13	.0036	.0784	II	1.63	49.44	.0035	.0670	II	1.52	49.44	.0035	.0670	II	1.52	49.44	.0035	.0670	II	1.52	49.44	.0035	.0670	
0445	75.6	80	69.26	3	151	1.77	59.90	.0021	.1001	II	1.77	51.64	.0033	.0754	II	0.96	50.05	.0035	.0754	II	4.17	59.09	.0044	.1381	II	4.17	59.09	.0044	.1381	II	4.17	59.09	.0044	.1381	
0500	74.5	81	68.53	3	158	1.77	58.83	.0021	.0946	II	1.77	50.49	.0033	.0732	II	1.26	48.89	.0035	.0647	II	1.14	48.89	.0035	.0647	II	1.14	48.89	.0035	.0647	II	1.14	48.89	.0035	.0647	
0515	74.5	82	68.87	4	156	2.36	60.86	.0023	.1065	II	2.36	53.87	.0037	.0774	II	1.28	49.09	.0036	.0656	II	5.56	60.70	.0048	.1792	II	5.56	60.70	.0048	.1792	II	5.56	60.70	.0048	.1792	
0530	75.0	82	69.37	4	148	2.36	61.43	.0023	.1098	II	2.36	54.49	.0037	.0799	II	1.28	49.70	.0036	.0683	II	5.56	61.27	.0047	.1836	II	5.56	61.27	.0047	.1836	II	5.56	61.27	.0047	.1836	
0545	75.2	82	69.57	5	151	2.95	62.94	.0023	.1316	II	2.95	56.93	.0040	.1018	II	1.60	49.95	.0038	.0694	II	6.95	63.07	.0048	.2317	II	6.95	63.07	.0048	.2317	II	6.95	63.07	.0048	.2317	
0600	74.7	81	68.73	5	141	2.95	62.14	.0023	.1273	II	2.95	56.11	.0039	.0975	II	1.60	49.14	.0035	.0658	II	6.95	62.27	.0045	.2241	II	6.95	62.27	.0045	.2241	II	6.95	62.27	.0045	.2241	
0615	75.3	80	68.97	6	143	3.54	63.54	.0023	.1504	II	3.54	58.26	.0040	.1203	II	1.92	50.55	.0036	.0681	II	8.34	63.80	.0045	.2730	II	8.34	63.80	.0045	.2730	II	8.34	63.80	.0045	.2730	
0630	75.6	80	69.26	5	153	2.95	62.92	.0023	.1314	II	2.95	56.95	.0038	.1017	II	1.60	50.05	.0035	.0698	II	6.95	63.01	.0046	.2311	II	6.95	63.01	.0046	.2311	II	6.95	63.01	.0046	.2311	
0645	75.5	80	69.17	4	164	2.36	61.55	.0023	.1096	II	2.36	54.63	.0036	.0804	II	1.68	49.93	.0035	.0692	II	1.52	49.93	.0035	.0692	II	1.52	49.93	.0035	.0692	II	1.52	49.93	.0035	.0692	
0700	75.0	81	69.02	4	167	2.36	61.20	.0023	.1080	II	2.36	54.25	.0036	.0789	II	1.63	49.51	.0035	.0673	II	1.52	49.51	.0035	.0673	II	1.52	49.51	.0035	.0673	II	1.52	49.51	.0035	.0673	
0715	74.7	82	69.07	4	191	2.36	61.09	.0023	.1075	II	2.36	54.11	.0037	.0784	II	1.68	49.33	.0036	.0667	II	1.52	49.33	.0036	.0667	II	1.52	49.33	.0036	.0667	II	1.52	49.33	.0036	.0667	
0730	74.4	82	68.77	4	209	2.36	60.74	.0023	.1060	II	2.36	53.74	.0037	.0769	II	1.28	48.96	.0036	.0650	II	5.44	60.42	.0047	.1744	II	5.44	60.42	.0047	.1744	II	5.44	60.42	.0047	.1744	
0745	74.1	83	68.82	4	214	2.36	60.62	.0023	.1054	II	2.36	53.62	.0037	.0764	II	1.28	48.78	.0036	.0643	II	5.44	60.33	.0047	.1737	II	5.44	60.33	.0047	.1737	II	5.44	60.33	.0047	.1737	

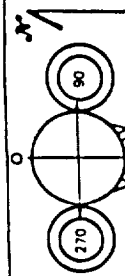

FIGURE 8. Ice/Frost Computer Predictions

STS-34		TEST:				S0007 Launch				DATE:		10/18/89		T-0 TIME: 233:40		DATE: 10/18/89														
ORBITER	ET	ISRB	MLP	PAD	LO2		LO2		LO2		LO2		LO2		LO2		LO2													
OV-104	27	B1032	1	39B	CHILLDOWN TIME: 0349	FAST FILL TIME: 0427	CHILLDOWN TIME: 0316	FAST FILL TIME: 0412	CHILLDOWN TIME: 0347	FAST FILL TIME: 0626	CHILLDOWN TIME: 0316	FAST FILL TIME: 0412	CHILLDOWN TIME: 0347	FAST FILL TIME: 0626	CHILLDOWN TIME: 0316	FAST FILL TIME: 0412	CHILLDOWN TIME: 0347	FAST FILL TIME: 0626												
LOCAL TIME		TEMP. OF	REL. MJM. %	DEW PT. OF	WIND VEL. KNTS	WIND DIR. DEG	REGION	LOCAL VEL. KNTS	SOFTI TEMP. OF	COND. RATE IN/HR	ICE RATE IN/HR	REC'DN KNTS	LOCAL VEL. KNTS	SOFTI TEMP. OF	COND. RATE IN/HR	ICE RATE IN/HR	REC'DN KNTS	LOCAL VEL. KNTS	SOFTI TEMP. OF	COND. RATE IN/HR	ICE RATE IN/HR	REC'DN KNTS	LOCAL VEL. KNTS	SOFTI TEMP. OF	COND. RATE IN/HR	ICE RATE IN/HR				
0800	74.8	83	59.51	4	208	II	2.36	61.42	.0024	.1091	II	2.36	54.47	.0038	.0799	II	1.28	49.65	.0036	.0581	II	1.28	54.47	.0038	.0799	II	5.44	61.12	.0048	.1797
0815	76.4	81	70.41	7	196	II	4.13	65.72	.0024	.1807	II	4.13	61.11	.0042	.1499	II	2.94	56.92	.0043	.1016	II	2.94	61.11	.0042	.1499	II	2.66	55.90	.0042	.0914
0830	76.0	81	70.01	5	202	II	2.95	63.66	.0023	.1351	II	2.95	57.67	.0038	.1053	II	2.10	52.73	.0038	.0729	II	2.10	57.67	.0038	.1053	II	1.90	51.55	.0037	.0729
0845	76.6	79	69.90	7	201	II	4.13	65.46	.0022	.1788	II	4.13	60.84	.0041	.1481	II	2.94	56.67	.0041	.1003	II	2.94	60.84	.0041	.1481	II	2.66	55.64	.0040	.0902
0900	77.2	79	70.49	6	199	II	3.54	65.39	.0023	.1617	II	3.54	60.24	.0040	.1313	II	2.52	55.79	.0040	.0883	II	2.52	60.24	.0040	.1313	II	2.28	54.69	.0039	.0794
0915	76.9	78	69.83	5	202	II	2.95	63.90	.0022	.1366	II	2.95	57.99	.0038	.1088	II	2.10	53.13	.0037	.0751	II	2.10	57.99	.0038	.1088	II	1.90	51.97	.0036	.0751
0930	77.2	78	70.13	5	188	II	2.95	64.24	.0022	.1385	II	2.95	58.35	.0038	.1086	II	2.10	53.51	.0037	.0768	II	2.10	58.35	.0038	.1086	II	1.90	52.35	.0036	.0768
0945	78.8	75	70.60	6	189	II	3.54	66.16	.0020	.1664	II	3.54	61.07	.0038	.1359	II	2.52	56.73	.0039	.0923	II	2.52	61.07	.0038	.1359	II	2.28	55.65	.0038	.0832
1000	80.2	73	71.21	6	184	II	3.54	67.16	.0019	.1728	II	3.54	62.14	.0037	.1421	II	2.52	57.90	.0038	.0974	II	2.52	62.14	.0037	.1421	II	2.28	56.84	.0037	.0867
1015	80.2	70	70.02	6	205	II	3.54	66.38	.0016	.1676	II	3.54	61.31	.0034	.1372	II	1.92	54.17	.0033	.0853	II	1.92	61.31	.0033	.1372	II	8.16	66.26	.0033	.2955
1030	80.8	69	70.20	6	204	II	3.54	66.75	.0015	.1670	II	3.54	61.72	.0034	.1395	II	1.92	54.64	.0033	.0876	II	1.92	61.72	.0033	.1395	II	8.16	66.61	.0032	.2994
1045	82.0	64	69.25	6	157	II	3.54	66.66	.0011	.1691	II	3.54	61.65	.0030	.1388	II	1.92	54.72	.0030	.0885	II	1.92	61.65	.0030	.1388	II	8.34	66.51	.0025	.3028
1100	82.6	61	68.49	9	170	II	5.31	67.93	.0004	.2315	II	5.31	64.24	.0024	.2000	II	3.78	61.01	.0030	.1405	II	3.78	64.24	.0024	.2000	II	3.42	60.17	.0030	.1276
1115	82.2	60	67.63	6	167	II	3.54	65.72	.0008	.1631	II	3.54	60.68	.0026	.1330	II	2.52	56.60	.0029	.0914	II	2.52	60.68	.0026	.1330	II	2.28	55.59	.0029	.0947
1130	84.3	56	67.73	11	170	I	6.49	70.16	.0000	.2744	II	6.49	65.58	.0015	.2422	II	4.62	62.83	.0024	.1719	II	4.62	65.58	.0015	.2422	II	4.18	62.10	.0025	.1564

EGC-V-340

FIGURE 9. Ice/Frost Computer Predictions

Liquid air drops and vapors continued to emanate from the -Y bipod DFI connector box vent hole (on the aft face) in a manner similar to that observed during the launch attempt the previous day. The ice/frost area was smaller than the previous day's accumulation and was considered acceptable per the response to IPR 34RV-0233.

The ET/ORB hydrogen detection sensor tygon tubing was not reinstalled after the scrub due lack of RSS access to the vehicle.

The summary of ice/frost team observation anomalies consists of 6 OTV recorded items:

Anomaly 001 recorded ice/frost formation on the +Y vertical strut/cable tray DFI location. This formation was within the experience database of the ice/debris team and was acceptable per NSTS-08303.

Anomaly 002 and 003 documented a crack with associated frost in the TPS of the +Y and -Y thrust strut crotch areas, respectively. These conditions were acceptable per NSTS-08303.

The formation of ice/frost along the -Y bipod DFI closeout bond line was documented on Anomaly 004. Liquid air dripped from the box vent hole. PR ET-27-TS-0065 was dispositioned to use-as-is with MRB acceptance.

Anomaly 005 recorded ice accumulation in a missing repair (2.5 inch divot) on the ET aft dome. Ice/frost had also formed on the bondline of a similar repair approximately 1 foot away in the -Y direction from the divot. The divot had been observed on the previous detanking. The anomaly was upgraded to PR ET-27-TS-0066 and dispositioned to use-as-is with MRB acceptance.

Anomaly 006 documented ice/frost accumulation in the LO2 feed-line brackets and bellows, and along the ice/frost ramp bond lines. These conditions were acceptable per NSTS-08303.

5.5 FACILITY OBSERVATIONS

No new debris concerns had been identified during the ice/frost inspection of the vehicle. No leaks were observed on either the LO2 or LH2 ORB T-0 umbilicals, though small amounts of ice had formed. There was also no apparent leakage anywhere on the GH2 vent line or GUCP. The modification to the GH2 vent line prevented ice from forming but some ice/frost, which was expected, had accumulated on the GUCP legs. Visual and infrared observations of the GOX seals confirmed no leakage. There were no icicles on the GOX vent ducts.



Overall view of Solid Rocket Booster/External Tank -Z side

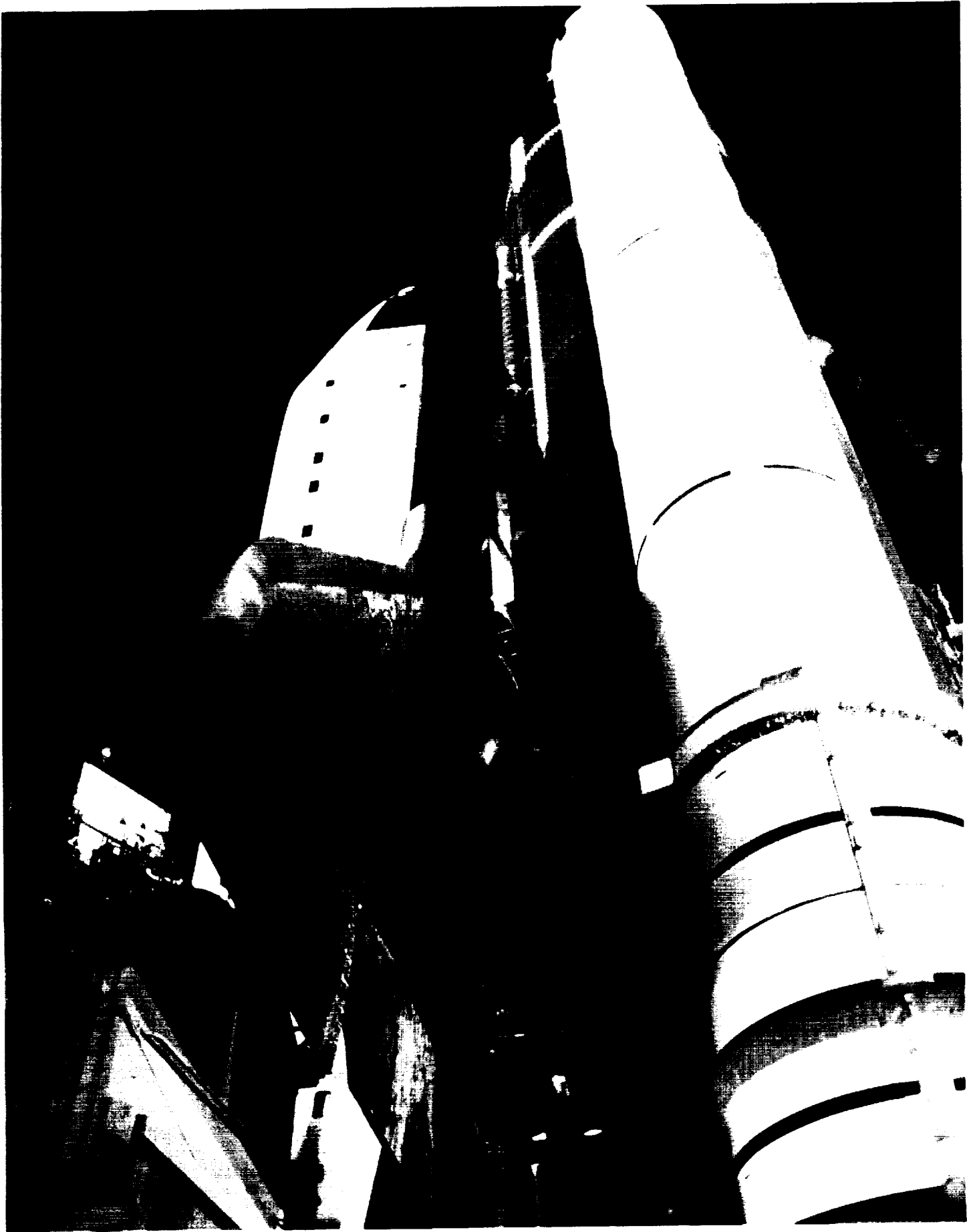

Overall view of L02 feedline and +Y+Z TPS acreage

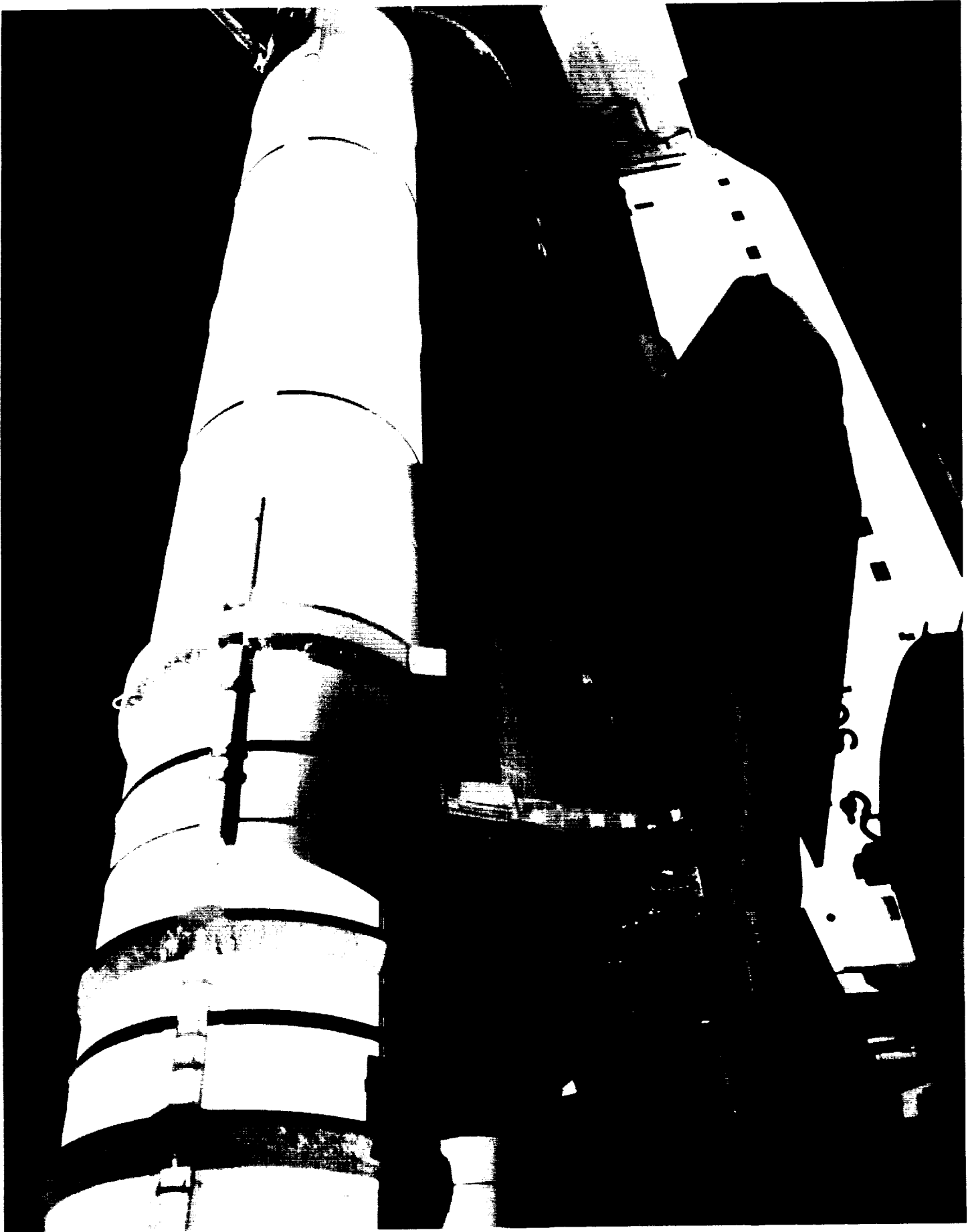

Overall view of -Y+Z TPS acreage and LH SRB

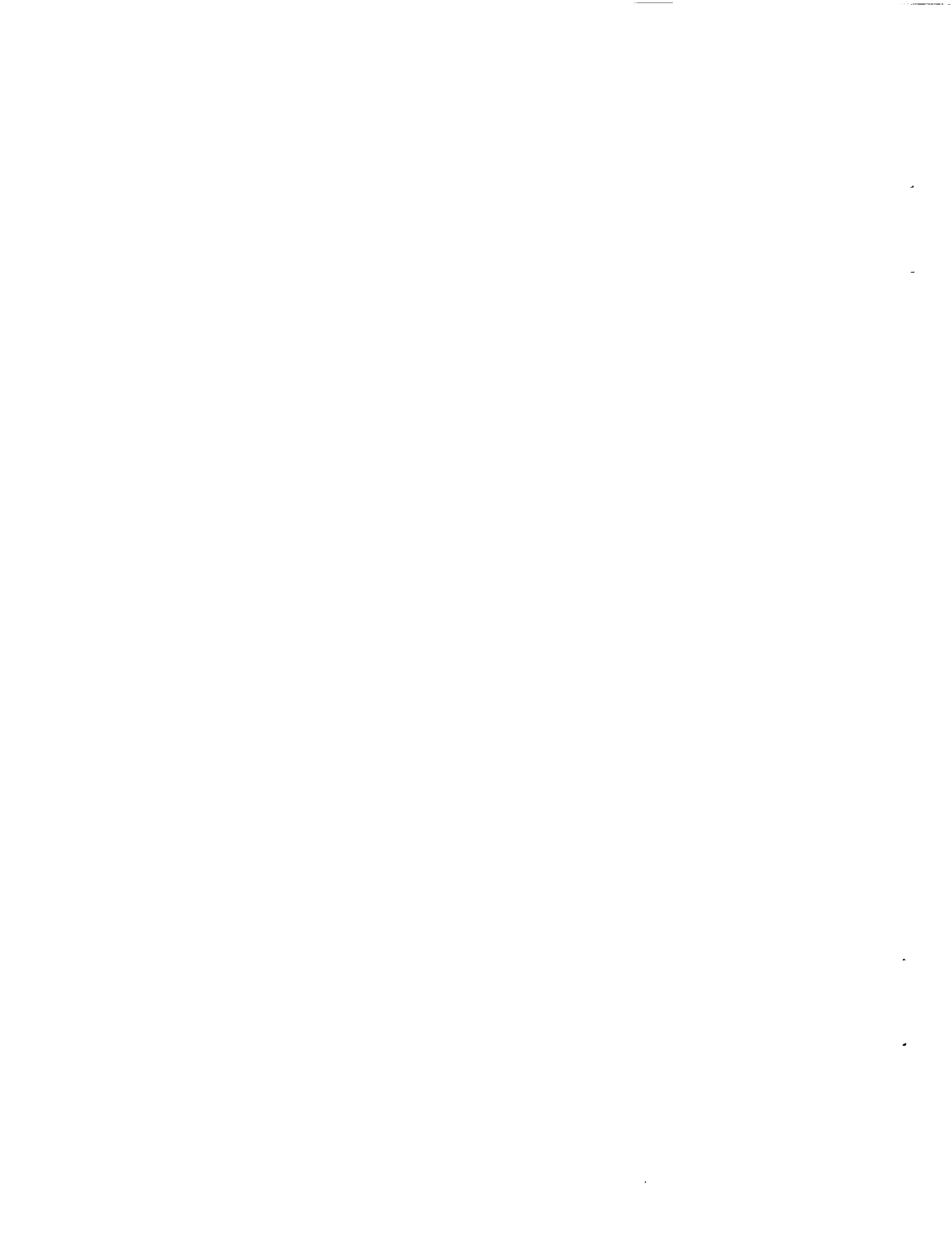

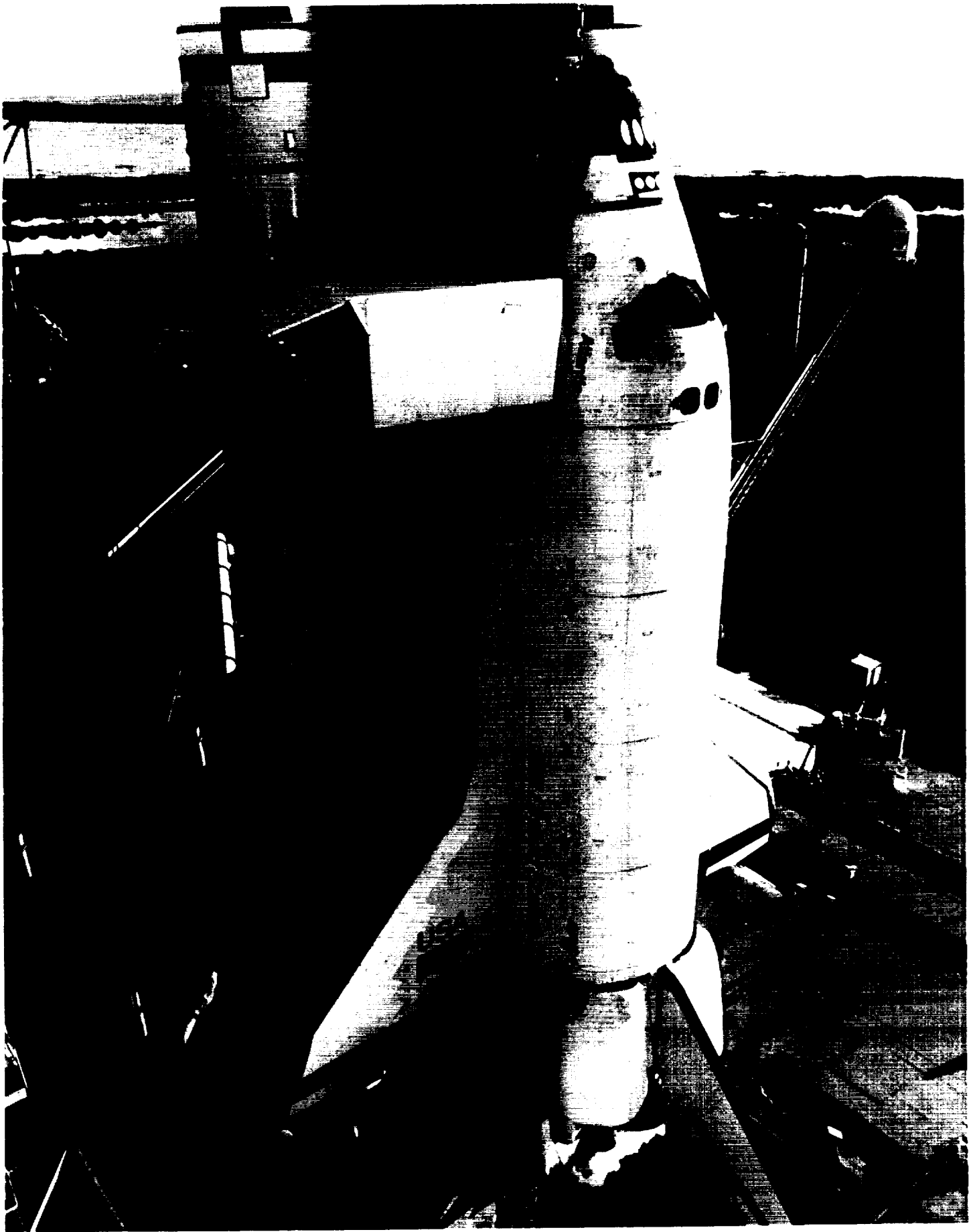

Overall view of Orbiter Atlantis after sunrise

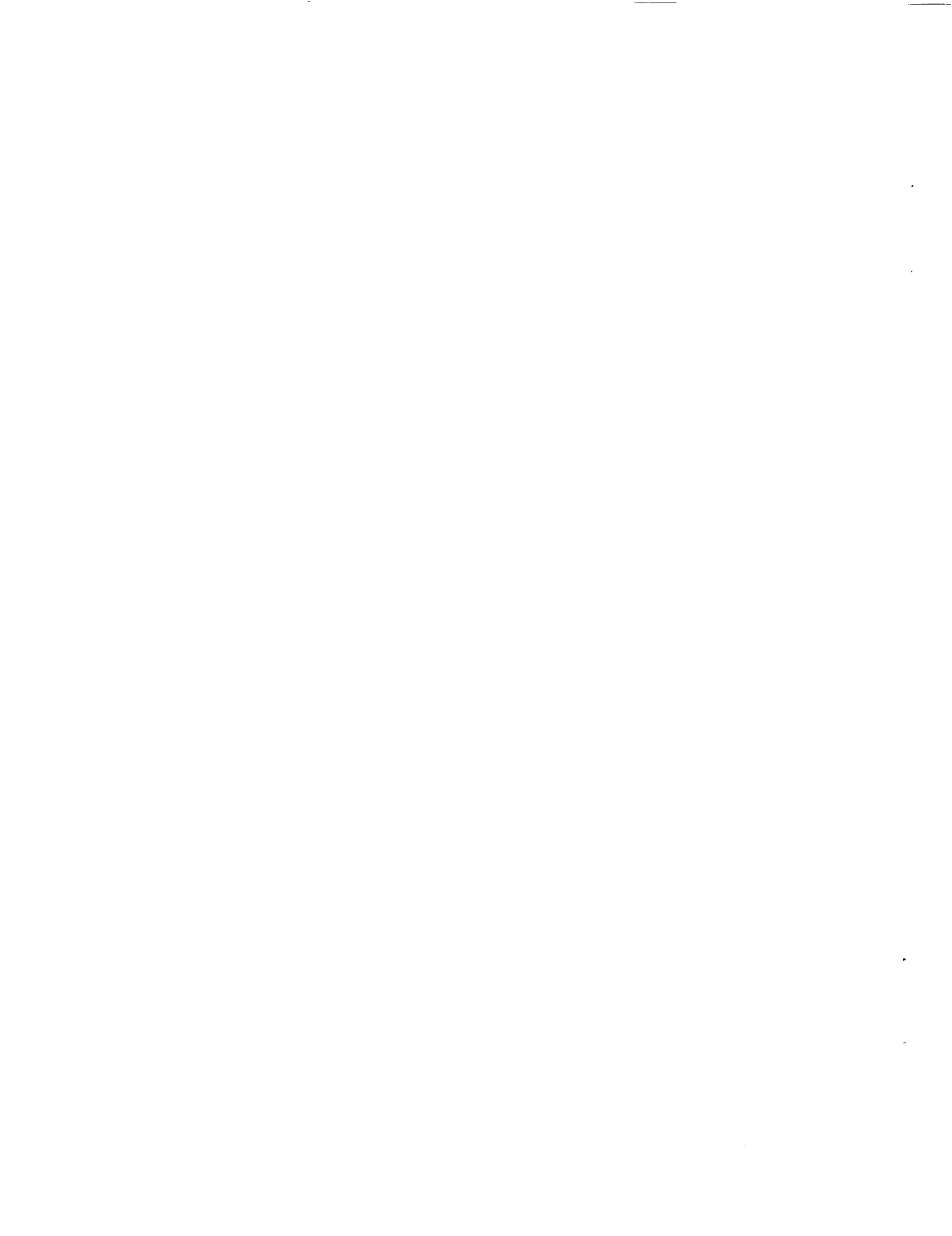



ORIGINAL PAGE
COLOR PHOTOGRAPH

Overall view of ET intertank and LO2 tank TPS acreage. Venting
GOX vapors are blown away from vehicle by southerly winds

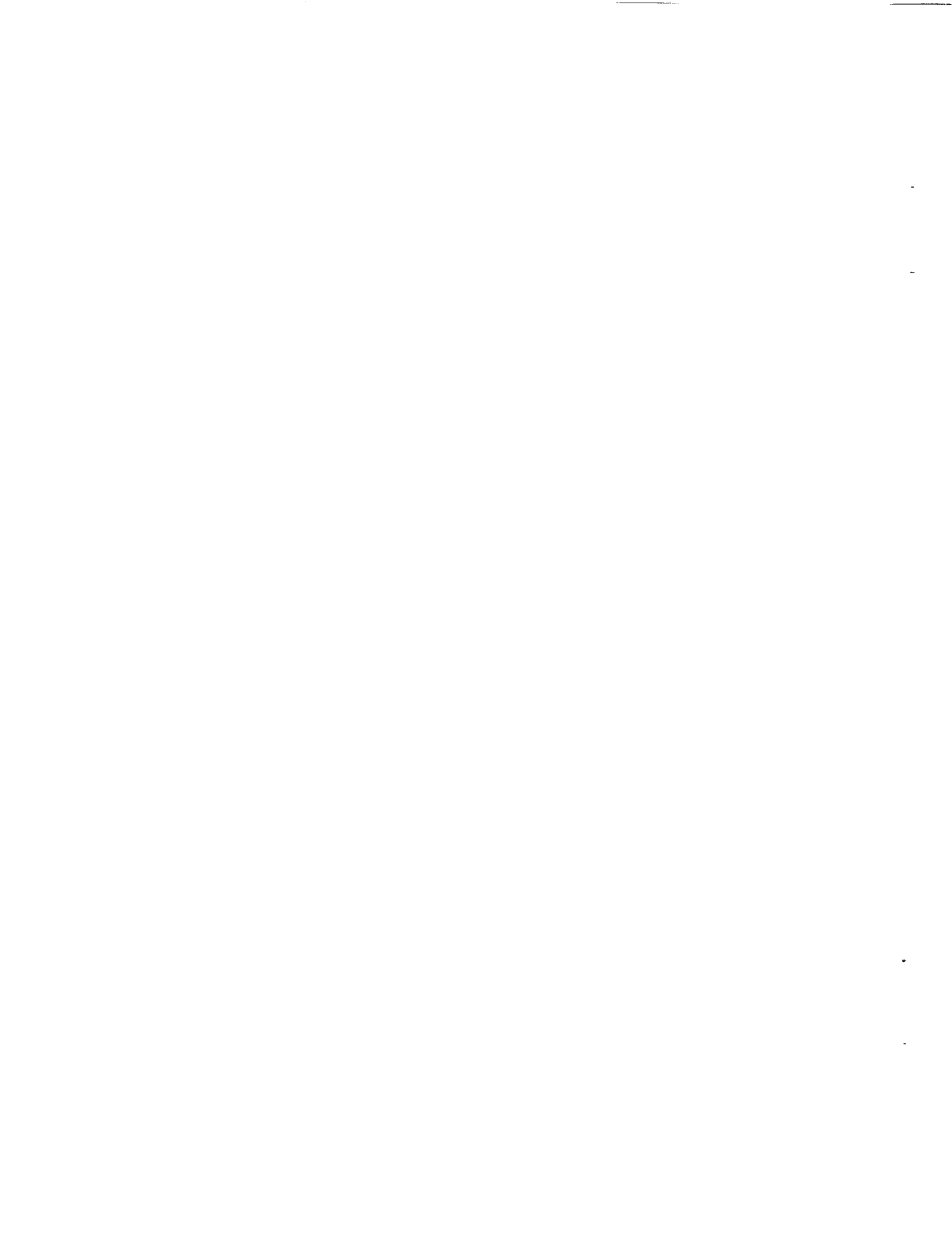

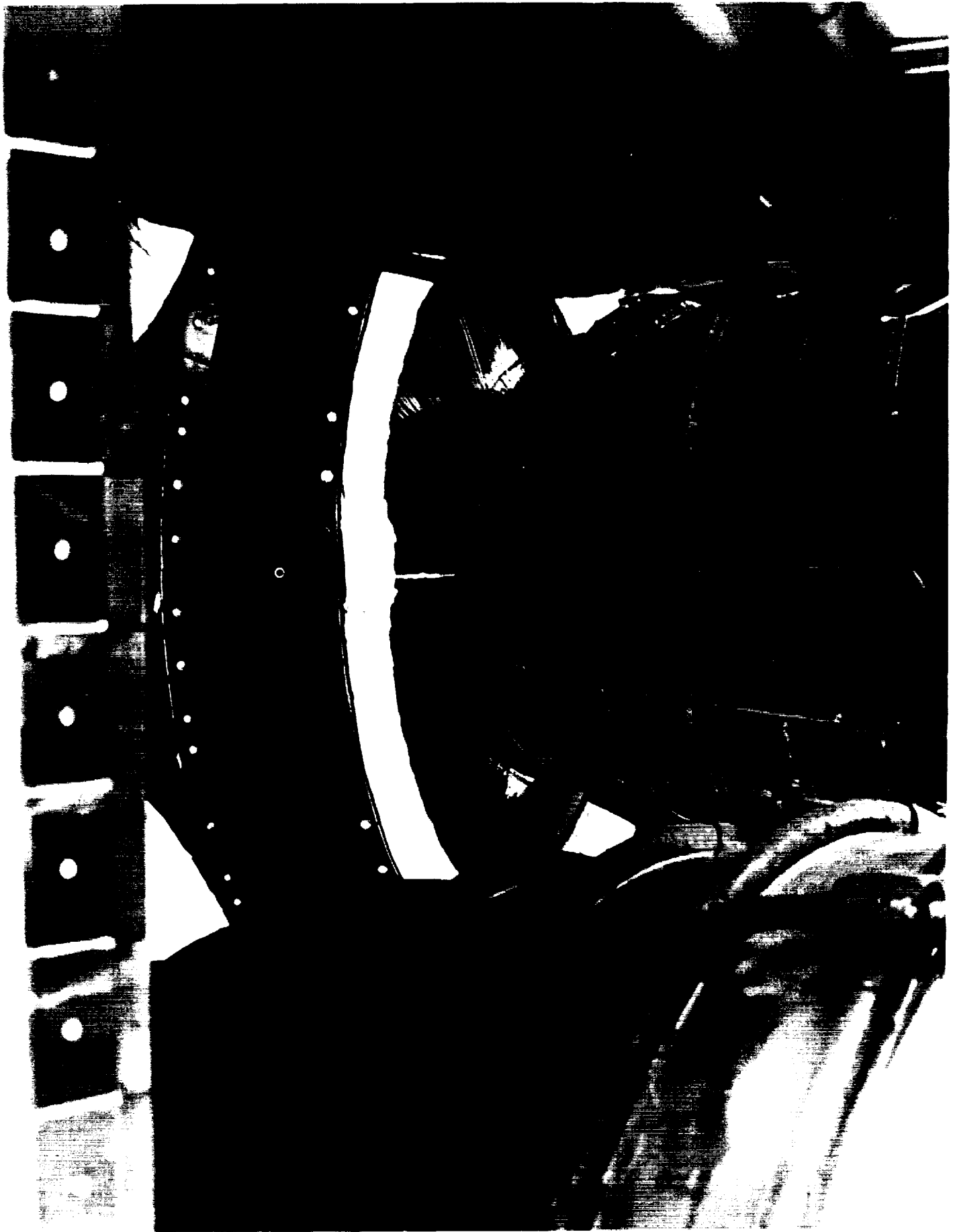

Condensate is visible on SSME #1 engine mounted heat shield.
Very little frost has formed on the nozzle interface.



Frost has formed at the SSME #2 nozzle-to-heat shield
interface 6 o'clock position



SSME #3 engine mounted heat shield exhibits no condensate/frost

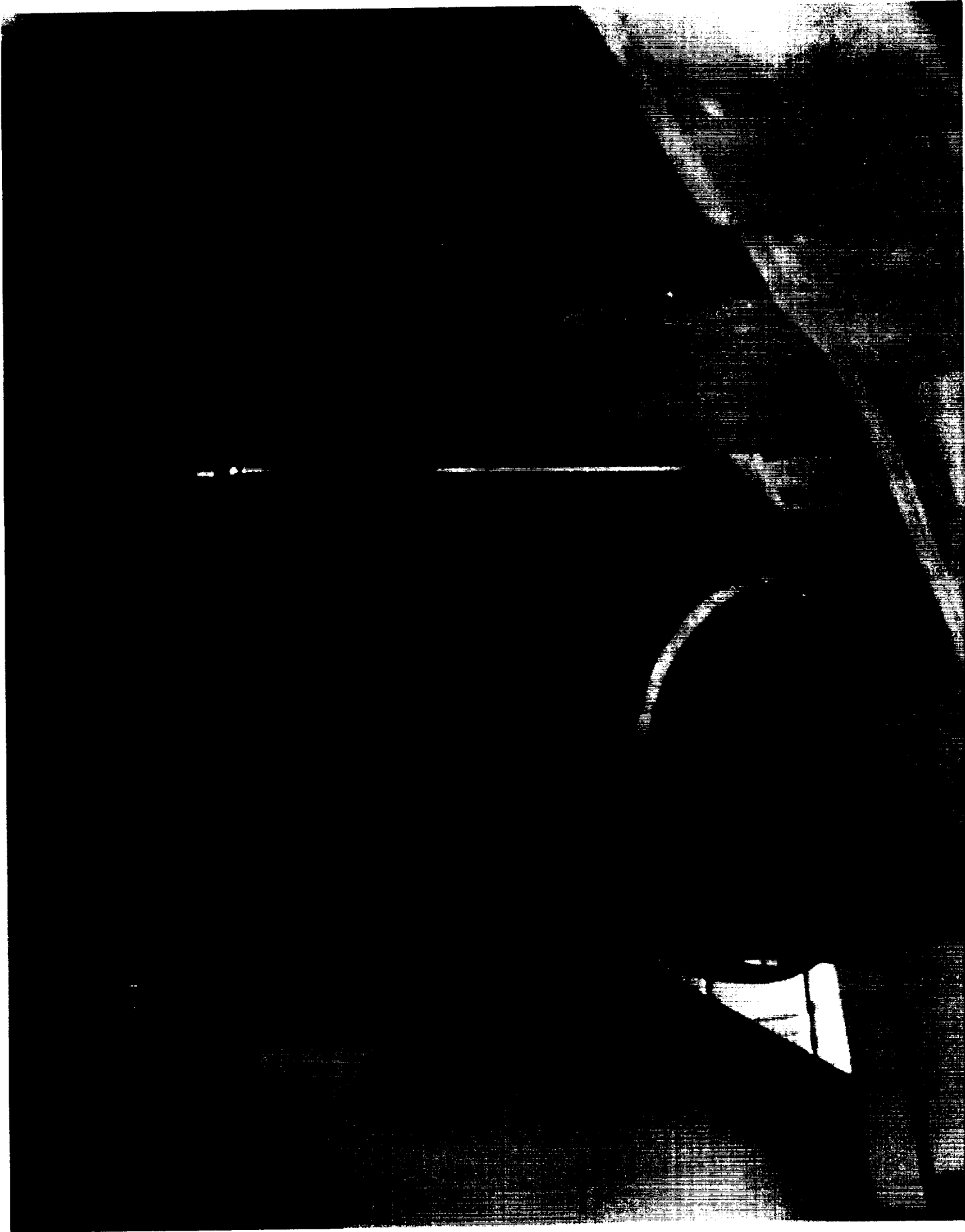

Typical accumulation of ice/frost in LO2 feedline bellows

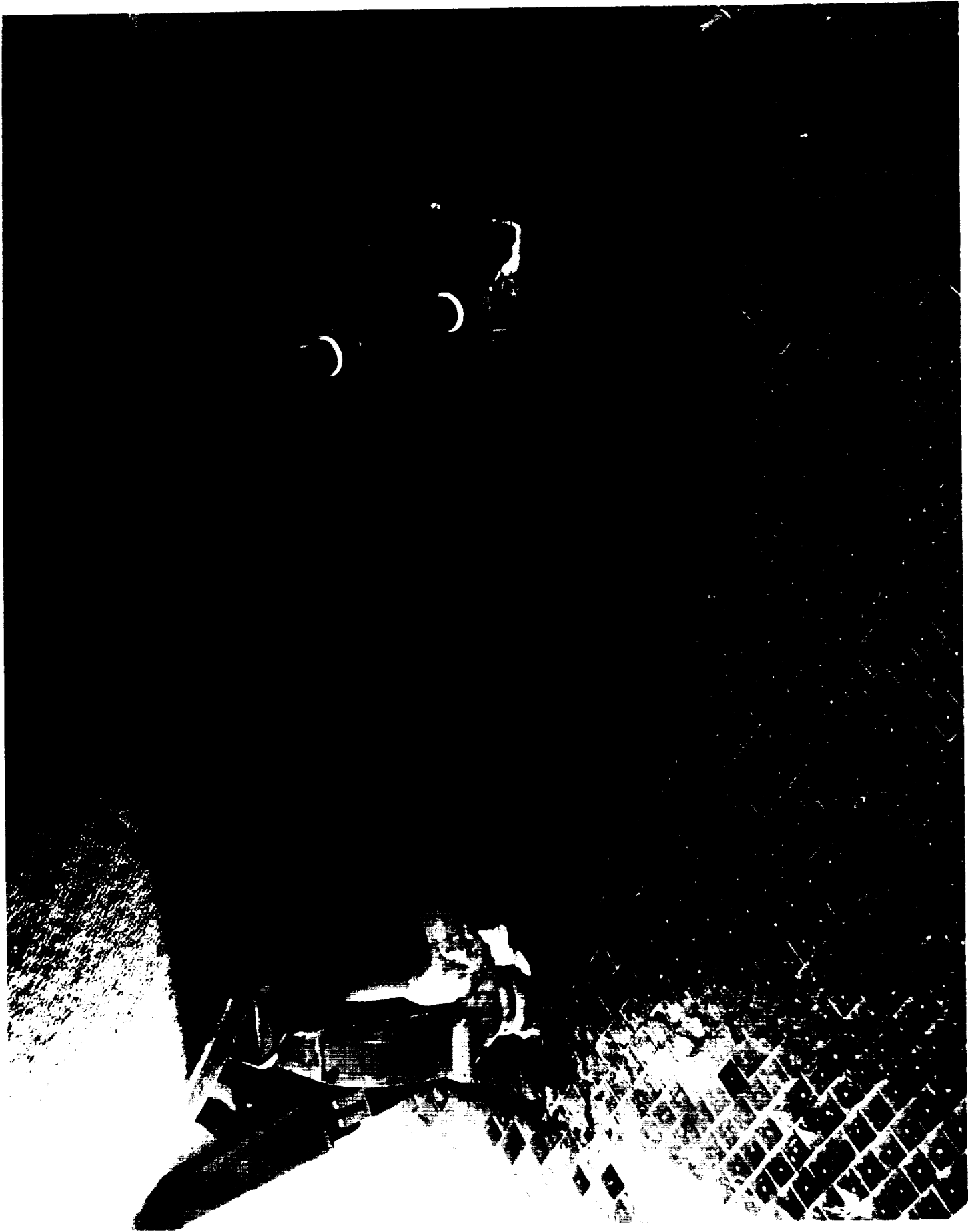

Overall view of ET/ORB LH2 and LO2 umbilicals. Accumulations of ice/frost are typical.

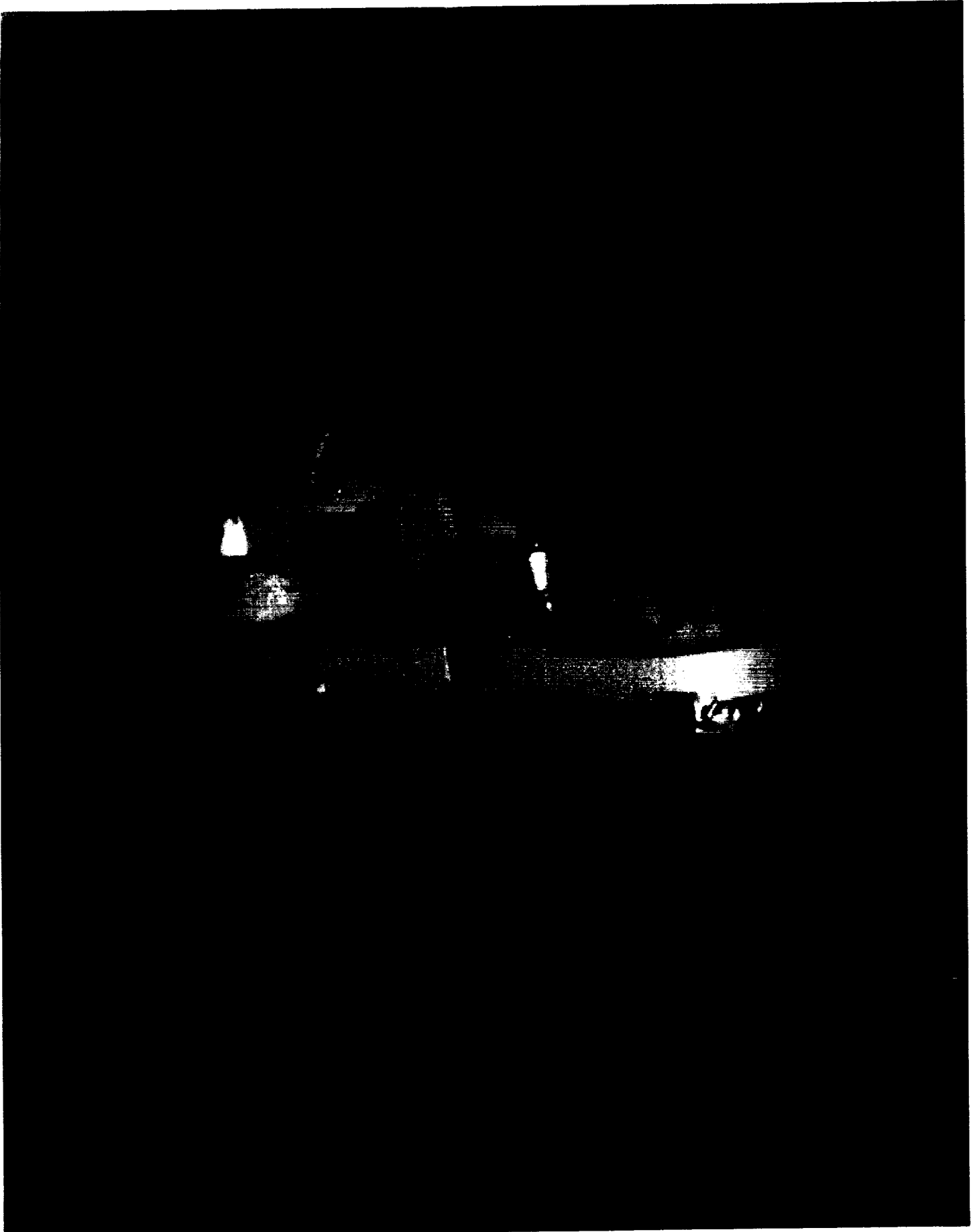

The LO2 ET/ORB umbilical is unusually frost-free except for
a frost finger on the purge vent

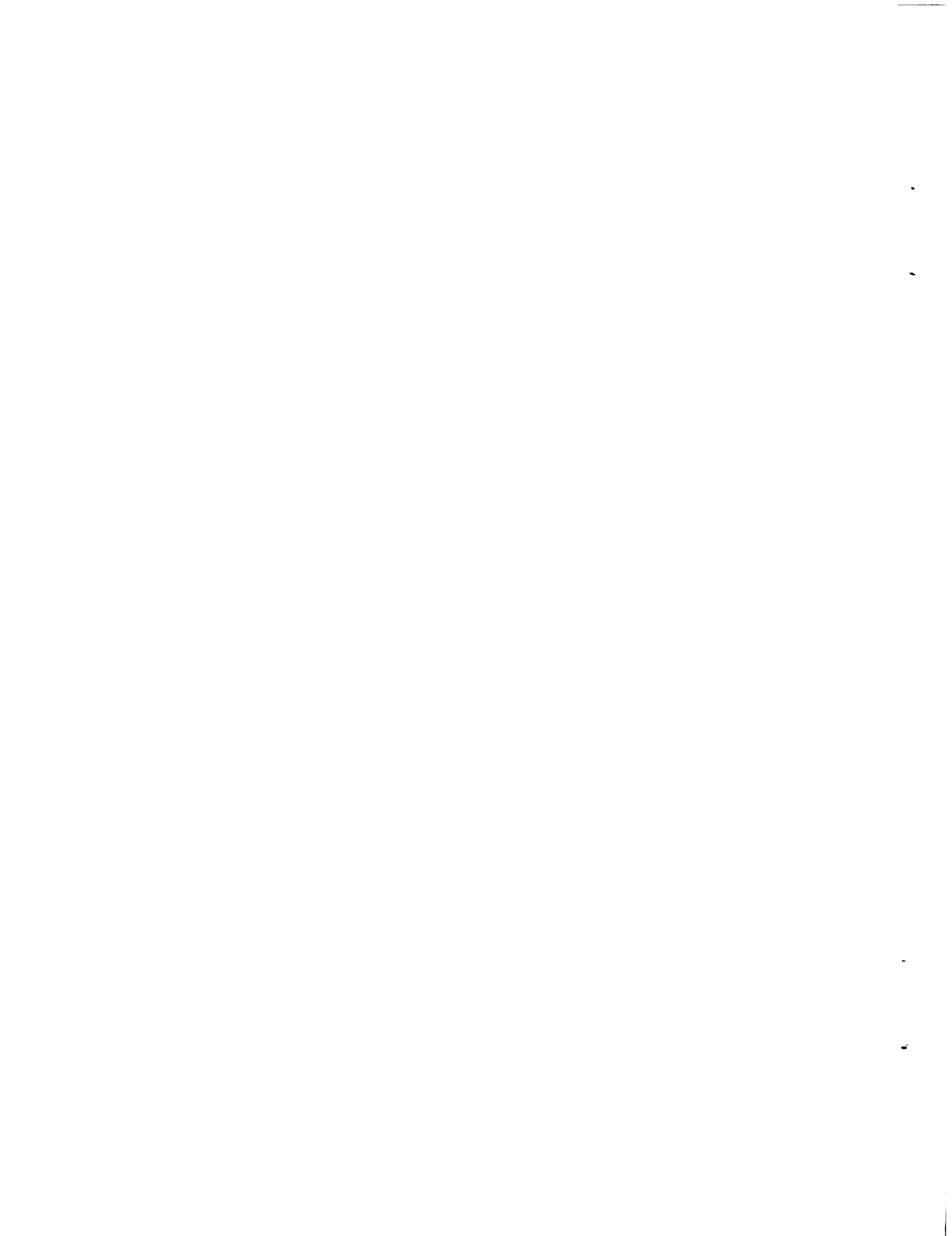



Formation of ice/frost on the LH2 ET/ORB umbilical is within the database. No frost appeared in the LH2 feedline bellows.

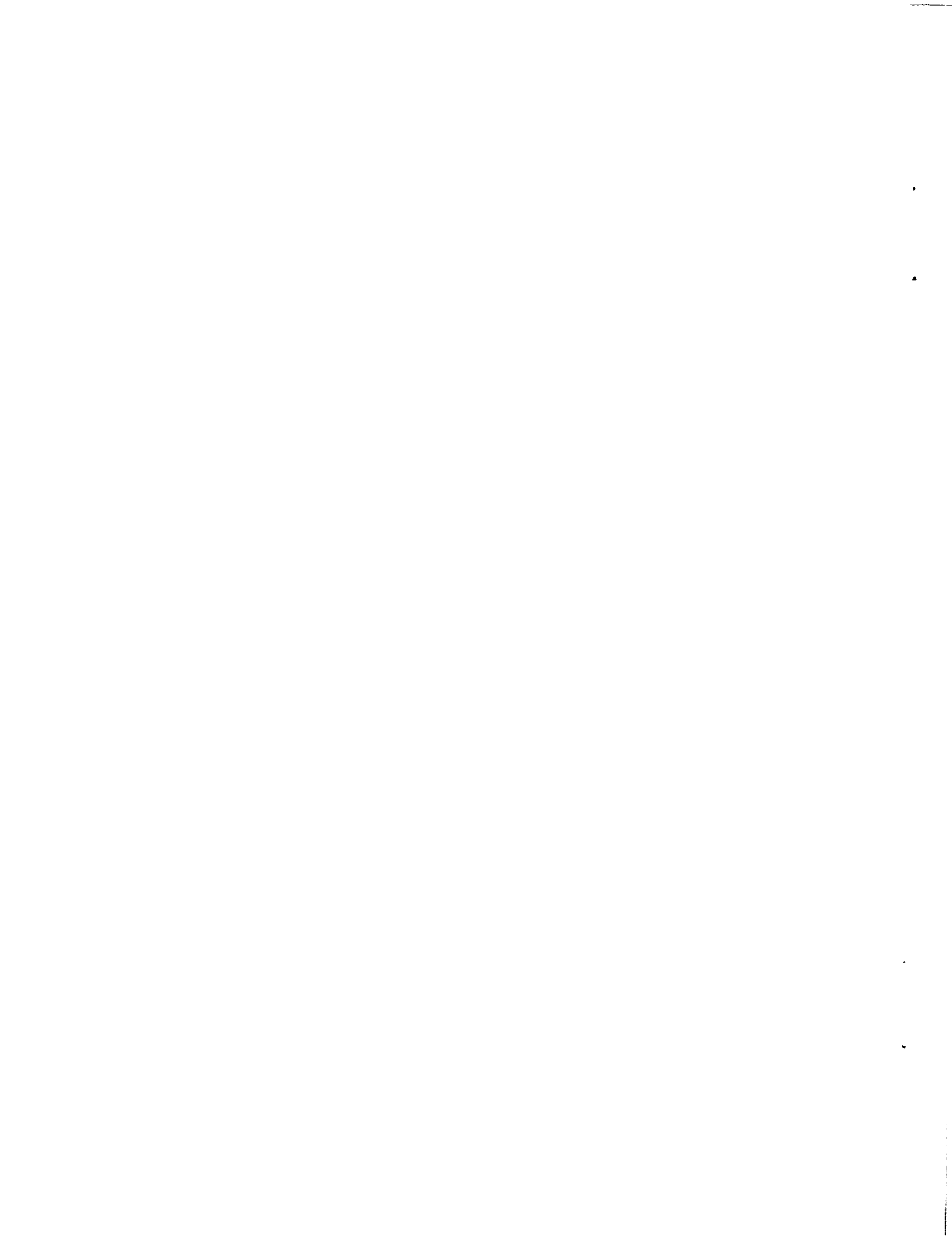



Close-in view of frost accumulation in the LH2 recirculation
line bellows, but none in the LH2 feedline bellows

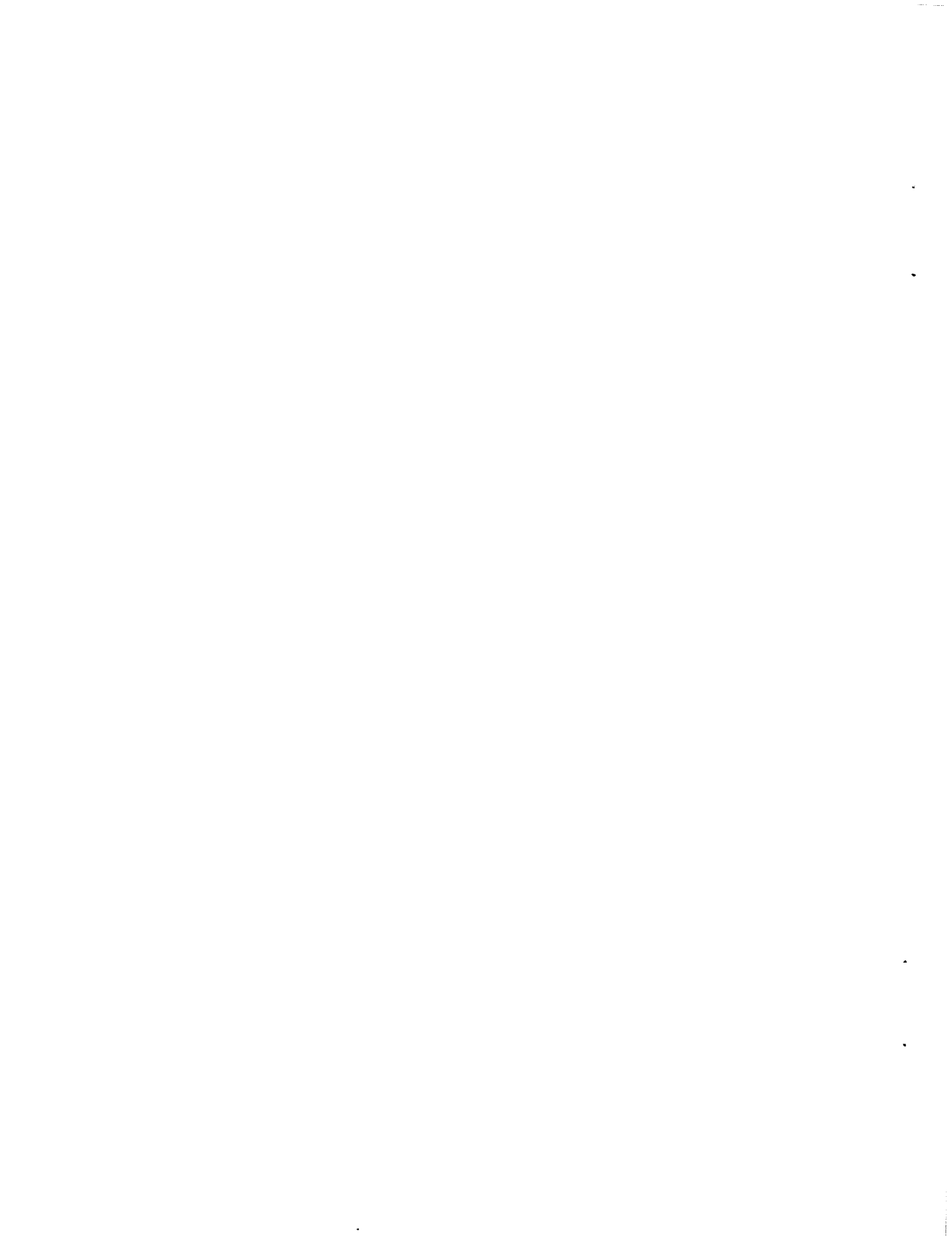

6.0 POST LAUNCH PAD DEBRIS INSPECTION

The post launch inspection of the pad and surrounding area began on 18 October 1989 from launch + 2 through 5 hours. The MLP, FSS, pad apron, and acreage areas were inspected. No significant flight hardware or TPS materials were found with the exception of five Q-felt closeout plugs from the Orbiter base heat shield tiles and one unusually large piece of SRB throat plug RTV (30" x 6"). The usual SRB throat plug material (foam and RTV) was found. Water trough material from the SRB exhaust holes was scattered from the pad apron to the perimeter fence.

SRB holddown post erosion was normal for this launch. South holddown post shim material was intact, but had debonded from the shoe sidewall. No conditions indicative of stud hang-up were visible. Half of the shim sidewall material was debonded on holddown post #4. All of the doghouse blast covers on the north holddown posts were in the closed position, exhibited no apparent damage, and did not appear to be missing any parts. The SRB aft skirt purge lines were in place and slightly damaged. The SRB joint heater umbilicals showed minor damage after separation.

Several pieces of facility debris were found on the pad perimeter. The number of facility items found was typical.

Launch damage to the GOX vent arm, Orbiter access arm, and Tail Service Masts was minimal. The GH2 vent arm was latched on the eighth tooth of the latching mechanism and no loose cables dangled from the haunch. However, the GH2 vent arm showed typical signs of SRB plume heating and cable impressions on the 7-inch QD (Ref PR S78-0220-00-007-0014). A spring tensioner from the GH2 vent line latching mechanism was found on the haunch deck grating. The spring remained attached to the opposing tensioner and had not become a second debris item.

All seven emergency egress slidewire baskets were secured on the FSS 195 foot level and sustained no launch damage.

Overall, there was very little damage to the launch pad.

Patrick AFB and MILA radars had been operated in a mode with slightly less sensitivity for SRB tracking requirements, so considerably less particles were recorded falling from the vehicle than previous flights. Only 8 particles were imaged in the 135-170 second time frame and no particles after 170 seconds. This compares to 30 particles during the same time period for the STS-28R flight. Two particles at 124 and 128 seconds did not appear to have exhaust plume velocity.

The debris inspection continued on 19 October 1989 and was expanded to include areas outside the perimeter fence. Ground teams searched the beach, railroad tracks, and beach access road from the northern KSC boundary to the Titan complex. The NASA helicopter was utilized to cover the water areas around the pad, the beach from the Cape lighthouse to a point 10 miles north of the pad, and the ocean area under the flight path. No flight hardware was found.



Post launch condition of holddown post #2 where stud hang-up occurred

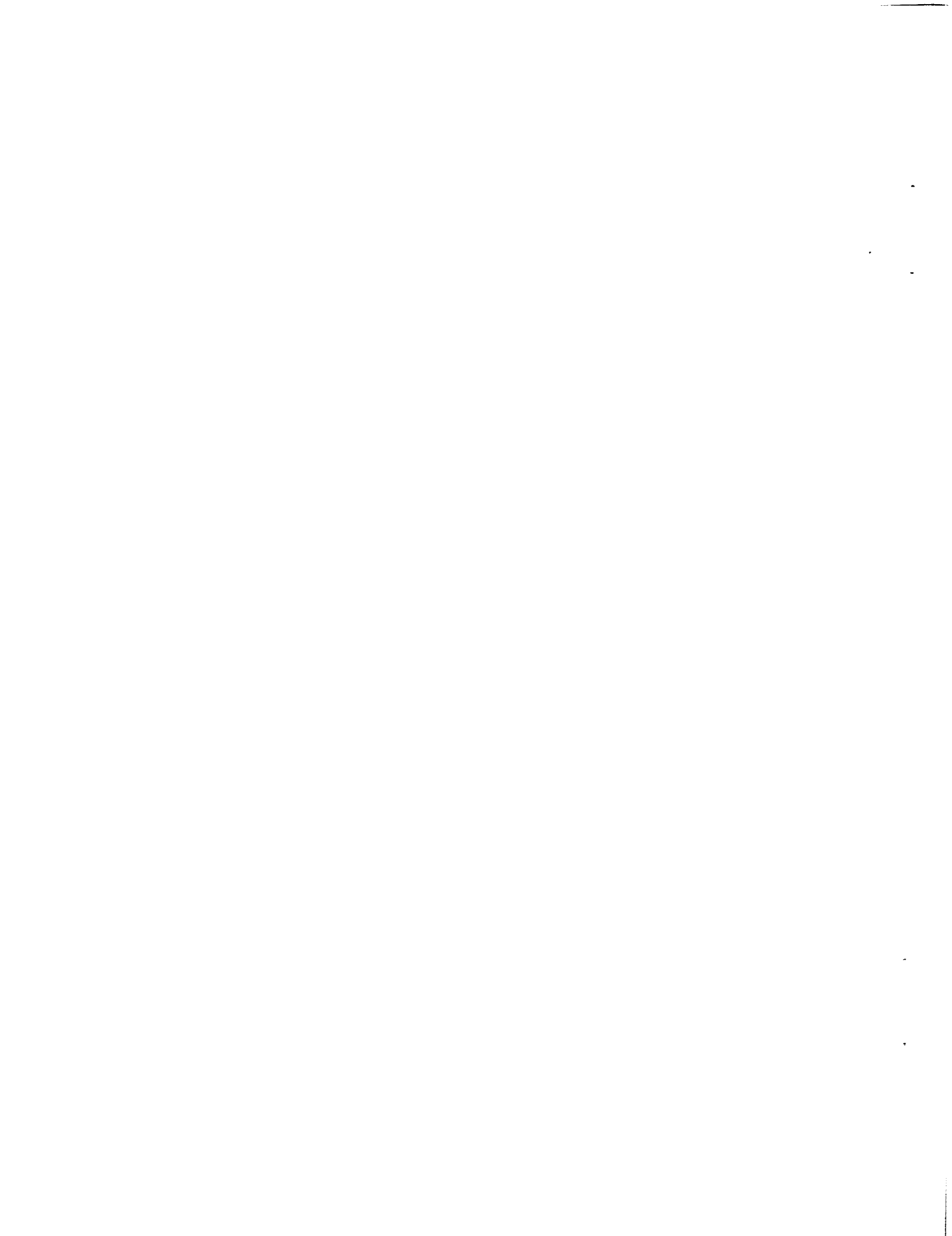



Typical debris collected on the pad after launch
includes Orbiter base heat shield Q-felt plugs

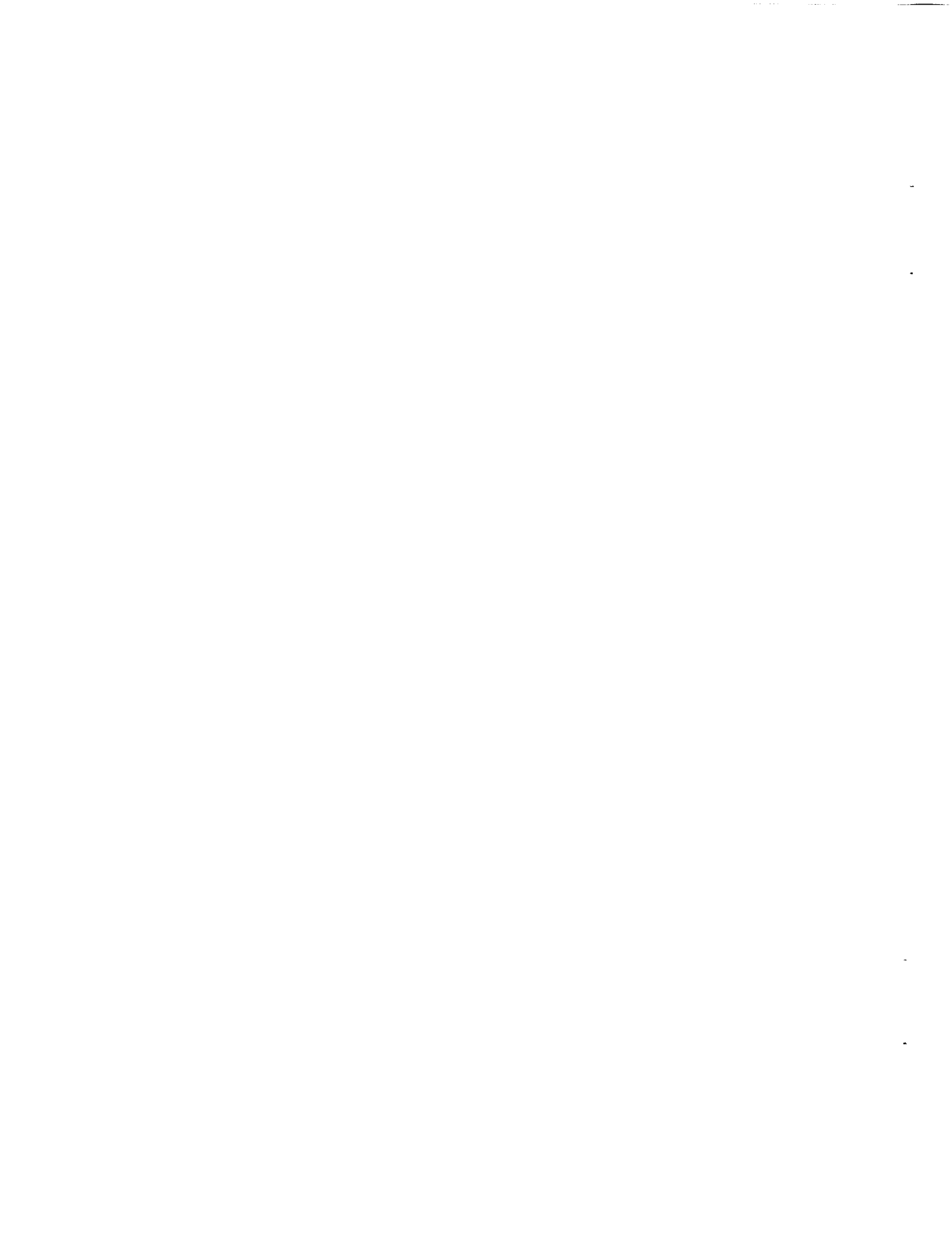

7.0 FILM REVIEW SUMMARY/PROBLEM REPORT DISPOSITION

A total of 129 film and video data items, which included 36 videos, 59 16mm films, 25 35mm films, 7 70mm films, and two special films were reviewed starting on launch day.

No major vehicle damage or lost flight hardware was observed that would have affected the mission. However, a stud 'hang-up' occurred on holddown post #2. The momentary drag caused by this condition was detectable in the Orbiter yaw accelerometer data. Film item E-8 showed that HDP #2 shoe and spherical bearing were lifted with the SRB aft skirt as the vehicle ascended (Figure 11). As the shoe and the aft skirt foot separated, the shoe pulled back onto the spherical bearing momentarily exposing the extended stud. The stud then fell into the holddown post sandbox. This film item also documented a piece of rymple cloth exiting the SRB aft skirt GN2 purge vent hole. This cloth is routinely wrapped around the purge line/disconnect to prevent instafoam from adhering to the line during TPS closeout operations.

A stream of cryogenic hydrogen exited SSME #1 nozzle prior to ignition (E-19, 20, 76, 77). Although this hydrogen 'lead' is expected during SSME startup, the physical size and duration of this hydrogen stream was somewhat longer than previously observed for main engine firings. Three orange flashes occurred in the plume of SSME #1 after the shock diamonds had formed (E-2, 3, 76, 77). Orange flashes are typically attributed to debris entering the SSME plume downstream of the nozzle and being consumed, but these flashes appeared to originate from inside the bell nozzle.

A 6"x1"x1/2" piece of SSME foil insulation fell from SSME #2 during ignition (E-18). Although it appeared to originate from the GOX drain line and its size matched the lengths of insulation attached to the line, visual inspection of the SSME's after Orbiter landing at Edwards AFB revealed no missing insulation. The changeout of the SSME #2 controller and other closeout work above the engine in the base heatshield area probably resulted in a piece of this insulation lodging against the nozzle. An orange GSE tile shim (feeler gage) fell from the Orbiter lower surface approximately 1 foot forward of the RH elevon hinge line (E-18, 31). A similar shim was embedded in an OMS pod tile on STS-28R and demonstrated that these shims can cause tile damage. A debris particle, dark colored on one side and light colored on the opposite side measuring 1"x1-1/2"x1/8" fell from behind the RH stinger during SSME ignition and was probably tile surface coating (E-23).

A heavy shower of ice and frost particles from the ET/ORB LH2 and LO2 umbilicals fell past the body flap during SSME ignition, but no Orbiter tile damage was visible (E-5, 6, 15, 16, 18, 26, 31, 36).

FIGURE 11. HDP #2 Motion Analysis

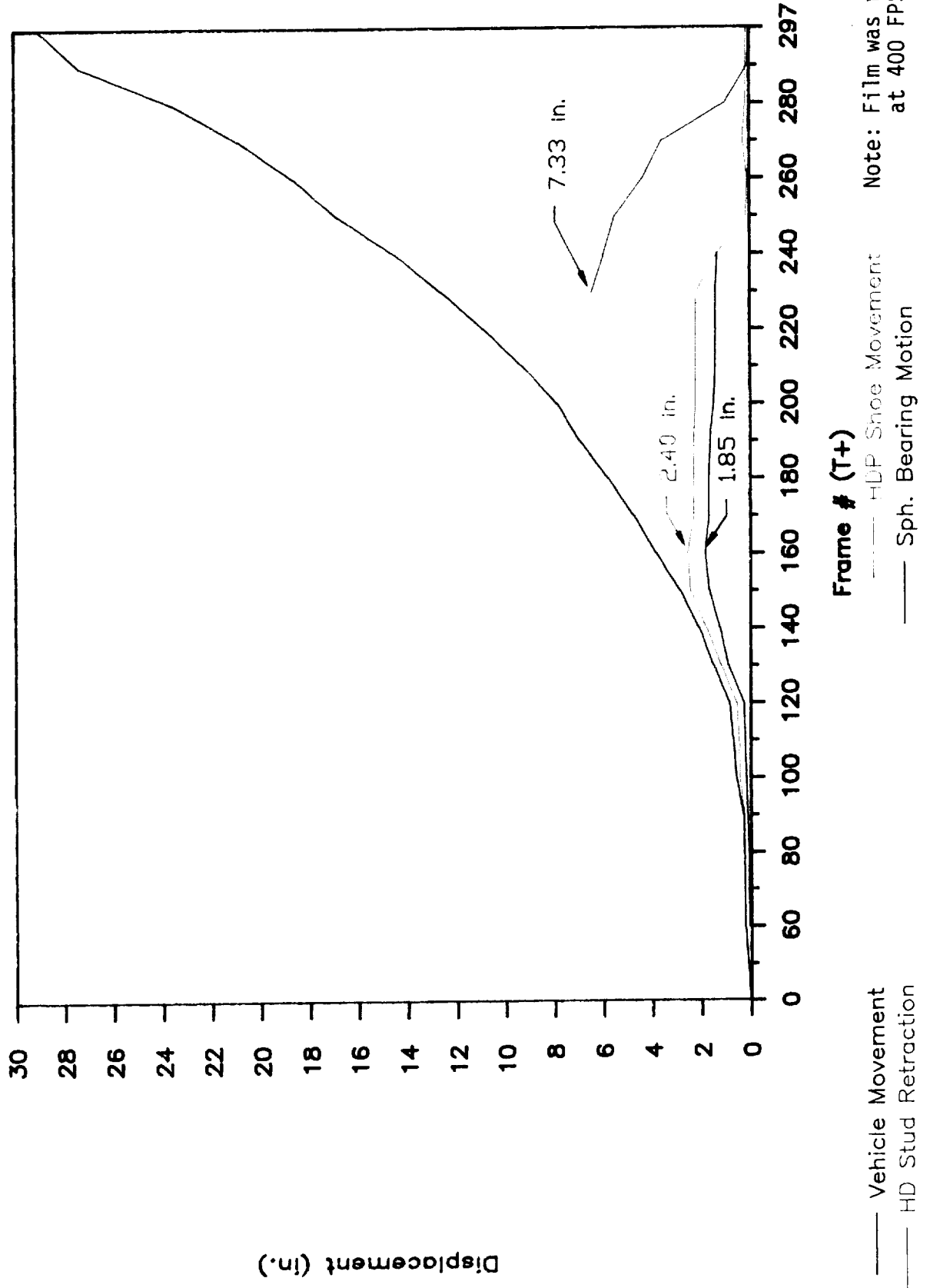

Movement of the SRB HDP #1 and #5 Debris Containment Assemblies (DCA) occurred at T-0 and consisted of two oscillations (EX1, EX4, 11, 12). Small pieces of K5NA closeout material appeared from behind the DCA's at liftoff (EX1, EX4, 8, 9, 12).

There were no major facility anomalies. No swing arms or other pad structures contacted the vehicle during liftoff. Ice was present at 3 locations on the intertank stringers near the GUCP. This ice formed when cold air impinged on the stringers from the GH2 vent line (E-33). A 4"x3" piece of intertank foam was missing from an area near the lower LH corner of the GUCP. Separation of the GUCP and retraction of the GH2 vent line was nominal (E-33, 41, 48). However, the vent line cable had excessive slack during retraction and impacted the GUCP 7-inch quick disconnect (E-42, 50). A spring tensioner from the GH2 vent line latching mechanism fails just after latchback and falls to the haunch deck grating. The released spring swings from the opposing tensioner, but does not become a second debris item (E-42).

Tracking data shows vehicle position/movement during SSME ignition, 'twang', and liftoff (Figures 12-15).

Many film and video items recorded various amounts of flying debris on the pad after the vehicle cleared the tower. This debris is SRB throat plug material and shredded sound suppression water troughs - an expected occurrence.

Movement of the Orbiter body flap was visible after the roll maneuver and through most of the ascent (E-207, 212, 221, 222). The motion appears to have an amplitude and frequency similar to that observed on OV-102 during STS-28R.

Shortly after the formation of local supersonic flow condensate on the Orbiter forward fuselage, vertical stabilizer, ET/SRB forward crossovers, and SRB ETA ring (E-205, 207, 212), a white object first appears outboard of the RH OMS nozzle. The object then passed behind SSME #1 nozzle, reappeared at the base of the vertical stabilizer at GMT 16:54:04, fell aft, and entered the plume (E-201, 202, 204, 207, 212, 220, 222).

Numerous pieces of debris from the vehicle were visible during ascent. Most have been identified as ice/frost particles from the ET/ORB umbilicals and RCS paper covers from the Orbiter (E-52, 54, 57, 58, 61). The particles falling from the vehicle after Max Q are either pieces of SRB propellant or SRB aft skirt instafoam (E-220, 222). Objects in the SRB plumes prior to and just after separation from the External Tank are chunks of SRB propellant slag (E-204, 205, 207, 208, 212, 223).



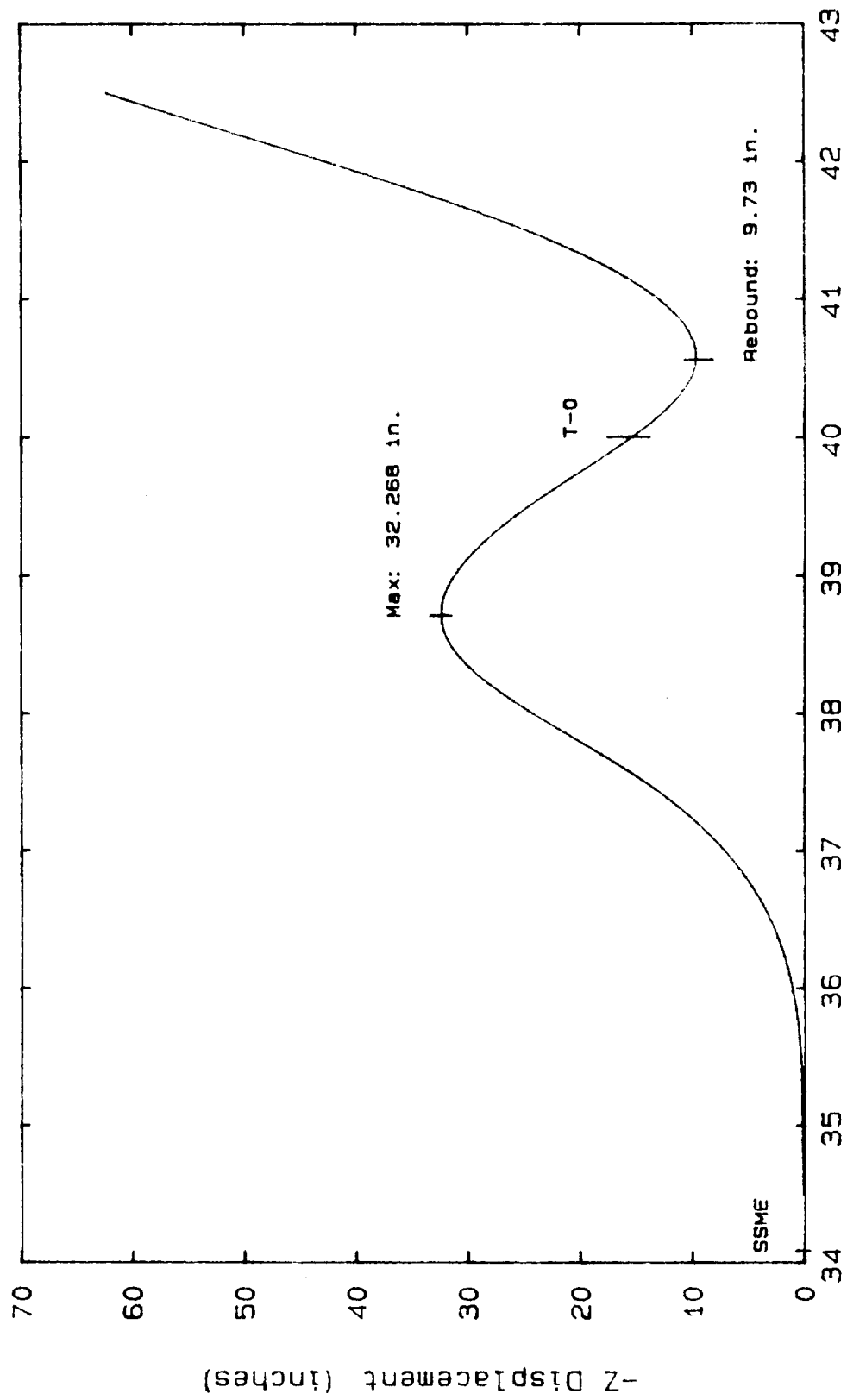

Time (GMT 16:53:xx)

FIGURE 12. ET Nose Spike Twang

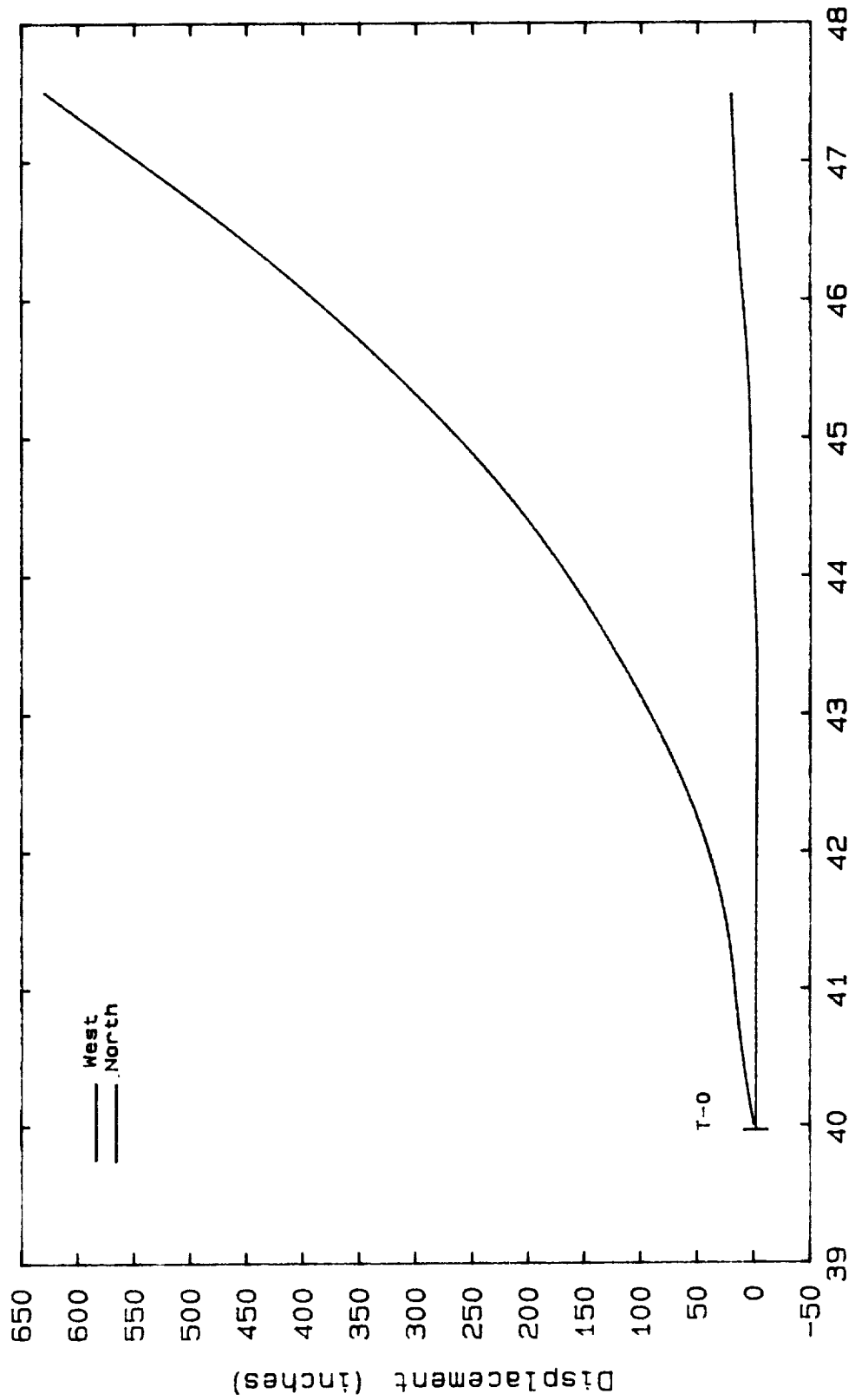
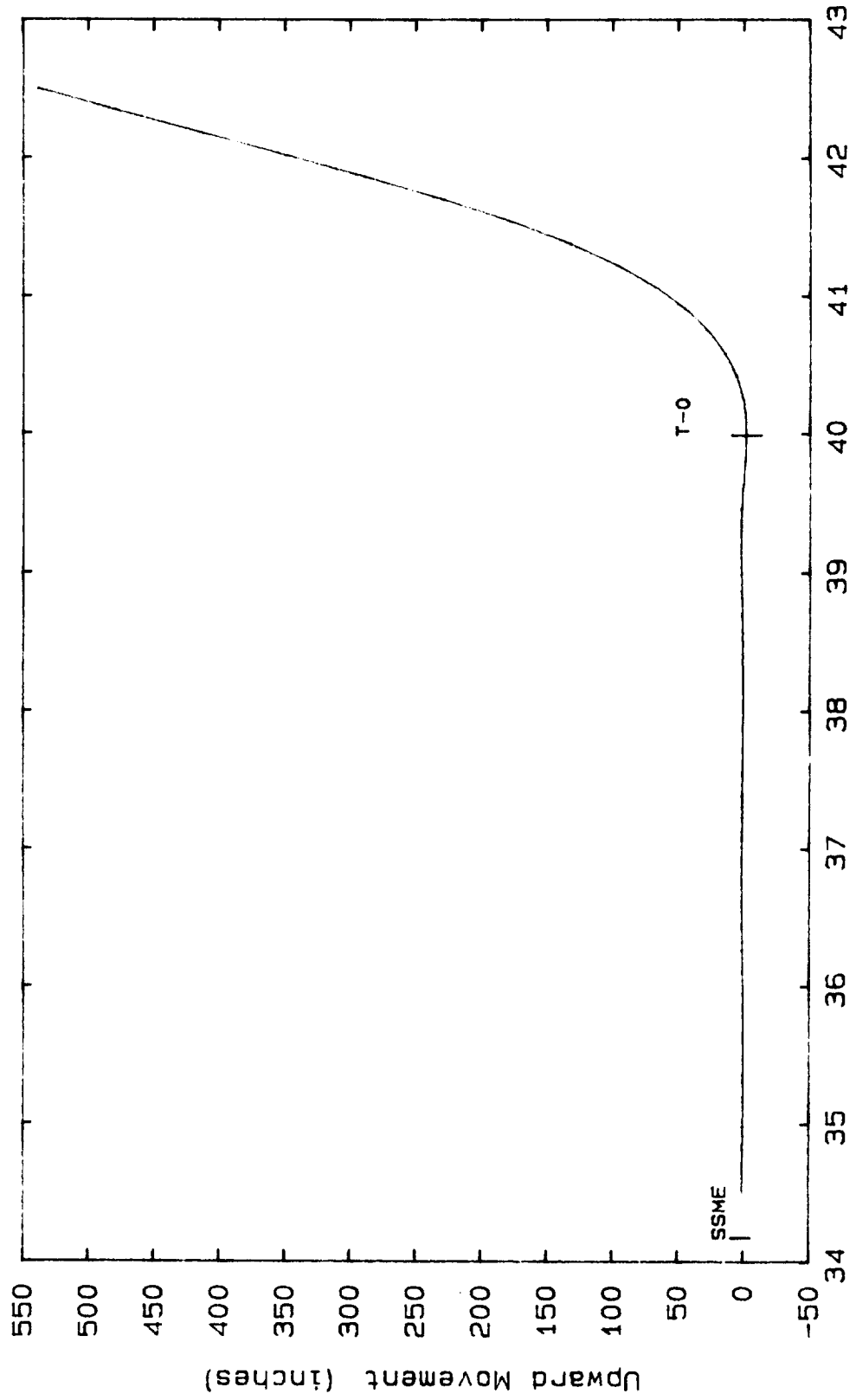

FIGURE 13. North and West Movement



Time (GMT 16: 53: xx)

FIGURE 14. Shuttle Liftoff

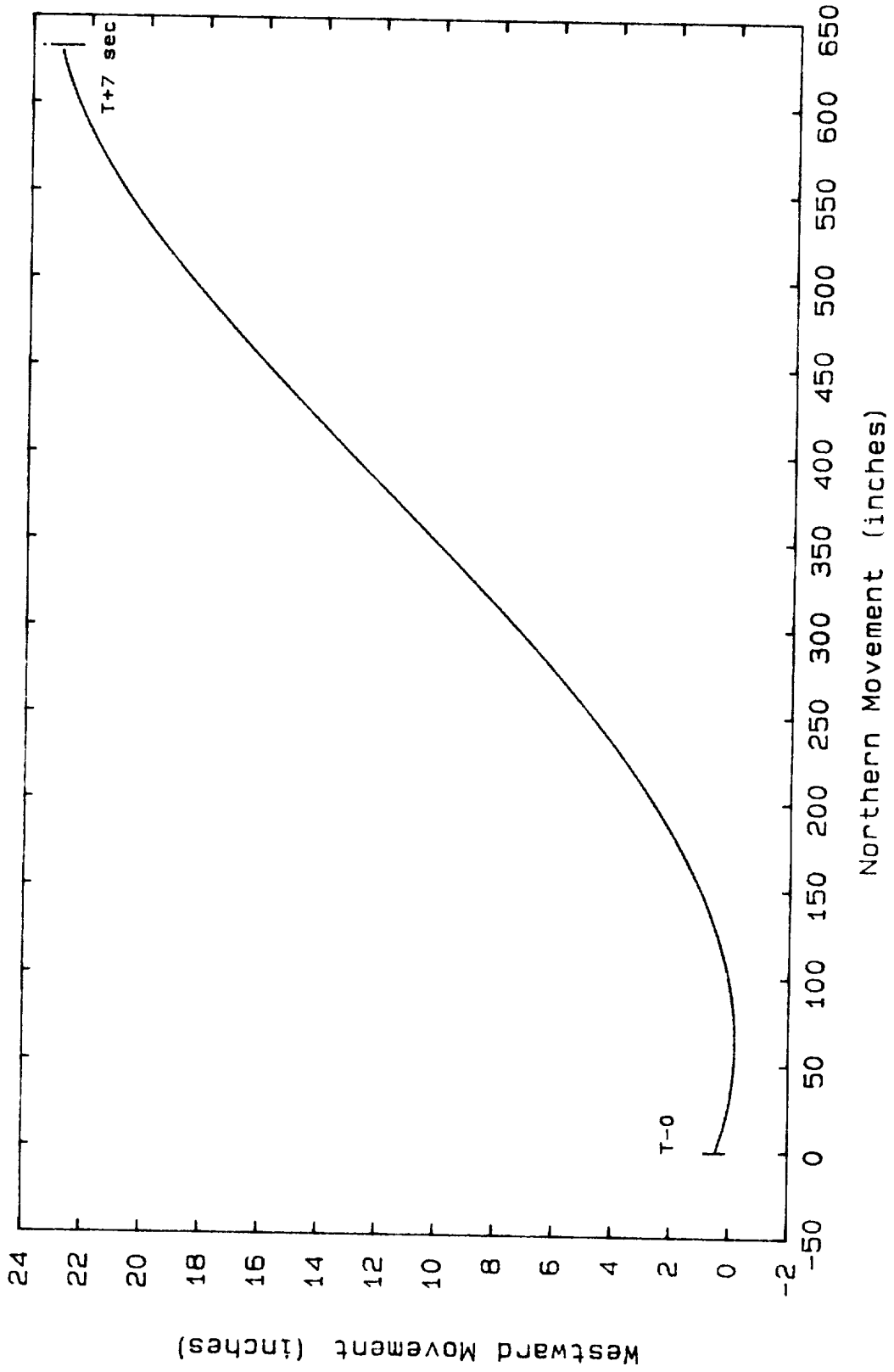
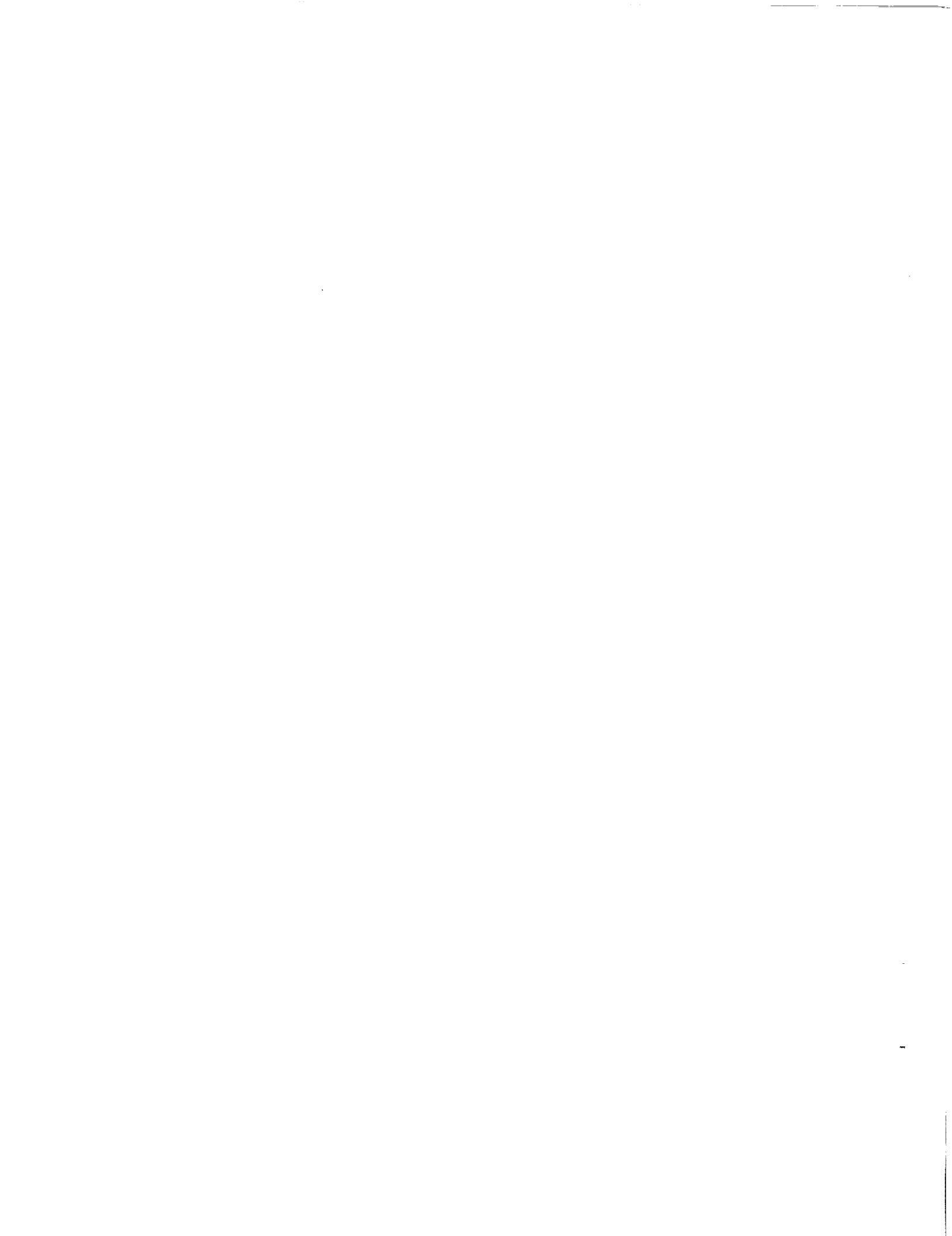

FIGURE 15. Shuttle Ground Track

LH MLG door opened and LH MLG wheel extended ahead of the right side similar to OV-102 on STS-28R. There were no unusual control surface oscillations prior to or after landing. LH MLG touched down slightly ahead of the RH MLG. Nose gear touchdown was smooth, though the strut flexed slightly fore-to-aft.

No PR's or IPR's were generated as a result of the film and video data review. However, the Post Launch Anomalies observed in the Film Review were presented to the Mission Management Team, Shuttle managers, and vehicle systems engineers. These anomalies are listed in Section 11.2.





ORIGINAL PAGE
COLOR PHOTOGRAPH

Hydrogen 'lead' from SSME #1 is somewhat longer in duration
than previously observed on main engine starts

ORIGINAL PAGE
COLOR PHOTOGRAPH

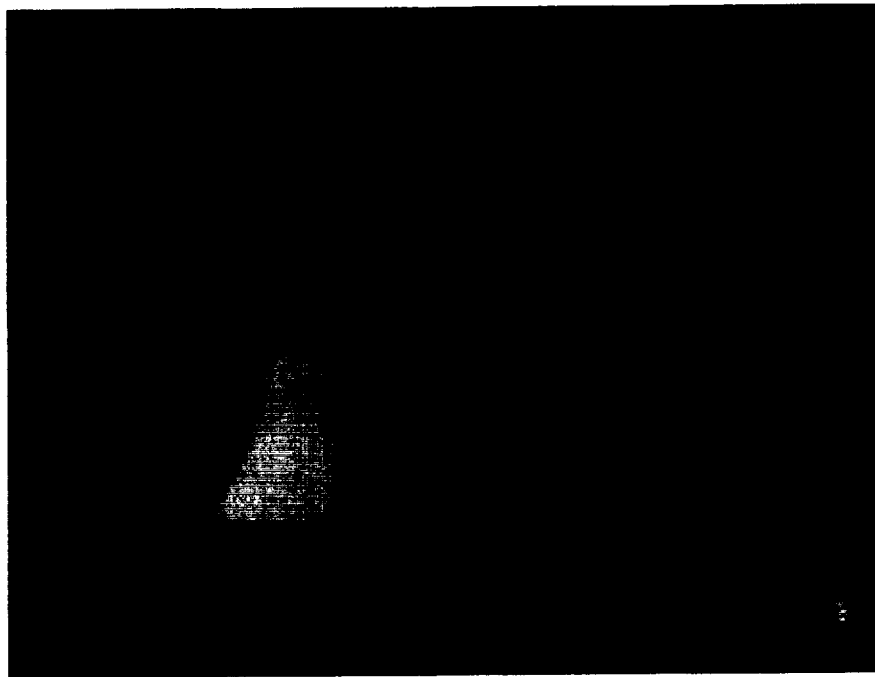
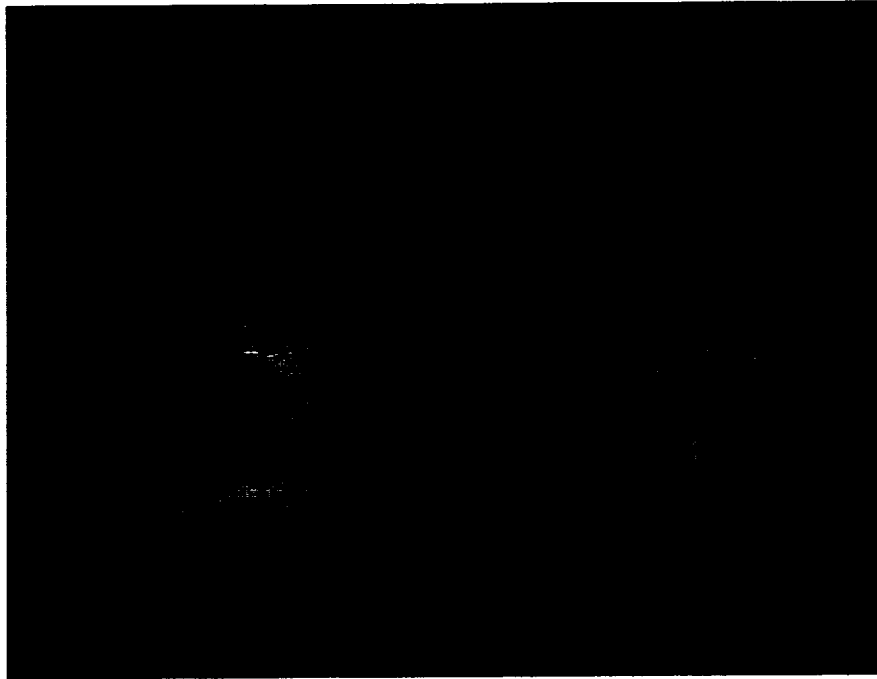

ST1 infrared view from camera site #2 shows free burning hydrogen blown north under body flap before plumes stabilize

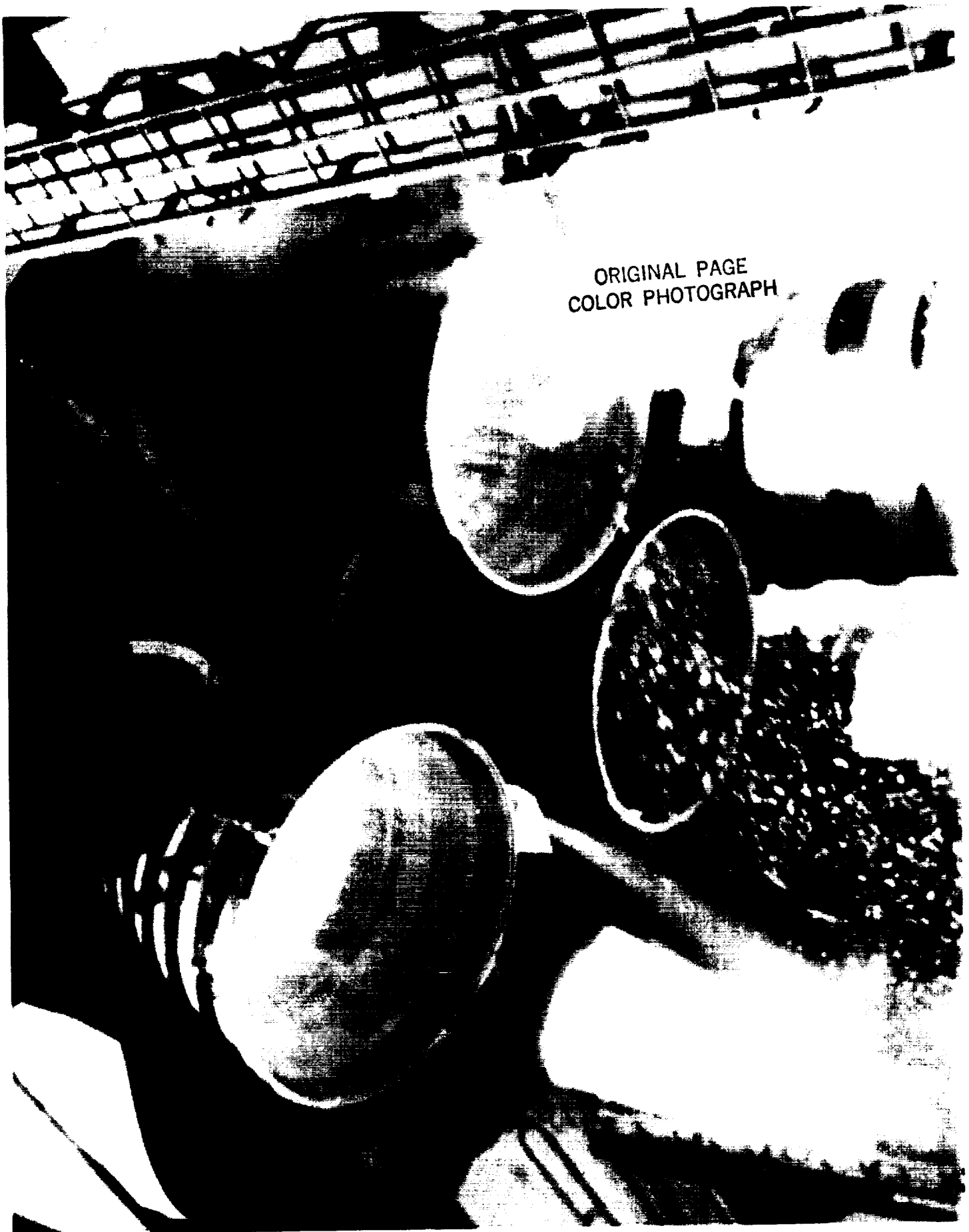

ORIGINAL PAGE
COLOR PHOTOGRAPH

Orange 'flash' occurred in plume of SSME #1 just after T-0. GOX clouds drift past SSME #3 during LO2 T-0 umbilical retraction.

ORIGINAL PAGE
COLOR PHOTOGRAPH

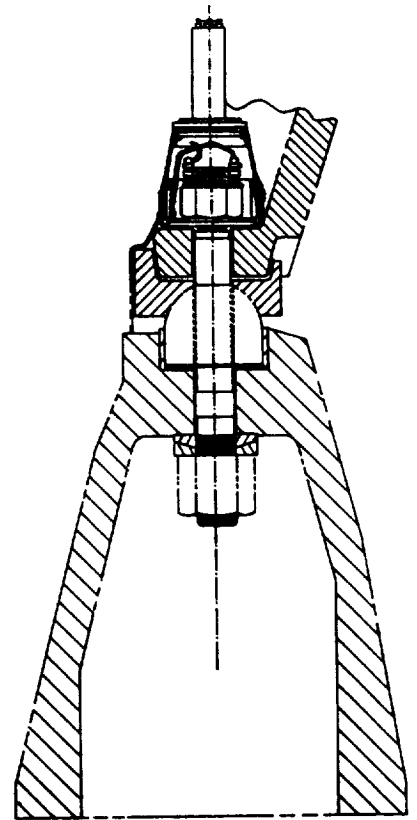
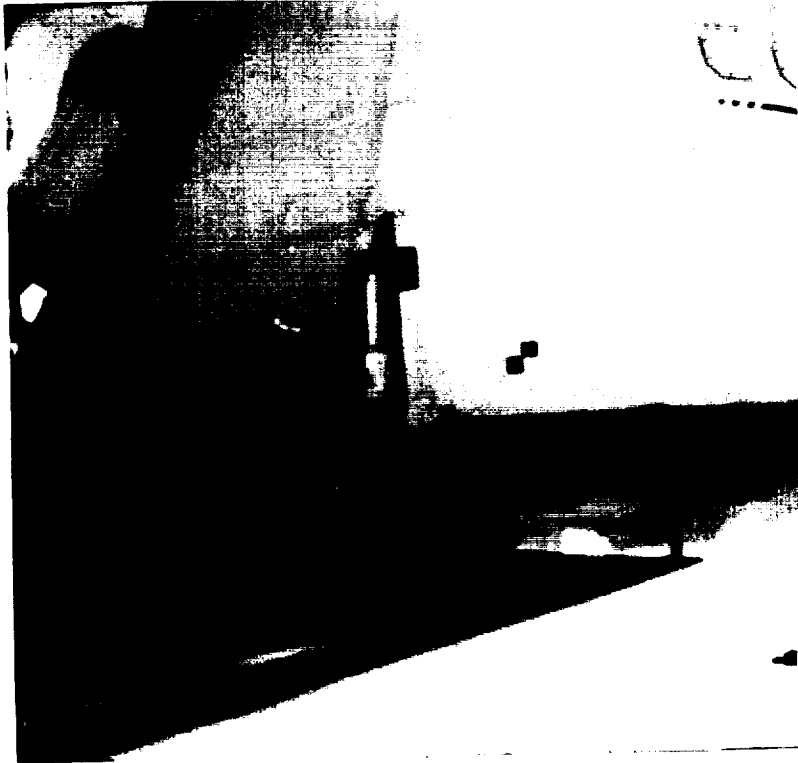

Configuration of Holddown Post #2 at SRB ignition

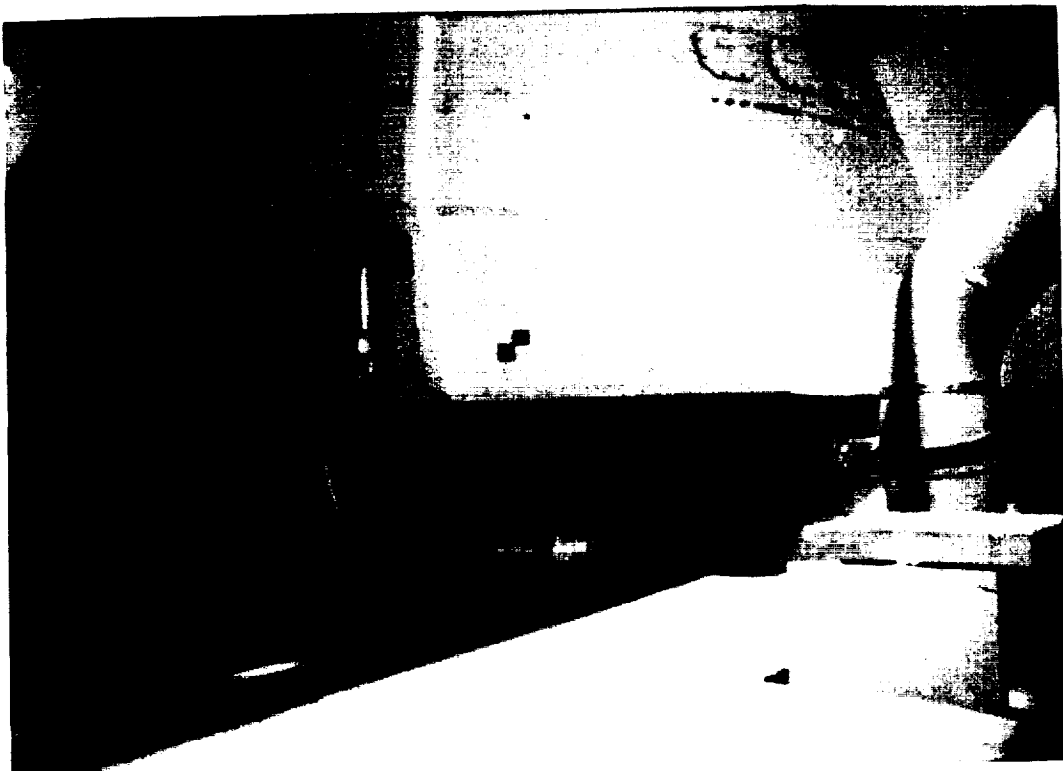

Stud hang-up causes holddown post shoe to be lifted off spherical bearing and pulled upward with rising vehicle

ORIGINAL PAGE
COLOR PHOTOGRAPH

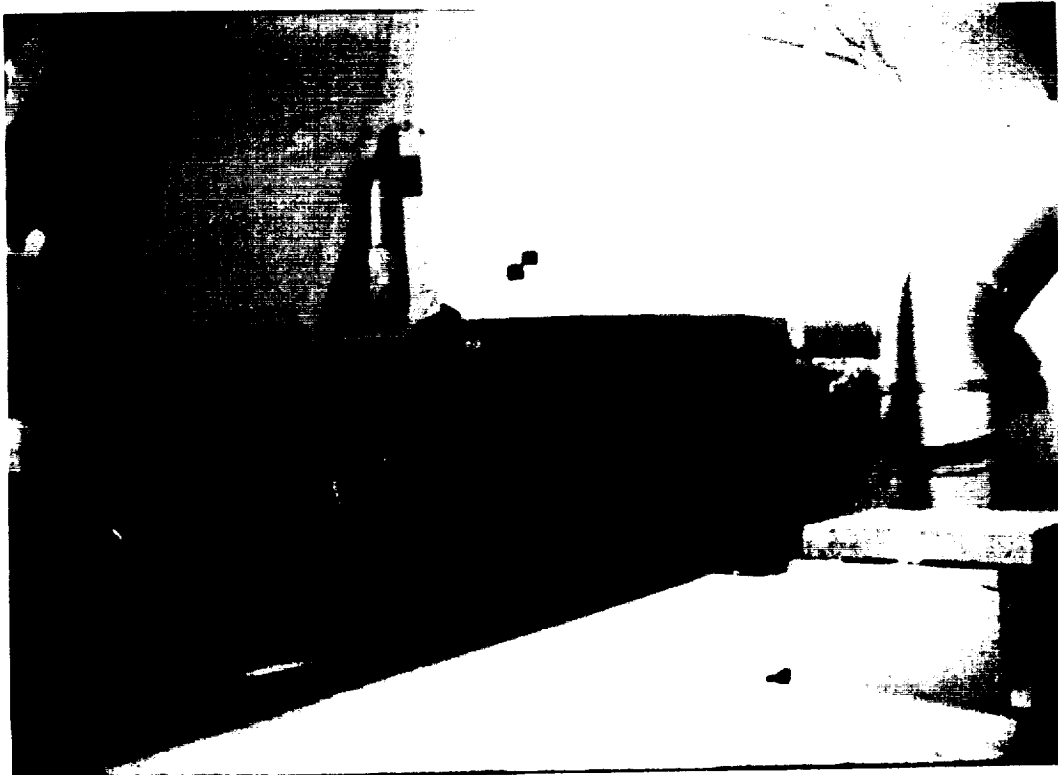

View just after aft skirt pulls away from holddown post shoe. HDP shoe has been lifted 2.4 inches. Note red rymple cloth exiting aft skirt GN2 purge port (arrow).

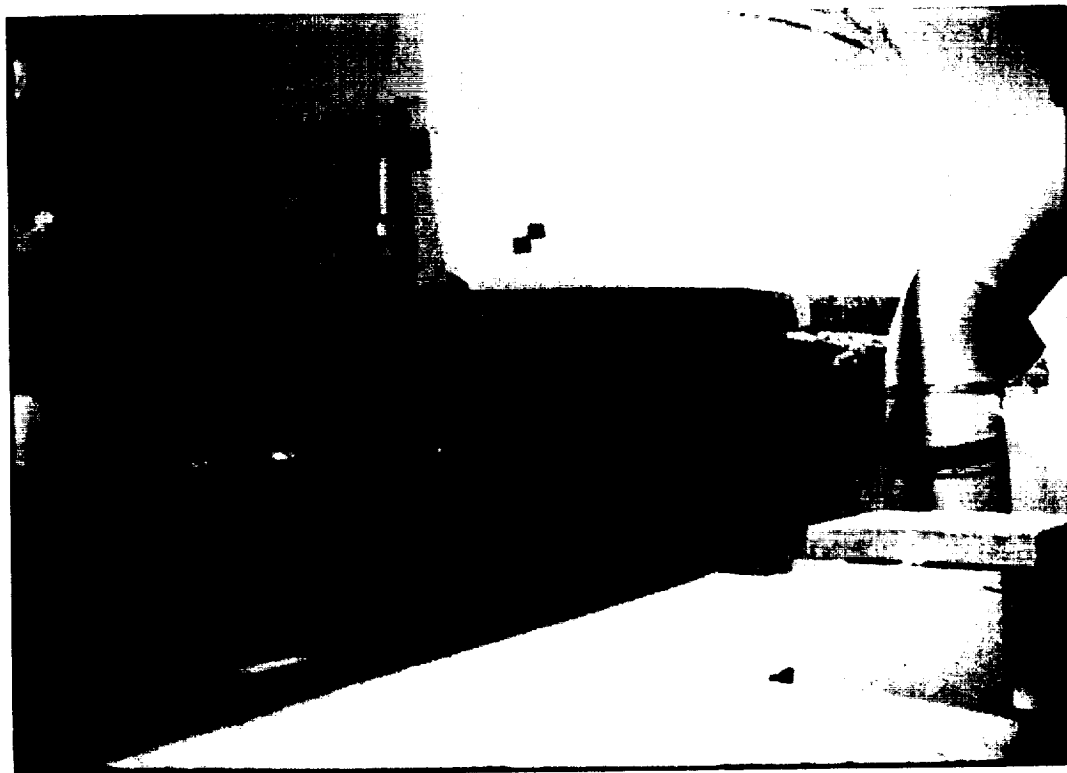

Holddown post shoe falls back to rest position on spherical bearing



ORIGINAL PAGE
COLOR PHOTOGRAPH

4"x3" divot shows where intertank TPS was pulled away during
GUCP separation. Frost has formed on TPS near ET UCP.

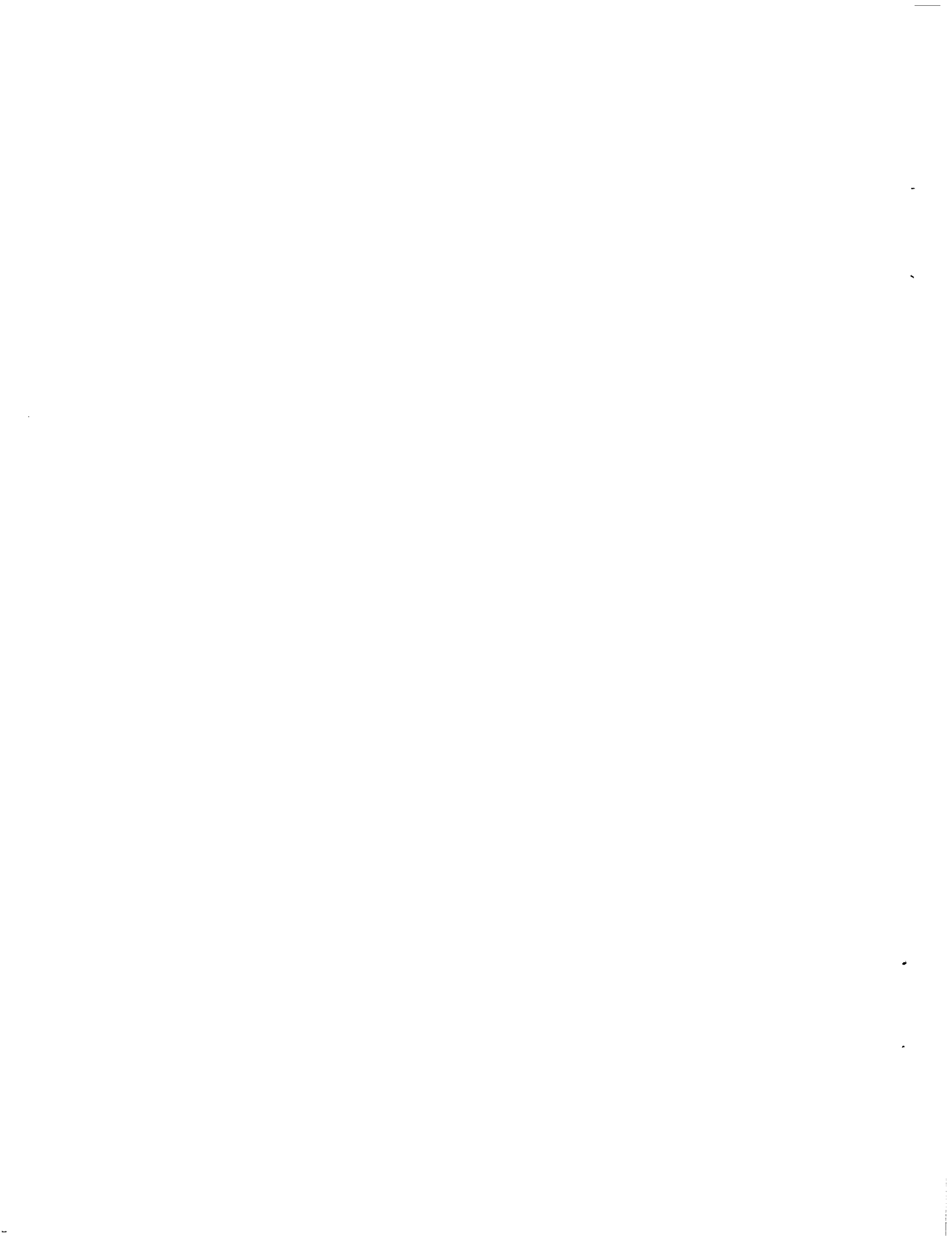



Local supersonic flow condensation forms on Orbiter, ET/SRB forward attach points, and SRB ETA ring in the Max Q region at GMT 16:54:28 (film item E-207)



RH RCS thruster paper cover appears at GMT 16:54:33



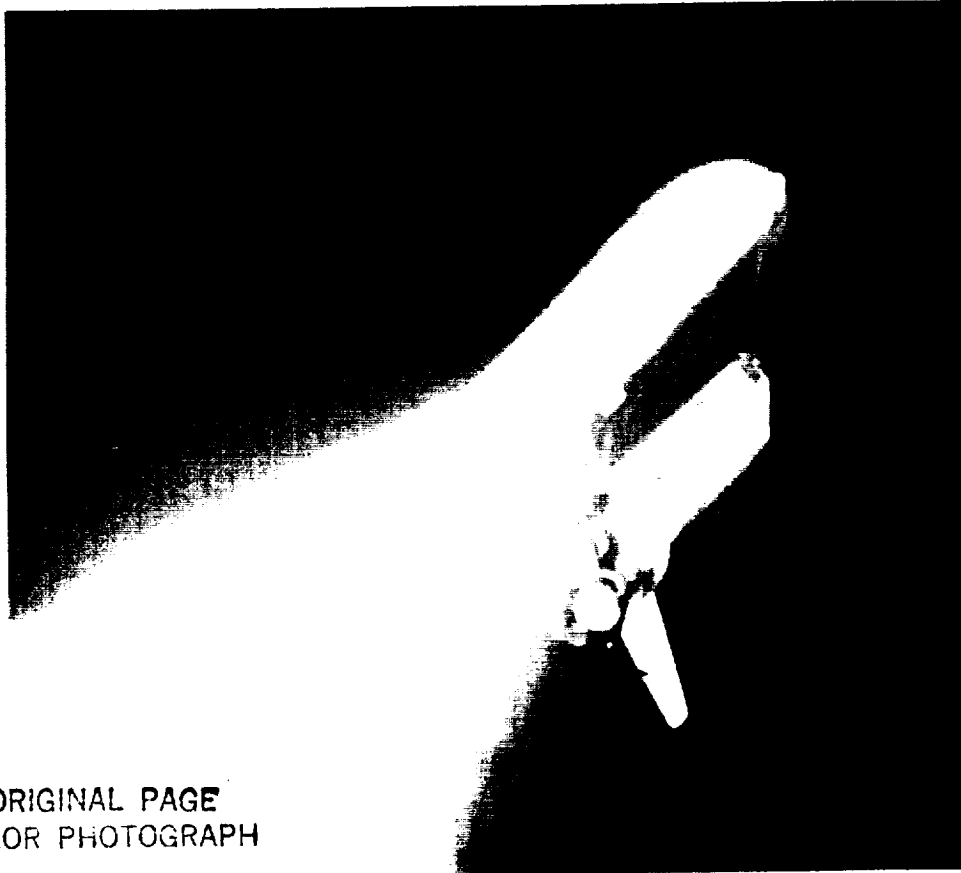

ORIGINAL PAGE
COLOR PHOTOGRAPH

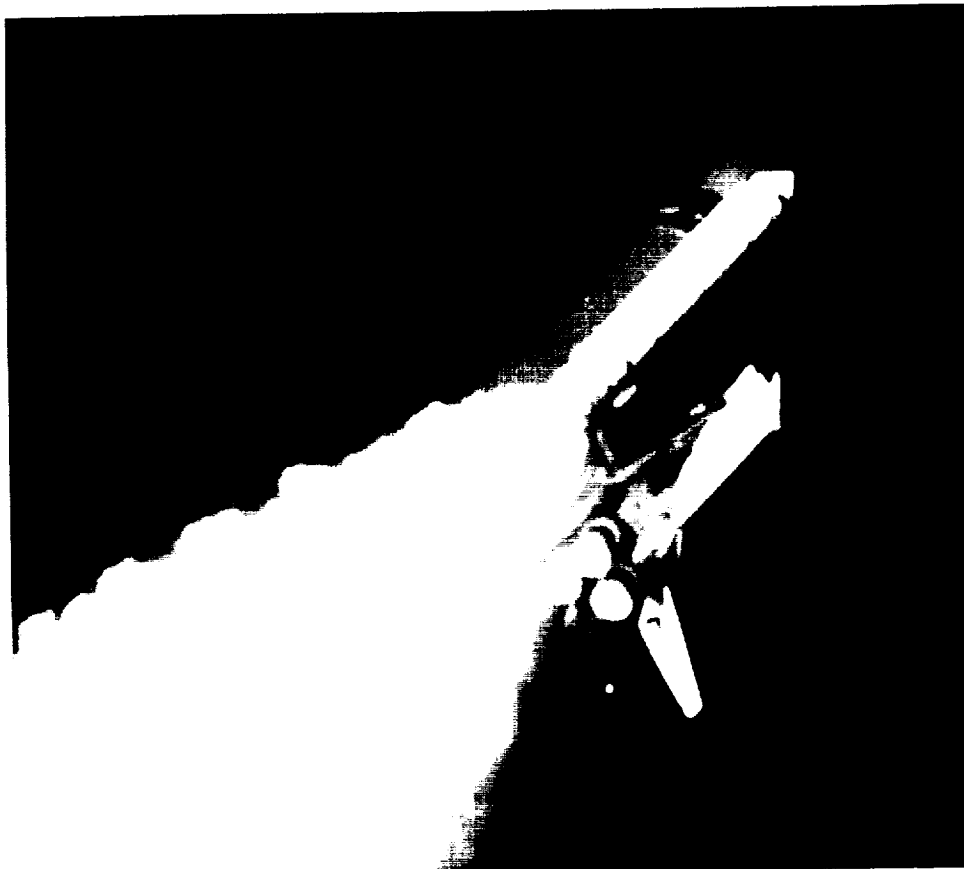

White object, believed to be a paper cover from RH RCS stinger, first appears near SSME #1 at GMT 16:54:33 and falls into SSME exhaust plume (film item E-220)

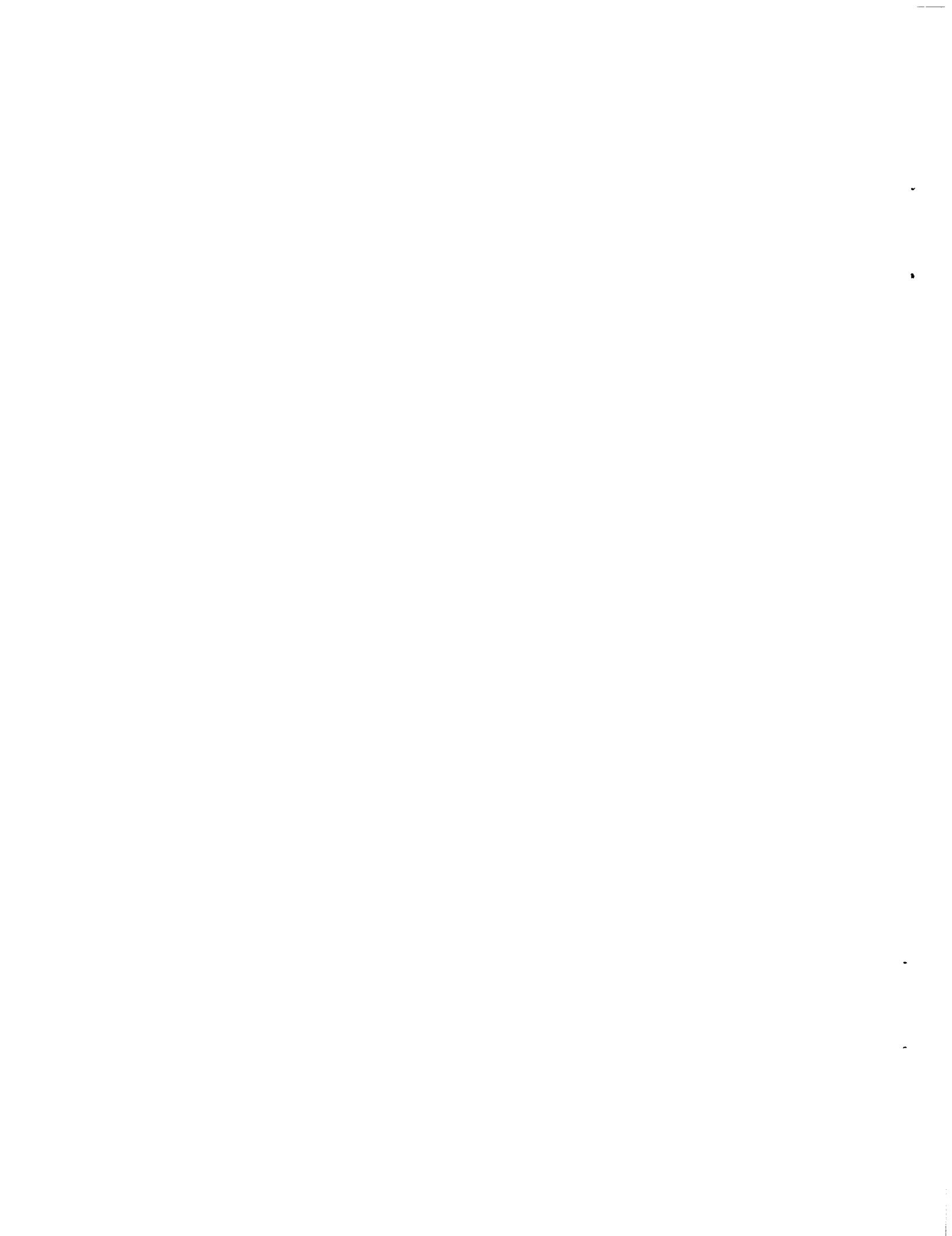



On-orbit view of External Tank after separation from Orbiter.
Some divots occurred on intertank flanges.

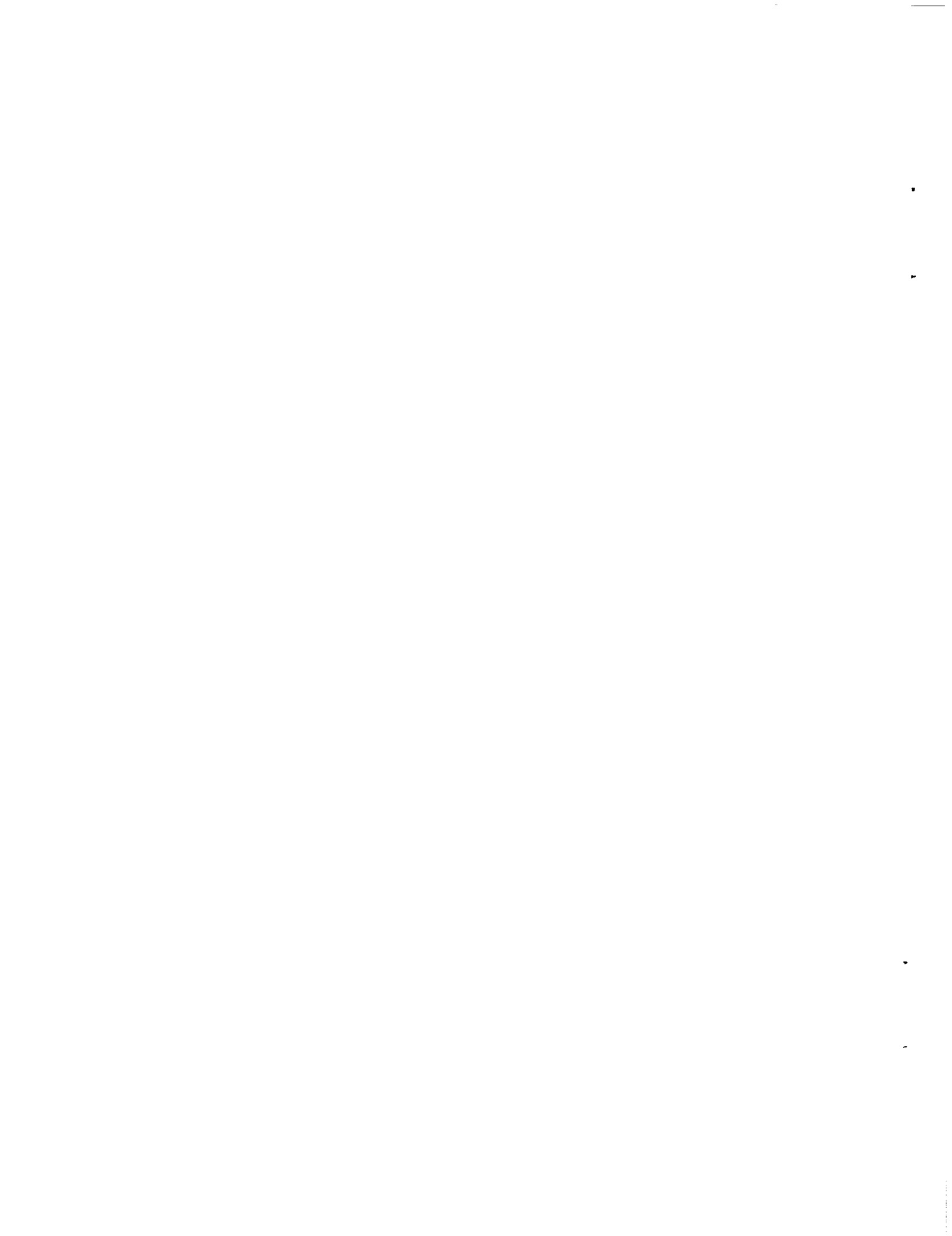

7.1 LAUNCH FILM AND VIDEO DATA REVIEW

FILM ITEMS

EX1 Camera is located on MLP deck south of RH SRB
400 FPS exhaust duct and looks north to view RH SRB Joint
16mm Heater Umbilical during ignition and liftoff.

Focus : OK
F. O. V.: OK
Exposure: OK

Comments: ROFI SMOKE IS BLOWN NORTHWARD. TYPICAL MLP DECK DEBRIS IS PULLED TOWARDS SSME FLAME HOLE BY ASPIRATION. THREE DEBRIS PARTICLES COME FROM BEHIND THE DEBRIS CONTAINER AFTER SSME START. T-0 OCCURS IN FRAME 4230. DEBRIS CONTAINER EXHIBITS TWO OSCILLATIONS AT T-0. HOLDDOWN POST SHOE ROCKS ON LIFTOFF. SRB JOINT HEATER UMBILICAL SEPARATES PROPERLY. NO DEBRIS FALLS FROM AFT STUD HOLE. TYPICAL QUANTITIES OF SRB THROAT PLUG MATERIAL ARE EJECTED FROM THE FLAME HOLE. AFT SKIRT THERMAL TAPE REMAINS ATTACHED.

EX2 Camera is located on the MLP deck west of RH SRB
400 FPS flame duct and looks east to view SRB Joint
16mm Heater Umbilical during ignition and liftoff.

Focus : OK
F. O. V.: HEATER UMBILICAL IS NOT CENTERED IN FRAME
Exposure: OK

Comments: ROFI SMOKE IS BLOWN NORTHWARD. TYPICAL MLP DECK DEBRIS IS PULLED TOWARDS SSME FLAME HOLE BY ASPIRATION. SRB JOINT HEATER UMBILICAL SEPARATES PROPERLY. WATER FROM SOUND SUPPRESSION TROUGHS GEYSERS AT T-0. TYPICAL QUANTITIES OF SRB THROAT PLUG MATERIAL ARE EJECTED FROM THE FLAME HOLE.

EX3 Camera is located on the MLP deck east of LH SRB
400 FPS flame duct and looks west to view SRB Heater
16mm Umbilical during ignition and liftoff.

Focus : OK
F. O. V.: HEATER UMBILICAL IS NOT CENTERED IN FRAME
Exposure: OK

Comments: THE SRB JOINT HEATER UMBILICAL SEPARATES PROPERLY, BUT THE NORTH END FALLS SLIGHTLY EARLIER THAN THE SOUTH. WATER FROM THE SOUND SUPPRESSION TROUGHS GEYSERS AT T-0. TYPICAL QUANTITIES OF SRB THROAT PLUG MATERIAL ARE EJECTED FROM THE FLAME HOLE. AFT SKIRT THERMAL CURTAIN TAPE REMAINS ATTACHED.

EX4 Camera is located on MLP deck south of LH SRB
400 FPS flame duct and looks north to view LH SRB Heater
16mm Umbilical during ignition and liftoff.

Focus : OK
F. O. V.: OK
Exposure: OK

Comments: TYPICAL MLP DECK DEBRIS IS PULLED TOWARDS SSME FLAME HOLE BY ASPIRATION. T-0 OCCURS IN FRAME 4129. DEBRIS PARTICLES FIRST APPEAR FROM BEHIND THE DEBRIS CONTAINER ASSEMBLY AFTER T-0. THE DEBRIS CONTAINER EXHIBITS TWO DISTINCT, SEPARATE OSCILLATIONS AT T-0 AND SHORTLY AFTER LIFT-OFF. HOLDDOWN POST SHOE ROCKS ON LIFTOFF. SRB JOINT HEATER UMBILICAL SEPARATES PROPERLY. A DEBRIS PARTICLE, PERHAPS DEBRIS PLUNGER RUBBER RETAINER, IS VISIBLE UNDERNEATH THE AFT SKIRT FOOT IN FRAME 4307. A SECOND PARTICLE, PERHAPS SILHOUETTED INSTAFOAM OR SHIM DAM MATERIAL APPEARS AT THE SAME LOCATION IN FRAME 4342. NO DEBRIS FALLS FROM AFT SKIRT STUD HOLE ONCE IT BECOMES VISIBLE. TYPICAL QUANTITIES OF SRB THROAT PLUG MATERIAL ARE EJECTED FROM THE FLAME HOLE. AFT SKIRT THERMAL TAPE REMAINS ATTACHED.

E-1 Camera is located on the NE corner of the MLP deck
400 FPS and views the lower ET, SRB's, and Orbiter.
16mm

Focus : OK
F. O. V.: OK
Exposure: OK

Comments: ROFI IGNITION OCCURS IN FRAME 485. SSME IGNITION STARTS AT FRAME 2343. MANY ICE PARTICLES FALL FROM THE ET/ORBITER UMBILICALS STARTING IN FRAME 2752 AND CONTINUING THROUGH FRAME 4869. T-0 OCCURS IN FRAME 4663. SOME PARTICLES COME OUT OF THE RIGHT SRB FLAME HOLE IN FRAME 4587. WATER FROM SRB STIFFENER RINGS AND CONDENSATE FROM ET AFT DOME VAPORIZE AFTER LIFTOFF.

E-2 Camera is located on the SE corner of the MLP deck
400 FPS and views Orbiter SSME and OMS engine nozzles.
16mm

Focus : OK
F. O. V.: OK
Exposure: OK

Comments: ROFI IGNITION OCCURS IN FRAME 479. SSME IGNITION STARTS IN FRAME 2160. THE PAPER COVERS ON THE +Y YAW RCS THRUSTERS ARE DISCOLORED, INDICATING LEAKING OXIDIZER. AN RCS PAPER COVER FALLS FROM THE RIGHT SIDE IN FRAME 2270. THE SSME PLUME IS BLOWN BACK OVER THE TOP OF THE MLP DECK IN FRAME 2715. AN ORANGE GLOW, BELOW THE SSME NOZZLES, IS DUE TO BURNING OF EXCESS HYDROGEN TRAPPED BY SOUTHERLY WINDS. T-0 OCCURS IN FRAME 4289. VAPORS EMANATE FROM THE LO2 T-0 UMBILICAL IN FRAME 4558. AN ORANGE STREAK APPEARS IN THE PLUME OF SSME #1 (6 O'CLOCK POSITION) IN FRAME 4625. THE LH2 TSM DOOR IS COMPLETELY CLOSED IN FRAME 4838. WATER FROM RH SRB STIFFENER RINGS VAPORIZES.

E-3 Camera is located on the SW corner of the MLP deck
400 FPS and views Orbiter SSME and OMS engine nozzles.
16mm

Focus : OK
F. O. V.: OK
Exposure: OK

Comments: ROFI IGNITION OCCURS IN FRAME 459 AND SSME START BEGINS IN FRAME 2034. THE -Y AFT RCS PAPER COVERS ARE TORN IN FRAME 2322. T-0 OCCURS IN FRAME 2315. AN ORANGE STREAK APPEARS FROM THE 7 O'CLOCK POSITION OF THE SSME #1 NOZZLE IN FRAME 4658. THE LO2 TSM DOOR REBOUNDS ONCE AND IS COMPLETELY CLOSED BY FRAME 4896. WATER FROM THE SRB STIFFENER RINGS VAPORIZES.

E-4 Camera is located on the NW corner of the MLP deck
400 FPS and views lower ET, SRB's, and Orbiter.
16mm

Focus : OK
F. O. V.: OK
Exposure: UNDEREXPOSED

Comments: ROFI IGNITION OCCURS IN FRAME 463. WATER FALLS FROM THE LH2 VENT ARM HAUNCH. SSME START-UP BEGINS IN FRAME 1005. ET/ORBITER UMBILICAL ICE FALLS SHORTLY AFTER SSME IGNITION. T-0 OCCURS IN FRAME 4272.

E-5 Camera is located on the east side of the MLP
400 FPS deck and views the Orbiter RH wing, body flap,
16mm and lower ET/SRB.

Focus : OK
F. O. V.: OK
Exposure: OK

Comments: ROFI IGNITION OCCURS IN FRAME 377 AND SSME IGNITION
BEGINS IN FRAME 1870. A SMALL PIECE OF DEBRIS FALLS THROUGH FRAME
FROM UPPER RIGHT. ICE PARTICLES FALL FROM THE LO2 T-0 UMBILICAL
AFTER SSME START. T-0 OCCURS IN FRAME 4267. BODY FLAP AND ELEVON
MOTION AT LIFTOFF IS TYPICAL. ICE PARTICLES FALL FROM BOTH THE
LO2 AND LH2 ET/ORBITER UMBILICALS.

E-6 Camera is located on the east side of the MLP deck
200 FPS and views the RH lower Orbiter wing, body flap, ET
16mm lower LOX feedline, and ET/Orbiter umbilical area.

Focus : OK
F. O. V.: OK
Exposure: OK

Comments: ICE PARTICLES FALL FROM THE ET/ORBITER UMBILICALS AND
THE +Y ET/SRB CABLE TRAY DURING MAIN ENGINE IGNITION. AFTER SSME
START, ICE PARTICLES FALL FROM THE LH2 AND LO2 FEEDLINE BELLOWS.
THE RH INBOARD AND OUTBOARD ELEVONS EXHIBIT TYPICAL MOTION AT
LIFTOFF. GOX FROM THE DISCONNECTED TSM UMBILICAL BLOWS AROUND
SSME #3 IN FRAME 5017. THE USUAL AMOUNT OF SRB THROAT PLUG AND
WATER TROUGH MATERIAL CROSSES THE FOV FROM RIGHT TO LEFT IN FRAME
5180, BUT DOES NOT STRIKE THE ORBITER.

E-7 Camera is located on the MLP deck and views the
400 FPS RH SRB northeast holddown post (HDP #4).
16mm

Focus : OK
F. O. V.: OK
Exposure: OK

Comments: HPU EXHAUST SMOKE IS BLOWN NORTHWARD. A BAT IS PULLED
INTO THE SRB FLAME HOLE BY SSME ASPIRATION IN FRAME 2980. T-0
OCCURS IN FRAME 4265. TYPICAL FACILITY DEBRIS IS EJECTED FROM THE
SRB FLAME HOLE AT T-0. NO HDP SHOE SHIM MATERIAL APPEARS TO BE
MISSING. THE HDP DOGHOUSE BLAST COVER FUNCTIONS PROPERLY.

E-8
400 FPS
16mm

Camera is located on the MLP deck and views the
RH SRB southeast holddown post (HDP #2).

Focus : OK
F. O. V.: OK
Exposure: OK

Comments: ICE PARTICLES FALL TO THE MLP DECK SHORTLY AFTER SSME IGNITION. T-0 OCCURS IN FRAME 4259. THE DEBRIS CONTAINER ASSEMBLY DOES NOT APPEAR TO MOVE AT T-0. PARTICLES COME OUT FROM BEHIND THE DEBRIS CONTAINER RIGHT AFTER T-0. TYPICAL QUANTITIES OF SRB THROAT PLUG MATERIAL ARE EJECTED FROM THE SRB FLAME HOLE. THE HOLDDOWN STUD IS HELD UP IN THE AFT SKIRT FOOT HOLE CAUSING THE STUD TO PROTRUDE A MAXIMUM OF 10 INCHES FROM THE SHOESEPARATION PLANE. DUE TO THE STUD HANG-UP, THE HOLDDOWN POST SHOE MOVES UPWARD APPROXIMATELY 2 1/2 INCHES BEFORE SEPARATING FROM THE AFT SKIRT FOOT. THE SPHERICAL BEARING FOLLOWS THE SHOE UPWARD TO A HEIGHT SLIGHTLY LESS THAN 2 INCHES. ONCE THE VEHICLE PULLS AWAY, THE STUD DROPS INTO THE HOLDDOWN POST SAND BOX. A PIECE OF RYMPLE CLOTH IS BLOWN OUT OF THE SRB AFT SKIRT GN2 PURGE PORT IN FRAME 4500 (RYMPLE CLOTH IS USED TO PREVENT INSTAFOAM FROM ADHERING TO THE PURGE PIPE DURING TPS CLOSEOUT). FIREX WATER IS PRESENT ON THE SRB NOZZLE AND THERMAL CURTAIN.

E-9
400 FPS
16mm

Camera is located on the MLP deck and views the
RH SRB southwest holddown post (HDP #1).

Focus : OK
F. O. V.: OK
Exposure: OK

Comments: ROFI SMOKE IS BLOWN NORTHWARD. ONE PIECE OF K5NA FALLS FROM BEHIND THE HDP DEBRIS CONTAINMENT ASSEMBLY. A SMALL PIECE OF MLP DECK SCALE IS PICKED UP AND PULLED INTO THE SSME FLAME HOLE BY ASPIRATION. TYPICAL DEBRIS COMES FROM THE SRB FLAME HOLE AT LIFTOFF. NO DEBRIS FALLS FROM AFT SKIRT STUD HOLE.

E-10
400 FPS
16mm

Camera is located on the MLP deck and views the
RH SRB northwest holddown post (HDP #3).

Focus : OK
F. O. V.: OK
Exposure: OK

Comments: T-0 OCCURS IN FRAME 4201. A PIECE OF DEBRIS, POSSIBLY INSTAFOAM, FALLS FROM THE HOLDDOWN POST SHOE RETAINER BRACKET AT T-0. NO DEBRIS CONTAINER ASSEMBLY MOVEMENT IS VISIBLE. TYPICAL AMOUNTS OF THROAT PLUG MATERIAL IS EJECTED FROM THE SRB FLAME HOLE. NO OBJECTS FALL FROM THE AFT SKIRT STUD HOLE. THERMAL CURTAIN TAPE REMAINS ATTACHED. HOLDDOWN POST DOGHOUSE BLAST COVER CLOSES PROPERLY.

E-11 Camera is located on the MLP deck and views the
400 FPS LH SRB northeast holddown post (HDP #7).
16mm

Focus : OK
F. O. V.: OK
Exposure: OK

Comments: A DARK, OUT-OF-FOCUS OBJECT PASSES THROUGH RH CORNER OF FOV IN FRAME 2492. T-0 OCCURS AT FRAME 4386. TYPICAL AMOUNTS OF SRB THROAT PLUG AND SOUND SUPPRESSION WATER TROUGH MATERIAL ARE EJECTED FROM THE FLAME HOLE. STARTING AT FRAME 4625, A LONG LENGTH OF SOUND SUPPRESSION WATER TROUGH CORD WHIPS THROUGH THE FOV. THE DEBRIS CONTAINMENT ASSEMBLY ROCKS SLIGHTLY AS THE VEHICLE RISES. THE HOLDDOWN POST DOGHOUSE BLAST COVER CLOSES PROPERLY. NO OBJECTS FALL FROM THE AFT SKIRT STUD HOLE.

E-12 Camera is located on the MLP deck and views the
400 FPS LH SRB southeast holddown post (HDP #5).
16mm

Focus : OK
F. O. V.: OK
Exposure: OK

Comments: ROFI SPARKS ARE BLOWN NORTHWARD. ICE PARTICLES FALL FROM THE LH2 ET/ORBITER UMBILICAL. T-0 OCCURS IN FRAME 4186. THE DEBRIS CONTAINMENT ASSEMBLY SHAKES SLIGHTLY IN FRAME 4231. A K5NA PARTICLE FALLS FROM BEHIND THE PLUNGER HOUSING AS THE VEHICLE RISES. NO DEBRIS FALLS FROM THE AFT SKIRT STUD HOLE.

E-13 Camera is located on the MLP deck and views the
400 FPS LH SRB southwest holddown post (HDP #6).
16mm

Focus : OK
F. O. V.: OK
Exposure: OK

Comments: SSME IGNITION OCCURS AT FRAME 2298 AND T-0 AT FRAME 4230. NO DEBRIS CONTAINMENT ASSEMBLY MOTION IS EVIDENT, BUT THE HOLDDOWN POST SHOE ROCKS SLIGHTLY AT LIFTOFF. A TYPICAL AMOUNT OF SRB THROAT PLUG MATERIAL IS EJECTED FROM THE SRB FLAME HOLE.

E-14 Camera is located on the MLP deck and views the
400 FPS LH SRB northwest holddown post (HDP #8).
16mm

Focus : OK
F. O. V.: OK
Exposure: OK

Comments: SRB IGNITION OCCURS IN FRAME 4192. A TYPICAL AMOUNT OF SRB THROAT PLUG MATERIAL IS EJECTED FROM THE FLAME HOLE. NO TAPE IS LOOSE ON THE AFT SKIRT THERMAL CURTAIN. HOLDDOWN POST DOGHOUSE BLAST SHIELD CLOSURE IS OBSCURED BY EXHAUST.

E-15 Camera is located on the MLP deck and views the RH
400 FPS SRB skirt, sound suppression water troughs, and RH
16mm lower Orbiter body flap.

Focus : OK
F. O. V.: OK
Exposure: OK

Comments: HPU EXHAUST IS VISIBLE ON THE EAST SIDE OF THE AFT SKIRT. ICE PARTICLES FALL FROM THE LO2 ET/ORBITER UMBILICAL DURING SSME START-UP. RCS PAPER COVERS FALL FROM THE RH OMS POD STINGER. A SILHOUETTED OBJECT (PROBABLY ICE) FALLS FROM AN AREA BEHIND THE BELL OF SSME #3, BUT IN FRONT OF THE VERTICAL STABILIZER IN FRAME 2387.

E-16 Camera is located on the MLP deck and views the LH
400 FPS SRB skirt, sound suppression water troughs, and LH
16mm lower Orbiter body flap.

Focus : OK
F. O. V.: OK
Exposure: OK

Comments: WATER DELUGE DROPLETS FALL IN FRONT OF THE CAMERA. A HEAVY SHOWER OF ICE FALLS FROM THE ET/ORBITER LH2 UMBILICAL, BUT NO TILE DAMAGE RESULTS. T-0 OCCURS IN FRAME 4380. BOTH HDP DOGHOUSE BLAST COVERS CLOSE ON TIME.

E-17 Camera is located on the MLP deck and views the
400 FPS -Z side of the LO2 T-0 Umbilical and TSM.
16mm

Focus : OK
F. O. V.: OK
Exposure: OK

Comments: ICE PARTICLES FALL FROM THE LO2 T-0 UMBILICAL. ROFI SMOKE, SPARKS, AND FREE BURNING HYDROGEN ARE BLOWN NORTHWARD. RCS PAPER COVERS TEAR AND FALL AWAY. T-0 OCCURS IN FRAME 4580. T-0 UMBILICAL RETRACTION IS NOMINAL. THE BODY FLAP EXHIBITS TYPICAL MOTION DURING SSME #3 START-UP. IN FRAME 4700, A LARGE PIECE OF ICE ENTERED THE F.O.V. FROM THE UPPER LEFT AND MOVED TO THE LOWER RIGHT.

E-18 Camera is located on the MLP deck and views the
400 FPS -Z side of the LH2 T-0 umbilical and TSM.
16mm

Focus : OK
F. O. V.: OK
Exposure: OK

Comments: FREE BURNING HYDROGEN, ROFI SPARKS, AND SMOKE ARE BLOWN NORTHWARD. THE BODY FLAP EXHIBITS TYPICAL MOTION DURING SSME #2 START-UP. RCS PAPER COVERS TEAR AND FALL AWAY. A HEAVY SHOWER OF ICE PARTICLES FALLS FROM THE LH2 ET/ORBITER UMBILICAL. A 6"x1"x1/2" PIECE OF SSME FOIL INSULATION IS SHAKEN LOOSE FROM THE GOX DRAIN LINE AREA, FALLS PAST THE BELL NOZZLE AND OUT OF VIEW. T-0 OCCURS IN FRAME 3530. T-0 UMBILICAL RETRACTION IS NOMINAL. IN FRAME 3890 AN ORANGE GSE TILE SHIM FALLS PAST THE IN-BOARD ELEVON.

E-19 Camera is located on the SE side of the MLP deck
400 FPS and views the SSME/OMS nozzles and Orbiter aft
16mm heat shield area.

Focus : OK
F. O. V.: OK
Exposure: OK

Comments: FREE BURNING HYDROGEN RISES. A PREBURN STREAM OF HYDROGEN (HYDROGEN 'LEAD') EXITS SSME #1 IN FRAME 2420. SSME #1 IGNITION OCCURS IN FRAME 4476. ICE FROM SSME OXYGEN DRAIN LINES FALL AT SSME IGNITION. RCS PAPER COVERS TEAR AND FALL AWAY. T-0

OCCURS IN FRAME 4239. THE ORBITER LO2 T-0 UMBILICAL DISCONNECT AND RETRACTION IS NOMINAL. THE LH2 TSM DOOR REBOUNDS OPEN, BUT CLOSES AGAIN BEFORE SSME'S PASS BY (FRAME 4563 - 4676).

E-20 Camera is located on the SW side of the MLP deck
400 FPS and views the SSME/OMS nozzles and Orbiter aft
16mm heat shield area.

Focus : OK
F. O. V.: OK
Exposure: OK

Comments: FREE BURNING HYDROGEN RISES. A PREBURN STREAM OF HYDROGEN (HYDROGEN 'LEAD') EXITS SSME #1 IN FRAME 2358 AND FROM SSME #2 IN FRAME 2336. ICE FROM SSME OXYGEN DRAIN LINES FALL AT SSME IGNITION. RCS PAPER COVERS TEAR AND FALL AWAY. T-0 OCCURS IN FRAME 4333. THE ORBITER LH2 T-0 UMBILICAL DISCONNECT AND RETRACTION IS NOMINAL. THE LO2 TSM DOOR REBOUNDS OPEN, BUT CLOSES AGAIN BEFORE SSME'S PASS BY (FRAME 4795 - 4931).

E-21 Camera is located inside the LO2 TSM and views
200 FPS the disconnection of the T-0 umbilical.
16mm

Focus : SOFT
F. O. V.: OK
Exposure: OK

Comments: ICE PARTICLES FALL FROM THE LO2 T-0 UMBILICAL. VEHICLE TWANG AND T-0 DISCONNECT IS NORMAL. RESIDUAL GO2 VAPOR EMANATES FROM ORBITER UMBILICAL AFTER DISCONNECT AND IS PULLED TOWARDS THE SSME BY ASPIRATION. T-0 OCCURS IN FRAME 4524. A DEBRIS PARTICLE FALLS FROM BETWEEN THE CARRIER PLATE AND THE ORBITER IN FRAME 4645. A SECOND PARTICLE FALLS TO THE RIGHT OF THE CARRIER PLATE, NEAR THE TSM, IN FRAME 4792.

E-22 Camera is located inside the LH2 TSM and views
200 FPS the disconnection of the T-0 umbilical.
16mm

Focus : OK
F. O. V.: OK
Exposure: OK

Comments: PURGE BARRIER REMAINS INTACT UNTIL SSME IGNITION. VEHICLE TWANG IS NORMAL AND LH2 T-0 UMBILICAL RETRACTION IS NOMINAL. TSM DOOR BOUNCE IS 2 TO 3 INCHES.

E-23 Camera is located on the MLP deck and views the
400 FPS RH OMS engine nozzle.
16mm

Focus : OK
F. O. V.: OK
Exposure: OK

Comments: SSME START OCCURS IN FRAME 2434. ICE PARTICLES FALL FROM THE LO2 T-0 UMBILICAL AND RCS BUTCHER PAPER COVERS TEAR LOOSE DURING SSME IGNITION. RESIDUAL LO2 VAPORIZES AS THE T-0 UMBILICAL RETRACTS. A DEBRIS PARTICLE 1" X 1-1/2" X 1/8" (PROBABLY TILE SURFACE COATING) FALLS FROM BEHIND THE RH STINGER AREA IN FRAME 4694.

E-24 Camera is located on the MLP deck and views the
400 FPS LH OMS engine nozzle.
16mm

Focus : OK
F. O. V.: OK
Exposure: OK

Comments: MAIN ENGINE START OCCURS IN FRAME 2501. ICE PARTICLES FALL FROM THE ET/ORBITER LO2 AND LH2 UMBILICALS. RESIDUAL LH2 VAPORIZES AS THE LH2 T-0 UMBILICAL RETRACTS.

E-25 Camera is located on the east side of the MLP and
400 FPS views between Orbiter and ET/SRB during liftoff.
16mm

Focus : OK
F. O. V.: OK
Exposure: OK

Comments: SSME START BEGINS IN FRAME 1515. ICE PARTICLES FALL FROM BOTH THE LH2 AND LO2 ET/ORBITER UMBILICALS AND THE LO2 T-0 UMBILICAL. ELEVON AND BODY FLAP MOTION DURING SSME START-UP AND LIFTOFF IS TYPICAL. SRB THROAT PLUG MATERIAL RISES FROM THE RH SRB FLAME HOLE TOWARDS THE ORBITER WING, BUT DOES NOT MAKE CONTACT. A PAPER COVER FALLS FROM THE RH RCS PITCH NOZZLE #4 AS THE VEHICLE RISES.

E-26 Camera is located on the west side of the MLP and
400 FPS views between Orbiter and ET/SRB during liftoff.
16mm

Focus : OK
F. O. V.: OK
Exposure: OK

Comments: WATER DELUGE SYSTEM FOR LH2 VENT ARM ALREADY ACTIVATED AT START OF FILM. SSME START BEGINS IN FRAME 1466. ELEVON MOTION DURING SSME START-UP AND LIFTOFF IS TYPICAL. T-0 OCCURS IN FRAME 3530. ICE PARTICLES FALL FROM BOTH THE LH2 AND LO2 ET/ORBITER UMBILICALS. GUCP SEPARATION AND LH2 VENT LINE LATCHBACK BOTH APPEAR NORMAL. THE LEFT OMS POD PITCH JET PAPER COVER FALLS AS THE VEHICLE RISES.

E-27 Camera is located on the MLP deck and views RH SRB
400 FPS northwest holddown post (HDP #3) blast cover.
16mm

Focus : OK
F. O. V.: OK
Exposure: OK

Comments: SSME IGNITION OCCURRED AT FRAME 1823 FOLLOWED BY T-0 AT FRAME 3699. THE HDP DOGHOUSE BLAST COVERS CLOSED NOMINALLY. NO DEBRIS FELL FROM THE AFT SKIRT STUD HOLES. TYPICAL AMOUNTS OF THROAT PLUG MATERIAL WERE EJECTED OUT OF THE EXHAUST HOLES. NO TAPE WAS LOOSE ON THE SRB THERMAL CURTAINS, HOWEVER SOME MATERIAL WAS LOOSE (ZINC CHROMATE PUTTY).

E-28 Camera is located on the MLP deck and views LH SRB
400 FPS northeast holddown post (HDP #7) blast cover.
16mm

Focus : OK
F. O. V.: OK
Exposure: OK

Comments: SSME IGNITION OCCURRED AT FRAME 2317 FOLLOWED BY T-0 AT FRAME 4264. THERE WAS NO APPARENT MOVEMENT OF THE DEBRIS CONTAINMENT ASSEMBLY. THE HDP DOGHOUSE BLAST COVERS CLOSED NORMALLY. NO DEBRIS FELL FROM THE AFT SKIRT STUD HOLES. TYPICAL AMOUNTS OF SRB THROAT PLUG MATERIAL WERE EJECTED FROM THE EXHAUST HOLES.

E-30 Camera is located on the FSS 195 foot level and
400 FPS views LH SRB and sound suppression water troughs.
16mm

Focus : OK
F. O. V.: OK
Exposure: OK

Comments: SSME IGNITION OCCURS AT FRAME 1943 FOLLOWED BY T-0 AT
FRAME 4199. FREE BURNING HYDROGEN IS BLOWN NORTH (FRAME 1993).
ICE FALLS FROM THE ET/ORB UMBILICALS DURING IGNITION AND LIFTOFF.
TYPICAL AMOUNTS OF SRB THROAT PLUG MATERIAL ARE VISIBLE DURING
LIFTOFF.

E-31 Camera is located on the FSS 95 foot level and
100 FPS views the LH Orbiter wing, body flap, and
16mm ET/Orbiter LH2 umbilical area.

Focus : OK
F. O. V.: OK
Exposure: OK

Comments: SSME IGNITION OCCURS IN FRAME 593. BOTH THE INBOARD
AND OUTBOARD RH ELEVONS BEGIN TO EXHIBIT TYPICAL MOTION IN FRAME
648. ALSO IN FRAME 648, ICE PARTICLES BEGIN TO FALL FROM THE LO2
AND LH2 ET/ORBITER UMBILICALS. AN ORANGE GSE TILE SHIM (FEELER
GAGE) FALLS FROM A LOCATION ON THE ORBITER LOWER SURFACE
APPROXIMATELY ONE FOOT FORWARD OF THE CENTER OF THE RH INBOARD
ELEVON HINGE (FRAME 902). ICE FALLS FROM THE LH2 FEEDLINE BELLOWS
ONTO THE LH2 RECIRCULATION LINE IN FRAME 902. FROM FRAMES 1015 TO
1135, A PIECE OF FACILITY DEBRIS CROSSES THE FOV FROM RIGHT TO
LEFT. T-0 OCCURS IN FRAME 1165. WATER VAPORIZES ON THE ET AFT
DOME AND ICE PARTICLES CONTINUE TO FALL FROM THE ET/ORBITER
UMBILICALS AS THE VEHICLE RISES.

E-33 Camera is located on the FSS 235 foot level and
400 FPS views the ET GH2 vent line and GUCP.
16mm

Focus : OK
F. O. V.: OK
Exposure: OK

Comments: ICE IS PRESENT AT 3 LOCATIONS ON THE INTERTANK
STRINGERS NEAR THE GUCP. THIS ICE FORMED WHEN COLD AIR IMPINGED
ON THE STRINGERS FROM THE GH2 VENT LINE. SEVERAL ICE PARTICLES
FALL FROM THE GUCP AT SSME START (FRAME 1199). T-0 OCCURS IN
FRAME 3002. A 4"x3" PIECE OF INTERTANK FOAM IS MISSING FROM AN

AREA NEAR THE LOWER LH CORNER OF THE GUCP. GUCP SEPARATION AND VENT LINE RETRACTION IS NOMINAL. A BAT COMES FROM BETWEEN THE ET AND SRB AND CROSSES FOV FROM FRAMES 3253 TO 3387.

E-34 Camera is located on FSS at 255 foot level and
400 FPS views upper Orbiter tile surfaces.
16mm

Focus : OK
F. O. V.: OK
Exposure: OK

Comments: SEVERAL PIECES OF ICE FALL FROM THE GUCP SHORTLY AFTER T-0. ICE PARTICLES FALL FROM THE ET/ORBITER UMBILICALS. ET BUTCHER PAPER REMAINS INTACT, ICE REMAINS ON THE LH2 UMBILICAL, AND THE LH2 BAGGIE IS INTACT AS THE VEHICLE PASSES THROUGH THE FOV. BUTCHER PAPER FALLS AWAY FROM THE PITCH RCS JETS.

E-35 Camera is located on the FSS 255 foot level and
400 FPS views the mid-Orbiter/ET/SRB area.
16mm

Focus : OK
F. O. V.: OK
Exposure: OK

Comments: T-0 OCCURS IN FRAME 2600. SEVERAL PIECES OF ICE FALL FROM GUCP AT SEPARATION. ET AFT DOME CONDENSATE VAPORIZES AFTER T-0.

E-36 Camera is located on the FSS 255 foot level and
400 FPS views lower Orbiter, ET, SRB's, and water trough.
16mm

Focus : OK
F. O. V.: OK
Exposure: OK

Comments: SSME START BEGINS AT FRAME 1096. ICE FALLS FROM THE ET/ORBITER UMBILICALS NEAR THE BODY FLAP, BUT NO TILE DAMAGE IS VISIBLE. T-0 OCCURS IN FRAME 3243. BUTCHER PAPER FALLS FROM THE LH RCS PITCH THRUSTERS IN FRAME 4135. LH2 T-0 UMBILICAL RETRACTION APPEARS NOMINAL.

E-39 Camera is located on the FSS 185 foot level and
400 FPS views GH2 vent line latchback.
16mm

Focus : OK
F. O. V.: OK
Exposure: UNDEREXPOSED

Comments: WATER DELUGE WORKS PROPERLY. IMAGE IS DARK UNTIL MPS
LIGHTENS SCENE. GH2 VENT LINE LATCHBACK IS NOT VISIBLE. VENT LINE
SWAYS WITHIN LATCHBACK MECHANISM AFTER VEHICLE HAS PASSED.
FACILITY DEBRIS ENTERS FOV WELL AFTER VEHICLE CLEARS THE PAD.

E-40 Camera is located on the FSS 275 foot level and
400 FPS views the ET ogive, SRB nosecone, and Orbiter
16mm tiled surfaces.

Focus : OK
F. O. V.: OK
Exposure: OK

Comments: T-0 OCCURS IN FRAME 3384. CONDENSATE ON THE ET AFT
DOME AND WATER FROM THE SRB STIFFENER RINGS VAPORIZES. WATER
VAPOR FALLS FROM THE SPLIT SPEED BRAKE/RUDDER. NO UNUSUAL VAPORS
EMANATE FROM THE ET/ORBITER UMBILICALS. SOME PIECES OF ICE FALL
FROM THE ET/ORBITER UMBILICALS, BUT CAUSE NO TILE DAMAGE.
FACILITY DEBRIS, BELIEVED TO BE DECK SCALE FROM THE HAMMERHEAD
CRANE LEVEL, ENTERS THE FOV WELL AFTER THE VEHICLE CLEARS THE
TOWER.

E-41 Camera is located on the FSS 255 foot level and
400 FPS views the GH2 vent line during rotation. Also
16mm shows clearance between structure and SRB aft
skirt.

Focus : OK
F. O. V.: OK
Exposure: OK

Comments: T-0 OCCURS AT FRAME 2953. GUCP SEPARATION AND GH2
VENT LINE RETRACTION IS NOMINAL. TWO ICE PARTICLES FALL FROM THE
BIPOD STRUT AREA. CONDENSATE VAPORIZES ON THE ET AFT DOME.
TYPICAL FACILITY DEBRIS PASSES THROUGH FOV AS VEHICLE CLEARS THE
TOWER.

E-42 Camera is located on the FSS 185 foot level and
400 FPS views the GH2 vent line drop, deceleration, and
16mm latchback.

Focus : OK
F. O. V.: OK
Exposure: OK

Comments: A BAT CROSSES FOV PRIOR TO LIFTOFF. FIRST MOTION OF VENT LINE IS IN FRAME 687. THE VENT LINE CABLE HAS EXCESSIVE SLACK DURING RETRACTION AND IMPACTS THE GUCP 7-INCH QUICK DISCONNECT. A SPRING TENSIONER FROM THE GH2 VENT LINE LATCHING MECHANISM FAILS JUST AFTER LATCHBACK AND FALLS TO THE HAUNCH DECK GRATING IN FRAME 3541. THE RELEASED SPRING SWINGS FROM THE OPPOSING TENSIONER, BUT DOES NOT BECOME A SECOND DEBRIS ITEM. VENT LINE RETRACTION IS COMPLETE IN FRAME 3548. TYPICAL FACILITY DEBRIS PASSES THROUGH FOV AS VEHICLE CLEARS THE TOWER.

E-44 Camera is located on the FSS 155 foot level and
400 FPS views the LH OMS Pod leading edge tiles during
16mm ignition and liftoff.

Focus : OK
F. O. V.: OK
Exposure: OK

Comments: T-0 OCCURS IN FRAME 3998. LH2 T-0 UMBILICAL RETRACTION IS NOMINAL. NO OMS POD TILE DAMAGE. THE LO2 TSM DOOR REBOUNDS ONCE BEFORE CLOSING COMPLETELY.

E-48 Camera is located on the FSS 215 foot level (ET
400 FPS Intertank access arm structure) and views the GH2
16mm vent line during GUCP disconnection, rotation, and
latchback.

Focus : OK
F. O. V.: OK
Exposure: SLIGHTLY UNDEREXPOSED

Comments: GH2 VENT LINE DISCONNECT AND RETRACTION IS NORMAL. ICE PARTICLES FALL FROM THE LO2 AND LH2 ET/ORBITER UMBILICALS AT SSME IGNITION. VEHICLE TWANG MOTION IS NORMAL. T-0 OCCURS IN FRAME 2887. RESIDUAL LH2 VAPORIZES FROM THE GUCP AND THE ET UCA DISCONNECT DURING ARM RETRACTION. NO ANOMALIES ARE VISIBLE AS VEHICLE RISES. CONDENSATE VAPORIZES ON THE ET AFT DOME.

E-50 Camera is located at camera site 1 at NE pad
400 FPS perimeter and views entire GH2 vent line and
16mm GUCP during rotation and latchback.

Focus : OK
F. O. V.: OK
Exposure: UNDEREXPOSED

Comments: FIRST MOVEMENT OF GH2 VENT LINE OCCURS IN FRAME 4213.
VENT LINE CABLE HAS EXCESSIVE SLACK ON RETRACTION. LATCHBACK OF
VENT LINE IS COMPLETE IN FRAME 5145. AFT SKIRT CLEARS HAUNCH BY
APPROXIMATELY 10 FEET.

E-52 Camera is located at camera site 2 on the east pad
96 FPS perimeter. Remote tracking of lower one-third of
35mm launch vehicle from ignition to 1200 feet.

Focus : OK
F. O. V.: OK
Exposure: OK

Comments: RUSTY DELUGE WATER FLOWS FROM SOUTH END OF MLP. WATER
VAPORIZES ON THE ET AFT DOME AND ON THE SRB AFT BOOSTER STIFFENER
RINGS. SIX PIECES OF ICE, AND NUMEROUS PIECES OF BUTCHER PAPER
FALL FROM THE VEHICLE PRIOR TO ROLL MANEUVER. NUMEROUS FLASHES
APPEAR IN SSME PLUME. AT LEAST 5 PIECES OF BUTCHER PAPER FALL
FROM THE OMS POD STINGERS DURING VEHICLE ROLL MANEUVER. TRACKING
IS LOST FOR A PORTION OF THE ASCENT. PARTICLES, MOST LIKELY ICE
AND BUTCHER PAPER, CONTINUOUSLY FALL FROM THE ET/ORBITER UMBILI-
CAL AREA AS THE VEHICLE ASCENTS.

E-53 Camera is located at camera site 2 on the east pad
96 FPS perimeter. Remote tracking of middle one-third of
35mm launch vehicle from ignition to 1200 feet.

Focus : OK
F. O. V.: OK
Exposure: OK

Comments: RUSTY DELUGE FALLS FROM GH2 VENT LINE HAUNCH. VEHICLE
TWANG MOTION AND GH2 VENT LINE RETRACTION IS NORMAL. WATER
VAPORIZES ON ET AFT DOME AND THE SRB AFT BOOSTER STIFFENER RINGS.
ICE PARTICLES FALL PRIOR TO AND DURING ROLL MANEUVER. SEE COM-
MENTS FOR ITEM E-52.

E-54 Camera is located at camera site 2 on the east pad
96 FPS perimeter. Remote tracking of upper one-third of
35mm launch vehicle from ignition to 1200 feet.

Focus : CAMERA SHAKE/VIBRATION
F. O. V.: OK
Exposure: OK

Comments: ACTIVATION OF THE FACILITY WATER DELUGE SYSTEM WAS ON TIME. VEHICLE 'TWANG' APPEARS TYPICAL DURING SSME THRUST BUILD UP. PARTICLES BEGIN TO FALL OUT OF THE EXHAUST PLUME AT FRAME 127-08. AN ORANGE STREAK APPEARS AFT OF THE VEHICLE ON THE RIGHT SIDE. THE LH2 UMBILICAL BAGGIE FALLS AWAY FROM THE VEHICLE AT FRAME 158-13. THREE FLASHES OCCUR IN THE SSME PLUME. NUMEROUS PIECES OF AFT SKIRT INSTAFOAM OR SRB PROPELLANT ARE VISIBLE IN THE LH SRB PLUME BEGINNING AT FRAME 179-05.

E-57 Camera is located at camera site 6 on the NW pad
96 FPS perimeter. Remote tracking of lower one-third of
35mm launch vehicle from ignition to 1200 feet.

Focus : OK
F. O. V.: TRACKING LOST SHORTLY AFTER ROLL MANEUVER
Exposure: OK

Comments: WATER VAPORIZES ON ET AFT DOME AND SRB AFT BOOSTER STIFFENER RINGS. SEVERAL PARTICLES, MOST LIKELY BUTCHER PAPER, FALL FROM LH OMS POD STINGER AREA PRIOR TO ROLL MANEUVER. THREE CLUSTERS OF PARTICLES, PROBABLY BUTCHER PAPER FROM THE FRCS, FALL OVER THE RH ORBITER WING DURING AND AFTER THE ROLL MANEUVER. FLASHES IN THE SSME PLUME ARE VISIBLE AFTER ROLL MANEUVER.

E-58 Camera is located at camera site 6 on the NW pad
96 FPS perimeter. Remote tracking of center one-third of
35mm launch vehicle from ignition to 1200 feet.

Focus : OK
F. O. V.: TRACKING LOST SHORTLY AFTER ROLL MANEUVER
Exposure: OK

Comments: WATER VAPORIZES ON ET AFT DOME AND SRB AFT BOOSTER STIFFENER RINGS. SEVERAL PARTICLES, MOST LIKELY BUTCHER PAPER, FALL FROM LH OMS POD STINGER AREA PRIOR TO ROLL MANEUVER. THREE CLUSTERS OF PARTICLES, PROBABLY BUTCHER PAPER FROM THE FRCS, FALL OVER THE RH ORBITER WING DURING AND AFTER THE ROLL MANEUVER. FLASHES ARE VISIBLE IN THE MAIN ENGINE PLUME AFTER ROLL MANEUVER.

E-59 Camera is located at camera site 6 on the NW pad
96 FPS perimeter. Remote tracking of upper one-third of
35mm launch vehicle from ignition to 1200 feet.

Focus : EXCELLENT
F. O. V.: TRACKING OF VEHICLE LOST EARLY
Exposure: OK

Comments: FACILITY WATER DELUGE SYSTEM WAS ACTIVATED ON TIME.
RESIDUAL VAPORS EMANATED FROM THE ET UCA DURING LIFTOFF. NO EMER-
GENCY EGRESS SLIDEWIRE BASKETS WERE RELEASED DURING LAUNCH.

E-60 Camera is located on north pad perimeter at camera
96 FPS site 1 and views the entire launch vehicle, FSS,
35mm and MLP zero level.

Focus : OK
F. O. V.: OK
Exposure: OK

Comments: ICE PARTICLES FALL FROM ET/ORBITER UMBILICALS. WATER
VAPORIZES ON ET AFT DOME AND SRB AFT SEGMENT STIFFENER RINGS.
RESIDUAL LO2 VAPORIZES DURING RETRACTION OF THE LO2 T-0 UMBILI-
CAL. GH2 VENT LINE RETRACTION AND LATCHBACK APPEARS NORMAL.

E-61 Camera is located at camera site 2 on the east pad
96 FPS perimeter and views the launch vehicle, FSS, and
35mm MLP.

Focus : OK
F. O. V.: OK
Exposure: OK

Comments: GUCP DISCONNECT AND GH2 VENT ARM LATCHBACK IS NOMINAL.
WATER DELUGE, THOUGH RUST-COLORED, IS ACTIVATED ON TIME. OXYGEN
VAPORS EMANATE FROM THE LO2 TSM T-0 AT LIFTOFF. WATER FROM SRB
STIFFENER RINGS AND CONDENSATE ON ET AFT DOME VAPORIZE AFTER
LIFTOFF. PARTICLES FALLING FROM VEHICLE ARE PIECES OF ICE FROM
THE ET/ORB UMBILICALS AND RCS PAPER COVERS.

E-62 Camera is located on the SE pad perimeter at
96 FPS camera site 3 and views entire vehicle, FSS, and
35mm MLP.

Focus : OK
F. O. V.: OK
Exposure: OK

Comments: CRYOGENIC HYDROGEN 'LEAD' EXITS SSME #1 NOZZLE AT FRAME 26-08. WATER DELUGE CONTAINS RUST, BUT ACTIVATES PROPERLY. RCS PAPER COVERS TEAR AND FALL FROM THE VEHICLE STARTING AT SSME IGNITION AND CONTINUING UNTIL THE VEHICLE LEAVES THE FOV. HYDROGEN VAPORS EMANATE FROM THE LH2 TSM T-0 AT LIFTOFF. WATER FROM SRB STIFFENER RINGS AND CONDENSATE ON ET AFT DOME VAPORIZE AFTER LIFTOFF.

E-63 Camera is located on SW pad perimeter at camera
96 FPS site 4 and views entire launch vehicle, FSS, and
35mm MLP.

Focus : OK
F. O. V.: OK
Exposure: OK

Comments: CRYOGENIC HYDROGEN 'LEAD' EXITS SSME #1 NOZZLE AT FRAME 23-14. RESIDUAL VAPORS EMANATE FROM THE LH2 AND LO2 TSM T-0 DISCONNECTS. RCS PAPER COVERS AND ET/ORB UMBILICAL ICE FALL FROM THE VEHICLE DURING LIFTOFF. ORANGE STREAK AFT OF SSME #1 NOZZLE OCCURS AFTER LIFTOFF AT FRAME 58-05. WATER FROM SRB STIFFENER RINGS AND CONDENSATE ON ET AFT DOME VAPORIZE SHORTLY AFTER LIFT-OFF.

E-64 Camera is located on NW pad perimeter at camera
96 FPS site 6 and views entire launch vehicle, FSS, and
35mm MLP.

Focus : OK
F. O. V.: OK
Exposure: OK

Comments: GUCP DISCONNECT AND GH2 VENT ARM LATCHBACK IS NORMAL. SHOCK WAVE EFFECTS ARE VISIBLE FROM SRB IGNITION OVERPRESSURE. NO EMERGENCY SLIDEWIRE BASKETS ARE RELEASED DURING LAUNCH. PAPER COVERS ARE STILL INTACT ON THE LH FWD RCS AS THE VEHICLE ASCENDS. WATER IN SRB STIFFENER RINGS AND CONDENSATE ON ET AFT DOME VAPORIZE SHORTLY AFTER LIFTOFF.

E-65 Camera is located on east pad perimeter at camera
100 FPS site 2 and views ET LO2 feedline, ET intertank,
16mm and RH SRB as vehicle passes through the frame.

Focus : OK
F. O. V.: TOO FAR RIGHT
Exposure: OK

Comments: TWANG IS SIMILAR TO PREVIOUS VEHICLES. THREE BIRDS PASS CLOSE TO CAMERA LONG AFTER VEHICLE CLEARS FOV. T-0 OCCURS AT FRAME 964. NO FEEDLINE ANOMALIES. CONDENSATE ON THE AFT DOME AND WATER ON THE SRB STIFFENER RINGS VAPORIZES. SEVERAL ICE PARTICLES FROM THE ET/ORBITER UMBILICALS FALL PAST THE BODY FLAP, BUT NO TILE DAMAGE IS VISIBLE. AN ICEBALL IS STILL ATTACHED TO THE CABLE TRAY MICROPHONE INSTRUMENTATION AS THE VEHICLE RISES. ICE PARTICLES FALL FROM THE LO2 FEEDLINE FORWARD BELLOWS IN FRAME 1069.

E-76 Camera is located on SE pad perimeter at camera
96 FPS site 3 and views SSME engines #1 and #3 and the RH
35mm OMS engine nozzle.

Focus : OK
F. O. V.: OK
Exposure: OK

Comments: SSME IGNITION OCCURS AT FRAME 19-04. VEHICLE TWANG IS VISIBLE FROM THE MOTION OF THE VERTICAL STABILIZER. ICE FALLS FROM THE LO2 T-0 DURING SSME IGNITION. A CRYOGENIC HYDROGEN 'LEAD' STREAMS OUT OF SSME #1 AT FRAME 19-13. ORANGE FLASHES ARE VISIBLE IN THE PLUME OF SSME #1. RCS PAPER COVERS TEAR AND FALL FROM RH STINGER A FRAME 20-11. FIRST MOTION OF LO2 T-0 UMBILICAL OCCURS AT FRAME 49-04. LH2 TSM DOOR CLOSED BY FRAME 58-08. ICE FALLS FROM ET/ORB LH2 AND LO2 UMBILICALS DURING LIFTOFF. WATER FROM RH SRB STIFFENER RINGS VAPORIZES DURING EARLY ASCENT. RESIDUAL GOX VAPORS CONTINUE TO EMANATE FROM ORBITER LO2 T-0 UMBILICAL AFTER LIFTOFF.

E-77 Camera is located on SW pad perimeter at camera
96 FPS site 4 and views SSME engines #1 and #2 and the LH
35mm OMS engine nozzle.

Focus : OK
F. O. V.: OK
Exposure: OK

Comments: SSME IGNITION OCCURS AT FRAME 17-11. VEHICLE TWANG IS VISIBLE FROM THE MOTION OF THE VERTICAL STABILIZER. ICE FALLS FROM THE LO2 T-0 DURING SSME IGNITION. A CRYOGENIC HYDROGEN 'LEAD' STREAMS OUT OF SSME #1 AT FRAME 17-16. RCS PAPER COVERS TEAR AND FALL FROM LH STINGER. FIRST MOTION OF LH2 T-0 UMBILICAL OCCURS AT FRAME 48-11. LO2 TSM DOOR REBOUNDS UPON CLOSING. ICE FALLS FROM ET/ORB LH2 AND LO2 UMBILICALS DURING LIFTOFF. RESIDUAL GH2 AND GO2 VAPORS CONTINUE TO EMANATE FROM THE ORBITER LH2 AND LO2 T-0 UMBILICALS AFTER LIFTOFF. AN ORANGE FLASH IS VISIBLE IN THE PLUME OF SSME #1 (FRAME 53-15).

E-78 Camera is located on SE pad perimeter at camera
400 FPS site 3 and views RH OMS Pod leading edge.
16mm

Focus : SHOULD BE FOCUSED ON RH OMS POD, NOT WING.
F. O. V.: TOO FAR LEFT. RH OMS POD SHOULD BE CENTERED IN FOV.
Exposure: OK

Comments: NO TPS ANOMALIES. WATER VAPORIZES ON RH SRB STIFFENER
RINGS. A PARTICLE STRIKES THE LH SRB AFT SKIRT IN FRAME 4177.

E-79 Camera is located on east pad perimeter at
100 FPS camera site 2 and views the ET nosecone, louver,
16mm and ogive.

Focus : SOFT
F. O. V.: TOO LOW. TWANG DISTANCE REFERENCE TARGET IS NOT IN FOV
Exposure: OK

Comments: SSME START OCCURS IN FRAME 619. VEHICLE TWANG APPEARS
NORMAL. T-0 OCCURS IN FRAME 1122. ICE PARTICLES FALL FROM
ET/ORBITER UMBILICALS. A LARGE PIECE OF DEBRIS ENTERS THE FOV IN
FRAME 1543.

E-201 UCS-9 IFLOT tracking of launch vehicle from
30 FPS ignition and early flight through LOV.
70mm

Focus : OK
F. O. V.: OK
Exposure: OK

Comments: WATER VAPORIZES ON ET AFT DOME AND SRB AFT BOOSTER
STIFFENER RINGS. SHORTLY AFTER THE FORMATION OF LOCAL SUPERSONIC
FLOW CONDENSATE, A WHITE PARTICLE FALLS AFT OF THE RH OMS NOZZLE.

E-202 UCS-15 IFLOT tracking of launch vehicle from
30 FPS ignition and early flight through LOV.
70mm

Focus : OK
F. O. V.: OK
Exposure: UNDEREXPOSED

Comments: WATER FROM SRB STIFFENER RINGS VAPORIZES SOON AFTER LIFTOFF. LOCAL SUPERSONIC FLOW CONDENSATE BECOMES VISIBLE AT MAX Q. A WHITE PARTICLE FIRST APPEARS IN THE AREA BETWEEN THE SSME #1 NOZZLE AND VERTICAL STABILIZER, FALLS AFT, AND ENTERS THE PLUME. FEWER PARTICLES FALLING FROM THE VEHICLE DURING ASCENT ARE VISIBLE DUE TO THE SLOWER FRAME RATE. SRB SEPARATION IS NOMINAL.

E-203 UCS-6 IFLOT tracking of launch vehicle from
30 FPS ignition and early flight through LOV.
70mm

Focus : OK
F. O. V.: OK
Exposure: OK

Comments: FILM IS UNDEREXPOSED TO STUDY SRB PLUME. ICE PARTICLES FALL FROM THE ET/ORBITER UMBILICALS DURING THE ROLL MANEUVER. A BIRD PASSES THROUGH THE FOV EARLY IN FLIGHT, BUT IS NOT NEAR THE VEHICLE. FORMATION OF LOCAL SUPERSONIC FLOW CONDENSATE IS NORMAL. VEHICLE BECOMES OBSCURED BY SRB PLUME LATER IN FLIGHT THEN BECOMES VISIBLE APPROXIMATELY 35 SECONDS LATER.

E-204 PAFB IGOR tracking of launch vehicle from
48 FPS acquisition to SRB separation. Tracks ET/ORB
35mm after SRB separation to LOV.

Focus : OK
F. O. V.: OK
Exposure: OK

Comments: CHARRING OF TPS ON ET AFT DOME IS MINIMAL UNTIL PLUME RECIRCULATION. LOCAL SUPERSONIC FLOW CONDENSATE BEGINS AT FRAME 23-00. A WHITE PARTICLE ORIGINATES FROM EITHER THE SSME #1 NOZZLE AREA OR OMS POD AREA AT FRAME 52-13. PLUME RECIRCULATION OCCURS FROM FRAME 180-00 TO 208-00. TWO PIECES OF SRB PROPELLANT SLAG APPEAR (FRAME 252-00) PRIOR TO SRB SEPARATION AT FRAME 266-04. SEVERAL PIECES OF SRB SLAG FALL AWAY JUST AFTER SRB SEPARATION.

E-205 Shiloh IFLOT tracking of launch vehicle from
48 FPS acquisition to SRB separation. Tracks ET/ORB
35mm after SRB separation to LOV.

Focus : OK
F. O. V.: OK
Exposure: OK

Comments: THIS IS THE FIRST FILM WHERE LOCAL SUPERSONIC FLOW CONDENSATE FROM BOTH SRB FORWARD CROSSOVERS ARE VISIBLE TOGETHER. A FEW PIECES OF SRB PROPELLANT SLAG APPEAR BEFORE AND NUMEROUS PIECES AFTER SRB SEPARATION.

E-206 Melbourne Beach ROTI tracking of launch vehicle
48 FPS from acquisition to SRB separation. Tracks ET/ORB
35mm after SRB separation to LOV.

Focus : POOR DUE TO ATMOSPHERIC HAZE
F. O. V.: OK
Exposure: OK

Comments: LOCAL SUPERSONIC FLOW CONDENSATE BEGINS AT FRAME 72-00. RECIRCULATION PHENOMENON IS VISIBLE FROM FRAME 232-00 THROUGH 265-00. SRB SEPARATION OCCURS AT 320-05.

E-207 UCS-10 MIGOR tracking of launch vehicle from
96 FPS acquisition to SRB separation. Tracks ET/ORB
35mm after SRB separation to LOV.

Focus : OK
F. O. V.: OK
Exposure: OK

Comments: BODY FLAP MOTION BEGINS AT FRAME 118-00. THIS MOTION APPEARS TO HAVE AN AMPLITUDE AND FREQUENCY SIMILAR TO THAT OBSERVED ON OV-102 DURING STS-28R. LOCAL SUPERSONIC FLOW CONDENSATE BECOMES VISIBLE AT FRAME 138-00. A WHITE PARTICLE PASSES OUTBOARD OF THE RH OMS NOZZLE AND THEN PASSES BEHIND SSME #1 (FRAME 198-00). SEVERAL OBJECTS, MOST LIKELY SRB PROPELLANT SLAG, APPEAR OUT OF THE SRB EXHAUST PLUME PRIOR TO SRB SEPARATION, WHICH OCCURS AT FRAME 631-13. AFTER SRB SEP, AS MANY AS 50 PROPELLANT SLAG PARTICLES ARE VISIBLE IN THE SRB PLUMES (FRAMES 631-13 THROUGH 710-00). NO TPS APPEARED TO BE MISSING FROM THE EXTERNAL TANK DURING ASCENT.

E-208 Cocoa Beach DOAMS tracking of launch vehicle
48 FPS from acquisition to SRB separation. Tracks ET/ORB
35mm after SRB separation to LOV.

Focus : POOR
F. O. V.: OK
Exposure: OK

Comments: RECIRCULATION PHENOMENON IS TYPICAL. DEBRIS APPEARS IN VICINITY OF SRB AFT BOOSTER/PLUME AREA JUST PRIOR TO AND AFTER SRB SEPARATION.

E-209 SHILOH IFLOT intermediate tracking of
30 FPS launch vehicle from acquisition to LOV.
70mm

Focus : OK
F. O. V.: OK
Exposure: UNDEREXPOSED

Comments: VEHICLE NOT ACQUIRED UNTIL WELL AFTER ROLL MANEUVER.
VIEW IS TOO DISTANT TO RESOLVE MANY PARTICLES FALLING FROM THE
VEHICLE. LOCAL SUPERSONIC FLOW CONDENSATE IS NORMAL AT MAX Q. SRB
SEPARATION IS NOMINAL.

E-210 UCS-26 IFLOT intermediate tracking of
30 FPS launch vehicle from acquisition to LOV.
70mm

Focus : SOFT DUE TO ATMOSPHERIC EFFECTS
F. O. V.: OK
Exposure: OK

Comments: VEHICLE OBSCURED BY CLOUDS SOON AFTER ROLL MANEUVER.
AFTER ACQUISITION, VIEW IS TOO DISTANT TO RESOLVE FINE DETAIL.
SRB SEPARATION IS NOMINAL.

E-211 UCS-13 IFLOT intermediate tracking of forward
96 FPS portion of ORB and ET from acquisition to LOV.
35mm

Focus : SOFT DUE TO ATMOSPHERIC EFFECTS
F. O. V.: OK
Exposure: OK

Comments: ATMOSPHERIC HAZE PRECLUDES FINE DETAIL RESOLUTION.
VEHICLE TRACKING IS LOST FROM SHORTLY AFTER ROLL MANEUVER UNTIL
JUST PRIOR TO APPEARANCE OF LOCAL SUPERSONIC FLOW CONDENSATION.
AS NOTED IN OTHER TRACKING ITEMS, PARTICLES OF ICE, RCS COVER
PAPER, AND INSTAFOAM FALL FROM VEHICLE THROUGHOUT ASCENT.

E-212 UCS-23 MIGOR tracking of launch vehicle
96 FPS from acquisition to LOV.
35mm

Focus : OK
F. O. V.: OK
Exposure: OK

Comments: LOCAL SUPERSONIC FLOW CONDENSATION BEGINS IN FRAME 182-00. SECONDARY SHOCK WAVE APPEARS NEAR THE ORBITER VERTICAL TAIL. A PARTICLE FALLS FROM THE AREA OF SSME #1 IN FRAME 239-11. BODY FLAP MOTION IS APPARENT. IN FRAME 302-00, A STRAIGHT LINE OPTICAL PHENOMENON PASSES BY THE ORBITER FUSELAGE INTO THE SRB PLUME. SLAG FALLS FROM THE SRB PLUME IN FRAME 639-05. SRB SEPARATION OCCURS IN FRAME 667-03. NUMEROUS PARTICLES FALL FROM THE SRB PLUMES AFTER SEPARATION.

E-213 UCS-7 MOTS tracking of forward portion of ORB and
96 FPS ET from acquisition to LOV.
35mm

Comments: CAMERA MALFUNCTION - DID NOT RUN.

E-217 Beach Road IFLOT close-in tracking of launch
30 FPS vehicle during ignition, liftoff, and early
70mm portion of flight through LOV.

Focus : OK
F. O. V.: OK
Exposure: OK

Comments: WATER FROM THE SRB STIFFENER RINGS VAPORIZES SOON AFTER LIFTOFF. A FLASH OCCURS IN THE SSME PLUME JUST AFTER THE ROLL MANEUVER. FEWER PARTICLES FALLING FROM THE VEHICLE DURING ASCENT ARE VISIBLE DUE TO THE SLOWER FILM RATE.

E-218 UCS-26 IFLOT intermediate tracking of
96 FPS launch vehicle from acquisition through LOV.
35mm

Focus : OK
F. O. V.: POOR TRACKING
Exposure: OK

Comments: IMAGE IS SOFT DUE TO ATMOSPHERIC HAZE. SRB SEPARATION OCCURS AT FRAME 691-10.

E-219 UCS-3 IFLOT close-in tracking of launch
30 FPS vehicle during ignition, liftoff, and early
70mm portion of flight through LOV.

Focus : OK
F. O. V.: OK
Exposure: OK

Comments: THREE BIRDS ENTER FOV, BUT ARE NOT NEAR THE VEHICLE. WATER FROM SRB STIFFENER RINGS VAPORIZES SOON AFTER LIFTOFF. LOCAL SUPERSONIC FLOW CONDENSATE FORMATION IS NORMAL. NOT AS MANY PARTICLES FALLING FROM THE VEHICLE ARE VISIBLE AS IN SOME OF THE OTHER FILM ITEMS DUE TO THE SLOWER FRAME RATE. VEHICLE ENTERS CLOUDS AND TRACKING IS LOST.

E-220 UCS-15 IFLOT close-in tracking of forward
96 FPS portion of ORB and ET during ignition, liftoff,
35mm and early portion of flight through LOV.

Focus : OK
F. O. V.: VEHICLE IS NOT CENTERED IN FRAME
Exposure: OK

Comments: THREE BIRDS APPEAR NEAR VEHICLE AT LIFTOFF, BUT DO NOT MAKE CONTACT. LOCAL SUPERSONIC FLOW CONDENSATION BEGINS IN FRAME 262-00. A LARGE PARTICLE FALLS FROM BEHIND SSME #1 NOZZLE (3 O'CLOCK POSITION RELATIVE TO BELL) IN FRAME 316-08. TEN PIECES OF DEBRIS EMANATE FROM THE SRB PLUME STARTING WITH FRAME 346-10 AND FIFTEEN MORE PIECES FALL STARTING WITH FRAME 360-05. A LARGE PARTICLE, PRECEDED BY TWO SMALLER PARTICLES FALL FROM THE VEHICLE IN FRAME 388-13. NUMEROUS PARTICLES FALL FROM THE VEHICLE JUST PRIOR TO SRB SEPARATION. SRB SEPARATION OCCURS IN FRAME 718-11.

E-221 UCS-3 IFLOT close-in tracking of forward portion
96 FPS of ORB and ET during ignition, liftoff, and early
35mm portion of flight through LOV.

Focus : OK
F. O. V.: OK
Exposure: OK

Comments: WATER FROM SRB STIFFENER RINGS AND CONDENSATE ON ET AFT DOME VAPORIZE AFTER LIFTOFF. NO CHARRING OF ET AFT DOME TPS IS VISIBLE. ROLL MANEUVER BEGINS AT FRAME 71-00. RCS PAPER COVERS FALL FROM VEHICLE STARTING AT FRAME 114-03. MOVEMENT OF THE BODY FLAP BEGINS AT FRAME 205-00 AND CONTINUES UNTIL THE AFT END OF

THE ORBITER IS OBSCURED BY SRB PLUME. ORANGE FLASHES ARE VISIBLE IN THE SSME PLUME AT FRAMES 152-14, 234-02, AND 260-03. LOCAL SUPERSONIC FLOW CONDENSATE FIRST BECOMES VISIBLE AT FRAME 274-04.

E-222 Beach Road IFLOT close-in tracking of forward
96 FPS portion of ORB and ET during ignition, liftoff,
35mm and early portion of flight through LOV.

Focus : OK
F. O. V.: OK
Exposure: OK

Comments: WATER FROM SRB STIFFENER RINGS VAPORIZES AFTER LIFT-OFF. T-0 OCCURS AT GMT 16:53:40 FOLLOWED BY ROLL MANEUVER AT GMT 16:53:48. RCS PAPER COVERS APPEAR IN SSME REGION AT 16:53:58. FLASH OCCURS IN PLUME OF SSME #1 AT 16:54:03. A PARTICLE FIRST APPEARS NEAR SSME #1 NOZZLE 3 O'CLOCK POSITION AT 16:54:04. PAPER COVER FALLS FROM FWD RCS AND PASSES OVER LH WING AT 16:54:05. BODY FLAP MOTION BEGINS AT 16:54:14. LOCAL SUPERSONIC FLOW CONDENSATE OBSERVED FROM 16:54:24 - 16:54:33. AT 16:54:33, A PIECE OF SRB PROPELLANT SLAG APPEARS IN THE AREA OF THE SRB PLUME.

E-223 UCS-9 IFLOT intermediate tracking of forward
96 FPS portion of ORB and ET during ignition, liftoff,
35mm and early portion of flight through LOV.

Focus : SOFT
F. O. V.: NOT CENTERED
Exposure: OK

Comments: THE ET AFT DOME EXHIBITS WATER VAPORIZATION , BUT NO CHARRING. IN FRAME 122-09, A PARTICLE (MOST LIKELY RCS PAPER COVER) APPEARS BETWEEN THE SRB'S BELOW THE ET AFT DOME. LOCAL SUPERSONIC FLOW CONDENSATE ON THE ORBITER FORWARD FUSELAGE, SRB FORWARD CROSSOVERS, AND SRB ETA RING APPEAR IN FRAMES 226-09, 265-00, AND 355-11. PROPELLANT SLAG PARTICLES FALL FROM THE SRB'S IN FRAMES 456-11, 541-00, AND 543-00.

HIGH ALTITUDE Liftoff coverage

Focus : OK
F. O. V.: OK
Exposure: OK

Comments: ALTHOUGH THE SHUTTLE VEHICLE WAS IMAGED BY A GREATER NUMBER OF FRAMES THAN PREVIOUS FLIGHTS, THE OVERALL SIZE OF THE VEHICLE WITHIN THE FRAME WAS QUITE SMALL AND ENLARGEMENT OF THE DATA WILL BE REQUIRED. FIRST ASSESSMENT OF THE DATA SHOWED NO OBVIOUS VEHICLE LAUNCH DAMAGE OR MISSING TPS.

E-233 Castglance airborne tracking of RH SRB
35mm

Focus : OK
F. O. V.: TRACKING IS EXCELLENT
Exposure: OK

Comments: RH SRB CHUFFS THROUGHOUT DESCENT. NOSECAP SEPARATION, DROGUE DEPLOYMENT, AND FRUSTUM SEPARATION ARE NORMAL. ALTHOUGH ONE MAIN PARACHUTE LAGS (REEFS) LONGER THAN THE OTHER TWO, ALL MAIN CHUTES ARE FULLY INFLATED PRIOR TO WATER IMPACT. WATER IMPACT IS MORE BENIGN THAN USUAL AND APPEARS TO EXERT MINIMAL FORCES ON THE SRB. THE BOOSTER SUBMERGES ONLY TO THE AFT CENTER SEGMENT AND WATER GEYSERS AWAY FROM THE BOOSTER RATHER THAN UP ALONG SIDE RESULTING IN SUBSTANTIALLY LESS IMPACT LOADS.

E-233 Castglance airborne tracking of LH SRB
35mm

Focus : OK
F. O. V.: TRACKING IS EXCELLENT
Exposure: OK

Comments: LH SRB CHUFFS THROUGHOUT DESCENT. NOSECAP SEPARATION, DROGUE DEPLOYMENT, AND FRUSTUM SEPARATION ARE NORMAL. ALTHOUGH ONE MAIN PARACHUTE LAGS (REEFS) LONGER THAN THE OTHER TWO, ALL MAIN CHUTES ARE FULLY INFLATED PRIOR TO WATER IMPACT. WATER IMPACT IS MORE BENIGN THAN USUAL AND APPEARS TO EXERT MINIMAL FORCES ON THE SRB. THE BOOSTER SUBMERGES ONLY TO THE AFT CENTER SEGMENT AREA AND WATER GEYSERS AWAY FROM THE BOOSTER RATHER THAN UP ALONG SIDE RESULTING IN SUBSTANTIALLY LESS IMPACT LOADS.

E-301 RH SRB parachute deployment
200 FPS
16mm

Focus : OK
F. O. V.: OK
Exposure: OK

Comments: RH FRUSTUM SEPARATION APPEARS NORMAL. CORD-LIKE DEBRIS
FLOATS BY THE FIELD OF VIEW AFTER THE PARACHUTES ARE RELEASED.
ONE OF THE MAIN PARACHUTES REEFS LONGER AND OPENS SLOWER THAN THE
OTHER TWO PARACHUTES. ALL MAIN PARACHUTES ARE FULLY INFLATED
PRIOR TO WATER IMPACT. NOZZLE SEVERANCE DEBRIS RISES UPWARD, BUT
NO MAJOR DAMAGE TO THE PARACHUTES IS VISIBLE.

E-302 LH SRB parachute deployment
200 FPS
16mm

Focus : OK
F. O. V.: OK
Exposure: OK

Comments: LH FRUSTUM SEPARATION APPEARS NORMAL. CORD-LIKE DEBRIS
FLOATS BY THE FOV AFTER THE PARACHUTES ARE RELEASED. ONE OF THE
MAIN PARACHUTES REEFS LONGER AND OPENS SLOWER THAN THE OTHER TWO
PARACHUTES. ALL MAIN PARACHUTES ARE FULLY INFLATED PRIOR TO WATER
IMPACT. SMALL PIECES OF BURNING SOLID PROPELLANT FALL FROM THE
EXPENDED SRB AND ARE PASSED BY THE DESCENDING BOOSTER. NOZZLE
SEVERANCE DEBRIS RISES UPWARD, BUT NO MAJOR DAMAGE TO THE
PARACHUTES IS VISIBLE.

VIDEO ITEMS

OTV 101 Views aft end of Orbiter from the FSS 255 foot
B/W M-II level.

Comments: AT T-15 SECONDS, VENT DOORS #8 AND #9 MOVE TO THE FULL OPEN POSITION. VEHICLE TWANG APPEARS NORMAL. SSME IGNITION IS NOMINAL. ENGINE STARTUP CAUSES ICE TO FALL FROM THE T-0 UMBILICAL DISCONNECT AND RETRACTION OF THE T-0 UMBILICAL APPEARS NOMINAL.

OTV 103 Views GUCP and GH2 vent line.
B/W M-II

Comments: SSME IGNITION CAUSES PARTICLES OF ICE TO FALL FROM THE GUCP AND THE ET TPS, WHERE THE COLD AIR IMPINGEMENT OCCURRED. VEHICLE TWANG APPEARS NORMAL. DISCONNECT OF THE GUCP AND RETRACTION OF THE GH2 VENT ARM IS NOMINAL IN THIS VIEW. SOME FROST REMAINS ON THE ET TPS DURING LIFTOFF.

OTV 109 Views ET/Orbiter LH2 umbilical area from the 95
B/W M-II foot level of the FSS.

Comments: HYDROGEN FIRE DETECTORS (BUTCHER PAPER) IS INTACT IN THE LH2 UMBILICAL AREA. SSME IGNITION CAUSES PIECES OF ICE TO FALL FROM THE TOP SURFACE OF THE ET/ORB LH2 UMBILICAL. HOWEVER, THE ICE ADHERING TO THE SIDES OF THE UMBILICAL REMAINS ATTACHED. NO UNUSUAL VAPORS EMANATE FROM THE UMBILICAL AREA. ICE FALLS NEAR THE BODY FLAP DURING LIFTOFF, BUT NO TILE DAMAGE IS VISIBLE.

OTV 141 Views and tracks vehicle from camera site 2.
B/W

Comments: TWO FLASHES ARE VISIBLE IN THE SSME PLUME DURING THE ROLL MANEUVER.

OTV 143 Views east side of launch vehicle and pad from
B/W camera site 2.

Comments: VEHICLE TWANG APPEARS NORMAL. ET INTERTANK ACCESS STRUCTURE WATER DELUGE IS ACTIVATED ON TIME. AUTOMATIC EXPOSURE CONTROL ON THE CAMERA STOPS DOWN TOO FAR AFTER SRB IGNITION.

OTV 148 Launch and tracking view from camera site 6.
B/W

Comments: FACILITY WATER DELUGE ACTIVATES PROPERLY. VEHICLE 'TWANG' APPEARS NORMAL. TRACKING OF THE VEHICLE IS INCONSISTENT.

OTV 149 Views Orbiter LO2 T-0 umbilical from MLP deck.
B/W M-II

Comments: DISCONNECT AND RETRACTION OF THE T-0 UMBILICAL APPEARS NORMAL. RESIDUAL VAPORS EXIT THE FLIGHT QD DURING LIFTOFF.

OTV 150 Views Orbiter LH2 T-0 umbilical from SW MLP deck.
B/W M-II

Comments: ICE/FROST FORMATION ON THE LH2 T-0 UMBILICAL WAS MINIMAL. DISCONNECT AND RETRACTION OF THE UMBILICAL APPEARS NORMAL. RESIDUAL VAPORS EXIT THE FLIGHT QD DURING LIFTOFF.

OTV 151 Views main engine cluster.
B/W M-II

Comments: SSME IGNITION APPEARS NOMINAL. PAPER COVERS ON THE AFT RCS THRUSTERS TEAR AND FALL AWAY. PARTICLES OF ICE ON THE SSME GOX DRAIN LINES AND LO2 T-0 UMBILICAL ARE SHAKEN LOOSE DURING SSME STARTUP.

OTV 154 Views ET/Orbiter LO2 umbilical and Orbiter RH wing
B/W M-II

Comments: SSME IGNITION CAUSES PIECES OF ICE FROM THE INBOARD AND LOWER SIDES OF THE ET/ORB LO2 UMBILICAL TO SHAKE LOOSE. THE ICE FALLS PAST THE BODY FLAP, BUT NO TILE DAMAGE IS VISIBLE.

OTV 155 Views RH SRB and underside of Orbiter RH wing.
B/W M-II

Comments: SSME IGNITION CAUSES PIECES OF ICE FROM THE ET/ORB LO2 UMBILICAL TO SHAKE LOOSE. THE ICE FALLS PAST THE ORBITER LOWER SURFACE AND BODY FLAP, BUT NO TILE DAMAGE OCCURS. NO VEHICLE ANOMALIES DURING LIFTOFF.

OTV 156 Views LH SRB and underside of Orbiter LH wing.
B/W M-II

Comments: WATER DELUGE SPRAY FROM THE FSS DRIFTS INTO THE FOV. SSME IGNITION CAUSES PIECES OF ICE FROM THE ET/ORB LH2 UMBILICAL TO FALL PAST THE ORBITER LOWER SURFACE AND BODY FLAP, BUT NO TILE DAMAGE OCCURS. NO ANOMALIES DURING VEHICLE LIFTOFF.

OTV 160 Views ET nosecone and NE louver from water tower.
Color M-II

Comments: ROFI SMOKE AND WATER DELUGE FROM THE ET INTERTANK ACCESS STRUCTURE IS BLOWN NORTHWARD. WATER DELUGE ON THE SOUTH SIDE OF THE MLP CONTAINS RUST. FREE BURNING HYDROGEN IS BLOWN NORTH AT THE START OF SSME IGNITION. ALTHOUGH THE VIEW WAS TOO DISTANT TO CONFIRM GH2 VENT ARM LATCHBACK, THE LINE DID NOT REBOUND. WATER FROM SRB STIFFENER RINGS AND CONDENSATE ON ET AFT DOME VAPORIZE JUST AFTER LIFTOFF.

OTV 161 Views ET nosecone and SW louver from the FSS.
Color M-II

Comments: AN INSECT MOVES AROUND ON THE ET LO2 TANK ACREAGE AND IS NEAR THE BOTTOM EDGE OF THE LOUVER WHEN THE VEHICLE LIFTS OFF. THERE IS NO ICE OR FROST IN THE LOUVER, BUT VERY LIGHT GOX VAPOR IS BLOWN NORTHWARD. ALL TPS CLOSEOUTS ARE INTACT. THERE ARE NO ANOMALIES ON THE NOSECONE FAIRING. SLIGHT EROSION OF THE TOPCOAT HAS OCCURRED AT TWO PLACES BELOW THE LOUVER AND SOME OF THE GRID IS MISSING IN TWO PLACES (UPPER LEFT AND LOWER RIGHT). PIECES OF ET/ORB UMBILICAL ICE FALL DURING EARLY ASCENT.

OTV 163 Views ET/Orbiter umbilical and Orbiter T-0
Color M-II umbilical from the FSS.

Comments: FREE BURNING HYDROGEN IS BLOWN NORTH AT THE START OF SSME IGNITION, BUT IS PULLED BACK INTO THE SSME PLUME BY ASPIRATION. A HEAVY SHOWER OF ICE/FROST PARTICLES FALL FROM THE ET/ORB UMBILICALS, BUT NO TILE DAMAGE IS VISIBLE. SEPARATION OF THE ORBITER LH2 T-0 UMBILICAL IS NORMAL. THE WINGS MOVE SLIGHTLY DURING SSME STARTUP. THERE ARE NO UNUSUAL VAPORS IN THE AREA OF THE ET/ORB UMBILICALS DURING ASCENT.

OTV 170 Views overall vehicle from SE direction.
Color M-II

Comments: WATER DELUGE ON THE SOUTH SIDE OF THE MLP CONTAINS RUST. SSME IGNITION APPEARS NOMINAL AND PIECES OF ICE FALL FROM THE SSME GOX DRAIN LINES. PAPER COVERS ON THE RH RCS STINGER TEAR AND FALL OFF. ICE/FROST PARTICLES FALL FROM THE LO2 T-0 UMBILICAL AND RESIDUAL GOX VENTS FROM THE DISCONNECT AS THE T-0 RETRACTS.

OTV 171 Views overall vehicle from SW direction.
Color M-II

Comments: FREE BURNING HYDROGEN RISES TO THE BASE HEATSHIELD AREA AT THE START OF SSME IGNITION. RCS PAPER COVERS TEAR AND FALL AWAY. RETRACTION OF THE LH2 T-0 UMBILICAL IS NORMAL. THERE IS NO UNUSUAL OMS NOZZLE OR VERTICAL STABILIZER MOVEMENT DURING SSME IGNITION AND LIFTOFF.

STI (C/S 2) Infrared view from camera site 2.
B/W M-II

Comments: FREE BURNING HYDROGEN RISES TOWARD BASE HEATSHIELD AND IS BLOWN NORTHWARD AT THE START OF SSME IGNITION AND THEN PULLED BACK INTO THE SSME PLUME BY ASPIRATION. TRACKING OF VEHICLE THROUGH LIFTOFF AND TOWER CLEAR SHOWS THERMAL PATTERNS ON THE BASE HEATSHIELD, VERTICAL STABILIZER, AND SRB AFT SKIRT, ALL OF WHICH WERE NORMAL.

STI (RSS) Infrared view from RSS roof.
B/W M-II

Comments: COLD GOX VAPORS ARE VENTED FROM SSME GOX DRAIN LINES. COLD WATER DELUGE FILLS SSME EXHAUST HOLE PRIOR TO SSME IGNITION. SCANNER IS THEN OVERDRIVEN BY LOW TEMPERATURE RANGE SETTING.

TV-2 Views entire launch vehicle from SLF convoy.
Color M-II

Comments: VIEW IS TOO DISTANT FOR CLOSE DETAIL. TRACKING IS LOST AS VEHICLE PASSES THROUGH CLOUDS.

TV-3 Views entire launch vehicle from camera site 9
Color M-II northwest of the pad.

Comments: VIEW IS TOO DISTANT FOR CLOSE DETAIL. ROLL MANEUVER AND SRB SEPARATION APPEAR NORMAL. NO VEHICLE ANOMALIES DURING ASCENT.

TV-4 Views entire vehicle from Beach Road IFLOT Site.
Color M-II

Comments: TWO BIRDS CROSS FOV, BUT ARE NOT NEAR VEHICLE. WATER DELUGE CONTAINS RUST. SSME IGNITION APPEARS NOMINAL. WATER FROM SRB STIFFENER RINGS VAPORIZES SHORTLY AFTER LIFTOFF. ROLL MANEUVER FROM T+7 THROUGH 16 SECONDS LOOKS NORMAL. LOCAL SUPER-SONIC FLOW CONDENSATE IS VISIBLE ON THE ORBITER FORWARD FUSELAGE AND ET/SRB FORWARD CROSSOVERS AT T+42 SECONDS. A SECONDARY WAVE OF CONDENSATE IS VISIBLE ON THE VERTICAL STABILIZER AND PASSING BY THE ET AFT DOME AT T+48 SEC. A FLASH OCCURS IN THE PLUME OF SSME #1 AT T+42 SECONDS. A WHITE OBJECT APPEARS FROM THE AREA BETWEEN SSME #1 NOZZLE AND THE VERTICAL STABILIZER (T+52 SECONDS), SPLITS INTO TWO PIECES, AND FALLS INTO THE SSME PLUME. NUMEROUS PARTICLES APPEAR EITHER FALLING OUT OF THE SRB PLUME OR ORIGINATING IN THE AFT SKIRT AREA: T+59.5, 65 (FIVE PIECES), 66, 68-69, AND 70 SECONDS (1 LARGE PIECE). THESE PARTICLES ARE MOST LIKELY INSTAFOAM FROM THE SRB AFT SKIRT/AFT RING OR PIECES OF SRB SOLID PROPELLANT. AT T+1:59, ONE OBJECT FALLS FROM THE LH SRB PLUME AND IS PROBABLY SRB SLAG. SEPARATION APPEARS NOMINAL.

TV-5 Views launch from VAB roof.
Color M-II

Comments: DISTANT VIEW - NO DETAIL.

TV-7 Views entire launch vehicle from camera site 2
Color M-II east of pad.

Comments: NO VEHICLE ANOMALIES.

TV-11 Views entire vehicle from SLF TV Tower #1.
Color M-II

Comments: VIEW IS TOO DISTANT FOR FINE DETAIL. NO VEHICLE ANOMALIES DURING ASCENT.

TV-13 Cocoa Beach DOAMS video. Tracks launch vehicle
Color M-II from acquisition to LOV.

Comments: THREE OBJECTS FALL OUT OF SRB PLUME AT 4.6, 1.5, AND 1.0 SECONDS PRIOR TO BSM FIRING. TWO MORE OBJECTS ARE VISIBLE AT 2.5 AND 4.6 SECONDS AFTER SRB SEPARATION. ALL OF THESE OBJECTS ARE SRB PROPELLANT SLAG.

TV-16 View from helicopter orbiting west of pad and VAB.
Color M-II

Comments: VIEW IS TOO DISTANT FOR FINE DETAIL.

TV-18 Malabar ITEC video. Tracks launch vehicle from
Color M-II acquisition to LOV.

Comments: HAZY VIEW DUE TO ATMOSPHERIC EFFECTS. TRACKING IS IN-
CONSISTENT.

TV-21 DTLR south of the launch pad
Color M-II

Comments: INITIAL VIEW IS OBSCURED BY STEAM. ROLL MANEUVER
APPEARS NORMAL. LOCAL SUPERSONIC FLOW CONDENSATE BECOMES VISIBLE
AT T+42 SECONDS.

ET-204 Patrick IGOR video. Tracks launch vehicle from
Color M-II acquisition to LOV.

Comments: INITIAL IMAGE IS HAZY DUE TO ATMOSPHERIC EFFECTS.
LOCAL SUPERSONIC FLOW CONDENSATION FORMS AT APPROX T+42 SECONDS
AS THE VEHICLE APPROACHES MAX Q. PLUME RECIRCULATION PHENOMENON
IS NORMAL. SRB SEPARATION IS NOMINAL AND SEVERAL PIECES OF
PROPELLANT SLAG ARE VISIBLE IN THE SRB PLUMES.

ET-206 Melbourne Beach ROTI video. Tracks launch vehicle
Color M-II from acquisition to LOV.

Comments: IMAGE IS HAZY DUE TO ATMOSPHERIC EFFECTS. LOCAL SUPER-
SONIC FLOW CONDENSATION FORMS AT APPROX T+42 SECONDS. SEPARATION
OF THE SRB'S IS NOMINAL.

ET-207 UCS-10 MIGOR video. Tracks launch vehicle from
Color M-II acquisition to LOV.

Comments: WATER DELUGE FROM THE ET INTERTANK ACCESS STRUCTURE IS
BLOWN NORTHWARD. TWO BIRDS CROSS FOV, BUT ARE NOT NEAR THE
VEHICLE. ROLL MANEUVER APPEARS NORMAL, THOUGH THE VEHICLE OVER-
ROLLS SLIGHTLY. LOCAL SUPERSONIC FLOW CONDENSATE IS VISIBLE AT
T+42 SECONDS. A WHITE PARTICLE FIRST APPEARS BETWEEN SSME #1

NOZZLE AND THE BASE OF THE VERTICAL STABILIZER, FALLS AFT, AND ENTER THE PLUME. SEVERAL OBJECTS FALL OUT OF THE SRB PLUMES AFTER MAX Q AND ARE MOST LIKE PIECES OF SRB AFT SKIRT INSTAFOAM OR SRB PROPELLANT. NUMEROUS PIECES OF SRB PROPELLANT SLAG FALL OUT OF THE PLUME JUST PRIOR TO AND AFTER SRB SEPARATION.

ET-208 Cocoa Beach DOAMS video. Tracks launch vehicle
Color M-II from acquisition to LOV.

Comments: VEHICLE IS ACQUIRED AS LOCAL SUPERSONIC FLOW CONDENSATION FORMS ON THE VEHICLE. FEATURES ON THE EXTERNAL TANK, SUCH AS THE INTERTANK FLIGHT DOOR AND UCA, ARE EASILY VISIBLE. NUMEROUS OBJECTS, SRB AFT SKIRT INSTAFOAM OR PIECES OF SOLID PROPELLANT, FALL UT OF THE SRB PLUME THROUGHOUT ASCENT. SRB SEPARATION IS NOMINAL. NUMEROUS PIECES OF PROPELLANT SLAG FALL FROM THE SEPARATED SRB'S. CHARRED TPS ON THE AFT DOME OF THE EXTERNAL TANK IS VISIBLE AFTER SRB HAVE SEPARATED.

ET-212 UCS-23 MIGOR video. Tracks launch vehicle from
Color M-II acquisition to LOV.

Comments: LOCAL SUPERSONIC FLOW CONDENSATE OCCURS AT APPROX T+42 SECONDS. A WHITE OBJECT FIRST APPEARS BETWEEN SSME #1 NOZZLE AND THE VERTICAL STABILIZER, FALLS AFT, AND ENTERS THE PLUME. NUMEROUS PIECES OF PROPELLANT SLAG FALL OUT OF THE SRB PLUMES JUST PRIOR TO AND AFTER SRB SEPARATION.

ET-213 UCS-7 MOTS video. Tracks launch vehicle from
Color M-II acquisition to LOV.

Comments: T-0 OCCURS AT GMT 16:53:40. TRACKING IS UNSTEADY. VEHICLE IS SOON OBSCURED BY SRB PLUME.

7.2 ON-ORBIT FILM DATA REVIEW

ON-ORBIT View of External Tank after separation from the
70mm still Orbiter. Photos were taken by flight crew using
a hand-held camera.

Focus : SOMEWHAT SOFT
F. O. V.: STILL NEED A LONGER LENS
Exposure: OK

Comments: VERIFICATION OF THE TPS INTEGRITY WAS MORE DIFFICULT FOR THIS VEHICLE DUE TO THE LIGHTING CONDITIONS. THE TANK ACREAGE TPS WAS GENERALLY IN GOOD CONDITION. THE NOSECONE TOPCOAT WAS CHARRED, BUT MISSING NO TPS MATERIAL. A VERY DISTINCT LINE WAS VISIBLE AT STATION 371 (FRAME 16). FRAMES 18 AND 31 SHOW 4 DIVOTS ON THE -Z INTERTANK-TO-LO2 TANK FLANGE AND 2 DIVOTS ON THE -Z INTERTANK-TO-LH2 TANK FLANGE. TWO SPOTS ON THE INTERTANK ACREAGE NEAR THE FLIGHT DOOR MAY BE DIVOTS (FRAME 11), BUT THESE SPOTS CANNOT BE CONFIRMED FROM THE OTHER FRAMES. THE INTERTANK-TO-LH2 TANK FLANGE ON THE +Z SIDE TO THE RIGHT OF THE PAL RAMP CONTAINS A POSSIBLE DIVOT (FRAME 43). THE BIPODS HAD NOT FOLDED UP AGAINST THE TANK AFTER SEPARATION FROM THE ORBITER.

7.3 LANDING FILM AND DATA REVIEW

E-1001 Orbiter landing at Ames-Dryden Flight Research
16mm Facility

Focus : OK
F. O. V.: OK
Exposure: OK

Comments: OPENING OF RH MLG DOOR AND EXTENSION OF RH MAIN GEAR SLIGHTLY LAGGED LEFT SIDE. LH MLG WHEELS CONTACTED RUNWAY FIRST FOLLOWED ALMOST IMMEDIATELY BY RIGHT WHEELS. NO UNUSUAL CONTROL SURFACE MOVEMENT OCCURRED PRIOR TO OR AFTER LANDING. REMAINING FOOTAGE WAS CLOSE-IN AND CENTERED ON MID-BODY FUSELAGE - SHOULD HAVE BEEN ON WHEELS.

E-1002 Orbiter landing at Ames-Dryden Flight Research
16mm Facility

Focus : SLIGHTLY SOFT
F. O. V.: OK
Exposure: OK

Comments: ALTHOUGH CAMERA WAS FAR FROM TOUCHDOWN POINT, WHEELS APPEARED TO CONTACT RUNWAY ALMOST SIMULTANEOUSLY AND SMOOTHLY. TOUCHDOWN OF NOSE WHEEL ALSO APPEARED NOMINAL. NO UNUSUAL ELEVON MOVEMENT OR DAMAGE TO TILES WAS VISIBLE.

E-1005 Orbiter landing at Ames-Dryden Flight Research
35mm Facility

Focus : OK
F. O. V.: OK
Exposure: OK

Comments: RH MLG DOOR OPENING AND RH MAIN GEAR DEPLOYMENT SLIGHTLY LAGS THE LEFT SIDE. LH MLG WHEELS TOUCH DOWN FIRST FOLLOWED ALMOST IMMEDIATELY BY THE RH WHEELS. NO UNUSUAL CONTROL SURFACE MOVEMENT OR TPS DAMAGE IS VISIBLE. NOSE GEAR TOUCHDOWN IS NOMINAL, THOUGH STRUT FLEXES SLIGHTLY IN FORE/AFT DIRECTION.

E-1006 Orbiter landing at Ames-Dryden Flight Research
35mm Facility

Focus : OK
F. O. V.: OK
Exposure: OK

Comments: OPENING OF LH MLG DOOR AND EXTENSION OF LH MAIN GEAR SLIGHTLY PRECEDED THE RIGHT SIDE. MAIN GEAR APPEARED TO CONTACT RUNWAY ALMOST SIMULTANEOUSLY. TOUCHDOWN OF NOSE GEAR WAS ALSO NOMINAL. NO UNUSUAL CONTROL SURFACE MOVEMENTS OR TILE DAMAGE WERE VISIBLE.

E-1007 Orbiter landing at Ames-Dryden Flight Research
16mm Facility

Focus : UNKNOWN
F. O. V.: UNKNOWN
Exposure: EXTREMELY UNDEREXPOSED

Comments: VERY LITTLE DETAIL IS DISCERNIBLE.

E-1008 Orbiter landing at Ames-Dryden Flight Research
35mm Facility

Comments: CAMERA DID NOT RUN.

E-1009 Orbiter landing at Ames-Dryden Flight Research
16mm Facility

Comments: CAMERA DID NOT RUN.

E-1011 Orbiter landing at Ames-Dryden Flight Research
16mm Facility

Focus : OK
F. O. V.: MUCH CAMERA MOVEMENT
Exposure: OK

Comments: RH MLG DOOR OPENING AND RH MAIN GEAR EXTENSION SLIGHTLY LAGS LEFT SIDE. MAIN GEAR TOUCHES DOWN SIMULTANEOUSLY. NOSE GEAR TOUCHDOWN IS ALSO NOMINAL. NO UNUSUAL CONTROL SURFACE MOVEMENT OR TILE DAMAGE IS VISIBLE.

E-1012 Orbiter landing at Ames-Dryden Flight Research
16mm Facility

Focus : OK

F. O. V.: OK, BUT TRACKING WAS VERY UNSTEADY

Exposure: OK

Comments: OPENING OF RH MLG DOOR AND EXTENSION OF RH MAIN GEAR
WHEELS SLIGHTLY LAGGED THE LEFT SIDE. NO UNUSUAL CONTROL SURFACE
MOVEMENT OCCURRED PRIOR TO OR AFTER LANDING. NOSE WHEEL TOUCHDOWN
WAS SMOOTH.

8.0 SRB POST FLIGHT/RETRIEVAL DEBRIS ASSESSMENT

Both Solid Rocket Boosters were inspected for debris damage and debris sources at CCAFS Hangar AF on 21 October 1989 from 0730 to 1000 hours. In general, the SRB's appeared to be in good condition.

8.1 RH SOLID ROCKET BOOSTER DEBRIS INSPECTION

The nose cap was not recovered. The RH frustum was missing no MSA-2 TPS but exhibited three debonds, all of which measured 1 inch in diameter. The Hypalon paint had blistered slightly only in localized areas (Figure 16). The four BSM aero heatshield covers were intact and locked in the open position. The attachment rings exhibited the same bending/twisting characteristics and screw hole elongations as noted on previous missions.

The RH Forward Skirt exhibited no missing TPS or debonds. The Hypalon paint on the leading edge of the systems tunnel was blistered. Phenolic plates on the RSS antennae and K5NA closeouts were intact (Figure 17). Separation of the forward attach fitting was nominal and the RSS cables separated cleanly. K5NA closeouts were not accomplished on the inboard corners of the RSS interface cable tray. Over 500 gallons of seawater were present in the retrieved forward skirt due to an unplugged bolt hole on the skirt dome.

A systems tunnel cover on the forward case segment was missing a 30"x8" area of MSA-1. The substrate was generally covered with residual MSA, but showed no signs of ascent heating. The exact cause of this lost MSA-1 is still under investigation. A detailed review of splashdown film ruled out water impact as a probable cause. There was a 1"x2" blister on the systems tunnel covers of both the aft center and aft segments.

All field joint closeouts were undamaged. Known void areas on the field joint closeouts and repairs remained intact. Minor trailing edge damage to the GEI cork runs was attributed to debris hits from nozzle extension severance. Two 2"x3" pieces of GEI cork were missing from the aft booster and the resulting cavities were slightly sooted. Two GEI ID epoxy-covered tags were missing from the aft booster.

The center stiffener ring sustained water impact damage. Some Instafoam was lost from the stiffener rings at splashdown. A 3"x1-1/2"x1-1/2" piece of the ET/SRB upper strut EPDM cover was missing along with a cover attachment bolt head. This bolt head was later found embedded in adjacent foam. K5NA closeouts on the IEA covers were intact, but the Hypalon paint exhibited some blistering.

FIGURE 16. RIGHT SRB FRUSTUM

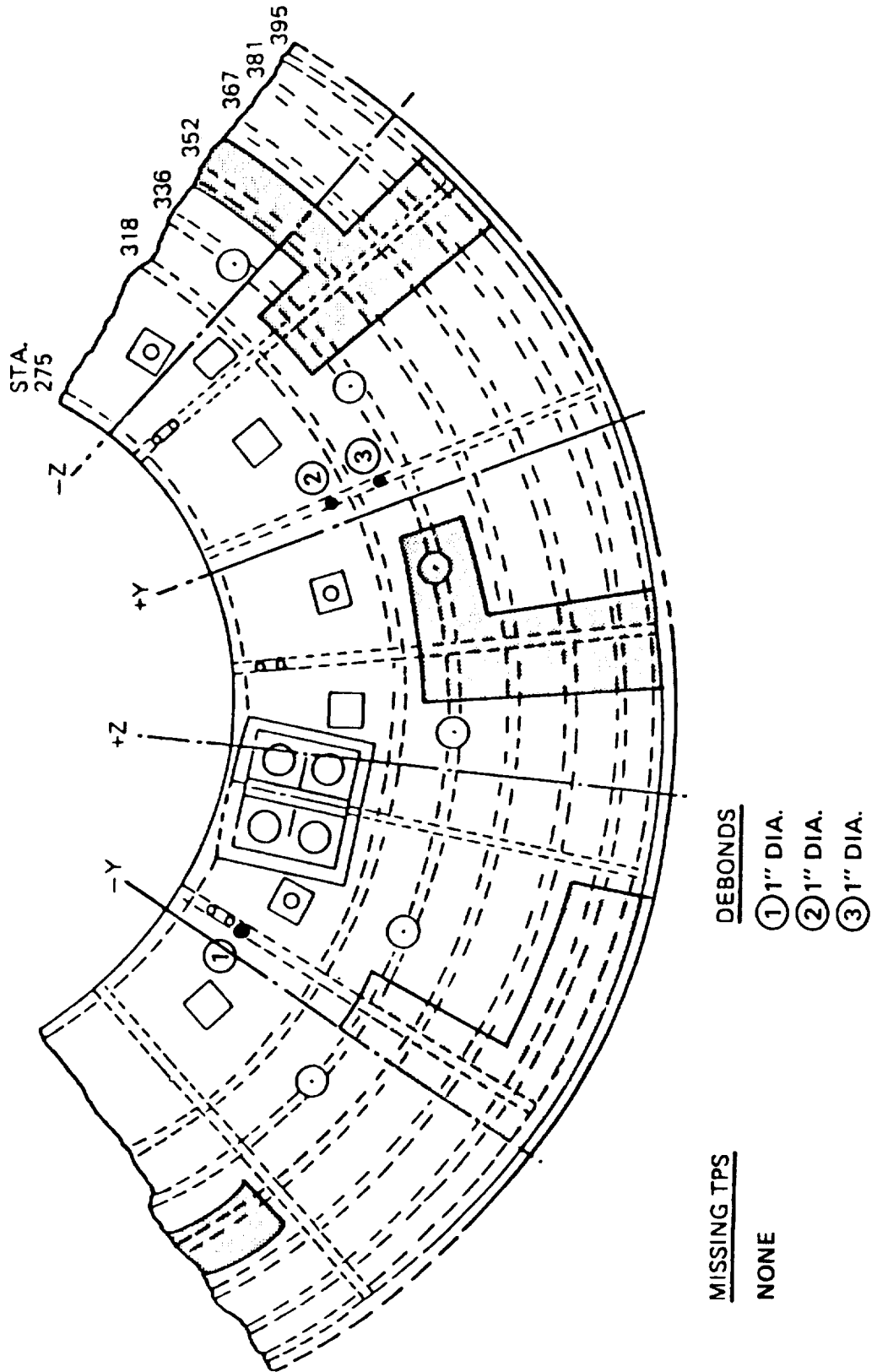
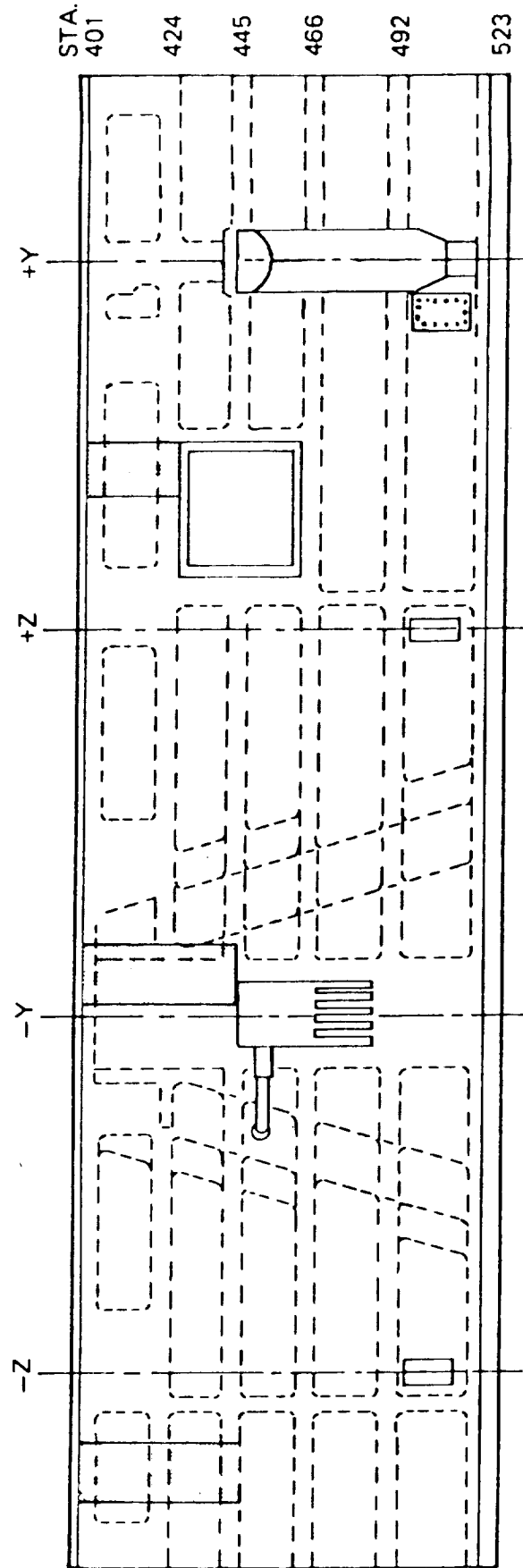

FIGURE 17. RIGHT SRB FWD SKIRT



TPS MISSING
NONE

DEBONDS
NONE

The phenolic material on the kick ring delaminated in some locations. Seventeen K5NA thermal protective domes were missing from bolt heads on the aft side of the kick ring. K5NA was also missing from all four aft BSM nozzles. The TPS over the aft skirt acreage was generally in good condition (Figure 18). The TVC system appeared to be undamaged. Instafoam was missing from the aft ring around the aft skirt feet, HPU exhaust horns, and joint heater umbilical. K5NA was missing from the inboard edge of all aft skirt feet. All holddown post debris containment assemblies had been removed prior to inspection, but were reported to have functioned properly without loss of contents. No holddown post shim material was lost prior to water impact.

Holddown post #2 aft skirt foot hole showed evidence of stud 'hang-up' (PR PV6-142926, USBI PV4-027704). Thread marks from the Inconel stud were impressed around the aft one-third of the inner aluminum surface of the hole. The stud abraded a 1/2" deep chamfer inclined 45 degrees on the outboard aft edge of the hole, and 3/4 of the paint from the aft inner surface of the hole was removed by the broaching. Some evidence of stud contact was found in all aft skirt stud holes except for HDP #5.

Stud hang-ups have occurred on five previous flights (STS-2, 4, 51-I, 51-J, and 61-A). Broaching similar to that experienced on STS-34 occurred on three of those flights. Minor broaching and thread impressions have occurred on 46 holddown posts of ten previous flights. Holddown post shoes have been lifted on STS-2 and 29. Further investigation revealed HDP #2 stud preload limits and shoe dimensions were within specification just prior to liftoff. The raised inner web on the frangible nut fracture plane exhibited evidence of ductile, tensile failure, indicating this web separated before its pyrotechnic detonated. The web on the frangible nut and the embedded booster cartridge metal on the holddown stud were the most significant contributors to the stud hang-up and were caused by the non-simultaneous firing of the pyrotechnics.

FIGURE 18. RIGHT SRB AFT SKIRT EXTERIOR TPS

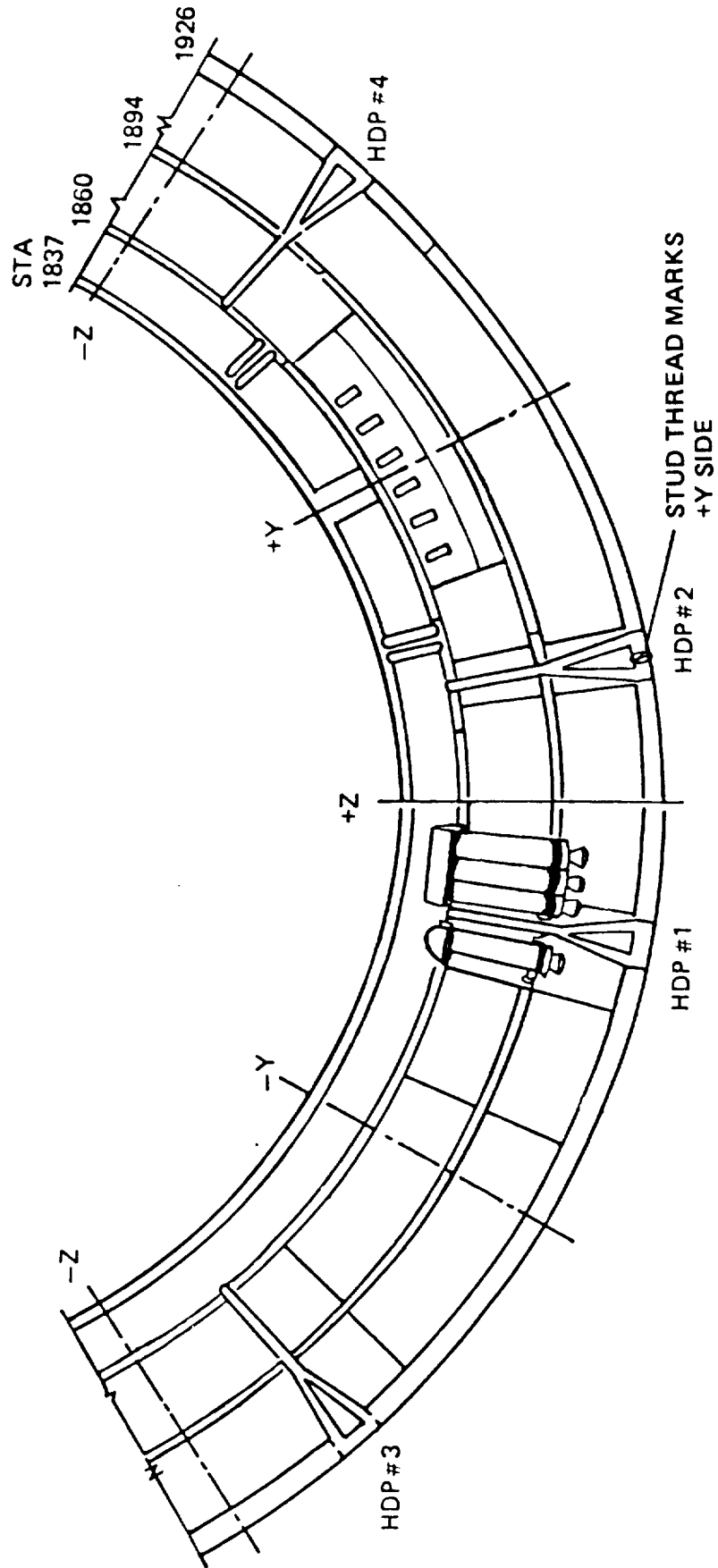

8.2 LH SOLID ROCKET BOOSTER DEBRIS INSPECTION

The nose cap was not recovered. The LH frustum exhibited no missing MSA-2 TPS, but did have 8 debonds ranging in size from 0.5 to 2.25 inches in diameter. There was minor blistering of the Hypalon paint along the entire circumference of the 395 ring frame (Figure 19). The BSM aero heatshield covers were removed prior to inspection, but had been intact and locked in the open position. The attachment rings exhibited the same bending/ twisting characteristics and screw hole elongations as noted on previous missions.

The LH Forward Skirt exhibited no debonds and 5 small areas of missing TPS, all of which appeared to have occurred during descent (Figure 20). Hypalon paint was slightly blistered near the forward ET/SRB thrust post. Phenolic plates on the RSS antennae and K5NA closeouts were intact. Separation of the forward attach fitting was nominal and the RSS cables separated cleanly. K5NA closeouts were not accomplished on the inboard corners of the interface cable tray. Sea water intrusion into the forward skirt amounted to 62 gallons. This water probably entered through the skirt aft seal.

The K5NA closeout on the trailing edge of the forward center field joint was debonded from both the case wall and the cork trailing edge at approximately 320 degrees radial location and measured 7 inches in length. The remaining field joint closeouts were undamaged and known void areas in the field joint closeouts were still intact. Two of the factory joints exhibited debonds of the vulcanized EPDM moisture seals. The first, 225-248 degrees radial location at station 531.5, was on the leading edge of the LH forward dome joint seal and was approximately 30 inches in length. The second, 45 degrees radial location at station 1011.5, was also on the leading edge of the LH forward center segment and was approximately 7 inches in length. Trailing edge damage to the GEI cork runs was attributed to debris hits from the nozzle extension severance. One and one-third GEI ID epoxy-covered tags were missing on the aft booster.

Instafoam was missing from all three stiffener rings from 220 - 280 degrees and was caused by water impact. Two stiffener rings had cracked K5NA that coincided with missing Instafoam. K5NA closeouts on the IEA covers were intact, but the Hypalon paint exhibited some blistering. Some TPS was missing from the ETA ring. Separation of the aft ET/SRB struts was nominal.

FIGURE 19. LEFT SRB FRUSTUM

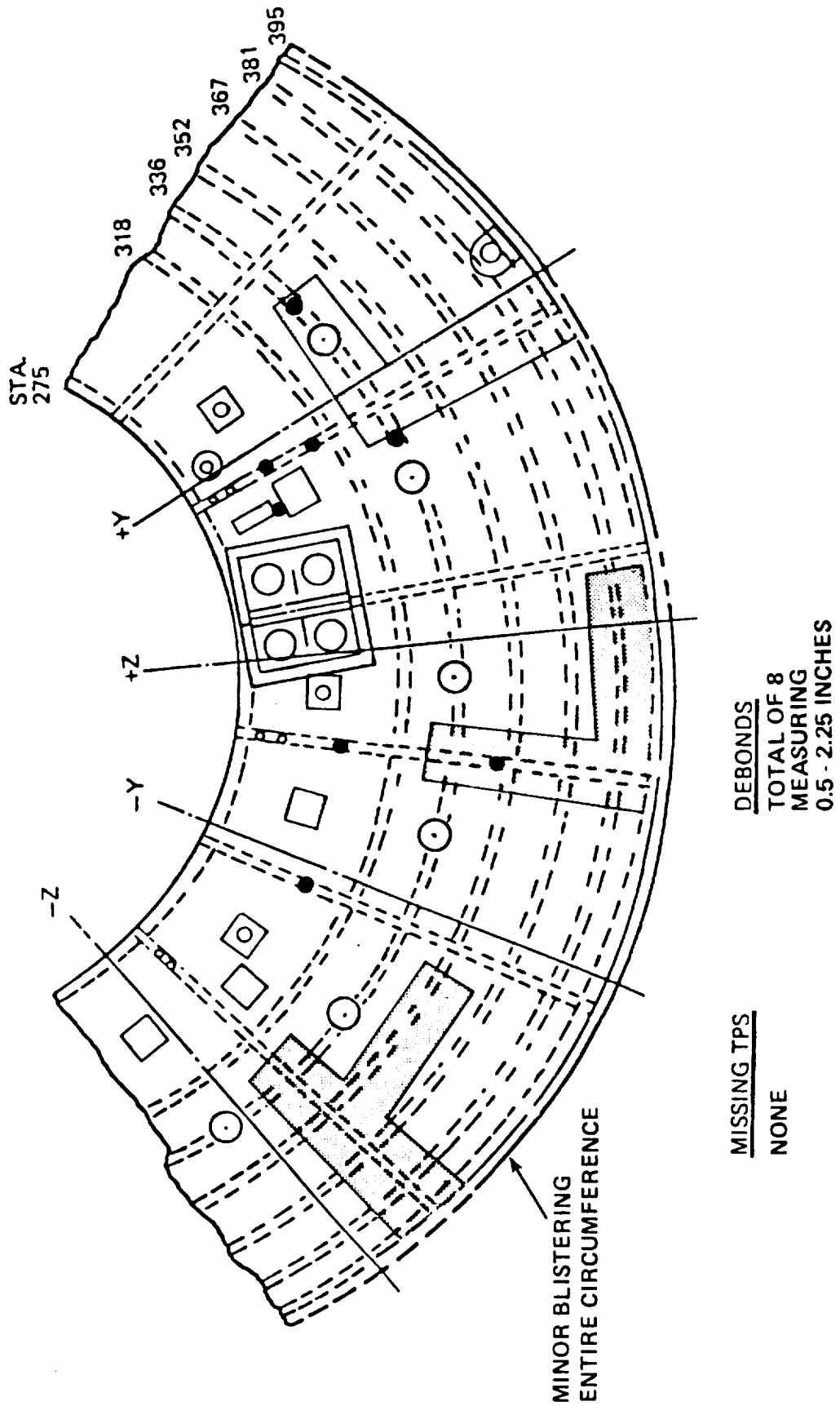
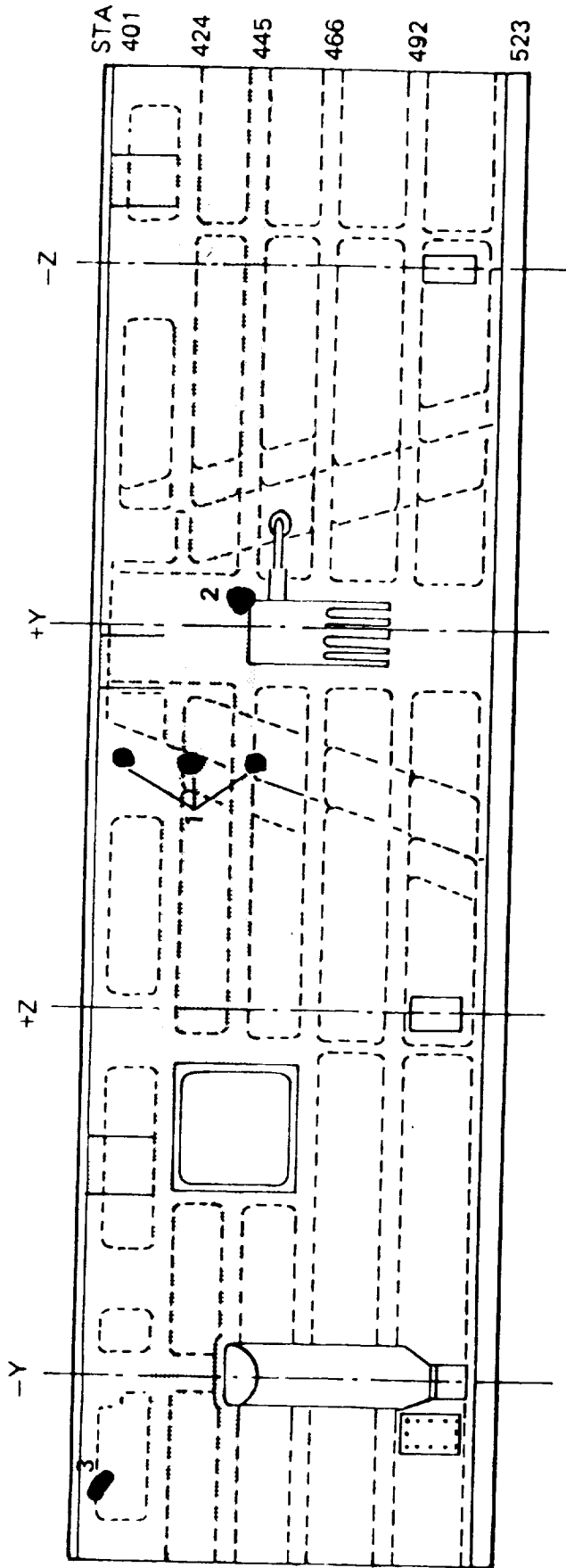

FIGURE 20. LEFT SRB FWD SKIRT



TPS MISSING

- ① 4 AREAS $1\ 1/2'' \times 2''$
 $1\ 1/2'' \times 2''$
 $1/4'' \times 1/2''$
 $1/4'' \times 1/2''$ } DFSCEN 1

- ② BLISTERING AROUND

GENERAL AREA ET/SRB POST

- ③ $1\ 1/2'' \times 1''$ FACING AFT

DEBONDS

NONE

Phenolic kick ring material was torn and delaminated in some places. K5NA was missing from all four aft BSM nozzles. The TPS acreage areas on the aft skirt were in good condition (Figure 21). The TVC system was damaged. The rock actuator-to-nozzle extension attach bracket separated. Instafoam was missing from the aft ring around the holddown post shoes, the HPU exhaust horns, and the joint heater umbilical. K5NA was missing from the inboard edge of all aft skirt feet. A 3 inch diameter and a 1 x 5 inch piece of material was missing from the holddown post #8 shim prior to water impact. All holddown post debris containment assemblies had been removed prior to inspection, but had been reported to have functioned properly without loss of contents.

FIGURE 21. LEFT SRB AFT SKIRT EXTERIOR TPS

- ① KSNA MISSING AROUND ALL BSM NOZZLE
- ② TILT TVC ACTUATOR BROKE AT ATTACH POINT TO NOZZLE

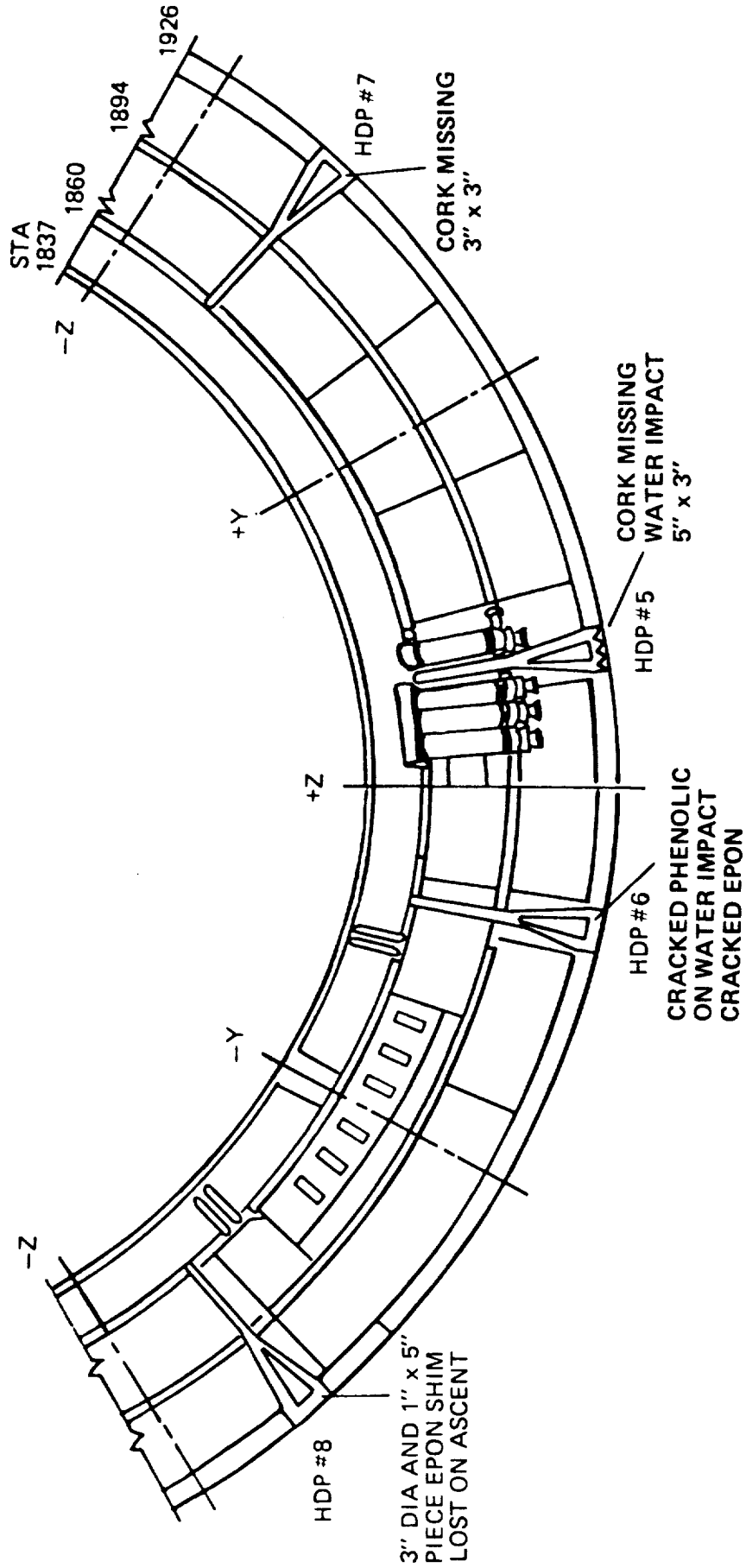

8.3 RECOVERED SRB DISASSEMBLY FINDINGS

During post flight assessment of the STS-34 booster set, several discrepancies were found with connector torquing and safety wiring. The nose cap release NSI and the RSS closed loop test cable were not torqued. The RH upper strut firing line and the recovery battery were not safety wired. The LH ET/SRB interface cable was safety wired backwards. All accessible connectors on the STS-33 booster set were inspected again. A documentation and closeout photograph review was conducted on the connectors that were not accessible.

Other major anomalies include the broached aft skirt stud hole at HDP #2 resulting from the stud hang-up. Sea water intrusion into the LH forward assembly, over 500 gallons, was attributed to a missing bolt on the skirt dome. The RH forward assembly contained 62 gallons of water, but the intrusion point is not known. The LH rock actuator bracket separated from the aft edit cone. This will result in the scrapping of the exit cone fragment. Excessive putty had been applied to the RH ignitor and the resulting 'squeeze-out' contacted the gask-o-seal. A new lay-up should prevent this problem on subsequent vehicles. Vehicles currently being processed are being verified. A 100 percent adhesive failure of the nozzle-to-case joint polysulfide/insulation interface occurred. The carbon filled (CF) EPDM in the aft dome insulation blistered on both aft segments. The most severely affected area measured 5.5"x4.5". This is the first occurrence of such blistering and the cause is unknown.

Post launch anomalies are listed in Section 11.3.

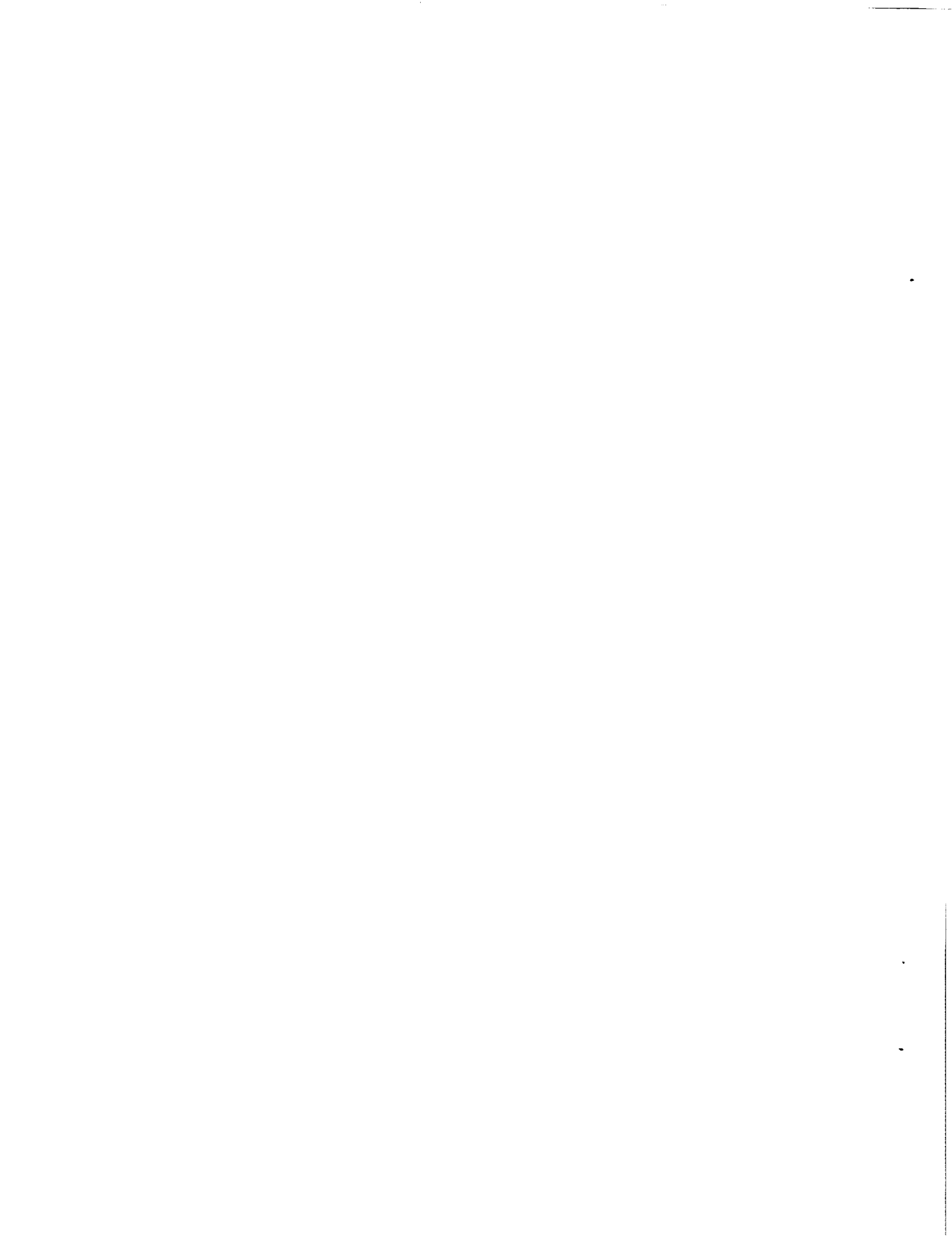

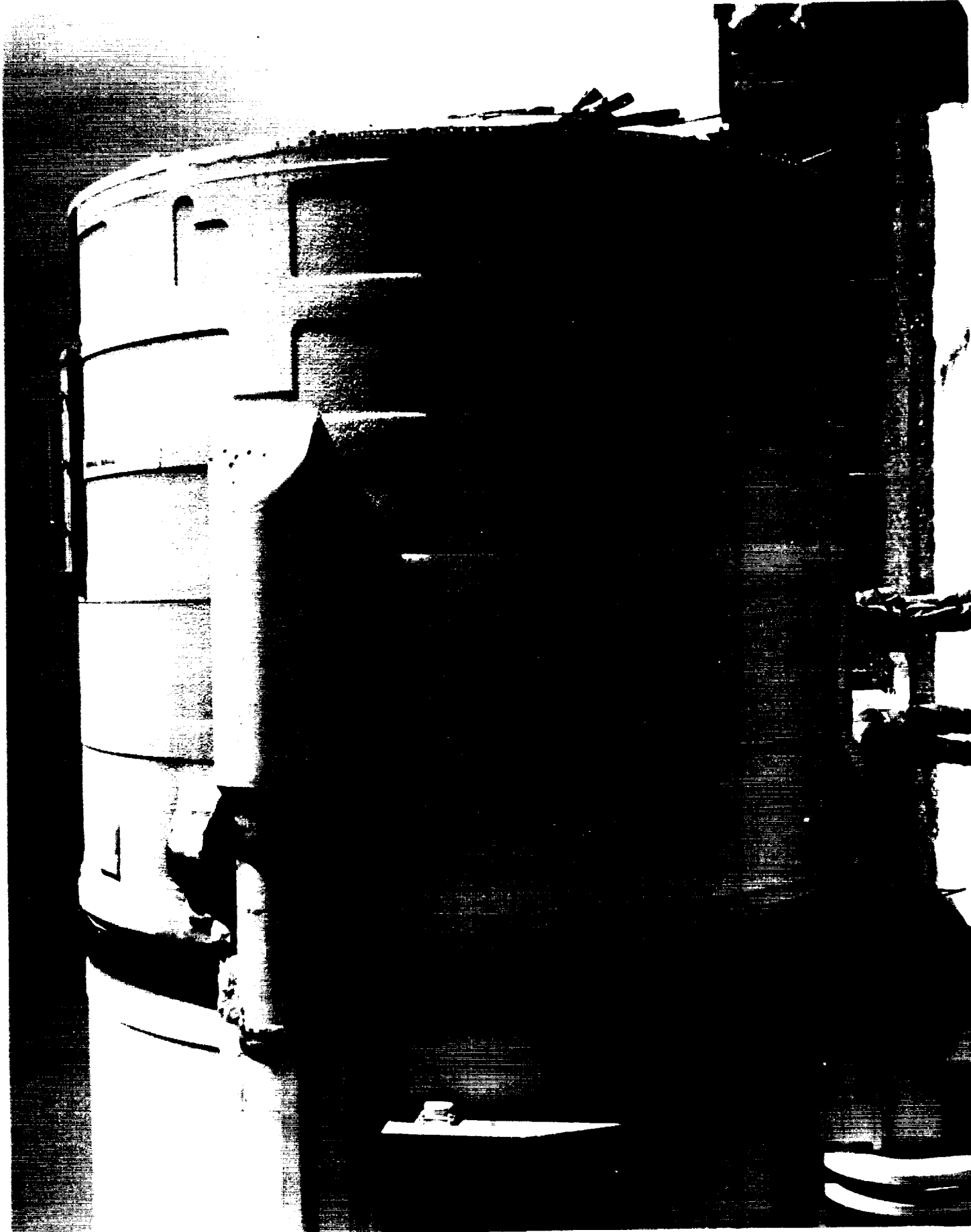

Post flight condition of RH SRB forward skirt

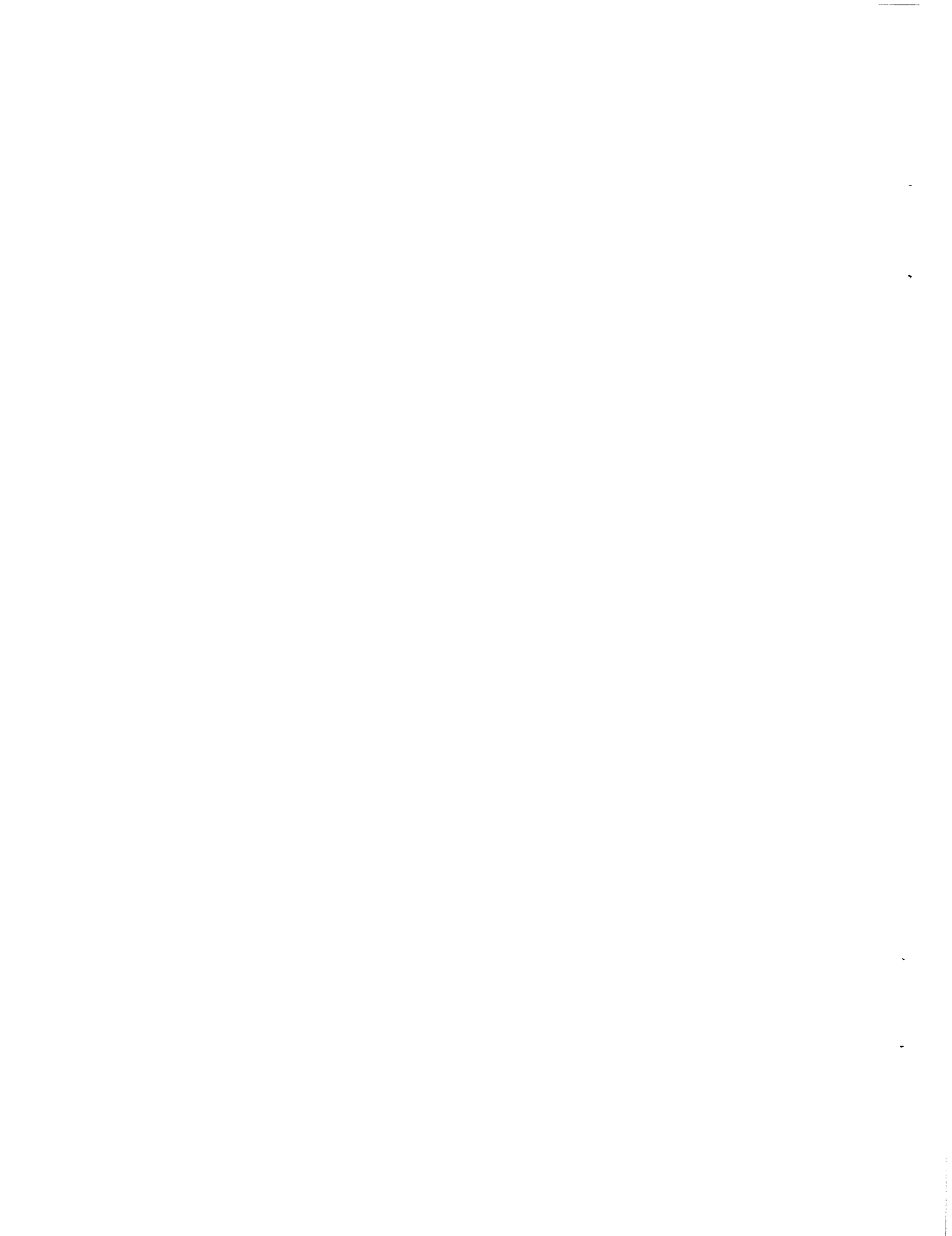

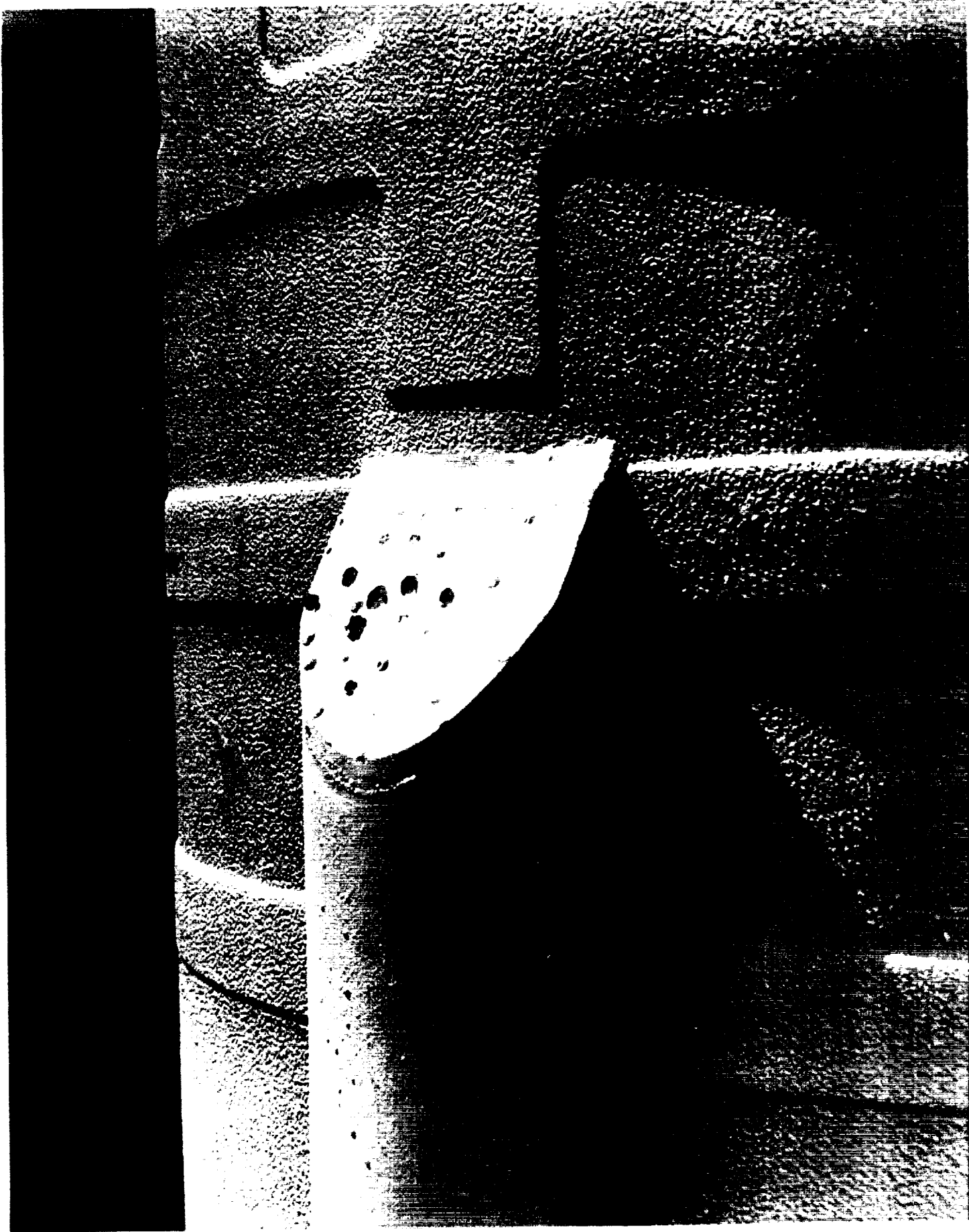

Some layers of MSA adhered to the blistered Hypalon paint

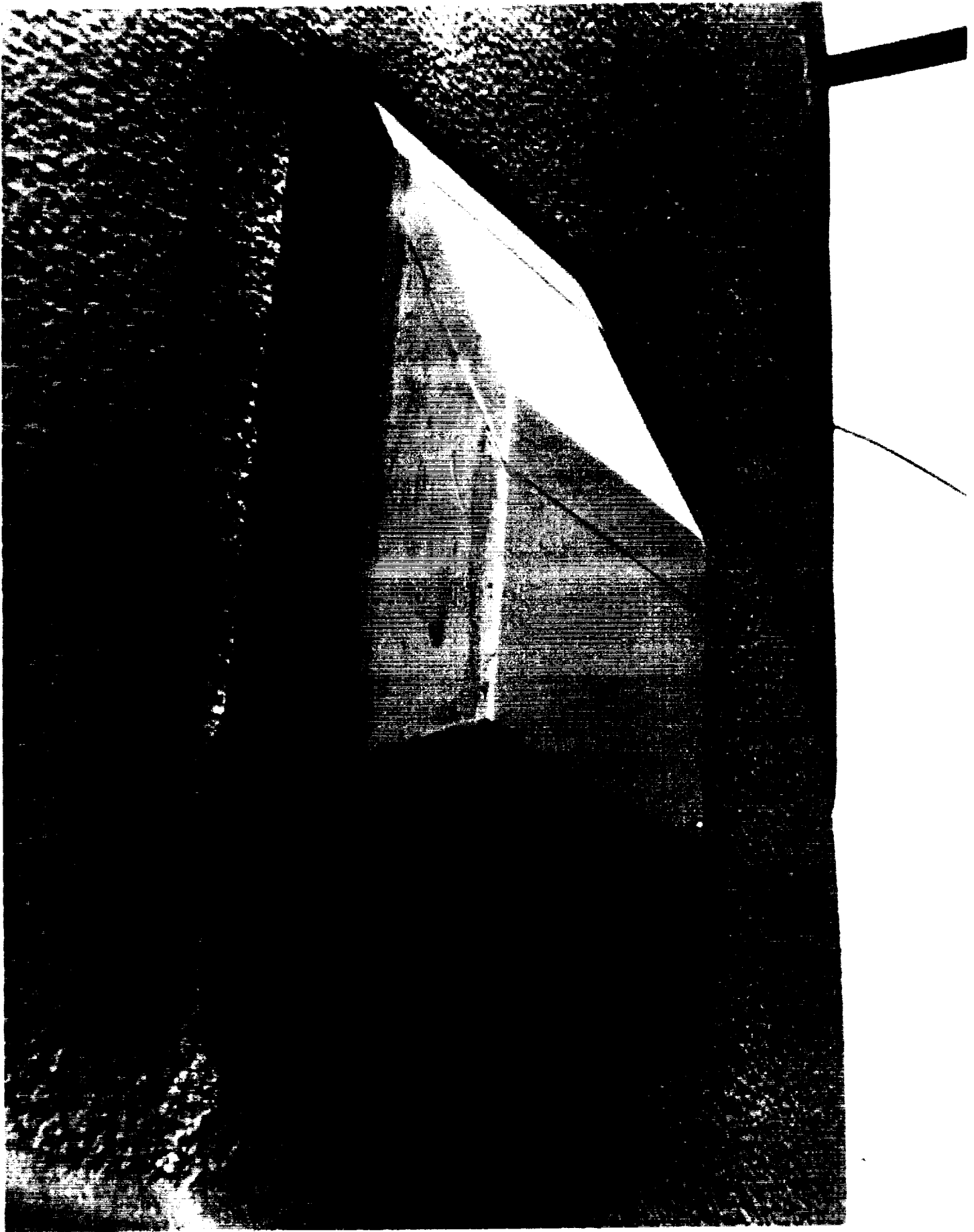

Phenolic plate and K5NA closeouts are intact on RSS antenna

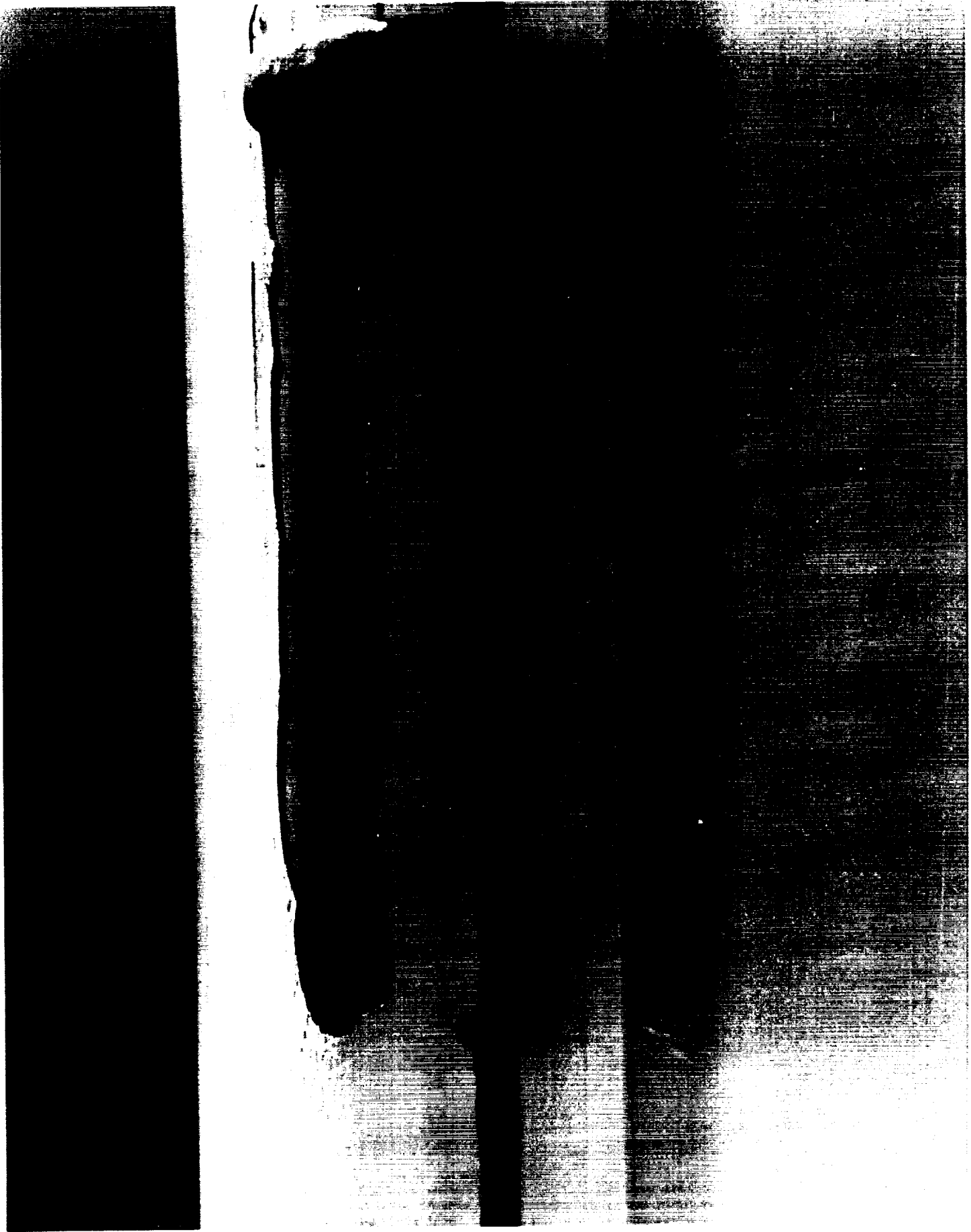

30"x8" piece of MSA missing from SRB systems tunnel cover. Film review shows this anomaly was not caused by water impact.

147

ORIGINAL PAGE
COLOR PHOTOGRAPH

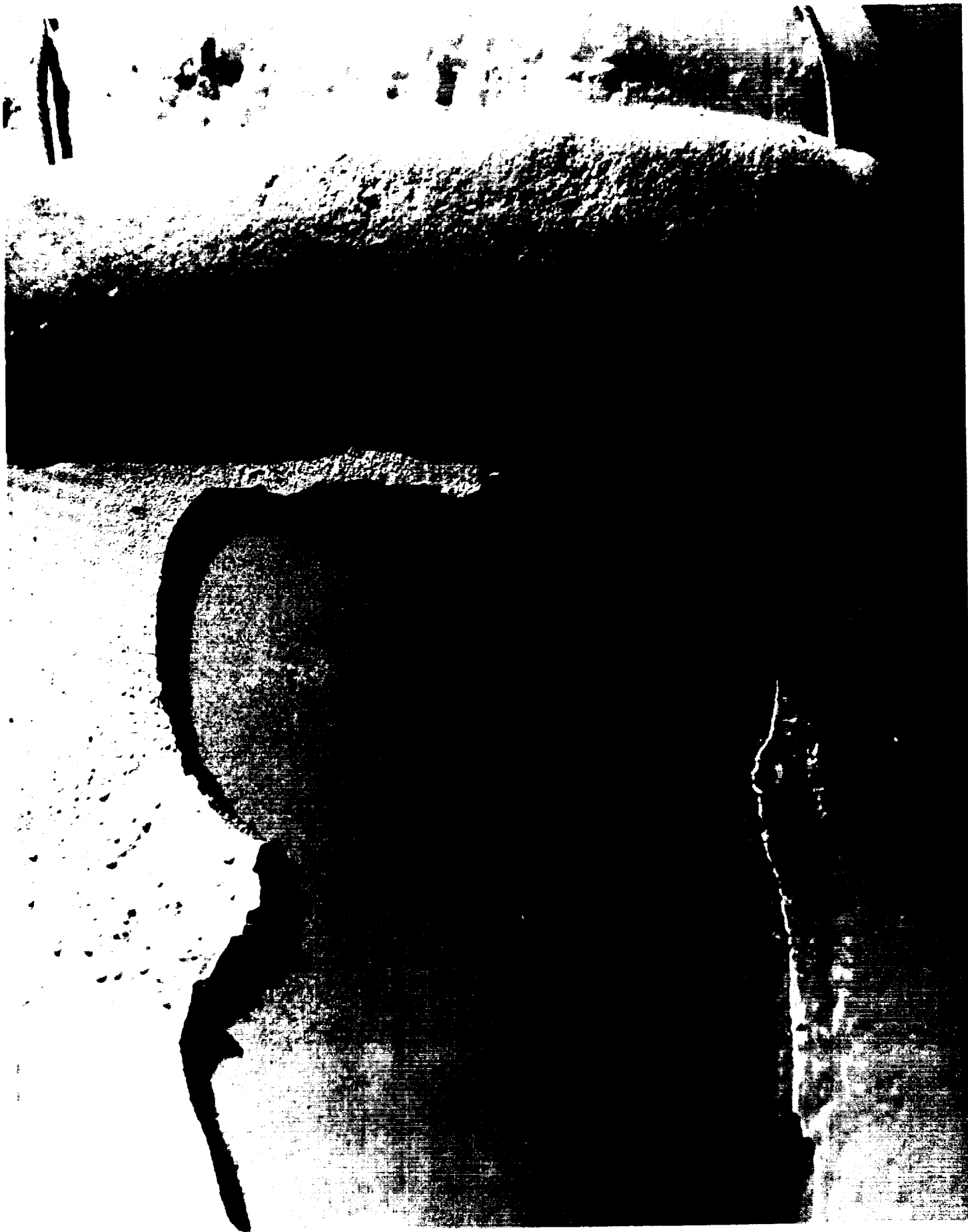

Close up view of missing MSA shows some ablator-to-substrate
bond line inconsistencies

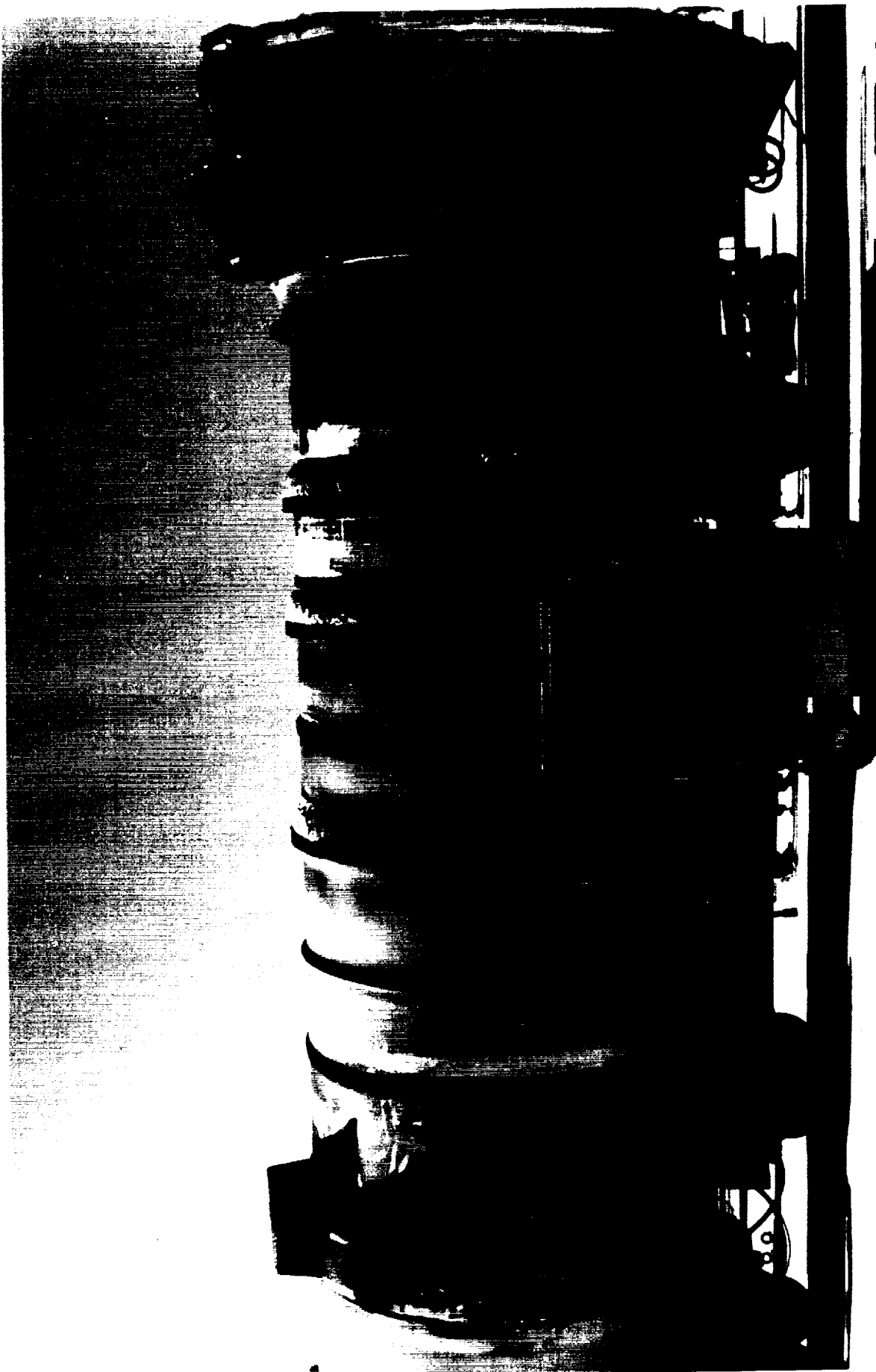

Post flight condition of RH SRB aft booster





Phenolic material has delaminated on the aft kick ring. Some K5NA domes were missing from the boltheads prior to splashdown

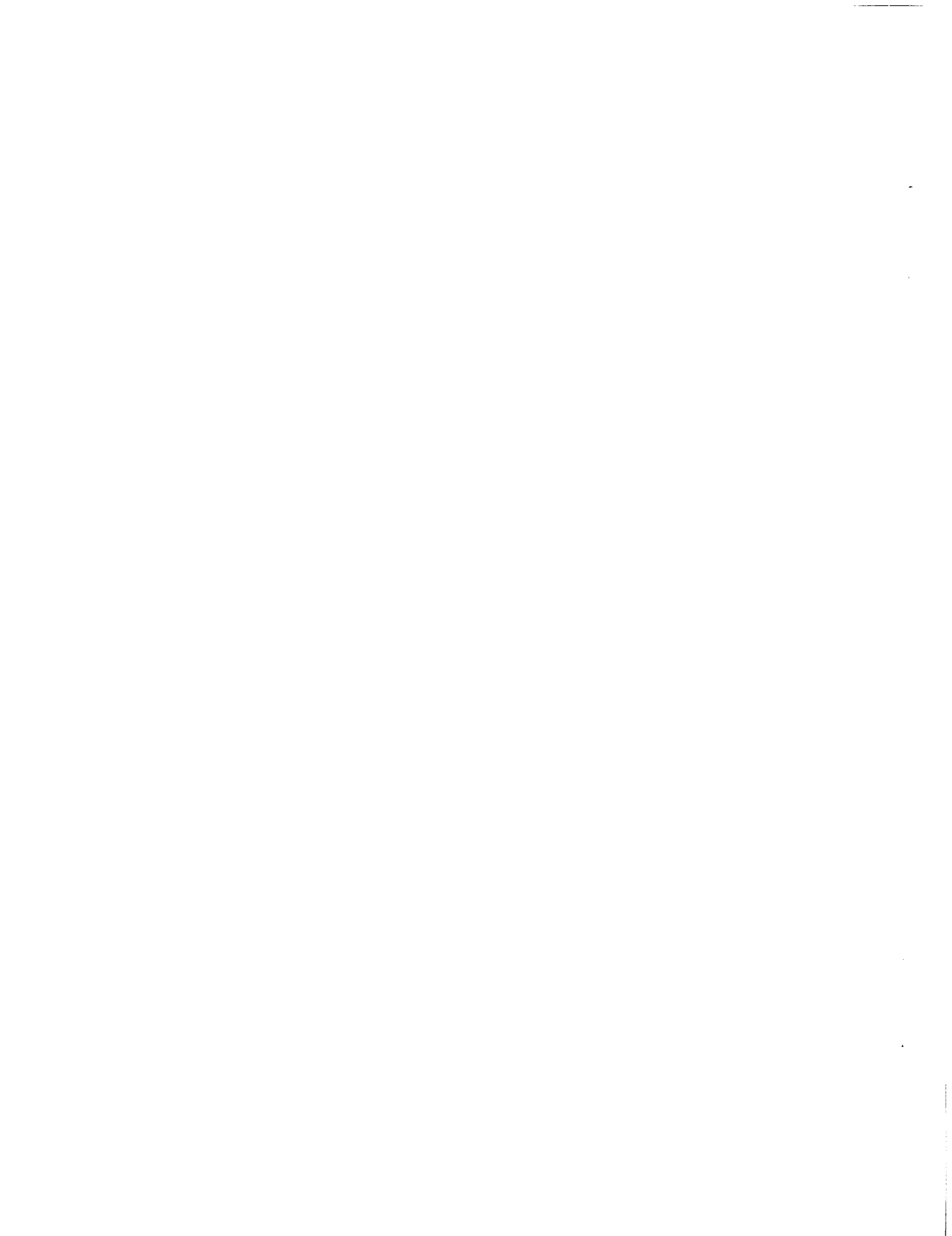



Typical loss of TPS material around aft skirt HDP foot

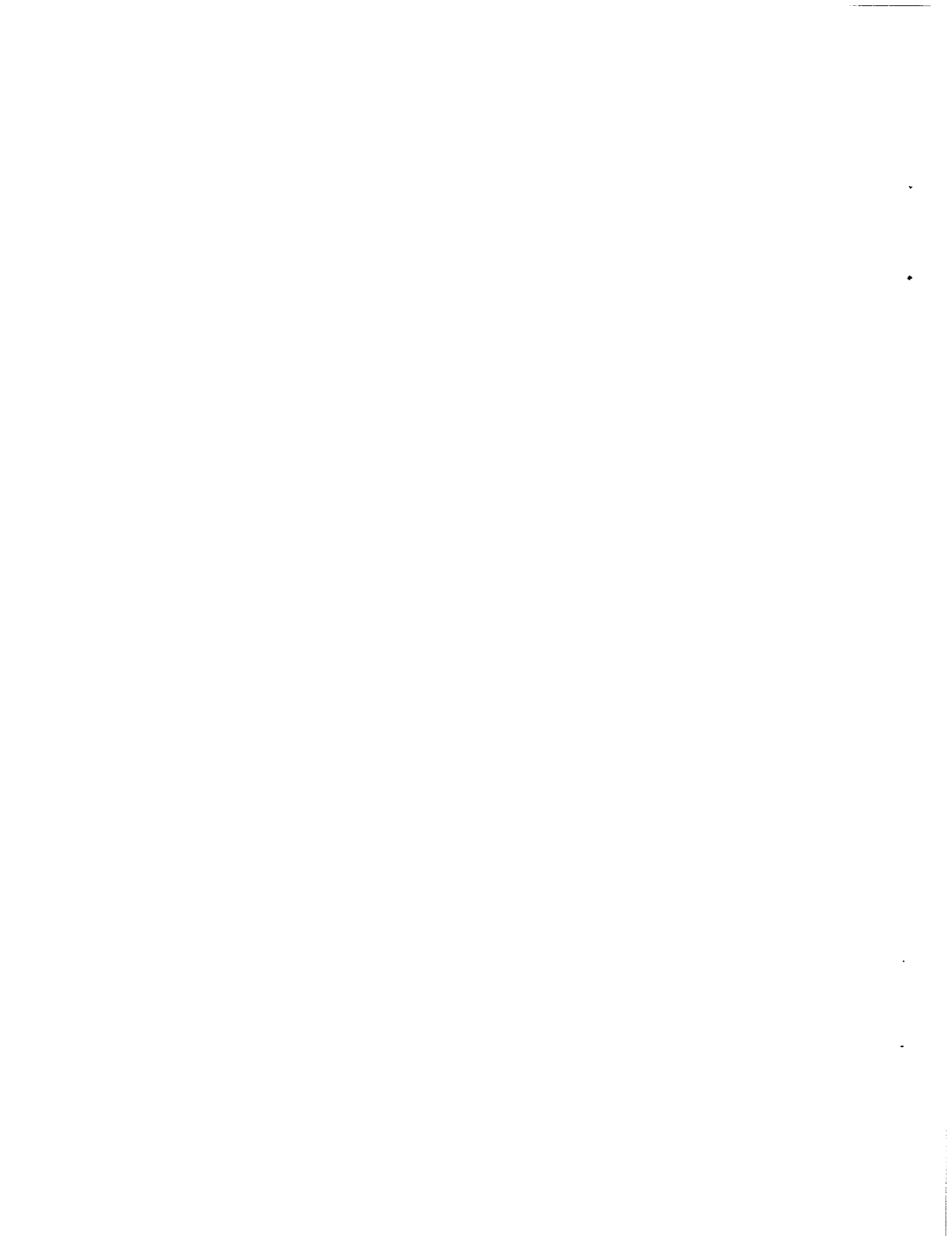



Aft skirt HDP #2 foot bore is broached by stud hang-up
at liftoff

152

ORIGINAL PAGE
COLOR PHOTOGRAPH

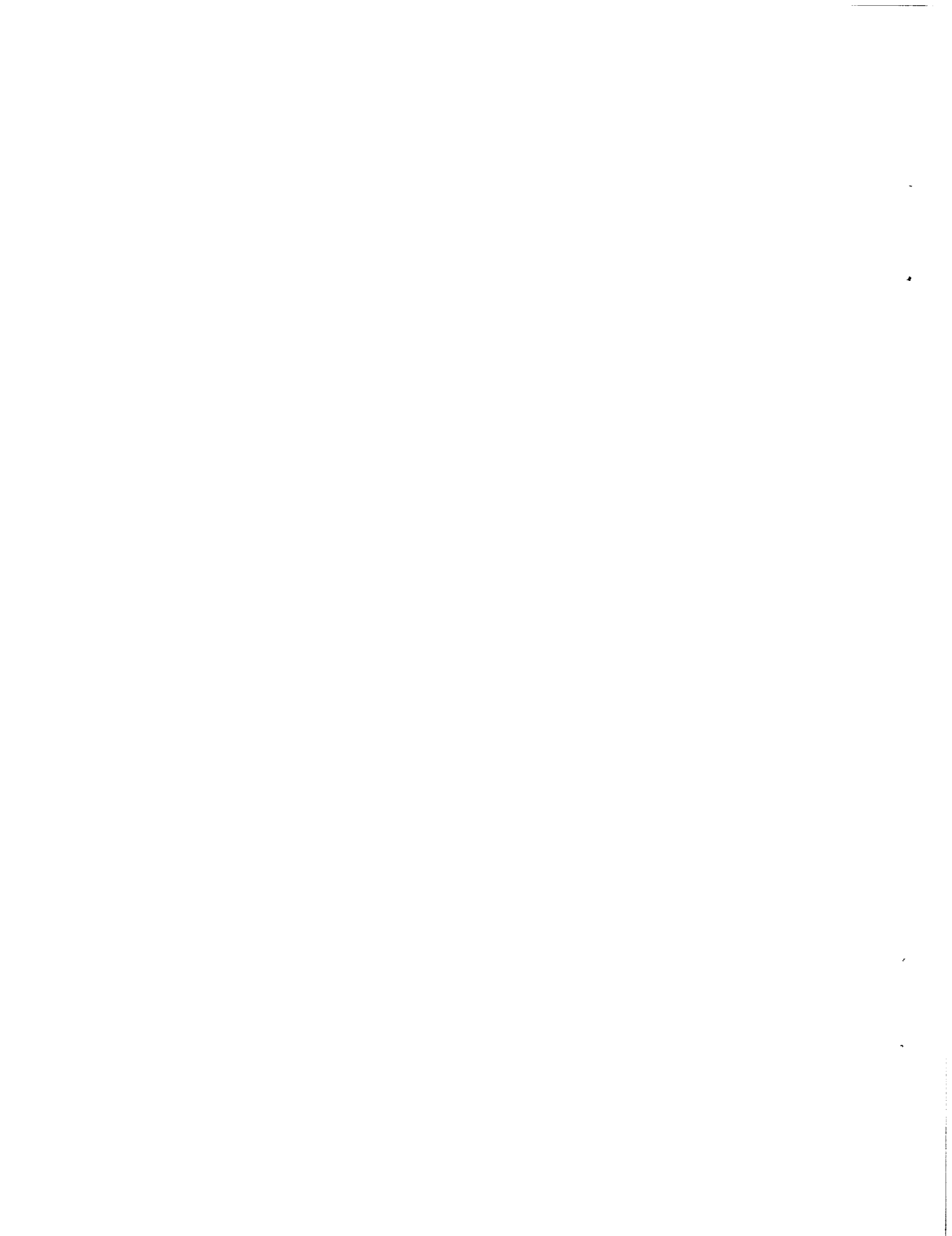



Aft skirt HDP #2 foot bore shows stud thread impressions
from stud hang-up at liftoff

153

ORIGINAL PAGE
COLOR PHOTOGRAPH



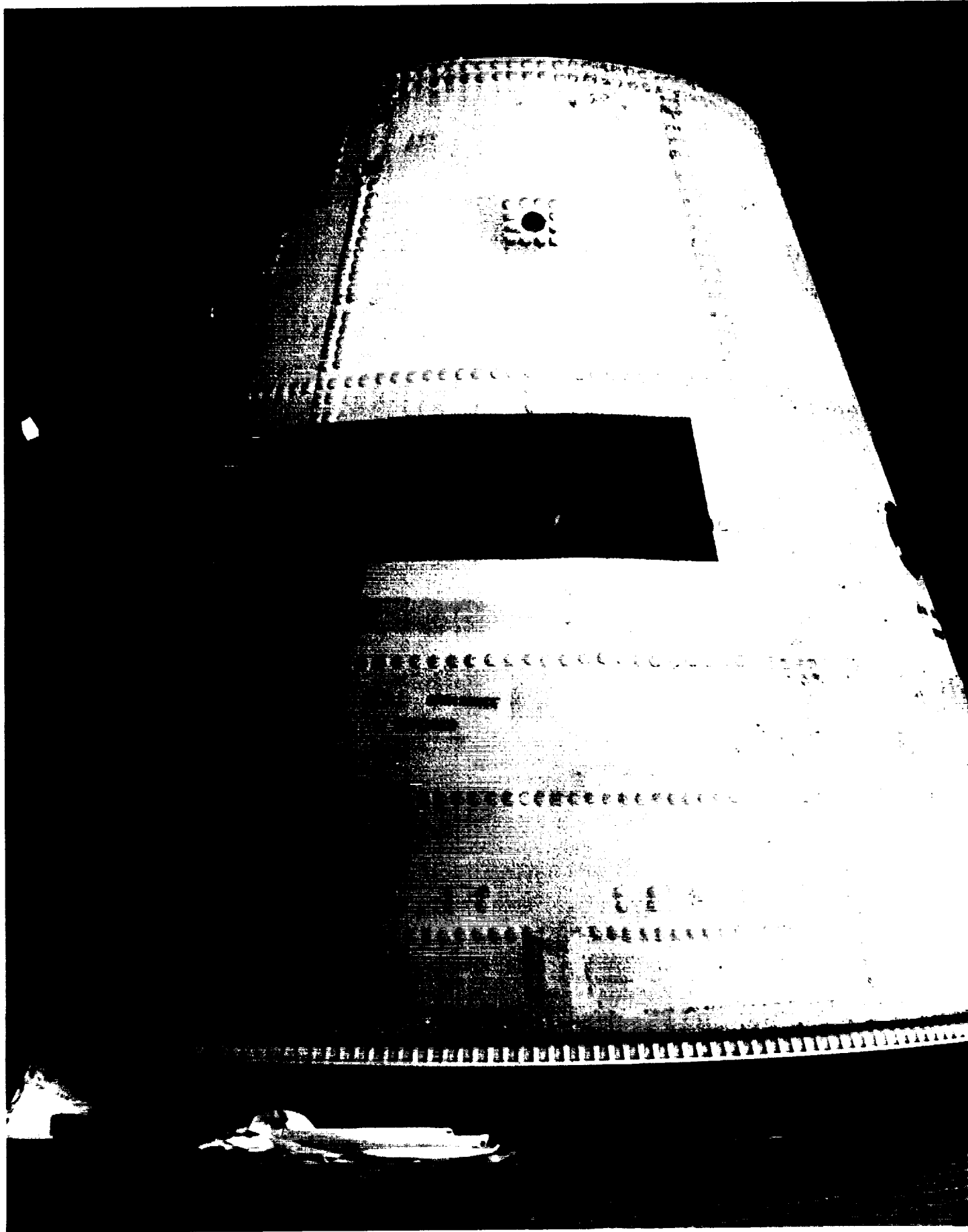

Post flight condition of LH SRB frustum

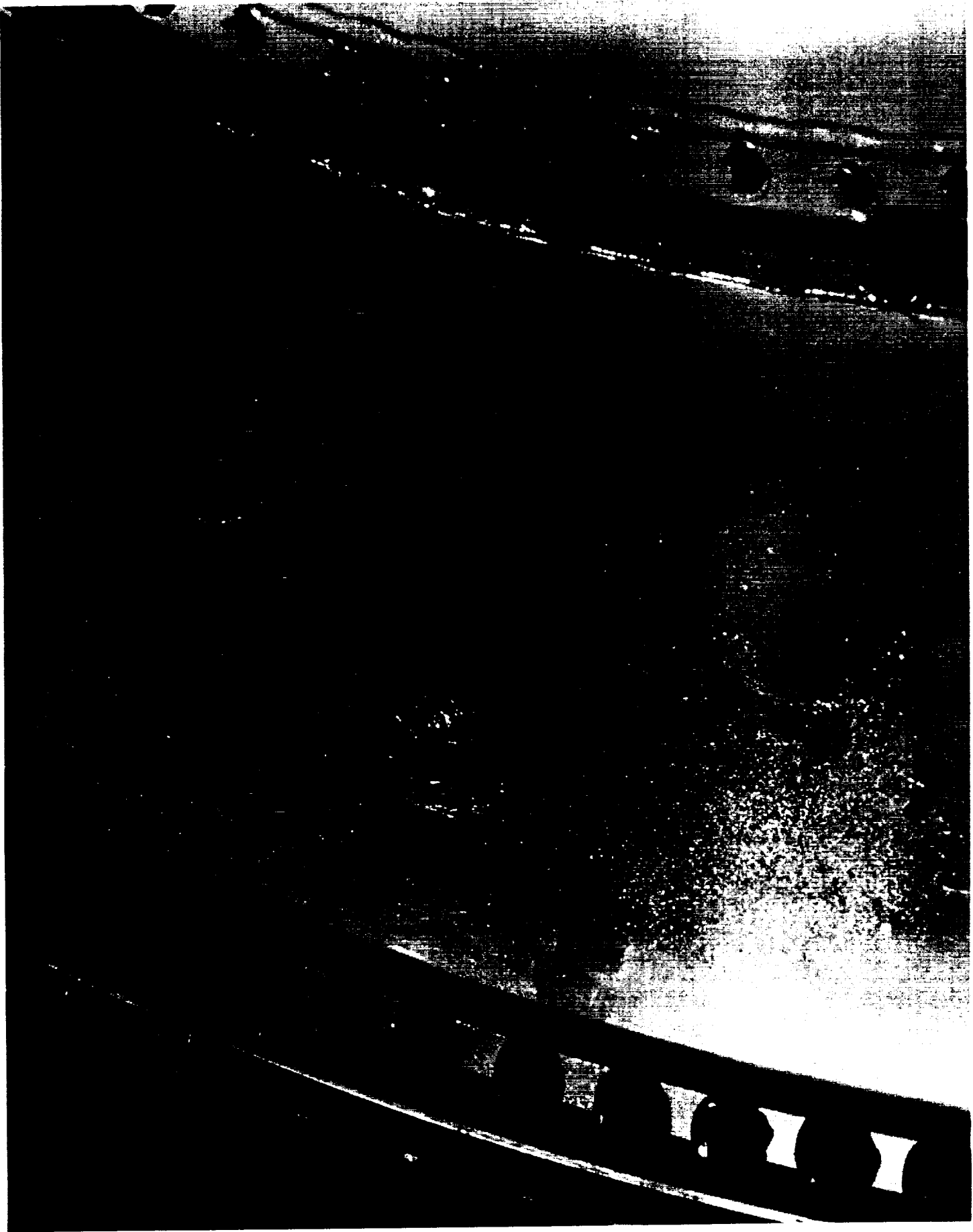

Unplugged bolt hole on LH SRB forward skirt dome allowed
more than 500 gallons of sea water intrusion

155

ORIGINAL PAGE
COLOR PHOTOGRAPH



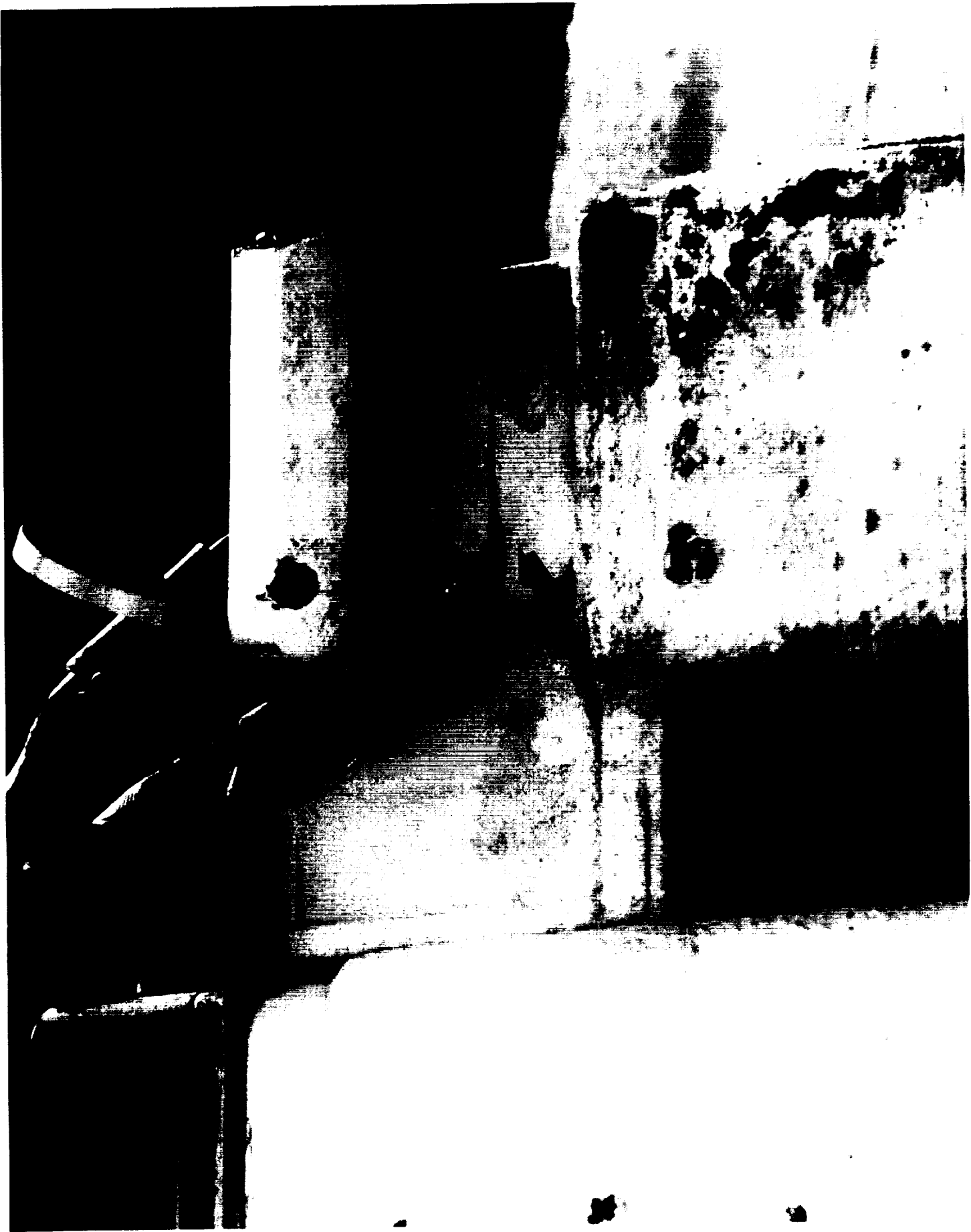

K5NA closeouts were not accomplished on the ET/SRB
forward crossovers

156

ORIGINAL PAGE
COLOR PHOTOGRAPH

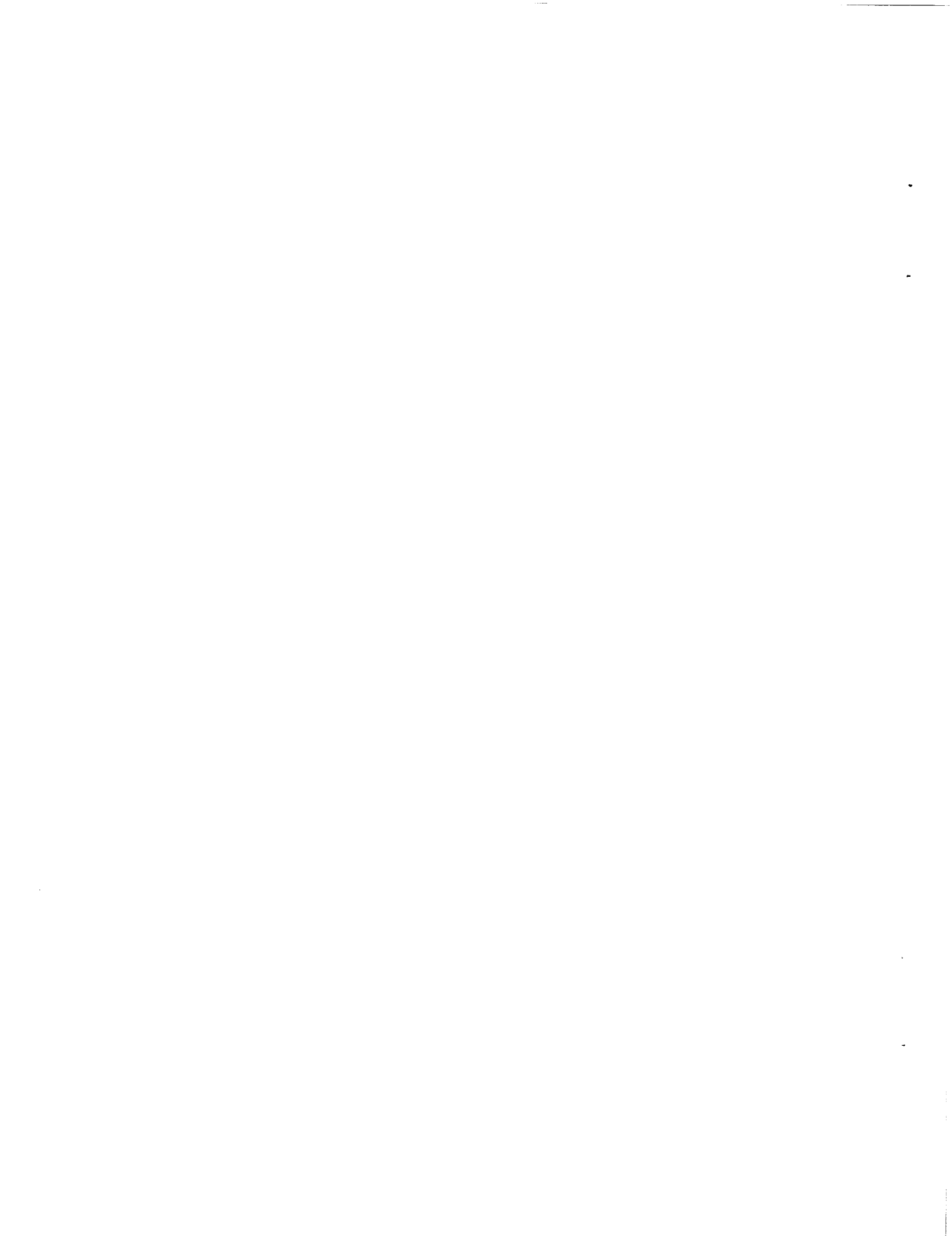



Trailing edge K5NA closeout on the LH forward center field joint was debonded from both the case wall and cork

157

ORIGINAL PAGE
COLOR PHOTOGRAPH

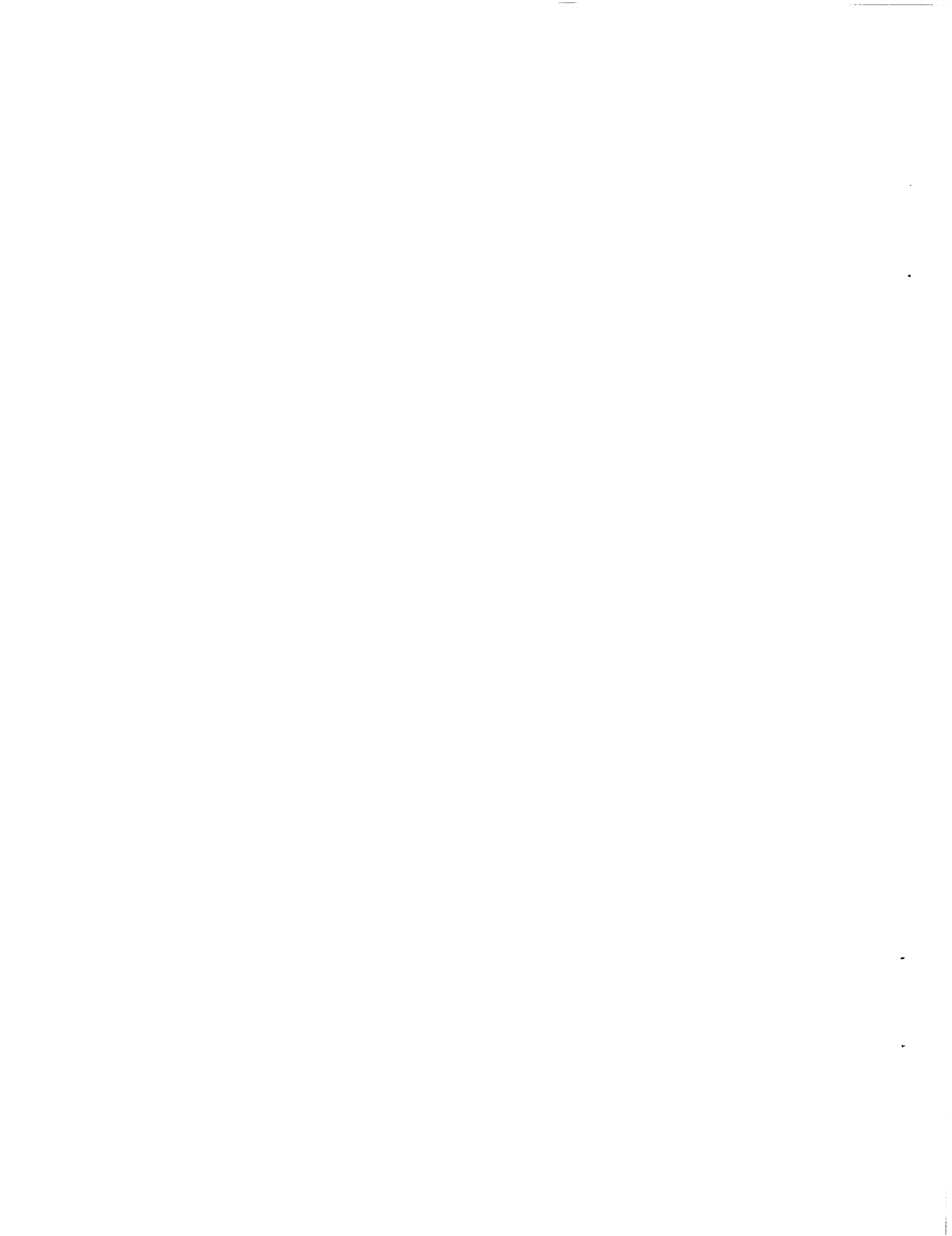

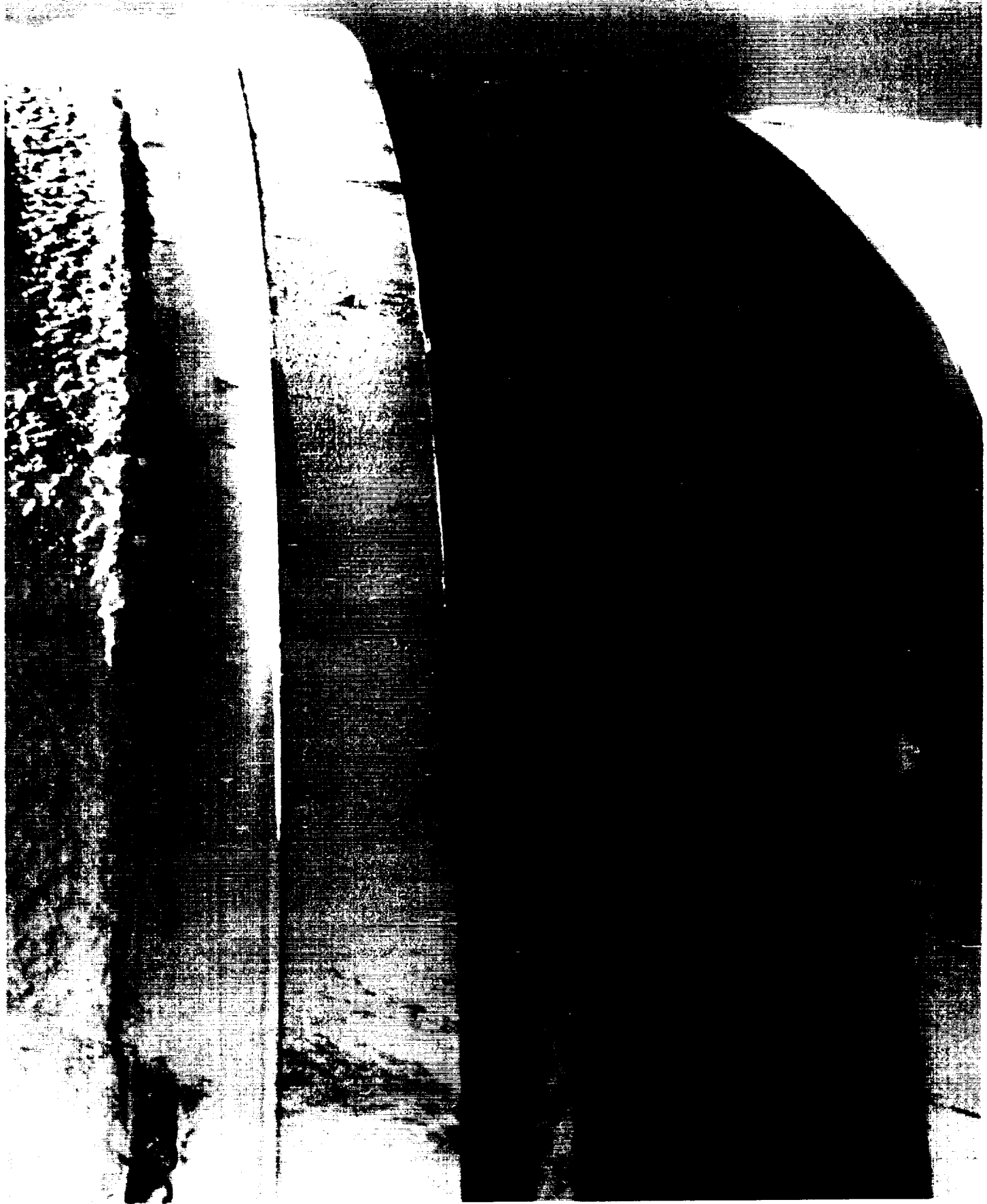

LH forward dome factory joint EPDM moisture seal was debonded
along the leading edge for approximately 30 inches

158

ORIGINAL PAGE
COLOR PHOTOGRAPH

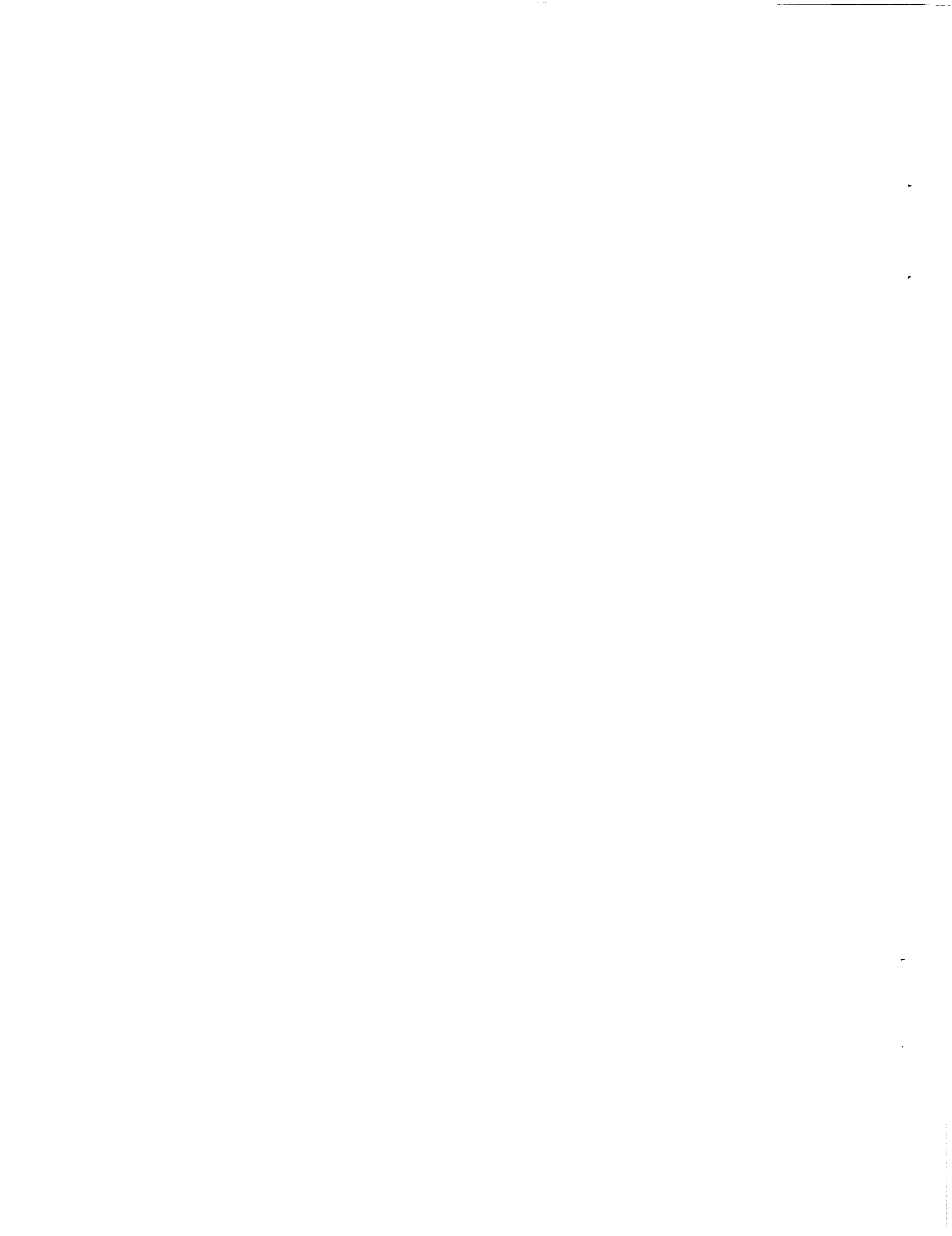



LH forward center segment factory joint EPDM moisture seal was debonded along the leading edge for approximately 7 inches

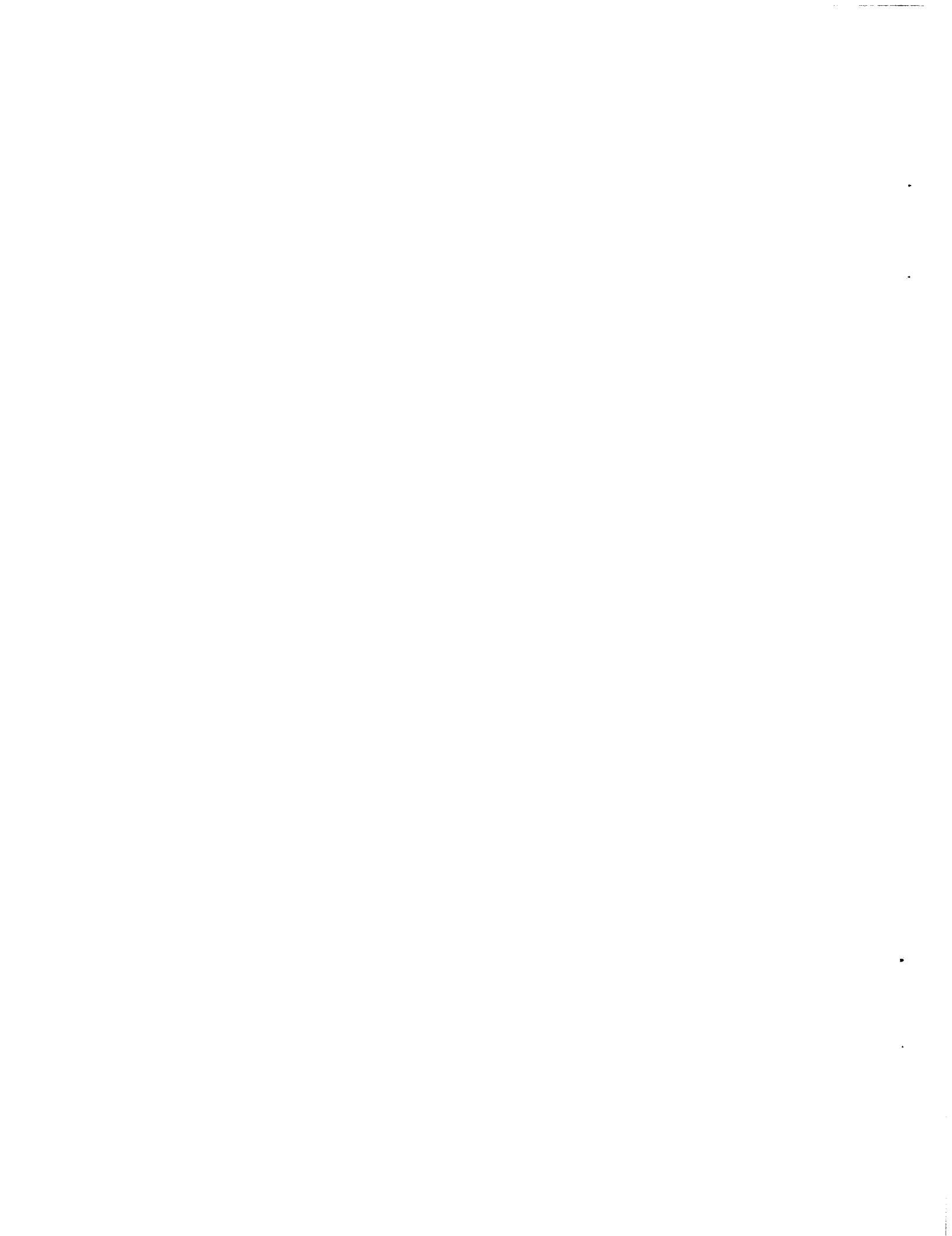

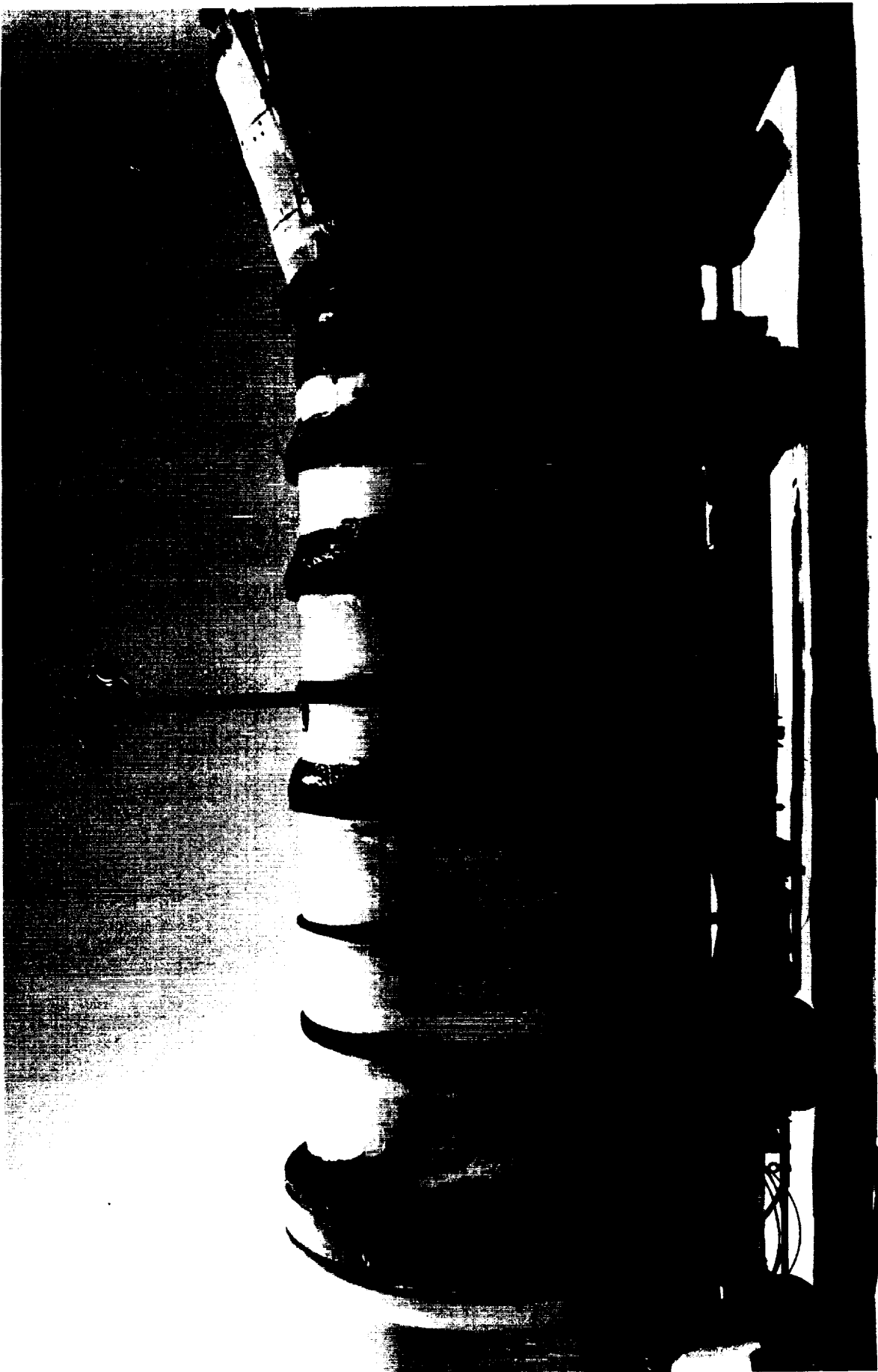

Post flight condition of LH SRB aft booster

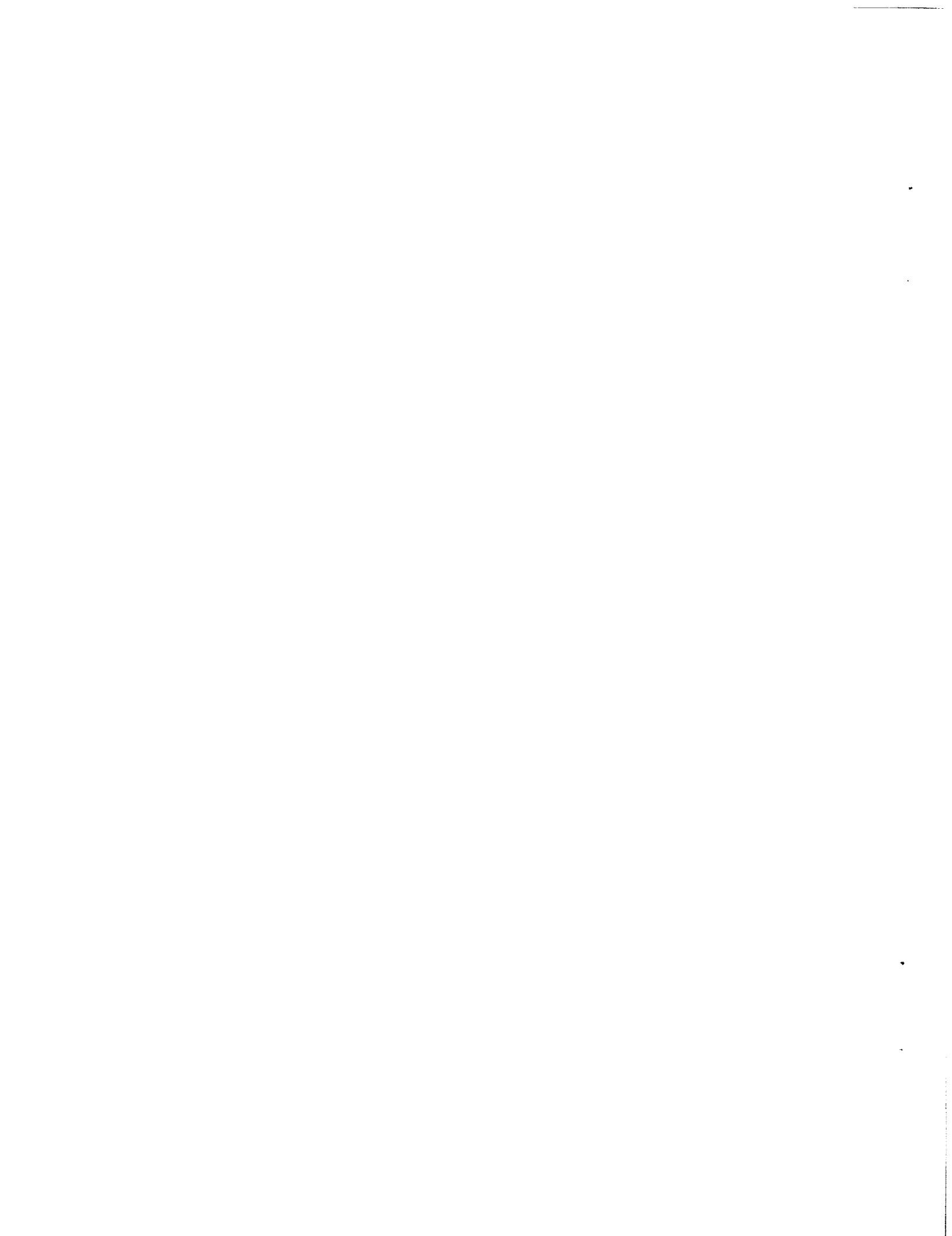

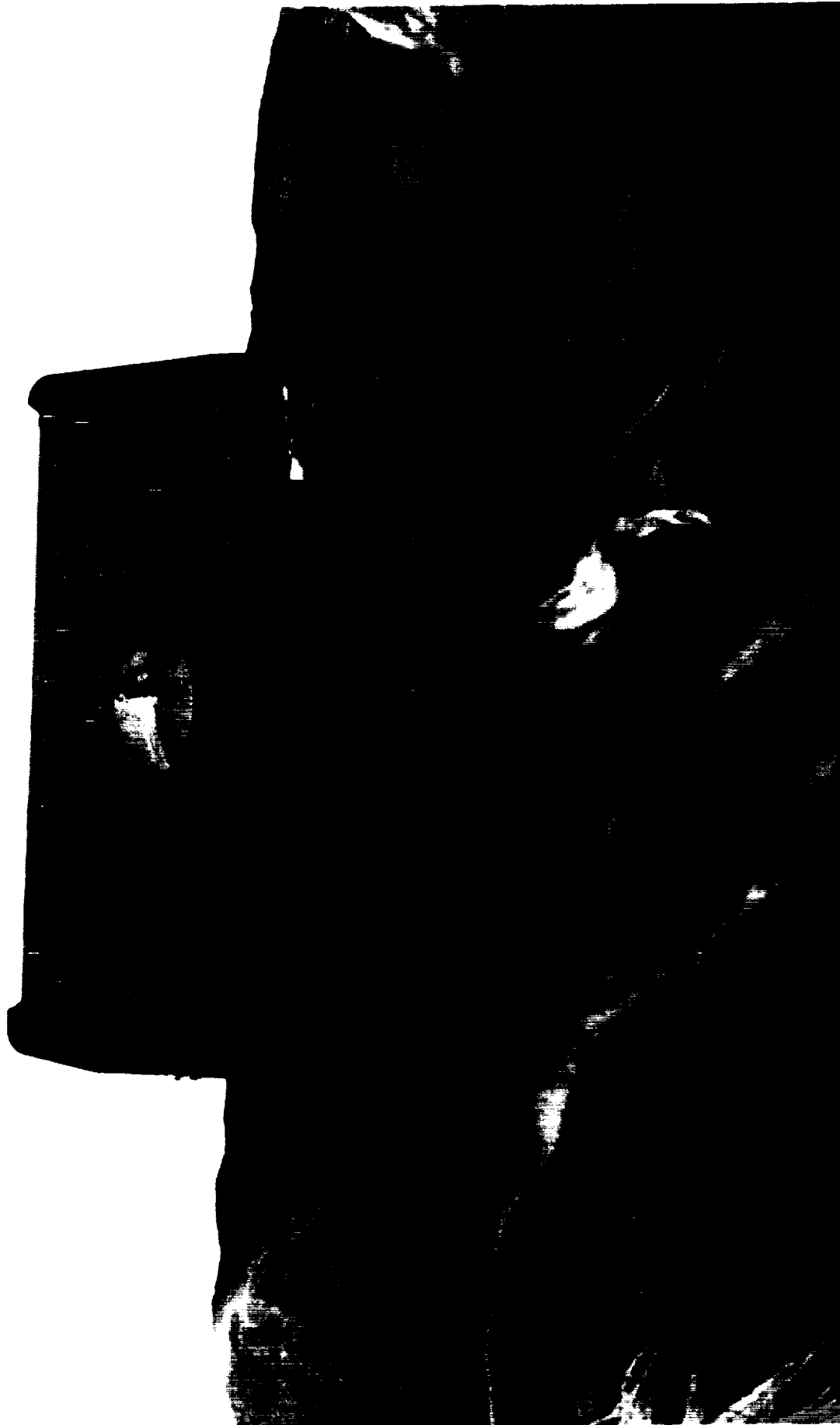

Dark spot indicates loss of Epon shim material during ascent

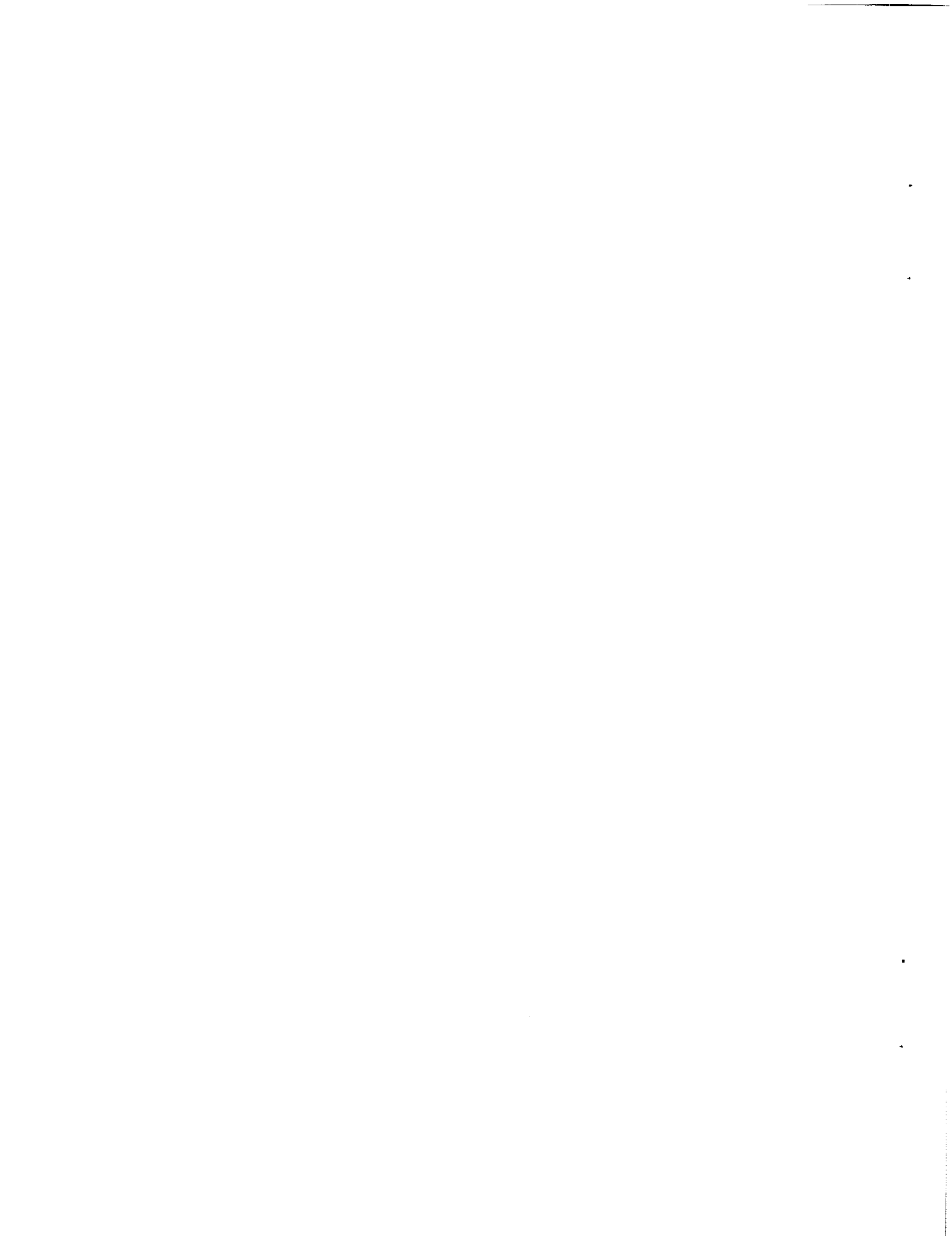

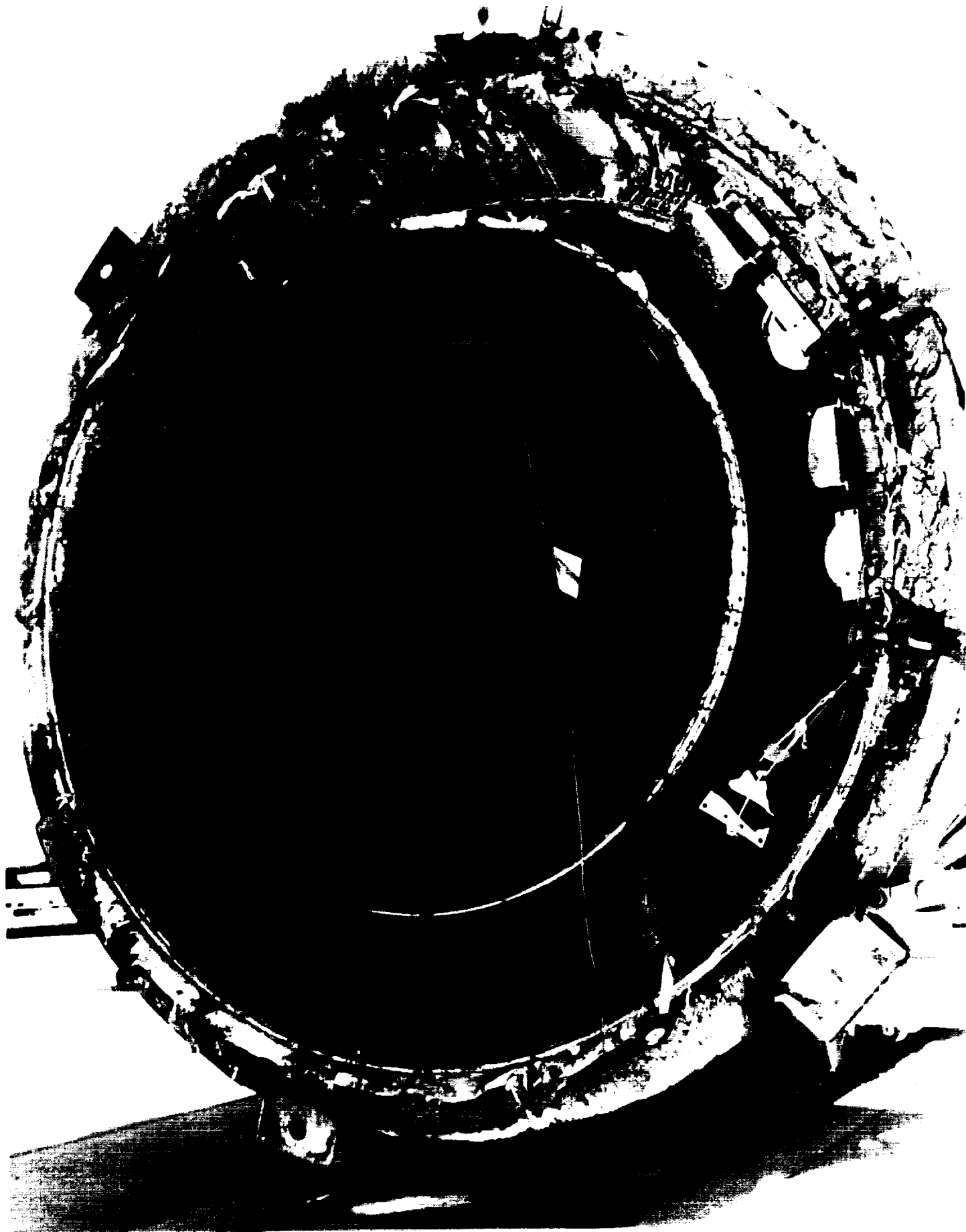

Post flight condition of LH SRB aft skirt interior. Note 30 ft
section of nozzle DFI cable that was loose during recovery

162

ORIGINAL PAGE
COLOR PHOTOGRAPH

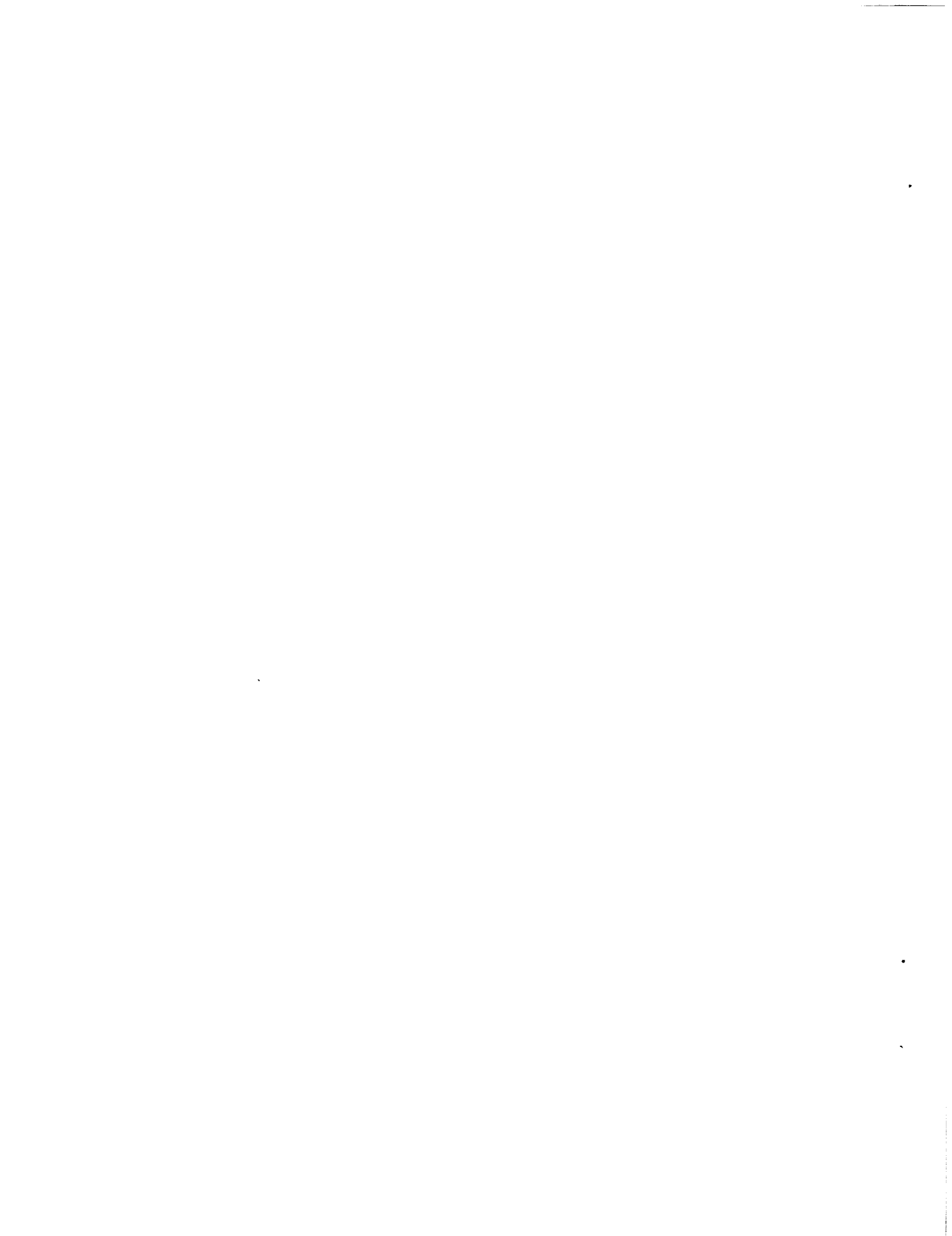

9.0 ORBITER POST LANDING DEBRIS ASSESSMENT

A detailed Post Landing Inspection of OV-104 (Atlantis) was conducted October 23-24, 1989, at Ames-Dryden (EAFB) on Runway 23 and in the Mate/Demate Device (MDD) to identify debris impact damage, and if possible, debris sources. The Orbiter TPS sustained a total of 53 hits, of which 18 had a major dimension of one inch or greater. This total does not include the approximately 50 hits on the base heat shield.

The Orbiter lower surface had a total of 51 hits, of which 17 had a major dimension of one inch or greater. Thirteen of the hits greater than one inch were located on the right side. These hits were uniformly distributed between the centerline and outboard edge of the right main landing gear door. The 4 hits on the left side greater than one inch were all located aft of the main landing gear door. The hits smaller than one inch were primarily located aft of the main landing gear doors in the vicinity of the umbilicals. A comparison of these numbers to statistics from 23 previous missions of similar configuration (excluding missions STS-24, 25, 26, 26R, and 27R which had damage from known debris sources), indicates the total number of hits on the lower surface is less than average. Also, based on the severity of damage as indicated by surface area and depth, this flight is considered to be better than average. Figures 22-25 show the TPS debris damage assessment for STS-34.

The largest damage site (3"x5"x3/4") occurred on the outboard aft lower corner of the left hand OMS pod stinger and involved 3 tiles. Damage of this magnitude and in this location has not been previously observed.

Damage to the base heat shield tiles was considerably less than average. The main engine closeout blankets had minor damage on SSME #1 and #2. No damage to the SSME nozzle insulation occurred. A bolt washer and retainer insert were missing from SSME #2 carrier panel at the 2 o'clock position. Q-Felt plugs were missing from 2 closeout panel screw holes and recessed in several others.

A number 10 washer (approximately 1/2-inch in diameter) was embedded in one of the lower surface tiles forward of the LH2 ET/ORB umbilical area. The washer was removed before towback for subsequent material analysis. The washer and the area on the tile immediately downstream of the washer showed indications of re-entry heating.

Two protruding gap fillers were observed on the lower surface. Two pieces of gap filler sleeving, approximately 4 inches long, were loose on the right OMS pod. No damage to adjacent tiles resulted from these gap fillers.

STS-34

FIGURE 22. DEBRIS DAMAGE LOCATIONS

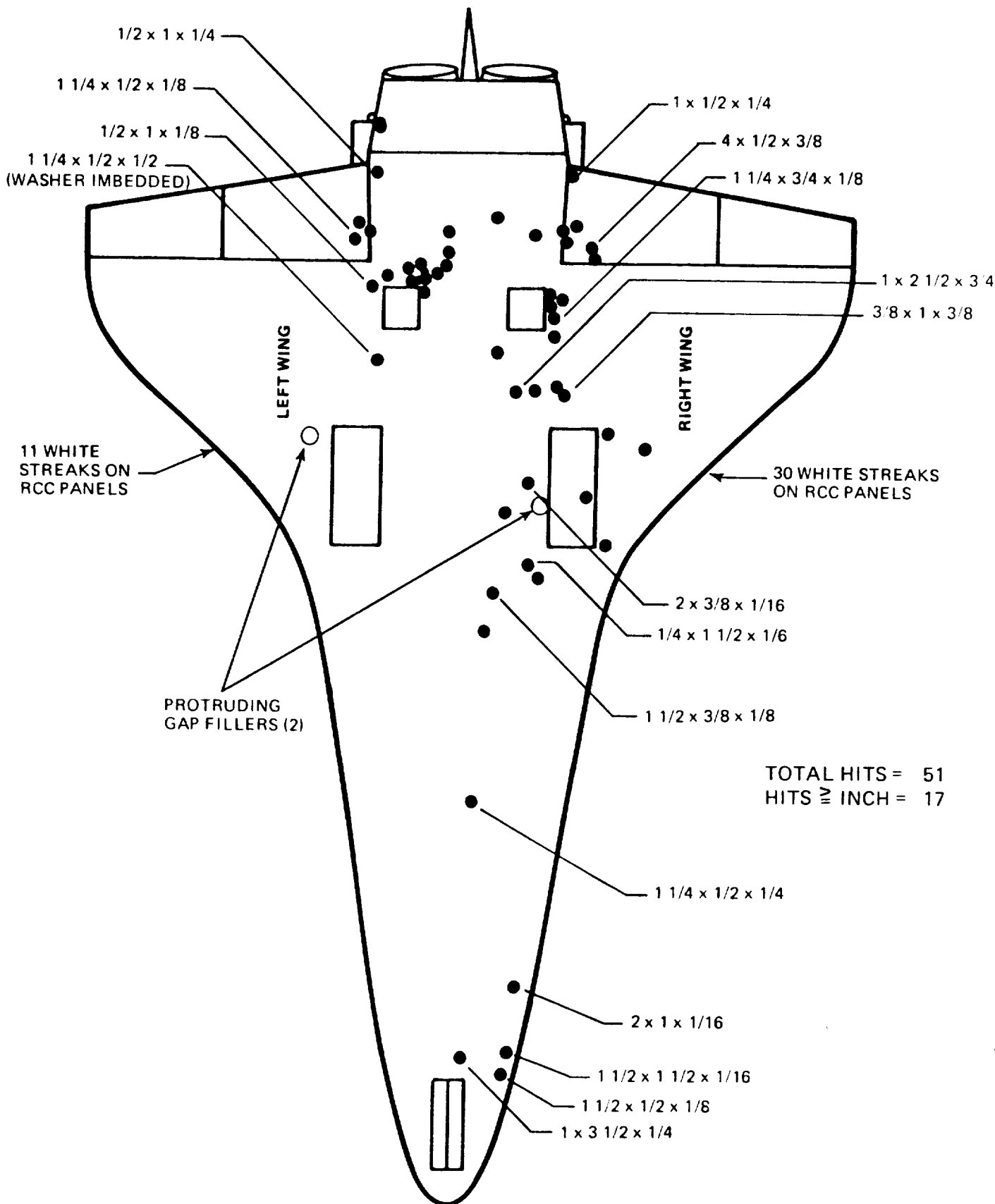

STS-34

FIGURE 23. DEBRIS DAMAGE LOCATIONS

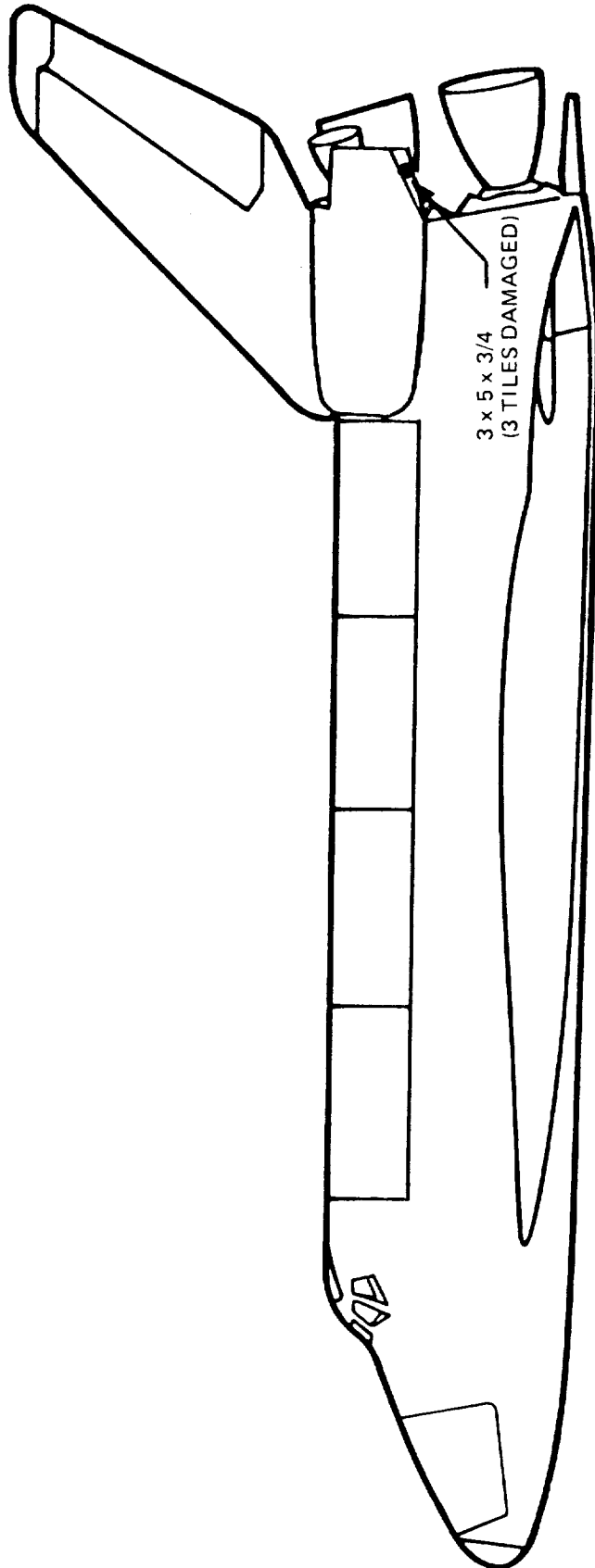

TOTAL HITS = 1
HITS \geq 1 INCH = 1

STS-34

FIGURE 24. DEBRIS DAMAGE LOCATIONS

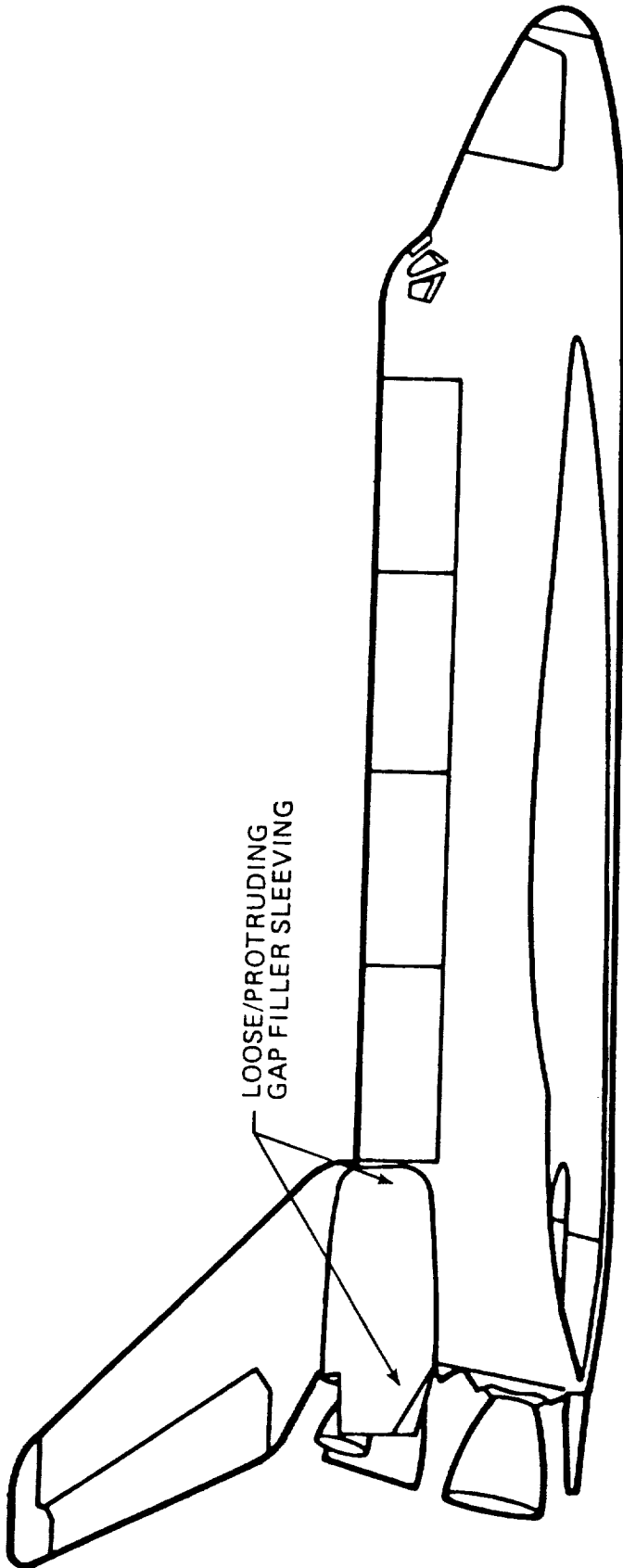

TOTAL HITS = 0
HITS \geq 1 INCH = 0

STS-34

FIGURE 25. DEBRIS DAMAGE LOCATIONS

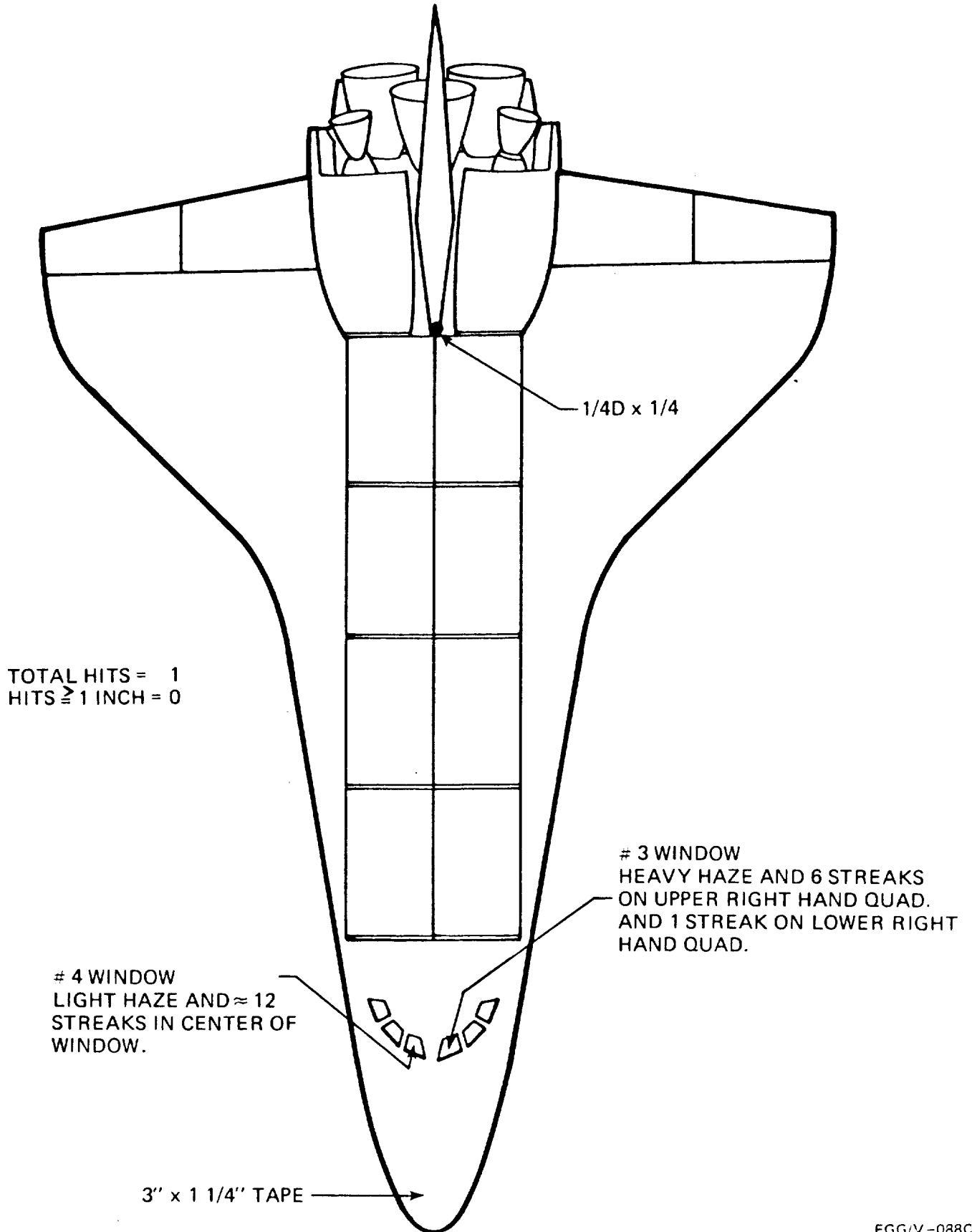

Samples of deposits/material were taken from the windows, RCC wing panels, and other selected damage sites as shown in Figures 26-27 for laboratory analysis. White streaks were present on both wing leading edge RCC panels. There were 11 streaks on the left side and 30 on the right side. Orbiter window #3 was heavily hazed with 7 streaks. Window #4 was lightly hazed in the outboard upper corner and had 12 streaks. Several pieces of tape or charred tape residue adhered to the surface of tiles.

During pyro removal and system safing, a stop-bolt from the ET/ORB forward attach point (EO-1) bolt's centering mechanism was found to be compressed and bent (PR PYR-4-06-0085). The bolt is located on the right side of the centering mechanism and along with the left hand stop bolt, limits the separation bolt's movement from side to side and prevent tile damage during ground processing. These bolts are not designed for large loads. The damaged assembly was removed for analysis by RI-DWY. The cause is still under investigation.

A piece of the ET/ORB separation ordnance device wire harness backshell 1/2" dia. x 3/4" long fell from the EO-3 fitting when the LO2 ET/ORB umbilical door was opened (PR V070-4-06-0161). The loose debris was a result of the EO-3 ball fitting ordnance plunger failing to seat properly (PR PYR-4-06-0082).

A washer 1/4-inch in diameter also fell onto the runway when the LO2 ET/ORB umbilical door was opened. Although the origin of the washer has not been determined yet, preliminary research shows the washer was not part of the EO-3 ordnance device.

No TPS damage was attributed to material from the tires, wheels, or brakes. Aluminum tape on the inside surface of the LH main landing gear door had pulled loose at two locations, but was still partially attached after landing.

An infrared imaging system similar to the KSC Shuttle Thermal Imager (STI) was used to record the surface temperatures of several areas on the Orbiter. The nose cap RCC measured 160 degrees F ten minutes after landing. Forty-five minutes after landing, the wing RCC panels measured 80 degrees F (Figure 28).

Runways 17 and 23 were inspected by the Debris Team on October 22, 1989 and potentially damaging debris was removed. The general condition of the runways was good. Runway 22 had been inspected and cleaned by Air Force personnel.

The post landing walkdown of Runway 23 was initiated approximately 30 minutes after landing. No flight hardware was found during the runway walkdown. A survey marker installed in a 1 foot diameter concrete post protruded approximately 3/4 inch above the runway surface. It was located on the centerline 1500 feet past the threshold and 371 feet away from the point where Atlantis touched down (Figure 29). The current configura

STS-34

FIGURE 26. DEBRIS DAMAGE SAMPLE LOCATIONS

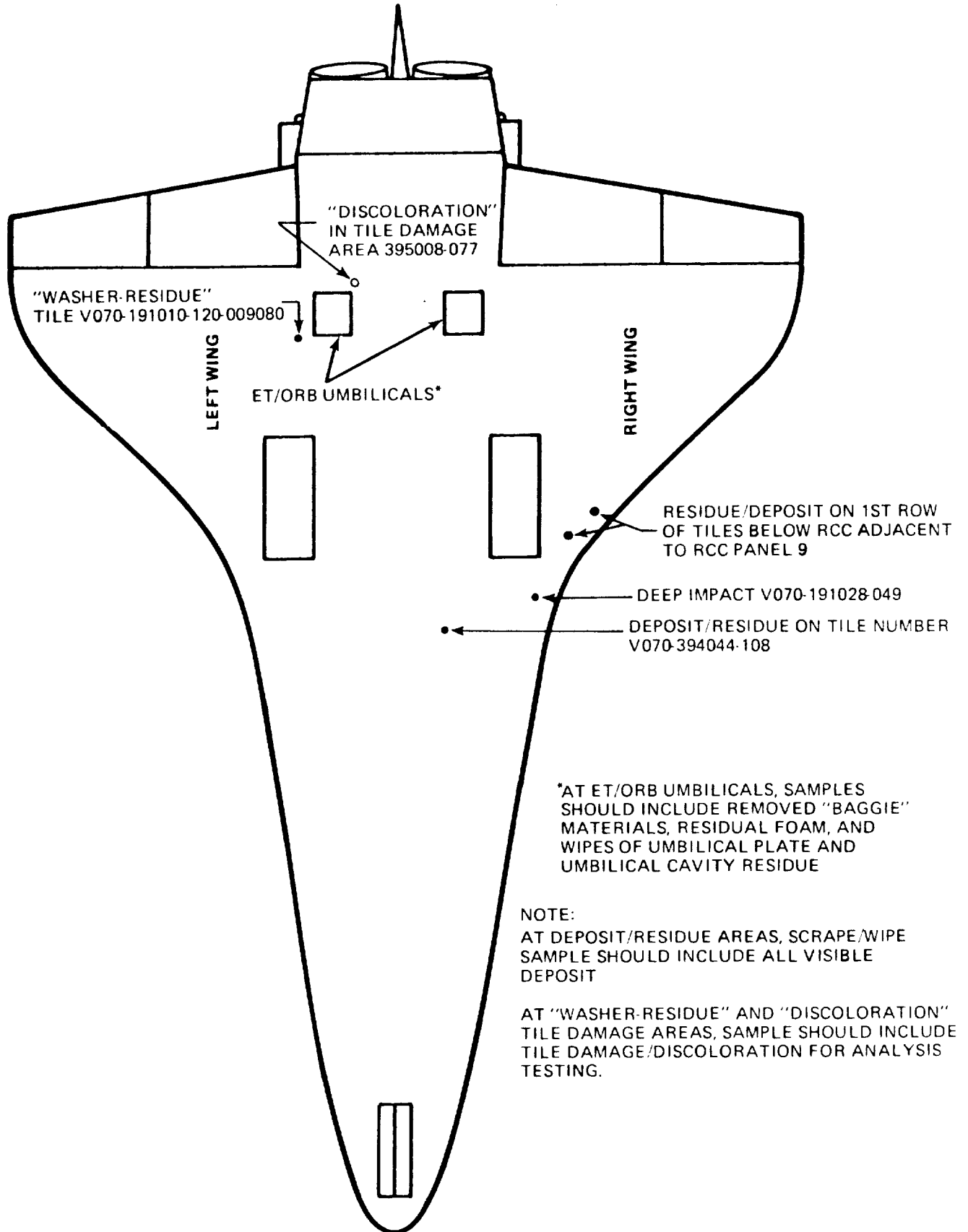

STS-34

FIGURE 27. DEBRIS DAMAGE SAMPLE LOCATIONS

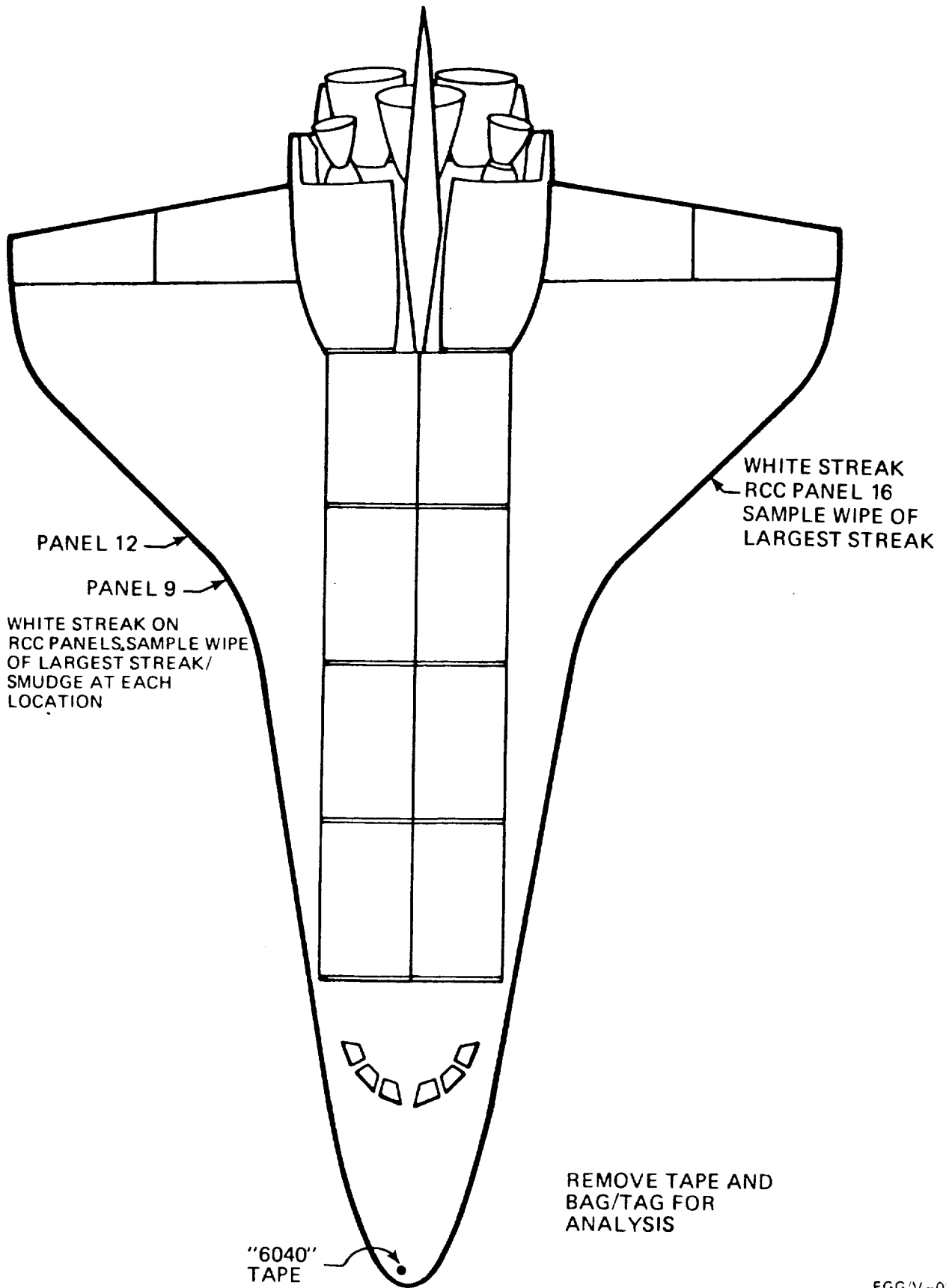

STS-34

FIGURE 28. TEMPERATURE MEASUREMENTS

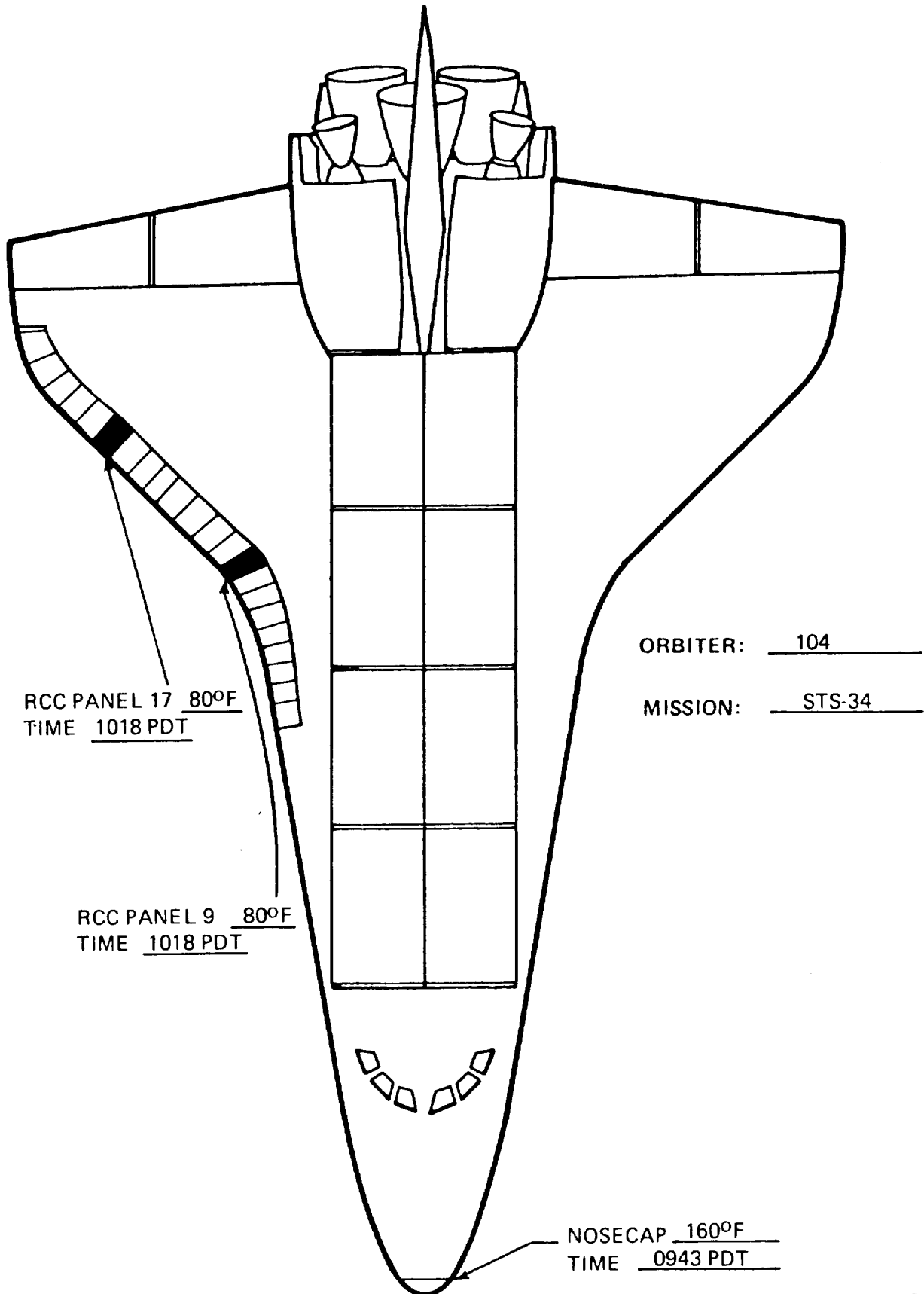

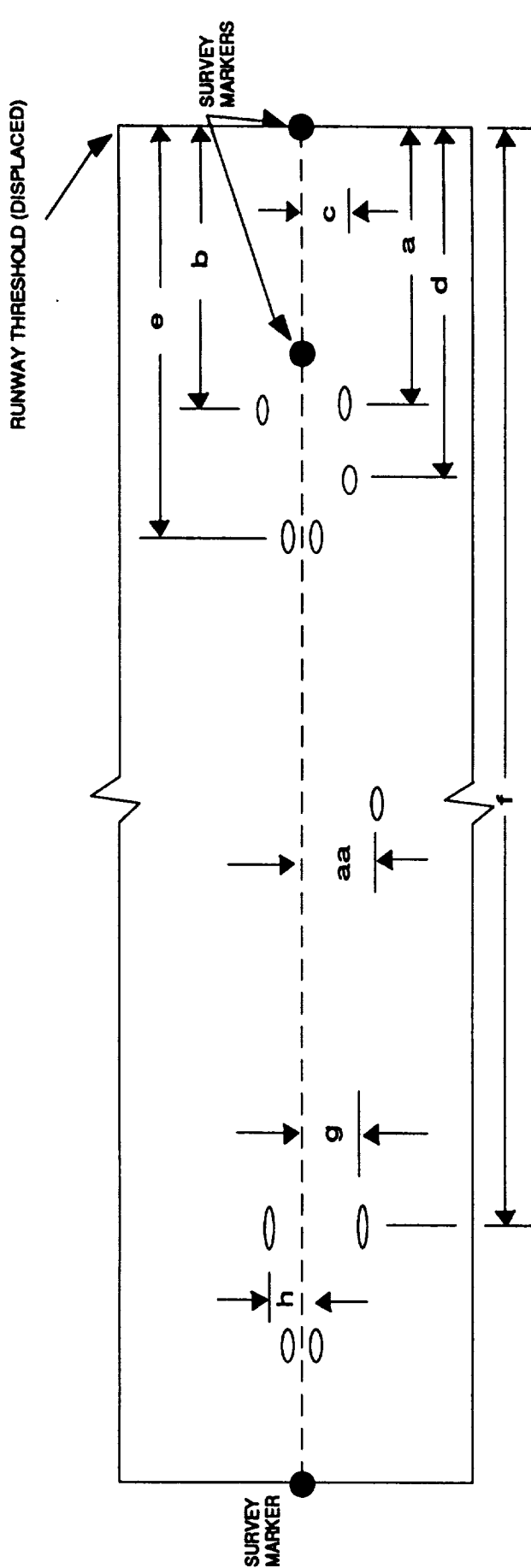

- aa. MAXIMUM LATERAL DISPLACEMENT/FROM THRESHOLD
53.5 ft left/8155 ft
- a. LEFT MAIN TOUCHDOWN TO THRESHOLD
1871 ft/15 ft left of ϕ
- b. RIGHT MAIN TOUCHDOWN TO THRESHOLD
1906 ft/8 ft right of ϕ
- c. LEFT MAIN LATERAL DISPLACEMENT FROM RUNWAY CENTER LINE
15 ft left
- d. SUBSEQUENT TOUCHDOWN
left 2127 ft/right 2132 ft
- e. NOSE GEAR TOUCHDOWN
5355 ft/4 ft right of ϕ
- f. MAIN GEAR STOP TO THRESHOLD
11548 ft
- g. LEFT MAIN LATERAL DISPLACEMENT
9.5 ft left of ϕ
- h. RIGHT MAIN LATERAL DISPLACEMENT
13.5 ft right of ϕ
- f-b. ROLLOUT DISTANCE
9677 ft

FIGURE 29. Positions of Runway Survey Markers

tion and location of this marker is unacceptable for Shuttle landings per existing OMRSD requirements. The survey marker has since been removed. The two other markers located on each threshold will also be removed. A live 50 caliber shell was found approximately 0.3 miles before the runway threshold 33 feet east of the centerline.

In summary, the total number of lower surface Orbiter TPS debris hits was less than average when compared to previous flights as shown in the comparison chart (Figure 30-31). The distribution of hits on the Orbiter does not point to a single source for ascent debris, but indicates a shedding of ice and TPS debris from random sources. The potential identification of sources of debris for mission STS-34 will be based on the laboratory analysis of TPS damage sites, inspection of the recovered SRB components, and analysis of ground/air photography.

Orbiter Post Launch Anomalies are listed in Section 11.4.

FIGURE 30. STS-34 DEBRIS DAMAGE ASSESSMENT SUMMARY

	<u>Hits > or = 1"</u>	<u>Total Hits</u>
Lower Surface	17	51
Upper Surface	0	1
Right Side	0	0
Left Side	1	1
Right OMS Pod	0	0
Left OMS Pod	0	0
TOTALS	18	53

COMPARISON TABLE

STS-6	36	120
STS-7	48	253
STS-8	7	56
STS-9 (41-A)	14	58
STS-11 (41-B)	34	63
STS-13 (41-C)	8	36
STS-14 (41-D)	30	111
STS-17 (41-G)	36	154
STS-19 (51-A)	20	87
STS-20 (51-C)	28	81
STS-23 (51-D)	46	152
STS-24 (51-B)	63	140
STS-25 (51-G)	144	315
STS-26 (51-F)	226	553
STS-27 (51-I)	33	141
STS-28 (51-J)	17	111
STS-30 (61-A)	34	183
STS-31 (61-B)	55	257
STS-32 (61-C)	39	193
STS-26R	55	411
STS-27R	298	707
STS-29R	23	132
STS-30R	56	151
STS-28R	20	76
STS-34	18	53

FIGURE 31. **COMPARISON TABLE**

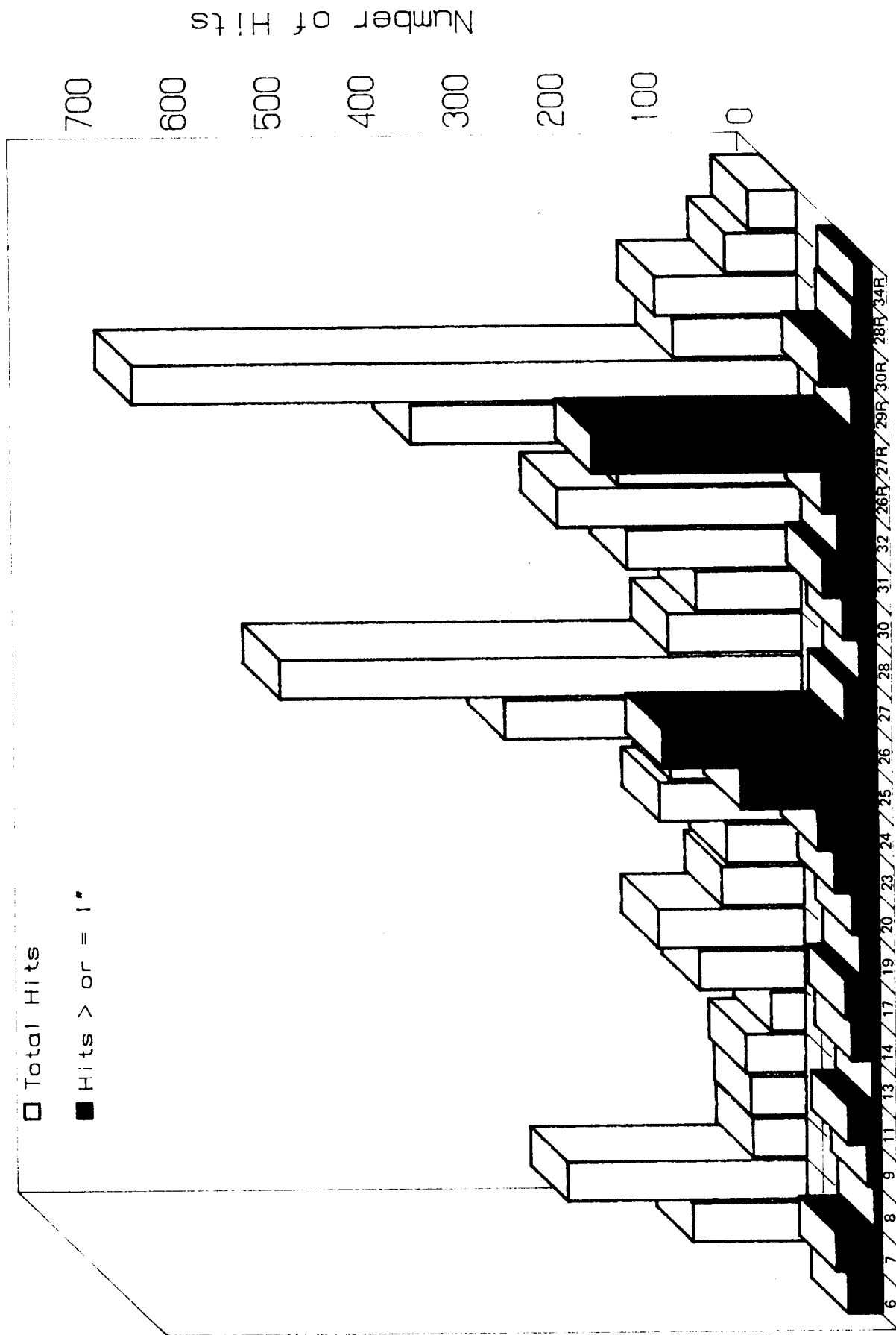

STS

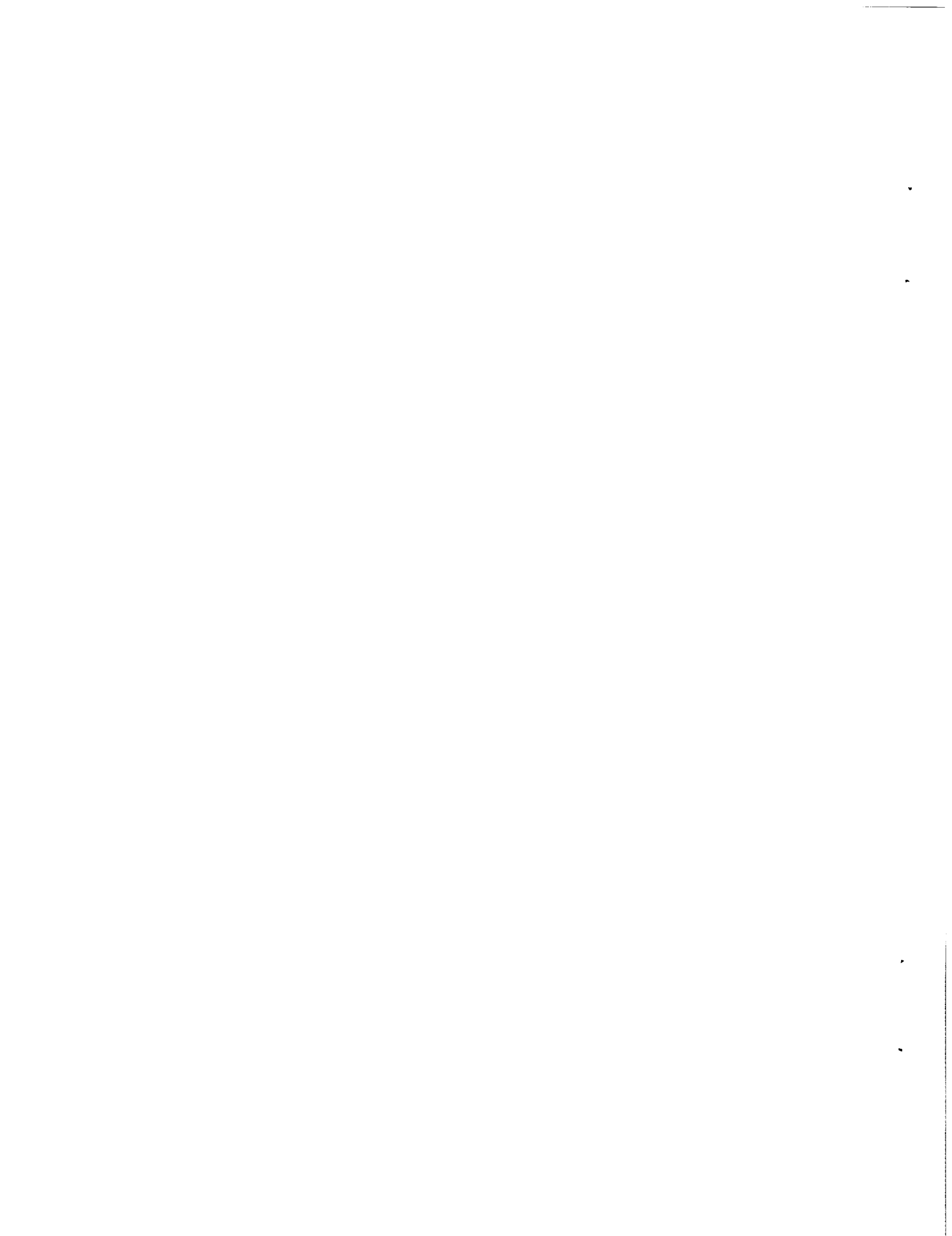

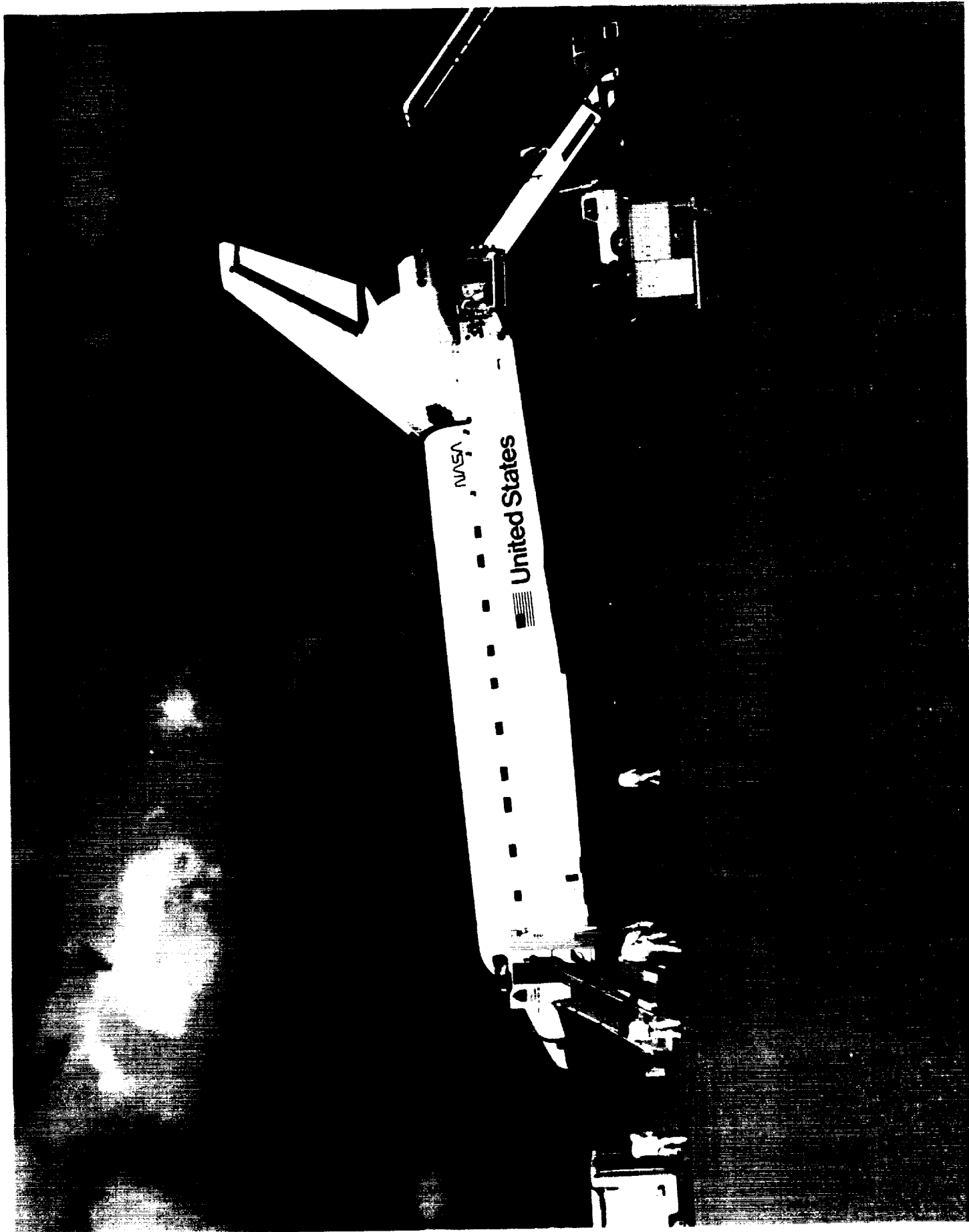

Overall view of Orbiter left side after landing

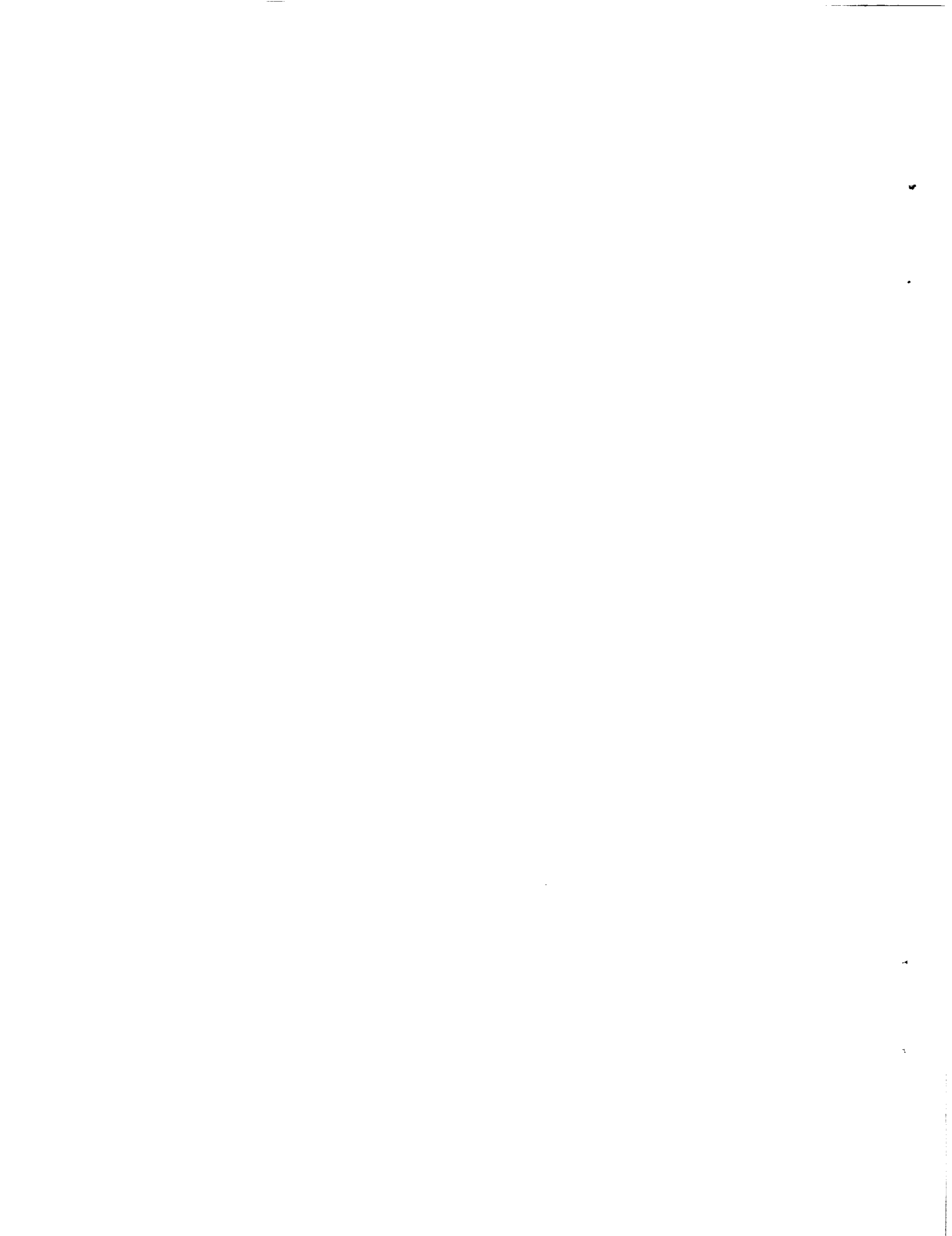

ORIGINAL PAGE
COLOR PHOTOGRAPH



Overall view of Orbiter right side after landing

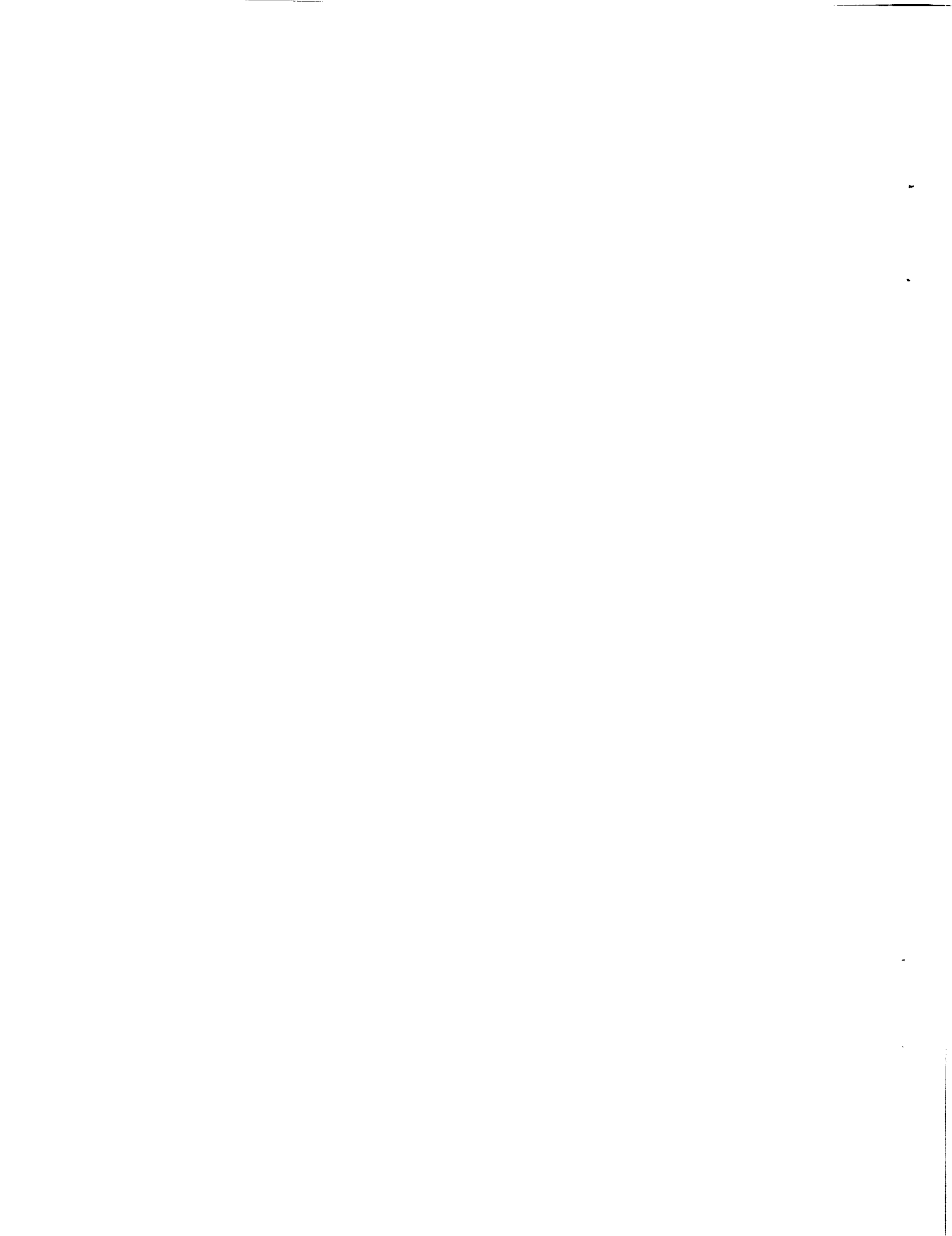



Tile damage site measuring 3"x5"x3/4" occurred on the
outboard aft lower corner of the LH OMS pod

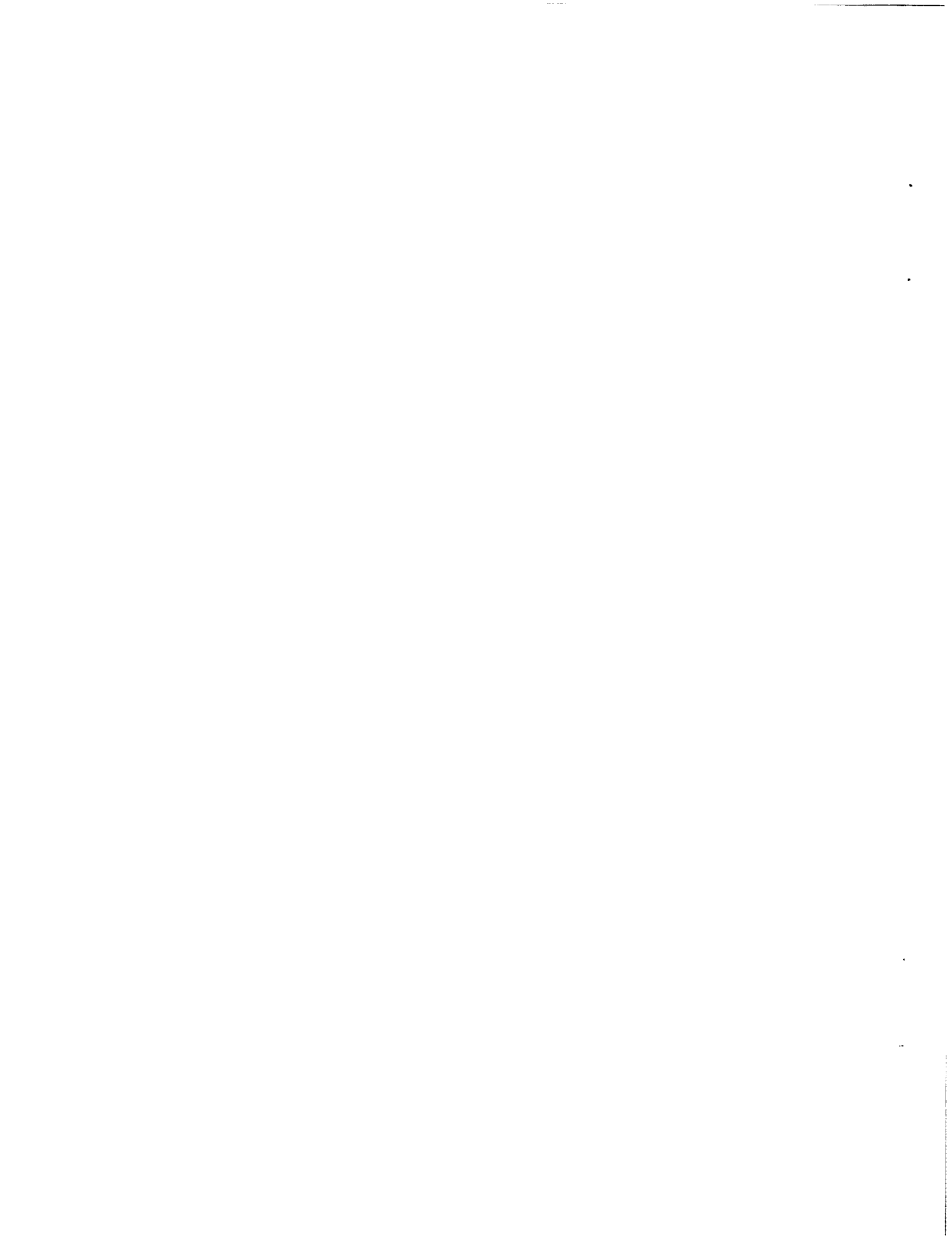

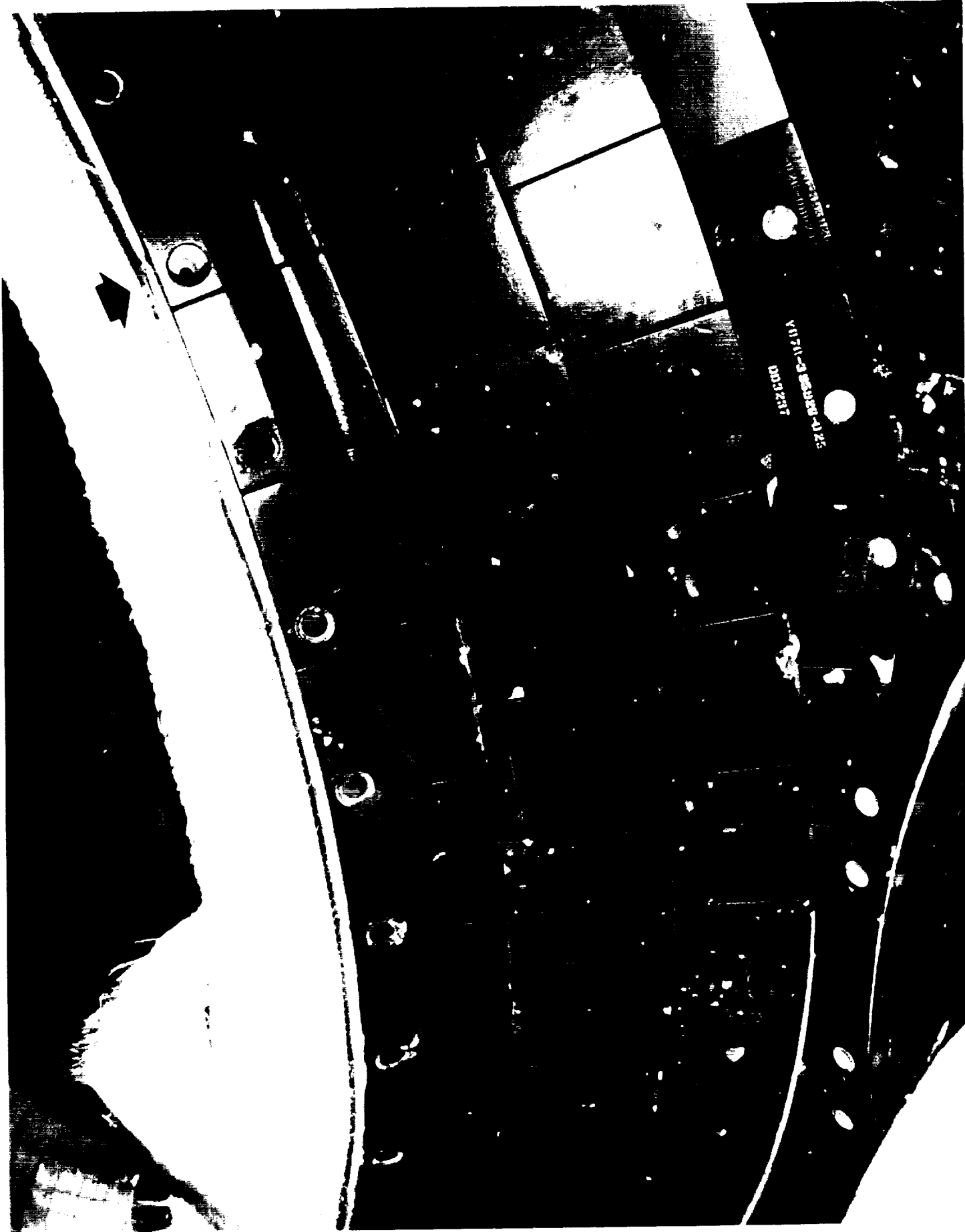

A bolt washer and retaining insert were missing from
SSME #2 carrier panel

179

ORIGINAL PAGE
COLOR PHOTOGRAPH

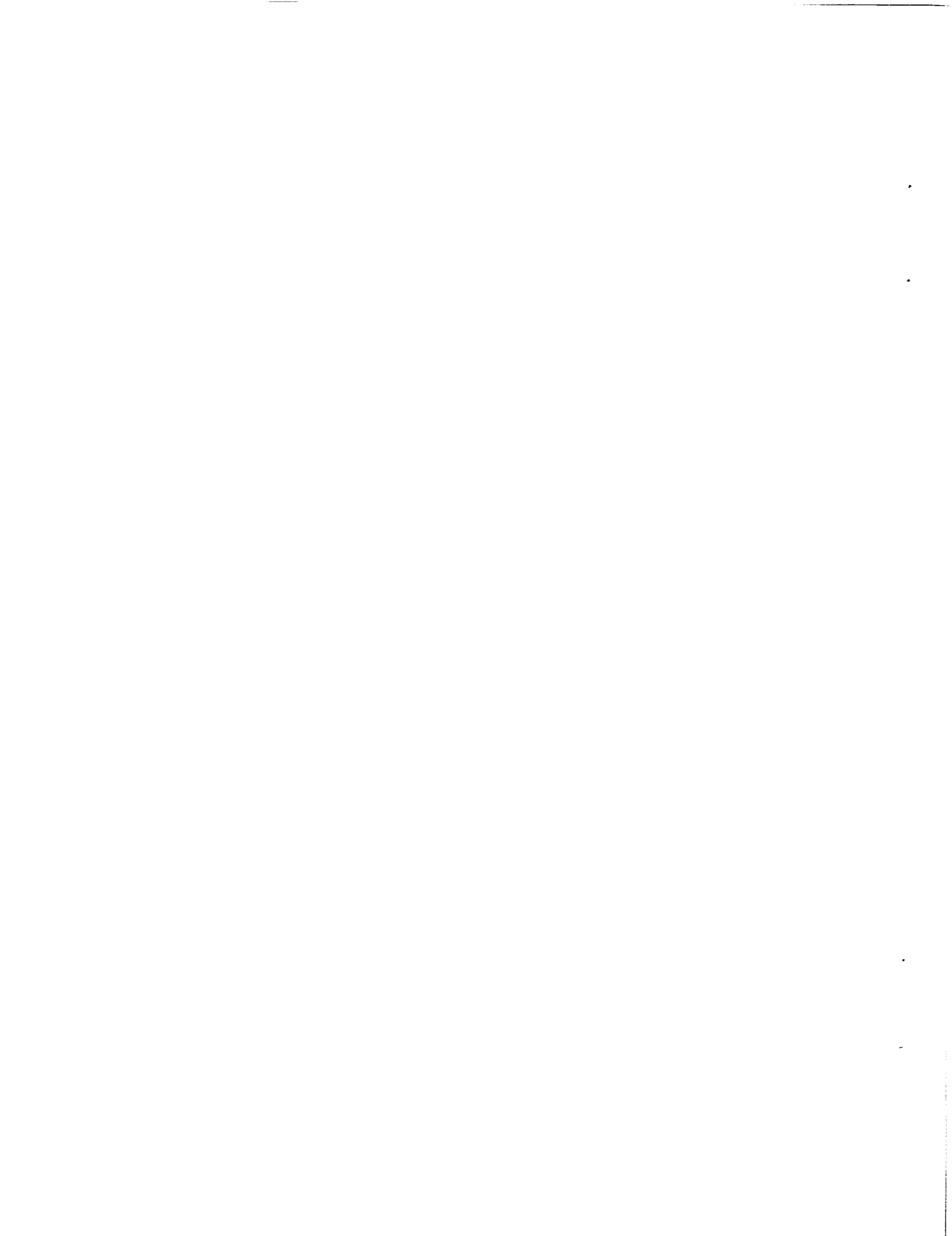



A #10 washer embedded in one of the lower surface tiles forward
of the LH2 umbilical area shows signs of re-entry heating

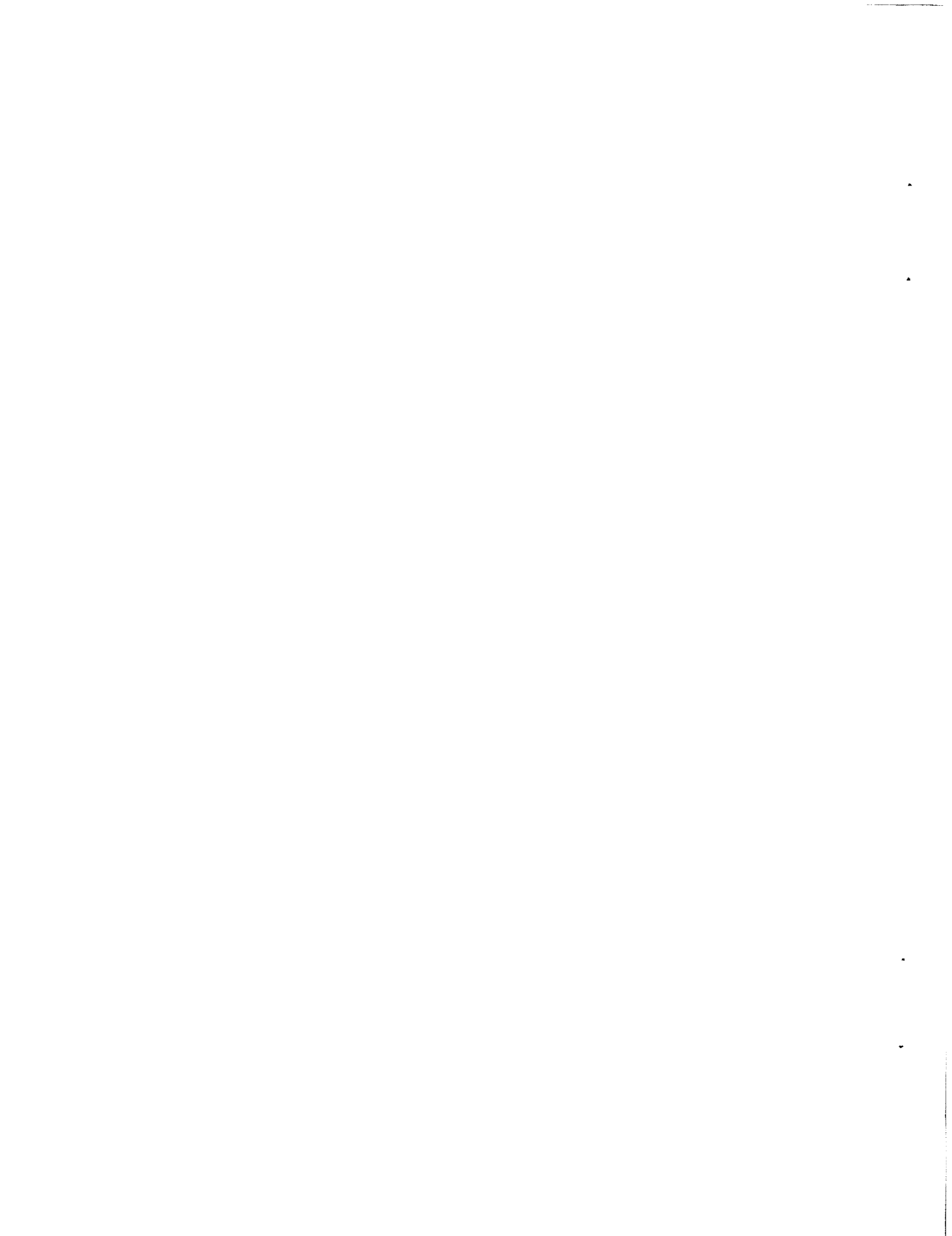

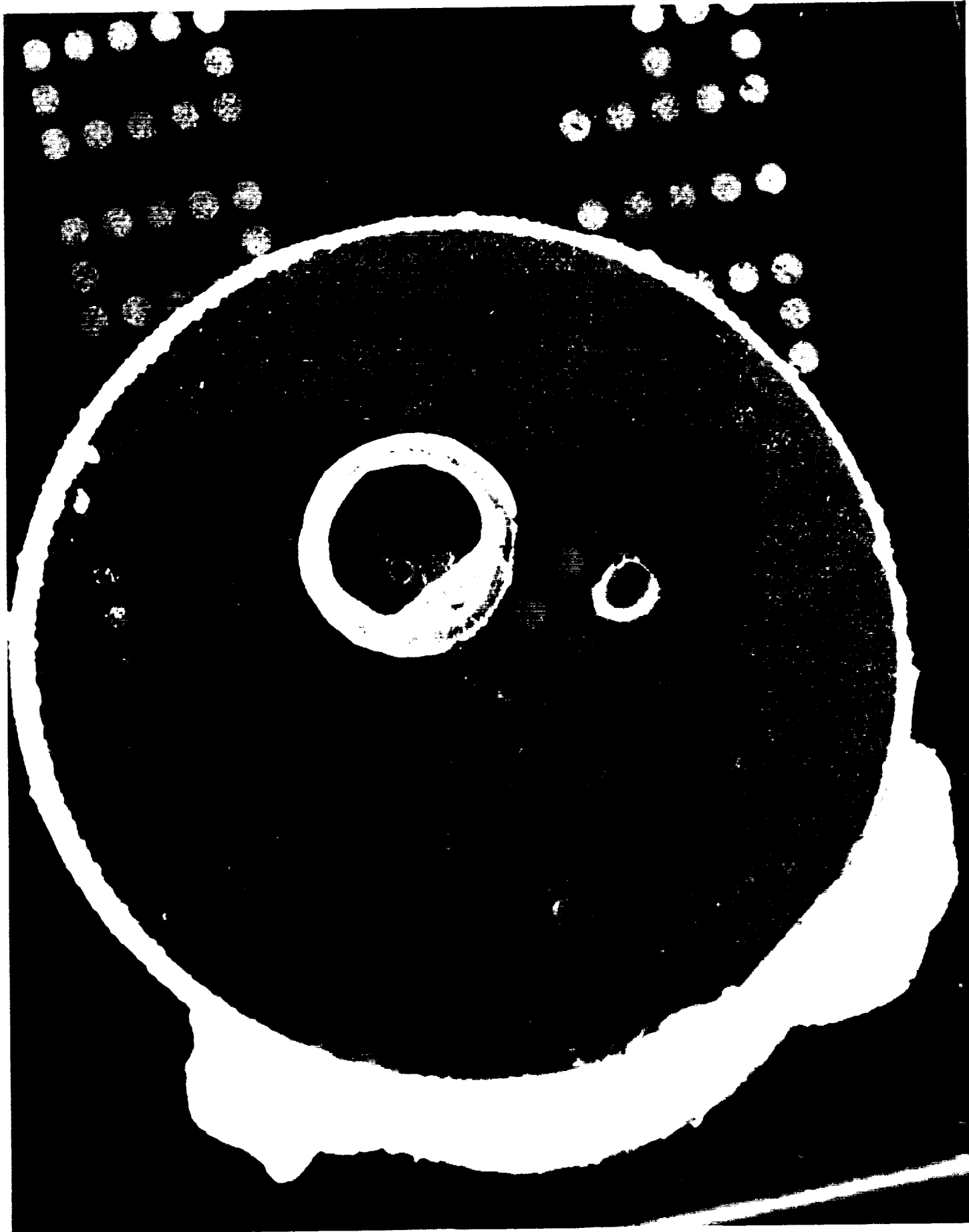

On-orbit micrometeorite impact in a tile repair area





Piece of tape adhering to forward RCS tile

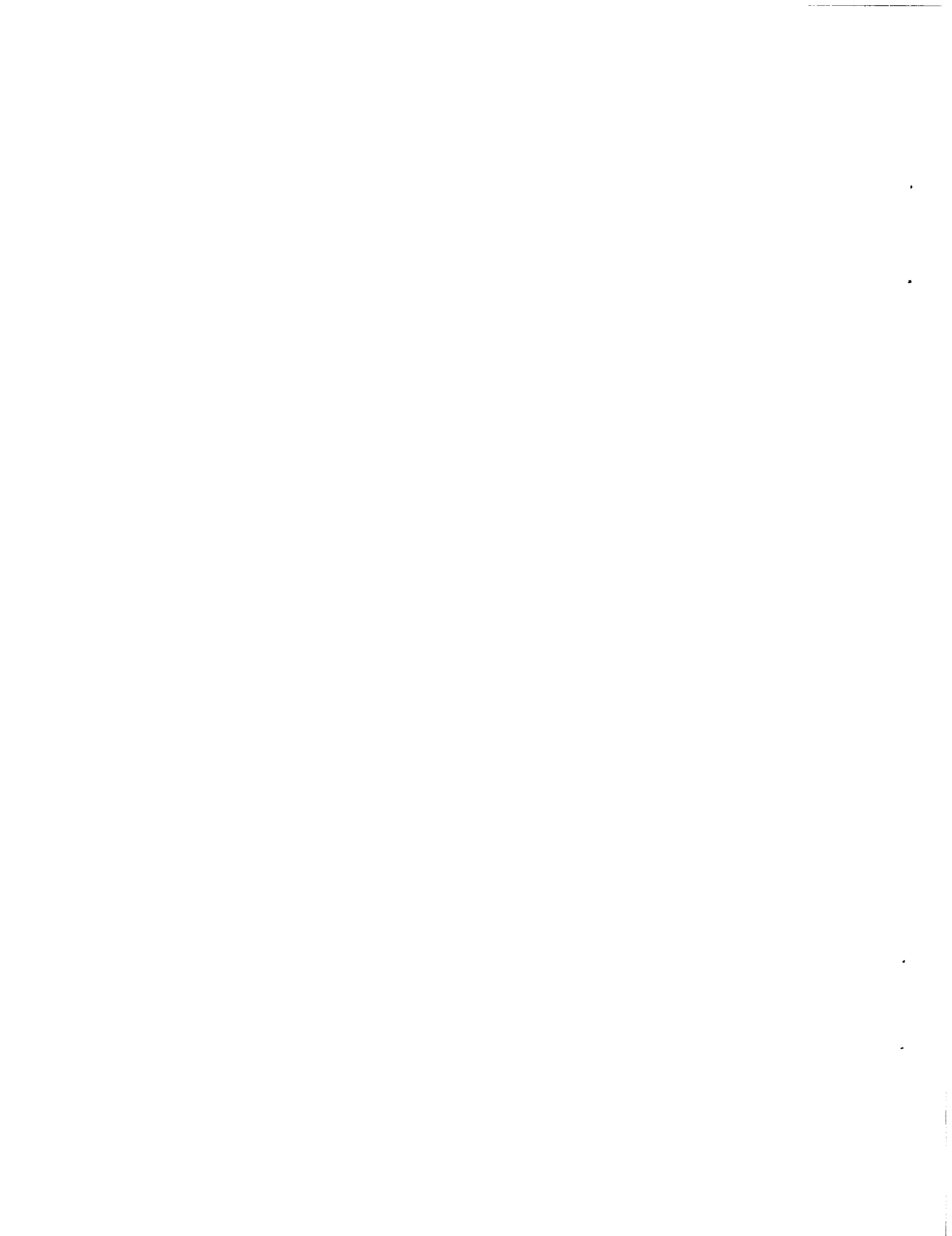



Tape residue on lower surface tile adjacent to RCC panel

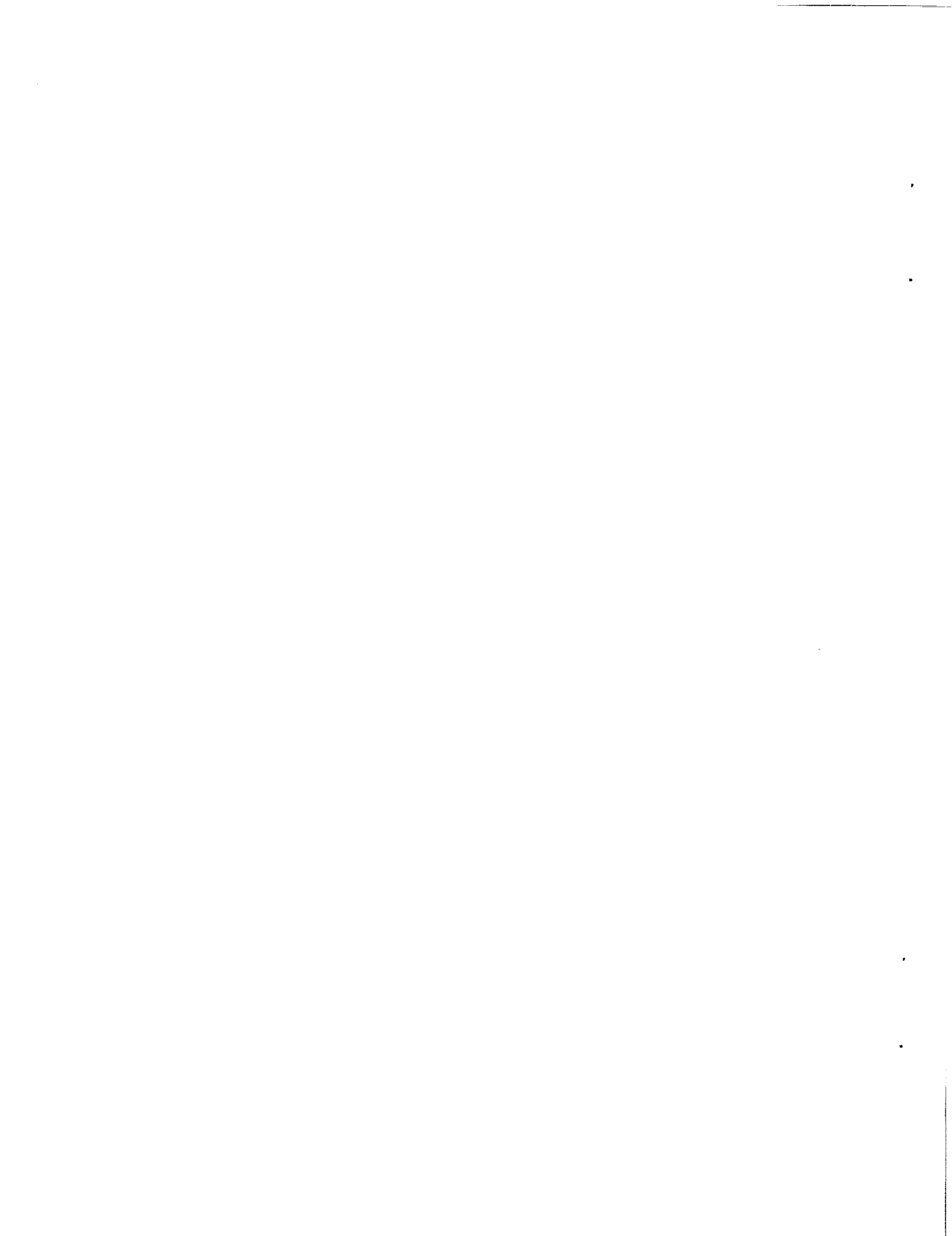



White streaks on wing leading edge RCC panels

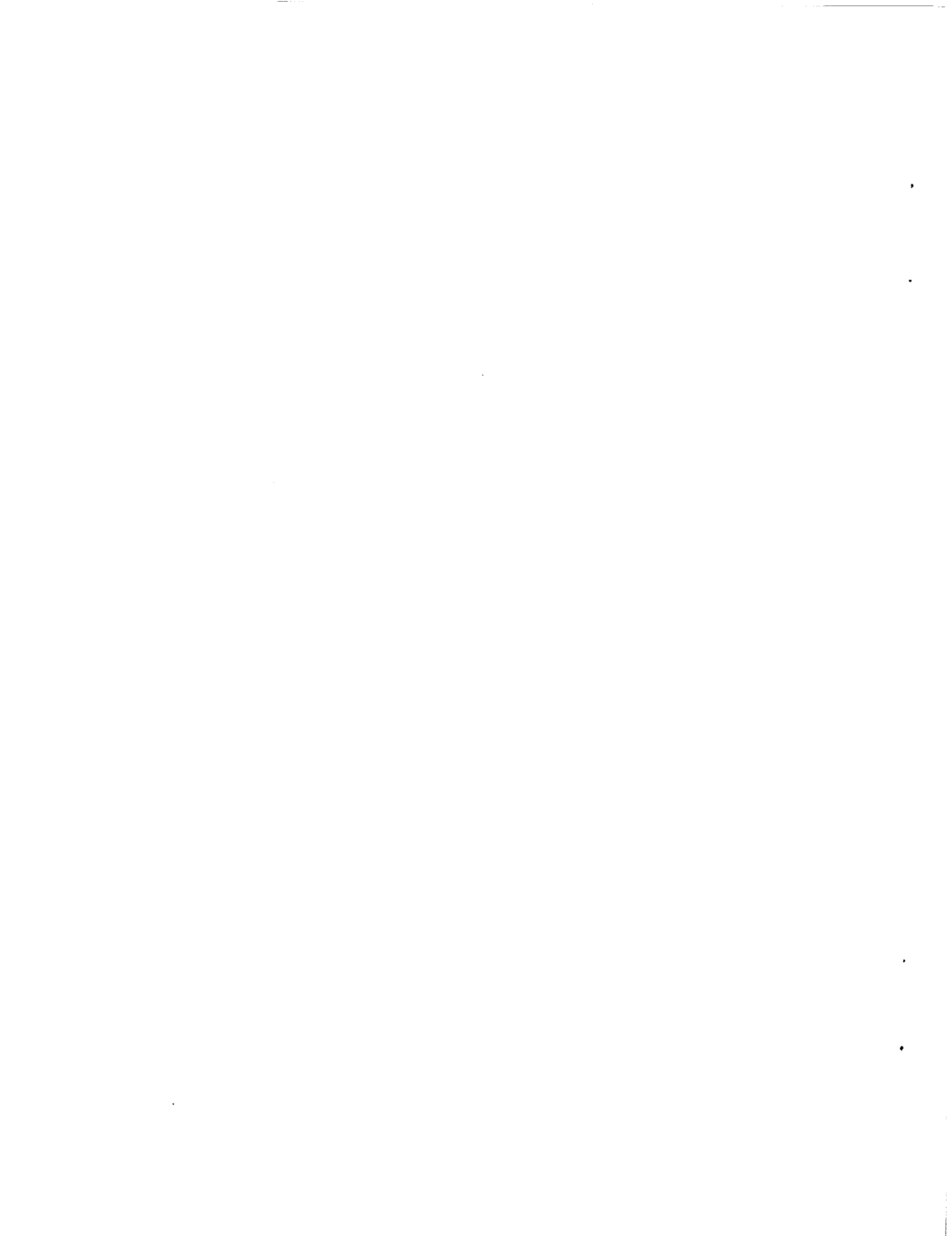



White streak and black deposit on wing RCC panel

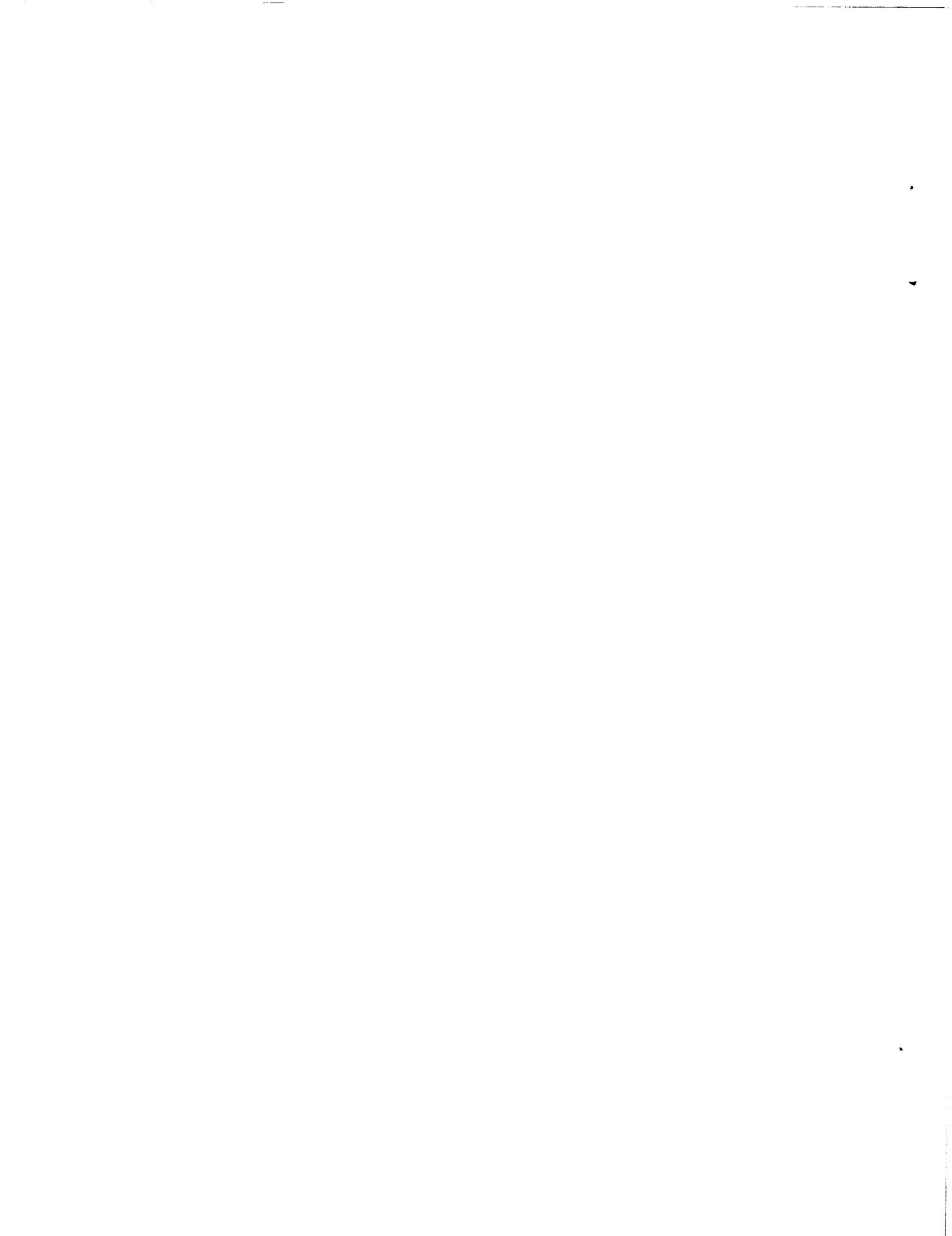

ORIGINAL PAGE
COLOR PHOTOGRAPH

Window #3 was heavily hazed; window #4 was slightly hazed

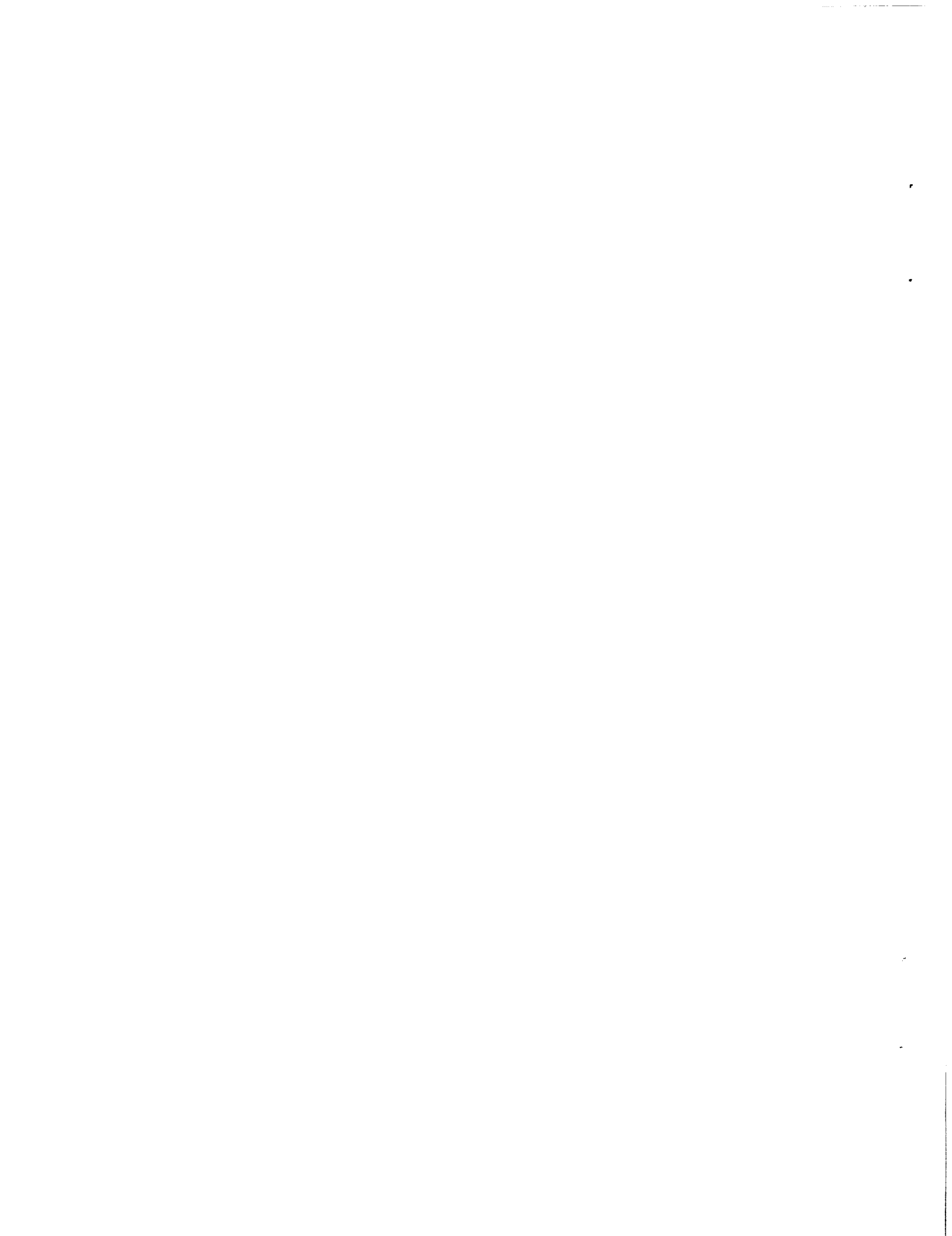

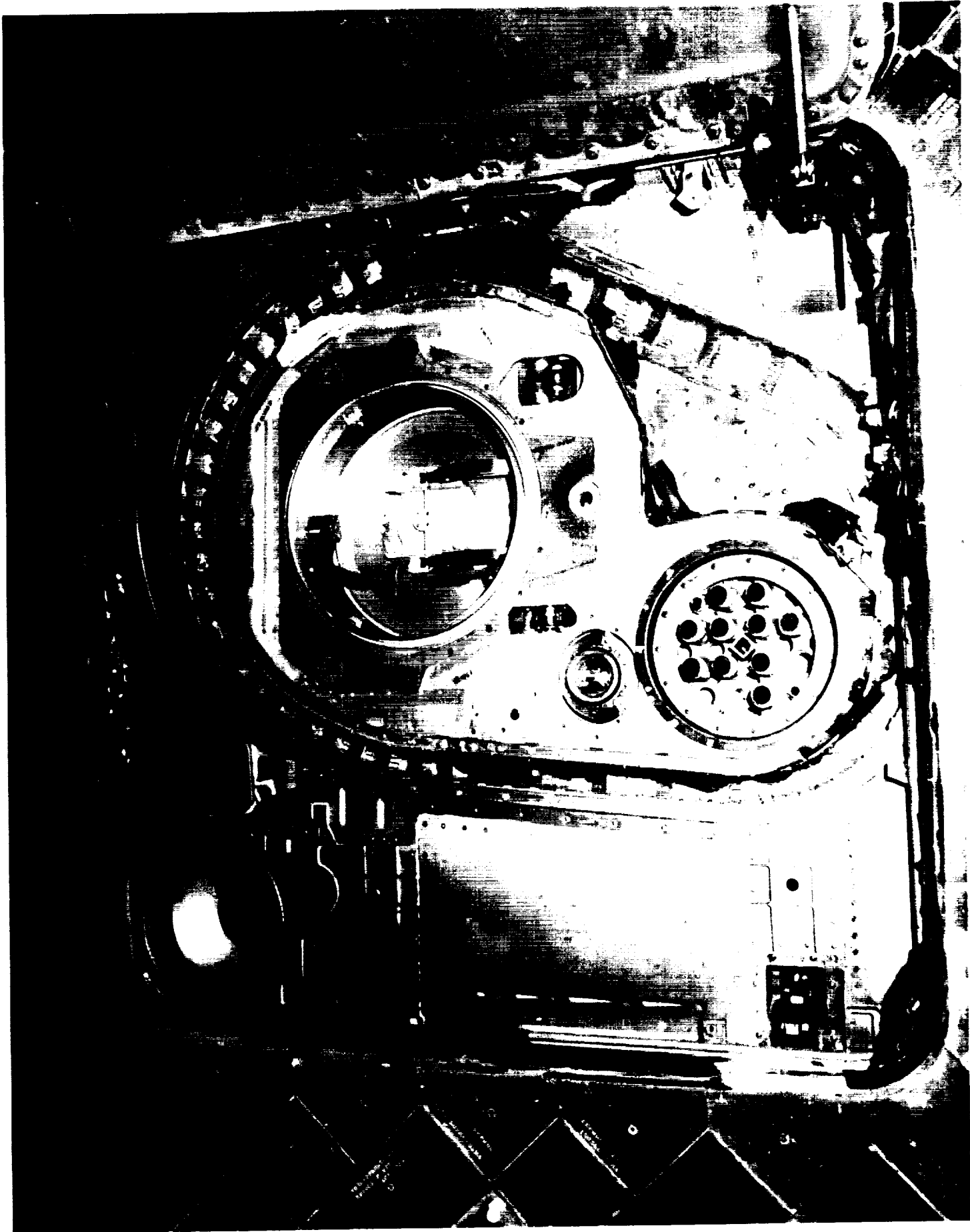

Overall view of LO2 ET/ORB umbilical. Note foam intrusion along closeout line of umbilical near 17-inch valve.

187

ORIGINAL PAGE
COLOR PHOTOGRAPH

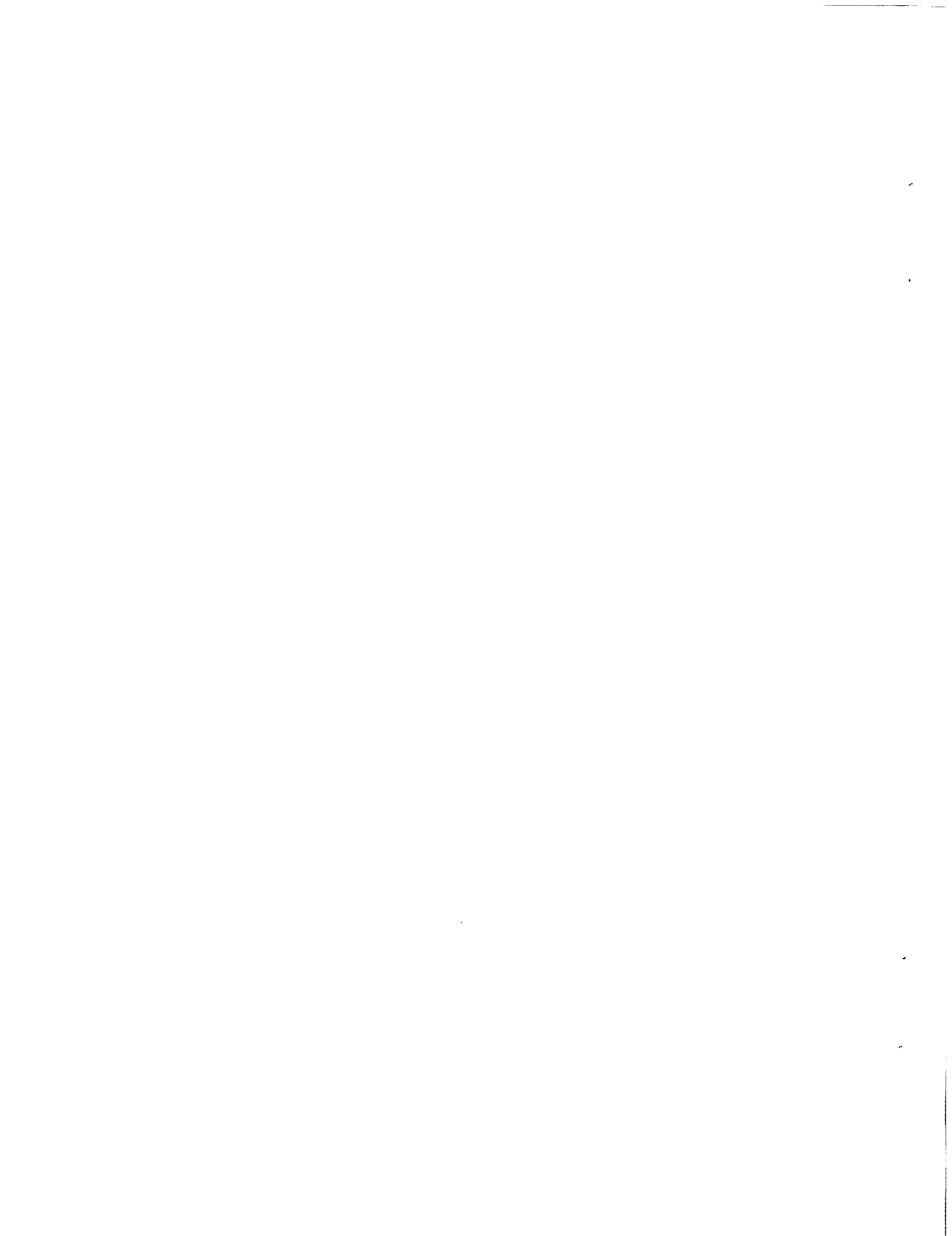

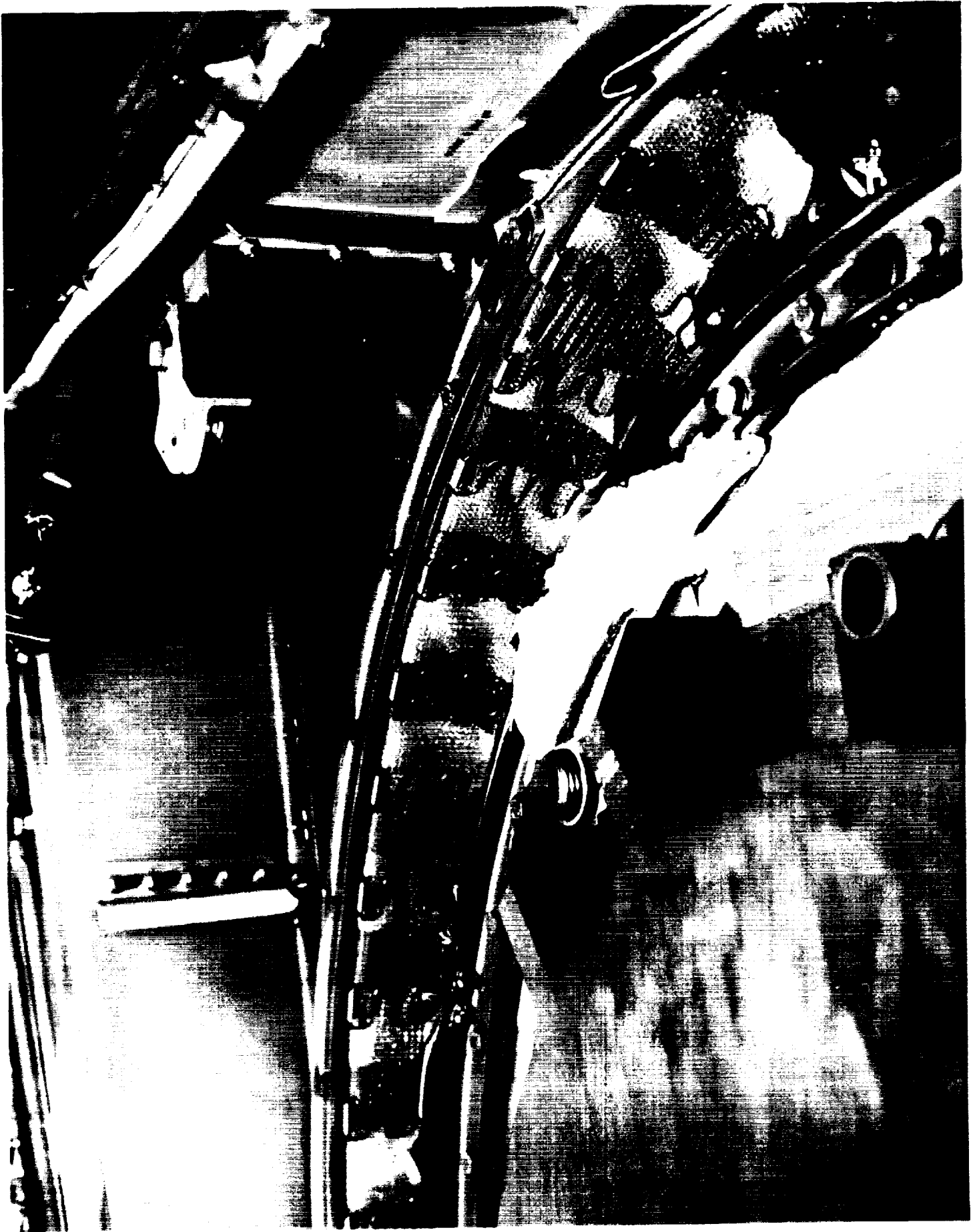

Close up view of closeout foam intrusion

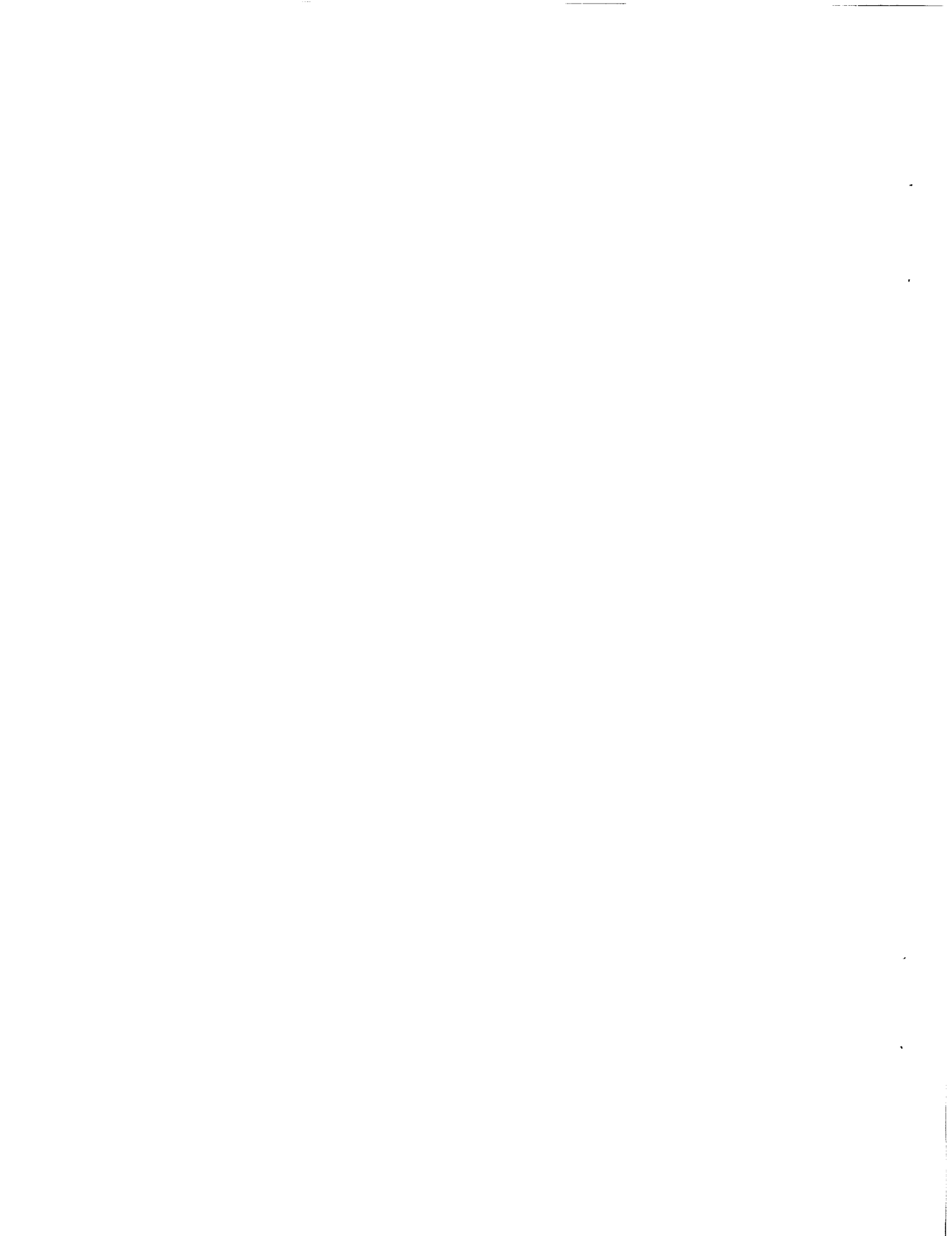

ORIGINAL PAGE
COLOR PHOTOGRAPH

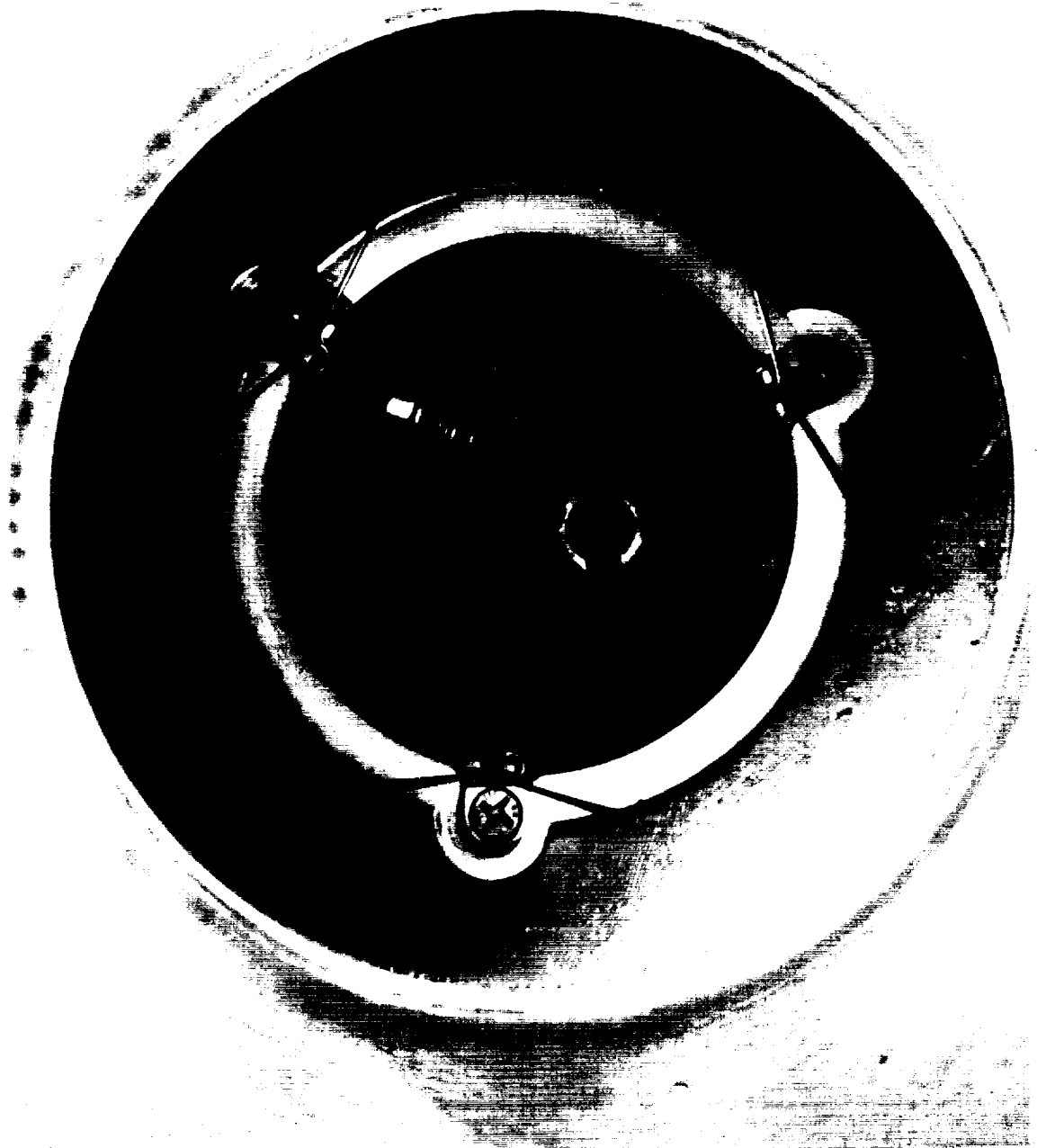

EO-3 ordnance device debris plunger failed to seat properly

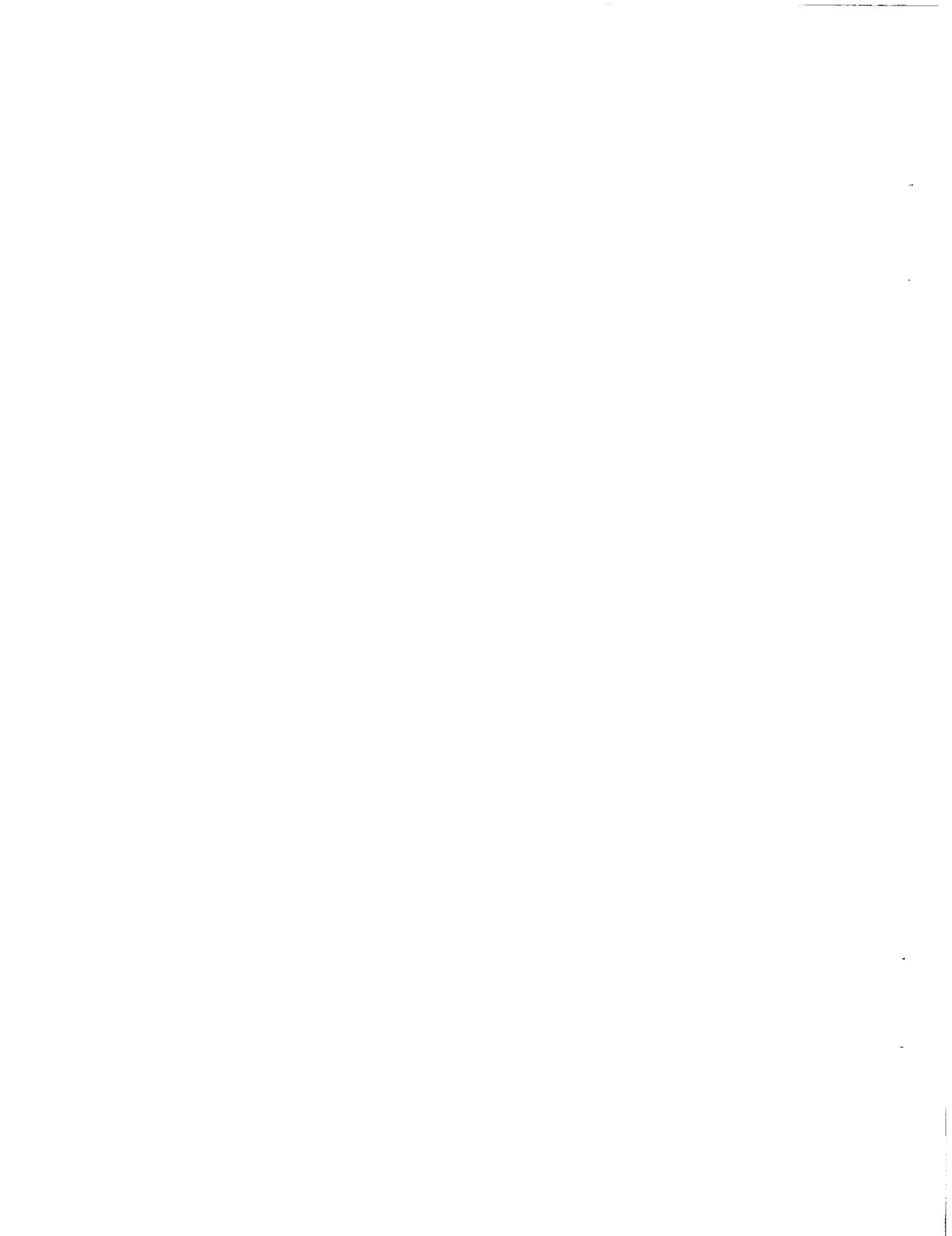



EO-3 ordnance device fragment and unidentified washer fell onto
the runway when the LO2 ET/ORB umbilical door was opened

190

ORIGINAL PAGE
COLOR PHOTOGRAPH

03



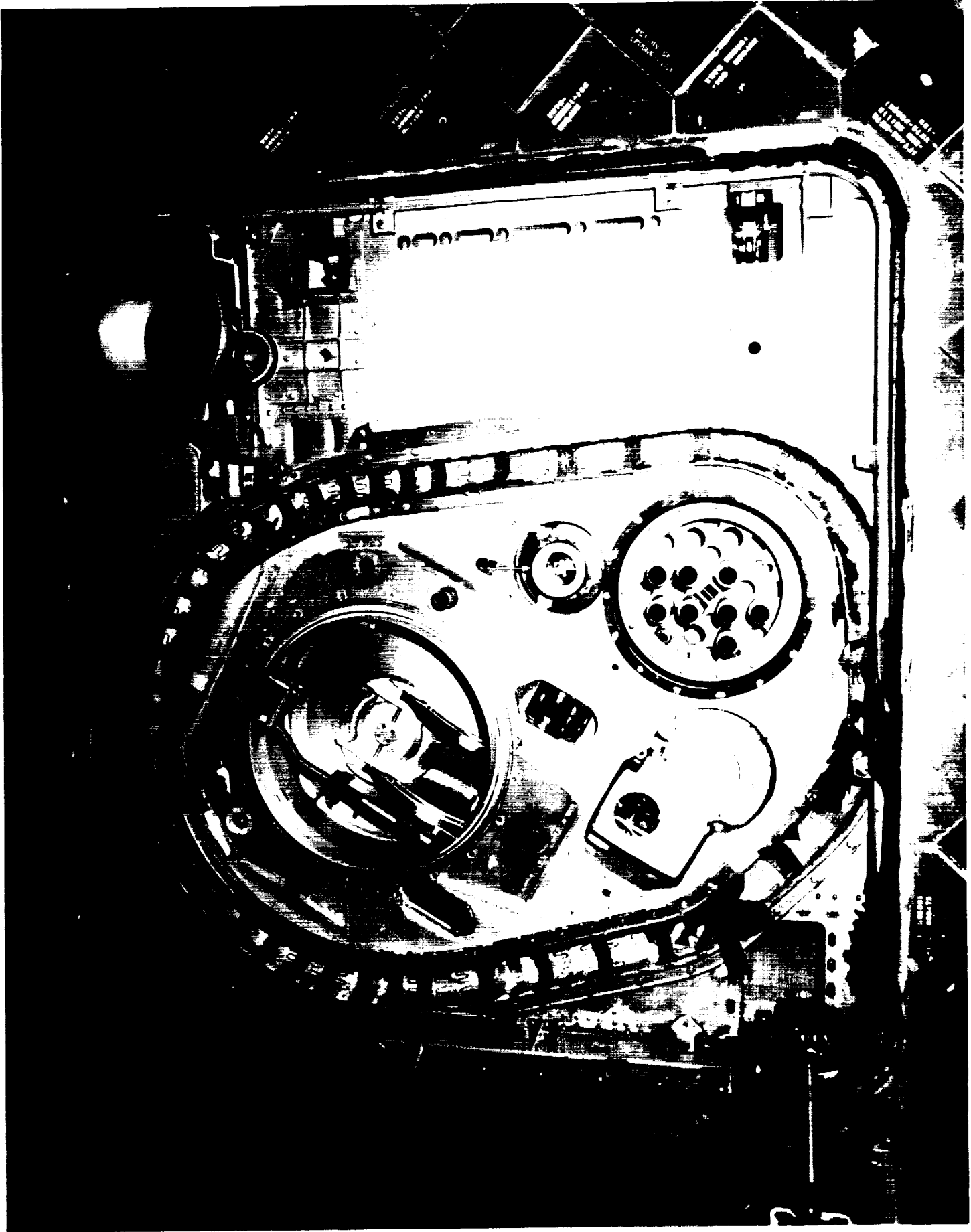

Overall view of LH2 ET/ORB umbilical





ORIGINAL PAGE IS
OF POOR QUALITY

Aluminum tape on the inside surface of the LH MLG door pulled
loose at two locations prior to landing



ORIGINAL PAGE IS
OF POOR QUALITY

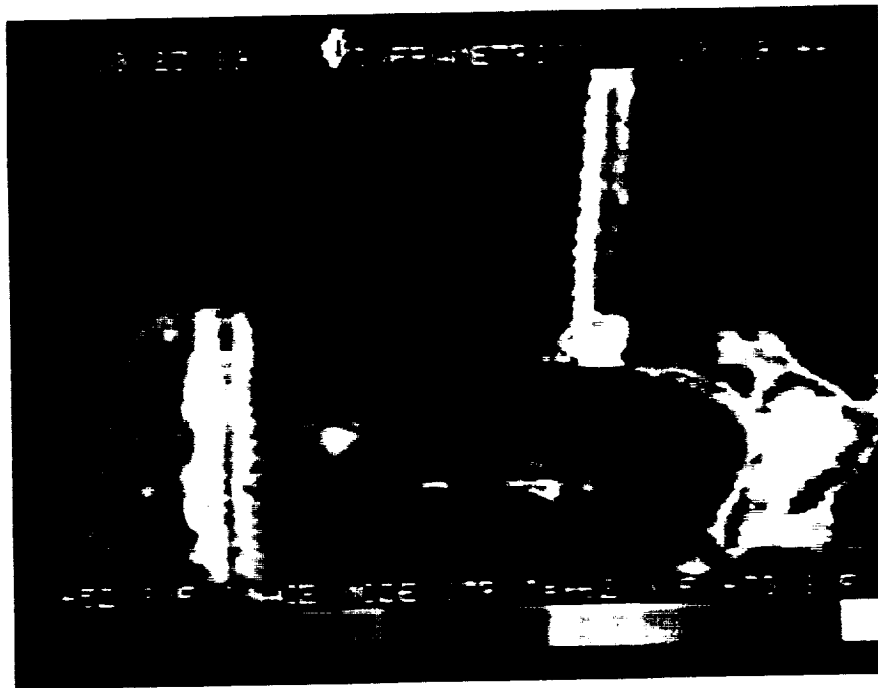
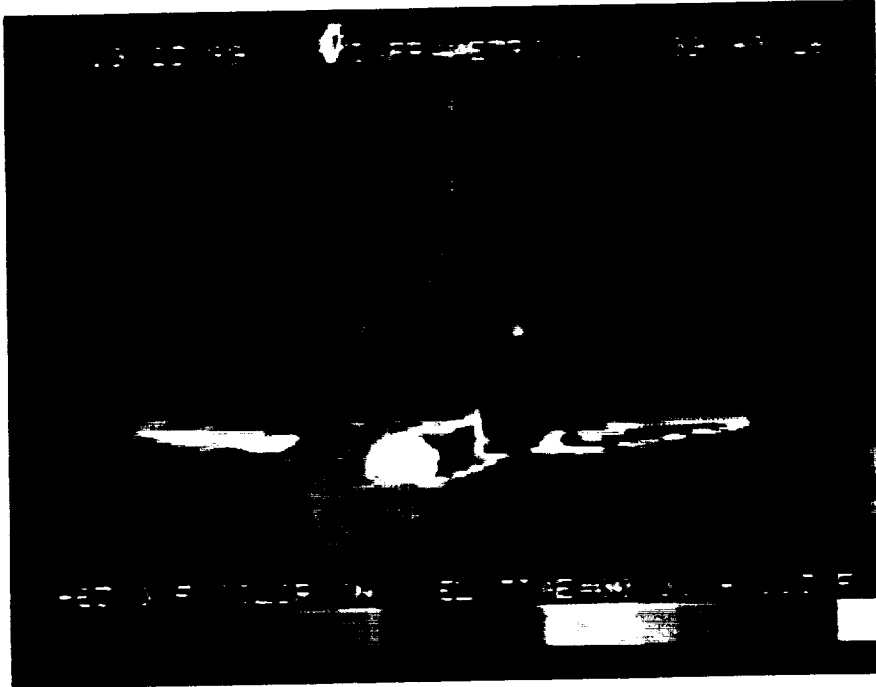

Shuttle Thermal Imager (STI) highlights warm RCC panels on
Orbiter after landing. Note APU exhaust near tail.

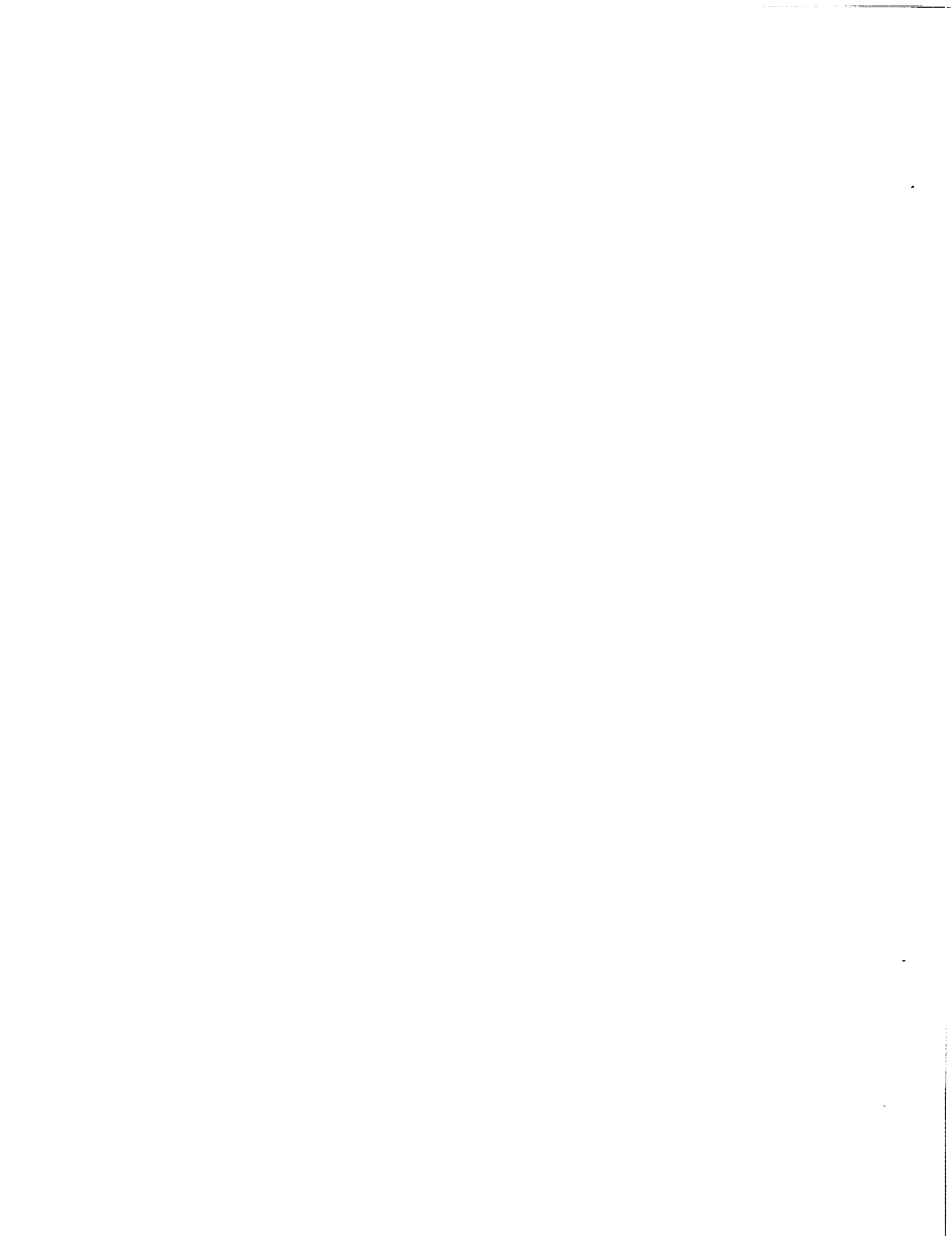

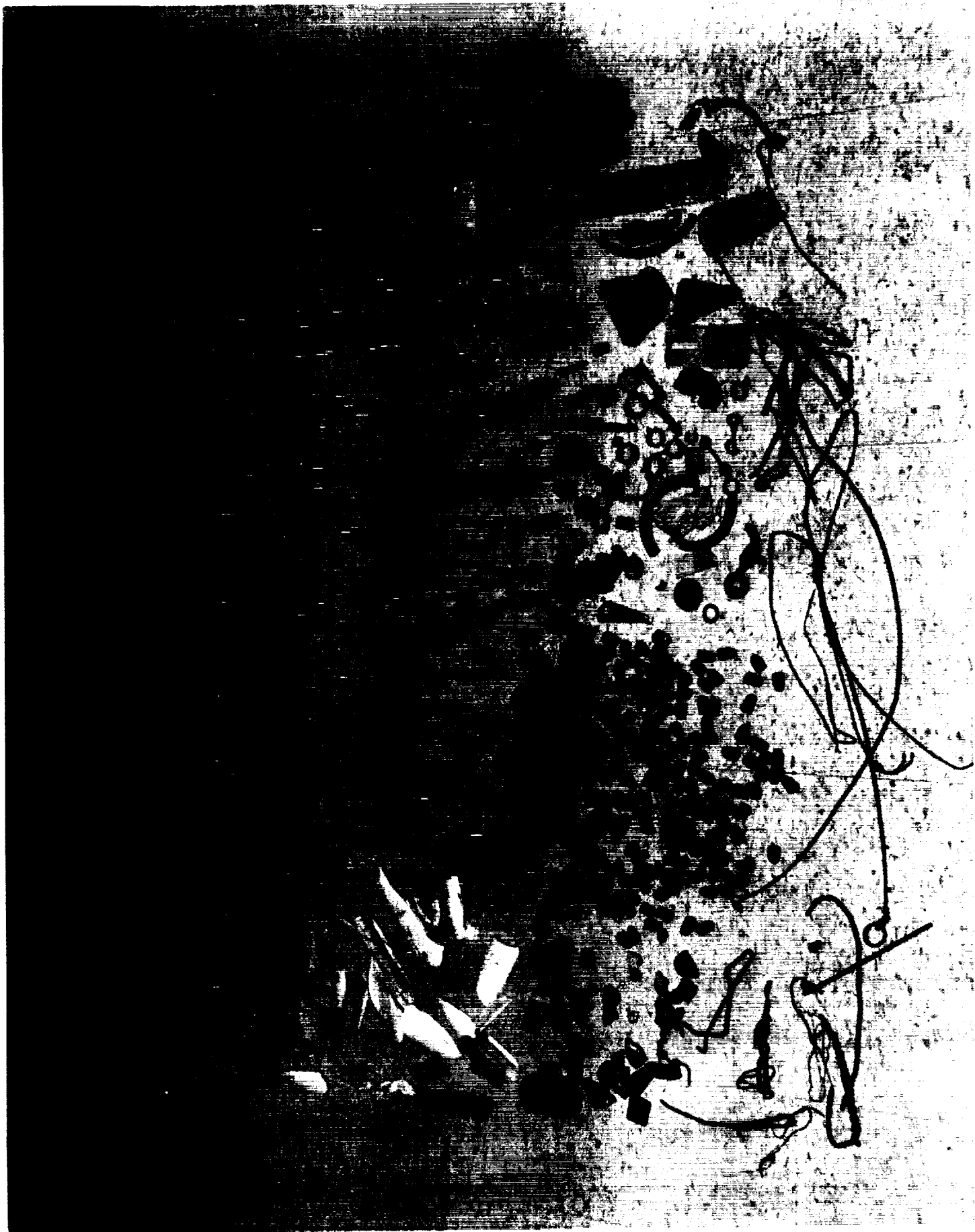

Typical debris collected during pre-landing runway inspections

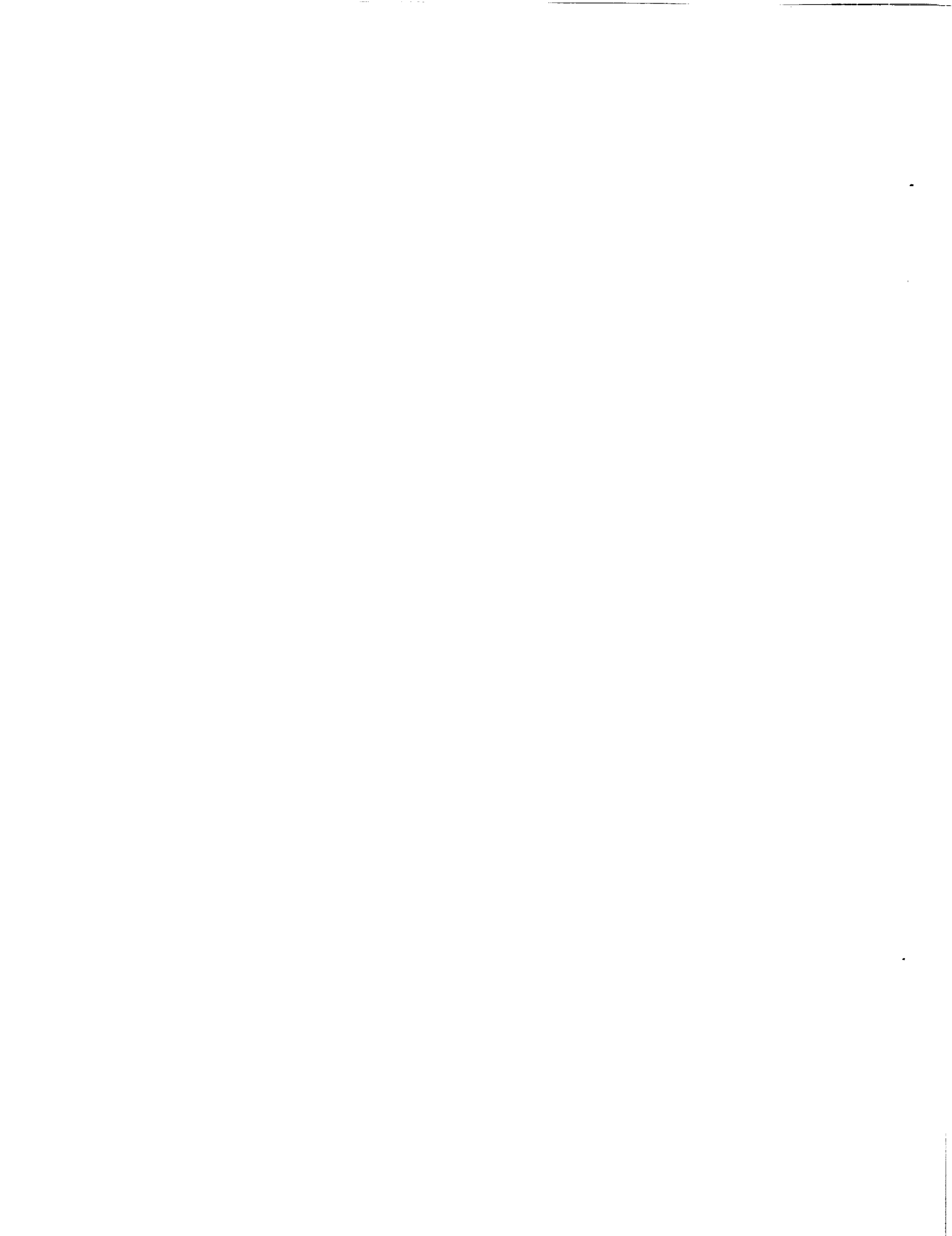

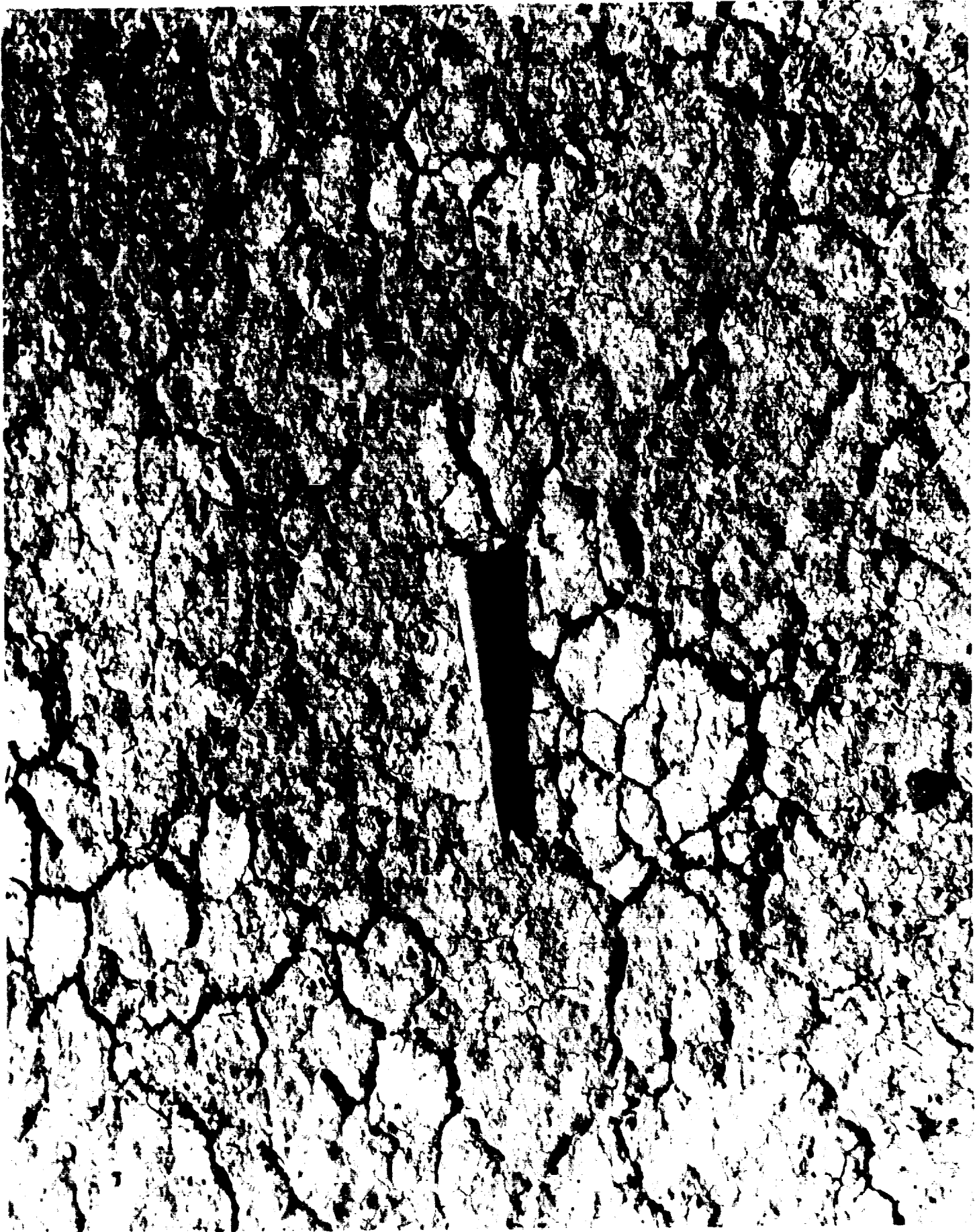

Live round of ammunition found 0.3 miles from Runway 23
threshold, 33 feet east of the centerline

195

ORIGINAL PAGE IS
OF POOR QUALITY

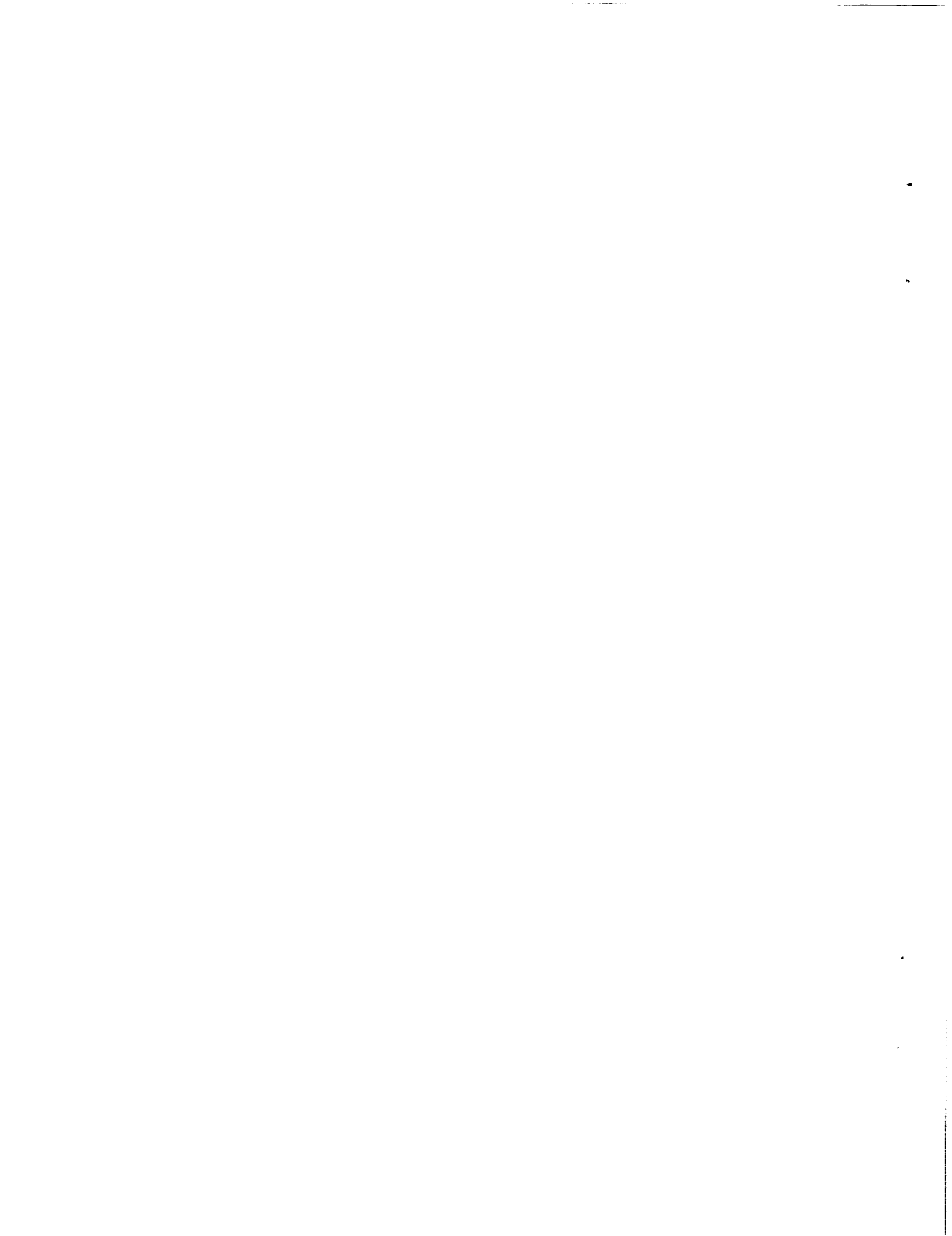



Survey marker/concrete post protruded 3/4-inch above Runway 23
surface 287 feet away from the Orbiter touchdown point



10.0 DEBRIS SAMPLE LAB REPORTS

A total of 28 samples were obtained from Orbiter OV-104 during the STS-34 post-landing debris assessment at Ames-Dryden Flight Research Facility, California. The 28 submitted samples consisted of 8 orbiter window wipes, 3 tile samples, 6 wipes from the wing leading edge RCC panels, 2 samples of tape residue, 8 samples from the ET/ORB umbilical area, and 1 washer embedded in a lower surface tile forward of the LH2 ET/ORB umbilical area. The samples were analyzed by the NASA KSC Microchemical Analysis Branch (MAB) for material composition and comparison to known STS materials. The specific elemental analysis is shown in the appended MAB reports. Debris samples and analyses are provided by Orbiter location in the following summaries.

Orbiter Windows

Chemical analysis identified the following materials from Orbiter windows W-1 through W-9:

1. Metallics (aluminum, tin) W-1, W-5
(carbon steel spheres) W-1
2. calcite and gypsum W-1,3,4,5,7,8
3. black-colored rust and dust W-1 through W-8
4. RTV W-1, W-7
5. brown-colored potassium-silicon-aluminum-iron rich flakes W-1 through W-8
6. salt (sodium chloride) or alpha-quartz (SiO₂) W-1,5-8
7. uncrystallized silicon-aluminum with cerium and lanthanum compounds W-2 through W-6
8. crystallized silicon-aluminum W-1, 3-8
9. pollen W-1
10. brown-colored iron-potassium-calcium-silicon-aluminum on W-7

Debris analysis provides the following correlations:

1. The most probable source of metallics is the flight environment. Aluminum occurs in SRM/BSM exhaust; tin in ET/SRB paint.
2. Calcite and gypsum are typical landing site products.
3. Rust is a probable SRB separation product. Dust is a typical landing site product.
4. RTV is a primary Orbiter tile bonding material.
5. The brown-colored K-Si-Al-Fe rich flakes in crystallized form are probably landing site products.
6. Salt is a probable landing site product. Alpha-quartz is a heated product of the tile TPS or a naturally occurring form of the earth mineral silica.
7. Uncrystallized Si-Al particles are most probably heated tile material or SRB exhaust products. Traces of cerium and lanthanum are naturally occurring elements at the landing site.
8. Crystallized silicon-aluminum are most likely products from the landing site.

9. Pollen occurs naturally at the landing site.
10. Brown-colored Fe-K-Ca-Si-Al also probably originated from the landing site.

Lower Surface Orbiter Tiles

Results of the tile debris analysis revealed most of the material to be of tile thermal protection system origin. The elemental analysis indicates silicon and iron, which are the major components of heated tile/RTV system. The exception is the washer damage site.

Debris analysis of the tile damage area samples show tile slumping, which indicates the damage sites experienced heating effects. The absence of non-tile material indicates the damage-causing debris was either not retained at the damage site or the debris itself was tile material.

Orbiter Wing RCC Panels

Chemical analysis results of the RCC panel samples revealed the presence of the following materials:

1. metallic aluminum
2. RTV and primer
3. glass fiber
4. dust, rust
5. black and white tile material
6. paint
7. carbon steel

Debris analysis provides the following correlations:

1. Metallic aluminum is most likely SRB separation or landing site products.
2. Silicone RTV is a primary bonding agent of the thermal protection system.
3. Glass fibers probably originated from tile.
4. Dust would occur at the landing site. Rust is probably a separation product from the SRB's.
5. Black and white tile material originated from the Orbiter TPS.
6. Paint particles may originate from processing activities on the flight elements, facility, or ground support equipment; or as vehicle particulate debris.
7. Carbon steel may be attributed to flight element attach hardware or from the BSM nozzles.

ET/ORB Umbilicals

Chemical analysis of samples from the ET/ORB umbilicals revealed the following materials:

1. organics, foam
2. silicates, calcium products, dust
3. aluminum, iron, stainless steel, zinc, carbon steel
4. paint
5. RTV
6. rust
7. Viton rubber
8. phenolic microballoons

Debris analysis of these materials provides the following correlations:

1. The organics and organic foam particles are most likely from closeout material residuals. The number of different materials show that the umbilical cavities are good areas for the entrapment of debris particles.

2. Calcium products probably originated from the landing site. Silicates originate from heated tile-residuals or naturally occurring landing site products.

3. Metallic particles probably originated from the flight elements, but are not a debris concern in this size range (micrometer).

4. Paint is used as a coating on Shuttle elements.

5. Rust is probably a separation product of the SRB's.

7. Viton rubber is used in main propulsion system pneumatic seals.

8. Phenolic microballoons are a component of ablator material and could have been shed as an ablation product. This trace material is not a debris concern.

Embedded Washer Damage Site

The embedded washer was a Series-300 stainless steel. The washer exhibited three different areas of deposits or discolorations. The three color distinctions were red, white, and gray. Chemical analysis of these areas revealed the presence of the following materials:

1. Red material - Hematite (Fe_2O_3)
2. White material - alpha quartz (SiO_2), alpha cristobalite (SiO_2), maghematite (Fe_2O_3)
3. Gray material - hematite (Fe_2O_3), iron (Fe metal), and Wuestite (FeO)

This mission provided unique data in the form of a washer embedded in a lower surface tile. Approximately one half of the washer protruded into the aerodynamic flow and was oriented perpendicular to the air flow. Chemical analysis of the washer revealed the temperature range of exposure. The texture, structure, and adhesion properties of adhering hematite (iron oxide)

suggested formation of this material was high temperature exposure rather than corrosion. Additional data supporting the non-corrosion formation is the absence of sulfur and other chemicals that normally occur with corrosion. The high temperature hematite formation theory is supported by the presence of alpha-cristobalite on the washer. The alpha-cristobalite has a conversion (formation) temperature of 2678 degrees F from silica glass (tile). Hematite's conversion temperature is 1250 degrees F, and has a melting temperature of 2849 degrees F. The melting point of a 300-series stainless steel is 2500 degrees F. The alpha-cristobalite formation temperature can be lowered by the presence of halides or metal oxides. These temperature data indicate the washer had been subjected to a temperature between 2678 to 2849 degrees F. However, based on the absence of severe slumping at the tile damage site, that temperature range could not have occurred at this location. The uncertainty of specific local temperature could indicate heating of the washer prior to tile impact.

Conclusions

The lower surface Orbiter tile samples indicate localized heating effects in the damage sites. This data correlates tile damage prior to re-entry heating - most probably the ascent phase of the mission. With the exception of the embedded washer, the only materials recovered from the damage sites were tile thermal protection system elements. So the damaging agent was either not held within the tile or was tile material itself

The Orbiter wing RCC panel samples contained a variety of elemental/material compounds. The earth mineral and thermal protection system compound sources are easily discernible, as are those of SRB separation products. The paint particles probably originated from ground processing or as a flight vehicle ablation product.

The ET/ORB umbilical samples contain a variety of closeout residue, earth-mineral, Viton rubber, phenolic microballoons, and tile TPS materials. The variety of materials indicate the umbilical area's capability to entrap debris residuals. Debris analysis does not promote a concern with this residual variety.

Although the embedded washer demonstrates a program debris concern, the limited or localized damage provides a good indication of the resiliency of densified Orbiter tile. The source of the washer is still under investigation. The flight elements are considered the most probable source.

Based on the debris sample analyses, this mission did not produce unusual debris concerns. There was one tile that sustained an on-orbit micrometeorite impact. However, efforts to obtain a sample for lab analysis failed when the material disintegrated into ash. There were no unexplained debris sample chemical analyses.

MICROCHEMICAL ANALYSIS BRANCH
DM-MSL-1, ROOM 1274, O&C BUILDING.
NASA/KSC
NOVEMBER 9, 1989

SUBJECT: Debris From Mission STS-34, OV-104 (Atlantis)

LABORATORY REQUEST NO: MCB-0998-89

RELATED DOCUMENTATION: Intercenter Debris Team Requirements

1.0 FOREWORD:

1.1 REQUESTER: S. A. Higginbotham/TV-MSD-22/7-0806

1.2 REQUESTER'S SAMPLE DESCRIPTION:

The particles were removed from OV-104 (Atlantis), mission STS-34 landing at DFRF/EAFB, and were identified as follows:

- #1: Alcohol wipe and swabs from orbiter window #1.
- #2: Alcohol wipe and swabs from orbiter window #2.
- #3: Alcohol wipe and swabs from orbiter window #3.
- #4: Alcohol wipe and swabs from orbiter window #4.
- #5: Alcohol wipe and swabs from orbiter window #5.
- #6: Alcohol wipe and swabs from orbiter window #6.
- #7: Alcohol wipe and swabs from orbiter windows #7 and #8. (Overhead windows.)
- #8: Alcohol wipe and swabs from orbiter window #9. (Crew module hatch window.)
- #9: Washer found embedded in orbiter tile V070-191010-120.

1.3 REQUESTED:

1. Identify composition of residual materials collected by wipes/swabs and compare to known STS materials.
2. Identify composition of washer. Identify any reentry effects including, if possible, the maximum temperature washer was exposed to.

2.0 CHEMICAL ANALYSIS AND RESULTS:

2.1 Procedure:

The samples were analyzed by means of optical microscopy (OM), x-ray diffraction (XRD), and electron microprobe with energy dispersive spectrometry (EDS), and wavelength dispersive spectrometry (WDS).

2.2 Results:

2.2.1 The particulates were classified into components on the basis of color and texture by OM. The classified components from all samples are listed in Table 1 with the possible identification of each component and elemental analysis.

Table 1

Component ID	Possible Ident.	Elemental Analysis by EDS*	
		Major	Minor
1. Metallics	C-Steel, Al-, Sn-Metals	Al, Sn, Fe,	
2. Black Mtls	Rust, Dust	Fe, Ca, Si	S, Cl, K, Ti, Al
3. Red Rubbery	RTV	Fe, Si	
4. Red Mtls	Rust	Fe, O	Al, Cl
5. Lgt-Brn Mtls	K-Si-Al-Fe Flake	K, Si, Al, Fe	Ti, Mg
6. White Clear	NaCl, α-Quartz	Na, Cl, Si	
7. White Mtls	CaCO ₃ , CaSO ₄ SiO ₂	Si, Ca, Al, S	Fe, K
8. Black Sphere	C-Steel	Fe	
9. LgtGreyPowder	Si-Al Rich Mtls	Si, Al	Le, Fe, K, S, Mg, Ti, Ca, Ce
10. Glass Fiber	High Temp. Insulation	Si, Al	
11. BrnDenseMtls	Fe-K-Ca-Si-Al	Fe, K, Ca, Si, Al	Mg

2.2.2 Table 2 lists estimated amounts of each component versus sample number.

Table 2

Sample No. Amt. Sample	#1	#2	#3	#4	#5	#6	#7	#8
1. Metallics	1(Al)	X	X	X	T(Sn)	X	X	X
2. Black Rust&Dust	12	T	3	3	6	10	8	5
3. RTV	1	X	X	X	X	X	T	X
4. Rust	X	X	X	T	X	X	X	X
5. K-Si-Al- Fe Flake	30	2	5	10	6	30	32	15
6. NaCl or Al-SiO ₂	18	X	X	X	20	15	13	20
7. CaCO ₃ , CaSO ₄ . 2H ₂ O, Al-SiO ₂	30	X	20	7	5	X	42	60
8. C-Steel Sphere	T	X	X	X	X	X	X	X
9. Si-Al Amorphous Mtls	X	98	70	80	63	45	X	X
10. HighTemp Glass Fiber	8	X	2	T	T	T	5	T
11. Pollens	T	X	X	X	X	X	X	X
12. Brown DenseMtls	X	X	X	X	X	X	T	X
13. Particle Size Range um	1-80	1-35	1-100	1-100	1-110	1-200	1-300	1-100

X: Not detected. T: Trace
(Al) and (Sn); Al-, Sn- Metals

2.2.3 Table 3 list the elemental analysis of the embedded washer with possible identification of phases.

Table 1

Component ID	Elemental Analysis		Phases By XRD
	Major	Minor	
1. <u>WASHER</u> Red Mtls	Fe,Cr,O Si	Ni K,Cl	Fe ₂ O ₂ (Hematite) SiO ₂ (β -Cristobalite) α -Quartz, Fe ₂ O ₃ (Maghematite)
2. White Mtls			
3. Dark Grey Mtls	Cr,Fe	Ni,Ti,Si,Cu,O	Fe ₂ O ₃ (Hematite), Fe, FeO (Wuestite)

- 2.2.4 Figures 1 and 2 are SEM photomicrographs of light-brown colored flakes and white clear colored materials, respectively, to show the morphological features of these materials.
- 2.2.5 Figure 3 and 4 are low magnification OM photomicrographs of the embedded washer. Figures 5 and 6 are high magnification OM photomicrographs of the embedded washer to show the distribution of the red (1), white (2), and dark grey (3) areas for further analysis.
- 2.2.6 figures 7 and 8 are low and high magnification SEM photomicrographs of the area 1 in Figure 5 to show the fitted surface and granular texture of individual particles.
- 2.2.7 Figure 9 is SEM photomicrograph of the area 2 in Figure 5 to show the distribution of the white materials.
- 2.2.8 Figures 10 and 11 are low and high magnification SEM photomicrographs of the area 3 in Figure 5.
- 2.2.9 Figures 12, 13, 14, 15, 16, 17, 18, and 19 are EDS spectra of white clear materials, glass fiber, dark grey and white powder, light brownish flake, black materials, and area 1 (red), area 2 (white), and area 3 (dark grey) from washer, respectively.

3.0 CONCLUSIONS:

3.1 Particulates from Wipe and Swabs

- 3.1.1 The sample numbers 1 and 5 contained trace amounts of metallics. The metallics were composed of Al-and Sn-metals.
- 3.1.2 All samples contained black colored rust and dust.
- 3.1.3 The sample numbers 1 and 7 contained red RTV, and sample number 4 contained rust materials.
- 3.1.4 All samples contained light brown colored K-Si-Al-Fe rich flakes.
- 3.1.5 The sample numbers 1, 5, 6, 7, and 8 contained white colored NaCl or alpha-SiO₂ (alpha-quartz).
- 3.1.6 The sample numbers 1, 3, 4, 5, 7, and 8 contained large amounts of CaCO₃ (calcite) and CaSO₄.2H₂O (gypsum).
- 3.1.7 The sample number 1 contained trace amounts of carbon steel spheres.
- 3.1.8 The sample numbers 2, 3, 4, 5, and 6 contained large amounts of Si-Al amorphous materials. These materials might be formed from the thermal tile upon reentry. Those powdery and grey-colored Si-Al rich materials contained small amounts of cerium and lanthanum compound.
- 3.1.9 The sample numbers 1, 3, 4, 5, 6, 7, and 8 contained Si-Al rich high temperature glass fiber.
- 3.1.10 The sample number 1 and sample number 7 contained pollens and brown dense materials, respectively.
- 3.1.11 The particle sizes were estimated to be in the range of 1 to 300 micrometers.

3.1.12 The Si-Al rich amorphous materials and high temperature glass fiber appeared to be originated from TPS, and the rest of materials appeared to be originated from the natural environments.

3.2 Washer

3.2.1 The washer was composed of a 300 series stainless steel.

3.2.2 The washer was classified into red area, white area, and dark grey area (Table 3). The red materials were identified to be Fe₂O₃ (hematite). The white materials were composed of alpha-quartz (alpha-SiO₂), alpha-cristobalite (SiO₂) and maghematite (Fe₂O₃). The alpha-cristobalite was formed at conversion temperature of 1470 degree C. The dark grey materials were composed of Fe₂O₃ (hematite), Fe-metal and FeO (wuestite).

3.2.3 Both the red and dark grey materials were more easily removed from the washer than the usual effort required for corrosion products. The white materials was "stuck" much harder to the washer.

3.2.4 The washer surface shows the fitted surface with fine granular texture. The texture of grains suggested that the sample might have been oxidized at high temperature.

CHEMIST:

H. S. Kim

H. S. Kim

APPROVED:

J. V. Jones

J. V. Jones

ORIGINAL PAGE
BLACK AND WHITE PHOTOGRAPH



FIGURE 1. SEM PHOTOMICROGRAPH OF LIGHT BROWN COLORED FLAKES. 200X. #3



FIGURE 2. SEM PHOTOMICROGRAPH OF WHITE CLEAR COLORED MATERIALS. 200X. #3

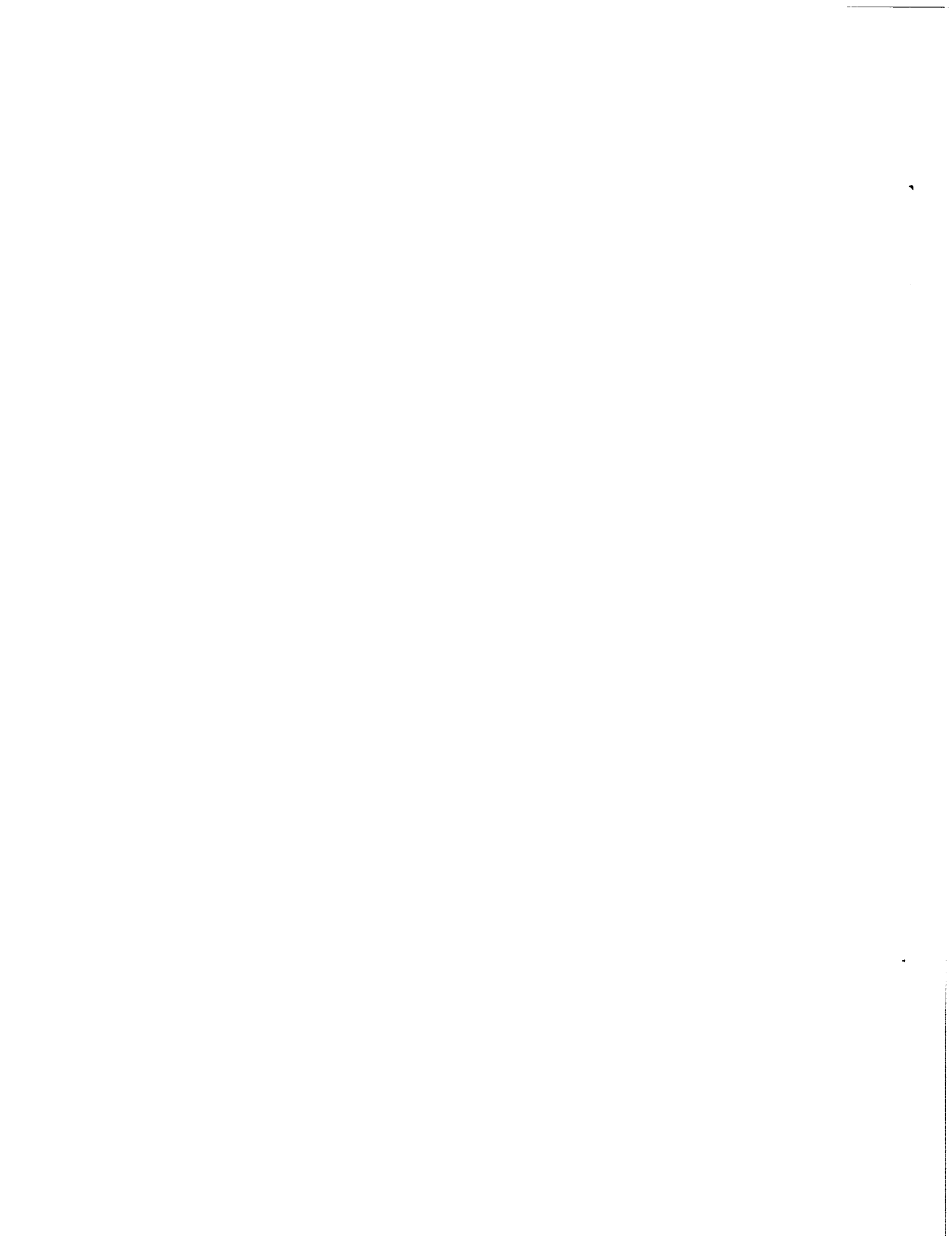

ORIGINAL PAGE IS
OF POOR QUALITY

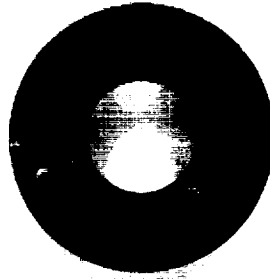

FIGURE 3. LOW MAGNIFICATION ON PHOTOMICROGRAPH OF THE
EMBEDDED WASHER. 2X

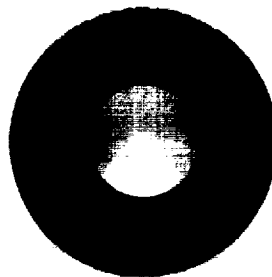
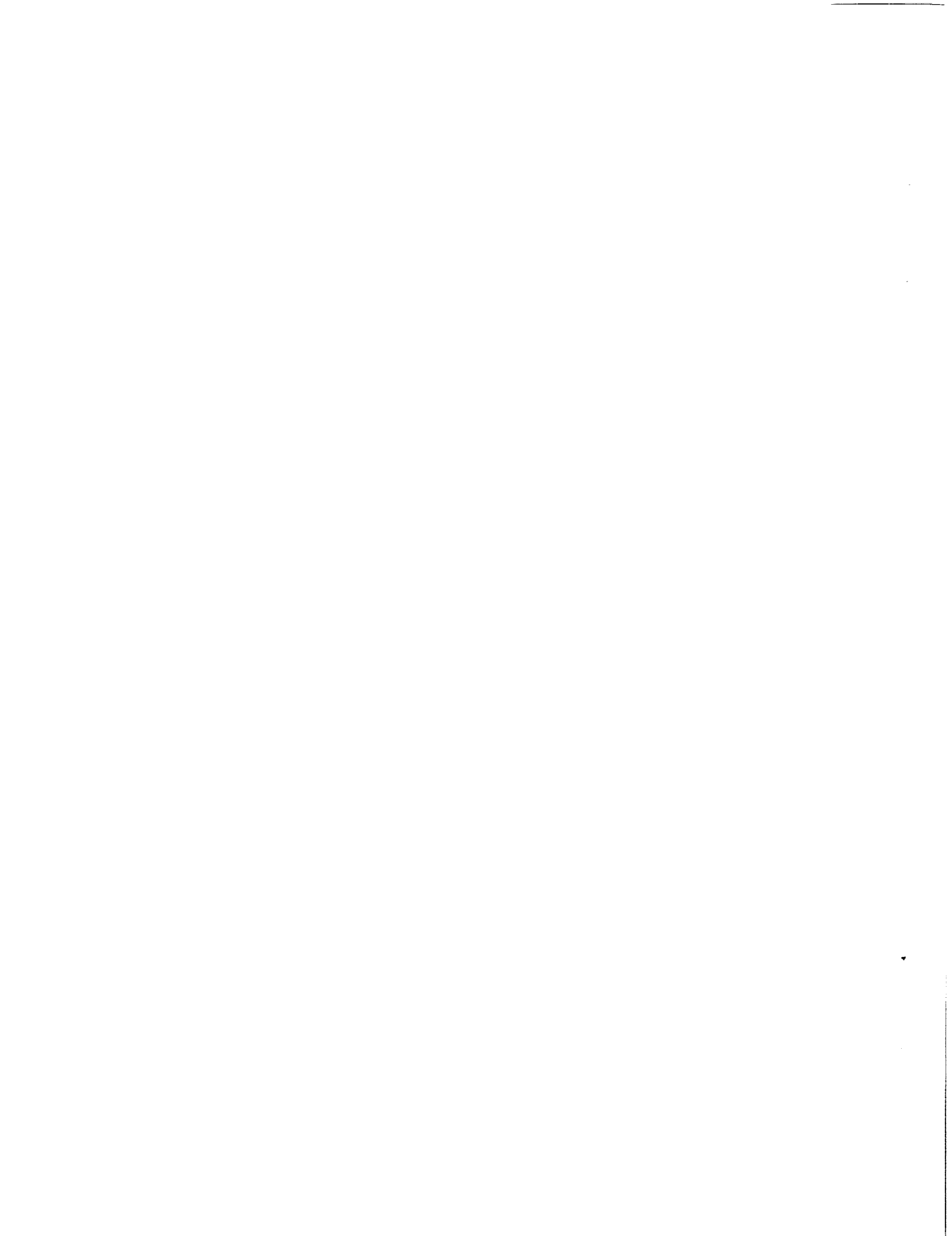

FIGURE 4. LOW MAGNIFICATION ON PHOTOMICROGRAPH OF THE
OTHER SIDE OF THE EMBEDDED WASHER. 2X



ORIGINAL PAGE IS
OF POOR QUALITY

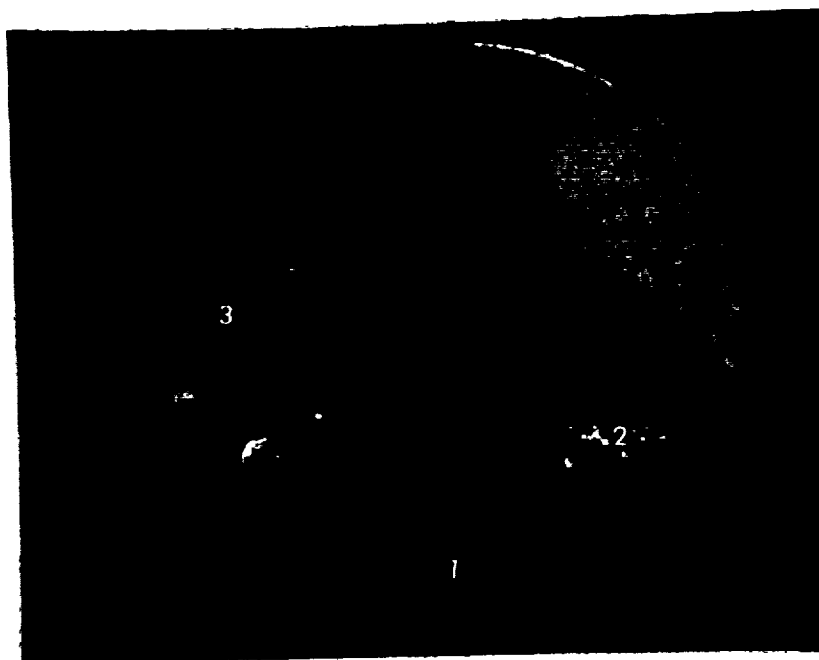

FIGURE 5. HIGH MAGNIFICATION ON PHOTOMACROGRAPH OF
WASHER TO SHOW THE AREAS (1, 2, 3) OF FURTHER SEM
ANALYSIS. 6.5X

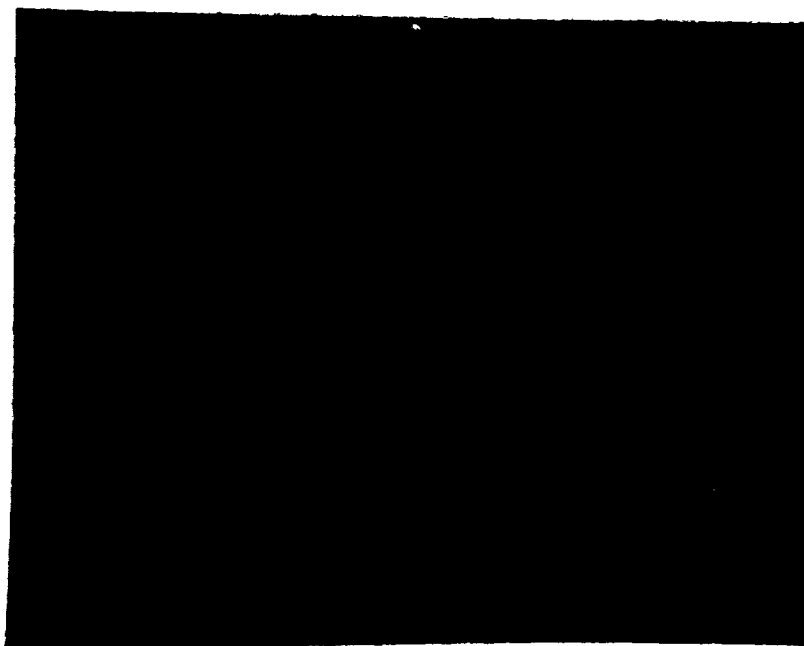

FIGURE 6. HIGH MAGNIFICATION ON PHOTOMACROGRAPH OF
OTHER SIDE OF WASHER. 6.5X



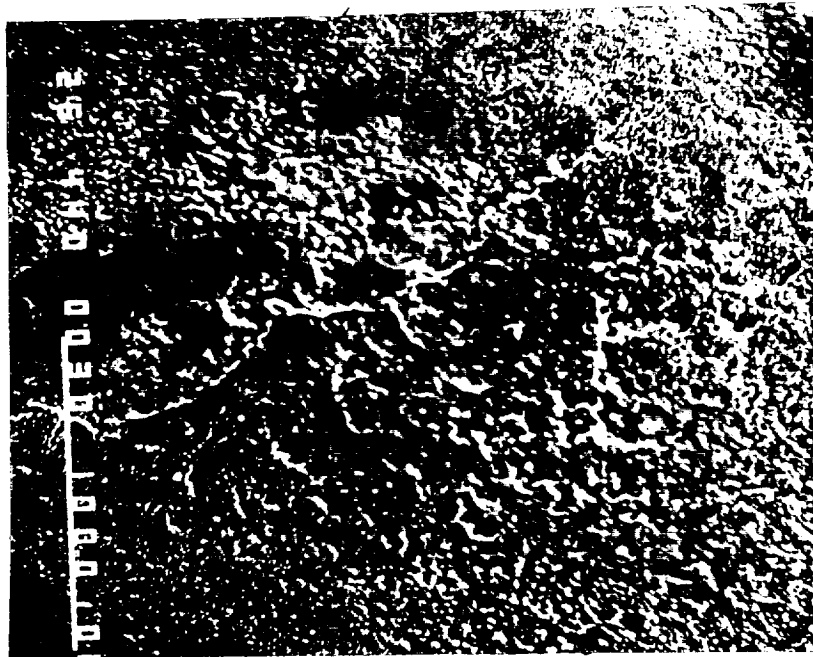

FIGURE 7. SEM PHOTOMICROGRAPH OF AREA 1 IN FIGURE 5 TO SHOW THE FITTED SURFACE. 44X

ORIGINAL PAGE
BLACK AND WHITE PHOTOGRAPH

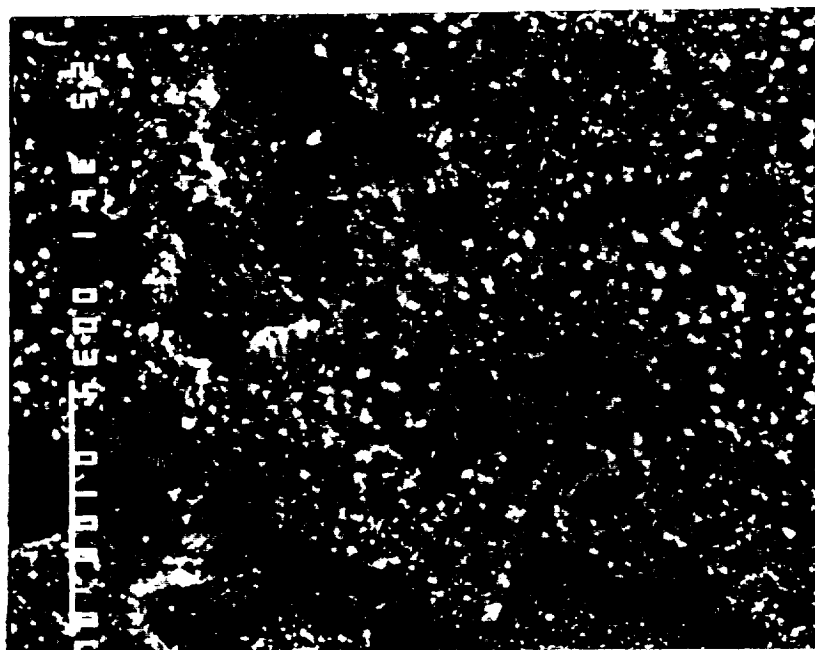
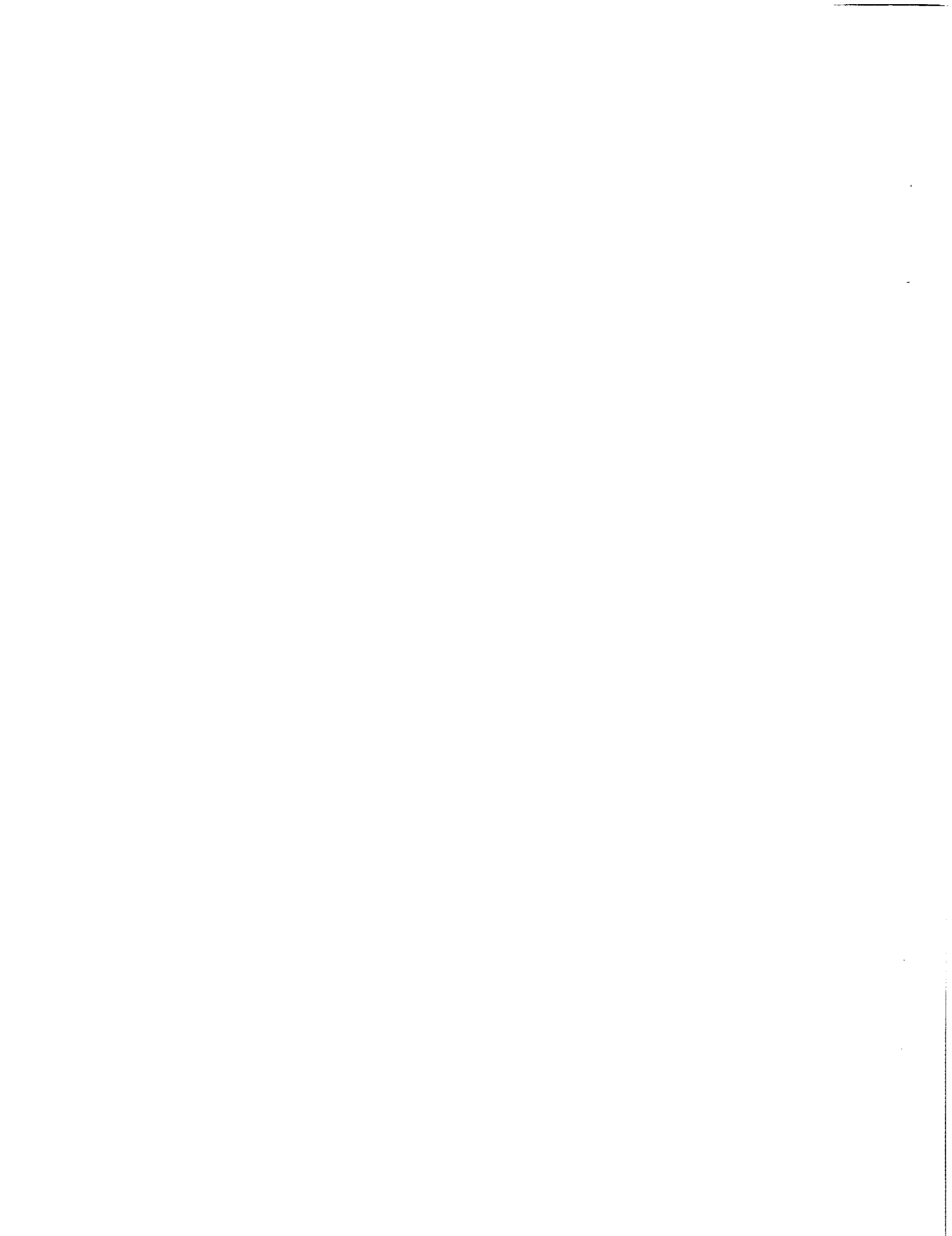

FIGURE 8. HIGH MAGNIFICATION SEM VIEW OF THE FIGURE 7 TO SHOW THE GRANULAR TEXTURE OF THE PARTICLES. 360X
200.10



ORIGINAL PAGE
BLACK AND WHITE PHOTOGRAPH

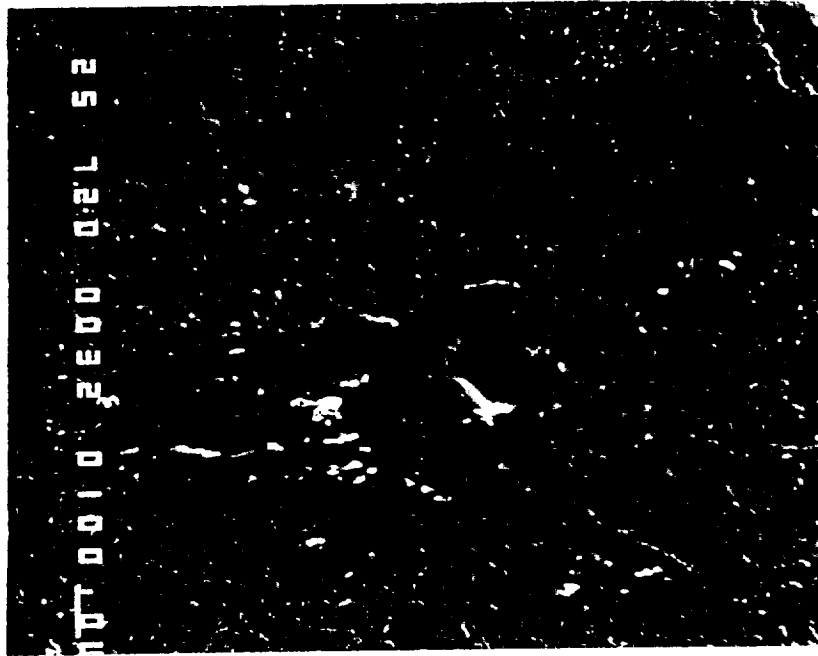

FIGURE 9. SEM PHOTOMICROGRAPH OF THE AREA 2 IN FIGURE 5 TO SHOW THE WHITE MATERIALS. 72X

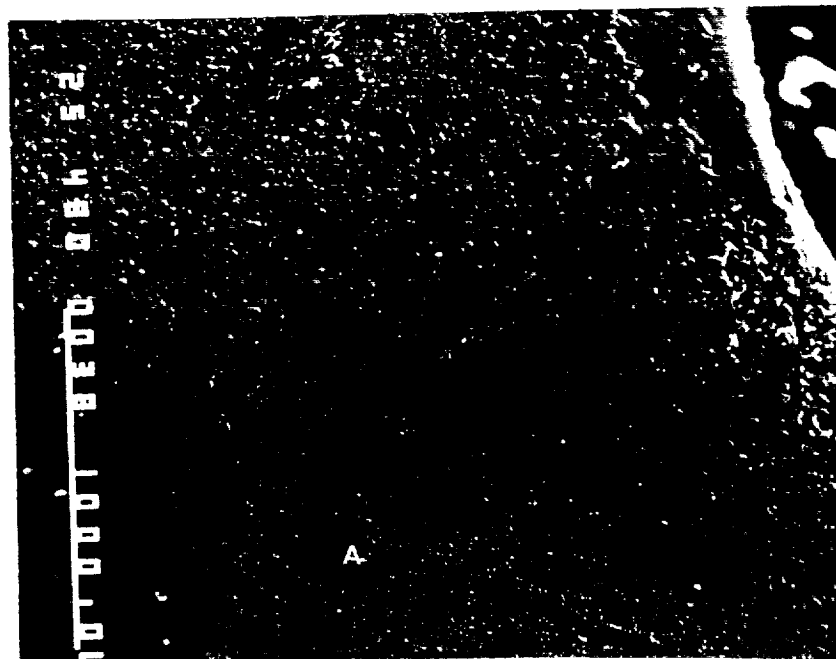
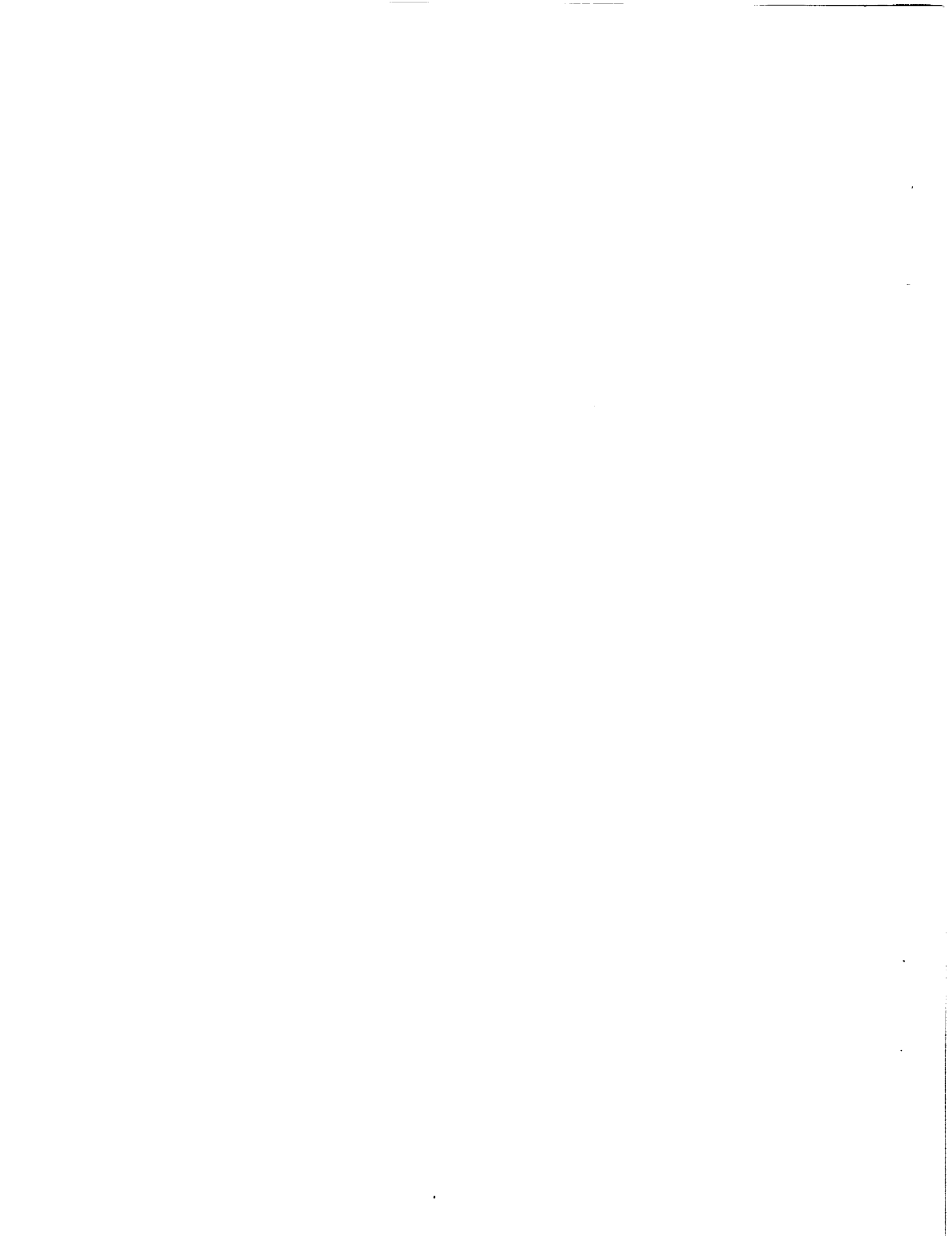

FIGURE 10. LOW MAGNIFICATION SEM PHOTOMICROGRAPH OF THE AREA 3 IN FIGURE 5. 48X



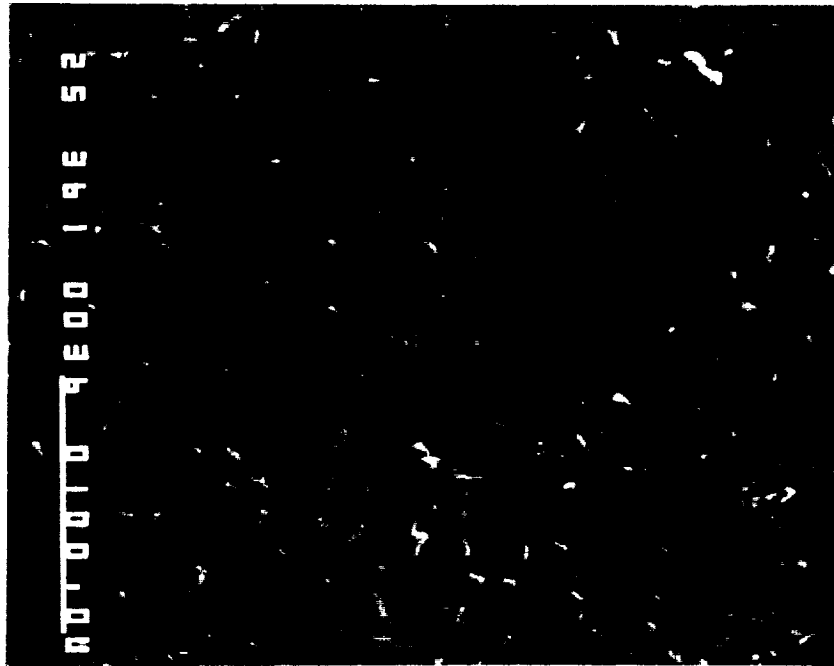

FIGURE 11. HIGH MAGNIFICATION SEM PHOTOMICROGRAPH OF THE AREA A IN FIGURE 10 TO SHOW THE MORPHOLOGY AND DISTRIBUTION OF THE GRANULAR PARTICLES.

ORIGINAL PAGE
BLACK AND WHITE PHOTOGRAPH

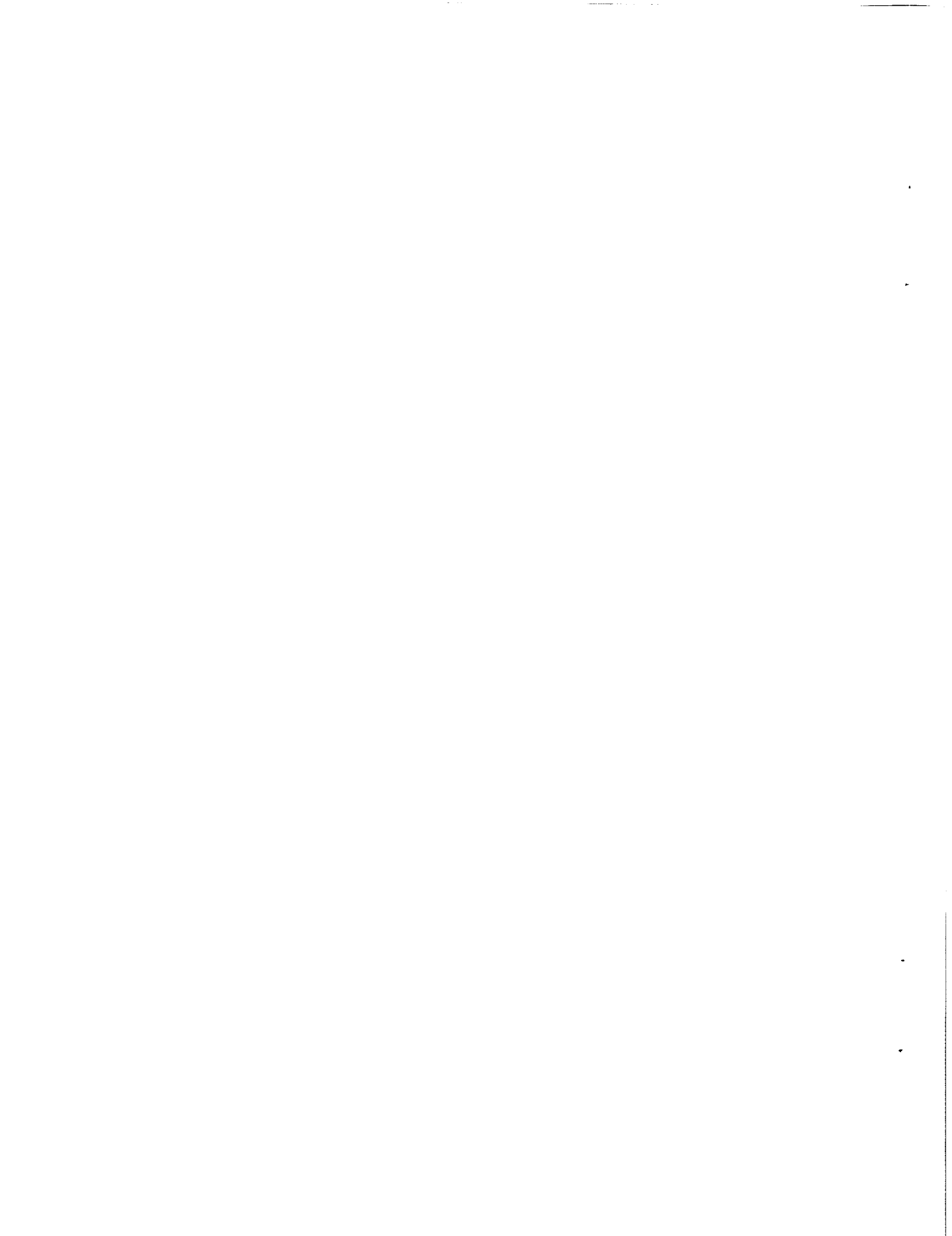

Figure 12 WHITE CLEAR MTL, 1,998-89

SPECTRUM LABEL

SPECTRUM FILE NAME

13969

13969

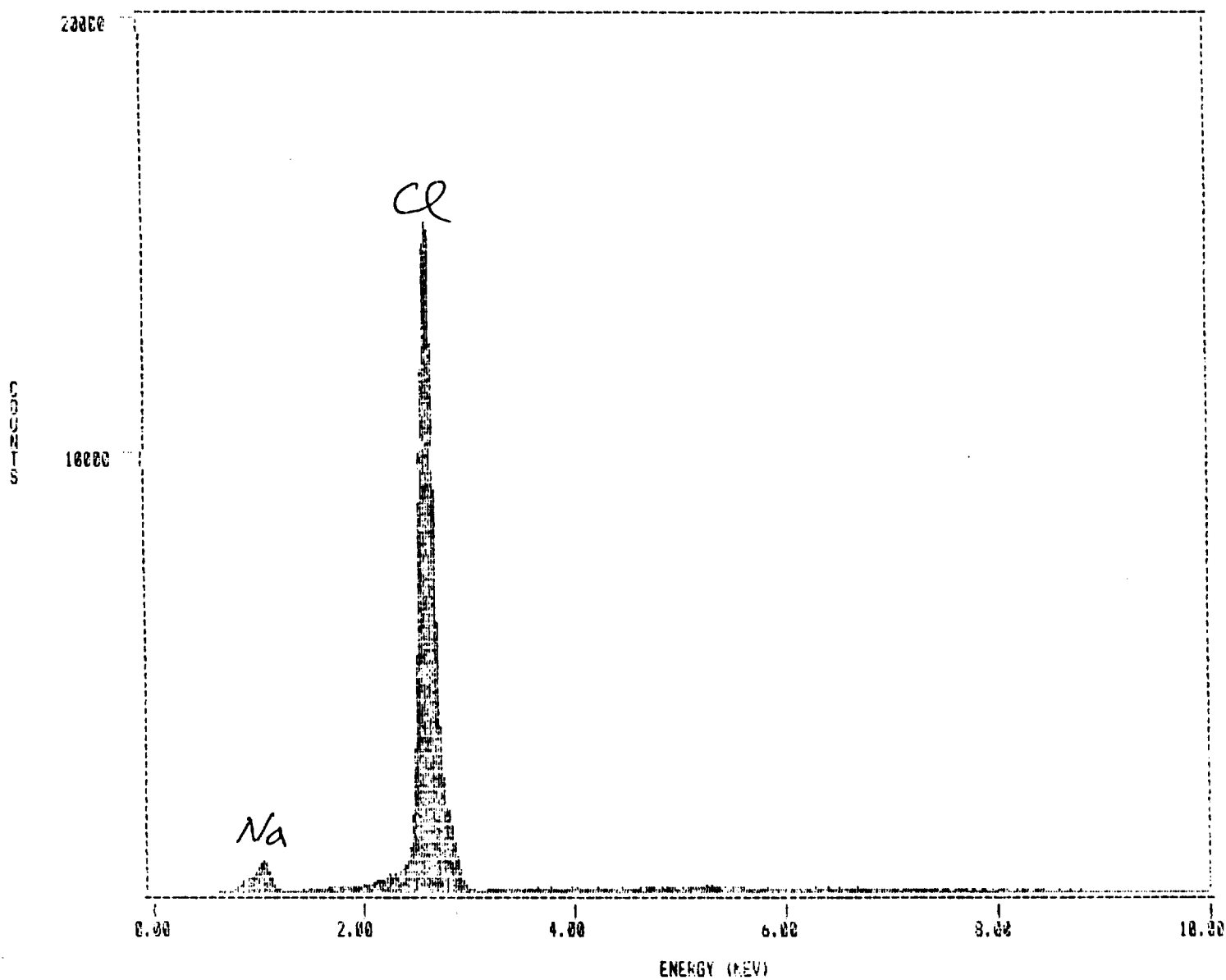

8 P (B) (T)

Figure 13 GLASS FIBER, 1,998-89

SPECTRUM LABEL

SPECTRUM FILE NAME

0000

0000 13989

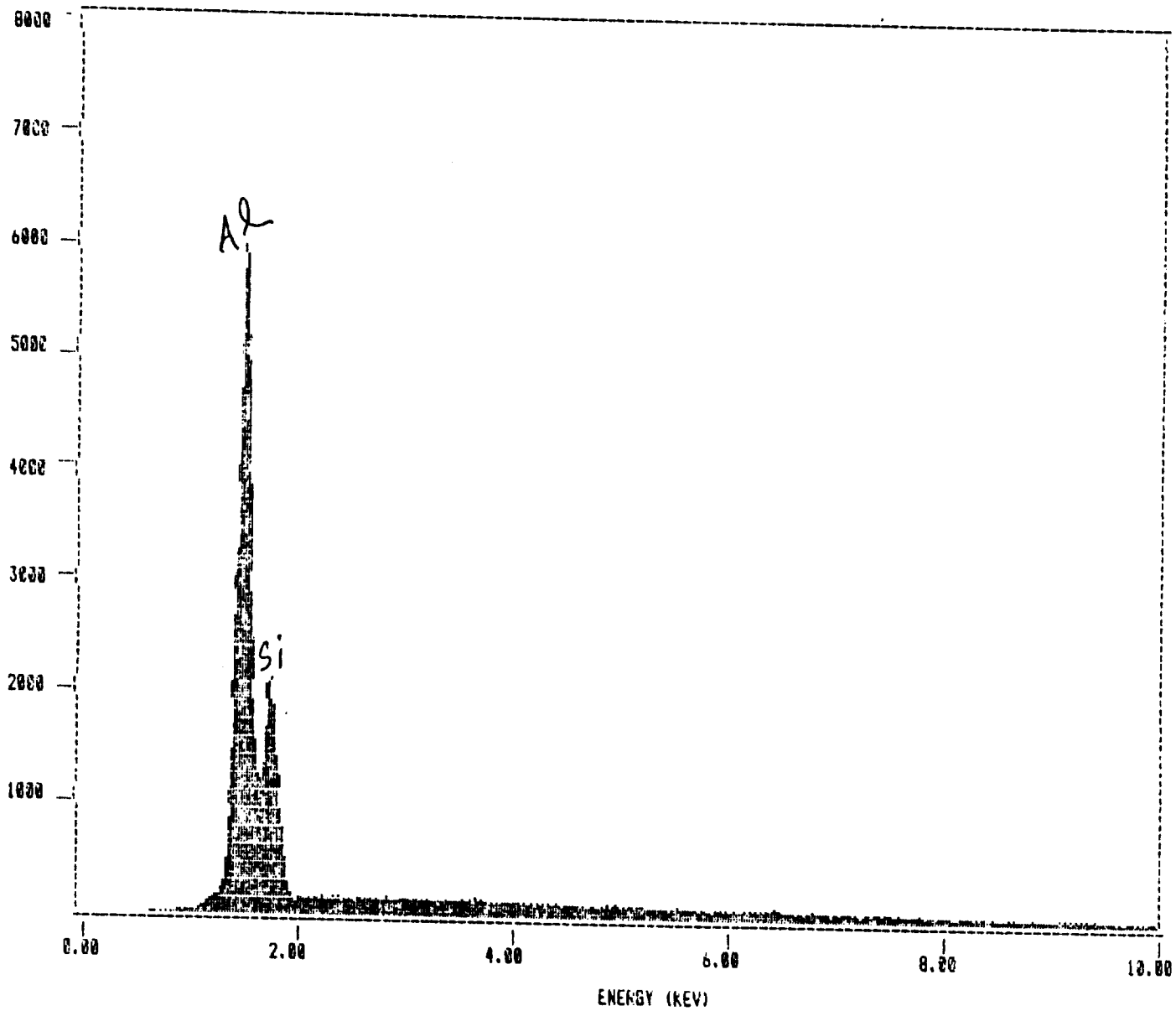

8 PIGIT I

Figure 14. DARK GREY AND WHITE, 2,998-89

SPECTRUM LABEL

████

SPECTRUM FILE NAME

████ 13957

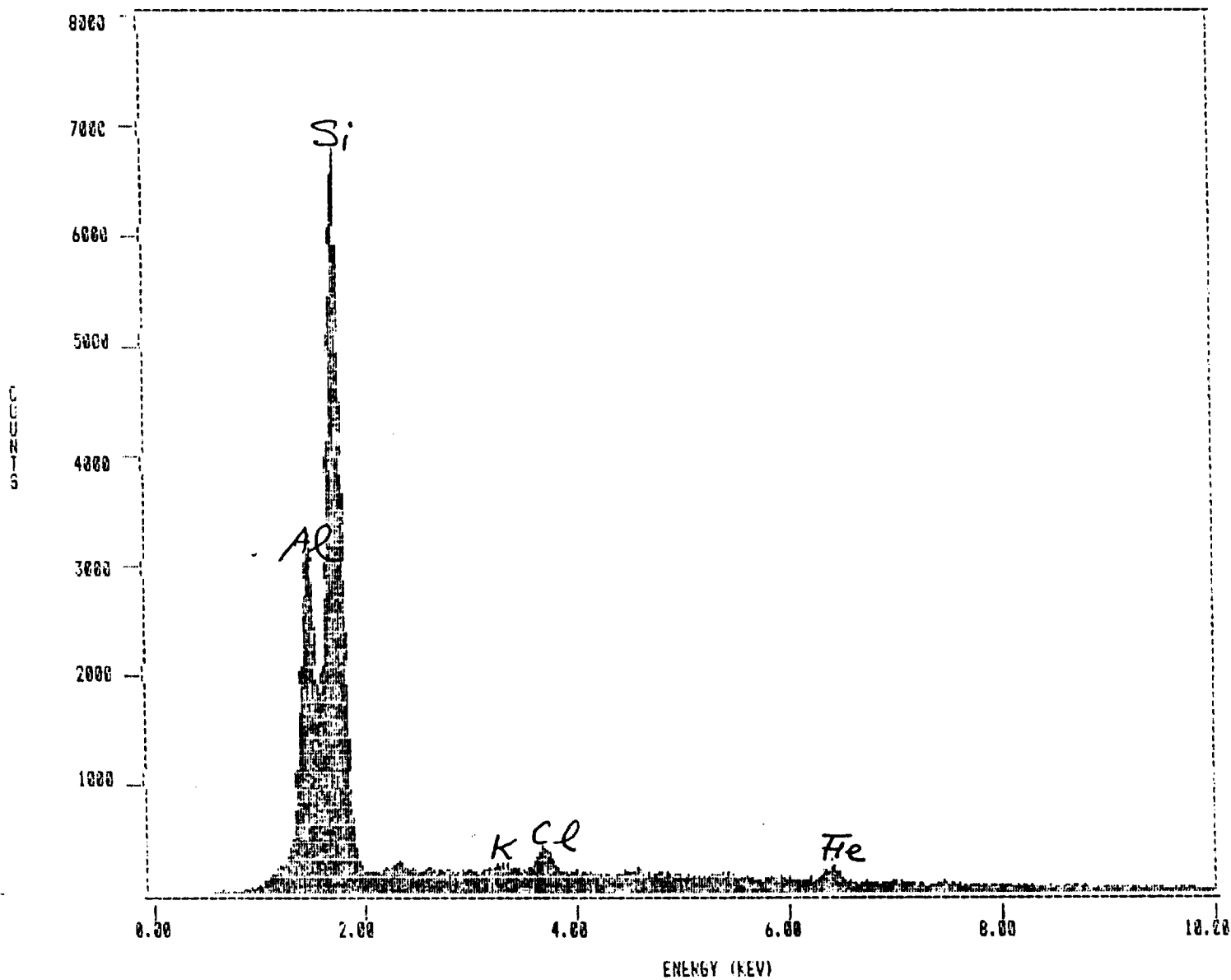

8 PIGIT1

Figure 15.

BRN FLAKE, 3,998-89

SPECTRUM LABEL

████

SPECTRUM FILE NAME

████ 14367

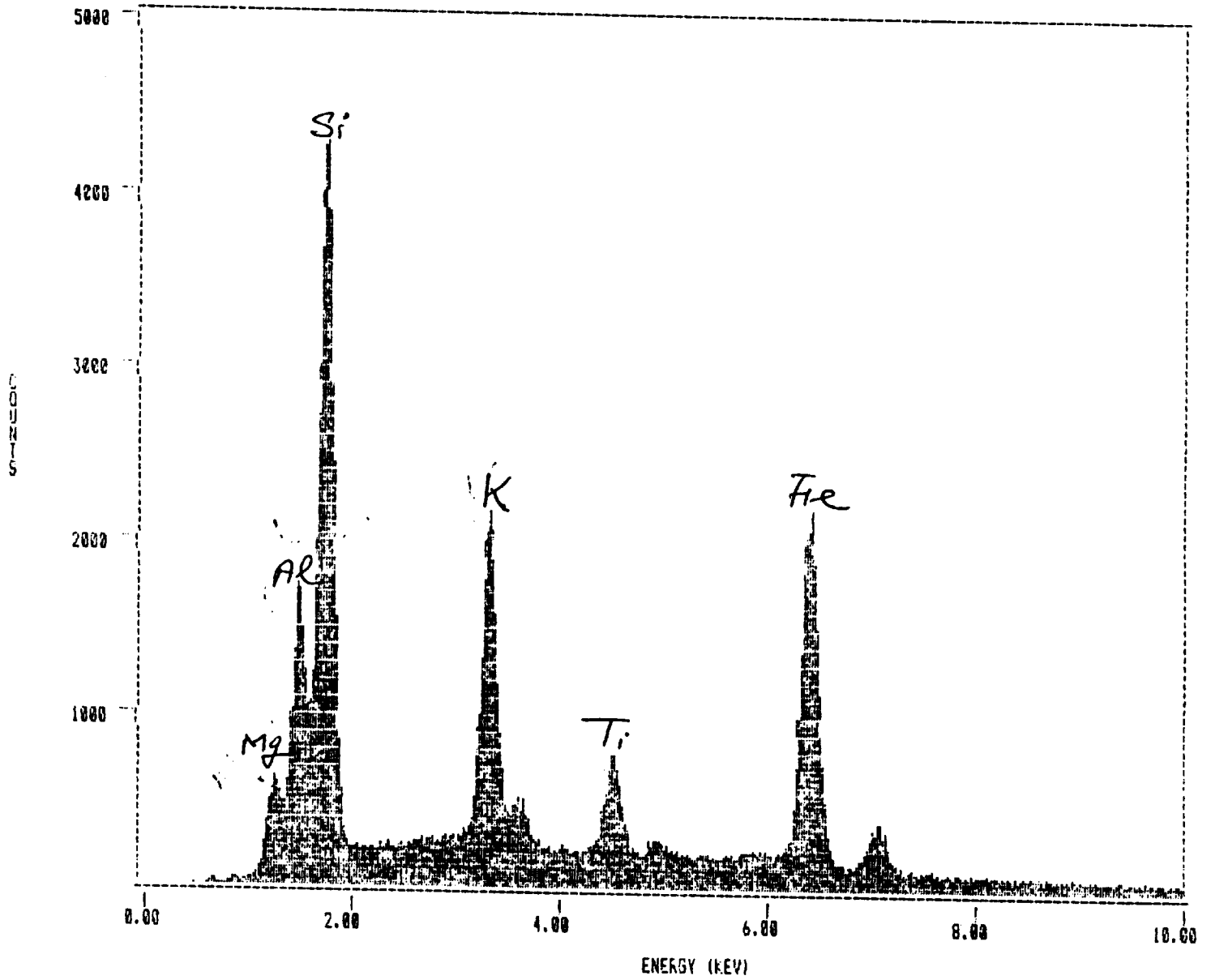

8 FIGIT1

Figure 16

BLACK MTL5,3,998-89

SPECTRUM LABEL

SPECTRUM FILE NAME

BLACK MTL5,3,998-89

14885

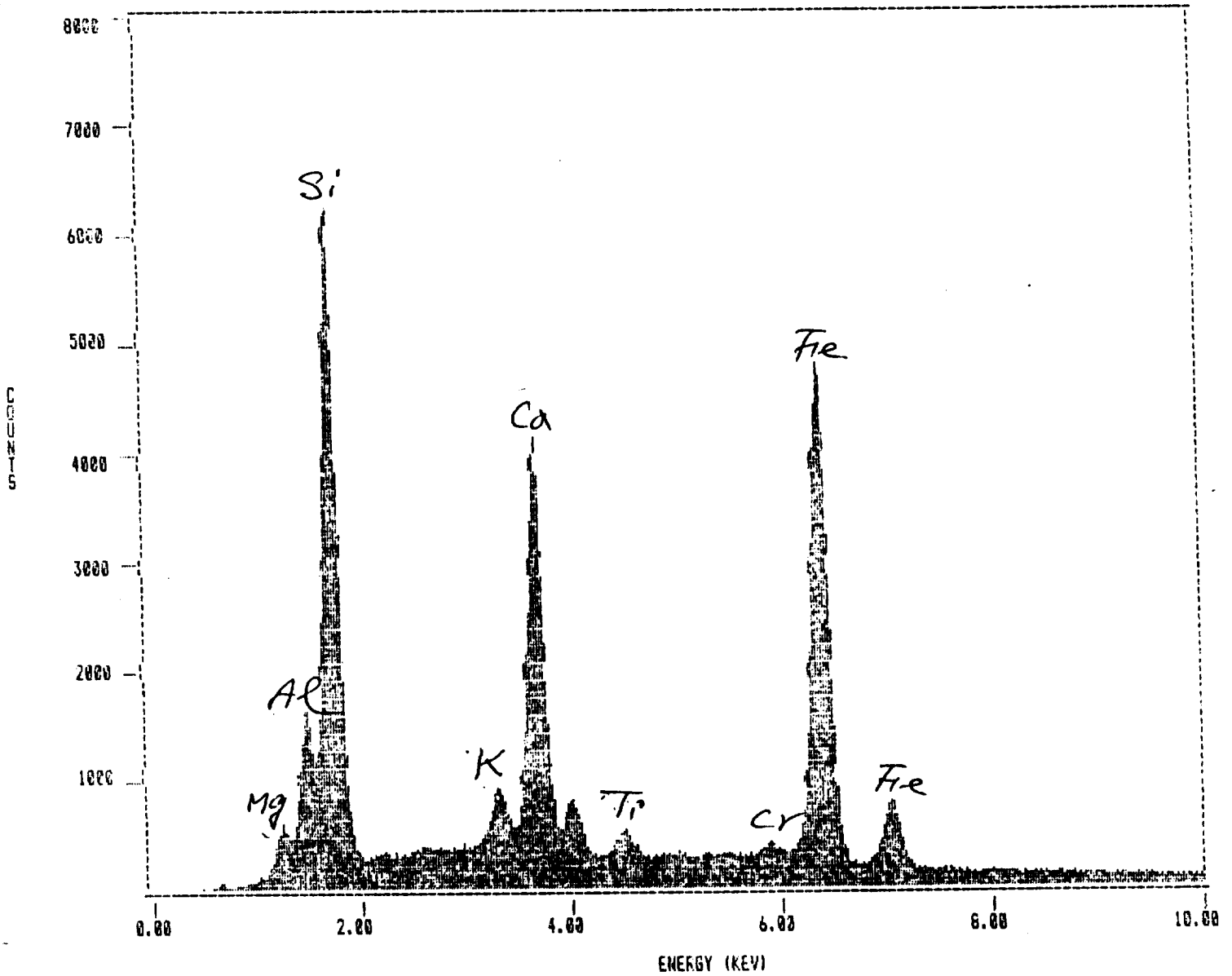

8 PIGIT1

Figure 17 AREA 1, WHOLE, WASHER, 998-89

SPECTRUM LABEL

SPECTRUM FILE NAME

████

████ 14189

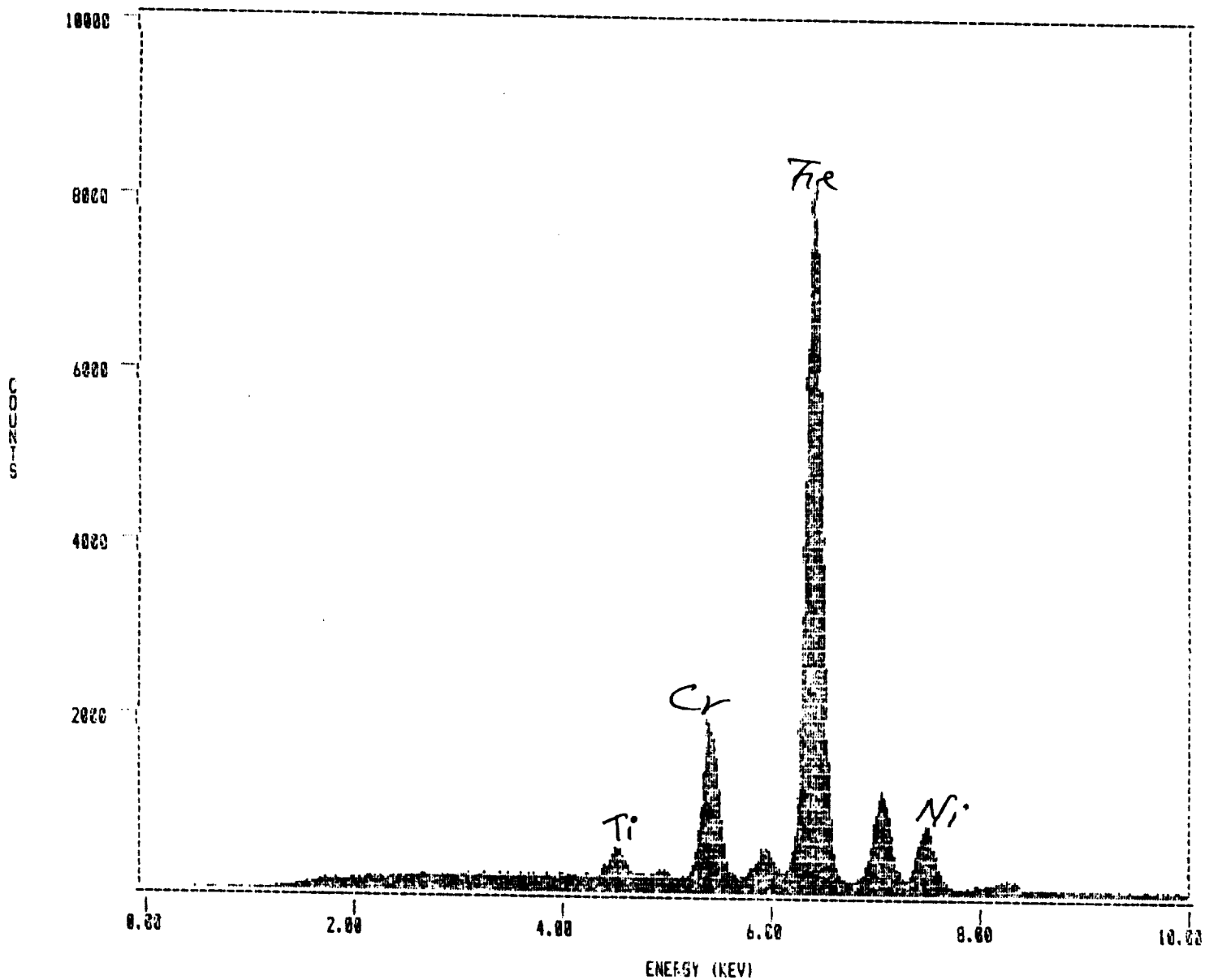

γ PIGITI

Figure 18

AREA 2, WHITE, WASHER, 998-89

SPECTRUM LABEL

998-89

SPECTRUM FILE NAME

998-89 14189

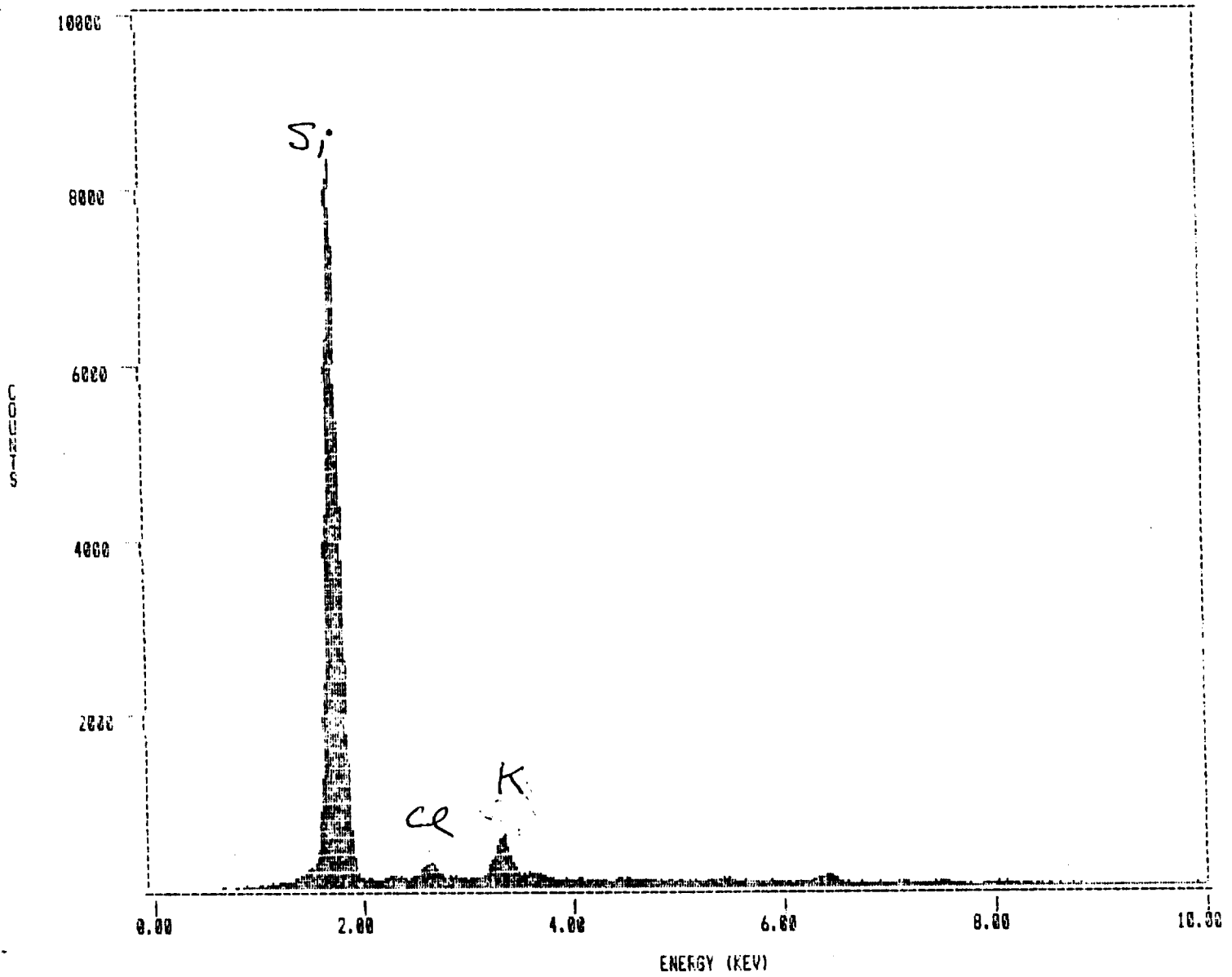

8 DIGIT

Figure 19.

AREA 3, WASHER, 998-89

SPECTRUM LABEL

SPECTRUM FILE NAME

AREA

14189

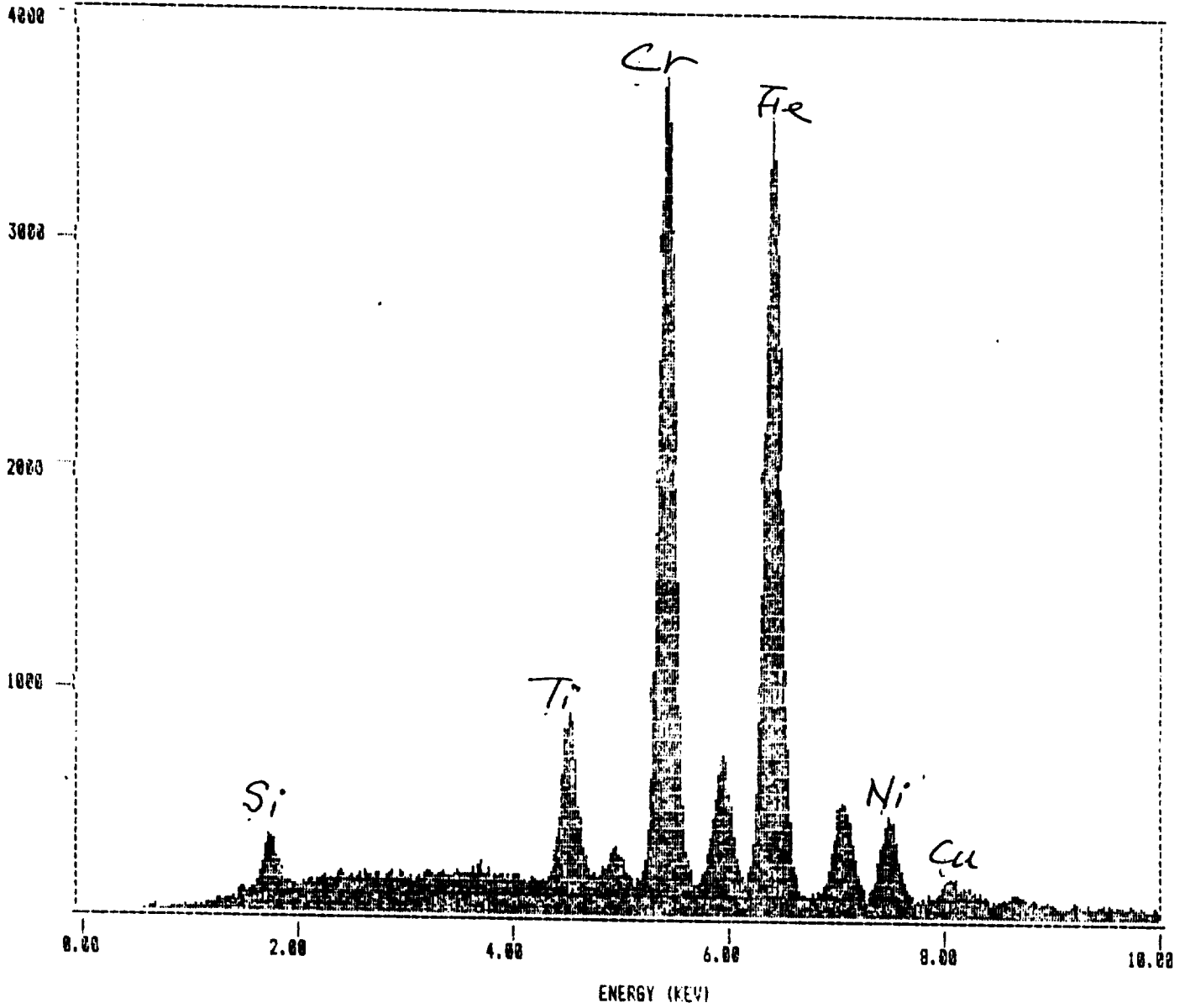

8 DIGIT

MICROCHEMICAL ANALYSIS BRANCH
DM-MSL-1, ROOM 1274, O&C BUILDING
NASA/KSC
NOVEMBER 14, 1989

SUBJECT: Orbiter Debris Samples

LABORATORY REQUEST NO: MCB-1004-89

RELATED DOCUMENTATION: Intercenter Debris Team Requirements

1.0 FOREWORD:

1.1 REQUESTER: R. F. Speece/TV-MSD-22/7-0806

1.2 REQUESTER'S SAMPLE DESCRIPTION:

The samples were removed from OV-104, STS-34, post landing at DFRF, and were identified as follows:

1. Tape from nose top numbered "6040."
2. RCC #9, Right.
3. RCC #12, good luck right.
4. RCC #14, right.
5. Left RCC #16.
6. Less lower #9, right adj to RCC #9.
7. Less lower #11, right adj to RCC #11.
8. Tape residue V070-394044-108.
9. Washer in tile, V070-191010-120-009080.
10. Deep impact, very small V070-191028-049.
11. One ft inb, 2 ft aft, L.E.T. 395009-077.
12. Right ET, umb cavity.
13. Right ET door foam.
14. Right ET umb plate.
15. Right ET baggie.
16. Left ET door "baggie mat."
17. Left ET door foam.
18. Left ET umbil cavity.
19. Left ET umbilical plate wipe.
20. TX 318, lintfree blank - control.

1.3 REQUESTED: Determine composition, identity, reentry affects (if any) and provide comparative analysis to shuttle element and ground system materials as origin of residue.

2.0 CHEMICAL ANALYSIS AND RESULTS:

2.1 Procedure:

The submitted samples were analyzed by means of optical microscopy (OM), infrared spectrometry and electron microprobe with energy dispersive spectrometry (EDS).

2.2 Results:

2.2.1 The particulates were classified into components on the basis of color and texture by OM. The classified components from all samples are listed in Table 1 with the possible identification of each component and elemental analysis.

Table 1

Component ID	Possible Ident.	Elemental Analysis by EDS*	
		Major	Minor
1. Metallics	Al,Zn,Cd Metals SS Carbon Steel	Al,Zn,Cd Fe,Cr	Ni
2. White Mtls	White tile	Si	
3. Black Mtls	Black tile	Si	
4. Red Rubbery	RTV	Fe,Si	
5. Lgt-Grn Mtls	Primer or Paint	Zn,Fe,Si	K
6. Black Sphere	C-Steel	Fe	
7. Glass Fiber	Insulation Glass High Temp Glass	Si,Al,Ca Si,Al	
8. Lgt-Brn Mtls	Si-Al-Sb-Cl Mtls	Si,Al,Sb,Cl	P,S,Fe,Ti
9. Organics			
10. Black Powder	Pb-Cl-Ca, dust	Pb,Fe,Cr,K,Cl,Ca	Cr,Ni,Zn,Ti,Si
11. Amber Sphere	Microballoon		
12. Off Wht Mtls	Calcite	Ca	
13. Blk Mtls	Si-Mg-Ca Mtls	Si,Mg,Ca	Al,Cl,Fe
14. Amber Flake	Fe-K-Si-Al	Fe,K,Si,Al	Ca,Mg

2.2.2 Table 2 lists estimated amounts of each component versus sample number.

Table 2

Sample No.	1	2	3	4	5	6	7	8	9	10	11
1. Metallics	Al	X	NO	X	X	X	X	X	X	X	X
2. White Tile	40	10		60	98	90	45	50	85	95	70
3. Black Tile	2	10		40	2	10	50	50	15	5	30
4. RTV	T	X		X	X	T	T	T	X	X	X
5. Primer	T	X		X	X	X	X	X	X	X	X
6. Paint	X	80		X	X	X	X	X	X	X	X
7. C-Steel	T	X		X	X	X	X	X	X	X	X
8. Glass Fiber	X	X		X	X	T	5	X	X	X	X
9. Si-Al-Sb-Cl Mtls	X	X		X	X	X	X	X	X	X	X
10. Organics	X	X		X	X	X	X	X	X	X	X
11. Pb-Cl-Ca Dust	X	X		X	X	X	X	X	X	X	X
12. Microballoon	X	X		X	X	X	X	X	X	X	X
13. Calcite	X	X		X	X	X	X	X	X	X	X
14. Dust, Rust	58	X		X	X	X	X	T	T	X	X
15. Blk Si-Mg-Ca Mtls	X	X		X	X	X	X	X	X	X	X
16. Amber Flakes	X	X		X	X	X	X	X	X	X	X
Particle Size Um	1- 200	1- 250		1- 5000	1- 80	1- 200	1- 100	1- 50	1- 4000	1- 150	1- 250

Al: Al-metal; NO: No Sample; T: Trace; X: Not detected.

Table 2

Sample No.	12	13	14	15	16	17	18	19
1. Metallics	X	X	X	Al	Al, Fe	X	Al, Zn	Ss, Al
2. White Tile	X	X	X	X	X	X	X	X
3. Black Tile	X	X	X	X	X	X	X	X
4. RTV	X	X	X	T	T	X	X	X
5. Primer	X	X	X	X	T	X	X	X
6. Paint	13	X	X	X	X	X	X	X
7. C-Steel	X	X	X	T	T	X	X	X
8. Glass Fiber	X	X	T	5	3	X	T	T
9. Si-Al-Sb-Cl Mtls	81	X	96	X	X	X	99	99
10. Organics	1	100	T	24	40	100	X	X
11. Pb-Cl-Ca Dust	X	T	4	X	X	X	X	X
12. Microballoon	X	X	X	X	T	X	X	X
13. Calcite	X	X	X	8	5	X	X	X
14. Dust, Rust	5	T	X	X	T	X	X	X
15. Blk Si-Mg-Ca Mtls	X	X	X	63	52	X	1	1
16. Amber Flakes	X	X	X	T	T	X	X	X
Particle Size Um	1- 300	ND	1- 250	1- 7000	1- 2000	ND	1- 110	1- 120

Al: Al-Metal; Fe: Carbon Steel; Zn: Zinc Metal;
 SS: 300 Series Stainless Steel; T: Trace;
 NO: Not Detected.

2.2.3 Figures 1 and 2 are OM photo micrograph of the black tile and SEM photomicrograph of amber-colored microballoon, respectively, to show the morphological features of those materials.

3.0 CONCLUSIONS:

- 3.1 The sample numbers 1, 15, 16, 18, and 19 contained trace amounts of metallics. The metallics were composed of a combination of Al-metal, Zn-metals, carbon steel, and a 300 series stainless steel.
- 3.2 Sample number 3 did not contain any particles.
- 3.3 The sample numbers 1 through 11 contained appreciable amounts of tile materials. The tiles were composed of black tile and white tile. Some particles of black tile surface show the melted or fused appearance which might have been at high temperature (Figure 1). No evidence of high temperature forms of mineral was noted from these particles.
- 3.4 The sample numbers 1, 6, 7, 8, and 15 contained trace amounts of room temperature vulcanizing rubber (RTV).
- 3.5 The sample numbers 1 and 16 contained trace amounts of light-green colored primer.
- 3.6 The sample numbers 2 and 12 contained appreciable amounts of paints.
- 3.7 The sample numbers 1, 15, and 16 contained trace amounts of carbon steel spheres.
- 3.8 The sample numbers 6, 7, 14, 15, 16, 18, and 19 contained trace amounts of glass fibers. The glass fibers were identified to be a combination of insulation, tile, and high temperature Al, Si, B glass.
- 3.9 The sample numbers 12, 14, 18, and 19 contained large amounts of light-brown colored Si-Al-Sb-Cl rich materials.
- 3.10 The sample numbers 12 through 17 contained organics. The organics were composed of polyurethane (similar to type "PDL") and black-colored vitan rubber with talc-like filler materials. The light amber organic colored tapes were identified to be Kapton-type polyimide film.

- 3.11 The sample numbers 13, and 14 contained pb-Cl-Ca rich materials and dust particles.
- 3.12 The sample numbers 16 contained small amounts of microballoon.
- 3.13 The sample numbers 1, 8, 9, 12, 13, and 16 contained appreciable amounts of dust and rust materials.
- 3.14 The sample numbers 15, 16, 18, and 19 contained large amounts of black colored Si-Mg-Ca rich materials (probably vitan rubber with talc filler).
- 3.15 The sample numbers 15 and 16 contained amber-colored Fe-K-Si-Al rich flakes (probably micaceous materials).
- 3.16 The particle sizes were estimated to be in the range of 1 to 7000 micrometers.
- 3.17 The particulates of sample numbers 12 through 19 could be related to the natural environments and these of samples 1 through 11 could be related to the TPS system.

CHEMIST: H. S. Kim
H. S. Kim

APPROVED: J. F. Jones
J. F. Jones

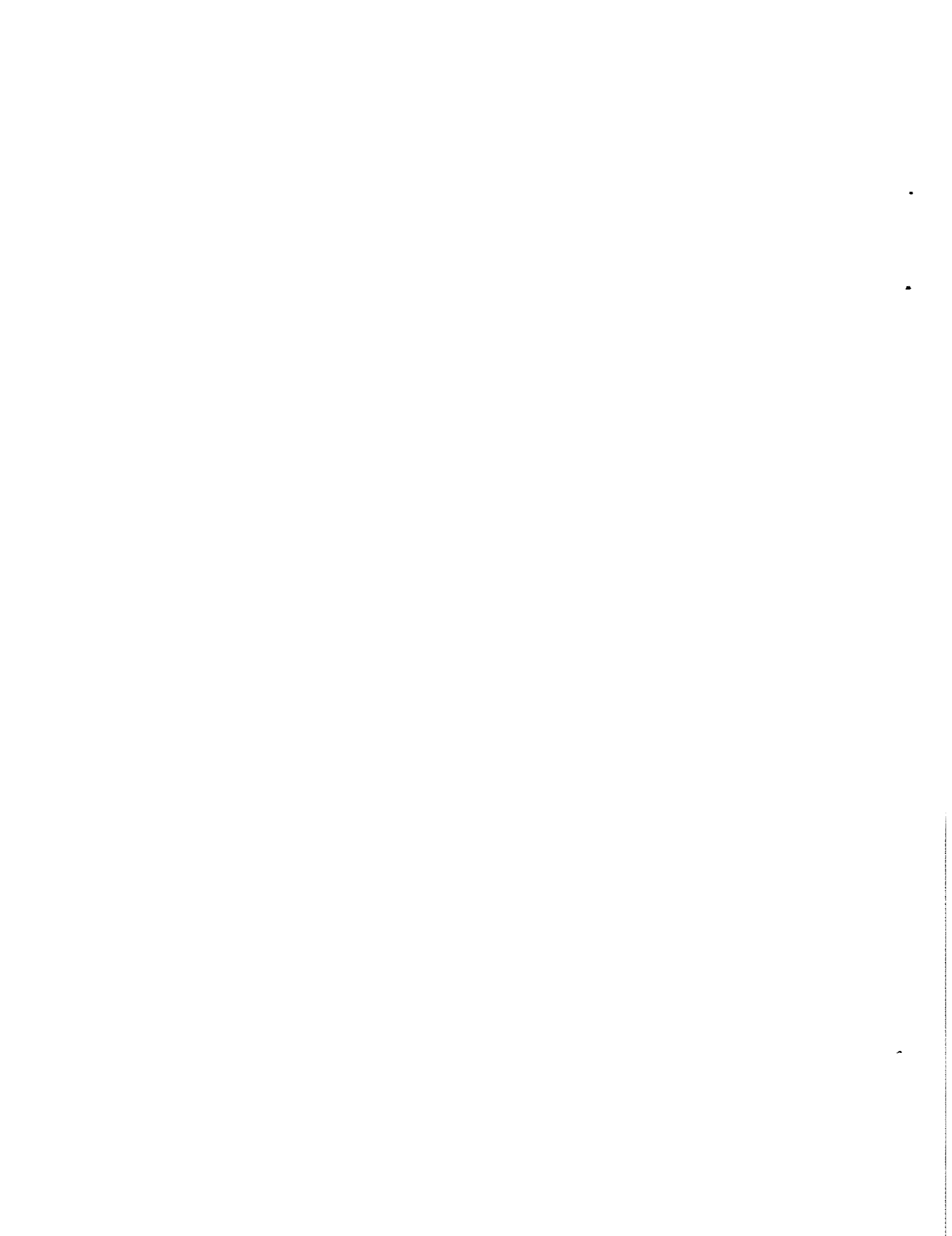

ORIGINAL PAGE
 BLACK AND WHITE PHOTOGRAPH



FIGURE 1. OM PHOTOMICROGRAPH OF THE BLACK TILE. THE SURFACE OF TILE SHOWS THE MELTED OR FUSED APPEARANCE. 20X, #4

ORIGINAL PAGE
 BLACK AND WHITE PHOTOGRAPH

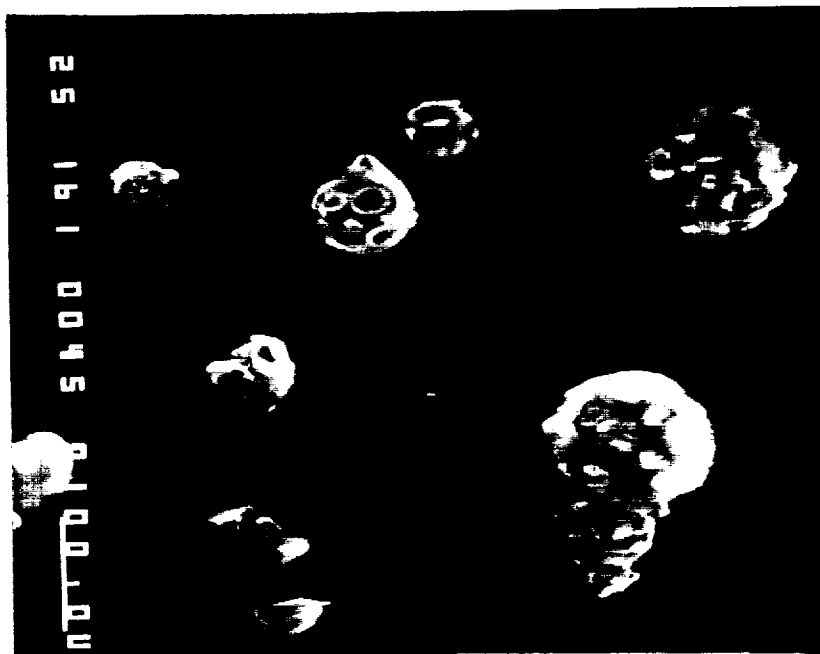
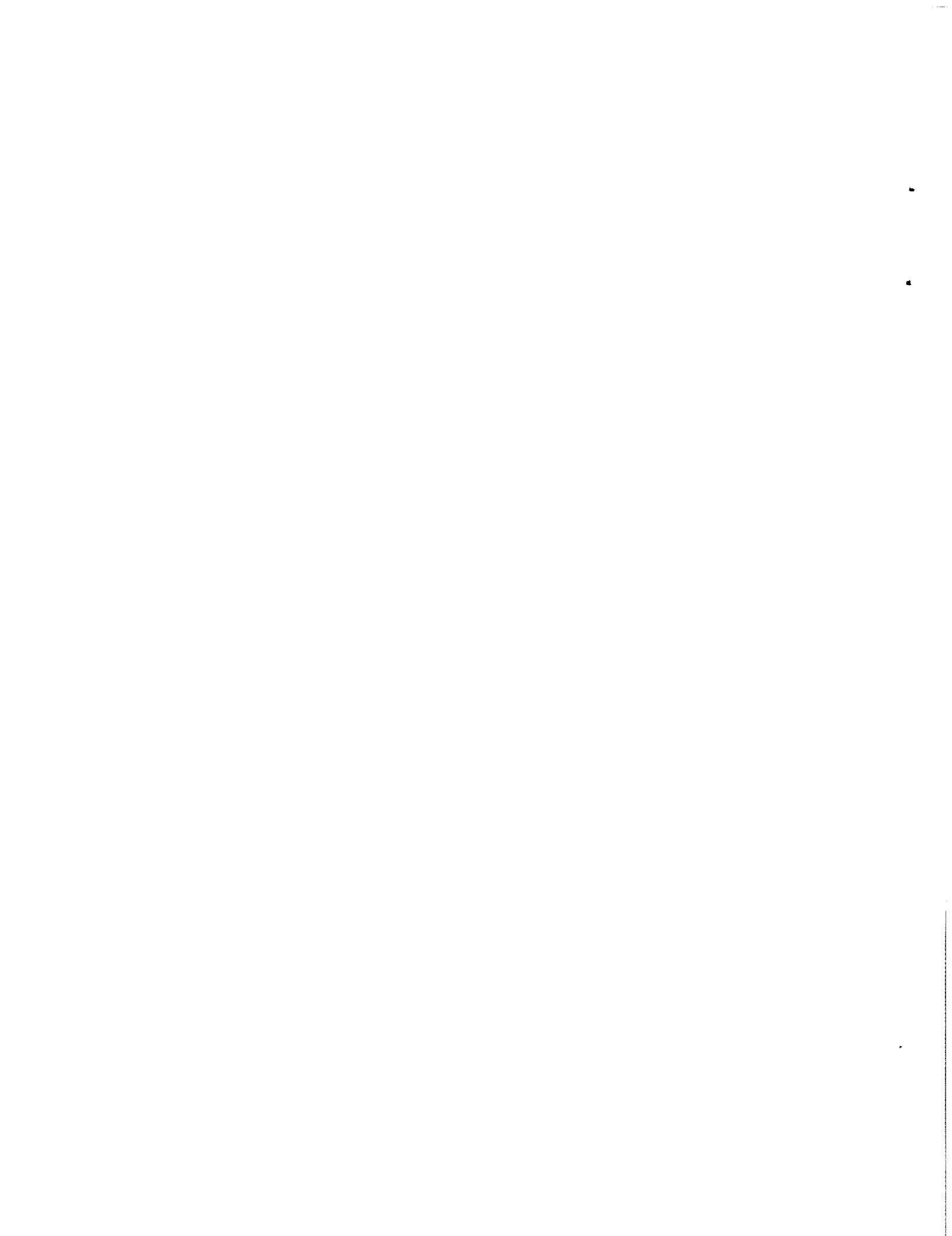

FIGURE 2. SEM PHOTOMICROGRAPH OF MICROBALLOON. 160X, #16



11.0 POST LAUNCH ANOMALIES

Based on the debris inspections and film review, 39 Post Launch Anomalies were observed for STS-34.

11.1 POST LAUNCH PAD DEBRIS INSPECTION

There were no post launch anomalies documented during the pad debris inspection after launch.

11.2 FILM REVIEW

1. Stud 'hang-up' at liftoff on holddown post #2 caused unusual upward movement of the HDP shoe and spherical bearing.
2. Hydrogen 'lead' exited SSME #1 nozzle prior to ignition and appeared to be longer in duration than previously observed main engine firings. Three orange flashes occurred in the plume of SSME #1 and appeared to originate inside the bell nozzle.
3. SRB Holddown Post #1 and #5 Debris Containment Assemblies (DCA) shook slightly at T-0. No movement was expected.
4. An orange GSE tile shim (feeler gage) was left in a tile gap at a location 1 foot forward and centered above the RH inboard elevon hinge line and became debris during liftoff.
5. Numerous unidentified objects (as many as 50) fall out of the SRB plume before and after separation. These objects may be pieces of SRB propellant or slag.
6. Rympel cloth is blown from the RH SRB aft skirt GN2 purge port.
7. A 4"x3" piece of intertank foam was pulled from an area near the lower LH corner of the ET umbilical carrier plate during GUCP disconnect.
8. The GH2 vent line lanyard had excessive slack during retraction and contacted the 7-inch quick disconnect probe.
9. Body flap motion occurs after roll maneuver and throughout most of the ascent. Amplitude and frequency appear to be similar to that observed on OV-102 during STS-28R.
10. On-orbit photos of the External Tank showed divots on both LH2 tank-to-intertank and LO2 tank-to-intertank flanges. The bipods had not folded up against the tank after separation.

11.3 SRB POST FLIGHT/RETRIEVAL INSPECTION

11. MSA-2 was debonded at 3 locations on the RH frustum.
12. BSM attachment rings on both frustums exhibited the same bending/twisting characteristics and screw hole elongations as noted on previous missions.
13. K5NA closeouts were not accomplished on the inboard corners of the forward ET/SRB interface cable trays on both SRB's.
14. Sea water had penetrated into both forward skirts.
15. A 30"x8" area of MSA-1 was missing from a RH forward segment systems tunnel cover.
16. Two 2"x3" pieces of GEI cork were missing from the RH aft booster and appeared to come off during ascent.
17. A RH ETA ring cover attachment bolt head was broken.
18. K5NA was missing from all 8 BSM nozzles.
19. Instafoam was missing from the aft ring around the aft skirt feet, HPU exhaust horns, and joint heater umbilicals on both SRB's.
20. Holddown post #2 aft skirt stud hole was broached. Stud thread impressions occurred near the aft end of the bore. Some stud contact was visible in all the other aft skirt stud holes except for HDP #5.
21. The K5NA closeout on the trailing edge of the LH SRB forward center field joint was debonded from both the case wall and the cork trailing edge at the 320 degree radial location. The debond measured 7 inches in length. An impact occurred on the trailing edge, but this should not cause a debond.
22. Two of the LH SRB factory joints exhibited insulation-to-case debonds. The first, at station 531.5, 225-248 degree radial location, was on the leading edge of the LH forward dome joint seal and was approximately 30 inches in length. The second, at station 1011.5, 45 degree radial location, was also on the leading edge of the LH forward center segment joint seal and was 7 inches in length.
23. Two GEI ID epoxy-covered tags were missing from both aft boosters.
24. A 3-inch diameter and a 5"x1" piece of material was missing from holddown post #8 shim prior to water impact.
25. Electrical connector lockwire was either wired incorrectly or missing altogether.

11.4 ORBITER POST LANDING INSPECTION

26. A large damage site measuring 3"x5"x3/4" occurred on the outboard aft corner of the LH OMS pod stinger and involved three tiles.
27. The SSME closeout blankets were damaged on SSME #1 and #2.
28. Q-felt plugs were missing from two closeout panel fastener holes on the base heatshield.
29. A #10 washer approximately 1/2-inch in diameter was embedded in one of the lower surface tiles.
30. Two gap fillers were protruding on the lower surface.
31. Two pieces of gap filler sleeving 4 inches long were loose on the RH OMS pod.
32. Aluminum tape on the inside surface of the LH MLG door had pulled loose at two locations.
33. Several pieces of tape, or charred tape residue, still adhered to tile surfaces.
34. A piece of the ordnance device wire shielding (1/2" dia by 3/4-inch long) and a 1/4-inch diameter washer fell from the EO-3 fitting when the ET/ORB LO2 umbilical door was opened.
35. The EO-3 ball fitting ordnance plunger failed to seat properly.
36. A survey marker/concrete post 1 foot in diameter protruded approximately 3/4-inch above the Runway 23 surface - 287 feet away from the Orbiter touchdown point.
37. A live 50 caliber shell lay approximately 0.3 miles before the Runway 23 threshold, 33 feet east of the centerline.
38. A bolt washer and retainer insert were missing from SSME #2 carrier panel at the 2 o'clock position.
39. A stop-bolt was bent in the EO-1 attach point assembly.

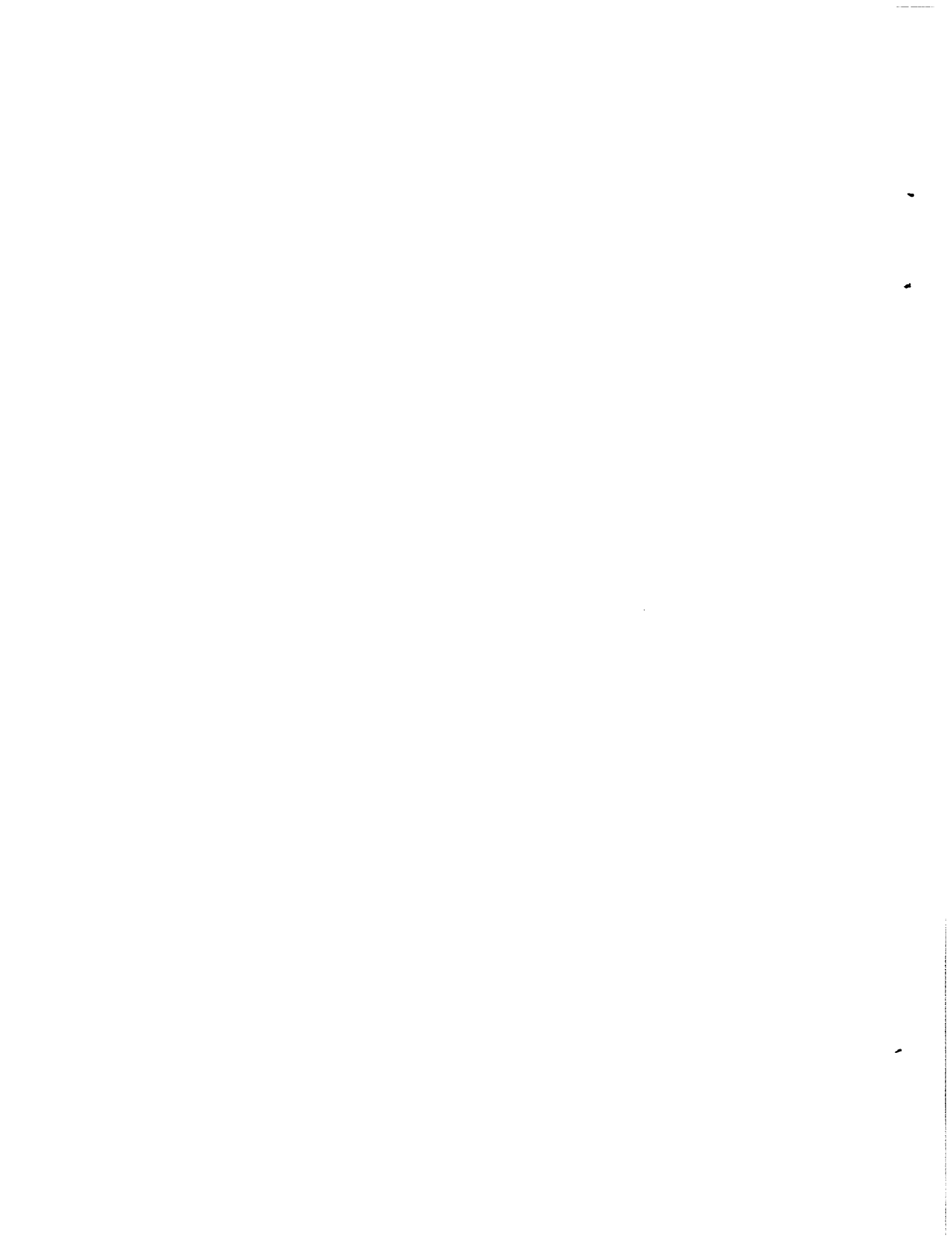



Report Documentation Page

1. Report No. TM 102153		2. Government Accession No.		3. Recipient's Catalog No.	
4. Title and Subtitle Debris/Ice/TPS Assessment and Photographic Analysis for Shuttle Mission STS-34				5. Report Date November 1989	
				6. Performing Organization Code	
7. Author(s) Charles G. Stevenson Gregory N. Katnik Scott A. Higginbotham				8. Performing Organization Report No.	
				10. Work Unit No.	
9. Performing Organization Name and Address NASA External Tank Mechanical Systems Division Mail Code: TV-MSD-22 Kennedy Space Center, Florida 32899				11. Contract or Grant No.	
				13. Type of Report and Period Covered	
12. Sponsoring Agency Name and Address				14. Sponsoring Agency Code	
				15. Supplementary Notes	
16. Abstract <p>A Debris/Ice/TPS assessment and photographic analysis was conducted for Space Shuttle Mission STS-34. Debris inspections of the flight elements and launch pad are performed before and after launch. Ice/frost conditions on the External Tank are assessed by the use of computer programs, nomographs, and infrared scanner data during cryogenic loading of the vehicle followed by on-pad visual inspection. High speed photography is analyzed after launch to identify ice/debris sources and evaluate potential vehicle damage and/or in-flight anomalies. This report documents the debris/ice/TPS conditions and photographic analysis of Mission STS-34, and their overall effect on the Space Shuttle Program.</p>					
17. Key Words (Suggested by Author(s)) STS-34 Ice Frost Debris Thermal Protection System (TPS) Photographic Analysis				18. Distribution Statement Publicly available Unclassified - Unlimited	
19. Security Classif. (of this report) Unclassified		20. Security Classif. (of this page) Unclassified		21. No. of pages	22. Price

