

119.  
11-03-CR  
253804  
1958.

# California Air Transportation Study

## A Transportation System for the California Corridor of the Year 2010

Presented to

Professor A. E. Andreoli

by

The Senior Design Class  
Aeronautical Engineering Department  
California Polytechnic State University  
San Luis Obispo

22 May 1989

(NASA-CR-186219) CALIFORNIA AIR  
TRANSPORTATION STUDY: A TRANSPORTATION  
SYSTEM FOR THE CALIFORNIA CORRIDOR OF THE  
YEAR 2010 (California Polytechnic State  
Univ.) 195 p

N90-14212

Unclas  
CSCL 01C G3/03 0253804

## Table of Contents

|   |    |
|---|----|
| ABSTRACT  |    |
| (Mark Cameron, Sean McMillin)   |    |
| SUMMARY   | 2  |
| (Naseer Khan)   |    |
| VTOL  | 3  |
| ECTOL   | 3  |
| Mag-Lev   | 3  |
| CONCLUSION  | 5  |
| (Naseer Khan)   |    |
| CORRIDOR MARKET ANALYSIS  | 6  |
| (Mark Cameron, Steve Chen, Cliff Harvey, Naseer Khan, Kevin Mahaffy, Lan<br>To, Glenn Wilcox, Annette Wolf, Glenn Yanagi) |    |
| Physical Definition of the California Corridor  | 6  |
| Economic Impact of Transportation in California   | 7  |
| Evolution of Ground Transportation by the Year 2010   | 7  |
| Automobile Trends   | 8  |
| Currently Proposed Solutions  | 12 |
| Air Travel  | 13 |
| Commuter Aircraft Forecast  | 17 |
| Airport Access  | 21 |
| Pollution Concerns in the California Corridor   | 22 |
| Freight Transportation  | 22 |
| Financing Transportation in the California Corridor   | 23 |
| Travel Into The Twenty First Century  | 25 |
| Conclusions   | 26 |
| DEMAND MODEL  | 29 |
| (Naseer Khan)   |    |
| Gravity Model   | 30 |
| Geographical Set-Up   | 31 |
| Model Implementation  | 31 |
| Model Calibration   | 32 |
| Applications  | 36 |
| Conclusions   | 39 |

|  |     |
|--|-----|
| FUTURE OF AIR TRANSPORTATION   | 41  |
| (Kevin Mahaffy)  |     |
| CALIFORNIA CORRIDOR AIR TRANSIT SYSTEM   | 46  |
| (Steve Chen, Lisa Lechmanski, Kevin Mahaffy, Todd Riddle, Victor Sikora)   |     |
| Air Traffic Control  | 48  |
| Noise Considerations   | 51  |
| Integration and implementation   | 53  |
| NOISE  | 56  |
| (Michael Forster, Sandra Grabhorn, Kyle Naydo, Todd Riddle)  |     |
| Introduction   | 56  |
| Noise Measurement  | 56  |
| Acceptance and Regulation  | 62  |
| Noise Reduction  | 65  |
| Conclusion   | 66  |
| CORRIDOR ACCESS PORT   | 68  |
| (Steve Chen, Kevin Mahaffy, Todd Riddle, Lan To, Glenn Yanagi)   |     |
| Overview   | 68  |
| Air Traffic Control  | 71  |
| Weather  | 72  |
| Utilities and Facilities   | 73  |
| Air-Carrier Politics   | 74  |
| CONFIGURATIONS INVESTIGATION SUMMARY   | 77  |
| (Steve Chen, Paul Davis, Cliff Harvey, Lisa Lechmanski, Jim Lee, Stephanie<br>Los, John Lung, Todd Riddle, Glenn Yanagi) |     |
| ELECTRIC CONVENTIONAL TAKEOFF AND LANDING AIRCRAFT   | 85  |
| (Mark Cameron, Michael Forster, Sean McMillin, Pete Van Horn, Glenn<br>Wilcox)   |     |
| Mission Specifications   | 86  |
| Configuration  | 87  |
| Fuselage Design  | 92  |
| Wing Design  | 96  |
| Landing Gear   | 99  |
| Empennage and Control Surface Sizing   | 103 |
| Propulsion system  | 104 |
| Avionics   | 111 |
| Weights and Balance  | 111 |

|  |            |
|--|------------|
| Performance  | 112        |
| Drag Polars  | 113        |
| Power Required, Power Available, and Rate of Climb | 118        |
| Lift over Drag Ratios                              | 120        |
| Thrust Required vs. Velocity                       | 122        |
| Stability Derivatives                              | 122        |
| Propeller Performance Calculations                 | 122        |
| Materials/Structures                               | 123        |
| Cost Analysis                                      | 123        |
| Conclusion   | 126        |
| <b>MAG-LEV TRAIN SYSTEM</b>                        | <b>128</b> |
| (Kyle Naydo, Annette Wolf, Terri Wolthers)         |            |
| Introduction                                       | 128        |
| Passenger Demand                                   | 128        |
| Routing  | 131        |
| Scheduling   | 133        |
| Vehicle Design                                     | 133        |
| Guideway   | 136        |
| Costs  | 140        |
| System Flexibility                                 | 140        |
| Mag-Lev Noise                                      | 140        |
| Mag-Lev Pollution                                  | 140        |
| Levitation System                                  | 143        |
| Propulsion   | 148        |
| Guidance   | 152        |
| Safety   | 156        |
| <b>THE WILDCAT -- A TILT ROTOR FOR 2010</b>        | <b>160</b> |
| (Paul Davis, Lisa Lechmanski, Victor Sikora)       |            |
| Mission Specifications                             | 160        |
| Design Method                                      | 162        |
| Configuration                                      | 162        |
| Wing and Empennage                                 | 163        |
| Rotor Airfoil                                      | 164        |
| Propulsion System                                  | 166        |
| Liquid Hydrogen Fuel System                        | 166        |
| Performance  | 168        |

|  |     |
|--|-----|
| Cockpit and Cabin Layouts                              | 172 |
| Landing Gear   | 172 |
| Noise  | 173 |
| Safety   | 173 |
| Ground Facilities                                      | 174 |
| Cost Analysis  | 174 |
| Areas of Further Study                                 | 177 |
| Conclusions  | 178 |
| APPENDIX A. Electric CTOL Aircraft Sample Calculations |     |
| APPENDIX B. Tilt Rotor Aircraft Sample Calculations    |     |
| APPENDIX C. Areas of Further Research                  |     |
| Fuels and Propulsions Study                            |     |
| Advanced Aircraft Materials                            |     |
| Airship Transportation System                          |     |
| APPENDIX D. Vehicle Overview                           |     |
| APPENDIX E. The Compound Helicopter                    |     |
| APPENDIX F. Configurations Evaluation Trade-off Data   |     |
| APPENDIX G. Demand Model Input/Output Data             |     |
| APPENDIX H. Vehicle Cost Analysis                      |     |
| APPENDIX I. Noise Assessment Program                   |     |

1  
2  
3  
4  
5  
6  
7  
8  
9  
10  
11  
12  
13  
14  
15  
16  
17  
18  
19  
20

## ABSTRACT

To define and solve the problems of transportation in the California Corridor in the year 2010, the 1989 California Polytechnic State University Aeronautical Engineering Senior Design class determined future corridor transportation needs and developed a system to meet the requirements. A market study, which included interpreting travel demand and gauging the future of regional and national air travel in and out of the corridor, allowed the goals of the project to be accurately refined. Comprehensive trade-off studies of several proposed transportation systems were conducted to determine which components would form the final proposed system, then preliminary design and further analysis was performed for each resulting component.

The proposed system consists of three vehicles a special hub or mode mixer, the Corridor Access Port (CAP). The vehicles are an electric powered aircraft to serve secondary airports and the CAP, a high speed magnetic levitation train running through the CAP and the high population density areas of the corridor, and a vertical takeoff and landing tilt rotor aircraft to serve both intercity and intra-metropolitan travelers from the CAP and city vertiports. The CAP is a combination and an extension of the hub, mode mixer, and Wayport concepts. The CAP is an integrated part of the system which meets the travel demands in the corridor, and interfaces with interstate and international travel.

## SUMMARY

The California Corridor Air Transit (CAT) System is designed around the concept of the central hub known as the Corridor Access Port (CAP). To provide service throughout the Corridor using the CAP, two types of aircraft have been designed: a tilt rotor vertical takeoff and landing aircraft (VTOL) using hydrogen fuel, and a conventional takeoff and landing aircraft using electric propulsion (ECTOL). The forte of the VTOL is in serving the large metropolitan areas such as Los Angeles, San Francisco, and San Diego, because it can operate closer to its passengers initial origins or final destinations, thereby eliminating ground access problems. The ECTOL would provide an additional means of transport with less of a door-to-door nature. It will fly routes between the CAP and existing airports such as Long Beach, Orange County, or Ontario in the L.A. area, Oakland, Concord, or San Jose in the Bay Area, or small cities such as Santa Barbara and Reno. To supplement the handling of the total traffic generated in the California Corridor, a high speed rail ground system, incorporating magnetic levitation (Mag-Lev) has been additionally designed into the system. This train will run north-south routes from San Diego to Sacramento. It provides service for high volumes of traffic at low operating cost.

In order to meet the specifications set by the corridor transportation analysis, and to provide service for the travel demand expected, each part of the system will have a certain number of vehicles, terminals, and support facilities.



## VTOL

By placing vertiports in the major metropolitan areas, namely Los Angeles, San Francisco, San Diego, and Sacramento, using the requirements laid down by the level-of-service criteria and the noise guidelines, it was estimated that there would be approximately 58 vertiports required throughout the Corridor. There would be up to 6 flights per hour for the urban vertiports, while the suburban vertiports would handle 4 flights per hour. Working with vehicle flow dynamics and assuming a load-unload time of 10 minutes and refuel times of 5 to 10 minutes, it was calculated that there would be at least 8 VTOLs per urban vertiport and 6 VTOLs per suburban vertiport required to fly between the CAP and the vertiport during peak times. Assuming that half the vertiports would be of the urban type and half would be of the suburban type, it was calculated that 406 VTOL aircraft would be required. Accounting for aircraft out of service for maintenance and other miscellaneous reasons, it was estimated that 450 aircraft would initially be manufactured. By stipulating that the major portion of refueling and maintenance be done at one central location, and adjusting the vehicle schedules and overhauls accordingly, a single fueling and maintenance facility could be located at the CAP.

## ECTOL

The electric CTOL (ECTOL) would serve the airports currently being served by commuter airlines. Their niche in the system would be service to existing airports in the metropolitan areas throughout the Corridor. In the large cities, these ECTOLs would provide a somewhat lower level service at higher load factors than the VTOL, and would do so at a somewhat lower cost. For smaller cities that are not served by VTOLs and are not on the Mag-Lev route, the ECTOLs would be the only source of Corridor transportation. From the above conditions, 32 airports in the California Corridor were targeted for ECTOL operations. The existent terminals will require minor modifications to accommodate electric propulsion aircraft. To serve these ports with a specified frequency of 4 flights per hour would result in a requirement of six ECTOLs per link, for a total of 192 aircraft. With overhead, a final estimate resulted in the need for about 210 aircraft. Fuel and maintenance facilities will be located at each airport served with a central support facility at the CAP.

## Mag-Lev

The Mag-Lev will run from San Diego to Sacramento with a branch at Los Angeles going to Indio and a branch at Stockton going to Concord in the Bay Area. In order to provide optimum service, an attractive balance was established between two factors. By placing as many stops as possible along the way, the travel demand would increase. However, with too many stops, the stage length and average speed would decrease beyond acceptable levels. Therefore, an optimum selection based on operating cost

was made. This allowed for 12 terminals in the following locations: Sacramento, Stockton, Concord, Fresno, the CAP, Bakersfield, Glendale, Los Angeles, Anaheim, San Diego, Ontario, and Indio. To transport the flow expected during peak times, it was calculated that 56 cars would be needed; a fleet estimate of 66 cars allows for overhead. For this particular route selection, allowing rail movement in both direction, there would be 585 miles of double guideway required. Two stockyards and maintenance facilities will be located at Stockton and Ontario.

## CONCLUSION

The numbers of vehicles, terminals, and support facilities for each of the modes in the CAT system will adequately provide service for the forecasted demand of intercity, national, and international travelers in the year 2010. While the system will be pushed to its limits during its peak periods, there will be extra vehicles available during the longer duration base and night periods. This will allow for alternative uses such as mail, cargo, or specialized transport. Additionally, all parts of the system have been designed with room for growth in mind. For example, if the passenger traffic increases, or cargo hauling proves to be a very profitable venture, additional VTOL and ECTOL aircraft and Mag-Lev trains can be added, or the frequency of flights can be increased. New terminal facilities can also be constructed. With proper consideration to marginal benefit and additional cost, the system can be expanded extensively.

## CORRIDOR MARKET ANALYSIS

The purpose of this market analysis is to present a study of a transportation system to meet the needs within the California Corridor in the year 2010. The rapidly growing population of California has been described as one of the major problems facing the state, and, at a projected influx of nine million people over the next twenty years, is similar in magnitude to the populations of Nevada, Oregon, and Utah. As population is one of the most important factors influencing the demand on transportation, a new system must be developed to augment the state's already overburdened transportation system. The public though, will not endorse a revolutionary system if it cannot be competitive with current alternatives in terms of cost, reliability, time, and convenience. Thus, this market analysis covers present transportation systems in California, and discusses several proposed concepts, in order to determine the most feasible system for the future.

### **Physical Definition of the California Corridor**

The California Corridor includes any point within approximately 500 nautical miles of any of California's four major cities (Los Angeles, San Francisco, San Diego, and Sacramento), which contain seventy percent of the State's population. Although this definition of the Corridor encompasses destinations outside of California's borders, such as Las Vegas, Reno, Phoenix, and Portland, this analysis will concentrate mainly on the transportation system within California.

## **Economic Impact of Transportation in California**

Transportation plays a major economic role in California; it affects the price and desirability of all goods and services the State produces (Ref. 1). Furthermore, in the future, transportation may be the most critical link in the state's economic competitiveness and infrastructure (Ref.27).

Transportation accounts for nearly 17 percent of the Gross State Product. The transportation service industries employ 306,000 California residents. The manufacturers of transportation equipment employ an additional 274,000. If those industries which support the transportation industry were considered, the previously mentioned figures would be doubled. This shows that a total of approximately 11 percent of California's working population is employed in a transportation-related field (Ref. 3). Californians in general use transportation extensively for commuting. With a complete breakdown of all vehicle-based transportation, 70 percent of the employees in the State would be unable to get to work.

Another major contributor to the high volume of travel in the California Corridor is tourism. Travelers spend \$24.9 billion in the state every year on transportation. Since travelers from non-adjacent states usually do not bring their own automobiles, they must utilize the State's transportation, whether private or publicly owned. Every dollar spent by travelers generates better than 22 cents in wages, an average of \$208 of annual income for each resident of California. Almost 498,000 jobs have been generated by travel spending (Ref. 31).

## **Evolution of Ground Transportation by the Year 2010**

In many ways, transportation has made California what it is today. According to *Transformation of Transportation* (Ref. 5), "We now live in a society, especially in California, whose very social fabric is woven with transportation." There is little doubt that a system could capture a significant percentage of California's travel, based on the number of miles currently traveled, by offering inexpensive and convenient service on par with that of personal vehicles. Of the many factors which affect the commuter's use of a system, travel time may be more significant in determining future travel demand than fares or other out-of-pocket costs (Ref. 6). However, current public transit systems face considerable problems in California. The 1980 census revealed that the systems were used by only 16.4 percent of the workers in the San Francisco-Oakland area, 7 percent in Los Angeles, 3.5 percent in Sacramento, and 3.3 percent in San Diego. Because of this low ridership, these systems have experienced revenue deficits. However, new rail systems are planned in Sacramento, San Jose and Los Angeles (Ref. 4). Possible reasons for low ridership are that the public transportation systems offer few advantages, they are no faster than driving, they do not go exactly where the passenger wishes to go, and they require the passenger to plan his life around the system. A new system that does not address these concerns is destined to suffer the same fate as the current systems.

In a study that was integrated with the 1980 U.S. Census, 12.5 of the 13.6 million considered in the Census used a vehicle to travel to work (Ref. 7). A number of the areas represented in the Census study were in California, including Los Angeles-Long Beach, Fresno, San Francisco, Anaheim-Santa Ana, Riverside, Bakersfield, San Diego, and Sacramento. These statistics illustrate the significance of transportation in California. During the 1970 to 1977 time period, the use of public transportation decreased by three percent, while this same time period saw great increases in the amount of personal vehicles in use on California's roads, highways, and freeways. In the Los Angeles-Long Beach area, 93 percent of all commuter miles were accumulated in personally owned vehicles. Of these miles, 75 percent were driven by solo commuters. The situation is similar in most of the state. Despite government promotion of ridesharing by means of special carpool freeway lanes and advertising, only 16 to 23 percent of commuters carpool (Ref. 7).

According to Christopher Swan, "the dominant use of automobiles and the relative insignificance of public transit and non-motorized transport has led to a situation where one often has no choice but to drive. If serving the widest range of people in the safest, most economical, most equitable and environmentally benign way is the purpose of our (current) transportation systems, then they fall far short of reaching that objective" (Ref. 5).

### **Automobile Trends**

One of the biggest complaints of the automobile commuter is the delays due to heavy congestion on roads and freeways. An evaluation of the present and future prospects of automobile traffic will reveal much about the prospects for an alternate transportation system in the years to come. Currently the 15 million residents of Southern California spend a half million hours per day in over 300 miles of traffic, averaging 31 miles per hour. The heavily traveled 60 mile commute from Riverside to Los Angeles typically takes 2 to 2.5 hours (Ref. 8). Projected trends show that the congestion of the highways will continue. The U.S. Department of Transportation says that the size of the automobile fleet will continue to increase throughout the 1980's and 1990's. Figure 1 shows the predictions of several studies as to the number of vehicles which will be in operation in the future. All in all, with the expected trend of increasing population, there is going to be a similar increase in the number of cars clogging the ground transportation system. Therefore, it will become necessary to find an alternate mode of transportation (Ref. 9).

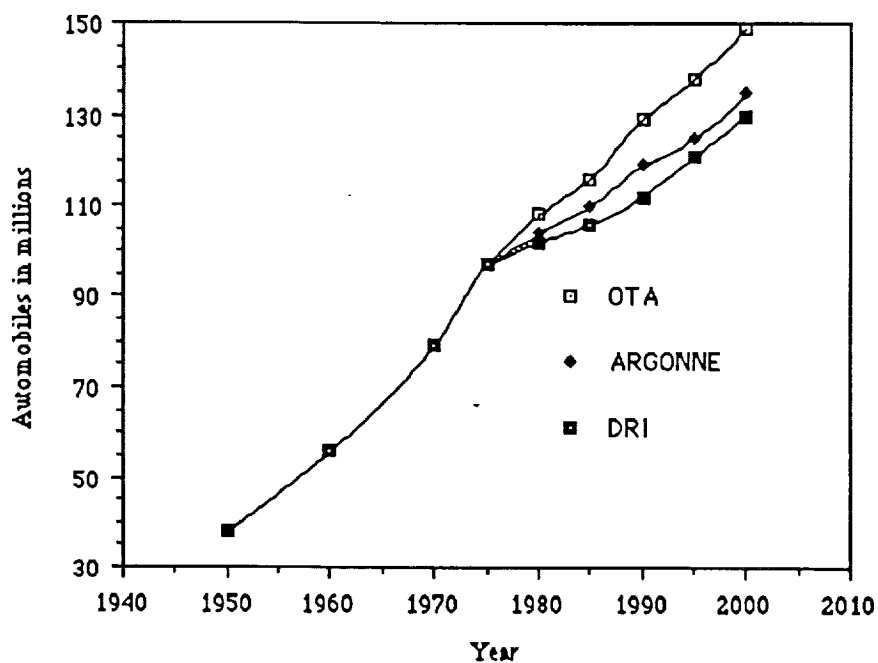

Figure 1. U. S. Automobiles in Operation

Total costs to drive an automobile can be divided into two sections: fixed costs and variable costs. Fixed costs include insurance, license and registration, and depreciation and finance charges. Variable costs consider gas and oil, maintenance, and tires.

The rising fixed costs of driving an automobile are shown in Figure 2. In addition, with the passing of Proposition 103, the insurance initiative, the cost of insuring an automobile may decrease slightly or level off in the future. Figure 3 shows slight decreases in variable costs in the years 1973 - 74, 1976 - 77, and 1983 -84, possibly due to fluctuations in the costs of gas, oil, maintenance, and tires.

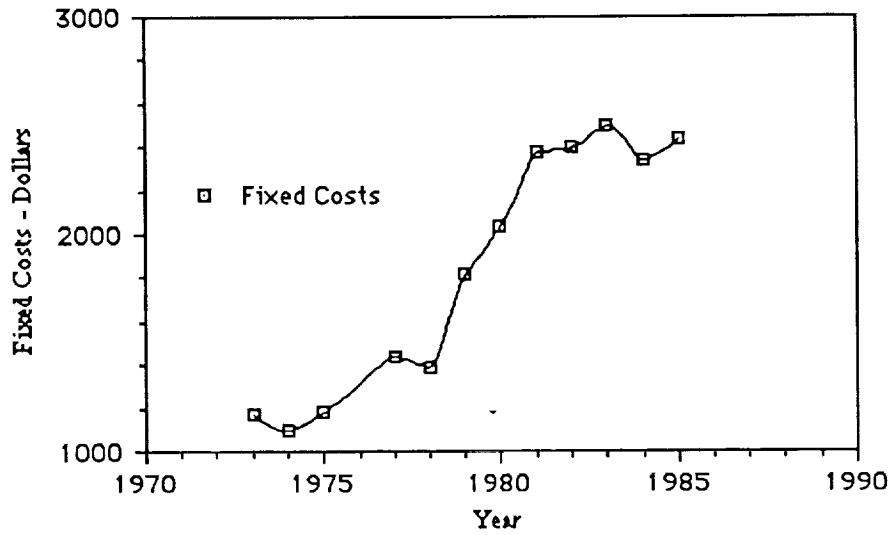

Figure 2. Automobile Fixed Costs

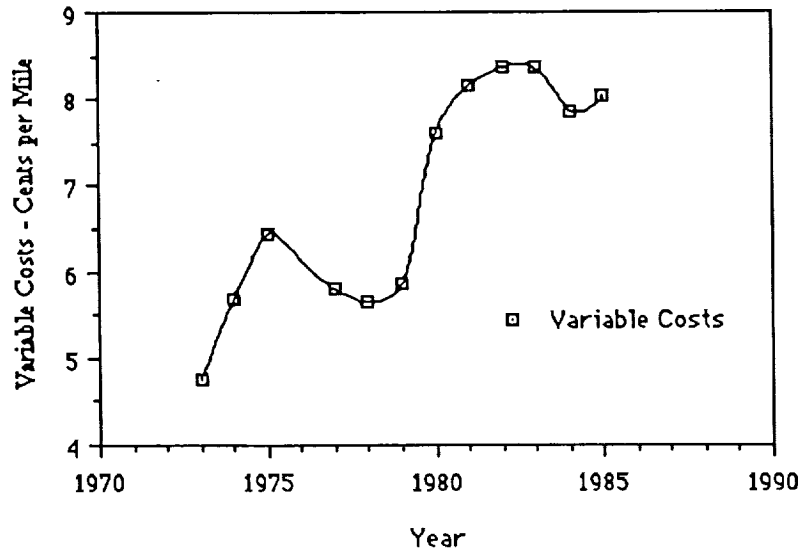

Figure 3. Automobile Variable Costs

Figure 4 demonstrates that the total cost to own and operate an automobile increased between 1973 and 1983, and decreased between 1983 and 1985. This latter decrease is not comparable to the increase in fixed



and variable costs for the same time period. A possible reason for this discrepancy is that automobiles have become more efficient and thus less expensive. The trends shown for total, fixed, and variable costs are expected to continue until the year 2010 (Ref. 7).

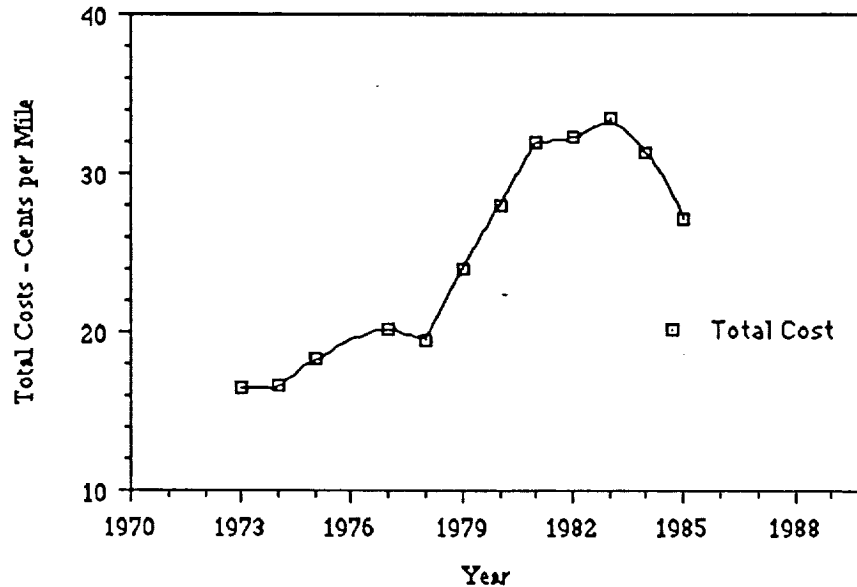

Figure 4. Automobile Total Costs

Many civic authorities identify traffic congestion as one of California's most pressing problems. In the years from 1964 to 1987, California's population increased by 44 percent, the number of registered vehicles increased by 94 percent, and the vehicle miles traveled increased by 63 percent. The construction of new freeway lane miles increased by only 32 percent (Ref. 10). The growth of traffic has out-paced the increase in freeway capacity by a factor of five-to-one (Ref. 4).

As bad as traffic is currently, it is expected to get much worse. The average freeway speeds in Southern California will drop to only 11 miles per hour in 2010. A motorist traveling from San Diego to Santa Monica will crawl at only 7 miles per hour (Ref. 8). These speeds take into account all the new freeways currently planned to be operational by this time. By 2010, commuters could be spending 50 percent of their waking hours stuck in traffic. If all proposed Capital Intensive Rail and High Occupancy Vehicle projects are built, the average speeds could be brought up to 15 miles per hour. This would leave the commuters stuck in traffic only 45 percent of the time (Ref. 11). The average one-way commute which currently takes 45 minutes would rise to 2 full hours (Ref. 6). California could partially build its way out of the impending mess by adding 1000 miles of new freeways and 350 miles of rail lines at a cost of 110 billion dollars (Ref. 4).

It is seen that with the increase in population there will be an increase in the number of automobiles on the already clogged highway system. Therefore, it is necessary to find alternate modes of transportation to meet the needs and demands of commuters and travelers. In addition, the cost of alternate modes of transportation must be competitive enough to motivate the public to use them.

### **Currently Proposed Solutions**

The Southern California Association of Governments (SCAG) proposed, in their Draft Regional Mobility Plan, ideas for cutting demand by 4 million trips (Ref. 12). Encouraging telecommuting, which is working at home via computer telecommunications, is seen as a substitute for commuting to work for some employees, and modification of the work week could eliminate approximately 3 million daily trips (Ref. 13). An additional 100,000 trips could be absorbed by ridesharing. Finally, SCAG believes that approximately 900,000 trips could be eliminated by rapid transit systems (Ref. 12). This study has critics, however, such as Mary Ann Von Glinow, a professor at the University of Southern California, who does not believe that telecommuting is any kind of panacea for our transportation problems (Ref. 14). Also, ridesharing programs have not been popular in California, and no currently planned rapid transit system will handle the volume SCAG has requested. Finally, one half of all trips at peak commuting hours are not work related (Ref. 15). SCAG also made some general recommendations such as: use of private transportation services to meet transit needs shall be encouraged; circuitous routings of goods should be eliminated; the effects of railroad and truck traffic, such as noise and traffic delay, should be minimized; and the user should pay for transportation projects (Ref. 15). Finally, the politically powerful land development industry must not be allowed to overshadow other considerations when deciding how land is to be used. The infrastructure must be developed to enable the state to handle further growth (Ref. 4).

The public transportation systems currently in use are subsidized in the magnitude of billions of dollars. The federal government has provided funds for railroad tracks, the State has maintained roads, and commuter airlines have received subsidies for serving rural areas. Therefore, new transportation systems will have to compete with these existing systems for future subsidies if they cannot operate profitably. If the users could be made to directly pay the true cost of their transportation, as opposed to indirectly paying through higher taxes, the chances of a new system taking hold of a market share would increase greatly. It is generally agreed, for example, that the trucking industry does a great deal of damage to the nation's roads and highways. The consumer pays for this in his taxes rather than in a higher price for the goods delivered by truck. If this situation were reversed, the prospects of a system that did not damage the roads would be increased. The Legislative Analyst of the State of California believes that if people were made to pay the true cost of driving, they would be more willing to seek alternate forms of transportation (Ref. 16).

It is often assumed that rail and bus service is always the most efficient solution to the ground transportation problem. However, such statements cannot be accepted without critical analysis. In Reference 5, it is stated that "contributing to the confusion is the belief that buses and trains are more efficient than automobiles in all circumstances. For instance, compared to cars averaging over 25 miles per gallon, diesel buses of 60 to 80 person capacity can be efficient on long commute runs, assuming they are full; but if half-empty and stopping frequently in congested city streets, they may not be efficient. The Bay Area Rapid Transit system was built on the belief that high-speed rail transit was more efficient than buses or cars, a seemingly logical notion considering how little energy trains can consume in operation. But BART consumed an enormous quantity of energy in the construction of elevated concrete tracks, subways and an underwater tunnel of barge-sized tubes. Over 10 years and \$1.6 billion went into BART, and it now carries only 2 to 5 percent of the regional transit volume. The energy BART can save will not surpass that used in construction for perhaps a century". A design study done by Stanford University in 1969 (Ref. 17) used helicopters to provide transportation in the San Francisco Bay area. The results of this report show that, "For longer range routes and with lower densities the (Metropolitan Air Transit System) shows a considerable cost advantage (over the BART system). The reason for the high cost of BART transportation at low traffic densities is the very fixed costs of real estate and tracks."

## Air Travel

In "California Aviation into the Future" (Ref. 18), the California Committee on Aviation and Airports reported that California has seven of the nation's twenty busiest airports and the busiest air corridor in the entire world, and that 50% of the international trade in California passes through the State's airports. Airport usage in the California corridor was analyzed using the cumulative airline flight schedules for 1988, which list all airline flights in North America by origin and destination. Airports considered for the Corridor were public airports currently being serviced by commuter airlines and major airports that could be serviced by a 500 nmi. service range aircraft, including, Las Vegas, Portland, Phoenix, and Reno. The data for the number of flights per day were then totaled by airport (Table I) and city pair (Table II) in the corridor. Results from the study were: 1) of 283 public airports in California, only 32 have daily scheduled commuter flights (suggesting that certain airports are over used or underused and usage could be evened out); 2) the airport pair of LAX and Linbergh Field in San Diego, the largest and third largest airports in California, respectively, has more flights per day than does the pair of LAX and San Francisco International, the two largest airports; 3) even with only 32 commuter airports, there are still 122 airport pairs (direct routes) currently being flown in the corridor; and 4) 59% of the flights originating in the corridor stay in the corridor. Other results from the study, such as the fact that about 48% of the flights at LAX are commuter flights (in corridor) compare well with current suggested figures. Due to the fact that data for this survey were taken from airline flight schedule information,

these results for airport usage reflect only passenger usage of corridor airports and do\_not include any freight or cargo-only flights (as well as general aviation traffic).

Table I. Flights per Day at Corridor Airports

| <u>Airport</u>  | <u>In Corridor<br/>(flights/day)</u> | <u>Out of Corridor<br/>(flights/day)</u> | <u>Total</u> |
|-----------------|--------------------------------------|--|--------------|
| Bakersfield     | 36                                   | 2  | 38           |
| Burbank         | 102                                  | 45                                       | 147          |
| Fresno          | 45                                   | 4  | 49           |
| Lake Tahoe      | 13                                   | 0  | 13           |
| Long Beach      | 42                                   | 28                                       | 70           |
| LAX             | 473                                  | 504                                      | 977          |
| Mammoth         | 2                                    | 0  | 2            |
| Modesto         | 11                                   | 0  | 11           |
| Monterey        | 45                                   | 1  | 46           |
| Ontario         | 112                                  | 133                                      | 245          |
| Orange County   | 112                                  | 74                                       | 186          |
| Oxnard          | 10                                   | 0  | 10           |
| Palm Springs    | 57                                   | 25                                       | 82           |
| Redding         | 16                                   | 0  | 16           |
| Sacramento      | 142                                  | 57                                       | 199          |
| San Diego       | 223                                  | 173                                      | 396          |
| SFO             | 381                                  | 329                                      | 710          |
| Oakland         | 105                                  | 56                                       | 161          |
| San Jose        | 123                                  | 83                                       | 206          |
| San Luis Obispo | 47                                   | 0  | 47           |
| Santa Barbara   | 70                                   | 0  | 70           |
| Santa Maria     | 30                                   | 0  | 30           |

Table II. Direct Flights Between Corridor Airport Pairs

| <u>City Pair</u>    | <u># Flights per Day</u> |
|---------------------|--------------------------|
| LAX-San Diego       | 156                      |
| SFO-LAX             | 122                      |
| Phoenix-LAX         | 87                       |
| Las Vegas-LAX       | 65                       |
| Phoenix-San Diego   | 60                       |
| SFO-Sacramento      | 56                       |
| LAX-San Jose        | 54                       |
| Phoenix-Ontario     | 52                       |
| LAX-Palm Springs    | 48                       |
| San Diego-SFO       | 48                       |
| LAX-Santa Barbara   | 46                       |
| Orange County-SFO   | 41                       |
| Monterey-SFO        | 36                       |
| Portland-SFO        | 36                       |
| Burbank-SFO         | 34                       |
| Reno-SFO            | 34                       |
| Bakersfield-LAX     | 31                       |
| San Luis Obispo-LAX | 31                       |
| Sacramento-LAX      | 31                       |
| Ontario-SFO         | 30                       |
| Las Vegas-San Diego | 30                       |
| Fresno-SFO          | 30                       |

## Commuter Aircraft Forecast

With the enactment of the Airline Deregulation Act of 1978, the restrictions on aircraft size were relaxed significantly, and this, together with developments which have occurred in the nine years since deregulation, has dramatically changed the character of the commuter airline industry. Initially, deregulation accelerated the route rationalization programs of the large jet operators, opening additional markets for the commuters. This resulted in dramatic growth in traffic and in the number of commuter operators.

In fiscal year 1987, the growth of the commuter airline industry again outpaced the growth of the larger commercial air carriers. Total revenue passenger enplanements increased by 13.3 percent to 27.2 million, while revenue passenger miles increased by 16.1 percent to 4.2 billion (Ref. 19).

As shown in Figure 5, revenue passenger miles are expected to total 11 billion in 1999. Passenger miles are projected to increase by an average of 8.3 percent per year over the 12 year forecast period (1987-1999). In the 48 contiguous states, revenue passenger miles are forecast to total 10.4 billion in 1999, with an average increase of 8.4 percent per year between 1987 and 1999. Traffic in Hawaii, Puerto Rico, and the U.S Virgin Islands is forecast to show an average increase of 6.4 percent over the entire forecast period, totalling 587.2 million passenger miles in 1999 (Ref. 19).

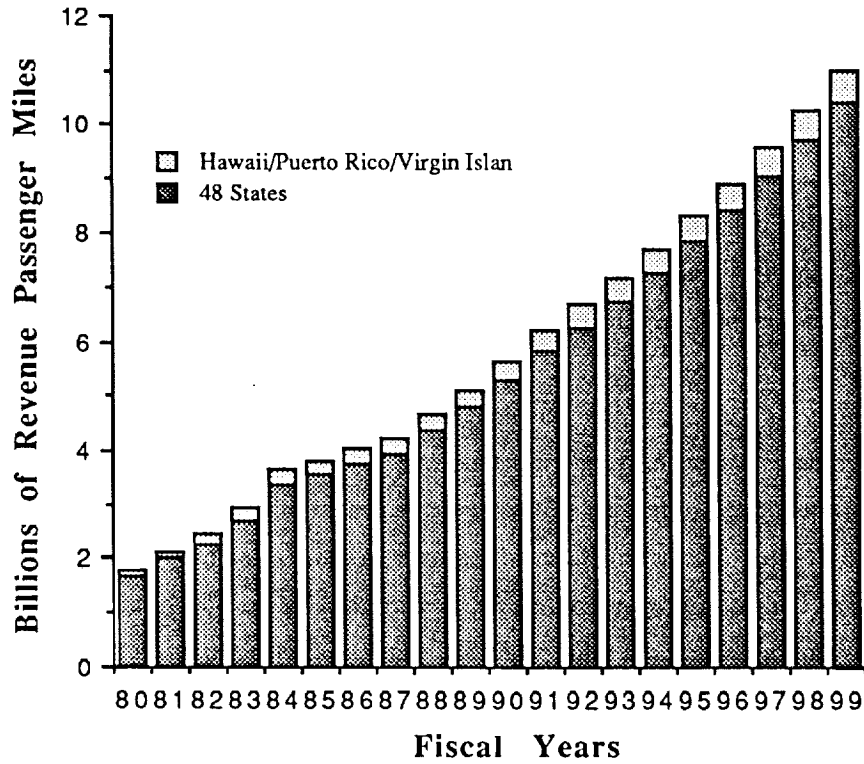

**Figure 5. U. S. Regional/Commuters Scheduled Revenue Miles.**  
 Source: FAA Aviation Forecast 1987-1999

Figure 6 shows that passenger enplanements are forecast to reach 57.9 million in 1999, more than double the 1987 enplanements. Overall, passenger enplanements are expected to increase with an average of 6.5 percent over the forecast period. In the 48 states, passenger enplanements are projected to increase 7.0 percent in 1988 and 6.5 percent in 1989, and with an average of 6.5 percent between 1987-1999, totalling 52 million in 1999. In Hawaii, Puerto Rico, and the U.S. Virgin Islands forecast to total 5.9 million in 1999, and averaging 6.4 percent over the 12-year forecast period.



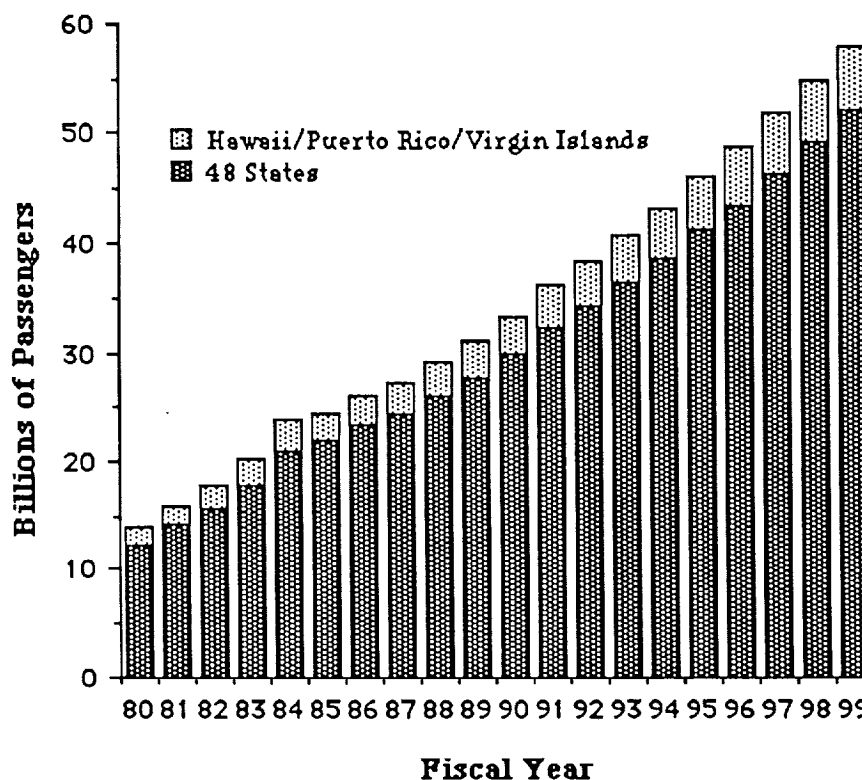
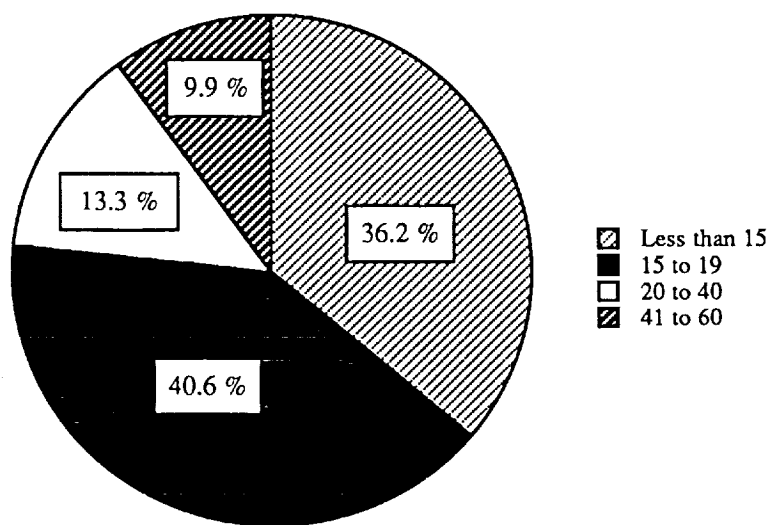

Figure 6. U. S. Regionals/Commuters Scheduled Passenger Emplanements.  
Source: FAA Aviation Forecast 1987-1999.

With deregulation and the relaxation of the aircraft size restriction, the door was opened for the development and introduction of a new generation of aircraft designed specifically for use in commuter markets. During the forecast period, the average number of seats per aircraft is projected to grow at an annual rate of 3.1 percent, increasing from 20.1 in 1987 to 29.1 in 1999. The number of commuter aircraft in the U. S. is projected to grow at an annual rate of 2.9 percent, increasing from 1604 in 1987 to 2252 in 1999. The average passenger trip length in the 48 states is projected to increase from 161.1 miles in 1987 to 200 miles in 1999, an average growth rate of 1.8 percent per year; while the average trip length for Hawaii, Puerto Rico and the U.S. Virgin Islands is expected to remain constant at 98.0 miles over the forecast period. The average load factor is expected to increase from 45.5 percent in 1987 to 46.8 percent in 1999 (Ref. 19).

Figure 7 shows the percentages of commuter aircraft in size categories for 1987; aircraft with less than 15 seats and between 15 and 19 seats accounted for 36.2 percent and 40.7 percent of the total fleet, respectively. The number of aircraft with less than 15 seats is expected to decline from 36.2 percent in 1987 to 7.6 percent of the total fleet in 1999. The quantity of 15-19 seat aircraft category is expected to decline from 40.7 percent to 34.2 percent of the total fleet in 1999, which will still be the second largest portion of the fleet; however, it is expected to keep decreasing after the year 2000 (Ref. 19).



**Figure 7. 1987 Commuter Aircraft Categorized by Number of Seats.**  
Source: FAA Aviation Forecast.

In Figure 8, the commuter aircraft sizes are shown for 1999. The largest growth in the commuter fleet will be in the "20-40 seats" and the "greater than 40 seats" categories. In 1987, the "20-40 seats" category had increased to 13.3 percent and the "greater than 40 seats" category to 9.8 percent of the total fleet. By 1999, these two categories are expected to account for over 57.3 percent of the total fleet, 32.9 percent in the "20-40 seats" category and 24.4 percent in the "greater than 40 seats" category. During the forecast period, aircraft in the "20-40 seats" category are expected to increase from 213 aircraft in 1987 to 714 in 1999, an average annual increase of 10.9 percent. The aircraft in the "greater than 40 seats" category are expected to increase from 158 aircraft in 1987 to 549 in 1999, an average annual growth of 10.9 percent (Ref. 19).

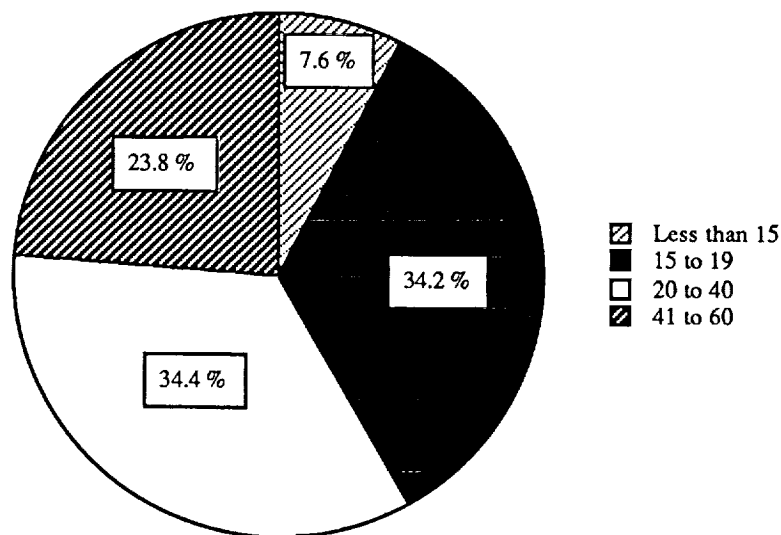

**Figure 8. 1999 Commuter Aircraft Categorized by Number of Seats**  
**Source: FAA Aviation Forecast 1987-1999.**

### **Airport Access**

As was mentioned earlier, travel time may be more important to a commuter than cost in his decision to use a transportation system. However, the speed advantages of air travel are often diminished by the problems associated with access to the airport. These access problems can be dealt with by using an integrated ticketing, transportation, and baggage-handling service, in which all components necessary to make the door-to-door trip could be arranged by a single phone call. The Department of Transportation believes that this type of system would even cost less than the present system (Ref. 6). The vast majority of these air trips have been and will continue to be multi-modal; for example, a traveler might drive his car to an off-airport parking lot and take a bus to the terminal. Advances must be made to improve the speeds of these separate modes, or they must be eliminated. The poor connection between modes remains a major weakness of intercity service (Ref. 20). The air transportation system of the future should include the following: more direct flights, greater frequency of service, origin-to-destination service, a high degree of certainty as to trip length, better intermodal efficiency, and a greater variety of charter services (Ref. 6). The highest growth rate for air service will be in the "specialized" market such as air cargo and passenger charter flights, and it is likely that these needs will be served by smaller aircraft (Ref. 6).

Turn around time will be improved by use of advanced aircraft handling techniques such as drive-through loading ports (Ref. 21).

### **Pollution Concerns in the California Corridor**

Transportation is currently 97 percent dependent on petroleum; however, engineering and geological factors indicate that the world's petroleum production will reach a plateau by the end of the twentieth century (Ref. 22). *The Global 2000 Report to the President-Entering the Twenty-First Century* stated "A world transition away from petroleum dependence must take place, but there is still much uncertainty as to how this transition will occur" (Ref. 22). The effects of fossil fuel usage on our environment are extensive and could bring about grave consequences in the future. California's Air Quality Management District (AQMD) estimates that air pollution costs the state 12 billion dollars a year. Furthermore, even if current plans are carried through, the state will still be below current minimum health standards (Ref. 23).

The levels of sulfur dioxide, particulates, nitrogen dioxide, and carbon monoxide in many of the world's major cities are far above levels considered safe by the World Health Organization. Emissions of nitrogen oxides and sulfur are especially of concern because they can combine with the water vapor in the atmosphere to form acid rain, resulting in damage to lakes, soils, forests, and crops. The so-called "Green House Effect" in which the carbon dioxide left after combustion leads to a warming of the planet, is another feared problem created in part by the combustion of fossil fuels. The amount of CO<sub>2</sub> in the world's atmosphere has actually risen 15 percent in this century alone. Current trends indicate that the CO<sub>2</sub> content of the planet will double by the middle of the twenty-first century. The resulting warming could eventually disrupt the world's agricultural system. The exclusive use of petroleum products makes transportation much more vulnerable to disruption than other sectors of the economy (Ref. 20).

Any new transportation system for the California Corridor must be designed to be environmentally sensitive. The vehicles used must, at an absolute minimum, create no more pollution than the vehicles already in existence. Therefore, fossil fuels must one day be phased out of use.

### **Freight Transportation**

Freight transportation accounts for about 40 percent of the capital spent on transportation. The fast freight-moving business is one of the fastest growing in the United States. For this reason, a new transportation system in the California Corridor should also consider hauling freight, especially in non-peak traveling hours. In terms of total tonnage moved, about 18 percent is by pipeline, 21 percent by rail, 28 percent by truck, and 33 percent by water. Concerning the trucking industry, great controversy exists as to how much pavement and infrastructure damage is actually attributable to trucks (Ref. 6). For reasons such as these, it is hard to determine the true costs of moving goods.

In *National Transportation Trends and Choices Through 2000* (Ref. 6), the DoT concluded that for a trip distance of 500 miles, a freight only, narrow-body container system costs twice as much, in dollars per ton, as the most expensive method of trucking for the same distance. A wide body, lower-hold container system in the belly of a passenger plane, on the other hand, costs 30 percent less than the aforementioned trucking method. The DoT stated that "for containerized shipments moving in the lower hold of wide body passenger jets, it has been impossible to separate the line haul costs from those incurred in transporting the passengers, and these movements appear less costly than direct truckload(s)." This information suggests that, rather than incorporating an individual subsystem for handling freight within the Corridor system, it would be more economical and cost effective to have a system which is capable of hauling cargo with passengers. The DoT concluded by saying that there were numerous areas where technological innovation was likely, "but none had such large scale implications as the potential changes in rail,"

### **Financing Transportation in the California Corridor**

Obviously, financing is an integral part of any transportation system. However, one of the complexities is that there is not one absolute plan to fit all systems. Any proposed system is a unique time/place phenomenon which must be dealt with on an individual basis. Perhaps the major problem with trying to determine a financial plan for a transportation system in the California Corridor is deciding what that system will be and what level of service the system will address.

For any transportation system, the word "financing" is a multi-dimensional term. Many variables come into play, such as the identification of the potential users of the system, the type of socio-economic development in which the system is to be situated, who or what will administer or manage the system, and the modes of transportation the system will utilize. Other factors include the size and extent of the system, and the factor of risk in recovering the initial costs of the system.

With any given system, while it might be possible to generally determine where the funding might come from, it may not be possible to accurately determine the cost. For example, an air system that proposes a new kind of aircraft to service general aviation and large hub airports perhaps need only consider upcoming trends in aircraft technology, air traffic control, and enplanement projections. This would be a conservative plan. A financial study might concentrate on how much it will cost to acquire new aircraft and improve existing facilities. One of the major projections for the upcoming century does not show much new construction of airports of the existing type (Ref. 19), and there is only a relatively small part of the total population that sees a need to fly between the points determined by those airports.

In this conservative air system (conservative because the systems they expound are generally the current state of affairs), ground transportation would probably be left to its own devices, and separate financial planning on the land side might center around the more conventional aspects of subways, light

rails, and high occupancy vehicles (HOV). In this area, much literature exists to help determine levels of ridership and fares. References 24, 25, 32, 26, & 28 were produced by the Urban Mass Transportation Administration (UMTA) and the Department of Transportation for use by planners attempting to determine such factors as speed, capacity, labor costs, system operating costs, energy consumption, pollution, capital costs, and accident frequency, and their effects upon a proposed ground transportation system.

In a less conservative case, such as an integrated VTOL/HOV system that proposes neighborhood-to-neighborhood service, financial planning would have to incorporate and mesh together aspects of both the air side and land side. Data to help generate this financial model is scarce, since not only is this type of association rare, but the VTOLs in this case might be tilt rotor or tilt-wing vehicles, which are relatively new technologies that have not yet lent themselves to passenger operations (Ref. 29).

In the business of air travel, time is the commodity that is for sale, not that the customers can purchase even a moment of it. Rather, they may utilize more of the time they have in some pursuits other than travel. In this way, time of travel is the primary consideration. The public desires flights that leave when they want to leave and arrive at their destination quickly. It is generally believed in the airline business that the frequency of flights is more important than the cost. Indeed, the customer will usually first ask what flights are leaving at his desired time of travel and then ask which of these are the least expensive.

There are three basic methods of financing and operating the transportation system that will be investigated in the California Corridor Study. The first is to have the entire system financed and operated by the state government. The second method is to have the government fund the system and contract a private enterprise corporation to administrate it. Last of all, the entire organization could be completely owned and operated by private enterprise.

Creating and installing a comprehensive transportation system to serve the needs of the California Corridor in a short time period would take an enormous amount of capital. The transportation entities already in place that are even close to the size of the Corridor system (the major air carriers) did not spring into being overnight; they grew into the size they are now. Smaller entities that did come into being in previous years (mass transit systems in urban areas) have all been state and federally funded. Thus, the logical path for funding the Corridor system would be to get governmental support.

The funding could come from a bond issue and federal funds for mass transit. Getting the bond issue to pass would not be that difficult, since the ratio of pass to fail of bond issues in this decade is twenty five to two. The key to getting the bond issue passed is to have the system attractive to a wide base of Californians. Voters would be likely to vote for this if they can see themselves using the system, and the proposed system could be used by all Californians.

Criticisms of public sector bureaucracies have been leveled at the inefficiency and rigidity, at the lack of incentives to reduce costs or improve performance, and at the political tendency to retain and

expand programs regardless of cost-effectiveness. The private sector can avoid these problems because of the discipline and incentives of the marketplace. The market encourages competition and risk-taking and rewards good ideas through profits. Pricing allocates resources and tailors services to meet consumer demand. Local government experience indicates that competitive contracting may cut costs from 20 to 50 percent, while maintaining or improving service (Ref. 4).

The actual operation of the system could be contracted out to the private sector since privately run operations are consistently more economical than their governmental counterparts. Government owned privately run entities are successful today, (nuclear processing is one example). If the system establishes itself as a profitable venture, it could go completely private, thus freeing itself of governmental control.

### **Travel Into The Twenty First Century**

The National Transportation Policy Study Commission (Ref. 20) concluded that changing demographic trends will further increase the demand for travel in the future. These trends include: 1) expansion of industries and occupations with high travel potential, such as service industries and white collar occupations; 2) increased affluence and more leisure time, stimulating pleasure travel and tourism; 3) changing age distribution, meaning more persons in high-travel-potential age groups; 4) having fewer dependants, allowing more time and disposable income for travel; and 5) the rising relative affluence abroad increasing tourism to the United States, and creating new demands on the intercity system.

The State of California is predicting that the growth of the suburbs will continue because of the desire to live in affordable, low density housing (Ref. 16). The process of suburbanization in the nation's sun belt is mainly one of increasing the square miles that need to be served by transportation, rather than increasing the population. Across the country, even areas of declining or slow growing population are still showing an increase in commuting. For instance, Washington D.C. experienced a 5 percent population gain from 1960 to 1980, yet gained 24 percent more commuters. Buffalo lost 8 percent of its population at the end of the 1970's, but still gained an increase of 1 percent in commuter traffic (Ref. 30). Present day commuting also tends to be suburb-to-suburb, as well as the traditional suburb to city center travel. In California, the land-area expansion is coupled with a huge population growth (Ref. 6).

In the year 2010, California's transportation system must also be ready to serve the state's aging population. Many younger people have left the rural areas to live closer to the city center. This has created a situation in which the remaining older population has a mobility deficiency. They are dependant on public transportation. Studies have been conducted that indicate that the teen-aged, the old, and those in lower income brackets have a large, yet unfulfilled, demand for transportation. To reach these potential customers, the price of service must be brought down (Ref. 6).

## Conclusions

In summary, the California Corridor of the year 2010 is a wide open market. All phases of current transportation are breaking down while the demand for transportation is growing at an unprecedented rate; therefore, many different types of systems could succeed in the Corridor. As freeway congestion is moving average speeds downward toward 7 to 15 miles per hour, alternative transportation systems are required. Such systems, due to the increased congestion, must address the concept of "door-to-door" service. In addition to the ground traffic problem, air traffic at the major California airports must be reduced or relocated because the major airports in California are already operating near capacity. The Corridor system should address all areas of transportation within the corridor such as mail, freight, tourism, and commuter transportation. In general, the system must be more convenient, more economically feasible, and cleaner than currently operating systems.



## References

1. California Engineering Foundation, "California Master Plan For Economic Development And Competitiveness", 1988.
3. Deakin, Elizabeth, *Transportation And Economic Development: Recommended Options For California*, 1986.
4. California Economic Development Corporation, *Vision: California 2010*.
5. Swan, Christopher, "Transformation of Transportation, Calif. 1981.
6. US Department of Transportation, *National Transportation-Trends and Choices (To the year 2000)*, 1979.
7. US Department of Commerce, Bureau of the Census, *Statistical Abstract of the United States*, U.S. Government Printing Office, 1988 c.2.
8. "Stuck in Traffic", A presentation of KCET television in Los Angeles, 1985, hosted by Jeffery Kaye.
9. US Department of Transportation, *Metropolitan Areas*, December 1980.
10. California Business Roundtable, Transportation Task Force, *Principles For Guiding The Reform of California's Transportation Planning Process.*, 1986.
11. Wachs, Martin, University of California at Los Angeles's Urban Planning Department, "Stuck in Traffic", 1985.
12. Southern California Association of Governments (SCAG), Draft Regional Mobility Plan, October 1988.
13. Harris, Dr. Robert, California Economic Development Corporation, *California Telecommunications Policy For The Twenty-First Century*, 1984, p. 21.
14. Von Glinow, Mary Ann, Professor University of Southern California, "Stuck in Traffic", 1985.
15. Poole, Robert, "Stuck in Traffic", 1985.
16. State of California, "Report of the Legislative Analyst to the Joint Budget Committee", The 1988-89 Budget Perspectives & Issues.
17. Stanford University, *A Design Study of a Metropolitan Air Transit System*, August 1969.
18. US Department of Commerce, *Economic Indicators*, U.S Government Printing Office, Washington, D.C., August, 1988.
19. US Federal Aviation Administration, DOT, *FAA Aviation Forecasts, FY 1988-2000*, USGPO, Washington, D.C.
20. National Transportation Policy Study Commission, *National Transportation Policies-Through the Year 2000*, June 1979.
21. Ott, James, "FAA Will Test Wayport Concept As Remedy to Airport Congestion", *Aviation Week & Space Technology*, January 9, 1989.
22. Global 2000 Commision, *The Global 2000 Report to the President - Entering the Twenty-First Century*, 1980.

23. Younglove, Norton Air Quality Management District, "Stuck in Traffic", 1985.
24. Urban Mass Transportation Administration, DOT, *Characteristics of Urban Transportation Systems*, USGPO, Washington, D.C., October 1985.
25. Urban Mass Transportation Administration, UMTA, DOT, Statistical Tables, *Demographic Change and Worktrip Travel Trends, Volume 2*, USGPO, Washington, D.C., February 1985.
26. US Department of Commerce, Bureau of the Census, *1980 Census of the Population: Subject Reports: Place of Work*, Report number PC80-2-6E, June 1984.
27. US Department of Commerce, Bureau of the Census, 1980 Census, "Journey to Work: Characteristics of workers in Metropolitan Areas."
28. US Department of Transportation, Office of the Assistant Secretary for Policy, Plans, and International Affairs, *Land Use Impacts of Rapid Transit; Implications of Recent Experience*, USGPO, Washington, D.C. August 1977.
29. Albers, James A. & Zuk, John, "V/STOL Aircraft Configurations and Opportunities in the Pacific Basin," *SAE Technical Paper Series #872403*, Society of Automotive Engineers, Warrendale, PA, 1987.
30. Futurist Magazine, "Techtrends" May-June 1988.
31. California Office of Tourism, *The Economic Impact of Travel in California*, December 1981.
32. Urban Mass Transportation Administration, UMTA, DOT, *Demographic Change and Worktrip Travel Trends, Volume 1, Final Report*, USGPO, Washington, D.C., February, 1985.<sup>1</sup>

## DEMAND MODEL

One of the major factors utilized in the design of a transportation system and the determination of vehicle characteristics required is the demand for travel in the area under consideration. In California, this demand is generated by various types of travelers; business commuters, major airport feeder traffic, tourists, people making trips required in daily metropolitan life, and so on. Various political, socio-economic, and geographical factors affect the amount of travel generated by the population in any specific area. For example, the income level would determine the public's ability to pay a certain fare and consequently the propensity to take that particular trip by a specific mode of transit. Alternatively, a river that runs down the middle of a city would serve to assure adequate travel on a bridge spanning that river or a ferry providing service to cross it. Demand is generated in cyclical patterns varying by seasons, day-of-week, time-of-day, etc., with peaks and valleys in the curve of demand versus time. Commuters would tend to be in transit daily in the mornings and evenings while tourists flock to certain areas during the favorable seasons in the year.

To design an air travel system in the California Corridor in the year 2010, a forecast of travel demand was required. There were two uses envisioned for these demand figures: validation of any specific system by checking whether the demand model prediction is within the system's required operating range and determination of the basic parameters, such as range, speed, and capacity, of any vehicles utilized in the system. The demand model was not required to supply information with adequate detail to set up routes and schedules of the vehicles, because this step would not be performed in the preliminary design of the system. Instead, numbers that represented an overall average of the travel demand from a macroscopic viewpoint would suffice. Therefore, the patterns of travel due to commuters, tourists, business, and other

types were not separated. The cycles in the demand curve were not scrutinized because it was assumed that demand was homogeneous over time and that the predicted demand would be equivalent to a time average. Since the primary purpose was to design a system of transportation by air, the demand model was to concentrate on acquiring data that related to air travel demand in the California Corridor.

### Gravity Model

The model chosen to forecast demand was a travel generator model known as the Gravity Model. Such a model calculates the demand between two cities based on the populations of the two cities and the distance between them. Certain other characteristics such as average income of a city and the change in population and air travel in recent times were also included in the model. Other factors such as attractiveness of a city, geographical conditions, and climate were not used because, in California, these do not represent major boosters or dampeners of travel, and would not make a significant change in the coarse approximation numbers generated. These numbers can be considered to be time averages of the demand curve and therefore typical of any time in the year, week, or day. It is important to recognize that the numbers represent the best estimates of one way air travel demand between city pairs in the California Corridor.

The Gravity Model is based on the principle that the traffic demand between two population centers is proportional to the product of their populations and inversely proportional to some power of the distance between them. This model was originally postulated at the Massachusetts Institute of Technology (Ref. 1). Lockheed-Georgia Company expanded the model to include the income of origin in order to reflect the capability of the passengers to travel and the attractiveness of destination to show the desirability of travel (Ref. 2). An adjustment was made to the model at the Georgia Institute of Technology (Ref. 3) to reflect the rapid increase in air travel as compared with population and to dampen the demand for very short flights because of the model's inverse proportionality to distance. This modified gravity model was the one used to generate air travel demand and forecast it for the years ahead.

## Geographical Set-Up

Instead of finding the demand between airports, it was more desirable to obtain the demand between centers of population. The counties that comprise the metropolitan areas in the California Corridor were combined together. The travel generated in these centers comprises more than 95 percent of the total travel in the California corridor. Therefore, by using these fourteen "cities," the demand model effectively covers the entire area under consideration. The following is a listing of the counties included in each area:

|                  |  |
|------------------|--|
| San Francisco:   | Sonoma, Marin, San Francisco, San Mateo, Santa Clara, Alameda, Contra Costa, Solano, and Napa Counties |
| Los Angeles:     | Los Angeles, Orange, Ventura, San Bernardino, and Riverside Counties.                                  |
| San Diego:       | San Diego County   |
| Sacramento:      | Sacramento, San Joaquin, Yolo, and El Dorado Counties  |
| Fresno:          | Fresno and Madeira Counties  |
| San Luis Obispo: | San Luis Obispo County   |
| Bakersfield:     | Kern County  |
| Redding:         | Shasta County  |
| Santa Barbara:   | Santa Barbara County   |
| Monterey:        | Monterey and Santa Cruz Counties   |
| Portland, OR:    | Multnomah, Clackamas, Washington, Yamhill, Columbia, and Marion Counties                               |
| Reno, NE:        | Storey, Lyon, Douglas, and Washoe Counties   |
| Las Vegas, NE:   | Clark County   |
| Phoenix, AZ:     | Maricopa County  |

## Model Implementation

The procedure followed in implementing the model on computer consisted of three main steps: 1) entering the program and debugging it for a successful run, 2) collecting data for the input to the program, and 3) calibrating the model to apply to California. The program listing was acquired from the Georgia Tech. report (Ref. 3). This FORTRAN program was entered and executed. Extensive debugging was required because of errors in the original listing. Changes were also made to make the program apply to the current system area and time periods. The output format was altered to suit desired needs. The information required as input to the program includes population for the last two census dates, latitude and longitude of the city center, average city income, and percentage change in air travel demand. The population and income information was obtained from Reference 4. The latitudes and longitudes were

acquired from Reference 5. The percentage change in air travel was available in Reference 6. Once this data was input and the program was running, output was generated in the form of a grid with the cities as rows and columns and containing the distance and one-way air travel demand between city pairs at cross-grid connections.

### Model Calibration

There remained the additional step of calibrating the program to adjust for California's actual air travel scenario. In the modified gravity model equation, there are three arbitrary constants that relate to the proportionality of travel to populations and distance, the effect of distance, and the dampening of demand in short flights. These are to be empirically derived from actual data. Since the task was to find air travel demand, then the model output portion for the present time needed to be matched with a set of numbers acquired independently that were representative of actual air travel today. The actual data was acquired for the year 1988. Information on the number of flights between city pairs was acquired from cumulative airline flight schedules for 1988, which lists all airlines flights in the Corridor. To calculate the actual passengers per year traveling one way between a city pair, several math operations were performed on basic information available. The actual enplaned passengers per year divided by half the annual operations per year in all airports in a certain metropolitan area (Ref. 6) yields actual passengers per departure. This result multiplied by the flights per day one-way between a specific city pair gives actual passengers per day traveling one-way between that city pair. Using 365 days per year, the upper bound on the actual travel can be estimated. Alternatively postulating that there are six effective air travel days per week to account for weekends and holidays, it can be said that there are 312 days per year where air travel is concerned. This would yield the lower bound on actual travel. The product of actual passengers per day multiplied by the days per year, either 312 or 365, is the actual passengers per year traveling one-way between a specific city pair. To summarize:

$$\frac{\text{Actual Enplanements per year}}{\frac{1}{2} \times \text{Operations per year}} \times \frac{\text{One-Way Flights}}{\text{Day}} \times \frac{\text{Days}}{\text{Year}} = \frac{\text{Passengers}}{\text{Year}}$$

These arithmetic operations performed repeatedly for a few sample city pairs gives a set of numbers to be used for the calibration of the demand model. These figures were compared with the demand model output for the 1990 because this was the time period closest to 1988 in the quantized output from the program. It was assumed that due to the coarse quality of the calibration, the small discrepancy in the years will not present a significant problem. Table I shows the comparison between actual air travel and the final output from the demand program for a sample set of city pairs. The numbers from the output are the final results after calibration by working with the empirical constants.

Table I. Actual Air Travel vs. Demand Model

| <u>City Pair</u>         | <u>Actual Travel (1988)</u> |                    | <u>Demand Model</u>         |
|--------------------------|-----------------------------|--------------------|-----------------------------|
|                          | <u>312 days/yr</u>          | <u>365 days/yr</u> | <u>Passengers/yr (1990)</u> |
| 1. L.A.-San Fran.        | 5,474,040                   | 6,403,040          | 6,374,556                   |
| 2. Sacr.-San Diego       | 124,800                     | 146,000            | 117,646                     |
| 3. Sacr.-Fresno          | 46,800                      | 54,750             | 45,944                      |
| 4. Sacr.-S.L.O.          | 18,252                      | 21,352             | 13,633                      |
| 5. Sacr.-Monterey        | 34,570                      | 40,442             | 34,134                      |
| 6. San Diego-Fresno      | 47,736                      | 55,845             | 48,280                      |
| 7. San Diego-S.L.O.      | 9,360                       | 10,950             | 10,938                      |
| 8. San Diego-Santa Barb. | 28,080                      | 32,850             | 29,415                      |
| 9. Fresno-L.A.           | 624,000                     | 730,000            | 450,411                     |
| 10. Bakersfield-L.A.     | 218,400                     | 255,500            | 169,984                     |
| 11. San Diego-L.A.       | 2,004,912                   | 2,345,490          | 450,145                     |
| 12. Santa Barb.-L.A.     | 217,433                     | 254,369            | 124,479                     |
| 13. Phoenix-L.A.         | 1,760,304                   | 2,059,330          | 744,218                     |
| 14. San Diego-San Fran.  | 1,451,175                   | 1,697,688          | 627,333                     |
| 15. Sacr.-San Fran.      | 953,971                     | 1,116,024          | 247,465                     |
| 16. Monterey-San Fran.   | 320,112                     | 374,490            | 96,579                      |
| 17. Santa Barb.-Fresno   | 3,120                       | 3,650              | 12,509                      |
| 18. Bakersfield-Fresno   | 3,120                       | 3,650              | 7,859                       |
| 19. Bakersfield-Sacr.    | 24,960                      | 29,200             | 46,530                      |
| 20. Redding-San Fran.    | 20,592                      | 24,090             | 45,560                      |

Table I shows three types of correlations between actual travel and demand model output numbers. The first eight sample legs show that the model output, which can be considered to be natural demand, is close to, or within the range of actual travel. The next eight city pairs give an actual travel that is much higher than the natural demand predicted. The last four pairs give an actual travel that is significantly lower than the natural demand. Considering the state of air travel in California today, two existent phenomena, hubbing and stunted service, can be used to explain the discrepancies noted. The reason for actual travel to be much higher than natural demand would be if one of the cities is not the initial origin or final destination, and is instead being used as a hub. This would be the case if the travel was between a small or medium sized city and a large metropolitan area. Obviously, Los Angeles and San Francisco are the acting hubs and the other cities such as Fresno, Santa Barbara, San Diego, and Sacramento

are the smaller "feeder" cities. This meshes with what is known to be the case existing in California. The case of actual travel being much lower than the natural demand can be explained by the phenomenon of stunted service. The carriers providing intrastate air transport in California have set certain numbers of flights for many legs between city pairs of small or medium sized cities. This restricts air travel available to well below the predicted demand. This level of service is usually set because the airlines find that actual demand warrants only that amount. The difference between predicted demand and actual demand is then occurring because of factors such as the public's propensity to drive (especially in some remote areas), ease of driving, etc. These factors were not included in the demand model and consequently throw it off in these areas.

In retrospect, it can be seen that the city pairs that had a good match between actual and natural demand were in fact free of the phenomena of hubbing or stunted service. The Los Angeles to San Francisco leg does not require hubbing because both have major airports in the area and have adequate actual demand for the connecting service to exist to full potential. The connections between cities of medium size such as San Diego, Sacramento, Fresno, Monterey, and Santa Barbara have no hubbing activity because none of these cities are hubs and have service matching full potential. These can be considered to be "true" legs because they are free of the two discrepancy causing situations. It is well that the demand model shows good correlation with actual travel for these "true" legs. After considering the hubbing activity and the stunted service, it is evident that the demand model has an overall good representation of real world air travel. If the corridor air transit system is implemented as envisioned, it would eliminate the hubbing activity between cities and replace it with its own types of travel. Also, the system would set the actual service based on demand and economics and reduce the phenomenon of stunted service. Consequently, the demand model would yield an an even closer match with the actual travel scenario existent after system implementation. The forecast numbers in the output would then be representative of all parts of the corridor and can be used to ascertain many aspects of the system. Therefore, it can be said that the demand model stands calibrated and is valid for use as a tool in system and vehicle design.

The input and output data from the use of the program in this system design are included in Appendix. The program listing is given in Appendix. Table II provides an excerpt from the complete output information provided in Appendix. It gives the total air travel one-way from each of the 14 cities in the California Corridor for the years 1990 and 2010. Figure 1 is a graph of the cumulative percentage of travel in the entire corridor as related to distance. It provides a visual aid in determining the optimum range for a vehicle making direct flights between the cities in the area.



Table II. Excerpt from Demand Model Output

| City            | Total One-Way<br>1990 | Air Travel Demand<br>2010 |
|-----------------|-----------------------|---------------------------|
| San Francisco   | 9,181,493             | 17,463,182                |
| Los Angeles     | 10,843,806            | 19,385,346                |
| San Diego       | 1,498,924             | 1,638,386                 |
| Sacramento      | 1,994,017             | 3,660,600                 |
| Fresno          | 909,231               | 1,668,697                 |
| San Luis Obispo | 205,132               | 329,702                   |
| Bakersfield     | 586,254               | 1,153,653                 |
| Redding         | 149,844               | 219,721                   |
| Santa Barbara   | 516,056               | 1,053,850                 |
| Monterey        | 693,697               | 1,132,851                 |
| Las Vegas       | 390,382               | 308,934                   |
| Reno            | 122,288               | 67,030                    |
| Phoenix         | 1,535,106             | 1,531,894                 |
| Portland        | 1,033,043             | 740,940                   |
| Total           | 14,829,635            | 50,354,786                |

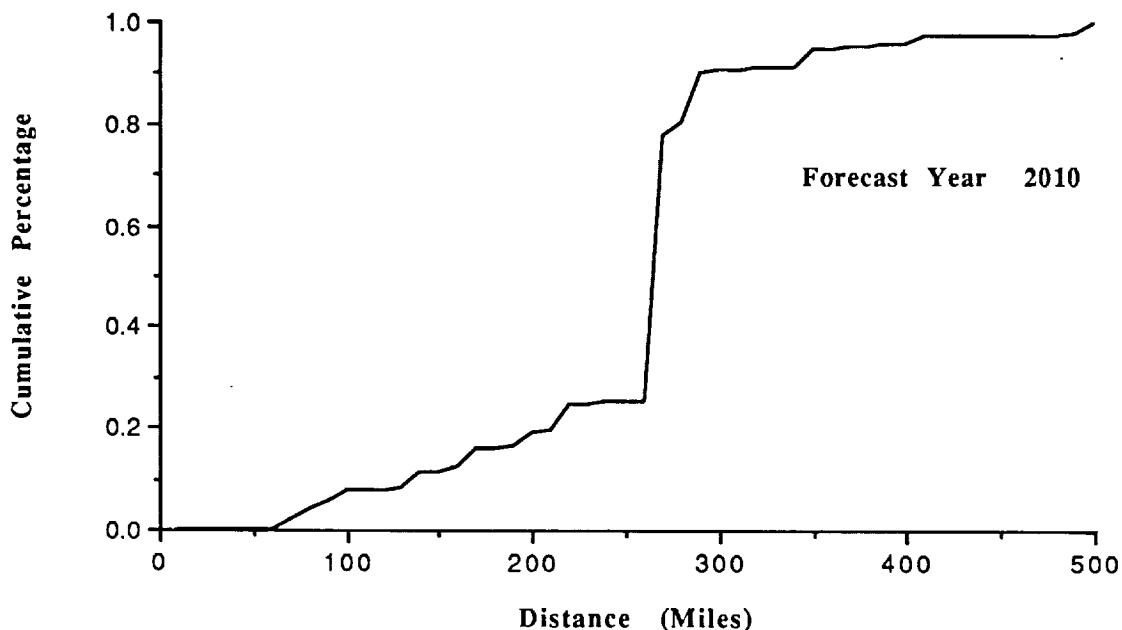

Figure 1. Marginal Demand vs. Range

## Applications

The following examples illustrate a few ways of applying the information available from the demand model in the design of a system. The Los Angeles metropolitan area is approximately 60 miles by 60 miles or 3600 square miles. If the level of service set for a VTOL aircraft dictates that vertiports be, at most, 5 miles away from a passenger's initial origin point, then the area of service of each vertiport would be equal to the area of a circle with a radius of 5 miles extending from the port. Each vertiport would then cover about 80 square miles. To serve the entire L.A. area would require 45 vertiports. In order to place this number of vertiports in the metropolitan area, it would be unavoidable to locate some of them in "bedroom" communities. It would also be desirable to place them close to residential areas to provide a more door-to-door type service. The noise guidelines in these zones are quite stringent and would play a major role in system design. We see from noise calculations that such a location would allow up to 44 departures a day with the following breakdown:

| Category | Time  | x | Depart/Hr | = | Departures |
|----------|-------|---|-----------|---|------------|
| Peak     | 4     | x | 3         | = | 12         |
| Base     | 8     | x | 2         | = | 16         |
| Evening  | 4     | x | 2         | = | 8          |
| Night    | 8     | x | 1         | = | 8          |
| =====    | ===== |   |           |   | =====      |
| Total    | 24    |   |           |   | 44         |

Using the analogy that a chain is only as strong as its weakest link, it can be said that this "bedroom" community vertiport would be the representative port used in further calculations since it would operate in the most restricted environment. By looking up total one-way air travel per year from Table II, it can be seen that L.A. is forecasted to have 19,385,346 enplanements per year for the year 2010. Assuming that there are effectively six days of travel per week, because of weekends and holidays, yields 312 travel days per year. Using a homogeneous distribution of travel between all 45 vertiports, and going through the following math step, the enplanements per day at each vertiport is achieved.

$$\frac{19,385,346 \text{ enplan.}}{1 \text{ year}} \times \frac{1 \text{ year}}{312 \text{ days}} \times \frac{\text{L.A. Area}}{45 \text{ vports}} = \frac{1330 \text{ enplan./day}}{\text{vertiport}}$$

Now, utilizing the characteristic vertiport and the number of departures allowed per day by noise restrictions, it can be calculated that there are will be 31.4 enplanements per departure. By designing the VTOL vehicle to be 40 passenger capacity, we would be attaining an average load factor of 87.5%. This is a high load factor, and is desirable because it would yield a good profit margin for the system.

One of the proposed systems for providing transportation in California is one that utilizes a central hub located near Kettleman City in the Tulare Dry Lake area. In order to calculate either the range required or a standard stage length for the vehicle to serve this hub, the following procedure can be followed. The distance from each of the cities to this central hub (to be introduced later as the Corridor Access Port (CAP)) can be determined. Multiplying the distance with the respective enplanements from each city from Table II, adding all these together, and dividing by the total travel in the entire area gives a weighted mean distance. This mean distance reflects the demand from each city. Therefore, it is much more representative of the trip length being flown by the vehicle in each one-way trip to or from the CAP. This mean distance can be considered to the stage length of the vehicle serving the hub system. The numerical calculation for this particular case follows:

| City            | Distance to CAP<br>(naut. miles) | x | Total Enplanements<br>per year | = | Product             |
|-----------------|----------------------------------|---|--------------------------------|---|---------------------|
| San Francisco   | 135                              | x | 17,463,182                     | = | $2.358 \times 10^9$ |
| Los Angeles     | 126                              | x | 19,385,346                     | = | $2.443 \times 10^9$ |
| San Diego       | 206                              | x | 1,638,386                      | = | $3.375 \times 10^8$ |
| Sacramento      | 146                              | x | 3,660,600                      | = | $5.344 \times 10^8$ |
| Fresno          | 35                               | x | 1,668,697                      | = | $5.840 \times 10^7$ |
| San Luis Obispo | 46                               | x | 329,702                        | = | $1.517 \times 10^7$ |
| Bakersfield     | 52                               | x | 1,153,653                      | = | $5.999 \times 10^7$ |
| Redding         | 255                              | x | 219,721                        | = | $5.603 \times 10^7$ |
| Santa Barbara   | 81                               | x | 1,053,850                      | = | $8.536 \times 10^7$ |
| Monterey        | 84                               | x | 1,132,851                      | = | $9.516 \times 10^7$ |
| Las Vegas       | 200                              | x | 308,934                        | = | $6.179 \times 10^7$ |
| Reno            | 181                              | x | 67,030                         | = | $1.213 \times 10^7$ |
| Phoenix         | 360                              | x | 1,531,894                      | = | $5.515 \times 10^8$ |
| Portland        | 499                              | x | 740,940                        | = | $3.697 \times 10^8$ |
| =====           |                                  |   | =====                          |   | =====               |
| Total           |                                  |   | 50,354,786                     |   | $7.037 \times 10^9$ |

$$\begin{aligned} \text{Mean Distance to CAP} &= \\ &= \frac{7.037 \times 10^9 \text{ enplanement-n. miles}}{50,354,786 \text{ enplanements}} \\ &= \underline{\underline{139.75 \text{ n. mi.}}} \end{aligned}$$

It follows that, for the central hub concept, the stage length could be estimated to be 140 nautical miles. Figure 2 shows a graph of the above numbers. It can be seen in the figure that there are three peaks. The peaks around 200 n. mi. and 350 n. mi. would tend to pull the mean value a little to the right of the main peak that is around 120 n. mi. Therefore, a mean value of 140 n. mi. is acceptable by visual verification.

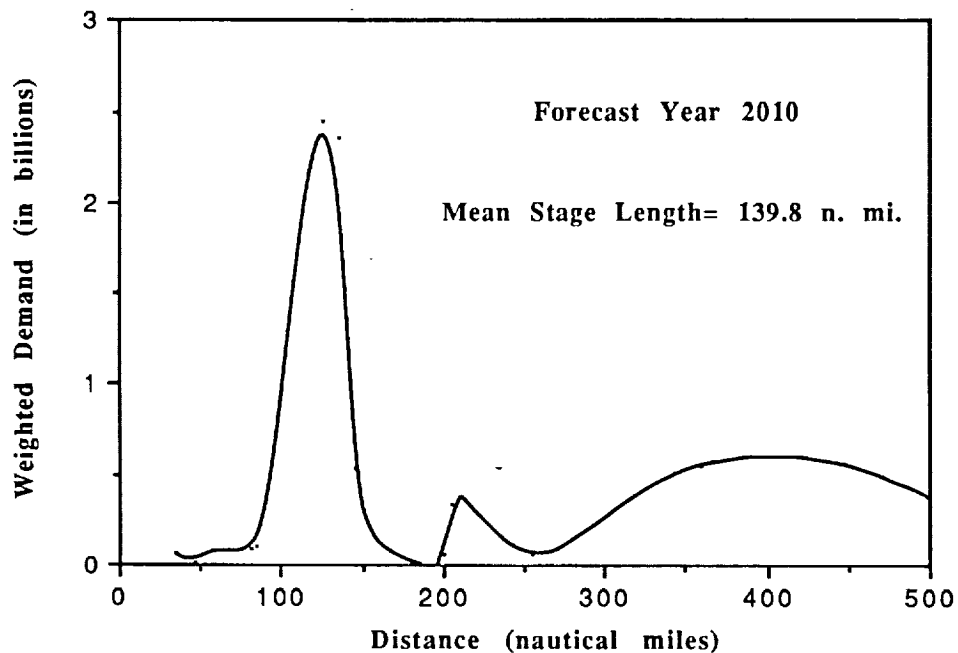

Figure 2. Weighed Factor vs. Stage Length

## Conclusion

Using the demand model output along with other information such as noise restrictions and cost analysis, many aspects of the system and vehicle can be determined. Among the many characteristics that can be derived are such things as cities to be served and routes to be flown, coarse approximations of the number of terminals and vehicles, the required range, speed, and capacity of the vehicle, and rough estimates of schedules. In turn, these specifications can lead to system trade-off criteria such as total system cost, block time, and user convenience.

## References

1. Massachusetts Institute of Technology Flight Transportation Laboratory, *A Systems Analysis of Short Haul Air Transportation*. Technical Report 65-1. Cambridge, August, 1965.
2. Lockheed-Georgia Company, *Mass Air Transportation Study Final Report*. Marietta, Georgia: 1968.
3. Georgia Institute of Technology Complex Systems Design, *Interurban Air Transportation System*. Atlanta, Georgia: 1969.
4. U.S. Census of Population, 1980. *Local Population Estimates: California*, (P-26/82-5-SC), Washington DC: Government Printing Office, September, 1984.
5. Aircraft Owners and Pilots Association, *AOPA's Airports USA*. 1989.
6. California Department of Transportation, Division of Aeronautics, *The California Aviation System Plan*, "Element II: Forecasts." August 1988.

## FUTURE OF AIR TRANSPORTATION

Since the deregulation of the late 1970's, the demand for airline transportation has grown to the point that existing facilities have reached their capacity limits. The airport facilities that still have additional capacity available are limited by noise constraints. Despite this, mechanisms must be found that will allow the expected doubling of the demand for air travel in the year 2010. Furthermore, a new class of flight vehicles is expected to be operational at this time. These include: tilt rotors, supersonic transports (SST), hypersonic transports (HST), and high capacity aircraft. A means to accommodate and intelligently employ these new modes of travel is needed.

The first means of dealing with the future that were explored were to use only existing facilities, yet move a larger number of passengers. It has been estimated that the number of conventional aircraft able to land at Los Angeles International could be increased by as much as 15 to 20 percent using advanced technologies. This increase is an option, but it intensifies the problems such as noise associated with airports and does not in and of itself come close to solving the total problem.

The concept of using high-speed hovercraft to provide a means of landing the aircraft at sea and then transporting them quickly to the on-shore airports was also evaluated. It would be possible to develop computer controls to position and control the path of these vehicles under these conditions, though. The safety problems associated with this would be unquestionably great. Furthermore, research was done to determine the feasibility of such a hovercraft. It would take an enormous amount of power to operate such a large hovercraft. The speeds necessary to perform this function are beyond the capability expected for hovercraft in the year 2010.

Another proposed solution was to build new conventional airports as close to population centers as possible. The most prominent of the attempts to accomplish this is the planned Palmdale International Airport (PMD). The Palmdale International airport plan illustrates one of the problems that attempting to locate a new, major airport near a population center might encounter. At the time PMD was planned, Palmdale was a tiny community. Today, because of skyrocketing land costs in the Los Angeles Basin, many commuters have chosen to live in Palmdale where they can find affordable, quality housing, and then commute about one and one-half hours to their place of employment. This trend has made Palmdale one of the fastest-growing cities in the state. Placing a major airport into such an environment would only delay the problem for a short time. It might also involve a highly contested political fight.

Another option involving the building of new facilities is the construction of two new hubs in the State of California. One would be located in Southern California, accessible to the Los Angeles area, and the second would be situated as near as possible to the San Francisco Bay. The first problems this proposal encounters are that the closer these hubs are to the major cities, the land is likely to become more expensive, and the opposition tends to be more fierce. In locating the Southern hub, the logical procedure is to start at Los Angeles' center and proceed out in every direction in search of a viable location. Ontario may appear to be the first likely possibility. Ontario is in fact an International Airport with room for further expansion. Ontario International is also already on the list of California's ten foremost noise problems. In the San Francisco Bay Area, due to strict land use regulations and expensive real estate prices, there is little chance of finding a suitable location for a major airport.

Two locations where land could be made available for hubs are Mather and George Air Force Bases, which the Air Force will be closing soon. Mather AFB is located adjacent to Sacramento, which casts doubt on the use of Mather due to possible noise and congestion problems. George AFB is ideal in that it is located away from the metropolitan areas, however, it is not expected that a large scale airport could be located only forty miles from Edwards Air Force Base. It should be remembered that the closer these sites are to the cities the more likely it is that travelers will drive there rather than use other forms of transportation.

Jim Sheppard of the Federal Aviation Administration in Orlando, Florida has proposed the Wayport concept as a solution to future air travel demand. The Wayport would be a large multi-purpose airport located well away from congested airspace. It would not be an origin or destination for any traveler. Instead, passengers could make transfers and catch connecting flights there. The Wayport would also serve as a major hub for express and cargo companies. The remote location of the Wayport would eliminate many of the problems with the building of major new airports such as noise, air space congestion, need for additional roads and highways, environmental impact, infrastructure, political concerns, high cost of land acquisition, and reduce the delays at airports which cost consumers 3 billion dollars a year (Ref. 1).



A trade-off study was conducted on the merits of a two-hub system versus a variant of the Wayport concept. For travel within the corridor, a passenger would have to make more vehicle transfers with the two-hub concept, resulting in greater passenger inconvenience and an increased chance of delays as compared to the Wayport. The land costs of the Wayport would be lower and noise would not be a problem due to the remote site. Other costs could be made lower in the Wayport concept since each facility would not have to be duplicated as it would with the two hub concept. Also, by virtue of its remote location the Wayport could be designed to easily expand to meet future demand.

The distance chart shown in Table I demonstrates another useful comparison between the two concepts. To reach their respective hubs in the two-hub system, the residents of Los Angeles and San Francisco must face either a long drive, or an additional mode change should they chose to fly to the hub. Once they have completed this trip to the hub they would have covered most of the distance it would have taken to get to the Wayport location. The fact that the Wayport is further from the customers' point of origin would discourage travelers from driving there, thus decreasing congestion, and encouraging the use of alternate modes of transportation. For out-of-corridor travel, the Wayport concept is clearly superior for air carriers due to the ability to centralize flights at one location, and thus provide higher load factors on all aircraft. The Wayport concept is greatly enhanced through its situation in a travel corridor, for not only is the demand for airport usage coming from long-distance traffic, but it is also coming from the high demand of the corridor itself. For these reasons, it was decided that a variant of the Wayport concept would be the best means of coping with the future increase in the demand for air travel in the California Corridor.

Table I. Distances to Corridor Access Port

| <u>From</u>     | <u>Distance to George AFB</u> | <u>Distance to CAP</u> |
|-----------------|-------------------------------|------------------------|
| Los Angeles     | 67                            | 148                    |
| San Diego       | 113                           | 232                    |
| Las Vegas       | 141                           | 230                    |
| Bakersfield     | 93                            | 53                     |
| San Luis Obispo | 201                           | 58                     |

| <u>From</u>     | <u>Distance to Mather AFB</u> | <u>Distance to CAP</u> |
|-----------------|-------------------------------|------------------------|
| San Francisco   | 76                            | 158                    |
| Reno            | 91                            | 213                    |
| Sacramento      | 5                             | 174                    |
| Fresno          | 129                           | 48                     |
| San Luis Obispo | 201                           | 58                     |

**References**

1. Sheppard, J., The Wayport Concept, May 25, 1989.

## CALIFORNIA CORRIDOR AIR TRANSIT SYSTEM

The California Corridor Air Transit (CAT) system will be a competitor in the new transportation opportunities created by the Corridor Access Port (CAP) and other factors in the year 2010. Electric CTOLs, magnetic levitation trains, and tilt rotors are the primary vehicles that will make up the CAT system. These vehicles each will have their portion of the market allocated by the consumer's demand for various levels of service and price ranges. Furthermore, there is a link between the rail and air transport vehicles. Air transportation tends to accelerate the development of a region, leading to the development of a demand density that may warrant an investment in rapid rail transit (Ref. 1).

The electric CTOL is the main component of the first phase fo the CAT/CAP implementation plan (see Cal Poly ECTOL). This advanced airplane design features low pollution and noise compared to existing aircraft, and thus is predicted to be more readily accepted by airport communities. It will use existing airports which will allow rapid implementation of the aircraft, and little initial cost since there is no need to create new landing sites or build tracks. The ECTOL fleet is planned to provide inter-city, airport-to-airport service initially, slowly phasing out the smaller, conventional passenger planes. Also, since it will be operating while the CAP and magnetic levitation trains (Mag-Lev) are under construction, it will provide a source of income to help offset the expenses. When the CAP is completed, the ECTOL will merge with the tilt rotor and the Mag-Lev in order to handle the predicted passenger traffic demand of the CAP. The ECTOL will also continue to serve those areas desiring direct airport-to-airport service.

The Mag-Lev will be another important component of the CAT system. Plans for a high speed rail system have already been proposed through California's Central Valley. Interfacing with the CAP makes such a project even more promising since ridership of this train would be made up not only of those

traveling point-to-point along the train route, but also includes those who wish to transfer at the CAP to a domestic or international airport.

Both the ECTOL and the Mag-Lev will require secondary modes of transportation such as cars, buses, and commuter trains in order for passengers to reach the nearest terminals if their home, place of work, or other origin/destination is not next to one. The tilt rotor system (Wildcat) will decrease this need by providing terminals closer to the areas of highest demand. This is due to the ability of the Wildcat to takeoff and land vertically, and thus requires less space for a terminal. With this advantage and the low noise and pollution of this advanced technology tilt rotor, Wildcat terminals can be built in residential areas, commercial roof-tops, shopping center parking lots, recreational areas, and other places where near door-to-door service is desired. Funding and approval of a terminal could be accomplished locally; if a community or business wishes Wildcat service, all they need to do is to build their own terminal, define an operating schedule that they desire, and the Wildcat will serve it. This eliminates the communication problems caused by flying into an area where the Wildcat is not appreciated or operating while residents are sleeping because the residents decide whether they want it, and they define the schedule.

The Wildcat will serve two markets: city-to-city, and direct flights to the CAP. The city-to-city service is defined as hops of greater than 40 nautical miles due to the less cost efficient operation of the tilt rotor below this distance. This service will fly between Wildcat terminal pairs only if the demand is sufficient for near door-to-door service between the two areas. Interfacing with the CAP will allow a level of tilt rotor service unsurpassed by solely point-to-point transit. The CAP serves as a mode sorter in that persons from a given location are able to easily make connecting flights to other parts of the corridor as well as interstate and international flights. This allows for higher load factors to be obtained on VTOL aircraft at each vertiport. Take, for example, a businessman from Santa Ana in Southern California who desires to travel to Palo Alto in the San Francisco Bay area. The demand for this route would probably not be sufficient to warrant a direct flight, but because of the CAP, travelers Santa Ana bound for many destinations could all board the same tilt rotor. Once in the CAP the businessman could quickly board another tilt rotor bound for Palo Alto along with others arriving from all-around and outside the corridor.

The intra-urban market is the demand for air transportation that originates and ends within the major metropolitan area. In the past this role was filled with partial success by the helicopter. These services have met with many problems. Foremost is the prohibitive cost of such transportation. Currently, a chartered helicopter trip from Los Angeles to Palm Springs, California would cost about one thousand dollars. One could buy a ticket to London, England for that amount (Ref. 2). Other problems that have plagued this industry are public rejection due to noise and lack of vertiports (Ref. 3). It is predicted that the use of tilt rotor technology may be able to overcome many of these technical difficulties (Ref. 4). Present predictions show, however, that the tilt rotor will not be as cost effective

as ground transportation for distances under 40 nautical miles. This limitation may become almost negligible, though, as ground transportation becomes increasingly congested, and the cost of time wasted in transit exceeds the additional expenses incurred by the short distance flights. At this point, passengers may be willing to pay a little extra for intra-urban hops to save time. Whether the Wildcat serves this market will be determined by the demand for it.

The California Corridor Air Transit system will be a completely integrated system. An important means of implementing this is to supply travelers with CAT-system ID cards. These cards will not only be used for purposes of identification but will allow the traveler to quickly access the system and be automatically billed for the trip. Baggage will be linked with the ID card, and thus can be checked in at the beginning of the trip and picked up at the end, no matter how many transfers are made in the system.

### **Air Traffic Control**

The VTOL ports in the metropolitan areas will handle less concentrated traffic flow than the Corridor Access Port, but due to the close proximity of homes and businesses, safety must not be compromised.

In order to accommodate this system with maximum safety, all aircraft operating in California airspace would be required to have sophisticated electronic avionics. It is predicted that this type of requirement would face stiff political opposition. Currently, there are approximately 262 thousand members in the Aircraft Owners and Pilot's Association (AOPA), a politically active club that has many lobbyists working in the state and federal government sectors. In the past, they have successfully influenced the legislation of various bills dealing with the flying environment, and acted as advisors in many committees. Examples are the winning of a court case against discriminatory airport usage fees in Chicago (penalizing smaller airplanes using the airports due to smaller number of passengers) and airplane equipment requirements, such as mandatory mode C transponder installation (the government is now requiring installation in a stepwise-time scale instead of all at once) (Ref. 5). Their position is generally against new legislation which may hinder their freedom to fly. Since many pilots (from students to airline pilots) and aircraft owners are members of this organization, AOPA's views cannot be overlooked.

Secondly, the installation of automated equipment into existing aircraft will be an additional cost that aircraft owners may balk at. There is also the problem that many general aviation (GA) aircraft may require extensive modification in order to be fitted with such a system since they were never designed to have them.

In the interest of public safety, government agencies may be able to implement this equipment requirement for operation within the CAT area, and thus exclude all non-automated aircraft (NAA) from the area. This would provide optimum safety within the area, but the flight restrictions thus created for

the NAA would be severe. There would also be much resistance by the NAA owners due to the necessity of having to relocate their aircraft bases elsewhere. Satellite NAA airports on the outskirts of the system with free travel allowance within the CAT area for the NAA pilots may alleviate some of the inconvenience, but would also increase congestion in the outlying area, not to mention require another move if the CAT was to expand into that area.

At the other extreme is no automation except for the CAT aircraft. This option is not feasible due to the system design in terms of safety considerations, strict scheduling, and all-weather operation requirements. The primary safety obstacle is that the non-automated aircraft (NAA) add a random factor into the aircraft separation scenario. For example, if a NAA strays into the path of a CAT shuttle, the shuttle will have to deviate from its course, perhaps abruptly, in order to avoid collision. If by chance, the NAA attempted to do the same, but instead turned toward the shuttle's evasive path, collision may still be eminent, and perhaps now unavoidable. In the proximity of a terminal where aircraft are arriving and departing, this factor is even more critical due to the reduced maneuverability of arriving/departing aircraft. This is a worst-case scenario, but even if collision did not occur, the discomfort to the passengers, schedule alterations due to the course deviation, or possible public protest on the issue of safety may result. As long as NAA are operating within or in the vicinity of the CAT routes, this conflict is a definite possibility.

CAT route corridors (CRCs) are good compromises for air traffic separation providing interaction of CAT aircraft and NAAs in an efficient and safe manner. The CRCs must be large enough to provide an adequate buffer for minor CRC airspace intrusion by NAA, but must not severely limit NAA-usable airspace. Such CRCs can be visualized as tunnels in the sky that link the CAT terminals and within which the CAT shuttles fly. Outside of these tunnels would be the airspace for the NAA. In order to warn the NAA pilot that he has transgressed into the CRC, a low-cost CRC intrusion alarm must be installed as a minimum, providing an audible and visual alarm, and indicating the best direction to alter course in order to leave the CRC. Such a device can be easily produced using existing technology. This simple system will provide adequate safety against en-route collisions. A disadvantage is that the fixed CRCs may not allow optimum CAT operations (straight-line courses) since a web of optimum routes may significantly interfere with NAA operations. A more accurate study will require more information of proposed terminal locations and major routes.

In the vicinity of the public air terminals, the solution is not as definite. For NAA pilots, the takeoff and landing phases of the flight are the most demanding, and this results in a greater possibility of mistakes occurring. This, combined with the increased traffic density, both automated and non-automated, creates a critical situation. Ideally, if NAA were equipped with automated equipment so that the CAT system can have control over just the takeoff and landing phases of the flight, safety would be adequately ensured in the terminal areas. However, the same considerations about automation must be taken as discussed earlier. Thus, non-automated pilot takeoffs and landings at terminals are predicted to continue.

Separation of CAT vehicles and NAA via different runways/landing sites and a local CAT route corridor will help alleviate the problem; however, due to the smaller relative airspace around the airport, these methods will not be as effective compared to the en-route airspace safety. Note that this is only a concern where NAA and CAT aircraft are sharing the same terminal. Minimizing this situation will yield the highest possible safety factor.

The technological advancement in the field of aircraft avionics and control systems is predicted to be adequate to meet the needs of the CAT system by the year 2010. Total automation of all phases of aircraft operation will be safe and reliable due to sufficient redundancy of both land and airborne equipment. A flight manager with proficiency in operating all phases of the vehicle flight should be available on each vehicle as the final redundant factor, and also for the ease of mind of the passengers. Ground based navigational aids to be used for en-route guidance for the CRC are already sufficient in most areas of the proposed CAT routes, and thus transition to the CRC system can be easily performed with little additional expense. The Global Positioning System (GPS), a satellite-based navigation system, may be used with sufficient accuracy for en-route navigation in all areas.

Communication between ground and air will be assisted by CRT messages and graphic displays. This will remove the possibility for error in misinterpreting verbal instructions given by air traffic control. Digital data communication between the CAT computers and the CAT aircraft can be achieved with current communication methods, but CAT aircraft must have a system that can operate independently of the ground computers in case of communication failure or jamming until the next terminal is reached.

Care must be taken in choosing and designing sites for the CAT terminals and flight paths. For example, a minimum obstruction clearance for a straight-in approach for STOLs and VTOLs that was suggested by the FAA is shown in Figure 1. From 30 feet to 1 mile out along the approach path, there should not be any obstructions on a 20:1 glide-slope. From 1 mile to 3 miles, the suggested clearance is 14:1. On each side of the path, there should be a transitional area with a clearance of 4:1 extending 500 feet perpendicular to the approach center line (Ref. 6). These suggestions were developed before curved, instrument approach paths were made possible by the microwave landing system, and thus do not reflect the increased flexibility inherent with the MLS system. However, a similar study should be made at every proposed site to ensure sufficient clearance from obstacles.



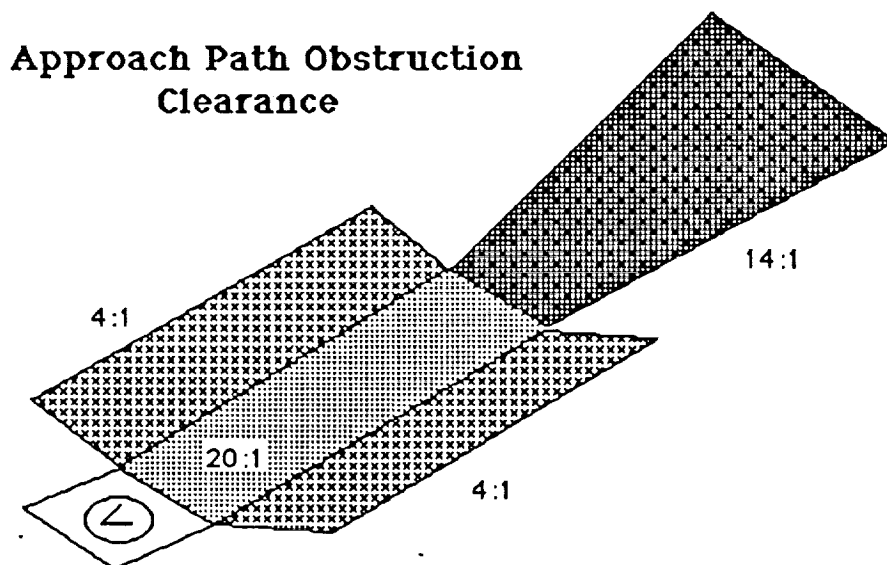

**Figure 1. Minimum Suggested Approach Path Clearance**

### Noise Considerations

Of the vehicles being proposed for the California Corridor Air Transit system, the tilt rotor attracts the most concern from a noise standpoint. In order to provide the near door-to-door service planned with the tilt rotor, the number of tilt rotors will be much higher than the number of other corridor vehicles, and it will tend to operate closest to the bedroom communities located outside the metropolitan regions of the state. The acceptability of this vehicle, both publicly and economically, will be dependent to some extent on noise vs. cost and noise vs. weight trade-offs, as well as on how well the vehicle is able to meet the noise standards of the year 2010 and beyond.

In order to function in the bedroom communities, the tilt rotor must be able to operate at or below the noise levels set by the EPA and the FAA (see the chapter on noise). This means the day-night average sound level (Ldn) of the tilt rotor should not exceed 57 dBA, the typical level for a suburban community. This limit, however, is not rigid due to the inability of the public to perceive any noticeable change in loudness or annoyance for a change of less than 10 dBA. As a result, some sources note a maximum level of 65 dBA as an allowable Ldn for land uses involving residential housing (Ref. 7).

The value of the Ldn is indirectly determined by the EPNL of the tilt rotor, and is also a function of the peak EPNdB time span and the number of night-time flights. The results of a noise assessment procedure developed for a rotorcraft were based on these three variables. However, the first step to this assessment was to determine a realistic noise level for the tilt rotor.

The maximum noise levels of the tilt rotor are assumed to be determined using the ICAO helicopter limits shown in the Appendix. Based on a maximum gross takeoff weight of 50,000 pounds, these limits gave maximum noise levels of 100.5, 101.5, and 99.5 EPNdB for takeoff, approach, and flyover, respectively. It is assumed that the ICAO limits will be forced to decrease in the future such that the same size vehicle will have to be quieter than at present in order to be certifiable.

Three significant sources of noise in the tilt rotor vehicle are the engines, the drive system, and the prop-rotors (Ref. 8). Engines can be quieted in a number of ways, from treating inlets and exhaust ports with acoustic absorption material to increasing the engine installation weight factor to as much as 2.00 for a vehicle with an overall noise level goal of 80 EPNdB (Ref. 8). The drive system can be acoustically treated; however, as with the engine, this would be done at the expense of a higher vehicle empty weight. The most dramatic reductions in tilt rotor noise involve the rotors. Reduction of rotor tip speed is the most effective means of reducing noise annoyance created by the vehicle (References 8 and 9). (As was stated in the chapter on noise, the noise level of an object is proportional to the object's velocity cubed.) Normally, to decrease the noise level of a rotorcraft, the rotor disk loading is decreased by increasing either the number or length of the rotor blades; trends show the decrease in noise to be approximately twice the magnitude of the decrease in disk loading (i.e., a drop of 6 psf in disk loading results in a 12 EPNdB decrease in noise) (Ref. 10). This allows tip speeds to decrease at the expense of added weight and cost to the vehicle. The prop-rotors of a tilt rotor vehicle do not need to spin at high rpm's, since a tilt rotor will not normally operate at high speeds in the helicopter mode. Therefore, rotor length does not need to increase. However, to provide lift in the low-speed helicopter mode (particularly during takeoff and landing) and forward thrust in the high speed airplane mode, a sizable solidity is required, meaning that a weight and cost penalty is incurred. (An area of further study is to determine whether this penalty is less than or greater than that for a standard helicopter.)

According to a V/STOL study done by Bell Helicopters (Ref. 11), a prop-rotor sounds much like a propeller and does not emit the characteristic blade slap of high speed helicopter rotors. Noise in cruise mode, at tilt angles between 0 and 30 degrees, is at least 7 to 10 dBA lower than that for the takeoff mode, which produces the maximum noise exposure, and predictions show a reduction on the order of 20 dBA as being possible.

As was stated in the chapter on noise, operational procedures can be used to reduce the perceived noise level of the tilt rotor vehicle without actually decreasing the amount of noise produced. These procedures are beneficial for the aircraft operator, since no weight penalties are introduced (as would occur if sound-insulating materials had to be incorporated in the vehicle). Performance, however, may suffer during takeoff and landing, as certain ascent and descent patterns must be followed to satisfy vertiport noise abatement requirements. Examples of approach and departure patterns are shown in References 9 & 11. Reference 11 also states that procedures such as entering the conversion corridor (the region where

conversions from vertical to horizontal flight can be safely made) at the lowest possible airspeed will assure minimum noise generation on the ground.

The conclusion to this analysis is that, with the predictions shown, and with the noise data of the XV-15 being promising, it is not unreasonable to assume a civil tilt rotor vehicle will be built by the year 2010 with a noise level at or below 80 EPNdB.

The two remaining vehicles being implemented into the California Corridor Air Transit system are the electric-propulsion CTOL (ECTOL) aircraft and the magnetic levitation (Mag-Lev) train. Neither of these vehicles will be operating as close to the bedroom communities as the tilt rotor vehicle; however, they will have an impact on the overall system, due to their use throughout the Corridor.

The electric-propulsion CTOL aircraft will be significantly quieted by the use of electric engines. Since fuel cells will be used rather than turbines and compressors, overall aircraft noise will become a function of aerodynamics. Aerodynamic noise can be decreased through the use of laminar-flow airfoils, which reduce noise due to turbulence. The ECTOL's ability to operate only out of large airports (4000 ft runways) will keep it separated from quieter communities, as these airports will continue to be surrounded by less noise-sensitive, light industry regions. Frequency of ECTOL vehicle flights will be less than that of the tilt rotor vehicles. Therefore, the contribution of the ECTOL to the overall Ldn of the system will not be significant.

The Mag-Lev train, by virtue of its magnetic drive system, can be said to follow the same reasoning as the ECTOL craft in terms of powerplant and turbulence noise reduction. The train will have the least effect on populated areas, as its route will take it mainly through farmland regions in the San Joaquin Valley.

## **Integration and implementation**

As the implementation of an entirely new transportation system will face stiff opposition, a logical plan for this must be used. The first thing to be done will be the integration of the electric CTOL (ECTOL) aircraft into the existing community airports. Because the ECTOL is the most evolutionary of the proposed vehicles, it is likely to encounter the least opposition from the communities. It will be attractive to these communities in that it provides convenient air service, while the aircraft produces no pollution and little noise. It has been shown that currently there is sufficient demand to warrant the construction of the Mag-Lev train between Los Angeles and the San Francisco Bay Area, so construction will begin on the track. This system will have implementation opposition in populated areas, but as the population of California continues to grow, the demand for travel between these cities will also increase. If the air transportation system cannot be expanded to meet the rising demand, a high volume system such as Mag-Lev could meet these needs. As the Corridor Access Port (CAP) has been shown to be a viable

and attractive concept for a number of reasons, construction will begin at its location near Kettleman City. These three items comprise the first stage of implementation of the CAT system.

The second stage of the implementation begins with the opening of the CAP. At first it will be served by the ECTOL aircraft and the Mag-Lev train for Corridor traffic, as well as by long range domestic and international flights. As political pressure and restrictions are placed on the airports in the metropolitan areas, the long range flights will be diverted to the CAP. This diversion will increase the demand for corridor travel to the CAP. For the residents of the metro areas, the ECTOL aircraft is convenient for those who live within a close proximity to an airport, while the Mag-Lev is only convenient for those near the train stations. The rest of the population will also require similar convenience if the system is to be successful. Since there is not sufficient land available to construct new airports in most metropolitan areas, vertiports will be constructed. These can be located in industrial areas, shopping centers, sports facilities, and similar locations. With the construction of the vertiports, the second stage of implementation will be completed.

The final phase of the CAT system implementation involves the incorporation of the tilt rotor aircraft into the metropolitan vertiports. After this is accomplished, the CAP will be easily accessible for all persons, although the cost for this convenience will vary depending on the mode of transportation. Public opposition to the noise and congestion at the major metropolitan airports will continue to increase, leading to the diversion of more long range flights to the CAP. At this point, the CAT system will be fully implemented. It must be realized that only through careful and intelligent planning could the system be fully implemented.

## References

1. Lockheed-California Company, Study of Aircraft in Intraurban Transportation Systems, June 1971.
2. Briles, Wing & Helicopter, April 27, 1989.
3. Smith, L. K., "Helicopter Commuters: An Optimistic Outlook," Vertiflite, American Helicopter Society, September/October, 1982.
4. Hanley, A., "Tilt-Rotor, Airpower of the Future," Airpower Magazine, Vol. 19, No. 3, May 1989.
5. AOPA, Commentary, AOPA Pilot, Aircraft Owners and Pilots Association, December 1988.
6. Federal Aviation Agency, STOL and VTOL System Study: SF-LA Model by FAA Study Group, Federal Aviation Agency, Aircraft Development Service, Dec. 1966.
7. U.S. Department of Transportation, "Noise Control and Compatibility Planning for Airports," August 5, 1983.
8. Faulkner, Henry B., The Cost of Noise Reduction in Commercial Tilt Rotor Aircraft, MIT Department of Aeronautics and Astronautics, August 1974.
9. Magee, J.P., R. Clark, and H. Alexander, Conceptual Design Studies of 1985 Commercial VTOL Transports that Utilize Rotors, Volume I, Boeing Vertol Company, Nov. 1974.
10. True, H.C., and E.J. Rickley, "Noise Characteristics of Eight Helicopters," U.S. Department of Transportation, Federal Aviation Administration, p. 50-62, July 1977.
11. "V/STOL Tilt-Rotor Study Task II," Research Aircraft Design, Bell Helicopter Co., 1974.

## NOISE

### Introduction

The development of the California Corridor Air Transit system is dependent on community acceptance, and a major element of this acceptance is noise pollution. Noise has been determined to be a criteria of utmost importance and concern in driving the design and implementation of any transportation system that wishes to deliver a pseudo door-to-door service and still retain a reasonable level of community acceptance. Research has been done to investigate techniques of noise measurement, regulation, and reduction, so that conclusions can be reached as to what can be expected in the way of technology and acceptance trade-offs in the year 2010.

### Noise Measurement

Noise is defined as unwanted sound. Unwanted sound is any sound that tends to intrude upon a person's everyday life, by means of interrupting conversation or sleep, or, more generally, by just being a continual annoyance. As a result, noise measurement techniques have strived to established scales based on the psychological response of the public, so as to reflect quantitatively the qualitative judgements of those bothered by the noise.

Noise is measured in terms of decibels, a logarithmic relationship defined as

$$dB = 10 \cdot \text{LOG}_{10}(P/P^{\circ}) \quad (\text{in dB}) \quad [1]$$

where the reference pressure  $P^{\circ} = 0.00002$  Pascals is the lowest sound pressure audible to the human ear.

The most common decibel scale used for measuring sound is the sound pressure level, defined as

$$L_{sp} = 10 \cdot \text{LOG}_{10}(P^2/P^{\circ 2}) = 20 \cdot \text{LOG}_{10}(P/P^{\circ}) \quad (\text{in dB}) \quad [2]$$

Figure 1 shows the relationship of Equation [2], and highlights the fact that an increase of 6 dB results in a doubling of the sound pressure level, while a change of 20 dB is equivalent to a ten-fold change in the sound pressure.

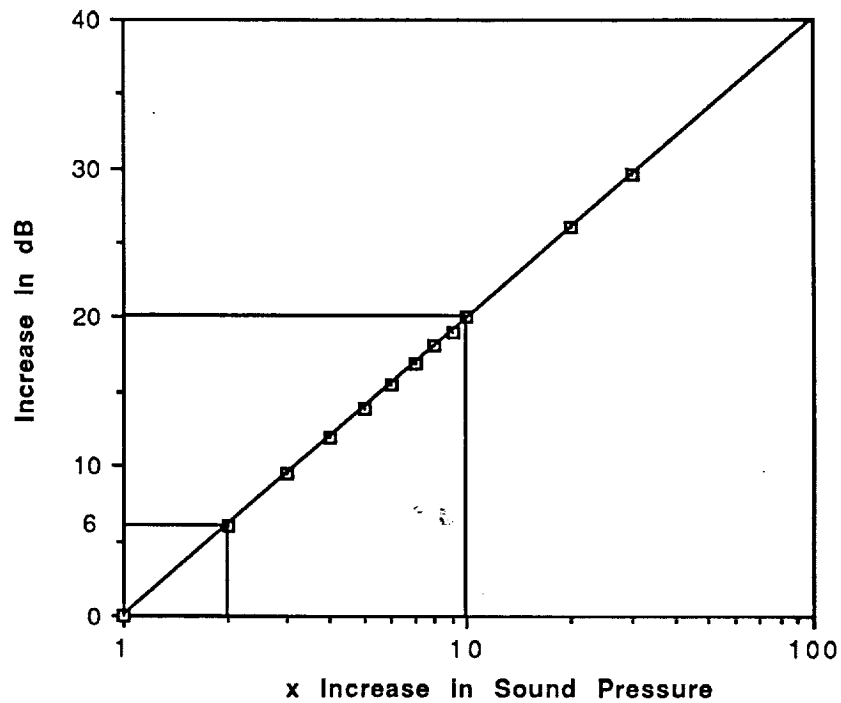

Figure 1. Change in dB vs. Change in Sound Pressure

The effect of changes in sound pressure level, while being mathematically large, are not as significant when described by people as changes in loudness. Figure 2 (Ref. 1), besides listing some reference decibel levels and their sources, demonstrates the common inability of humans to detect any significant change in sound pressure level below a change of 10 dB. Therefore, as seen in Figure 2, a perceived doubling of sound pressure, or loudness, occurs for a 10 dB increase rather than for a 6 dB increase. This difference, while making it easier for a normally quiet sound to be occasionally louder without much disturbance, makes it difficult for a loud sound to be even moderately loud due to the large required decrease in dB level. This is a problem of sound reduction, discussed later.

ORIGINAL PAGE IS  
OF POOR QUALITY

| dB(A) <sup>2</sup> | OVER-ALL LEVEL<br>(Sound Pressure Level<br>Approx. 0.0002 Microbar) | COMMUNITY<br>(Outdoor)   | HOME OR INDUSTRY<br>(Indoor)  | LOUDNESS<br>(Human Judgment of<br>Different Sound Levels) |
|--------------------|---|--|---|---|
| 130                | UNCOMFORTABLY<br>LOUD   | Military Jet Aircraft Take-Off<br>With After-Burner From<br>Aircraft Carrier @ 50 Ft. (130)  | Oxygen Torch (121) <sup>2</sup>   | 120 dB(A) 32 Times As Loud                                |
| 110                | VERY<br>LOUD  | Turbo-Fan Aircraft @ Take-Off<br>Power @ 200 Ft. (118) <sup>2</sup><br><br>Jet Flyover @ 1000 Ft. (103)<br>Boeing 707, DC-8 @ 6080 Ft.<br>Before Landing (106) <sup>3</sup><br>Bell J-2A Helicopter @ 100 Ft. (100) <sup>4</sup> | Riveting Machine (110)<br>Rock-N-Roll Band (108-114)  | 110 dB(A) 16 Times As Loud                                |
| 100                | VERY<br>LOUD  | Power Mower (96)<br>Boeing 737, DC-9 @ 6080 Ft.<br>Before Landing (97) <sup>1</sup><br>Motorcycle @ 25 Ft. (90)  | Newspaper Press (97)  | 100 dB(A) 8 Times As Loud                                 |
| 90                 |   | Car Wash @ 20 Ft. (89) <sup>1</sup><br>Prop. Plane Flyover @ 1000 Ft. (88)<br>Diesel Truck, 40 MPH @ 50 Ft. (84)<br>Diesel Train, 45 MPH @ 100 Ft. (83)  | Food Blender (88)<br>Milling Machine (85)<br>Garbage Disposal (80)  | 90 dB(A) 4 Times As Loud                                  |
| 80                 | MODERATELY<br>LOUD  | High Urban Ambient Sound (80)<br>Passenger Car, 65 MPH @ 25 Ft. (77)<br>Freeway @ 50 Ft. from Pavement<br>Edge, 10 A.M. (76 ± 6) <sup>1</sup>  | Living Room Music (76)  | 80 dB(A) 2 Times As Loud                                  |
| 70                 |   |  | TV-Audib. Vacuum Cleaner (70)   | 70 dB(A)  |
| 60                 |   | Air Conditioning Unit @ 100 Ft. (60)   | Cash Register @ 10 Ft. (65-70) <sup>1</sup><br>Electric Typewriter @ 10 Ft. (64) <sup>1</sup><br>Dishwasher (Rinse) @ 10 Ft. (60) <sup>1</sup><br>Conversation (60) | 60 dB(A) ½ As Loud  |
| 50                 | QUIET   | Large Transformers @ 100 Ft. (50)<br><br>Bird Calls (44) <sup>1</sup><br>Lower Limit.<br>Urban Ambient Sound (40)  |   | 50 dB(A) ¼ As Loud  |
| 40                 | JUST AUDIBLE  | (dB(A) Scale Interrupted)  |   | 40 dB(A) ⅓ As Loud  |
| 10                 | THRESHOLD<br>OF HEARING   |  |   |   |

Figure 2. Sound Levels and Loudness

SOURCE: Reproduced from Melville, C. Branch and R. Dale Beland, "Outdoor Noise in the Metropolitan Environment", Published by the City of Los Angeles, 1970, p.2.



Noise data is measured, discussed, and listed in many forms. In this report, the following common terminology is employed:

**A-Weighted Decibels (dBA)**

the scale which most closely imitates the frequency characteristics of the human ear.

**Equivalent Sound Level ( $L_{eq}$ )**

the constant sound level for which the acoustic energy is equivalent to the acoustic energy of a measured fluctuating sound (usually measured over a 24-hr period).

**Day-Night Average Sound Level ( $L_{dn}$ )**

used by the EPA to measure the  $L_{eq}$  for a 24-hr period, with the addition of a 10 dB penalty for each nighttime noise measurement (nighttime is defined as 10:00 pm to 7:00am).

**Perceived Noise Level (PNL in PNdB)**

the noise level measured for a single event (such as a single aircraft fly-over). This measurement is based on known levels of people's annoyance from fixed-wing jet aircraft fly-over noise.

**Effective Perceived Noise Level (EPNL in EPNdB)**

the maximum PNdB reading for a single event plus the time interval during which the sound level is within 10 dB of this maximum.

When discussing vehicle noise, and, in specific, aircraft noise, the measurement most often used is the Effective Perceived Noise Level, or EPNL, which has the units of EPNdB (or effective perceived noise in decibels). However, quite often, noise levels for air-craft takeoffs, level flyovers, and approaches (the three noise levels recorded during flight tests) are listed in terms of Perceived Noise Level, or PNL, which has the units of PNdB. While PNL is a more accurate measure of the noise people perceive from a particular event, it only accounts for the highest instantaneous sound pressure level emanated during that event. EPNdB, on the other hand, accounts for the length of time that an event is creating a perceived noise level within a 10 dB range of the highest measured PNL ( $PNL_{max}$ ), and therefore is a better scale to use in determining time-related annoyance typical of air-craft noise. From Reference 2,

$$EPNL = PNL_{max} + 10 \cdot \log_{10}(\Delta T/20) + 3 \text{dB} \quad (\text{in EPNdB}) \quad [3]$$

where  $\Delta T$  is the time in seconds during which the noise level is within 10 dB of  $PNL_{max}$  (this is referred to as the 10 dB down-time of an intermittent noise source). As can be seen from Equation [3], a noise source will be louder (have a higher EPNL) as the 10 dB down-time increases; therefore, a proposed vehicle should either have a low  $PNL_{max}$  or be as quiet as possible, as soon as possible, before and after creating its highest noise level. The use of EPNL is a good way of quantitatively comparing noise sources; for instance, while two noise sources could have the same maximum value of PNL, their values of EPNL could be drastically different.

One problem encountered when converting from PNL values to EPNL values is not knowing the time span of the down-time,  $\Delta T$ . In most reports dealing with aircraft noise measurement experiments, time history graphs are included. These show the variation of the PNL of a source with respect to the length of time that the noise is perceivable. Figure 3 shows a typical time history graph of a helicopter, as well as the graphical method employed to derive an approximation of  $\Delta T$  in seconds, which is then used to determine the EPNL. Note that the sound of the advancing source contributes most to the down-time, while the retreating source has a small effect. This is due to the Doppler effect, which tends to increase the frequency of an approaching sound by increasing the relative velocity of that sound from the source to the observer.

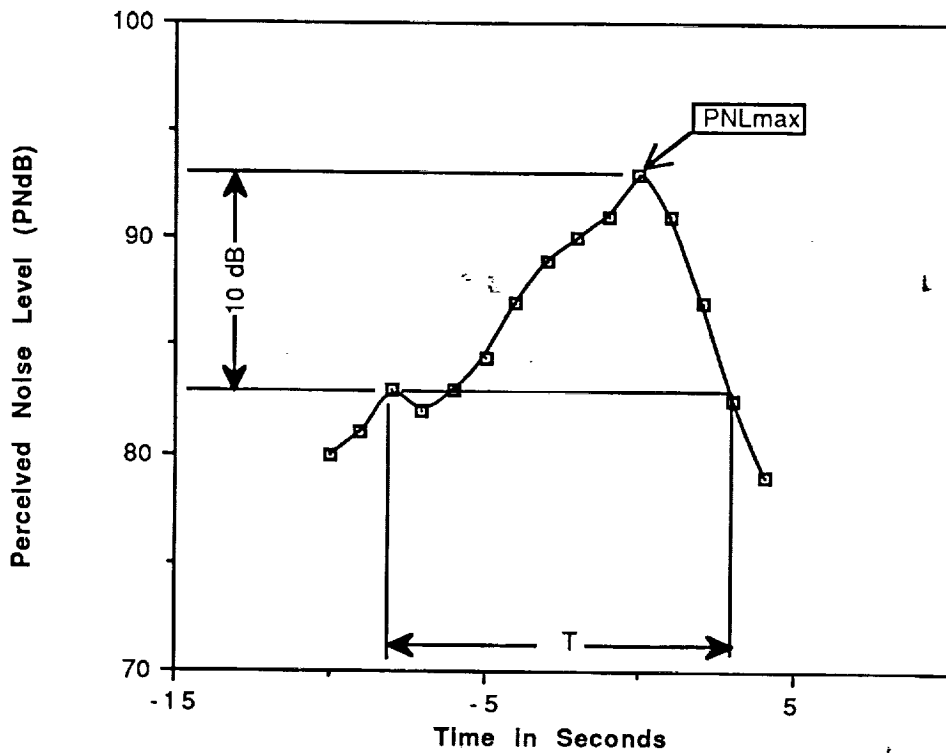

Figure 3. Typical Time History Graph

Figure 4 shows a relationship between noise levels in terms of dBA and PNdB (Ref. 3), both of which are measures of single events. Because of the fact that conversion from dBA to EPNdB (a time-dependent scale) cannot be done directly, it is necessary to convert from dBA to PNdB, using Figure 4, then from PNdB to EPNdB, so as to make the quantitative and time-related comparisons previously

mentioned. A procedure outlined in the Appendix demonstrates these conversions and their usefulness when conducting a noise assessment study.

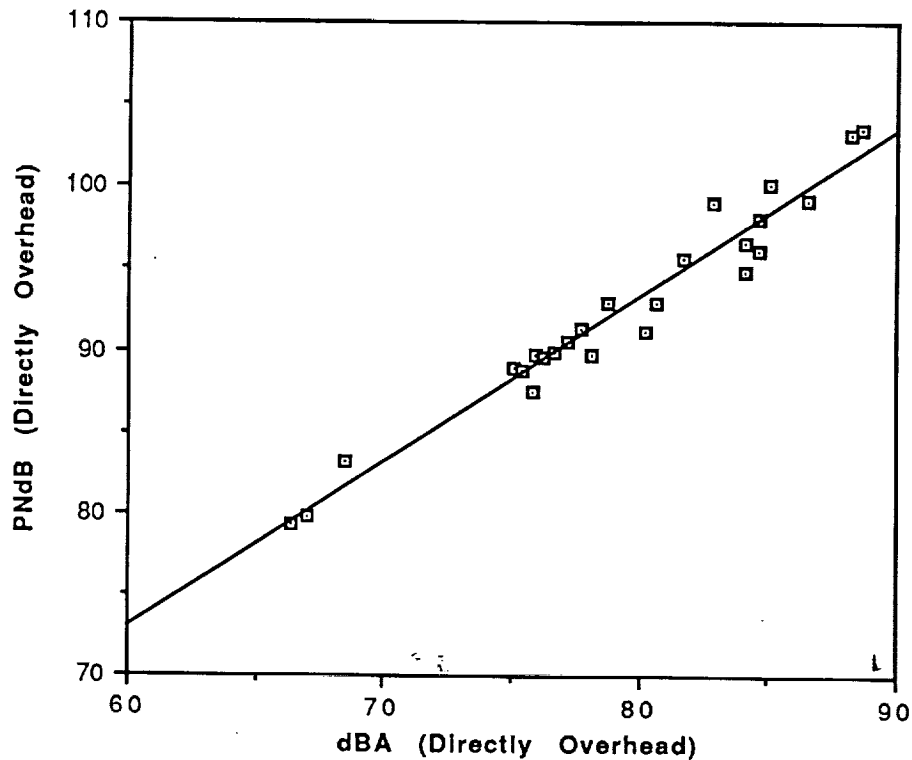

Figure 4. Comparison of Noise Rating Scales

The EPNL and the  $L_{dn}$  scales are both commonly used in determining Noise Exposure Forecast (NEF) contours, contours of constant noise level spreading outward from an air-port (specifically from the runways or helipads within the airport boundaries). To understand the significance of NEF contours, the following should be considered: a reduction of one NEF unit is equivalent to 1) a reduction of about 2% in the number of people highly annoyed by aircraft noise (based on 1976 population statistics), 2), a reduction of 14% in the area exposed to the same level of noise, and 3) an increase of 0.5% in property values (Ref. 4). Values given to particular NEF contours are related to the  $L_{dn}$  (in terms of dBA) by

$$NEF = (L_{dn} - 35) \pm 3 \text{ dBA.} \quad [4]$$

The use of EPNL in determining NEF involves using the peak EPNdB reading of that region as well as the number of day-time and night-time flights over that region. A summation is made of NEF levels generated by individual aircraft (variable  $i$ ) flying along individual flight paths (variable  $j$ ), compensating

for the psychological effect of a single night-time flight by having it contribute to the NEF calculation as much as seventeen day-time flights (Ref. 2).

$$NEF_{ij} = EPNL_{ij} + 10 * \text{LOG}_{10}(N_{dij} + 16.7 * N_{nij}) - 88 \quad (\text{in dB}) \quad [5]$$

Approximations of NEF contour distances from an airport are made using the airport traffic index, a sum of day-time flights and seventeen times the number of night-time flights (Ref. 2), which gives a rough estimate of runway-to-contour distances.

### **Acceptance and Regulation**

The need to design a quiet vehicle within the California Corridor has its origins in the noise acceptance standards that the public has demanded since the late 1960's, when jet aircraft became more abundant and noticeable. This need has also come about in the regulations and restrictions set down by all levels of government as a means of protecting the public against ever increasing air and ground traffic noise. A system that wishes to serve the commuter with the highest level of convenience and public acceptability must work to acknowledge both the public demand and the regulatory laws and recommendations so as to remain a viable system.

Federal and state regulations have grown out of complaints from those living around airports. Qualitative and quantitative tests have concluded that people are comfortable with  $L_{dn}$  values of 45 dBA, but will tend to tolerate suburban noise levels up to  $L_{dn}$  values of 55 dBA (most people will accept these levels as consequences of modern technology). As outdoor levels in residential regions increase nearer to those of NEF-30 contours ( $L_{dn}$  of 65 dBA), complaints, law suits, and political actions become more abundant; these tend to be directed toward the airports and their operators, air carriers, and/or local, state, and federal regulation agencies. According to the *San Luis Obispo County Noise Element of 1976*, there are four government agencies that have some say in the amount of noise produced in and around airports: the Environmental Protection Agency (EPA), the California Department of Transportation (Cal Trans), the Department of Housing and Urban Development (HUD), and the Federal Aviation Administration (FAA). As a result of these complaints, etc., the EPA, through the Noise Control Act of 1972, has established acceptable land-use noise levels. Although the noise level breakdowns are rather specific, the following list of general limits, set by the FAA in Part 150 of the Federal Aviation Regulations (FARs), serves initial design purposes quite well:

| <u>Community</u> | <u><math>L_{dn}</math></u> | <u>NEF</u>          |
|------------------|----------------------------|---------------------|
| Residential      |                            |                     |
| Suburban         | 57                         | Just inside NEF-20  |
| Urban            | 67                         | Just inside NEF-30  |
| City Center      | 72                         | Just outside NEF-40 |
| Commercial       | 72                         | Just outside NEF-40 |
| Industrial       | 77                         | Just inside NEF-40  |

Cal Trans, through its Department of Aeronautics, still uses an early form of the  $L_{dn}$  restriction known as the Community Noise Equivalent Level (CNEL). In addition to the 10 dBA penalty for night-time noise, the CNEL includes a 5 dBA penalty for evening hours (7:00-10:00 pm). The HUD policy dictates maximum time periods within a given 24-hr period that a certain sound level may be present within a particular environment (e.g., a site is unsuitable for residential housing when an outdoor sound level of 75 dBA is present for more than 8 hours per 24-hr period, or when a sound level of 80 dBA is present for more than one hour per 24-hr period) (Ref. 2). Finally, through FAR Part 36, the FAA has established maximum noise level guidelines that must be met for type certification of all aircraft. The most recent guidelines, established in 1976 as the Stage 3 regulations, are dependent on maximum gross takeoff weight, and are meant to decrease approach, departure, and sideline noise, so as to decrease the size of NEF contours and the day-time average noise levels in communities near airports. A noise standard similar to FAR Part 36 is Annex 16 of the International Civil Aviation Organization (ICAO). This document, in addition to aircraft, covers noise standards for helicopters, also based on maximum gross takeoff weight. Requirements for both the FAA and the ICAO are listed in the Appendix.

The restrictions of the above listed agencies must be kept in mind when designing an aircraft. Takeoff and landing noise and flight patterns into and out of airports (minimizing impact on surrounding areas), and number of night-time flights (minimizing impact on average noise levels) must be considered, and the set requirements and restrictions met, to have a system that is certifiable and publicly acceptable. This is because community acceptance, vital in maintaining a viable air transit system that will operate close to suburban population centers, has been found to be dependent on the frequency of aircraft intrusions, the nearness of aircraft operations to noise-sensitive areas, and on levels of compensation from the aircraft operators.

The more frequently a loud sound intrudes on conversation, sleeping, or leisure activities, the louder it is perceived to be by the listener. Therefore, if a system is planned to operate 24 hours a day, with many of those hours spent going into and out of suburban communities, it must be able to remain at or (preferably) below the FAR Part 150 land-use noise levels defined earlier. What this indicates is that it is currently nearly impossible to get an aircraft into an urban or suburban area with much frequency, especially during the late evening, unless that vehicle can be designed with an EPNL well below some undetermined minimum. The procedure contained in the Appendix (mentioned earlier) serves as a means of determining the number and time-spans of allowable intrusions, based on the FAA limits listed above, and gives some indication of the subsequent maximum aircraft noise level.

The frequency of vehicle operations into and out of a given community is also a function of the distance at which the vehicle intends to operate from noise-sensitive areas. Generally, noise-sensitive areas are any place where residents object strongly to noise levels that are significantly higher, for a considerable length of time each day, than the ambient noise level. The purpose of the EPA and FAA land-use guidelines is to separate noise-sensitive regions (such as suburban communities) and noise-impacted regions (airport approach and departure corridors). However, by the time these standards were implemented, many major and secondary airports already had large mixed urban development around them. In 1972, approximately 600,000 people lived within NEF-40 contours around some of the nation's busiest airports (6.7 million people lived within the NEF-30 contours of those same airports) (Ref. 8). This development has turned public opinion against large airports, where noise levels are almost always higher than the surrounding communities would like.

In the situation where a vehicle cannot adequately meet the noise restrictions handed down by city and county governments (restrictions determined most often by public complaint), the operator may be able to secure variances from these bodies. Currently, airports are granted variances, agreements with the surrounding community that state eventual elimination of certain noise sources over a period of time, usually two to five years. This would allow a system to start up at noise levels that may not be enjoyed, but which may be temporarily accepted by the public, until such time that the system is able to initiate the use of quieter vehicles. If the system is able to show good response with these variances, it may be able to gradually bring about a quiet system, rather than trying to develop that system all at once. If this

avenue does not prove to be advantageous, the only other alternative, aside from paying fines or not operating the system, would be to compensate the neighborhoods surrounding the points of operation. This idea has been passed around for many years between community pressure groups and local governments, and would seem to work as a means of quieting community protest and as a less expensive way for the airlines to lower their "perceived" noise levels for a short while. In most cases, one would want to use compensation only on a temporary basis, to allow starting up a slightly noisy system, until the operator can afford, or show the need, to phase in quieter vehicles. The politics and economics of variances and compensation leave this area wide open for debate, and the operator's position will be greatly dependent on technology levels and initial capital investments available to the system in the year 2010.

### Noise Reduction

It is assumed that pressure from local and state interest groups, as well as from the EPA, will force the FAA to set lower maximum sound levels than currently exist as the Stage 3 limits and set tighter restrictions, both in terms of noise measuring techniques and punishment for noisy operations, by the year 2010. In order to meet these projected sound level and operational restrictions of the future, two sound reduction methods should be considered: aircraft operation and aircraft design. An increased involvement by airframe manufacturers is being seen in these two areas, since modes of operation, configuration, and aerodynamics have been shown to have significant effects on sound generation.

Operational sound reduction does not reduce the levels of noise produced by the aircraft; rather, it reduces the amount of noise that is perceived by people on the ground. Methods include steeper glide slopes, day-time flying, and operating away from people. A steeper glide slope upon landing reduces the noise level because the aircraft is able to spend more time in the air at higher altitudes, meaning the sound has a longer distance to attenuate. Approach and departure footprints are also greatly reduced. Day-time flying masks most of the noise with background sound, and the warmer temperatures during the day do not transmit sound as well as the cooler temperatures at night. However, a system restricted to operating only during the day is not used to its full potential. Finally, operating away from people, or near other loud sources, can reduce the perceived noise levels of aircraft. This, too, is a disadvantage, because the transportation system in the Corridor is expected to offer nearly door-to-door serviced, and must therefore operate close to the public and within the communities. Thus the only realistic operational sound reduction technique, of the three listed, is that of using a steeper glide, an operation best suited for vertical takeoff and landing (VTOL) aircraft.

Sound reduction through aircraft design falls under two categories: passive (de-signing of low sound-producing components) and active (cancelling out noise produced by the aircraft). Passive sound reduction includes the use of laminar airfoils, lower disk loadings, high by-pass engines, and better judgement in determining engine location. Laminar airfoils reduce the turbulence that creates aerodynamic

noise; lower disk loadings, which decrease noise levels, can be accomplished by using longer rotor or propeller blades, which can be spun slower, leading to a reduction of blade tip velocity and another decrease in the noise (since noise is proportional to velocity cubed); high by-pass engines produce high mass flow rates with less power out (noise is proportional to power to the eighth power); engine location is a trade-off between interior (cabin) and exterior (ground) noise, which has thus far gone mainly to the benefit of the paying customer in terms of quieter cabins. Some of these designs will be discussed in the vehicle studies. Active sound reduction includes the use of synchrophasing, vibrational damping, and white noise. The first method has sound produced on one side of an aircraft cancelling out sound produced on the other side; in the second method, structural vibration (which is caused by and creates sound waves) is quickly and heavily damped; the third method fights sound with sound by artificially generating noise which is out of phase with that being produced by the aircraft (this method is easier to use for cabin noise than for complex exterior noise).

However, no matter which method is used, or to what extent both methods are used, the question of how sound reduction will affect the design, performance, and cost of the aircraft will also need to be closely examined. Answers to these questions are attempted in the vehicle studies.

## **Conclusion**

Noise is an important parameter in any transportation system, be it produced by aircraft or ground-based vehicles. Indeed, it is an element of modern day transportation systems that everyone encounters on a daily basis. The people who do not use the system should not have to be exposed to the noise generated for the convenience of those who do. Therefore, noise must be reduced, and designers, governments, and communities will have to work together to meet that goal.



## References

1. Branch, Melville c., and R. Dale Beland, "Outdoor Noise in the Metropolitan Environment," Published by the City of Los Angeles, 1970, p. 2.
2. Cunniff, Patrick F., *Environmental Noise Pollution*, John Wiley & Sons, Inc., 1977.
3. True, H.C., and E.J. Rickley, "Noise Characteristics of Eight Helicopters," U.S. Department of Transportation, Federal Aviation Administration, July 1977, p. 50-62.
4. U.S. Department of Transportation, *Aviation Noise Abatement Policy*, November 18, 1976, p. 16.
5. Shevell, Richard S., "Studies in Short Haul Transportation in the California Corridor," Department of Aeronautics and Astronautics, Stanford University, July 1973, p. 21-29.

## CORRIDOR ACCESS PORT

### Overview

The Corridor Access Port (CAP) will be a Wayport located in a heavily traveled corridor, but away from population centers. The philosophy behind this is that a facility having only one purpose is likely to die with time, but one with many uses will thrive (Ref. 4). A Wayport located in northern Nevada, for example, would be useful for domestic and international flights, but would do little to aid travel within the California Corridor. What is needed is a location that is along the north to south path connecting most of the Pacific coast's major cities. The CAP should also be as equidistant as possible from the States two largest cities Los Angeles and San Francisco.

The Corridor Access Port will require about 60 square miles of land. The land around the site will remain under the airport's control. This will allow for future expansion, and will help safeguard the airport from land use which may jeopardize its operation. The primary terminal building will be located adjacent to Highway 5. This terminal will manage the passengers from all the modes of transportation that will use the CAP. The CAP will be designed to serve all types of conventional takeoff and landing aircraft (CTOL), vertical takeoff and landing (VTOL). The Corridor Access Port would also include major maintenance facilities for the support of these modes of transportation.

A tentative site has been selected for comparison purposes. It is located along Highway 5, South of the Tule Basin near Kettleman City. The advantages of this site include the lack of surrounding population, flat land, low land costs, and it is almost equidistant from San Francisco and Los Angeles. It

is also not in the proximity of any wildlife refuges. The nearest wildlife refuges are the Kern Wildlife Refuge and the Pixely Wildlife Refuge. It is believed that this site merits further serious consideration.

Most airports currently in service were designed with land constraints as a major factor. The Corridor Access Port will be designed to optimize CTOL operations using land as this requires. The runways will be oriented on a heading of 320° in order to be aligned with the prevailing winds. An inbound aircraft will approach from the southeast. The aircraft will then make a landing on the runway south of the terminal. Next, the aircraft will approach one of the "Drive Thru" terminals to refuel and take on passengers. Passengers will use an underground rail system to move quickly between the main terminal and the various drive-thru terminals. The takeoff will be made from the runway north of the terminal. The CTOL operations will be organized in this manner to simplify air traffic control (ATC), to keep the amount of aircraft taxiing to a minimum, and to minimize the turn around time. Some future aircraft--supersonic and hypersonic transports--will require long runways for takeoff. This airport design allows room to lengthen individual runways as demand requires.

An overview of the Corridor Access Port is shown in Figure 1. Adjacent to Interstate 5 are the main terminal and parking structure. A Mag-Lev train station is located in the main terminal. East of the terminal are the vertiports or landing pads for vertical takeoff and landing aircraft. Further east are runways for commuter aircraft and high capacity transports. An underground rail system connects all facilities.

Figure 2 further demonstrates some of the outstanding features of the Corridor Access Port design. As is evident in the figure, the landing runway is adjacent to the take-off runway corresponding to the terminal to its east. This stagger increases air safety. Two aircraft making an approach for landing have not only the 2500 feet lateral spacing required by the Federal Aviation Administration, but have increased vertical spacing from other aircraft as well. This design shares several features with the new Denver International Airport which is now approaching the ground breaking stage (Ref. 7).

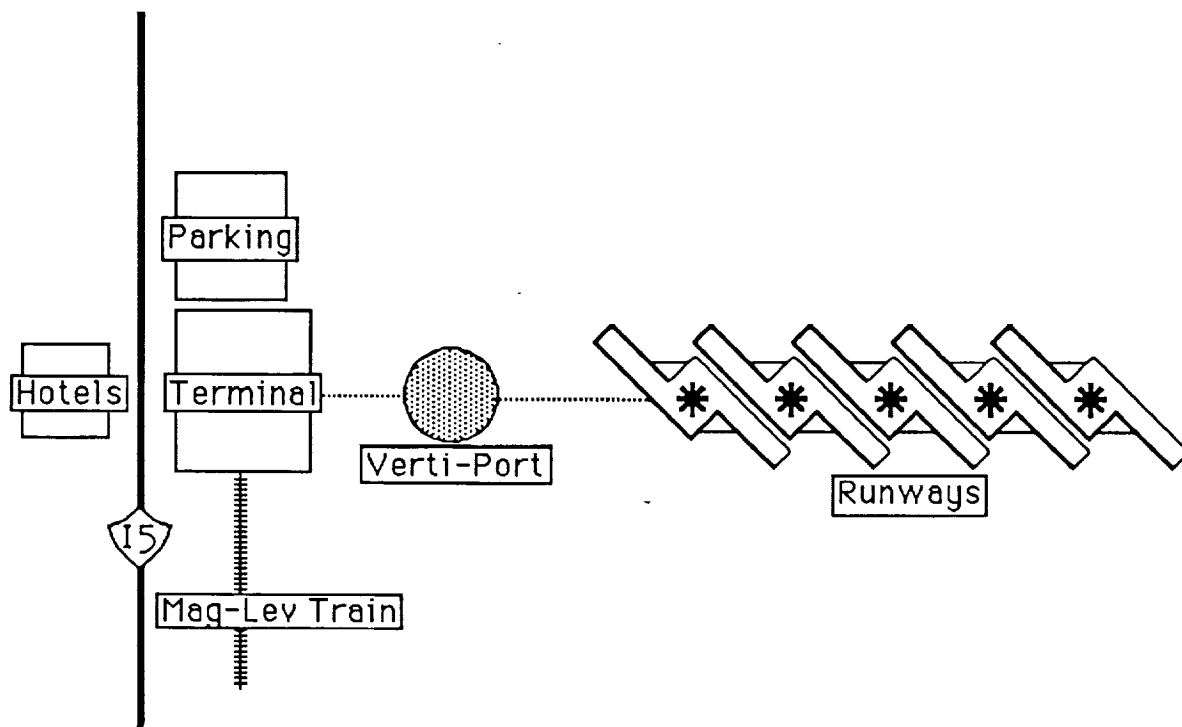
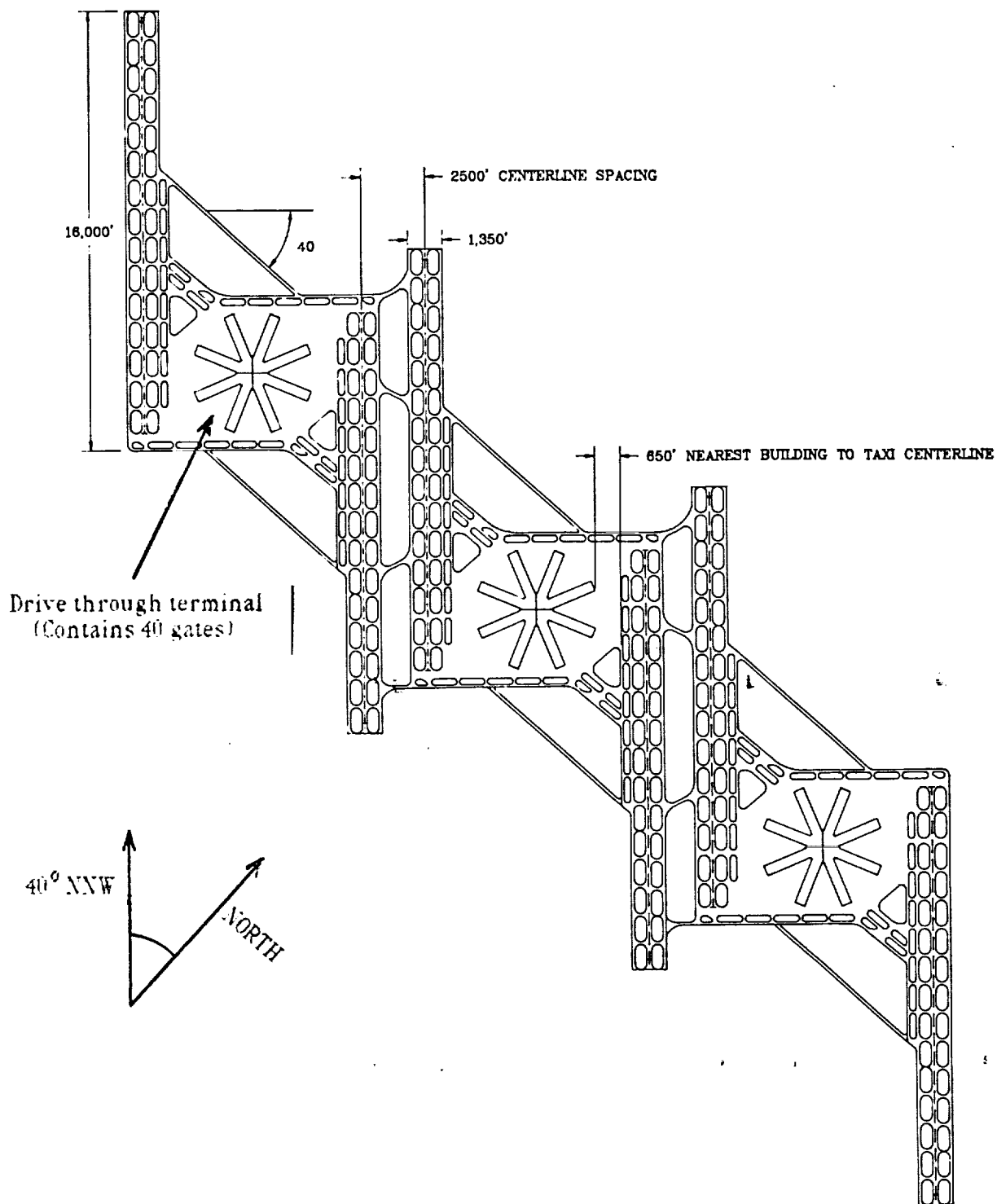

Figure 1. Overview of Corridor Access Port

The Corridor Access Port provides opportunities to explore never before feasible air transport concepts. For example, this facility will serve so many travelers that it will make it possible to consider large capacity conventional aircraft. Aircraft that may be feasible are the 600 to 1000 passenger aircraft and million pound cargo airlifters (Ref. 1). Alternate fuels such as liquid hydrogen could be made available to the air transport industry. The Golden State Corridor Access Port could become the location of operations for projects such as the National Aerospace Plane (NASP). It is difficult to imagine supersonic and hypersonic transports operating anywhere else due to noise constraints.

### Air Traffic Control

The CAP will be the primary collection point for air travel to, from, and in the California Corridor region. Preliminary estimates predict that in 2010 the traffic volume at the CAP will exceed the current volume at Los Angeles International Airport by a factor of four. With the current air traffic control system, such a traffic volume would barely be manageable. Implementation of a microwave landing system (MLS) which will be at all international airports by 1998 will help alleviate the problem



**Figure 2.** CAP runway layout. Runway centerlines are canted 40 degrees NNW into the prevailing winds of the proposed San Joaquin Valley site.

by allowing multiple, precision-approach paths. The instrument landing system (ILS), used today, allows only a single, straight-in approach path per runway (Ref. 2).

For increased safety and all-weather operations, automated approach and landing systems for all aircraft will be required. Automated landing of CTOL airplanes is not new; one of the first, the Smiths Auto-Land System was successfully used for the Hawker-Siddeley Trident airplane. More advanced systems have been developed since then, with multiple redundancy for increased safety. Since the auto-land systems were first implemented, the safety record of auto-land systems is about 1 fatal accident in ten million landings (Ref. 3). In 1982, NASA Ames experimented with helical automatic approaches for helicopters using the MLS with success. The system utilized a 60 knot approach speed, descended in a helix enclosed within a square 0.75 mile on each side, and performed successfully in up to 15 knot winds (Ref. 4).

The airspace above and within a 15 nautical mile radius of the proposed CAP will be under the control of a Terminal Control Area (TCA) environment which places equipment and communication requirements on all aircraft flying within the controlled area. This also allows the air traffic controllers to vector aircraft to and from the CAP, and to advise routes that provide adequate separation between aircraft. The TCA is a standard system that has been in use for many years, and has been proven effective.

One tool that will be used is the airborne Traffic Alert and Warning System (TCAS II). This system has a required installation date of 1991 for all U.S. air carriers with thirty or more seats. It features a map-like display and visual and audio warning of converging transponder-equipped traffic within four nautical miles of the host airplane. If converging aircraft are twenty to thirty seconds away, the TCAS II will inform the pilot of an escape maneuver to avoid the oncoming aircraft. This system will help pilots to locate and avoid previously "invisible" aircraft (Ref. 5).

Applied together, these tools are predicted to be satisfactory in handling the air traffic volume at the CAP.

## **Weather**

Portions of the San Joaquin Valley, specifically in the region of the CAP, are covered by dense fog for an average of 23.2 days out of the year, or 6.4% of the year. Dense fog in this context is defined as visibility of less than one quarter mile. Since automated landing systems qualified for Category IIIC instrument flight conditions (zero visibility, zero feet ceiling) are standard equipment for all aircraft using the CAP, fog will not be an obstacle for CAP operation.

The prevailing winds in the Great Central Valley generally blow northwesterly with an average velocity of 6.4 knots. Occasionally, strong winds blow from the southeast, with the record peak velocity of 46.0 (December 1977). The period of high winds tend to occur once a year (Ref. 6).

## Utilities and Facilities

The CAP is designed to be self-sufficient in order to produce the least amount of negative economic, environmental and political impact to the surrounding communities. In order to best achieve this goal, careful evaluation and planning must be performed in supplying the operational needs of the CAP, and for choosing the types of facilities and services to be provided at the CAP.

The basic utilities that the CAP requires are electricity, water, telephone, trash disposal and sewage. High voltage power lines already traverse the proposed CAP site, paralleling Interstate 5. Whether these power lines can supply sufficient electric power to the CAP is doubtful; however, more lines can be provided following the same route, or a more direct route from other electric power plants. Also, these power lines will have to be relocated in the vicinity of the CAP for air safety reasons.

The California Aqueduct flows adjacent to the highway, in close proximity to the CAP site. The Aqueduct holds sufficient water to supply the needs of the CAP, though other water collection and storage facilities should be used to lessen impact on other Aqueduct users. An on-site water treatment plant will have to be built to purify the water, which opens the possibility of supplying water to the surrounding communities.

Telephone service will have to be contracted from the telephone company, requiring new phone lines to be installed. One option could be a direct satellite link, thus removing the need for new phone lines.

Trash will have to be moved out by train or by truck since there are no nearby landfill sites of sufficient size for the predicted quantity of trash produced by CAP. An incineration and recycling plant at the CAP is a possible alternative, but this is viable only if the resulting pollutants can be effectively reduced or eliminated by filtration or chemical treatment.

Sewage disposal will require an on-site treatment plant. Due to the low altitude of the site and the barrier formed by the surrounding hills, the treated waste will not be able to be passed directly out to the ocean. The nearest river is the San Joaquin River, 10 miles east of the CAP site, and this may be used as an outlet for the treated water. An environmental impact study of the effects of such a action has not been done.

Apart from the basic operational requirements of the CAP, passenger needs must be examined. Ideally, the CAP will only be used as a transfer point for intra/inter-corridor and international travel, and thus few customer facilities would be required. However, for customer convenience, flexibility, and due to unforeseen events such as delays and missed flights, a range of services should be provided. The quantity and quality of services that should be resident at the CAP cannot be determined without a market and economic study. These studies were not performed in order to not detract from the primary purpose of this project. A list of suggested services that might be needed follows. Note that this list is by no means complete.

|                                  |                      |
|----------------------------------|----------------------|
| Restrooms/showers                | Medical              |
| Fire                             | Security             |
| Aircraft maintenance             | Towing               |
| Fuel (aircraft, automobile)      | Power plant (backup) |
| Computer/Electronics maintenance | Restaurant/Cafes     |
| Meeting rooms                    | Customs office       |
| Duty free shops                  | Convenience stores   |
| Money changers                   | Travel agents        |
| Bank teller machines             | Telephones           |
| Fax service/telegram             | Insurance            |
| Overnight lodging                | Information desks    |
| Seats, couches, benches          | Lounge/Bar           |
| Museum                           | Porters              |
| Baggage carts/handling systems   | People movers        |

Due to the centralized location of the CAP and the accessibility of the CAP from any place in California via the CAT system, employees at the CAP can live just about anywhere in California and still remain within easy reach of their workplace. This would reduce the "boomtown" effect that would result if all the employees were to live in the area immediately surrounding the CAP.

### **Air-Carrier Politics**

The primary focus of the CAP is to provide a central location for air operations. In order to accomplish this goal, air-carriers, both international and domestic, should use the CAP as their primary California airport. This would involve relocating their current facilities from the San Francisco and Los Angeles areas to the CAP. This is not an inexpensive nor a necessarily convenient task. Thus, it is important for the CAP to be a sufficiently attractive alternative for them if they are to seriously consider using it.

Currently, most air-carriers lease their air terminal space from the airport. This is a direct operating cost for them which may reach into the millions of dollars per year at major airports. An attractive incentive that the CAP might offer is free rent for the first few years of the air-carrier's operation. Also, since the air-carrier will be operating one facility at the CAP instead of two or more around California, the carrier would be able to consolidate their management, equipment, maintenance and other facilities at the one location.



Another advantage of using the CAP is that it will be a new facility, boasting top of the line equipment and efficient design.. This airport will be designed for the current and proposed fleet of aircraft and the predicted future traffic volume, thus providing a permanent base for the air-carrier. Also, if there is sufficient volume, one or more runways can be dedicated to an air-carrier, thus essentially creating their own airport, and removing delays due to competing traffic.

Though not as attractive as a motivator, public pressure at the current airports may provide incentive for the air-carriers to relocate. Already, communities have raised complaints about noise and air pollution, safety, and traffic problems near major airports. In some instances, the complaints have been strong enough to convince the government to impose regulations on airport operations. With a viable alternative such as the CAP available, the public may even strongly suggest that the air-carriers move to the CAP, thereby benefitting both the public and the air-carrier.

The CAP will also be a solution to the operational problems at the large airports. Los Angeles International Airport, for example, has already reached its maximum capacity with no room for expansion. Thus, if the air-carriers wish to expand their services, they would have to either compete for a time slot that does not really exist, or open an alternate facility at another airport.

## Reference

1. Sheppard, J., The Wayport Concept, May 25, 1989.
2. Staff, "FAA Refines MLS Plan," *Flying*, May 1989, pg. 21.
3. G. Worthington, *Airline Instrument Flying*, London Sir Isaac Pitman & Sons, Ltd., 1968, pp. 260-265.
4. J. Foster, L. McGee, D. Dugan, "Helical Automatic Approaches of Helicopters with Microwave Landing Systems," NASA Technical Paper 2109, Dec. 1982.
5. J. McClellan, "Collision Vision," *Flying*, May 1989, pp. 54-61.
6. Phone conversation, National Weather Service, Bakersfield, California, May 4, 1989.
7. Peña, Federico, *The New Denver International Airport Report*, The Department of Public Works, City & County of Denver, 1988.

## CONFIGURATIONS INVESTIGATION SUMMARY

A study done in the early 1970's by NASA Ames Research Center predicted that if conventional takeoff and landing (CTOL) aircraft continued to be used in the 1980's and beyond congestion would begin to dictate price. It would reach the point where the normally higher cost of a short takeoff and landing (STOL) aircraft would become comparable to the normally more economical CTOL aircraft. This would occur because of ground and air delays, and invariably higher fuel consumption which is passed on to the customer in the form of a higher ticket price. That time has come. Statistics show that the inter-regional commuter is currently suffering from chronic delay and price increases due to existing airport congestion. Additionally, air transportation does not solve the problem of travel within a metropolitan region for the vast majority of people. For these reasons along with space restrictions, vertical takeoff and landing (VTOL) vehicles as well as short takeoff and landing (STOL) vehicles were investigated and evaluated for application within the California corridor.

With no official guidelines to follow, a search was conducted on a variety of VTOL and STOL vehicles, to familiarize the class with various configurations. Descriptions, advantages and disadvantages, as well as some variations on the original configurations were gathered in hopes that a small database of information could be used to pick a vehicle configuration once some specifications had been chosen. These descriptions are in Appendix.

As this process drew to a close, it became apparent that there were a number of vehicles that were finding favor. A sample mission specification was chosen for the maximum distance in the corridor as defined by the California corridor study. The range was set at 500 nm and desired airspeed was 500 knots. The payload was 20,000 lbs (100 passengers at 200 lbs per passenger). Using this mission profile,

a trade-off study was conducted to determine if one or several configurations could be eliminated from consideration. Design criteria were chosen and given a weighting factor, signifying their relative importance. Based on a scale of 1 to 5, with 5 being the most desirable weighting factor, the design criteria were rated as follows:

|                                  |   |
|----------------------------------|---|
| Direct Operating Cost (DOC)      | 5 |
| Productivity Parameter           | 4 |
| Time (Door-to-door)              | 3 |
| Noise (at a 500 foot sideline) 2 | 2 |
| Technical Risk                   | 1 |

Direct Operating Cost was decided to be the most important design driver due to the simple fact that if a passenger has to pay too much money he will choose another mode of transportation. This could eventually lead to the closure of the more expensive transportation system. Productivity parameter is an indication of the efficiency of moving passengers. This is rated highly because of its importance to the air carrier, as it reflects profit. Time was rated, reflecting the importance people place on their time. Noise was important as well, but not seen as a driver like the other three parameters. This was changed in later studies.

The trade-off study is presented in Table I. Data used for the rating of each configuration was gathered from existing California Corridor configuration studies. Although there was a margin of uncertainty, STOL vehicles employing externally blown flaps or and augmentor flap were considered inefficient for the sample mission.

Table I. Sample Vehicle Trade-Off Study

| Mission Profile          |        | Range:    | 500 nm     |      |    |    |     |    |        |    |      |    |    |    |
|--------------------------|--------|-----------|------------|------|----|----|-----|----|--------|----|------|----|----|----|
|                          |        | Velocity: | 500 knots  |      |    |    |     |    |        |    |      |    |    |    |
|                          |        | Payload:  | 20,000 lbs |      |    |    |     |    |        |    |      |    |    |    |
| Design Criteria          | Factor | Wt. EBF   | AW         |      | MF |    | USB |    | STOWED |    | TILT |    |    |    |
|                          |        |           | R*         | ST** | R  | ST | R   | ST | R      | ST | R    | ST |    |    |
| DOC                      | 5      |           | 3          | 15   | 2  | 10 | 3   | 15 | 5      | 25 | 4    | 20 | 5  | 25 |
| Productivity Parameter   | 4      |           | 3          | 12   | 2  | 8  | 3   | 12 | 4      | 16 | 3    | 12 | 4  | 16 |
| Time                     | 3      |           | 2          | 6    | 3  | 9  | 3   | 9  | 2      | 6  | 5    | 15 | 3  | 9  |
| Noise (500 ft. sideline) | 2      |           | 2          | 4    | 2  | 4  | 2   | 4  | 4      | 8  | 2    | 4  | 3  | 6  |
| Technical Risk           | 1      |           | 4          | 4    | 4  | 4  | 5   | 5  | 5      | 5  | 2    | 2  | 4  | 4  |
| TOTALS                   |        |           | 41         |      | 35 |    | 45  |    | 63     |    | 53   |    | 50 |    |

Note: EBF = Externally blown flaps  
 AW = Augmentor flap  
 MF = Mechanical flap  
 USB = Upper surface blown flap  
 STOWED = Stowed Rotor  
 TILT = Tilt Rotor

\* This is the rating given a vehicles in a criteria category

\*\* This is the subtotal, the rating multiplied by its weighting factor

This led to a more encompassing trade-off study comparing vehicles serving a particular market in a transportation system. Two typical mission profiles were chosen to emulate a short distance intrametropolitan trip and a longer range, inter-metropolitan journey. The intra-metropolitan mission had a stage length of 35 nautical miles and a system capacity of 10,000 passengers a day. This was felt to be indicative of a typical commuter hop. The inter-metropolitan mission had a stage length of 270 nautical miles and a system passenger capacity of 40,000 passengers per day, approximating a trip from San Francisco to Los Angeles.

The list of design criteria grew much larger than the first trade-off study. The driving parameters were considered to be cost, time, noise, pollution, and user convenience. Safety was rated lower than these parameters because it was felt that the design should not be driven by safety beyond the strict level of certification through the FAA.

There were five systems considered for the trade study, with eight vehicles in all. Vehicles and their appropriate transportation system considered for this trade-off study are listed in Table II. For purposes of comparison an automobile was included in the intra-metropolitan mission, dubbed the regional route. A 100 passenger CTOL aircraft was added along with the automobile for the inter-metropolitan journey, henceforth referred to as the state-wide route.

**Table II. Vehicles and Systems in the Trade-Off Study**

| <u>System</u> | <u>Vehicles</u>  |
|---------------|--|
| STOL Only     | <ul style="list-style-type: none"> <li>* 30 passenger DeHavilland Dash-7 derivative for short and low density routes.</li> <li>* 60 passenger DeHavilland Dash-7 derivative for longer and high density routes.</li> </ul>   |
| VTOL/STOL     | <ul style="list-style-type: none"> <li>* 40 passenger low speed VTOL aircraft - compound helicopter, to service intra-metropolitan travel.</li> <li>* 150 passenger upper surface blowing (USB) STOL aircraft with 4000 foot runway requirement to service inter-metropolitan travel.</li> </ul>                                       |
| One Hub       | <ul style="list-style-type: none"> <li>* 40 passenger high speed VTOL - tilt rotor, to use one or two hubs in the middle of California as a mixing station. Will serve neighborhood to neighborhood.</li> </ul>  |
| LTA/VTOL      | <ul style="list-style-type: none"> <li>* A combination airship and compound helicopter team will serve both intra- and inter-metropolitan routes. The airship will continually circle in a predetermined route while VTOL fly from vertiports and dock on the LTA, unloading and loading passengers on this hub in the sky.</li> </ul> |
| Mag Lev       | <ul style="list-style-type: none"> <li>* A magnetically levitated train running the length of California down the central valley, servicing only high density routes. It utilized existing rail transportation within a metropolitan area.</li> </ul>  |

Competing in the regional route were four vehicles: the auto, a 40 passenger low speed VTOL aircraft (compound helicopter), a 40 passenger high speed VTOL aircraft (tilt rotor), and a airship with support from a 40 passenger compound helicopter. Each vehicle was rated in twelve design criteria categories on a scale of 1 to 10, 10 being the most desirable. When the ratings were multiplied by specific weighting factors a subtotal was achieved. Adding all subtotals, a total value was arrived at for each vehicle. The auto ranked the highest, with the tilt rotor and compound helicopter falling in second and third. Allowing for a 10 percent uncertainty (5 percent on each side of the total), only the 30 passenger STOL aircraft did not fall within some common range of numbers, showing that it was clearly not suitable for the proposed mission. Although the LTA/VTOL combination fell within the percentage uncertainty, doubt developed as to its potential in the regional route.

For the state-wide route seven vehicles were studied: the 60 passenger STOL aircraft, 40 passenger tilt rotor, 150 passenger USB STOL, 600 passenger airship, mag lev train, 100 passenger CTOL aircraft, and the automobile. Again each vehicle was ranked in 12 design criteria categories, revealing that the automobile is the least desirable vehicle for a state-wide route. Applying a 10 percent uncertainty all

the other vehicles were considered competitive with one another. The airship/VTOL system and 100 passenger CTOL aircraft, however, made weak showings. A summary of the trade-off study is located in Table III. An index to clarify how criteria were defined and how ratings were chosen can be found in the Appendix.

**Table III. Regional Route Vehicle Comparison**

| Design Criteria     | Wt. Factor | <u>Vehicles</u> |            |                 |              |                |            |                |              |      |              |
|---------------------|------------|-----------------|------------|-----------------|--------------|----------------|------------|----------------|--------------|------|--------------|
|                     |            | 30 Pax STOL     |            | 40 Pax Compound |              | 40 Pax T Rotor |            | 600 Pax LTA/CH |              | Auto |              |
|                     |            | R*              | ST**       | R               | ST           | R              | ST         | R              | ST           | R    | ST           |
| Cost                | 10         | 8               | 80         | 6               | 60           | 4              | 40         | 1              | 10           | 10   | 100          |
| Noise               | 10         | 6               | 60         | 7               | 70           | 8              | 80         | 7              | 70           | 9    | 90           |
| User Convenience    | 10         | 1               | 10         | 8               | 80           | 8              | 80         | 7              | 70           | 10   | 100          |
| Time                | 9          | 6               | 54         | 9               | 81           | 8              | 72         | 8              | 72           | 5    | 45           |
| Pollution           | 9          | 5               | 45         | 3.5             | 31.5         | 5              | 45         | 10             | 90           | 0    | 0            |
| Flexibility         | 7          | 7               | 49         | 9               | 63           | 7              | 49         | 8              | 56           | 10   | 70           |
| Resources Used      | 7          | 6               | 42         | 5               | 35           | 5              | 35         | 5.5            | 38.5         | 4    | 28           |
| Safety              | 5          | 7               | 35         | 5               | 25           | 5              | 25         | 5              | 25           | 6.5  | 32.5         |
| Technical Risk      | 5          | 9               | 45         | 9               | 45           | 8              | 40         | 6              | 30           | 10   | 100          |
| Weather/<br>Terrain | 5          | 8               | 40         | 8               | 40           | 8              | 40         | 7              | 35           | 9    | 45           |
| ATC/TTC             | 3          | 5               | 15         | 8               | 24           | 8              | 24         | 7              | 21           | 2    | 6            |
| Aesthetics          | 2          | 8               | 16         | 7               | 14           | 8              | 16         | 6              | 12           | 2    | 10           |
| <b>TOTALS</b>       |            |                 | <u>491</u> |                 | <u>568.5</u> |                | <u>546</u> |                | <u>529.5</u> |      | <u>586.5</u> |
| [ 10 % Uncertainty] |            |                 | [466-516]  |                 | [540-597]    |                | [519-573]  |                | [504-556]    |      | [557-616]    |

\* This is the rating given a vehicles in a criteria category

\*\* This is the subtotal, the ranking multiplied by the weighting factor



**Table III. Regional Route Vehicle Comparison  
(continued)**

Mission profile: Range: 270 nm  
Passenger capacity: 40,000 Pax/day

| Design Criteria     | Wt. Factor | <u>Vehicles</u> |              |                |              |              |              |                  |              |
|---------------------|------------|-----------------|--------------|----------------|--------------|--------------|--------------|------------------|--------------|
|                     |            | 60 Pax STOL     |              | 40 Pax T Rotor |              | 150 Pax STOL |              | 600 Pax LTA/VTOL |              |
|                     |            | R*              | ST**         | R              | ST           | R            | ST           | R                | ST           |
| Cost                | 10         | 9               | 90           | 8              | 80           | 8            | 80           | 3                | 30           |
| Noise               | 10         | 7               | 70           | 8              | 80           | 8            | 80           | 8                | 80           |
| User Convenience    | 10         | 9               | 90           | 10             | 100          | 8.4          | 84           | 6.5              | 65           |
| Time                | 9          | 7               | 63           | 5              | 45           | 7            | 63           | 5                | 45           |
| Pollution           | 9          | 5               | 45           | 3.5            | 31.5         | 5            | 45           | 10               | 90           |
| Flexibility         | 7          | 7               | 49           | 9              | 63           | 7            | 49           | 8                | 56           |
| Resources Used      | 7          | 6               | 42           | 5              | 35           | 5            | 35           | 5.5              | 38.5         |
| Safety              | 5          | 7.5             | 37.5         | 6              | 30           | 6            | 30           | 6                | 30           |
| Technical Risk      | 5          | 9               | 45           | 8              | 40           | 9            | 45           | 6                | 30           |
| Weather/<br>Terrain | 5          | 8               | 40           | 8              | 40           | 8            | 40           | 7                | 35           |
| ATC/TTC             | 3          | 6               | 18           | 8              | 24           | 6            | 18           | 7                | 21           |
| Aesthetics          | 2          | 8               | 16           | 7              | 14           | 8            | 16           | 6                | 12           |
| <b>TOTALS</b>       |            |                 | <u>605.5</u> |                | <u>582.5</u> |              | <u>584.5</u> |                  | <u>532.5</u> |
| [10 % Uncertainty]  |            |                 | [575 - 636]  |                | [553 - 612]  |              | [555 - 613]  |                  | [506 - 559]  |

\* This is the rating given a vehicles in a criteria category

\*\* This is the subtotal, the ranking multiplied by the weighting factor

**Table III. Regional Route Vehicle Comparison  
(continued)**

Mission profile:           Range: 270 nm  
 Passenger capacity:   40,000 pax/day

| Design<br>Criteria  | Wt.<br>Factor | <u>Vehicles</u>  |             |                 |              |      |              |
|---------------------|---------------|------------------|-------------|-----------------|--------------|------|--------------|
|                     |               | Mag Lev<br>Train |             | 100 Pax<br>CTOL |              | Auto |              |
|                     |               | R*               | ST**        | R               | ST           | R    | ST           |
| Cost                | 10            | 4                | 40          | 10              | 100          | 10   | 100          |
| Noise               | 10            | 7                | 70          | 3               | 30           | 9    | 90           |
| User Convenience    | 10            | 9.3              | 93          | 7               | 70           | 7    | 70           |
| Time                | 9             | 7                | 63          | 6               | 54           | 0    | 0            |
| Pollution           | 9             | 10               | 90          | 6.5             | 58.5         | 0    | 0            |
| Flexibility         | 7             | 6                | 42          | 6               | 42           | 10   | 70           |
| Resources Used      | 7             | 8                | 56          | 4               | 28           | 4    | 28           |
| Safety              | 5             | 9                | 45          | 7.5             | 37.5         | 6.5  | 32.5         |
| Technical Risk      | 5             | 8                | 40          | 10              | 50           | 10   | 50           |
| Weather/<br>Terrain | 5             | 8                | 40          | 7.5             | 37.5         | 9    | 45           |
| ATC/TTC             | 3             | 10               | 30          | 6               | 18           | 2    | 6            |
| Aesthetics          | 2             | 6                | 12          | 9               | 18           | 10   | 20           |
| <b>TOTALS</b>       |               |                  | <u>621</u>  |                 | <u>543.5</u> |      | <u>511.5</u> |
| [ 10 % Uncertainty] |               |                  | [590 - 652] |                 | [516 - 570]  |      | [486 - 537]  |

\* This is the rating given a vehicles in a criteria category

\*\* This is the subtotal, the ranking multiplied by the weighting factor

## ELECTRIC CONVENTIONAL TAKEOFF AND LANDING AIRCRAFT

The Electric-powered Conventional Takeoff and Landing (ECTOL) aircraft is the most evolutionary vehicle in the CAT system. The ECTOL has been designed to immediately serve secondary airports and the CAP (when constructed), providing clean, quiet, and convenient service.

Electric propulsion was chosen for several reasons. First, since pollution is an ever-growing concern, the completely non-pollutive ECTOL combined with clean methods of recycling lithium slurry that is quite possible in the future, would present an environmentally attractive system. The electric propulsion is also quiet compared to conventional turboprop engines because of the lack of compressor inlet or turbine exhaust noise. The final reason for choosing electric propulsion was to explore the possibilities of this technology as applied to a full-size transport aircraft.

The basic design philosophy behind the ECTOL was to build an inexpensive, easily maintainable, efficient aircraft that could be used in systems world-wide similar to the California Corridor. This philosophy lead to decisions as the 8,500 ft cruise altitude which requires no pressurization, and a completely automated flight system. The automated flight system would cut crew costs, the major portion of airline expenses, and increase operations per hour by precisely monitoring individual operations (Ref. 11).

## Mission Specifications

|                          |        |
|--------------------------|--------|
| • Range (nm)             | 470    |
| • Cruise Altitude (feet) | 8,500  |
| • Runway length (feet)   | 4000   |
| • Payload (passengers)   | 31     |
| • Cruise speed (knots)   | 250    |
| • Crew                   | 2      |
| • Certification          | Far 25 |

The mission specifications dictate a maximum range of 470 nautical miles. The longest distance expected to be served by the ECTOL aircraft in the California Corridor is a route from San Diego to San Francisco, a distance of 400 nautical miles. A 15 percent energy reserve is added to this distance to allow the aircraft to land at alternate airports. With the use of the CAP, the maximum needed range from major populous areas to the CAP is 200 statute miles, allowing for a round trip without refueling while still achieving a 15 percent reserve.

The aircraft will be non-pressurized, and thus will have a cruise altitude of 8,500 feet, thereby providing adequate oxygen for pilot, crew and passengers. A non-pressurized aircraft allowed for cost savings and ease of structural maintenance as well as an extended fuselage life compared to a pressurized hull.

A required runway length of 4,000 feet allowed the ECTOL to use all existing airstrips in California currently being served by a commuter air carrier. This runway length also allowed for the expansion into other existing neighborhood airstrips not currently being served due to a present lack of passenger demand or community pressure to eliminate noise pollution. The expected landing noise production of the ECTOL, 70 EPNdB, allows for the opportunity to conveniently serve the market demand not currently being served due to the noise issue.

Due to an FAA forecast (Ref U.S. Federal aviation administration, DOT, FAA Aviation Forecast, FY 1988-2000, USGPO, Washington, D.C.) to the year 2000 which projected that aircraft sizes of 20-40 passengers will be needed to fill the commuter air carrier demand, the ECTOL was chosen to have a capacity of 30 passengers. A cruise speed of 250 knots was decided upon since that was the maximum speed permitted for an aircraft operating under 10,000 feet by the Federal Aviation Administration (FAR 91.7 Part A).

A crew of two is required for the ECTOL aircraft -- one flight attendant and one pilot. An automated flight control system will act as the primary aircraft control system with the pilot acting as a secondary crewman in the event of incapacitation of the main system. The automated flight control system will be able to perform basic workload functions such as flight control path, collision avoidance,

navigation, communication, operation and monitoring of aircraft engines and systems, and performing command decisions.

## Configuration

The configuration of the ECTOL is quite conventional: the ECTOL is a low-wing aircraft, with conventional empennage consisting of a single vertical stabilizer and a horizontal tail mounted high at the aft end of the fuselage (Figures 1-4). Ease of loading and unloading the fuel cells, as well as shortened landing gear length, made the low wing an obvious choice. A major consideration in tail placement is the relative location of the tail and the propeller slipstream; it is desirable to have the tail out of the propeller slipstream for better aircraft handling qualities and avoidance of tail fatigue. The ECTOL is configured with the engine nacelles mounted on the low wing, so the tail is higher than the propeller centerline by approximately the fuselage height. This separation is adequate for any slipstream effects to be negligible at operating angles of attack, as a study of similar aircraft verified (Ref. 9).

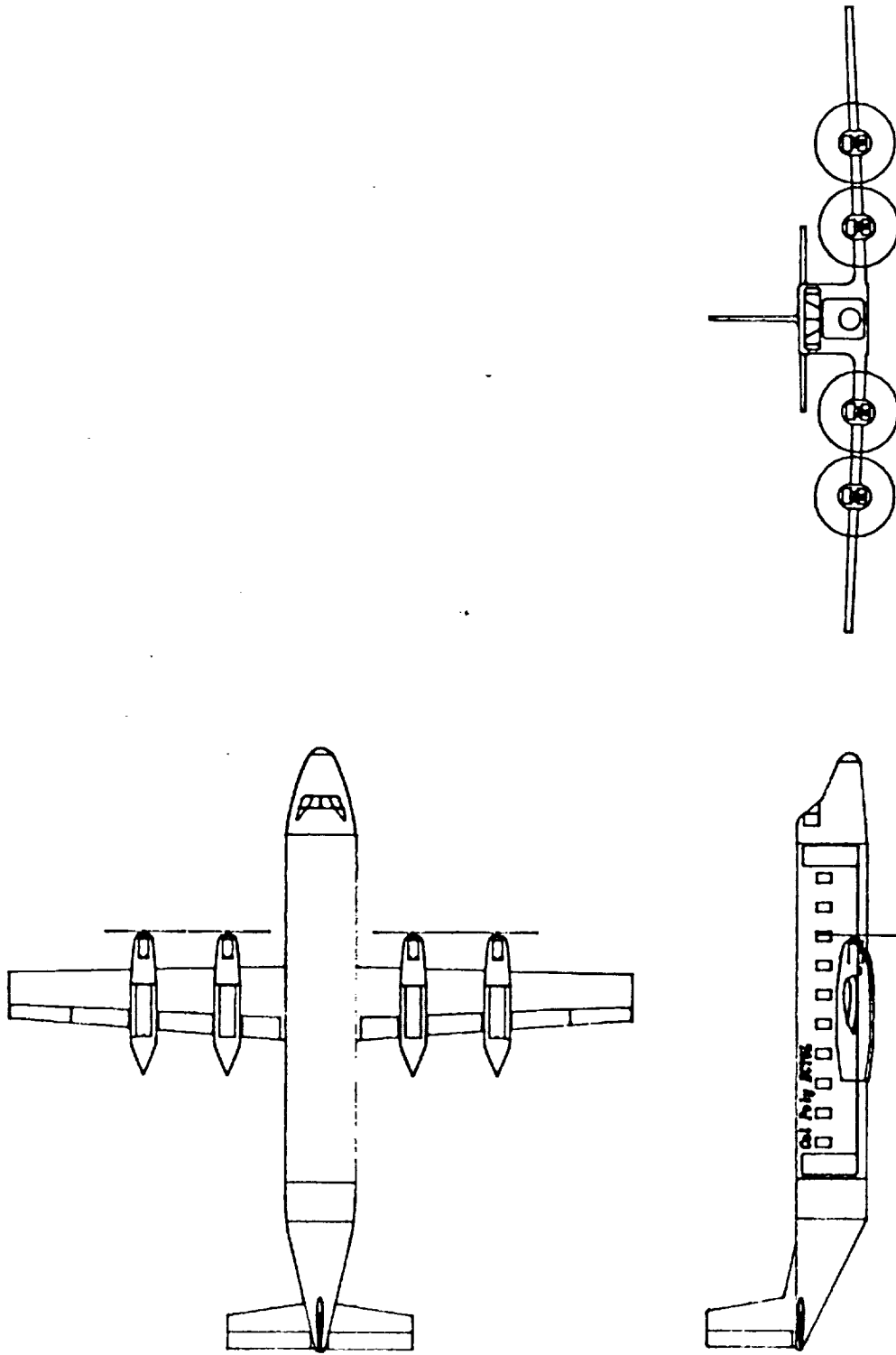

Figure 1. Electric CTOL 3-View Drawing

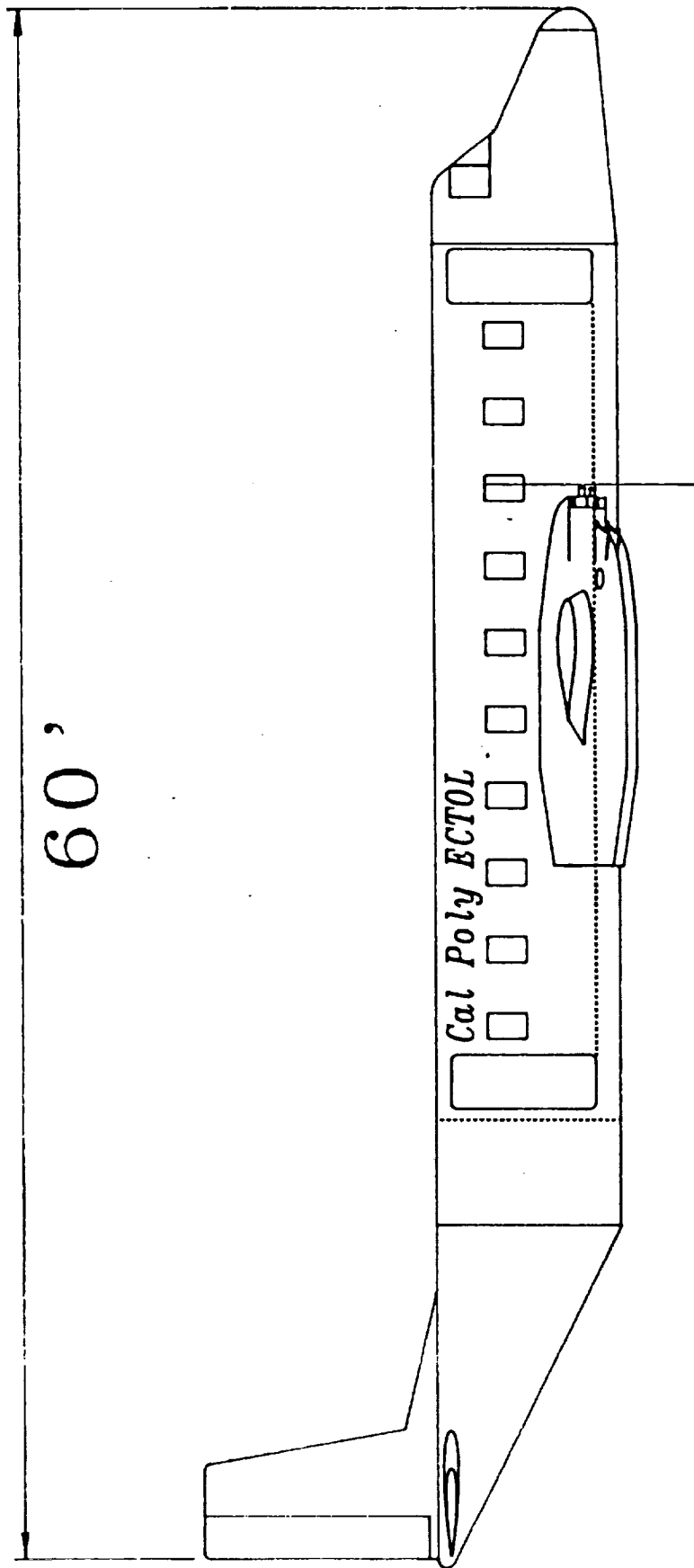

Figure 2. Side View of ECTOL

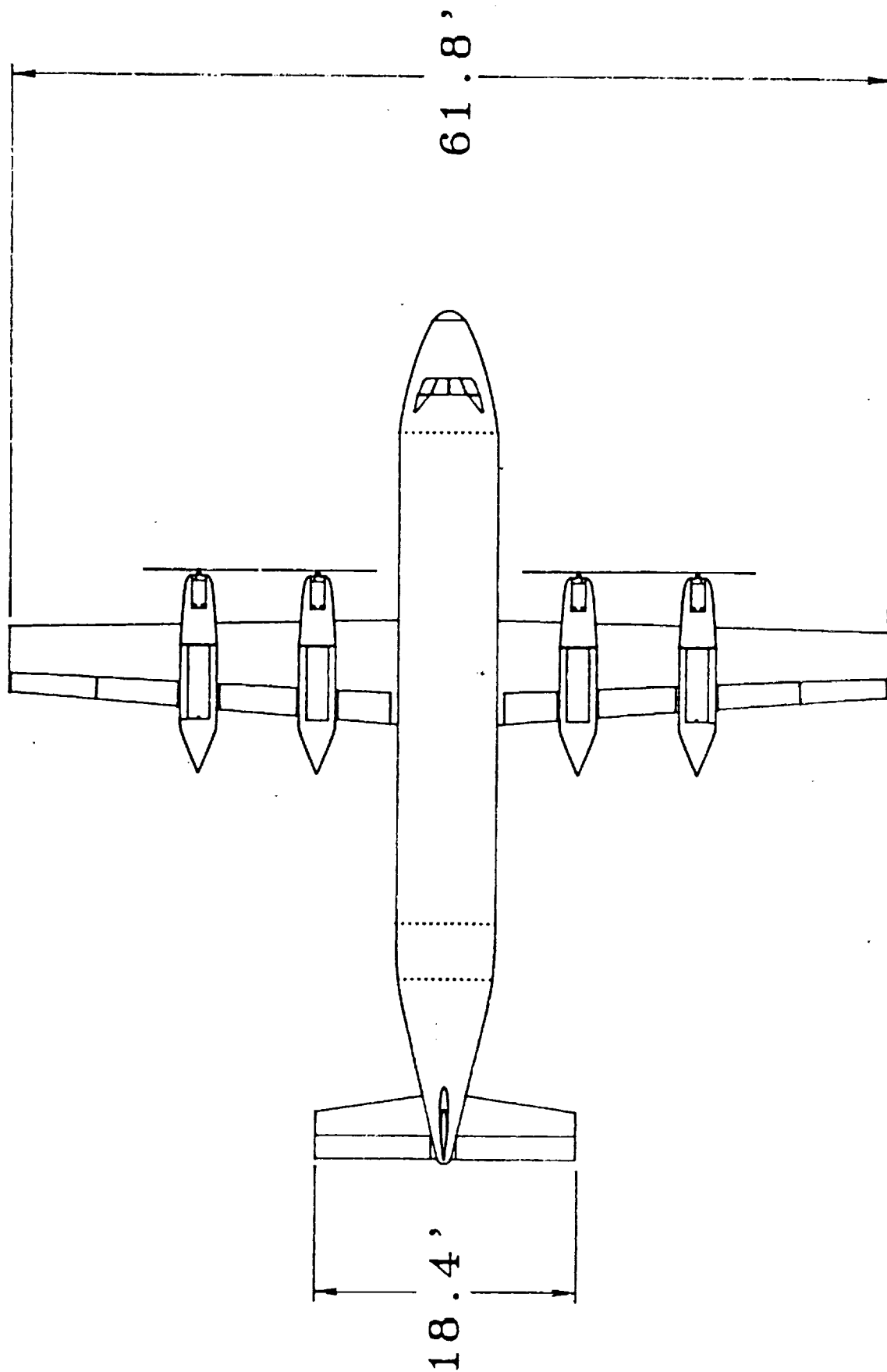

Figure 3. Top View of ECTOL



Wing Dihedral = 3 degrees

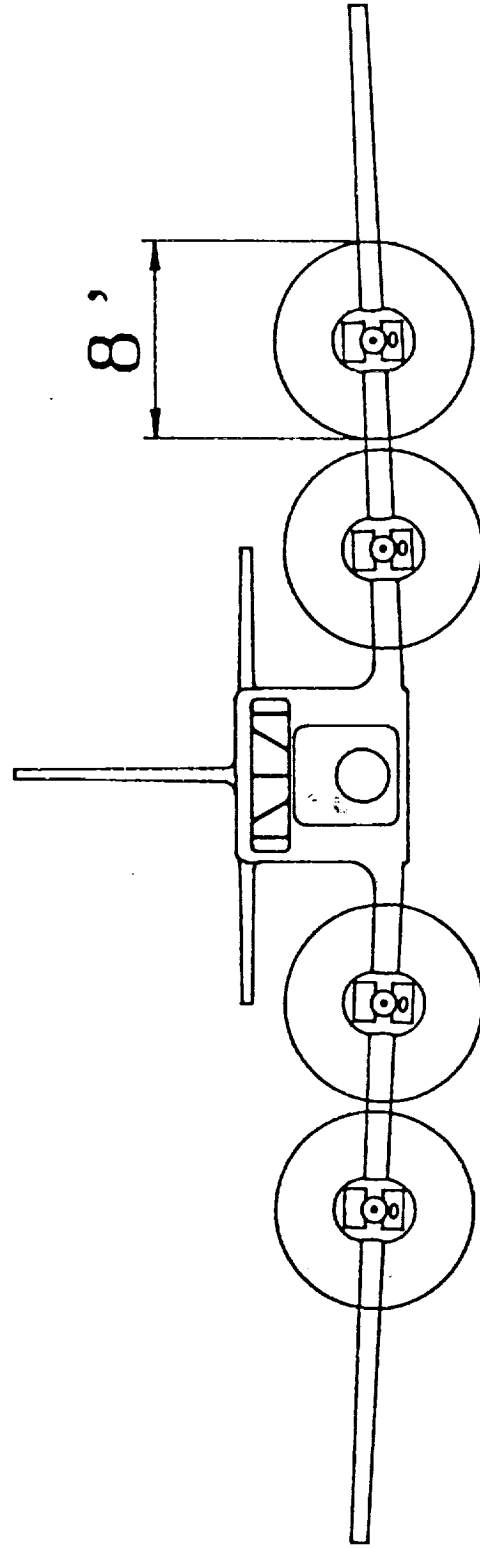

Figure 4. Front View of ECTOL

The wing-nacelle integration was driven mainly by the structural considerations of the propulsion system. A preliminary structural analysis of the wing-nacelle, as well as considerations of propeller distance to the ground and associated landing gear length, were performed in this design.

## Fuselage Design

Initial fuselage sizing was driven primarily by the mission requirement of 30 passengers and the seating arrangement. Three basic seating arrangements were considered: two, three, and four abreast. The only benefits of two abreast seating would be that the passengers, sitting on either side of a central aisle, would not have to be seated shoulder to shoulder. There were four disadvantages to two abreast seating: first, the fuselage slenderness ratio (length/diameter) was very high (approximately 12) yielding unfavorable skin friction drag compared with other layouts; second, the high slenderness ratio also incurred high weight penalties due to the extra structure required to support the long, thin fuselage; third, the small cross sectional area produced very little headroom in the cabin; and fourth, future possibilities of stretching such a long fuselage would be remote. The four abreast arrangement, while having a much more favorable slenderness ratio (approximately 5.5), excellent cabin room, and lends itself well to being lengthened should the need ever arise, unfortunately had the highest cross-sectional area (calculated by determining the width of the fuselage and projecting it into the vertical plane to form a square) and the associated possibility of excess base drag. For the final configuration, three abreast seating was chosen (similar to the Gulfstream American commuter and the Embraer Brasilia) as a good compromise. This seating arrangement, with two passengers on one side of the aisle and one on the other yielded a final slenderness ratio of 7.7. The final cross section of the fuselage is a square, 6.9 ft per side, which, with a 10" false floor above the top of the lower former, has an interior cabin height (aisle) of 5' 5". While this interior height might seem low, the Fairchild Metro III SA227AC, has a maximum aisle height of 4' 9" and the Embraer Brasilia has an aisle height of 5' 7", indicating that the fuselage sizing is comparable to other current commuter aircraft (Figures 5-7).

C-2

Aisle Width = 19"

Seat Width = 17"

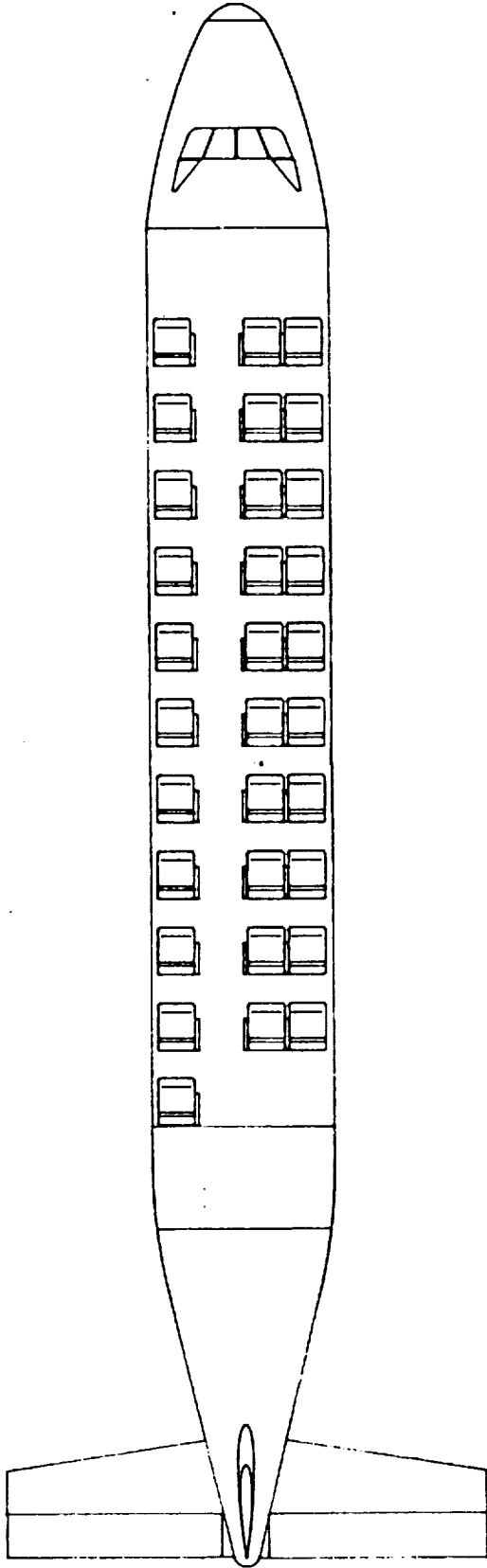

Figure 5. ECTOL Seating Arrangement

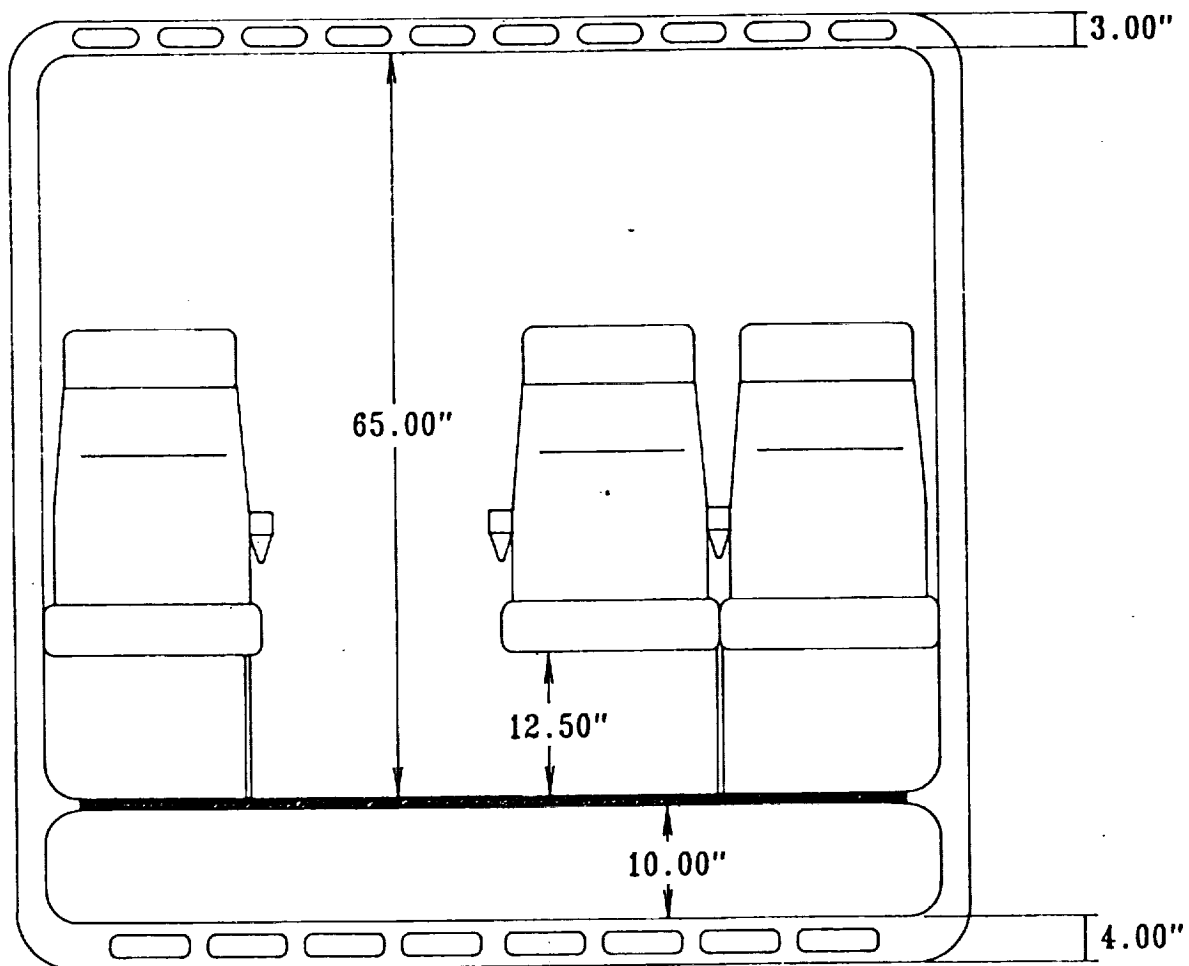

Figure 6. Fuselage Cross-Section

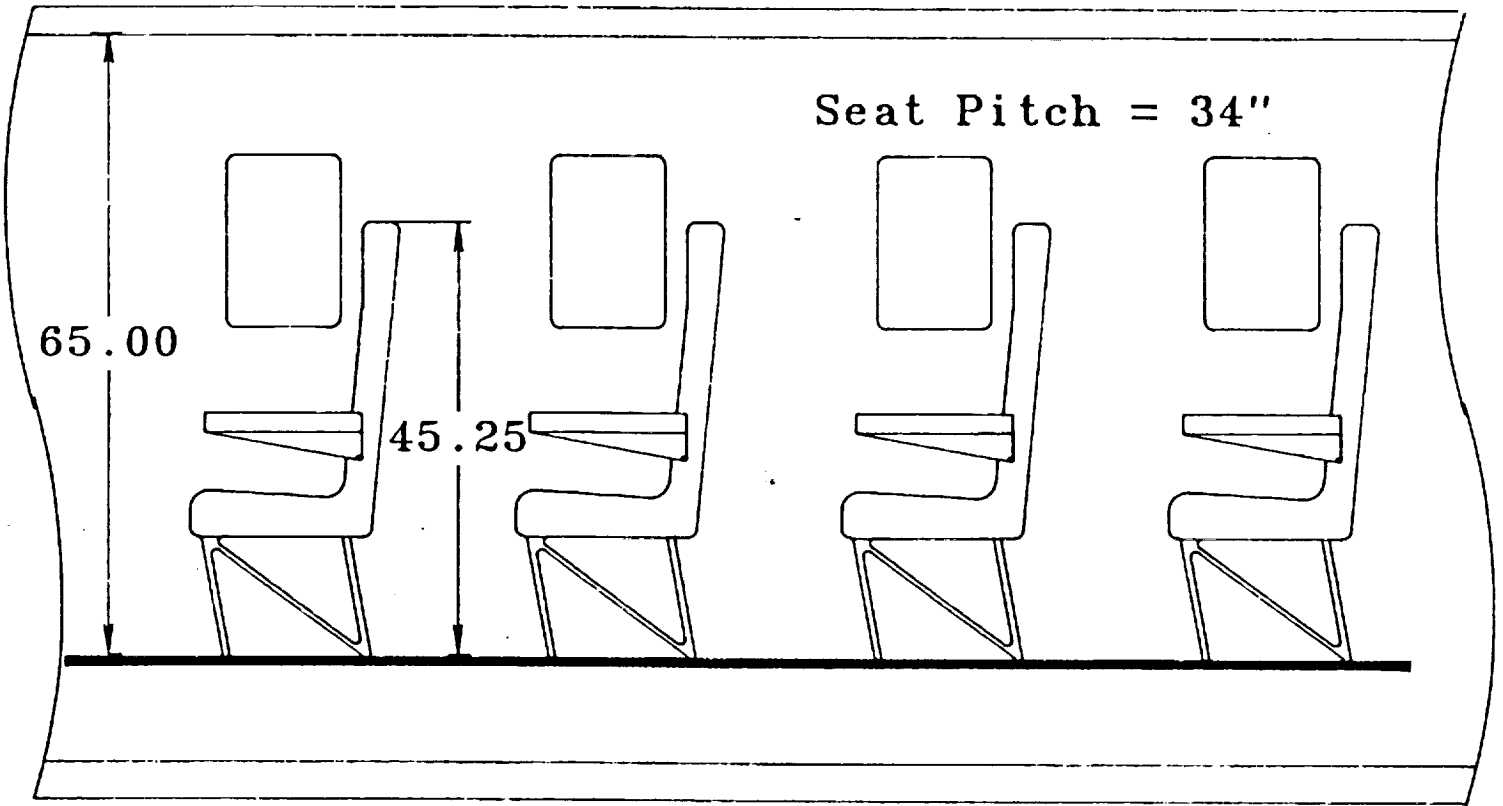

Figure 7. ECTOL Cabin Cutaway

Other advantages gained by using a square fuselage cross section in addition to extra under seat storage are reduced maintenance and construction costs. Construction costs are not only reduced by eliminating the need for a completely sealed pressure vessel, but also by the fact that simple, straight-sided shapes such as squares are easier (and inherently less expensive) to manufacture. Maintenance costs, particularly in the structural repair aspect, are considerably less expensive due to the use of FAR 43:13 maintenance regulations for unpressurized aircraft. The square cross-section of the passenger compartment is carried from the aft wall of the baggage compartment, all the way back to the tail to preserve the simplicity of the structure and keep it structurally sound. The only portion of the fuselage which is not square in cross-section is the nose which blends into a spherical, aerodynamic shape.

## Wing Design

The wing planform area of 382.4 square feet was determined from the ratio of maximum takeoff weight to desired wing loading. Important parameters in the design of the wing were aspect ratio, taper ratio, sweep angle, and thickness ratio. From the thickness ratio, the airfoil section was chosen.

The aspect ratio of 10 was decided upon by studying similar aircraft, such as the Shorts 360 and the DeHaviland DHC-7 (Ref. 9). The high aspect ratio-wing yields a lower induced drag, though, a weight penalty is incurred. The aspect ratio chosen is appropriate for the ECTOL.

The taper ratio selection process was a trade-off between available fuel volume and wing weight. Higher taper ratios produce lower fuel volumes and higher structural weights. Fuel volume was dictated by the needs of the propulsion system. Assuming a root thickness ratio of 0.15 yielded a taper ratio of 0.7. As with aspect ratio, a study of similar aircraft yielded similar taper ratios.

From Reference 6, the wing lift curve vs. angle of attack slope for subsonic, conventional, straight-tapered wings with low sweep angles was obtained as a function of semi-chord sweep. This relationship, with the cruise Mach number of 0.39, aspect ratio of 10, and section lift curve slope of 0.116 per degree, is shown below in Figure 8. From the figure, it was determined that a half-chord sweep angle of zero would yield a maximum value of lift curve slope. Obviously, the maximum lift curve slope is desirable so that a specified lift coefficient can be achieved at as low an angle of attack as possible. The wing weight is also at a minimum and propeller slipstream effects are optimum when the half chord sweep angle is zero (Ref. 6). Because of the low Mach numbers (0.39 at cruise) of the ECTOL, the wing critical Mach number will not be attained and no wave drag will be associated with the zero sweep angle.

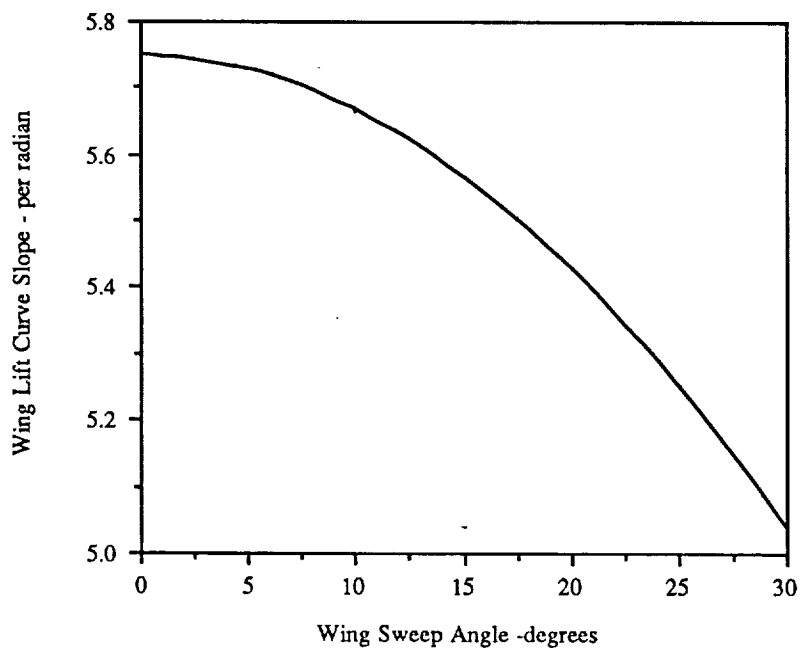

**Figure 8. Effect of Wing Sweep on Lift Curve Slope**

From the estimated fuel volume, it was determined that a thickness ratio of at least 0.14 was necessary to accommodate the lithium and hydrogen peroxide storage from the relationship illustrated in Figure 9. From Figure 10 a thickness ratio of 0.15 was chosen to yield a satisfactory maximum section lift coefficient; this thickness ratio produced a relatively low wing weight, as can be seen in Figure 11. A NACA 63-215 airfoil was chosen as the wing section for the ECTOL.

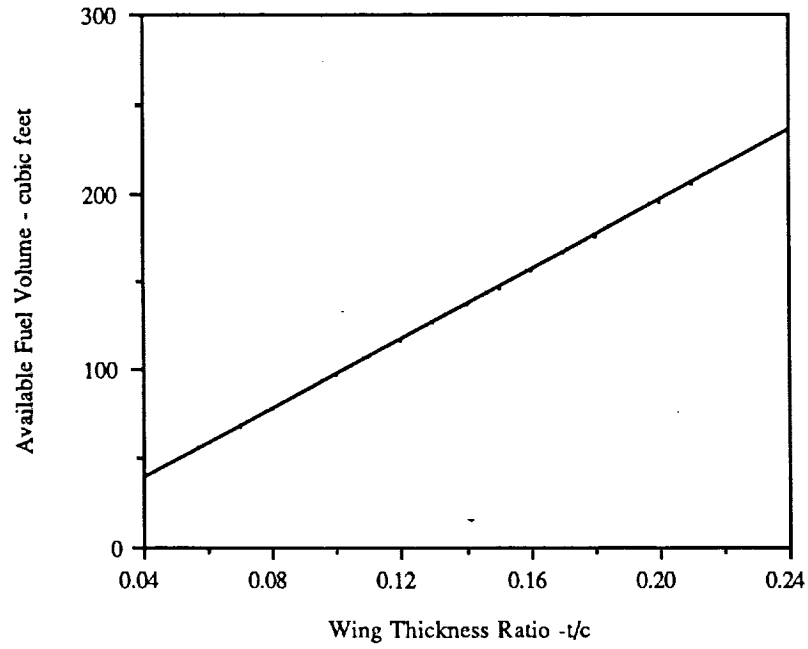

Figure 9. Effect on Wing Thickness Ratio on Available Fuel Volume

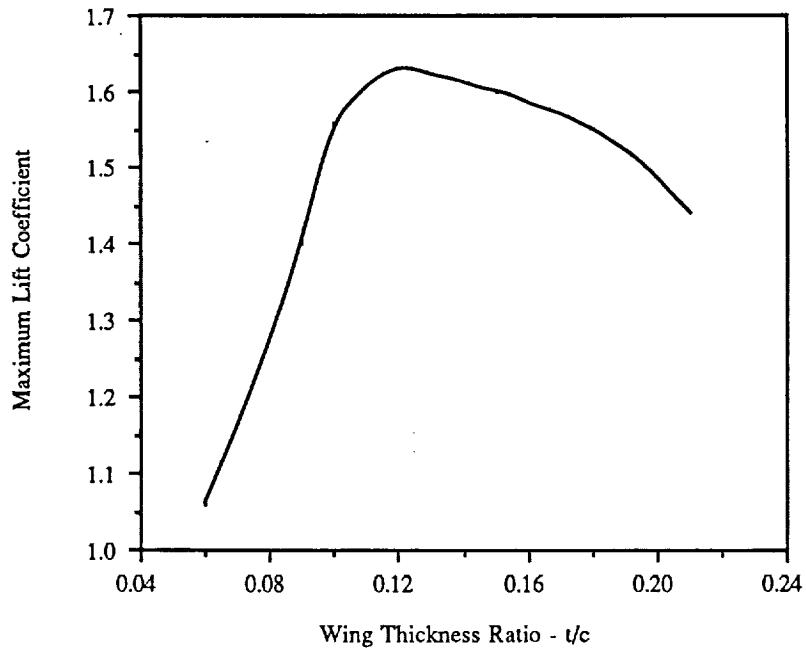

Figure 10. Effect of Wing Thickness Ratio on Maximum Lift Coefficient



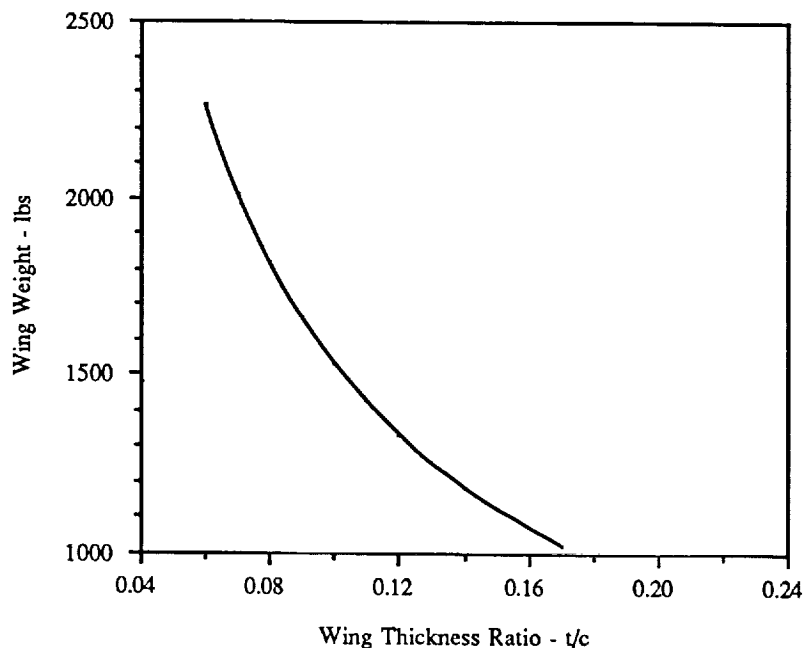

Figure 11. Effect of Wing Thickness Ratio on Wing Weight

## Landing Gear

The landing gear must be capable of absorbing landing and taxi loads, as well as transmit part of those loads to the airframe. Using the design process specified by Roskam, trade-offs and computations were performed to determine the configuration and sizing of the gear.

Since the ECTOL cruises at 250 kts., a retractable configuration was chosen. A tricycle gear configuration was selected for maneuverability and vision when taxiing. Using the results from weight and balance and the method dictated by Roskam, the loads for each gear leg were computed. The main gear load,  $P_m$  was 5948.5 lbs. The nose gear load,  $P_n$  was 4183 lbs. The dynamic nose gear load was calculated to be 6274.78 lbs. The loads necessitated a dual wheel configuration for both the main and nose gears. Tire selection was accomplished by matching the load ratings and max. tire operating speed to the smallest tire in the tire tables listed in Roskam. With the nose and gear tires sized optimally, there was only a one inch difference in width and only a 3.5 lbs. difference in weight. In the interests of the original goal of simplicity, it was decided to use the same tire on both the main and front gear. The tire selected was a 18" x 5.5" 14 ply tubeless B.F. Goodrich tire. Strut-wheel interface, shock absorber stroke length, and strut size were then computed using the Roskam method. The clearance between the strut and tire which included a safety factor of 2 was one inch. The maximum kinetic energy that the main gear had to absorb was 16,219.77 ft. lbs. This was done with the tires previously mentioned and a 3.76 in. diameter shock with a stroke of 10.98 in. for the main gear, and 4.84 in. for the nose gear. After a trade-

off study, an anti-lock brake system was chosen. An analysis of the tip-over characteristics of the landing gear placements revealed a Y-angle of  $46.33^\circ$  which is less than maximum allowed for tip-over stability (Appendix). The ground clearance was complied with the limits given in Roskam (Appendix). A chin tire will be required to avoid spray from a wet runway. The points of the main gear legs corresponds with the back spar of the wing, thus alleviating any additional structure requirements (Appendix). The retracting mechanism chosen for the main gear was an inward folding gear leg with a folding main strut (Figures 12 and 13). The forward gear is the same mechanism but retracts back. The floor of the fuselage above the retracted wheel compartment had to be raised eight inches to allow enough room for the wheels, thus that set of seats will not have any under-seat space.

ORIGINAL PAGE IS  
OF POOR QUALITY

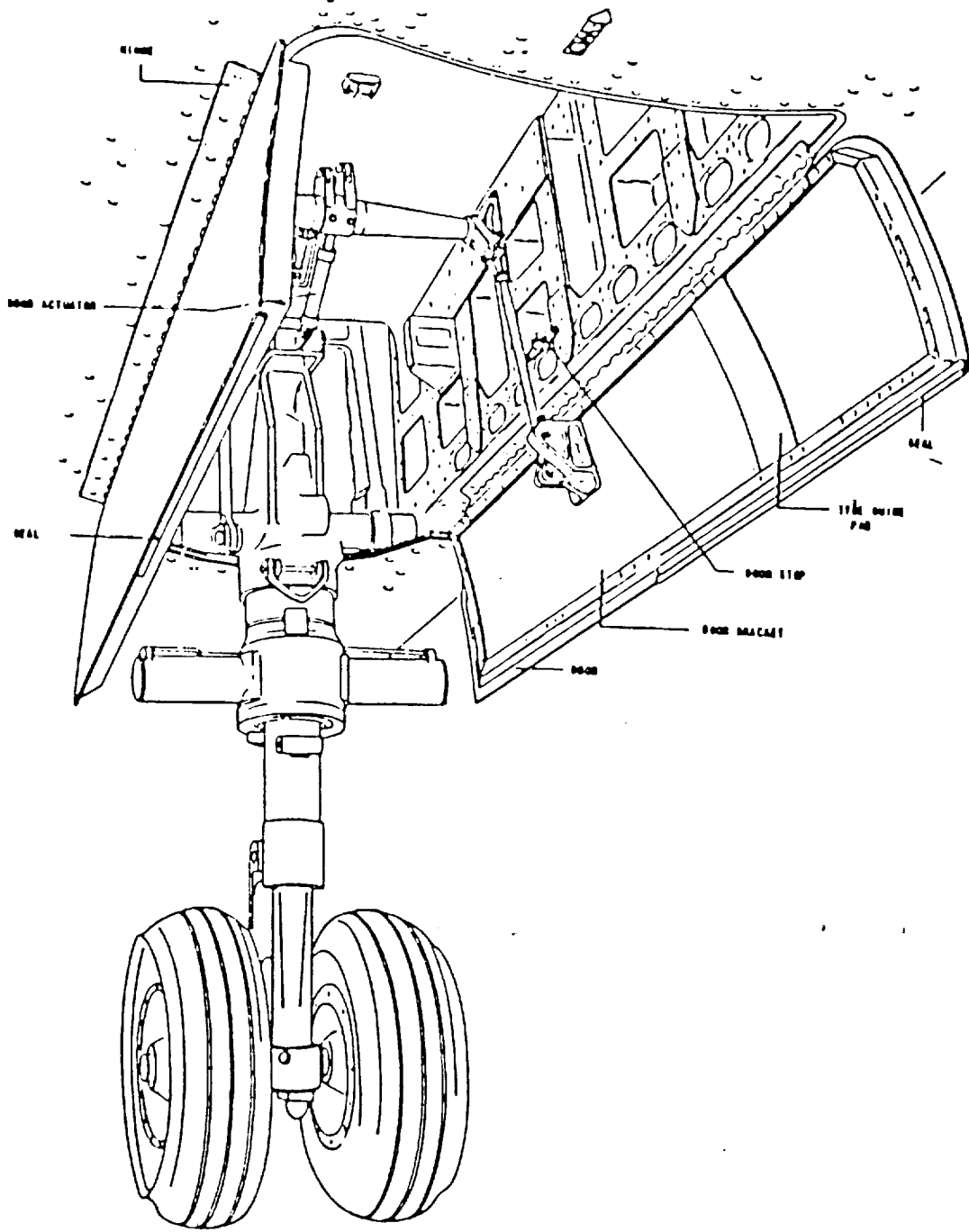

Figure 12. Landing Gear Retracting Mechanism

Source: Reference 8

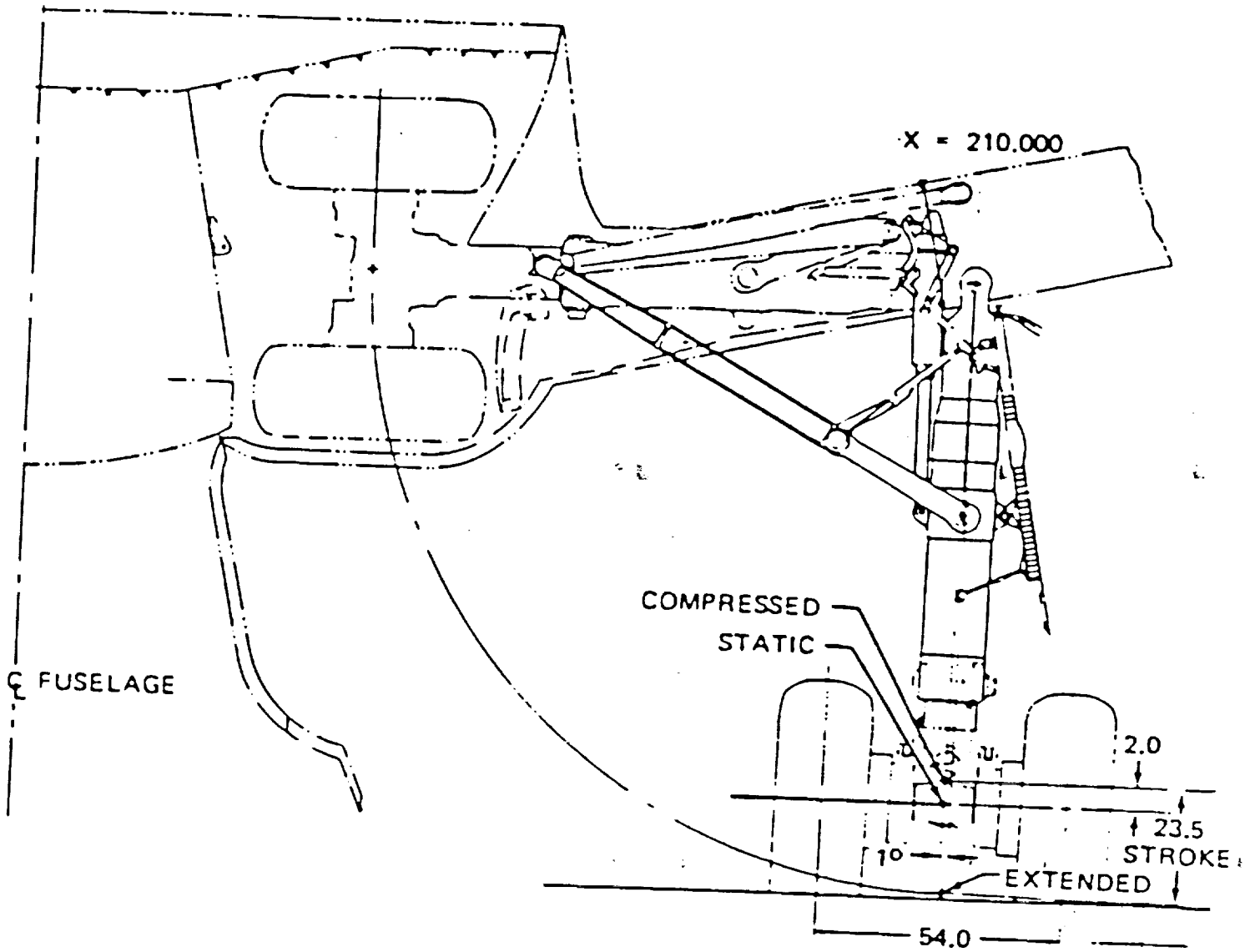

Figure 13. Landing Gear Retracting Mechanism  
Source: Reference 8

ORIGINAL PAGE IS  
OF POOR QUALITY

## Empennage and Control Surface Sizing

The empennage and control surface sizing was done using methods outlined in References 6 and 8. Stability and control analysis were performed with the ECTOL design with stability considerations leading to the sizing of the horizontal and vertical stabilizers; control considerations were used to size the elevator, rudder, and ailerons. The results of the stability and control analysis often lead to radical design changes if the aircraft cannot meet accepted standards of handling and ride quality. However, the ECTOL design was fortunate enough to be able to meet stability and control requirements through appropriate, conventional empennage and control surface design.

The horizontal tail was sized for the furthest aft center of gravity limit, because the shortest moment arm from the tail to the center of gravity would dictate the largest, and thus the critical, tail size. As with the wing design, the horizontal tail aspect ratio was chosen from studying similar aircraft (Ref. 9). Because tail induced drag is not a consideration, a lower aspect ratio would be desirable to keep structural weight to a minimum. An aspect ratio of 4.5 was chosen for the ECTOL horizontal tail. In a similar manner, a taper ratio of 0.7 was selected. A NACA 0012 section was deemed appropriate for its symmetry and thickness ratio appropriate for the low subsonic speeds of the ECTOL. To find the area, a static margin was decided upon; the value of 0.08 was believed to be a good balance between stability and control, with an inclination toward stability. A final horizontal stabilizer area of 74.6 square feet was computed.

The aspect ratio of 2.0, taper ratio of 0.7, and the NACA 0012 section were chosen using the same methodology as for the horizontal tail. The horizontal tail sizing was done again for the aft center of gravity (C.G.) limit, and the area was driven by the desired value of the stability derivative  $C_{nB}$ , the coefficient of variation of yawing moment with sideslip angle. From Reference 6, a value of 0.10 was chosen as appropriate for the ECTOL. The contributions of the wing (very small) and the fuselage (destabilizing) were computed, and a final value of 38.5 square feet was obtained for the vertical stabilizer. Initially, this value seemed small; however, considering the long moment arm for the ECTOL tail and studying the ratios of tail area to wing area for similar aircraft (Ref. 9), showed that 38.5 square feet was reasonable.

The elevator was sized using the aft C.G. limit and a downwash value of 0.40. Two flight conditions were considered: approach and takeoff. During approach, moments were calculated about the C.G., while during takeoff the moments were taken about the main gear. Again using the method from Reference 6, approach was found to be the critical condition, yielding a ratio of elevator area to horizontal tail area of 0.50. Sizing the rudder was done similarly to the elevator sizing, with the following cases being considered: one engine out (with the worst case being at takeoff, with high thrust and low dynamic pressure), and a cross wind equal to 20% of the aircraft velocity (FAR regulations) at

both cruise and landing. The cross wind landing was the critical case, producing a ratio of rudder area to vertical stabilizer area of 0.36.

The aileron was sized using the methodology of Reference 6, and was driven by the desired rolling stability and control of the ECTOL. Ailerons of 30% chord, running from 80% half wing span to the wing tips, were determined to be sufficient. The ailerons did not interfere with the designed Fowler flap configuration, avoiding the use of a flaperon-type of system.

## Propulsion system

In the past, the predominant problem with electric propulsion has been the weight of the fuel system. With the improvement of lithium based fuel cells, this problem has been solved. In a report written by A.D. Galbraith entitled, *Electric Propulsion for High Performance Light Aircraft* (1979) (Ref. 3), such a fuel system was designed for use in a Beech Bonanza model 35. In 1981, Hughes helicopters in conjunction with A.D. Galbraith, designed a similar system for use in a TH-55A helicopter. This same technology, now as much as 11 years old, was proposed for the propulsion system in a 31 passenger transport.

The 30 passenger ECTOL aircraft is propelled by four electric motors, each rated at 750 hp (560 kw) and 20,000 rpm. Each motor drives a 3-blade, constant-speed, fully-feathering propeller with spinner. The motors are fueled by electric current at 300 volts and 1866.7 amps at full throttle. Resources suggest that an electrical motor of this size has never been built. However, Gould electronics has built a 6 phase AC induction motor rated at 300 hp with a 3.9 hp/lb power density. With the addition of an inverter and gearbox the power density is reduced to 2.6 hp/lb. Incidentally this motor and motors of similar design have a 97% energy efficiency. For the ECTOL, this density was scaled up for a 750 hp system. This resulted in a motor system weighing a mere 288.5 lb. Using the same methodology, the dimensions of this system were calculated to be 1 ft. diameter by 2.38 ft. in length (Ref. 4).

Each motor is supplied by 2 fuel stacks connected in parallel, resulting in a total of 8 fuel stacks for the aircraft. With this system, if a fuel cell should fail, half power can still be delivered to the engine. Each set of fuel stacks (two in each nacelle) is fed electrolyte by a single pump located in the fuselage just in front of the wing. One back-up pump is available in the case of a failure. These pumps are supplied electricity directly from the fuel stack after passing through a transformer.

Electricity is generated in the fuel cell via a chemical reaction between lithium (the cathode) and hydrogen peroxide (part of the electrolyte). In this reaction an electric potential of approximately 2.2 volts are generated, after certain losses (which will be explained later) are taken into account. This parameter is important because it determines how many reactions must be connected in series to get the necessary voltage for the motor. For this reason, each fuel stack requires 150 cells. The current density of the reaction depends upon operating temperature.

At a temperature of 35 degrees Celsius, a current density of  $0.75 \text{ amp/cm}^2$  is acquired, which can be maintained indefinitely. At a temperature of 55 degrees Celsius, a current density of  $1.5 \text{ amp/cm}^2$  is acquired; however, because of decline in the ratio of current to current density, this current density can only be maintained for about 45 minutes. The former parameter represents the cruise characteristics while the latter represents the takeoff characteristics. Both parameters are important in determining the size of the fuel cell. For the current requirement of 1866.7 amps, a cross-sectional area of  $1244.5 \text{ cm}^2$  is required. Since there are two fuel stacks connected in parallel, a current requirement of only 933.4 amps per fuel stack for takeoff is required. This results in an area requirement of  $622.2 \text{ cm}^2$ . While cruising, the engines run at 75% power or 562.5 hp (420 kw). For a current density of  $0.75 \text{ amps/cm}^2$  and a current requirement of 700 amps per fuel stack, a a cruise cross-sectional area of  $933.3 \text{ cm}^2$  is required. The cruise area is therefore the dominating factor in determining the size of the fuel stack (Ref. 4).

The fuel stack operates by flowing electrolyte between the lithium cathode and a silver oxide anode. Each anode is bonded to a neighboring cathode resulting in a sandwich configuration (Fig. 14). As the lithium is dissolved into the electrolyte, a jackscrew system at the end of the stack maintains the necessary spacing between cathode and anode (Fig. 15). The electrolyte is fed through the stack via a common manifold. These manifolds offer a conductive path which results in a voltage loss across the stack, however, the low solubility of LiOH keeps this loss to a minimum, giving the voltage potential of 2.2 volts per reaction.

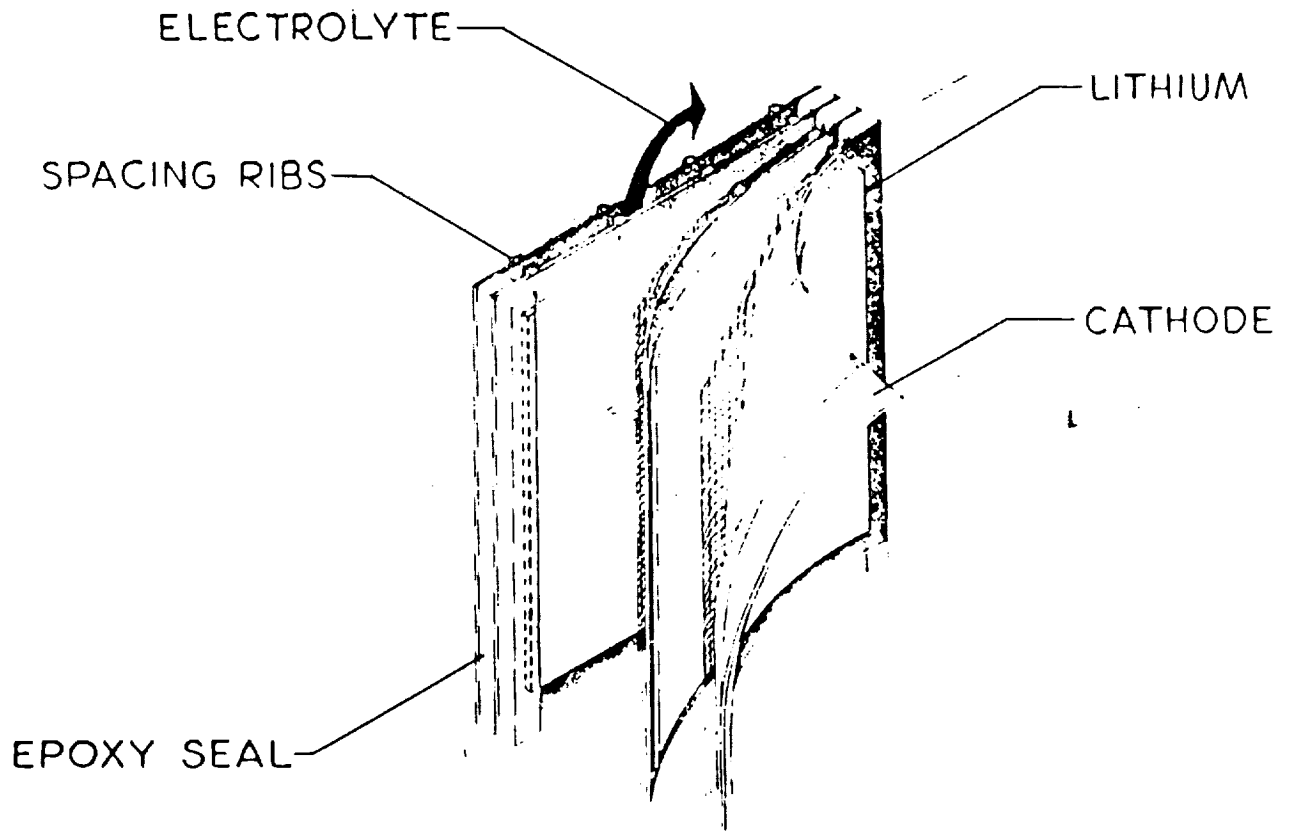

Figure 14. Sandwich (bipolar) Configuration

Source: A.D. Galbraith



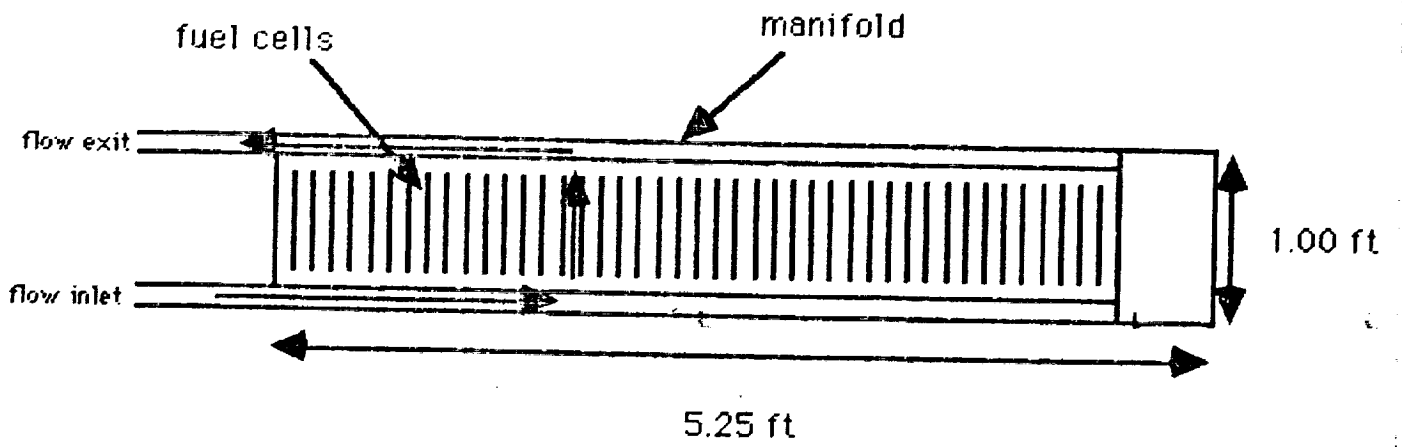

Figure 15. Fuel Cell Cutaway

Once the electrolyte leaves the stack, it is fed through a cooling coil mounted along the inside of the leading edge of the wing. The cooling coil serves two purposes: first, by cooling the spent electrolyte, the lithium will precipitate forming  $\text{LiOH}\cdot\text{H}_2\text{O}$ , allowing it to be separated along with gaseous hydrogen from the flow; second, the coil maintains the required temperature of the fuel stack. The electrolyte which is not drained off is introduced back into the system and mixed with fresh hydrogen peroxide (Fig. 16). The drained off electrolyte is collected in a tank inside the wings, where it is stored until landing. Upon landing it is drained and taken to be recycled.

ORIGINAL PAGE IS  
OF POOR QUALITY

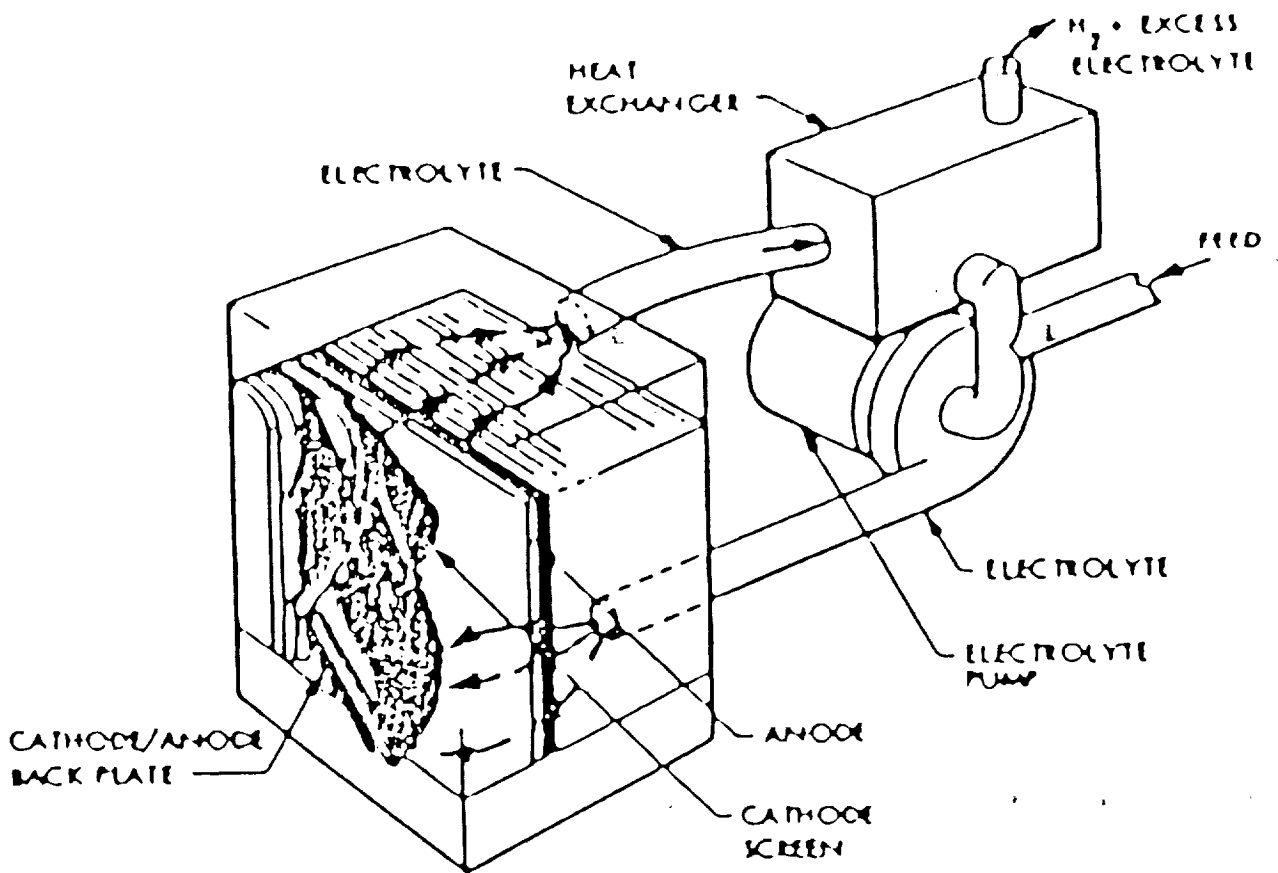

Figure 16. Schematic of Pump System

Source: Galbraith, "Electric Propulsion for High Performance Light Aircraft"

The mission requirement of the ECTOL requires an energy of approximately 12.8 MBtu (3748.3 kW-hr). Lithium offers a theoretical energy density of 6 kW-hr/lb. With the system being implemented 4 kW-hr/lb is attainable, resulting in a 66.3% energy efficiency of the fuel stack. Using this energy density, the weight of the lithium fuel is 937.1 lb. Unfortunately, such a fuel system requires the on-board storage of the oxidizer, which in this case is hydrogen peroxide. For every pound of lithium consumed, 5 pounds of hydrogen peroxide is required, resulting in 4685.4 lb of hydrogen peroxide.

Other systems which collect the oxidizer from the atmosphere have been studied and offer the advantage of not having to store the oxidizer on-board. These systems, however, suffer from low power density along with the air anode having a limited lifetime and being quite expensive. For these reasons, it was decided to use the more reliable hydrogen peroxide system and pay the weight penalty (Ref. 4).

In order to start the system, an auxiliary power unit (APU) is wheeled out to the aircraft and connected to the electrolyte pumps; this is similar to the method used to start conventional transport aircraft. However, instead of connecting the APU to the compressor of the turboprop engine, it is connected to the electrolyte pumps.

There are some obvious advantages to operating an electrical propulsion system, such as the one designed for this aircraft. However, there are also drawbacks which need to be taken into account. The most apparent of which is the weight of the fuel system. In this system, lithium produces about 13.65 kBtu/lb; however, the weight of the hydrogen peroxide must also be taken into account, resulting in approximately kBtu/lb of reactants. In an internal combustion engine, somewhat more fuel efficient than a turboprop engine, about 10.236 kBtu/lb of gasoline is achieved. The internal combustion engine, of course, takes its oxidizer from the air. Other disadvantages to this system include the cost of the lithium which is currently \$20/lb when purchased in relatively small amounts. The recycling process has been estimated by A.D. Galbraith to cost somewhere between \$1.00 and \$0.65 per pound of recycled lithium. The recycling process requires electrical power from some source which could lead to air pollution (Ref. 4).

The advantages of operating such an aircraft are numerous. The noise of the aircraft will be reduced due to the ability of electrical motors to operate quietly. Since electrical engines are very reliable and easily maintained, and because of the parallel fuel stack configuration being used, system safety is enhanced. By using electric motors engine lifetime will be extended by orders of magnitude compared to conventional airplane engines. Air ducts are very small for electrical engines, resulting in increased performance due to reduced drag. Because the fuel remains on board throughout the flight the C.G. movement is minimal. The combination of fuel stack and electric motor is very energy efficient, about 64%, compared to the 40% energy efficiency of turboprop engines. In addition, electric propulsion doesn't require the use of fossil fuels.

## Avionics

Since one of the driving forces in this design was affordability, an automated flight control system was chosen to be used. This system cuts pilot costs by over 50% since the single, backup pilot can be paid less than a regular pilot. In addition to the automated flight control system mentioned in the California Corridor chapter, an optimizing computer engine/fuel cell control system will be incorporated into the ECTOL. The engine/fuel cell control system will allow the ECTOL to be a completely automated airplane. In the event of failure of the automated flight control system, or the automated engine/fuel cell control system the pilot aboard will be capable of continuing the mission. Incorporated in the computer will be a global positioning system using satellites to continuously update the aircraft's position. These systems, with the exception of the automated flight control, should be commonplace by the year 2010 and will fit within the goal of affordability.

## Weights and Balance

At the end of the first design iteration, a detailed weight analysis was performed using the methods, based upon empirical data, outlined in Reference 6. The result gave a new gross takeoff weight that was lower than the initial assumption; the initial design process was then reiterated with the new weight, leading to changes in the entire design, from wing area to drag polars. The final iteration values of the ECTOL component weights are shown below in Table I. In the Appendix, the weights along with their corresponding distances from the aircraft nose are listed. These distances were used to find the center of gravity (C.G.) of the aircraft, an extremely important aircraft parameter since many designs are driven by C.G. location. The vertical C.G. location was also determined, so that ground stability with the designed landing gear could be assured.

The electric propulsion system of the ECTOL is very unconventional in the respect that the C.G. travel is minimal because no fuel is burned; the only C.G. travel in flight would be due to the shifting of weight from the lithium rods to the slurry tanks, which could be eliminated through careful design. The significant C.G. travel in the ECTOL would be due to asymmetric passenger loading, that is, more people in the rear of the plane than the front. A C.G. excursion envelope (Appendix) was obtained by calculating the C.G. location for the worst cases of only passengers in the rear, and only passengers in the front, both with fuel (for flight) and without fuel (ground refueling). The wing location was varied until the C.G. travel was within reasonable limits for stability and control considerations. It is generally desirable to have a C.G. location at 35% mean aerodynamic chord (MAC) because, for subsonic flow, the aerodynamic center (a.c.) of the wing (assumed to be the a.c. of the aircraft) is located at approximately 25% MAC; the C.G. location should be about 10% of the MAC aft of the a.c. for the best stability and

control characteristics of the transport vehicle. Moving the C.G. further aft of the a.c. gives greater control and degrades static stability, while moving the C.G. forward has the opposite effect.

**Table I. ECTOL Component Weights**

| <u>Component</u>  | <u>Weight (lbs)</u> |
|-------------------|---------------------|
| Wing              | 1137                |
| Fuselage          | 1393                |
| Horizontal tail   | 170                 |
| Vertical tail     | 212                 |
| Engines           | 1800                |
| Fuel cells        | 5622                |
| Fuel tanks        | 5025                |
| Engine controls   | 700                 |
| Propellers        | 900                 |
| Surface controls  | 446                 |
| Electrical system | 1070                |
| Indicators        | 59                  |
| Furnishings       | 1275                |
| Air conditioning  | 200                 |
| Crew and pax      | 6765                |

### Performance

The analysis of the ECTOL aircraft involved the calculation of several performance parameters for varying flight conditions. These parameters are listed in the following table:

## Table II. Performance Parameters

- Lift coefficient vs. angle of attack
- Lift coefficient vs. drag coefficient
- Rate of climb vs. altitude
- Power required and power available vs. velocity
- Lift over drag ratios
- Thrust required vs. velocity
- Stability derivatives
- Stall velocity
- Maximum lift coefficient
- Load factor
- Maximum thrust of propellers

### Drag Polars

The drag polars were calculated using equations from Nicolai (Ref. 6). Parasite drags were estimated for the wing, nacelles, body, empennage, and the flaps at three flap configurations (clean, takeoff, landing). In addition, the Oswald efficiency factor was adjusted for the three flap settings. With the flaps fully extended at a 30 degree angle of deflection, an Oswald efficiency factor of .70 was used. For takeoff flaps the Oswald efficiency factor was raised to .75. The drag polars are labeled as Figures 17 through 20. The calculations for these drag polars can be found in the appendices.

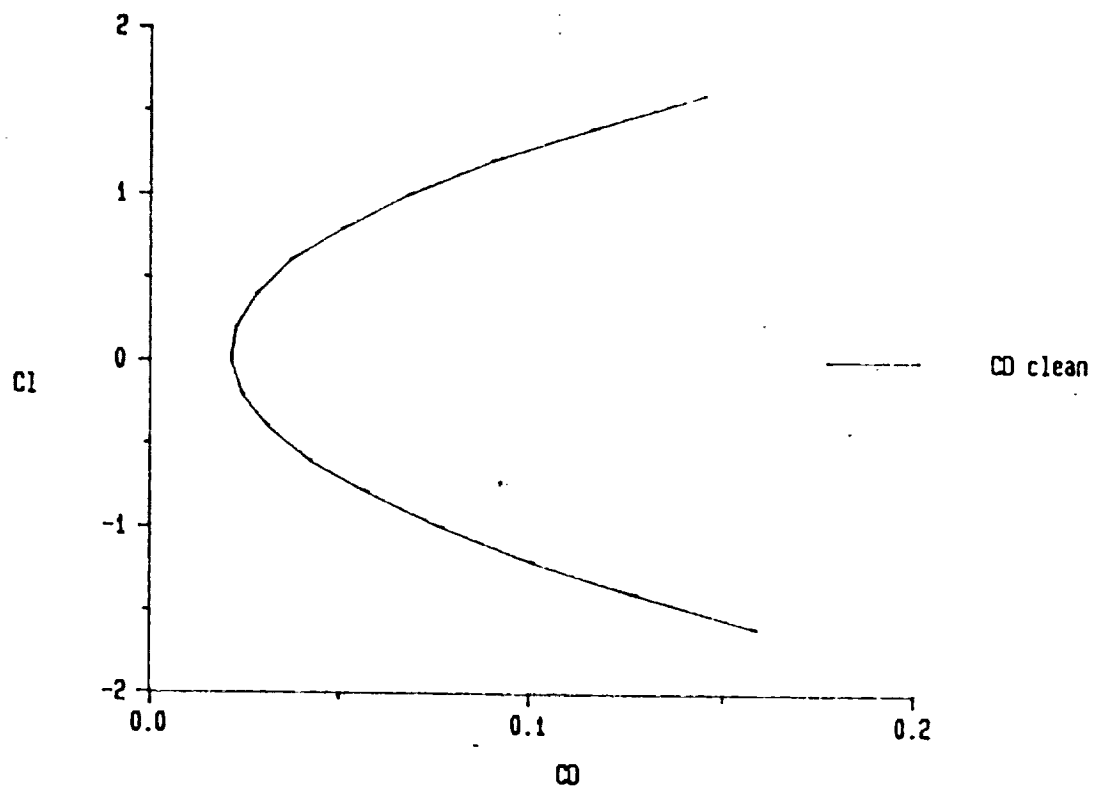

Figure 17. Drag Polar for Clean Configuration



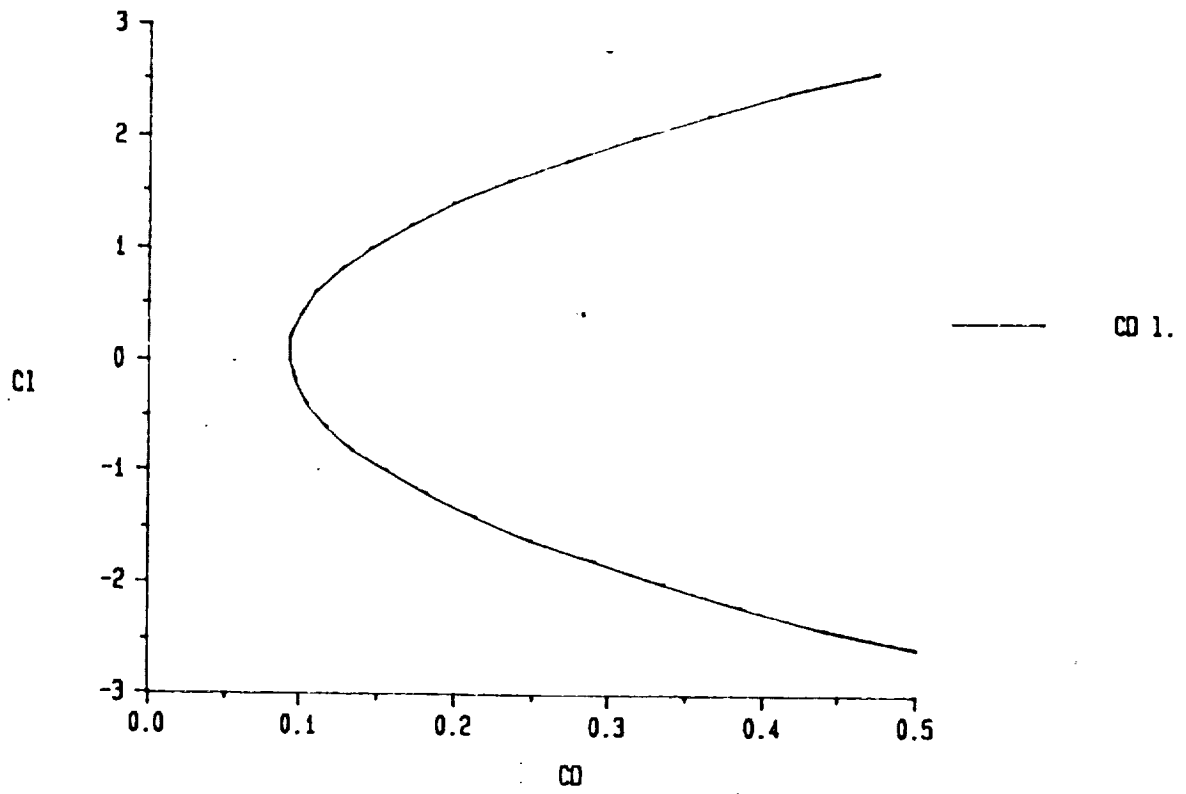

Figure 18. Drag Polar for Landing with Gear Up

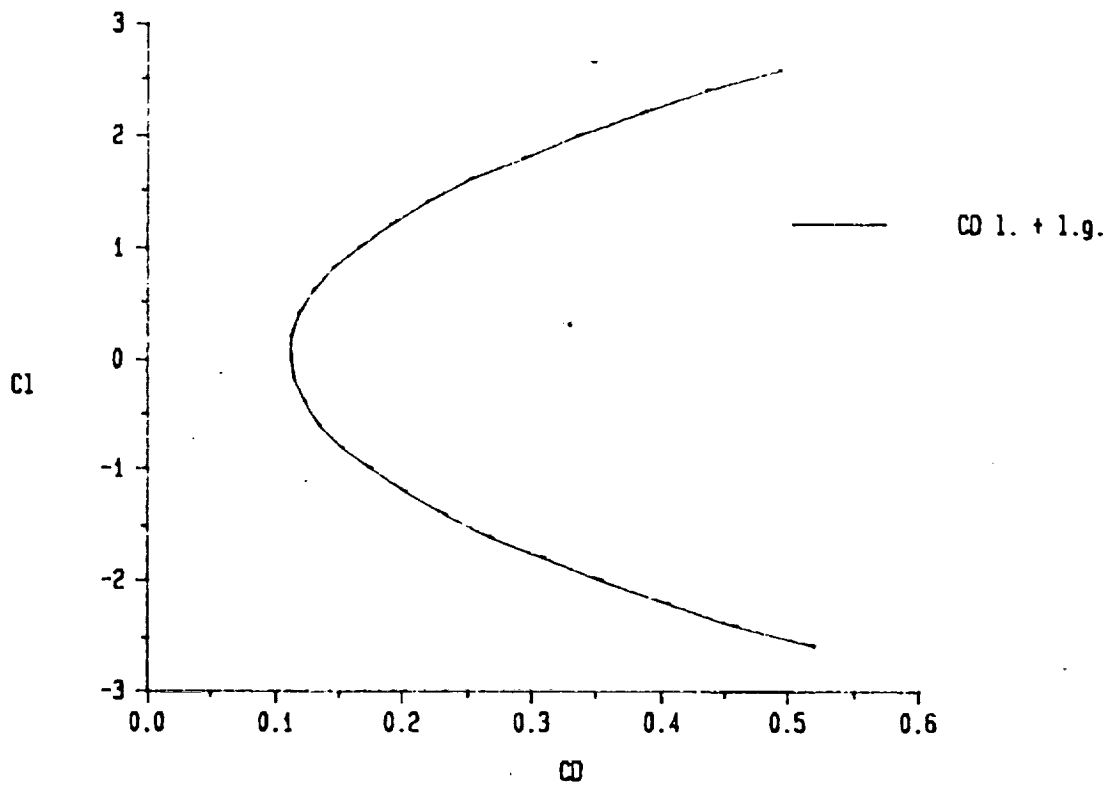

Figure 19. Drag Polar for Landing with Gear Down

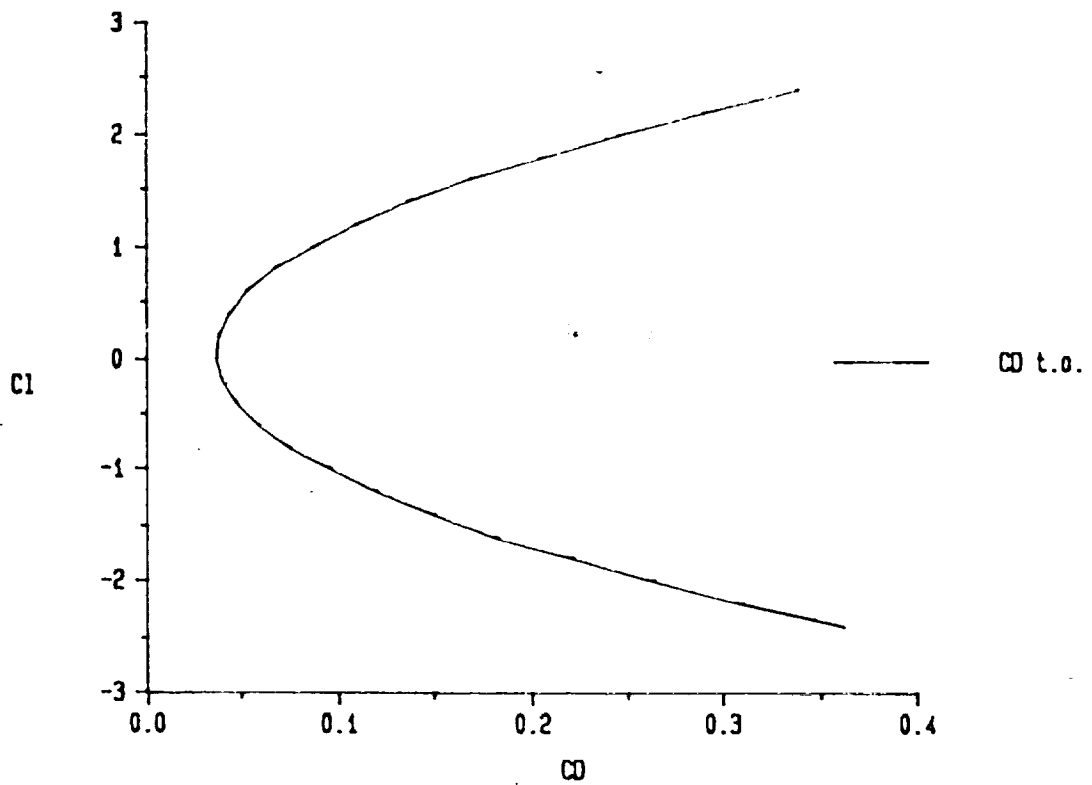

Figure 20. Drag Polar for Takeoff Configuration

### Power Required, Power Available, and Rate of Climb

Electrical power plants have a unique quality among aircraft power plants, it is absolutely insensitive to altitude. Thus, the ECTOL power available is constant. With variable pitch propellers, the efficiency of the propeller stays relatively constant. The power required varies as a normal aircraft since  $P_r$  depends on drag and velocity (Fig. 21). Rate of climb was calculated by the excess power method (Ref. 2). Since power required is dependent on altitude, rate of climb is also dependent on altitude (Fig. 22).

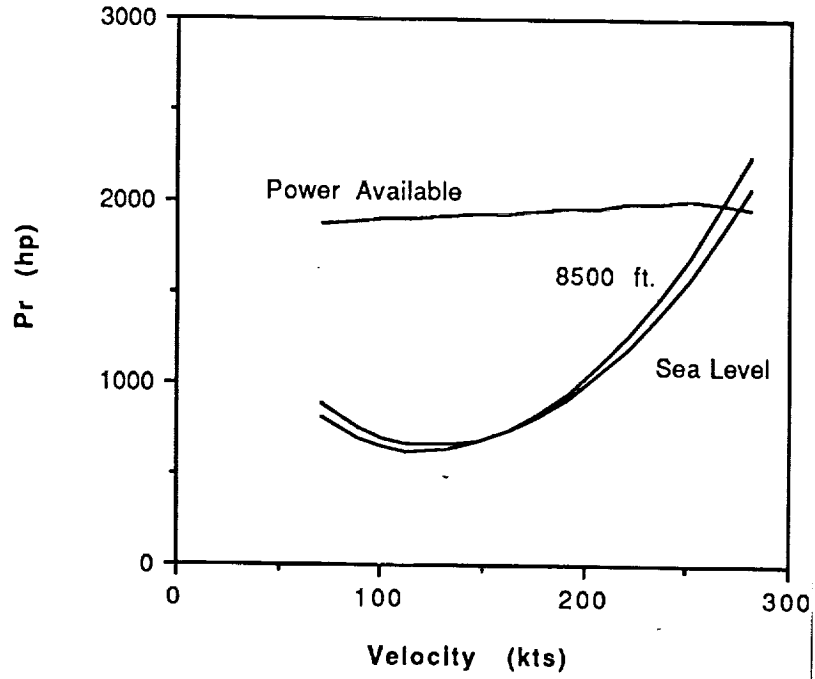

Figure 21. Power Required and Power Available vs. velocity

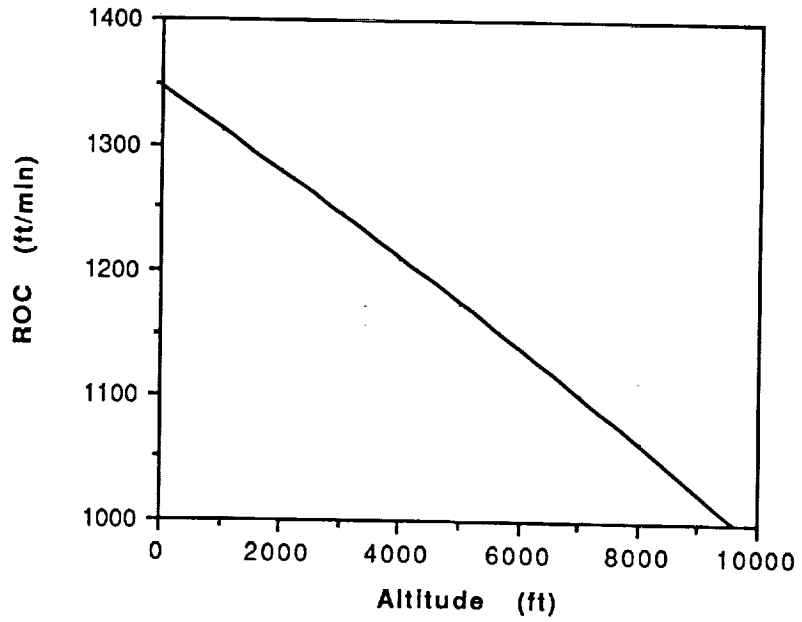

Figure 22. Rate of Climb vs. Altitude

## Lift over Drag Ratios

Using the aerodynamic data of the aircraft, it was possible to calculate lift over drag ratios for the cruise, landing, and takeoff regimes.  $L/D$  max for cruise turned out to be the maximum  $L/D$  among the three as expected. From Figure 23 the point of  $L/D$  maximum occurs at 200 kts.

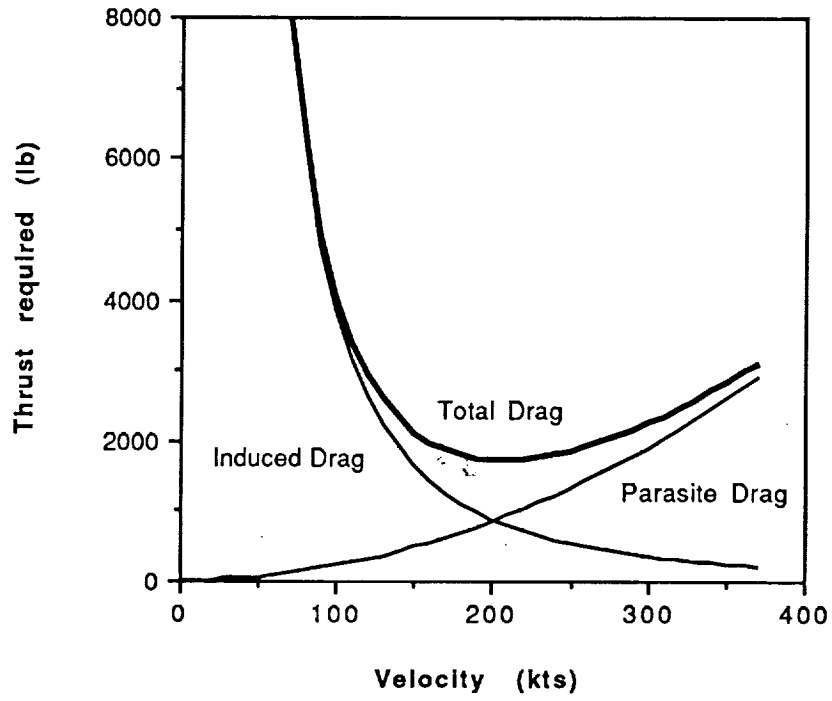

Figure 23. Thrust Required vs. Velocity

### Thrust Required vs. Velocity

Induced and parasite drag were calculated using equations from both Nicolai (Ref. 6) and Anderson (Ref. 2). These quantities were plotted against velocity in Figure 23. The curves are for the clean configuration at the cruise altitude of 8500 ft. Parasite drag quantities were the same used for the drag polar calculations. According to the figure the minimum thrust required occurs at a velocity of 200 kts. At the cruise velocity of 250 kts the thrust required was calculated to be 1850 lb.

### Stability Derivatives

The aircraft was determined to be statically stable by using the process stated in Nicolai. The stability derivatives were calculated with the same process and are as follows

|                 |       |
|-----------------|-------|
| $C_{m\delta}$   | -2.37 |
| $C_{lB}$        | -.11  |
| $C_{l\delta a}$ | .26   |
| $C_{m\alpha}$   | -.56  |
| $C_{nB}$        | .10   |
| $C_{m\delta e}$ | -1.58 |

### Propeller Performance Calculations

Propeller characteristics were chosen by comparing propellers of similar aircraft and engine horsepower. For a transport aircraft with 750 hp engines, a 3-blade propeller with an 8 ft diameter was typical and therefore applied to the ECTOL. Other characteristics chosen for the propeller were a design lift coefficient of 0.500 and an activity factor of 140. These numbers were chosen in order to stay within conservative boundaries. Since a constant-speed, variable-pitch propeller is being used, the rpm and consequently the integrated design lift coefficient, both remain constant at varying velocities and attitudes.

Hamilton Standard's "Generalized Method of Propeller Performance Estimation" (Ref. 5) was used to determine the thrust produced by the motor and propeller. The data is limited to conditions when compressibility effects are small. The maximum static thrust for a single propeller was found to be 1898.3 lb and 650 lb at cruise. This propeller comfortably meets the aircraft's thrust requirements. The constructed propeller performance charts can be found in the Appendix.



## Materials/Structures

The extensive use of aluminum for the aircraft structure is incorporated in the ECTOL design in order to achieve one major goal, affordable cost of manufacture and subsequently ease of mass production. The ECTOL aircraft features a monocoque fuselage, low wing, retractable gear and conventional tail design.

The fuselage, a box shaped monocoque structure, consists of aluminum skins riveted to frames, formers, bulkheads, stringers and keelson beams to insure multiple load paths throughout the aircraft to the wing spars.

The wings are of cantilever low wing design incorporating standard wing structure design, 24" rib spacing, stringers and skin. The front spar is located at 20% cord and the rear spar is located at 65% cord allowing for adequate volume for electrolyte and lithium tanks. The wings incorporate a typical carry through multiple spar fail safe system.

The vertical tail of conventional design is incorporated into the fuselage with the use of an aft bulkhead and keelson beam attached to the vertical spar. The vertical tail is then attached to the vertical spar, the main load carrying member of the vertical tail. The horizontal tail also incorporates the aft keelson beam and aft bulkhead to attach the horizontal carry through spar to the monocoque fuselage.

With a cruise speed of 250 kts. the maximum positive wing load factor ( $n$ ) is 2.74 with a maximum negative wing load factor of 1 (Appendix). At the maximum positive wing load factor of 2.74, assuming an elliptical wing lift distribution and that every square inch of the wing creates an equal amount of lift ( $k$ ), the maximum wing bending moment of 500,000 ft.lbs was calculated.

The ECTOL load paths incorporate the monocoque fuselage to carry all loads induced on the aircraft to the forward and rear wing spars. The wing to fuselage attach points, wing intercostals, are the primary load transfer points. For the loads induced on the fuselage the monocoque structure, a load carrying structure transfers the loads to the spars via the wing intercostals. For loads induced on the vertical tail the force is carried down the vertical spar into the aft bulkhead and aft keelson beam where it can be dispersed into the aft fuselage and subsequently transferred to the wing spars. For loads induced on the horizontal tail the force is transmitted by the carry through spar into the aft bulkhead/ keelson beam assembly where it is dispersed into the fuselage.

## Cost Analysis

An initial cost analysis, using Reference 6, was performed for the ECTOL. Assuming 4 aircraft for development, test, and evaluation (DT&E) and a production run of 500 aircraft, and amortizing the

DT&E cost over the production run, a unit cost of \$3.83 million was obtained. This value appears to be low, perhaps indicating the insufficient methodology of calculating the costs of electric propulsion. More accurate methods must be determined to better estimate unit cost. Table III presents the distribution of total DT&E costs, total production costs, and determination of unit cost.

Table III. Cost Estimation.

## Total DT&amp;E Cost:

|                         |    |                  |
|-------------------------|----|------------------|
| Airframe engineering    | \$ | 15,546,000       |
| Development support     |    | 3,890,000        |
| Flight test aircraft    |    | 71,368,000       |
| engines                 | \$ | 3,450,000        |
| avionics                |    | 6,000,000        |
| manual labor            |    | 27,675,000       |
| materials and equipment |    | 3,387,000        |
| tooling                 |    | 27,258,000       |
| quality control         |    | 3,598,000        |
| Flight test operations  |    | 1,801,000        |
| Test facilities         |    | 0                |
| Subtotal                | \$ | 96,205,000       |
| Profit (10%)            |    | <u>9,603,000</u> |
| Total DT&E cost         | \$ | 101,866,000      |

## Total Production Cost:

|                          |    |                    |
|--------------------------|----|--------------------|
| Engines                  | \$ | 345,000,000        |
| Avionics                 |    | 750,000,000        |
| Manufacturing labor      |    | 319,752,000        |
| Materials and equipment  |    | 121,798,000        |
| Sustaining engineering   |    | 22,068,000         |
| Tooling                  |    | 47,687,000         |
| Quality control          |    | 41,568,000         |
| Manufacturing facilities |    | 0                  |
| Subtotal                 | \$ | 1,647,873,000      |
| Profit (10%)             |    | <u>164,787,000</u> |
| Total                    | \$ | 1,812,660,000      |

Amortize the DT&E costs over 500 aircraft:

Unit cost = \$ 3,829,000

The direct operating cost was calculated using a method from Reference 10. Since electric propulsion is being implemented, special considerations had to be made in determining the operating cost. As can be found in the Appendix, the cost of the airplane fuel for the 570 mile mission was calculated to be \$2350.25. This takes into account predicted costs to manufacture and recycle lithium along with the cost of hydrogen peroxide. When including the other components of operating cost an overall D.O.C. was calculated to be \$0.26/pass mile. These calculations were compiled with a computer program which can be found in the Appendix.

## Conclusion

The initial iterations of the ECTOL design process revealed no insurmountable problems with electric propulsion for use in transport aircraft. This is significant, suggesting that further research in applications of electric propulsion in aircraft design is warranted. Other forms of the electric propulsion system, such as an air cathode system partially or completely replacing the stored oxygen (stored in the form of hydrogen peroxide), should be investigated. Further iterations of the ECTOL design would be necessary to more accurately describe the vehicle structure.

Automated flight control, though certainly not a new technology, has yet be proven in a totally automated passenger aircraft. The avionics and logistics of this system appear to be manageable with today's technology; the major unknown is the implementation of a fully automated ECTOL is public acceptance. Whether or not people would be willing to fly on an airplane with no pilot at the controls remains to be seen, and should be studied.

A final area of recommended research is in the refueling method used for the ECTOL. Because the refueling time is estimated to be the critical factor in turnaround time for the ECTOL, more efficient refueling would be very cost effective. A possible solution would be the use of modular refueling, whereby a new module containing the lithium rods for the fuel cells could quickly replace a spent module.

The ECTOL design produced in this early design phase met all required specifications; the ECTOL is a clean and efficient aircraft that will serve the California Corridor, integrating as planned with all CAT system components.

## References

1. Abbot, Ira H. and Albert E. Von Doenhoff, *Theory of Wing Sections*, New York, Dover Publications, 1959.
2. Anderson, John D. Jr., *Introduction to Flight*, New York, McGraw-Hill Book Company, 1985.
3. Galbraith, A. D., *Electric Propulsion for High Performance Light Aircraft*, Continental Group, Inc., Palo Alto, CA, #79-1265 presented at AIAA/SAE/ASME 15th Joint Propulsion Conference, June 18-20, 1979.
4. Galbraith, A. D., *Practical Feasibility Assessment of Electric Power Propulsion in Small Helicopters using Lithium Hydroxide Battery Technology*, Los Angeles, Hughes Helicopters, Inc., 1981.
5. Hamilton Standard, *Generalized Method of Propeller Performance Estimation*, United Aircraft Corporation.
6. Nicolai, Leland M., *Fundamentals of Aircraft Design*, U.S.A., 1975.
7. Perkins, Courtland D., *Airplane Performance Stability and Control*, New York, John Wiley and Sons, 1949.
8. Roskam, Dr. Jan, *Airplane Design: Parts I - VI*, Ottawa, Kansas, Roskam Aviation and Engineering Corporation, 1985.
9. Taylor, John W. R., ed., *Jane's All the World Aircraft*, London, Jane's Publishing Company Limited, 1986.
10. Schoendorfer, D. L. and Edward Morlok, *Cost Characteristics of Tilt-Rotor, Conventional Air and High Speed Rail Short-Haul Intercity Passenger Service*, University of Pennsylvania, PA, May 1985.
11. Cal Poly Aeronautical Senior Design, "California Corridor Study," Cal Poly State University, San Luis Obispo, CA, 1988.

## MAG-LEV TRAIN SYSTEM

### Introduction

Today's transportation problems of over crowded highways, airways, pollution, and noise cannot be solved with existing transportation systems. Certainly, our present day railways, motorways, and airways will not be able to meet the increasing demand of traveling population. It would appear that the key to future high speed mass transportation will lie in the innovative technology of superconducting magnetic levitation trains. To this end a number of research groups throughout the world are investigating this technology (Ref. 1).

The magnetically levitated train (Mag-Lev) is designed to aid and assist in solving the transportation problems of the California Corridor for the 2010. Although the present demand would enable the Mag-Lev to operate as a single vehicle transportation system, the Mag-Lev was designed as an integral part of existing mass transit systems, such as BART and future systems such as the LA Metro and the Corridor Access Port or CAP. By integrating with other systems all modes of transportation are made more convenient and versatile to the user and each transportation vehicle is complimented by the other, including the Mag-Lev. The Mag-Lev would add a new dimension to public transportation by drastically reducing the journey time between major city centers (Ref. 2 ).

### Passenger Demand

Passenger demand analysis was performed, as shown in Table 1, to determine the volume of travel between city pairs. Air travel demand was based on the Interstate Travel Demand Report, while automobile travel demand was determined using the Las Vegas Super Speed ground Transport Report and the Boeing Report (Ref. 4, Ref 2, Ref 3).

Based on information obtained from the Las Vegas Super Speed Ground Transport Report, automobile travel was approximately 67% of total demand between city pairs (Ref 2). It was estimated that 35% of the automobile travel between any chosen city pairs could be influenced to ride the Mag-Lev. Another report on airport usage estimates that between 16000 and 24000 additional passengers a day can be expected to ride due to the diversion of out of state and country flights from such places as LAX and SFO to the CAP facility (Ref. 5). Additionally, due to the novelty of a magnetically levitated train traveling in excess of 300 miles per hour, it is expected there will be an additional 2,000,000 riders per year (Ref.2).

ORIGINAL PAGE IS  
OF POOR QUALITY

Table 1. Passenger demand analysis

City pair demand figures for the California Corridor. Data generated by the Mag-Lev group. 18 May 1969.

| <u>CITY PAIRS</u>  | <u>AIR*</u><br><u>PAX/DAY</u> | <u>AUTO**</u><br><u>PAX/DAY</u> | <u>DISTANCE</u> | <u>TOTAL</u><br><u>PAX/DAY</u> |
|--------------------|-------------------------------|---------------------------------|-----------------|--------------------------------|
| S.F. - L.A.        | 60,000                        | 3,008                           | 432             | 63,008                         |
| S.F. - S.D.        | 3,636                         | 12,538                          | 557             | 16,174                         |
| S.F. - SAC.        | 4,618                         | 7,534                           | 80              | 12,152                         |
| S.F. - Fresno      | 3,520                         | 929                             | 200             | 4,449                          |
| S.F. - Bakersfield | 2,912                         | 288                             | 300             | 3,200                          |
| L.A. - SAC         | 11,160                        | 2,100                           | 412             | 13,260                         |
| L.A. - Fresno      | 4,444                         | 1,594                           | 212             | 6,038                          |
| L.A. - Bakersfield | 2,430                         | 4,973                           | 112             | 7,403                          |
| L.A. - S.D.        | 3,384                         | 47,000                          | 125             | 50,384                         |
| SAC - Fresno       | 568                           | 40                              | 200             | 608                            |
| SAC - Stockton     | 1,517                         | 1,873                           | 50              | 3,390                          |
| Stockton - S.F.    | 3,557                         | 4,952                           | 50              | 8,509                          |
| SAC - Bakersfield  | 64                            | 79                              | 300             | 143                            |
| S.D. - SAC         | 635                           | 100                             | 537             | 735                            |
| S.D. - Fresno      | 252                           | 83                              | 337             | 335                            |
| S.D. - Bakersfield | 213                           | 104                             | 237             | 317                            |
| <b>TOTALS</b>      | <b>102,910</b>                | <b>87,195</b>                   |                 | <b>200,105</b>                 |

\*(Ref 4)

\*\* (Total Travel X .67% Auto X 35%) = No. Cars /Day. (Ref. 1&3)

1) Airport studies indicate that between 16,000 and 24,000 passengers per day from out of state and country will arrive at the CAP (Ref. 5).

2) Las Vegas SSGT Report indicates 2,000,000 passengers per year will ride due to novelty of magnetic levitation (Ref. 1).



## Routing

Beginning in the northern most area and working south, the system services Sacramento to Stockton using existing Amtrak routes along highway 99 interfacing with BART at Concord ( Fig. 1). The Mag-Lev will also service Stockton to Fresno following routes along highway 99 using existing Amtrak routes. The system will then follow existing Amtrak routes along 99 with the next stop at Fresno . From Fresno track will be built to the CAP facility near Kettleman City. At the CAP facility passengers traveling via aircraft can board the Mag-Lev and continue to their destination whether it be south or north. Track needs to be built to connect the CAP facility to Bakersfield. Additionally, track will be built to connect Bakersfield to the Los Angeles area, stopping in Glendale, along interstate 5. Once in the Los Angeles area, the traveling population has the ability to interface with the Los Angeles Metro at the existing downtown Amtrak station. From Los Angeles the route splits and goes south and east. The southern route will have a station built in LA Mirada to interface with the LA Metro line which is expected to service LAX. The Route continues southbound along existing coast routes stopping at San Diego. From the San Diego area there is existing transportation to the boarder of Mexico. The eastern routing from Los Angeles follows existing Amtrak routes, along interstate 10, stopping in Ontario (Ontario Airport), and continuing to Indio.

This routing was chosen because of the high volumes of travel done between these cities as shown from the demand studies (Ref. 2, 9). If future studies indicate a particular area or city has a high enough demand to warrant a stop there, then adding additional stations will be considered. However, at this time it is felt that the proposed stations will most adequately complement the overall CAP transportation system.

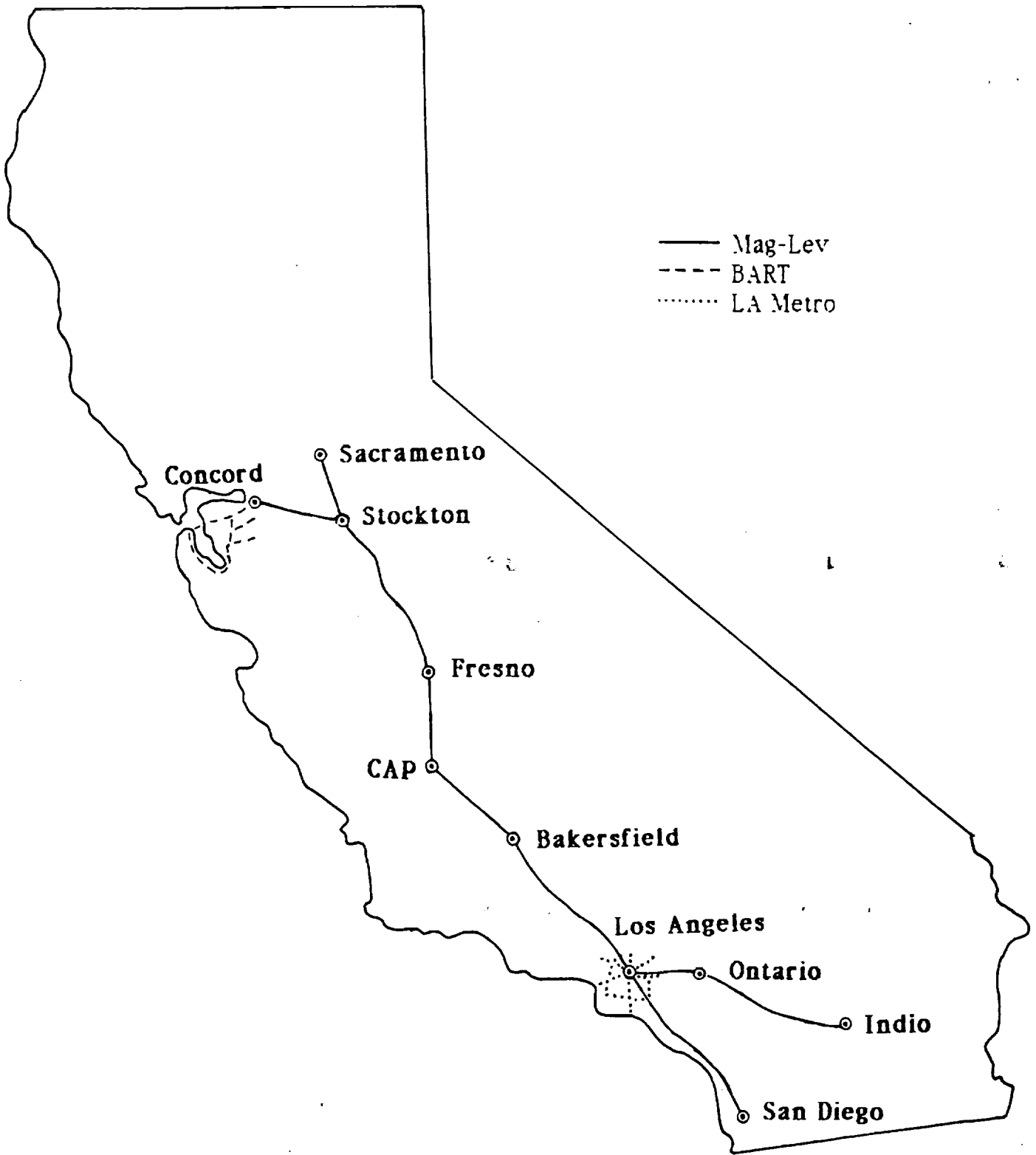

**Figure 1 Routing of Mag-Lev**

## Scheduling

The scheduling of the Mag-Lev will be based on the demand of the city-to-city travel and the peak hour usage of 6:00 - 9:00 am and 3:00 - 6:00 pm. During peak hours, 62 Mag-Lev vehicles will be transporting a maximum of 62,000 passenger at any one time. Departures from terminals will be every 5 minutes in each direction, enabling 72 departures from each station. During the off peak hours, 9:00 am - 3:00 pm and 6:00 - 8:00 pm, the running fleet of Mag-Lev vehicles will be reduced to 42 with a departure interval of 10 minutes from the terminals. 8:00 pm - 6:00 am is the night operation time, where only 39 Mag-Lev vehicle will be required to meet the demand.

The 24 hour running time was established to be able to service the CAP at all times. Because of the low noise that the Mag-Lev produces, operation at these hours should not be a problem. To make the Mag-Lev more acceptable during these hours the max cruise velocity will be reduced to 170 kts, where the lower velocity will create less aerodynamic noise and operate at the bottom of the drag bucket, thus requiring less power to operate.

Should the demand show a need for express Mag-Levs (i.e., Los Angeles to San Francisco, non-stop) then scheduling will be incorporated so the overall system is not compromised. Express Mag-Levs would require guideway switching. The stopping Mag-Lev would be switched off the main guideway at the terminal to let the express Mag-Lev pass the loading Mag-Lev.

## Vehicle Design

The Mag-Lev Train has a 100 passenger capacity with option for 2 of the seats to be folded to provide space for 2 handicapped persons. These handicapped spaces will be positioned near one of the doors for easy accessibility. There are two 32 inch wide doors located on the right side of the train to allow people to enter 2 abreast for minimum passenger loading times. There are 50 windows located along the length of the passenger train. Safety glass, similar to that used on aircraft, will be used for all windows. Air conditioning and heating will be available for operation in adverse weather conditions to maintain an ambient temperature of 71° F. No smoking is allowed on board the Mag-Lev train. There will be 4 watts of lighting per square foot of floor space down the center of the train, with an individual 4 watt reading light available for each seat. There are three emergency hatches located along the ceiling of the train.(Figure 2). Bathrooms are located in the forward part of the train behind the cockpit. The cockpit has capacity for two crew members and will contain all the radio, electronic, and override equipment. Overhead compartments will allow 3.23 cubic feet of carry on baggage per passenger. For passengers transporting more than 3.23 cubic feet of luggage, a baggage compartment in the rear of the train will be available.

The baggage compartment have a fully automated loading system. The Mag-Lev train has a lightweight body made of an Aluminum alloy stressed skin/stringer frame structure with fibre-glass insulation between the outer skin and cabin liner (Ref. 6).

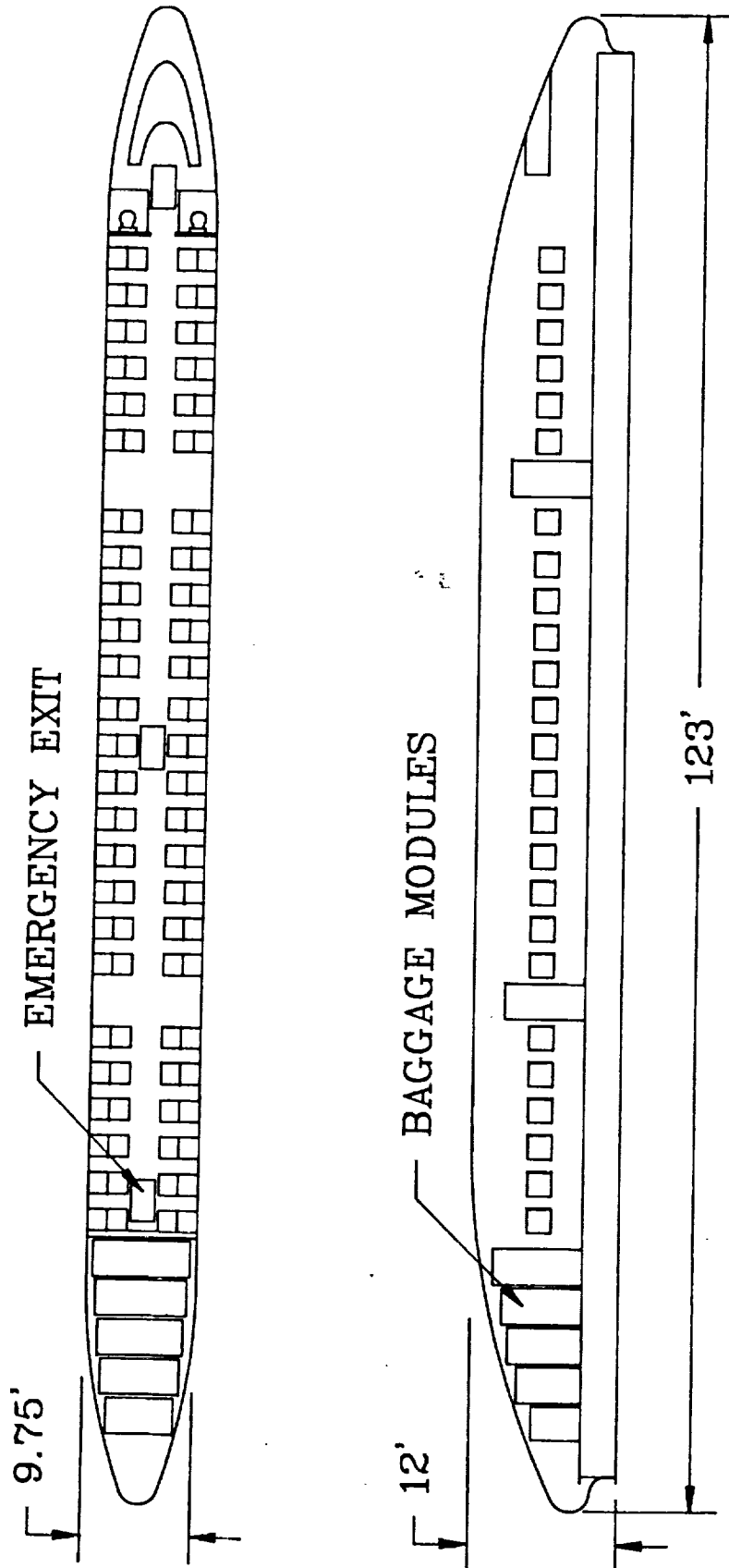

Figure 2 Side View and Top View of Mag-Lev

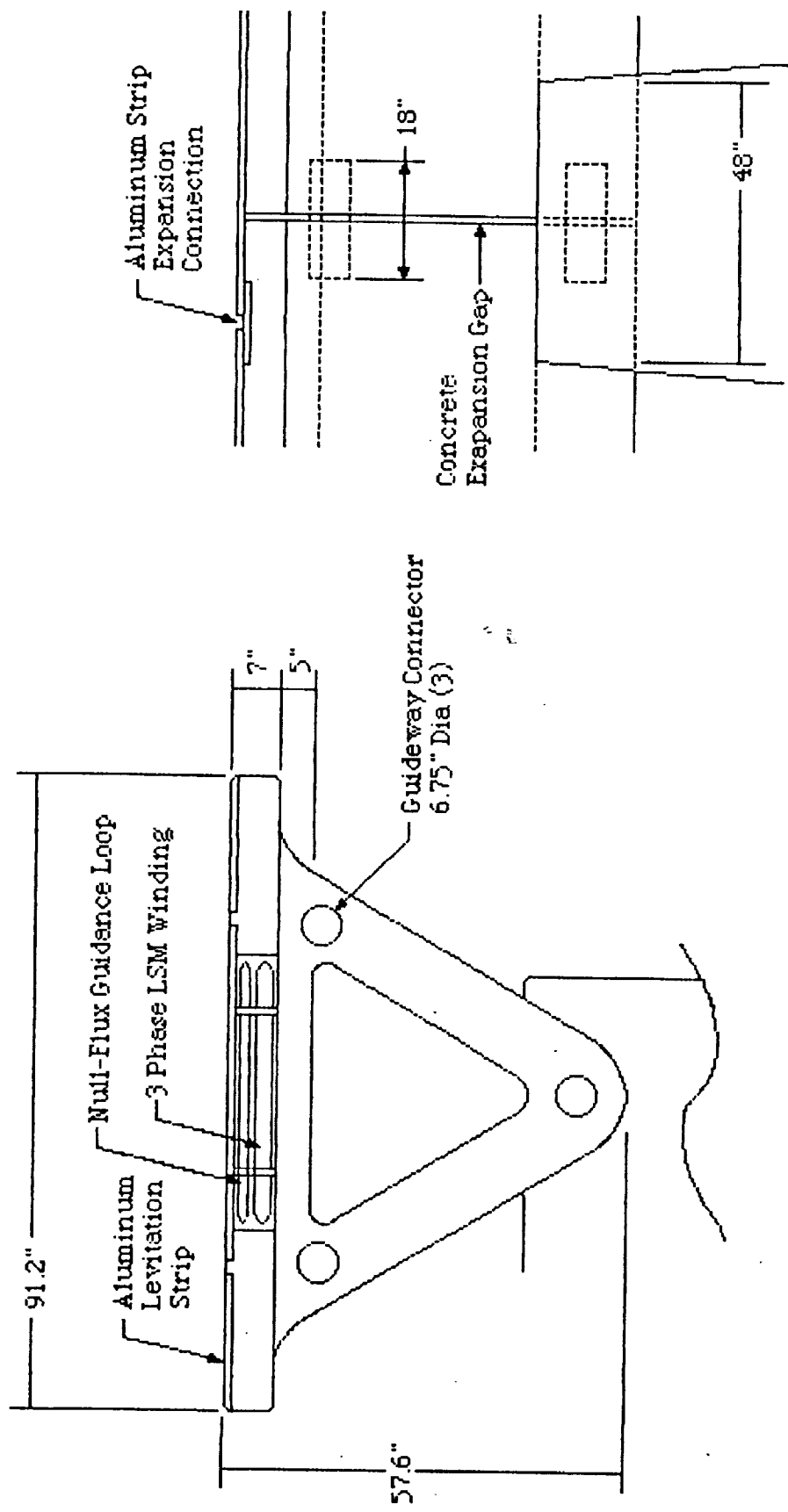

Figure 3 Guideway Detail

## Guideway

Along the 600 miles of proposed city-to-city routes runs a double guideway structure enabling the Mag-Lev vehicles to travel in both directions at the same time. A double guideway structure was chosen over a single guideway with passing lanes because of the high frequency of vehicle travel at peak hours. The guideway structure consist of elevated straight flat concrete slabs that house the aluminum levitation strips, 3 phase LSM winding, and null-flux guidance loops (Fig. 3). Concrete being very resistant to the elements of weather, the maintenance of the guideway structure should not result in frequent down time for repairs.

The dynamic loading of the concrete is relatively small when compared to the weight of the levitated Mag-Lev vehicle. However, the guideway still must be able to support the weight of the Mag-Lev vehicle when it is traveling slower than 47 kts or if there is a power outage of the levitation system. To reduce costs, the guideway will be prefabricated in 80 ft sections of prestressed concrete. The prefabricated sections will be joined by three connectors at the vertical support structures and will allow 2 inches of expansion caused by an increase in temperature (Fig. 3).

For safety reasons the Mag-Lev vehicle will always be elevated a minimum of 12 ft by the guideway structure. On the majority of the city-to-city routing the guideway height clearance will be 24 ft to allow for existing wheel on rail trains to operate along side and beneath the guideway (Fig. 4). The height of the guideway vertical supports will be dictated by making the guideway flat and allowing smooth transition to at grade conditions (Fig. 5). It is important for the guideway to be flat or for transition to occur smoothly for passenger comfort. The radius of the guideway in the vertical plane depends on the velocity and a maximum force of 0.5g (Fig.6). At a cruise velocity of 270 kts, a wavy guideway can produce similar passenger discomfort to that of air turbulence to air carrier passengers.

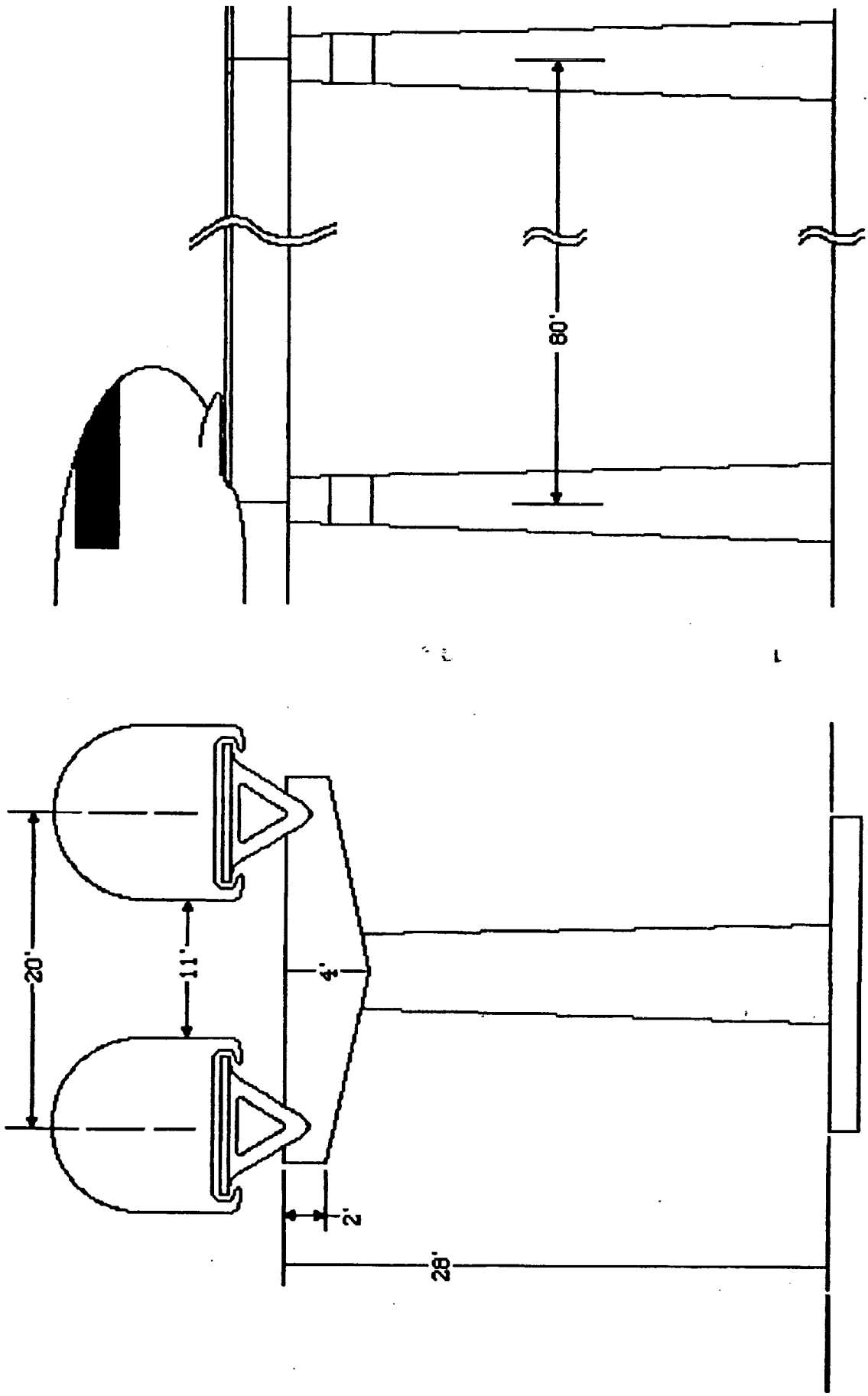

Figure 4 Guideway Support Structure

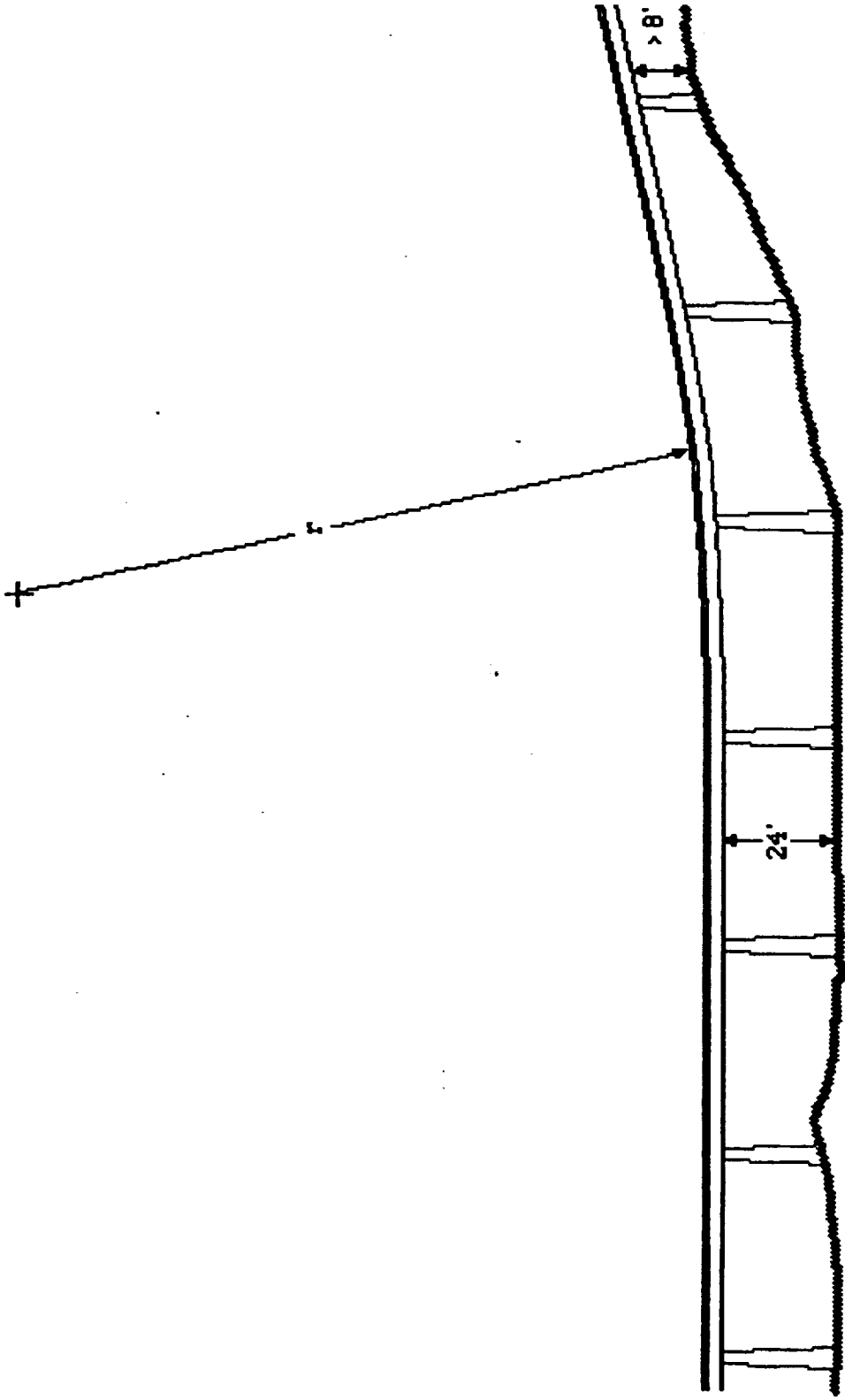

Figure 5 Guideway Terrain Following



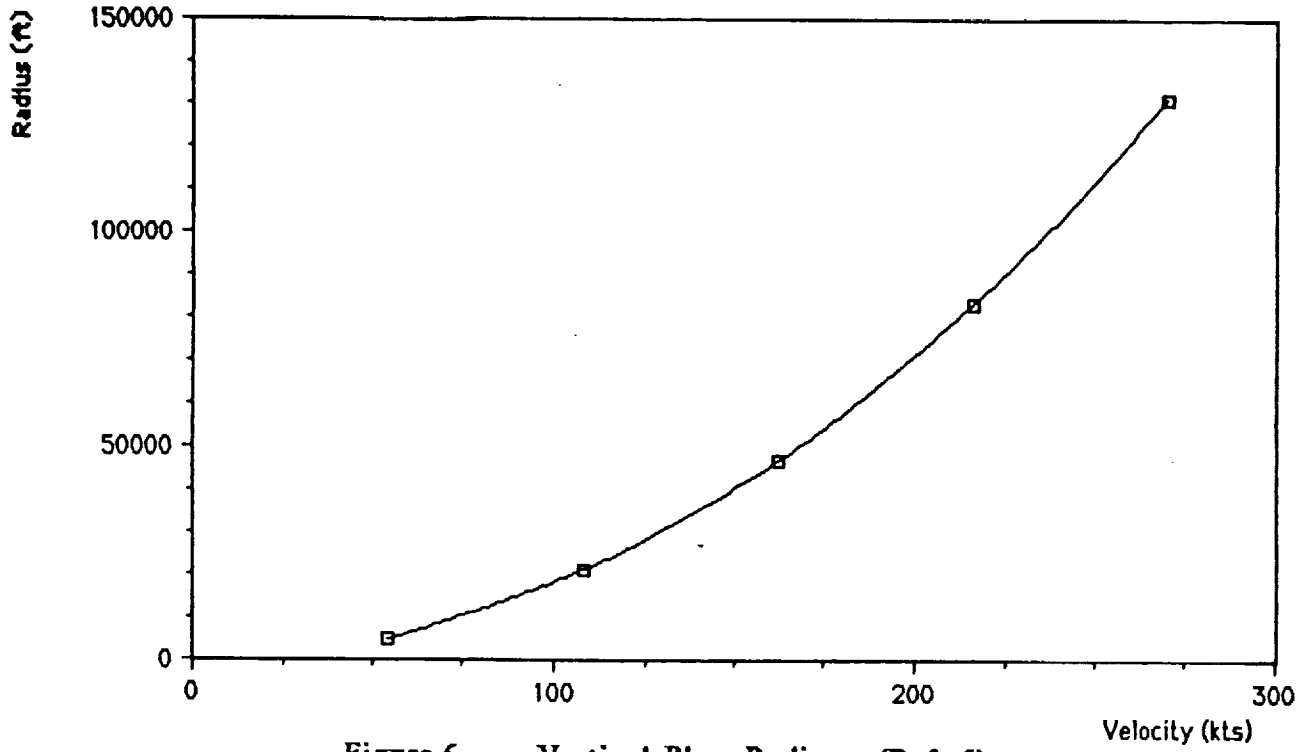

Figure 6 Vertical Plane Radius (Ref. 6)

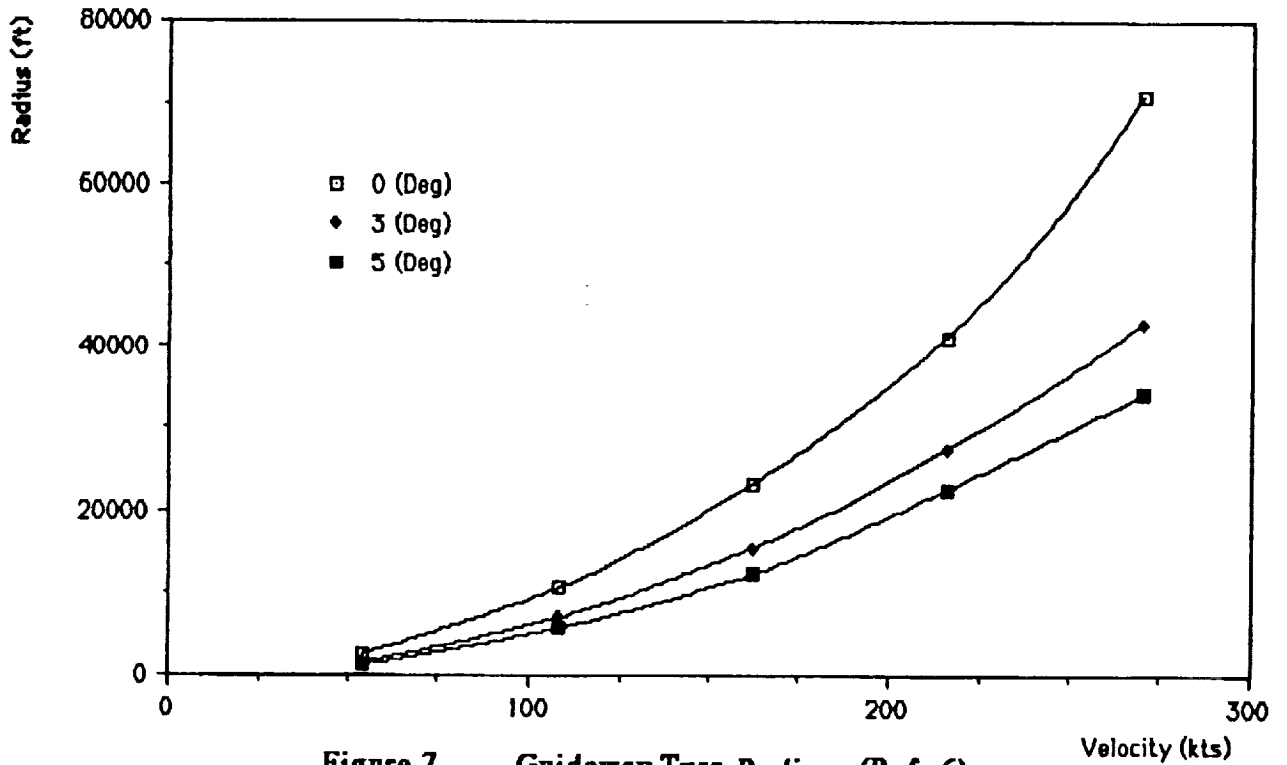

Figure 7 Guideway Turn Radius (Ref. 6)

Not only is a flat guideway important for comfort, but any turns will induce lateral g forces on the passengers. The guideway turn radius will be limited to a 0.1 g lateral force, which is the generally accepted limit for passenger comfort (Fig. 7). If terrain dictates a turning radius resulting in higher g forces, the velocity of the Mag-Lev vehicle must be reduced. Banking of the guideway will allow for tighter turns, but will be limited to 5° in case a vehicle stops on a turn due to mechanical or electrical failure.

The parallel distances between the guideways is dictated by aerodynamic pressure forces induced by the Mag-Lev vehicles passing in opposite directions. The pressure forces created will cause an impulse loading, first pushing the walls of the vehicle inward then suddenly reversing the load and pulling the walls outward. A sufficient distance is needed between the passing vehicles to reduce the effects to where fatigue to the vehicle structure is minimal and passenger comfort is not compromised (Ref. 6). By using passing separation distances of existing rail services and extrapolating for the Mag-Levs velocity range, a passing separation distance of 11 ft was determined (Fig. 8).

The Mag-Lev will be able to switch guideways by the use of a flexible section of guideway that is able to move over from one guideway lane to another by the use of hydraulics. Switch guideways are important to the Mag-Lev system so that a vehicle stopping at a terminal will be off the main guideway enabling an express Mag-Lev to pass by. The location of the guideway switch will be 2 miles from a terminal when the needed land is available. If the needed land is not available then the size of the guideway switch and location will depend on the velocity of the decelerating/accelerating Mag-Lev and the 0° bank turn radius at that velocity (Fig 9.).

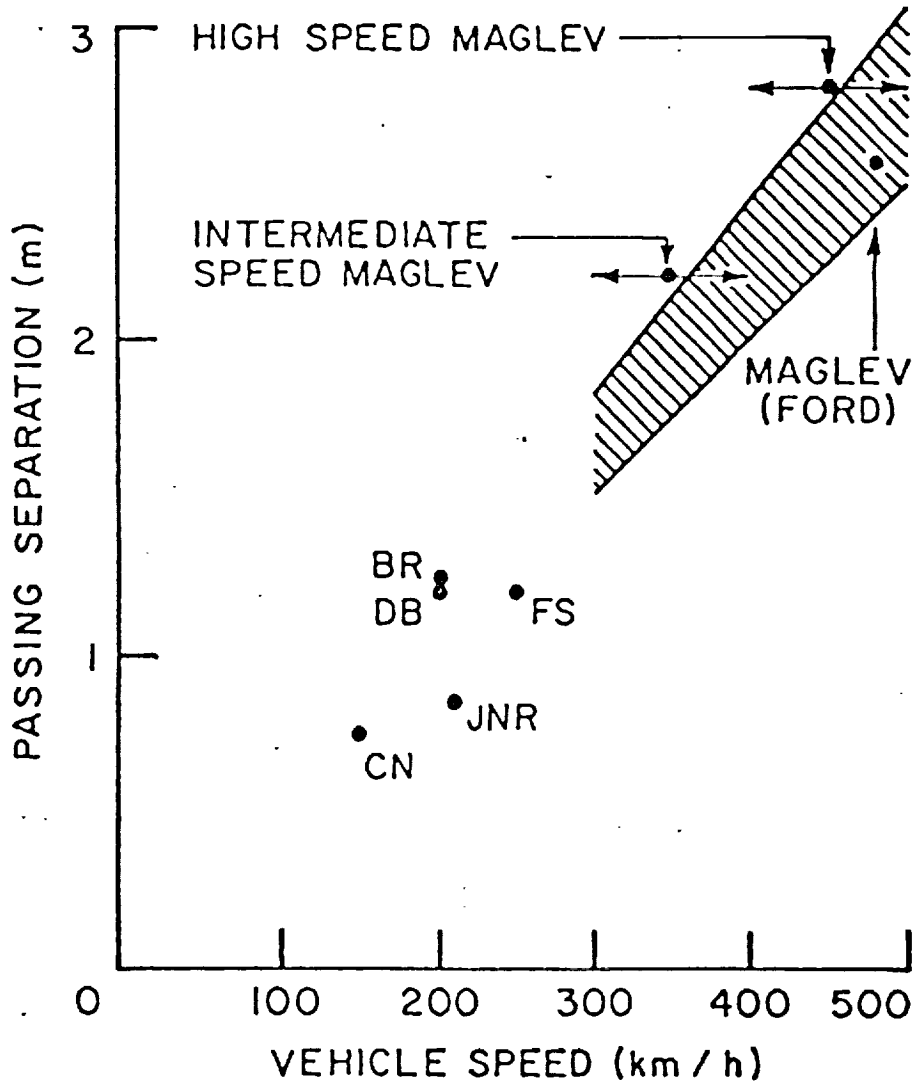

Figure 8 Vehicle Passing Separation (Ref. 6)

## **Costs**

The Morlok cost analysis program was to be a fair way to judge all modes of transportation proposed for the California Corridor. First and foremost, the problem lay in the fact that the Morlok Program was designed for cost analysis of a locomotive, high speed rail, which is considerably different than a magnetically levitated train system. Since, at this time the Morlok Program is not lending itself to be a fair comparison, the cost analysis using this mode is not addressed. A brief explanation of cost analysis can be found in the CAP report under Analysis for the Magnetic Levitation Train, Hydrogen Tilt Rotor VTOL, and Electric CTOL California 2010 Project. At this point it is felt that the present cost analysis was comparable to the other systems.

## **System Flexibility**

System flexibility considers the ability to meet the demands of the traveling population. The Mag-Lev route is a static system. Should a large group of individuals decide they want to travel to say, Mexico, a place which is not serviced, the Mag-Lev system could not meet the immediate demand whereas another system could. However, the Mag-Lev system could be extended to that area to meet the demand, though it would not be instantaneous. One advantage the magnetic levitation system does have with respect to meeting immediate demand is the ability to add more trains to the system and increase capacity as demand deems.

## **Mag-Lev Noise**

When two sounds are heard consecutively, a minimum change of 3 dB is needed to perceive the change in noise level. With a time interval of 5 minutes, which is the peak frequency of the Mag-Lev, a change of 5 dB would be required to subjectively perceive the increase in noise level. In populated areas the Mag-Lev runs along or near heavy road traffic which is rated at 65 dB. Therefore the noise produced by the Mag-Lev is just perceivable in these areas of operation at cruise velocity (Ref. 7). A further analysis in the comparison in the noise produced by the other vehicles in the CAP system can be found in Appendix F.

## **Mag-Lev Pollution**

The magnetically levitated train system is "relatively clean (any pollution is confined to central power stations)." This does not mean there is no pollution associated with magnetic levitation, there is. When different systems are compared as on Figure 10 of Primary Energy Consumption, the Mag-Lev is considerably below the aircraft and comparable to the automobile.

Insofar as pollution is concerned, since no new power generating plants are proposed, this element of the proposed system would not impact air quality. In the building stage however, construction related activities may impact local air quality though site specific and temporary.

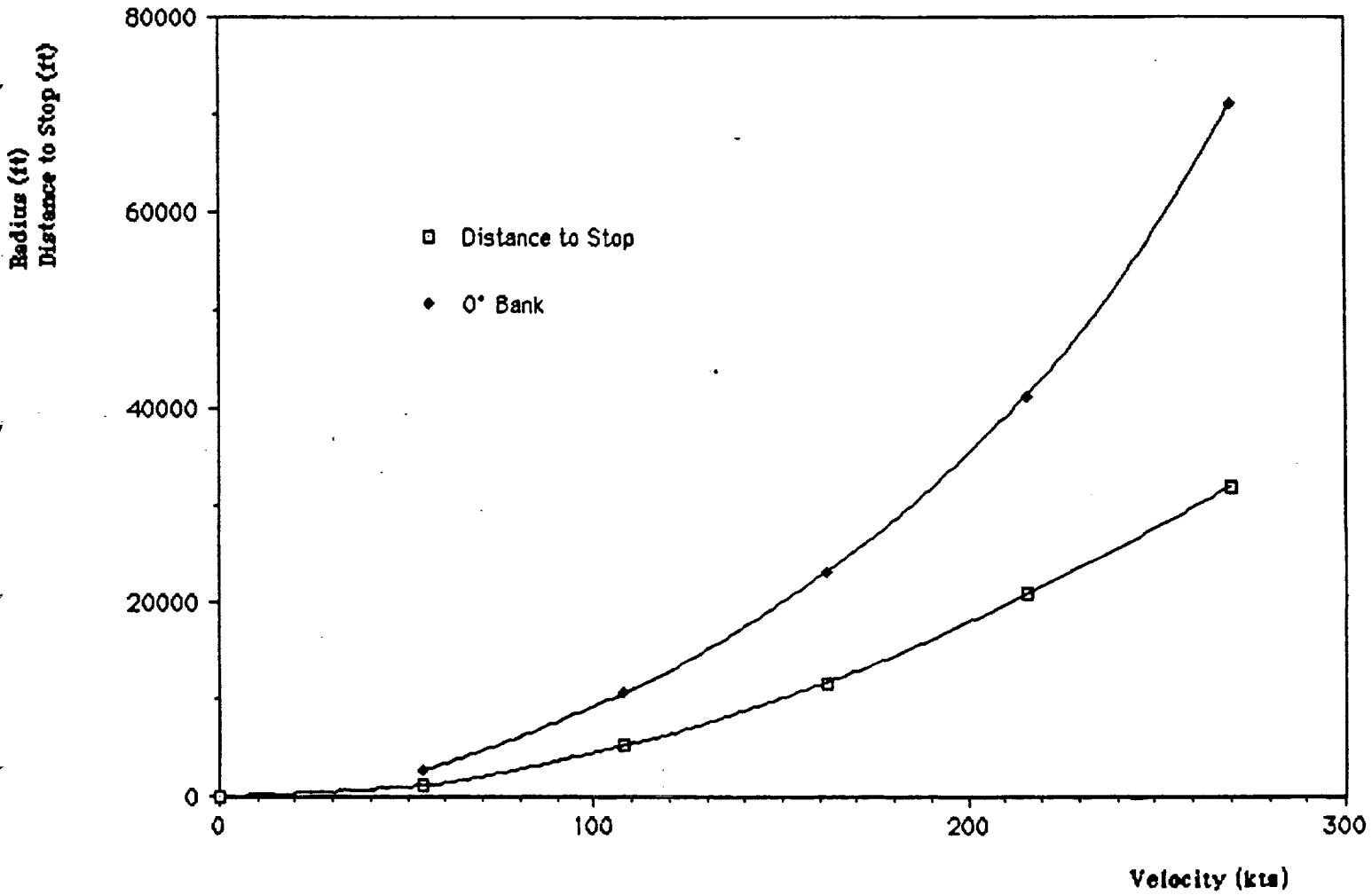

Figure 9 Switch Placement Curve

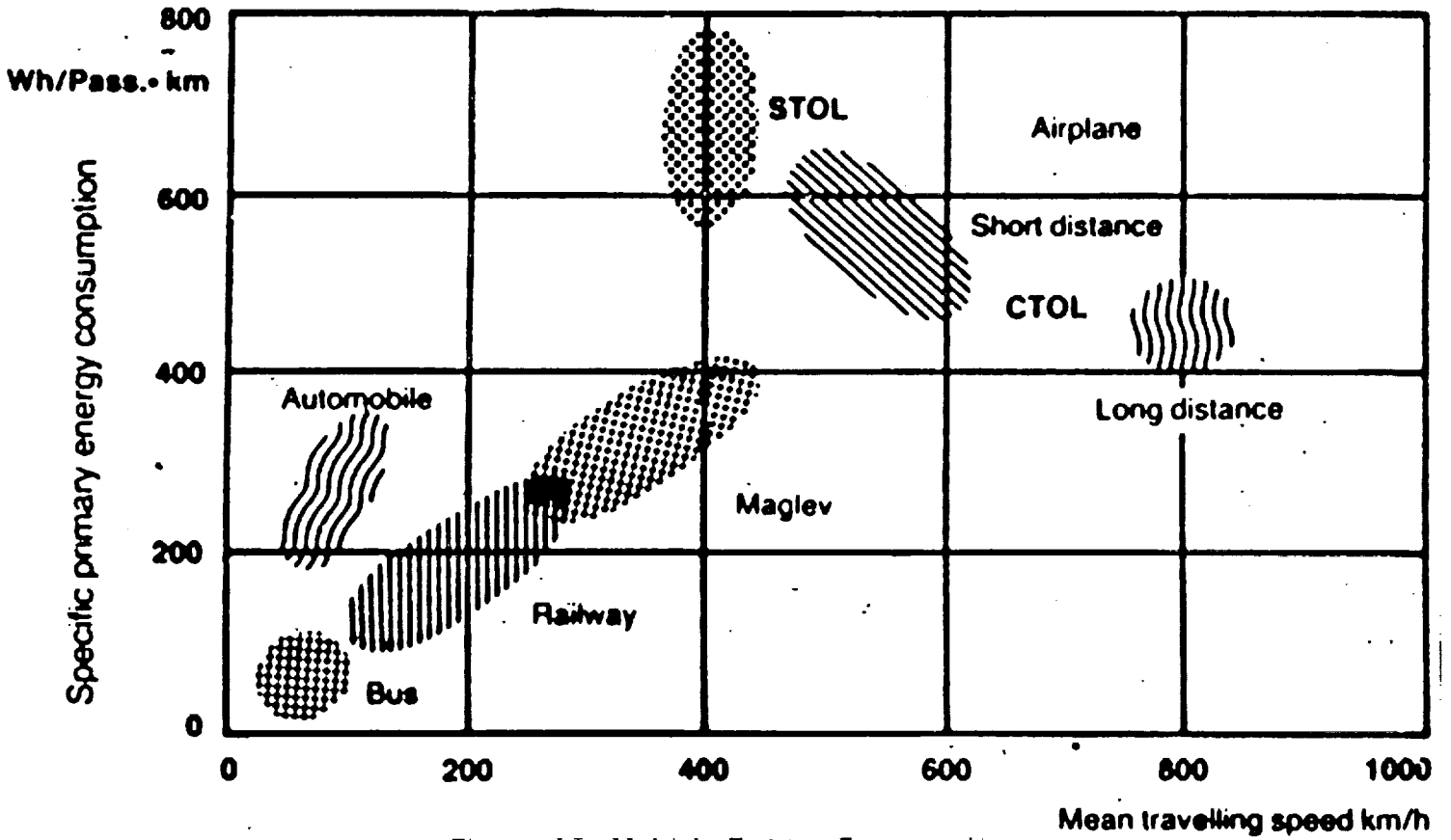

Figure 10. Vehicle Energy Consumptions

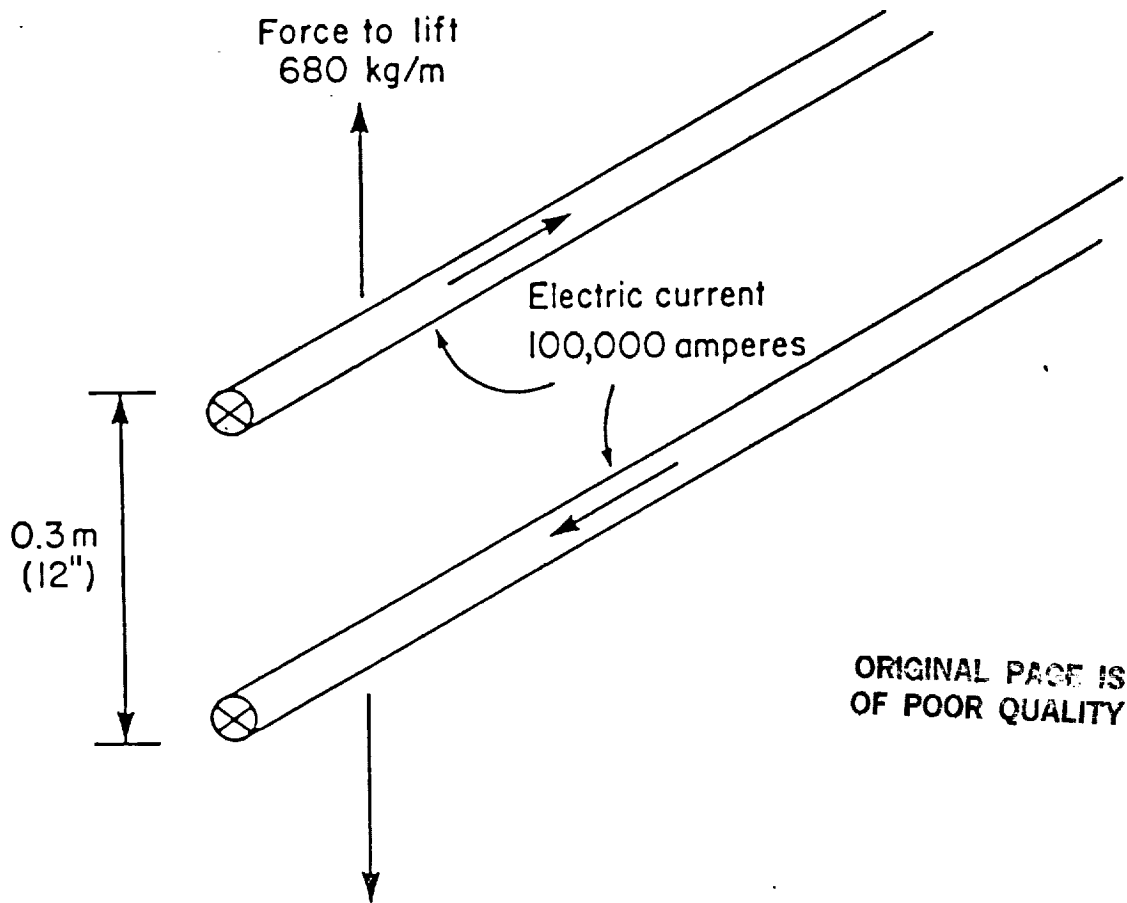

Figure 11. Force Between Two Current Carrying Conductors (ref. 9)

## Levitation System

A contact-free electromagnetic suspension derives from the phenomenon that oppositely directed electric currents in two parallel conductors repel each other. With the development of the superconducting magnets over recent years, a lightweight source of intense magnetic fields has become generally available. Superconductivity, or the state of zero electric resistance occurs in certain metal and alloys such as Niobium Tin, Niobium Titanium or Yttrium-Barium-Copper-Oxide. When superconductors are cooled to temperatures in the range of 77K to 94K (-320 F to -290 F) larger currents can be carried in relatively small conductors (Ref. 1,8).

Two ordinary electrical conductors spaced 12 inches apart each with current of 100,000 amperes can support a vehicle of 680 kg per meter (450 lbm/ft.) (Fig. 11). With the advent of superconductivity the current of any given cross sectional area can carry more than 100 times as much current than non-superconducting materials such as copper (Ref. 9)

The levitation system used by the Mag-Lev is a repulsive force, or electrodynamic system. Theoretically, as shown in Figure 12, a current runs about a moving superconducting coil on the Mag-Lev that passes over a stationary coil. The current triggers magnetic flux which penetrates the passive coil as the moving coil passes over it. As long as the magnetic flux through the passive coil is either increasing or decreasing, it induces an opposite current in the passive coil which repels the moving coil.

ORIGINAL PAGE IS  
OF POOR QUALITY

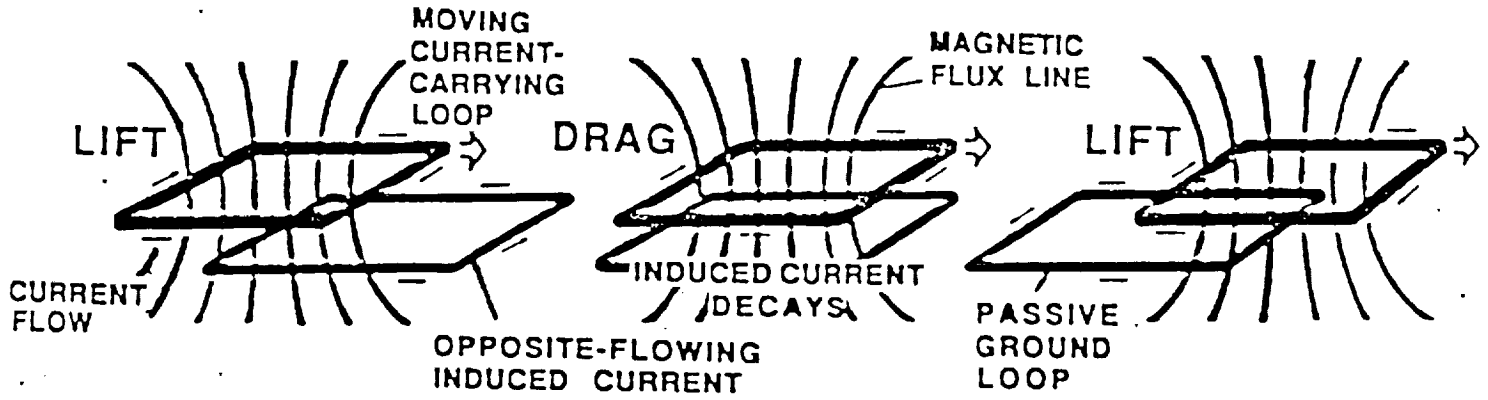

Figure 12. Repulsion (Ref. 11)

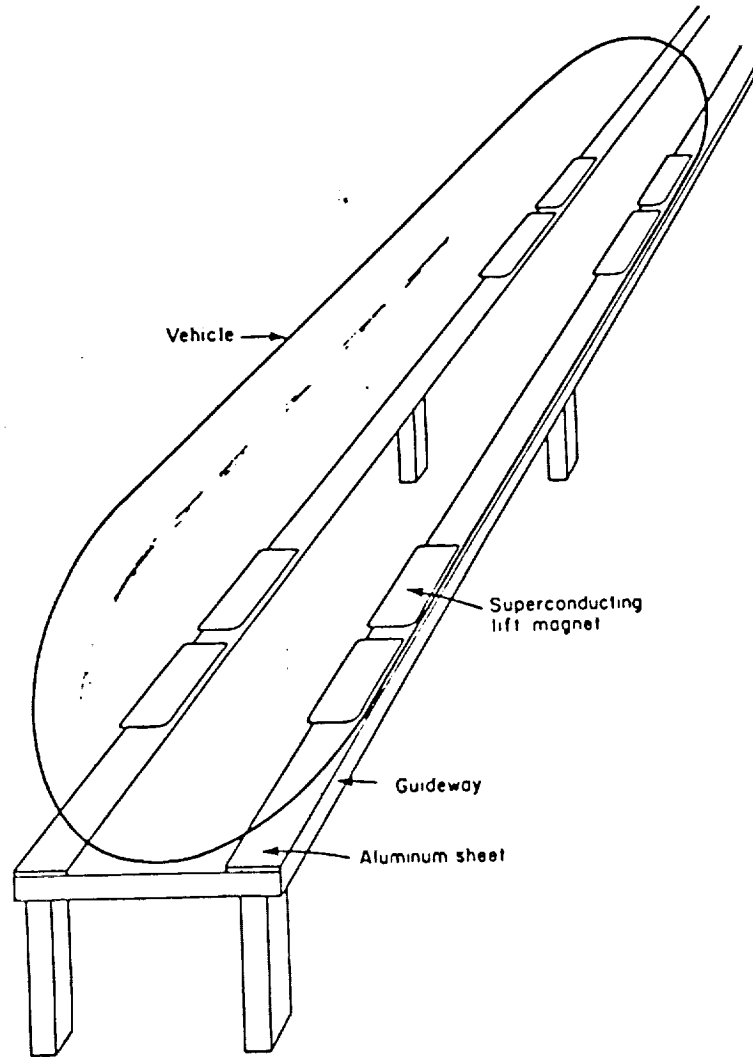

Figure 13. Vehicle And Guideway (Ref. 9)



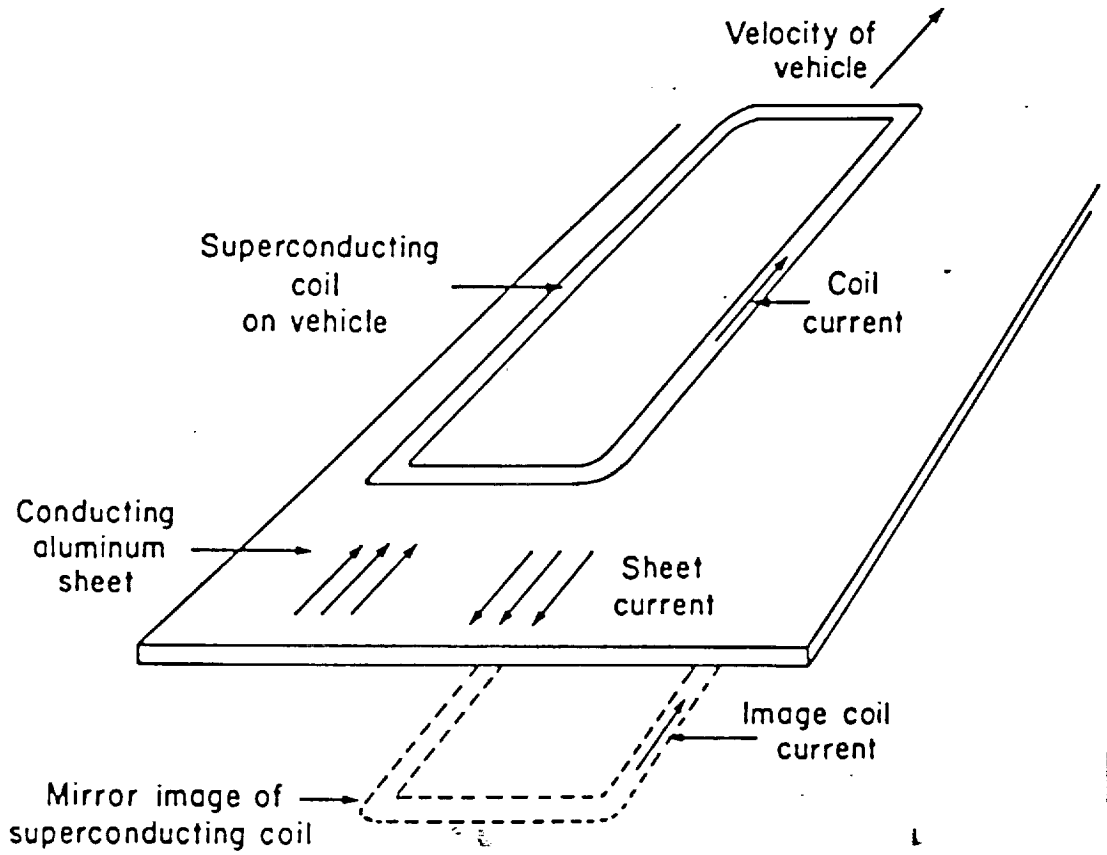

Figure 14. Superconducting Magnet Moving Over A Conducting Plate [Ref. 9]

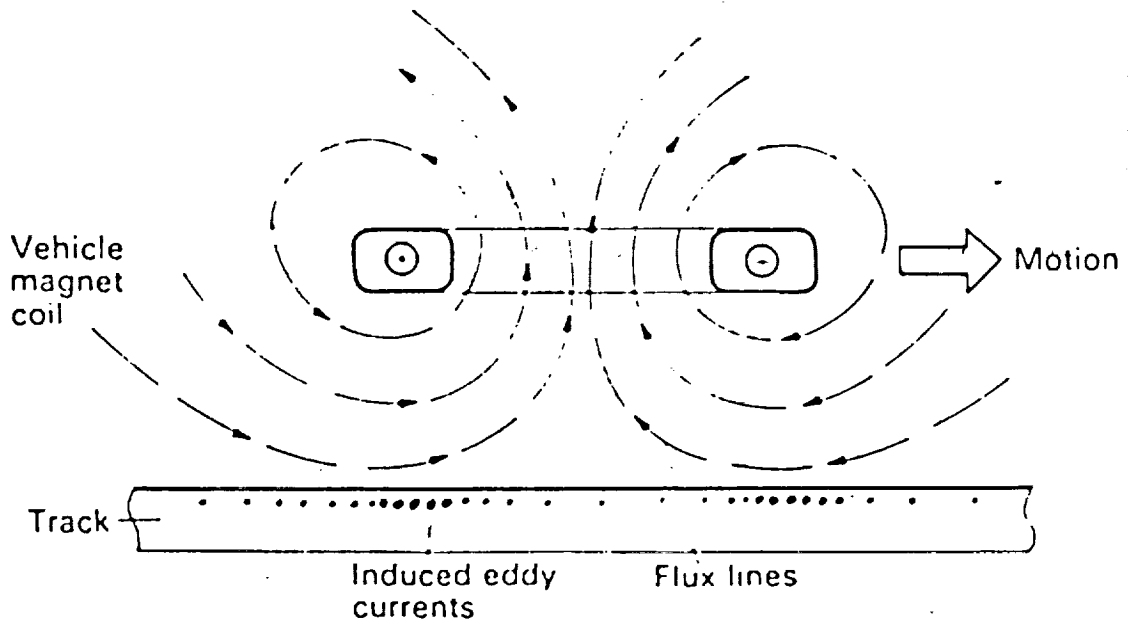

Figure 15. Electrodynamic (Repulsive) Levitation (Ref. 1)

The repulsion suspension system of the Mag-Lev consists of passive coils sunk into a concrete guideway, with superconducting magnets on board the vehicle ( Fig. 13) A sheet conductor in the form of an aluminum strip track is exposed to a rapidly changing magnetic field as the vehicle travels over it (Fig. 14). As a result, circulating eddy currents are induced in the aluminum opposing the field and preventing it from penetrating the track. As shown in Figure 15, the flux lines are compressed in the air gap between the vehicle and the track. Because of this flux compression, a magnetic pressure equivalent to:

$$B^2/2\mu_0$$

where B is the magnetic field strength at the track and  $\mu_0$  is the permeability of free space. The magnetic field strength of the track of the Mag-Lev is 1 Tesla (T) and the permeability of free space is  $4\pi \times 10^{-7}$  T m/A, thus the magnetic pressure is equal to 3.93 atmospheres. To get a "feel" for these units, we note that the magnetic field of the Earth's surface is about  $0.5 \times 10^{-4}$  T (Ref. 10). The pressure can be produced over a considerable area so that levitation of the Mag-Levs 34 ton, 100 passenger vehicle is possible.

The magnetic repulsion generates lift when there is opposite current in the passive coil. Only when the moving coil is directly over the passive coils is there no change in flux. The repulsion weakens, causing drag (Fig.14). However, the faster the Mag-Lev travels, the less time the moving coils spend directly over the passive coils. As can be seen in Figure 16, electrodynamic drag decreases with increasing velocity, unlike aerodynamic drag which increases with increasing velocity (Ref. 11).

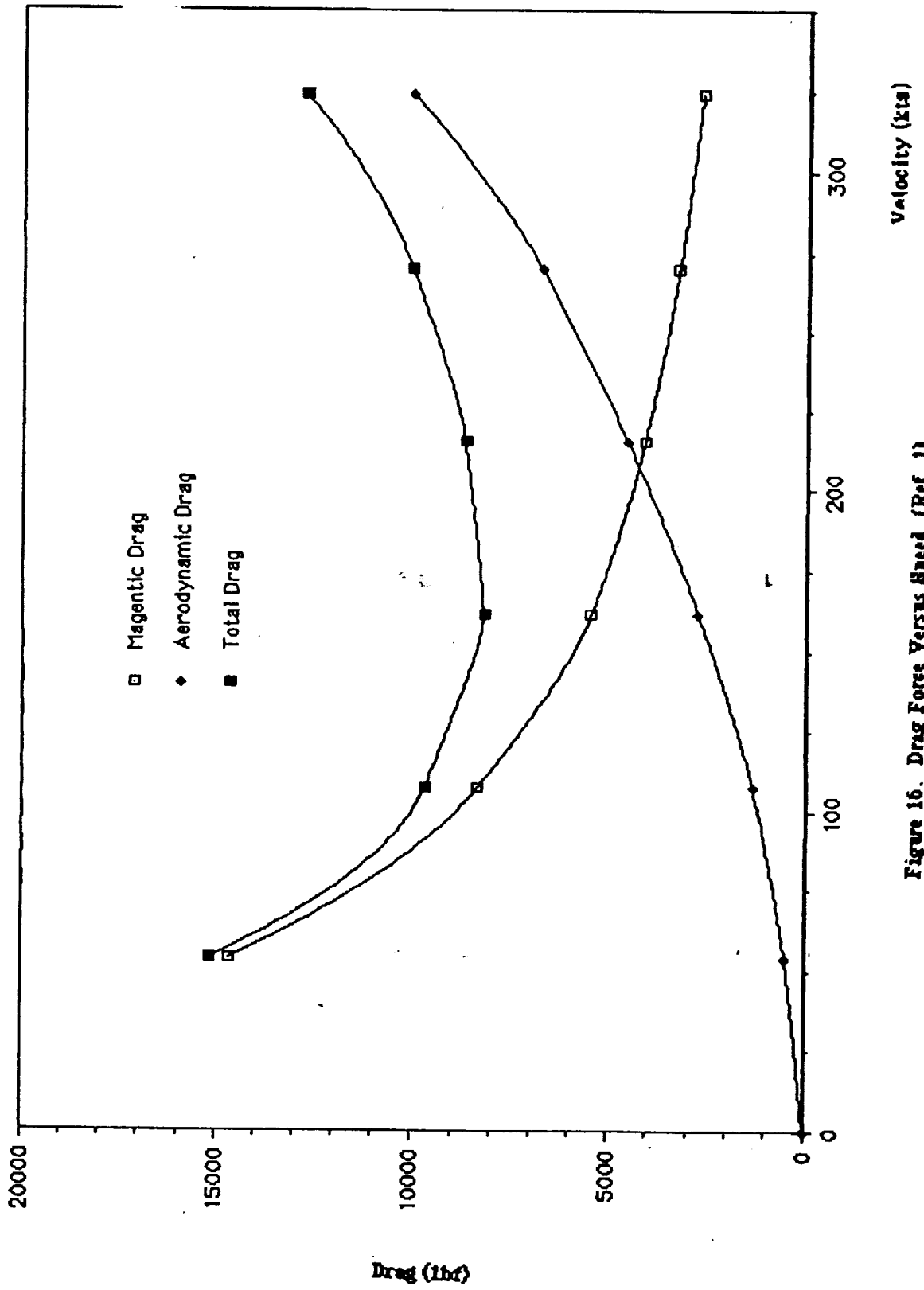

Figure 16. Drag Force Versus Speed (Ref. 1)

## Propulsion

The propulsion system must provide a thrust to overcome the aerodynamic drag of the Mag-Lev and provide adequate acceleration and grade climbing ability. Additionally, thrust must be provided to overcome the magnetic drag caused by levitation.

Since the Mag-Lev is magnetically suspended, the propulsion thrust is accomplished without physical contact by the Linear Synchronous Motor or LSM. The motor makes use of the same physical phenomenon employed for levitation, i.e., the forces between parallel current-carrying conductors. As can be seen in Figure 17, the LSM consists of 50 race track wound superconducting coils. These superconducting coils are arranged in seven pods mounted centrally along the underside of the Mag-Lev. To minimize interaction between pods, one end magnet in each set is made both narrower and weaker. The size of the magnets is 1.74 feet long by 5.58 feet wide with a strength of  $5 \times 10^5$  amperes turns (Ref 1). Each magnet is superconducting and carries a total current of about 500,000 amps. The required cruising thrust can be achieved by the use of a current in each aluminium guideway cable of 245 amps (Ref. 9).

The guideway winding consists of six stranded aluminum cables each about .4 inches in diameter. The cables spaced about 3.6 inches apart, are covered with standard electrical insulation and housed in the concrete of the guideway (Ref. 9).

At a cruise speed of 270 kts the propulsion unit must provide a minimum thrust of 40,500 pounds to overcome the aerodynamic drag requiring a propulsion power of 6.5 mW. During acceleration of .1g a total thrust of approximately 15700 lbf is required with a power limitation of 8 mW (Ref 6).

At low velocities, below 43 knots, the generated electrodynamic lift and guidance forces are inadequate to suspend the Mag-Lev. The Mag-Lev vehicle is supported by semi-retractable tired wheels along the underside of the Mag-Lev, until there is enough electrodynamic lift to support the vehicle. Hydraulic power for the semi-retractable wheels and power for the other systems is generated by linear generators. Ni-Cod 440V batteries provides the on-board power when the linear generator is not active, i.e., at low speeds (Ref. 12).

ORIGINAL PAGE IS  
OF POOR QUALITY

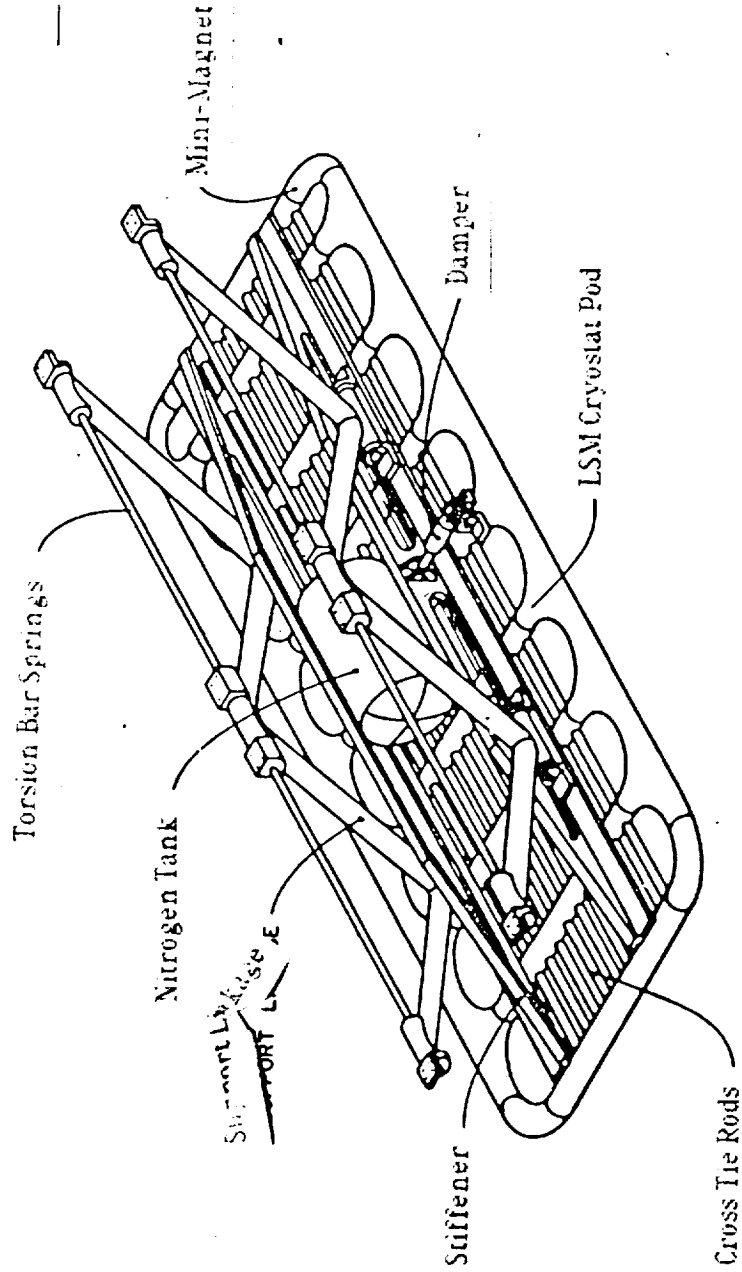

Figure 17. Linear Synchronous Motor And Support (Ref. 1)

The principle of operation of the Linear Synchronous Motor is shown in Figure 18 where the magnet and guideway conductors are shown in cross-section. Currents away from the observer are indicated by a cross, and toward the observer by a dot. Similarly-directed currents attract each other while oppositely-directed current repel. The net thrust on the vehicle is forward. As the vehicle moves forward the currents in the six guideway cables must be adjusted so that the cable carrying maximum current is always positioned approximately on the central axis of the magnet coil above it. This is accomplished by using 3 phase alternating current supply to the cable windings and adjusting the frequency of this supply to the precise value required for the vehicle velocity. The propulsion magnets in Figure 19 are spaced 1.9 feet center to center. The frequency of the supply must be 122 Hz for a speed of 270 nautical miles per hour (Ref. 9)

The stator windings, or 3 phase track armature winding, shown in Figure 20, provides traveling magnetic waves to which the vehicle magnets are synchronously linked. The flat split-three phase winding each displaced  $\lambda / 3$  from the other two is housed in the guideway between the two levitation strips (Fig. 19). The stator is laid in sections, each 3.1 miles in length, which are sequentially energized by trackside variable frequency inverters. The terminal voltage and current requirements of a single conductor are about 6 kV and 500 amps (Ref. 1). The Mag-Lev has two conductors per pole separated by about 1/6 pole pitch (Fig. 20).

For realistic values, but assuming a fairly high traffic density ( and average loading of one train every 5 minutes) the optimum energized length is between 1.4 and 2.7 nautical miles (Ref. 1). It might be expected that this motor would be very inefficient in view of the fact that only 123 feet of a 2.7 NM energized track is being used at any instant to produce power. However 75% of the power supplied by the power conditioner to the track winding is converted into mechanical power. This efficiency can be increased, if desired, by increasing the size of the cables or by reducing the track section length. Shorter lengths would give a slightly higher efficiency but , in order to halve the overall losses (from 70 percent efficiency to 85 per cent), the energized length must be reduced by a factor of 10 (Ref. 1). The values chosen for this design were obtained from an optimization study which balanced the costs of cable, power conditioning apparatus and electrical energy to obtain a minimum overall annual cost (Ref. 9).

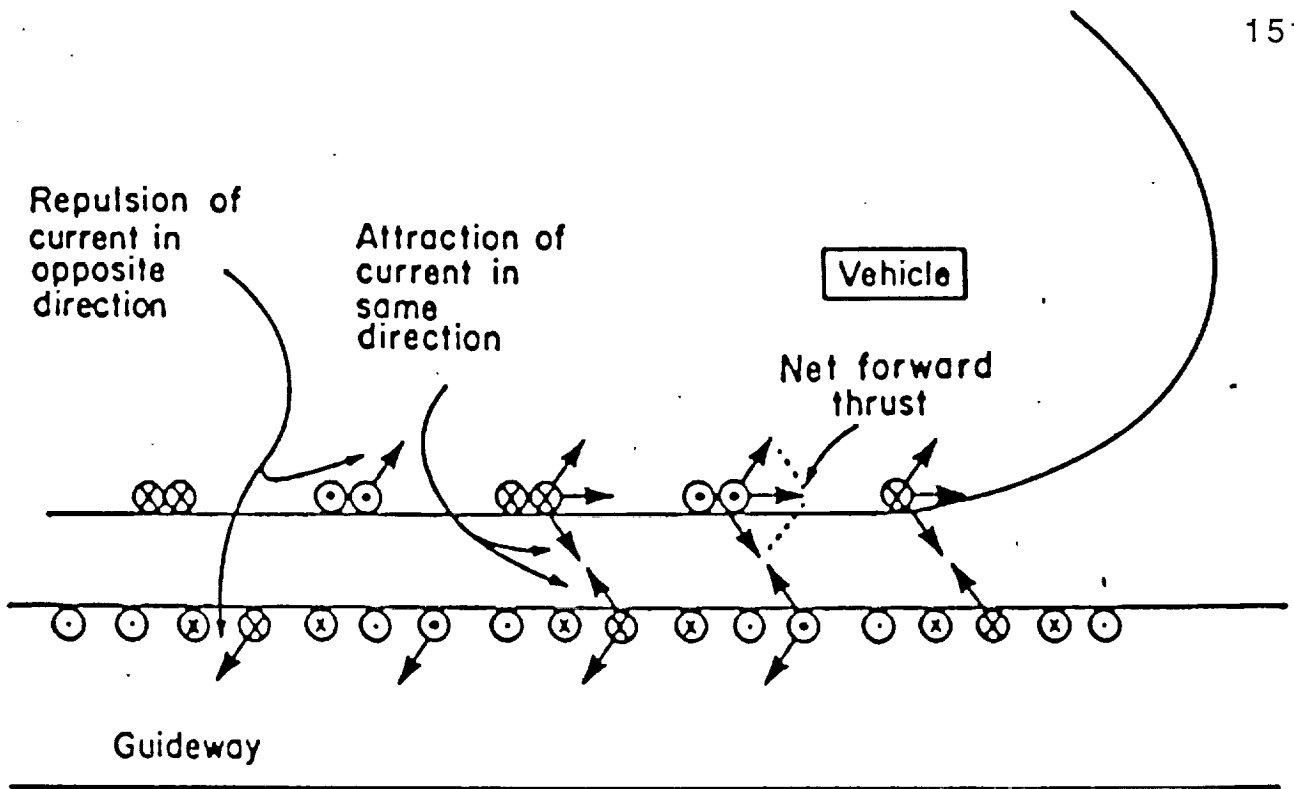

Figure 18. Principle of Linear Synchronous Motor (Ref. 19)

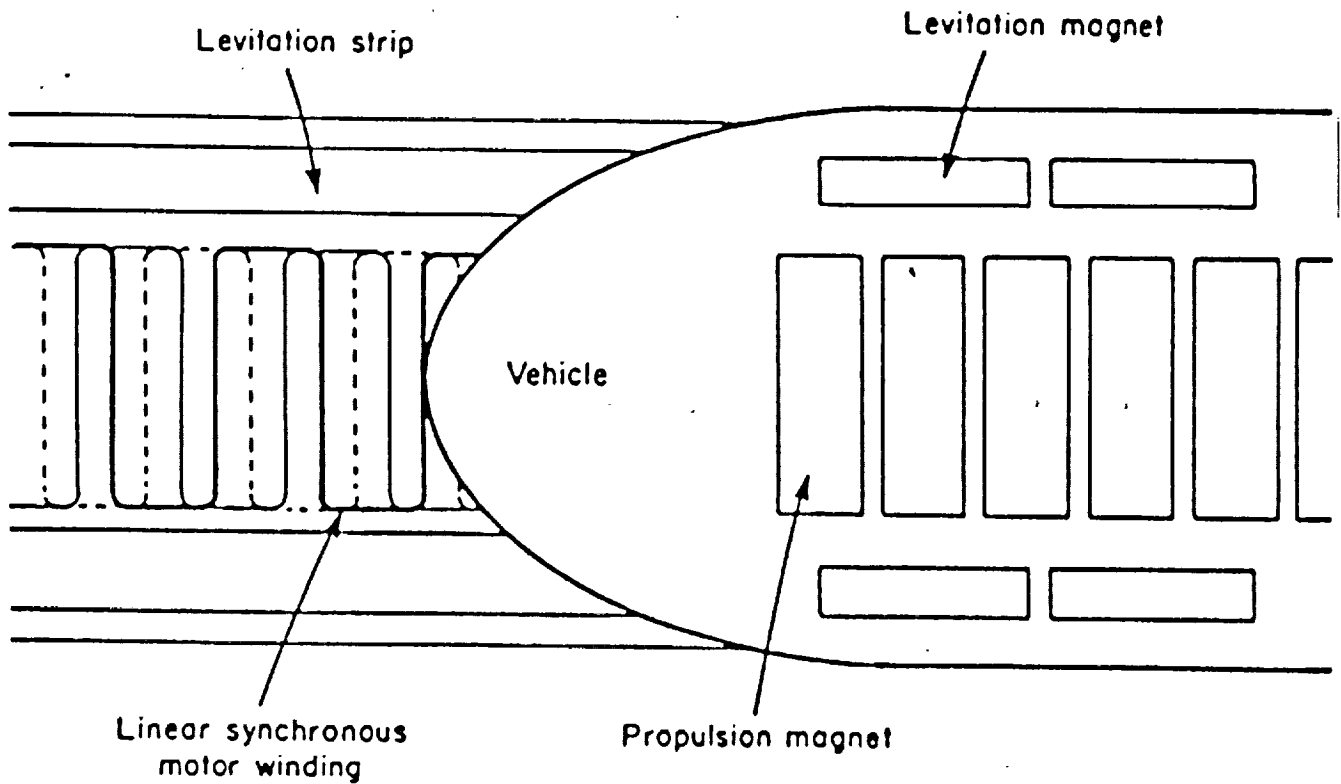

Figure 19. Linear Synchronous Motor, Propulsion Magnet, Levitation Magnet, and Levitation Strip (Ref. 9)

The major advantage of the LSM is that it requires no on-board power for propulsion. All the power is supplied from the guideway. Additionally, the LSM can provide a retarding thrust to the Mag-Lev for deceleration. The timing, or the phase of the guideway currents can be adjusted so that the currents away from and toward the observer in Figure 18 are reversed. The magnitude of the deceleration may then be adjusted by adjusting the magnitude of the current from the power conditioner. The LSM is designed to provide normal deceleration of  $5.3 \times 10^{-4} \text{ NM/s}^2$  (.1g), and an emergency deceleration of  $1.6 \times 10^{-3} \text{ NM/s}^2$  (.3g). At this emergency rate, the vehicle can be brought from full speed to a stop in a distance of about 1.75 NM and a time of about 47 seconds.

## Guidance

The magnetically levitated train is operated over an elevated flat topped guideway and is guided by the interaction of the LSM magnet array with figure eight shaped loops overlying the active LSM as shown in Figure 21 (Ref. 6).

The complete levitation and propulsion system of the Mag-Lev can provide adequate guidance forces. In the event of large lateral displacements due to, for example, strong wind gusts, guidance is available from the repulsive interaction of the LSM array with the edge of the levitation strips. When the Mag-Lev moves to one side, the edges of the propulsion magnet induce currents in the edges of the levitation strips. These currents tend to repel the magnets and return the vehicle to its desired central position. It has been estimated that the maximum side force obtainable in this way is equivalent to the total weight of the vehicle and is therefore greatly in excess of that required even in severe gale winds. The maximum electrodynamic restoring force has been found to be in excess of 67,400 pounds (Ref. 1).

While the interaction between propulsion magnets and levitation strips can provide adequate stabilizing forces, there may be undesirable oscillations leading to poor ride quality. It is proposed to damp these out by the use of guidance loops placed on the vehicle just below some of the superconducting magnets (Ref. 9). If the magnetically levitated train traverses the loops off-center, the induced electromagnetic force (EMF), produced by the changing magnetic field, in the open portion of each loop are imbalanced and the net current is induced which tends to force the Mag-Lev back to the center or "null flux" position (Ref. 6).



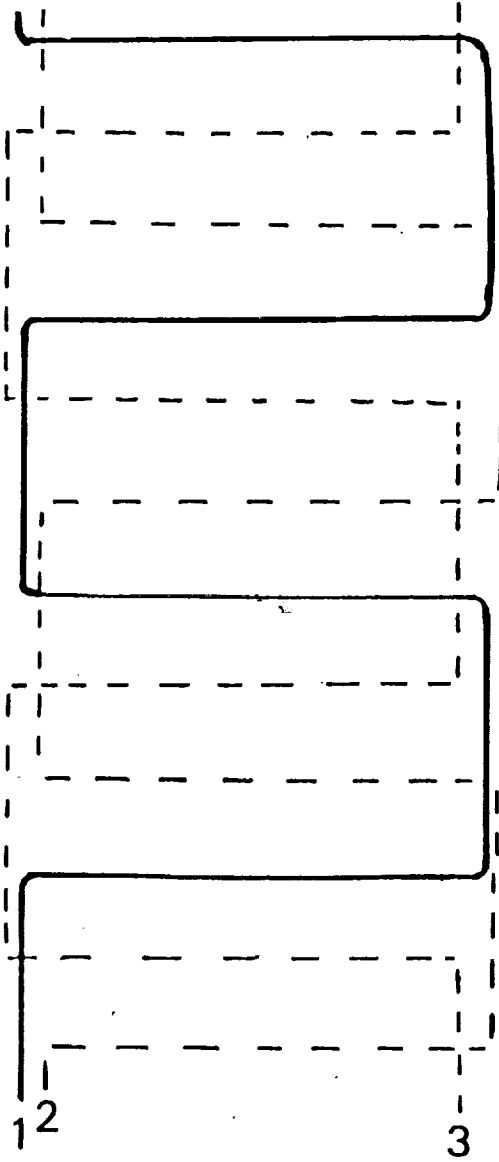
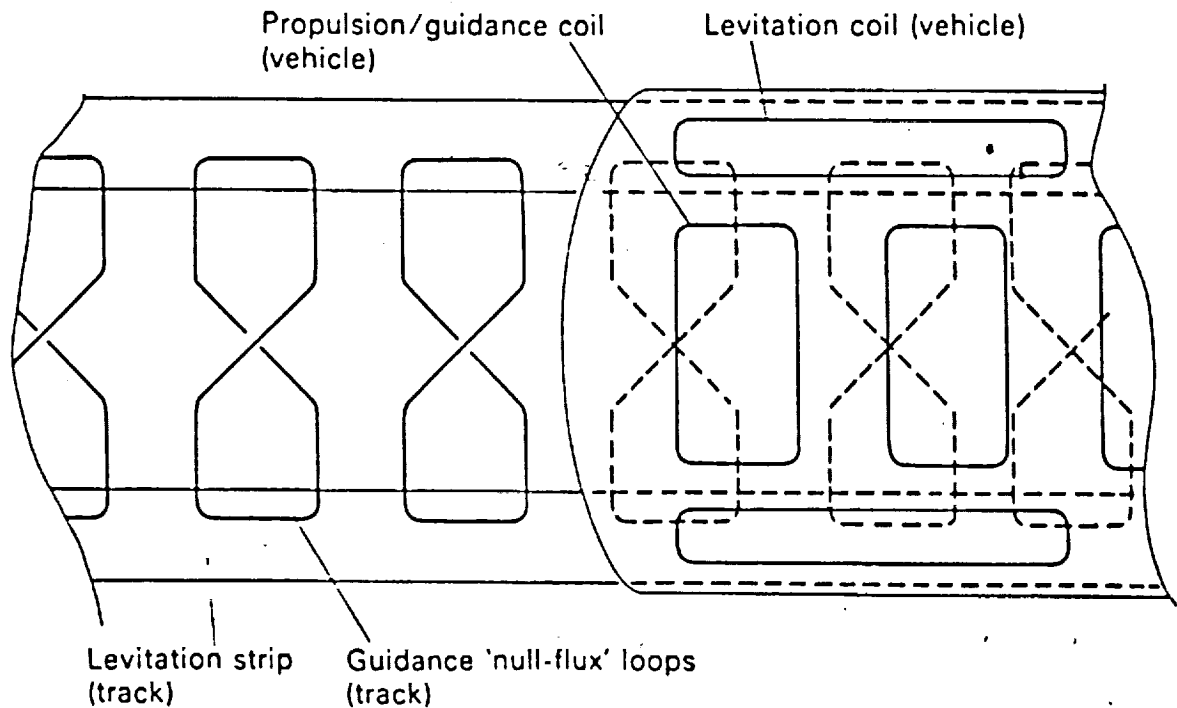

Figure 20. Plan of Linear Motor Track Winding 3-Phase Winding (Ref.1)

The null flux scheme has been designed to limit lateral displacement of the vehicle to 1.97 inches due to the combined effects of a 54 NM/hr cross wind and cornering at .1g. This produces a side force of approximately 15,700 pounds (Ref. 6).

For safety purposes a lateral restraint connected to the Mag-Lev, with an outrigger tire between the track and restraint as shown in Figure 22. This additional safety design will be utilized in the event of cryogenic equipment failure.



**Figure 21. Null-Flux Loops (Ref. 1)**

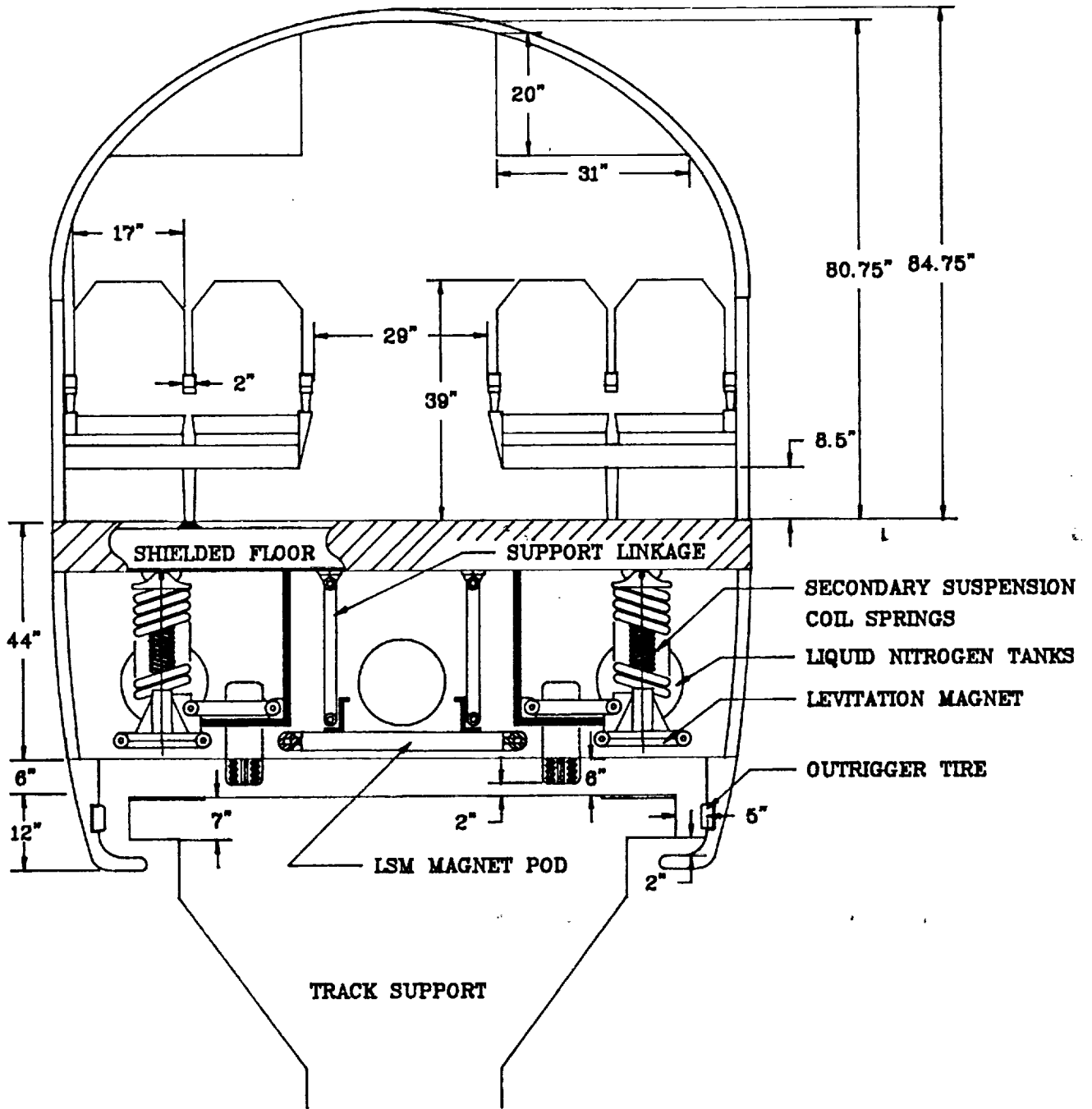

Figure 22. Cross-Sectional View

## Mag-Lev System Parameters

### VEHICLE

|   |             |
|---|-------------|
| Passenger Capacity                      | 100 Pax     |
| Length                                  | 123 Feet    |
| Width X Height                          | 9 x 12 Feet |
| Estimated Laden Weight                  | 68,500 lbf  |
| Maximum Cruising Speed                  | 270 NM/hr   |
| Guideway Clearance                      | 6 inches    |
| Estimated Aerodynamic Drag (Max. Speed) | 6800 lbf    |

### ELECTRODYNAMIC SUSPENSION

|                                   |                              |
|-----------------------------------|------------------------------|
| Number of Superconducting Magnets | 10                           |
| Strength                          | 3.08 X 105 Ampere-turns      |
| Size                              | 3.48 ft. long X .98 ft. wide |
| Levitation Strips                 | 1.9 ft. wide X .39 in. thick |
| Magnetic Suspension Height        | 6 inches                     |
| Suspension Stiffness              | 2.47 X 105                   |
| Magnetic Drag (Max Speed)         | 3300 lbf                     |

### LINEAR SYNCHRONOUS MOTOR PROPULSION

|  |                               |
|--|-------------------------------|
| Equivalent Number of Superconducting Magnets | 50                            |
| Strength                                     | 5 X105                        |
| Size   | 1.74 ft. long X 5.58 ft. wide |
| Pitch  | 1.87 ft.                      |
| Thrust                                       | 10,500 lbf                    |
| Guideway Stator Section Length               | 1.87 ft.                      |
| Efficiency                                   | .75                           |
| Power Factor                                 | .93                           |

### GUIDANCE

|  |                     |
|--|---------------------|
| Null-Flux Loop Length                  | 1.87 ft.            |
| Pitch                                  | 1.03 ft.            |
| Conductor Cross Section                | .59 in <sup>2</sup> |
| Estimated 54 NM/hr Side-wind Load      | 15,700 lbf          |
| Maximum Electrodynamic Restoring Force | > 67,400 lbf        |
| Lateral Stiffness                      | 1.78 X 105 lbf/ft.  |

### Safety

Safety was a major concern in the design of the Mag-Lev. The under-carriage of the Mag-Lev is partially wrapped around the guideway in order to prevent the vehicle from derailing, by being physically attached. The doors of the Mag-Lev will automatically be securely locked when the vehicle is in motion. This is to prevent anyone from exiting the vehicle on the elevated guideway. Because of the high velocities

the Mag-Lev travels at, windows of the vehicle must be made of safety glass, similar to that of aircraft. The design of the levitation magnets and the propulsion system of the Mag-Lev vehicle is very modular so that the failure of one magnet will not shut down the entire vehicle. Also, the modular design will result in easy and quick repair of the vehicle by pulling out and replacing any broken components. Through the use of computers the location and status of all vehicles and guideway will be constantly monitored and adjusted for any emergency situation.

In case of a power failure in a section of the guideway, all vehicles of the affected guideway between stations will brake through the use of the landing gear brakes. Vehicles that are not effected from the loss of power will travel and unload at the next nearest station. Passengers in stranded vehicles will remain on the vehicle until power is restored.

In case of a fire or a need for emergency exiting, the Mag-Lev would come to a complete stop, the doors would be manually opened, and emergency chutes below the doors would inflate for passengers to slide down from the elevated guideway. It was questioned whether to have the passenger windows pop out during an emergency for exit, but was thought to be unwise unless emergency chutes were deployed along the length of the vehicle. Therefore, the two passenger doors and two emergency doors were placed such that a passenger would only have to travel a maximum distance of 25 ft to exit the vehicle. In case it is impossible to exit through the doors, due to obstruction or damage to the doors, passengers will exit through the three escape hatches in the ceiling of the vehicle.

In the event of a breakdown where the levitating magnets fail to lift the Mag-Lev, the vehicle will land on its semi-retractable landing gear. The vehicle will remain in service, operating at a lower velocity rolling on its landing gear until it can be diverted from the main guideway. The null-flux loops and out rigger wheels will act as the guidance system.

Should all propulsion magnets of the Mag-Lev go out, the vehicle will remain on the guideway until it can be fixed. If the time for repair will cripple the system, another Mag-Lev vehicle will pull the down Mag-Lev to a place where it can be removed from the main guideway.

Loss of vehicle computers or system computers and all of their backup systems will result in the on-board crew manually operating the Mag-Lev.

The guideway should be inspected by a test vehicle at least every three weeks to check for damage or need of re-alignment. This guideway check can be conducted during the off peak night hours so as that necessary repairs may be completed before the next morning rush hours at 6:00 am.

The guideway is elevated so that there will be no cross traffic of other forms of transportation, as in the case of existing wheel on rail trains. The guideway is also elevated to make it difficult for people to get up on the guideway. The guideway is flat instead of U shaped, so that it will be less likely to have objects trapped on the guideway. The strength of the guideway will be proportional to that of freeways, which have proven to be earthquake worthy.

The worst foreseen case of safety of the Mag-Lev is a derailment of an existing wheel on rail train, which run along side or below the Mag-Lev and its guideway. A derailment of a wheel on rail train may collide and destroy a vertical support structure, resulting in the collapse of the guideway. A vehicle traveling at its maximum cruise velocity of 270 kts, an emergency 0.3 g deceleration would take 1.75 NM of guideway to come to a stop, so there would be a possibility of a Mag-Lev falling from the guideway.

The effects of magnetic field exposure on the passengers is not known to have any immediate health hazard, except for a person with a device such as a pacemaker. However, the possibility of long term effects cannot be ignored. The distance from the magnets to the hand-body of a seated passenger is far enough to be exposed to less than .002 Tesla, which is the less than the 0.02 Tesla tolerable limit (Ref. 1). In case the intensity of the magnetic field is stronger due to the concentration of super conducting magnets, below the cabin floor is a screen of magnetically soft material.

## References

1. Rhodes, R.G, and B.E. Mulhall, *Magnetic Levitation for Rail Transport*, Oxford University Press, 1981.
2. *Super Speed Ground Transportation System*, Las Vegas, Nevada, 1988.
3. Joner, B., *Feasibility Study of Modern Airships, Final Report* , Boeing Vertol Company, May, 1975.
4. Kahn, Nasser, *Intrastate Travel Demand*, March 13, 1989.
5. Cameron, Mark, *Market Analysis of the California Corridor Transportation System Feasibility Study for 2010*, January 20, 1989.
6. Eggleton, Peter L, *The Development of the Magnetically Levitated Transportation System in Canada*.
7. Dickson, P.J. and Lergi, JB, *The Problem of Modeling Community Noise*, Stanford Press, circa 1972.
8. "Superconductivity," *Popular Science*, April, 1988.
9. Laithwaite, E.R., *Transport Without Wheels*, Westview press, Inc., 1977.
10. Giancoli, Douglas.C., *Physics Principles with Applications*, Prentice-Hall International, Inc., 1980.
11. "Magnetic Levitation," *Popular Mechanics*, June, 1981.
12. *Advanced Rail Technology*, Committee on Science and Technology, U.S. Government Printing Office, April 5, 1982.

## THE WILDCAT -- A TILT ROTOR FOR 2010

### Overview

A Vertical Takeoff and Landing (VTOL) aircraft fulfills a major requirement of the California Corridor Air Transit (CAT) system. It could be used to alleviate both air and ground congestion as well as provide a fast and convenient means of travelling within the Corridor. The VTOL will be operating from local vertiports, and therefore must satisfy noise and safety requirements, and should have a high speed capability in order to serve the Corridor Access Port (CAP). A typical mission would be for the VTOL aircraft to takeoff from a residential vertiport, fly to either another city, the CAP, or across town to another vertiport on top of an office building.

A cost analysis of the forty passenger tilt rotor aircraft, along with the magnetically levitated train, electric CTOL aircraft and airship, was conducted and showed that the tilt rotor was very cost competitive. The study predicted a trip from Los Angeles to San Francisco (304 nm) would cost about \$65. For distances under 115 nm a comparison was done with a 19-passenger compound helicopter. This comparison showed that the 40-passenger tilt rotor could be used effectively for the short range (115 nm or less) as well as the medium range (435 nm).

### Mission Specifications

The mission specifications for the Wildcat, Table I, were determined from several criteria. The number of passengers was chosen to be 40 based on the trends and recommendations discussed in the Corridor study. The range was chosen based on the definition of the corridor and on the CAP location. The corridor boundaries were defined as being 435 nm from California's four major cities. By using this distance as the aircraft's range, complete service of the entire corridor would be possible. A range of 435 nm would



also allow the Wildcat to make round-trips between all the major metropolitan areas in the corridor without refueling. This could be very important, especially if it is decided not to store fuel at all vertiport locations. High cruise speed is a definite advantage of the tilt rotor: the cruise speed of 304 knots was chosen because, high operating speeds yield a high level of service. The number of crew (2 pilots and 1 flight attendant) was chosen to meet the minimum requirements outlined in FAR Part 91. If it is feasible by the year 2010 to operate with an automated system then one or even both of the pilots could be eliminated. The minimum of one flight attendant was chosen because the majority of the flights will be 200 nm or less and at a speed of 304 knots.

**Table I. Wildcat Mission Specifications**

|                        |        |
|------------------------|--------|
| Range, nm              | 435    |
| Cruise Velocity, knots | 304    |
| Cruise Altitude, ft    | 20,000 |
| Passenger Capacity     | 40     |
| Crew                   | 3      |

**Important Design Goals**

- Neighborhood to neighborhood service
- Acceptable noise levels in hover and cruise
- Acceptable pollution levels
- High level of safety

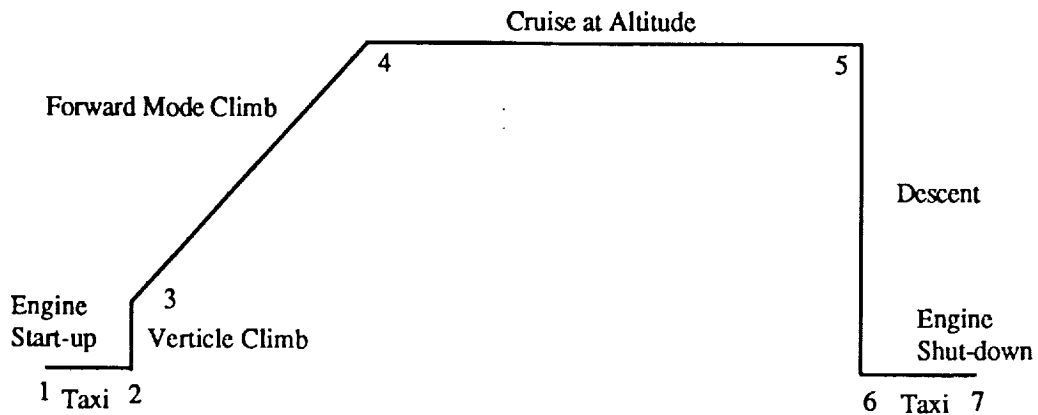

**Figure 1. Mission Profile**

## Design Method

A major decision in the initial stage of the tilt rotor design was deciding on the type of propulsion system to use and how to implement it. Once that was determined, the weight, drag and power requirements were calculated using the method outlined by Roskam (Ref. 13) in his aircraft design series. To calculate the size of the empennage and estimate the component weights, both Roskam and Torenbeek (Ref. 14) were used. Sizing of the fuselage, aircraft interior, landing gear, and control surfaces, were done by following the methods and examples of Roskam. The cost analysis study was performed using a cost analysis program written by Dr. Edward Morlok of the University of Pennsylvania (Ref. 11).

## Configuration

The Wildcat is a high speed derivative of the V-22 Osprey tilt rotor. The design has been improved in many areas. Due to the military requirements of the V-22 there are restrictions which can be eliminated. The wing of the V-22 has to be capable of being rotated for storage on aircraft carriers, thereby increasing the structural weight. The removal of military equipment from the configuration would reduce the weight significantly though this would be somewhat offset by the addition of passenger seating and other accommodations (Ref. 10). To increase the high speed performance a lower wing thickness would be used (the V-22 has a 23% thickness ratio). Although this will increase the wing's weight, the lower thickness ratio is necessary for better performance at high speeds. As with the V-22, composites will be used extensively. Further advances in composites could further reduce weight, but since the V-22 uses so many composites now any additional weight savings would be small. Since the engine used for the V-22 is a derivative of the Allison 501-M62, a derivative of the same engine was scaled down to fit the Wildcat power requirements. A major difference in the propulsion system will be the replacement of JP-4 fuel with liquid hydrogen (LH<sub>2</sub>). The reasons for using hydrogen will be discussed later in the report. Like the V-22, the Wildcat will have engine cross-shafting to provide for an engine failure.

**Table II. Aircraft Weights**

|                            |        |
|----------------------------|--------|
| Gross Takeoff, lb          | 32,200 |
| Empty, lb                  | 20,453 |
| Fuel(LH <sub>2</sub> ), lb | 2140   |
| Payload, lb                | 9440   |

---

## Wing and Empennage

Investigations into existing tilt rotor wing airfoils revealed that the V-22 had a thickness ratio of 23 percent. This had been chosen, in part, because a large volume in the wings was necessary in order to store fuel like a conventional aircraft. Fuel in the Wildcat, however, will be stored in integrated fuselage tanks. A thinner airfoil was chosen for the Wildcat due to this reason and for improved performance at high speeds. A NACA 2415 was selected over a 6-series laminar airfoil because most of the wing will be in the propeller downwash and the 2415 has a higher maximum lift coefficient.

**Table III. Wing and Empennage Specifications**

### Wing

|                                  |           |
|----------------------------------|-----------|
| Area, ft <sup>2</sup>            | 357.8     |
| Chord, ft                        | 7.4       |
| Span, ft                         | 48.2      |
| Quarter Chord Sweepback, degrees | -6.0      |
| Taper Ratio                      | 1.0       |
| Aspect Ratio                     | 6.5       |
| Airfoil Section                  | NACA 2415 |

### Horizontal Tail

|                                  |       |
|----------------------------------|-------|
| Area, ft <sup>2</sup>            | 100.1 |
| Average Chord, ft                | 5.2   |
| Span, ft                         | 20.0  |
| Taper Ratio                      | 0.5   |
| Quarter Chord Sweepback, degrees | 30.0  |
| Aspect Ratio                     | 4.0   |

### Vertical Tail

|                                  |      |
|----------------------------------|------|
| Area, ft <sup>2</sup>            | 68.6 |
| Average Chord, ft                | 8.2  |
| Span, ft                         | 8.7  |
| Taper Ratio                      | 0.5  |
| Quarter Chord Sweepback, degrees | 40.0 |
| Aspect Ratio                     | 1.1  |

---

## Rotor Airfoil

The rotor system design was an important process because of the need to use the rotors in both hover and cruise. The rotor design also has a great effect on the noise generated, a critical area of the design. The rotors were designed with six blades to help reduce noise levels; by going to a higher number of blades the rotor tip speeds can be reduced, lessening the noise produced. The disadvantage of increasing the number of blades from four to six was a 300 lb increase in empty weight. Another way of reducing the tip speed is to increase the rotor diameter. Although this is fine for hover, the blades on the tilt rotor are already oversized for forward flight and an increase in diameter would only subtract from the cruise performance. An alternative would be a variable diameter rotor which could reduce the rotor diameter in forward flight and then enlarge it again for vertical flight. This mechanism improves efficiency in cruise, but would not decrease noise in hover. It was decided not to use the variable diameter because of the weight penalty associated with the retracting mechanism. If the number of blades was increased to six, along with using the variable rotor, there would be an even greater weight penalty.

The diameters of the rotors were kept about the same size of those on the V-22, because the Wildcat's wingspan is approximately equal to the V-22 wing span. Once the rotor diameter was known the disc loading could be determined. A disc loading of 14.9 was obtained, comparing well to the XV-15 and the V-22 which have disc loadings of 13.2 and 17.4 respectively. The XV-15 has a low disc loading because it is a small experimental aircraft. The V-22 is much higher than the XV-15 and the Wildcat design attempted to achieve a low disc loading without having to increase the rotor diameter much more than the V-22. A low disc loading is desirable because low disc loading corresponds to low noise.

After deciding on the number of blades and the disc loading, a tip speed had to be chosen. A tip speed of 450 ft/s was chosen for both hover and cruise. These are very low numbers compared to the V-22 which has tip speeds of 790 ft/s in hover and 662 ft/s in cruise. One of the reasons is because a six blade configuration was used, as opposed to three blades on the V-22. In addition is that because hydrogen fuel is being used, the takeoff weight is lower and less thrust is required to hover. Normally the rotor speed is reduced in the cruise mode because of the compressibility effects at high tip speeds. For this case, however, it was kept the same because the speed was low enough to disregard compressibility effects.

The rotor airfoil used for the Wildcat is the Bell XN12. This is a current airfoil, chosen partially because the performance data is available. It must be noted that there is currently a vast amount of research being done on advanced airfoils for tilt rotors and by using an advanced airfoil the overall performance could be improved. The XN12 is 12% thick and has a  $C_{Lmax}$  of 1.40 at a Mach number of .45 (Ref. 12). This airfoil section was modified by tapering the blade tips. This helps to alleviate noise and it also improves rotor performance. The choice of the tip shape was based on data in Reference 6. An inboard twist slope of -48 degrees and an outboard twist of -34 degrees was determined to be an optimum combination (Ref. 9).

**Table IV. Rotor Specifications**

|                                   |           |
|-----------------------------------|-----------|
| Radius, ft                        | 18.6      |
| Chord, ft                         | 1.9       |
| Number of blades                  | 6         |
| Disc Loading, lb/ft <sup>2</sup>  | 14.8      |
| Solidity                          | 0.193     |
| Tip Speed, ft/s                   | 450.0     |
| Twist (inboard/outboard), degrees | -48/-34   |
| Airfoil Section                   | Bell XN12 |

---

### Propulsion System

The engines used are a rubberized version of the Allison 501-M62 turbo-prop. They are rated at 5775 shp each, as was determined from the one engine inoperative vertical climb requirements. They also have been modified to burn hydrogen fuel.

**Table V. Wildcat Engine Specifications**

|                             |      |
|-----------------------------|------|
| Width, in                   | 25.2 |
| Height, in                  | 30.9 |
| Length, in                  | 5.9  |
| Intake Diameter, in         | 17.2 |
| Jet Pipe Diameter, in       | 23.6 |
| Rated Shaft Horsepower, shp | 5775 |

---

### Liquid Hydrogen Fuel System

Liquid hydrogen (LH<sub>2</sub>) was chosen as the fuel for the Wildcat for several reasons. One reason is that virtually no pollutants are produced from burning LH<sub>2</sub> as opposed to burning kerosene based fuels. Air pollution is currently a major environmental problem in California, and the situation will only get worse unless drastic changes are made. Air transportation only produces a small percentage of the air pollution, but there should still be concern about reducing what is produced. LH<sub>2</sub> is one way that the dependency on fossil fuels can be reduced. LH<sub>2</sub> is abundantly available throughout most of the world and cost competitive with

other fuels in the United States. The cost to produce LH<sub>2</sub> by nuclear electrolytic methods was ten cents per pound in 1987 (Ref. 3).

In the event of a spill or crash, hydrogen would be safer than conventional jet fuel. Due to the buoyancy effect of LH<sub>2</sub>, it would rise quickly away from the spill. It also burns much faster than current jet fuel. Passengers aboard an aircraft using LH<sub>2</sub> would have a good chance of surviving the fire because it would burn up away from them and would burn away very quickly (Ref. 2). Passengers caught in a Jet-A fuel fire would probably suffer longer and have a greater chance of dying because the kerosene based jet fuels tend to linger and burn longer.

The LH<sub>2</sub> is stored in large integral tanks located near the front and aft sections of the fuselage. Integral tanks not only serve as fuel containers, but are also designed to be part of the basic aircraft structure (Ref. 2). These integral tanks can be designed so that in the event of a crash they would rupture at the top, and the fuel would be expelled upwards so that the passengers would not be affected as the hydrogen burned.

The fuel tanks are insulated with microspheres (hollow borosilicate spheres 80 microns in diameter) contained in an annulus surrounding the tank, preventing boil off. The annulus is pumped to create a soft vacuum of about 0.00193 psi (Ref. 2). The total thickness of the tank and insulation is about four inches which adds 536 lbs to the aircraft weight. The weight is largely due to the large volume the LH<sub>2</sub> requires. Nevertheless, because hydrogen can supply the same amount of energy as Jet-A for 2.8 times lower weight, there is an overall weight savings. Table VI shows the weight saved using LH<sub>2</sub> over Jet-A for the Wildcat. The benefits of hydrogen that affected the decision to use it are summarized in Table VII.

**Table VI. Weight Comparison of LH<sub>2</sub> and Jet-A Fuels**

| <u>LH<sub>2</sub> Fuel (Weights)</u> | <u>Jet-A Fuel (Weights)</u> |
|--------------------------------------|-----------------------------|
| Fuel System: 536 lb                  | Fuel System: 454 lb         |
| Fuel: 1962 lb                        | Fuel: 5971 lb               |
| Total = 2498 lb                      | Total = 6425 lb             |

Net weight savings using LH<sub>2</sub> = 3927 lb

---

Table VII. Benefits of LH-2 vs. Jet-A Fuel

|                                   |   |
|-----------------------------------|---|
| <b><u>Aircraft Dimensions</u></b> | Reduced gross weight  |
| <b><u>Noise</u></b>               | Reduced engine noise  |
| <b><u>Pollution</u></b>           | No hydrocarbons (CO <sub>x</sub> , SO <sub>x</sub> ) particulates, or odors<br>Reduced NO <sub>x</sub> concentrations |
| <b><u>Cost</u></b>                | Lighter, less costly aircraft<br>Longer engine life - less maintenance  |
| <b><u>Safety</u></b>              | Equal or better   |
| <b><u>Availability</u></b>        | Can be made using any energy source   |

---

### Performance

The Wildcat is overpowered for cruise and even for hover with all engines operating (AEO), due to the requirement of being able to climb vertically with one engine inoperative (OEI). The requirement is that the minimum rate of climb (ROC) must be at least 100 feet per minute (fpm) with OEI. The OEI requirement is shown in Figure 2 as a function of power loading and wing loading. Along with the hover requirement is the cruise requirement. From Figure 2, a wing loading and power loading were determined. The corresponding values must fall under both of the curves. A high wing loading of 90 lb/ft<sup>2</sup> was used. From this and the OEI hover line, a power loading was determined.

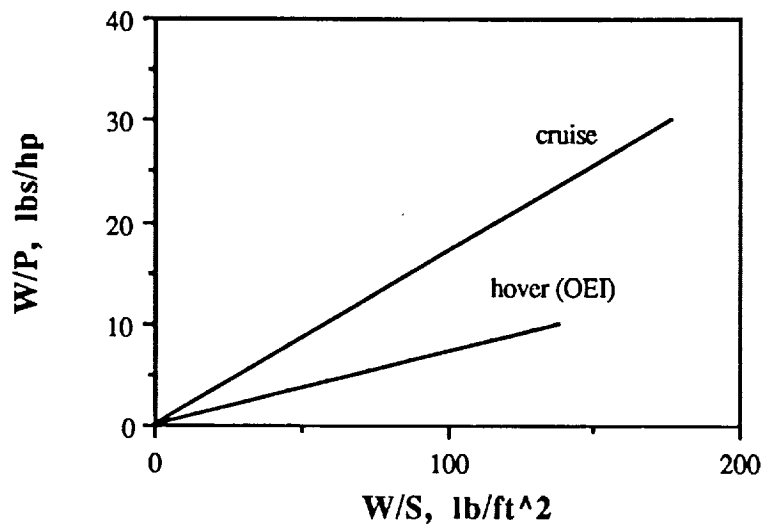
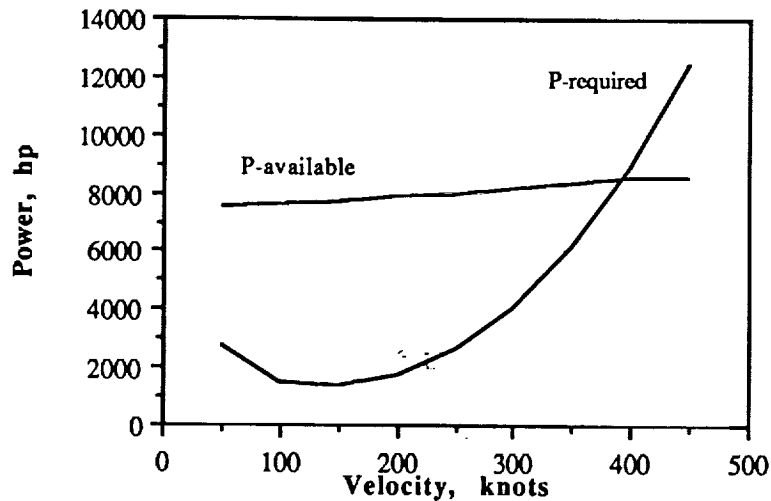

Figure 2. Power Loading vs. Wing Loading

Since the turbo-prop engines were rubberized and converted to use LH<sub>2</sub>, the power available versus velocity relationship had to be estimated. The power available for a turbo-prop engine increases slightly as forward velocity is increased. When a high enough velocity is attained the propeller efficiency begins to rapidly decrease and thus the available power decreases. The power required is that which is necessary to overcome the parasite and induced drag. Figure 3 shows the available and required powers as functions of velocity for sea level. According to this graph the maximum velocity at sea level would be about 380 knots. The graph also shows that the velocity for maximum range to be 180 knots and 145 knots for maximum endurance.



**Figure 3. Power vs. Velocity at Sea Level**

Figure 4 is power versus velocity for an altitude of 20,000 ft. This graph shows the same trends as Figure 3. This was interesting because normally a higher maximum velocity can be achieved at the cruise altitude because of the lower density. In the two cases shown, a slightly higher maximum velocity is obtained operating the Wildcat at sea level even though the required and available powers were greater than at the cruise altitude. From Figure 4, it can be seen that the velocities for maximum range and maximum endurance at 20,000 feet altitude, are 215 knots and 190 knots respectively.



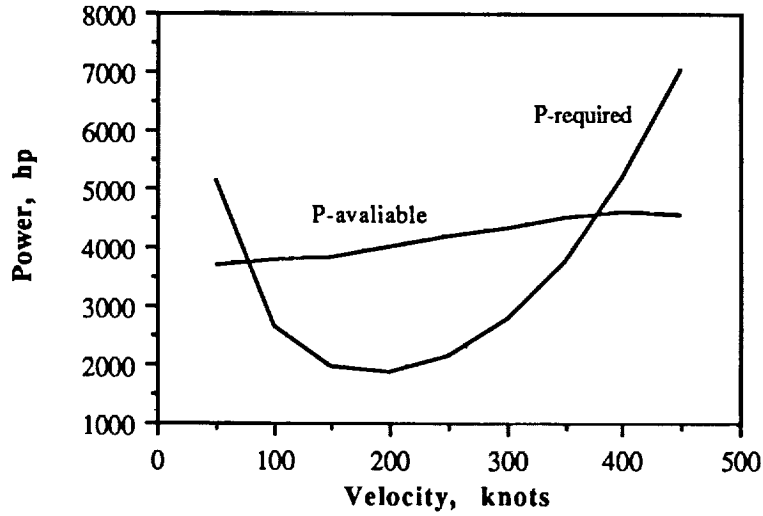

Figure 4. Power vs. Velocity at 20,000 ft.

Another area of performance determined was  $ROC_{max}$  for AEO. This is shown in Figure 5. According to this data the cruise  $ROC_{max}$  at sea level is close to 6400 fpm. The service ceiling in the cruise mode seems to be about 29,900 ft. These rates of climb are very acceptable, and are large because of the excess power available.

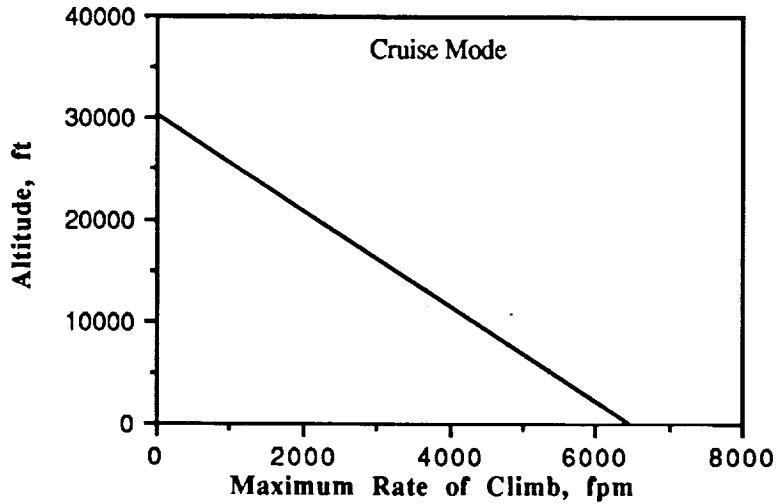

Figure 5. Altitude vs. Rate of Climb

## Cockpit and Cabin Layouts

The Wildcat's cockpit is equipped with provisions for a pilot and co-pilot. Because of the location of the forward fuel tank the cockpit is not accessible from the cabin compartment. Therefore it is necessary for the cockpit to have its own door. In addition to the one cockpit exit there is one primary passenger exit and three emergency exits to satisfy FAR Part 25.

The cabin will accommodate forty passengers and one flight attendant. It is equipped with a lavatory for passenger convenience and is pressurized for operating at high altitudes. The baggage compartment is larger than a typical 40 passenger aircraft, so that there is enough space to accommodate excess baggage for passengers transferring at the CAP to international and transcontinental flights. When the baggage compartment is not completely filled, the extra room can be used to transport freight. There is also enough overhead room for carry-on luggage. The diameter of the fuselage is large enough to allow for two rows of two seats abreast each. A critical change to the fuselage was lengthening it to allow for the volume required for the LH<sub>2</sub> tanks. The tanks are positioned at each end of the fuselage for center of gravity purposes.

## Landing Gear

The main landing gear is fully retractable. When in the wheel down position, the main gear are located 33 feet back from the aircraft nose. Each main gear is equipped with one tire 30 inches in diameter and 9 inches wide. The struts for the main gear are 5.5 inches in diameter. The nose gear fully retracts underneath the cockpit, swinging rearward and twisting ninety degrees so that it can fit in the shallow space underneath the cockpit. The nose gear uses dual tires that are 23.4 inches in diameter and 6.5 inches wide.

## Noise

One of the design priorities was to have a relatively quiet aircraft since it will need to operate in residential areas to provide near door-to-door service. As already mentioned in Table VII, hydrogen fueled engines are not as loud as engines that burn Jet-A. Because of the low rotor tip speeds, noise was significantly reduced in hover and in cruise. Another factor which will help in noise reduction is the tip shape. It was difficult, however, to determine just how much the noise levels would be reduced. The effective perceived noise levels of the Wildcat were calculated using Faulkner's method (Ref. 5). The resulting noise levels (in dB), were then converted to equivalent perceived noise levels (in EPNdB). The noise level in hover at 500 feet altitude was found to be 87.0 EPNdB, while 69.3 EPNdB was the noise level in cruise at 217 knots at 500 feet. These noise levels are highly acceptable, since a helicopter having an equivalent takeoff weight would normally have a noise level of 98.6 EPNdB in hover (Ref. 4).

## Safety

Aircraft flight safety for the Wildcat is of primary importance. Since the Wildcat will be operating over densely populated areas in large cities, it should be designed to be overly safe and easily operated. As mentioned before, the Wildcat uses a cross-shaft to handle an engine failure. If an engine were to fail, the Wildcat is sized with enough power so that one engine would be able to drive both rotors and provide enough thrust to climb vertically at 100 fpm. Another added safety feature is the use of hydrogen fuel which has many safety advantages over Jet-A type fuels. These safety factors were discussed previously in the fuel section.

Other safety features would include the use of advanced digital avionics and on board computers to ease the crew's workload, increase systems reliability, and reduce maintenance time. Fly-by-wire flight controls also will contribute to better safety because of higher reliability. Current examples of this type of electronic technology are the reduced workload cockpits of the General Dynamics F-16 Falcon and the McDonnell Douglas F/A-18 Hornet.

More extensive civilian pilot training programs could also be implemented to make more proficient aircrews. Examples of such programs are the the pilot training programs of the United States military, where heavy emphasis is placed on emergency procedures, aircraft recovery from unusual flight attitudes, instrument flying, and precision flying. To summarize the concerns regarding flight safety; high technology cockpits will reduce the aircrew's workload, prevent task saturation, and increase situational awareness.

## Ground Facilities

There are essentially two ways to refuel an aircraft at a landing site. One way is to deliver the fuel to the aircraft with fuel trucks, the other is to have underground transfer lines to the aircraft parking site. The transfer line solution is generally more economical than the mobile tank (semi-trailer or truck) solution for short distances (a few miles) and large quantities (greater than 30 cubic feet per minute). At the CAP, underground transfer lines will be preferred over using a large number of vehicles to refuel (Ref. 1).

The LH<sub>2</sub> could be stored at airports either in large, heavily, insulated tanks above ground or in less heavily insulated tanks below ground level. When the aircraft is being refueled, all lines and connections must be completely leak proof. The refueling facilities would also have a gaseous H<sub>2</sub> recovery system for the hydrogen that will boil off due to the warm ambient temperatures.

If only one type of aircraft in a transportation system uses LH<sub>2</sub> for fuel, the refueling facilities would be relatively expensive. However, in the next century, alternative fuels like LH<sub>2</sub> will probably be widely used among the aircraft industry. Because the Wildcat is an aircraft designed to be operational after

the year 2010, the proposed LH<sub>2</sub> refueling facilities will be able to accommodate other hydrogen aircraft, thus making the LH<sub>2</sub> refueling facilities cost competitive with current types of refueling facilities.

**Cost Analysis**

Figure 6 shows the relationship of cost per mile for three different volumes of passenger service. In the initial phase of VTOL operation, approximately 5000 passengers per day would be served. Eventually, as more tilt rotors enter service this number would be increased to about 100,000 passengers per day. The figures show that for trip lengths above 40 miles, the cost of traveling on the Wildcat is very affordable. These trips are between vertiports, located every 10 miles, serving communities and business districts within a five mile radius. This reduces ground time, making the Wildcat both convenient and affordable.

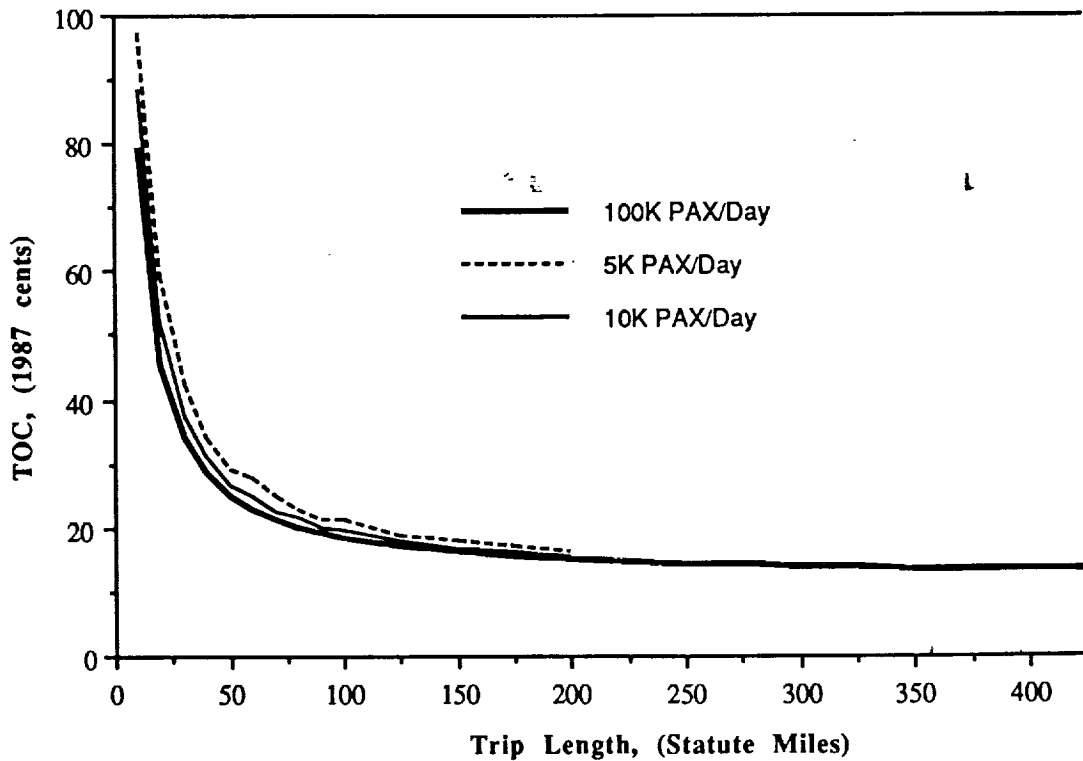

**Figure 6. Total Operating Cost per Trip Length**

## Areas of Further Study

Areas of further study include technological breakthroughs in how to pump LH<sub>2</sub>, ground storage facilities of LH<sub>2</sub>, electric methods of propulsion, and variable diameter rotors. The current LH<sub>2</sub> pumps used on aircraft are the ones used on the space shuttles. Because the pumps have to withstand extremely cold temperatures, the pumps on the space shuttles are only usable for one flight.

Because LH<sub>2</sub> requires a large volume for storage, areas for storing the LH<sub>2</sub> at existing and proposed airports would have to be found. For example, some existing airports that are located where the water table is just below ground level would have to store the LH<sub>2</sub> above ground, requiring more above ground storage area.

Electric propulsion is also an alternative to current aviation fuels. Electric fuel cells that use lithium for an anode, a silver oxide sheet as a cathode, and air or hydrogen peroxide for an oxidizer have been theoretically shown to provide enough amperage to electric motors that in turn provide enough power to propel commercial sized aircraft (Ref. 7 and 8). Advantages of using electric propulsion are: no air pollution, low engine noise, independence from fossil fuels, and a virtually infinite supply of lithium and water for hydrogen peroxide production.

Variable diameter rotors could improve tilt rotor performance. During hover the rotor blades could be extended to the maximum diameter allowed for the aircraft to provide enough lift without having high tip speeds. When the tilt rotor is in forward cruise, the rotors would be retracted to the minimum allowable diameter so that the blade tips do not experience the resulting high vector velocities. One possible way of extending and retracting the rotor blades is to use a system of jackscrews. However, a possible problem that could require extensive analysis, is that of rotor blade vibrations.

## Conclusions

The Wildcat can effectively serve the California Corridor in the next century. Airport congestion would be reduced because the passenger flow would be diverted through the vertiports and the trip time of the passenger would be reduced because the average distance to a vertiport would be three and a half miles from the passenger's home. With the use of a major hub located in the central San Joaquin Valley, large numbers of people who need to travel to different parts of the state could be served efficiently.

The time that passengers spend on the ground in the aircraft would be reduced because of the virtual elimination of aircraft taxi time. Because of the design speed of 304 knots, and the possibility of an increase in cruise velocity to nearly 350 knots in the future using high speed tip shapes and variable diameter rotors. The Wildcat and any future derivatives would be very competitive with regional turboprops in cruise.

The Wildcat would not contribute to air pollution in California, nor the depletion of valuable fossil fuels. It would be relatively quiet for neighborhood service and would be safer in the event of an aircraft

accident. The Wildcat is a highly flexible aircraft capable of providing service between existing airports, heliports, and future vertiports. Tilt rotor aircraft, such as the Wildcat, have the potential of becoming highly successful commercial aircraft not only in California, but in any other region of the world plagued by transportation problems.

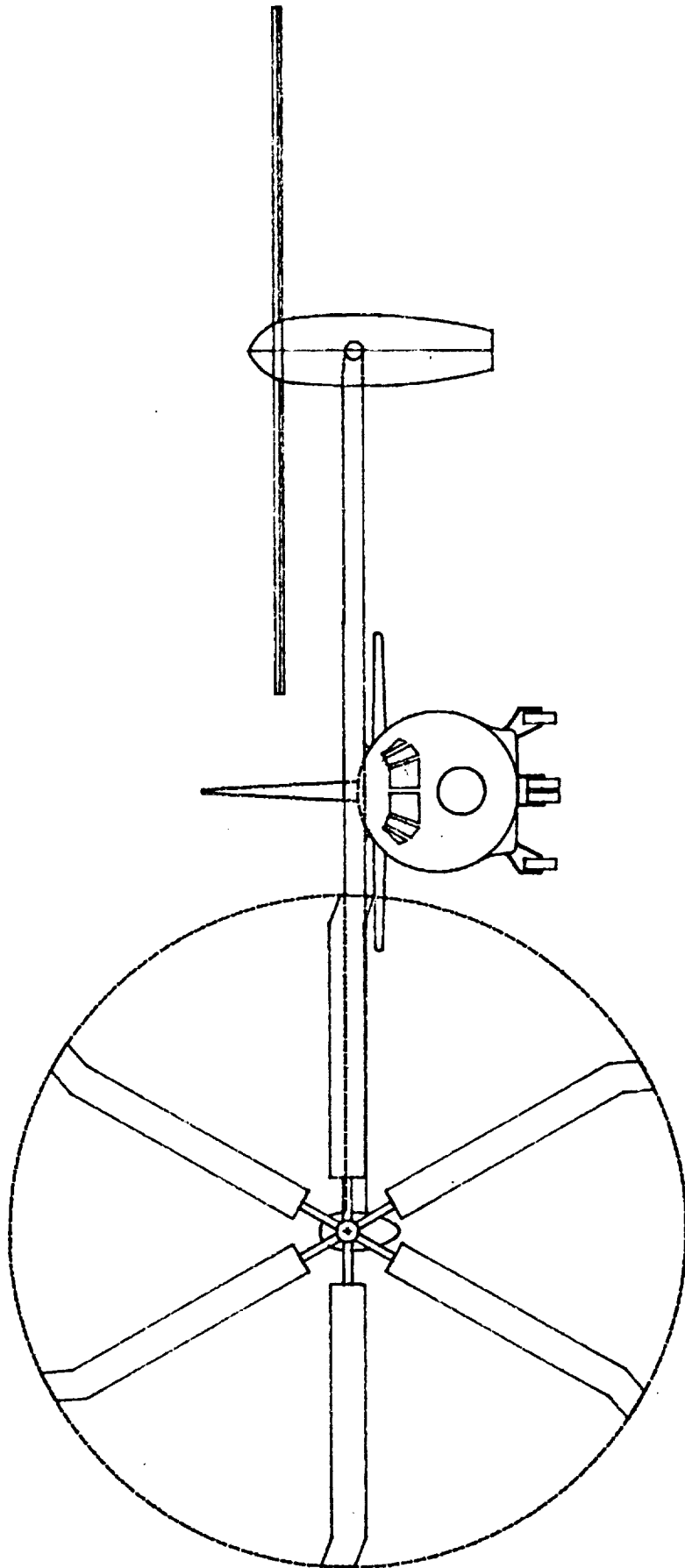

Figure 7. Front View

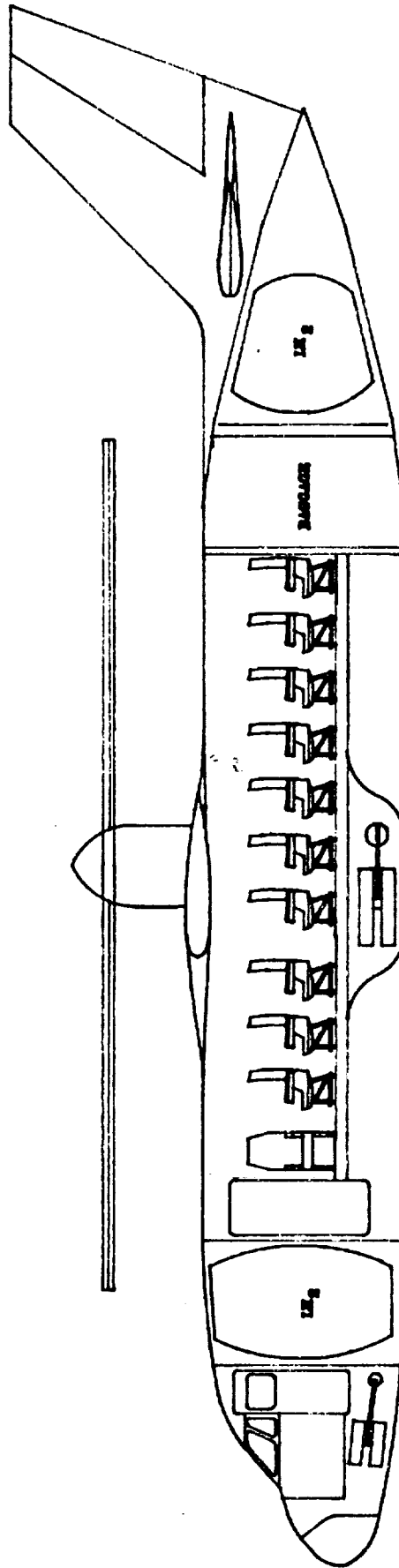

Figure 8. Side View



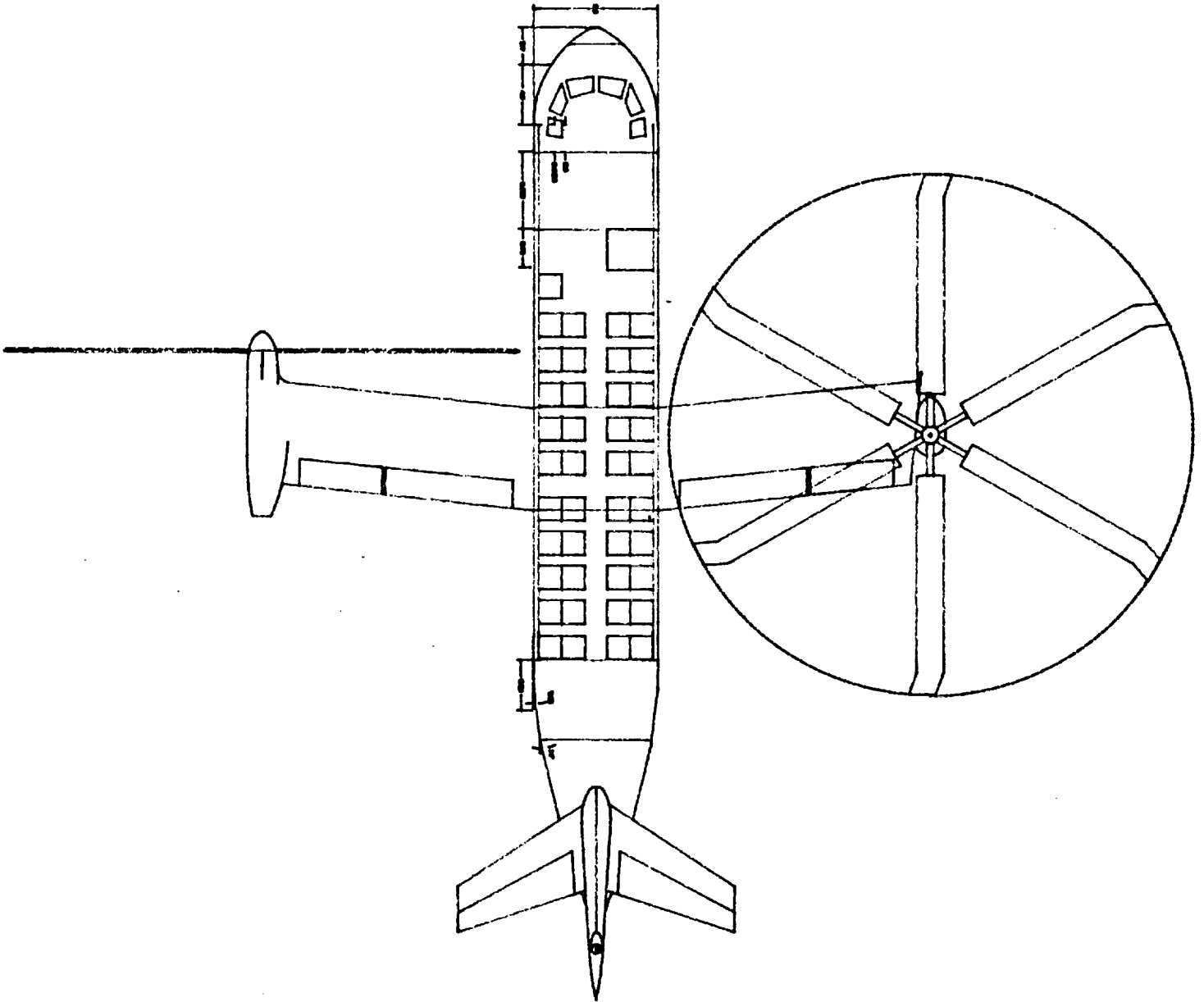

Figure 9. Top View

## References

1. Alexander, Arthur D. III, *Economic Study of Future Aircraft Fuels (1970 - 2000)*; NASA Technical Memorandum, Office of Aeronautics and Space Technology, Advanced Concepts and Missions Division, Moffett Field, CA 94035, Sept. 1972
2. Brewer, G.D., *Characteristics of Liquid Hydrogen - Fueled Aircraft*, Lockheed - California Company, Burbank, CA 91520
3. Cunningham, George R. Jr., *Analysis and Design of Insulation Systems for LH-2 Fueled Aircraft*; Senior Staff Scientist, Lockheed Palo Alto Research Laboratory, Palo Alto, CA 94340
4. Department of Transportation, *Measured of Estimated (Uncertificated) Airplane Noise Levels*; February 12, 1986
5. Faulkner, Henry B., *The Cost of Noise Reduction in Commercial Tilt Rotor Aircraft*; MIT, Dept. of Aeronautics and Astronautics, Aug. 1974
6. Felker, Fort F., Maisel, Martin D., Betzna, D., *Full Scale Tilt Rotor Hover Performance*; reprinted from the Journal of the American Helicopter Society, April 1986
7. Galbraith, A.D., *Power Cell Program Memo #3*, Interdepartmental Communication, Lockheed Aircraft Co.
8. Galbraith, Jacoby, A.D., and Kirchen, P. T. *Practical Feasibility Assessment of Electric Power Propulsion in Small Helicopters Using Lithium Hydroxide Battery Technology*; Hughes Helicopters, Inc., Dec. 1981
9. Johnson, Wayne, Lau, Benton, H., Bowles, Jeffrey, V., *Calculated Performance, Stability, and Maneuverability of High Speed Tilting Proprotor Aircraft*; NASA Ames research Center, Moffett Field, CA 94035, July 1986
10. Martin, Stanley Jr., *JVX Design Update*, Director - JVX Engineering Bell-Boeing Tiltrotor Team, Bell Helicopter Textron, Fortworth, TX. William B. Peck, Deputy Director - JVX Engineering Bell Boeing Vertol Company, Philadelphia, Penn.

11. Morlok, Edward K., Schoendorfer, David L., *Cost Characteristics of Tilt-Rotor, Conventional Air and High Speed Rail Short-Haul Intercity Passenger Service*; Civil Engineering Dept., University of Pennsylvania, Philadelphia, PA, May 1985
12. Narramore, J.C., *Airfoil Design, Test, and Evaluations for the V-22 Tilt Rotor Vehicle*; Bell Helicopter Textron Inc., Fort Worth, Texas, May 1987.
13. Roskam, Dr. Jan, *Airplane Design, Parts I through V*; Roskam Aviation and Engineering Corporation , 1985
14. Torenbeck, Egbert, Synthesis of Subsonic Airplane Design; Delft University Press, 1982



## Bibliography

- Abbot, Ira H. and Albert E. Von Doenhoff, *Theory of Wing Sections*, New York, Dover Publications, 1959.
- Advanced Rail Technology*, Committee on Science and Technology, U.S. Government Printing Office, April 5, 1982.
- Aircraft Owners and Pilots Association, *AOPA's Airports USA*. 1989.
- Albers, James A. & Zuk, John, "V/STOL Aircraft Configurations and Opportunities in the Pacific Basin," *SAE Technical Paper Series #872403*, Society of Automotive Engineers, Warrendale, PA, 1987.
- Anderson, John D. Jr., *Introduction to Flight*, New York, McGraw-Hill Book Company, 1985.
- Anon. National Benefits Associated With Commerical Application of Fuel Cell Powerplants, Energy Research & Development Administration.
- AOPA, Commentary, AOPA Pilot, Aircraft Owners and Pilots Association, December 1988.
- Appleby, A. J., Fuel Cells Trends in Research and Application, Hemisphere Publishing Corp.
- Arkell, B., Helicopter and Hovercraft Design, Weidenfeld & Nicolson LTD., 1963.
- Baker, B., Hydrocarbon Fuel Cell Technology, Academic Press, 1965.
- Bean, Walton and James Rawls, *California An Interpretive History*, Fourth Edition, McGrawhill Book Company.
- Belina, F.W. and L.R. Bush, *A Study of Commuter Air Service*, NASA CR-152005, Contract number NAS2-9380, The Aerospace Corporation, for Ames Research Center, NASA., June 1977.
- Berger, C., Handbook of Fuel Cell Technology, Prentic-Hall, Inc., Englewood Cliffs, New Jersey, 1968.
- Branch, Melville c., and R. Dale Beland, "Outdoor Noise in the Metropolitan Environment," Published by the City of Los Angeles, 1970, p. 2.
- Brewer, G., Ion Propulsion, Gordon And Breach Science Publishers, New York 1970.
- Briles, Wing & Helicopter, April 27, 1989.
- Bumby, J. R., Superconducting Rotating Electrical Machines, Clarendo Press., Oxford, 1983.
- Cagle, Malcom, Rear Admiral, U.S.N., Flying Ships-Hovercraft and Hydrofoils, Dodd, Mead & Company, New York, 1970.
- Cal Poly Aeronautical Senior Design, "California Corridor Study," Cal Poly State University, San Luis Obispo, CA, 1988.
- California Business Roundtable, Transportation Task Force, *Principles For Guiding The Reform of California's Transportation Planning Process.*, 1986.
- California Department of Transportation, Division of Aeronautics, *The California Aviation System Plan*, "Element II: Forecasts." August 1988.
- California Economic Development Corporation, *Vision: California 2010*.

**PRECEDING PAGE BLANK NOT FILMED**

California Engineering Foundation, "California Master Plan For Economic Development And Competitiveness", 1988.

California Office of Tourism, *The Economic Impact of Travel in California*, December 1981.

Cameron, Mark, *Market Analysis of the California Corridor Transportation System Feasibility Study for 2010*, January 20, 1989.

Carter, M.M. et al., *Transit Corridor Analysis: A Manual Sketch Planning Technique*, COMSIS Corp., etc., for the Office of Planning Methods and Support, UMTA, DOT. April 1979.

Cervero, Robert, "America's Suburban Centers: A Study of the Land Use - Transportation Link. Final Report," University of California, Berkeley, for the Office of Policy and Budget, UMTA, DOT, January 1988.

Charles River Associates, Inc., "Characteristics of Urban Transportation Demand: An Update," Revised Edition, for the UMTA, DoT, July 1988.

Clausing, D., *The Aviator's Guide to Modern Navigation*, 1987.

Congress of the United States, Congressional Budget Office, *Policies for the Deregulated Airline Industry, A Special Study*, USGPO, Washington, D.C., July 1988.

Congress of the United States, Congressional Budget Office, *Review of the FAA 1982 National Aerospace System Plan*.

Croome, Angella, Hovercraft, Brockhampton Press, 1960.

Cunniff, Patrick F., *Environmental Noise Pollution*, John Wiley & Sons, Inc., 1977.

De Neufville, Richard, *Airport Systems Planning: A Critical Look at the Methods and Experience*, The MIT Press, Cambridge, Mass., 1976.

Deakin, Elizabeth, *Transportation And Economic Development: Recommended Options For California*, 1986.

Dickson, P.J. and Largi, JB, *The Problem of Modeling Community Noise*, Stanford Press, circa 1972.

Dugan, Daniel C., Erhart, Ronald G., and Schroers, Laurel G., *The XV-15 Tilt Rotor Research Aircraft*; Sept. 1980, NASA Technical Memorandum 811244, AVRADCOM Technical Report 80-A-15.

Earl, T. D., Ground Effect machines, North Atlantic Treaty Organization, January 1962.

Eggleton, Peter L, *The Development of the Magnetically Levitated Transportation System in Canada*.

Elsley, G. H., and A. J. Devereux, Hovercraft Design and Construction, David & Charles Newton Abbot, 1968.

Ewart, W. D., Hydroplanes And Hovercraft, Frederick Muller Limited, London, 1962.

Faulkner, Henry B., *The Cost of Noise Reduction in Commercial Tilt Rotor Aircraft*, MIT Department of Aeronautics and Astronautics, August 1974.

- Federal Aviation Agency, STOL and VTOL System Study: SF-LA Model by FAA Study Group, Federal Aviation Agency, Aircraft Development Service, Dec. 1966.
- Forrester, A. and G. Kuskevics, Ion Propulsion, AIAA Selected Reprints 1961-1968.
- Futures Group, Inc., Market Potential of Electrolytic Hydrogen Production in three Northeastern Utilities' Service Territories, Futures Group Inc., May 1984.
- Futurist Magazine, "Techtrends" May-June 1988.
- G. Worthington, *Airline Instrument Flying*, London Sir Isaac Pitman & Sons, Ltd., 1968, pp. 260-265.
- Galbraith, A. D., *Electric Propulsion for High Performance Light Aircraft*, Continential Group, Inc., Palo Alto, CA, #79-1265 presented at AIAA/SAE/ASME 15th Joint Propulsion Conference, June 18-20, 1979.
- Galbraith, A. D., *Practical Feasibility Assessment of Electric Power Propulsion in Small Helicopters using Lithium Hydroxide Battery Technology*, Los Angeles, Hughes Helicopters, Inc., 1981.
- Galbraith, A.D., *Power Cell Program Memo #3*, Inter-departmental Communication, Lockheed Aircraft Co.
- Galbraith, Jacoby, A.D., and Kirchen, P. T. *Practical Feasibility Assessment of Electric Power Propulsion in Small Helicopters Using Lithium Hydroxide Battery Technology*; Hughes Helicopters, Inc., Dec. 1981.
- General Electric Company, Improved Motors for Utility Applications, Vol 1: Industry Assessment Study: Update and Analysis, General Electric Company, Sept. 1985.
- Georgia Institute of Technology Complex Systems Design, *Interurban Air Transportation System*. Atlanta, Georgia: 1969.
- Georgia Tech, *Interurban Air Transportation System* 1969.
- Giancoli, Douglas.C., *Physics Principles with Applications*, Prentice-Hall International, Inc., 1980.
- Global 2000 Commision, *The Global 2000 Report to the President - Entering the Twenty-First Century*, 1980.
- Graduate School of Business Administration, Fuel Cells Power For The Future, Harvard University, 1960.
- Gregerly, Mathewes, and Edelsach, The Science and Technology of Super Conductivity, Plenum Press, New York, Vol 2, 1973.
- Hamilton Standard, *Generalized Method of Propeller Performance Estimation*, United Aircraft Corporation.
- Hanley, A., "Tilt-Rotor, Airpower of the Future," Airpower Magazine, Vol. 19, No. 3, May 1989.
- Harris, Dr. Robert, California Economic Development Corporation, *California Telecommunications Policy For The Twenty-First Century*, 1984, p. 21.
- Hockaday, S., California Polytechnic State University, San Luis Obispo.

- J. Foster, L. McGee, D. Dugan, "Helical Automatic Approaches of Helicopters with Microwave Landing Systems," NASA Technical Paper 2109, Dec. 1982.
- J. McClellan, "Collision Vision," *Flying*, May 1989, pp. 54-61.
- Jahn, Robert G., Physics of Electric Propulsion, McGraw-Hill Book Company, 1968.
- Johnson, Wayne, Lau, Benton, H., Bowles, Jeffrey, V., *Calculated Performance, Stability, and Maneuverability of High Speed Tilting Proprotor Aircraft*; NASA Ames Research Center, Moffett Field, CA 94035, July 1986.
- Joint Center for Political Studies, "Demographic Change and Worktrip Travel Trends, Volume 1, Final Report," Cooperative Agreement DC-09-7009, for the UMTA, DOT. February 1988.
- Joner, B., *Feasibility Study of Modern Airships, Final Report*, Boeing Vertol Company, May, 1975.
- Kahn, Nasser, *Intrastate Travel Demand*, March 13, 1989.
- Kain, John F.; Fauth, Gary R.; and Zax, Jeffrey, "Forecasting Auto Ownership and Mode Choice for U.S. Metropolitan Areas, Volume 1. Final Report," Harvard University Graduate School of Design, for the Office of University Research, Research and Special Programs Administration, DOT. December 1978.
- Knight, Robert L. and Trygg, Lisa L., of De Leuw, Cather and Company, "Land Use Impacts of Rapid Transit: Implications of Recent Experience. Final Report," for the Assistant Secretary for Policy, Plans and International Affairs, DOT, August 1977.
- Kuchemann, D., *The Aerodynamic Design of Aircraft*; Pergamon Press, 1978.
- Laithwaite, E.R., *Transport Without Wheels*, Westview press, Inc., 1977.
- Larsen, Egon, Hovercraft And Hydrofoils Work Like This, J.M. Dent & Sons LTD., London, 1970.
- Liebhafsky & Cairns, Fuel Cells and Fuel Batteries: A Guide to Their Research and Development, John Wiley & Sons, Inc., New York, 1968
- Lockheed-California Company, "Preliminary Market Analysis of the CL-1026 Compound Aircraft" June, 1967.
- Lockheed-California Company, Study of Aircraft in Intraurban Transportation Systems, June 1971.
- Lockheed-Georgia Company, *Mass Air Transportation Study Final Report*. Marietta, Georgia: 1968.
- Los Angeles Times, "Offer Could Delay Airport at Palmdale.", Part II:3, . Friday, 3 June, 1988.
- Maderosian, Ara, "Selecting The Best Structure Design And Construction System For The Potential Los Angeles/ Southern California Regional Offshore Airport Facility", 1988
- Magee, J.P., Clark, R., Alexander, H., *Conceptual Design Studies of 1985 Commercial VTOL Transports that Utilize Rotors*, Volumes I and II; Boeing Vertol Co., Philadelphia, Penn., Nov. 1974.
- Magee, J.P., Clark, R.D., Widdison, C.A., *Conceptual Engineering Design Studies of 1985 - ERA Commercial VTOL and STOL Transports that Utilize Rotors*; NASA Contractor Report, Boeing Vertol Co., May 1975.



- Magee, J.P., R. Clark, and H. Alexander, *Conceptual Design Studies of 1985 Commercial VTOL Transports that Utilize Rotors*, Volume I, Boeing Vertol Company, Nov. 1974.
- "Magnetic Levitation," *Popular Mechanics*, June 1981.
- Mahmoodi, Amir Saeid, "An Offshore Floating Airport," California Polytechnic State University, June 1986.
- Mantell, C. L., Batteries and Energy Systems, Second Edition, McGraw Hill Book Co.
- Marble, F. and J. Surugue, Physics And Technology Of Ion Motors, NATO documents, Gordon And Breach Science Publishers, New York, 1963.
- Massachusetts Institute of Technology Flight Transportation Laboratory, *A Systems Analysis of Short Haul Airt Transportation*. Technical Report 65-1. Cambridge, August, 1965.
- McCormick, Barnes W., *Aerodynamics, Aeronautics, and Flight Mechanics*; John Wiley & Sons, 1979.
- Morlok, Edward R, Univ. of Penn, personal interview, 11 Jan. 1989
- Mulready, R.C., *Liquid Hydrogen Engines*; Pratt & Whitney Aircraft Group, Sept. 13, 1979.
- Municipality of Metropolitan Seattle, Service Planning and Market Development Division, *Encouraging Public Transportation Through Effective Land Use Actions*, DOT-I-87-35, for the DoT. May 1987.
- National Aeronautics and Space Administration, "Quiet, Powered-Lift Propulsion : A conference held at Lewis Research Center, Cleveland, Ohio. November 14-15, 1978," NASA Conference Publication 2077, Scientific and Technical Information Office, NASA. 1979.
- National Aeronautics and Space Administration, *Terminal Area Automatic Navigation, Guidance, and Control Research Using the MLS* (NAS 1.26:3451).
- National Aeronautics and Space Administration, *Vehicle Technology For Civil Aviation, The Seventies and Beyond*, Langley Research Center, 1971.
- National Research Council, *Measuring Airport Landside Capacity*, Special Report 215, Transportation Research Board, 2101 Constitution Avenue, N.W., Washington, D.C. 20418. 1987.
- National Transportation Policy Study Commission, *National Transportation Policies-Through the Year 2000*, June 1979.
- Nicolai, Leland M., *Fundamentals of Aircraft Design*, U.S.A., 1975.
- Nobbe, George, "Tokyo's Aquapolis", OMNI Magazine August 1988.
- Oniciu, L., Fuel Cells, Abacus Press, 1971.
- Optima Publications, *Pilot's Guide to California Airports*, 1988.
- Ott, James, "FAA Will Test Wayport Concept As Remedy to Airport Congestion", *Aviation Week & Space Technology*, January 9, 1989.
- Paisley, David J., *Rotor Aerodynamic Optimization for High Speed Tiltrotors*; Senior Engineer, Boeing Vertol Co., Philadelphia, Penn. (Presented at the 43rd Annual Forum of the American Helicopter Society, St. Louis, Mo., May 1987).

Partners for Livable Spaces, "The Way to Go: The Benefits of Quality Design in Transportation," Design Arts Program of The National Endowment for the Arts, and the DOT. April 1983.

Peña, Federico, *The New Denver International Airport Report*, The Department of Public Works, City & County of Denver, 1988.

Perkins, Courtland D., *Airplane Performance Stability and Control*, New York, John Wiley and Sons, 1949.

Phone conversation, National Weather Service, Bakersfield, California, May 4, 1989.

Poole, Robert, "Stuck in Traffic", 1985.

Prouty, Raymond W., *Helicopter Performance, Stability, and Control*; PWS Engineering, Boston, 1986.

Pulgrano, L., Tracked Air Cushion Research Vehicle: Vehicle/Guideway Dynamic Analysis, Grumman Aerospace Corporation - U.S. Department of Transportation, March 1971.

Reno, Arlee T., and Bixby, Ronald H., "Characteristics of Urban Transportation Systems," of System Design Concepts, Inc., UMTA, DOT, October 1988.

Rhodes, R.G. and B.E. Mulhall, *Magnetic Levitation for Rail Transport*, Oxford University Press, 1981.

Roskam, Dr. Jan, *Airplane Design, Parts I through V*; Roskam Aviation and Engineering Corporation, 1985.

Roskam, Dr. Jan, *Airplane Design: Parts I - VI*, Ottawa, Kansas, Roskam Aviation and Engineering Corporation, 1985.

*Rotor & Wing International*, June 1985; PJS Publications Inc., Peoria, Ill.

Samaras, Demetrios G., Applications of Ion Flow Dynamics, Prentice-Hall, Inc., New Jersey, 1962.

Savatteri, C. and J. Helgesen, Tracked Air Cushion Research Vehicle-Vehicle Performance, Grumman Aerospace Corporation - U.S. Department of Transportation, March 1971.

Schlosser, A., Tracked Air Cushion Research Vehicle Subsystem, Grumman Aerospace Corporation - U.S. Department of Transportation, March 1971.

Schneider, J.B. et al., *Planning and Designing a Transit Center Based Transit System: Guidelines and Examples from Case Studies in Twenty-two Cities*, Departments of Civil Engineering and Urban Planning, University of Washington, Seattle, WA, 98195, for the UMTA, DOT, September 1980.

Schoendorfer, D. L. and Edward Morlok, *Cost Characteristics of Tilt-Rotor, Conventional Air and High Speed Rail Short-Haul Intercity Passenger Service*, University of Pennsylvania, PA, May 1985.

Sheppard, J., The Wayport Concept, May 25, 1989.

Shevell, Richard S., "Studies in Short Haul Transportation in the California Corridor," Department of Aeronautics and Astronautics, Stanford University, July 1973, p. 21-29.

Skidmore, Owings and Merrill, "Airport Planning and Environmental Assessment, Notebook 1: Guidance Notebooks for the Environmental Assessment of Airport Development Projects," for the DOT. 1978.

Smith, L. K., "Helicopter Commuters: An Optimistic Outlook," *Vertiflite*, American Helicopter Society, September/October, 1982.

Sosslau, Arthur B., *Transportation Planners' Guide to Using The 1980 Census, Final Report*, COMSIS Corporation, for the Urban Planning and Transportation Management Division, DoT. January 1983.

Southern California Association of Governments (SCAG), Draft Regional Mobility Plan, October 1988.

Southern California Association of Governments, Howard Needles Tammen and Bergendoff, 1979.

Spielberg, F., et al., "Impact of Demographic and Migration Trends on Future Travel in Metropolitan Areas," SG Associates, Inc., for the Assistant Secretary for Policy and International Affairs, DOT, December 1980.

Sponseller, Michael, "Magnetic Train", Popular Science Magazine December, 1988.

Staff, "FAA Refines MLS Plan," *Flying*, May 1989, pg. 21. Stanford University, *A Design Study of a Metropolitan Air Transit System*, August 1969.

State of California, "Report of the Legislative Analyst to the Joint Budget Committee", The 1988-89 Budget Perspectives & Issues.

Stepniewski, W.Z., *Rotary-Wing Aerodynamics*; C.N. Keys, Dover Publications, Inc., New York, 1984.

"Stuck in Traffic", A presentation of KCET television in Los Angeles, 1985, hosted by Jeffery Kaye.

*Super Speed Ground Transportation System*, Las Vegas, Nevada, 1988.

"Superconductivity," *Popular Science*, April, 1988.

Swan, Christopher, "Transformation of Transportation, Calif. 1981.

Talbot, Peter E., Bowles, Jeffrey V., Lee, Henry C., *Helicopter Rotor and Engine Sizing for Preliminary Performance Estimation*; Ames Research Center, Moffet Field, CA.

Taylor, John W. R., ed., *Jane's All the World Aircraft*, London, Jane's Publishing Company Limited, 1986.

Thibault, J.J., *Hydrogen Liquefaction, Storage and Transfer on an Airport Site*; International Symposium "Hydrogen in Air Transportation", Stuttgart, Germany, September 11-14, 1979.

Torenbeck, Egbert, *Synthesis of Subsonic Airplane Design*; Delft University Press, 1982.

True, H.C., and E.J. Rickley, "Noise Characteristics of Eight Helicopters," U.S. Department of Transportation, Federal Aviation Administration, p. 50-62, July 1977.

True, H.C., and E.J. Rickley, "Noise Characteristics of Eight Helicopters," U.S. Department of Transportation, Federal Aviation Administration, July 1977, p. 50-62.

U.S. Census of Population, 1980. *Local Population Estimates: California*, (P-26/82-5-SC), Washington DC: Government Printing Office, September, 1984.

U.S. Department of Transportation, *Aviation Noise Abatement Policy*, November 18, 1976, p. 16.

U.S. Department of Transportation, "Noise Control and Compatibility Planning for Airports," August 5, 1983.

Urban Mass Transportation Administration, DOT, *Characteristics of Urban Transportation Demand, An Update*, USGPO, Washington, D.C., July 1988.31. California Department of Finance, *Population Projections for California Counties 1975 - 2020*, Report 74, Sacramento, California, June 1974.

Urban Mass Transportation Administration, DOT, *Characteristics of Urban Transportation Systems*, USGPO, Washington, D.C., October 1985.

Urban Mass Transportation Administration, UMTA, DOT, *Demographic Change and Worktrip Travel Trends, Volume 1, Final Report*, USGPO, Washington, D.C., February, 1985.

Urban Mass Transportation Administration, UMTA, DOT, Statistical Tables, *Demographic Change and Worktrip Travel Trends, Volume 2*, USGPO, Washington, D.C., February 1985.

US Department of Commerce, Bureau of the Census, *1980 Census of the Population: Subject Reports: Place of Work*, Report number PC80-2-6E, June 1984.

US Department of Commerce, Bureau of the Census, 1980 Census, "Journey to Work: Characteristics of workers in Metropolitan Areas."

US Department of Commerce, Bureau of the Census, *Statistical Abstract of the United States*, U.S. Government Printing Office, 1988 c.2.

US Department of Commerce, *Economic Indicators*, U.S. Government Printing Office, Washington, D.C., August, 1988.

US Department of Transportation, *Metropolitan Areas*, December 1980.

US Department of Transportation, *National Transportation-Trends and Choices (To the year 2000)*, 1979.

US Department of Transportation, Office of the Assistant Secretary for Policy, Plans, and International Affairs, *Land Use Impacts of Rapid Transit; Implications of Recent Experience*, USGPO, Washington, D.C. August 1977.

US Department of Transportation, Office of the Secretary of Transportation, *Washington, D.C. Heliport Study. Executive Summary*, October 1984.

US Department of Transportation, "Terminal Area Forecasts", Federal Aviation Administration, April 1988.

US Federal Aviation Administration, Associate Administrator for Aviation Standards, Rotorcraft Program Office, *Rotorcraft Master Plan, Executive Summary and Overview*, December 1984.

US Federal Aviation Administration, Aviation Forecast Branch, Office of Aviation Policy, *Hourly Airport Activity Profiles: 30 airports by user, 3 airports by user and equipment type. Selected days in June, July, and August 1978.*

US Federal Aviation Administration, DOT, *FAA Aviation Forecasts, FY 1988-2000*, USGPO, Washington, D.C.

US Federal Aviation Administration, *National Airspace System Plan: Facilities, Equipment and Associated Development*, April 1984.

US Federal Aviation Administration, Office of Aviation Policy and Plans, Eighth Annual FAA Forecast Conference "Proceedings, Fiscal Years 1983-1994", February, 1983.

US Federal Aviation Administration, Office of Aviation Policy, Aviation Forecast Branch, FAA, DOT, *Domestic and International Air Carrier Activity, National and Selected Hub Forecasts*, November 1979.

- US Federal Aviation Administration, Office of Aviation Policy, *Terminal Area Forecasts: Fiscal Years 1980-1991*, November, 1979.
- US Federal Aviation Administration, Policy Analysis Division, Office of Aviation Policy, *Commuter Air Carrier Loan Guarantee Study*, TD 4.32/11: 80-1, January 1980.
- US Federal Aviation Administration, R, E & D Project Plans, *The Federal Aviation Administration Plan for Research, Engineering and Development, Volume 2*, October 1985.
- US Federal Aviation Administration, Research and Special Programs Administration, *Airport Activity Statistics of Certificated Route Air Carriers*, 12 Months Ending December 31, 1987.
- US Federal Aviation Administration, *The Federal Aviation Administration Plan for Research, Engineering and Development, Volume 1, Plan Overview*, October 1985.
- US House of Representatives, 97th Congress, Advanced Rail Technology, Hearings before the Subcommittee on Investigations and Oversight of the Committee on Science and Technology, USGPO, Washington, D.C.
- US House of Representatives, 97th Congress, Hearings before the Subcommittee on Investigations and Oversight of the Committee on Science and Technology, *Advanced Rail Technology*, USGPO, Washington, D.C.
- "V/STOL Tilt-Rotor Study Task II," Research Aircraft Design, Bell Helicopter Co., 1974.
- Von Glinow, Mary Ann, Professor University of Southern California, "Stuck in Traffic", 1985.
- Wachs, Martin, University of California at Los Angeles's Urban Planning Department, "Stuck in Traffic", 1985.
- Wagner, Ronald, *Air Transportation Systems for the California Corridor of 2010*, California Polytechnic State University, San Luis Obispo, 1987.
- Wiley, John R., *Airport Administration and Management*, Eno Foundation for Transportation, Box 2055, Westport, Conn. 06880, 1986.
- Williams, K. R., An Introduction to Fuel Cells, Elsevier Publishing Co.
- Winfrey, Tom, Los Angeles Department of Airports spokesman, personal interview, Thursday, 1 December 1988.
- Workshop Proceedings Generator Monitoring and Surveillance, Proceedings, August 1984.
- Yen, A.M., et al., *Assessment of The Passenger Shuttle System (PSS) at Tampa International Airport*, SRI International, Menlo Park, CA., for the UMTA, DOT, December 1977.
- Young, G. J., Fuel Cells, Reinhold Publishing Corp., pg. 300.
- Younglove, Norton Air Quality Management District, "Stuck in Traffic", 1985.
- Zahavi, Yacov; Beckmann, Martin J.; and Golob, Thomas F., *The "UMOT"/Urban Interactions*, Mobility Systems Inc., for the Research and Special Programs Administration, Systems Analysis Division, DOT. January, 1981.