

NASA Technical Memorandum 101658

SHUTTLE-C UTILIZATION FOR ASSEMBLY OF THE REPHASED FREEDOM CONFIGURATION

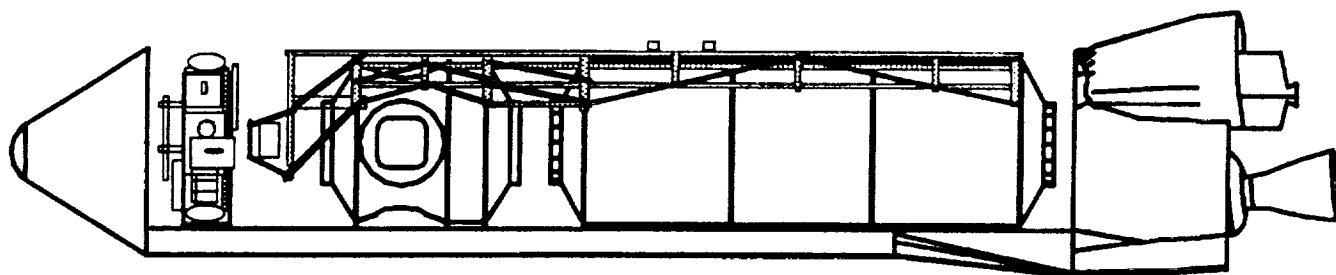

(NASA-TM-101658) SHUTTLE-C UTILIZATION FOR
ASSEMBLY OF THE REPHASED FREEDOM
CONFIGURATION (NASA) 57 p CSCL 22B

N90-15120

Unclas
G3/15 0257100

L. J. DeRyder
W. A. Sasamoto
P. A. Troutman

NASA
National Aeronautics and
Space Administration
Langley Research Center
Hampton, Virginia 23665-5225

August 1989

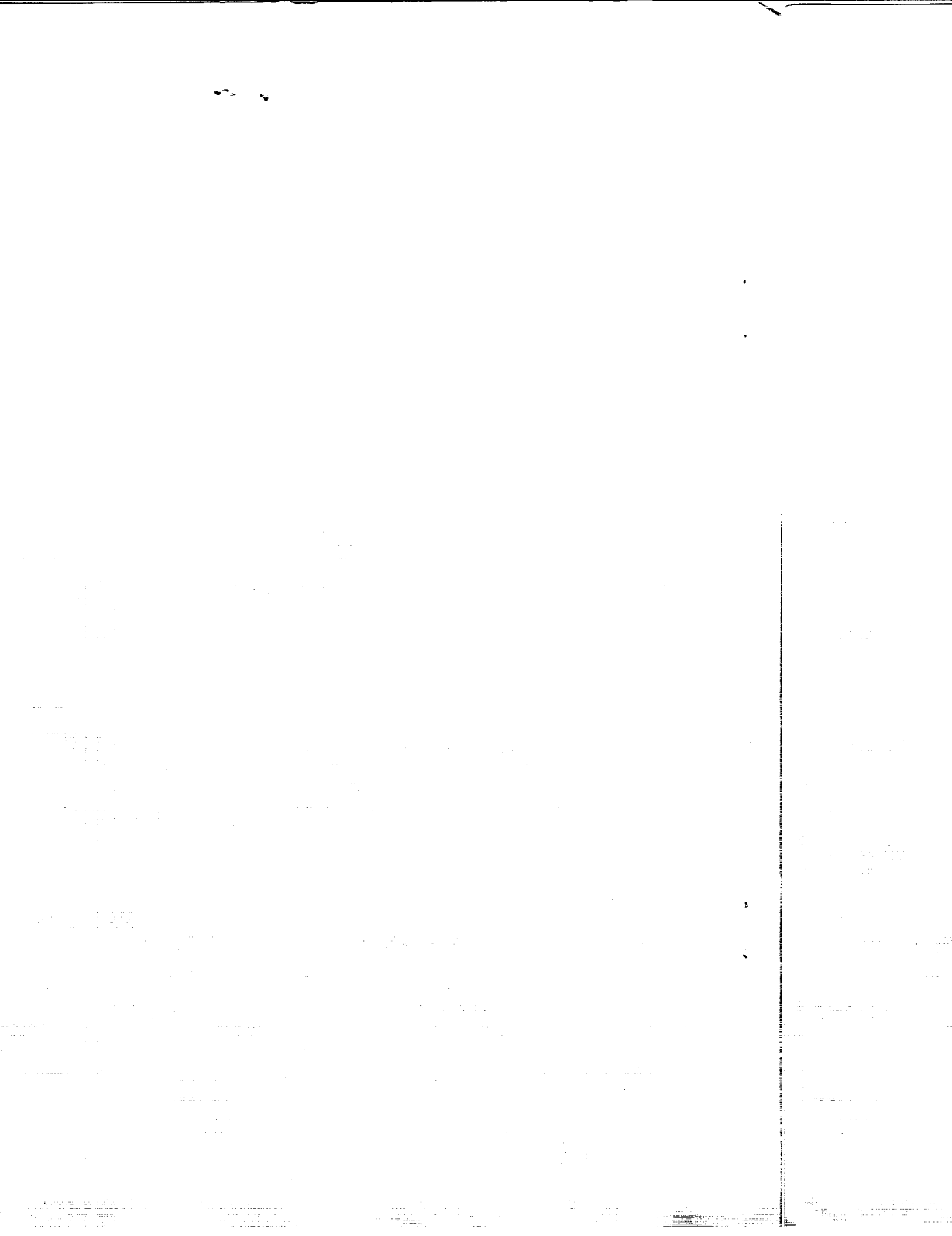

INTRODUCTION

The Space Station Freedom configuration defined by NASA will require almost five Space Shuttle missions per year beginning in 1995. Current assembly flight scenarios are envisioned that require a two year on-orbit build up process to achieve a permanent manned capability configuration. More than five years are predicted to achieve a final configuration that completes the assembly process based on current multi-year budget level projections for NASA.

The Freedom configuration design is uniquely dependent on the Shuttle Orbiter to launch the various station elements to a secure orbital altitude for assembly by Shuttle astronauts using the robotic capability of the Orbiter's remote manipulator arm. Alternate launch vehicle development for Freedom program utilization would need to provide a sufficient performance increase to justify development and operation expenditures as well as meet future national needs for new space initiatives and operational support capabilities.

The purpose of this report is to assess the utilization of an expendable heavy lift unmanned launch vehicle derived from the Space Shuttle hardware design, known as the Shuttle-C, to augment the delivery to earth orbit of elements for assembly of a rephased definition of Space Station Freedom currently under definition within NASA. A past history of previous heavy lift launch vehicle studies performed with respect to assembly of the Freedom station will be reviewed and conclusions extrapolated that are appropriate for the new rephased Freedom definition. The rephased Freedom definition will be explained, utilization scenarios will be developed, and related assessments provided.

LAUNCH VEHICLE CONSIDERATIONS FOR FREEDOM ASSEMBLY FLIGHTS

NASA has considered several scenarios for utilizing alternate unmanned expendable launch vehicles to augment the Space Shuttle capabilities to enhance the Freedom assembly process. The obvious initial consideration is to minimize the Shuttle flight rate and the total number of launches required to complete the Freedom assembly process. Another consideration is the potential for reducing the heavy dependence on astronaut Extravehicular Activity (EVA) which requires crew to work in the Shuttle cargo bay in pressurized space suits to assemble Freedom elements. The use of heavy lift launch vehicles (HLLV) with more mass and volume to orbit capability than the Shuttle Orbiter performance provides could offer more opportunities to pre-integrate Freedom station elements on the ground prior to launch thereby obviating the need to do those particular tasks during space flight. For initial assembly flights, the more pre-integration that can be accomplished prior to launch the more the reduction in the demand for EVA while in earth orbit. Later during the Freedom assembly sequence, when the heavier elements such as the pressurized laboratories and crew habitation modules are launched, more internal outfitting can be initially included thereby reducing the logistics and resupply demands that must be interleaved with assembly flights to complete the build up process. Utilizing HLLV provides the potential for shortening the assembly process to offer NASA an option for earlier science utilization or reducing the launch rate required to achieve an assembly complete configuration.

MIXED FLEET/HLLV UTILIZATION
KEY FREEDOM PROGRAM CONSIDERATIONS FROM
PREVIOUS STUDIES STILL APPLY

- **MINIMIZE THE NUMBER AND RATE OF SHUTTLE ASSEMBLY FLIGHTS**
- **MINIMIZE HEAVY DEPENDENCE ON EVA FOR STATION ASSEMBLY**
- **MAXIMIZE ELEMENT AND SUBSYSTEM PRE-LAUNCH INTEGRATION/VERIFICATION**
- **IMPROVE HAB/LAB MODULE OUTFITTING LOGISTICS AND RESUPPLY**
- **ENHANCE EARLY SCIENCE/UTILIZATION**

NASA ALTERNATE LAUNCH VEHICLE STUDIES FOR FREEDOM ASSEMBLY

NASA has documented a series of studies which considered the use of augmenting the Space Shuttle with expendable launch vehicles for Space Station Freedom assembly flights beginning in 1986. Former NASA Administrator Dr. James Fletcher released NASA's post Challenger Mixed Fleet Report which announced NASA's intention to reduce the dependence on Space Shuttle as the Nation's primary launch vehicle. A plan was developed that specified the use of expendable launch vehicles for certain satellite launches to reduce the rate at which Shuttle was required to fly and reduced the total number of required Shuttle launches over a multi-year period. It called for the use of expendable launch vehicles to deploy Space Station program polar and co-orbiting platforms in low earth orbit. This was a deviation from the assembly sequence baseline established by the Space Station Critical Evaluation Task Force (CETF) which mandated total Shuttle Orbiter launch vehicle dependence.

Also in 1986 General James Abramson, head the Air Force Strategic Defense Initiative (SDI) program, in a December report to the President outlined SDI satellite deployment plans that required the use of launch vehicles with more lift capacity than the Space Shuttle. This prompted Congress to request NASA to report on its future need for heavy lift launch vehicles. Since Space Station was NASA's near term need, studies were conducted that considered new and modified definitions for Freedom hardware as well as approaches to Freedom assembly that were unique to HLLV utilization for which only vehicle concepts existed at that time.

Following NASA Deputy Administrator Dale Myers' March 1987 congressional testimony regarding HLLV utilization, Congress commissioned the National Research Council to form a special committee to study space station transportation needs. Studies were performed that considered and compared various assembly sequence scenarios for existing Freedom hardware definitions using enhanced launch vehicle descriptions. Several versions of unmanned Shuttle derived cargo carrier launch vehicles (Shuttle-C) and manned Shuttle Orbiter vehicles with advanced solid rocket motors (ASRM) were assessed for Freedom assembly comparisons.

ENHANCED LAUNCH VEHICLE STUDIES FOR FREEDOM ASSEMBLY

- LATE 1986 - MIXED FLEET EXPENDABLE LAUNCH VEHICLE (ELV)
 - STUDIES FOR DECEMBER 1986, FLETCHER POST CHALLENGER MIXED FLEET REPORT
 - UTILIZATION OF ELV'S TO REDUCE SHUTTLE ASSEMBLY FLIGHTS AND RATE
 - CETF BASELINE STATION HARDWARE DEFINITIONS

- EARLY 1987 - HEAVY LIFT LAUNCH VEHICLE (HLLV) STUDIES
 - SUPPORT MARCH 1987 CONGRESSIONAL TESTIMONY
 - RESPONSE TO DECEMBER 1986 ABRAMSON/SD1 WHITE HOUSE REPORT
 - ADVANCED NASA, AIR FORCE AND INTERNATIONAL CONCEPTS CONSIDERED
 - NEW AND MODIFIED DEFINITIONS FOR FREEDOM HARDWARE CONSIDERED

- MID 1987 - SPACE STATION TRANSPORTATION STUDIES
 - AUGUST/SEPTEMBER 1987 REPORTS TO NRC SPECIAL COMMITTEE
 - SHUTTLE DERIVED VEHICLE (SDV) SHUTTLE-C CLASS LV'S CONSIDERED
 - APRIL 1987 PHASED PROGRAM FREEDOM HARDWARE DEFINITIONS

FREEDOM ASSEMBLY ENHANCED LAUNCH VEHICLE STUDIES

As a result of the Shuttle program focus on the development of ASRM to enhance the Orbiter lift capacity by approximately 12,000 pounds, Freedom Program Manager Thomas Moser requested that a study be performed to assess the use of ASRM enhanced Shuttle launches for Freedom assembly, outfitting and resupply missions. Special study emphasis was focused on establishing conservative Freedom weight growth contingency and program reserve margins for these missions.

In early 1989 a NASA study was performed jointly by the Office of Space Station and the Office of Space Flight to assess the use of currently developed expendable launch vehicle (ELV) designs to support Freedom station operations and logistics requirements. This study examined the benefits, implications and costs associated with implementing a mixed launch vehicle fleet operations traffic model that included the use of both Shuttle Orbiters and ELV payload carriers. A study recommendation was made for the use of both ASRM enhanced Shuttle and ELV flights to meet Freedom operations and logistics needs.

ENHANCED LAUNCH VEHICLE STUDIES FOR FREEDOM ASSEMBLY

(Cont.)

- MID 1988 - ENHANCED STS STUDIES
 - AD HOC STUDY FOR FREEDOM PROGRAM DIRECTOR
 - STS AUGMENTED WITH ADVANCED SOLID ROCKET MOTORS (ASRM)
 - NOVEMBER 1987 (NOVREF) FREEDOM HARDWARE DEFINITIONS

- EARLY 1989 - JOINT OSS/OSF ELV LOGISTICS OPERATIONS STUDY
 - BENEFITS, IMPLICATIONS AND COSTS OF MIXED STS/ELV FLEET
 - MAY 1989 REPORT TO OSF AND OSS ASSOCIATE ADMINISTRATORS
 - ASRM OR ELV STS AUGMENTATION RECOMMENDED

FREEDOM ENHANCED LAUNCH VEHICLE UTILIZATION STUDY REPORTS

Listed here are reports that document the NASA studies described in the preceding pages herein for utilizing expendable and enhanced performance launch vehicles to augment the use of the Shuttle Orbiter to assemble, resupply and operate the Space Station Freedom. These reports cover a period of three years from 1986 thru 1989.

The purpose of this report is to assess the use of the Shuttle -C launch vehicle for the assembly of a re-phased definition of the Space Station Freedom Program configuration. This assessment was performed at the request of the present Freedom Program Director, Mr. Richard Kohrs, to provide impacts and options to consider for using the capabilities as presently defined, for Shuttle-C development to augment Space Shuttle launches for assembly of Freedom elements that have reduced capability definitions. The reduced Freedom capability definitions provide budget reduction options but maintain the current station configuration profile to permit a phased add back of capability as program budget multi-year profile projections permit.

This assessment addresses Shuttle-C performance capabilities, Freedom assembly considerations and program development schedules. Cost assessments are not presented. Two utilization scenarios are presented that considers Shuttle-C use early in the Freedom program and use later on in the assembly flight sequence.

MAJOR SDV/HLLV REPORTS FOR SPACE STATION APPLICATIONS

- ADMINISTRATOR'S MIXED FLEET REPORT (DEC 86)
- SPACE STATION HEAVY LIFT LAUNCH VEHICLE UTILIZATION STUDY RESULTS (JAN 87)
- SPACE STATION HEAVY LIFT LAUNCH VEHICLE UTILIZATION (FEB 87)
- MANNED MARS MISSION ACCOMMODATION AND HEAVY LIFT LAUNCH VEHICLE UTILIZATION - A REPORT TO DALE MYERS (MAR 87)
- SHUTTLE-C CARGO ELEMENT (SCE) UTILIZATION FOR ASSEMBLY (PLUS ADDENDUM) - FINAL DATA DROP (JULY 22, 1987)
- REPORT TO THE NATIONAL RESEARCH COUNCIL ON THE NASA SPACE STATION TRANSPORTATION STUDY (AUG 3, 1987)
- NASA SPACE STATION TRANSPORTATION STUDY REPORT (AUG 31, 1987)
- ENHANCED STS PERFORMANCE UTILIZATION FOR SPACE STATION FLIGHT ASSEMBLY (MAY 27, 1988)
- JOINT OSS/OSF STUDY FOR ELV'S IN THE SPACE STATION FREEDOM LOGISTICS OPERATIONS (MAY 1989)

SHUTTLE-C ASCENT PERFORMANCE VERSUS FREEDOM HEAVY LIFT NEEDS

The heaviest Freedom elements defined for launch are the pressurized laboratory modules and the crew habitation module. The Freedom re-phased definition weight estimates show a reduction in weight for the U. S. Lab module and an increase in weight for the crew Hab module from the previous baseline (B/L) definition described in the Freedom Program Design Requirements Document (PDRD) which describes a 20 Shuttle flight assembly sequence that establishes a permanent manned capability on the 13th flight. In either case only one module, the European Space Agency (ESA) module, is capable of being launched fully outfitted in a single Shuttle mission. The U. S. Lab and Hab as well as the Japanese Experiment Module (JEM) can not be launched at full capacity with the Shuttle and requires additional follow-on Orbiter missions to achieve their full operational capability.

The increase in weight of the U. S. Hab module defined in this report is due primarily to a revised system definition for heat rejection at the module itself rather than at a central set of thermal radiators located external to the module, and a revised crew support system definition that requires larger storage tanks for cabin air gases and water.

Also note that an ASRM enhanced Shuttle lacks the capability to launch either a fully loaded U. S. Lab or Hab module.

Configuration options are currently defined for the Shuttle-C depending on payload heavy lift launch capability need. Since the Space Shuttle Main Engines (SSME) is a major cost consideration for an expendable Shuttle-C launch application, a 3 engine or a 2 engine version are planned. Using the current Shuttle program 104% throttle up limit, a 2 engine Shuttle-C configuration is sufficient to meet the heaviest Freedom element launch need to assembly orbital altitude.

ASCENT PERFORMANCE CAPABILITIES VS FREEDOM HEAVY LIFT NEEDS

LAUNCH VEHICLE CONSIDERATIONS

KLB TO 220 NMI
@ 28.5°

- 2 SSME @ 100% 82
- 2 SSME @ 104% 88
- 3 SSME @ 100% 141
- 3 SSME @ 104% 145

SHUTTLE ORBITER:

- 3 SSME @ 104% 39
- 3 SSME @ 104% 51
(WITH ASRM)

HEAVY FREEDOM ELEMENTS

(KLB WT. W/15% CONT.)

	<u>LAB</u>	<u>HAB</u>	<u>JEM</u>	<u>ESA</u>
● 20/13 PDRD B/L	79.4	58.4	47.6	34.5
● EST. REPHASE	69.7	61.8	47.6	34.5

DUAL SSME SHUTTLE-C WILL
SATISFY FREEDOM ASSEMBLY
HLLV NEED

- FULLY OUTFITTED MODULES

REPHASED FREEDOM PROGRAM BASELINE FEATURES

As a result of planning exercises in the spring of 1989 in response to anticipated lower yearly budget levels, Freedom program management directed that development efforts be reduced in key spacecraft subsystem areas and decided to delay the on-orbit placement of certain key capabilities until the establishment of a lower level initial operational capability:

- Required power reduced to 38 kilowatts with direct current distribution,
- Four permanent crew person capability,
- Open metabolic oxygen loop with 90 day nominal cryogenic resupply,
- Eliminate recovery of used crew water,
- Eliminate dish/clothes washer and dryer hardware,
- Single phase body mounted thermal rejection radiators,
- No unique Shuttle Orbiter proximity operations equipment,
- Reduction in Cupola size and capability,
- Reduced Communication, Tracking, Guidance, Navigation and Control requirements,
- Reduced number of station structure payload attachment points,
- No separate user data management system/network,
- Replacement of H₂O₂ Propulsion/Reaction Control System with hydrazine systems.
- Only Shuttle based EVA with station based Shuttle suits for contingency.

The assembly sequence for the rephased definition calls for a total of 17 total Shuttle missions consisting of 12 assembly flights, 3 module and payload outfitting flights, and 2 logistics resupply flights.

Another major change is the requirement not to have an active operationally functional spacecraft until the third assembly flight.

Assuming a first element launch in the first quarter of 1995, and a Shuttle flight rate of 5 flights per year, the rephased Freedom program definition could achieve a man tended capability (MTC) in early 1996, and a permanent manned capability (PMC) with full International Partner participation in the mid to late 1997 time period.

REPHASED BASELINE FEATURES

- **17 TOTAL STS FLIGHTS**
 - 12 ASSEMBLY
 - 3 OUTFITTING
 - 2 LOGISTICS
- **INITIAL FLIGHTS PASSIVE**
 - FUNCTIONAL S/C AFTER FLIGHT 3
- **MTC @ FLIGHT 6**
- **PMC @ FLIGHT 12**
- **JEM @ FLIGHT 13**
- **ESA @ FLIGHT 14**

RE-PHASED FREEDOM INITIAL FLIGHT ASSEMBLY SEQUENCE PROFILE

The first 5 initial assembly flight configurations of the re-phased Freedom assembly sequence are depicted. The first four flights are defined to have a vehicle attitude orientation which has a high degree of gravity gradient stabilization.

On the first flight Shuttle astronaut EVA deploys an 18.75 kw power module, three bays of truss structure, a Sun tracking alpha rotation mechanism, and an astronaut work platform (AWP). Flight 2 construction adds 7 more truss structure bays, two reaction control system (RCS) pallets, a control moment gyro (CMG) pallet and an antenna pallet. A node module with a docking system capable of providing a pressurized attachment to the Shuttle Orbiter is added on flight 3 along with a fluid management distribution (FMAD) system to provide a functional operating spacecraft capability. Flight 4 EVA duplicates the truss structure construction of flight 2 (with the exception of an CMG pallet). Flight 5 adds the mobile servicing center with a station manipulator arm to aid in the final truss structure and power system construction. The Freedom configuration at this point has a capacity of 38 KW of electrical power installed and is re-oriented in flight with the length of the truss structure perpendicular to the orbital plane with the solar arrays revolving about the alpha joints to track the sun.

RE-PHASED FREEDOM ASSEMBLY SEQUENCE

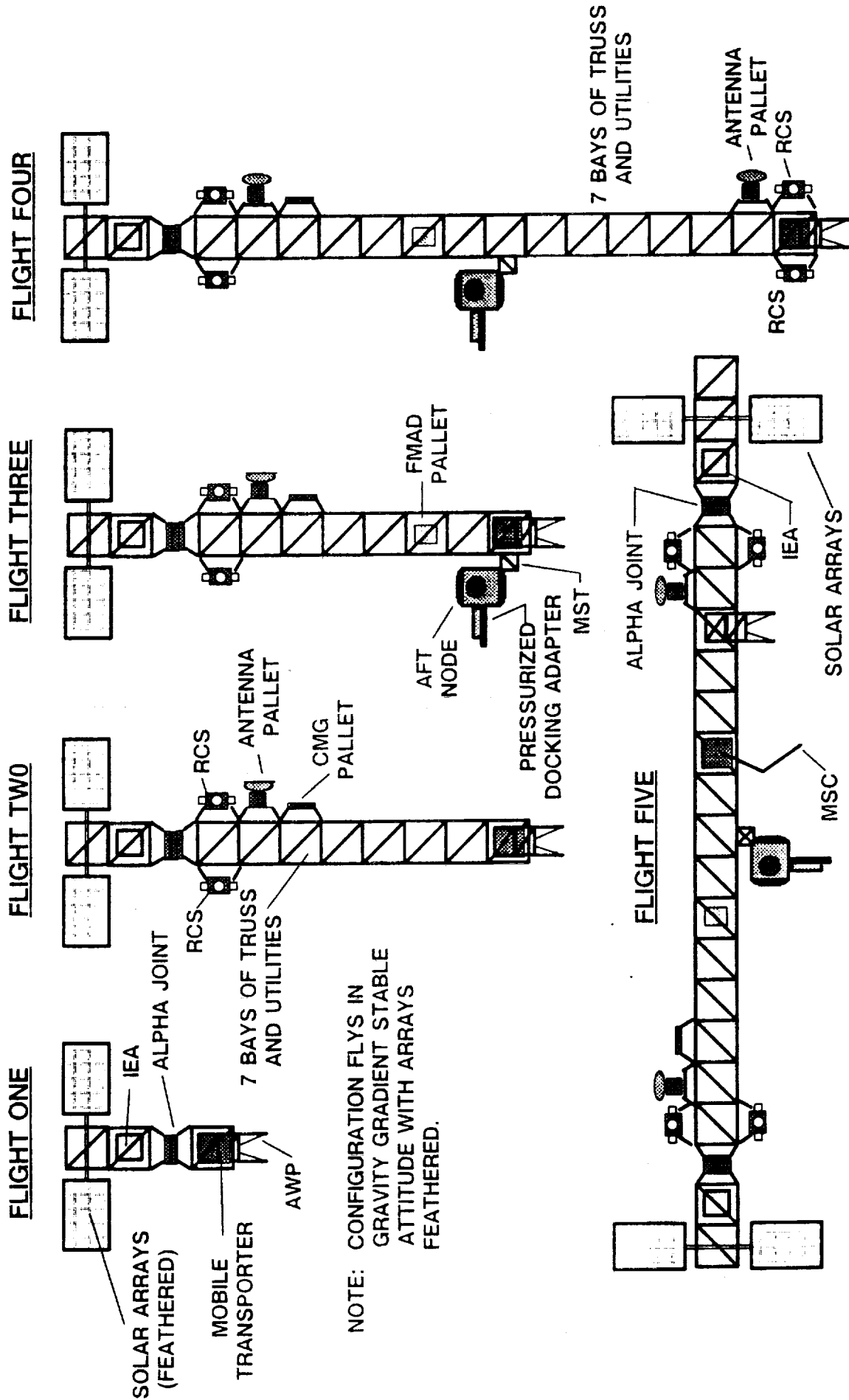

NOTE: CONFIGURATION NOW FLIES IN THE NORMAL LVLH MODE WITH SUNTRACKING ARRAYS

REPHASED FREEDOM ASSEMBLY SEQUENCE DEFINITION

A definition for the complete rephased Freedom program assembly sequence is listed. The delivery of the U. S. laboratory and habitation modules are shown to be flights 6 & 9 respectively with the Japanese module delivered on flight 13 and the European module on flight 14.

Logistics are provided at flight 12 for a permanent crew nominal stay time of 90 days although they may be rotated out as early as 45 days on subsequent Shuttle flights. A second Shuttle logistics resupply mission is required on flight 15 prior to the 17th and final flight to provide crew supplies. The last flight is an outfitting flight to deliver equipment consistent with the level of capability established for the rephased program definition.

Shuttle missions to support the assembly sequence described require the Orbiter to carry the Freedom elements to be assembled in the Orbiter cargo bay. The Mission profiles call for the Orbiter to rendezvous and dock with the existing Freedom assembly stage and for Shuttle astronauts to attach the elements carried by the Orbiter. Mixed fleet launch vehicle mission scenarios using an expendable launch vehicle to carry Freedom elements require automatic rendezvous at a prescribed orbital location to meet with the Space Shuttle to provide the astronaut EVA and robotic mechanism operation assembly capability. This Freedom, Shuttle and ELV three body mission operation requires utilization of space transportation hardware and operations methods which are not yet developed capabilities for use within NASA. The Freedom program exclusive use of the Space Shuttle is to a large measure based on not requiring dual launch and orbital rendezvous system parallel development for station assembly.

The assembly sequence presented here only describes the build up of the rephased Freedom program. A capability "add-back" plan is currently under development within the Freedom program to restore the station to its original specified capability as defined prior to the rephasing exercise. This will add additional assembly and resupply flights to the build up sequence shown here. Assembly complete is envisioned to occur in the last quarter of 1999.

REPHASED DEFINITION ASSEMBLY SEQUENCE

FLIGHT ASSEMBLY ELEMENTS

1	FEL	MB-1	STBD INBOARD INTEGRATED EQUIPMENT ASSEMBLY (IEA), SOLAR ARRAY/BETA JOINT (2), TRUSS (SA2-SB8), STBD UTILITIES (SA2-SB8), ALPHA JOINT, ASSEMBLY WORK PLATFORM/ASTRONAUT POSITIONING SYSTEM, MOBILE TRANSPORTER
2		MB-2	TRUSS/UTILITIES (SB7-SB1), STBD ANTENNA PALLET (Ku-BAND), GNC PALLET (4 CMGS), PROPULSION PALLETS (2)
3		MB-3	AFT STBD NODE, PRESS. DOCKING ADAPTER, FMAD PALLET, MODULE SUPPORT TRUSS (MST)
4		MB-4	TRUSS/UTILITIES (PB1-PB7), PORT ANTENNA PALLET (Ku-BAND), PROPULSION PALLETS (2), MT BATTERIES
5		MB-5	PORT INBOARD INTEGRATED EQUIPMENT ASSEMBLY (IEA), SOLAR ARRAY/BETA JOINT (2), TRUSS/UTILITIES (PA1-PA3), ALPHA JOINT, MSC
6	EMTC	MB-6	US LAB MODULE (44 FEET)
7		OF-1	PRESSURIZED LOGISTICS MODULE, LAB OUTFITTING (19 RACKS), APAE (FIXED)
8		MB-7	FORWARD STBD NODE, AFT PORT NODE, CUPOLA
9		MB-8	HAB MODULE (44 FEET)
10		OF-2	PRESSURIZED LOGISTICS MODULE, HAB OUTFITTING (19 RACKS), PRESSURIZED DOCKING ADAPTER, SPDM
11		MB-9	FORWARD PORT NODE, AIRLOCK, ULC BERTHING MECHANISM
12	PMC	L-1	CREW (4), PRESSURIZED LOGISTICS MODULE, UNPRESSURIZED LOGISTICS CARRIER, LOGISTICS RESUPPLY
13		MB-10	JEM MODULE
14		MB-11	ESA MODULE
15		L-2	PRESSURIZED LOGISTICS MODULE, UNPRESSURIZED LOGISTICS CARRIER, LOGISTICS RESUPPLY
16		MB-12	JEM EXPOSED FACILITY 1 & 2, JEM ELM
17		OF-3	PRESSURIZED LOGISTICS MODULE, MODULE OUTFITTING (19 RACKS), MMD

SHUTTLE-C FREEDOM MISSION SCENARIO

The scenario shown typifies a mission profile for utilizing an expendable Shuttle-C heavy lift launch vehicle for Freedom assembly or resupply. From a mission operations point of view it is complicated by the requirement to launch two vehicles within a defined operational window since Shuttle based EVA is required for any assembly activity for the rephased Freedom definition. Also, the Shuttle is required to return the Orbital Maneuvering Vehicle to earth for servicing. As will be described, utilization of the OMV is an integral definition of the Shuttle-C payload carrier operations definition.

The Shuttle-C configuration includes a SSME module, or "boat tail", which is joined with an aerodynamic shroud that encloses the payload carrier structure and an OMV. This configuration is attached to a Shuttle external fuel tank to which two Shuttle solid rocket boosters (SRB) are mated. After launch the SRBs are separated and recovered. After the SSME powered boost phase, at main engine cutoff (MECO), the shroud enclosure and external tank (ET) are jettisoned for a non-recoverable re-entry into the earth's atmosphere. The OMV is activated from a boost phase parking orbit to rendezvous the Shuttle-C payload carrier at the Freedom orbit position. The OMV then maneuvers the payload carrier within a proximity operations zone for either an automatic docking operation at a prescribed Freedom berthing location or for a grapple by the Freedom manipulator arm which attaches the carrier at a designated berth. An astronaut EVA crew is launched with the Space Shuttle (also with a prescribed cargo within the Orbiter bay) within a designated mission operations window whose 15 to 60 day length is a function of:

- 1 - Astronaut activity tasks,
- 2 - SSME boat tail on orbit stay time logistics if required to be berthed with the Shuttle-C payload carrier,
- 3 - OMV operational stay time capability.

After completion of the Shuttle mission operation tasks at the station, both the Orbiter and the OMV separate from their respective berthed positions. The OMV controls the carrier/boat tail configuration to a non-recovery re-entry trajectory into the earth's atmosphere. After initiating this maneuver the OMV separates to proceed to a parking orbit for rendezvous by the Shuttle Orbiter for return to an earth landing for servicing and reuse.

MISSION PROFILE REQUIRES MULTI-VEHICLE RENDEZVOUS

1 - OMV USED FOR P/L CARRIER

2 - STS CONCURRENT LAUNCH FOR ASSEMBLY EVA

3 - STS RETRIEVES OMV FOR GROUND SERVICING

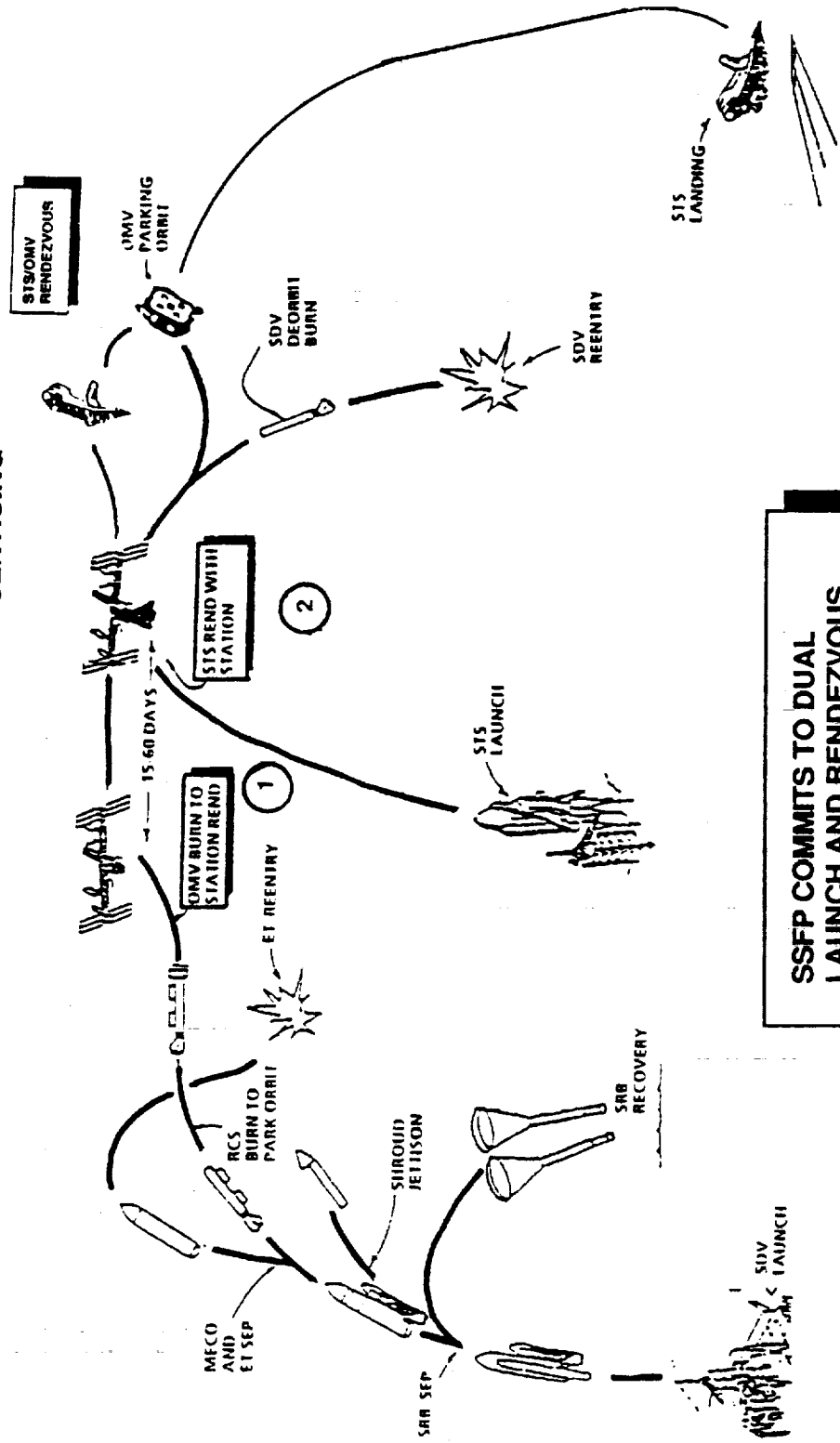

SSFP COMMITS TO DUAL LAUNCH AND RENDEZVOUS SYSTEM PARALLEL DEVELOPMENT

SHUTTLE-C FREEDOM ELEMENT ORBITAL CARRIER CONCEPTS

A concept is shown for a Shuttle-C payload carrier configuration for Space Station Freedom pressurized elements that is representative of a heavy lift launch application. The payload carrier concept depicted does not include the SSME boattail as part of the Shuttle-C elements needed to provide orbital transfer capability to and from Freedom. This configuration consists of:

- an Aerospace Support Equipment (ASE) Payload Adapter structure,
- an Orbital Maneuvering Vehicle (OMV),
- a Shuttle Payload Deployment System (SPDS),

Shown here are a Freedom pressurized module, Hab or Lab, and a connecting node mounted to the ASE Payload Adapter using Shuttle Orbiter Compatible cargo bay trunnion locations. The entire payload carrier including the OMV is deployed from the Shuttle-C structure using the rotational Shuttle Payload Deployment System (SPDS) concept illustrated here. The SPDS deployment concept requires two motions to be executed. The first motion is a vertical translation to provide clearance of the payload carrier's keel pin prior to the second motion which rotates the payload carrier clear of the Shuttle-C structure.

After the payload carrier is deployed from the Shuttle-C structure, the OMV is commanded to separate from its launched position at the end of the payload stack and to re-berth to the mid position shown to form the orbital carrier configuration for rendezvous and subsequent docking to the Freedom space station.

When considering utilization options for the Shuttle-C vehicle by the Space Station Freedom program, the development and flight demonstration schedules of both the launch vehicle and the payload carrier automated rendezvous and docking systems must be considered in the context of the mission profile previously described. In addition to the complexities of these mission control functions which must be operationally demonstrated, the subsequent return and turn around of the OMV must be included in launch facility ground processing operations at Kennedy Space Center along with Shuttle Orbiter processing. Also, Freedom launch element processing must also consider payload processing for two launch vehicles - the Shuttle Orbiter and the Shuttle-C.

FREEDOM PACKAGING, DEPLOYMENT AND ORBITAL CARRIER CONCEPTS

PRESSURIZED MODULE LAUNCH PACKAGING

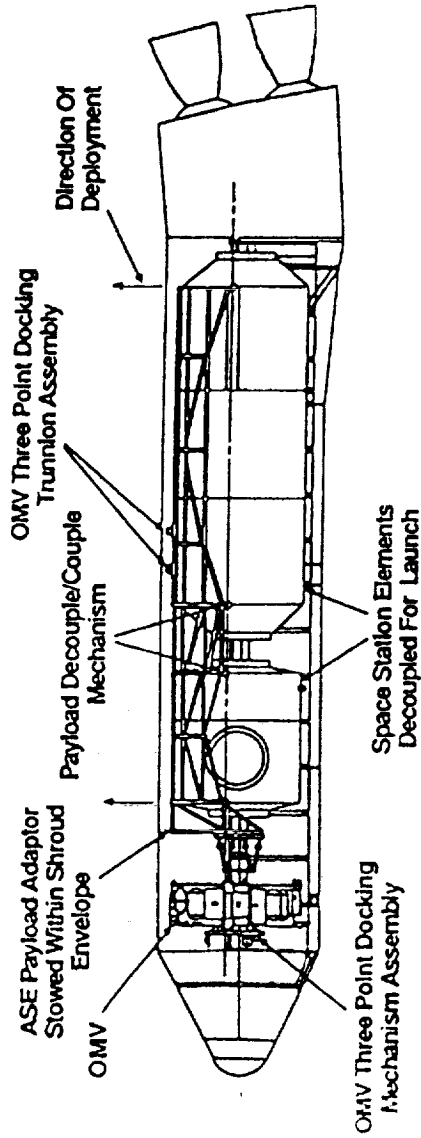

ORBITAL STATION TRANSFER CARRIER

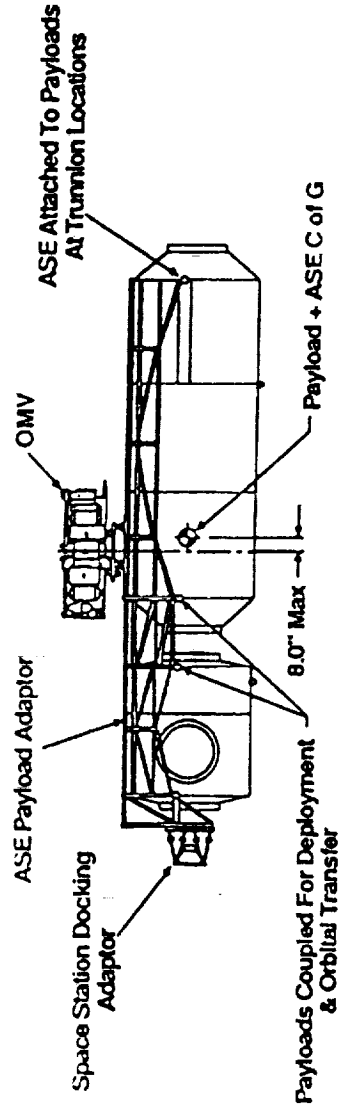

DEPLOYMENT CONCEPT

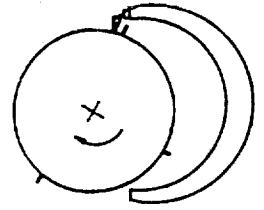
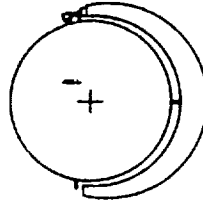
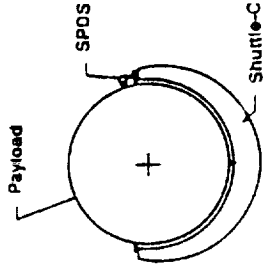

MULTI-PROGRAM DEVELOPMENT/INTEGRATION CONSIDERATIONS

Space Station Freedom utilization of the Shuttle-C as a heavy lift launch vehicle involves the parallel development and integration of three development programs within NASA. Shown here are the development and planned flight schedules for the rephased Freedom program, the Shuttle-C program and the OMV program. These schedules shown assume that current fiscal year 1990 funding profiles permit an authority to proceed in each case. For purposes of this report, the development of the Shuttle-C payload carrier for Freedom launch elements is assumed to be part of the Shuttle-C development activities.

Two utilization scenarios can be considered with reference to the development schedules illustrated. The first consideration utilizes the Shuttle-C approximately one year after Freedom first element launch. The heavy lift launch capability would be used to deploy the pressurized modules to accomplish the later assembly sequence milestones to provide the Man Tended Capability (MTC), the Permanent Manned Capability (PMC), and deploy the JEM and ESA international partnership modules. This utilization consideration would provide 21 months between the First Shuttle-C flight qualification launch and the first Freedom element heavy lift launch requirement. It also provides 30 months between the first OMV qualification launch and the first Freedom payload carrier utilization requirement. Conceivably, this could permit opportunities for operational demonstration of the previously discussed mission profile and launch processing capabilities required for Freedom utilization.

A second utilization consideration would use the Shuttle-C early in the Freedom assembly sequence to maximize the amount of prelaunch element integration to minimize the amount of on-orbit EVA required. The 3 and 12 month time periods respectively between the first Shuttle-C and OMV qualification launches and the first Freedom element launch requirement appear to be too short to permit the demonstration of the necessary mission and launch processing operational capabilities. Coordinated schedule or content adjustments would appear to be necessary within the three programs to provide ample flight demonstration opportunities.

The advantages and disadvantages of these two "Early" and "Late" utilization considerations will be discussed in the following pages of this report.

MULTI-PROGRAM DEVELOPMENT/INTEGRATION CONSIDERATIONS

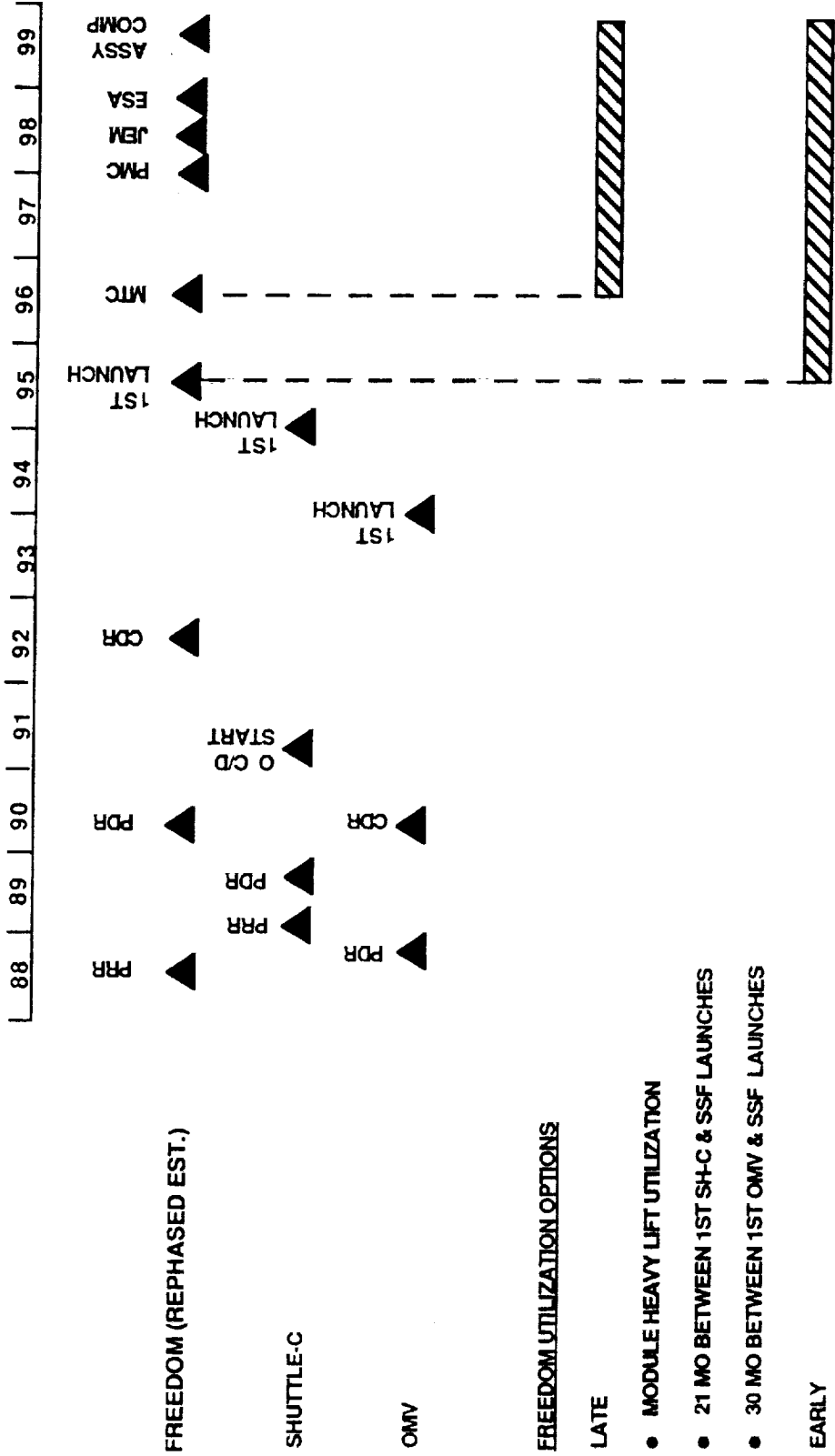

LATE SHUTTLE-C UTILIZATION FEATURES/CONSIDERATIONS

This "late" Shuttle-C utilization consideration would use a heavy lift capability to launch the pressurized modules of the Freedom configuration of which the first is the U. S. Lab module in 1996 about one year after first element launch. This scenario would manifest the Lab module and a Node module on a single Shuttle-C launch which would be the sixth Freedom assembly mission. Module outfitting would be optimized to maximize the amount of prelaunch module integration for flight 6 and subsequent flights. On-orbit outfitting would be minimized by using heavy lift Shuttle-C module/node launches after flight 6 to obviate the need for follow-on outfitting flights consistent with science/utilization requirements.

The early Freedom flights prior to the Shuttle-C launch of the Lab module would occur as specified by the previously described assembly sequence. As will be described, the first launch of a Shuttle-C heavy lift vehicle for this utilization scenario would be 21 months after the first Freedom assembly flight. This could provide adequate time to develop and flight certify the unmanned automatic rendezvous and docking mission profiles to the Freedom station.

Since Shuttle-C represents a parallel program development in the same time frame as Freedom development, all Freedom launch elements would maintain a design compatibility with the Space Shuttle as the primary development path. Shuttle based EVA would remain the primary method for Freedom assembly on orbit. Given these ground rules, a Freedom assembly sequence could be conceived for the re-phased definition that requires 12 launches consisting of 9 Shuttle and 3 Shuttle-C launches. This would be 5 flights less than the previously described Shuttle Orbiter only reference assembly sequence with PMC occurring one flight sooner on flight 10.

As a comparison, using only the Shuttle Orbiter with the same volume and manifesting constraints but with lift performance enhanced by the use of advanced solid rocket motors (ASRM), a total of 15 flights would be needed for Freedom assembly requiring 7 ASRM launches. Because of volume and EVA constraints, PMC would still occur on flight 11.

Detailed manifest listings for each flight will be described on the following pages for both Shuttle-C and ASRM assembly sequences.

LATE SHUTTLE-C UTILIZATION FEATURES/CONSIDERATIONS

- **MODULE HEAVY LIFT UTILIZATION**
 - OPTIMIZED MODULE OUTFITTING/INTEGRATION
- **FIRST SHUTTLE-C FLIGHT LAUNCHES HAB AND NODE MTC
HARDWARE (FLIGHT 6)**
 - EARLY FLIGHTS PER REPHASED BASELINE
- **APPROXIMATELY 21 MONTHS BETWEEN FIRST SHUTTLE-C
LAUNCH AND FIRST SSF UTILIZATION**
 - ADEQUATE TIME TO DEVELOP AND TEST RENDEZVOUS MISSION
PROFILES
- **SSF ELEMENTS MAINTAIN STS COMPATIBILITY**
- **STS BASED ASSEMBLY EVA**
- **REQUIRES NINE STS AND THREE SHUTTLE-C LAUNCHES**
 - PMC @ FLIGHT 10
- **ASRM STS COMPARISON:**

TOTAL FLIGHTS	=	15
ASRM FLIGHTS	=	7
PMC @ FLIGHT 11		

SHUTTLE-C MANIFESTING OF FREEDOM PRESSURIZED MODULES

The U. S. Lab and Hab are shown as manifested for Shuttle-C launch on manned base (MB) assembly flights 6 and 8 respectively for the assembly sequence conceived for the "late" utilization scenario. Flights designated as "MB" flights are Freedom hardware element delivery launches. Other flights will be designated as "L" launches for logistics missions to resupply the station, and "OF" for module outfitting missions to complete the furnishing of the pressurized modules on orbit. On each of the flight 6 and 8 launches a node module would also be manifested to complete the Freedom pressurized module "race track" pattern.

The Shuttle-C payload carrier concept is shown for a flight MB-10 mission in its orbit transfer configuration for rendezvous and docking to Freedom. This mission would manifest the Japanese hardware elements which are:

- 1 - the Japanese Experiment Module (JEM),
- 2 - the Experiment Logistics Module (ELM),
- 3 - and the two Exposed Facilities (EF).

SHUTTLE-C FREEDOM HARDWARE MANIFESTING

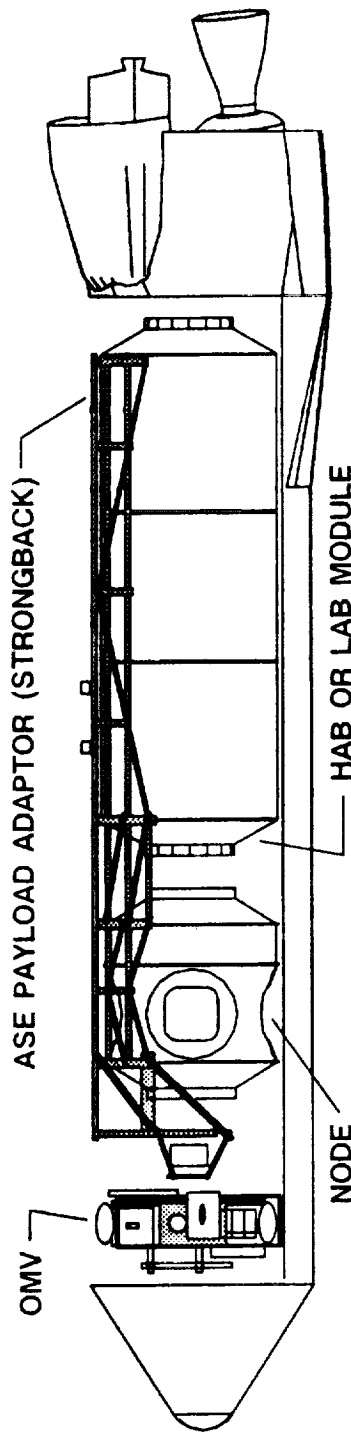

**OMV AND PAYLOAD STOWED WITHIN SHROUD ENVELOPE
(MB-6 & MB-8)**

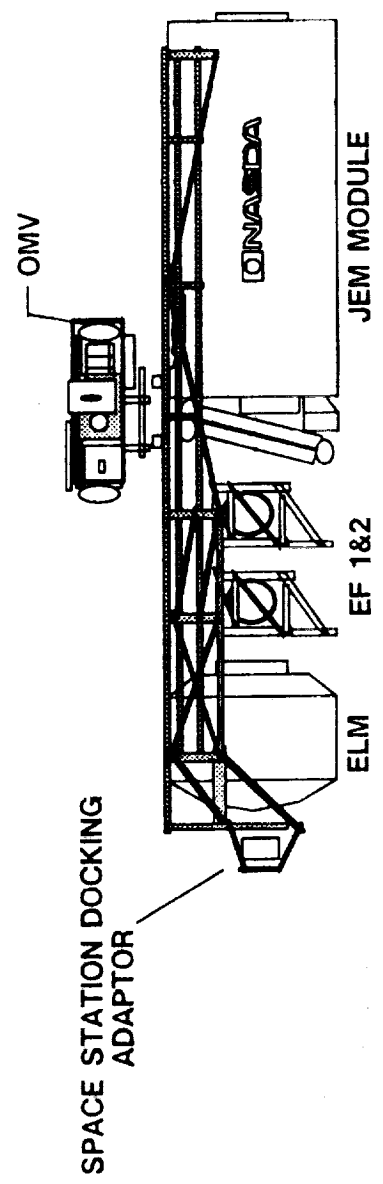

**OMV DOCKING FOR ON ORBIT DEPLOYMENT & TRANSFER
TO SPACE STATION (MB-10)**

REPHASED FREEDOM ASSEMBLY SEQUENCE USING SHUTTLE-C

Listed here is an assembly sequence derived for Space Station Freedom for a "late" utilization consideration using Shuttle-C launches. This sequence was devised to achieve the minimum number of total flights consistent with the Freedom rephased requirements for on-orbit capability deployment. Three Shuttle-C missions would be required in this 12 flight total scenario. A PMC capability can be achieved on flight 10 one flight sooner than the Rephased Freedom reference assembly sequence using only Shuttle Orbiter launches.

This sequence envisions that sufficient logistics and capability are provided on orbit to sustain the crew and maintain the station such that only the Flight 10 logistics mission would be required to complete the rephased Freedom definition assembly.

Flights 7, 9 and 12 would be Space Shuttle flights which must provide sufficient EVA capability to assemble or deploy the hardware delivered by the preceding Shuttle-C mission as well as the hardware manifested in the Orbiter cargo bay for that particular flight. It is envisioned that unique EVA aids and operational methods would be required to handle assembly from both the Shuttle-C payload carrier and the Orbiter cargo bay during a single Shuttle mission to the Freedom station.

REPASSED ASSEMBLY SEQUENCE USING SHUTTLE-C

FLIGHT ASSEMBLY ELEMENTS

1	FEL	MB-1	STBD INBOARD INTEGRATED EQUIPMENT ASSEMBLY (IEA), SOLAR ARRAY/BETA JOINT (2), TRUSS (SA2-SB8)
2		MB-2	STBD UTILITIES (SA2-SB8) ALPHA JOINT, ASSEMBLY WORK PLATFORM/ASTRONAUT POSITIONING SYSTEM, MOBILE TRANSPORTER
3		MB-3	TRUSS/UTILITIES (SB7-SB1), STBD ANTENNA PALLET (Ku-BAND), GNC PALLET (4 CMGS), PROPULSION PALLETS (2)
4		MB-4	AFT STBD NODE, PRESS. DOCKING ADAPTER, FMAD PALLET, MODULE SUPPORT TRUSS (MST)
5		MB-5	TRUSS/UTILITIES (PB1-PB7), PORT ANTENNA PALLET (Ku-BAND), PROPULSION PALLETS (2), MT BATTERIES, OMV DOCKING RING
6	EMTC	MB-6	PORT INBOARD INTEGRATED EQUIPMENT ASSEMBLY (IEA), SOLAR ARRAY/BETA JOINT (2), TRUSS/UTILITIES (PA1-PA3), ALPHA JOINT, MSC
7		MB-7	US LAB MODULE (44 FEET), FWD STBD NODE, OMV (SHUTTLE-C)
8		MB-8	AFT PORT NODE, CUPOLA, APAE, SPDM, PRESSURIZED DOCKING ADAPTOR
9		MB-9	HAB MODULE (44 FEET), FWD PORT NODE, OMV (SHUTTLE-C)
10	PMC	L-1	AIRLOCK, ULC BERTHING MECHANISM, UNPRESSURIZED LOGISTICS CARRIER, LOGISTICS RESUPPLY , JEM ELM ES
11		MB-10	CREW (4), PRESSURIZED LOGISTICS MODULE, LOGISTICS RESUPPLY, MMD
12		MB-11	JEM MODULE, JEM ELM PS, JEM EXPOSED FACILITY 1 AND 2, OMV (SHUTTLE-C)
			ESA MODULE

(N) DENOTES SHUTTLE-C LAUNCH

REPHASED FREEDOM ASSEMBLY SEQUENCE USING ASRM

This assembly sequence for the rephased Freedom definition was derived to compare Shuttle-C utilization with the use of the Space Shuttle with enhanced ASRM performance. A total of 15 flights would be required where seven of these flights are ASRM launches. PMC is seen to occur on flight 11 which is consistent with the rephased assembly sequence. However, only one outfitting flight is required compared to a total of three for the rephased reference build-up sequence.

Comparison to the Shuttle-C assembly sequence shows that the ASRM enhanced Shuttle flight sequence would require one more MB assembly flight, one more logistics flight and a module outfitting flight for a total of three additional flights.

The first 5 Freedom assembly flights are highly EVA and volume constrained such that utilization of the ASRM improved lift capability of about 12,000 pounds can not be effectively exploited except to the advantage of providing extra performance margin for early flight contingency.

REPHASED ASSEMBLY SEQUENCE USING ASRMS

FLIGHT ASSEMBLY ELEMENTS

1	FEL	MB-1	STBD INBOARD INTEGRATED EQUIPMENT ASSEMBLY (IEA), SOLAR ARRAY/BETA JOINT (2), TRUSS (SA2-SB8) STBD UTILITIES (SA2-2SB8) ALPHAOINT, ASSEMBLY WORK PLATFORM/ASTRONAUT POSITIONING SYSTEM, MOBILE TRANSPORTER
2		MB-2	TRUSS/UTILITIES (SB7-SB1), STBD ANTENNA PALLET (Ku-BAND), GNC PALLET (4 CMGS), PROPULSION PALLETS(2)
3		MB-3	AFT STBD NODE, PRESS. DOCKING ADAPTER, FMAD PALLET, MODULE SUPPORT TRUSS (MST)
4		MB-4	TRUSS/UTILITIES (PB1-PB7), PORT ANTENNA PALLET (Ku-BAND), PROPULSION PALLETS (2), MT BATTERIES, OMV DOCKING RING
5		MB-5	PORT INBOARD INTEGRATED EQUIPMENT ASSEMBLY (IEA), SOLAR ARRAY/BETA JOINT (2), TRUSS/UTILITIES (PA1-PA3), ALPHA JOINT, MSC
6	EMTC	MB-6	US LAB MODULE (44 FEET) (ASRM)
7		MB-7	FORWARD STBD NODE, AFT PORT NODE, CUPOLA
8		MB-8	HAB MODULE (44 FEET) (ASRM)
9		OF-1	PRESSURIZED LOGISTICS MODULE, HAB/LAB OUTFITTING, APAE (FIXED), PRESSURIZED DOCKING ADAPTER, SPDM (ASRM)
10		MB-9	FORWARD PORT NODE, AIRLOCK, ULC BERTHING MECHANISM
11	PMC	L-1	CREW (4), PRESSURIZED LOGISTICS MODULE, UNPRESSURIZED LOGISTICS CARRIER, LOGISTICS RESUPPLY, JEM ELM RD (ASRM)
12		MB-10	JEM MODULE, JEM EXPOSED FACILITY (ASRM)
13		MB-11	ESA MODULE
14		L-2	PRESSURIZED LOGISTICS MODULE, UNPRESSURIZED LOGISTICS CARRIER, LOGISTICS RESUPPLY, MMD (ASRM)
15		MB-12	JEM EXPOSED FACILITY 2, JEM ELM PS, PRESSURIZED LOGISTICS MODULE, MODULE OUTFITTING (ASRM)

① DENOTES ASRM STS LAUNCH

EARLY SHUTTLE-C UTILIZATION CONSIDERATIONS

Currently defined initial Freedom assembly flights are severely constrained by the Shuttle lift performance with respect to the weight definitions of the early elements that are required to provide a functional orbiting spacecraft capability. EVA and Orbiter cargo bay volume constraints also limit the choice and combination of Freedom elements that can be manifested on these early flights. This has contributed to the present consideration of defining passive assembly flight configurations requiring additional hardware and increased EVA. On-orbit integration and verification of initial critical Freedom elements and subsystems is required to achieve a functional spacecraft operational capability. This is a critical key design definition that the Freedom program must concern itself with during the current preliminary design activity.

Utilization of Shuttle-C early in the Freedom assembly sequence would be of great benefit if its use could significantly improve the amount of pre-integration of station elements and subsystems that could be achieved prior to launch for the purpose of minimizing Shuttle EVA to build the station. Prelaunch maximization of ground integration and verification of key elements and subsystems reduces the risk of providing a functional on-orbit spacecraft capability.

The previously mentioned congressional mandated study by the special committee on Space Station performed by the National Research Council in the summer of 1987 concluded that a functional spacecraft definition for initial assembly flight configuration definitions was highly desirable in terms of providing a high degree of survivability to overcome uncertainties due to previously undemonstrated performance and operational capabilities. When considering Shuttle-C utilization, any other alternative consideration would either deliver to orbit a larger number, or greater size, of passive elements and subsystems that require integration and verification in space. It is not apparent that this passive alternative consideration would provide any improvement to EVA requirements or Freedom program risks. It appears to worsen both. Therefore, this study focused on Shuttle-C early utilization to provide a functional spacecraft concept for each Freedom assembly flight.

EARLY SHUTTLE-C UTILIZATION CONSIDERATIONS

- **INITIAL STS ASSEMBLY FLIGHTS ARE ALSO EVA AND VOLUME LIMITED**
 - CONTRIBUTES TO INITIAL FLIGHT PASSIVE ASSEMBLY DEFINITIONS
 - INCREASED EVA
 - FORCES ON-ORBIT INITIAL INTEGRATION/VERIFICATION OF CRITICAL SSF ELEMENTS AND SUBSYSTEMS

- **EARLY UTILIZATION FOCUS IS ON PRE-LAUNCH INTEGRATION OPTIMIZATION**
 - MINIMIZE EVA
 - MAXIMIZE GROUND INTEGRATION/VERIFICATION

- **INITIAL FLIGHT FUNCTIONAL S/C CONCEPT DESIRED**
 - BASIS OF PAST CONGRESSIONAL/NRC STUDY REPORTS
 - EARLY UTILIZATION ALTERNATIVE IS LARGER NUMBER/SIZE OF PASSIVE ELEMENTS

DEPLOYABLE FREEDOM FIRST ELEMENT LAUNCH (FEL) CONCEPT

The optimum use of an initial heavy lift launch capability would be to deploy a fully functional capability with no requirement for EVA. The higher the need for EVA the higher the need for EVA support equipment which results in less spacecraft functional capability delivered to orbit. As an example the current Freedom FEL requires 24 hours of EVA and 13,000 pounds of EVA support equipment which is 30% of the mass to orbit capability to the planned 220 nautical mile orbit. This is a significant overhead to deliver a passive first launch configuration. This large overhead is also a measure of the high risk of obtaining a controllable, functional, and survivable first launch space flight configuration.

There is no present concept for a Freedom deployable and fully functional FEL configuration. To conceive such a configuration using currently defined Freedom hardware elements would first of all require a minimum capability definition that could also be qualified for a Shuttle Orbiter launch as a program option. Shown here are the necessary elements that could provide an initial functional minimal capability. The aft node module depicted here houses critical subsystem control avionics and dissipates waste heat by the use of body mounted radiators (BMR). Connected to the node is a pre-integrated pallet type structure, which is compatible with the Shuttle Orbiter cargo bay, that consists of communications antennas, propulsion and reaction control system (RCS) including a hydrazine fuel tank configured as an orbit replaceable unit (ORU). The power system consists of deployable photovoltaic arrays to generate electricity from the energy of the sun, a deployable thermal radiator to reject waste heat and an integrated equipment assembly that includes power control distribution equipment and electrical energy storage batteries.

The concept shown would weigh about 44,000 pounds and be launched by the Space Shuttle to an altitude of near 180 nautical miles.

DEPLOYABLE FIRST ELEMENT LAUNCH USING PREINTEGRATED ELEMENTS

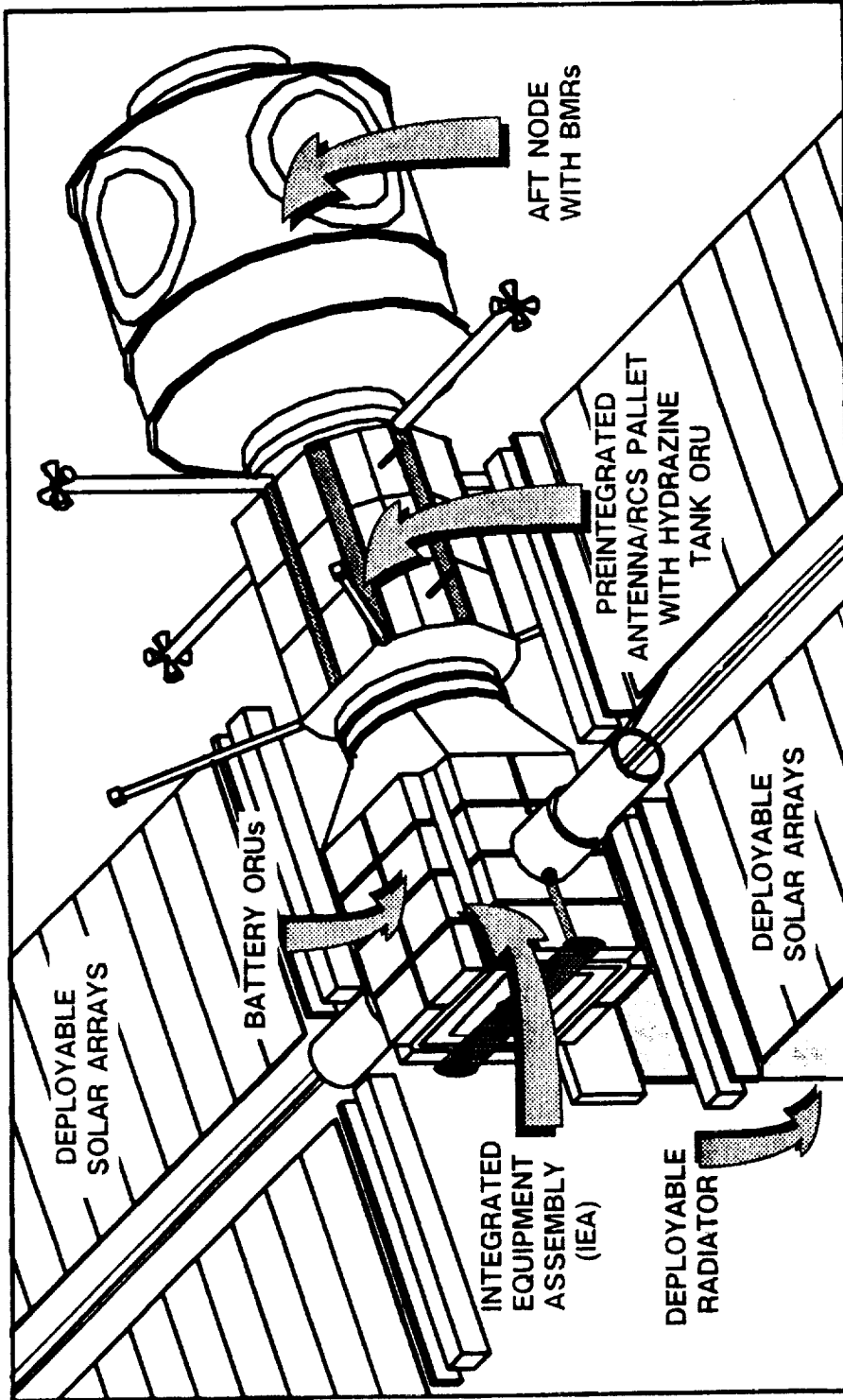

DEPLOYABLE FIRST ELEMENT LAUNCH ELIMINATES NEED FOR SOME SUPPORT EQUIPMENT:

- EVA RESERVE - 2873 LBMS
- STS DOCKING MODULE - 1550 LBMS
- ASSEMBLY WORK PLATFORM - 5728 LBMS
- MOBILE TRANSPORTER - 2329 LBMS

RESULTING IN OVER 13,000 POUNDS MORE LIFT FOR SPACE STATION HARDWARE.

PRE-INTEGRATED MANIFESTING OPTIONS FOR EARLY SHUTTLE-C UTILIZATION

Two concepts are shown here for fully functional pre-integrated spacecraft configurations for Space Station Freedom first element launch (FEL) for early utilization consideration of the Shuttle-C. The Shuttle Orbiter FEL launch packaging depicted is intended to provide the minimum capability configuration described on the preceding page. The Shuttle-C FEL launch packaging depicted would provide more on orbit capability than the Shuttle Orbiter FEL by including an additional pre-integrated node module and options for more initial power, propulsion, data, communication or even attached science capability.

The launch packages shown would be deployable concepts from both the Shuttle-C as the primary Freedom FEL configuration and the Shuttle Orbiter as an alternative option. This alternative option drives the Shuttle Orbiter compatibility issue as an attempt to protect against Freedom FEL launch date schedule slippage in the event of Shuttle-C development difficulties. As previously described, the current Shuttle-C development schedule and the need date for Freedom FEL is a key issue for early Shuttle-C utilization consideration.

EARLY PRE-INTEGRATION FEL MANIFESTING OPTIONS

- FULLY FUNCTIONAL PRE-LAUNCH INTEGRATED SPACECRAFT
- NO FEL EVA
- DUAL SHUTTLE-C/SHUTTLE ORBITER COMPATIBILITY
- SHUTTLE-C PRIME WITH STS AS BACK-OUT OPTION

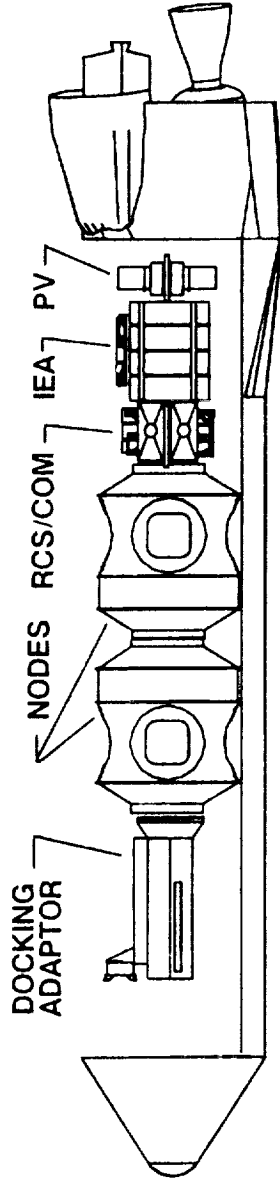

SHUTTLE-C PRE-INTEGRATED HARDWARE F.E.L. PACKAGING

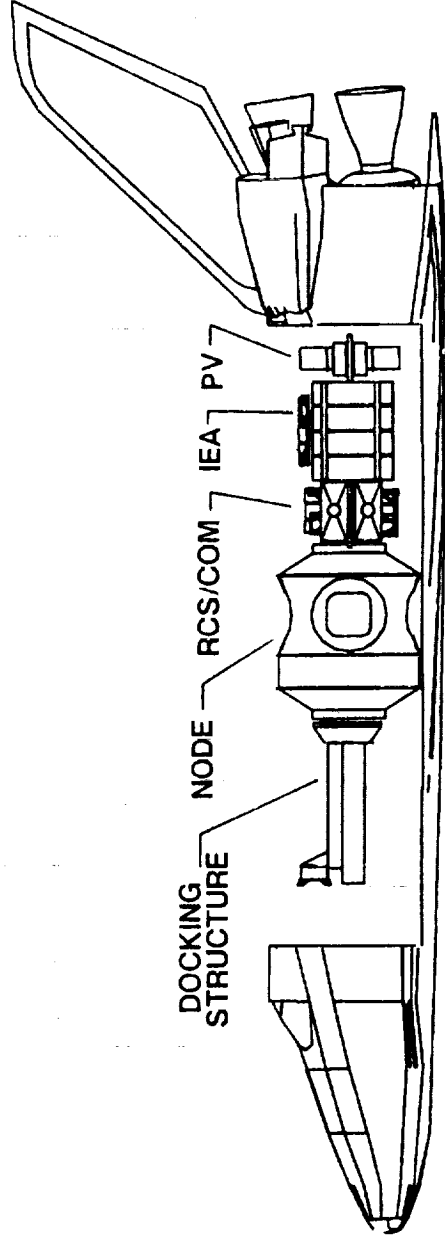

STS PRE-INTEGRATED HARDWARE F.E.L. PACKAGING

KEY FEATURES/ISSUES OF EARLY SHUTTLE-C PRE-INTEGRATION UTILIZATION

After the Freedom fully functional pre-integrated first element launch (FEL), the station build up would follow the rephased definition assembly sequence. The second assembly flight would be a Shuttle Orbiter launch which would deliver to orbit the starboard, or port, section of the transverse boom structure for assembly by STS based EVA.

A major concern for this early Shuttle-C utilization consideration is the short period between the first Shuttle-C flight demonstration launch and the need date for the first Freedom FEL. Program schedule adjustments seem to be an apparent consideration for either Shuttle-C development or Freedom deployment, or both. The first need date for an unmanned rendezvous mission for the Shuttle-C and the OMV with the space station is seen to be about a year after Freedom FEL to launch the U. S. Laboratory module. Development and analyses of detailed unmanned rendezvous and docking flight demonstration schedules is required to determine the adequacy of this one year time period.

Freedom assembly sequences for the re-phased program definition have been conceived for an early Shuttle-C utilization consideration based on the pre-integrated fully functional spacecraft concept. A more detailed description on the following pages define a Freedom build up sequence that would require 4 Shuttle-C launches and 6 Shuttle Orbiter launches that would provide a permanently manned capability (PMC) at flight number eight.

SHUTTLE-C EARLY PRE-INTEGRATION UTILIZATION FEATURES/ISSUES

- ASSEMBLY SEQUENCE AFTER FEL FOLLOWS REPHASED DEFINITION
 - STARBOARD TRUSS ON FIRST STS FLIGHT
 - STS BASED EVA
- APPROXIMATELY 3 MONTHS BETWEEN FIRST SHUTTLE-C LAUNCH AND FIRST SSF UTILIZATION
 - FIRST SHUTTLE-C/OMV RENDEZVOUS MISSION 12 MONTHS AFTER SSF FEL
- REQUIRES SIX STS AND FOUR SHUTTLE-C LAUNCHES
 - PMC @ FLIGHT 8
- ASRM STS COMPARISON:
 - 15 TOTAL FLIGHTS
 - 7 ASRM FLIGHTS
 - PMC @ FLIGHT 11

SHUTTLE-C EARLY PRE-INTEGRATION UTILIZATION ASSEMBLY CONCEPT

The initial Freedom assembly flight configurations are graphically depicted here for an early Shuttle-C utilization consideration of the pre-integrated functional spacecraft concept. Flight one shows a gravity gradient flight attitude profile, which assumes earth nadir at the bottom of the page, after deployment from the Shuttle-C payload carrier. Flight 2 would be a Shuttle Orbiter flight which brings to orbit 8 bays of truss and utilities, the astronaut assembly work platform (AWP) for structural EVA assembly operations, a control moment gyro (CMG) pallet, and the Canadian Mobile Servicing Center (MSC). The construction proceeds along the direction of earth nadir to maintain a gravity gradient flight attitude profile.

Flight 3 would complete the construction of one side of the transverse boom truss structure including the addition of the solar power system, communication antennas, propulsion and reaction control system (RCS).

The construction of the transverse boom would be completed on flight 4. The flight attitude of this configuration would be changed from gravity gradient to the normal Freedom local vertical, local horizontal orientation which would be maintained for the station's operational lifetime. The OMV docking mechanism is added to provide for auto-docking of the U.S. laboratory module which would be launched on a Shuttle-C as the fifth assembly flight.

SHUTTLE-C EARLY PRE-INTEGRATION UTILIZATION ASSEMBLY CONCEPT

FLIGHT ONE (SHUTTLE-C)

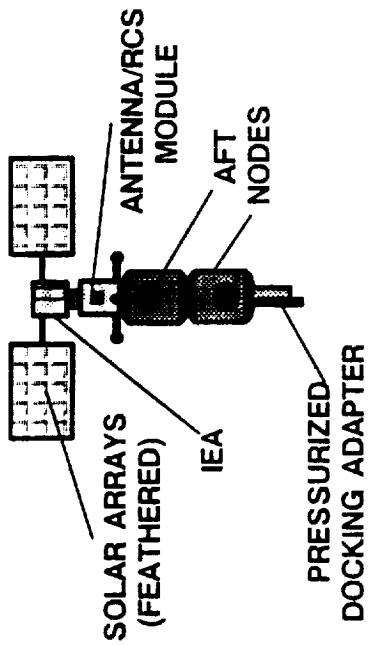

FLIGHT TWO (SHUTTLE)

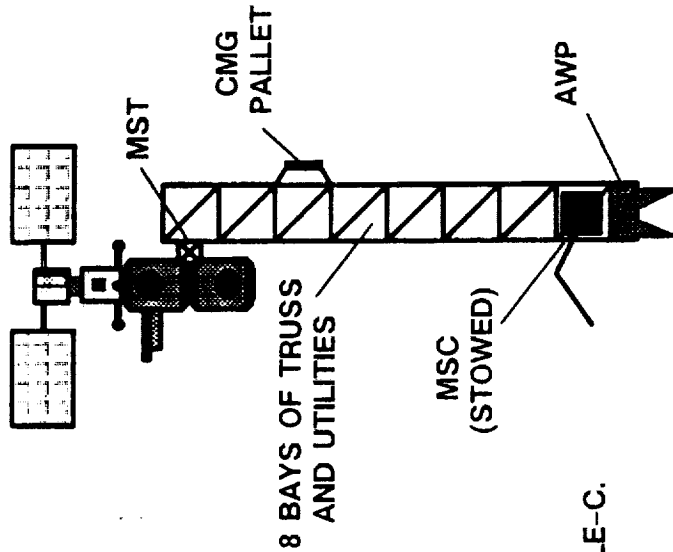

FLIGHT THREE (SHUTTLE)

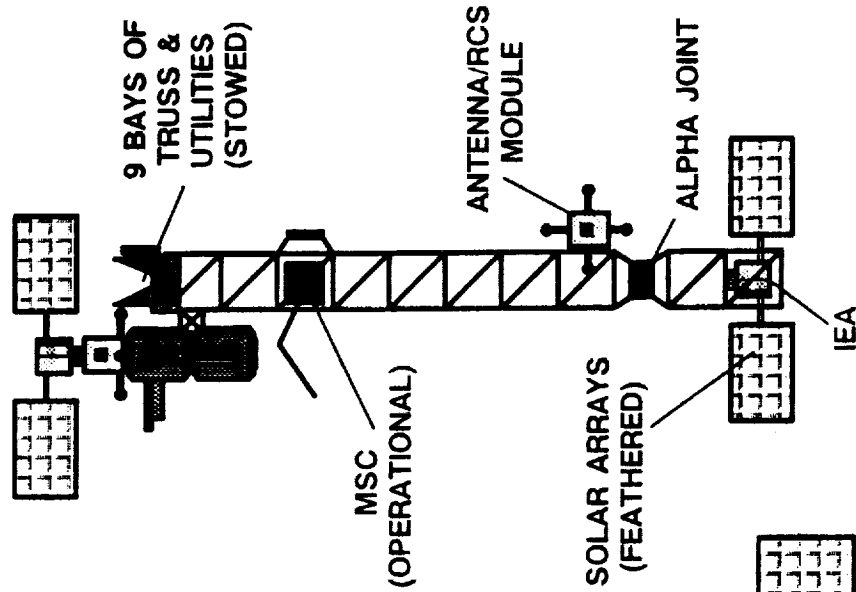

NOTE: CONFIGURATION FLIES IN GRAVITY GRADIENT STABLE ATTITUDE WITH ARRAYS FEATHERED AFTER AUTO DEPLOYMENT FROM SHUTTLE-C.

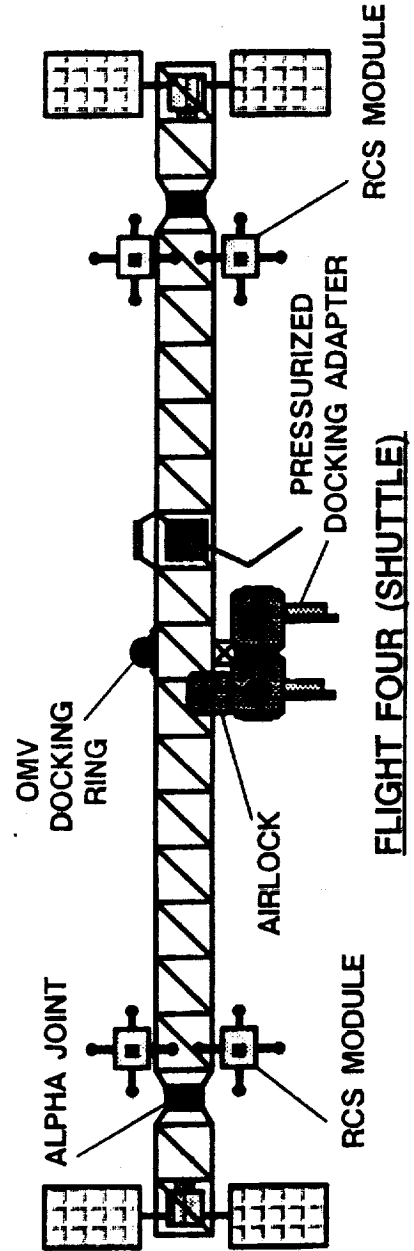

FLIGHT FOUR (SHUTTLE)

NOTE: CONFIGURATION NOW FLIES IN THE NORMAL LVLH MODE WITH SUNTRACKING ARRAYS

EARLY SHUTTLE-C UTILIZATION PRE-INTEGRATED ASSEMBLY SEQUENCE OPTION

The complete assembly sequence for the re-phased Freedom program is listed for an early Shuttle-C utilization consideration of a pre-integrated first element launch (FEL) concept. Five Shuttle-C launches are shown to be needed which permits an early man tended capability (EMTC) on flight 6 and a permanently manned capability (PMC) on flight 8.

EARLY PRE-INTEGRATED OPTION ASSEMBLY SEQUENCE (SHUTTLE-C)

FLIGHT ASSEMBLY ELEMENTS

- | | | | |
|----|------|-------|---|
| ① | FEL | MB-1 | STBD INBOARD INTEGRATED EQUIPMENT ASSEMBLY (IEA), SOLAR ARRAY/BETA JOINT (2), ANTENNA/RCS PALLET, AFT STBD NODE, AFT PORT NODE, PRESSURIZED DOCKING ADAPTER |
| 2 | | MB-2 | TRUSS/UTILITIES (8 BAYS), GNC PALLET (4 CMGS), ASSEMBLY WORK PLATFORM/ASTRONAUT POSITIONING SYSTEM , MOBILE TRANSPORTER, MSC, MST |
| 3 | | MB-3 | PORT SOLAR ARRAYS/BETA JOINTS, PORT INBOARD INTEGRATED EQUIPMENT ASSEMBLY ((IEA) ANTENNA/RCS PALLET, 11 BAYS TRUSS/UTILITIES, ALPHA JOINT |
| 4 | | MB-4 | AIRLOCK, ALPHA JOINT, PRESSURIZED DOCKING ADAPTER, OMV DOCKING RING, 2 RCS PALLETS |
| ⑤ | | MB-6 | US LAB MODULE (44 FEET) FWD PORT NODE , OMV |
| 6 | EMTC | MB-7 | MMD, SPDM, APAE, ULC BERTHING MECHANISMS, JEM ELM ES |
| ⑦ | | MB-8 | HAB MODULE (44 FEET), FWD STBD NODE, OMV |
| 8 | PMC | L-1 | CREW (4), PRESSURIZED LOGISTICS MODULE, UNPRESSURIZED LOGISTICS CARRIER, LOGISTICS RESUPPLY |
| ⑨ | | MB-10 | JEM MODULE, JEM ELM PS, JEM EXPOSED FACILITY 1 & 2, OMV |
| 10 | | MB-11 | ESA MODULE |

⑩ DENOTES SHUTTLE-C LAUNCH

STS PRE-INTEGRATED FEL CONCEPT ASSEMBLY SEQUENCE

This assembly sequence depicts a set of initial assembly flights that could be launched with the Shuttle Orbiter as an alternative to a Shuttle-C pre-integrated concept first element launch. The major differences to the Shuttle-C FEL assembly sequence previously described is:

- (1) - only one node would be manifested on flight 1,
- (2) - the second node would be manifested on flight 4,
- (3) - flight 5 would add elements deferred from manifesting the node on flight 4.

Key elements deferred from flight 4 to accommodate the node would include one half of the RCS and one of the pressurized docking modules.

STS EARLY PRE-INTEGRATION UTILIZATION ASSEMBLY CONCEPT

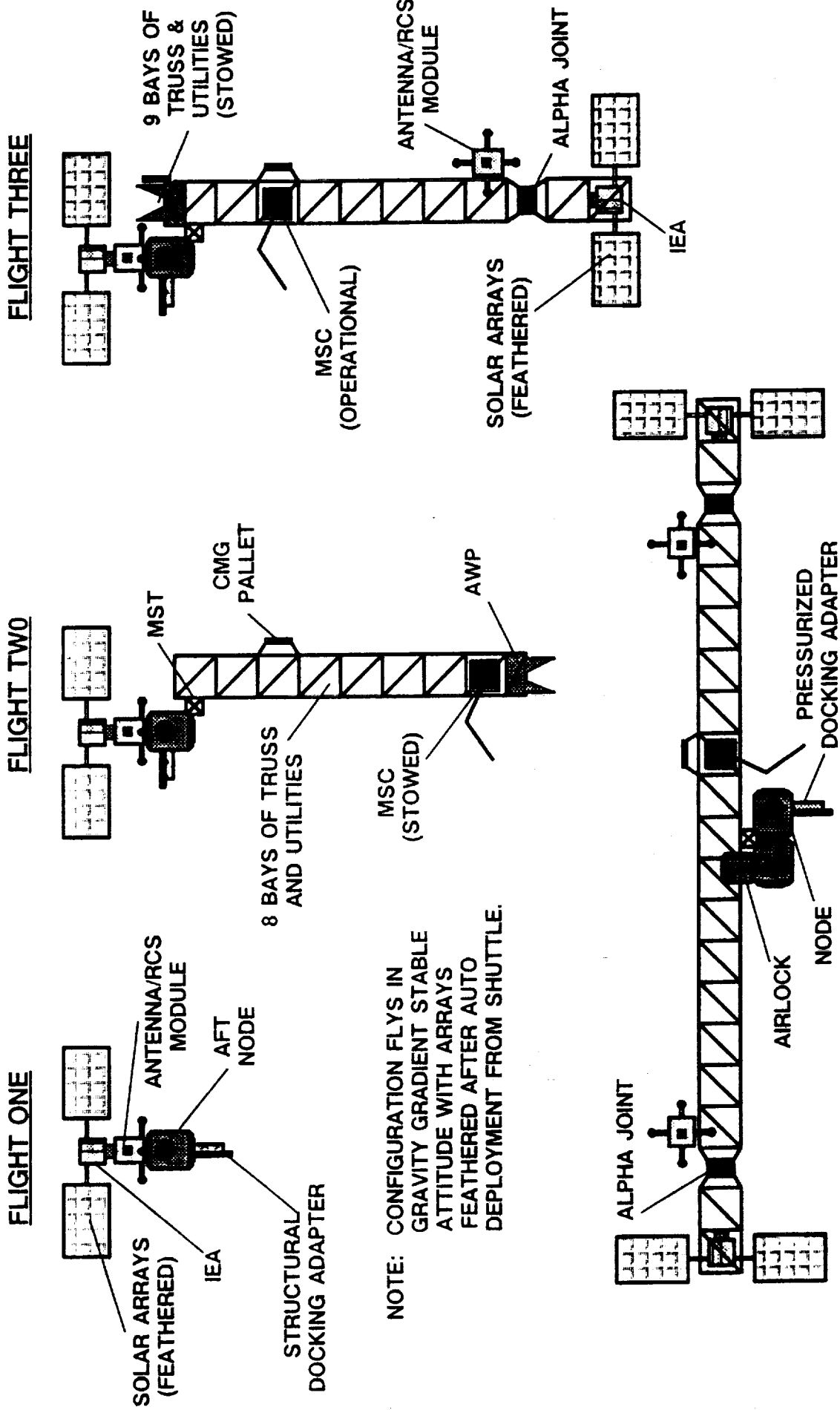

NOTE: CONFIGURATION FLIES IN GRAVITY GRADIENT STABLE ATTITUDE WITH ARRAYS FEATHERED AFTER AUTO DEPLOYMENT FROM SHUTTLE.

NOTE: CONFIGURATION NOW FLIES IN THE NORMAL LVLH MODE WITH SUNTRACKING ARRAYS

PRE-INTEGRATED FEL STS ONLY ASSEMBLY SEQUENCE

A seventeen flight assembly sequence Shuttle Orbiter launch manifest is listed for the pre-integrated first element launch (FEL) concept. This sequence does not provide for an OMV docking mechanism, therefore the total mass to orbit would be similar to the re-phased baseline 17 flight sequence described earlier.

This assembly sequence was generated to compare the re-phased baseline to the pre-integrated FEL concept. To consider a late Shuttle-C utilization for the pre-integrated FEL concept, an adjustment to the assembly sequence would be necessary similar to the assembly sequence definition for the previously described re-phased program late utilization consideration. This assembly sequence manifested the OMV docking mechanism on flight 4 to accommodate an automatic docking of the U. S. Lab module from a Shuttle-C launch on flight 6.

EARLY PRE-INTEGRATED OPTION ASSEMBLY SEQUENCE (STS ONLY)

FLIGHT ASSEMBLY ELEMENTS

1	FEL	MB-1	STBD INBOARD INTEGRATED EQUIPMENT ASSEMBLY (IEA), SOLAR ARRAY/BETA JOINT, ANTENNA/RCS PALLET, NODE, STRUCTURAL DOCKING ADAPTOR
2		MB-2	TRUSS/UTILITIES (8 BAYS), GNC PALLET (4 CMGS), ASSEMBLY WORK PLATFORM/ASTRONAUT POSITIONING SYSTEM, MOBILE TRANSPORTER, MSC MODULE SUPPORT TRUSS (MST)
3		MB-3	PORT INBOARD INTEGRATED EQUIPMENT ASSEMBLY (IEA), SOLAR ARRAY/BETA JOINT ANTENNA/RCS PALLET, 11 BAYS TRUSS/UTILITIES, ALPHA JOINT
4		MB-4	NODE, AIRLOCK, ALPHA JOINT, PRESSURIZED DOCKING ADAPTER
5		MB-5	RCS PALLETS (2), THREE ADDITIONAL ENERGY STORAGE UNITS FOR STBD IEA, PRESSURIZED DOCKING ADAPTOR, APAE AND PAYLOAD, PUMP PALLET FOR MODULE BODY-MOUNTED RADIATORS
6	EMTC	MB-6	US LAB MODULE (44 FEET)
7		OF-1	PRESSURIZED LOGISTICS MODULE, LAB OUTFITTING (19 RACKS), TDASS ANTENNA
8		MB-7	FORWARD STBD NODE, AFT PORT NODE, CUPOLA
9		MB-8	HAB MODULE (44 FEET)
10		OF-2	PRESSURIZED LOGISTICS MODULE, HAB OUTFITTING (19 RACKS), SPDM
11		MB-9	FORWARD PORT NODE, AIRLOCK, ULC BERTHING MECHANISM
12	PMC	L-1	CREW (4), PRESSURIZED LOGISTICS MODULE, UNPRESSURIZED LOGISTICS CARRIER, LOGISTICS RESUPPLY
13		MB-10	JEM MODULE
14		MB-11	ESA MODULE
15		L-2	PRESSURIZED LOGISTICS MODULE, UNPRESSURIZED LOGISTICS CARRIER, LOGISTICS RESUPPLY
16		MB-12	JEM EXPOWED FACILITY 1 AND 2, JEM ELM
17		OF-3	PRESSURIZED LOGISTICS MODULE, MODULE OUTFITTING (19 RACKS), MMD

STS/ASRM PRE-INTEGRATED FEL ALTERNATIVE FREEDOM ASSEMBLY SEQUENCE

This assembly sequence for the pre-integrated Freedom fully functional spacecraft first element launch (FEL) using the Shuttle Orbiter only, and enhanced with Advanced Solid Rocket Motors (ASRM) where necessary for a heavy lift capability where needed, was generated for comparison with other assembly sequence concepts considered in this report. When compared to the rephased Freedom program baseline enhanced with ASRM launches it shows the same number of assembly flights with identical occurrences of FEL, Early Man Tended Capability (EMTC), and Permanent Manned Capability (PMC) within the flight sequence. This would be expected since the time phased capability, except for FEL, and the total mass to orbit is the same for both sequences where the initial early flights are constrained by available STS based EVA capability.

EARLY PRE-INTEGRATED OPTION ASSEMBLY SEQUENCE (STS & STS/ASRM)

FLIGHT ASSEMBLY ELEMENTS

1	FEL	MB-1	STBD INBOARD INTEGRATED EQUIPMENT ASSEMBLY (IEA), SOLAR ARRAY/BETA JOINT , ANTENNA/RCS PALLET, NODE, STRUCTURAL DOCKING ADAPTOR
2		MB-2	TRUSS/UTILITIES (8 BAYS), GNC PALLET (4 CMGS), ASSEMBLY WORK PLATFORM/ASTRONAUT POSITIONING SYSTEM, MOBILE TRANSPORTER, MSC , MODULE SUPPORT TRUSS (MST)
3		MB-3	PORT INBOARD INTEGRATED EQUIPMENT ASSEMBLY (IEA,) SOLAR ARRAY/BETA JOINT ANTENNA/RCS PALLET, 11 BAYS TRUSS/UTILITIES, ALPHA JOINT
4		MB-4	NODE, AIRLOCK, ALPHA JOINT, PRESSURIZED DOCKING ADAPTER
5		MB-5	RCS PALLETS (2), THREE ADDITIONAL ENERGY STORAGE UNITS FOR STBD IEA, PRESSURIZED DOCKING ADAPTOR, APAE AND PAYLOAD, PUMP PALLET FOR MODULE BODY-MOUNTED RADIATORS
6	EMTC	MB-6	US LAB MODULE (44 FEET)
7		MB-7	FORWARD STBD NODE, AFT PORT NODE, CUPOLA
8		MB-8	HAB MODULE (44 FEET)
9		OF-2(220)	PRESSURIZED LOGISTICS MODULE, HAB OUTFITTING (19 RACKS), TDASS ANTENNA, SPDM
10		MB-9	FORWARD PORT NODE, AIRLOCK, ULC BERTHING MECHANISM
11	PMC	L-1(220)	CREW (4), PRESSURIZED LOGISTICS MODULE, UNPRESSURIZED LOGISTICS CARRIER, LOGISTICS RESUPPLY, JE M ELM ES
12		MB-10	JEM MODULE, EXPOSED FACILITY #1
13		MB-11	ESA MODULE
14		L-2(220)	PRESSURIZED LOGISTICS MODULE, UNPRESSURIZED LOGISTICS CARRIER, LOGISTICS RESUPPLY, MMD
15		MB-12	JEM EXPOSED FACILITY #2, JEM ELM, PRESSURIZED LOGISTICS MODULE (MODULE OUTFITTING

(N) DENOTES ASRM ENHANCED STS LAUNCH

RE-PHASED CONFIGURATION ASSEMBLY SEQUENCE LAUNCH SYSTEM SUMMARY

A summary of the launch vehicle systems considered in this report for the re-phased Freedom program assembly sequence is shown. The total number of flights is graphed for both a late Shuttle-C utilization consideration, and an early Shuttle-C utilization consideration, and also indicates for each option the required Shuttle-C and ASRM enhanced Shuttle launches to provide a heavy lift capability where needed. A horizontal dashed line on each bar graph shows the occurrence of the PMC within the assembly sequence.

The comparison of the total number of launches, and the different types of launch vehicles necessary for each consideration, requires a cost analysis evaluation which was not within the scope of this report. However, this report does generate data from which such a comparison could be made. A point can be made, therefore, that the effective use of Shuttle-C can achieve a significant reduction in total flights (30%) and required manned Shuttle Orbiter flights (50%) which should result in launch cost reductions. Any cost advantage would require a trade comparison against Freedom program resources required to develop a dual launch capability and in particular the introduction of an OMV automatic rendezvous and docking capability required for Shuttle-C utilization. However, the reduction of needed EVA resources is significant due to prelaunch integration opportunities as can be seen from the dramatic reduction of Shuttle Orbiter flights.

Another key comparison is the amount of Lab/Hab module outfitting that can be provided at launch with a heavy lift capability. The rephased program definition has scaled back the total amount of outfitting to 71% of total capability for the Lab and 75% for the Hab. This capability is to be added back over a period of time after completion of the re-phased program assembly to the full 100% for each module. The initial Lab outfitting flight for the rephased program is seen to provide a 13% total capability (compared to 100% add back capability) and 30% for the Hab module launch.

The percentages of module outfitting for the assembly sequences shown here are all normalized to a minimum total flight number consideration. In this regard, Shuttle-C utilization can triple the amount of module outfitting (14% compared to 50%) that can be provided by the Shuttle Orbiter for the initial Lab deployment, and can exceed by 13% (88% compared to 75%) the capability defined for the rephased program Hab outfitting for its initial deployment.

REPHASSED CONFIGURATION ASSEMBLY SEQUENCE LAUNCH SYSTEM SUMMARY

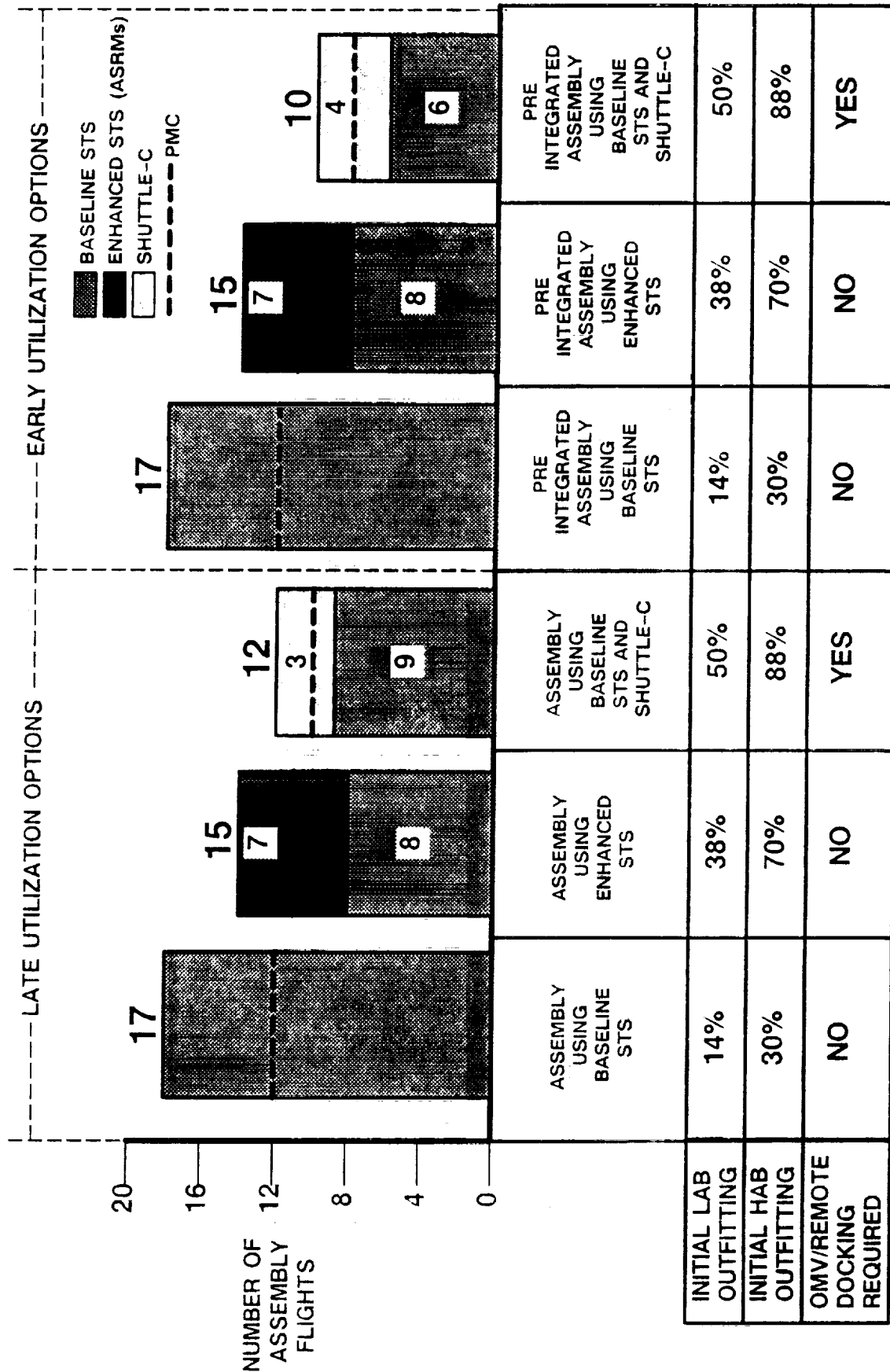

REPHASSED CONFIGURATION LAB MODULE REQUIRES 71% OF MAXIMUM AVAILABLE OUTFITTING.
 REPHASSED CONFIGURATION HAB MODULE REQUIRES 75% OF MAXIMUM AVAILABLE OUTFITTING.

FREEDOM ASSEMBLY SEQUENCE LAUNCH SCHEDULE COMPARISON

The launch schedules for comparison of options for a late Shuttle-C utilization consideration and an early Shuttle-C utilization consideration are shown anchored to maintaining the occurrence of a permanent manned capability (PMC) in June of 1997. Accordingly, the epochs have been adjusted for the first element launch (FEL), the early man tended capability (MTC), and the deployment of the Japanese Experiment Module (JEM) and the European Space Agency (ESA) module. The schedules for Shuttle-C utilization anchored at the current FEL launch date of March 31, 1995 would represent a dramatic forward time shift of Freedom program funding levels to permit earlier than planned flight hardware deliveries which is an apparent unreasonable consideration in terms of the primary goal of the rephased program definition to reduce the 1990 through 1995 funding levels. Anchoring at PMC is seen to provide positive early FEL program schedule contingency for Shuttle-C utilization considerations which could possibly be a back-up consideration to the Shuttle launch assembly sequence schedule to protect the down stream milestones which include full international participation.

It can also be seen that the consideration of an early Shuttle-C utilization would call for a FEL about 18 months later than the current rephased program definition. This would provide almost a two year time period between the first Shuttle-C demonstration launch and the first Freedom launch need which is judged to be adequate to coordinate the dual program integration and flight demonstration needs. It would, however, require a Freedom program commitment to Shuttle-C as a primary Freedom FEL configuration design driver for an EVA-less first launch which would require a major concept definition change within the Freedom program. The Shuttle Orbiter would be a back-up FEL launch capability for this consideration.

ASSEMBLY SEQUENCE LAUNCH SCHEDULE COMPARISON

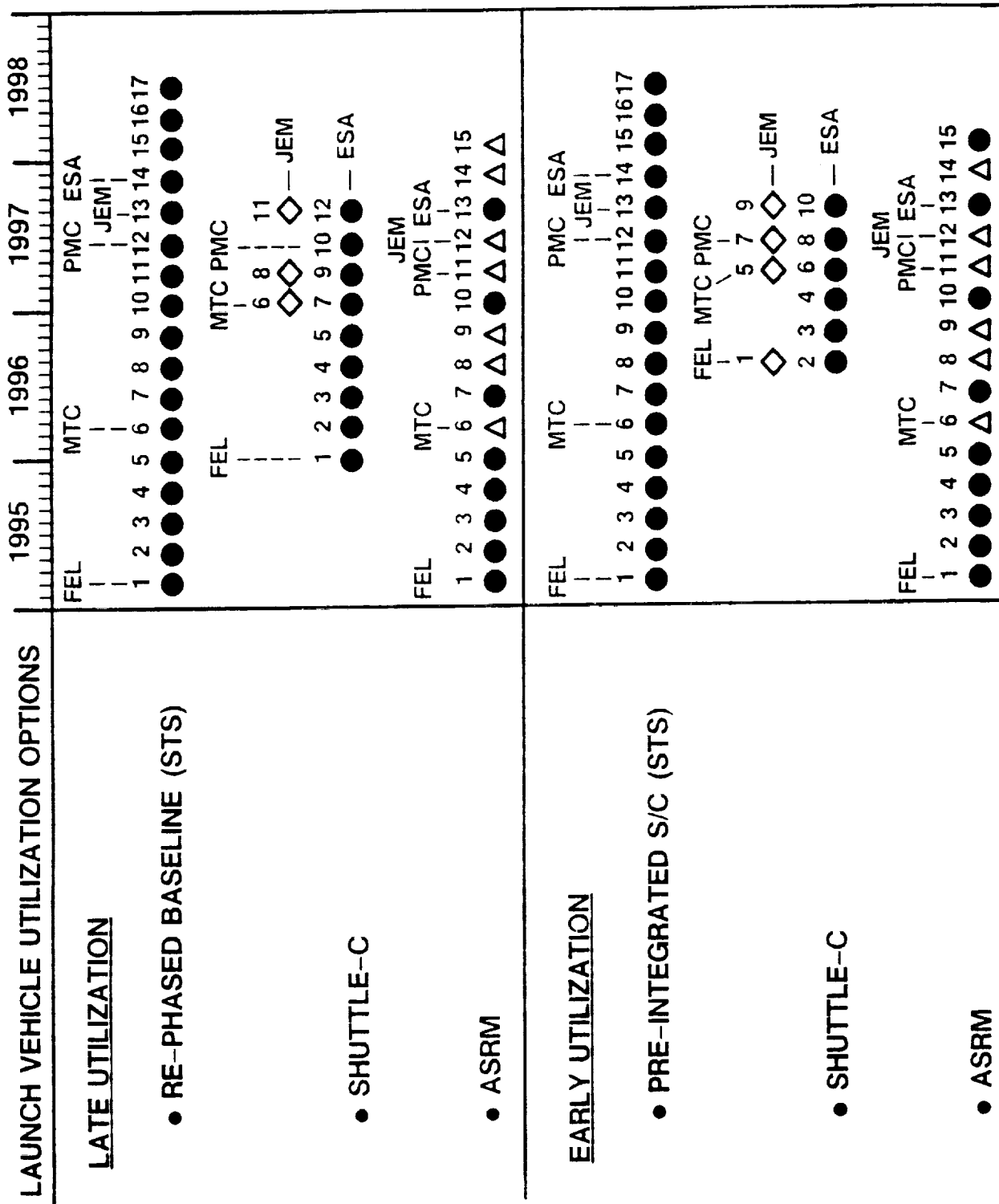

SUMMARY

In terms of reducing the total number of Shuttle Orbiter flights required for the Freedom re-phased program assembly, an early utilization consideration provides the most dramatic reduction whereby 4 Shuttle-C launches substitute for 11 Shuttle orbiter launches. To reduce the current dual program development risk, a schedule adjustment, as previously described, that provides an adequate time period greater than the 3 months presently identified is required that calls for a later FEL date but maintains PMC and international participation epochs. An early utilization consideration also requires a new Freedom program definition for a functional spacecraft FEL to reduce EVA and on-orbit integration and systems verification. This is the key commitment necessary to seriously consider an early Shuttle-C utilization.

A late Shuttle-C utilization consideration also shows a significant reduction in Shuttle Orbiter flights whereby 3 Shuttle-C launches replace 8 Shuttle Orbiter missions. It offers the advantage of a more forgiving dual program development and flight schedule. The primary advantage, however, is to gain a greater level of functional capability for initial deployment of the Freedom pressurized modules obviating the need for additional module outfitting flights.

SUMMARY

- **EARLY UTILIZATION REDUCES STS MISSIONS BY 67%**
 - HIGHER SCHEDULE RISK
 - FIRST USE APPROXIMATELY 3 MONTHS AFTER FIRST SHUTTLE-C LAUNCH
 - REQUIRES INITIAL FUNCTIONAL SPACECRAFT DEFINITION
 - REQUIRES FOUR SHUTTLE-C VEHICLES
 - MINIMIZES EVA AND ON-ORBIT INTEGRATION/VERIFICATION

- **LATE UTILIZATION REDUCES STS MISSIONS ABOUT 50%**
 - MORE FORGIVING DEVELOPMENT/FLIGHT SCHEDULE
 - FIRST USE: ABOUT 18 MONTHS AFTER SSF FEL
ABOUT 21 MONTHS AFTER FIRST SHUTTLE-C LAUNCH
 - SATISFIES SSF PRESSURIZED MODULE HLLV NEEDS
 - PERMITS FULLY OUTFITTED MODULE DEPLOYMENT
 - REQUIRES THREE SHUTTLE-C VEHICLES
 - INITIAL EVA AND ON-ORBIT INTEGRATION/VERIFICATION NOT HELPED



Report Documentation Page

1. Report No. NASA TM-101658		2. Government Accession No.		3. Recipient's Catalog No.	
4. Title and Subtitle Shuttle-C Utilization for Assembly of the Rephased Freedom Configuration				5. Report Date August 1989	
				6. Performing Organization Code	
7. Author(s) Leonard J. DeRyder Washito A. Sasamoto Patrick A. Troutman				8. Performing Organization Report No.	
				10. Work Unit No. 486-14-06-01	
9. Performing Organization Name and Address NASA Langley Research Center Hampton, Virginia 23665-5225				11. Contract or Grant No.	
				13. Type of Report and Period Covered Technical Memorandum	
12. Sponsoring Agency Name and Address National Aeronautics and Space Administration Washington, D. C. 20546-0001				14. Sponsoring Agency Code	
15. Supplementary Notes					
16. Abstract The utilization of the Shuttle-C Heavy Lift Launch Vehicle (HLLV) to augment the Shuttle orbiter to deliver to Earth orbit elements for assembly of a rephased definition of Space Station Freedom is assessed. A past history of previous HLLV studies performed with respect to Freedom launch and assembly is reviewed and conclusions extrapolated that are appropriate to consider for the new rephased Freedom definition. The rephased Freedom definition is explained, two utilization scenarios are developed and related assessments are provided for Shuttle-C utilization early in the assembly sequence or utilization later in the on-orbit build up phase.					
17. Key Words (Suggested by Author(s)) Space Station Shuttle-C Heavy Lift Launch Vehicle Rephased Definition				18. Distribution Statement Unclassified - Unlimited Subject Category: 15	
19. Security Classif. (of this report) Unclassified		20. Security Classif. (of this page) Unclassified		21. No. of pages 56	22. Price A04