

**NASA Technical Memorandum 100533, Part 1**

P-500

**1985 and 1986 DIRECT STRIKE LIGHTNING DATA**

**Klaus P. Zaepfel**

**and**

**Harold K. Carney**

**March 1988**

Date for general release March 31, 1990



National Aeronautics and  
Space Administration

**Langley Research Center**  
Hampton, Virginia 23665

(NASA-TM-100533-Part-1) THE 1985 AND 1986  
DIRECT STRIKE LIGHTNING DATA, PART 1 (NASA)  
200 p CSCL 04B

N90-13125

Unclass

63/47 0270225



CONTENTS

Part 1

SUMMARY .....	1
SYMBOLS .....	2
INTRODUCTION .....	3
DATA SYSTEMS .....	3
LIGHTNING DATA.....	6
CONCLUSION .....	10
REFERENCES .....	11
TABLES .....	12
FIGURES .....	21

Part 2\*

FIGURES .....	498
---------------	-----

\*Part 2 published under separate cover



1985-86 DIRECT STRIKE LIGHTNING DATA

Klaus P. Zaepfel and Harold K. Carney  
Langley Research Center  
Hampton, Virginia 23665

SUMMARY

This report presents the wideband waveforms and peak detector measurements recorded during the 1985-86 Direct-Strike Lightning Tests of the NASA Langley Research Center lightning-instrumented F-106B aircraft. The tests were conducted within about 150 nautical miles of the NASA Langley Research Center, Hampton, Virginia, where the aircraft was based. Transient recorder data for 42 strikes and 8 nearby flashes and peak detector measurements for 29 flights are presented in this report.

## SYMBOLS AND SUBSCRIPTS

### SYMBOLS:

B	magnetic flux density, tesla
D	electric flux density, coulomb per square meter
I	current, ampere
m	meter
Hz	hertz
T	tesla
A	ampere
s	second
V	volt

### SUBSCRIPTS:

f	forward fuselage
l	longitudinal (or longitudinal current when subscripting $\dot{B}$ )
t	tail (or transverse current when subscripting $\dot{B}$ )
w	wing
wl	wing-left
wr	wing-right

In the text and on the computer plots of the waveforms, a dot over a symbol of a quantity, or the hyphenated suffix "-dot" (e.g.,  $\dot{B}_1$  or  $B_1$ -dot) indicates the time-rate-of-change (derivative with respect to time) of that quantity.

## INTRODUCTION

This report presents the wideband direct-strike lightning data obtained by the digital transient recorders during the 1985 and 1986 Lightning Flight Tests of the NASA Langley Research Center lightning-instrumented F-106B aircraft. There were 77 strikes to the aircraft and 11 nearby flashes during these tests. Previously, there had been 10 strikes in each of the 1980 and 1981 tests, which were reported in references 1 and 2; 156 strikes in the 1982 tests, which were reported in reference 3; 214 strikes in the 1983 tests, which were reported in reference 4; and 247 strikes in the 1984 tests, which were reported in reference 10. The instrumentation system, transient recorders, external sensors, a summary overview of the previous tests, and internal sensors and cables are described in references 5, 6, 7, 8, and 9, respectively.

A statistically sufficient quantity of data to characterize high-altitude strikes had been obtained by 1985. An attempt to obtain also low-altitude strike data was made during the 85/86 seasons, but it resulted in less data than in previous years because lightning activity typically occurs less often at lower altitudes and because fewer thunderstorms moved through the flight test area in the last two years of the flight test program.

## DATA SYSTEMS

Data from nine external, wideband electromagnetic field sensors, three current sensors, and eight voltage and current sensors on internal aircraft cables were recorded with a twelve-channel, digital transient recorder configured to accommodate various combinations of these sensors. The external sensors (reference 7) and internal sensors (reference 9) have fre-

quency responses from near zero to 100 MHz for time-derivative measurements and 0 to 50 MHz for a current measurement. Transmission lines connecting sensors to the recorder are 50-ohm coaxial cables, all properly terminated. Solid-shield coaxial cable were used for long (15-20 feet) transmission lines in the aircraft, with some short lengths (less than 3 feet) of more flexible double-braid shielded cable used in close proximity to the sensors. For the data channels with integrated sensor outputs, commercial active integrators with 10- $\mu$ s time constants and lower-frequency limits of 100 Hz were used. The twelve transient recorder channels are grouped into four units of three channels each. The available trigger options are: to trigger each unit of three channels from a separate data source, or to trigger any combination up to all channels from a single source, or to trigger all channels from any one of four separate sources. These options are available by using a special "fan-out" device (see Figure 1). The transient recorder stores 65 536 data samples for each channel with 8-bit resolution using sample rates which are selectable from 1.5625MHz to 200MHz (sample interval from 640 nanoseconds to 5 nanoseconds). The sample intervals and trigger sources for the data channels are shown in Table I. Peak detectors were used to measure the maximum parameter values attained during each flight. These instruments were isolated from aircraft power and ground by being battery powered, and were specified to measure transients as short as a single half-sine, 5-ns wide pulse (Reference 11).<sup>1</sup> Both single-ended input models and differential input models were used. Where a sensor supplied a measurement to two or more recording devices, power

---

1. These peak detectors were designed for nuclear EMP tests and are specified only for a single, 5-ns (or 10- $\mu$ s for another model) wide, half-sine pulse.



splitters were used for impedance matching. Each measurement was ranged by using selected attenuators inserted in the transmission line from the sensor to each data input on the transient recorder and to each peak detector input.

The external sensor locations on the aircraft and polarity conventions of field densities and currents are shown in Figures 2 and 3, respectively. In Figure 3, positive polarities are defined by the directions of the arrows. The polarities of time-derivative measurements are defined as follows: given the polarity conventions of Figure 3, the time-derivative measurements are positive whenever the field densities or currents increase with time (exhibit positive slopes). The following voltage and current measurements on internal wires and cables are labeled and located in the aircraft as shown in Figure 4: TP100 is a voltage measurement of an insulated, 18-gauge wire located in the leading edge of the left wing; TP101 is a voltage measurement of an insulated, 18-gauge wire in the forward fuselage; TP102 is a voltage measurement on the center conductor of a coaxial cable in the forward fuselage; TP105 is a current measurement on an insulated, 10-gauge AC power cable running from the forward to mid-fuselage; TP106 is a current measurement of the shield of the same coaxial cable as TP102. As shown in Figure 5, TP112 is a current measurement on a bundle of signal wires from the forward portion of the fuselage to the cockpit; TP113 is a current measurement of a 20-gauge power cable for the right-wing position light; TP116 is a current measurement on a position light power cable in mid-fuselage. As shown in Figure 6, TP123 is a current measurement on the power cable to an aircraft radio; TP125 is a current measurement on the shield of the same coaxial antenna cable as TP123; and TP126 is a current measurement of the signal cables for the forward and aft cockpit Horizontal

Situation Indicator. The voltages are measured at 50-ohm terminations at one end of each wire or cable, and the other end (and shield on coax cable) is connected to aircraft structure. The currents are measured on functional aircraft cables.

Because more measurements were required than data recording channels were available, 12 configurations of sensors, measurement ranges, trigger sources, and sampling intervals were used for the flights of 1985 and 1986; the 10 that produced data are shown in Table I. On Flights 85-018 through 85-037, all transient recorder channels were triggered by the first sensor response above the trigger threshold of either  $D_f\text{-dot}$ ,  $D_t\text{-dot}$ , or  $D_{wr}\text{-dot}$ , and on Flights 85-041 through 85-043, all transient recorder channels were triggered simultaneously by the  $D_f\text{-dot}$  sensor only. On Flight 86-013 all channels of the transient recorder were triggered by the first response above the trigger threshold associated with either of the measurements of  $\dot{I}$ ,  $I_1$ , or  $\int \dot{B}_t dt$ .

#### LIGHTNING DATA

The 1985 and 1986 tests resulted in 77 direct strikes to the aircraft and 11 nearby flashes from storm penetration flights. In the 1985 tests, transient data from 41 strikes and 8 nearby flashes was obtained at flight levels generally between 15 000 and 22 000 feet, while in the 1986 tests, transient data from 1 strike was obtained at 15 100 feet.<sup>2</sup> Peak detector

---

2. Lower altitudes were flown because, historically, low level aircraft/lightning encounters are the more common, but the F-106 research airplane had obtained most of the previous data at high altitudes, where lightning activity is much greater. The goal for 85/86 was to obtain data from the higher amplitude encounters expected at lower altitudes, and the data channels and trigger levels were ranged accordingly for the 1986 flights; 1985 was a transition period during which instrumentation was ranged for low and high levels and flights were flown at high and low altitudes.

measurements were obtained for maximum parameter values obtained for each of 20 flights in 1985 and for each of 9 flights in 1986. Less data was obtained during the 85/86 seasons than in the previous years and is attributable to several factors. (1) Lightning encounters were fewer than in the previous year because fewer thunderstorms occurred in 1985 and in 1986. (2) Many flights were deliberately flown at lower altitudes, where fewer lightning strokes occur. (3) The transient recorders triggered less because it was often ranged for the larger strikes that were expected at lower altitudes.

Table II summarizes by flight and run numbers the 1985 and 1986 data records acquired with the twelve-channel transient recorder. The entries in each measurement column are the run numbers for which that measurement was plotted. The number of lightning strikes or nearby flashes that produced data during each flight are also presented. (A run consists of all the transient recorder data associated with a trigger from one lightning event. A strike is defined as a lightning event confirmed by sight, camera, or current measurement; a nearby is defined by a trigger of the transient recorder only.) The plots presented in this report are usually of a small portion of the lightning process, which may continue for up to one second. The duration of the transient measurements, however, were constrained to 640  $\mu$ s or 320  $\mu$ s by the total memory and the sampling rates of the recorder's data channels, thereby recording usually the first pulses among many to exceed a preselected trigger level. Subsequent pulses might have been missed because, once it was triggered, the transient recorder transferred the data via PCM channels to an analog tape recorder and was, therefore, unavailable for data acquisition for the next 19 seconds. Time scales (X-axes) for plots were chosen to show the pulse structure in suit-

able detail, and in many events more than one plot was required for each measurement. Straight-line interpolation between points was used and is apparent in those plots with high time-scale resolution. When the memory contained more than one group of pulses, the entire contents of the memories for all channels are usually plotted for that event. Correlation among plots can be achieved from the plot labels indicating flight number, run number, Coordinated Universal Time, strike number (example: S-001), and nearby flash number (example: N-001). These numbers were reset to 1 for the first event of each flight. On the horizontal axes of the data plots, zeros indicate the trigger times when the transient recorder was triggered by the lightning events, the minus values indicate pre-trigger times, and the positive values indicate post-trigger times. Trigger-time inaccuracies are typically  $\pm 0.12 \mu\text{s}$  or less, except in Channel No. 3.2 during S-005 of Flight 85-032, when a D-dot transient occurred  $0.68 \mu\text{s}$  earlier than seems reasonable.

Some of the raw data contains segments that could not be interpreted as valid data. Offsets that were unreasonably large in amplitude or long in duration for current or time-derivative measurements were removed in the plots by an offset-removal algorithm which assumed that the average value of several points ahead of the beginning of the event represented a value of zero. Another type of invalid data are wild points, non-recoverable data frames, and/or sections of questionable data that are not attributable to physical events. These points were deleted from the plots, leaving visible gaps where they are large compared to the plotted time scales. There were times when wild points occurred so often that point elimination became impractical, so a decision was made to leave them if they were less than an arbitrary 5% of the Y-axis scale and to remove the entire plot if

greater than that. An example of the effects of point elimination are shown in Figure 7.

During each flight in 1985 and 1986, battery powered peak-level recorders were used on the aircraft to continuously monitor and record the maximum amplitude achieved by each of the  $D_f$ -dot, I-dot, and  $I_t$  sensors (the results are shown in Table III). Depending on which of two models of peak detectors was used for a channel, the entries in the table are either single polarity or dual polarity measurements. The maximum current recorded from the  $I_t$  sensor with this method was  $\geq 25.6$  kA in 1985 on Flight 85-033, and  $\geq 22$  kA in 1986 on Flight 86-013. The maximum rate-of-change of current recorded from the I-dot sensor in 1985 was  $\geq 2.4E10$  A/s which occurred on Flight 85-027, and  $\geq 9.7E10$  A/s in 1986, on Flight 86-010. The largest peak level recorded for  $D_f$ -dot was 78 A/m<sup>2</sup> on Flight 85-029 in 1985, and 140 A/m<sup>2</sup> on Flight 86-013 in 1986. A characteristic of the peak detector data required investigation. When several consecutive flights in 1985 produced peak detector readings of exactly the same value for one sensor output, the peak detectors became suspect. Lab tests on several of the peak detectors identified a problem that was probably the cause. These tests showed that activating the data read-out switches on the peak detectors apparently produce small, but significant, transients that modify the readings. Because the lab tests produced worst-case errors of only  $\pm 2.5\%$  of full scale, it was not unreasonable to assume an error band of  $\pm 2.5\%$  about all readings. In Table III each reading that is  $\pm 2.5\%$  of full scale or less about zero is marked with an asterisk to call attention to a value

that is small compared to its large measurement range and, therefore, could very likely have been zero.<sup>3</sup>

#### CONCLUSION

The waveforms recorded in 1985 and 1986 are a significant addition to the data set of simultaneously recorded currents and electromagnetic fields which have been acquired to study and define the aircraft/lightning interaction. The data presented in this paper are time-correlated measurements from multiple points on the surface of the aircraft and on internal aircraft wires and cables extending for several hundred microseconds with 5 or 10 nanosecond time resolutions. Maximum values attained by certain measurements during each flight were also obtained using peak detectors. Data was acquired from lightning strikes to the aircraft between the altitudes of 12 000 and 22 000 feet. The bandwidth of the data system makes it possible to analyze electromagnetic data acquired on the surface of the aircraft at the aircraft fundamental resonant frequency and several higher harmonics, coupling to the interior, and phenomenology studies at small resolutions in time.

---

3. Because peak detector ranges were set much larger than transient recorder ranges, the  $\pm 2.5\%$  error band was often larger than the transient recorder trigger values. Hence, a peak detector measurement of zero would answer the concern of why, on some flights, the transient recorders did not trigger when peak detectors produced a reading.

## REFERENCES

1. Pitts, Felix L.; and Thomas, Mitchel E.: 1980 Direct Strike Lightning Data. NASA TM 81946, Feb. 1981.
2. Pitts, Felix L.; and Thomas, Mitchel E.: 1981 Direct Strike Lightning Data. NASA TM 83273, Mar. 1982.
3. Thomas, Mitchel E.; and Pitts, Felix L.: 1982 Direct Strike Lightning Data. NASA TM 84626, Mar. 1983.
4. Thomas, Mitchel E.: 1983 Direct Stride Lightning Data. NASA TM 86426, August 1985.
5. Thomas, Mitchel E.: Direct Strike Lightning Measurement System, AIAA/SETP/SFTE/SAE, 1st Flight Testing Conference, Las Vegas, Nevada, Nov. 1981. AIAA 81-2513.
6. Thomas, Robert M., Jr.: Expanded Interleaved Solid-State Memory of a Wide Bandwidth Transient Waveform Recorder. NASA CP-2128, FAA-RD-8-30. Lightning Technology, NASA Langley Research Center, April 22-24, 1980, p. 119.
7. Trost, Thomas F.; and Zaepfel, Klaus P.: Broadband Electromagnetic Sensors for Aircraft Lightning Research. op.cit., p. 131.
8. Pitts, Felix L.: Electromagnetic Measurement of Lightning Strikes to Aircraft. AIAA Journal of Aircraft, Vol. 19, No. 3, Mar. 1982, pp. 246-250.
9. Andersh, Capt. Dennis J.; Julian, Capt. Ronald G.; Steil, Lt. Joseph; Thomas, Mitchel; Stohler, Robert L.: Frequency Domain Calibration of NASA F-106 On-Board Instrumentation Cables. AFWL-TN-86-06, January 1986.
10. Thomas, Mitchel E.; and Carney, Harold K.: 1984 Direct Strike Lightning Data NASA TM 87690, September 1986.
11. Pitts, Felix L.; Lee, Larry D.; Perala, Rodney A.; and Rudolph, Terence H.: New Methods and Results for Quantification of Lightning-Aircraft Electrodynamics. NASA TP 2737, June 1987.

TABLE I. 1985-1986 TRANSIENT DATA MEASUREMENT RANGES

FLIGHT NUMBER	MEASUREMENT	FULL SCALE	SAMPLE INTERVAL	TRIGGER SOURCE(S) AND THRESHOLD
85-018 to -022	$\dot{D}_t$	$\pm 2.2 \text{ A/m}^2$	5 ns	$\dot{D}_t (\pm 0.7 \text{ A/m}^2)$ or $\dot{D}_f$ or $\dot{D}_{wr}$
	$\dot{D}_f$	$\pm 8.4 \text{ A/m}^2$	10 ns	$\dot{D}_f (\pm 2.5 \text{ A/m}^2)$ or $\dot{D}_t$ or $\dot{D}_{wr}$
	$\dot{D}_{wt}$	$\pm 12 \text{ A/m}^2$	10 ns	$\dot{D}_{wr} (\pm 3.6 \text{ A/m}^2)$ or $\dot{D}_f$ or $\dot{D}_t$
	$I_t$	$\pm 38.3 \text{E}3 \text{ A}$	5 ns	triggered by $\dot{D}_f$ or $\dot{D}_t$ or $\dot{D}_{wr}$
	$\dot{I}$	$\pm 1.4 \text{E}11 \text{ A/s}$	5 ns	triggered by $\dot{D}_f$ or $\dot{D}_t$ or $\dot{D}_{wr}$
	$\dot{B}_{wt}$	$\pm 808 \text{ T/s}$	5 ns	triggered by $\dot{D}_f$ or $\dot{D}_t$ or $\dot{D}_{wr}$
	$\dot{B}_{wr}$	$\pm 781 \text{ T/s}$	10 ns	triggered by $\dot{D}_f$ or $\dot{D}_t$ or $\dot{D}_{wr}$
	$\dot{B}_l$	$\pm 758 \text{ T/s}$	5 ns	triggered by $\dot{D}_f$ or $\dot{D}_t$ or $\dot{D}_{wr}$
	TP100	$\pm 26.8 \text{ V}$	5 ns	triggered by $\dot{D}_f$ or $\dot{D}_t$ or $\dot{D}_{wr}$
	TP106	$\pm 2.2 \text{ A}$	5 ns	triggered by $\dot{D}_f$ or $\dot{D}_t$ or $\dot{D}_{wr}$
TP125	$\pm .25 \text{ A}$	5 ns	triggered by $\dot{D}_f$ or $\dot{D}_t$ or $\dot{D}_{wr}$	
85-023 to -029	$\dot{D}_t$	$\pm 2.2 \text{ A/m}^2$	5 ns	$\dot{D}_t (\pm 0.7 \text{ A/m}^2)$ or $\dot{D}_f$ or $\dot{D}_{wr}$
	$\dot{D}_f$	$\pm 8.4 \text{ A/m}^2$	10 ns	$\dot{D}_f (\pm 2.5 \text{ A/m}^2)$ or $\dot{D}_t$ or $\dot{D}_{wr}$
	$\dot{D}_{wt}$	$\pm 12 \text{ A/m}^2$	10 ns	$\dot{D}_{wr} (\pm 3.6 \text{ A/m}^2)$ or $\dot{D}_f$ or $\dot{D}_t$
	$I_t$	$\pm 38.3 \text{E}3 \text{ A}$	5 ns	triggered by $\dot{D}_f$ or $\dot{D}_t$ or $\dot{D}_{wr}$
	$\dot{I}$	$\pm 1.4 \text{E}11 \text{ A/s}$	5 ns	triggered by $\dot{D}_f$ or $\dot{D}_t$ or $\dot{D}_{wr}$
	$\dot{B}_{wt}$	$\pm 808 \text{ T/s}$	5 ns	triggered by $\dot{D}_f$ or $\dot{D}_t$ or $\dot{D}_{wr}$
	$\dot{B}_{wr}$	$\pm 781 \text{ T/s}$	10 ns	triggered by $\dot{D}_f$ or $\dot{D}_t$ or $\dot{D}_{wr}$
	$\dot{B}_l$	$\pm 758 \text{ T/s}$	5 ns	triggered by $\dot{D}_f$ or $\dot{D}_t$ or $\dot{D}_{wr}$
	TP100	$\pm 20.3 \text{ V}$	5 ns	triggered by $\dot{D}_f$ or $\dot{D}_t$ or $\dot{D}_{wr}$
	TP106	$\pm 2.2 \text{ A}$	5 ns	triggered by $\dot{D}_f$ or $\dot{D}_t$ or $\dot{D}_{wr}$
TP125	$\pm .25 \text{ A}$	5 ns	triggered by $\dot{D}_f$ or $\dot{D}_t$ or $\dot{D}_{wr}$	



TABLE I. Continued

FLIGHT NUMBER	MEASURE- MENT	FULL SCALE	SAMPLE INTERVAL	TRIGGER SOURCE(S) AND THRESHOLD	
85-030 -031	$\dot{D}_t$	$\pm 2.2 \text{ A/m}^2$	5 ns	$\dot{D}_t (\pm 0.7 \text{ A/m}^2)$ or $\dot{D}_f$ or $\dot{D}_{wr}$	
	$\dot{D}_f$	$\pm 8.4 \text{ A/m}^2$	10 ns	$\dot{D}_f (\pm 2.5 \text{ A/m}^2)$ or $\dot{D}_t$ or $\dot{D}_{wr}$	
	$\dot{D}_{wr}$	$\pm 12 \text{ A/m}^2$	10 ns	$\dot{D}_{wr} (\pm 3.6 \text{ A/m}^2)$ or $\dot{D}_f$ or $\dot{D}_t$	
	$I_t$	$\pm 38.3 \text{E}3 \text{ A}$	5 ns	triggered by $\dot{D}_f$ or $\dot{D}_t$ or $\dot{D}_{wr}$	
	$i$	$\pm 1.4 \text{E}11 \text{ A}$	5 ns	triggered by $\dot{D}_f$ or $\dot{D}_t$ or $\dot{D}_{wr}$	
	$\dot{B}_{wi}$	$\pm 808 \text{ T/s}$	5 ns	triggered by $\dot{D}_f$ or $\dot{D}_t$ or $\dot{D}_{wr}$	
	$\dot{B}_{wr}$	$\pm 781 \text{ T/s}$	10 ns	triggered by $\dot{D}_f$ or $\dot{D}_t$ or $\dot{D}_{wr}$	
	$\dot{B}_1$	$\pm 758 \text{ T/s}$	5 ns	triggered by $\dot{D}_f$ or $\dot{D}_t$ or $\dot{D}_{wr}$	
	TP100	$\pm 7.0 \text{ V}$	5 ns	triggered by $\dot{D}_f$ or $\dot{D}_t$ or $\dot{D}_{wr}$	
	TP106	$\pm 0.7 \text{ A}$	5 ns	triggered by $\dot{D}_f$ or $\dot{D}_t$ or $\dot{D}_{wr}$	
	TP125	$\pm 0.25 \text{ A}$	5 ns	triggered by $\dot{D}_f$ or $\dot{D}_t$ or $\dot{D}_{wr}$	
	85-032 to -033	$\dot{D}_t$	$\pm 2.2 \text{ A/m}^2$	5 ns	$\dot{D}_t (\pm 0.7 \text{ A/m}^2)$ or $\dot{D}_f$ or $\dot{D}_{wr}$
		$\dot{D}_f$	$\pm 8.4 \text{ A/m}^2$	10 ns	$\dot{D}_f (\pm 2.5 \text{ A/m}^2)$ or $\dot{D}_t$ or $\dot{D}_{wr}$
$\dot{D}_{wr}$		$\pm 12 \text{ A/m}^2$	10 ns	$\dot{D}_{wr} (\pm 3.6 \text{ A/m}^2)$ or $\dot{D}_f$ or $\dot{D}_t$	
$I_t$		$\pm 38.3 \text{E}3 \text{ A}$	5 ns	triggered by $\dot{D}_f$ or $\dot{D}_t$ or $\dot{D}_{wr}$	
$i$		$\pm 0.5 \text{E}11 \text{ A/s}$	5 ns	triggered by $\dot{D}_f$ or $\dot{D}_t$ or $\dot{D}_{wr}$	
$\dot{B}_{wi}$		$\pm 808 \text{ T/s}$	5 ns	triggered by $\dot{D}_f$ or $\dot{D}_t$ or $\dot{D}_{wr}$	
$\dot{B}_{wr}$		$\pm 781 \text{ T/s}$	10 ns	triggered by $\dot{D}_f$ or $\dot{D}_t$ or $\dot{D}_{wr}$	
$\dot{B}_1$		$\pm 758 \text{ T/s}$	5 ns	triggered by $\dot{D}_f$ or $\dot{D}_t$ or $\dot{D}_{wr}$	
TP101		$\pm 20.6 \text{ V}$	5 ns	triggered by $\dot{D}_f$ or $\dot{D}_t$ or $\dot{D}_{wr}$	
TP112		$\pm 0.25 \text{ A}$	5 ns	triggered by $\dot{D}_f$ or $\dot{D}_t$ or $\dot{D}_{wr}$	
TP116		$\pm 0.25 \text{ A}$	5 ns	triggered by $\dot{D}_f$ or $\dot{D}_t$ or $\dot{D}_{wr}$	

TABLE I. Continued

FLIGHT NUMBER	MEASURE- MENT	FULL SCALE	SAMPLE INTERVAL	TRIGGER SOURCE(S) AND THRESHOLD
85-034 to -035	$\dot{D}_t$	$\pm 2.2 \text{ A/m}^2$	5 ns	$\dot{D}_t (\pm 0.7 \text{ A/m}^2)$ or $\dot{D}_f$ or $\dot{D}_{wr}$
	$\dot{D}_f$	$\pm 8.4 \text{ A/m}^2$	10 ns	$\dot{D}_f (\pm 2.5 \text{ A/m}^2)$ or $\dot{D}_t$ or $\dot{D}_{wr}$
	$\dot{D}_{wr}$	$\pm 12 \text{ A/m}^2$	10 ns	$\dot{D}_{wr} (\pm 3.6 \text{ A/m}^2)$ or $\dot{D}_f$ or $\dot{D}_t$
	$I_t$	$\pm 19.4\text{E}3 \text{ A}$	5 ns	triggered by $\dot{D}_f$ or $\dot{D}_t$ or $\dot{D}_{wr}$
	$\dot{i}$	$\pm 0.5\text{E}11 \text{ A/s}$	5 ns	triggered by $\dot{D}_f$ or $\dot{D}_t$ or $\dot{D}_{wr}$
	$\dot{B}_{w1}$	$\pm 808 \text{ T/s}$	5 ns	triggered by $\dot{D}_f$ or $\dot{D}_t$ or $\dot{D}_{wr}$
	$\dot{B}_{wr}$	$\pm 781 \text{ T/s}$	10 ns	triggered by $\dot{D}_f$ or $\dot{D}_t$ or $\dot{D}_{wr}$
	$\dot{B}_1$	$\pm 758 \text{ T/s}$	5 ns	triggered by $\dot{D}_f$ or $\dot{D}_t$ or $\dot{D}_{wr}$
	TP101	$\pm 20.6 \text{ V}$	5 ns	triggered by $\dot{D}_f$ or $\dot{D}_t$ or $\dot{D}_{wr}$
	TP112	$\pm 0.25 \text{ A}$	5 ns	triggered by $\dot{D}_f$ or $\dot{D}_t$ or $\dot{D}_{wr}$
	TP116	$\pm 0.25 \text{ A}$	5 ns	triggered by $\dot{D}_f$ or $\dot{D}_t$ or $\dot{D}_{wr}$
	85-036	$\dot{D}_t$	$\pm 2.2 \text{ A/m}^2$	5 ns
$\dot{D}_f$		$\pm 8.4 \text{ A/m}^2$	10 ns	$\dot{D}_f (\pm 2.5 \text{ A/m}^2)$ or $\dot{D}_t$ or $\dot{D}_{wr}$
$\dot{D}_{wr}$		$\pm 12 \text{ A/m}^2$	10 ns	$\dot{D}_{wr} (\pm 3.6 \text{ A/m}^2)$ or $\dot{D}_f$ or $\dot{D}_t$
$I_t$		$\pm 19.4\text{E}3 \text{ A}$	5 ns	triggered by $\dot{D}_f$ or $\dot{D}_t$ or $\dot{D}_{wr}$
$\dot{i}$		$\pm 0.5\text{E}11 \text{ A/s}$	5 ns	triggered by $\dot{D}_f$ or $\dot{D}_t$ or $\dot{D}_{wr}$
$\dot{B}_{w1}$		$\pm 808 \text{ T/s}$	5 ns	triggered by $\dot{D}_f$ or $\dot{D}_t$ or $\dot{D}_{wr}$
$\dot{B}_{wr}$		$\pm 781 \text{ T/s}$	10 ns	triggered by $\dot{D}_f$ or $\dot{D}_t$ or $\dot{D}_{wr}$
$\dot{B}_1$		$\pm 758 \text{ T/s}$	5 ns	triggered by $\dot{D}_f$ or $\dot{D}_t$ or $\dot{D}_{wr}$
TP102		$\pm 0.25 \text{ V}$	5 ns	triggered by $\dot{D}_f$ or $\dot{D}_t$ or $\dot{D}_{wr}$
TP105		$\pm 0.25 \text{ A}$	5 ns	triggered by $\dot{D}_f$ or $\dot{D}_t$ or $\dot{D}_{wr}$
TP123		$\pm 2.2 \text{ A}$	5 ns	triggered by $\dot{D}_f$ or $\dot{D}_t$ or $\dot{D}_{wr}$

TABLE I. Continued

FLIGHT NUMBER	MEASUREMENT	FULL SCALE	SAMPLE INTERVAL	TRIGGER SOURCE(S) AND THRESHOLD	
85-037	$\dot{D}_t$	$\pm 20.0 \text{ A/m}^2$	5 ns	$\dot{D}_t (\pm 6.0 \text{ A/m}^2)$ or $\dot{D}_f$ or $\dot{D}_{wr}$	
	$\dot{D}_f$	$\pm 48.0 \text{ A/m}^2$	10 ns	$\dot{D}_f (\pm 14.4 \text{ A/m}^2)$ or $\dot{D}_t$ or $\dot{D}_{wr}$	
	$\dot{D}_{wr}$	$\pm 34.5 \text{ A/m}^2$	10 ns	$\dot{D}_{wr} (\pm 10.3 \text{ A/m}^2)$ or $\dot{D}_f$ or $\dot{D}_t$	
	$I_t$	$\pm 19.4\text{E}3 \text{ A}$	5 ns	triggered by $\dot{D}_f$ or $\dot{D}_t$ or $\dot{D}_{wr}$	
	$\dot{i}$	$\pm 0.5\text{E}11 \text{ A/s}$	5 ns	triggered by $\dot{D}_f$ or $\dot{D}_t$ or $\dot{D}_{wr}$	
	$\dot{B}_{w1}$	$\pm 808 \text{ T/s}$	5 ns	triggered by $\dot{D}_f$ or $\dot{D}_t$ or $\dot{D}_{wr}$	
	$\dot{B}_{wr}$	$\pm 781 \text{ T/s}$	10 ns	triggered by $\dot{D}_f$ or $\dot{D}_t$ or $\dot{D}_{wr}$	
	$\dot{B}_1$	$\pm 758 \text{ T/s}$	5 ns	triggered by $\dot{D}_f$ or $\dot{D}_t$ or $\dot{D}_{wr}$	
	TP102	$\pm 0.25 \text{ V}$	5 ns	triggered by $\dot{D}_f$ or $\dot{D}_t$ or $\dot{D}_{wr}$	
	TP105	$\pm 0.25 \text{ A}$	5 ns	triggered by $\dot{D}_f$ or $\dot{D}_t$ or $\dot{D}_{wr}$	
	TP123	$\pm 2.2 \text{ A}$	5 ns	triggered by $\dot{D}_f$ or $\dot{D}_t$ or $\dot{D}_{wr}$	
	85-041	$\dot{D}_t$	$\pm 19.8 \text{ A/m}^2$	5 ns	triggered by $\dot{D}_f$
		$\dot{D}_f$	$\pm 26.7 \text{ A/m}^2$	10 ns	$\dot{D}_f (\pm 8.0) \text{ A/m}^2$
$I_{t-10}$		$\pm 53.3\text{E}3 \text{ A}$	5 ns	triggered by $\dot{D}_f$	
$I_{t-hi}$		$\pm 9.9\text{E}3 \text{ A}$	10 ns	triggered by $\dot{D}_f$	
$\dot{i}$		$\pm 0.5\text{E}11 \text{ A/s}$	5 ns	triggered by $\dot{D}_f$	
$\dot{B}_{w1}$		$\pm 808 \text{ T/s}$	5 ns	triggered by $\dot{D}_f$	
$\dot{B}_{wr}$		$\pm 781 \text{ T/s}$	10 ns	triggered by $\dot{D}_f$	
$\dot{B}_1$		$\pm 758 \text{ T/s}$	5 ns	triggered by $\dot{D}_f$	
TP113		$\pm 0.25 \text{ A}$	5 ns	triggered by $\dot{D}_f$	
TP126		$\pm 0.25 \text{ A}$	5 ns	triggered by $\dot{D}_f$	

TABLE I. Concluded.

FLIGHT NUMBER	MEASURE- MENT	FULL SCALE	SAMPLE INTERVAL	TRIGGER SOURCE(S) AND THRESHOLD
85-042 to -043	$\dot{D}_t$	$\pm 19.8 \text{ A/m}^2$	5 ns	triggered by $\dot{D}_f$
	$\dot{D}_f$	$\pm 27.6 \text{ A/m}^2$	5 ns	$\dot{D}_f$ ( $\pm 8.2 \text{ A/m}^2$ )
	$I_{t-10}$	$\pm 59.3 \text{E}3 \text{ A}$	5 ns	triggered by $\dot{D}_f$
	$I_{t-hi}$	$\pm 9.9 \text{E}3 \text{ A}$	10 ns	triggered by $\dot{D}_f$
	$\dot{i}$	$\pm 0.5 \text{E}11 \text{ A/s}$	5 ns	triggered by $\dot{D}_f$
	$\dot{B}_{wr}$	$\pm 781 \text{ T/s}$	10 ns	triggered by $\dot{D}_f$
	$\dot{B}_1$	$\pm 758 \text{ T/s}$	5 ns	triggered by $\dot{D}_f$
	TP113	$\pm 0.25 \text{ A}$	5 ns	triggered by $\dot{D}_f$
	TP126	$\pm 0.25 \text{ A}$	5 ns	triggered by $\dot{D}_f$
86-013	$\dot{D}_{f-hi}$	$\pm 52.0 \text{ A/m}^2$	10 ns	triggered by $\dot{i}$ or $I_t$ or $\int \dot{B}_t dt$
	$\dot{B}_{1-hi}$	$\pm 3.0 \text{E}3 \text{ T/s}$	10 ns	triggered by $\dot{i}$ or $I_t$ or $\int \dot{B}_t dt$
	$\dot{B}_t$	$\pm 3.0 \text{E}3 \text{ T/s}$	10 ns	triggered by $\dot{i}$ or $I_t$ or $\int \dot{B}_t dt$
	$\dot{D}_{f-10}$	$\pm 103.8 \text{ A/m}^2$	10 ns	triggered by $\dot{i}$ or $I_t$ or $\int \dot{B}_t dt$
	$\dot{i}$	$\pm 1.1 \text{E}11 \text{ A/s}$	10 ns	$\dot{i}$ ( $\pm 0.27 \text{E}11 \text{ A/s}$ ), or $I_t$ or $\int \dot{B}_t dt$
	$I_{t-hi}$	$\pm 21.3 \text{E}3 \text{ A}$	10 ns	$I_t$ ( $\pm 5.4 \text{E}3 \text{ A}$ ), or $\dot{i}$ or $\int \dot{B}_t dt$
	$\dot{B}_{1-10}$	$\pm 5.7 \text{E}3 \text{ T/s}$	10 ns	triggered by $\dot{i}$ or $I_t$ or $\int \dot{B}_t dt$
	$\dot{B}_{wr}$	$\pm 1.9 \text{E}3 \text{ T/s}$	10 ns	triggered by $\dot{i}$ or $I_t$ or $\int \dot{B}_t dt$
	$\int \dot{B}_t dt$	$\pm 108.4 \text{E}-4 \text{ T}$	10 ns	$\int \dot{B}_t dt$ ( $\pm 3.0 \text{E}-4 \text{ T}$ ), or $\dot{i}$ or $I_t$
	$I_{t-10}$	$\pm 203.1 \text{E}3 \text{ A}$	10 ns	triggered by $\dot{i}$ or $I_t$ or $\int \dot{B}_t dt$

TABLE II. 1985-1986 DATA SUMMARY FOR FLIGHTS 85-018 through 86-015

1985 DATE	FLT NUM	ACQUIRED		RUN NUMBERS OF MEASUREMENTS											
		NUM STKS	NUM NRBY	$\dot{D}_t$	$I_t$	$\dot{B}_{w1}$	$\dot{i}$	$\dot{B}_1$	$\dot{D}_{wr}$	$\dot{B}_{wr}$	$\dot{D}_f$	100	106	125	
6/12	018	1	1	1-2	1-2	1-2	1-2	1-2	1-2	1-2	1-2	1-2	1-2	1-2	1-2
6/18	022	2	1	1-4	1-2	1-4	1-4	1-4	1-4	1-4	1-4	1-4	1-4	1-4	1-4
6/24	023	2	0	1-5	1-5	1-5	1-5	1-5	1-5	1-5	1-5	1-5	1-5	1-5	1-5
7/2	026	4	0	1-4	1-4	1-4	1-4	1-4	1-2	1-2	1-2	1-4	1-4	1-4	1-4
7/6	027	2	0	1-2	1-2	1-2	1-2	1-2	1-2	1-2	1-2	1-2	1-2	1-2	1-2
7/10	028	1	0	---	---	1	1	1	1	1	1	1	1	1	1
7/12	029	5	6	1,2 4-6 8-12	1,2 4-6 8-12	1-6 8-12	1-6 8-12	1,5-6 12	1,2 4-6 8-12	1,2 4-6 8-12	1,2 4-6 8-12	1,2 4-6 8-12	1,2 4-6 8-12	1,2 4-6 8-12	1,2 4-6 8-12
7/16	030	1	0	---	---	1	1	1	1	1	1	1	1	1	1
7/22	031	2	0	1-2	1-2	1-2	1-2	1	1-2	1-2	1-2	1-2	1-2	1-2	1-2
(MEASUREMENT CHANGE)				$\dot{D}_t$	$I_t$	$\dot{B}_{w1}$	$\dot{i}$	$\dot{B}_1$	$\dot{D}_{wr}$	$\dot{B}_{wr}$	$\dot{D}_f$	101	116	112	
7/27	032	6	0	1-6	1-6	1-6	1-6	1	1-6	1-6	1-6	1-6	1-6	1-6	1-6
7/31	033	5	0	1-5	1-5	1-5	1-5	---	1-5	1-5	1-5	1-5	1-5	1-5	1-5
8/8	035	6	0	1-6	1-6	1-6	1-6	1-6	1-6	1-6	1-6	1-6	1-6	1-6	1-6
(MEASUREMENT CHANGE)				$\dot{D}_t$	$I_t$	$\dot{B}_{w1}$	$\dot{i}$	$\dot{B}_1$	$\dot{D}_{wr}$	$\dot{B}_{wr}$	$\dot{D}_f$	102	105	123	
8/16	036	3	0	---	1-3	1-3	1-3	1-3	1-3	1-3	1-3	1-3	1-3	1-3	1-3

TABLE II. Concluded.

1985 DATE	FLT NUM	ACQUIRED		RUN NUMBERS OF MEASUREMENTS								
		NUM STKS	NUM NRBY	$\dot{D}_t$	$I_{t-1,0}$	$\dot{D}_f$	$\dot{I}$	$\dot{B}_l$	$I_{t-h,1}$	$\dot{B}_{wr}$	$I_{t-1,0}$	
9/11	043	1	0	1	1	1	1	—	1	1	113	126

1986 DATE	FLT NUM	ACQUIRED		RUN NUMBERS OF MEASUREMENTS									
		NUM STKS	NUM NRBY	$\dot{D}_{f-h,1}$	$\dot{B}_{l-h,1}$	$\dot{B}_t$	$\dot{D}_{f-1,0}$	$\dot{I}$	$I_{t-h,1}$	$\dot{B}_{l-1,0}$	$\dot{B}_{wr}$	$\int \dot{B}_t dt$	$I_{t-1,0}$
8/8	013	1	0	14	14	14	14	14	14	14	14	14	14

TABLE III. 1985-1986 DATA SUMMARY--PEAK LEVELS

DATE	FLIGHT NUMBER	ENCOUNTERED		PEAK LEVELS RECORDED		
		NUMBER STRIKES	NUMBER NEAR-BY	$\dot{D}_f$ (A/m <sup>2</sup> )	$\dot{i}$ (A/s)	$I_t$ (kA)
6/12/85	85-018	1	1	-43	4.3E10*	- 0.0* + 0.0*
6/18/85	85-022	5	1	-26	5.8E09*	- 2.8* + 5.6*
6/24/85	85-023	2	3	-39	3.4E10*	- 0.0* + 0.0*
7/2/85	85-026	4	0	-39	7.6E09*	- 2.8* + 0.0*
7/6/85	85-027	2	0	-10	2.4E11	- 5.6* + 0.0*
7/10/85	85-028	1	0	-5*	1.9E09*	- 0.0* + 0.0*
7/12/85	85-029	6	6	-78	2.1E10*	- 0.0* + 0.0*
7/16/85	85-030	1	0	-10	7.6E09*	- 2.8* + 2.8*
7/22/85	85-031	2	0	-33	1.1E10*	- 2.8* + 8.4*
7/27/85	85-032	7	0	-42	2.3E10*	- 0.0* + 6.6*
7/31/85	85-033	6	0	-16	4.9E10	-25.6 + 3.4*
8/1/85	85-034	0	0	0*	0.0E09*	- 0.0* + 0.0*
8/8/85	85-035	7	0	-42	9.7E10	- 2.6* + 3.0*
8/16/85	85-036	3	0	-12	0.0E09*	- 0.0* + 0.0*
8/17/85	85-037	1	0	-20	9.6E09*	- 0.0* + 0.0*
8/27/85	85-039	0	0	0*	0.0E09*	- 0.0* + 0.0*
8/30/85	85-040	2	0	-15	0.0E09*	- 0.0* + 0.0*
9/9/85	85-041	2	0	-24	7.6E09*	- 0.0* + 0.0*

continued

TABLE III. Concluded.

DATE	FLIGHT NUMBER	ENCOUNTERED		PEAK LEVELS RECORDED		
		NUMBER STRIKES	NUMBER NEAR-BY	$\dot{D}_f$ (A/m <sup>2</sup> )	$\dot{i}$ (A/s)	$I_t$ (kA)
9/10/85	85-042	0	0	0*	0.0E09*	- 0.0* + 0.0*
9/11/85	85-043	1	0	-47	0.0E09*	- 9.9* + 1.9*

DATE	FLIGHT NUMBER	NUMBER STRIKES	NUMBER NEAR-BY	PEAK LEVELS RECORDED		
				$\dot{D}_f$ (A/m <sup>2</sup> )	$\dot{i}$ (A/s)	$I_t$ (kA)
7/11/86	86-005	1	0	+ 60 - 15	+6.0E09* -4.5E09*	**
7/12/86	86-006	3	0	+ 18 - 2*	+2.9E10 -8.4E10	**
7/17/86	86-009	3	0	+ 49 - 12	+8.3E10 -1.3E10	+ 0.0* - 0.0*
7/19/86	86-010	3	0	+ 46 -125	+9.7E10 -2.2E10	+ 0.0* - 0.0*
7/25/86	86-011	0	0	+ 3* - 0*	+2.0E09* -2.0E09*	+ 0.0* - 0.0*
7/26/86	86-012	2	0	+ 75 - 20	+5.7E10 -3.2E10	+ 0.0* - 0.0*
8/8/86	86-013	12	0	+140 - 28	+5.4E10 -4.9E10	+22.0 - 1.6*
8/11/86	86-014	0	0	+ 18 - 0*	+8.3E10 -0.0E09*	+ 3.1* - 4.7*
8/27/86	86-015	0	0	+ 20 - 0*	+0.0E09* -0.0E09*	+ 0.0* - 0.0*

\* Readings less than or equal to error of  $\pm 2.5\%$  of full scale (see text).  
 \*\* Sensor inoperative.



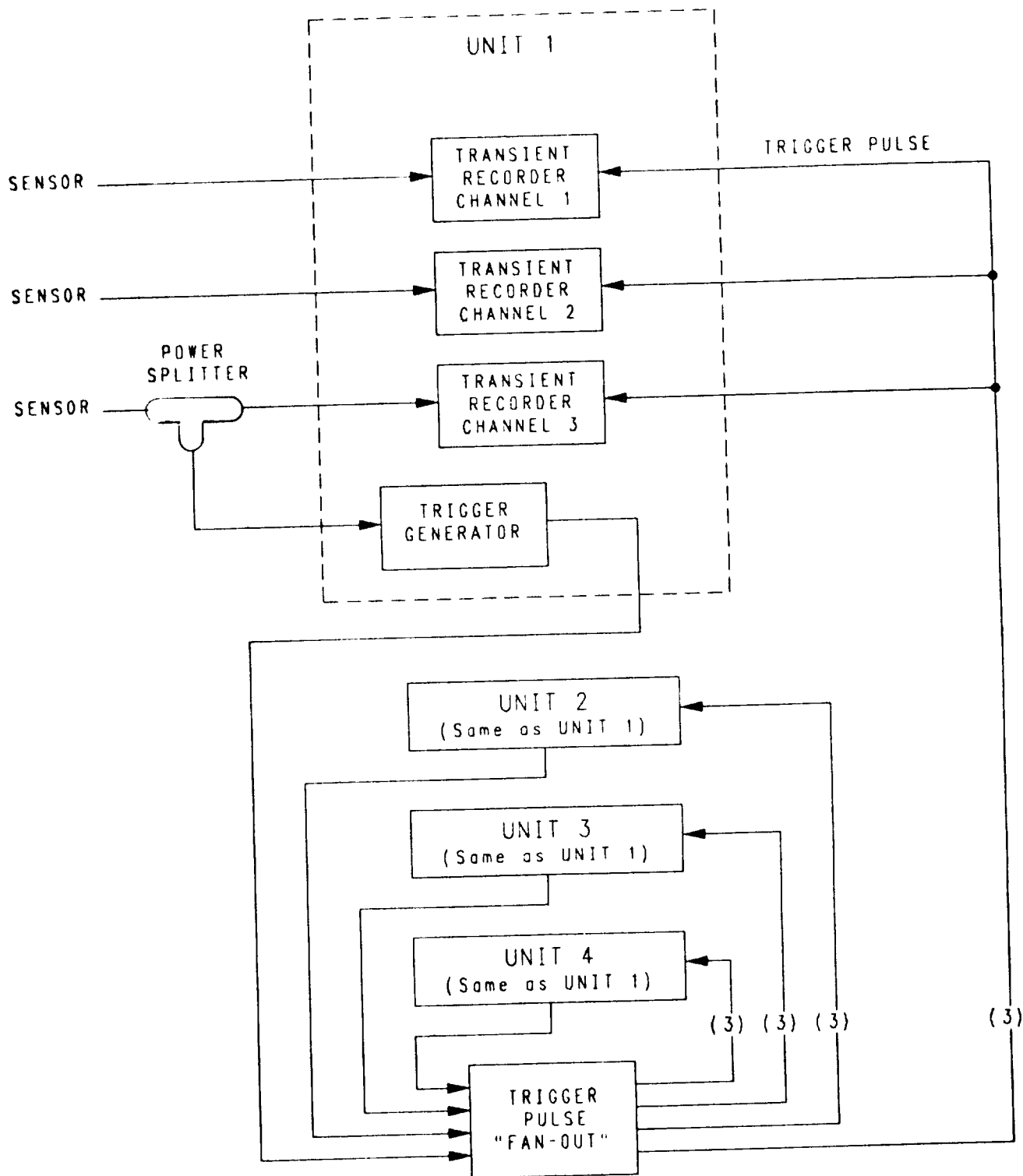

FIGURE 1. Transient Recorder Trigger Configuration

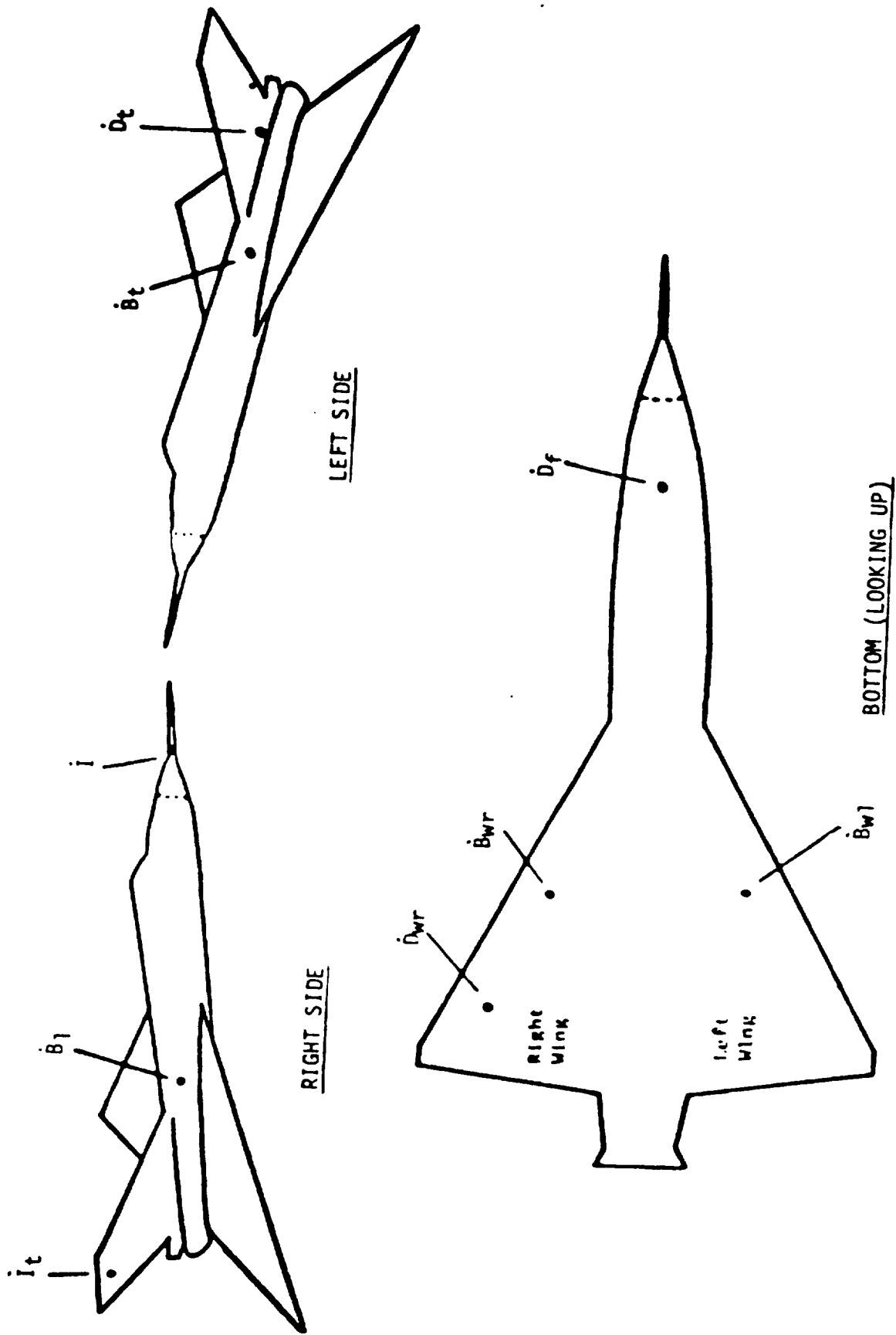

FIGURE 2. External Sensor Locations

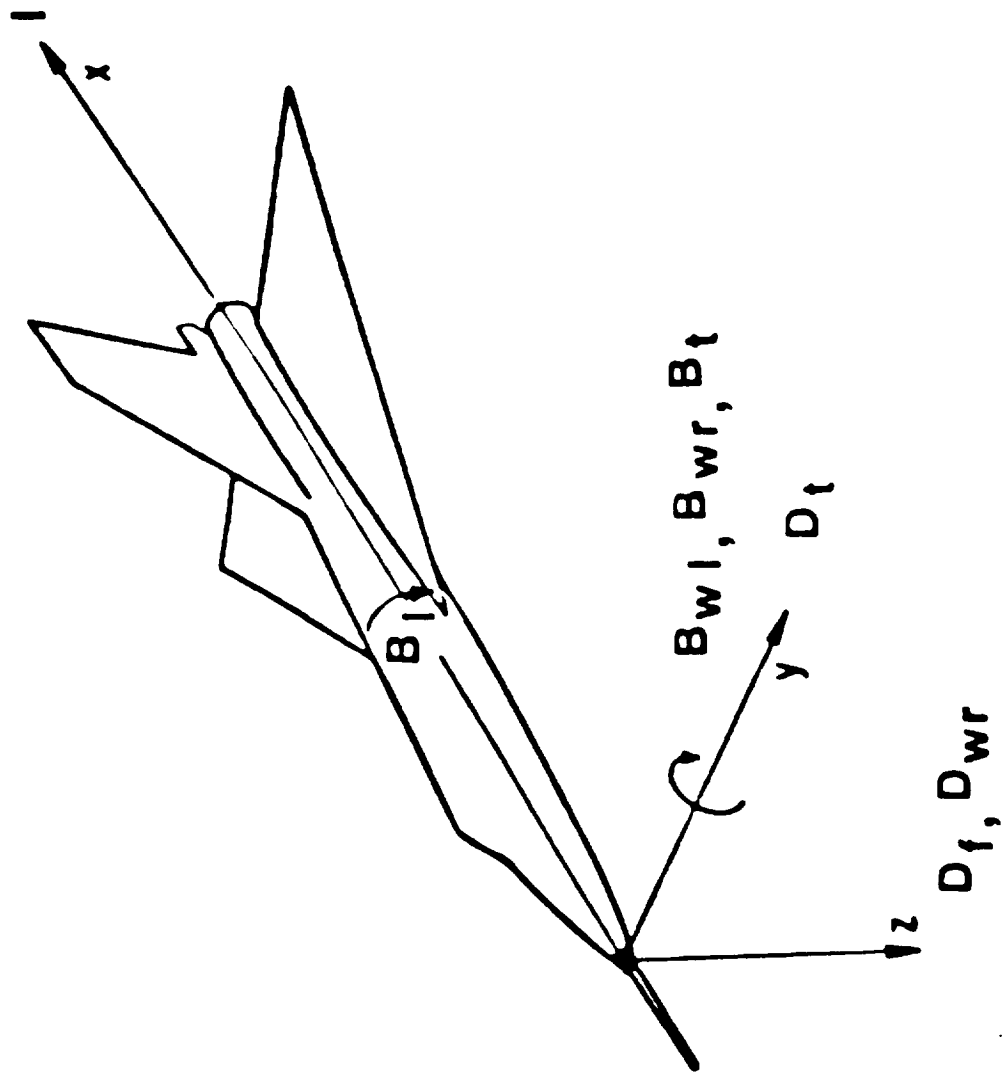
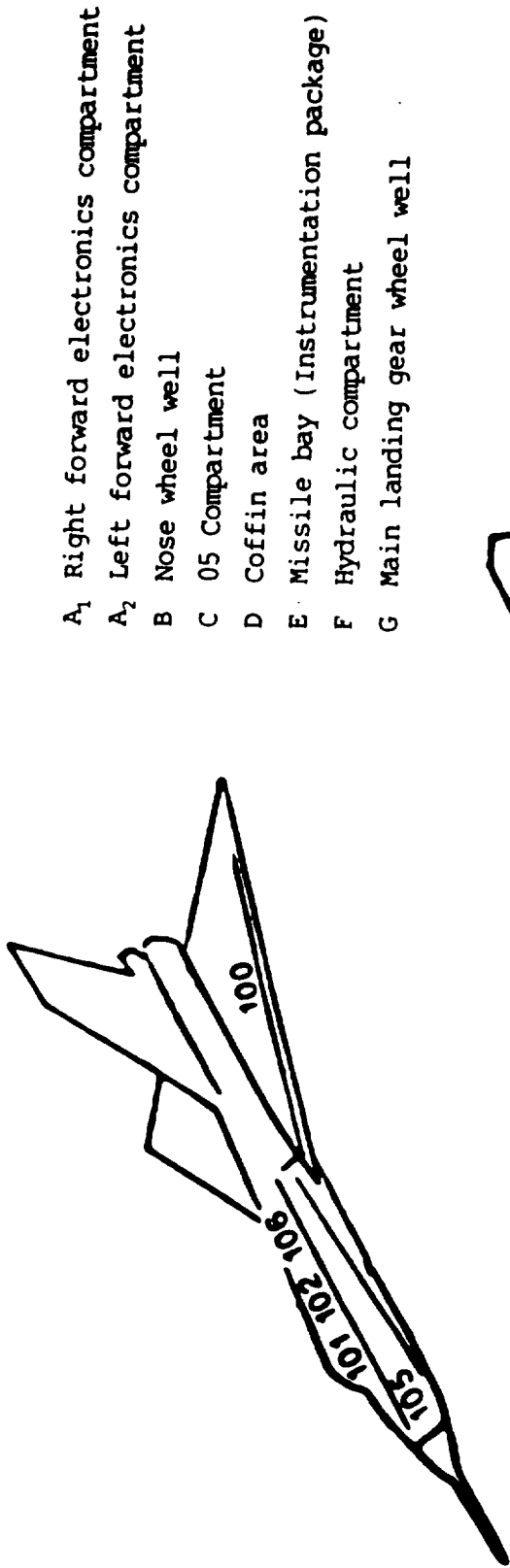
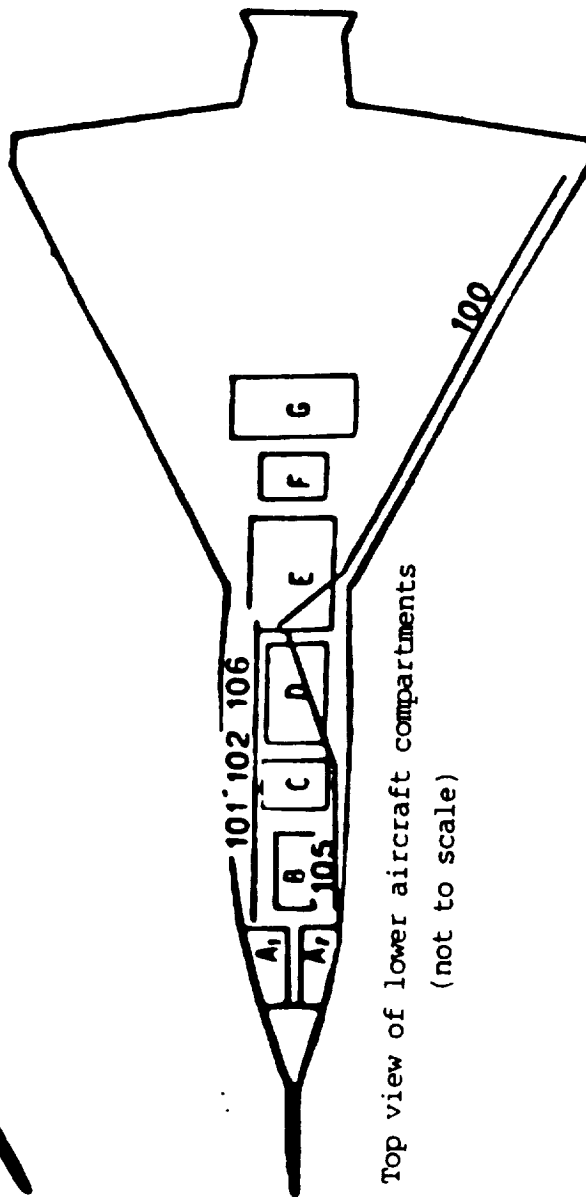

FIGURE 3. Polarity Conventions for Currents and Field Densities



- A<sub>1</sub> Right forward electronics compartment
- A<sub>2</sub> Left forward electronics compartment
- B Nose wheel well
- C O5 Compartment
- D Coffin area
- E Missile bay (Instrumentation package)
- F Hydraulic compartment
- G Main landing gear wheel well



Top view of lower aircraft compartments  
(not to scale)

FIGURE 4. Internal Test Points 100, 101, 102, 105, and 106

- A<sub>1</sub> Right forward electronics compartment
- A<sub>2</sub> Left forward electronics compartment
- B Nose wheel well
- C O5 Compartment
- D Coffin area
- E Missile bay (Instrumentation package)
- F Hydraulic compartment
- G Main landing gear wheel well

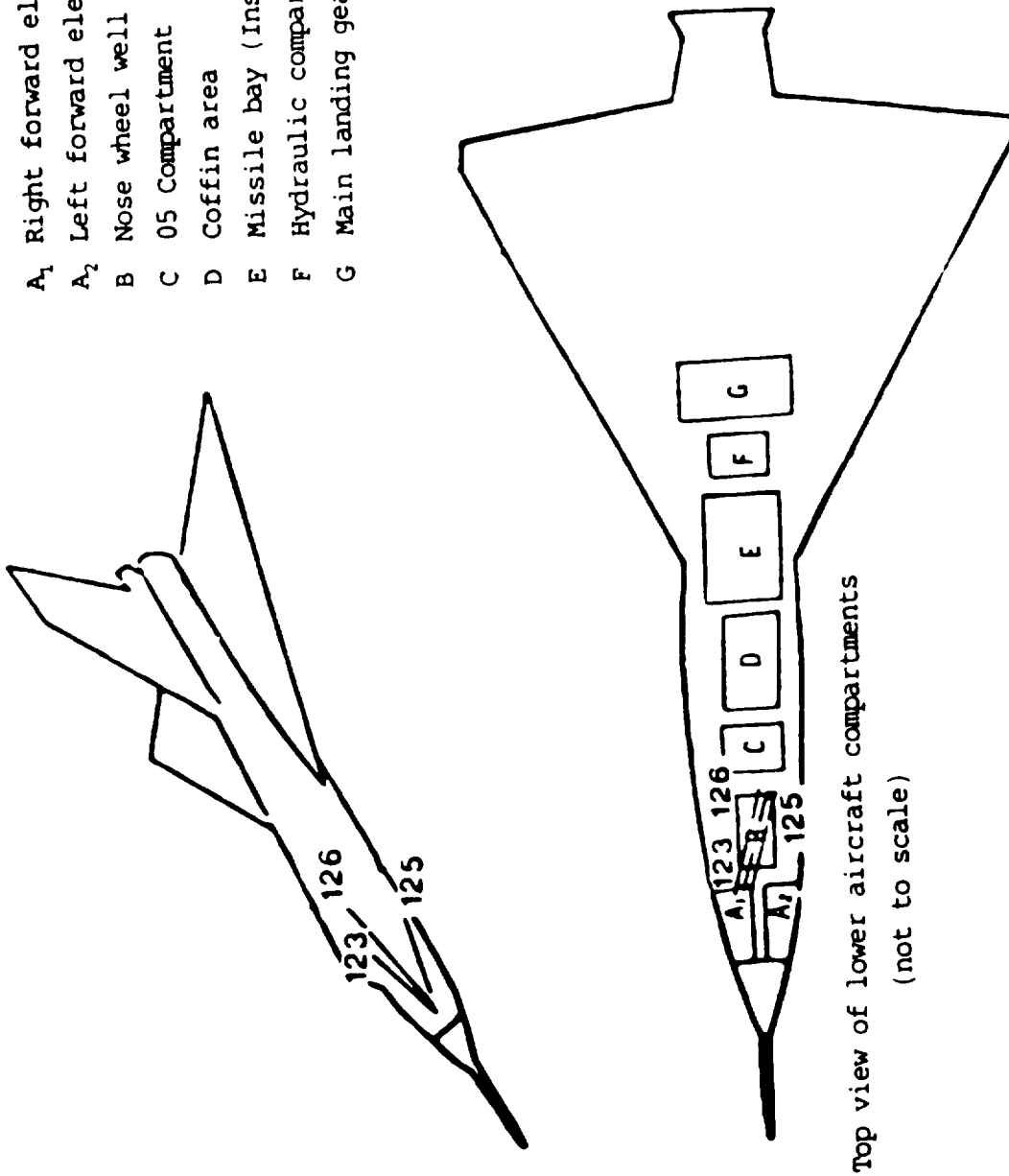
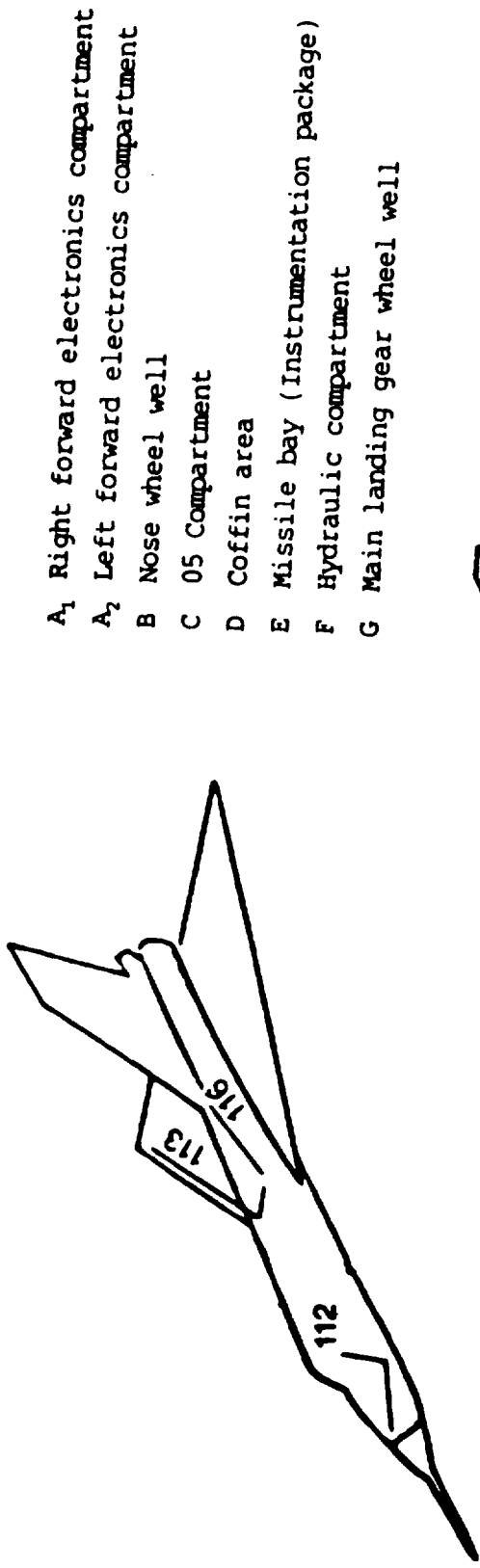

FIGURE 5. Internal Test Points 123, 124, and 125



- A<sub>1</sub> Right forward electronics compartment
- A<sub>2</sub> Left forward electronics compartment
- B Nose wheel well
- C O5 Compartment
- D Coffin area
- E Missile bay (Instrumentation package)
- F Hydraulic compartment
- G Main landing gear wheel well

Top view of lower aircraft compartments  
(not to scale)

FIGURE 6. Internal Test Points 112, 113, and 116

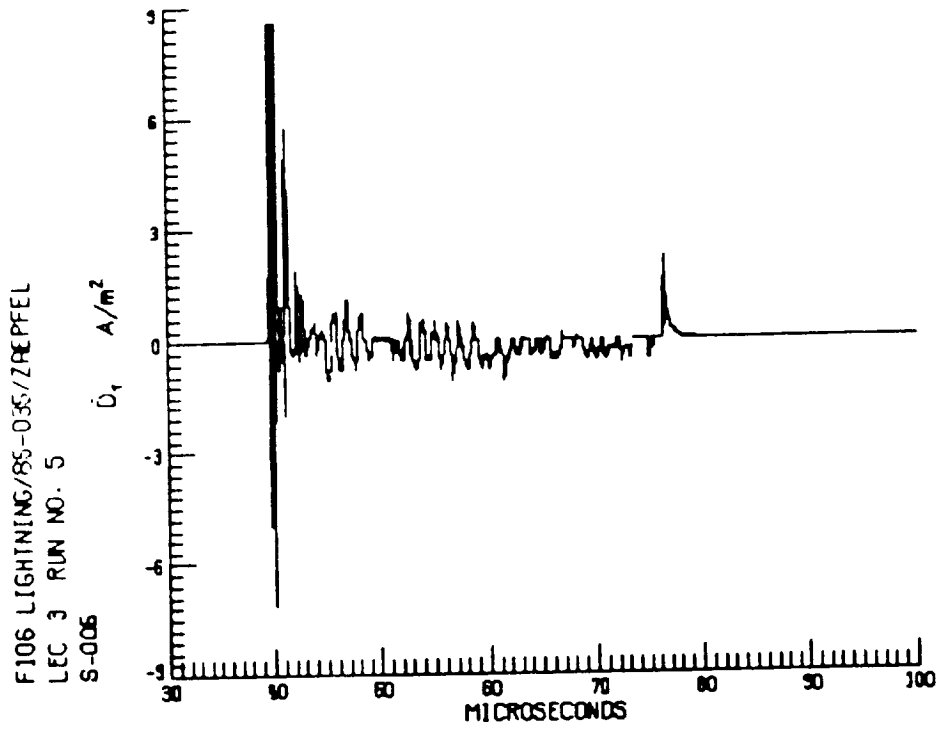
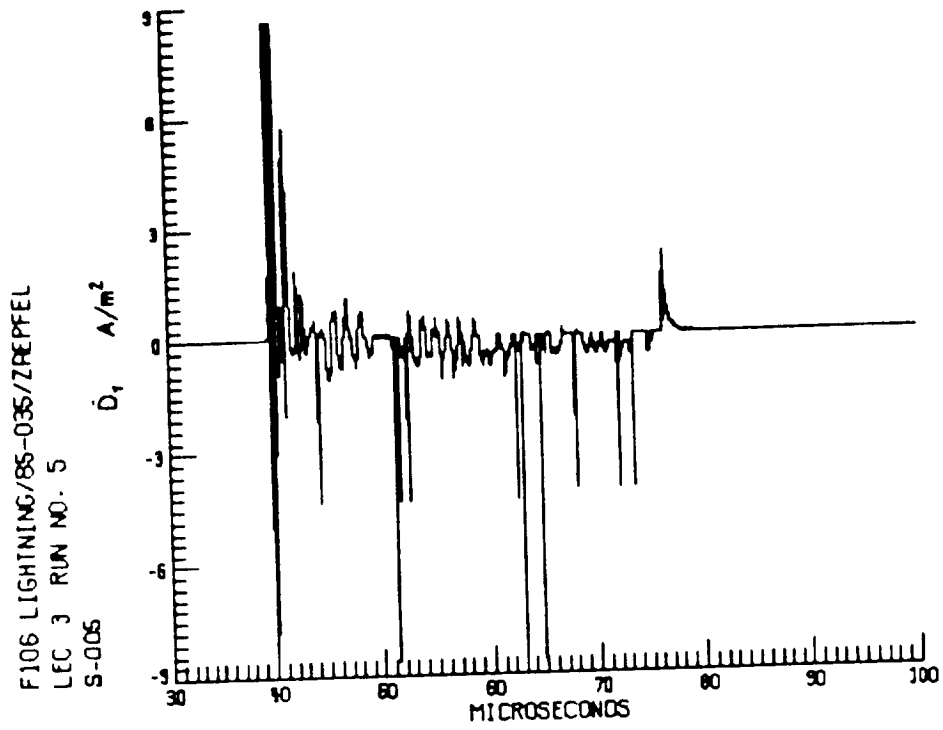

21:13:09.6  
 CHANNEL NO. 3.2

FIGURE 7. Example of Wild-Point Elimination

F106 LIGHTNING/85-018/ZAEPFEL

LEC 1 RUN NO. 1

N-001

$\dot{D}_t$  A/m<sup>2</sup>

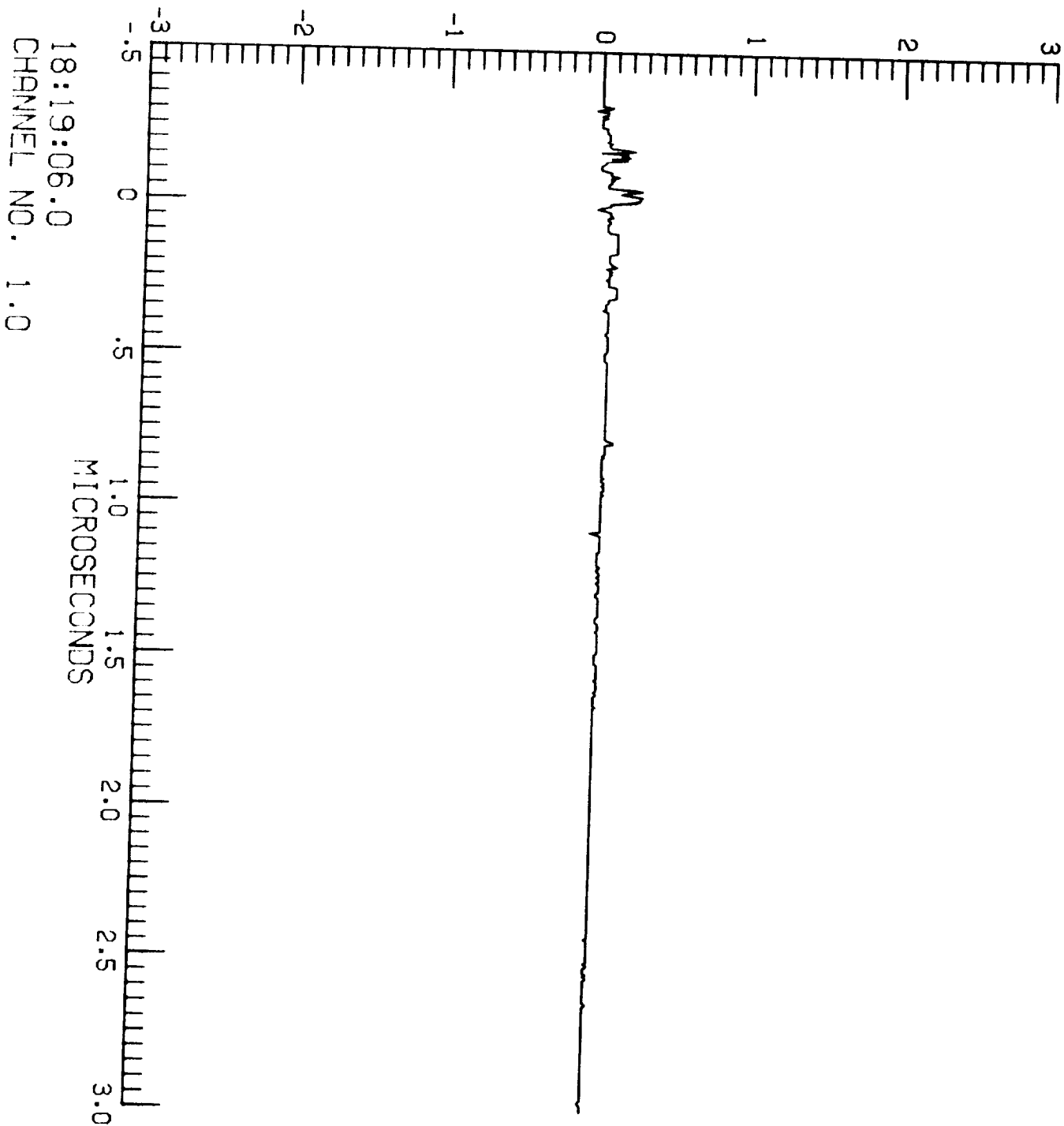



F106 LIGHTNING/85-018/ZAEPFEL  
LEC 1 RUN NO. 1  
N-001

$\dot{D}_t$  A/m<sup>2</sup>

18:19:06.0  
CHANNEL NO. 1.0

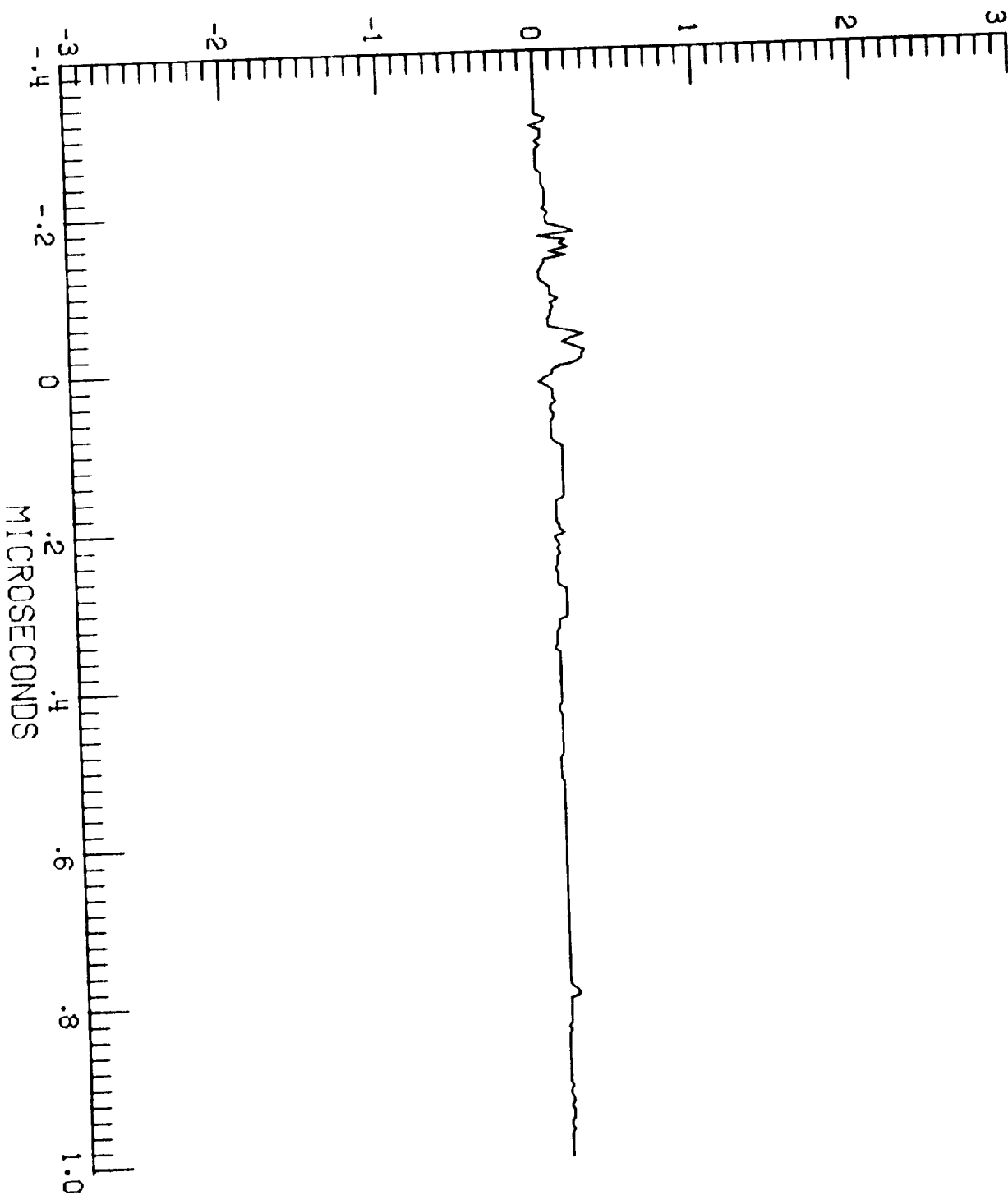

F106 LIGHTNING/85-018/ZAEPFEL

LEC 1 RUN NO. 1

N-001

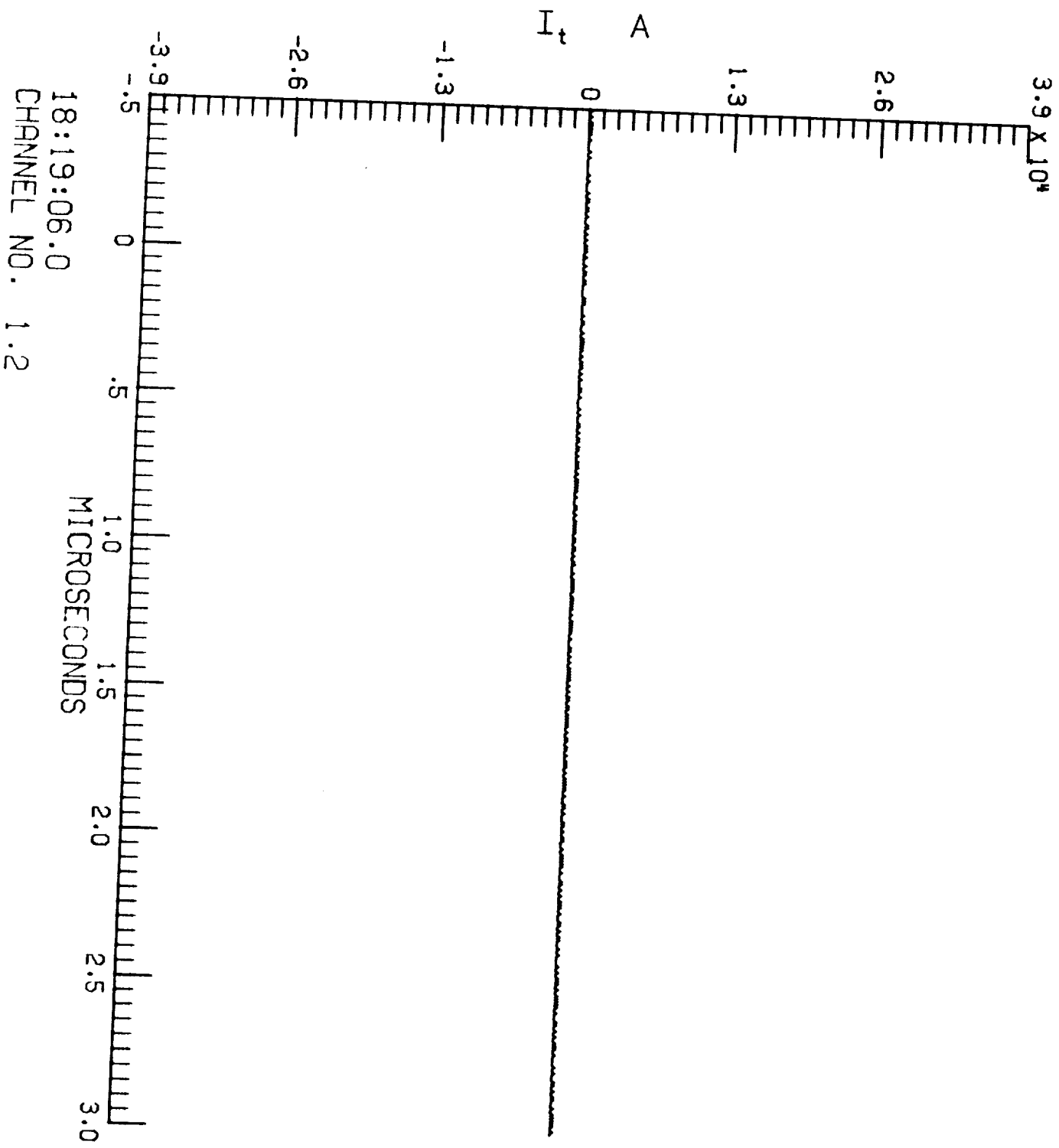

18:19:06.0  
CHANNEL NO. 1.2

F106 LIGHTNING/85-018/ZAEPFEL

LEC 2 RUN NO. 1

N-001

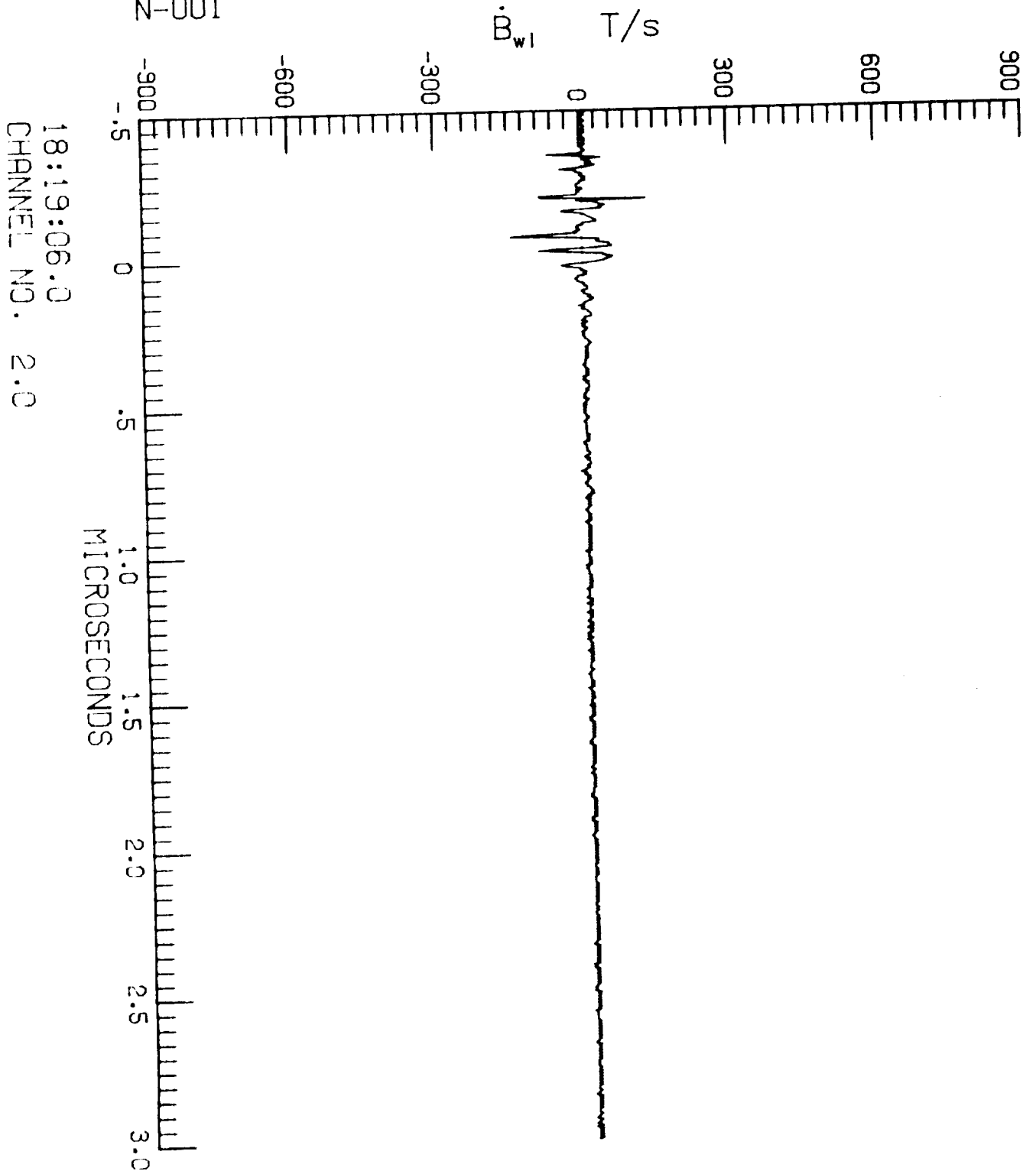

18:19:06.0  
CHANNEL NO. 2.0

F106 LIGHTNING/85-018/ZAEPFEL

LEC 2 RUN NO. 1

N-001

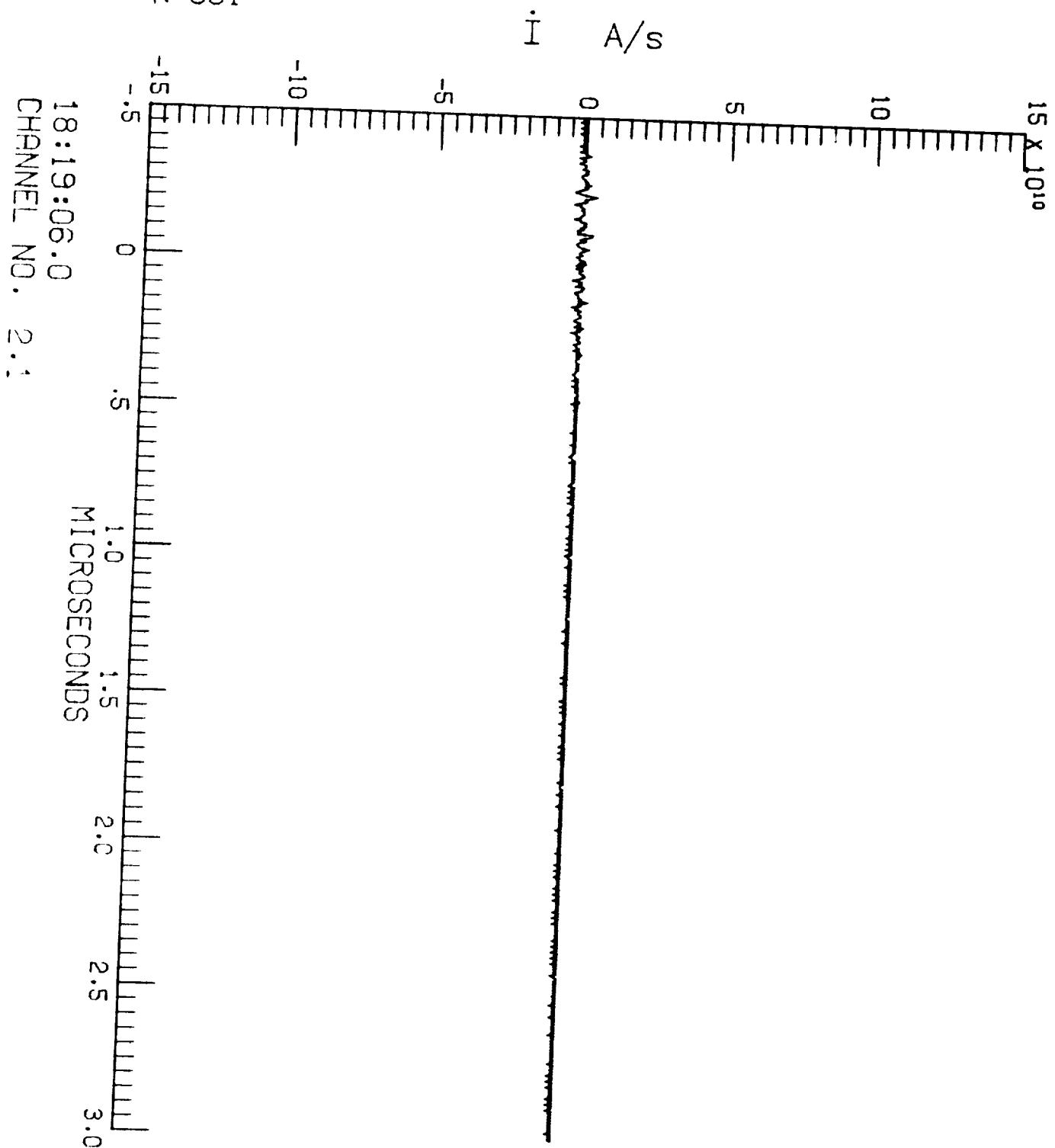

F106 LIGHTNING/85-018/ZAEPFEL  
LEC 2 RUN NO. 1  
N-001

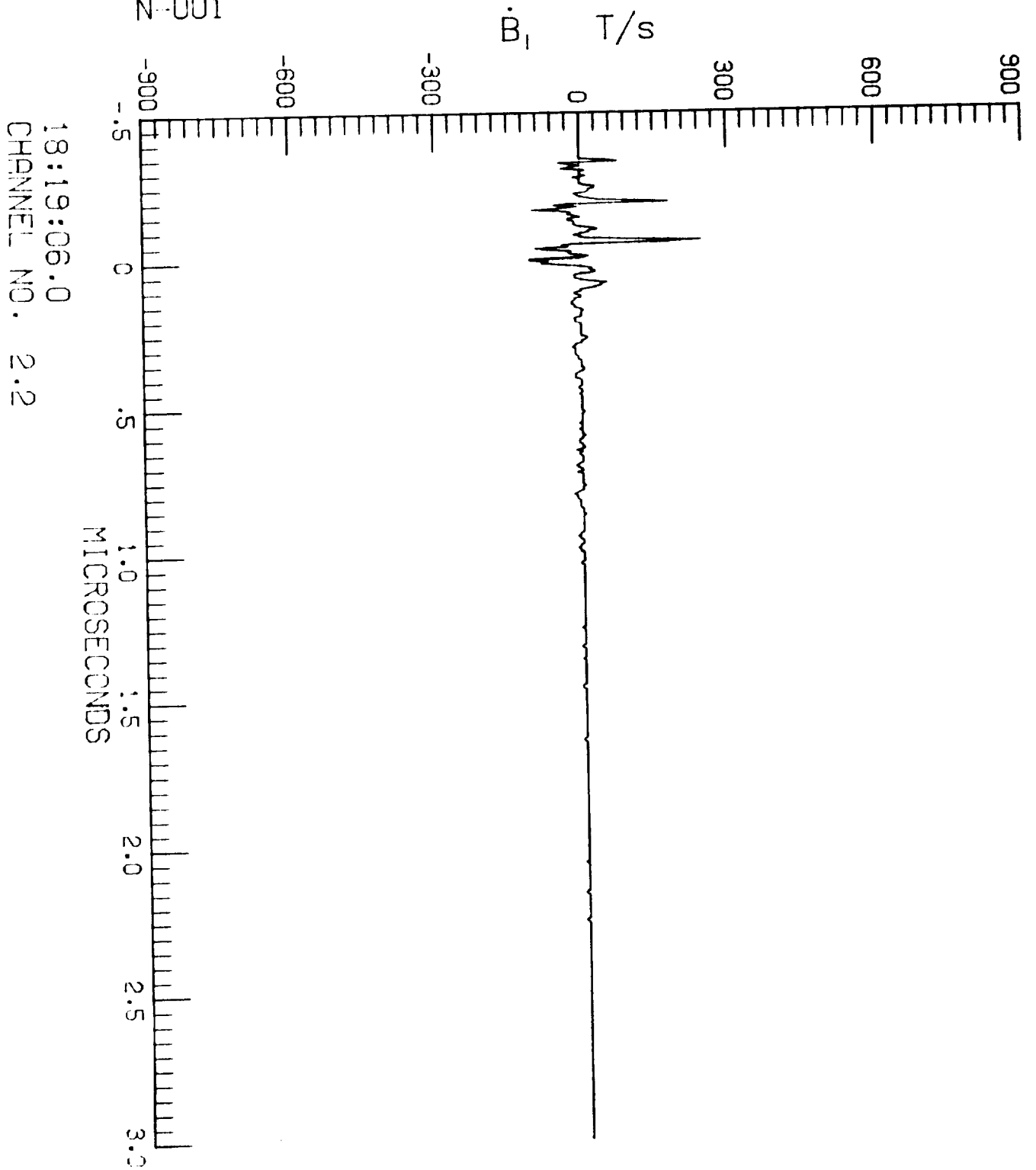

18:19:06.0  
CHANNEL NO. 2.2

F106 LIGHTNING/85-018/ZAEPFEL

LEC 3 RUN NO. 1

N-001

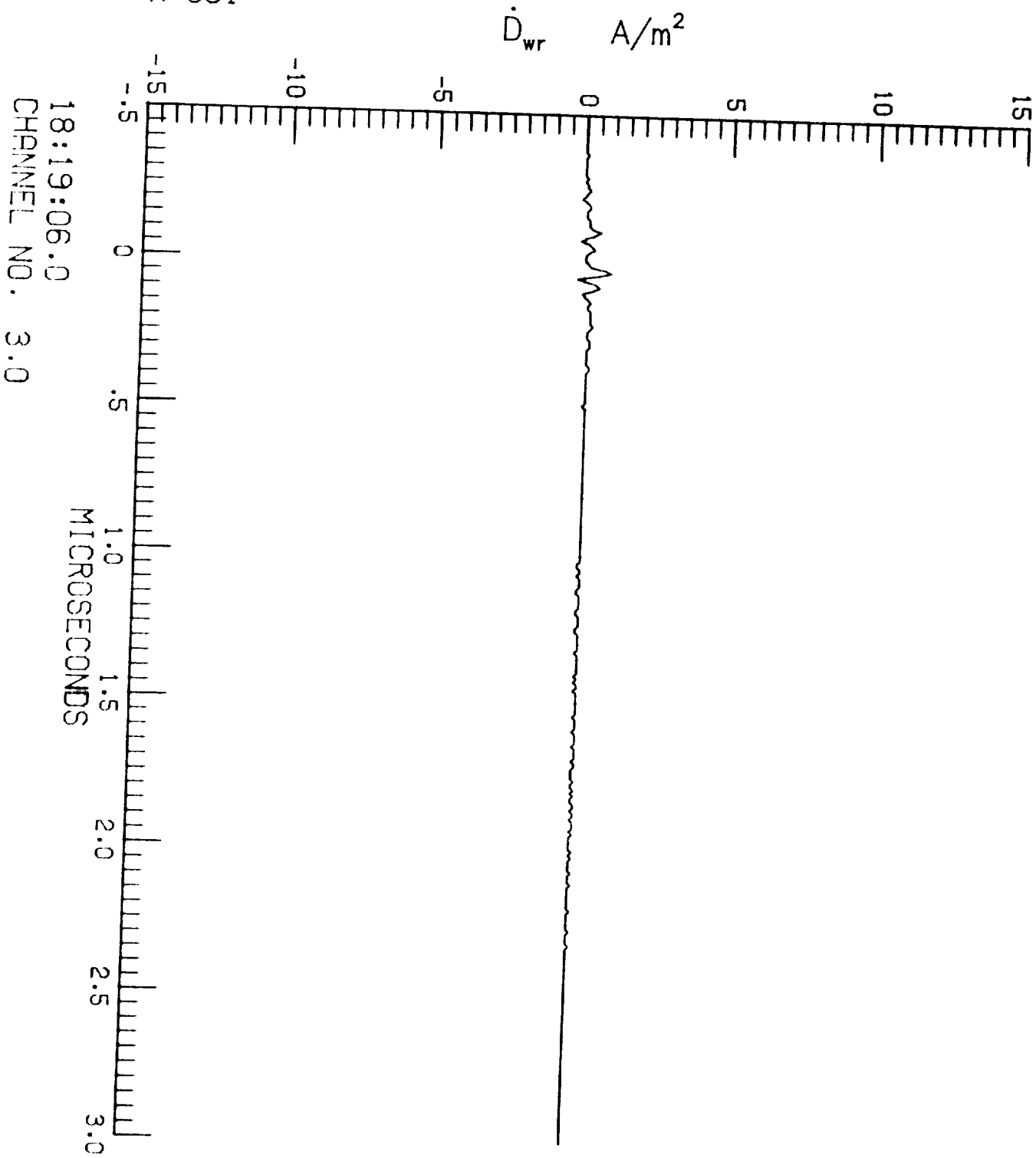

F106 LIGHTNING/85-018/ZAEPFEL  
LEC 3 RUN NO. 1  
N-001

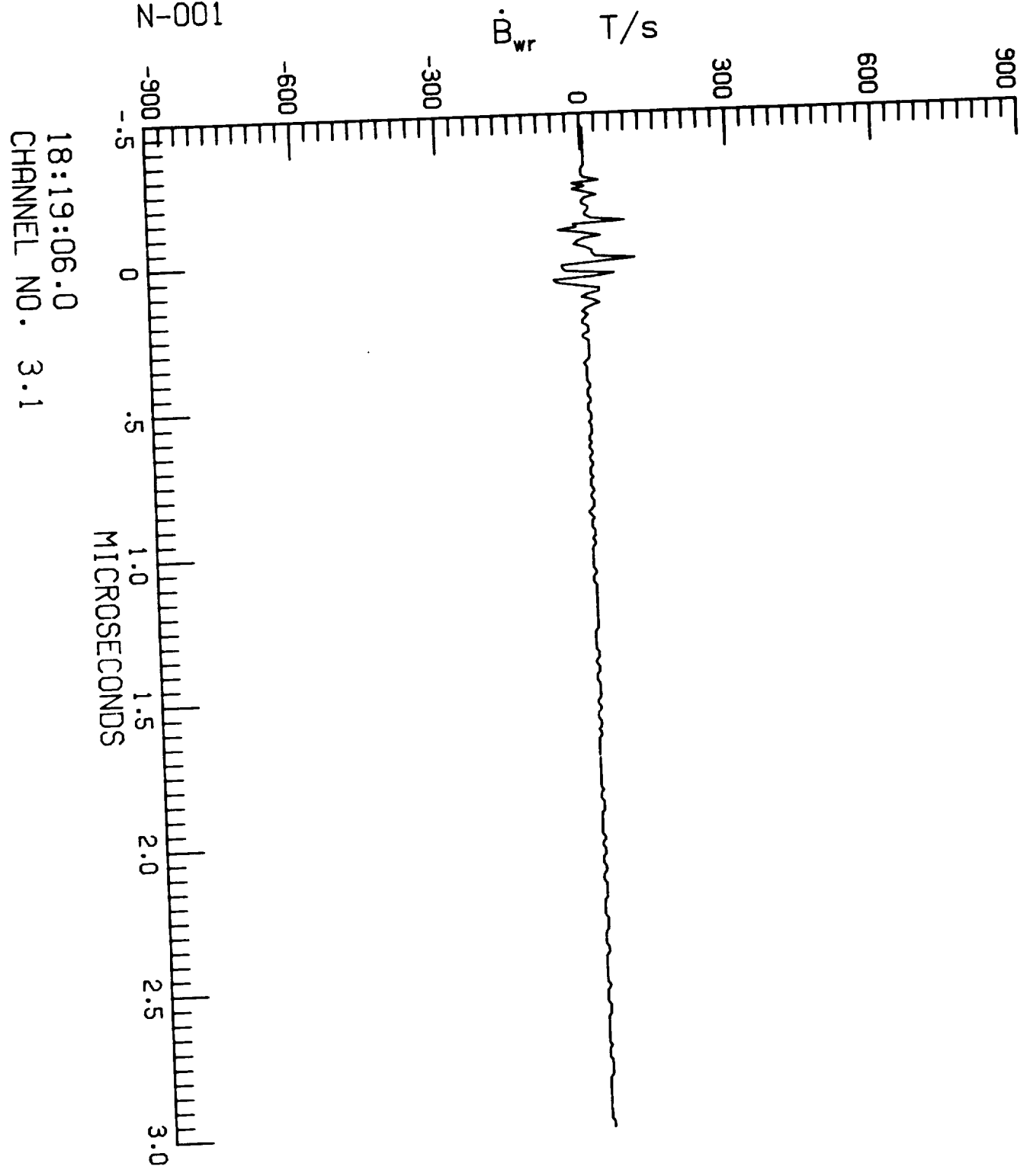

18:19:06.0  
CHANNEL NO. 3.1

F106 LIGHTNING/85-018/ZAEPFEL

LEC 3 RUN NO. 1

N-001

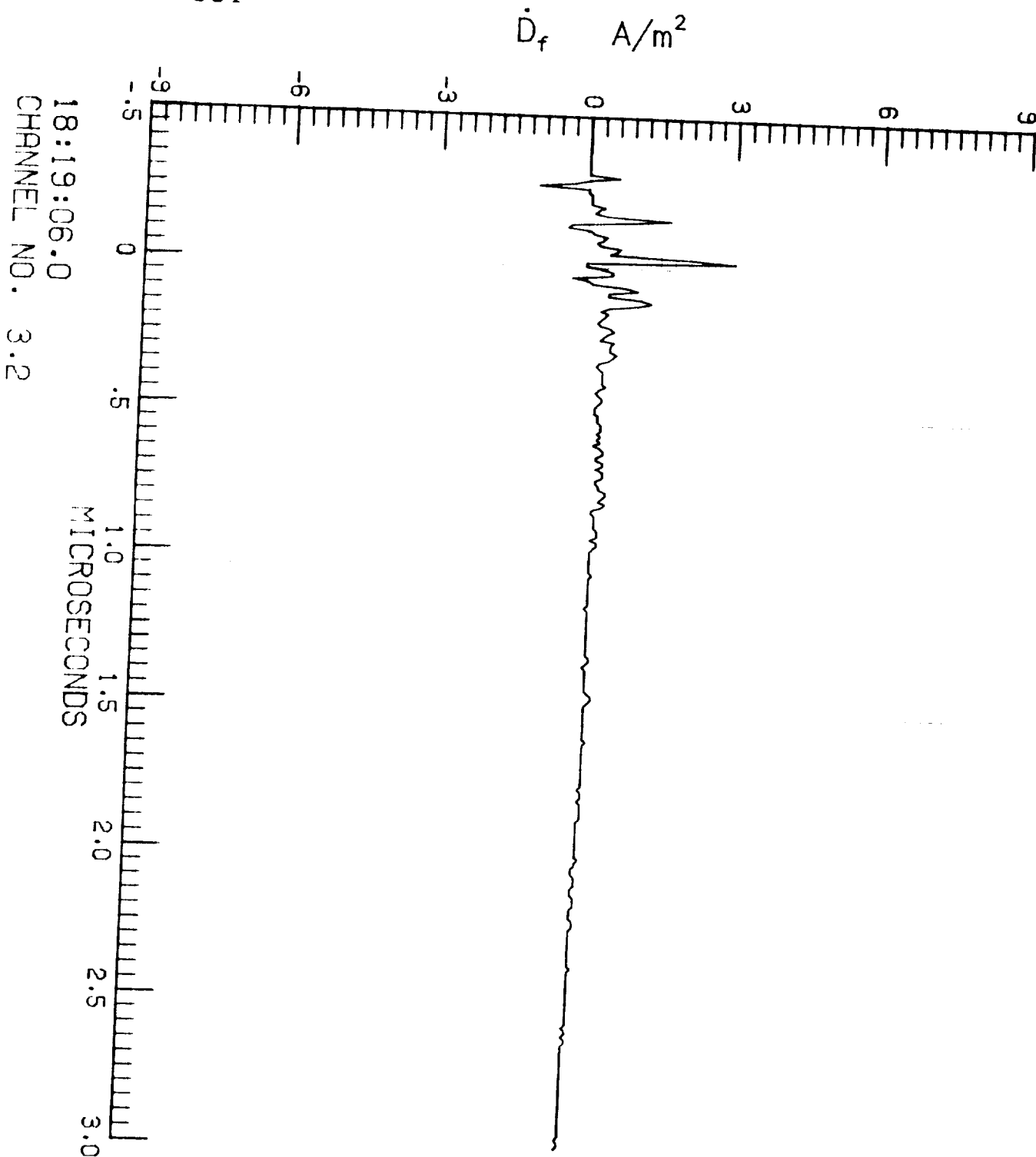



F106 LIGHTNING/85-018/ZAEPFEL  
LEC 4 RUN NO. 1  
N-001

TP100 V

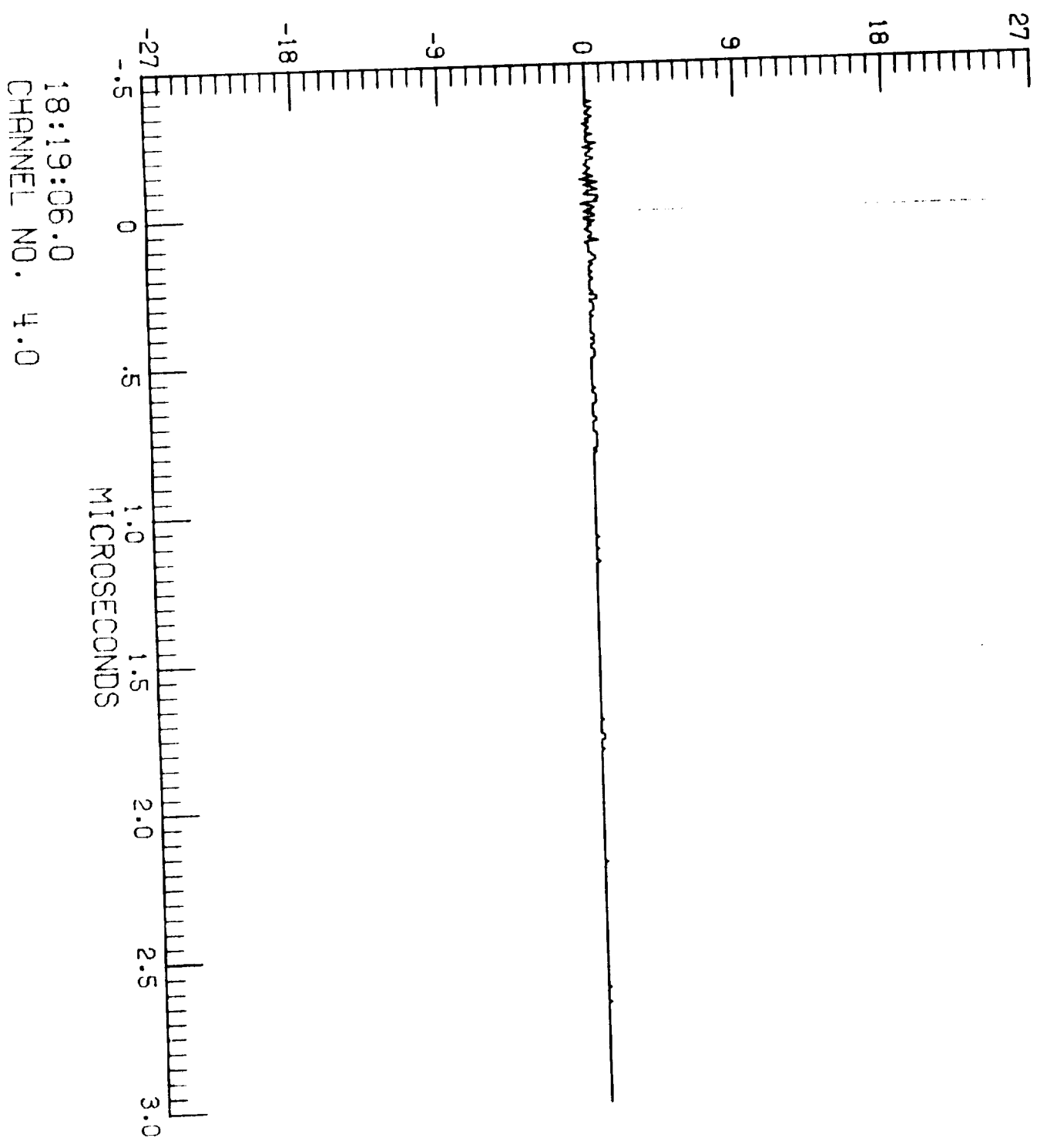

18:19:06.0  
CHANNEL NO. 4.0

F106 LIGHTNING/85-018/ZAEPFEL

LEC 4 RUN NO. 1

N-001

TP106 A

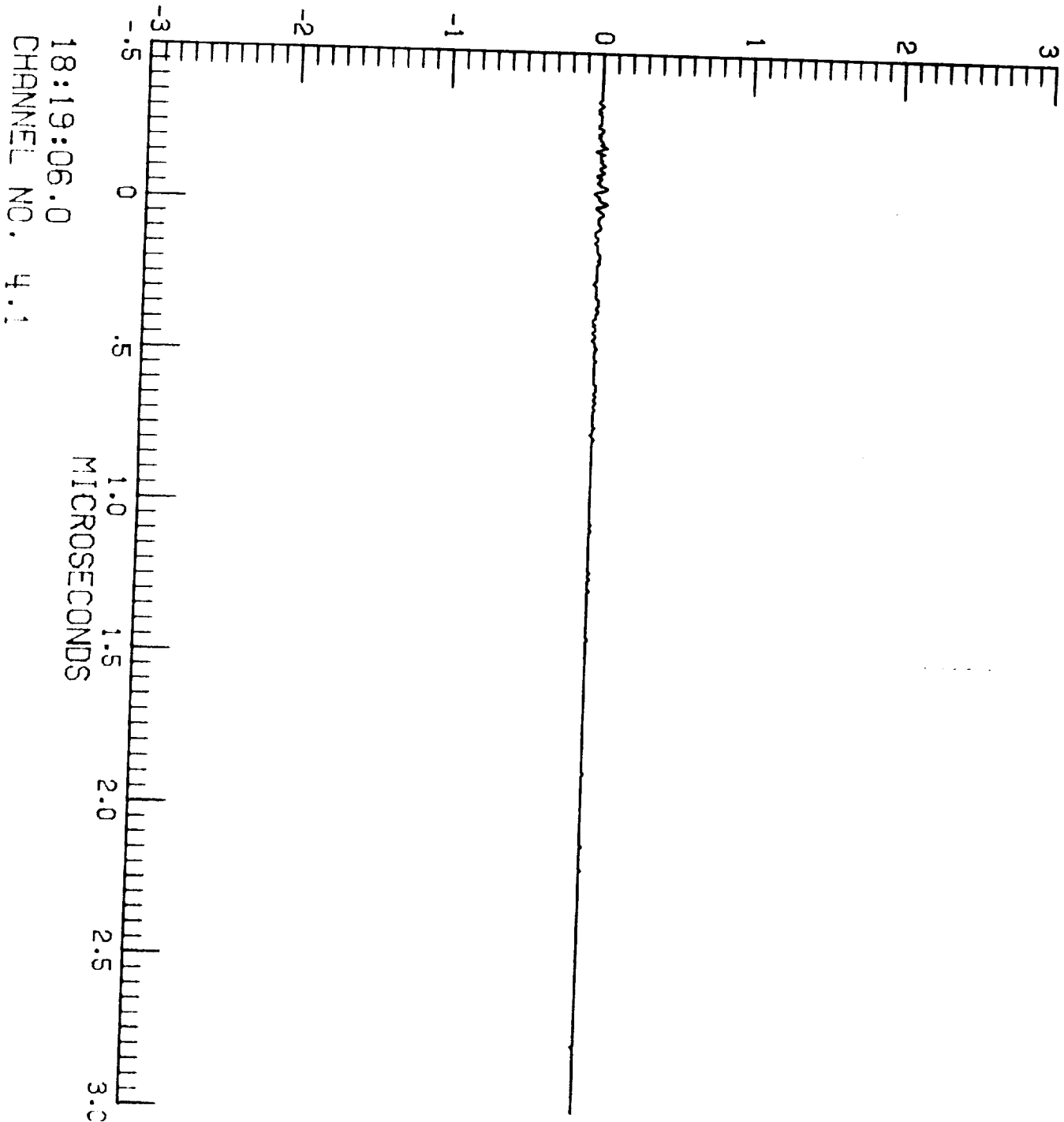

F106 LIGHTNING/85-018/ZAEPFEL

LEC 4 RUN NO. 1

N-001

TP125

A

18:19:06.0  
CHANNEL NO. 4.2

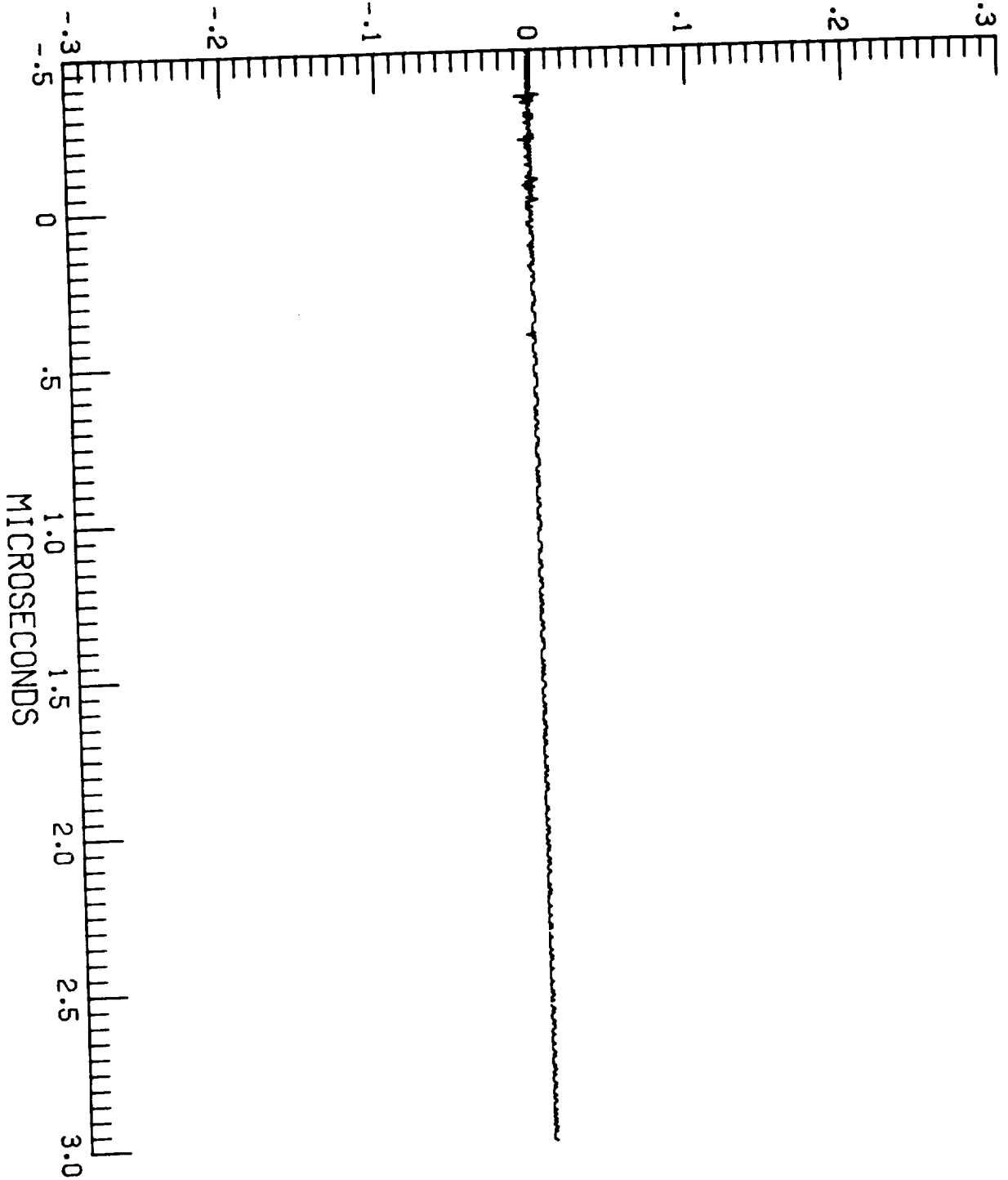

F106 LIGHTNING/85-018/ZAEPFEL

LEC 1 RUN NO. 2

S-001

$\dot{D}_t$  A/m<sup>2</sup>

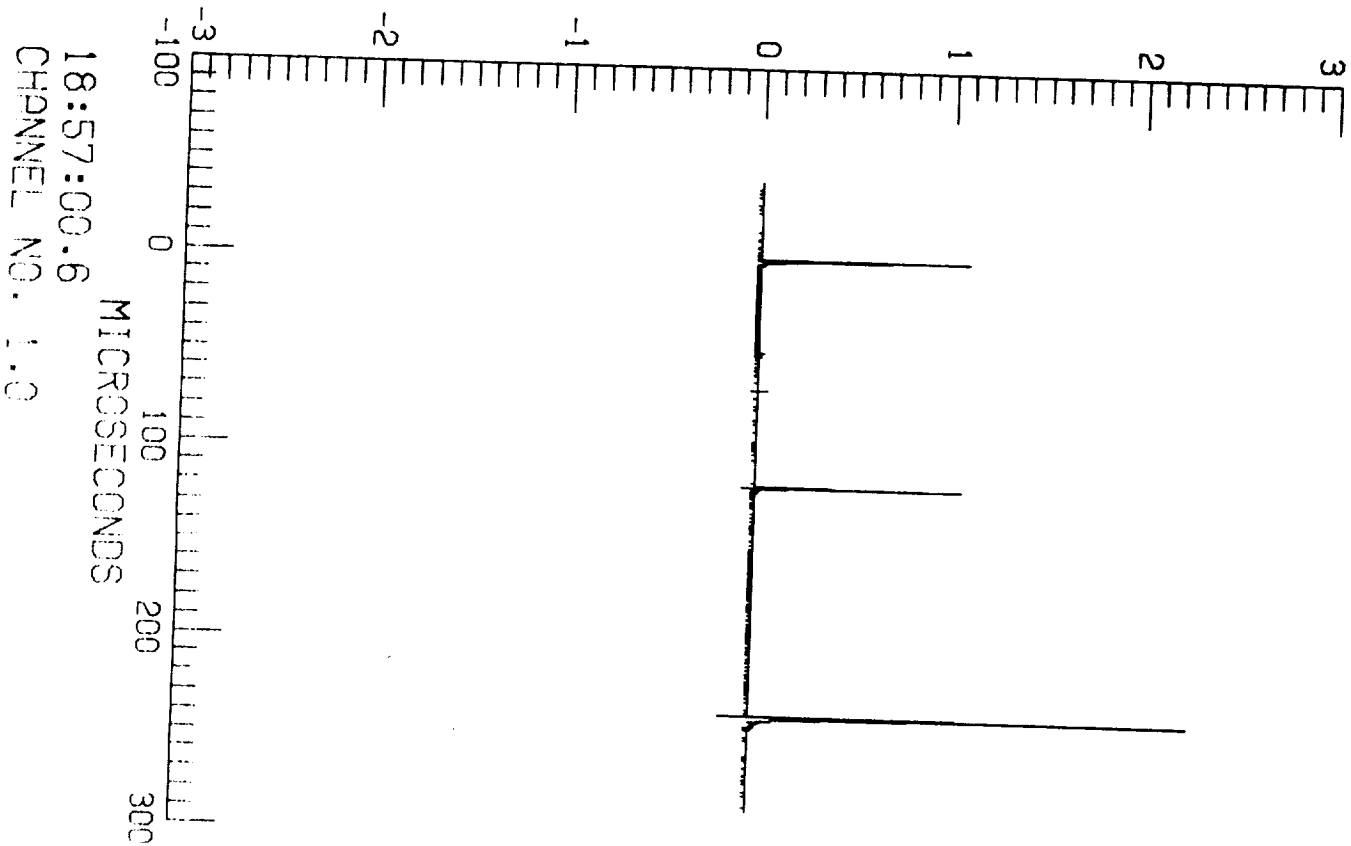

F106 LIGHTNING/85-018/ZAEPFEL

LEC 1

RUN NO. 2

S-001

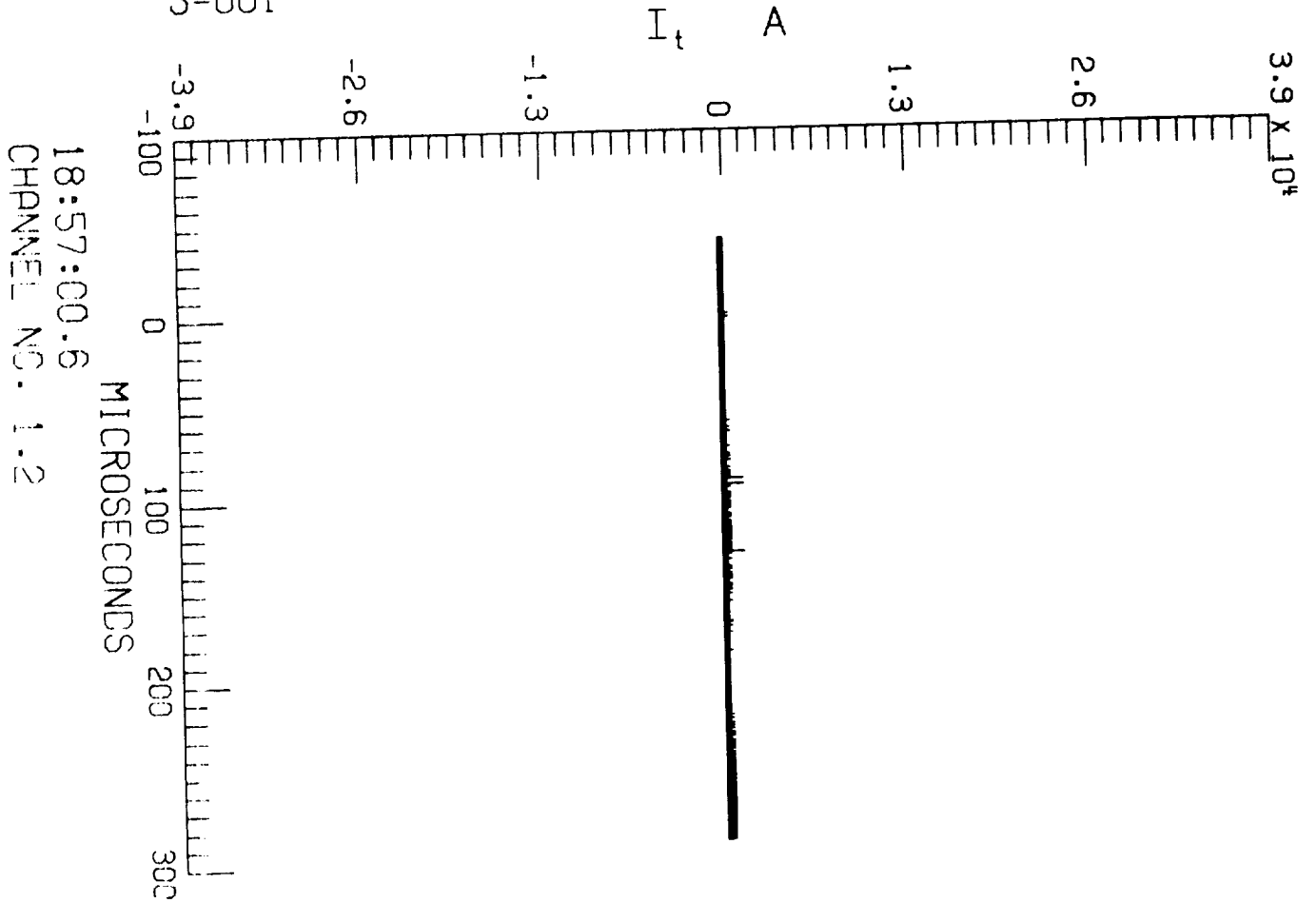

F106 LIGHTNING/85-018/ZAEPFEL  
LEC 2 RUN NO. 2  
S-001

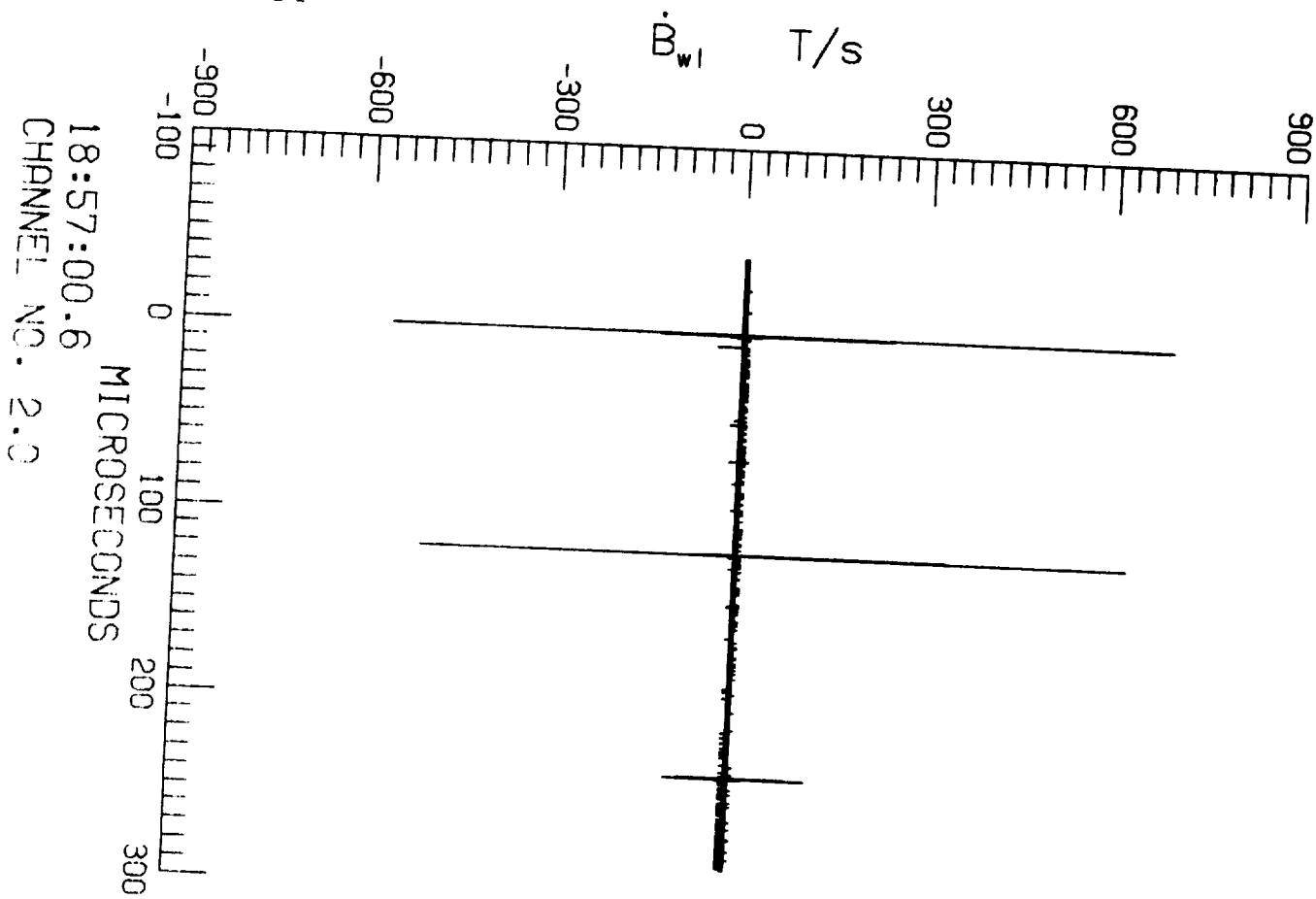

F106 LIGHTNING/85-018/ZAEPFEL

LEC 2

RUN NO. 2

S-001

$\dot{i}$  A/s

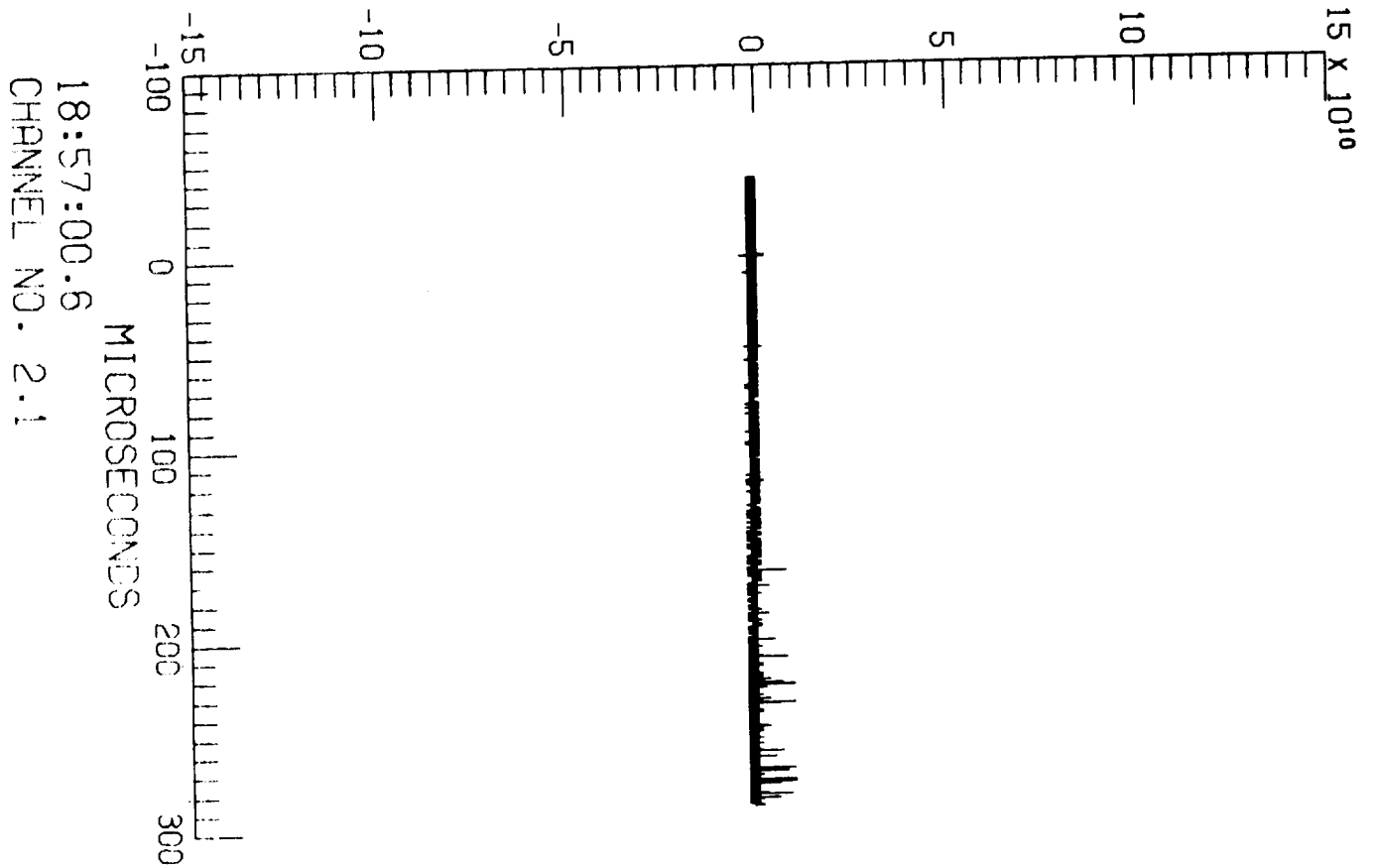

F106 LIGHTNING/85-018/ZAEPFEL

LEC 2

RUN NO. 2

S-001

$\dot{B}_1$  T/s

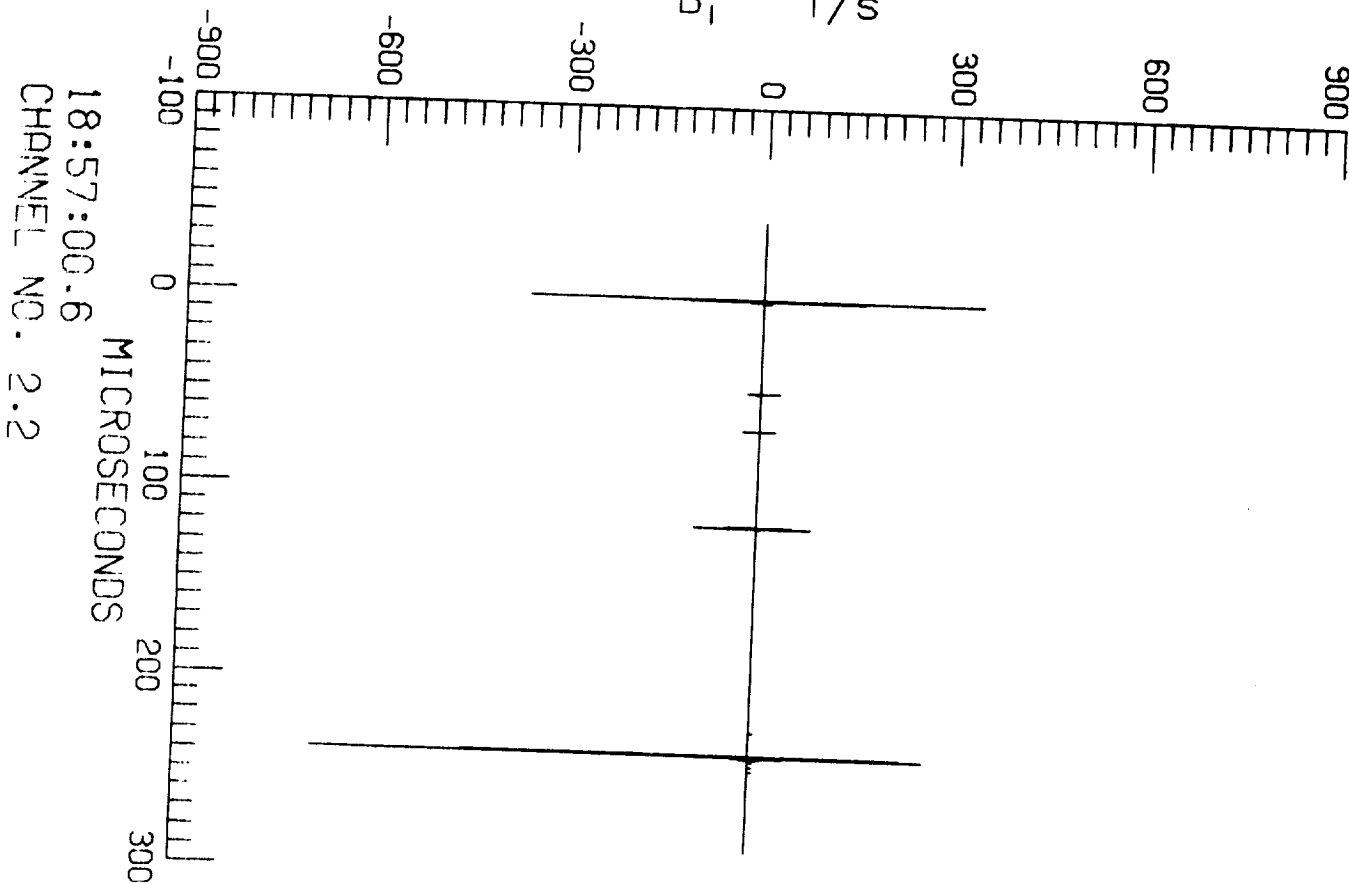

18:57:00.6

CHANNEL NO. 2.2



F106 LIGHTNING/85-018/ZAEFFEL

LEC 3

RUN NO. 2

S-001

$\dot{D}_{wr}$  A/m<sup>2</sup>

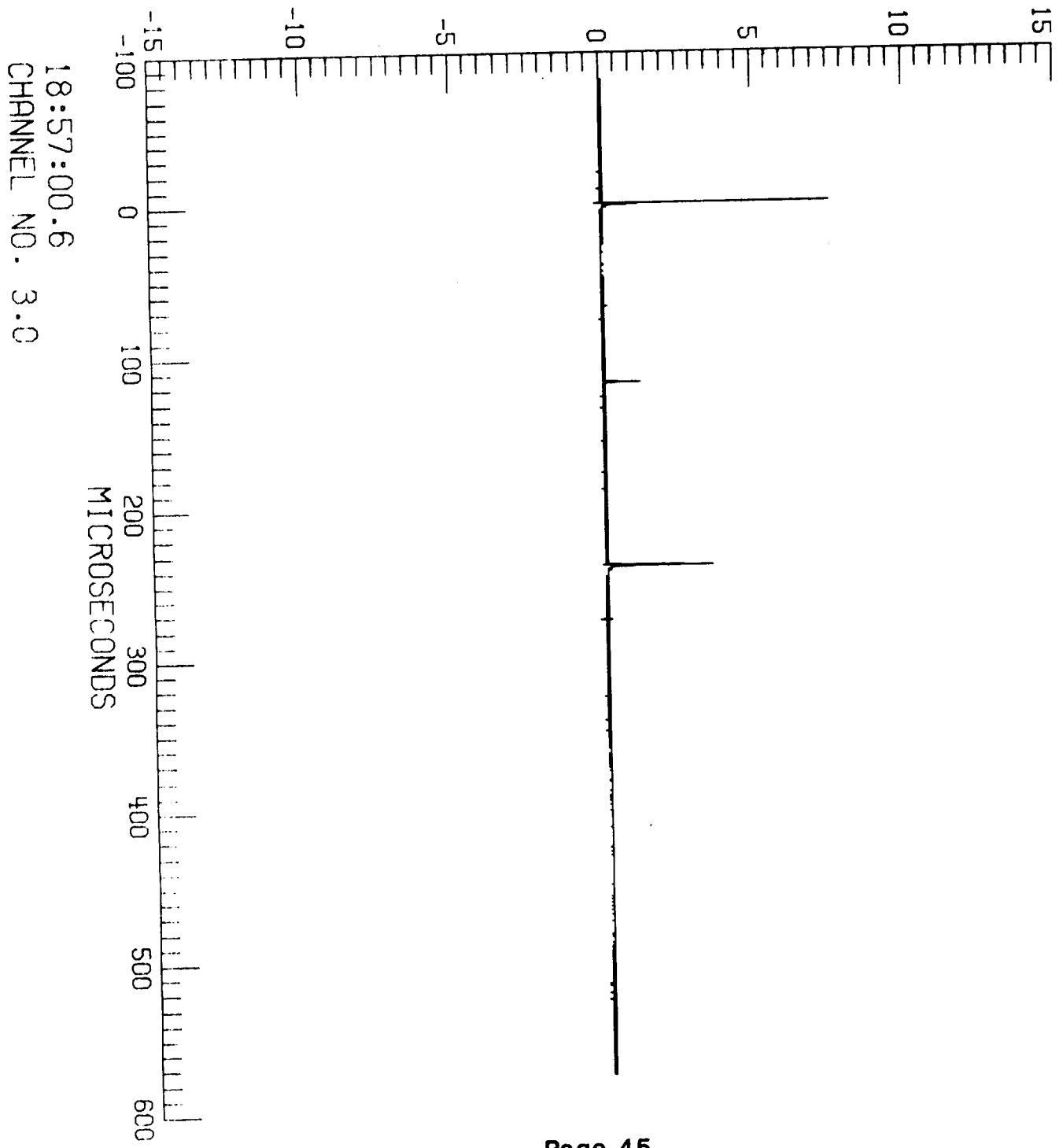

F106 LIGHTNING/85-018/ZAEPFEL  
LEC 3 RUN NO. 2  
S-001

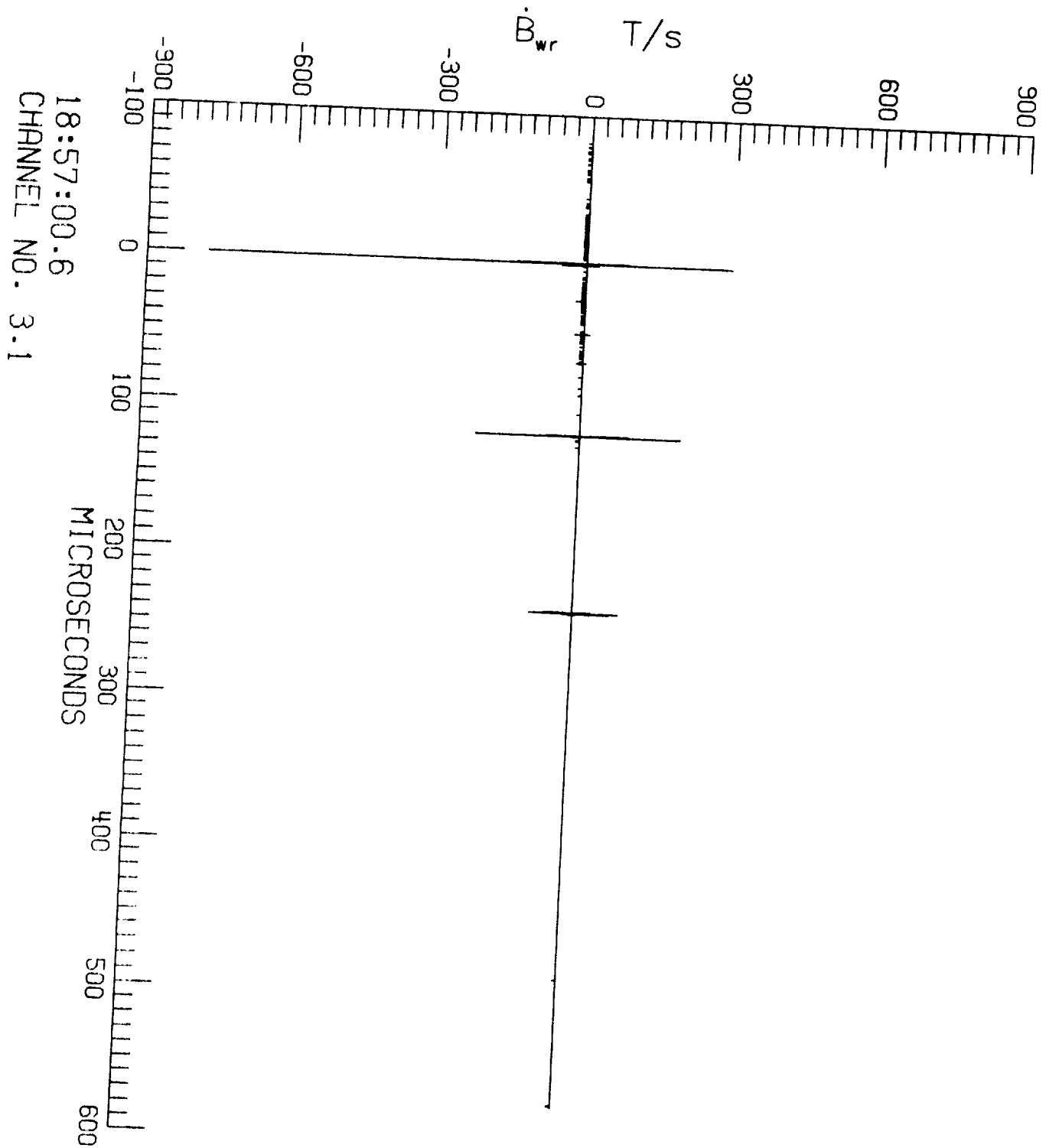

F106 LIGHTNING/85-018/ZAEPFEL

LEC 3 RUN NO. 2

S-001

$\dot{D}_f$  A/m<sup>2</sup>

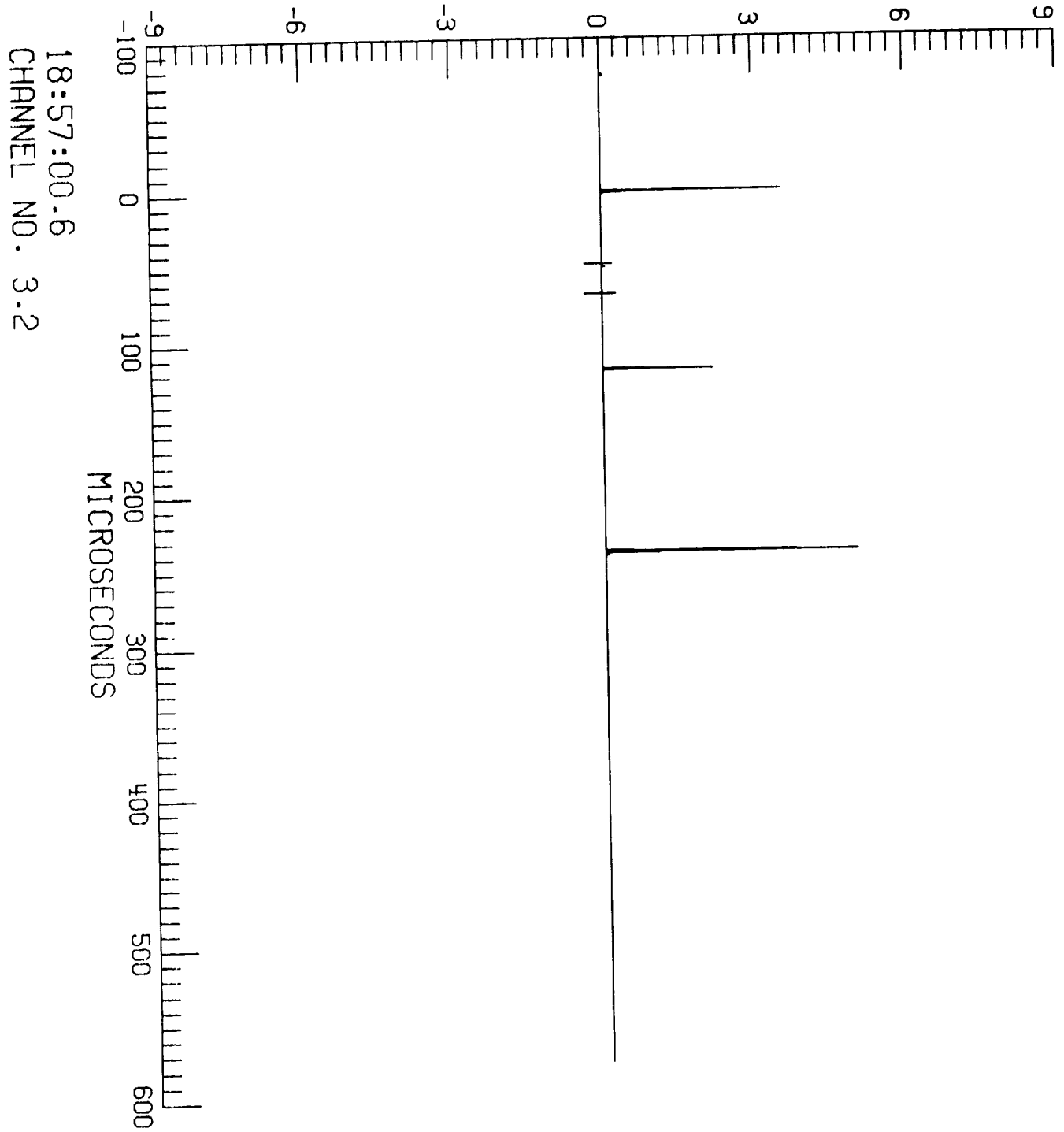

F106 LIGHTNING/85-018/ZAEPFEL

LEC 4 RUN NO. 2

S-001

TP100 V

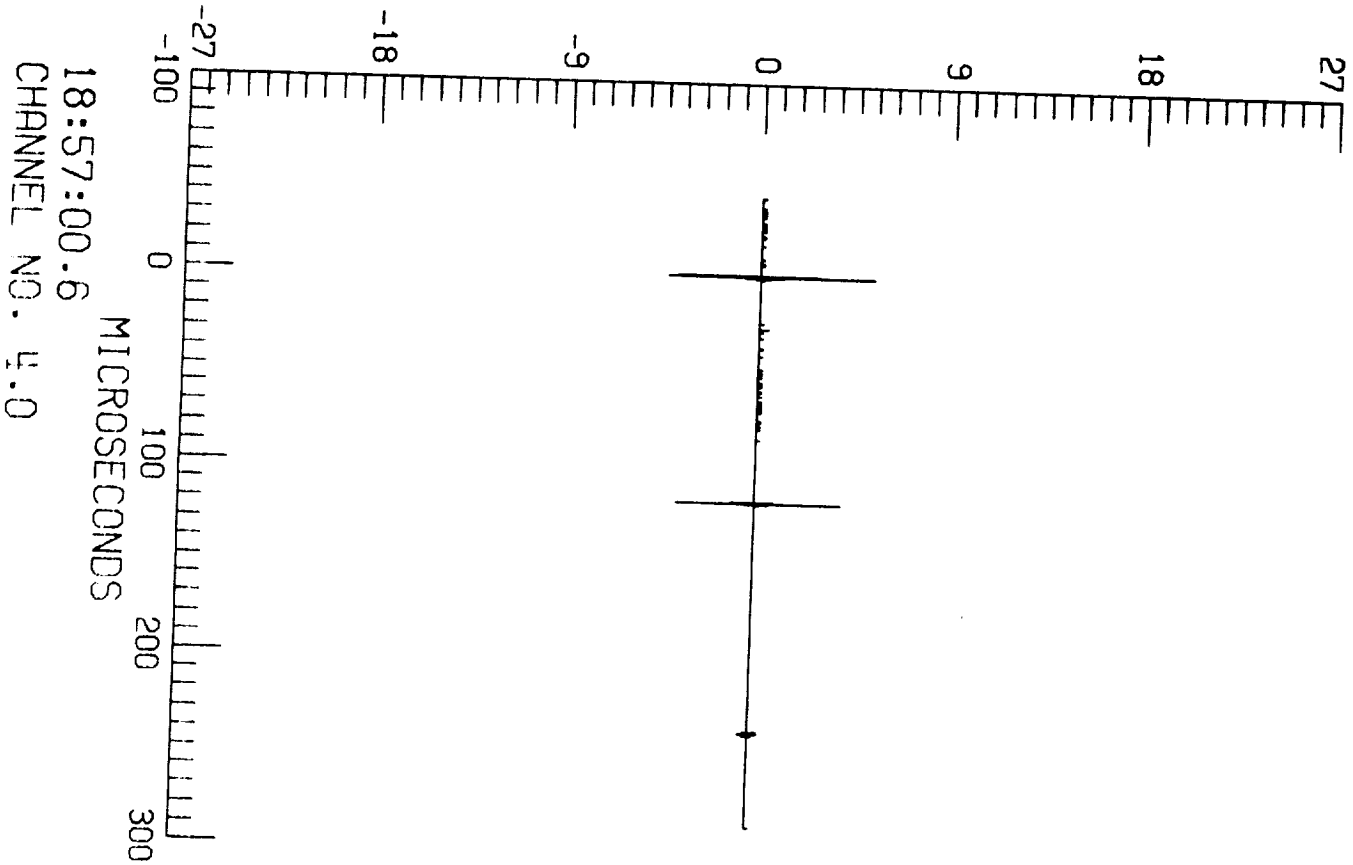

F106 LIGHTNING/85-018/ZAEPFEL

LEC 4 RUN NO. 2

S-001

TP106 A

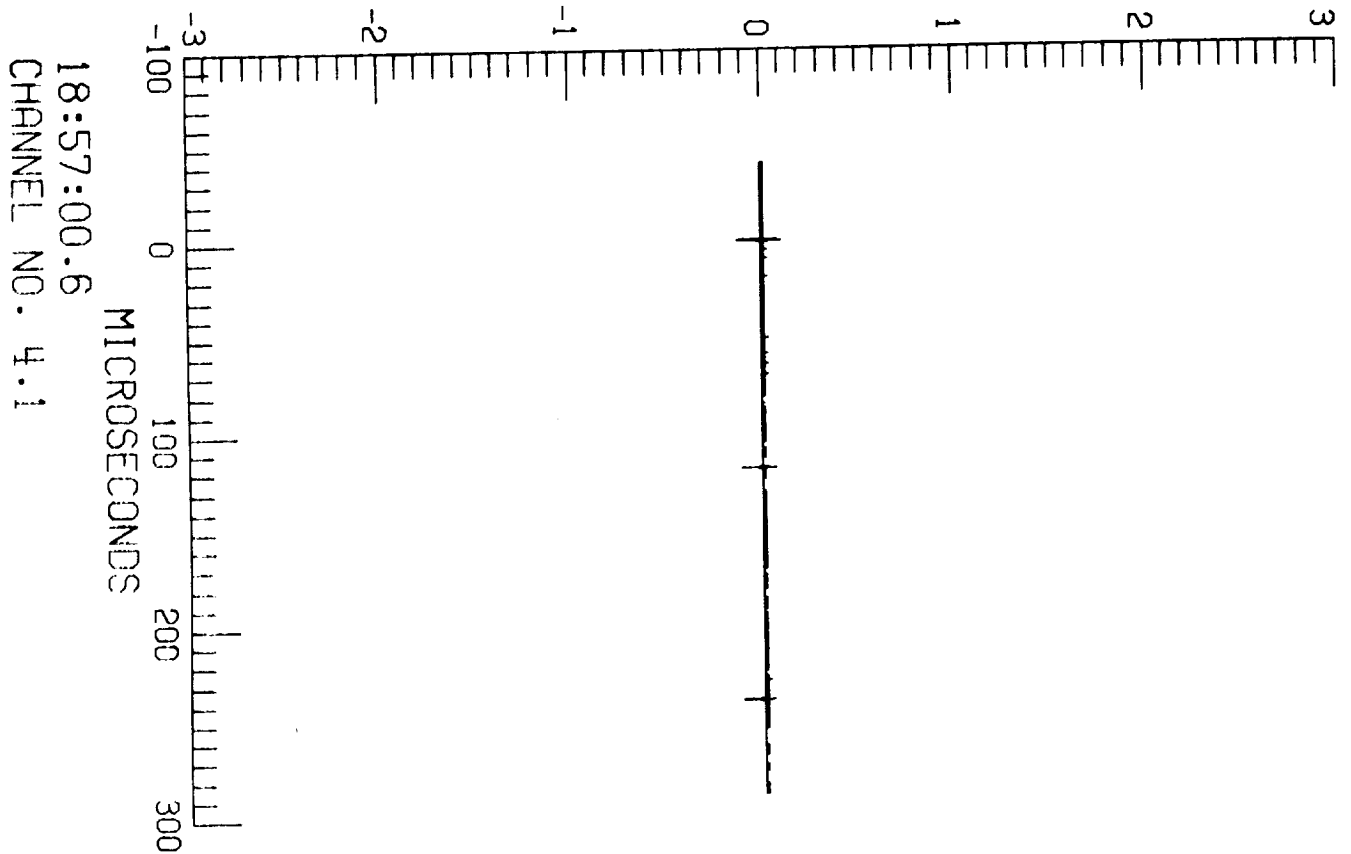

18:57:00.6  
CHANNEL NO. 4.1

F106 LIGHTNING/85-018/ZAEPFEL

LEC 4

RUN NO. 2

S-001

TP125 A

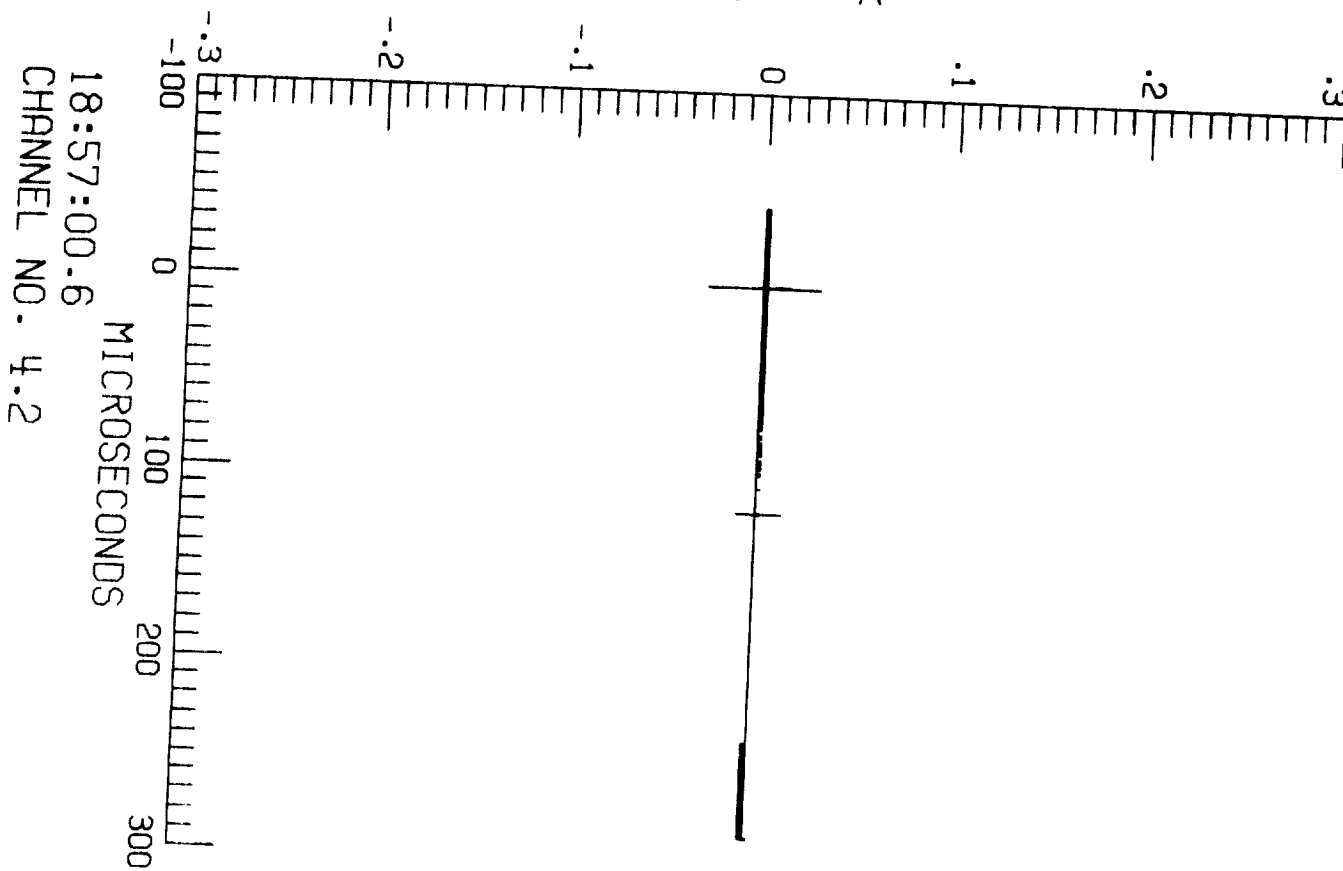

F106 LIGHTNING/85-018/ZAEPFEL

LEC 1 RUN NO. 2

S-001

$\dot{D}_t$  A/m<sup>2</sup>

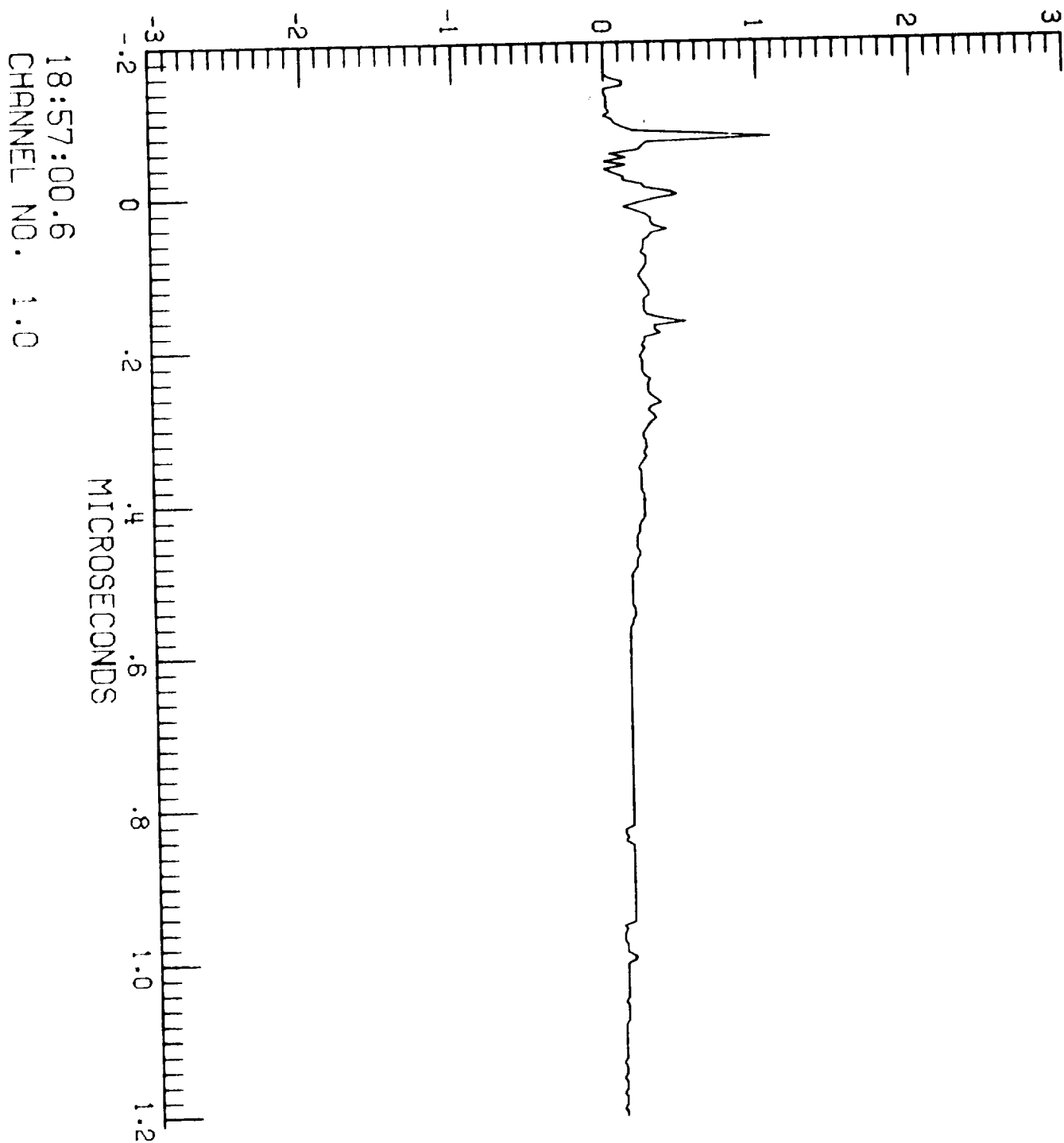

F106 LIGHTNING/85-018/ZAEPFEL

LEC 1 RUN NO. 2

S-001

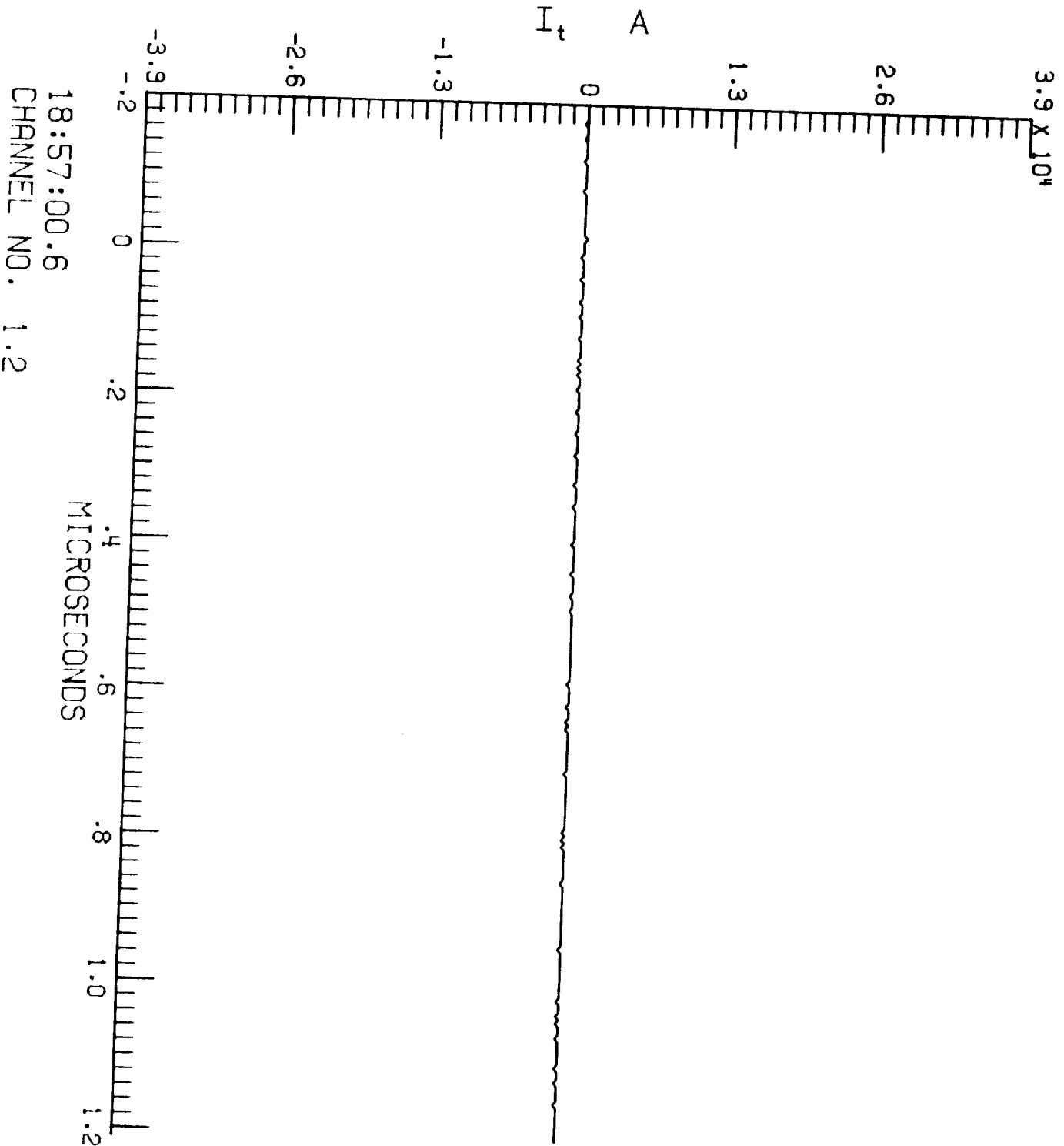



F106 LIGHTNING/85-018/ZAEPFEL  
LEC 2 RUN NO. 2  
S-001

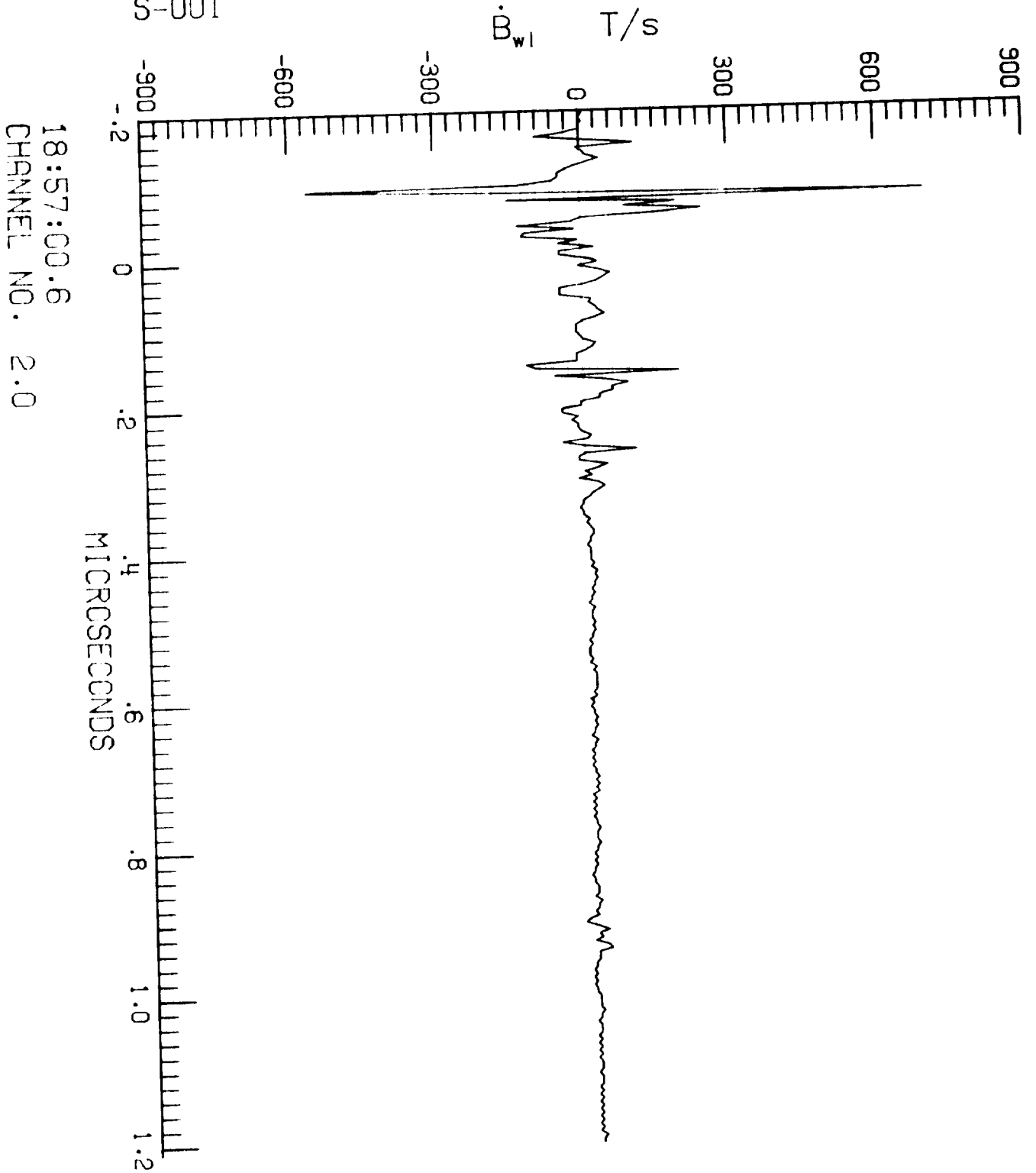

18:57:00.6  
CHANNEL NO. 2.0

F106 LIGHTNING/85-018/ZAEPFEL

LEC 2 RUN NO. 2

S-001

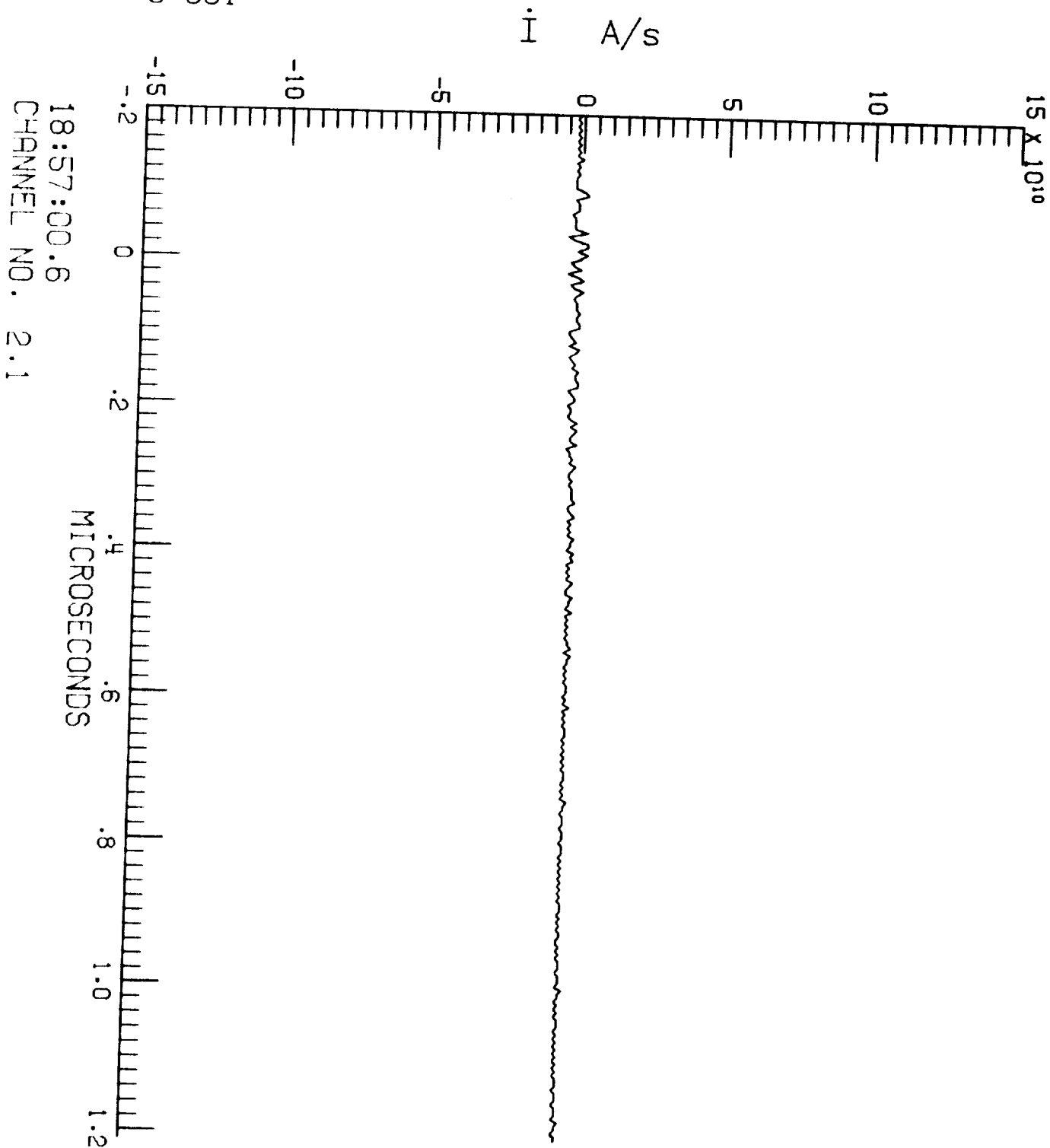

F106 LIGHTNING/85-018/ZAEPFEL

LEC 2 RUN NO. 2

S-001

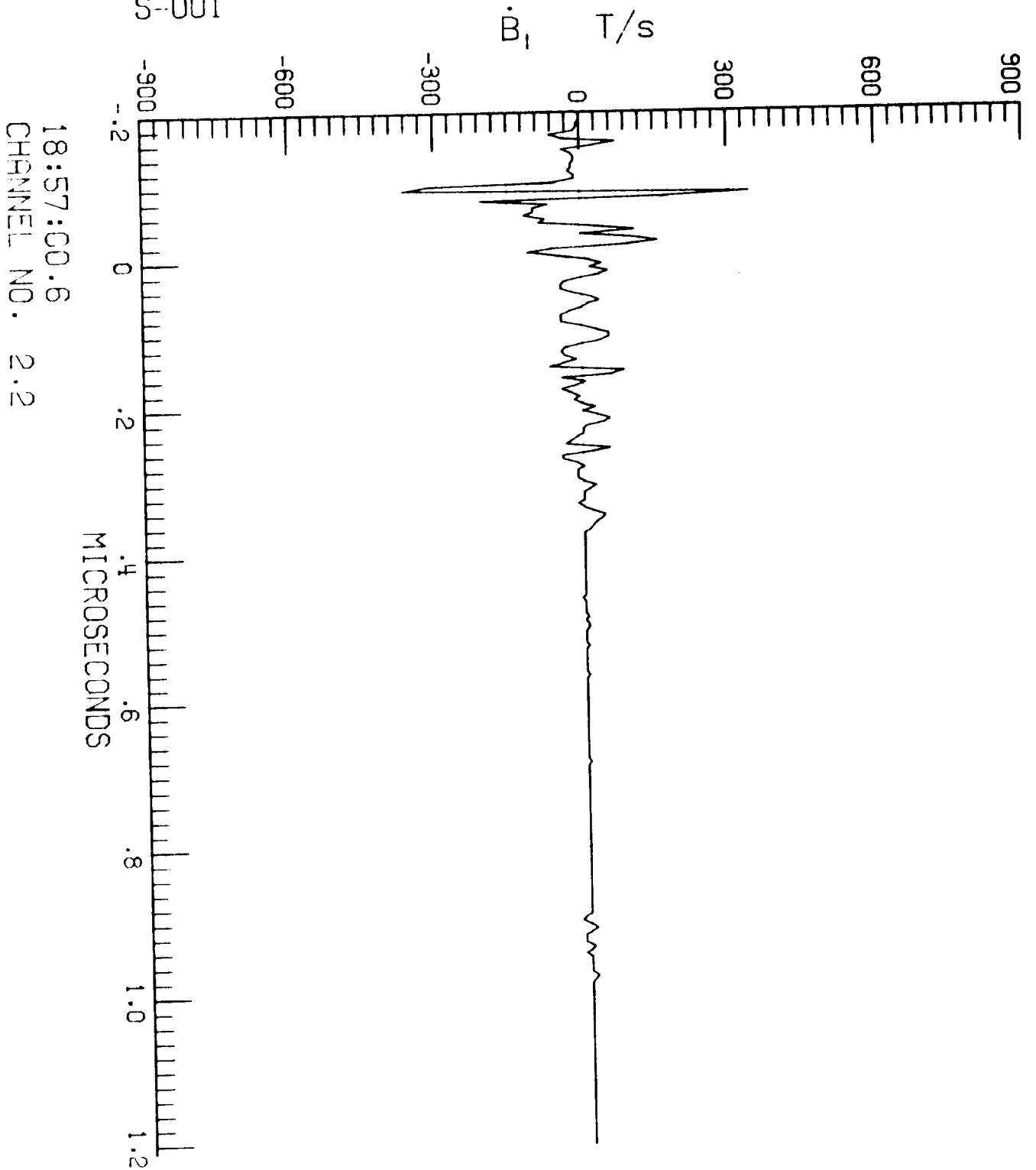

18:57:00.6  
CHANNEL NO. 2.2

F106 LIGHTNING/85-018/ZAEPFEL

LEC 3 RUN NO. 2

S-001

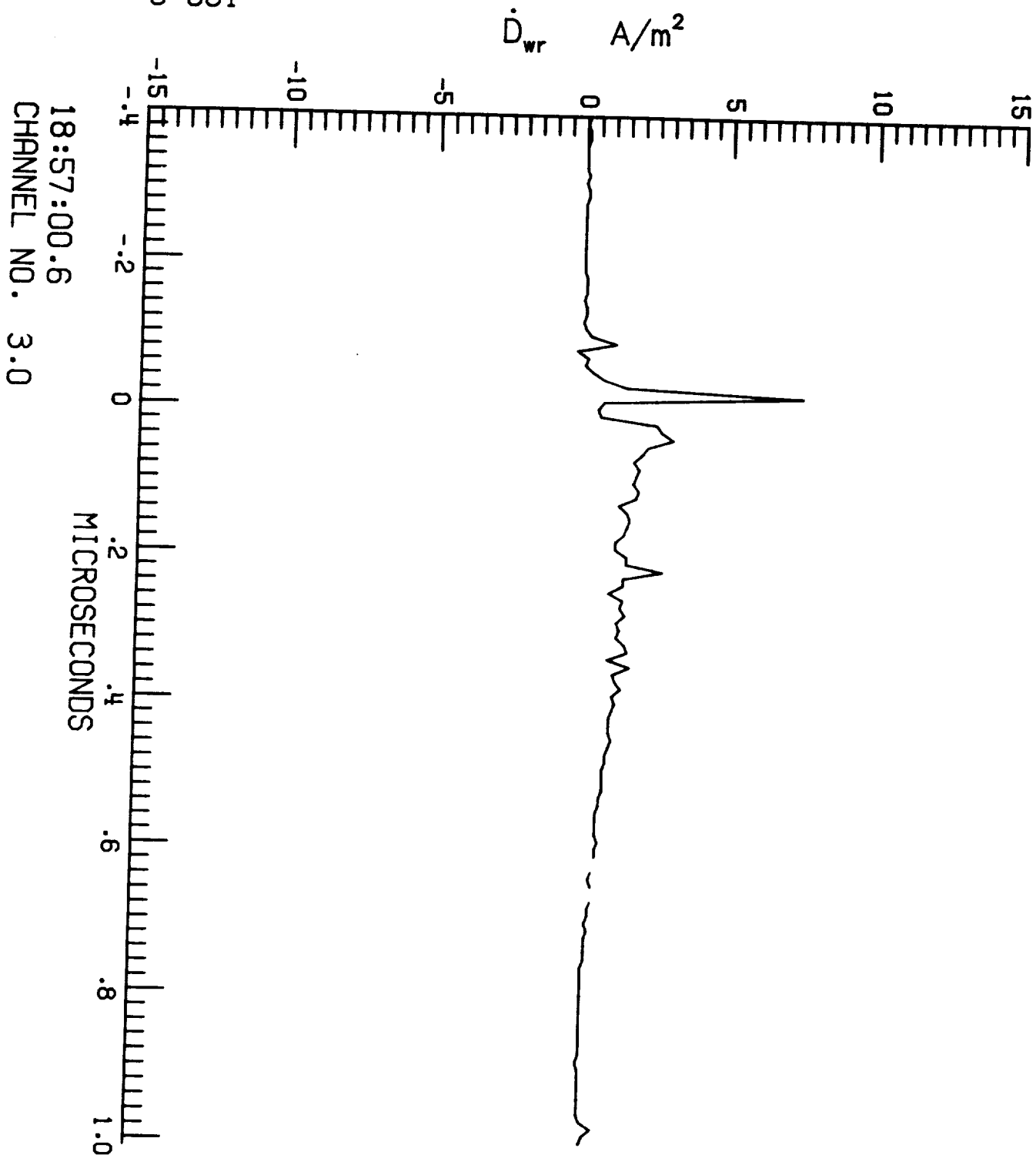

18:57:00.6  
CHANNEL NO. 3.0

F106 LIGHTNING/85-018/ZAEPFEL

LEC 3 RUN NO. 2

S-001

18:57:00.6  
CHANNEL NO. 3.1

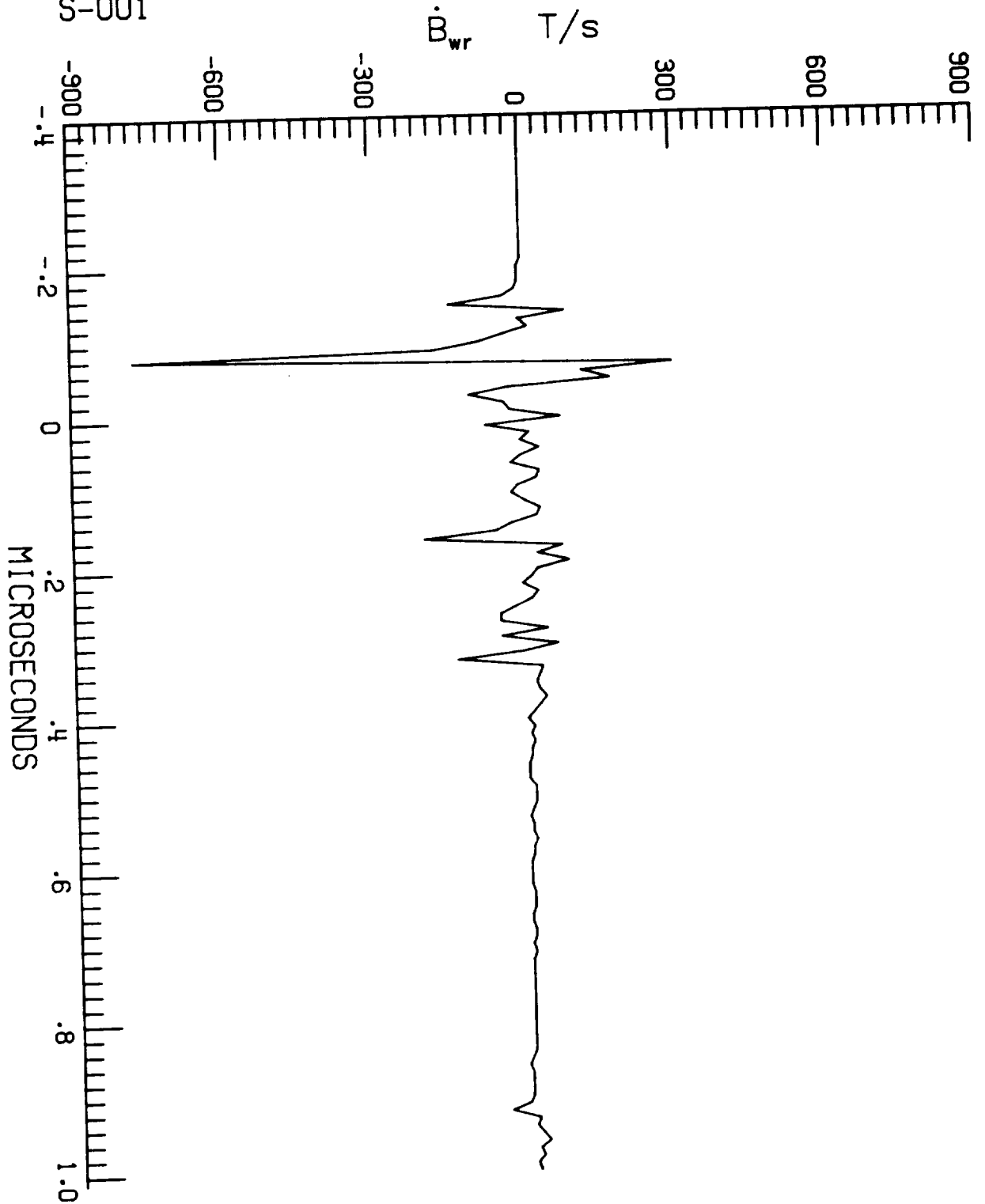

F106 LIGHTNING/85-018/ZAEPFEL  
LEC 3 RUN NO. 2  
S-001

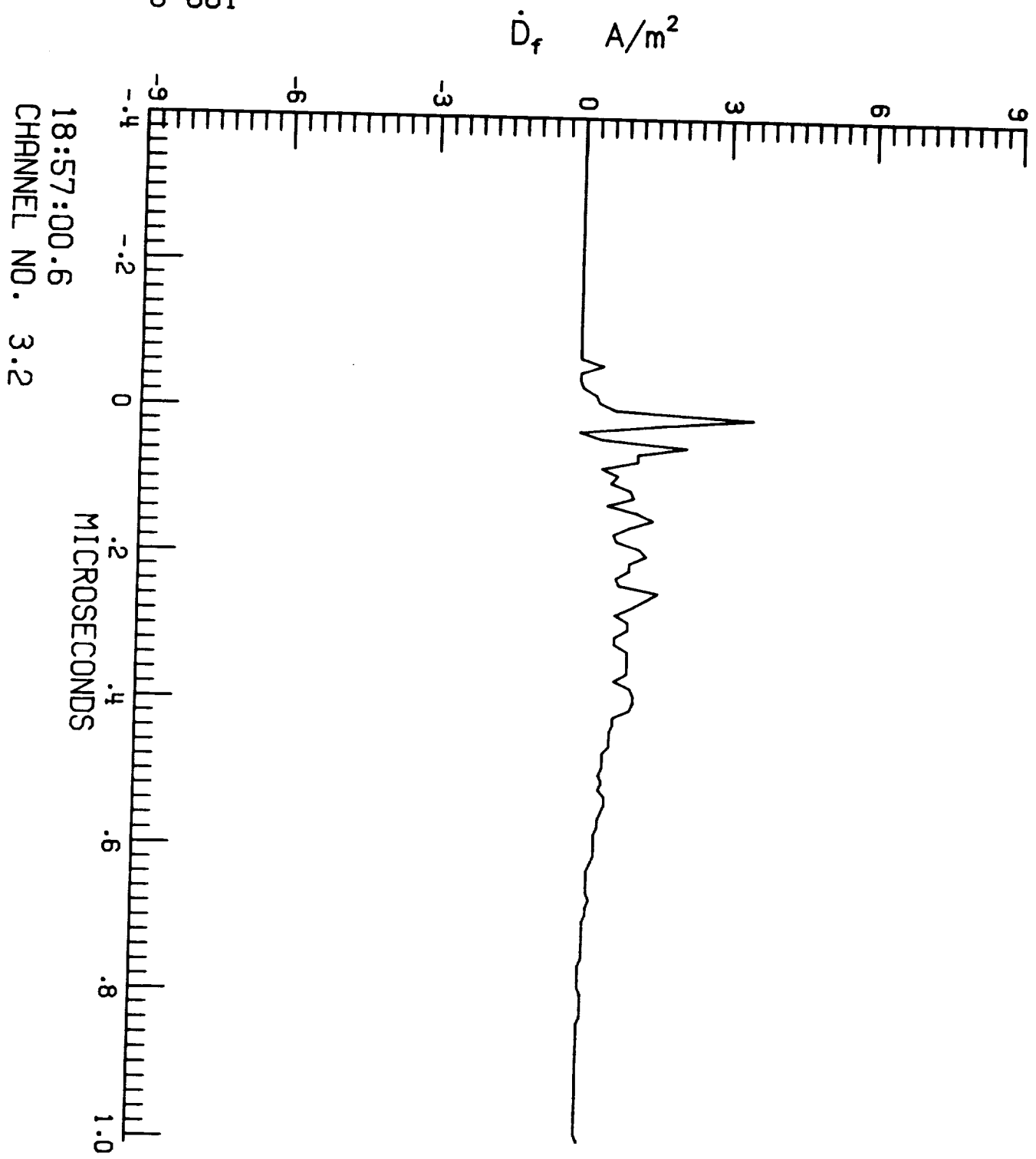

F106 LIGHTNING/85-018/ZAEPFEL

LEC 4 RUN NO. 2

S-001

TP100 V

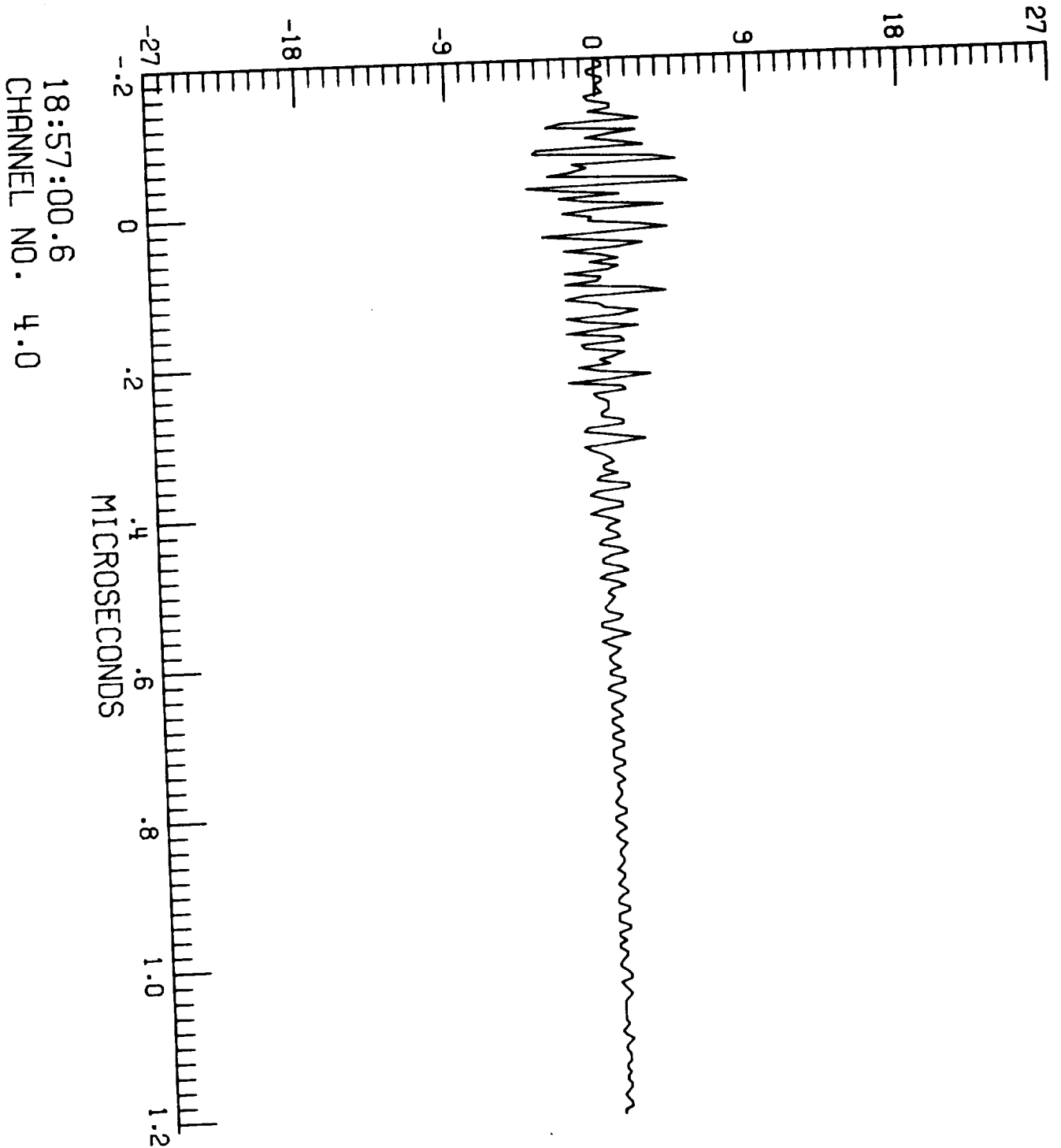

18:57:00.6  
CHANNEL NO. 4.0

F106 LIGHTNING/85-018/ZAEPFEL

LEC 4 RUN NO. 2

S-001

TP106 A

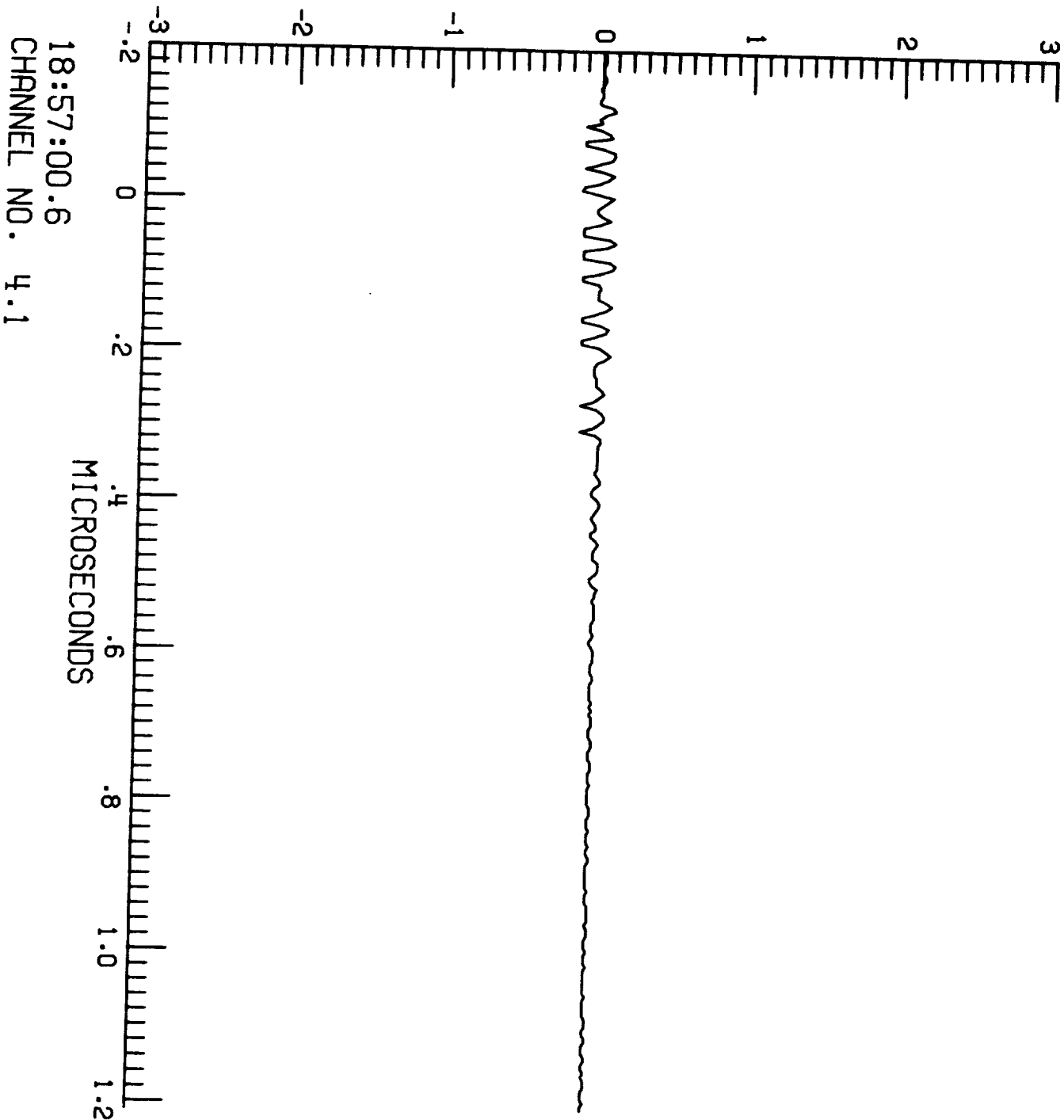



F106 LIGHTNING/85-018/ZAEPFEL

LEC 4 RUN NO. 2

S-001

TP125 A

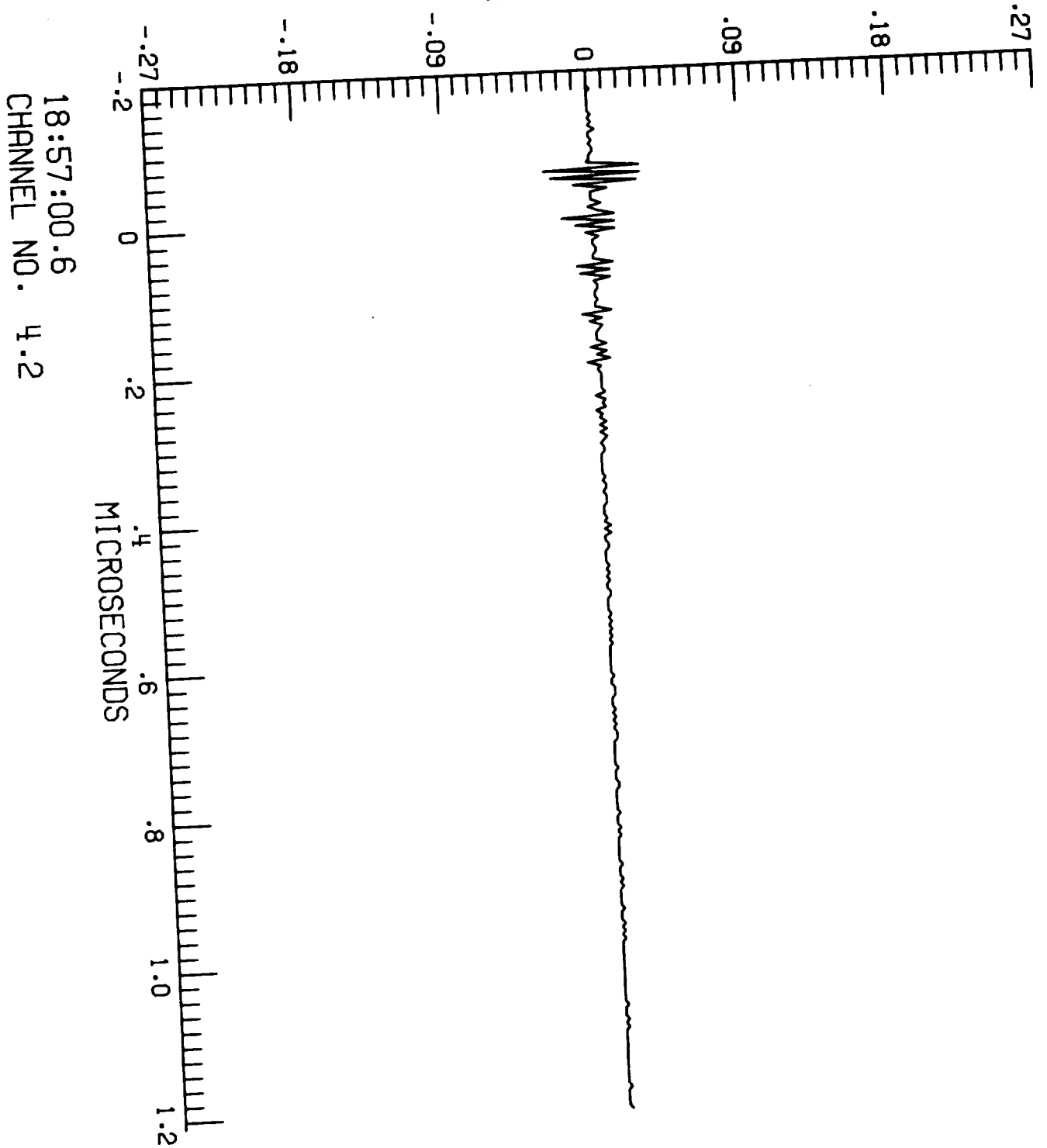

18:57:00.6  
CHANNEL NO. 4.2

F106 LIGHTNING/85-018/ZAEPFEL  
LEC 1 RUN NO. 2  
S-001

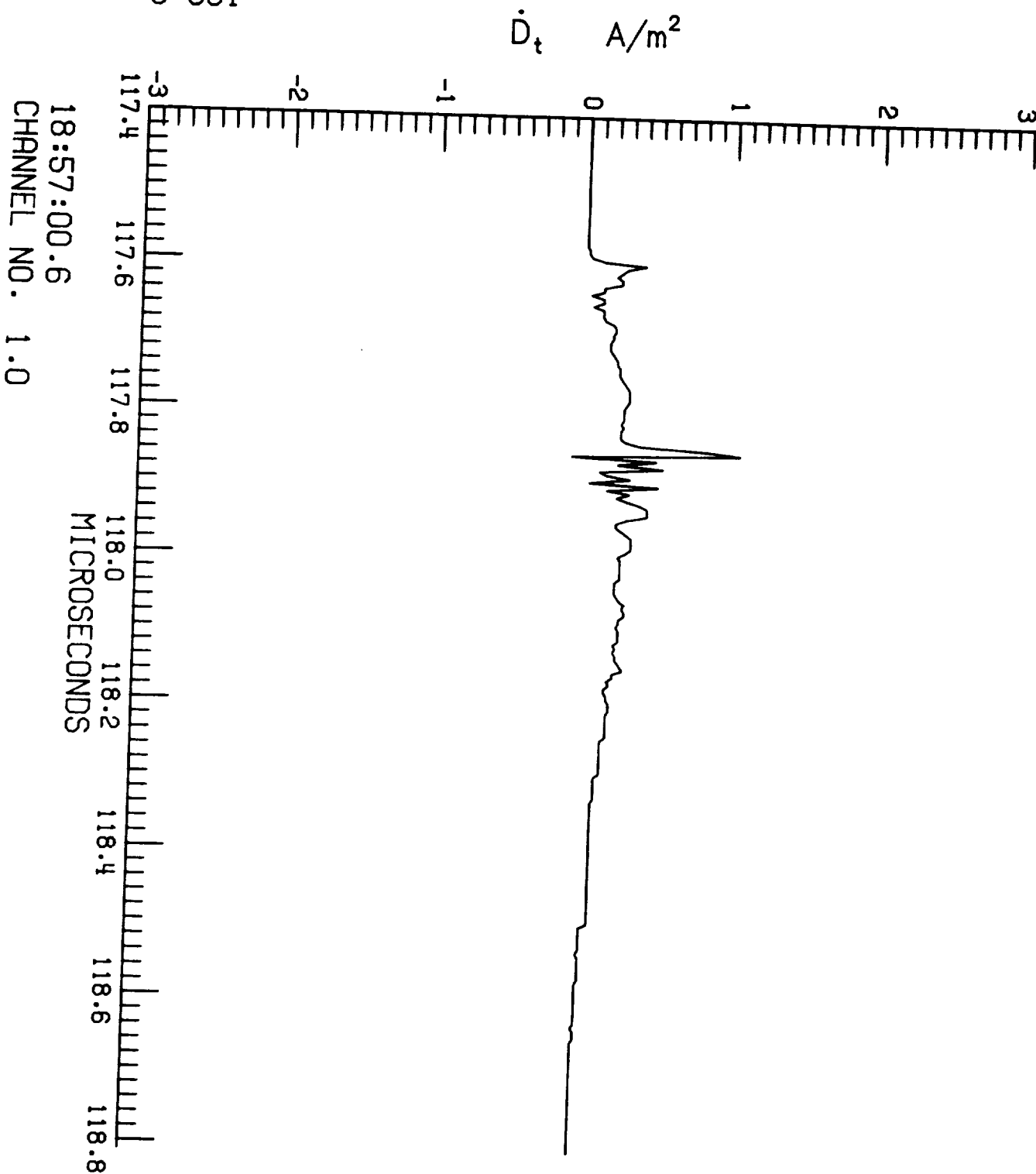

F106 LIGHTNING/85-018/ZAEPFEL

LEC 1 RUN NO. 2

S-001

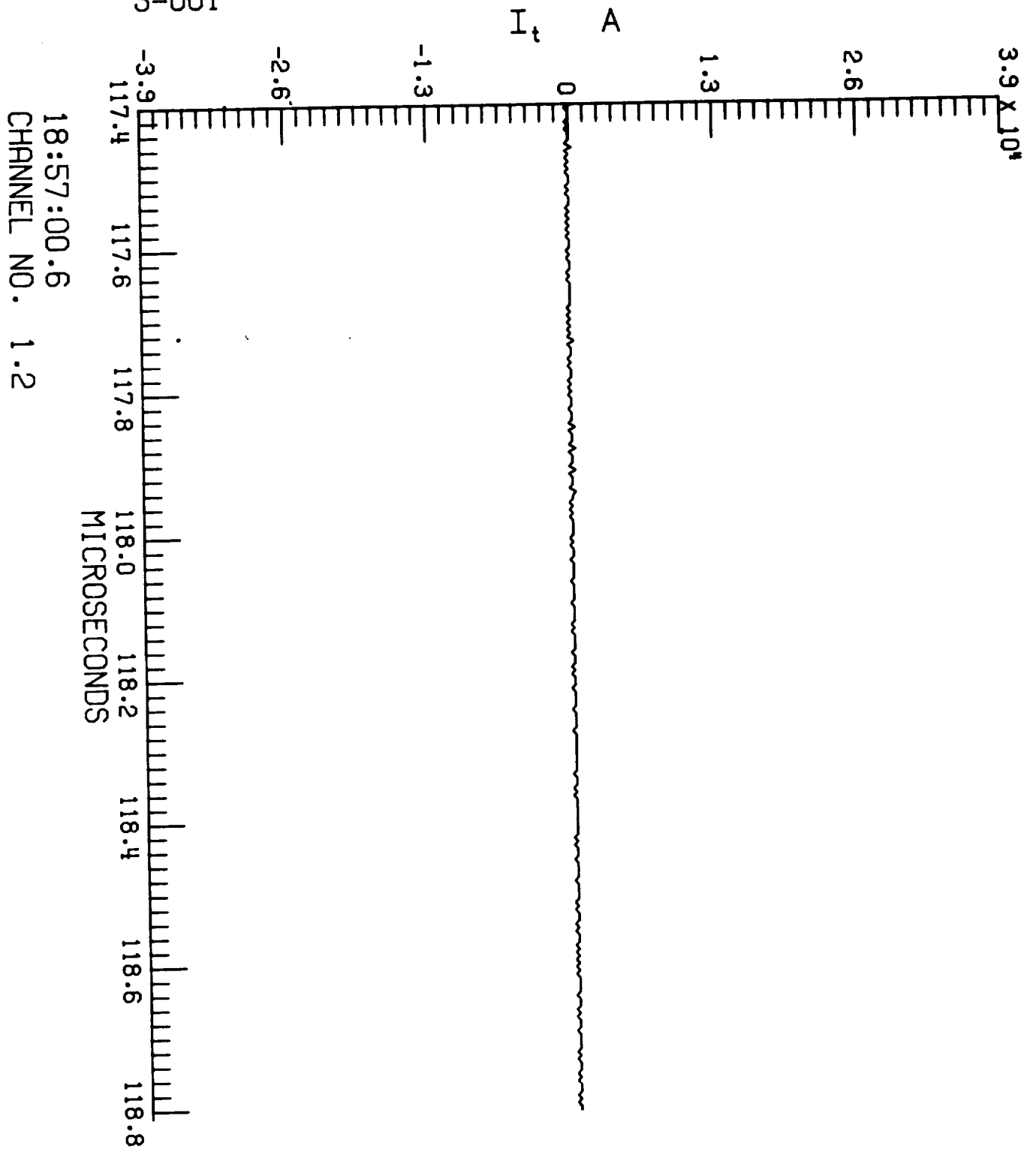

F106 LIGHTNING/85-018/ZAEPFEL

LEC 2 RUN NO. 2

S-001

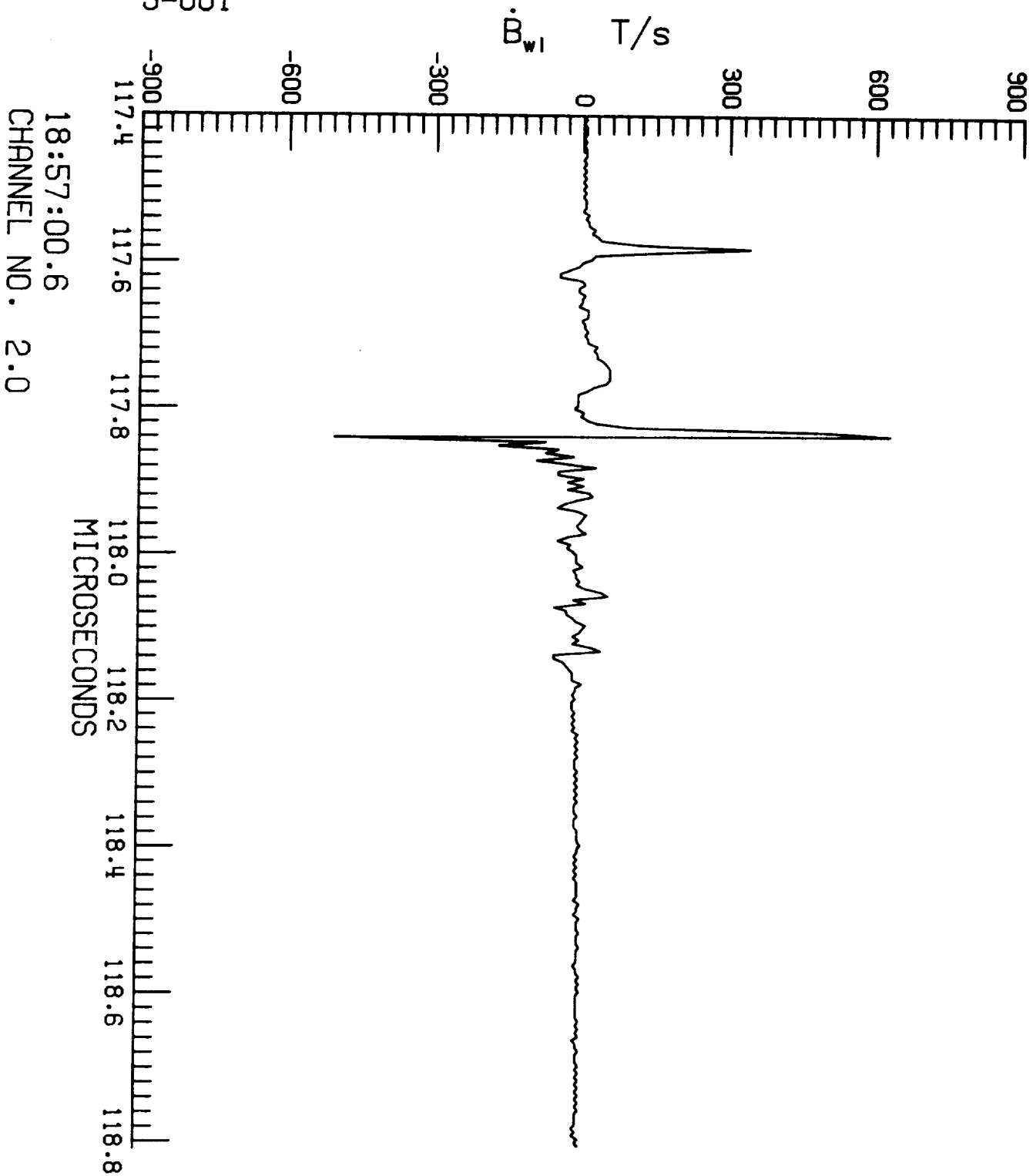

F106 LIGHTNING/85-018/ZAEPFEL

LEC 2 RUN NO. 2

S-001

i A/s

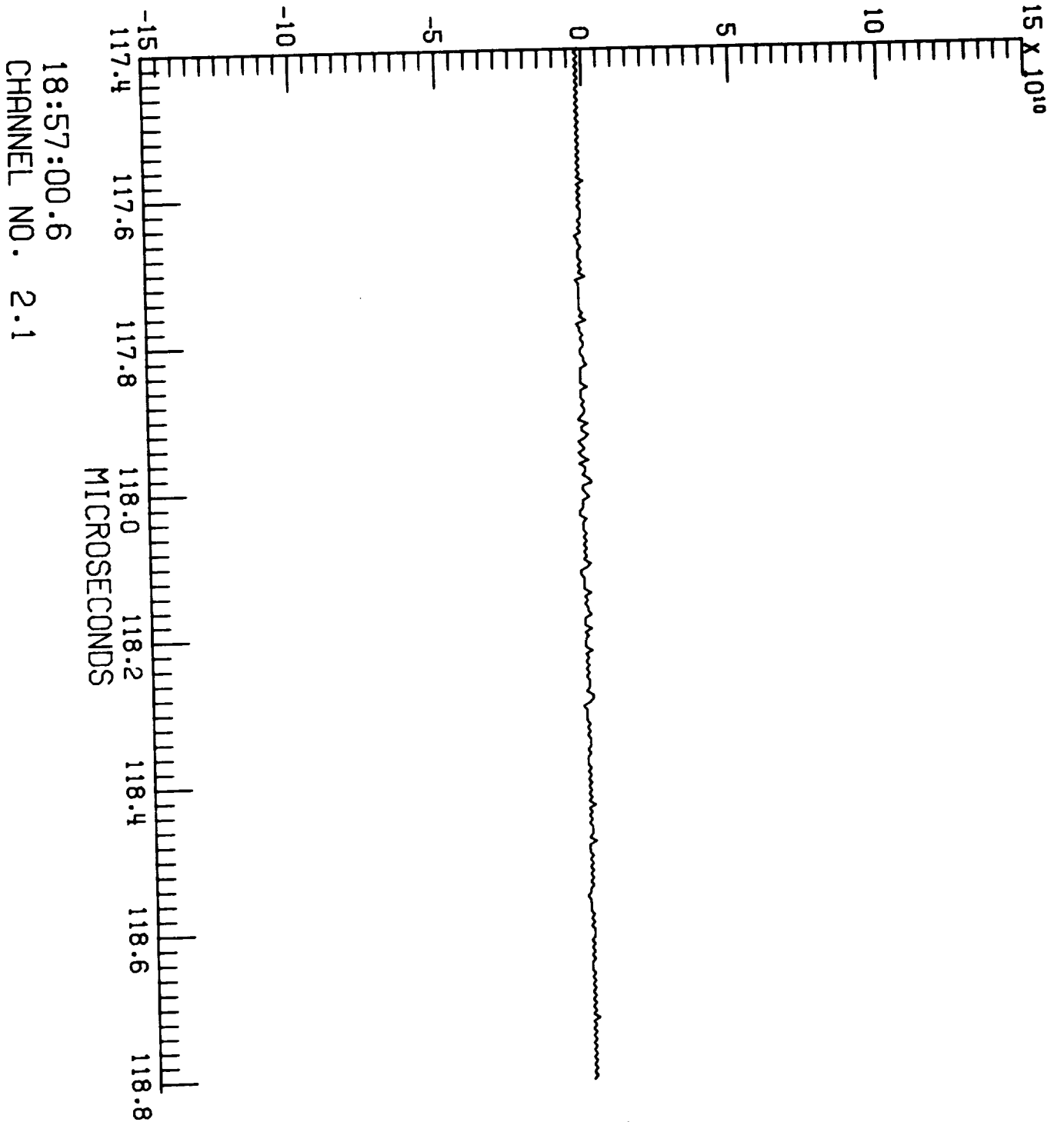

F106 LIGHTNING/85-018/ZAEPFEL  
LEC 2 RUN NO. 2  
S-001

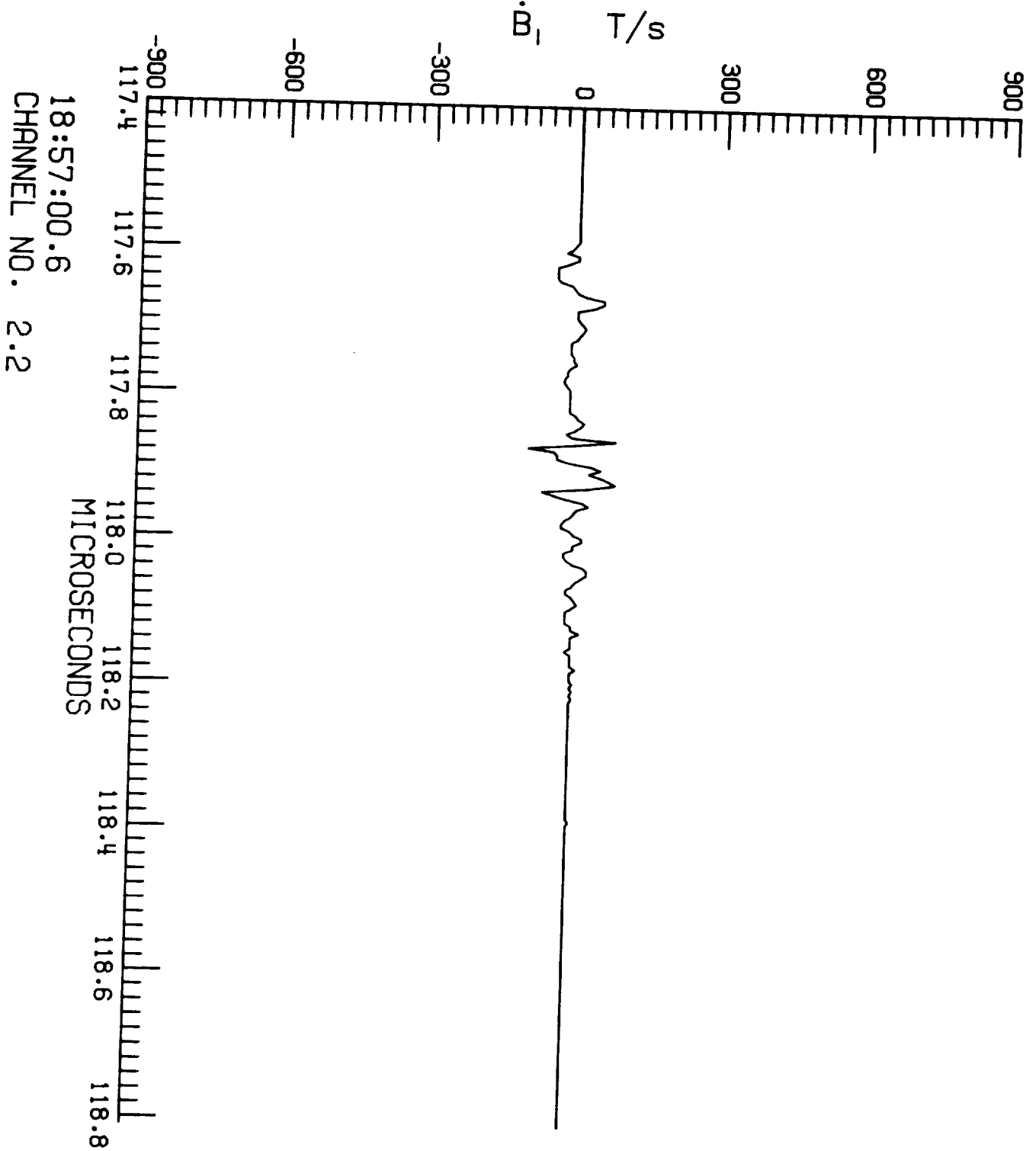

F106 LIGHTNING/85-018/ZAEPFEL

LEC 3 RUN NO. 2

S-001

$\dot{D}_{wr}$  A/m<sup>2</sup>

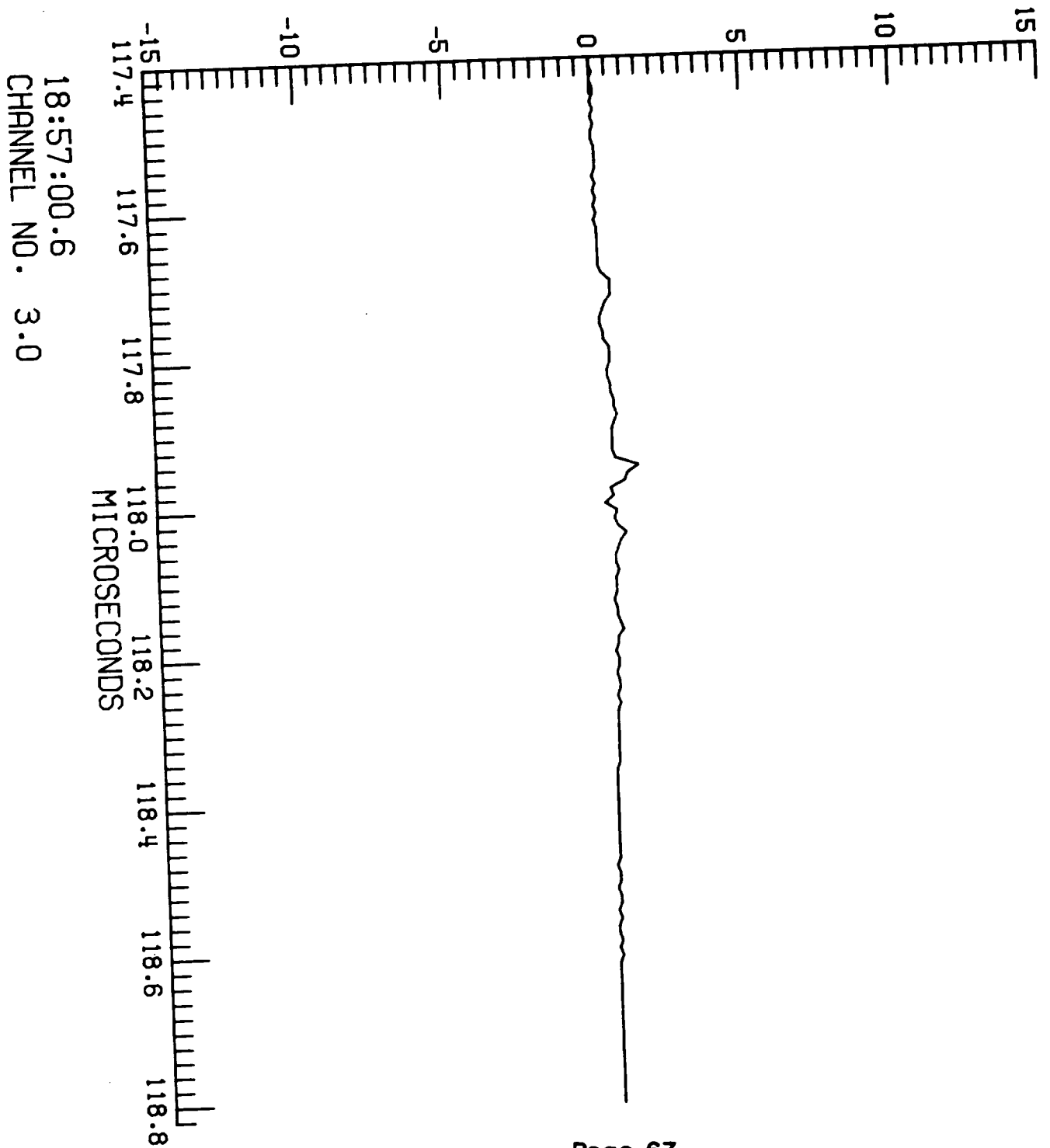

F106 LIGHTNING/85-018/ZAEPFEL

LEC 3 RUN NO. 2

S-001

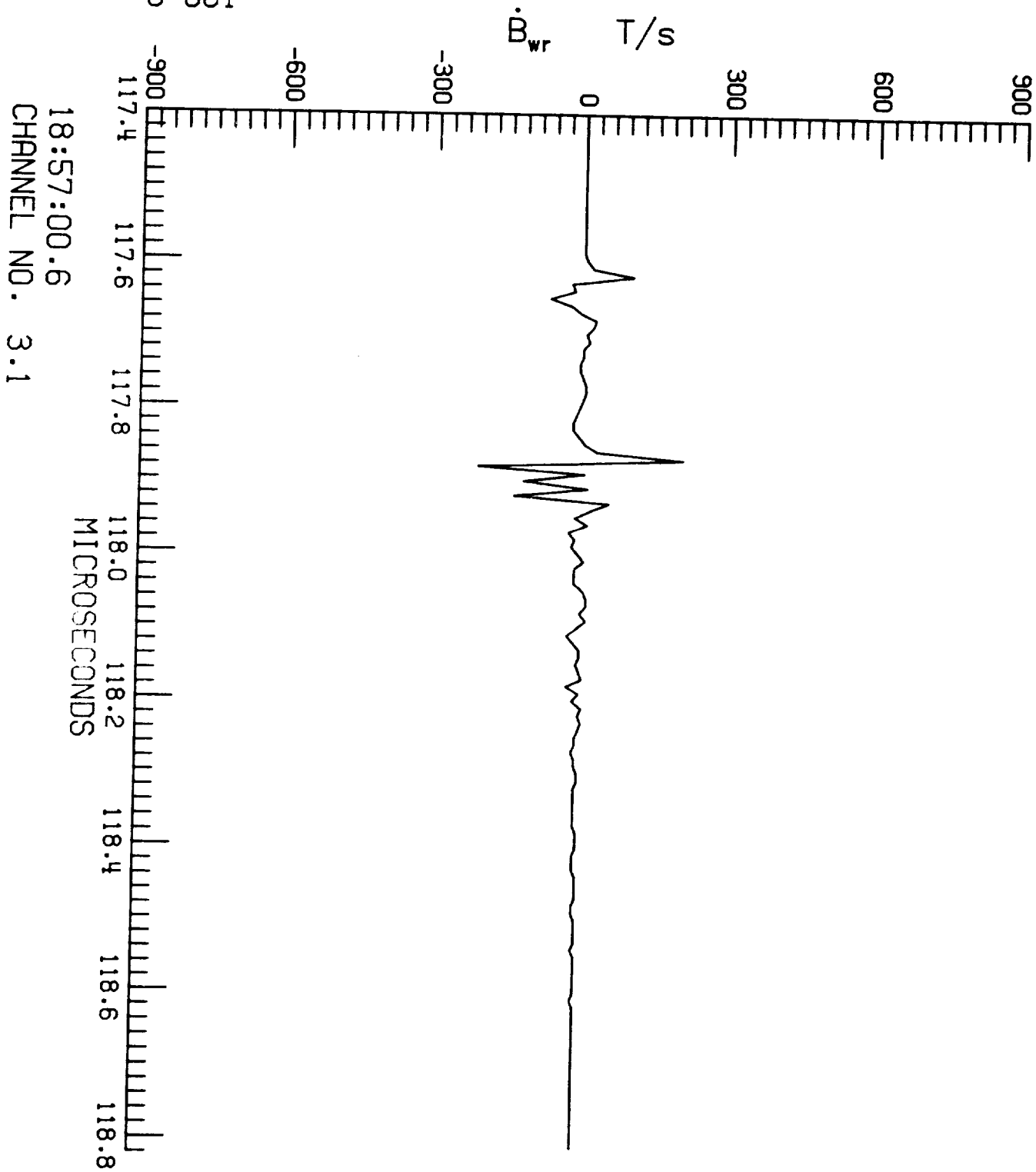



F106 LIGHTNING/85-018/ZAEPFEL

LEC 3 RUN NO. 2

S-001

$\dot{D}_f$  A/m<sup>2</sup>

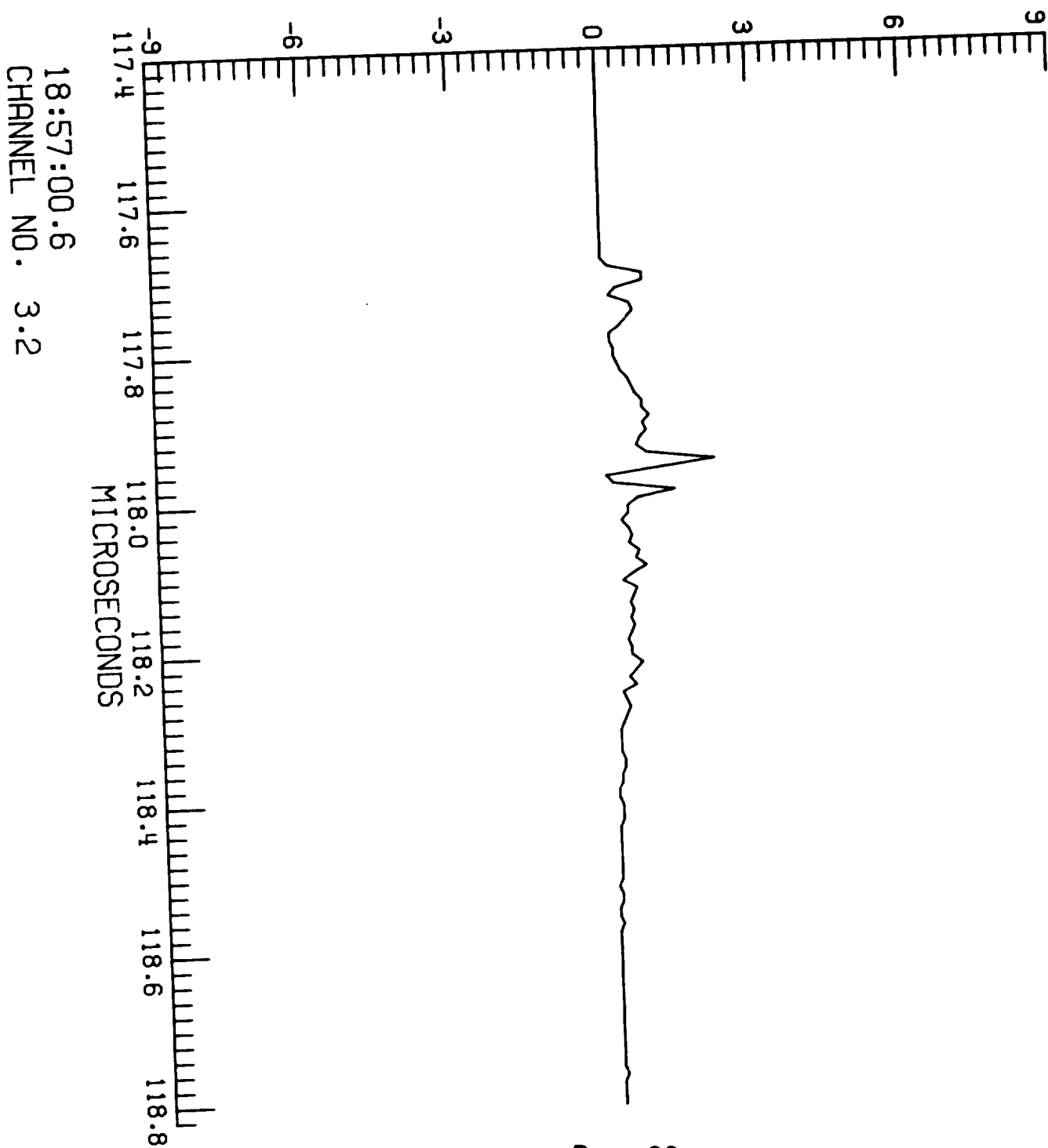

F106 LIGHTNING/85-018/ZAEPFEL

LEC 4 RUN NO. 2

S-001

TP100 V

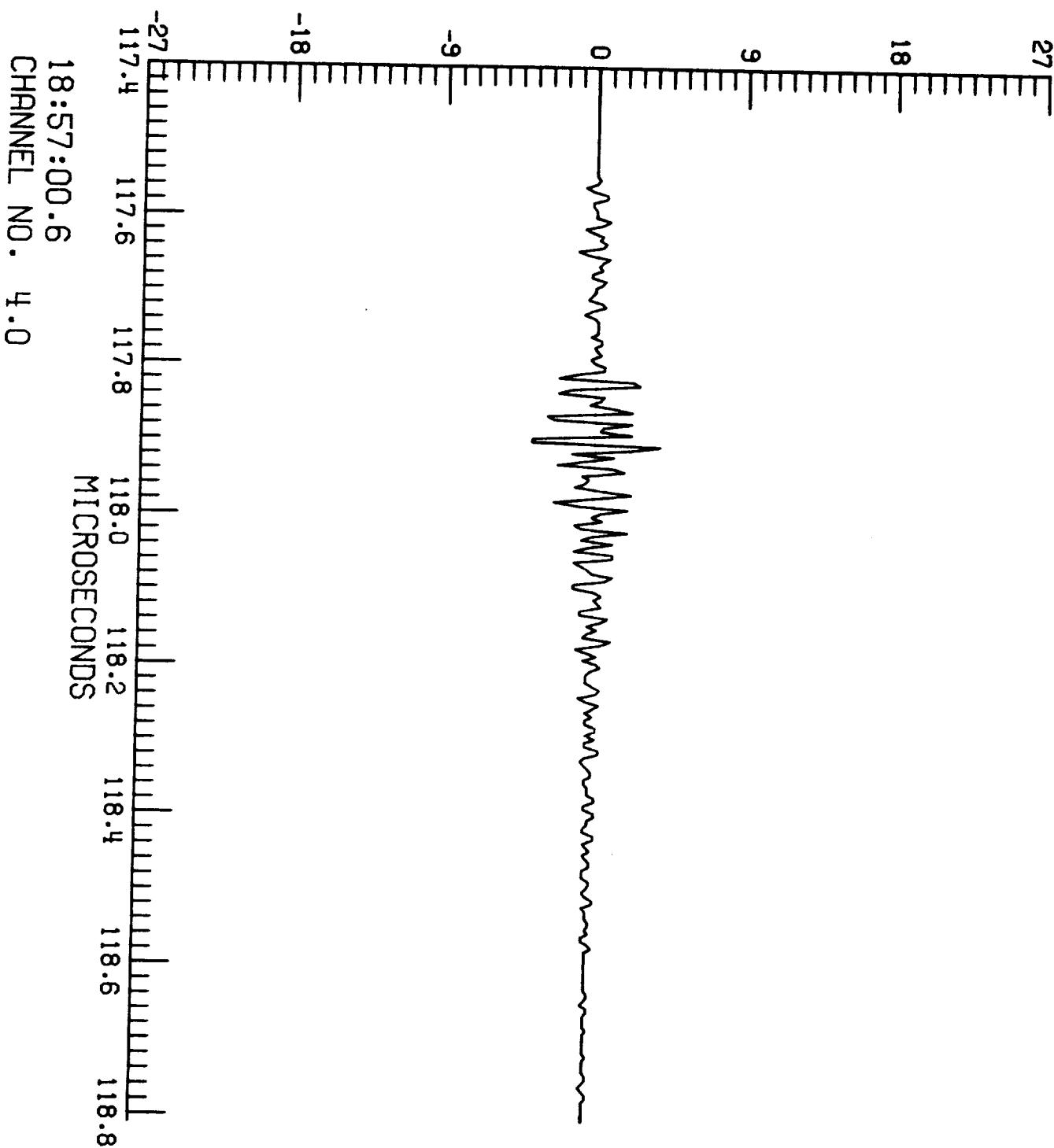

F106 LIGHTNING/85-018/ZAEPFEL

LEC 4 RUN NO. 2

S-001

TP106 A

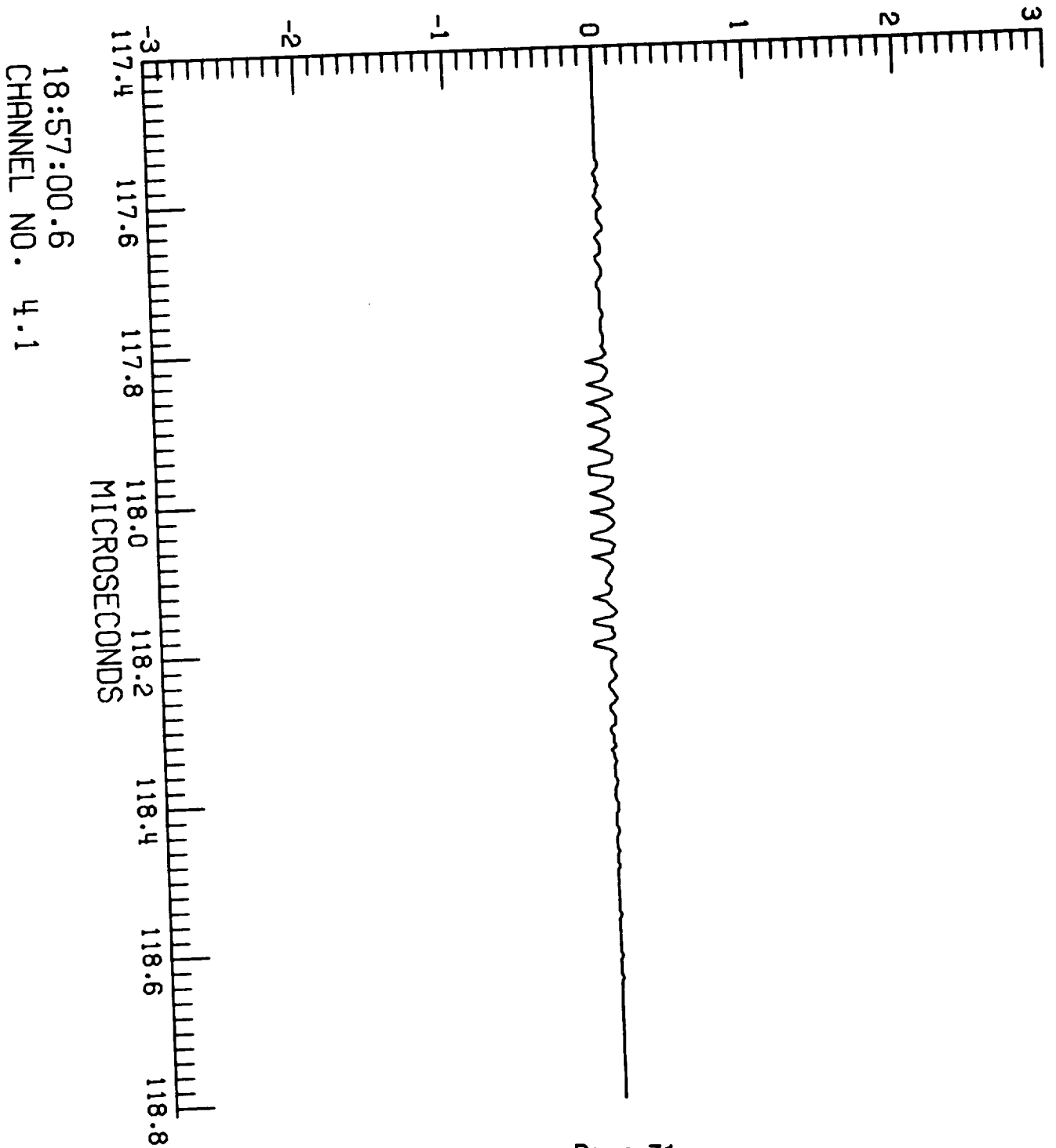

F106 LIGHTNING/85-018/ZAEPFEL

LEC 4 RUN NO. 2

S-001

TP125 A

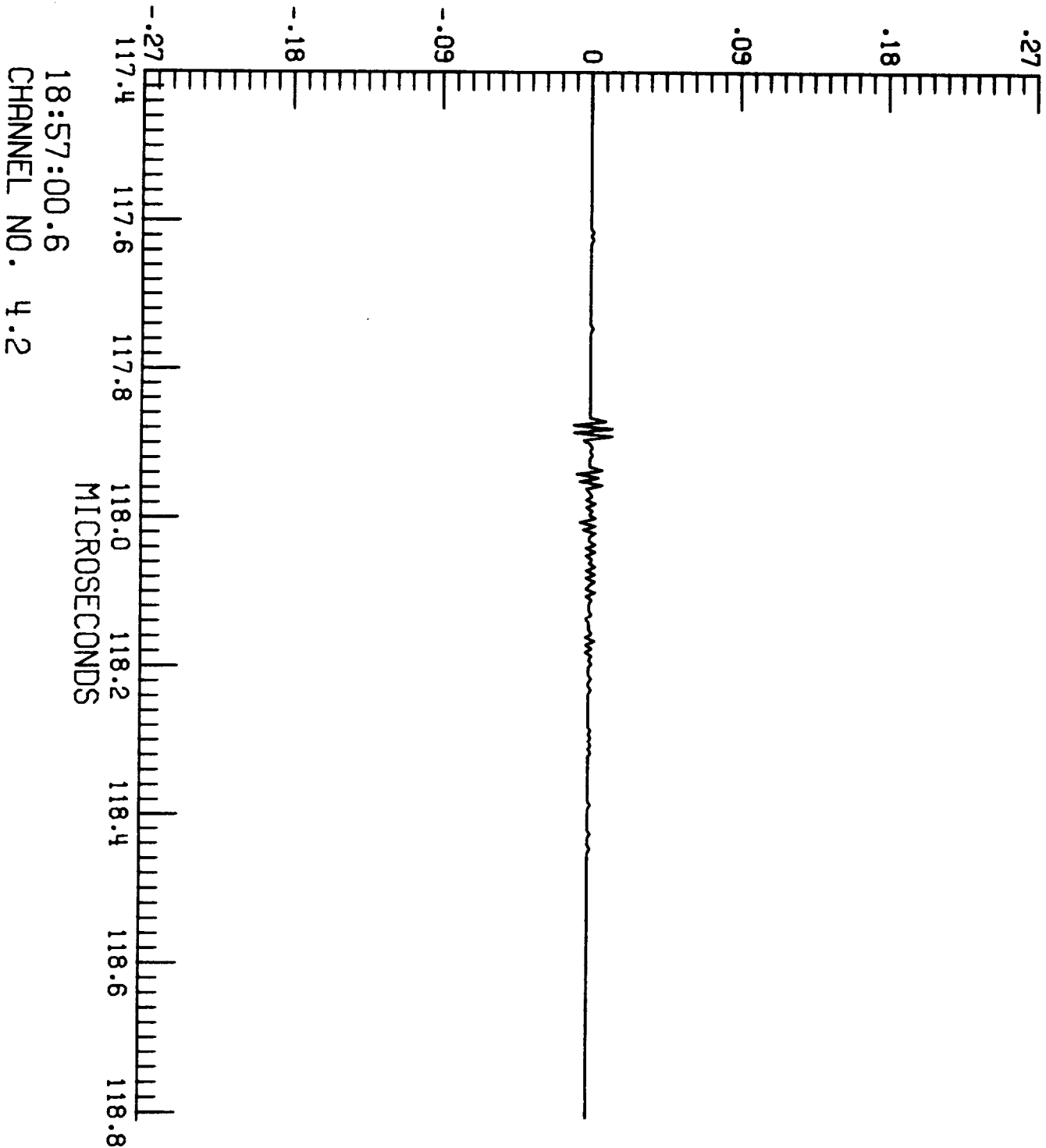

F106 LIGHTNING/85-018/ZAEPFEL

LEC 1 RUN NO. 2

S-001

$\dot{D}_t$  A/m<sup>2</sup>

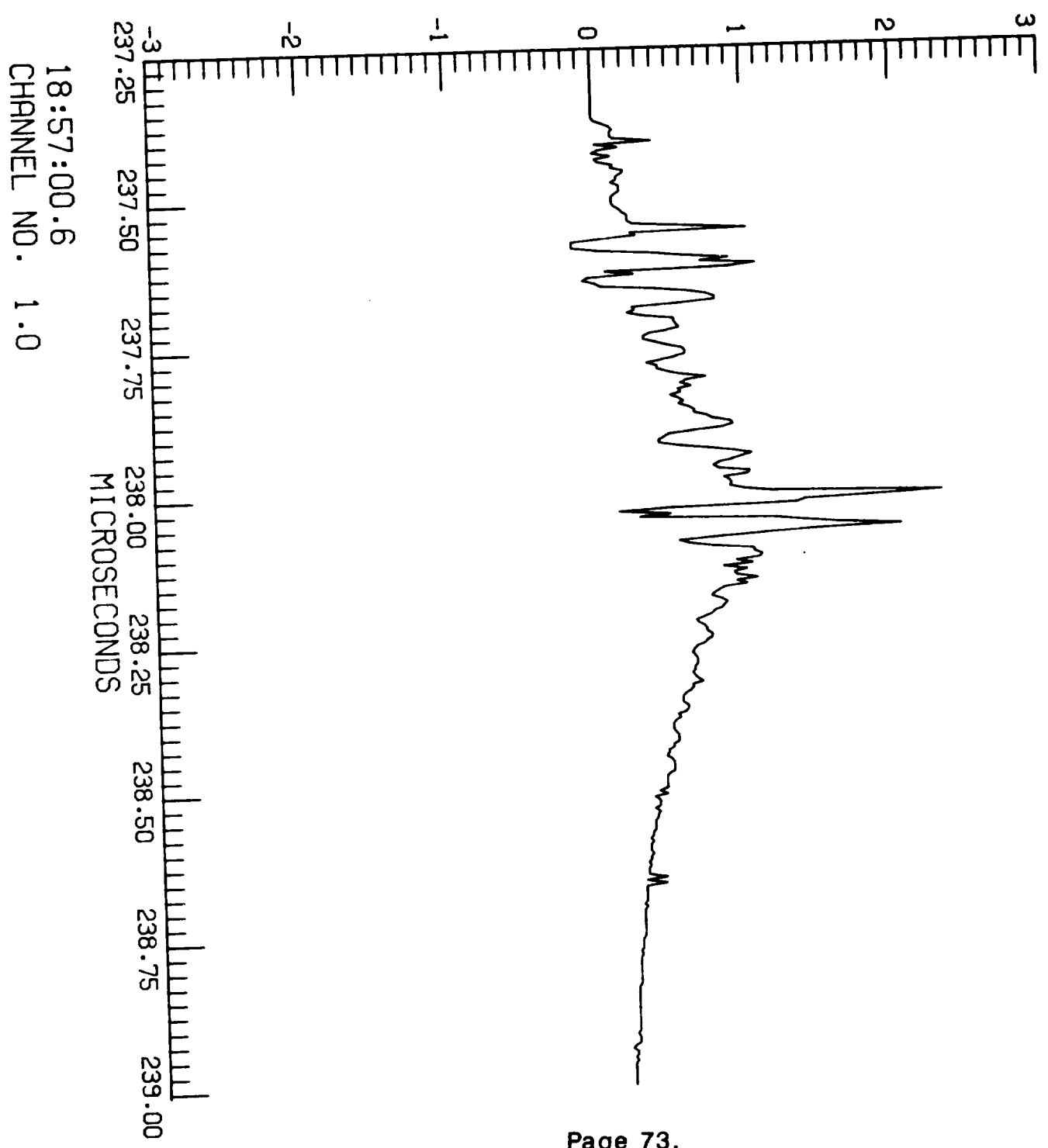

F106 LIGHTNING/85-018/ZAEPFEL

LEC 1 RUN NO. 2

S-001

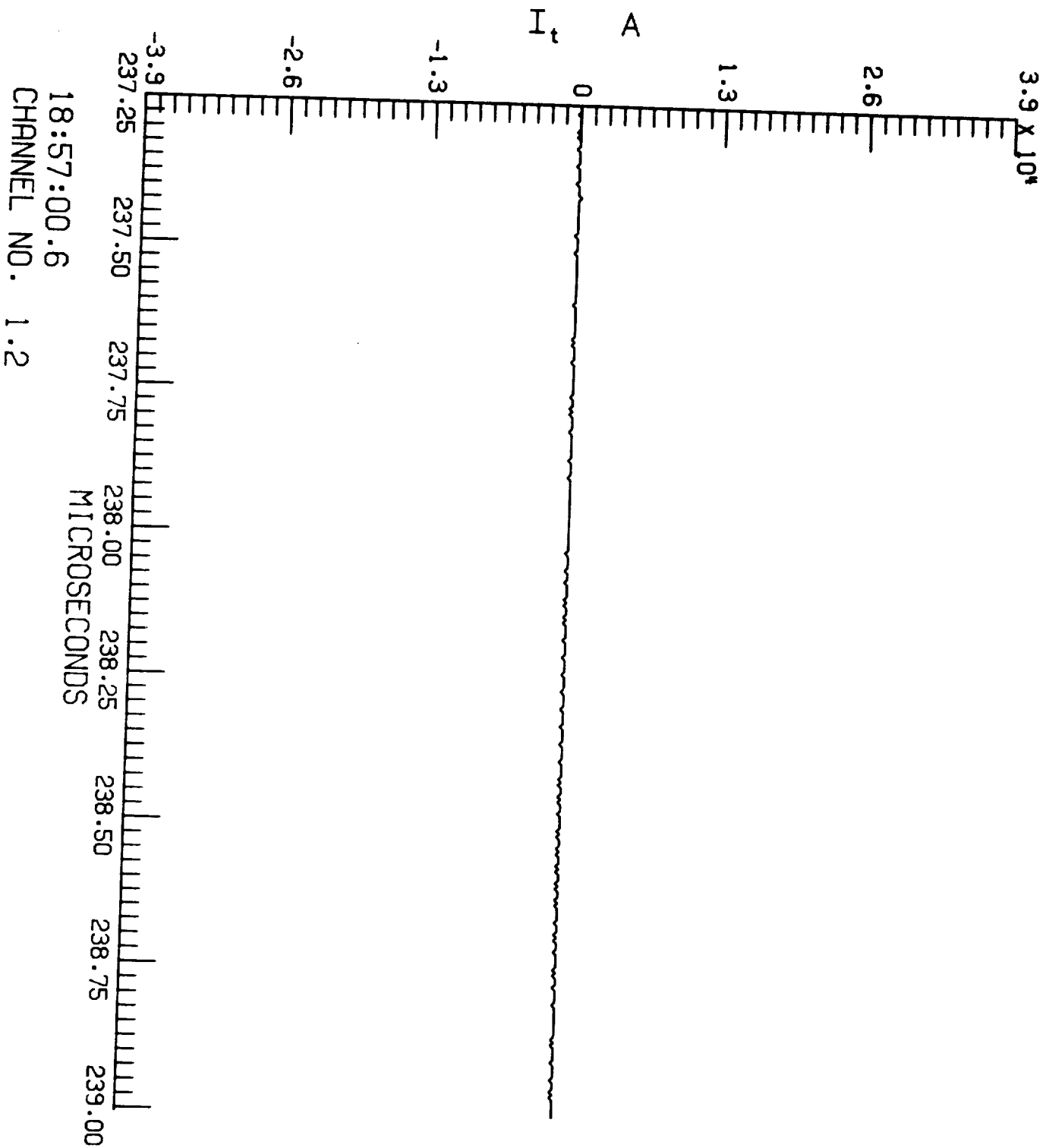

18:57:00.6  
CHANNEL NO. 1.2

F106 LIGHTNING/85-018/ZAEPFEL

LEC 2 RUN NO. 2

S-001

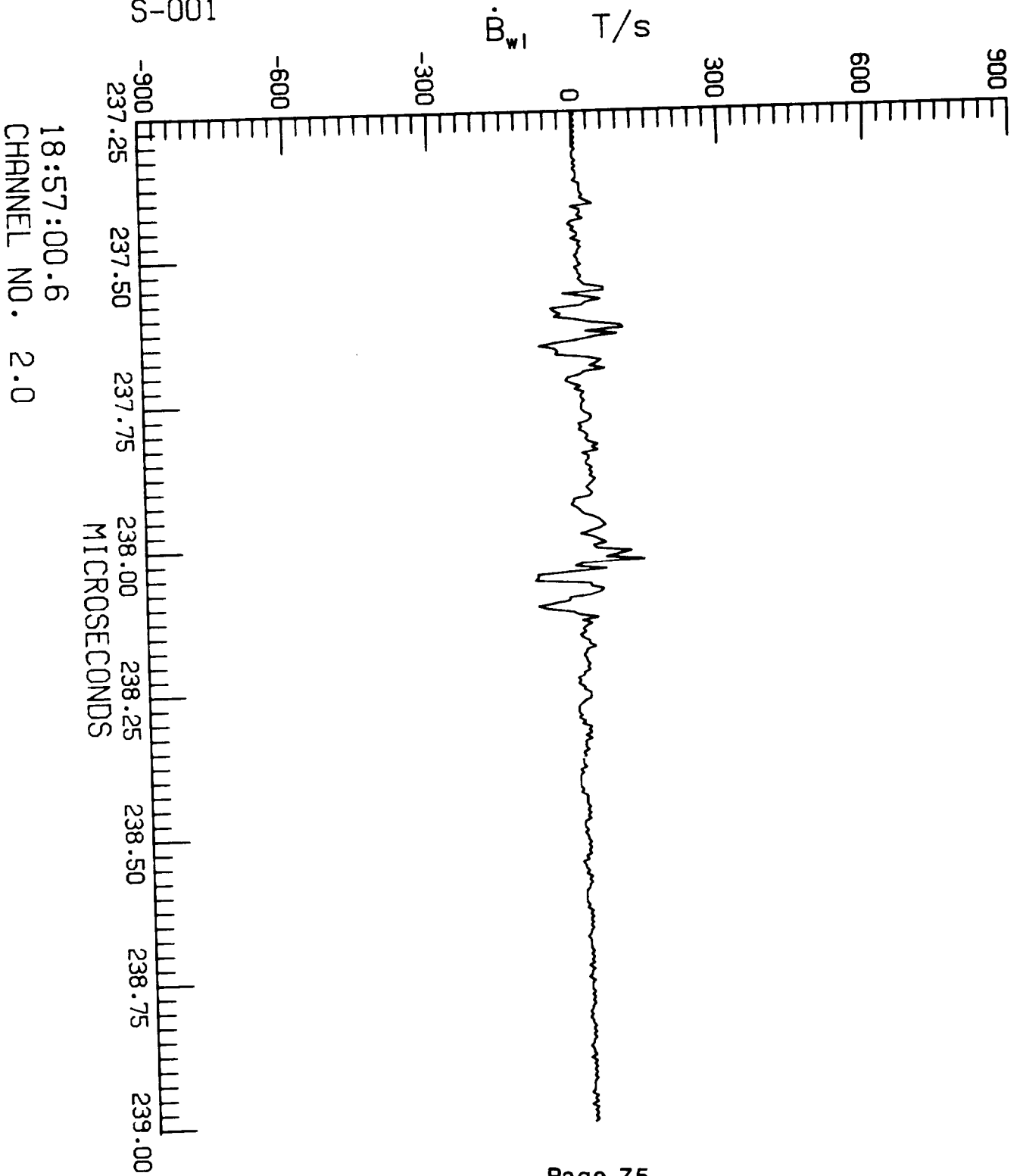

18:57:00.6  
CHANNEL NO. 2.0

F106 LIGHTNING/85-018/ZAEPFEL

LEC 2 RUN NO. 2

S-001

$\dot{i}$  A/s

$15 \times 10^{10}$

10

5

0

-5

-10

-15

237.25 237.50 237.75 238.00 238.25 238.50 238.75 239.00

MICROSECONDS

18:57:00.6

CHANNEL NO. 2.1



F106 LIGHTNING/85-018/ZAEPFEL

LEC 2 RUN NO. 2

S-001

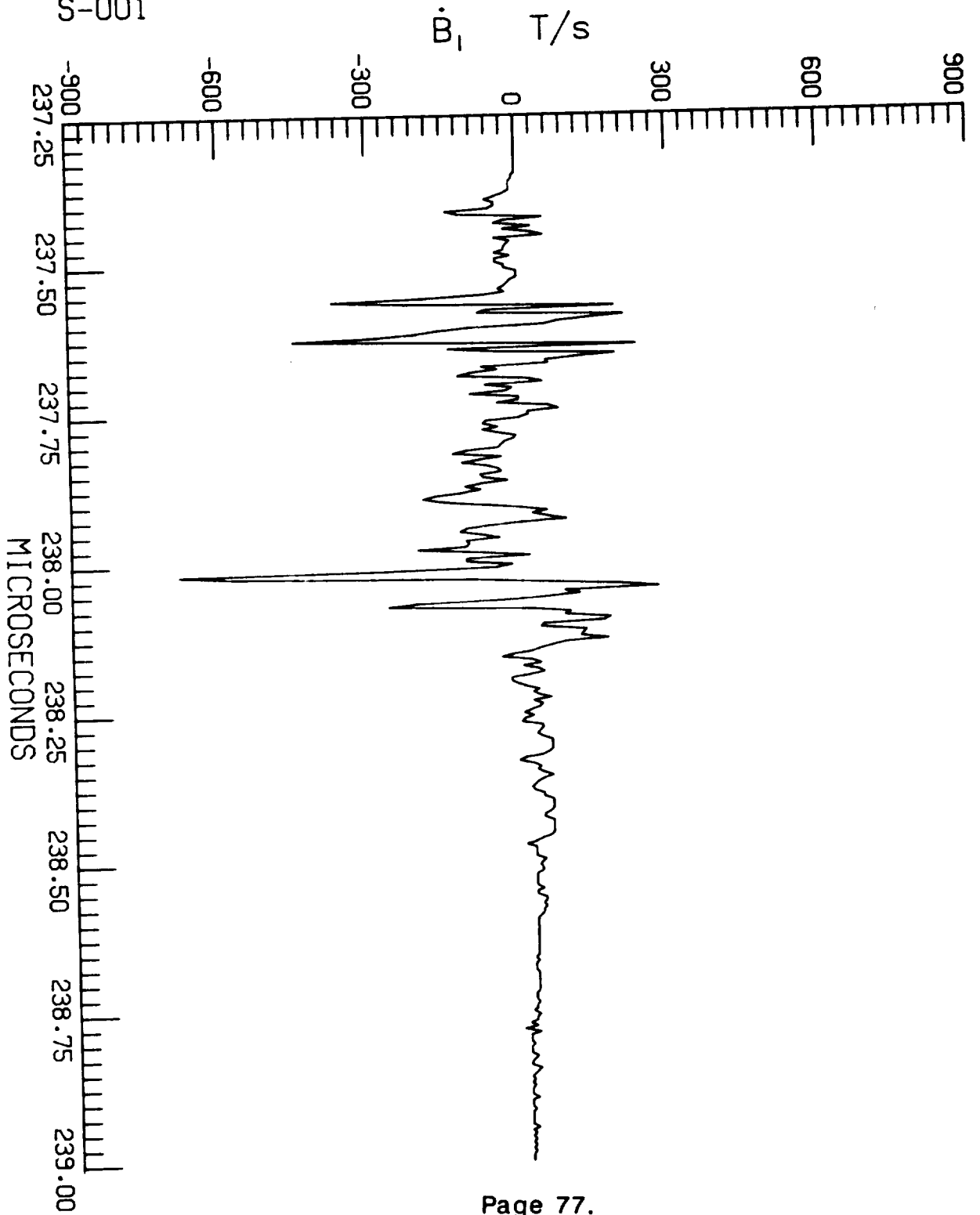

18:57:00.6  
CHANNEL NO. 2.2

F106 LIGHTNING/85-018/ZAEPFEL

LEC 3 RUN NO. 2

S-001

$\dot{D}_{wr}$  A/m<sup>2</sup>

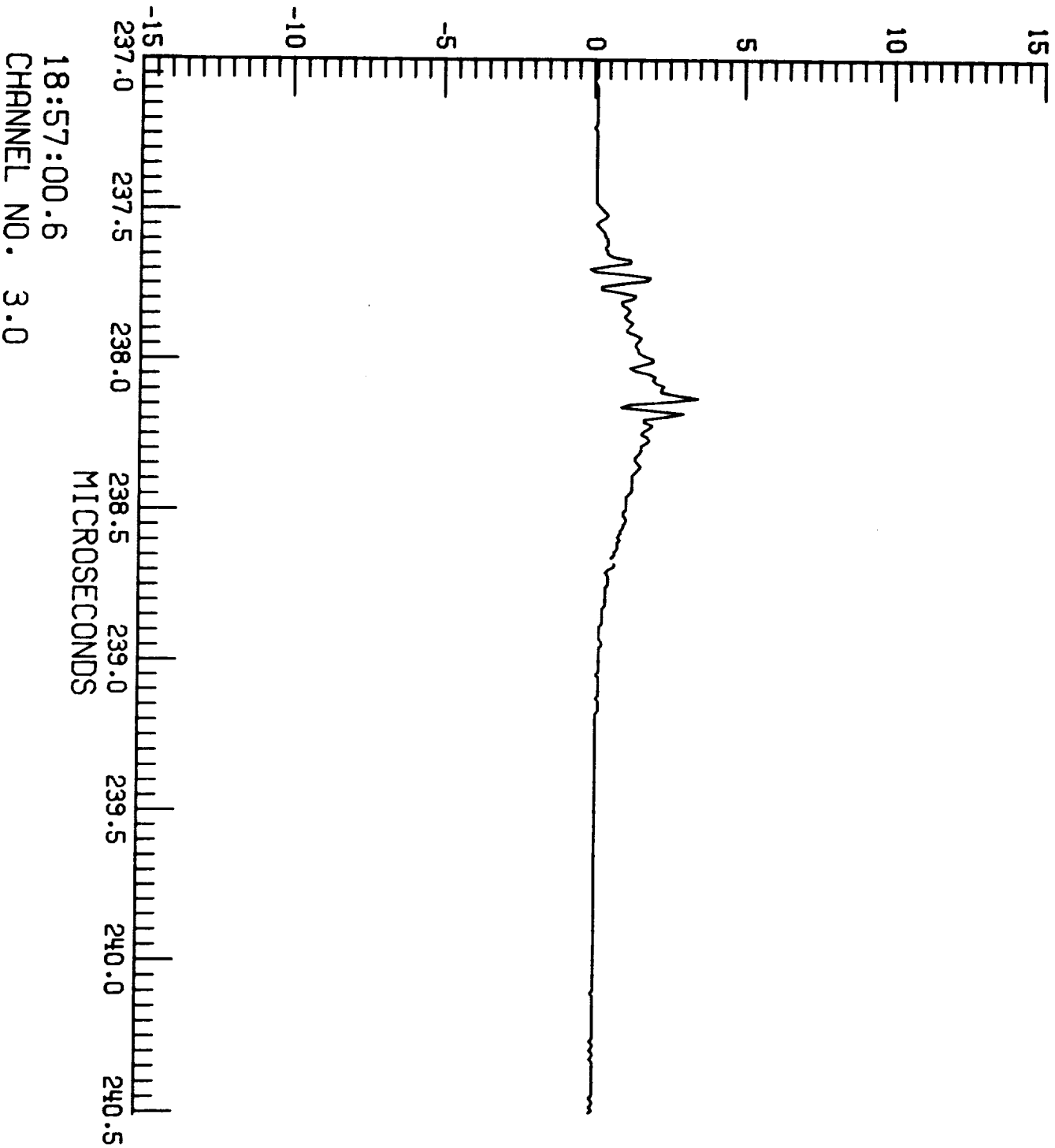

F106 LIGHTNING/85-018/ZAEPFEL  
LEC 3 RUN NO. 2  
S-001

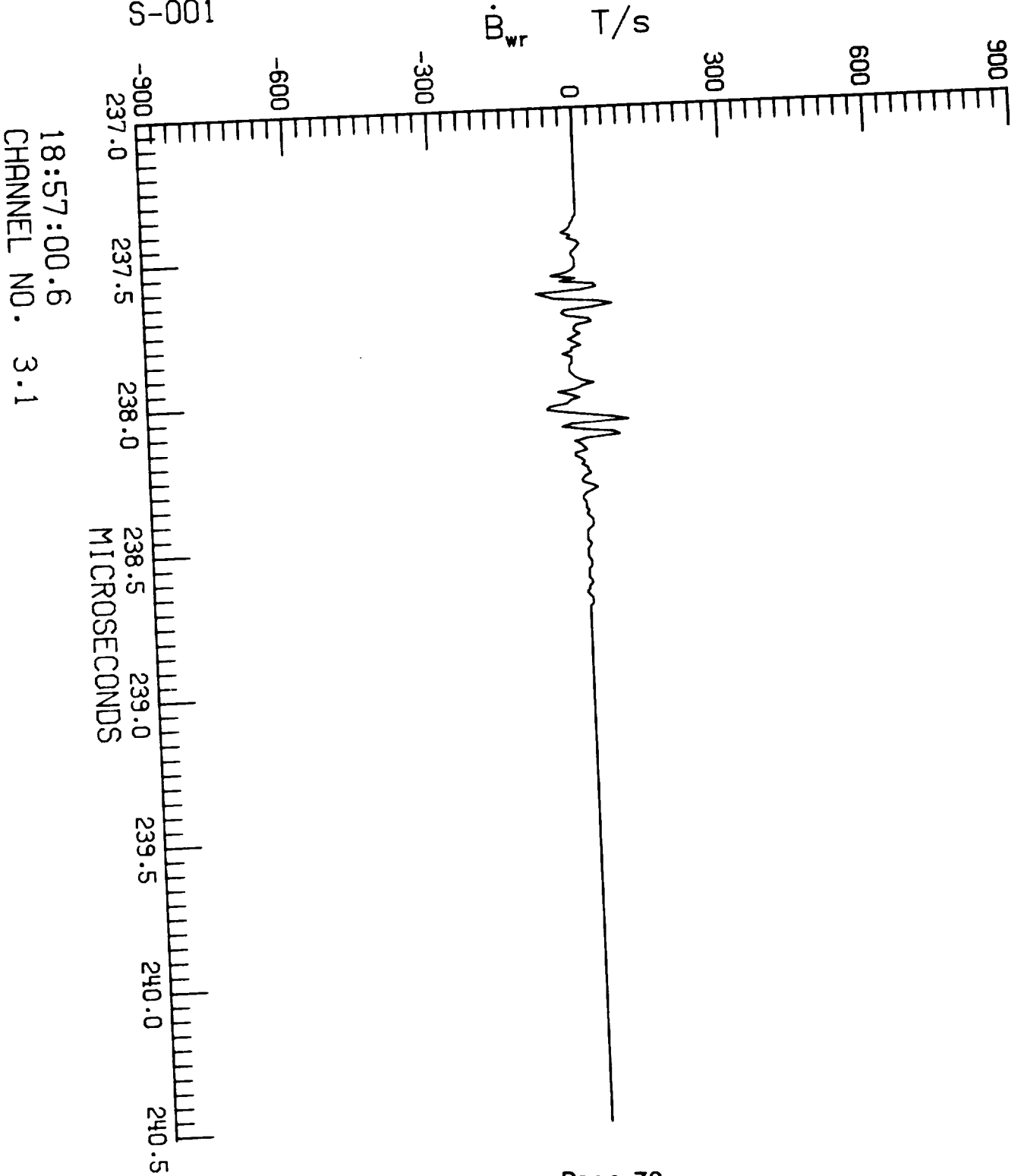

18:57:00.6  
CHANNEL NO. 3.1

F106 LIGHTNING/85-018/ZAEPFEL  
LEC 3 RUN NO. 2  
S-001

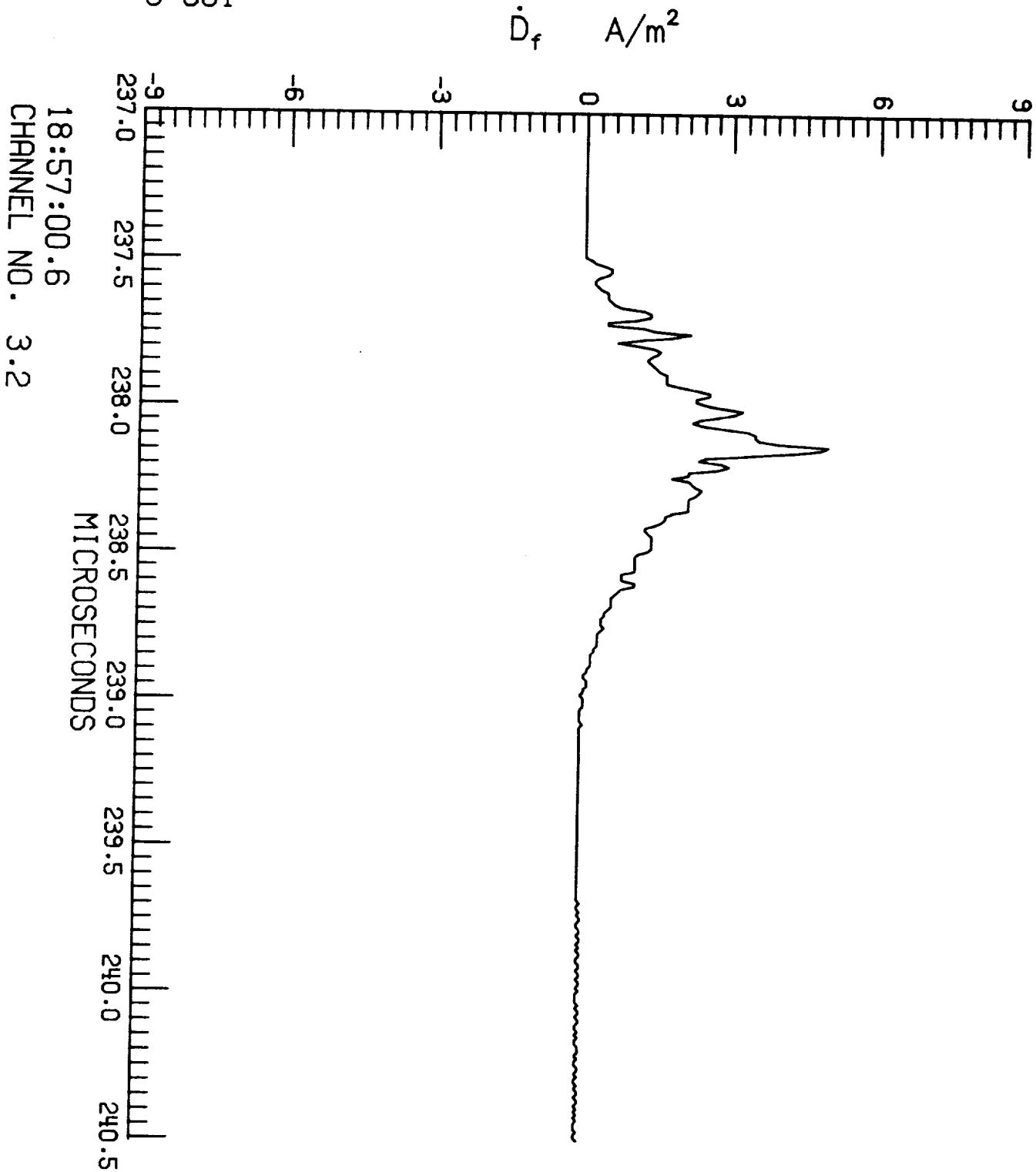

F106 LIGHTNING/85-018/ZAEPFEL

LEC 4 RUN NO. 2

S-001

TP100 V

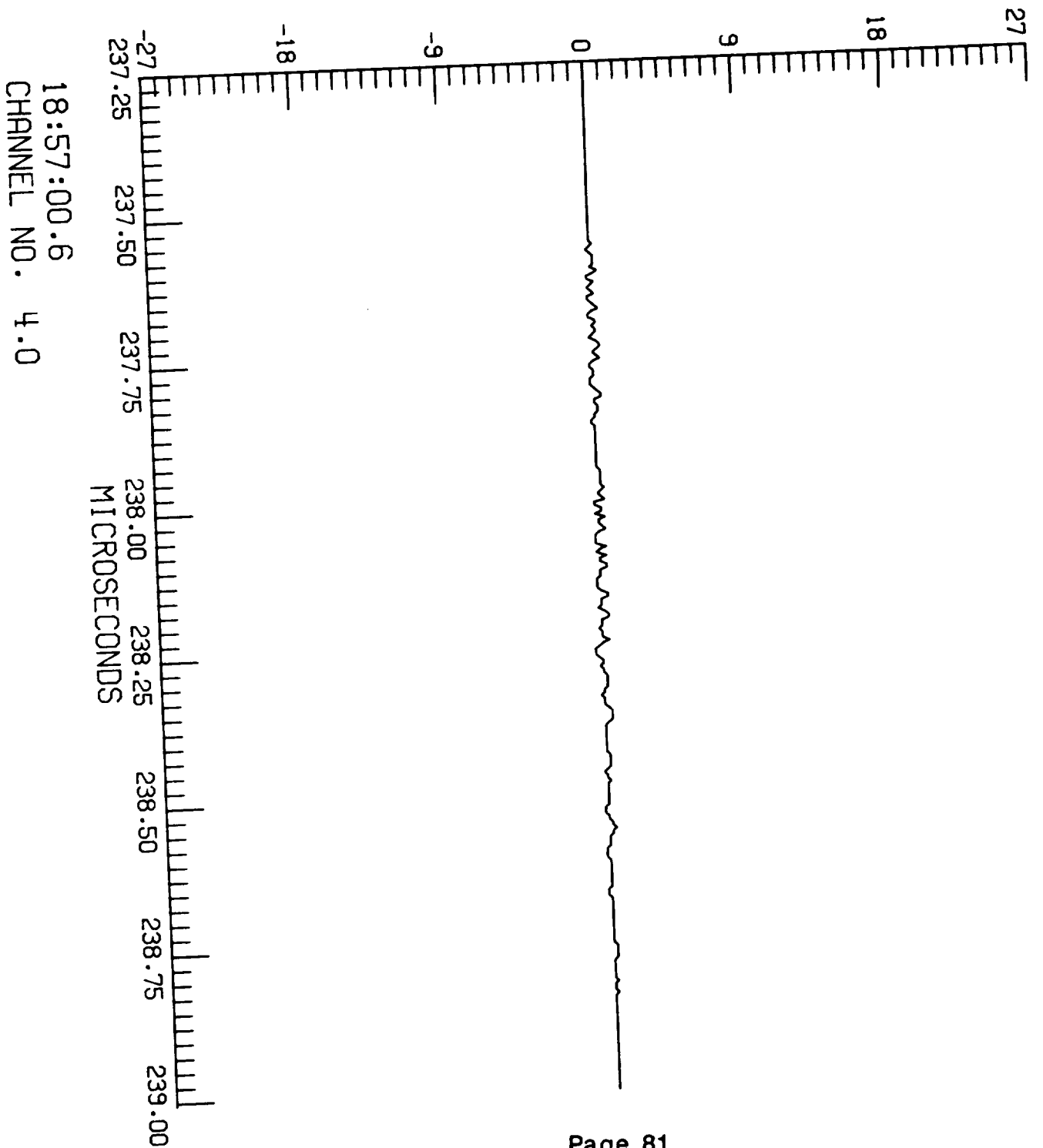

F106 LIGHTNING/85-018/ZAEPFEL

LEC 4 RUN NO. 2

S-001

TP106 A

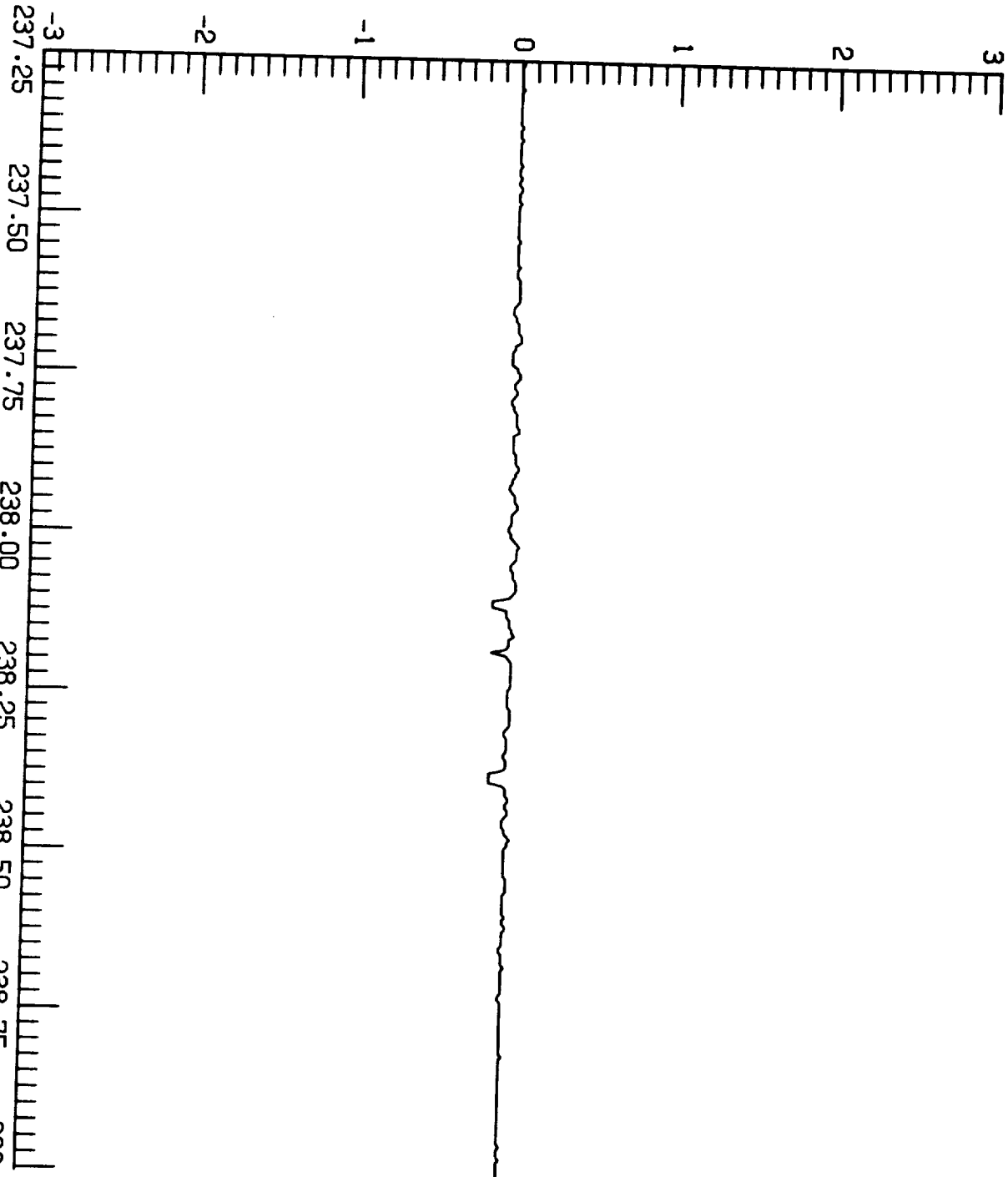

18:57:00.6  
CHANNEL NO. 4.1

MICROSECONDS

F106 LIGHTNING/85-018/ZAEPFEL

LEC 4 RUN NO. 2

S-001

TP125

A

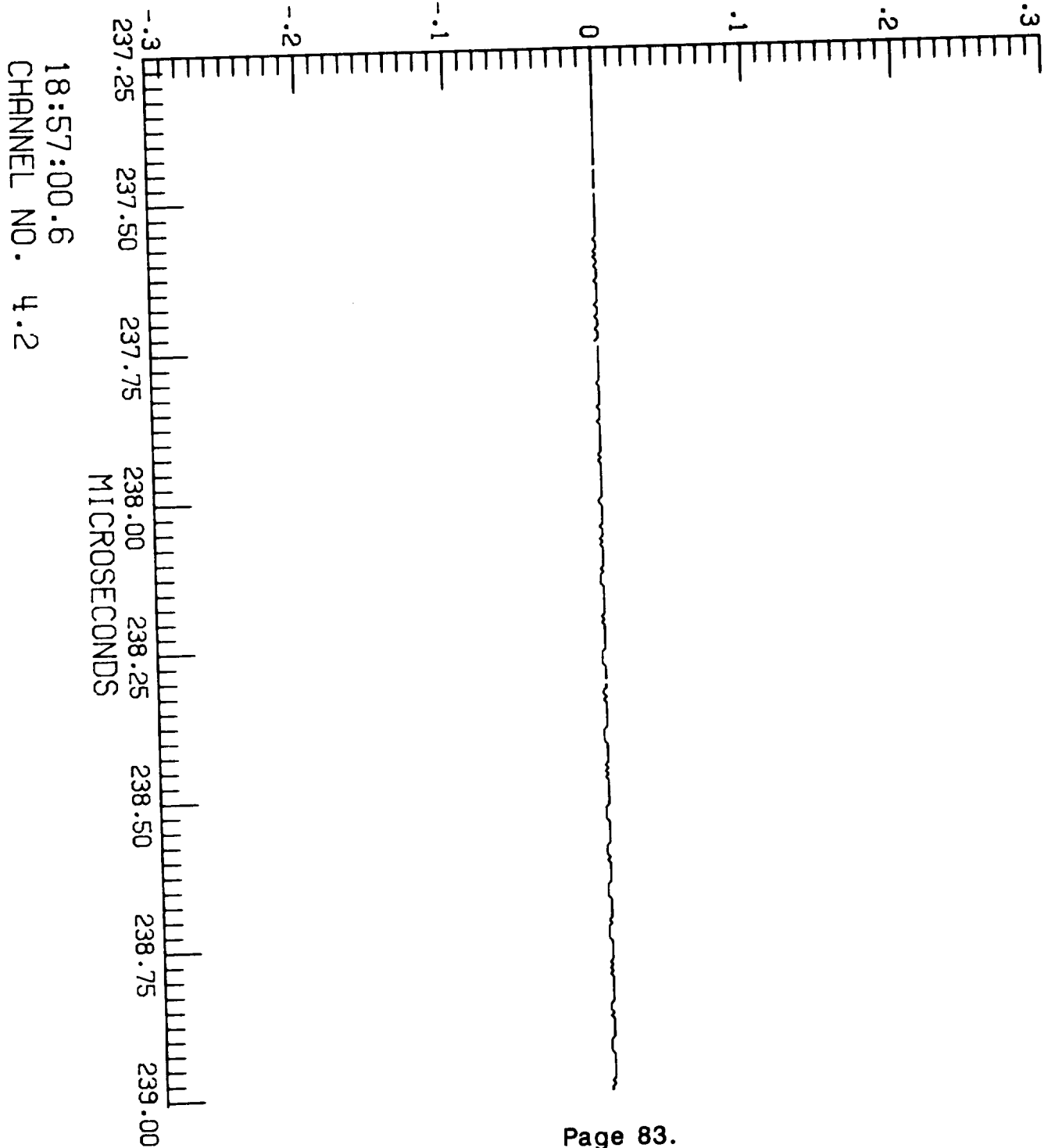

F106 LIGHTNING/85-022/ZAEPFEL

LEC 1 RUN NO. 1

N-001

$\dot{D}_t$  A/m<sup>2</sup>

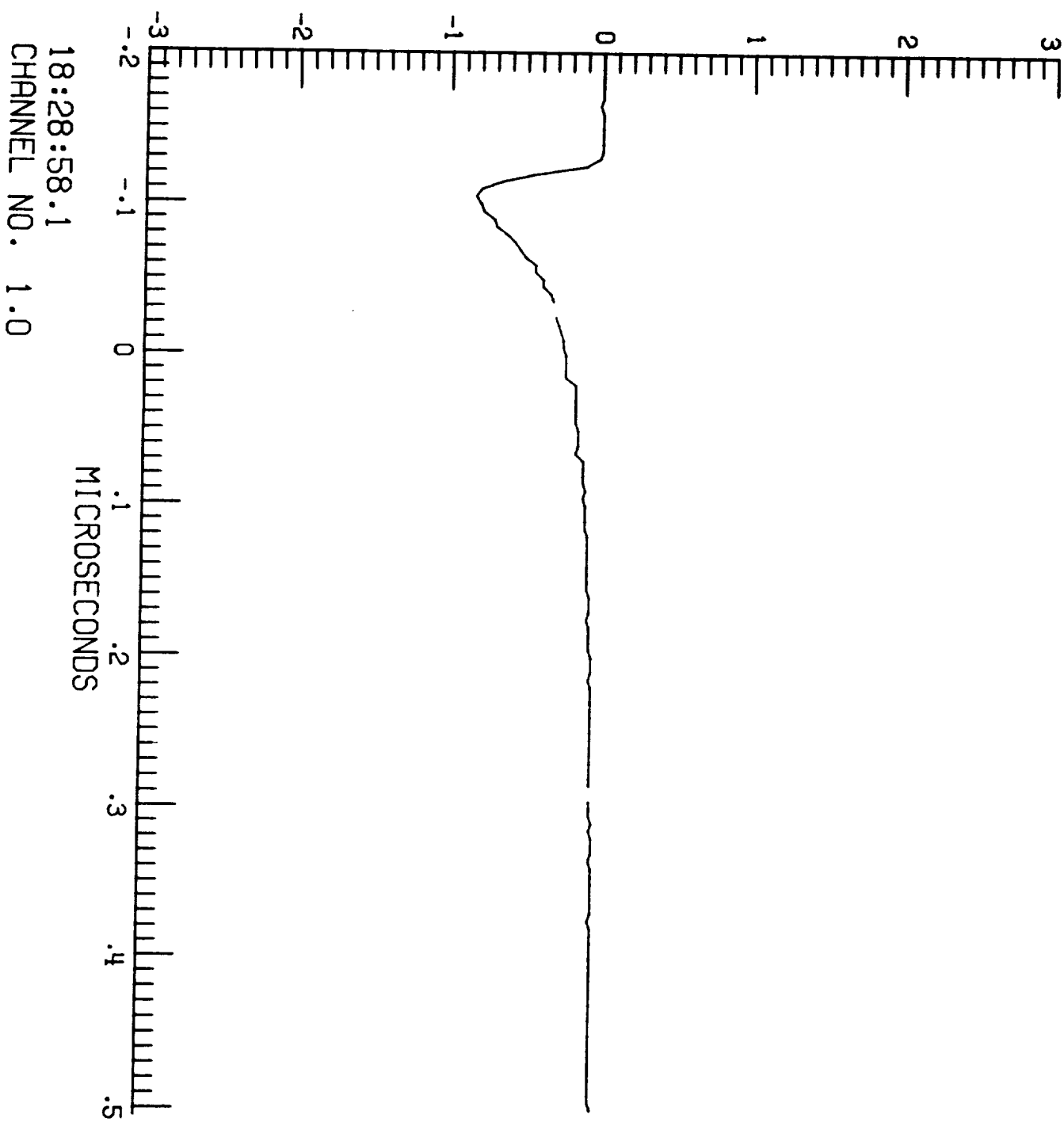

18:28:58.1  
CHANNEL NO. 1.0



F106 LIGHTNING/85-022/ZAEPFEL  
LEC 1 RUN NO. 1  
N-001

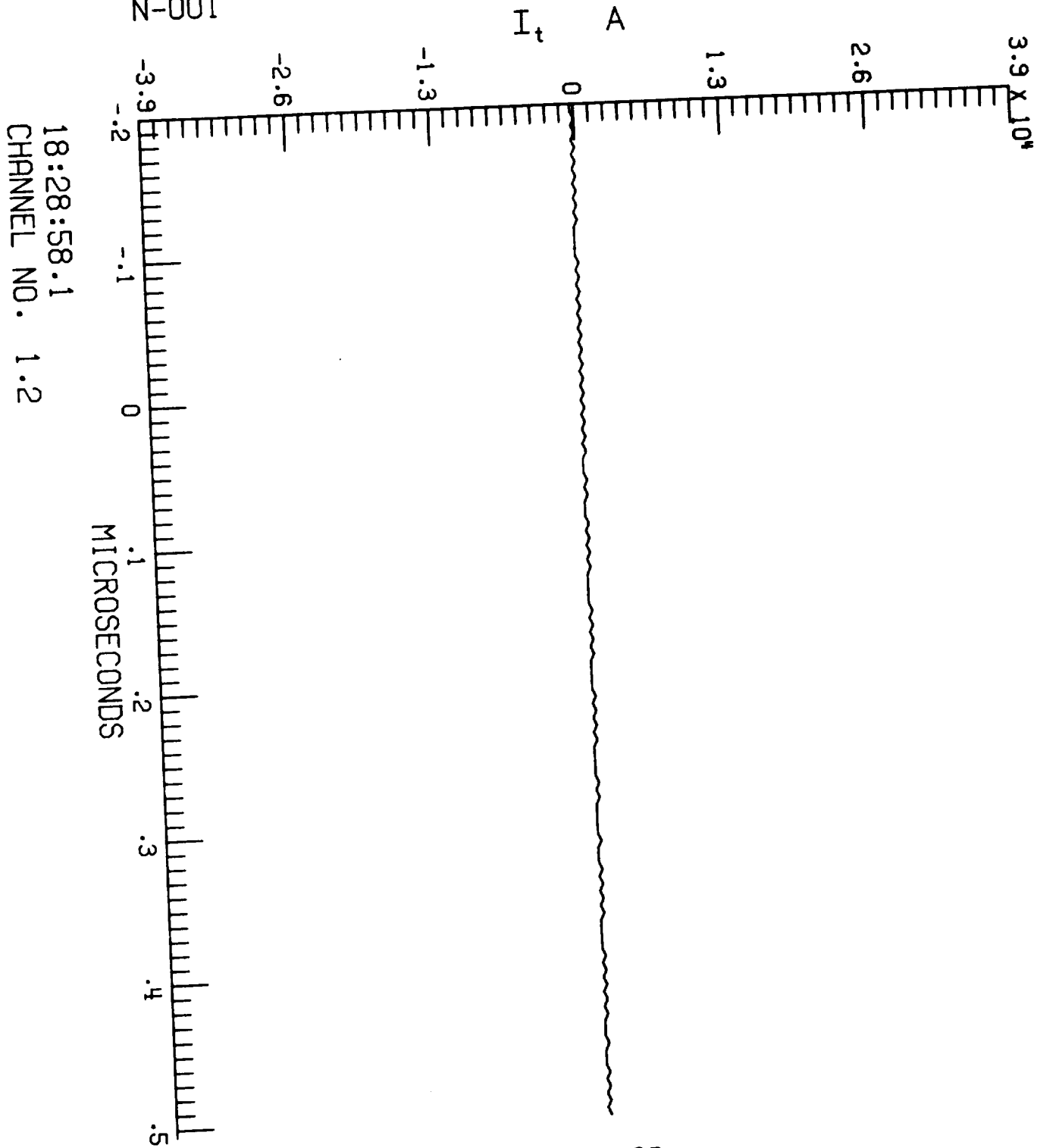

18:28:58.1  
CHANNEL NO. 1.2

F106 LIGHTNING/85-022/ZAEPFEL

LEC 2 RUN NO. 1

N-001

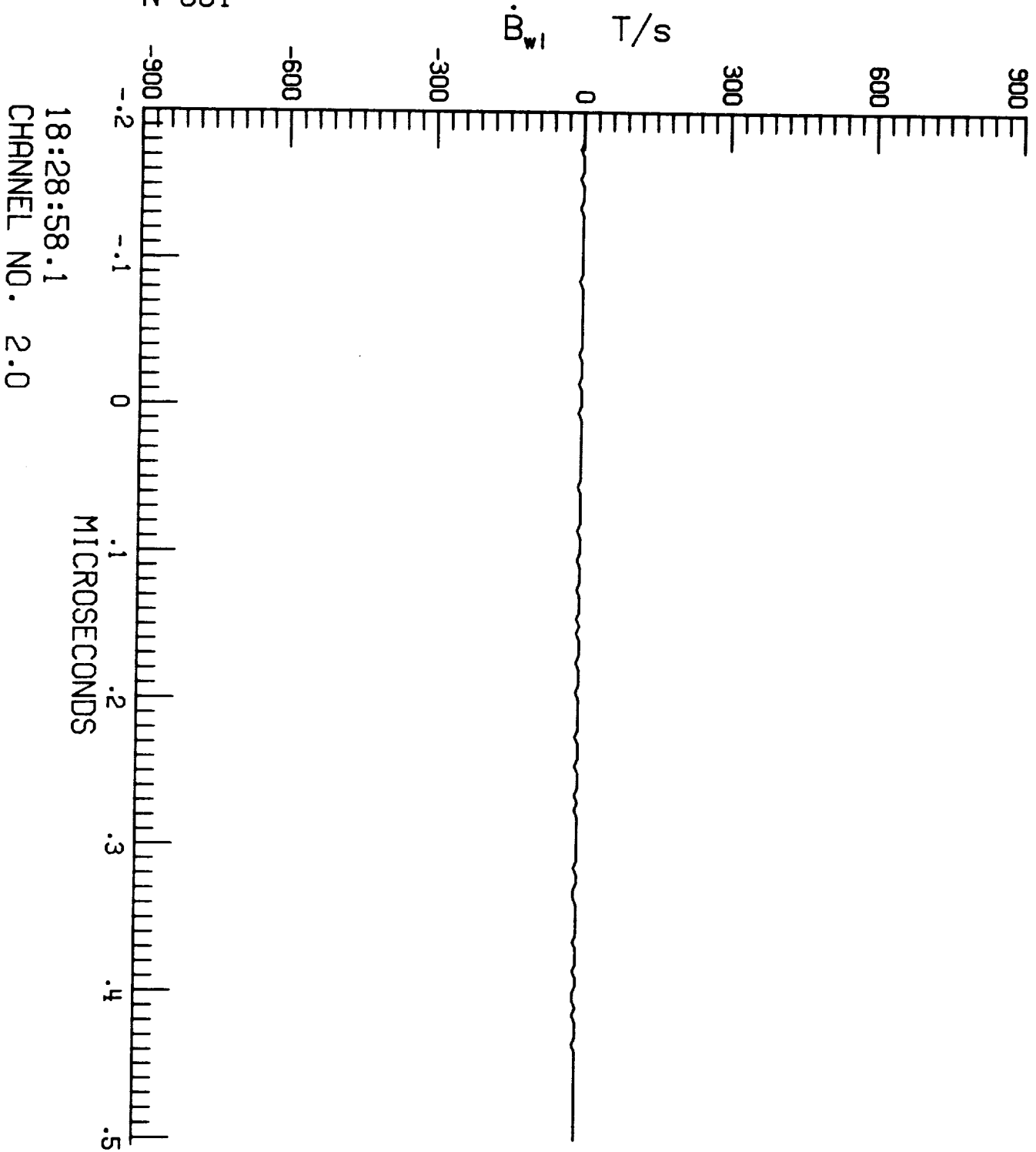

F106 LIGHTNING/85-022/ZAEPFEL  
LEC 2 RUN NO. 1  
N-001

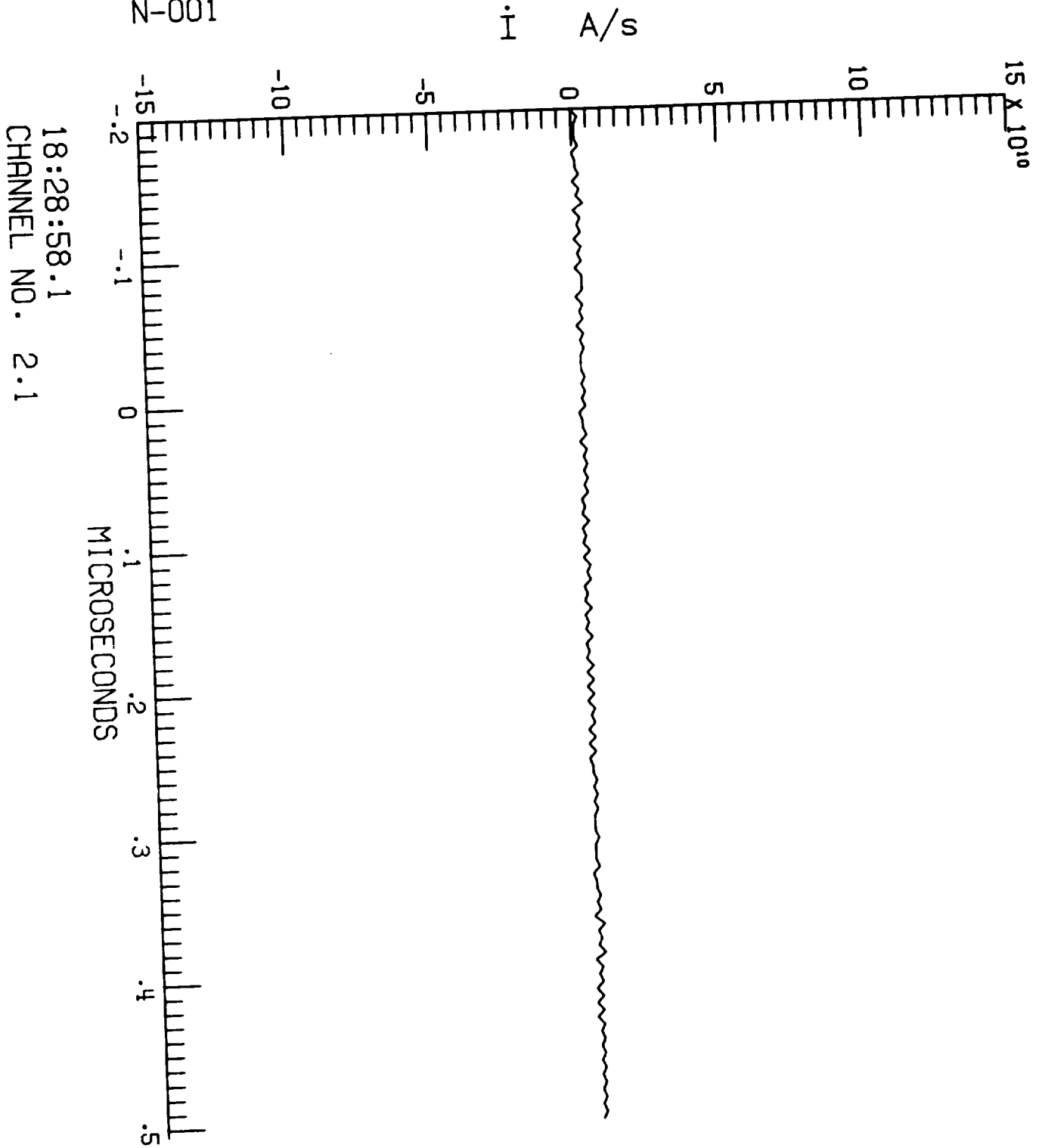

F106 LIGHTNING/85-022/ZAEPFEL

LEC 2 RUN NO. 1

N-001

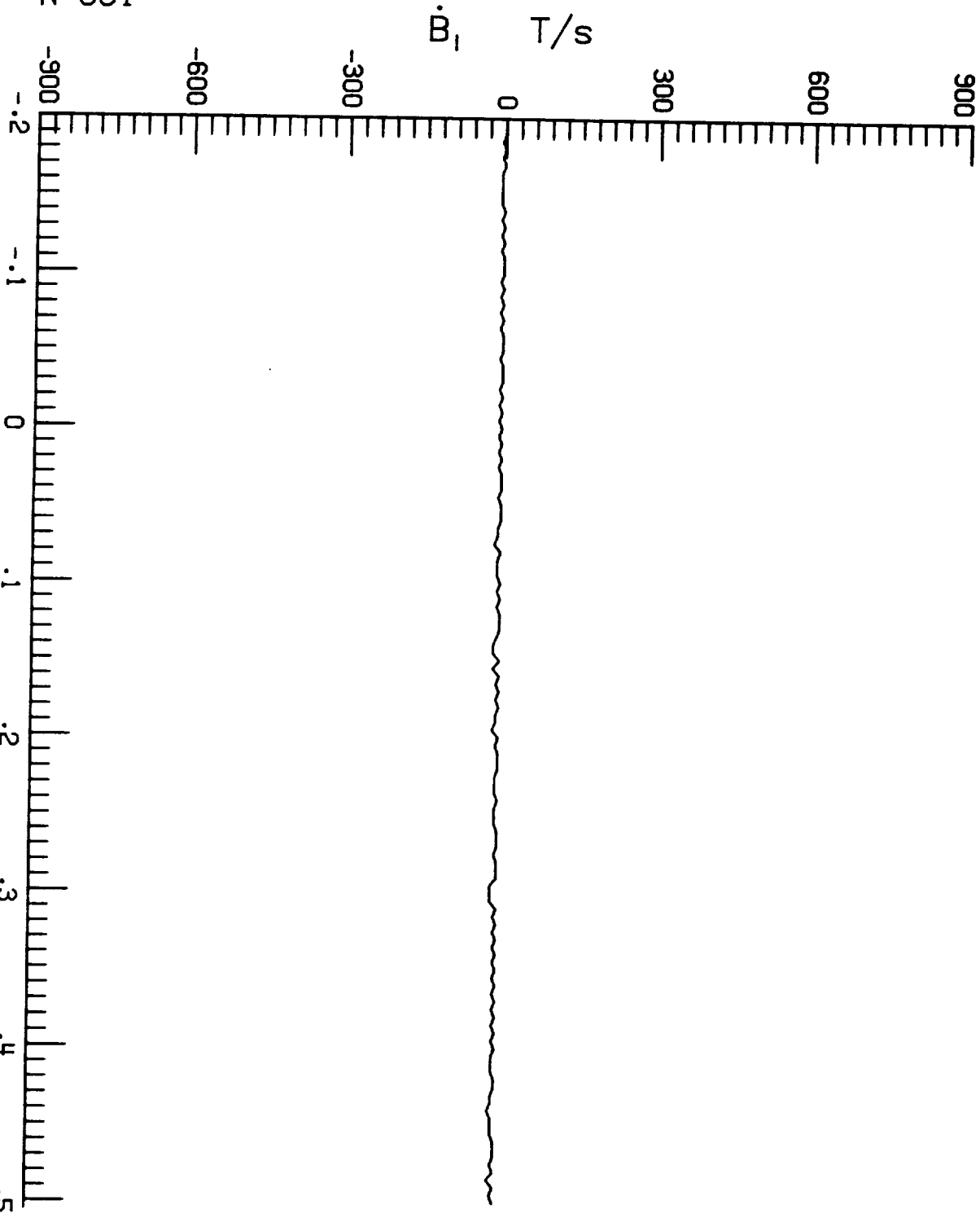

18:28:58.1  
CHANNEL NO. 2.2

MICROSECONDS

F106 LIGHTNING/85-022/ZAEPFEL

LEC 3 RUN NO. 1

N-001

$\dot{D}_{wr}$  A/m<sup>2</sup>

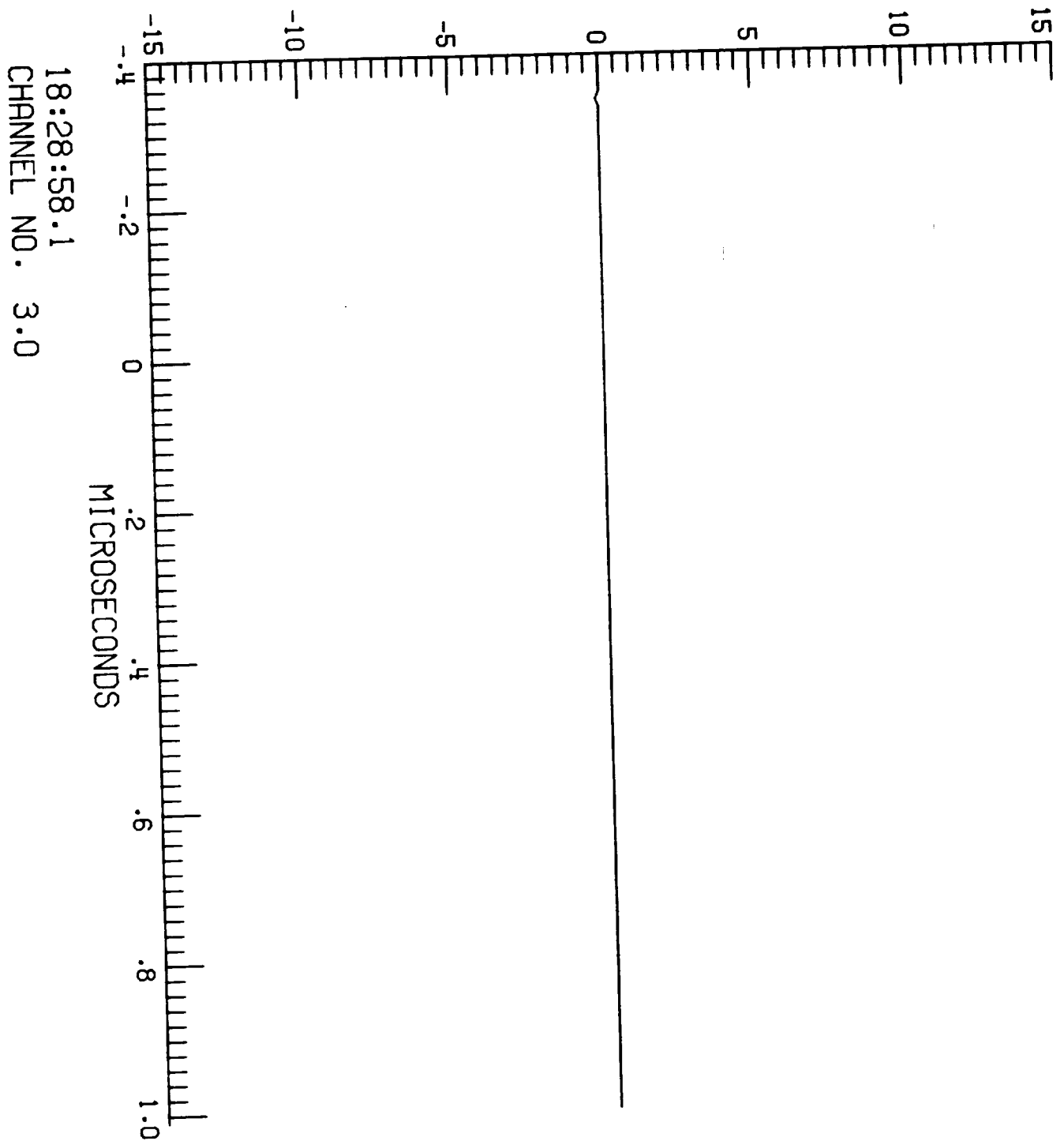

F106 LIGHTNING/85-022/ZAEPFEL

LEC 3 RUN NO. 1

N-001

$\dot{B}_{wr}$  T/s

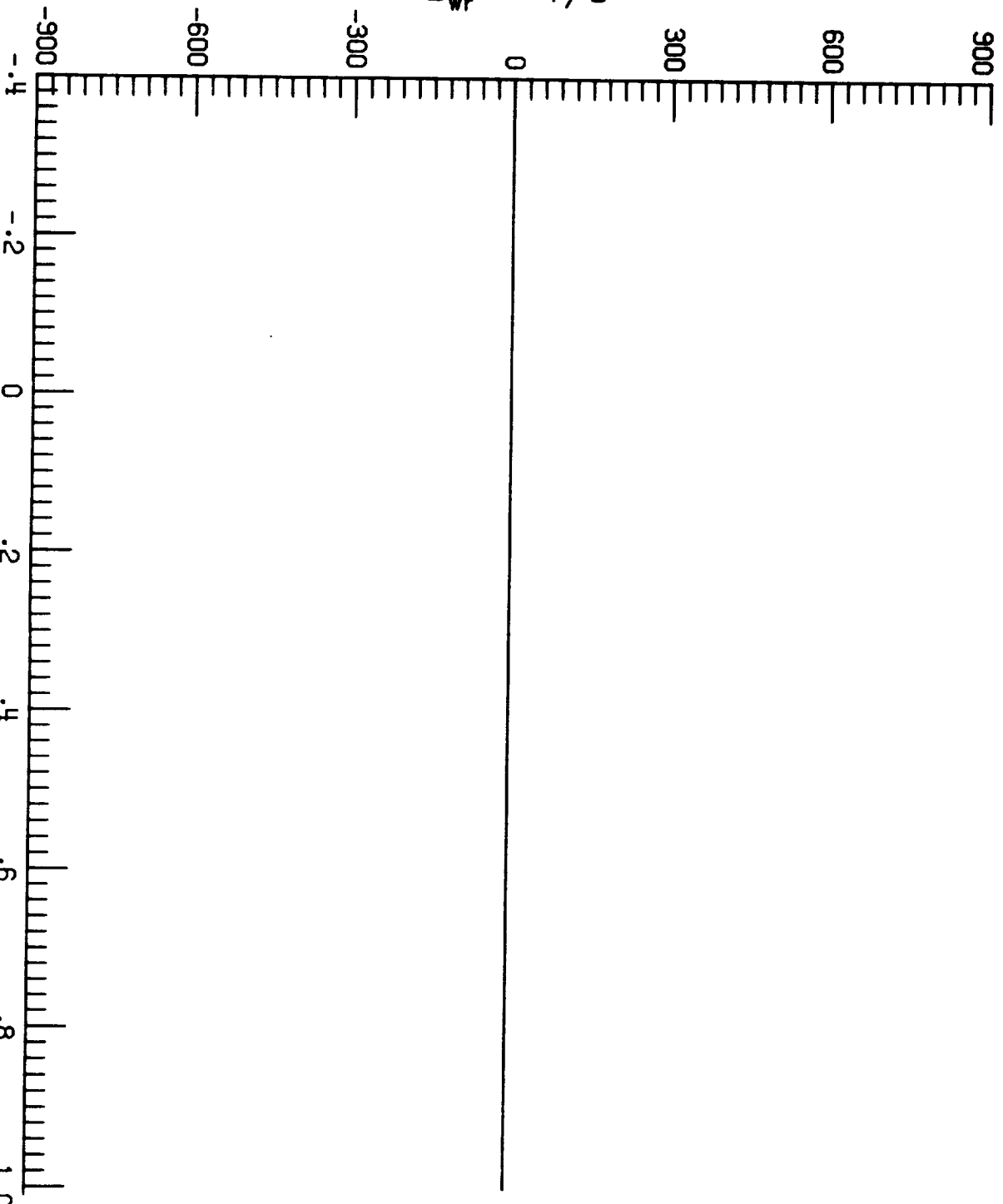

18:28:58.1  
CHANNEL NO. 3.1

F106 LIGHTNING/85-022/ZAEPFEL

LEC 3 RUN NO. 1

N-001

$\dot{D}_f$  A/m<sup>2</sup>

18:28:58.1  
CHANNEL NO. 3.2

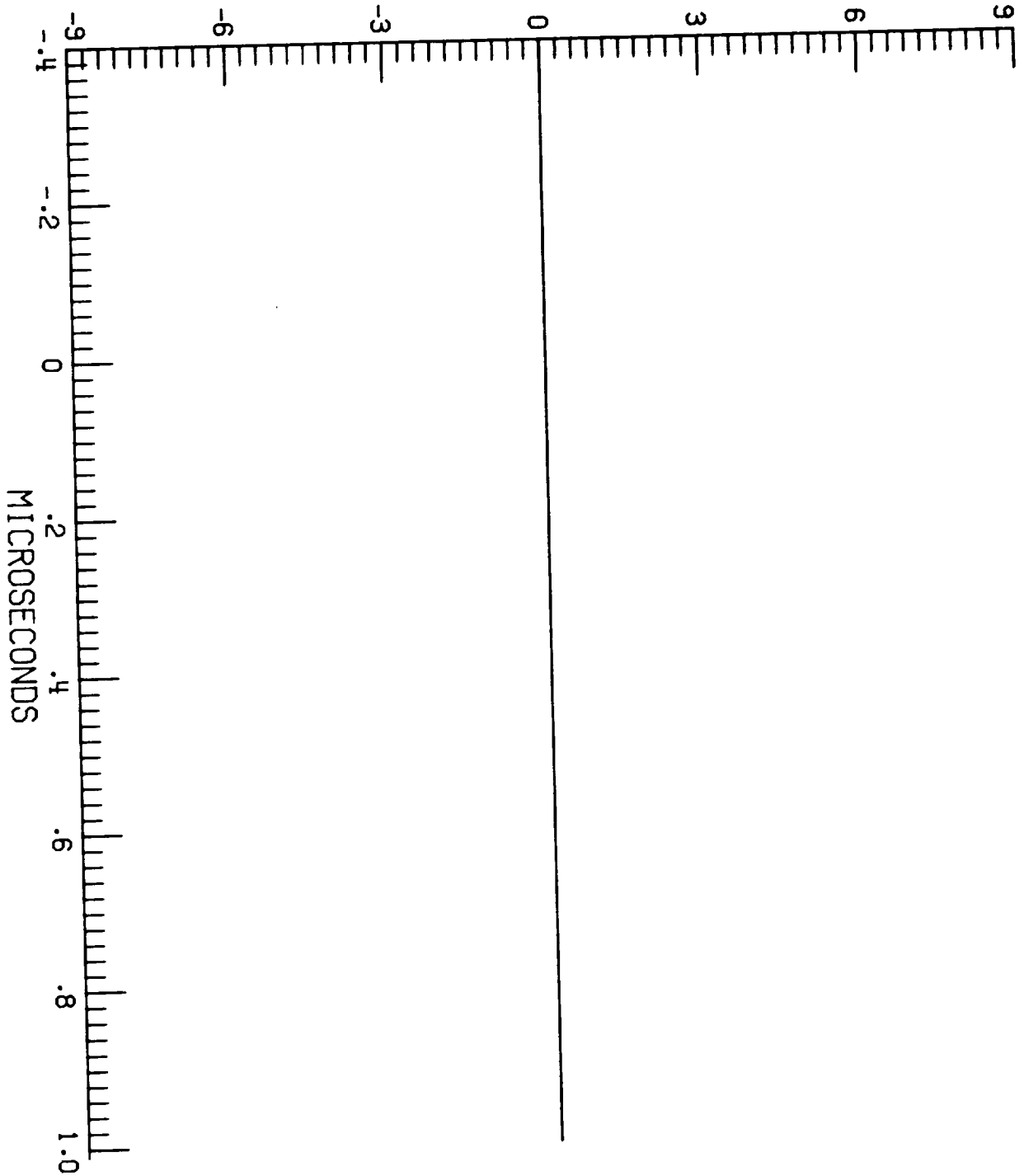

F106 LIGHTNING/85-022/ZAEPFEL

LEC 4 RUN NO. 1

N-001

TP100 V

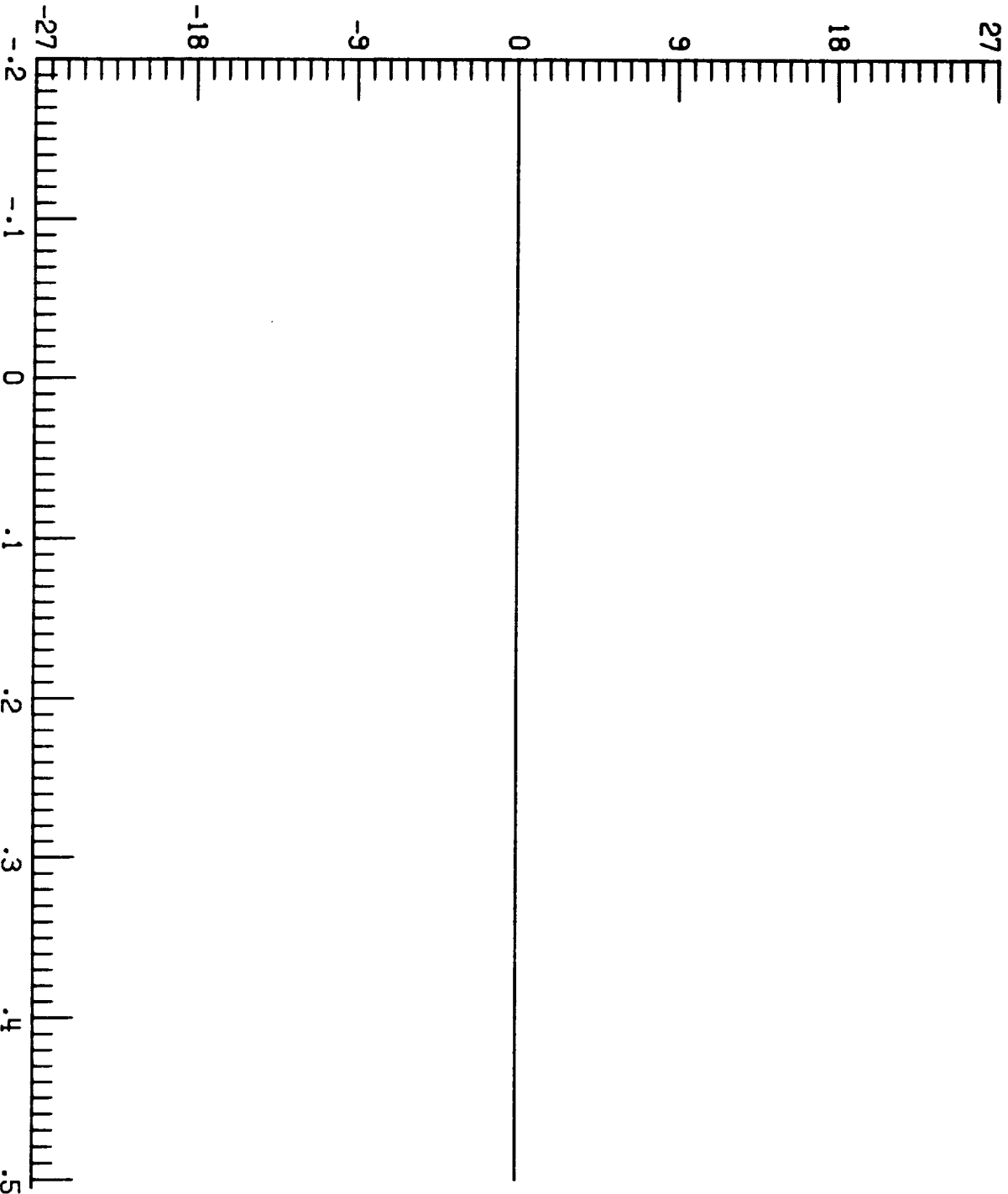

18:28:58.1  
CHANNEL NO. 4.0



F106 LIGHTNING/85-022/ZAEPFEL

LEC 4 RUN NO. 1

N-001

TP106

A

18:28:58.1  
CHANNEL NO. 4.1

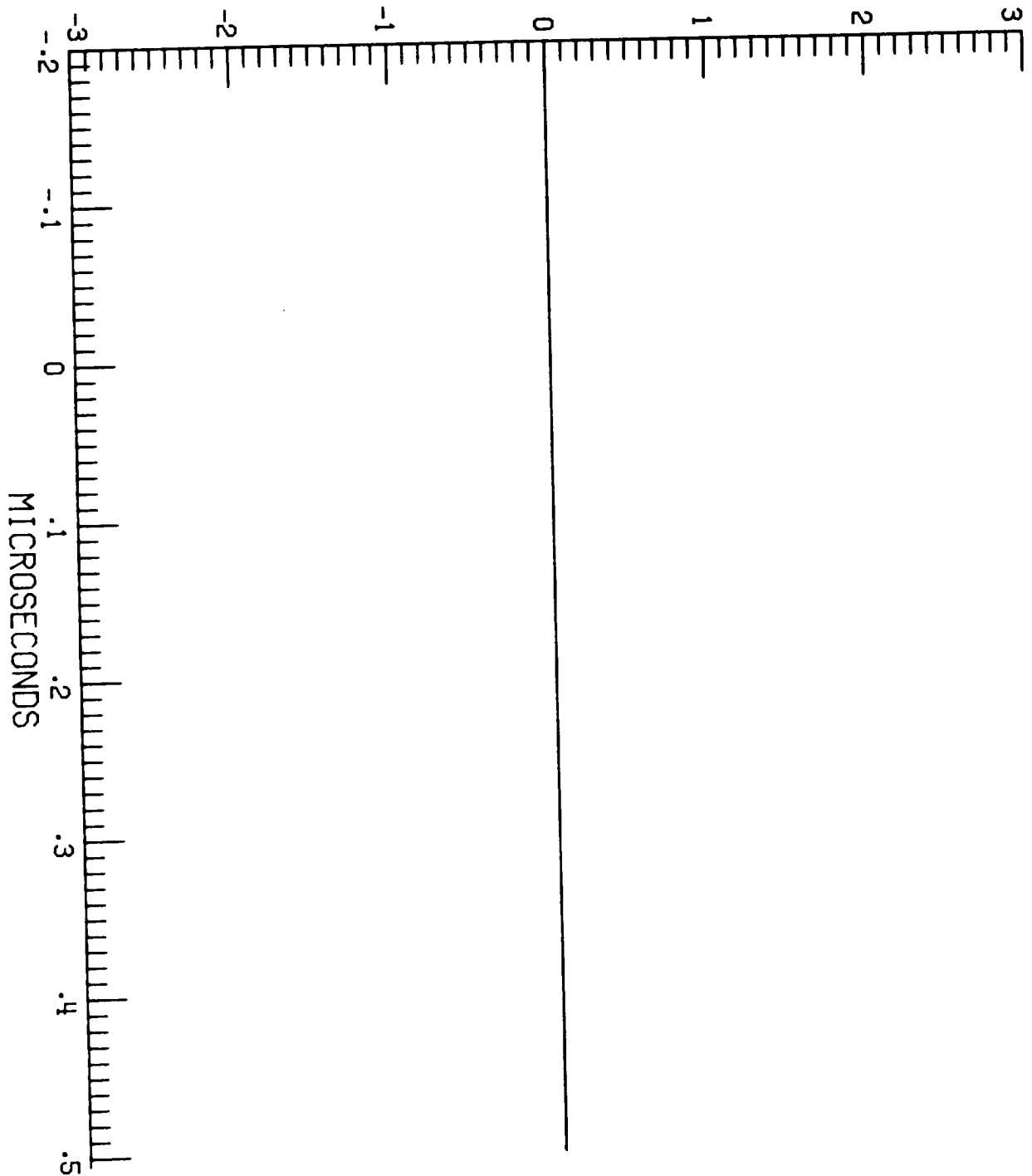

F106 LIGHTNING/85-022/ZAEPFEL

LEC 4 RUN NO. 1

N-001

TP125

A

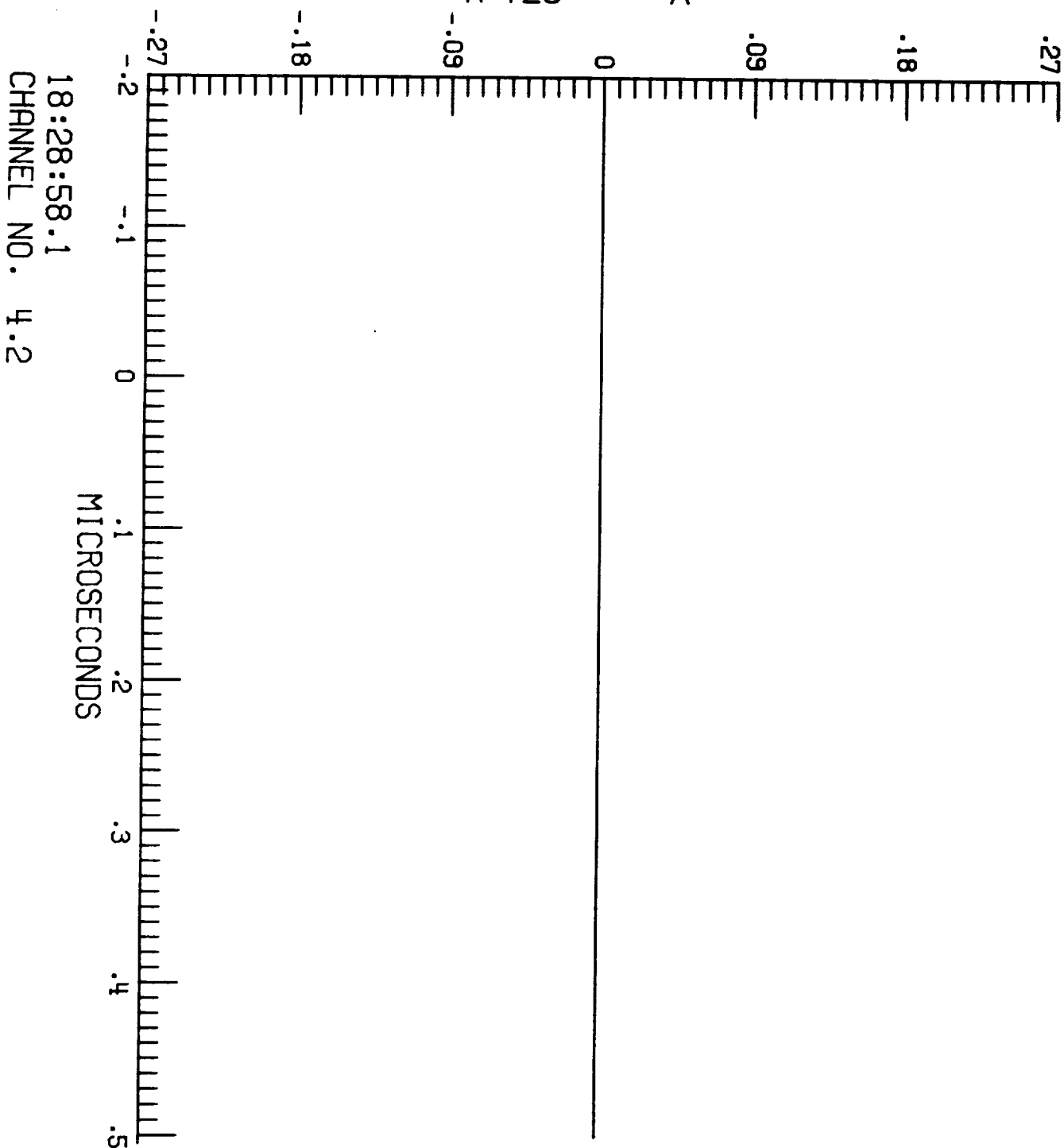

F106 LIGHTNING/85-022/ZAEPFEL

LEC 3

RUN NO. 3

S-003

$\dot{D}_{wr}$  A/m<sup>2</sup>

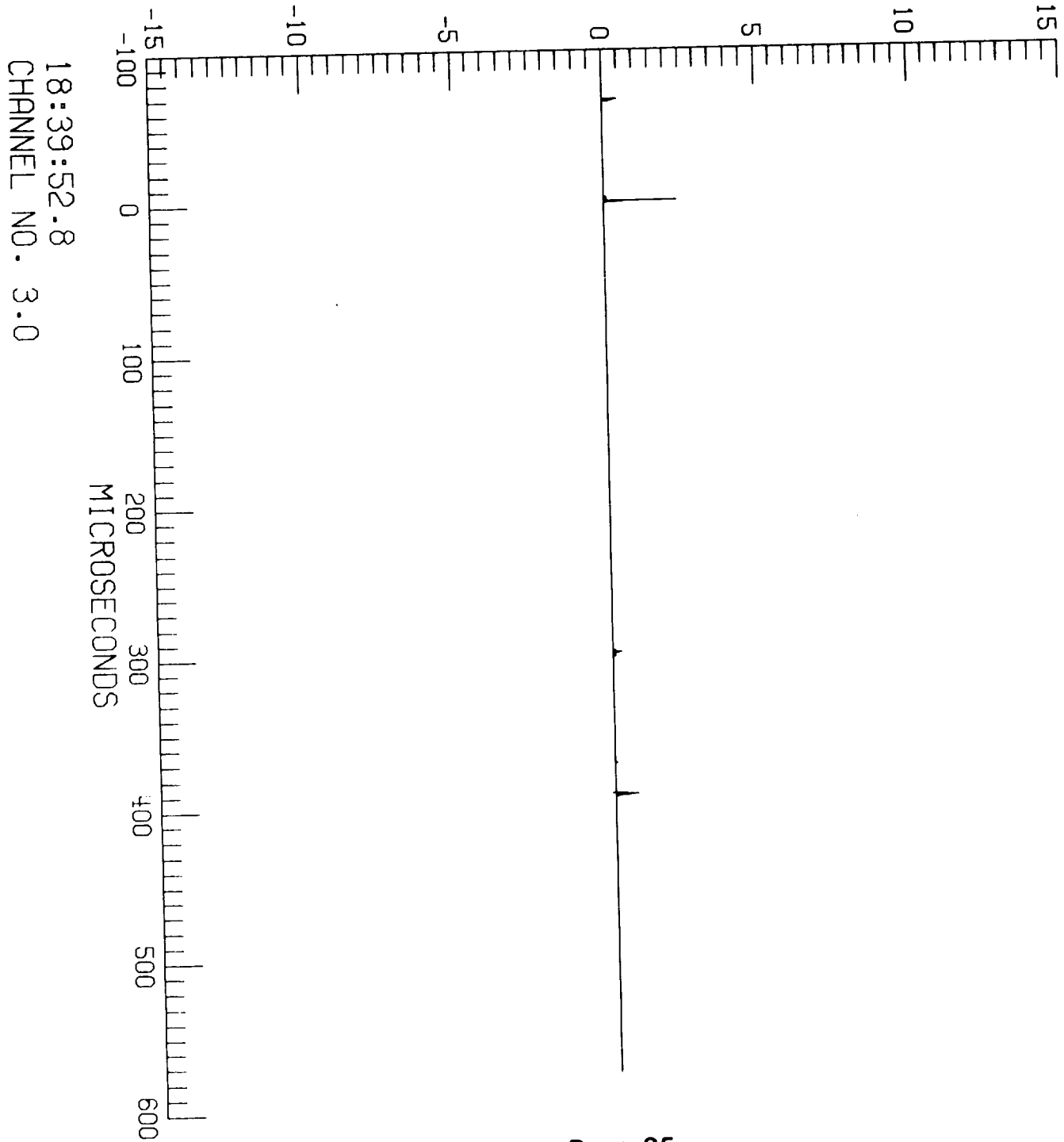

F106 LIGHTNING/85-022/ZAEPFEL

LEC 3 RUN NO. 3

S-003

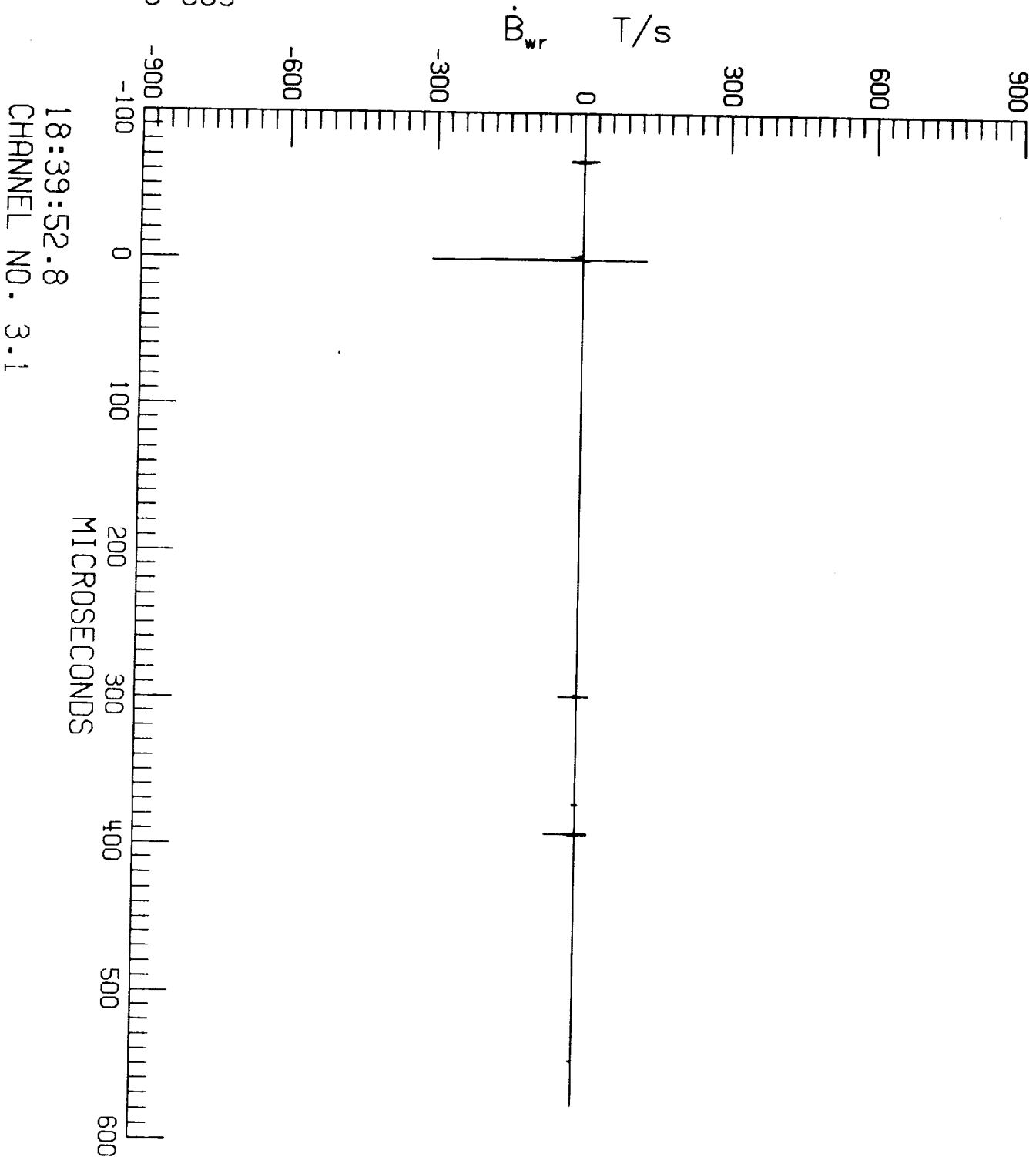

18:39:52.8  
CHANNEL NO. 3.1

F106 LIGHTNING/85-022/ZAEPFEL

LEC 3

RUN NO. 3

S-003

$\dot{D}_f$  A/m<sup>2</sup>

18:39:52.8  
CHANNEL NO. 3.2

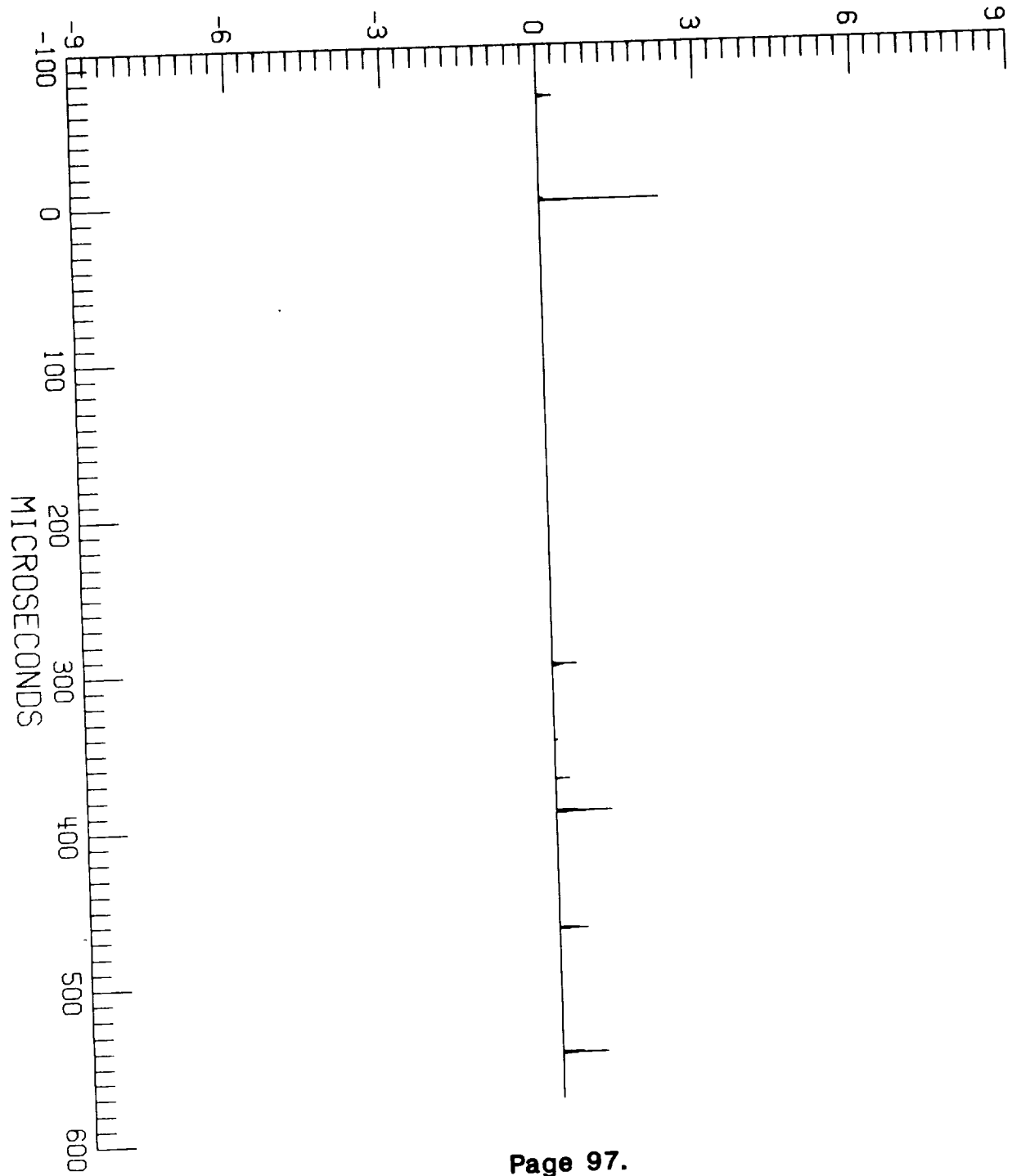

F106 LIGHTNING/85-022/ZAEPFEL  
LEC 1 RUN NO. 3  
S-003

$\dot{D}_t$  A/m<sup>2</sup>

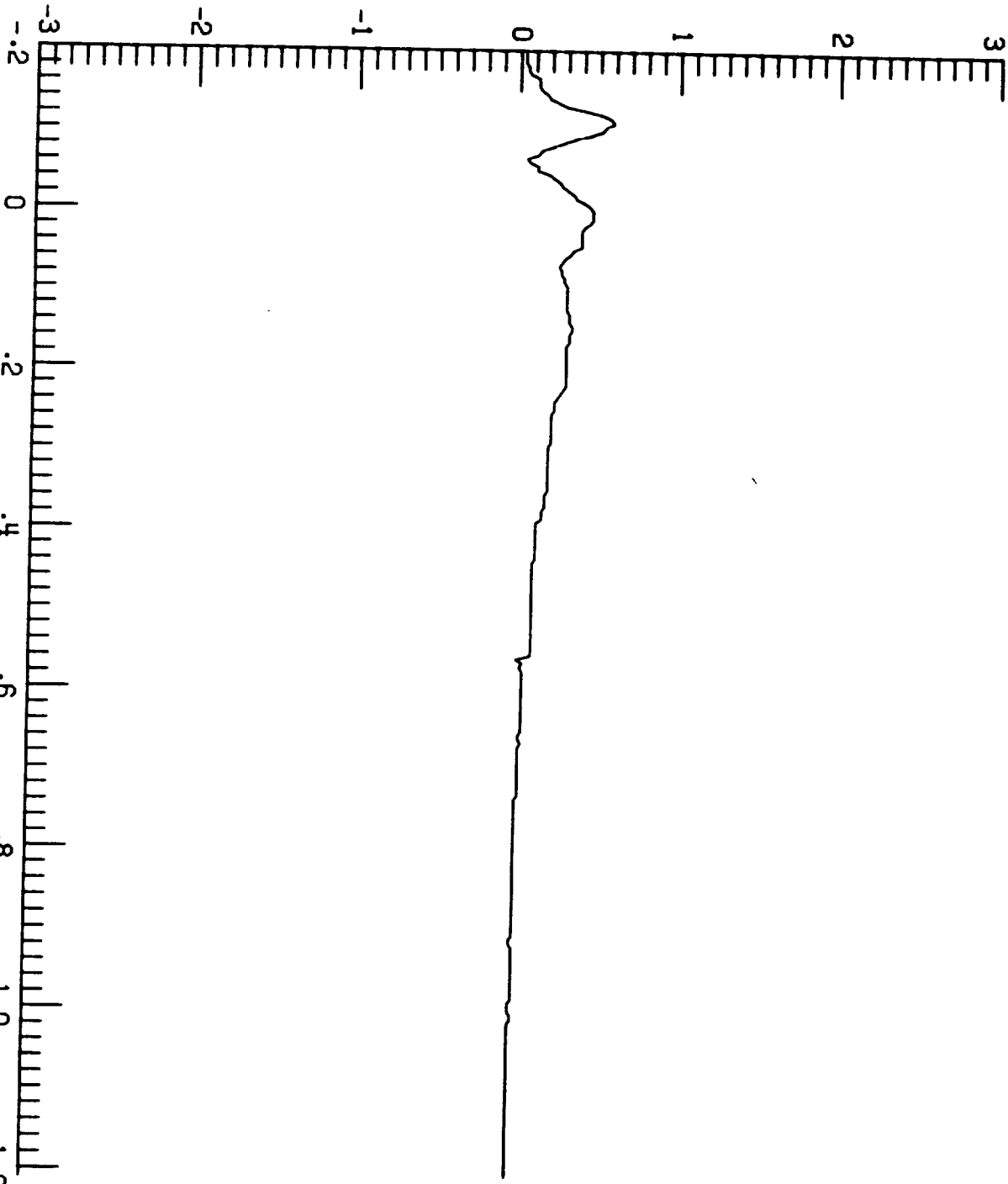

18:39:52.8  
CHANNEL NO. 1.0

F106 LIGHTNING/85-022/ZAEPFEL

LEC 1 RUN NO. 3

S-003

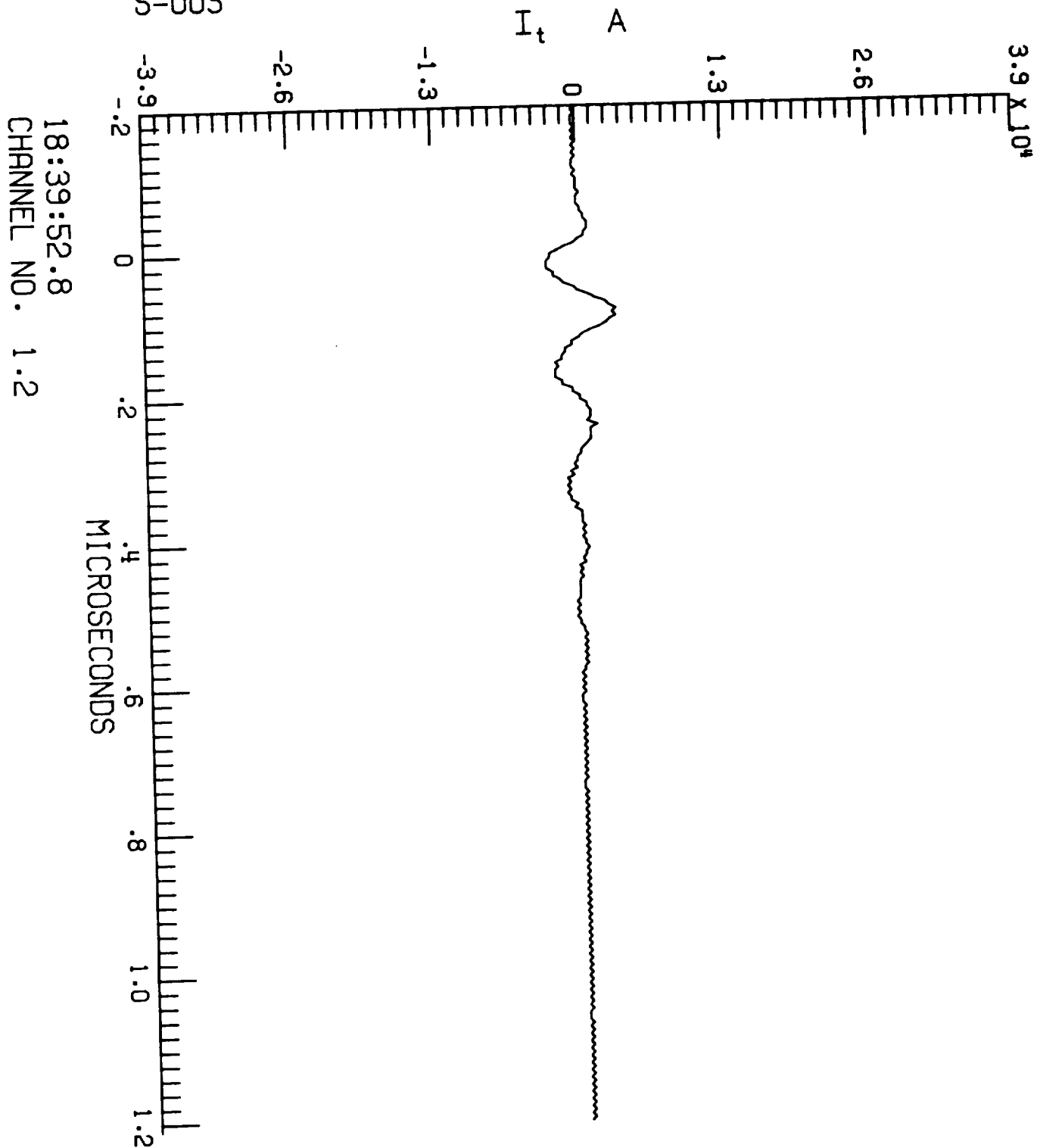

18:39:52.8  
CHANNEL NO. 1.2

F106 LIGHTNING/85-022/ZAEPFEL

LEC 2 RUN NO. 3

S-003

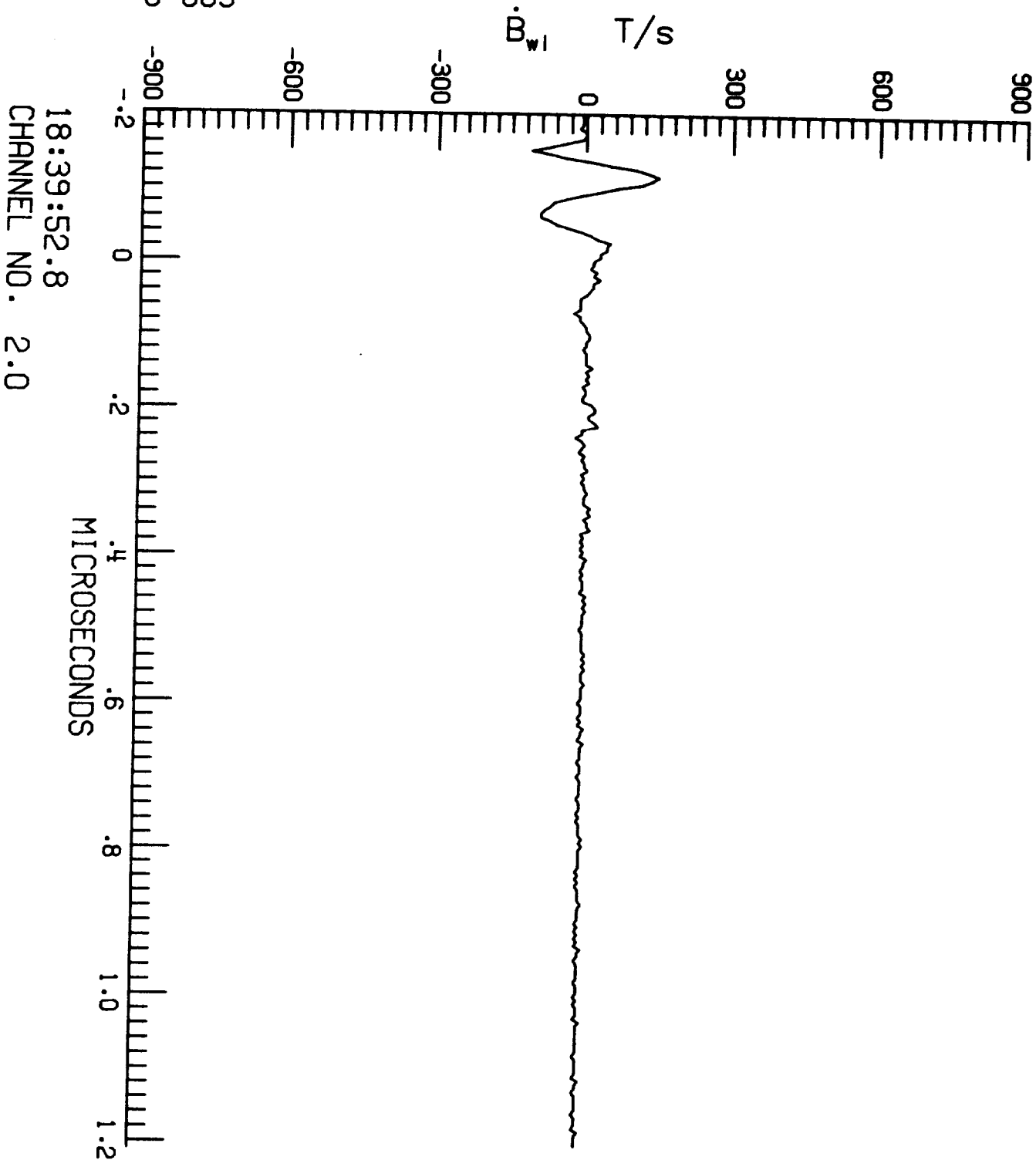

18:39:52.8  
CHANNEL NO. 2.0



F106 LIGHTNING/85-022/ZAEPFEL

LEC 2 RUN NO. 3

S-003

i A/s

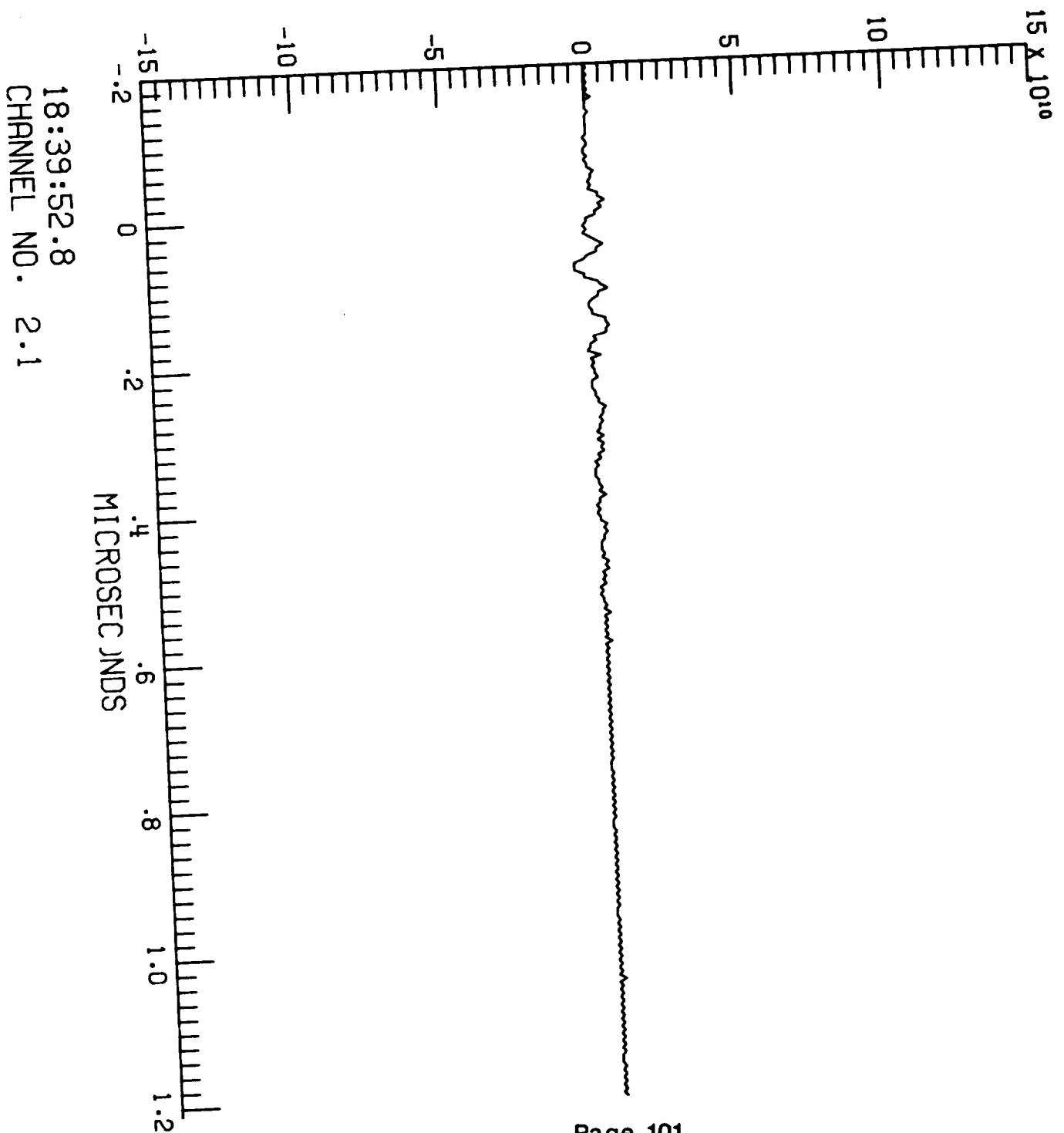

F106 LIGHTNING/85-022/ZAEPFEL  
LEC 2 RUN NO. 3  
S-003

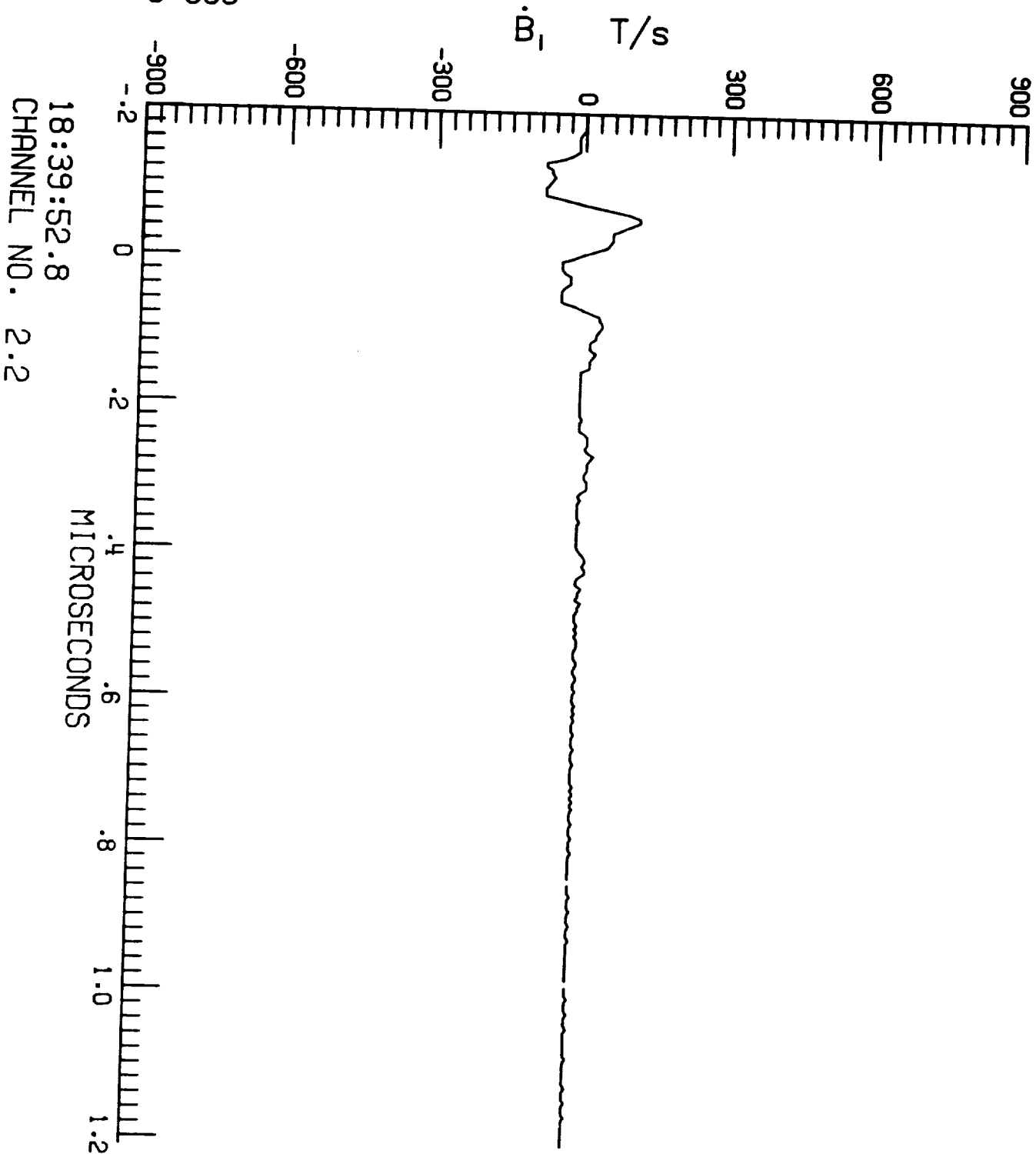

F106 LIGHTNING/85-022/ZAEPFEL

LEC 3 RUN NO. 3

S-003

$\dot{D}_{wr}$  A/m<sup>2</sup>

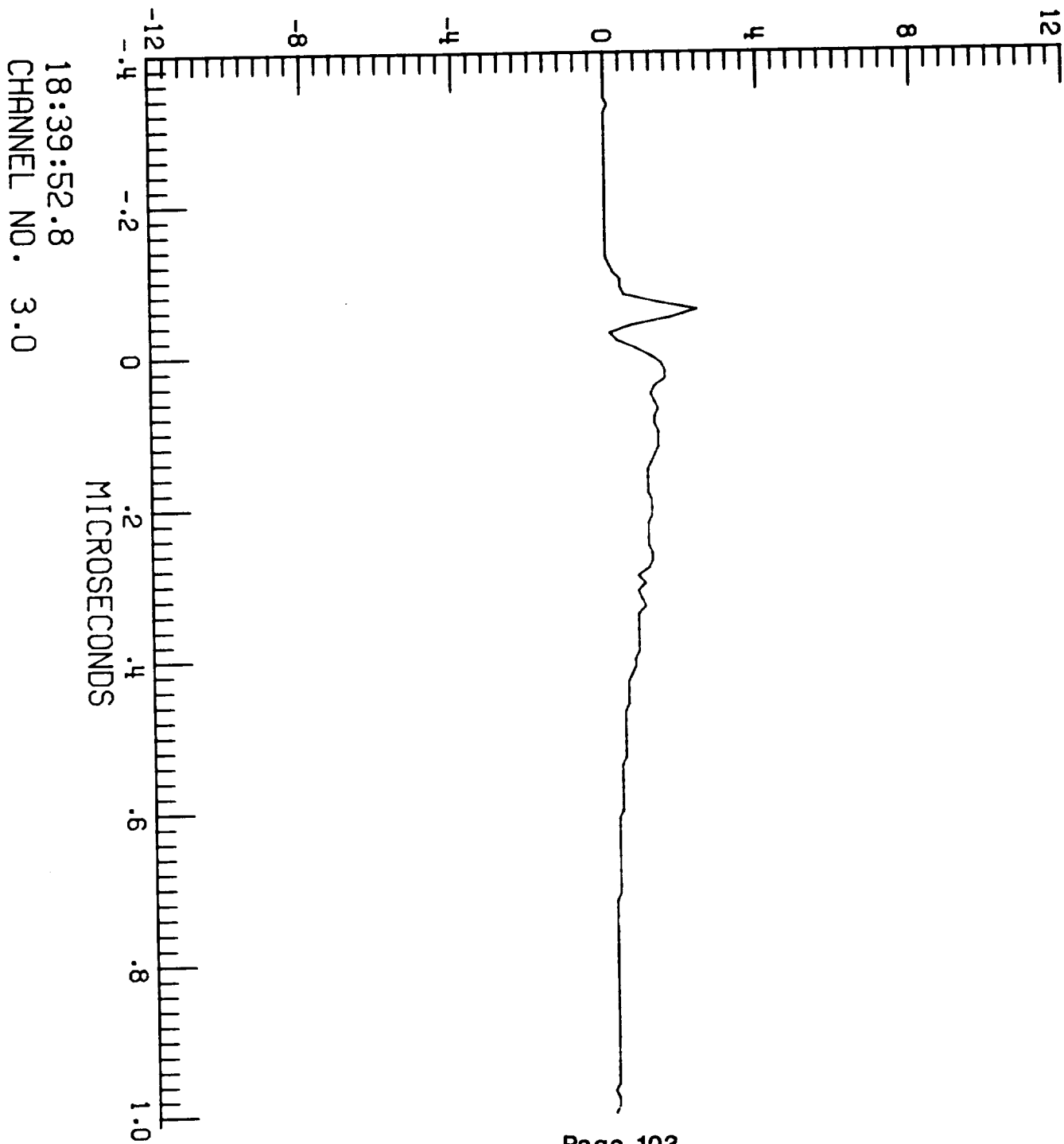

F106 LIGHTNING/85-022/ZAEPFEL

LEC 3 RUN NO. 3

S-003

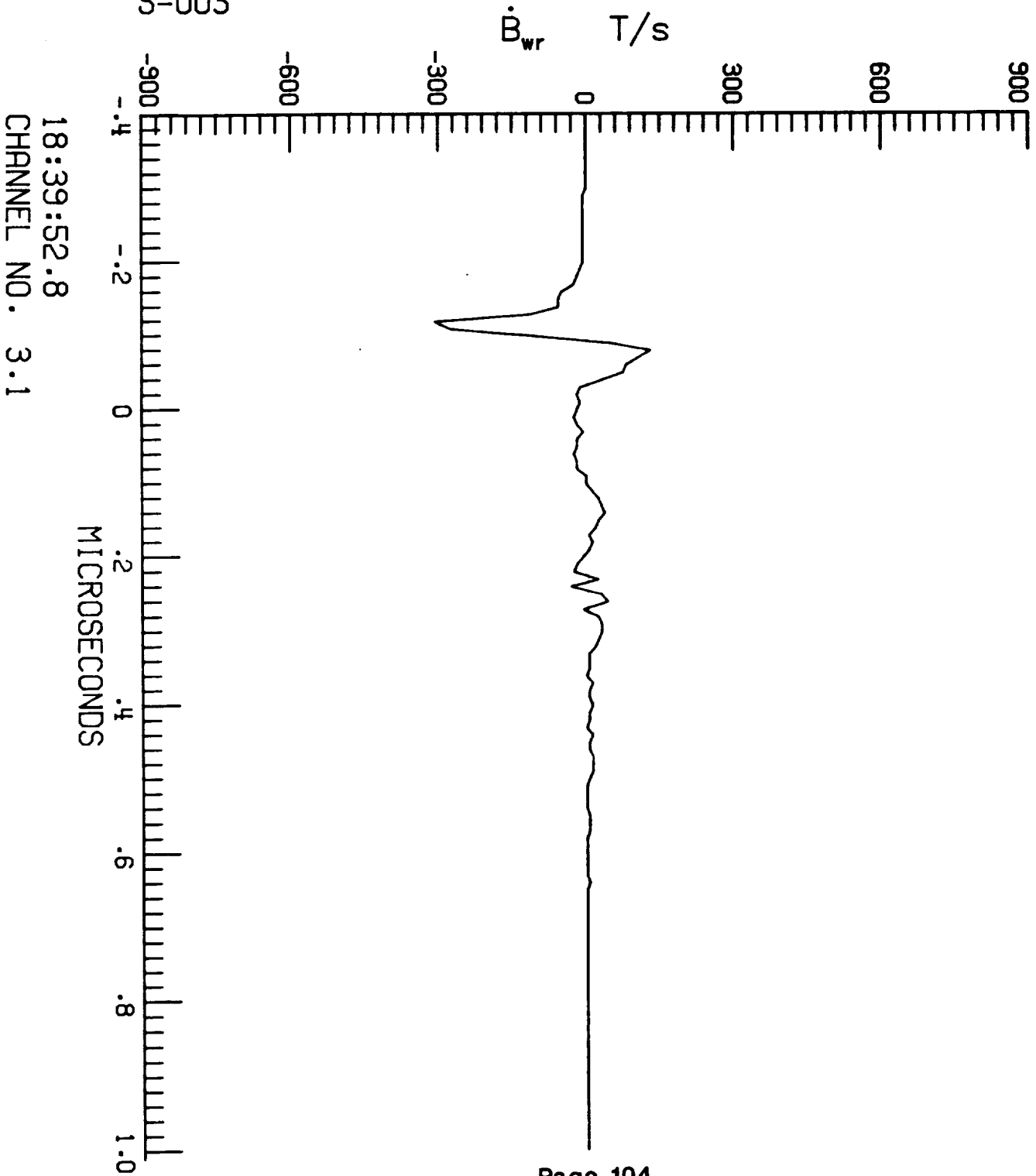

18:39:52.8  
CHANNEL NO. 3.1

F106 LIGHTNING/85-022/ZAEPFEL

LEC 3 RUN NO. 3

S-003

$\dot{D}_f$  A/m<sup>2</sup>

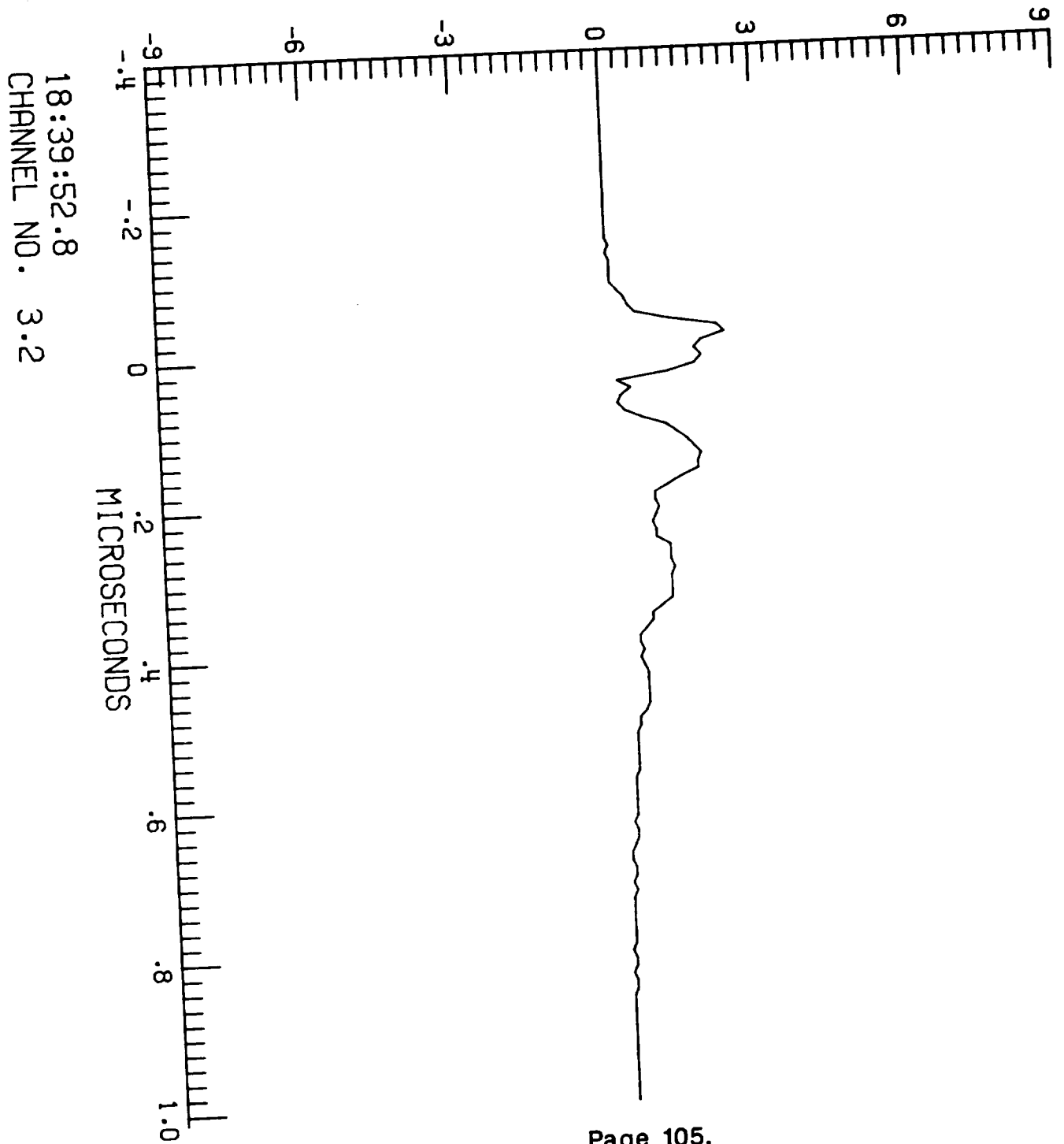

F106 LIGHTNING/85-022/ZAEPFEL

LEC 4 RUN NO. 3

S-003

TP100 V

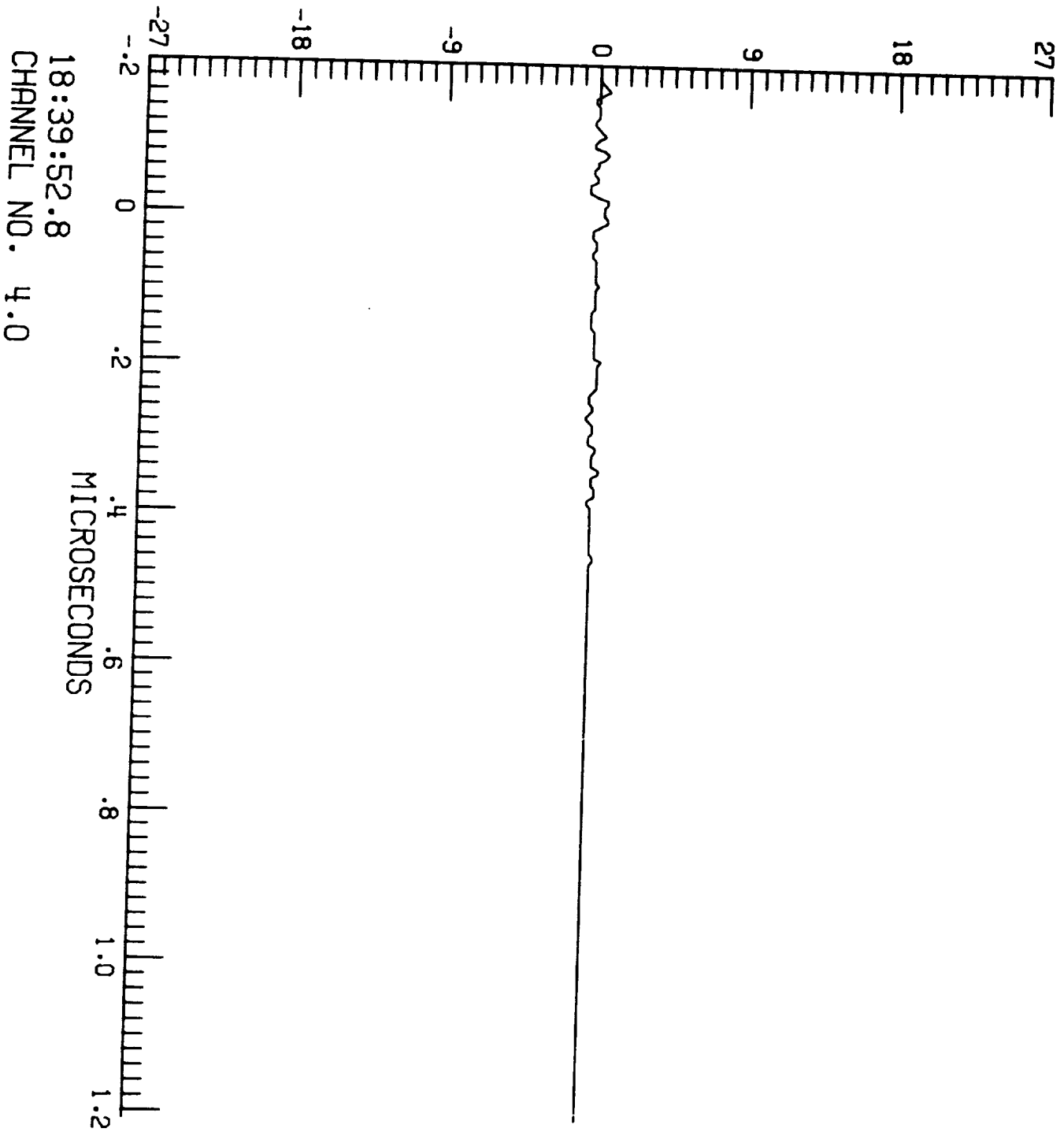

F106 LIGHTNING/85-022/ZAEPFEL

LEC 4 RUN NO. 3

S-003

TP106 A

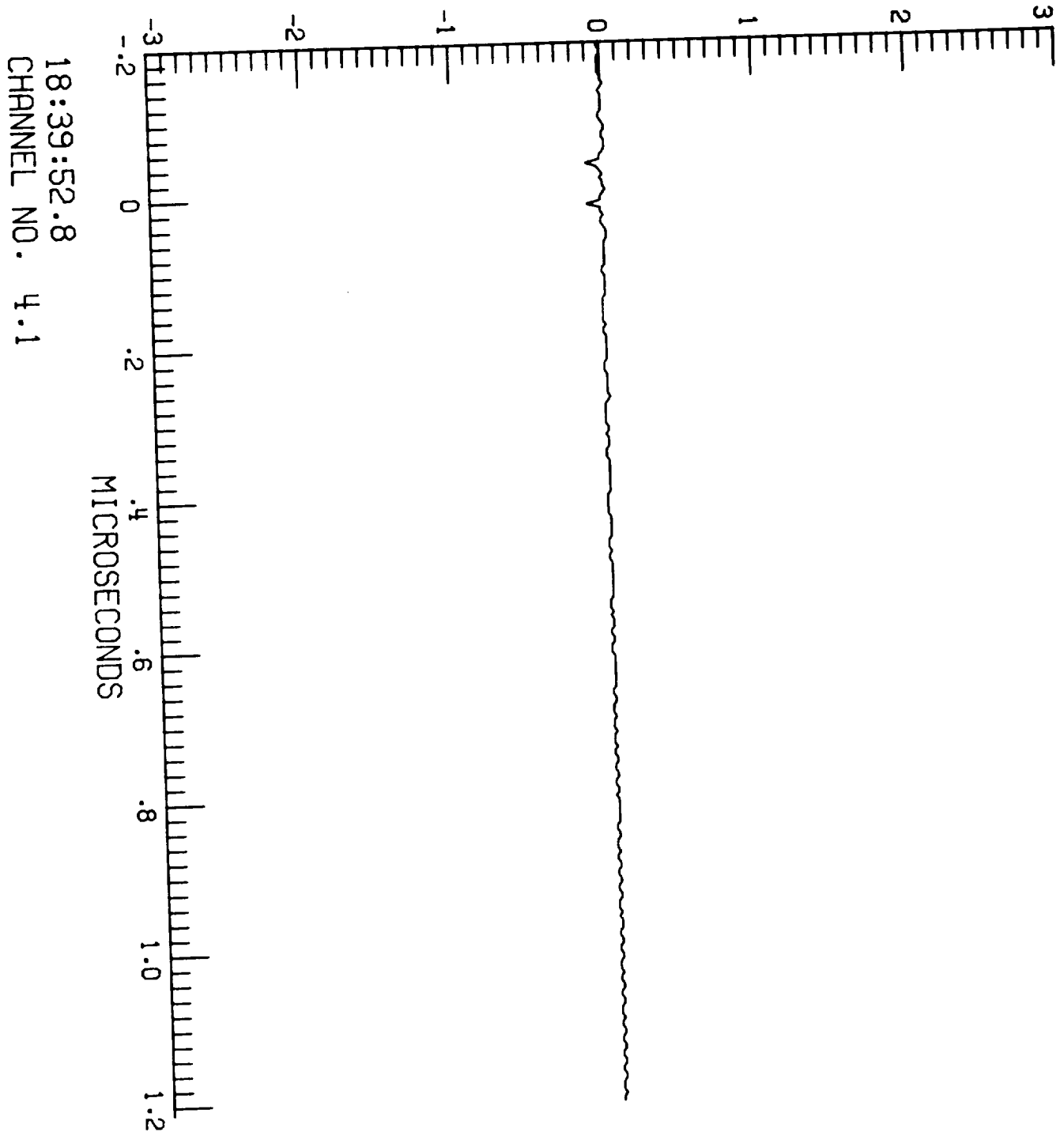

F106 LIGHTNING/85-022/ZAEPFEL

LEC 4 RUN NO. 3

S-003

TP125 A

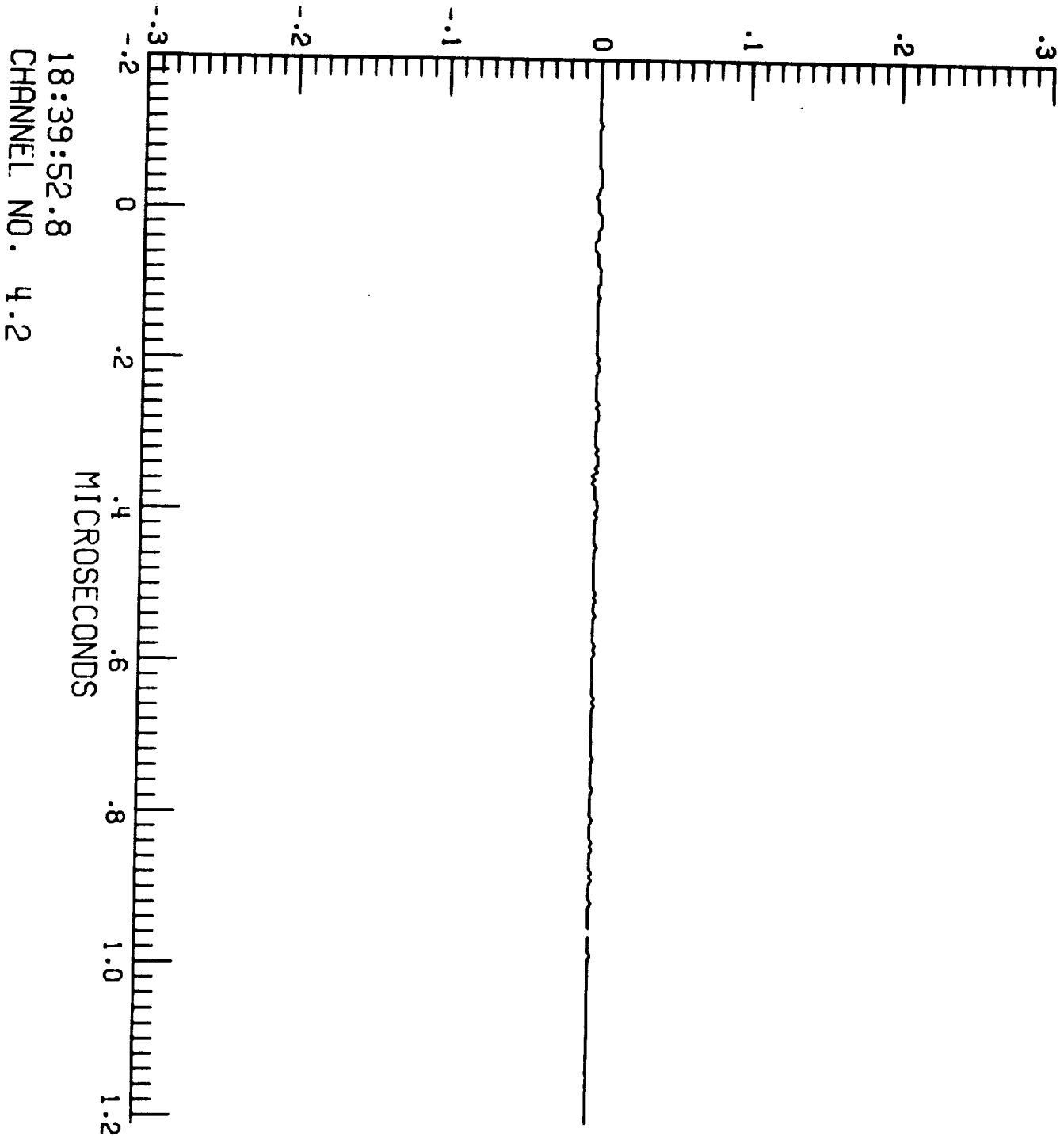



F106 LIGHTNING/85-022/ZAEPFEL

LEC 3 RUN NO. 3

S-003

$\dot{D}_{wr}$  A/m<sup>2</sup>

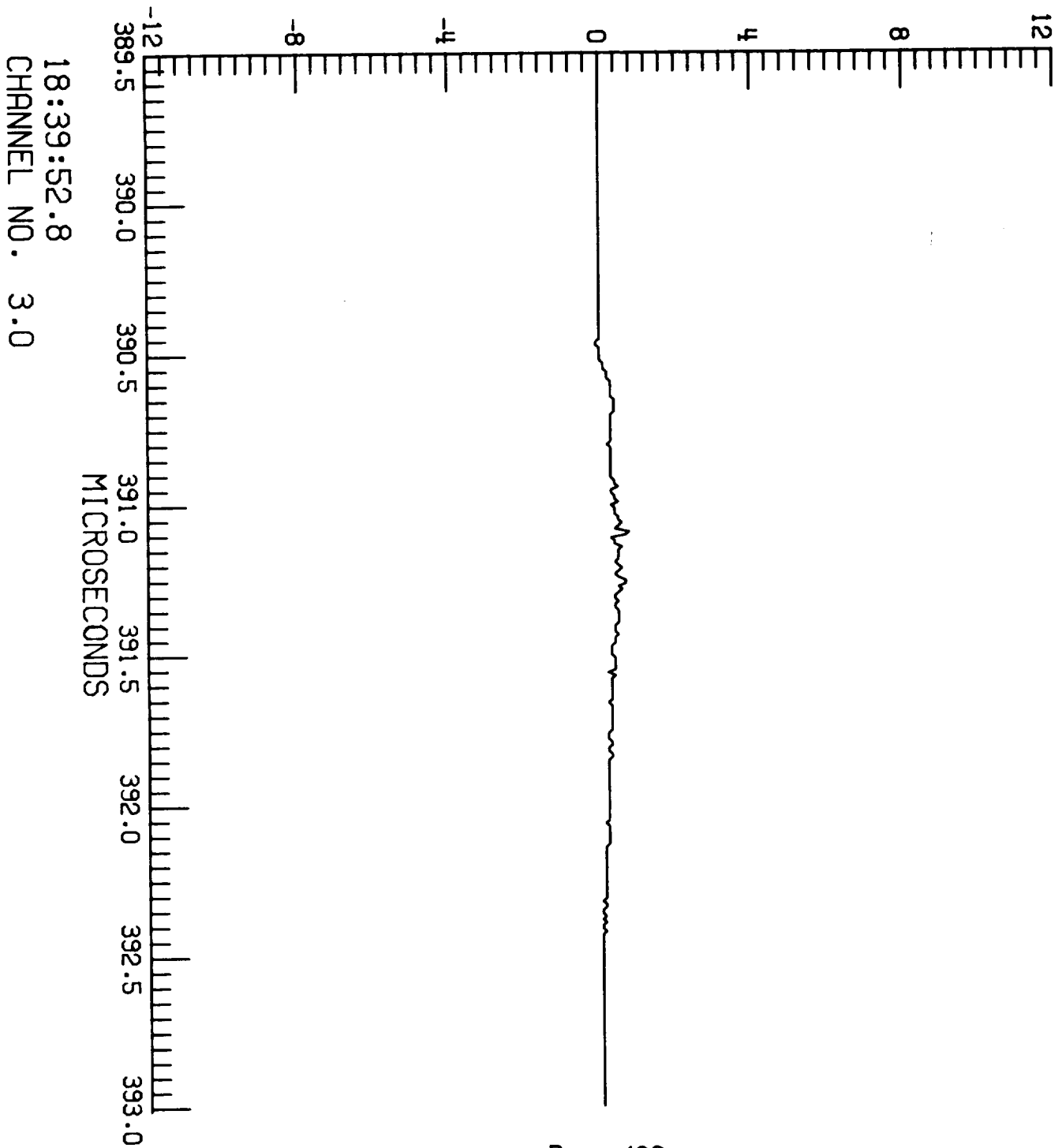

F106 LIGHTNING/85-022/ZAEPFEL

LEC 3 RUN NO. 3

S-003

$\dot{B}_{wr}$  T/s

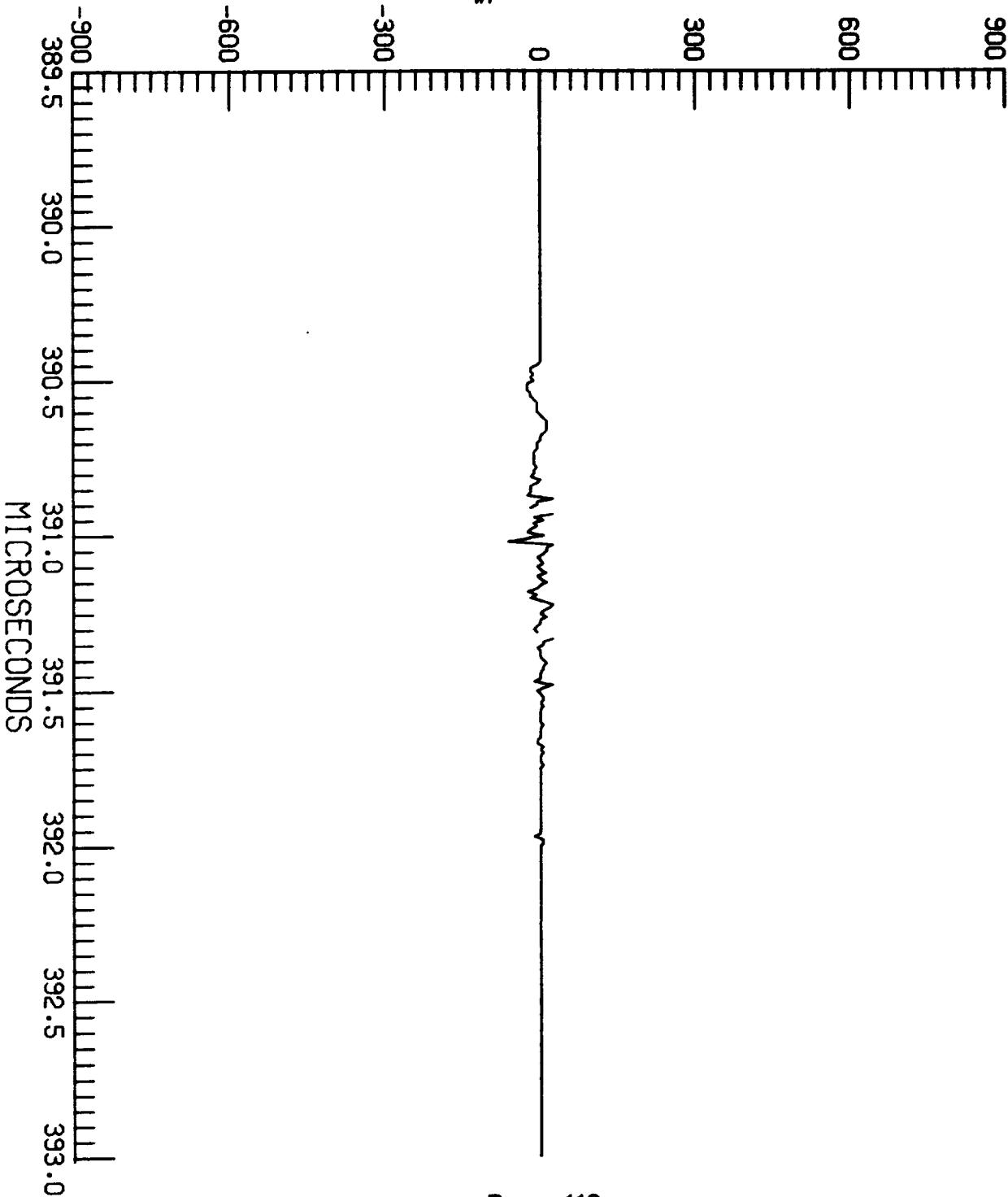

18:39:52.8  
CHANNEL NO. 3.1

F106 LIGHTNING/85-022/ZAEPFEL

LEC 3 RUN NO. 3

S-003

$\dot{D}_f$  A/m<sup>2</sup>

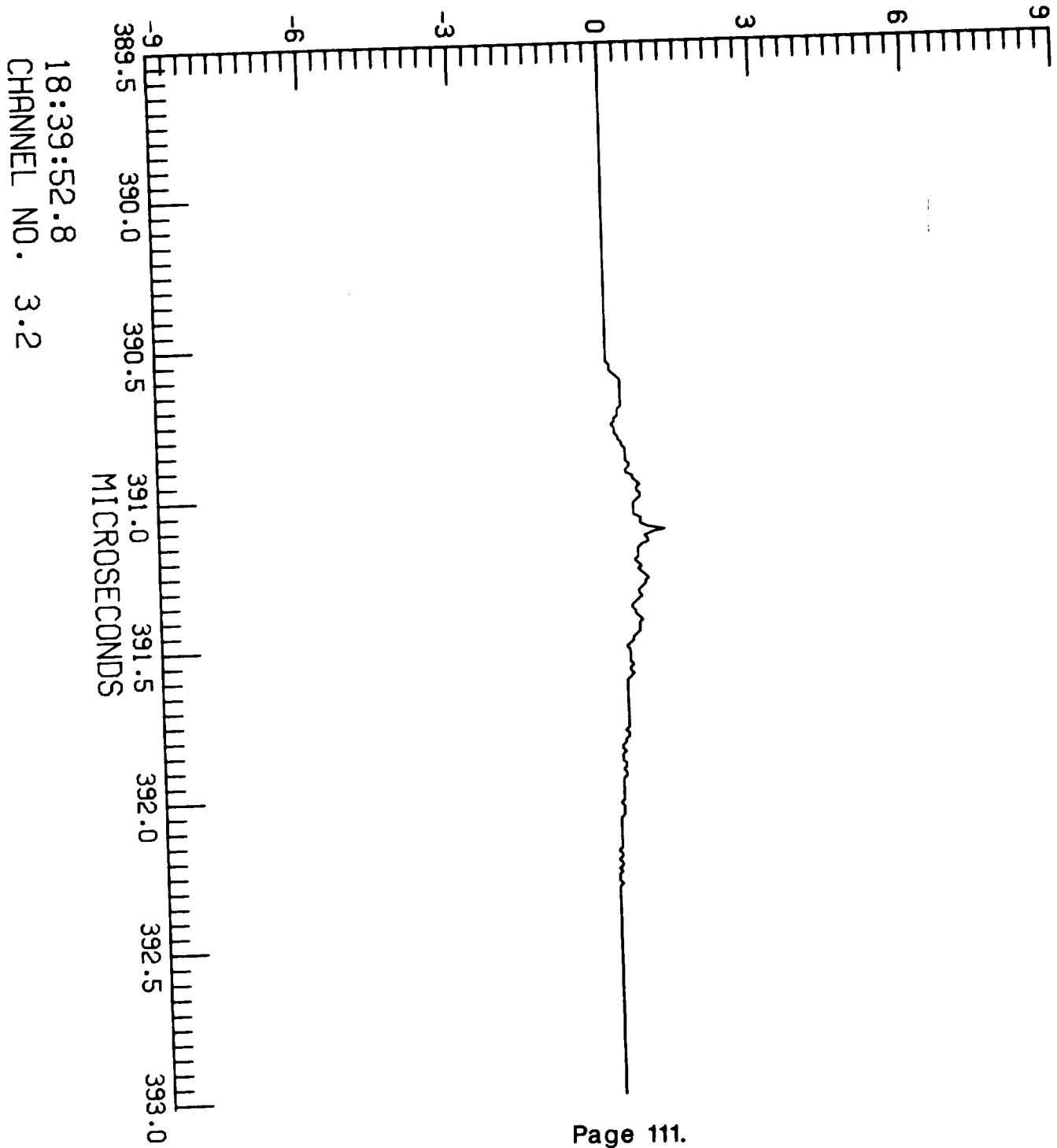

18:39:52.8  
CHANNEL NO. 3.2

F106 LIGHTNING/85-022/ZAEPFEL

LEC 1 RUN NO. 4

S-004

$\dot{D}_t$  A/m<sup>2</sup>

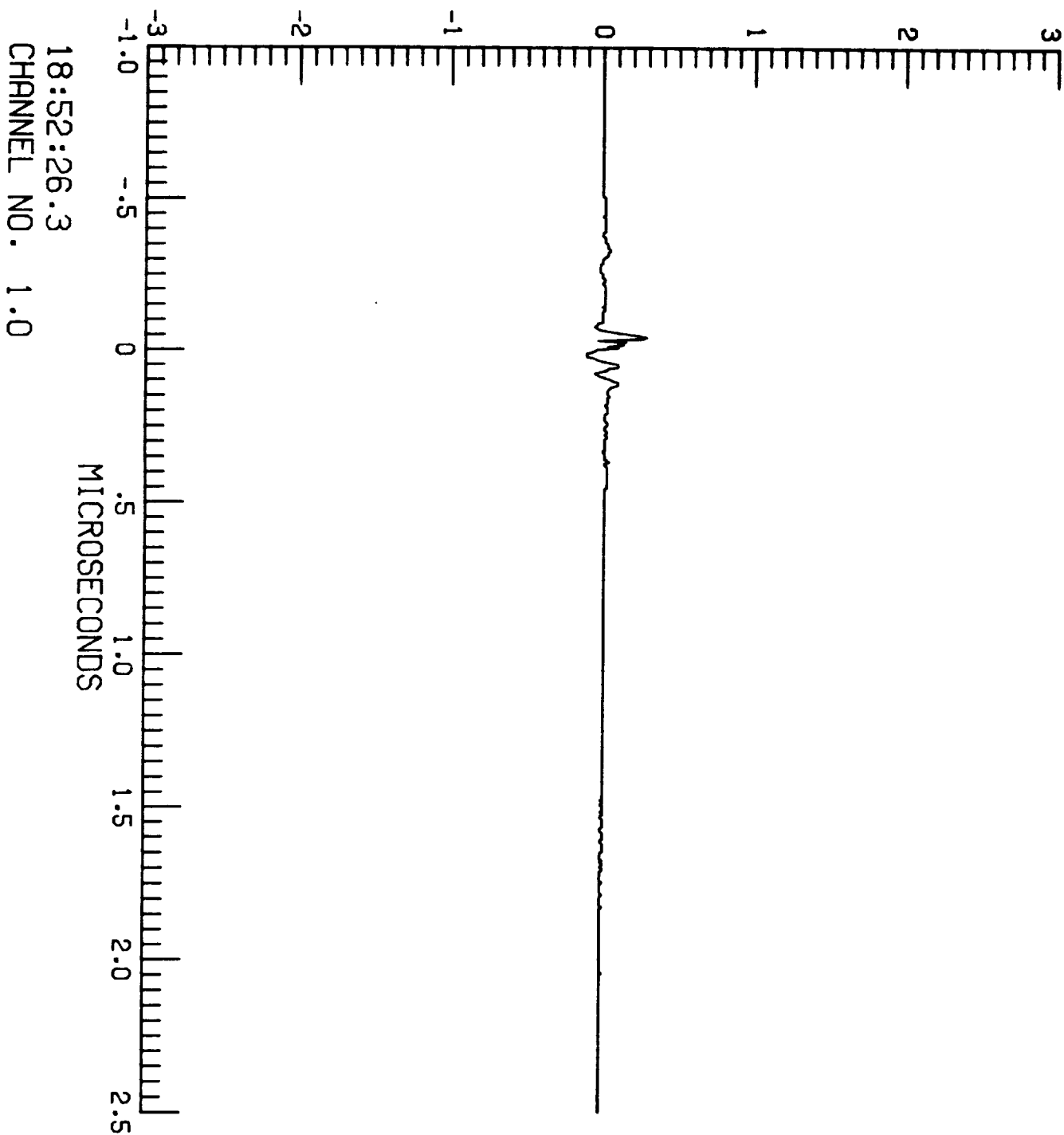

F106 LIGHTNING/85-022/ZAEPFEL  
LEC 1 RUN NO. 4  
S-004

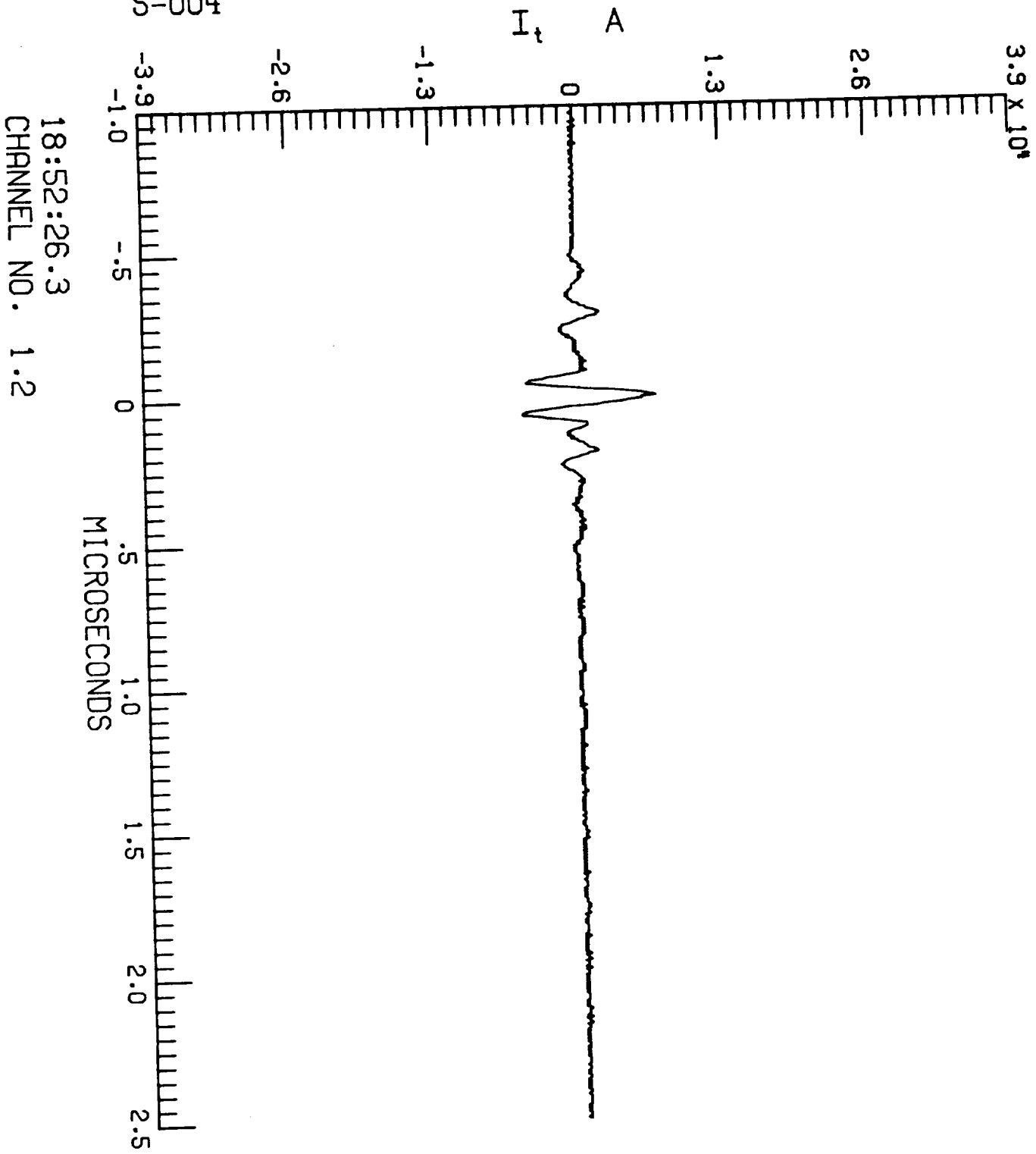

18:52:26.3  
CHANNEL NO. 1.2

F106 LIGHTNING/85-022/ZAEPFEL

LEC 2 RUN NO. 4

S-004

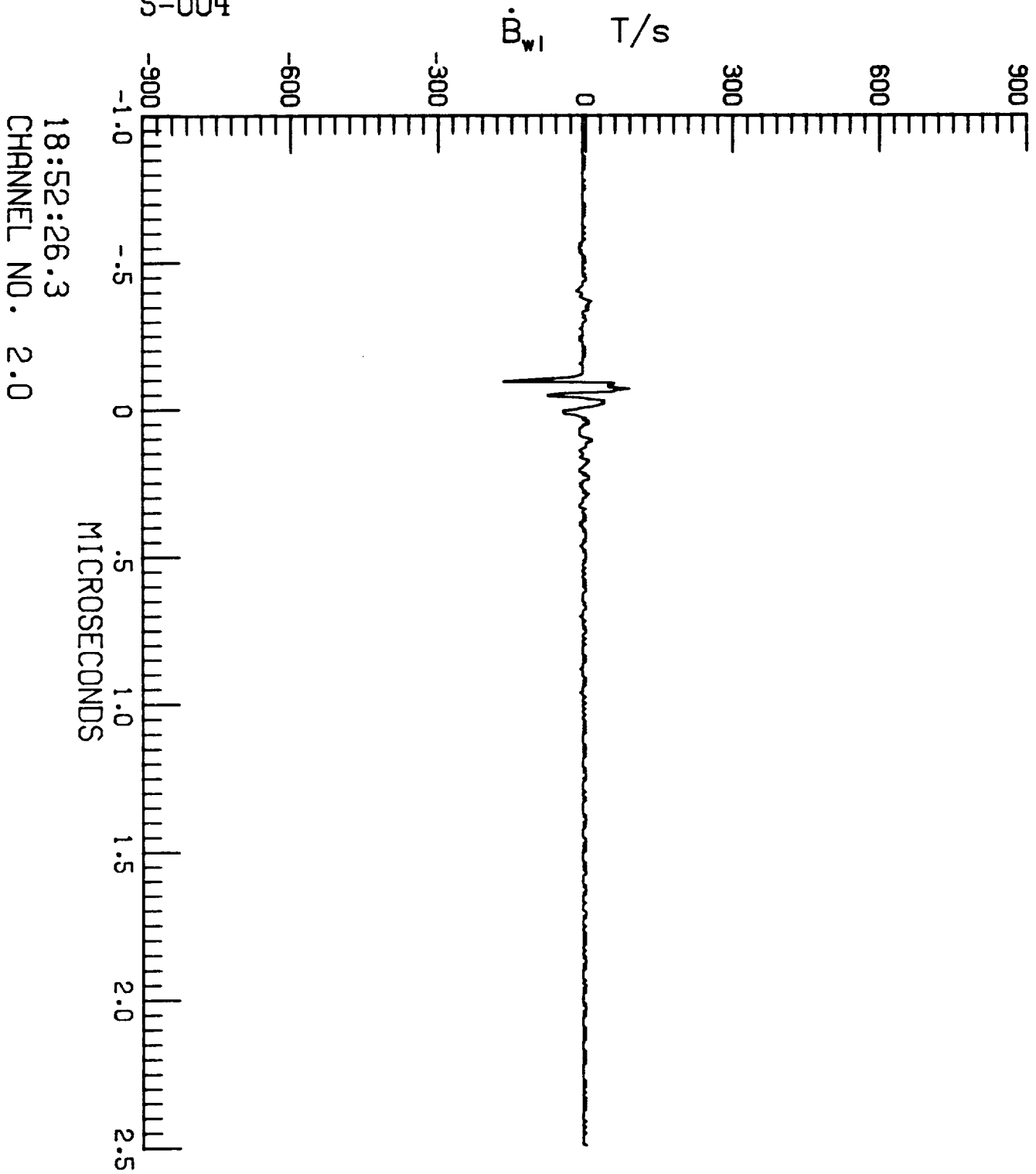

18:52:26.3  
CHANNEL NO. 2.0

F106 LIGHTNING/85-022/ZAEPFEL

LEC 2 RUN NO. 4

S-004

$\dot{i}$  A/s

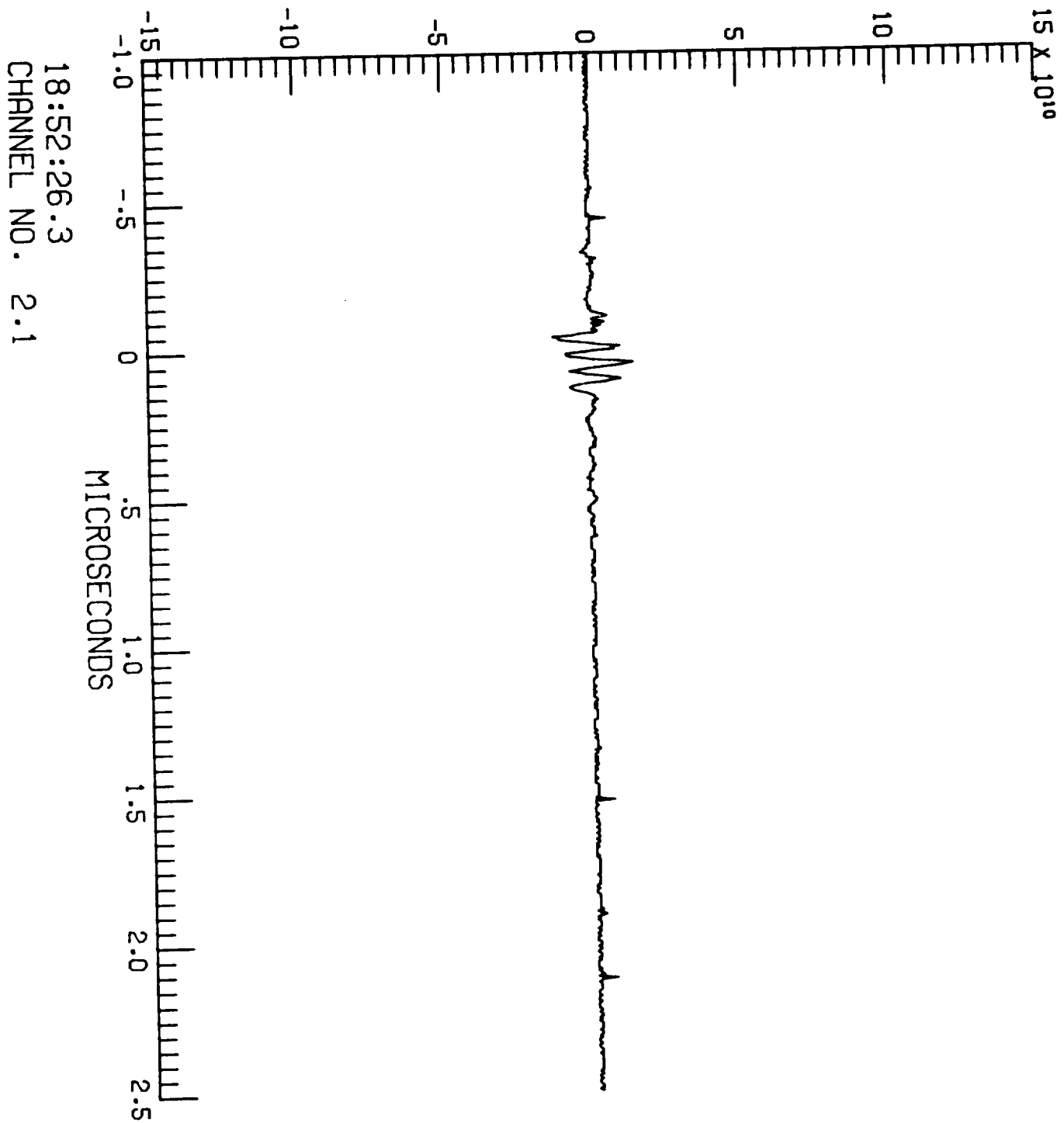

18:52:26.3  
CHANNEL NO. 2.1

F106 LIGHTNING/85-022/ZAEPFEL

LEC 2 RUN NO. 4

S-004

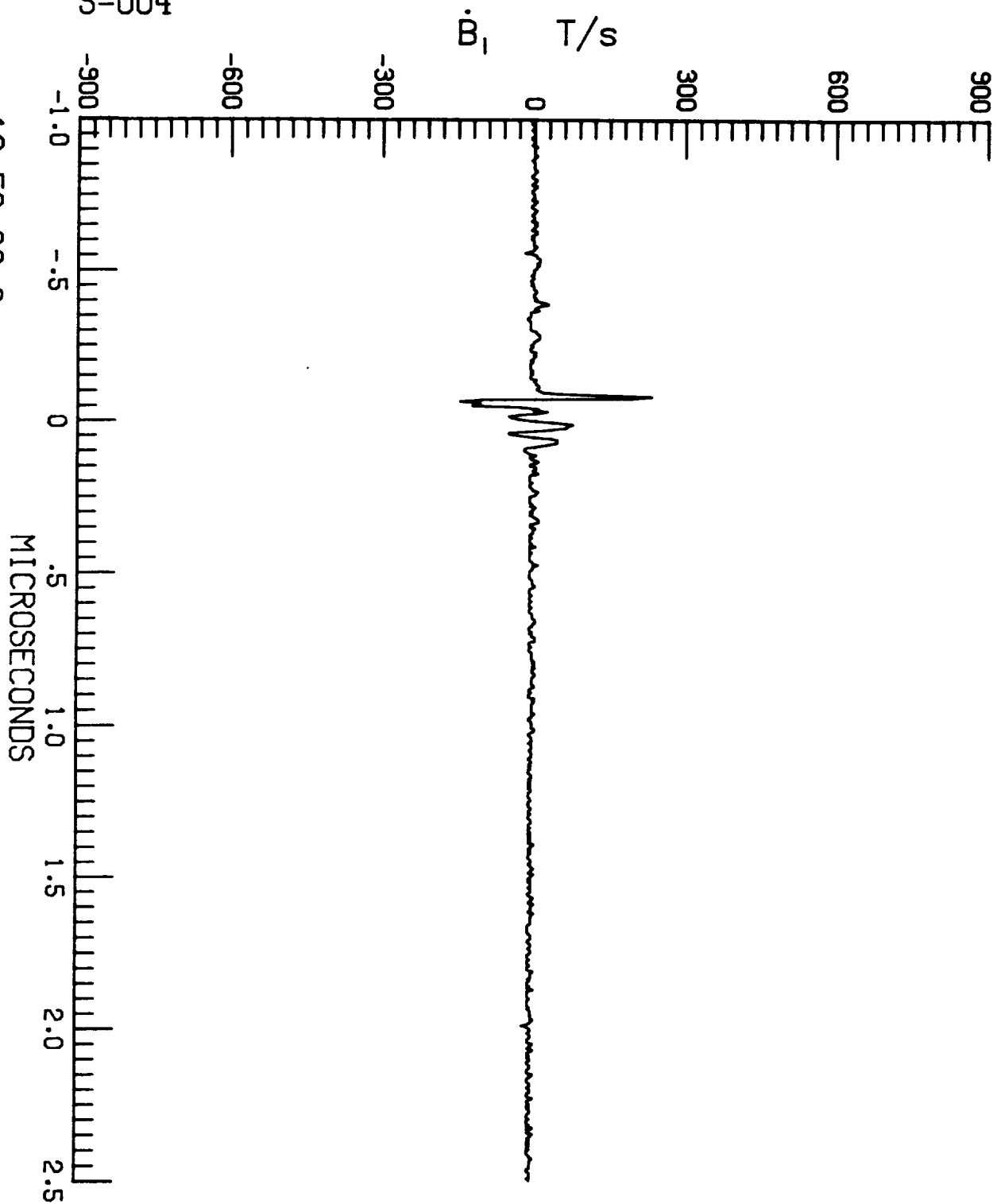

18:52:26.3  
CHANNEL NO. 2.2



F106 LIGHTNING/85-022/ZAEPFEL

LEC 3 RUN NO. 4

S-004

$\dot{D}_{wr}$  A/m<sup>2</sup>

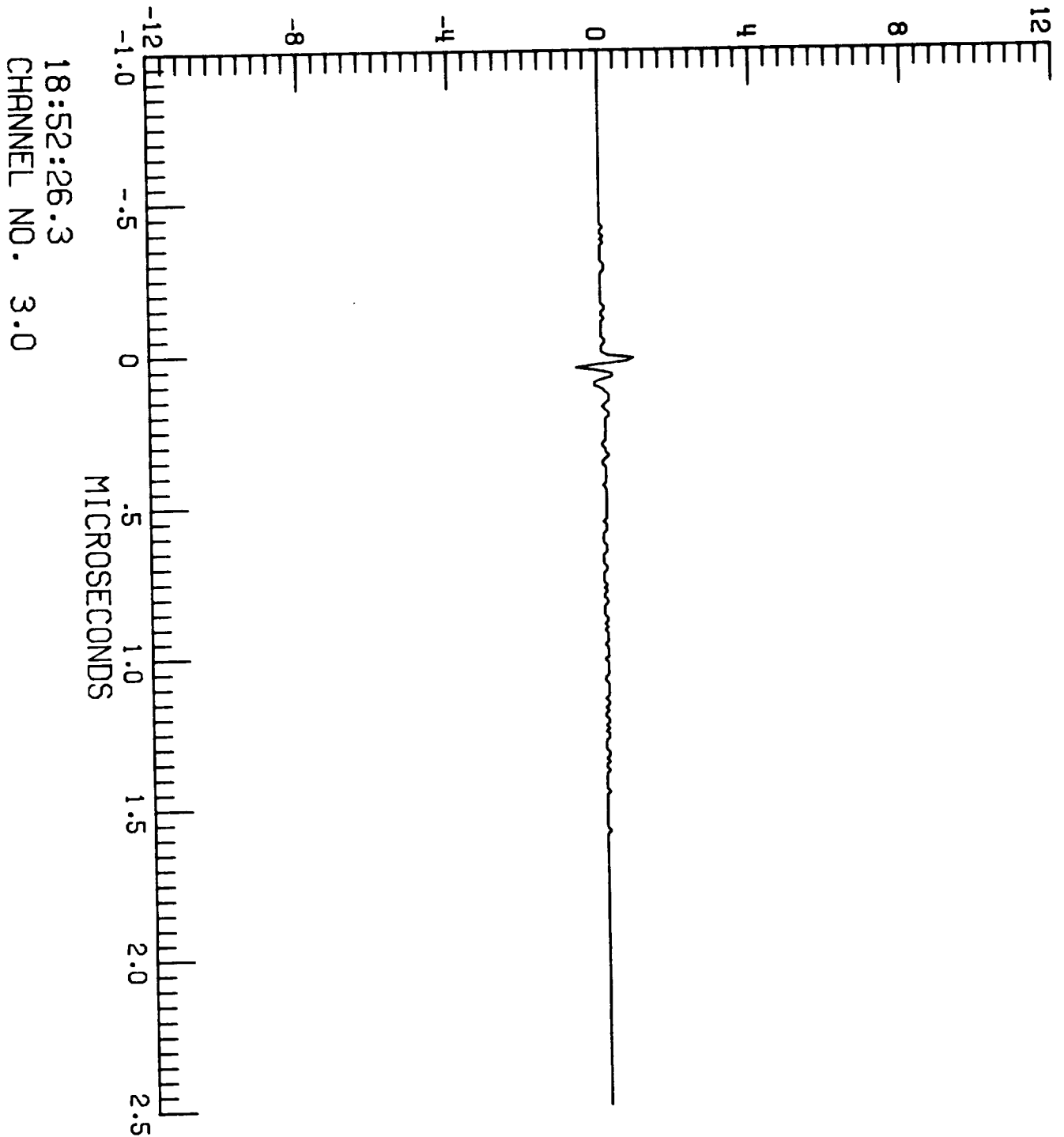

F106 LIGHTNING/85-022/ZAEPFEL

LEC 3 RUN NO. 4

S-004

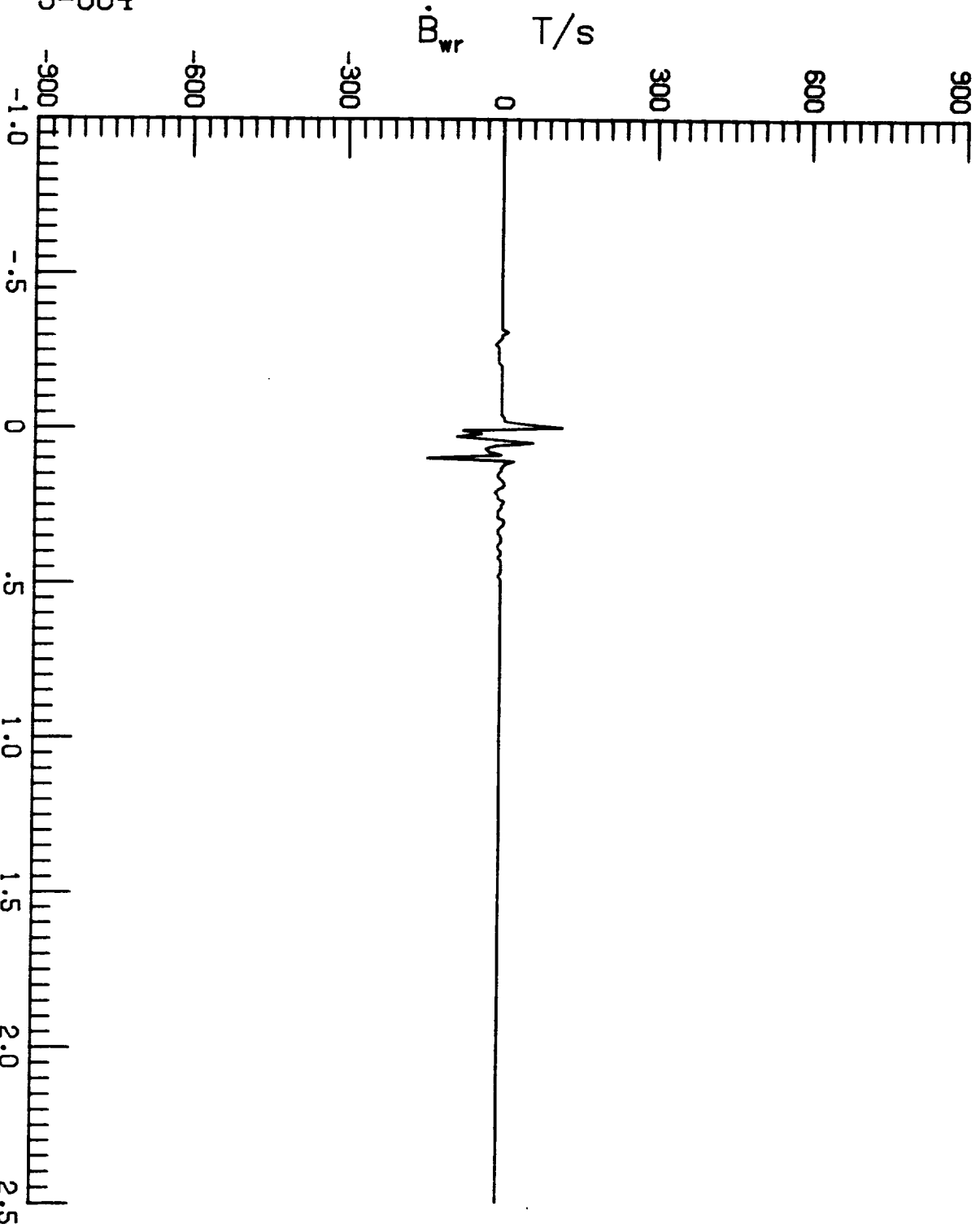

18:52:26.3  
CHANNEL NO. 3.1

F106 LIGHTNING/85-022/ZAEPFEL

LEC 3 RUN NO. 4

S-004

$\dot{D}_f$  A/m<sup>2</sup>

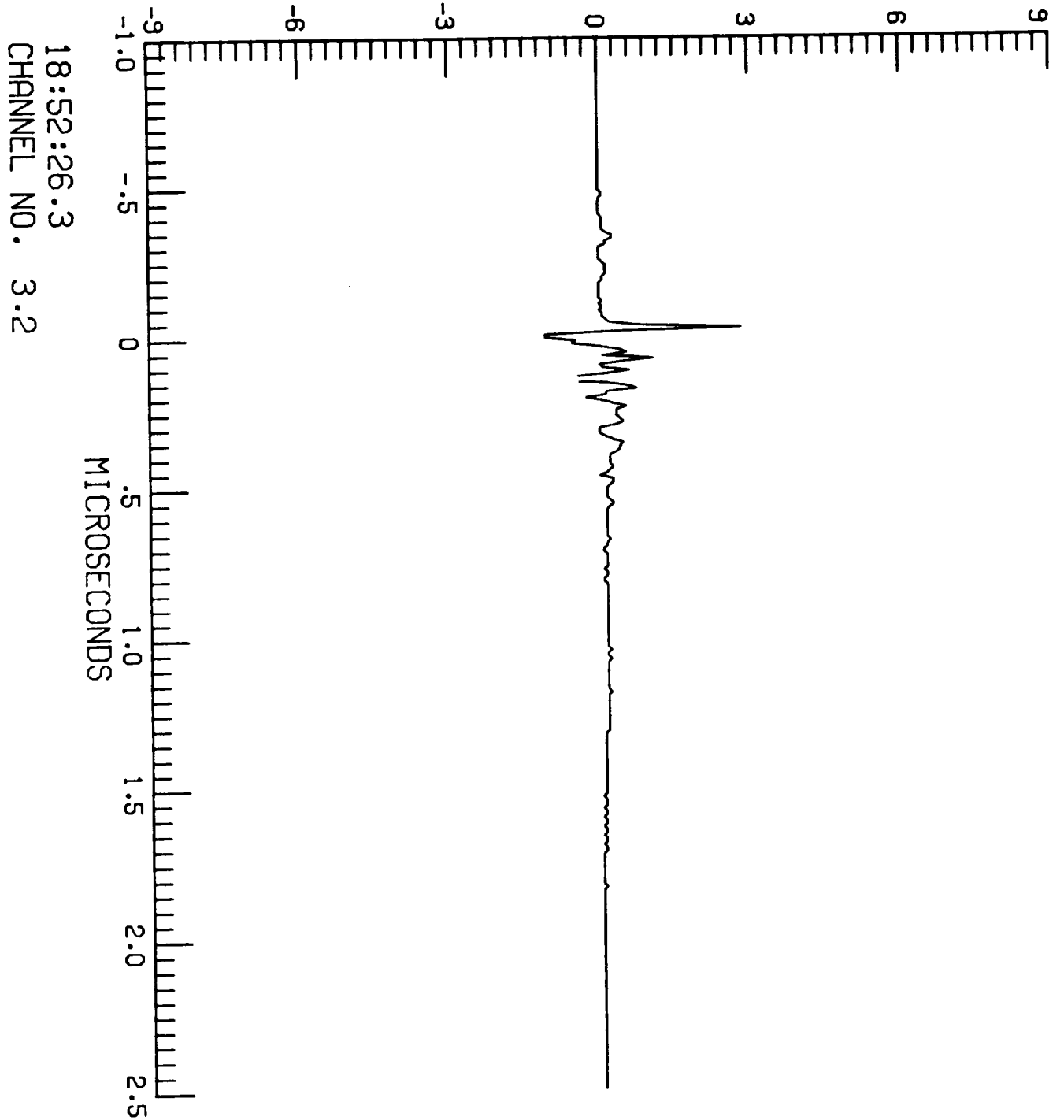

F106 LIGHTNING/85-022/ZAEPFEL

LEC 4 RUN NO. 4

S-004

TP100 V

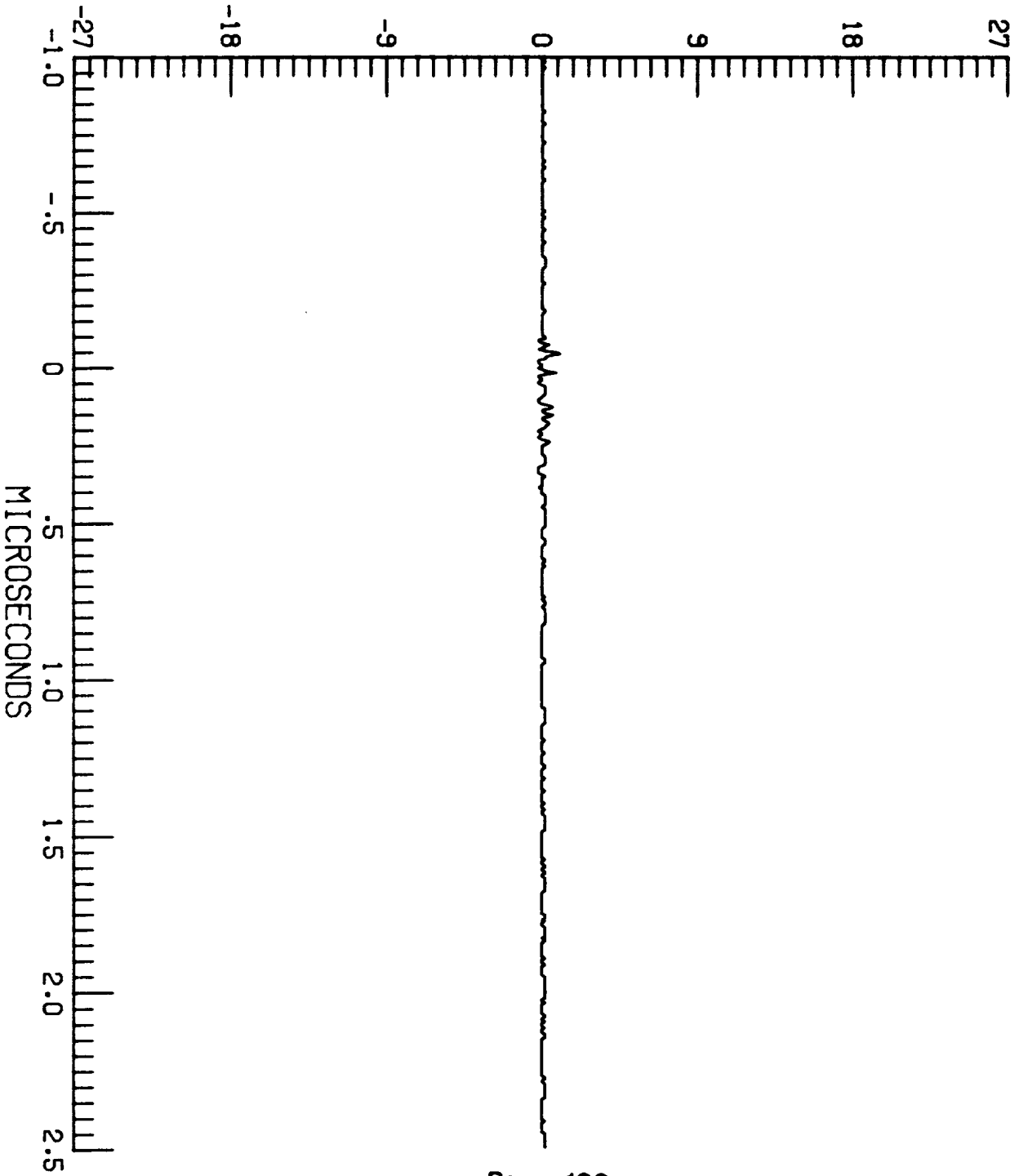

18:52:26.3  
CHANNEL NO. 4.0

F106 LIGHTNING/85-022/ZAEPFEL

LEC 4 RUN NO. 4

S-004

TP106 A

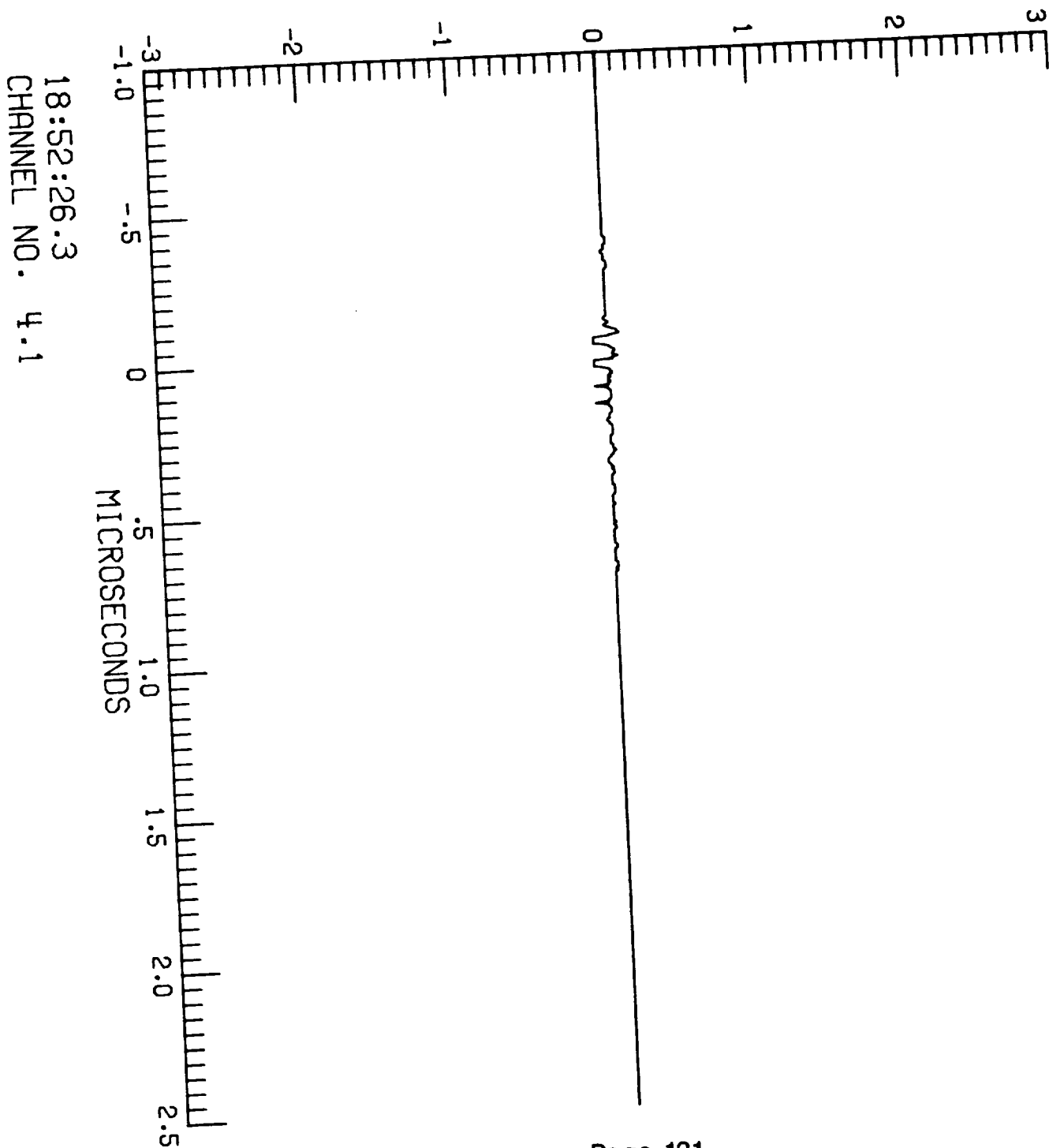

F106 LIGHTNING/85-022/ZAEPFEL

LEC 4 RUN NO. 4

S-004

TP125 A

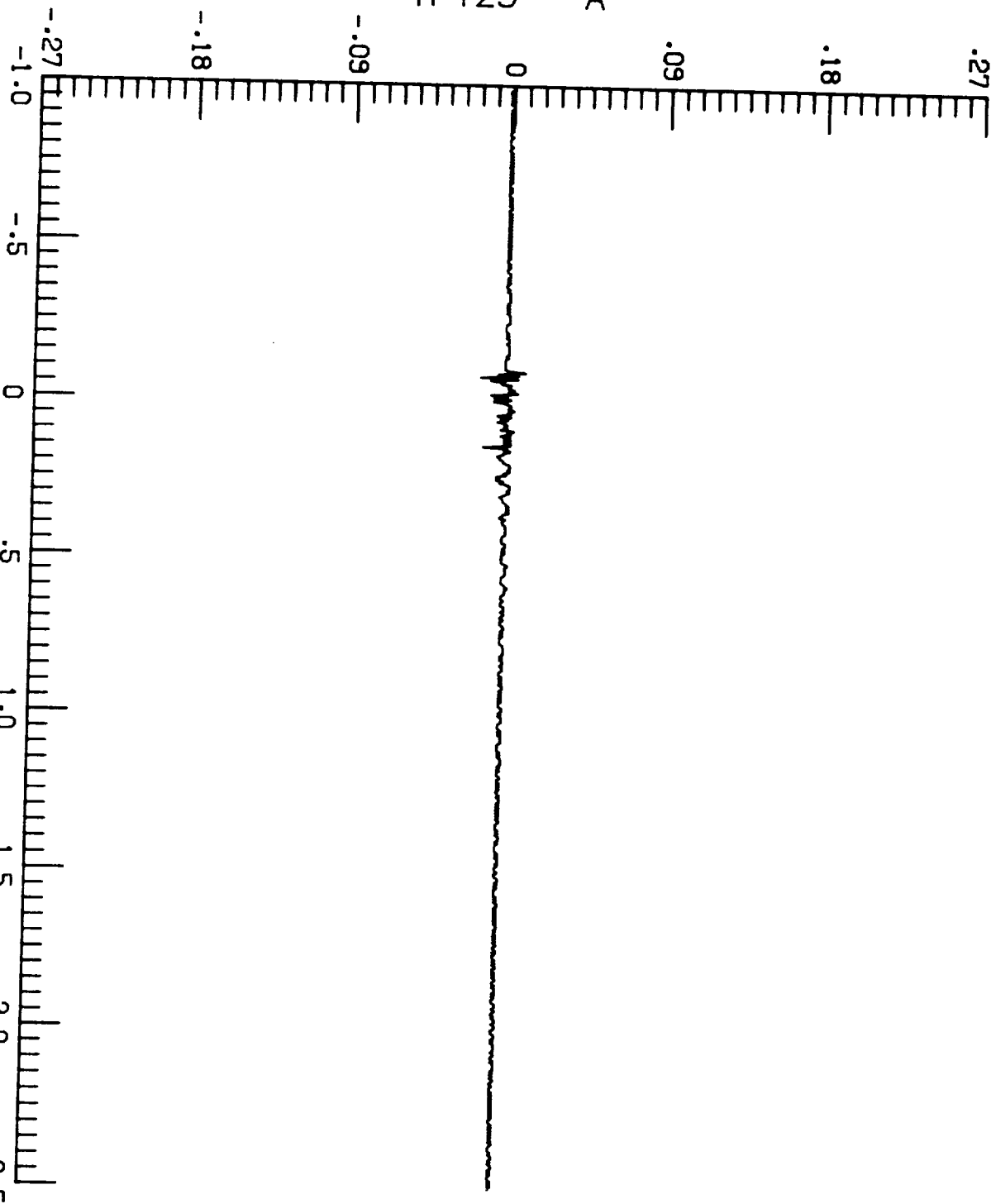

18:52:26.3  
CHANNEL NO. 4.2

F106 LIGHTNING/85-022/ZAEPFEL

LEC 4 RUN NO. 4

S-004

TP125 A

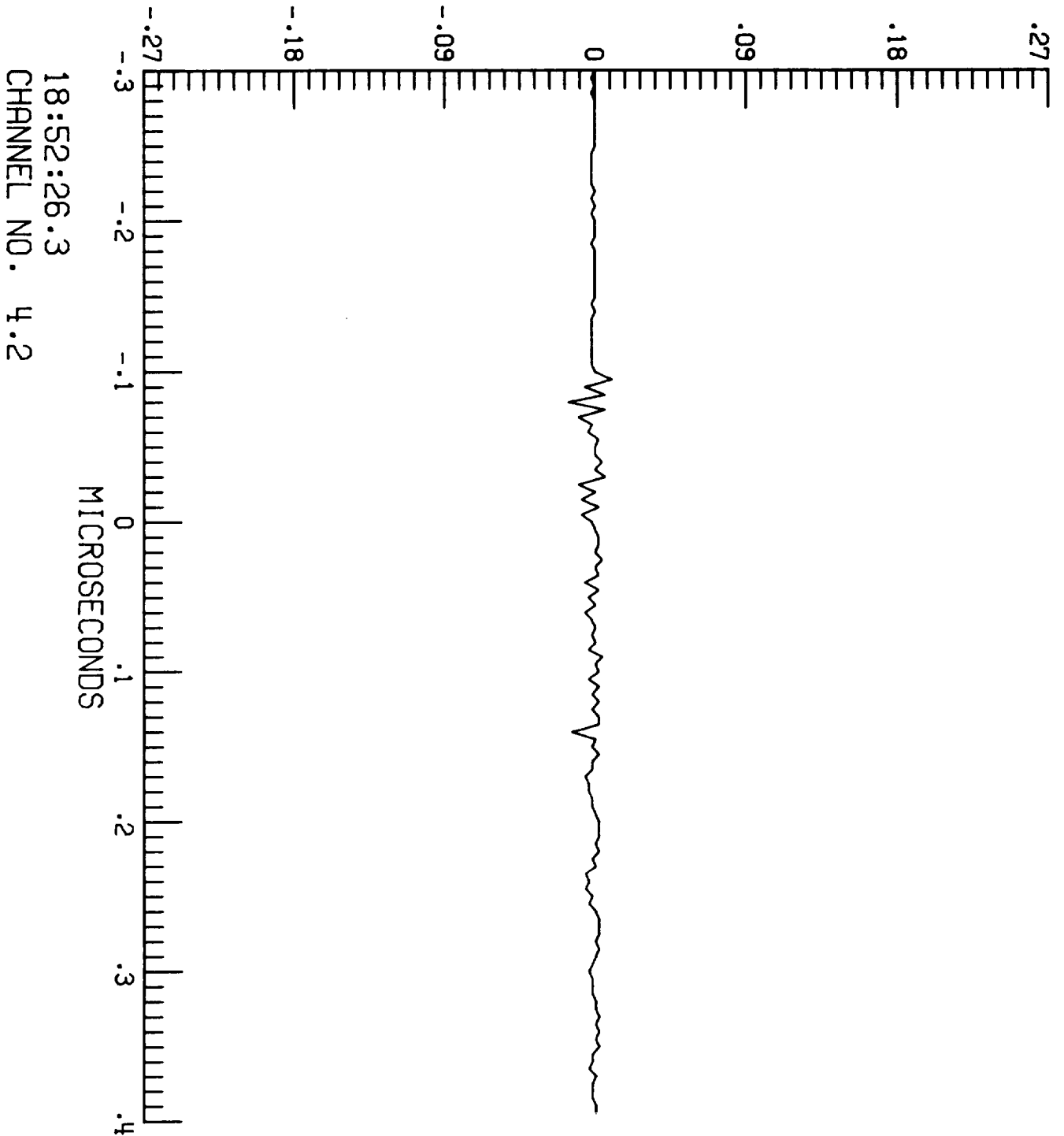

F106 LIGHTNING/85-023/ZAEPFEL

LEC 1 RUN NO. 3

S-001

$\dot{D}_t$  A/m<sup>2</sup>

21:42:02.5  
CHANNEL NO. 1.0

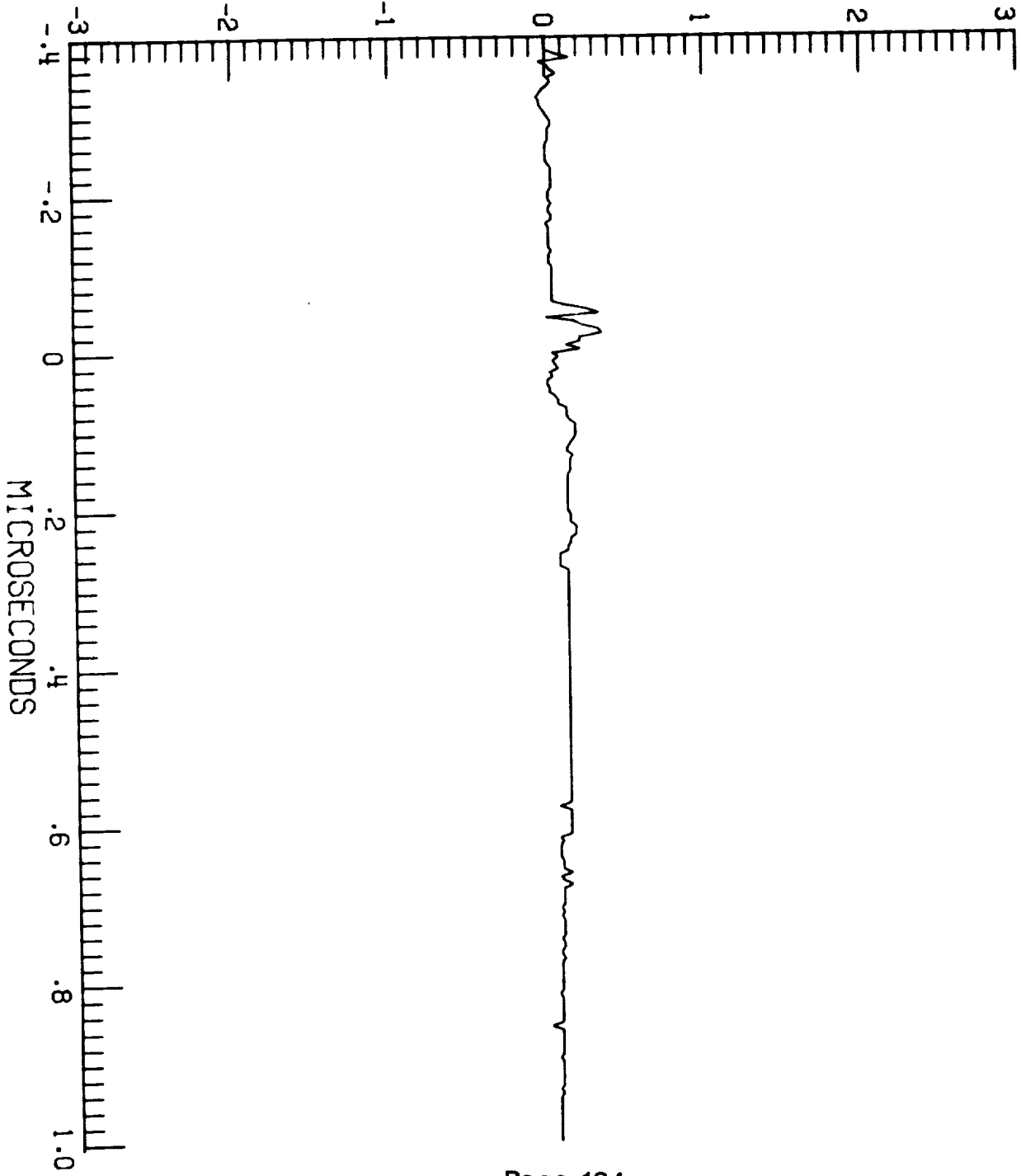



F106 LIGHTNING/85-023/ZAEPFEL  
LEC 1 RUN NO. 3  
S-001

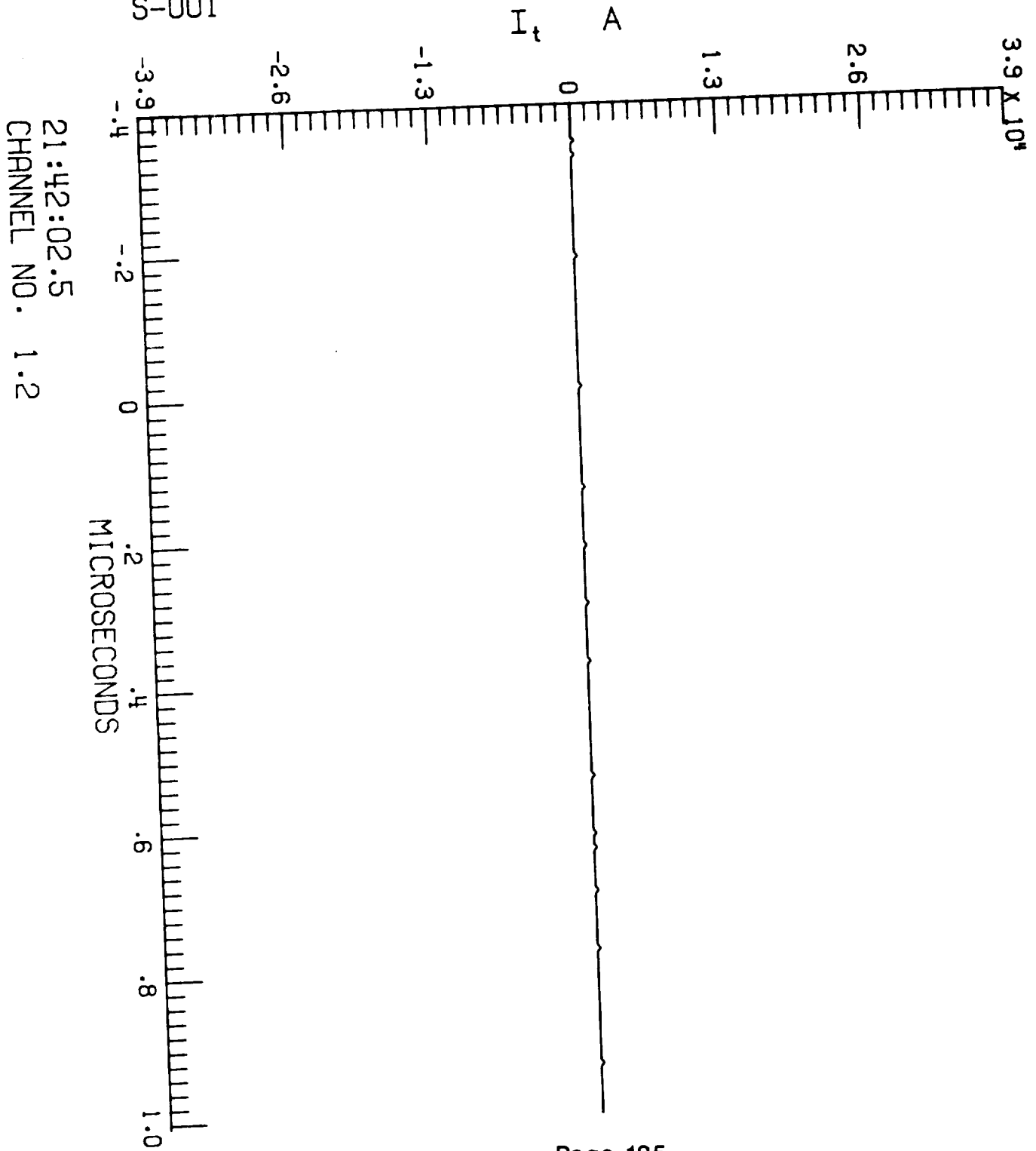

21:42:02.5  
CHANNEL NO. 1.2

F106 LIGHTNING/85-023/ZAEPFEL

LEC 2 RUN NO. 3

S-001

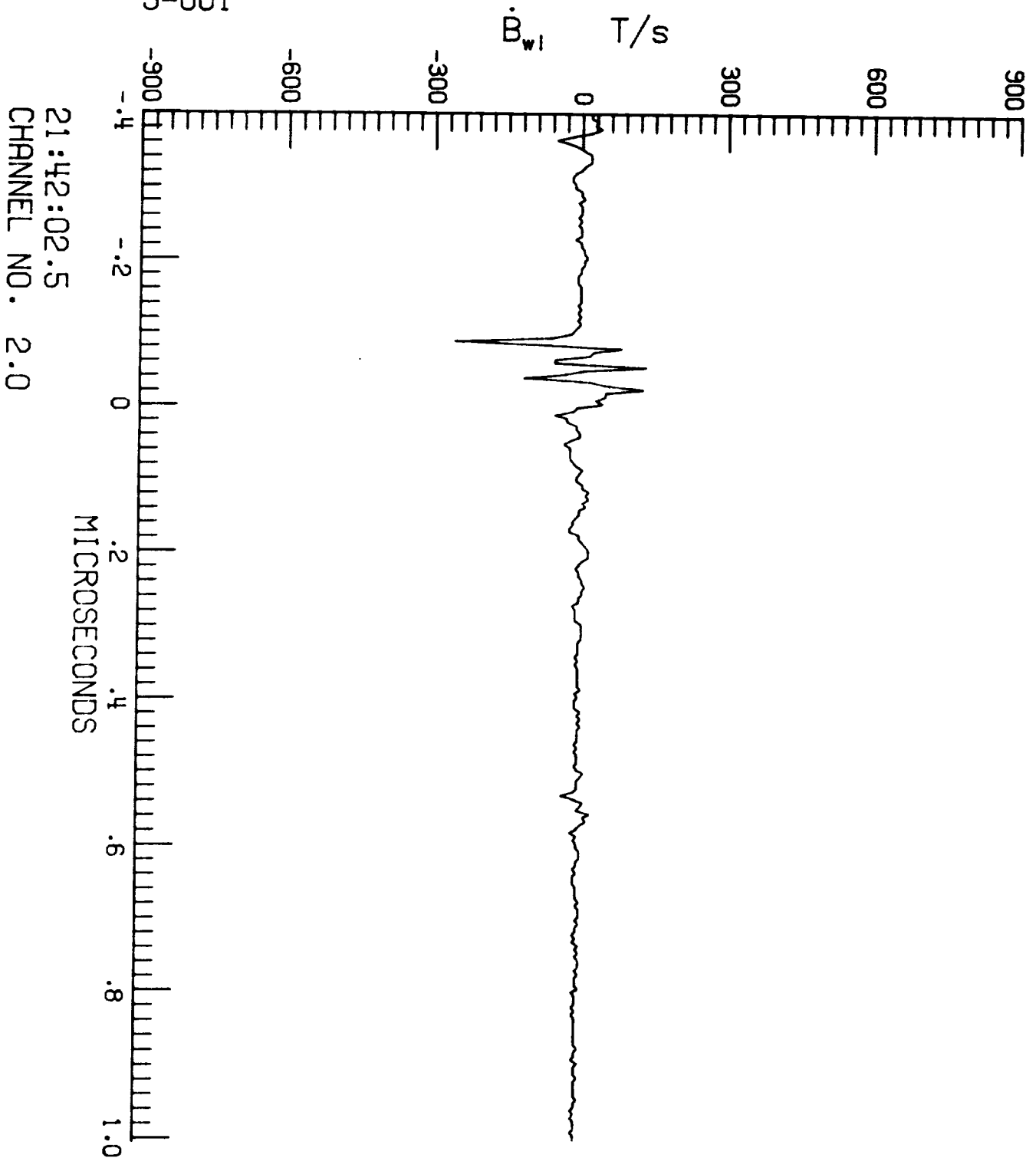

21:42:02.5  
CHANNEL NO. 2.0

F106 LIGHTNING/85-023/ZAEPFEL

LEC 2 RUN NO. 3

S-001

i A/s

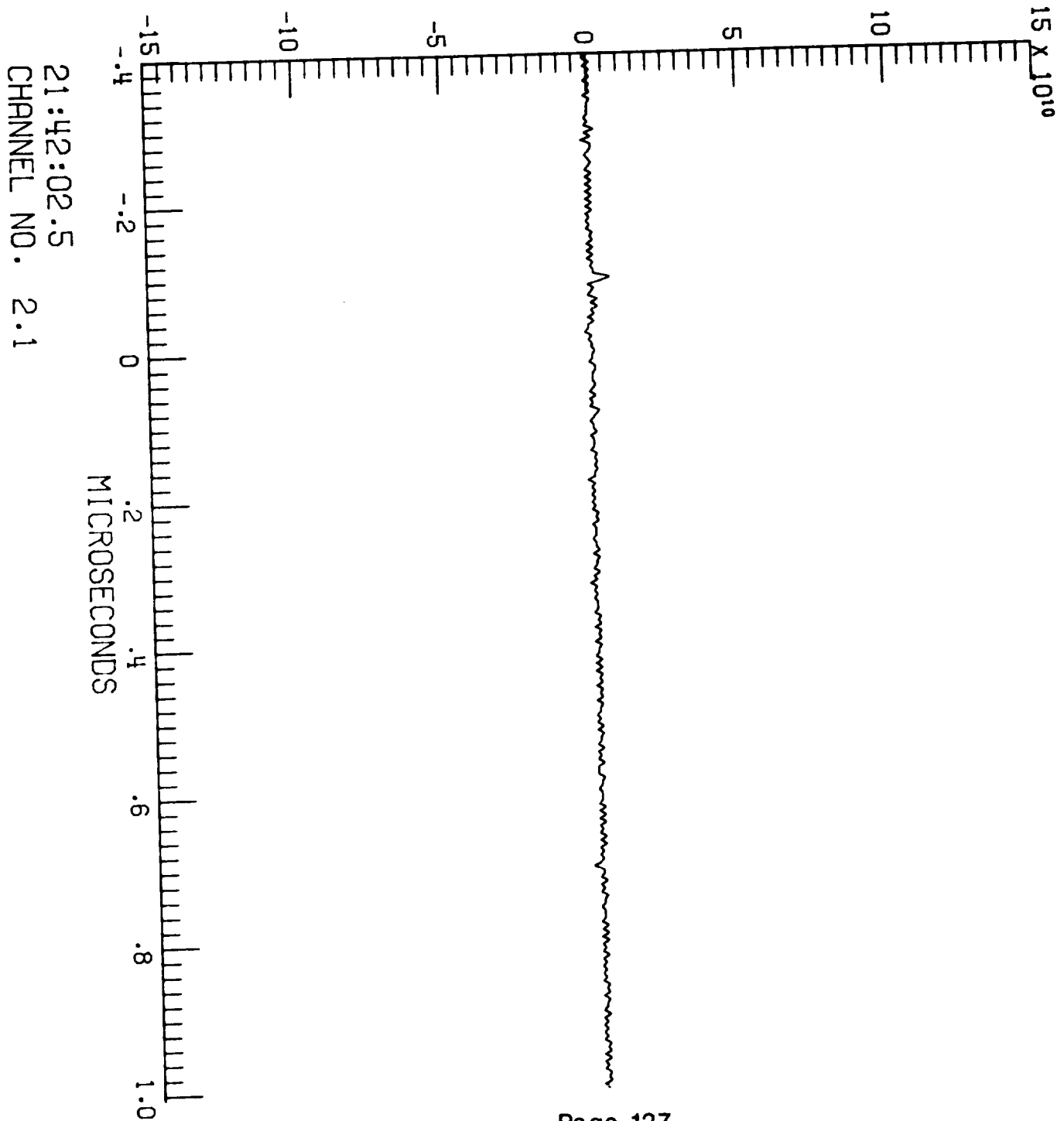

F106 LIGHTNING/85-023/ZAEPFEL

LEC 2 RUN NO. 3

S-001

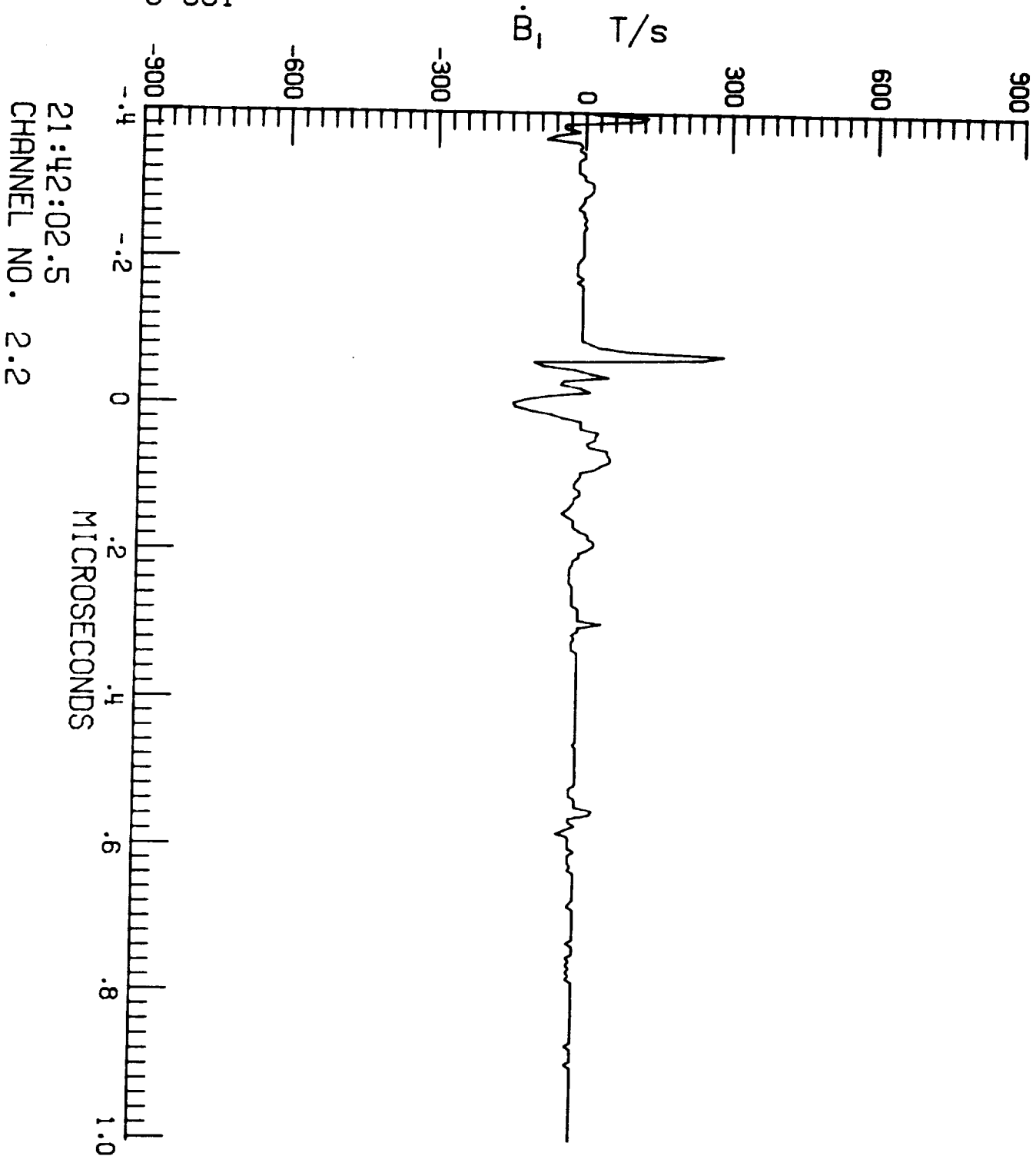

21:42:02.5  
CHANNEL NO. 2.2

F106 LIGHTNING/85-023/ZAEPFEL

LEC 3 RUN NO. 3

S-001

$\dot{D}_{wr}$  A/m<sup>2</sup>

21:42:02.5  
CHANNEL NO. 3.0

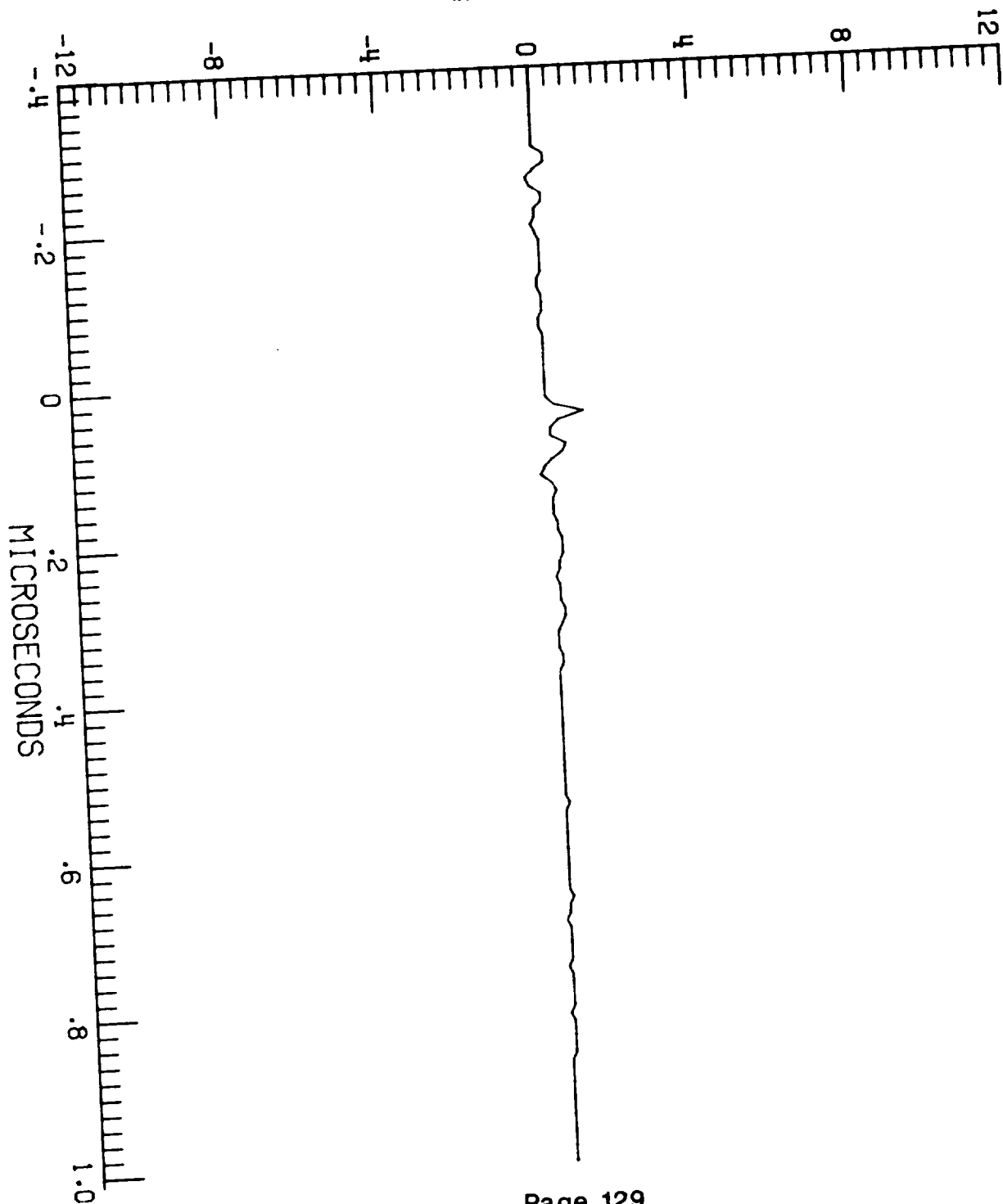

F106 LIGHTNING/85-023/ZAEPFEL

LEC 3 RUN NO. 3

S-001

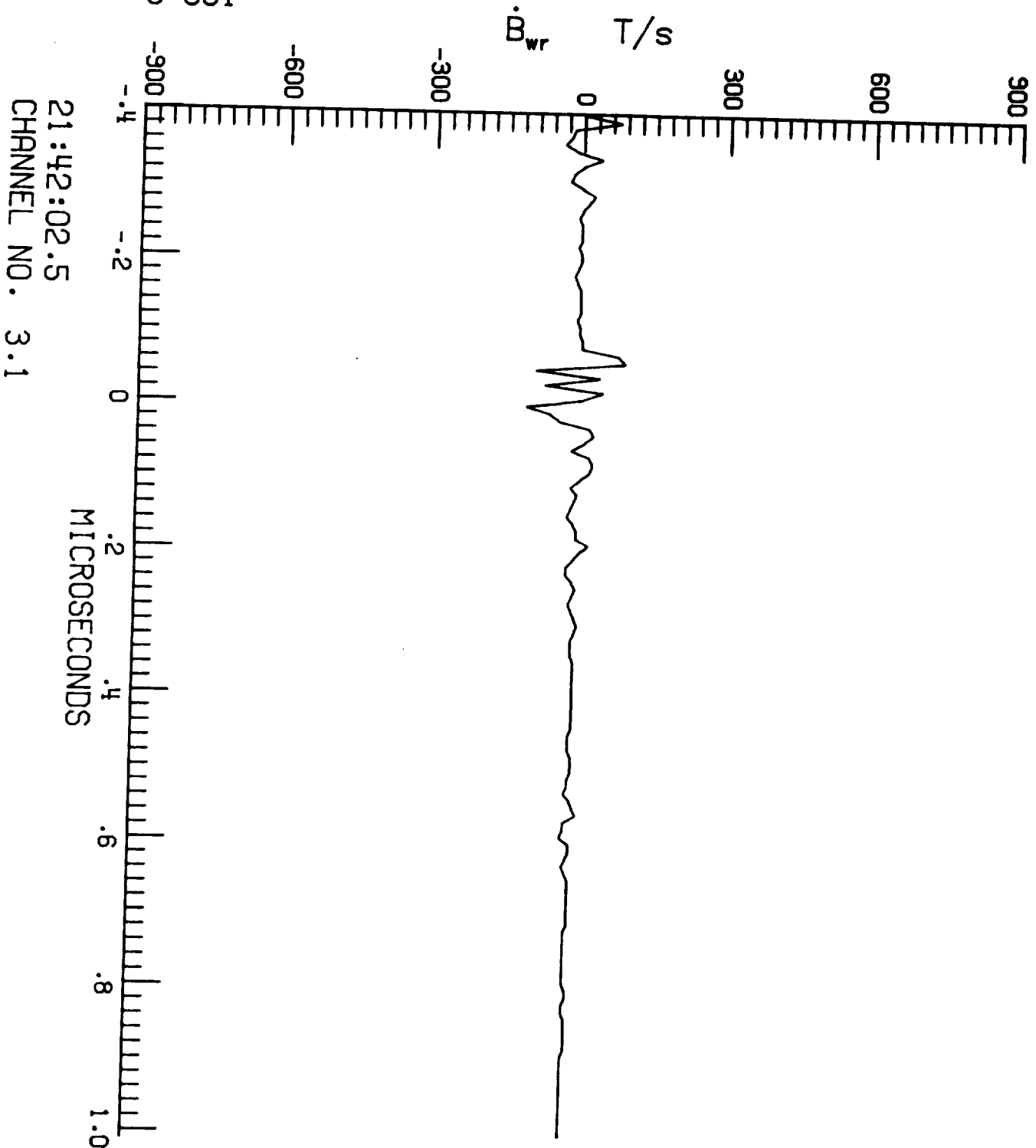

21:42:02.5  
CHANNEL NO. 3.1

F106 LIGHTNING/85-023/ZAEPFEL

LEC 3 RUN NO. 3

S-001

$\dot{D}_f$  A/m<sup>2</sup>

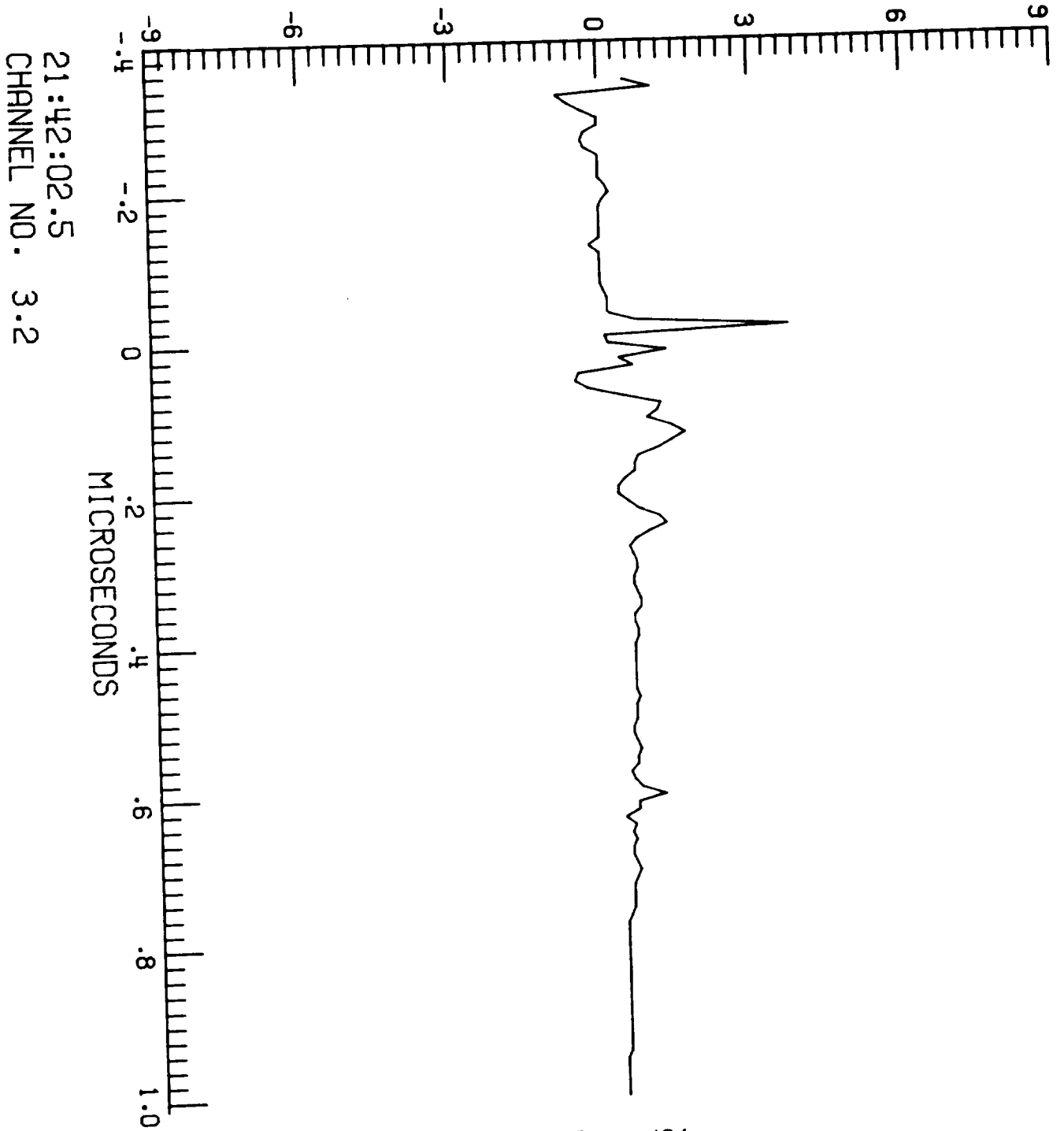

F106 LIGHTNING/85-023/ZAEPFEL

LEC 3 RUN NO. 3

S-001

$\dot{D}_f$  A/m<sup>2</sup>

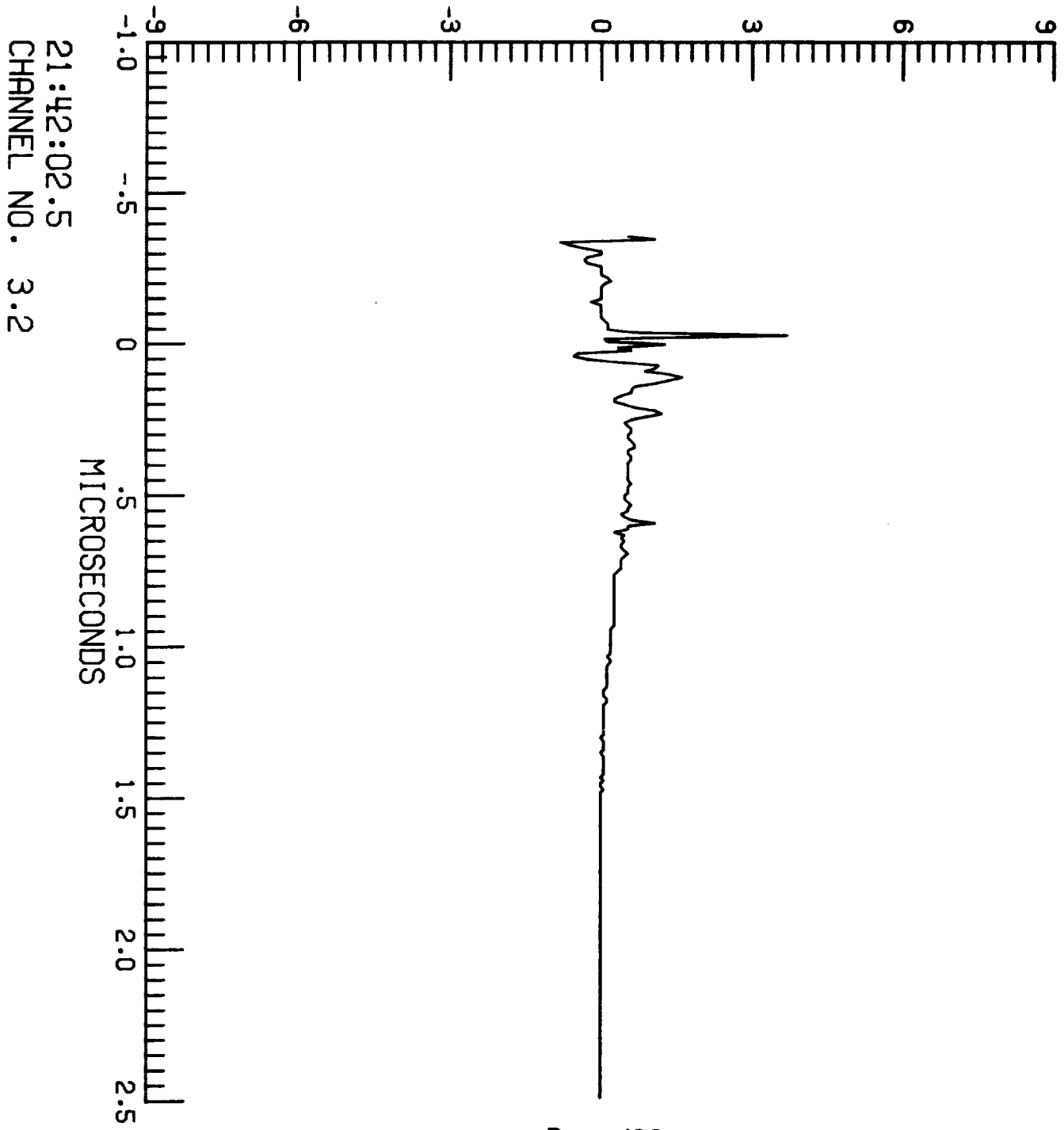

21:42:02.5  
CHANNEL NO. 3.2



F106 LIGHTNING/85-023/ZAEPFEL

LEC 4 RUN NO. 3

S-001

TP100 V

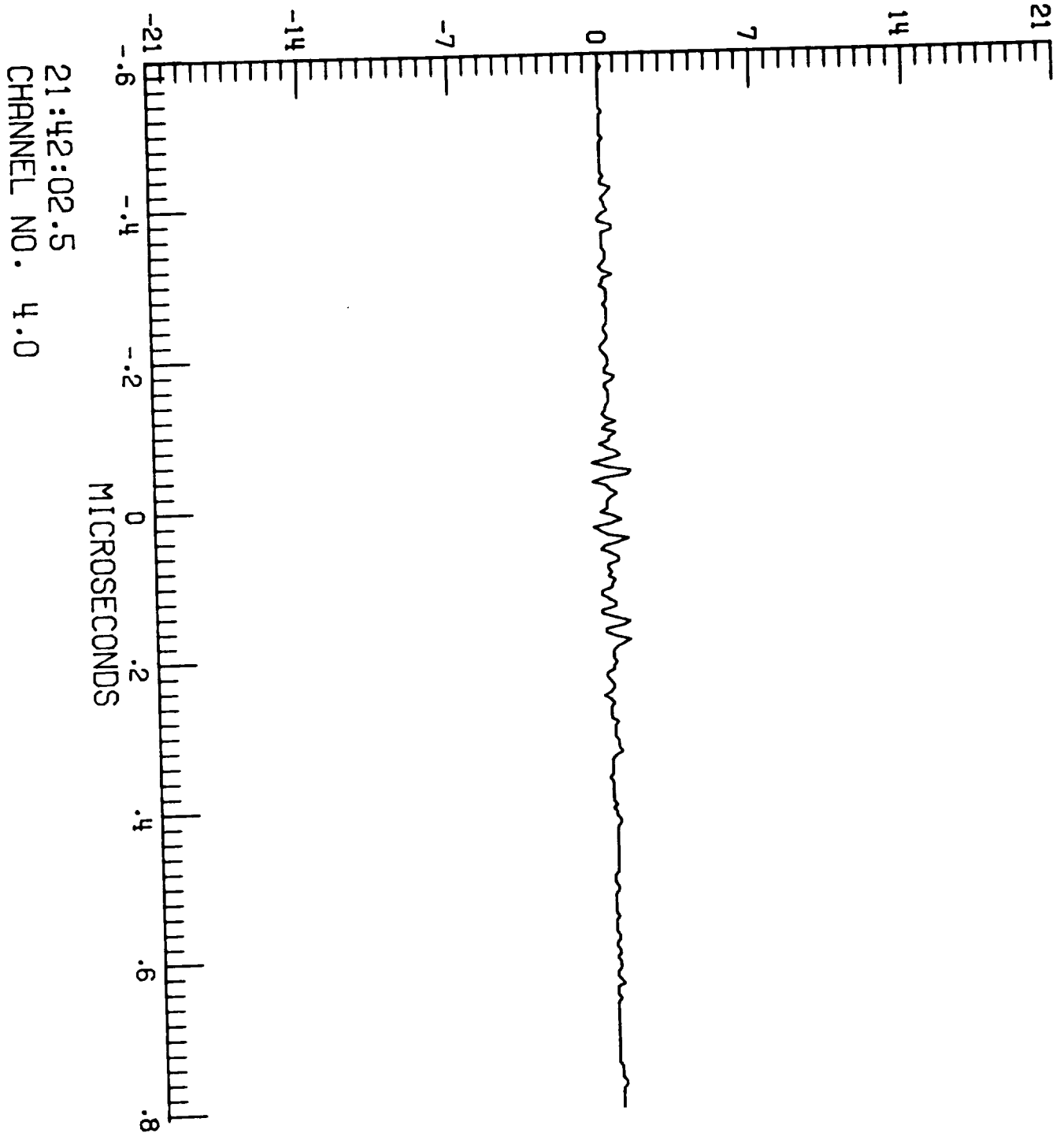

F106 LIGHTNING/85-023/ZAEPFEL

LEC 4 RUN NO. 3

S-001

TP106 A

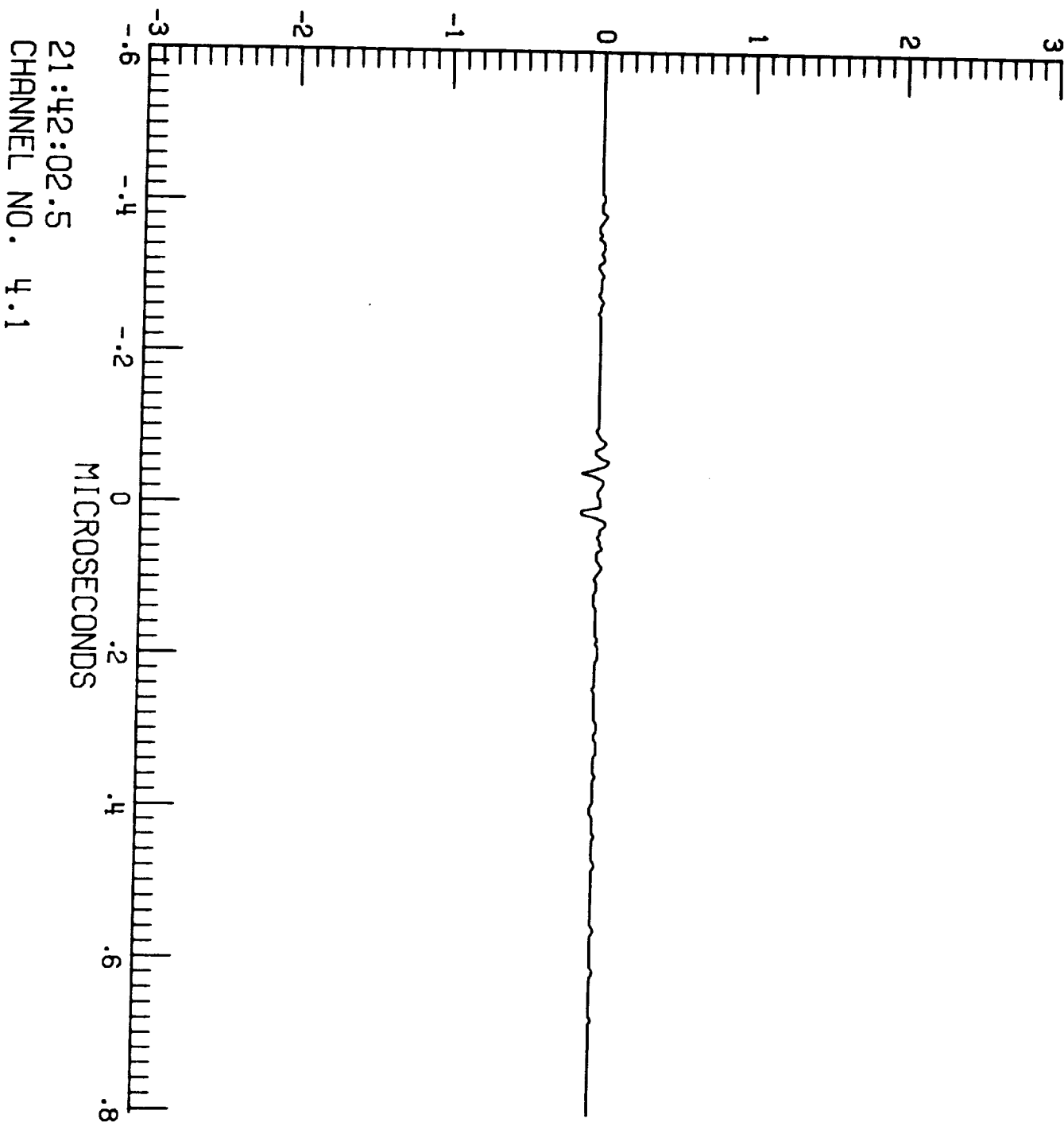

F106 LIGHTNING/85-023/ZAEPFEL

LEC 4 RUN NO. 3

S-001

TP125 A

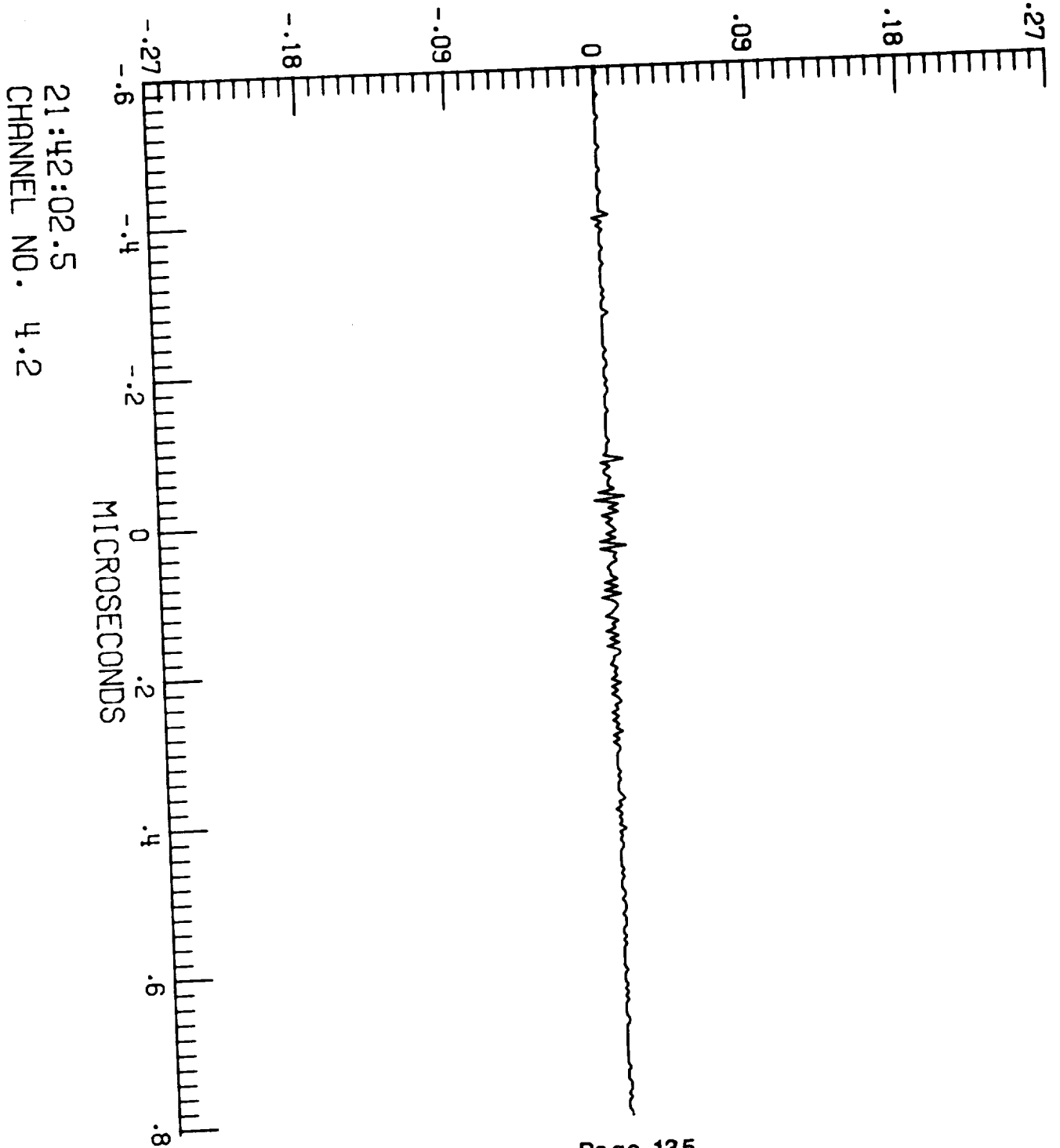

F106 LIGHTNING/85-023/ZAEPFEL  
LEC 1 RUN NO. 3  
S-001

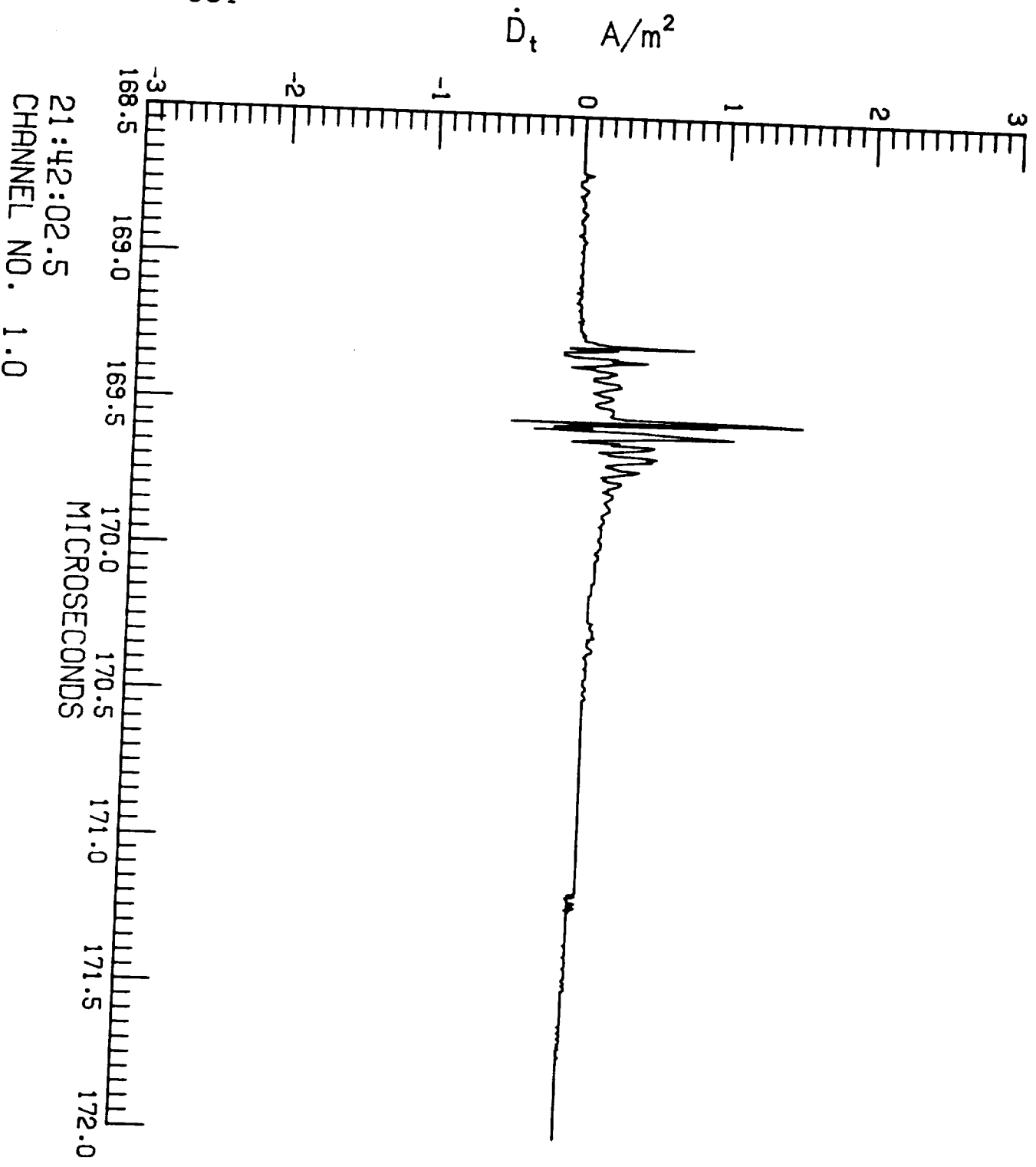

21:42:02.5  
CHANNEL NO. 1.0

F106 LIGHTNING/85-023/ZAEPFEL

LEC 1 RUN NO. 3

S-001

$\dot{D}_t$  A/m<sup>2</sup>

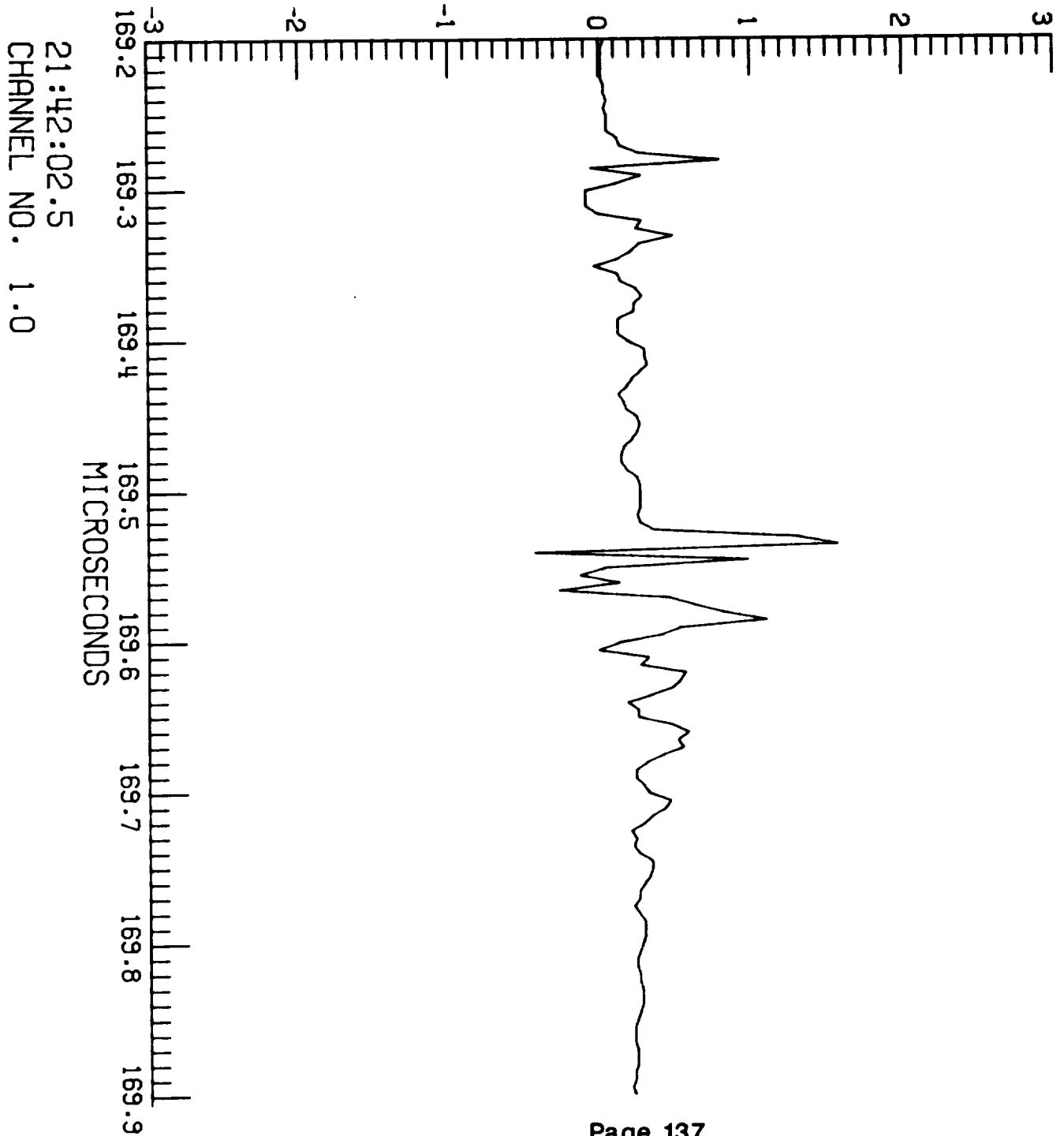

F106 LIGHTNING/85-023/ZAEPFEL

LEC 1 RUN NO. 3

S-001

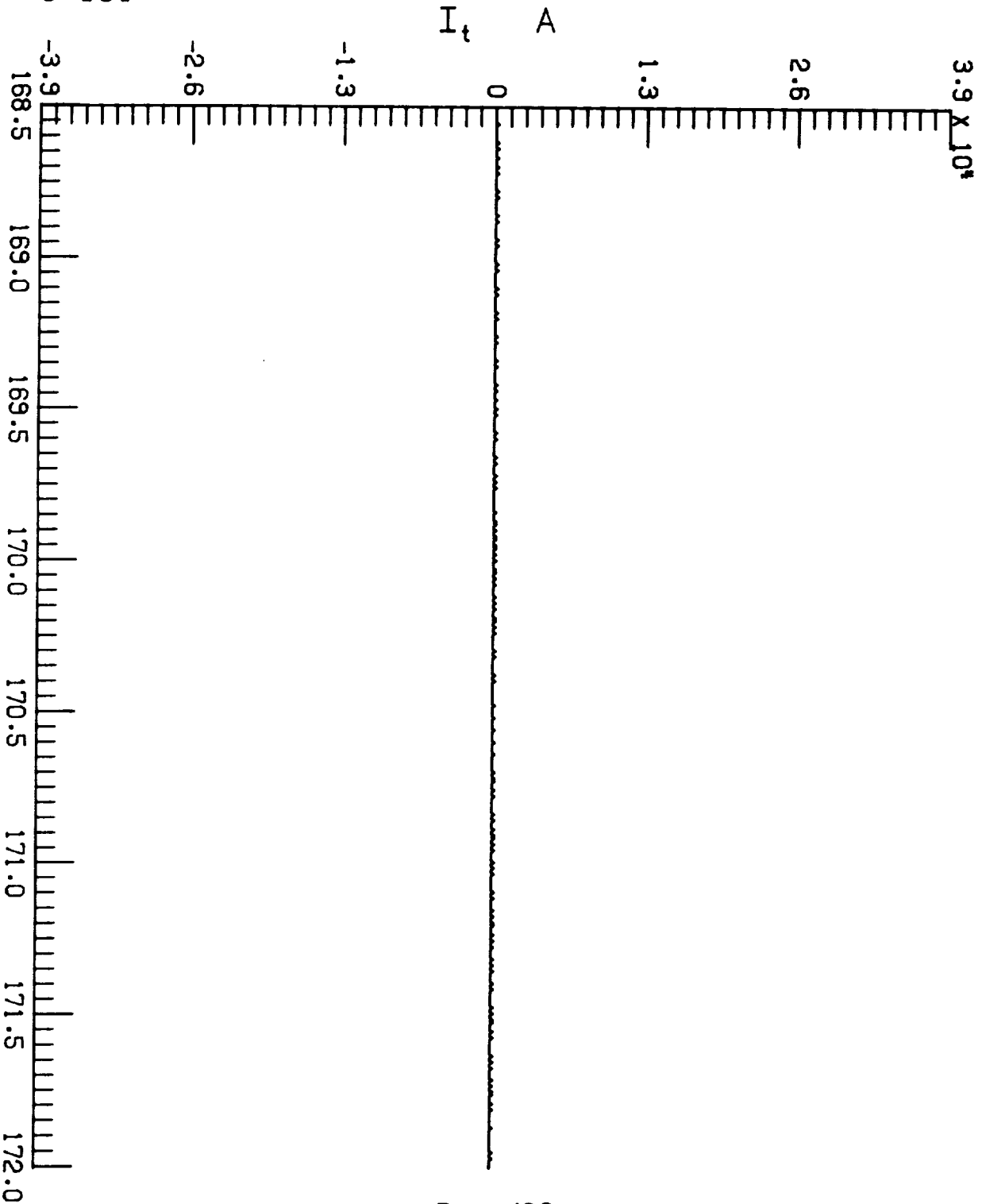

21:42:02.5  
CHANNEL NO. 1.2

F106 LIGHTNING/85-023/ZAEPFEL

LEC 2 RUN NO. 3

S-001

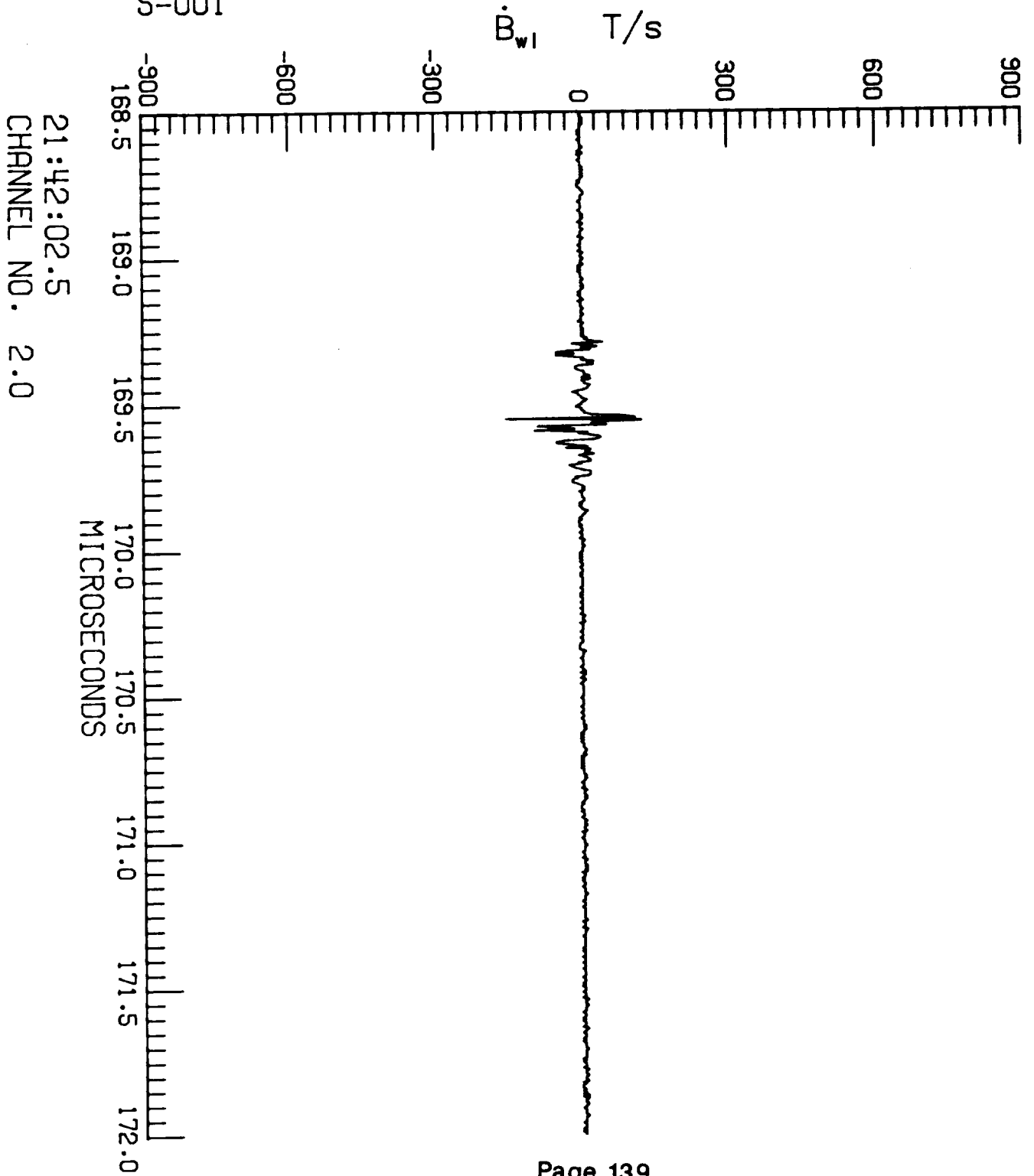

F106 LIGHTNING/85-023/ZAEPFEL  
LEC 2 RUN NO. 3  
S-001

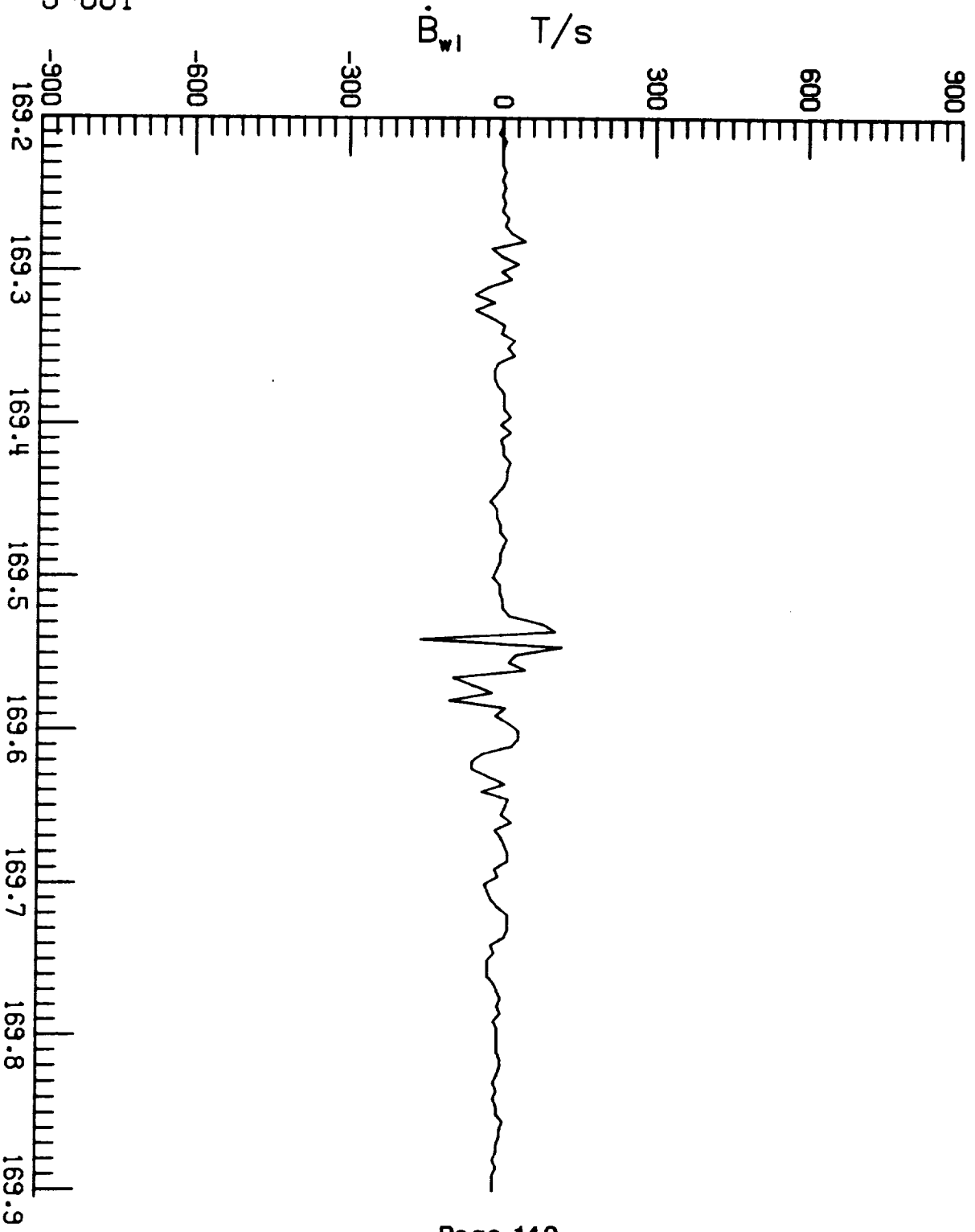

21:42:02.5  
CHANNEL NO. 2.0



F106 LIGHTNING/85-023/ZAEPFEL

LEC 2 RUN NO. 3

S-001

i A/s

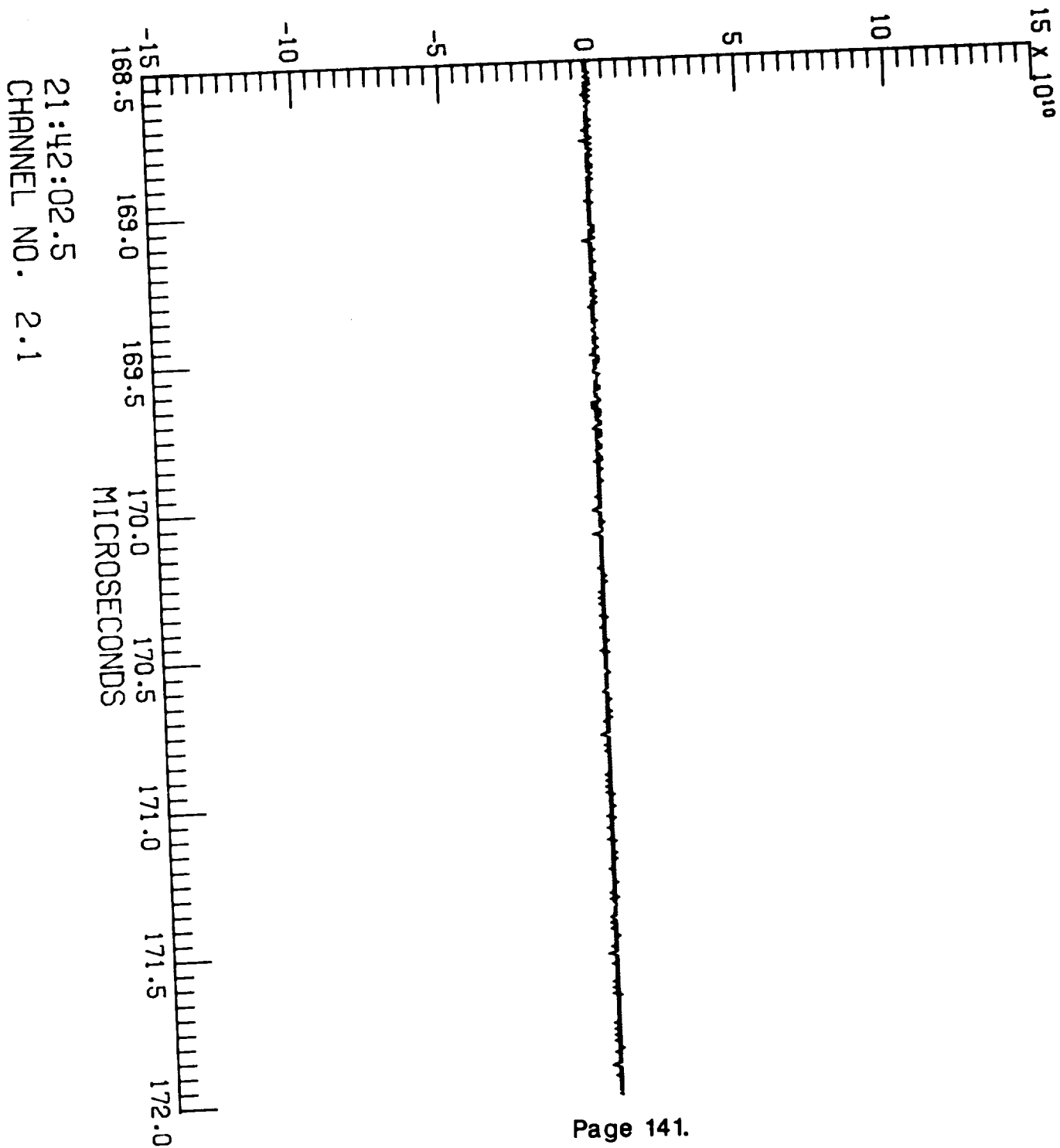

F106 LIGHTNING/85-023/ZAEPFEL

LEC 2 RUN NO. 3

S-001

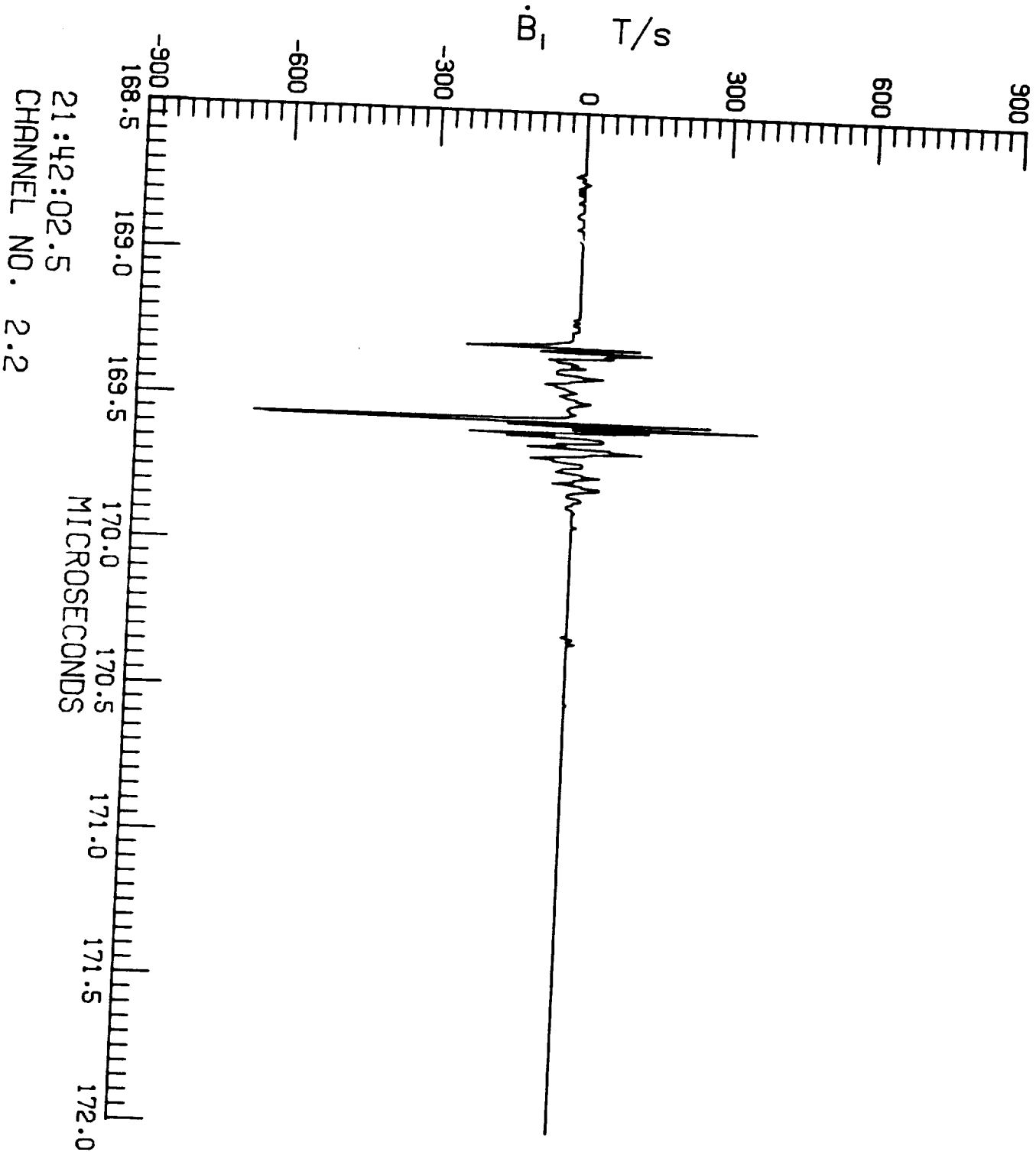

F106 LIGHTNING/85-023/ZAEPFEL

LEC 2 RUN NO. 3

S-001

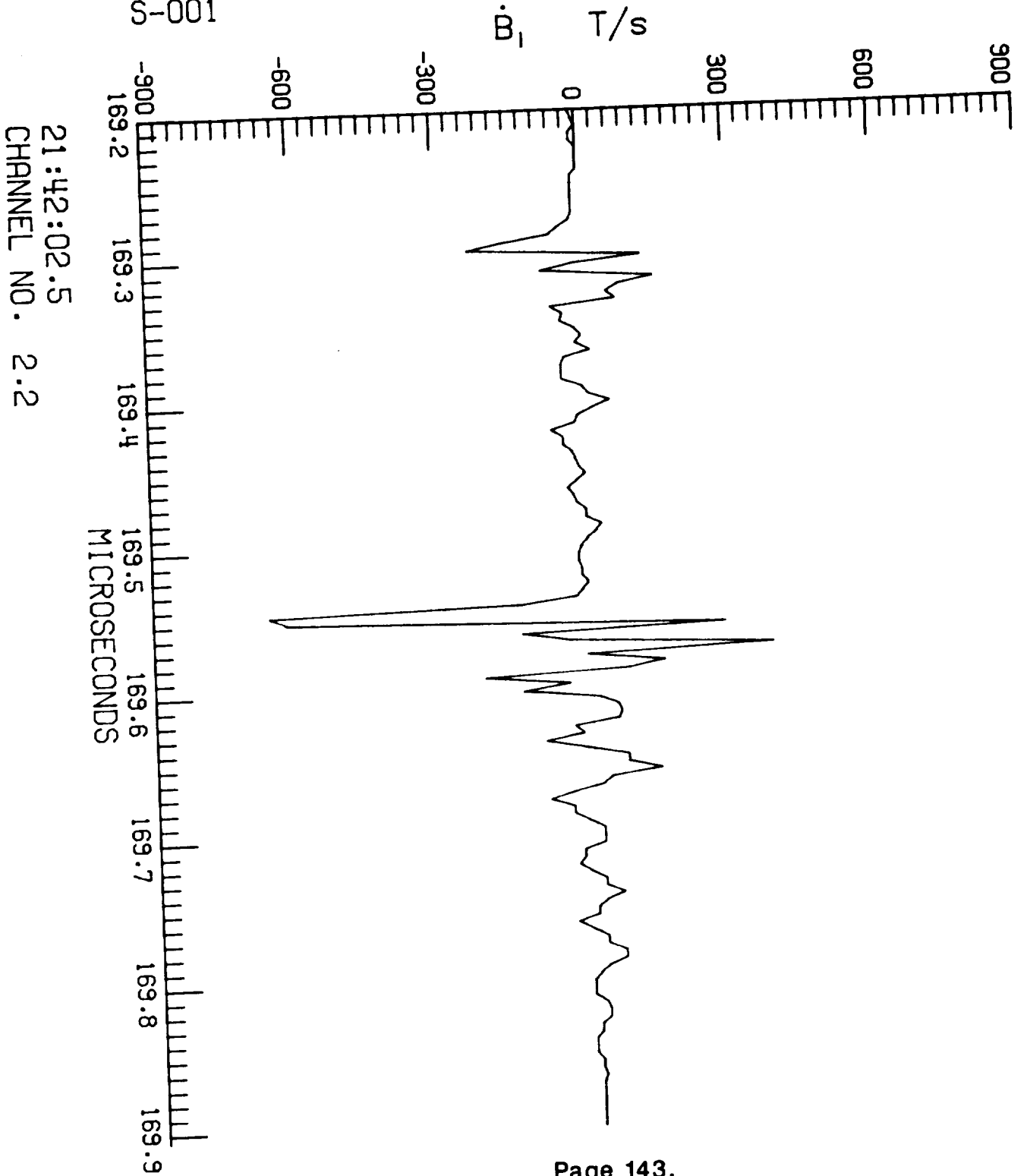

21:42:02.5  
CHANNEL NO. 2.2

F106 LIGHTNING/85-023/ZAEPFEL

LEC 3 RUN NO. 3

S-001

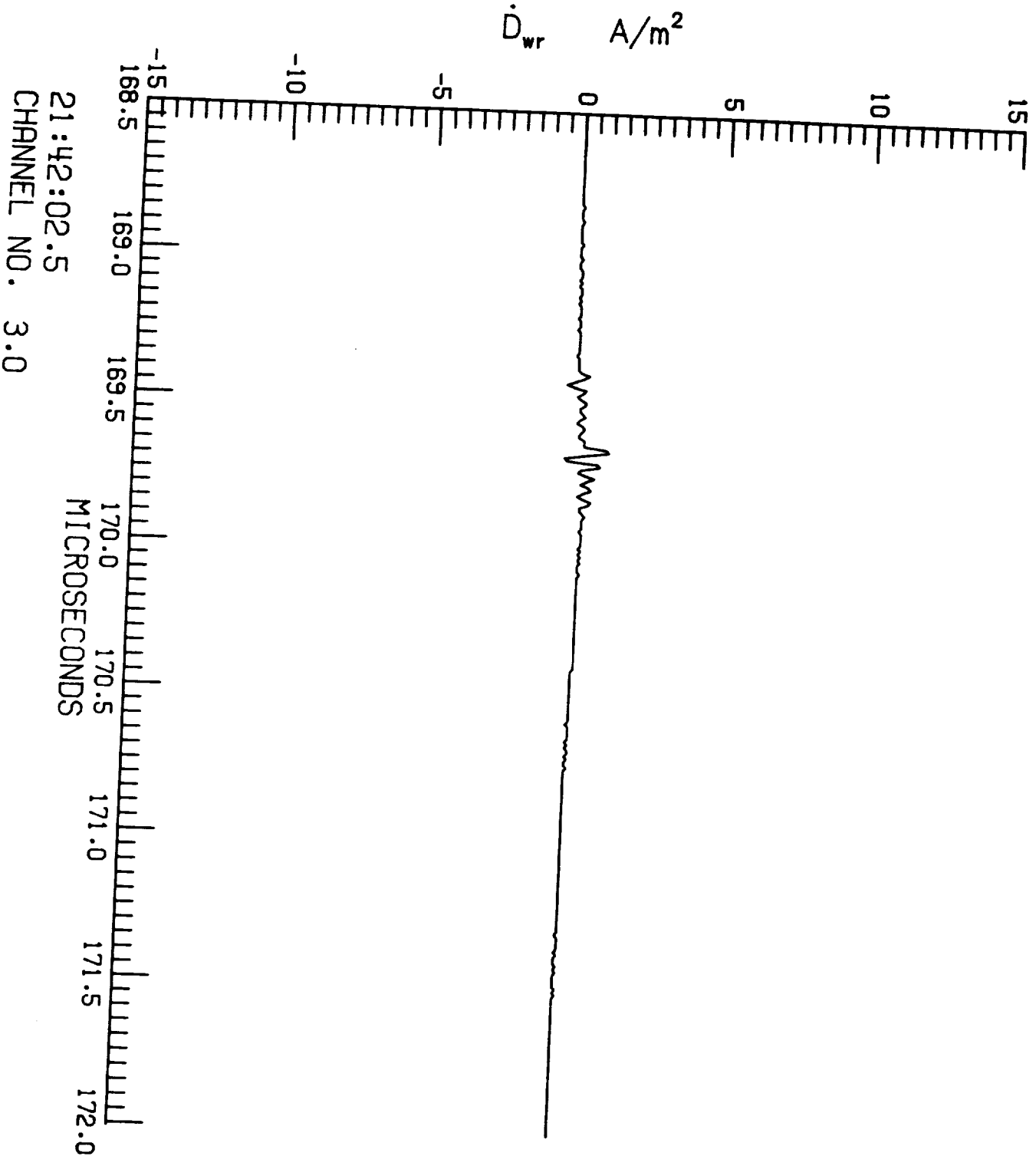

F106 LIGHTNING/85-023/ZAEPFEL  
LEC 3 RUN NO. 3  
S-001

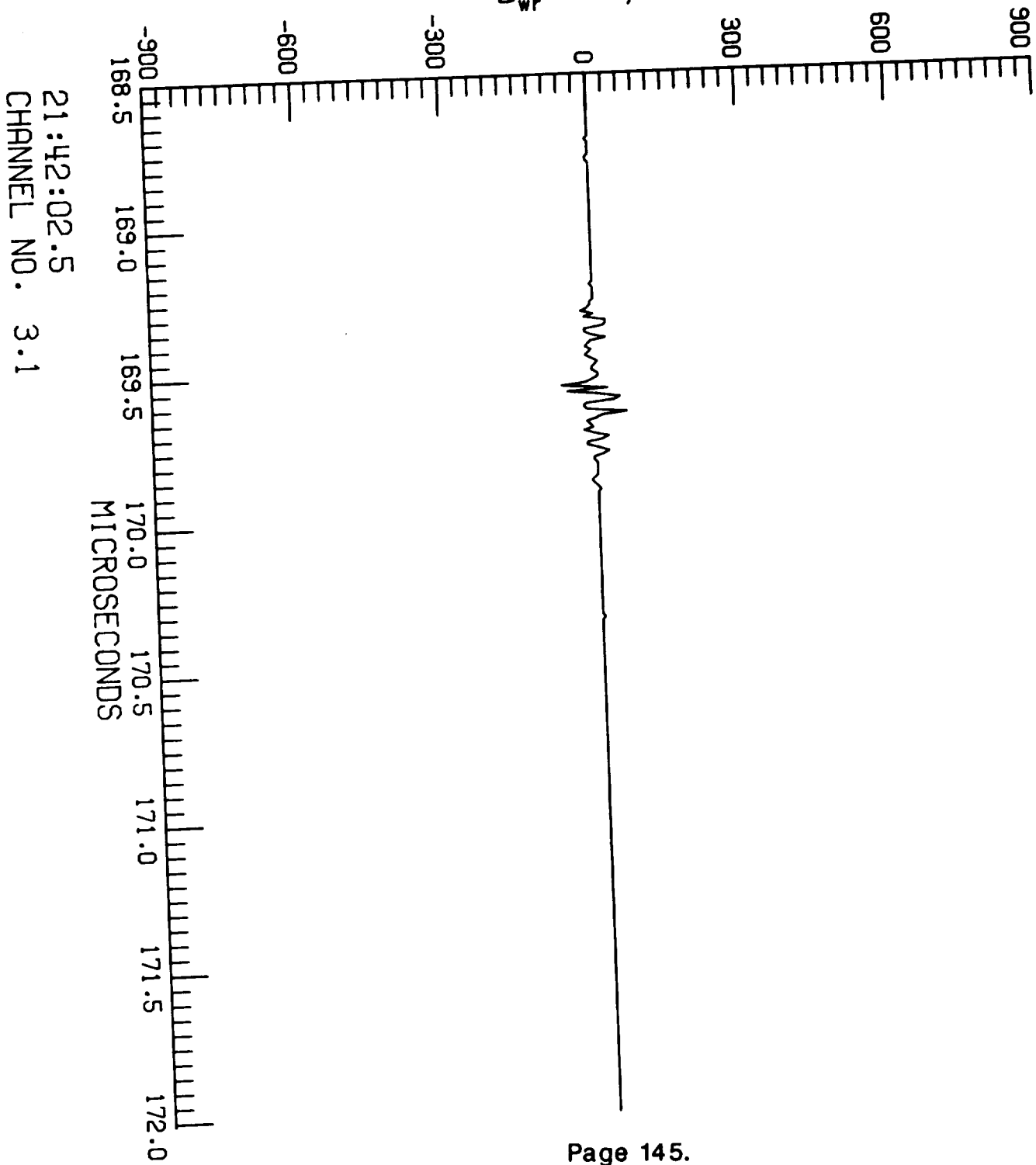

21:42:02.5  
CHANNEL NO. 3.1

F106 LIGHTNING/85-023/ZREPTEL  
LEC 3 RUN NO. 3  
S-001

$\dot{D}_f$  A/m<sup>2</sup>

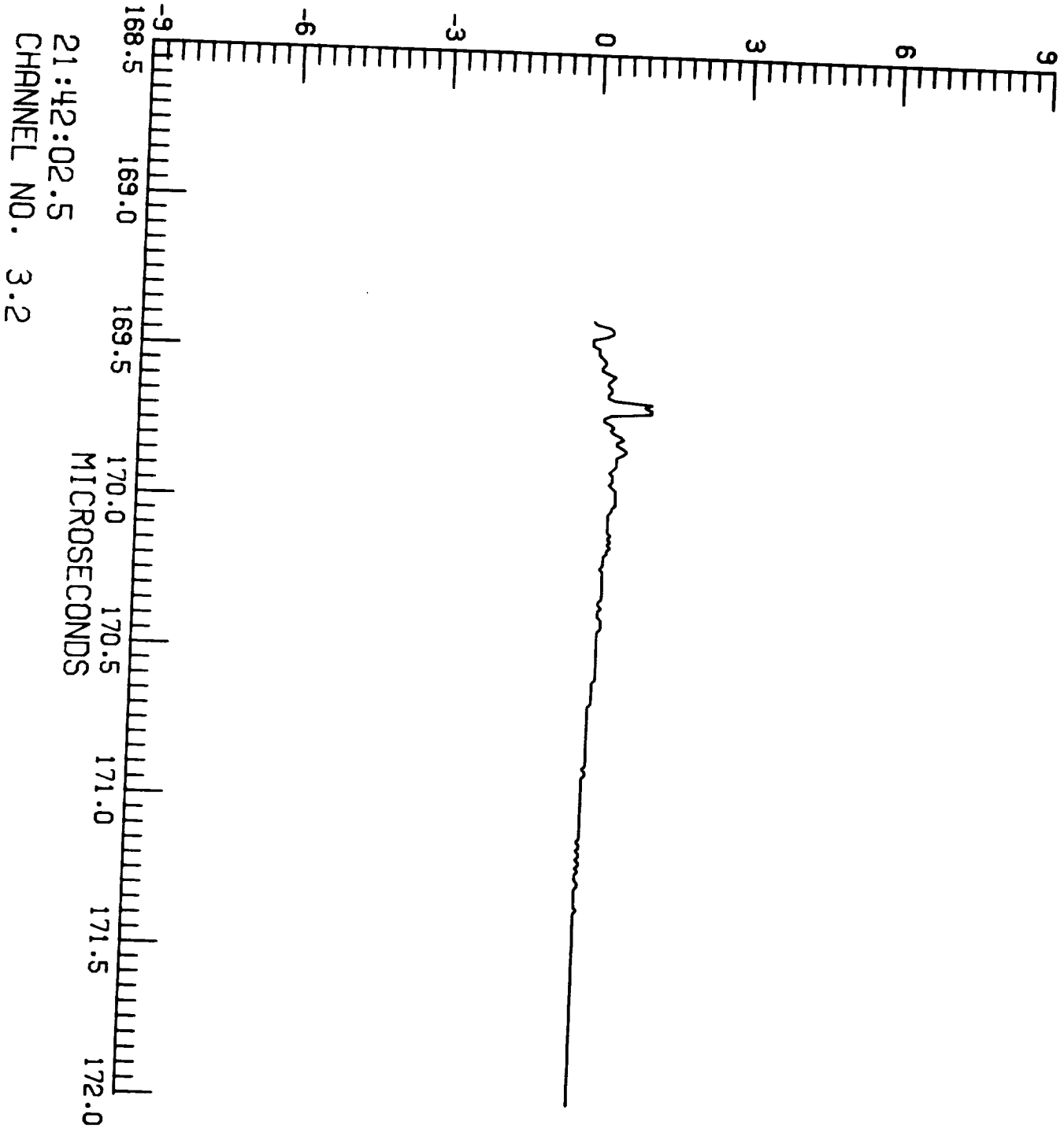

F106 LIGHTNING/85-023/ZAEPFEL

LEC 4 RUN NO. 3

S-001

TP100 V

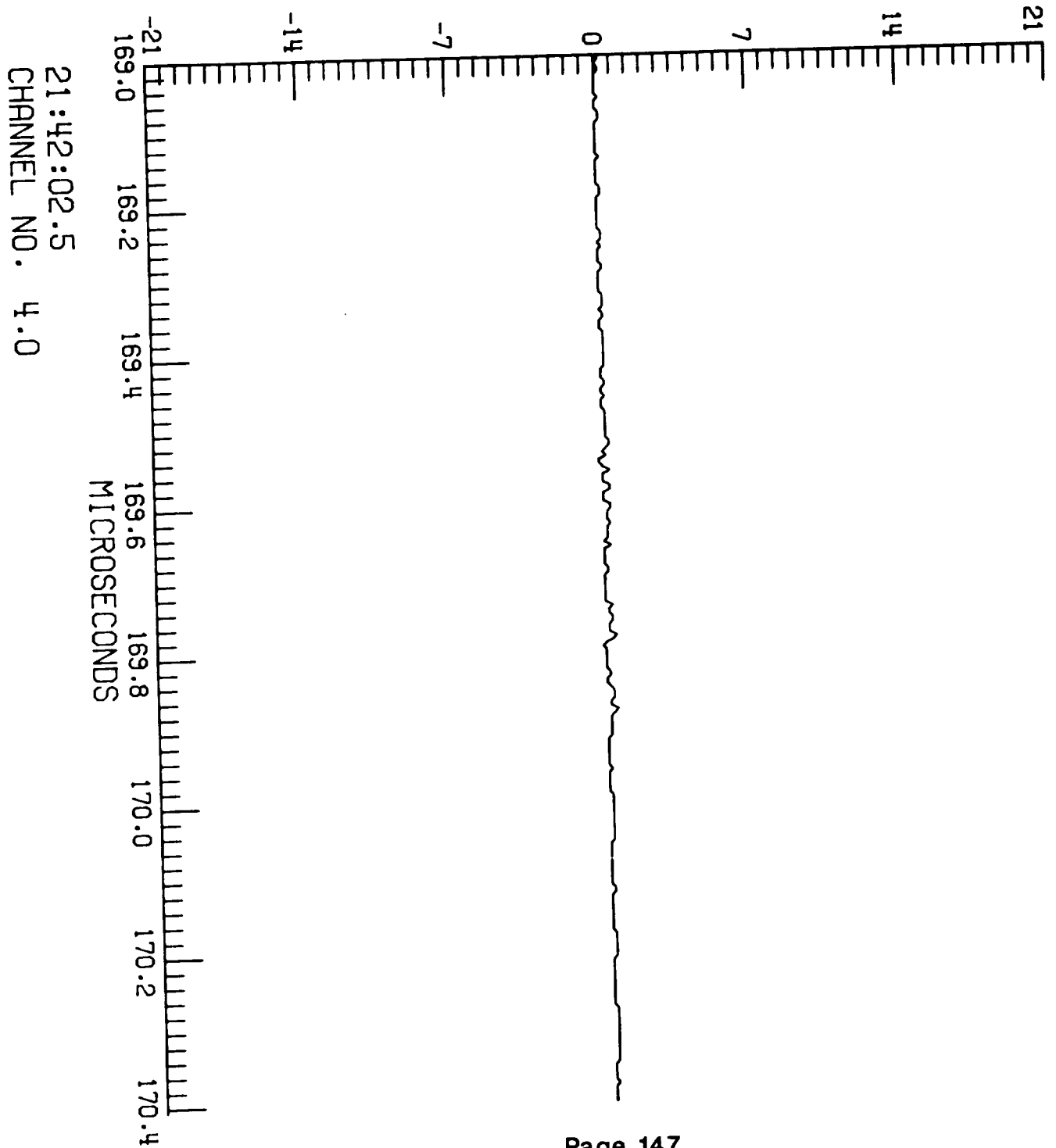

F106 LIGHTNING/85-023/ZAEPFEL

LEC 4 RUN NO. 3

S-001

TP106 A

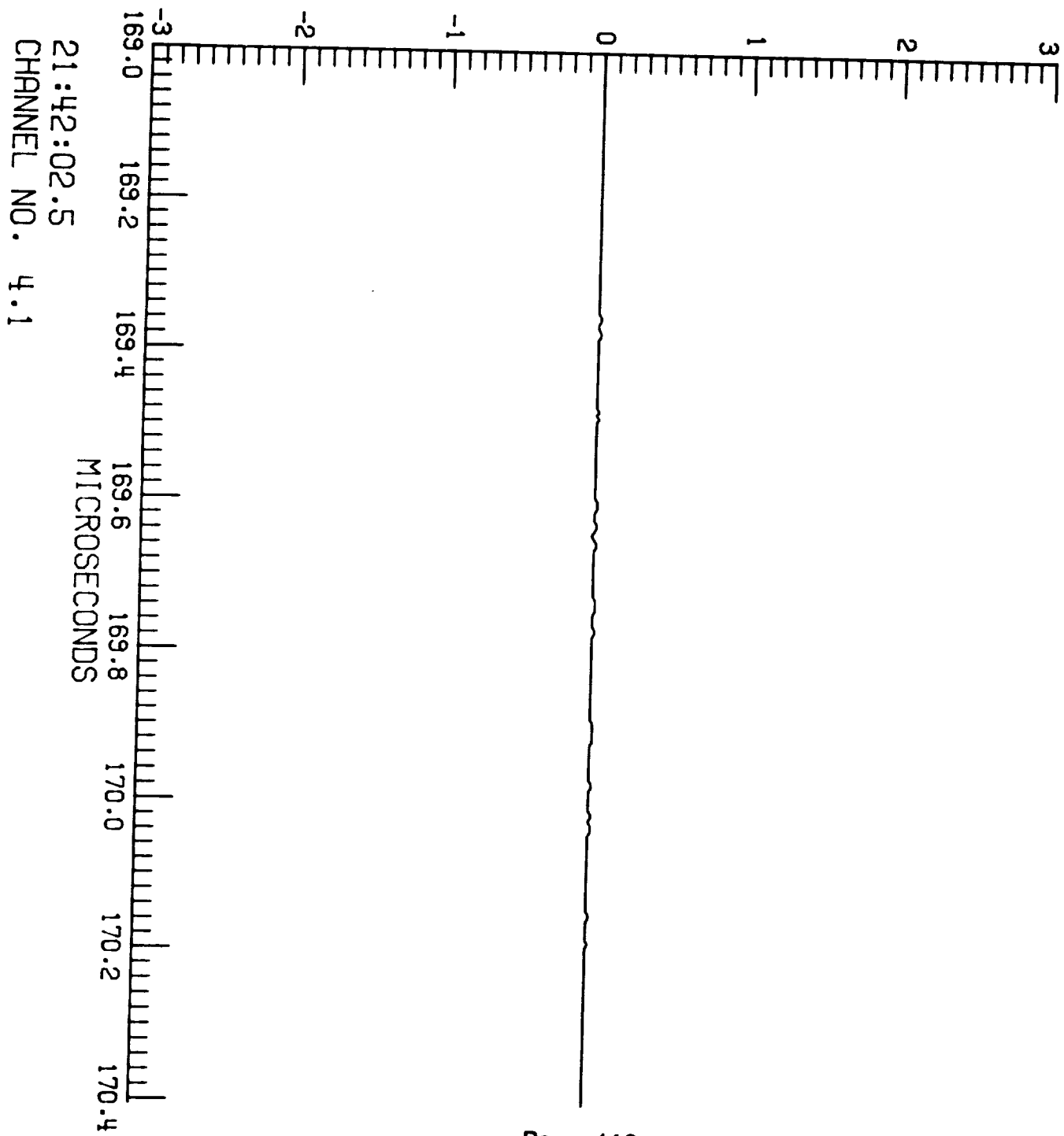



F106 LIGHTNING/85-023/ZAEPFEL

LEC 4 RUN NO. 3

S-001

TP125

A

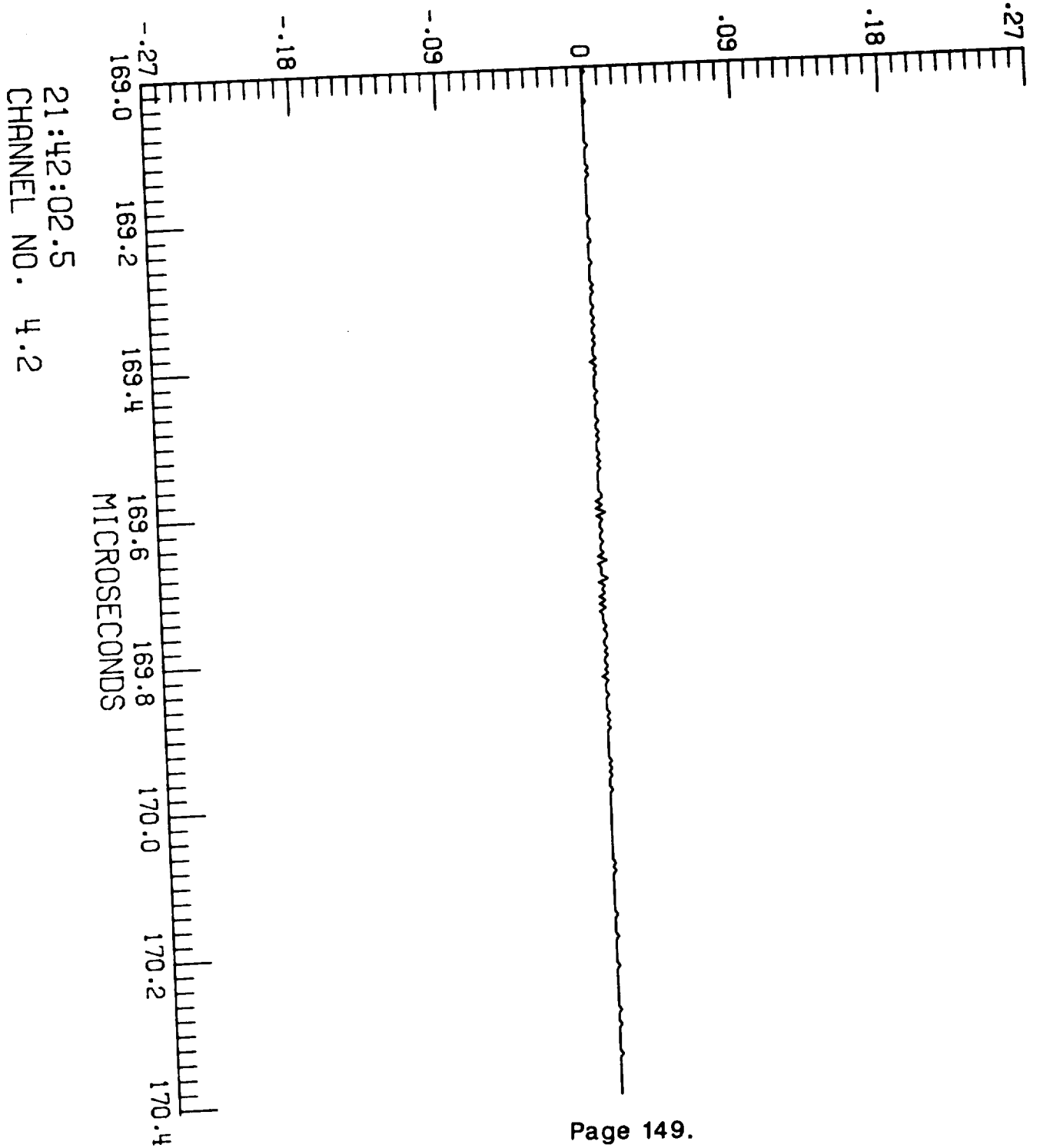

F106 LIGHTNING/85-023/ZAEPFEL  
LEC 3 RUN NO. 3  
S-001

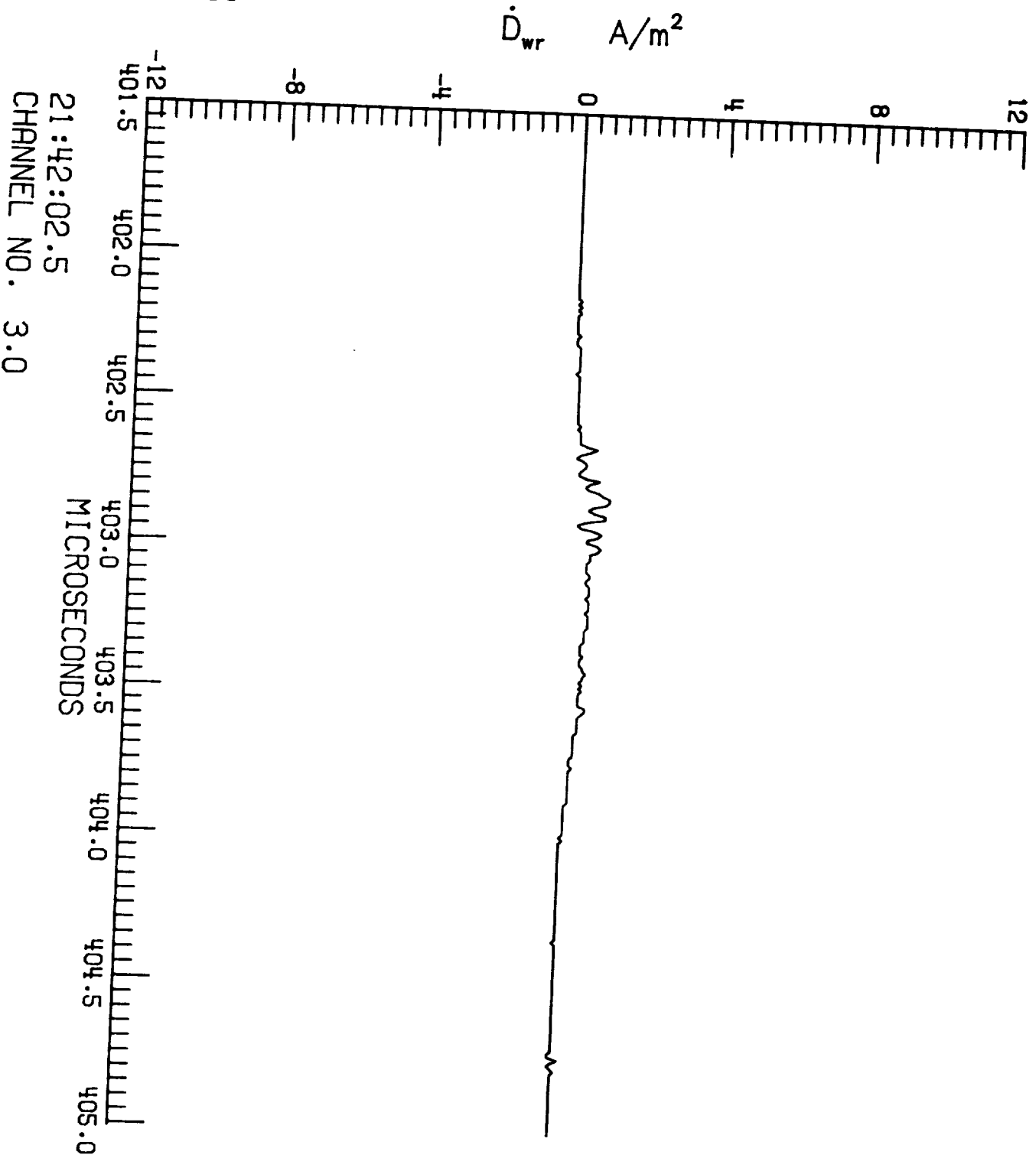

F106 LIGHTNING/85-023/ZAEPFEL  
LEC 3 RUN NO. 3  
S-001

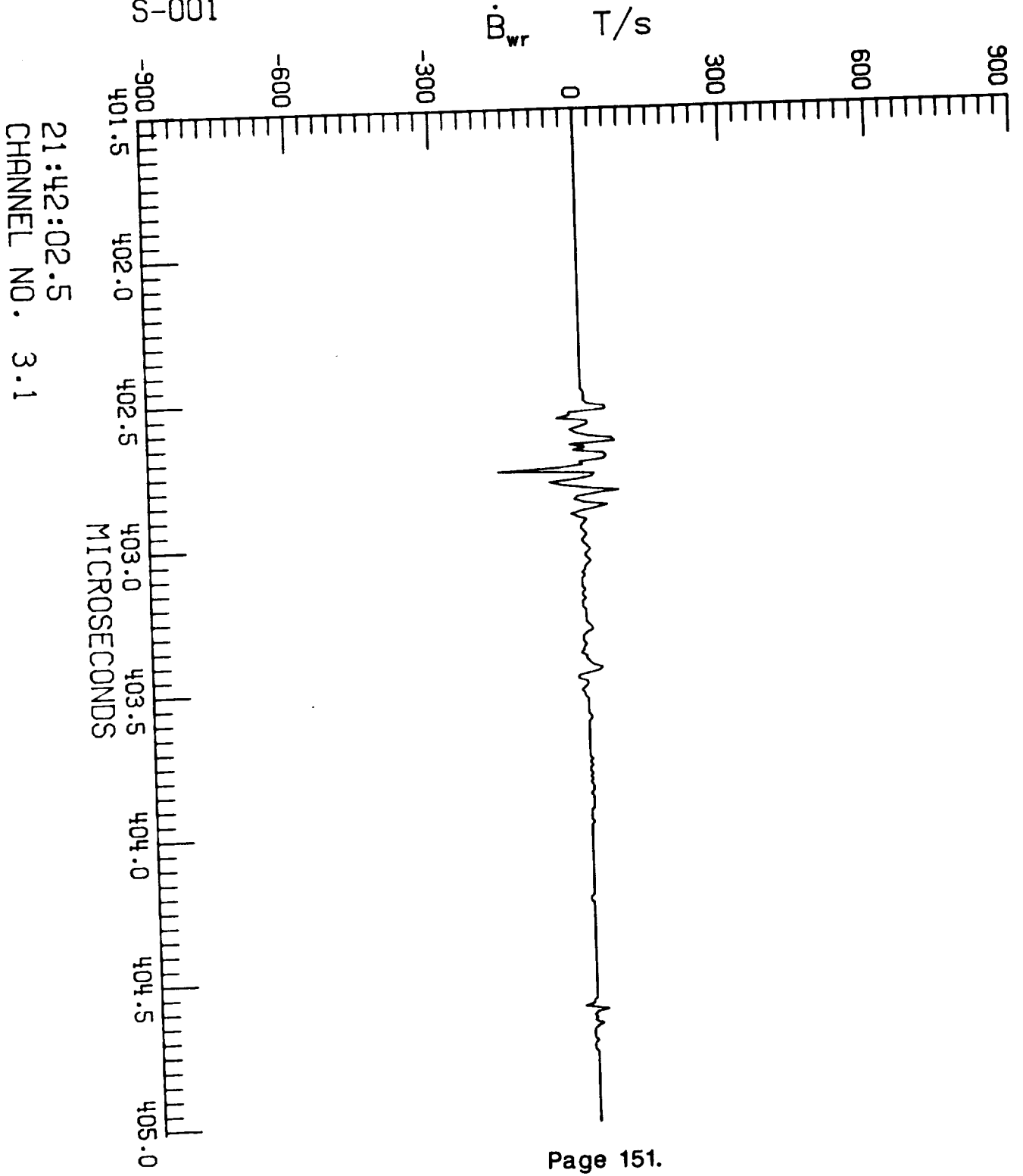

21:42:02.5  
CHANNEL NO. 3.1

F106 LIGHTNING/85-023/ZAEPFEL  
LEC 3 RUN NO. 3  
S-001

$\dot{D}_f$  A/m<sup>2</sup>

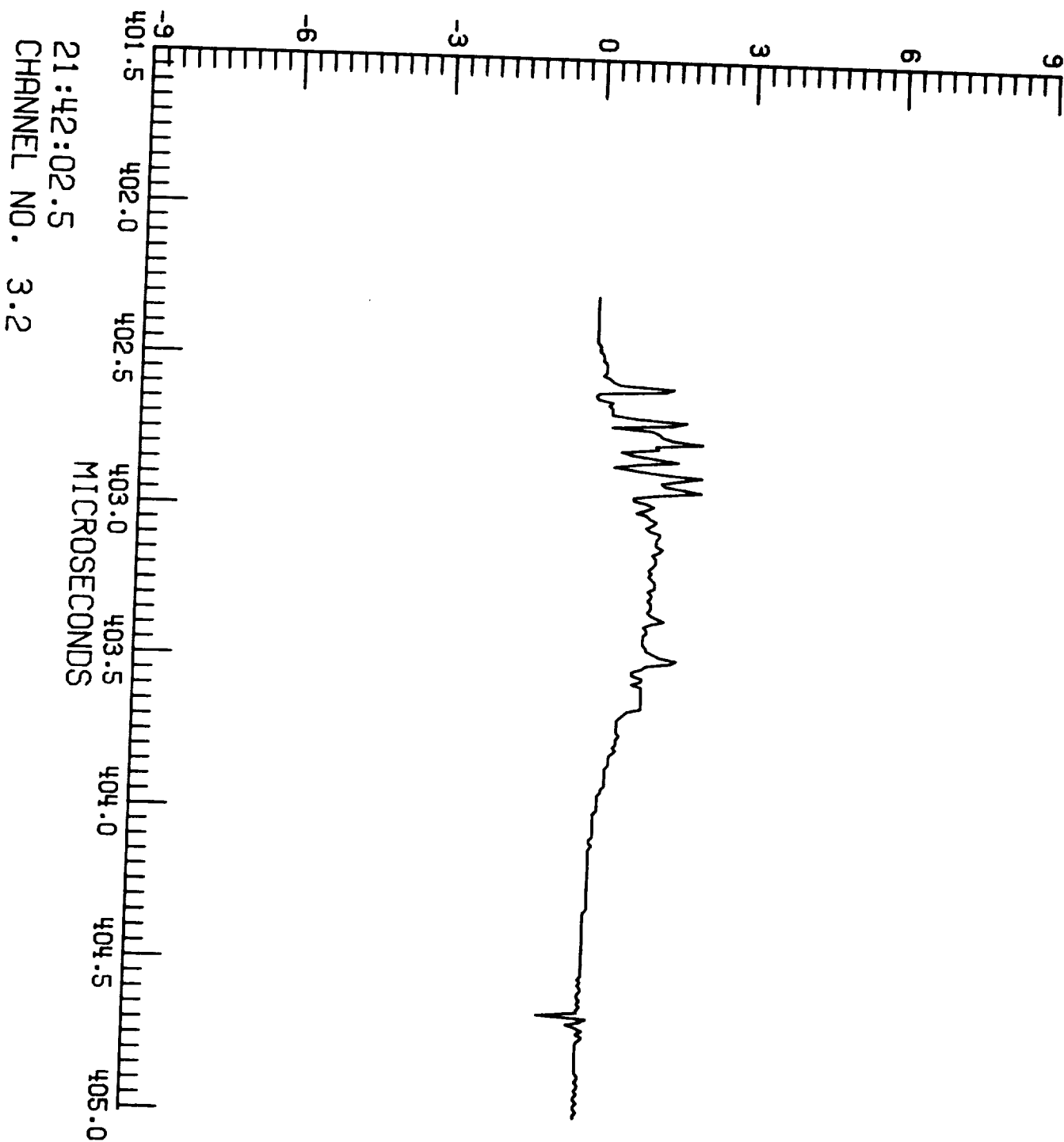

21:42:02.5  
CHANNEL NO. 3.2

F106 LIGHTNING/85-023/ZAEPFEL  
LEC 1 RUN NO. 5  
S-002

$\dot{D}_t$  A/m<sup>2</sup>

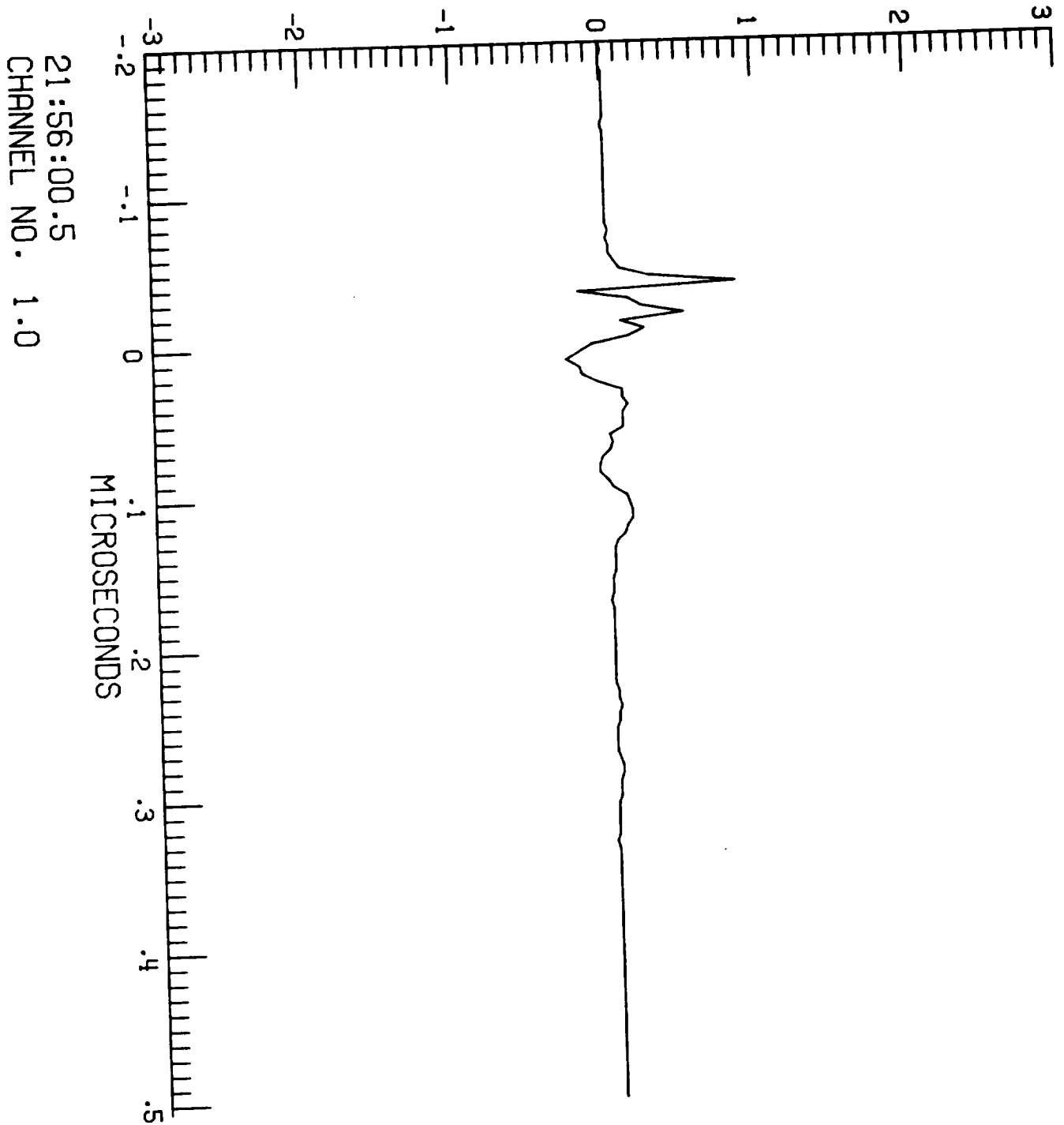

F106 LIGHTNING/85-023/ZAEPFEL

LEC 1 RUN NO. 5

S-002

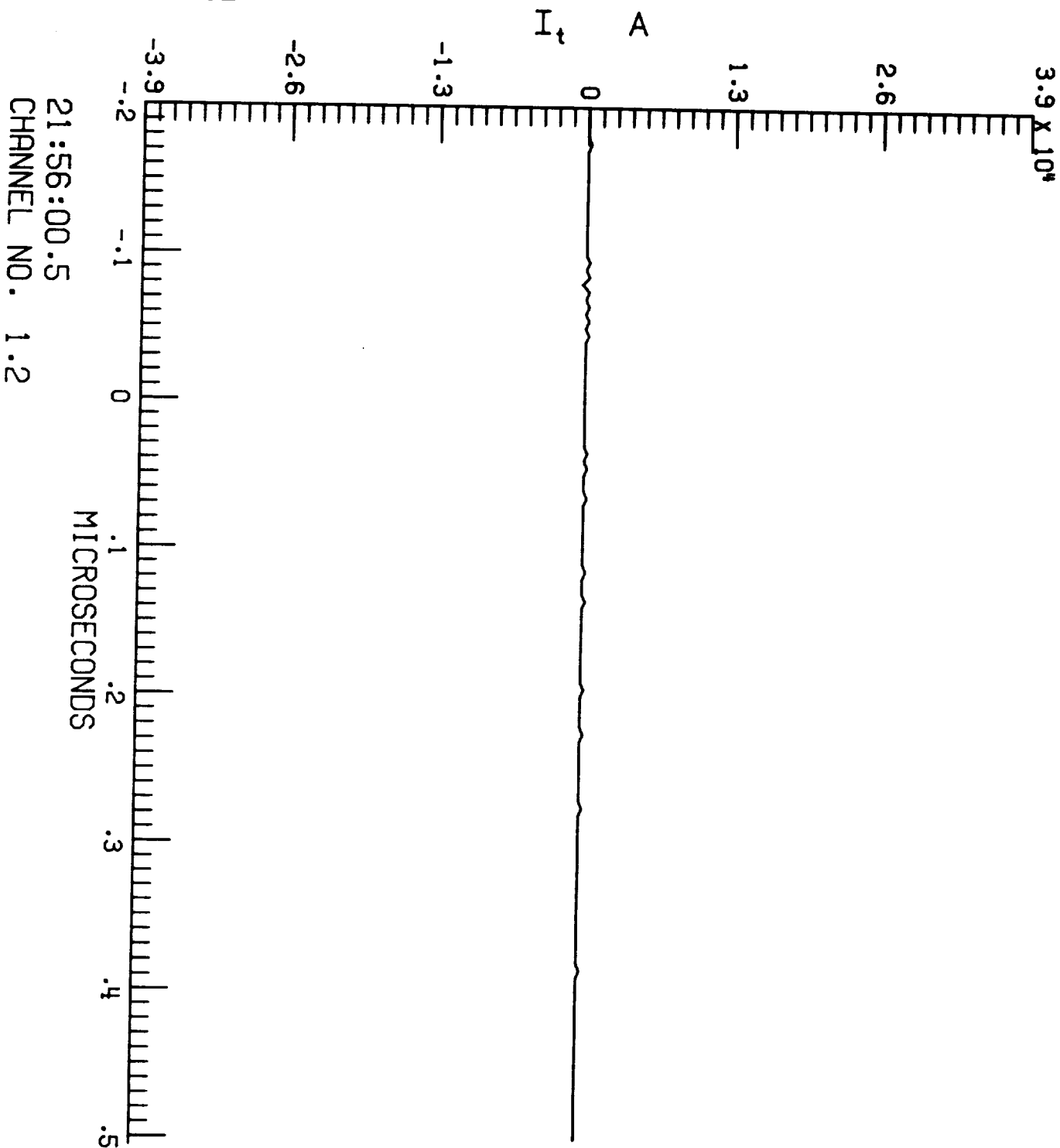

21:56:00.5  
CHANNEL NO. 1.2

F106 LIGHTNING/85-023/ZAEPFEL  
LEC 2 RUN NO. 5  
S-002

21:56:00.5  
CHANNEL NO. 2.0

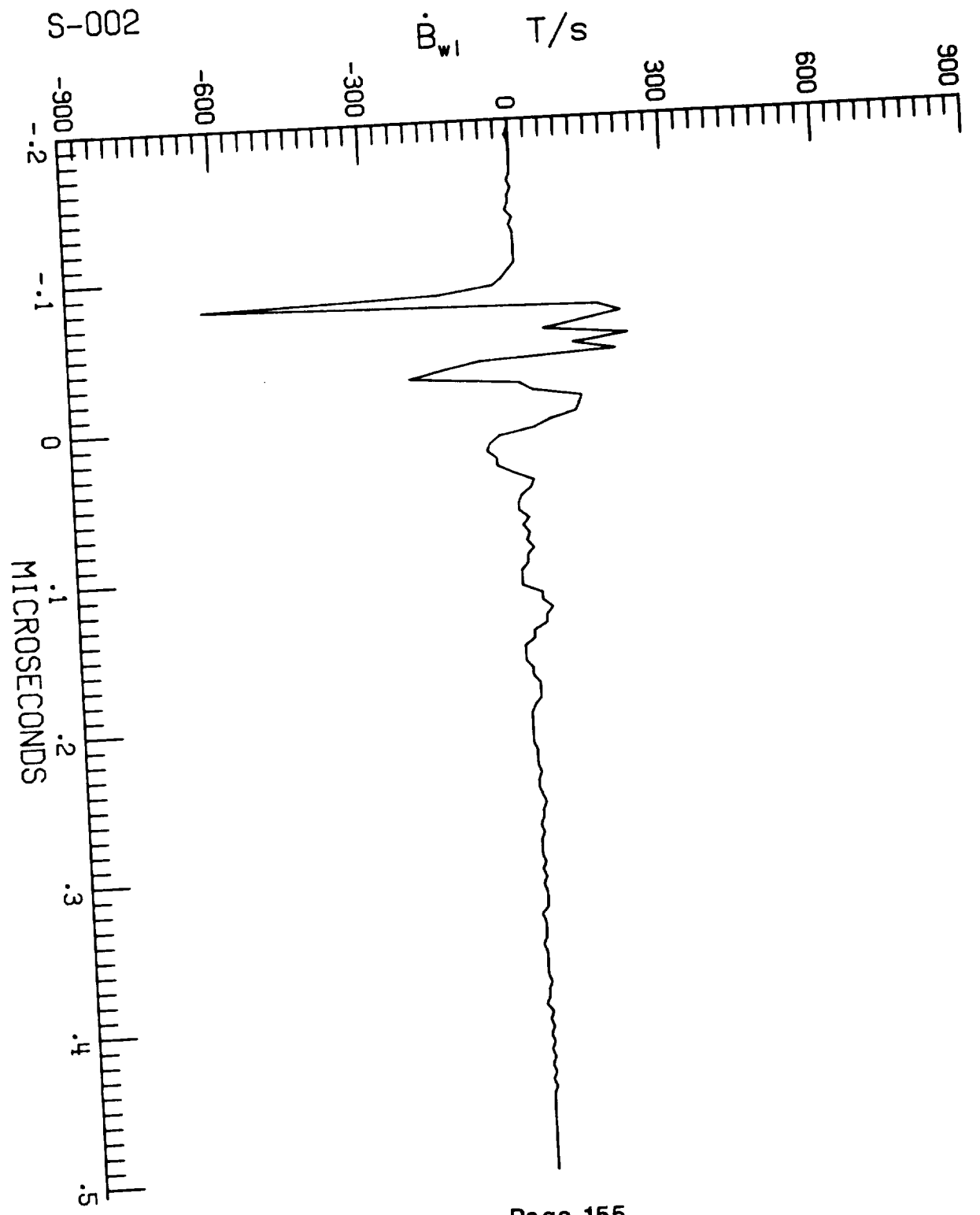

F106 LIGHTNING/85-023/ZAEPFEL

LEC 2 RUN NO. 5

S-002

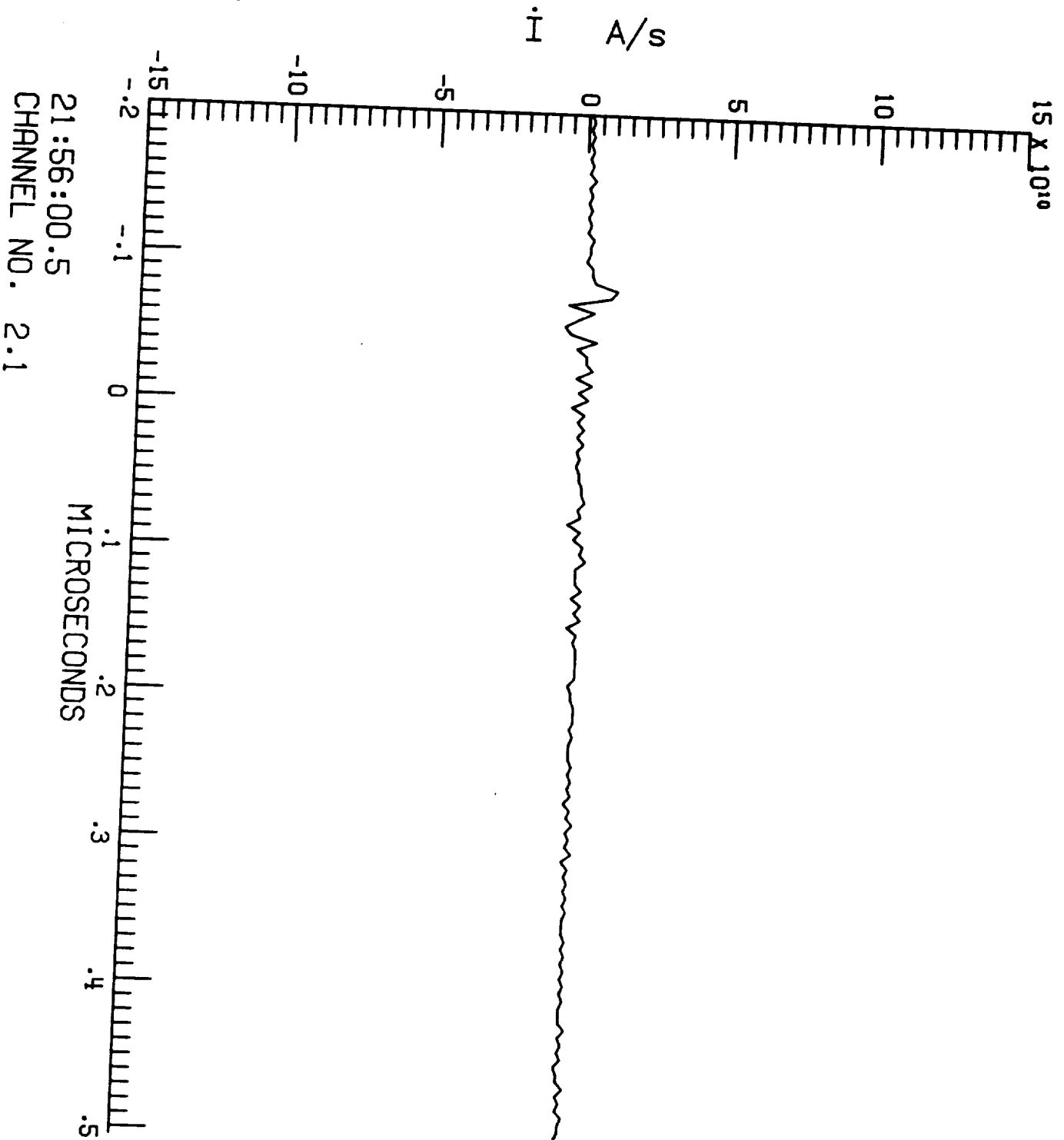



F106 LIGHTNING/85-023/ZAEPFEL  
LEC 2 RUN NO. 5  
S-002

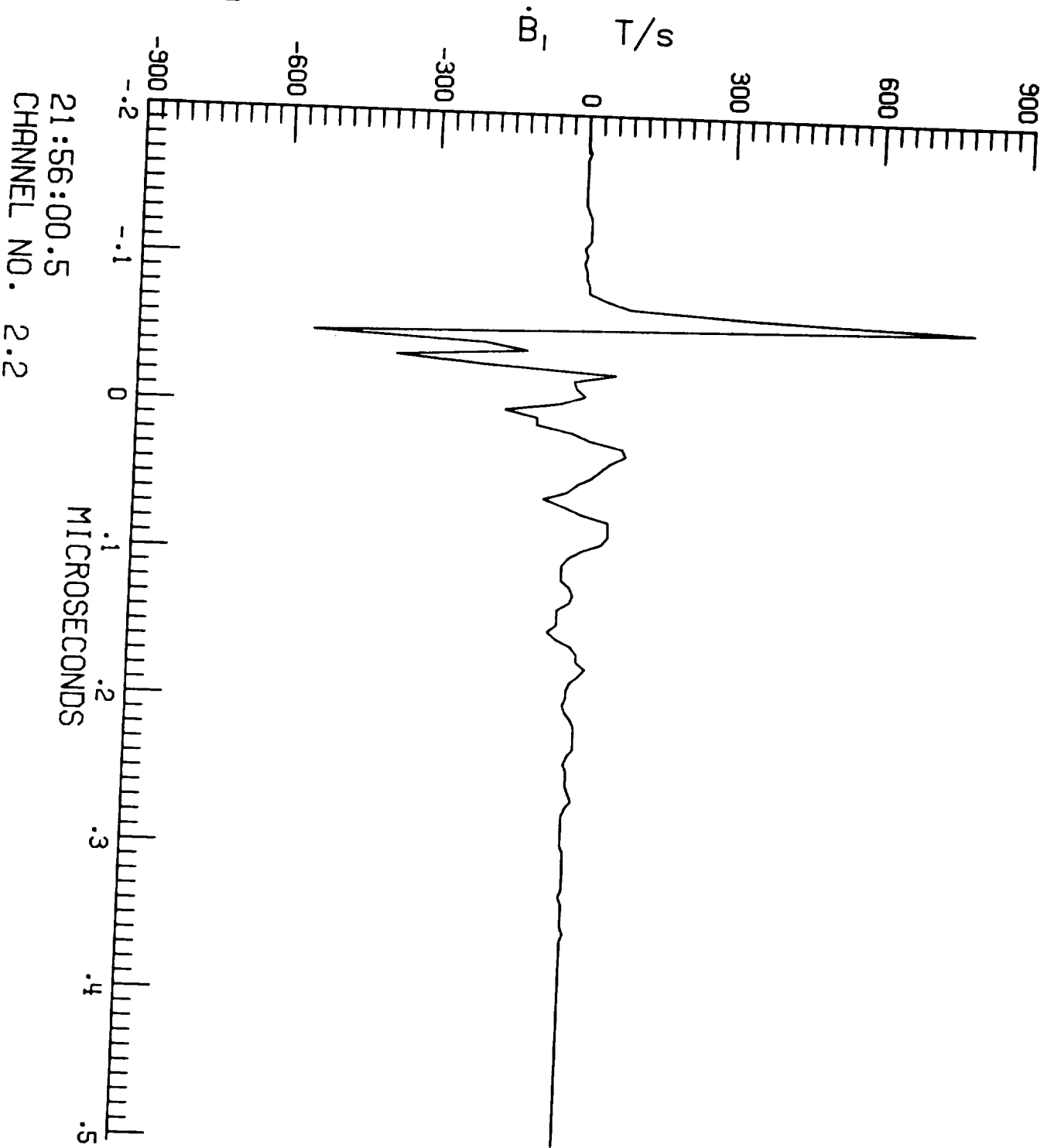

21:56:00.5  
CHANNEL NO. 2.2

F106 LIGHTNING/85-023/ZAEPFEL

LEC 3 RUN NO. 5

S-002

$\dot{D}_{wr}$  A/m<sup>2</sup>

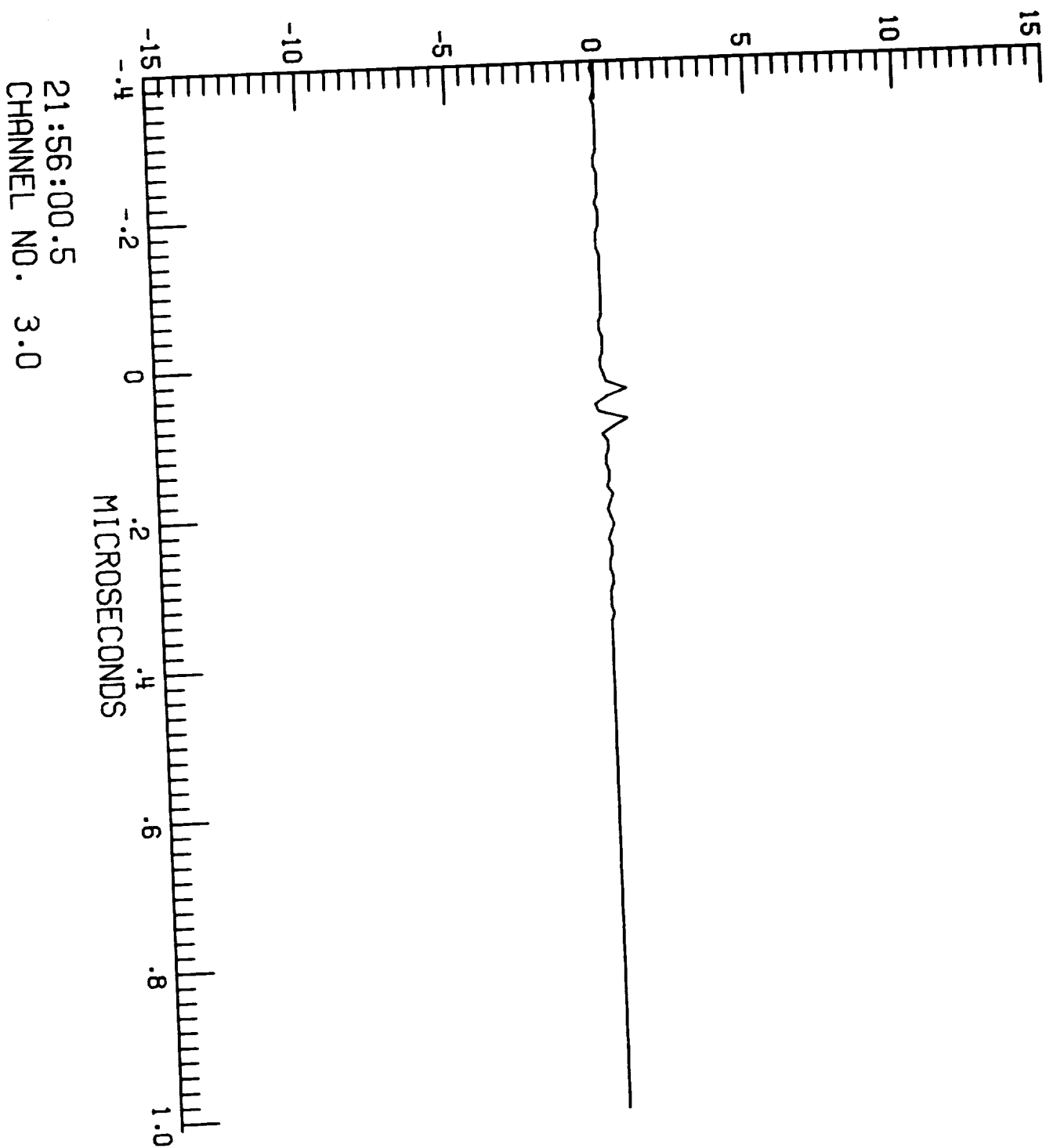

F106 LIGHTNING/85-023/ZAEPFEL

LEC 3 RUN NO. 5

S-002

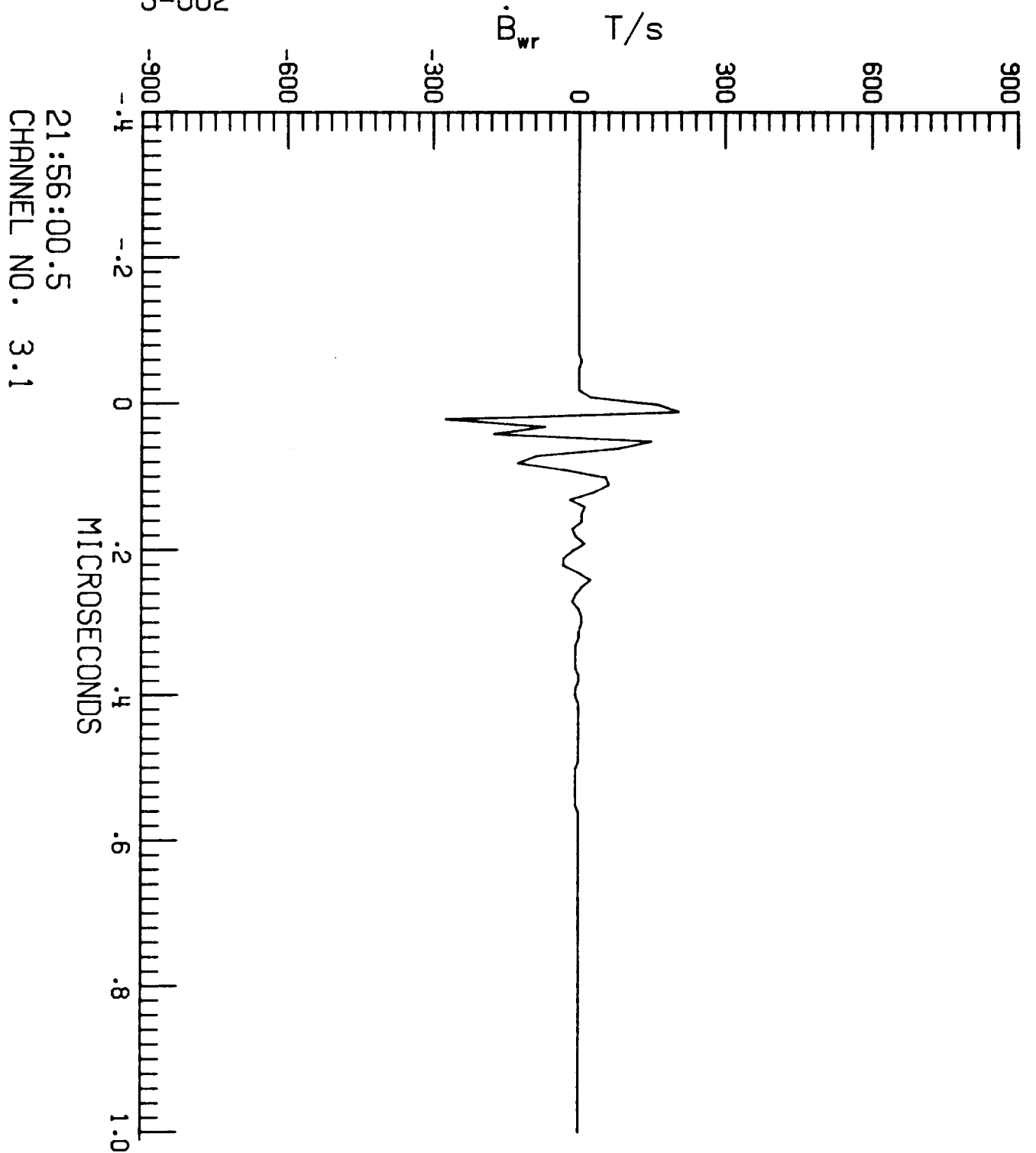

F106 LIGHTNING/85-023/ZAEPFEL

LEC 3 RUN NO. 5

S-002

$\dot{D}_f$  A/m<sup>2</sup>

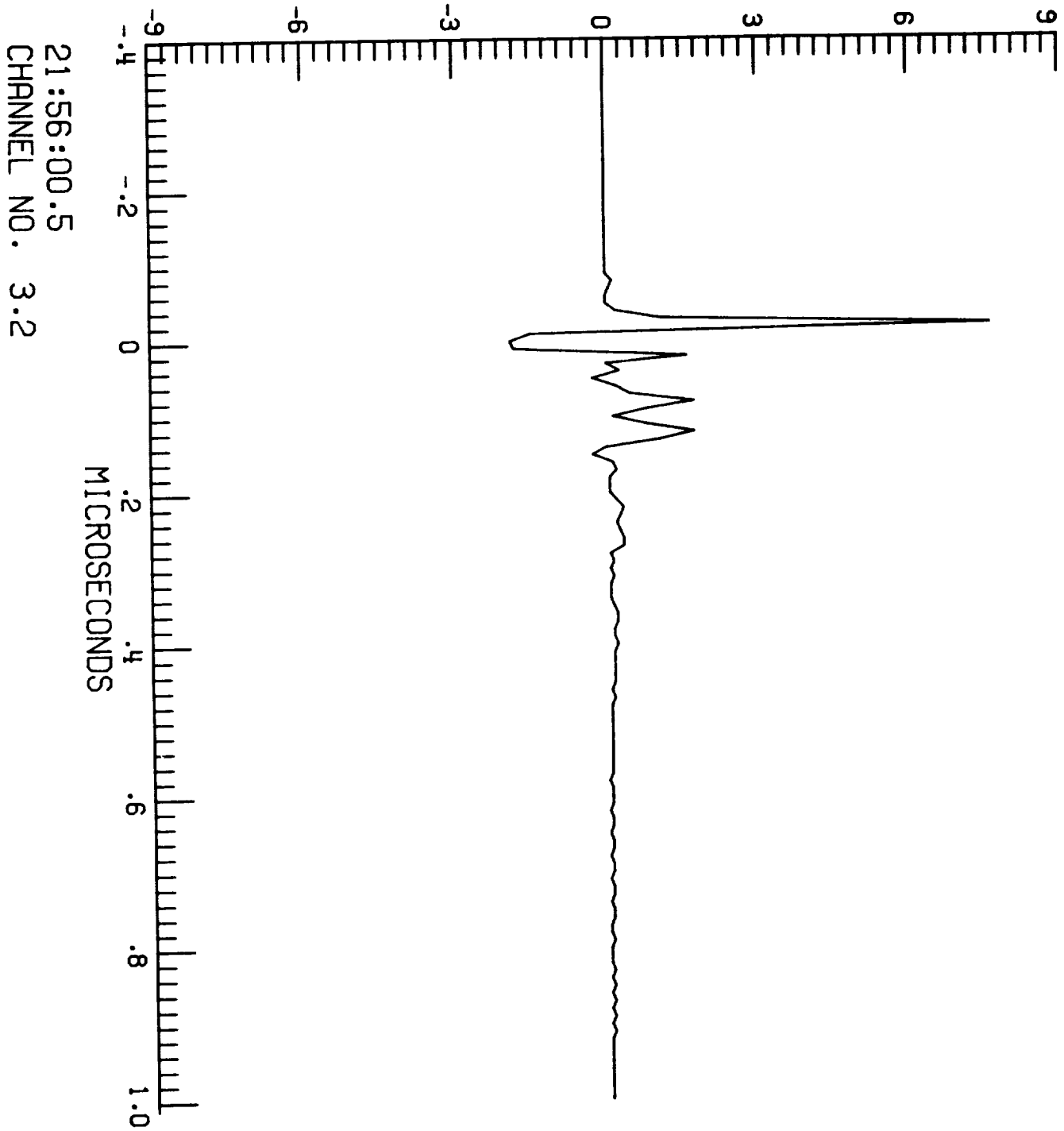

F106 LIGHTNING/85-023/ZAEPFEL

LEC 4 RUN NO. 5

S-002

TP100 V

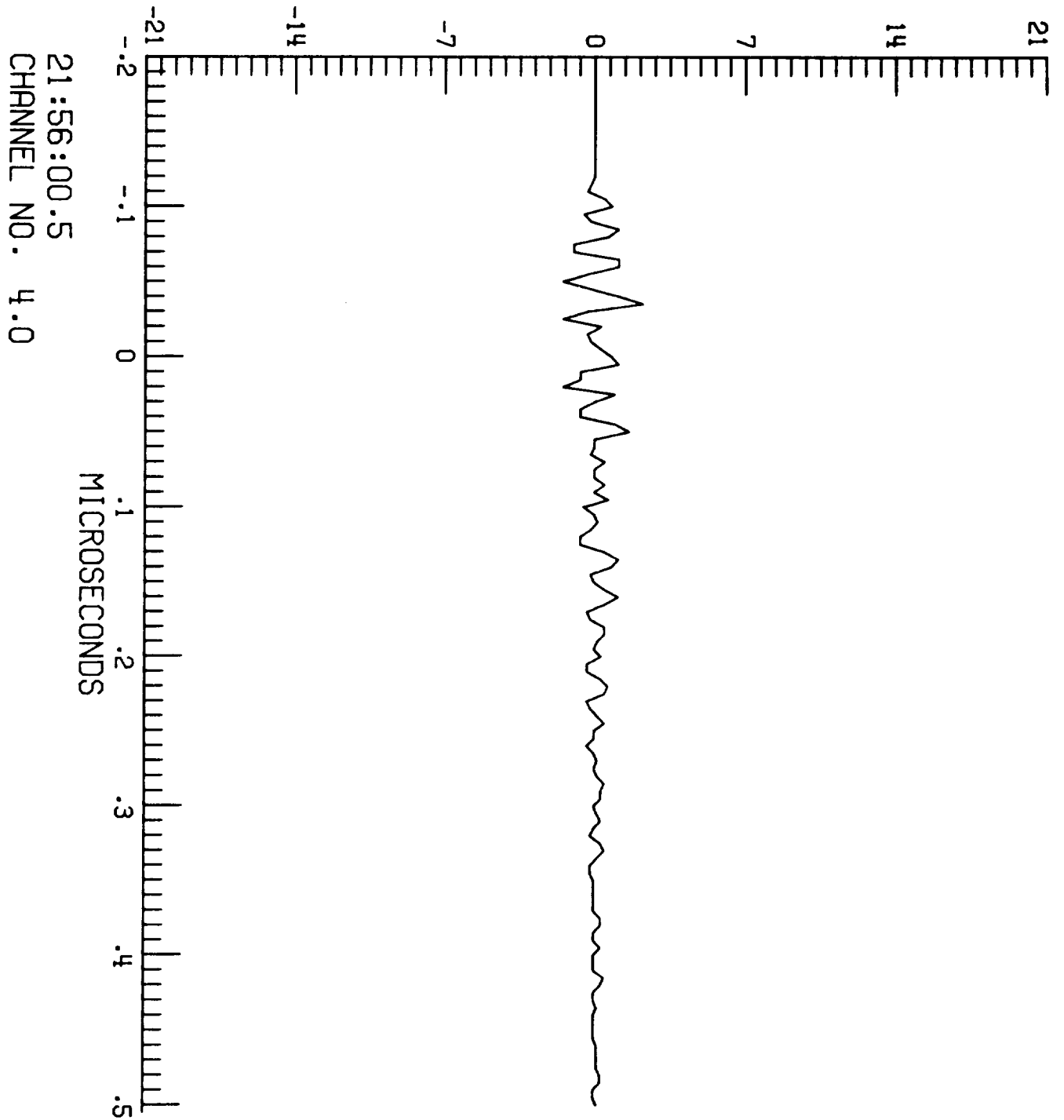

F106 LIGHTNING/85-023/ZAEPFEL

LEC 4 RUN NO. 5

S-002

TP106 A

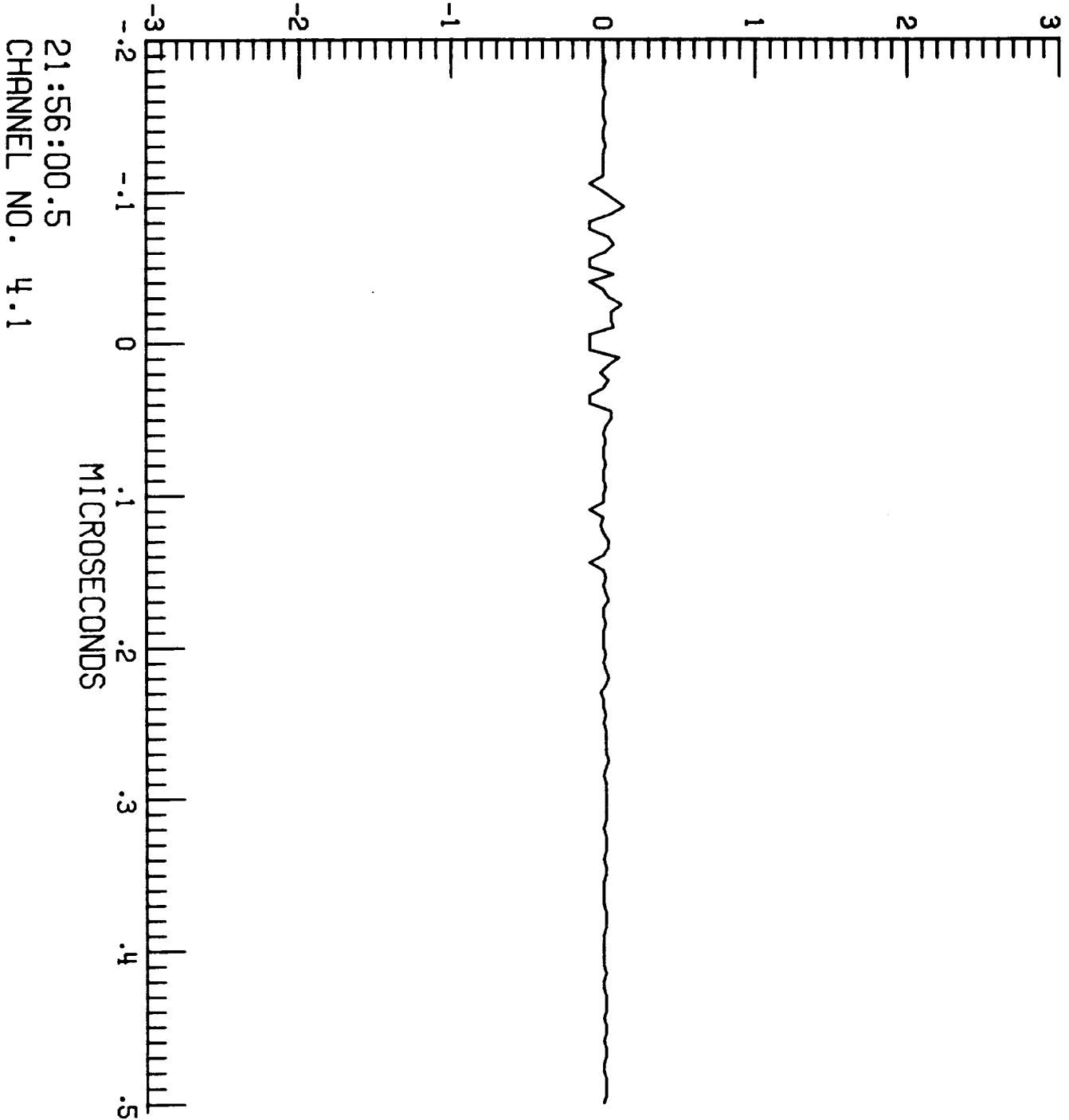

F106 LIGHTNING/85-023/ZAEPFEL

LEC 4 RUN NO. 5

S-002

TP125 A

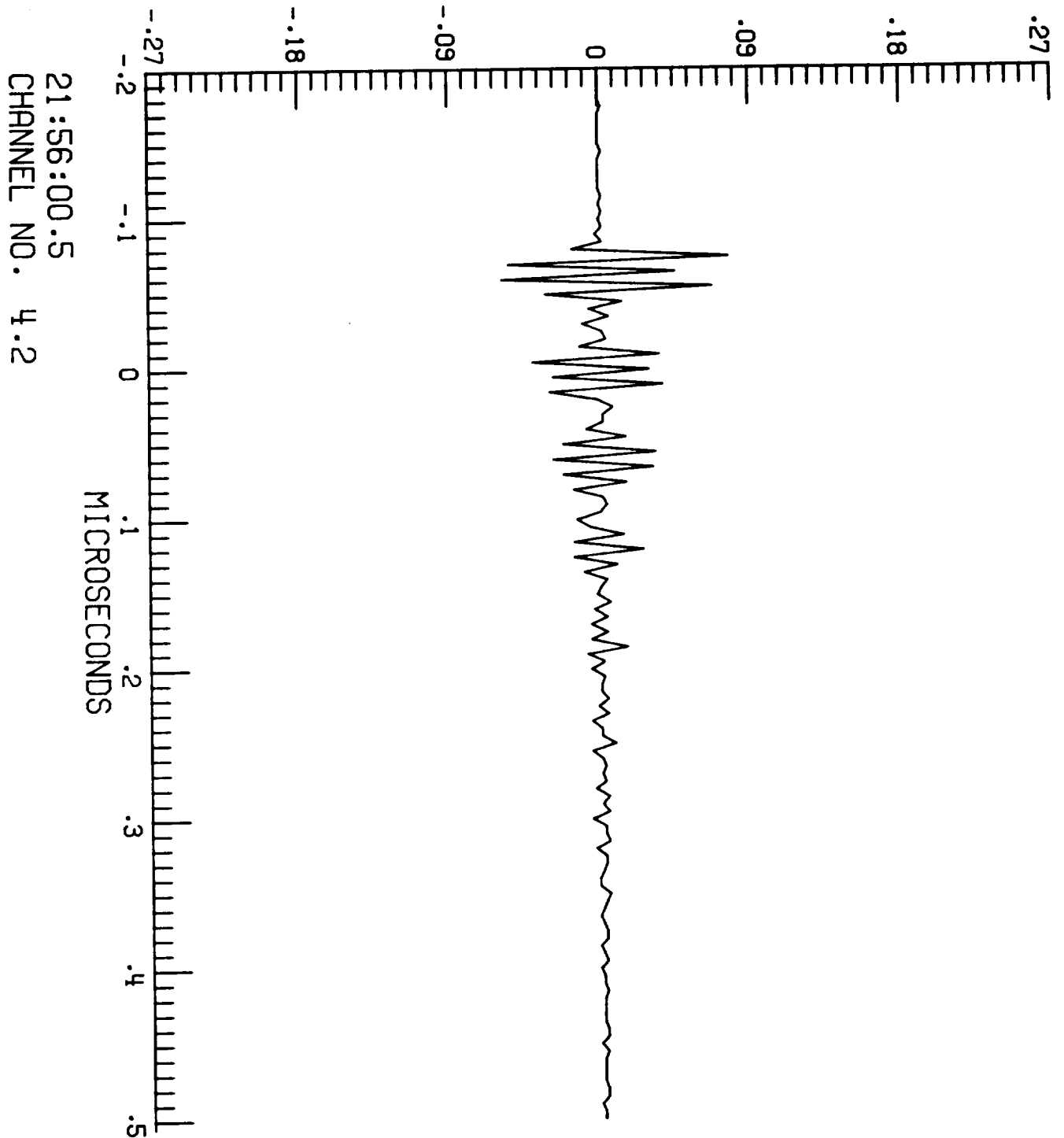

21:56:00.5  
CHANNEL NO. 4.2

F106 LIGHTNING/85-026/ZAEPFEL

LEC 1 RUN NO. 1

S-001

$\dot{D}_t$  A/m<sup>2</sup>

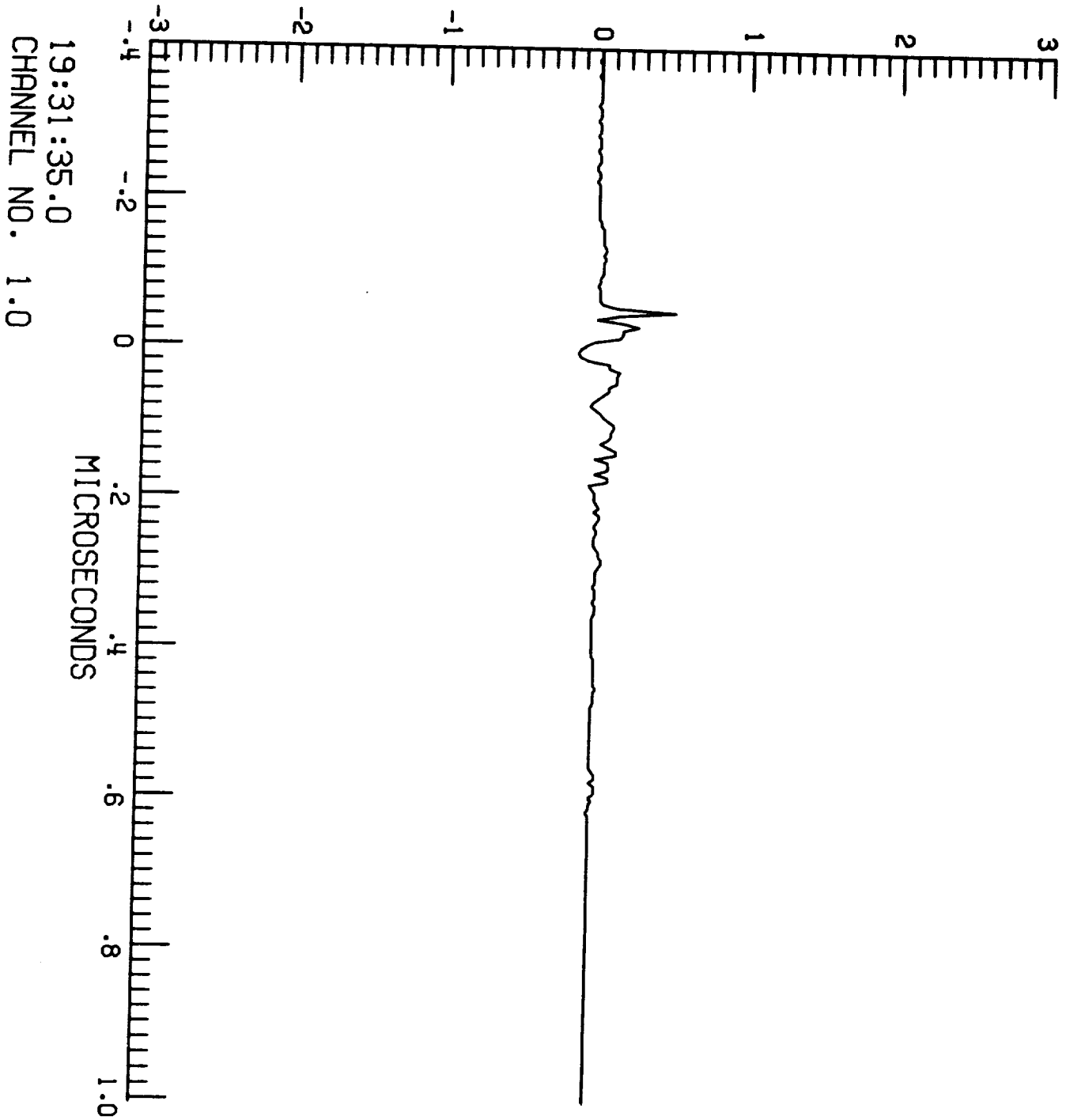



F106 LIGHTNING/85-026/ZAEPFEL

LEC 1 RUN NO. 1

S-001

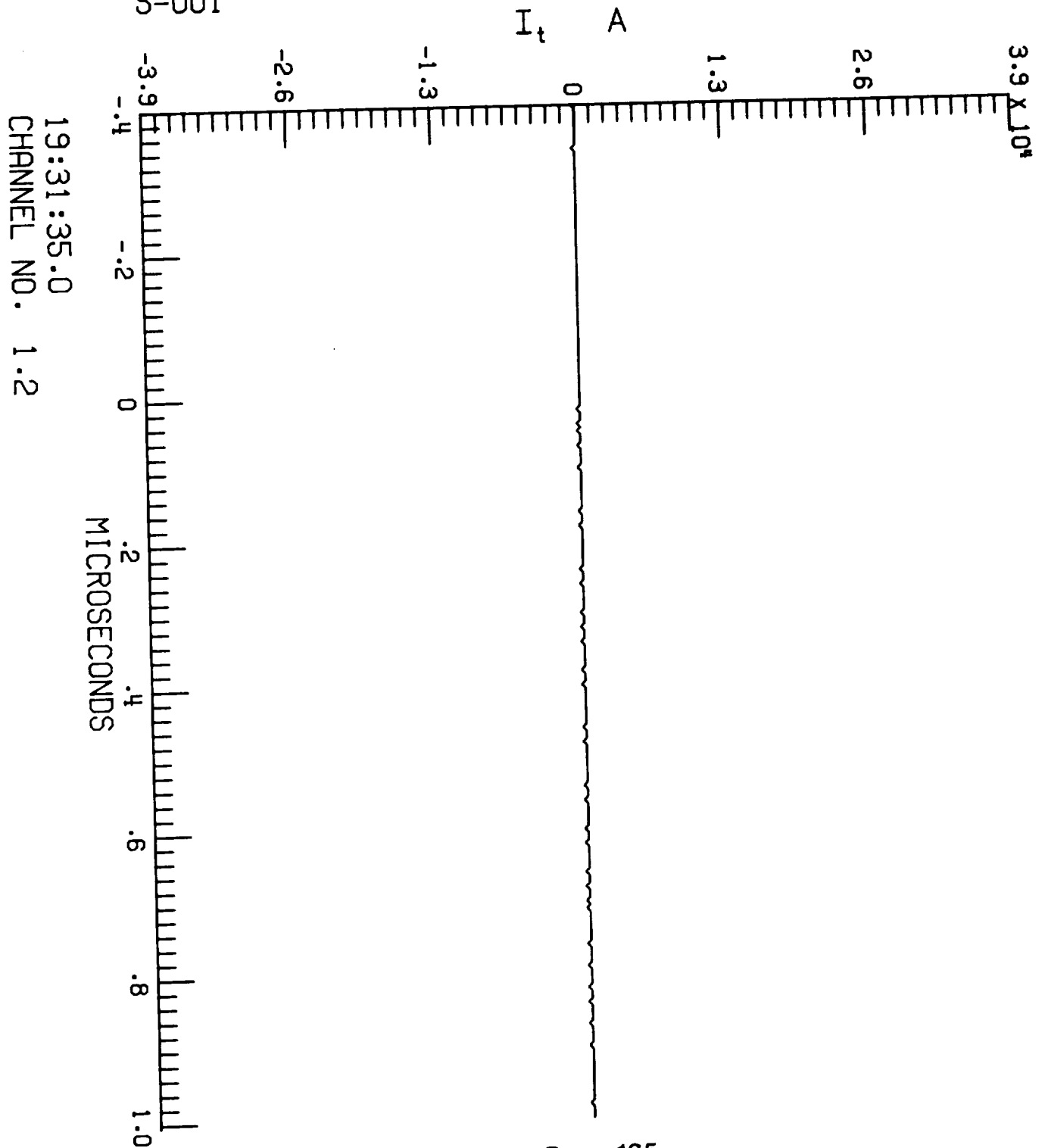

19:31:35.0  
CHANNEL NO. 1.2

F106 LIGHTNING/85-026/ZAEPFEL

LEC 2 RUN NO. 1

S=001

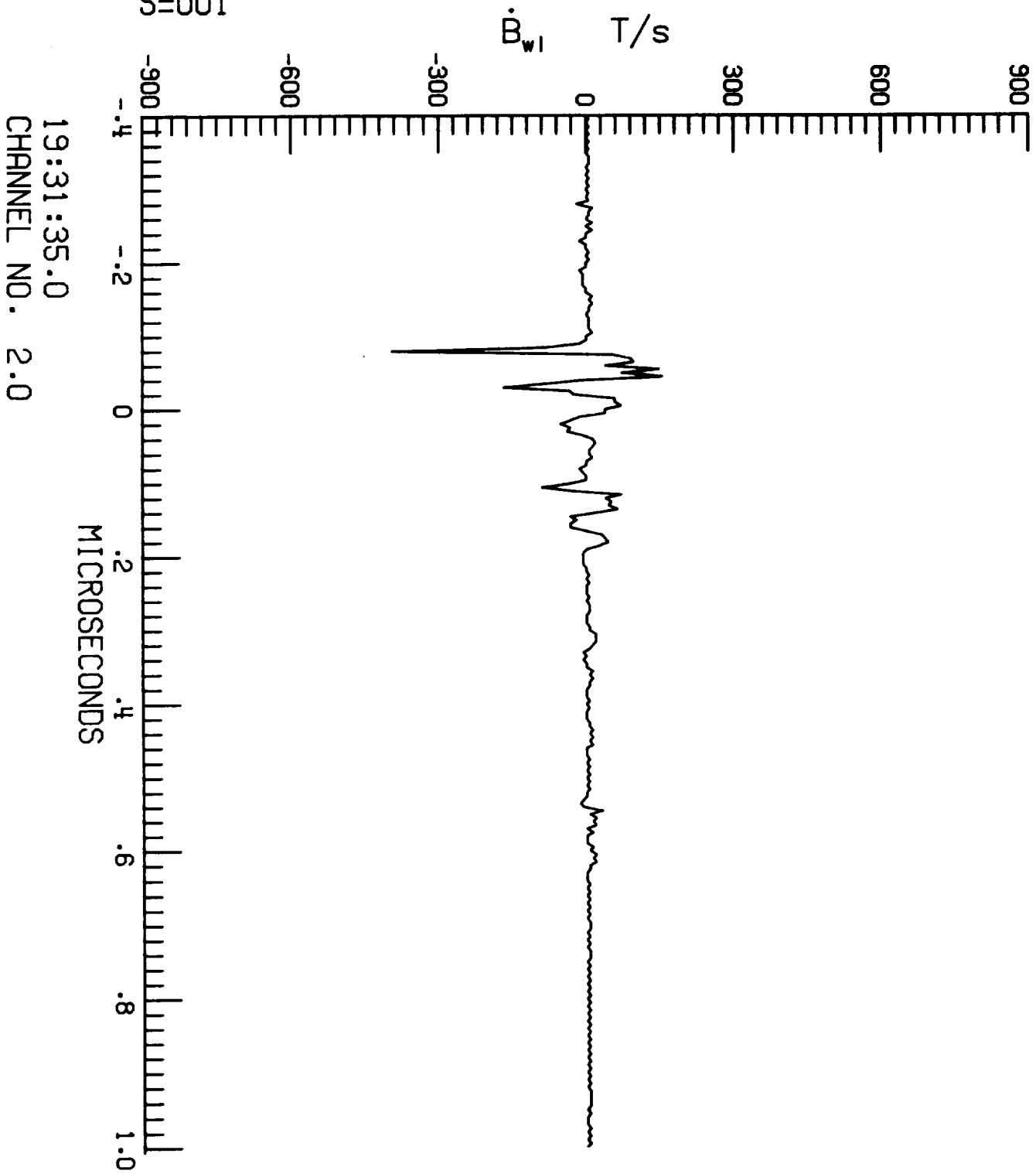

19:31:35.0  
CHANNEL NO. 2.0

F106 LIGHTNING/85-026/ZAEPFEL

LEC 2 RUN NO. 1

S=001

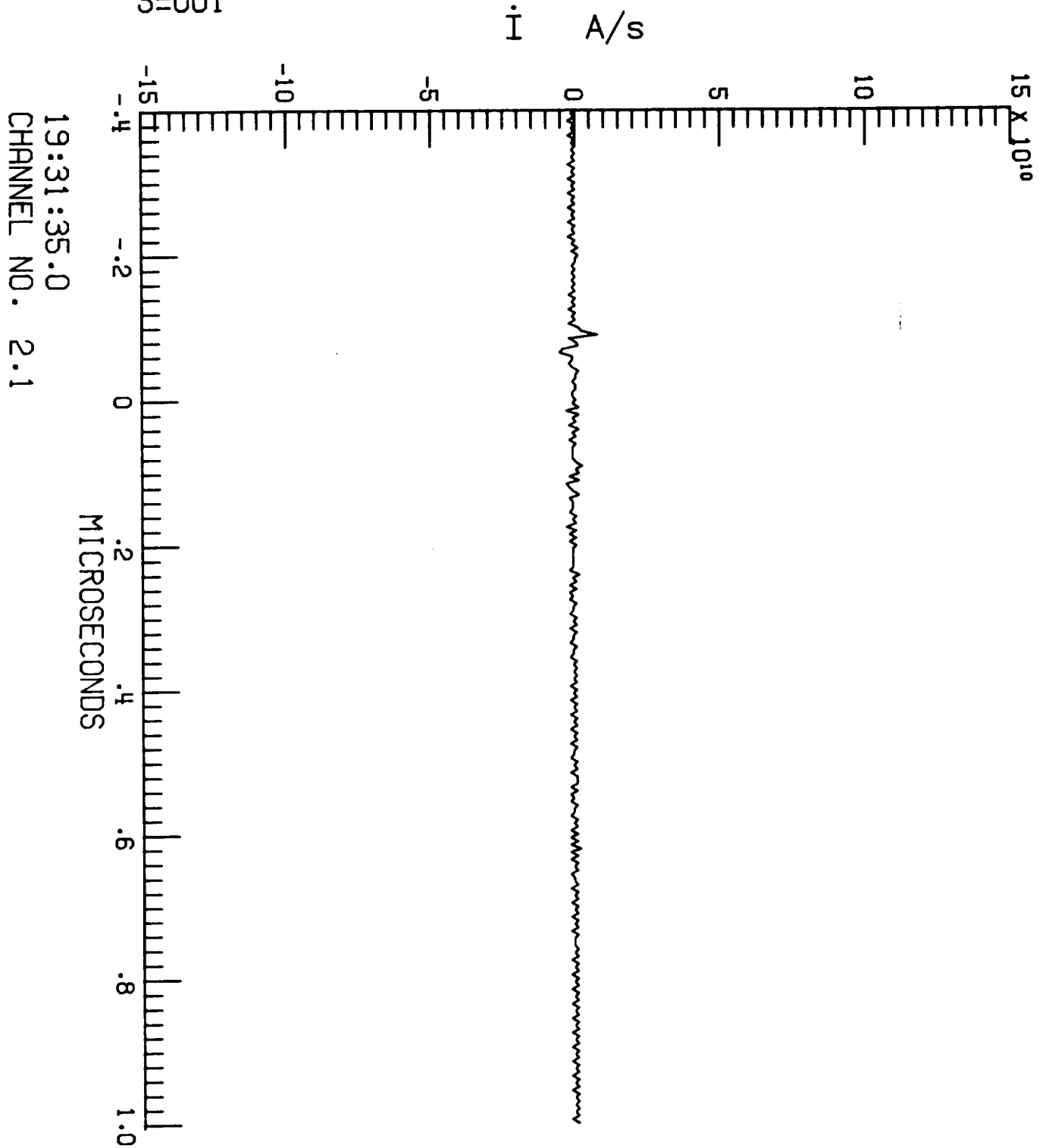

F106 LIGHTNING/85-026/ZAEPFEL

LEC 2 RUN NO. 1

S=001

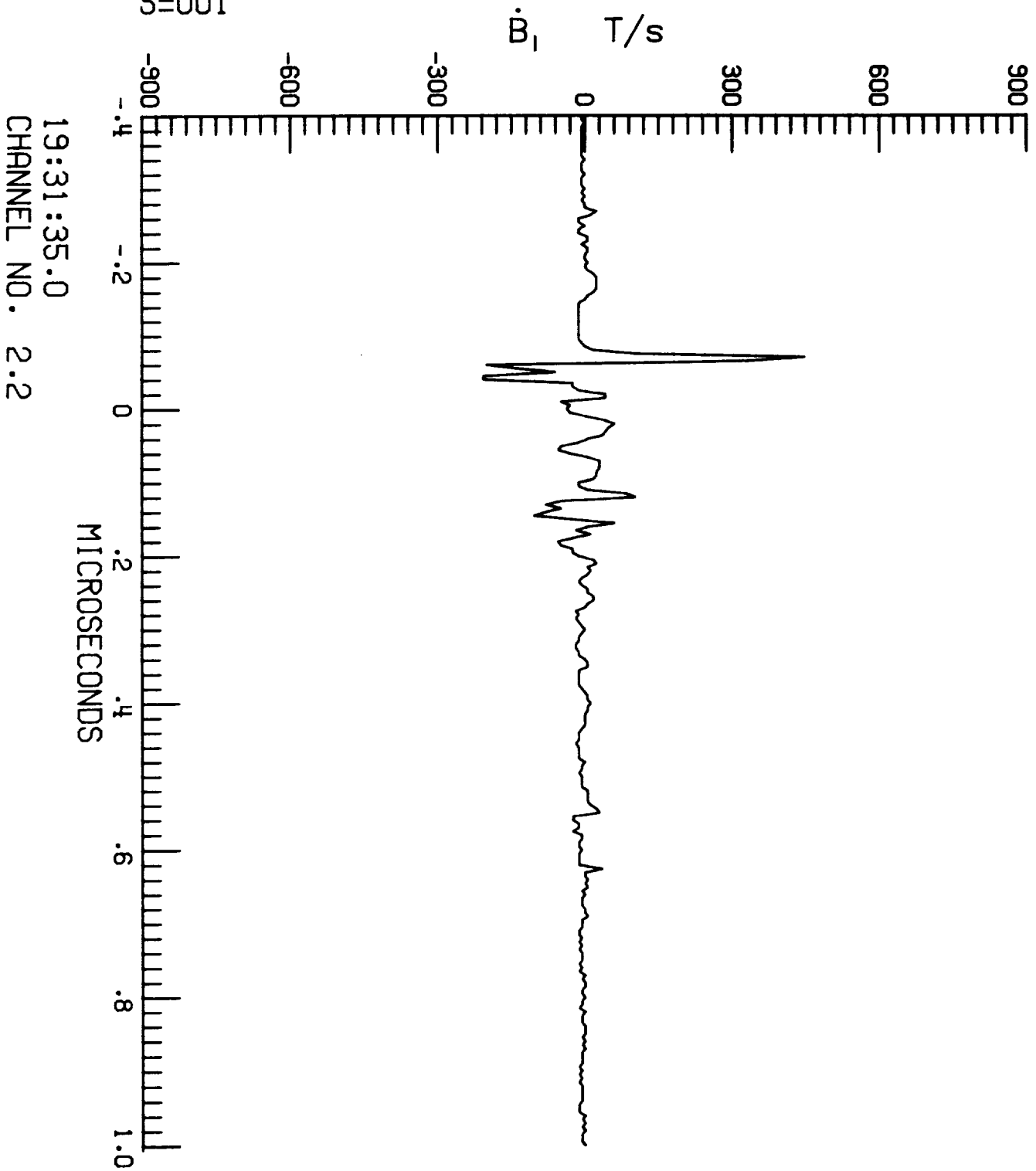

F106 LIGHTNING/85-026/ZAEPFEL

LEC 3 RUN NO. 1

S-001

$\dot{D}_{wr}$  A/m<sup>2</sup>

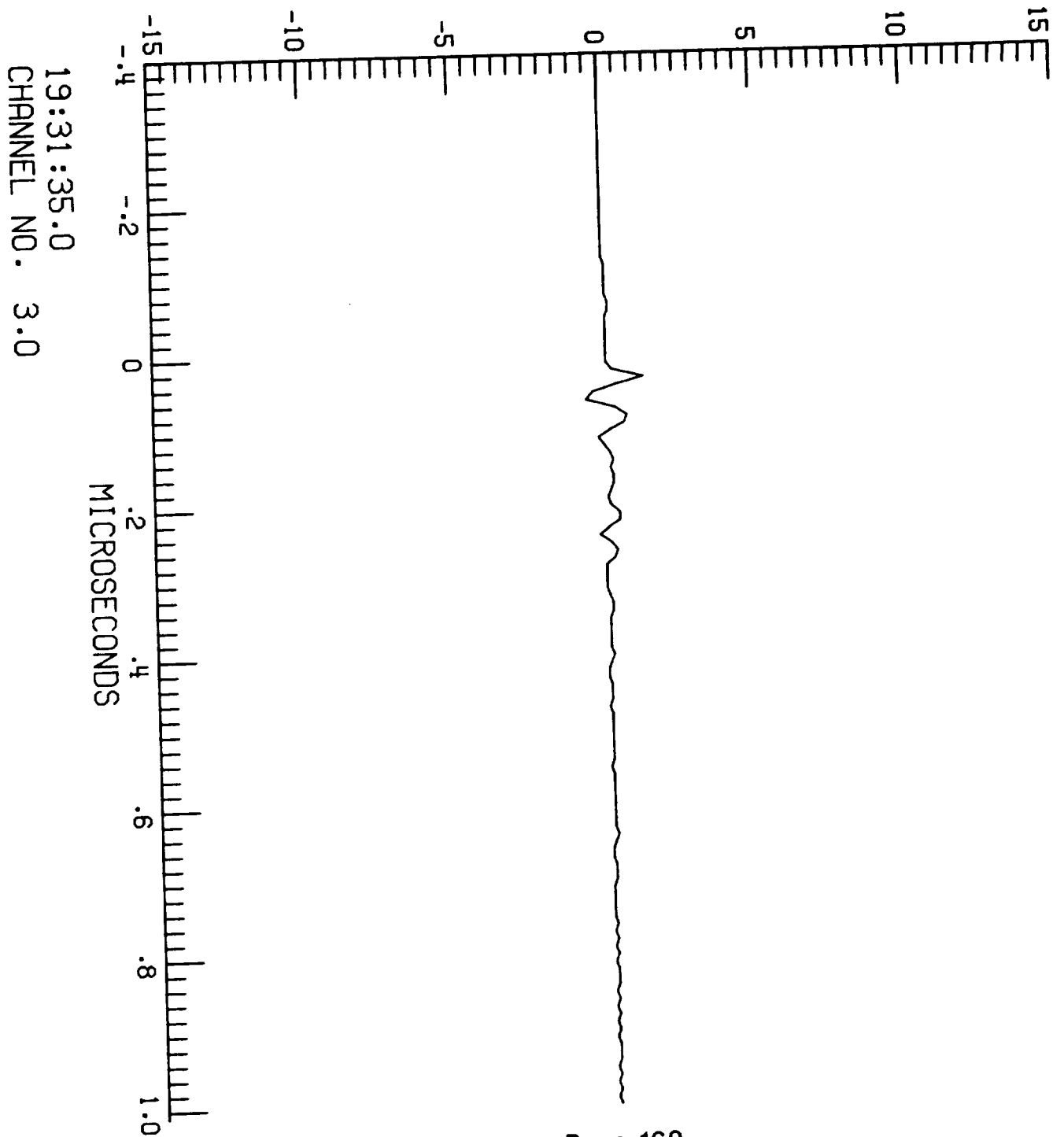

F106 LIGHTNING/85-026/ZAEPFEL

LEC 3 RUN NO. 1

S-001

$\dot{D}_{wr}$  A/m<sup>2</sup>

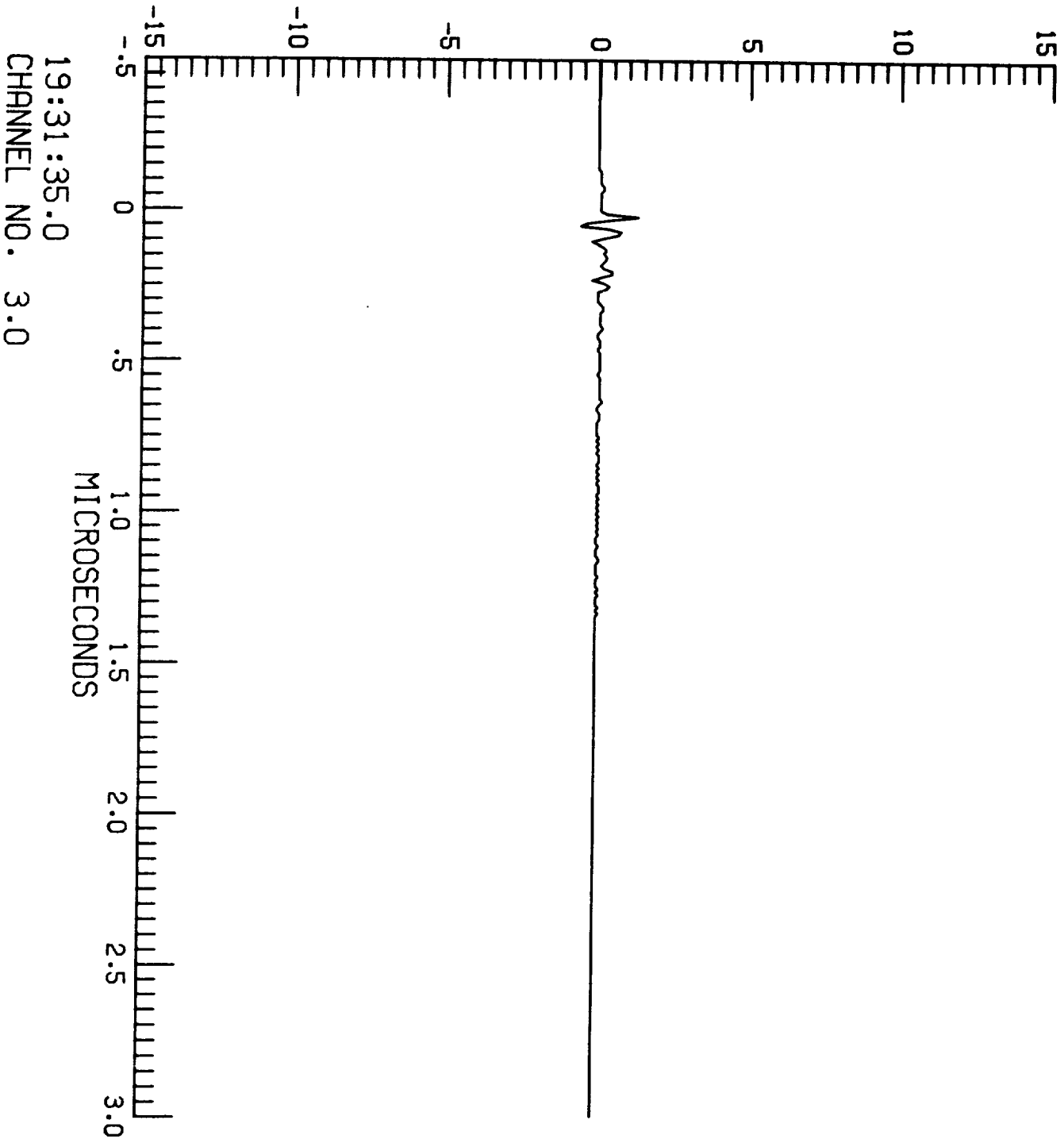

F106 LIGHTNING/85-026/ZAEPFEL

LEC 3 RUN NO. 1

S-001

19:31:35.0  
CHANNEL NO. 3.1

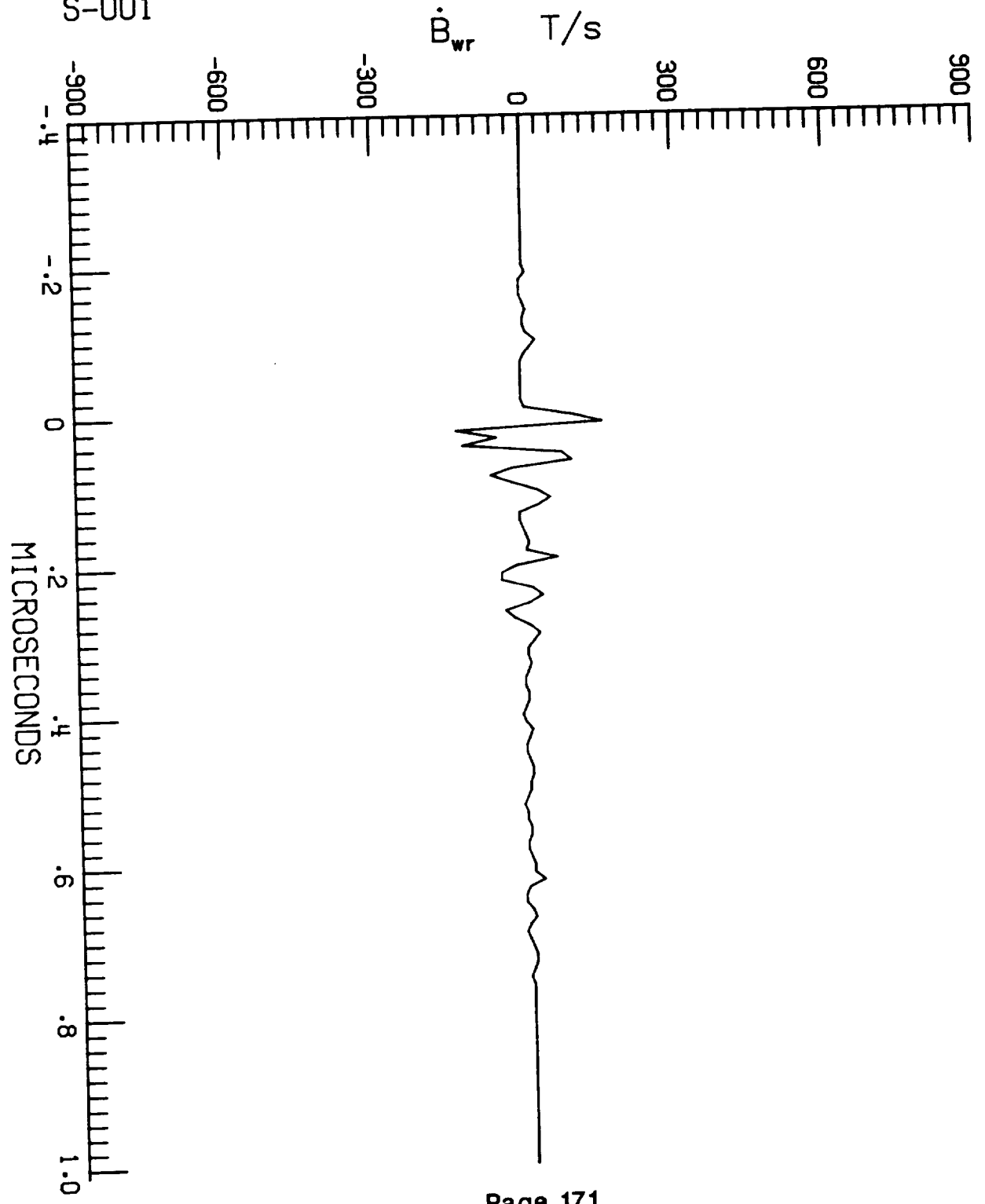

F106 LIGHTNING/85-026/ZAEPFEL

LEC 3 RUN NO. 1

S-001

$\dot{D}_f$  A/m<sup>2</sup>

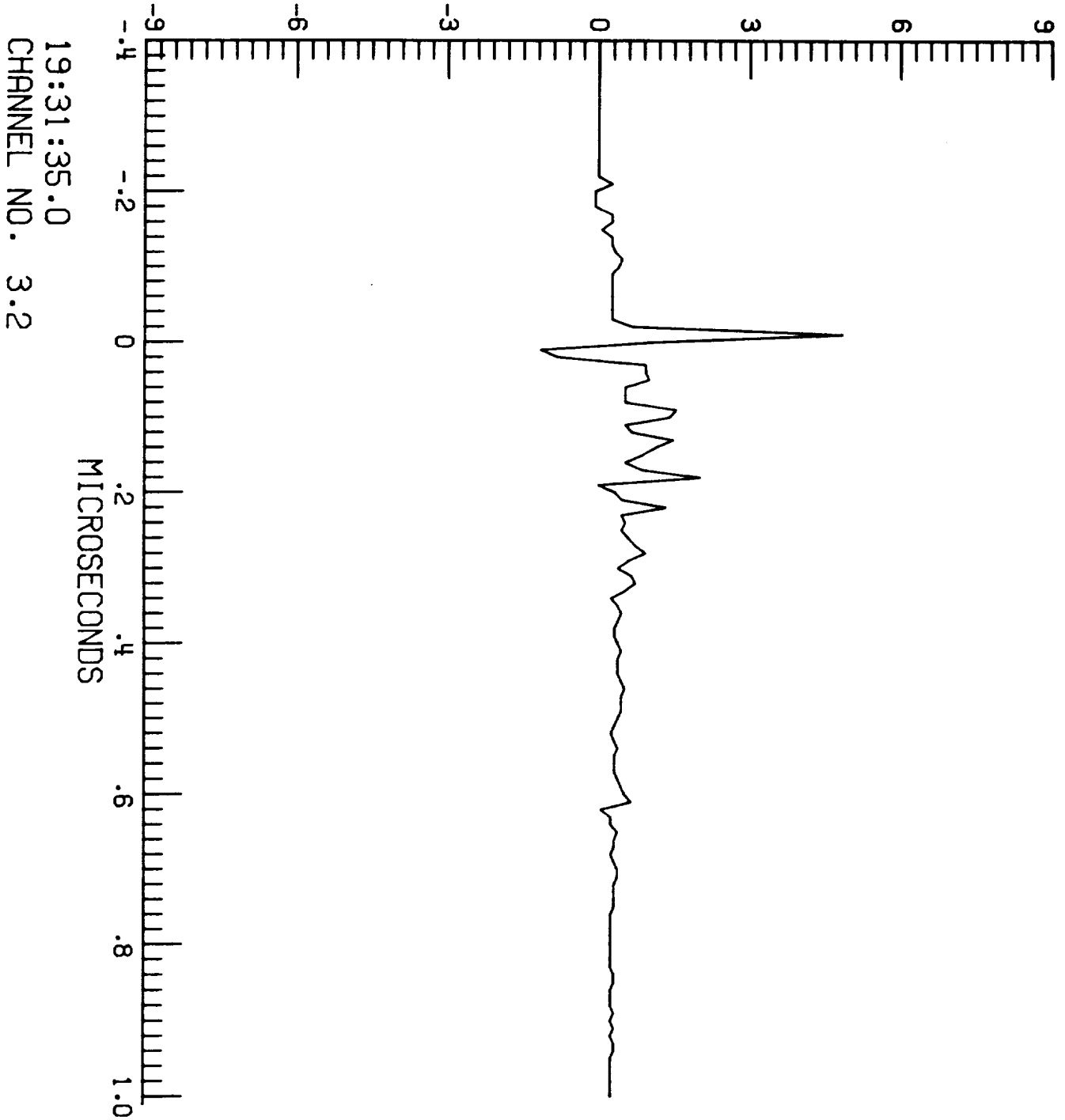

19:31:35.0  
CHANNEL NO. 3.2



F106 LIGHTNING/85-026/ZAEPFEL

LEC 3 RUN NO. 1

S-001

$\dot{D}_f$  A/m<sup>2</sup>

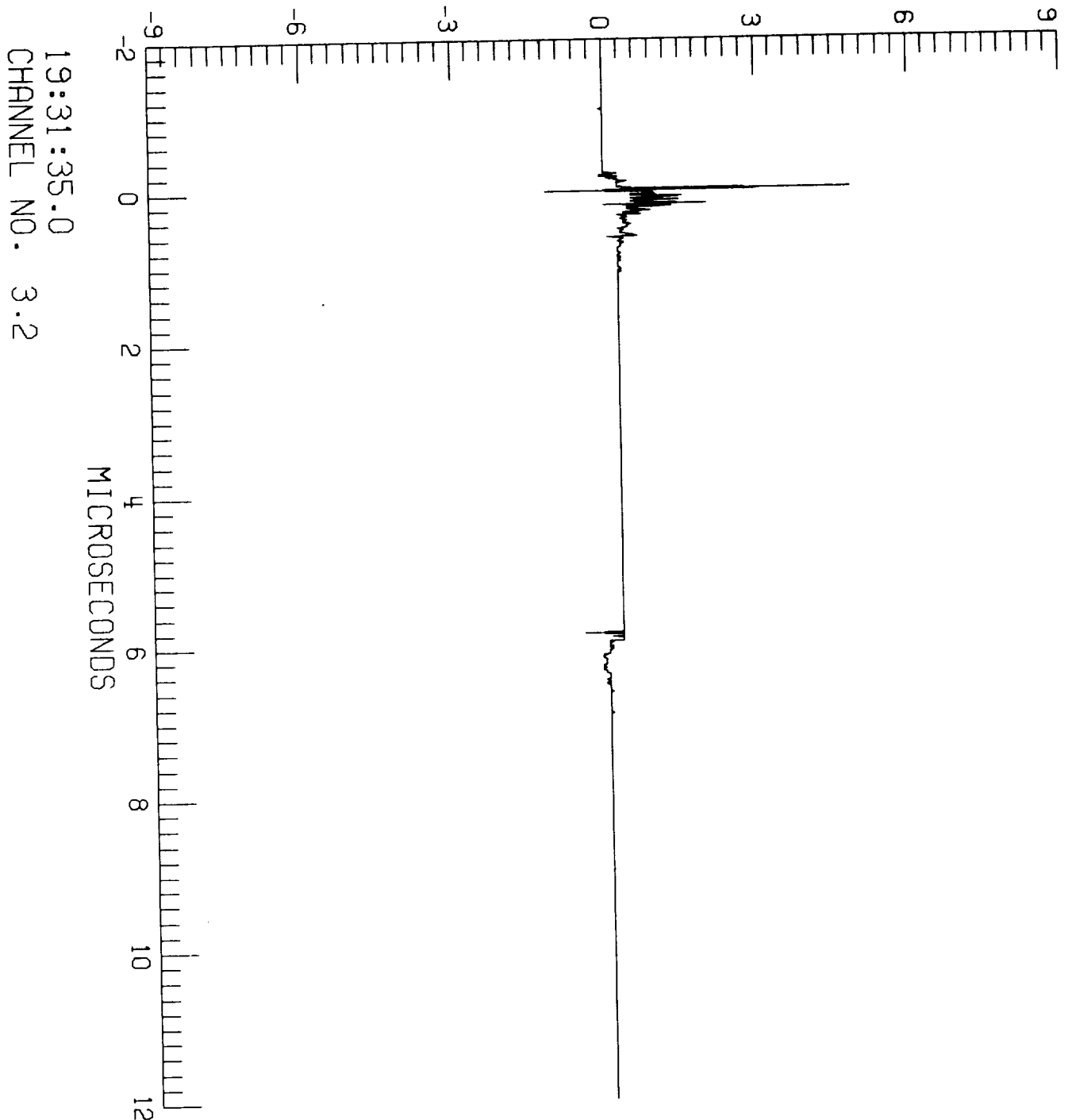

F106 LIGHTNING/85-026/ZAEPFEL

LEC 4 RUN NO. 1

S-001

TP100 V

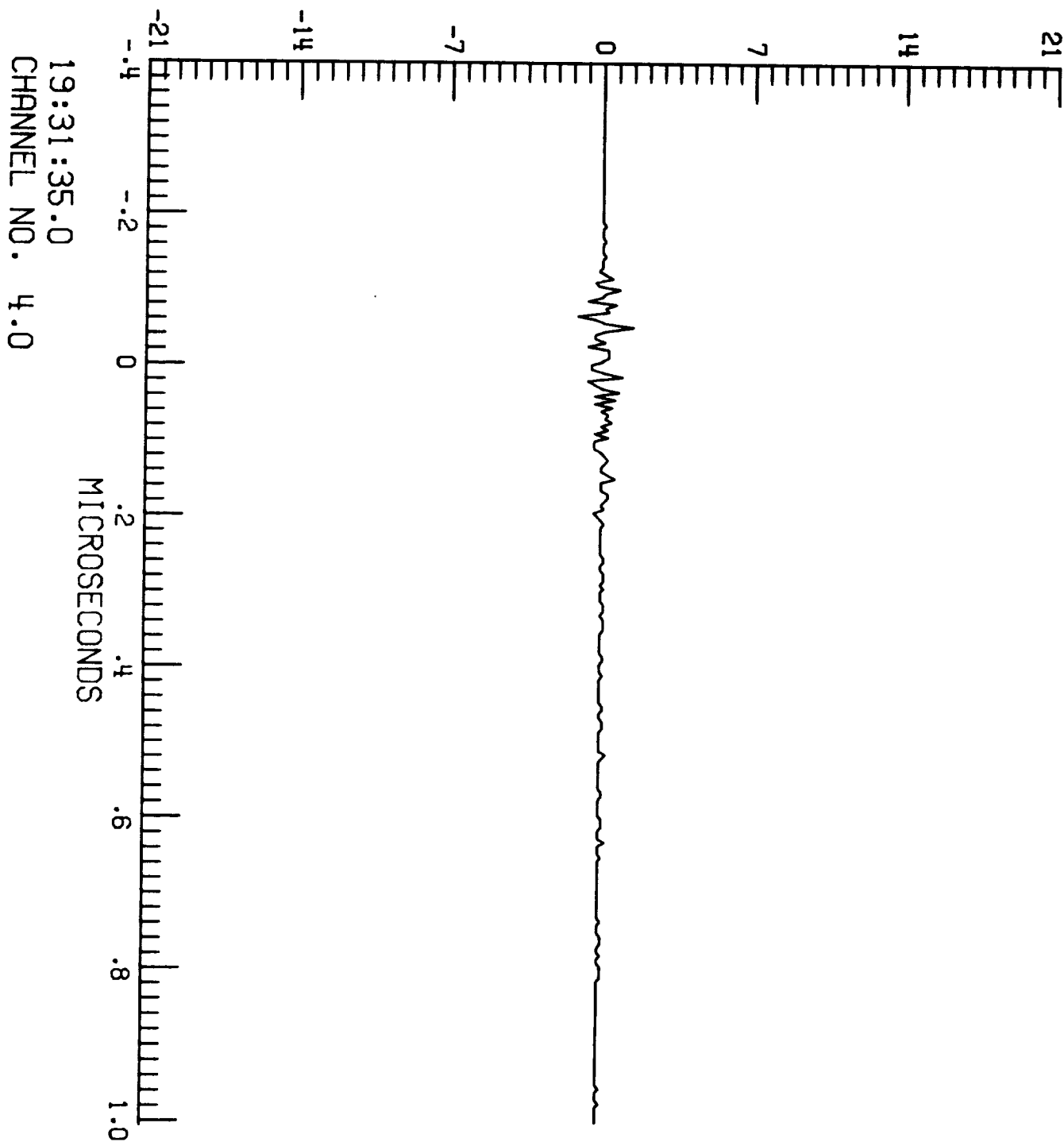

F106 LIGHTNING/85-026/ZAEPFEL

LEC 4 RUN NO. 1

S-001

TP106 A

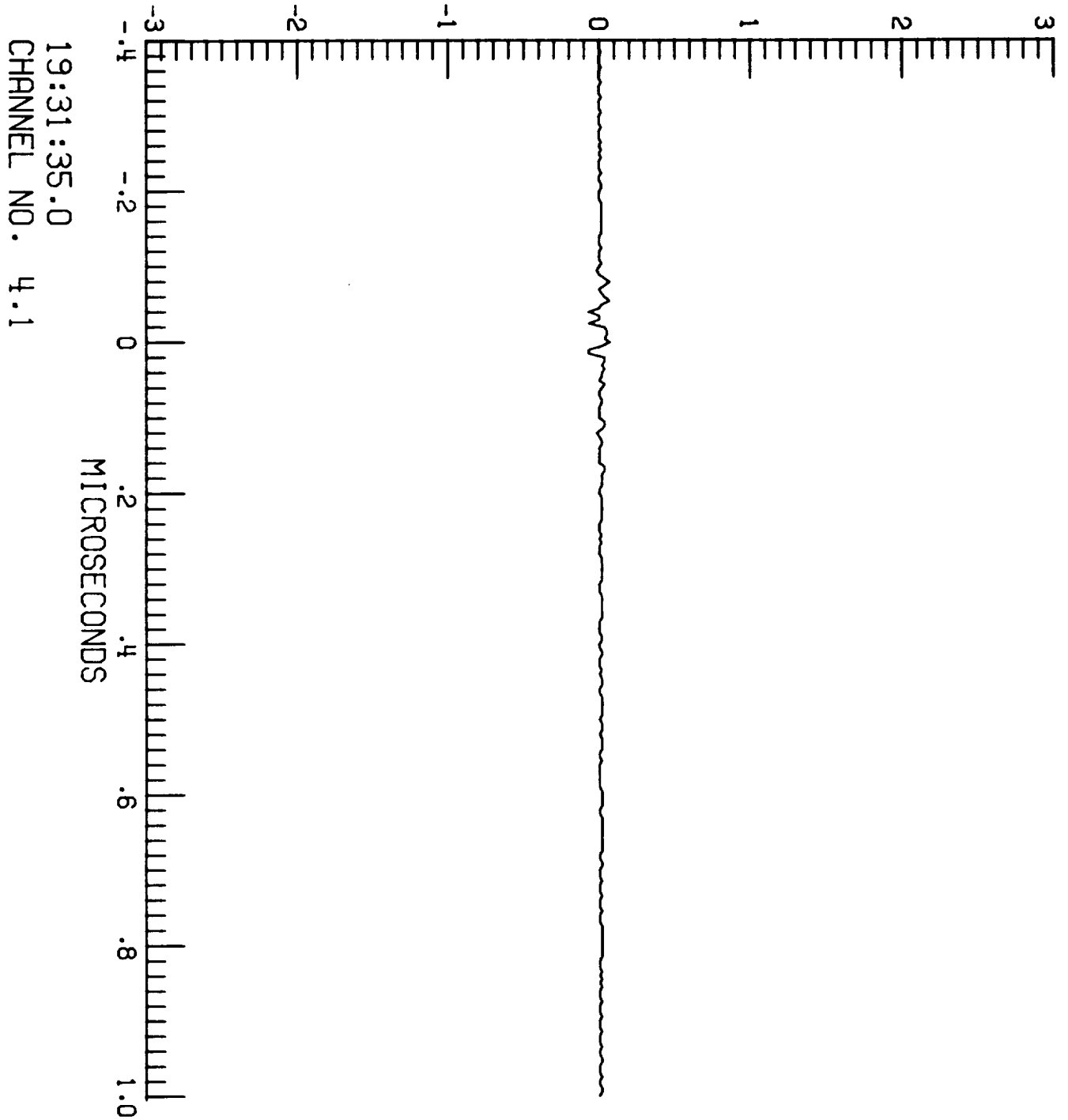

19:31:35.0  
CHANNEL NO. 4.1

F106 LIGHTNING/85-026/ZAEPFEL

LEC 4 RUN NO. 1

S-001

TP125 A

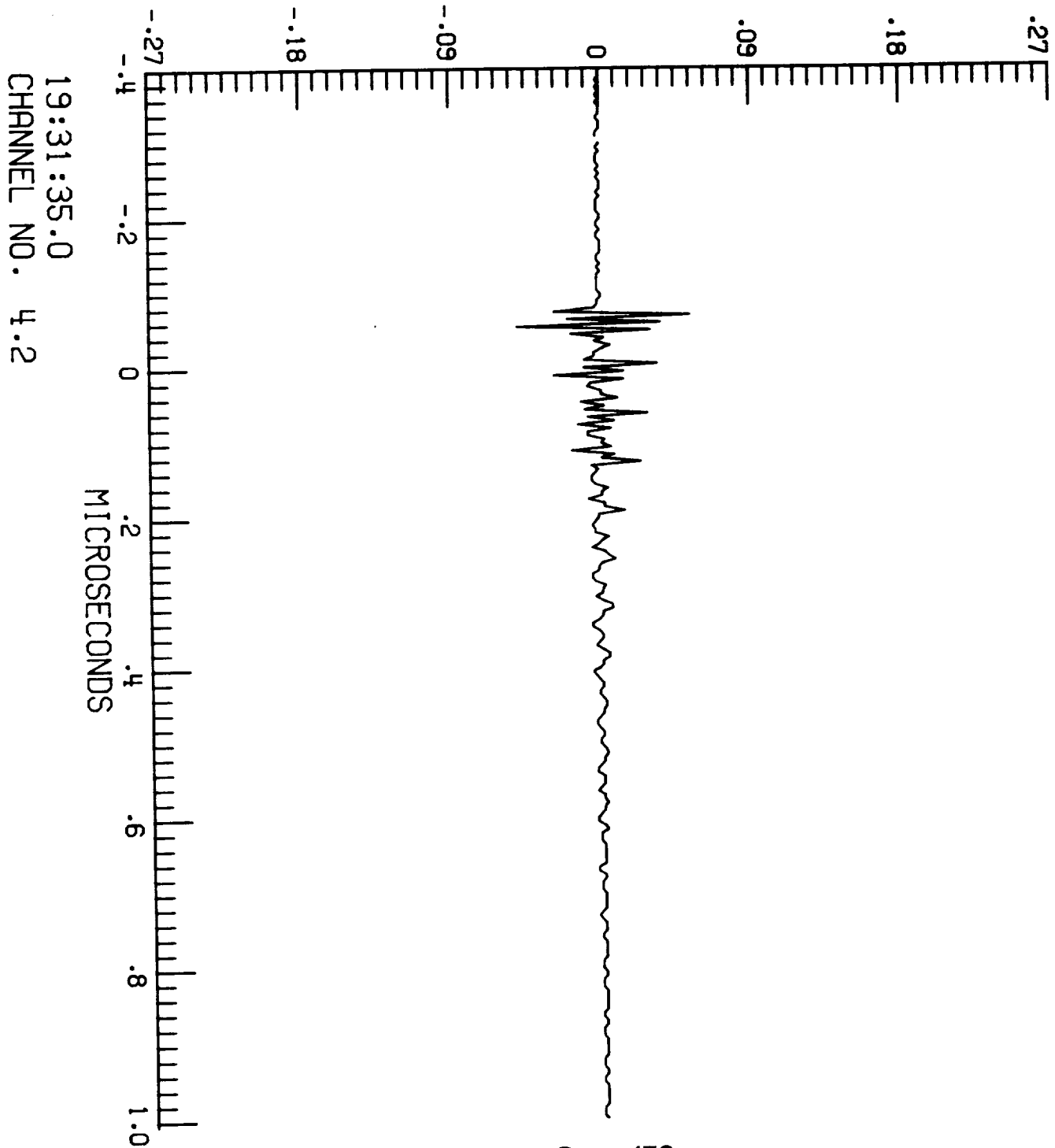

19:31:35.0  
CHANNEL NO. 4.2

F106 LIGHTNING/85-026/ZAEPFEL

LEC 1 RUN NO. 2

S-002

$\dot{D}_t$  A/m<sup>2</sup>

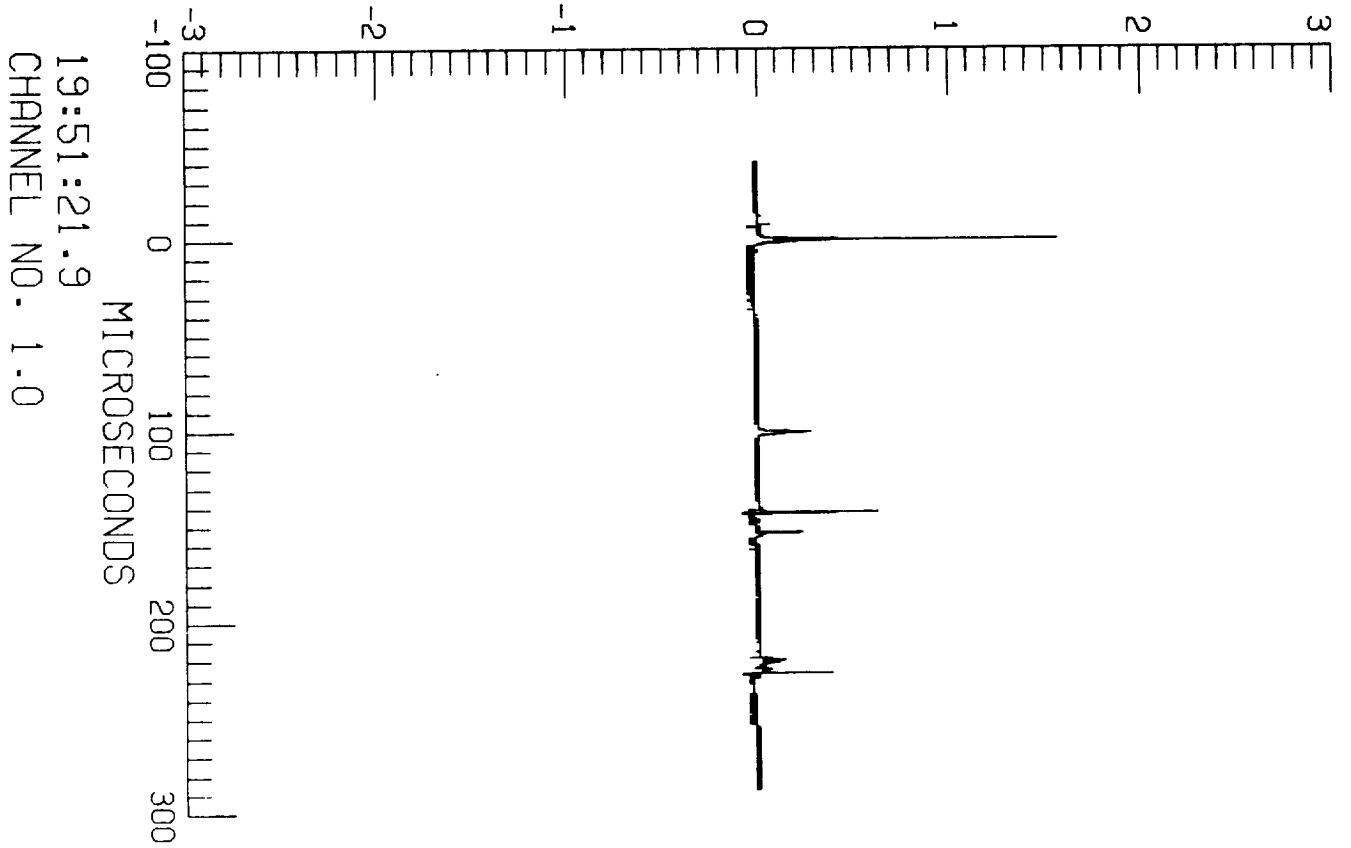

F106 LIGHTNING/85-026/ZAEPFEL

LEC 1

RUN NO. 2

S-002

$I_t$  A

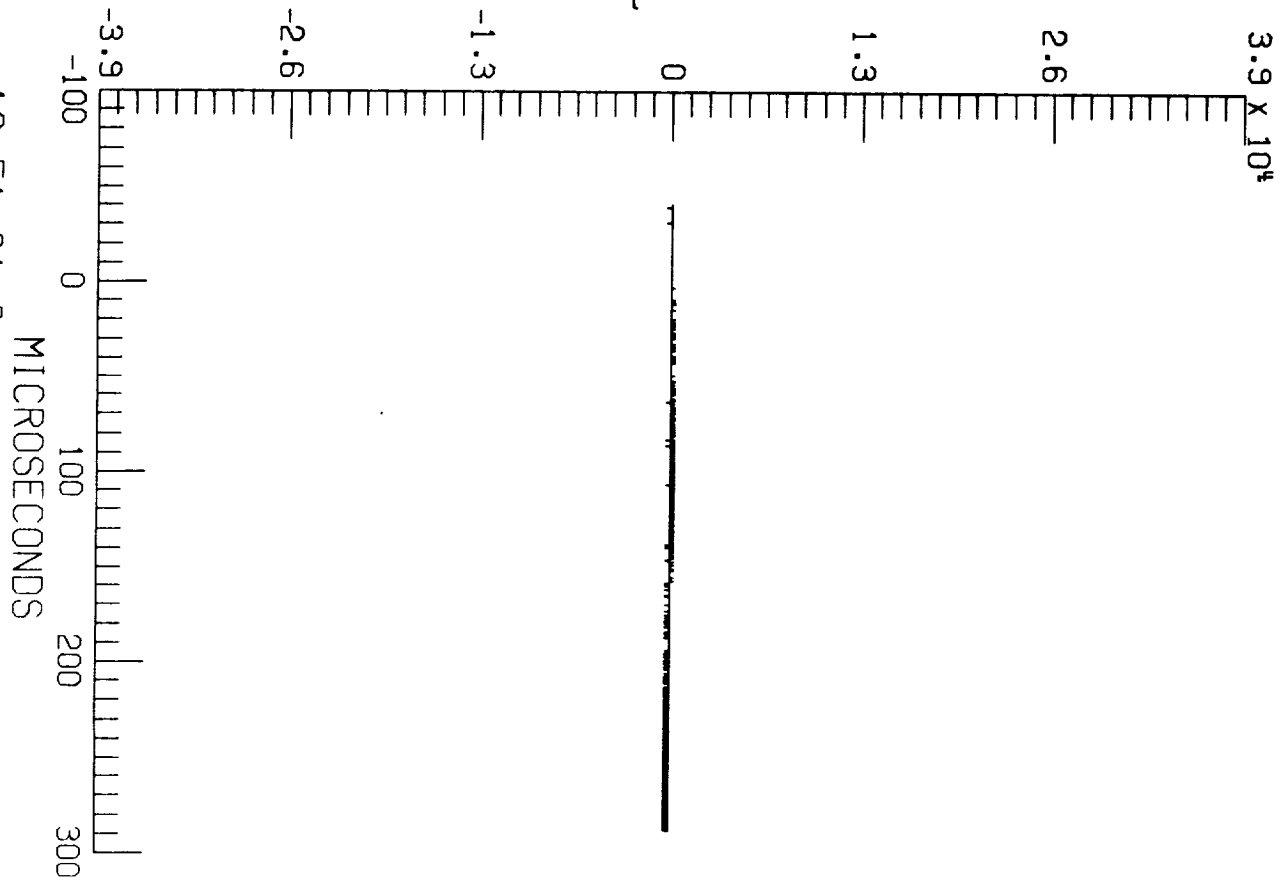

19:51:21.9  
CHANNEL NO. 1.2

F106 LIGHTNING/85-026/ZAEPFEL

LEC 2

RUN NO. 2

S-002

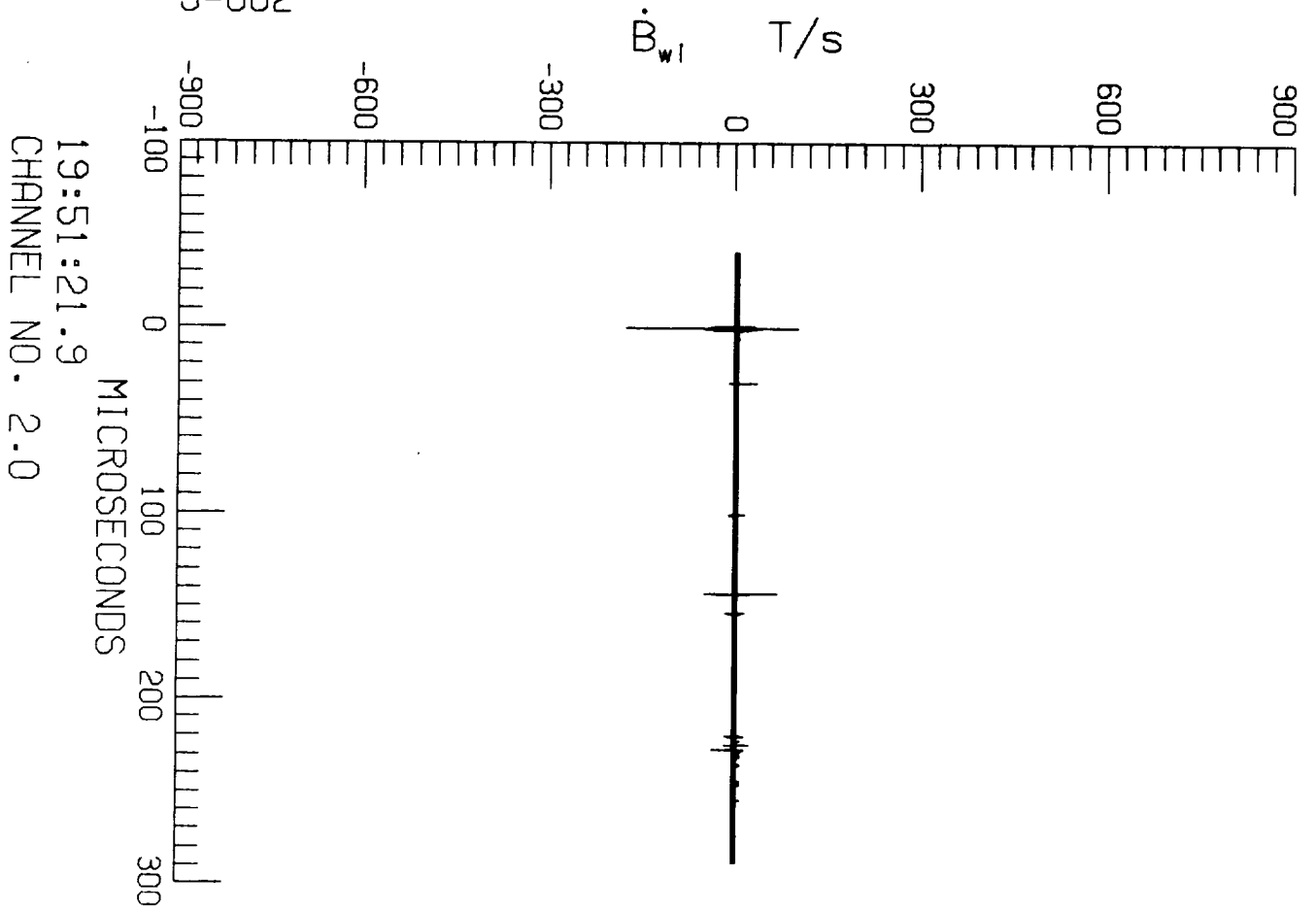

F106 LIGHTNING/85-026/ZAEPFEL

LEC 2

RUN NO. 2

S-002

$\dot{B}_1$  T/s

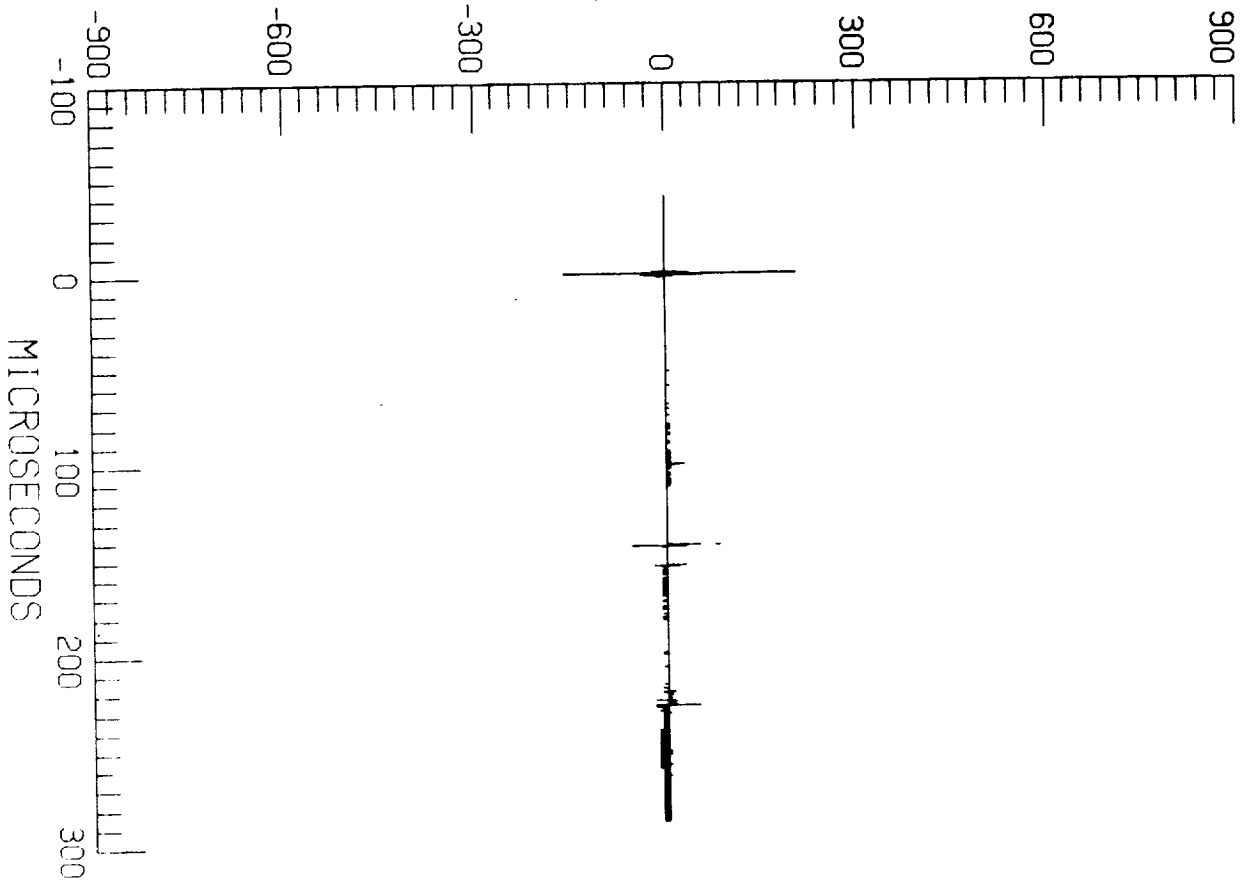

19:51:21.9  
CHANNEL NO. 2.2



F106 LIGHTNING/85-026/ZAEPFEL

LEC 3

RUN NO. 2

S-002

$\dot{D}_{wr}$  A/m<sup>2</sup>

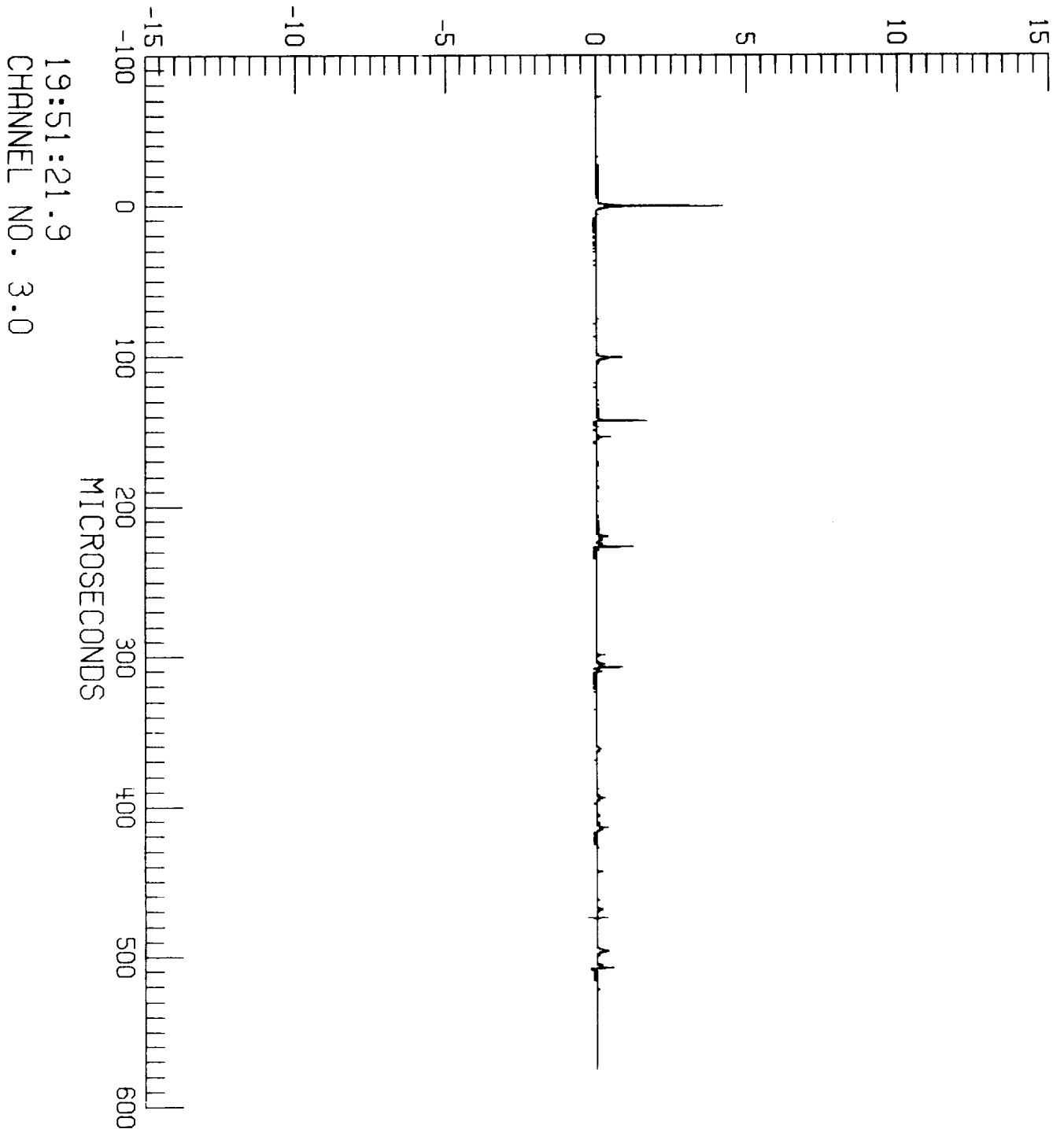

F106 LIGHTNING/85-026/ZAEPFEL

LEC 3 RUN NO. 2

S-002

$\dot{B}_{wr}$  T/s

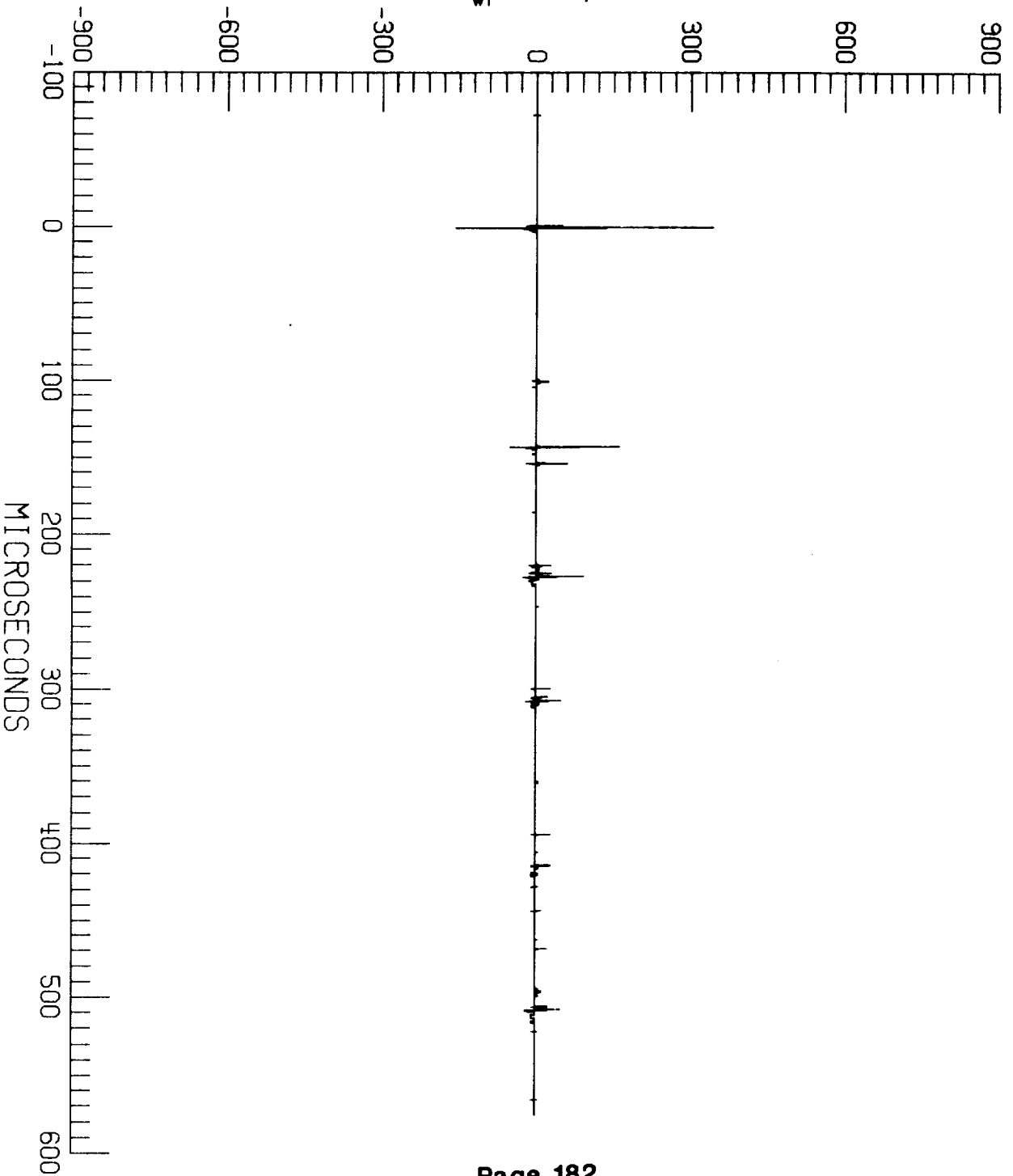

19:51:21.9  
CHANNEL NO. 3.1

F106 LIGHTNING/85-026/ZAEPFEL

LEC 3

RUN NO. 2

S-002

$\dot{D}_f$  A/m<sup>2</sup>

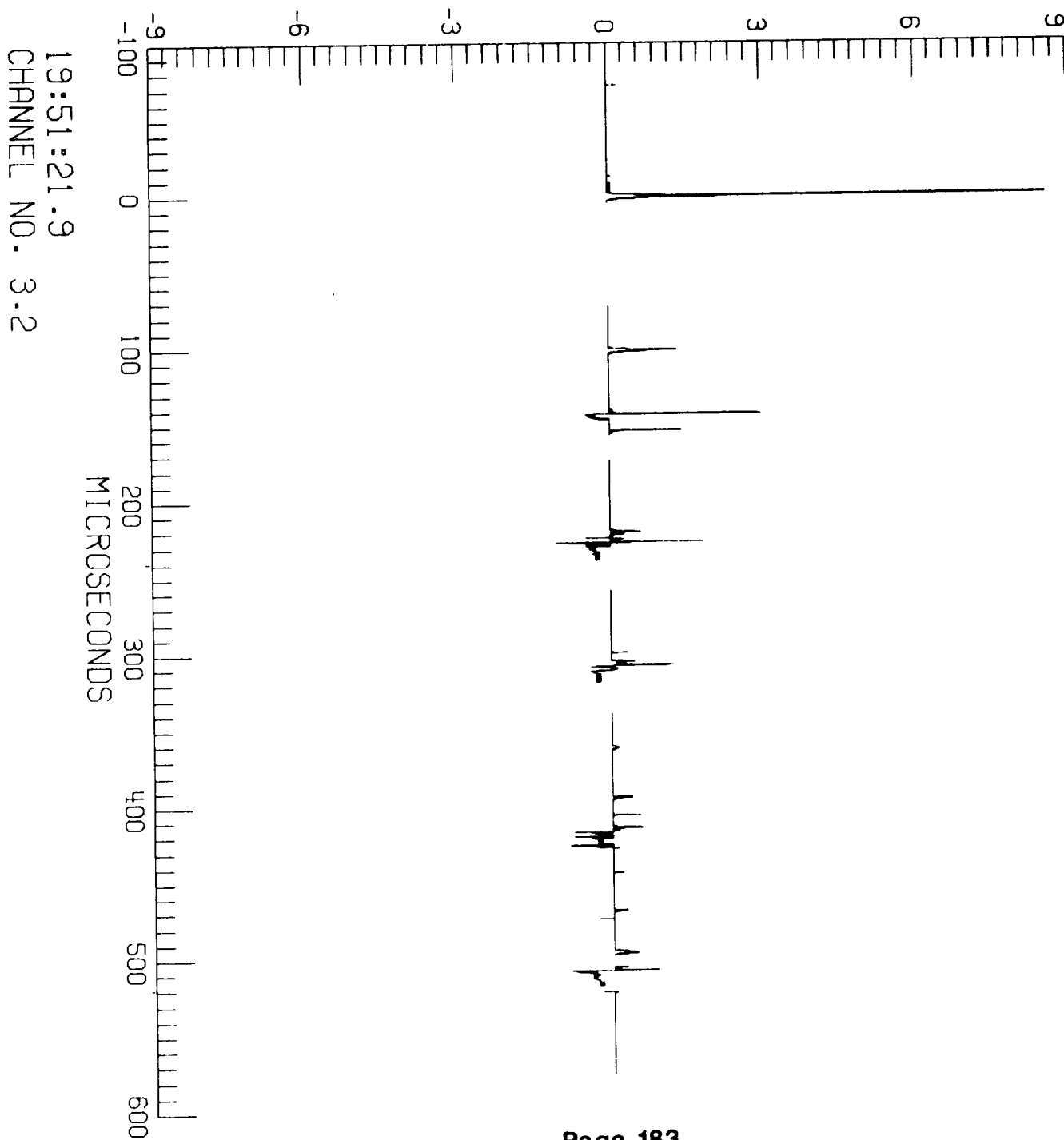

F106 LIGHTNING/85-026/ZAEPFEL

LEC 4

RUN NO. 2

S-002

TP100 V

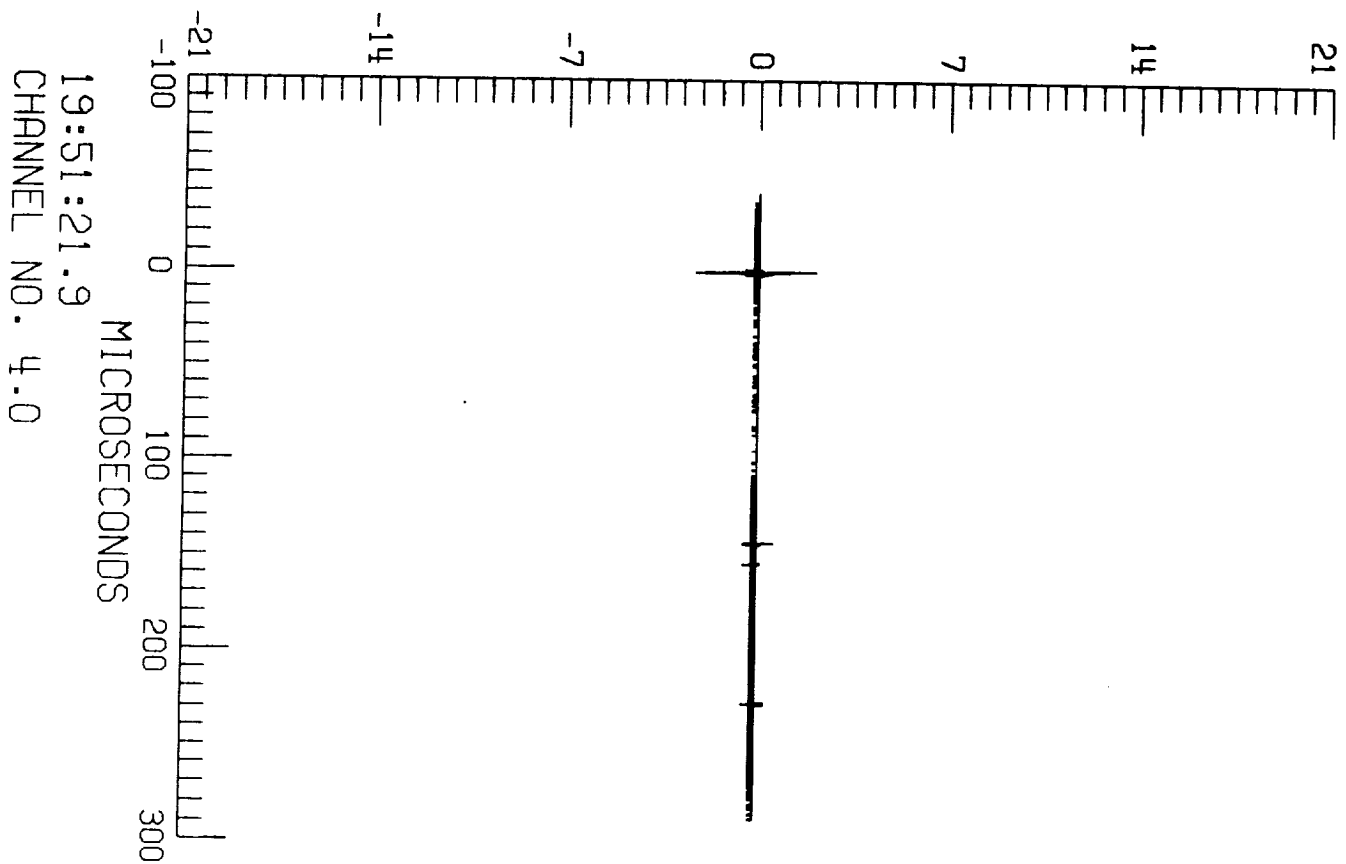

F106 LIGHTNING/85-026/ZAEPFEL

LEC 4 RUN NO. 2

S-002

TP106 A

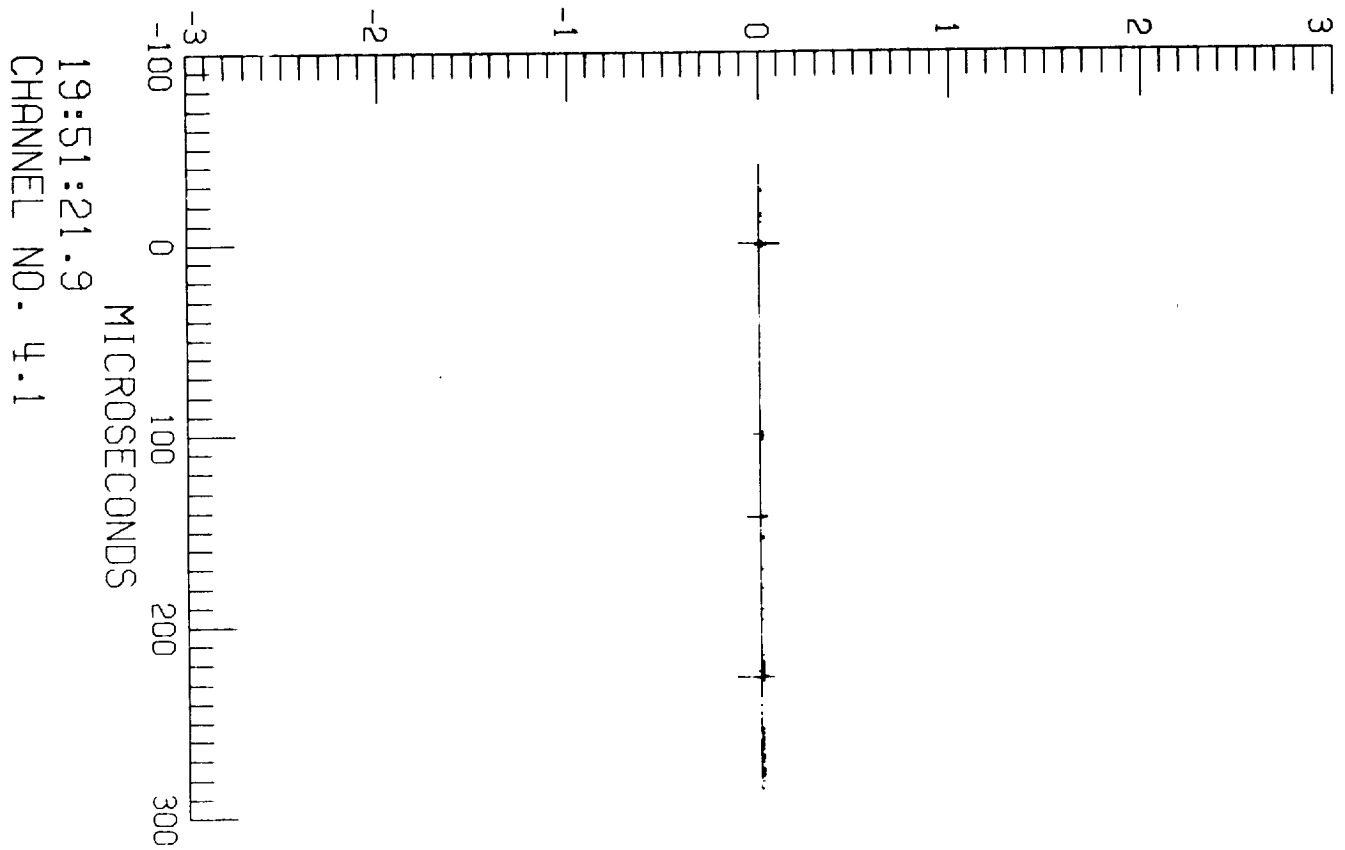

F106 LIGHTNING/85-026/ZAEPFEL

LEC 1 RUN NO. 2

S-002

$\dot{D}_t$  A/m<sup>2</sup>

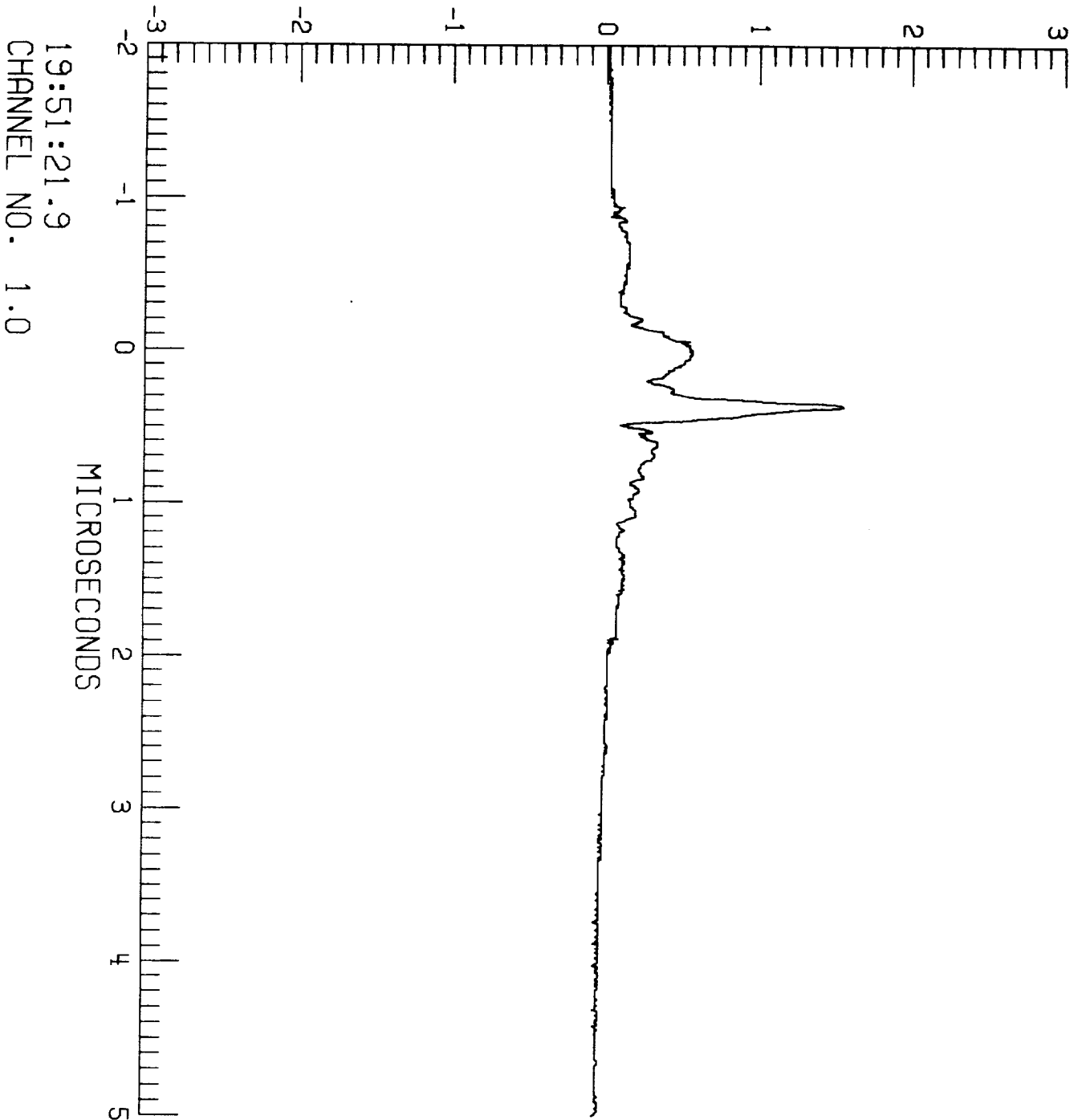

F106 LIGHTNING/85-026/ZAEPFEL

LEC 1 RUN NO. 2

S-002

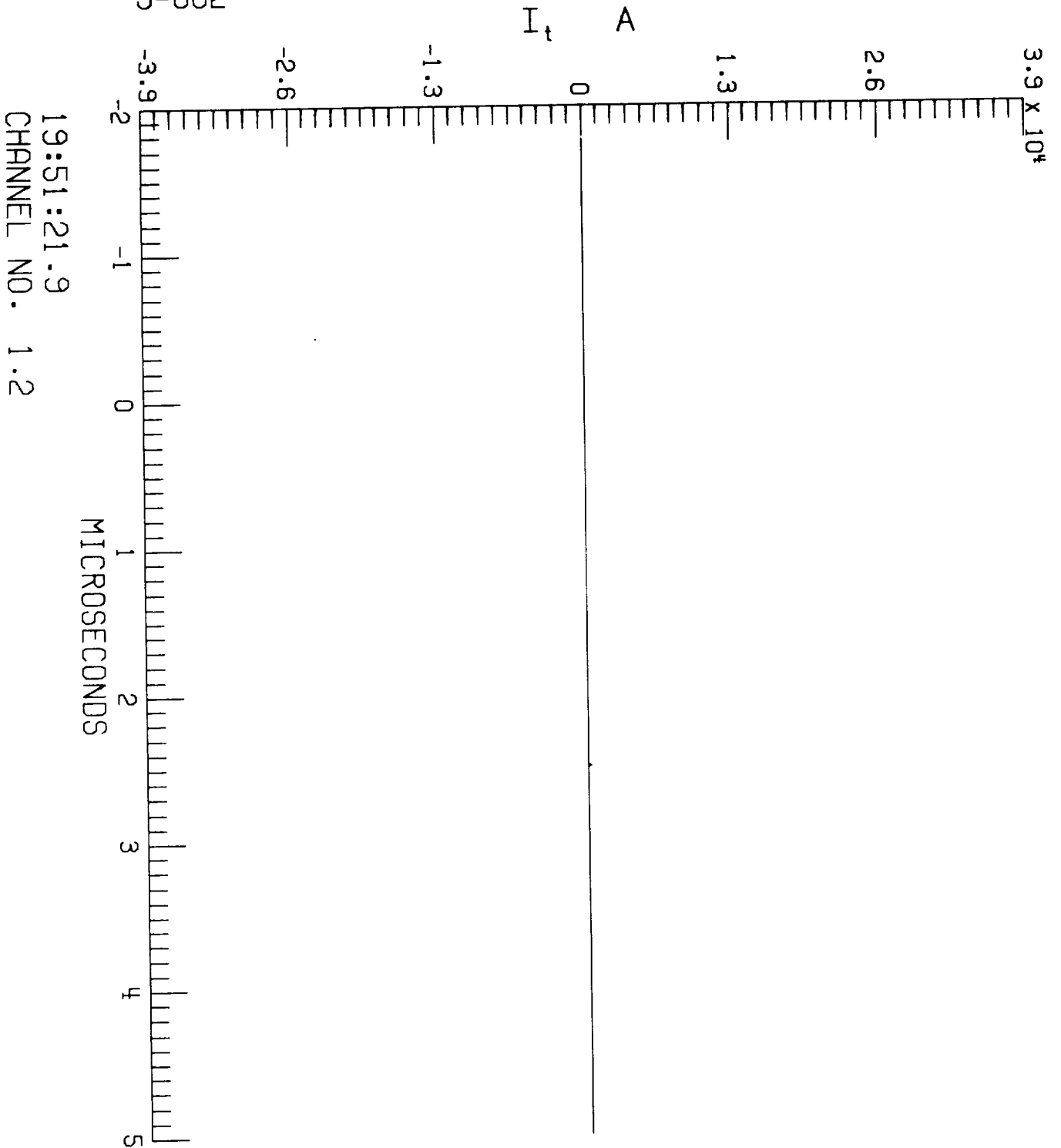

19:51:21.9  
CHANNEL NO. 1.2

F106 LIGHTNING/85-026/ZAEPFEL

LEC 2 RUN NO. 2

S-002

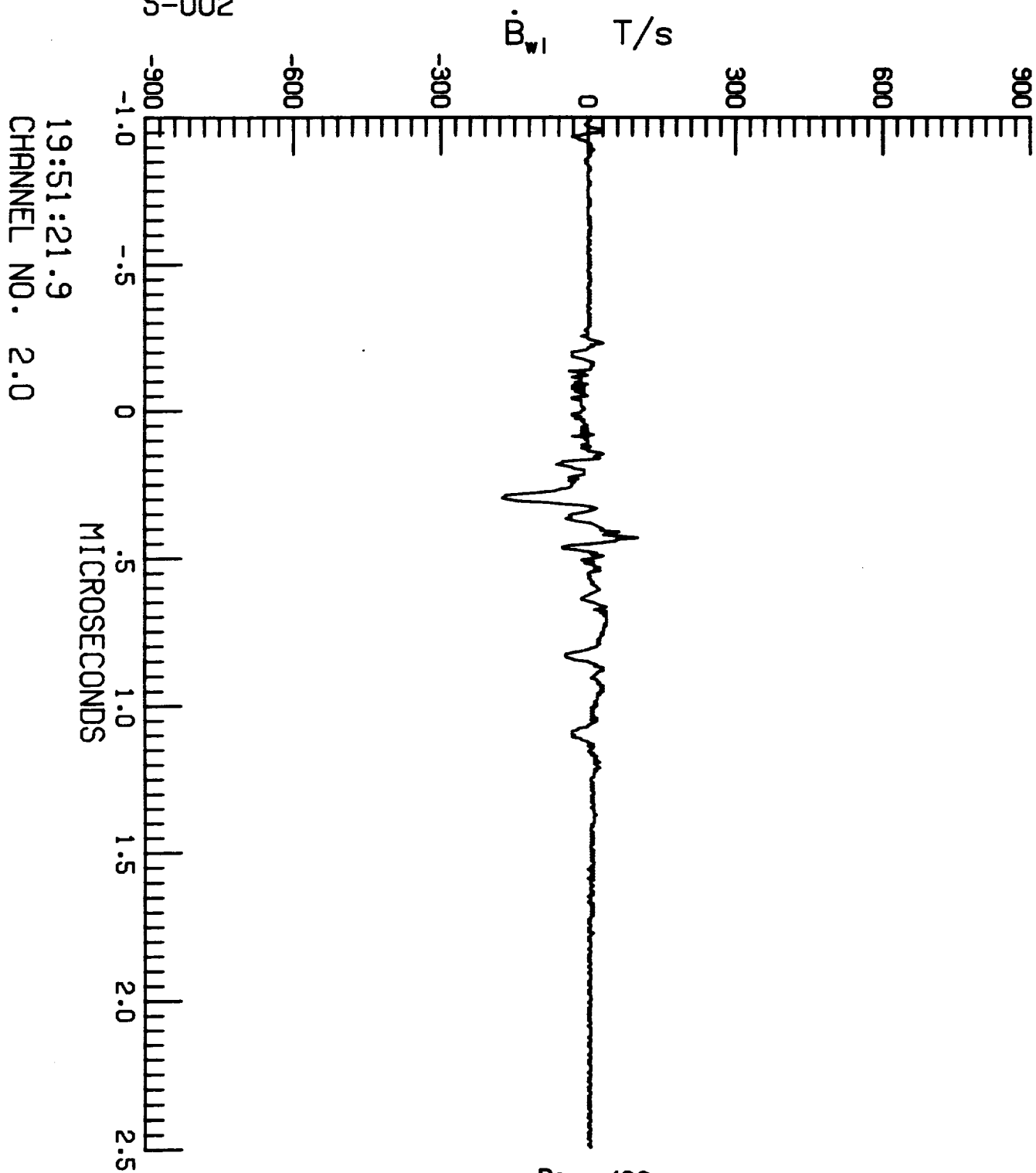

19:51:21.9  
CHANNEL NO. 2.0



F106 LIGHTNING/85-026/ZAEPFEL  
LEC 2 RUN NO. 2  
S-002

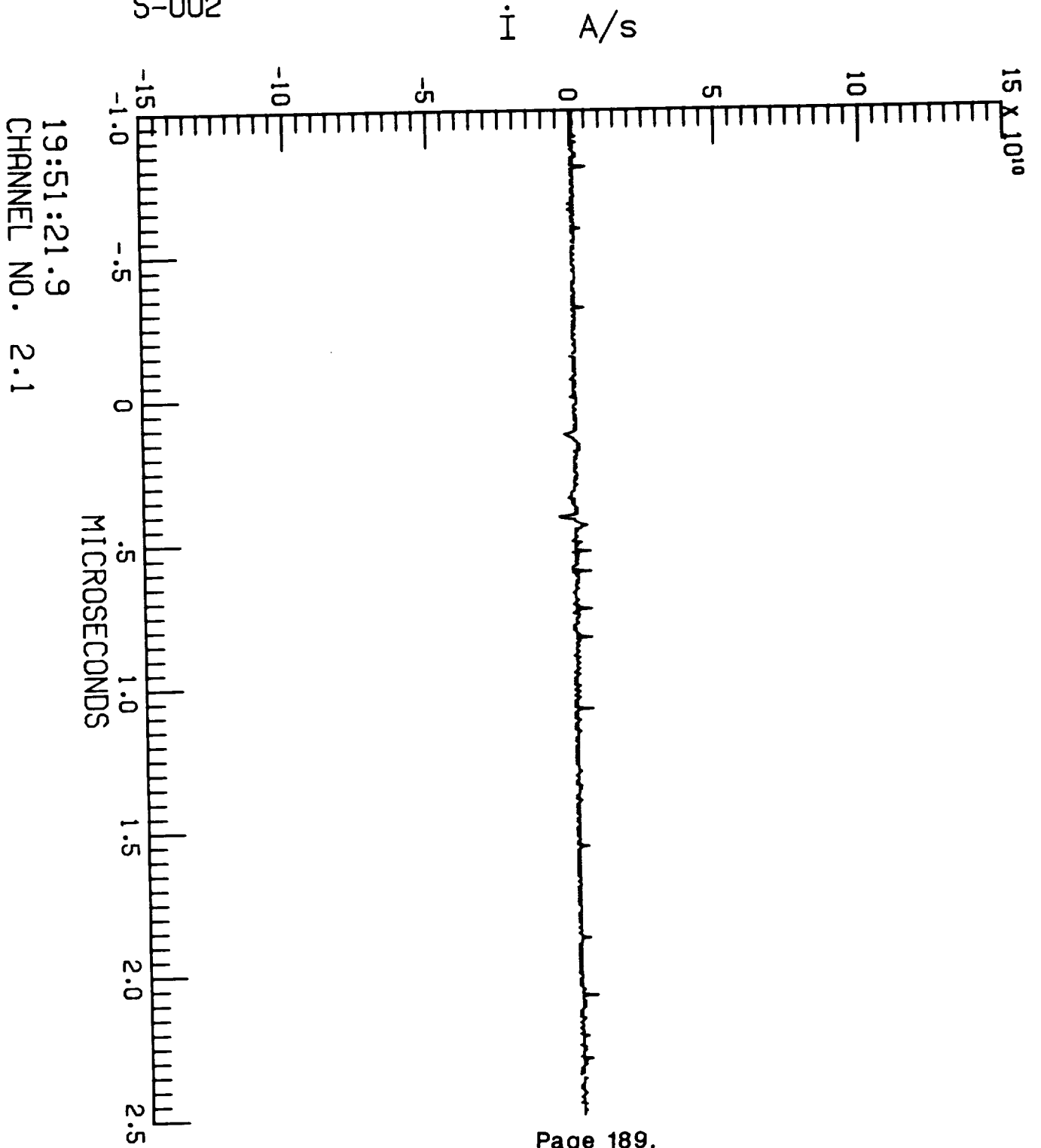

F106 LIGHTNING/85-026/ZAEPFEL

LEC 2 RUN NO. 2

S-002

$\dot{B}_1$  T/s

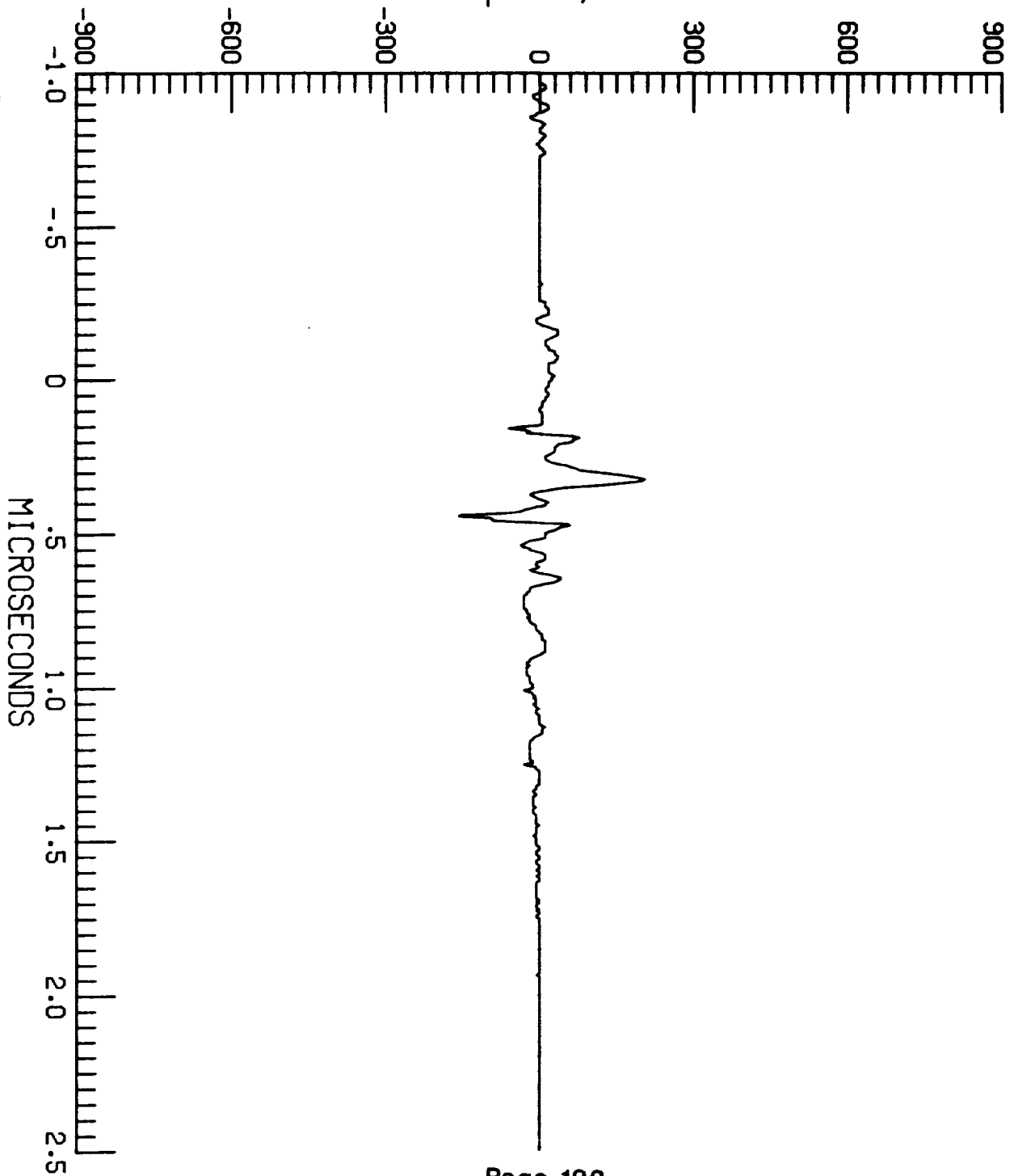

19:51:21.9  
CHANNEL NO. 2.2

F106 LIGHTNING/85-026/ZAEPFEL

LEC 3 RUN NO. 2

S-002

$\dot{D}_{wr}$  A/m<sup>2</sup>

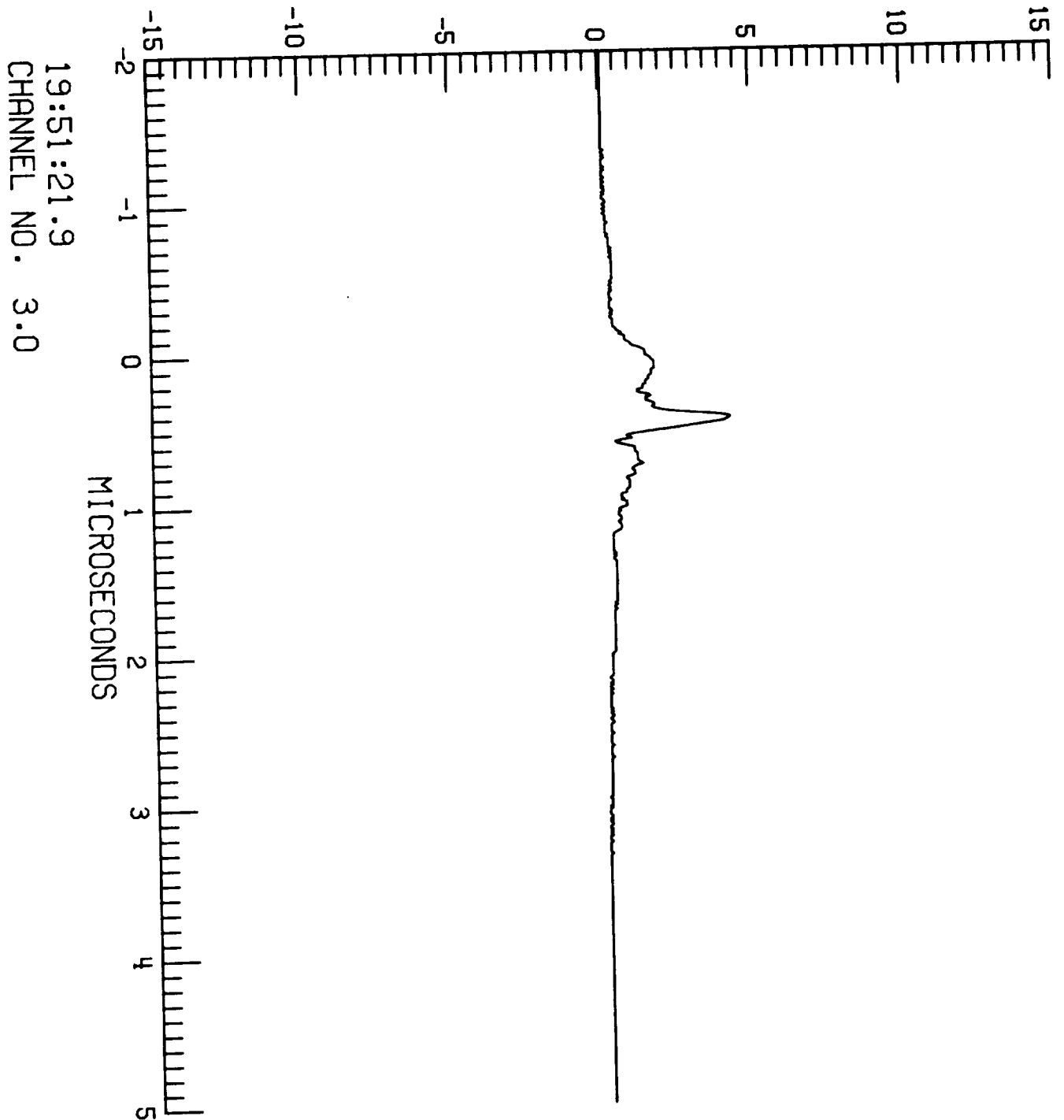

F106 LIGHTNING/85-026/ZAEPFEL

LEC 3 RUN NO. 2

S-002

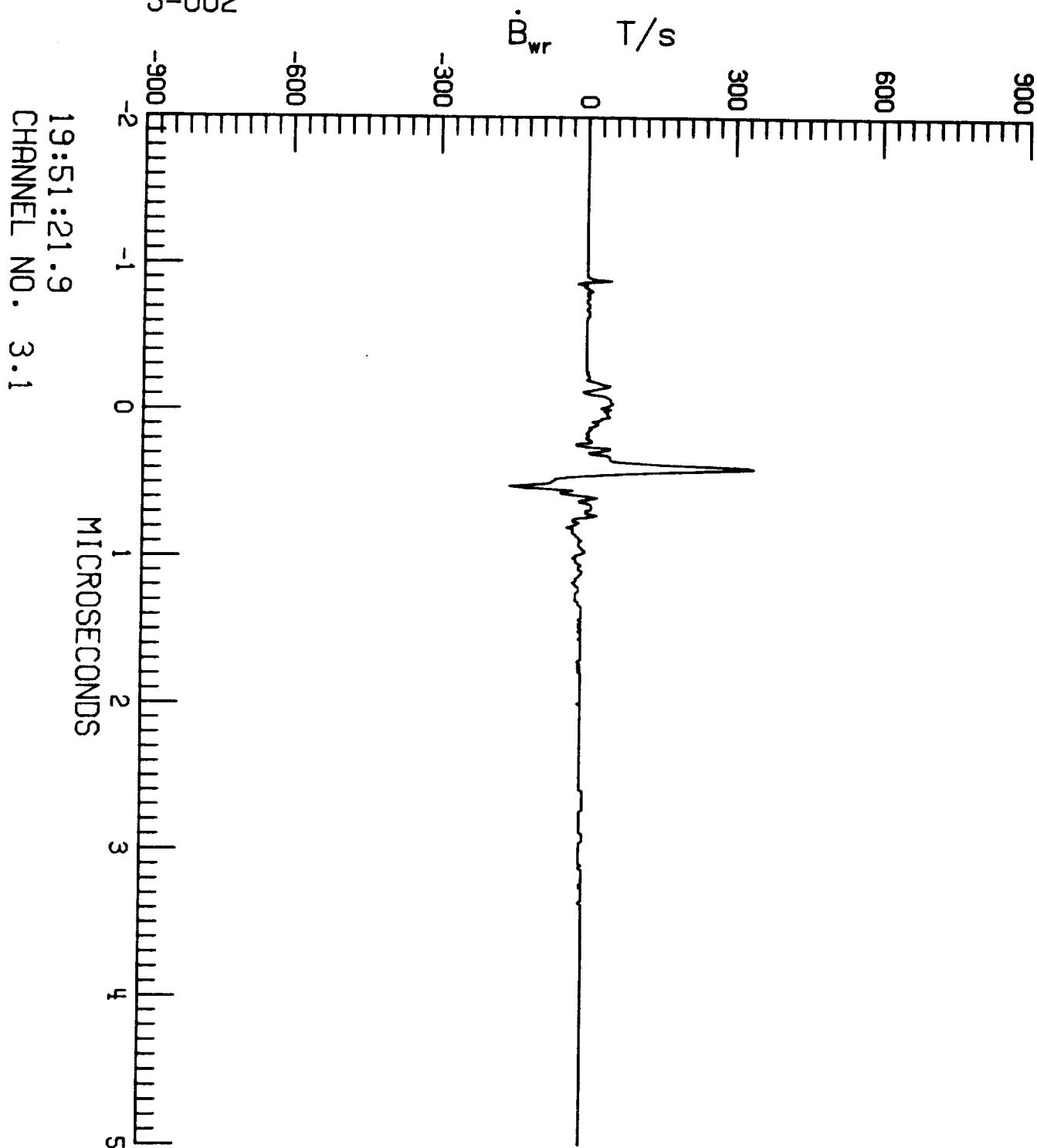

19:51:21.9  
CHANNEL NO. 3.1

F106 LIGHTNING/85-026/ZAEPFEL

LEC 3 RUN NO. 2

S-002

$\dot{D}_f$  A/m<sup>2</sup>

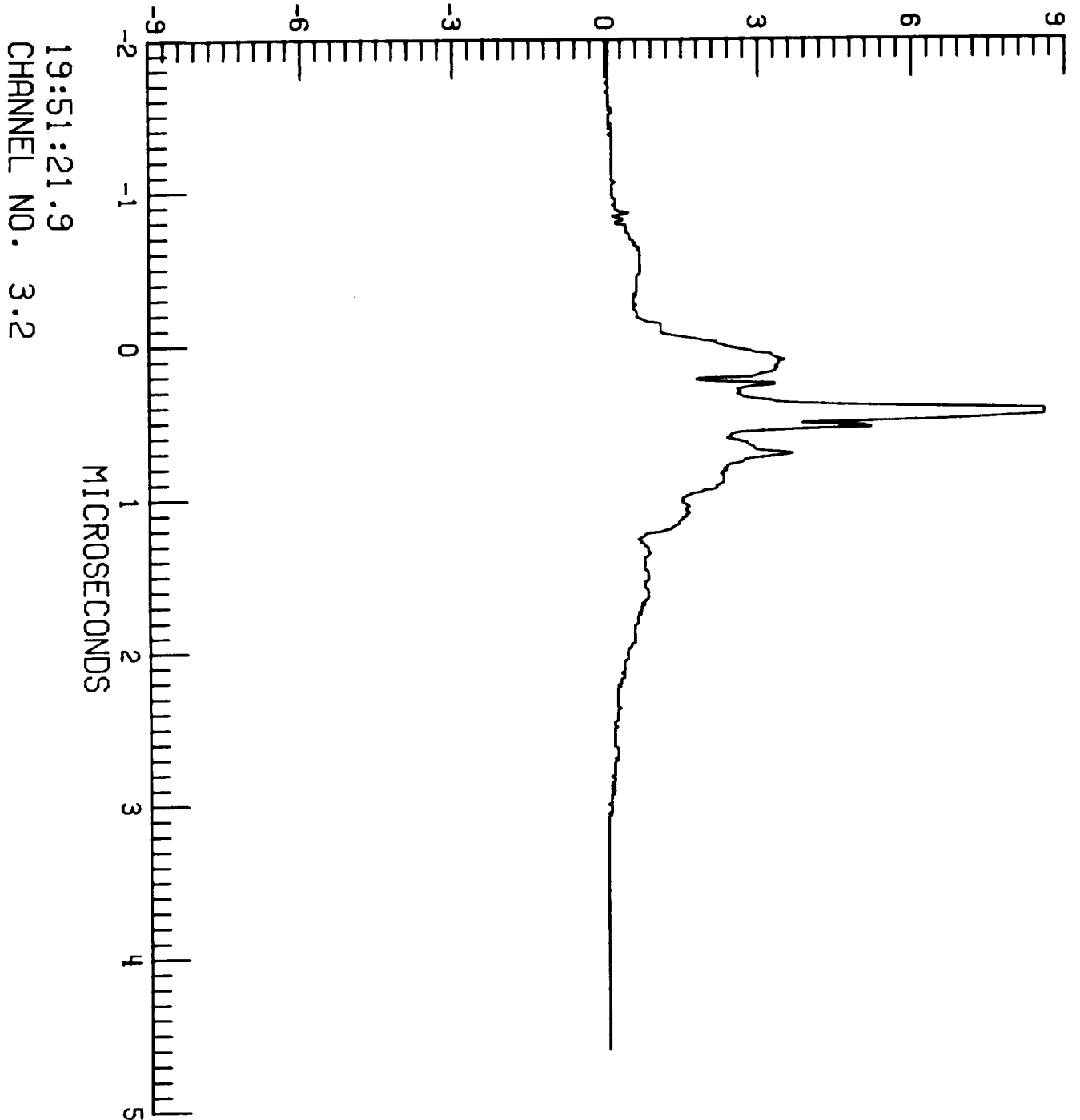

F106 LIGHTNING/85-026/ZREPTEL

LEC 4 RUN NO. 2

S-002

TP100 V

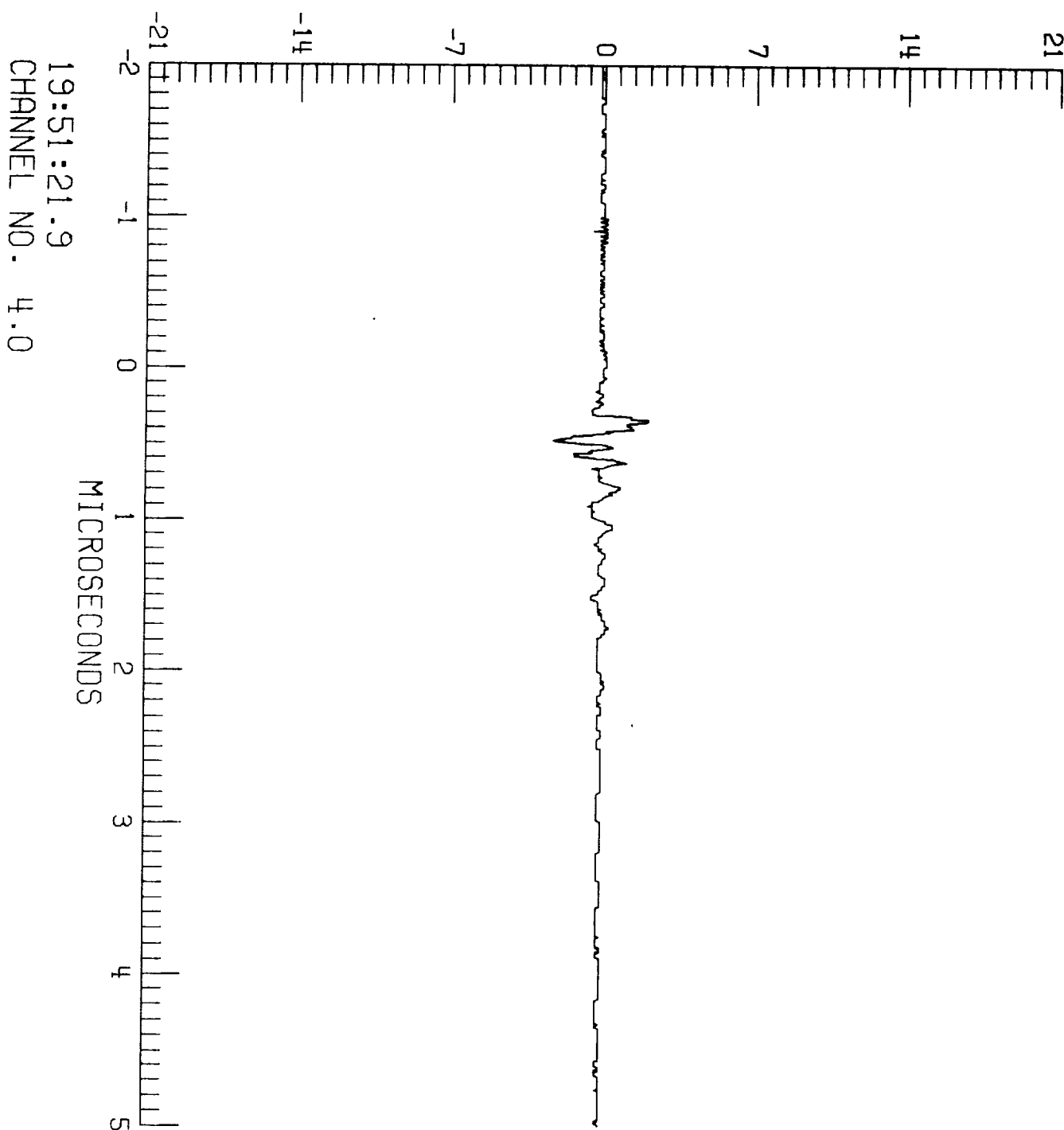

F106 LIGHTNING/85-026/ZAEPFEL

LEC 4 RUN NO. 2

S-002

TP106 A

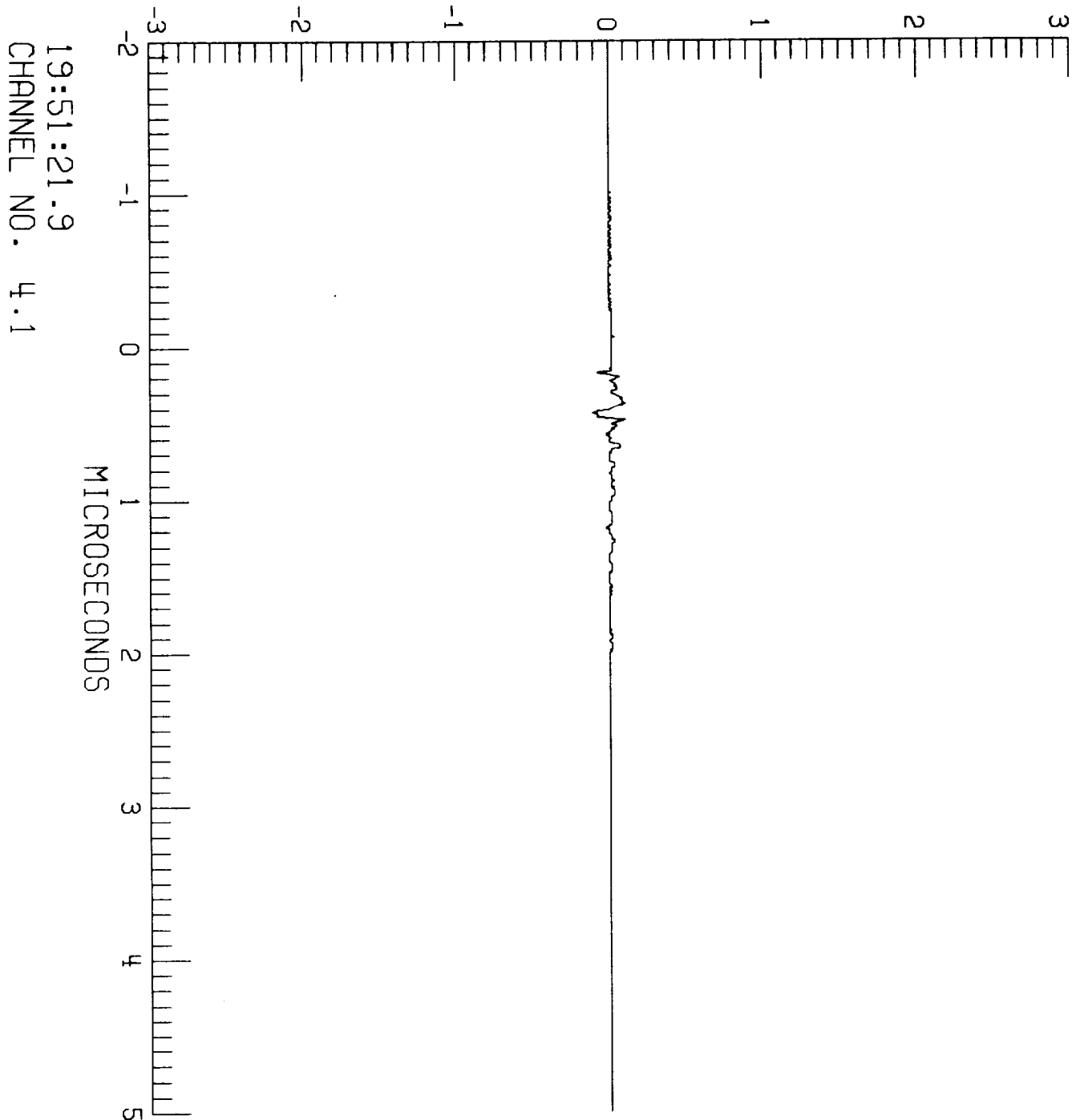

F106 LIGHTNING/85-026/ZAEPFEL

LEC 4 RUN NO. 2

S-002

TP125

A

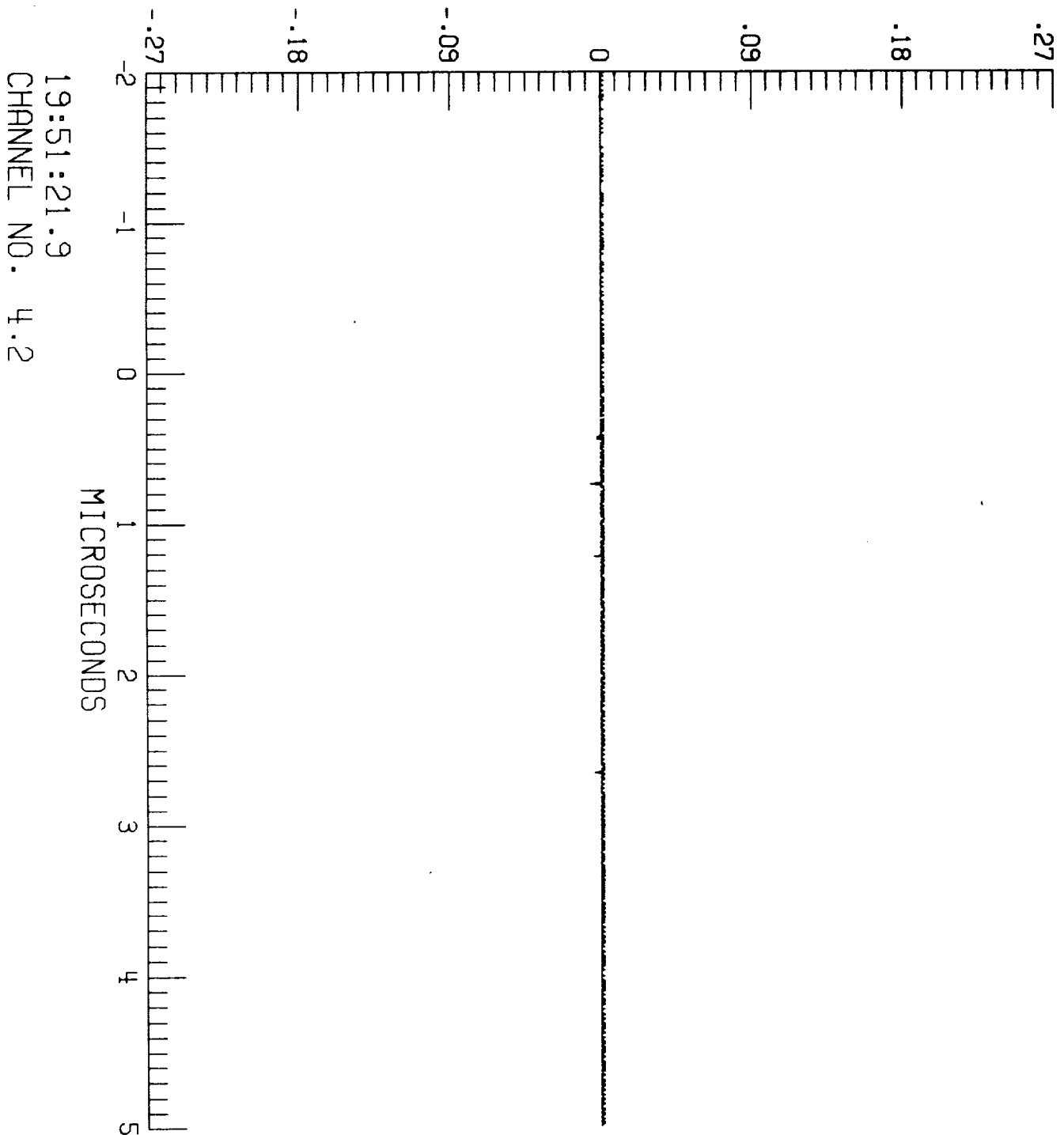



F106 LIGHTNING/85-026/ZAEPFEL

LEC 1 RUN NO. 2

S-002

$\dot{D}_t$  A/m<sup>2</sup>

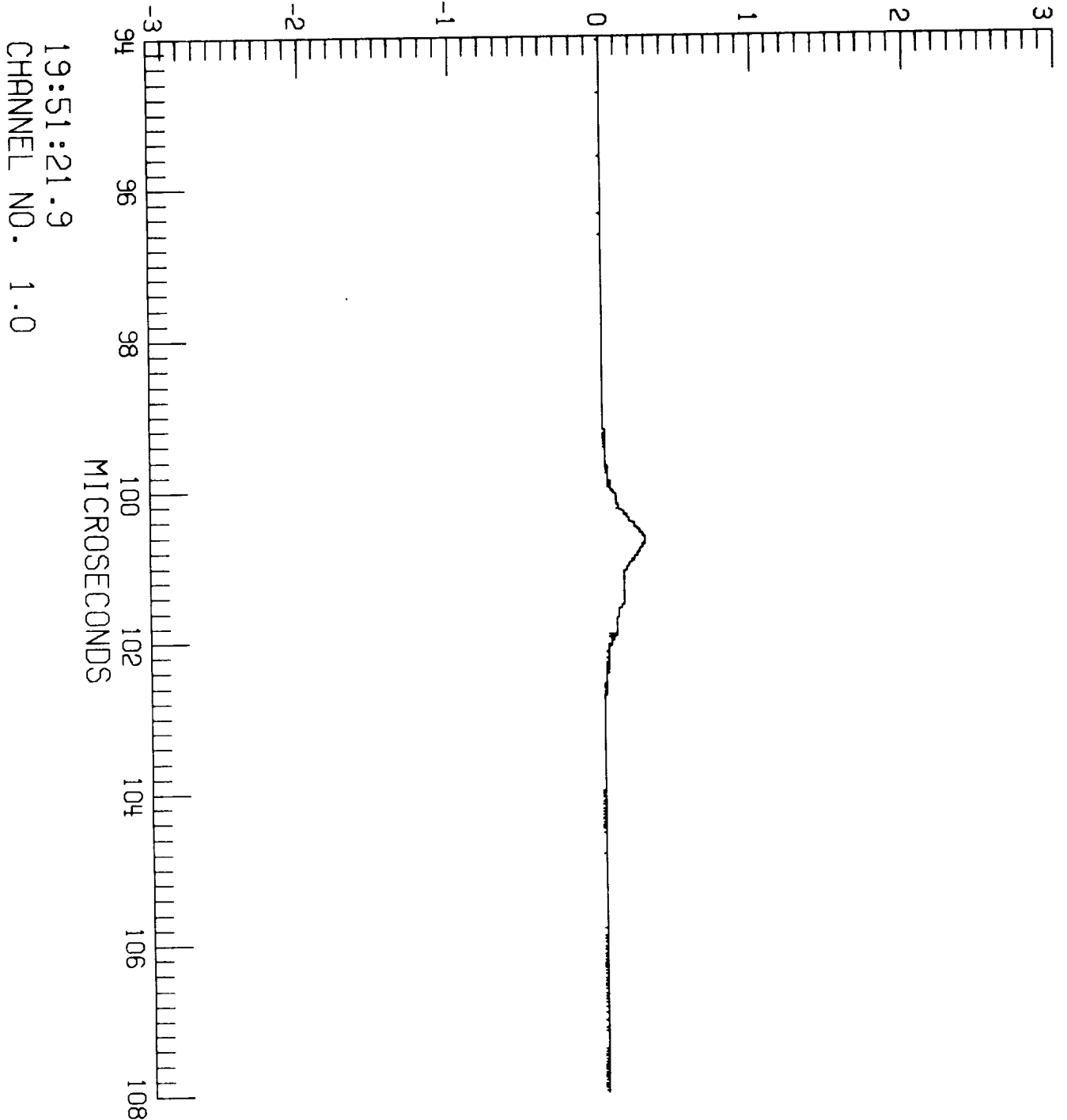

F106 LIGHTNING/85-026/ZAEPFEL

LEC 1 RUN NO. 2

S-002

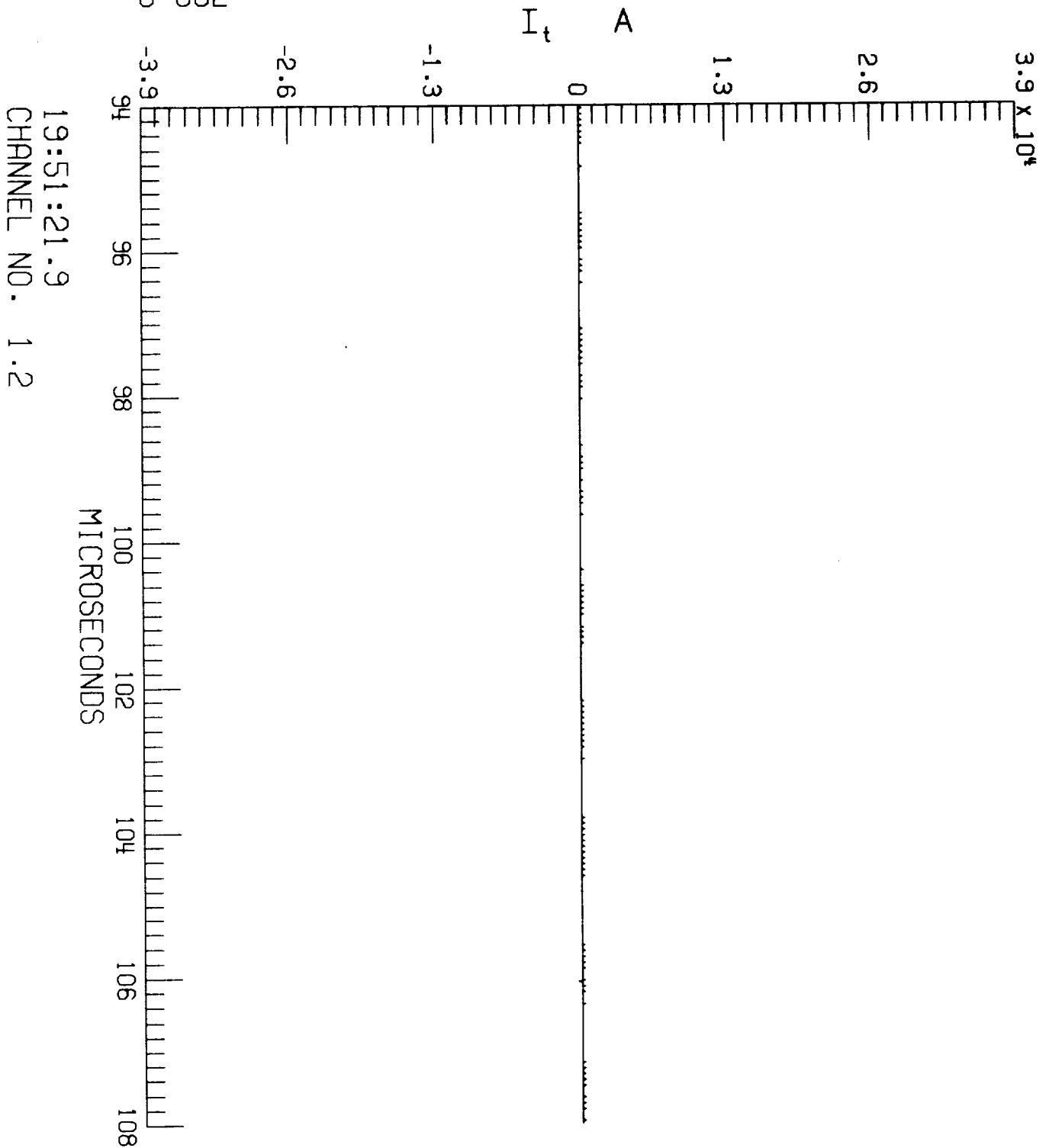

19:51:21.9  
CHANNEL NO. 1.2

F106 LIGHTNING/85-026/ZAEPFEL

LEC 2 RUN NO. 2

S-002

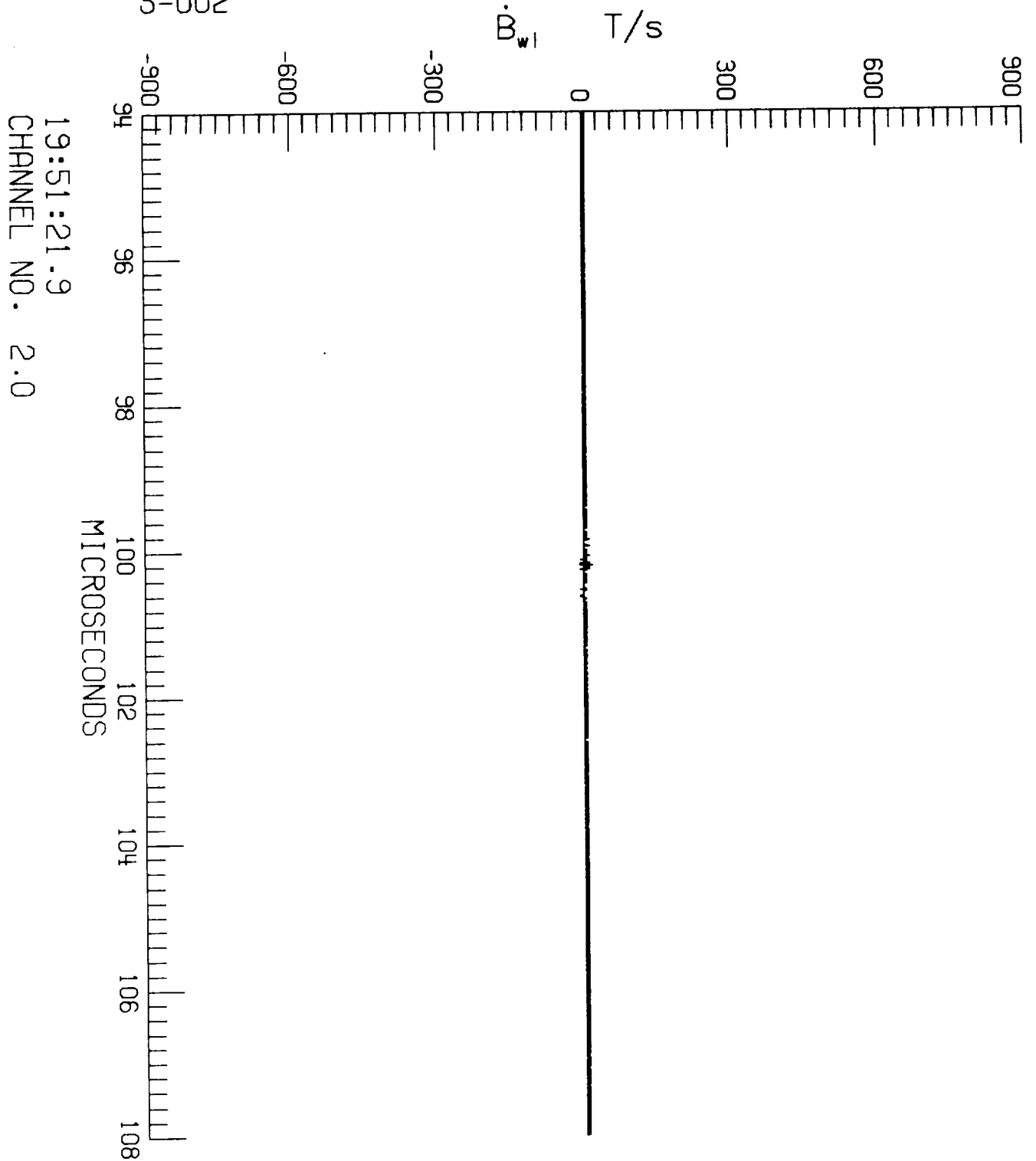

F106 LIGHTNING/85-026/ZAEPFEL

LEC 2 RUN NO. 2

S-002

$\dot{B}_1$  T/s

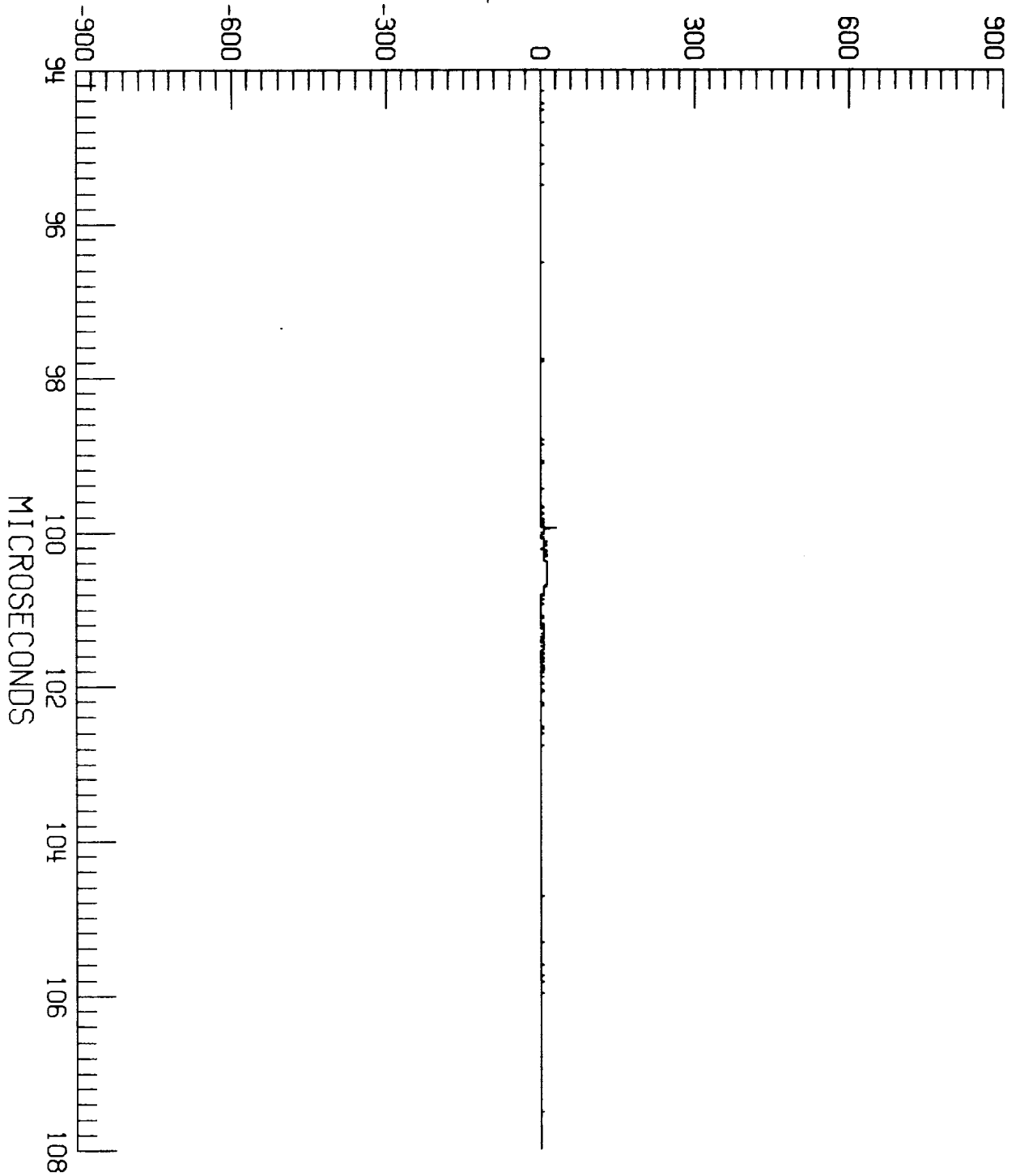

19:51:21.9  
CHANNEL NO. 2.2

F106 LIGHTNING/85-026/ZAEPFEL

LEC 3 RUN NO. 2

S-002

$\dot{D}_{wr}$  A/m<sup>2</sup>

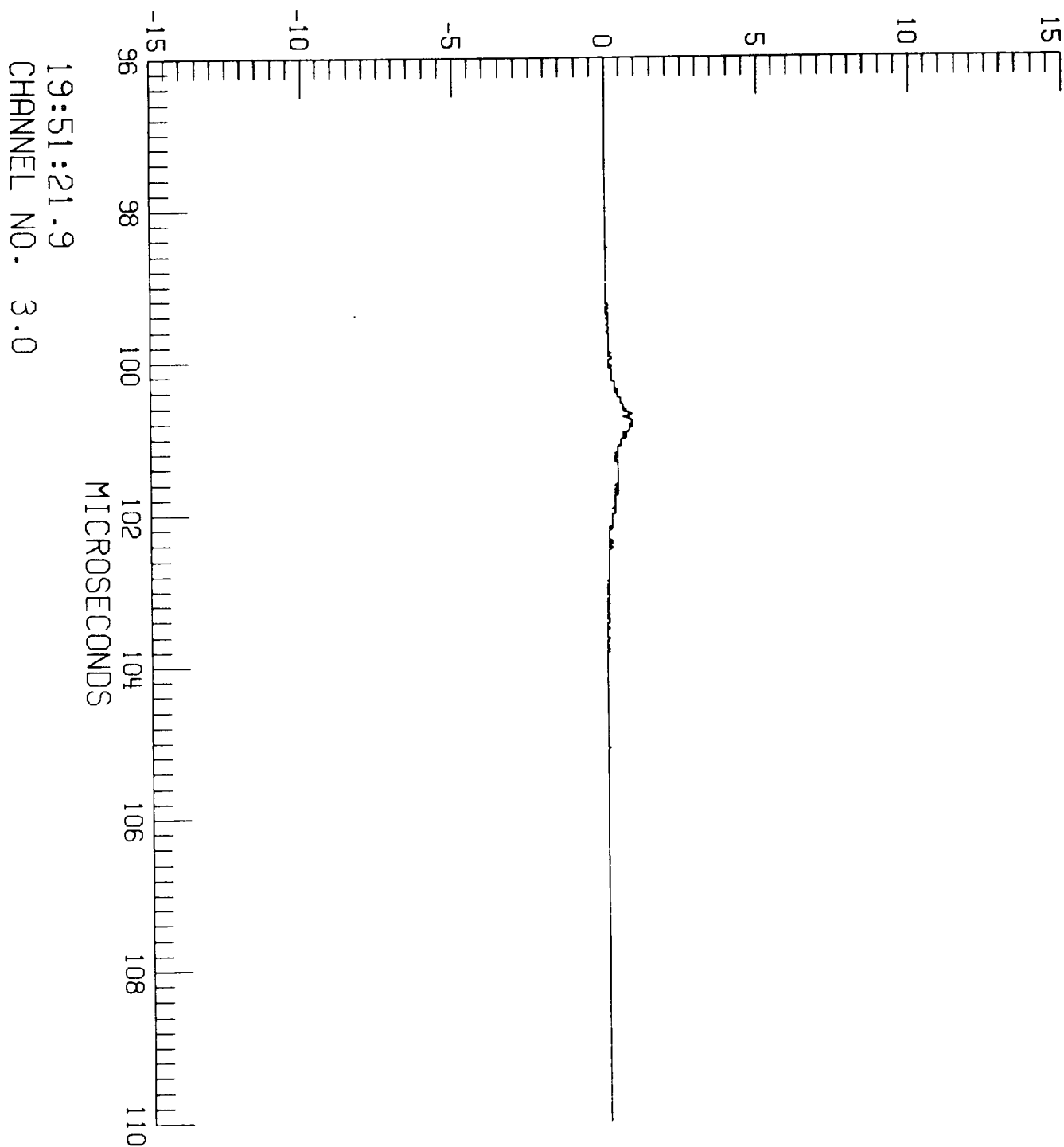

F106 LIGHTNING/85-026/ZAEPFEL

LEC 3 RUN NO. 2

S-002

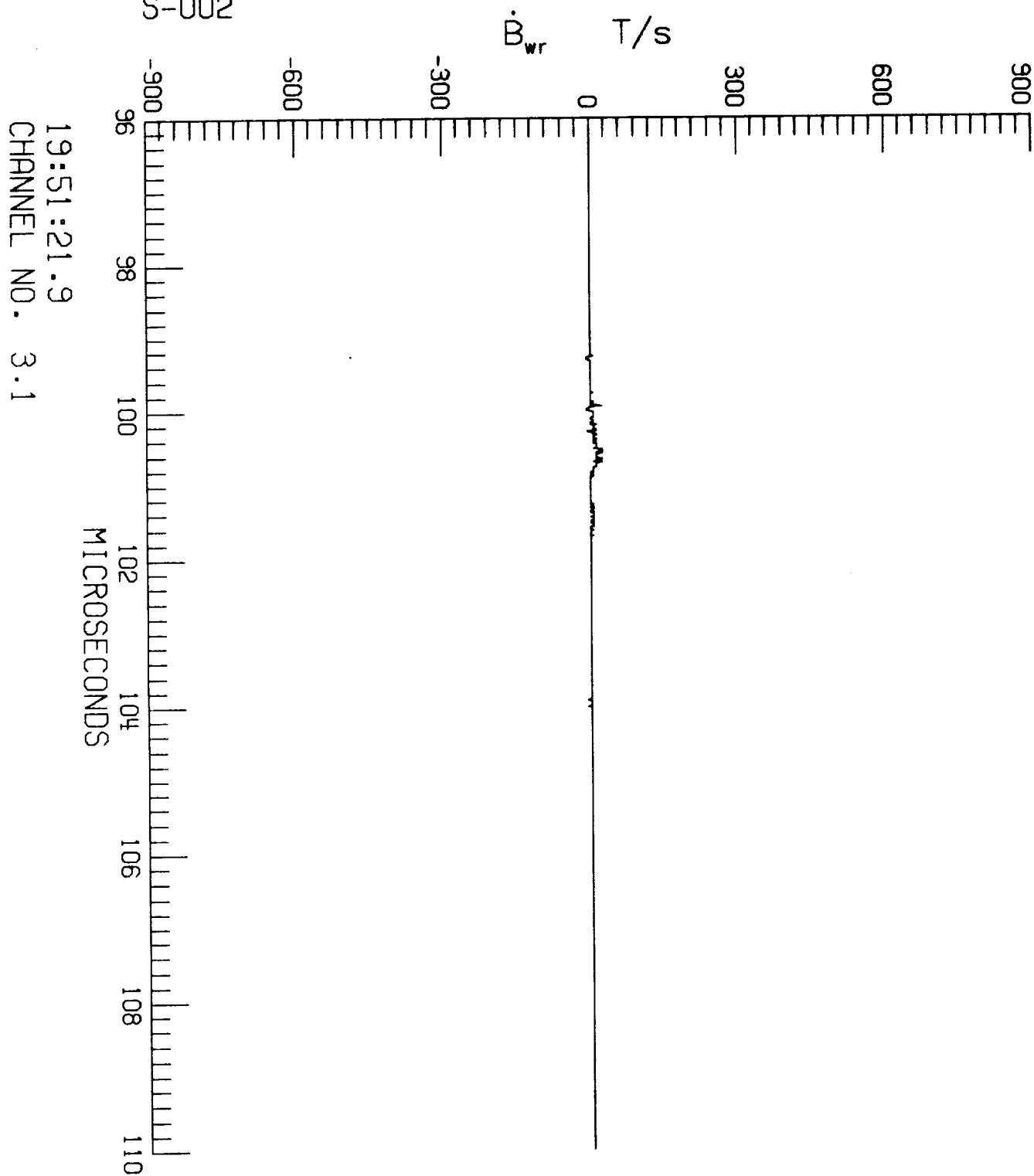

19:51:21.9  
CHANNEL NO. 3.1

F106 LIGHTNING/85-026/ZAEPFEL

LEC 3 RUN NO. 2

S-002

$\dot{D}_f$  A/m<sup>2</sup>

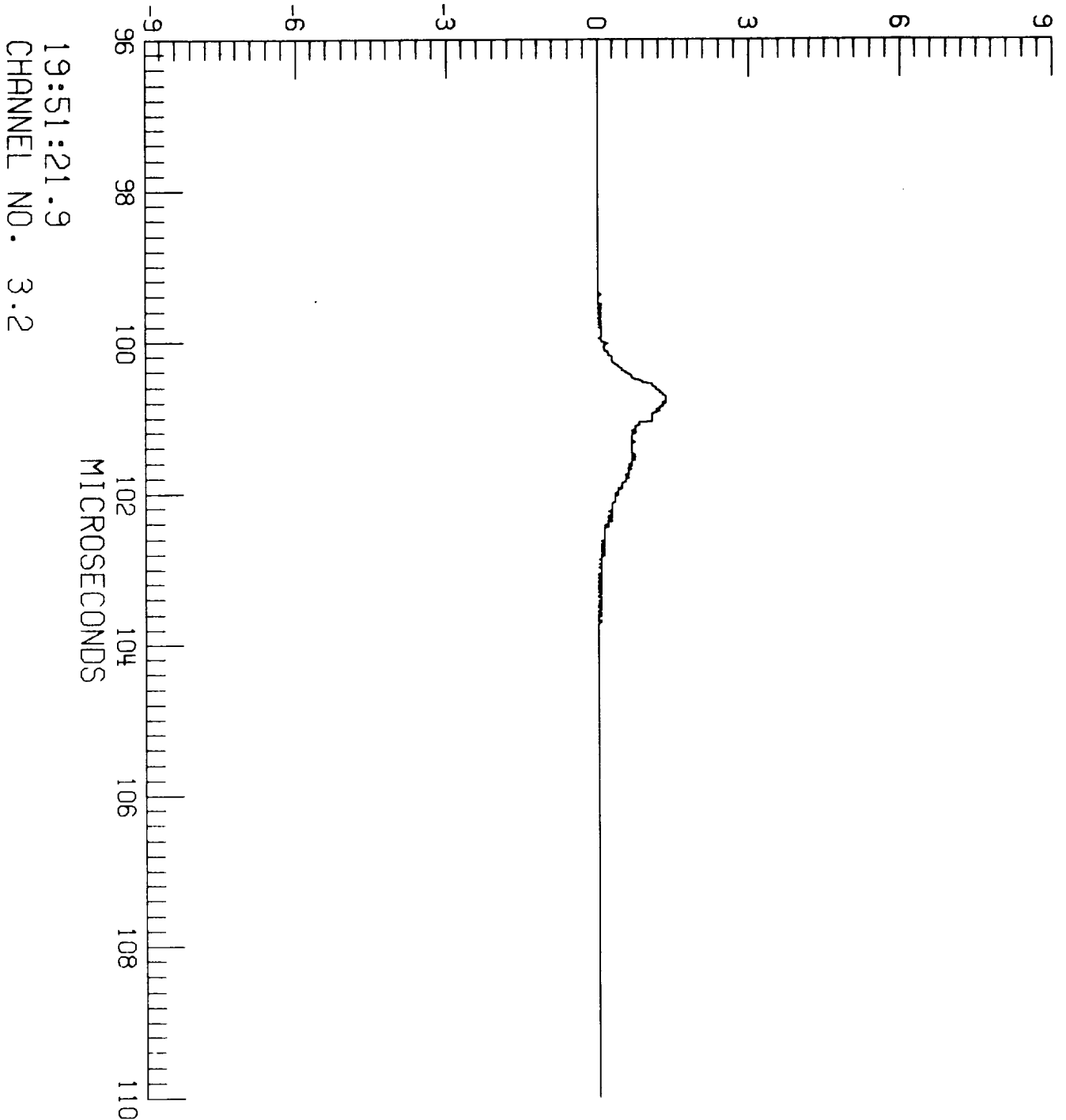

F106 LIGHTNING/85-026/ZAEPFEL

LEC 4 RUN NO. 2

S-002

TP100 V

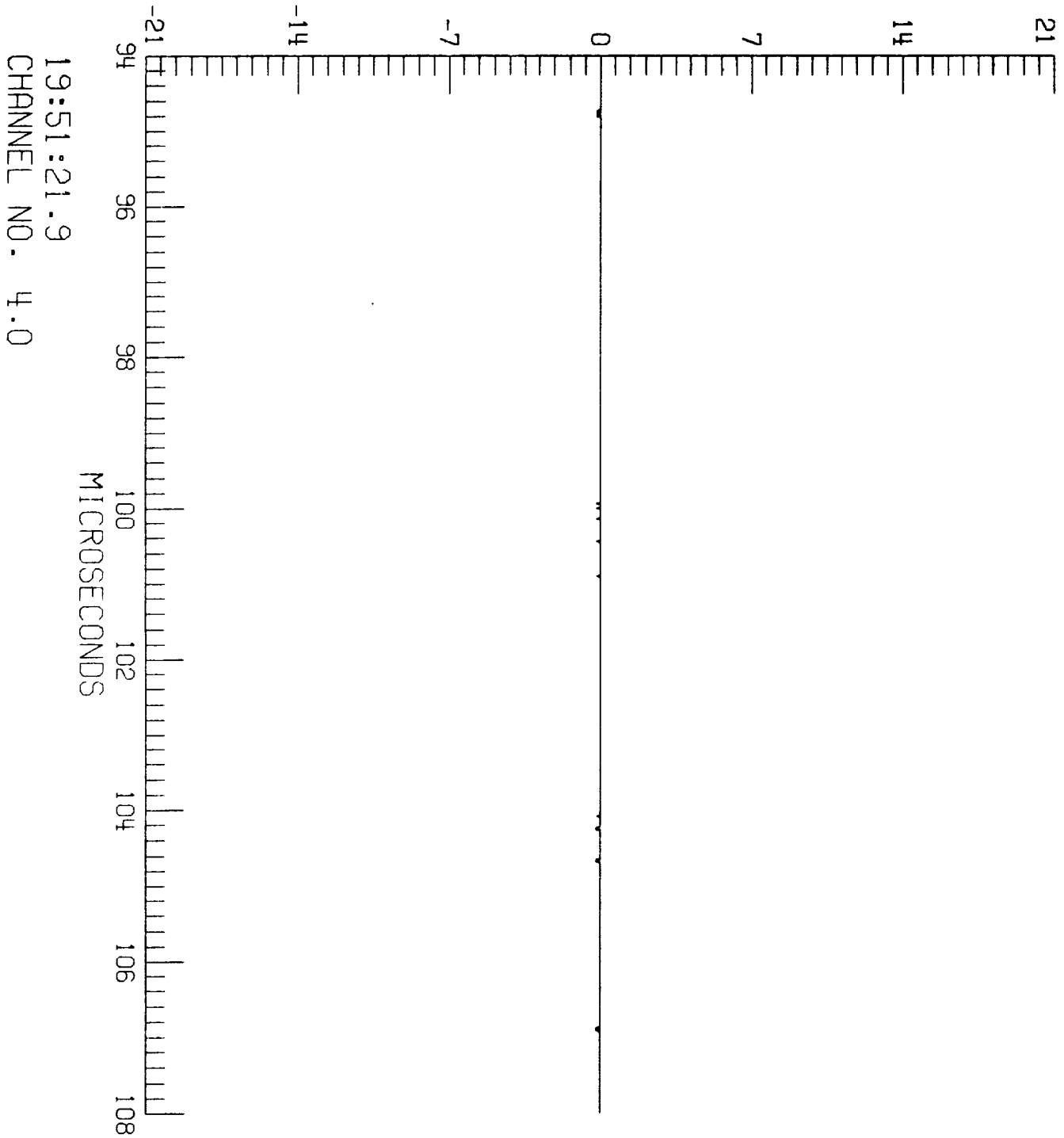



F106 LIGHTNING/85-026/ZAEPFEL

LEC 4 RUN NO. 2

S-002

TP106 A

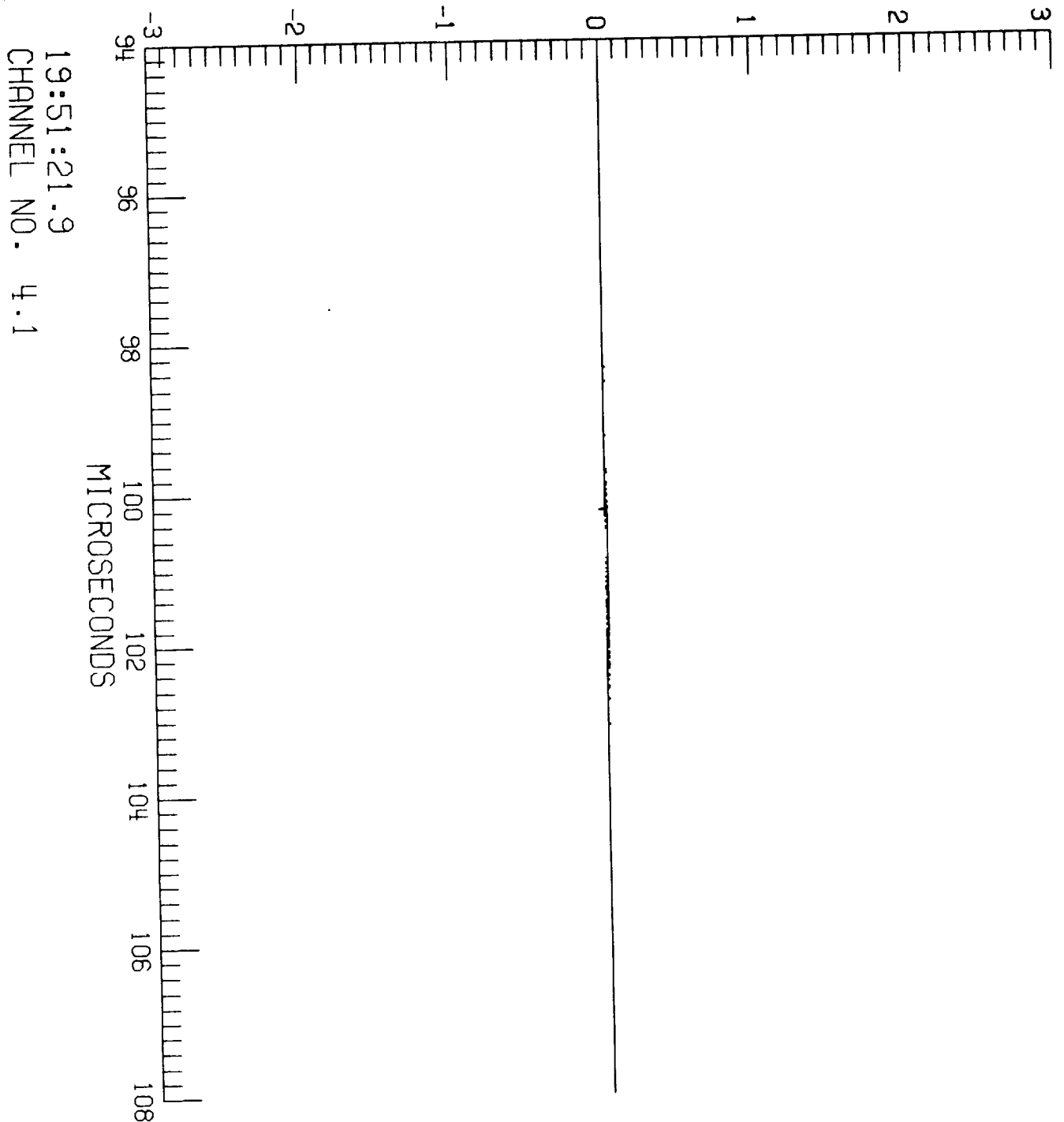

F106 LIGHTNING/85-026/ZAEPFEL

LEC 4 RUN NO. 2

S-002

TP125

A

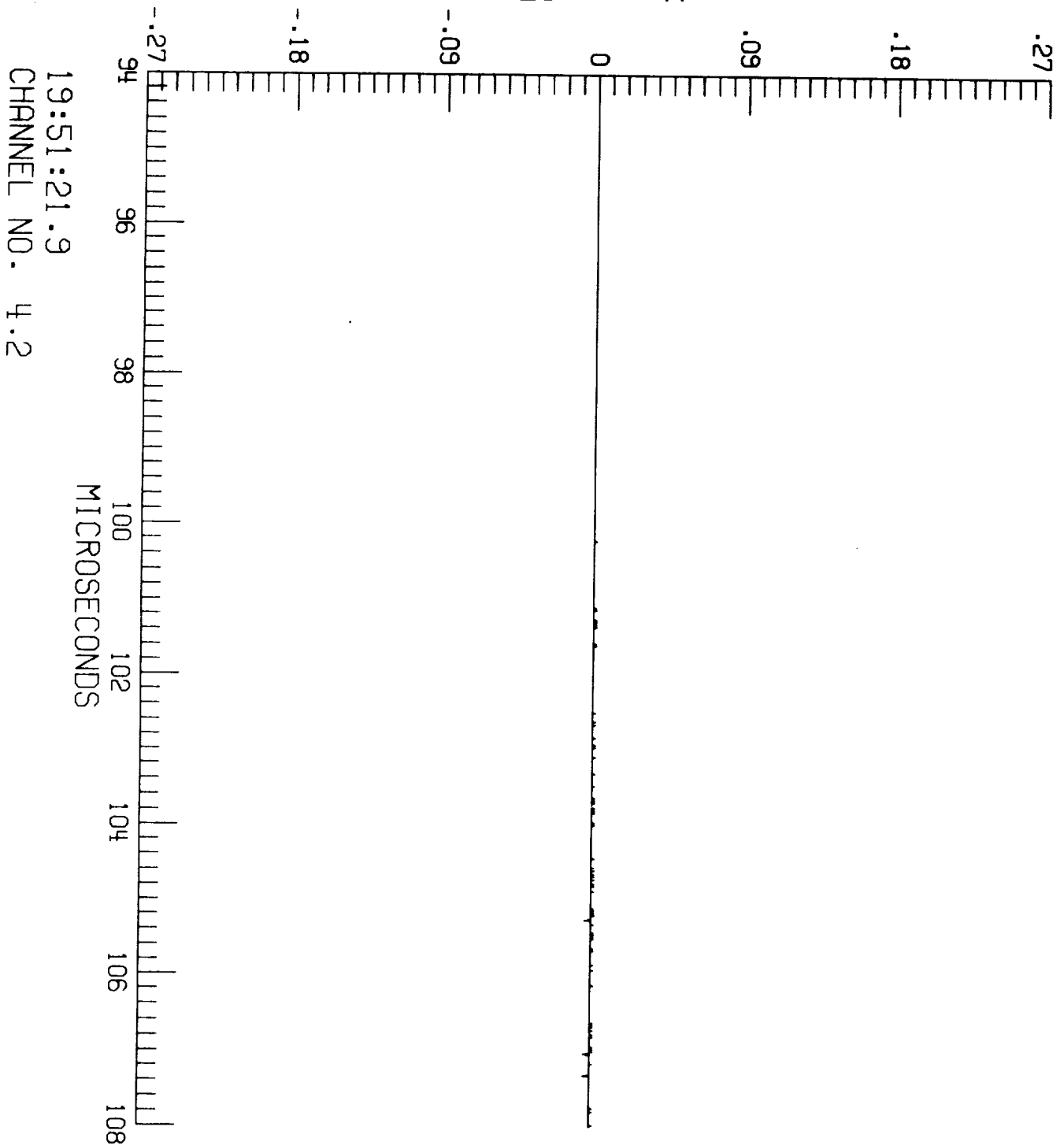

19:51:21.9  
CHANNEL NO. 4.2

F106 LIGHTNING/85-026/ZAEPFEL

LEC 1 RUN NO. 2

S-002

$\dot{D}_t$  A/m<sup>2</sup>

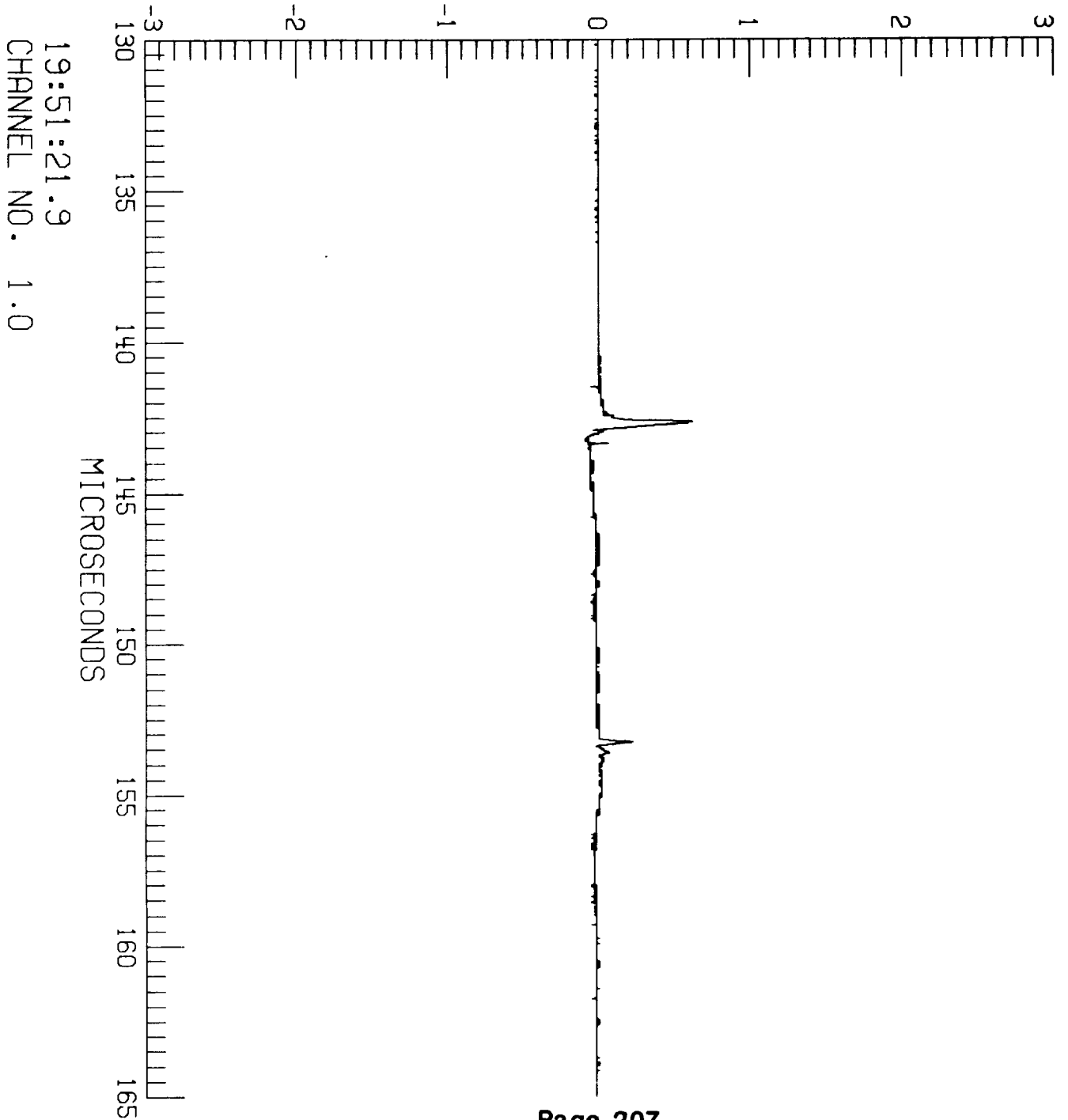

F106 LIGHTNING/85-026/ZAEPFEL

LEC 1 RUN NO. 2

S-002

$I_t$  A

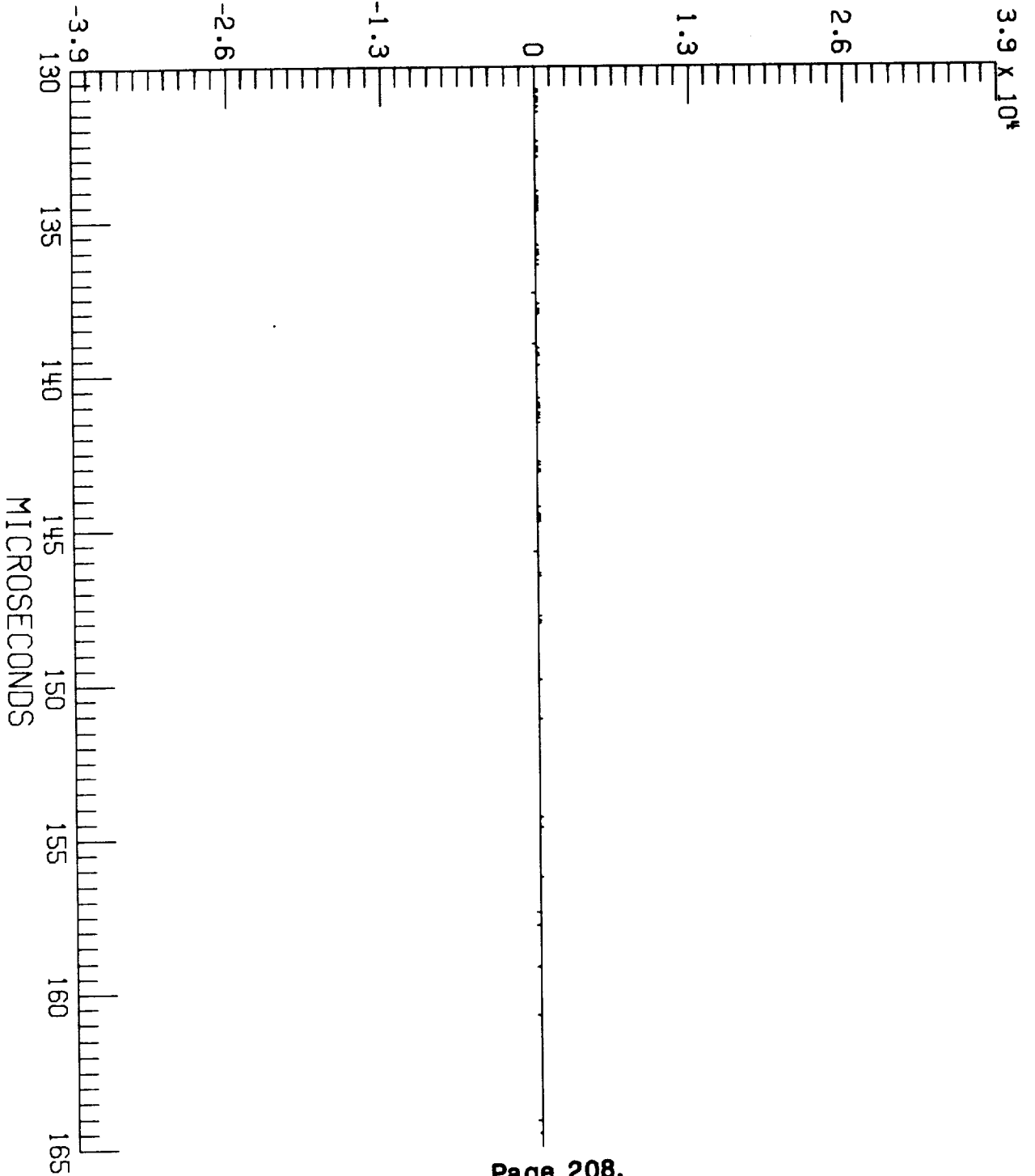

19:51:21.9  
CHANNEL NO. 1.2

F106 LIGHTNING/85-026/ZAEPFEL

LEC 2 RUN NO. 2

S-002

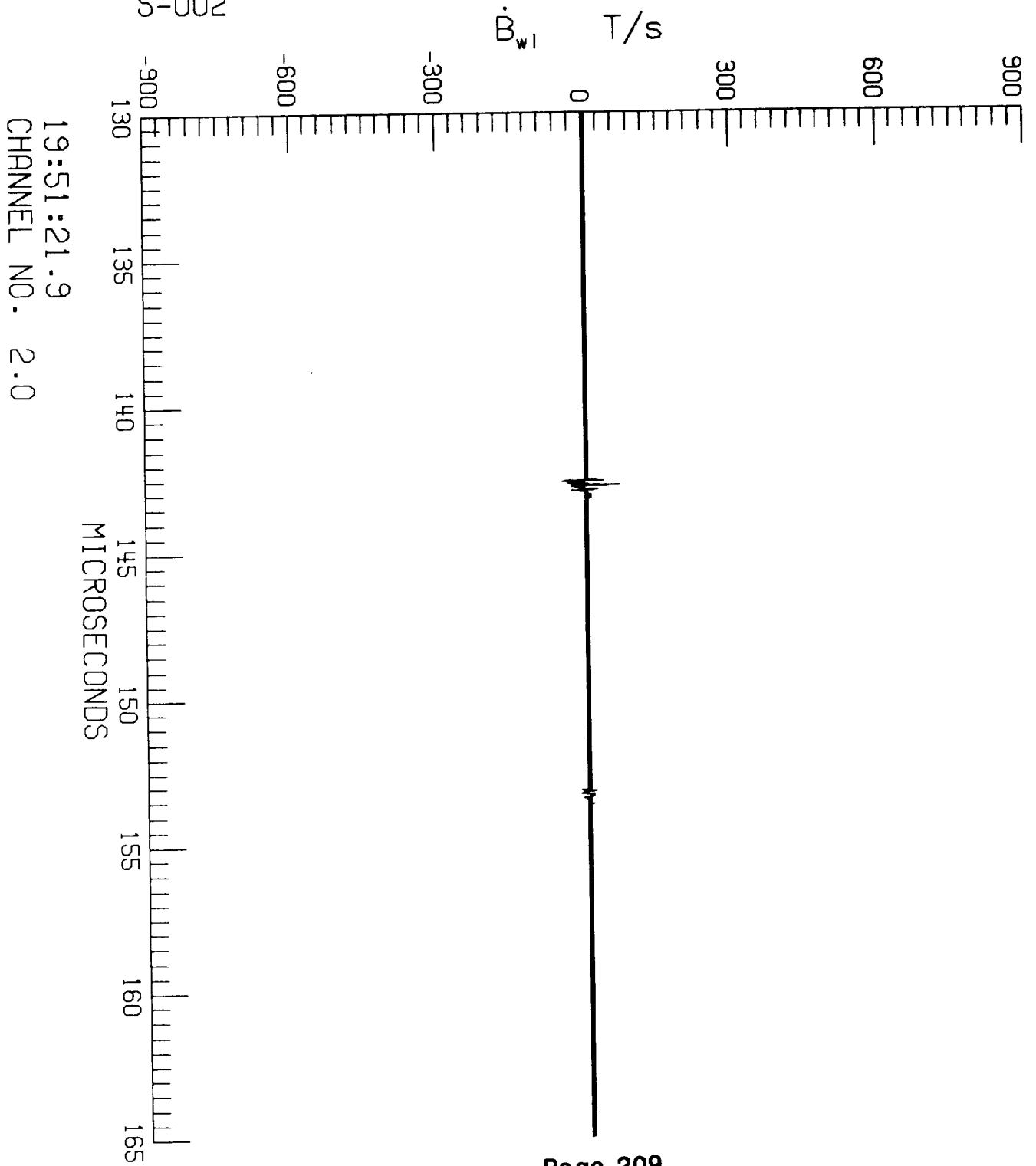

19:51:21.9  
CHANNEL NO. 2.0

F106 LIGHTNING/85-026/ZAEPFEL

LEC 2 RUN NO. 2

S-002

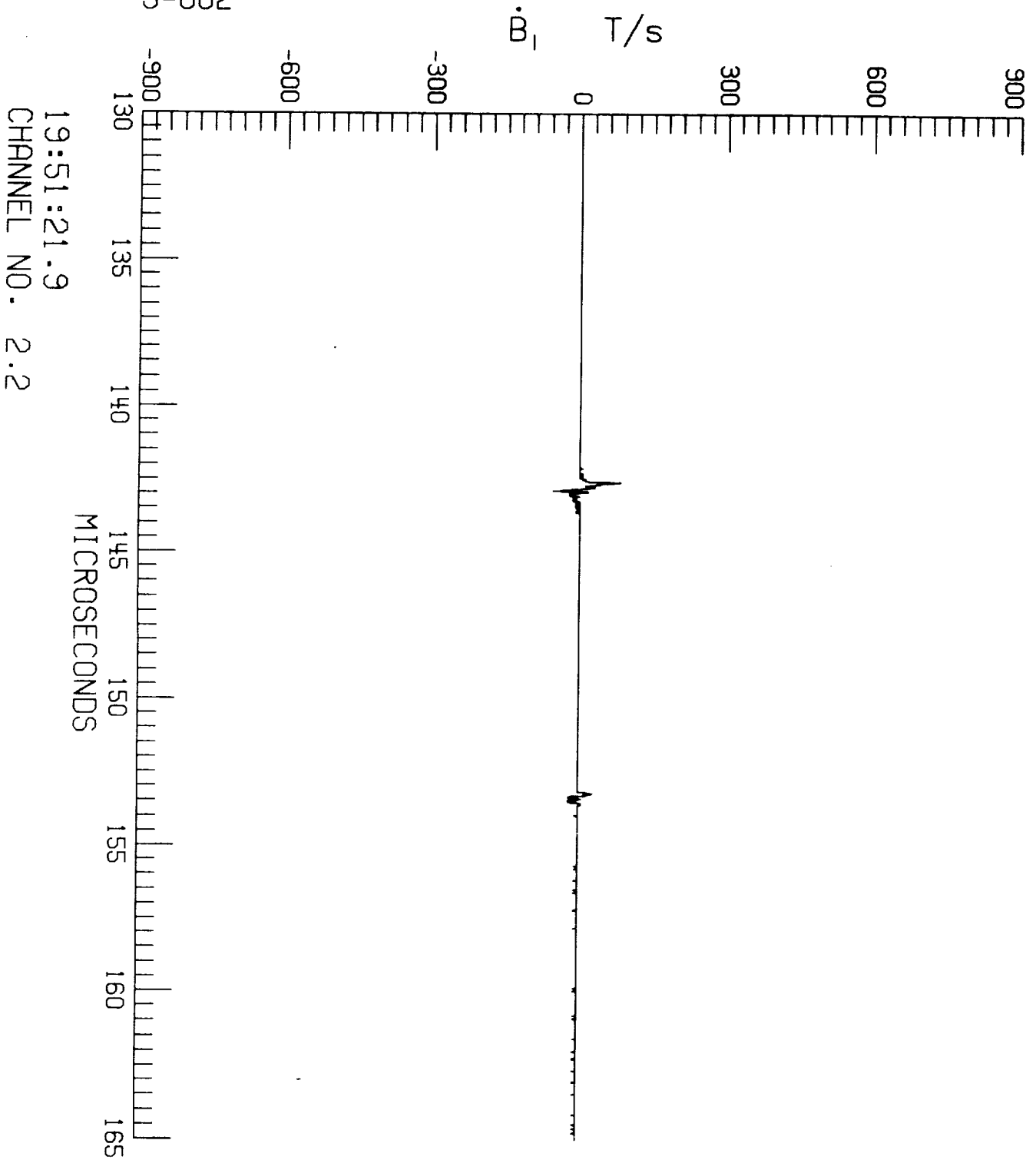

F106 LIGHTNING/85-026/ZAEPFEL  
LEC 3 RUN NO. 2  
S-002

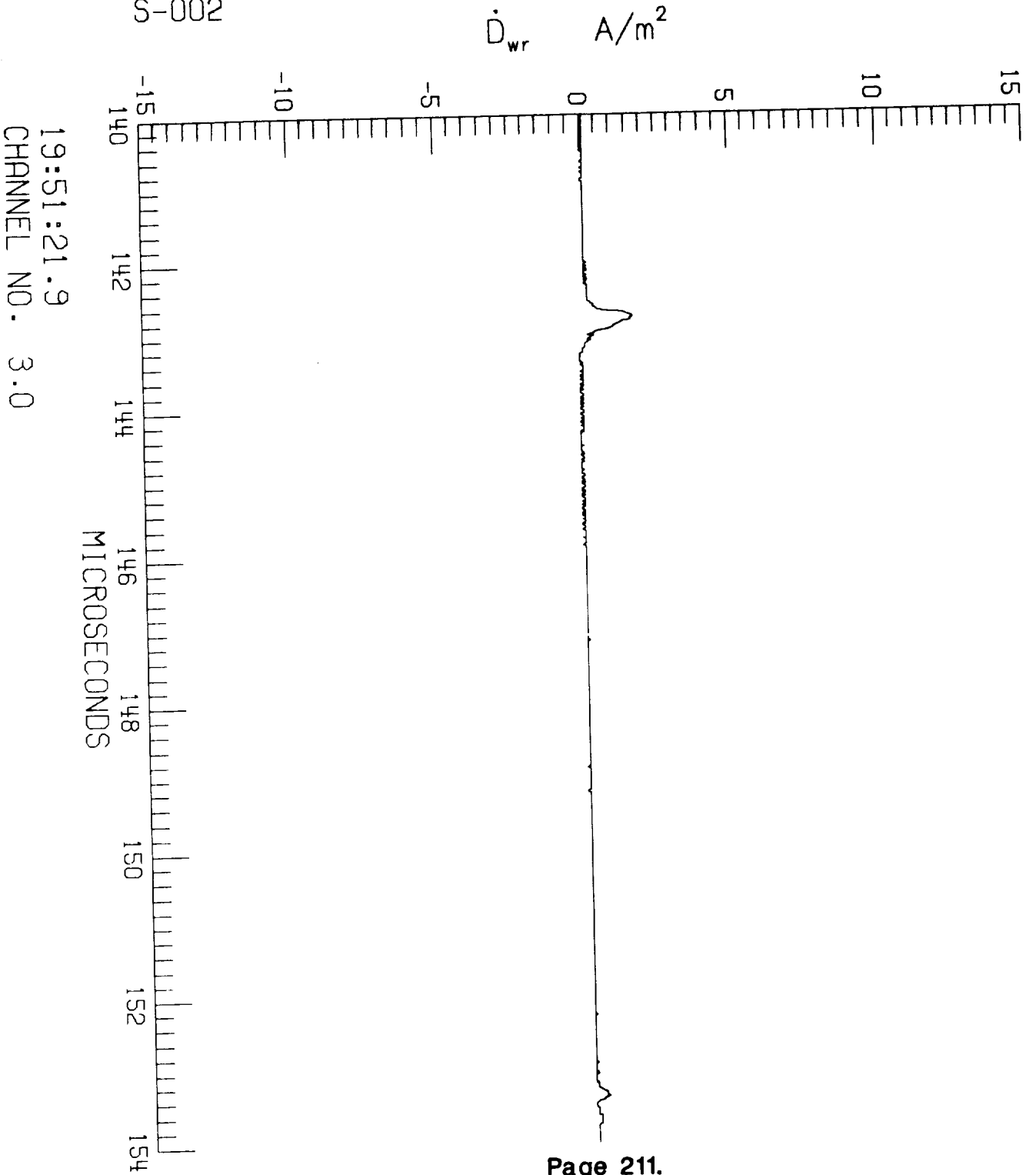

19:51:21.9  
CHANNEL NO. 3.0

F106 LIGHTNING/85-026/ZAEPFEL

LEC 3 RUN NO. 2

S-002

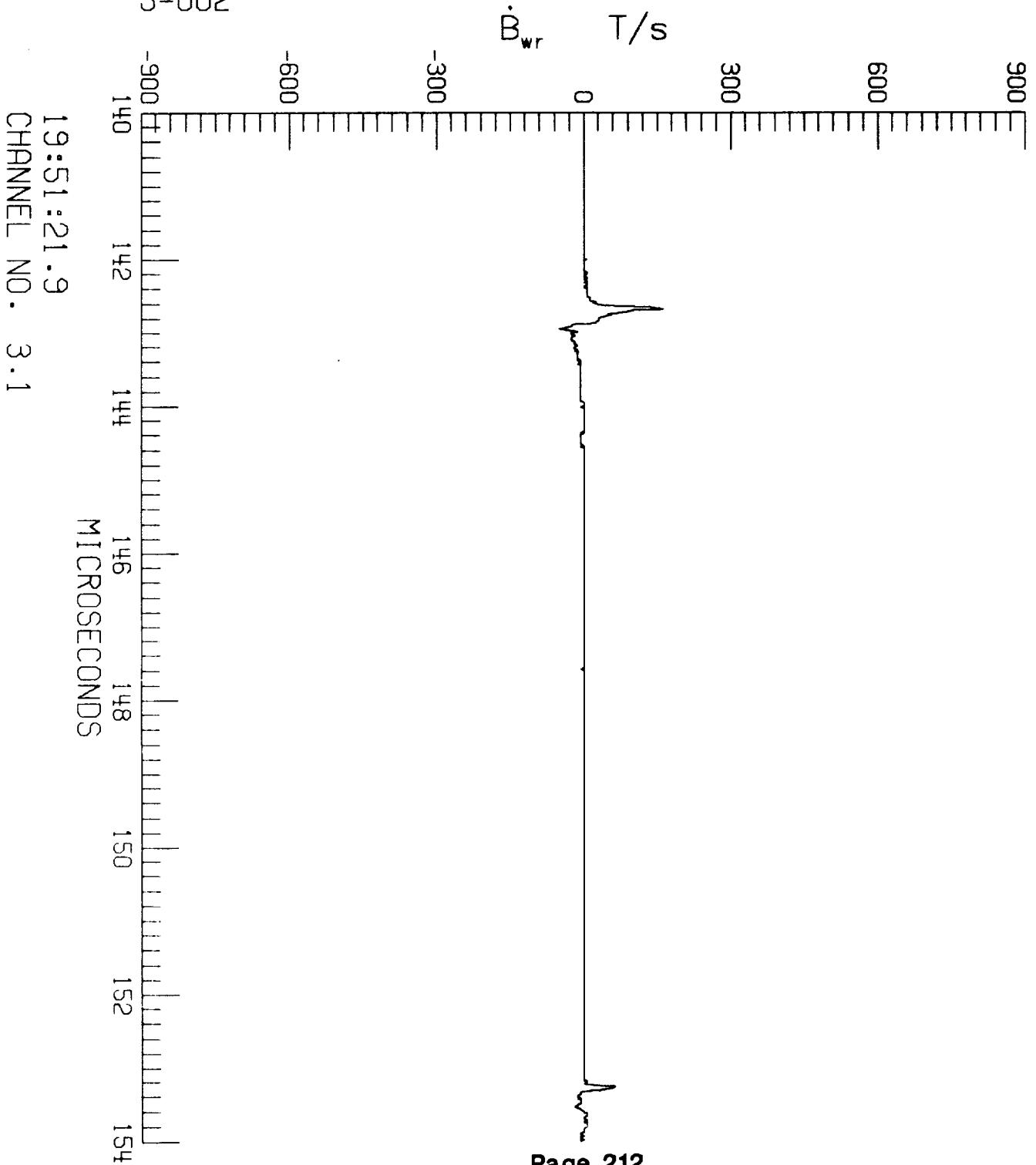

19:51:21.9  
CHANNEL NO. 3.1



F106 LIGHTNING/85-026/ZAEPFEL

LEC 3 RUN NO. 2

S-002

$\dot{D}_f$  A/m<sup>2</sup>

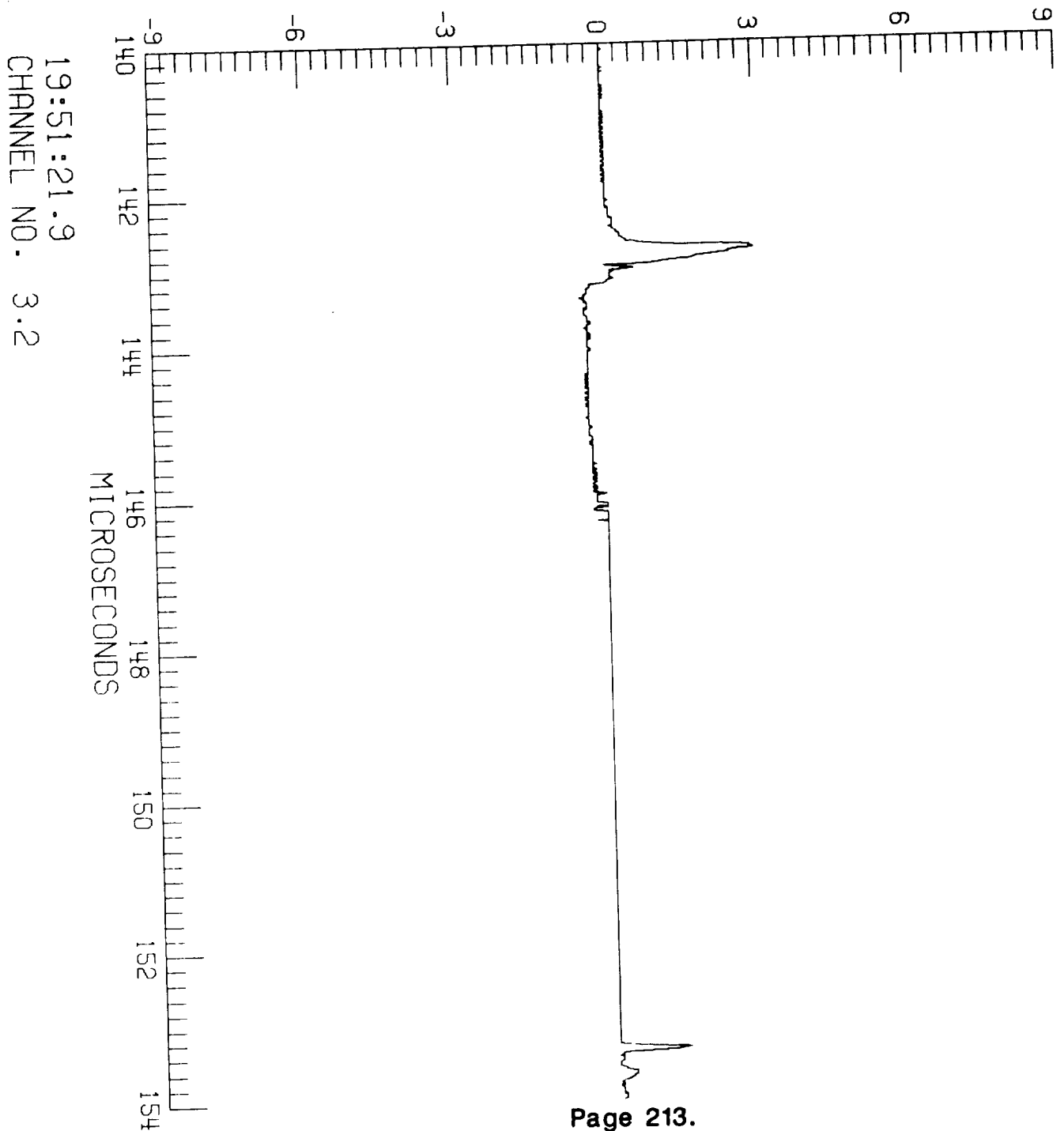

F106 LIGHTNING/85-026/ZAEPFEL

LEC 4 RUN NO. 2

S-002

TP100 V

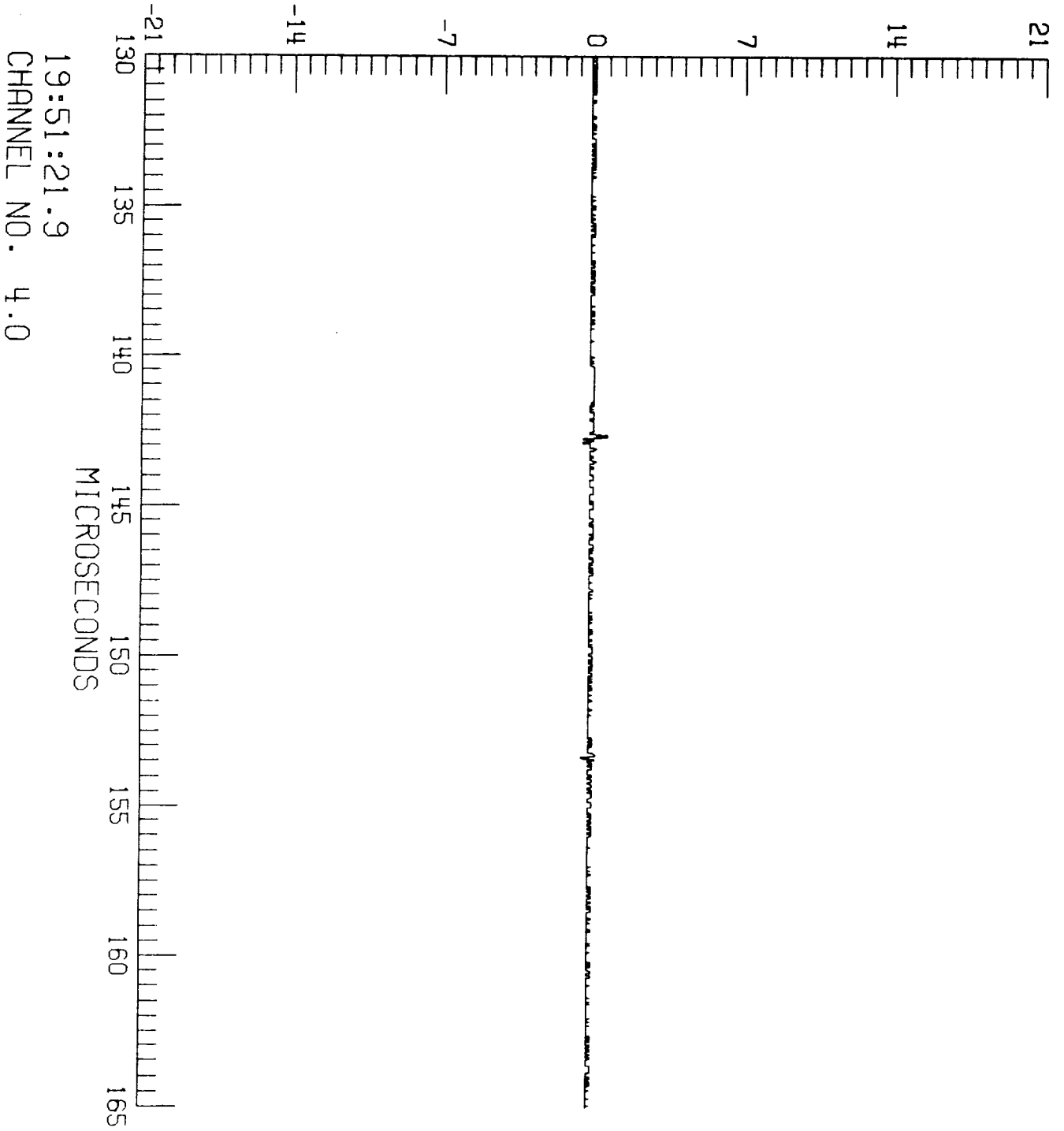

F106 LIGHTNING/85-026/ZAEPFEL

LEC 4 RUN NO. 2

S-002

TP106

A

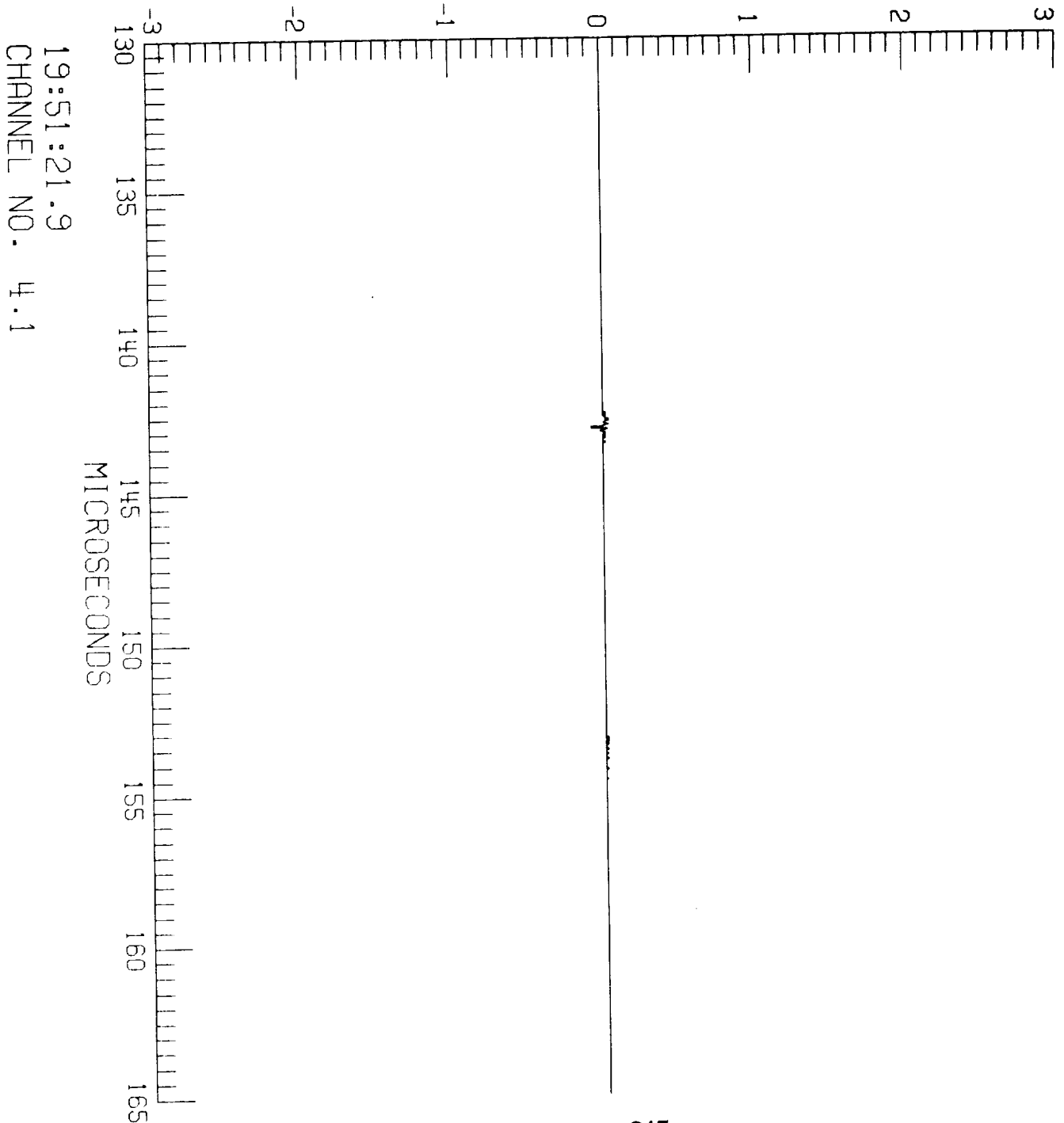

F106 LIGHTNING/85-026/ZAEPFEL

LEC 1 RUN NO. 2

S-002

$\dot{D}_t$  A/m<sup>2</sup>

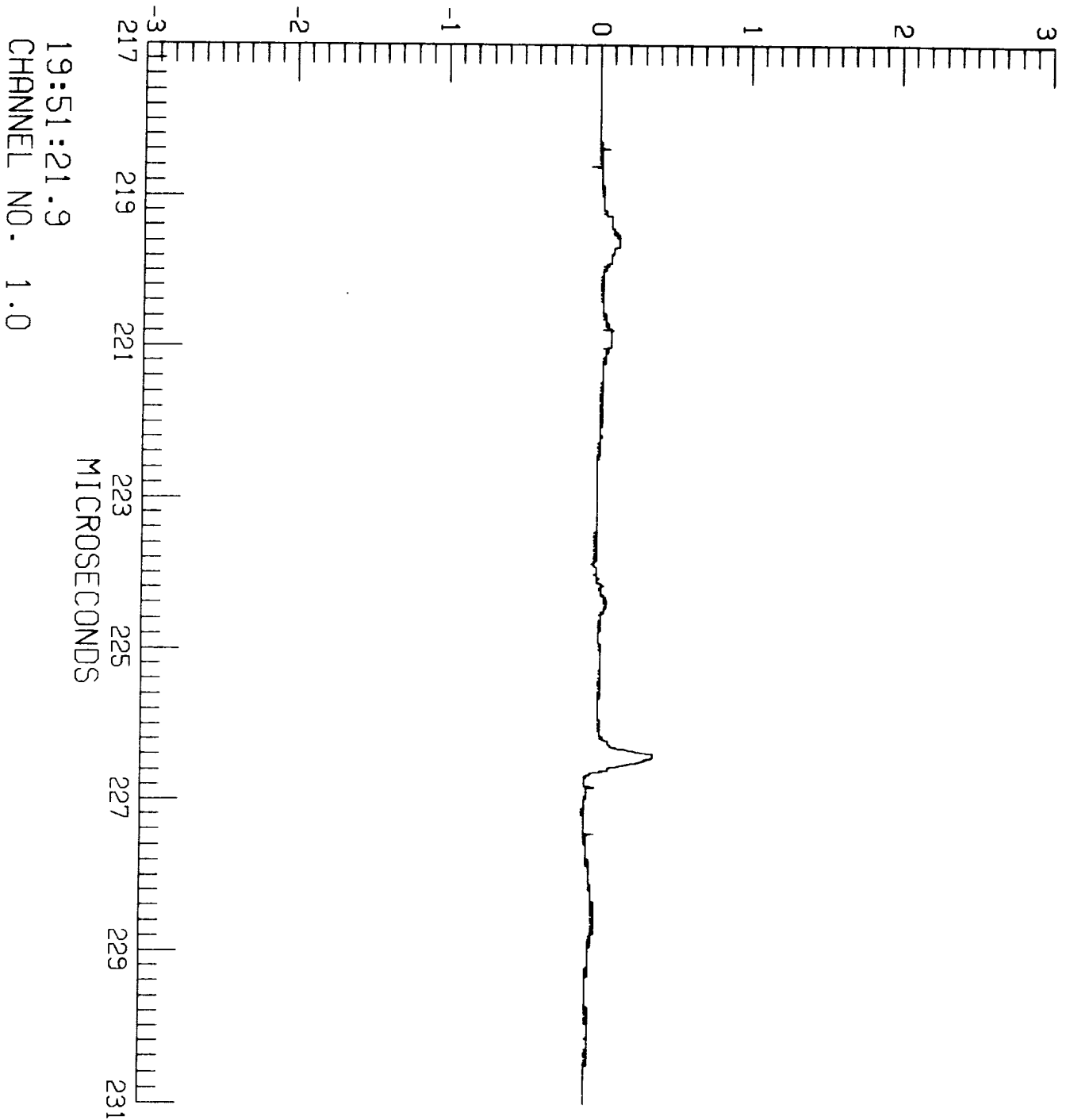

F106 LIGHTNING/85-026/ZAEPFEL

LEC 1 RUN NO. 2

S-002

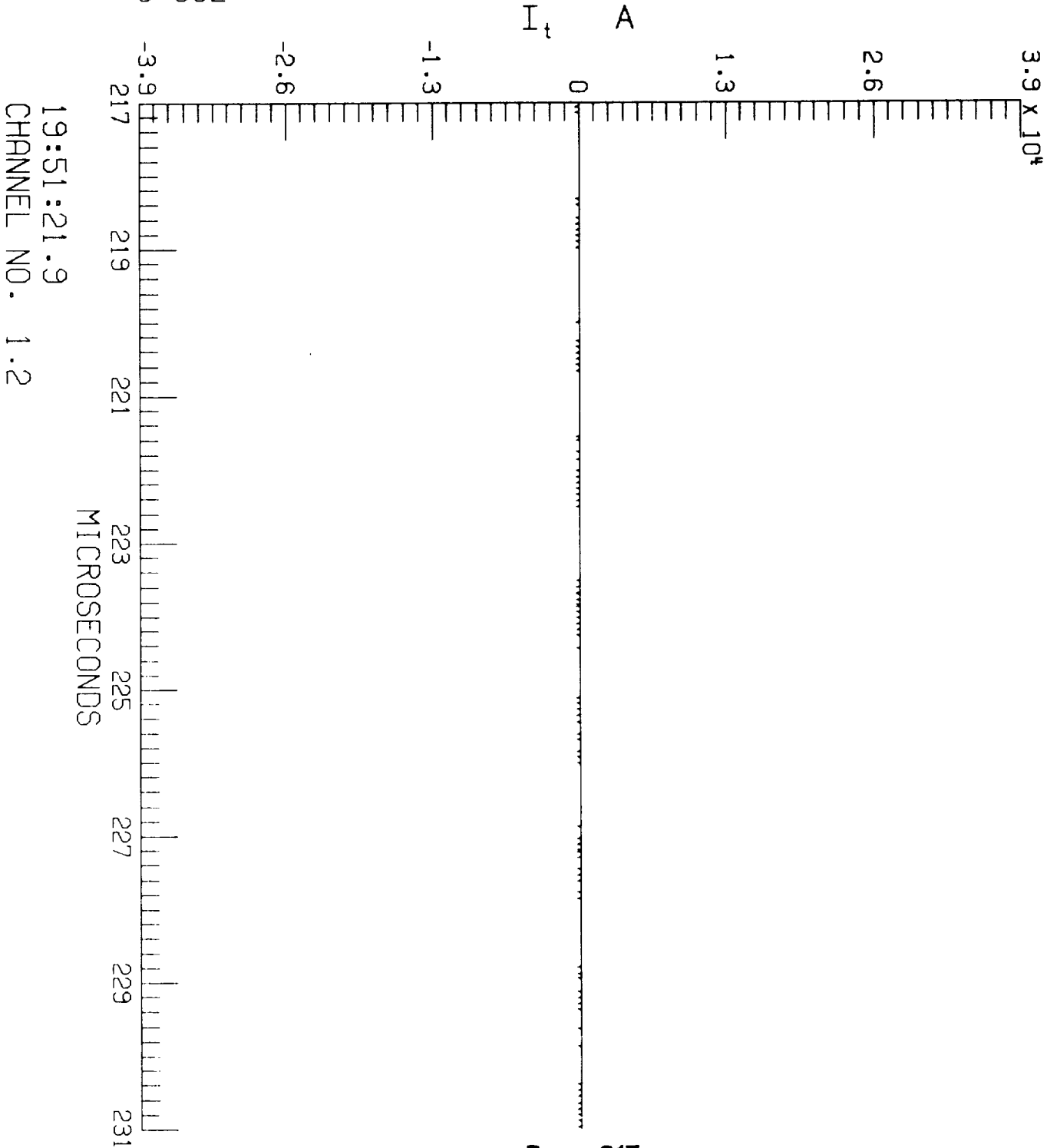

19:51:21.9  
CHANNEL NO. 1.2

F106 LIGHTNING/85-026/ZAEPFEL  
LEC 2 RUN NO. 2  
S-002

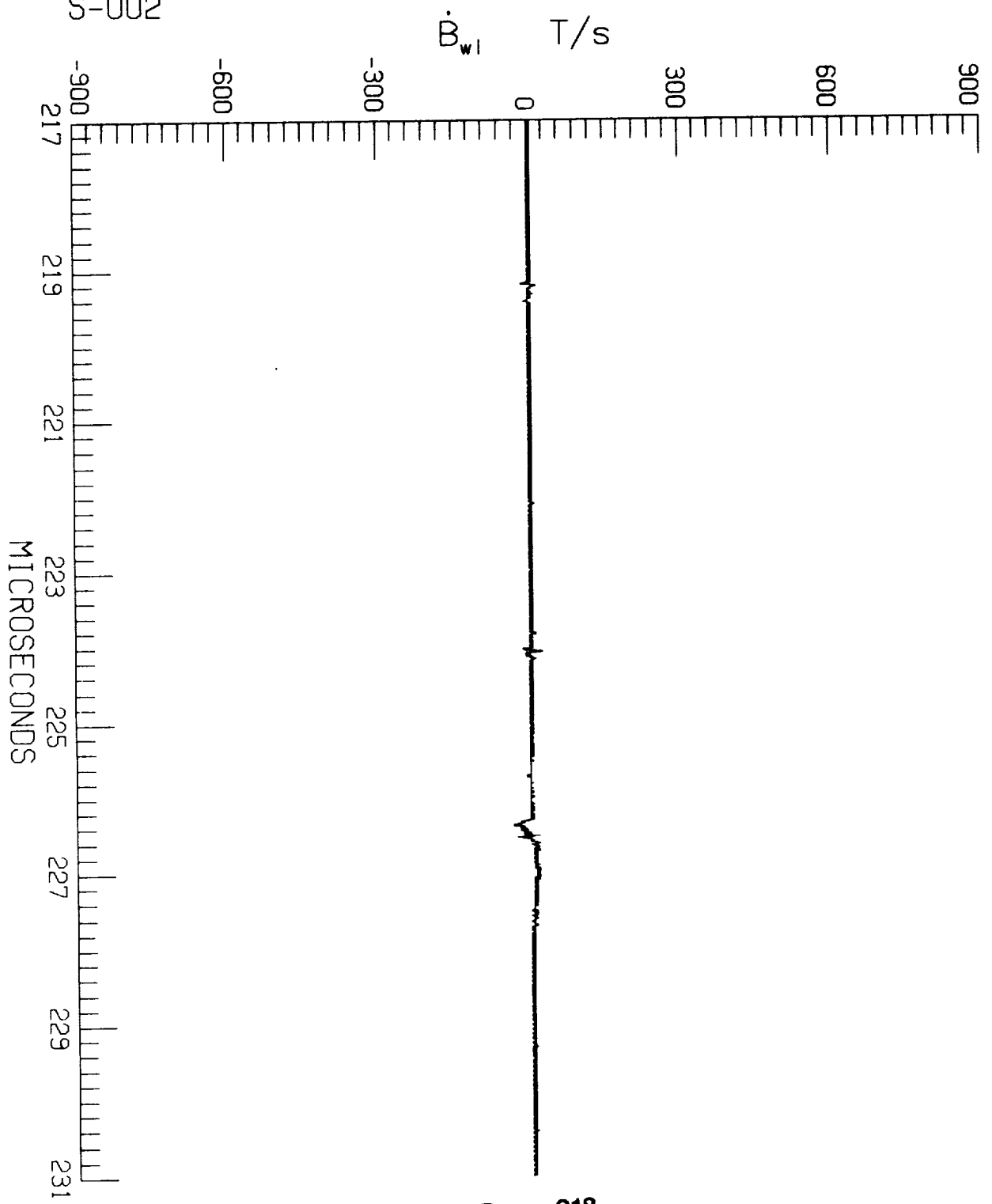

19:51:21.9  
CHANNEL NO. 2.0

F106 LIGHTNING/85-026/ZAEPFEL  
LEC 2 RUN NO. 2  
S-002

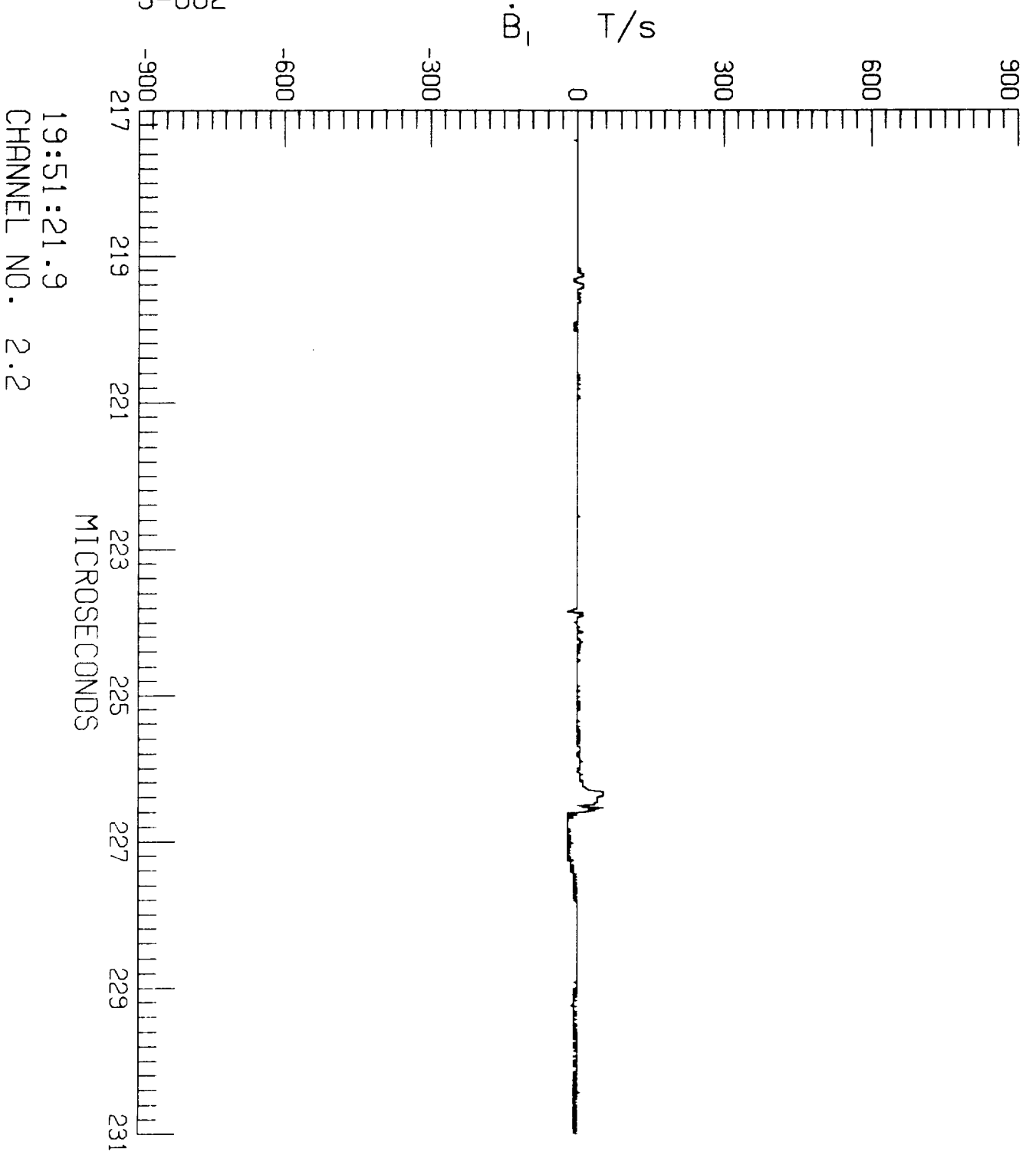

19:51:21.9  
CHANNEL NO. 2.2

F106 LIGHTNING/85-026/ZAEPFEL

LEC 3 RUN NO. 2

S-002

$\dot{D}_{wr}$  A/m<sup>2</sup>

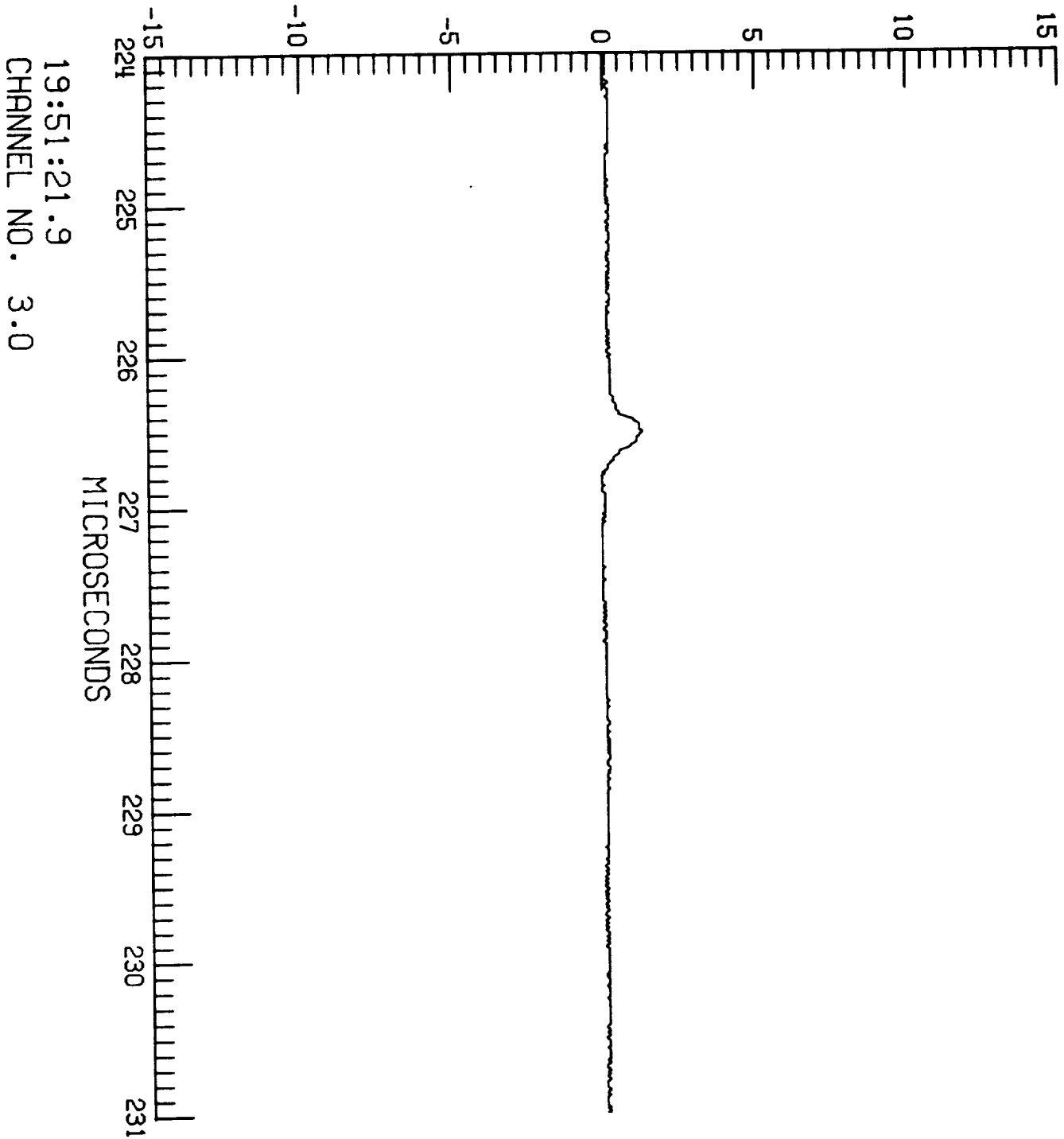



F106 LIGHTNING/85-026/ZAEPFEL  
LEC 3 RUN NO. 2  
S-002

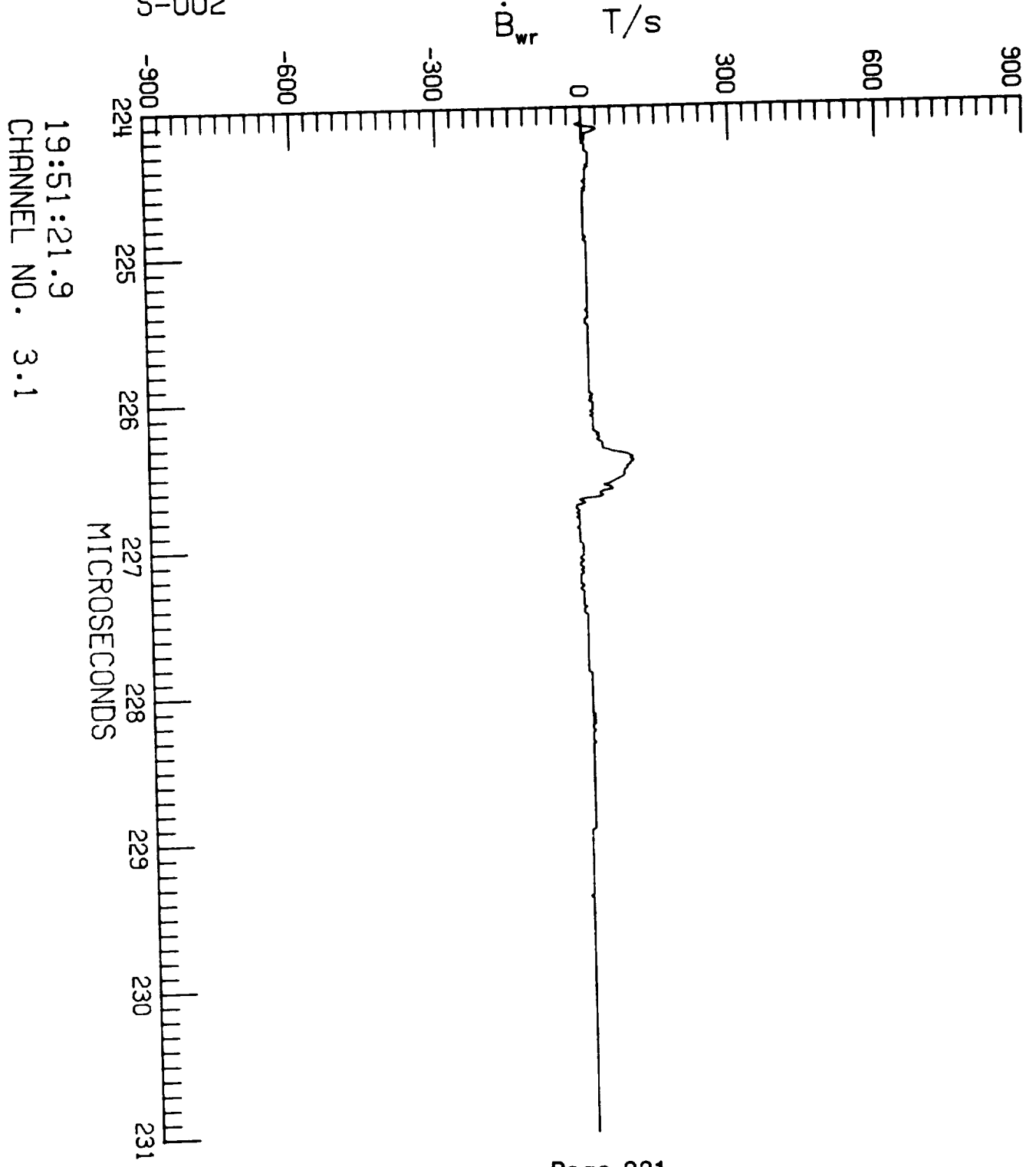

19:51:21.9  
CHANNEL NO. 3.1

F106 LIGHTNING/85-026/ZAEPFEL

LEC 3 RUN NO. 2

S-002

$\dot{D}_f$  A/m<sup>2</sup>

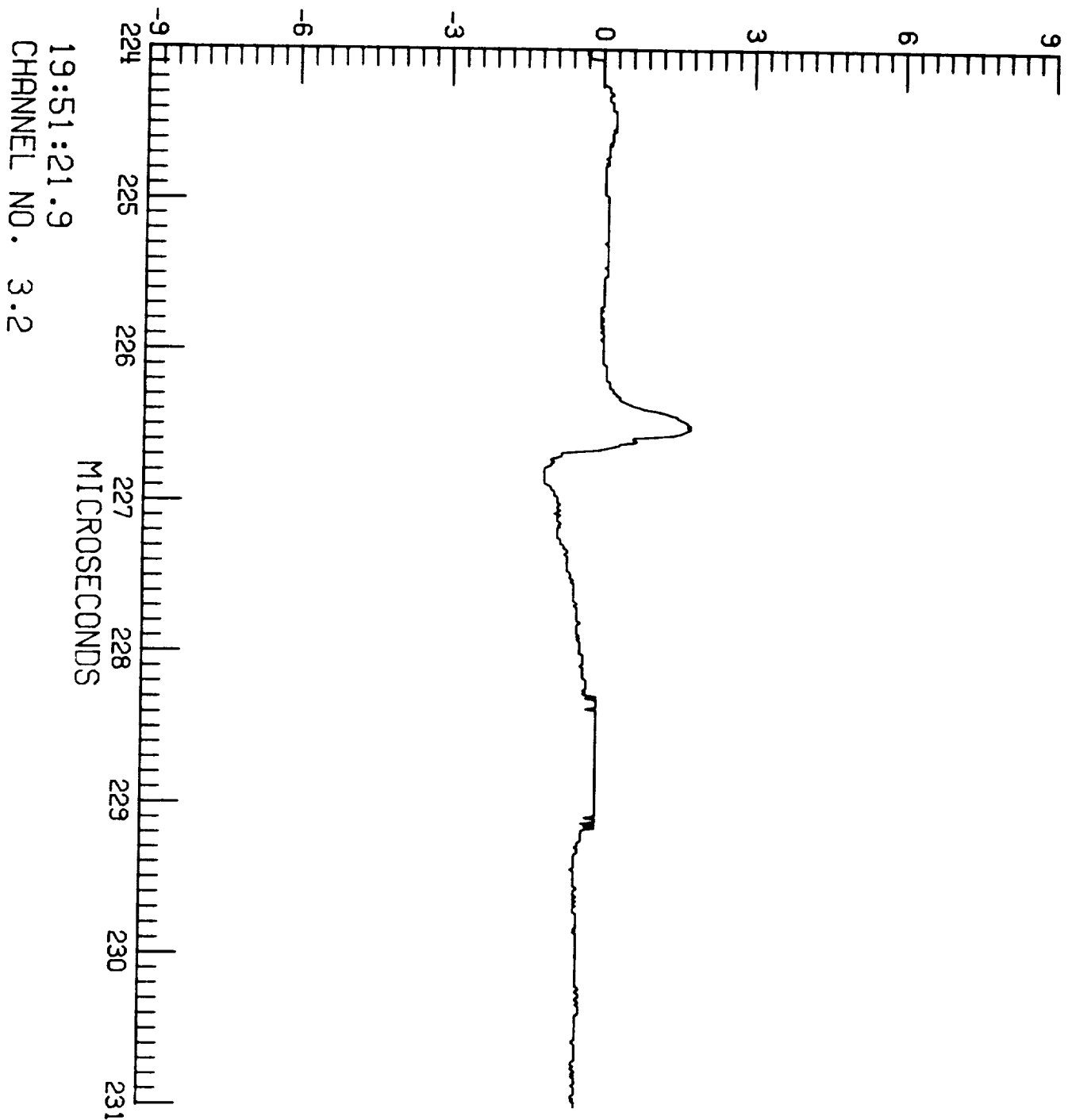

F106 LIGHTNING/85-026/ZAEPFEL

LEC 4 RUN NO. 2

S-002

TP100 V

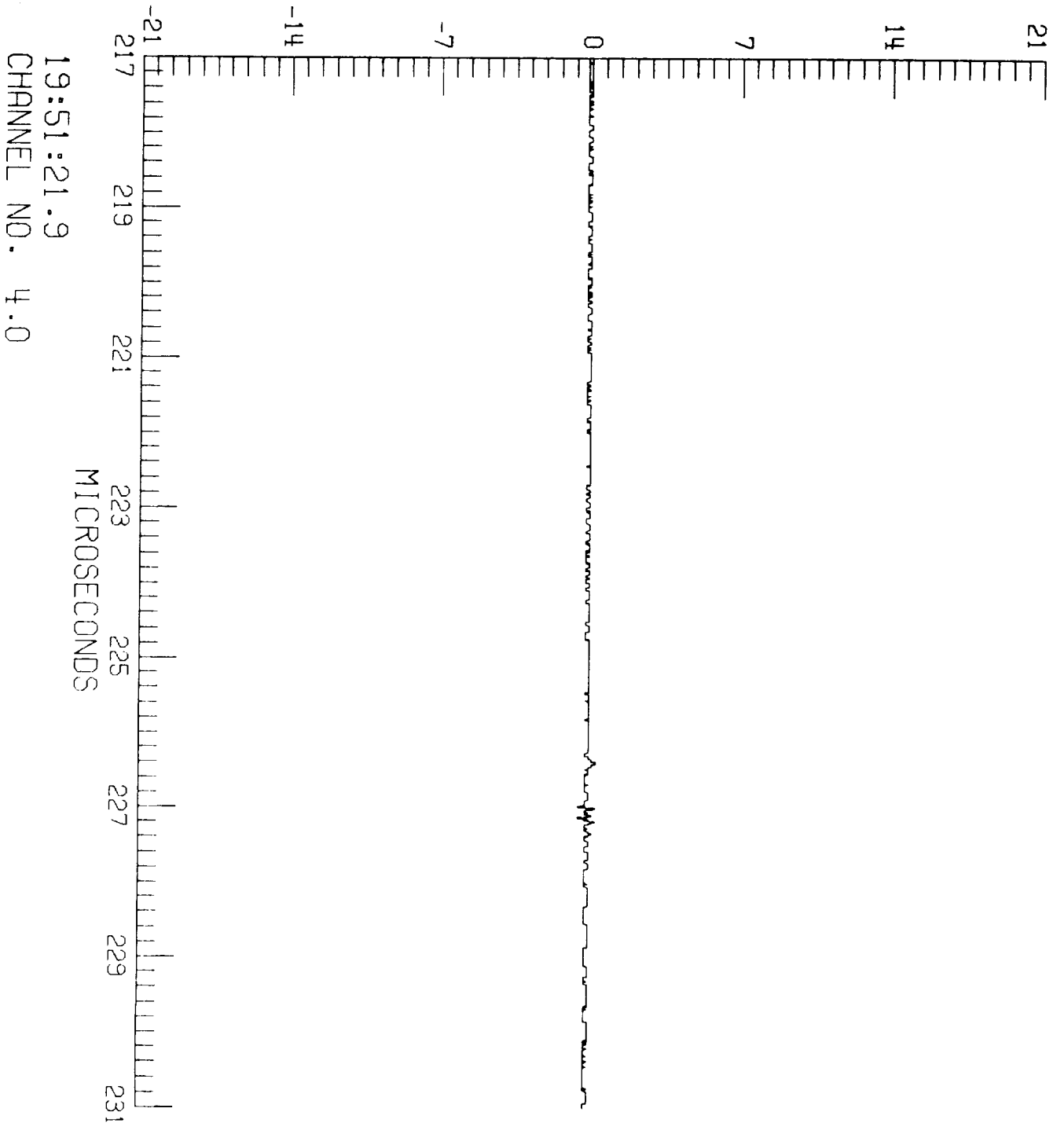

F106 LIGHTNING/85-026/ZAEPFEL

LEC 4 RUN NO. 2

S-002

TP106 A

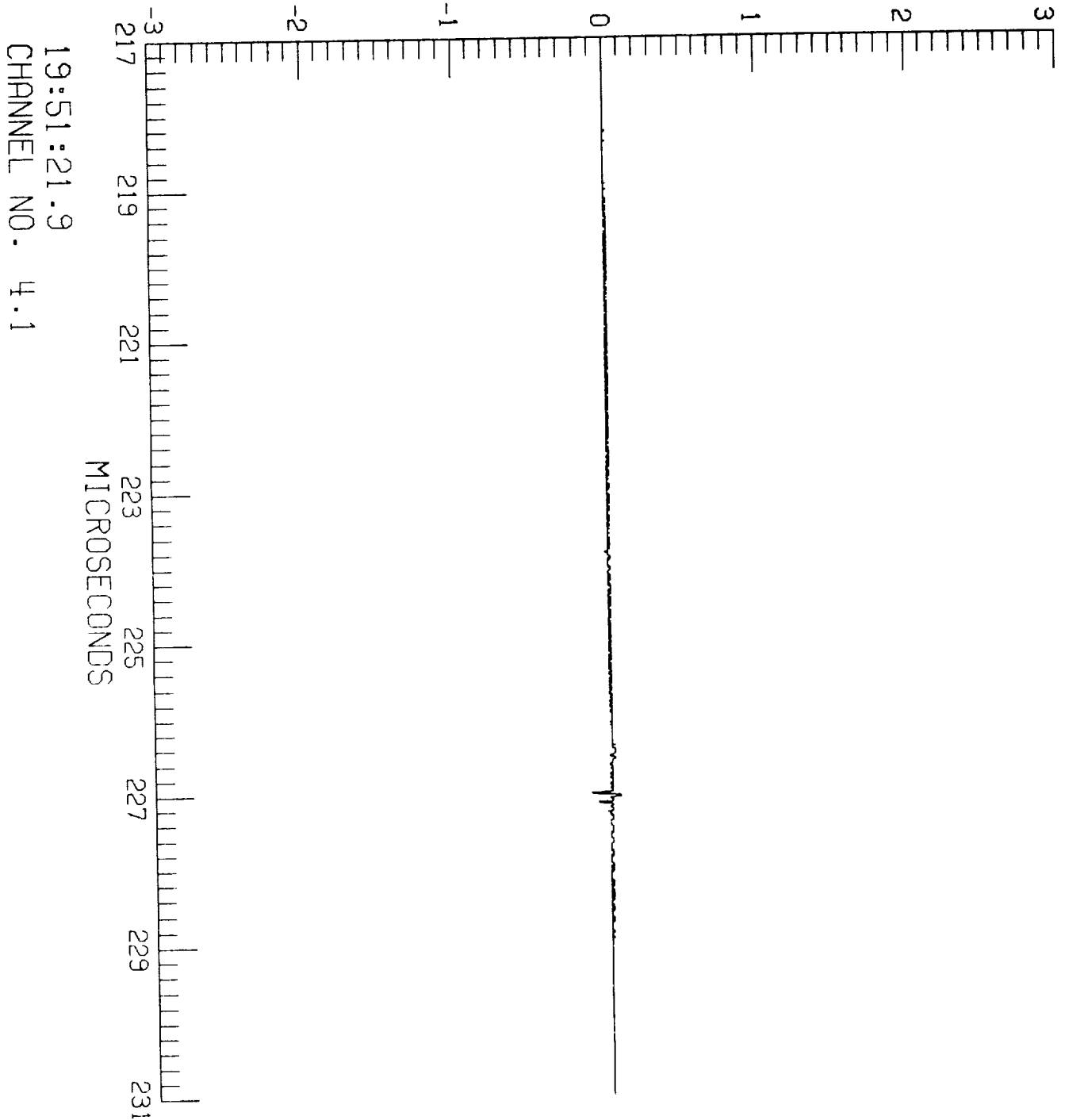

F106 LIGHTNING/85-026/ZAEPFEL

LEC 3 RUN NO. 2

S-002

19:51:21.9  
CHANNEL NO. 3.0

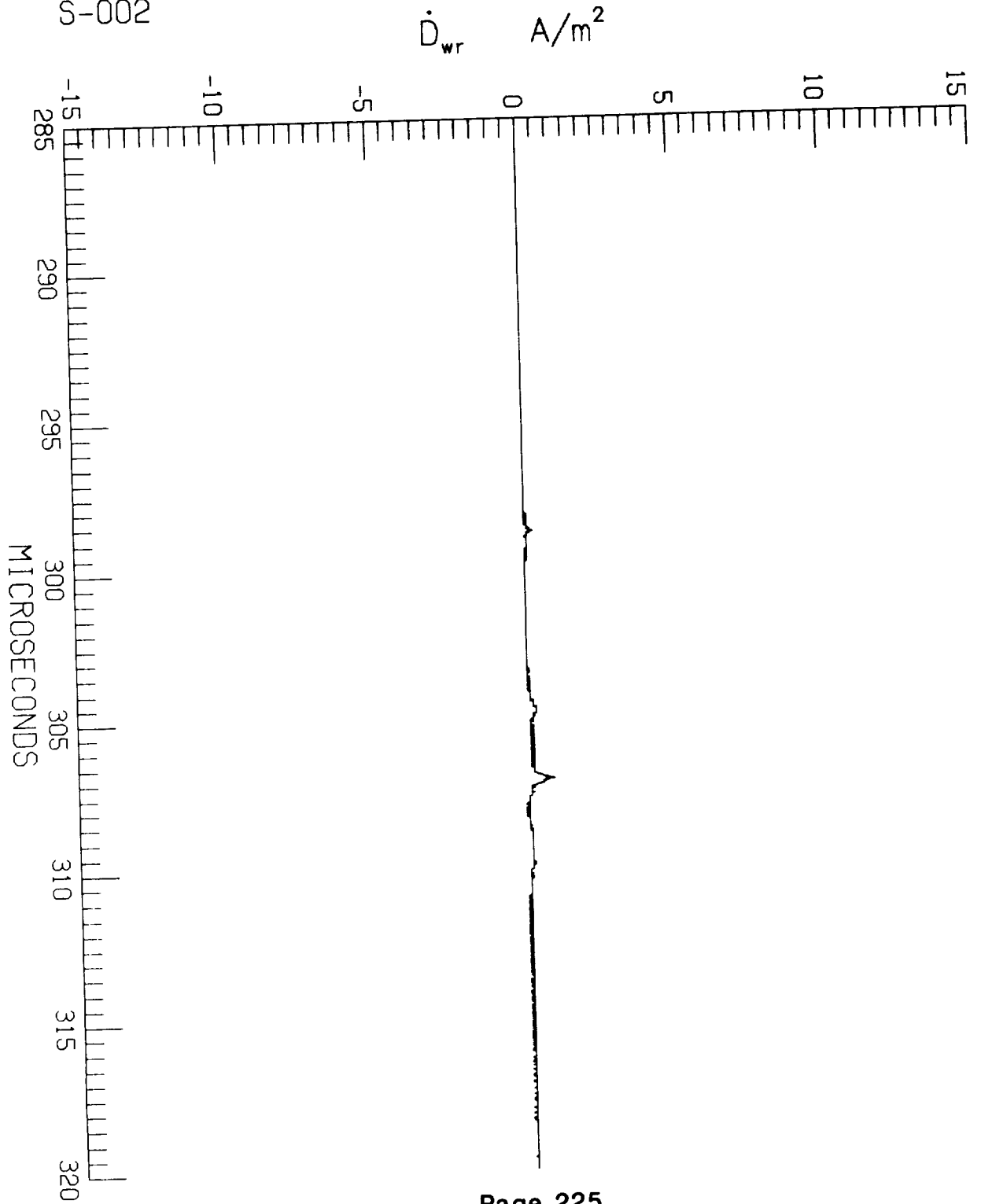

F106 LIGHTNING/85-026/ZAEPFEL

LEC 3 RUN NO. 2

S-002

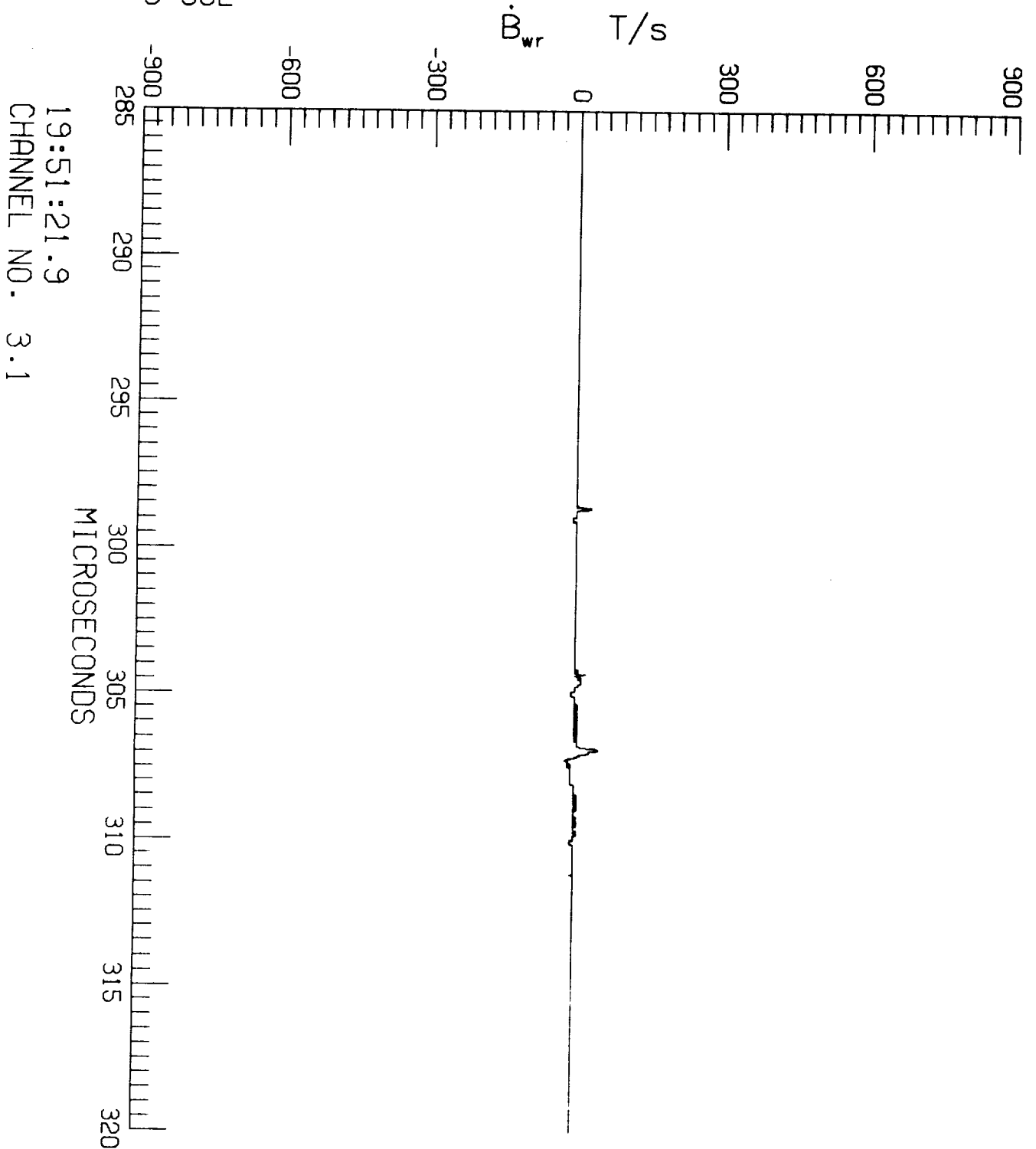

19:51:21.9  
CHANNEL NO. 3.1

F106 LIGHTNING/85-026/ZAEPFEL

LEC 3 RUN NO. 2

S-002

$\dot{D}_f$  A/m<sup>2</sup>

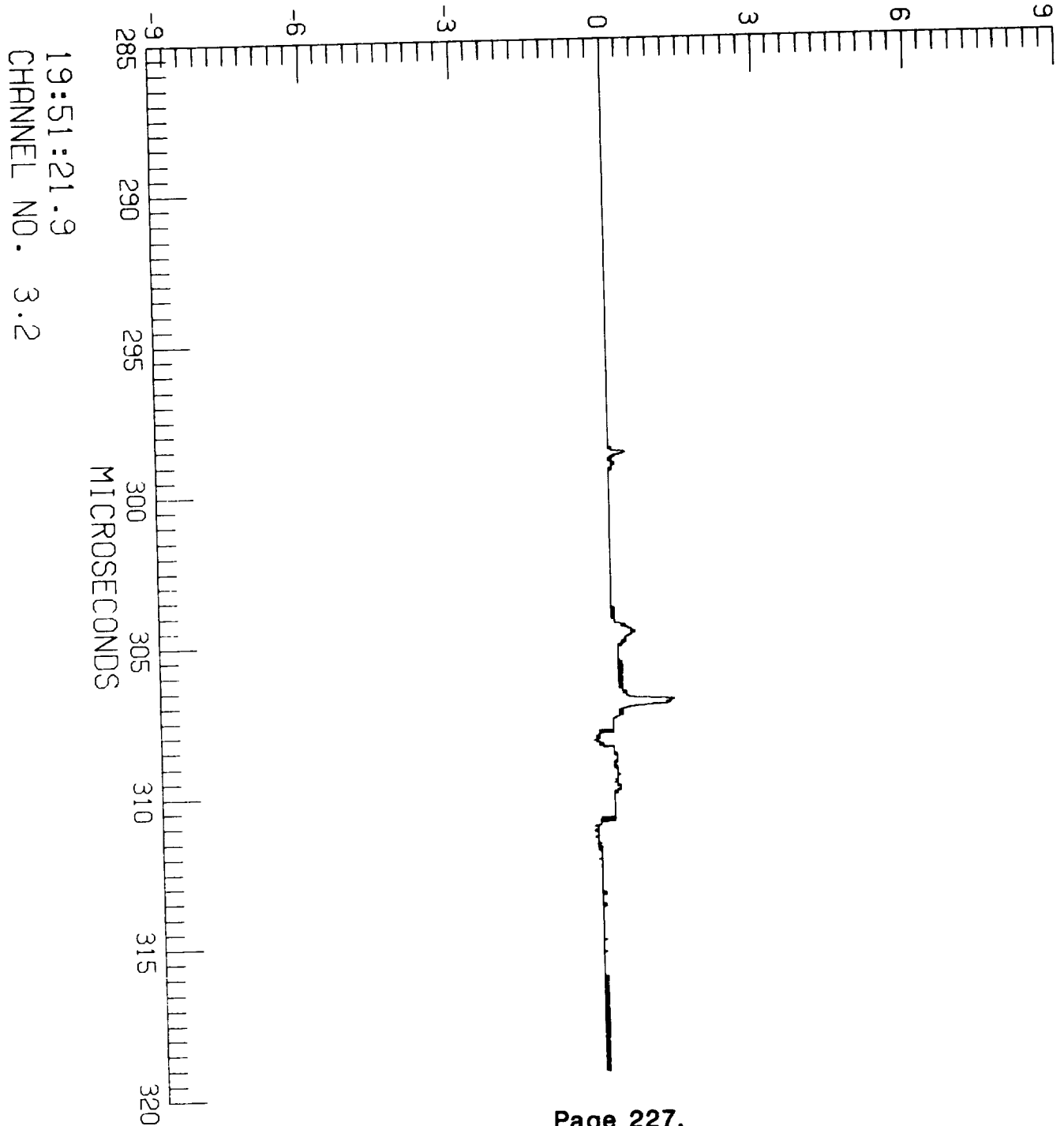

F106 LIGHTNING/85-026/ZAEPFEL

LEC 3 RUN NO. 2

S-002

$\dot{D}_{wr}$  A/m<sup>2</sup>

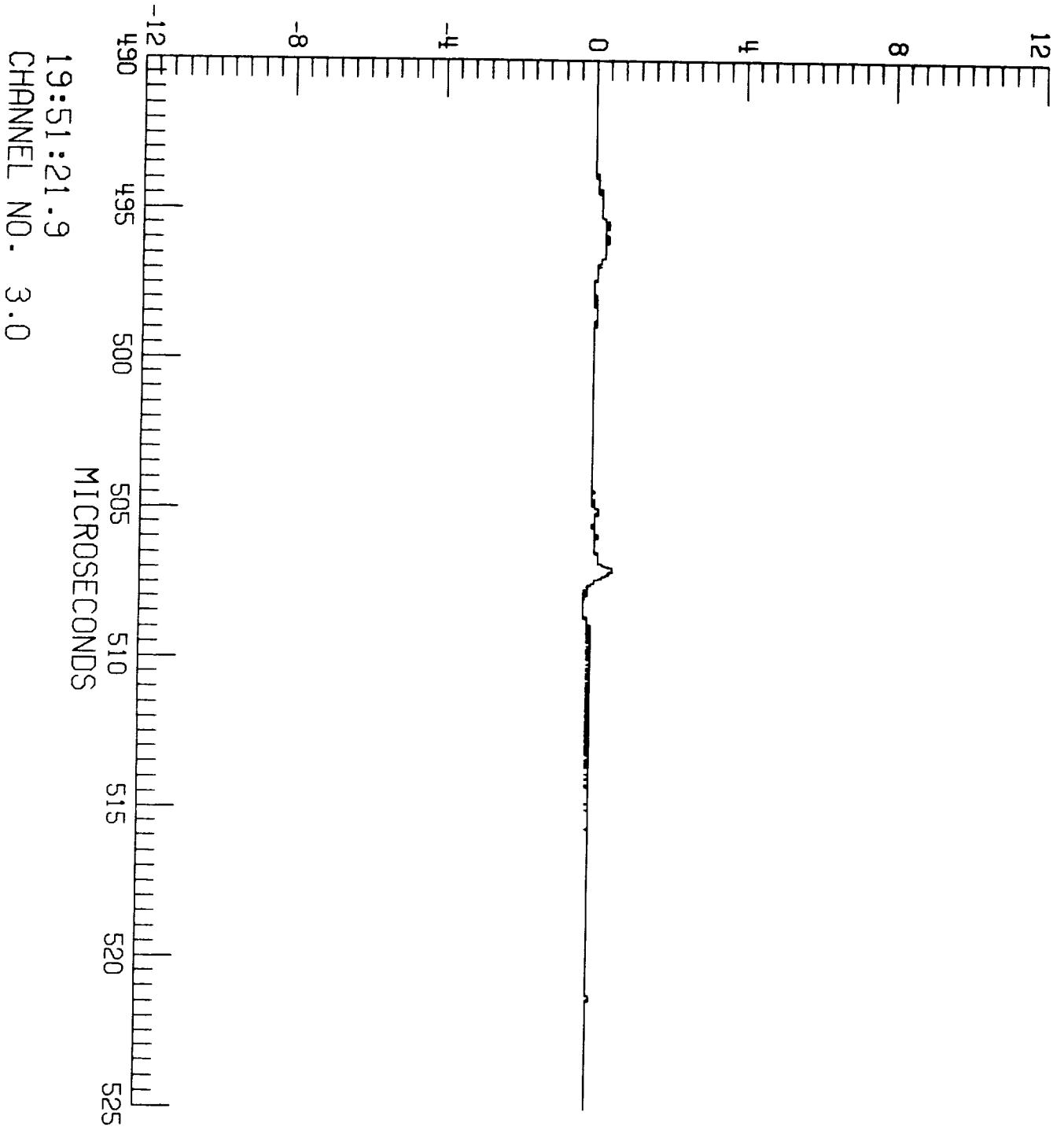



F106 LIGHTNING/85-026/ZAEPFEL  
LEC 3 RUN NO. 2  
S-002

19:51:21.9  
CHANNEL NO. 3.1

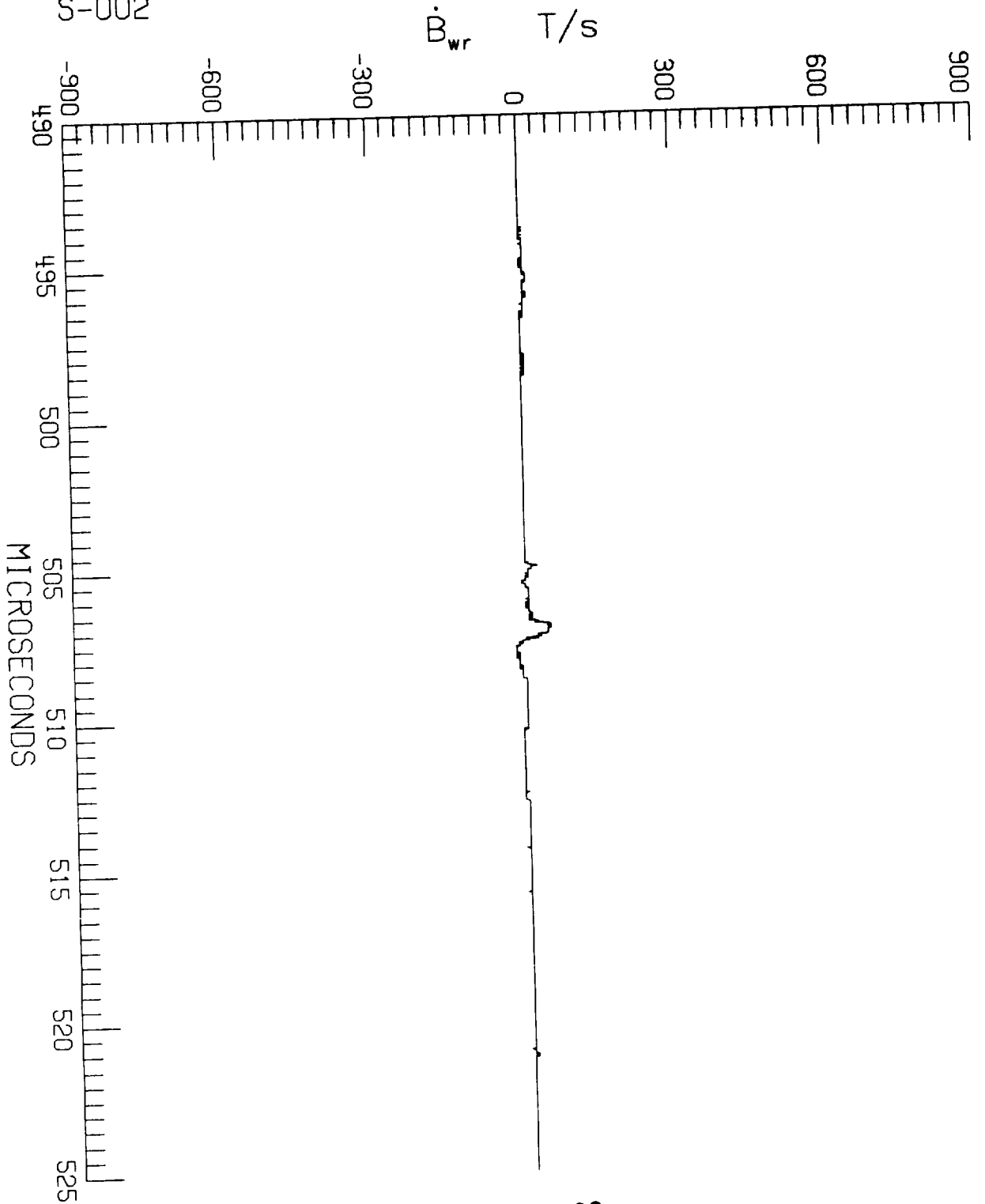

F106 LIGHTNING/85-026/ZAEPFEL

LEC 3 RUN NO. 2

S-002

$\dot{D}_f$  A/m<sup>2</sup>

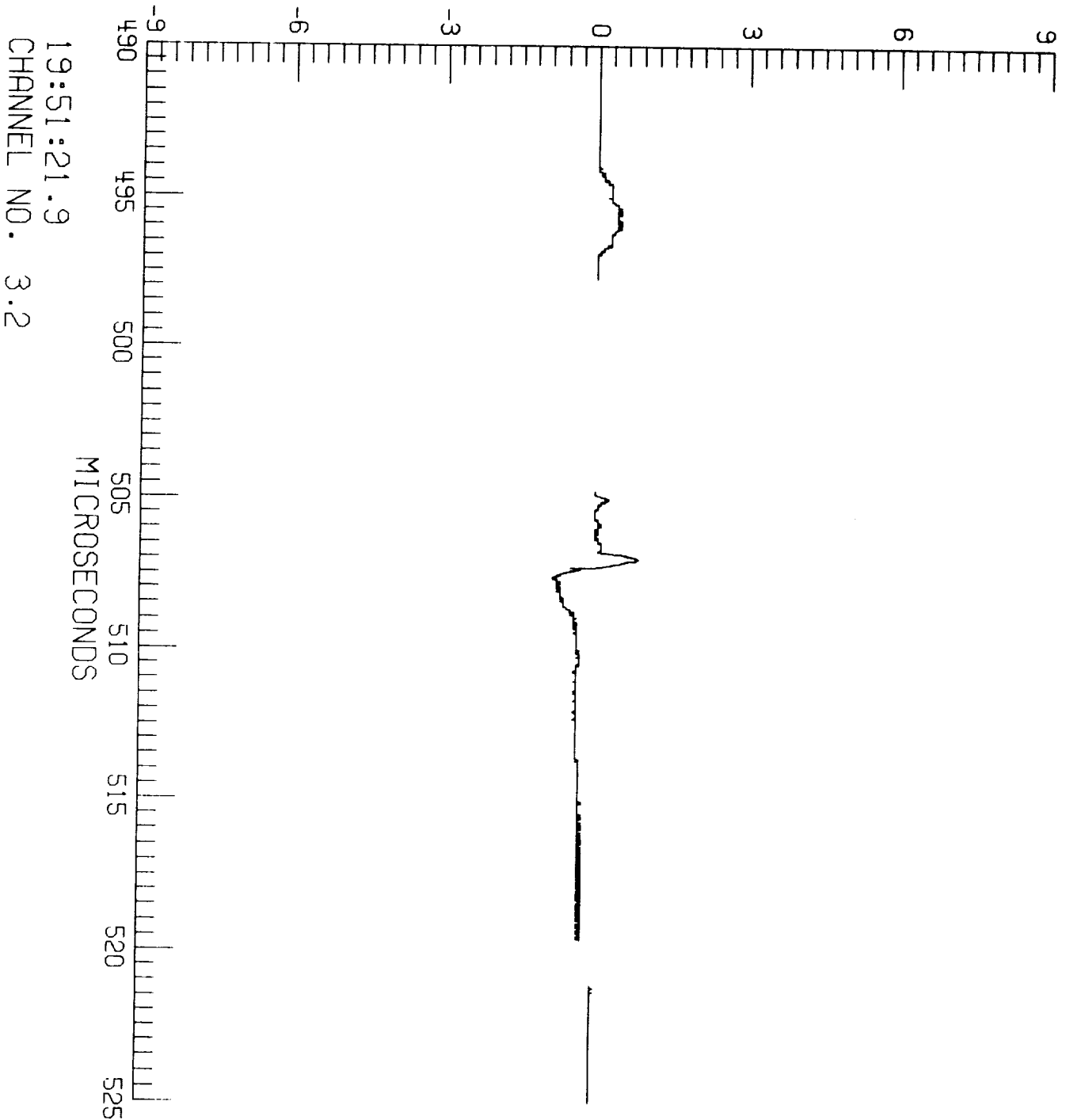

F106 LIGHTNING/85-026/ZAEPFEL

LEC 1 RUN NO. 3

S-003

$\dot{D}_t$  A/m<sup>2</sup>

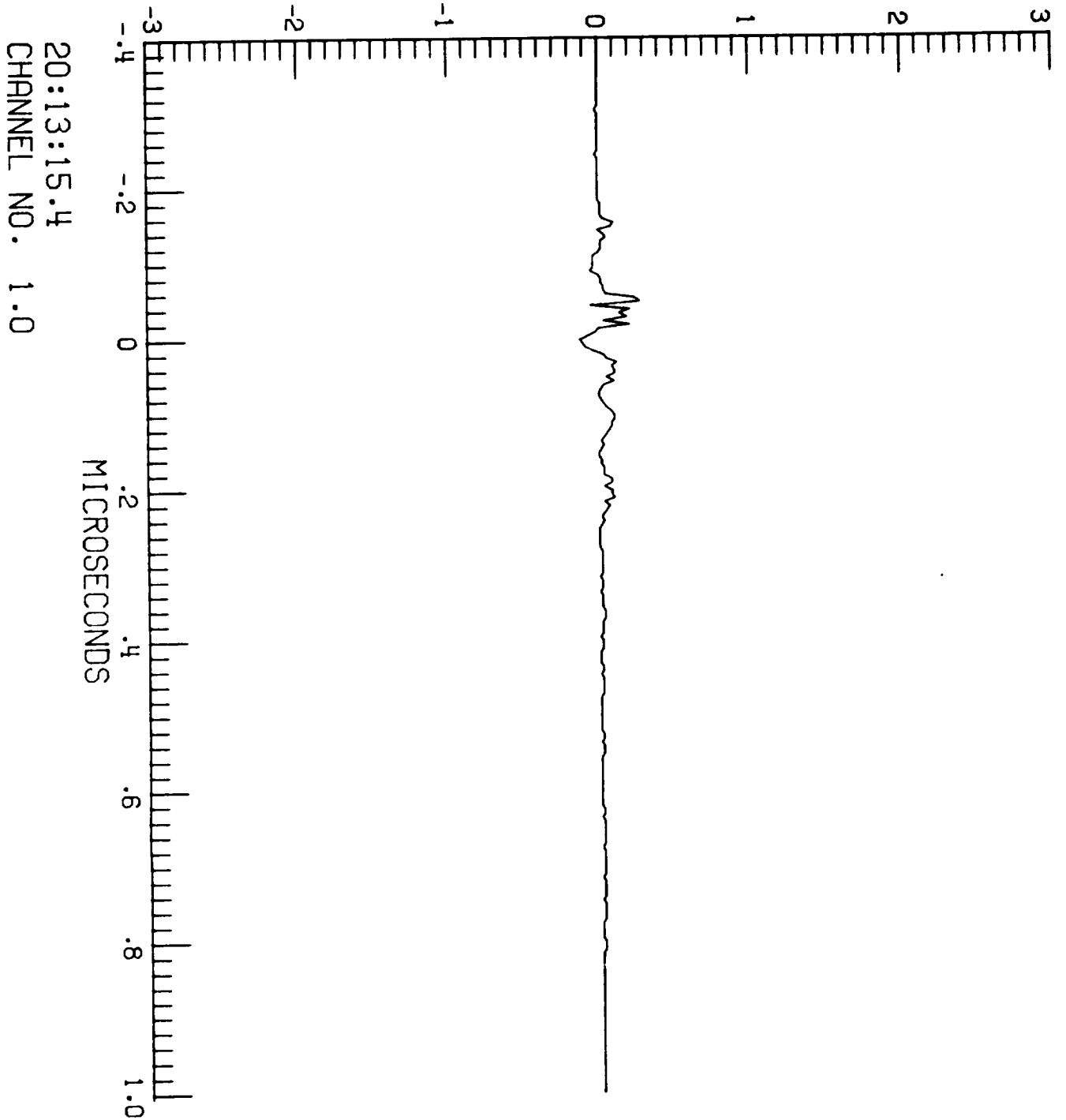

F106 LIGHTNING/85-026/ZAEPFEL

LEC 1 RUN NO. 3

S-003

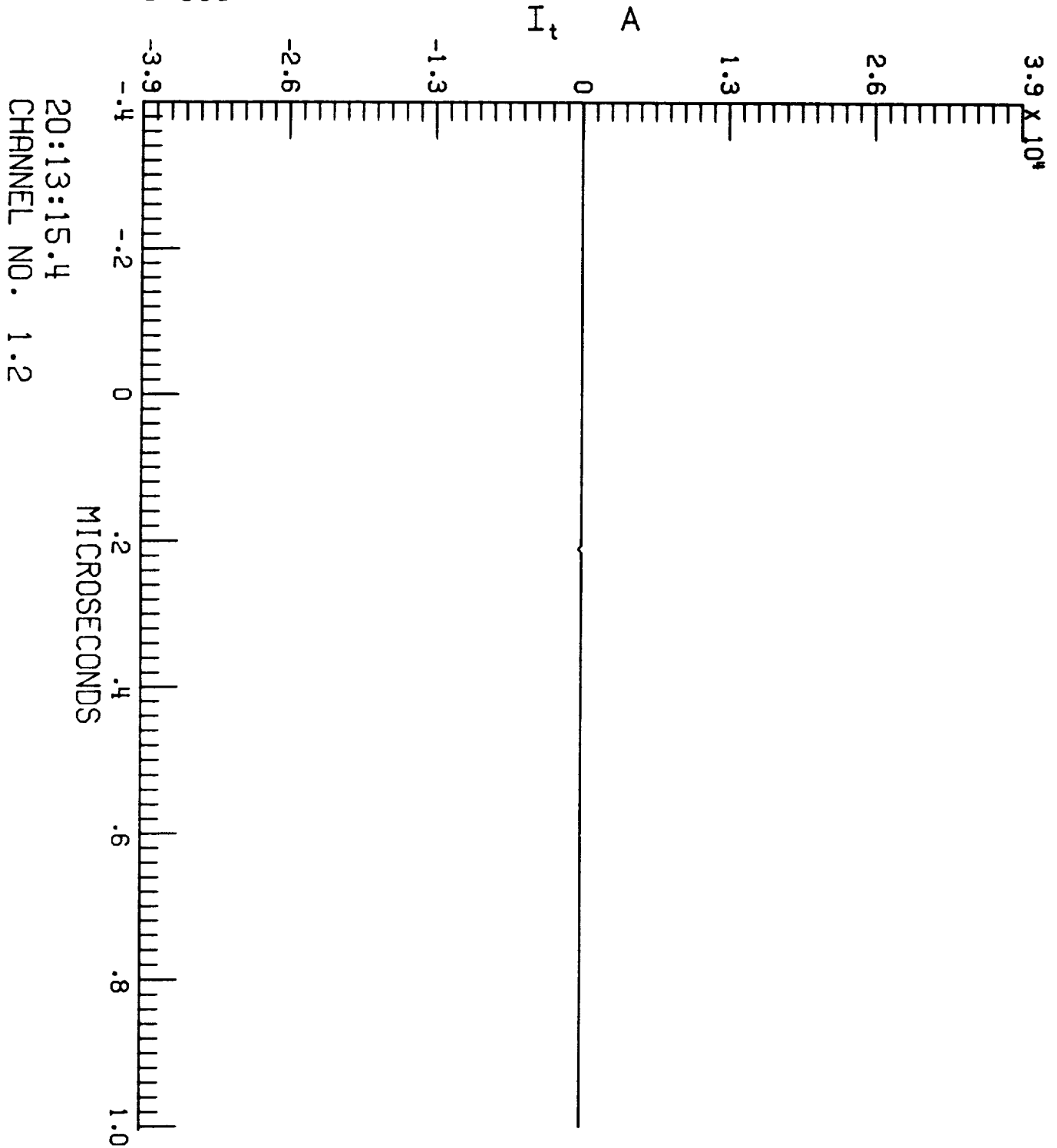

20:13:15.4  
CHANNEL NO. 1.2

F106 LIGHTNING/85-026/ZAEPFEL

LEC 2 RUN NO. 3

S-003

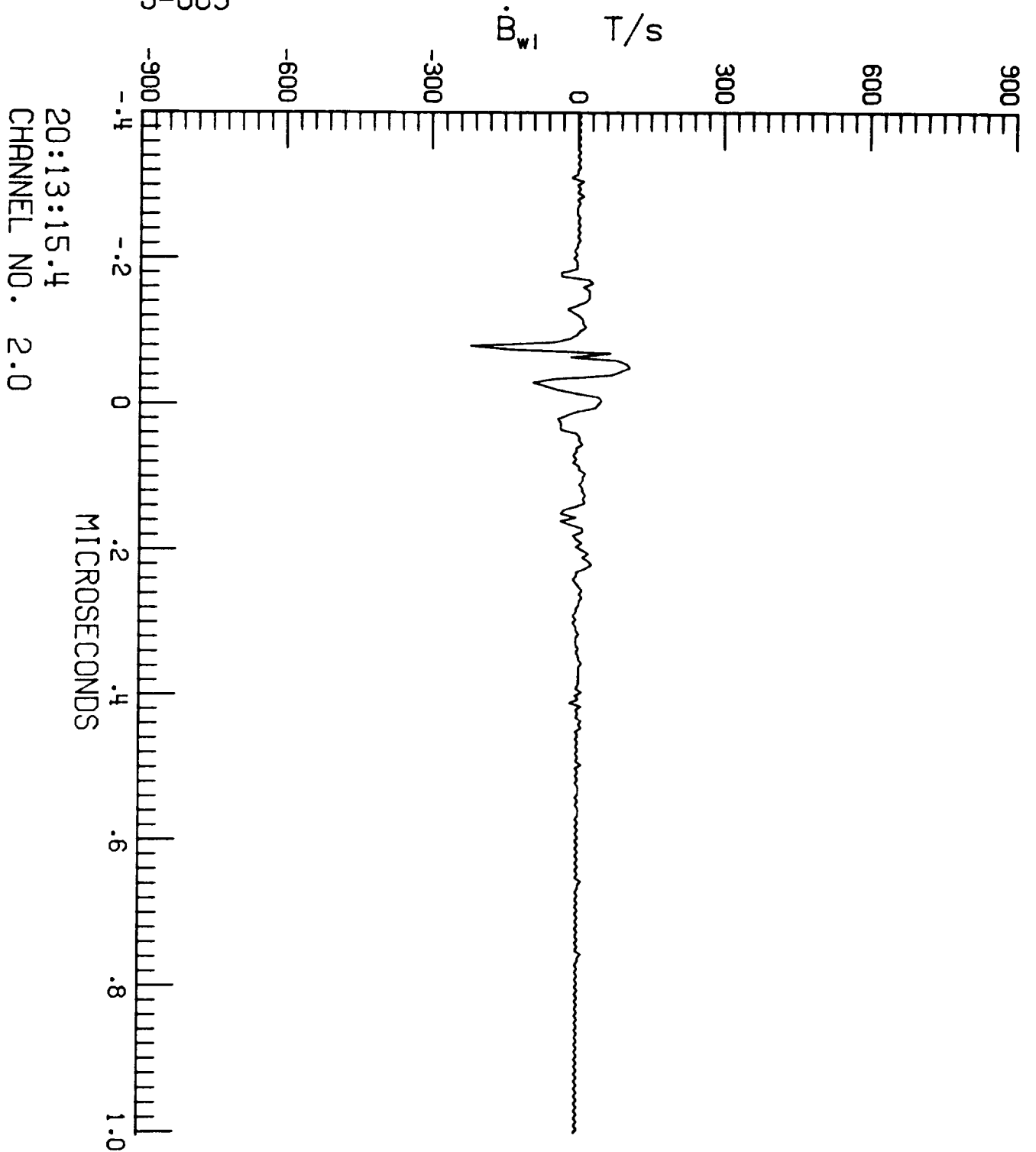

20:13:15.4  
CHANNEL NO. 2.0

F106 LIGHTNING/85-026/ZAEPFEL

LEC 2 RUN NO. 3

S-003

$\dot{i}$  A/s

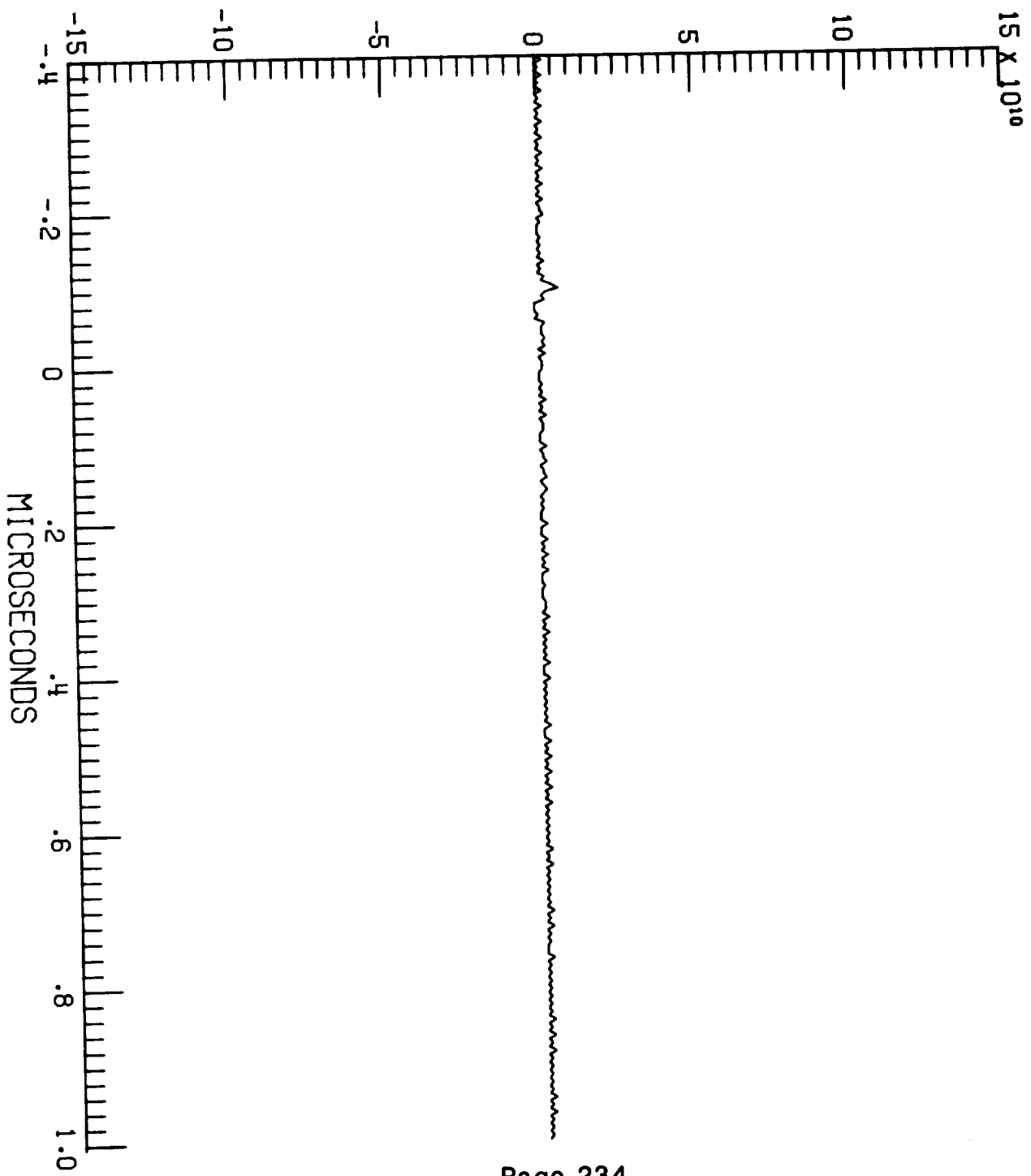

20:13:15.4  
CHANNEL NO. 2.1

F106 LIGHTNING/85-026/ZAEPFEL

LEC 2 RUN NO. 3

S-003

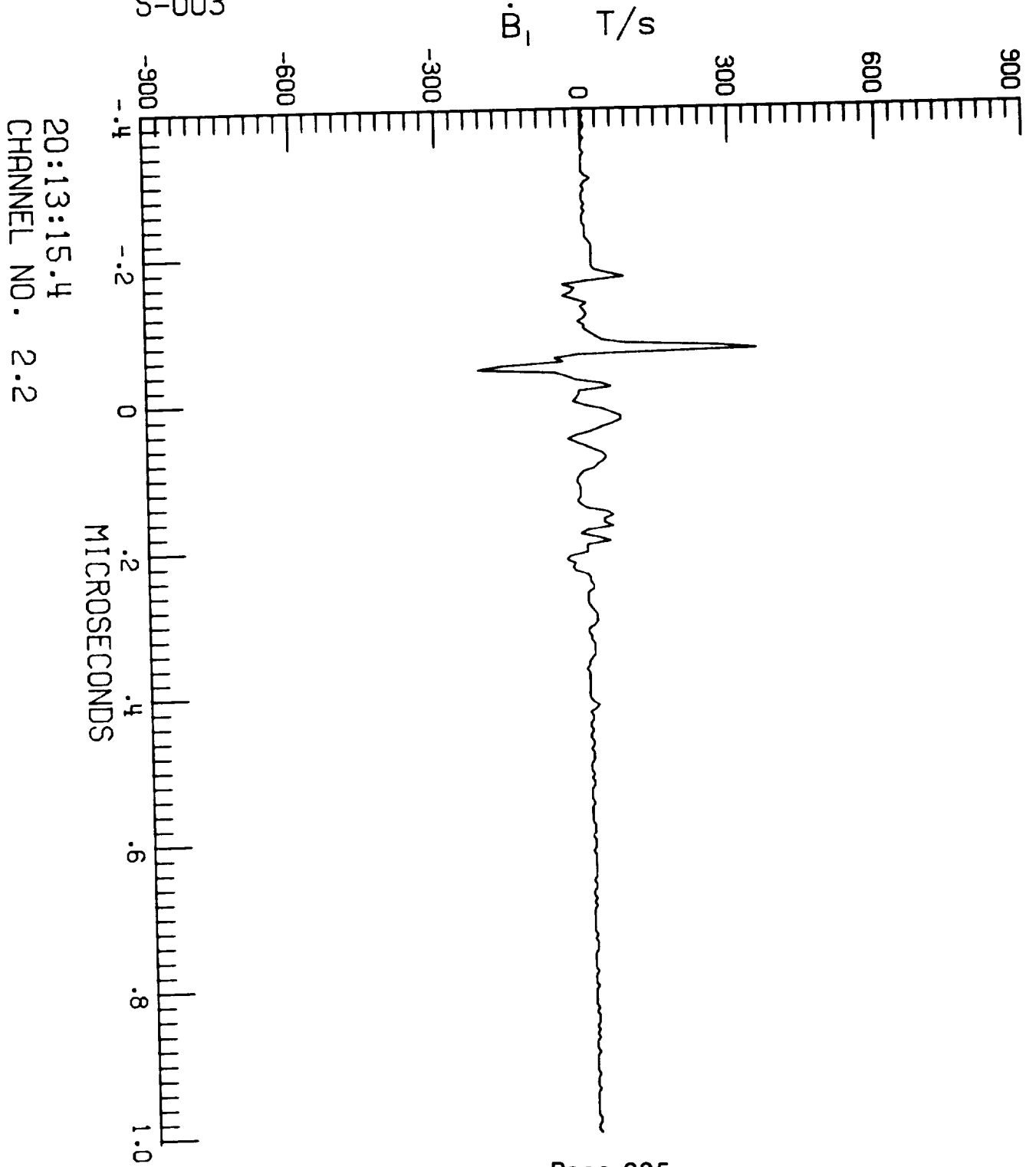

20:13:15.4  
CHANNEL NO. 2.2

F106 LIGHTNING/85-026/ZAEPFEL

LEC 4 RUN NO. 3

S-003

TP100 V

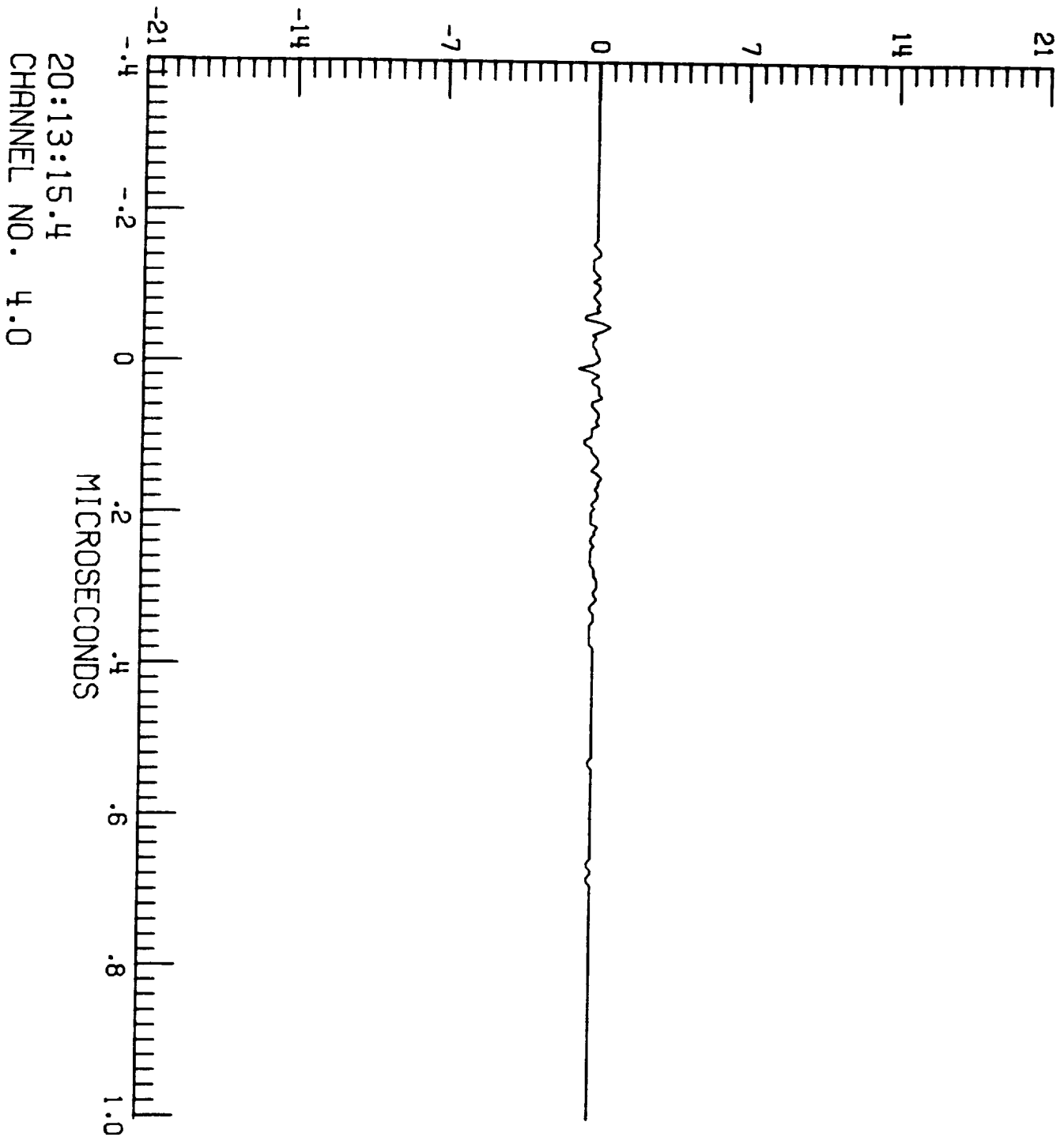



F106 LIGHTNING/85-026/ZAEPFEL

LEC 4 RUN NO. 3

S-003

TP106 A

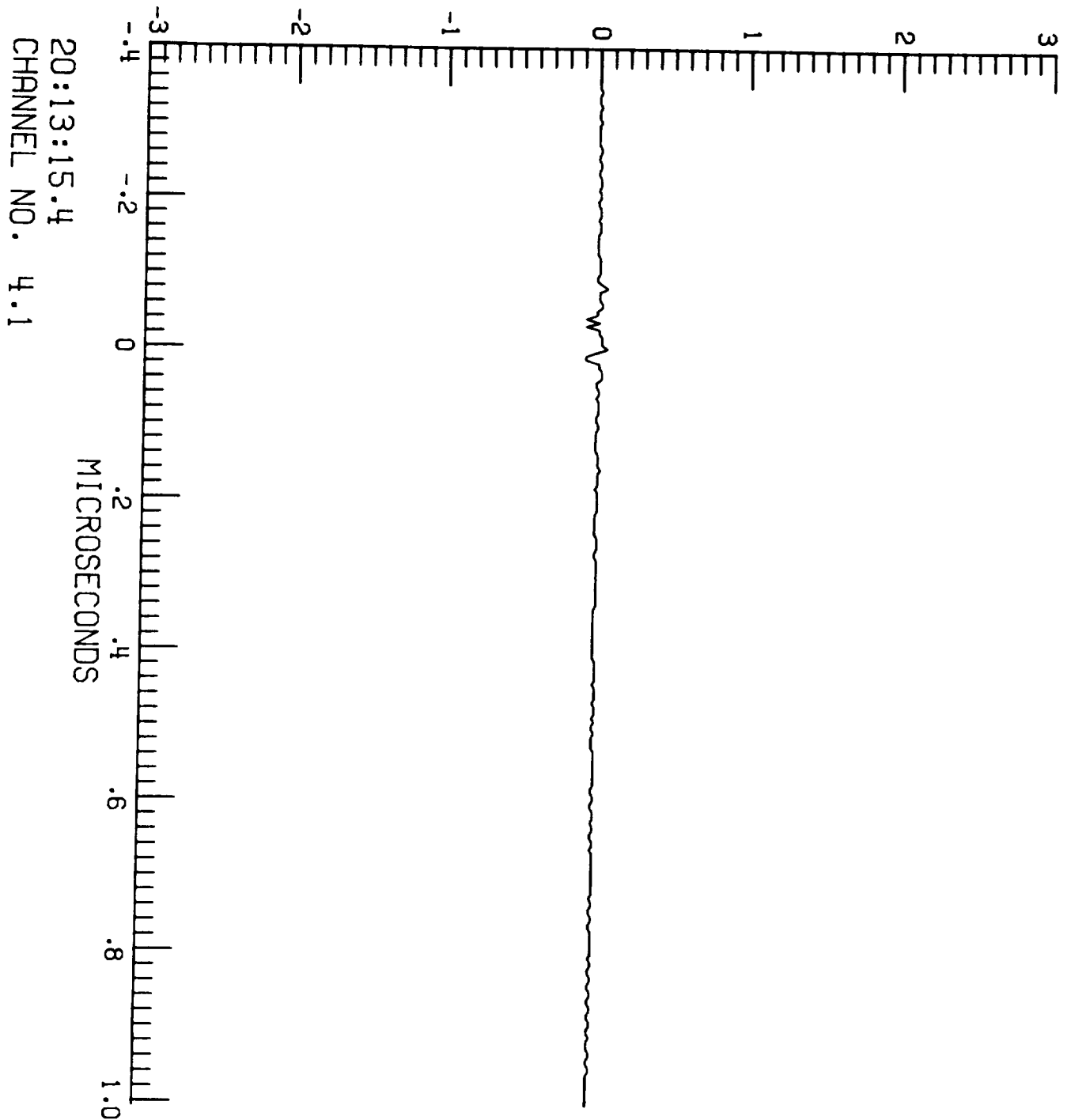

20:13:15.4  
CHANNEL NO. 4.1

F106 LIGHTNING/85-026/ZAEPFEL

LEC 4 RUN NO. 3

S-003

TP125 A

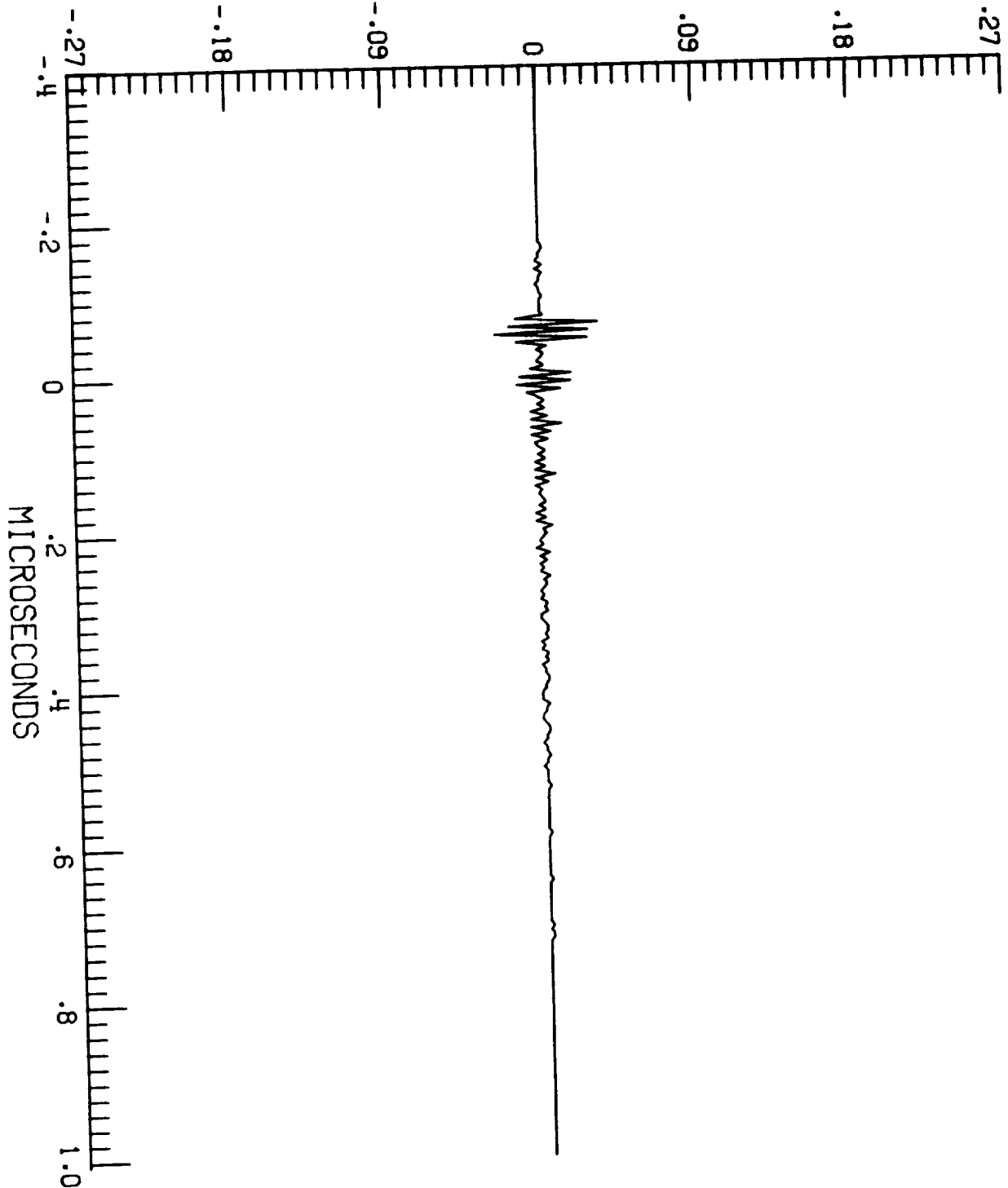

20:13:15.4  
CHANNEL NO. 4.2

F106 LIGHTNING/85-026/ZAEPFEL

LEC 1 RUN NO. 4

S=004

$\dot{D}_t$  A/m<sup>2</sup>

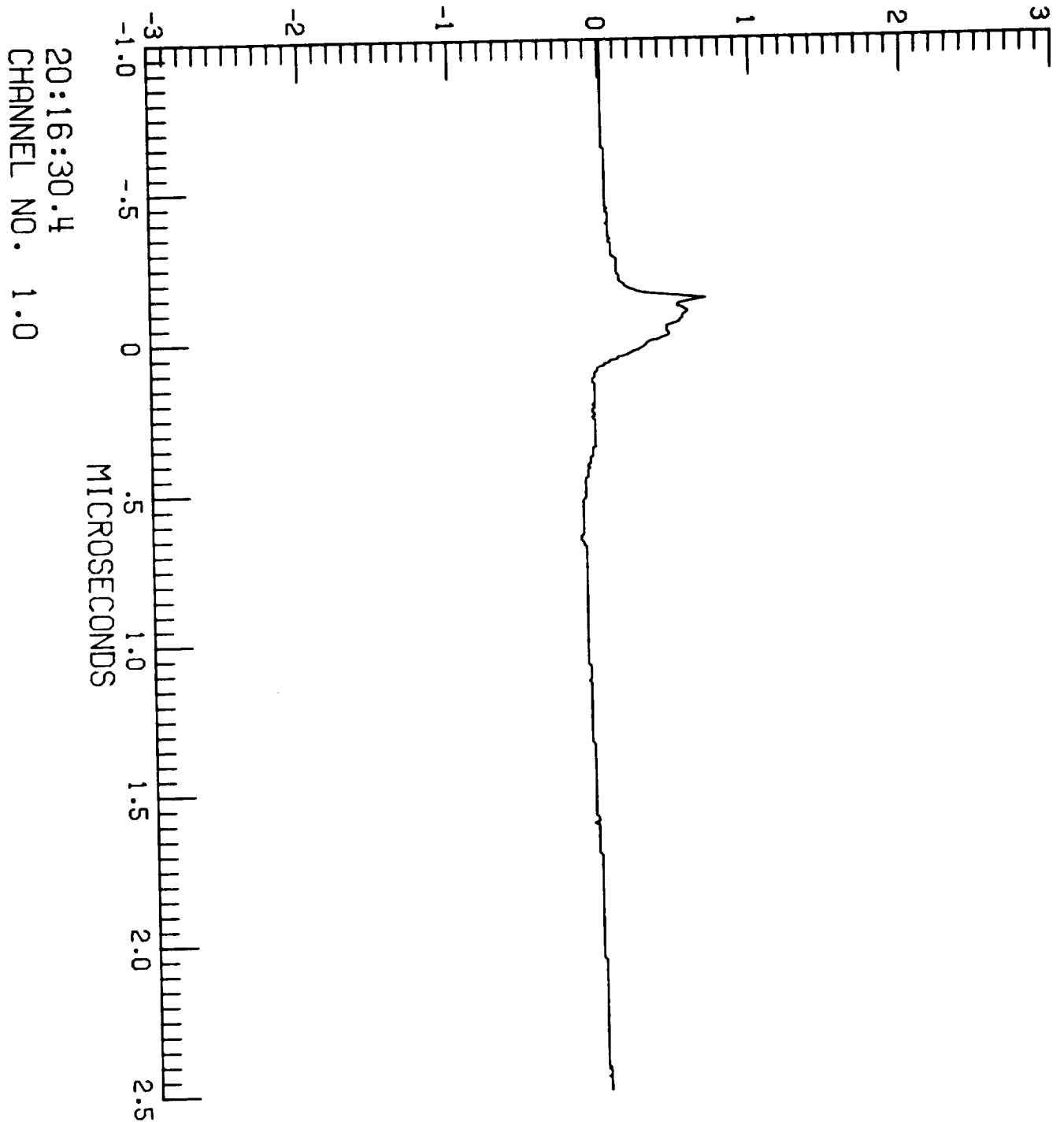

F106 LIGHTNING/85-026/ZAEPFEL

LEC 1 RUN NO. 4

S=004

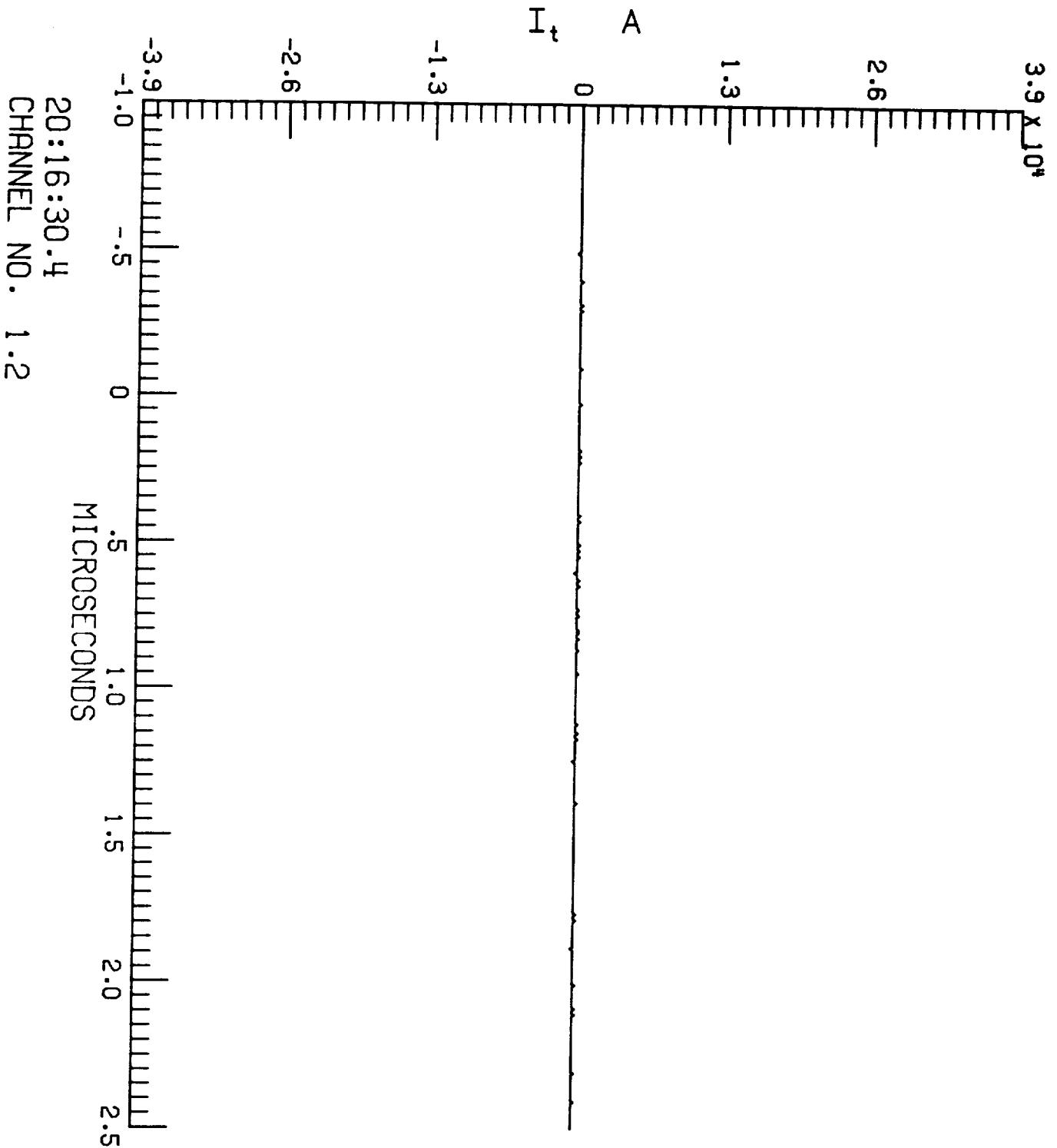

F106 LIGHTNING/85-026/ZAEPFEL  
LEC 2 RUN NO. 4  
S-004

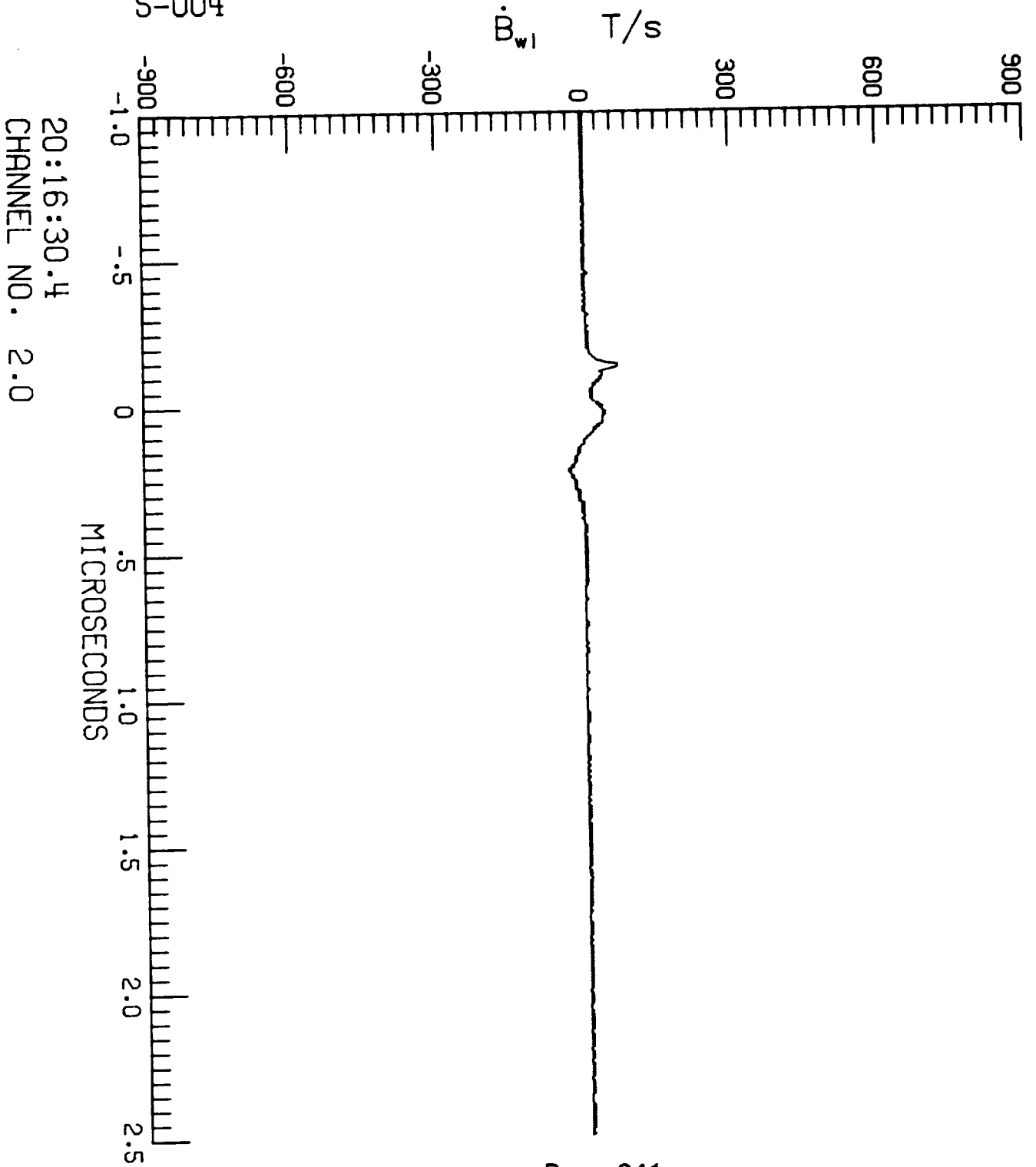

20:16:30.4  
CHANNEL NO. 2.0

F106 LIGHTNING/85-026/ZAEPFEL

LEC 2 RUN NO. 4

S-004

i A/s

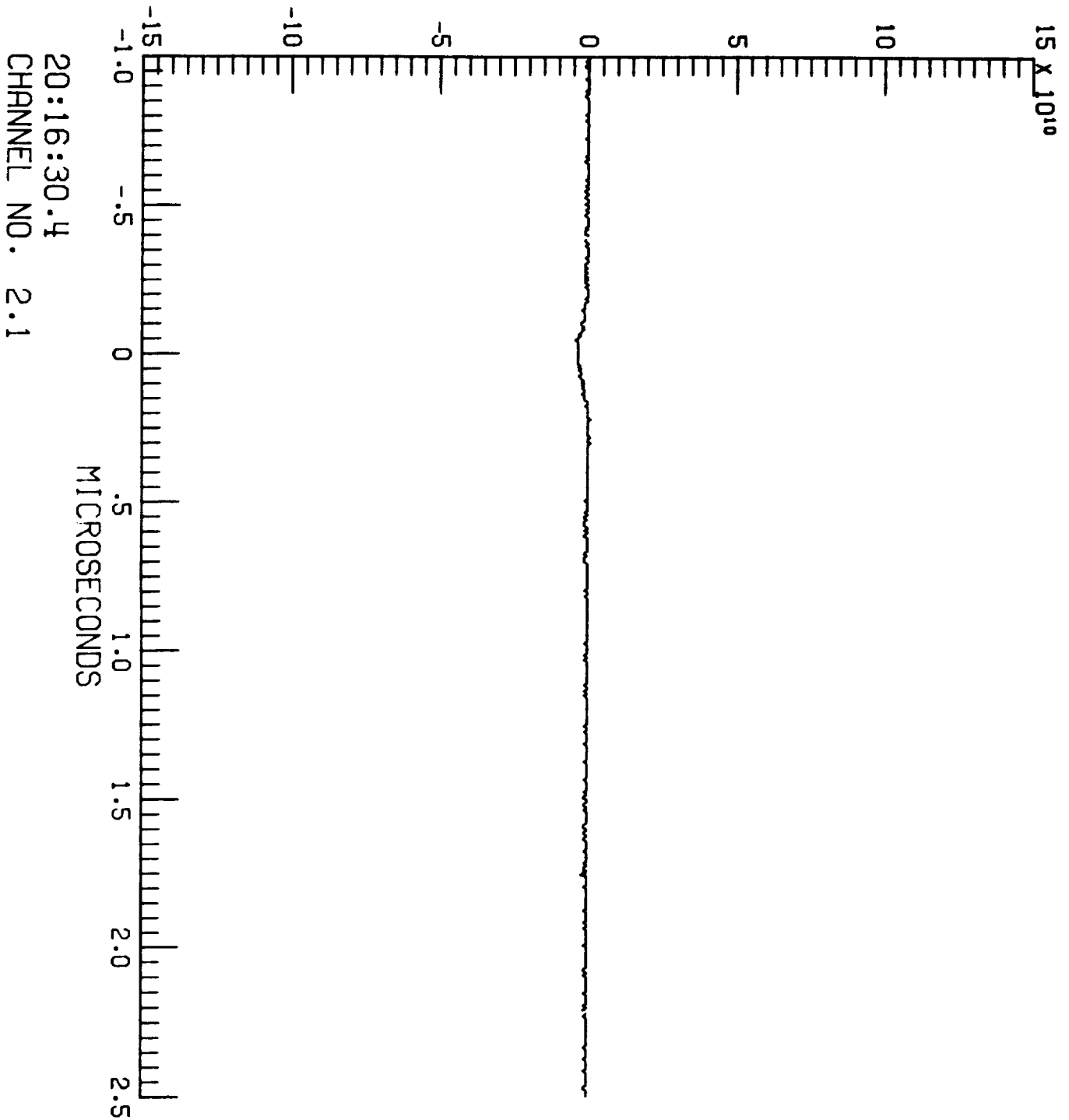

20:16:30.4  
CHANNEL NO. 2.1

F106 LIGHTNING/85-026/ZAEPFEL

LEC 2 RUN NO. 4

S-004

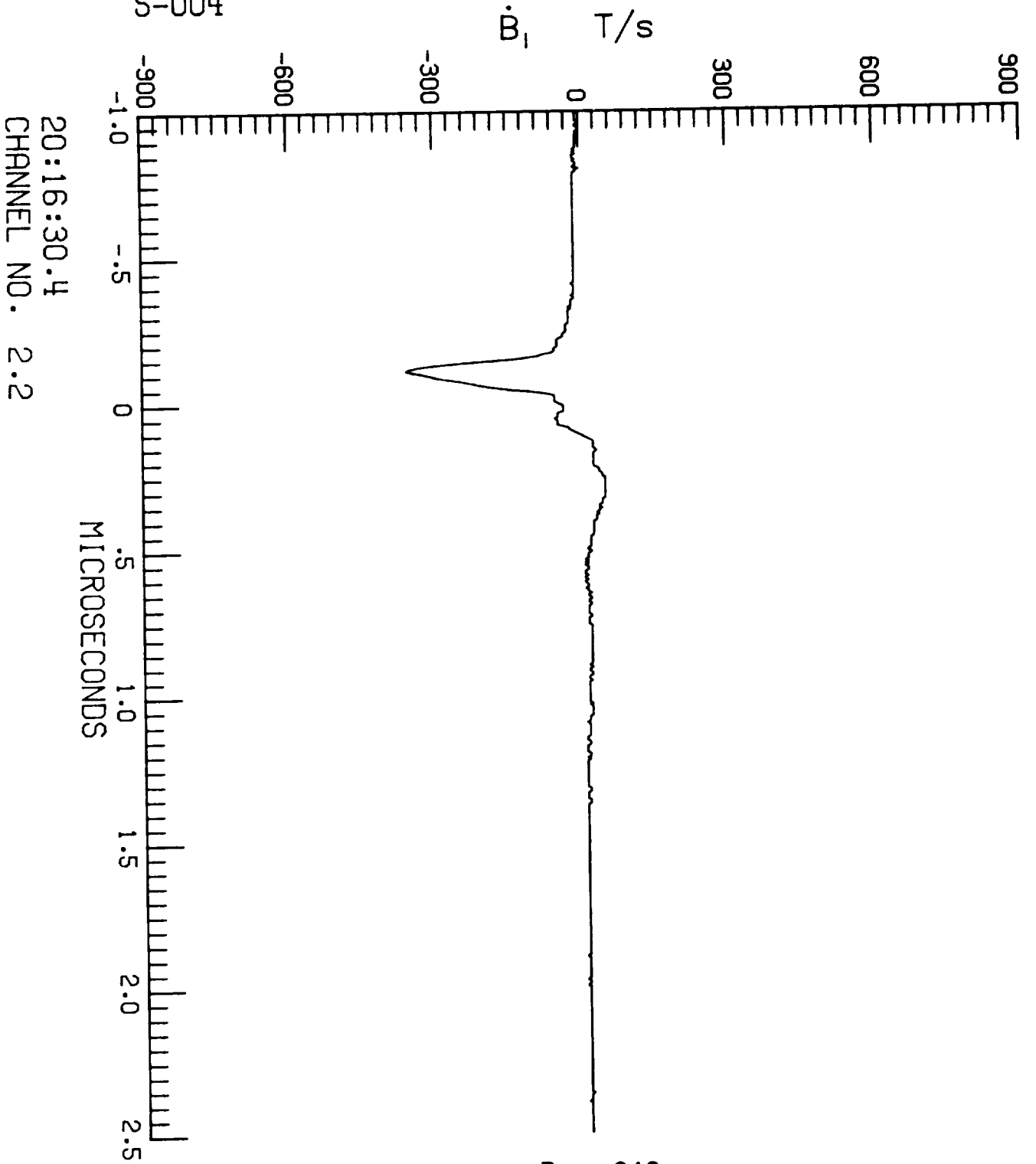

20:16:30.4  
CHANNEL NO. 2.2

F106 LIGHTNING/85-026/ZAEPFEL

LEC 4 RUN NO. 4

S-004

TP100 V

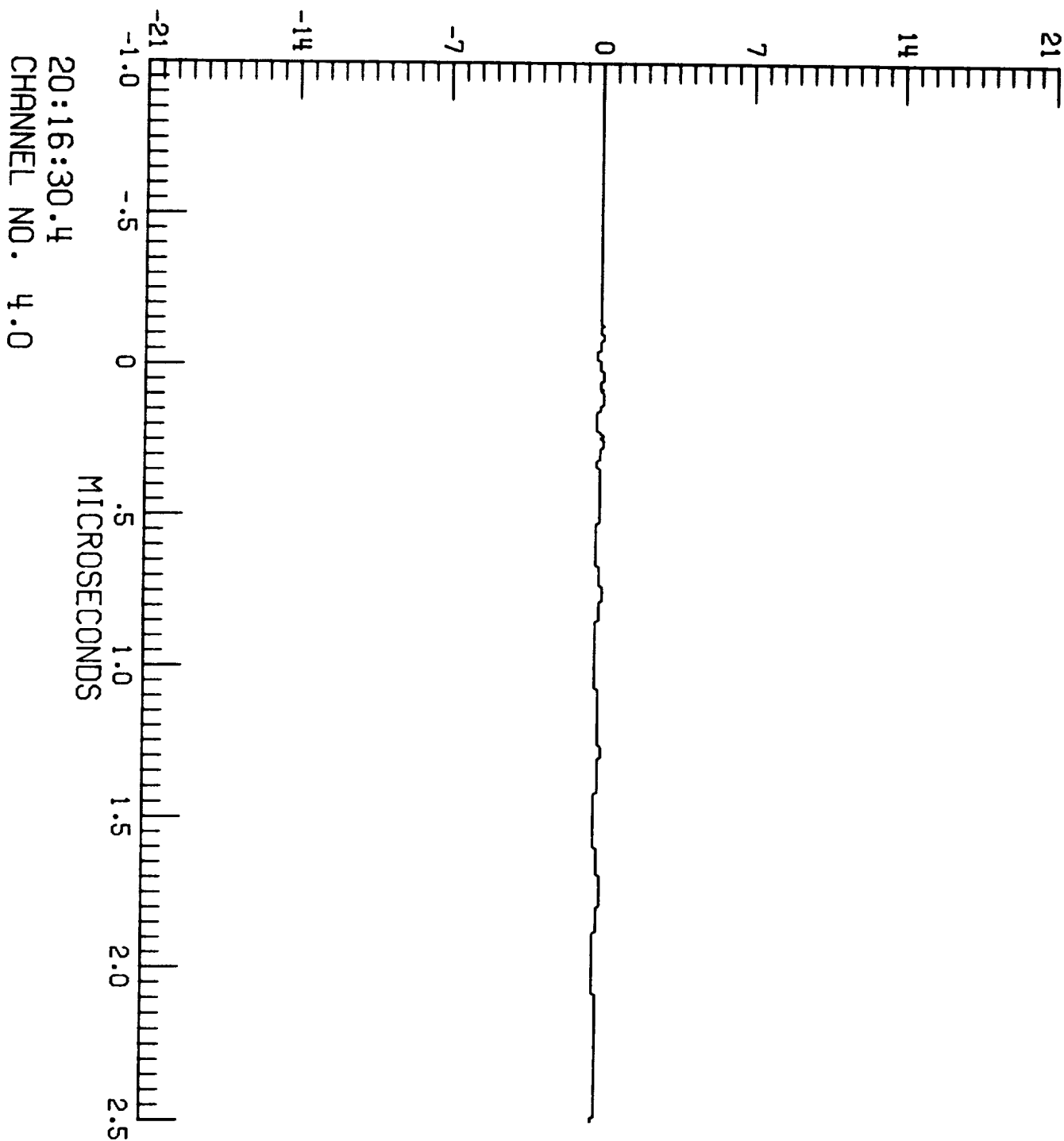



F106 LIGHTNING/85-026/ZAEPFEL

LEC 4 RUN NO. 4

S-004

TP106 A

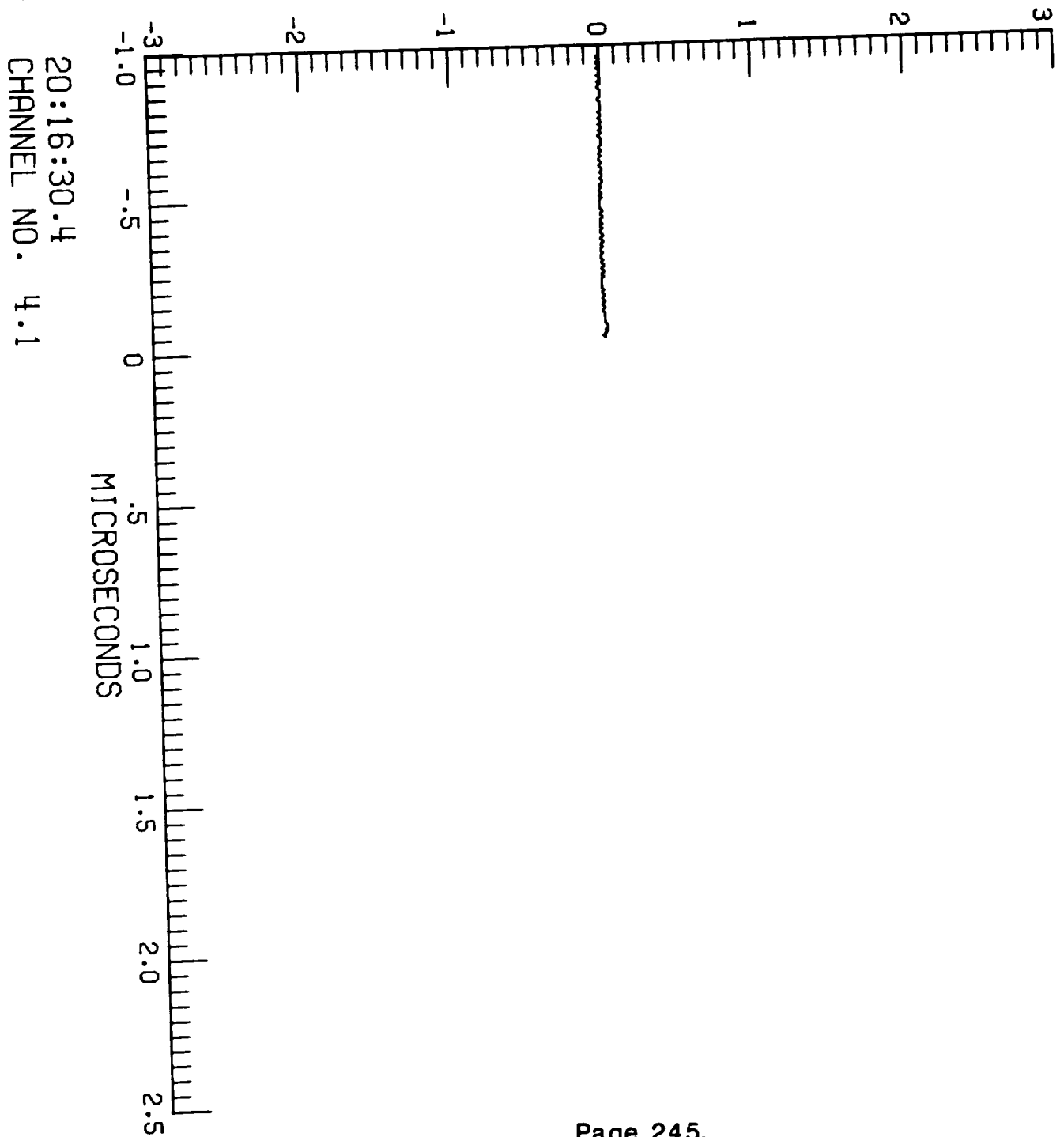

F106 LIGHTNING/85-026/ZAEPFEL

LEC 4 RUN NO. 4

S-004

TP125 A

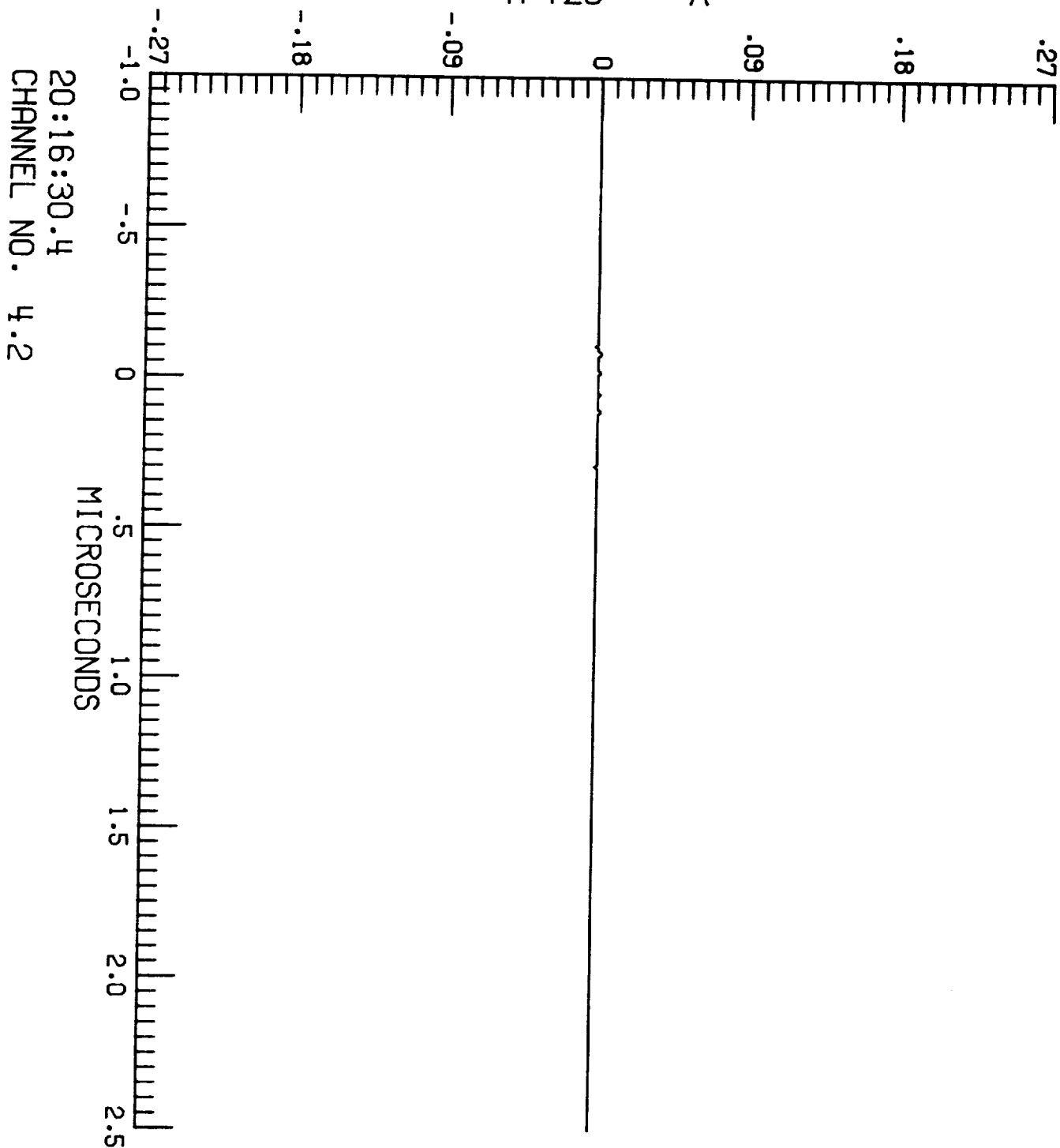

F106 LIGHTNING/85-027/ZAEPFEL

LEC 1 RUN NO. 1

S-001

$\dot{D}_t$  A/m<sup>2</sup>

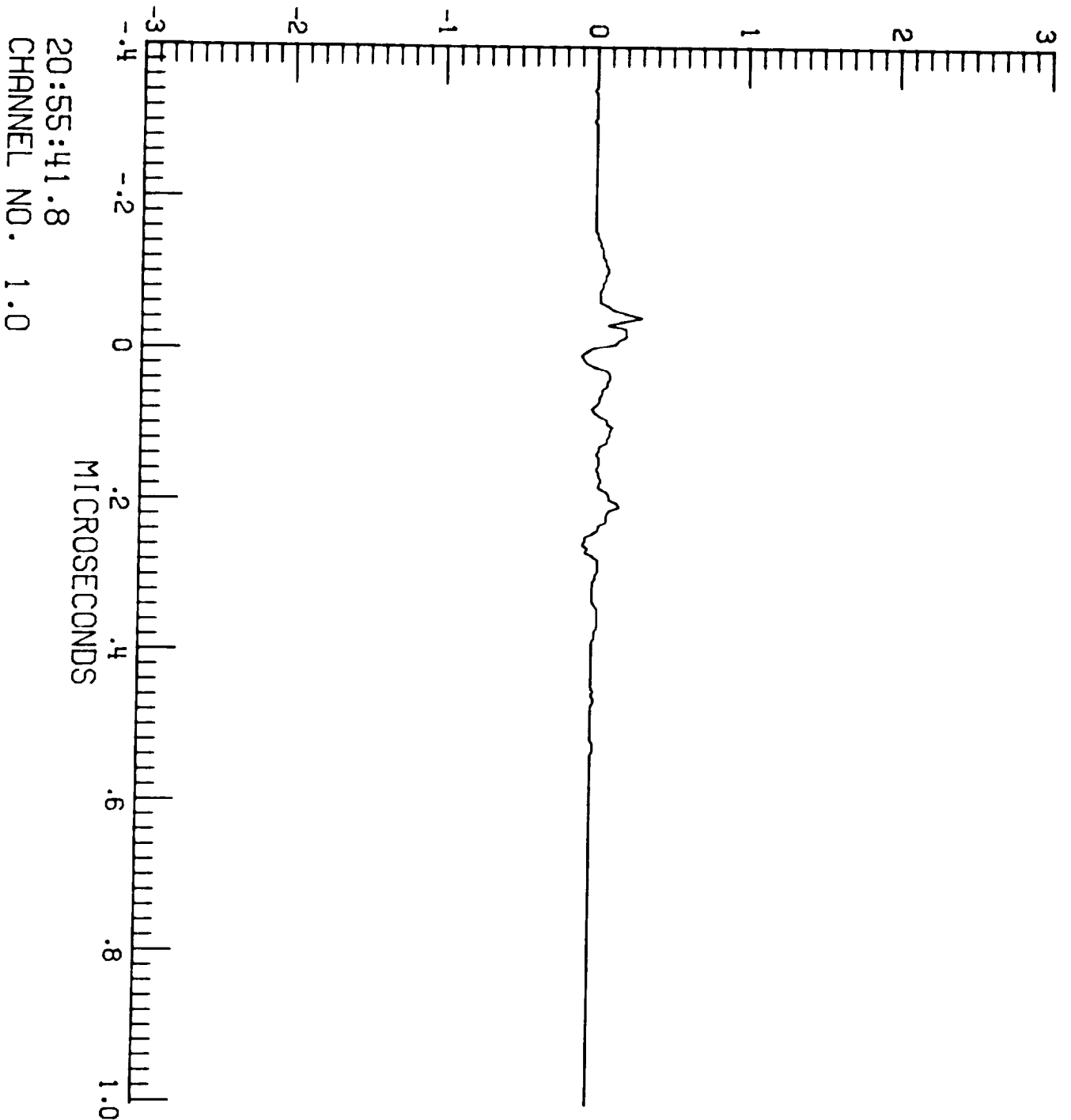

F106 LIGHTNING/85-027/ZAEPFEL

LEC 1 RUN NO. 1

S-001

$I_t$  A

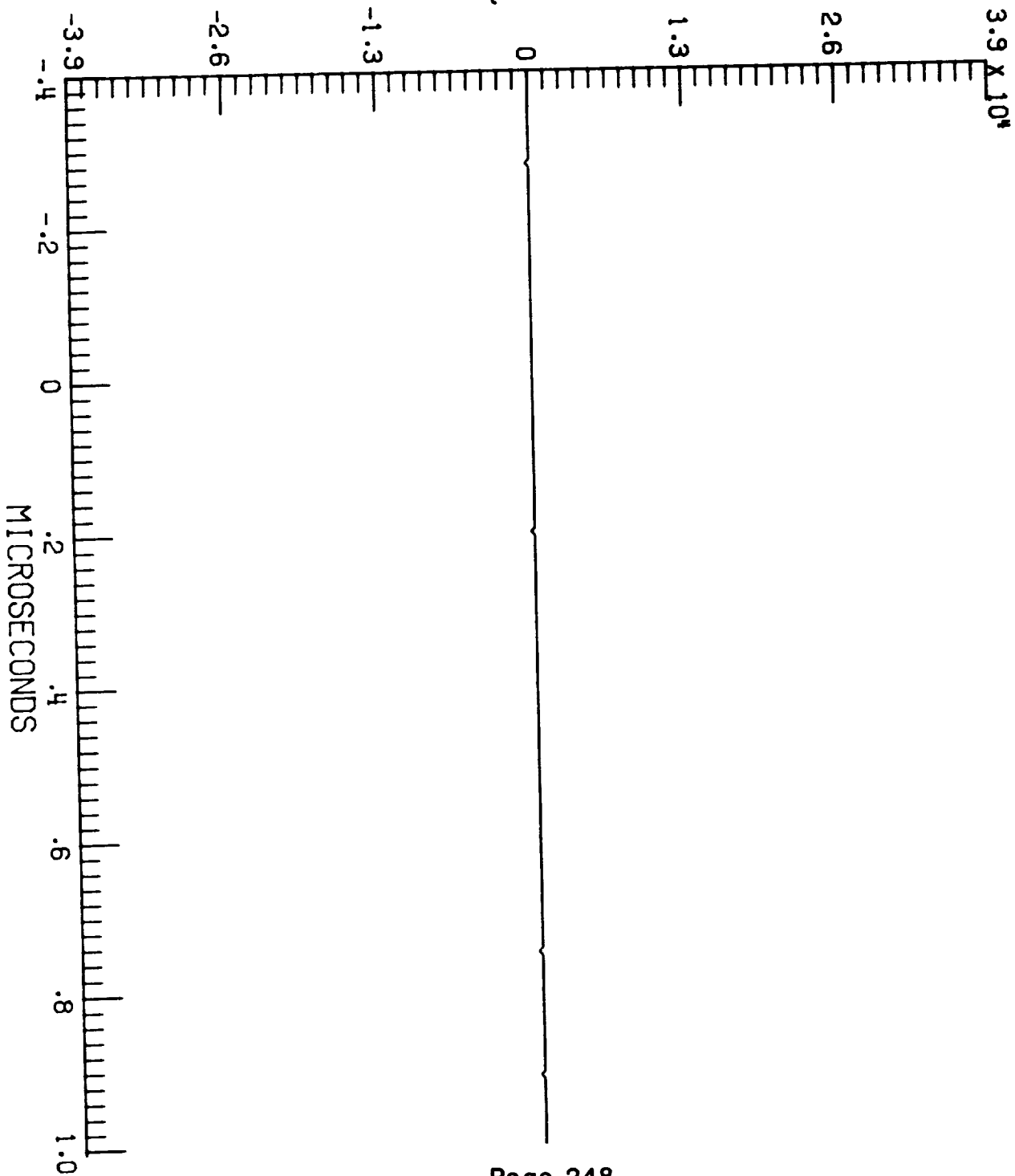

20:55:41.8  
CHANNEL NO. 1.2

F106 LIGHTNING/85-027/ZAEPFEL  
LEC 2 RUN NO. 1  
S-001

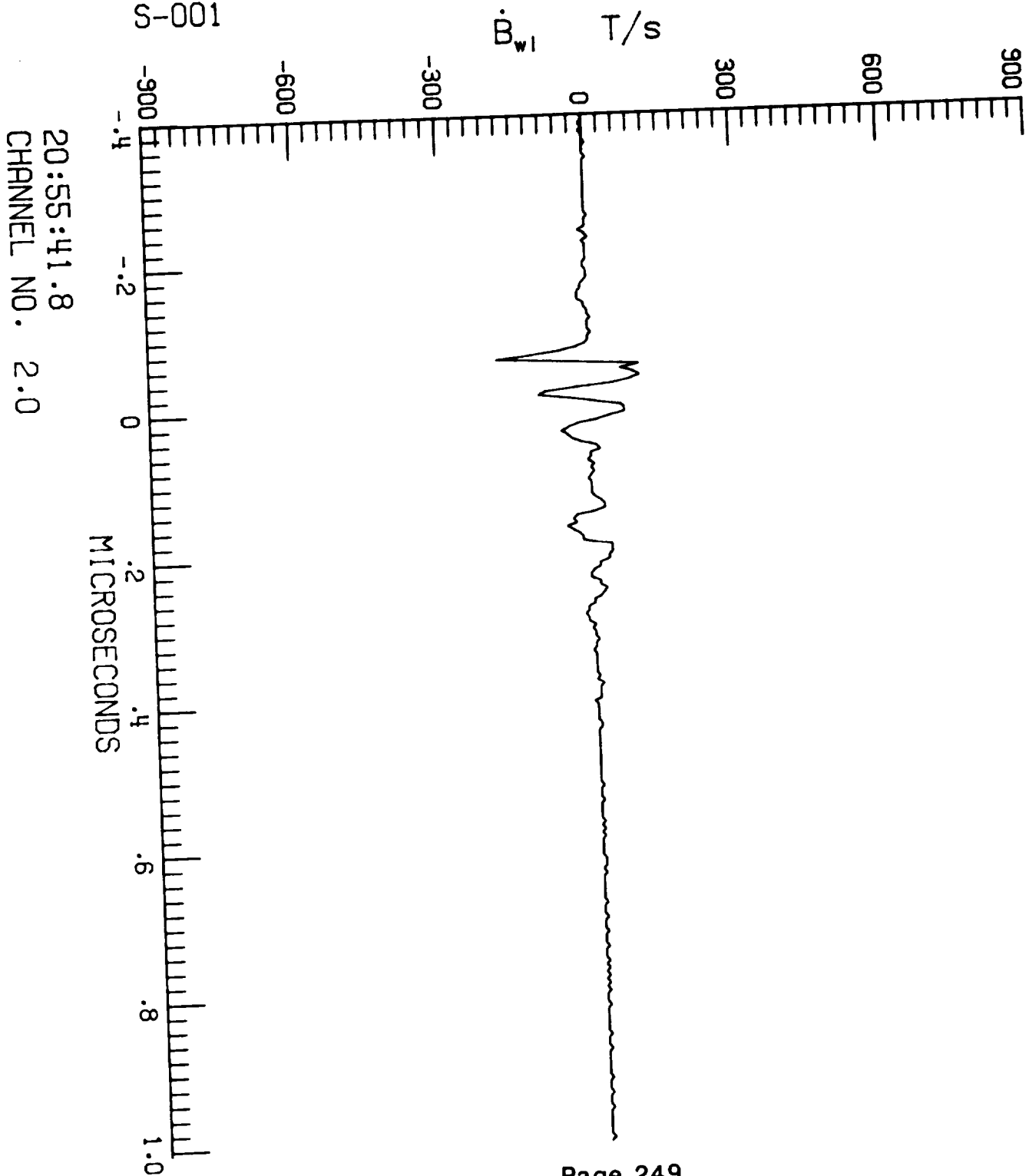

20:55:41.8  
CHANNEL NO. 2.0

F106 LIGHTNING/85-027/ZAEPFEL  
LEC 2 RUN NO. 1  
S-001

$\dot{i}$  A/s

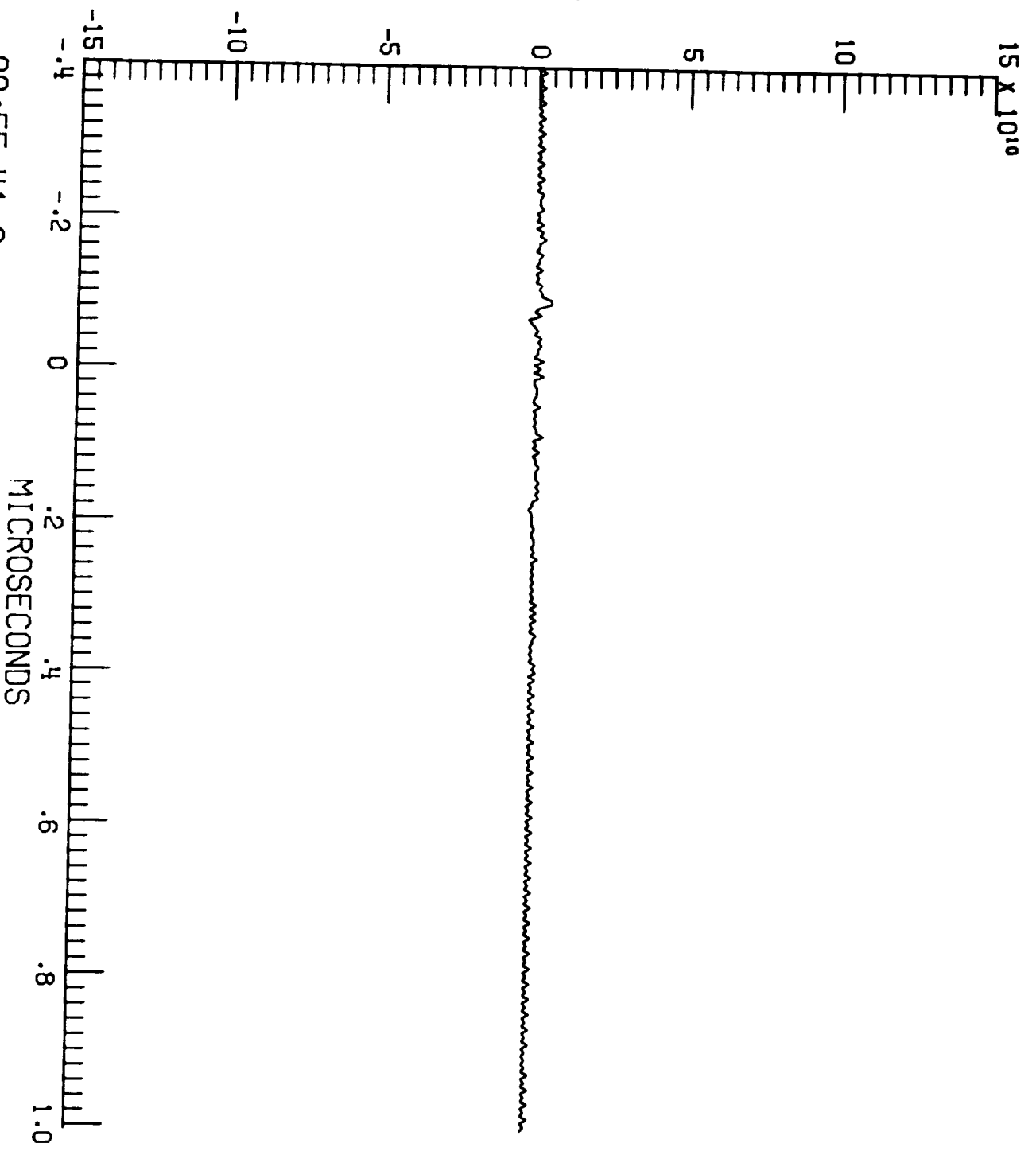

20:55:41.8  
CHANNEL NO. 2.1

F106 LIGHTNING/85-027/ZAEPFEL

LEC 2 RUN NO. 1

S-001

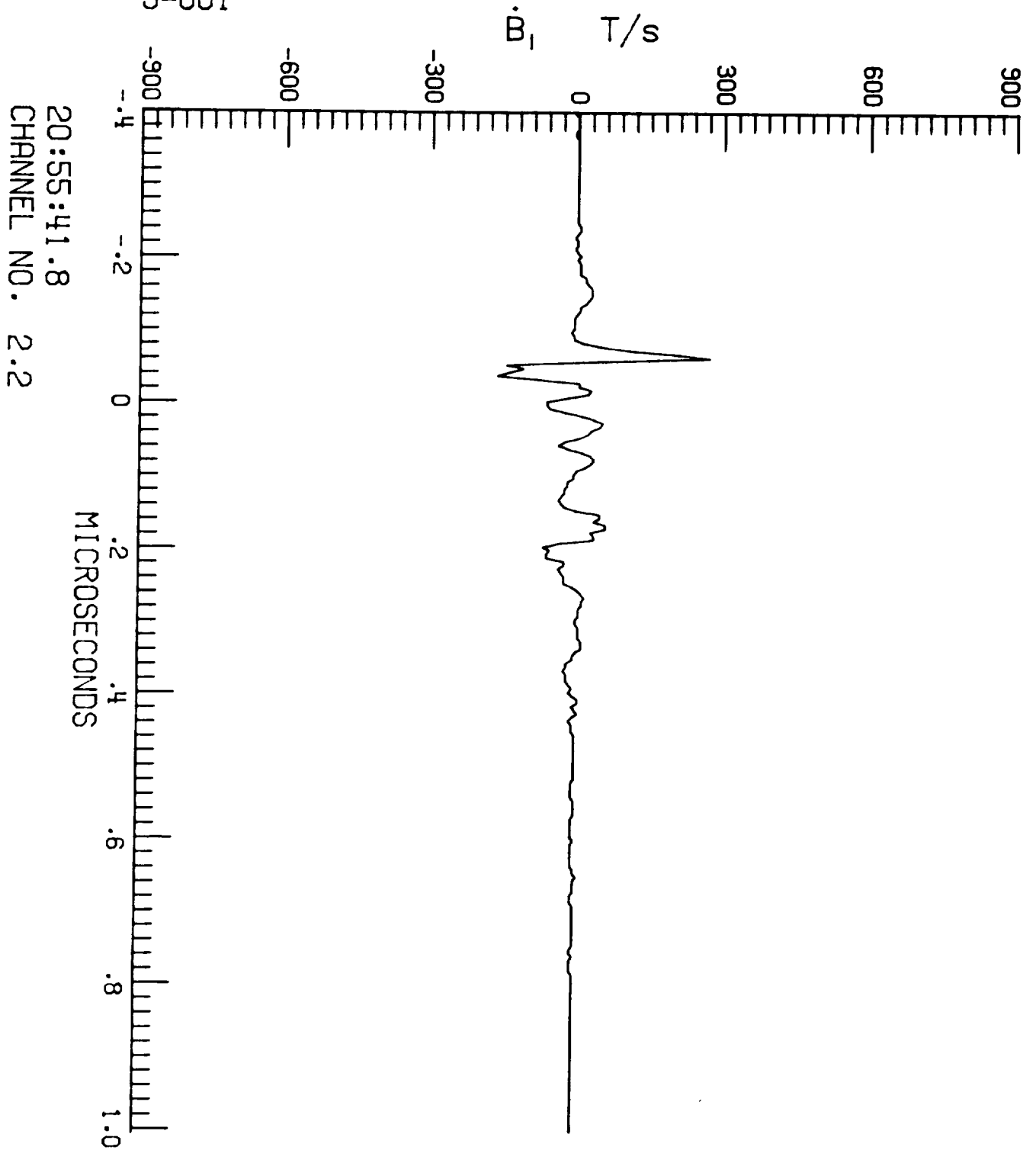

20:55:41.8  
CHANNEL NO. 2.2

F106 LIGHTNING/85-027/ZAEPFEL

LEC 3 RUN NO. 1

S-001

$\dot{D}_{wr}$  A/m<sup>2</sup>

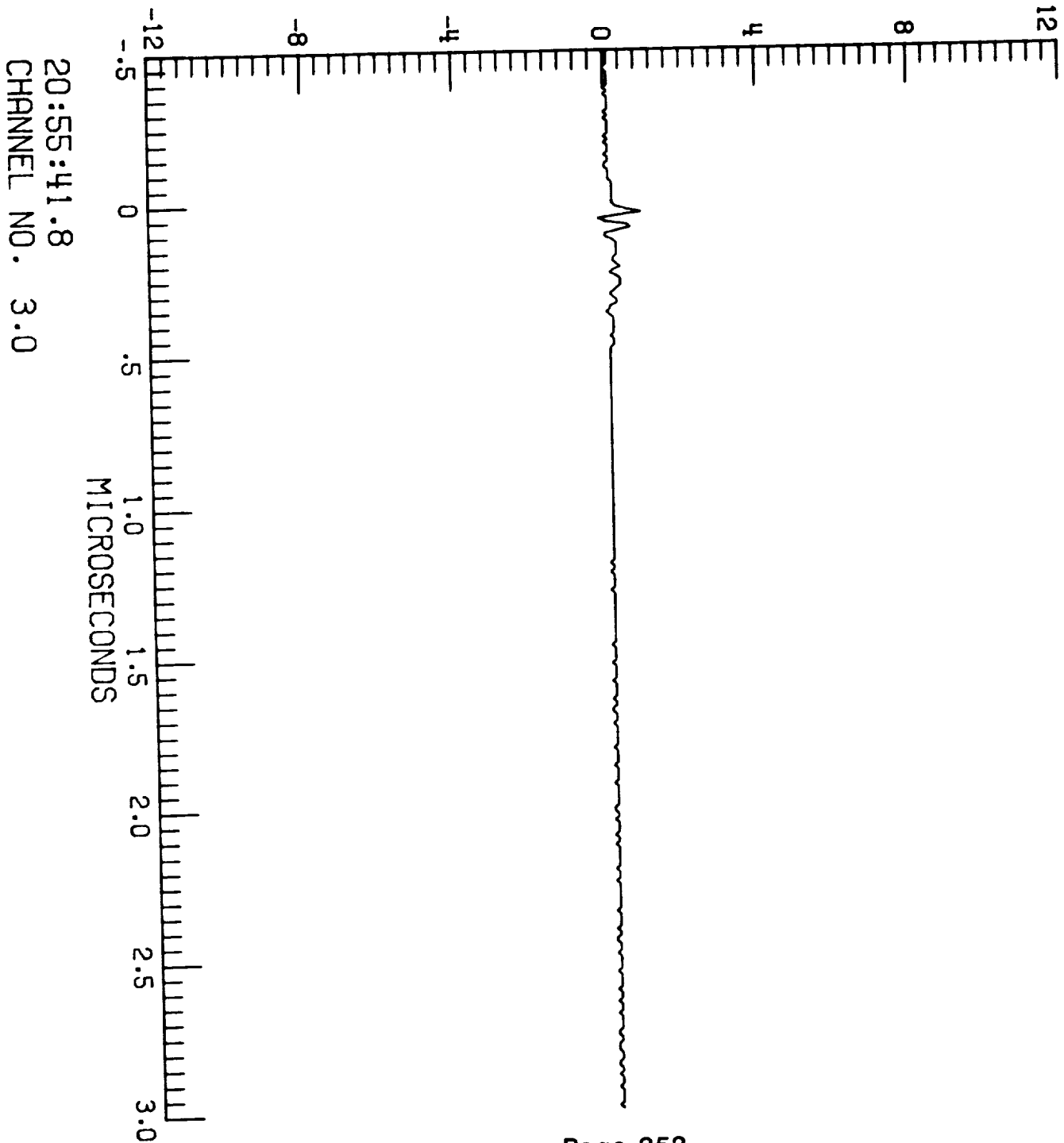



F106 LIGHTNING/85-027/ZAEPFEL

LEC 3 RUN NO. 1

S-001

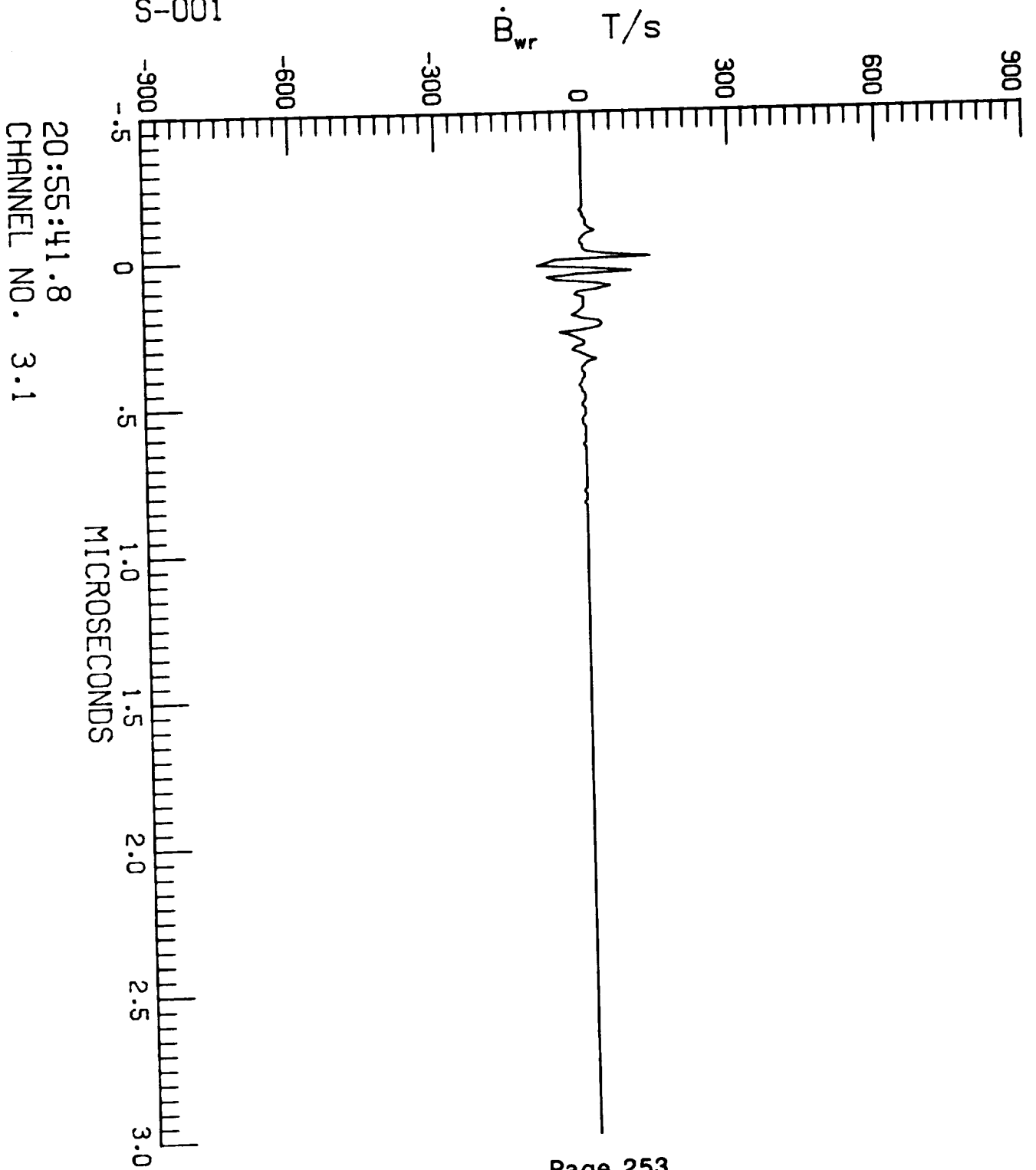

F106 LIGHTNING/85-027/ZAEPFEL

LEC 3 RUN NO. 1

S-001

$\dot{D}_f$  A/m<sup>2</sup>

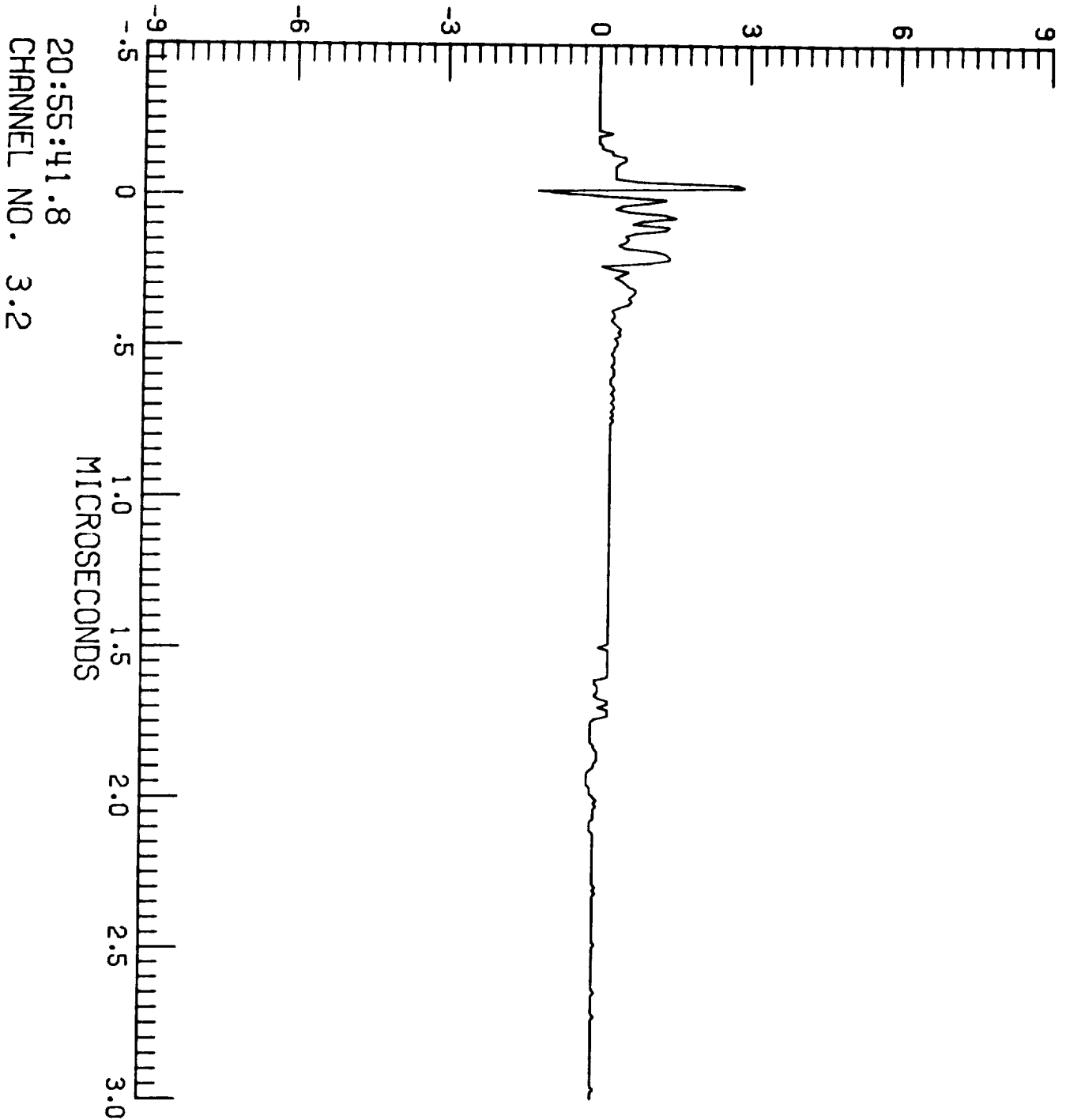

F106 LIGHTNING/85-027/ZAEPFEL

LEC 4 RUN NO. 1

S-001

TP100

V

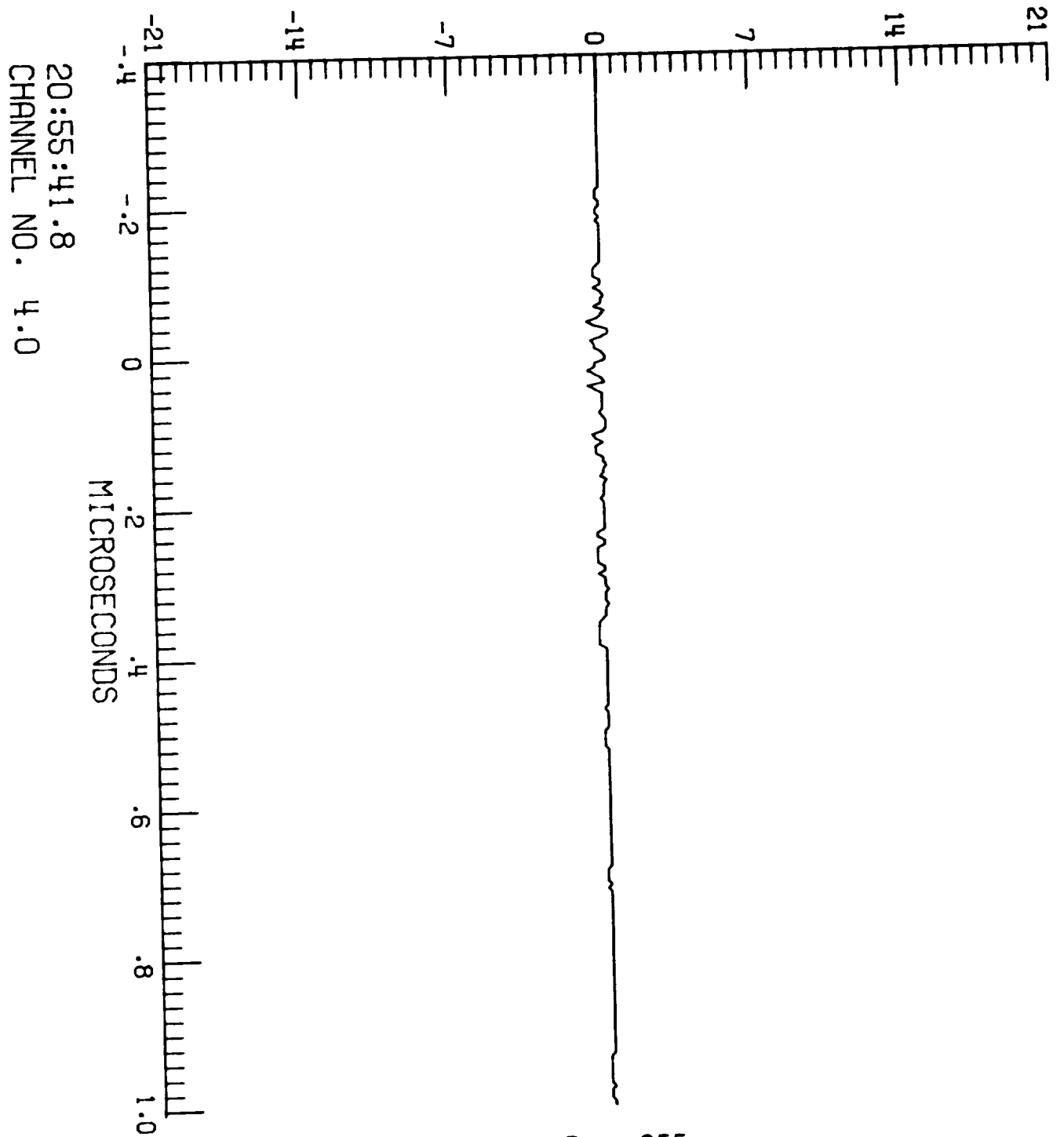

F106 LIGHTNING/85-027/ZAEPFEL

LEC 4 RUN NO. 1

S-001

TP106

A

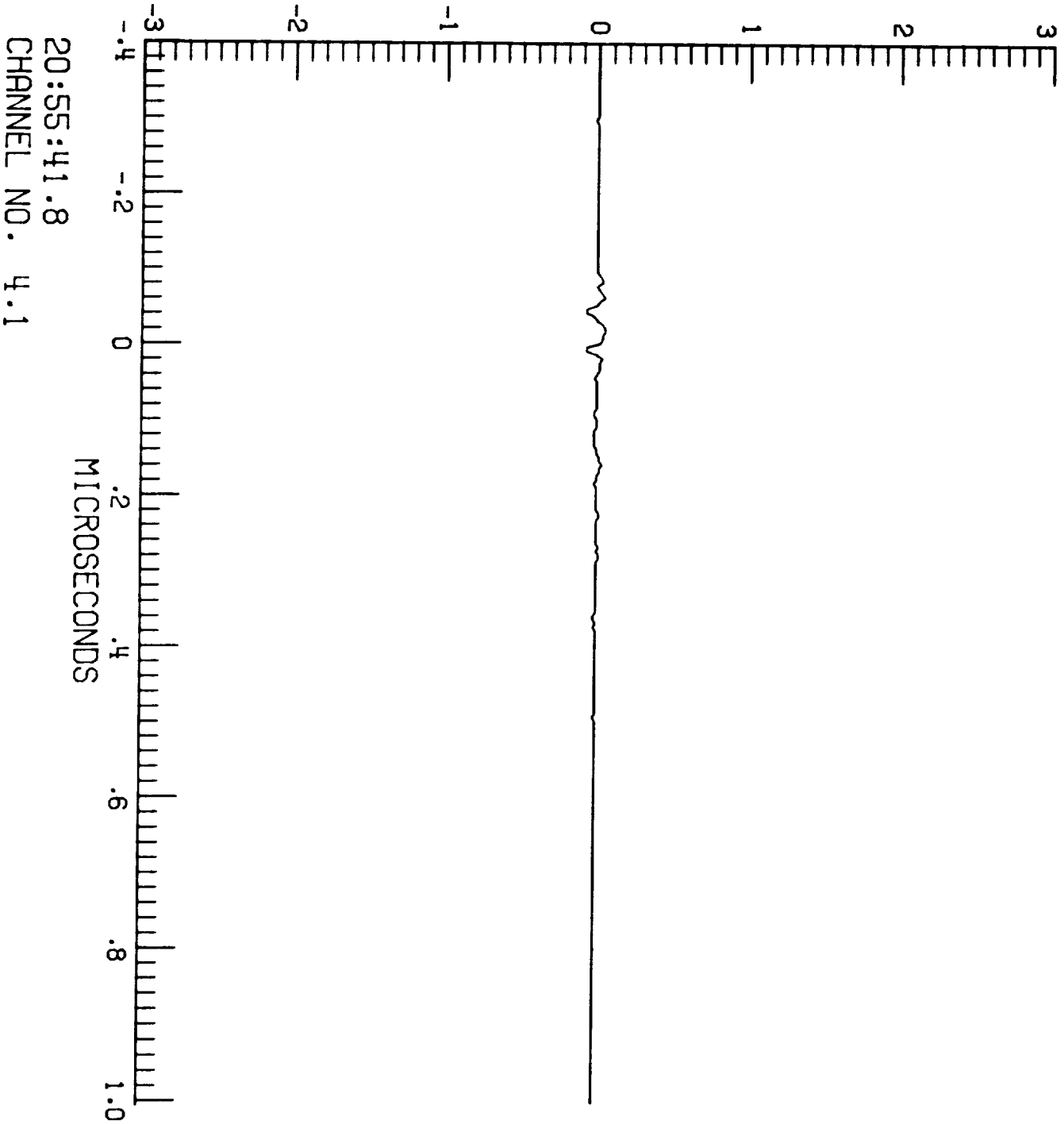

F106 LIGHTNING/85-027/ZAEPFEL

LEC 4 RUN NO. 1

S-001

TP125

A

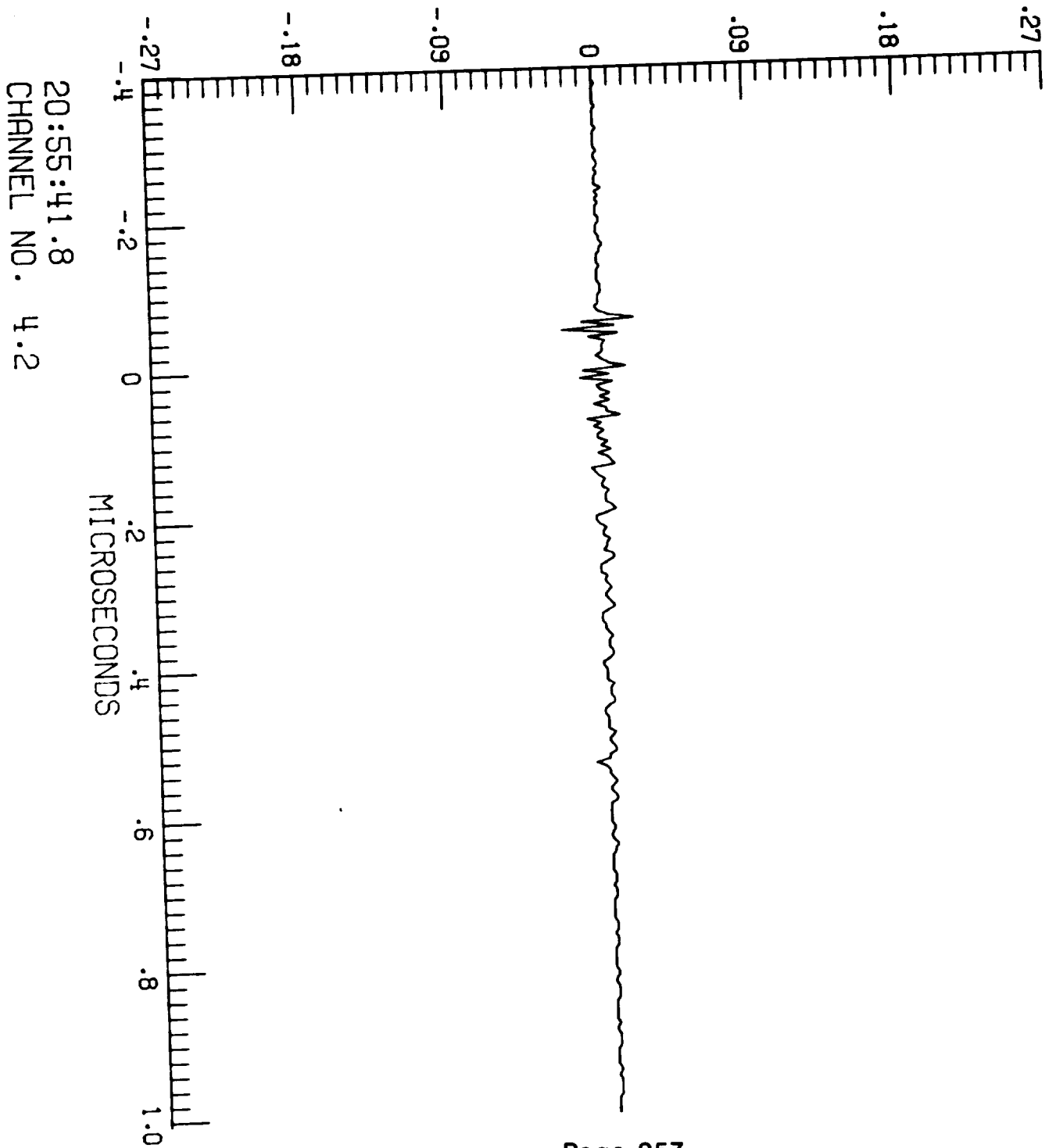

F106 LIGHTNING/85-027/ZAEPFEL

LEC 1 RUN NO. 2

S-002

$\dot{D}_t$  A/m<sup>2</sup>

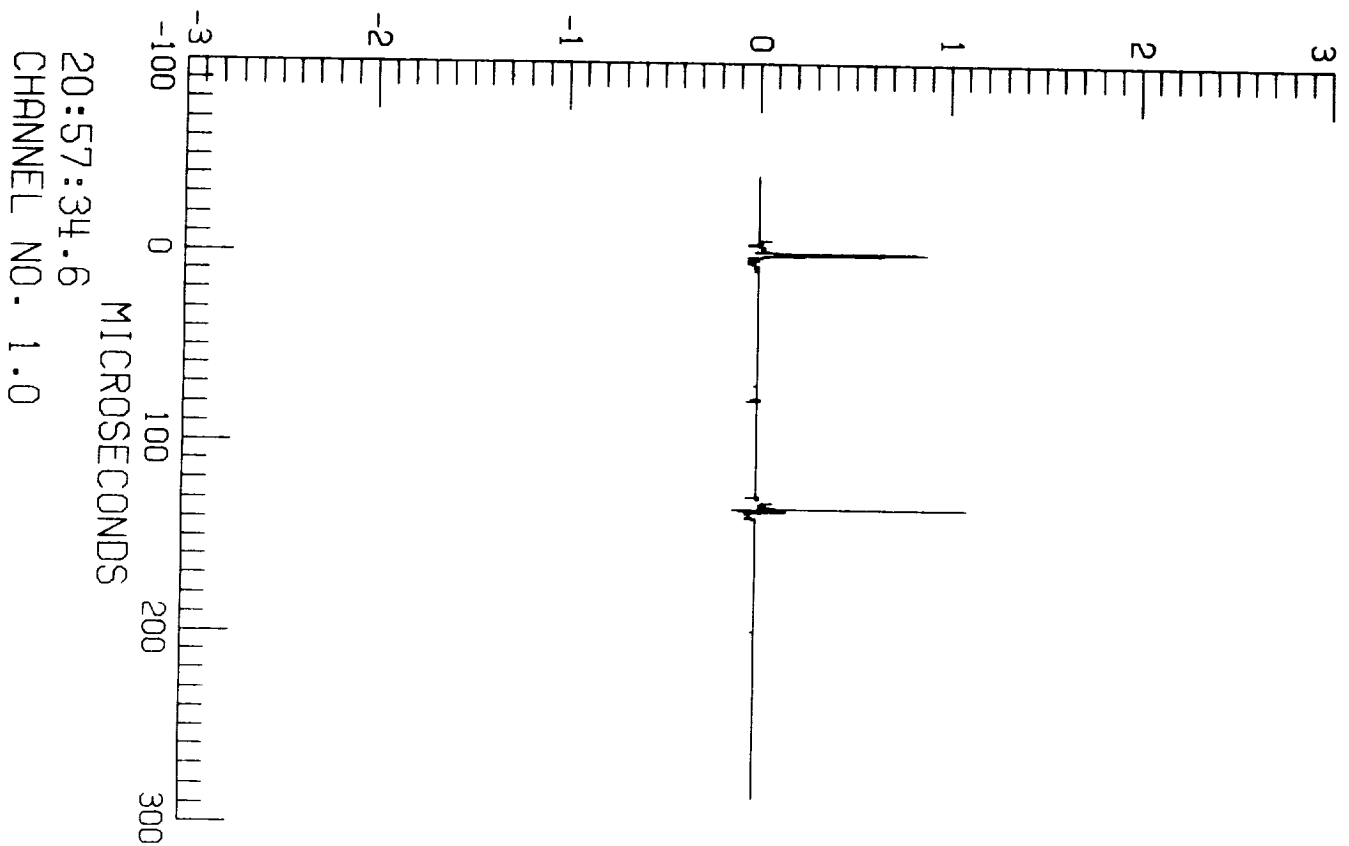

F106 LIGHTNING/85-027/ZAEPFEL

LEC 1

RUN NO. 2

S-002

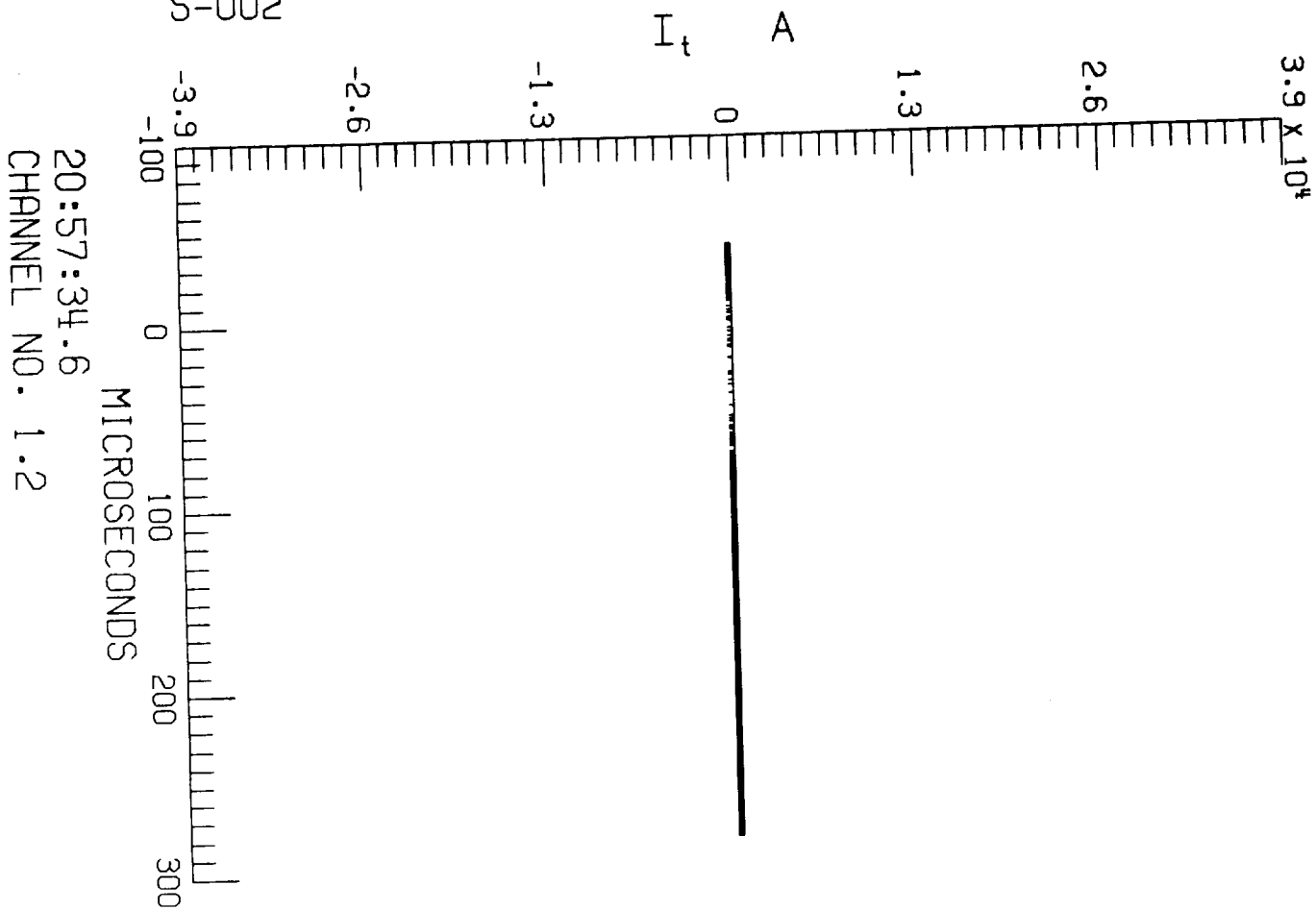

F106 LIGHTNING/85-027/ZAEPFEL

LEC 2 RUN NO. 2

S-002

$\dot{B}_{wl}$  T/s

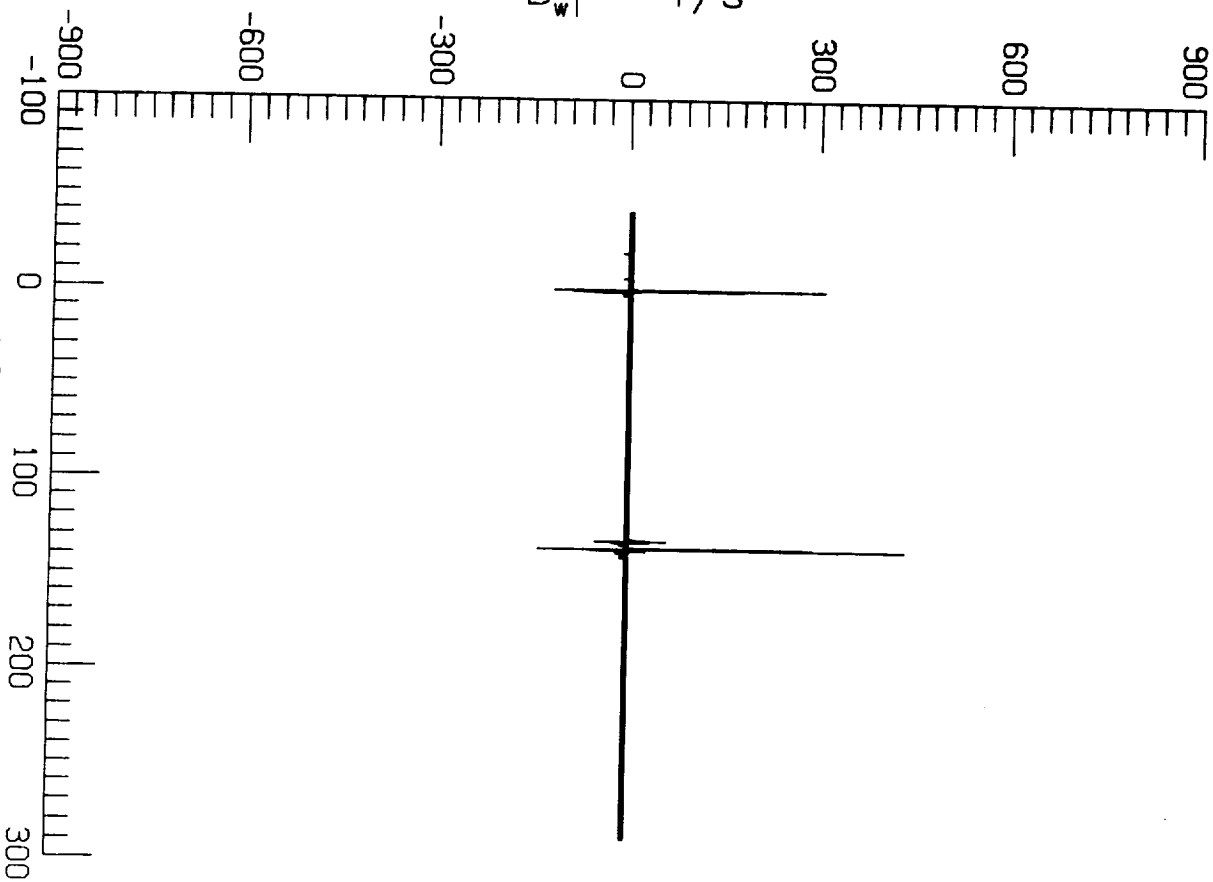

20:57:34.6  
CHANNEL NO. 2.0



F106 LIGHTNING/85-027/ZAEPFEL

LEC 2 RUN NO. 2

S-002

i A/s

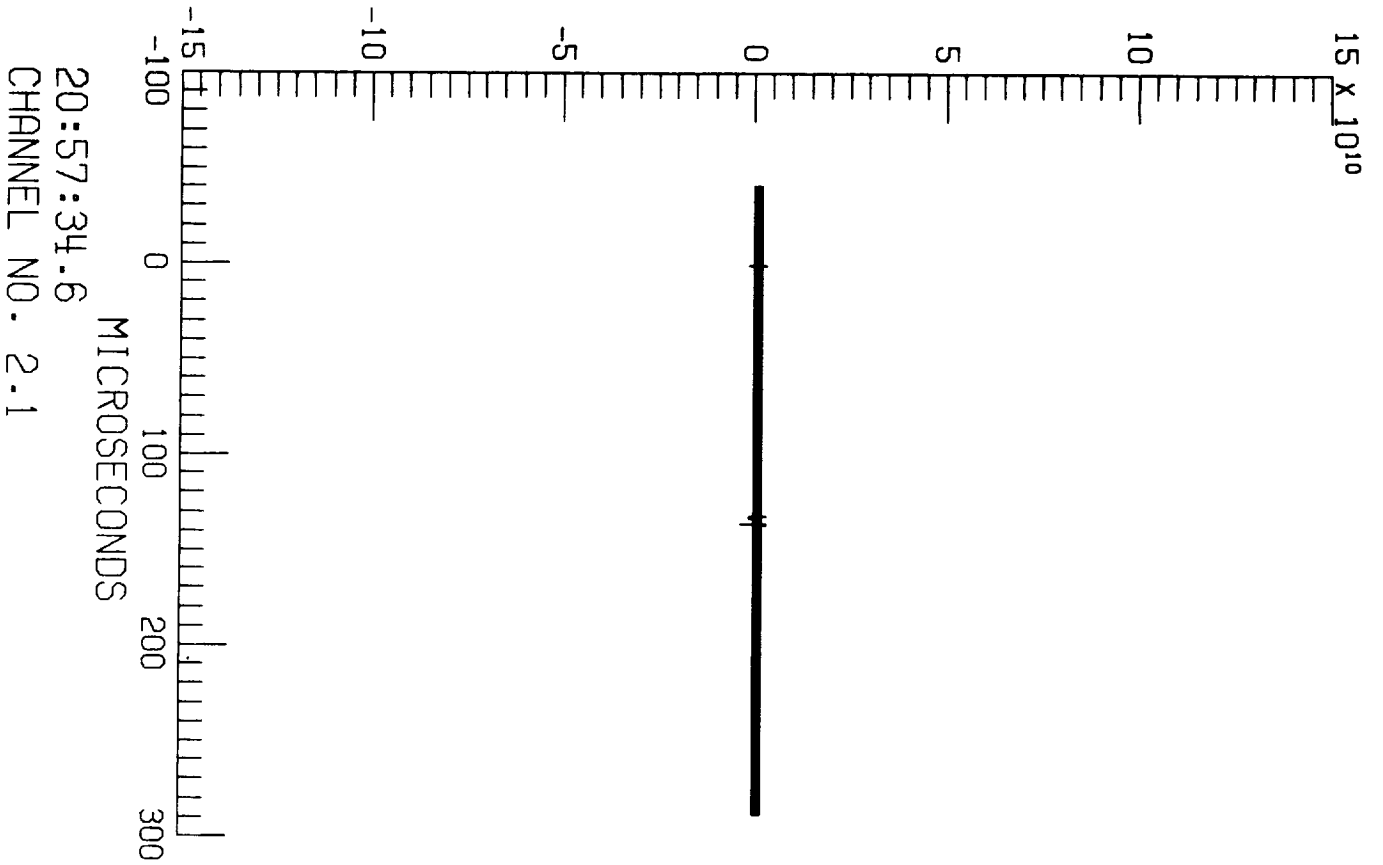

F106 LIGHTNING/85-027/ZAEPFEL

LEC 2 RUN NO. 2

S-002

$\dot{B}_1$  T/s

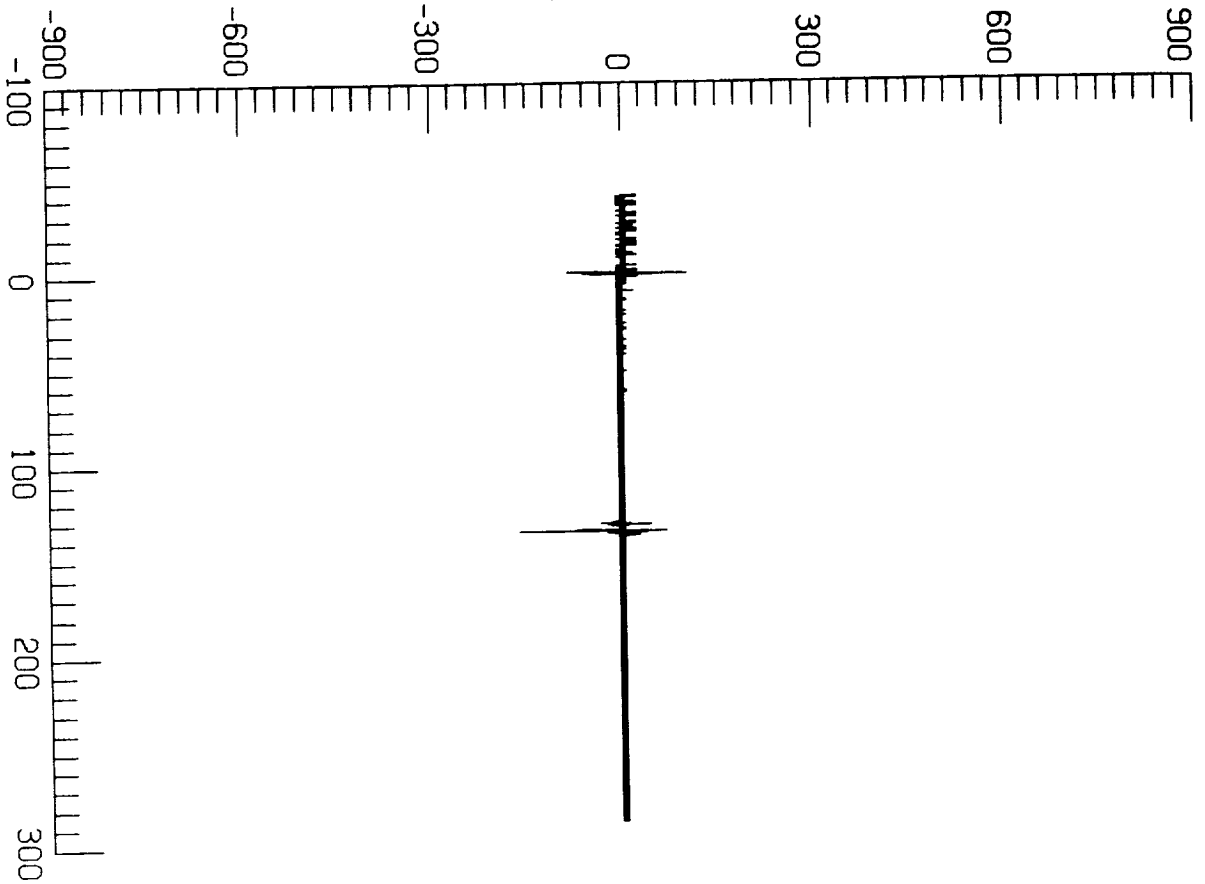

20:57:34.6  
CHANNEL NO. 2.2

F106 LIGHTNING/85-027/ZAEPFEL

LEC 3

RUN NO. 2

S-002

$\dot{D}_{wr}$  A/m<sup>2</sup>

20:57:34.6  
CHANNEL NO. 3.0

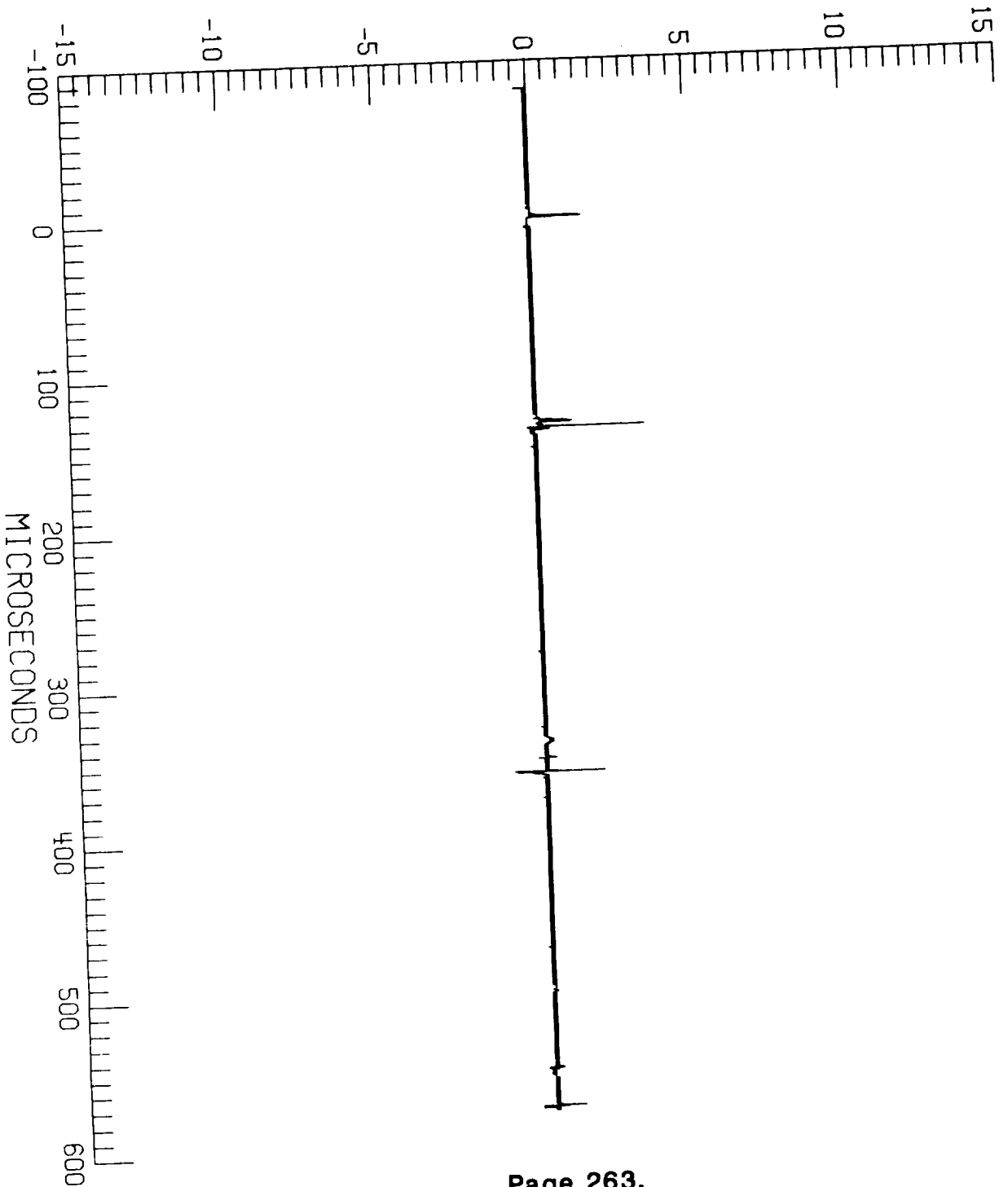

F106 LIGHTNING/85-027/ZAEPFEL

LEC 3

RUN NO. 2

S-002

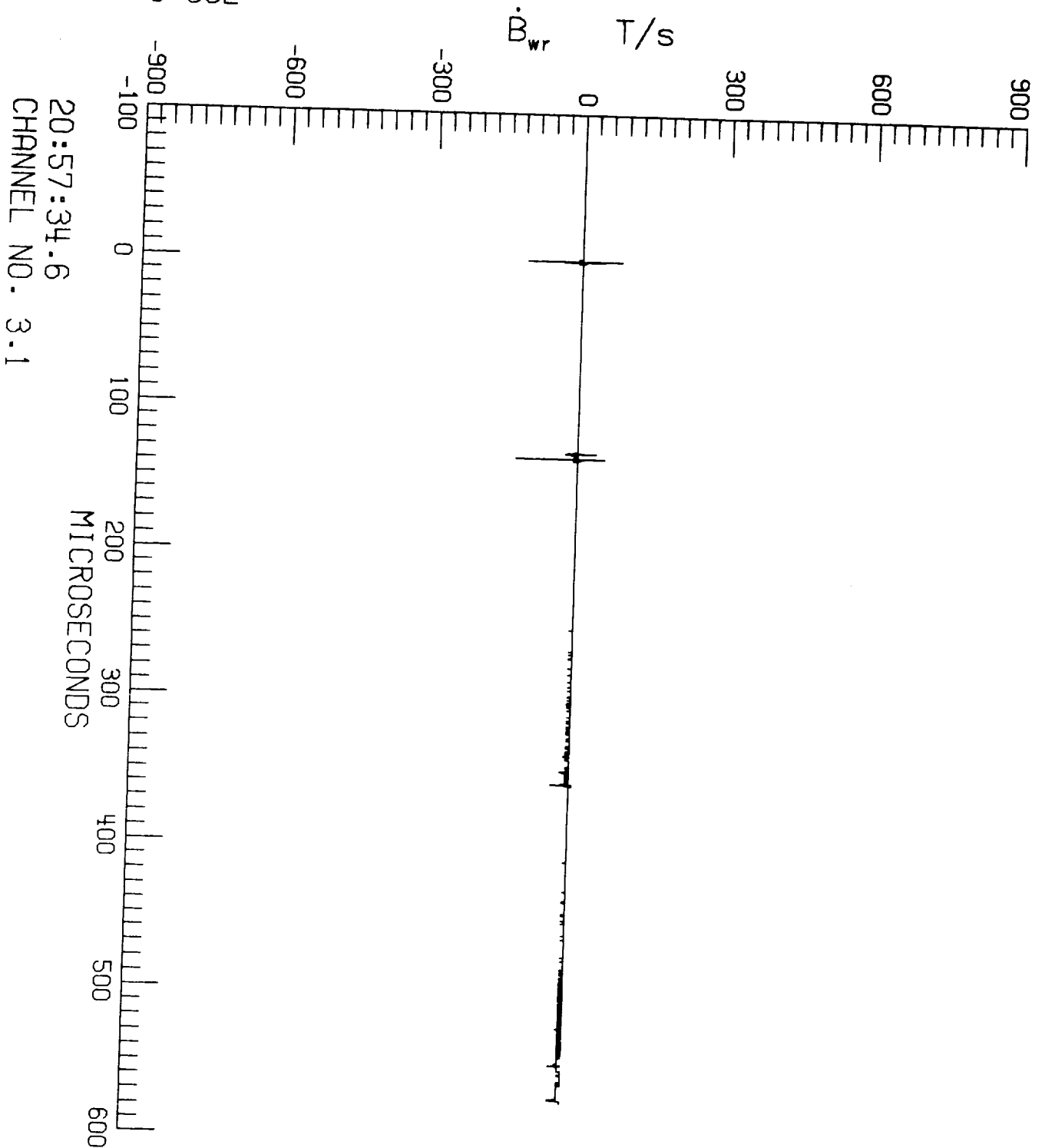

F106 LIGHTNING/85-027/ZAEPFEL

LEC 3

RUN NO. 2

S-002

$\dot{D}_f$  A/m<sup>2</sup>

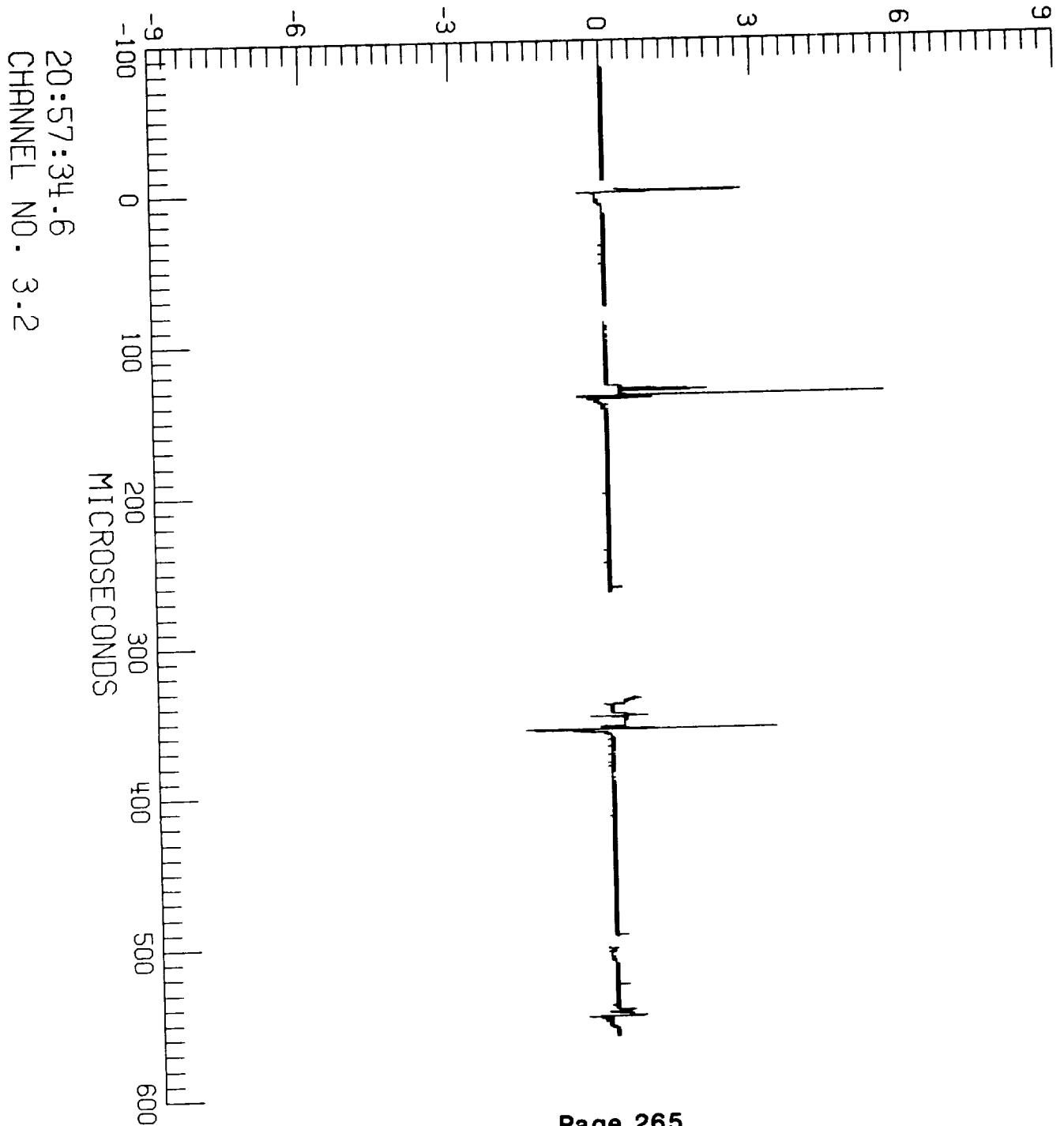

F106 LIGHTNING/85-027/ZAEPFEL

LEC 4

RUN NO. 2

S-002

TP100

V

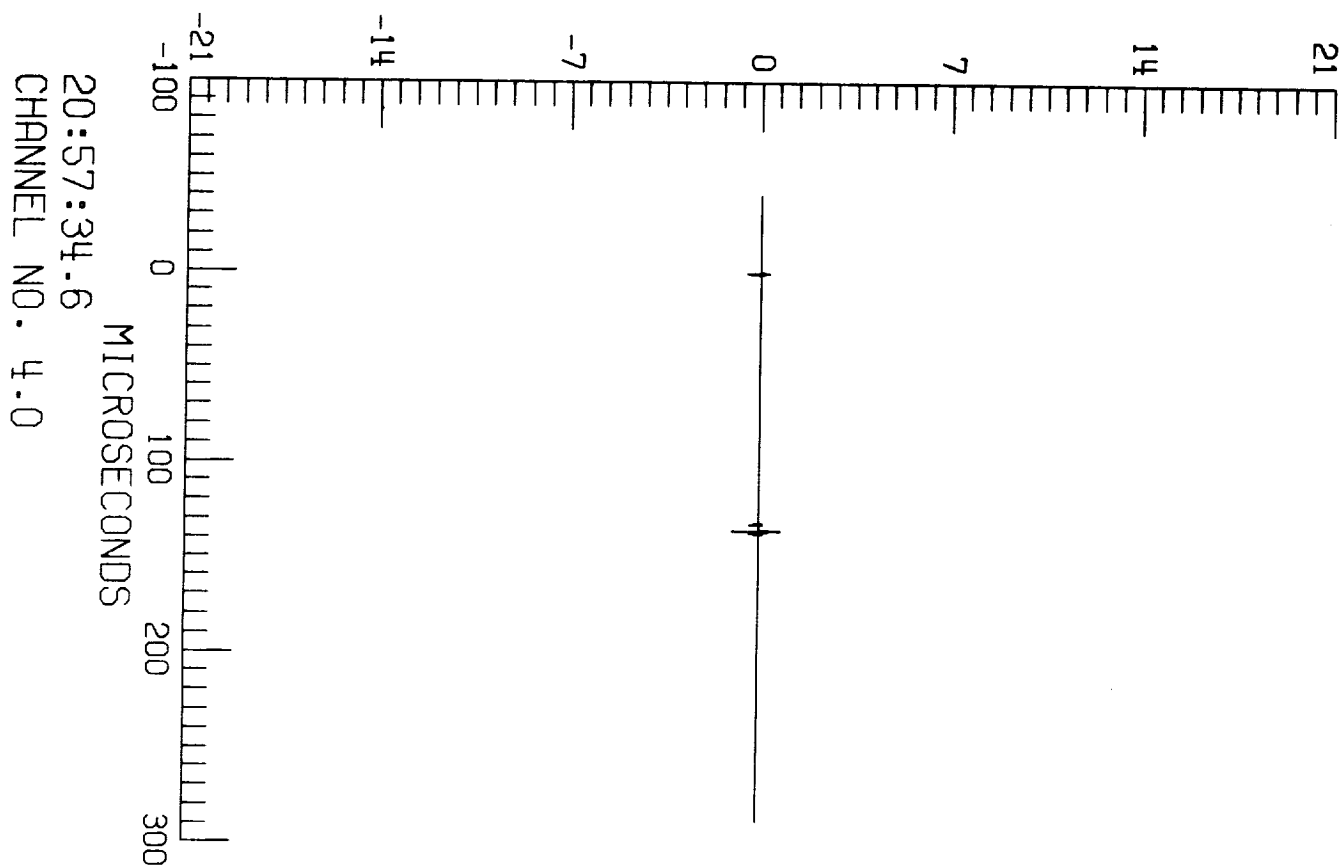

F106 LIGHTNING/85-027/ZAEPFEL

LEC 4

RUN NO. 2

S-002

TP106

A

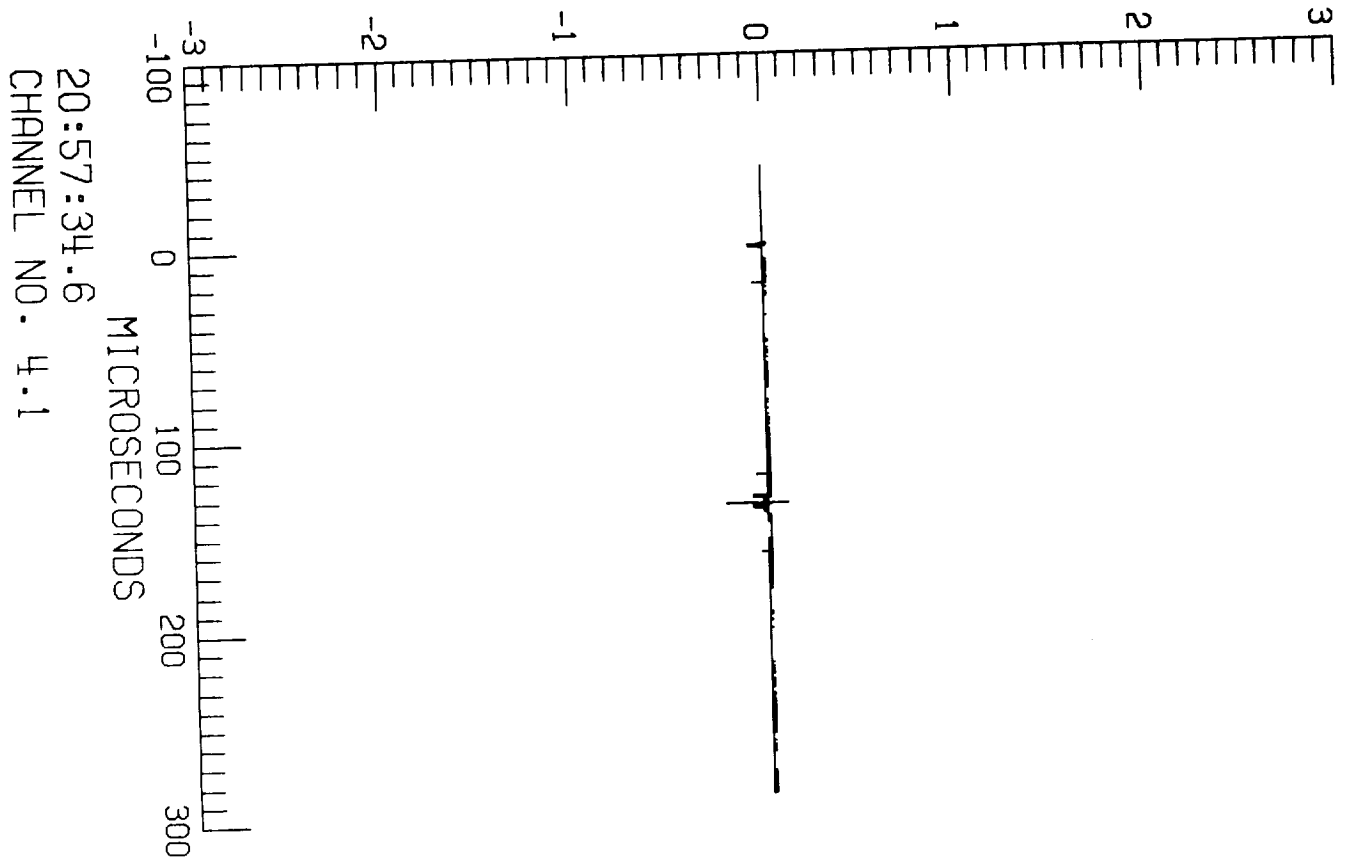

20:57:34.6  
CHANNEL NO. 4.1

F106 LIGHTNING/85-027/ZREPTEL

LEC 4

RUN NO. 2

S-002

TP125

A

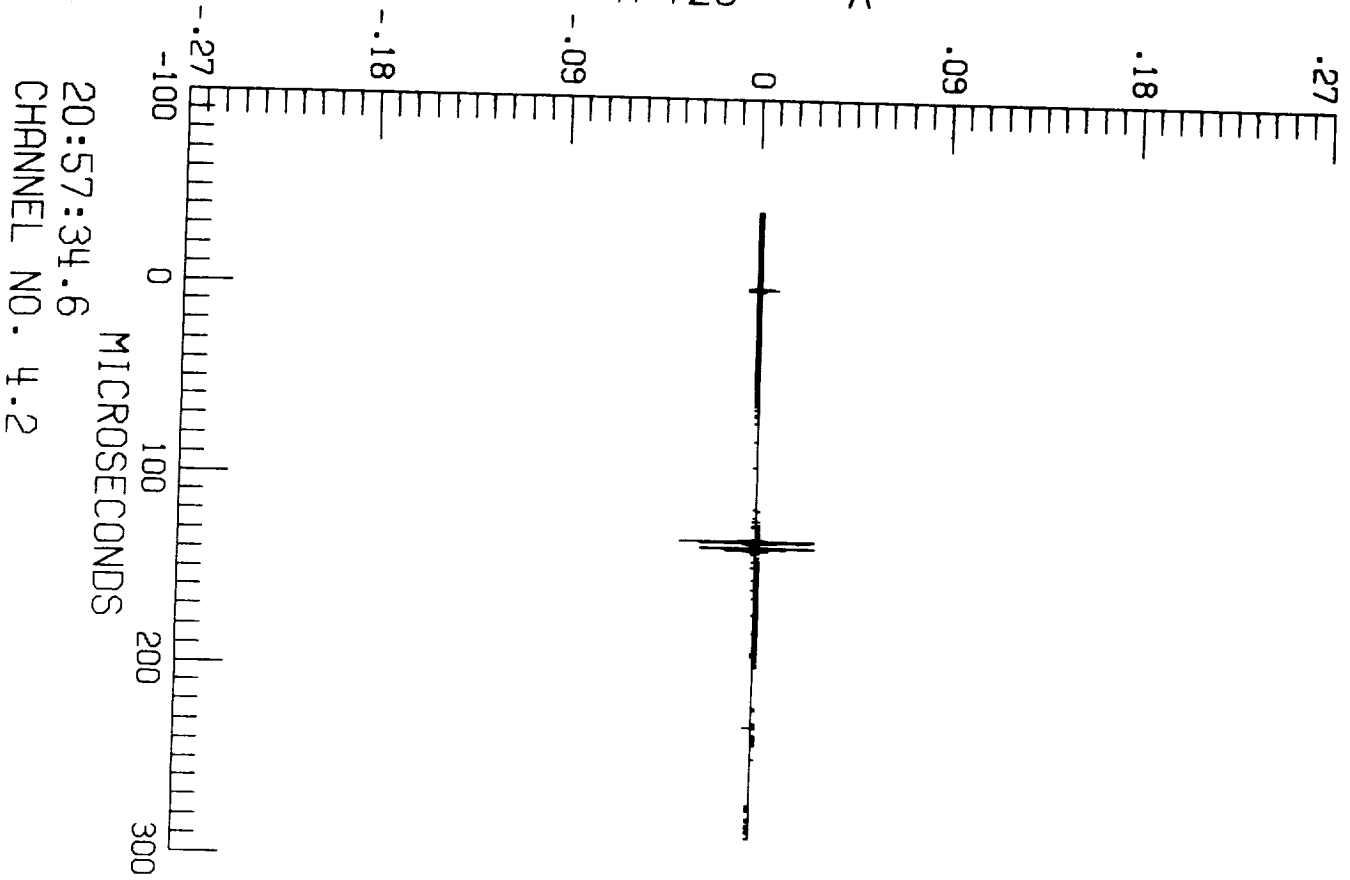

20:57:34.6  
CHANNEL NO. 4.2



F106 LIGHTNING/85-027/ZAEPFEL

LEC 1 RUN NO. 2

S-002

$\dot{D}_t$  A/m<sup>2</sup>

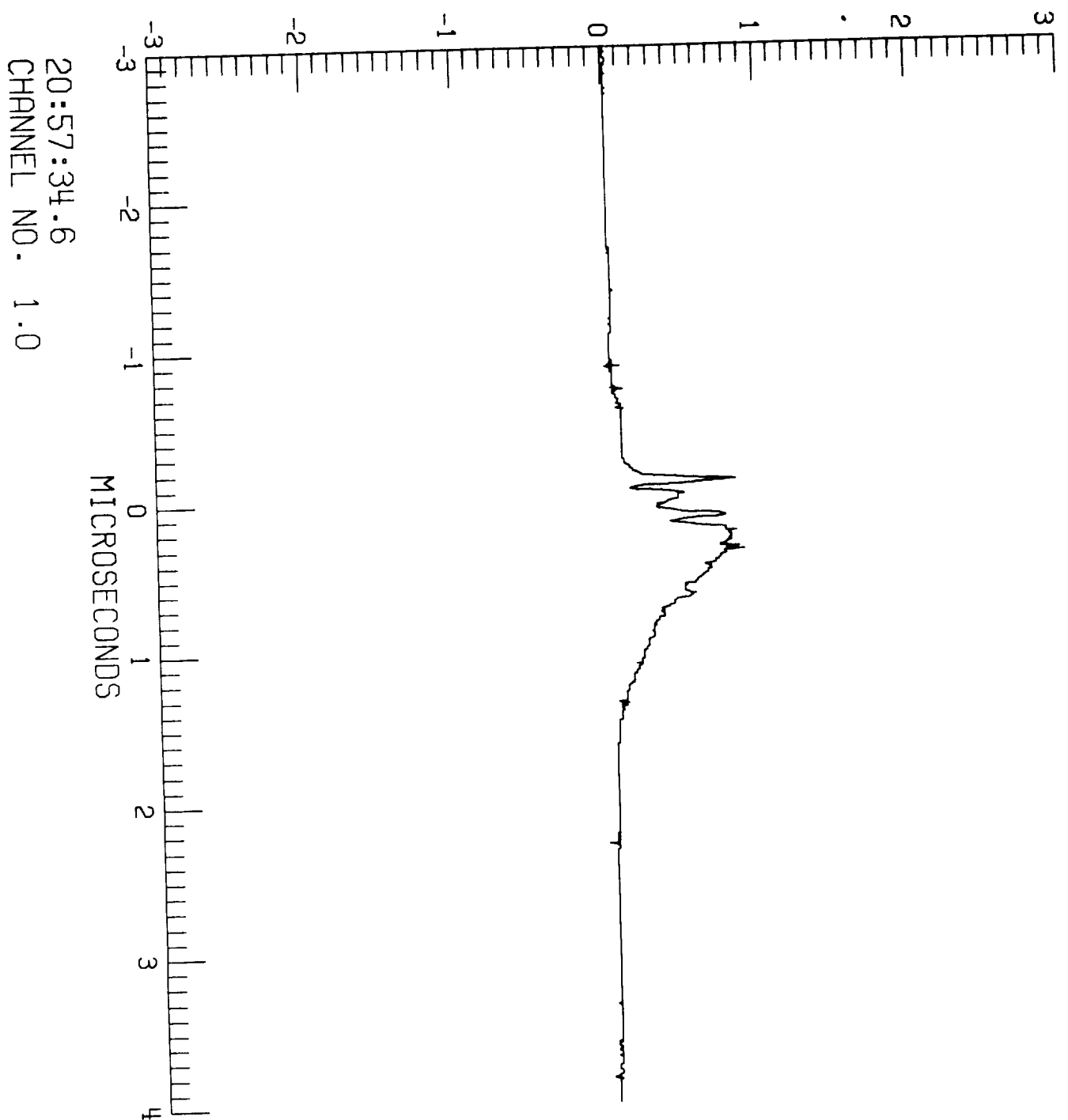

F106 LIGHTNING/85-027/ZAEPFEL

LEC 1 RUN NO. 2

S-002

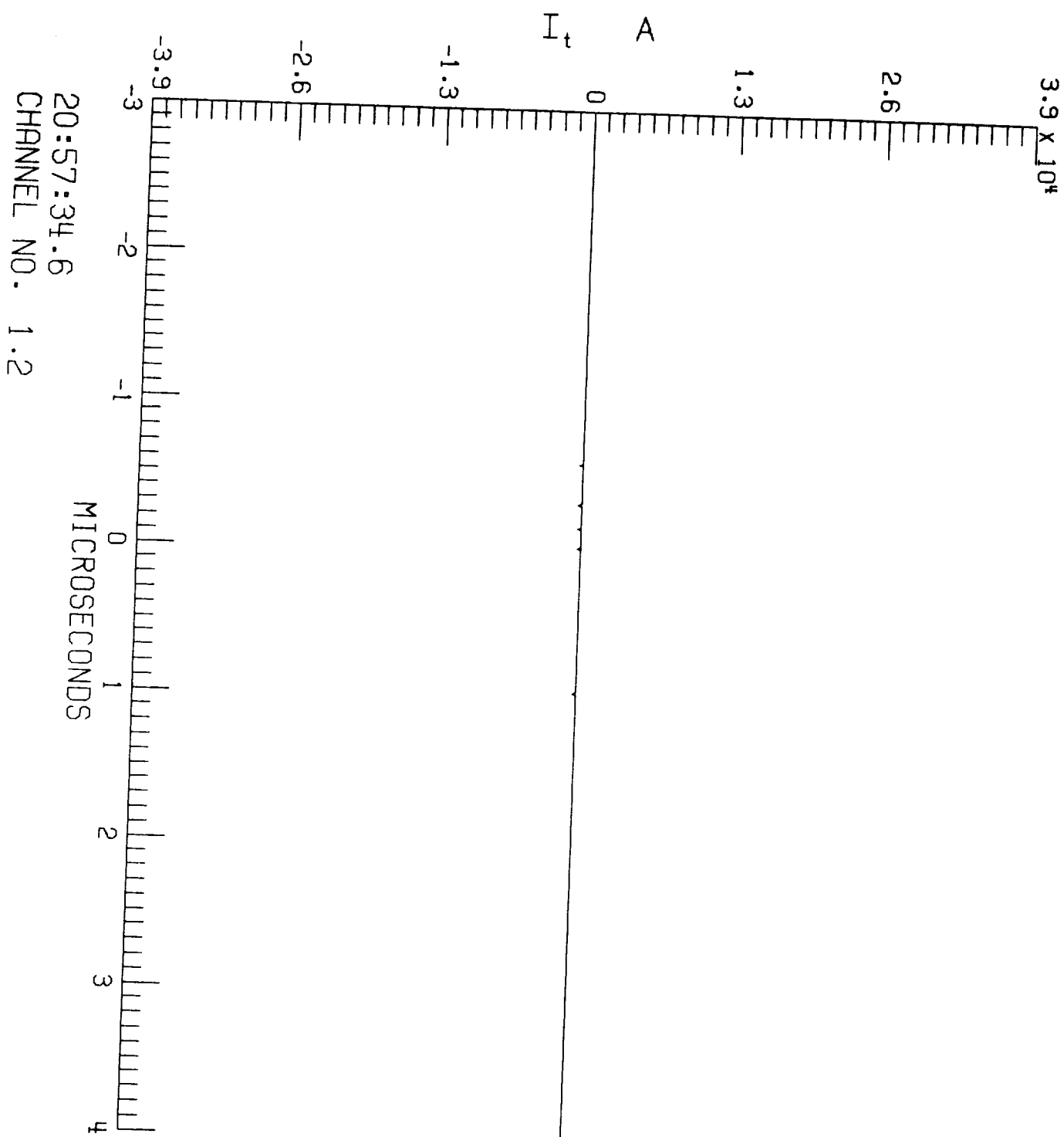

20:57:34.6  
CHANNEL NO. 1.2

F106 LIGHTNING/85-027/ZAEPFEL

LEC 2 RUN NO. 2

S-002

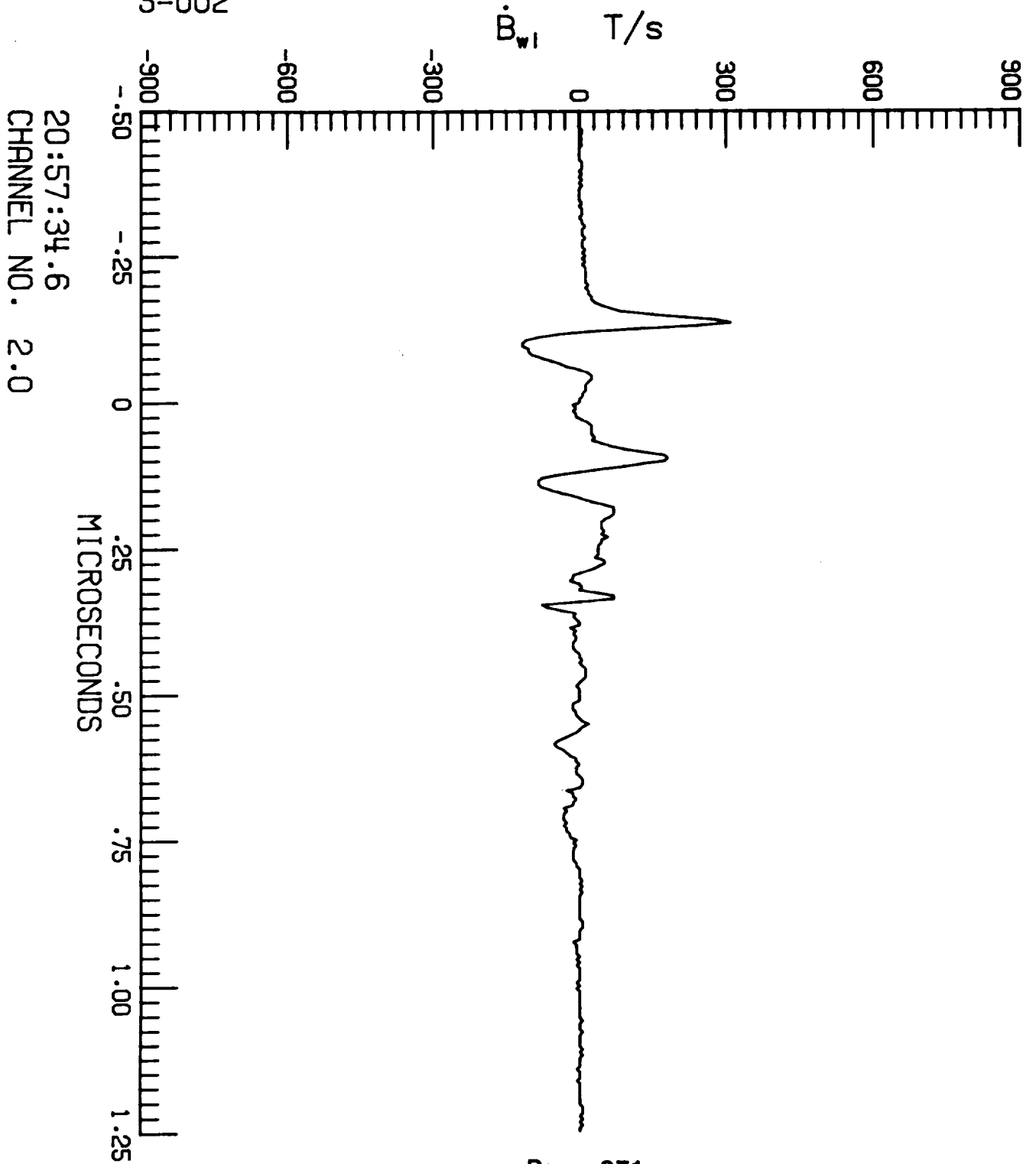

F106 LIGHTNING/85-027/ZAEPFEL

LEC 2 RUN NO. 2

S-002

i A/s

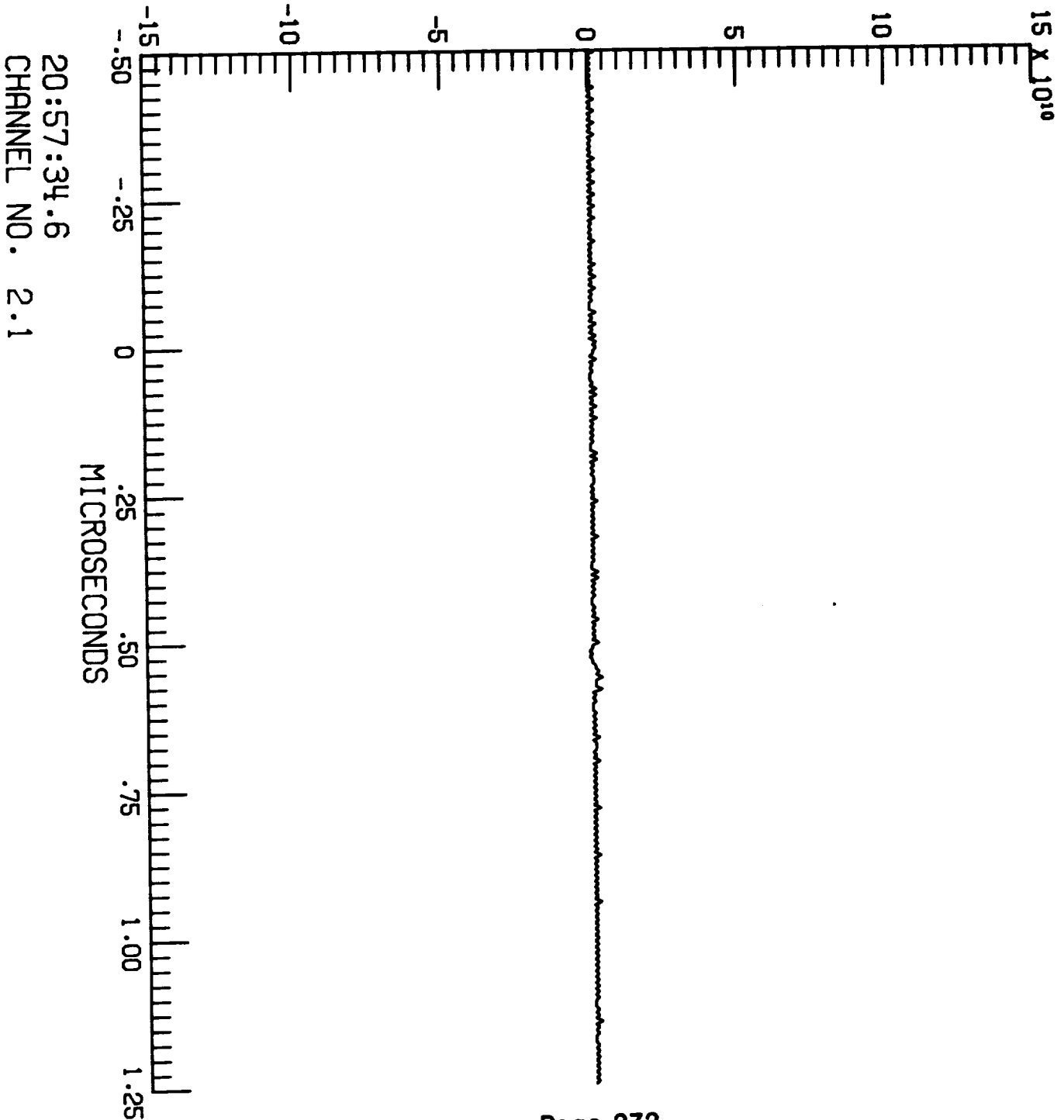

F106 LIGHTNING/85-027/ZAEPFEL

LEC 2 RUN NO. 2

S-002

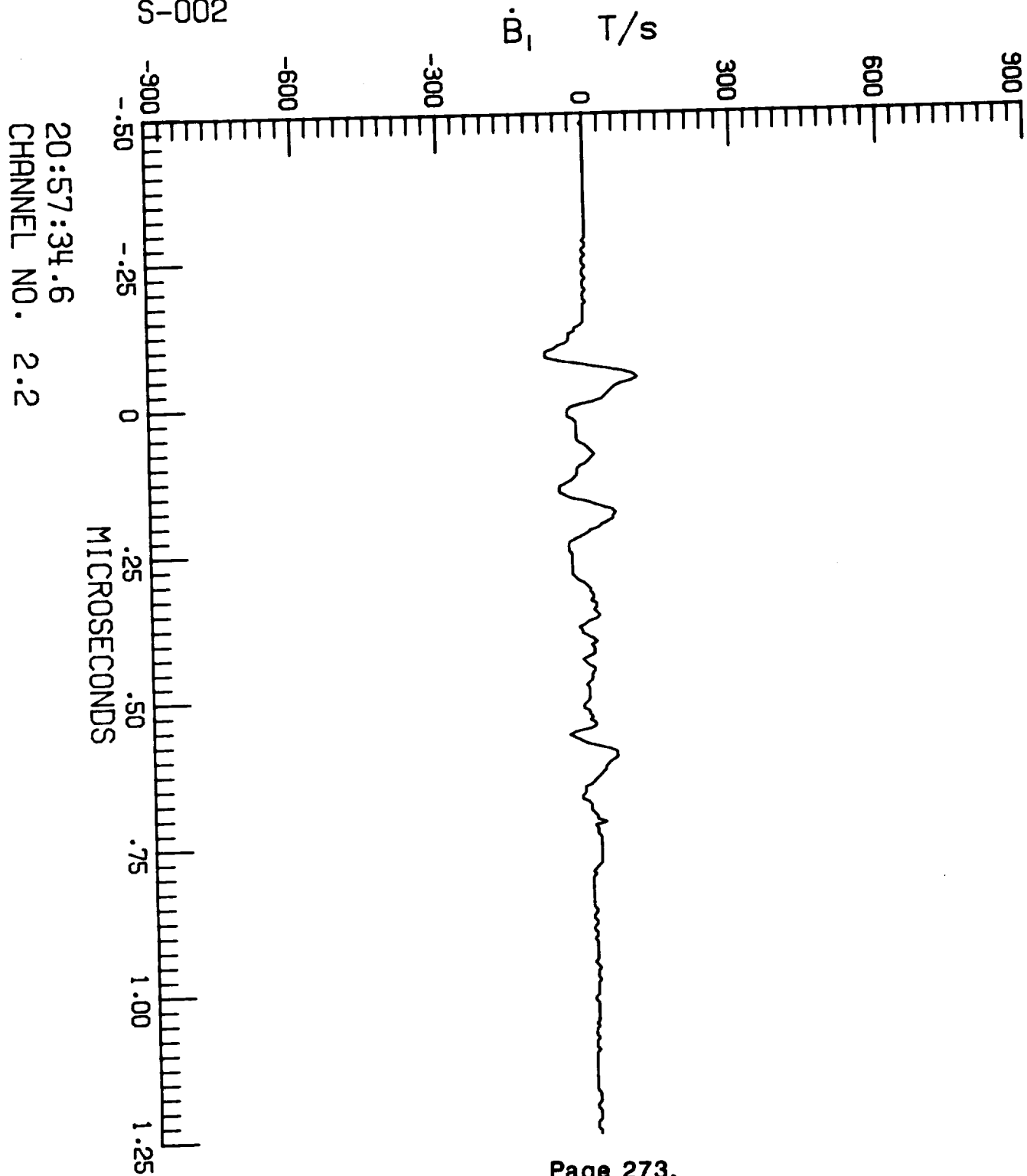

20:57:34.6  
CHANNEL NO. 2.2

F106 LIGHTNING/85-027/ZREPPEL

LEC 3 RUN NO. 2

S-002

$\dot{D}_{wr}$  A/m<sup>2</sup>

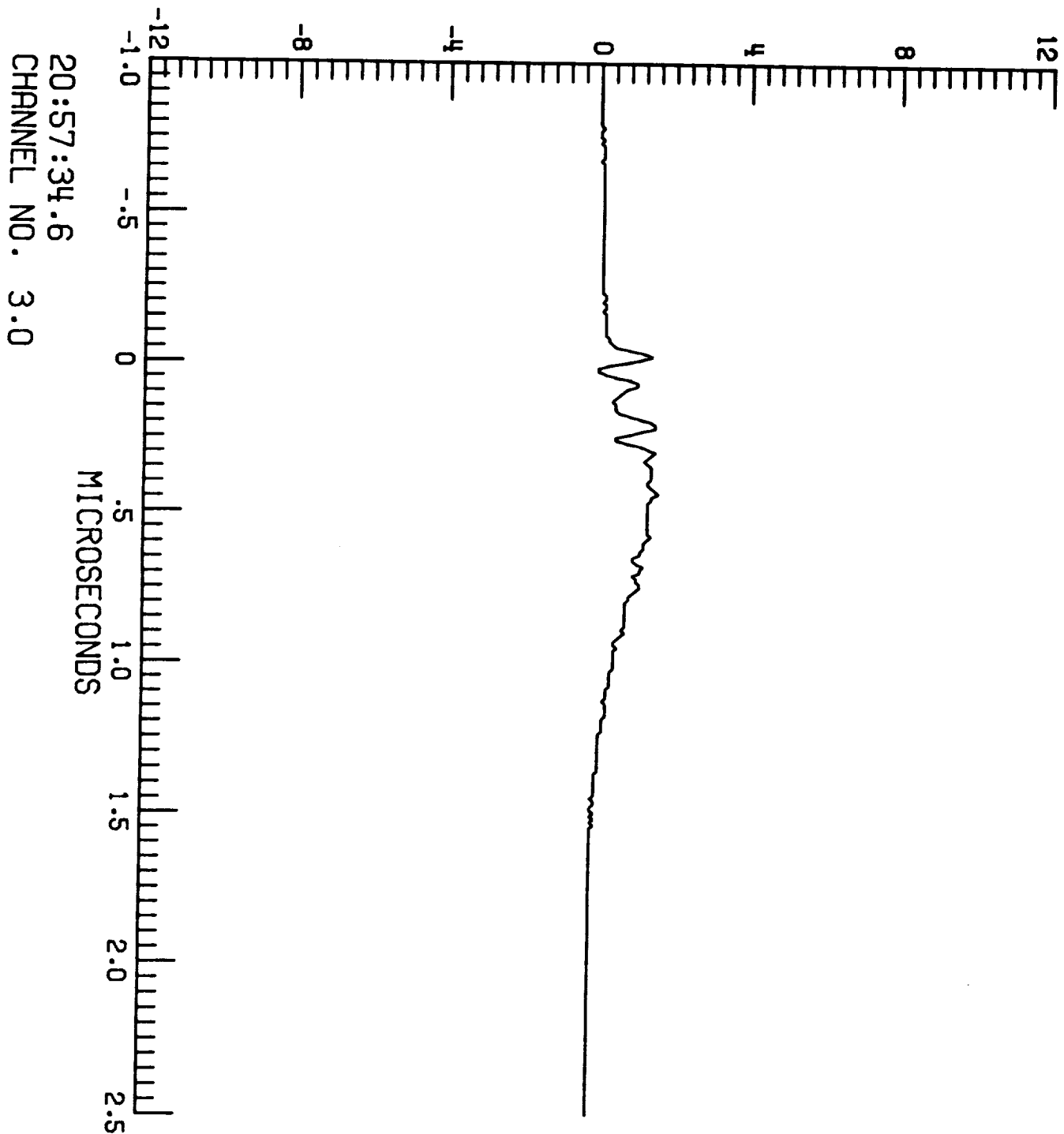

F106 LIGHTNING/85-027/ZAEPFEL

LEC 3 RUN NO. 2

S-002

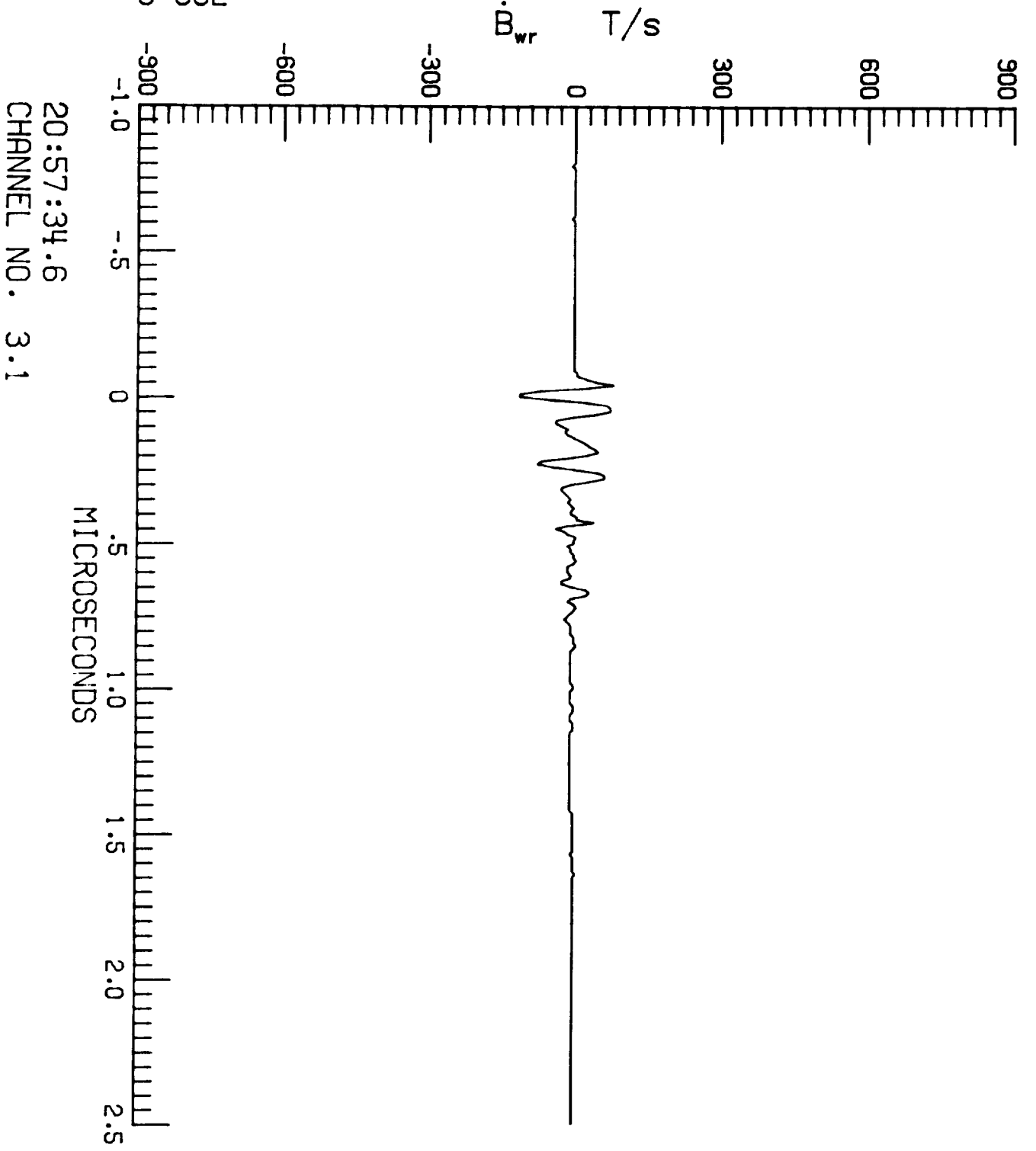

20:57:34.6  
CHANNEL NO. 3.1

F106 LIGHTNING/85-027/ZAEPFEL

LEC 3 RUN NO. 2

S-002

$\dot{D}_f$  A/m<sup>2</sup>

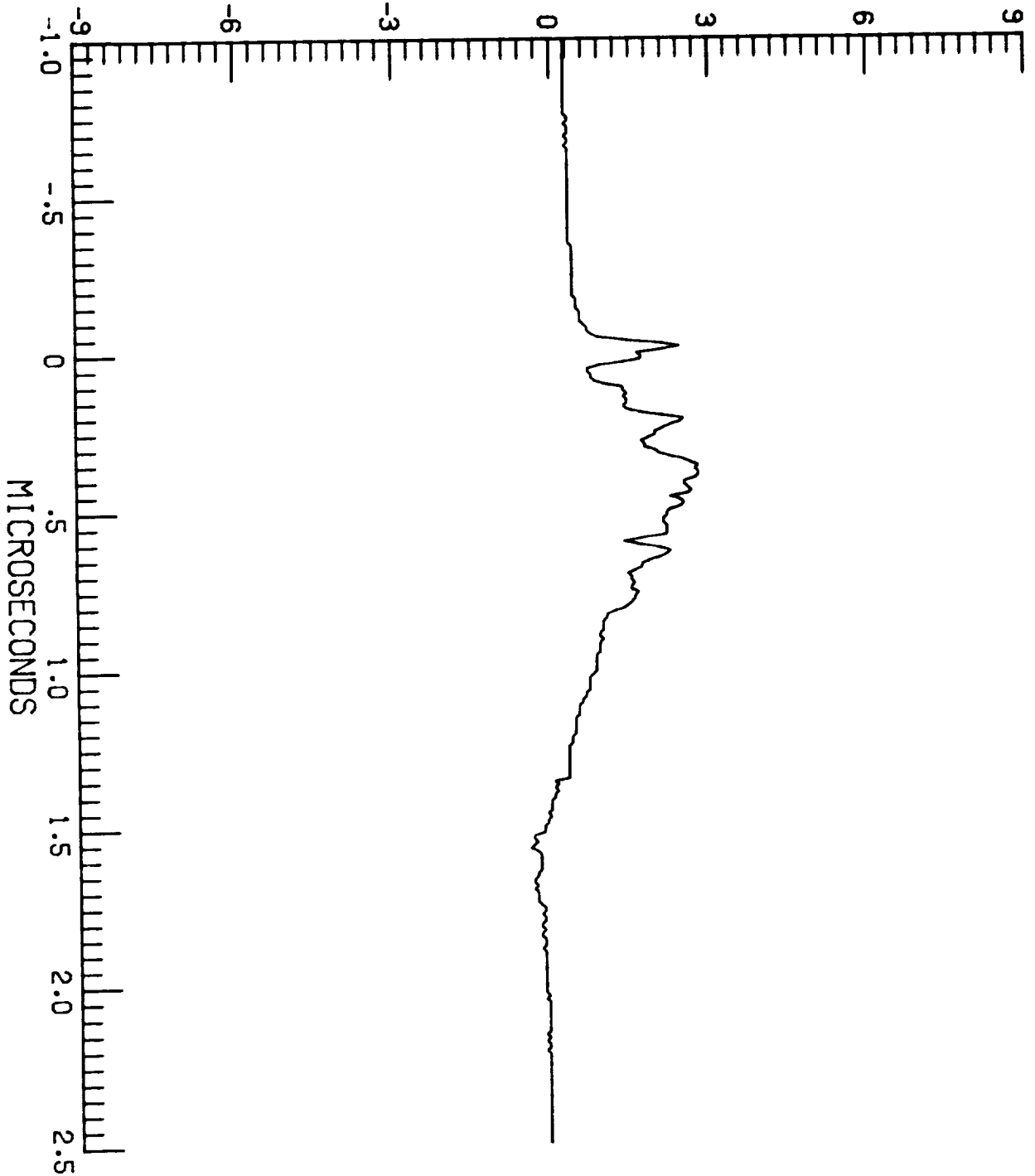

20:57:34.6  
CHANNEL NO. 3.2



F106 LIGHTNING/85-027/ZAEPFEL

LEC 4 RUN NO. 2

S-002

TP100

V

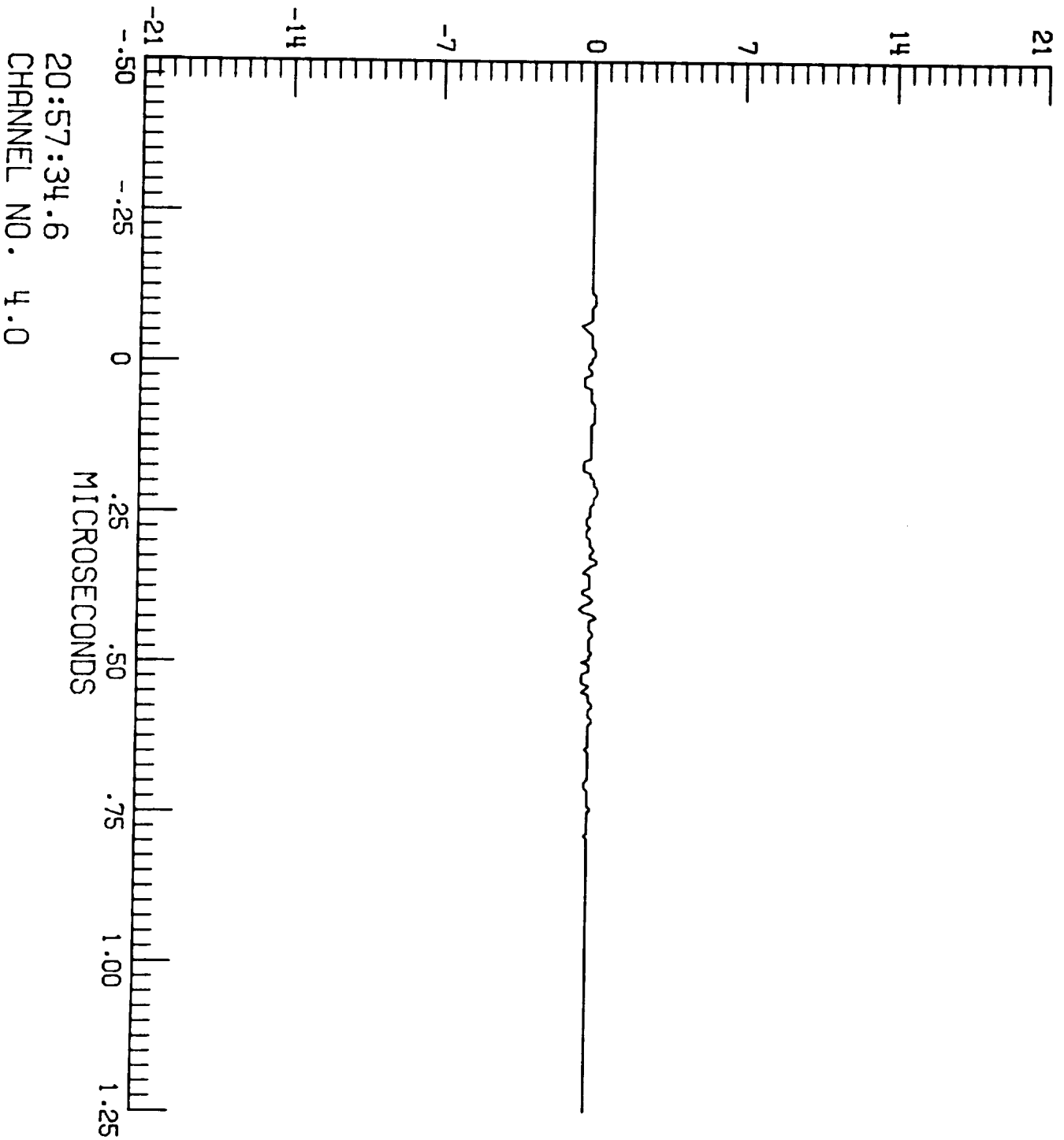

F106 LIGHTNING/85-027/ZAEPFEL

LEC 4 RUN NO. 2

S-002

TP106

A

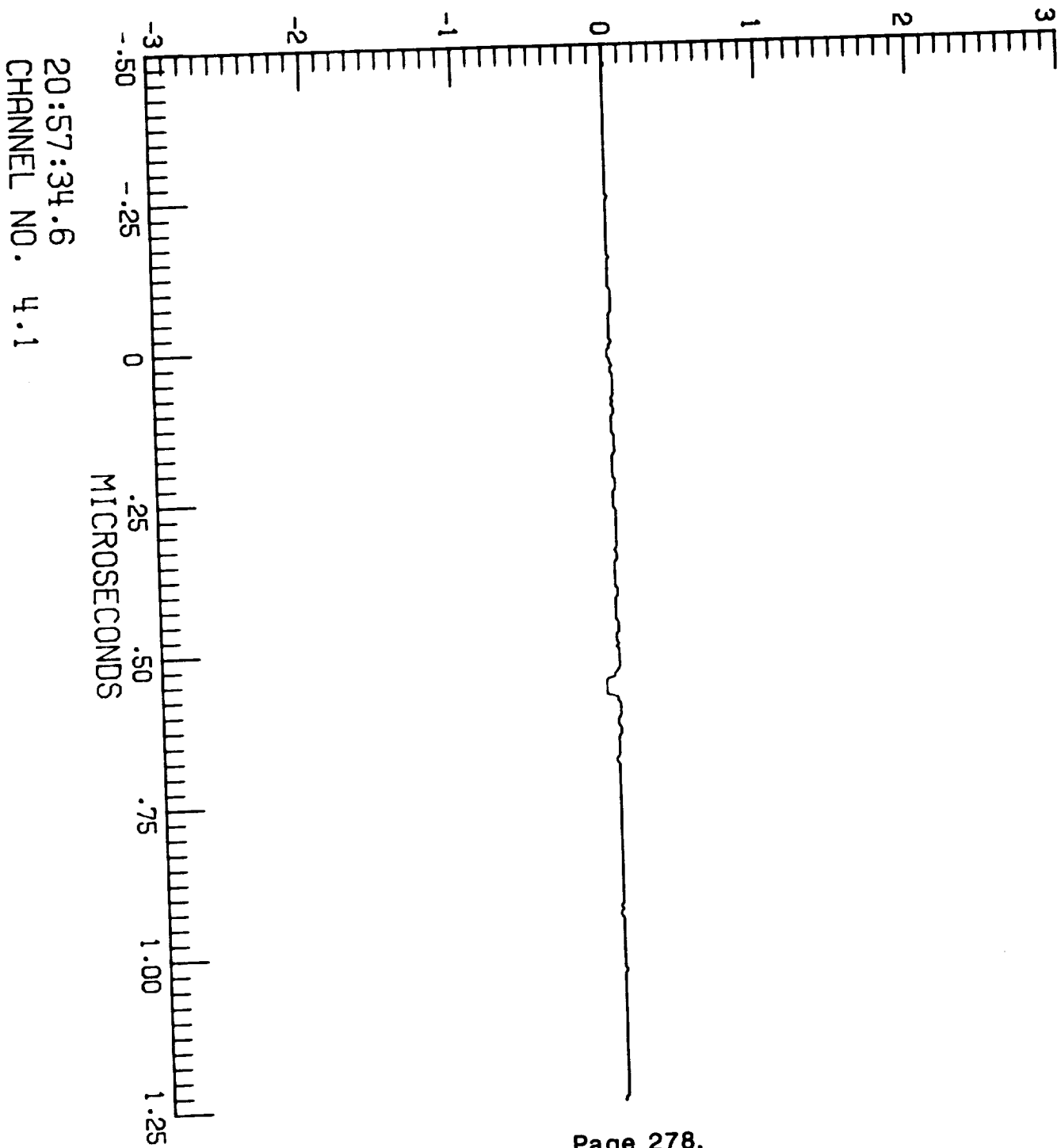

F106 LIGHTNING/85-027/ZAEPFEL

LEC 4 RUN NO. 2

S-002

TP125

A

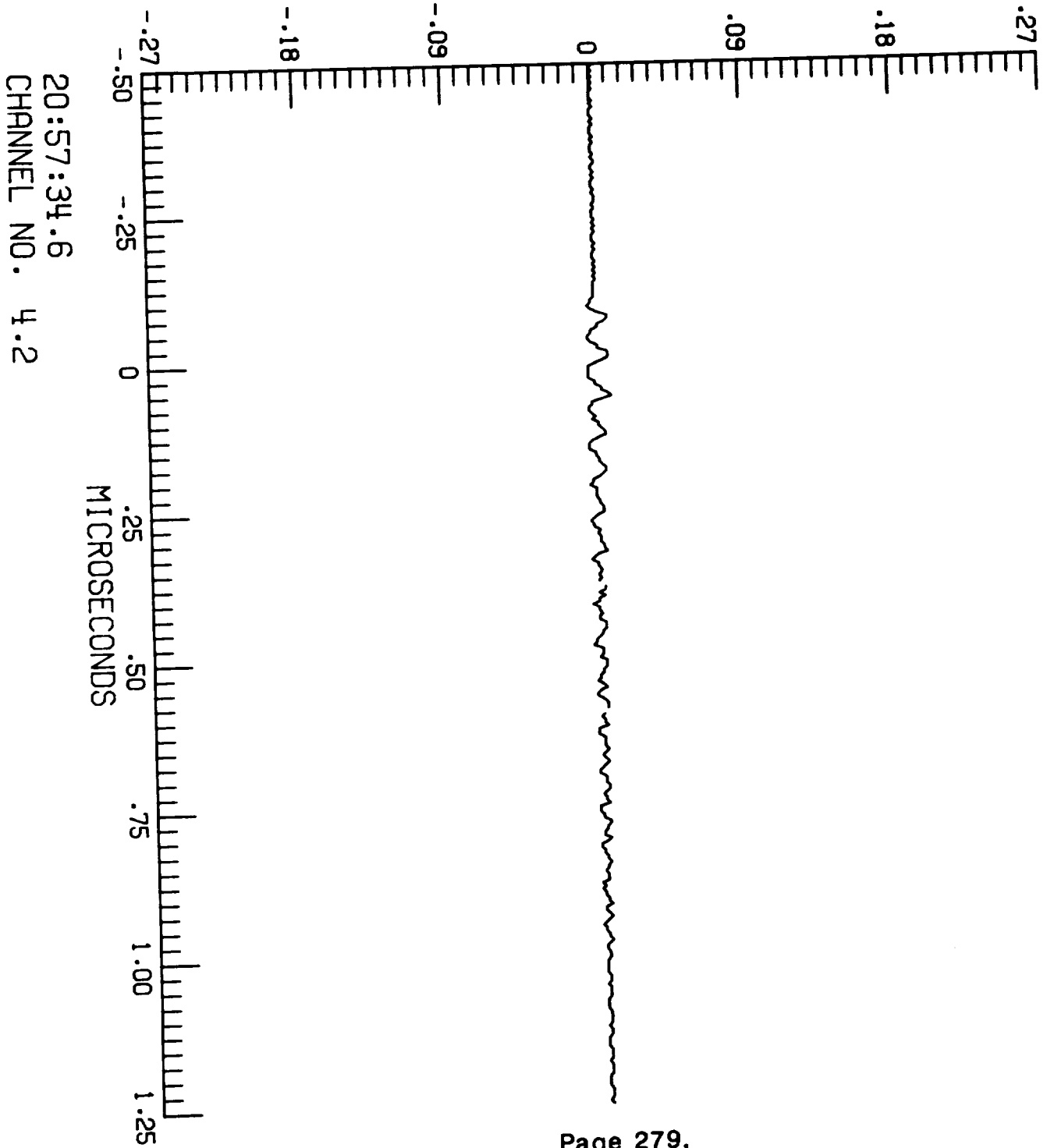

F106 LIGHTNING/85-027/ZAEPFEL  
LEC 1 RUN NO. 2  
S-002

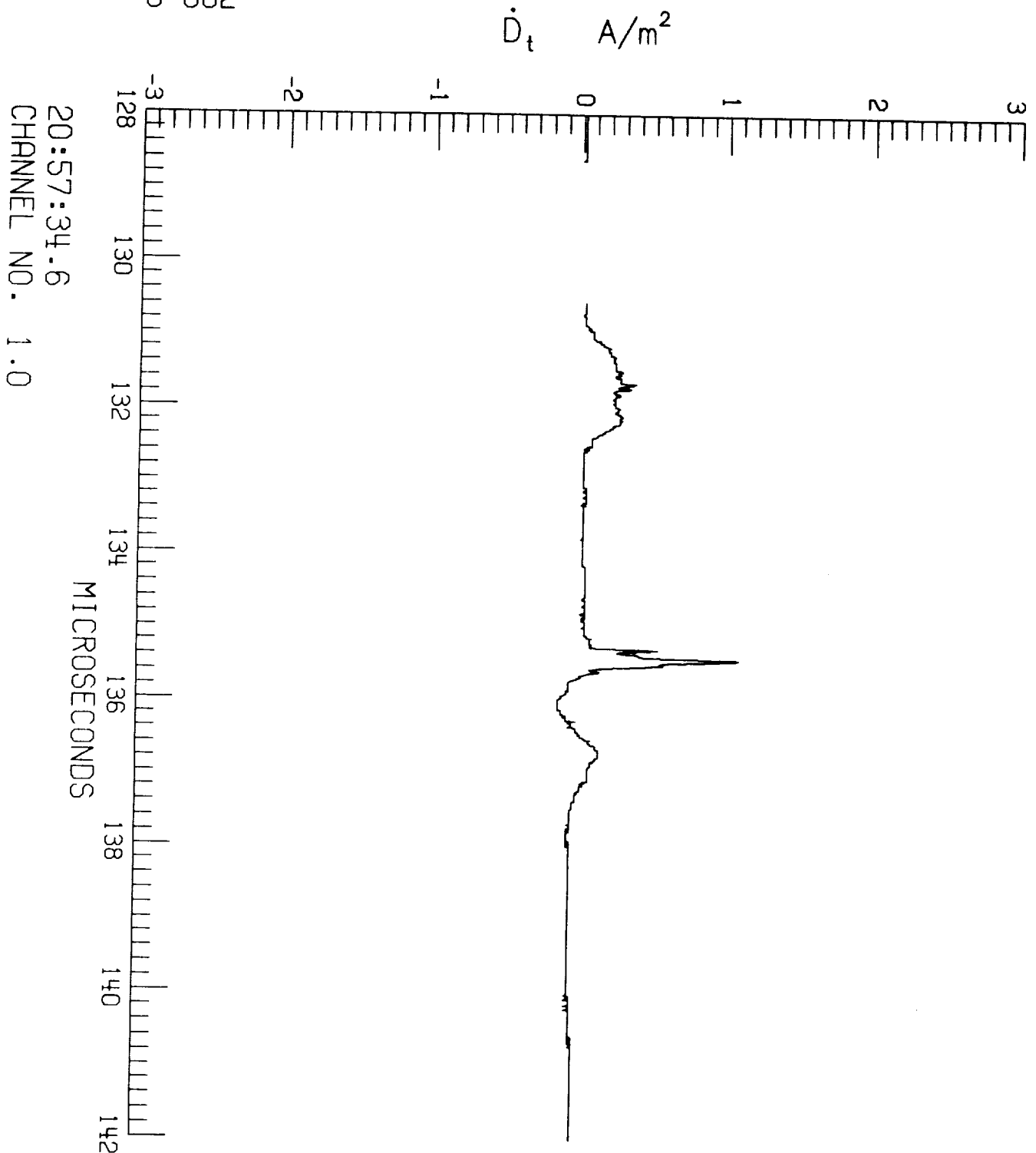

F106 LIGHTNING/85-027/ZAEPFEL

LEC 1 RUN NO. 2

S-002

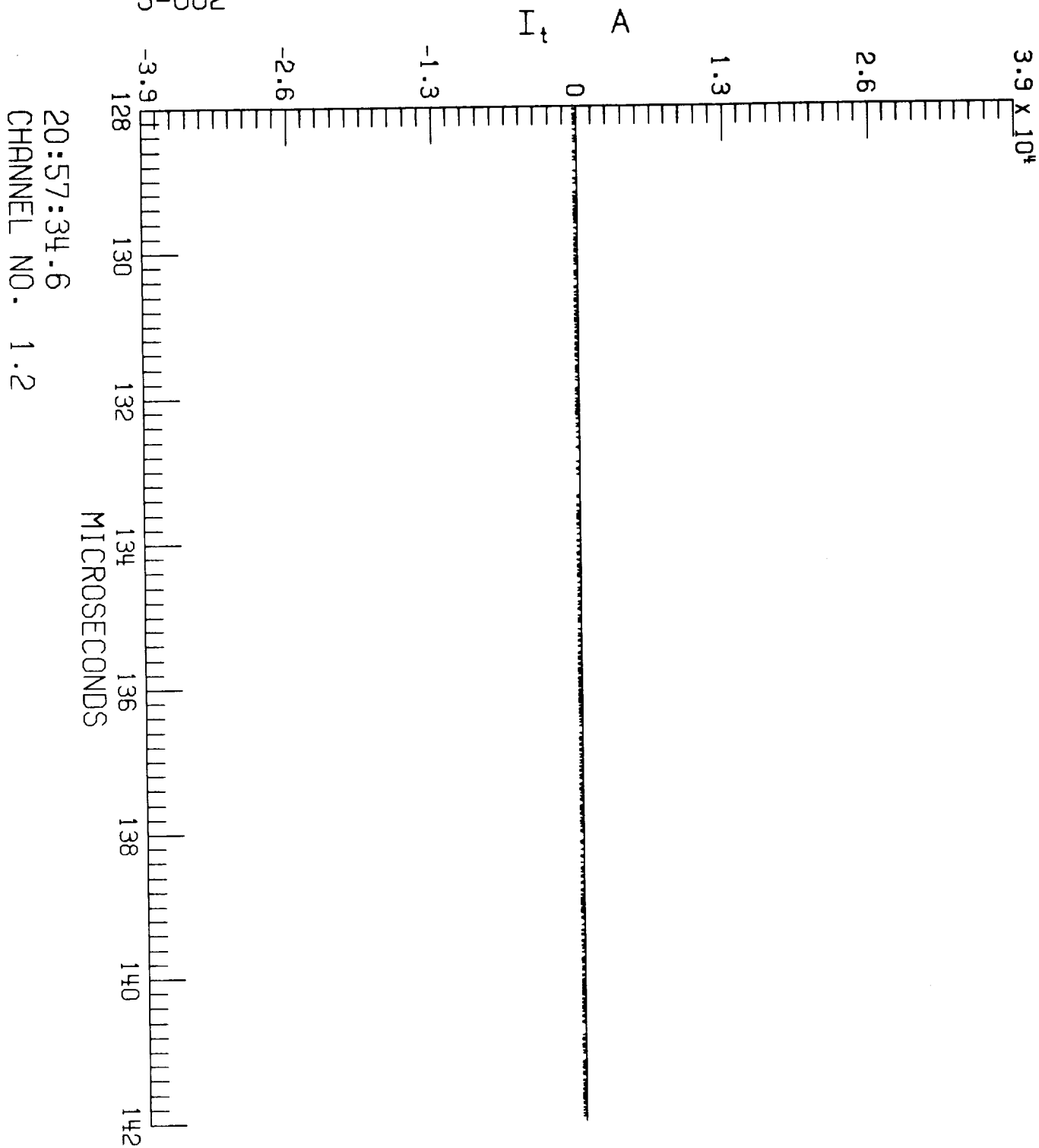

20:57:34.6  
CHANNEL NO. 1.2

F106 LIGHTNING/85-027/ZREPPEL

LEC 2 RUN NO. 2

S-002

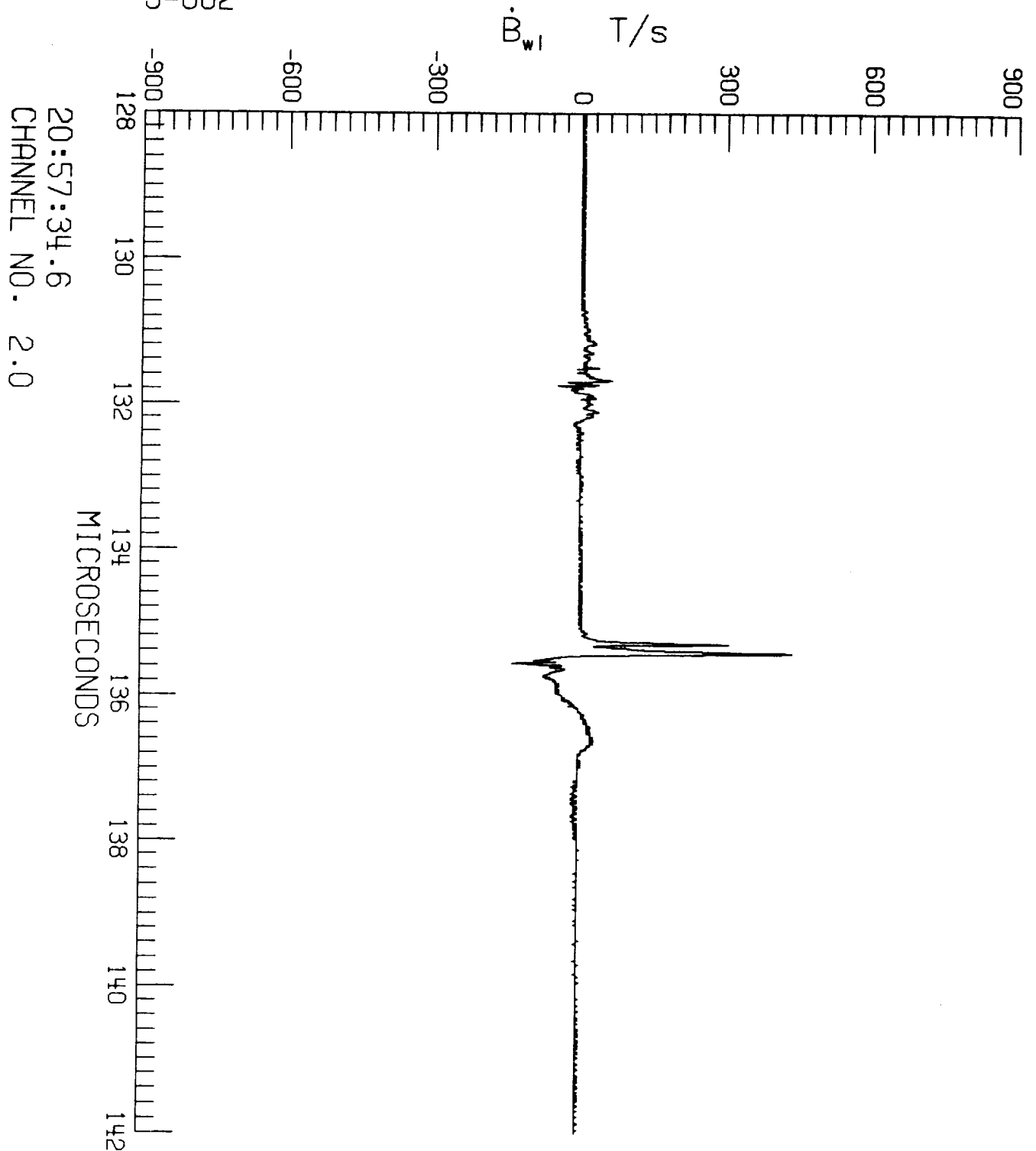

F106 LIGHTNING/85-027/ZAEPFEL  
LEC 2 RUN NO. 2  
S-002

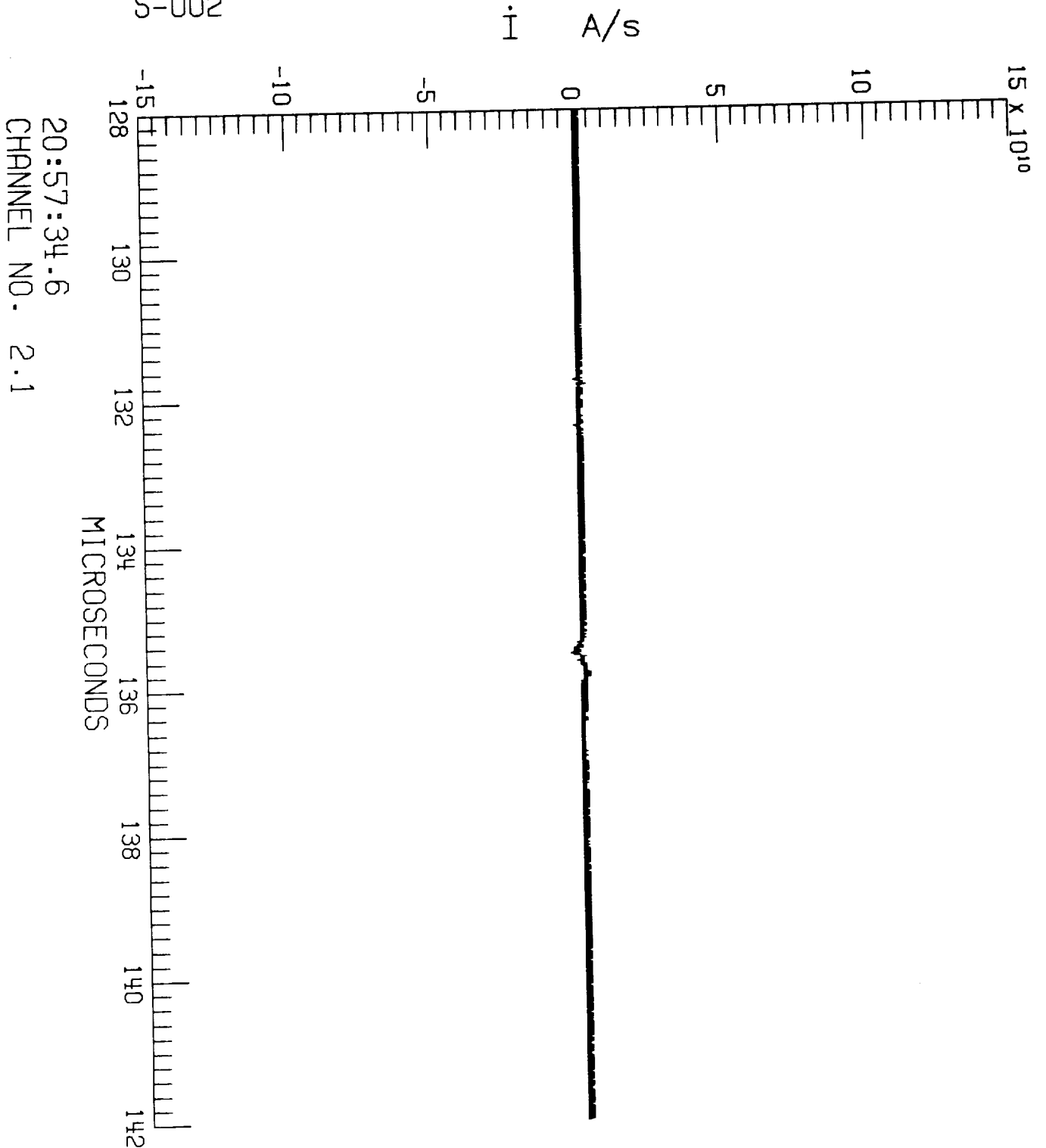

20:57:34.6  
CHANNEL NO. 2.1

F106 LIGHTNING/85-027/ZAEPFEL  
LEC 2 RUN NO. 2  
S-002

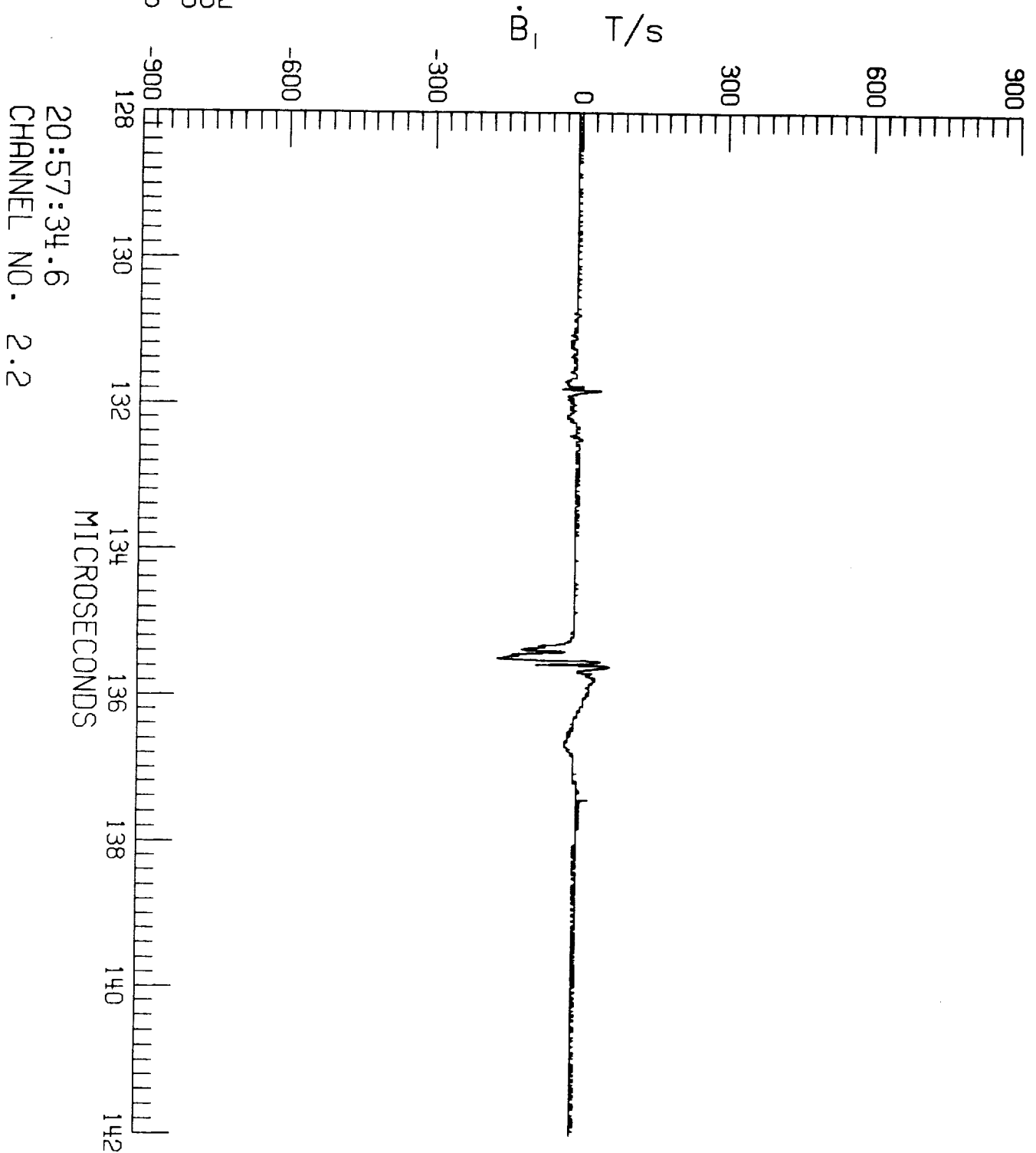



F106 LIGHTNING/85-027/ZAEPFEL

LEC 3 RUN NO. 2

S-002

$\dot{D}_{wr}$  A/m<sup>2</sup>

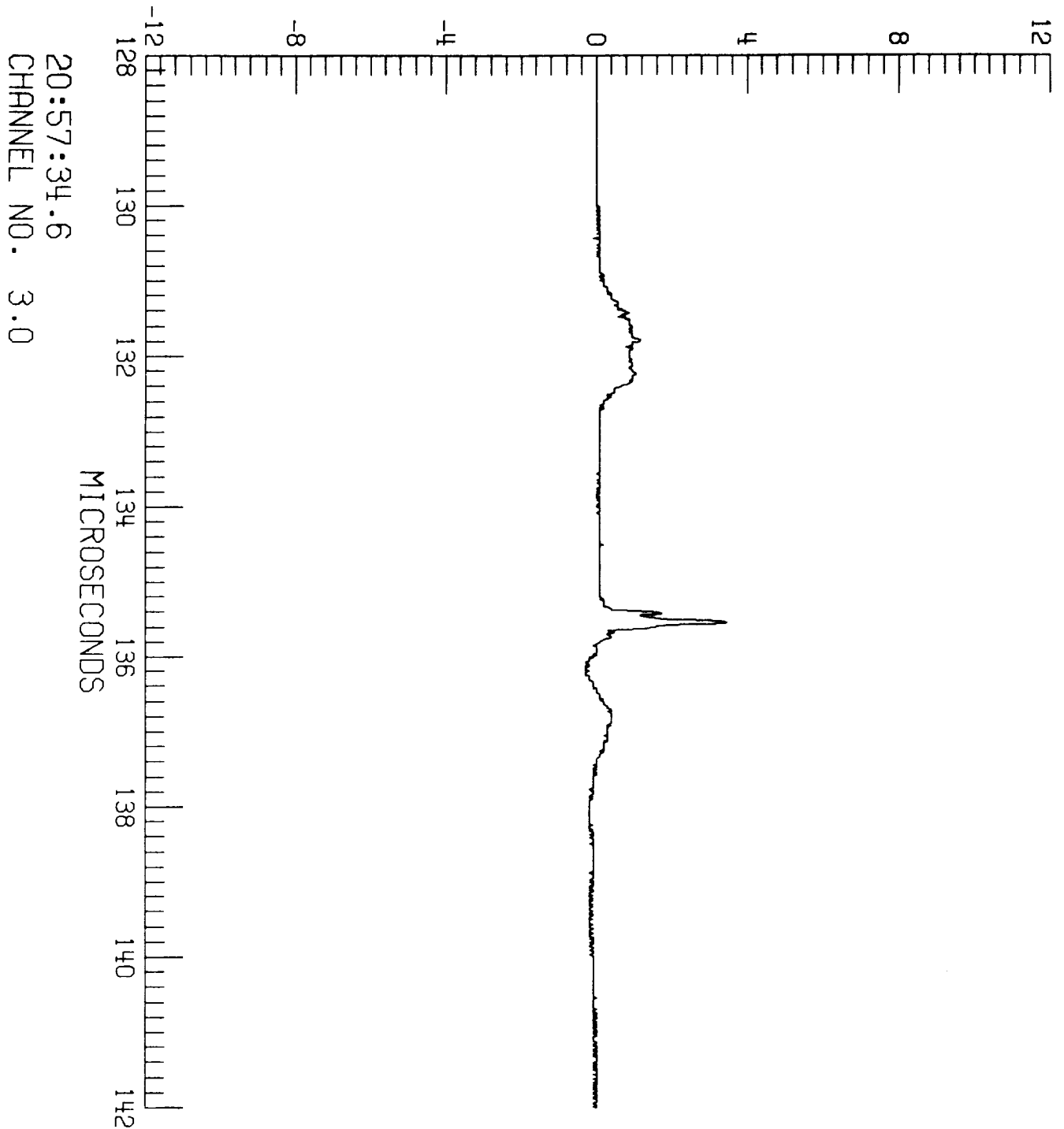

F106 LIGHTNING/85-027/ZAEPFEL

LEC 3 RUN NO. 2

S-002

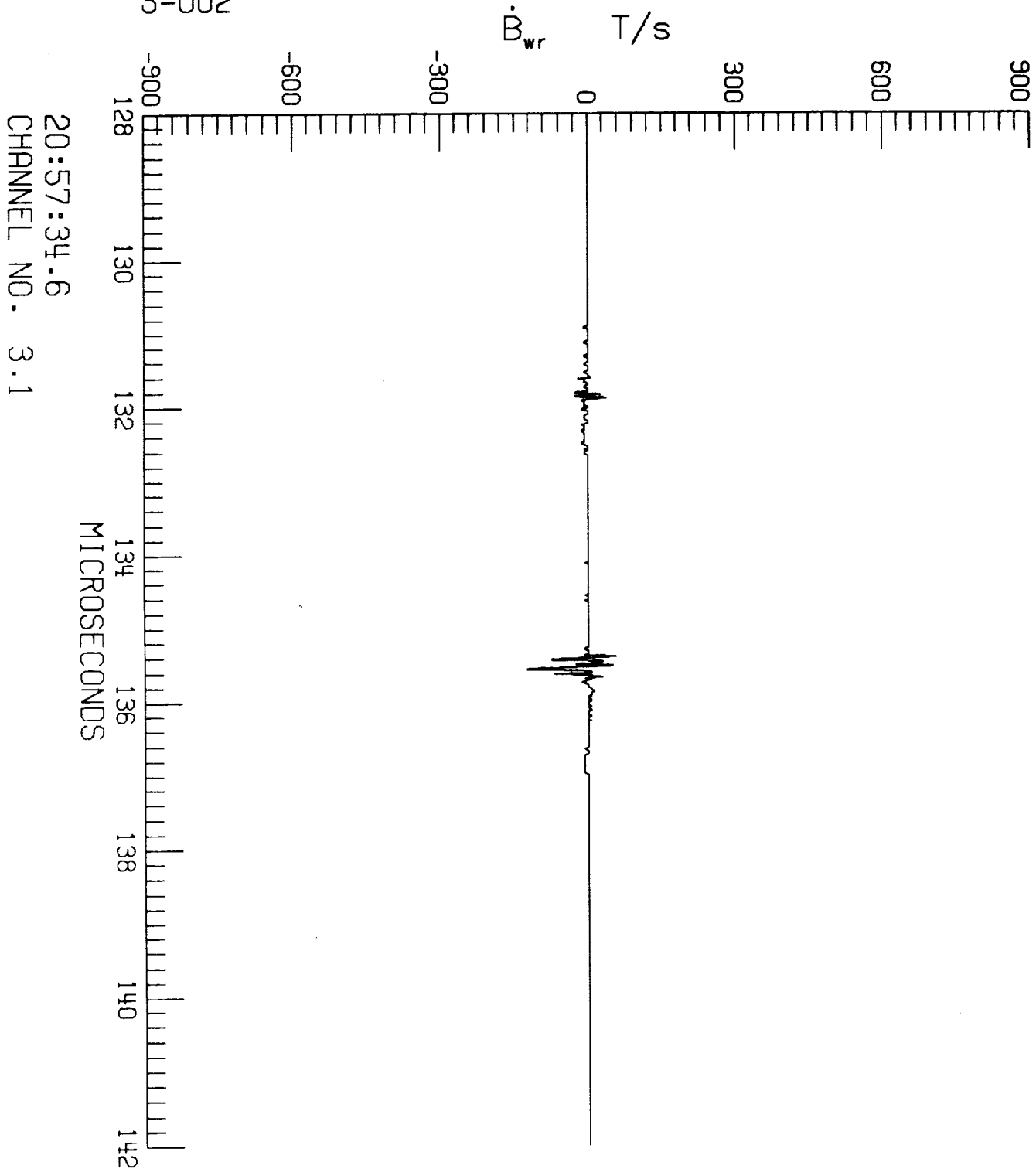

20:57:34.6  
CHANNEL NO. 3.1

F106 LIGHTNING/85-027/ZAEPFEL

LEC 3 RUN NO. 2

S-002

$\dot{D}_f$  A/m<sup>2</sup>

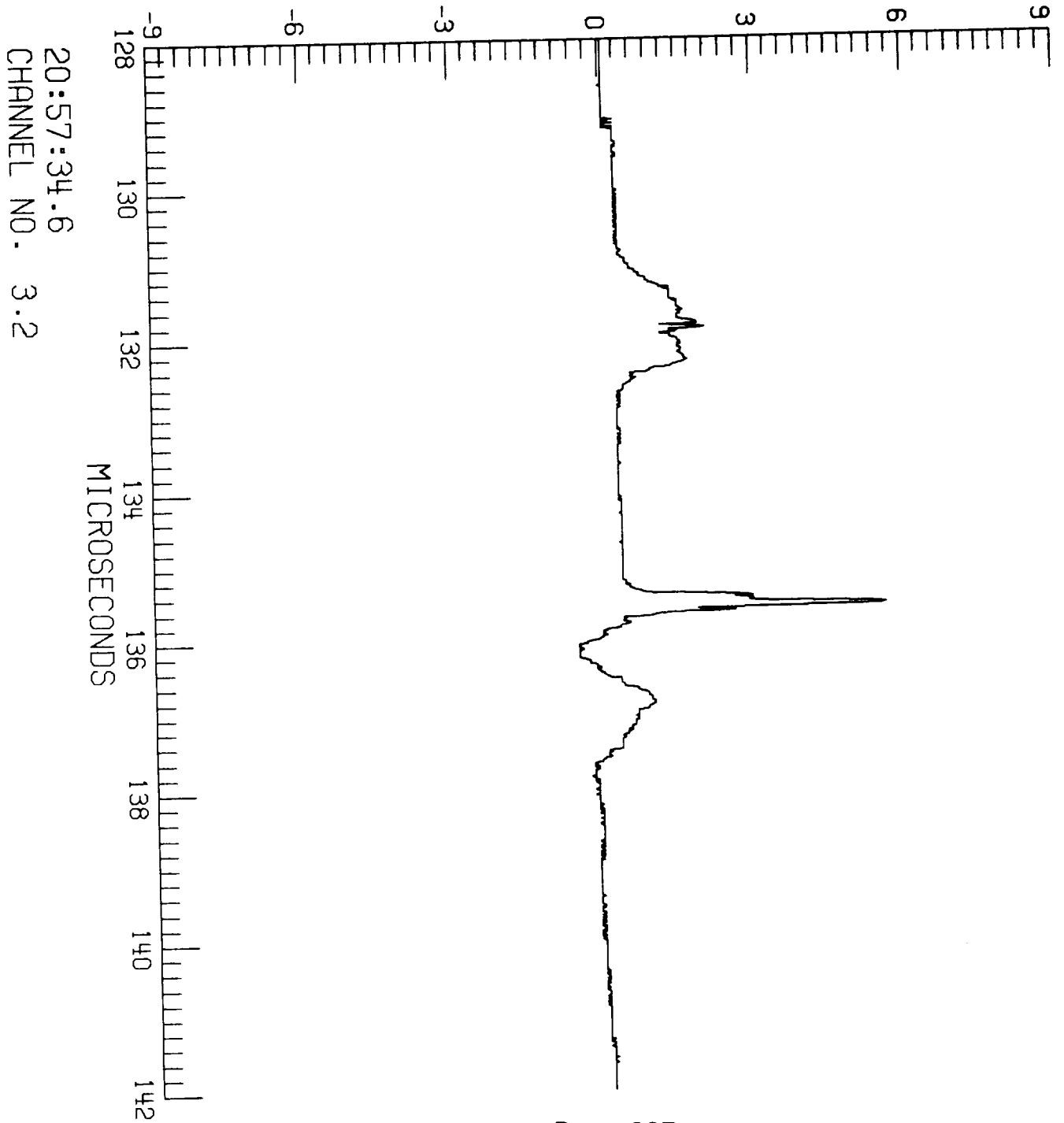

F106 LIGHTNING/85-027/ZAEPFEL

LEC 4 RUN NO. 2

S-002

TP100 V

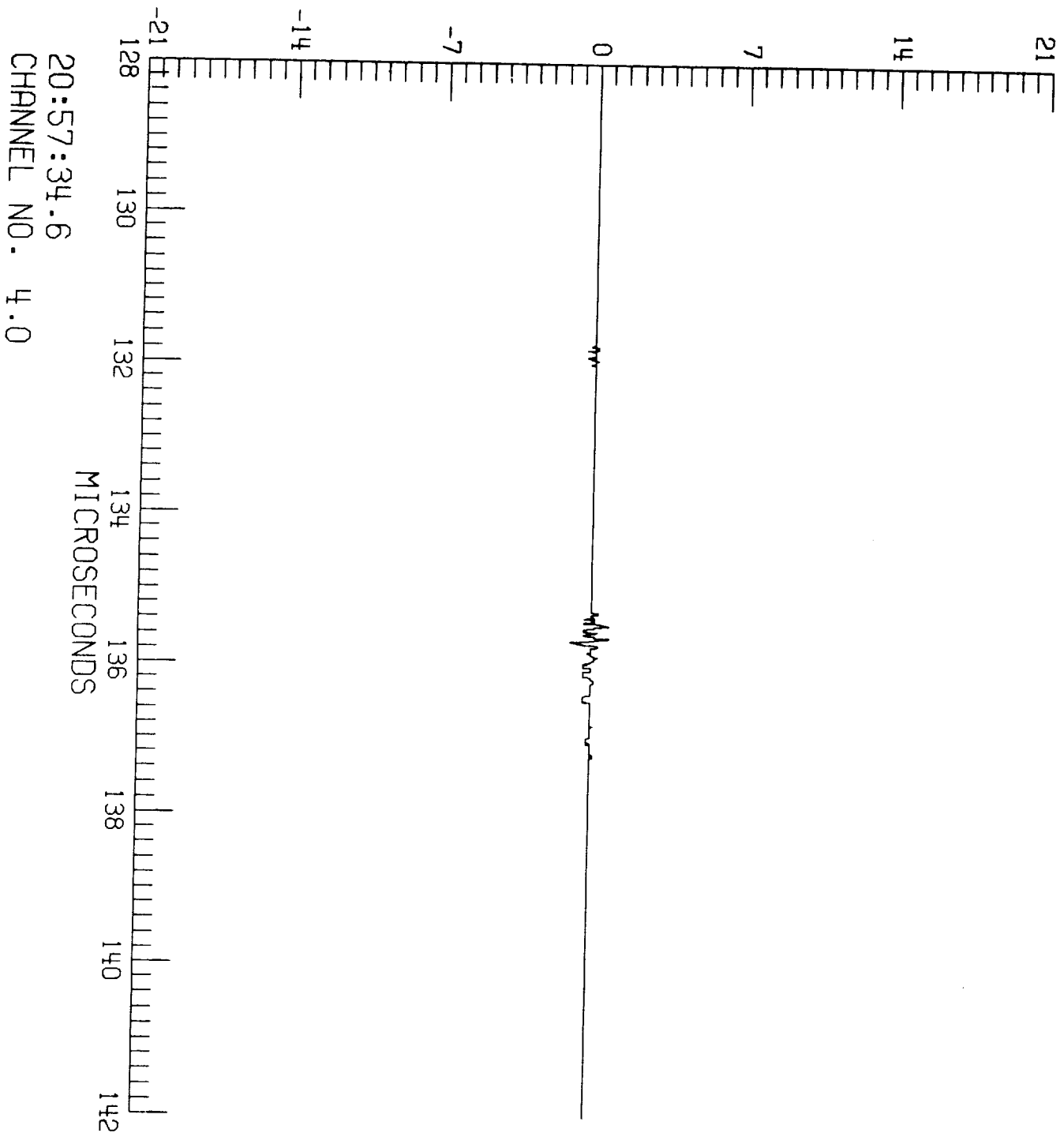

F106 LIGHTNING/85-027/ZAEPFEL

LEC 4 RUN NO. 2

S-002

TP106

A

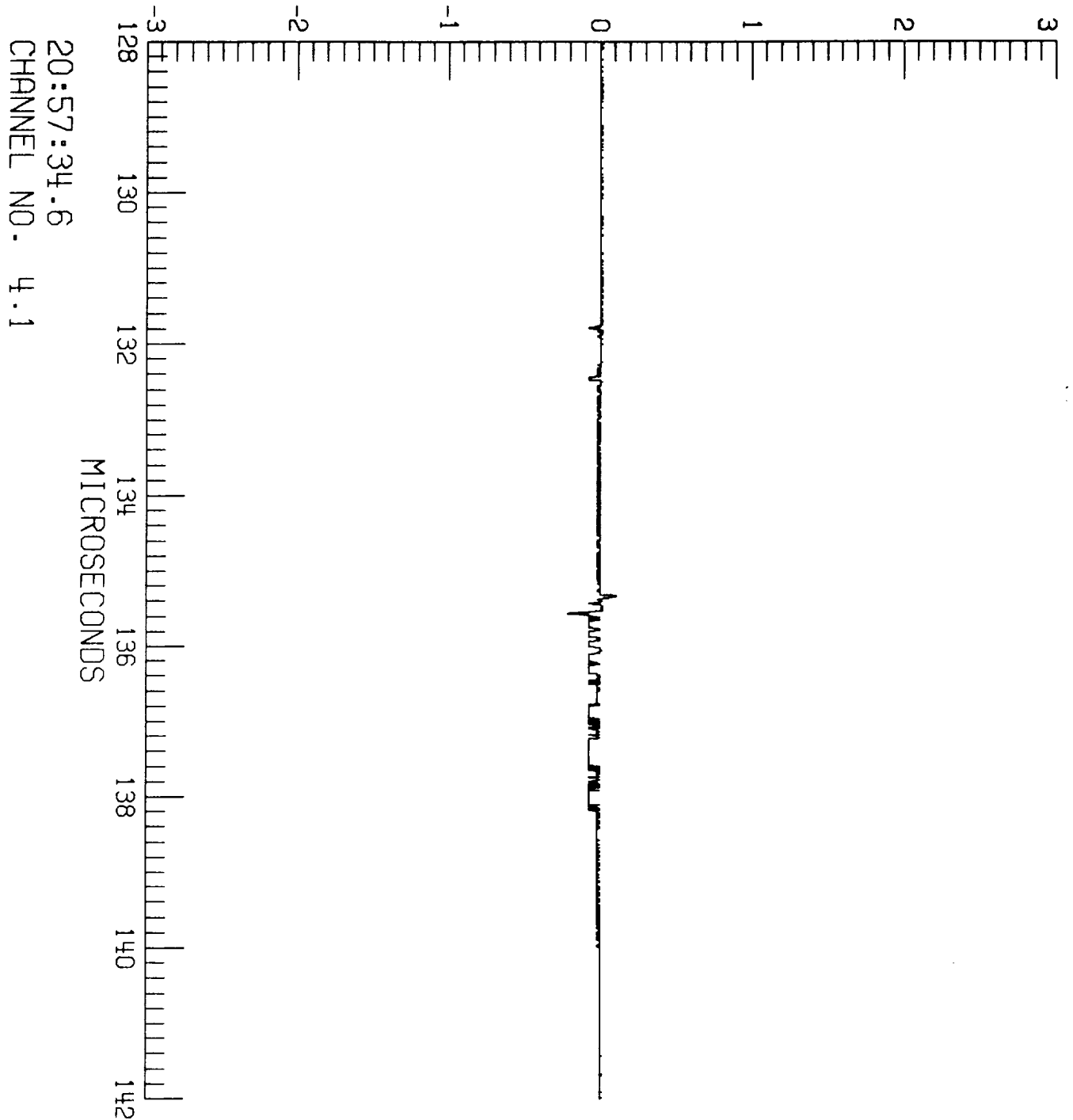

F106 LIGHTNING/85-027/ZAREPFEL

LEC 4 RUN NO. 2

S-002

TP125

A

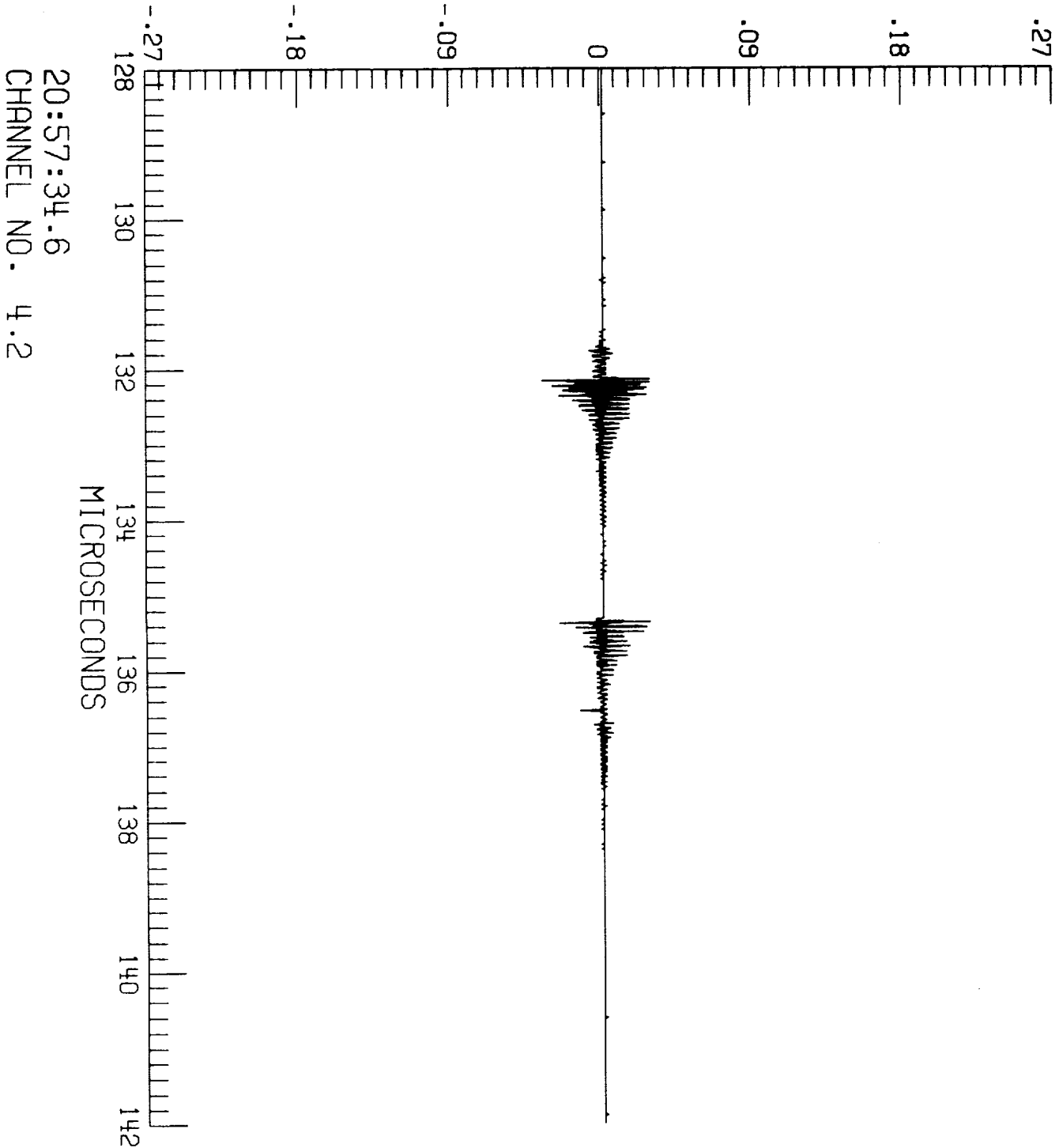

C4

F106 LIGHTNING/85-027/ZAEPFEL

LEC 4 RUN NO. 2

S-002

TP125

A

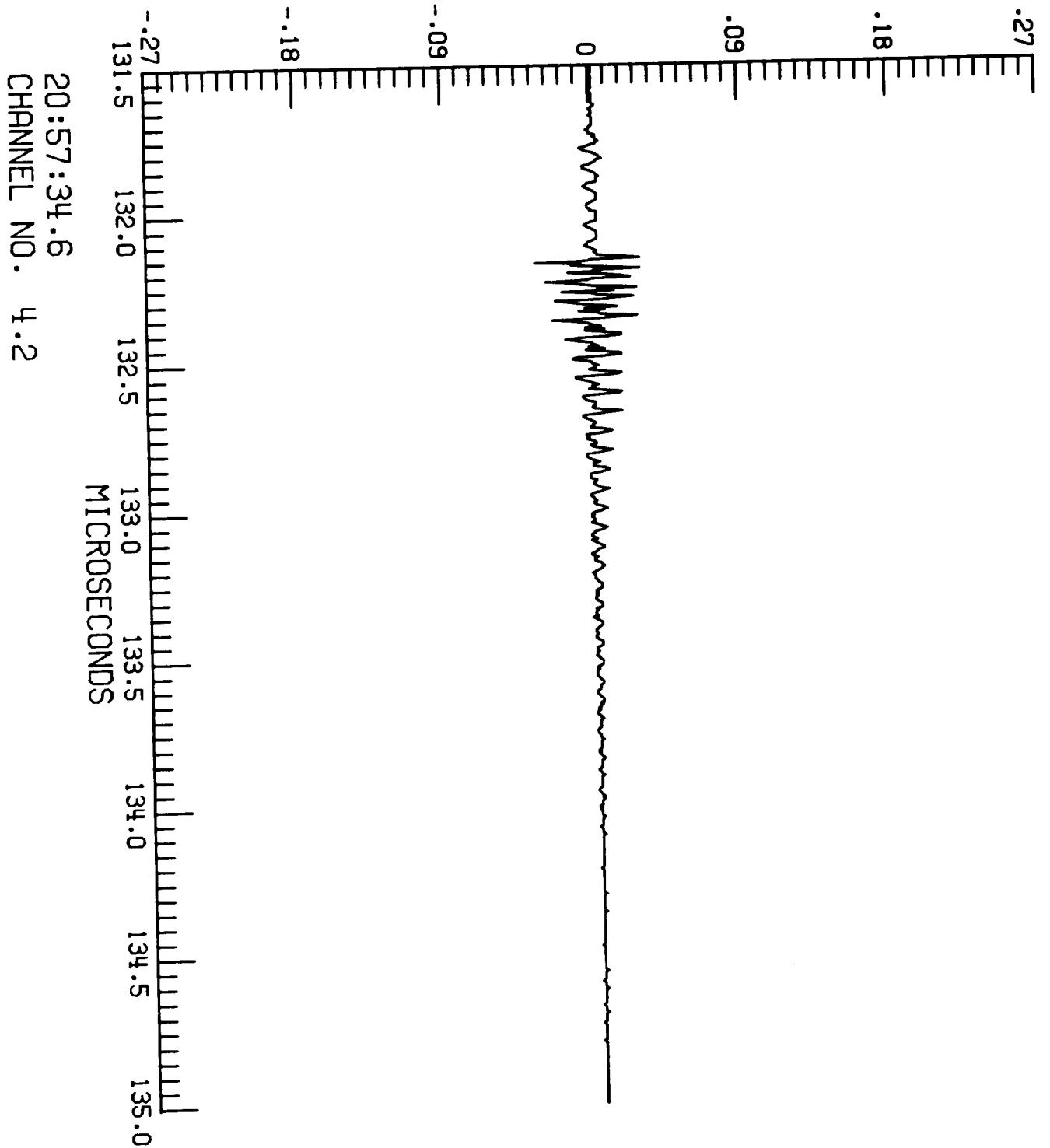

F106 LIGHTNING/85-027/ZAREPFEL

LEC 3 RUN NO. 2

S-002

$\dot{D}_{wr}$  A/m<sup>2</sup>

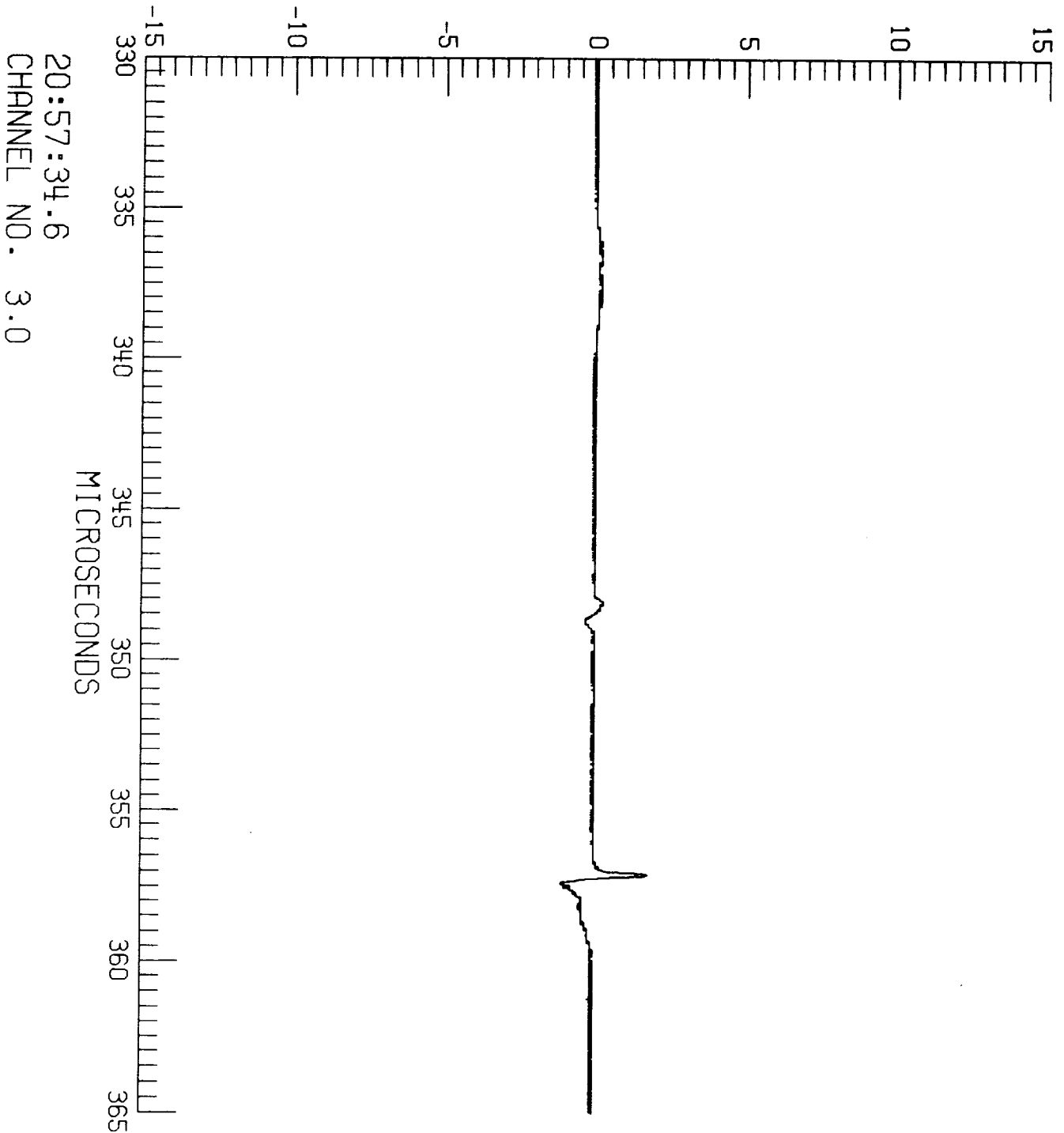



F106 LIGHTNING/85-027/ZAEPFEL  
LEC 3 RUN NO. 2  
S-002

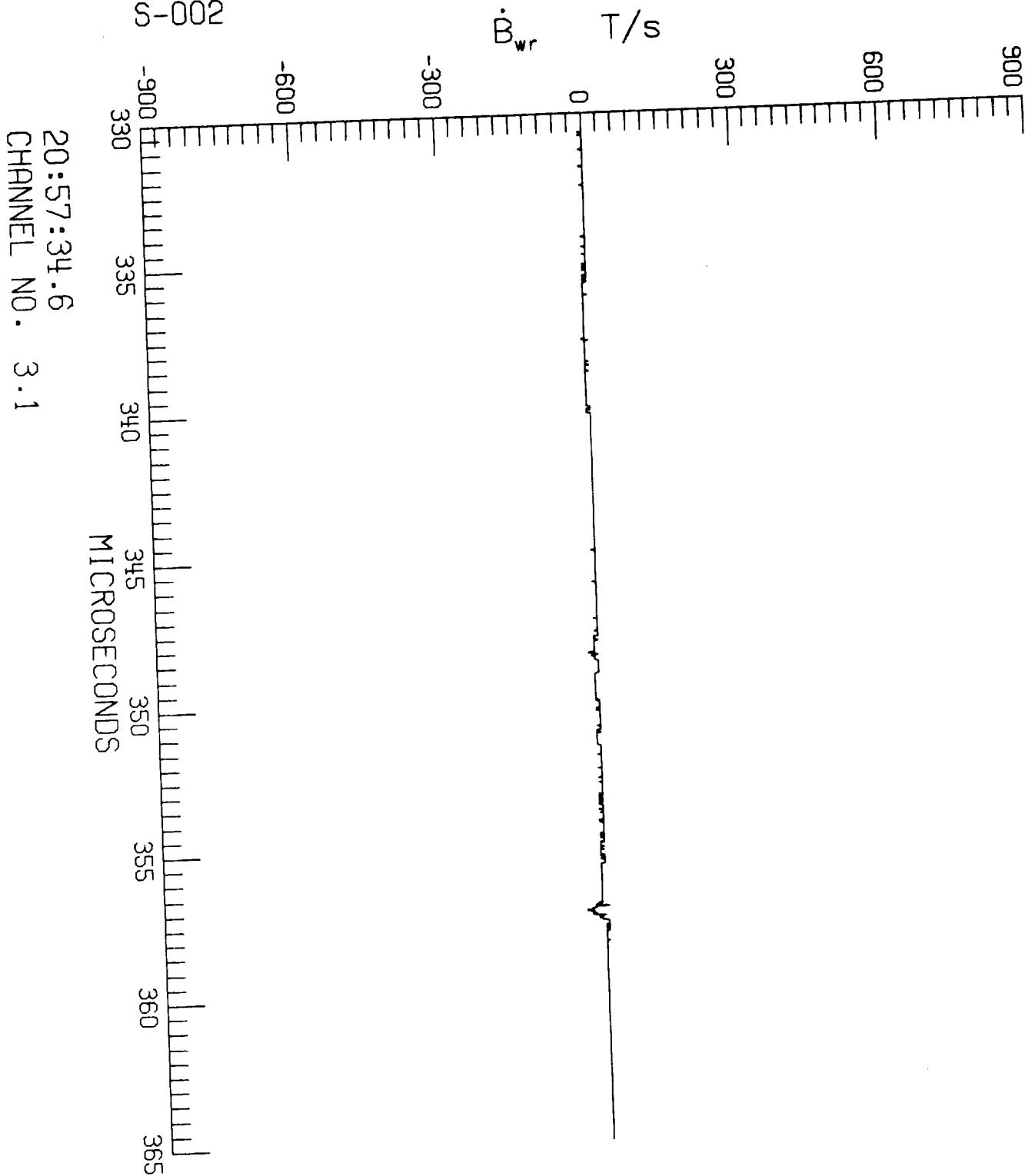

20:57:34.6  
CHANNEL NO. 3.1

F106 LIGHTNING/85-027/ZAEPFEL  
LEC 3 RUN NO. 2  
S-002

$\dot{D}_f$  A/m<sup>2</sup>

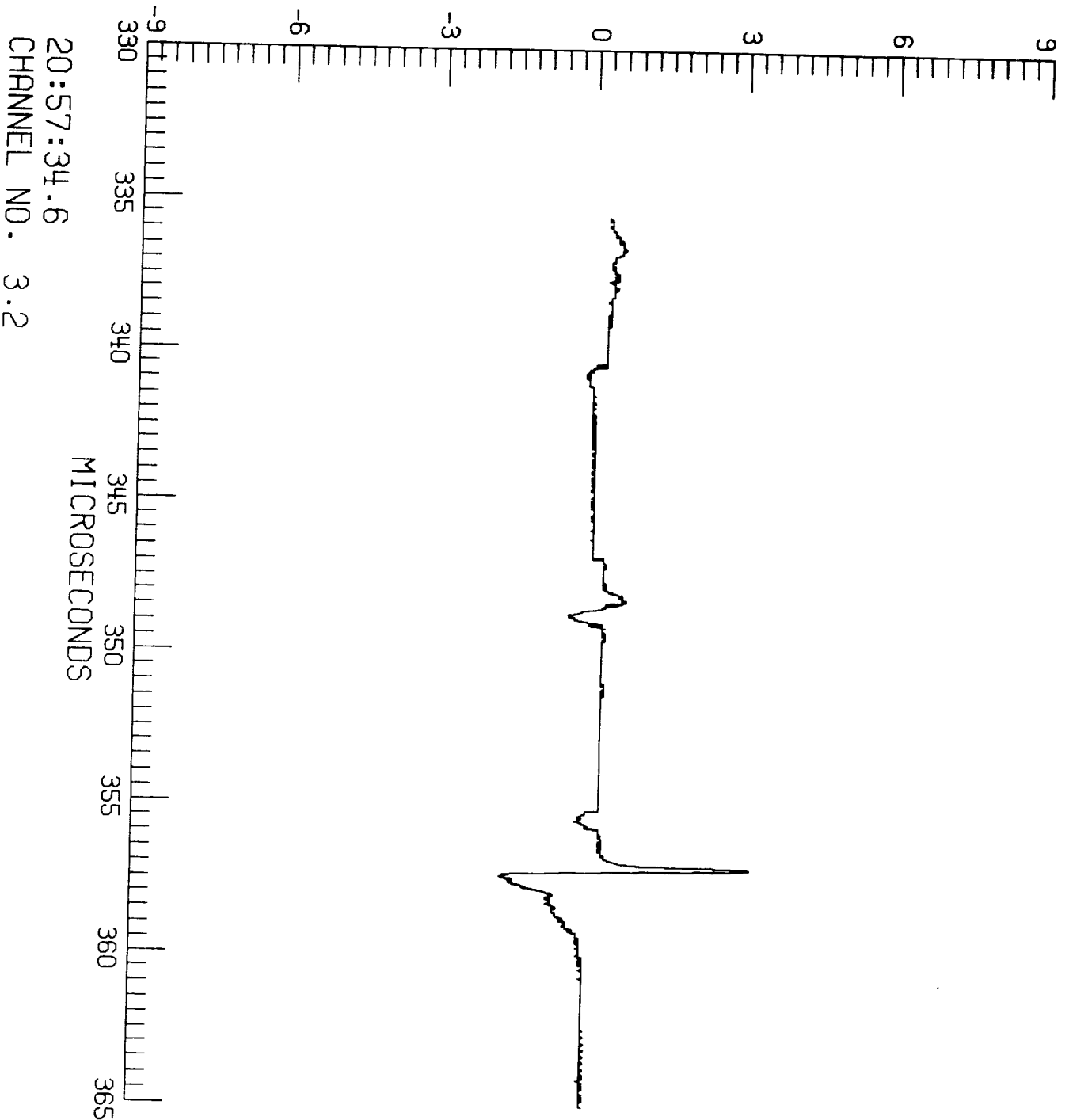

F106 LIGHTNING/85-028/ZAEPFEL  
LEC 2 RUN NO. 1  
S-001

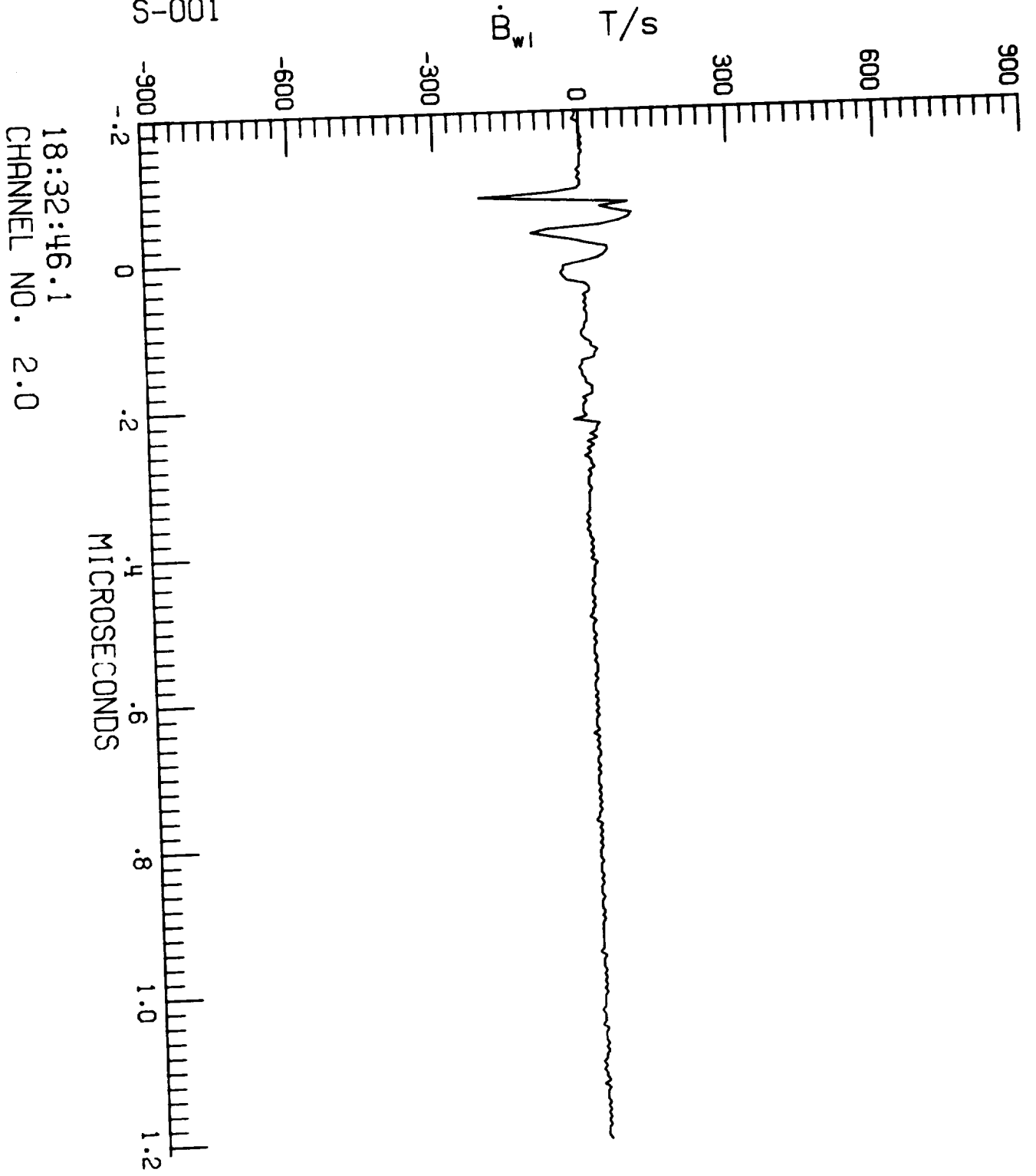

18:32:46.1  
CHANNEL NO. 2.0

F106 LIGHTNING/85-028/ZAEPFEL

LEC 2 RUN NO. 1

S-001

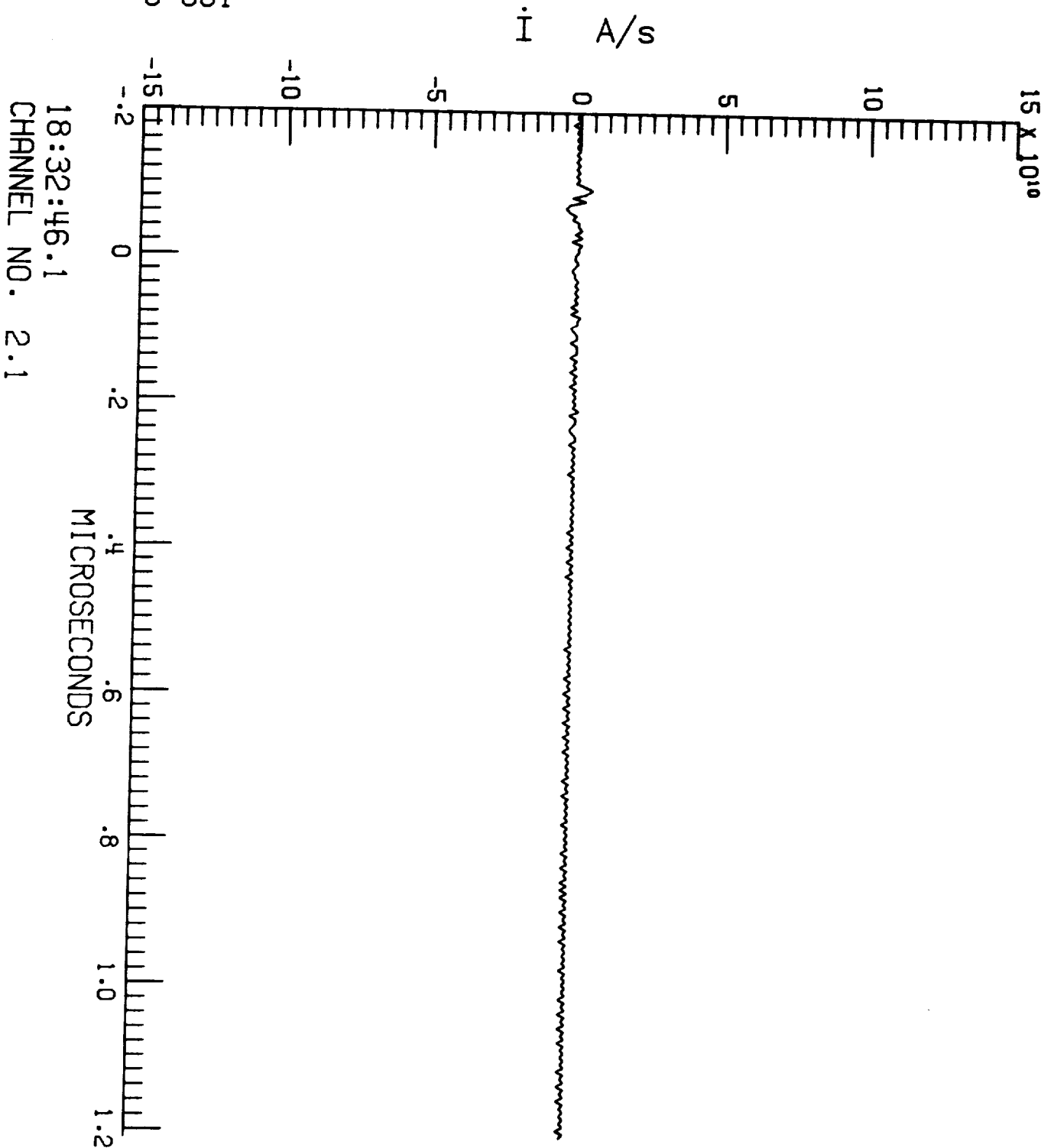

F106 LIGHTNING/85-028/ZAEPFEL

LEC 2 RUN NO. 1

S-001

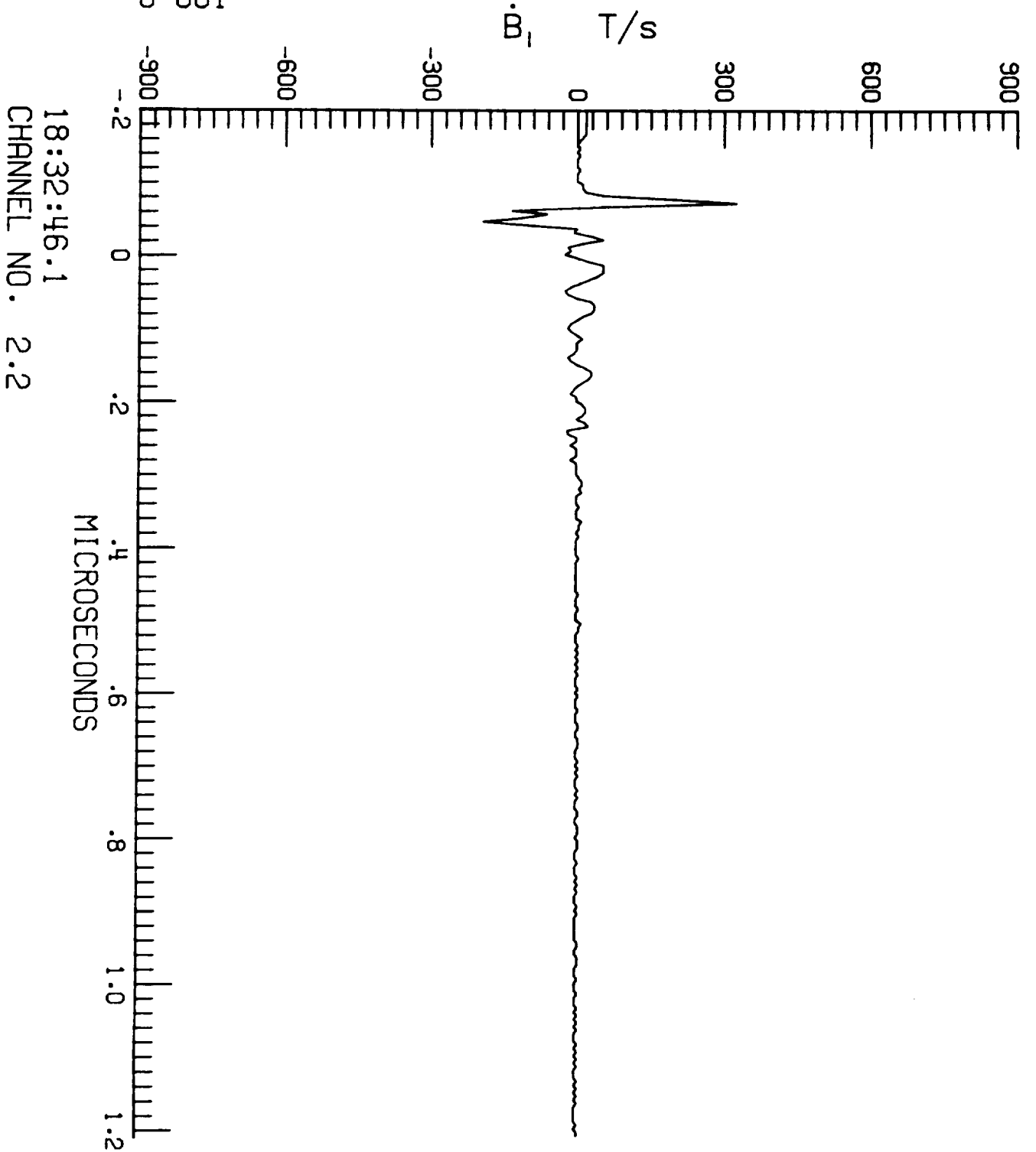

18:32:46.1  
CHANNEL NO. 2.2

F106 LIGHTNING/85-028/ZAEPFEL

LEC 3 RUN NO. 1

S-001

$\dot{D}_{wr}$  A/m<sup>2</sup>

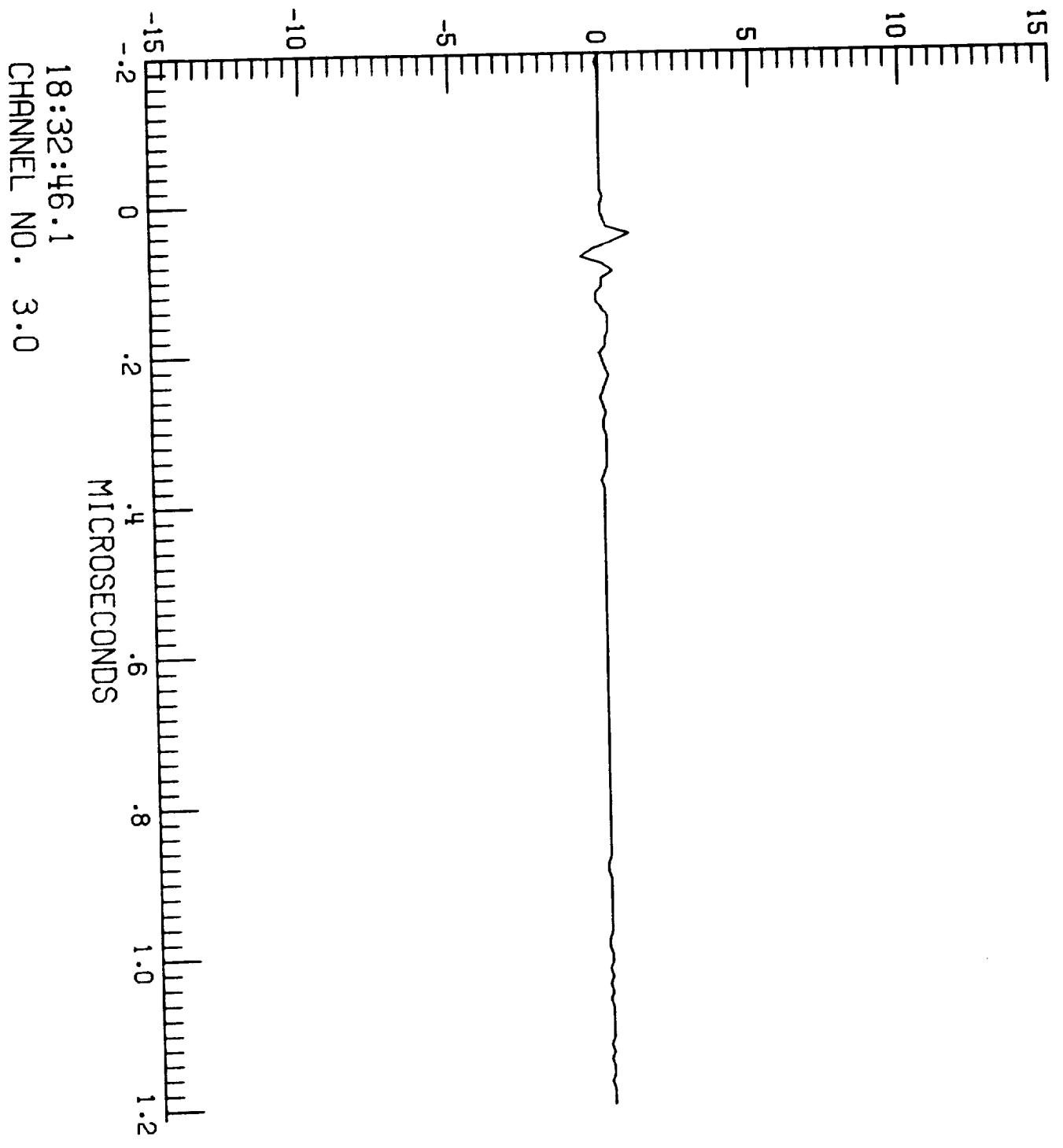

F106 LIGHTNING/85-028/ZAEPFEL  
LEC 3 RUN NO. 1  
S-001

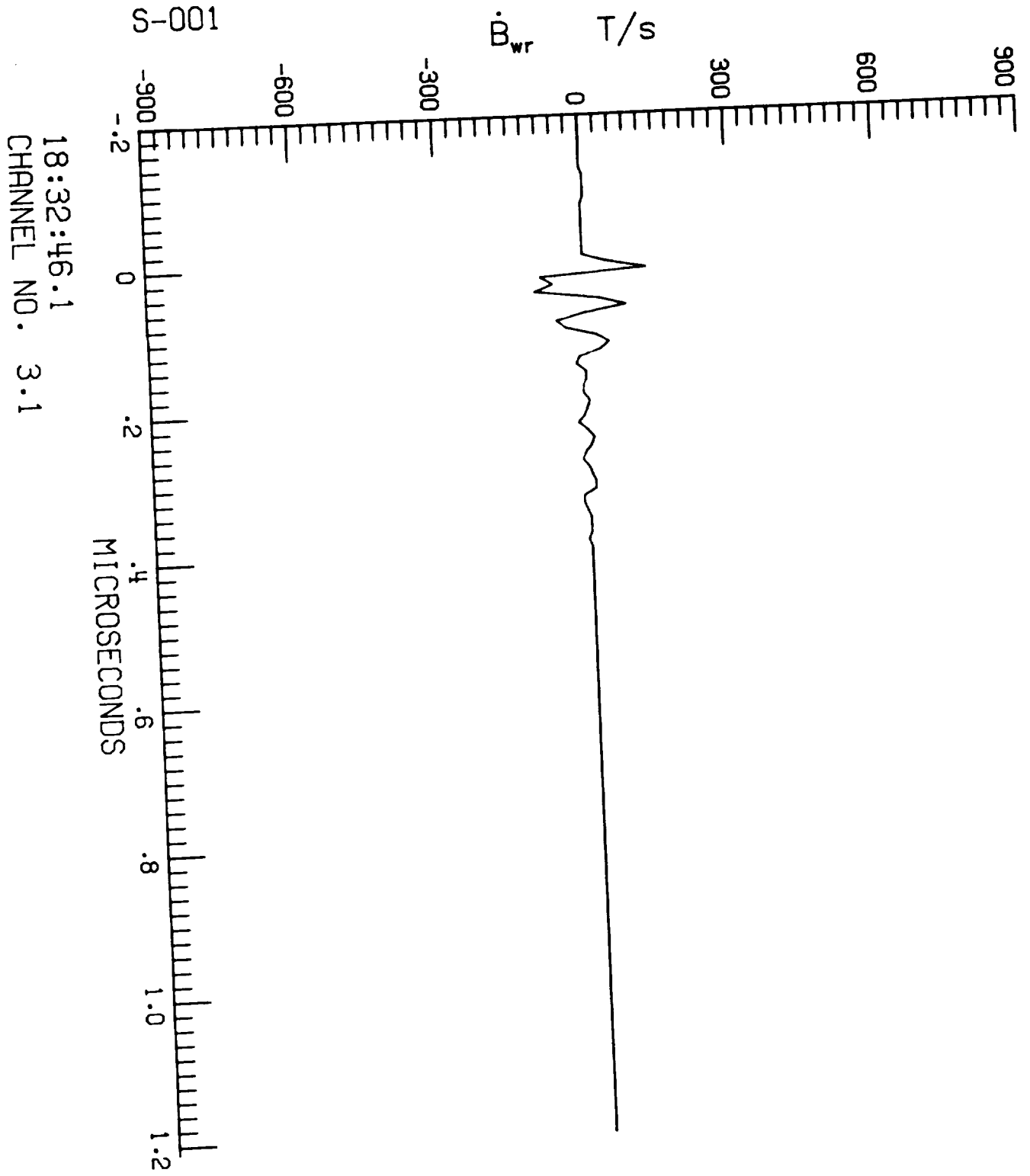

18:32:46.1  
CHANNEL NO. 3.1

F106 LIGHTNING/85-028/ZAEPFEL  
LEC 3 RUN NO. 1  
S-001

$\dot{D}_f$  A/m<sup>2</sup>

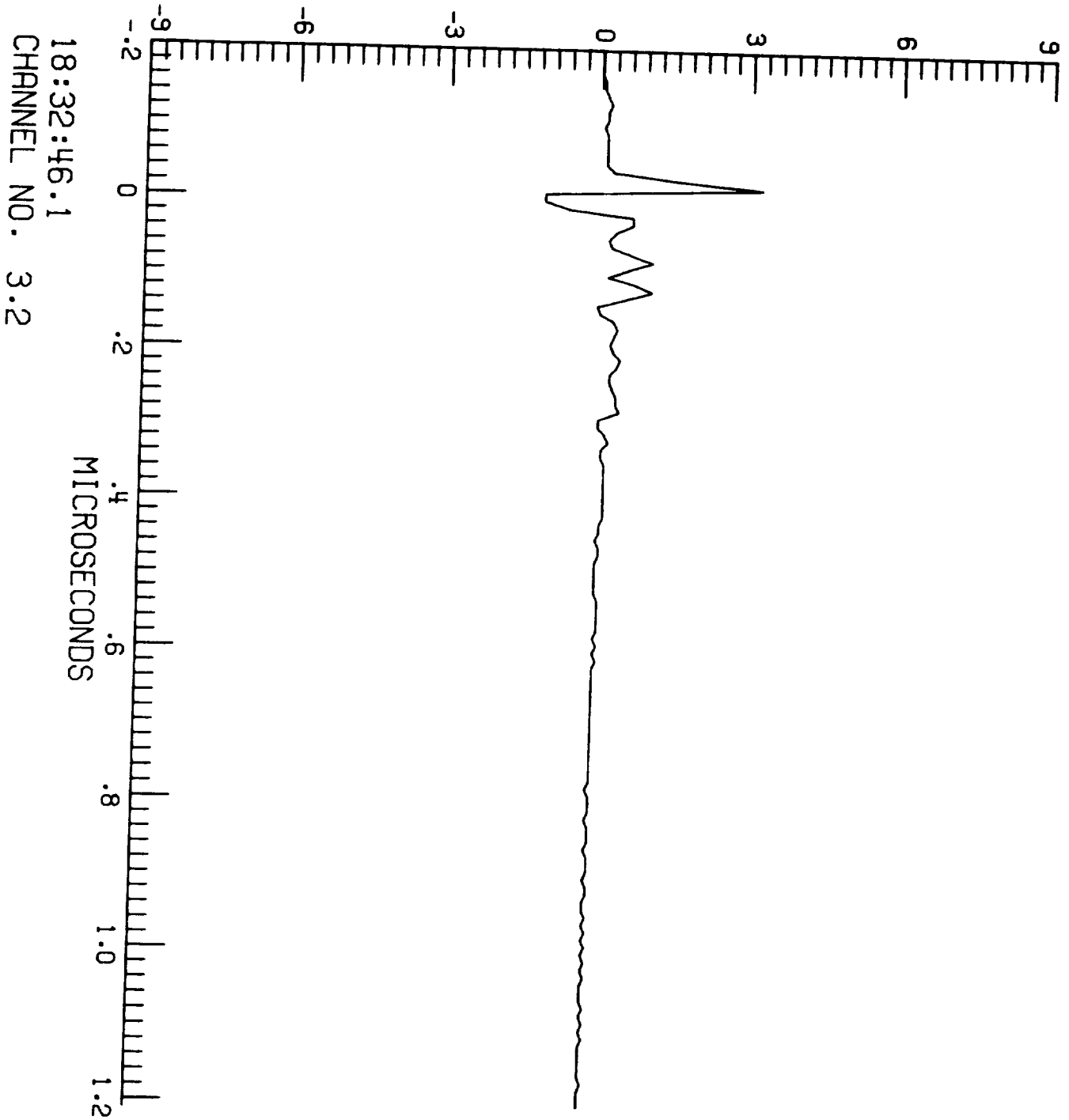



F106 LIGHTNING/85-028/ZAEPFEL

LEC 4 RUN NO. 1

S-001

TP100 V

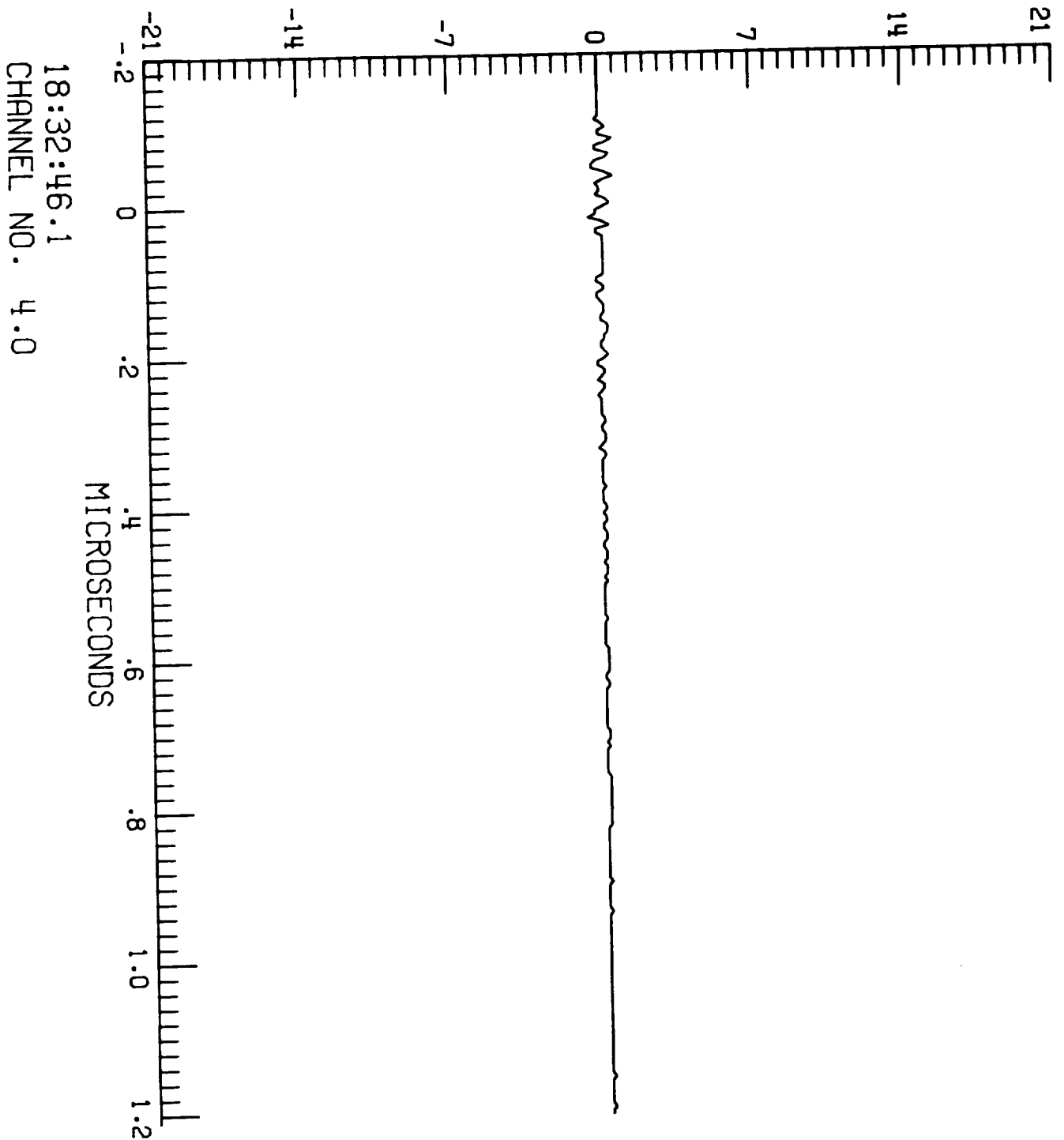

F106 LIGHTNING/85-028/ZAEPFEL

LEC 4 RUN NO. 1

S-001

TP106 A

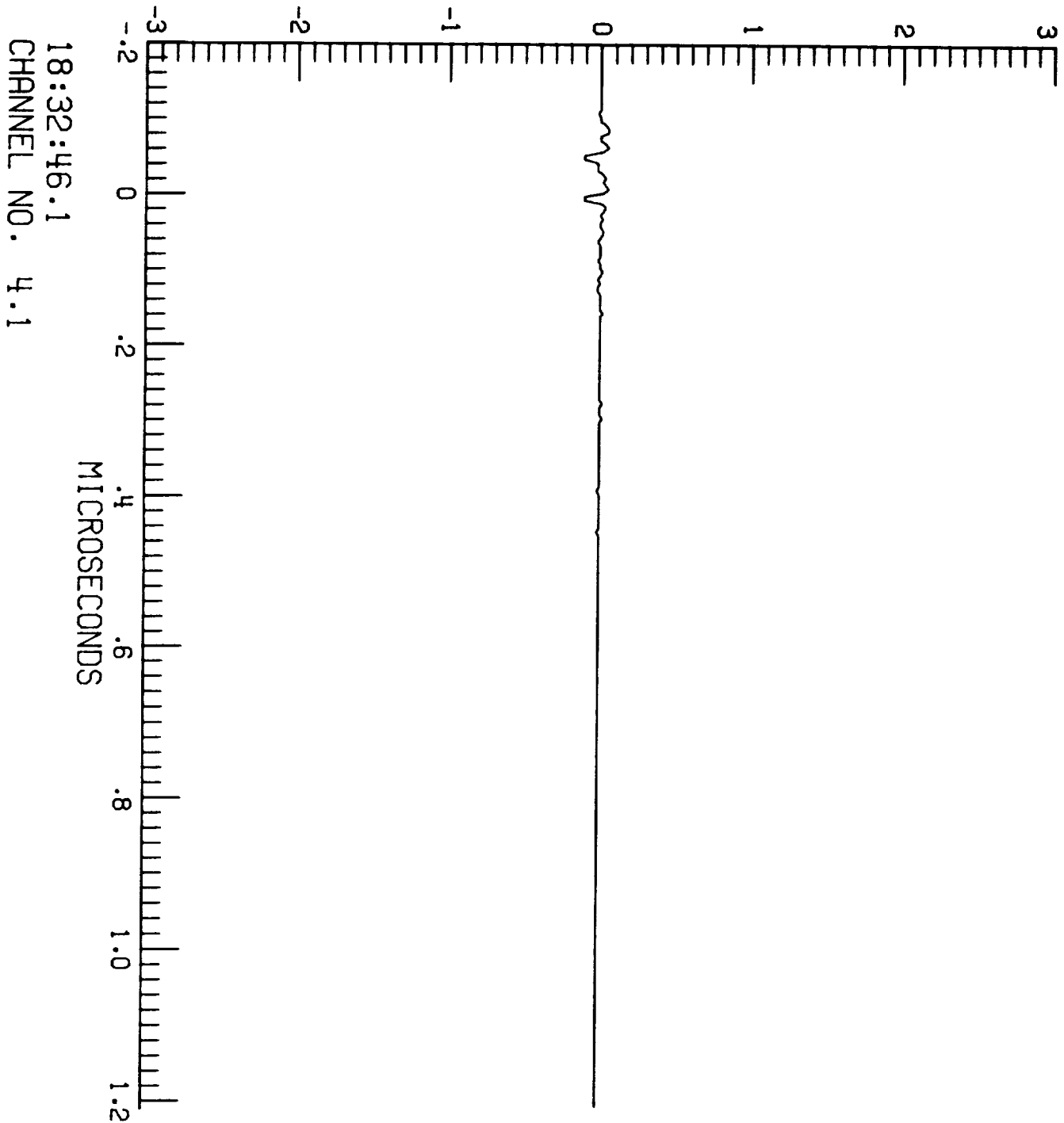

F106 LIGHTNING/85-028/ZAEPFEL

LEC 4 RUN NO. 1

S-001

TP125

A

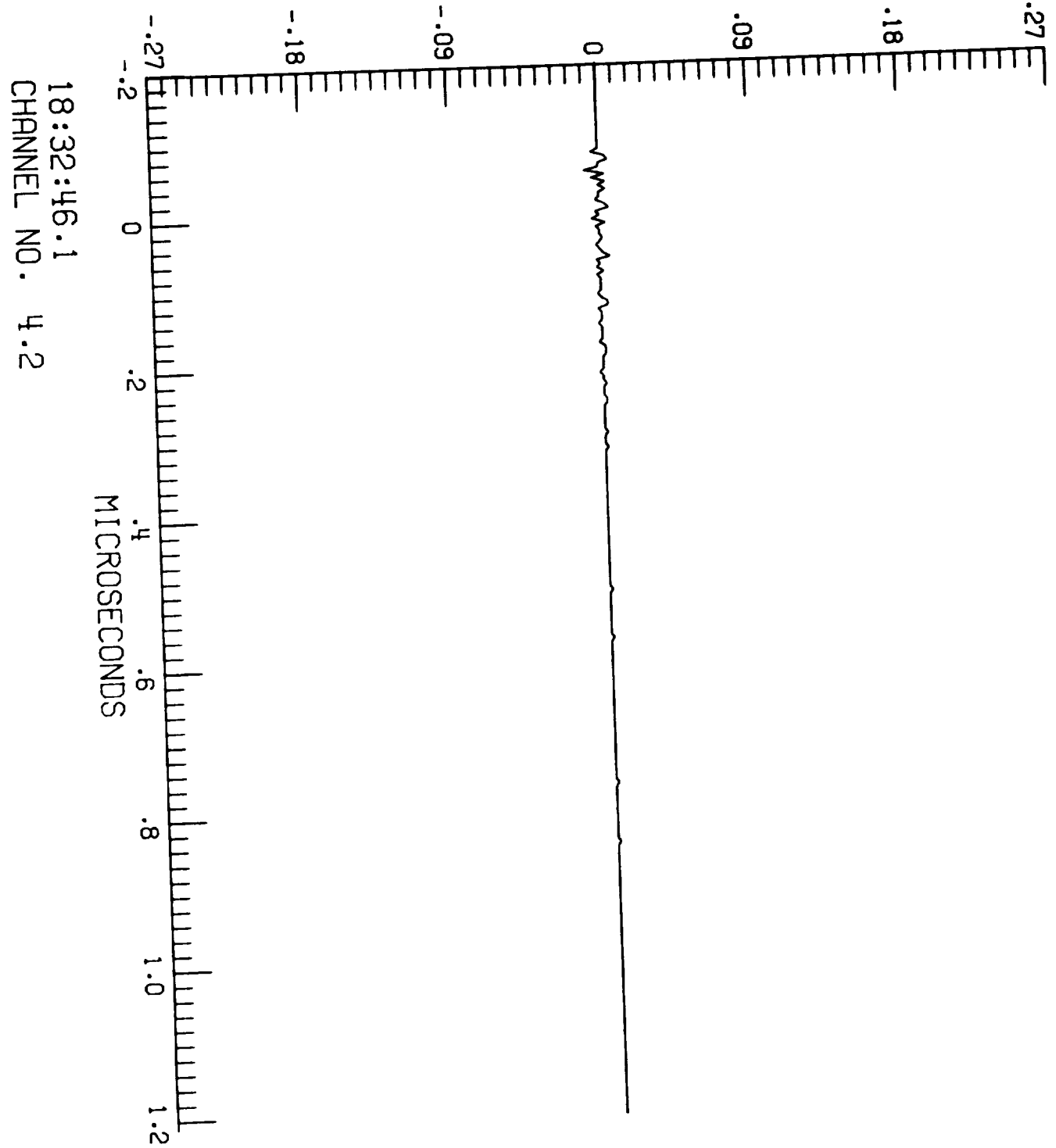

F106 LIGHTNING/85-029/ZAEPFEL  
LEC 1 RUN NO. 1  
N-001

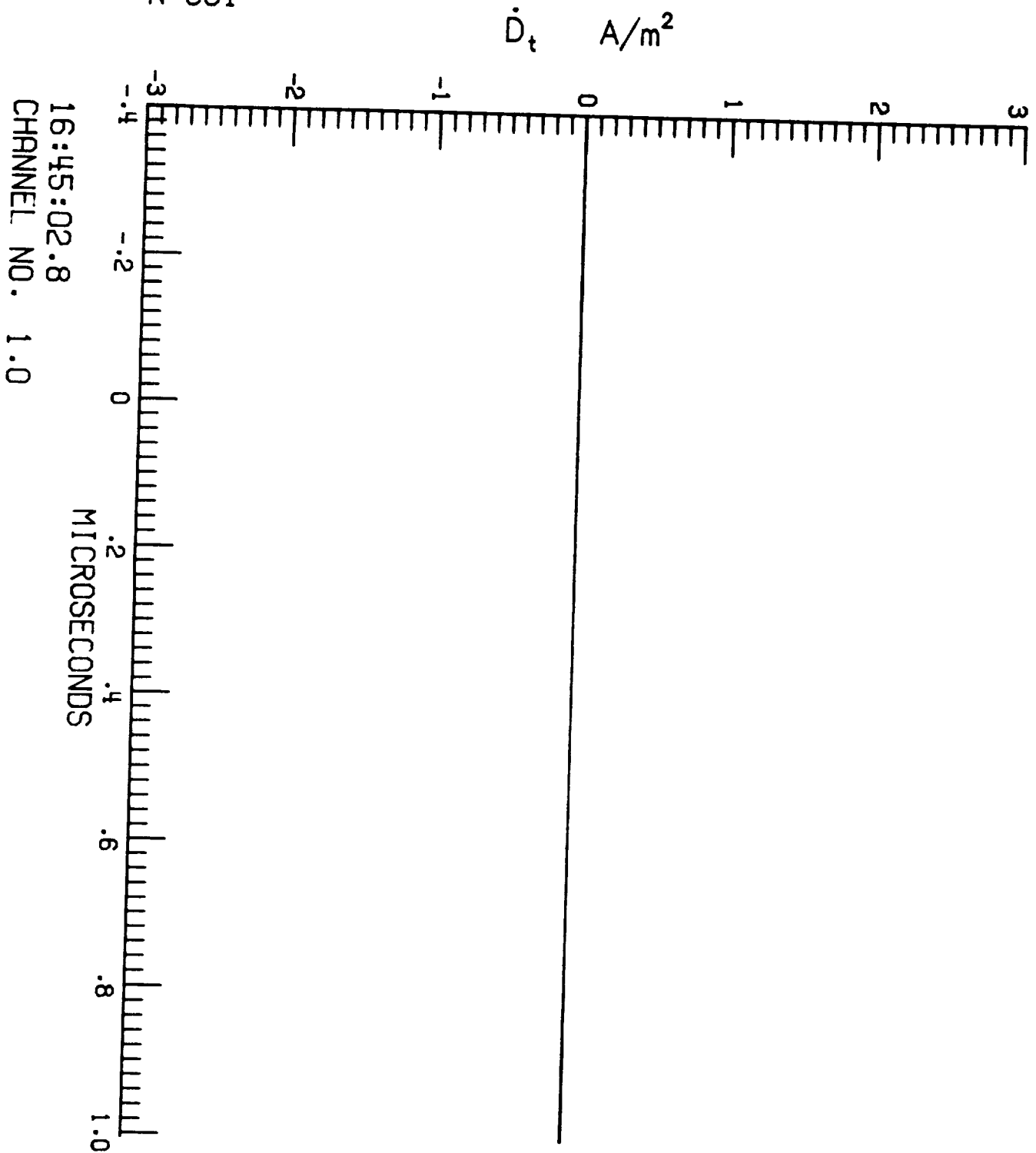

F106 LIGHTNING/85-029/ZAEPFEL

LEC 1 RUN NO. 1

N-001

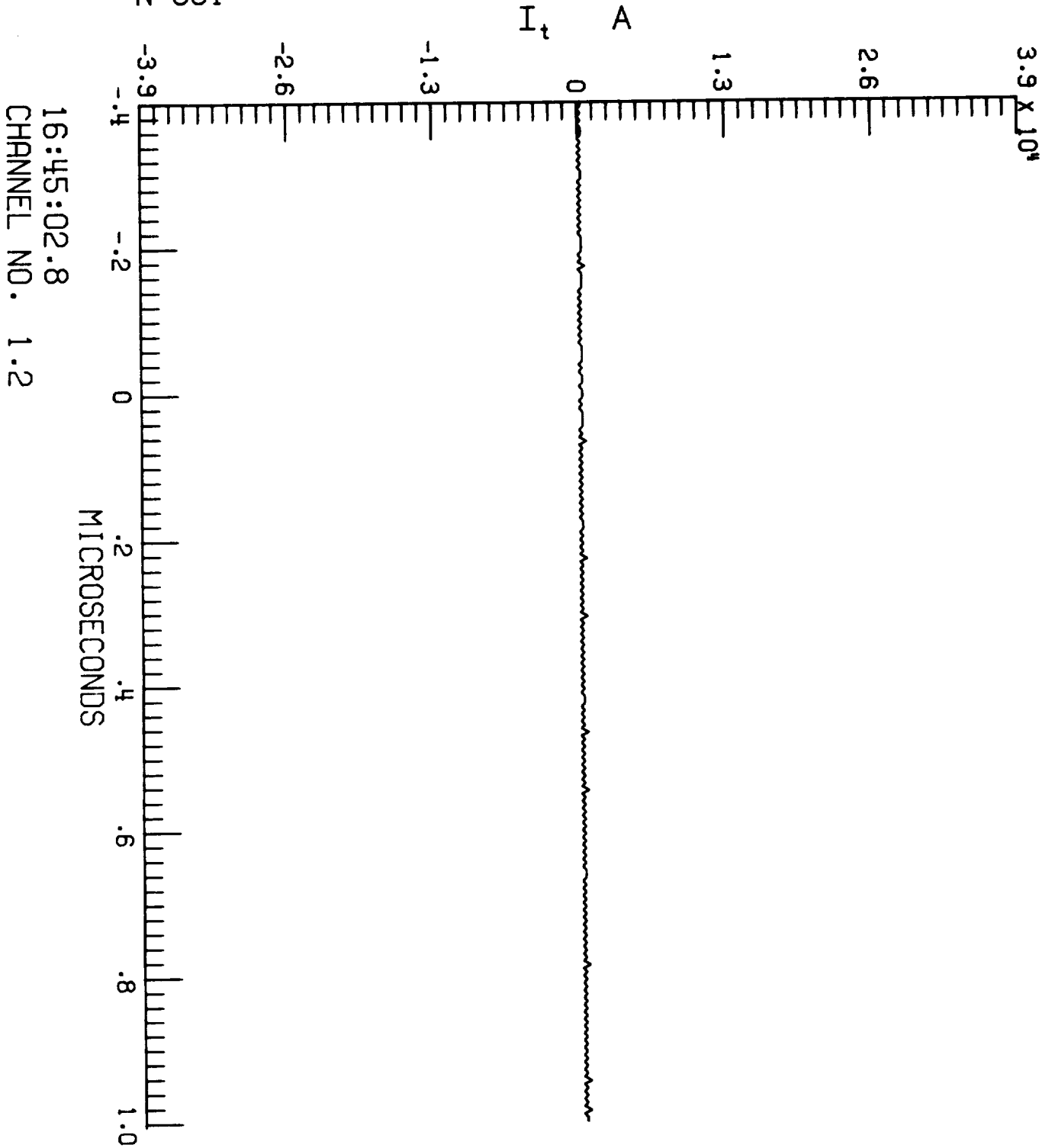

16:45:02.8  
CHANNEL NO. 1.2

F106 LIGHTNING/85-029/ZAEPFEL

LEC 2 RUN NO. 1

N-001

$\dot{B}_w$  T/s

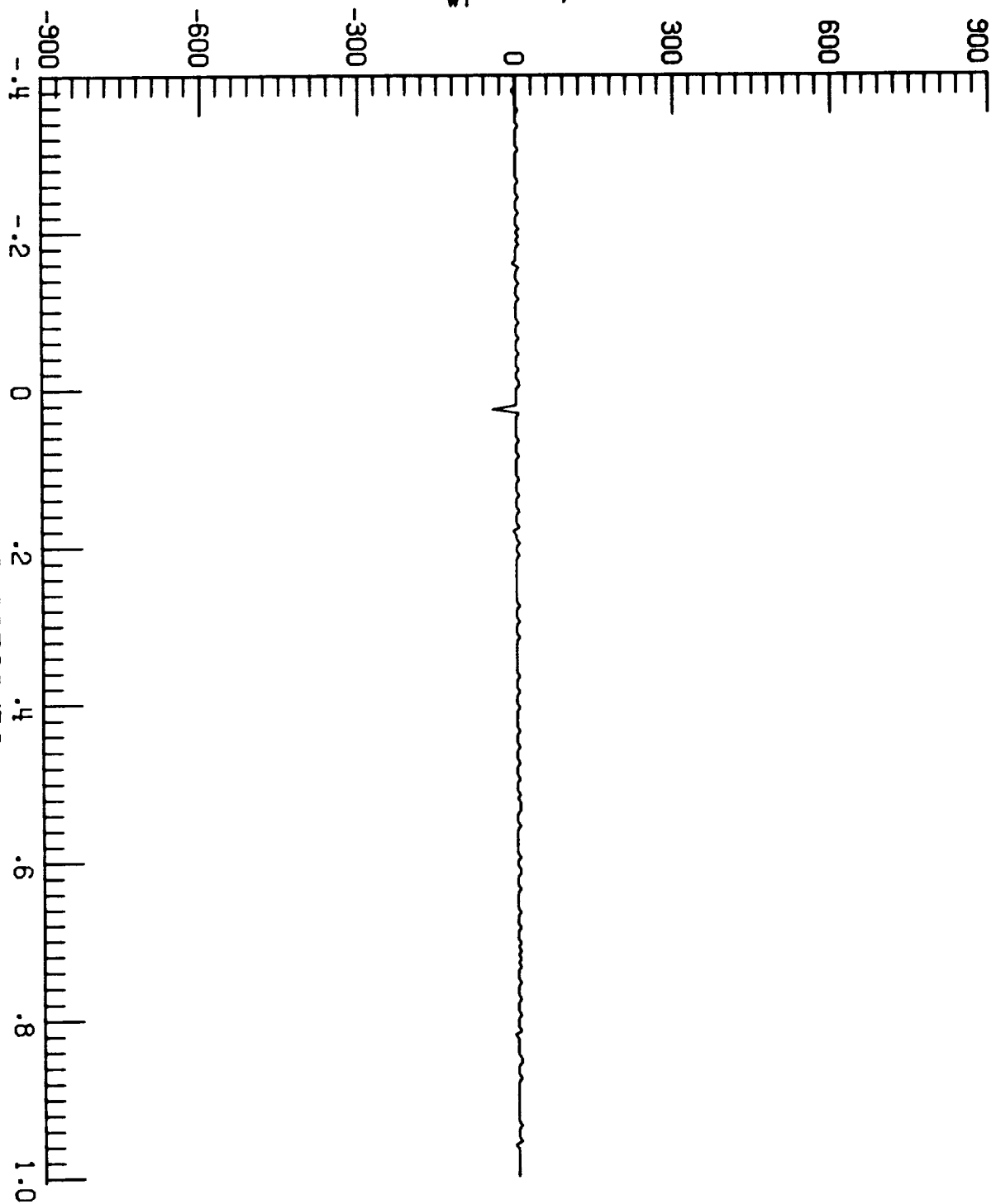

16:45:02.8  
CHANNEL NO. 2.0

F106 LIGHTNING/85-029/ZAEPFEL

LEC 2 RUN NO. 1

N-001

i A/s

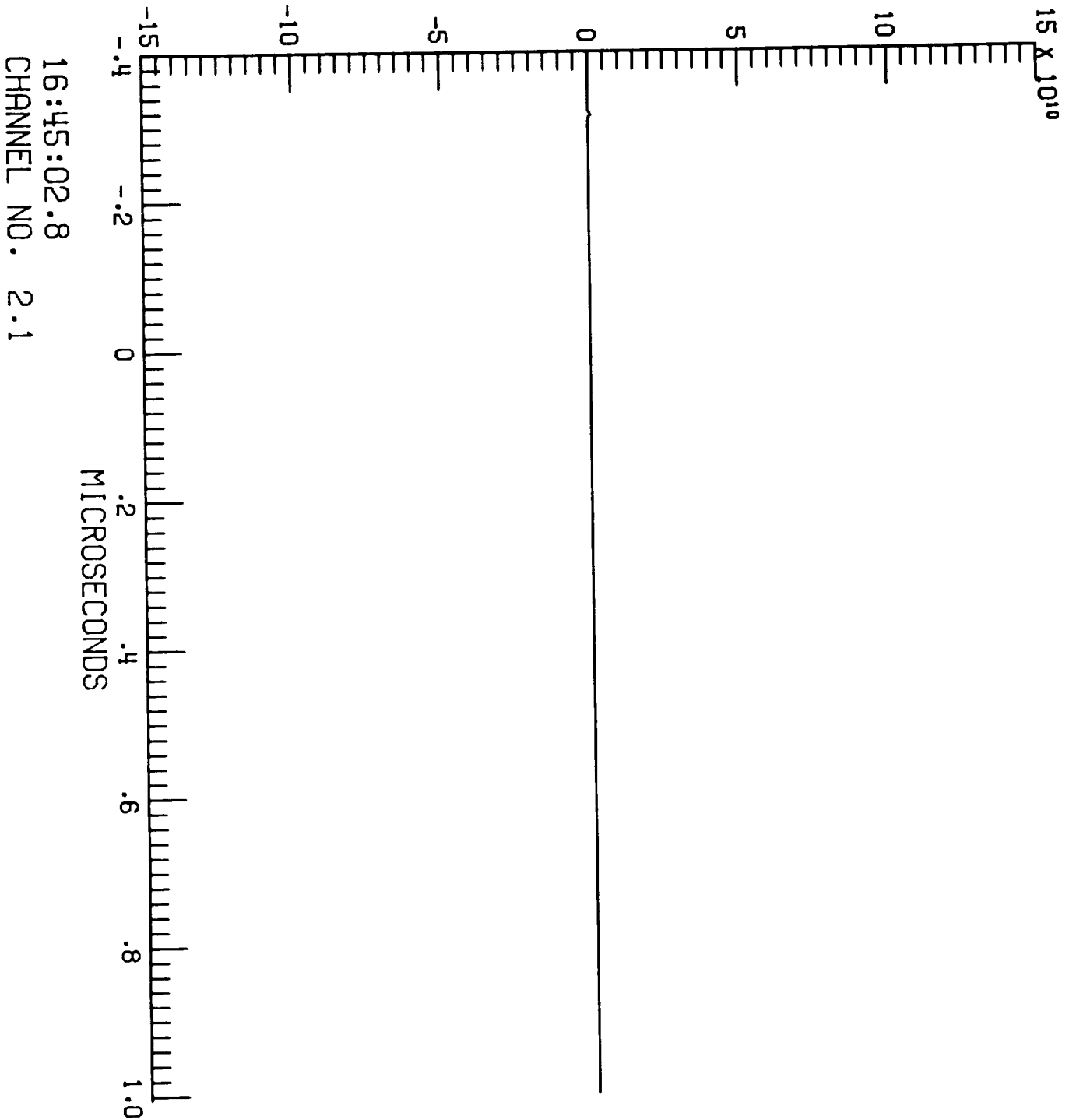

F106 LIGHTNING/85-029/ZAEPFEL

LEC 2 RUN NO. 1

N-001

$\dot{B}_1$  T/s

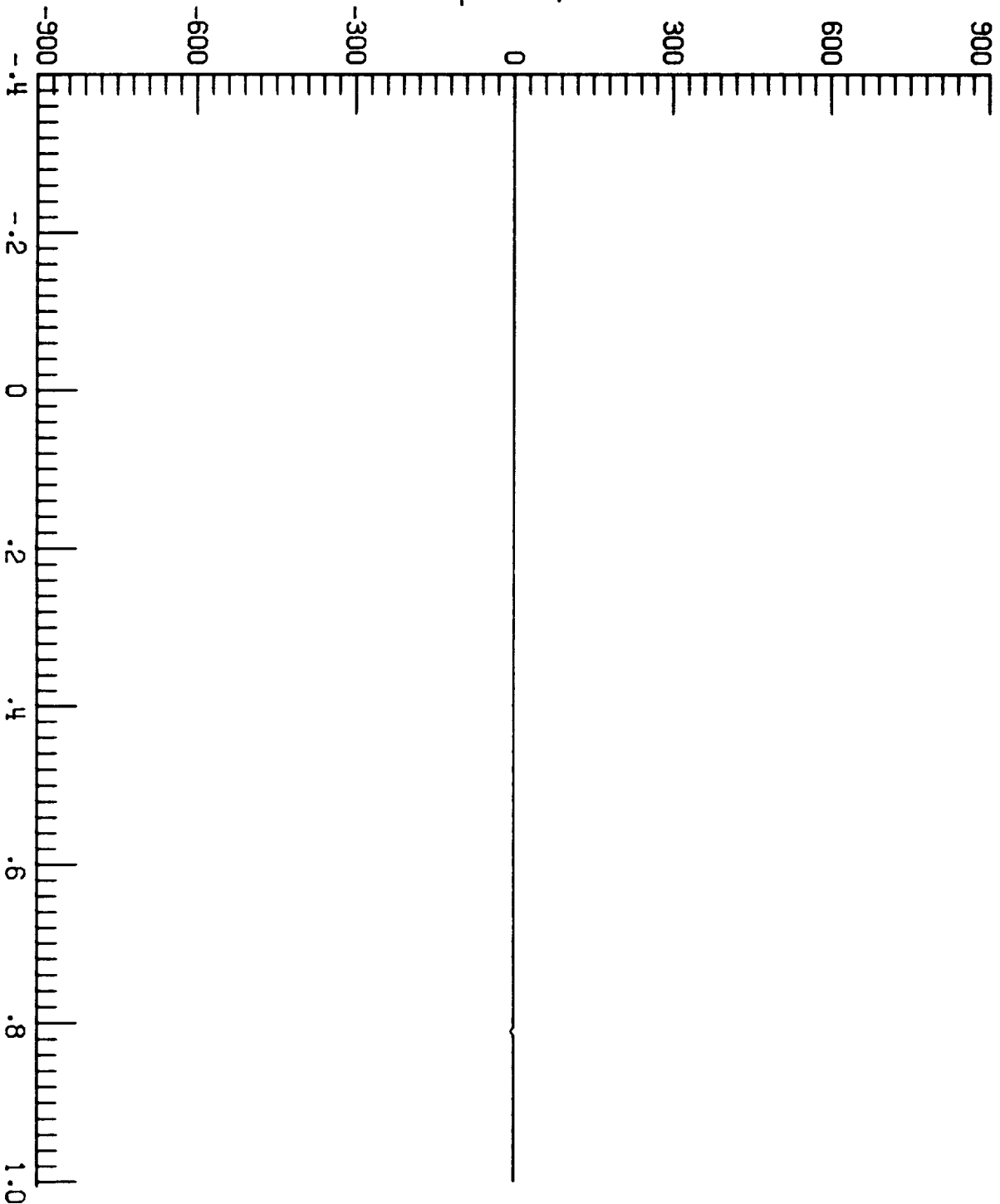

16:45:02.8  
CHANNEL NO. 2.2



F106 LIGHTNING/85-029/ZAEPFEL

LEC 3 RUN NO. 1

N-001

$\dot{D}_{wr}$  A/m<sup>2</sup>

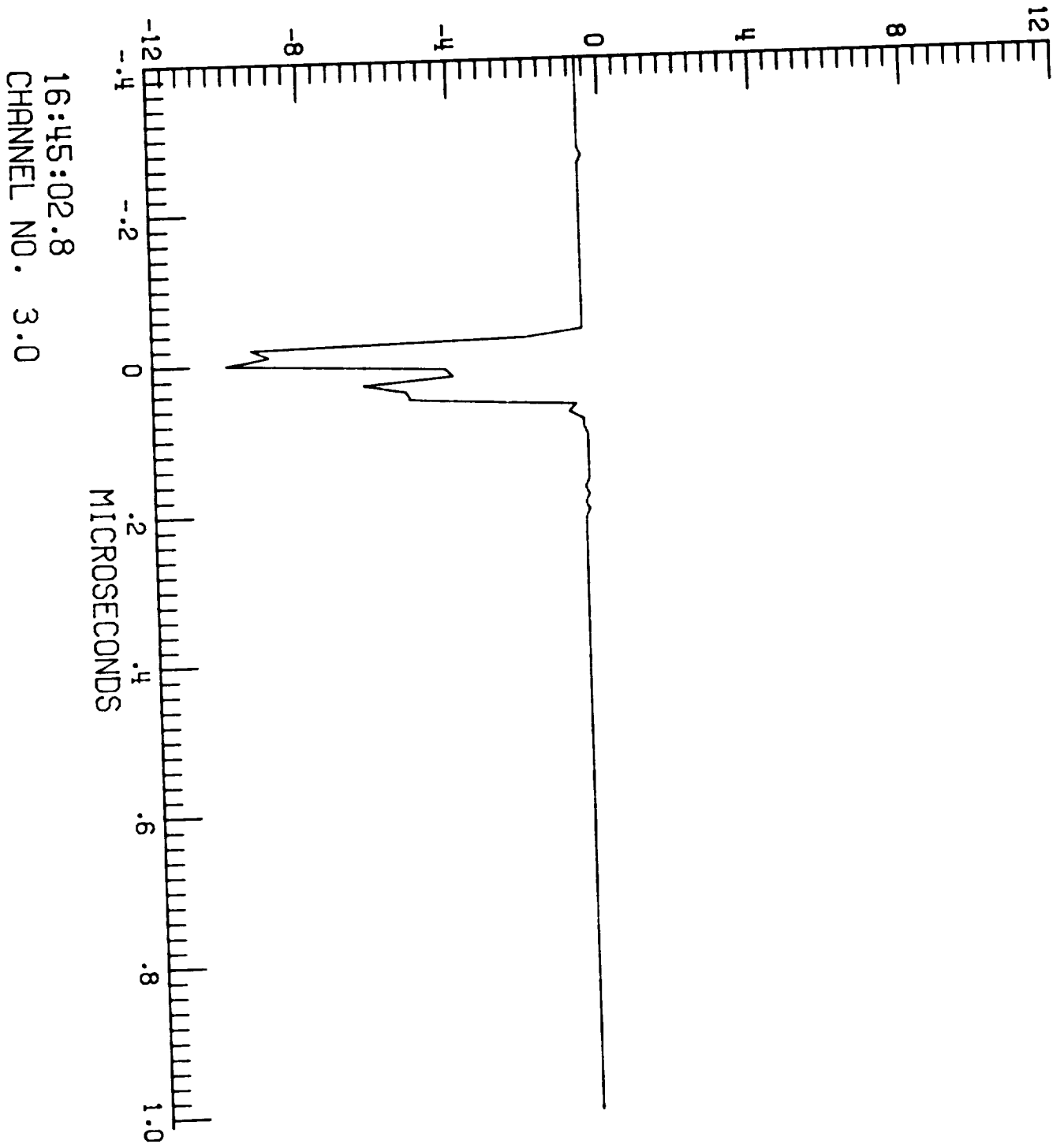

F106 LIGHTNING/85-029/ZAEPFEL  
LEC 3 RUN NO. 1  
N-001

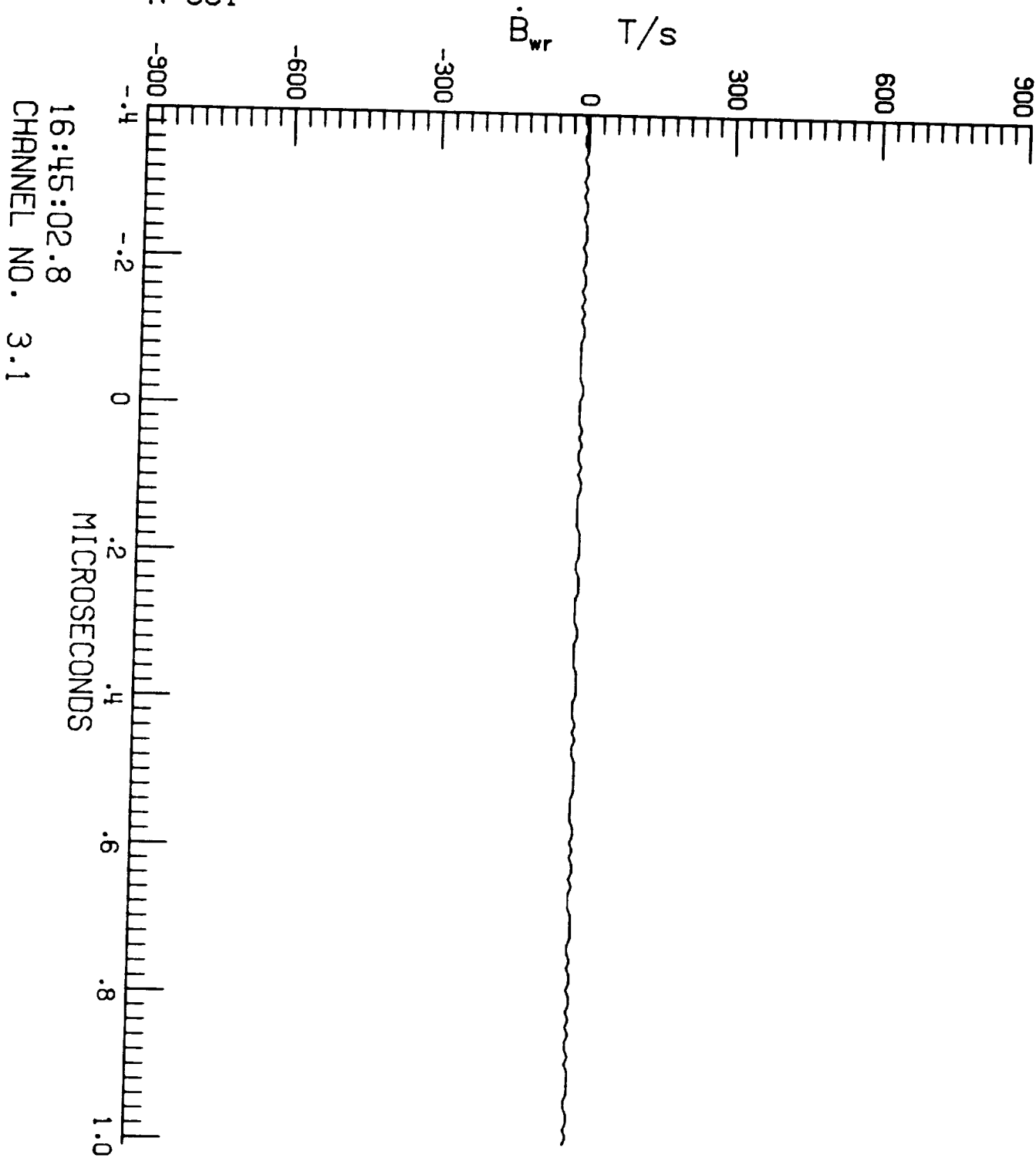

16:45:02.8  
CHANNEL NO. 3.1

F106 LIGHTNING/85-029/ZAEPFEL

LEC 4 RUN NO. 1

N-001

TP100

V

16:45:02.8  
CHANNEL NO. 4.0

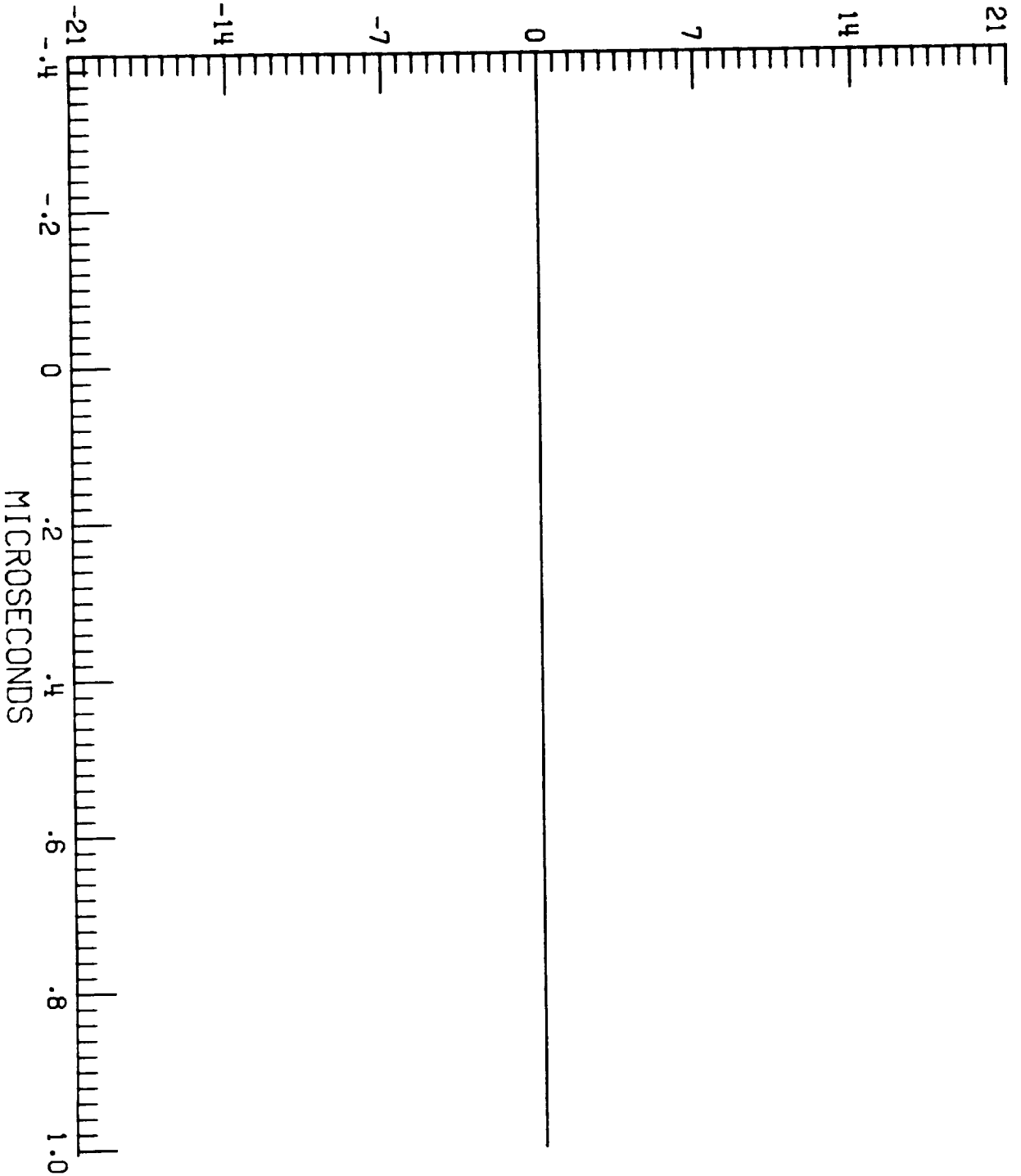

F106 LIGHTNING/85-029/ZAEPFEL

LEC 4 RUN NO. 1

N-001

TP106

A

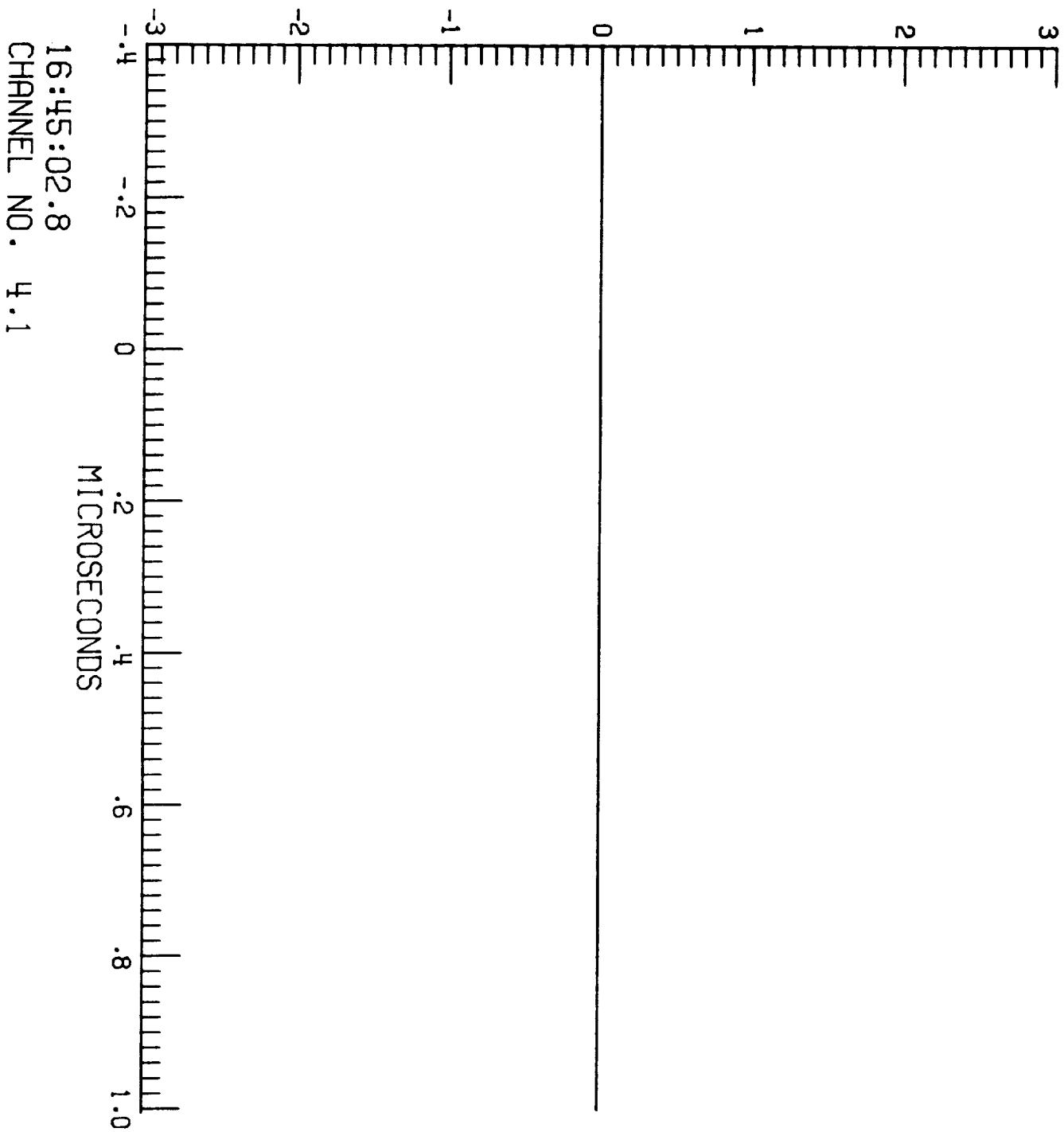

F106 LIGHTNING/85-029/ZAEPFEL

LEC 4 RUN NO. 1

N-001

TP125

A

16:45:02.8  
CHANNEL NO. 4.2

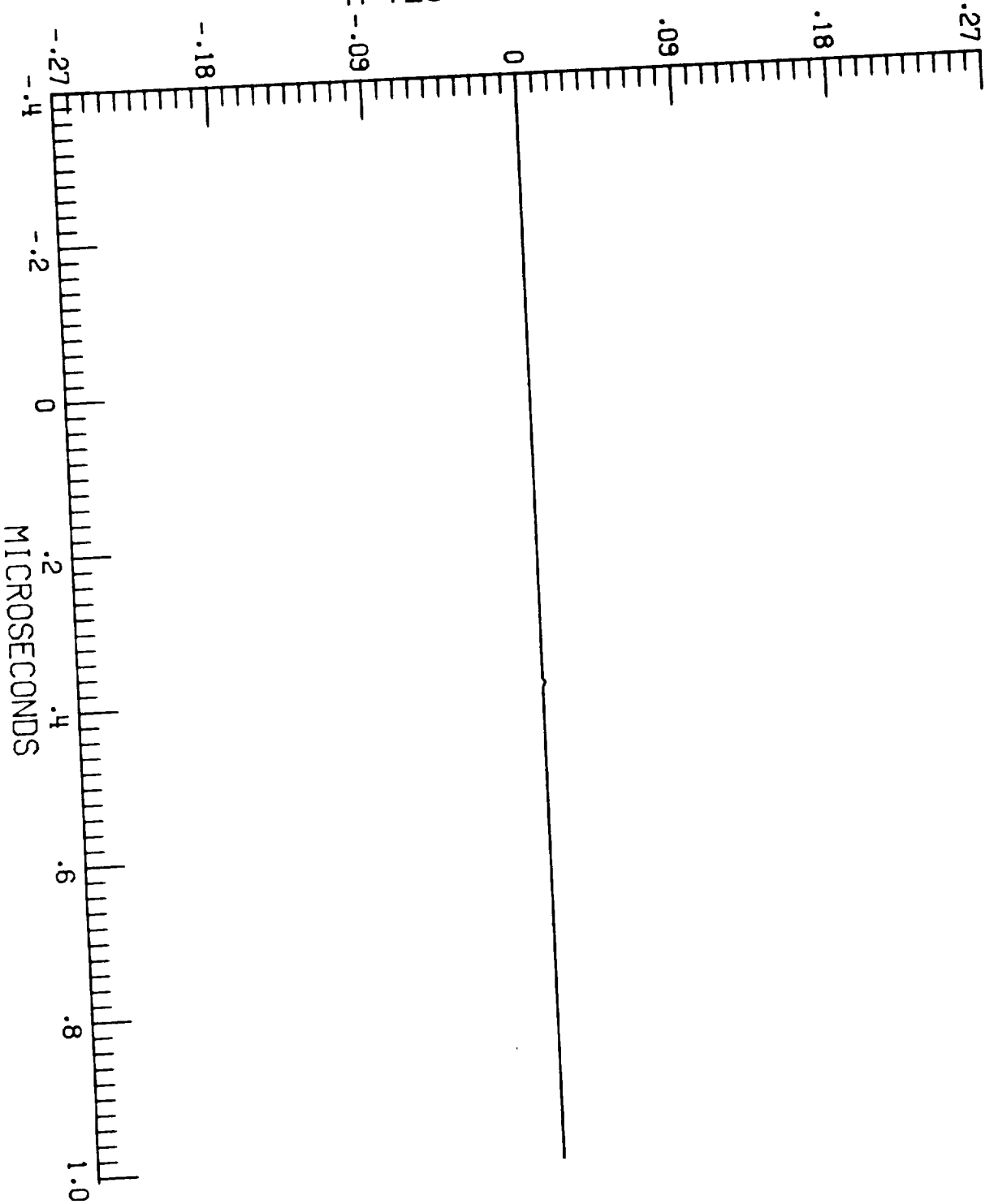

F106 LIGHTNING/85-029/ZAEPFEL

LEC 1 RUN NO. 2

S-001

$\dot{D}_t$  A/m<sup>2</sup>

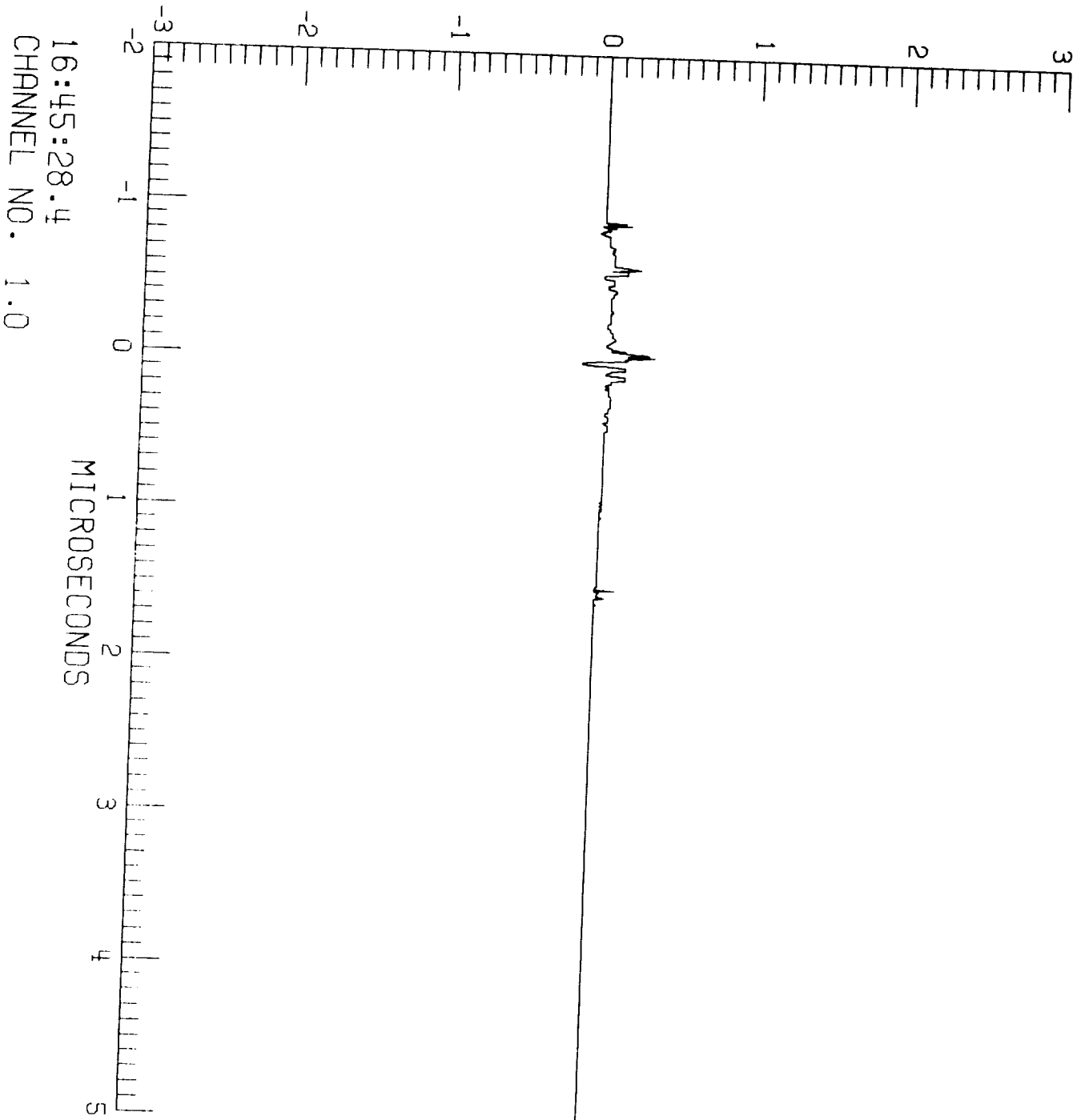

F106 LIGHTNING/85-029/ZAEPFEL

LEC 1 RUN NO. 2

S-001

$\dot{D}_t$  A/m<sup>2</sup>

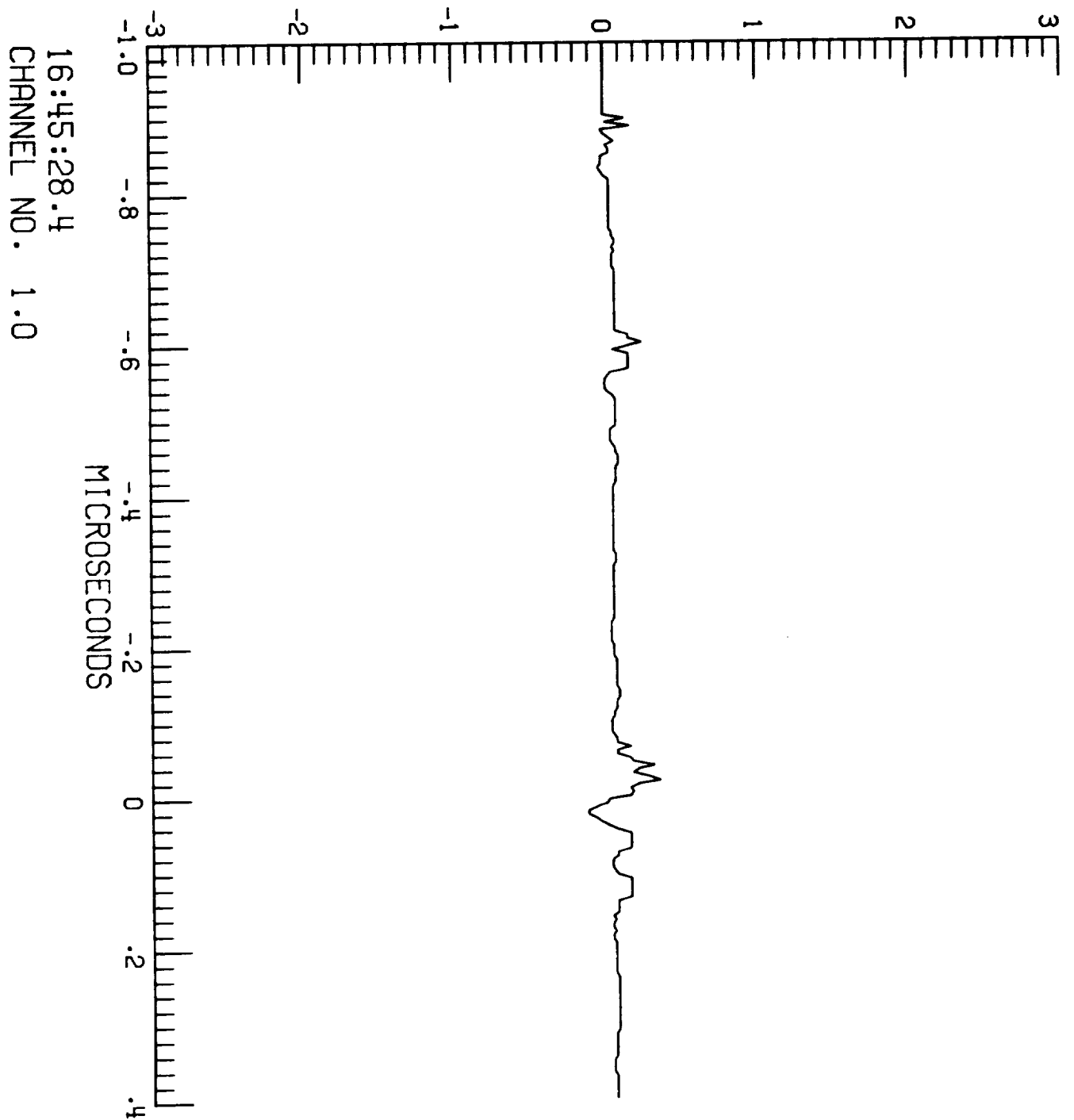

F106 LIGHTNING/85-029/ZAEPFEL

LEC 1 RUN NO. 2

S-001

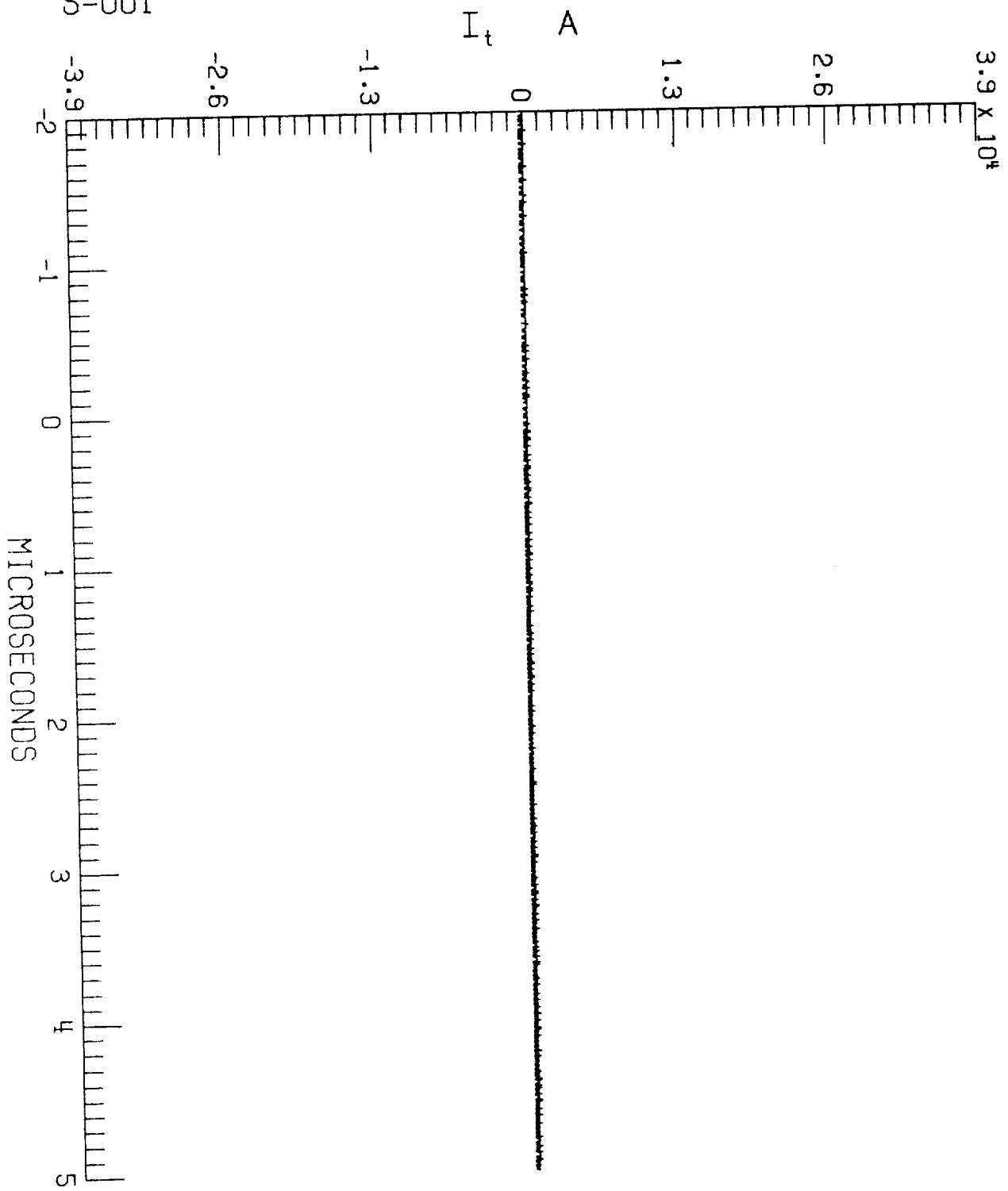

16:45:28.4  
CHANNEL NO. 1.2



F106 LIGHTNING/85-029/ZAEPFEL  
LEC 2 RUN NO. 2  
S-001

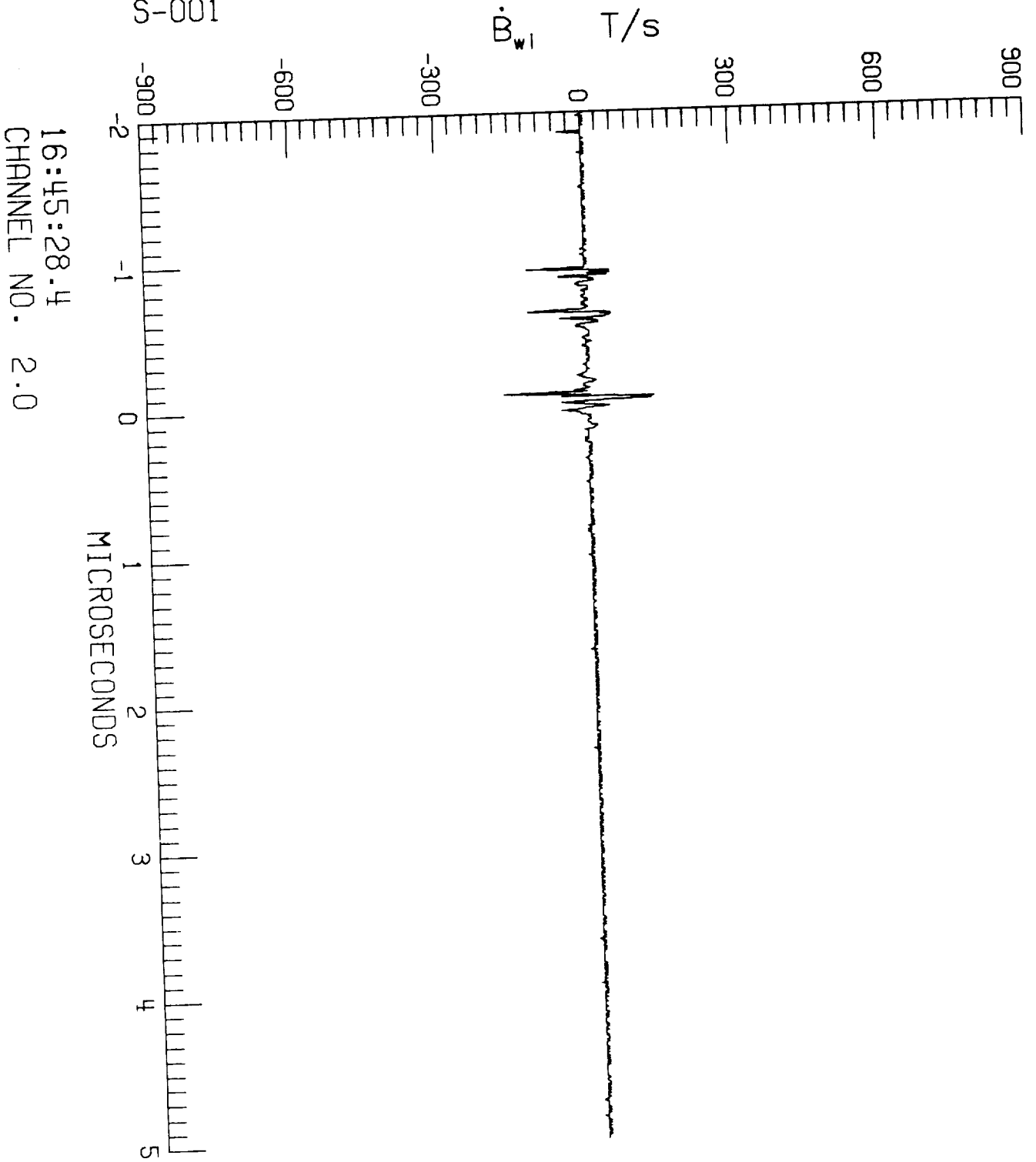

16:45:28.4  
CHANNEL NO. 2.0

F106 LIGHTNING/85-029/ZAEPFEL  
LEC 2 RUN NO. 2  
S-001

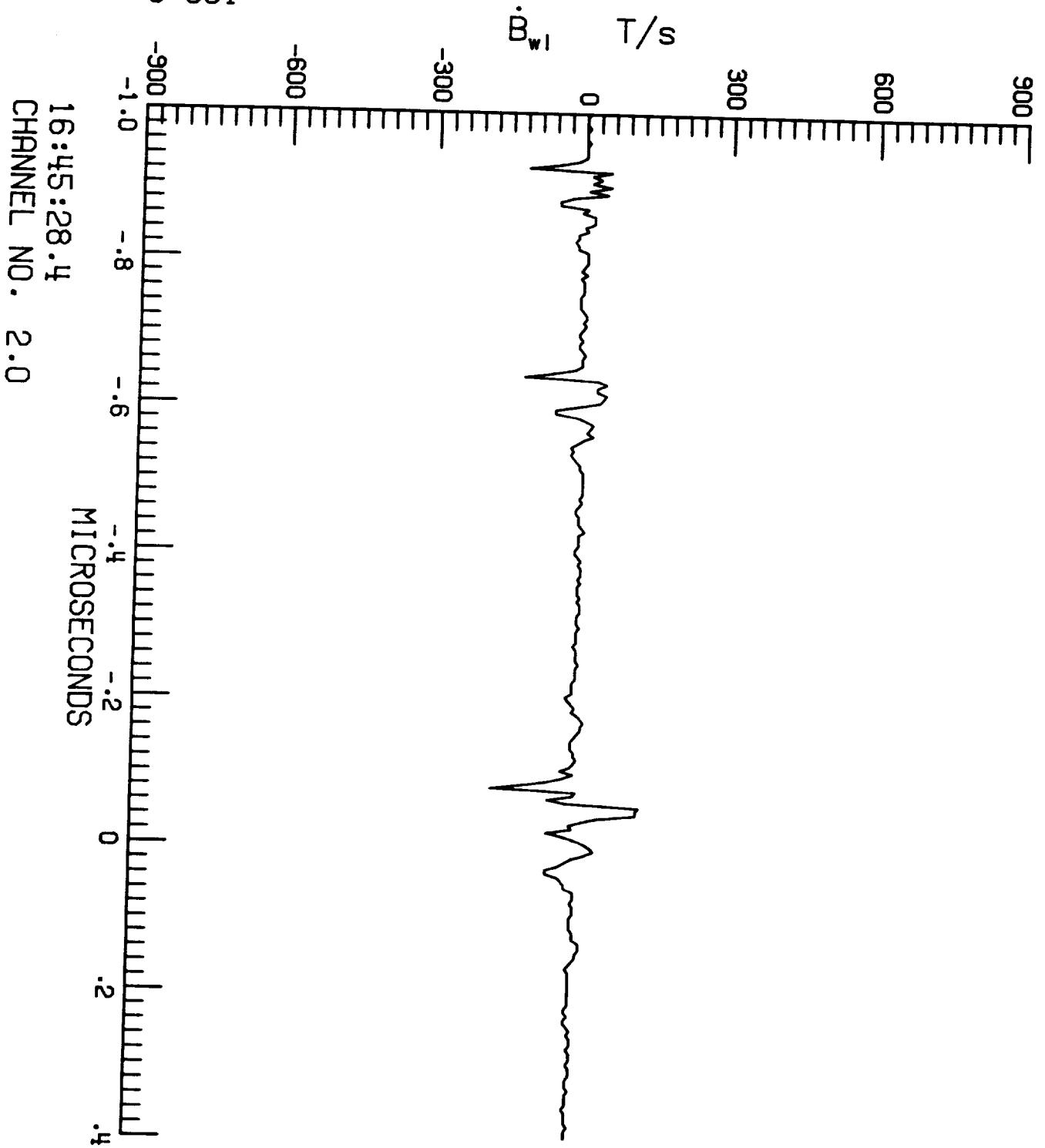

16:45:28.4  
CHANNEL NO. 2.0

F106 LIGHTNING/85-029/ZAEPFEL

LEC 2 RUN NO. 2

S-001

$\dot{i}$  A/s

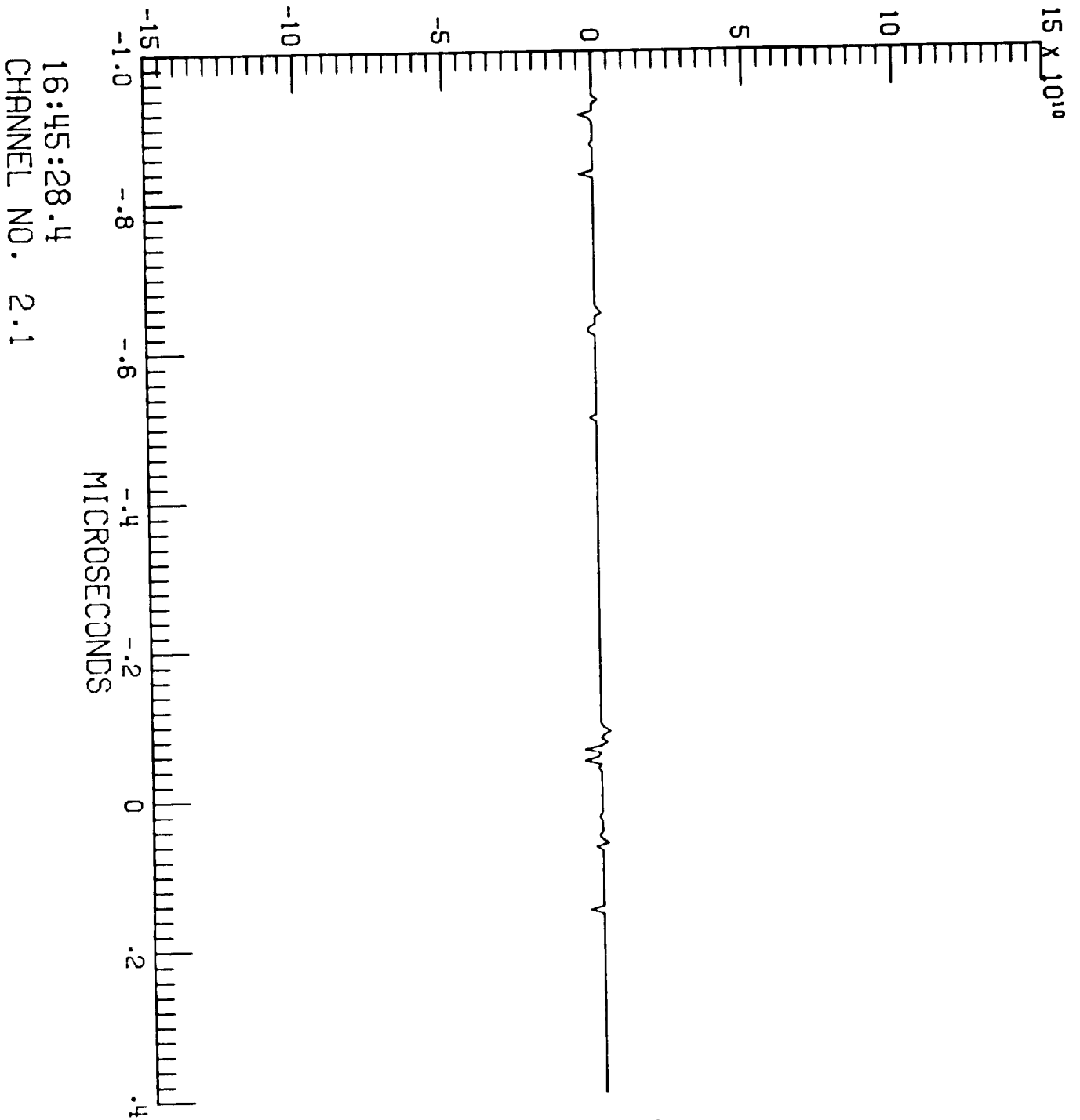

F106 LIGHTNING/85-029/ZAEPFEL  
LEC 3 RUN NO. 2  
S-001

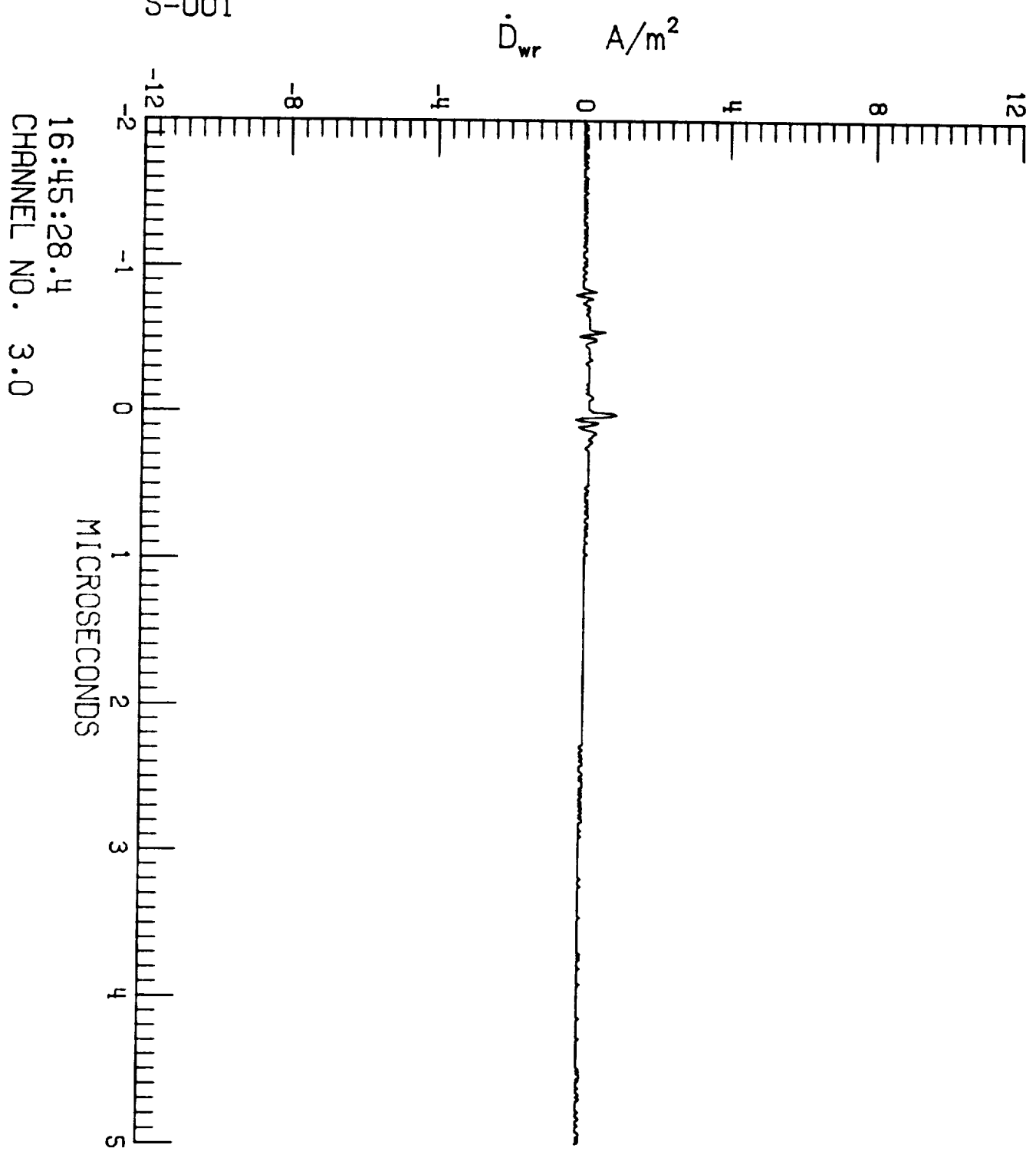

16:45:28.4  
CHANNEL NO. 3.0

F106 LIGHTNING/85-029/ZAEPFEL

LEC 3 RUN NO. 2

S-001

$\dot{D}_{wr}$  A/m<sup>2</sup>

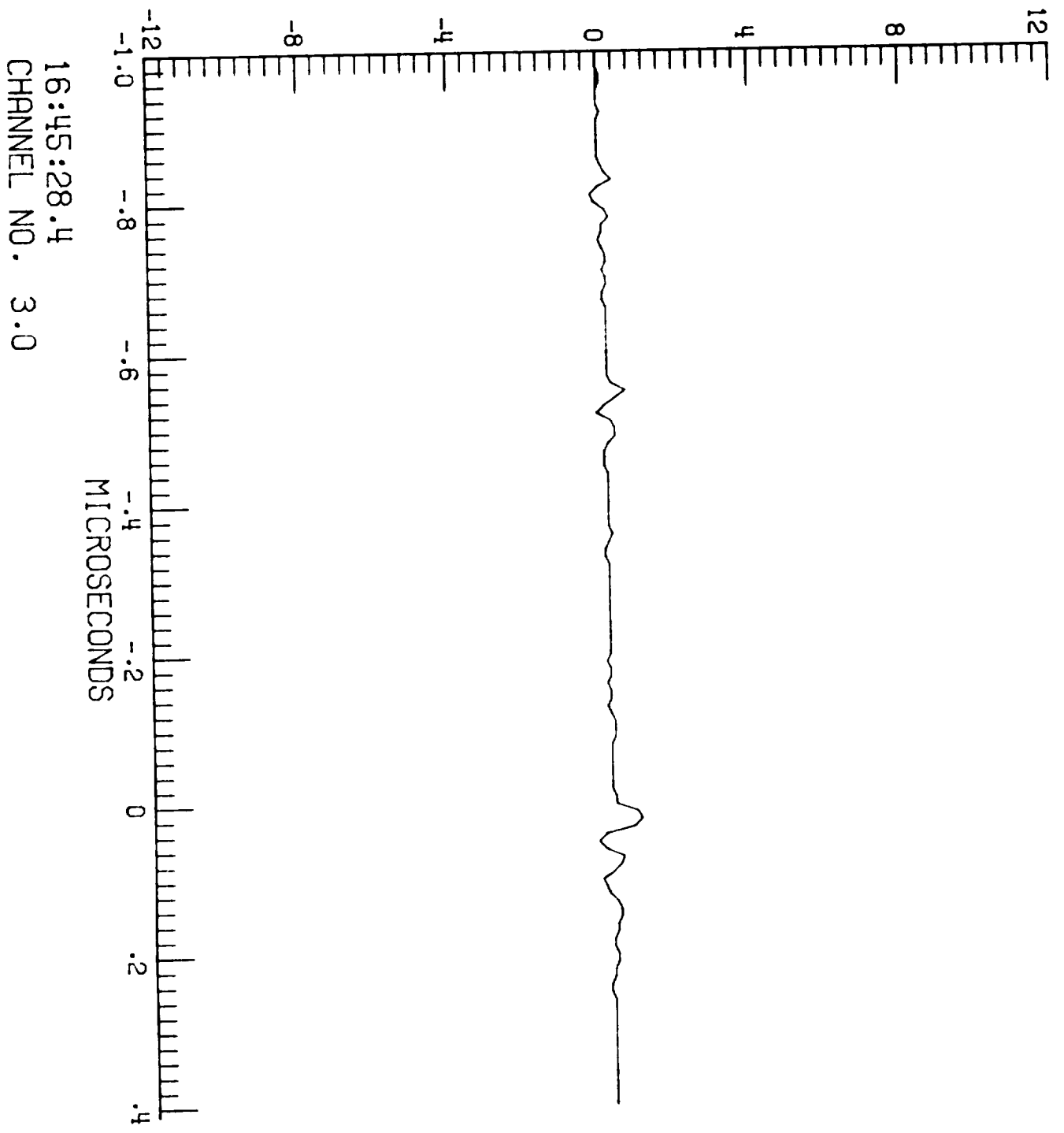

F106 LIGHTNING/85-029/ZAEPFEL

LEC 3 RUN NO. 2

S-001

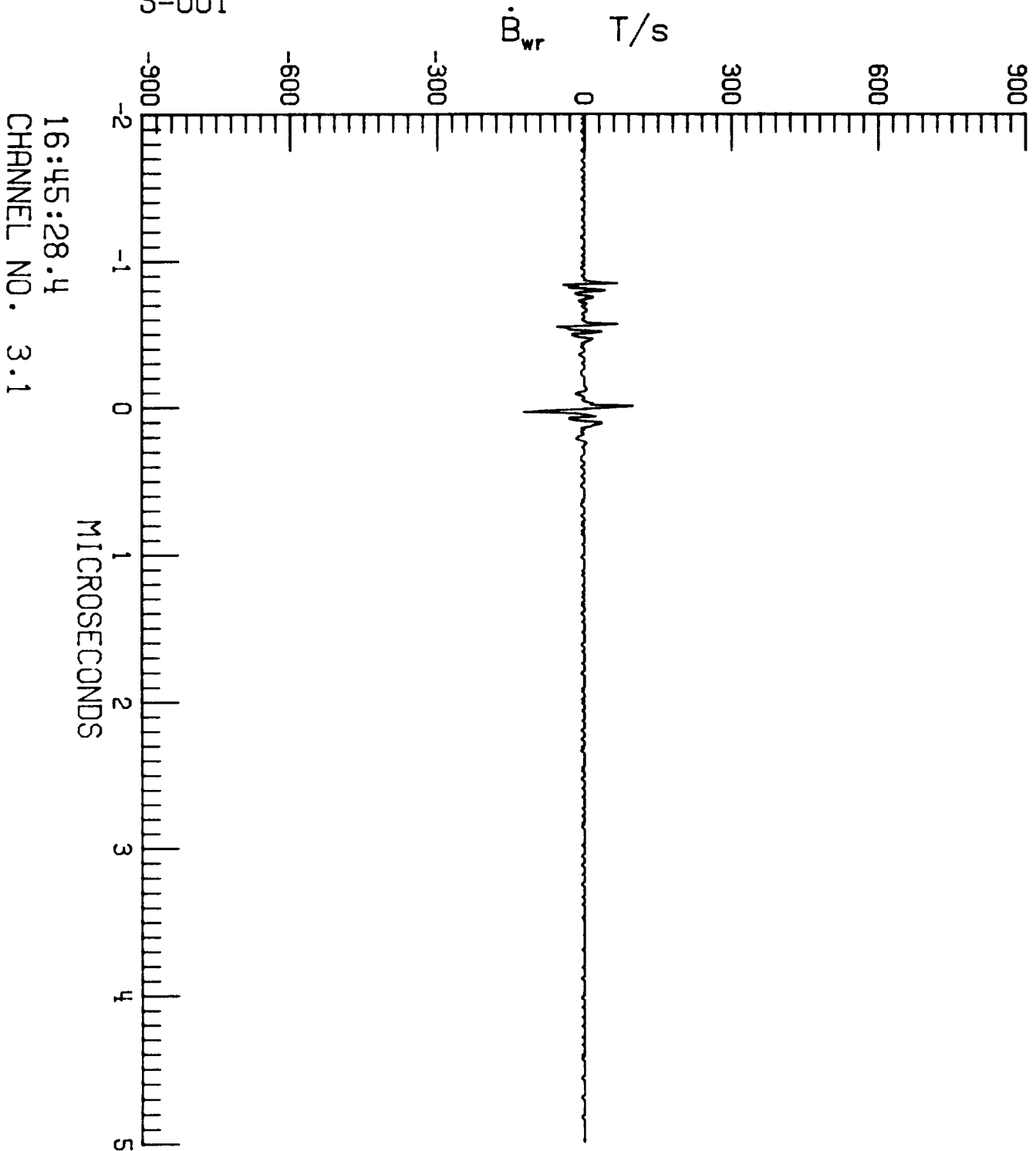

16:45:28.4  
CHANNEL NO. 3.1

F106 LIGHTNING/85-029/ZAEPFEL

LEC 3 RUN NO. 2

S-001

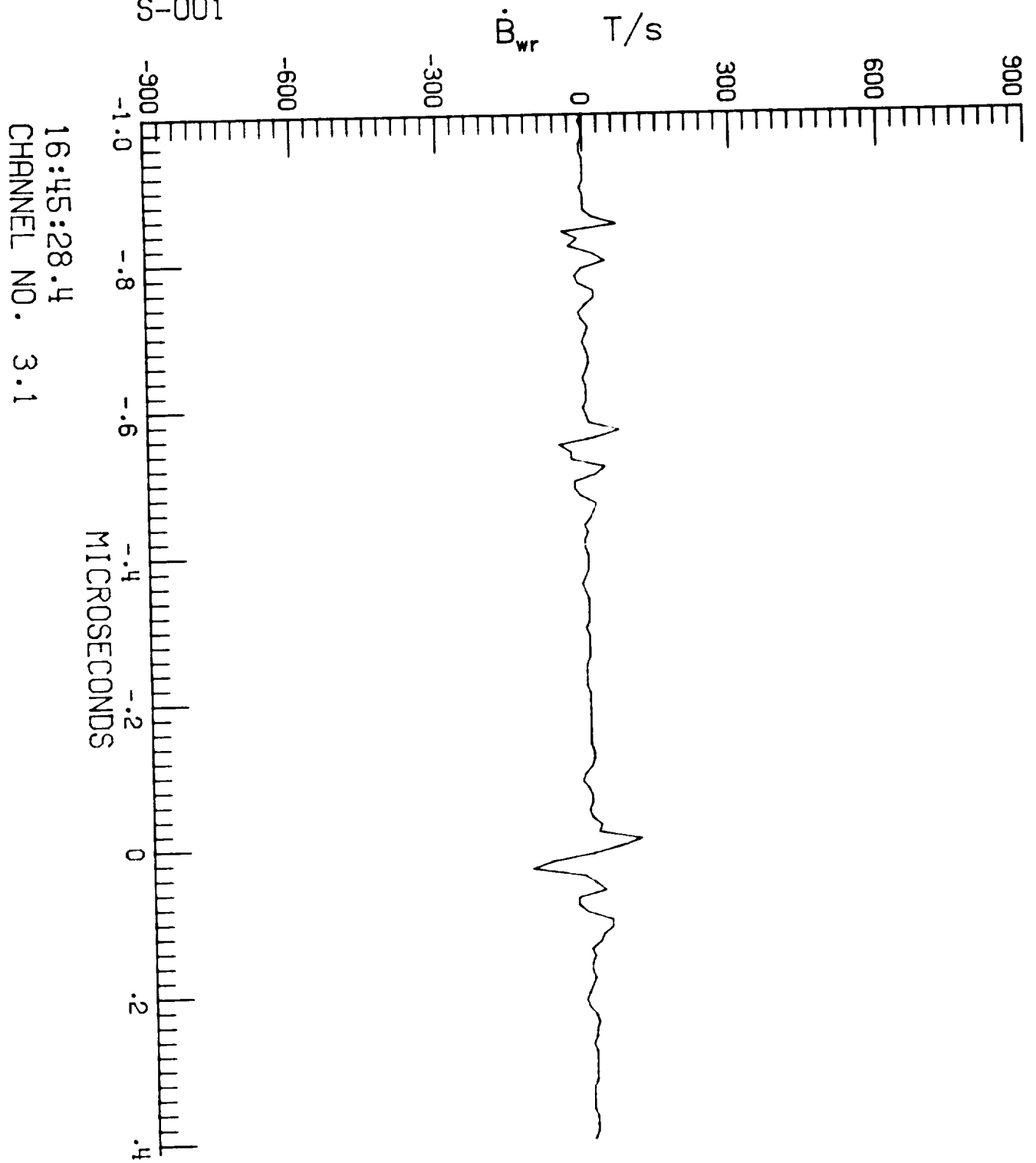

16:45:28.4  
CHANNEL NO. 3.1

F106 LIGHTNING/85-029/ZAEPFEL

LEC 3 RUN NO. 2

S-001

$\dot{D}_f$  A/m<sup>2</sup>

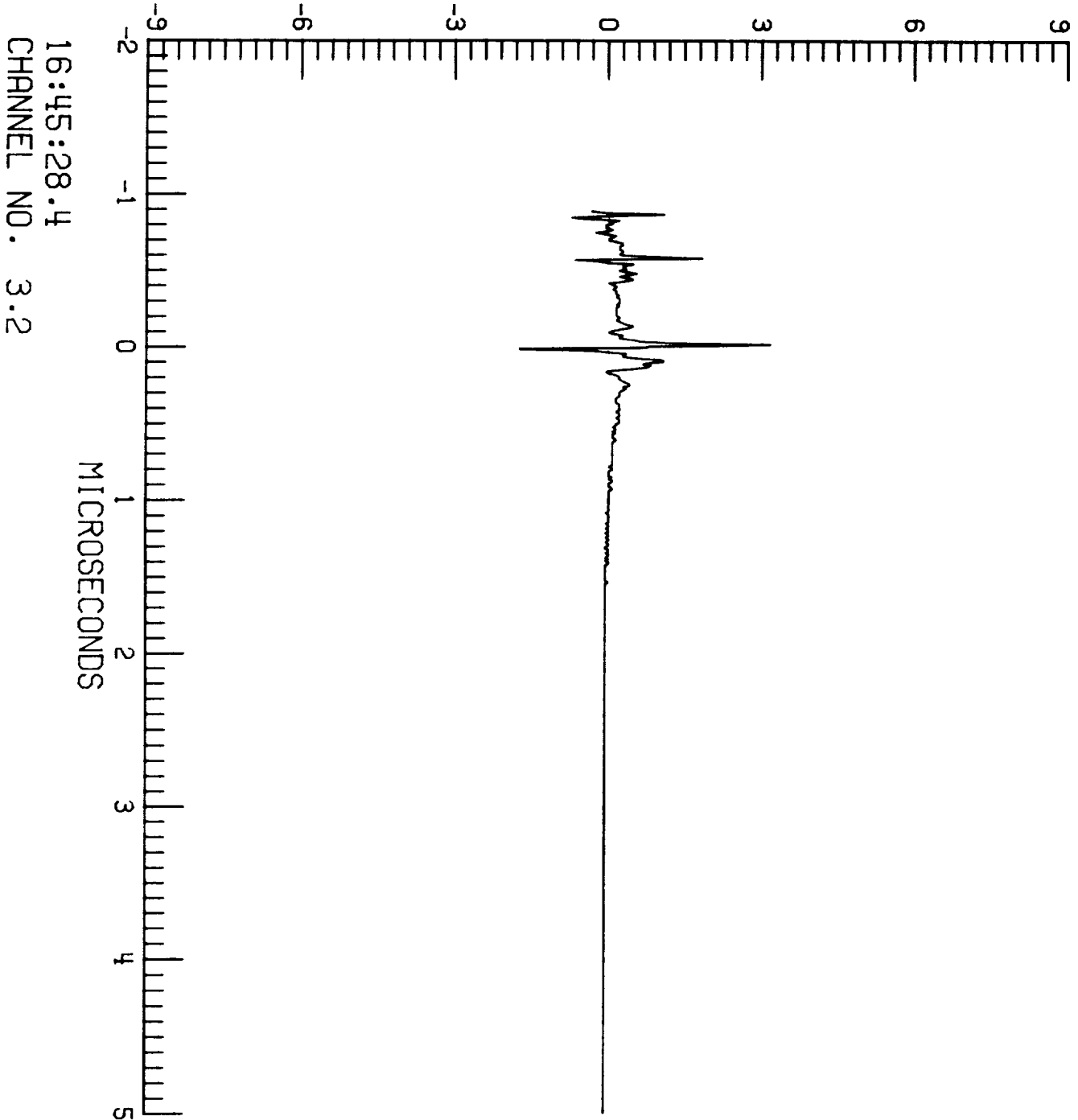



F106 LIGHTNING/85-029/ZAEPFEL

LEC 3 RUN NO. 2

S-001

$\dot{D}_f$  A/m<sup>2</sup>

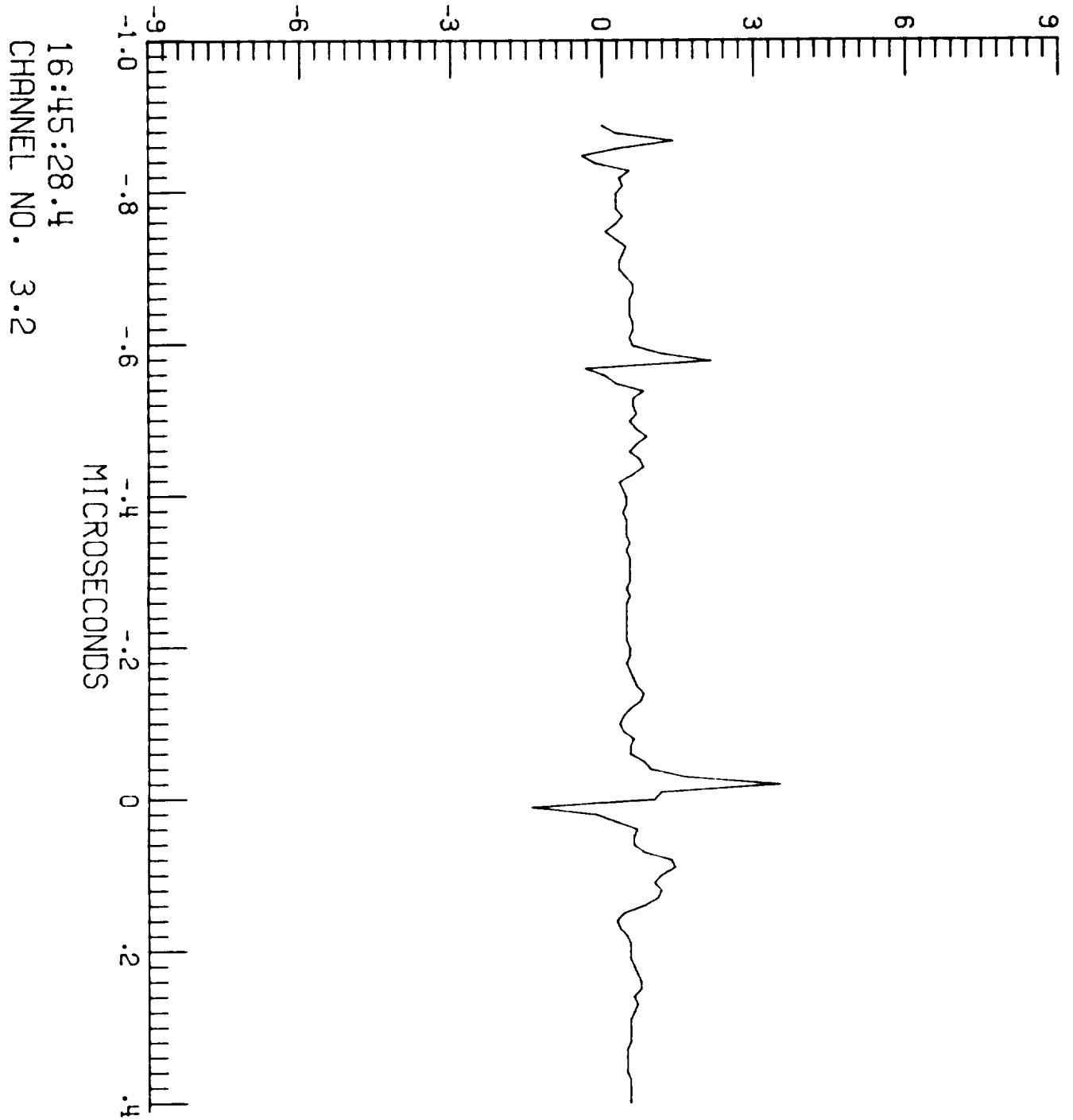

F106 LIGHTNING/85-029/ZAEPFEL

LEC 4 RUN NO. 2

S-001

TP100 V

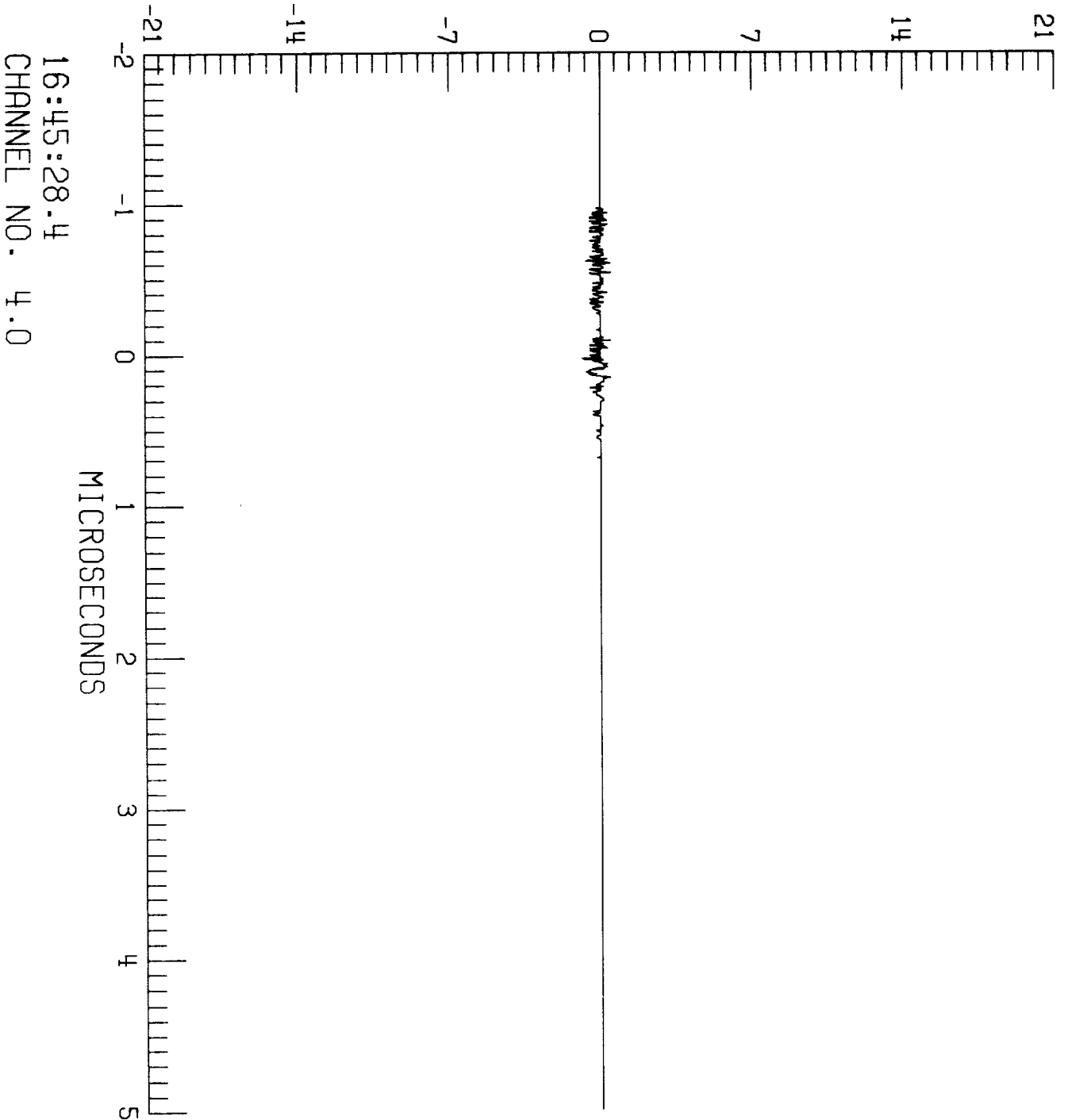

F106 LIGHTNING/85-029/ZAEPFEL

LEC 4 RUN NO. 2

S-001

TP100

V

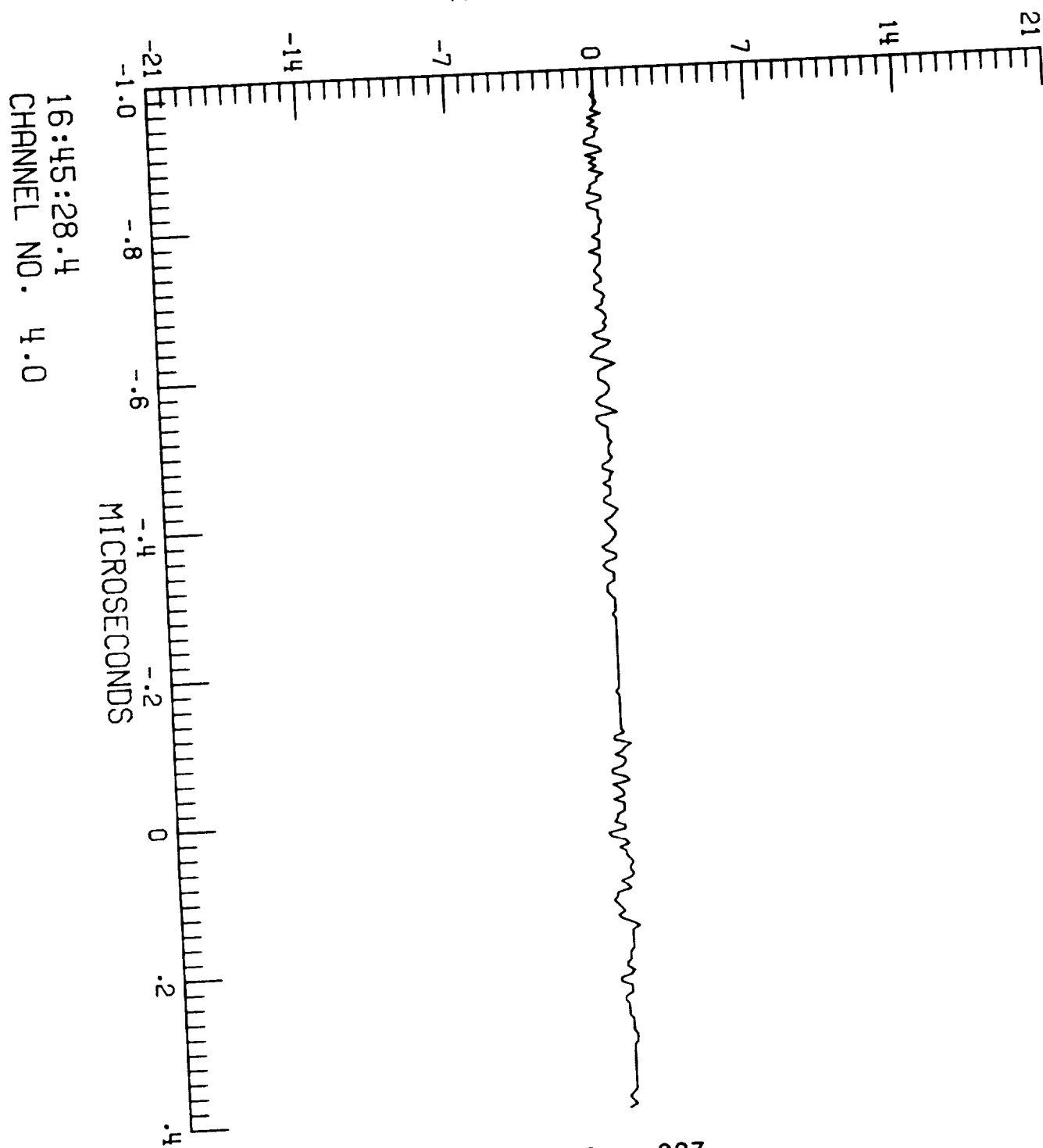

16:45:28.4  
CHANNEL NO. 4.0

F106 LIGHTNING/85-029/ZAEPFEL

LEC 4 RUN NO. 2

S-001

TP106

A

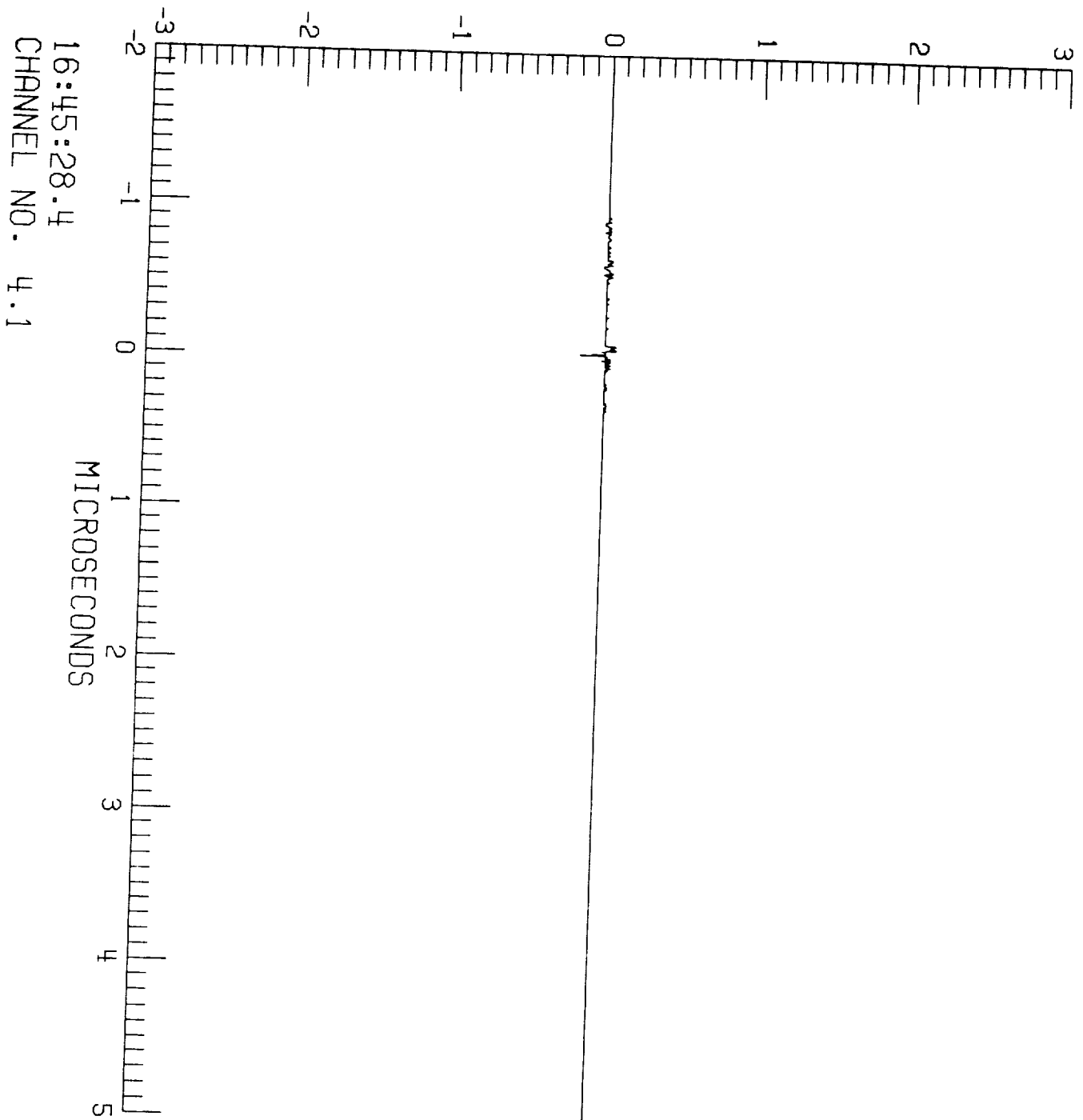

16:45:28.4  
CHANNEL NO. 4.1

F106 LIGHTNING/85-029/ZAEPFEL

LEC 4 RUN NO. 2

S-001

TP106

A

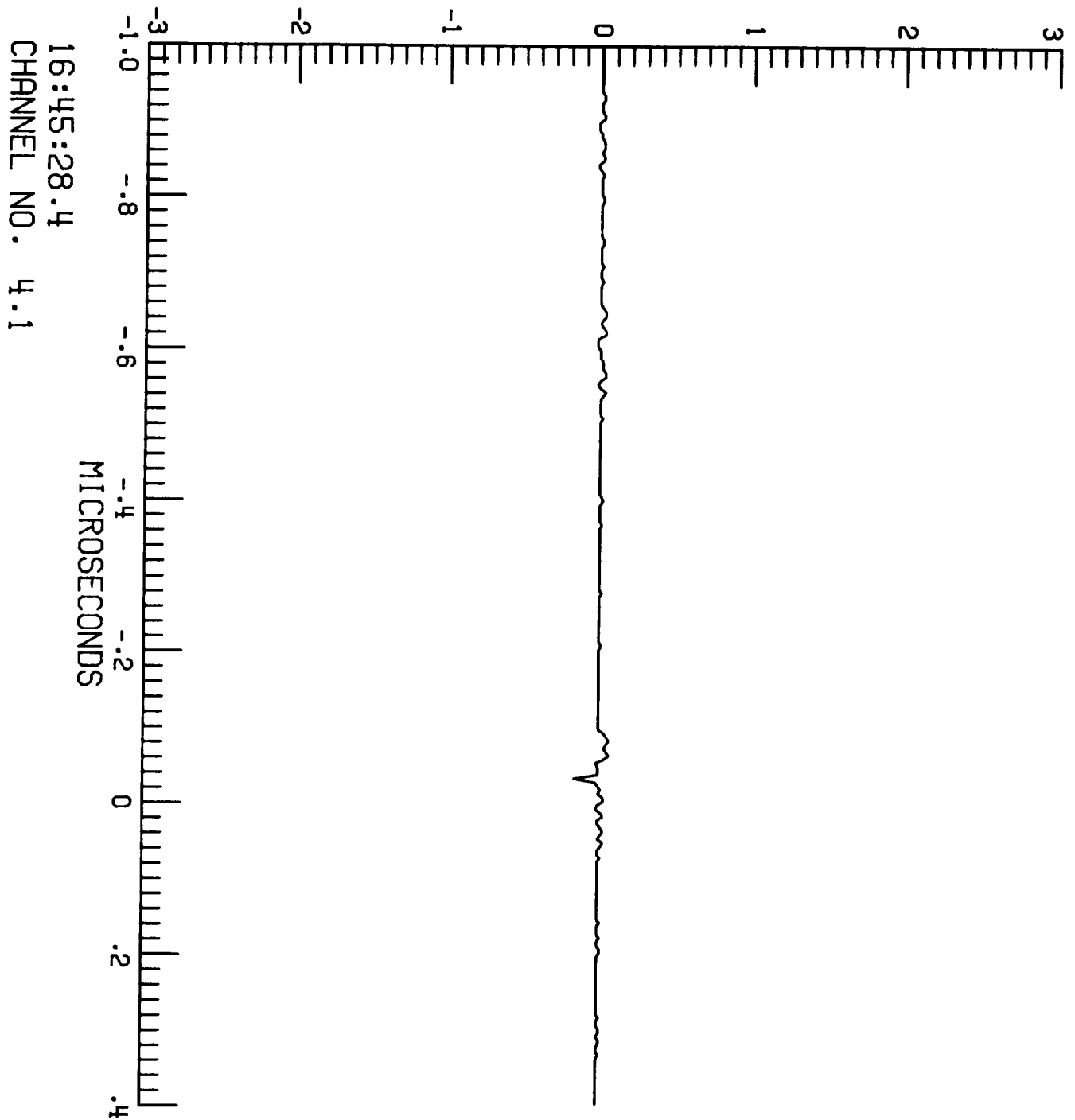

F106 LIGHTNING/85-029/ZAEPFEL

LEC 4 RUN NO. 2

S-001

TP125

A

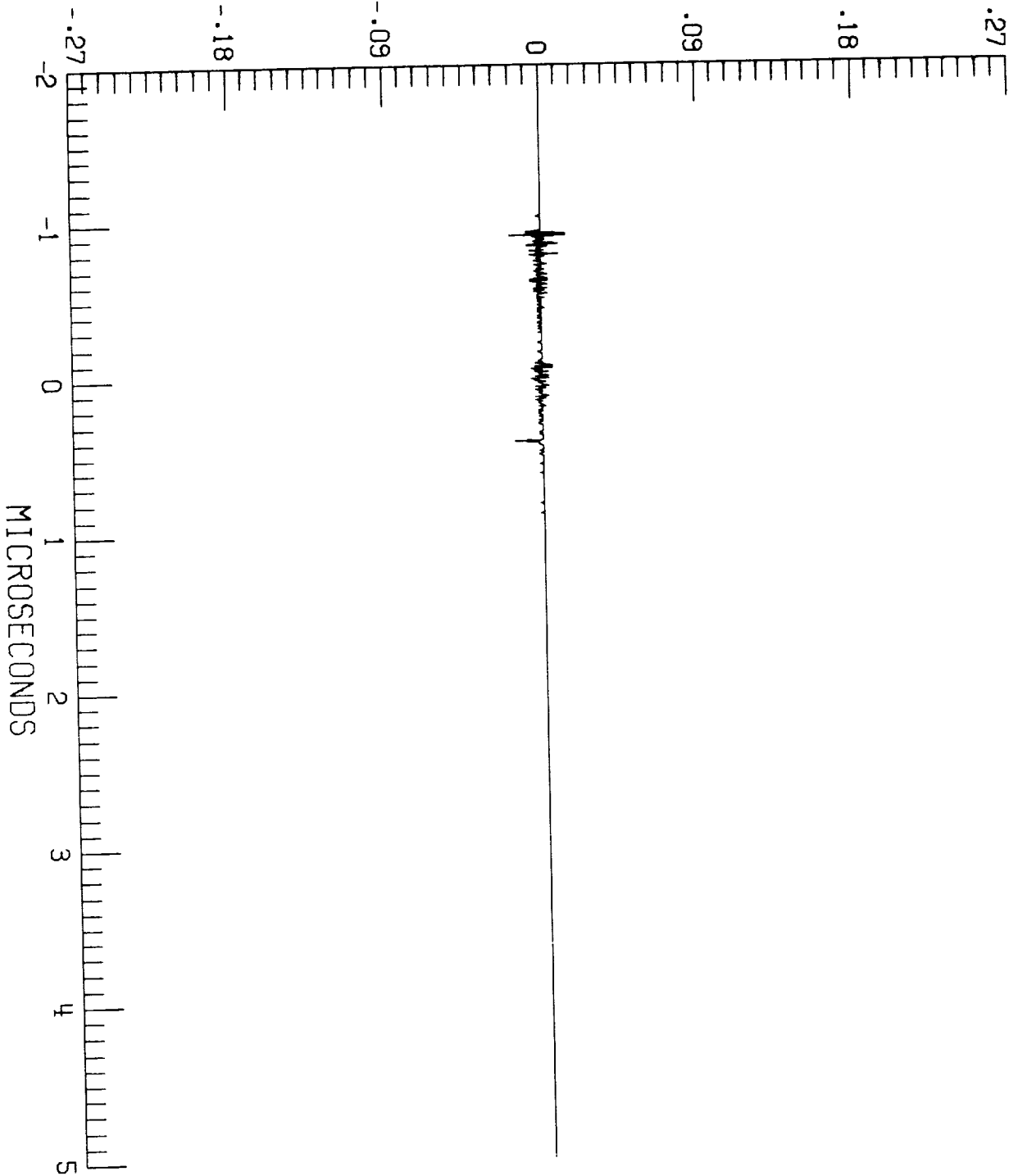

16:45:28.4  
CHANNEL NO. 4.2

F106 LIGHTNING/85-029/ZAEPFEL

LEC 4 RUN NO. 2

S-001

TP125

A

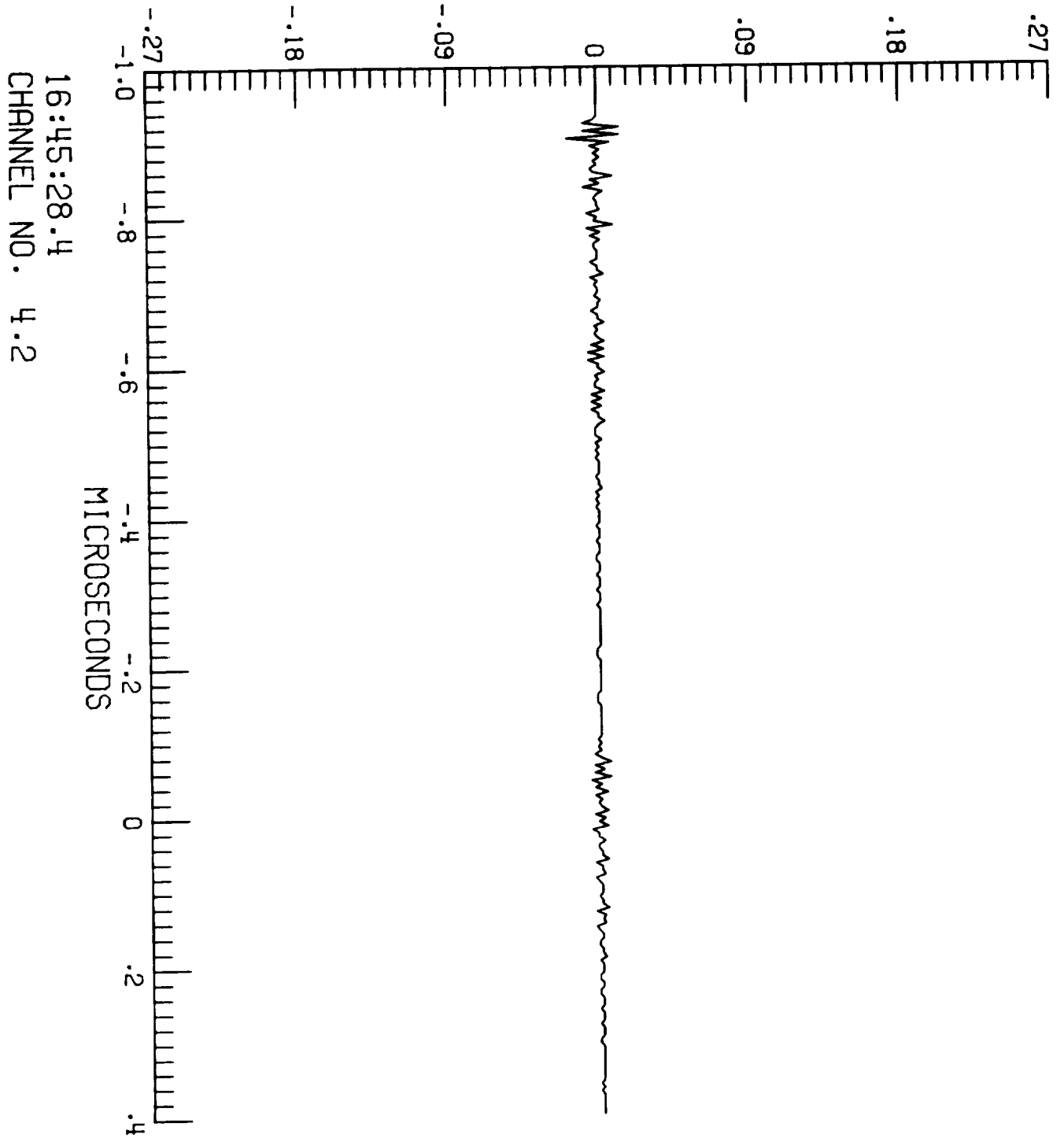

F106 LIGHTNING/85-029/ZAEPFEL

LEC 2 RUN NO. 3

S-002

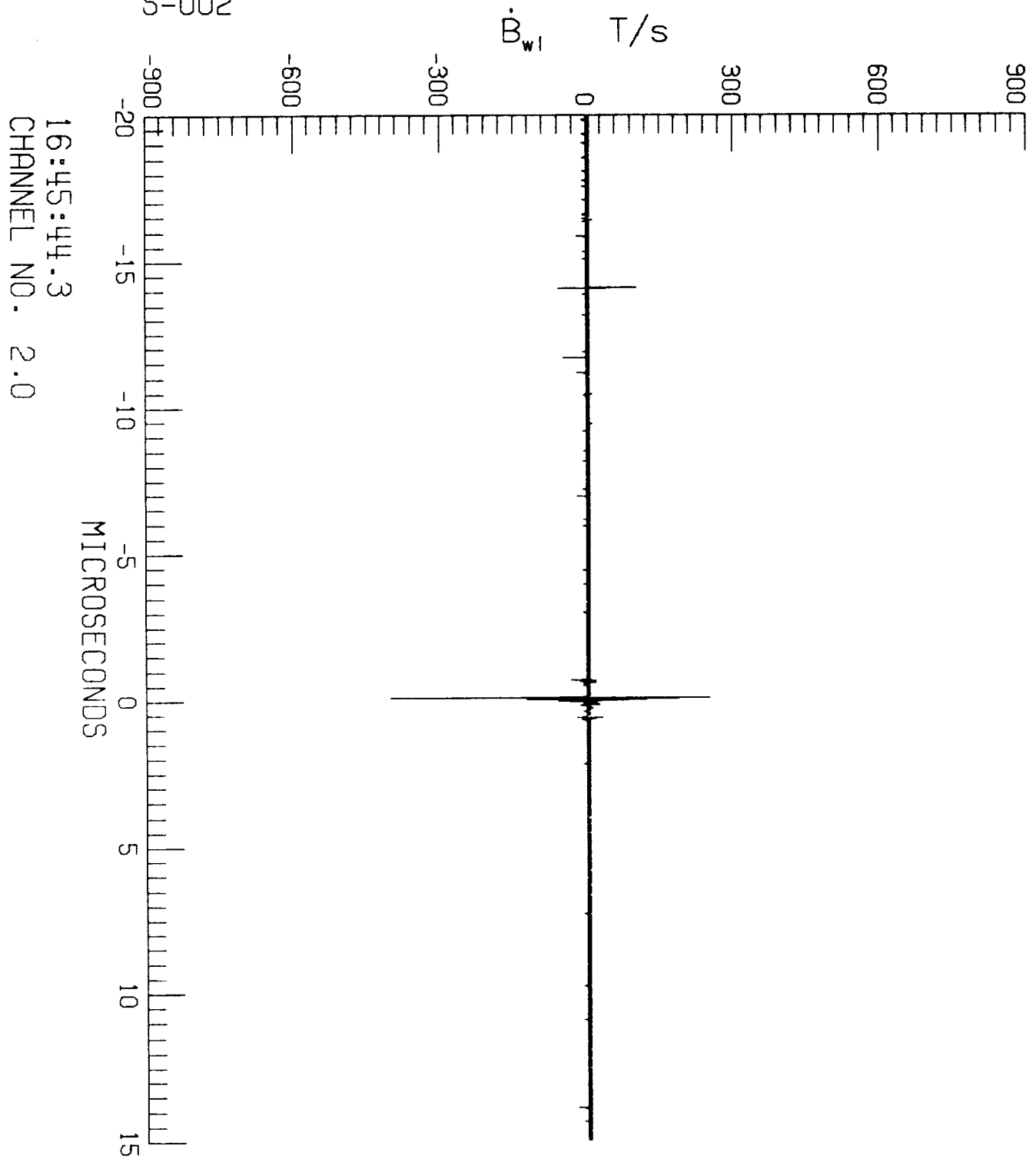

16:45:44.3  
CHANNEL NO. 2.0



F106 LIGHTNING/85-029/ZAEPFEL  
LEC 2 RUN NO. 3  
S-002

16:45:44.3  
CHANNEL NO. 2.0

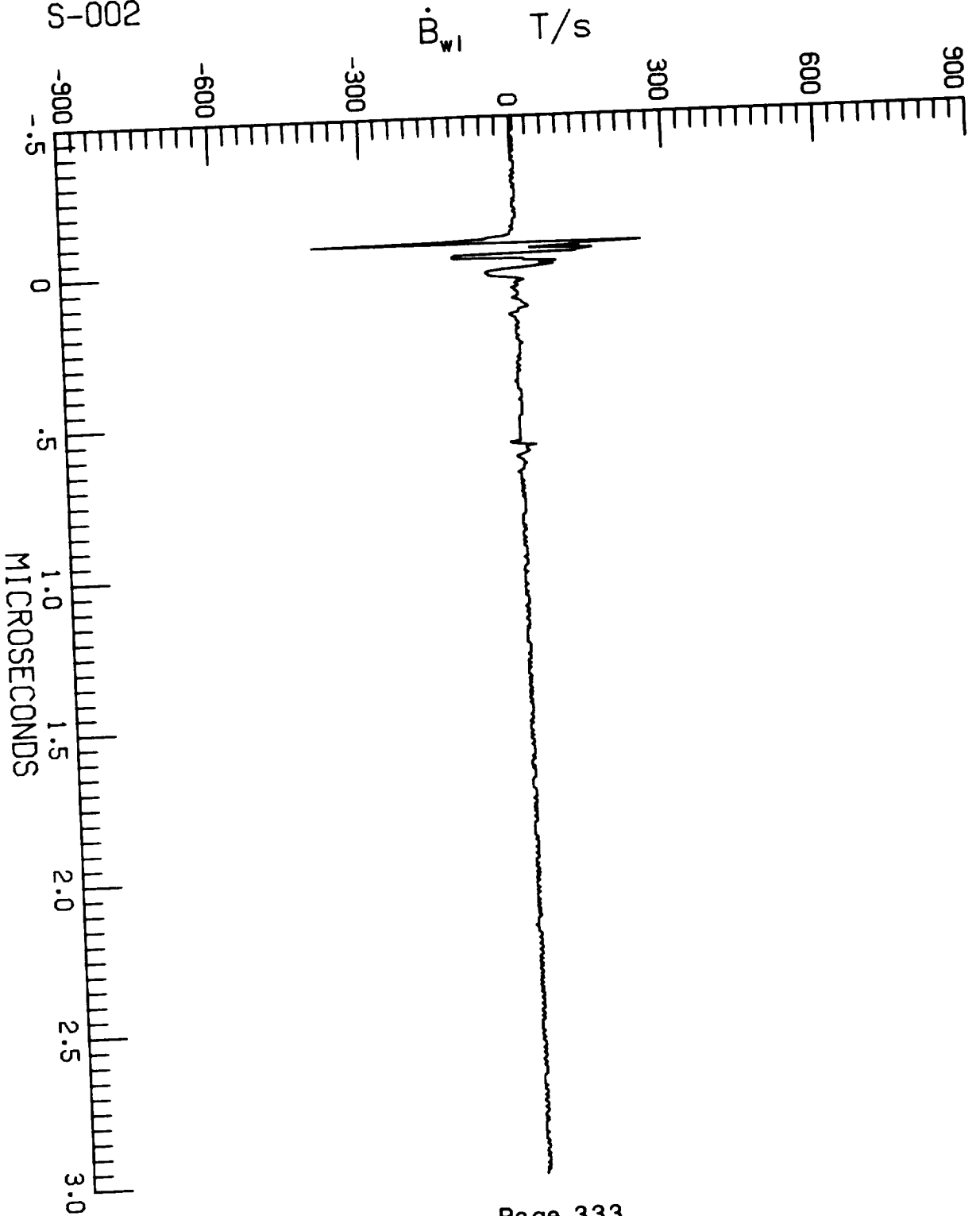

F106 LIGHTNING/85-029/ZAEPFEL  
LEC 2 RUN NO. 3  
S-002

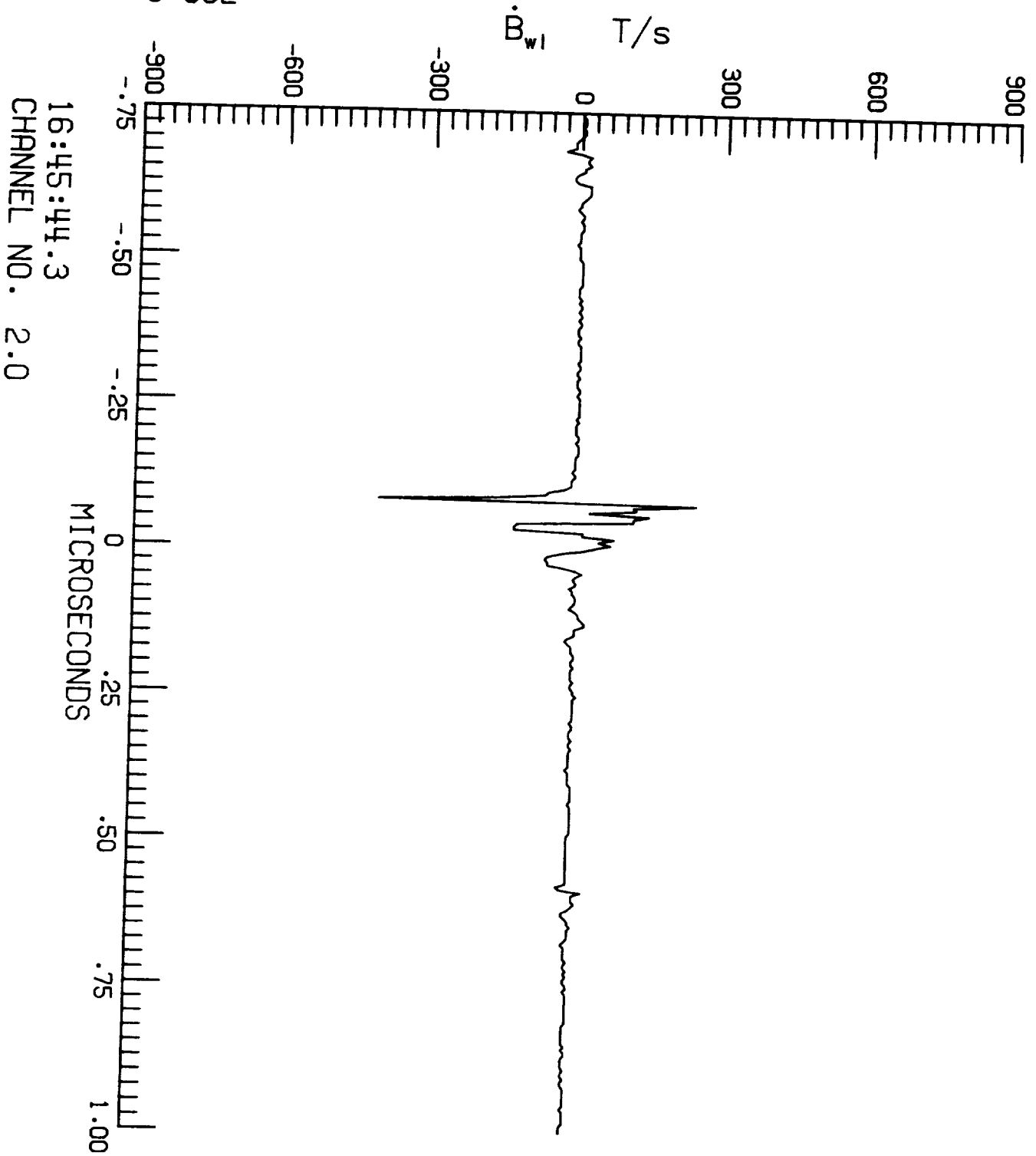

16:45:44.3  
CHANNEL NO. 2.0

F106 LIGHTNING/85-029/ZAEPFEL

LEC 2 RUN NO. 3

S-002

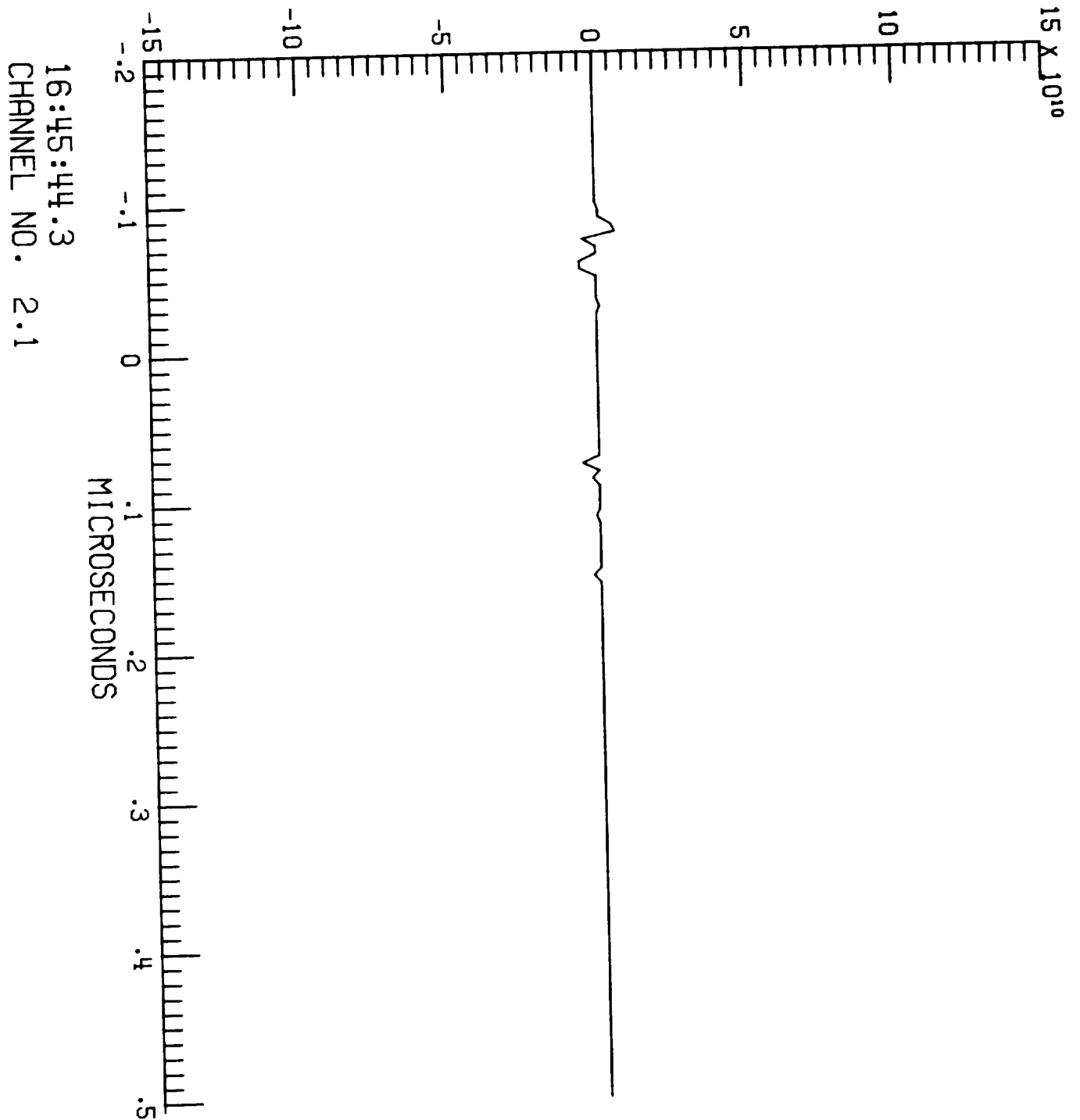

F106 LIGHTNING/85-029/ZAEPFEL

LEC 1 RUN NO. 4

N-002

$\dot{D}_t$  A/m<sup>2</sup>

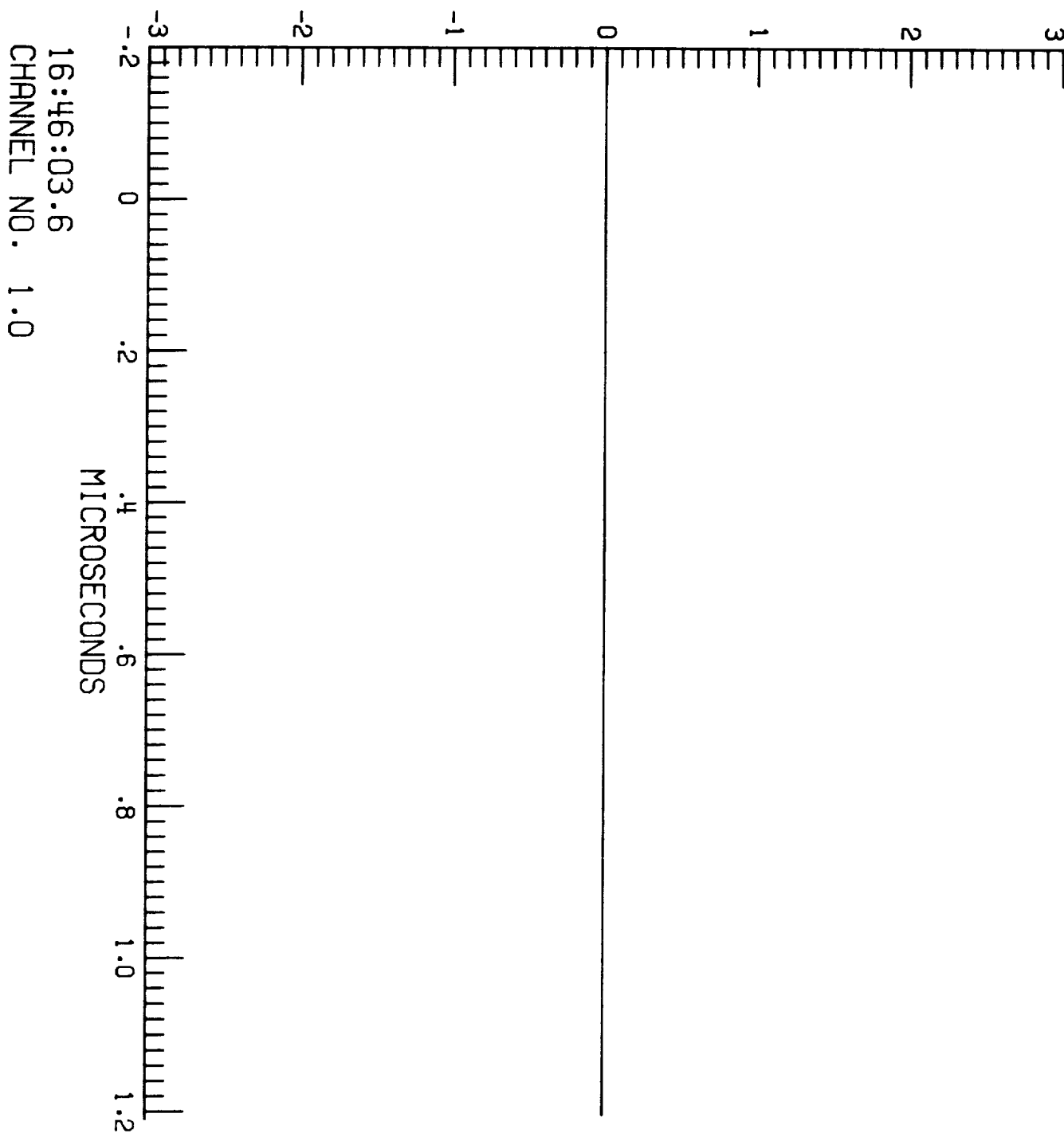

16:46:03.6  
CHANNEL NO. 1.0

F106 LIGHTNING/85-029/ZAEPFEL

LEC 1 RUN NO. 4

N-002

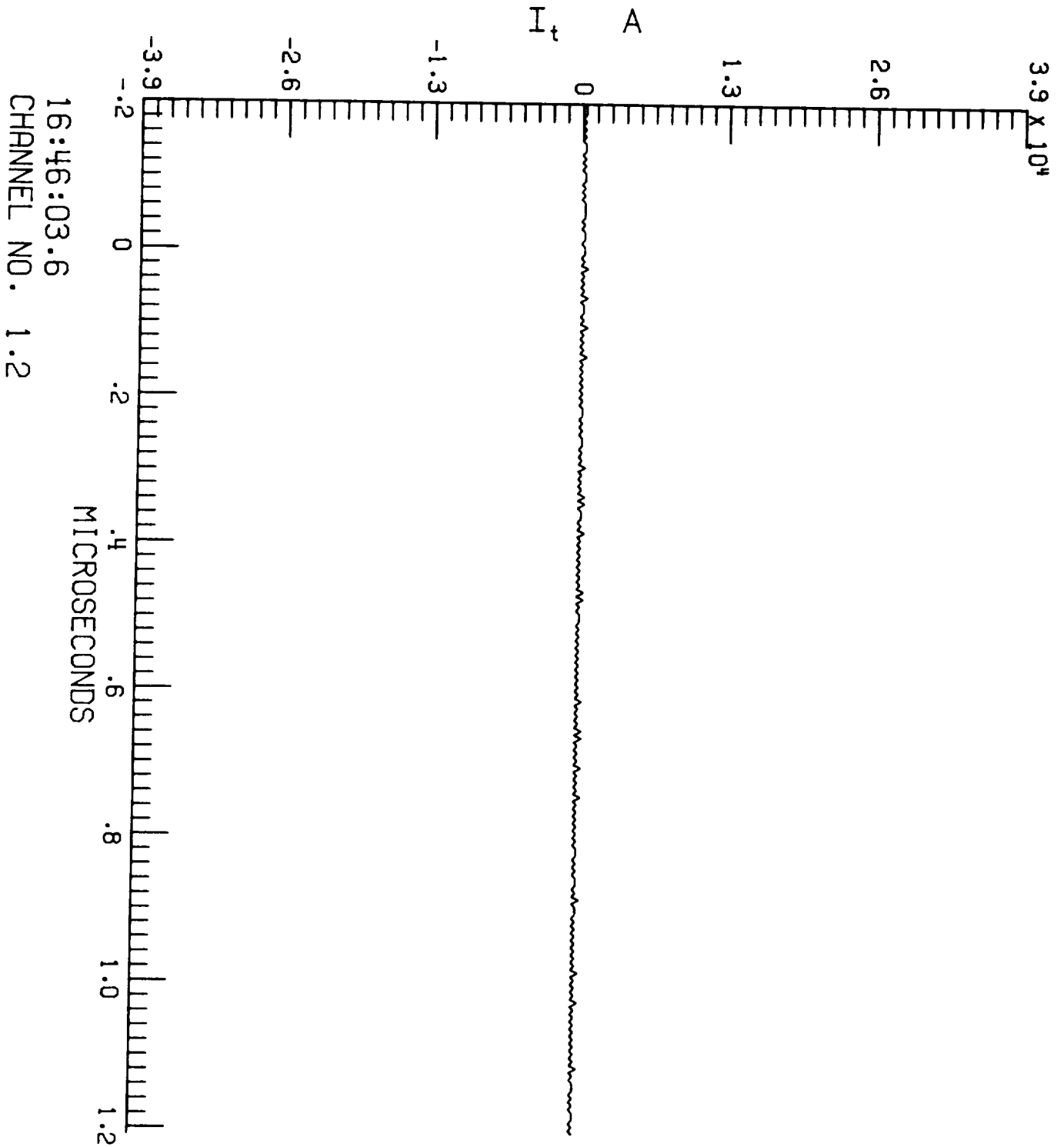

16:46:03.6  
CHANNEL NO. 1.2

F106 LIGHTNING/85-029/ZAEPFEL

LEC 2 RUN NO. 4

N-002

$\dot{B}_{wl}$  T/s

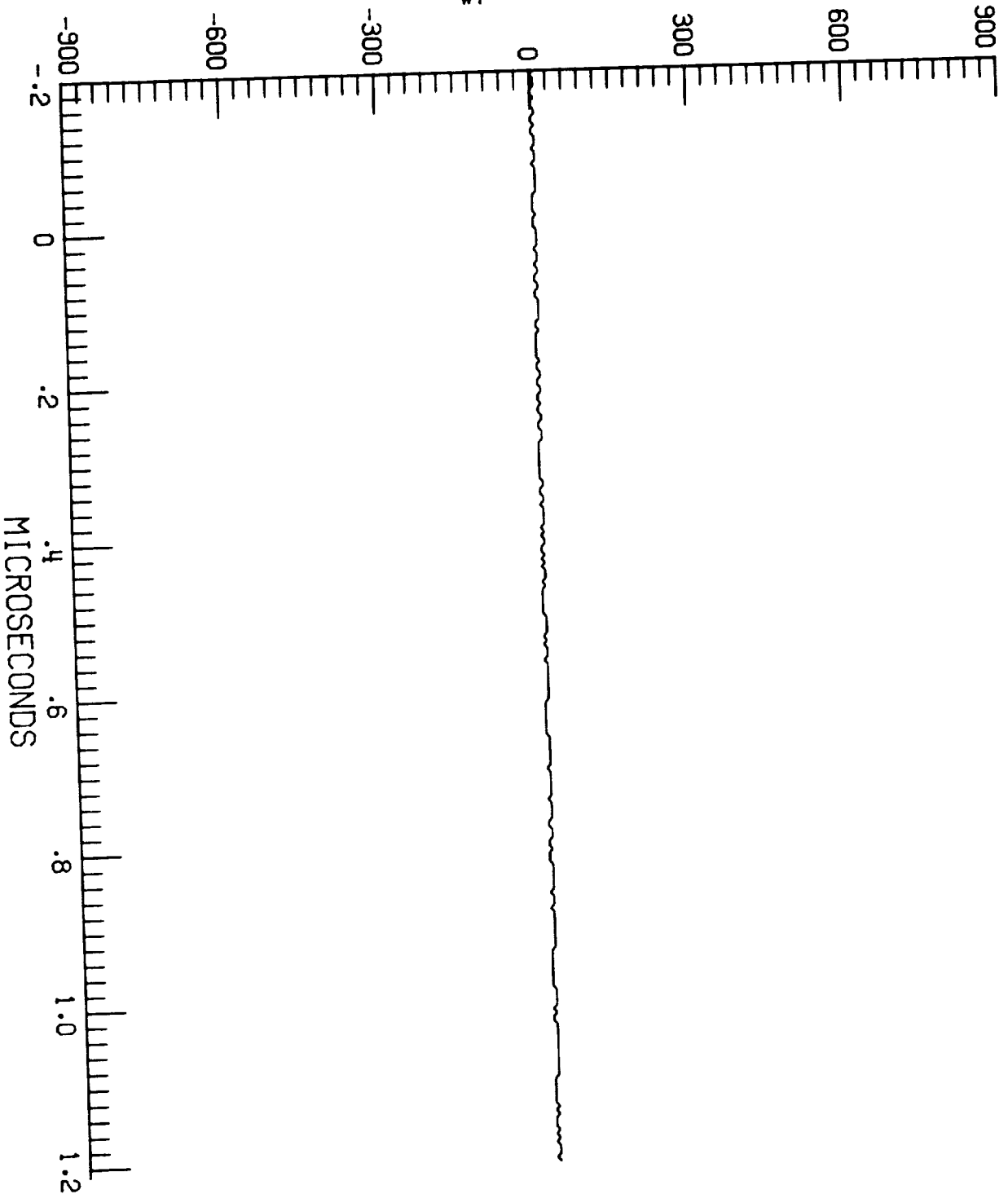

16:46:03.6  
CHANNEL NO. 2.0

F106 LIGHTNING/85-029/ZAEPFEL

LEC 2 RUN NO. 4

N-002

i A/s

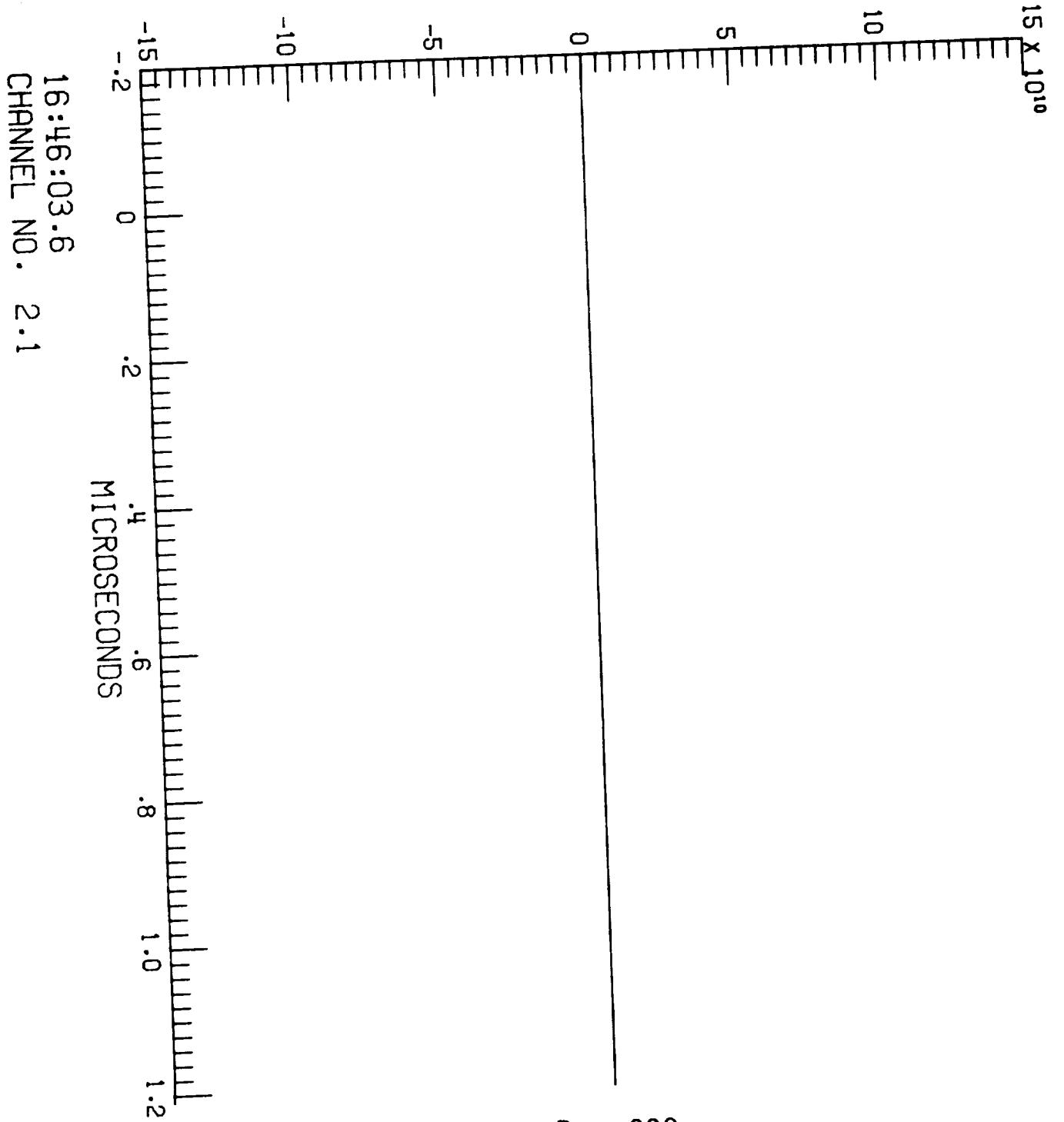

16:46:03.6  
CHANNEL NO. 2.1

F106 LIGHTNING/85-029/ZAEPFEL

LEC 3 RUN NO. 4

N-002

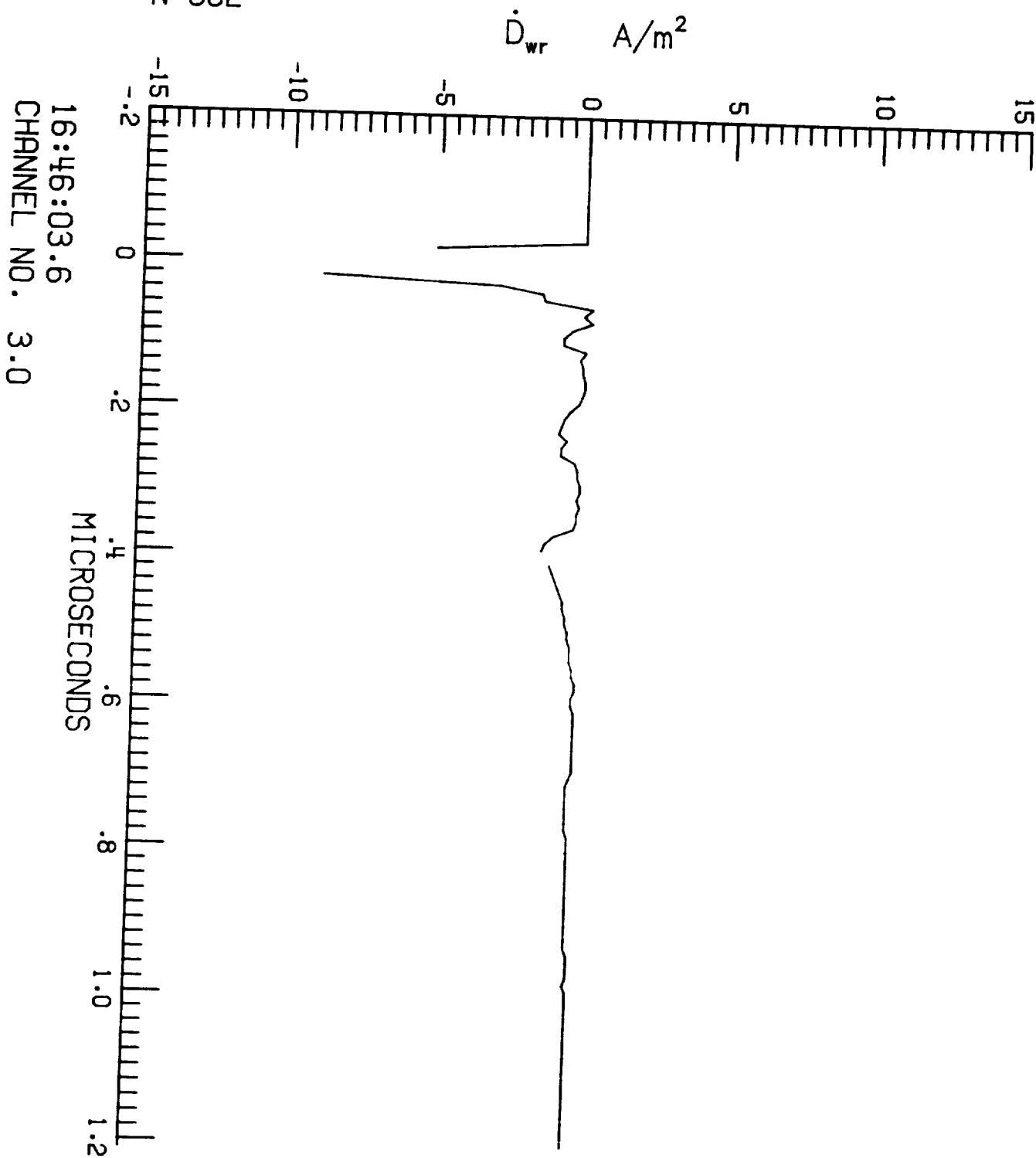

16:46:03.6  
CHANNEL NO. 3.0



F106 LIGHTNING/85-029/ZAEPFEL

LEC 3 RUN NO. 4

N-002

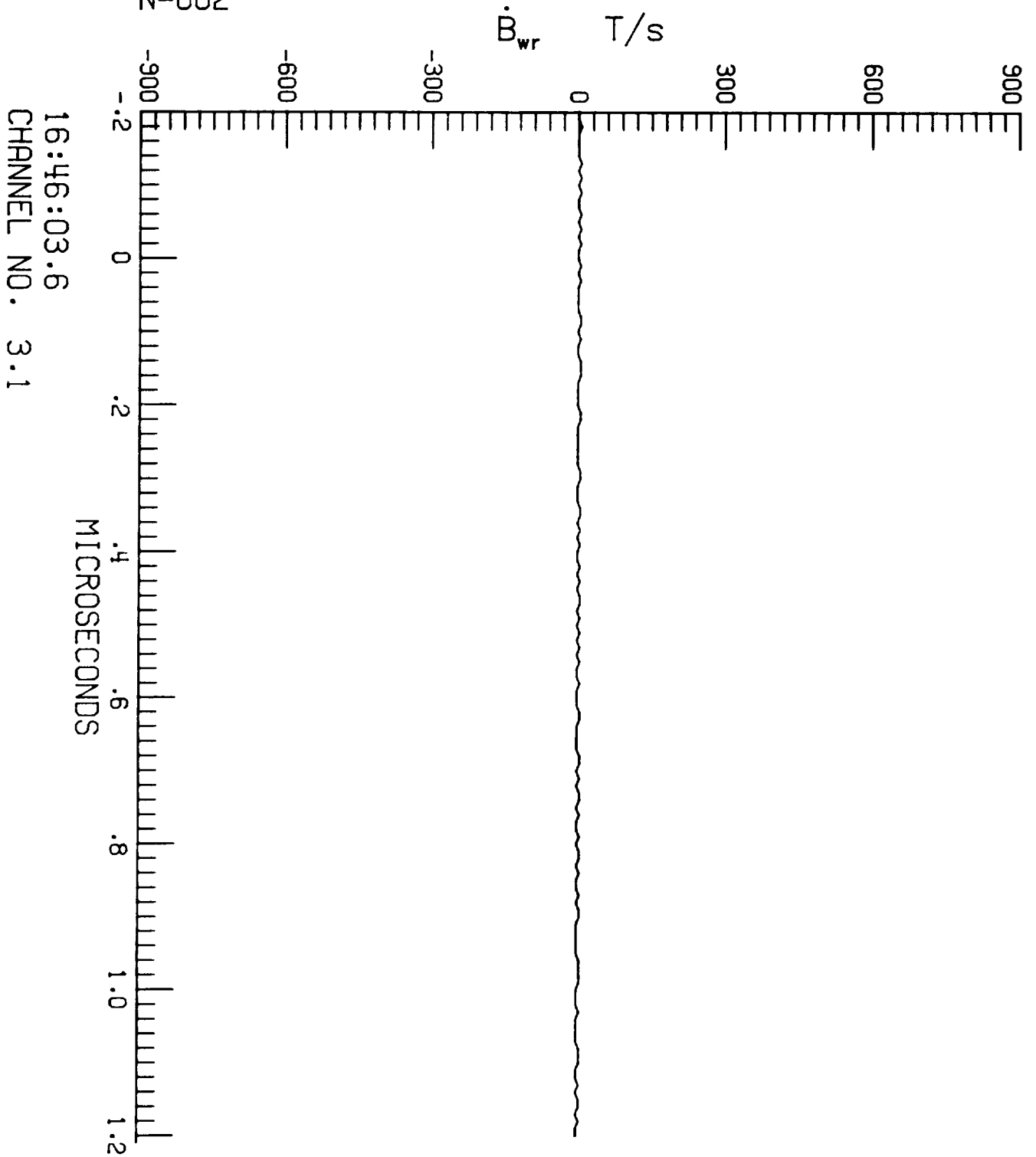

16:46:03.6  
CHANNEL NO. 3.1

F106 LIGHTNING/85-029/ZAEPFEL

LEC 4 RUN NO. 4

N-002

TP100

V

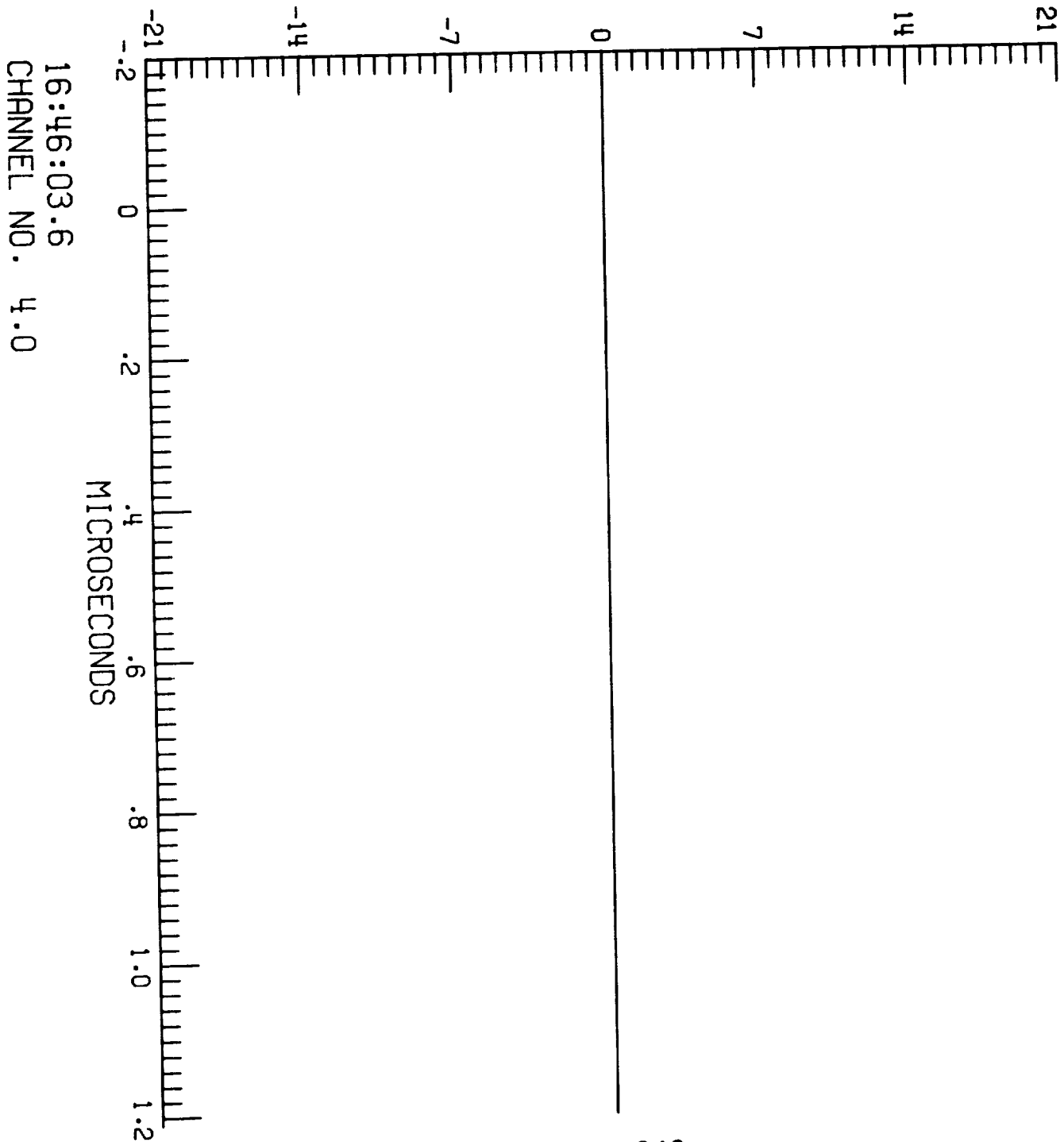

F106 LIGHTNING/85-029/ZAEPFEL

LEC 4 RUN NO. 4

N-002

TP106

A

16:46:03.6  
CHANNEL NO. 4.1

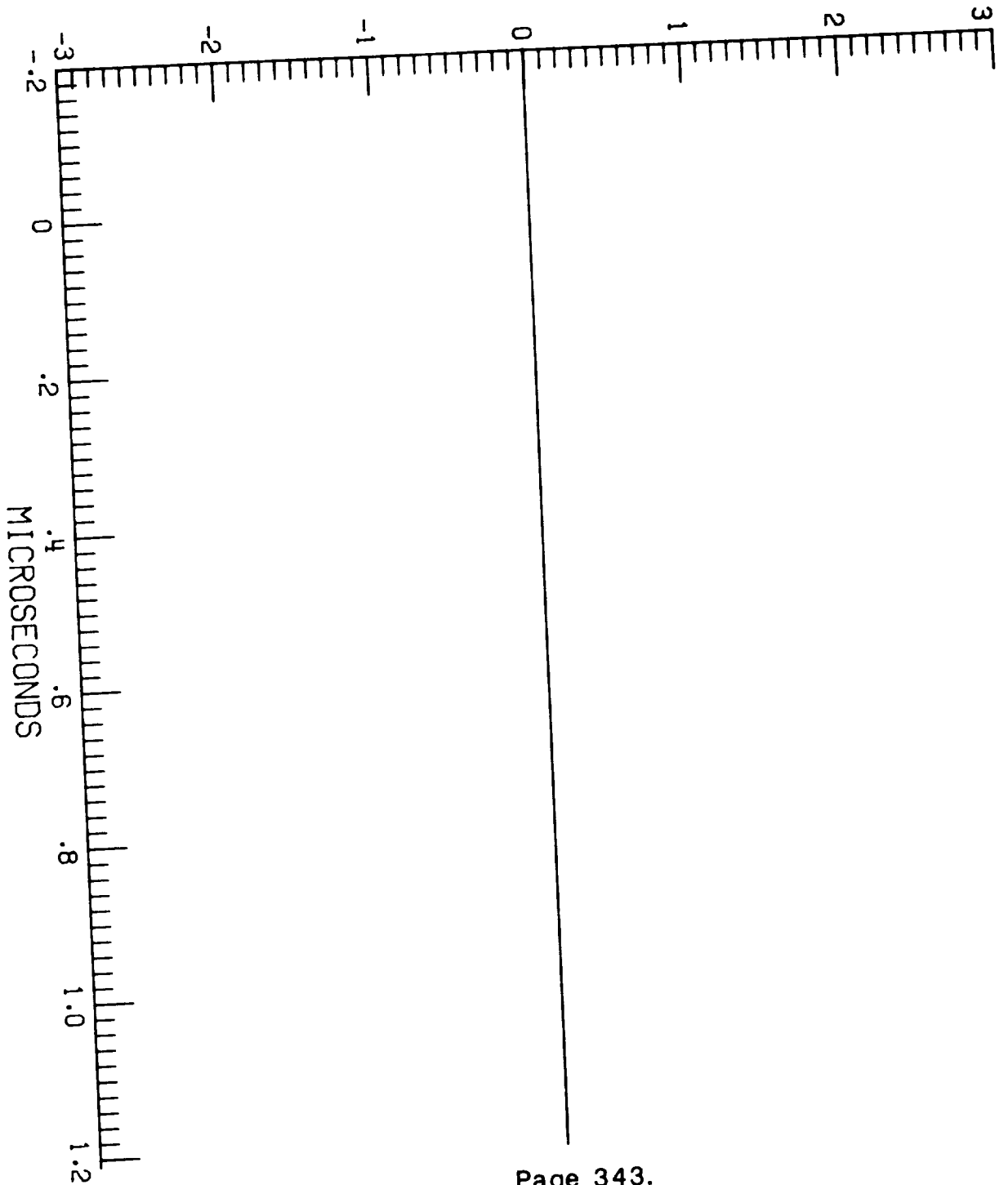

F106 LIGHTNING/85-029/ZAEPFEL

LEC 4 RUN NO. 4

N-002

TP125

A

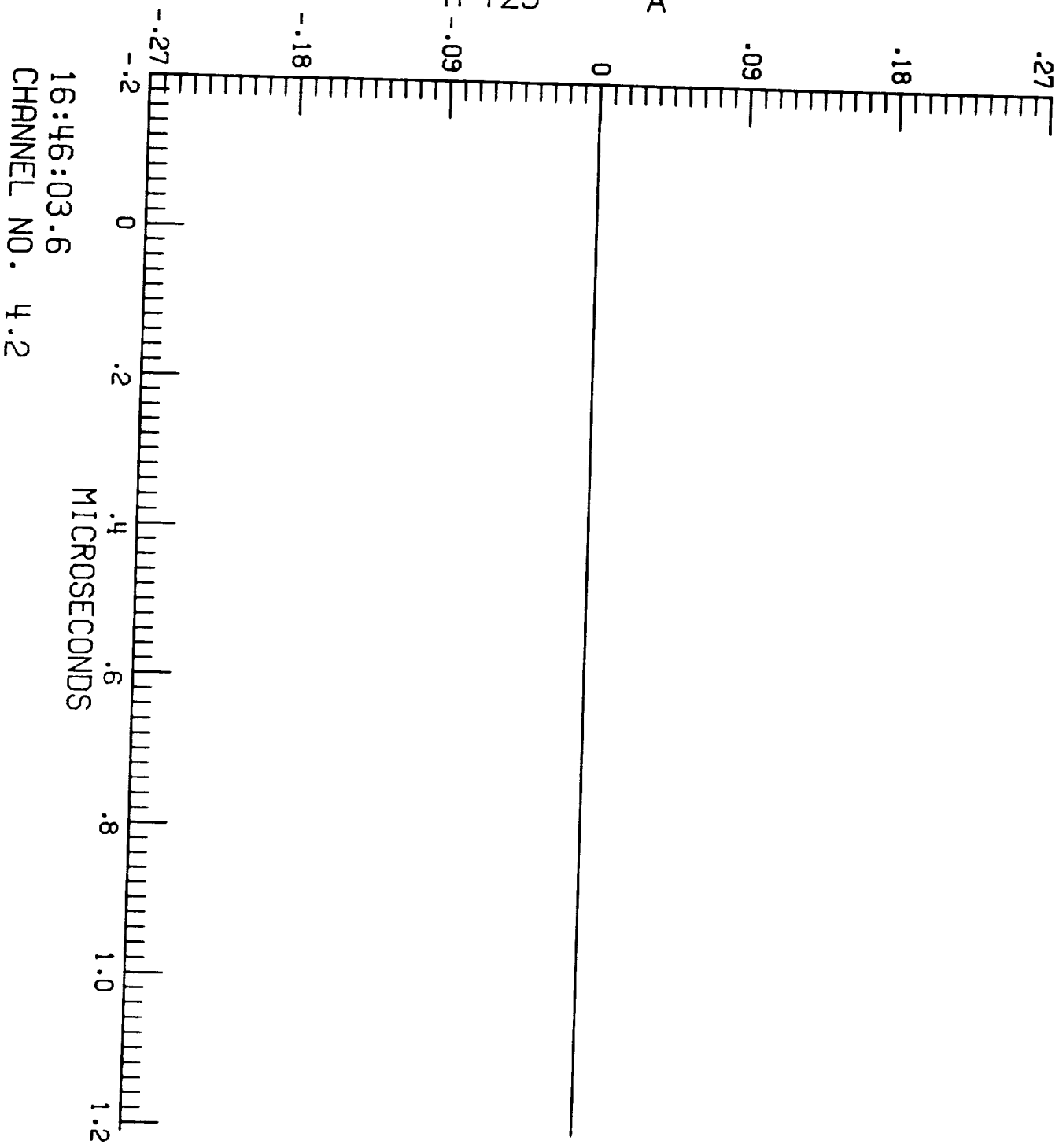

F106 LIGHTNING/85-029/ZAEPFEL

LEC 1 RUN NO. 5

S-003

$\dot{D}_t$  A/m<sup>2</sup>

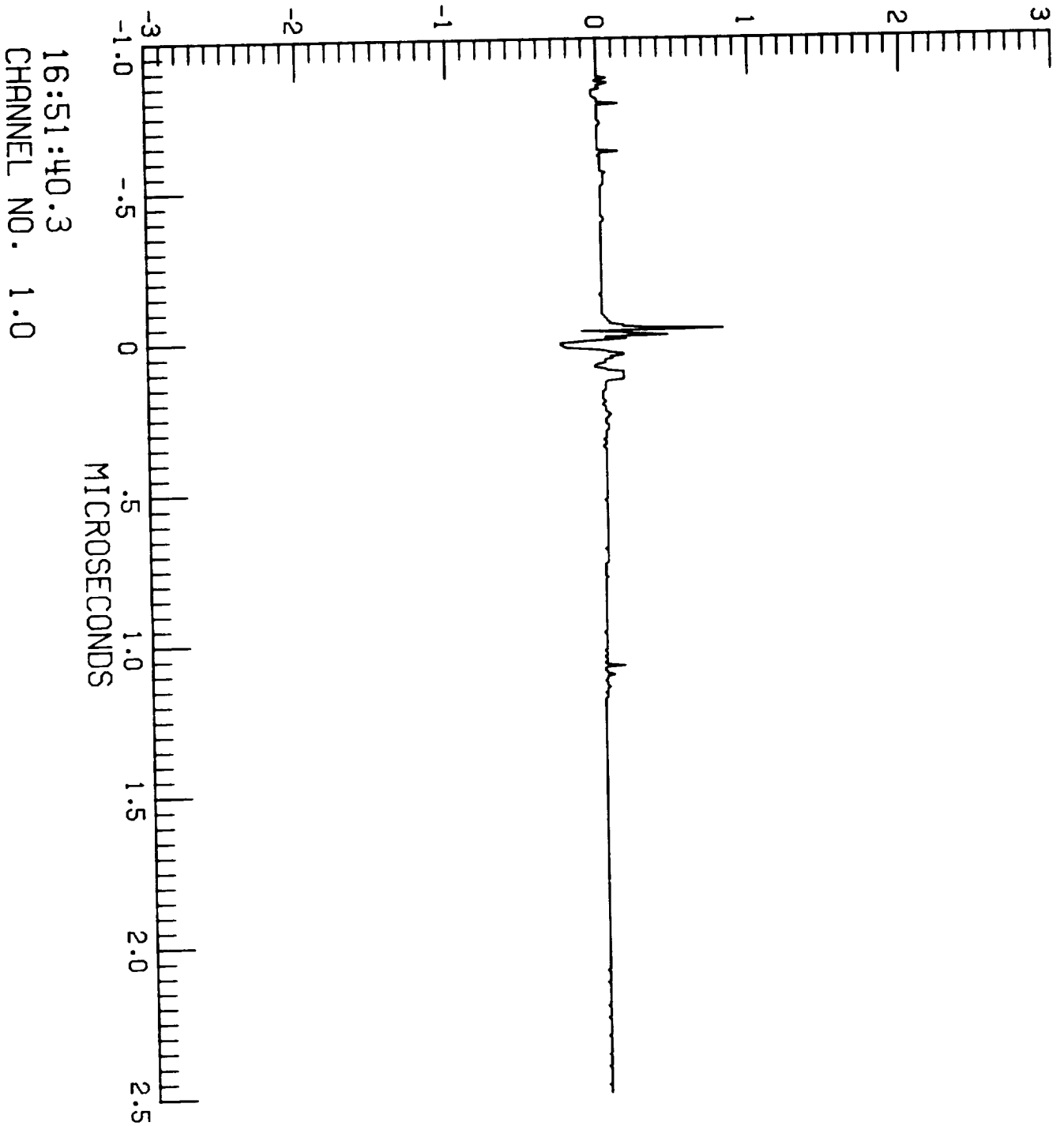

16:51:40.3  
CHANNEL NO. 1.0

F106 LIGHTNING/85-029/ZAEPFEL

LEC 1 RUN NO. 5

S-003

$I_t$  A

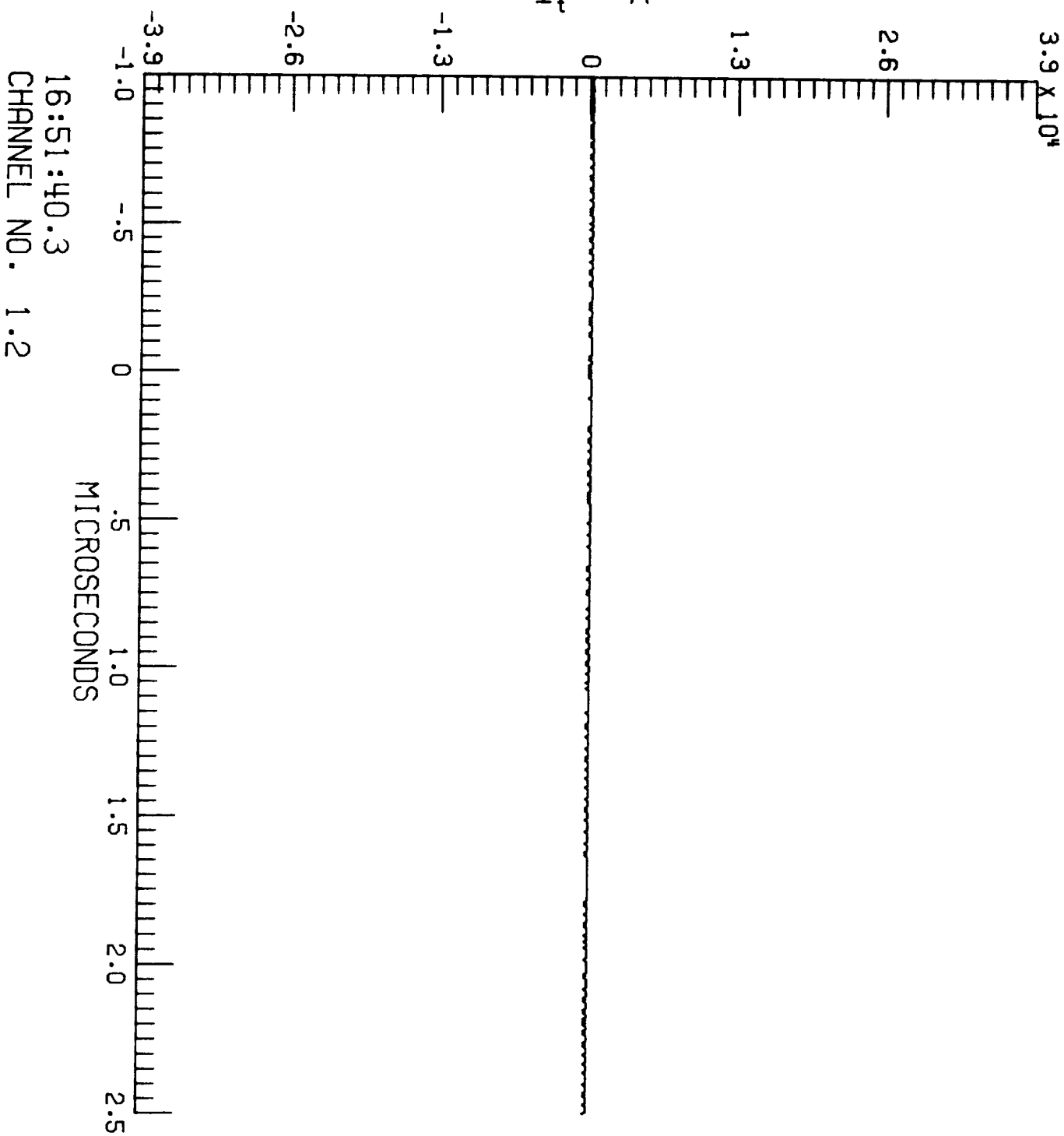

16:51:40.3  
CHANNEL NO. 1.2

F106 LIGHTNING/85-029/ZAEPFEL

LEC 2 RUN NO. 5

S-003

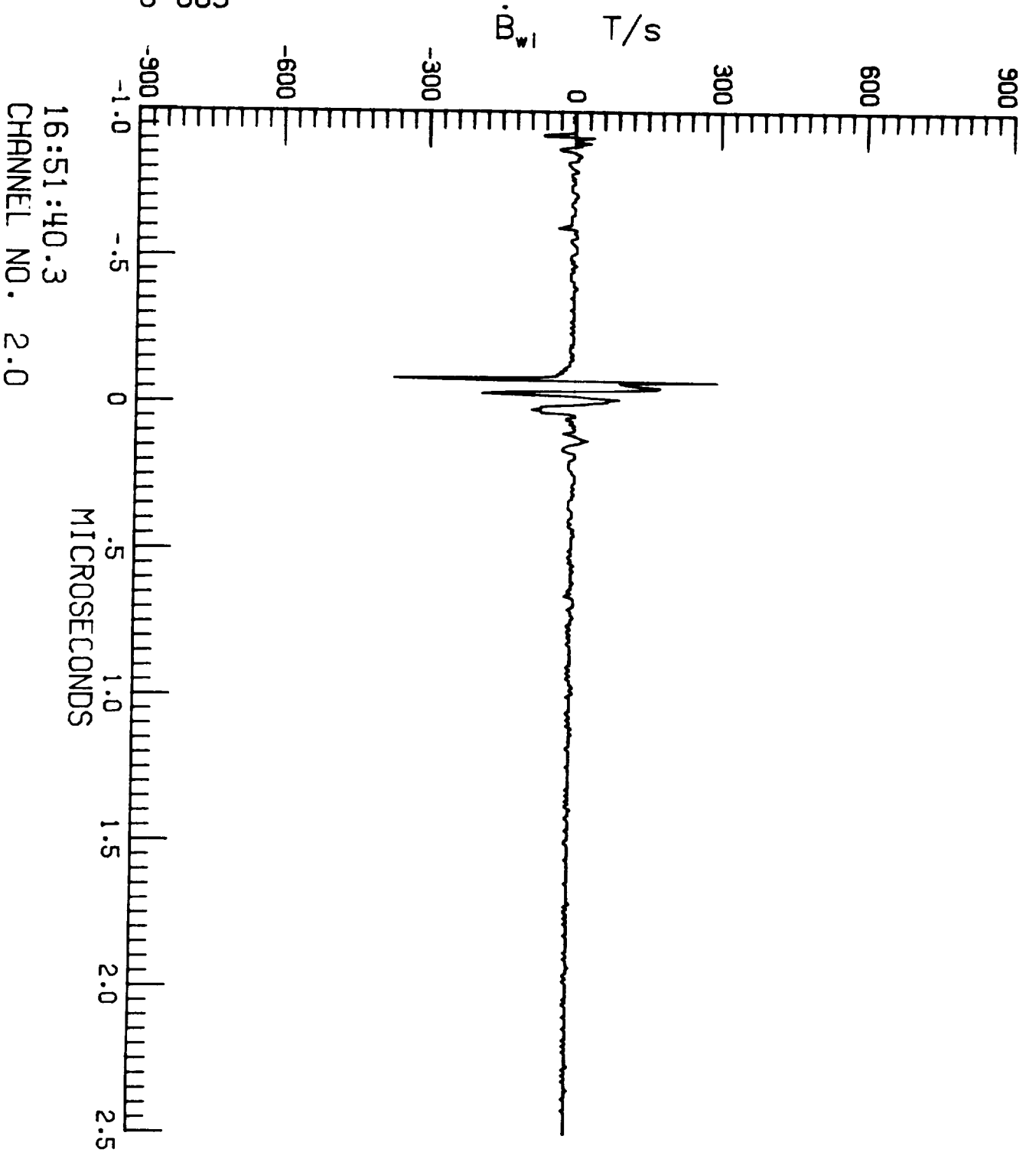

16:51:40.3  
CHANNEL NO. 2.0

F106 LIGHTNING/85-029/ZREPPEL  
LEC 2 RUN NO. 5  
S-003

$\dot{i}$  A/s

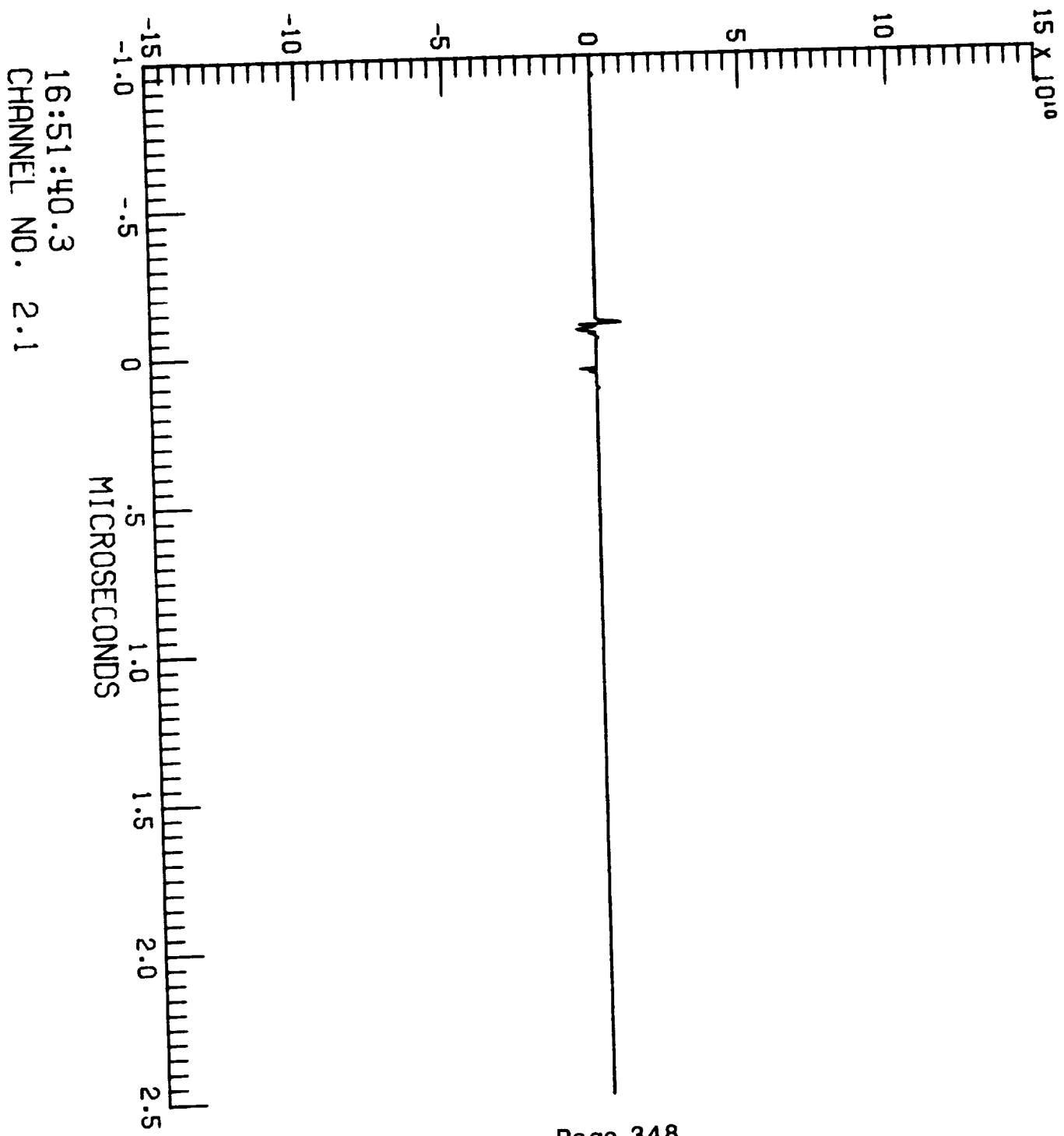

16:51:40.3  
CHANNEL NO. 2.1



F106 LIGHTNING/85-029/ZAEPFEL

LEC 2 RUN NO. 5

S-003

$\dot{B}_1$  T/s

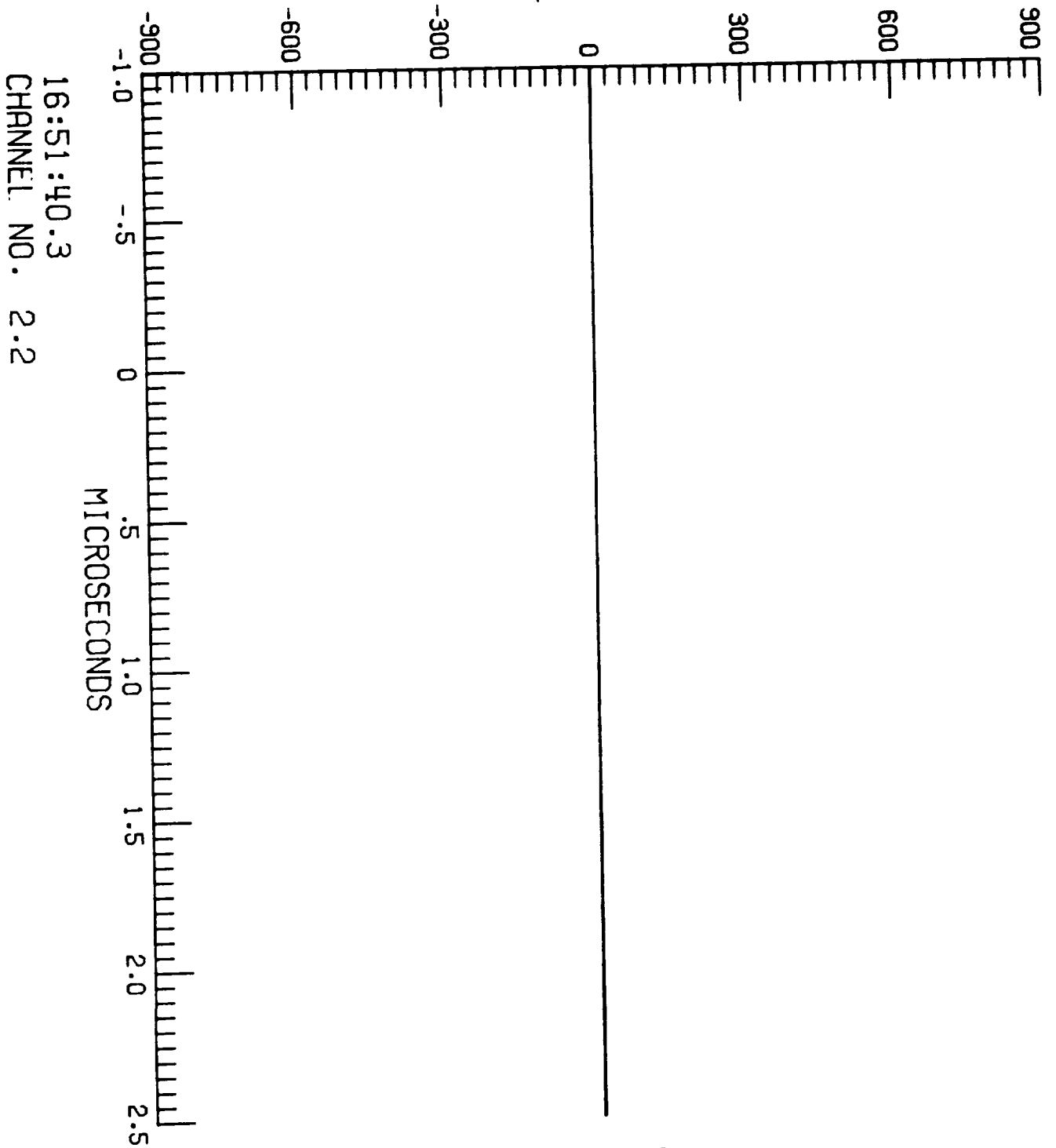

16:51:40.3  
CHANNEL NO. 2.2

F106 LIGHTNING/85-029/ZAEPFEL

LEC 3 RUN NO. 5

S-003

$\dot{D}_{wr}$  A/m<sup>2</sup>

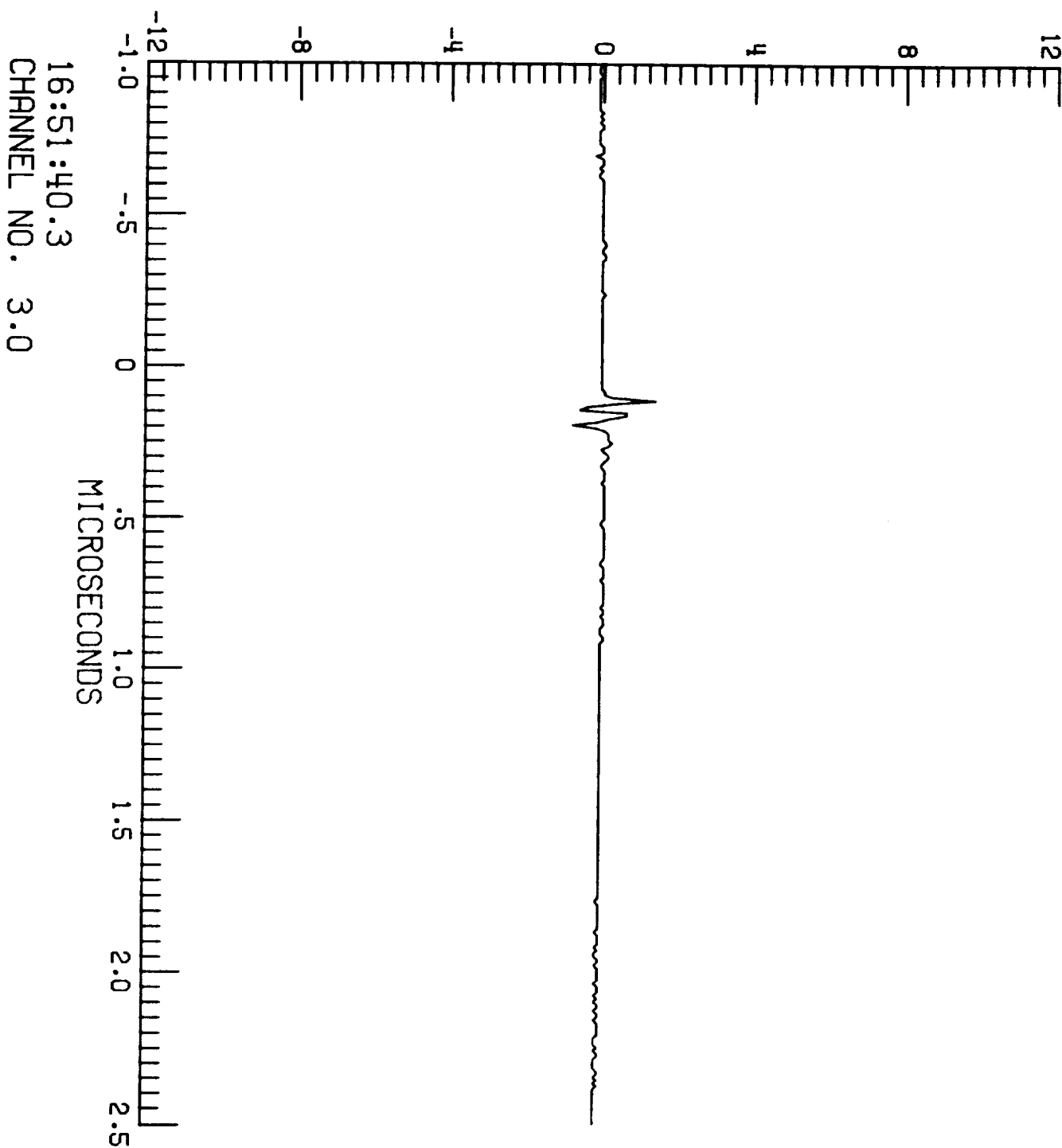

F106 LIGHTNING/85-029/ZAEPFEL

LEC 3 RUN NO. 5

S-003

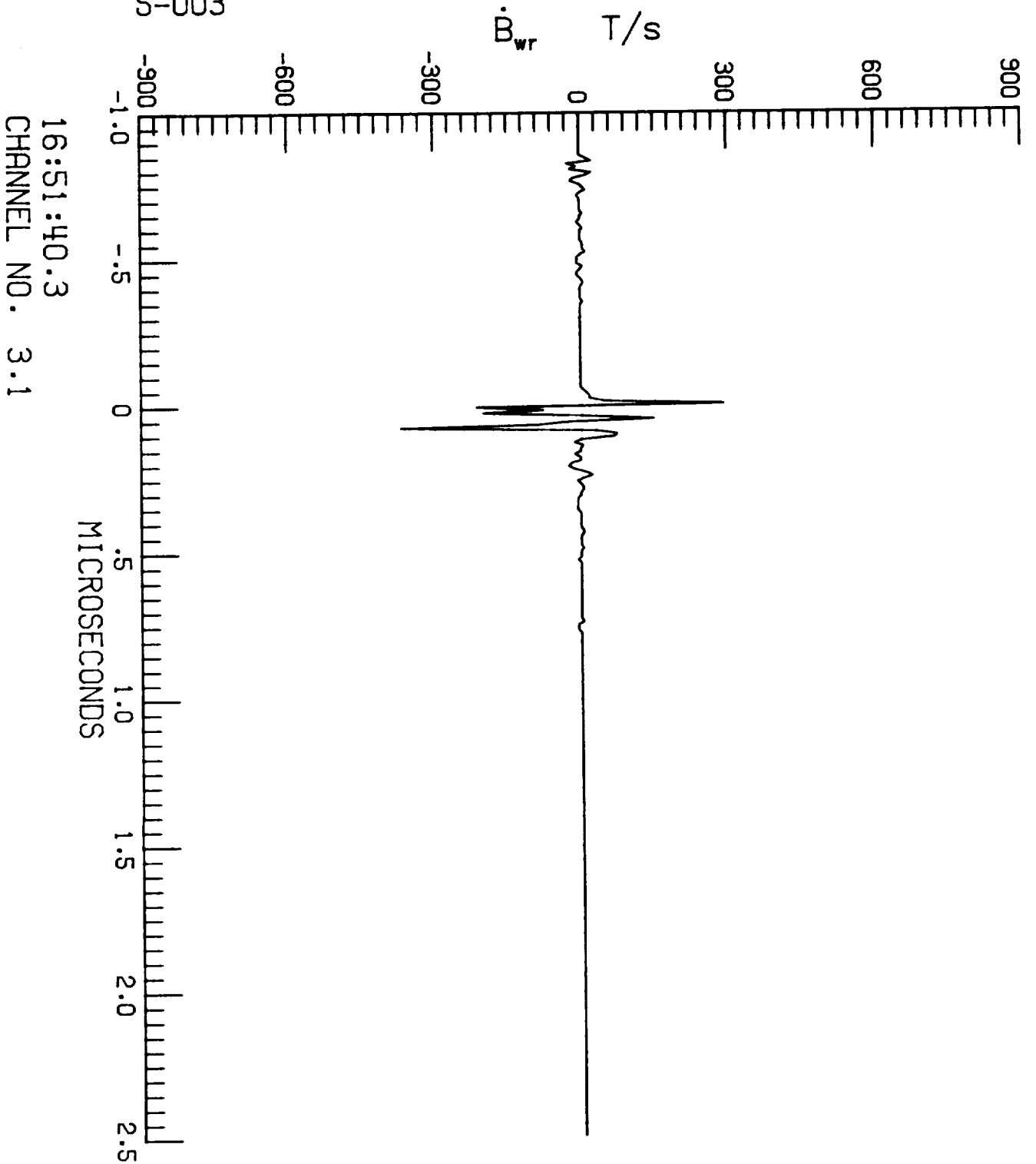

16:51:40.3  
CHANNEL NO. 3.1

F106 LIGHTNING/85-029/ZAEPFEL

LEC 3 RUN NO. 5

S-003

$\dot{D}_f$  A/m<sup>2</sup>

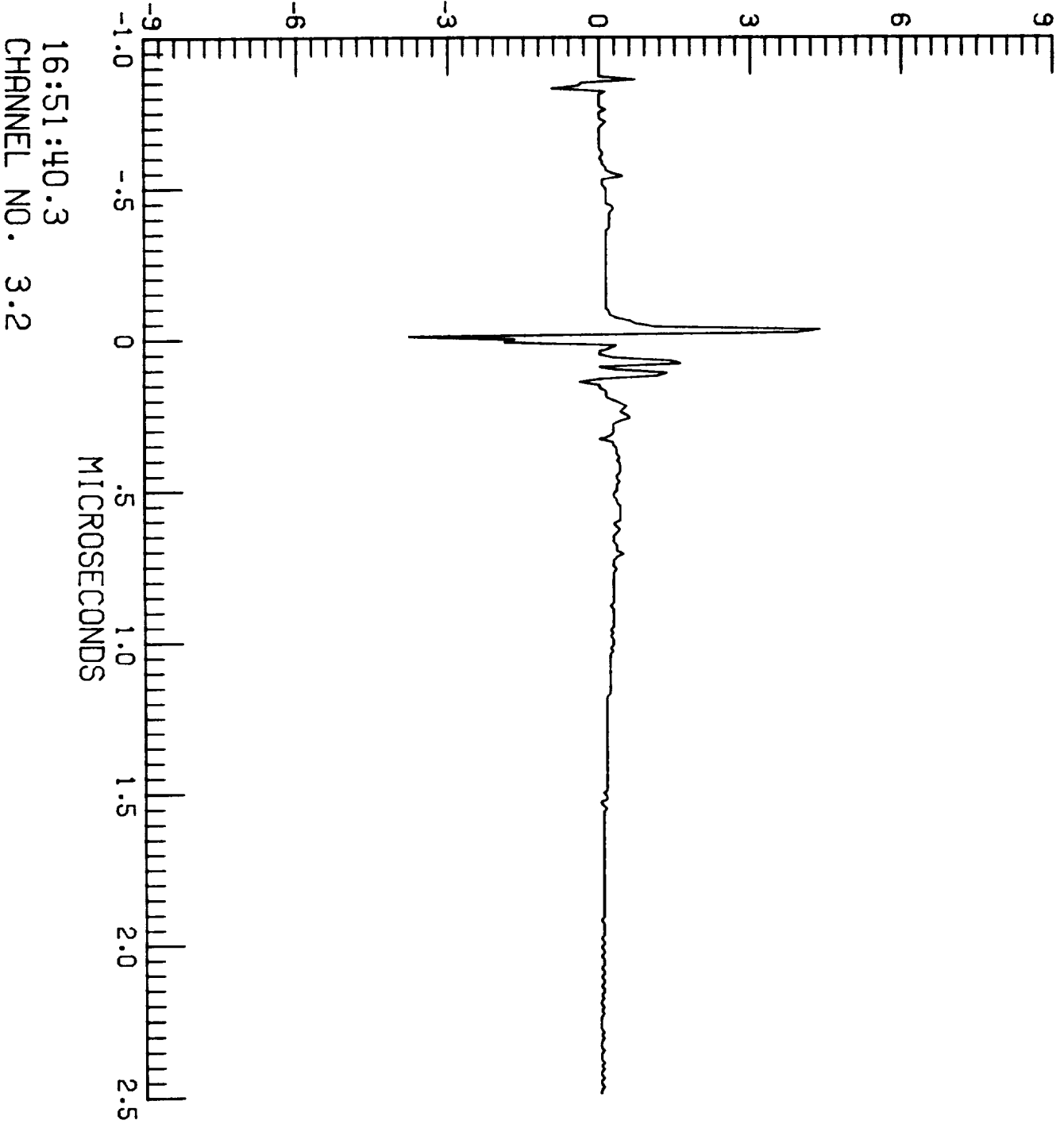

F106 LIGHTNING/85-029/ZAEPFEL  
LEC 4 RUN NO. 5  
S-003

TP100 V

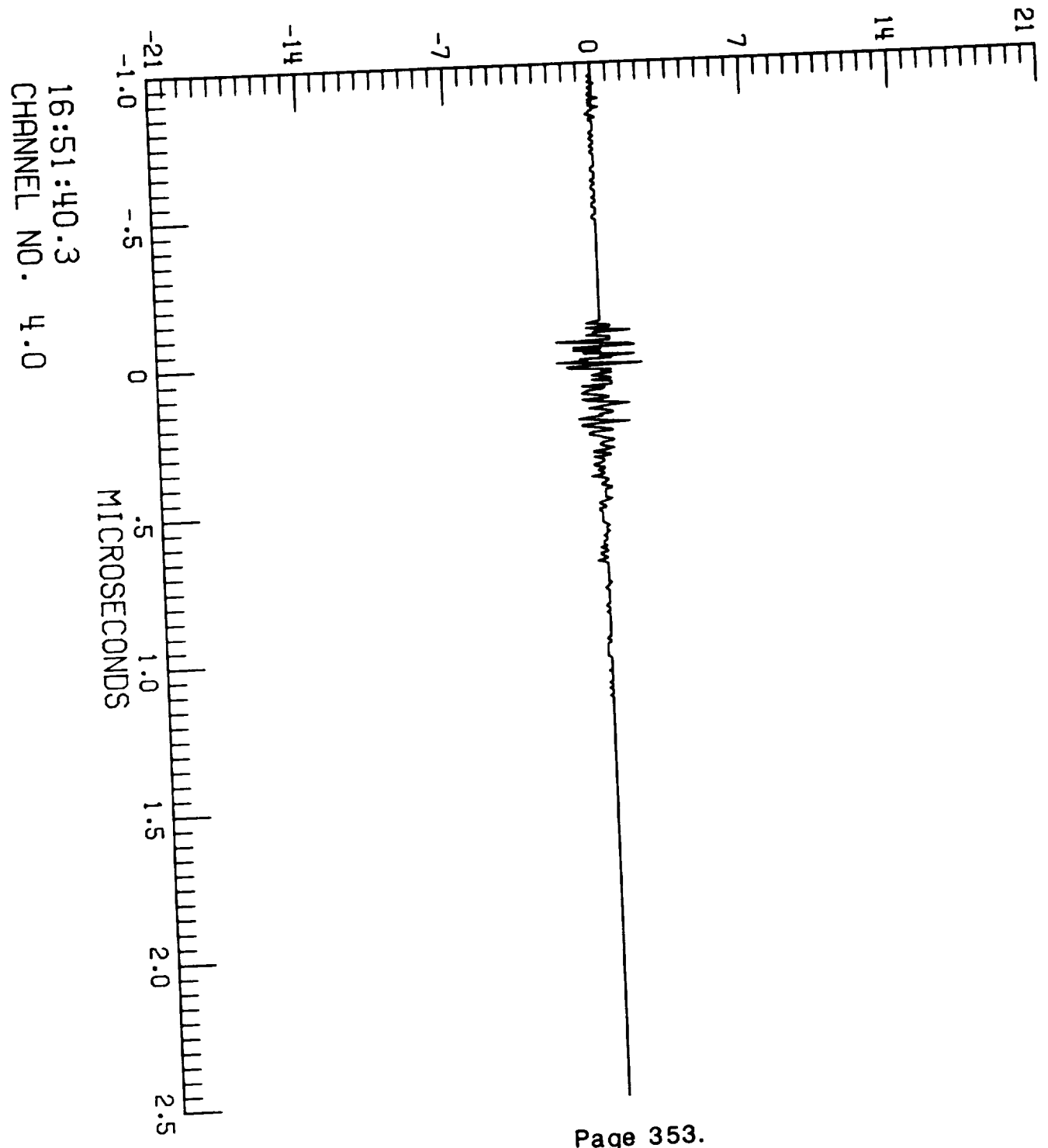

F106 LIGHTNING/85-029/ZAEPFEL  
LEC 4 RUN NO. 5  
S-003

TP106 A

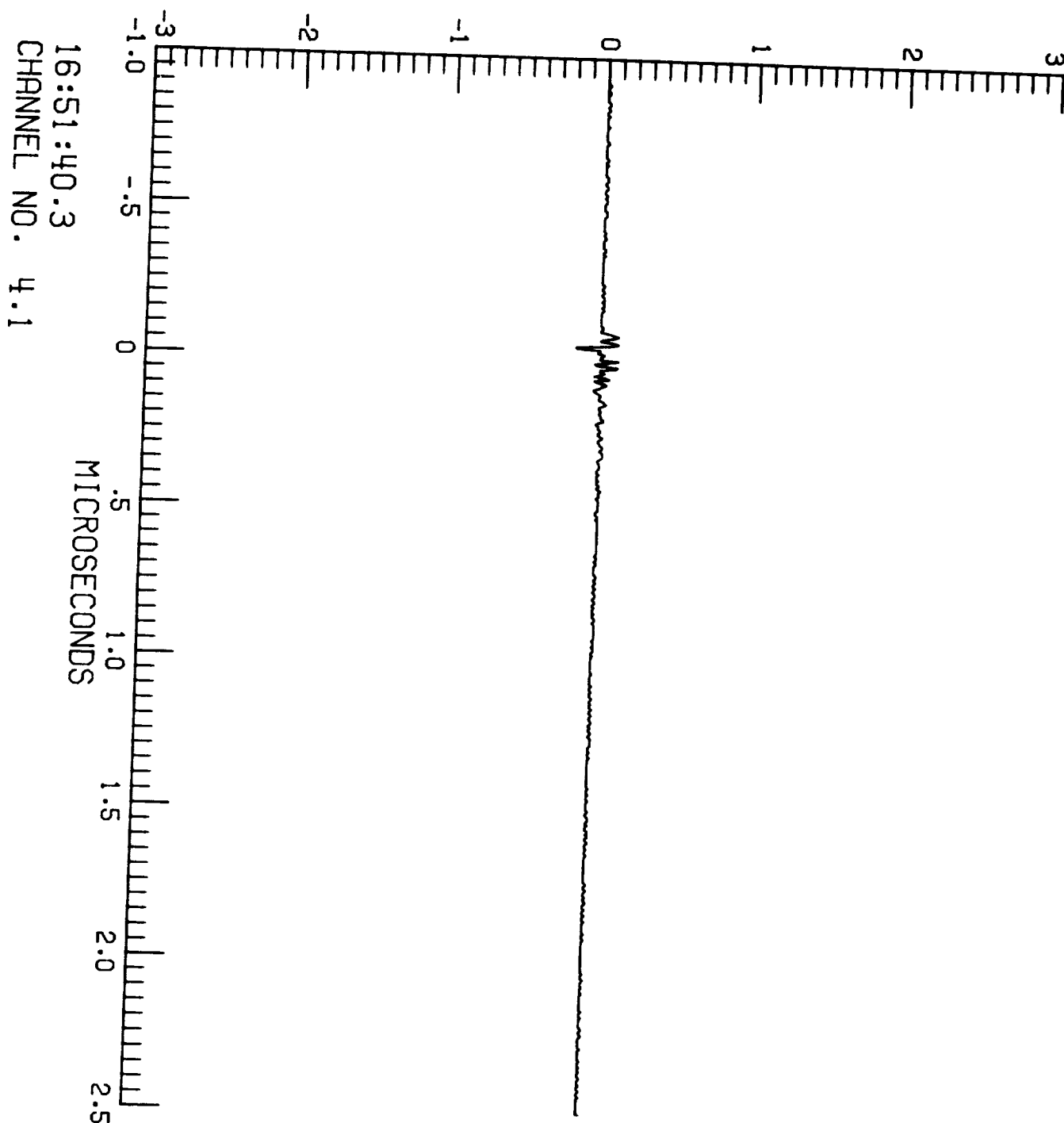

F106 LIGHTNING/85-029/ZAEPFEL

LEC 4 RUN NO. 5

S-003

TP125

A

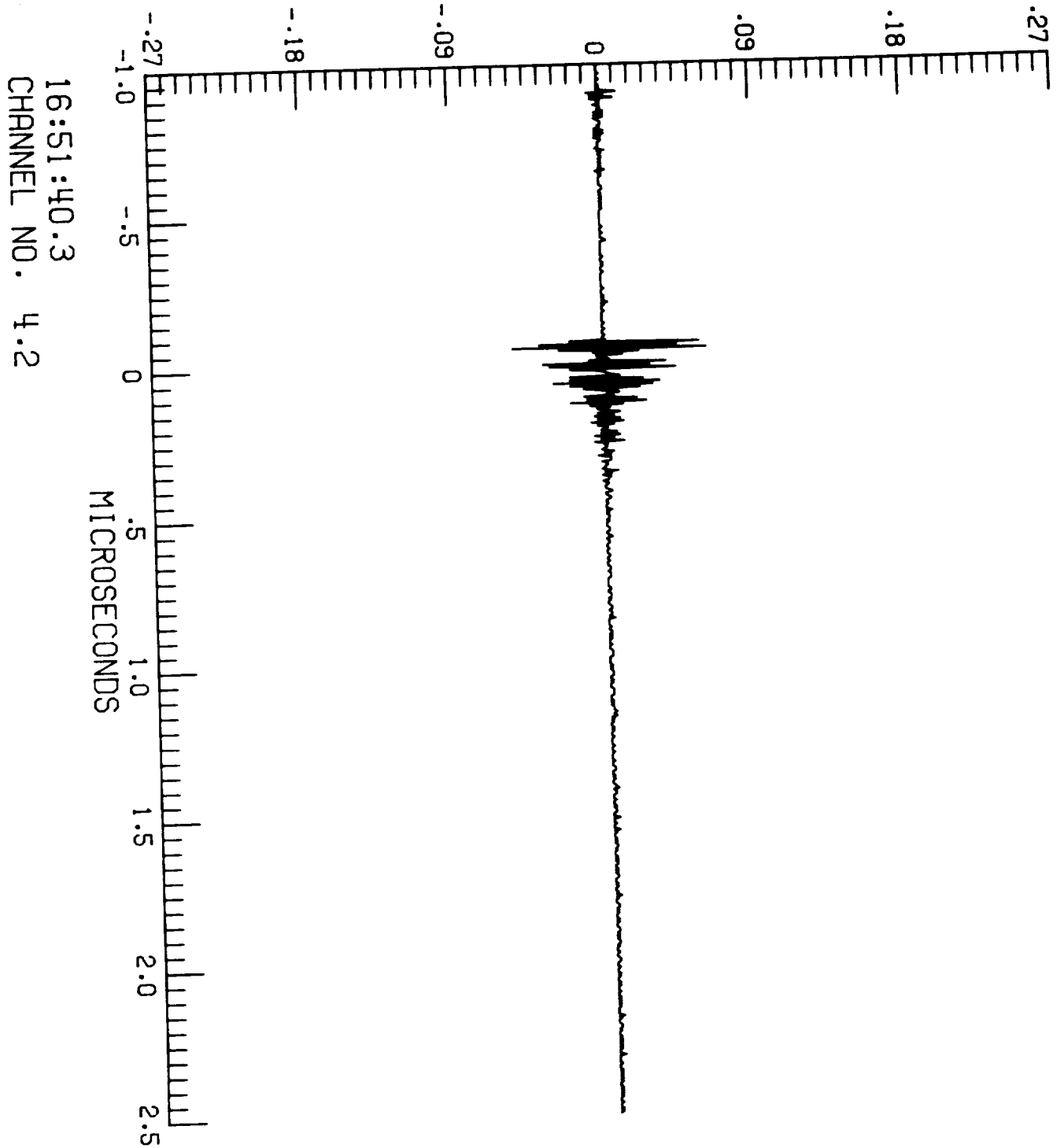

16:51:40.3  
CHANNEL NO. 4.2

F106 LIGHTNING/85-029/ZAEPFEL  
LEC 4 RUN NO. 5  
S-003

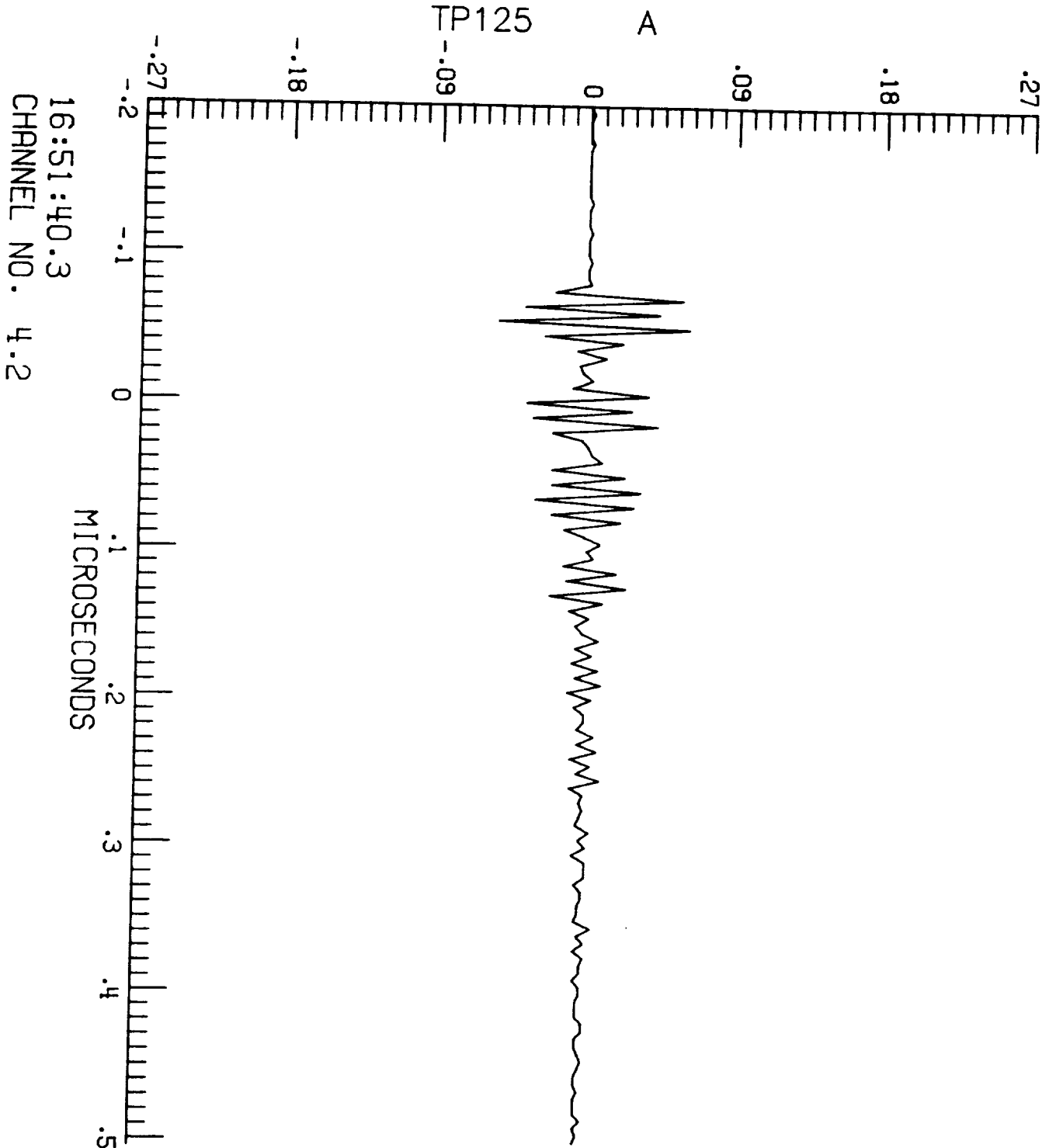



F106 LIGHTNING/85-029/ZAEPFEL  
LEC 1 RUN NO. 6  
S-005

$\dot{D}_t$  A/m<sup>2</sup>

16:54:23.1  
CHANNEL NO. 1.0

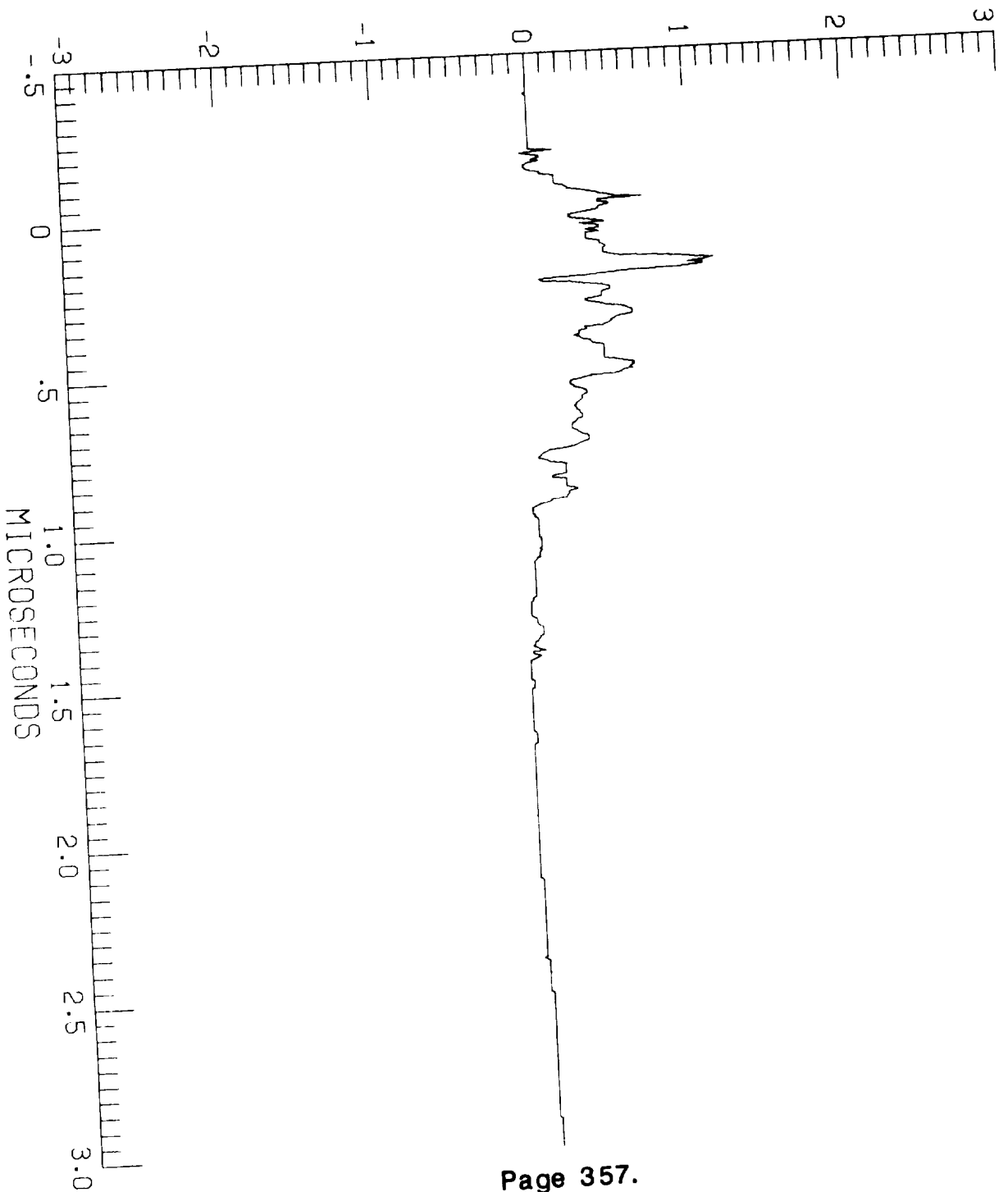

F106 LIGHTNING/85-029/ZAEPFEL  
LEC 1 RUN NO. 6  
S-005

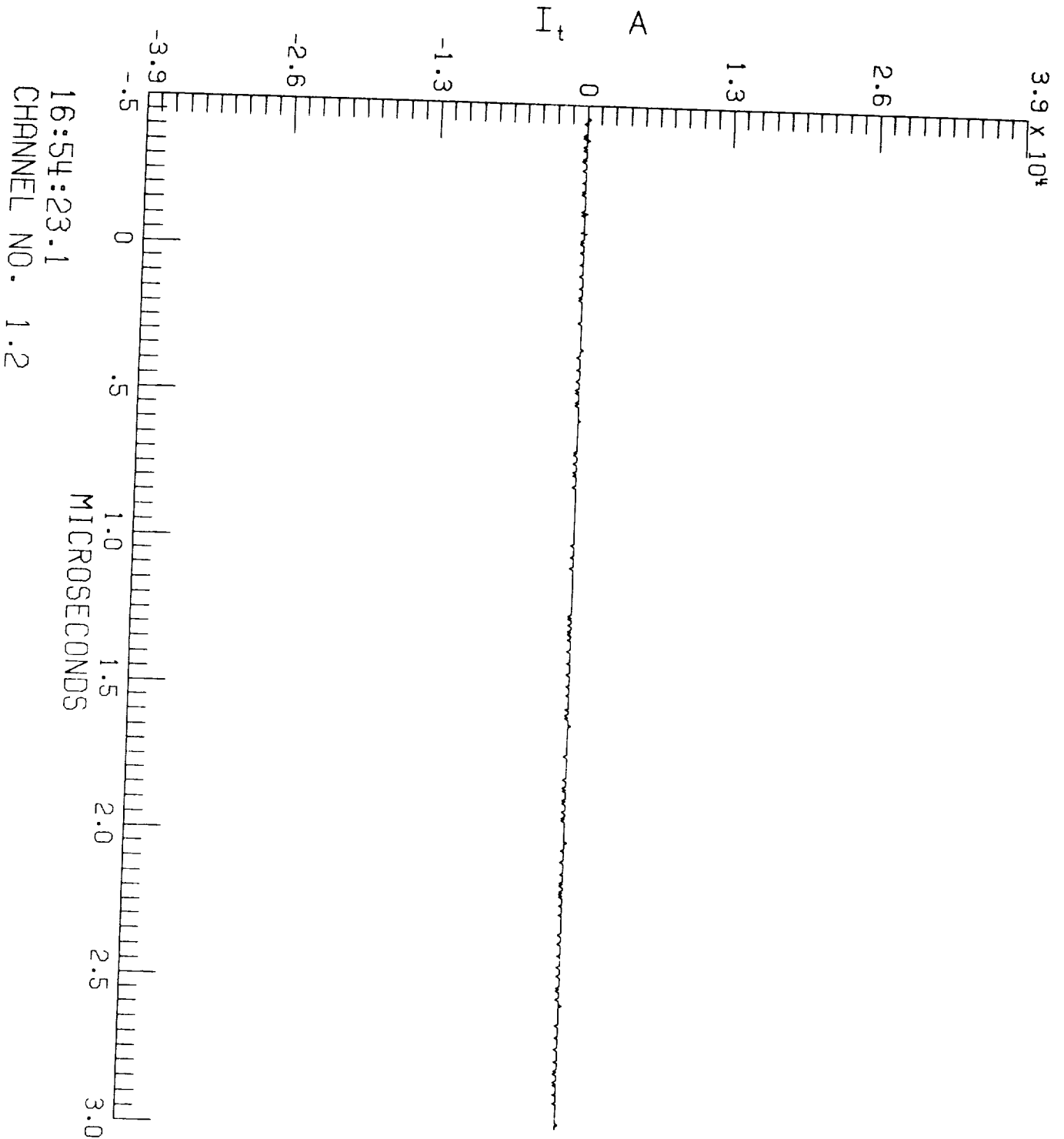

16:54:23.1  
CHANNEL NO. 1.2

F106 LIGHTNING/85-029/ZAEPFEL  
LEC 2 RUN NO. 6  
S-005

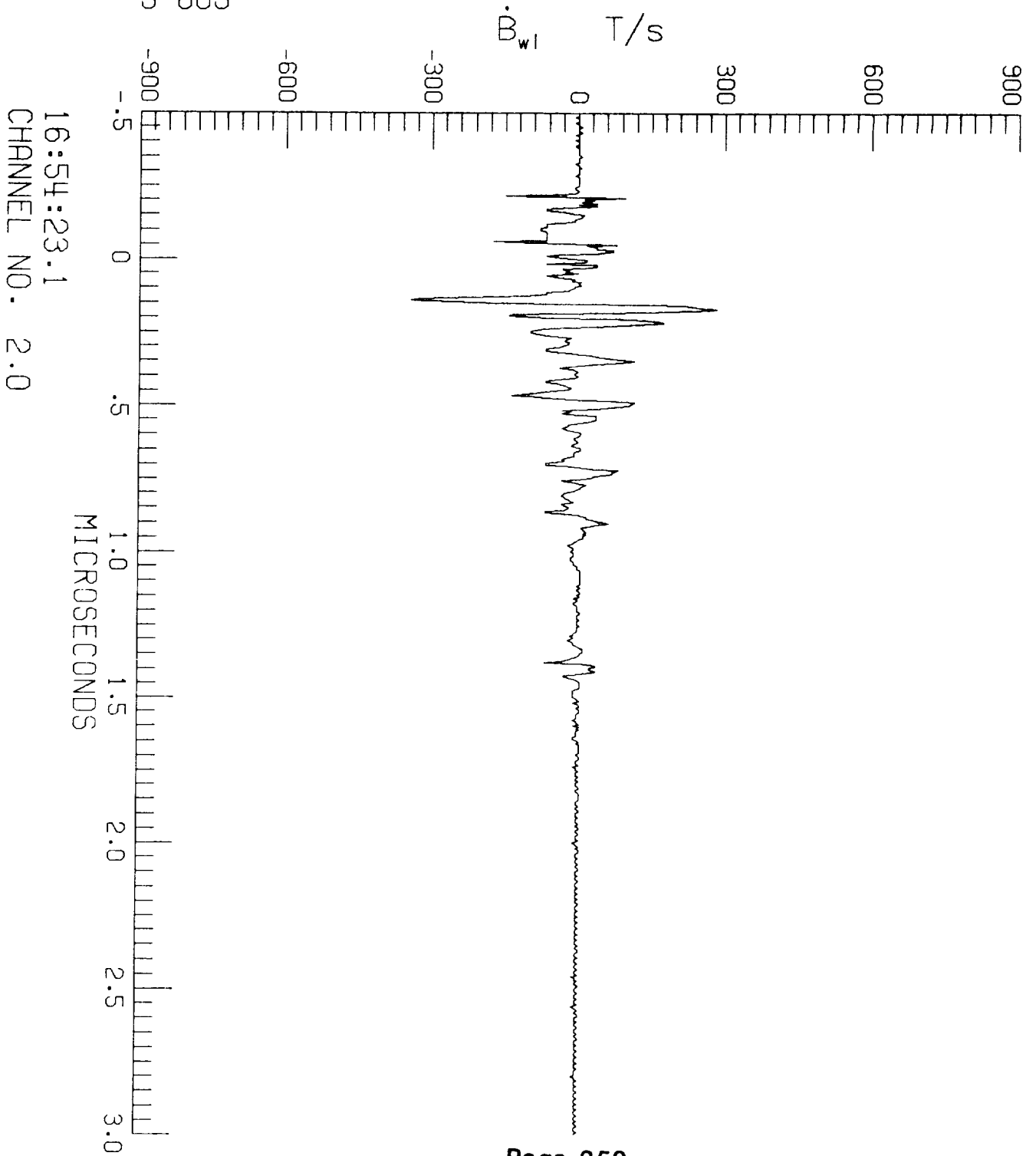

16:54:23.1  
CHANNEL NO. 2.0

F106 LIGHTNING/85-029/ZAEPFEL

LEC 2 RUN NO. 6

S-005

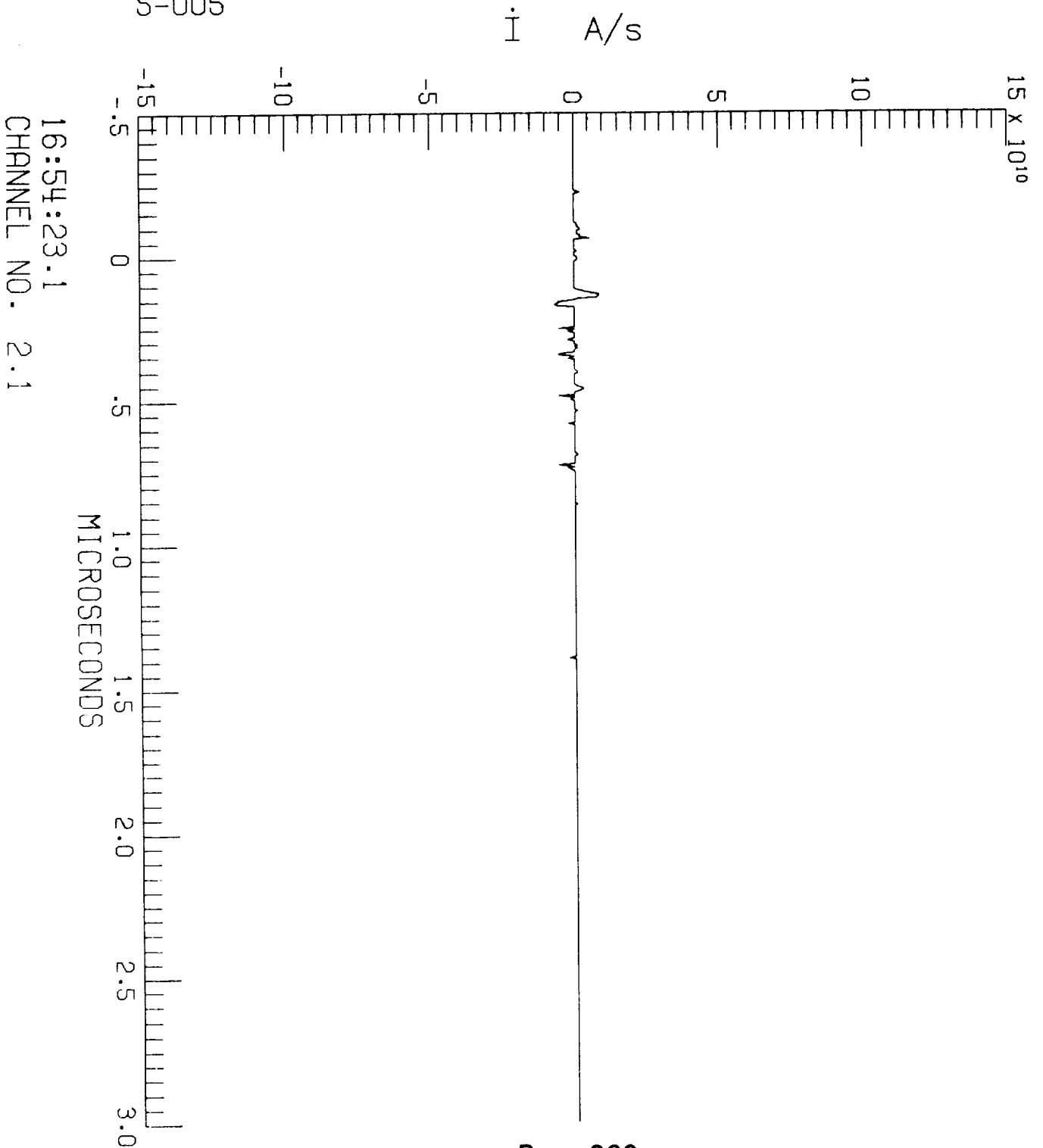

F106 LIGHTNING/85-029/ZAEPFEL  
LEC 2 RUN NO. 6  
S-005

16:54:23.1  
CHANNEL NO. 2.2

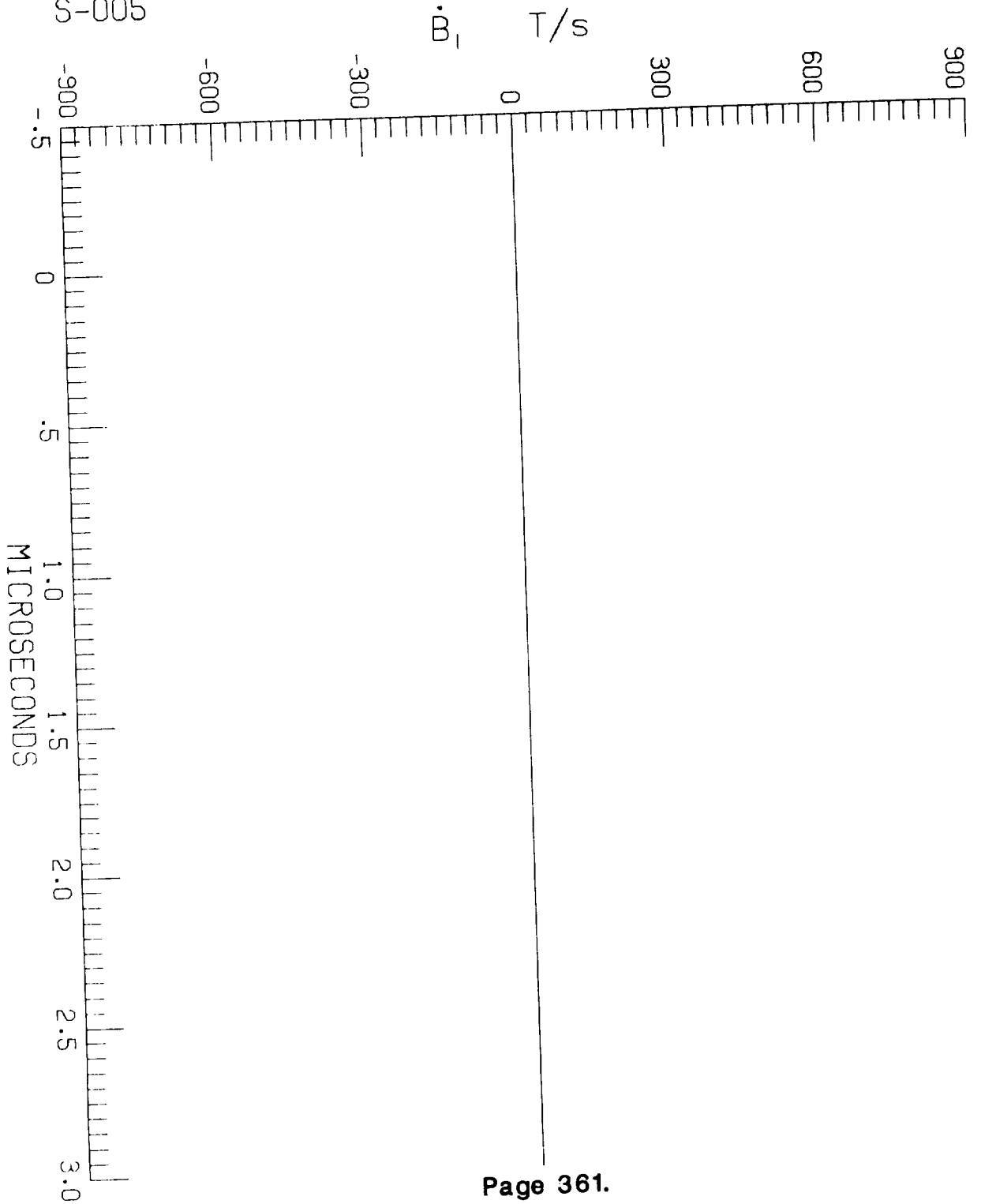

F106 LIGHTNING/85-029/ZAEPFEL  
LEC 3 RUN NO. 6  
S-005

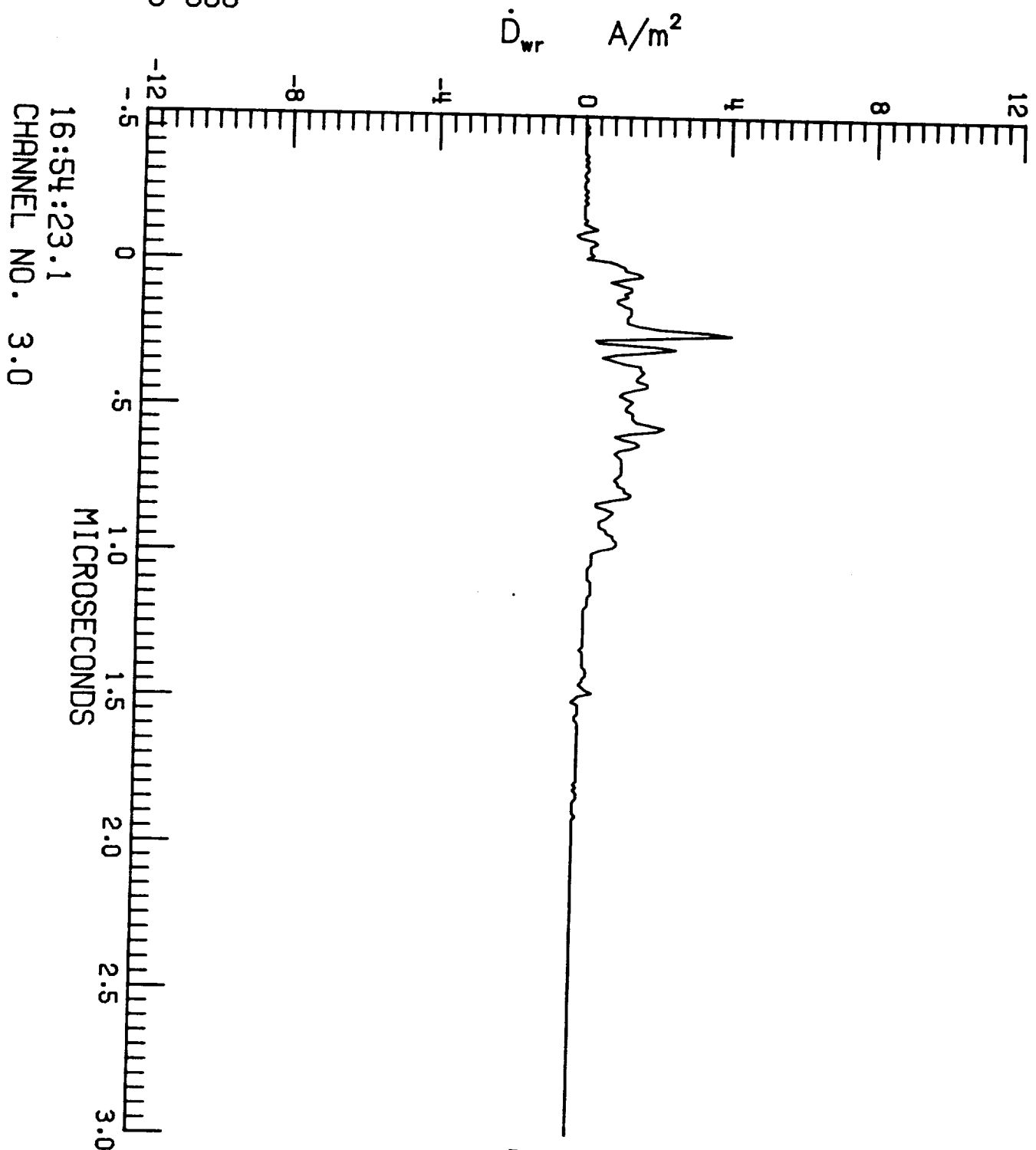

16:54:23.1  
CHANNEL NO. 3.0

F106 LIGHTNING/85-029/ZAEPFEL  
LEC 3 RUN NO. 6  
S-005

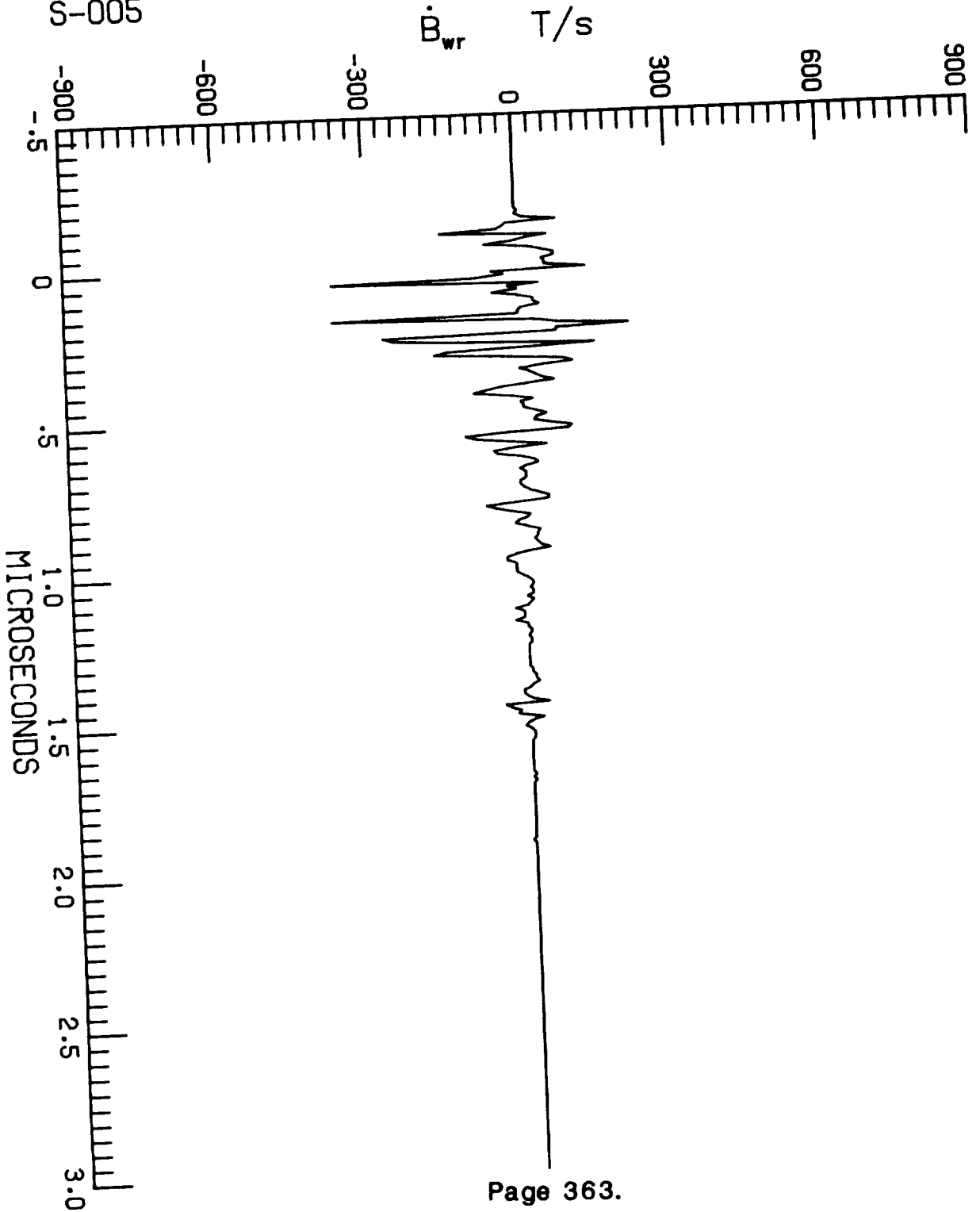

16:54:23.1  
CHANNEL NO. 3.1

F106 LIGHTNING/85-029/ZAEPFEL  
LEC 3 RUN NO. 6  
S-005

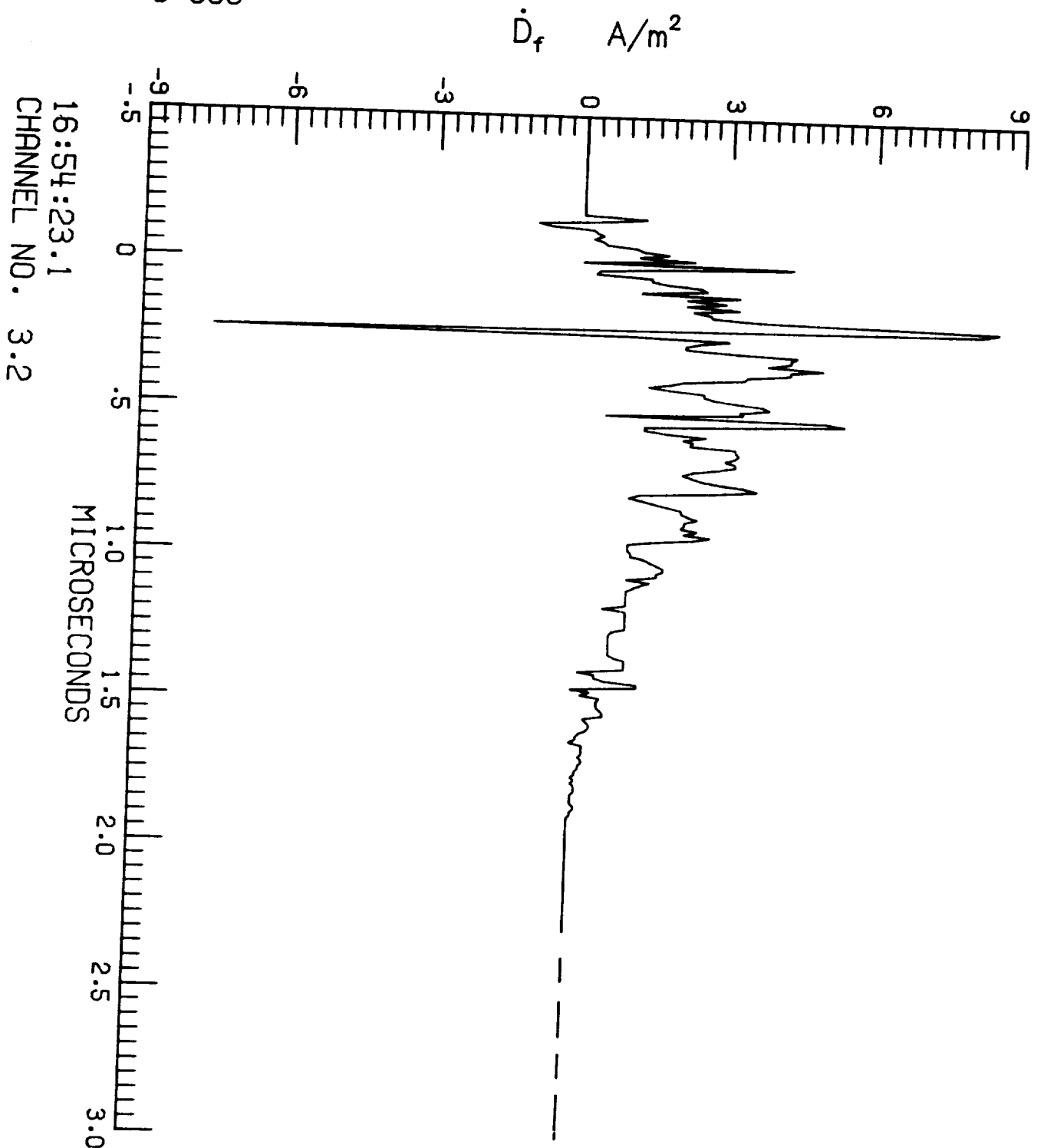



F106 LIGHTNING/85-029/ZAEPFEL

LEC 4 RUN NO. 6

S-005

TP100

V

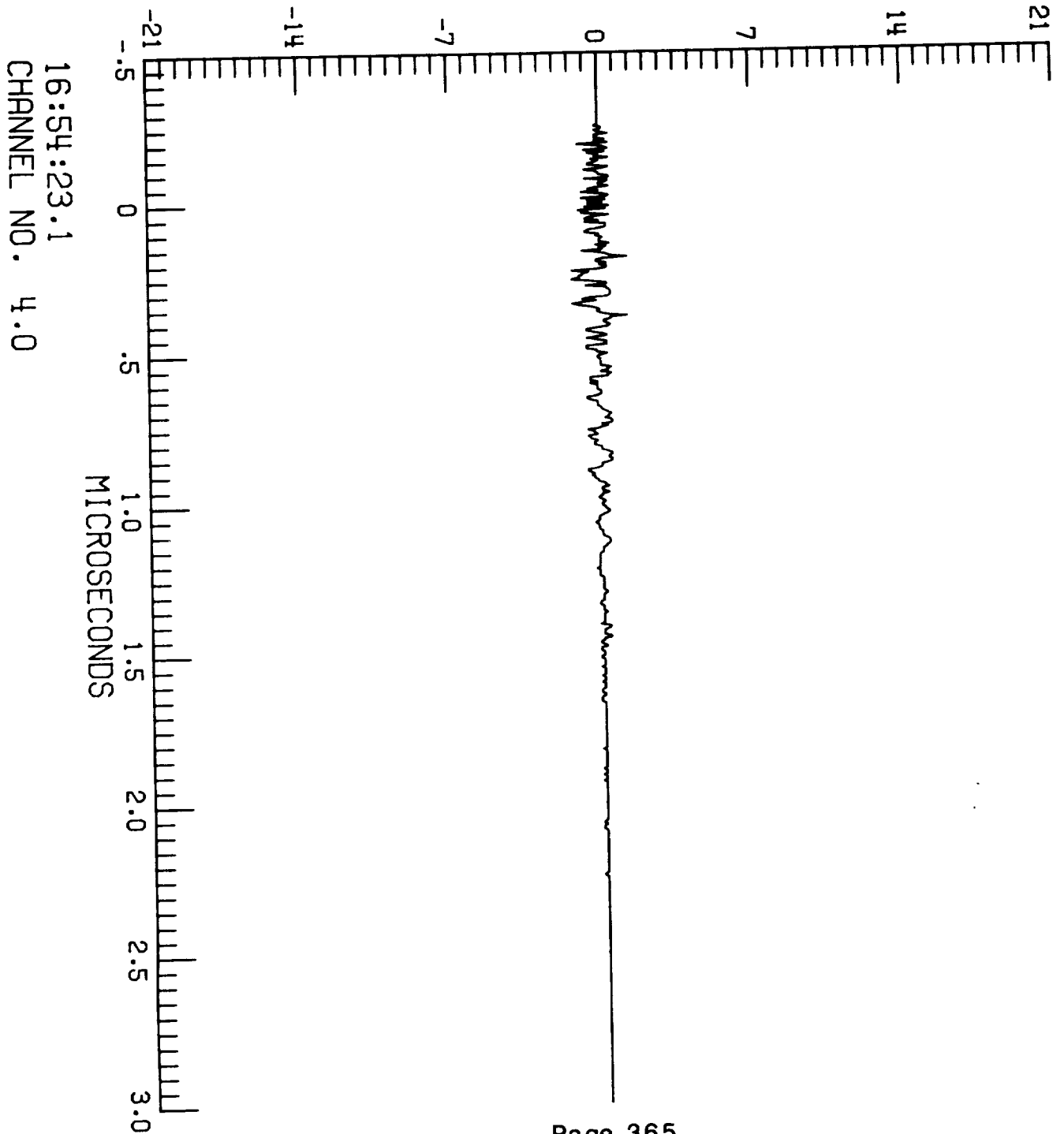

F106 LIGHTNING/85-029/ZAEPFEL  
LEC 4 RUN NO. 6  
S-005

TP106 A

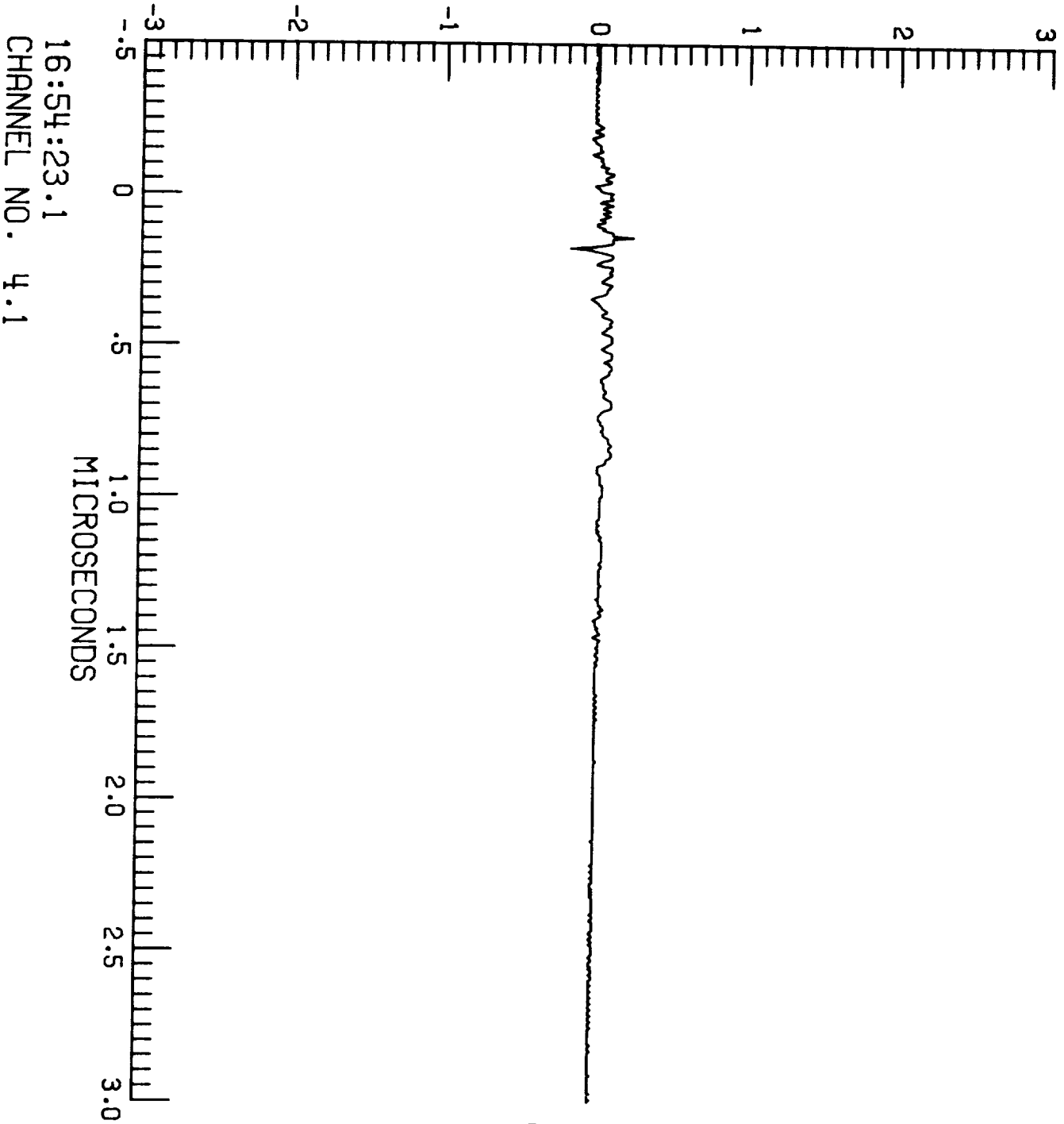

F106 LIGHTNING/85-029/ZAEPFEL

LEC 4 RUN NO. 6

S-005

TP125

A

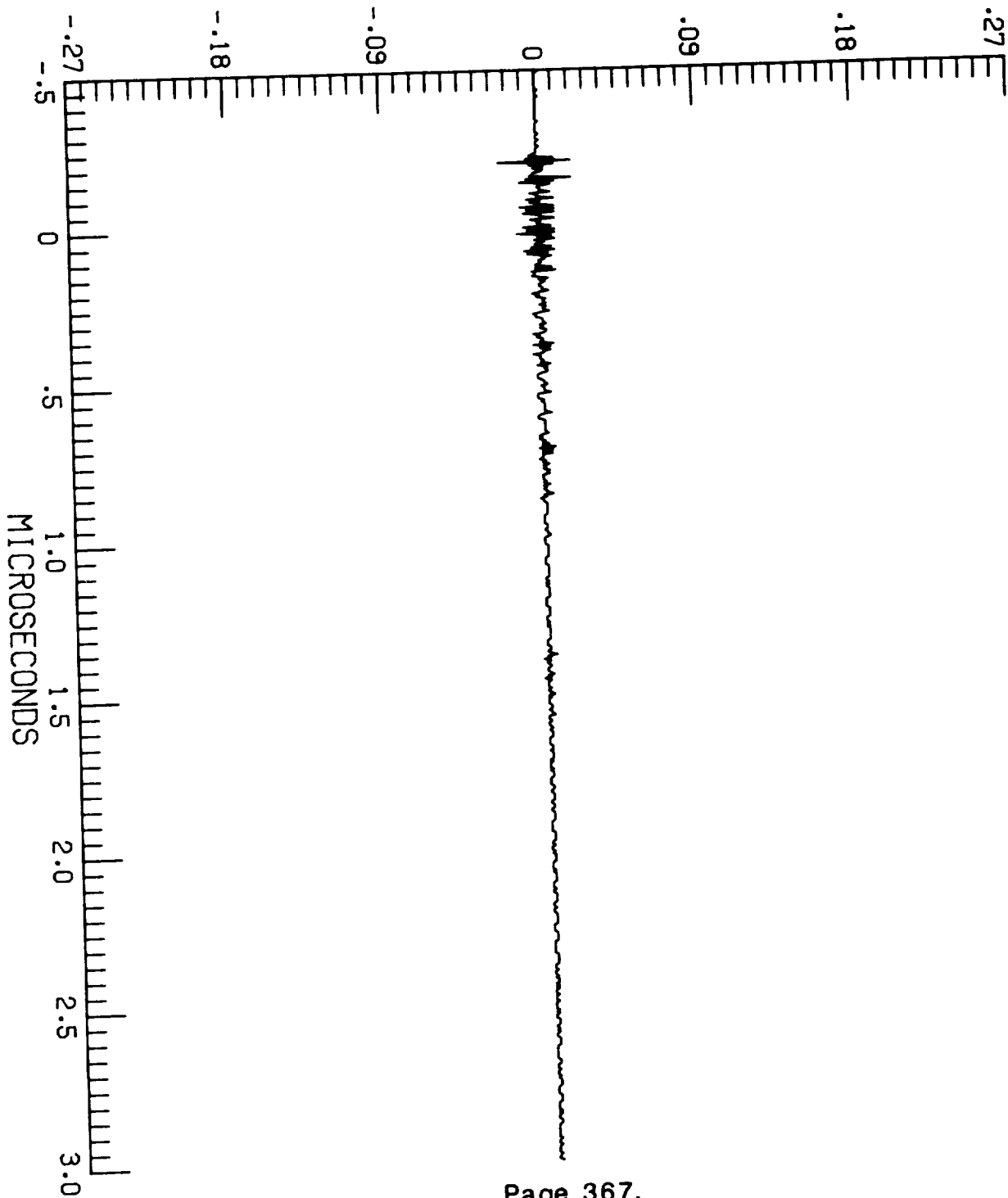

16:54:23.1  
CHANNEL NO. 4.2

F106 LIGHTNING/85-029/ZAEPFEL  
LEC 4 RUN NO. 6  
S-005

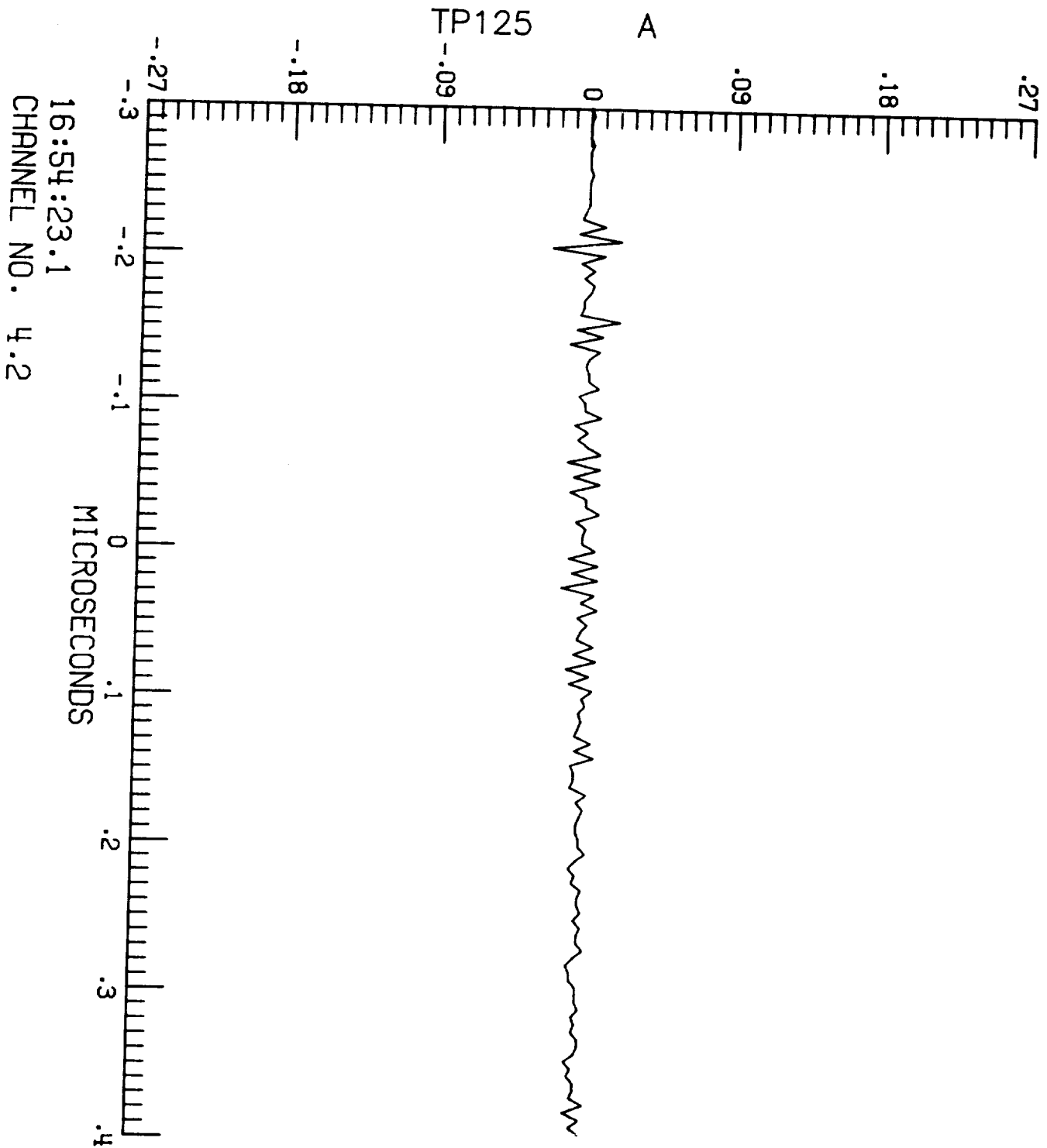

F106 LIGHTNING/85-029/ZAEPFEL

LEC 1 RUN NO. 8

S-006

$\dot{D}_t$  A/m<sup>2</sup>

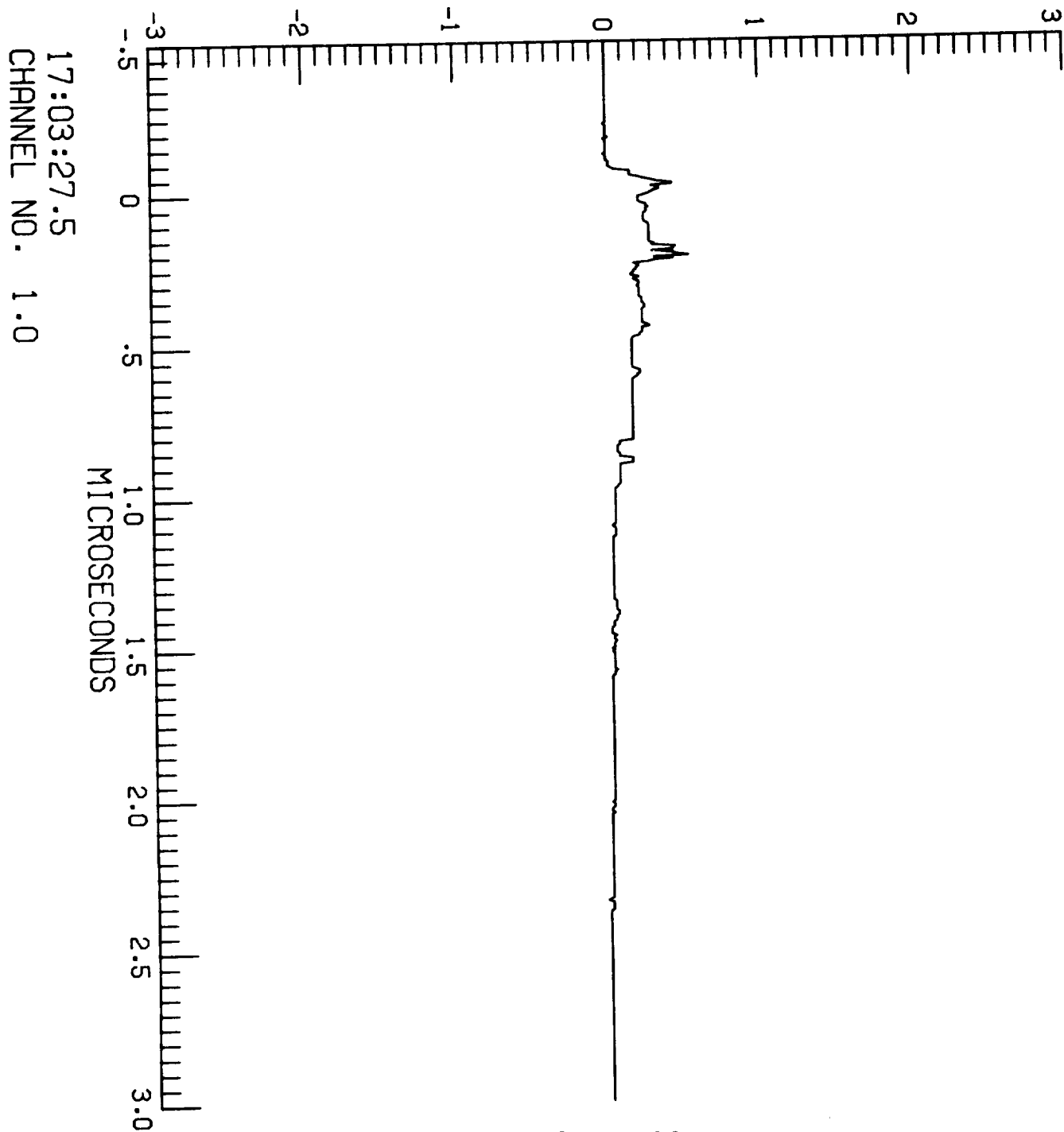

F106 LIGHTNING/85-029/ZAEPFEL  
LEC 1 RUN NO. 8  
S-006

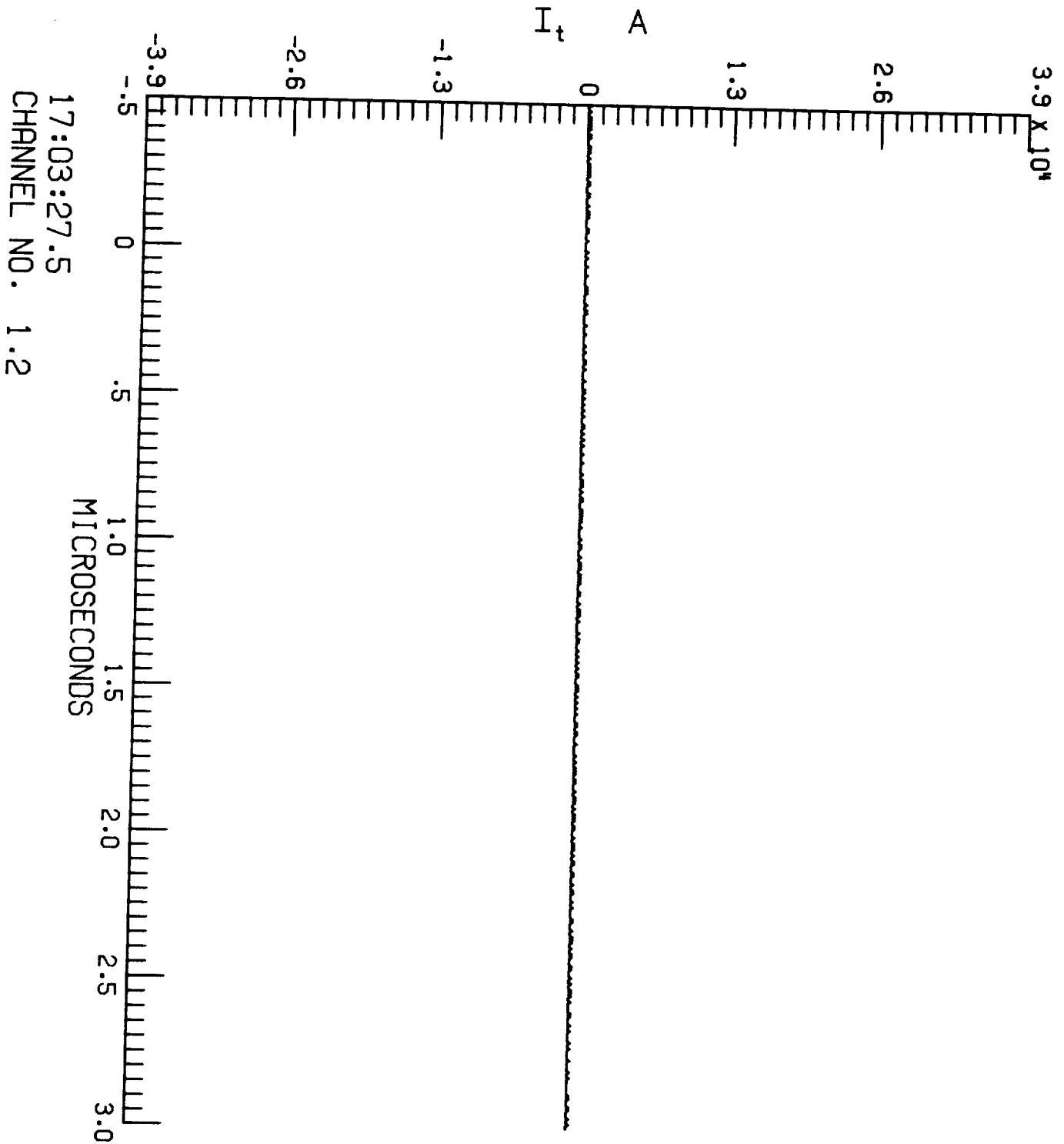

17:03:27.5  
CHANNEL NO. 1.2

F106 LIGHTNING/85-029/ZAEPFEL  
LEC 2 RUN NO. 8  
S-006

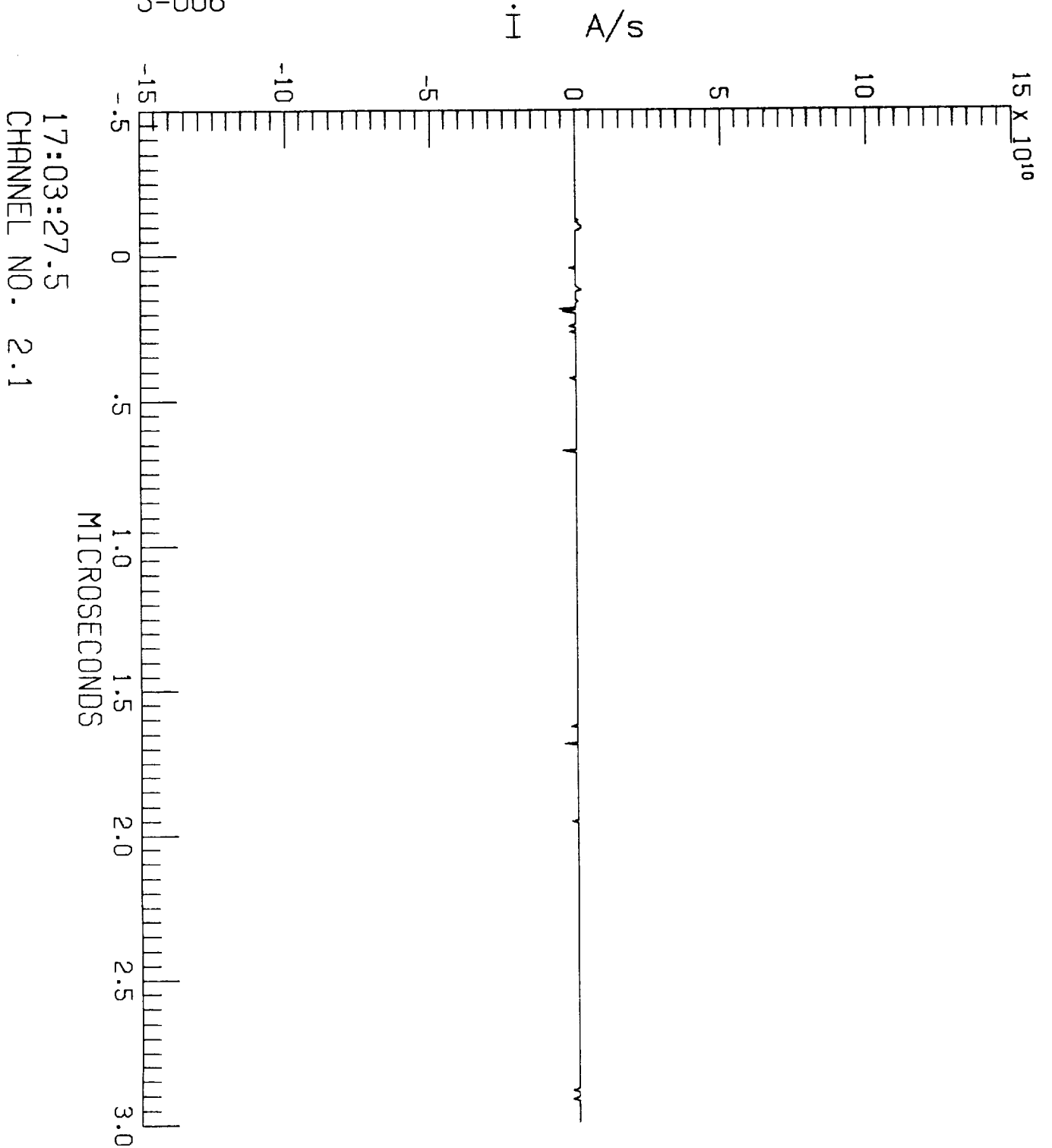

17:03:27.5  
CHANNEL NO. 2.1

F106 LIGHTNING/85-029/ZAEPFEL

LEC 2 RUN NO. 8

S-006

$\dot{B}_1$  T/s

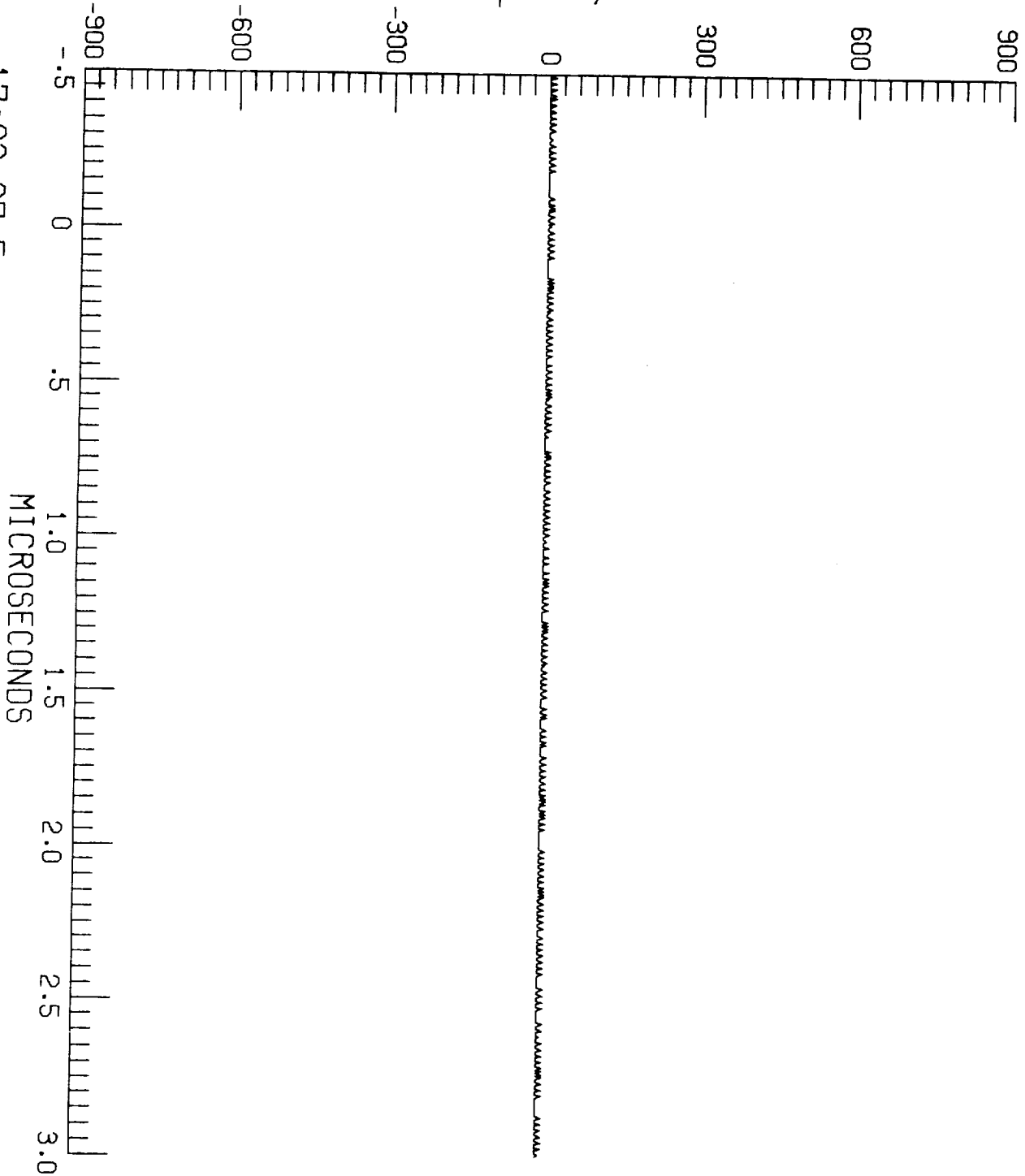

17:03:27.5  
CHANNEL NO. 2.2

MICROSECONDS



F106 LIGHTNING/85-029/ZAEPFEL  
LEC 3 RUN NO. 8  
S-006

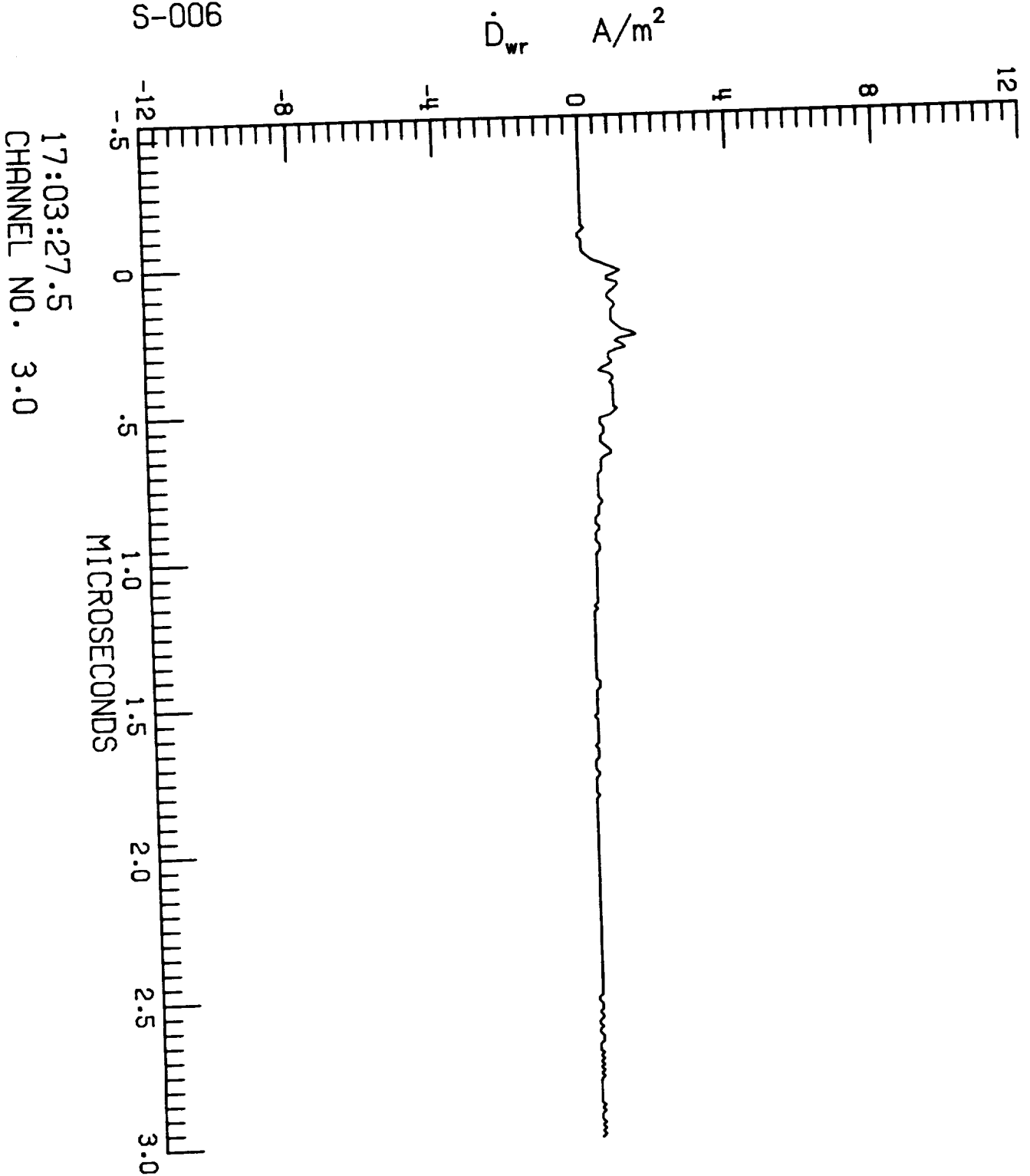

F106 LIGHTNING/85-029/ZAEPFEL  
LEC 3 RUN NO. 8  
S-006

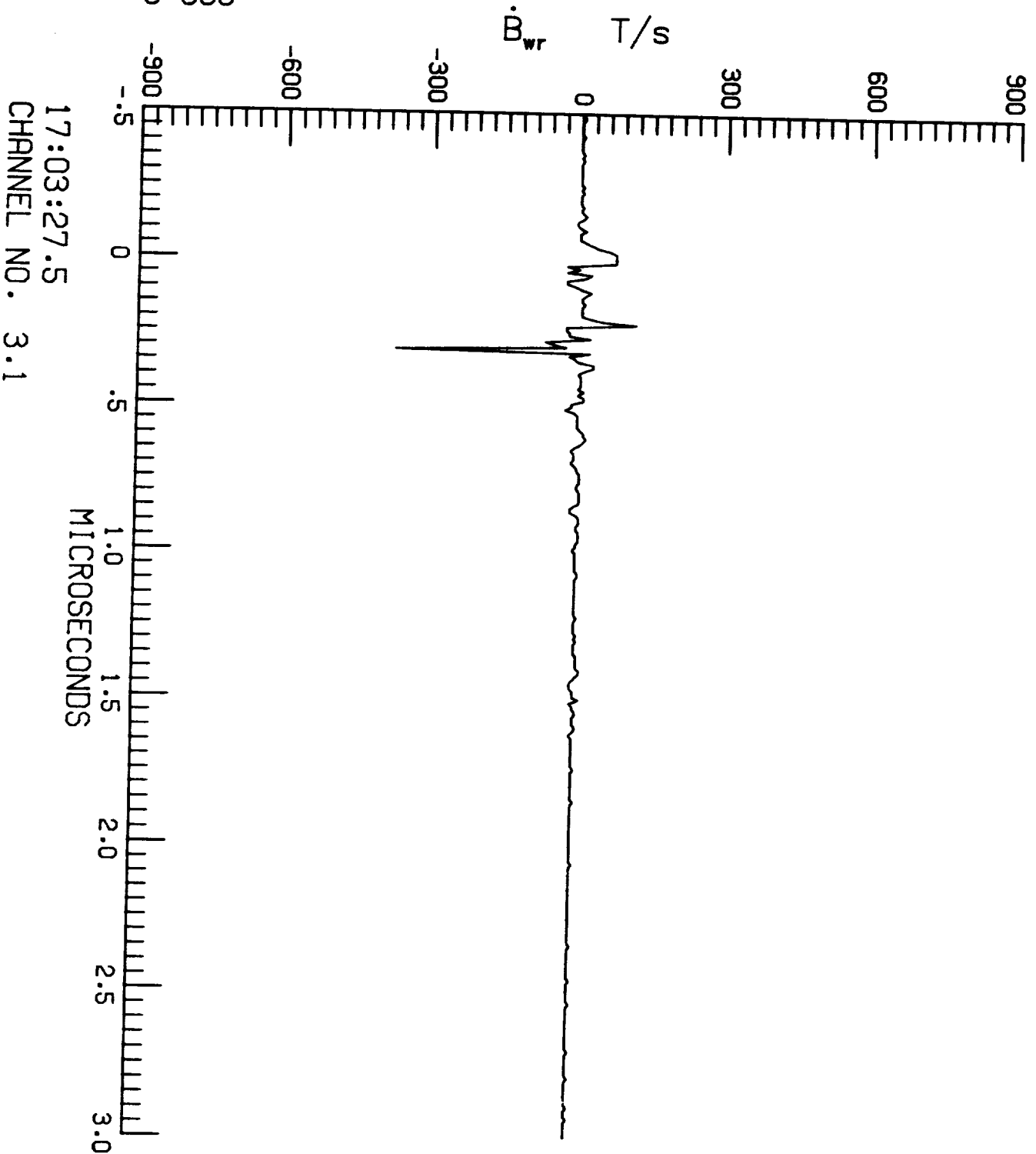

17:03:27.5  
CHANNEL NO. 3.1

F106 LIGHTNING/85-029/ZAEPFEL

LEC 3 RUN NO. 8

S-006

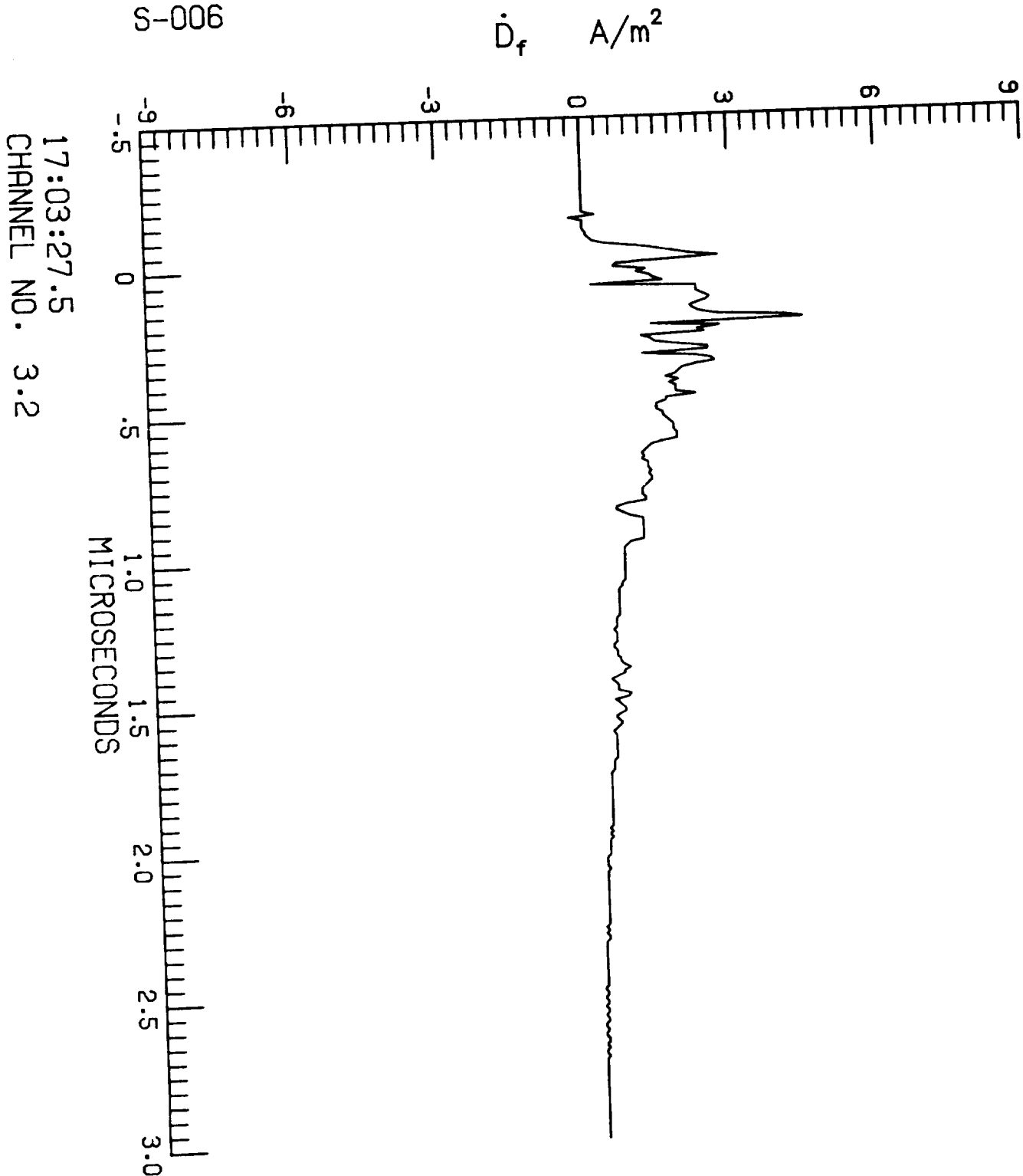

F106 LIGHTNING/85-029/ZAEPFEL  
LEC 4 RUN NO. 8  
S-006

TP100 V

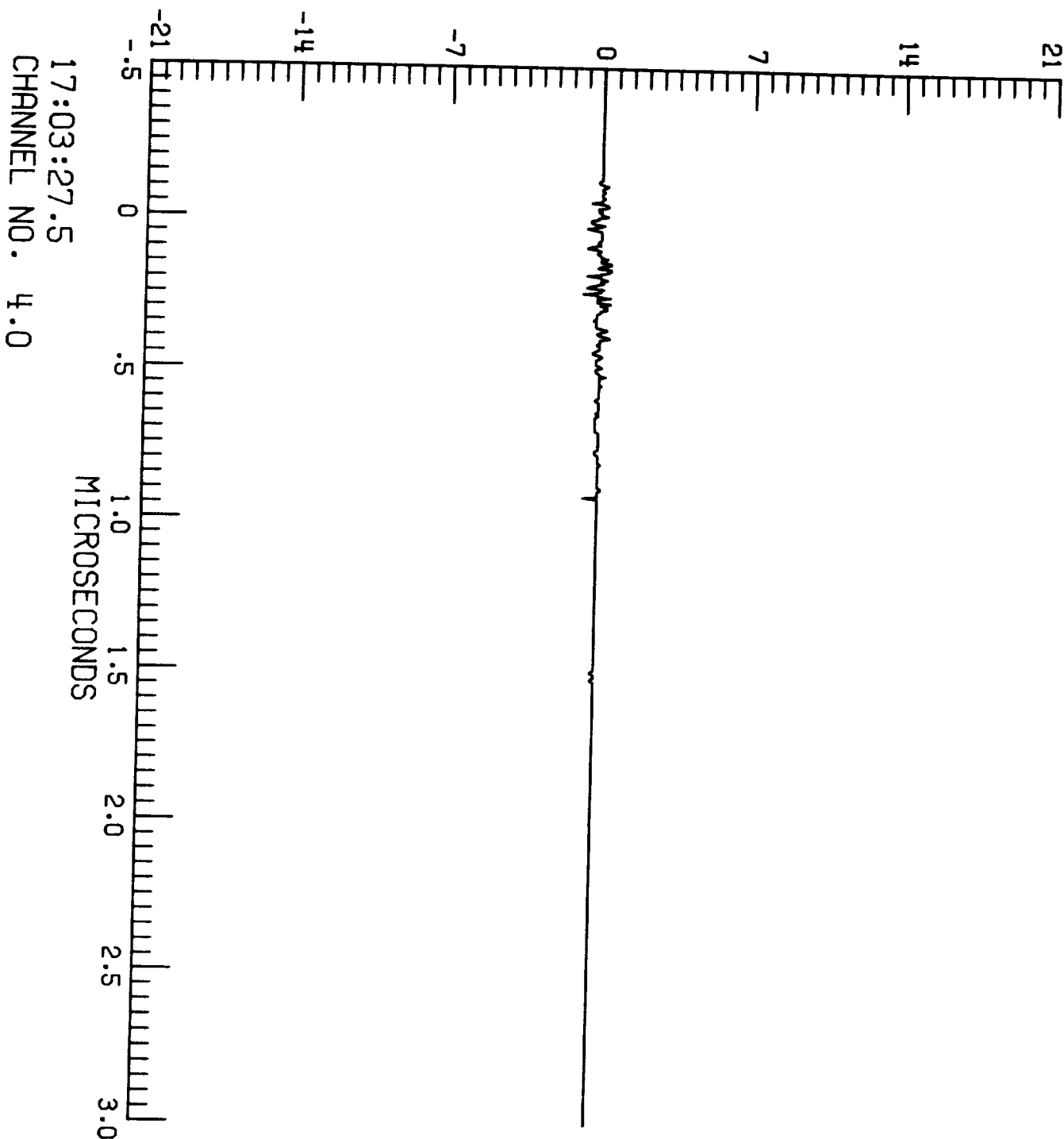

F106 LIGHTNING/85-029/ZAEPFEL

LEC 4 RUN NO. 8

S-006

TP106

A

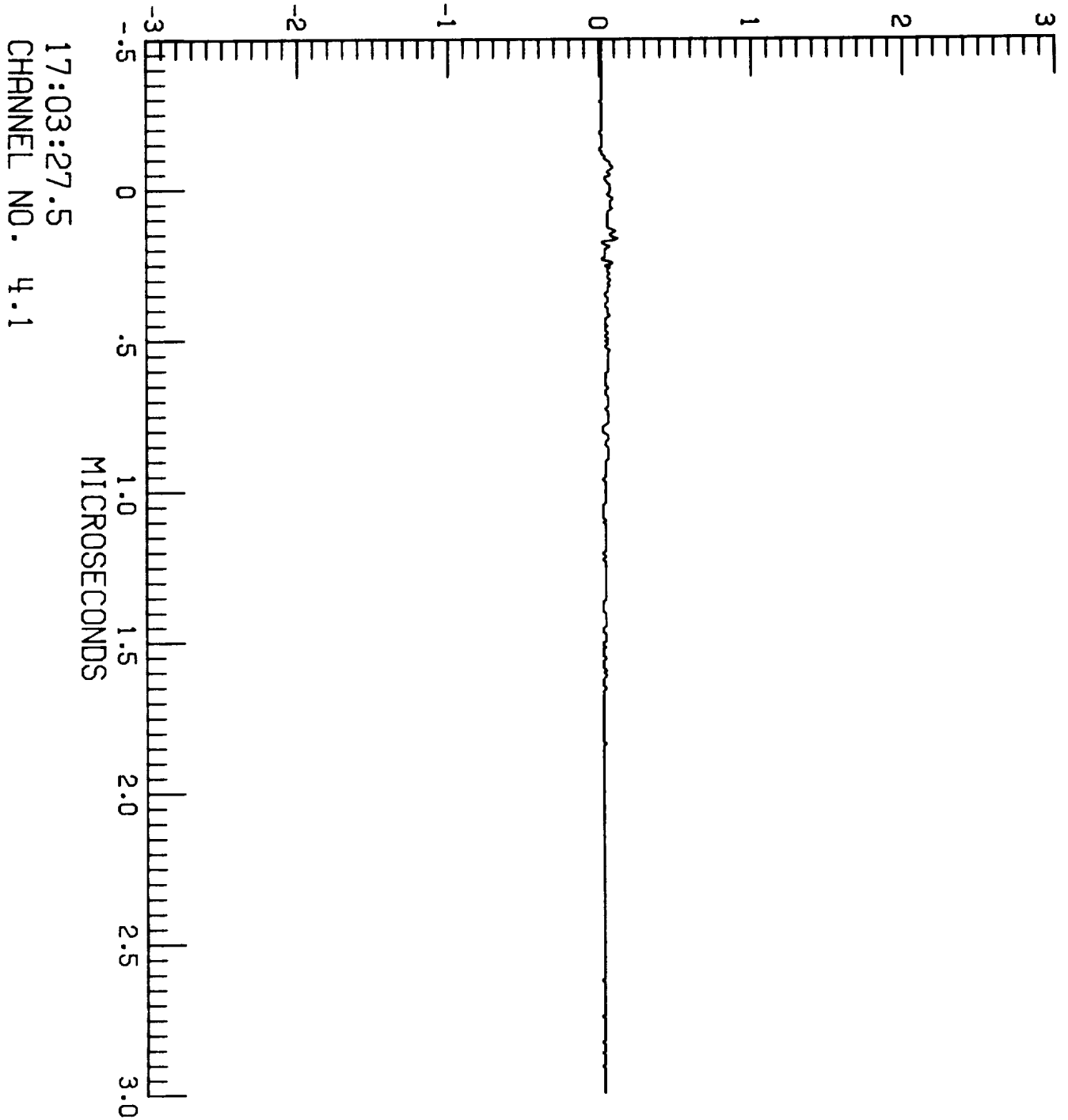

F106 LIGHTNING/85-029/ZAEPFEL

LEC 4 RUN NO. 8

S-006

TP125

A

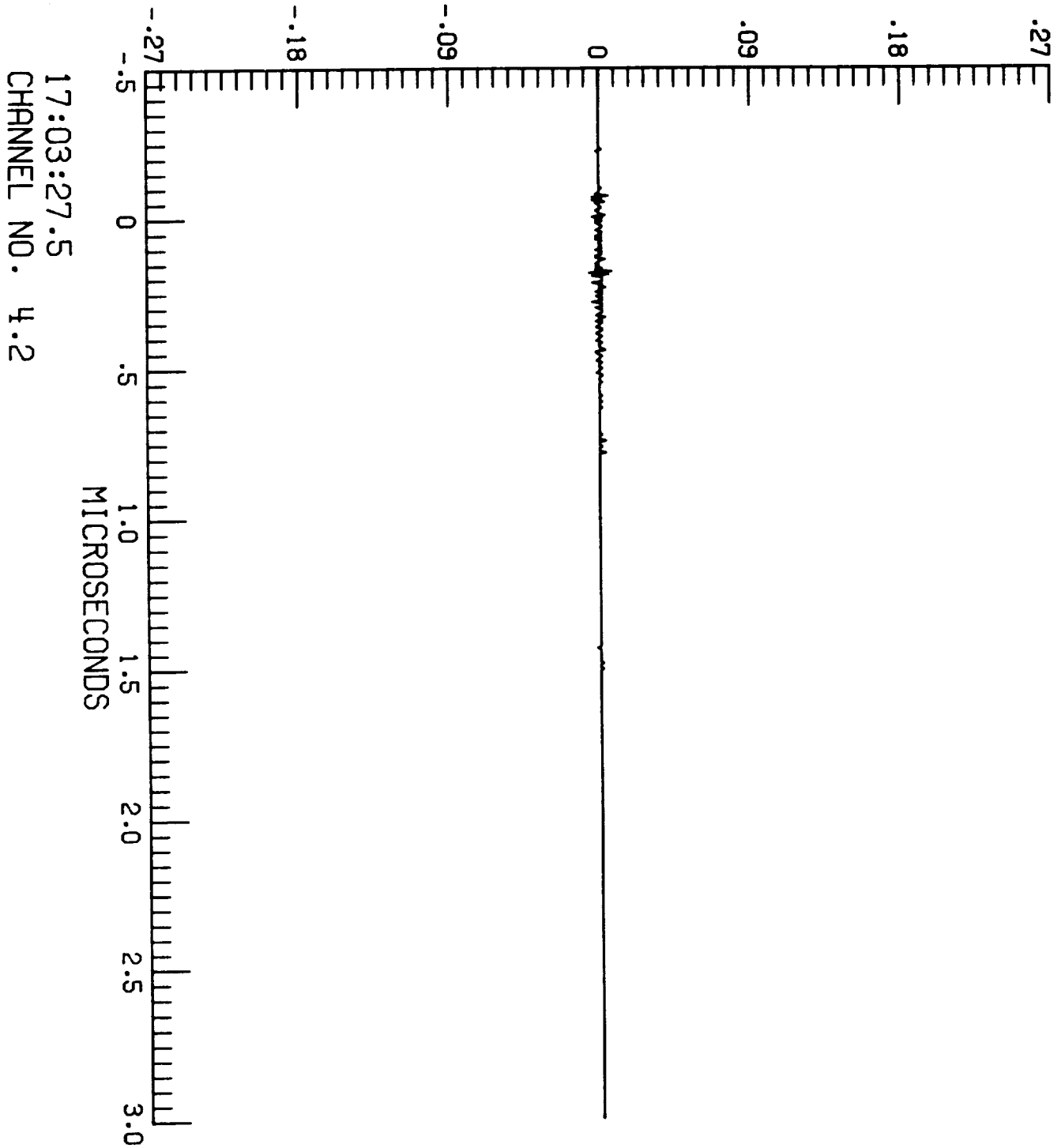

17:03:27.5  
CHANNEL NO. 4.2

F106 LIGHTNING/85-029/ZAEPFEL

LEC 1 RUN NO. 9

N-003

$\dot{D}_t$  A/m<sup>2</sup>

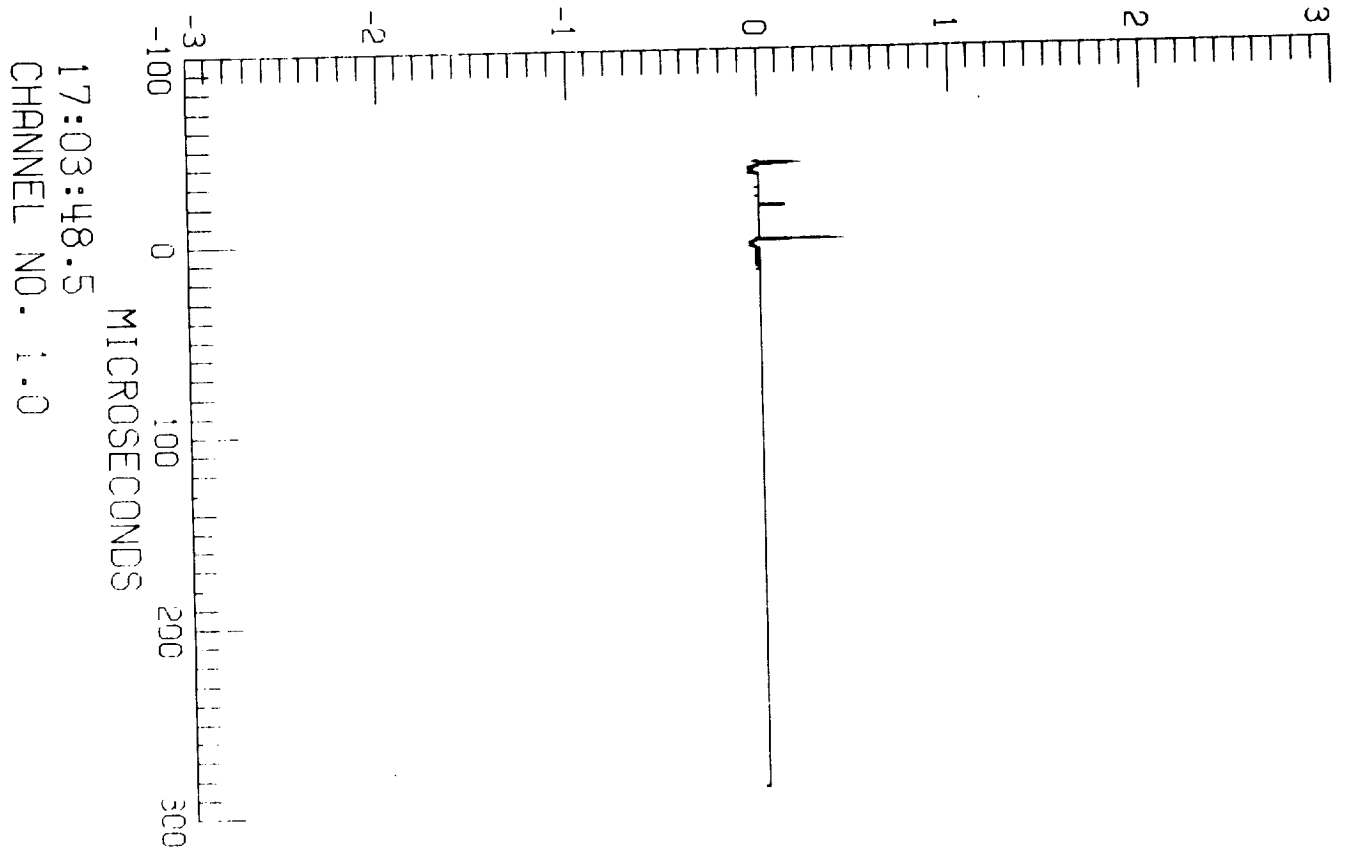

F106 LIGHTNING/85-029/ZAEPFEL

LEC 1 RUN NO. 9

N-003

$I_t$  A

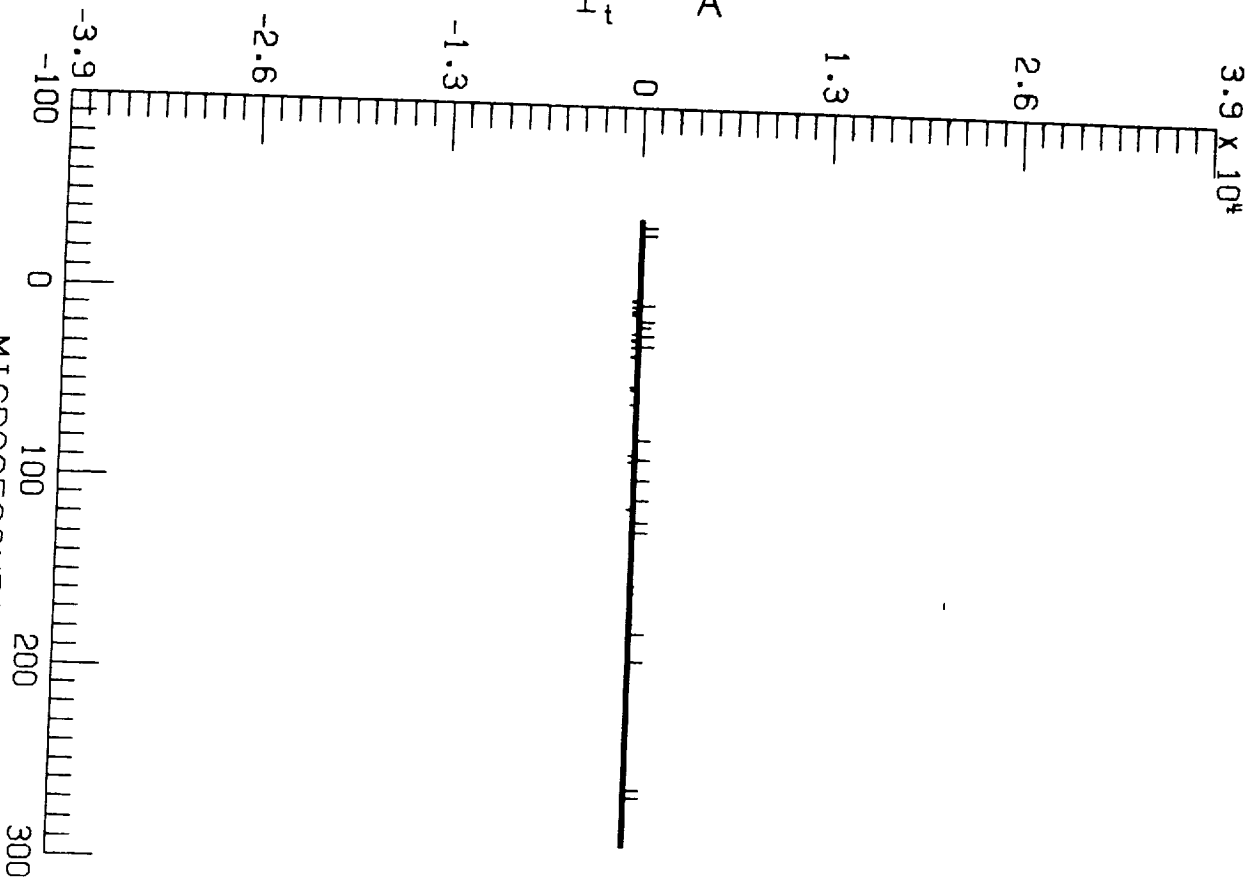

17:03:48.5  
CHANNEL NO. 1.2



F106 LIGHTNING/85-029/ZAEPFEL

LEC 2

RUN NO. 9

N-003

$\dot{B}_w$  T/s

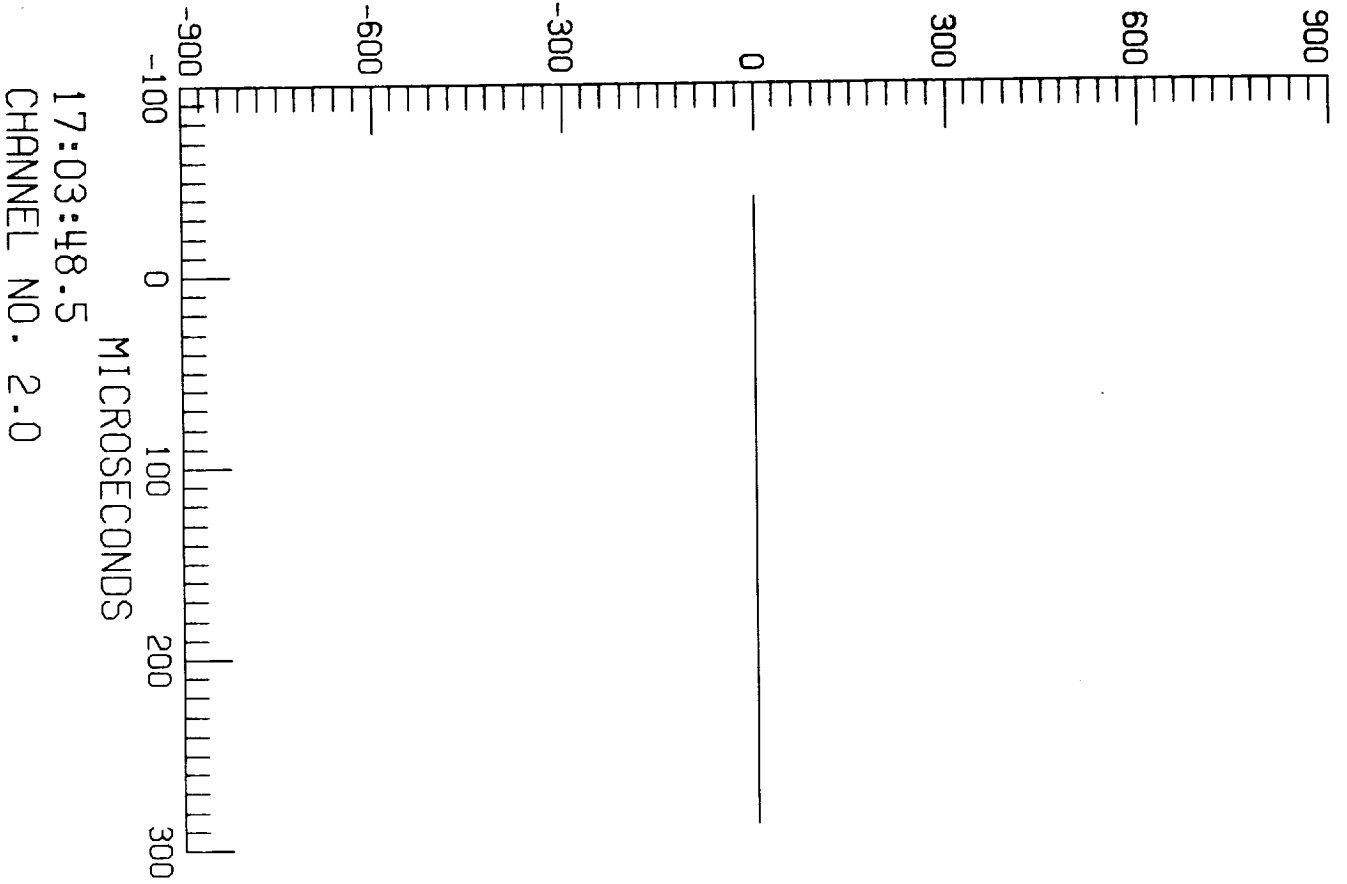

17:03:48.5  
CHANNEL NO. 2.0

F106 LIGHTNING/85-029/ZAEPFEL

LEC 2 RUN NO. 9

N-003

i A/s

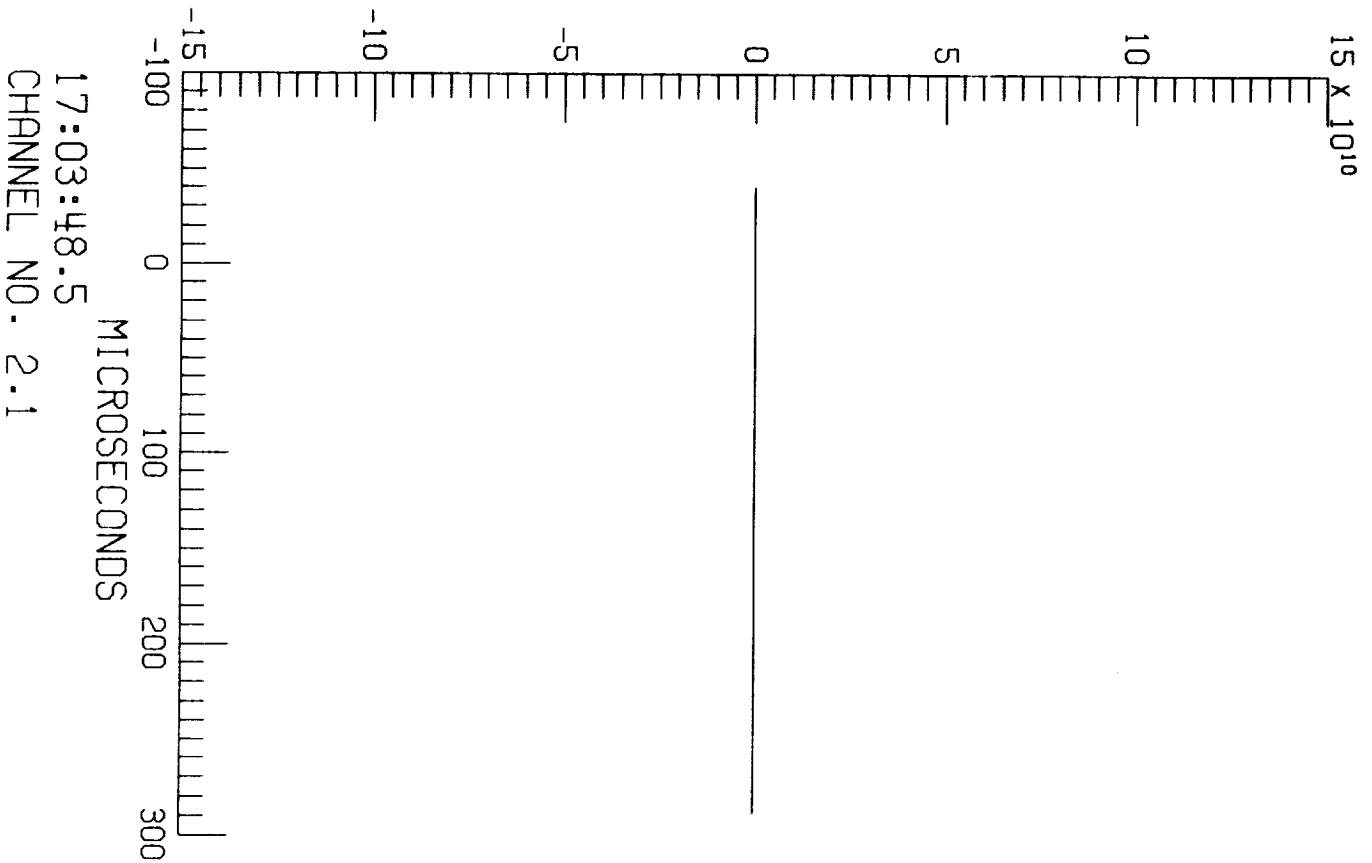

F106 LIGHTNING/85-029/ZAEPFEL

LEC 3

RUN NO. 9

N-003

$\dot{D}_{wr}$  A/m<sup>2</sup>

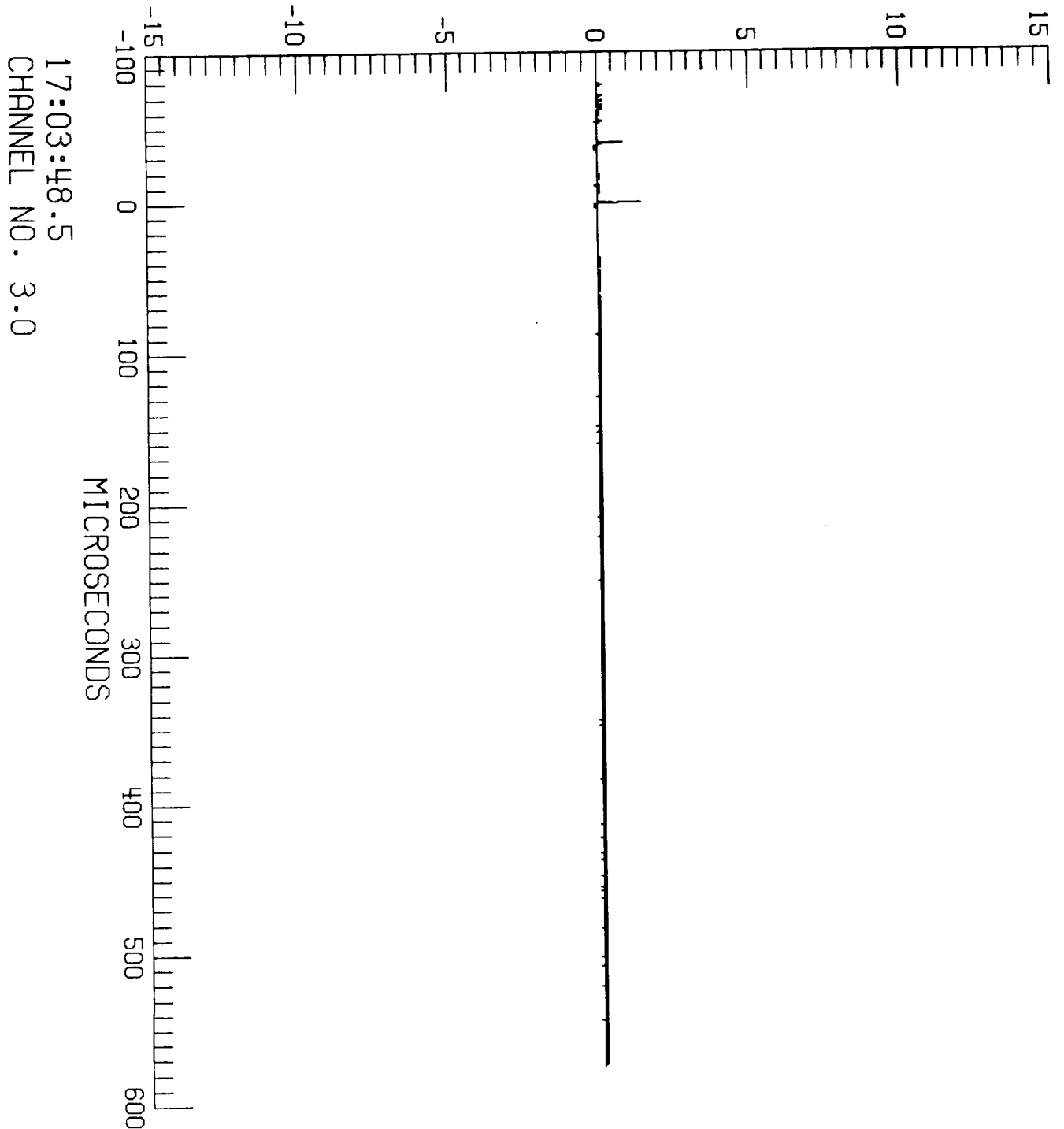

F106 LIGHTNING/85-029/ZAEPFEL

LEC 3 RUN NO. 9

N-003

$\dot{B}_{wr}$  T/s

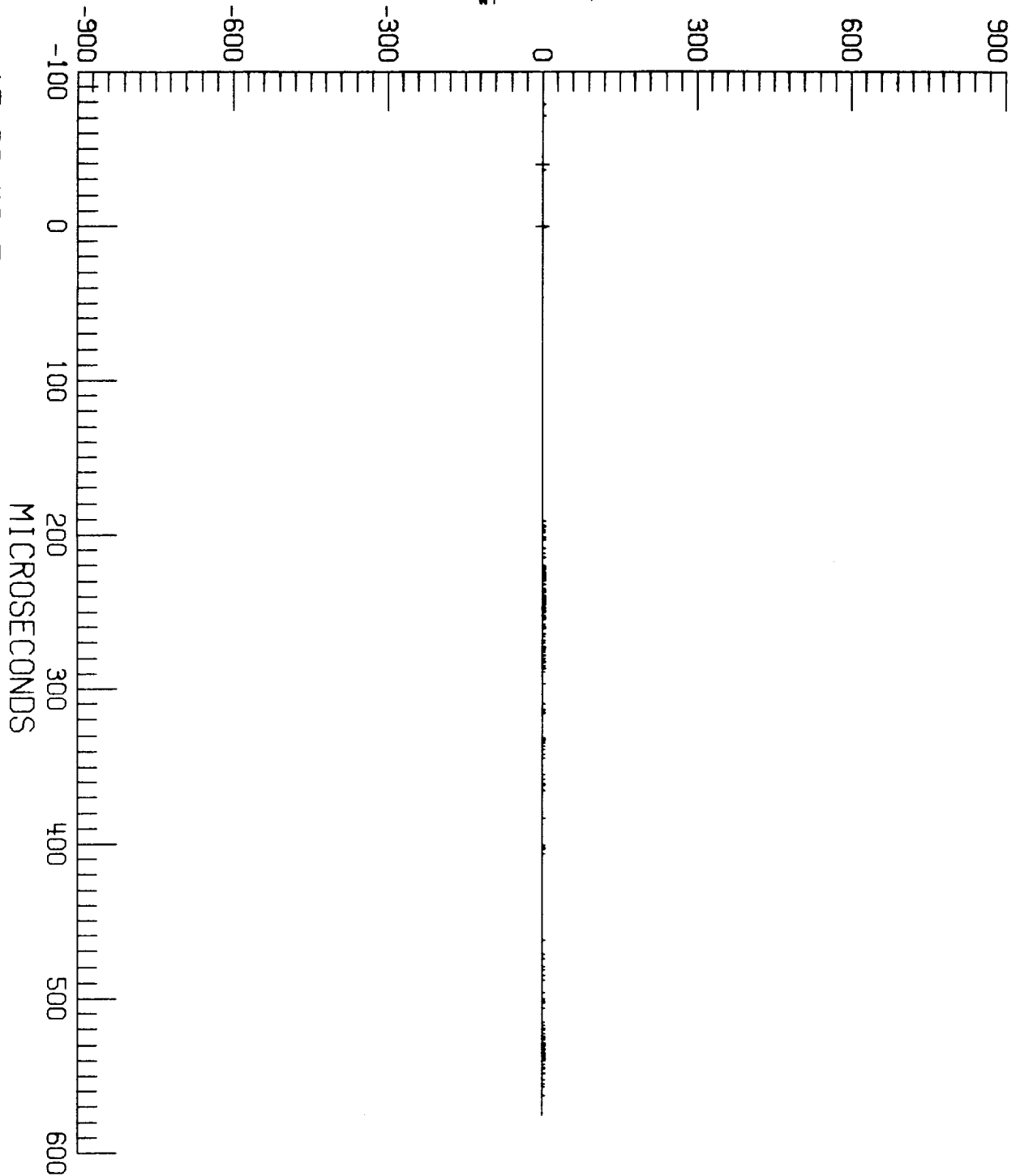

17:03:48.5  
CHANNEL NO. 3.1

F106 LIGHTNING/85-029/ZAEPFEL

LEC 3

RUN NO. 9

N-003

$\dot{D}_f$  A/m<sup>2</sup>

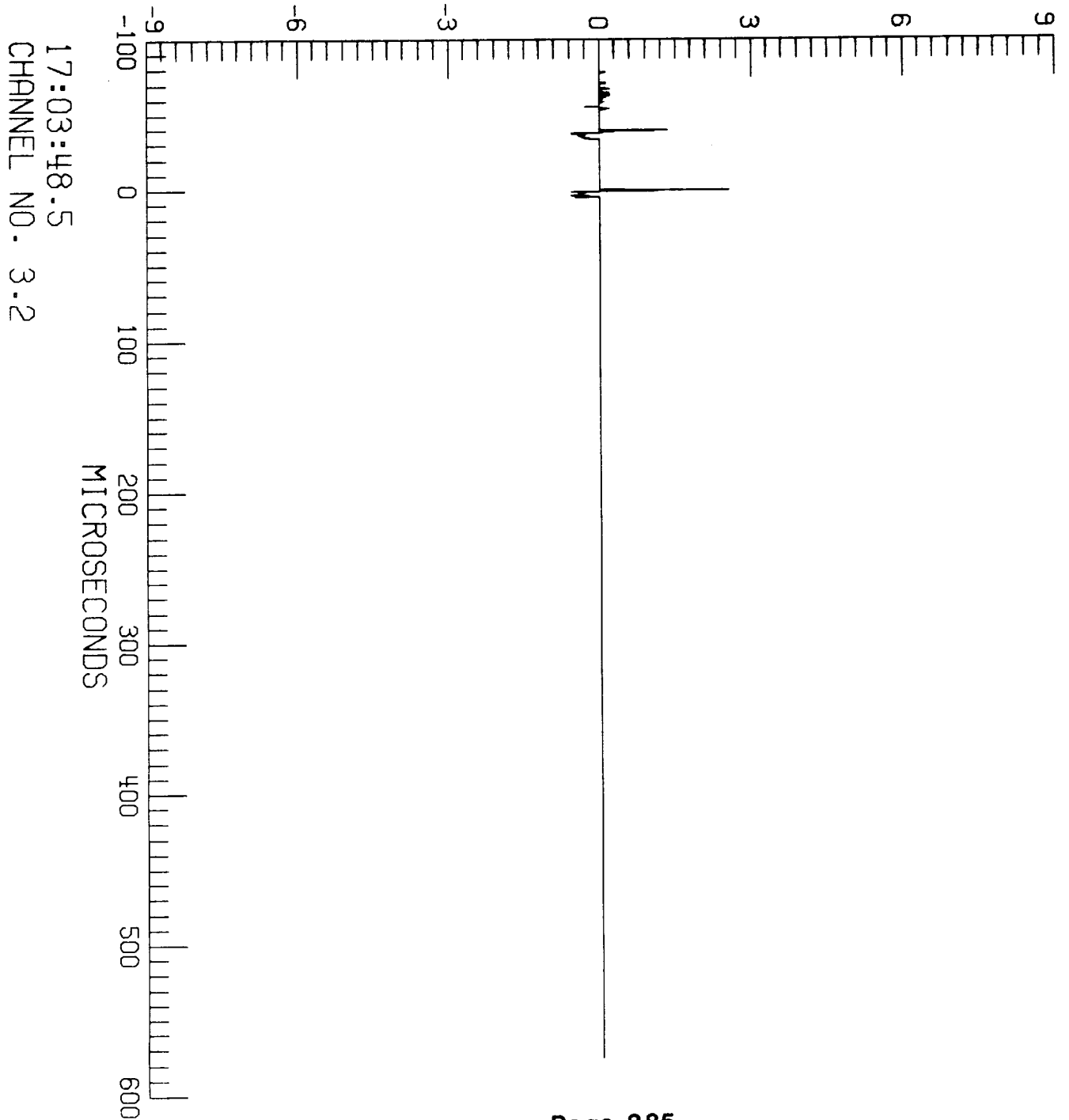

F106 LIGHTNING/85-029/ZAEPFEL

LEC 4

RUN NO. 9

N-003

TP100 V

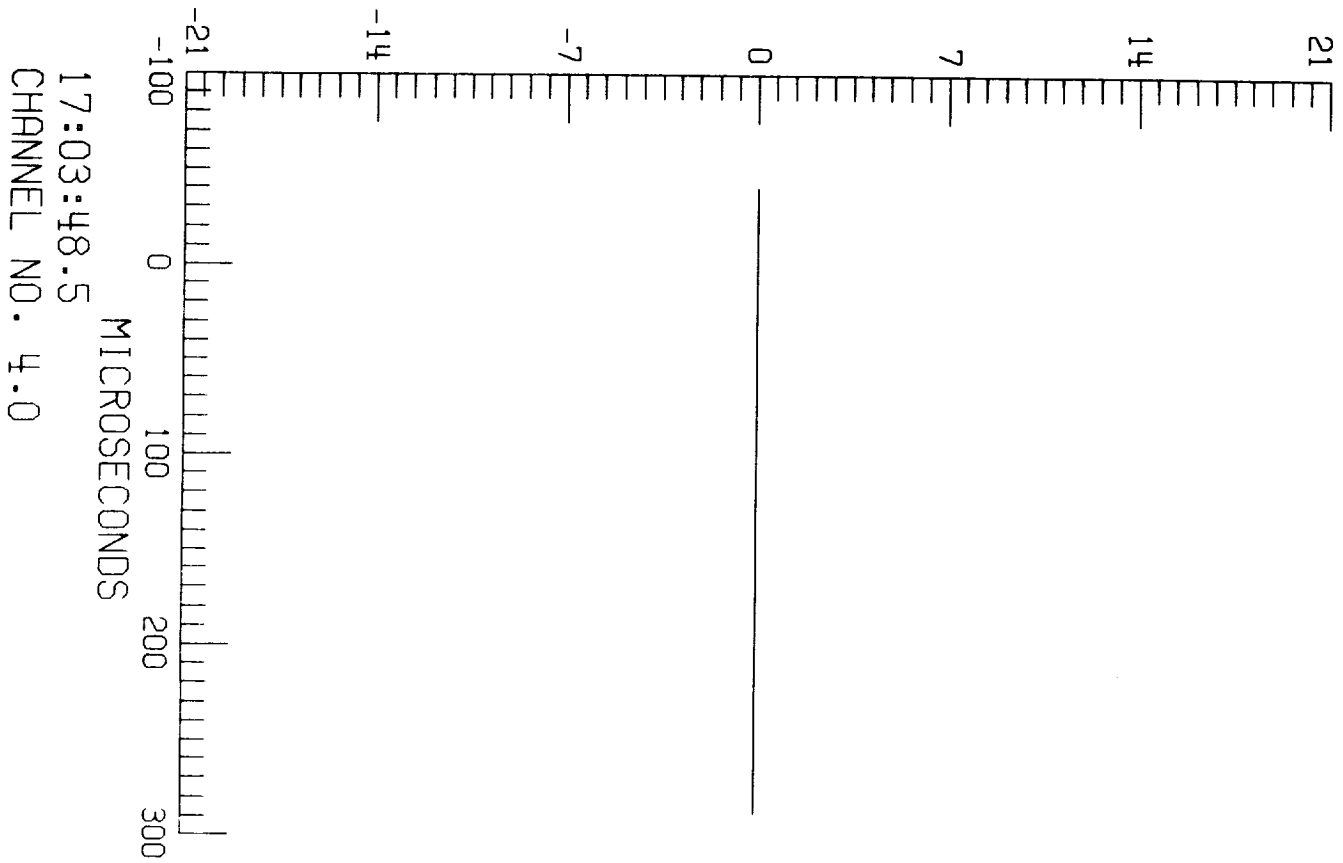

17:03:48.5  
CHANNEL NO. 4.0

F106 LIGHTNING/85-029/ZAEPFEL

LEC 4

RUN NO. 9

N-003

TP106

A

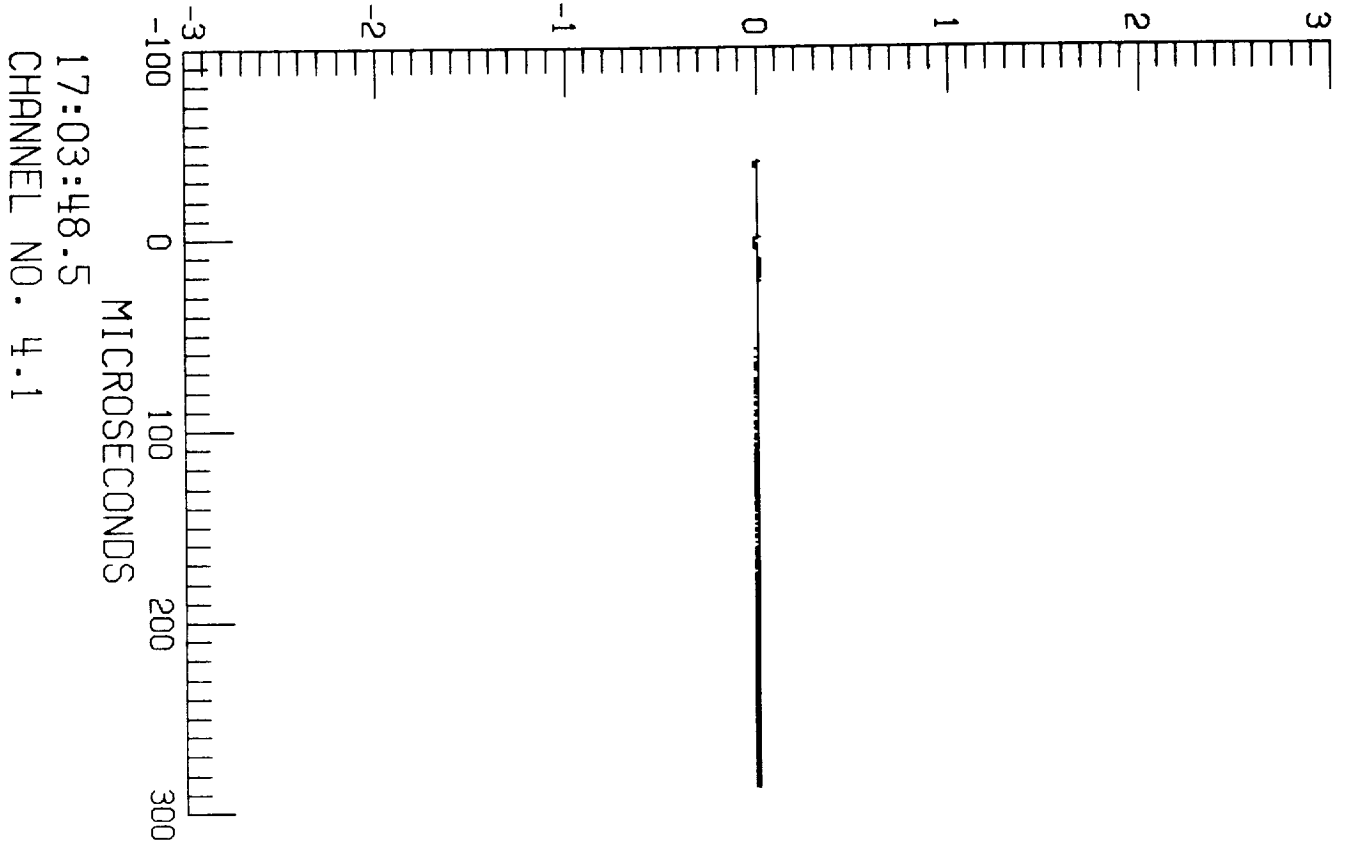

0.5

F106 LIGHTNING/85-029/ZAEPFEL

LEC 4

RUN NO. 9

N-003

TP125 A

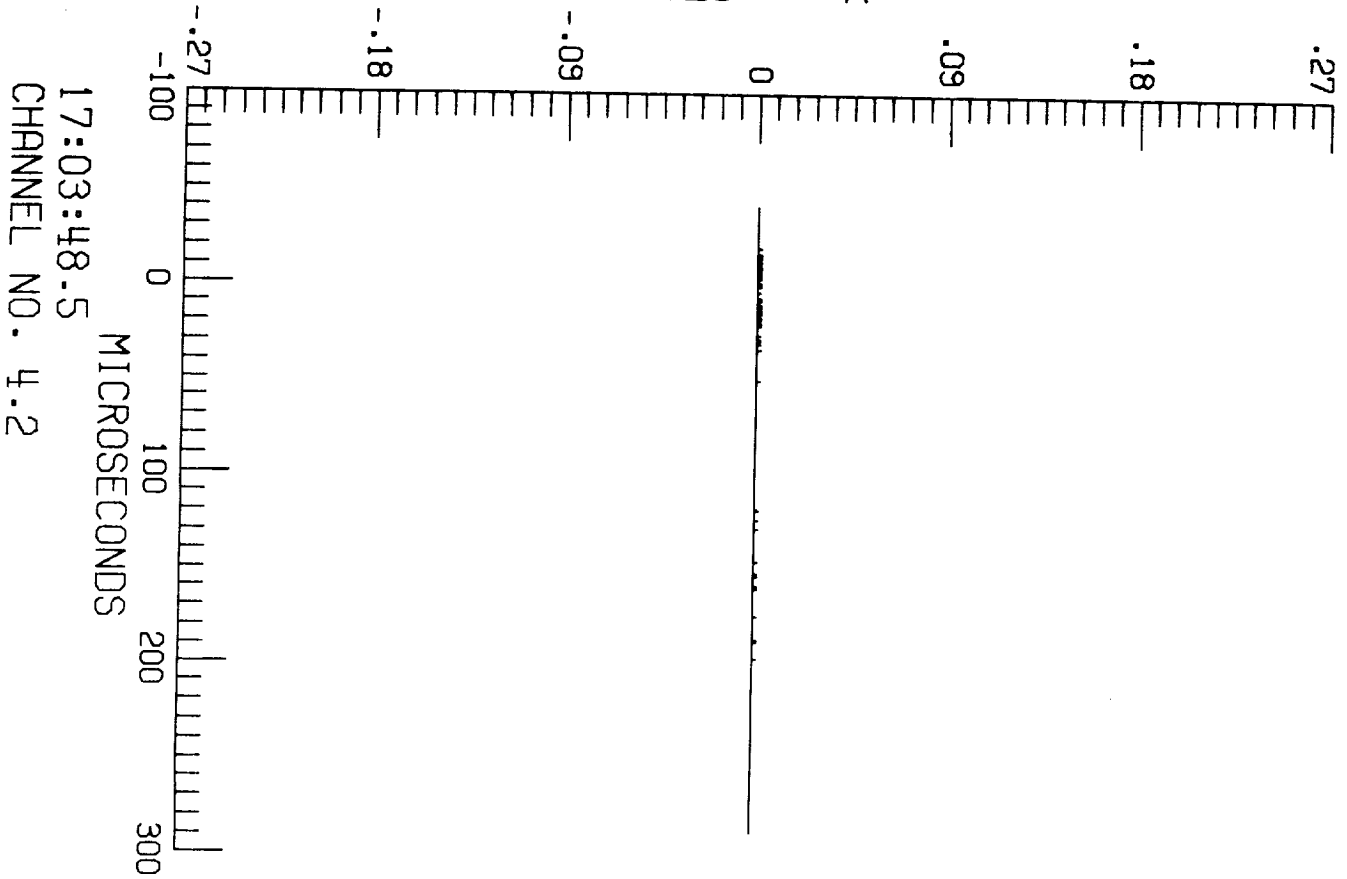

17:03:48.5  
CHANNEL NO. 4.2



F106 LIGHTNING/85-029/ZAEPFEL

LEC 1 RUN NO. 9

N-003

$\dot{D}_t$  A/m<sup>2</sup>

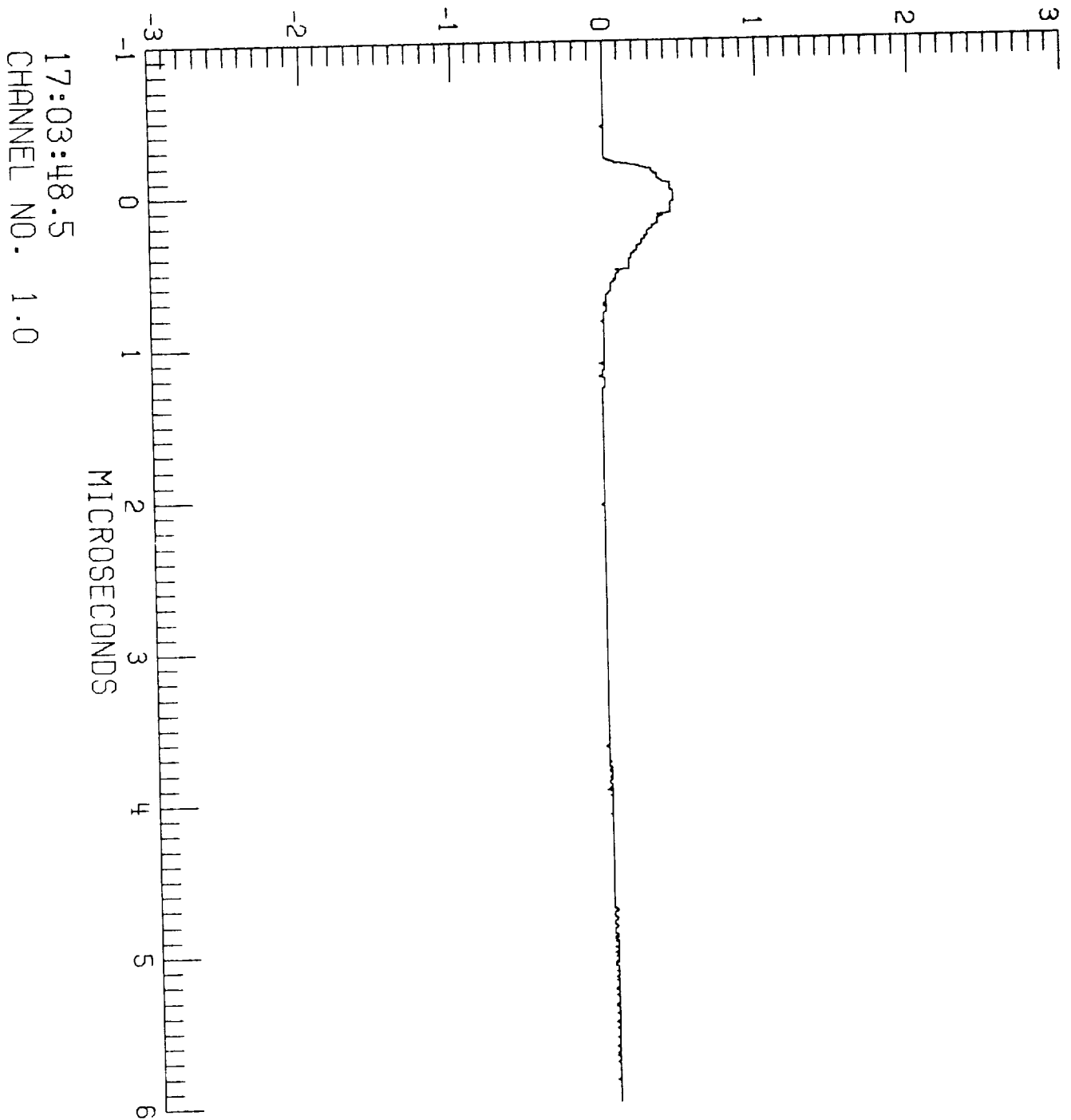

F106 LIGHTNING/85-029/ZAEPFEL

LEC 1 RUN NO. 9

N-003

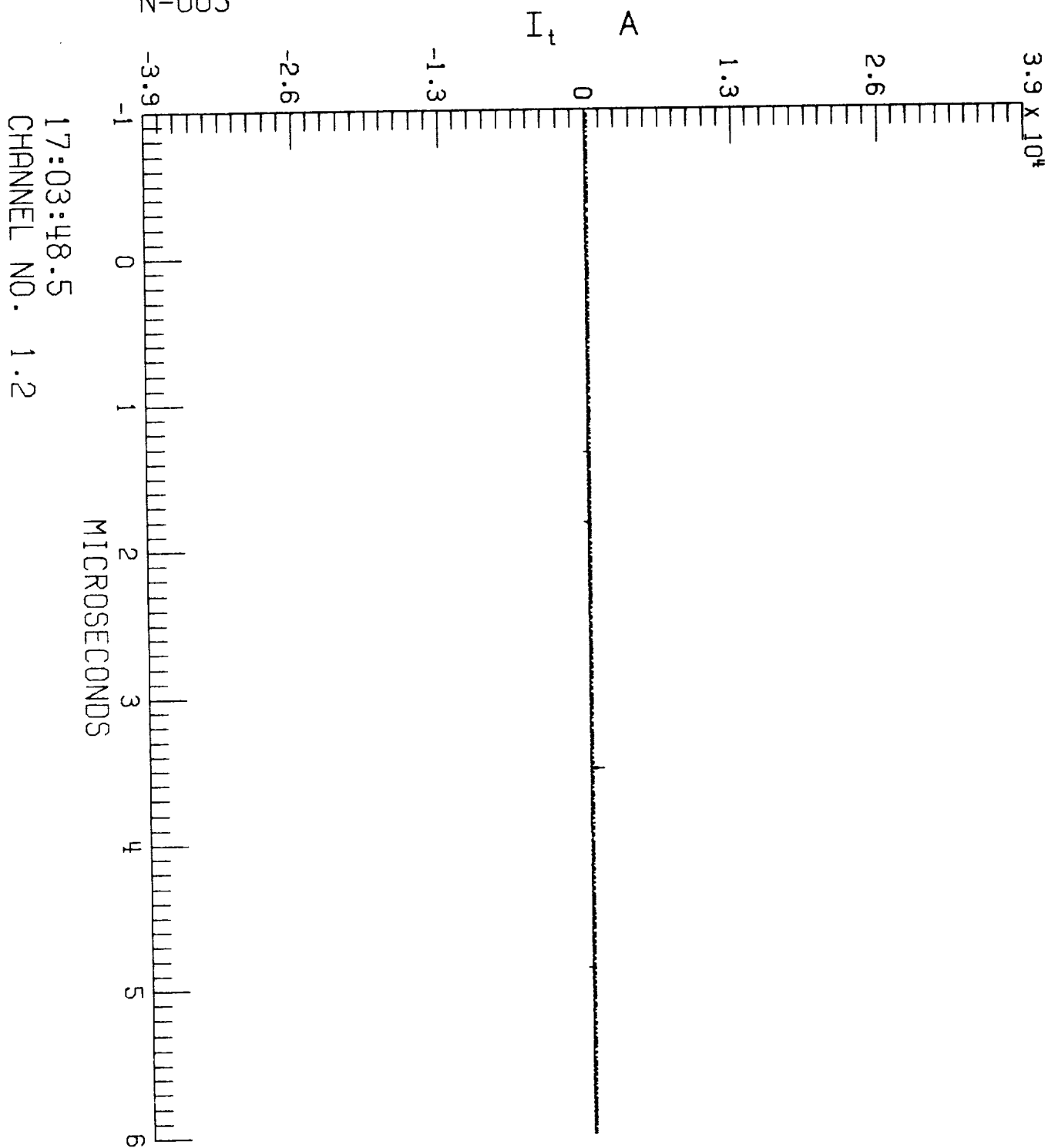

17:03:48.5  
CHANNEL NO. 1.2

F106 LIGHTNING/85-029/ZAEPFEL  
LEC 2 RUN NO. 9  
N-003

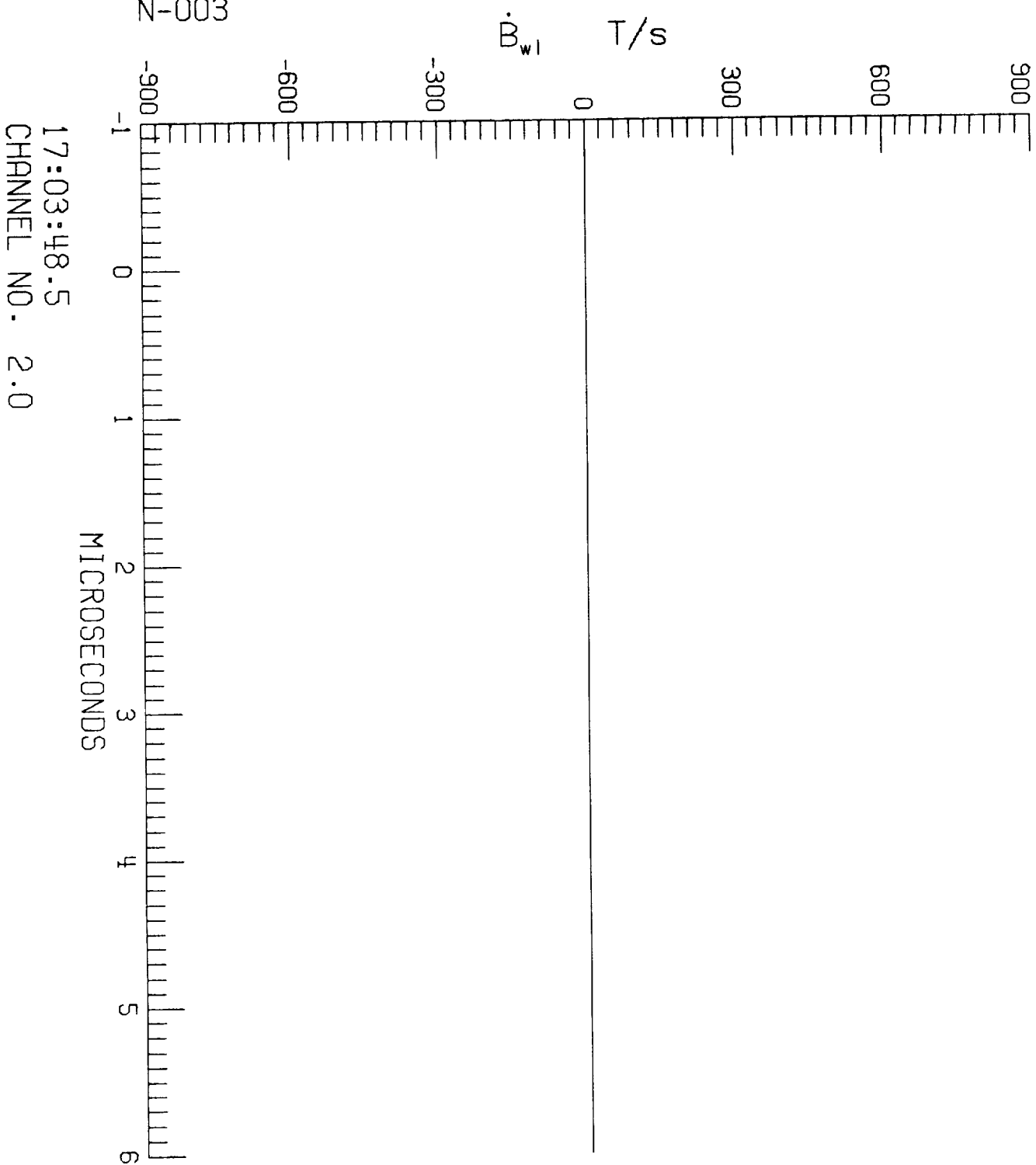

17:03:48.5  
CHANNEL NO. 2.0

F106 LIGHTNING/85-029/ZAEPFEL  
LEC 2 RUN NO. 9  
N-003

$\dot{i}$  A/s

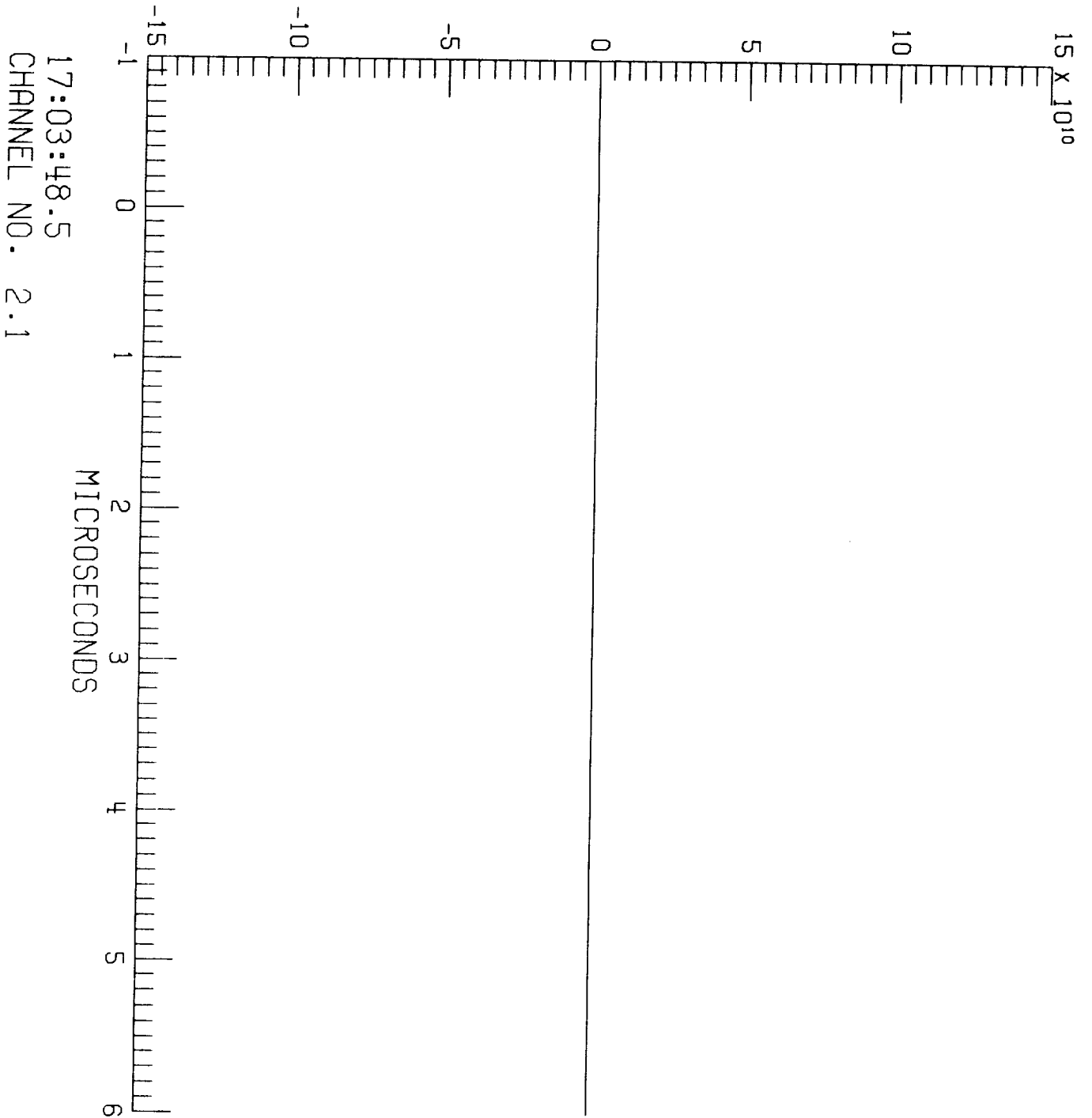

F106 LIGHTNING/85-029/ZAEPFEL

LEC 3 RUN NO. 9

N-003

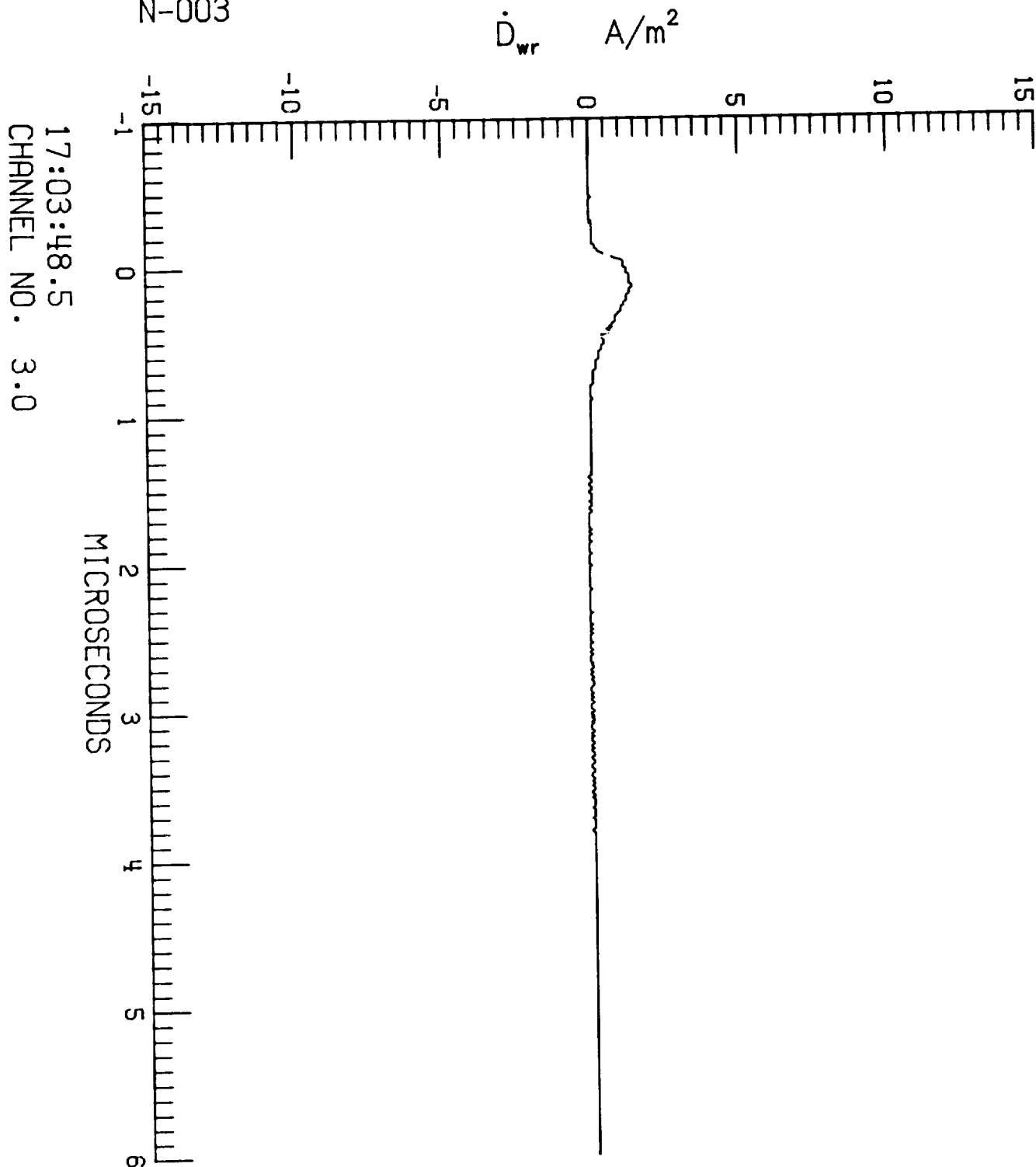

17:03:48.5  
CHANNEL NO. 3.0

F106 LIGHTNING/85-029/ZAEPFEL

LEC 3 RUN NO. 9

N-003

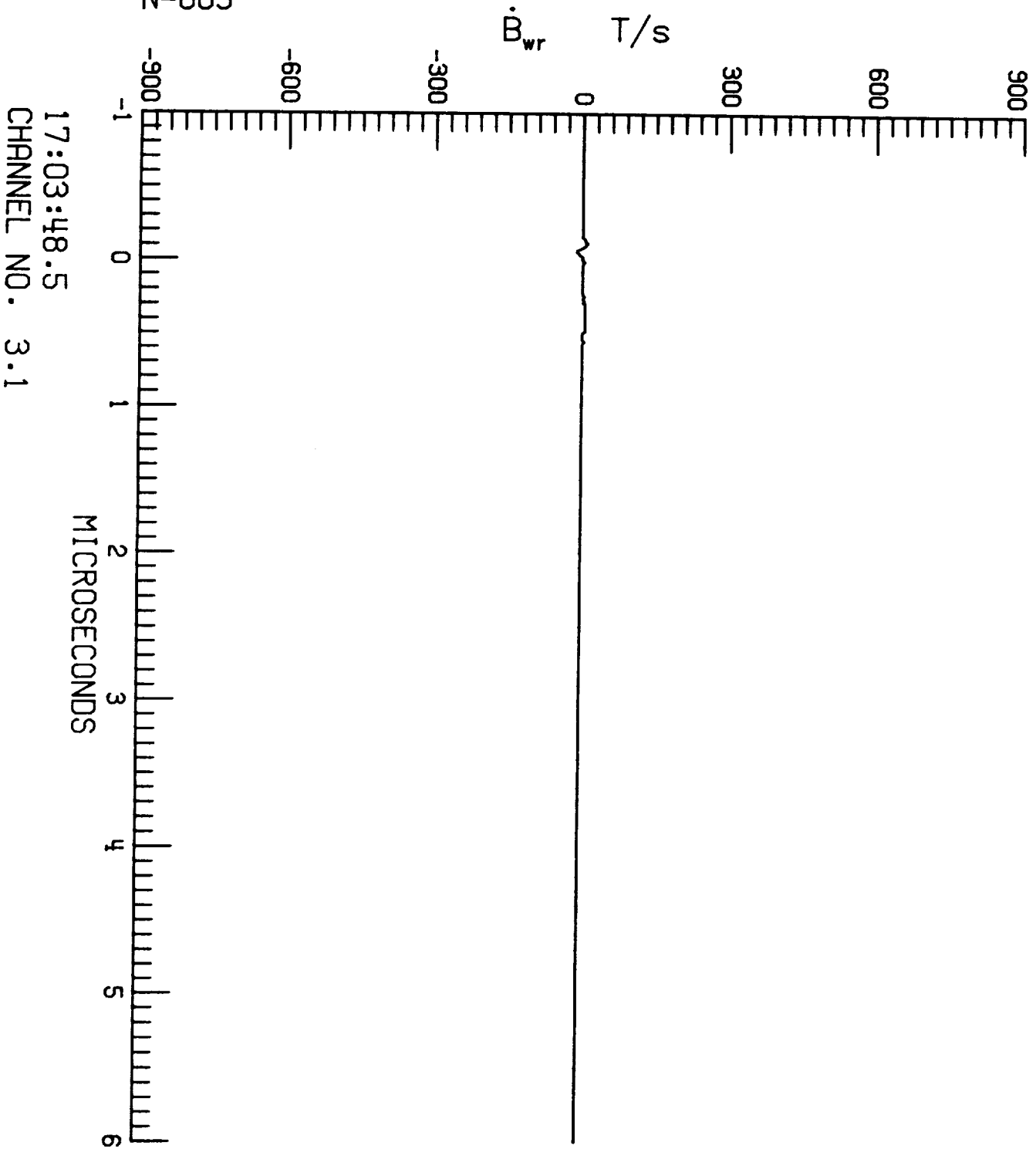

17:03:48.5  
CHANNEL NO. 3.1

MICROSECONDS

F106 LIGHTNING/85-029/ZAEPFEL  
LEC 3 RUN NO. 9  
N-003

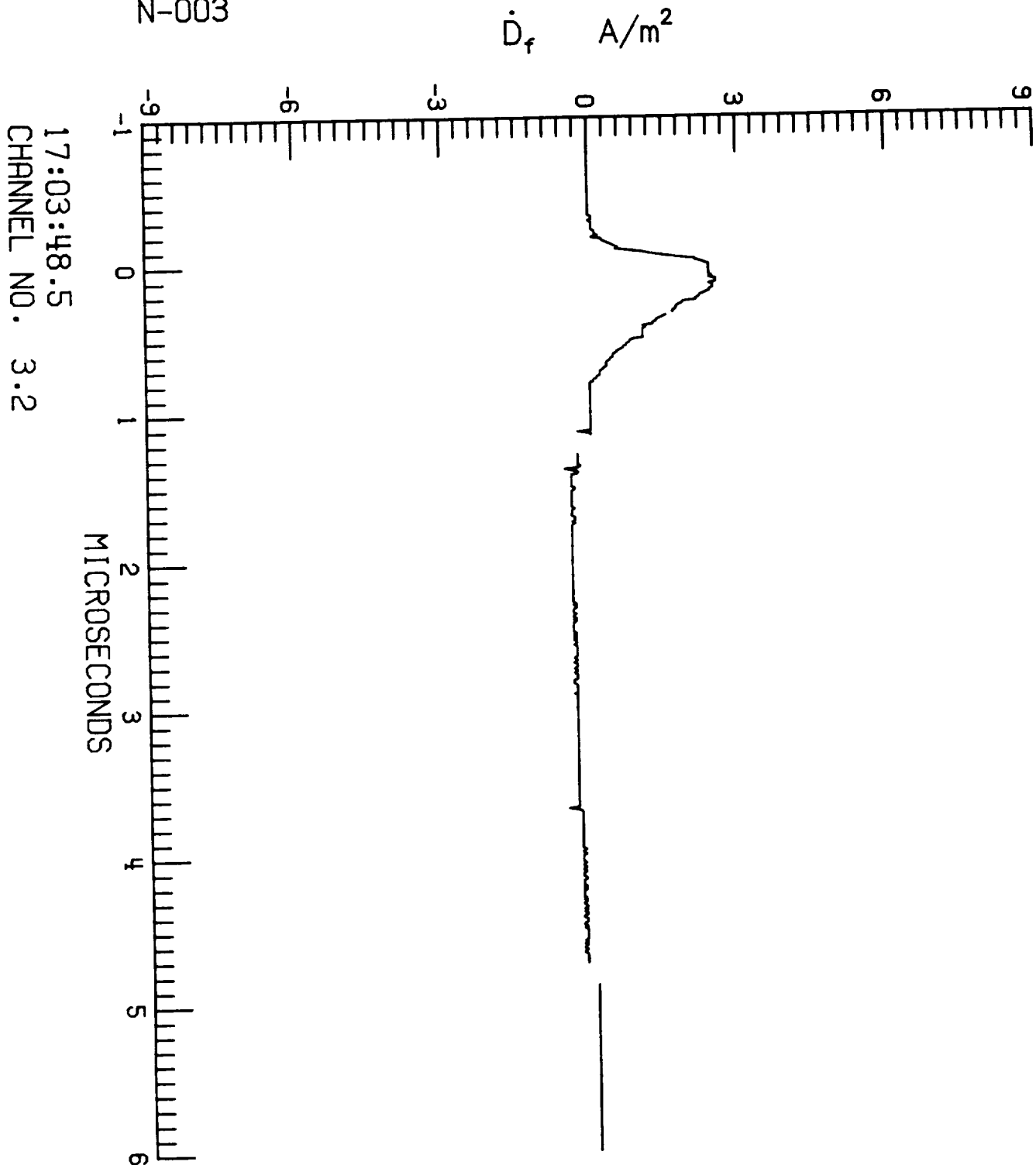

F106 LIGHTNING/85-029/ZAEPFEL

LEC 4 RUN NO. 9

N-003

TP100

V

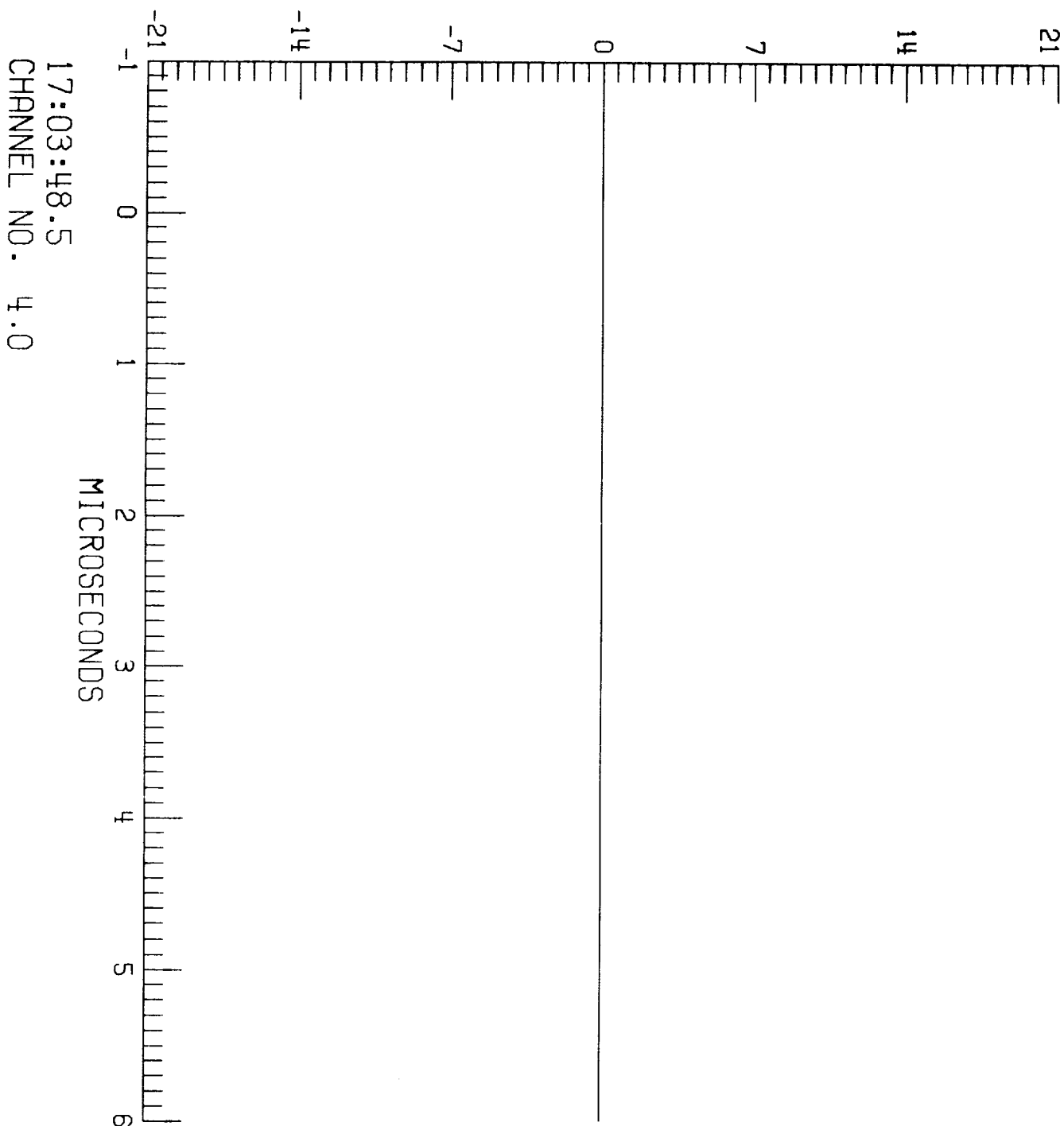



F106 LIGHTNING/85-029/ZAEPFEL

LEC 4 RUN NO. 9

N-003

TP106

A

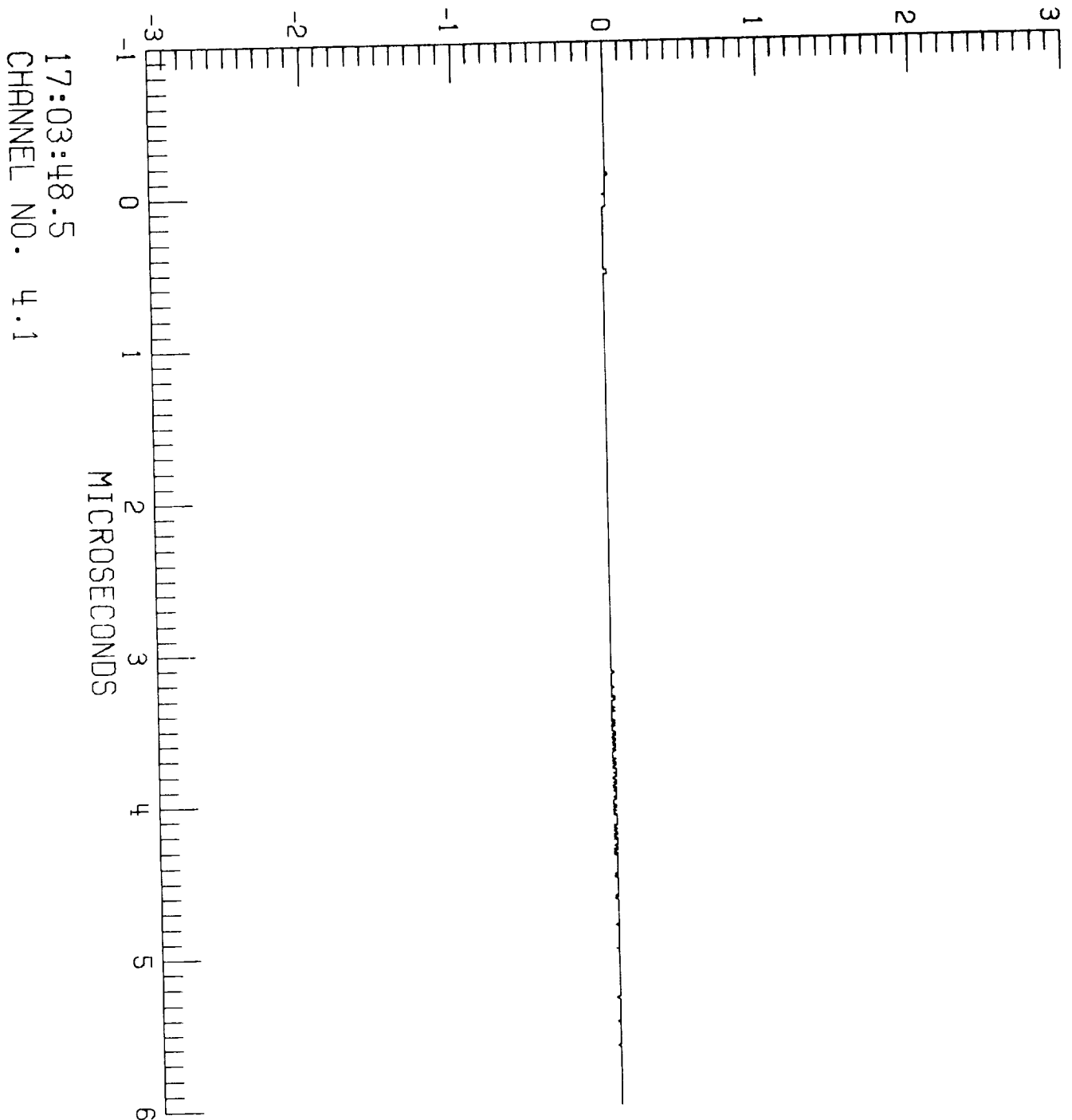

F106 LIGHTNING/85-029/ZAEPFEL

LEC 4 RUN NO. 9

N-003

TP125

A

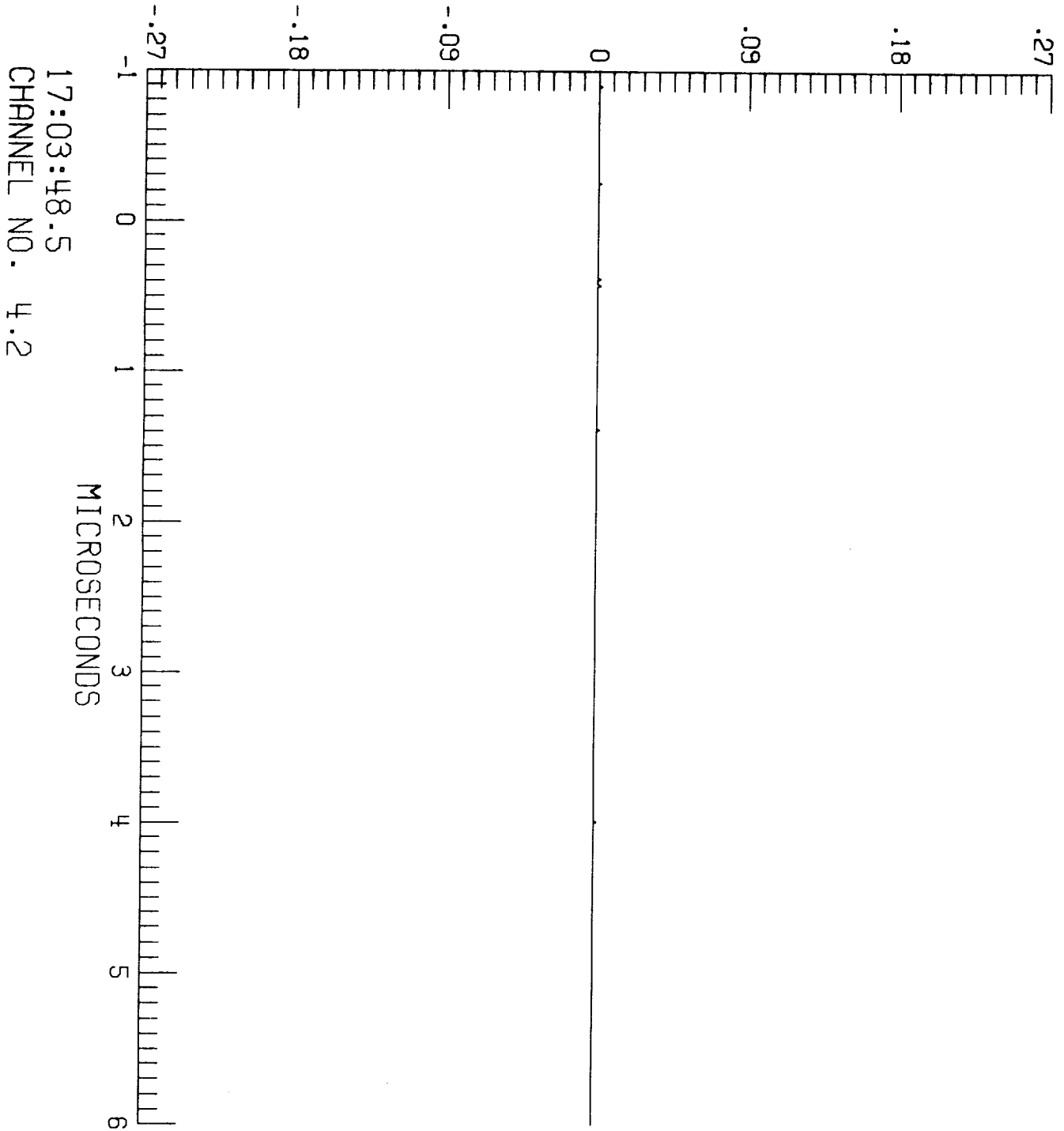

17:03:48.5  
CHANNEL NO. 4.2

F106 LIGHTNING/85-029/ZAEPFEL

LEC 1 RUN NO. 10

N-004

$\dot{D}_t$  A/m<sup>2</sup>

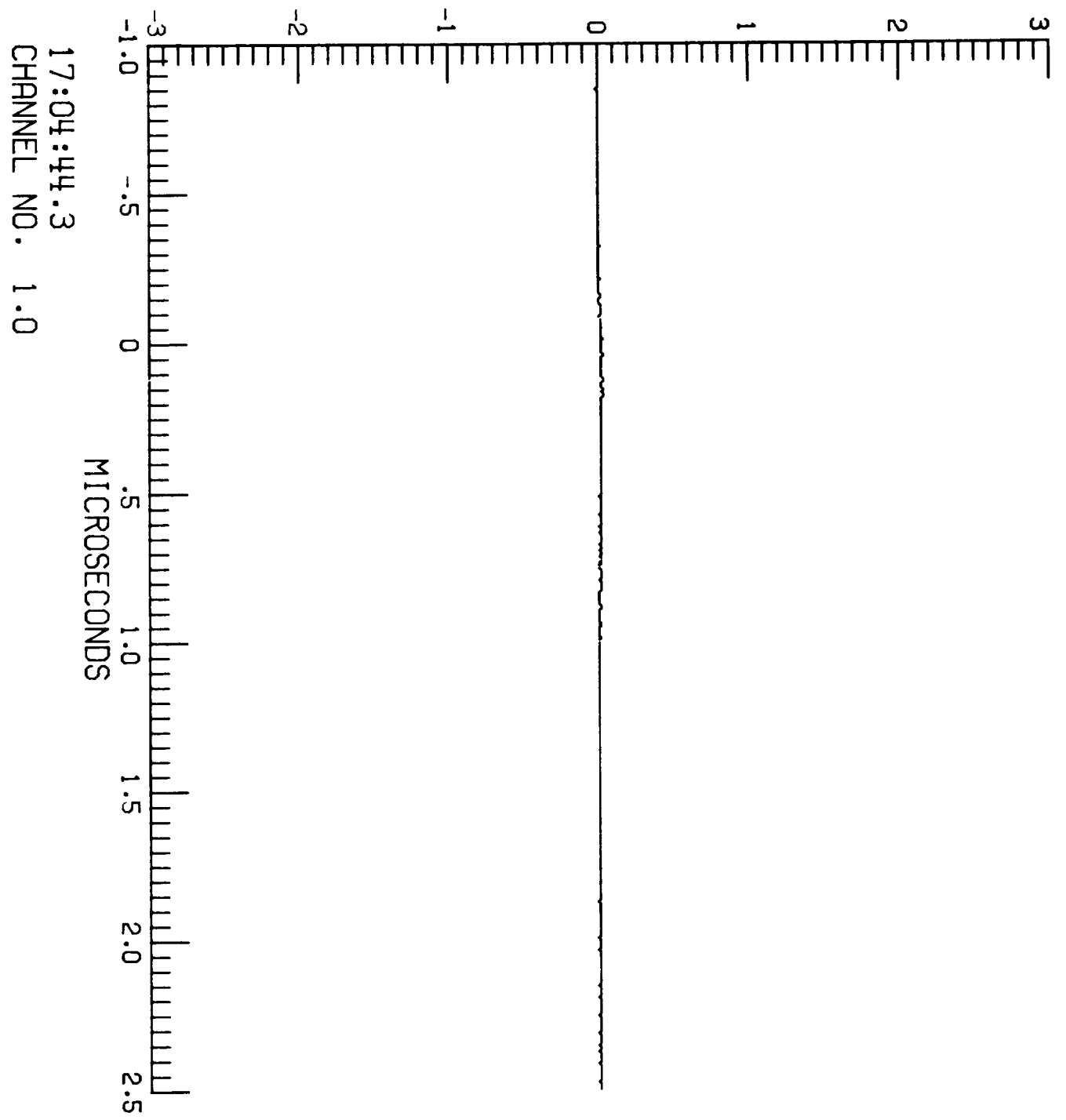

F106 LIGHTNING/85-029/ZAEPFEL

LEC 1 RUN NO. 10

N-004

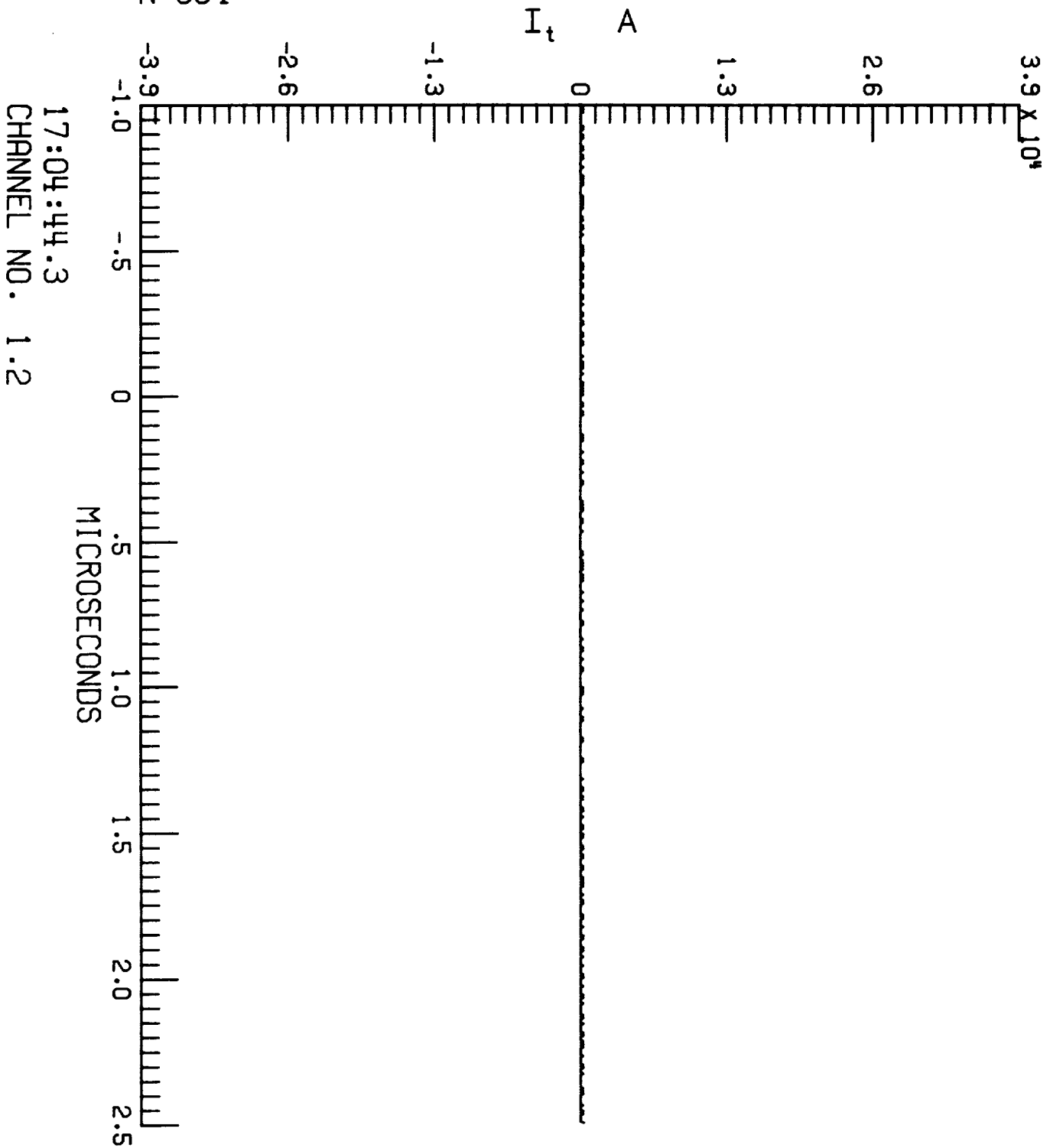

17:04:44.3  
CHANNEL NO. 1.2

F106 LIGHTNING/85-029/ZAEPFEL

LEC 2 RUN NO. 10

N-004

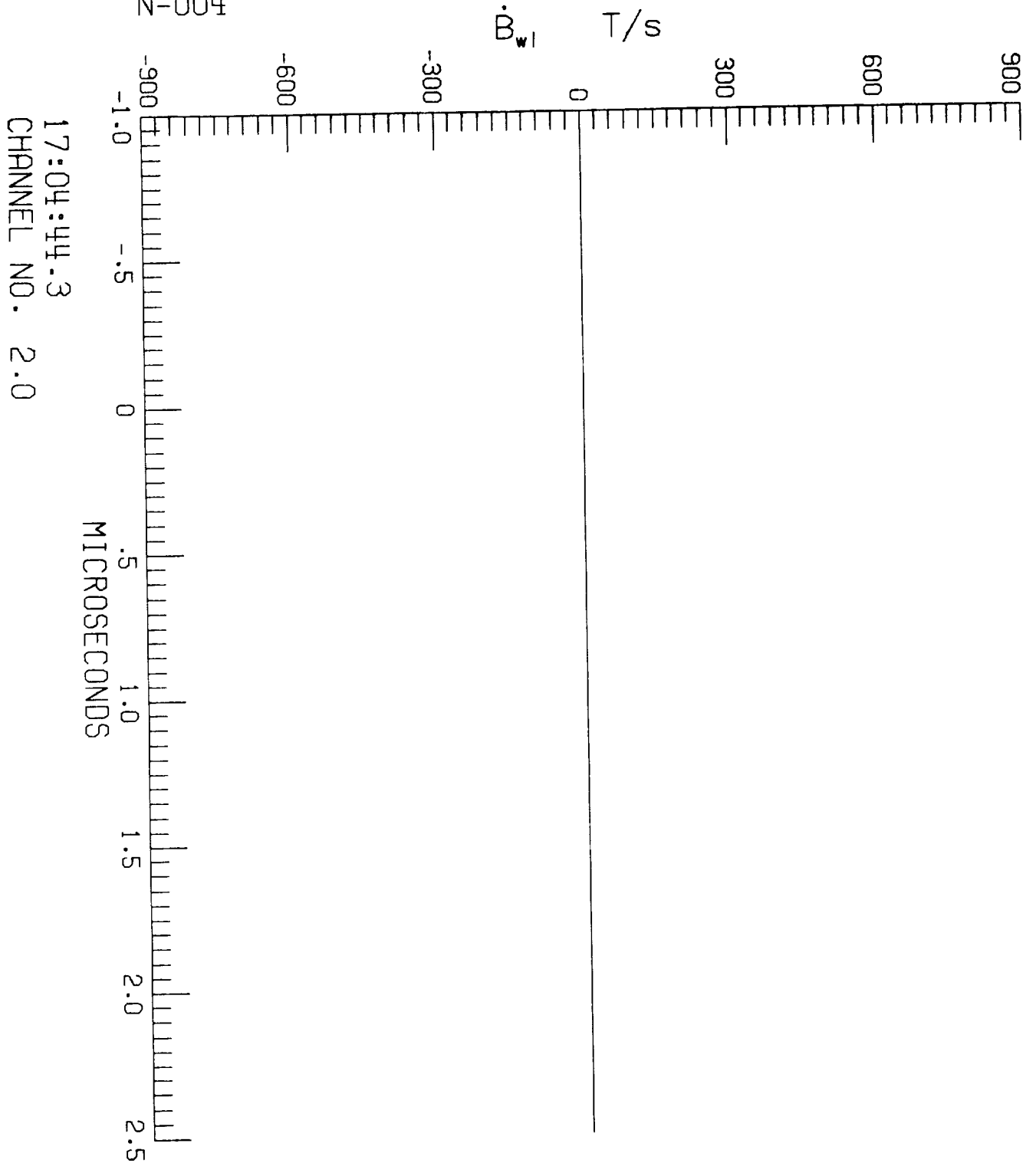

17:04:44.3  
CHANNEL NO. 2.0

F106 LIGHTNING/85-029/ZAEPFEL

LEC 2 RUN NO. 10

N-004

i A/s

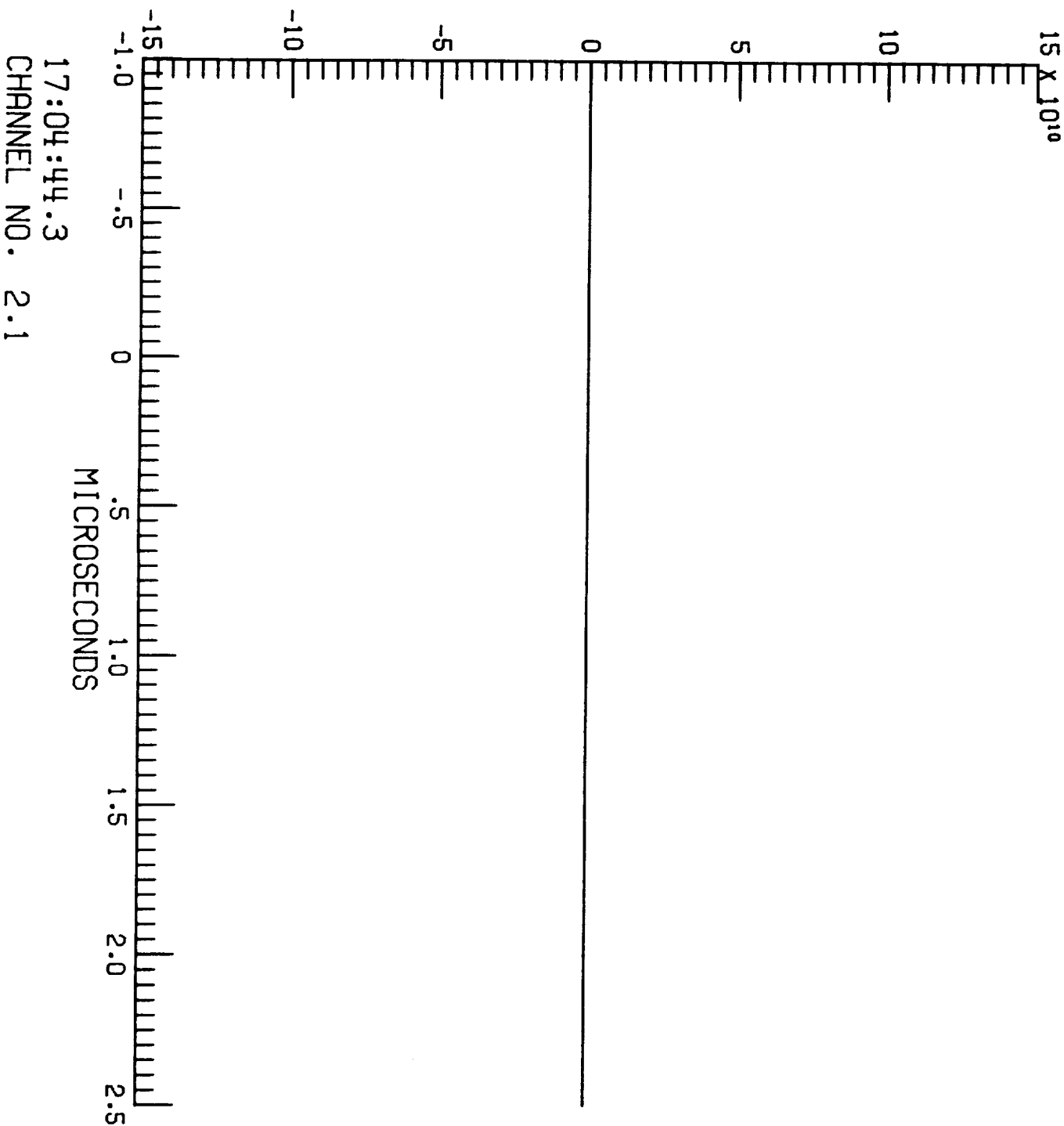

17:04:44.3  
CHANNEL NO. 2.1

F106 LIGHTNING/85-029/ZAEPFEL

LEC 3 RUN NO. 10

N-004

$\dot{D}_{wr}$  A/m<sup>2</sup>

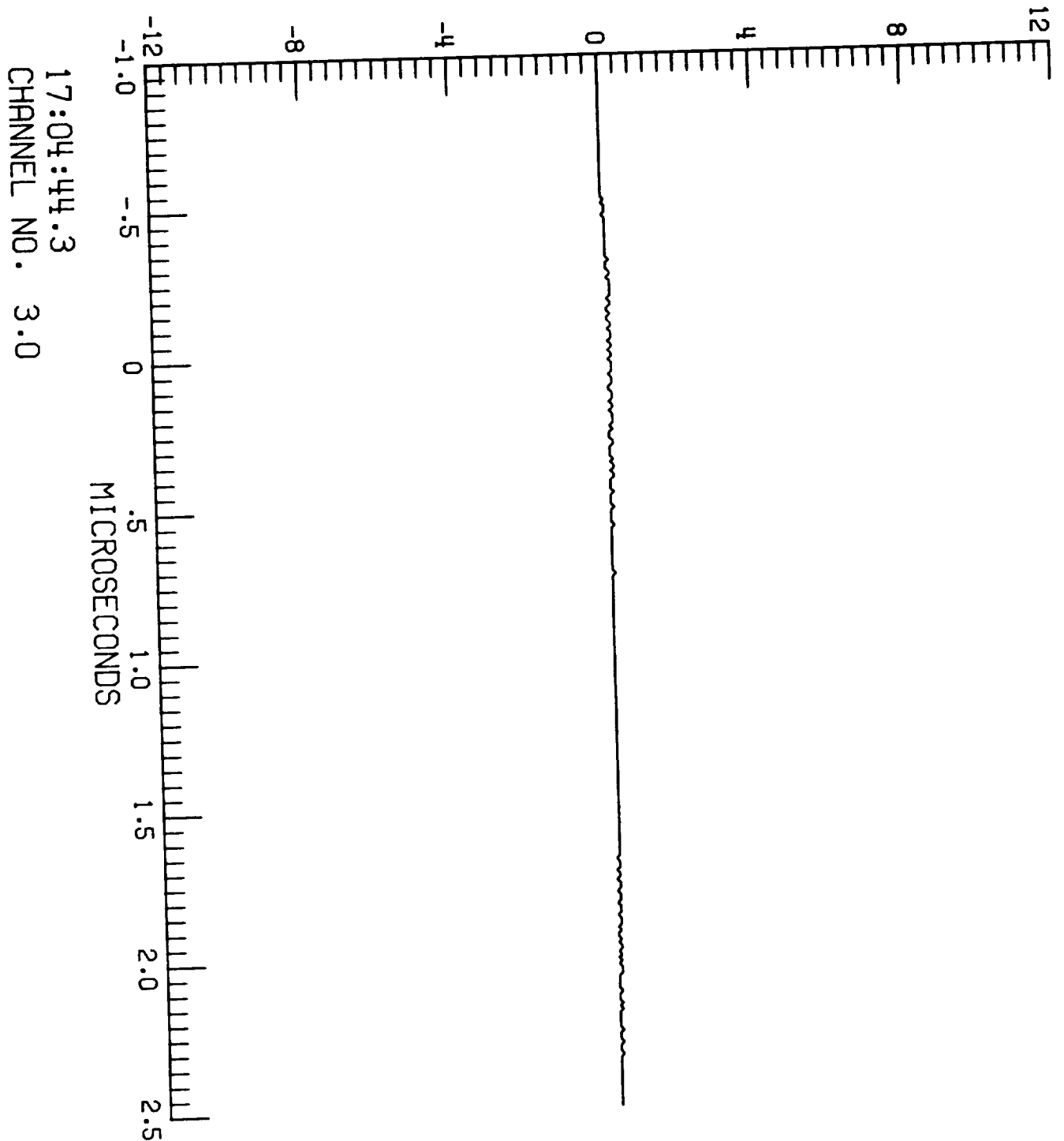

F106 LIGHTNING/85-029/ZAEPFEL

LEC 3 RUN NO. 10

N-004

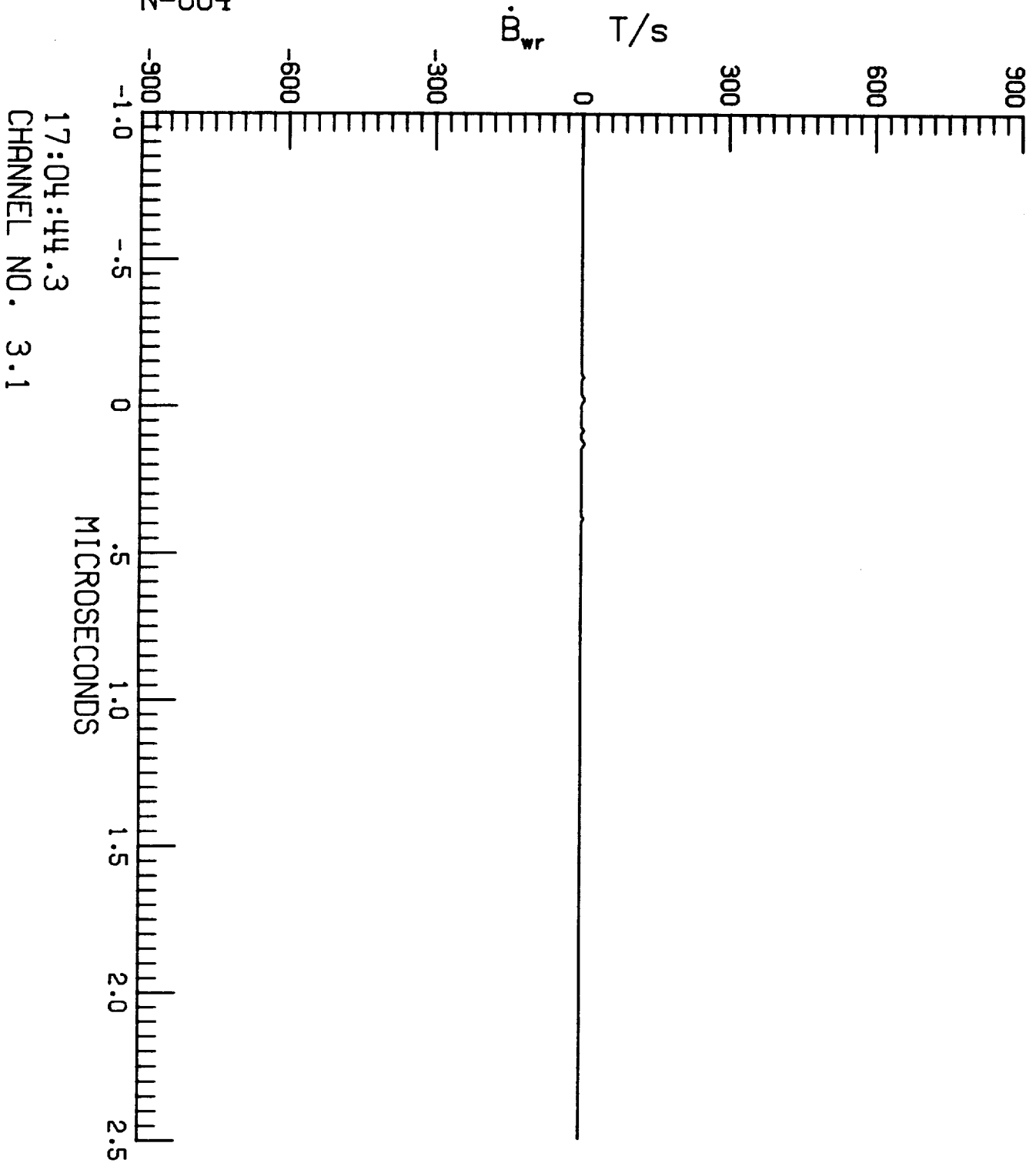

17:04:44.3  
CHANNEL NO. 3.1



F106 LIGHTNING/85-029/ZAEPFEL

LEC 3 RUN NO. 10

N-004

$\dot{D}_f$  A/m<sup>2</sup>

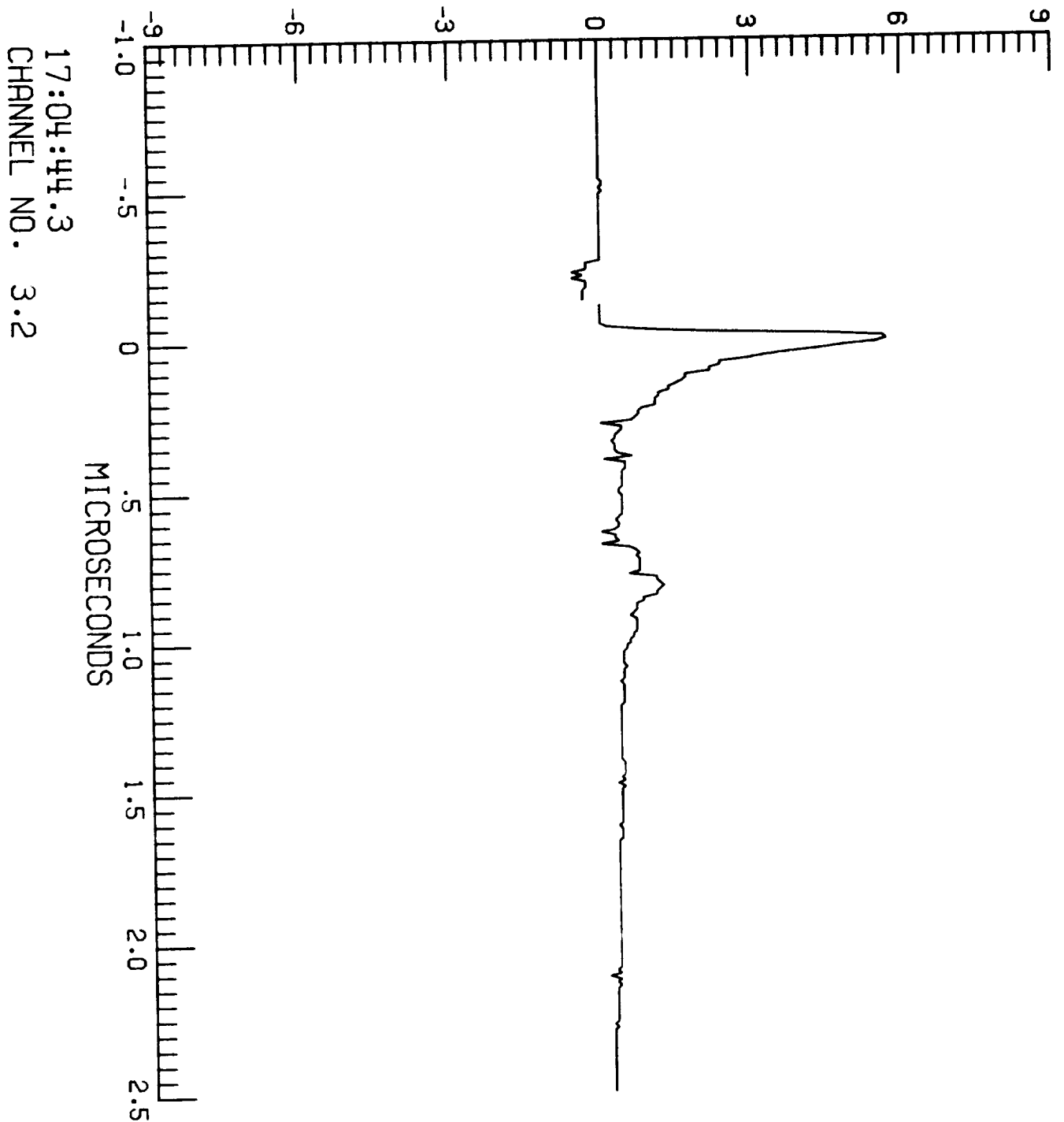

F106 LIGHTNING/85-029/ZAEPFEL

LEC 4 RUN NO. 10

N-004

TP100

V

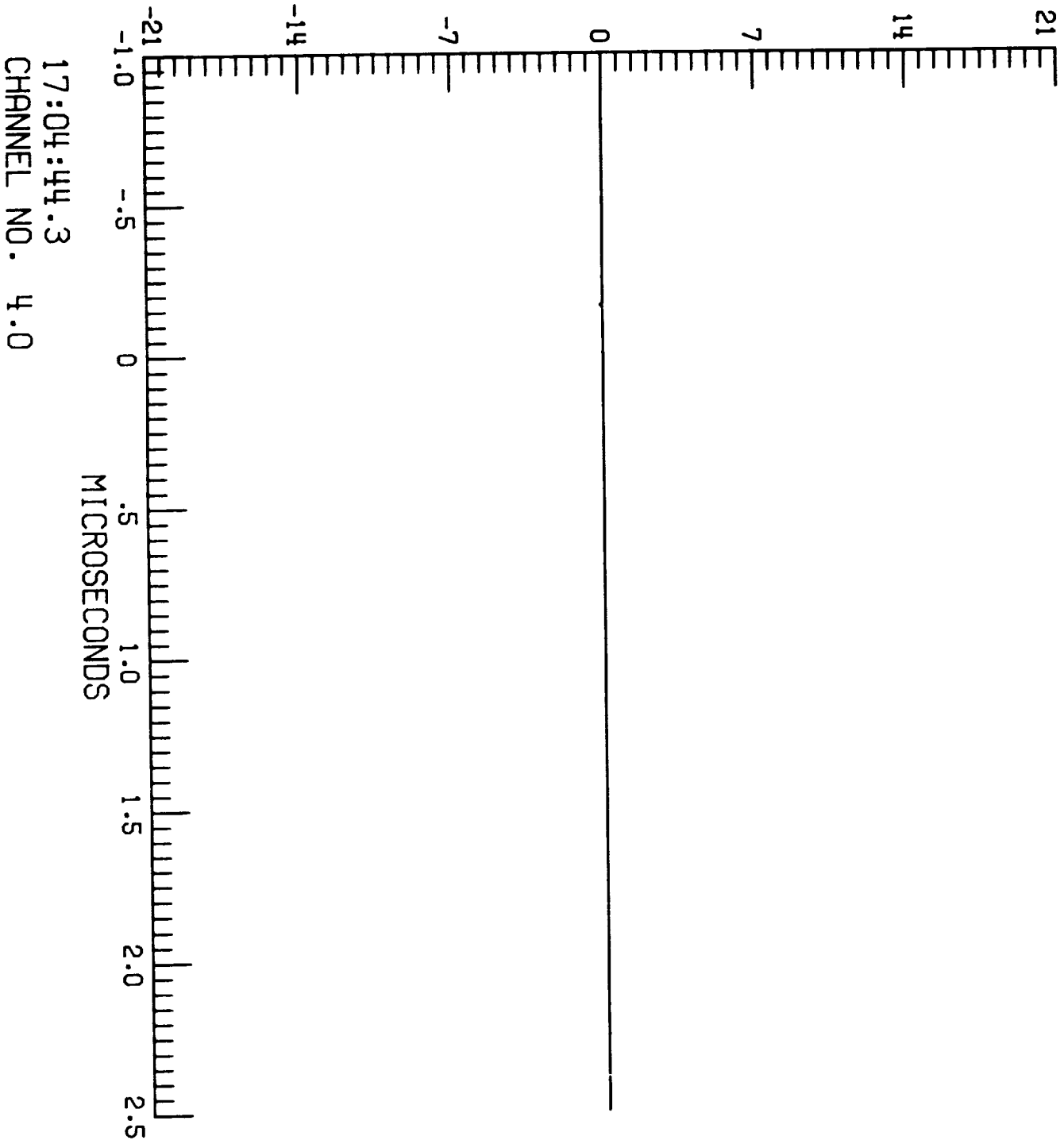

F106 LIGHTNING/85-029/ZAEPFEL

LEC 4 RUN NO. 10

N-004

TP106

A

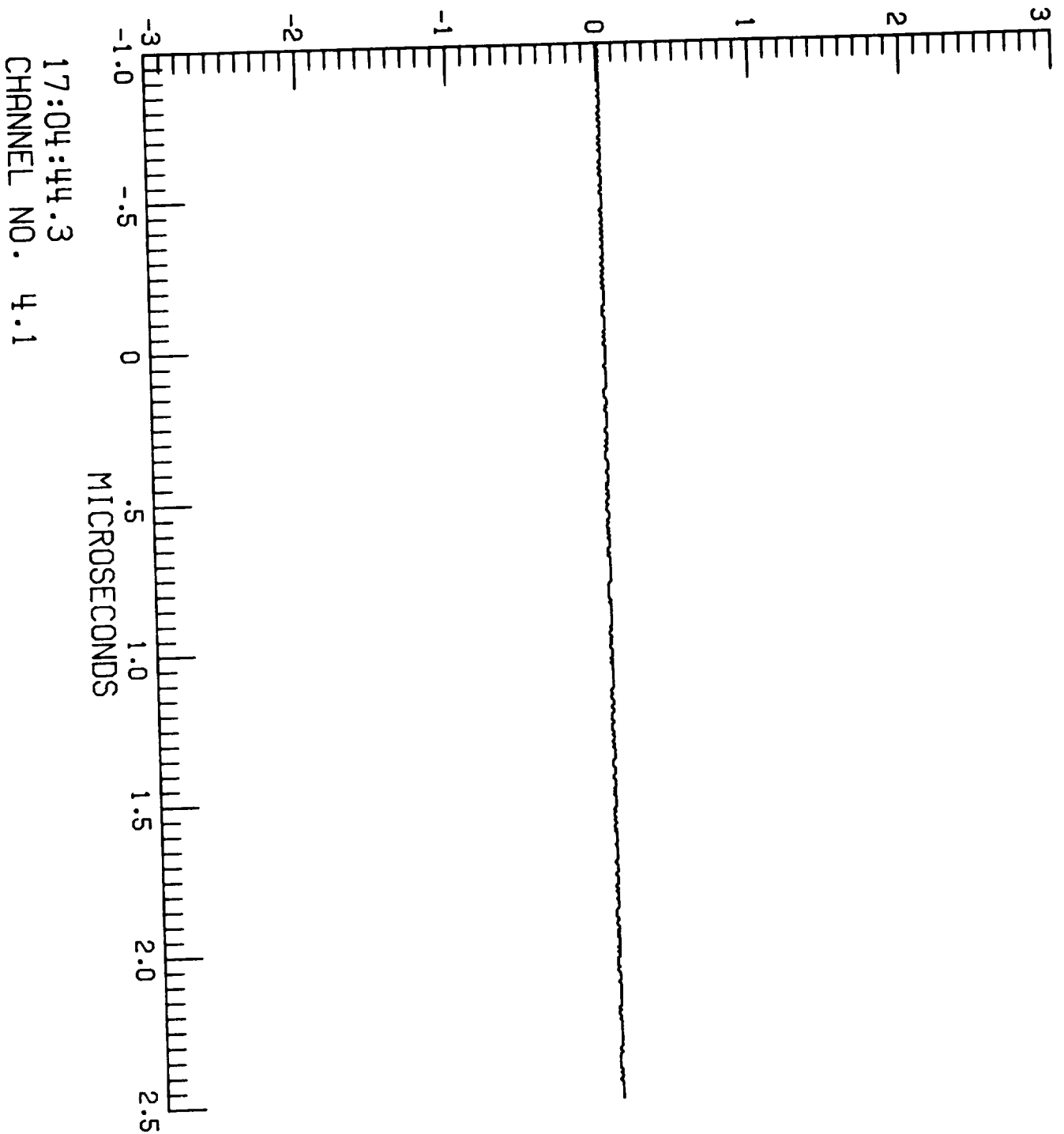

F106 LIGHTNING/85-029/ZAEPFEL

LEC 4 RUN NO. 10

N-004

TP125

A

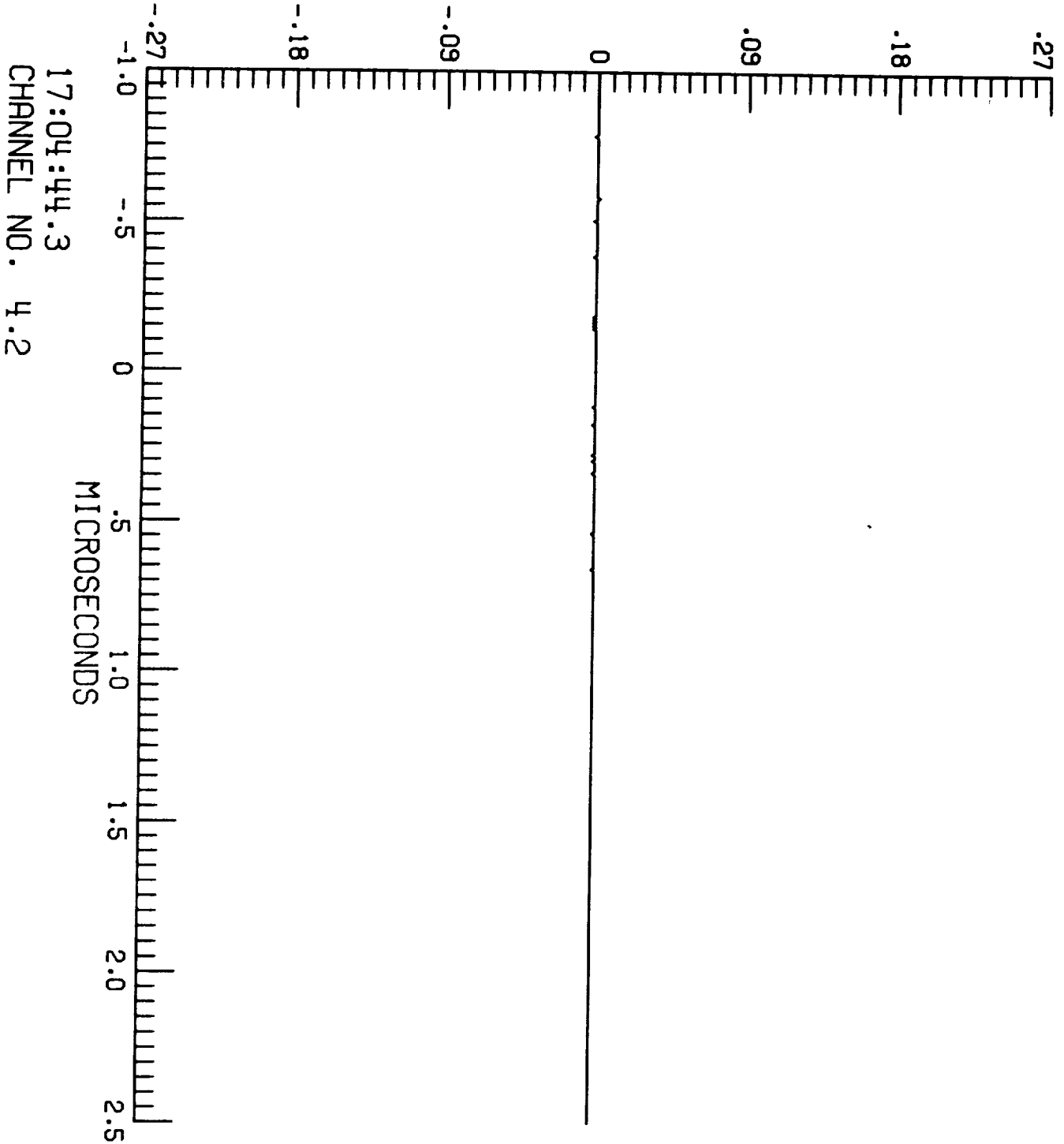

F106 LIGHTNING/85-029/ZREPTEL

LEC 1

RUN NO. 11

N-005

$\dot{D}_t$  A/m<sup>2</sup>

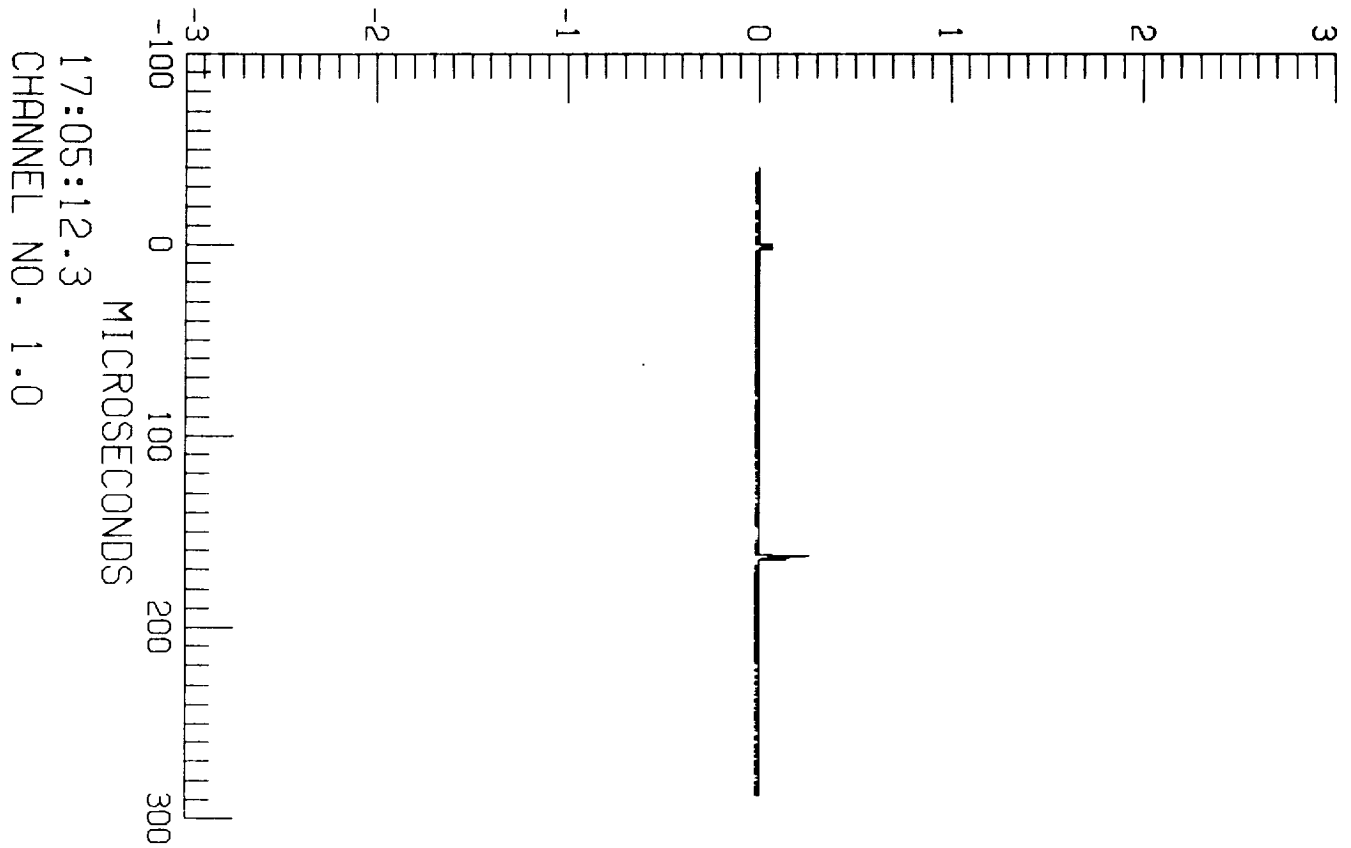

17:05:12.3  
CHANNEL NO. 1.0

F106 LIGHTNING/85-029/ZAEPFEL

LEC 1 RUN NO. 11

N-005

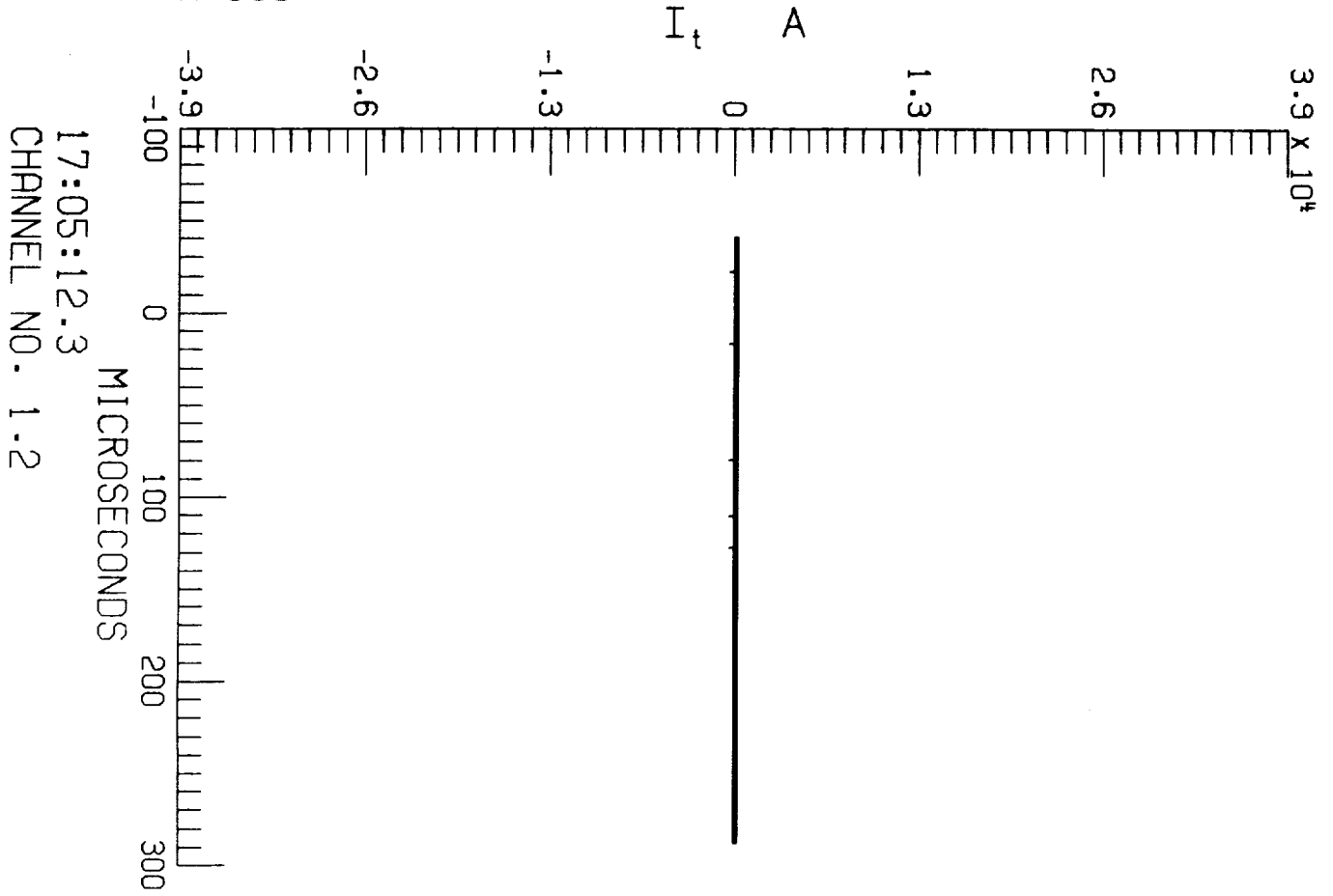

F106 LIGHTNING/85-029/ZAEPFEL

LEC 2

RUN NO. 11

N-005

$\dot{B}_w$  T/s

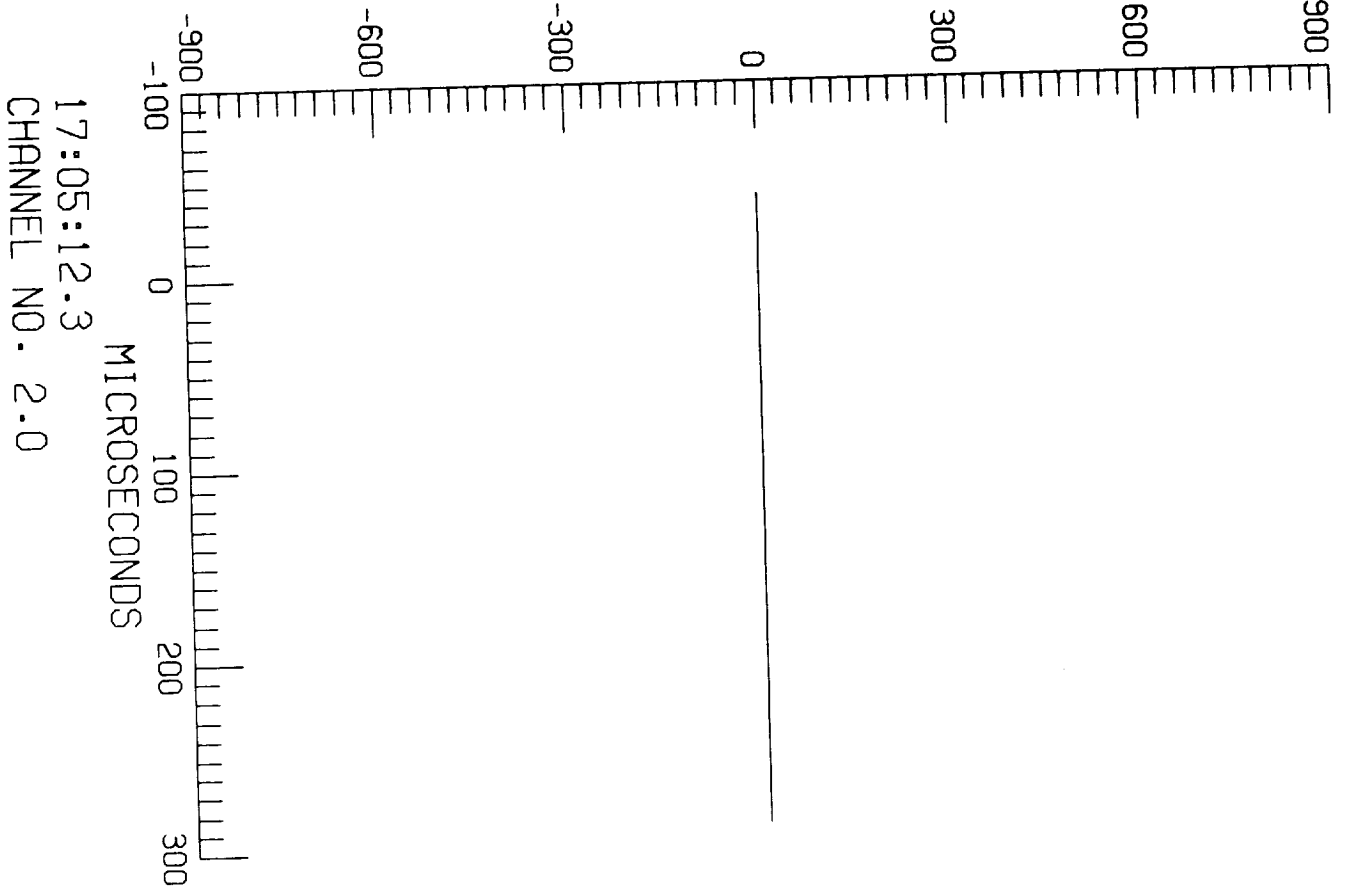

F106 LIGHTNING/85-029/ZAEPFEL

LEC 2

RUN NO. 11

N-005

$\dot{i}$  A/s

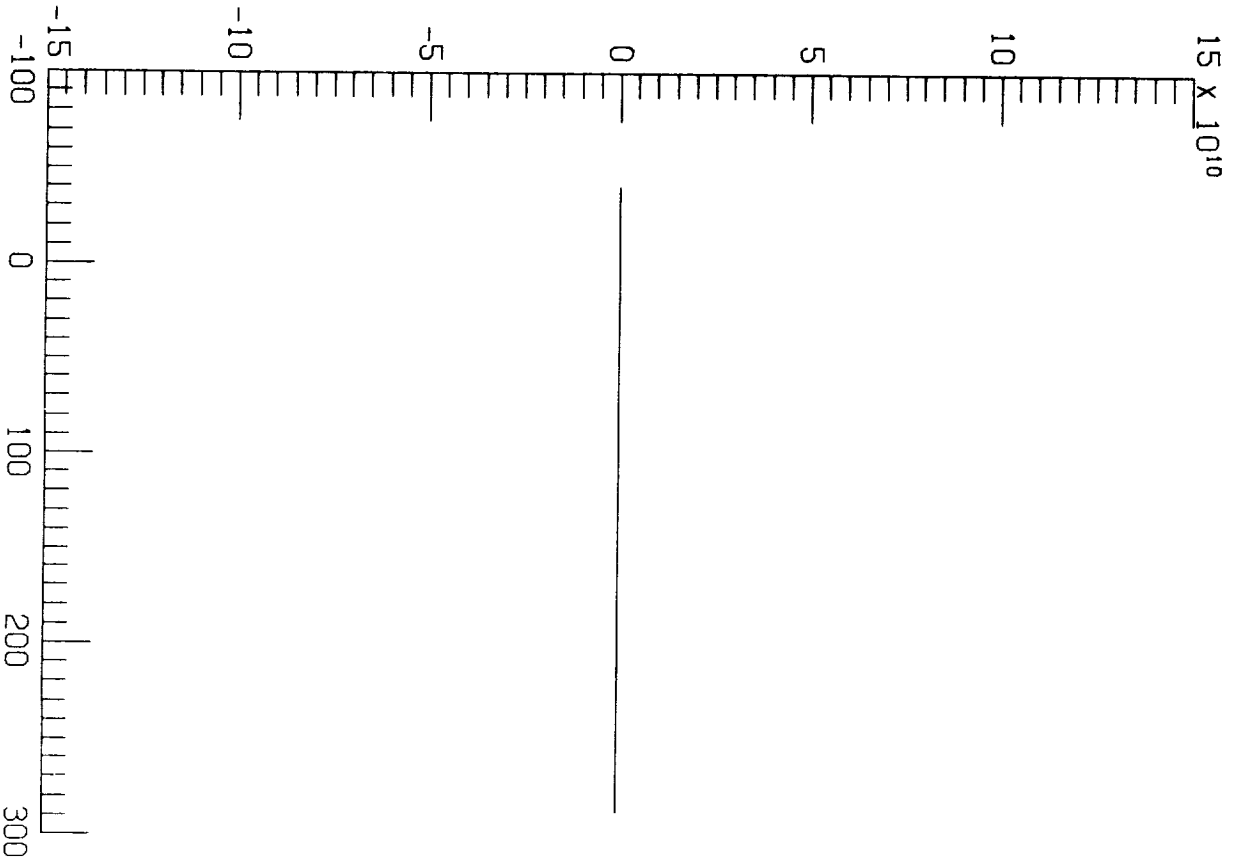

17:05:12.3  
CHANNEL NO. 2.1

MICROSECONDS



F106 LIGHTNING/85-029/ZREPPEL

LEC 3

RUN NO. 11

N-005

$\dot{D}_{wr}$  A/m<sup>2</sup>

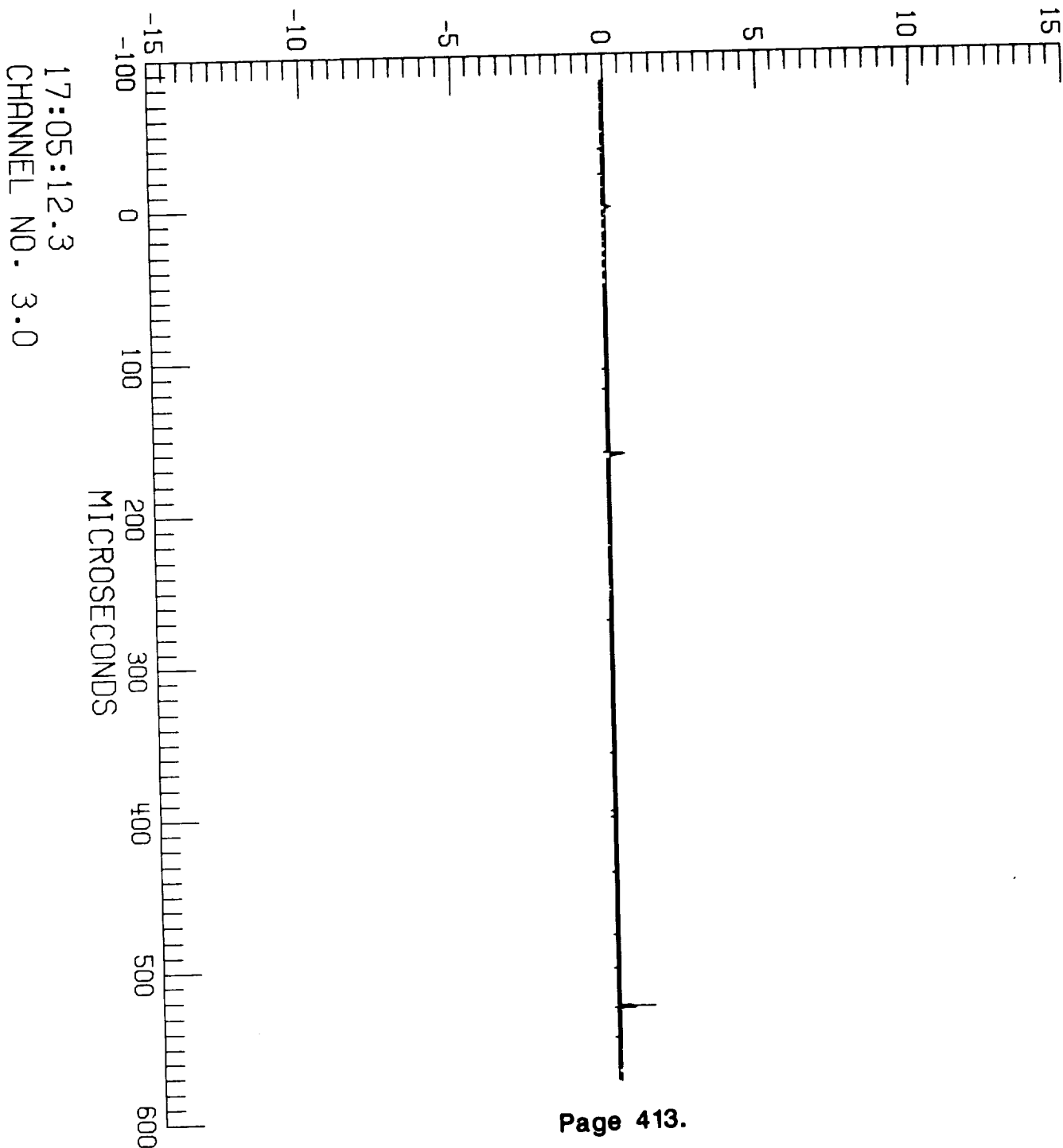

F106 LIGHTNING/85-029/ZAEPFEL

LEC 3

RUN NO. 11

N-005

$\dot{B}_{wr}$  T/s

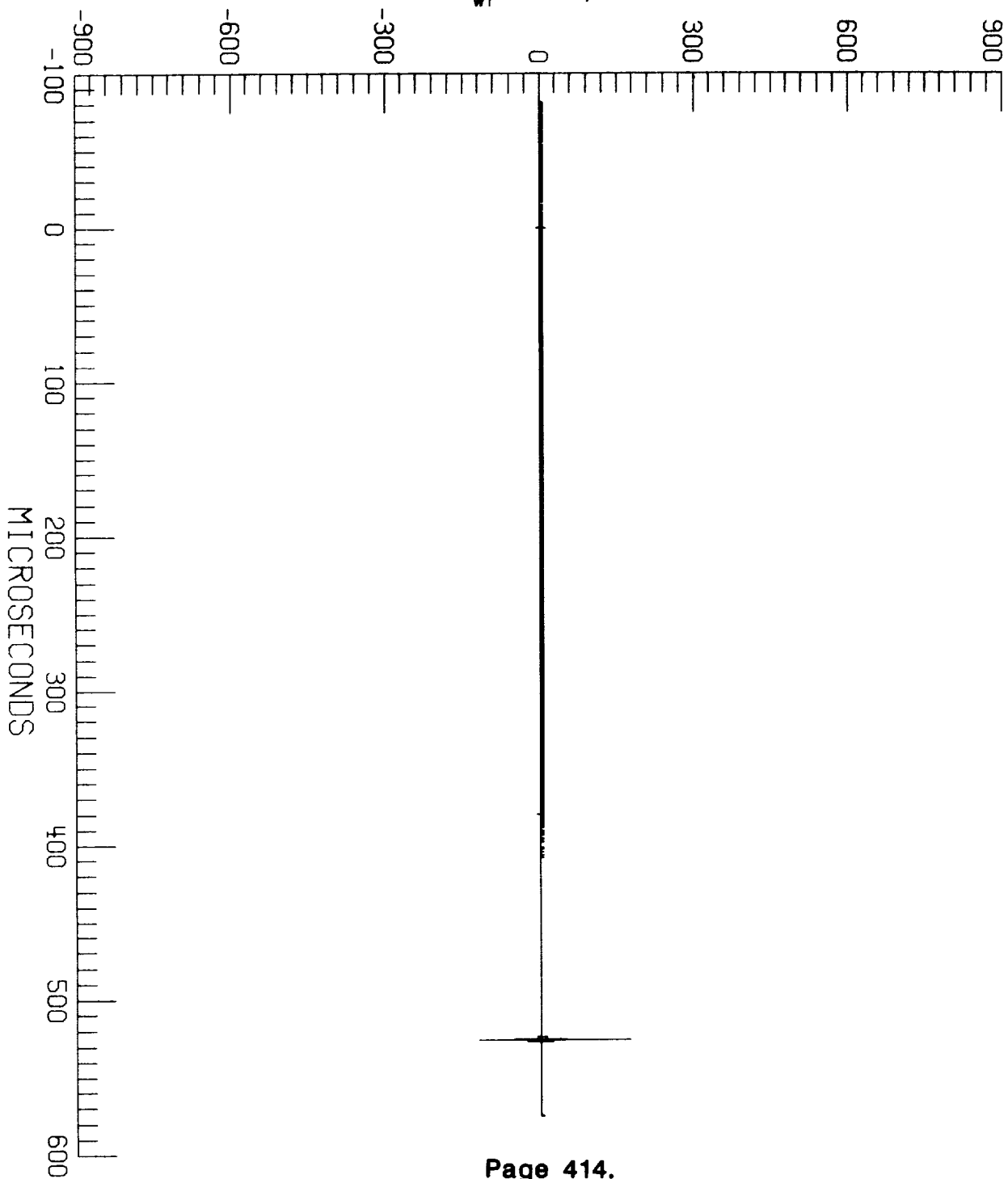

17:05:12.3  
CHANNEL NO. 3.1

F106 LIGHTNING/85-029/ZAEPFEL

LEC 3

RUN NO. 11

N-005

$\dot{D}_f$  A/m<sup>2</sup>

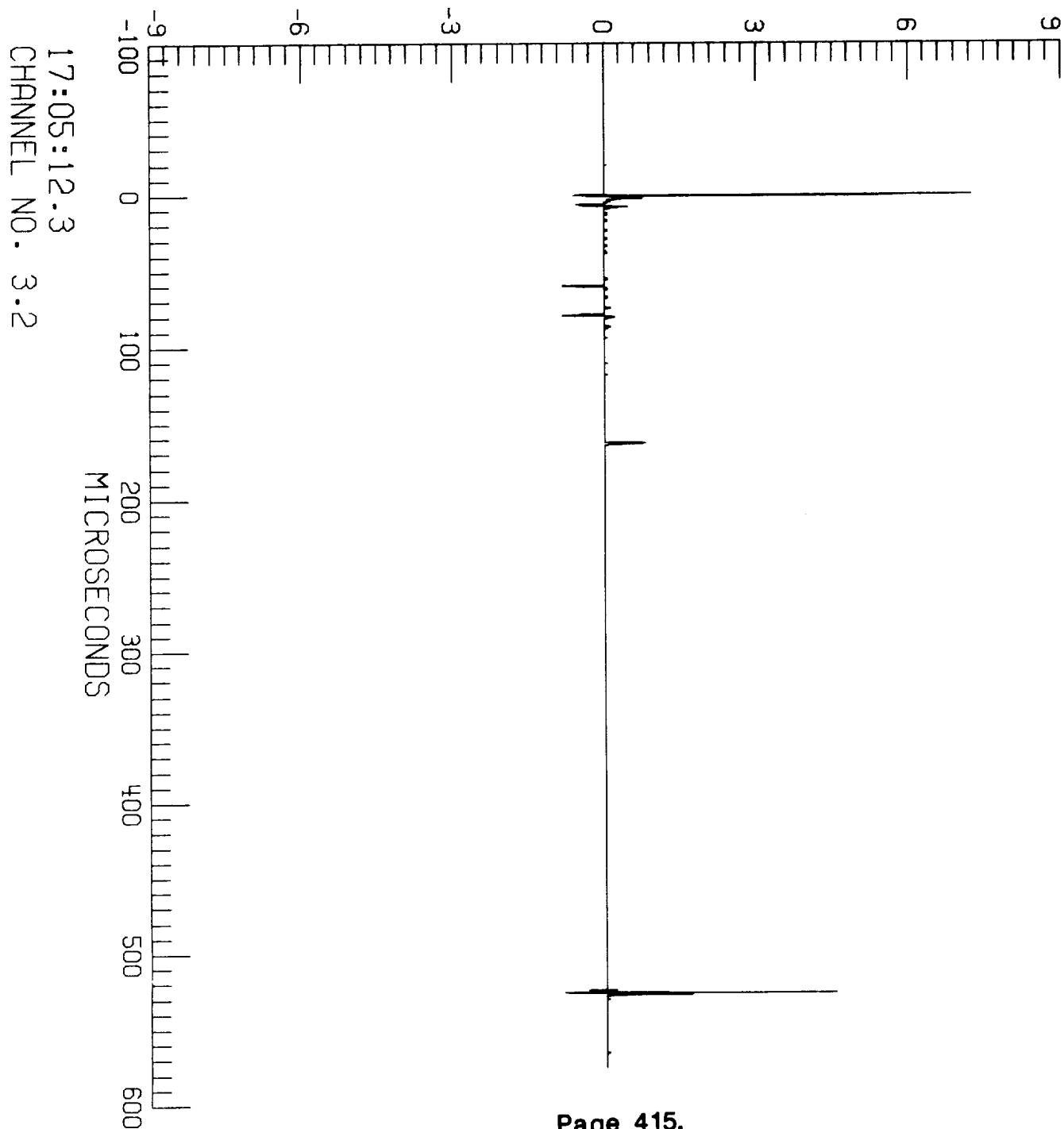

F106 LIGHTNING/85-029/ZAEPFEL

LEC 4

RUN NO. 11

N-005

TP100 V

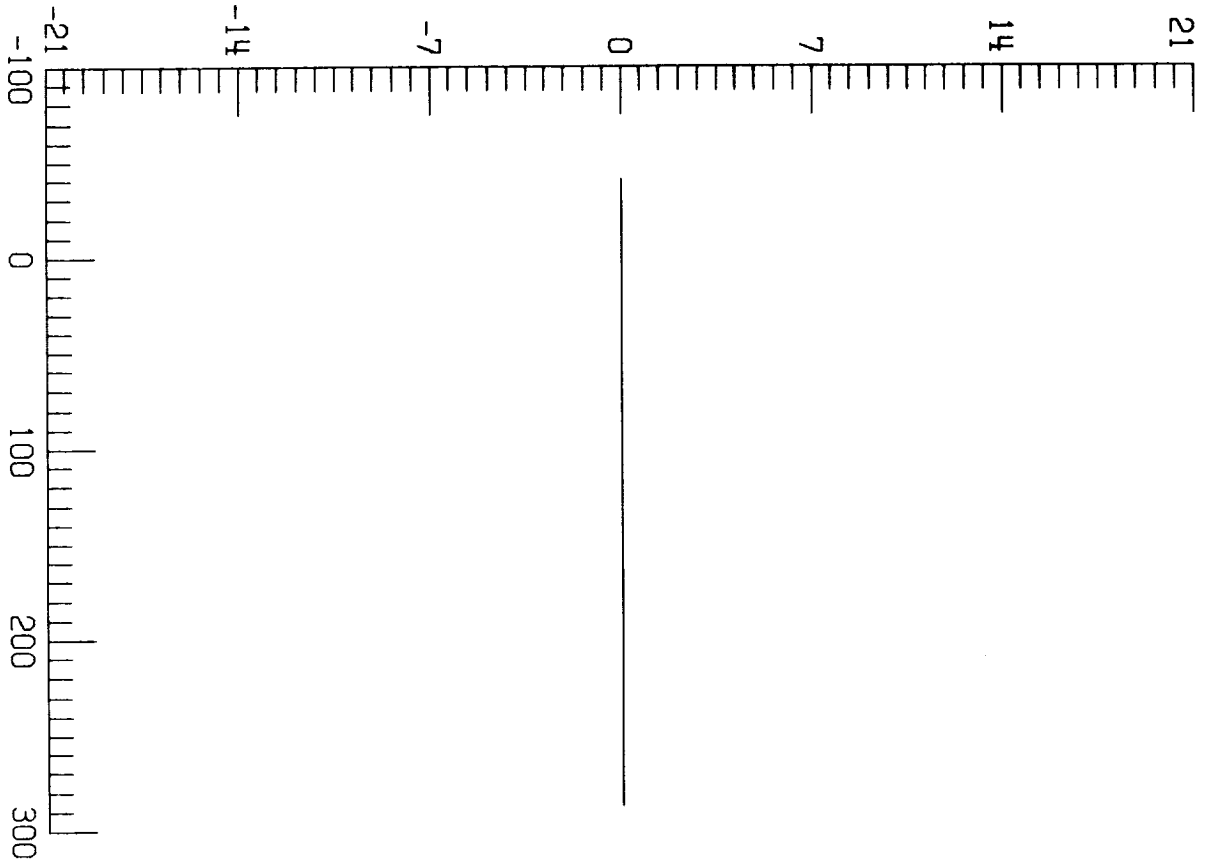

17:05:12.3  
CHANNEL NO. 4.0

F106 LIGHTNING/85-029/ZAEPFEL

LEC 4 RUN NO. 11

N-005

TP106 A

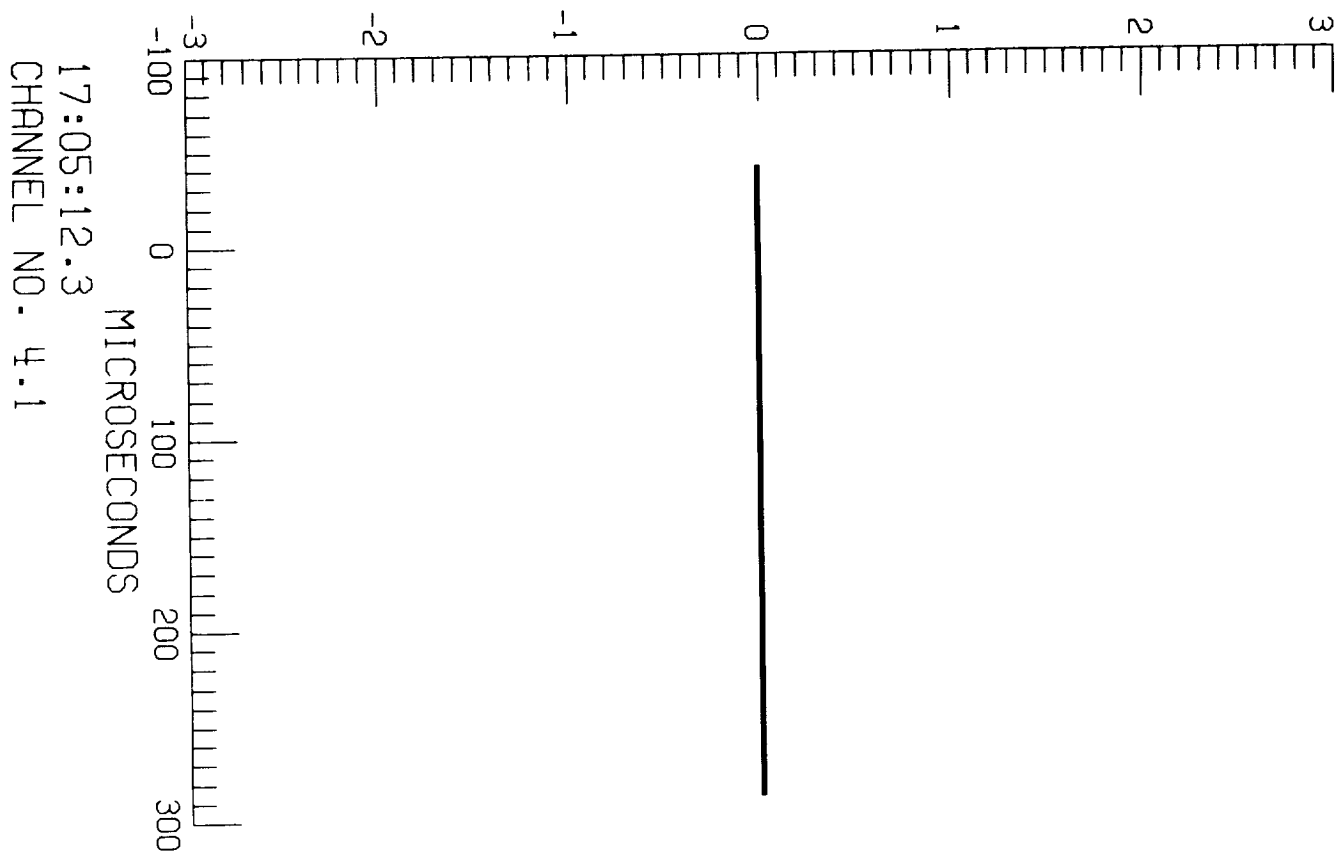

F106 LIGHTNING/85-029/ZAEPFEL

LEC 4 RUN NO. 11

N-005

TP125 A

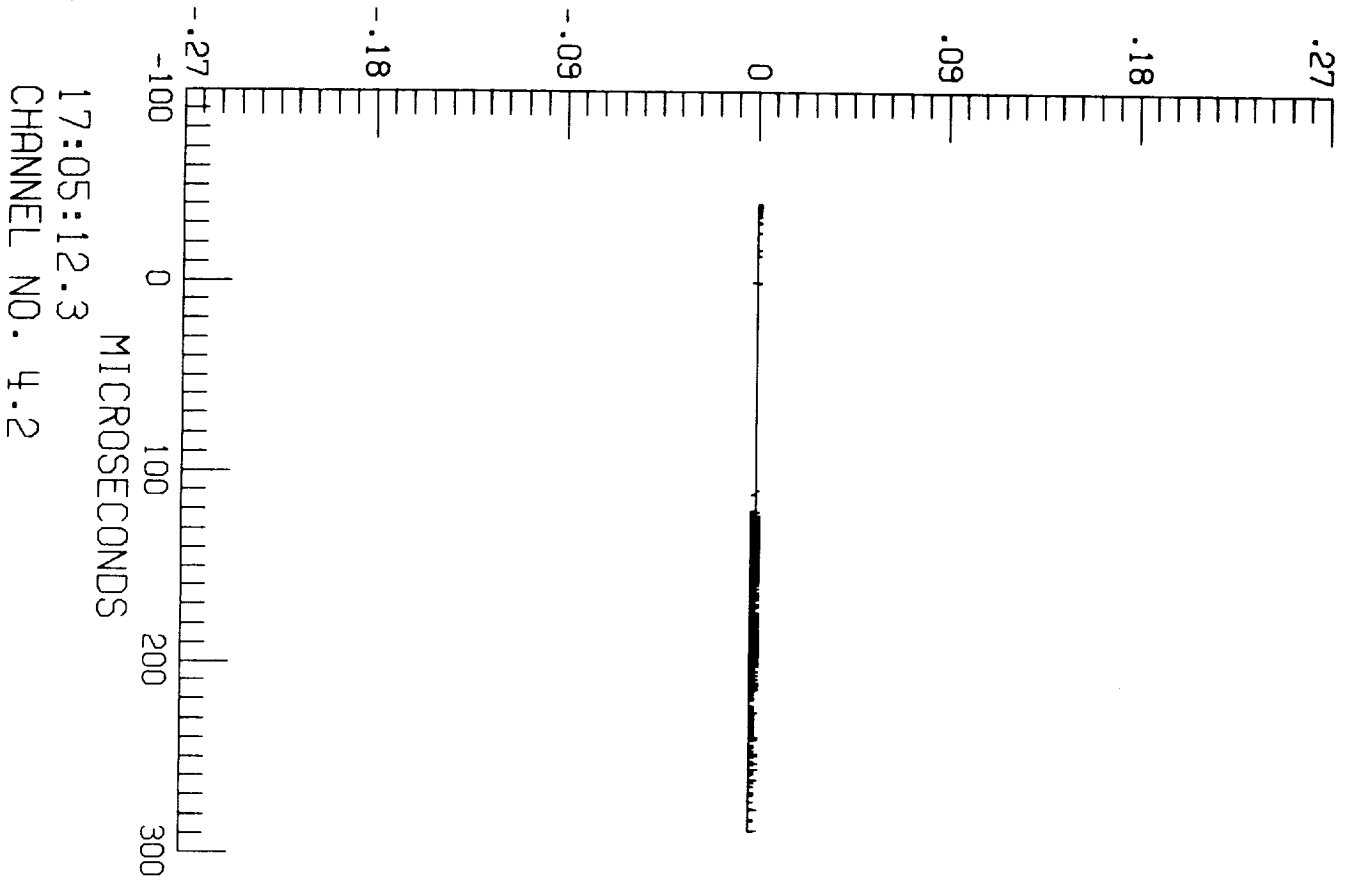

F106 LIGHTNING/85-029/ZAEPFEL  
LEC 1 RUN NO. 11  
N-005

$\dot{D}_t$  A/m<sup>2</sup>

17:05:12.3  
CHANNEL NO. 1.0

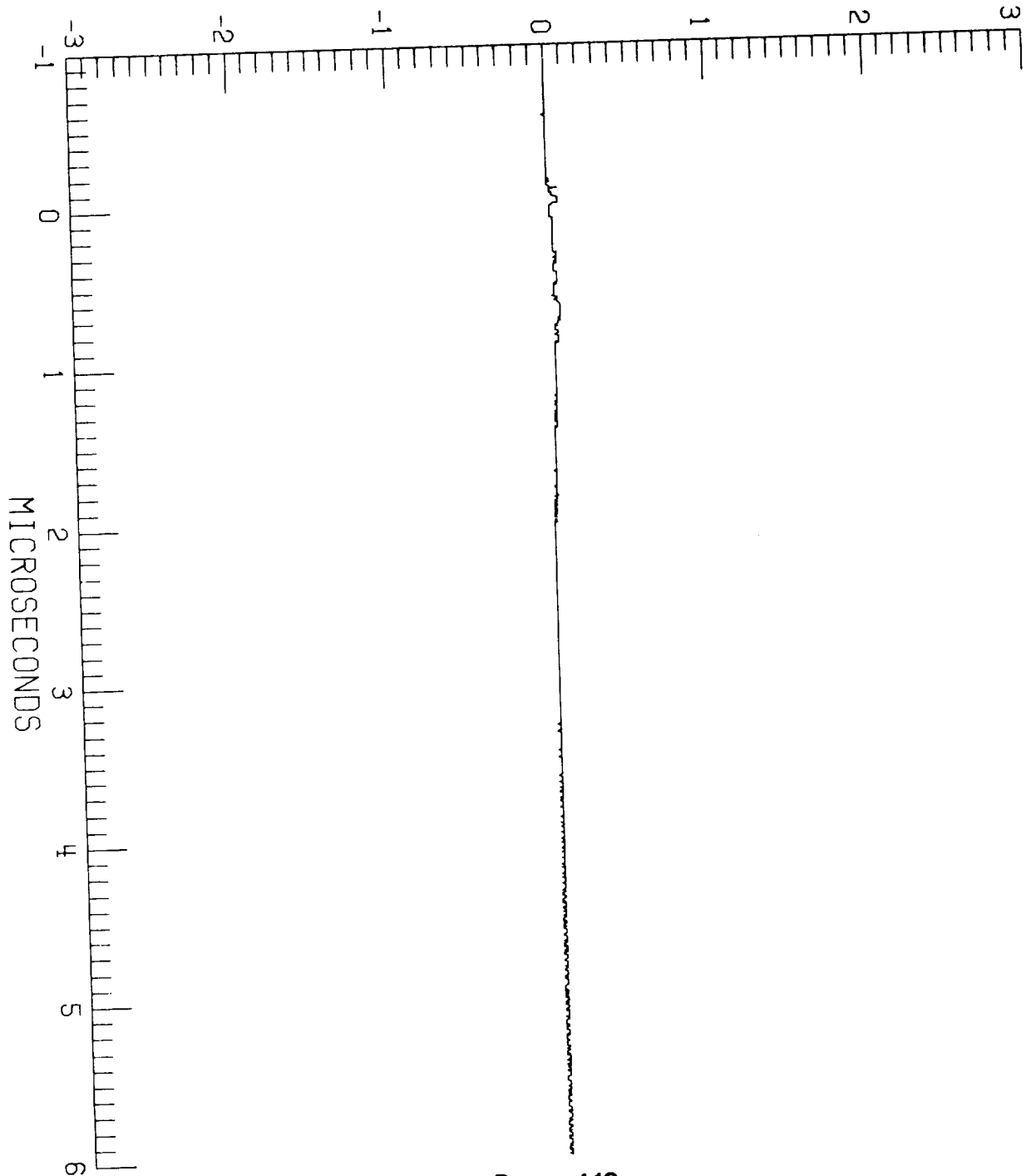

F106 LIGHTNING/85-029/ZAEPFEL

LEC 1 RUN NO. 11

N-005

$I_t$  A

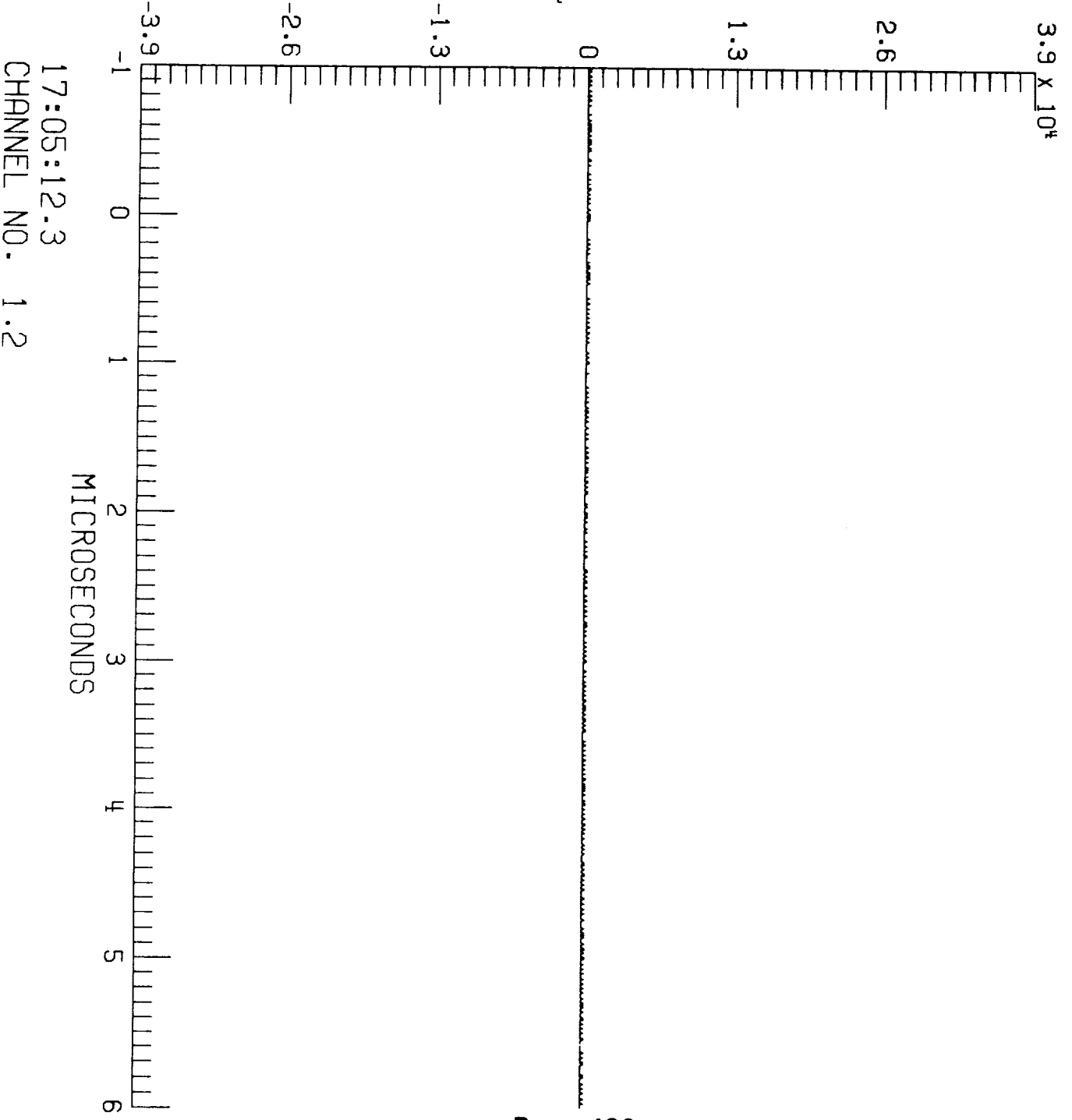

17:05:12.3  
CHANNEL NO. 1.2



F106 LIGHTNING/85-029/ZAEPFEL  
LEC 2 RUN NO. 11  
N-005

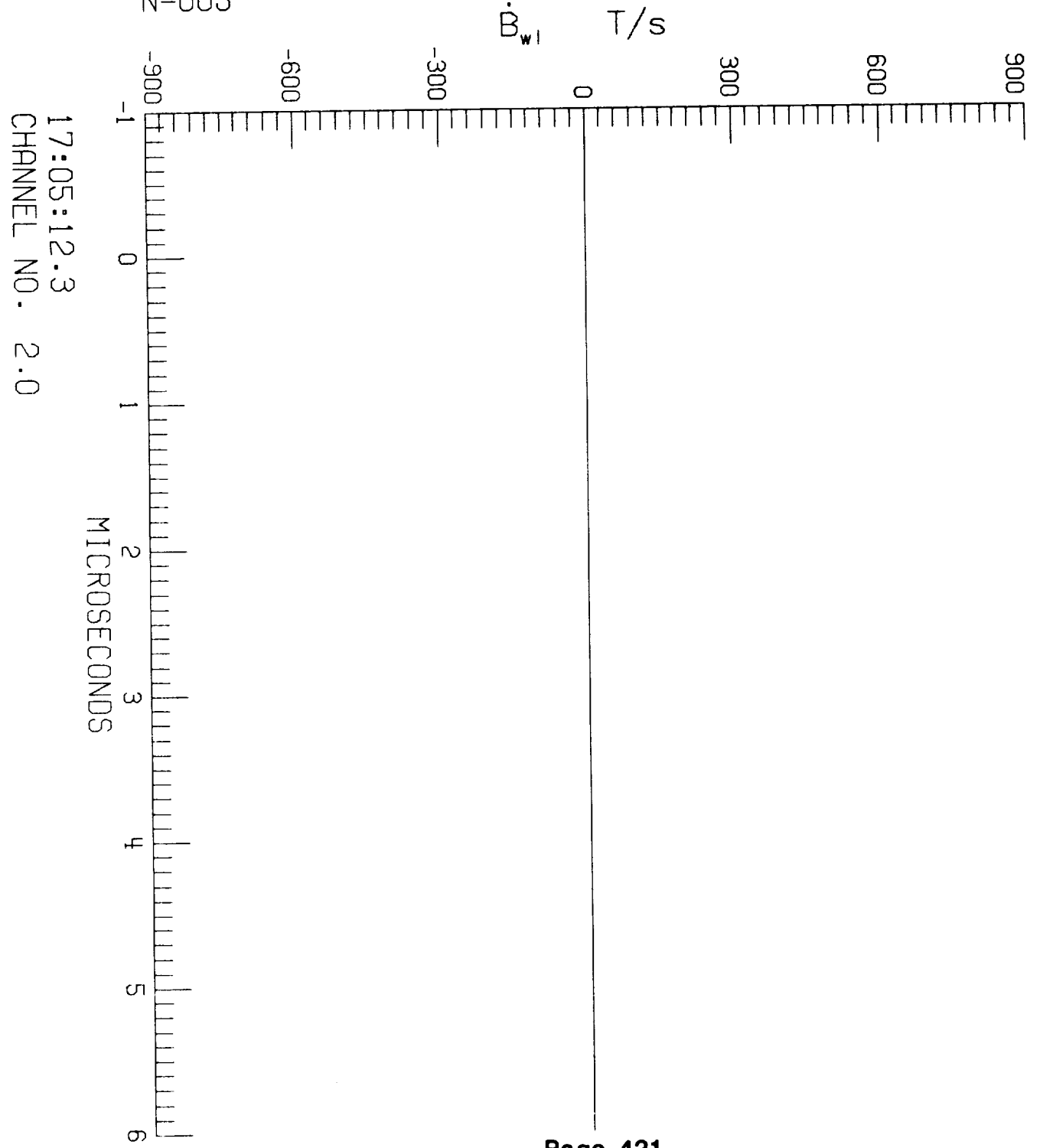

17:05:12.3  
CHANNEL NO. 2.0

F106 LIGHTNING/85-029/ZAEPFEL

LEC 2 RUN NO. 11

N-005

$\dot{i}$  A/s

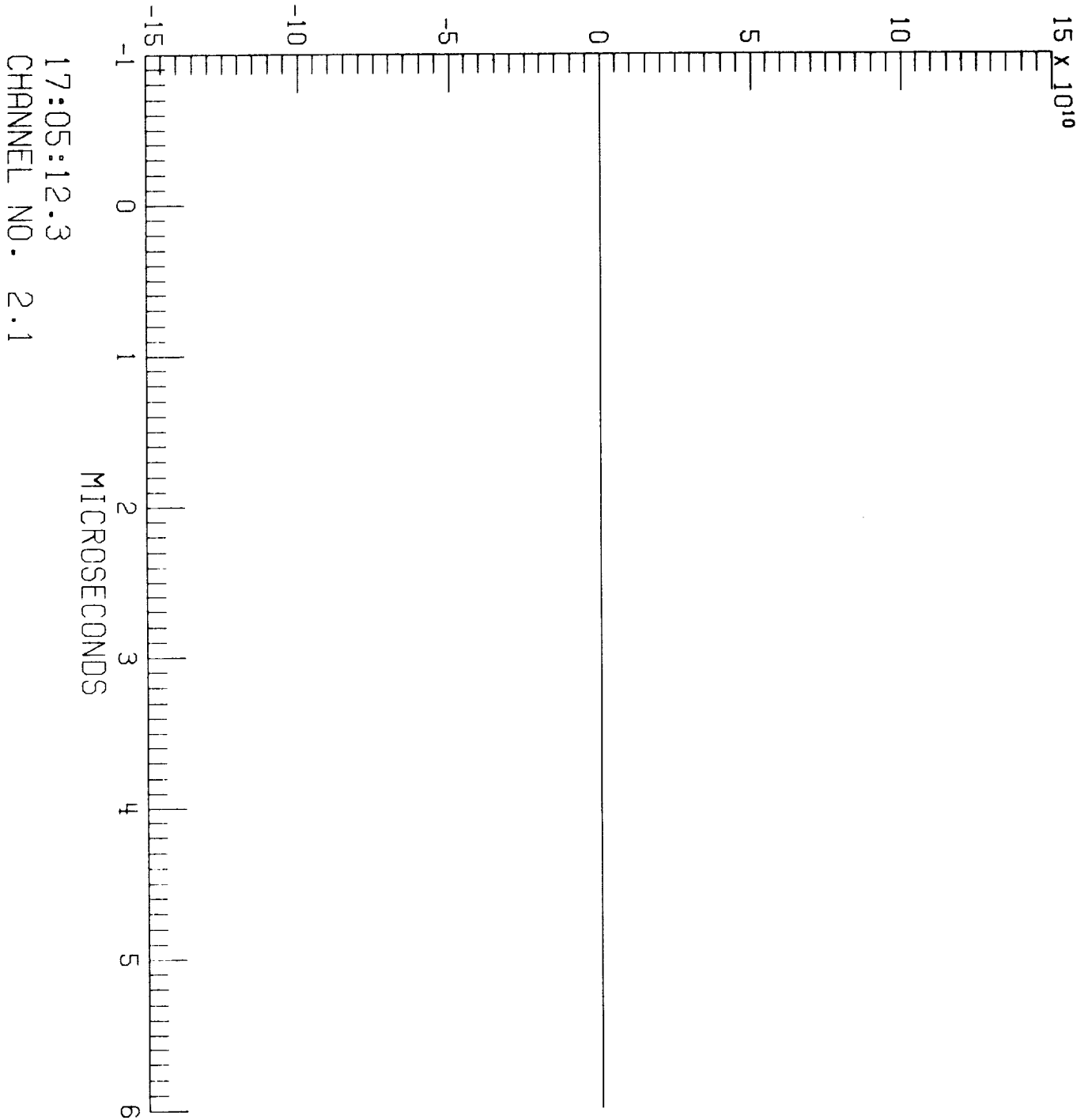

17:05:12.3  
CHANNEL NO. 2.1

F106 LIGHTNING/85-029/ZAEPFEL

LEC 3 RUN NO. 11

N-005

$\dot{D}_{wr}$  A/m<sup>2</sup>

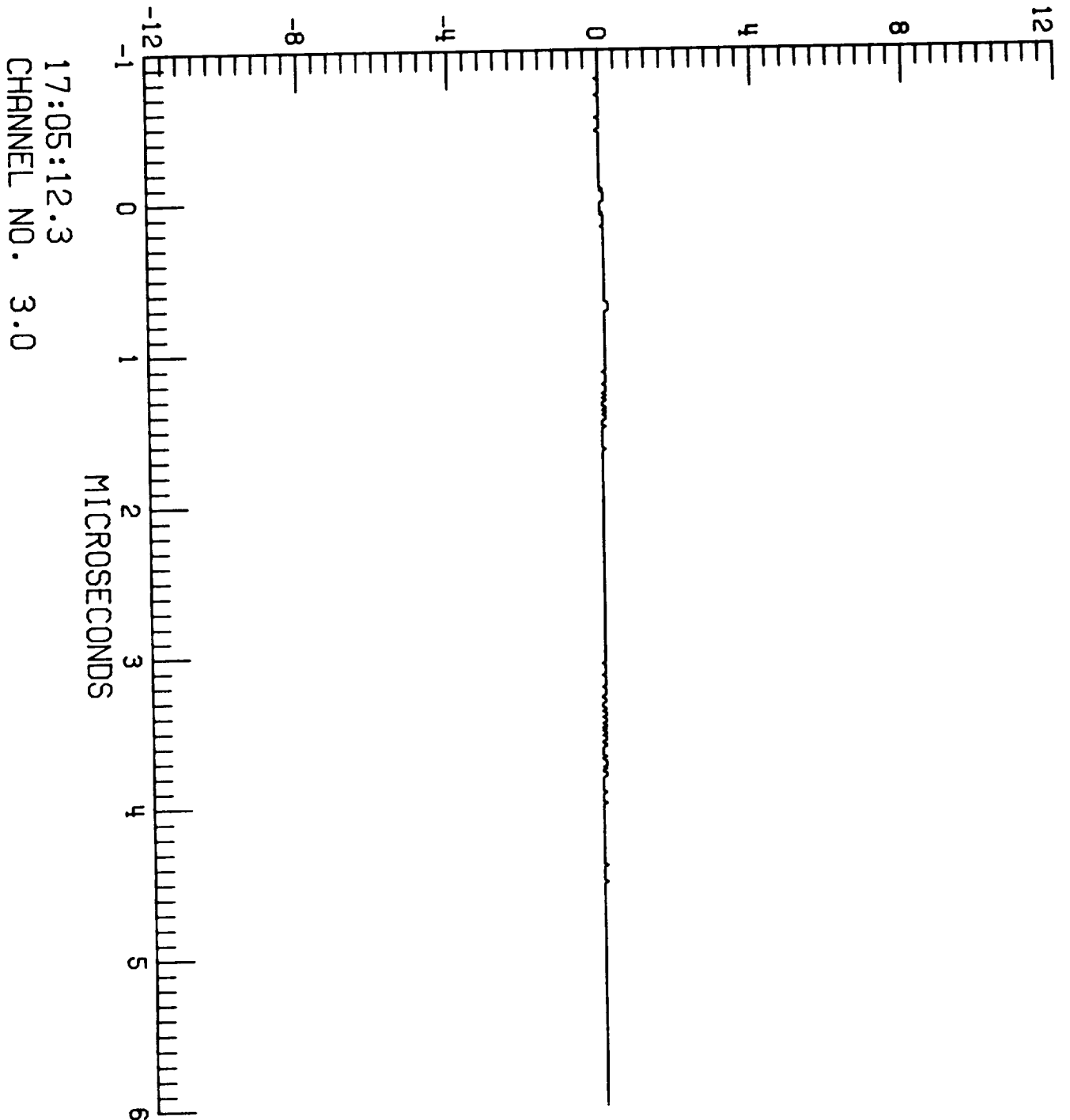

17:05:12.3  
CHANNEL NO. 3.0

F106 LIGHTNING/85-029/ZAEPFEL

LEC 3 RUN NO. 11

N-005

$\dot{B}_{wr}$  T/s

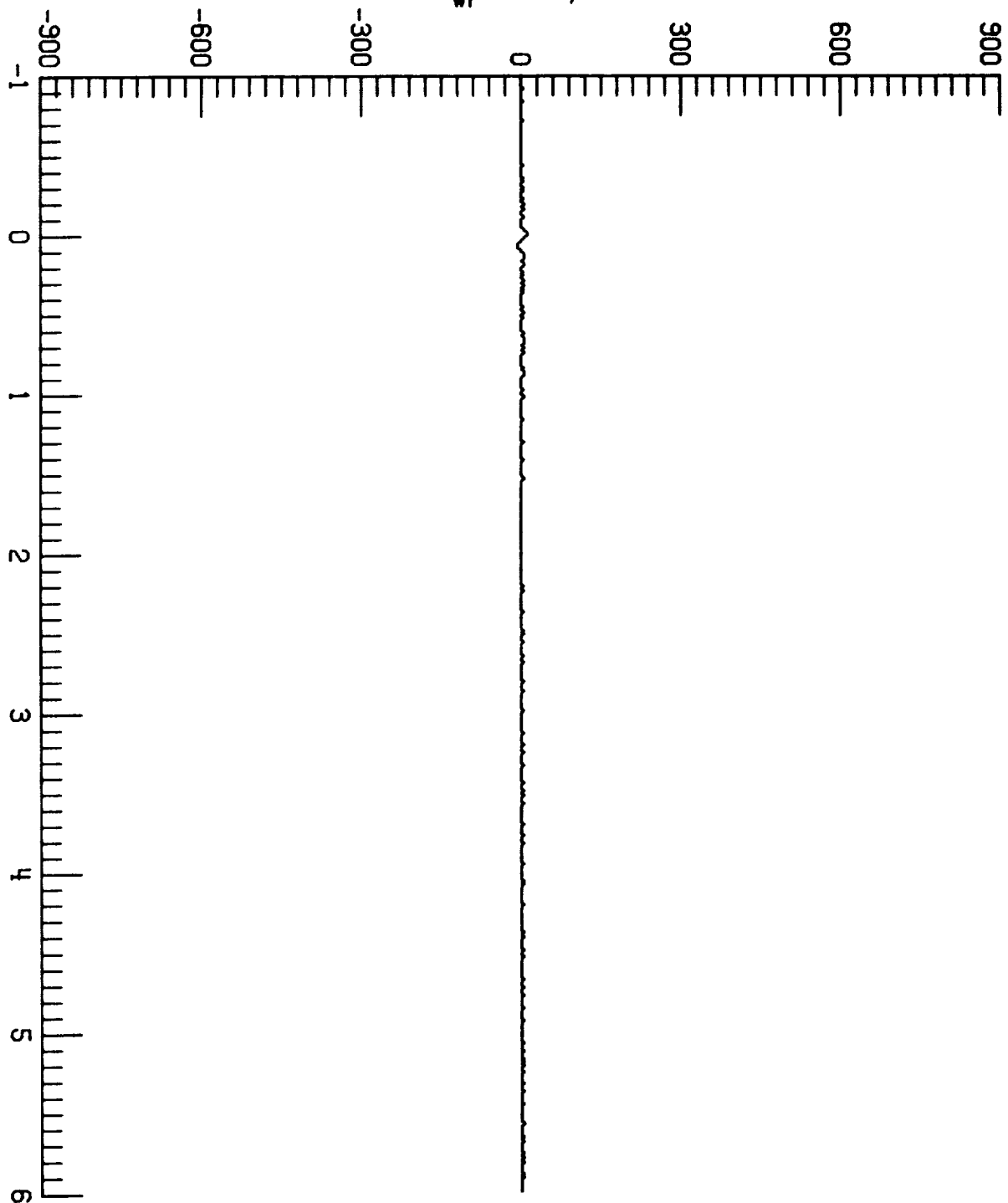

17:05:12.3  
CHANNEL NO. 3.1

F106 LIGHTNING/85-029/ZAEPFEL  
LEC 3 RUN NO. 11  
N-005

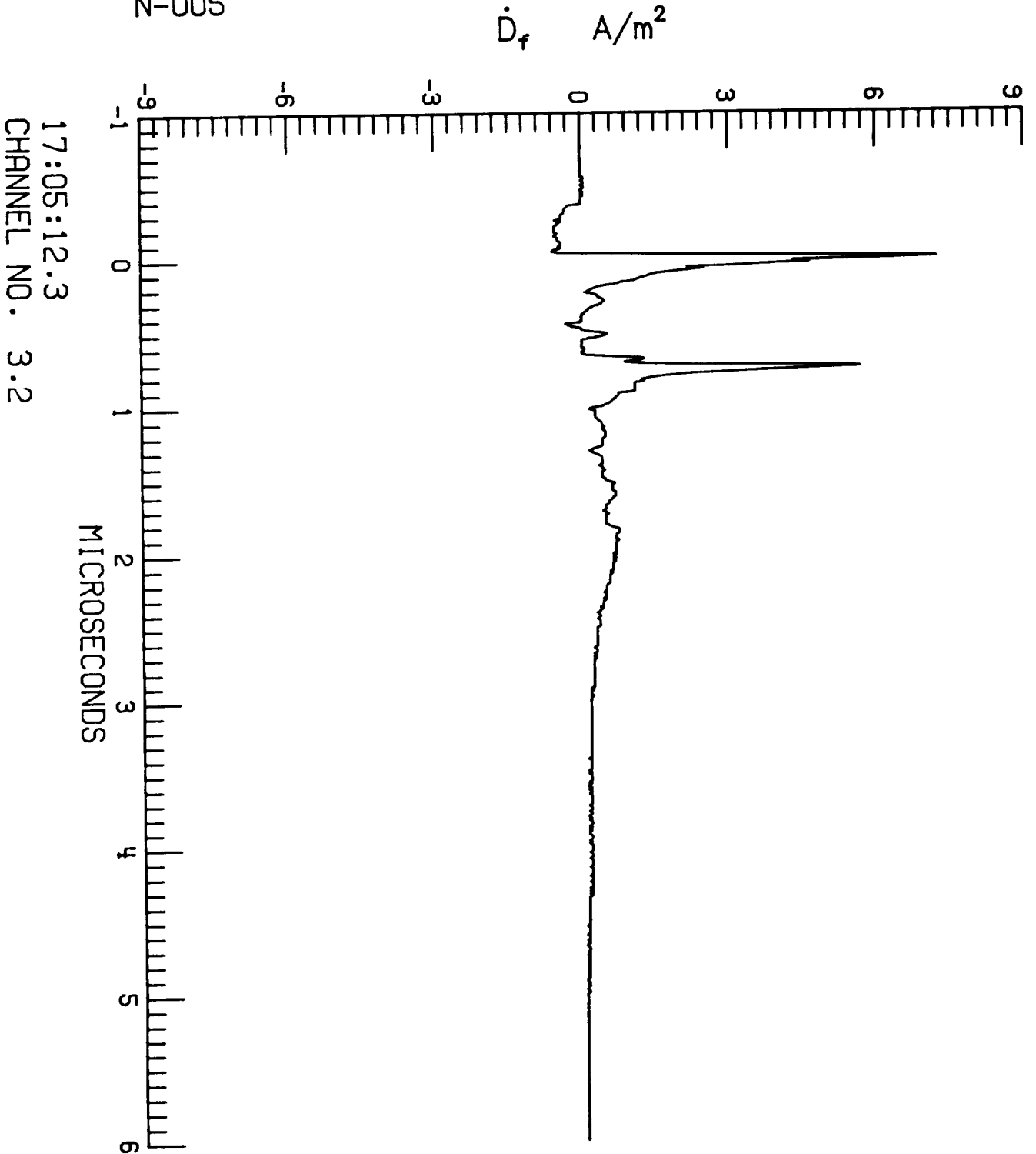

17:05:12.3  
CHANNEL NO. 3.2

F106 LIGHTNING/85-029/ZAEPFEL

LEC 3 RUN NO. 11

N-005

$\dot{D}_f$  A/m<sup>2</sup>

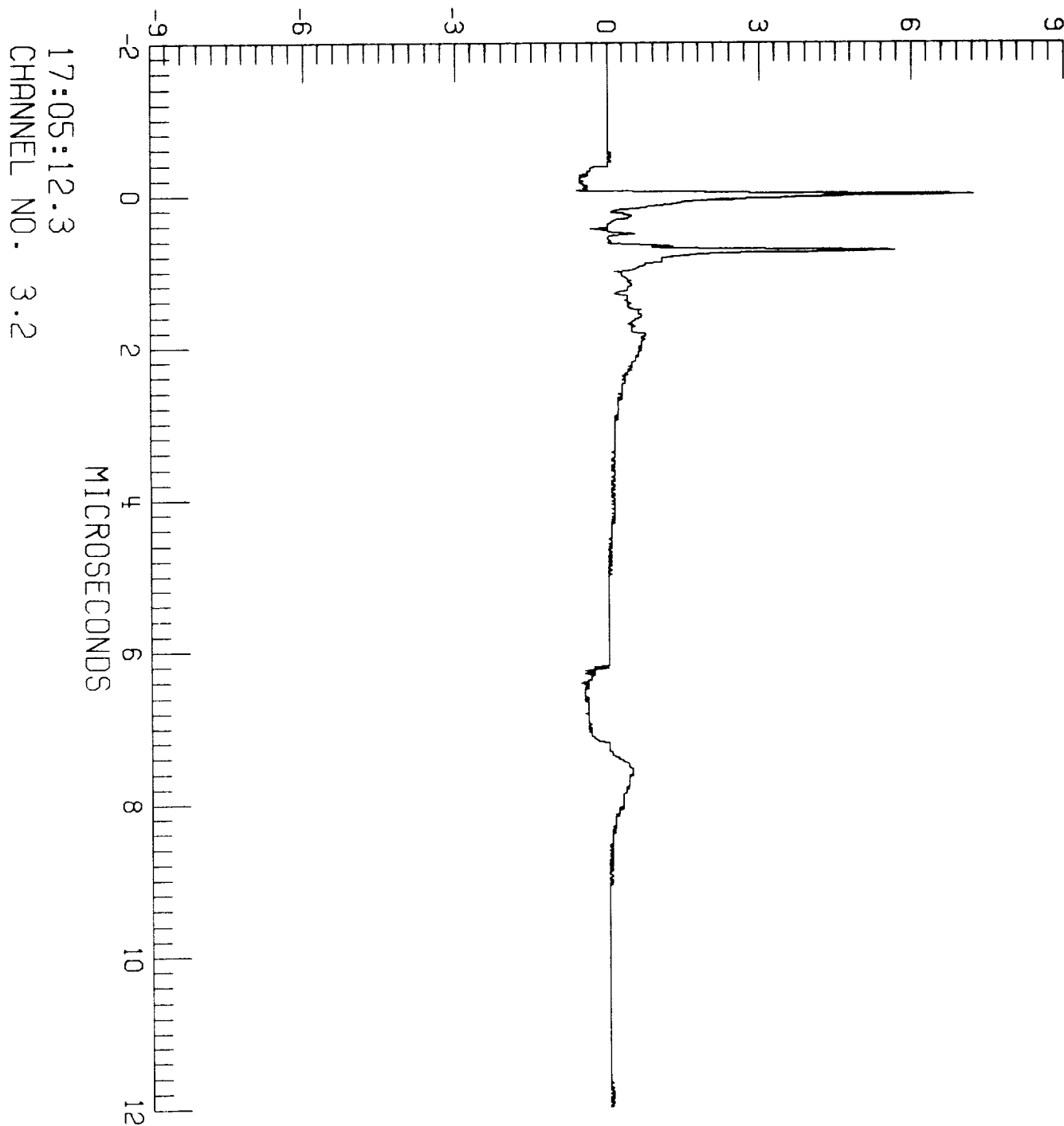

F106 LIGHTNING/85-029/ZAEPFEL

LEC 4 RUN NO. 11

N-005

TP100

V

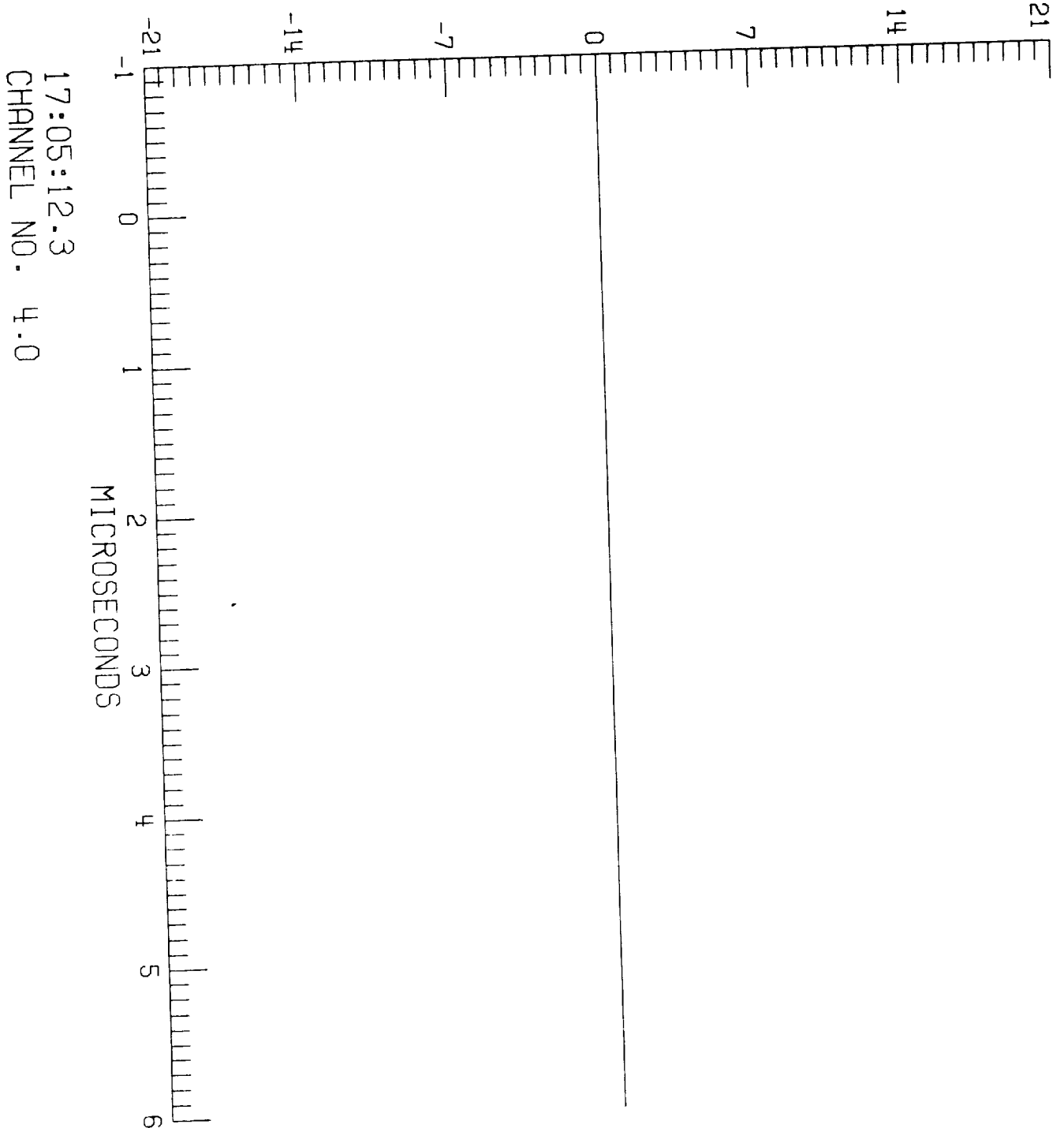

17:05:12.3  
CHANNEL NO. 4.0

F106 LIGHTNING/85-029/ZAEPFEL

LEC 4 RUN NO. 11

N-005

TP106 A

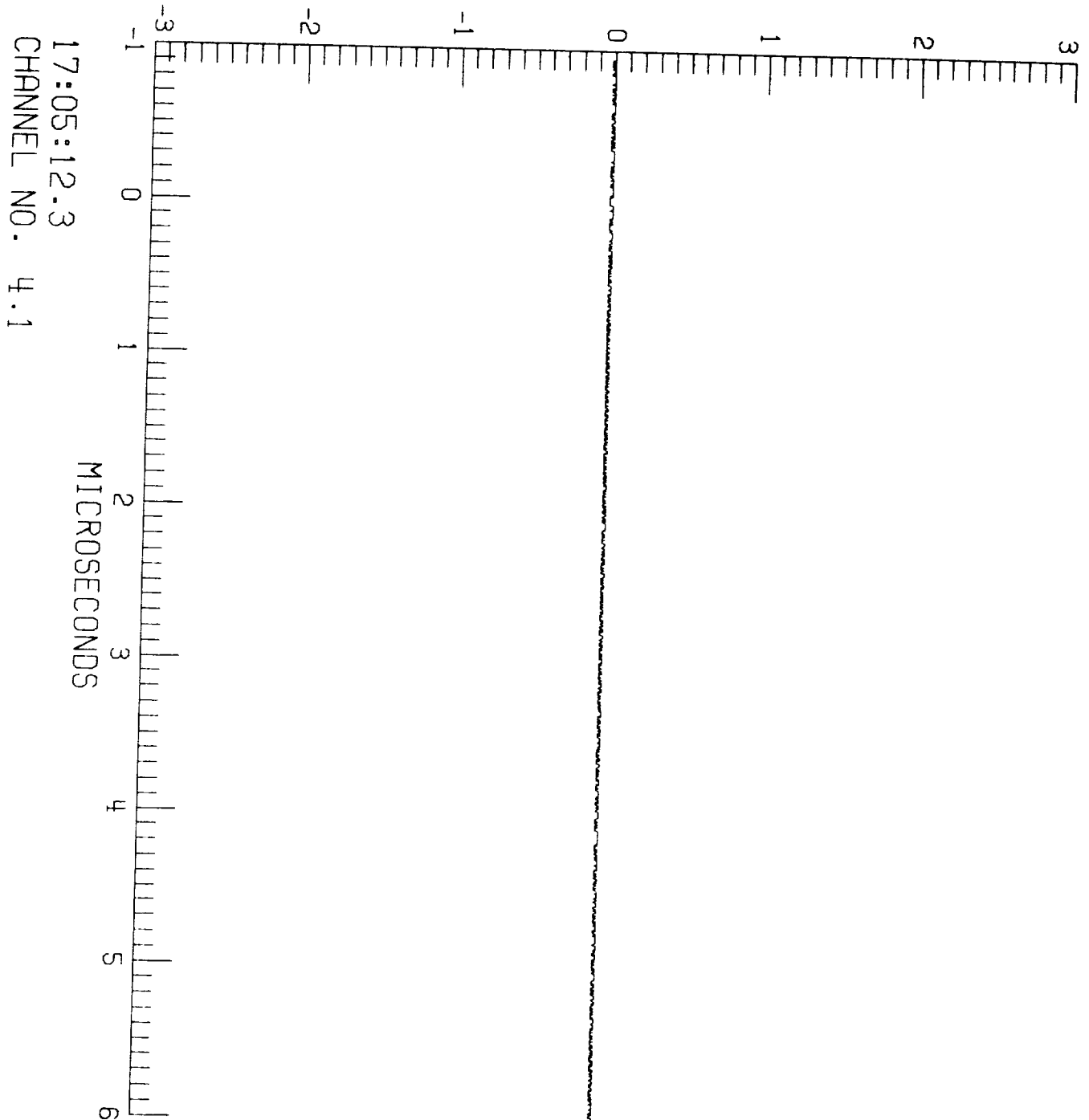



F106 LIGHTNING/85-029/ZAEPFEL

LEC 4 RUN NO. 11

N-005

TP125

A

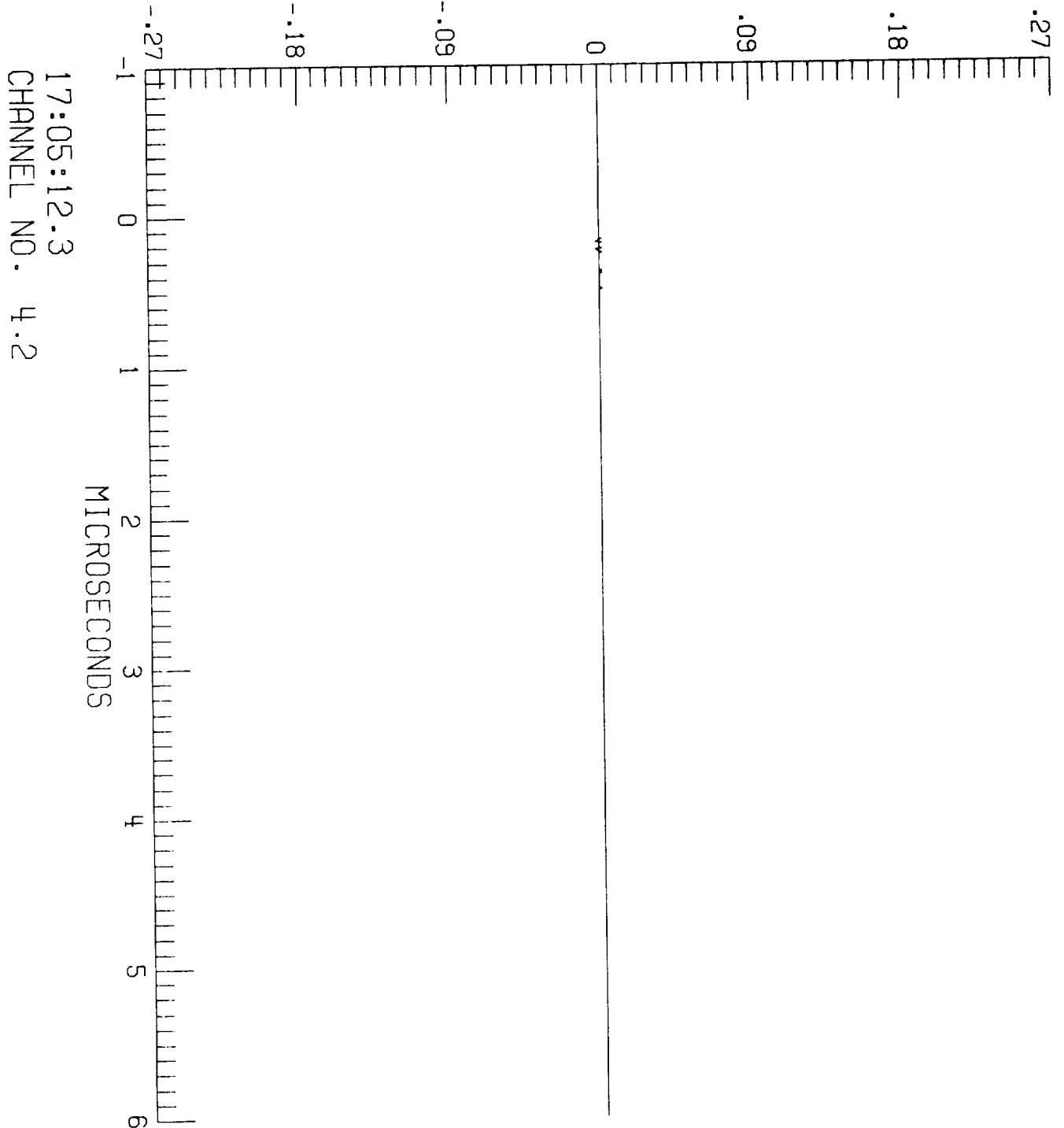

17:05:12.3  
CHANNEL NO. 4.2

F106 LIGHTNING/85-029/ZAEPFEL

LEC 1 RUN NO. 11

N-005

$\dot{D}_t$  A/m<sup>2</sup>

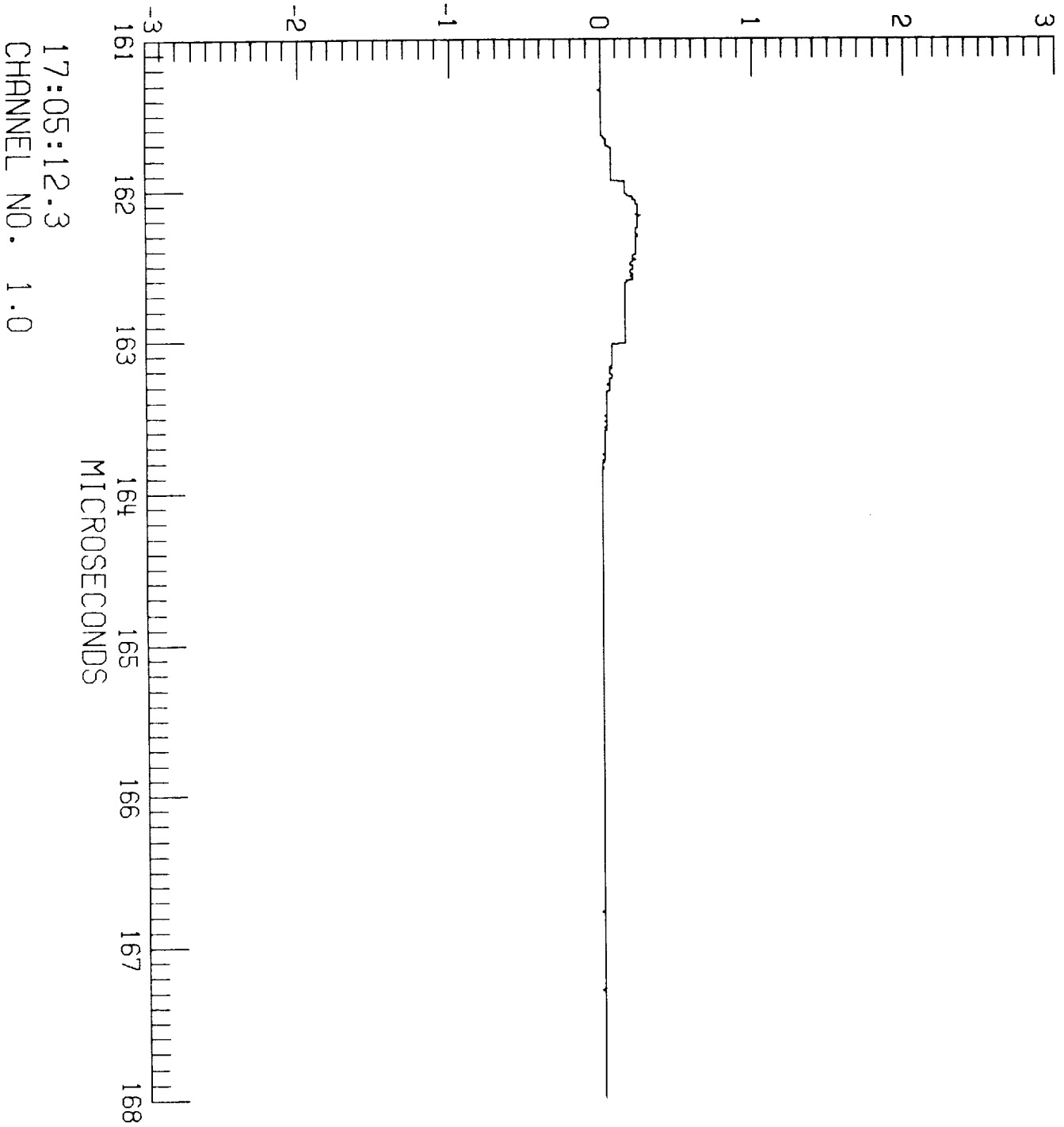

F106 LIGHTNING/85-029/ZAEPFEL  
LEC 1 RUN NO. 11  
N-005

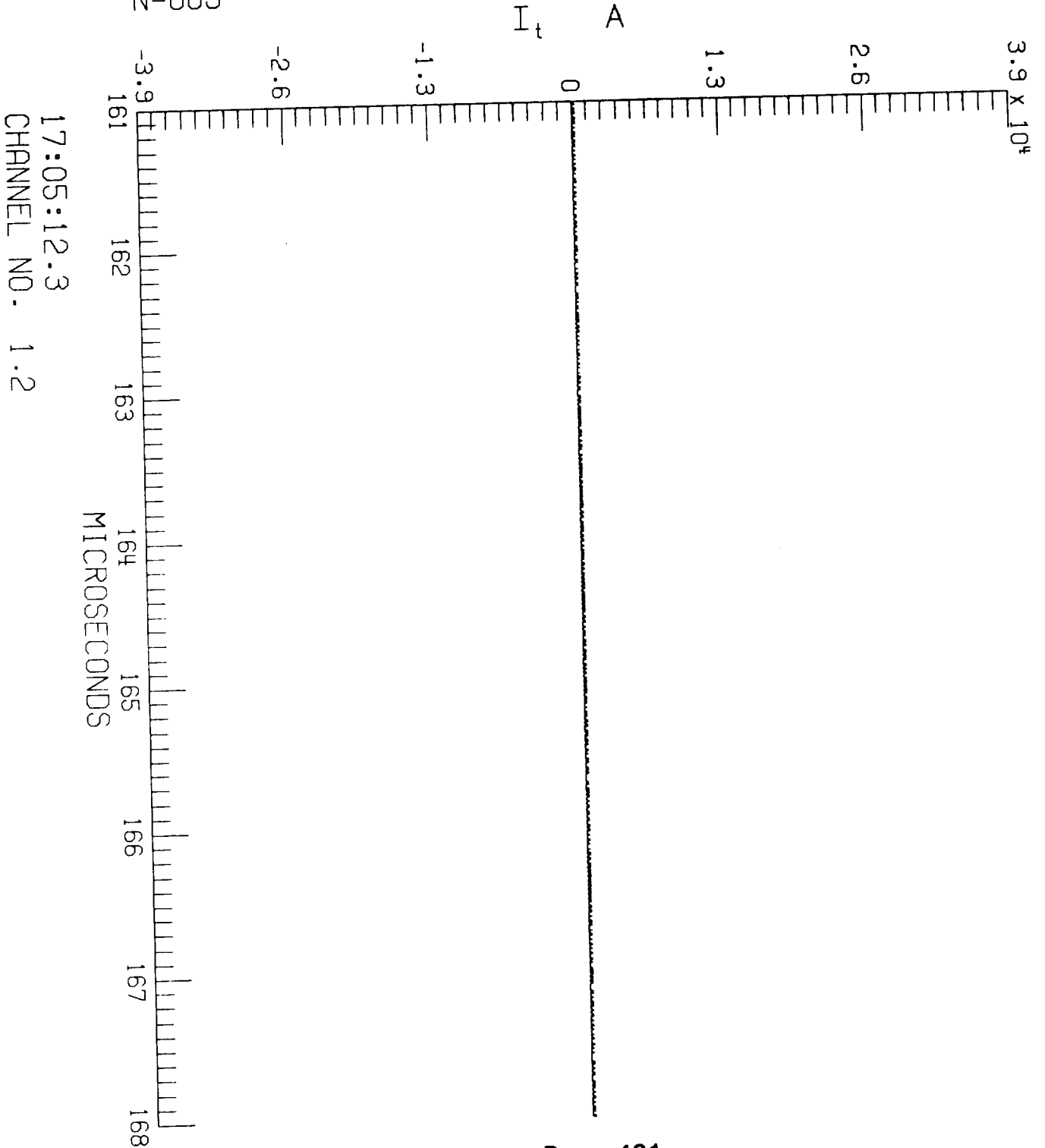

17:05:12.3  
CHANNEL NO. 1.2

F106 LIGHTNING/85-029/ZAEPFEL

LEC 2 RUN NO. 11

N-005

$\dot{B}_{wl}$  T/s

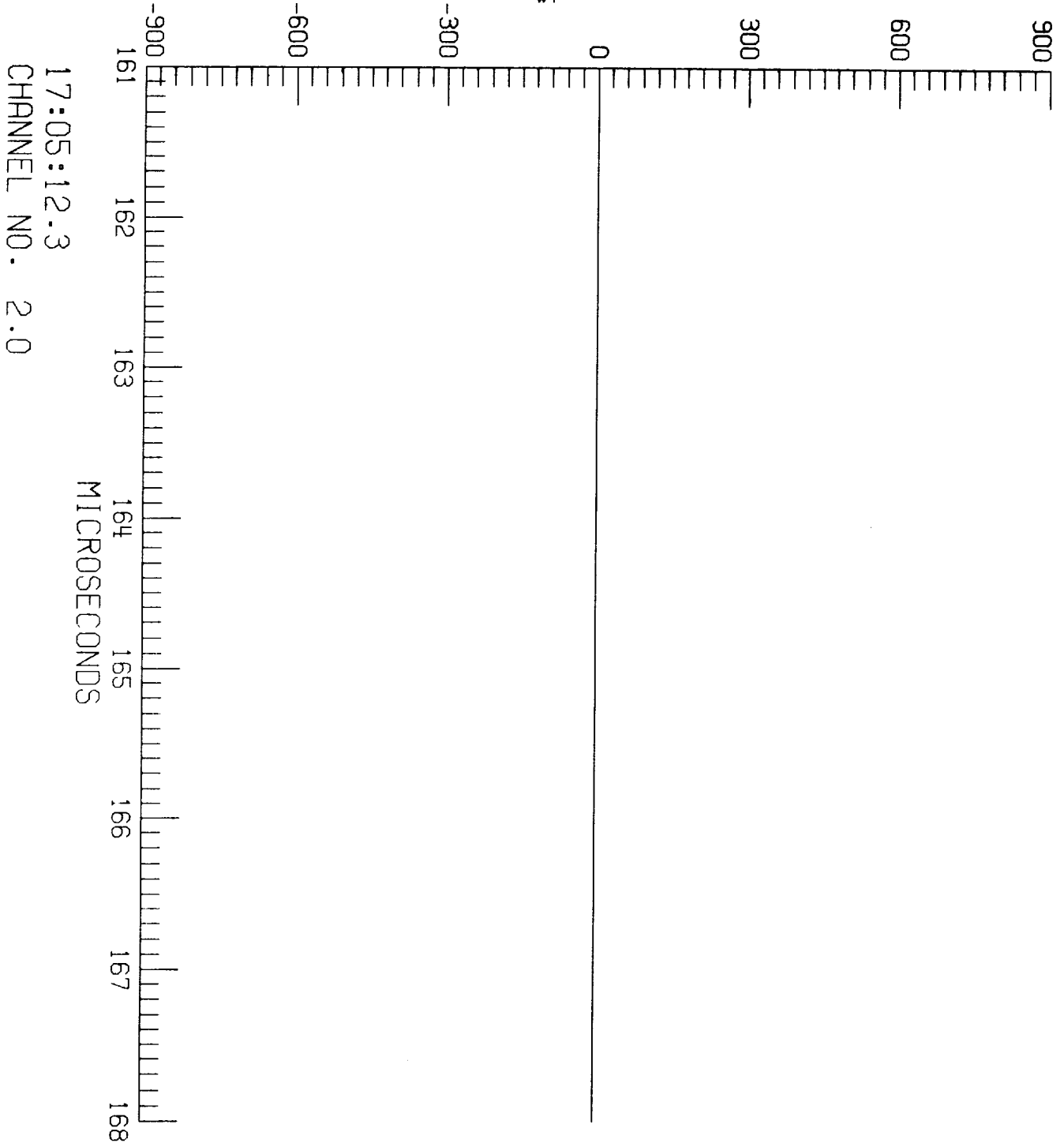

F106 LIGHTNING/85-029/ZAEPFEL

LEC 2 RUN NO. 11

N-005

$\dot{i}$  A/s

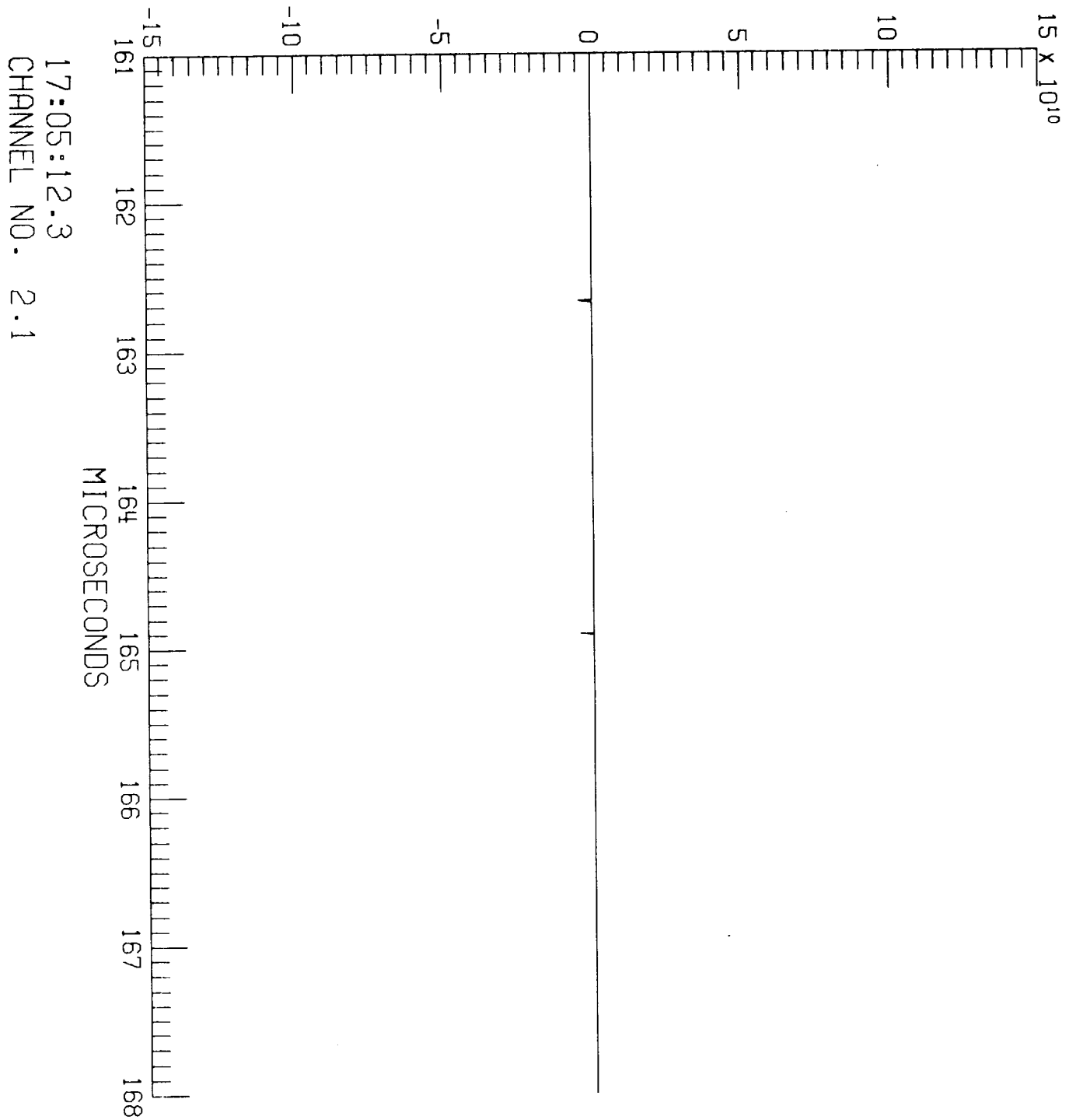

F106 LIGHTNING/85-029/ZAEPFEL

LEC 3 RUN NO. 11

N-005

$\dot{D}_{wr}$  A/m<sup>2</sup>

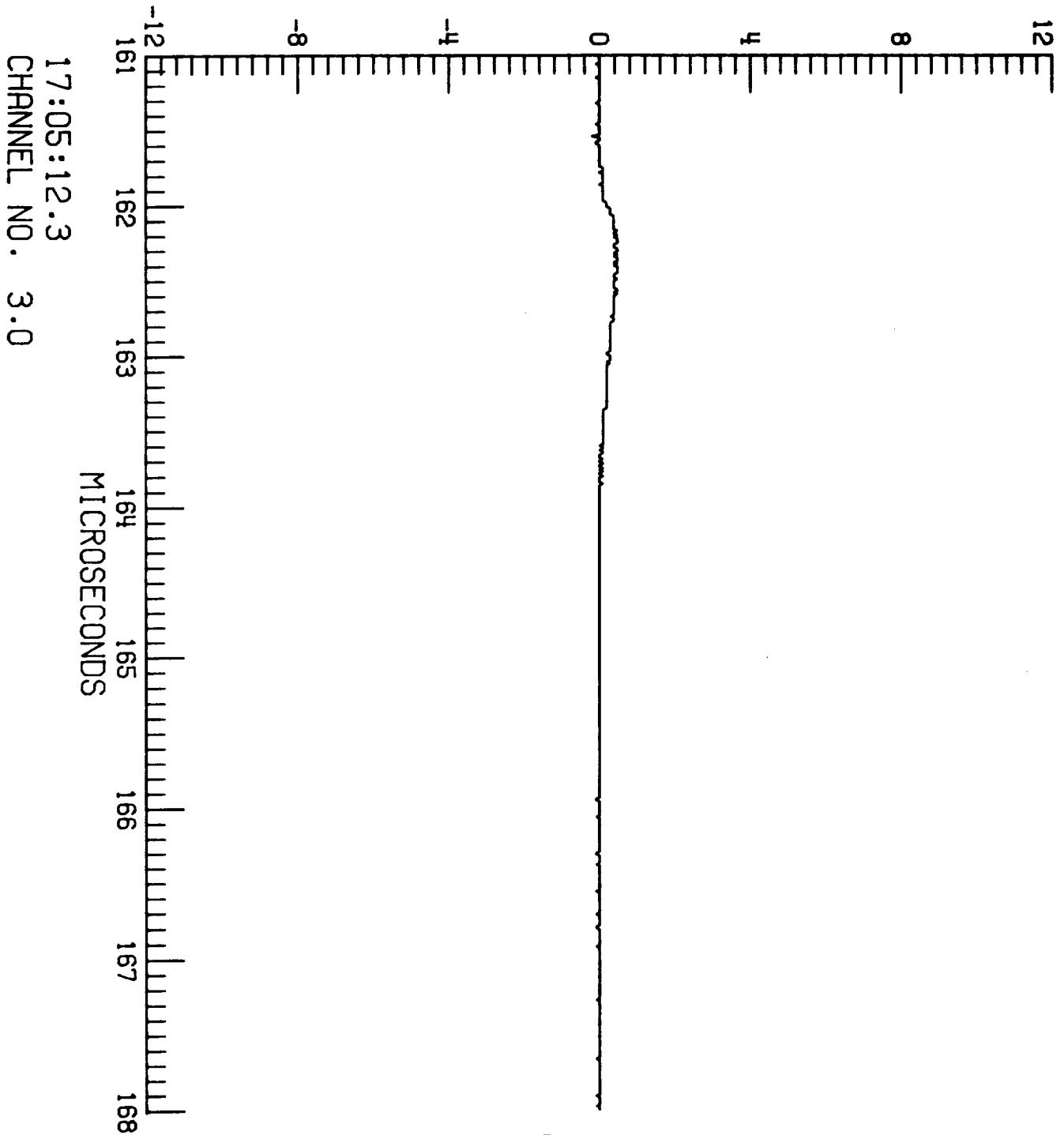

F106 LIGHTNING/85-029/ZAEPFEL

LEC 3 RUN NO. 11

N-005

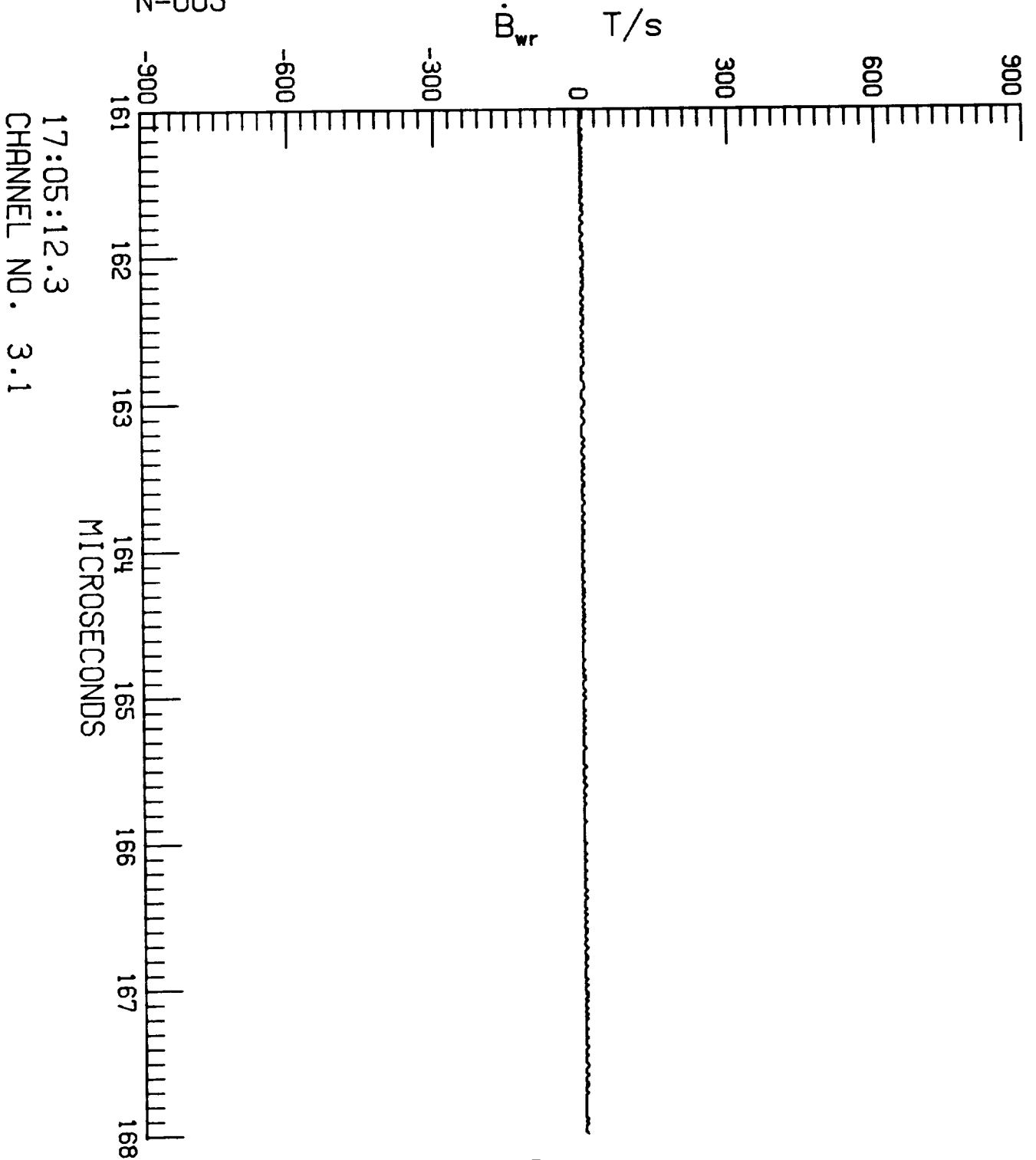

17:05:12.3  
CHANNEL NO. 3.1

F106 LIGHTNING/85-029/ZAEPFEL

LEC 3 RUN NO. 11

N-005

$\dot{D}_f$  A/m<sup>2</sup>

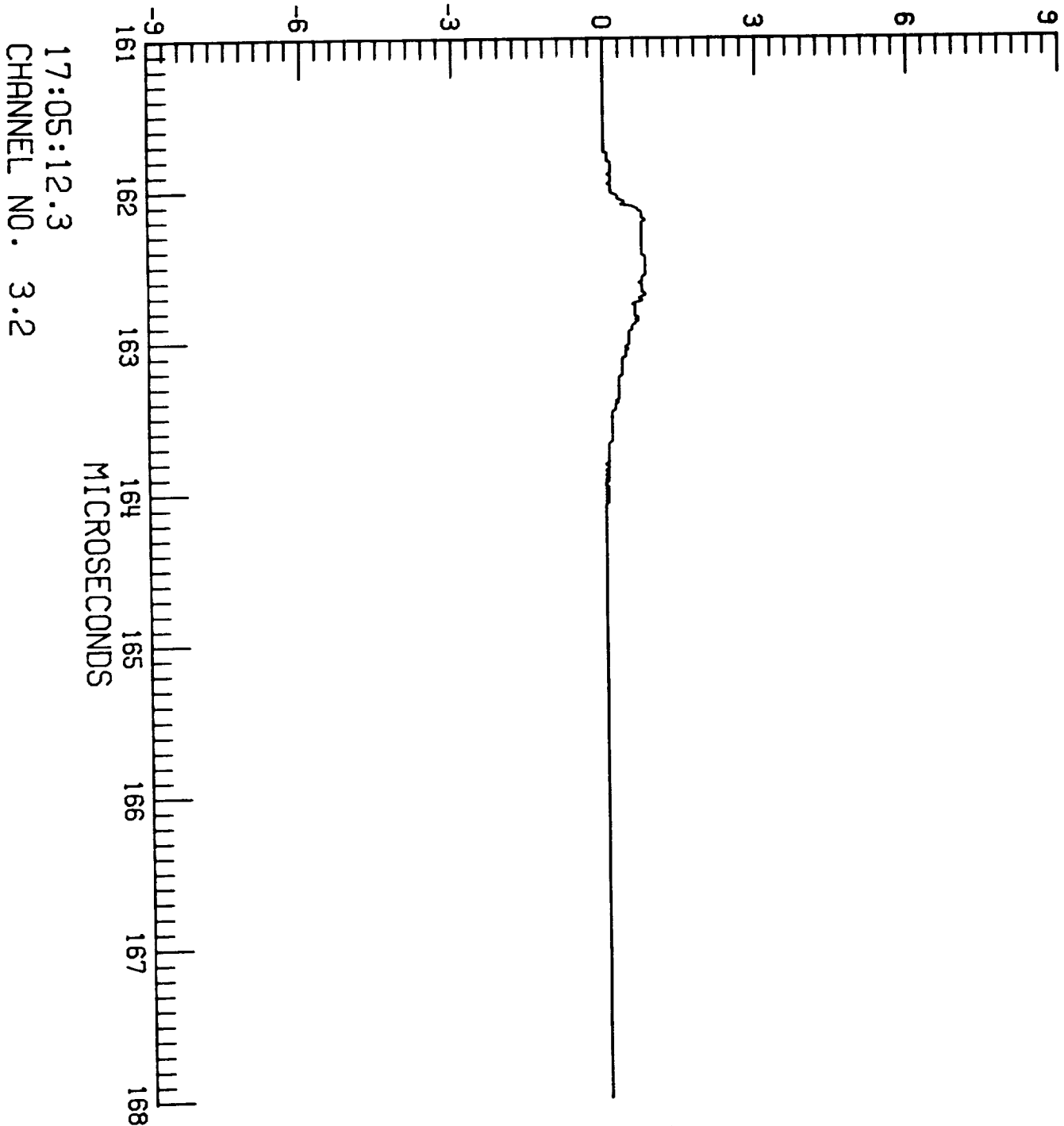



F106 LIGHTNING/85-029/ZAEPFEL

LEC 4 RUN NO. 11

N-005

TP100

V

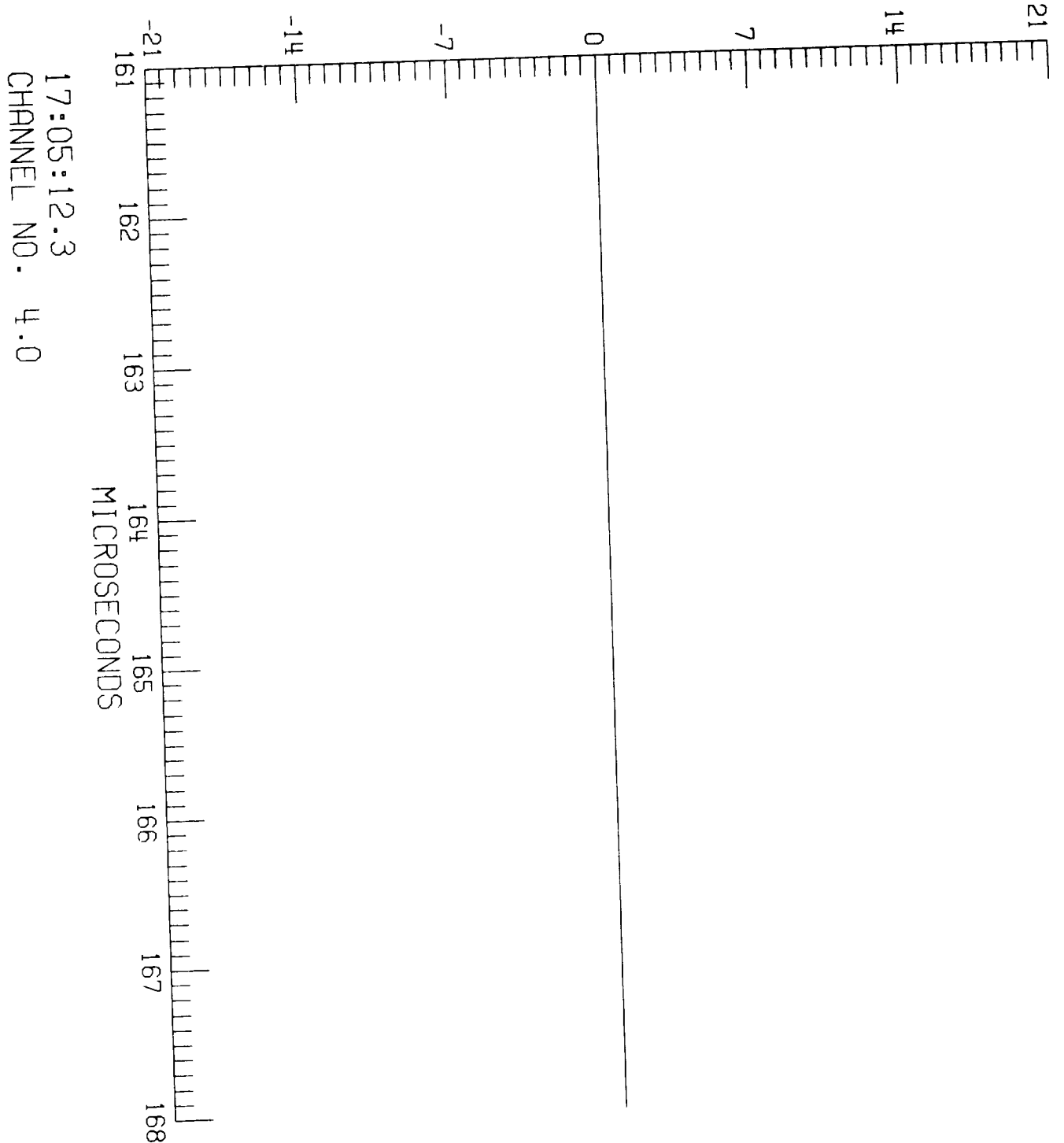

17:05:12.3  
CHANNEL NO. 4.0

F106 LIGHTNING/85-029/ZAEPFEL

LEC 4 RUN NO. 11

N-005

TP106 A

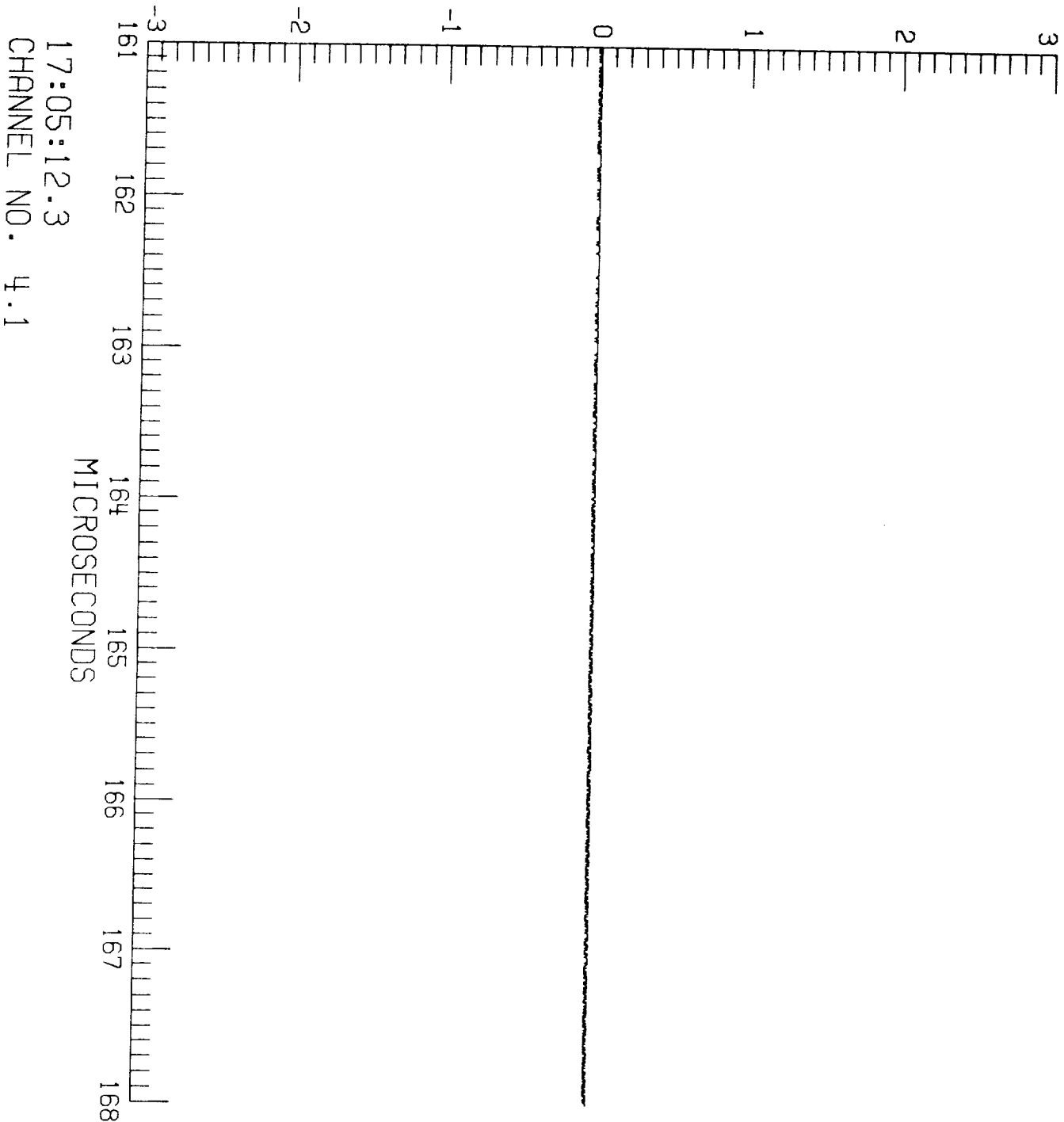

F106 LIGHTNING/85-029/ZAEPFEL

LEC 4 RUN NO. 11

N-005

TP125

A

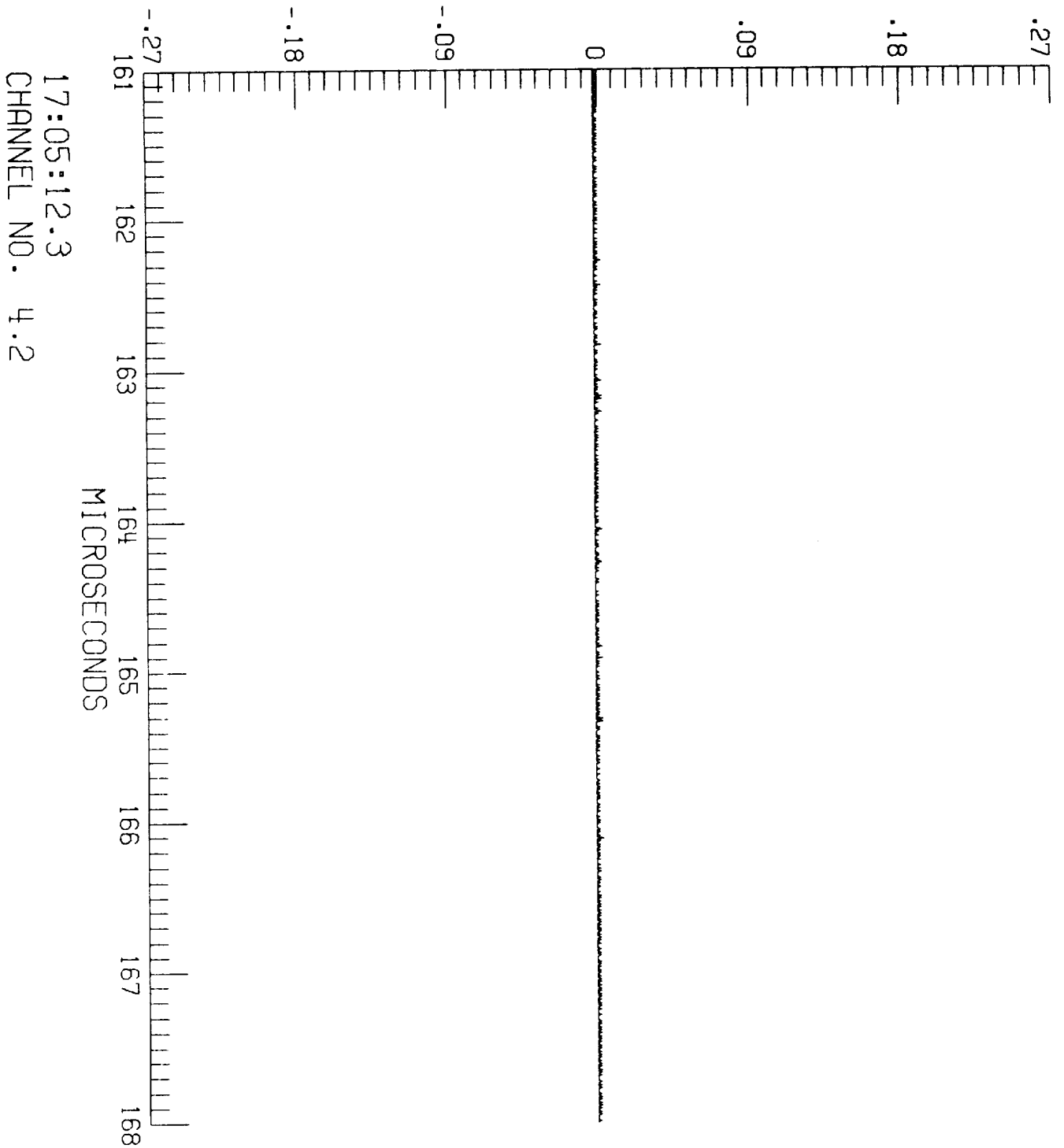

17:05:12.3  
CHANNEL NO. 4.2

F106 LIGHTNING/85-029/ZAEPFEL

LEC 3 RUN NO. 11

N-005

$\dot{D}_{wr}$  A/m<sup>2</sup>

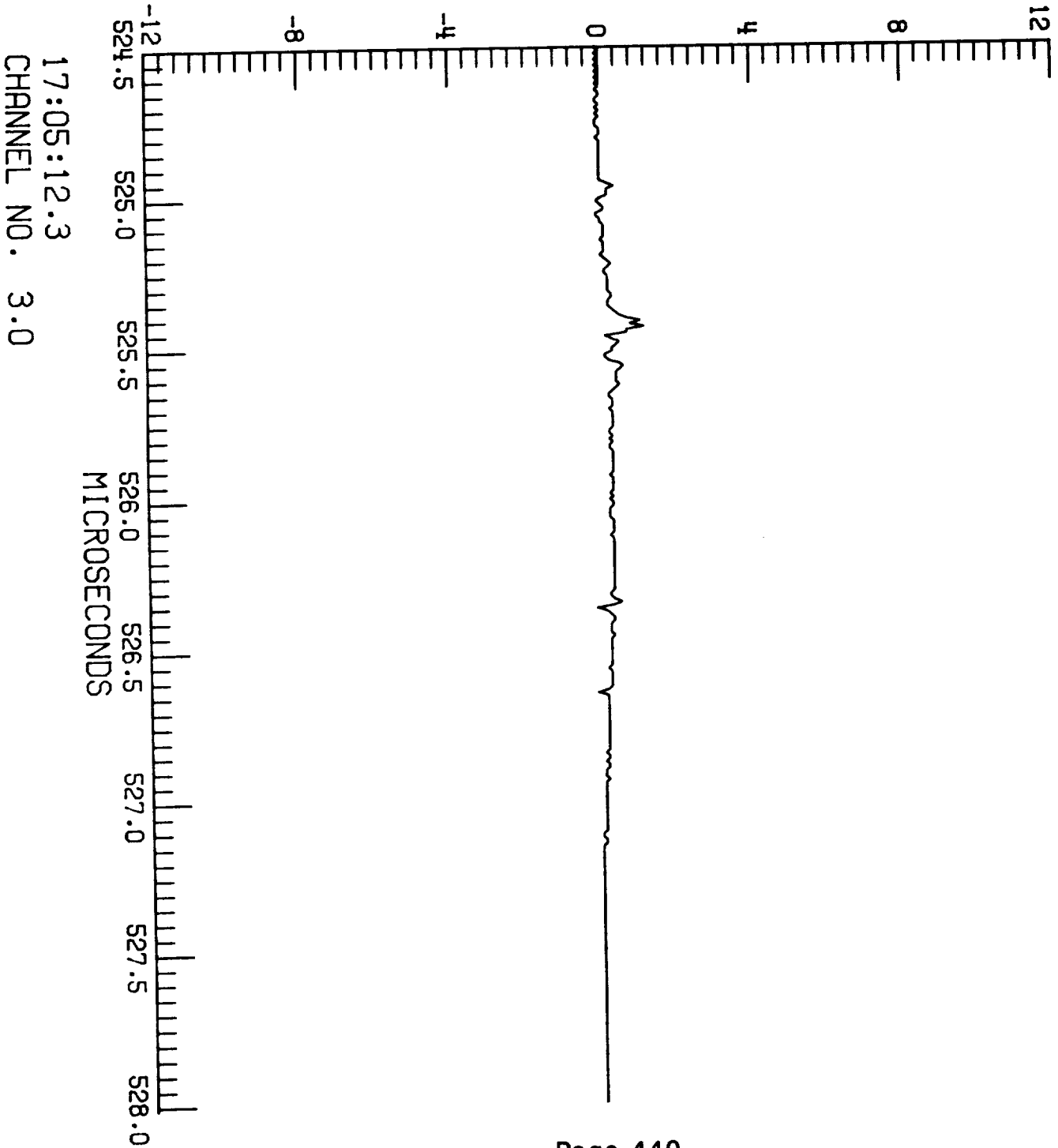

17:05:12.3  
CHANNEL NO. 3.0

F106 LIGHTNING/85-029/ZAEPFEL  
LEC 3 RUN NO. 11  
N-005

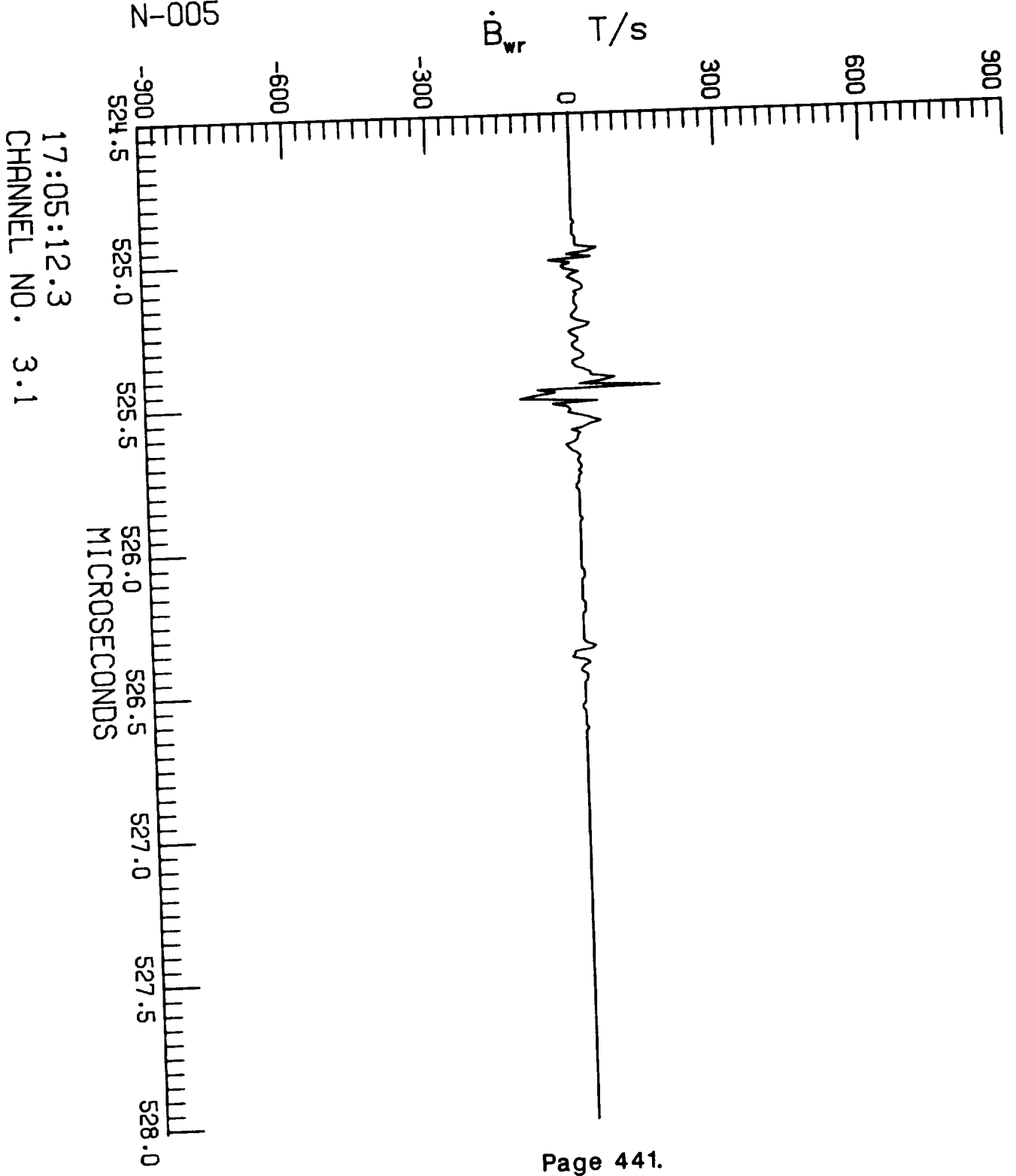

17:05:12.3  
CHANNEL NO. 3.1

F106 LIGHTNING/85-029/ZAEPFEL

LEC 3 RUN NO. 11

N-005

$\dot{D}_f$  A/m<sup>2</sup>

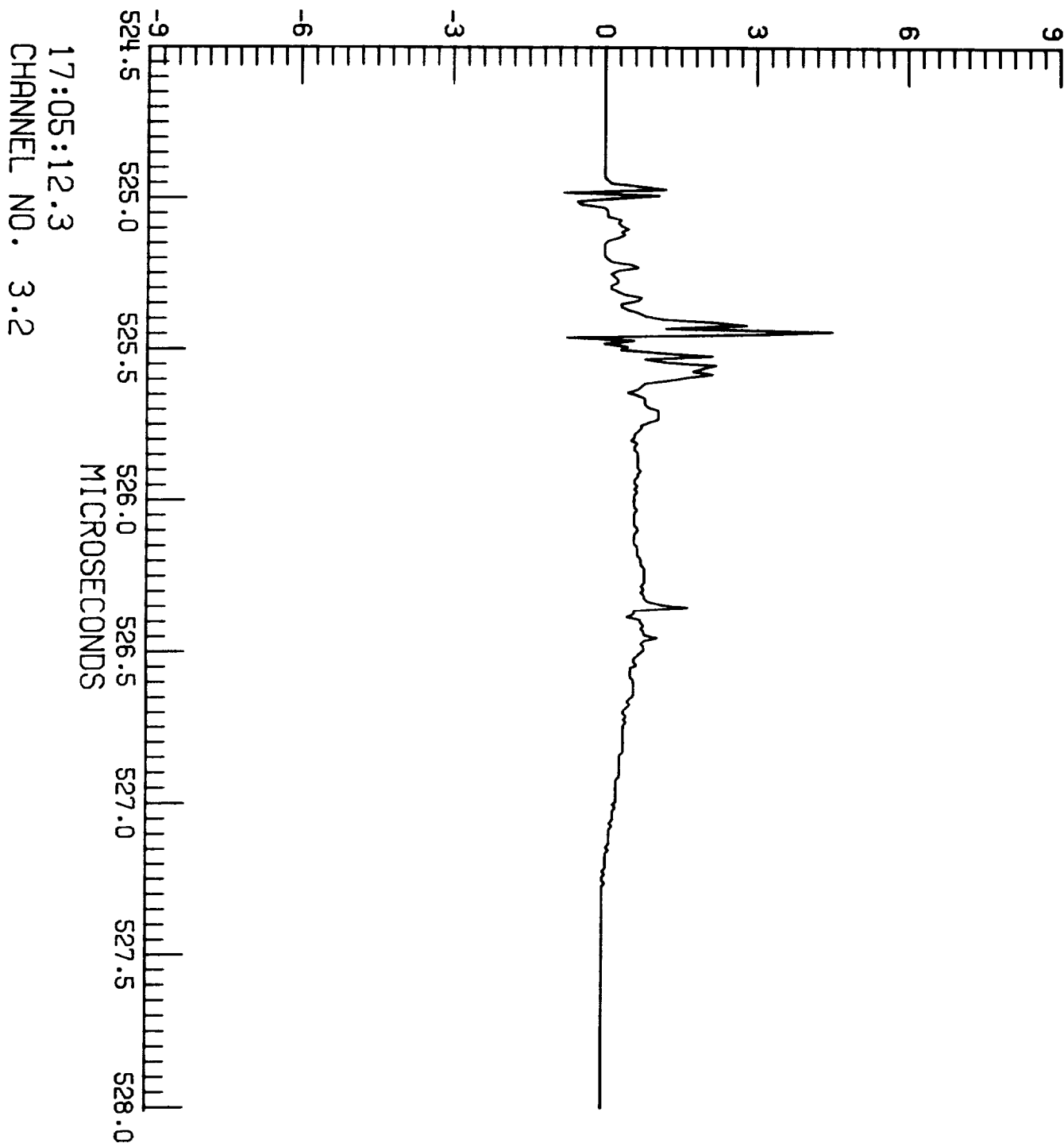

F106 LIGHTNING/85-029/ZAEPFEL

LEC 1 RUN NO. 12

N-006

$\dot{D}_t$  A/m<sup>2</sup>

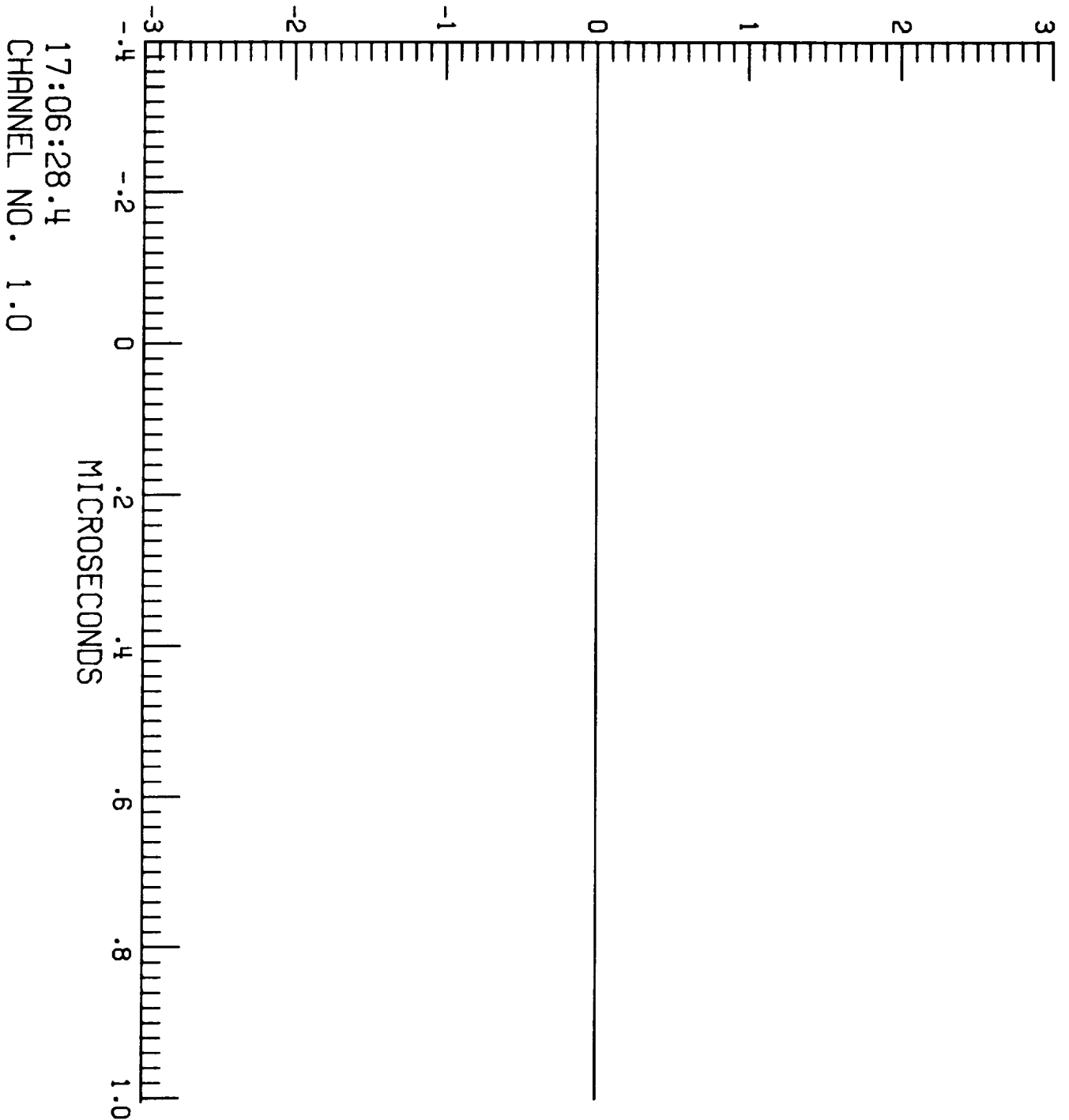

F106 LIGHTNING/85-029/ZAEPFEL

LEC 1 RUN NO. 12

N-006

$I_t$  A

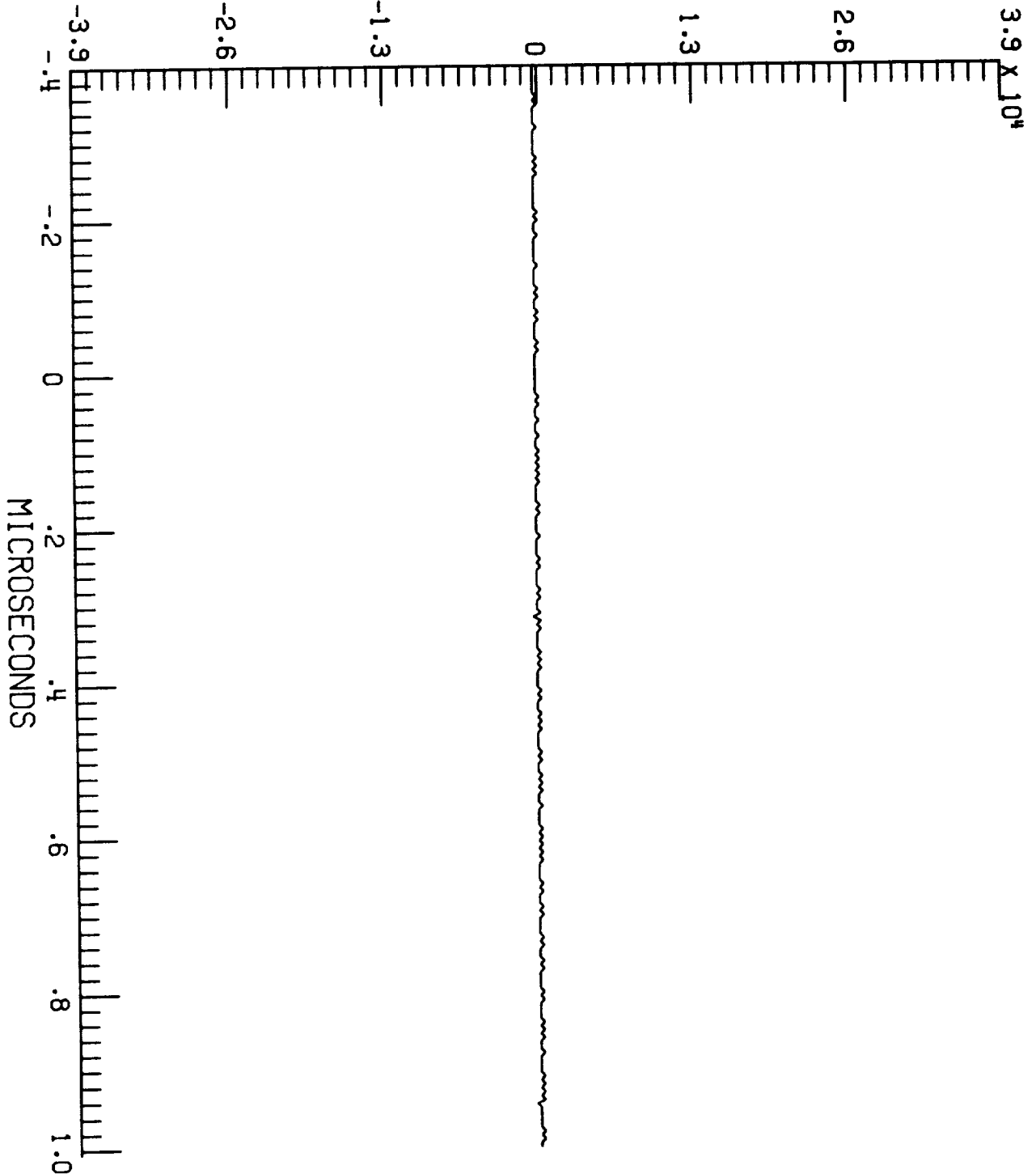

17:06:28.4  
CHANNEL NO. 1.2



F106 LIGHTNING/85-029/ZAEPFEL  
LEC 2 RUN NO. 12  
N-006

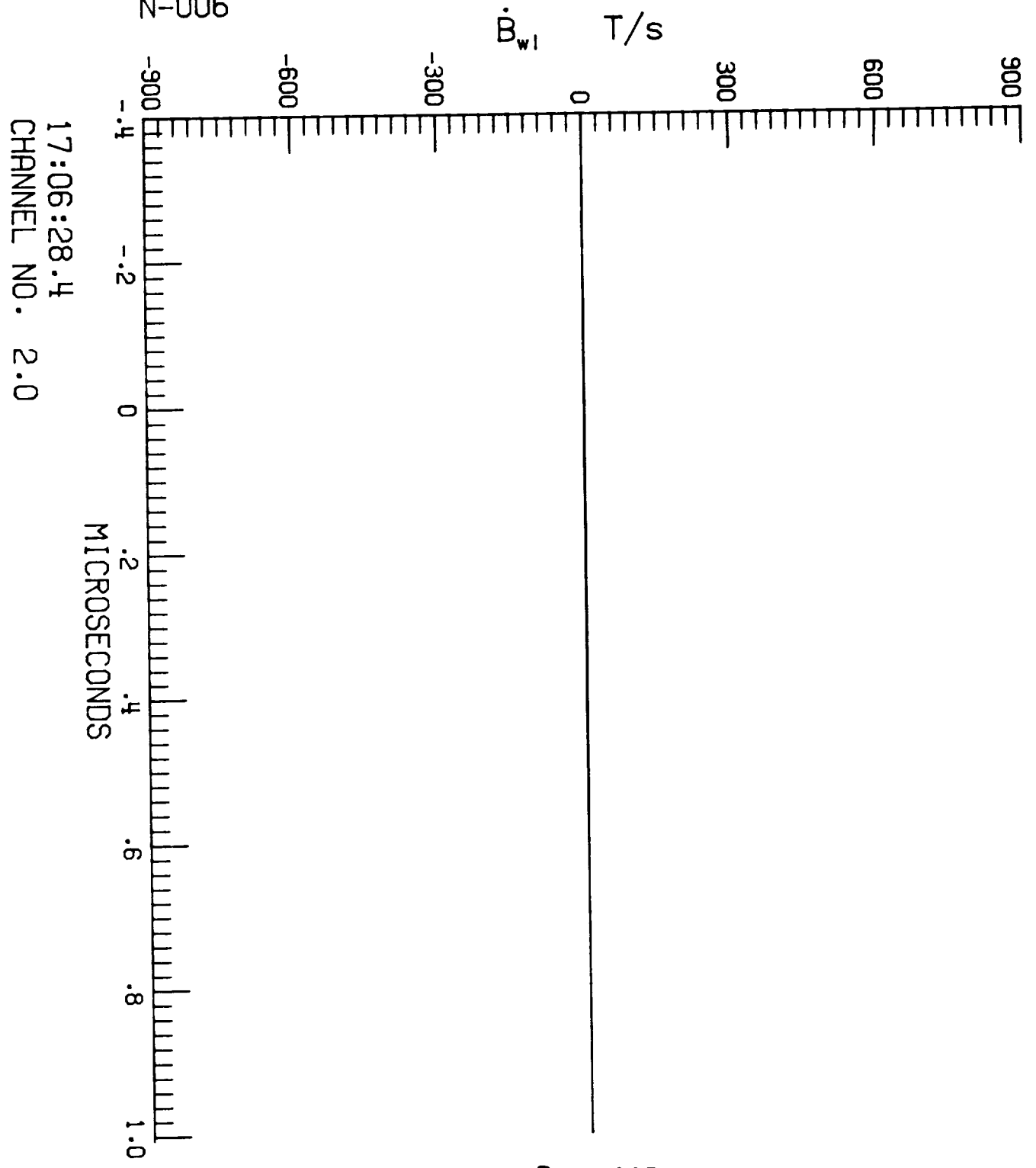

F106 LIGHTNING/85-029/ZAEPFEL

LEC 2 RUN NO. 12

N-006

$\dot{i}$  A/s

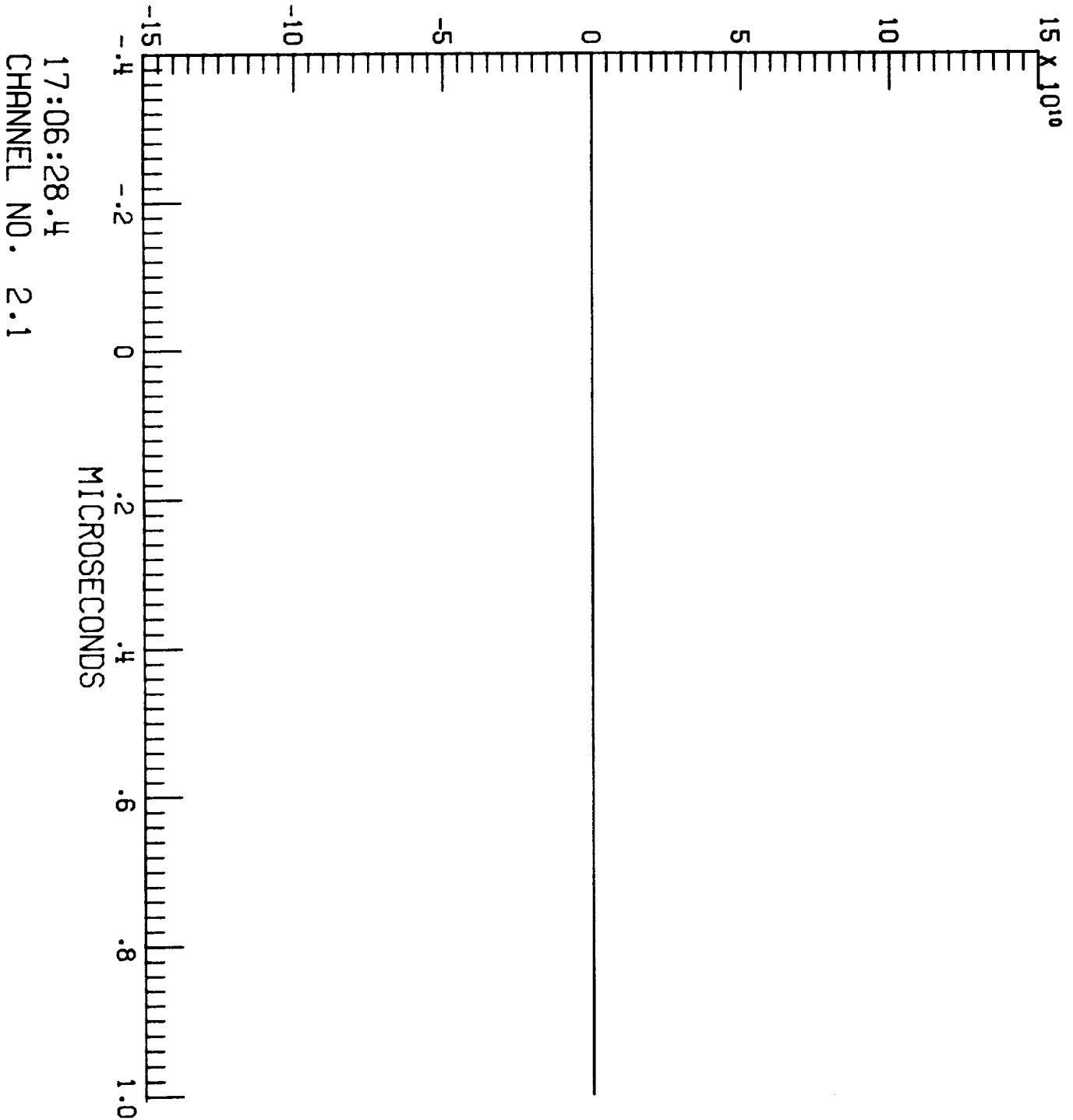

17:06:28.4  
CHANNEL NO. 2.1

F106 LIGHTNING/85-029/ZAEPFEL

LEC 2 RUN NO. 12

N-006

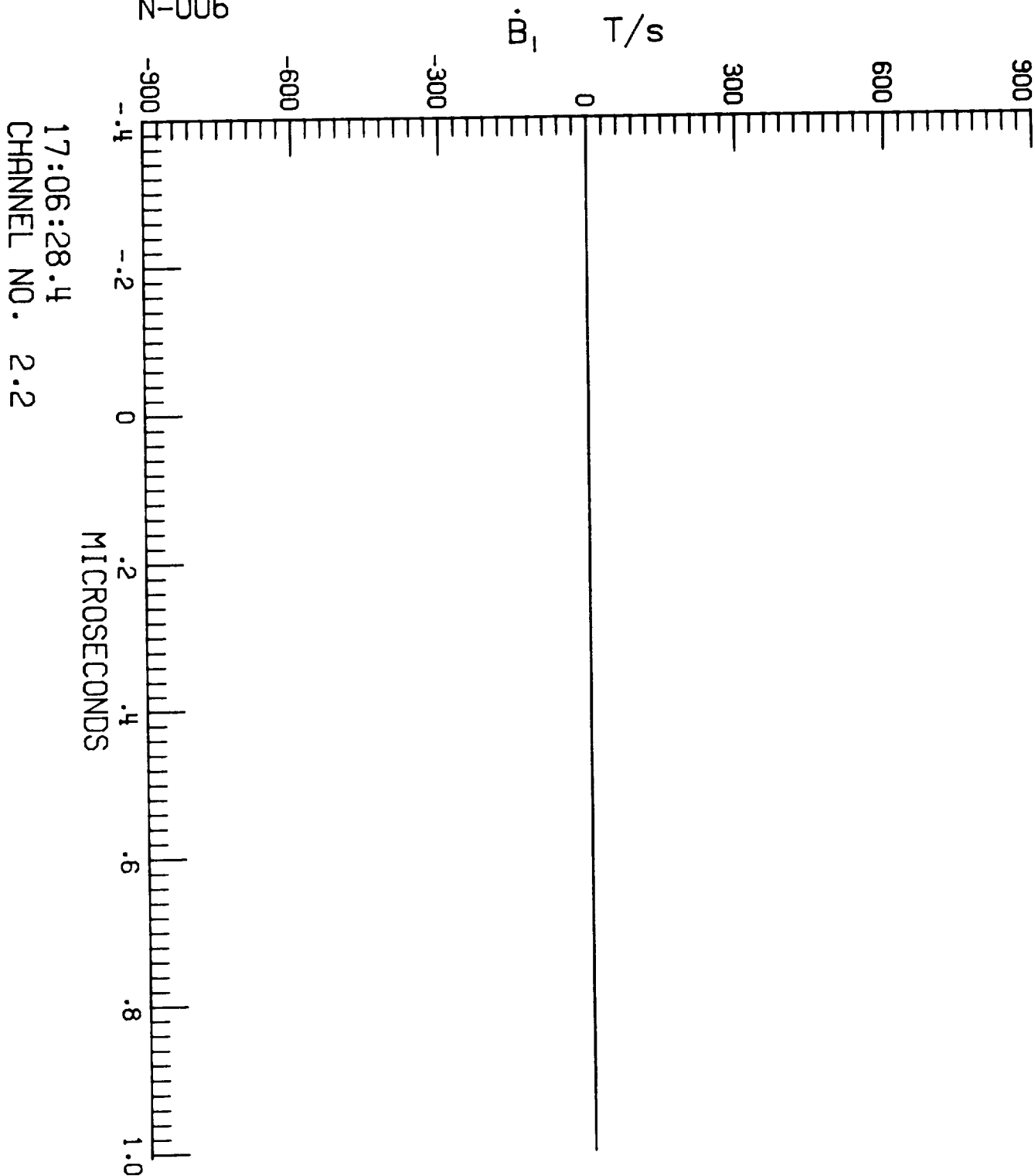

17:06:28.4  
CHANNEL NO. 2.2

F106 LIGHTNING/85-029/ZAEPFEL

LEC 3 RUN NO. 12

N-006

$\dot{D}_{wr}$  A/m<sup>2</sup>

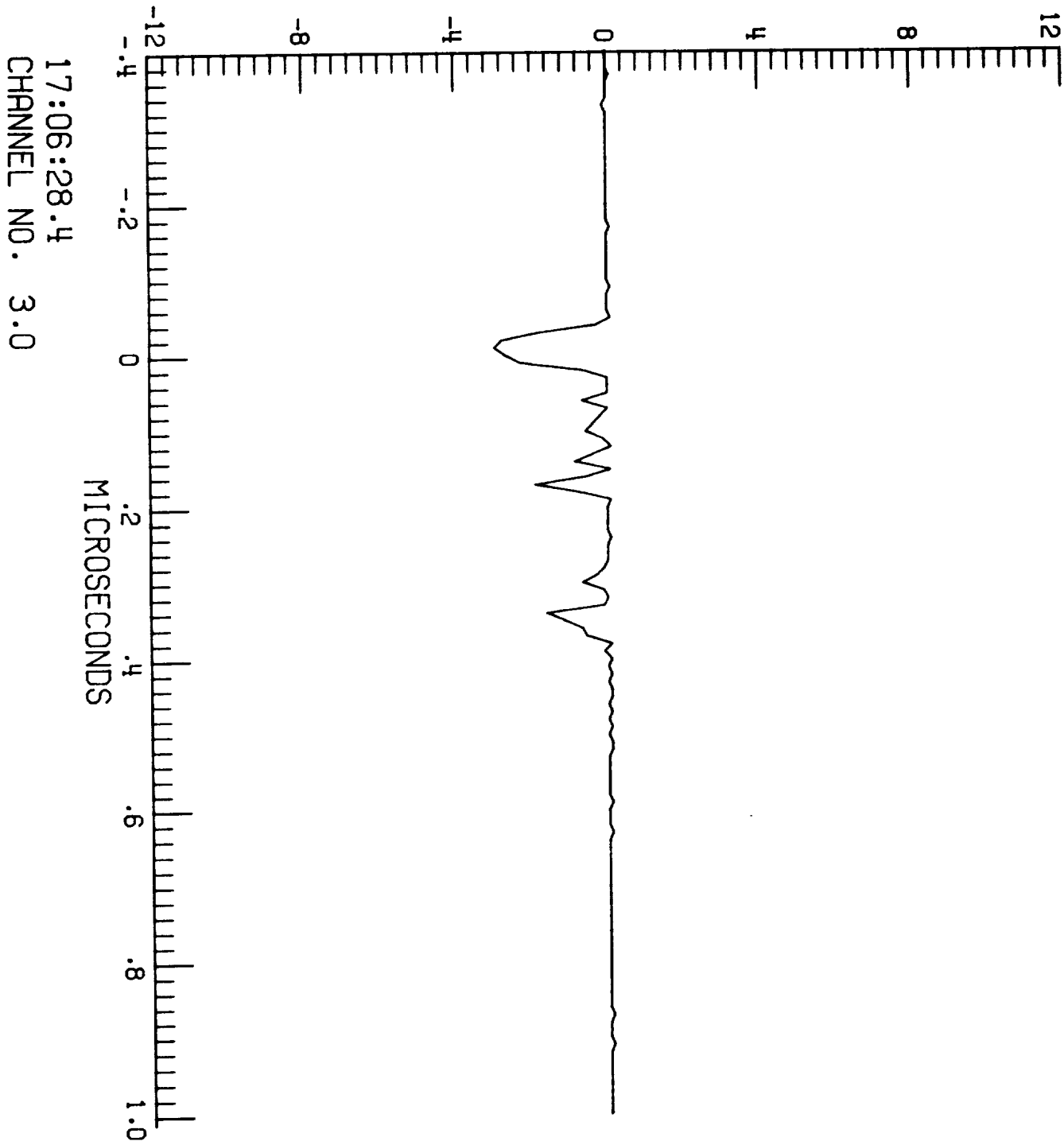

F106 LIGHTNING/85-029/ZAEPFEL  
LEC 3 RUN NO. 12  
N-006

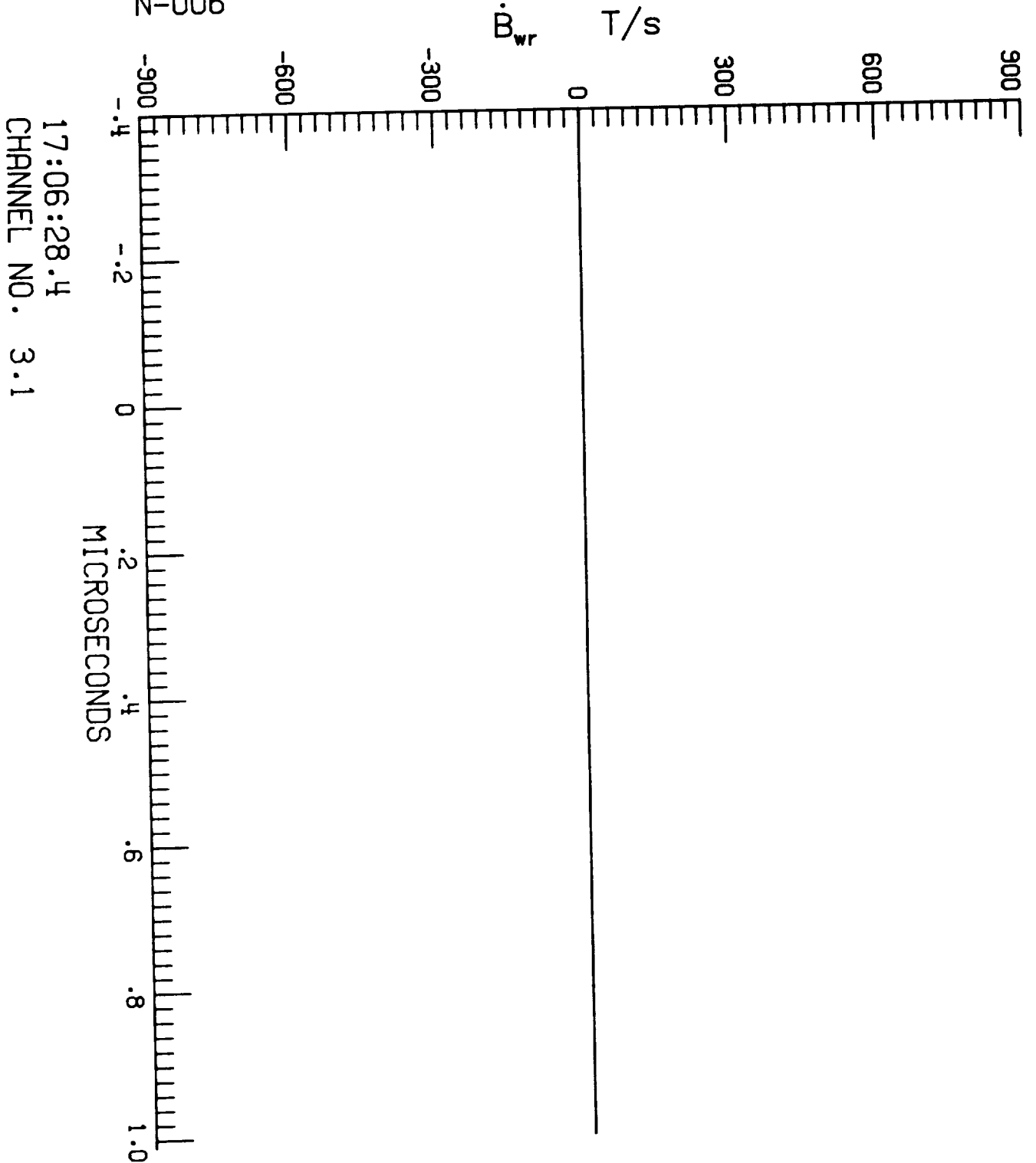

17:06:28.4  
CHANNEL NO. 3.1

F106 LIGHTNING/85-029/ZAEPFEL

LEC 3 RUN NO. 12

N-006

$\dot{D}_f$  A/m<sup>2</sup>

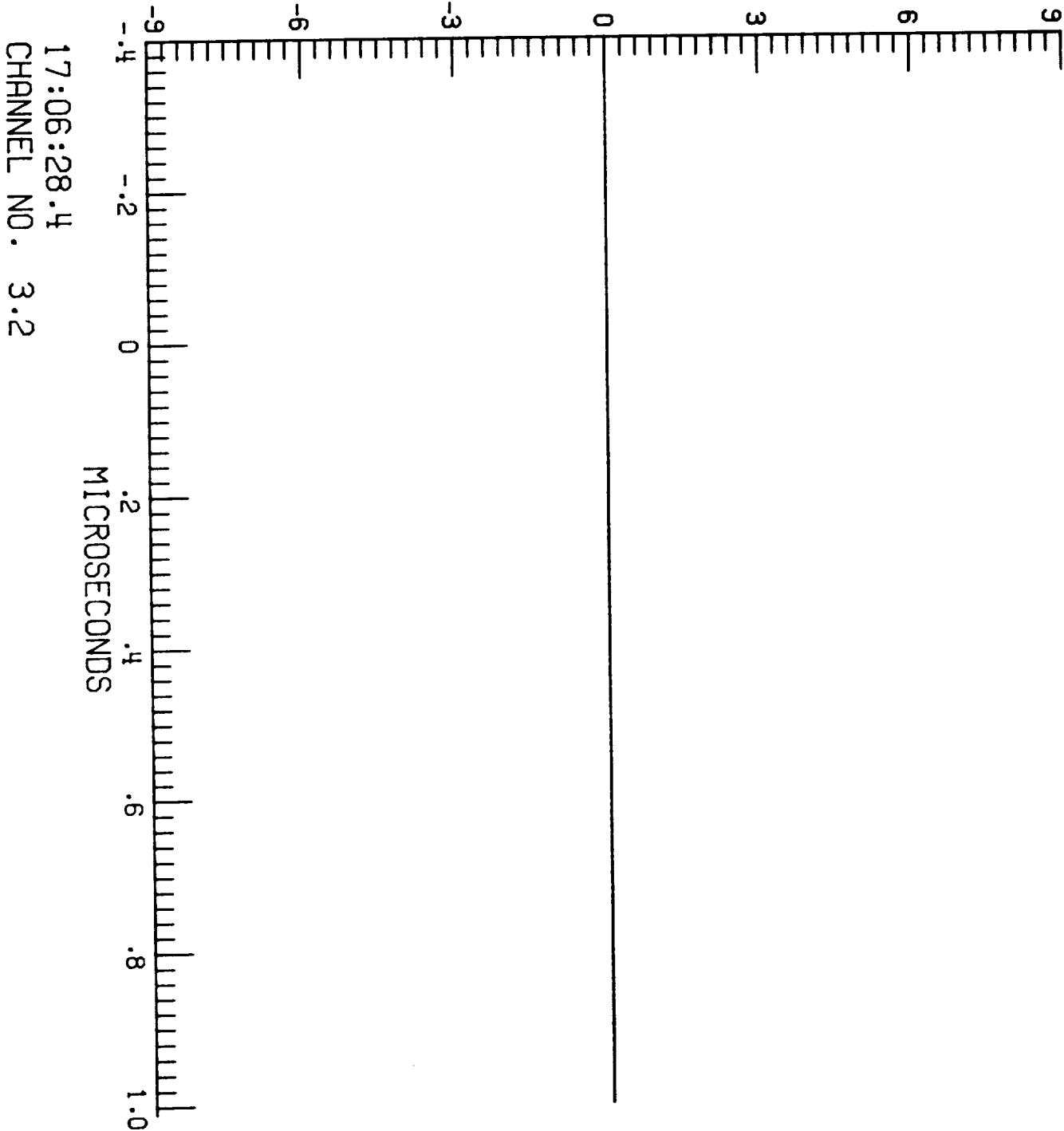

F106 LIGHTNING/85-029/ZAEPFEL

LEC 4 RUN NO. 12

N-006

TP100

V

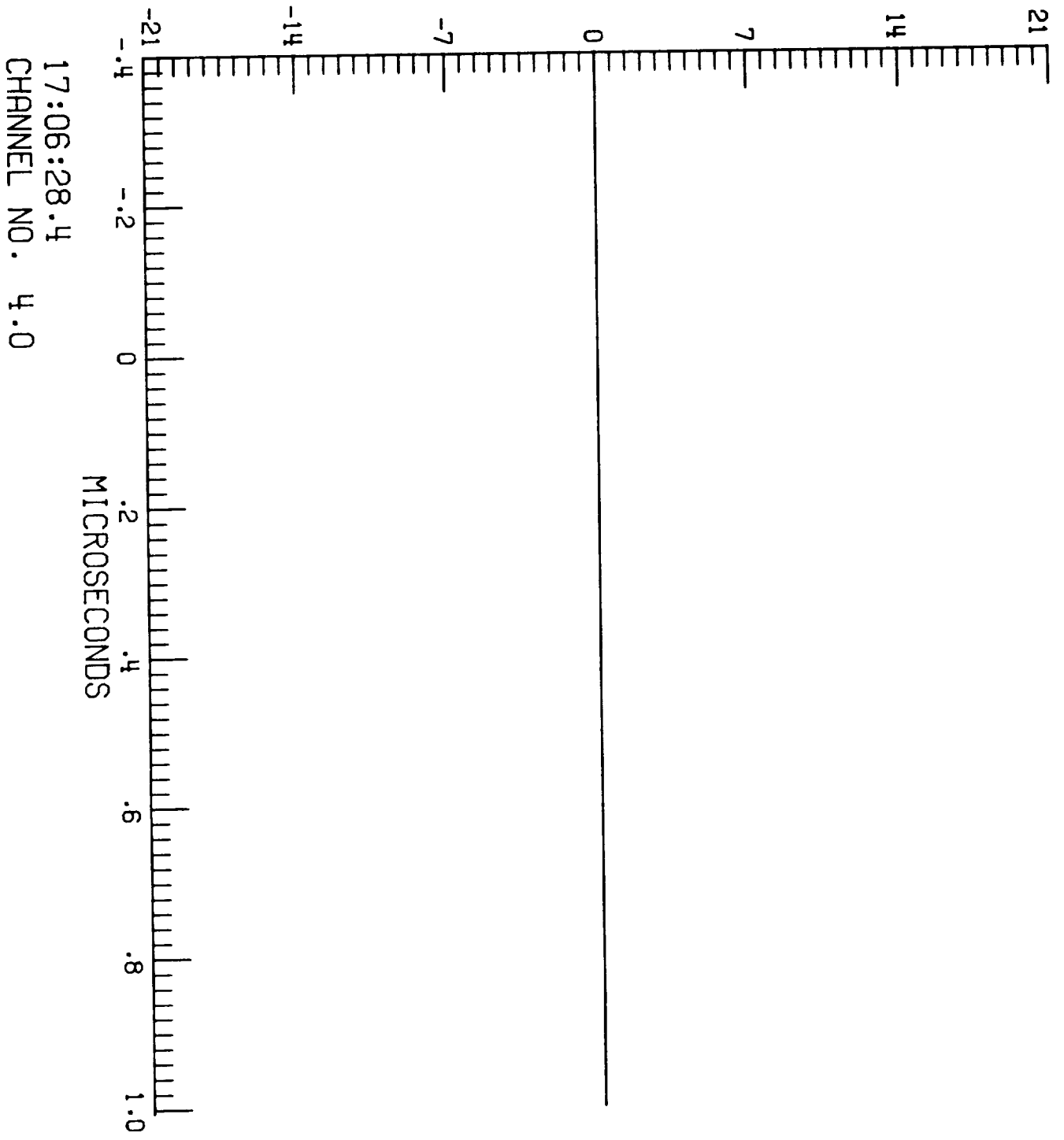

17:06:28.4  
CHANNEL NO. 4.0

F106 LIGHTNING/85-029/ZAEPFEL

LEC 4 RUN NO. 12

N-006

TP106

A

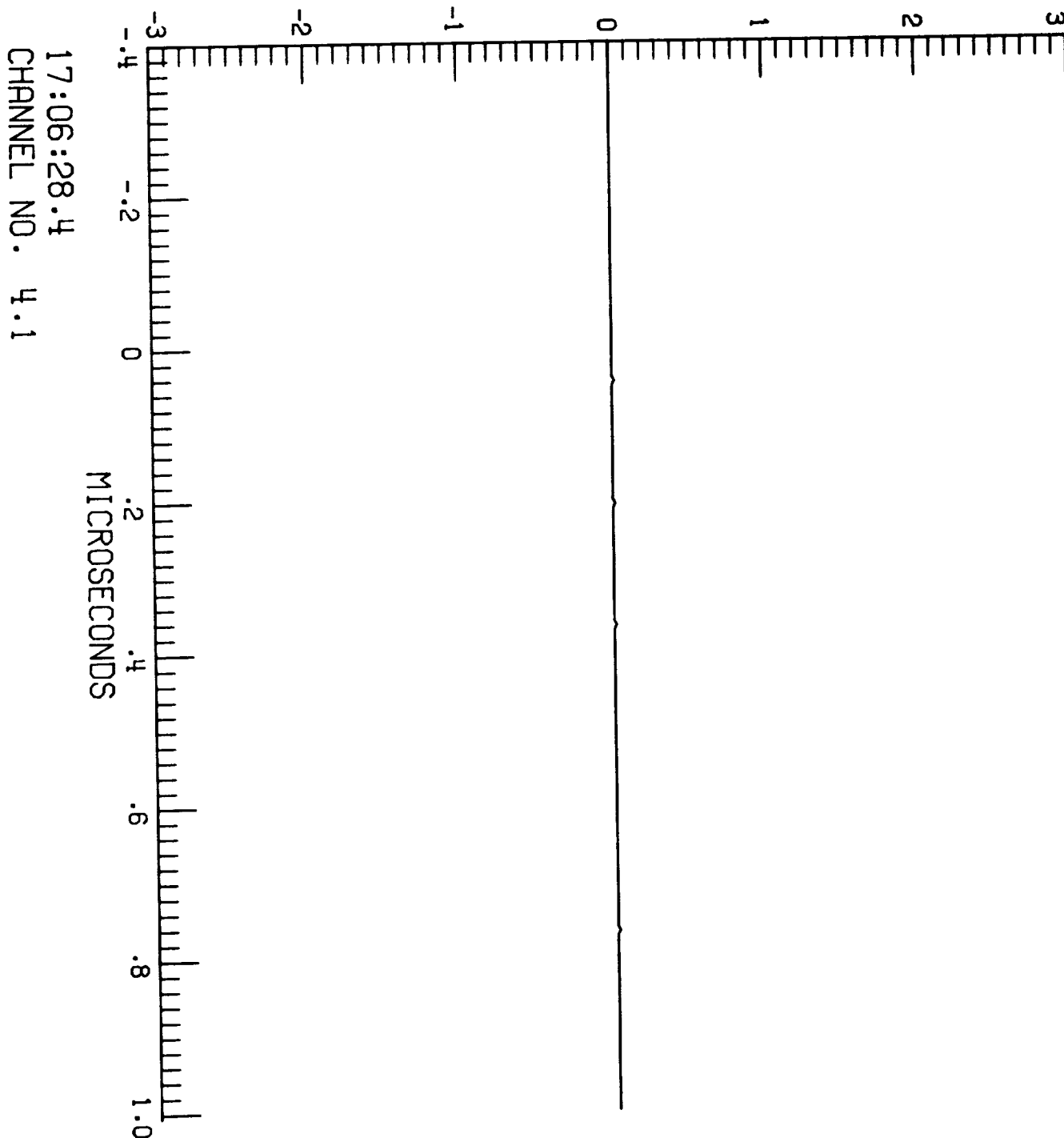

17:06:28.4  
CHANNEL NO. 4.1



F106 LIGHTNING/85-029/ZAEPFEL

LEC 4 RUN NO. 12

N-006

TP125

A

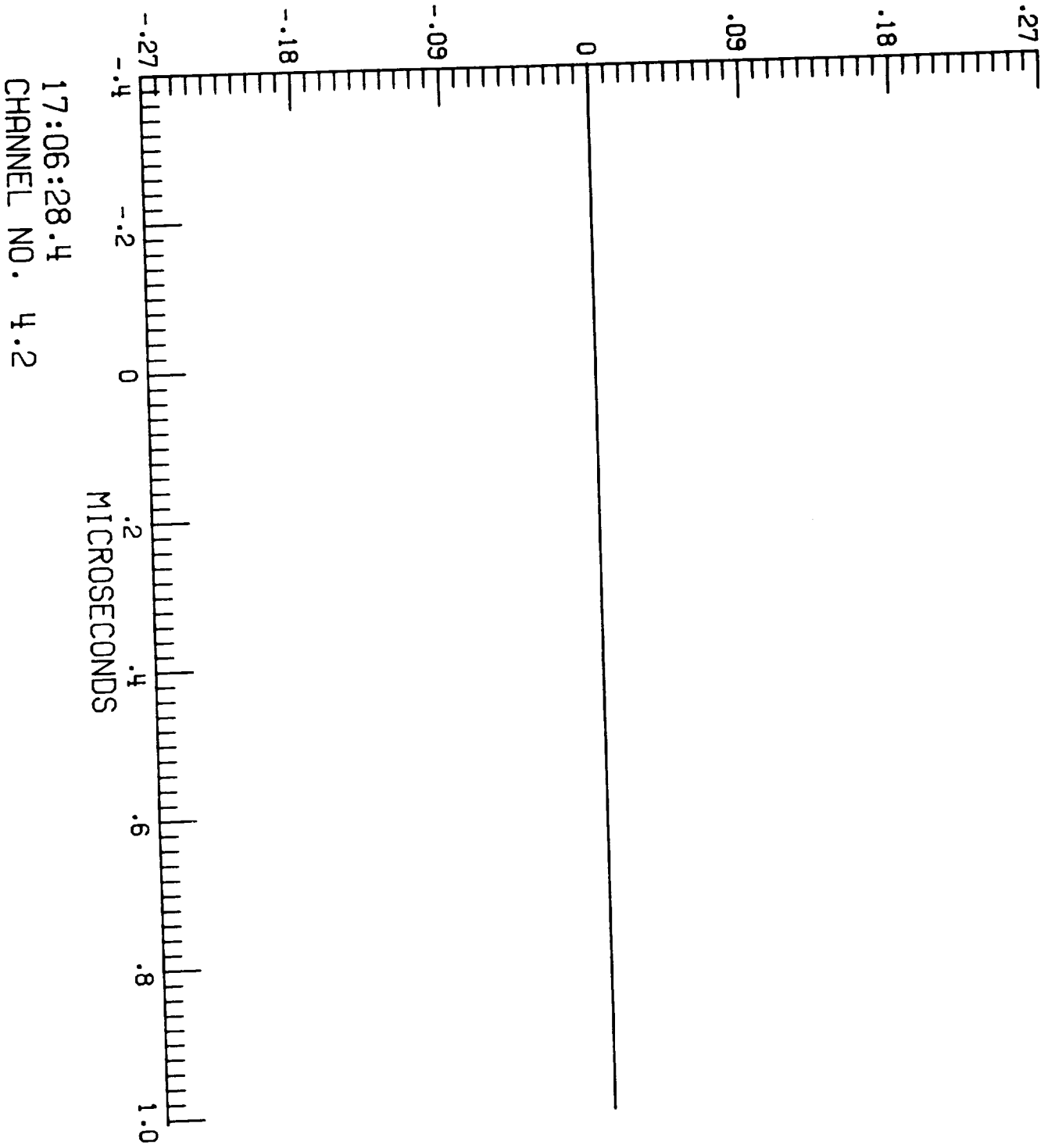

F106 LIGHTNING/85-030/ZAEPFEL

LEC 2 RUN NO. 1

S-001

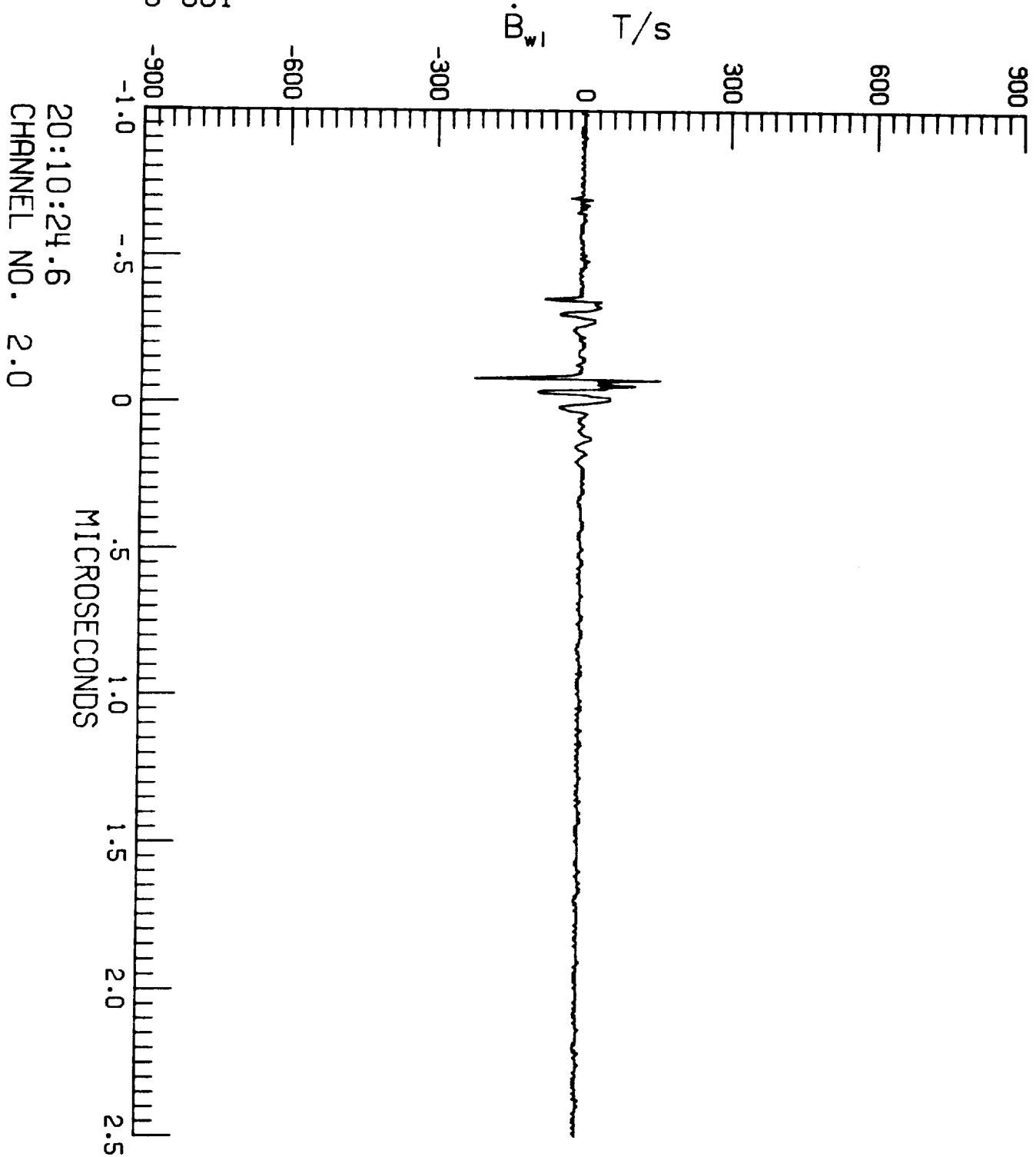

20:10:24.6  
CHANNEL NO. 2.0

F106 LIGHTNING/85-030/ZAEPFEL  
LEC 2 RUN NO. 1  
S-001

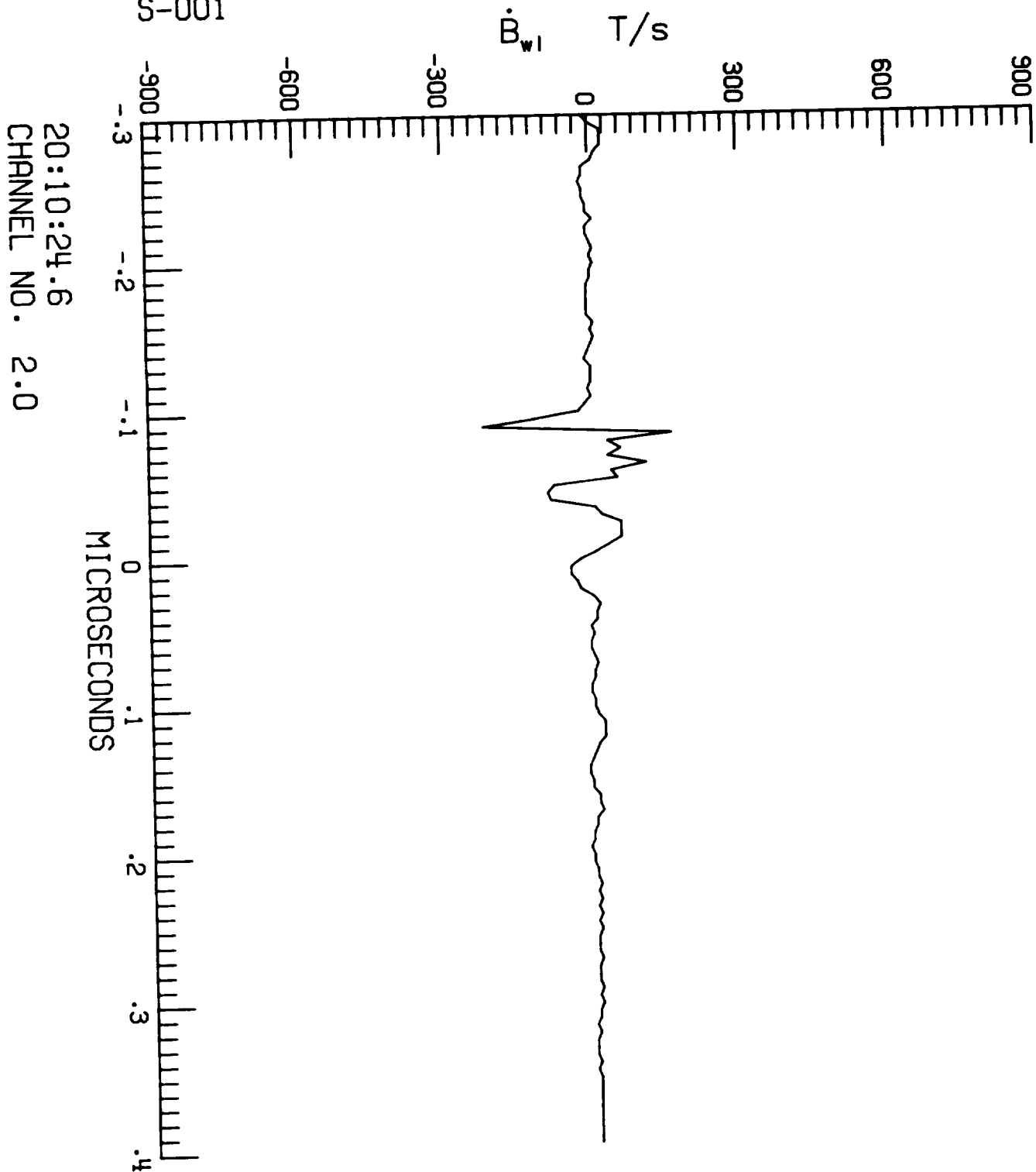

20:10:24.6  
CHANNEL NO. 2.0

F106 LIGHTNING/85-030/ZAEPFEL

LEC 2 RUN NO. 1

S-001

$\dot{i}$  A/s

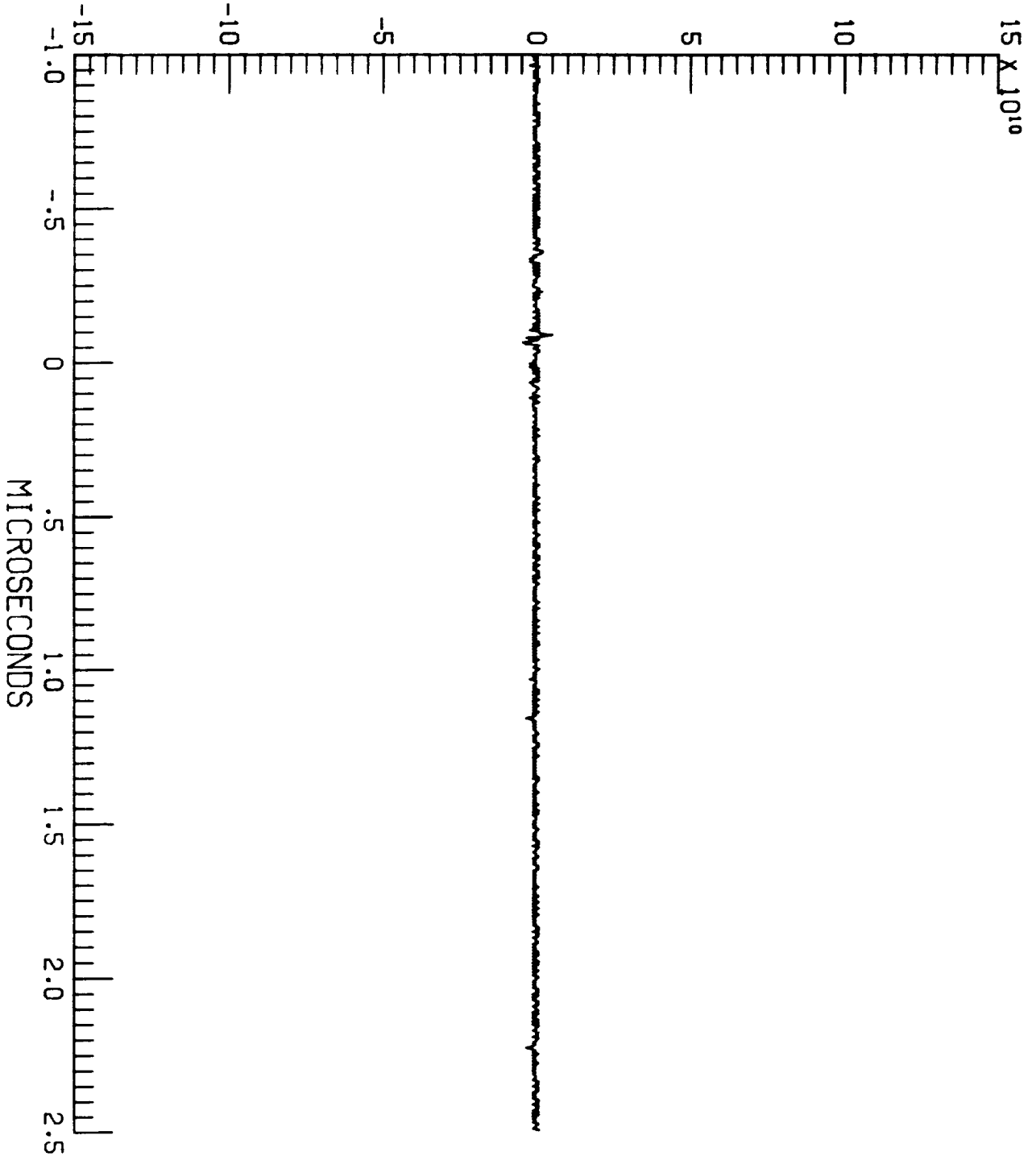

20:10:24.6  
CHANNEL NO. 2.1

F106 LIGHTNING/85-030/ZAEPFEL

LEC 2 RUN NO. 1

S-001

$\dot{B}_l$  T/s

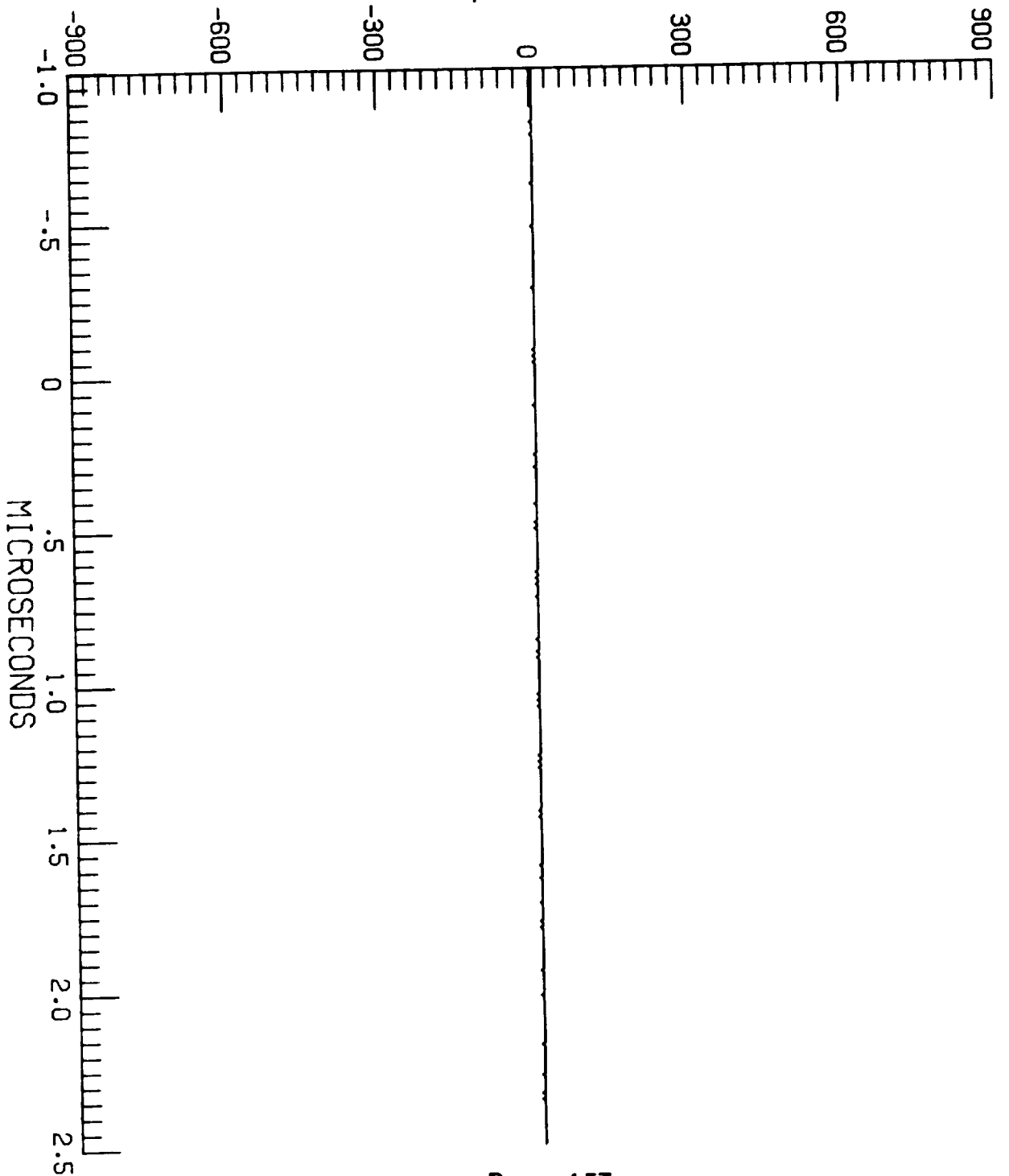

20:10:24.6  
CHANNEL NO. 2.2

F106 LIGHTNING/85-030/ZAEPFEL

LEC 3 RUN NO. 1

S-001

$\dot{D}_{wr}$  A/m<sup>2</sup>

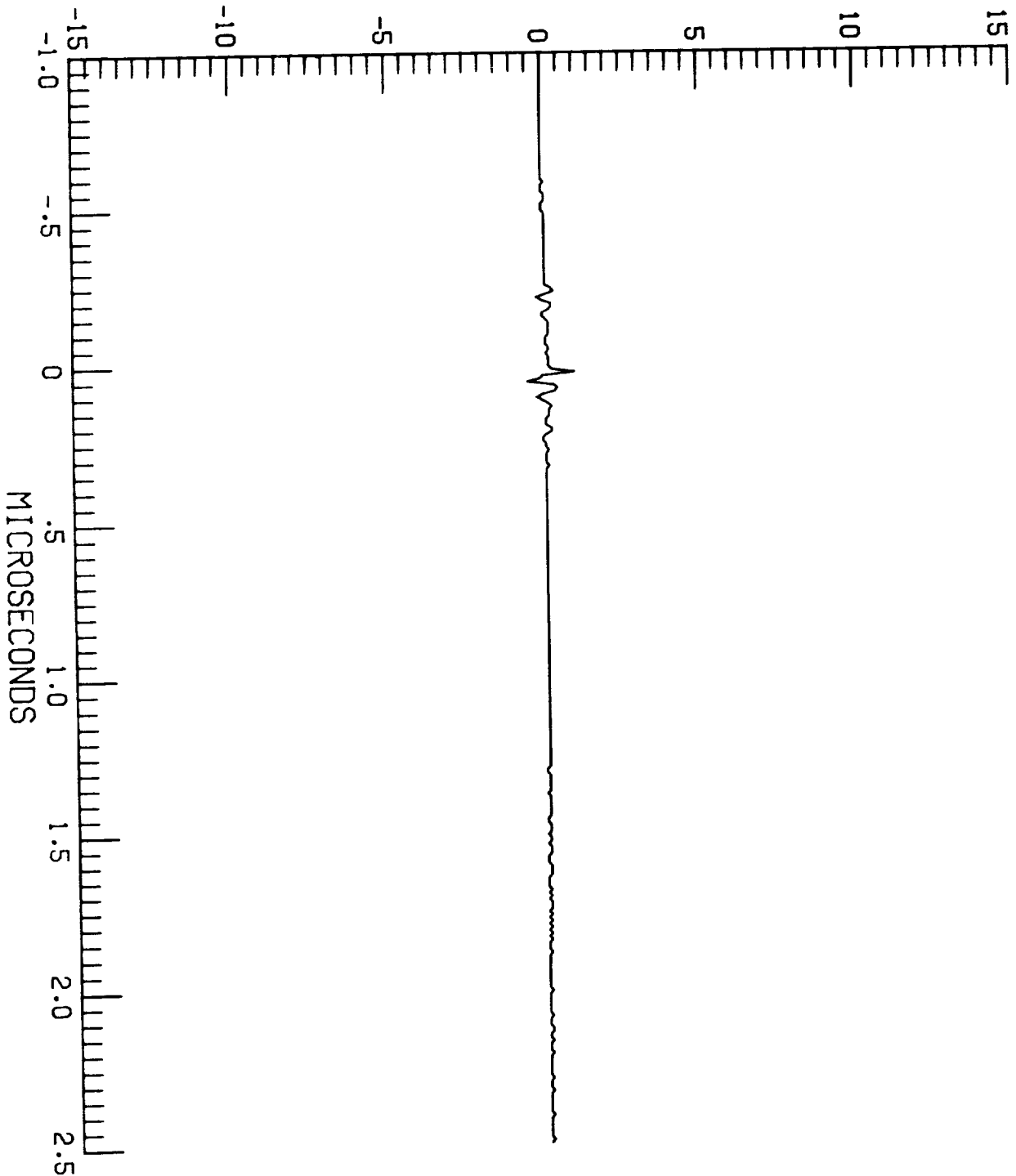

20:10:24.6  
CHANNEL NO. 3.0

F106 LIGHTNING/85-030/ZAEPFEL

LEC 3 RUN NO. 1

S-001

20:10:24.6  
CHANNEL NO. 3.1

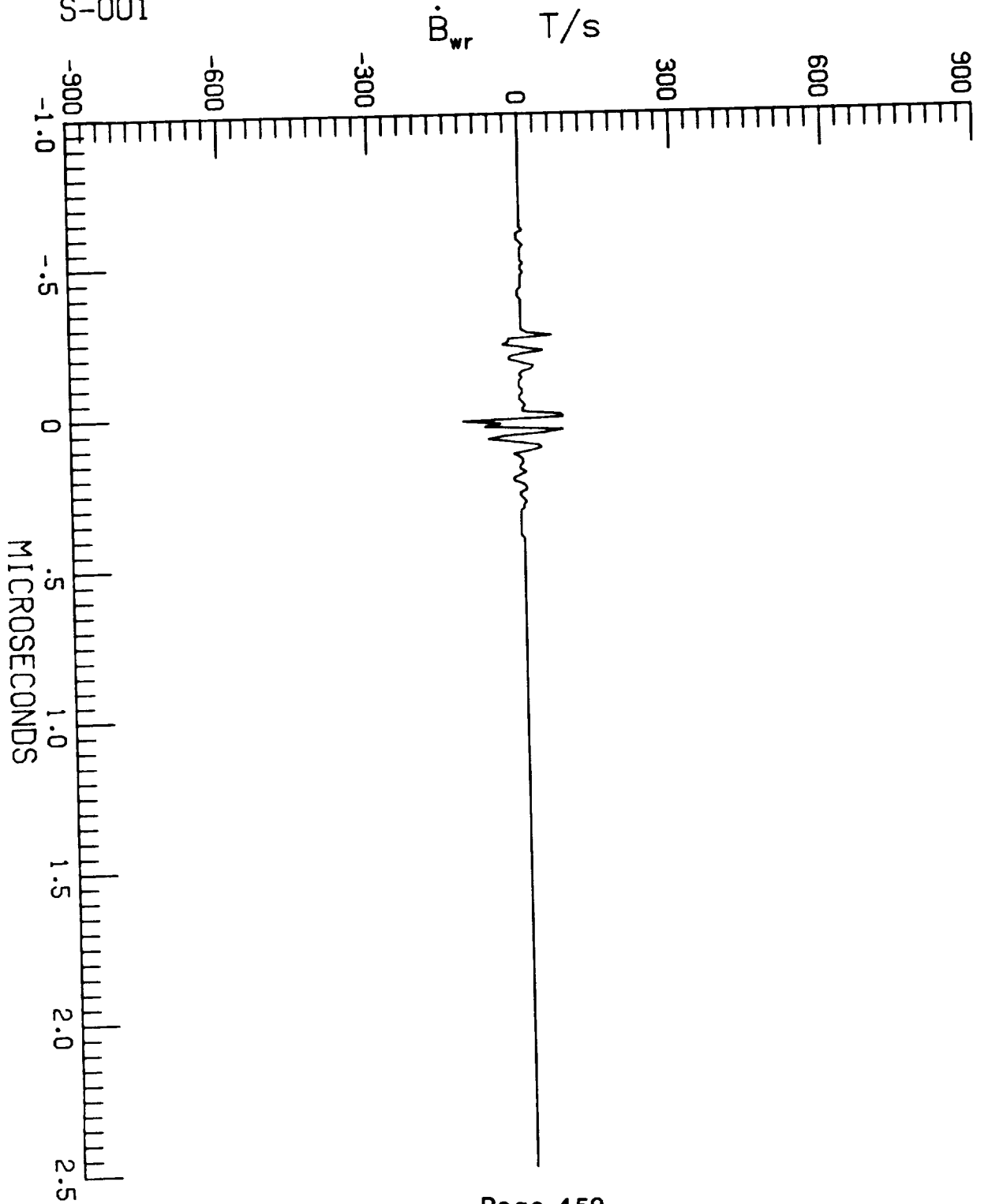

F106 LIGHTNING/85-030/ZAEPFEL

LEC 3 RUN NO. 1

S-001

$\dot{D}_f$  A/m<sup>2</sup>

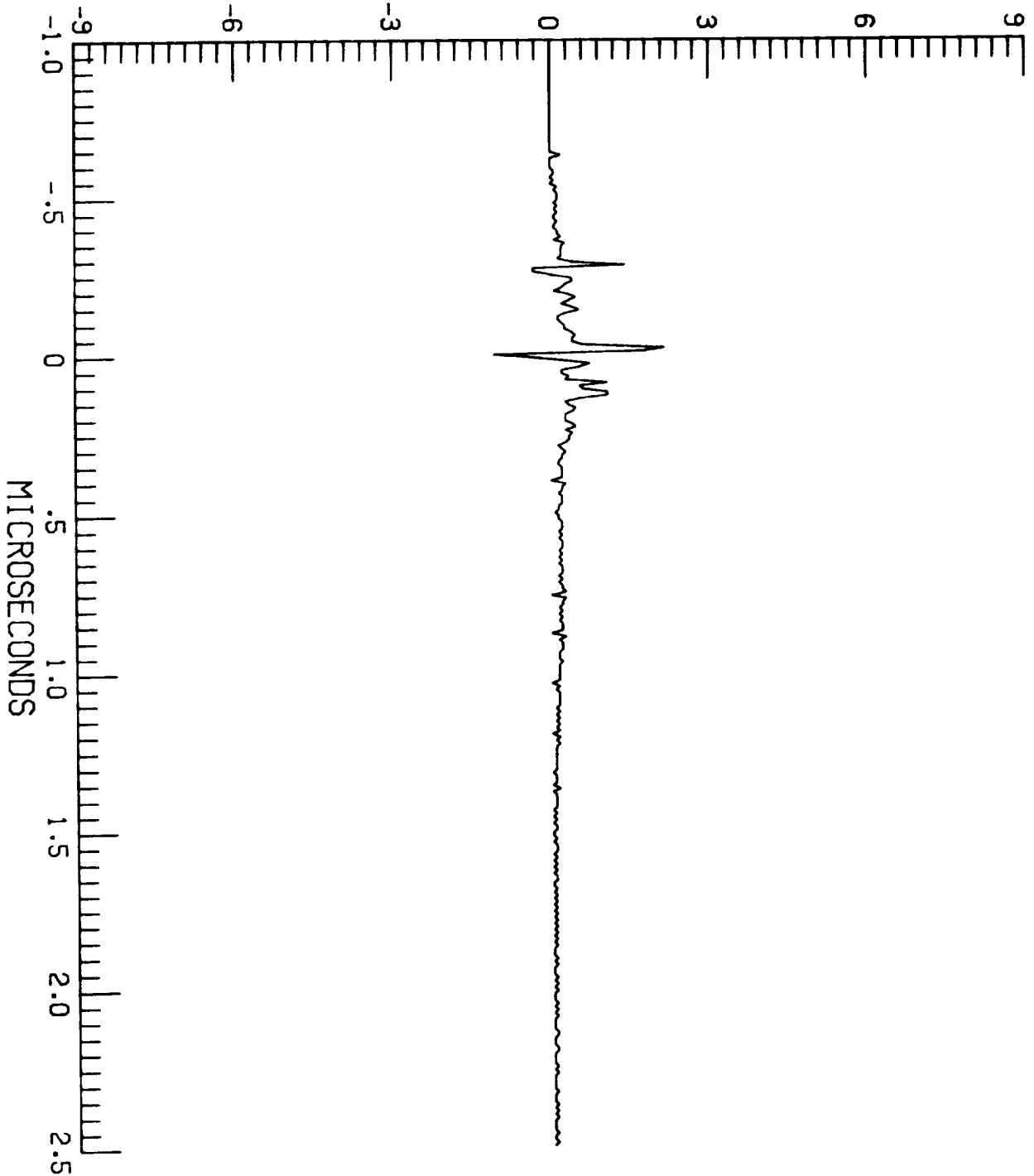

20:10:24.6  
CHANNEL NO. 3.2



F106 LIGHTNING/85-030/ZAEPFEL

LEC 4 RUN NO. 1

S-001

TP100

V

20:10:24.6  
CHANNEL NO. 4.0

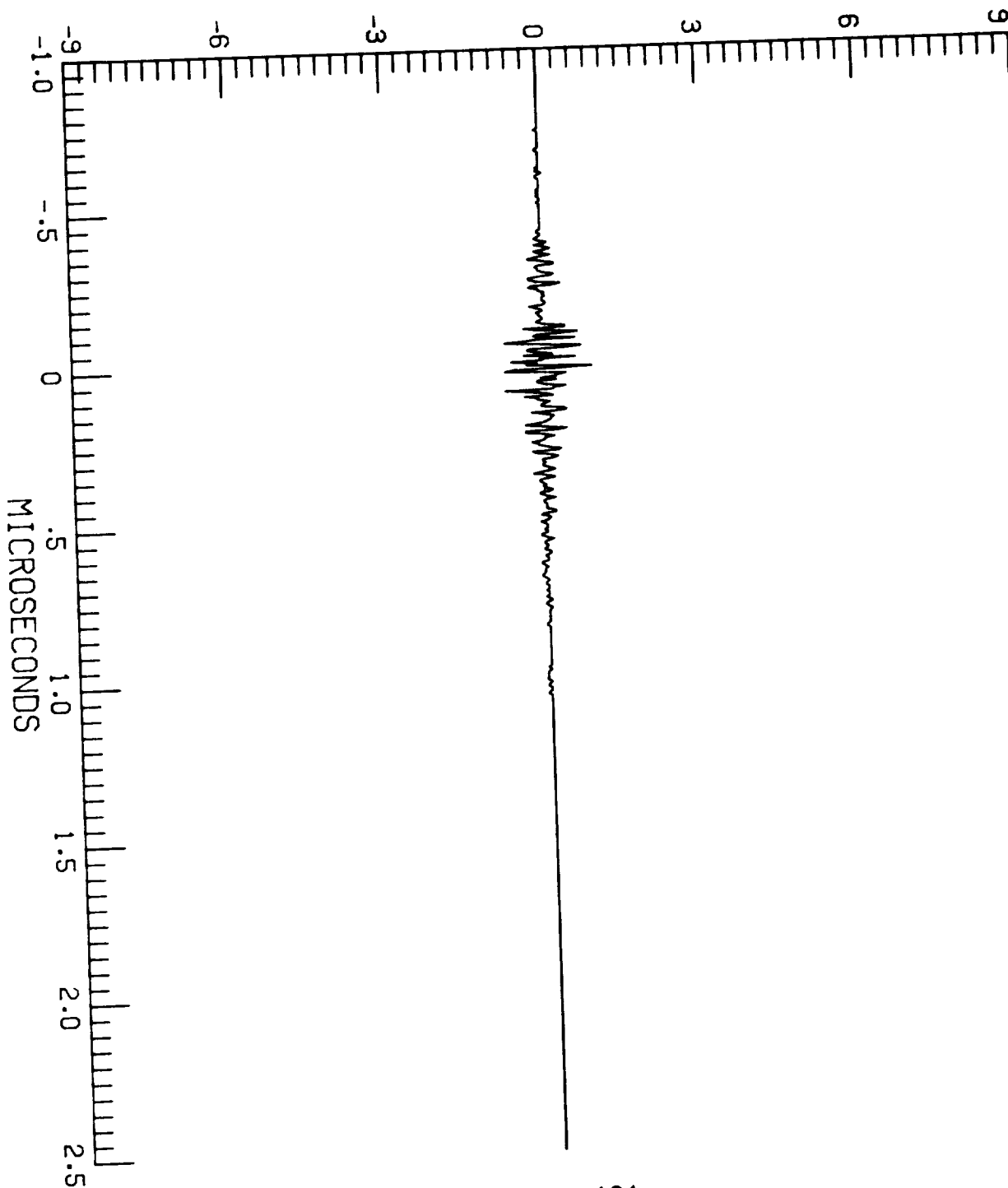

F106 LIGHTNING/85-030/ZAEPFEL

LEC 4 RUN NO. 1

S-001

TP106 A

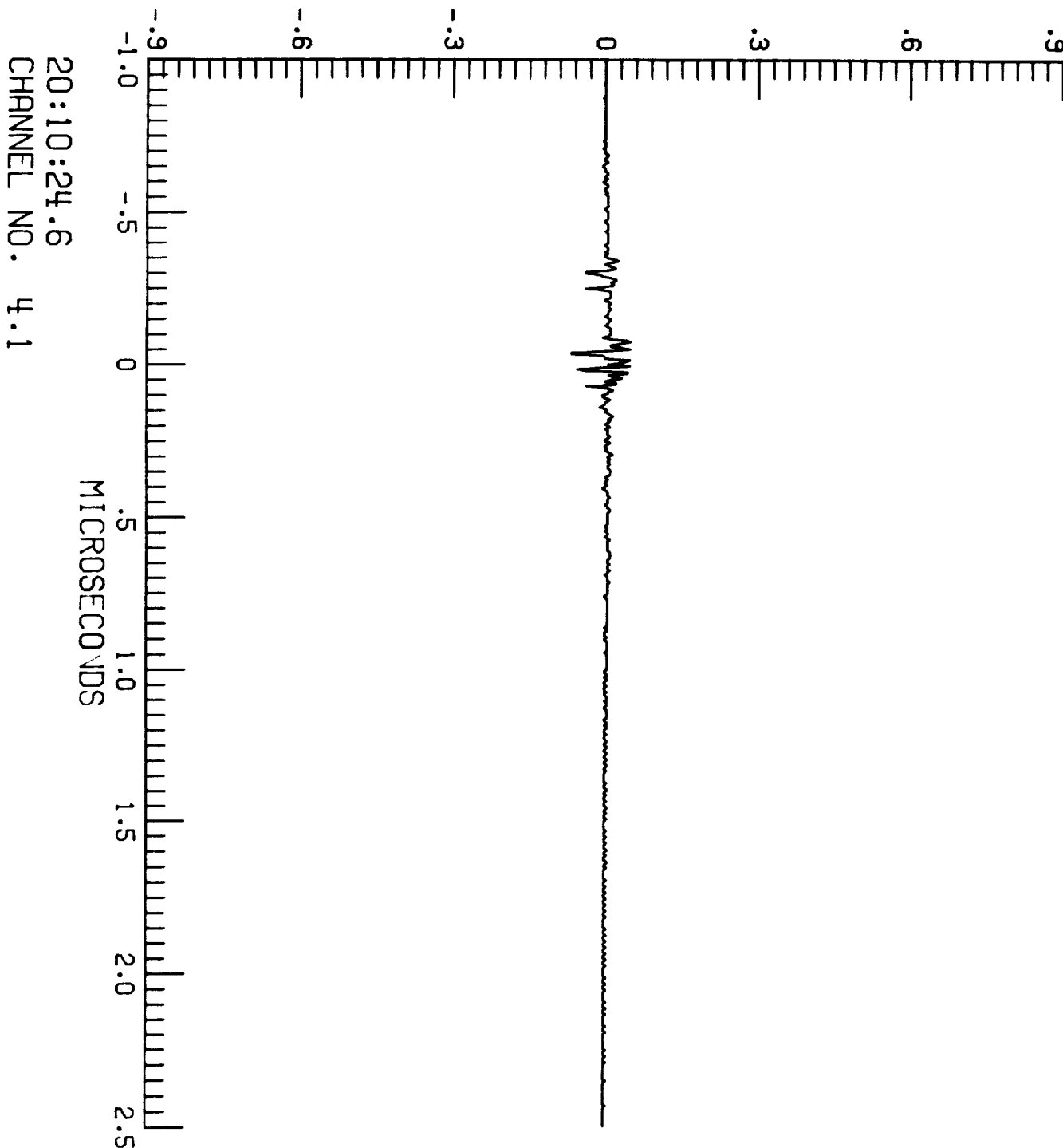

F106 LIGHTNING/85-030/ZAEPFEL

LEC 4 RUN NO. 1

S-001

TP125

A

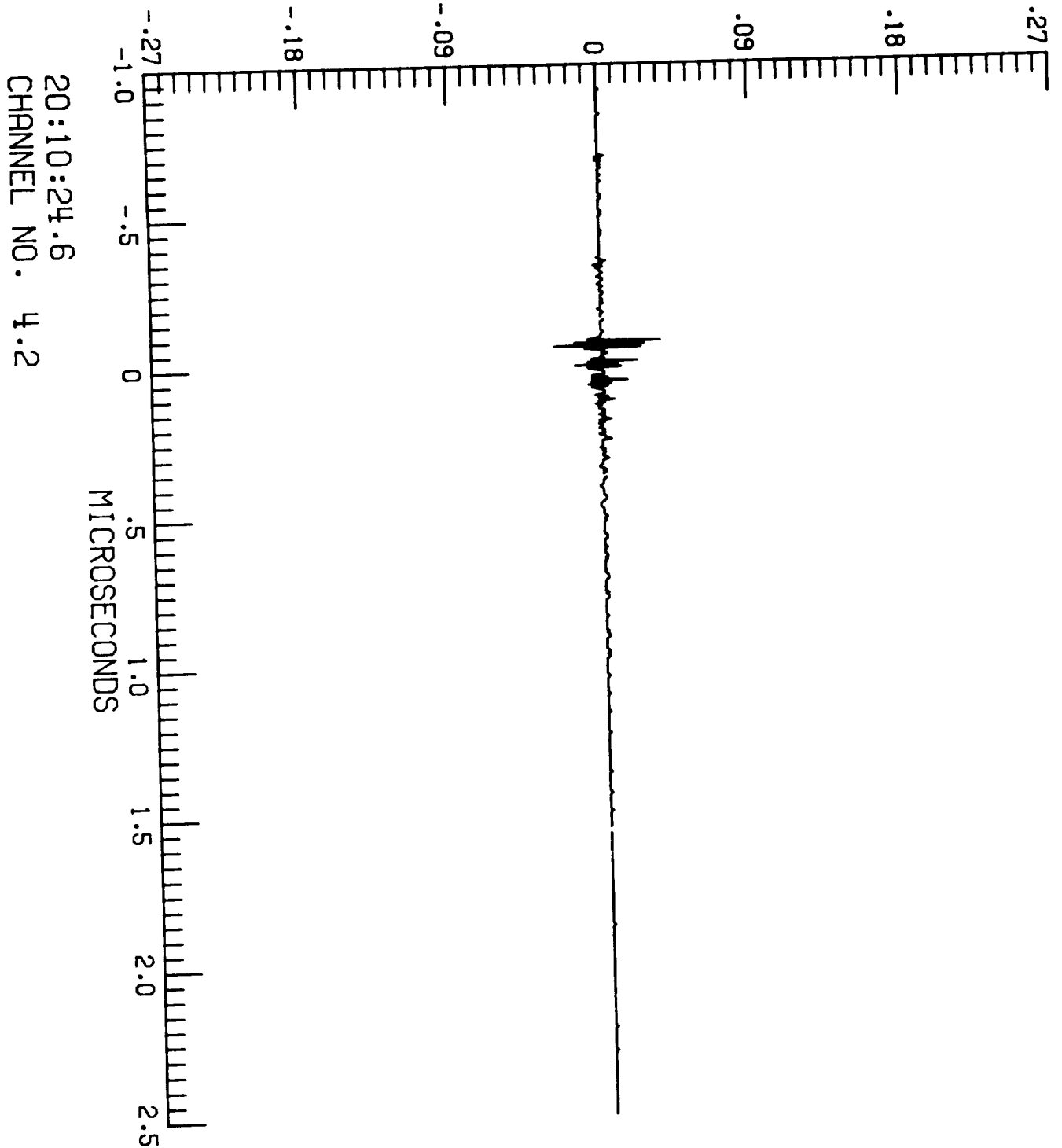

F106 LIGHTNING/85-030/ZAEPFEL

LEC 4 RUN NO. 1

S-001

TP125 A

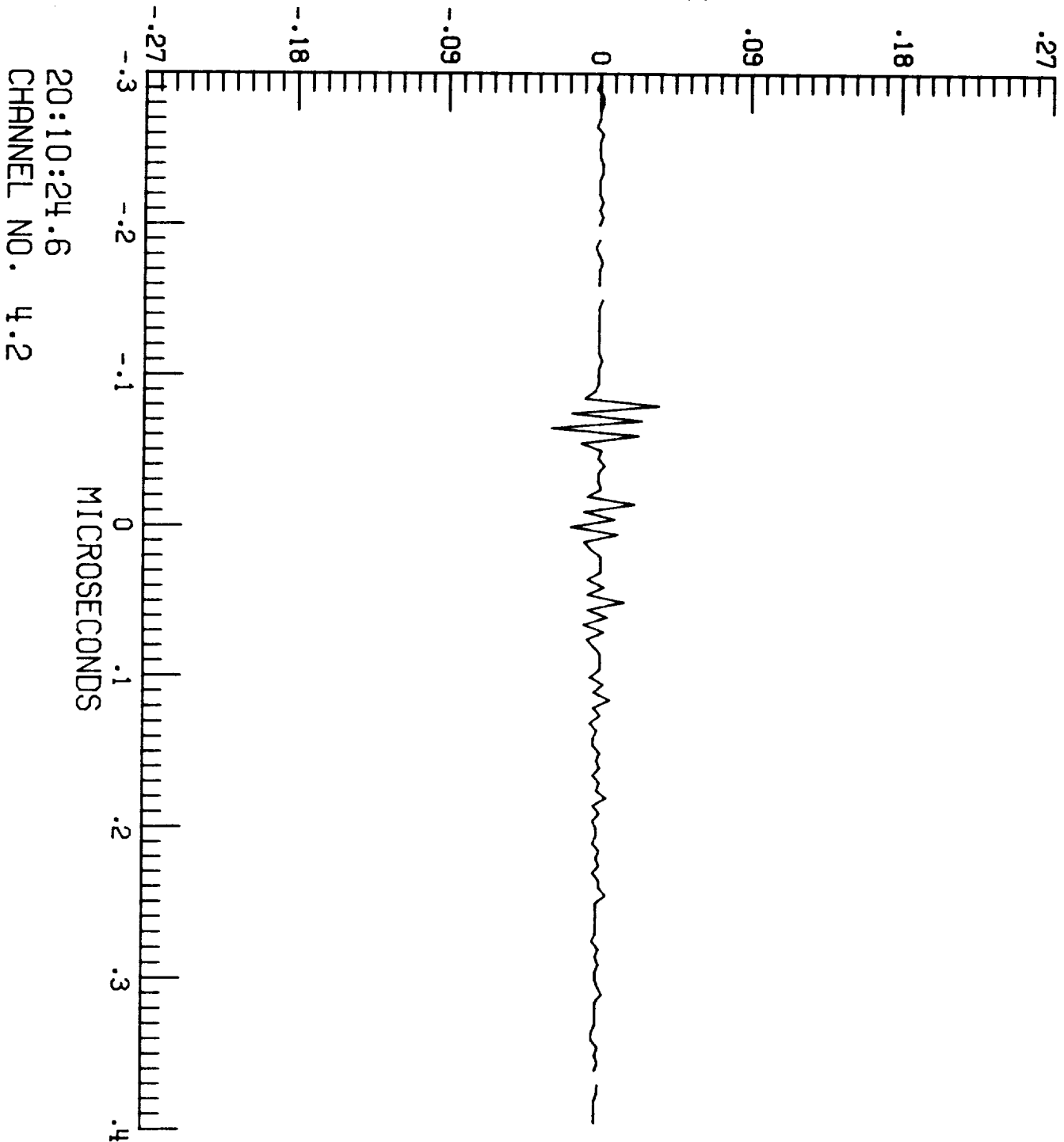

F106 LIGHTNING/85-031/ZAEPFEL

LEC 1 RUN NO. 1

S-001

$\dot{D}_t$  A/m<sup>2</sup>

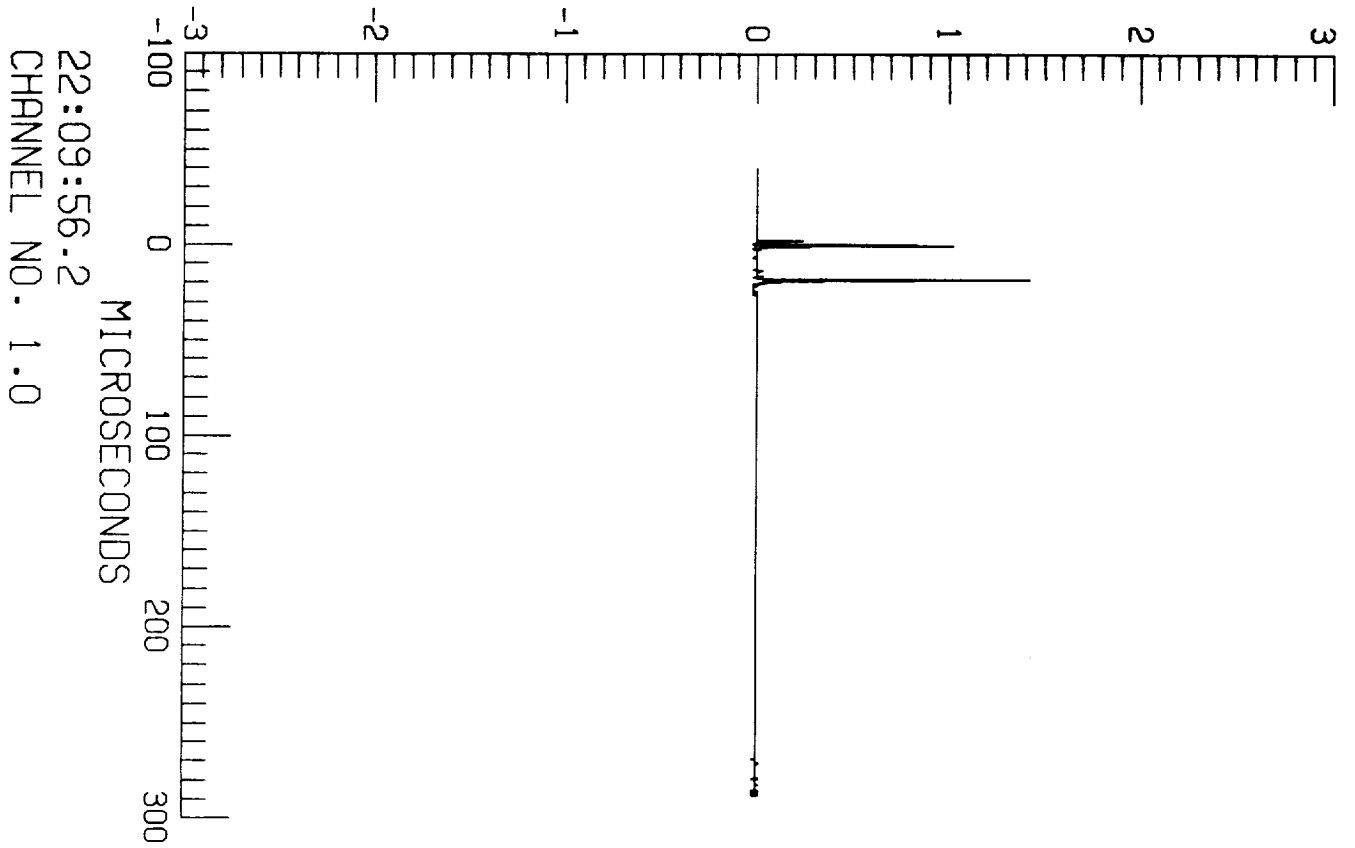

22:09:56.2  
CHANNEL NO. 1.0

F106 LIGHTNING/85-031/ZAEPFEL

LEC 1

RUN NO. 1

S-001

$I_t$  A

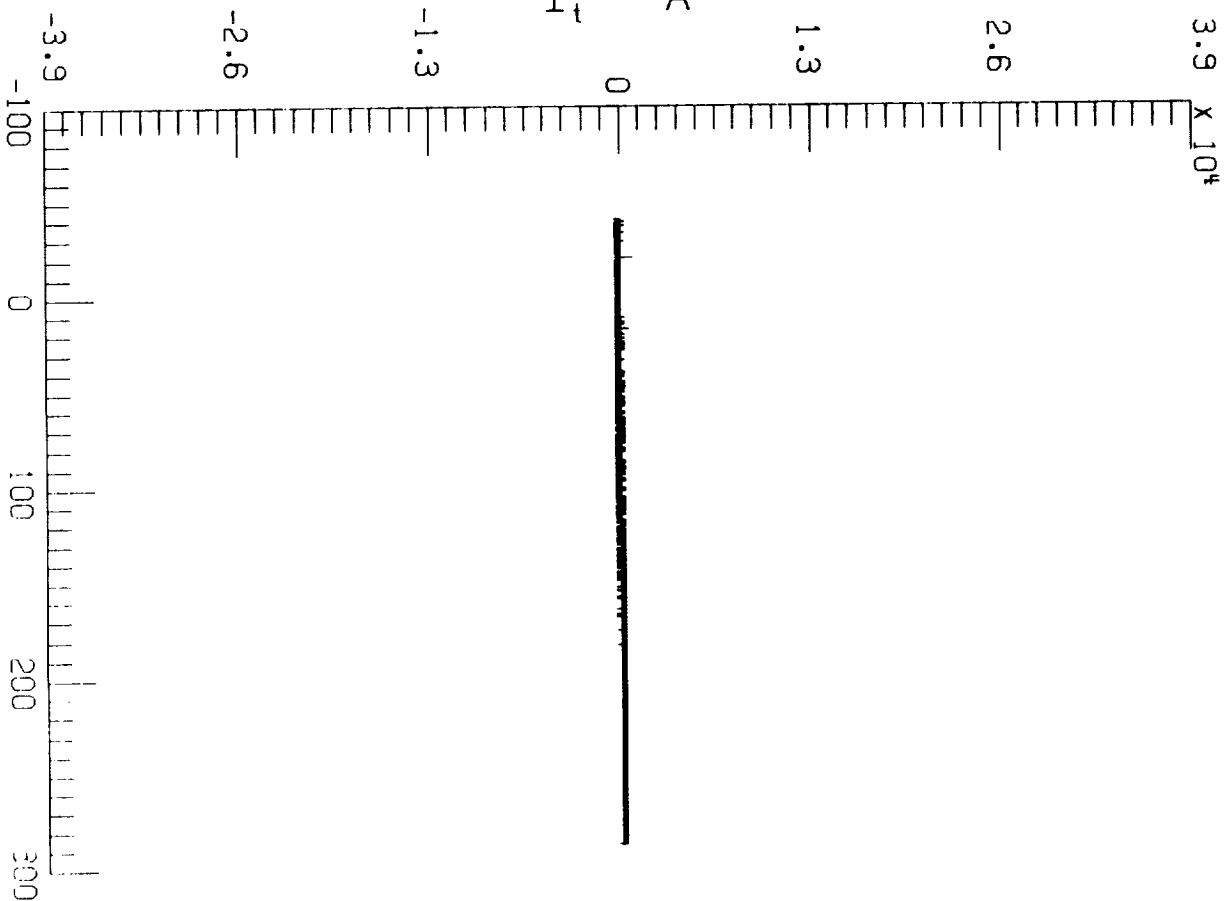

22:09:56.2  
CHANNEL NO. 1.2

F106 LIGHTNING/85-031/ZAEPFEL

LEC 2 RUN NO. 1

S-001

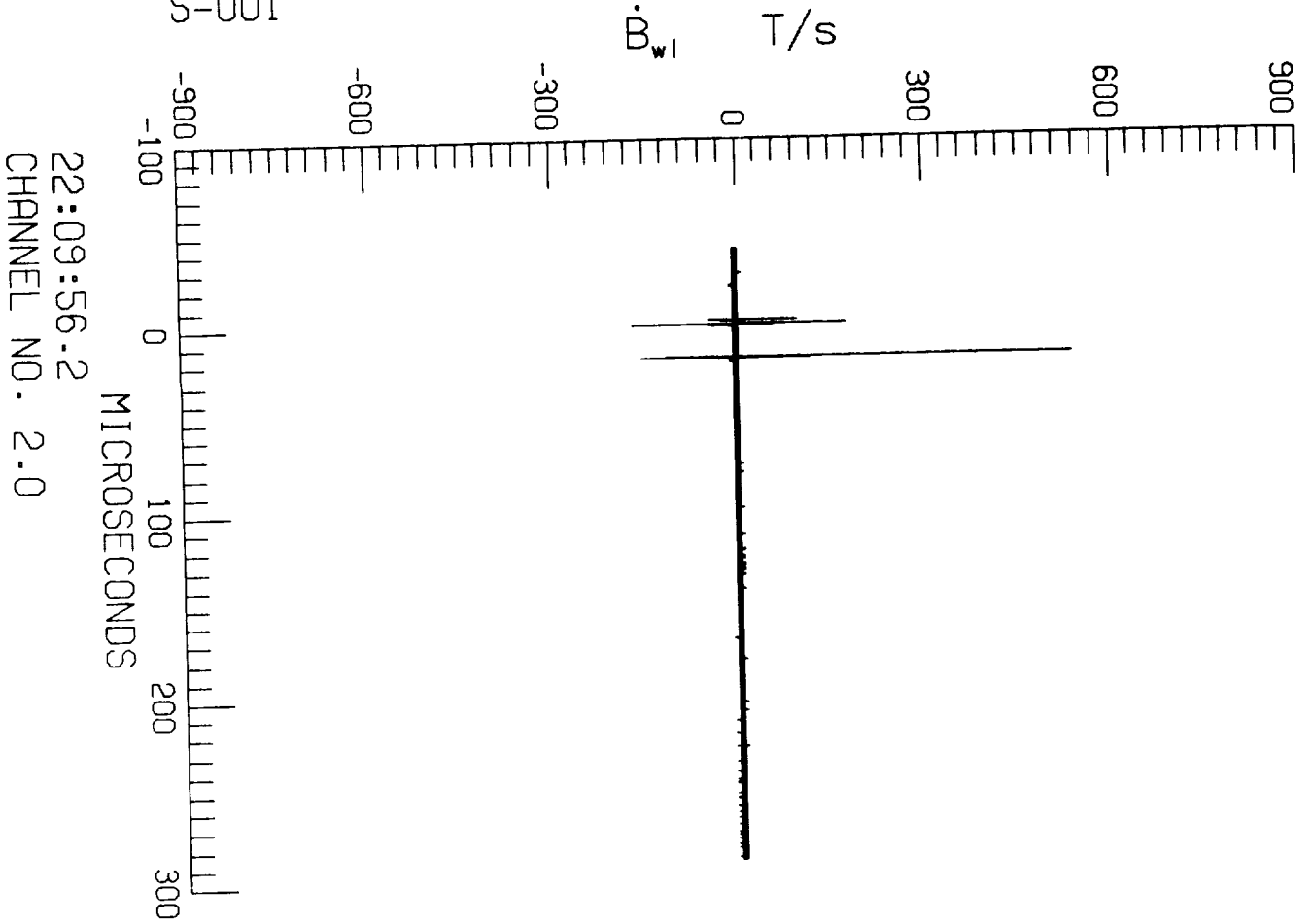

22:09:56.2  
CHANNEL NO. 2.0

F106 LIGHTNING/85-031/ZAEPFEL

LEC 2 RUN NO. 1

S-001

$\dot{I}$  A/s

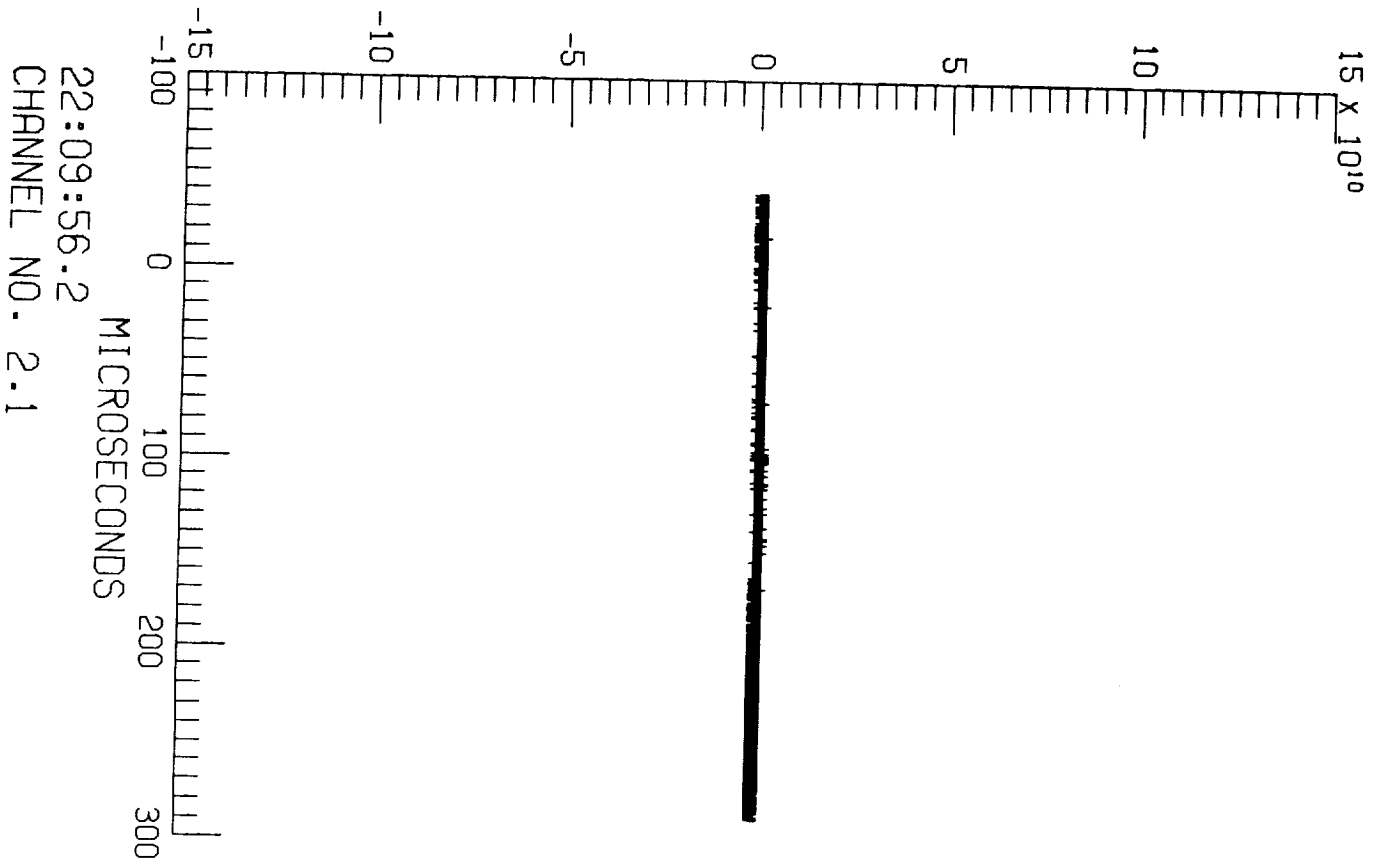

22:09:56.2  
CHANNEL NO. 2.1



F106 LIGHTNING/85-031/ZAEPFEL

LEC 2

RUN NO. 1

S-001

$\dot{B}_1$  T/s



22:09:56.2  
CHANNEL NO. 2.2

F106 LIGHTNING/85-031/ZAEPFEL

LEC 3 RUN NO. 1

S-001

$\dot{D}_{wr}$  A/m<sup>2</sup>

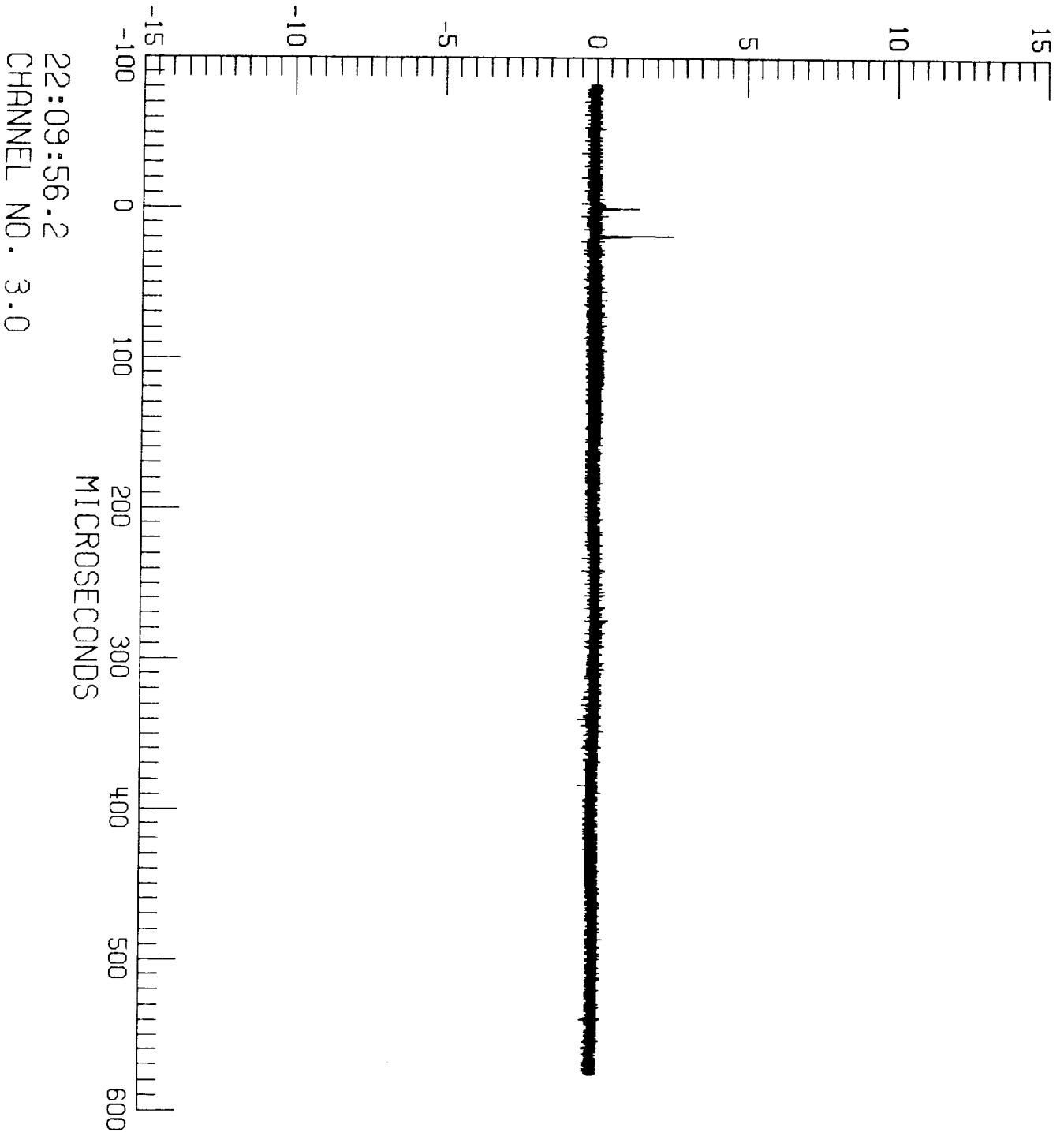

22:09:56.2

CHANNEL NO. 3.0

F106 LIGHTNING/85-031/ZAEPFEL

LEC 3

RUN NO. 1

S-001

22:09:56.2  
CHANNEL NO. 3.1

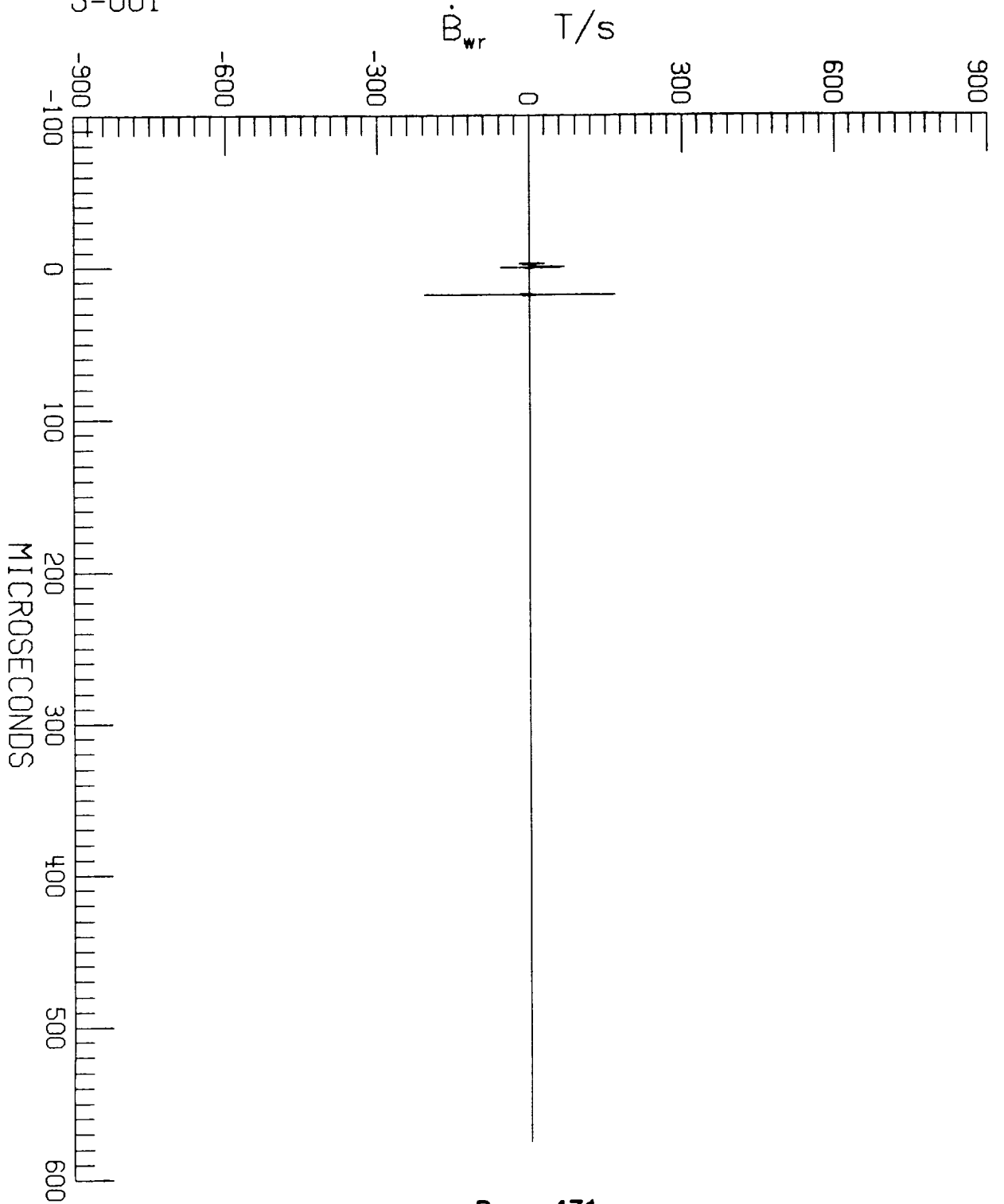

F106 LIGHTNING/85-031/ZAEPFEL

LEC 3

RUN NO. 1

S-001

$\dot{D}_f$  A/m<sup>2</sup>

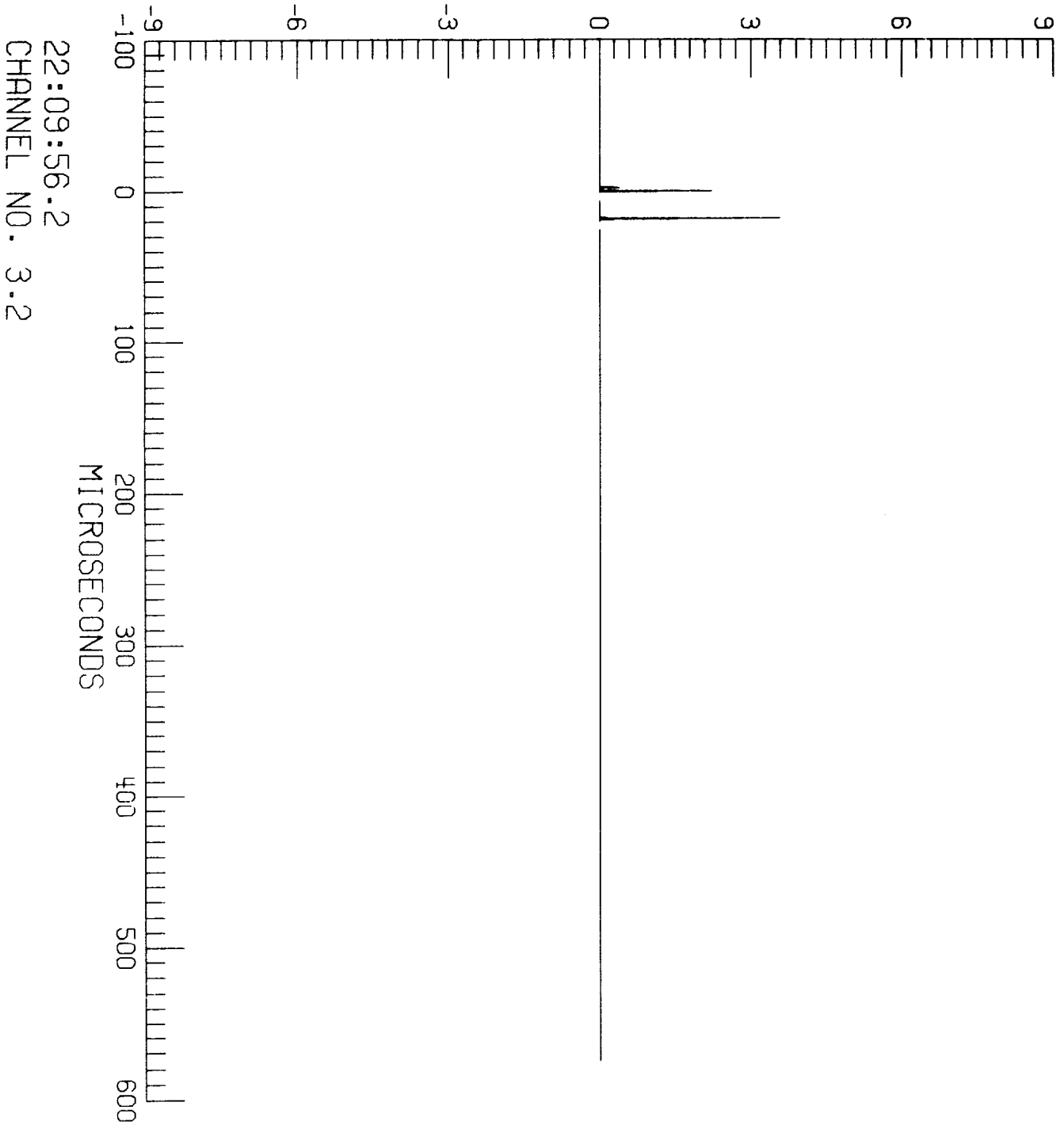

F106 LIGHTNING/85-031/ZAEPFEL

LEC 4 RUN NO. 1

S-001

TP100 V

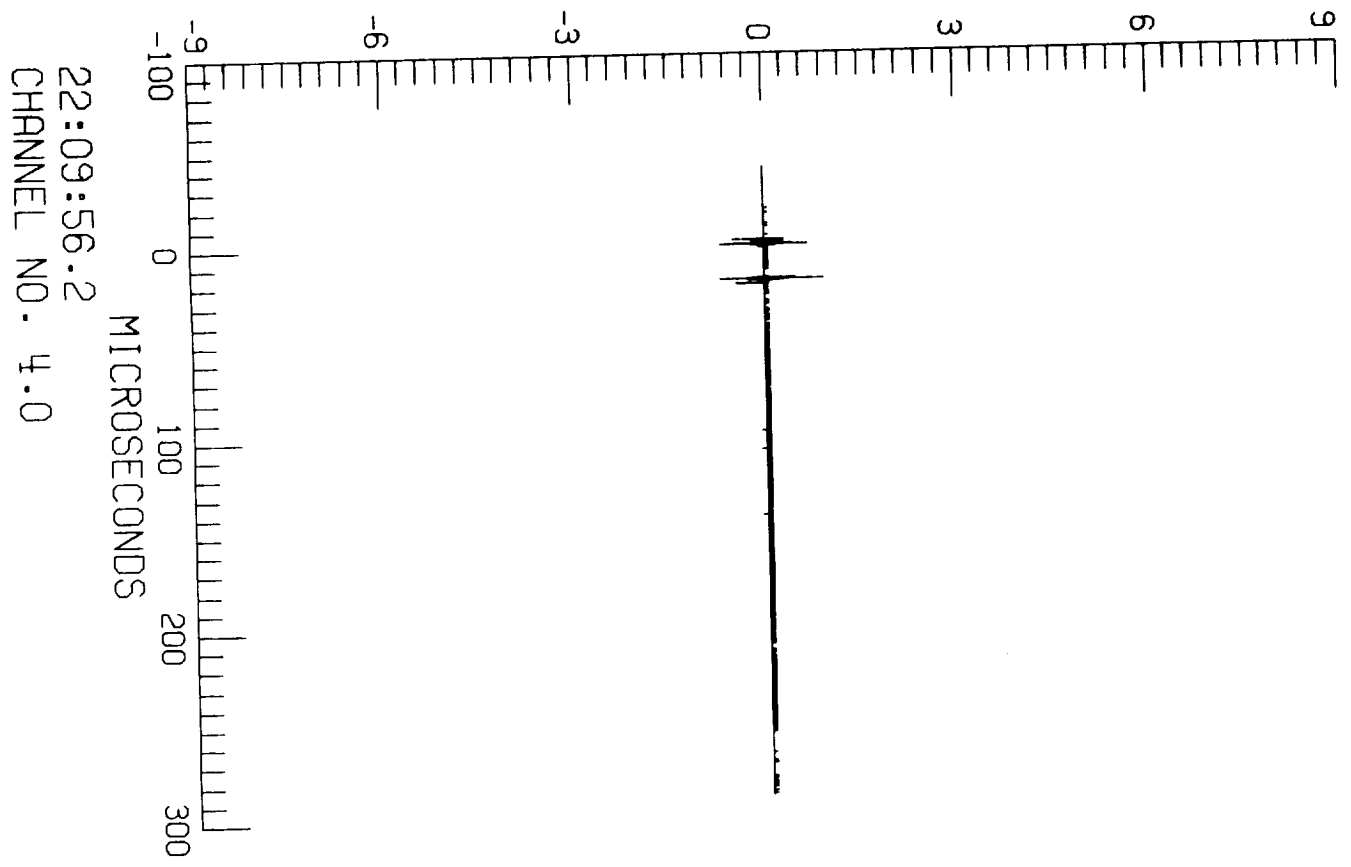

F106 LIGHTNING/85-031/ZAEPFEL

LEC 4 RUN NO. 1

S-001

TP106 A

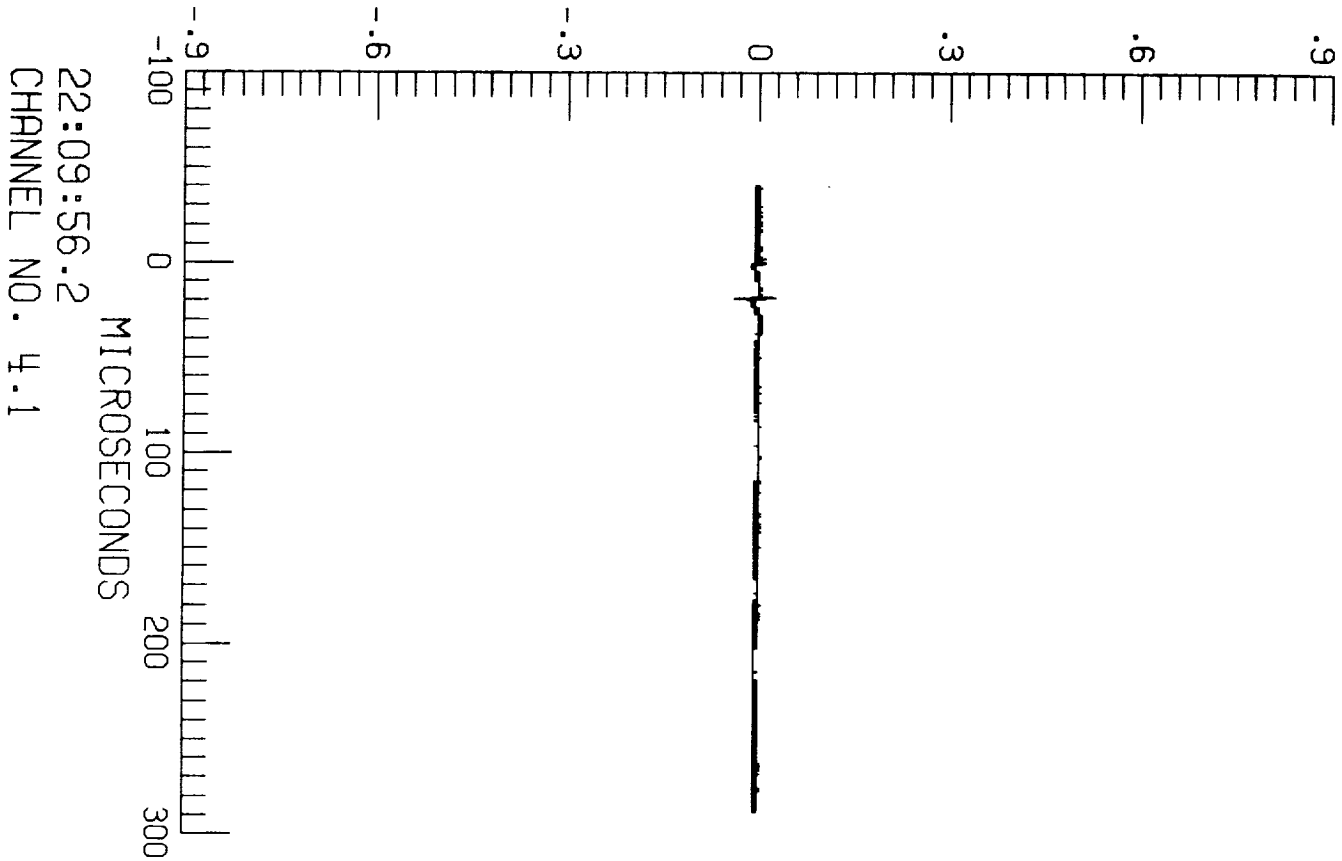

22:09:56.2  
CHANNEL NO. 4.1

F106 LIGHTNING/85-031/ZAEPFEL

LEC 4

RUN NO. 1

S-001

TP125 A

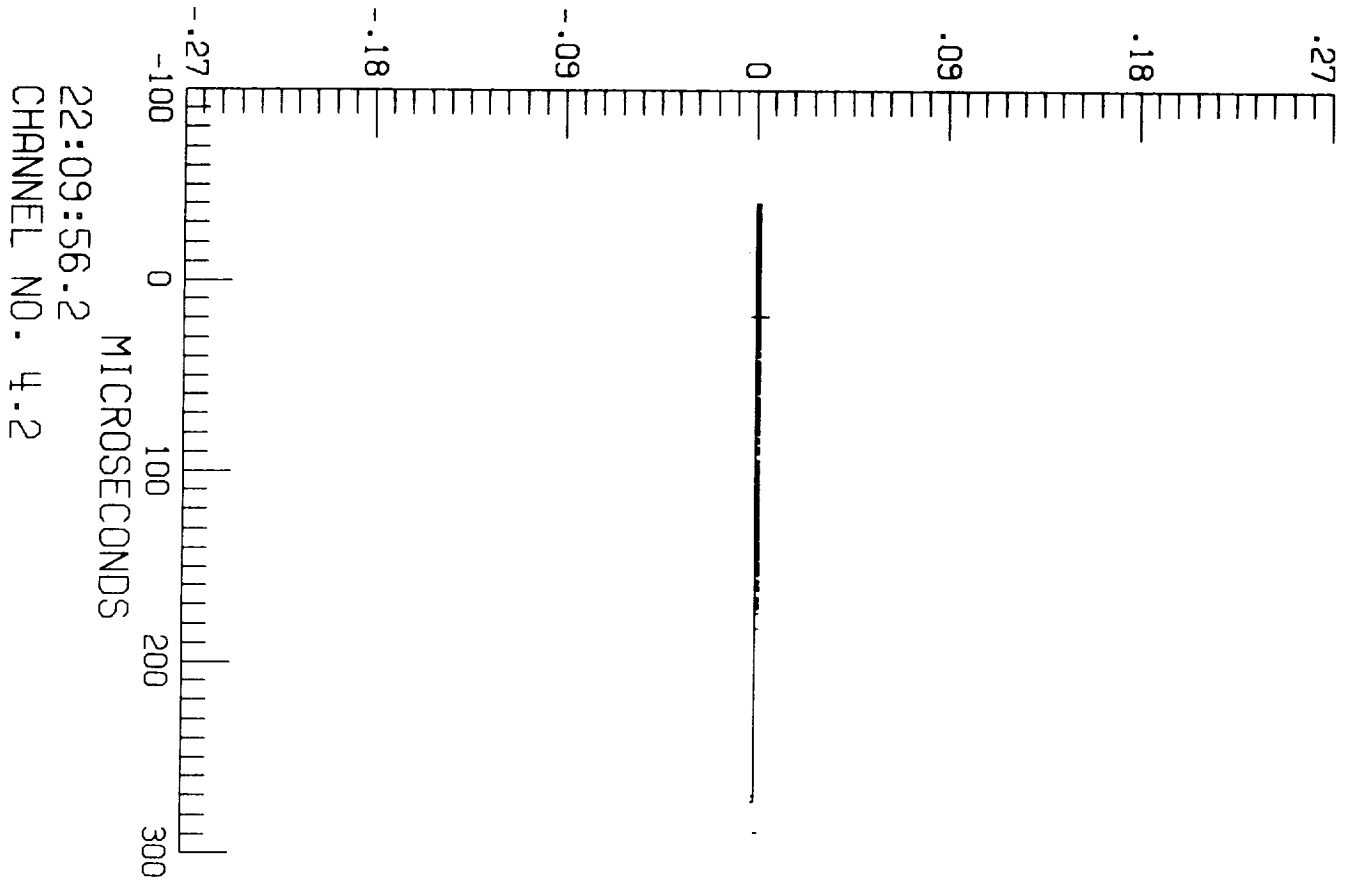

22:09:56.2  
CHANNEL NO. 4.2

F106 LIGHTNING/85-031/ZAEPFEL

LEC 1 RUN NO. 1

S-001

$\dot{D}_t$  A/m<sup>2</sup>

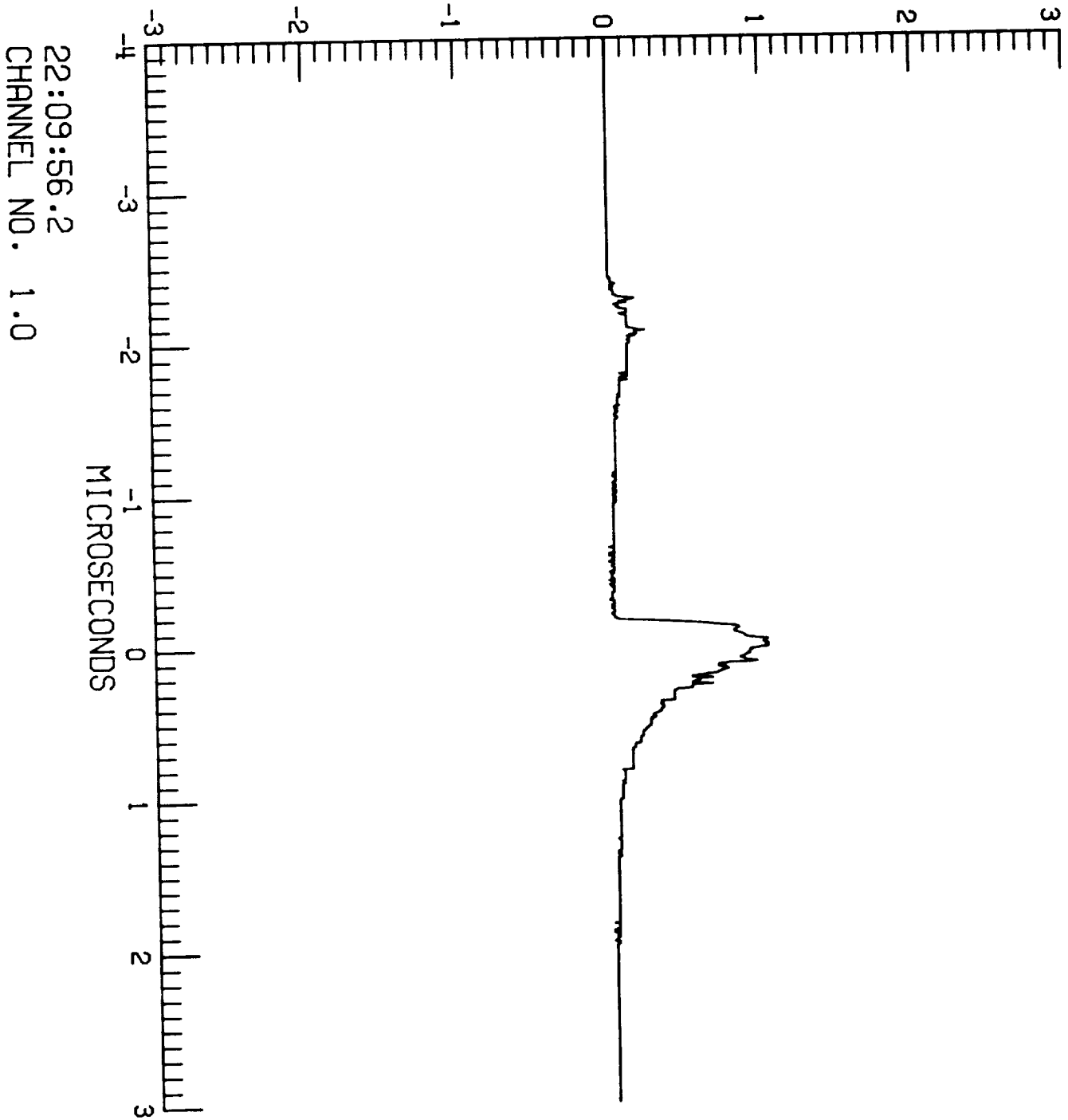



F106 LIGHTNING/85-031/ZAEPFEL

LEC 1 RUN NO. 1

S-001

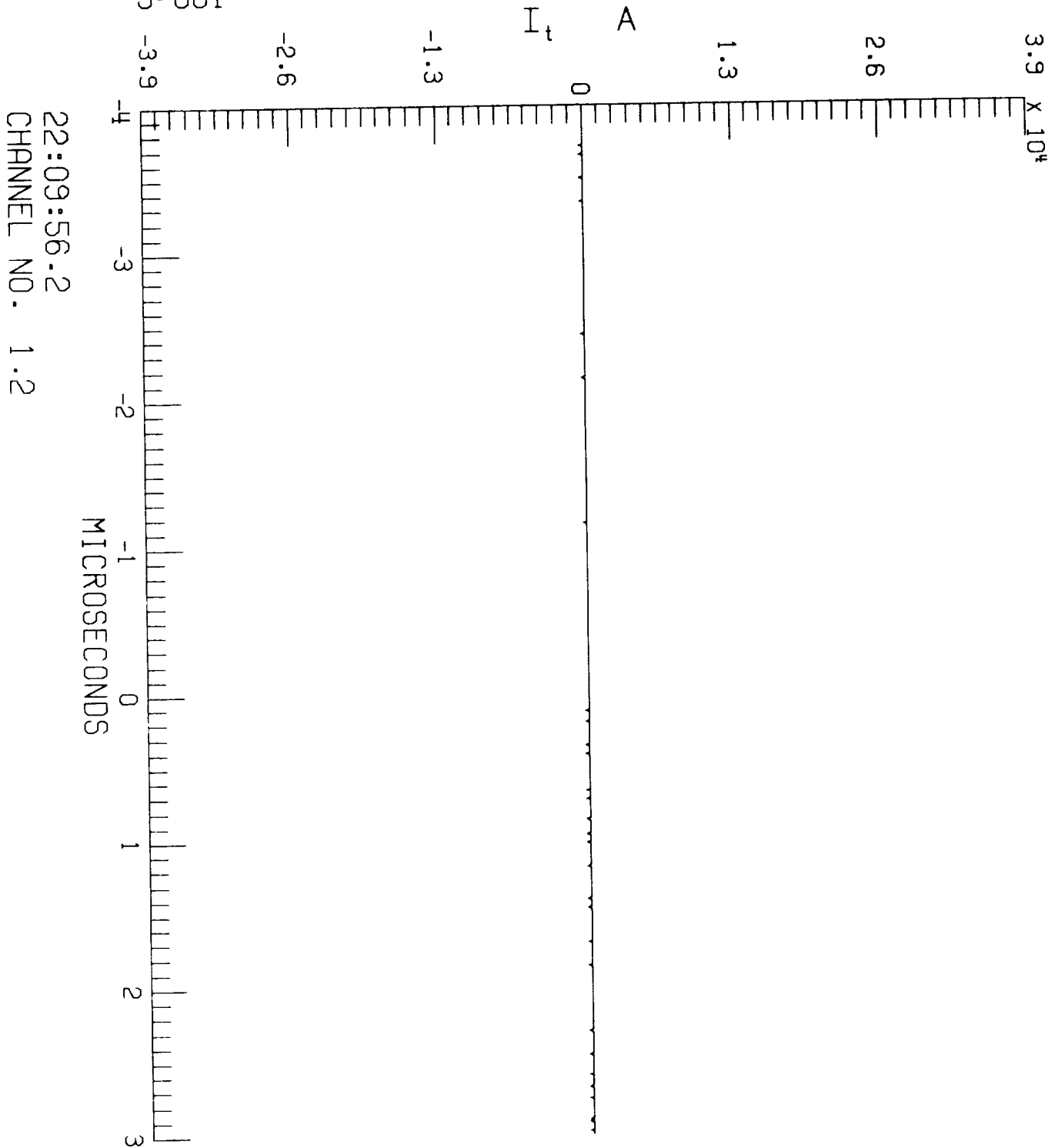

22:09:56.2  
CHANNEL NO. 1.2

F106 LIGHTNING/85-031/ZAEPFEL

LEC 2 RUN NO. 1

S-001

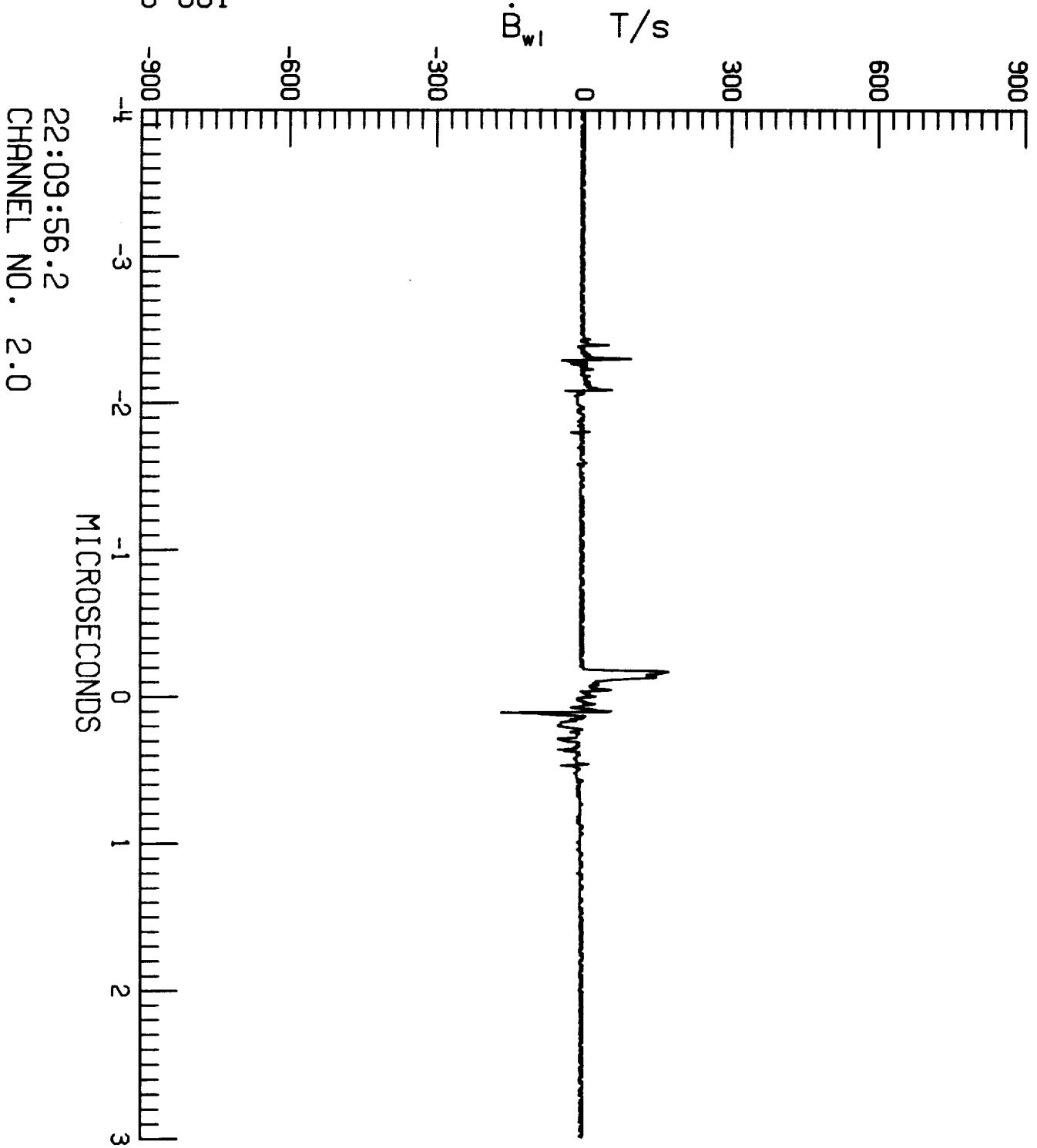

22:09:56.2  
CHANNEL NO. 2.0

F106 LIGHTNING/85-031/ZAEPFEL

LEC 2 RUN NO. 1

S-001

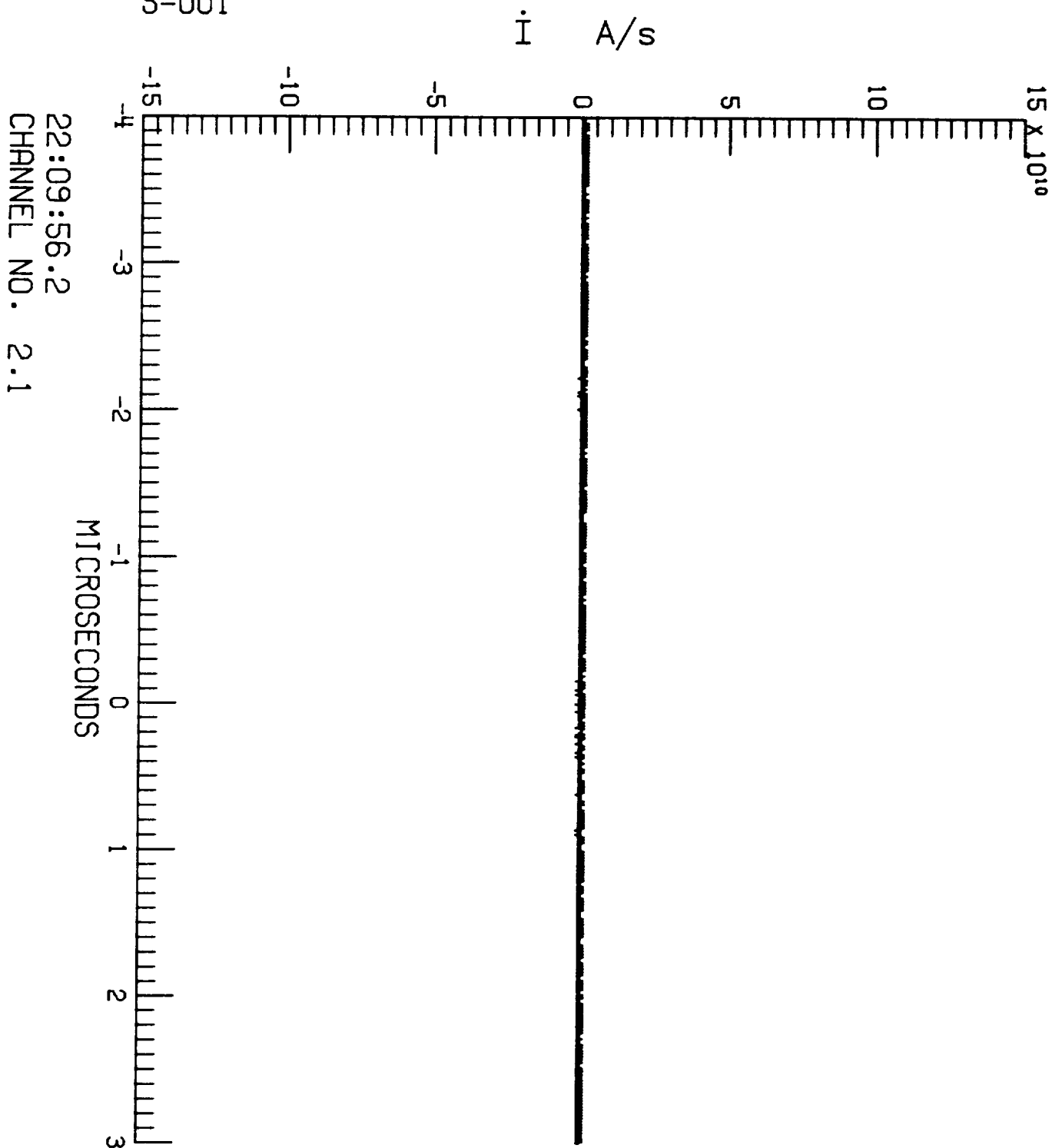

F106 LIGHTNING/85-031/ZAEPFEL

LEC 2 RUN NO. 1

S-001

$\dot{B}_1$  T/s

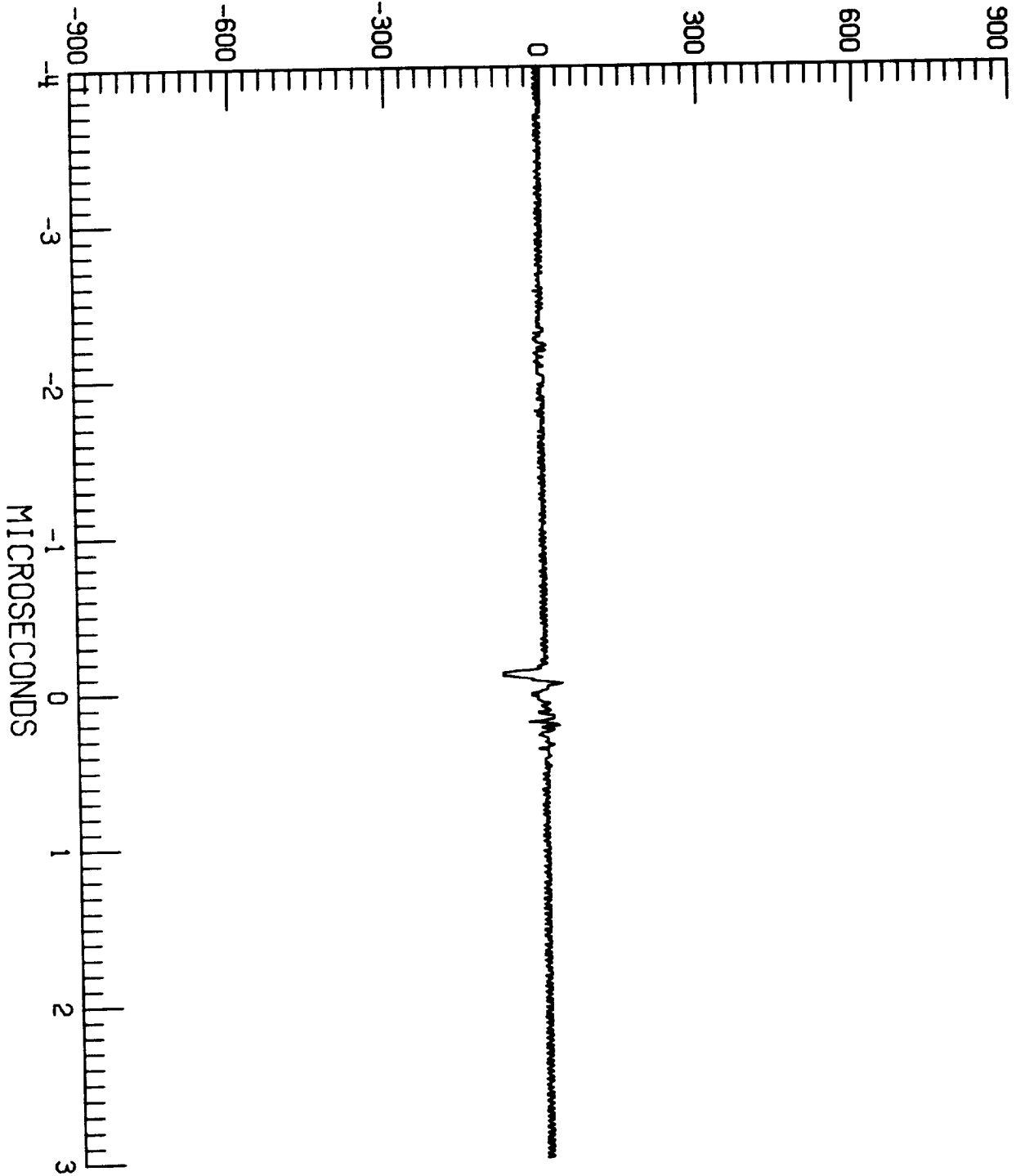

22:09:56.2  
CHANNEL NO. 2.2

F106 LIGHTNING/85-031/ZAEPFEL

LEC 3 RUN NO. 1

S-001

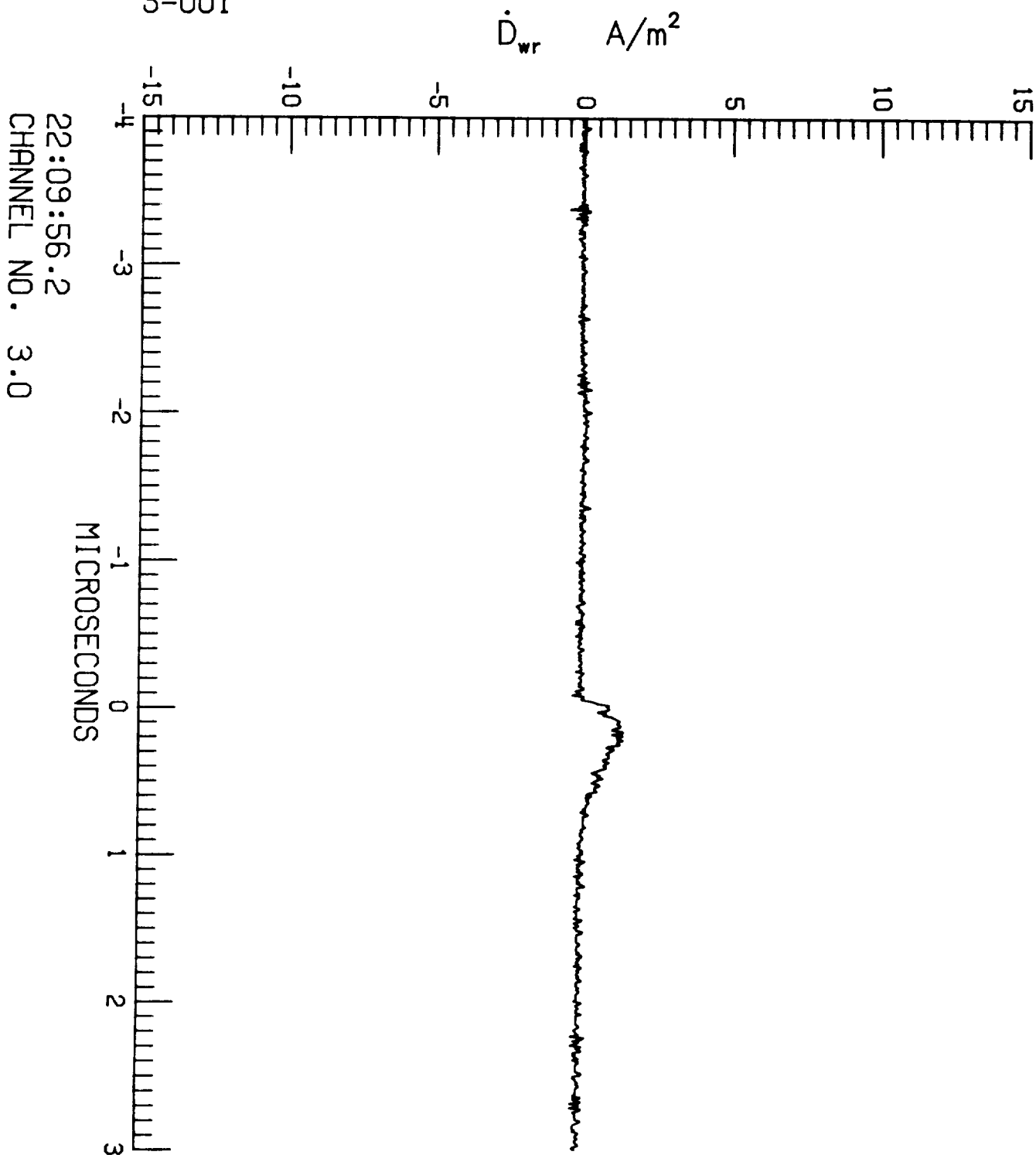

F106 LIGHTNING/85-031/ZAEPFEL

LEC 3 RUN NO. 1

S-001

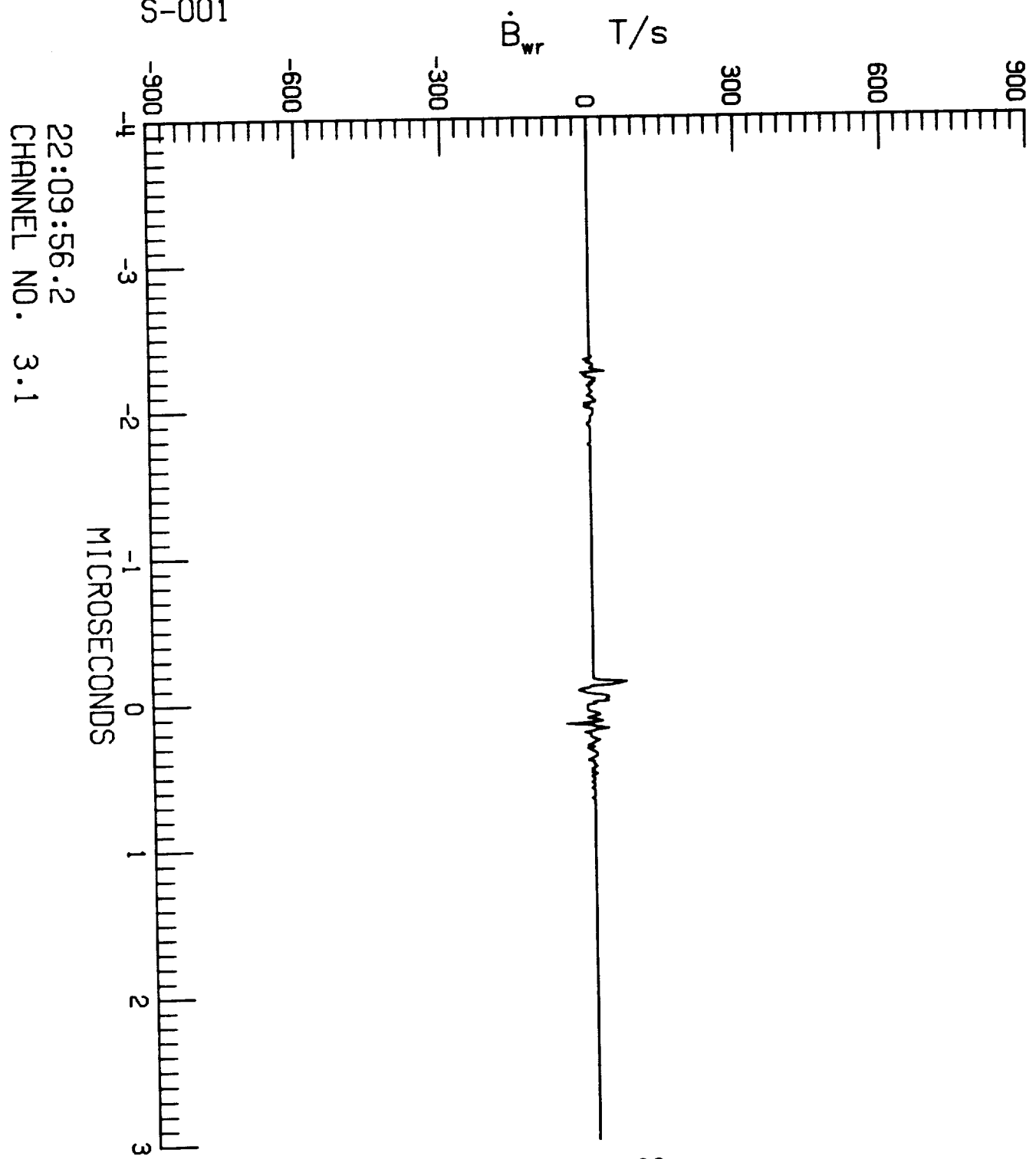

22:09:56.2  
CHANNEL NO. 3.1

F106 LIGHTNING/85-031/ZAEPFEL

LEC 3 RUN NO. 1

S-001

$\dot{D}_f$  A/m<sup>2</sup>

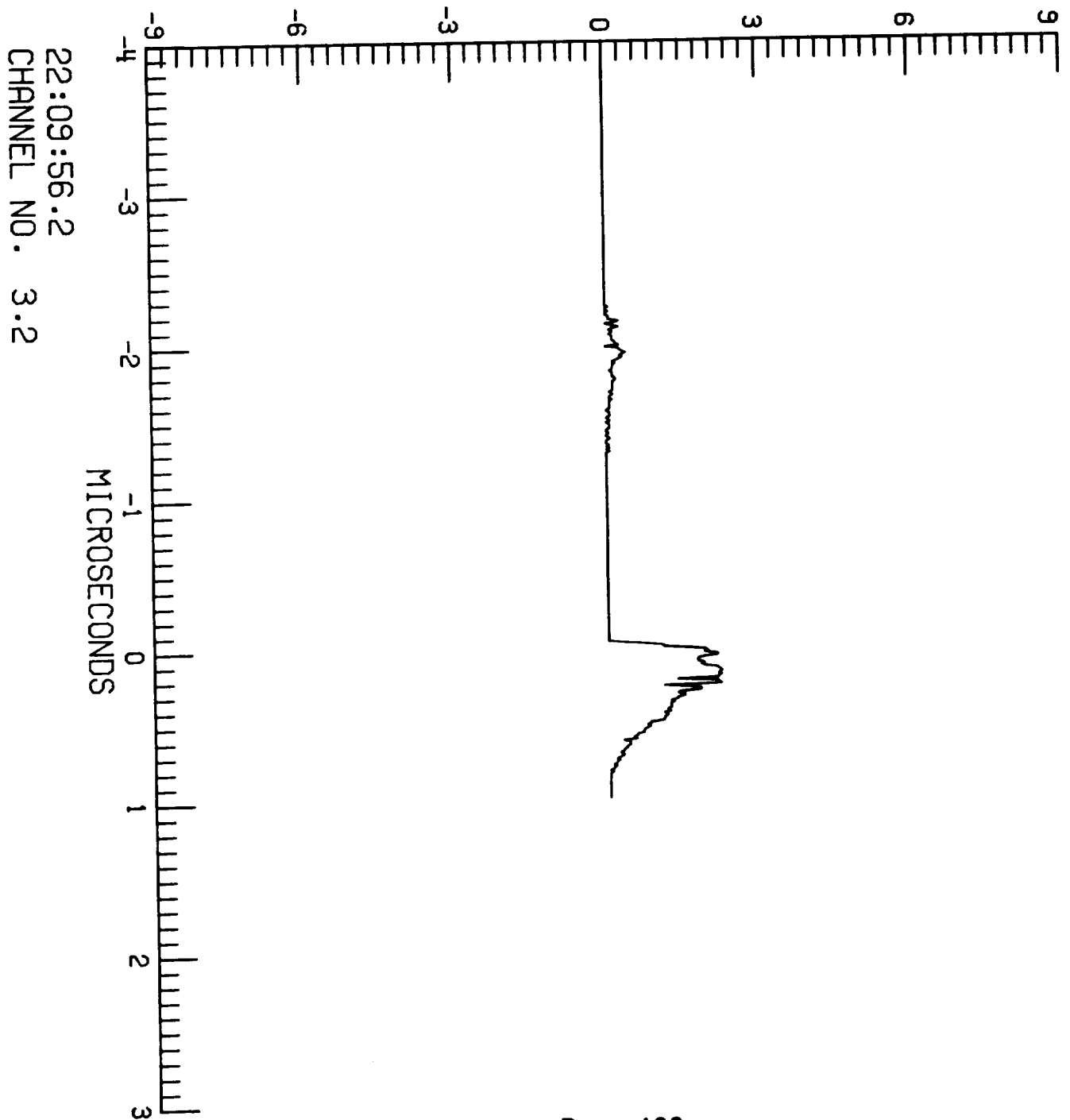

F106 LIGHTNING/85-031/ZAEPFEL

LEC 4 RUN NO. 1

S-001

TP100 V

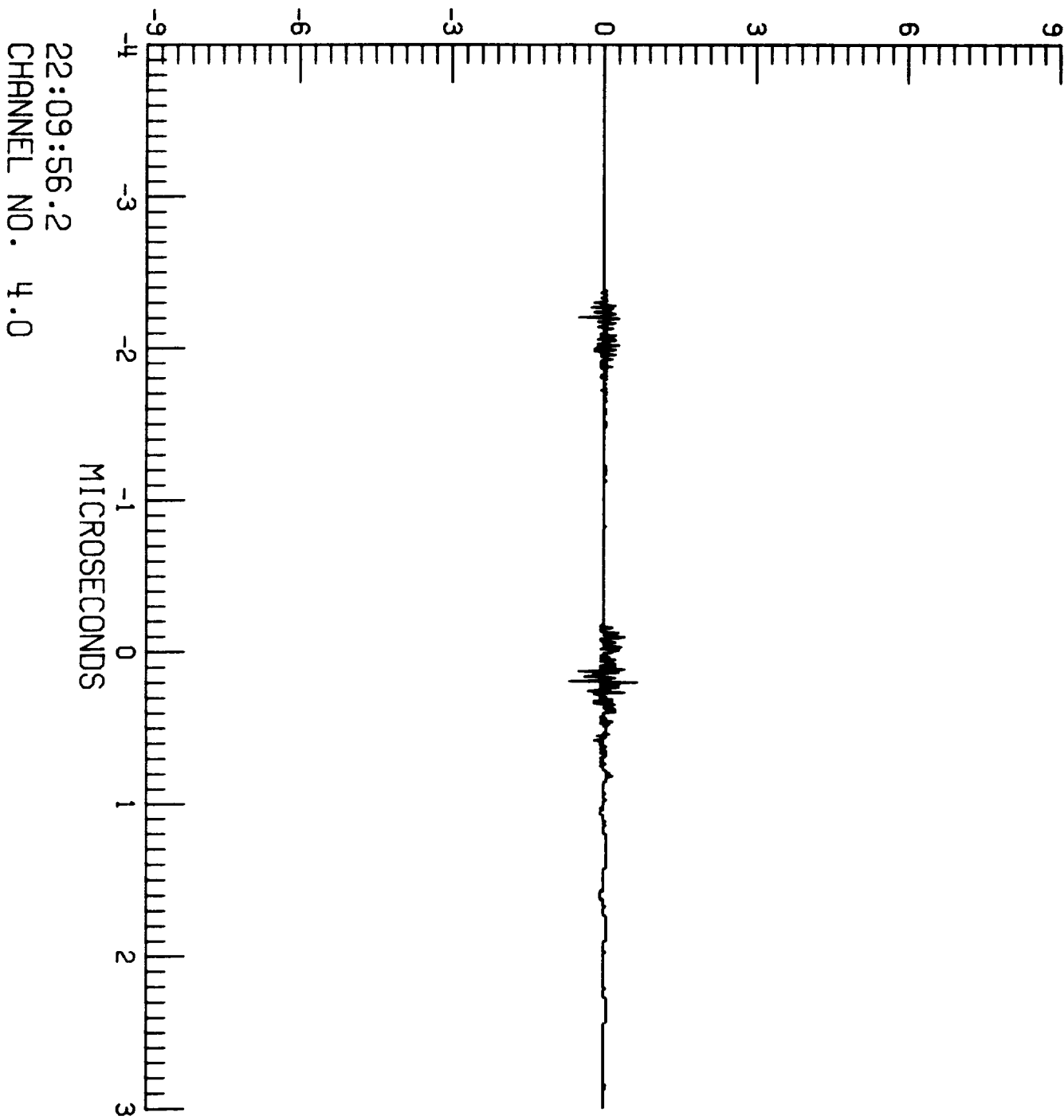



F106 LIGHTNING/85-031/ZAEPFEL

LEC 4 RUN NO. 1

S-001

TP106

A

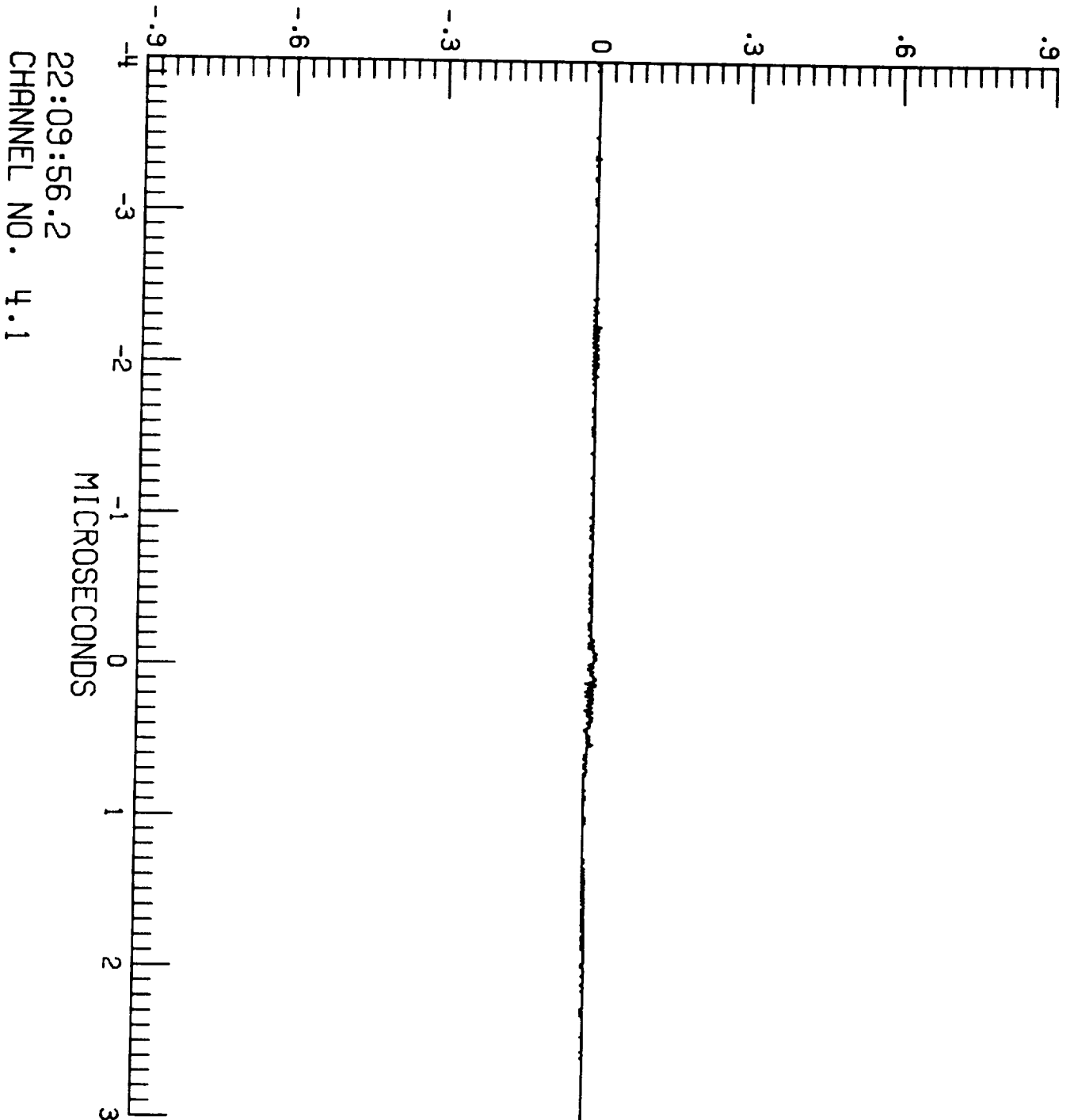

22:09:56.2  
CHANNEL NO. 4.1

F106 LIGHTNING/85-031/ZAEPFEL

LEC 4 RUN NO. 1

S-001

TP125

A

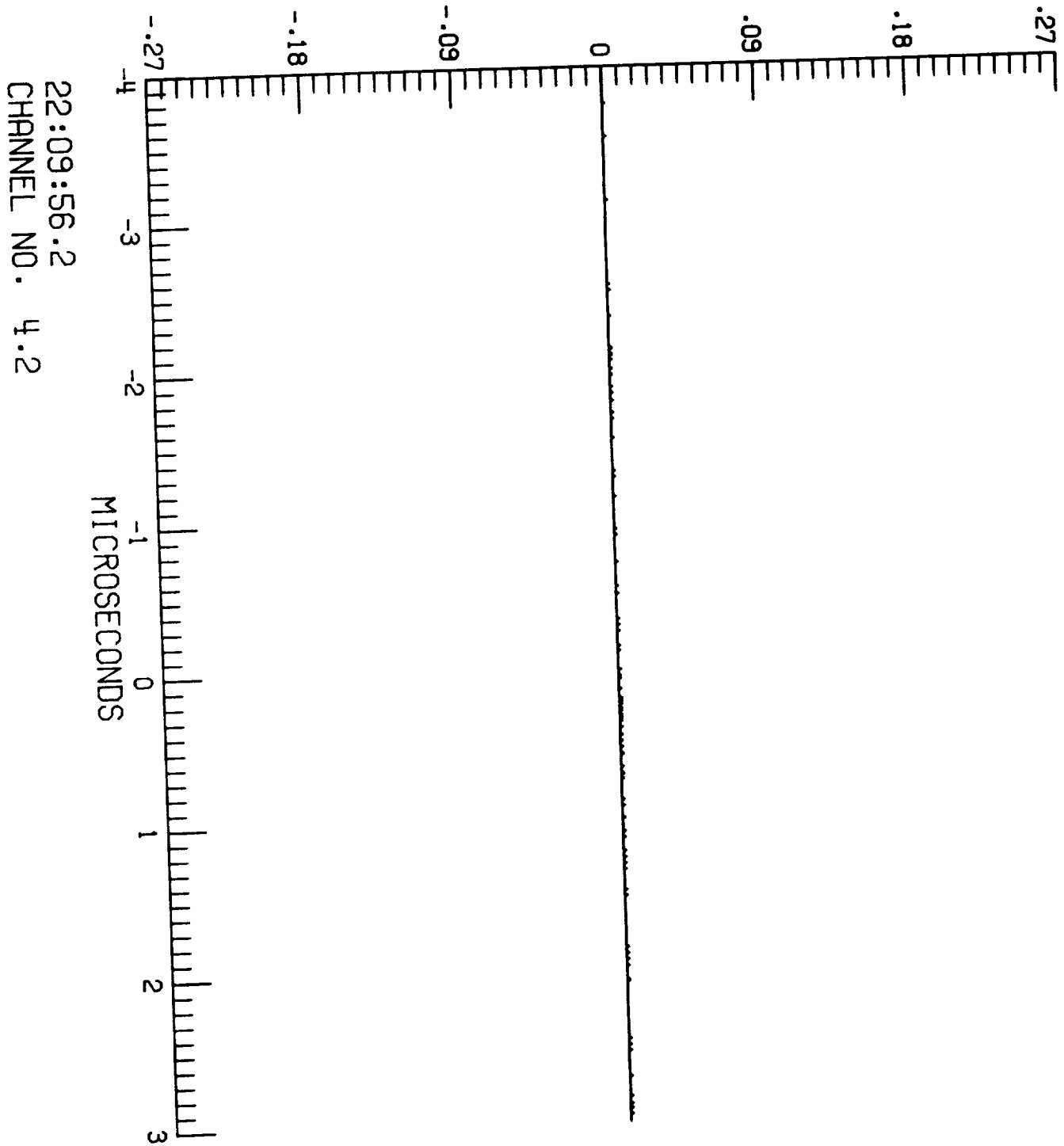

F106 LIGHTNING/85-031/ZAEPFEL

LEC 1 RUN NO. 1

S-001

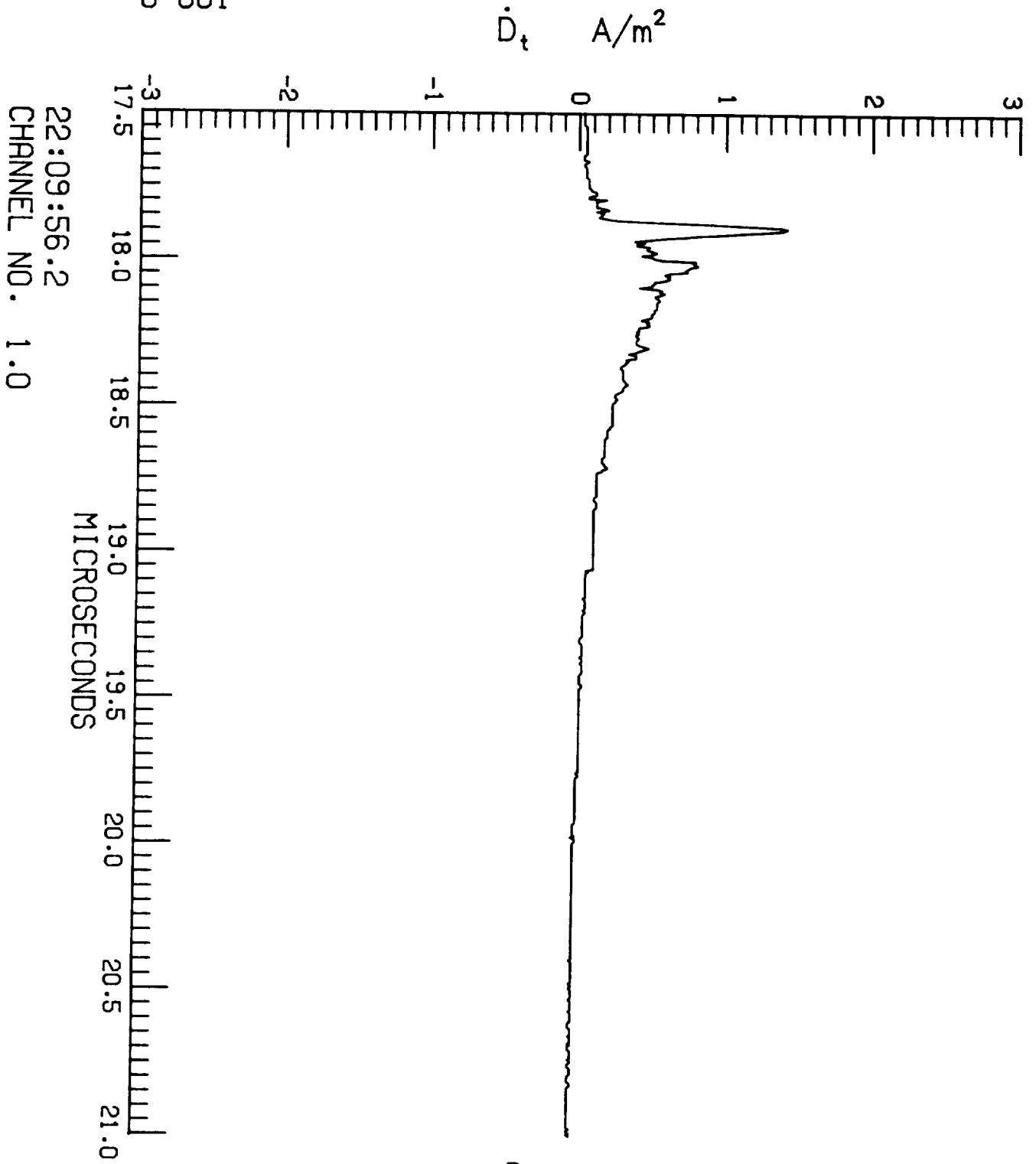

22:09:56.2  
CHANNEL NO. 1.0

F106 LIGHTNING/85-031/ZAEPFEL

LEC 1 RUN NO. 1

S-001

$I_t$  A

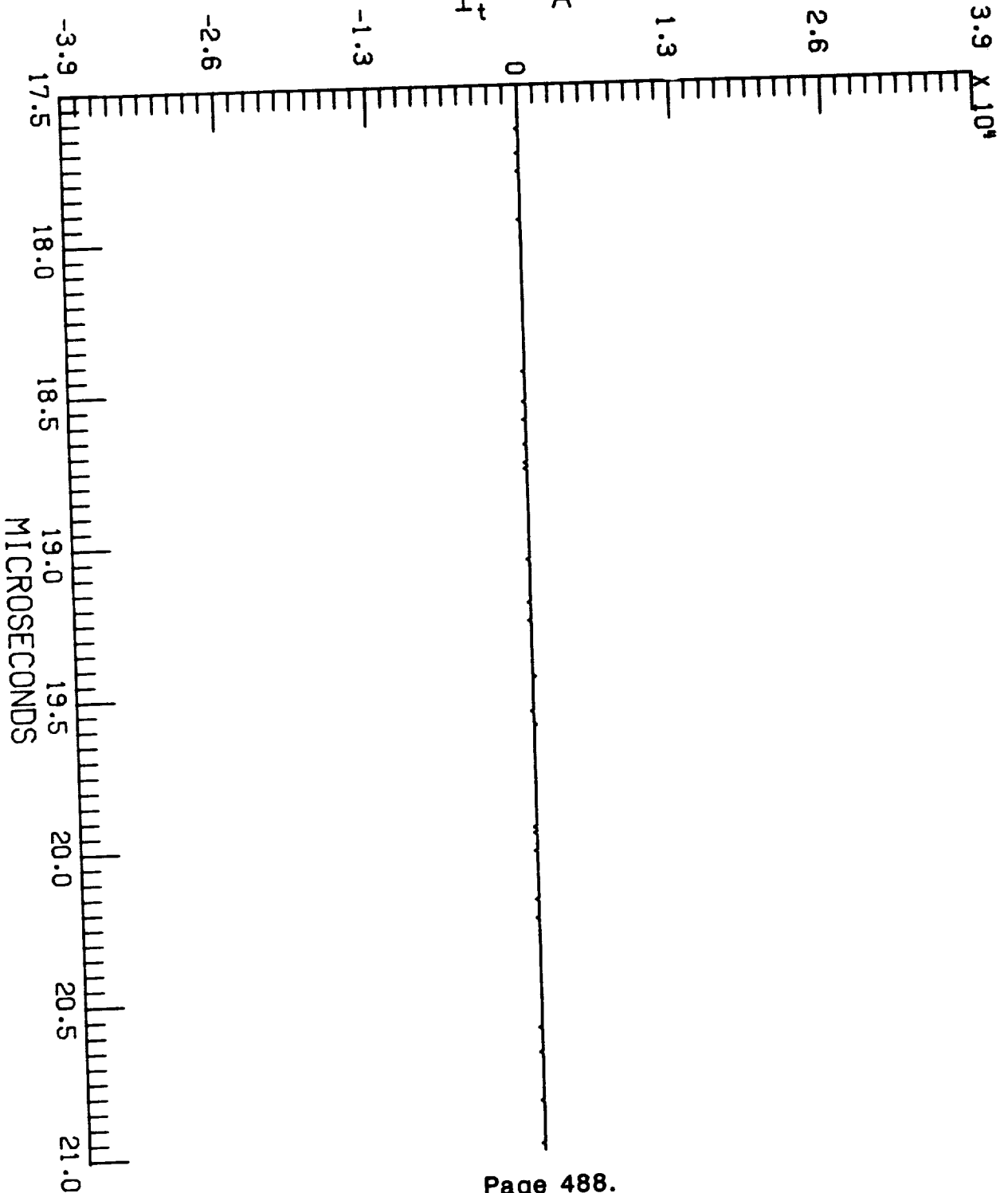

22:09:56.2  
CHANNEL NO. 1.2

F106 LIGHTNING/85-031/ZAEPFEL

LEC 2 RUN NO. 1

S-001

22:09:56.2  
CHANNEL NO. 2.0

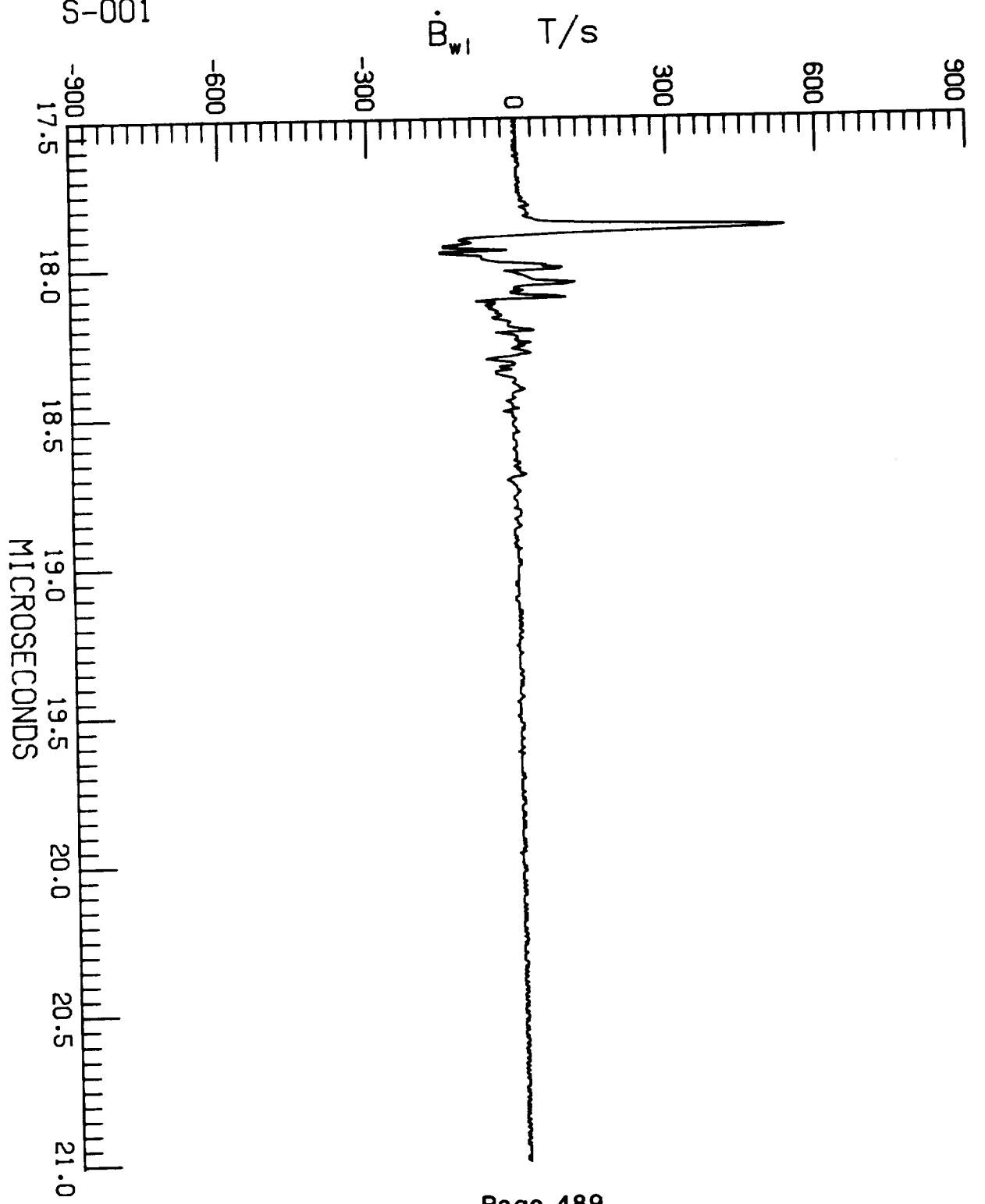

F106 LIGHTNING/85-031/ZAEPFEL

LEC 2 RUN NO. 1

S-001

$\dot{i}$  A/s

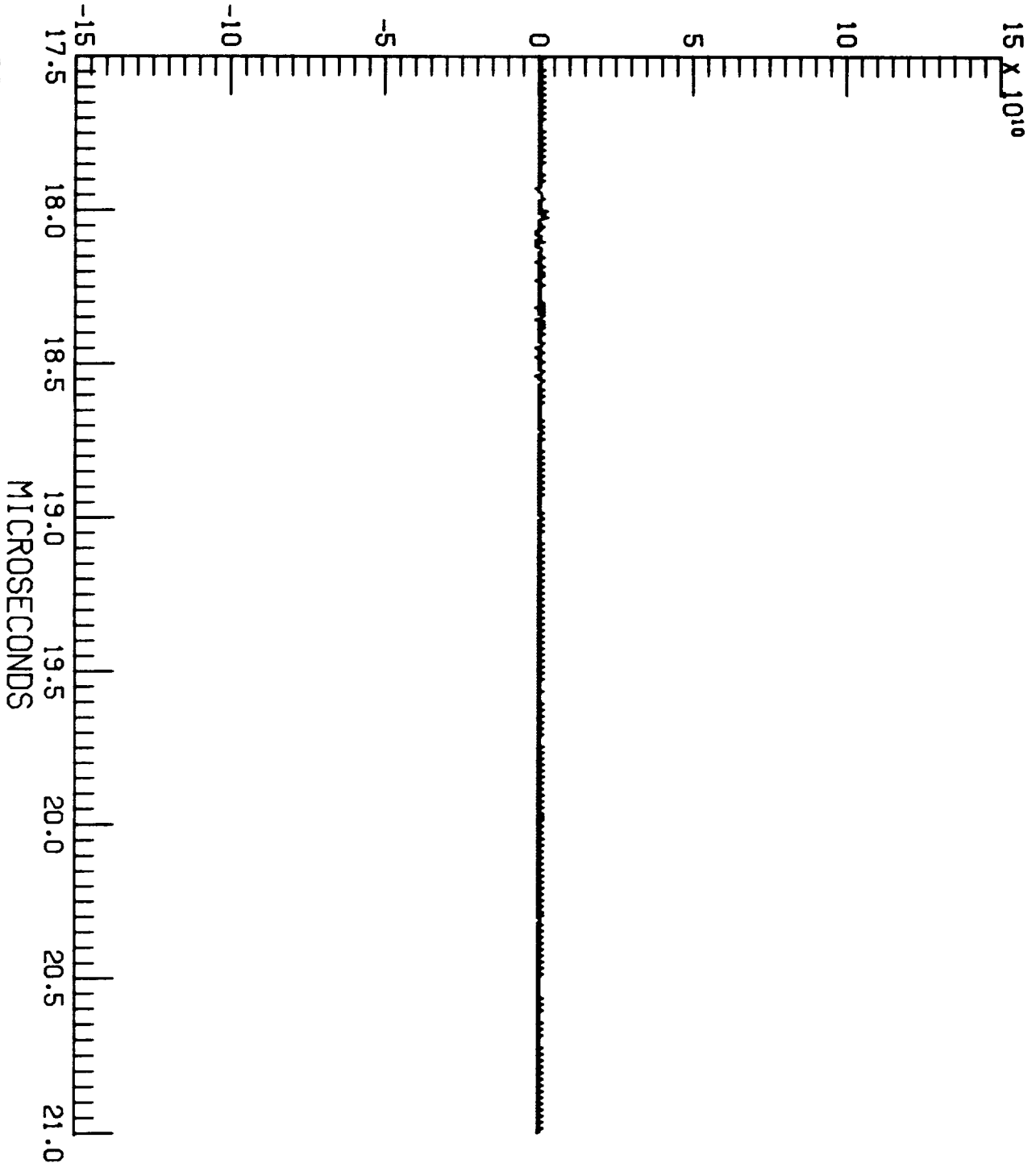

22:09:56.2  
CHANNEL NO. 2.1

F106 LIGHTNING/85-031/ZAEPFEL

LEC 2 RUN NO. 1

S-001

22:09:56.2  
CHANNEL NO. 2.2

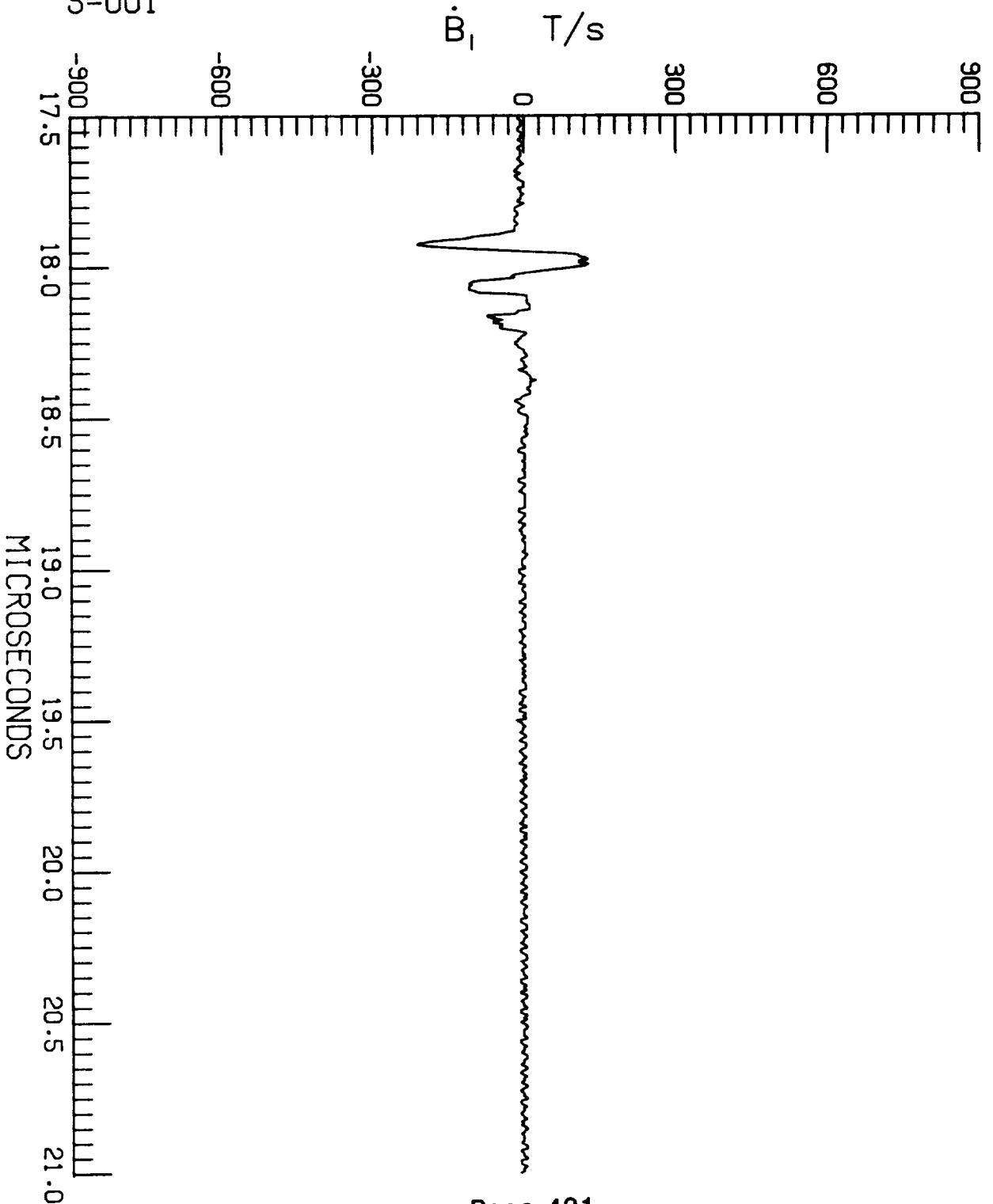

F106 LIGHTNING/85-031/ZREPTEL

LEC 3 RUN NO. 1

S-001

$\dot{D}_{wr}$  A/m<sup>2</sup>

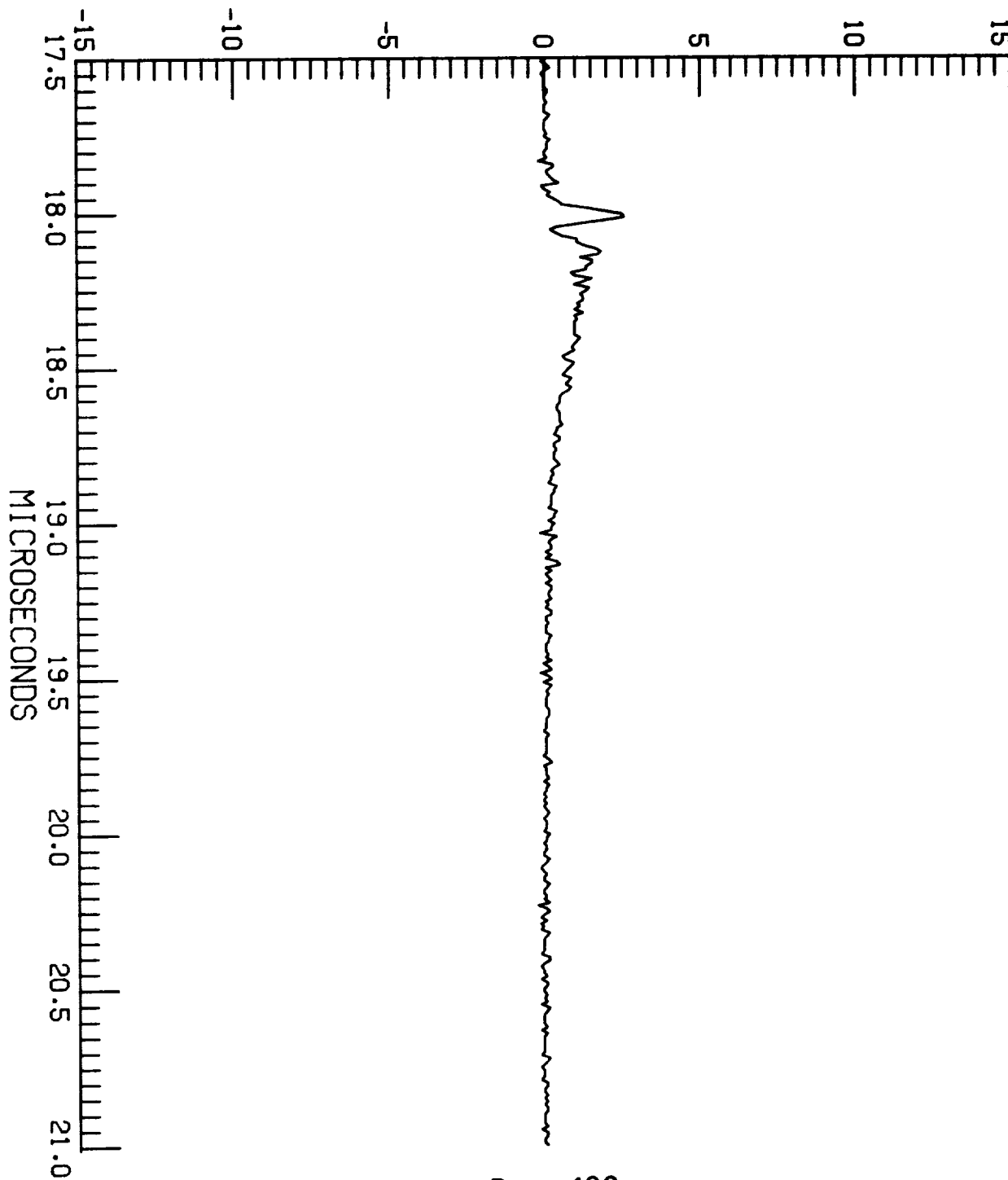

22:09:56.2  
CHANNEL NO. 3.0



F106 LIGHTNING/85-031/ZAEPFEL  
LEC 3 RUN NO. 1  
S-001

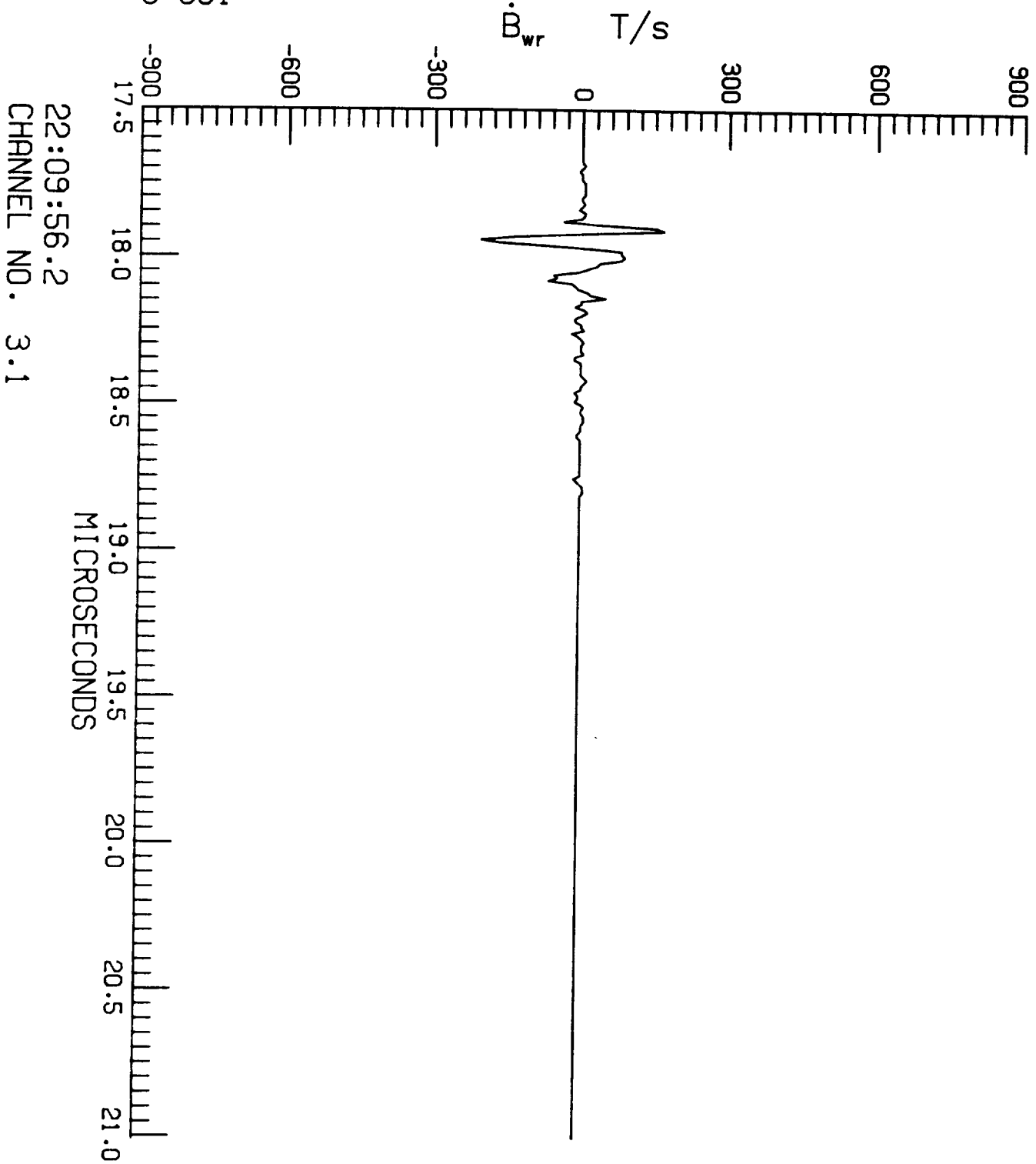

22:09:56.2  
CHANNEL NO. 3.1

F106 LIGHTNING/85-031/ZAEPFEL

LEC 3 RUN NO. 1

S-001

$\dot{D}_f$  A/m<sup>2</sup>

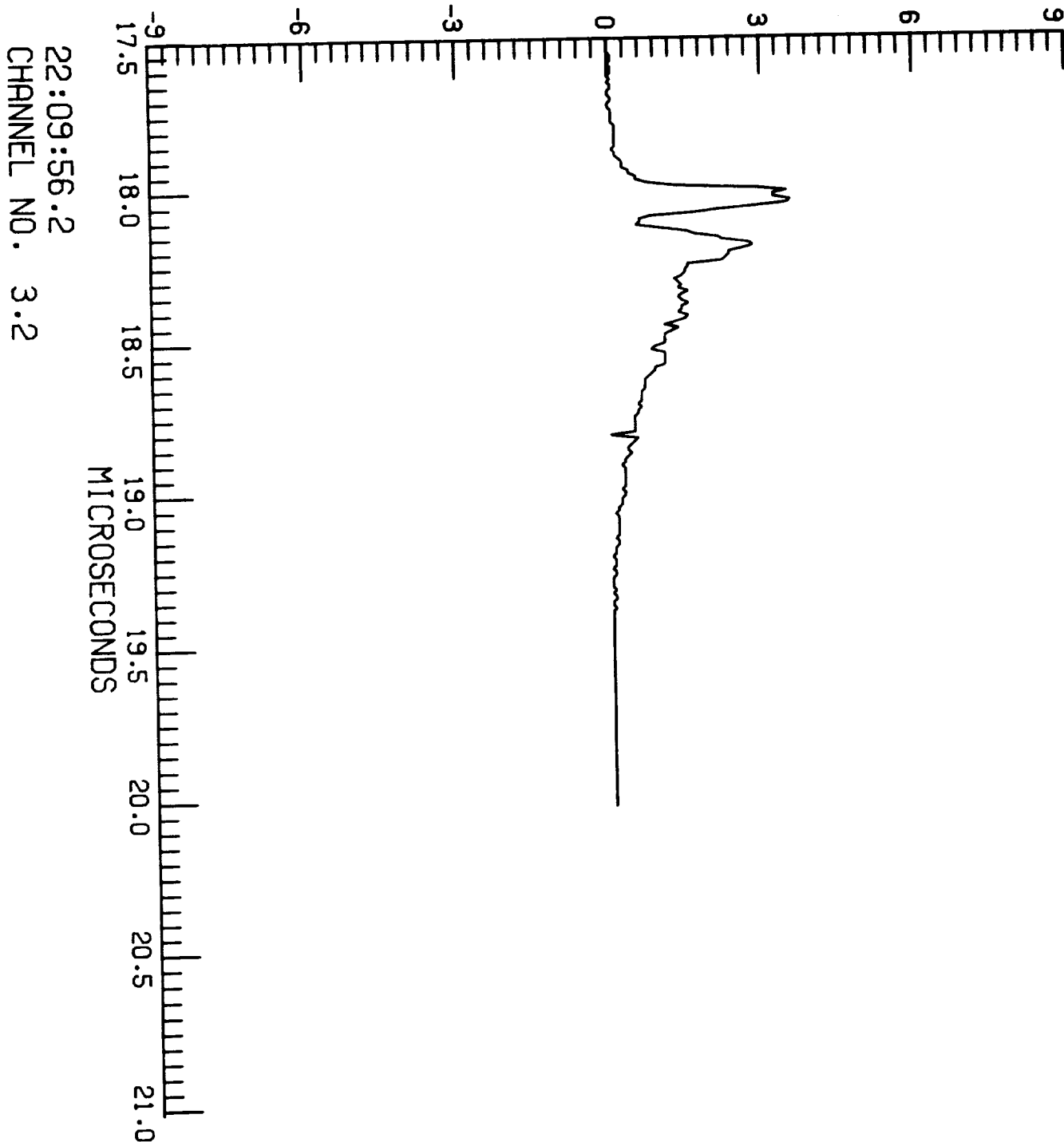

F106 LIGHTNING/85-031/ZAEPFEL

LEC 4 RUN NO. 1

S-001

TP100 V

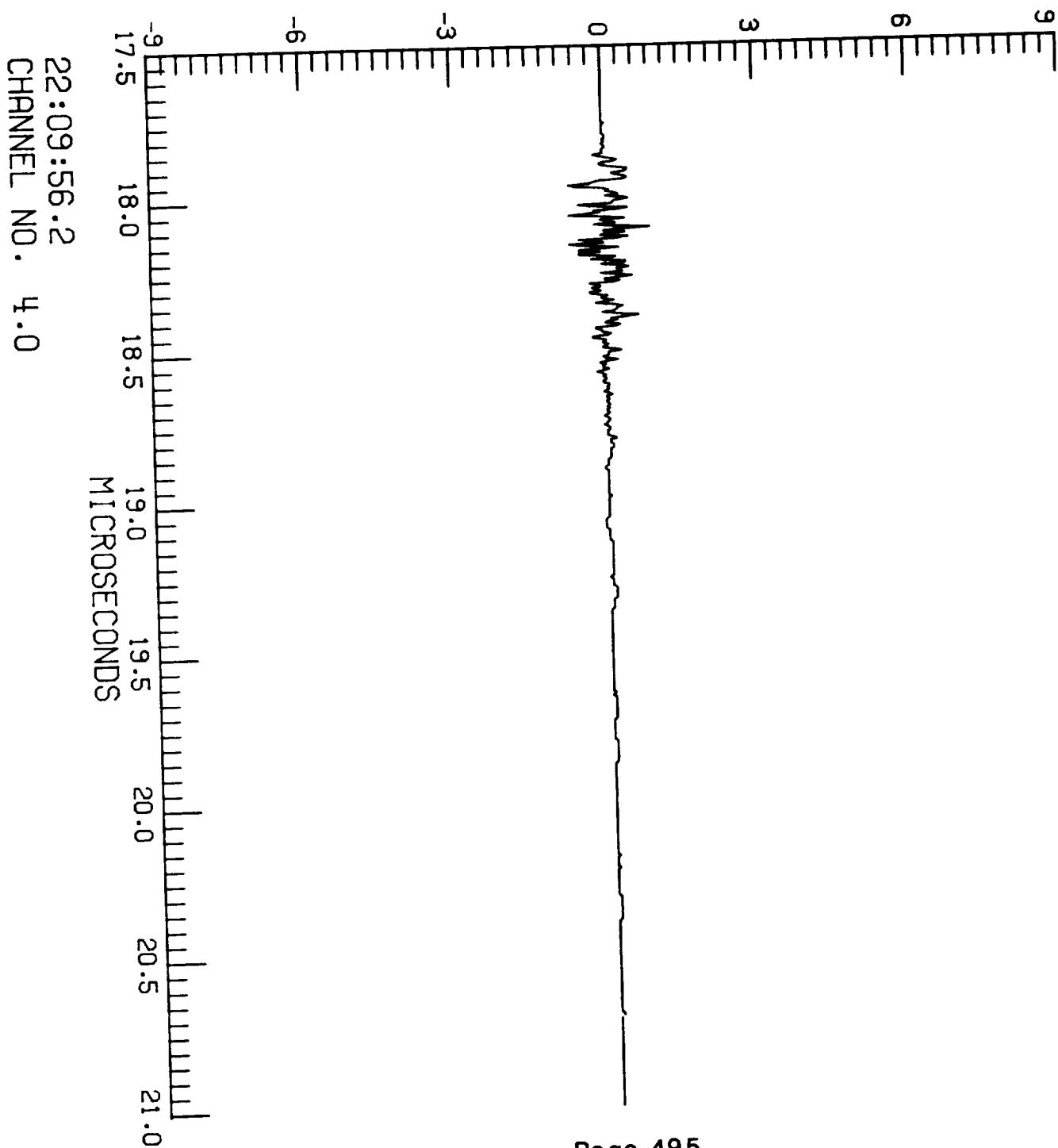

F106 LIGHTNING/85-031/ZAEPFEL

LEC 4 RUN NO. 1

S-001

TP106

A

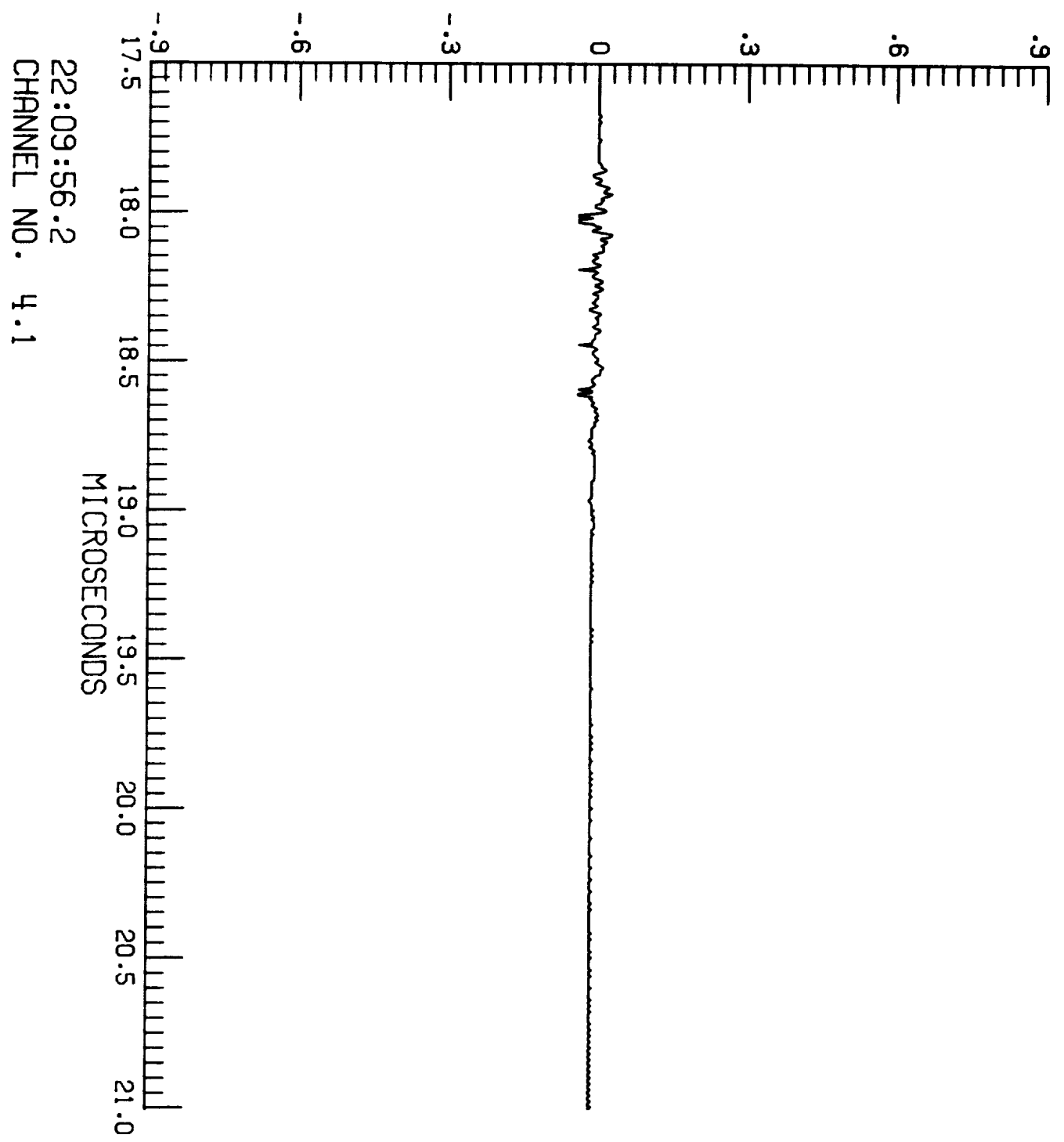

22:09:56.2  
CHANNEL NO. 4.1

F106 LIGHTNING/85-031/ZAEPFEL

LEC 4 RUN NO. 1

S-001

TP125

A

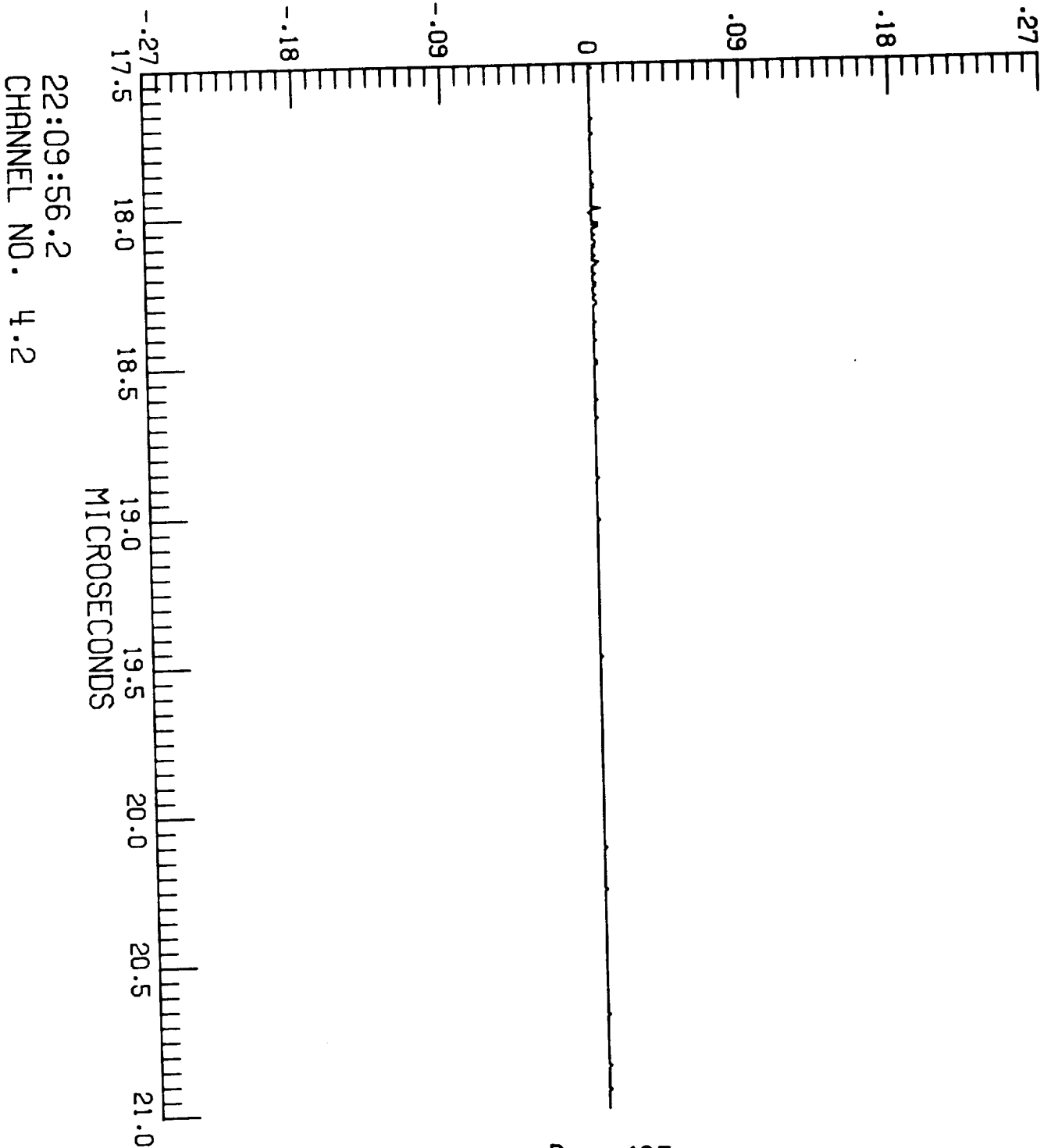



# Report Documentation Page

1. Report No. NASA TM-100533, Part 1		2. Government Accession No.		3. Recipient's Catalog No.	
4. Title and Subtitle 1985 and 1986 Direct Strike Lightning Data				5. Report Date March 1988	
				6. Performing Organization Code	
7. Author(s) Klaus P. Zaepfel and Harold K. Carney				8. Performing Organization Report No.	
				10. Work Unit No. 505-66-21-04	
9. Performing Organization Name and Address NASA Langley Research Center Hampton, VA 23665-5225				11. Contract or Grant No.	
				13. Type of Report and Period Covered Technical Memorandum	
12. Sponsoring Agency Name and Address National Aeronautics and Space Administration Washington, D.C. 20546-0001				14. Sponsoring Agency Code	
				15. Supplementary Notes	
16. Abstract  Data waveforms are presented which were obtained during the 1985 and 1986 direct-strike lightning tests utilizing the NASA F106-B aircraft specially instrumented for lightning electromagnetic measurements. The aircraft was operated in the vicinity of the NASA Langley Research Center, Hampton, Virginia, in a thunderstorm environment to elicit strikes. Electromagnetic field data and conduction currents on the aircraft were recorded for lightning.					
17. Key Words (Suggested by Author(s)) Lightning Direct-Strike Lightning Electromagnetic Measurement			18. Distribution Statement  until March 31, 1990 Subject Category 47		
19. Security Classif. (of this report) Unclassified		20. Security Classif. (of this page) Unclassified		21. No. of pages 499	22. Price