

NASA Contractor Report 181923

CALCULATION OF FLIGHT VIBRATION LEVELS OF THE AH-1G HELICOPTER AND CORRELATION WITH EXISTING FLIGHT VIBRATION MEASUREMENTS

**R.A. DiTaranto and V. Sankewitsch
BOEING HELICOPTERS
Philadelphia, Pa. 19142**

**Contract NAS1-17497
November 1989**

(NASA-CR-181923) CALCULATION OF FLIGHT
VIBRATION LEVELS OF THE AH-1G HELICOPTER AND
CORRELATION WITH EXISTING FLIGHT VIBRATION
MEASUREMENTS Final Report (Boeing
Helicopter Co.) 110 p

N90-18743

CSCL 20K G3/39 Unclas
0253012



National Aeronautics and
Space Administration

Langley Research Center
Hampton, Virginia 23665-5225

1
2

3
4

5
6
7
8
9
10
11
12
13
14
15
16
17
18
19
20
21
22
23
24
25
26
27
28
29
30
31
32
33
34
35
36
37
38
39
40
41
42
43
44
45
46
47
48
49
50
51
52
53
54
55
56
57
58
59
60
61
62
63
64
65
66
67
68
69
70
71
72
73
74
75
76
77
78
79
80
81
82
83
84
85
86
87
88
89
90
91
92
93
94
95
96
97
98
99
100

FOREWORD

Boeing Helicopters, together with other U.S. helicopter manufacturers, is engaged in a finite element applications program designed to emulate in the United States a superior capability to utilize finite element analysis models in support of helicopter airframe structural design. The Boeing effort is being performed under U.S. Government Contract NAS1-17497. The contract is monitored by NASA Langley Research Center, Structures Directorate.

This report reviews the method of analysis and presents results for the calculation of flight vibration levels of the AH-1G Helicopter and correlations with existing flight vibration measurements.

Key NASA and Boeing personnel in the program are listed below:

NASA Langley

P. H. Clark, Contracting Officer
J. W. Owens, Contract Specialist
J. H. Cline, Technical Representative
R. G. Kvaternik, Leader, Rotorcraft
Structural Dynamics Group

Boeing Helicopters

J. M. Kelleher, Contract Administrator
R. Gabel, Dynamics Unit Manager
V. Sankewitsch, Staff Engineer, Dynamics
R. A. DiTaranto, Dynamics Consultant,
Radson Engineering
N. S. Dorofee, Senior Technician, Dynamics

BLANK

TABLE OF CONTENTS

<u>SECTION</u>	PAGE
1.0 Introduction.....	1
2.0 Analysis Plan.....	5
2.1 Analysis Procedure.....	7
2.2 C60 Rotor Loads Program.....	13
2.3 Rotor-Fuselage Coupling Analysis.....	23
2.4 Calculation of the Fuselage Response.....	33
2.5 Flight Conditions and Fuselage Locations.....	37
3.0 Changes to Analysis Plan.....	41
3.1 Revised Analysis Procedure.....	45
4.0 Rotor Hub Modeling.....	49
5.0 Fuselage Mobility Matrix.....	59
6.0 "Trimmed" Conditions at Each Airspeed.....	65
7.0 Comparison of Analytical and Test Results.....	69
7.1 Blade Bending and Torsional Moments.....	71
7.2 Hub Loads and Fuselage Response.....	97
8.0 Summary and Conclusions.....	117
9.0 References.....	123

BLANK

1.0 Introduction

INTRODUCTION

The NASA Langley Research Center is sponsoring a rotorcraft structural dynamics program with the overall objective to establish in the United States a superior capability to utilize finite element analysis models for calculations to support industrial design of helicopter airframe structures. Viewed as a whole, the program is planned to include efforts by NASA, universities, and the U.S. helicopter industry. In the initial phase of the program, teams from the major U.S. manufacturers of helicopter airframes will apply extant finite element analysis methods to calculate static internal loads and vibrations of helicopter airframes of both metal and composite construction, conduct laboratory measurements of the structural behavior of these airframes, and perform correlations between analysis and measurements to build up a basis upon which to evaluate the results of the applications. To maintain the necessary scientific observation and control, emphasis throughout these activities will be on advance planning, documentation of methods and procedures, and thorough discussion of results and experiences, all with industry-wide critique to allow maximum technology transfer between companies. The finite element models formed in this phase will then serve as the basis for the development, application, and evaluation of both improved modeling techniques and advanced analytical and computational techniques, all aimed at strengthening and enhancing the technology base which supports industrial design of helicopter airframe structures. Here again, procedures for mutual critique have been established, and these procedures call for a thorough discussion among the program participants of each method prior to the applications and of the results and experiences after the applications. The aforementioned rotorcraft structural dynamics program has been given the acronym DAMVIBS (Design Analysis Methods for VIBrations).

Under the DAMVIBS program, NASA is sponsoring an activity to evaluate existing analysis methods applicable to calculate coupled rotor-airframe vibrations for the purpose of supporting helicopter airframe design work. Boeing Helicopters, together with several other U.S. helicopter manufacturers, has independently applied different analysis methods to calculate flight vibration levels of an existing helicopter and correlated the results with flight vibration measurements. The specified helicopter used in this evaluation was the AH-1G helicopter, designed and manufactured by Bell Helicopter Textron.

INTRODUCTION
(Continued)

Common data furnished by Bell Helicopter included: a detailed description of the AH-1G rotor system, blade physical properties, blade aerodynamic data and a NASTRAN model of the fuselage including the rotor weight, References 1 and 2. Flight conditions and corresponding flight data from the AH-1G Operational Load Survey (OLS), U.S. Army ATL Contract DAAJ02-73-C-0015, were also identified for correlation, Reference 3. The identified flight conditions consisted of six airspeeds in forward straight-and-level flight.

This report summarizes the results of the Boeing Helicopters effort. The planned analytical procedure, previously presented at a NASA Langley sponsored industry meeting, is reviewed. Changes to the analytical procedure are discussed, and results of the correlation study are presented.

BLANK

2.0 Analysis Plan

BLANK

2.1 Analysis Procedure

ANALYSIS PLAN

ANALYSIS PROCEDURE - OVERVIEW

The rotor consists of the two blades and a teetering hub. The Boeing C60 Rotor Loads Program is used to calculate the vibratory rotor hub loads including the effect of hub motion.

The 'fuselage' consists of the remainder of the helicopter wherein displacements, velocities and accelerations in response to applied rotor hub loads may be calculated at specified points using the NASTRAN program.

Coupling between the rotor hub and the adjacent fuselage is obtained by requiring the forces and displacements to be compatible at their juncture.

ANALYSIS PLAN ANALYSIS PROCEDURE - OVERVIEW

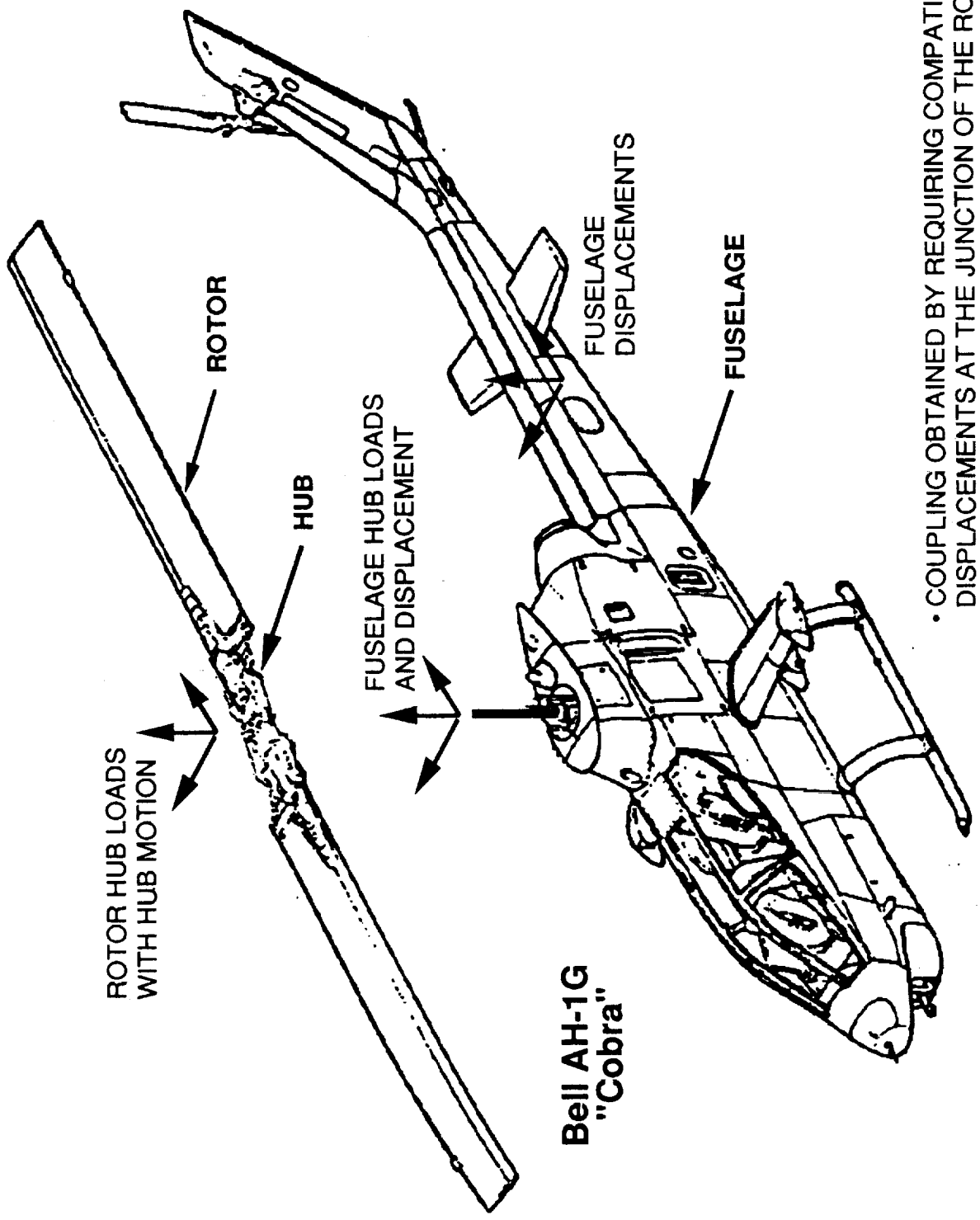

• COUPLING OBTAINED BY REQUIRING COMPATIBLE LOADS AND DISPLACEMENTS AT THE JUNCTION OF THE ROTOR AND FUSELAGE

ANALYSIS PLAN

ANALYSIS PROCEDURE - FLOW CHART

The analysis procedure to be used for calculation of the AH-1G flight vibration levels is summarized in the following flow chart.

The computational tools to accomplish this task are:

1. The C60 Program - Calculates the steady and harmonic rotor hub loads for trimmed flight conditions with no hub motion (rigid or fixed hub).
- Calculates the harmonic rotor hub loads with imposed harmonic motions of the hub for calculation of rotor impedance sensitivity coefficients.
2. NASTRAN Program - Calculates the fuselage mobility matrix for loads applied at the fuselage hub without rotor mass.
Calculates the accelerations for the fuselage using hub loads calculated for the coupled system.
3. Rotor-Fuselage Coupling Program - Calculates the hub loads and deflections for each flight condition using the fuselage hub mobility matrix, the harmonic rotor hub loads with rigid hub, and the sensitivity coefficients.

The relationships indicated in the flow chart are valid only if the rotor impedance sensitivity coefficients of matrix [A] and the fuselage hub mobility influence coefficients of matrix [B] are linear.

ANALYSIS PLAN ANALYSIS PROCEDURE - FLOW CHART

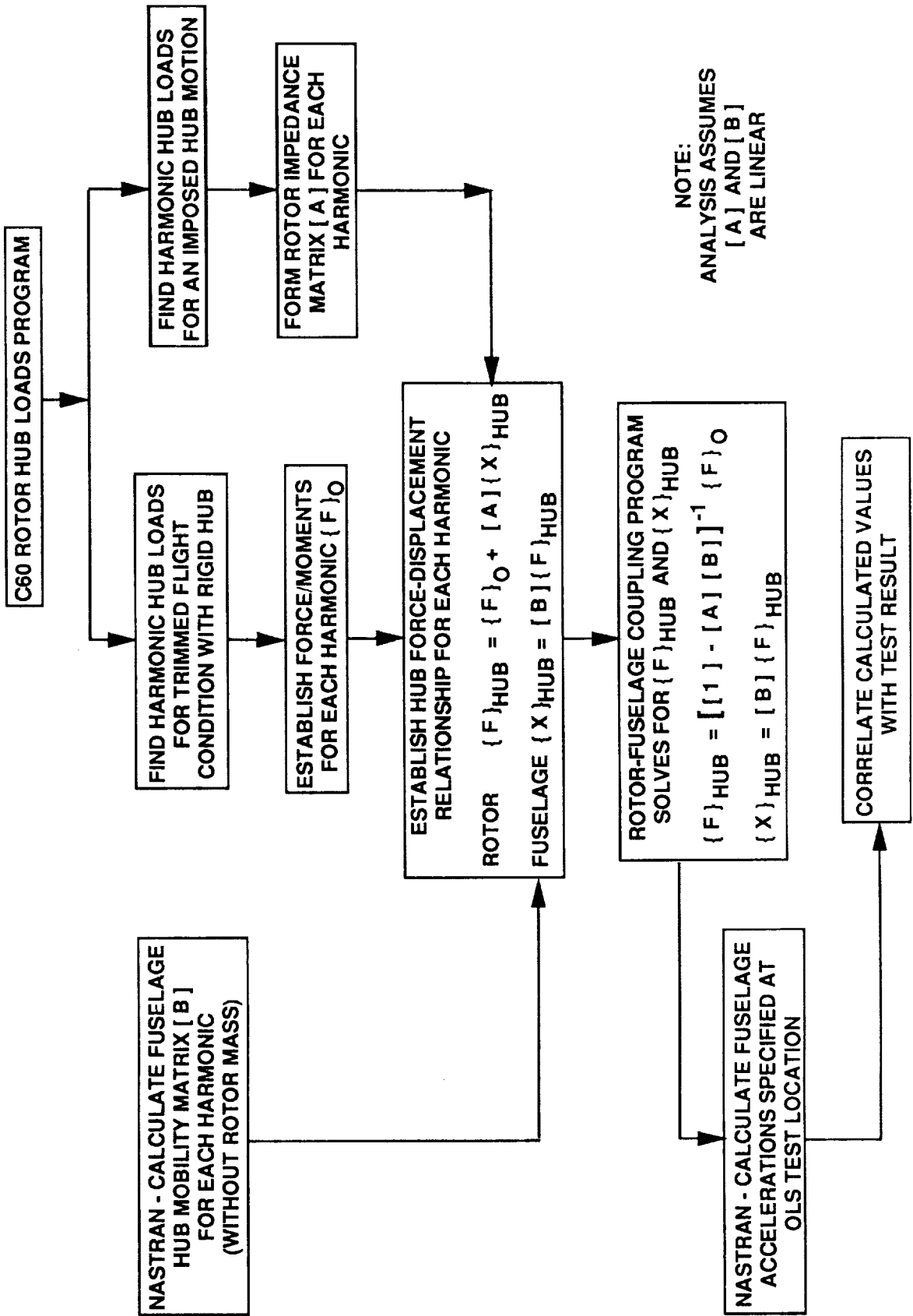

BLANK

2.2 C60 Rotor Loads Program

ANALYSIS PLAN

C60 ROTOR LOADS PROGRAM

C60, Reference 4, is a Boeing Helicopters comprehensive rotor loads program which calculates the steady and harmonic rotor loads for single or tandem rotor helicopters. It is a program initially written in the late '60's with constant updating and improvements. The principal features of the program are:

1. Calculates vibratory rotor blade motions, loads and moments as a function of stations along the blade radius as well as hub loads for a single or tandem rotorcraft
2. Has the capability of calculating induced velocities from tip and root vortices, and tip, root and sheet vortices
3. Calculates self-induced downwash velocities as well as those generated by rotor-rotor interference
4. Accounts for blade flexibility
5. Considers two or more blades per rotor
6. Considers various blade boundary conditions - including those of a teetering rotor
7. Harmonic motion of the rotor hub may be imposed and the resultant rotor hub loads and blade moments calculated

ANALYSIS PLAN C60 ROTOR LOADS PROGRAM

- **Calculates vibratory rotor blade motions, loads and moments as a function of stations along the blade radius as well as hub loads for a single or tandem rotorcraft**
- **Has the capability of calculating induced velocities from tip and root vortices, and tip, root and sheet vortices**
- **Calculates self-induced downwash velocities as well as those generated by rotor-rotor interference**
- **Accounts for blade flexibility**
- **Considers two or more blades per rotor**
- **Considers various blade boundary conditions - including those of a teetering rotor**
- **Harmonic motion of the rotor hub may be imposed and the resultant rotor hub loads and blade moments calculated**

ANALYSIS PLAN

C60 ROTOR LOADS PROGRAM - AERODYNAMICS

The calculations for the aerodynamic lift, drag and pitching moments utilize non-linear, compressible, unsteady lifting-line theory with yawed flow and 3-dimensional corrections.

Induced velocities are calculated from root and tip trailing vortices or sheet vortices and may consider self and rotor interference velocities induced by the rotor wake. Shed wake effects are included with a modified Theodorsen function. The essence of the aerodynamics considered is shown diagrammatically in the figure.

ANALYSIS PLAN C60 ROTOR LOADS PROGRAM - AERODYNAMICS

- Non-linear, compressible, unsteady lifting-line theory with yawed flow and 3-dimensional corrections

UNSTEADY STALL

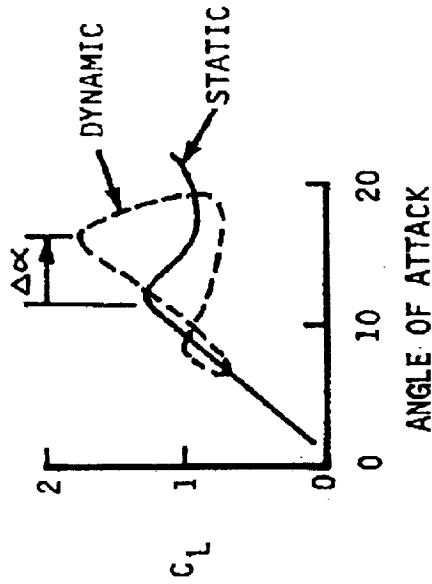

YAWED FLOW

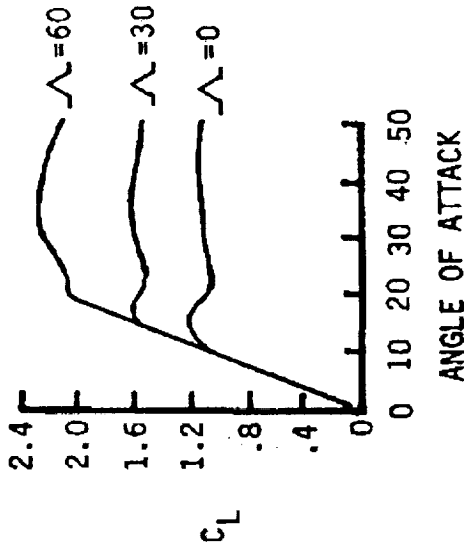

- Non-linear downwash, including self-induced and rotor interference

DOWNWASH CALCULATED FROM TRAILED VORTICES

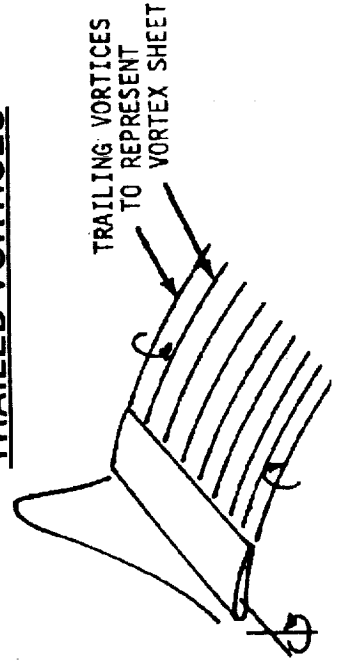

ROTOR INTERFERENCE INCLUDED

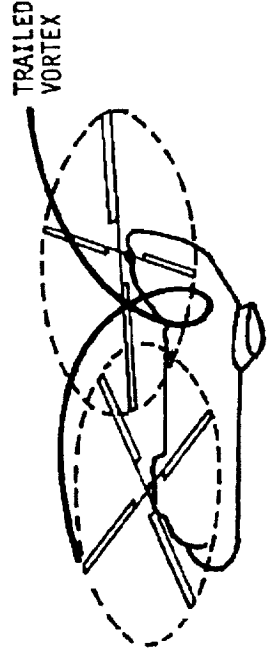

ANALYSIS PLAN

C60 ROTOR LOADS PROGRAM - DYNAMICS

A transfer matrix approach is used to determine the harmonic displacements, velocities, accelerations, shears and moments along the blade. The blade properties which are pertinent to the dynamics of the solution are the concentrated masses, appropriately offset from the pitch axis, approximating the actual mass distribution. As many as 25 masses may be used. Equivalent uniform elastic bays connect the concentrated masses. Coupled flap-torsion and uncoupled lag motions are considered.

The calculated harmonic aerodynamic forces and appropriate centrifugal forces excite the blade at each mass station.

An overview of the blade simulation is shown in the figure.

ANALYSIS PLAN C60 ROTOR LOADS PROGRAM - DYNAMICS

- Lumped parameter idealization with 25 bays
- Coupled flap-torsion
- Uncoupled lag

ACTUAL BLADE

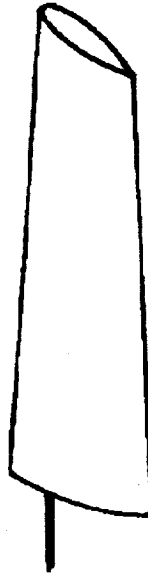

SEGMENTED APPROXIMATION

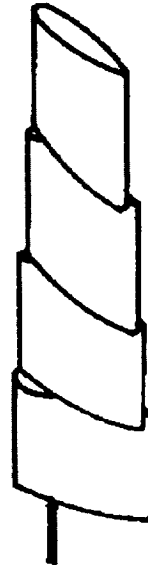

EQUIVALENT DYNAMIC SYSTEM

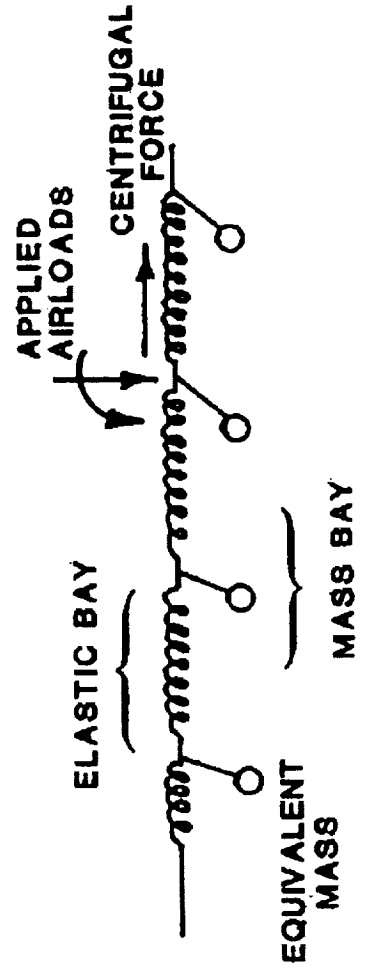

ANALYSIS PLAN

C60 ROTOR LOADS PROGRAM - PROGRAM SOLUTION

In general, the helicopter is initially trimmed by use of a Boeing trim analysis program and the computed trim control settings are input to C60. The C60 program will also accept measured control positions of the blade as input. C60's initial aerodynamic loading is found considering the blade to be rigid. Each calculated harmonic load is imposed on the elastic blade, and deflections and velocities are calculated using the transfer matrix approach. Using these blade displacements and velocities, the aerodynamic harmonic loads are updated and again used to excite the blade to calculate the harmonic displacements and velocities. This procedure is continued until the iteration results of two consecutive calculations attain a specified small difference.

Key steps in the solution sequence are shown below. Output of C60 includes rotor performance, blade loads, control loads and hub loads. These hub loads are the crucial ingredient in the rotor-fuselage coupling analysis.

ANALYSIS PLAN C60 ROTOR LOADS PROGRAM - PROGRAM SOLUTION

- Frequency Domain Solution (Harmonic Balance)
- Iterative Non-linear Aeroelastic Coupling
- Interactive Trim Match (Matches Steady Forces from Trim Program)

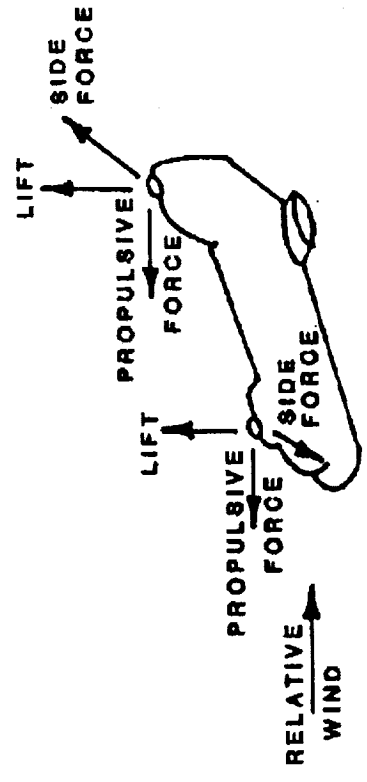
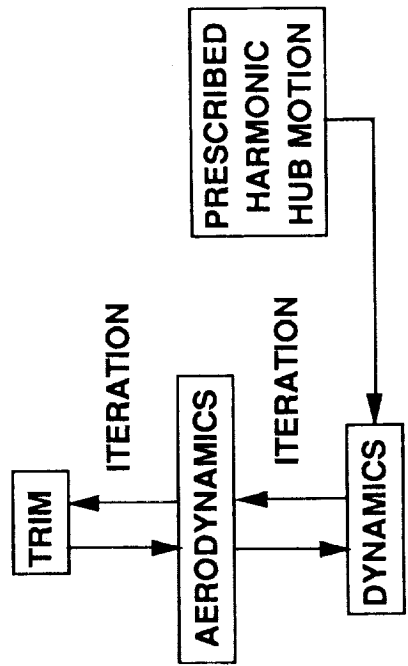

- Program Calculates:
 - Rotor Performance
 - Blade Loads
 - Control Loads
 - Hub Loads

BLANK

2.3 Rotor-Fuselage Coupling Analysis

ANALYSIS PLAN

ROTOR-FUSELAGE COUPLING ANALYSIS

The Boeing procedure for determining coupled rotor-fuselage response utilizes the fact that the loads and displacements at the junction of the rotor and fuselage are the same. As shown by the equations on the accompanying page, rotor hub forces for the coupled system are defined as the sum of the loads calculated with zero hub displacements plus an added load caused by harmonic motion of the hub. The incremental force is related to the hub displacement by a rotor hub impedance matrix [A] formed by the Rotor-Fuselage Coupling Program using input from C60. At the fuselage, the hub forces and displacements are related by a mobility matrix [B] which is calculated using NASTRAN output results. The stated relationships hold when the matrices [A] and [B] are linear. This impedance matching approach was previously published in Reference 5.

ANALYSIS PLAN ROTOR-FUSELAGE COUPLING ANALYSIS

- LOADS AND DISPLACEMENTS AT THE JUNCTION OF FUSELAGE AND ROTOR ARE THE SAME.

$$\begin{array}{ccccccc}
 \text{TO BE} & & \text{(C60)} & & \text{(C60)} & & \text{TO BE} \\
 \text{DETERMINED} & & & & & & \text{DETERMINED} \\
 \{ F_{\text{HUB}} \} & = & \{ F_0 \} & + & [A] & \times & \{ X_{\text{HUB}} \} \\
 \text{ROTOR FORCES} & & \text{FOR ZERO} & & \text{ADDED} & & \text{HUB} \\
 \text{FOR ZERO} & & \text{HUB} & & \text{FORCE} & & \text{MOTIONS} \\
 \text{HUB} & & \text{MOTION} & & \text{PER UNIT} & & \\
 \text{MOTION} & & & & \text{HUB} & & \\
 & & & & \text{MOTION} & &
 \end{array}$$

ROTOR FORCES
(EXCEPT TORQUE)

$$\begin{array}{ccccccc}
 \text{TO BE} & & & & \text{TO BE} & & \\
 \text{DETERMINED} & & & & \text{DETERMINED} & & \\
 \{ X_{\text{HUB}} \} & = & [B] & \times & \{ F_{\text{HUB}} \} & & \\
 \text{HUB} & & \text{HUB} & & \text{ROTOR} & & \\
 \text{MOTIONS} & & \text{MOTION} & & \text{FORCES} & & \\
 & & \text{PER UNIT} & & & & \\
 & & \text{FORCE} & & & & \\
 & & & & & & \text{OUT OF LOOP}
 \end{array}$$

(NASTRAN)

FUSELAGE HUB
MOTIONS
(EXCEPT YAW)

ANALYSIS PLAN

ROTOR-FUSELAGE COUPLING ANALYSIS-ROTOR HUB IMPEDANCE MATRIX

The rotor hub impedance matrix "A" relates rotor forces arising from unit harmonic hub motions. Overall it is a 10 x 10 matrix. It is composed of four 5 x 5 sub-matrices, a cosine-cosine group, a cosine-sine group, a sine-cosine group, and a sine-sine group. For instance, within the upper left sub-matrix, each element represents a cosine force in one of the five directions resulting from a cosine hub motion in one of the five directions. It is formed by individual perturbations of C60 by cosine and sine directional harmonic motions and reading out the resulting cosine and sine directional harmonic forces.

ANALYSIS PLAN

ROTOR-FUSELAGE COUPLING ANALYSIS - ROTOR HUB IMPEDANCE MATRIX

$$\text{ROTOR HUB IMPEDANCE MATRIX} = [A] = \begin{bmatrix} [A]_{CC} & [A]_{CS} \\ [A]_{SC} & [A]_{SS} \end{bmatrix}$$

[10 x 10]

WHERE:

THE SUB-MATRICES $[A]_{XX}$ ARE 5x5.
 THE 1ST SUBSCRIPT REFERS TO THE SIN OR
 COS COMPONENT OF THE FORCE AND THE 2ND
 TO THE COMPONENT OF THE HUB MOTION.

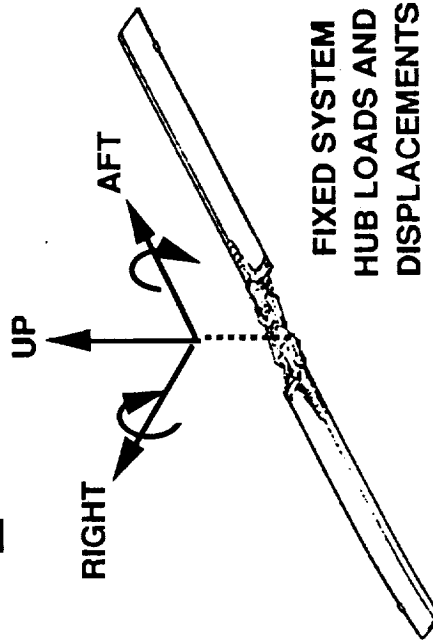

- ALL LOADS AND MOTIONS EXCEPT TORQUE AND YAW ARE CONSIDERED.
- TERMS OF THE IMPEDANCE MATRIX ARE FORMED BY IMPOSING SMALL HARMONIC HUB MOTIONS IN THE C60 ANALYSIS. AT THE IMPOSED HARMONIC, FIXED SYSTEM ROTOR LOADS ARE COMPARED WITH THOSE FOR ZERO HUB DISPLACEMENT TO OBTAIN INCREMENTAL FORCES AND MOMENTS PER UNIT HUB MOTION. RESULTS ARE ASSUMED TO BE LINEAR.

ANALYSIS PLAN

ROTOR-FUSELAGE COUPLING ANALYSIS-FUSELAGE HUB MOBILITY MATRIX

The fuselage hub mobility matrix "B" relates rotor hub motion arising from unit harmonic rotor hub forces. Overall it is a 10 x 10 matrix. It is composed of four 5 x 5 sub-matrices, a cosine-cosine group, a cosine-sine group, a sine-cosine group, and a sine-sine group. For instance within the upper left sub-matrix, each element represents a cosine hub motion in one of the five directions resulting from a cosine hub force in one of the five directions. It is formed by individual perturbations of the NASTRAN fuselage model by individual harmonic forces and reading out the resulting cosine and sine directional harmonic motions.

ANALYSIS PLAN
ROTOR-FUSELAGE COUPLING ANALYSIS - FUSELAGE HUB MOBILITY MATRIX

$$\text{FUSELAGE HUB MOBILITY MATRIX} = [B] = \begin{matrix} [10 \times 10] & \begin{bmatrix} [B]_{CC} & [B]_{CS} \\ [B]_{SC} & [B]_{SS} \end{bmatrix} \end{matrix}$$

WHERE:

THE SUB-MATRICES $[B]_{xx}$ ARE 5x5.
 THE 1ST SUBSCRIPT REFERS TO THE SIN OR
 COS COMPONENT OF THE DISPLACEMENT AND
 THE 2ND FOR THE COMPONENT OF THE FORCE.

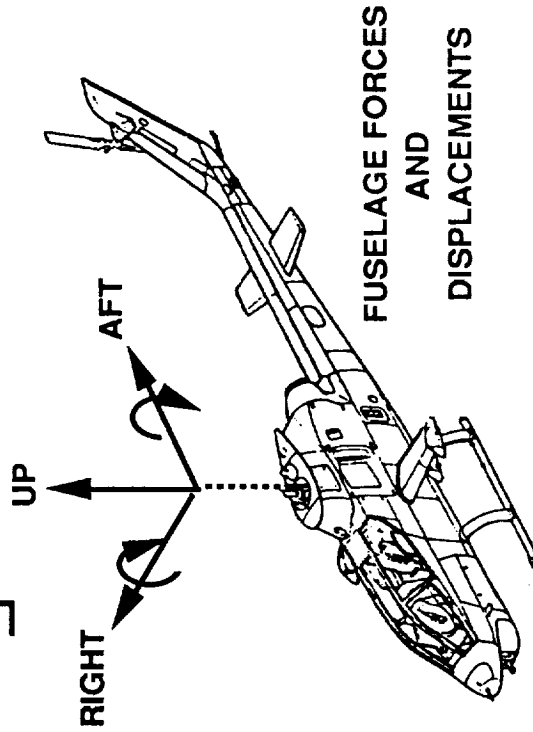

- ALL LOADS AND MOTIONS EXCEPT TORQUE AND YAW ARE CONSIDERED.
- FUSELAGE MODEL EXCLUDES ROTOR MASS (ACCOUNTED FOR IN C60).
- TERMS OF THE MOBILITY MATRIX ARE FORMED BY IMPOSING UNIT HARMONIC FORCES IN THE NASTRAN ANALYSIS. COMPUTED DEFLECTIONS AT THE HUB LOCATION ARE THE REQUIRED MOBILITY VALUES.

ANALYSIS PLAN

ROTOR-FUSELAGE COUPLING ANALYSIS-MODIFICATIONS FOR TEETERING HINGE AND UNDERSLINGING

The rotor of the Bell AH-1G helicopter has a teetering hinge attachment to the main shaft and is underslung. The effect of the teeter is to prevent flapping moments from being transmitted from the rotor to the shaft. The undersling imposes a kinematic constraint between the motion of the rotor and the fuselage.

This unique configuration required modification of the rotor-fuselage coupling procedure shown previously. Since modeling of this configuration would have required a major change of the C60 rotor loads program, it was represented approximately within the rotor-fuselage coupling analysis instead.

**ANALYSIS PLAN
ROTOR-FUSELAGE COUPLING ANALYSIS - MODIFICATIONS
FOR TEETERING HINGE AND UNDERSLINGING**

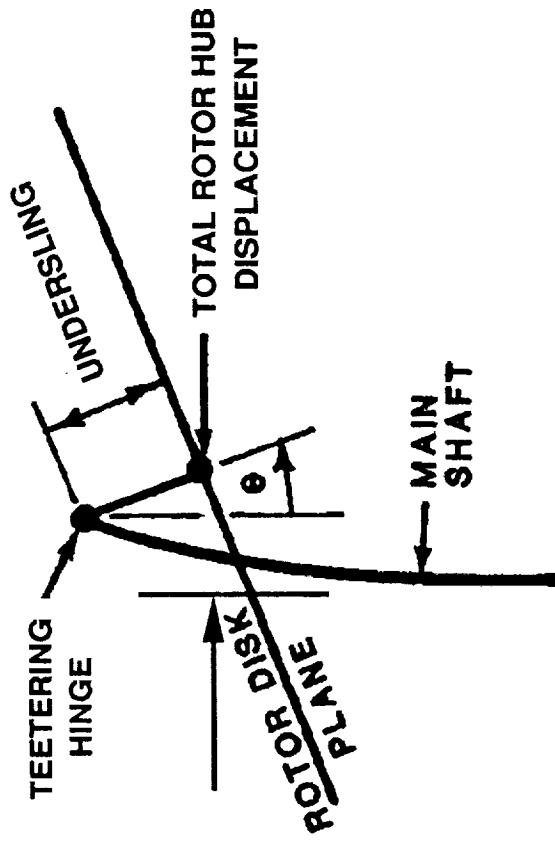

- LOADS AND DISPLACEMENTS AT THE FUSELAGE AND ROTOR HUB ARE NO LONGER THE SAME.
- MODIFICATION FOR UNDERSLINGING IN C60 REPRESENTS A MAJOR CHANGE.
- EFFECTS WILL BE IMPLEMENTED IN THE COUPLING ANALYSIS BY APPLYING KINEMATIC RELATIONSHIP BETWEEN HUB AND FUSELAGE.

BLANK

2.4 Calculation of the Fuselage Response

ANALYSIS PLAN

CALCULATION OF FUSELAGE RESPONSE

The C60 Rotor Loads Program will be used at each of six specified level flight airspeeds to calculate 2, 4 and 6/rev hub loads both with and without hub motion. These results will be used to calculate the rotor hub impedance matrix. The fuselage hub mobility matrix will be calculated using the NASTRAN program and the coupled rotor-fuselage equations will then be used to calculate the hub loads for the coupled system. Then, in turn, these coupled hub loads will be imposed on the NASTRAN finite element model of the fuselage to calculate the vibratory response at the same locations as those measured in flight test.

ANALYSIS PLAN CALCULATION OF FUSELAGE RESPONSE

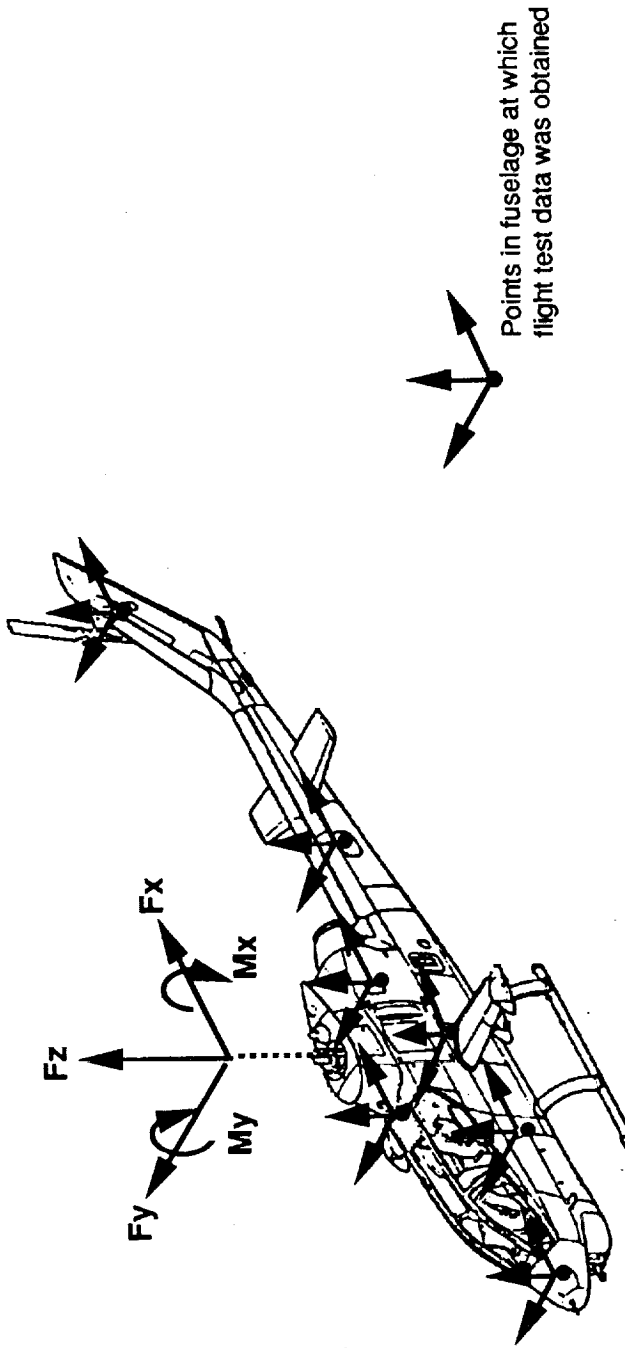

Use NASTRAN to Find Response at Specified Points

- Fuselage has no rotor mass (mass accounted for in C60)
- Impose calculated hub loads F_x , F_y , F_z , M_x , M_y at the main rotor mast teetering hinge attachment
- Use NASTRAN to calculate the vibratory response of the AH-1G at the same locations as those measured in flight

BLANK

2.5 Flight Conditions and Fuselage Locations

ANALYSIS PLAN

FLIGHT CONDITIONS AND FUSELAGE LOCATIONS

The specific flight conditions for which the calculations will be made are those listed in the Reference 3 OLS Common Data at the locations shown below. These are the flight conditions and locations at which flight test data were measured.

ANALYSIS PLAN FLIGHT CONDITIONS AND FUSELAGE LOCATIONS

- Flight conditions to be investigated
 - forward level flight (nominal rotor speed = 323.7 rpm)

142 knots - TAS	101 knots - TAS
128 knots	85 knots
114 knots	67 knots
- Fuselage locations for which responses will be calculated

<u>LOCATION</u>	<u>DIRECTION</u>	<u>UNITS</u>
Mast Tip	Fwd & Aft, Lat, Vert	g's
Nose Sta. 46	Vert & Lat	g's
Gunner Sta. 100	Vert & Lat	g's
Pilot Sta. 146	Vert & Lat	g's
Engine Deck Sta. 249	Vert & Lat	g's
Tail Boom Sta. 297	Vert & Lat	g's
Tail Boom Sta. 485	Vert & Lat	g's
90° Gear Box Sta. 518	Vert & Lat	g's
T/B Fin Load Sta. 521	Vert & Lat	g's

BLANK

3.0 Changes to Analysis Plan

CHANGES TO ANALYSIS PLAN

A number of changes in both the planned analysis procedure and the extent of the analysis were necessary as a result of several difficulties that were encountered during the work.

Measured flight data available was not sufficient to trim the rotor within the C60 program. Therefore, the thrust was assumed equal to the aircraft gross weight, and an approximate trimmed condition was obtained by matching the measured 1/rev flapping using a trial and error approach. This procedure is discussed more fully later.

The non-linear dependence of the rotor forces on the hub motion also required a trial and error approach to obtain rotor loads for each harmonic and flight condition. The hub motion input to the C60 program was varied until a match was obtained with the calculated fuselage hub motion. This process is also described more fully later.

Due to the preceding difficulties, only second harmonic (2/rev) hub motion was considered and only 2/rev fuselage vibration was calculated. In addition, the number of flight conditions (airspeeds) was reduced from six to three.

A planned modification of the coupling equations to account for the teetering hinge and under-sliding was attempted. Initial results appeared unreasonable and thus the modification was not employed in the final analysis.

CHANGES TO ANALYSIS PLAN

- Insufficient data available to obtain trimmed analysis within the C60 program. A trial and error approach was used to arrive at "trimmed" flight conditions.
- Non-linear behavior of rotor forces with hub motion required a trial and error approach for each harmonic and airspeed to obtain rotor loads.
- Fuselage vibration calculated for only one rotor harmonic (2/rev) and three airspeeds due to complexity of calculation.
- Modification of coupling equations to account for teeter hinge and underslinging produced unreasonable results and was not employed in the final analysis.

BLANK

3.1 Revised Analysis Procedure

CHANGES TO PLANNED ANALYSIS

REVISED ANALYSIS PROCEDURE

The accompanying chart illustrates the trial and error approaches required to "trim" the rotor and obtain the rotor loads using the C60 program.

To trim the rotor in the C60 program, the thrust (T) and propulsive force (X) must be known in addition to either the side force (Y) or 1/rev flapping (B1s, B1c). Because thrust was not measured in flight, the thrust was assumed equal to the aircraft weight. At each airspeed, the rotor was then trimmed to match the measured 1/rev flapping using the measured fuselage pitch attitude and trial and error values for the propulsive and side forces.

A trial and error solution was also required to obtain the coupled rotor hub loads. Individual harmonic hub displacements of 0.1 inch were input to the C60 program to obtain the rotor sensitivity matrix. The coupling analysis was then carried out and the calculated coupled hub displacements compared with the input. If the input and output did not agree, the input values were revised and the process repeated for 3 to 5 iterations until agreement was obtained. The final output displacements were then applied concurrently in the C60 program to obtain the coupled rotor hub loads which were then applied to the NASTRAN model. Because of the time consuming nature of these calculations, only 2/rev fuselage responses were calculated.

CHANGES TO PLANNED ANALYSIS REVISED ANALYSIS PROCEDURE

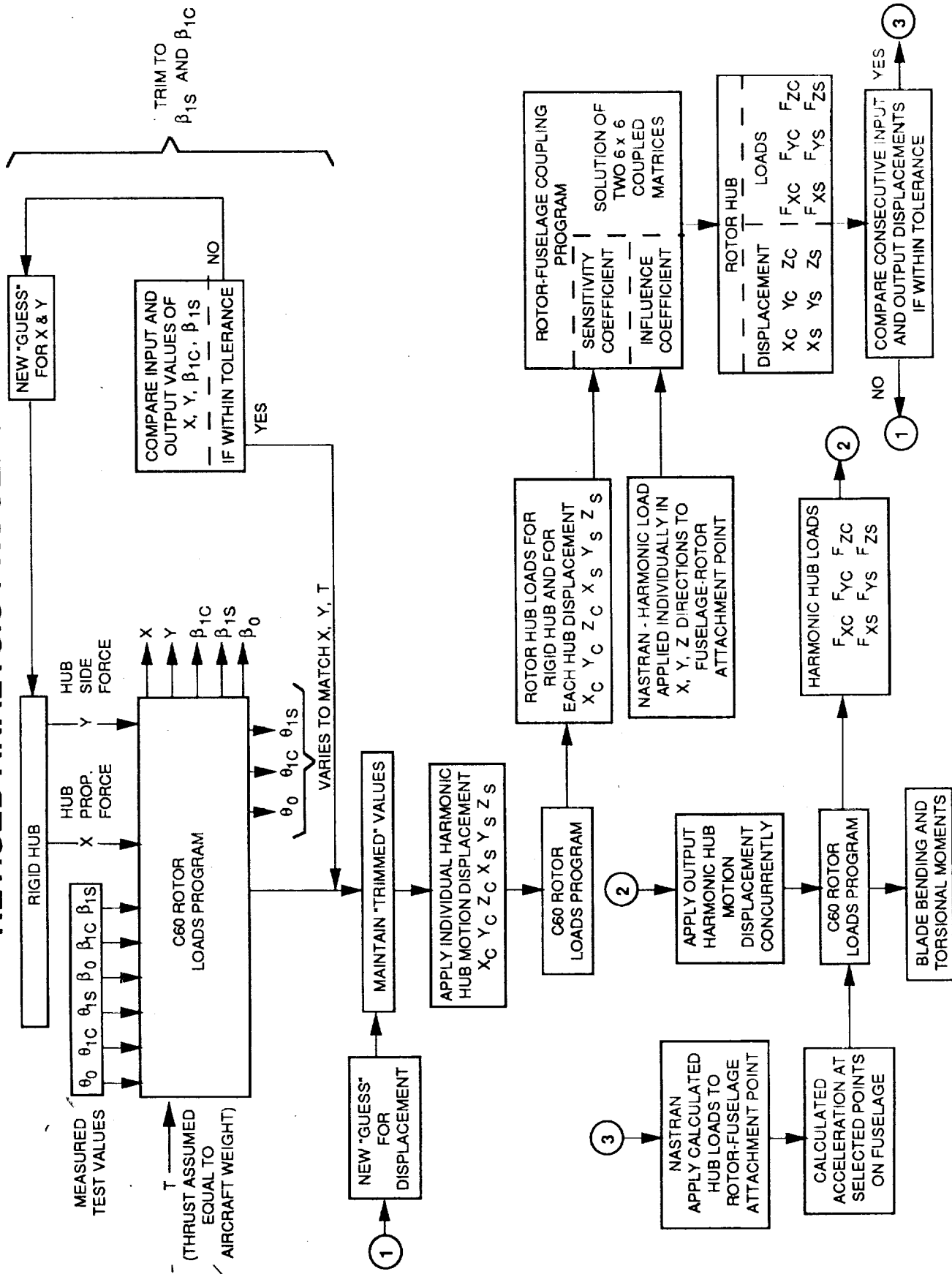

BLANK

4.0 Rotor Hub Modeling

ROTOR HUB MODELING

AH-1G OLS ROTOR HUB FEATURES

The principal features incorporated into the rotor model are illustrated. There are two blades attached to a teetering hub with the blades set at a precone angle of 2.75° . Each blade feathers within a pitch bearing housing which is integral with the hub. Blade torsional moments are reacted by the pitch link through the control system. The delta three angle is zero.

The hub teetering axis lies 4.5 inches above the intersection of the pitch change axis with the rotor shaft. The existing Boeing coupled rotor-fuselage analysis cannot account for the underslung AH-1G configuration. Consequently, the model analyzed placed the teetering hinge at the pitch change axis, as shown. It is recognized that this approximation primarily affects the calculated blade bending moments as well as those effects associated with motions due to the underslinging.

ROTOR HUB MODELING AH-1G OLS ROTOR HUB FEATURES

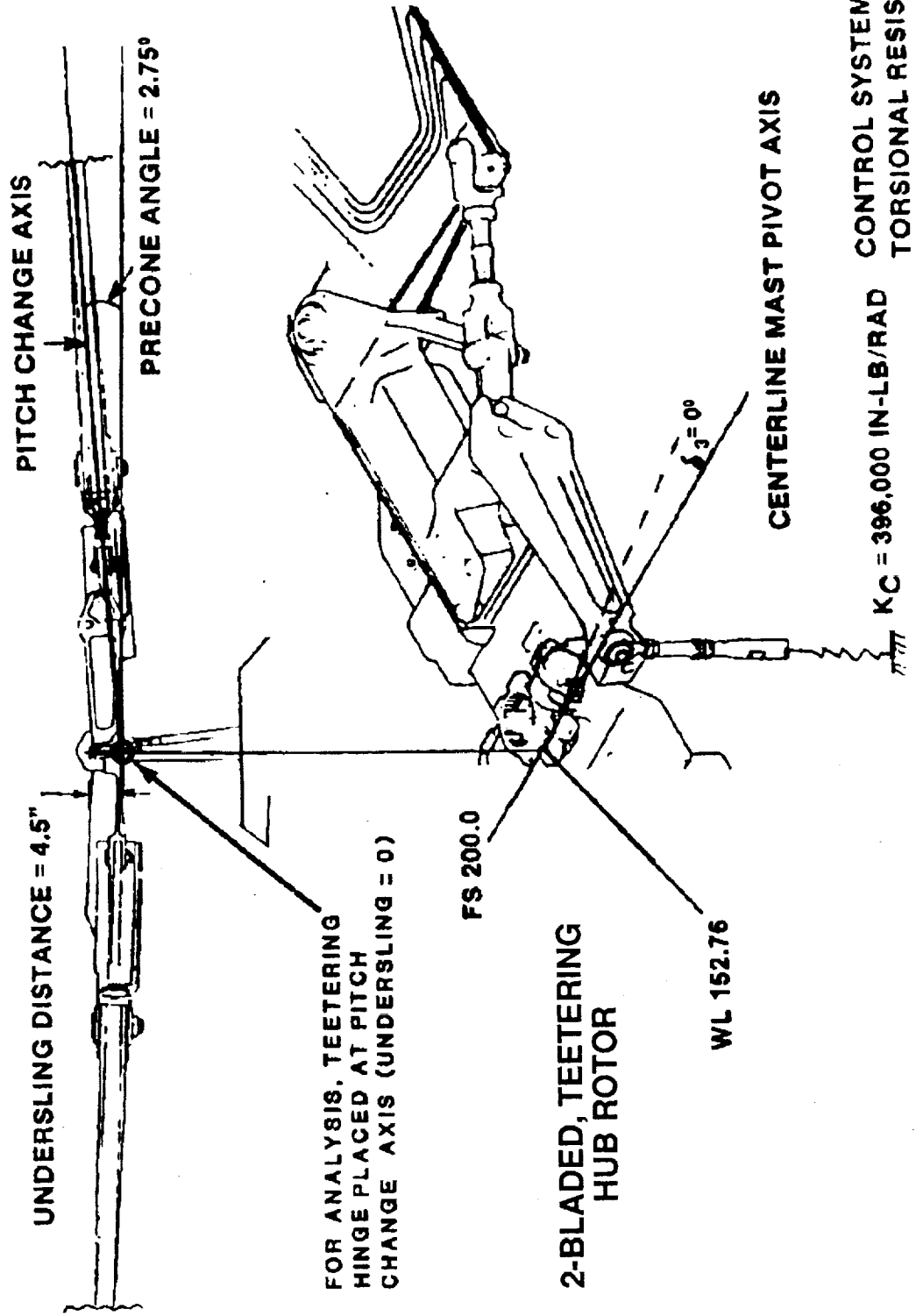

ROTOR HUB MODELING

AH-1G OLS MAIN ROTOR HUB GEOMETRY

The location of the pitch link and feathering bearings are illustrated in the sketch. Because the end of the pitch horn is on the flapping axis, the blade has no pitch-flap coupling ($\delta_{three} = \text{zero}$).

ROTOR HUB MODELING AH-1G OLS MAIN ROTOR HUB GEOMETRY

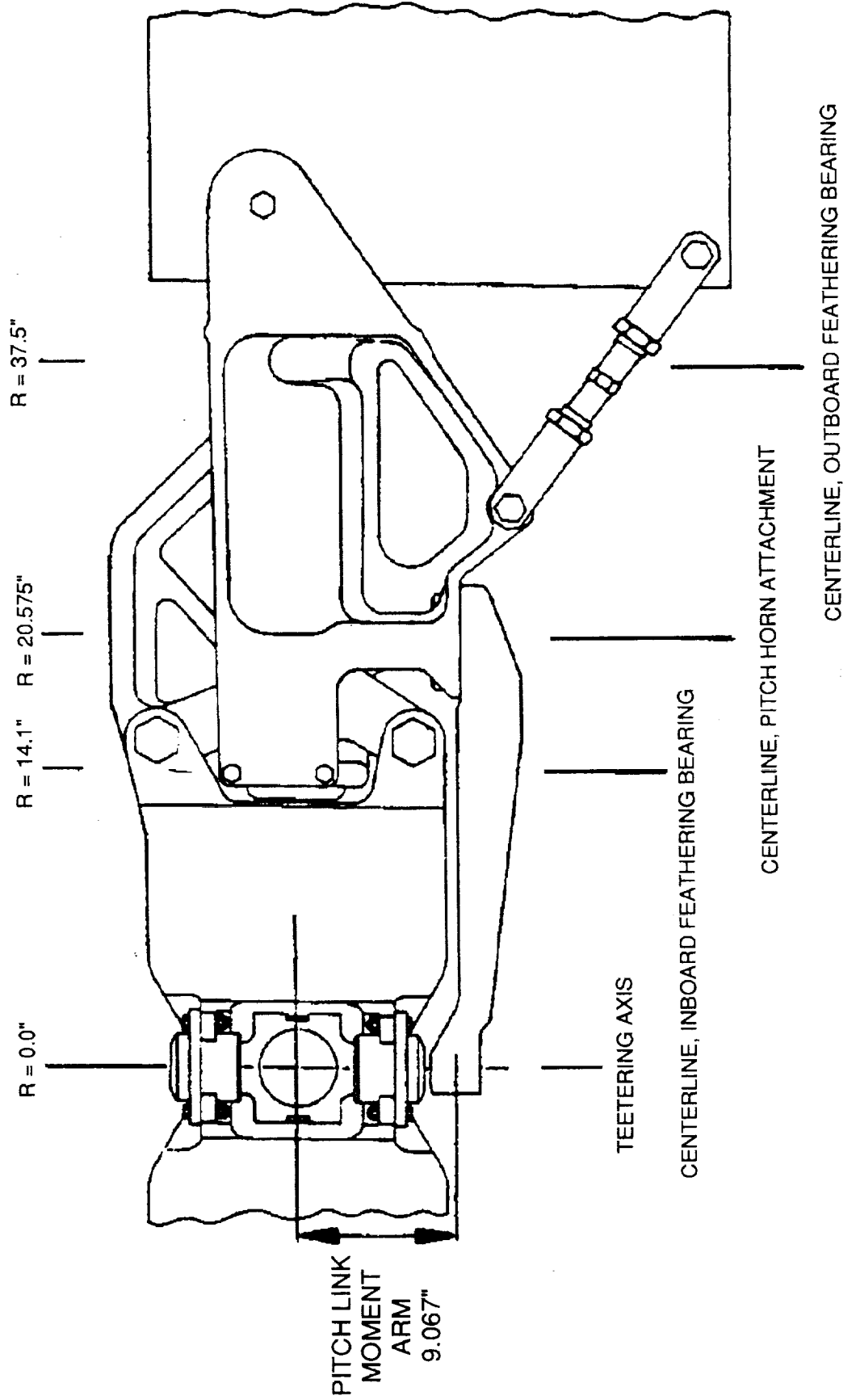

ROTOR HUB MODELING

AH-1G TEETERING ROTOR ROOT END CONDITIONS

For the AH-1G teetering rotor, a cantilevered flap root boundary is assumed for steady and even flapping harmonics, while a pinned root boundary is assumed for odd harmonics which have zero flapping moment. A cantilevered root boundary is assumed in the lead-lag direction for all harmonics. These special boundaries are needed in C60 because it is a "one bladed" analysis, and is not aware of the presence of the opposite blade.

**ROTOR HUB MODELING
AH-1G TEETERING ROTOR ROOT END CONDITIONS**

FLAP-ROOT BOUNDARY CONDITIONS:

- CANTILEVERED FOR STEADY AND EVEN HARMONICS
- PINNED FOR ODD HARMONICS

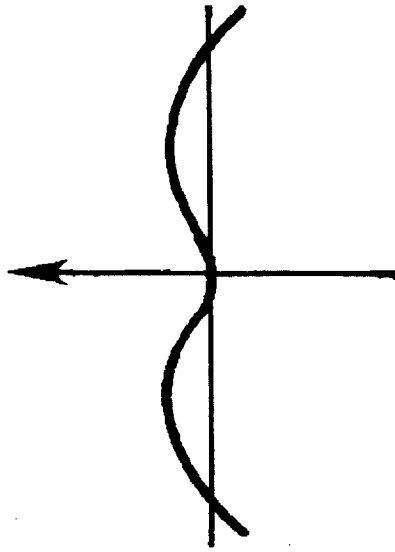

EVEN HARMONICS

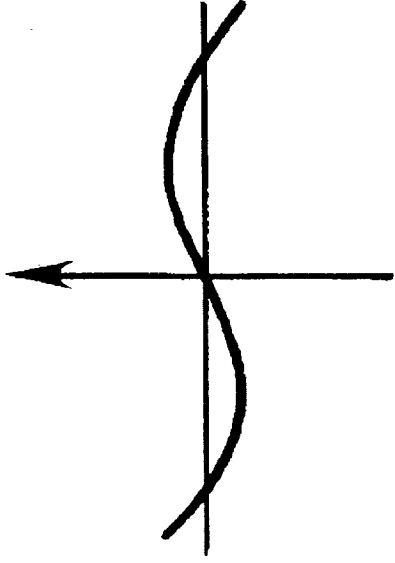

ODD HARMONICS

LEAD-LAG-ROOT BOUNDARY CONDITIONS:

- CANTILEVERED FOR ALL HARMONICS

ROTOR HUB MODELING

AH-1G TEETERING ROTOR ROOT END CONDITIONS

The accompanying figure illustrates the blade root torsional constraints. By virtue of the pitch bearing, no torsional moment is transmitted from the blade to the hub. The blade torsional moment is reacted through the control system which is represented in the analysis by a simple spring element. Placement of the pitch arm and pitch link relative to the teetering axis is such that δ_3 is zero.

**ROTOR HUB MODELING
AH-1G TEETERING ROTOR ROOT END CONDITIONS**

BLADE TORSIONAL BOUNDARY CONDITION:

- NO TORSIONAL MOMENT TRANSMITTED FROM THE BLADE TO THE HUB THROUGH THE PITCH BEARING
- BLADE TORSIONAL MOMENT REACTED THROUGH THE CONTROL SYSTEM REPRESENTED BY A SIMPLE SPRING ELEMENT

• $\delta_3 = 0^\circ$

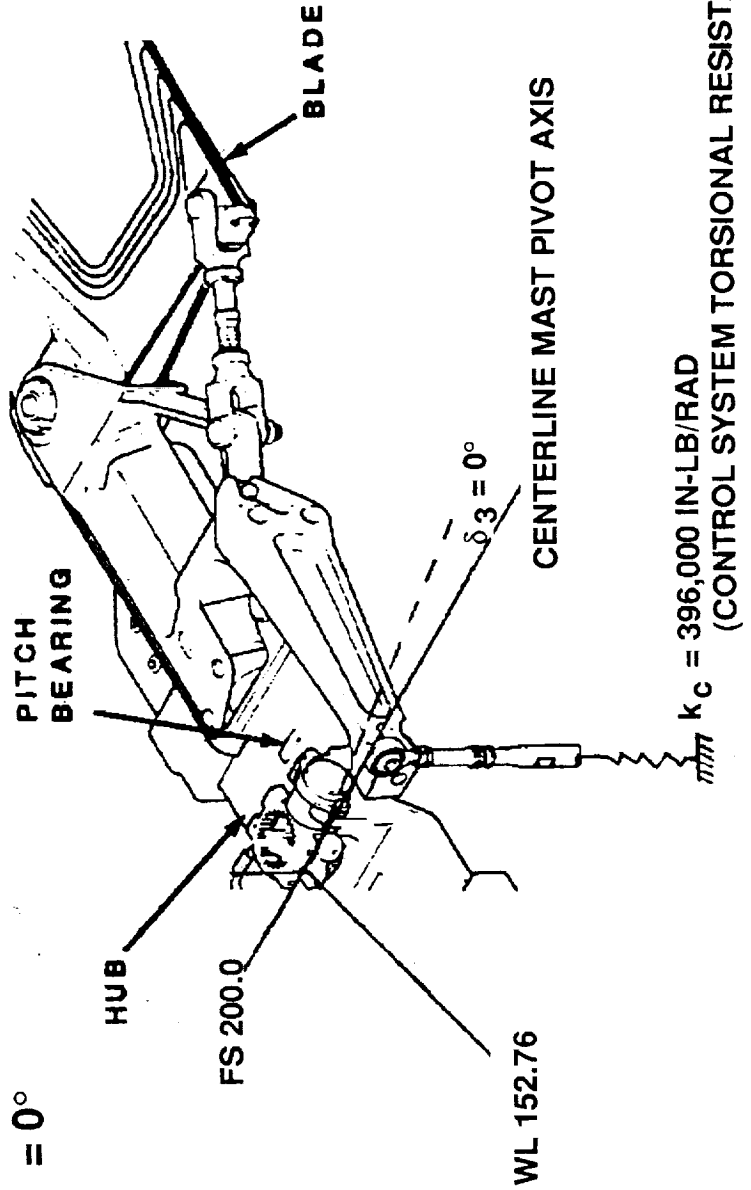

BLANK

5.0 Fuselage Mobility Matrix

FUSELAGE HUB MOBILITY MATRIX

A NASTRAN model of the AH-1G was supplied on tape by Bell Helicopter Textron. Since the C60 rotor program completely accounts for the rotor system dynamics (including its weight), the hub and blade weight were subsequently deleted from the NASTRAN mass properties. The fuselage mobility matrix was calculated at the rotor hub attachment point due to 2/rev unit loads in the longitudinal, lateral and vertical directions. No moments were imposed. Each harmonic load yielded sine and cosine component displacements in the X, Y and Z directions which were used to form a complex 6 x 6 mobility matrix.

FUSELAGE HUB MOBILITY MATRIX

• CALCULATION OF THE FUSELAGE MOBILITY MATRIX [B], WHERE

$$\begin{matrix} \{ X \}_{\text{HUB}} \\ 6 \times 1 \\ \text{MATRIX} \end{matrix} = \begin{matrix} [B] \\ 6 \times 6 \\ \text{MATRIX} \end{matrix} \begin{matrix} \{ F \}_{\text{HUB}} \\ 6 \times 1 \\ \text{MATRIX} \end{matrix} = \begin{matrix} \left\{ \begin{matrix} X C \\ Y C \\ Z C \\ X S \\ Y S \\ Z S \end{matrix} \right\} \\ \left\{ \begin{matrix} F X C \\ F Y C \\ F Z C \\ F X S \\ F Y S \\ F Z S \end{matrix} \right\} \\ \text{HUB} \\ = \end{matrix}$$

2/REV "UNIT" FORCES ARE APPLIED SEQUENTIALLY AT THE ROTOR HUB-FUSELAGE ATTACHMENT POINT (GRID 200153) IN THE FIXED SYSTEM AND THE DEFLECTIONS AT THAT POINT ARE CALCULATED USING NASTRAN.

NOTE: THE ROTOR SYSTEM WEIGHT IS NOT INCLUDED IN THE FUSELAGE MODEL.

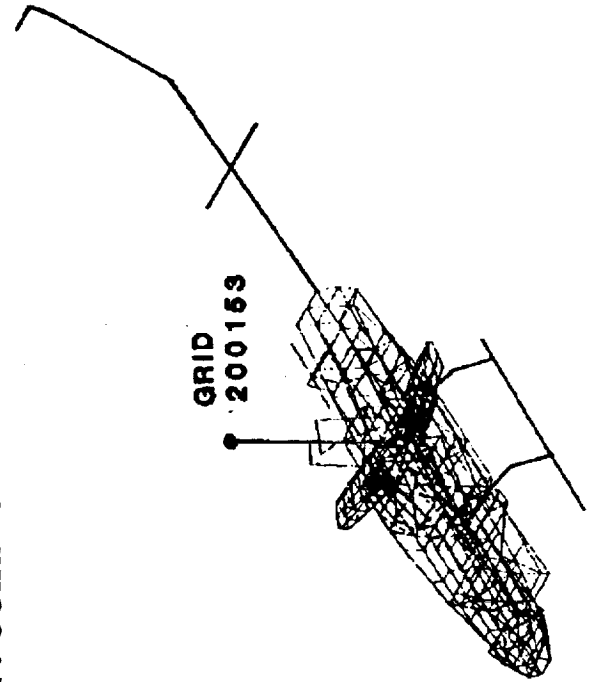

2/REV FUSELAGE MOBILITY MATRIX

The fuselage mobility matrix [B] corresponding to 2/rev forcing is shown here. Note that the matrix is symmetric. The NASTRAN forced response analysis required to obtain these numerical values was performed on an IBM 3084 using double precision.

BLANK

2/REV FUSELAGE MOBILITY MATRIX

(SYMMETRIC)

-0.105236D-02										
-0.617057D-05	-0.688790D-03									
0.482177D-05	-0.763896D-06	-0.111142D-04								
0.588349D-04	0.790474D-06	0.751621D-06	-0.105236D-02							
0.790474D-06	0.206831D-04	0.875758D-07	-0.617057D-05	-0.688790D-03						
0.751621D-06	0.875758D-07	0.359005D-06	0.432177D-05	-0.763896D-06	-0.111142D-04					

INDICATES DOUBLE PRECISION

6.0 "Trimmed" Conditions at Each Airspeed

"TRIMMED" CONDITIONS AT EACH AIRSPEED

As indicated previously, difficulty was experienced in obtaining a 'trimmed' condition at the various forward speeds since some of the input data required by the C60 program was not measured in the flight test. Thus, the 'trimmed' condition was defined as that flight condition for which the fuselage pitch attitude was set at the measured value and the side force and propulsive force were varied until the calculated value for β_{1S} and β_{1C} matched the measured values.

The resulting calculated values of the collective, lateral cyclic, longitudinal cyclic and longitudinal and lateral flapping are presented for each of the six forward speeds along with the corresponding measured values.

At 142 knots the C60 analysis would not converge, so no calculated results are shown.

"TRIMMED" CONDITIONS AT EACH AIRSPEED

β_{1C} β_{1S}

AIRSPEED KNOTS	COLLECTIVE AT 3/4R		LATERAL CYCLIC		LONGITUDINAL CYCLIC		LONGITUDINAL FLAP		LATERAL FLAP		FUSELAGE PITCH ATTITUDE
	CALC.	MEAS.	CALC.	MEAS.	CALC.	MEAS.	CALC.	MEAS.	CALC.	MEAS.	
067	8.42	12.46	-5.30	-4.428	0.644	2.47	1.931	1.979	0.407	0.423	-1.045
085	8.597	12.674	-6.724	-5.186	1.1767	2.933	2.224	2.222	0.7073	0.660	-0.271
101	9.013	13.293	-7.686	-6.219	0.819	2.678	2.2697	2.263	0.519	0.519	-1.096
114	9.595	12.67	-8.64	-7.39	0.9169	2.51	2.238	2.215	0.6867	0.636	-1.769
128	11.74	14.916	-10.44	-8.661	0.829	2.149	2.394	2.404	0.509	0.519	-3.628
142	-----	16.73	-----	-8.987	-----	5.16	-----	1.986	-----	1.59	-5.71

BLANK

7.0 Comparison of Analytical and Test Results

BLANK

7.1 Blade Bending and Torsional Moments

PRECEDING PAGE BLANK NOT FILMED

71

PAGE 70 INTENTIONALLY BLANK

BLADE FLAPWISE BENDING MOMENT

A comparison of the calculated and measured radial variation of the blade flapwise bending moments for 1, 2 and 3/rev are presented at airspeeds of 67, 101 and 128 knots. The 2/rev and 3/rev flap bending moments show fair to good correlation with measured values, whereas the 1/rev flap bending moments show poor comparison. It is believed that the discrepancy in the 1/rev flap bending moment is due to the assumption of zero underslinging of the hub in the analysis.

BLADE FLAPWISE BENDING MOMENT V = 67 KNOTS

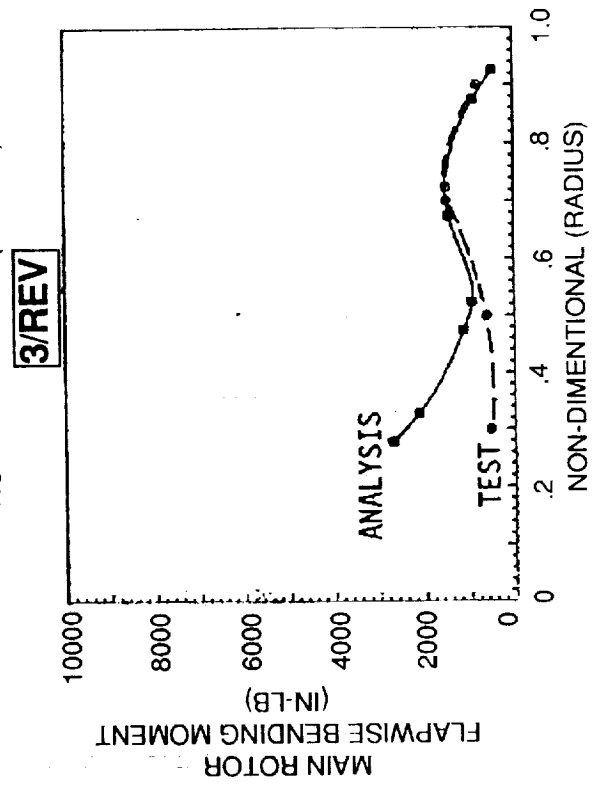
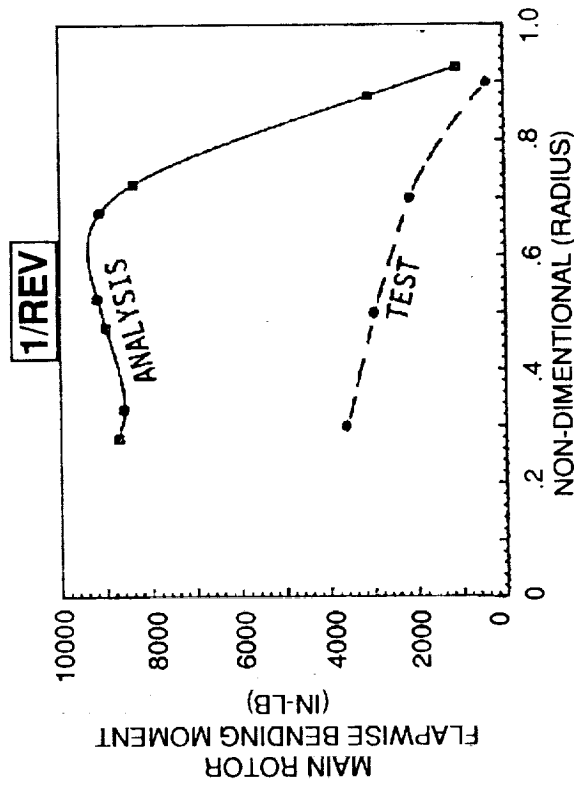
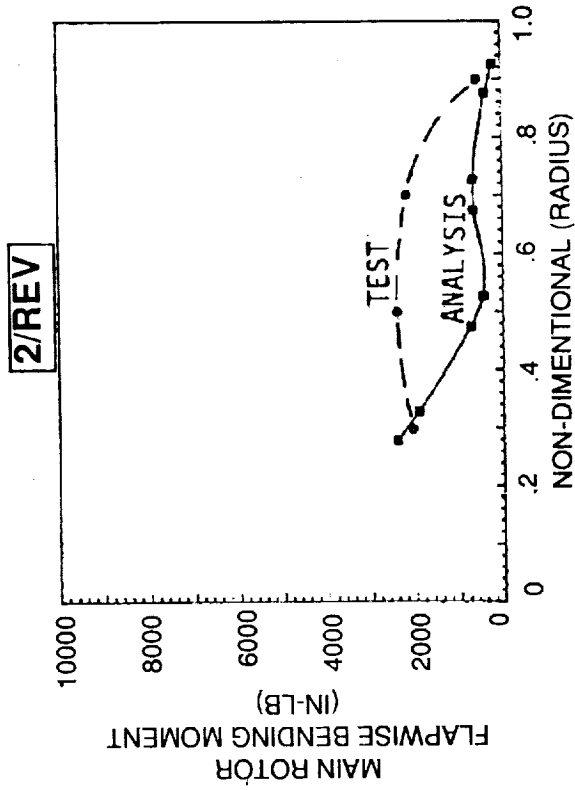

---○--- TEST DATA
 ---□--- ANALYSIS

BLADE FLAPWISE BENDING MOMENT V = 101 KNOTS

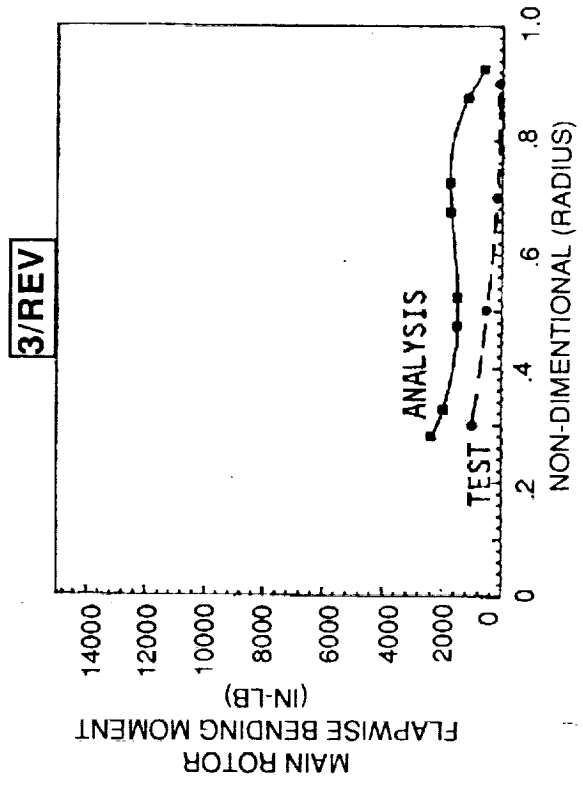
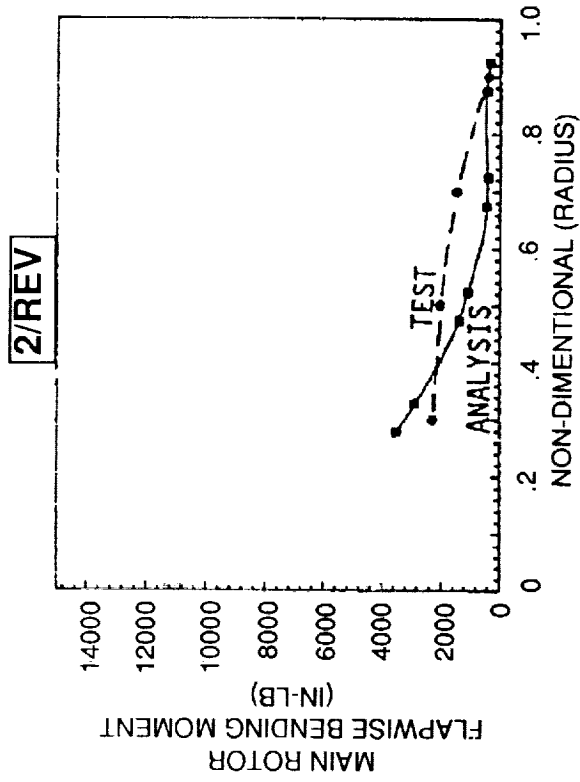
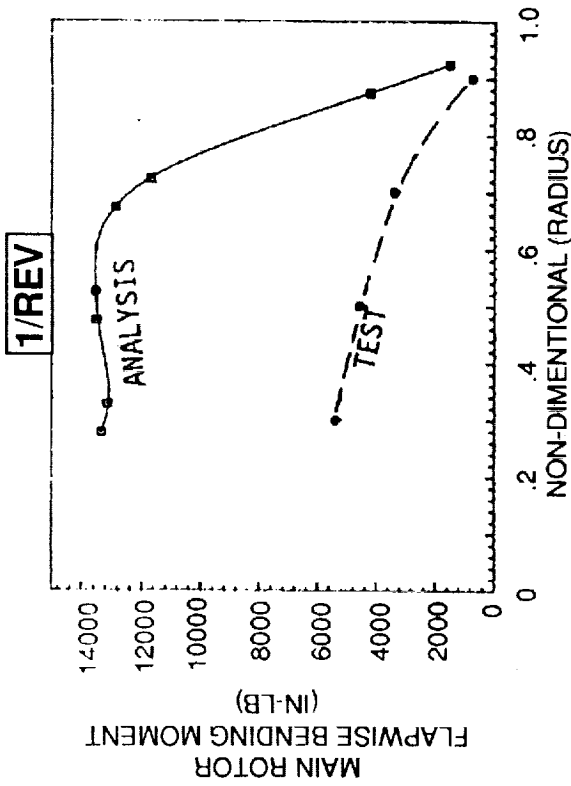

--- ○ --- TEST DATA
 — □ — ANALYSIS

BLADE FLAPWISE BENDING MOMENT V = 128 KNOTS

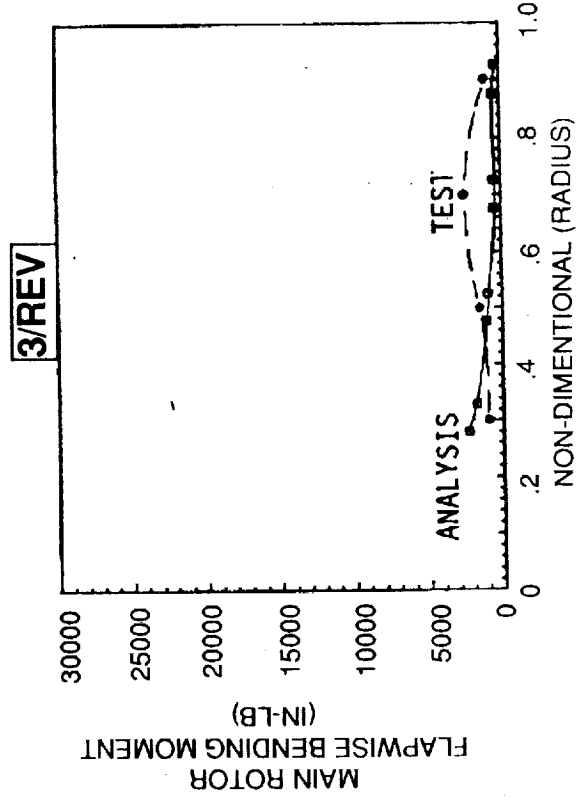
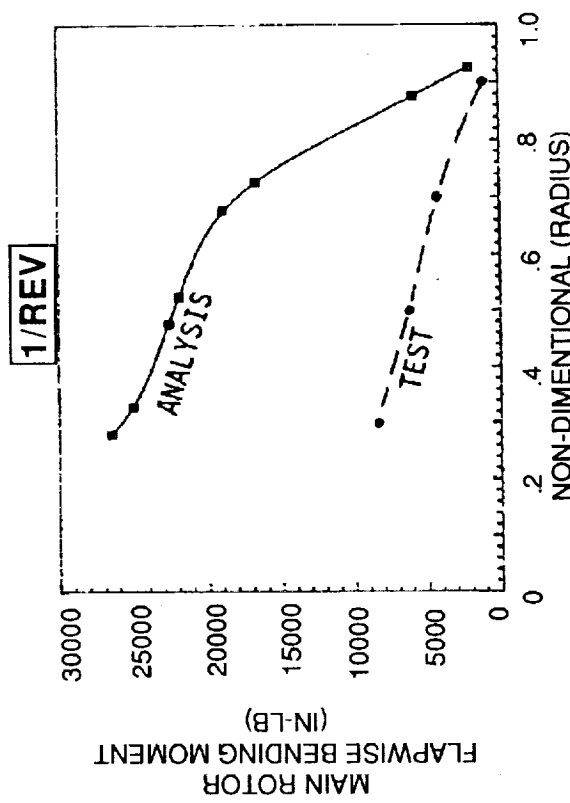
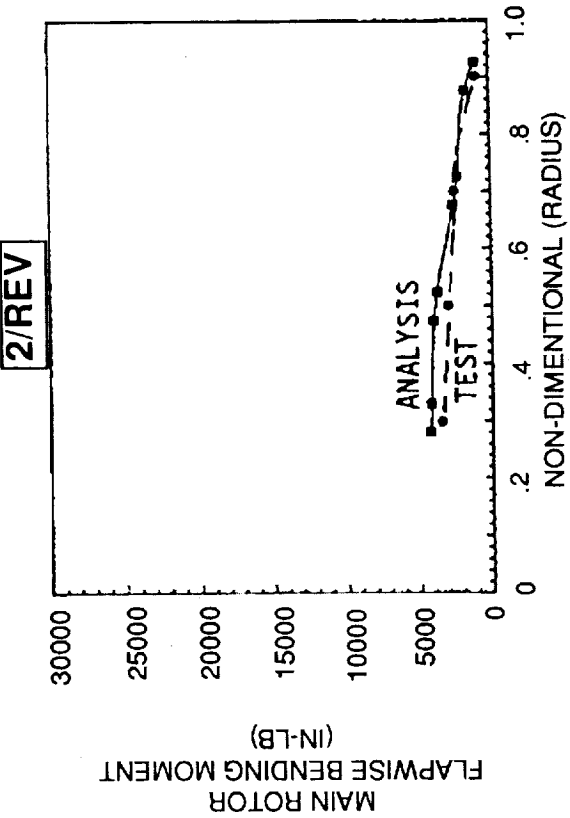

- - - ○ TEST DATA
 ——— □ ANALYSIS

BLADE EDGEWISE BENDING MOMENT

A comparison of calculated and measured 1, 2 and 3/rev blade edgewise bending moments along the radius of the blade are presented at airspeeds of 67, 101 and 128 knots. At 67 knots the 1 and 3/rev moments show good agreement with measured values whereas the 2/rev calculated moments show poor agreement. At 101 knots only the 1/rev moments show good agreement. At 128 knots the 2/rev results show very good agreement while the 1 and 3/rev moments show fair agreement.

BLADE EDGEWISE BENDING MOMENT V = 67 KNOTS

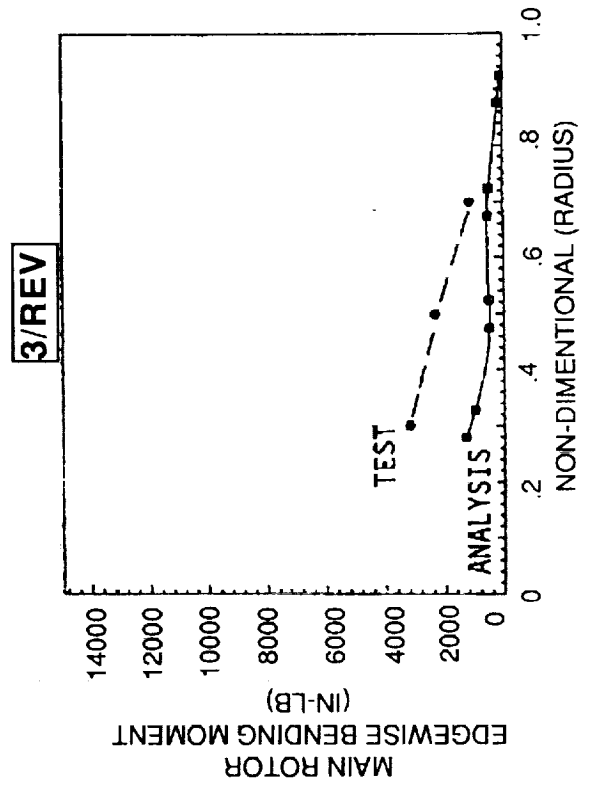
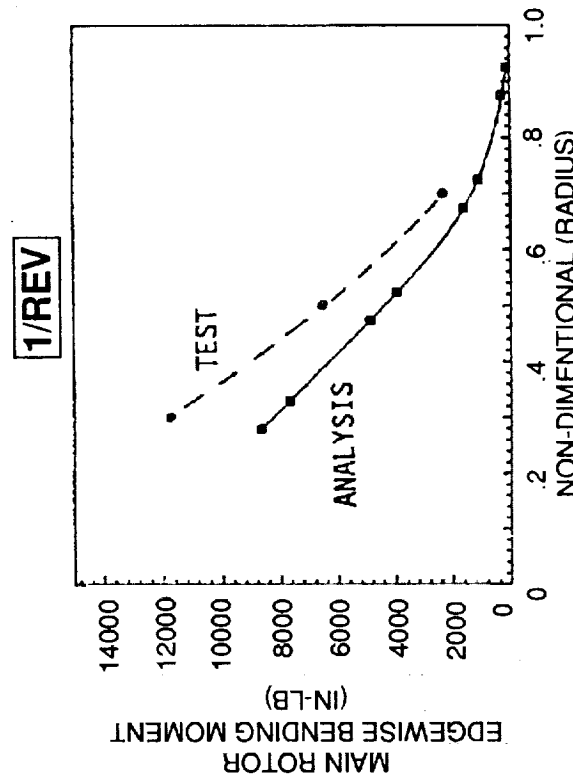
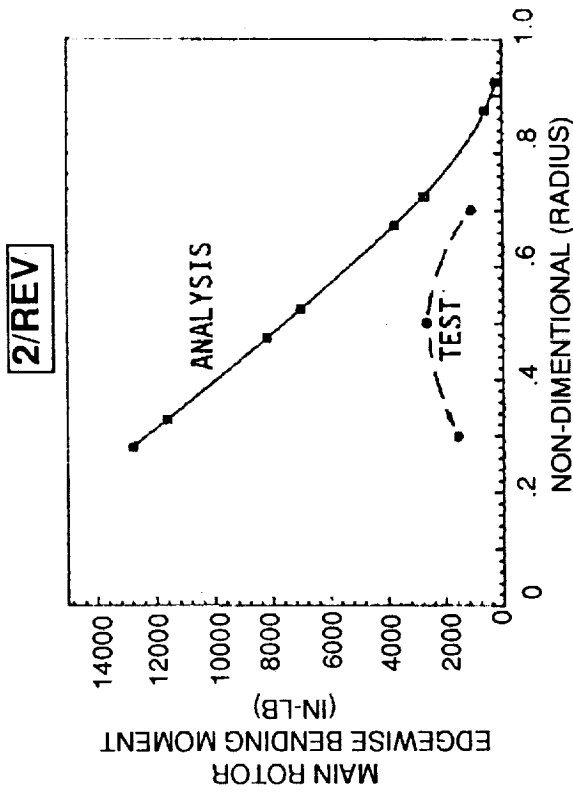

---○--- TEST DATA
 ---□--- ANALYSIS

BLADE EDGEWISE BENDING MOMENT V = 101 KNOTS

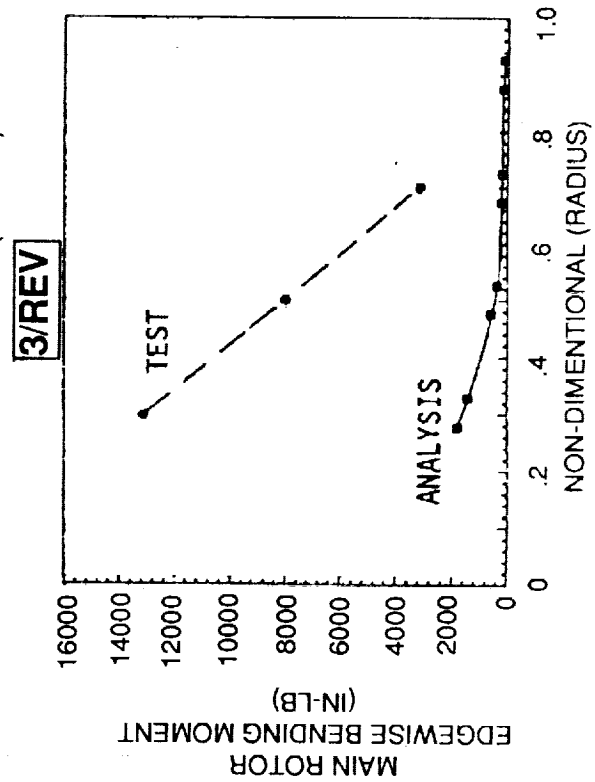
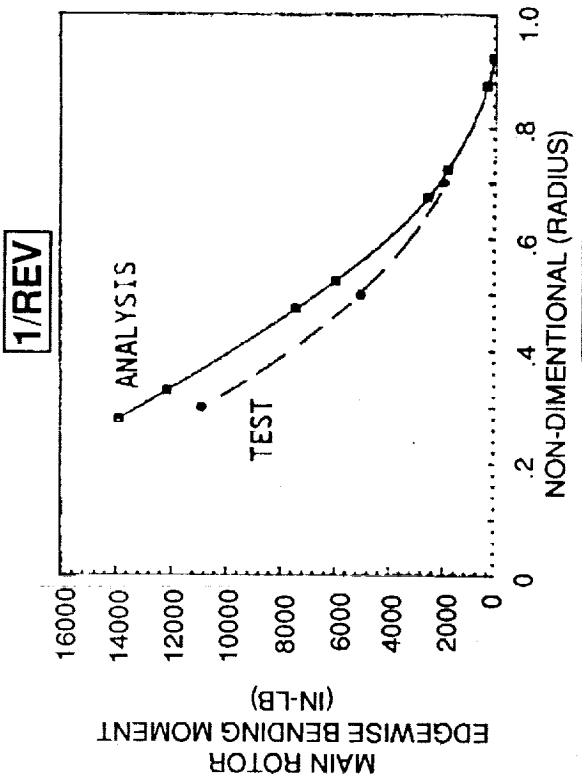
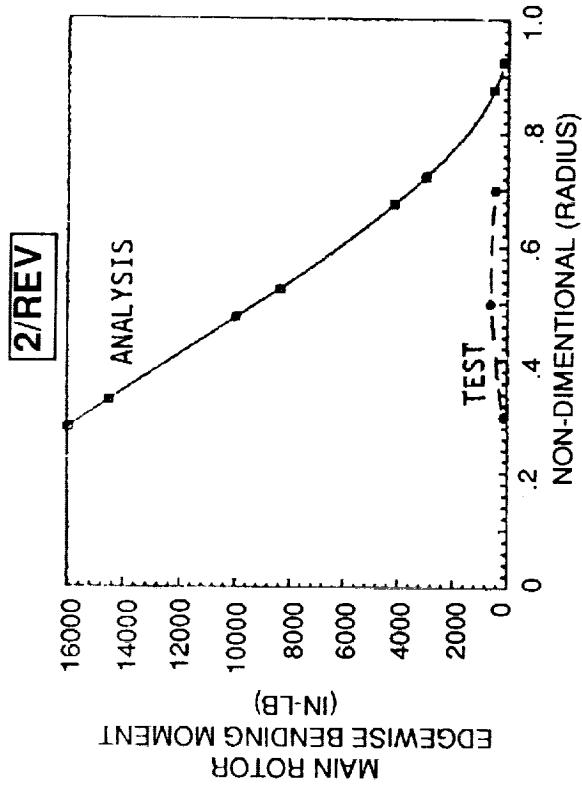

---○--- TEST DATA
 ---□--- ANALYSIS

BLADE EDGEWISE BENDING MOMENT V = 128 KNOTS

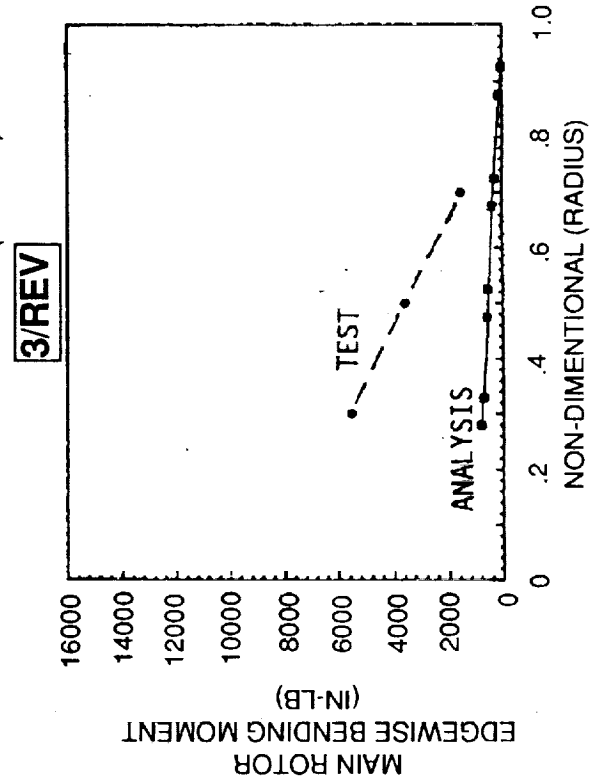
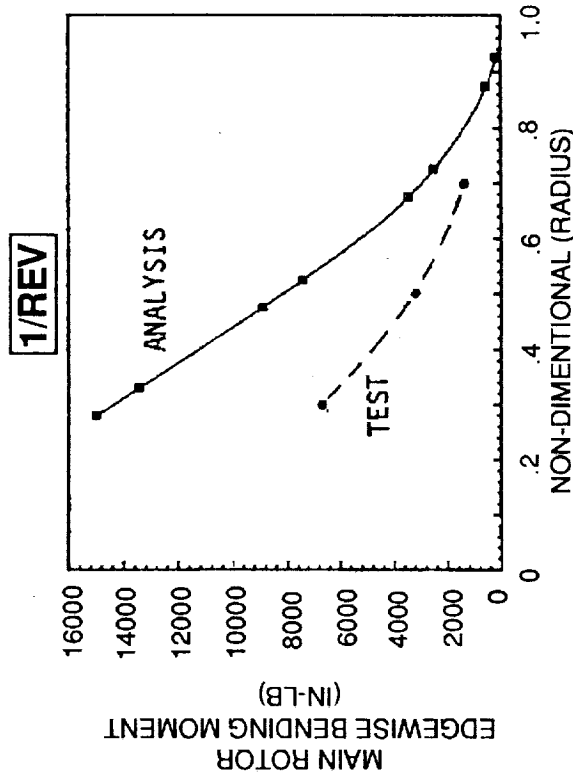
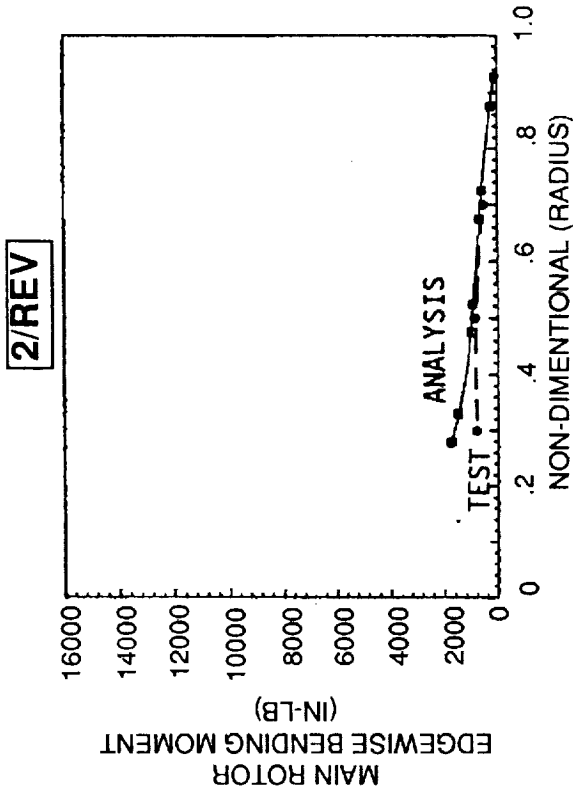

---○--- TEST DATA
 ---□--- ANALYSIS

BLADE TORSIONAL MOMENT

A comparison of calculated and measured 1, 2 and 3/rev blade torsional moments along the radius of the blade are presented at airspeeds of 67, 101 and 128 knots. The calculated and measured torsional moments show fair to good agreement at the three airspeeds.

BLADE TORSIONAL MOMENT

V = 67 KNOTS

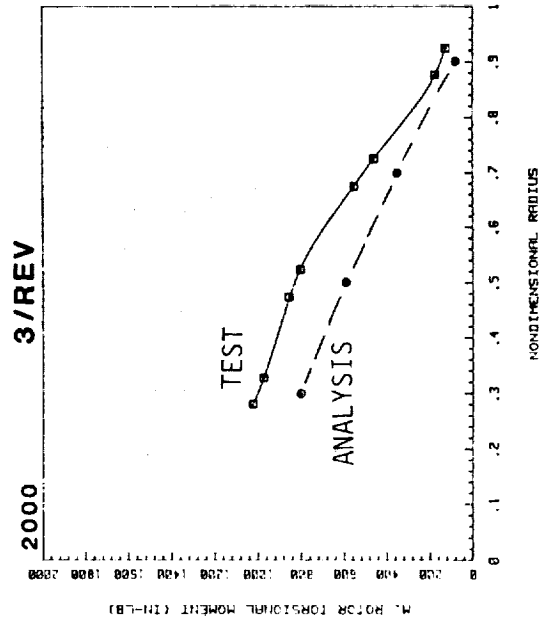
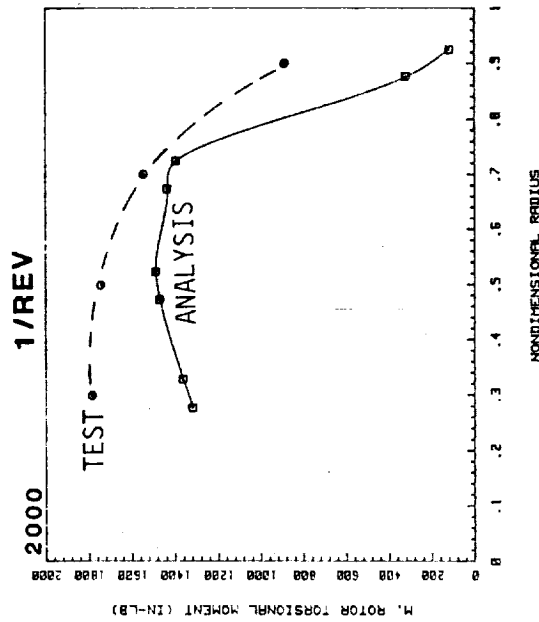
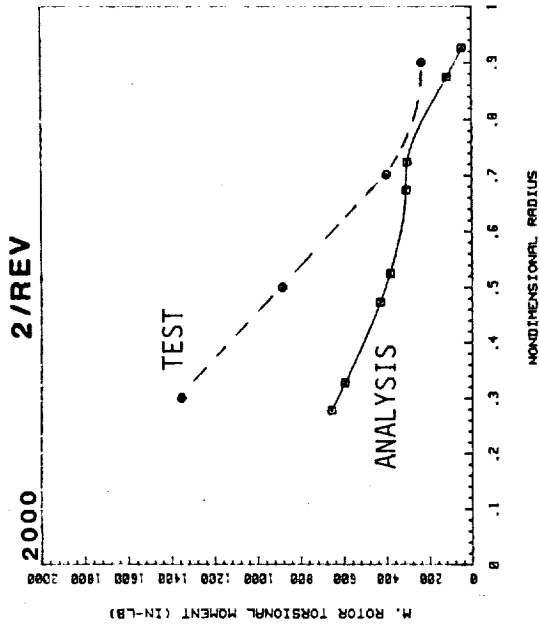

--- ○ TEST DATA
— □ ANALYSIS

BLADE TORSIONAL MOMENT V = 101 KNOTS

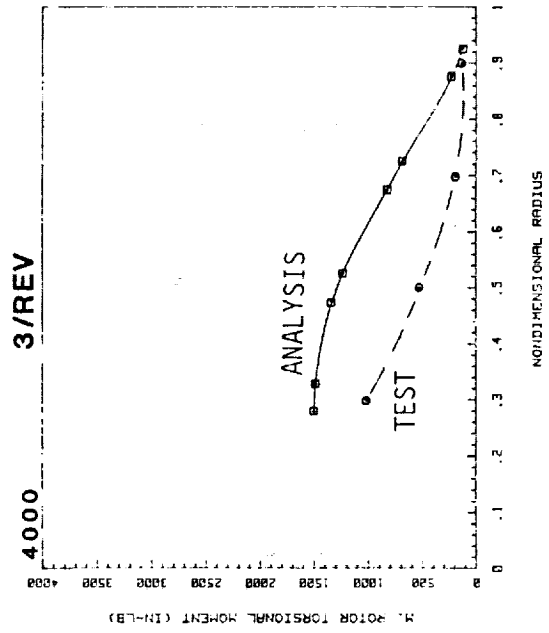
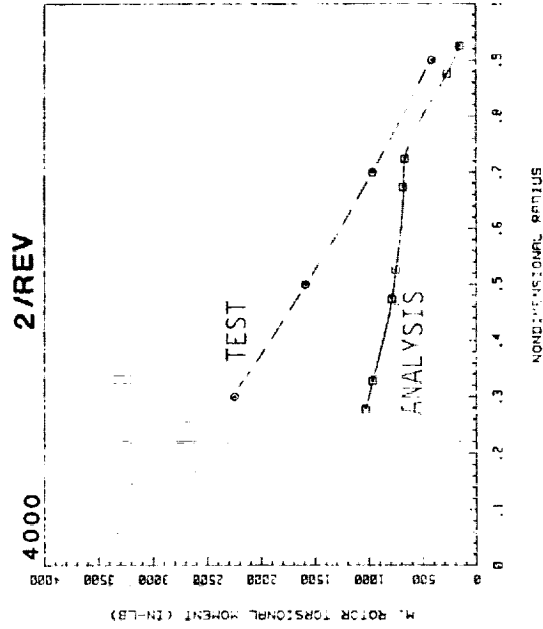
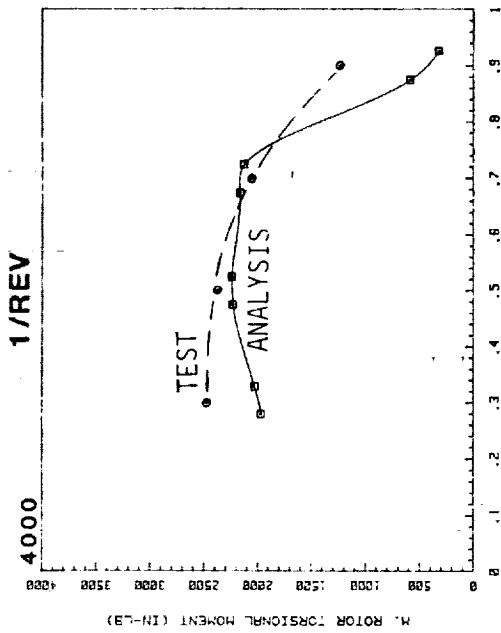

--- ○ TEST DATA
— □ ANALYSIS

ORIGINAL PAGE IS
OF POOR QUALITY

BLADE TORSIONAL MOMENT

V = 128 KNOTS

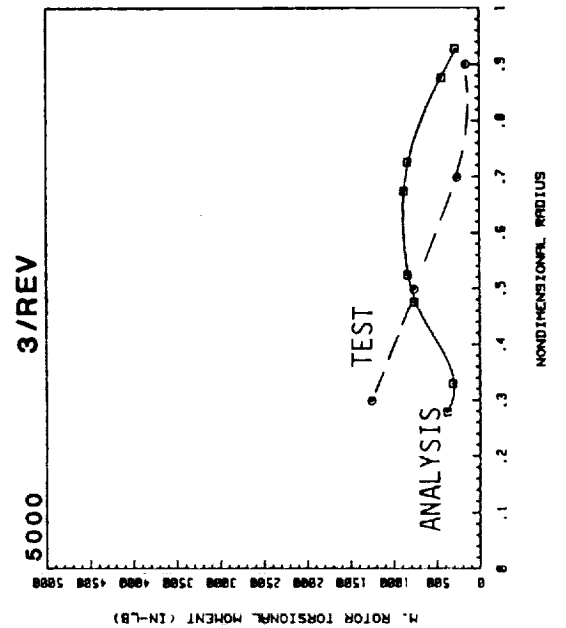
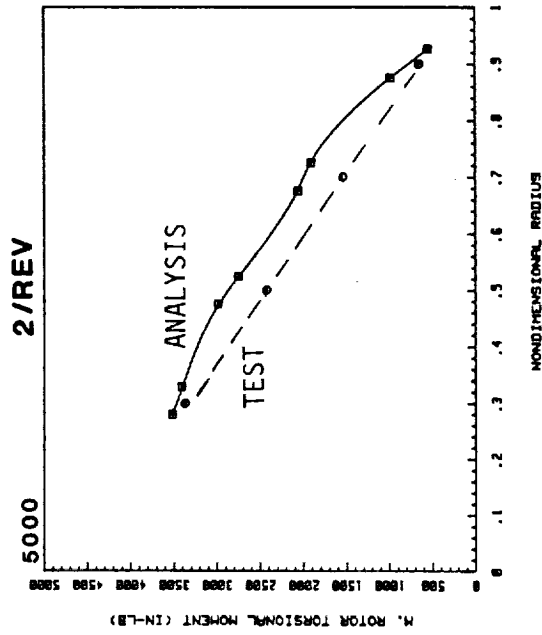
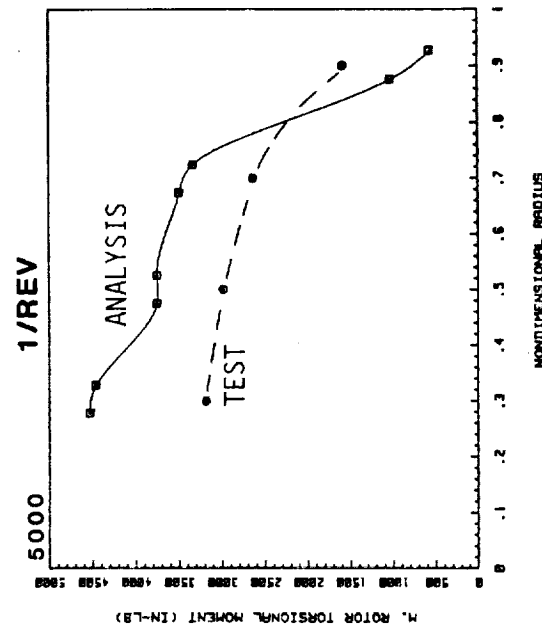

--- ○ --- TEST DATA
 — □ — ANALYSIS

THE HISTORY OF BLADE MOMENTS

The time history measured and calculated blade flapwise bending, edgewise bending and torsional moments are compared at airspeeds of 67, 101 and 128 knots. Forces and moments in the C60 program are determined at the mass locations in the blade model. These locations are not the same as the radial positions of the measured data. For comparison purposes, the analytical results bounding the measured locations are shown.

The time history for the measured data was synthesized using the six harmonic values listed at each radial position at the corresponding airspeed in the OLS data, Reference 3.

ORIGINAL PAGE IS
OF POOR QUALITY

BLADE FLAPWISE BENDING MOMENT - TIME HISTORY

V = 67 KNOTS

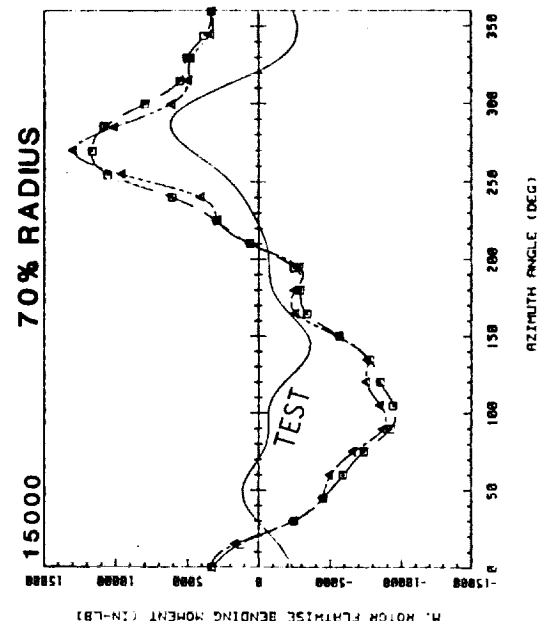
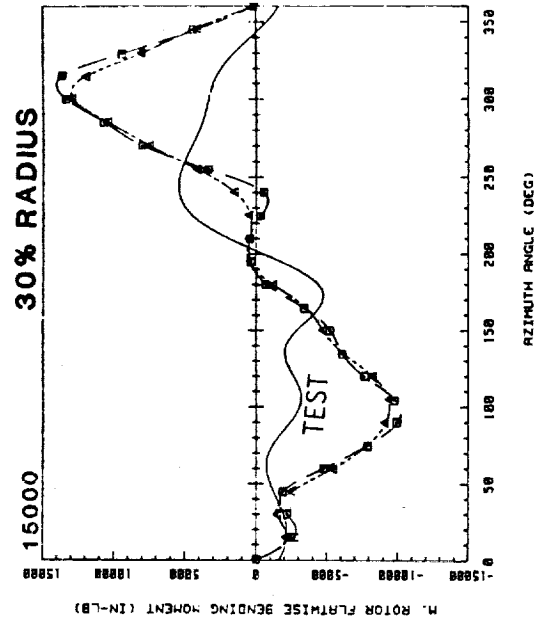
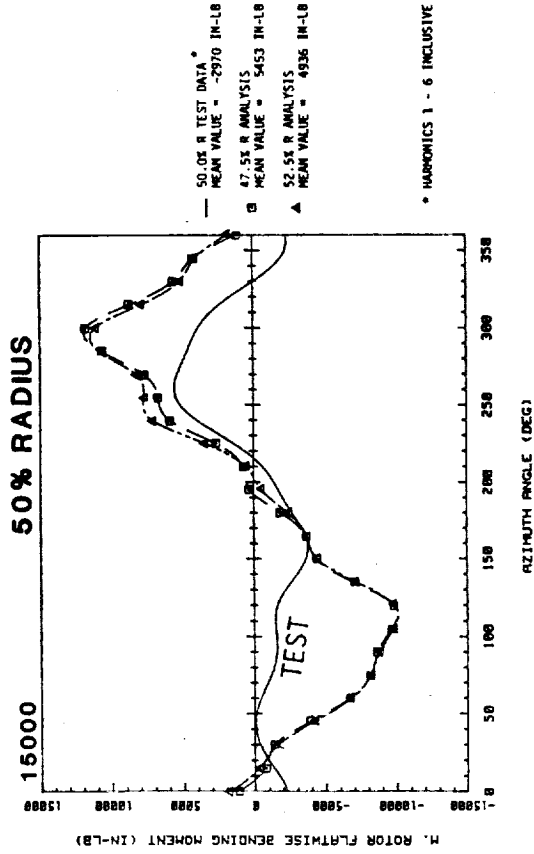
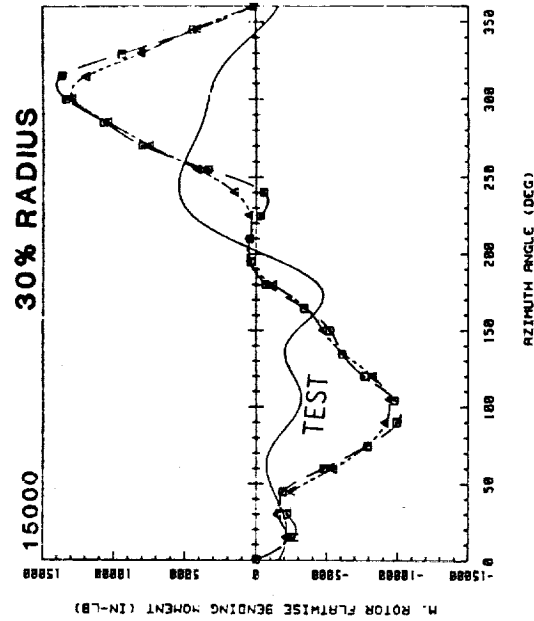

ORIGINAL PAGE IS
OF POOR QUALITY

BLADE FLAPWISE BENDING MOMENT - TIME HISTORY

V = 101 KNOTS

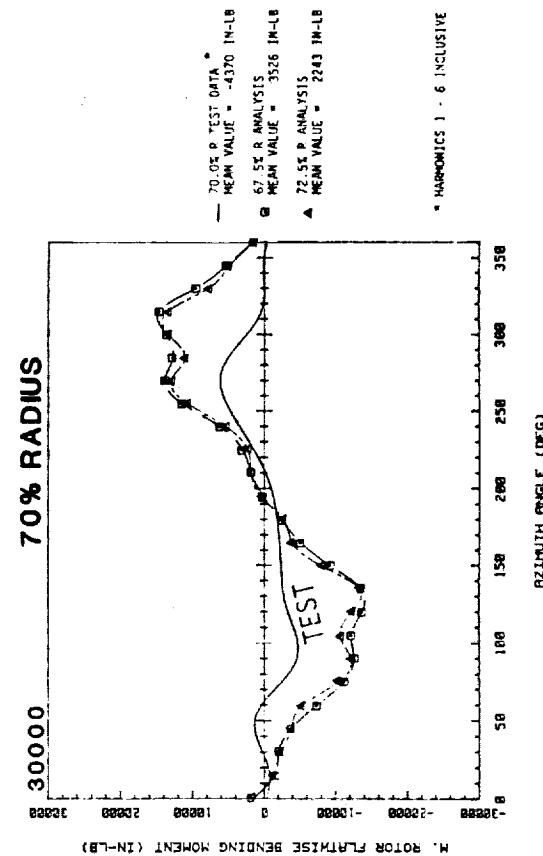
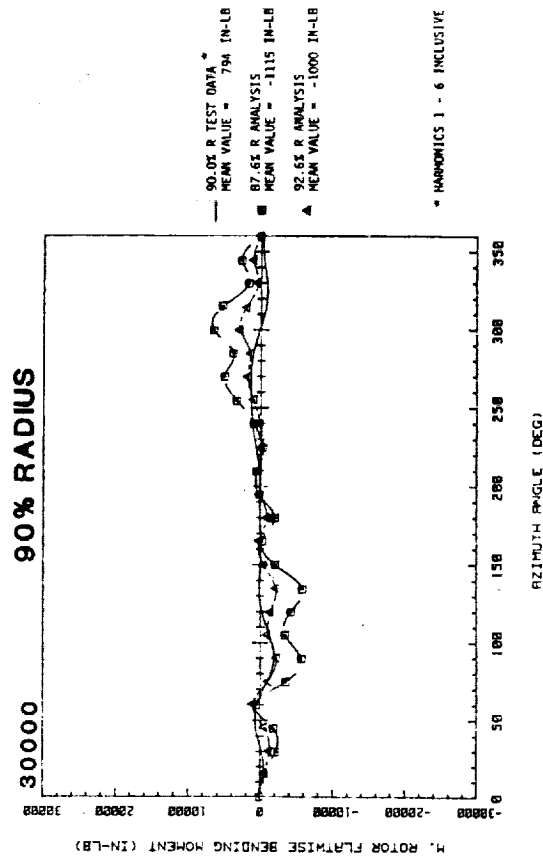
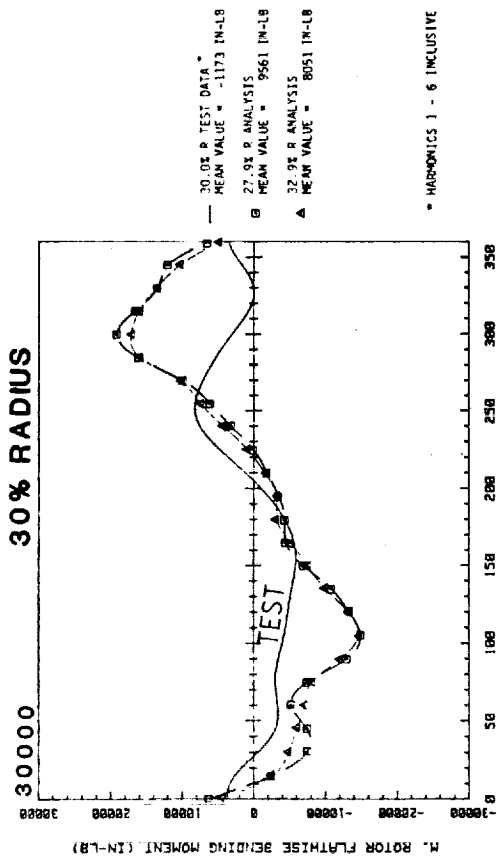
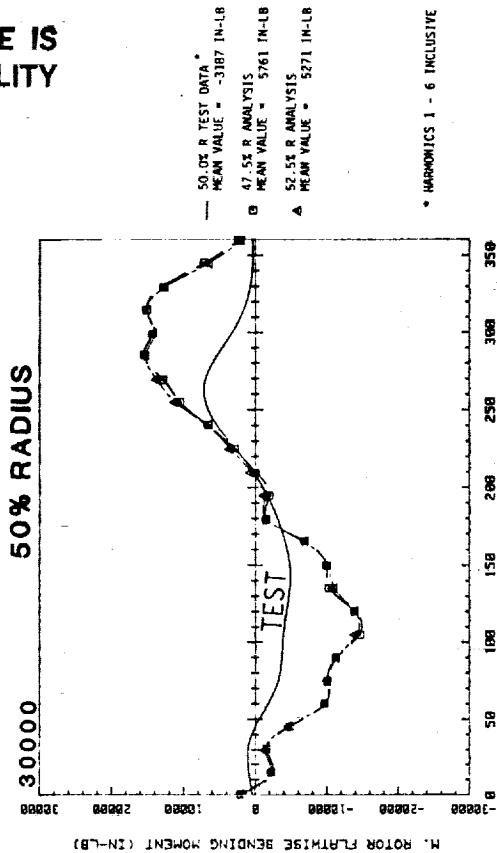

ORIGINAL PAGE IS
OF POOR QUALITY

BLADE FLAPWISE BENDING MOMENT - TIME HISTORY

V = 128 KNOTS

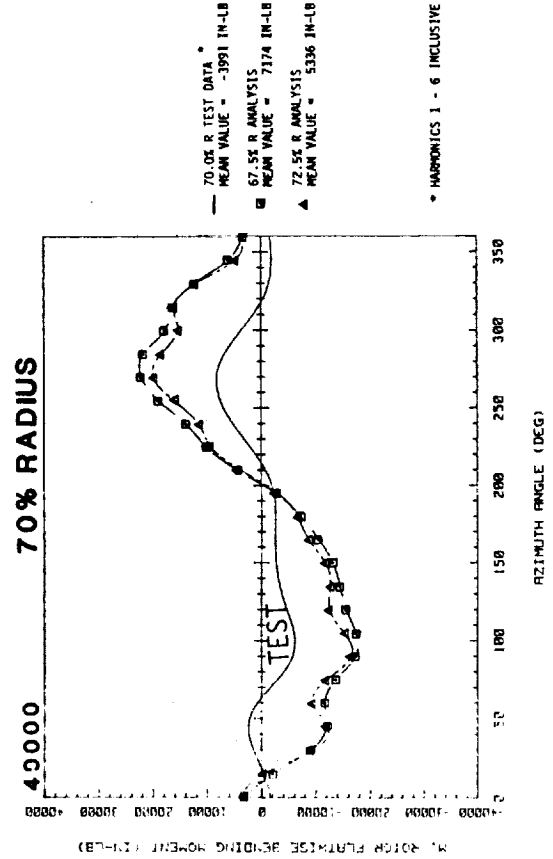
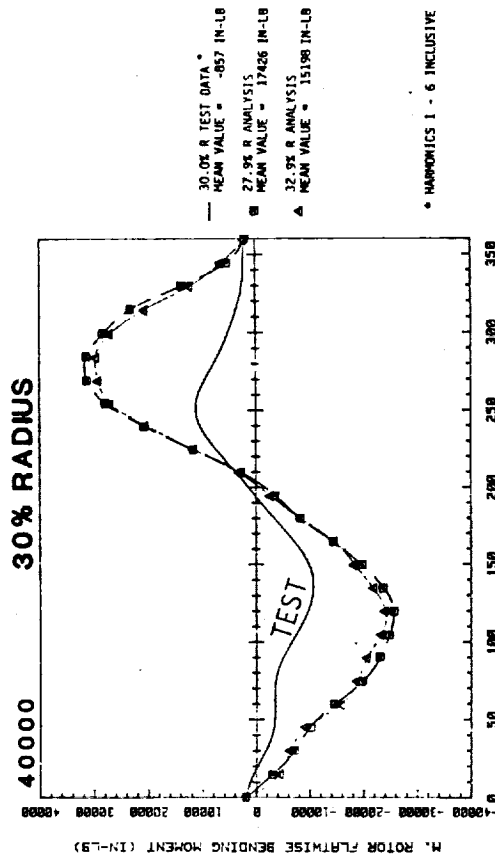
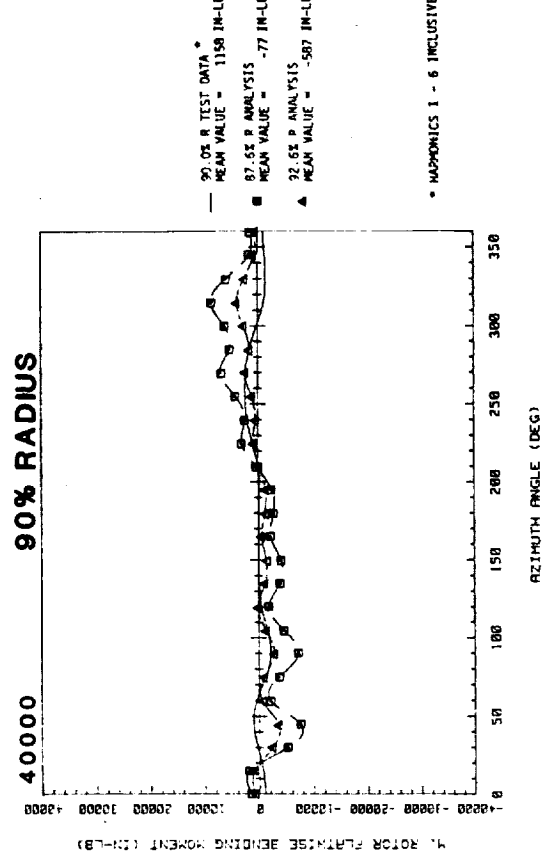
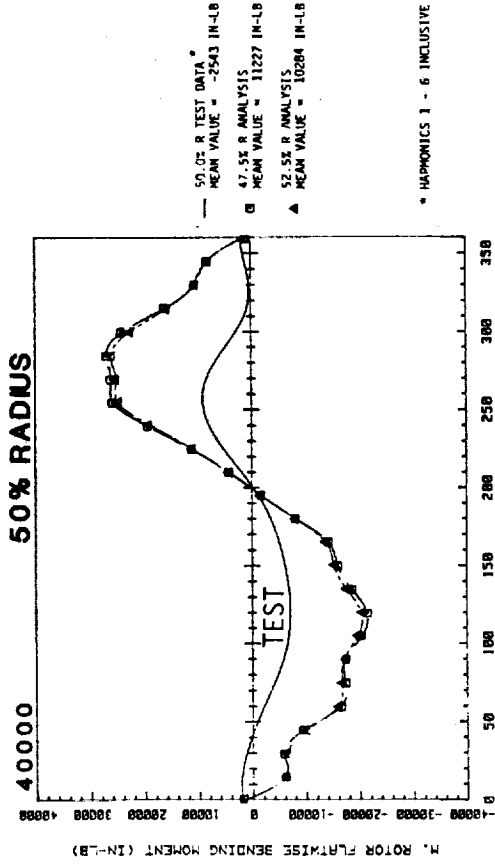

BLANK

ORIGINAL PAGE IS
OF POOR QUALITY

BLADE EDGEWISE BENDING MOMENT - TIME HISTORY

V = 67 KNOTS

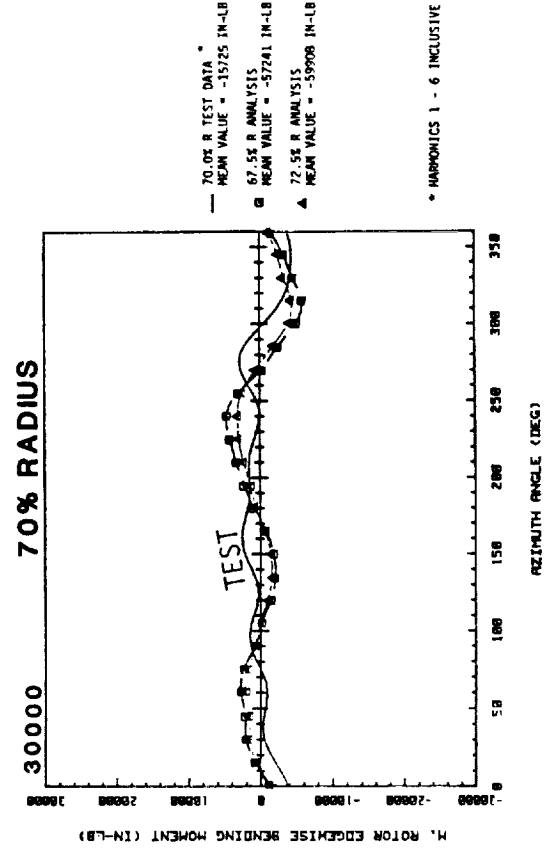
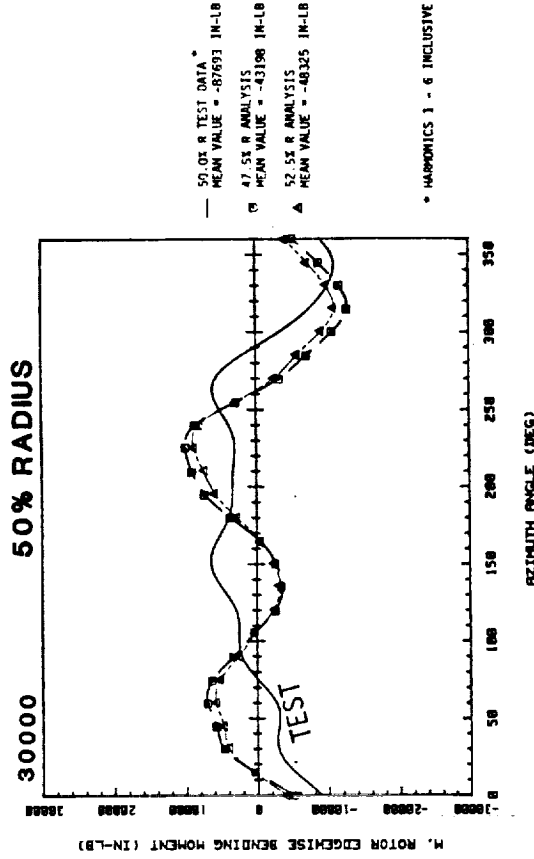
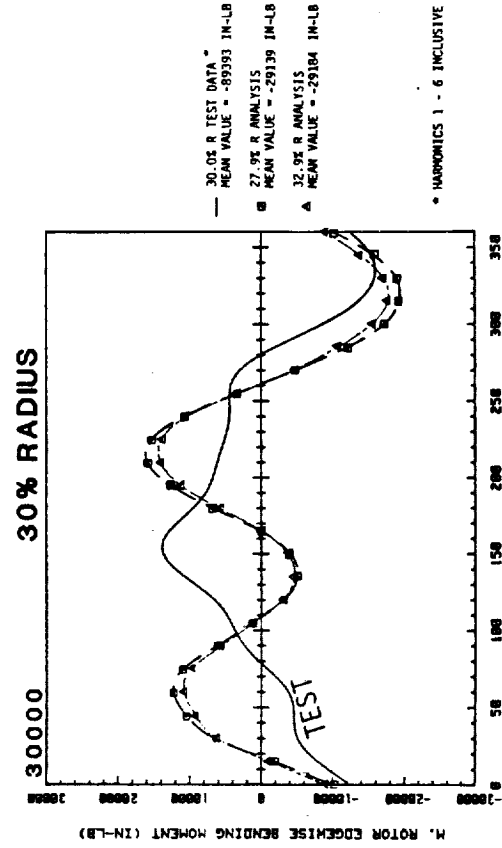

BLADE EDGEWISE BENDING MOMENT - TIME HISTORY

V = 101 KNOTS

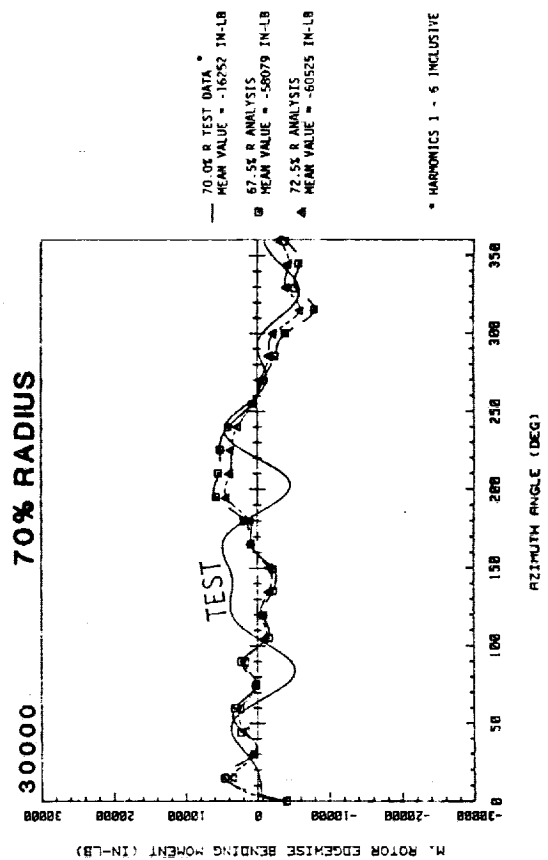
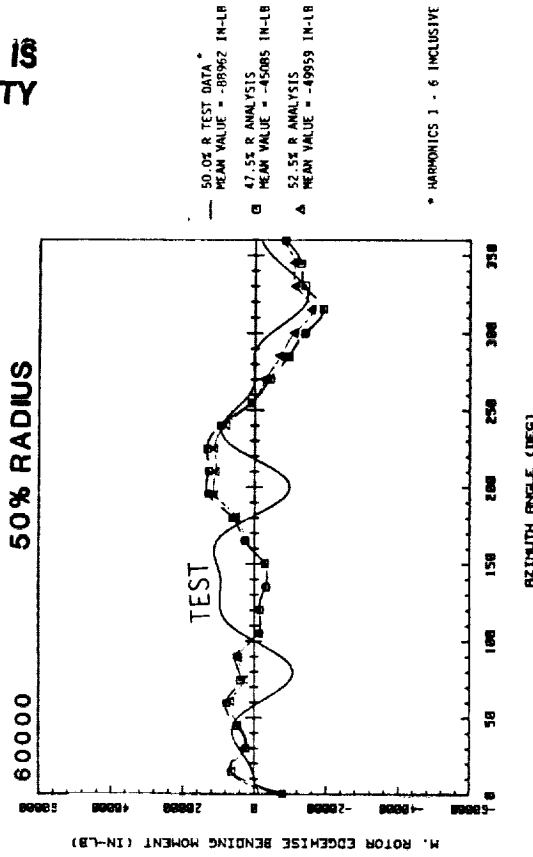
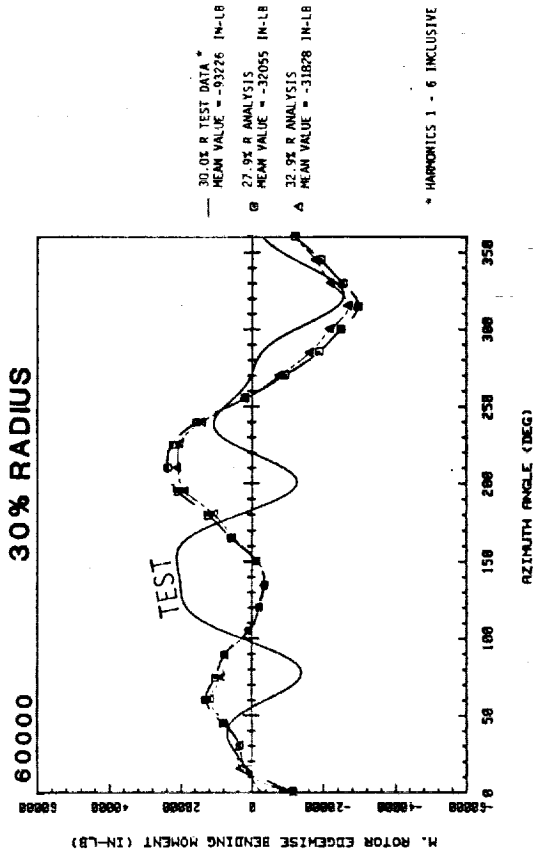

ORIGINAL PAGE IS
OF POOR QUALITY

BLADE EDGEWISE BENDING MOMENT - TIME HISTORY

V = 128 KNOTS

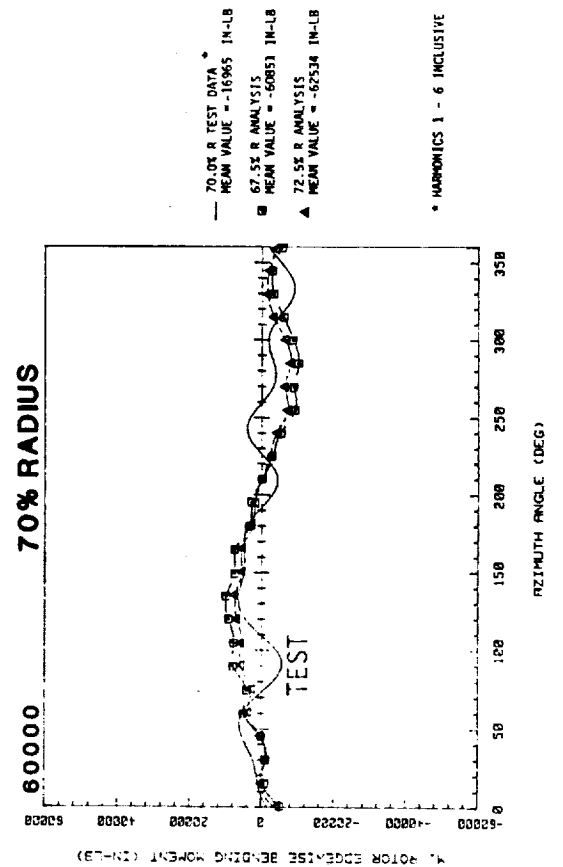
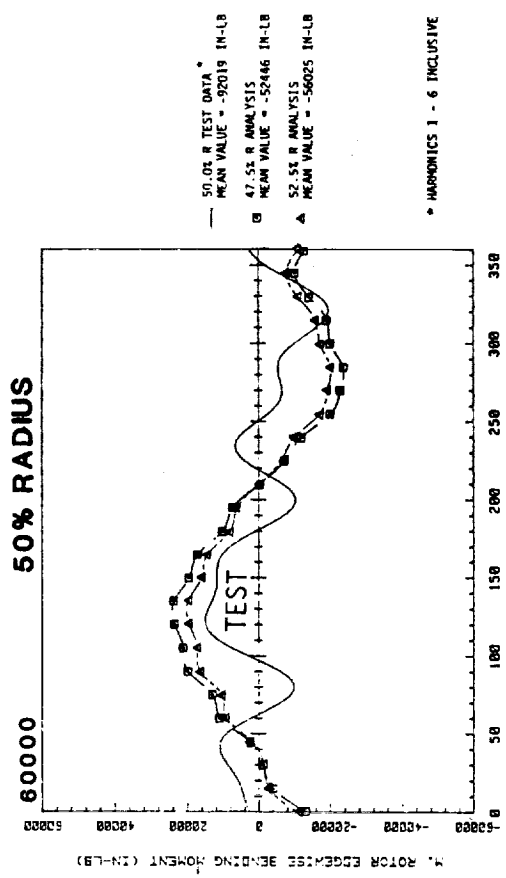
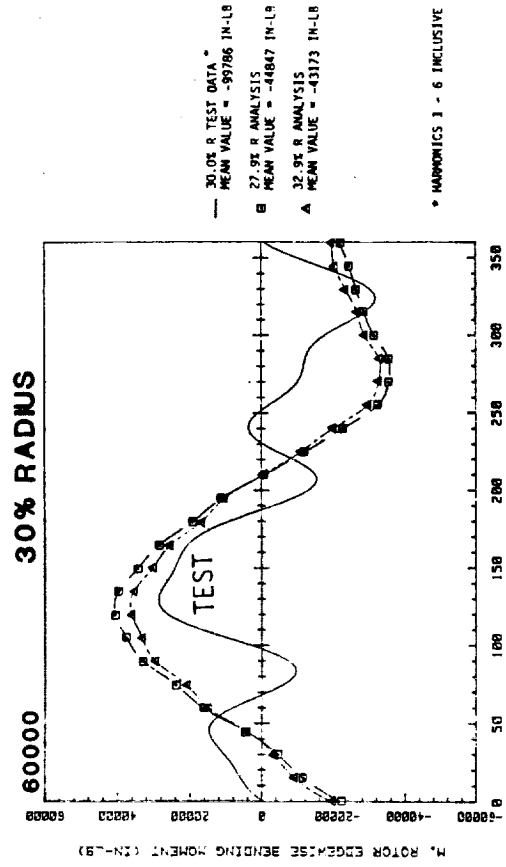

BLANK

ORIGINAL PAGE IS
OF POOR QUALITY

BLADE TORSIONAL MOMENT - TIME HISTORY

V = 67 KNOTS

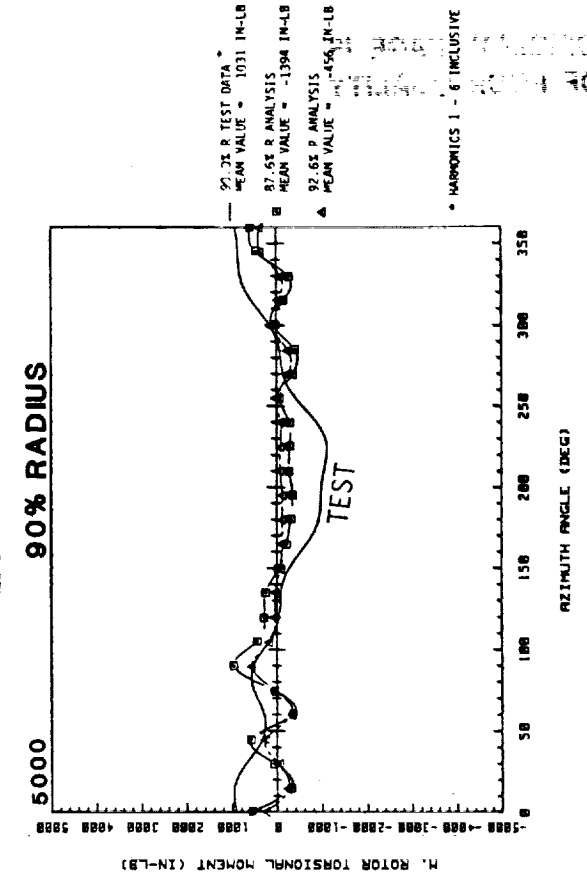
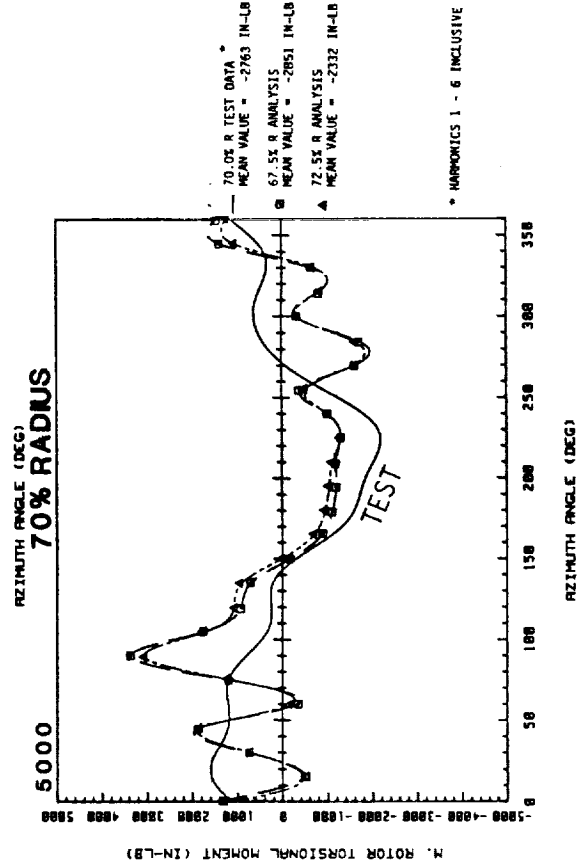
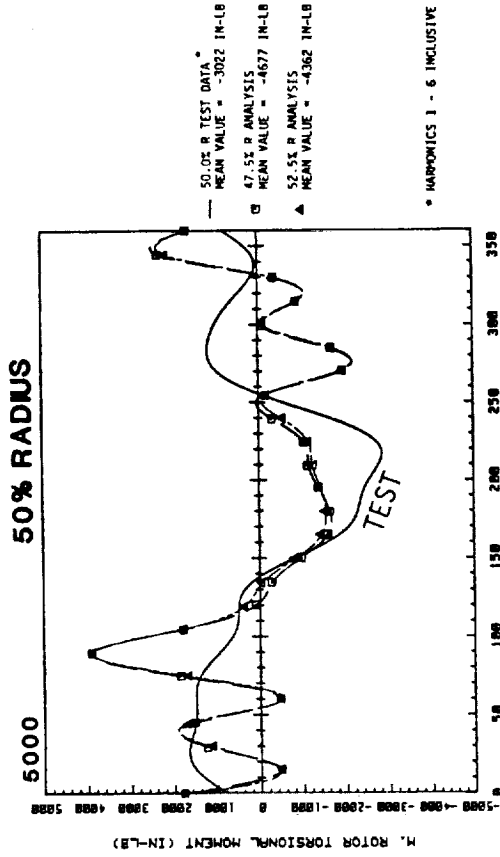
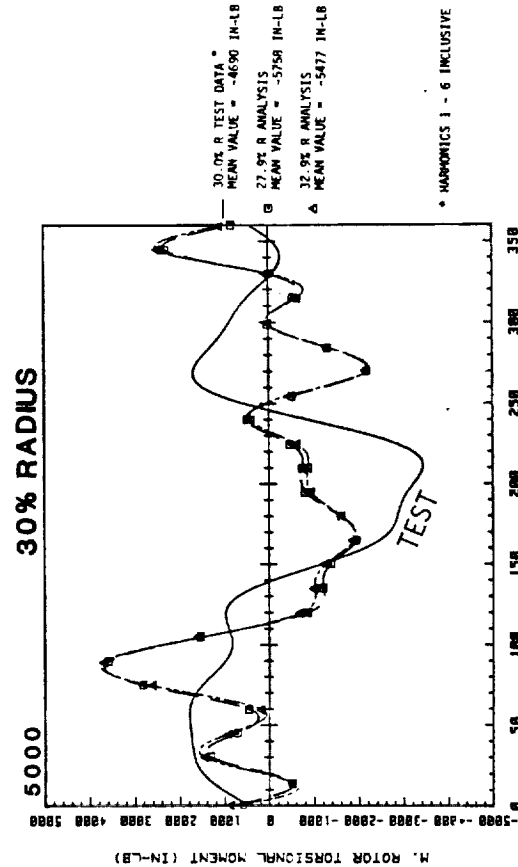

BLADE TORSIONAL MOMENT - TIME HISTORY

V = 101 KNOTS

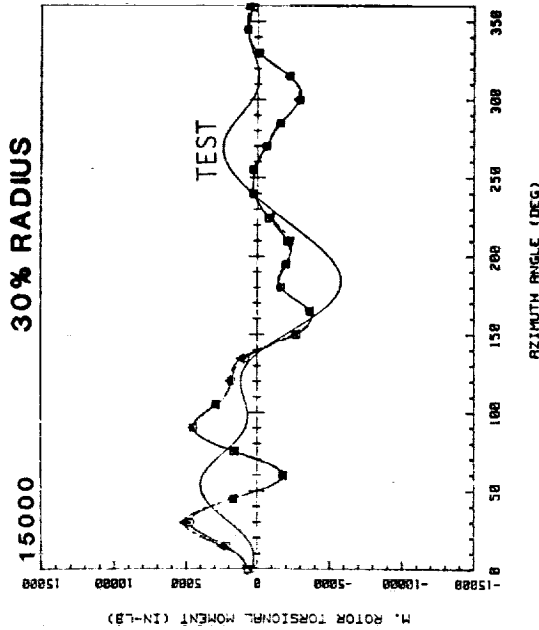

— 30.0% R. TEST DATA *
MEAN VALUE = -5324 IN-LB
□ 27.9% R. ANALYSIS
MEAN VALUE = -6360 IN-LB
▲ 32.9% R. ANALYSIS
MEAN VALUE = -5993 IN-LB

* HARMONICS 1 - 6 INCLUSIVE

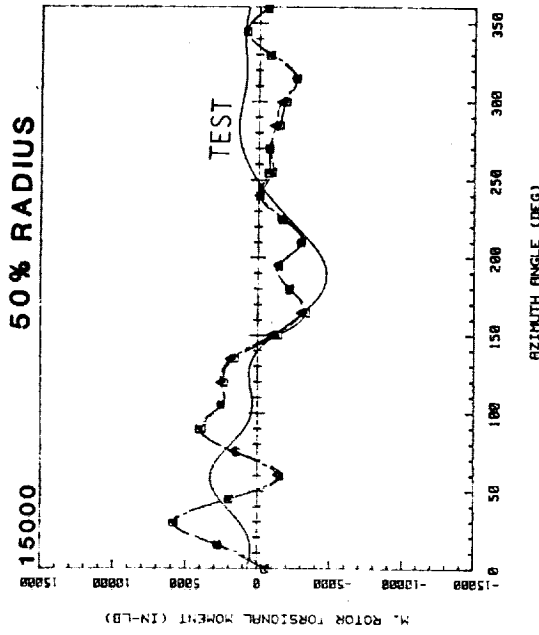

— 50.0% R. TEST DATA *
MEAN VALUE = -3378 IN-LB
□ 47.5% R. ANALYSIS
MEAN VALUE = -4876 IN-LB
▲ 52.5% R. ANALYSIS
MEAN VALUE = -4479 IN-LB

* HARMONICS 1 - 6 INCLUSIVE

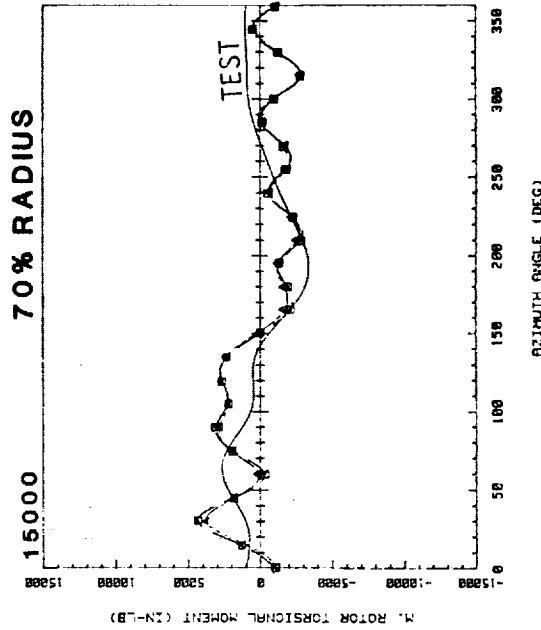

— 70.0% R. TEST DATA *
MEAN VALUE = -2978 IN-LB
□ 67.5% R. ANALYSIS
MEAN VALUE = -2790 IN-LB
▲ 72.5% R. ANALYSIS
MEAN VALUE = -2231 IN-LB

* HARMONICS 1 - 6 INCLUSIVE

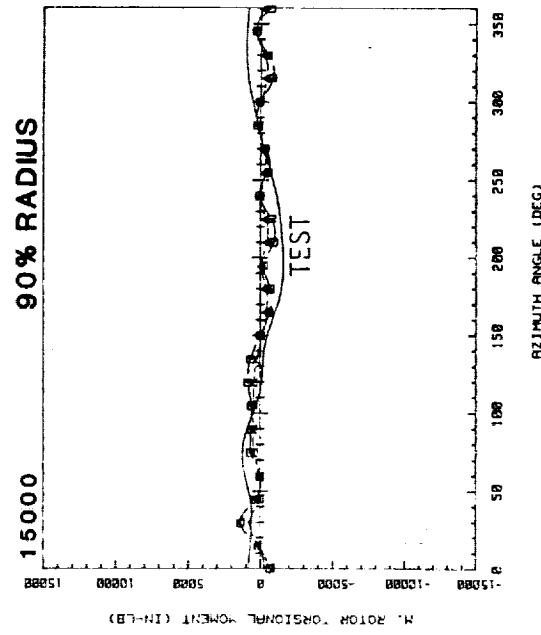

— 90.0% R. TEST DATA *
MEAN VALUE = -861 IN-LB
□ 87.5% R. ANALYSIS
MEAN VALUE = -1315 IN-LB
▲ 92.5% R. ANALYSIS
MEAN VALUE = -380 IN-LB

* HARMONICS 1 - 6 INCLUSIVE

BLADE TORSIONAL MOMENT - TIME HISTORY

V = 128 KNOTS

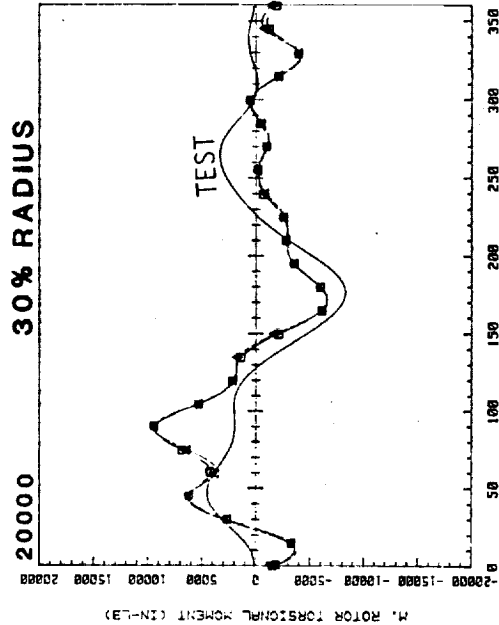

— 30.0% R TEST DATA *
MEAN VALUE = -6147 IN-LB
□ 27.5% R ANALYSIS
MEAN VALUE = -7633 IN-LB
▲ 32.5% R ANALYSIS
MEAN VALUE = -7232 IN-LB

* HARMONICS 1 - 6 INCLUSIVE

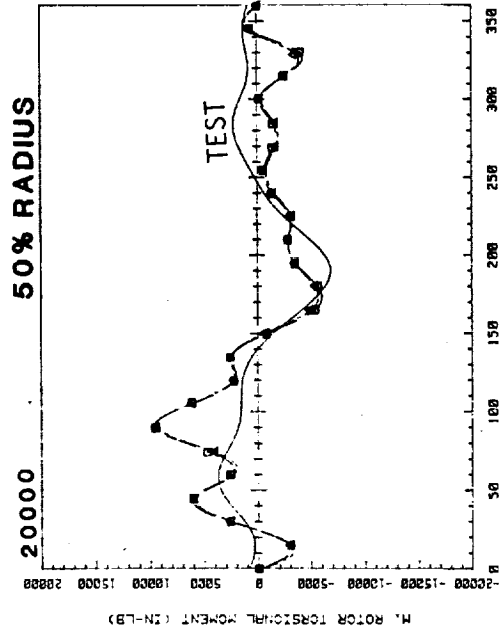

— 50.0% R TEST DATA *
MEAN VALUE = -4009 IN-LB
□ 47.5% R ANALYSIS
MEAN VALUE = -5964 IN-LB
▲ 52.5% R ANALYSIS
MEAN VALUE = -5488 IN-LB

* HARMONICS 1 - 6 INCLUSIVE

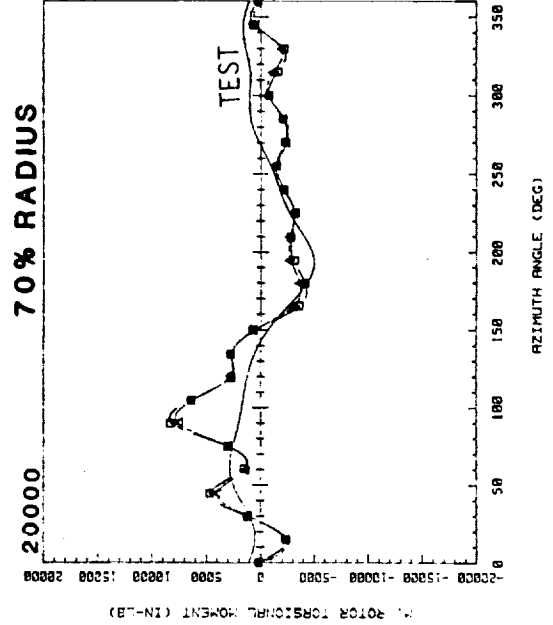

— 70.0% R TEST DATA *
MEAN VALUE = -5347 IN-LB
□ 67.5% R ANALYSIS
MEAN VALUE = -3430 IN-LB
▲ 72.5% R ANALYSIS
MEAN VALUE = -2734 IN-LB

* HARMONICS 1 - 6 INCLUSIVE

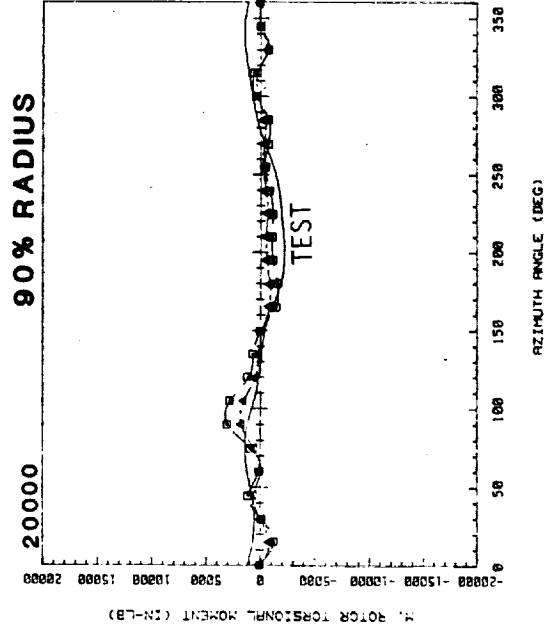

— 90.0% R TEST DATA *
MEAN VALUE = 676 IN-LB
□ 87.5% R ANALYSIS
MEAN VALUE = -1389 IN-LB
▲ 92.5% R ANALYSIS
MEAN VALUE = -389 IN-LB

* HARMONICS 1 - 6 INCLUSIVE

BLANK

7.2 Hub Loads and Fuselage Response

COMPUTED 2/REV HUB FORCES

The 2/rev uncoupled (rigid) and coupled (flexible) rotor hub forces computed from the C60 rotor loads program are shown for airspeeds of 67, 101 and 128 knots. As indicated previously, the planned number of airspeeds was reduced from six to three due to the excessive time required for the calculations. An analysis at the maximum test airspeed of 142 knots was not considered because the trim analysis would not converge.

In most cases, there is a significant difference in the uncoupled and coupled hub forces. This indicates a need for determining the coupled hub forces to correctly determine the fuselage response.

COMPUTED 2/REV HUB FORCES

<u>DIRECTION</u>	<u>FORCE (LB)</u>		
	<u>UNCOUPLED ROTOR ANALYSIS ("RIGID" HUB)</u>	<u>ROTOR-FUSELAGE COUPLED ANALYSIS ("FLEXIBLE" HUB)</u>	
XF	-793.35 + 264.63 I	-6.68 - 37.1 I	} 67 KNOTS
YF	-285.89 - 786.08 I	42.9 - 48.0 I	
ZF	-384.31 - 390.74 I	-352.8 - 347.0 I	
XF	-834.0 + 486.8 I	-30.8 + 16.57 I	} 101 KNOTS
YF	-518.4 - 915.9 I	-19.5 + 55.0 I	
ZF	-968.8 - 493.3 I	-880.8 - 423.0 I	
XF	-551.8 + 818.6 I	434.0 + 661.0 I	} 128 KNOTS
YF	-789.0 - 505.3 I	-928.0 + 315.0 I	
ZF	-677.6 - 1098.4 I	-598.0 - 964.0 I	

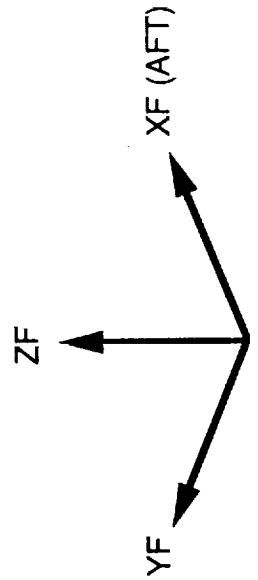

AH-1G LOCATION POINTS FOR CORRELATIONS

The calculated 2/rev hub loads were used in the NASTRAN program to calculate the fuselage response at the grid points (test measurement locations) shown.

AH-1G LOCATION POINTS FOR CORRELATION

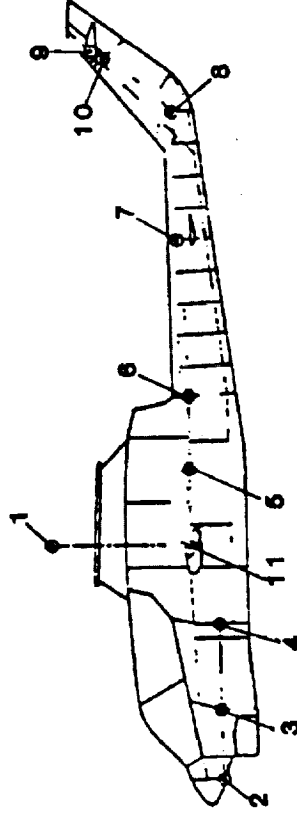
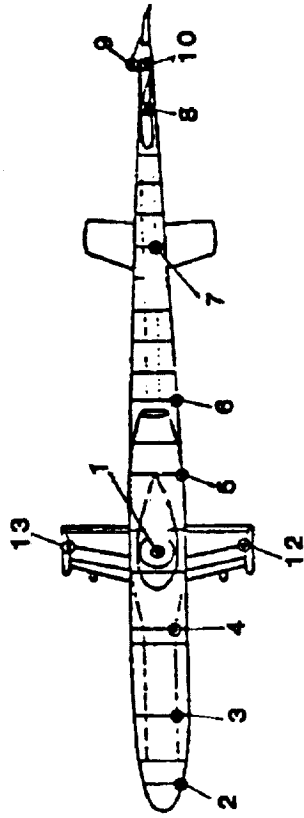

1. MAST TOP - GRID 200153
2. NOSE - GRID 4637
3. GUNNER - GRID 09337
4. PILOT - GRID 14837
5. ENGINE DECK - GRID 25069
6. TAIL BOOM - GRID 29969
7. TAIL BOOM - GRID 40147
8. TAIL BOOM - GRID 48845
9. 90° GEAR BOX - GRID 520079
10. TAIL BOOM VERTICAL FIN - GRID 51545
11. CENTER OF GRAVITY - GRID 20070
12. LEFT WING - GRID 75921
13. RIGHT WING - GRID 65921

AH-1G 2/REV FUSELAGE VIBRATION LEVELS

A comparison of the measured and calculated responses at the 13 test measurement locations are shown in turn, for the 67, 101 and 128 knot airspeeds. In each case a comparison of the response is shown for the values calculated using the uncoupled rotor hub loads (rigid hub) and values calculated using the coupled rotor hub loads (flexible hub).

AH-1G 2/REV FUSELAGE VIBRATION LEVELS MAST TOP - GRID 200153

V = 67 KNOTS

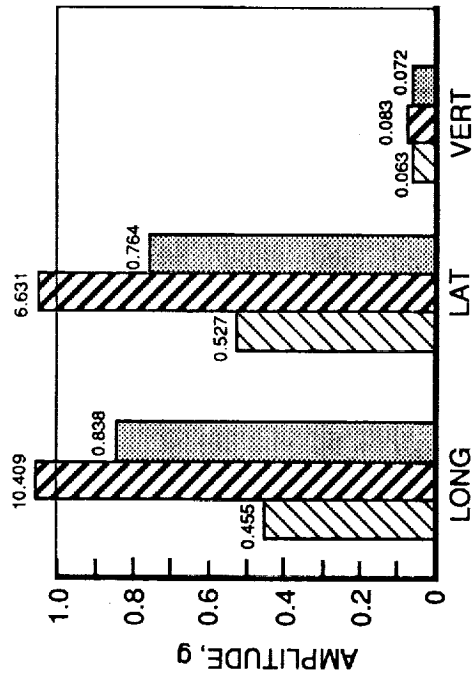

V = 101 KNOTS

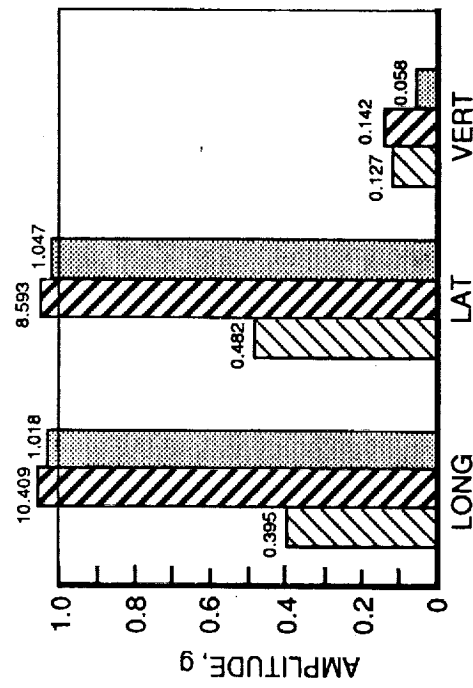

V = 128 KNOTS

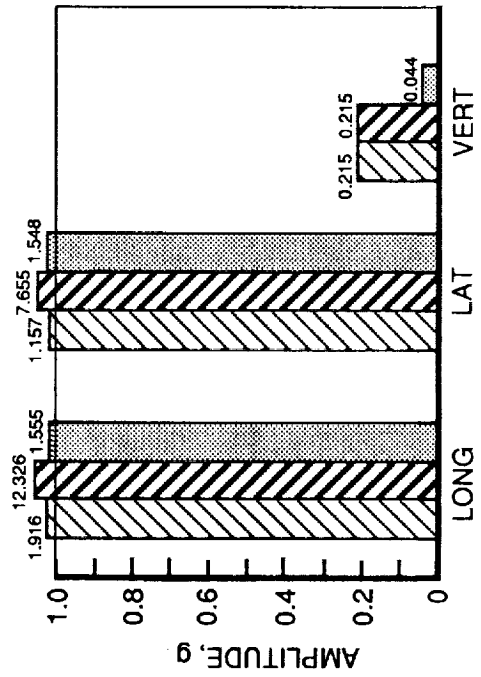

- FLEXIBLE HUB
- RIGID HUB
- TEST DATA

AH-1G 2/REV FUSELAGE VIBRATION LEVELS NOSE - GRID 4637

V = 67 KNOTS

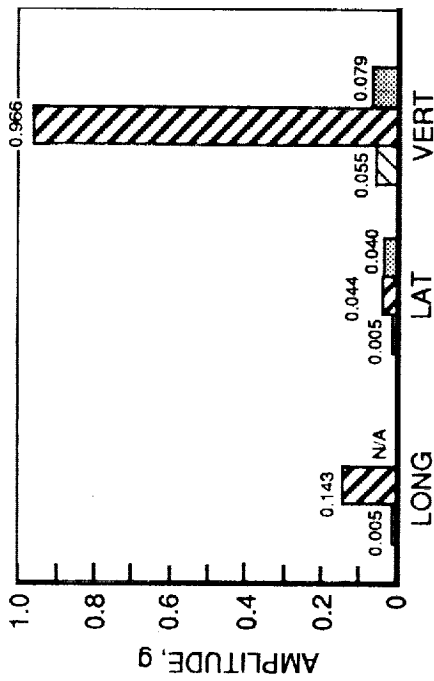

V = 101 KNOTS

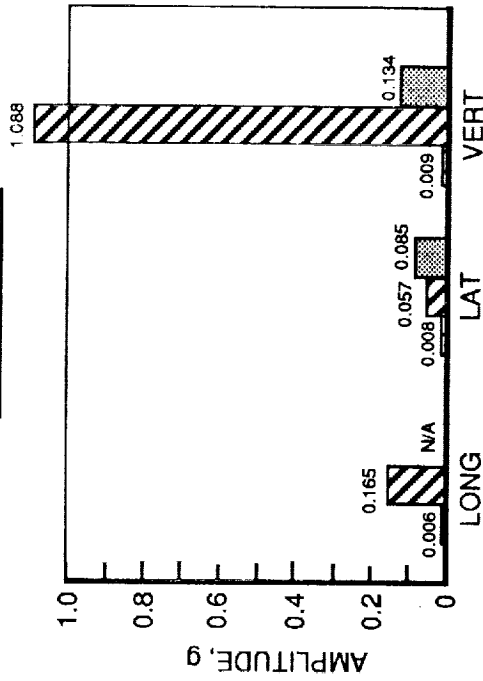

V = 128 KNOTS

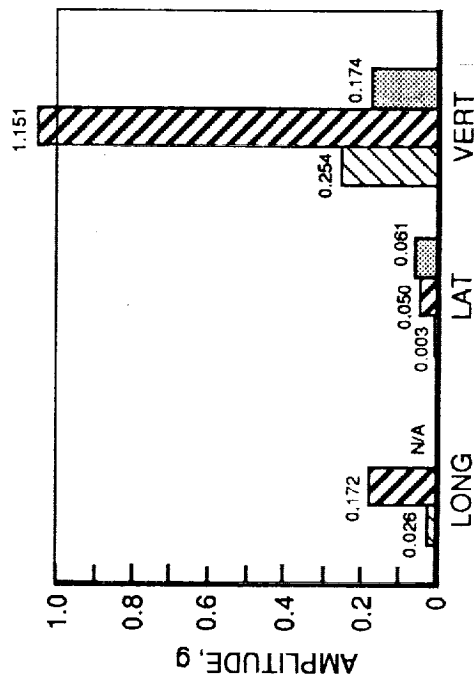

- FLEXIBLE HUB
- RIGID HUB
- TEST DATA

AH-1G 2/REV FUSELAGE VIBRATION LEVELS GUNNER - GRID 09337

V = 101 KNOTS

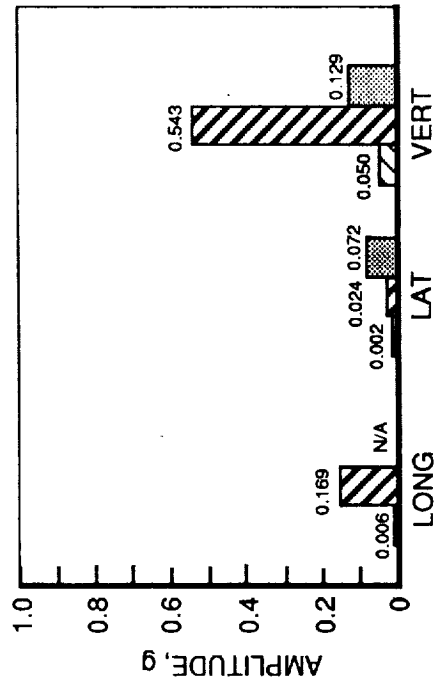

V = 67 KNOTS

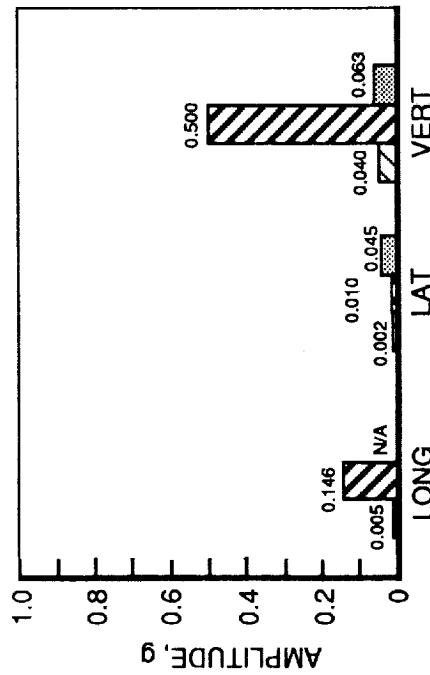

V = 128 KNOTS

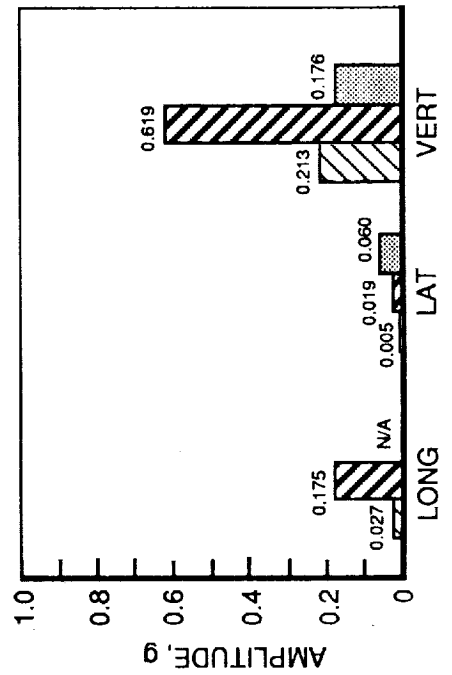

- FLEXIBLE HUB
- RIGID HUB
- TEST DATA

AH-1G 2/REV FUSELAGE VIBRATION LEVELS PILOT - GRID 14837

V = 67 KNOTS

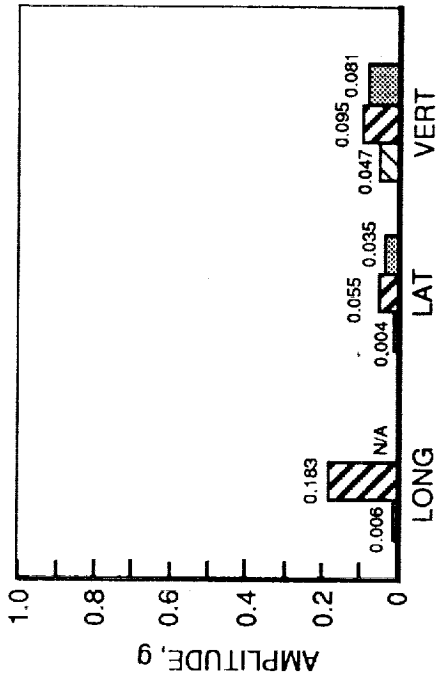

V = 101 KNOTS

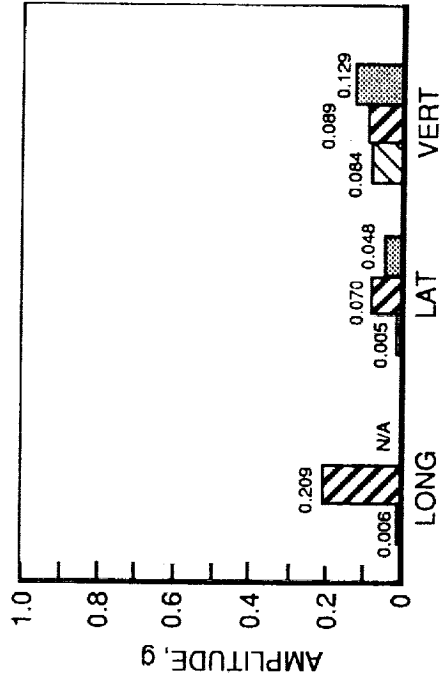

V = 128 KNOTS

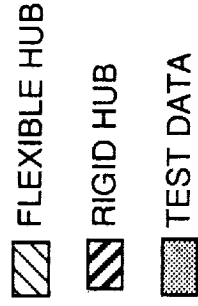
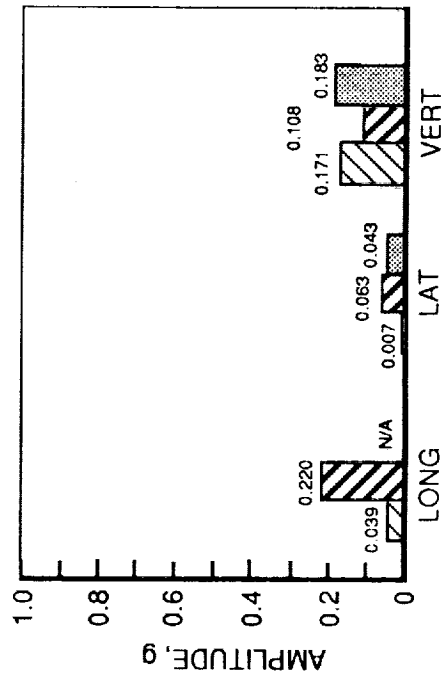

AH-1G 2/REV FUSELAGE VIBRATION LEVELS ENGINE DECK - GRID 25069

V = 67 KNOTS

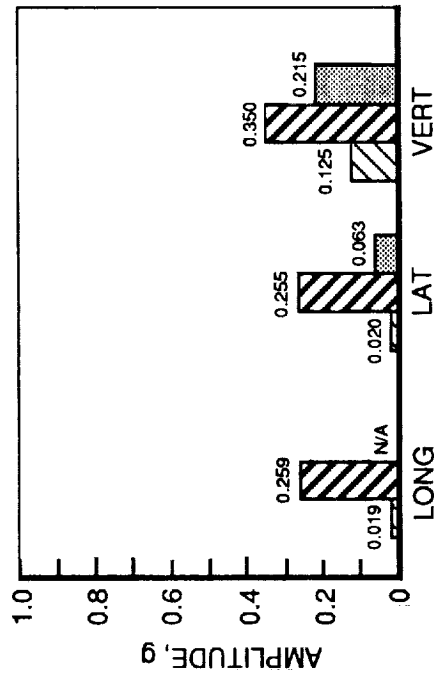

V = 101 KNOTS

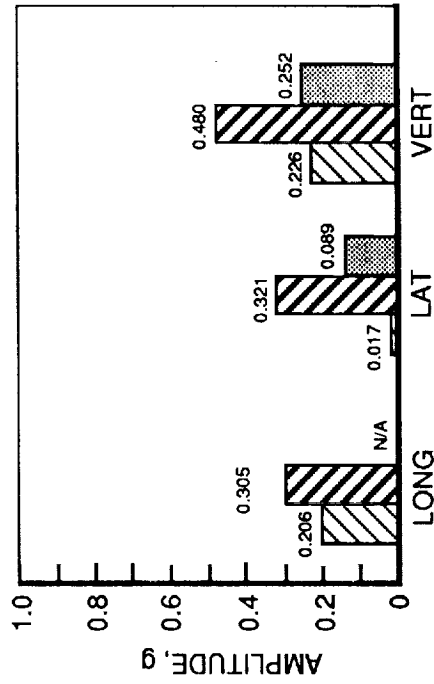

V = 128 KNOTS

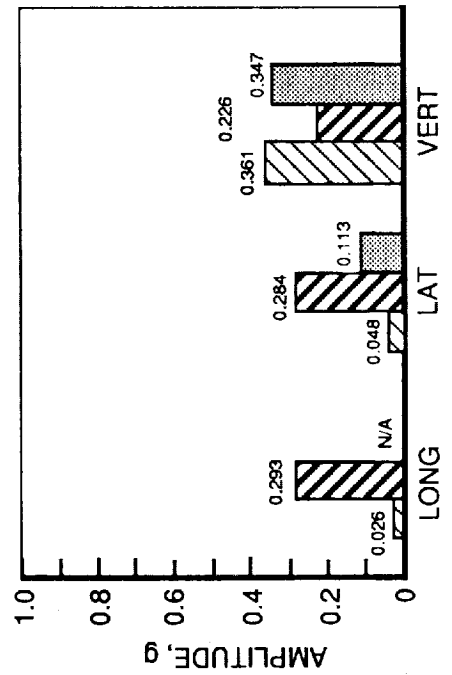

- FLEXIBLE HUB
- RIGID HUB
- TEST DATA

AH-1G 2/REV FUSELAGE VIBRATION LEVELS TAIL BOOM - GRID 29969

V = 67 KNOTS

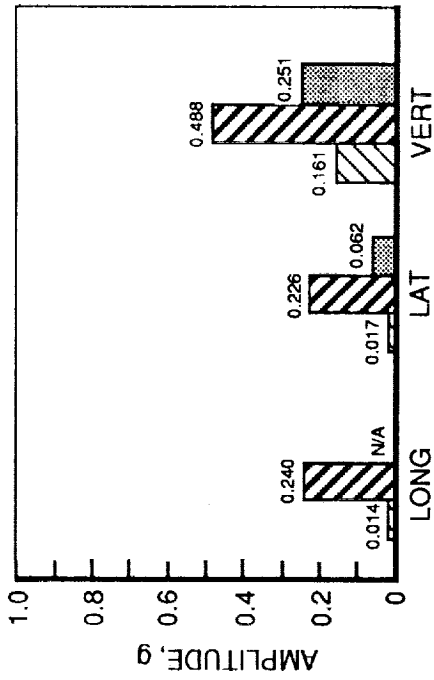

V = 101 KNOTS

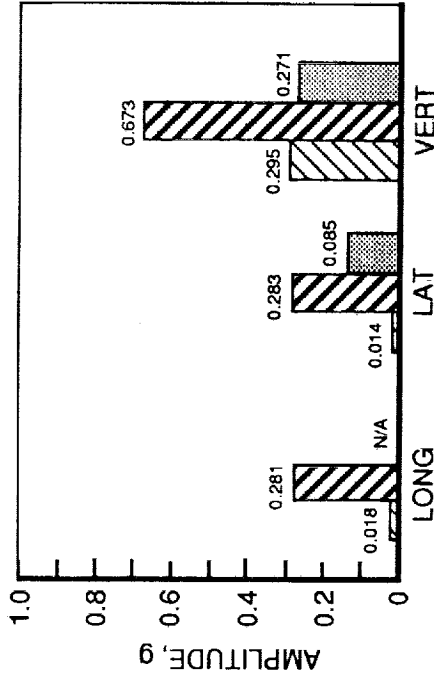

V = 128 KNOTS

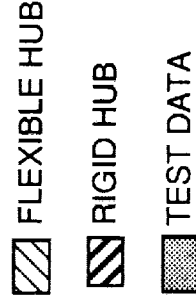
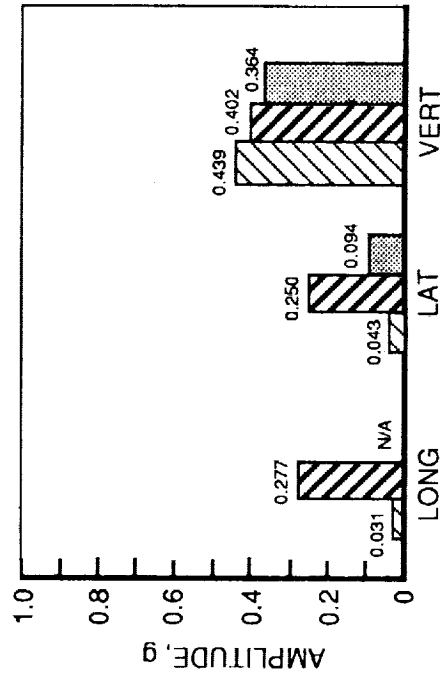

AH-1G 2/REV FUSELAGE VIBRATION LEVELS TAIL BOOM - GRID 40147

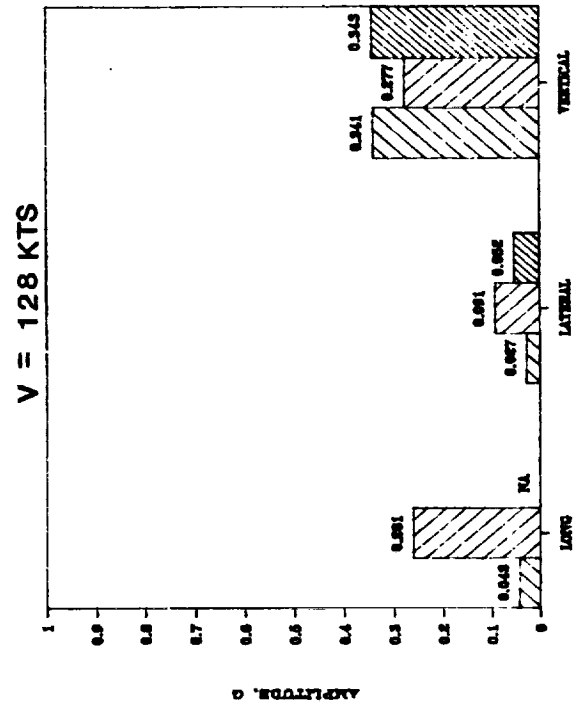
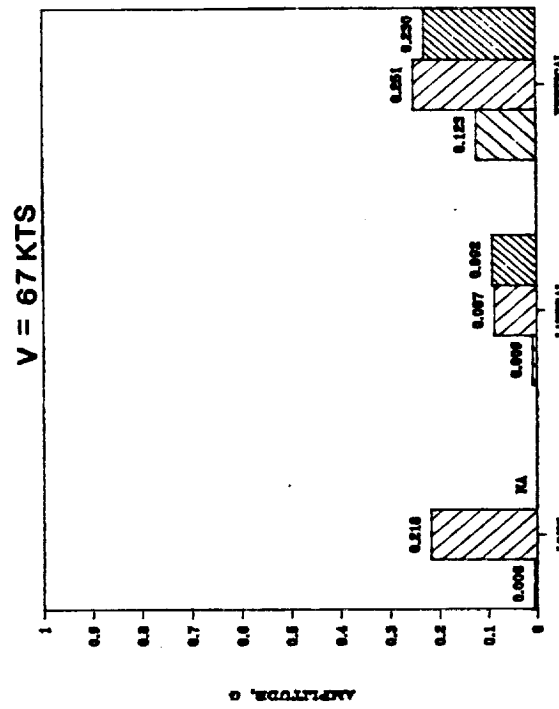
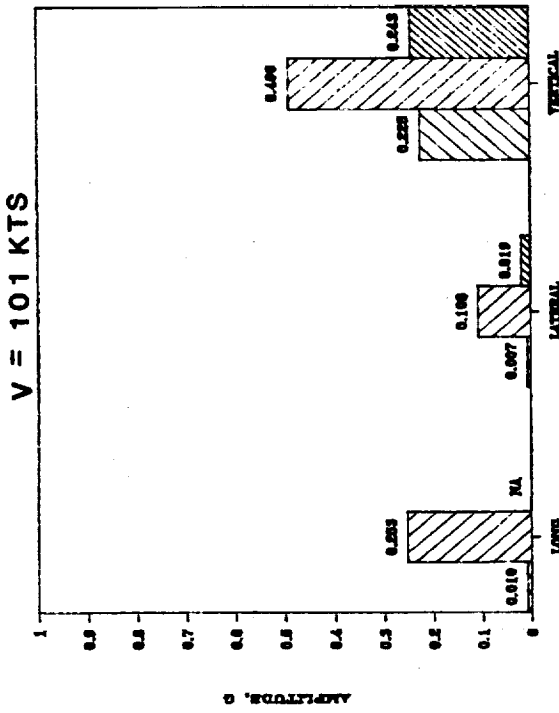

- FLEXIBLE HUB
- RIGID HUB
- TEST DATA

AH-1G 2/REV FUSELAGE VIBRATION LEVELS TAIL BOOM - GRID 48845

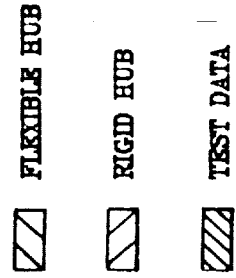
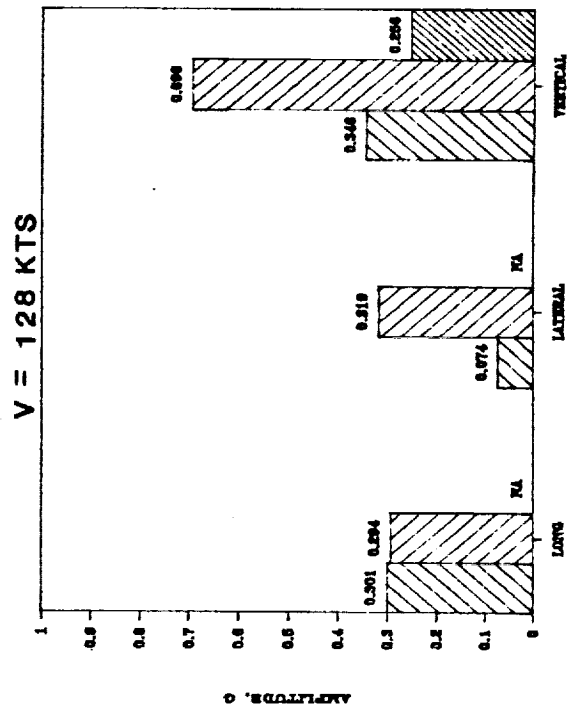
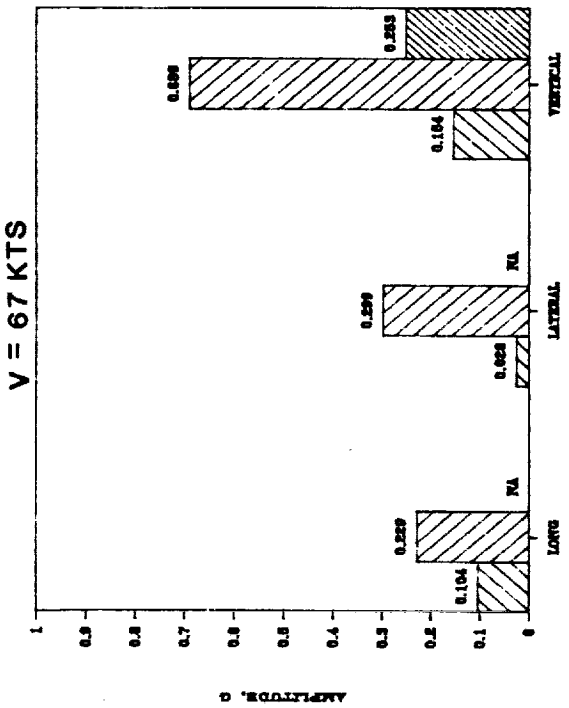
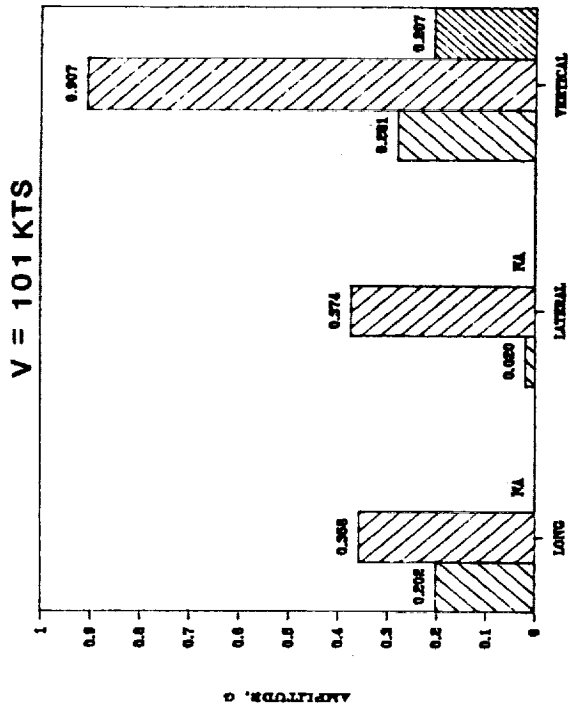

AH-1G 2/REV FUSELAGE VIBRATION LEVELS 90° GEAR BOX - GRID 520079

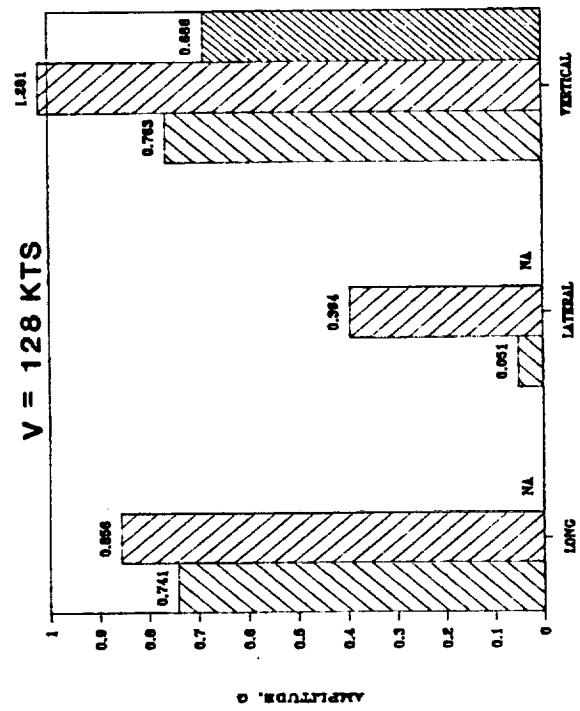
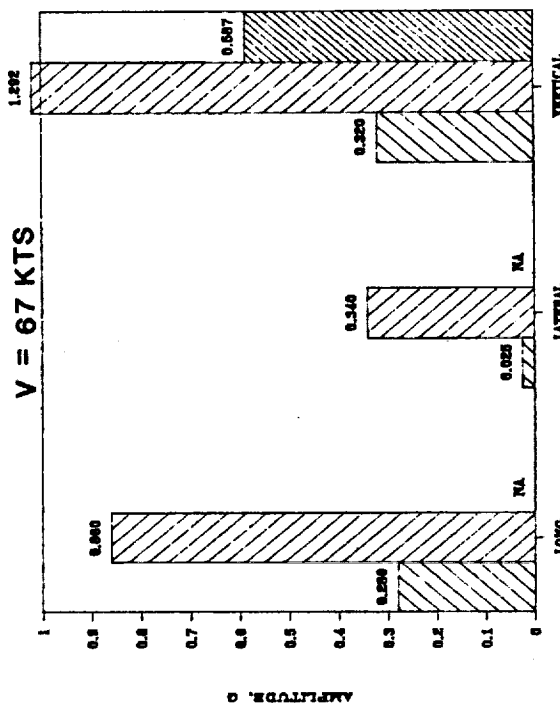
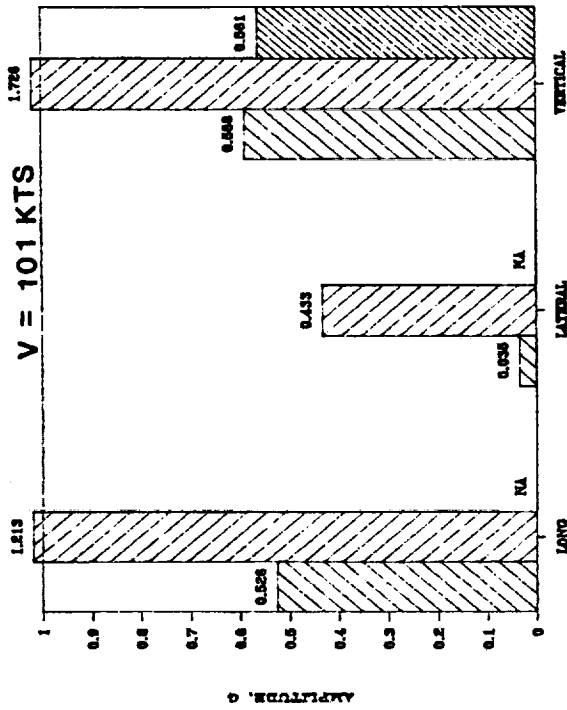

- FLEXIBLE HUB
- RIGID HUB
- TEST DATA

AH-1G 2/REV FUSELAGE VIBRATION LEVELS TAIL BOOM VERTICAL FIN - GRID 51545

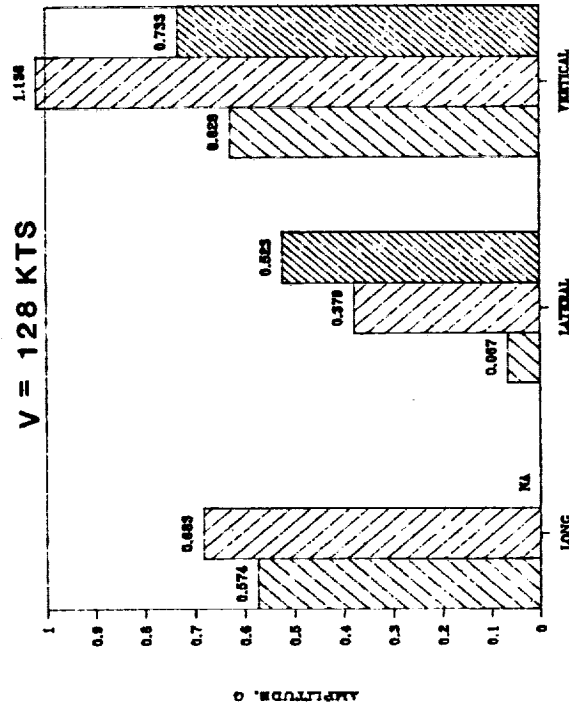
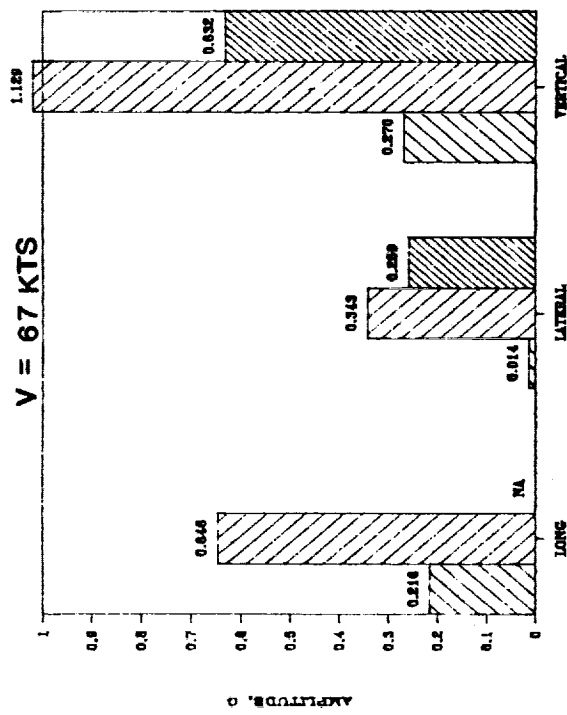
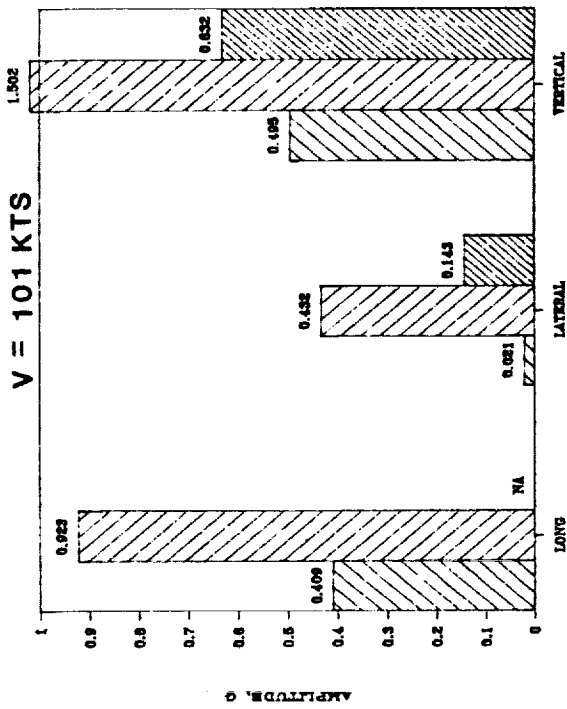

FLEXIBLE HUB
 RIGID HUB
 TEST DATA

AH-1G 2/REV FUSELAGE VIBRATION LEVELS CENTER OF GRAVITY - GRID 20070

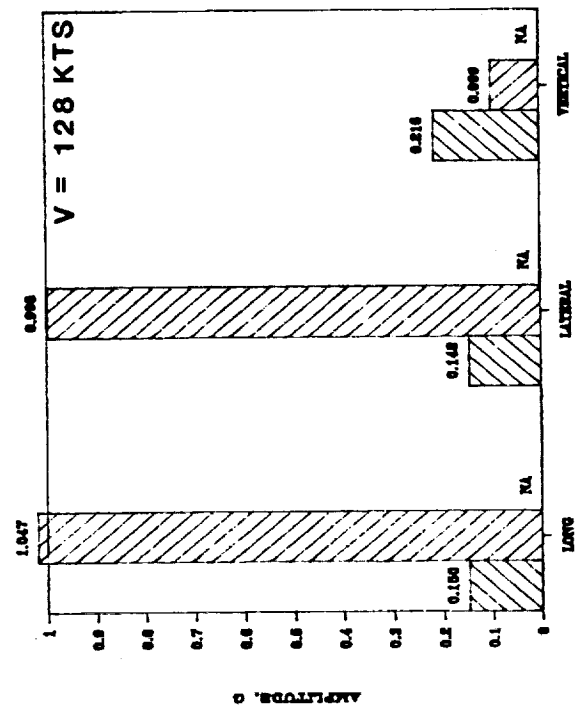
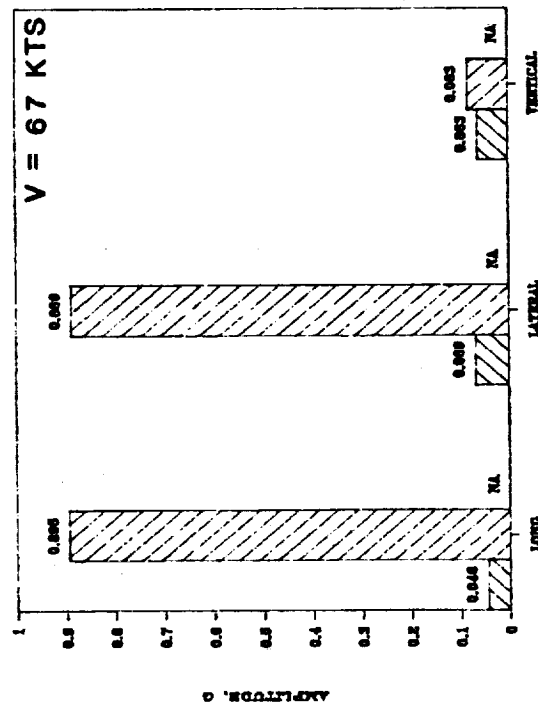
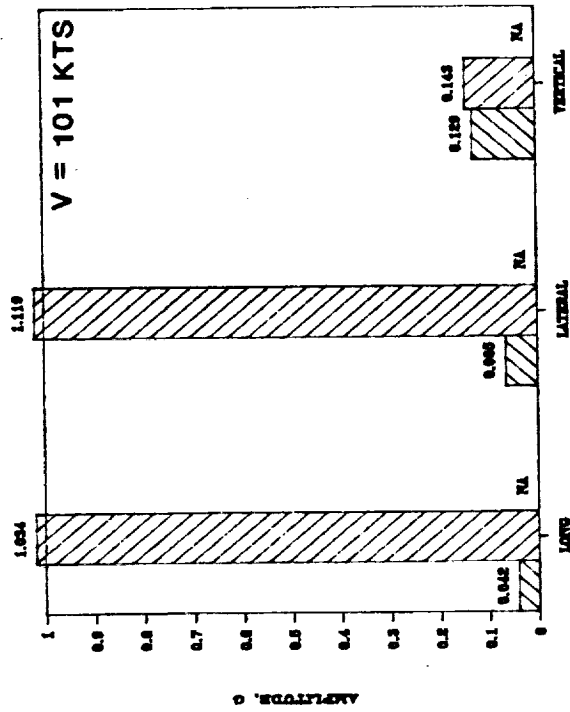

- FLEXIBLE HUB
- RIGID HUB
- TEST DATA

AH-1G 2/REV FUSELAGE VIBRATION LEVELS LEFT WING - GRID 75921

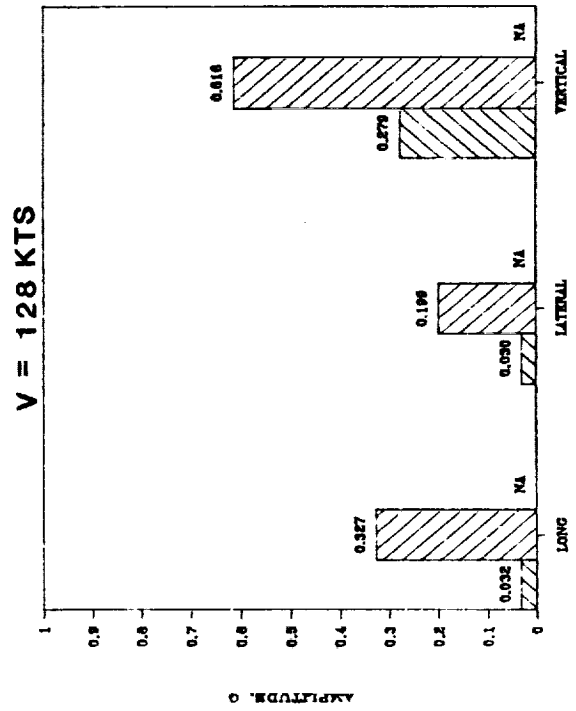
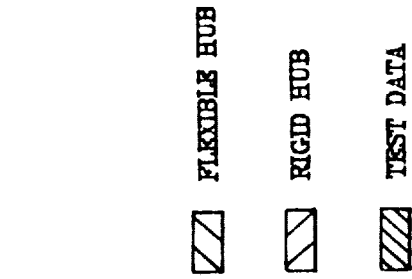
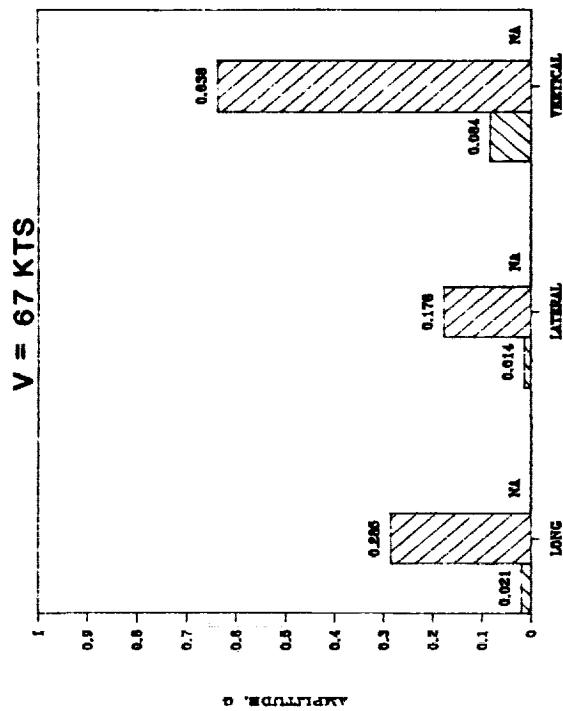
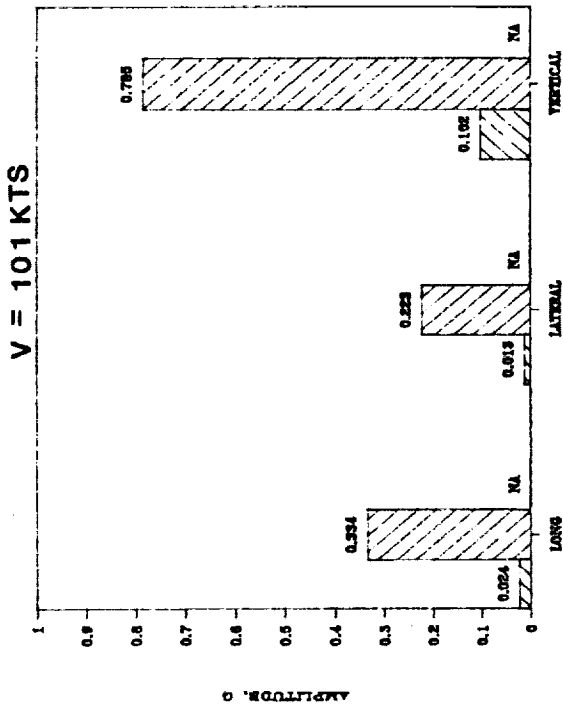

AH-1G 2/REV FUSELAGE VIBRATION LEVELS RIGHT WING - GRID 65921

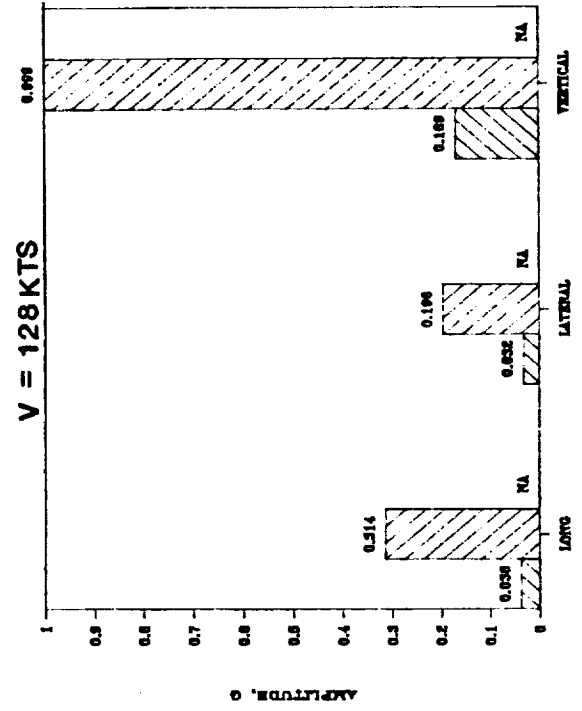
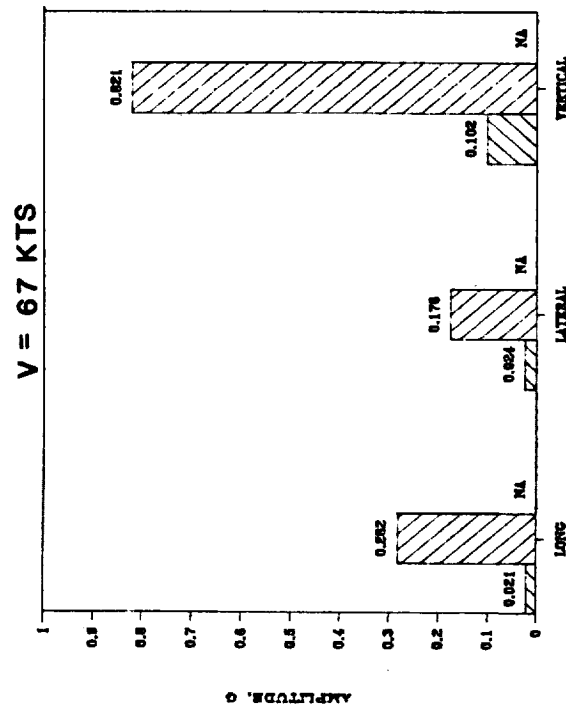
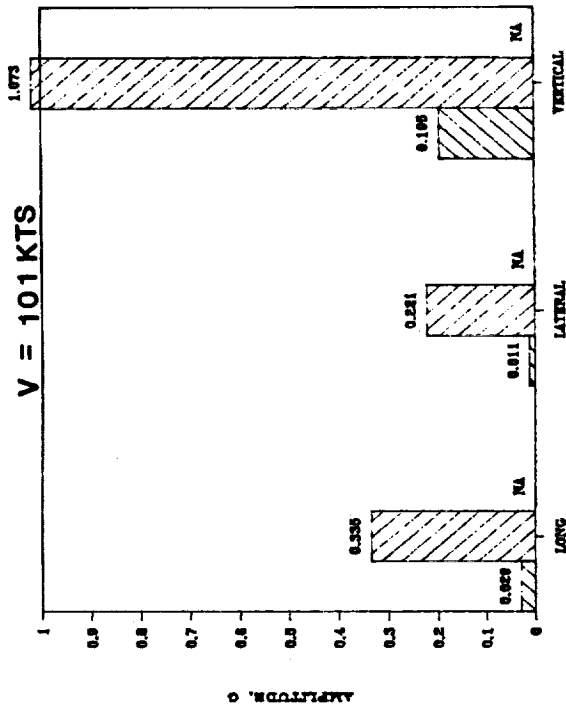

- FLEXIBLE HUB
- RIGID HUB
- TEST DATA

BLANK

8.0 Summary and Conclusions

MODELING ISSUES

The C60 program requires inputs which are dependent upon a proper knowledge of the trim condition of the helicopter. Additional trim information is required to obtain the propulsive and lift forces necessary to move the fuselage at the different airspeeds. In particular, the rotor thrust, propulsive force and side forces acting on the fuselage need to be known with good accuracy in a 'trimmed' position.

Due to the angular deflection of the mast tip caused by the hub loads, the values of the measured flap angles are questionable. A better understanding of the measurement of the flap angles and the elastic deformation of the rotor shaft is necessary for proper comparison of measured and calculated values.

With an underslung rotor, 1/rev flapping induces a 2/rev flapping motion of the rotor, which will have an effect on the 2/rev loads. This situation was recognized but not pursued.

It is known that the modeling of the wake affects the calculated vibratory hub loads. The effect of wake modeling on hub loads and sensitivity coefficients needs further consideration.

Finally, in order to properly calculate the vibratory response of the fuselage, the fuselage and empennage air loads need to be considered along with the rotor loads. Of these two, the empennage air loads are probably most significant.

MODELING ISSUES

- 1. ADDITIONAL INFORMATION IS REQUIRED TO ACHIEVE PROPER TRIM CONDITIONS IN C-60**
- 2. MEASURED FLAP AND PITCH ANGLES ARE AFFECTED BY THE MAST TOP ELASTIC ANGULAR DEFORMATION CAUSED BY THE HUB LOADS. THE MAGNITUDE AND IMPORTANCE OF THIS ELASTIC ANGULAR EFFECT UPON THE TRUE FLAP AND PITCH ANGLES NEEDS TO BE CONSIDERED**
- 3. RECOGNIZED BUT NOT CONSIDERED WAS THE FACT THAT 1/REV FLAPPING INDUCED 2/REV HUB MOTION WITH THE UNDERSLUNG AH-1G HUB**
- 4. EFFECT OF WAKE MODEL ON HUB LOADS AND SENSITIVITY COEFFICIENTS NEEDS FURTHER CONSIDERATION**
- 5. EFFECT OF AIR LOADS ON FUSELAGE AND EMPENNAGE NEED TO BE CONSIDERED**
- 6. EFFECT OF UPWARD AIR FLOW FROM THE "NOSE" INTO THE ROTOR WHILE IN FORWARD FLIGHT**

SUMMARY AND CONCLUSIONS

In order to obtain the necessary loads sensitivity data for use in a coupled rotor-fuselage analysis more efficiently, modification of the C60 rotor loads program is required. Non-linear response of the rotor loads with hub motion necessitated a time consuming trial and error approach. An iterative routine within the program is needed to obtain results in an expeditious manner.

Computer hub loads showed significant differences between the uncoupled rotor loads (rigid hub) and those obtained with rotor-fuselage coupling (flexible hub). Given accurate rotor and fuselage models, a suitable coupling program is, therefore, necessary to obtain correct rotor loads and fuselage response.

A better understanding of the effect of the underslung AH-1G rotor on the rotor-fuselage coupling is necessary if correlation is to be improved. Modeling of the underslung rotor presented problems using the existing Boeing C60 rotor loads program. Consequently, the underslinging was omitted.

Overall, the correlation between calculated and measured response was considered only fair.

SUMMARY AND CONCLUSIONS

- **The C60 program requires modification to more efficiently obtain the necessary loads sensitivity data for use in a coupled rotor-fuselage vibration analysis.**
- **Calculated vibratory hub loads are greatly influenced by the coupled rotor-fuselage motion. Accurate rotor and fuselage models together with a suitable coupling program are necessary to obtain correct rotor loads and fuselage response.**
- **Development effort is required to properly account for an underslung hub in the rotor-fuselage coupling program.**
- **Correlation of analytical and test results was fair.**

BLANK

9.0 References

BLANK

REFERENCES

1. Shockey, G.A., Cox, C.R. and Williamson, J.W.: AH-1G Helicopter Aerodynamic and Structural Loads Survey. USAAMRDL TR 76-39, February 1977.
2. Cronkhite, J.D., Berry, V.L., and Brunken, J.E.: A NASTRAN Vibration Model of the AH-1G Helicopter Airframe. U.S. Army Armament Command Report No. R-TR-74-045, June 1974.
3. Cronkhite, J.D. and Dompka, R.V., Summary of AH-1G Flight Vibration Data for Validation of Coupled Rotor-Fuselage Analyses, NASA CR-178160, November 1986.
4. Gabel, R.: Current Loads Technology for Helicopter Rotors. AGARD CP 122, April 1973.
5. Staley, J.A. and Sciarra, J.J.: Coupled Rotor/Airframe Vibration Prediction Methods. NASA SP 352, February 1974.
6. Novak, M.E.: Rotating Elements in the Direct Stiffness Method of Dynamic Analysis with Extensions to Computer Graphics. 40th Symposium on Shock and Vibration, Hampton, VA, October 1969.



Report Documentation Page

1. Report No. NASA CR - 181923		2. Government Accession No.		3. Recipient's Catalog No.	
4. Title and Subtitle Calculation of Flight Vibration Levels of the AH-1G Helicopter and Correlation with Existing Flight Vibration Measurements			5. Report Date November 1989		
			6. Performing Organization Code		
7. Author(s) R.A. DiTaranto and V. Sankewitsch			8. Performing Organization Report No.		
			10. Work Unit No. 505-63-51-01		
9. Performing Organization Name and Address Boeing Helicopters P.O. Box 16858 Phila., PA 19142-0858			11. Contract or Grant No. NAS1-17497		
			13. Type of Report and Period Covered Contractor Final Report		
12. Sponsoring Agency Name and Address National Aeronautics and Space Administration Langley Research Center Hampton, VA 23665-5225			14. Sponsoring Agency Code		
			15. Supplementary Notes Langley Technical Monitor: R.G. Kvaternik Final Report		
16. Abstract <p>Boeing Helicopters, together with other U.S. Helicopter manufacturers, participated in a finite element applications program to emplace in the United States a superior capability to utilize finite element analysis models in support of helicopter airframe design. The program was sponsored by the NASA Langley Research Center. Under this program, an activity was sponsored to evaluate existing analysis methods applicable to calculate coupled rotor-airframe vibrations. The helicopter used in this evaluation was the AH-1G helicopter manufactured by Bell Helicopter Textron.</p> <p>This report summarizes the results of the Boeing Helicopters efforts. The planned analytical procedure is reviewed. Changes to the planned procedure are discussed, and results of the correlation study are presented.</p>					
17. Key Words (Suggested by Author(s)) NASTRAN AH-1G Helicopter DAMVIBS Flight Vibration			18. Distribution Statement Unclassified - Unlimited Subject Category 39		
19. Security Classif. (of this report) Unclassified		20. Security Classif. (of this page) Unclassified		21. No. of pages 130	22. Price A07