

N90-21091

**INITIAL OPERATIONAL CAPABILITY OF THE
ASTREX LARGE SPACE STRUCTURES TEST BED**

**1Lt G. A. Norris, USAF
Air Force Astronautics Laboratory
Edwards AFB, CA**

Future DOD, NASA, and SDI space systems will be larger than any spacecraft flown before. The economics of placing these large space systems (LSS) into orbit dictates that they be as low in mass as possible. The combination of very large size and relatively low mass produces systems which possess little structural rigidity. This flexibility causes severe technical problems when combined with the precise shape and pointing requirements associated with many future LSS missions. Development of new control technologies which can solve these problems and enable future LSS missions is under way, but a test bed is needed for demonstration and evaluation of the emerging control hardware (sensors and actuators) and methodologies. In particular, the need exists for a facility which enables both large angle slewing and subsequent pointing/shape control of a variety of flexible bodies. The Air Force Astronautics Laboratory (AFAL) has conceived the Advanced Space Structures Technology Research Experiments (ASTREX) facility to fill this need.

Large Space System Dynamics & Control ...

The Problem:

- * Unprecedented Size and Low Structural Mass Density**
- * Very Precise Pointing and Shape Control Requirements**
- * Significant Onboard and Mission Induced Disturbances**
 - Unprecedented Degree of Control-Structure Interaction**
 - High Modal Density Complicates Control**
 - No Prior Experience in Modeling/Control of Such Systems**
 - Large Physical Size Makes Ground Testing Difficult**

Solution:

- * Combination of Passive and Active Vibration Damping**
- * Ground Facility to Test and Validate Emerging Space Structures Technology**

The range of technologies being developed in response to the LSS dynamics and control problem is broad. Included in this class of innovative technologies are many which must be demonstrated in ground test facilities. This class includes new actuators for slewing, vibration isolation, vibration suppression and shape control; structural sensors, including those embedded in composite structural elements during fabrication; structural solutions such as damping treatments, innovative materials, and advanced configurations; methodology advancements including new control and identification algorithms; and finally advances in ground test methods themselves, including scaling methodologies, micro-gravity simulation methods, etc.

NEW TECHNOLOGIES MUST BE DEMONSTRATED IN GROUND TEST FACILITIES

- **Control Algorithms**
- **Slew Actuators**
- **Vibration Suppression Actuators**
- **Shape Control Actuators**
- **Structural Sensors**
- **Vibration Isolators**
- **Damping Treatments**
- **Structural Materials**
- **Structural Configurations**
- **Analytical Models**
- **Identification Algorithms**
- **Scaling Methodology**
- **Micro-gravity Simulation Methods**

Given these testing needs, essential features of a new LSS ground test facility emerge. To ensure that test articles be fabricable with materials of reasonable cost, and to maximize the possibility of using materials which could actually fly, the facility should be large enough to accommodate test articles on the order of 1/3 to 1/2 scale. To ensure that experiments in the facility can address the breadth of LSS dynamics and control issues, the facility should not be "hard wired" to any specific test article or mission. This will allow for growth potential as well. Particular test articles should also be designed to incorporate modularity, so that they can readily accommodate substitution of innovative substructural elements (advanced materials, advanced structural designs, embedded sensors and actuators, etc). Finally, the facility should be accessible to as many users as possible. This serves two purposes. It provides a general test bed for the majority of LSS researchers who otherwise have no access to a realistic large-scale experimental facility, and also provides a means for comparatively evaluating the wide variety of hardware and methodologic solutions to the LSS dynamics and control problem.

DESIRABLE FEATURES FOR A NEW LSS GROUND TEST FACILITY

- **Size Large Enough to Accommodate 1/3 to 1/2 Scale Test Articles**
- **Do Not "Hard Wire" it to Any Specific Test Article or Mission**
- **Design Facility With Growth Potential**
- **Design For Test Article Modularity**
- **Make Facility Accessible to as Many Users as Possible**

ASTREX has been designed to incorporate all of the essential LSS ground test facility needs identified. The components which comprise this design include the following

1. A temperature-controlled, 40'x40'x40' facility with an overhead crane;
2. A spherical air bearing for frictionless, 3-axis rotational test article motion;
3. A real time control and data acquisition computer;
4. A dynamically scaled model of a Space Based Laser (SBL) 3-mirror beam expander as the initial experimental article;
5. A complement of sensors and actuators for system identification, pointing and shape control, and active vibration suppression.

ASTREX Hardware - Summary ...

Facility	: 40 ft X 40 ft X 40 ft Laboratory Overhead Crane Temperature Control
Air Bearing	: Spherical (3-Axis) Air Bearing, 19 inch Ball Cable Follower, Two Gimbal - 3 Axis Mechanical Arrangement Rigid Body Attitude Sensing - 1 arc sec Accuracy
Computer	: Real Time Control and Data Acquisition Computer 32 Inputs, 32 Outputs, 1000 Hz Sampling Rate 10 - 15 MFLOP Multi Processor / Array Processor System
Structure	: 3 Mirror Beam Expander 1/3 - 1/2 Dynamically Scaled Structure Modular, Graphite Epoxy Construction
Sensors/ Actuators	: Throttleable Cold Gas Thrusters Proof Mass Actuators, Reaction Wheels Provision for Control Moment Gyros (CMGs) Accelerometers Embedded Sensors and Actuators Optical Line of Sight Sensor

The facility will be housed in a large enclosure which is located inside an even larger hangar bay. The enclosure is air-tight to enable still-air conditions during experiments, and insulated so that temperatures will remain constant during experiments. The enclosure allows an unobstructed volume of 40'x40'x40', and includes an overhead crane capable of lifting up to 10,000 lbs. The seismic stability of the hangar floor has been tested, and the ASTREX site was found to be seismically quieter than many currently operational vibration test facilities.

Advanced Space Structure Technology Research Experiments (ASTREX)...

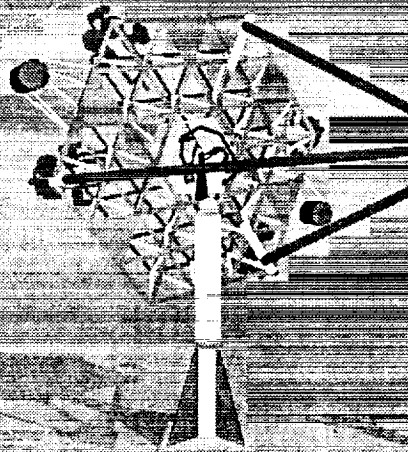
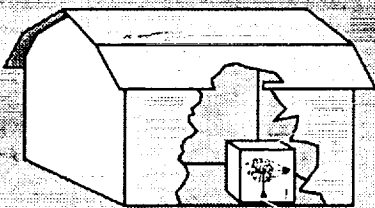

KEYWORDS:

Reduce Risk for Space Based Surveillance and Weapons Systems

ORIGINAL PAGE IS
OF POOR QUALITY

Experimental articles will be supported by a 19-inch spherical air bearing being developed by Boeing Aerospace. The air bearing is capable of supporting loads weighing up to 14,500 lbs. The air bearing system includes a sophisticated double gimbal, 3-axis cable follower which ensures that the multitude of supply lines to the experimental article will not induce measurable torque disturbances during slewing. The system will also provide rigid body attitude measurements of 1 arc second accuracy.

ASTREX Hardware - Pedestal

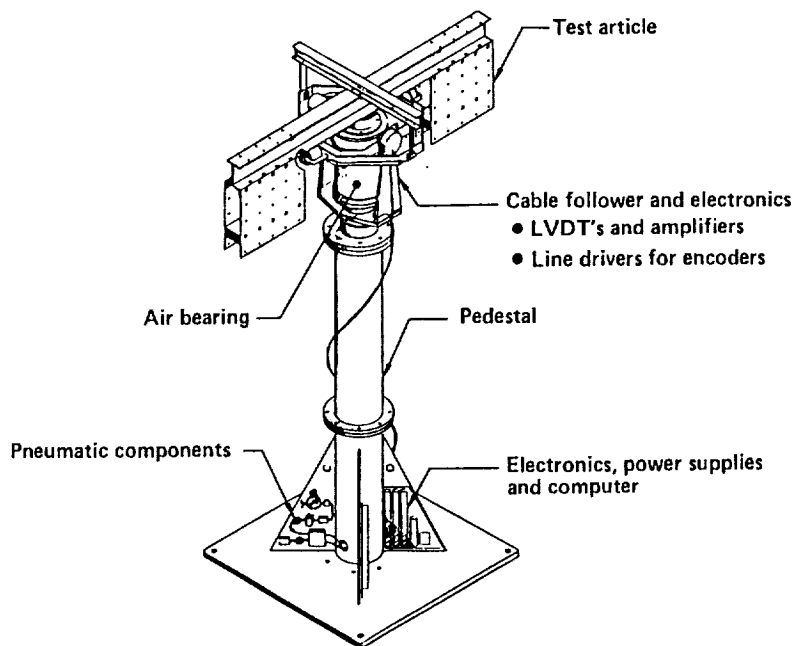

ASTREX will include a powerful real-time control and data acquisition computer (CDAC). The CDAC system will include the following components: a main computational unit for real time control processing; a remote unit, consisting primarily of A/D (analog to digital) and D/A (digital to analog) converters, to be located on the structure; and a workstation, which will run the control design and analysis software and provide the user interface for the CDAC system. The main CDAC unit will use multiple parallel processors to be capable of sustained calculation rates of 11 MFLOP (million floating point operations per second) under both linear and non-linear computational loads. The CDAC system will accommodate up to 32 input and 32 output channels, and will operate at sampling rates selectable by the user. The control design and analysis software running on the workstation will be highly integrated with the CDAC hardware, and will provide an extremely facile user interface, enabling time-efficient use of the CDAC by many different researchers and making high-speed computational performance possible without microcoding.

ASTREX Control/Data Acq. Computer (CDAC)

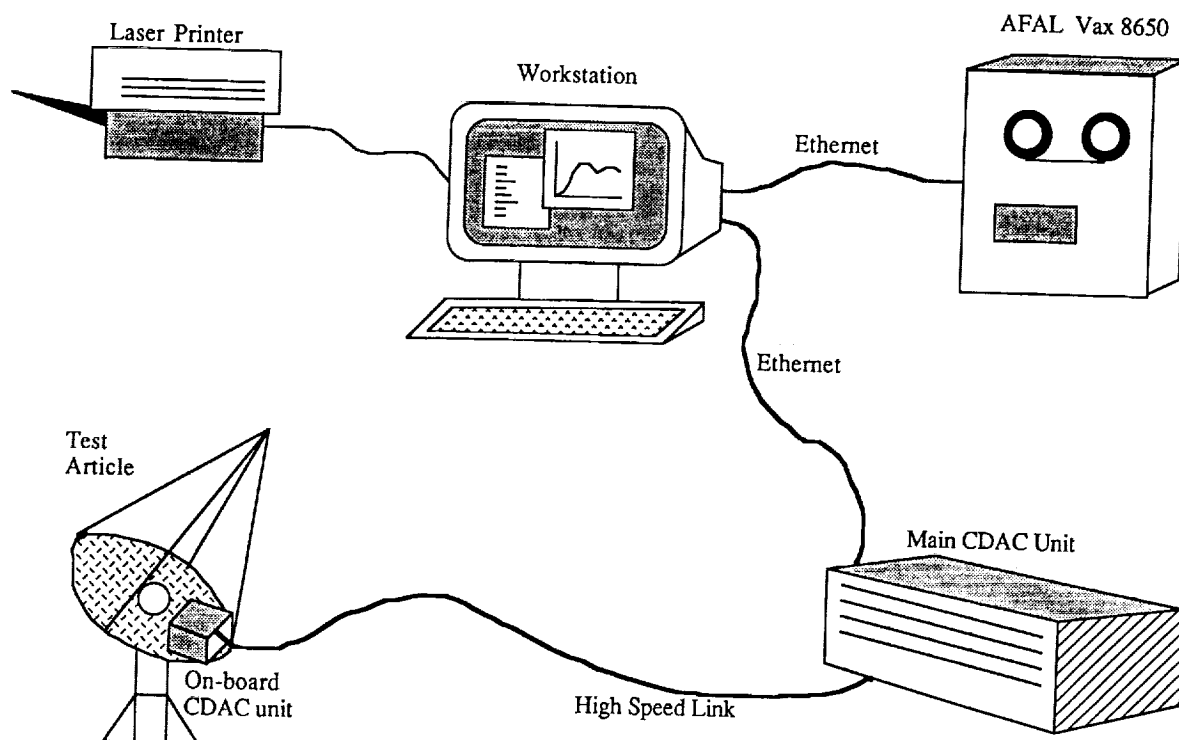

Initial success of the ASTREX facility depends largely upon design of an appropriate first experimental article. The experimental article must exhibit mission relevance, research relevance, technology relevance, and modularity. Mission relevance means that the structure should be closely representative of one or more Air Force or SDI future space missions. Research relevance means that the structure should exhibit many of the research challenges associated with the broad class of large space structures (for example, control/structures interaction, closely-spaced vibrational frequencies, etc.). Technology relevance means that the structure should be constructed with materials and hardware designs which are representative of those actually likely to be used on future missions (for example, graphite/epoxy construction, open truss construction, etc.) Finally, modularity means that the structure should be designed and constructed so that substructural elements can be removed and replaced with alternative components, such as "smart structural" elements. The attributes of modularity, mission relevance, research relevance and technology relevance have all been woven into the design of the initial ASTREX test article.

ASTREX Facility

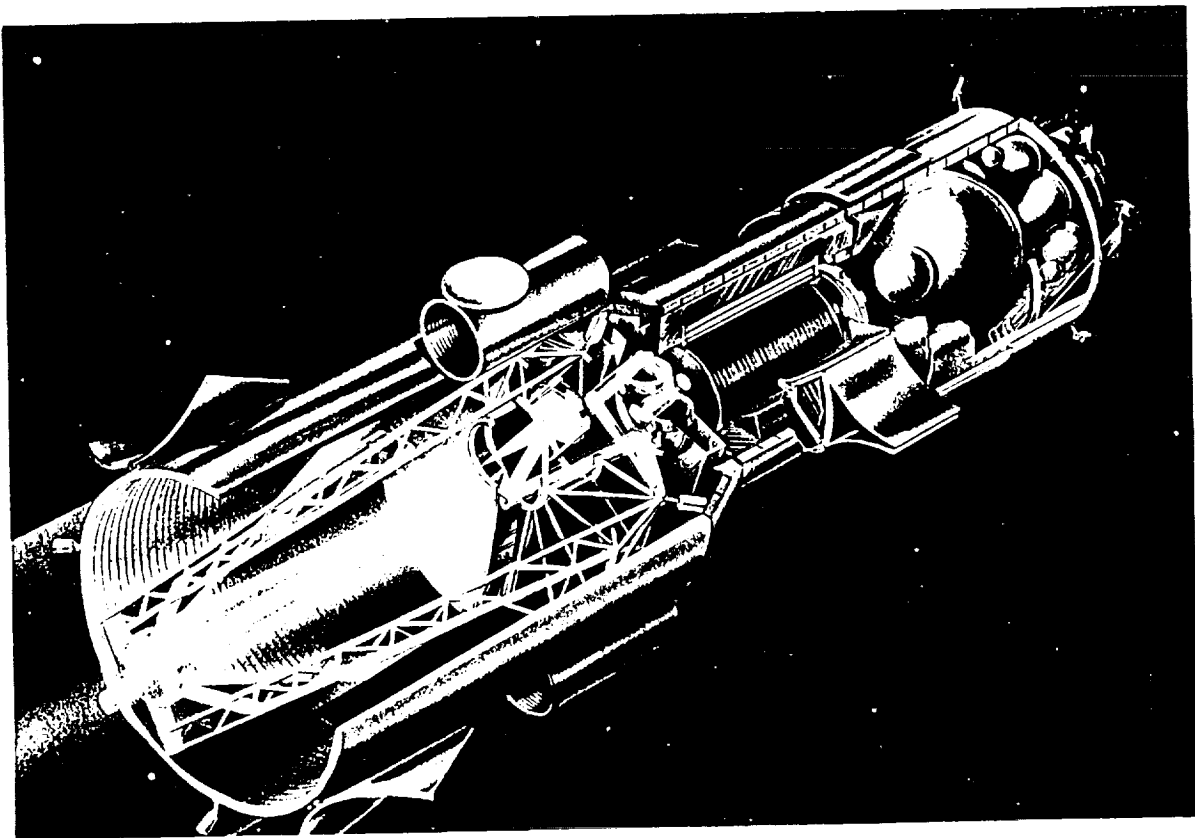

The ASTREX 3-mirror beam expander experimental article includes the following design details. The primary support structure is a tetrahedral space truss design, with graphite/epoxy (Gr/Ep) composite tubes and aluminum joints. The tripod metering truss is also of Gr/Ep construction with aluminum joints. A structural steel mass with aluminum struts will represent the inertial properties of the tertiary mirror. Steel masses will be used as well to represent all other non-structural masses, such as the primary mirror elements, optics control hardware, etc.

INITIAL ASTREX EXPERIMENTAL ARTICLE: 3-MIRROR SBL BEAM EXPANDER

- **Primary Support - tetrahedral space truss**
- **Truss struts - Gr/Ep composite tubes, aluminum joints**
- **Tripod metering truss - Gr/Ep composite tube, aluminum joints**
- **Tertiary mirror simulator - steel, with aluminum struts**
- **Non-structural masses - steel**

Modularity is a key feature of the ASTREX experimental article; this is incorporated in the following ways. First, two different secondary support trusses have been designed for the structure: a tubular tripod and a planar truss quadrapod. Either can be mounted onto the primary support structure. Also, the planar truss elements are removable, and can be exchanged with alternative elements (such as passively or actively damped elements, or struts constructed of innovative materials.) The primary support structural members are also removable/replaceable. Sensors and actuators will all be relocatable, with a multitude of mounting provisions located throughout the structure.

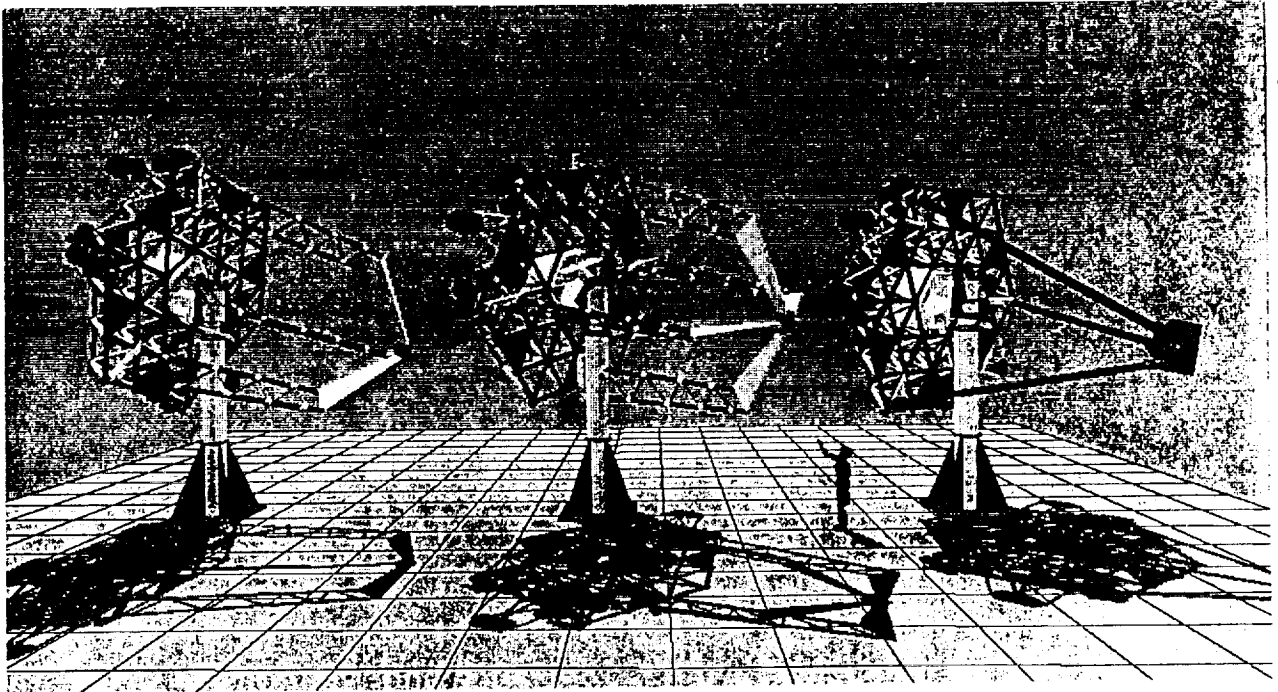

**ORIGINAL PAGE IS
OF POOR QUALITY**

An initial complement of sensors and actuators for system identification and shape/pointing/vibration control will be selected from among the following:

- 1) Throttleable Cold Gas Thrusters
- 2) Proof Mass Actuators
- 3) Reaction Wheels
- 4) Control Moment Gyros (CMGs)
- 5) Accelerometers
- 6) Embedded Sensors and Actuators
- 7) Optical Line of Sight Sensor

The sensors and actuators used in ASTREX will of course continue to change and evolve over time, and will not be restricted to those indicated on the above list.

SENSORS AND ACTUATORS FOR ASTREX

- **Throttleable Cold Gas Thrusters**
- **Proof Mass Actuators**
- **Reaction Wheels**
- **Control Moment Gyros (CMGs)**
- **Accelerometers**
- **Embedded Sensors and Actuators**
- **Optical Line of Sight Sensor**

All key elements of the ASTREX facility are currently in procurement, except for the environmentally controlled enclosure, of which construction is now complete. The Air Bearing System will be delivered under a contract currently in progress, with final installation and check-out scheduled for 31 May 89. The Control and Data Acquisition Computer (CDAC) will also be delivered under a contract currently in progress, with final installation and check-out scheduled for 31 June 89. The beam expander structure was designed by Boeing Aerospace; component procurement and experimental article fabrication is being managed "in-house" by AFAL personnel, with final assembly scheduled for fall of '89.

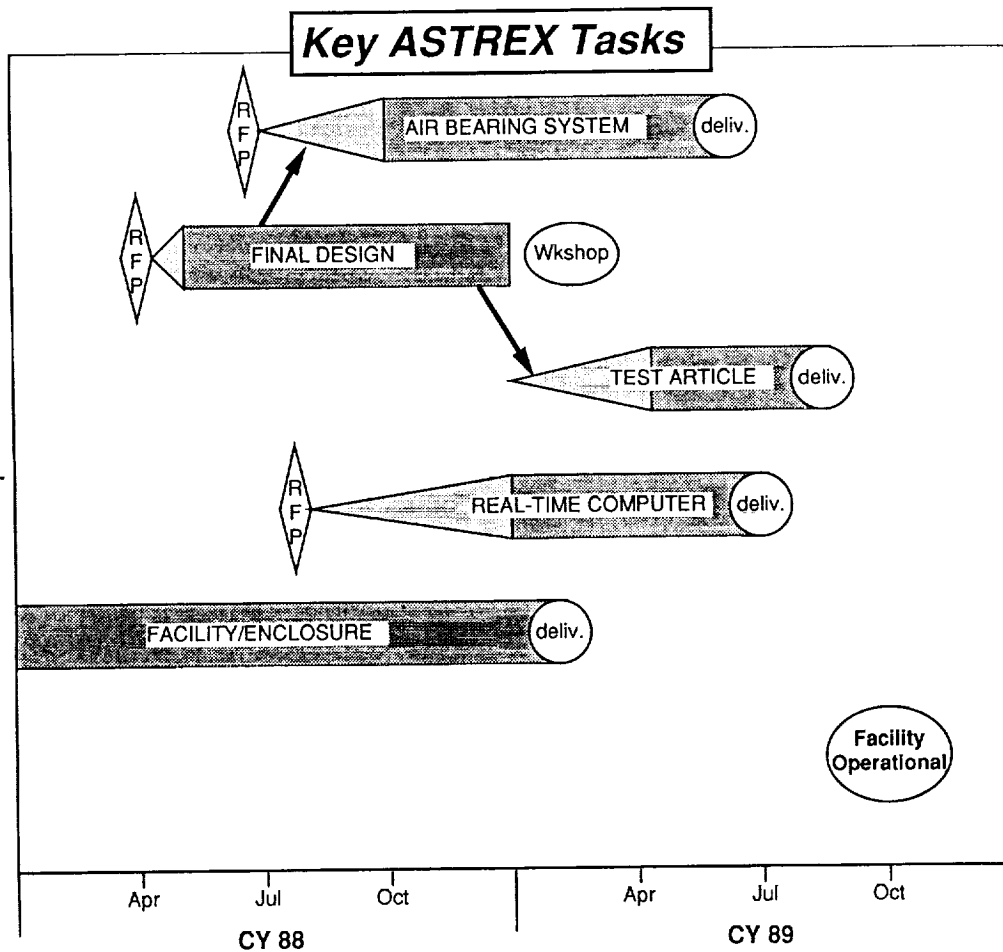

ASTREX will be the site of a variety of LSS experiments over the next several years. Currently, AFAL plans call for initial research to focus on system identification, which will generate progressively more refined models of the experimental article structure. Depending upon the initial slew actuators which are selected, initial control experiments may focus on thrust profile shaping for optimal slewing maneuvers. In conjunction with slewing, experiments will be a demonstration of multiple approaches to vibration suppression and shape control. In summer '91, ASTREX will provide the test bed for demonstration of the embedded sensor and actuator (ESA) members, or "smart structures," being developed under a contract at AFAL. Prior to these demonstrations, AFAL plans to demonstrate the smart structures which are developed under its own in-house development effort.

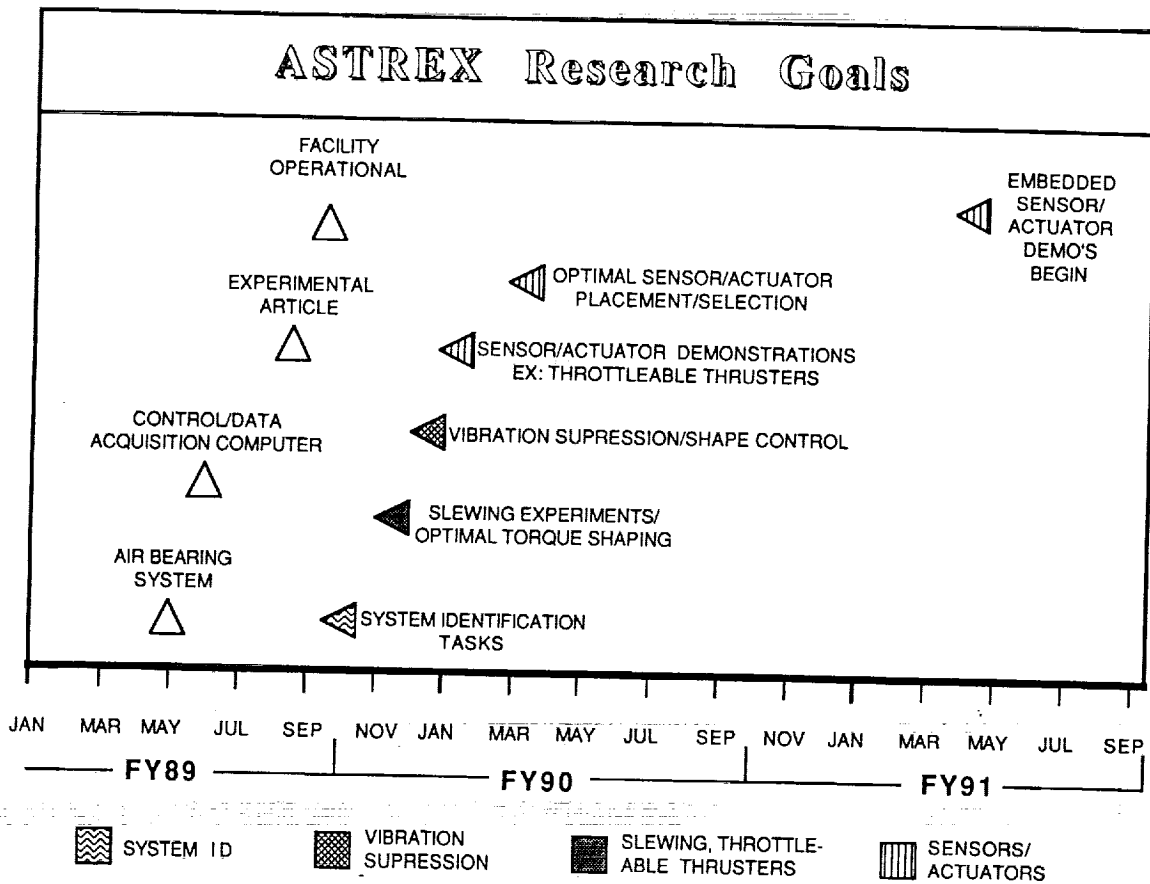

Several contractual vehicles will be available to researchers proposing to conduct research in the ASTREX facility. AFAL plans to collaborate with NASA on a joint guest investigator (GI) program for research in Controls/Structures Interaction (CSI) technologies. The CSI GI program will serve as a means to encourage and facilitate several concurrent 1-2 year research tasks in ASTREX (as well as in other NASA facilities). The initial emphasis of the research in ASTREX will be on experimental demonstration, comparison, and evaluation of existing state of the art control methodologies and hardware, as opposed to contract developing new theory. In addition to participation as a task under the CSI GI program, other potential users of ASTREX would include researchers with existing or future AFAL contracts (such as ESA) which called for experimental demonstration in a test bed. Likewise, researchers with contracts funded by other DOD agencies and NASA might use ASTREX for experimental demonstration. Finally, SBIR contracts might involve experiments in ASTREX. The key point to emphasize is the intended flexibility and open nature of the facility, which AFAL hopes will attract participation of many of the leading researchers in LSS control from Industry, Universities, and Government.

CONTRACTURAL VEHICLES FOR CONDUCTING RESEARCH IN ASTREX

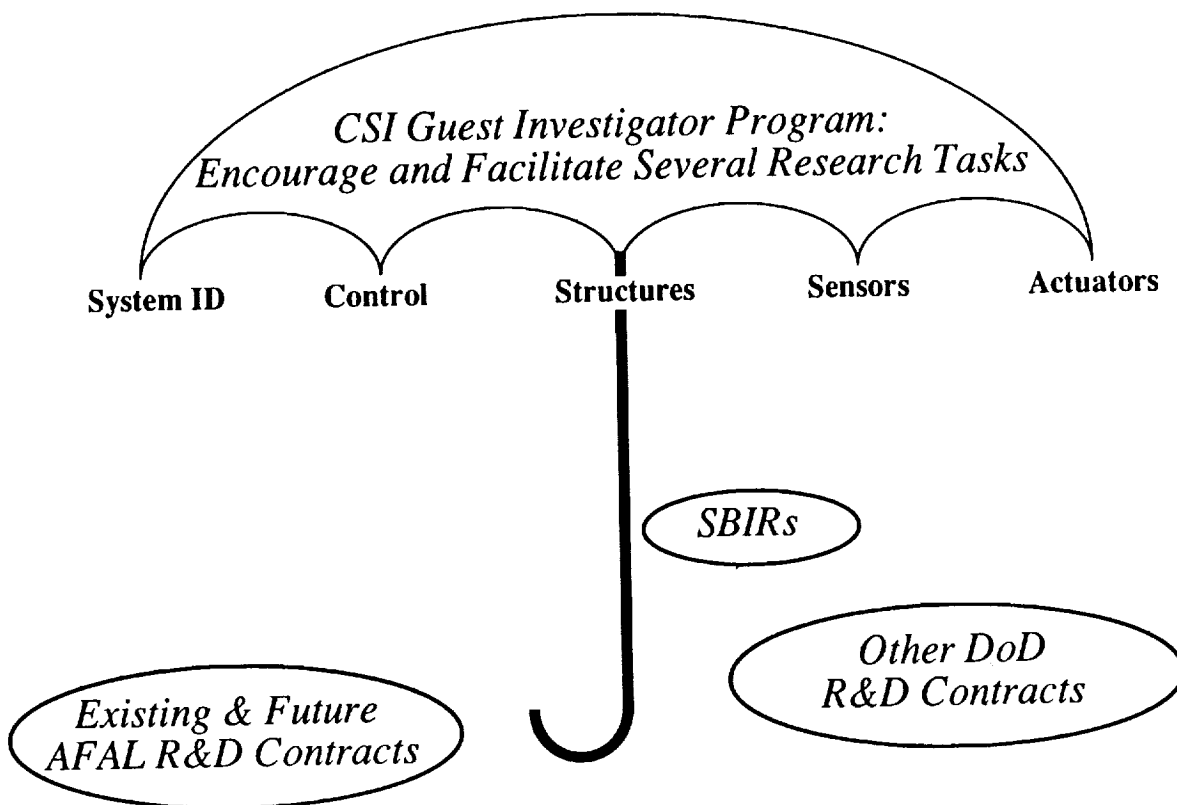

A workshop was held on 16 February 89 at AFAL to inform researchers from Industry, Universities, and Government about the initial operational capability of ASTREX. The major objectives of the workshop were to fully inform participants about the following:

- 1) The final design and configuration for the facility's air bearing system (now in procurement); (This information will be especially useful for researchers with an interest in fabricating their own space structure test articles for experimentation in ASTREX in the future).
- 2) The completed final designs for the facility's first two test articles (space structure models); (This information will be relevant to all researchers interested in conducting research in ASTREX using one or both of the facility's initial test articles).
- 3) The operational capabilities of the facility's experiment control computer (in procurement); (Important information for researchers planning to develop and implement system identification and/or real-time control algorithms on the ASTREX computer).
- 4) AFAL's goals and projected research schedule for ASTREX.

ASTREX WORKSHOP (16 FEB 89) AT AFAL

PROVIDED DETAILS CONCERNING:

- **FINAL DESIGN & CONFIGURATION OF AIR BEARING SYSTEM**
- **FINAL DESIGN & CONFIGURATION OF INITIAL TEST ARTICLES**
- **OPERATIONAL CAPABILITIES OF CONTROL/DATA ACQ. COMPUTER**
- **GOALS, PROJECTED RESEARCH FOR ASTREX**