

NASA Technical Memorandum 102814

Helicopter Airborne Laser Positioning System (HALPS)

Joseph C. Eppel, Howard Christiansen,
Jeffrey Cross, and Joseph Totah

March 1990

(NASA-TM-102814) HELICOPTER AIRBORNE LASER
POSITIONING SYSTEM (HALPS) (NASA) 21 p
CSCL 01D

N90-23399

Unclass
G3/06 0286254

NASA

National Aeronautics and
Space Administration

Vertical text along the right edge of the page, possibly a page number or margin indicator.

Helicopter Airborne Laser Positioning System (HALPS)

Joseph C. Eppel, Ames Research Center, Moffett Field, California
Howard Christiansen, Northrop Services, Inc., Sunnyvale, California
Jeffrey Cross and Joseph Totah, Ames Research Center, Moffett Field, California

March 1990



National Aeronautics and
Space Administration

Ames Research Center
Moffett Field, California 94035-1000



Helicopter Airborne Laser Positioning System (HALPS)

Joseph C. Eppel

NASA Ames Research Center
Moffett Field, CA 94035 USA

Howard Christiansen

Northrop Services, Inc.
Sunnyvale, CA 94089 USA

Jeffrey Cross and Joseph Totah

NASA Ames Research Center
Moffett Field, CA 94035 USA

ABSTRACT

This paper presents the theory of operation, configuration, laboratory and ground test results obtained with an helicopter airborne laser positioning system developed by Princeton University.¹ Unfortunately, due to time constraints, flight data could not be completed for presentation at this time. The system measures the relative position between two aircraft in three dimensions using two orthogonal fan-shaped laser beams sweeping across an array of four detectors. Specifically, the system calculates the relative range, elevation, and azimuth between an observation aircraft and a test helicopter with a high degree of accuracy. The detector array provides a wide field of view in the presence of solar interference due to compound parabolic concentrators and spectral filtering of the detector pulses. The detected pulses and their associated time delays are processed by the electronics and are sent as position errors to the helicopter pilot who repositions the aircraft as part of the closed loop system. Accuracies obtained in the laboratory at a range of 80 ft in the absence of sunlight were $\pm 1^\circ$ in elevation; $+0.5^\circ$ to -1.5° in azimuth; $+0.5$ to -1.0 ft in range; while elevation varied from 0 to $+28^\circ$ and the azimuth varied from 0 to $\pm 45^\circ$. Accuracies in sunlight were approximately the same for a range of 80 ft, except that the field of view was reduced to approximately 40° ($\pm 20^\circ$) in direct sunlight.

NOMENCLATURE

$-\theta$	-	Angle formed by laser beam sweep and detectors for two-dimensional case
R	-	Range and perpendicular distance from axis of beam sweep to the origin
d	-	Distance between detectors and the origin
f	-	Beam sweep freq, rev per sec
o,x,y,z	-	Location of detectors in the array
T	-	Time delay from the detectors to the origin as laser beam sweeps the detector array
d'	-	Perpendicular distance formed by the sweep and the array as the sweep intercepts the origin for the two-dimensional case
V	-	Laser beam sweep velocity, $2\pi fR$
V	-	Absolute value of V
\vec{V}_A, \vec{V}_B	-	Vector velocities of laser beam sweeps A and B, respectively
\vec{R}	-	Vector range
ω	-	$2\pi f$

Subscripts

- x_0, y_0, z_0 - Distance from the detectors to the origin
A, B - Laser beams A and B respectively

1. INTRODUCTION

NASA Ames Research Center and the U.S. Army Aeromechanics Laboratory have been conducting experiments on the in-flight radiated acoustic noise in the far field of several helicopters. In making these measurements, an accurate method is required for establishing the position of the helicopter relative to the listening or sound measuring equipment. Usually these measurements were made using ground-based listening devices which were subject to relative motion and ground reflections. To eliminate these drawbacks, in-flight relative positioning of the aircraft was done by the alignment of optical markers on the aircraft with an optical rangefinder. With this new system, the helicopter with the test rotor is positioned within known distances from the listening aircraft in a variety of flight positions and the resulting formation data are recorded along with the acoustical data.

In 1980 Professors R. B. Miles and L. M. Sweet of Princeton University, Department of Mechanical and Aerospace Engineering, received a grant from NASA Ames Research Center, Moffett Field, CA to develop a laser beacon that would accurately determine the range, azimuth and elevation range between two aircraft during flight experiments. Considerable research has been accomplished by Miles and Sweet in this area and more detailed information on optical and laser considerations may be obtained from their reports.^{2,3,4}

The system developed provides for positioning a helicopter behind a listening aircraft during acoustic noise measurements. A typical test configuration is shown in Fig. 1. The range is approximately two rotor radii diameters (60-80 ft) from the helicopter to the YO-3A, the listening aircraft. The YO-3A is a Lockheed Low Wing two-seater aircraft which is very quiet. The listening microphones are installed on the YO-3A. The laser positioning system is part of the closed loop that requires the helicopter pilot to provide loop closure by flying the helicopter so that his position error is zero. The beacon is mounted on the helicopter. Two orthogonal fan-shaped beams of collimated light from He-Ne lasers are reflected from two perpendicularly mounted rotating cylindrical mirrors. An optical array, mounted on the tail of the YO-3A senses each beam sweep across the array. The pulses from the detector are processed and calculations of relative range, azimuth and elevation angle are done in a real time computer system mounted in the YO-3A. The position data are recorded and position error signals are transmitted to the helicopter. The helicopter pilot then maintains his aircraft in a position so that the position errors are zero or at minimum during an acoustic measurement. A typical test scenario would be as follows: To operate the system in flight requires a pilot and test engineer in the YO-3A. The test engineer commands a desired helicopter position with a hand-held terminal. Error signals are sent via data link to the helicopter. The pilot and copilot in the helicopter maneuver the aircraft to cancel the error signals. Radio link between aircraft maintains communication and compliance with the commanded position so that a legitimate test point is established. A chase aircraft is required to insure safety of formation and to be on the lookout for potential air hazards while the acoustic measurements are being made.

2. THEORY OF OPERATION

The fundamental principle of the laser positioning system is the measurement of the time intervals between detectors using the velocity of a laser beacon sweeping across these detectors. Also the detectors must be arranged in a known array. Range and sweep angle is then derived from these measurements. For the sake of simplicity, an example showing how range (R) and bearing angle (θ) in a plane can be calculated using three detectors and single beam sweep. Figure 2 shows the detectors x and y forming a right isosceles triangle spaced a distance d from the origin detector (o). The laser beacon is at a distance R, which is large in comparison with the detector separation (d). If $R \gg d$ then it can be assumed that the focused laser beam is a parallel line sweeping past the detectors.

The sweep axis is perpendicular to the surface. As the beam passes each detector, a pulse is produced. The measured time intervals T_{x_0} and T_{y_0} between the detectors and the origin correspond to the projected distances d_{x_0} and d_{y_0} as seen by the beam with a velocity v in the following relationship:

$$d'_{x_0} = vT_{x_0} \quad (1)$$

$$d'_{oy} = VT_{oy} \quad (2)$$

The detectors as shown in Fig. 2 form equal legs of a right triangle and therefore can be expressed as

$$d_{xo} = d_{oy} = \sqrt{(d'_{xo})^2 + (d'_{oy})^2} \quad (3)$$

Squaring Eqs. 1 and 2, and adding the results yields

$$d'_{xo}{}^2 + d'_{oy}{}^2 = V^2 (T_{xo}{}^2 + T_{oy}{}^2) \quad (4)$$

$$\sqrt{d'_{xo}{}^2 + d'_{oy}{}^2} = V \sqrt{T_{xo}{}^2 + T_{oy}{}^2} \quad (5)$$

Substituting Eqs. (3) into (5) yields

$$d_{xo} = d_{oy} = V \sqrt{T_{xo}{}^2 + T_{oy}{}^2} \quad (6)$$

The velocity of the laser beam is $V = 2\pi fR$. Substituting in Eq. (6) and solving for R yields

$$\frac{d_{xo}}{2\pi f \sqrt{T_{xo}{}^2 + T_{oy}{}^2}} = R \quad (7)$$

The angle θ - or bearing of the beam can be calculated from

$$VT_{xo} = d'_{xo}; \quad VT_{oy} = d'_{oy} \quad (8)$$

$$d'_{xo}/d'_{oy} = T_{xo}/T_{oy} \quad (9)$$

From Fig. 2

$$\theta = \tan^{-1}(d'_{xo}/d'_{oy}) = \tan^{-1}T_{xo}/T_{oy}$$

Therefore for the two-dimensional case, R the range and θ the bearing can be calculated knowing the time delays, the sweep velocity of the laser beam (V) and the separation of the detectors from the origin (d).

The calculations for the three-dimensional case require an additional detector and a second laser beam orthogonal to the first. This configuration is shown in Fig. 3 where all detectors are mutually perpendicular to each other.

The derivation of the position determination equations, range, elevations, and azimuth for the three-dimensional case was accomplished by G. Russell at Princeton University. This derivation is contained in Appendix A of an M.S. Thesis written by Steven Webb.⁵ These equations when programmed into a microprocessor are faster than transcendental functions and do not rely on the beacon orientation. In the final report¹ of the laser beacon range measurement system, E. Wong discusses the equations developed by G. Russell. In this report he shows the relationship of the velocity of each orthogonal beam sweep to their respective time data and the range equation. In summary, the relationships between quantities shown in Fig. 3 are

$$|\vec{v}| = \frac{1}{(T_x^2 + T_y^2 + T_z^2)^{1/2}}$$

This equation relates time vector to the velocity vector. Since there are two orthogonal sweeps

$$\vec{v}_A = \vec{T}_A / |\vec{T}_A|^2$$

$$\vec{v}_B = \vec{T}_B / |\vec{T}_B|^2$$

The above equations relate each beam to their respective time delays or time vectors. The values R_A and R_B are the distances from the origin to each rotation axis

$$R_A = \frac{1}{2\pi f} \cdot |\vec{v}_A|; \quad R_B = \frac{1}{2\pi f} \cdot |\vec{v}_B|$$

The magnitude of the range vector is

$$|\vec{R}| = \left(\mu + \sqrt{\mu^2 - R_A^2 R_B^2 (1 - (\vec{v}_A \cdot \vec{v}_B)^2)} \right)^{1/2}$$

where $\mu = (R_A^2 + R_B^2) / 2$

SYSTEM OPERATION

A block diagram of the system is shown in Fig. 4. Here can be seen the major pieces of hardware in each aircraft. The laser beacon system is a functional means of measuring distances between two points in three dimensions. The system was built using state of the art optical and electronic components.

The laser beacon mounted on the helicopter emits two orthogonal fan shaped beams of collimated light. These fan shaped beams are developed by reflecting off of two perpendicularly mounted rotating cylindrical mirrors. The optical detectors on the tail of the YO-3A consist of four detectors arranged in space to form a right tetrahedron, one detector on each of the three axis legs and one at the vertex. The lengths of each leg to the origin are equal. As the laser beam sweeps past the detector, four pulses are obtained, establishing three time delays (one from each axis detector to the origin detector). The detected pulses are processed by the timer control unit. This unit produces the gate signals for three time delays. Error flags are also set by this unit if multiple or missing pulses are present in the incoming data. Signal processing of the sweeps A and B data is essential since there is no synchronization between the helicopter and the YO-3A. There is logic that differentiates between the two beams. If no error flags are set the data are passed on to the vector identification circuitry. Otherwise either the timer control network is reset for new data or a recovery procedure fills in the missing data point by using a prediction algorithm based on previous data points. If the origin pulse is missing, if there are multiple pulses, or more than one axis pulse is missing, the logic resets and waits for new data. The software identifies the vector and then proceeds with the range determination: otherwise it assigns the vector to an axis and restarts the identification process. The range calculations are sent to the FM recorder and to the test engineer's digital display. The position error is sent via the data link to the helicopter. The YO-3A computer system is based on the Z80 microprocessor and is shown in Fig. 5. The CPU contains a Z80A microprocessor and a Z80A-CTC counter timer chip that operates at 4 MHz. The microprocessor executes the machine code instructions contained in the memory. The Serial I/O (S_{I/O}) board is used for serial data communication between the CPU and external devices. This board has been configured to be used as two RS-232C compatible communication channels. One channel communicates with the hand held terminal, the other with the modem of the communication link between the YO-3A and the test helicopter.

The Parallel I/O (P_{I/O}) board has four 8-bit programmable parallel input/output data ports. Three ports of the Parallel I/O board are used in this system as follows: The A port of P_{I/O} #1 inputs the status bits from the time control board; the A port of P_{I/O} #2 outputs the LCD address lines; and the B port of P_{I/O} #2 outputs the LCD data lines. The memory boards contain the firmwave generated from the program and the storage memory for the operation of the system. One

board is configured to address 32K bytes of EPROM type memory, and the other board is configured to address 8K bytes of static RAM. The 9511A arithmetic processor is capable of doing 16 and 32 bit fixed point and 32 bit floating point computation as well as computing transcendental functions. The 16 bit counter-timer boards have fundamental time units of 500 nanosecs and measure the duration between detector and origin. The FM recorder DAC board outputs analog voltages from incoming digital information. These voltages are related to the position vector. The hand held terminal communicates with the YO-3A computer through serial lines using RS-232C. It has a 12-character LED display and accepts input from the 20 pad handheld terminal. The liquid crystal display (LCD) panel displays the commanded position and test information. The LCD was chosen over light-emitting diodes (LED) because of its readability in sunlight and low power consumption. Figure 6 shows a block diagram of the data link which consists of two 1200 band modems, FM transmitter and receiver. The YO-3A modem converts serial data from the S_{I/O} board to an audio signal. The conversion method of the modem is frequency shift keying (FSK). The complete time to transmit the 96 bits (8 characters × 12 bits/character) at 1200 band is 80 ms.

Figure 7 shows the helicopter position error system which consists of a microprocessor system, analog ammeter displays and status lights. The microprocessor receives data from the YO-3A computer via the data link and outputs the error on the displays. The loss of data light will be turned on when the counter has reached zero since no data have been received. The program assumes the data to be coming in a set pattern for each coordinate's error data. If this pattern is broken the syntax error light will be turned on. The syntax error light was eliminated via software since it was not considered essential information to the helicopter pilot. The helicopter pilot has an input selection that displays either 25 or 125 ft on the displays. The glide slope indicator (GSI) shows the pilot the azimuth (y) and elevation (z) errors, while the edgewise meter indicate range (x) error. Figures 8 and 9 show the GSI and edgewise meters, which are zero center devices with cross-hair meter movements. Errors are displayed as deviations from zero. Figure 10 shows the helicopter display layout of the above components.

3. SYSTEM DESCRIPTION

Figure 11 shows the configuration of that portion of the laser system that is contained in the SH-3G helicopter, which includes:

1. Laser beacon - 5 mW He-Ne continuous laser
2. Glideslope indicator - King radio KI-207
3. Edgewise Panel meter - AIRPAX E35 Panel Meter
4. Receiver and associated antenna
5. On-board computer
6. Power supply (+28 VDC)

In this section the laser beacon and the detector array on the YO-3A will be described in detail since they are the salient components of the system; the remaining units have been described in the system operation section.

Since the laser beacon is to be mounted on the nose of the helicopter, it had to be designed rugged enough to withstand vibrations and yet be as simple and lightweight as possible. A 5-mW continuous wave helium-neon laser at 6328 Å was selected. The laser beam is focused at a nominal range of 98 ft. A two-laser beacon system was decided upon because it is less complex, simpler to build and maintain, and yields more accurate results.

Figure 12 shows the bottom and top view of the laser beacon. The lasers are mounted to the bottom portion of the mounting plate along with the power supplies and prisms. The prisms reflect the laser beams 90° onto the top surface. From the prism, the laser beam passes through an expanding lens and a condensing lens to expand each beam to a specific source width and focus the beam at the nominal range of 98 ft. Each laser beam has its own set of lenses. The expanding lens is 60X microscopic objective lens ($f \approx 1$) and was chosen to maximize beam intensity while minimizing the distance between the two lenses. To minimize distortion the laser illuminates only the center portion of the lens and the beam is expanded about a cone angle of 18°. Adjusting the condensing lens attains the minimum beam width at the desired operating distance. The condensing lens used is a plano-convex lens with a 40-mm diameter.

After passing through the condensing lens, the laser light is expanded into a fan-shaped beam by semicircular cylindrical mirrors. The mirror's size is chosen so that all incident laser light is reflected. The mirrors have 120° segments. A synchronous motor drives the two reflecting mirrors. The mirror axes are orthogonal to each other and rotate 180° out of phase. The rotation rate of the beacon is set at 2 rev/sec. The beacon is supported by elastomeric mounts to reduce vibrations and shock loads due to landings and rotor vibrations. The mounting plate is set at an angle of 45° to the horizontal of the helicopter because during test operations, the YO-3A aircraft with its detector array is kept forward on a downward 45° angle relative to the helicopter. In this manner the helicopter pilot can maintain safe formation flying more easily.

Figure 13 shows the configuration of that portion of the laser positioning system that is in the YO-3A aircraft which includes:

1. Four-detector right tetrahedron array assembly
2. Transmitter and associated antenna
3. Flight Test Engineer's panel containing
 - a. LCD panel
 - b. Pulse amplifier and signal processor
 - c. Scope
 - d. Acoustic avionics
4. Hand-held terminal
5. Computer
6. Power supply (+28 V)

The pulses received from the array are routed to the amplifier and processed. The computer determines the error signals to be sent to the SH-3A helicopter so as to conform to the commanded position entered into the hand-held terminal and displayed on the LCD panel. The helicopter's actual position as determined by the system is also shown on the LCD.

The detector array which employs state of the art optical techniques deserves further discussion to illustrate the complexities involved. Each detector in the array is comprised of two compound parabolic concentrators (CPC), a spectral line filter to eliminate most of the sunlight, and a photodetector (Fig. 14). The concentrators collect and collimate the light from the laser through a 30 Å spectral width interference filter. The photodetector is a Meret MDA 530-680 and is a hybrid photodiode integrated with its amplifier circuit to form a single unit. The CPC according to Webb⁵ is a parabolic reflector on which the tip has been cut off and sides brought together so that laser light from a wide field of view can be focused and exited at a cone angle, which is less than the entrance cone angle. Designed to isentropically focus light, this collector has been found to closely approximate the thermodynamic limit with an f number approaching one-half. The performance and theory regarding CPCs can be found in Refs. 3, 6, and 7. Ideally, the first CPC can accept incident light up to a 90° acceptance angle, which corresponds to a 180° field of view. However, in tests by Webb, an accurate field of view for a CPC detector in direct sunlight is limited to approximately 150°. The CPC exit angle is selected by the limit of the interference filter. The filter is a 30 Å filter centered at about 6328 Å and passes only 10^{-3} of the solar spectrum. For maximum efficiency the second CPC was constructed similar to the first. The CPCs used were made from a mandril previously designed and constructed by the University of Chicago. The interdependence of exit and entrance aperture diameters and angles, the field of view and overall length are explained further in Webb's thesis.⁵

4. GROUND TESTS AND RESULTS

Initial tests at Ames Research Center on the laser beacon system were made in a laboratory in the absence of sunlight. The laser was mounted on a wooden platform. The four-detector array was placed on a fixture calibrated in elevation and azimuth. The fixture had the capability to move the array accurately in 0.5° increments, both in azimuth and elevation. The distance between the laser and detector array was measured to be exactly 80 ft.

The procedure was to enter the measured range, elevation and azimuth data into the hand terminal and observe on the LCD, both the measured entered data and the "actual" position as determined by the system.

Figure 15 presents azimuth error versus measured azimuth and shows $+0.25^\circ$ to -0.5° azimuth error for elevations of 0° to 15° as azimuth varied from $+45^\circ$ to -45° . Azimuth errors increased to $+0.5^\circ$ to -1.5° for an elevation of 28° as azimuth varied from $+45^\circ$ to -45° .

Figure 16 shows elevation angle error versus measured azimuth. Here for all elevations, 0° , 15° , and 28° , the errors are closely grouped from -2° to -4° ($\pm 1^\circ$). There is a constant -2° offset due to initial setup conditions.

The plot of detected range versus azimuth (Fig. 17) shows an error of ± 0.5 ft for elevations of 0° and 15° . At an elevation of 28° the error increases to approximately 1 ft.

The results obtained in the laboratory demonstrated that the signal pulse from a single leg (in this case the y leg) became intermittent beyond 45° in azimuth (90° field of view). This could be attributed to a faulty photodiode since the pulses from the other detectors were above the noise level of azimuth angles approaching 60° .

Upon completion of the laboratory test, the system was ground tested in the sunlight. The laser beacon, glideslope indicator and edgewise meter were kept on the wooden pedestal and placed on a hydraulic lift which simulated helicopter movement. The remaining portion of the system was installed in the YO-3A.

With the outdoor ground test setup shown in Fig. 18, data were taken on separate days with the detectors pointing away from the sun and with the sun shining into the detectors. With the detectors facing the sun reliable data were obtained at a range of 55 ft at elevations from 0° to $+23^\circ$ and azimuth angles from 0° to $\pm 20^\circ$. The errors were 5 to 10% in range, $\pm 1.5^\circ$ in azimuth and $\pm 1.5^\circ$ in elevation. Beyond this range the output became erratic due to the signal to noise ratio. Figure 19 shows the detector array mounted on the tail of the YO-3A and Fig. 20 shows the instrument panel used by the test engineer in the front seat of the YO-3A.

With the detectors pointing away from the sun, the best range obtained was 80 ft at elevations from 0° to $+23^\circ$ and azimuth angles from 0° to $\pm 42^\circ$. The errors were 5% in range up to 70 ft and 10% at 80 ft, $\pm 1.5^\circ$ in azimuth and $\pm 1.5^\circ$ in elevation.

As expected the noise or unwanted signal due to the sun's spectrum decreased the range and accuracy. The above ground data were obtained using approximately 31 data points. These initial tests were made to determine if the system was operational before installing the laser beacon on the SH-3. Figure 21 shows the laser beacon installed on the helicopter. Figure 22 shows the glideslope indicator and edgewise meter on the pilot instrument panel. Unfortunately, more data are not available at this time due to schedule delays. Additional ground tests are planned with the laser beacon positioning system installed in both aircraft prior to flight tests.

Conclusions

Laboratory data in the absence of sunlight confirmed the accuracy of the system for a range of 80 ft to be within

+0.5 to -1 ft (1.25%) in range
+0.5° to -1.5° in azimuth
 $\pm 1^\circ$ in elevation while elevation varied from 0° to $+28^\circ$ and azimuth varied $\pm 45^\circ$

In the presence of sunlight with the detectors pointed away from the sun for a range of 80 ft, the system accuracies were within

+3.5 to 8 ft (10%) in range
+1.5° in azimuth
 $\pm 1.5^\circ$ in elevation while elevation varied from 0 to $+23^\circ$ and azimuth varied $\pm 42^\circ$

With the detectors pointed into the sun for a decreased range of 55 ft, the system accuracies were within

+2 to 5 ft (10%) in range
 $\pm 1.5^\circ$ in elevation and azimuth while elevation varied from 0° to 23° and azimuth varied from a reduced field-of-view of $\pm 20^\circ$

Obviously since sunlight degrades the performance of the system, it is recommended that data test flights be made with the detectors pointing away from the sun and at times when the sunlight is not intense.

REFERENCES

1. Wong, Edward Yee, Final Report and System Manual for Laser Beacon Range Measurement System – NASA Grant NCC-2-94 (1981).
2. Miles, Richard B., Applied Optics, Vol. 19, No. 13 (1980).
3. Miles, R. B., Webb, S. G., and Griffith, E. L., Pub. Optics Letters, Vol. 6, No. 12 (1981).
4. Sweet, L. M., Miles, R. B., Webb, S. G., and Wong, E. Y., Wide Field of View Laser Beacon System for Three-Dimensional Aircraft Position Measurement, , ASME/81-WA/DSC-91/Nov. 15, 1981/Washington, DC.
5. Webb, S. G., "Aircraft Position Measurement Using Laser Beacon Optics," M.S.E., Thesis, Princeton Univ., 1981.
6. Welford, W. T., Optics of Nonimaging Concentrations, Academic Press, New York (1978).
7. Winston, R., J. Opt. Soc. of Am., Vol. 60, p. 245 (1970).

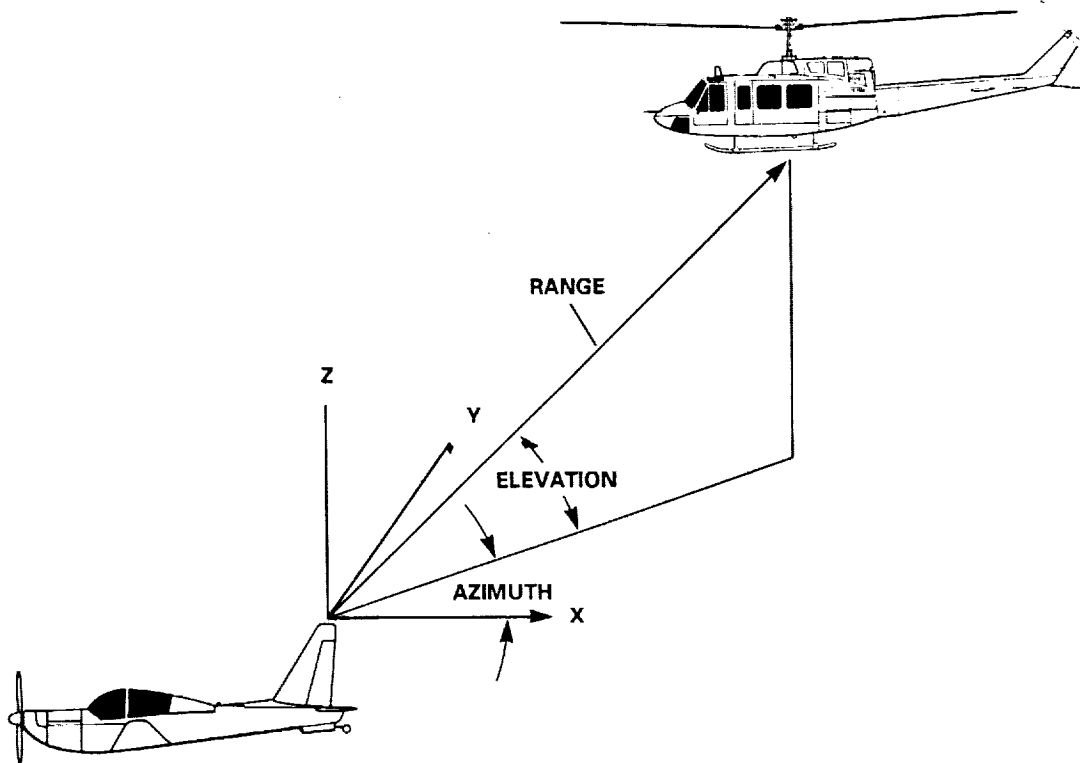

Figure 1. Relative position of test helicopter and YO-3A for acoustic noise measurements.

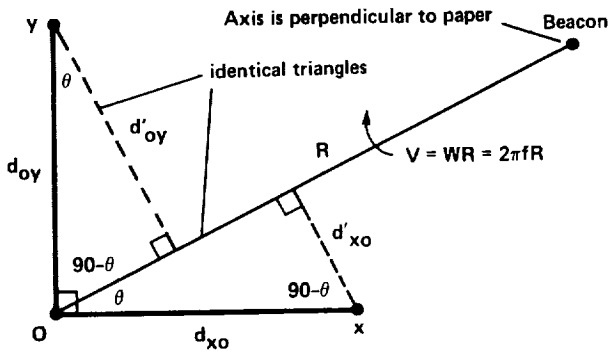

Figure 2. Two-dimensional geometry for range and bearing calculations.

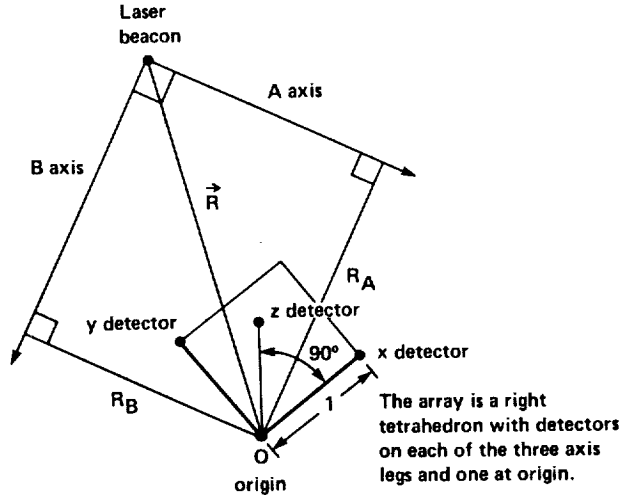

Figure 3. Four detector configuration x, y, z, and o with two sweeping orthogonal beams (A and B).

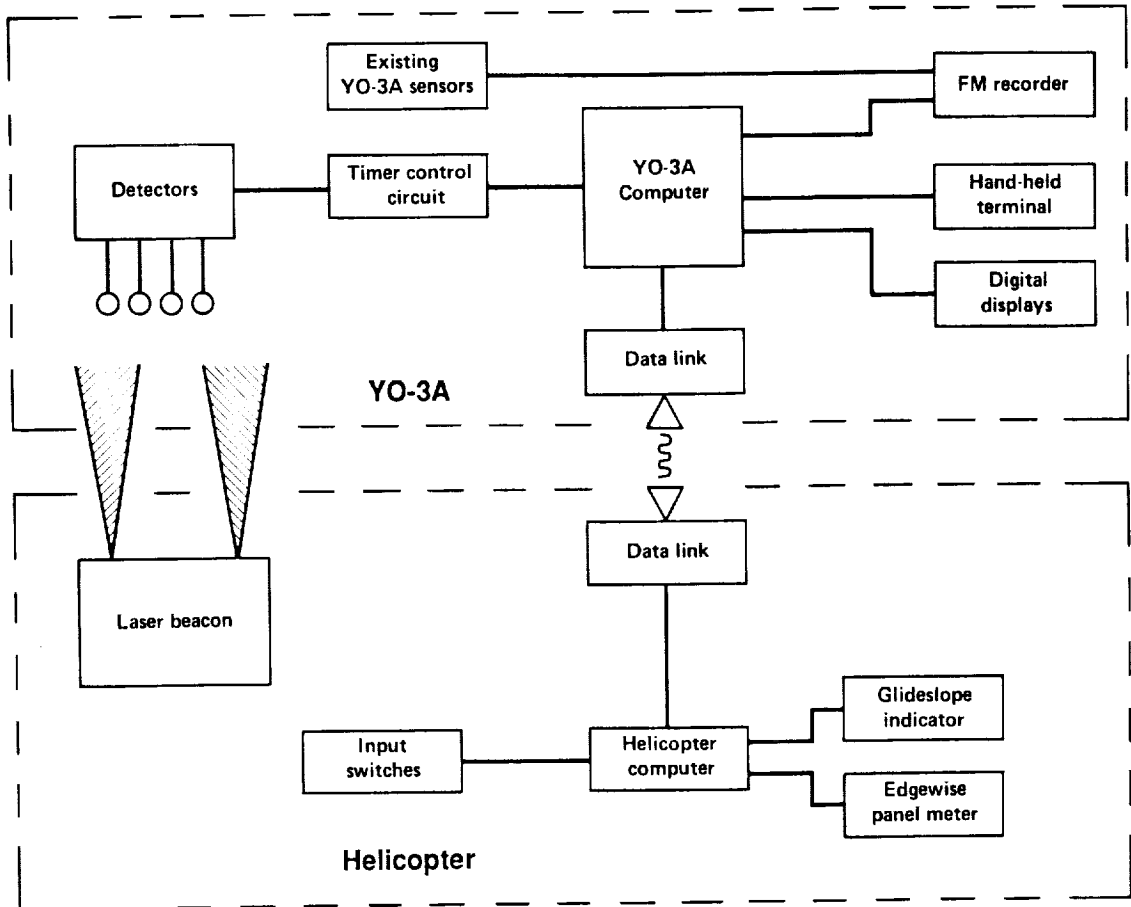

Figure 4. Block diagram of the laser beacon range measurement system.

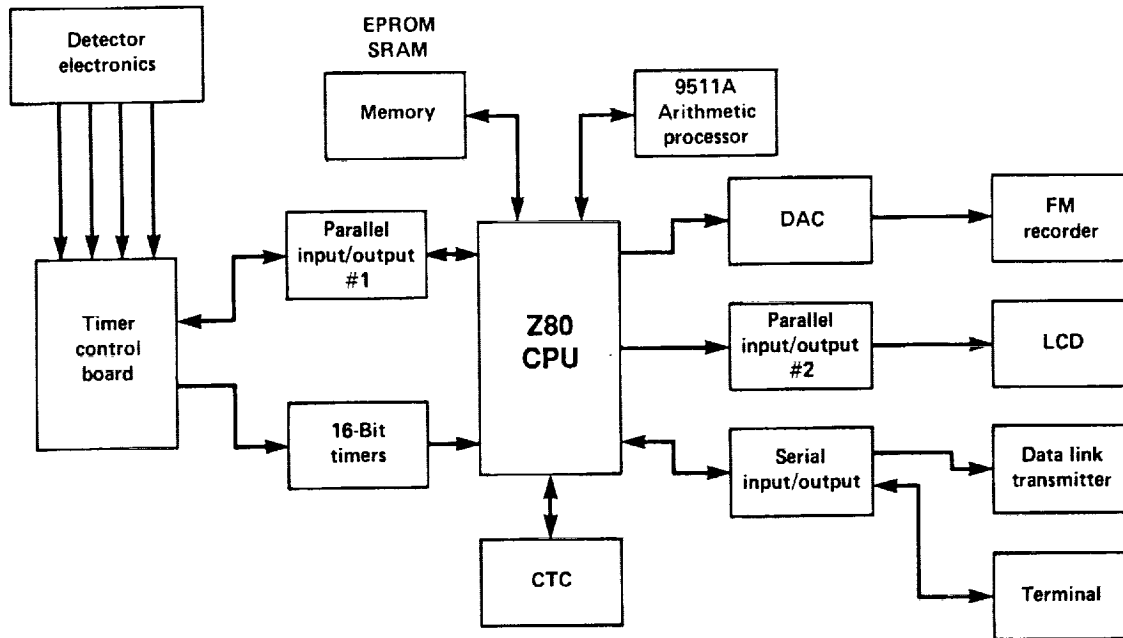

Figure 5. Block diagram of the YO-3A computer.

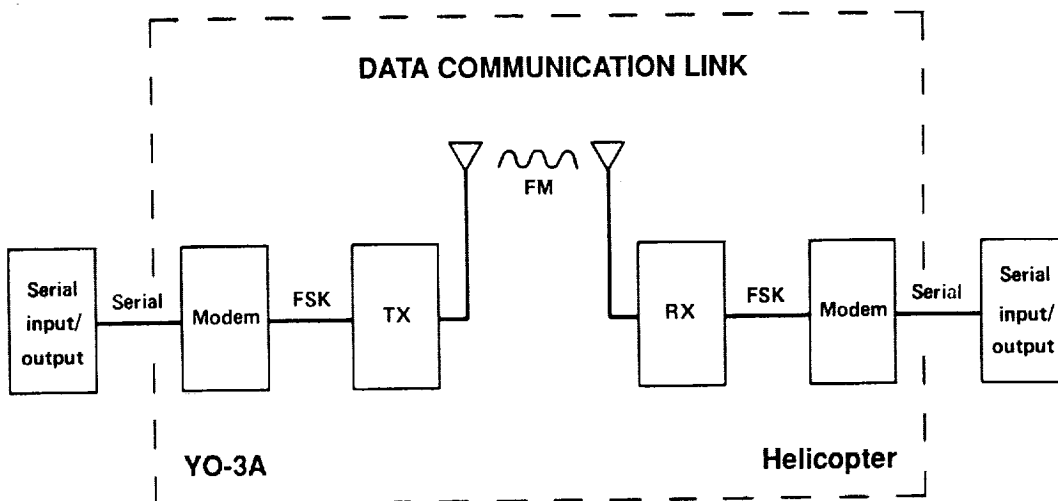

Figure 6. Block diagram of the data communication link.

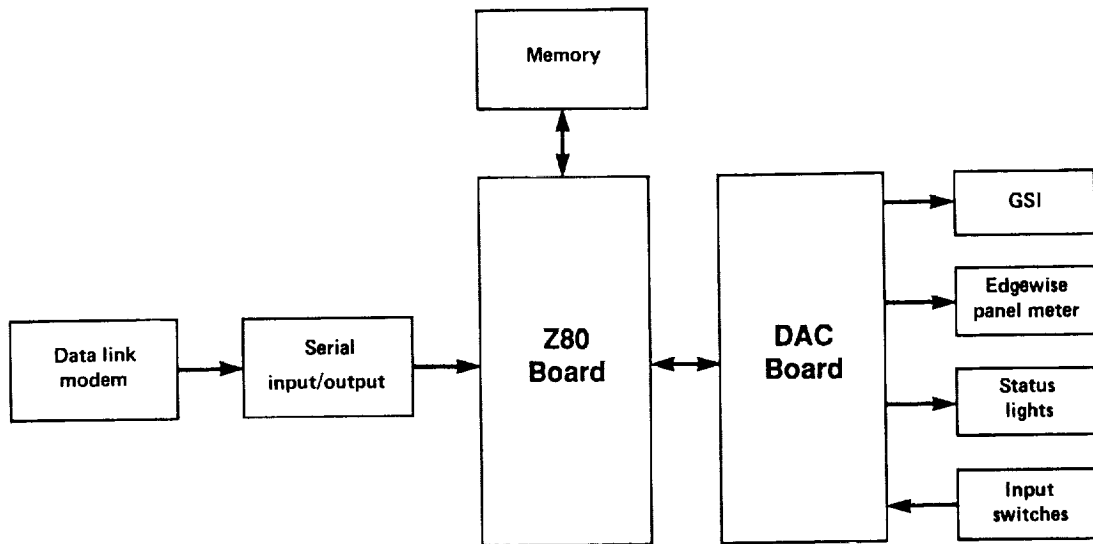

Figure 7. Block diagram of the helicopter display unit.

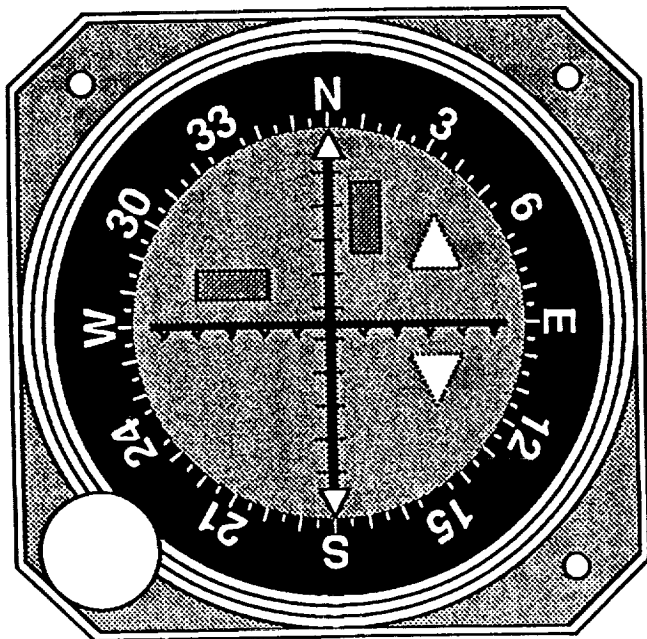

Figure 8. Faceplate of the King radio K1-207 glideslope indicator.

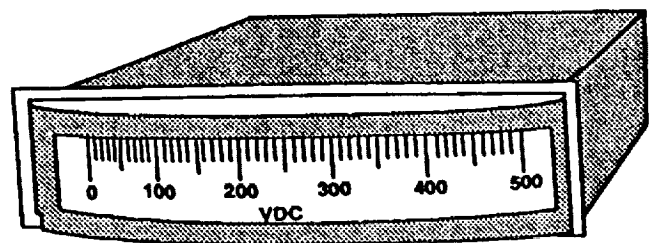

Figure 9. Airpax E35 edgewise panel meter.

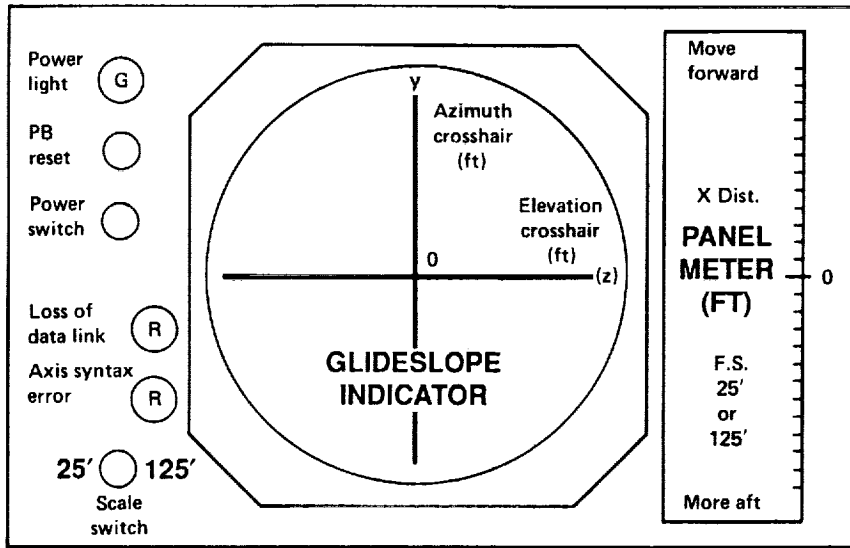

Figure 10. Component layout of the helicopter pilot's display.

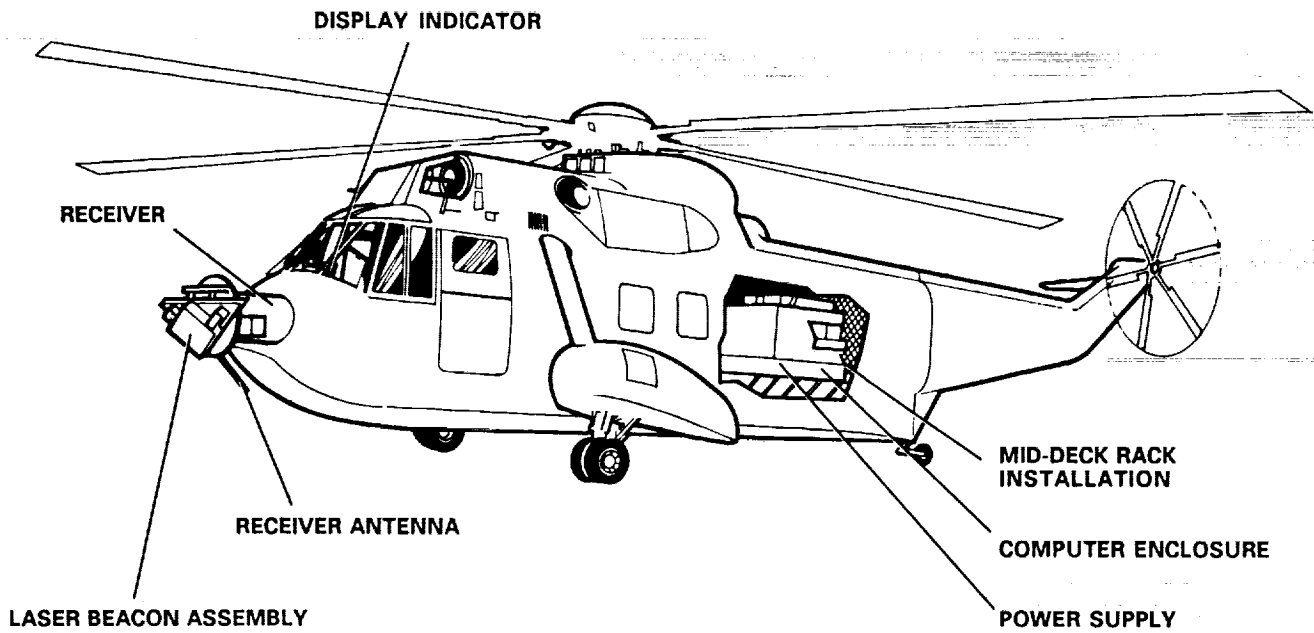

Figure 11. SH-3G HALPS system component locations.

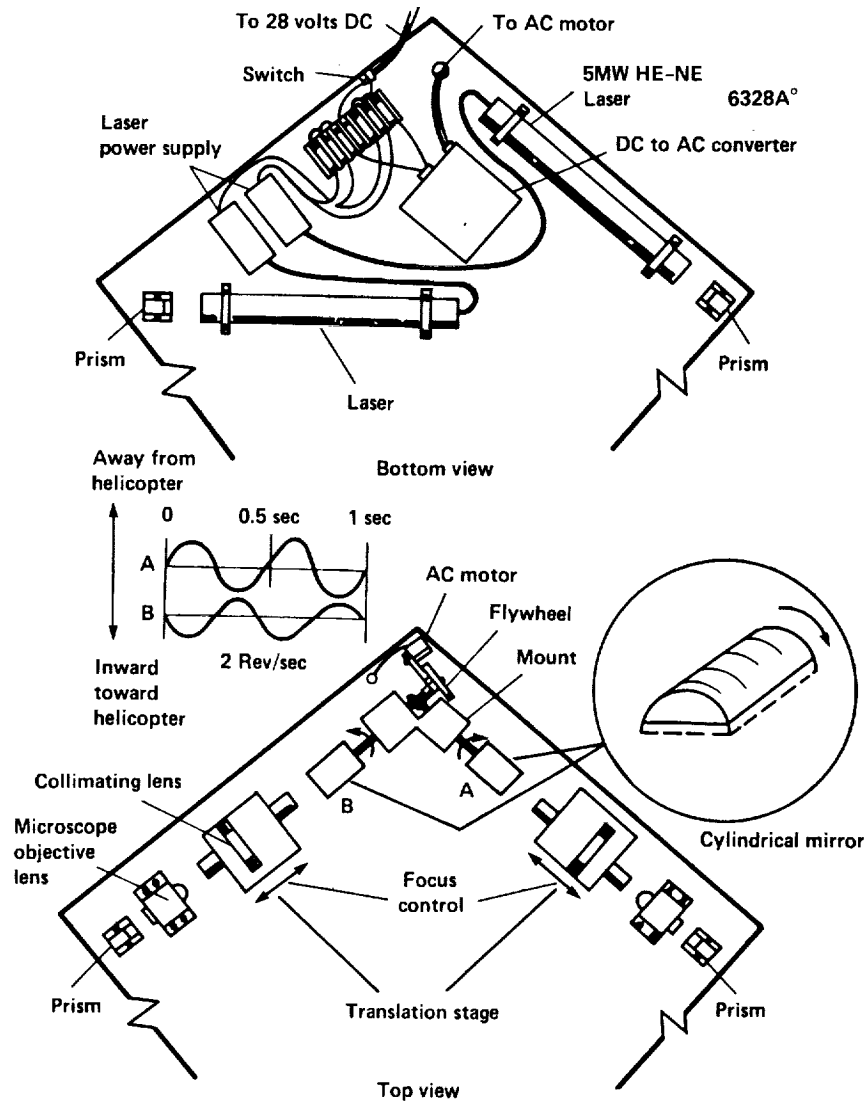

Figure 12. Laser beacon component layout.

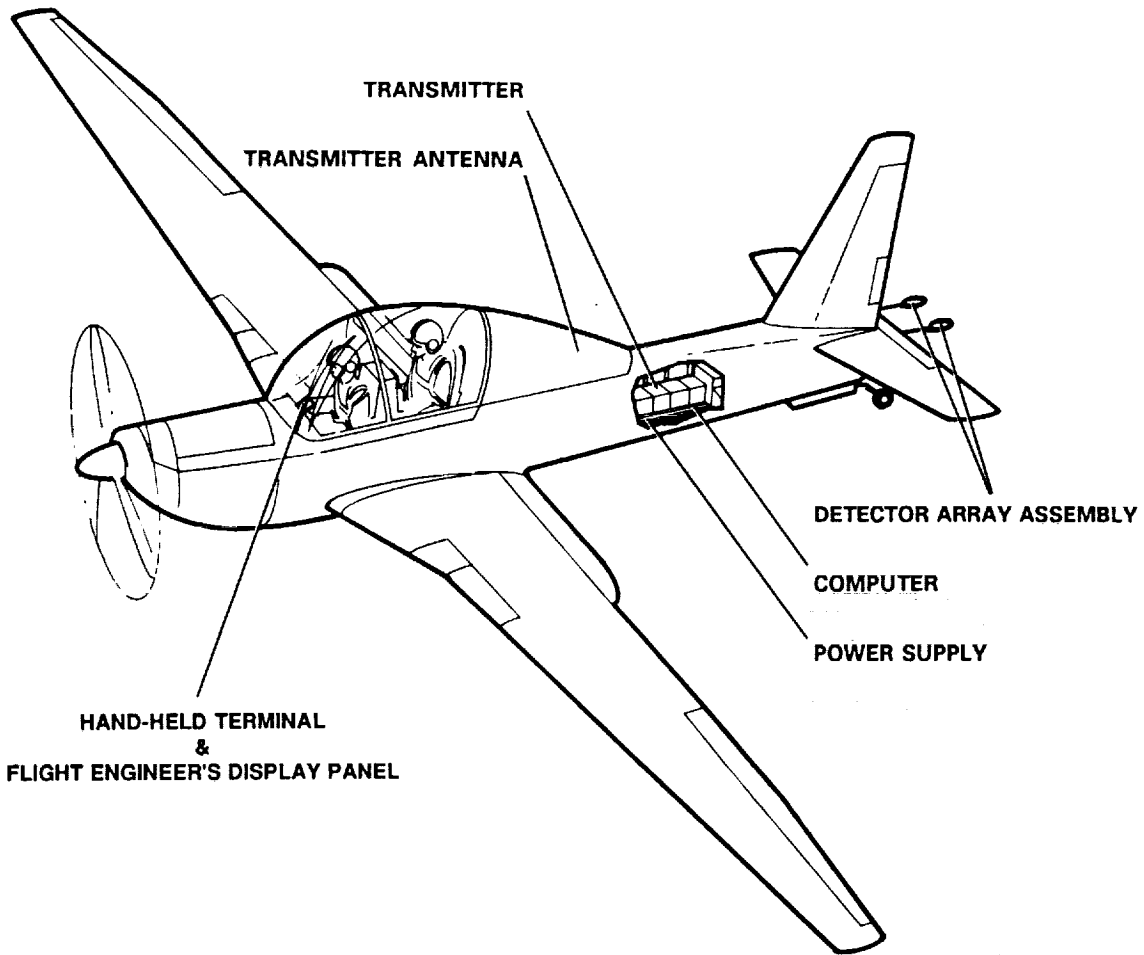

Figure 13. YO-3A HALPS system component locations.

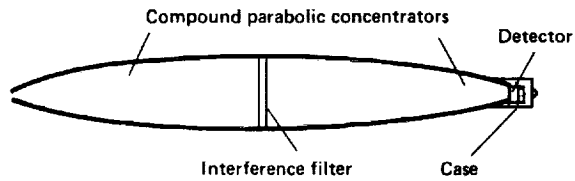

Figure 14. Detector design using compound parabolic concentrators.

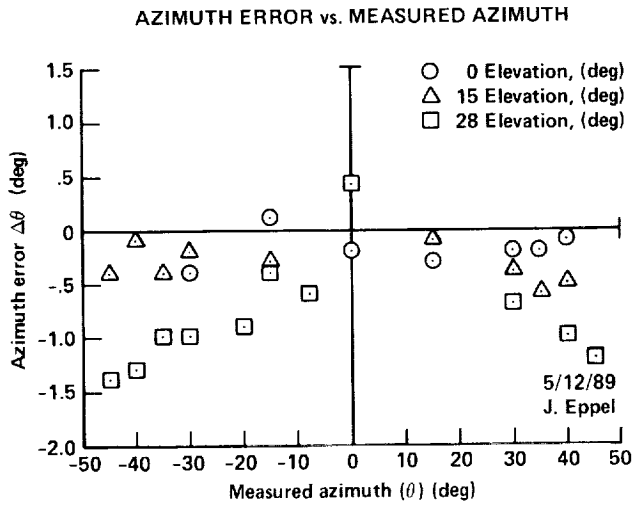

Figure 15. Azimuth error versus measured azimuth (lab results).

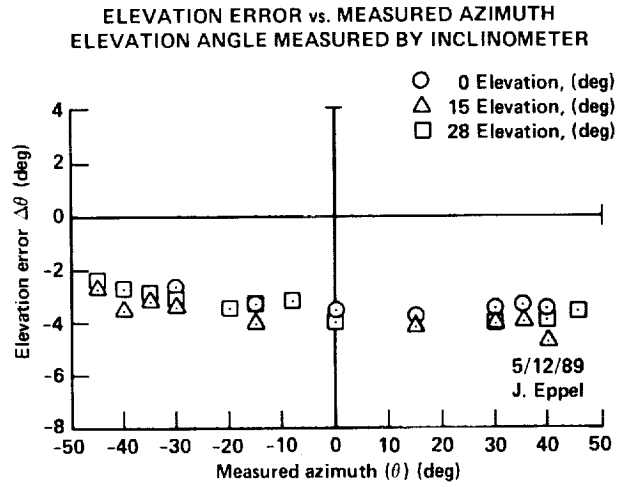

Figure 16. Elevation error versus measured azimuth (lab results).

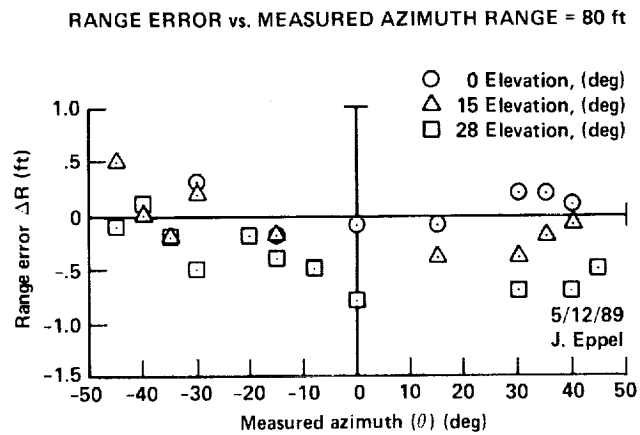

Figure 17. Range error versus measured azimuth (lab results).

ORIGINAL PAGE
BLACK AND WHITE PHOTOGRAPH



Figure 18. Ground test setup with YO-3A and laser beacon on hydraulic lift.

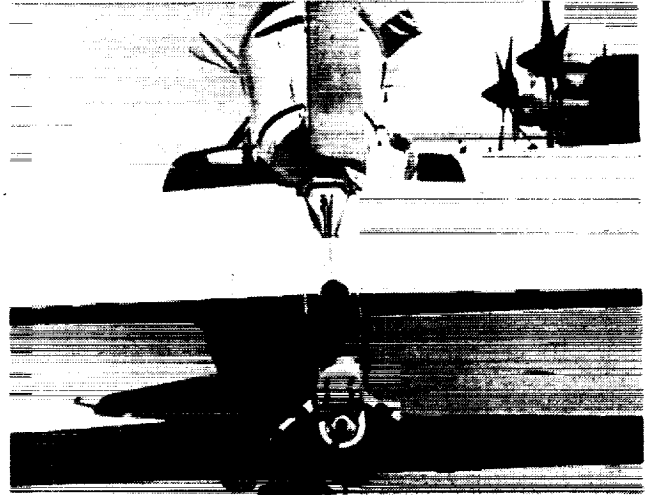

Figure 19. Detector array mounted on tail of the YO-3A.

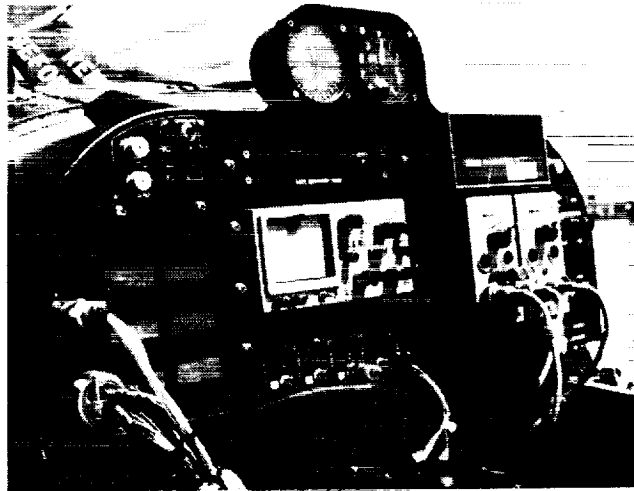

Figure 20. YO-3A instrument panel used by test engineer.

ORIGINAL PAGE IS
OF POOR QUALITY

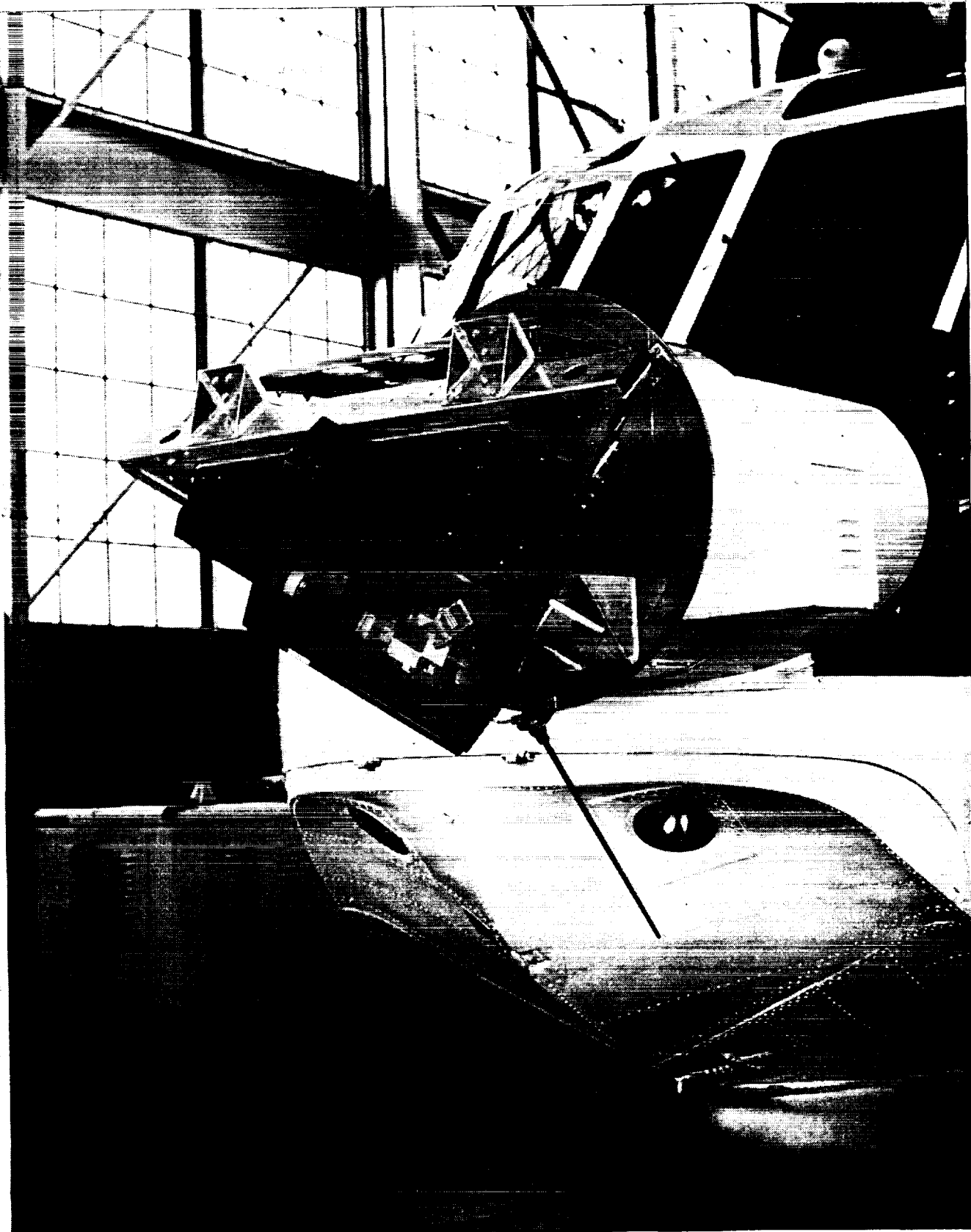

Figure 21. Laser beacon mounted on the test helicopter.

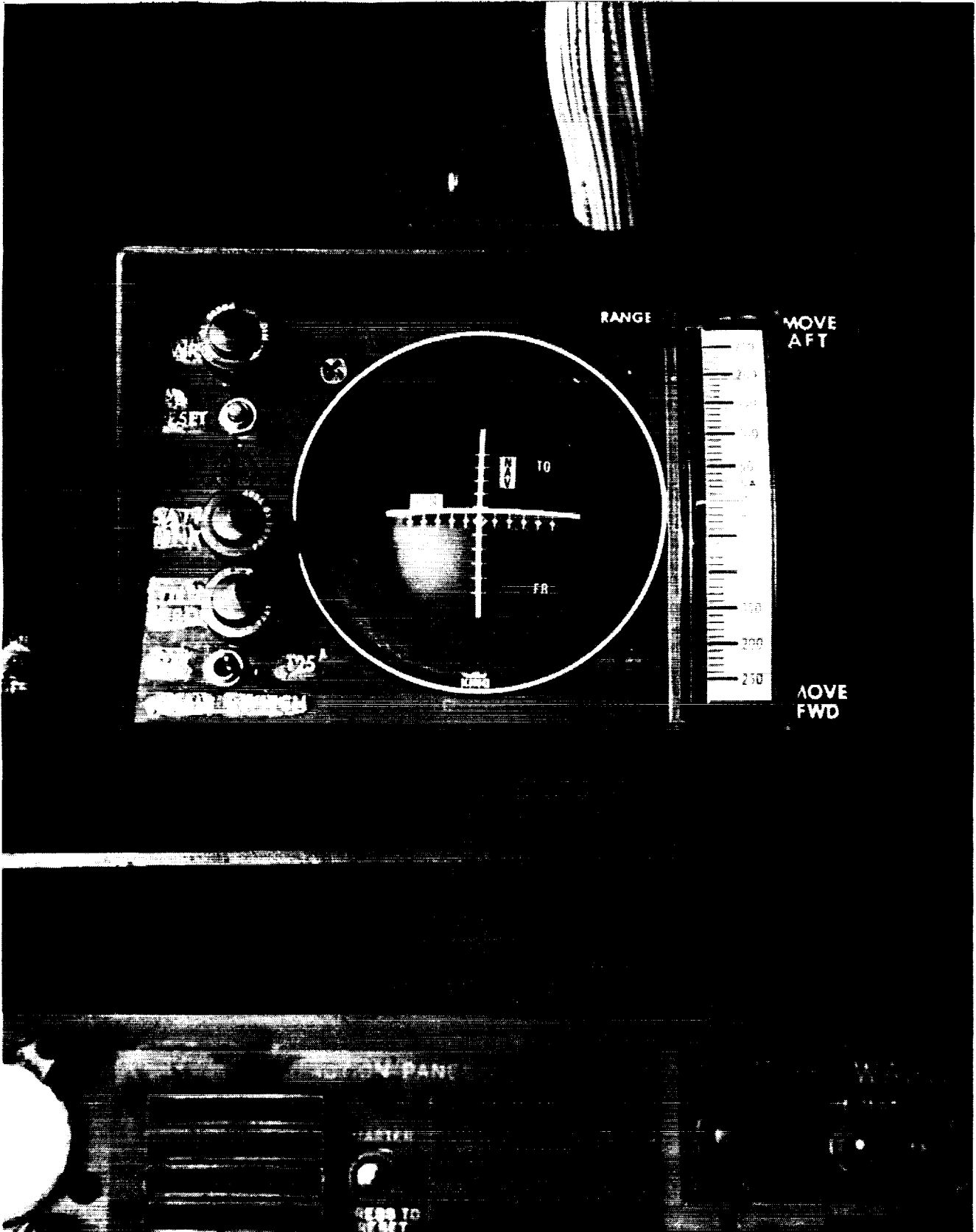

Figure 22. Helicopter pilot's display panel showing glideslope indicator and edgewise meter.



Report Documentation Page

1. Report No. NASA TM-102814		2. Government Accession No.		3. Recipient's Catalog No.	
4. Title and Subtitle Helicopter Airborne Laser Positioning System (HALPS)				5. Report Date March 1990	
				6. Performing Organization Code	
7. Author(s) Joseph C. Eppel, Howard Christiansen (Northrop Services, Inc., Sunnyvale, CA), Jeffrey Cross, and Joseph Totah				8. Performing Organization Report No. A-90139	
				10. Work Unit No. 505-61-51	
9. Performing Organization Name and Address Ames Research Center Moffett Field, CA 94035-1000				11. Contract or Grant No.	
				13. Type of Report and Period Covered Technical Memorandum	
12. Sponsoring Agency Name and Address National Aeronautics and Space Administration Washington, DC 20546-0001				14. Sponsoring Agency Code	
15. Supplementary Notes Point of Contact: Joseph C. Eppel, Ames Research Center, MS 237-3, Moffett Field, CA 94035-1000 (415) 604-6276 or FTS 464-6276 Presented at the Optical Engineering and Aerospace Sensing Meeting, Orlando, FL, Apr. 16-20, 1990.					
16. Abstract <p>This paper presents the theory of operation, configuration, laboratory, and ground test results obtained with an helicopter airborne laser positioning system developed by Princeton University. Unfortunately, due to time constraints, flight data could not be completed for presentation at this time. The system measures the relative position between two aircraft in three dimensions using two orthogonal fan-shaped laser beams sweeping across an array of four detectors. Specifically, the system calculates the relative range, elevation, and azimuth between an observation aircraft and a test helicopter with a high degree of accuracy. The detector array provides a wide field of view in the presence of solar interference due to compound parabolic concentrators and spectral filtering of the detector pulses. The detected pulses and their associated time delays are processed by the electronics and are sent as position errors to the helicopter pilot who repositions the aircraft as part of the closed loop system. Accuracies obtained in the laboratory at a range of 80 ft in the absence of sunlight were $\pm 1^\circ$ in elevation; $+0.5$ to -1.5° in azimuth; $+0.5$ to -1.0 ft in range; while elevation varied from 0 to $+28^\circ$ and the azimuth varied from 0° to $\pm 45^\circ$. Accuracies in sunlight were approximately the same for a range of 80 ft, except that the field of view was reduced to approximately 40° ($\pm 20^\circ$) in direct sunlight.</p>					
17. Key Words (Suggested by Author(s)) In-flight aircraft position In-flight acoustic measurements In-flight laser positioning system			18. Distribution Statement Unclassified-Unlimited Subject Category - 06		
19. Security Classif. (of this report) Unclassified		20. Security Classif. (of this page) Unclassified		21. No. of Pages 19	22. Price A02

