

ME 4182  
MECHANICAL DESIGN ENGINEERING

NASA/UNIVERSITY  
ADVANCED DESIGN PROGRAM

LUNAR BULK MATERIAL  
TRANSPORT VEHICLE

June, 1988

**ORIGINAL CONTAINS  
COLOR ILLUSTRATIONS**

Paul Daugherty  
Stewart Griner  
Alan Hendrix  
Chris Makarov  
Stephen Martiny  
Douglas Meyhoefer  
Cody Platt  
John Sivak  
Elizabeth Wheeler

(NASA-CR-184926) MECHANICAL DESIGN  
ENGINEERING. NASA/UNIVERSITY ADVANCED DESIGN  
PROGRAM: LUNAR BULK MATERIAL TRANSPORT  
VEHICLE (Georgia Inst. of Tech.) 131 p

CSC 13B G3/31

N90-24455

Unclas  
0200221

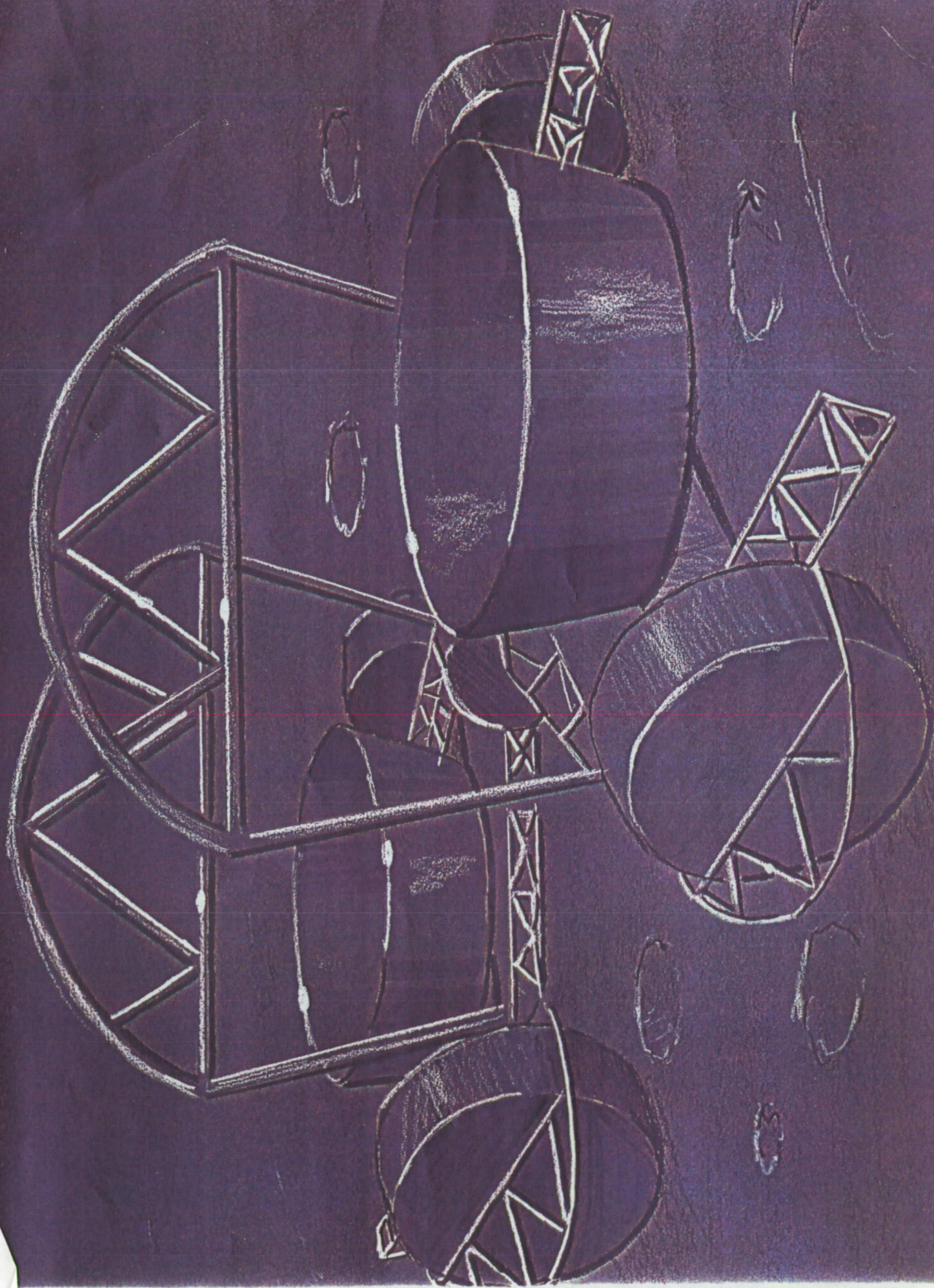

# TABLE OF CONTENTS

ABSTRACT	1
PROBLEM STATEMENT	2
DESCRIPTION	4
Introduction	4
Frame	4
Power Supply and Transmission	5
Center Joint and Steering Mechanism	5
Dump Mechanism	7
Wheels	8
Thermal Control System	8
Self-Righting Mechanism	9
Visual Control System	10
Control Panel	11
Interfaces and Attachments	12
Payload Bowl	13
ANALYSIS	14
Introduction	14
Frame	16
Power Supply and Transmission	17

Center Joint and Steering Mechanism	19
Dump Mechanism	20
Thermal Control System	20
Self-Righting Mechanism	22
CONCLUSIONS AND RECOMMENDATIONS	24
Combinations of Power Sources	24
Center Joint and Steering Mechanism	24
Thermal Control System	25
Dump Mechanism	26
ACKNOWLEDGEMENTS	27
REFERENCES	28
APPENDICES	30
Appendix A	Calculations
Appendix A.1	Frame
Appendix A.2	Center Joint
Appendix A.3	Power Supply
Appendix A.4	Bowl
Appendix A.5	Self-Righting Mechanism
Appendix A.6	Dump Mechanism
Appendix A.7	Thermal Control System

**Appendix A.8 Weight Analysis**

**Appendix B Spreadsheets and Graphs**

**Appendix C Progress Reports**

**Appendix D Invention Disclosure**

**Appendix E Figures**

**Appendix F Drawings**

## ABSTRACT

The design of a Lunar Bulk Material Transport Vehicle (LBMTV) is discussed. Goals set in the project include a payload of 50 cubic feet of lunar soil with a lunar weight of approximately 800 moon-pounds, a speed of 15 mph, and the ability to handle a grade of 20%. The report analyzes thermal control, an articulated steering mechanism, a dump mechanism, a self-righting mechanism, viable power sources, and a probable control panel.

The thermal control system involves the use of small strip heaters to heat the housing of electronic equipment in the absence of sufficient solar radiation and multi-layer insulation during periods of intense solar radiation. The entire system uses only 10 W and weighs about 60 pounds, or 10 moon-pounds.

The steering mechanism is an articulated steering joint at the center of the vehicle. It utilizes two actuators and yields a turning radius of 10.3 feet. The dump mechanism rotates the bulk material container through an angle of 100° using one actuator. The self-righting mechanism consists of two four bar linkages, each of which is powered by the same size actuator as the other linkages.

The LBMTV is powered by rechargeable batteries. A running time of at least two hours is attained under a worst case analysis. The weight of the batteries is 100 pounds.

A control panel consisting of feedback and control instruments is described. The panel includes all critical information necessary to control the vehicle remotely.

The LBMTV is capable of handling many types of cargo. It is able to interface with many types of removable bulk material containers. These containers are made to interface with the three-legged walker, SKITTER.

The overall vehicle is about 15 feet in length and has a weight of about 1000 pounds, or 170 lunar pounds.

## **PROBLEM STATEMENT**

A Bulk material transport vehicle has been designed twice previously. It is desired to refine prior designs for use in moving lunar work-station materials. A vehicle for lunar work stations is to be designed within the following performance specifications and constraints.

### I. Performance

- A. Slope - The vehicle must be able to travel up and down a 20% grade whether loaded or unloaded.
- B. Traction - Optimal traction is to be obtained since the Moon's soil is loose and gravity is 1/6 that of Earth's.
- C. Speed - The vehicle must be able to travel at a top speed of 5-15 mph.
- D. Payload Capacity - The hauling capacity should be at least 50 cubic feet and 800 Moon pounds.
- E. Self-righting - In the event of capsizing, the vehicle should be capable of self-righting.
- F. Reliability - In order to ensure maximum reliability, the vehicle should be as mechanically simple as possible.
- G. Power - The vehicle should operate on 5-15 horsepower.
- H. Center of Gravity - The center of gravity will be as low as possible to prevent capsizing.
- I. Ground Clearance - The ground clearance will be at least one foot.
- J. Weight - To minimize shipping costs, the vehicle will be made as light as possible.
- K. Control - The vehicle will be operated via remote control.

- L. Braking - A regenerative braking system would be optimal if proven feasible.

## II. Constraints

- A. Wheel-Bucket Ratio - The wheel to bucket ratio must be constant.
- B. Body Shape - Body should be symmetrical about a center pivot.
- C. Operating Range - The range of operation is limited to the line of sight.
- D. Thermal Range - Vehicle must operate between -120 C to 120 C
- E. Environment - The vehicle components must be able to withstand the abrasive soil and must operate with gravity 1/6 that of the Earth's.



# **DESCRIPTION**

## **INTRODUCTION**

The lunar bulk material transport vehicle (LBMTV) is capable of transporting bulk material over the lunar surface. It has four wheels, an articulated steering mechanism, and is symmetrical about the center steering pivot. The vehicle is capable of transporting approximately 800 moon-pounds of cargo of a variety of types. A thermal control system that uses strip heaters and multi-layer insulation are also part of the design. The vehicle has a self-righting mechanism that uses a four bar linkage to flip the LBMTV over if it should capsize.

The LBMTV is designed for a multitude of uses because of its ability to use many attachments. Therefore, it is more than just a dump truck. The different attachments used by the LBMTV are capable of being attached and removed by SKITTER.

The vehicle also has a multitude of feedback devices which allow it to be operated from a remote control station. A control panel is described in the report.

Figures OA1, OA2, and OA3 show the top, side, and end views of the LBMTV.

## **FRAME**

The frame of the LBMTV is a triangular truss arrangement. The truss is formed from tubes of 1.0 X 0.07 inch round tubing. A cross-section of the frame is 1 foot by 1.5 feet. The top of the frame is 1.0 foot in width. Each side of the frame is 1.58 feet. In an end view, the frame would appear as an upside down isosceles triangle inscribed in a 1 foot by 1.5 foot rectangle.

Each individual member of the truss is at a 33° angle with respect to the longitudinal axis. The frame is 4.2 feet in length from the end of the LBMTV then turns at a 35° angle toward the center of the vehicle and connects to the center joint/steering mechanism. Each of these segments is 2.6 feet in length.

The frame is constructed of 7075-T6 aluminum alloy. The total

length of tubing for the entire vehicle is 573 feet. With a weight of 0.121 pounds per linear foot, the total weight of the frame is 99.64 pounds which converts to 16.60 moon-pounds.

The largest loads imposed on the frame are at the following positions: wheel-motor mount, bowl pivot mount, near the center joint, and at the base of the roll bar. These points were analyzed to determine the sizing of the tubing necessary.

## **POWER SUPPLY AND TRANSMISSION**

The LBMTV will require 3.2 kiloWatts of power from a series of parallel connected lithium or sodium secondary batteries situated in the triangular truss structure of the LBMTV. The eight linear synchronous motors currently under development will be used to drive the vehicle(see Figure PS4). Their regeneration capabilities will be exploited to increase overall operation performance.

Recharging stations will consist of solar arrays due to the encouraging research being done in these areas. For this application, gallium arsenide solar cells will be the ideal array. The LBMTV will make scheduled stops for the recharging of its batteries. Given efficient charging methods, recharging times should be minimal.

The batteries used have a total weight of approximately 100 pounds, or 17 moon-pounds. They have a life expectancy of 5-6 years, which is the approximate projected life of the LBMTV.

## **CENTER JOINT AND STEERING MECHANISM**

### **CENTER JOINT - Axial Rotation**

The center joint provides rotation about the center axis and left to right steering capability at the dump body(See Figure CJ1). The joint is based on two 24 inch diameter, 1.3 inch thick plates connected with a hollow shaft having a one inch inside diameter and 3.5 inch outside diameter. 3.5 inch diameter thrust bearings and nuts are used on the shaft. A ball bearing race is located between the plates to compensate for the

high torques encountered. 63 ball bearings of 0.9973 inch diameter reside in a bearing race that is 20 inches in diameter. The indentation of the bearing race is .25 inches which results in 0.4473 inches between the plates. The bearings are greased, and a seal is achieved with a flexible polymer sleeve connected to each plate with a band clamp. In order to prevent tearing of the sleeve, two 1.5 inch long, 1.00 inch diameter pins are used to limit solidly to one plate and fit into arc-shaped grooves in the other plate.

### **CENTER JOINT - Left to Right Rotation**

Rotation in a horizontal plane at the center joint is provided by attaching the dump bodies to the round plates with a clevis-pin arrangement(See Figure CJ2). The nose of the dump body is Y-shaped to clear the center shaft and to provide a wide (20 inch) stance for the clevis-pins. A pair of two inch diameter, 3.25 inch long pins connect each dump body to the round plates. Each pin is nested in three rings of one inch square cross-sectional area that comprise the clevis(See Figure CJ3). A 0.125 inch thick bronze bushing fits between the pin and rings, and the pin is greased and capped with a 2.05 inch cap.

### **STEERING MECHANISM**

The left to right rotation at the center-joint provides the necessary motion for steering, and a 500 pound-force electro-mechanical actuator provides the steering force(See Figure CJ-4). The actuator is bolted to the top of the cross bar at the rear of the dump-body nose and is free to rotate about this bolt. A curved link connects the actuator to the round center-joint plate. This curved link is 5.01 inches tall, 1.67 inches thick, and has a 0.98 foot radius of curvature. The actuator has a 36.37 inch dead-length and a 24.00 inch free-length. The actuator is extended 12.00 inches at the neutral steering position and extends or retracts to steer the vehicle. Both dump-body noses have a 110 degree angle at the attachment as this gives the shortest possible length for the required steering torque. The maximum steering angle is 29.2 degrees in either direction for each half of the vehicle for a total steering angle of 58.4 degrees. Should an actuator fail, the vehicle can still be adequately

steered, but the effective steering angle would be reduced to a total of 29.2 degrees.

## **MATERIALS**

The part dimensions for the center-joint and steering mechanism is based on using UNS-A97055 aluminum for all of the metal parts discussed except for the clevis-pins and clevis-pin bushings. The clevis-pins are AISI-4142 steel and the bushings are bronze.

## **PERFORMANCE SPECIFICATIONS**

The design allows the vehicle to turn up a slope of 30° which is larger than the maximum grade of 20° which the rest of the vehicle is designed for. The turning radius is 10.31 feet and the curb-to-curb turning diameter is 27.71 feet. The vehicle can rotate 45 degrees clock-wise and 45 degrees counter clock-wise about the center axis for a total of 90 degrees rotation.

## **DUMP MECHANISM**

The main purpose of the LBMTV is to be able to transport objects and equipment from one point to another. It must also be able to dump cargo such as soil in addition to interfacing with SKITTER .

The dump payload is a flat plate that utilizes and interfaces with many different accessories including a bowl and a flat bed. The plate is connected to a rigid frame that is pinned to the frame of the vehicle which allows the plate to freely pivot about the hinge point. The plate is driven by an actuator mounted to the frame.

The actuator is three feet long at its dead length and allows the flat plate to rotate about 100° through a swing radius of about one foot. The actuator is pinned at one end to the frame. The other end is pinned to a rigid bar that extends 4.5 inches below the plate. The actuator is the same actuator used on the steering system and the roll bar. This was intentionally done to minimize the number of replacements parts needed.

The plate and rigid frame are made out of the same material as the frame (aluminum 7075-T6). The members of the linkage connected to the

actuator should be constructed from 1.0 X 0.044 inch round tubing. The plate and its interfaces with the other attachments are described in the section on interfaces. Total weight of the system should be approximately 20 lbs excluding the actuators.

## **WHEELS**

The wheels used in the LBMTV must overcome the environmental conditions present on the moon. Extreme changes in temperature, the absence of an atmosphere, and an extremely abrasive surface all contribute to a harsh environment which the vehicle's wheels must endure.

The single element elastic conical wheel developed by Grumman is ideal for the lunar environment. The wheel is light in weight, reliable, large in diameter, has a self-cleaning tendency, as well as favorable structural characteristics.

The wheel is formed from Fiberglass Reinforced Plastic. "S" glass fabric (778 Fiberglass) and Trevanno F-161 impregnating resin are used to create a material with superior fatigue properties and strength retention at temperatures as high as 400 degrees F. Around the circumference of the wheel are 30 Titanium Alloy (Ti-6Al-4V) cleats which provide superior resistance to abrasive wear and good thermal resistance. A protective covering of Tedlar Film over the wheel prevents the fiberglass from degradation due to ultraviolet radiation.

The life cycle of the wheel is  $10^6$  revolutions, which translates to approximately 1880 miles, using a wheel radius of 19 inches. The wheel has a width of 17 inches, a diameter of 38 inches, and is able to support a load of approximately 300 pounds. These wheels appear to be perfect for use on the LBMTV.

## **THERMAL CONTROL SYSTEM**

The cameras and electronic components of the LBMTV are housed in an enclosed portion of the truss frame. Proper temperature control of the enclosure housing the electronics is essential for prevention of damage and correct operation. The electronic housings are located in the last two feet of each of the four main truss legs. These compartments will be

equipped with heaters for heating during absence of solar radiation. Other components such as the pop-up cameras will be equipped with a radiative shielding only.

A design temperature of  $\pm 5^{\circ}\text{C}$  has been chosen for the electronic housings. The thermal control system consists of an aluminum housing, multi-layer insulation, and 0.25 Watt heating elements. The multi-layer insulation consists of aluminum coated Kapton inner and outer layers with alternating Mylar and Dacron mesh sub-layers. The multi-layer insulation achieves a total emissivity for the housing of 0.01. The total weight of the thermal control system is approximately 10.2 pounds on the lunar surface. The total power requirement of the thermal control system during periods of no solar radiation is 9.7 Watts.

The thermal control system has been designed for operation of the LBMTV during periods of intense radiation for up to two hours while operation of the vehicle during the absence of radiation is limited only by the capacity of the storage batteries.

The electronic housings are equipped with thermocouples coupled with an appropriate closed-loop feedback control system to alert an operator of the amount of time that remains until the housing temperature is at  $5^{\circ}\text{C}$ . If the truck is occasionally turned around so that one side of the truck does not receive direct solar radiation for the entire work cycle, the time to thermal saturation of the aluminum housing will be increased.

## **SELF-RIGHTING MECHANISM**

The self-righting mechanism consists of two four bar mechanisms, each of which is powered by an actuator. A diagram of the mechanism is shown in Figure SR1. The device operates on the principle of shifting the center of gravity of the LBMTV to one side of a wheel bar which extends outward around the wheels. The mechanism will use a 3 foot actuator, which is connected to the crank at one end and to the coupler at the other.

The coupler bar is a frame structure with its top being an arc. Thus, if the vehicle should capsize, it would not come to rest directly upside down. Instead, it would roll over and come to rest on one side or the other. When it comes to rest, it will be sitting on one of the wheel bars and a pin connecting the coupler to one of the legs. At this point, the line of action

of the center of gravity would be acting downward between these two points which the LBMTV rests upon.

If the crank is the leg closest to the ground, then the actuator would contract until the line of action of the center of gravity was shifted to the other side of the wheel. Similarly, if the actuator was on the upper side of the capsized vehicle, then the actuator would expand until the line of action of the center of gravity was again on the other side of the wheel guard from the coupler pin.

The size of the bars in the self-righting mechanism are 3.0 X 0.045 inches round tubing. The crank and follower bars are 7 feet in length while the coupler is 11 feet long. The base of the linkage is 5 feet.

## **VISUAL CONTROL SYSTEM**

The LBMTV visual-feedback control will consist of six cameras sending continuous signals to a central control station. Each truss-end of the main vehicle support frame will be equipped with a camera. The resulting visual feedback from these four cameras will enable the operator to see in front of and in back of the vehicle. Two pop-up cameras, one on each side of the LBMTV, will allow a panoramic view of the surrounding area. Figure VS1 shows the location and line of sight of the cameras.

The cameras located at the truss ends are enclosed in a one-way mirror enclosure. The cameras will be equipped with a zoom lens. The pop-up cameras will be mounted on a telescopic shaft. See Figure VS2 for an assembly of this setup. The pop-up cameras will enable viewing of the payload operations. During periods of high dust kick-up, the pop-up cameras could be extended above the dust cloud for sight when the truss-end cameras do not provide sufficient visual information. However, care should be taken to ensure that the cameras are retracted in the event of capsizing.

With the current design, the pop-up cameras would be easiest to clean since the lens is moved in and out of an enclosure; however, no solution is offered for cleaning of these or the truss-end camera one-way mirror enclosures.

The camera placement offers an advantage in that blackout of one

camera does not leave a blind area to the operator. If one truss-end camera fails, its vision can be made up by use of the adjacent camera. In the event that all four truss-end cameras fail, the telescopic pop-up cameras could be used temporarily, but the risk of damage due to capsizing would make this operation undesirable for an extended period of time.

## **CONTROL PANEL**

The earth based control of the LBMTV will be operated by one controller. The control panel itself is broken up into seven main areas: steering, self-righting, speed, power, temperature control, dumping, and visual systems. The three most important operations, steering, speed, and visual controls, are located directly in front of the operator and the other areas are located to the left and right. The entire control panel with video monitors is shown in Figure CB1. Directly above the panels are four monitors, one for each of the truss-end cameras, and one camera to each side for the pop-up cameras for a total of six monitors.

Steering is controlled through the use of a joystick leaving one hand free for other controls. The main feedback data of the steering operation are speed of each wheel, slip of each wheel, and the turning angle of the vehicle. The angle is indicated in several ways: the turning angle of each half of the vehicle, the total turning angle (the sum of the two angles), the length of each steering actuator, and the turning radius at that angle.

Power control is also indicated in several ways: total energy remaining in the batteries, total power being consumed by the vehicle, and the amount of power being consumed by each individual component.

The feedback for the dumping mechanism includes the angle for the bowl, the rate of change of the angle of the bowl, the length of the actuator, and the rate of change of the length of the actuator. The power consumption of the actuators is indicated on the power board.

In the self-righting portion of the panel, the indicated data are angle of the self-righting mechanism with respect to the vehicle and its rate of change, the length of the actuator and its rate of change, and the angle formed by the normal force and the line from the center of gravity to the point of rest at the wheel guard.

The controls for the pop-up cameras are also on the control panel.



From the control panel, the operator will be able to raise the cameras, rotate them about the axis of the telescopic shaft, and adjust the tilt relative to the frame of the vehicle.

Several warning lights are present on the panel to warn the operator of any danger that must be acted upon immediately. A display showing the amount of time left before recharge, given the current rate of power usage, would be positioned directly in front of the controller to make sure the vehicle is not allowed to venture too far from the recharging station and become stranded. Warning lights alerting the operator of an approaching thermal saturation would also be included.

All controls offer some resistance to movement to prevent accidental action. Color coding is used throughout to indicate operation speed, temperature, and actuator length. Bird's eye diagrammatic layouts are used on the panel to indicate locations on the LBMTV where the information is desired. By attaining feedback through the cameras and sensors located on the LBMTV, a trained operator will analyze and control the movement of the LBMTV via the control panel.

## **INTERFACES AND ATTACHMENTS**

The LBMTV is designed to have interchangeable flatbeds, dump truck like containers and other bulk material containers. These items must have interfaces that allow them to be attached and detached by SKITTER. They must not only have an interface that allows them to be handled by SKITTER, but they must also have an interface that allows them to be locked onto the LBMTV.

Figure IF1 shows the interface that is attached to SKITTER. This connection is attached to the center of SKITTER, and is lowered down to the article to be picked up. Figure IF2 shows the matching interface that will be attached to all implements to be used on the LBMTV. Three of these connections will be present on all of the bulk material containers.

The next interface is between the containers used and the LBMTV itself. The vehicle is designed with two flat plates to which all containers are secured. SKITTER will be responsible for positioning, locking, and removing these different containers.

The flatbeds are easily positioned by sliding them into the grooves shown in Figure IF3. Once the flatbed is in the correct position, SKITTER

presses a lever which activates a spring mechanism which releases a bar to secure the flatbed. To remove the flatbed, SKITTER presses down on the bar and it resets the spring mechanism and allows the bed to be removed.

For an attachment such as a bowl, two rails must be attached to the body of the bowl. These rails are then positioned in the grooves similarly to the flatbed (see Figure IF4). Another member is then connected which runs from rail to rail. This member has a groove cut out of it which allows it to be locked into place in the same manner as the flatbeds.

## **PAYLOAD BOWL**

The bowl was designed to carry 25 cubic feet of soil or other material. Also, the bowl diameter to wheel diameter ratio is approximately  $4/3$ . Based on a wheel diameter of 38 inches, the diameter of the bowl was determined to be 49.5 inches. The rest of the bowl dimensions were then scaled to this measurement.

The lip height was set equal to the radius of curvature of the outside of the bowl's bottom edge. Therefore, in order to attain a total diameter of 49.5 inches, these dimensions were equal to  $49.5/4$  or 12.4 inches. The bottom diameter of the bowl is one half of the top diameter or 24.7 inches. The volume of the bowl is 25.25 cubic feet and can hold a payload of 400 moon-pounds of lunar soil. The center of gravity is 13.2 inches from the bottom of the bowl and it is directly above the center of the bowl on the centerline. See Figure B1 for a drawing of the bowl.

# ANALYSIS

## INTRODUCTION

In order for any sort of construction to take place on the moon, a vehicle will have to be designed that would be able to move bulk material from one point to another. This vehicle must be able to withstand every aspect of the harsh lunar environment. The vehicle must be minimal in maintenance because there may or may not be someone on the site to correct any difficulty that may arise. With this in mind, a Lunar Bulk Material Transport Vehicle was designed. The process was one of examination of a number of possibilities for each aspect of the vehicle.

Our problem statement somewhat defined what type of vehicle should be designed. It had to have four wheels, it had to be as symmetrical as possible, and it was to be motored by a curvilinear synchronous motor. This ruled out a number of prospects which had been conceived of, such as a tracked vehicle like a bull dozer. Also, the bowl size and the wheel size were fixed at 5.33 and 4.00 feet diameters, respectively.

This left a number of separate tasks to be completed, all of which had to be compatible.

--A power supply system must be conceived.

It must be able to operate with low maintenance.

It must be kept at a minimum weight.

--A thermal control system had to be designed

It must be able to dispose of excess heat in the lunar day.

It must be able to heat components in the lunar night.

It must use minimal power and not add significantly to the weight.

- A frame had to be designed with the following criteria in mind:
  - It must house the motors and the power sources.
  - It must be able to support the entire load of the vehicle, perhaps over a very small area in some conceivable situations.
  - It must be made of a material that is resistant to the corrosive nature of the lunar soil.
  
- A steering mechanism had to be devised.
  - It must be mechanically simple.
  - It must use as little power as possible.
  - It must provide the necessary range of motions.
  
- A self-righting mechanism had to be designed.
  - The mechanism must be light weight and number few in parts.
  - The mechanism must be strong enough to support the load of vehicle.
  - The mechanism must function properly even if the vehicle should capsize on an incline.
  
- A mechanism to spill the payload had to be designed.
  - The mechanism must be light weight and number few in parts.
  - It must be able to rotate the bowl at least 90 degrees.
  - It must be able to support the weight of the payload.
  
- Wheels compatible with the lunar environment had to be selected.
  - They must have adequate traction on a sand-like surface.
  - They must be light in weight.
  - They must be able to support the load of the LBMTV.
  
- A visual system had to be designed for remote operation.
  - Cameras must provide view of the vehicle and its surroundings.
  - The cameras must be protected from damage caused by capsize or falling debris.
  
- An interface system had to be devised.
  - The different attachments must be secured onto the LBMTV.
  - SKITTER must be able to replace the different containers.

## FRAME TRUSS

The frame of the LBMTV was designed according to the geometric constraints on the vehicle and also the loading conditions imposed on the vehicle. The first step in the design process was the overall dimensioning of the vehicle. The width of the vehicle was constrained by the width of the cargo bay, which is 15 feet. Another constraint was that the vehicle had to be symmetrical about its middle joint. Additionally, the wheel diameter was defined as 4 feet and the bowl diameter as 5.33 feet.

Each half of the LBMTV is made of triangular truss sections that are welded together to form the U-shaped frame. The truss elements are to be made of Aluminum Alloy 7075-T6 extruded tubing. This alloy was chosen because of its high yield strength of 35 to 61 kpsi over a wide range of temperatures, -148 F to 250 F.

The actual sizing of the tubing to be used was determined by doing a force analysis on certain critical sections of the frame. These critical sections chosen are shown in Figures TF1 and TF2. They were chosen since the major loads of the vehicle act primarily on these sections. Upon analysis of section B, the bowl mount truss, it was determined that the critical load on an individual tube section would be 316 pound-force. To account for the simplified frame analysis used and also to compensate for the extreme loads that will be applied to the frame in the event of capsize and rollover, the frame sizing calculated was increased by a factor of 100. The tubing chosen has an outside diameter of 1.05 inches and a width of 0.05 inches.

The second section of the frame chosen for analysis was the area that the houses the motor (section A). The section analyzed will be an inner section of the truss on which the bowl mount truss rests and in which the motor is mounted. To simplify the analysis, the force that is exerted on one wheel of the LBMTV will be used to calculate the reactions of the truss element. Then the truss element will be isolated to analyze internal forces.

Upon analysis, it was found that the most compressed member was under a force of 3275 pounds-force. Using the Euler column formula for buckling, the moment of inertia of a 1 inch inner diameter section of tubing was found to be .0032 inches<sup>4</sup>. Once again a factor of safety of 5 was added to bring the moment of inertia up to 0.016 inches<sup>4</sup>. This yields a tube size of 1.07 inches X 0.07 inches thickness.

## **POWER REQUIREMENTS FOR LBMTV**

The elements of the LBMTV that will require electrical power are the electro-mechanical steering, dumping and self-righting actuators, drive motors, heating elements, and the electronic control components. By realizing that all major actuators will require the same power and that only three actuators will be operating at the same time and seeing that the two turning actuators will split the power consumption between them, the actuators under consideration will require a maximum of 350 Watts. Using a projected moon weight for the LBMTV of 960 pounds, the power requirements of the eight linear synchronous drive motors will total a maximum of 2.3 kW. This was computed as a maximum power requirement.

The case of maximum power requirement used was for the LBMTV operating on a grade of 20%, fully loaded with a minimum speed of 5 mph for its entire discharge time(see Figure PS1). In practical applications the extreme case will not occur often, but power of this magnitude could conceivably be required. Regeneration of power or the dynamic recharge of batteries by the linear synchronous motors was also considered in the analysis. During downhill operation, the motor would actually act as a generator converting the inertial mechanical energy to electrical energy. The projections of regenerated power for the motors was unavailable, but an estimate of 35-40% seems reasonable depending on the slope and the length of downhill runs. It may be possible to double the operation time of the LBMTV given a course highly suitable to power regeneration.

The heating elements that provide a constant temperature for the electronic enclosures during absence of solar radiation will require 10 Watts. Considering the magnitude of the drive motor requirements, power for communication systems is negligible. Lunar to Earth transmitter power will be derived from a lunar based power station and will not be vehicle based. A total conservative power requirement for the LBMTV is 3.2 kW.

## **POWER SOURCE OPTIONS**

Power sources considered were solar arrays, primary batteries, secondary batteries, fuel cells, and radio-isotope thermo-electrical

generators.

Solar arrays, though very promising for stationary and orbital power generation, are not feasible for the LBMTV due to the detrimental effects of the lunar dust on solar cell surfaces which would inhibit solar collection, low collector efficiencies, and large weight to power ratios for solar collectors. Operation during dark periods would also require an auxiliary battery or fuel cell system.

Primary batteries such as the silver-zinc system deliver about 150 Watt-hours/kg. Another promising primary battery is a lithium battery based on  $\text{SOCl}_2$  which can deliver 300 Watt-hours/kg with a discharge time of one hour. Although these primaries provide much power, problems with their inability to take a recharge make them undesirable for long term use.

Secondary or rechargeable batteries with lower energy densities of 25 Watt-hours/kg but much better recharging characteristics have been demonstrated. Large gains in the development of high energy Lithium and Sodium secondaries should be possible in the next two decades. Rechargeables on the order of 200 Watt-hours/kg may be possible in the near future.

Primary fuel cell stacks presently operating on shuttle missions have a specific power of 150 Watt-hours/kg and operation times are maximized at 5000 hr. Regenerative fuel cells are composed of a fuel cell working alternately in the conventional power-producing mode and then in reverse or power-consuming mode to regenerate the  $\text{H}_2$  and  $\text{O}_2$  reactants, with the primary power source being photo-voltaic cells. These RFC's may eventually produce as much as 1400 kiloWatt-hours/kg, but the technology is still in its early stages. The reversibility of this system may provide efficiencies approaching 85%.

Radio-isotope thermo-electric generators have been used successfully in both the Apollo and Voyager missions. Low specific power of only 8 Watts/kg and a high cost of \$1800/Watt deem them less attractive for the LBMTV.

Figures PS2 and PS3 show the tradeoffs of running time, velocity, and battery weights for a 200 kW-h/kg battery cell.

## CENTER JOINT AND STEERING MECHANISM

The center joint is designed with two degrees of freedom. The center pipe handles tensile/compressive forces developed from the force created due to a sudden stop of the vehicle. The force is based on the vehicle's mass and a stopping time of 0.025 seconds. A factor of safety of 1.25 was used since the pipe has a small diameter to neglect any bending stresses developed in the pipe. The calculated forces came to 418,000 pounds using a maximum speed of 15 mph. A thrust bearing of inside diameter 3.50 inches must handle 3,540 pounds. The Johnson column formula was used to check for buckling in the pipe.

The ball bearings withstand a shear of  $2.3 \times 10^4$  pounds in each of the 63 bearings. The Hertz contact stress theory was used to calculate the size of the bearings. In case of buckling at the joint, five bearings can handle the total force due to buckling. The nose piece of the frame has an angle of  $35^\circ$  for the distance from the actuator to the joint. The coefficient of friction for the moon soil of 0.49 was used to find the force the actuator must overcome to turn the vehicle.

The steering link can withstand a force of 418,000 pounds before failure. The link has a thickness of one third its height. This results in a link that can resist large bending moments. The 0.98 foot radius curved link allows for better force distribution during turns. The plates are circular with a slotted ring for the bearings race. The bearings handle the bending torque of  $4.18 \times 10^6$  foot pounds. The plate must handle this force along with the shear stress of  $60 \times 10^3$  psi. A factor of safety of 1.25 was used.

The pins are spaced at 10 inches from the center on both sides so that the torque created from the tendency of the vehicle to collapse in the center is handled. Each pin handles only shear stress due to the short pin length. The shear stress was found to be  $1.33 \times 10^5$  psi. Compressive stresses were calculated to find the pin diameter and length of 2.0 inches and 3.0 inches, respectively. Torsional shear in the pin was small due to the added bushing thickness of 0.125 inches. The stop pins turn through  $90^\circ$  and have a diameter of 1.0 inch due to a shear stress of  $60 \times 10^3$  psi and a factor of safety of 1.25.

Brace sizing was calculated from the tensile stress in its cross-sectional area. The maximum force of  $4.18 \times 10^5$  pounds gave an area of 4.4 X 3.3 inches. The hinge bands are each dimensioned 1.07 X 1.0 inches.



The steering angle of  $29.2^\circ$  on each side was produced from the actuator's 12 inch extension which results in a turning radius of 10.31 feet. The curb to curb diameter measures 27.7 feet.

The materials are AISI-4142 steel for the pins and UNS-A97075 aluminum for the joint, ball bearings, and plates. A bronze material is necessary for the bushings and pin caps. A high temperature rubber is used for the sealing of the bearings and is clamped to both edges of the plates. The distortion energy theory was used for the shearing strengths of the material. The total weight of the joint, excluding the steering actuators, is 108 pounds, or 18 moon-pounds. Each actuator weighs approximately 12 pounds.

### **DUMP MECHANISM**

From the spreadsheet analysis of the dump mechanism, the highest load imposed on the actuator is 280 pounds. This occurs when the actuator is at its extended position which is the neutral position of the actuator. The members near this force were then analyzed based on column buckling and on static deflection.

The largest force in any member was found to be 350 pounds. This member was then analyzed to find what size tubing would best support the load. Using a factor of safety of 10, the required moment of inertia was calculated to be  $0.008 \text{ in}^4$ . With an assumed outside diameter of 1.0 inches, the inside diameter was found to be 0.956 inches. Therefore, a tubing of 1.0 X .044 inches was selected.

Checking for deflection yielded a resultant static deflection of 0.01 inches. This was found by analyzing the forces normal to the member at the pin joint. The dump mechanism is shown in Figure DM1.

### **THERMAL CONTROL SYSTEM**

The methodology used to design the thermal control system of the LBMTV was to determine the amount of radiant heat absorbed by the electronic components housing via view factors and emissive powers of surrounding components. Once these values are determined, the aluminum

housing thicknesses are calculated by choosing an appropriate time to thermal saturation and maximum allowable change in temperature specifying this thermal saturation. Once the thicknesses of the aluminum housing are fixed, heaters are sized to deliver the appropriate power for keeping the enclosures at the design temperature for periods of no solar radiation.

Figure TC1 shows the simplified radiative system. The major components of the thermal control system are the aluminum housing and multi-layer insulation set. Determination of the view factors was simplified by projecting the bottom leg of the housing to the lunar surface. This system is shown in Figure TC2. The length of the lower leg of the housing is designated by  $L_H$  with geometry dictating that the lunar surface length is  $3.2L_H$  and the solar length is  $3L_H$ . The view factor from the lunar surface to the bottom leg of the housing is determined to be 0.19 and from the solar surroundings to the housing's top surface is 1.0.

The lunar surface and the solar surroundings are assumed to be black bodies. The emissive power of the lunar surface is  $1940 \text{ W/m}^2$  during periods of intense solar radiation and  $6.4 \text{ W/m}^2$  during absence of solar radiation. The emissive power of the solar surroundings is  $1350 \text{ W/m}^2$  during periods of intense solar radiation and  $0 \text{ W/m}^2$  during the absence of solar radiation. The design temperature of the electronic housing is  $0 \pm 5 \text{ }^\circ\text{C}$  which gives it an emissive power of  $314 \text{ W/m}^2$ . The emissivity resulting from the multi-layered insulation is 0.01.

The absorbed radiation of the lower legs of the housing is  $2.3 \text{ W/m}^2$  and  $10.16 \text{ W/m}^2$  for the top leg during periods of intense radiation. The net heat radiated by the bottom legs during absence of solar radiation is  $3.13 \text{ W/m}^2$  while the top leg radiates  $3.14 \text{ W/m}^2$ .

The housing material was chosen to be aluminum because of the material's high specific-heat to density ratio. The main truss frame of the LBMTV is made of aluminum, and this frame serves as a skeleton for the aluminum component housing. Choosing aluminum for the component housing will assure that thermal expansion of the frame and the housing remain the same relative to each other.

The allowable time to thermal saturation is chosen as two hours with an increase in temperature of  $5 \text{ }^\circ\text{C}$  defining thermal saturation. The required thickness of the bottom leg is calculated to be  $0.0014 \text{ m}$  and that for the top leg is  $0.006 \text{ m}$ . Strip-heaters will be installed that supply a total power of 9.7 Watts between all four enclosures.

The weight of the four aluminum enclosures including the multi-layered insulation, the housing, and the strip-heaters is 10.2 moon-pounds. The enclosure weight for the four enclosures is 7.7 moon-pounds. Figure TC3 shows the variation of the four enclosure weights with time to thermal saturation at a fixed 5 °C temperature increase.

## **SELF-RIGHTING MECHANISM**

The self-righting mechanism was analyzed based on the position of the center of gravity and the rotation of the roll-bar. Of course, the center of the vehicle would move depending on the loading conditions of the LBMTV at any given time. But based on the fact that the center of gravity of the fully loaded bowl was only 1.02 feet above the base of the bowl, the center of gravity of the vehicle was assumed to be no higher than one foot above the wheel base. It was also assumed to be in the middle of the vehicle.

Based on this position for the center of gravity of the LBMTV, calculations were made concerning the line of action of the gravitational force. If the vehicle were on level ground, it was found that the roll bar would have to rotate to a 45° angle between the crank and the frame for the capsized LBMTV to right itself. A worst case of a 15° angle sideslope is used, an angle of 35° is found for the minimum angle for the crank and the frame to cause the vehicle to self-right.

If the vehicle falls on the crank side of the vehicle on level ground, the actuator must contract to a length of 3.27 feet. If it falls on the opposite side on level ground, the actuator must expand to a length of 4.61 feet. Since the actuator dead length is 3.0 feet and the fully extended length is 4.95 feet, a factor of safety is built into the mechanism because it can rotate farther than the calculations indicate is necessary.

A force analysis was then performed on the members of the linkage to determine the size of tubing necessary to support the loads imposed. In the event of capsize with a fixed cargo, the worst possible load imposed on the linkage was assumed to be 1050 pounds. The moment of inertia necessary, including a factor of safety of 2, was calculated to be 0.22 in.<sup>4</sup>. The tubing necessary was then found to be 3.0 X .045 inches round, which has an area of 0.842 square inches and a moment of inertia of 0.22 in.<sup>4</sup>

The bar is constructed of 7075 aluminum alloy, the same material as the frame. Based on the density of the material and the 68 linear feet needed for the linkage, the total weight of the self-righting mechanism, not including the actuator, is 67 pounds, giving a moon weight of 11.2 moon-pounds.

# **CONCLUSIONS AND RECOMMENDATIONS**

## **COMBINATIONS OF POWER SOURCES**

Combinations of systems such as using solar arrays to charge secondary batteries or primary sources for regeneration of reactants in the RFC may be desirable. Larger long life RTG's may also be used as recharging stations.

We recommend the use of parallel connected secondary recharged by a solar array recharging station. The parallel connections would provide more current and thus more torque. To minimize the weight, the battery should provide an average constant power and enough current for sudden overloads of power where the maximum power of 36 kW is reached.

## **CENTER JOINT AND STEERING MECHANISM**

When designing the center-joint and steering mechanism, numerous ideas were considered before deciding on the final design. We considered various arrangements of U-joints for the center joint, but had trouble limiting the number of degrees of freedom to the two that are necessary. The original design for the center section included a very large center pin and no ball bearings, but the pin and round plates had to be so massive that we decided to incorporate a ball bearing race to handle the high torques encountered at this joint without the need for over-sized parts. We considered steering the vehicle with two actuators for each dump-body, but decided that one was adequate and would reduce weight and complexity. The attachment for the actuator was originally conceived as a straight link making a 90 degree angle with the round center-joint plates. The forces at this bend proved very large, so we decided to use a curved link to better distribute the forces. One rather exotic idea was to use six actuators arranged like a flight simulator as the center joint. This proved unnecessarily complex and would fail if only one of the actuators malfunctioned, so the idea was discarded. The final design is simple and the two halves of the vehicle are identical, allowing for limited operation in case of a part failure and greatly simplifying maintenance.

## THERMAL CONTROL SYSTEM

The multi-layer insulation chosen has a theoretical emissivity of 0.01 which means that one percent of the incident radiation is absorbed by the electronics housings. Unless strict attention is given to correctly installing the multi-layer insulation, as in Figure TC4, through-the-blanket conduction will be significantly increased. An evacuated space must also be maintained between the aluminum housing and the multi-layer insulation. If the multi-layer insulation comes into contact with the aluminum housing, a substantial increase in the rate of housing heat absorption will occur. Another factor that could potentially diminish the multi-layer insulation's effectiveness is the fastening method between the insulation and the housing. Fasteners tend to supply a direct route for heat, so non-conducting fasteners should be used. Proper electro-static grounding of the insulation is also necessary.

The maximum amount of time of operation before thermal saturation occurs is dependent on the length of time a certain housing is subjected to direct solar radiation. The design allows for two hours of direct solar radiation before thermal saturation occurs. This means that occasional shading of an electronic housing will result in extended operation time before saturation occurs. In the event that maximum thermal saturation occurs before the LBMTV is due for a power recharge, the LBMTV should be rotated 180° with respect to the solar radiation to allow further operation.

Thermo-electric converters were investigated for converting part of the absorbed heat into electricity, but due to their low efficiency they were not feasible. In the event that thermo-electric generators are made much more efficient in the future, the absorbed heat could be stored in the form of electricity for use in powering the heating system during periods of no solar radiation. Presently, the system draws about 10 Watts from the main LBMTV storage batteries for use in the thermal heating. Elimination of this power draw from the primary vehicle power source would be advantageous to longer work cycles of the LBMTV.

The ideal solution to the LBMTV thermal control system would be to design the electronics, cameras, motors, and batteries to withstand the extreme temperature differences on the lunar surface.

## **DUMP MECHANISM**

Some of the other ideas considered were a four-bar linkage that could rotate 360 degrees and was connected to a bowl and flat bed in one. That solution was discarded because of power and stability problems. Another thought was a gear train that could rotate a fixed frame that would accept accessories. This was not pursued due to excessive forces on the gear teeth and their exposure to the surroundings. The single actuator-driven dump mechanism was chosen for its simplicity, reliability, and minimum number of components.

## **ACKNOWLEDGEMENTS**

We gratefully acknowledge J. W. Brazell for his guidance throughout the course of the project. Thank you for helping us to learn to work as a team.

We also acknowledge Brice MacLaren and Gary McMurray for their help and practical advice.

We would especially like to thank Dr. Harold Johnson for his inspiration and expertise in the area of kinematics.



## REFERENCES

Baymeister. Mark's Handbook for Mechanical Engineers. Eighth Edition, McGraw-Hill Book Company, 1978.

Black, William Z. and Krieth, Frank. Basic Heat Transfer. Harper and Row Publishers, Cambridge, 1980.

CRC Handbook of Space Technology: Status and Projections.

Culp, Archie W., Jr. Principles of Energy Conversion. McGraw-Hill Book Company, New York, 1981.

Design and Fabrication of Wheels for a Lunar Surface Vehicle, Volume 1, NASA Report No. NASA-C-R-102755. Grumman Aerospace Corporation, Bethpage, NY, 1970.

Fitzgerald, A. E., etal. Basic Electrical Engineering. Fifth Edition, McGraw-Hill Book Company, New York, 1979.

Gerstle, Kurt H. Basic Structural Design. McGraw-Hill Book Company, NY, 1967.

Haverly, George C. Transit Thermal Control Design for Galileo Entry Probe for Planet Jupiter. NASA Report No. N8225294. General Electric Company, 1982.

Kantowitz, Barry H. and Sorkin, Robert D. Human Factors: Understanding People-System Relationship. John Wiley and Sons, New York, NY, 1983.

Larkar, A. D. Friction and Wear. Academic Press, New York, NY, 1980.

Mars / Lander Vehicle Development. Utah State University, 1986.

Mikk, George. Improved Multilayer Insulation Applications. NASA Report No. N8225293, Perkin-Elmer Corporation, 1982.

Parrish, A. Mechanical Engineer's Reference Book. London, England, London Butterworth Group, 1973.

Salisbury, John and Glaser, Peter. The Lunar Surface Layer. New York, NY, Academic Press, 1964.

Shigley, Joseph E. and Mitchell, Larry D. Mechanical Engineering Design. McGraw-Hill Book Company, New York, NY, 1983.

Smithells, Colia J. Metals Reference Book. Volume III, London, England, London Butterworth's Group, 1967.

SAE Handbook, Volume Four. Society of Automotive Engineers. 1987.

# **APPENDICES**

# **APPENDIX A**

## **CALCULATIONS**

## APPENDIX A.1--TRUSS FRAME

BOWL BASE:

LENGTH VALUES:

$$L_{AF} = L_{BF} = .2745 \text{ m}$$

$$L_{AB} = .4572 \text{ m}$$

$$L_{AE} = L_{BE} = .2286 \text{ m}$$

$$L_{BC} = L_{CF} = L_{DF} = L_{AD} = L_{CD} = L_{DE} = L_{CE} = .1373 \text{ m}$$

$$\angle CFD = 65.2^\circ$$

$$\angle FBA = \angle FAB = 57.4^\circ$$

Force on truss based on 400 lbf = 1779.3 N

$$R_{AY} = R_{AX} = 889.4 \text{ N}$$

[  $\Sigma M_E = 0$  ]:

$$(.2286)(889.4) + (.1156 F_C) - (.1373)(889.4) = 0$$

$$F_C = 702.4 \text{ N (compression)}$$

[  $\Sigma M_B = 0$  ]:

$$(.1373 F_E) - (.1156 F_C) = 0$$

$$F_E = 591.4 \text{ N (tension)}$$

[  $\Sigma F_Y = 0$  ]:

$$889.4 + F_{BY} - 749.4 = 0$$

$$F_{BY} = 358.2 \text{ N}$$

[  $\Sigma F_X = 0$  ]:

$$478.3 + 702.4 - 318.6 - 229.2 - F_{BX} = 0$$

$$F_{BX} = 633.15 \text{ N (tension)}$$

The largest compressive force in this truss section is in member DC which has a compressive force of 702.4 N. This will be the value used for  $P_{CR}$  in the Euler buckling equation to size the tubing for this part of the frame.

#### EULER BUCKLING LOAD FOR FIXED END COLUMNS:

$$P_{CR} = \pi^2 E I C / L^2$$

$$C = 1.2 \text{ for fixed - fixed end conditions}$$

For aluminum alloys, ALCOA recommends the use of a factor of  $102 \times 10^6$  psi to represent the quantity  $\pi^2 E$  in the above equation.

$$P_{CR} = 702.4 \text{ N} = 157.9 \text{ lbf}$$

$$L = 9 \text{ inches}$$

$$\text{Moment of inertia, } I = [ \pi / 64 ] ( d_{out}^4 - d_{in}^4 )$$

$$I = (P_{CR} L^2) / (102 \times 10^6)(1.2) = 0.000104 \text{ in}^4$$

Multiplying by a factor of safety of 100:

$$I = 0.0104$$

With  $d_{in} = 1$  inch, solve for  $d_{out}$ :

$$[ \pi / 64 ] ( d_{out}^4 - 1 ) = 0.0104$$

$d_{out} = 1.05$  inches, therefore tube thickness is 0.05 inches.

The resulting weight per foot tubing is:

$$\rho = 0.098 \text{ lbf}$$

$$V/\text{in. of cyl.} = 0.103 \text{ in}^3$$

$$\text{Weight/ft. of cyl.} = (.098 \text{ lb}_f/\text{in}^3)(0.103 \text{ in}^3)(12 \text{ in / ft}) = 0.121 \text{ lb}_f/\text{ft}$$

Total weight of bowl support truss:

$$\text{Weight}_{\text{total}} = (18.61 \text{ ft. tubing})(0.121 \text{ lb}_f/\text{ft}) = 2.25 \text{ lb}_f$$

WHEEL MOTOR MOUNT:

LENGTH VALUES:

$$L_{AB} = .3048 \text{ m}$$

$$L_{AE} = L_{BD} = .4572 \text{ m}$$

$$L_{EC} = L_{CD} = .1524 \text{ m}$$

Wheel mount causes triangular section to resist moment produced by darkened section.

$$[\Sigma M_A = 0]:$$

$$(-.2921)(425) - (.3048)(889.4) + (.4572)F_{Cx} - (.1524)F_{Cy} = 0$$

$$[\Sigma M_B = 0]:$$

$$(.3048)R_{Ay} + (.4572)F_{Cx} + (.1524)F_{Cy} - (425)(.5969) = 0$$

$$[\Sigma M_C = 0]:$$

$$(-425)(.4445) + (.4572)R_{Ax} + (.1524)R_{Ay} + (.4572)R_{Bx} - (.1524)(889.4) = 0$$

$$[\Sigma F_Y = 0]:$$

$$425 - R_{Ay} - 889.4 - F_{Cy} = 0$$

$$[\Sigma F_X = 0]:$$

$$- R_{Ax} - R_{Bx} + F_{Cx} = 0$$

Solve:

$$R_{Ax} = 2109.9 \text{ N}$$

$$R_{Ay} = 309.6 \text{ N}$$

$$R_{Bx} = 474.7 \text{ N}$$

$$F_{Cx} = 2584.7 \text{ N}$$

$$F_{Cy} = 774.1 \text{ N}$$

$$[ \Sigma M_C = 0 ]:$$

$$(.4572)(474.7) - (.1524)(889.4) + (.1524)F_B + (.4572)(2109.9) + (.1524)(309.6) - (.1524)F_A = 0$$

$$[ \Sigma M_A = 0 ]:$$

$$(.2891)F_R - (.3048)(889.4) + (.3048)F_B = 0$$

$$[ \Sigma M_B = 0 ]:$$

$$(309.6)(.3048) - (.3048)F_A - (.2891)F_L = 0$$

$$[ \Sigma F_Y = 0 ]:$$

$$-309.6 - 889.4 + F_A + F_B + F_L \cos(18.44^\circ) + F_R \sin(18.44^\circ) = 0$$

$$[ \Sigma F_X = 0 ]:$$

$$-2109.9 - 474.7 - F_L \sin(18.44^\circ) + F_R \sin(18.44^\circ) = 0$$

Solve:

$$F_A = 1131.6 \text{ N (tension)}$$

$$F_L = 4058.4 \text{ N (tension)}$$

$$F_R = 5445.3 \text{ N (compression)}$$

$$F_B = 1456.5 \text{ N (compression)}$$



Sizing of the truss tubing determined by the maximum compressive force which occurs on member BC = 5445.3 N:

$$P_{CR} = 1224.1 \text{ lbf}$$

$$d_{in} = 1 \text{ inch}$$

$$L = 18 \text{ inches}$$

$$I = [ P_{CR} L^2 ] / (102 \times 10^6)(1.2) = 0.0032 \text{ in}^4$$

Multiplying by factor of safety of 5:

$$I = 0.016 \text{ in}^4$$

Solve for  $d_{out}$ :

$$0.016 = [ \pi / 64 ](d_{out}^4 - 1)$$

$$d_{out} = 1.07 \text{ inch}$$

$$\text{Thickness} = 0.07$$

$$V_{1 \text{ in. of cyl.}} = 0.145 \text{ in}^3$$

$$\text{Weight/ft.} = (0.018 \text{ lbf/in}^3)(0.145 \text{ in}^3)(12 \text{ in/ft}) = 0.17 \text{ lbf/ft}$$

WEIGHT OF ENTIRE FRAME TUBING:

$$\text{Length of tubing on frame} = 572.9 \text{ feet}$$

$$\text{Weight of frame sections} = 97.39 \text{ lbf}$$

$$\text{Total weight of frame (Earth)} = 99.64 \text{ lbf}$$

$$\text{Total weight of frame (moon)} = 16.6 \text{ lbf}$$

# FIGURES FOR TRUSS ANALYSIS

## Bowl Base Analysis

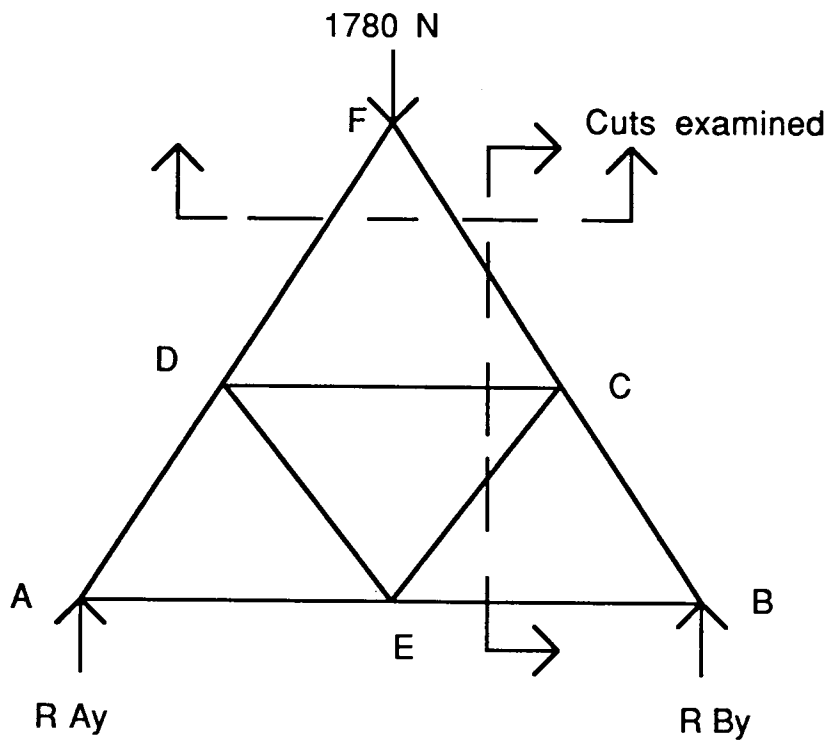

SECTION CUT

SECTION CUT

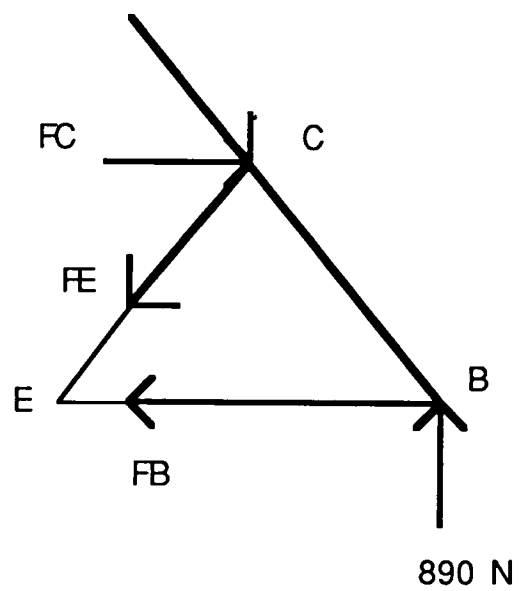
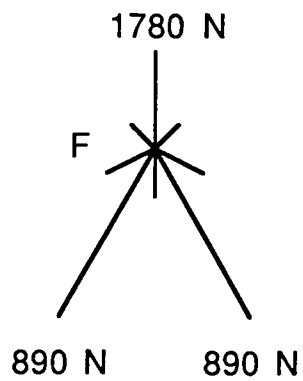

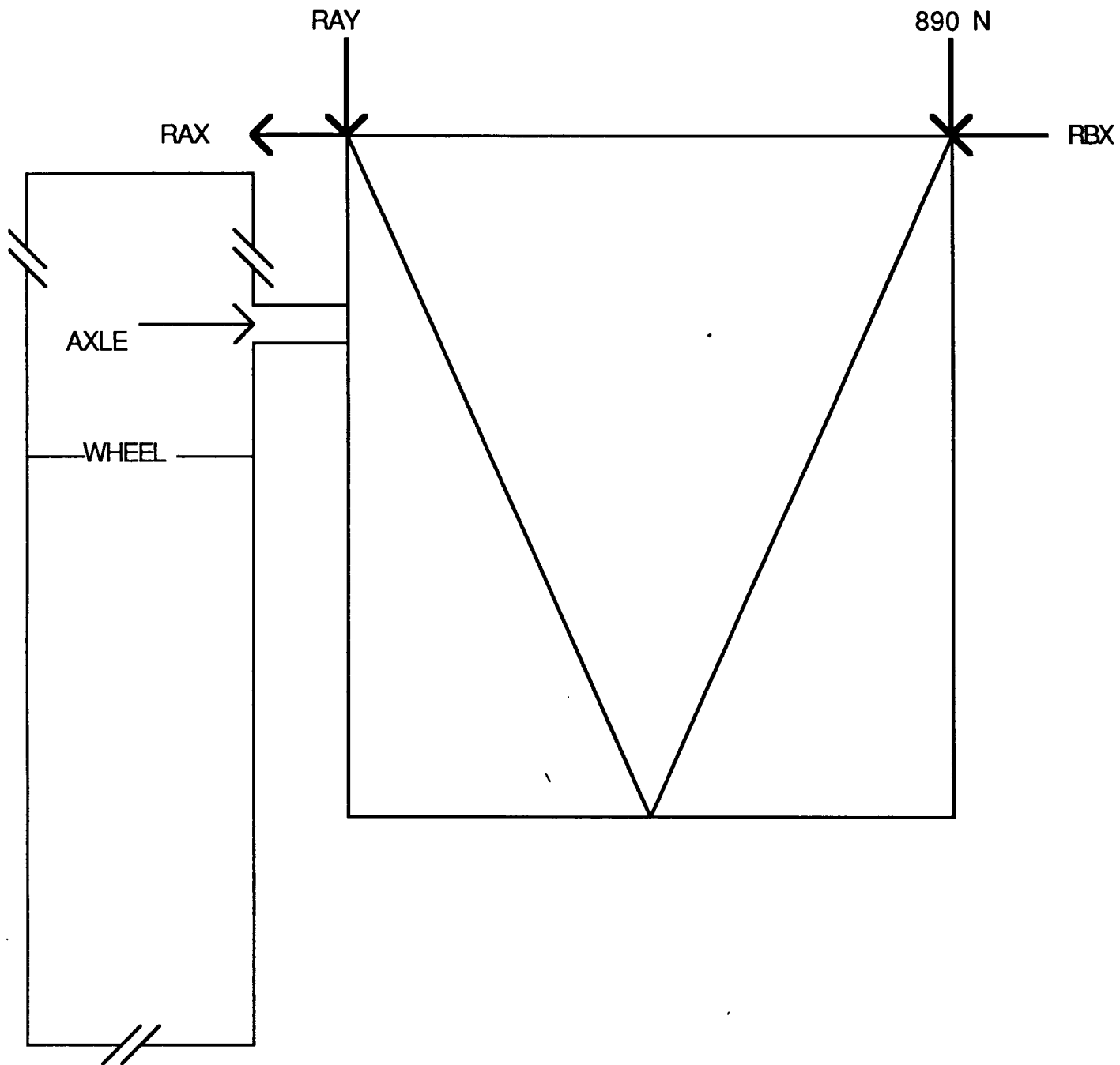

## APPENDIX A.2--CENTER JOINT AND STEERING MECHANISM

### I. Total force achieved during motion

$V_m$  = maximum velocity = 22.0 ft/sec

$T$  = sudden stop time

$A$  = acceleration =  $V/T = 22.0/(25/1000) = 880$  ft/sec<sup>2</sup>

$F_t$  = total force on the joint =  $ma$   
=  $475\text{lb}_m(880 \text{ ft/sec}^2) = 418,000 \text{ lb}_f$

$m$  = mass of the dump body = 475 lb.

### II. Center pipe sizing

$L$  = length of center shaft

$E_A$  = modulus of elasticity of UNS A97075 Aluminum

$S_y$  = yield strength of UNS A97075 Aluminum

$\sigma_A$  = shear strength of material

$n$  = factor of safety

$A_p$  = area of cross-section

$F_p$  = thrust load

$P_{cr}$  = critical load for buckling

$$\sigma_A/n = F_t/A_p$$

$$A_p = \Pi(D_o^2 - D_i^2)/4$$

$$D_o = [4n_p/\Pi(F_t/\sigma_A) + D_i^2]^{1/2}$$

$$F_t = 418,000 \text{ lb}_f$$

$$\sigma_a = 60,000 \text{ lb}_f/\text{in}^2$$

$$n = 1.25$$

$$D_i = 1.0 \text{ in}$$

$$D_o = [(4(1.25)/\Pi)(418,000/60,000) + (1.0)^2]^{1/2}$$
$$= 3.48 \text{ in} \approx 3.5 \text{ in}$$

$$F_p = 475/32.2(6/1)(1000/25) = 3540.1 \text{ lbf}$$

### Check Buckling with Johnson's Column Formula:

$$E_A = 10.3 \times 10^6 \text{ psi}$$

$$S_y = 60 \times 10^3 \text{ psi}$$

$$C = 1.0$$

$$L = 5.1 \text{ in}$$

$$P_{cr}/A_p = S_y - b(l/k)^2$$

$$k = [(D_o^2 + D_i^2)/16]^{1/2}$$

$$= [((3.5)^2 + (1)^2)/16]^{1/2} = 0.8385$$

$$b = (S_y/2\pi)^2/CE = (60,000/2\pi)^2 (1/10.3 \times 10^6) = 8.85$$

$$P_{cr} = A_p[S_y - b(l/k)^2]$$

$$= 8.835[(60 \times 10^3) - 8.85(5.1/0.8385)^2] = 59,672.55 \text{ psi}$$

$$\therefore 59,672.55 \text{ psi} < 60,000 \text{ psi}$$

### III. BALL BEARING SIZE

$r$  = radius of bearing center from axis

$d$  = diameter of bearing

$P_b$  = maximum bearing stress

$F_b$  = ball bearing shear force

$\sigma_c$  = total shear stress of bearings

$N$  = number of bearings

$\sigma_t$  = shear stress from distortion energy theory

$sf$  = shear stress of five bearings

$$2\pi r = 2\pi(10 \text{ in}) = 62.832 \text{ inches}$$

$$d = 0.9973 \text{ in}$$

$$N = 63$$

$$P_b = 3F/2\pi r^2$$

$$z/b = 0.75$$

$$\sigma_\tau = (0.577)(60,000) = 35000 \text{ psi}$$

$$P_b = \sigma_\tau [1 + (z/b)^2]^{1/2} = 3.5 \times 10^4 [1 + (0.75)^2]^{1/2}$$

$$= 4.3 \times 10^4 \text{ lbf/in}^2$$

$$F_b = [P_b(2\pi)(P^2/4)]/3 = [4.3 \times 10^4(2\pi)(0.5)^2]^{1/2}$$

$$= 2.3 \times 10^4 \text{ lbf}$$

$$\sigma_c = [418,000(4)]/[2(6)(0.9973)^2] = 140,088.8 \text{ psi}$$

$$\sigma_f = [5(2.3 \times 10^4)(4)]/[\pi(0.9973)^2] = 140,000 \text{ psi}$$

$$\therefore 140,000 < 140,088.8$$

#### IV. NOSE PIECE ANGLE

$r_n$  = half width of dump body

$z$  = distance from dump body center to front frame

$R$  = distance from front frame to nose point

$u$  = friction coefficient of moon soil

$T$  = torque on center joint

$F_o$  = force on actuator

$N$  = normal force of dump body

$$\tan \Theta = R/r_n$$

$$\Theta = 35^\circ$$

$$R = r_n \tan \Theta = 2.56(\tan 35^\circ) = 1.79 \text{ feet}$$

$$N = 475 \text{ lbf}$$

$$P = Nu = 475(.49) = 233 \text{ lb}$$

$$T = (z+R)P = (2.06 + 1.79)233 = 897.1 \text{ lbf-ft}$$

$$F_0 = T/R = 897.1/1.79 = 500 \text{ lbf}$$

## V. STEERING LINK SIZE

$F_x$  = x- direction force on link

$F_y$  = y- direction force on link

$F_L$  = total force on link

H = height of link

T = thickness of link

n = factor of safety = 1.2

$\sigma_L$  = maximum allowable shear stress =  $60 \times 10^3$  psi

Q = radius of curvature of link

$$F_L = [(F_y)^2 + (F_x)^2]^{1/2} = [(418,000)^2 + (500)^2]^{1/2}$$

$$= 418,000 \text{ lbf}$$

$$T = 1/3 H$$

$$A = 1/3 H^2$$

$$\sigma/n = F_L/A$$

$$H = [3F_L n / \sigma]^{1/2} = [(3)(418,000)(1.2)/60,000]^{1/2}$$

$$= 5.008 \text{ in}$$

$$T = 1/3 H = 1/3(5.008 \text{ in}) = 1.67 \text{ in}$$

$$Q = (R + T/4)/2 = 1.79 + (1.67/4)/2 = .93 \text{ feet}$$

## VI. PLATE SIZING

$T_T$  = Total torque on plate at a 10 inch radius from axis

h = height of plate

b = thickness of plate

w = radius of ball bearings

$n = \text{factor of safety} = 1.25$

$\sigma_L = 60 \times 10^3 \text{ psi}$

$T_T = F_T(10) = 418,000(10) = 4.18 \times 10^6 \text{ lb}_f\text{-in}$

$h = 2(10\text{in}) = 20 \text{ inches}$

$\sigma/n = T_T(6h)/bh^3$

$b = T_L(6h)/\sigma h^3 = (4.18 \times 10^6)(6)(1.25)/(60 \times 10^3)(20)^2$   
 $= 1.3 \text{ inches}$

$W = [(d-0.5)/2](1.12) = [(0.9973 - 0.5)/2](1.12) = 0.34 \text{ inches}$

## VII. PIN SIZING

$\nu = \text{Poisson's ratio of steel}$

$S_y = \text{shear strength of AISI 4142 Steel}$

$\sigma_s = \text{shear strength from distortion energy theory}$

$A = \text{pin cross sectional area}$

$\sigma_o = \text{compressive strength}$

$E_s = \text{modulus of elasticity}$

$L_p = \text{length of pipe}$

$D_p = \text{diameter of pin}$

$T_s = \text{torsional shear}$

$m = \text{torque due to friction}$

$u_c = \text{frictional coefficient of steel on steel}$

$s = \text{tangent force}$

$S_y = 230 \times 10^3 \text{ psi}$

$\sigma_s = 0.577(233 \times 10^3) = 1.33 \times 10^5 \text{ psi}$

$\nu = 0.292$

$E = 30 \times 10^6 \text{ psi}$

$u = 0.32$

$\sigma_s = F_T/A = 4F_T/\pi D^2$



$$D = [(4/\pi)(F_T/\sigma_s)]^{1/2} = [(4/\pi)(418,000/1.33 \times 10^5)]^{1/2}$$

$$D = 2.003 \text{ inches}$$

$$k = (1 - \nu^2)/(\pi E) = (1 - (0.292)^2)/(\pi(30 \times 10^3)) = 9.71 \times 10^{-9} \text{ psi}$$

$$\sigma_o = 0.318[(F_T(R_2 - R_1))/(R_1 R_2 L(2k))]^{1/2}$$

$$1.33 \times 10^5 = 0.318[(418,000)(1.025 - 1)/(1.025)(1)(2)(9.71 \times 10^{-9})L]^{1/2}$$

$$L_1 = 3.017 \text{ inches}$$

$$L_{\text{caps}} = 0.125 \text{ inches}$$

$$L = L_1 + L_{\text{caps}} = 3.017 + 2(0.125) = 3.25 \text{ inches}$$

$$T_s = MD/2J$$

$$J = \pi D^4/32 = \pi(2)^4/32 = 23.18$$

$$m = uS = (0.32)(897.5)(12) = 3445.2 \text{ lbf-in}$$

$$T_s = [3445.2(2)]/[2(23.18)] = 291.3 \text{ psi}$$

$$\therefore 291.3 \text{ psi} < 1.33 \times 10^5 \text{ psi}$$

## VIII. STOP PIN SIZING

$L_{ST}$  = Length of stop pin

$N$  = Factor of safety

$\sigma_A$  = shear strength of aluminum

$F_s$  = total force on the pin

$A$  = cross sectional area

$$\sigma_A/n = F_s/A$$

$$A = \pi D^2/4$$

$$D = [(4/\pi)(nF_s/\sigma)]^{1/2} = [(4(1.8)/\pi)(500(25)/60 \times 10^3)]^{1/2}$$

$$= 0.71\text{in} \approx 1.0 \text{ in}$$

$$L_{st} = 1.0 \text{ inches}$$

## IX. BRACE SIZING

Constraints: Each hinge band height = 1.1 in.

$T_B$  = brace thickness at bands

$H_B$  = height of bands

$A_B$  = cross sectional area of bands

$\sigma_A$  = shear strength of aluminum

$F_T$  = total force on the bands

$$\sigma_A = F_T/A_B = 60 \times 10^3 \text{ psi}$$

$$F_T = 418,000 \text{ lbf}$$

$$A_B = H_B T_B$$

$$T_B = F_T/\sigma_A H = 418,000/(60 \times 10^3)(3.3) = 2.12 \text{ inches}$$

$$\text{Thickness of one band} = 2.12/2 = 1.07 \text{ inches}$$

## X. STEERING TURNING RADIUS

$D_P$  = distance from center of dump body to joint

$D_A$  = actuator extension distance

$R$  = actuator distance to joint

$PP$  = turning radius

$\Theta$  = turning radius angle

$CC$  = curb to curb turning diameter

$RS$  = distance from center of dump body to frame edge

$$D_A = 12 \text{ inches}$$

$$R = 21.48 \text{ inches}$$

$$D_P = 5.0 \text{ feet}$$

$$\tan \Theta = DA/R$$

$$\Theta = \tan^{-1}(DA/R) = \tan^{-1}(12/21.48) = 29.2^\circ$$

$$\tan \Theta = D_P/PP$$

$$PP = D_P/\tan\Theta = 5/\tan 29.2 = 10.31 \text{ feet}$$

$$RS = 3.1/\sin 61^\circ = 3.5 \text{ feet}$$

$$CC = 2(RS) + PP = 2(3.5) + 10.31 = 27.71 \text{ feet}$$

## XI. WEIGHT CALCULATIONS

$$\rho_A = \text{density of aluminum} = .098$$

$$\rho_S = \text{density of steel} = 0.292$$

$W_e$  = weight of center joint on the earth

$W_m$  = weight of center joint on the moon

$V_p$  = volume of plates

$V_i$  = volume of pins

$V_B$  = volume of bearings

$V_s$  = volume of stop pins

$V_R$  = volume of braces

$V_L$  = Volume of steering links

$$V_p = P(10)^2(1.3) = 408.40 \text{ in}^3$$

$$V_i = P(1)^2(3.3) = 10.37 \text{ in}^3$$

$$V_B = 4/3(P)(0.5)^3 = 0.524 \text{ in}^3$$

$$V_s = P(0.5)^2(1) = 0.785 \text{ in}^3$$

$$V_R = (4.49)(3.3)(4) = 59.27 \text{ in}^3$$

$$V_L = (1.67)(5.008)(P)(0.98)(12) = 308.99 \text{ in}^3$$

$$W_e = \rho_A[2(V_p)+63(V_B)+2(V_s)+4(V_R)+2(V_L)] + \rho_S[4(V_i)]$$

$$\begin{aligned} &= (.098) [2(408.4)+63(0.524)+2(0.785)+4(59.27)+2(308.99)] \\ &+ (0.292)(4)(10.37) \end{aligned}$$

$$= (167.23 + 48.5)$$

$$W_e = 218 \text{ lb}$$

$$W_m = W_e/6 = 218/6 = 36 \text{ lb}$$

$$W_{\text{moon}} = 36 \text{ lb.}$$

## APPENDIX A.3--POWER REQUIREMENTS

Load per wheel = 240 moon pounds

Coefficient of rolling friction = 0.05

Radius of wheel = 1.6 feet

$$F = 240 \times \sin(11^\circ) + 240 \times \cos(11^\circ) \times (0.05)$$

$$F = 45.8 + 11.8$$

$$F = 57.6 \text{ pounds} \cong 58 \text{ pounds}$$

$$T_{\text{required}} = F \times R$$

$$T = 58 \text{ pounds} \times 1.6 \text{ feet}$$

$$T = 92.8 \text{ ft-lbs.}$$

Uphill speed required = 5 mph

$$5 \text{ mph} \times (1 \text{ hr./}3600\text{sec}) \times (5182 \text{ feet/}1\text{mile}) = 7.2 \text{ feet/sec}$$

$$7.2 = 1.6 \times \omega \quad \therefore \omega = 4.5 \text{ rad/sec}$$

$$\text{Power} = T \times \omega$$

$$= 92.8 \times 4.5$$

$$= 417.6 \text{ ft-lb/s (1hp/550 ft-lb/s)}$$

$$= 0.75 \text{ hp (.746 kw/hp)}$$

$$= 0.57 \text{ kw/wheel} \times 4 \text{ wheels} = 2.3 \text{ kw Total}$$

## APPENDIX A.4--PAYLOAD BOWL

Choose diameter = 4.12 ft.

$$V_{\text{Bowl}} = (\pi/4)(4.12)^2(1.03) + (\pi/4)(2.06)^2(1.03) + (.785)(\pi/4)(1.03)(4.12^2 - 2.06^2)$$

$$V_{\text{Bowl}} = 25.25 \text{ ft}^3$$

$$A_{\text{Surface}} = (2\pi)(4.12)(1.03) + \int \int 2\pi \, dr \, dh$$

$$A_{\text{Surface}} = 33.4 \text{ ft}^2$$

$$\text{Payload} = (93.64 \text{ lb}_f/\text{ft}^3)(23.25 \text{ ft}^3) = 2364 \text{ lb}_f \text{ on Earth}$$

$$\text{Payload} = 394 \text{ lb}_f \text{ on moon}$$

$$\text{C.G.} = [(13.732)(1.03 + 1.03/2) + (3.433)(1.03/2) + 8.0845(1.03/3)] / 25.25$$

## APPENDIX A.4--PAYLOAD BOWL

Choose diameter = 4.12 ft.

$$V_{\text{Bowl}} = (\pi/4)(4.12)^2(1.03) + (\pi/4)(2.06)^2(1.03) + (.785)(\pi/4)(1.03)(4.12^2 - 2.06^2)$$

$$V_{\text{Bowl}} = 25.25 \text{ ft}^3$$

$$A_{\text{Surface}} = (2\pi)(4.12)(1.03) + \int \int 2\pi \, dr \, dh$$

$$A_{\text{Surface}} = 33.4 \text{ ft}^2$$

$$\text{Payload} = (93.64 \text{ lb}_f/\text{ft}^3)(23.25 \text{ ft}^3) = 2364 \text{ lb}_f \text{ on Earth}$$

$$\text{Payload} = 394 \text{ lb}_f \text{ on moon}$$

$$\text{C.G.} = [(13.732)(1.03 + 1.03/2) + (3.433)(1.03/2) + 8.0845(1.03/3)] / 25.25$$

## APPENDIX A.6 DUMP MECHANISM

Force on actuator = 283 pounds

$$\sum F_x = 0 = 283\cos(4.7^\circ) - F_1\cos(\tan^{-1}(.37/.5))$$

$$\therefore F_1 = 283\cos(4.7^\circ) / (\cos(36.5^\circ))$$

$$F_1 = 351 \text{ lbs.}$$

$$\sum F_y = 0 = 283\sin(4.7^\circ) + F_1\sin(36.5^\circ) - F_2$$

$$\therefore F_2 = 283\sin(4.7^\circ) + F_1\sin(36.5^\circ)$$

$$F_2 = 232 \text{ lbs.}$$

Sizing members using the Euler Column Theory--

$$351 = (\Pi^2 EI) / (4 L^2)$$

$$\therefore I = (351)(4)(7.5)^2 / ((\Pi^2)(10 \times 10^6)) = 0.00079 \text{ in.}^4$$

Using a factor of safety of 10, choose  $I = 0.008 \text{ in.}^4$

$$I = \Pi(d_o^4 - d_i^4) / 64$$

Choosing an outer diameter equal to 1.00 inches, and solving for the inner diameter, we find

$$d_i = 0.956 \text{ inches}$$

Now check for static beam deflection

$$\begin{aligned} \text{Total downward force} &= 232\sin(90^\circ - 36.5^\circ) + 283\sin(36.5^\circ - 4^\circ) \\ &= 232\sin(53.5^\circ) + 283\sin(32.5^\circ) = 339 \text{ lbs.} \end{aligned}$$



Maximum static deflection =  $y_{\max}$

$$y_{\max} = FL^3 / 3EI$$

$$y_{\max} = (339)(7.5)^3 / (3(10 \times 10^6))(0.008) = 0.01 \text{ in.}$$

Use 1.0 in. X 0.044 in. round tubing:

$$\text{weight/ft.} = \pi(1.0^2 - 0.956^2)(12)(0.098) = 0.314 \text{ lb}_f/\text{ft.}$$

$$\text{total length} = 2(((0.5)(2)^{0.5}) + 3(0.5) + 0.37 + 0.62) + 4(2.1 + 2.8)$$

$$\text{total length} = 25 \text{ feet}$$

$$\text{total weight} = 25(0.31) = 8 \text{ pounds}$$

Note: this weight does not include the actuator used in each mechanism.

## APPENDIX A.7--THERMAL CONTROL SYSTEM

For calculation of the view factors, the length of the electronics housing is denoted as  $L_H$ . The length of the lunar surface is  $3.2L_H$ , and the length of the solar surface completing the enclosure is  $3L_H$ . The view factors are determined using the crossed-strings method as follows:

$$F_{\text{Solar-Housing}} = \left\{ \frac{1}{2}(3L_H) \right\} [ 3L_H + L_H - 3.2L_H ] = 0.13$$

$$F_{\text{Lunar-Housing}} = \left\{ \frac{1}{2}(3.2L_H) \right\} [ 3.2L_H + L_H - 3L_H ] = 0.19$$

$$F_{\text{Housing-Solar}} = \left\{ \frac{3L_H}{L_H} \right\} (0.13) = 0.39$$

$$F_{\text{Housing-Lunar}} = 1 - F_{\text{Housing-Solar}} = 0.61$$

$$F_{\text{Lunar-Solar}} = 1 - F_{\text{Lunar-Housing}} = 0.81$$

$$F_{\text{Solar-Lunar}} = 1 - F_{\text{Solar-Housing}} = 0.87$$

For this simplified model, calculation of the view factors for the top surface of the truss is not required as it is a one-to-one radiative exchange with the solar surroundings.

### CONSTANTS USED IN THE CALCULATIONS:

H = Subscript denotes housing property

S = Subscript denotes solar property

L = Subscript denotes lunar property

$\sigma$  = Stefan - Boltzman constant =  $5.67 \times 10^{-8} \text{ W/m}^2\text{K}^4$

$\epsilon$  = emissivity

$\alpha$  = absorptivity

$\epsilon_H$  = emissivity of housing = 0.01

$\epsilon_s = \epsilon_L = 1.0$  (black-body assumption)

$T_L = 430 \text{ K}$  (during peak solar radiation)

$T_L = 103 \text{ K}$  (during absence of solar radiation)

$T_H = 273 \pm 5 \text{ K}$  (design temperature of housing)

$E_{b,s} = 1350 \text{ W/m}^2$  (solar radiation during peak radiation)

$E_{b,s} = 0 \text{ W/m}^2$  (solar radiation during absence of solar radiation)

$E_{b,L} = \sigma T_L^4 = 1940 \text{ W/m}^2$  (radiosity of moon at peak radiation)

$E_{b,L} = \sigma T_L^4 = 6.38 \text{ W/m}^2$  (radiosity of moon with no radiation)

$E_{b,H} = \sigma T_H^4 = 314 \text{ W/m}^2$  (black body emissive power of housing)

$C_A = \text{specific heat of aluminum} = 896 \text{ J/kg K}$

$\rho_A = \text{density of aluminum} = 2702 \text{ kg/m}^3$

#### HEAT ABSORBED BY THE HOUSING DURING PEAK RADIATION:

Bottom legs:

$$Q''_H = \alpha_H \epsilon_L E_{b,L} F_{L-H} + \alpha_H \epsilon_s E_{b,s} F_{s-H} - \epsilon_H E_{b,H}$$

$$Q''_H = (.01)(1)(1940)(.19) + (.01)(1)(1350)(.13) - (.01)(314)$$

$$Q''_H = 2.3 \text{ W/m}^2$$

Top leg:

$$Q''_H = \alpha_H \epsilon_s E_{b,s} F_{s-H} - \epsilon_H E_{b,H}$$

$$Q''_H = (.01)(1)(1350)(1) - (.01)(314) = 10.36 \text{ W/m}^2$$

#### HEAT RADIATED BY HOUSING DURING NO SOLAR RADIATION:

Bottom legs:

$$Q''_H = (.01)(1)(6.38)(.19) + 0 - (.01)(314) = -3.13 \text{ W/m}^2$$

Top leg:

$$Q''_H = 0 - (.01)(314) = -3.14 \text{ W/m}^2$$

#### REQUIRED THICKNESS OF ALUMINUM HOUSING DURING PEAK RADIATION:

Saturation time =  $\Delta t = 7200$  seconds

$\Delta T_H = 5 \text{ K}$  (allowable housing temperature rise)

$A_B = \text{area of bottom leg surface}$

$A_T = \text{area of top leg surface}$

$W_B$  = thickness of bottom leg of housing

$W_T$  = thickness of top leg of housing

$dQ_H/dt = mC_A (\Delta T_H/\Delta t) =$  (energy equation for housing wall)

Bottom legs:

$$m_H = \rho A A_B W_B$$

$$dQ_H/dt = Q''_H A_B = (2.3)(.294) = 0.68 \text{ W}$$

$$W_B = (dQ_H/dt)[\Delta t/C_A \rho A A_B \Delta T_H]$$

$$W_B = [(.68)(7200)/(896)(2702)(.294)(5)] = 0.0014 \text{ m}$$

Top leg:

$$m_H = \rho A A_T W_T$$

$$dQ_H/dt = Q''_H A_T = (10.36)(.186) = 1.93 \text{ W}$$

$$W_T = (dQ_H/dt)[\Delta t/C_A \rho A A_T \Delta T_H]$$

$$W_T = (1.93)(7200) / [(896)(2702)(.186)(5)] = 0.006 \text{ m}$$

POWER REQUIRED TO HEAT HOUSING DURING NO RADIATION:

Bottom legs:

$$dQ_H/dt = Q''_H A_B = (-3.13)(.294) = -0.92 \text{ W}$$

$$\text{power required} = \text{heat loss} = 0.92 \text{ W}$$

Top leg:

$$dQ_H/dt = Q''_H A_T = (-3.14)(.186) = -0.58 \text{ W}$$

$$\text{power required} = \text{heat loss} = 0.58 \text{ W}$$

TOTAL POWER REQUIRED TO HEAT ALL COMPONENT HOUSINGS:

$$\text{total power} = (8 \text{ bottom legs})(.92\text{W}) + (4 \text{ top legs})(.58\text{W})$$

$$\text{total power for heaters} = 9.68 \text{ W}$$

#### WEIGHT OF ALUMINUM HOUSING:

Bottom legs:

$$M_B = \rho A A_B W_B$$

$$M_B = (2702)(.294)(.0014) = 1.11 \text{ kg}$$

Top leg:

$$M_T = \rho A A_T W_T$$

$$M_T = (2702)(.186)(.006) = 3.02 \text{ kg}$$

Total mass of housing:

$$M_{\text{Total}} = (8 \text{ bottom legs})(1.11 \text{ kg}) + (4 \text{ top legs})(3.02 \text{ kg})$$

$$M_{\text{Total}} = 21 \text{ kg}$$

Weight on lunar surface:

$$\text{Weight of four housings} = 34.3 \text{ N (7.7 lbf)}$$

#### MISCELLANEOUS THERMAL CONTROL SYSTEM COMPONENTS:

Strip Heaters:

Bottom legs:

4 - 0.25 Watt heaters spaced evenly

Top leg:

3 - 0.25 Watt heaters spaced evenly

Weight:

heaters weigh .046 N each

total strip heater weight = 2 N ( 0.47 lbf)

Multi-Layer Insulation:

Kapton, Mylar, and Polyester at  $\epsilon_{\text{Total}} = 0.01$

$\text{Mass}_{\text{multi-layer insulation}} = 1.8 \text{ kg/m}^2$

$\text{Area}_{\text{total}} = 3 \text{ m}^2$

$\text{Mass}_{\text{total}} = 5.6 \text{ kg}$

Total multi-layer insulation weight = 9.2 N(2.2 lbf)

**TOTAL WEIGHT OF THERMAL CONTROL SYSTEM = 45.5 N (10.2 lbf)**

## APPENDIX A.8--WEIGHT ANALYSIS OF THE LBMTV

<u>Component</u>	<u>Weight of each</u> pounds	<u>#</u>	<u>Total weight</u> pounds
Actuators	12	6	72
Cameras	5	6	30
Control systems	30	2	60
Dump mechanism	8	2	16
Frame	50	2	100
Thermal control system	15	4	60
Motor for wheels	25	8	200
Steering mech./centerjoint	240	1	240
Batteries	25	4	100
Self-righting mech.	70	2	140
Wheels	15	4	60
<b>Total Vehicle Weight</b>			<b>1080 pounds<sub>Earth</sub></b>
			<b>180 pounds<sub>Moon</sub></b>
<b>Moon Payload Weight</b>			<b>788 pounds</b>
<b>Gross Weight (moon)</b>			<b>970 pounds</b>
<b>Payload : Vehicle weight ratio</b>			<b>4.4</b>
<b>Approximate shipping cost (\$ millions)</b>			<b>2.4</b>

# **APPENDIX B**

## **SPREADSHEETS AND GRAPHS**



DUMPING MECHANISM

LENGTH OF ACTUATOR (ft): 3.0  
 1.65\*LENGTH OF ACTUATOR (ft): 4.9  
 NEUTRAL LENGTH OF ACTUATOR (ft): 4.5  
 DUMP LENGTH OF ACTUATOR (ft): 3.1  
 HEIGHT OF PLATE TO PIVOT (ft): 0.5  
 LENGTH OF PIN TO PIVOT (ft): 4.0  
 PIN OF ACT TO PIN OF ROT (ft): 4.0  
 ROTATION RADIUS (ft): 1.0  
 HEIGHT OF PLATE TO ACTUATOR (ft): 0.9  
 NUETRAL ANGLE (degrees): 112.9  
 DEGREES OF ROTATION (degrees): 95.0  
 MAXIMUM FORCE ON ACTUATOR (lbs): 283

ANGLE OF ROTAT (deg)	LENGTH OF ACT (ft)
0.00	4.51
5.00	4.44
10.00	4.36
15.00	4.28
20.00	4.20
25.00	4.12
30.00	4.03
35.00	3.94
40.00	3.86
45.00	3.77
50.00	3.68
55.00	3.60
60.00	3.52
65.00	3.44
70.00	3.37
75.00	3.30
80.00	3.24
85.00	3.18
90.00	3.13
95.00	3.09
100.00	3.06

# RADIUS OF ROTATION FOR DUMP MECHANISM

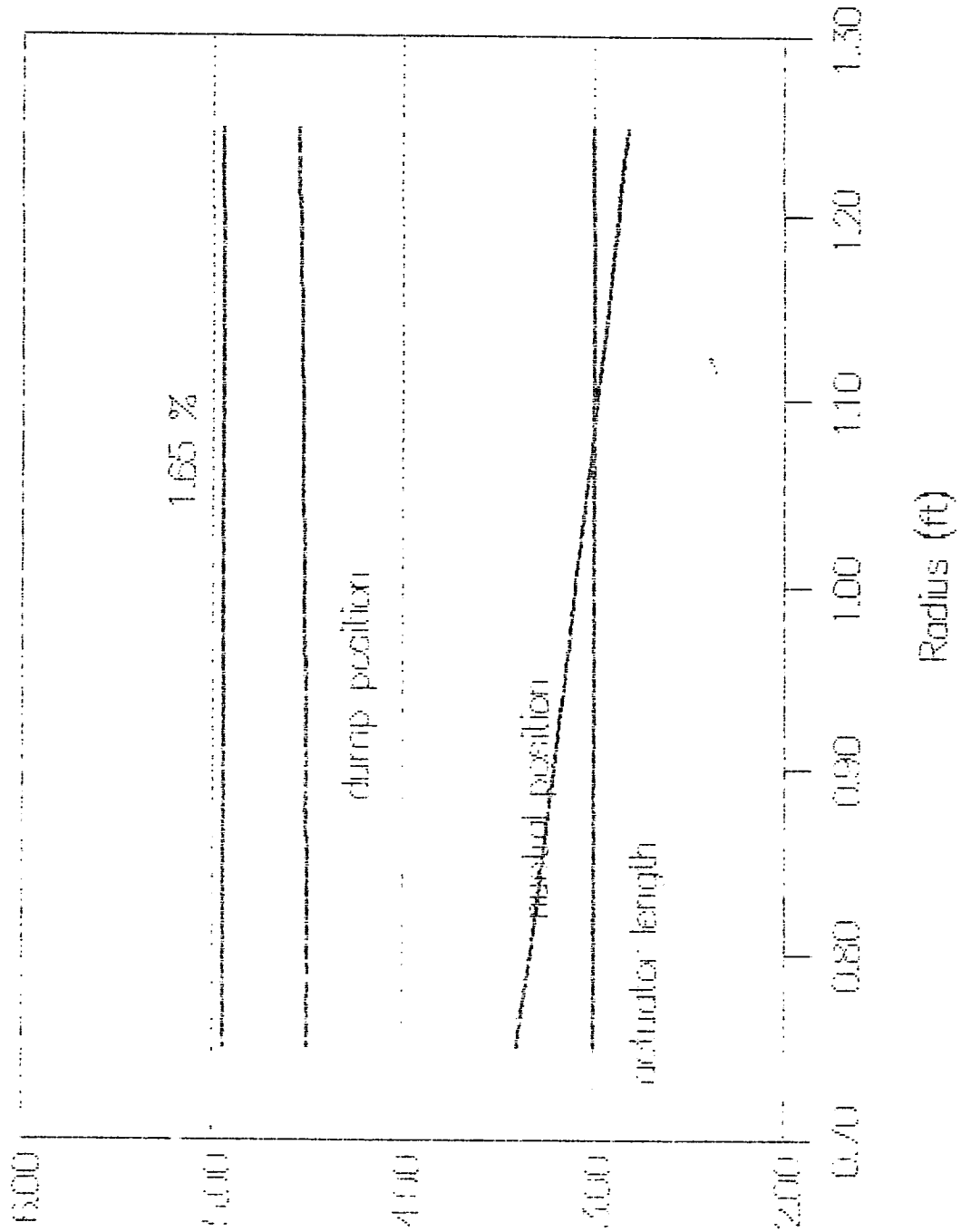

Length of Actuator (ft)

# FORCE IMPOSED ON ACTUATOR

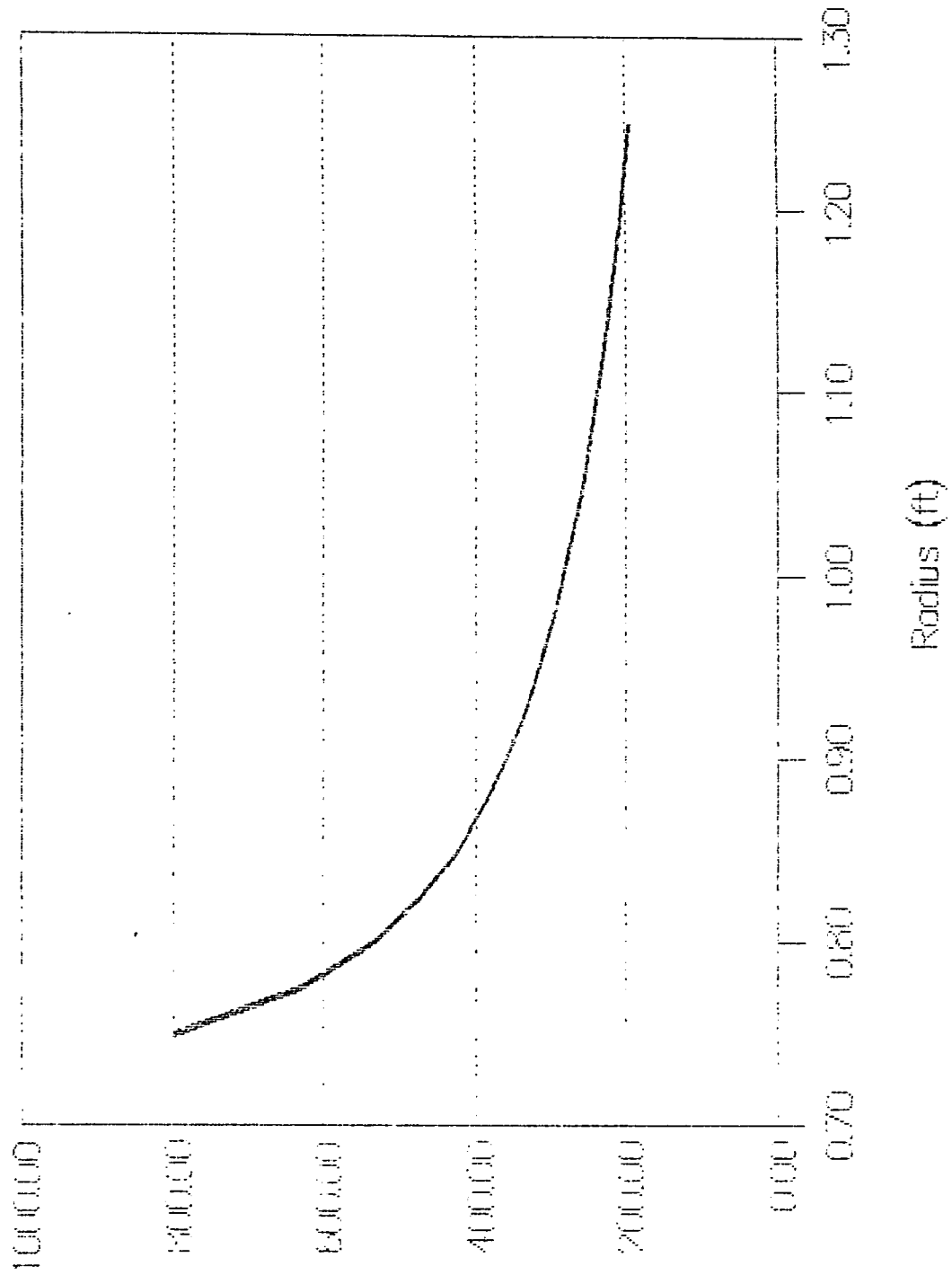

Force (lb)

ORIGINAL PAGE IS  
OF POOR QUALITY

# FORCE IMPOSED ON ACTUATOR

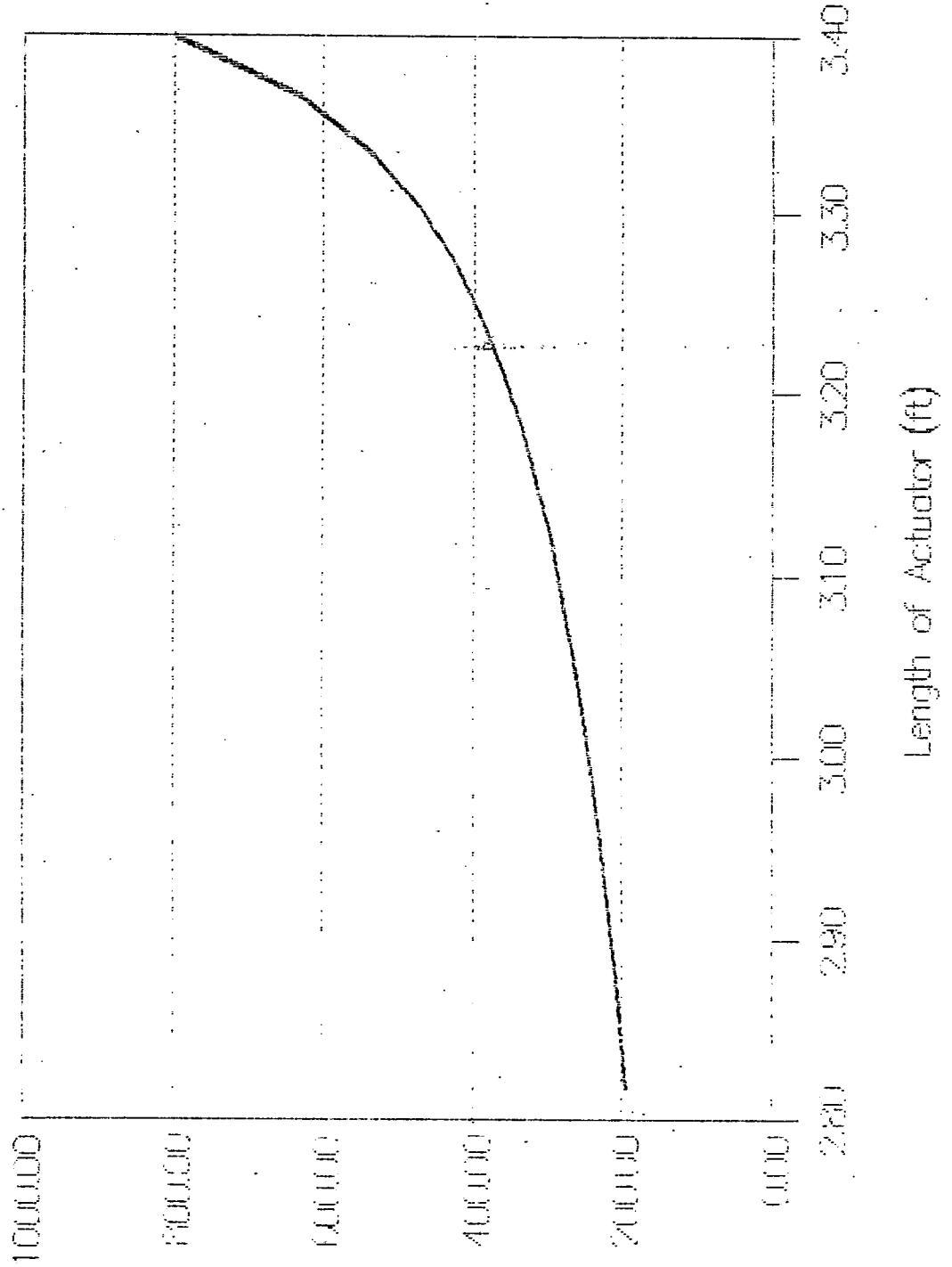

Force (lb)

ORIGINAL PAGE IS  
OF POOR QUALITY

# OUTPUT ROTATION OF DUMP MECHANISM

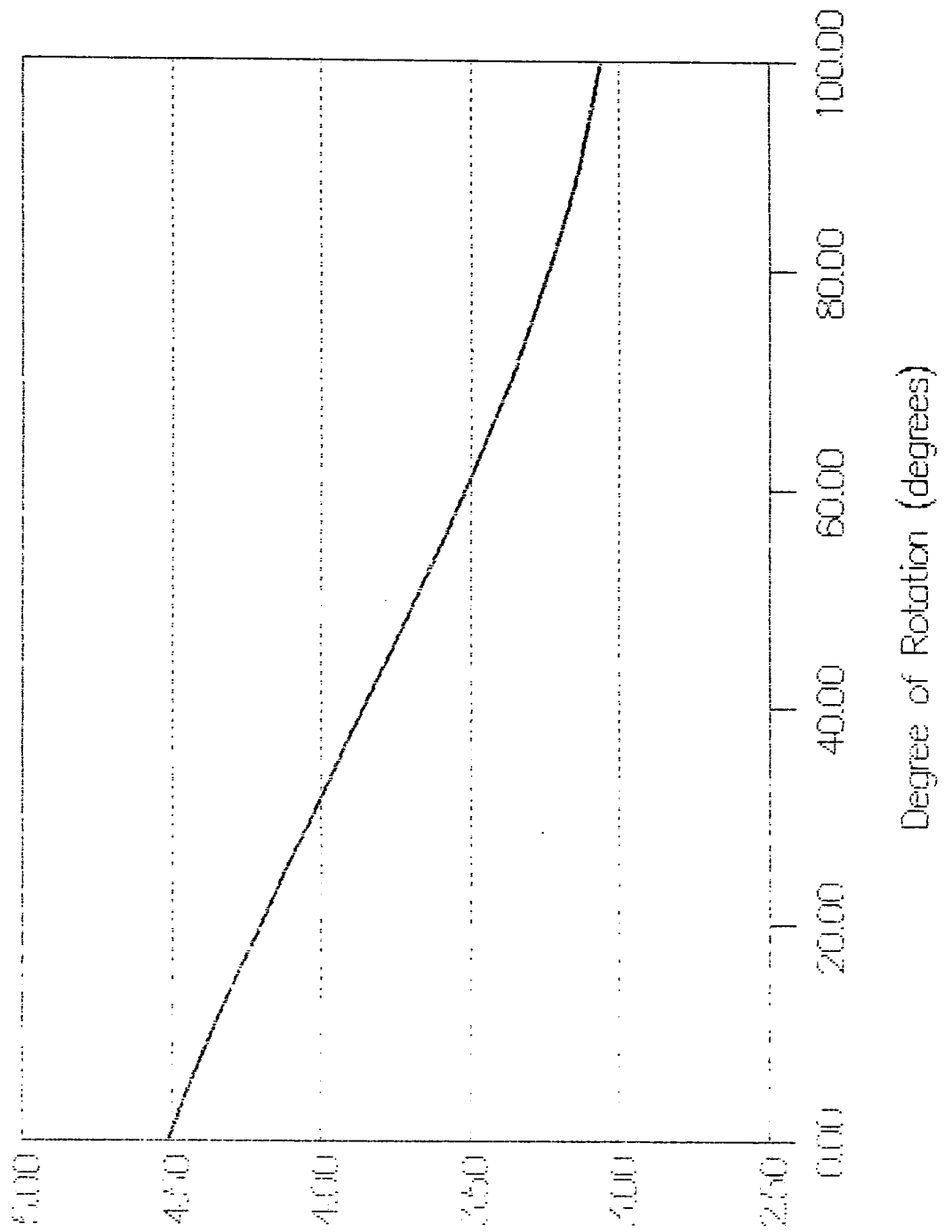

length of vector (4)

ORIGINAL PAGE IS  
OF POOR QUALITY

ROLL BAR: NEUTRAL POSITION

CRANK AND FOLLOWER LENGTH (ft):	7.00
COUPLER LENGTH (ft):	11.00
FRAME LENGTH (ft):	5.00
% OF CRANK	0.300
% OF COUPLER	0.410
CONVERSION FACTOR FOR DEGREES:	57.30
VALUE OF PI:	3.14
CRANK-FRAME ANGLE THETA1 (deg):	115.38
CRANK-COUPLER ANGLE THETA2 (deg):	64.62
COUPLER-FOLLOWER ANGLE THETA3 (deg):	64.62
FOLLOWER-FRAME ANGLE THETA4 (deg):	115.38
TOTAL DEGREES (=360):	360.00
DIAGONAL OF TRAPEZOID (ft):	10.20

---

COUPLE-CRANK PIN TO ACTUATOR PIN LENGTH:

CRANK (ft):	2.10
COUPLER (ft):	4.51
LENGTH OF ACTUATOR (ft):	4.08

DEAD LENGTH OF ACTUATOR (ft):	3.00
1.65 % OF ACTUATOR DEAD LENGTH (ft):	4.95

\*\*\*\*\*

NOTE % OF BAR MEASURED FROM COUPLER-CRANK PIN

ROLL BAR: CLOSED POSITION

CRANK AND FOLLOWER LENGTH (ft):	7.00
COUPLER LENGTH (ft):	11.00
FRAME LENGTH (ft):	5.00
% OF CRANK	0.30
% OF COUPLER	0.41
CONVERSION FACTOR FOR DEGREES:	57.30
VALUE OF PI:	3.14
CRANK-FRAME ANGLE THETA1 (deg):	164.00
CRANK-COUPLER ANGLE THETA2 (deg):	42.01
COUPLER-FOLLOWER ANGLE THETA3 (deg):	79.26
FOLLOWER-FRAME ANGLE THETA4 (deg):	74.73
TOTAL DEGREES (=360):	360.00
DIAGONAL OF TRAPEZOID (ft):	11.89

---

COUPLE-CRANK PIN TO ACTUATOR PIN LENGTH:	
CRANK (ft):	2.10
COUPLER (ft):	4.51
LENGTH OF ACTUATOR (ft):	3.27

DEAD LENGTH OF ACTUATOR (ft):	3.00
1.65 % OF ACTUATOR DEAD LENGTH (ft):	4.95

\*\*\*\*\*  
NOTE % OF BAR MEASURED FROM COUPLER-CRANK PIN

ROLL BAR: EXTENDED POSITION

CRANK AND FOLLOWER LENGTH (ft):	7.00
COUPLER LENGTH (ft):	11.00
FRAME LENGTH (ft):	5.00
% OF CRANK	0.30
% OF COUPLER	0.41
CONVERSION FACTOR FOR DEGREES:	57.30
VALUE OF PI:	3.14
CRANK-FRAME ANGLE THETA1 (deg):	74.73
CRANK-COUPLER ANGLE THETA2 (deg):	79.26
COUPLER-FOLLOWER ANGLE THETA3 (deg):	42.01
FOLLOWER-FRAME ANGLE THETA4 (deg):	164.00
TOTAL DEGREES (=360):	360.00
DIAGONAL OF TRAPEZOID (ft):	7.45

---

COUPLE-CRANK PIN TO ACTUATOR PIN LENGTH:	--
CRANK (ft):	2.10
COUPLER (ft):	4.51
LENGTH OF ACTUATOR (ft):	4.61

DEAD LENGTH OF ACTUATOR (ft):	3.00
1.65 % OF ACTUATOR DEAD LENGTH (ft):	4.95

\*\*\*\*\*  
NOTE % OF BAR MEASURED FROM COUPLER-CRANK PIN



# SELF-RIGHTING MECHANISM

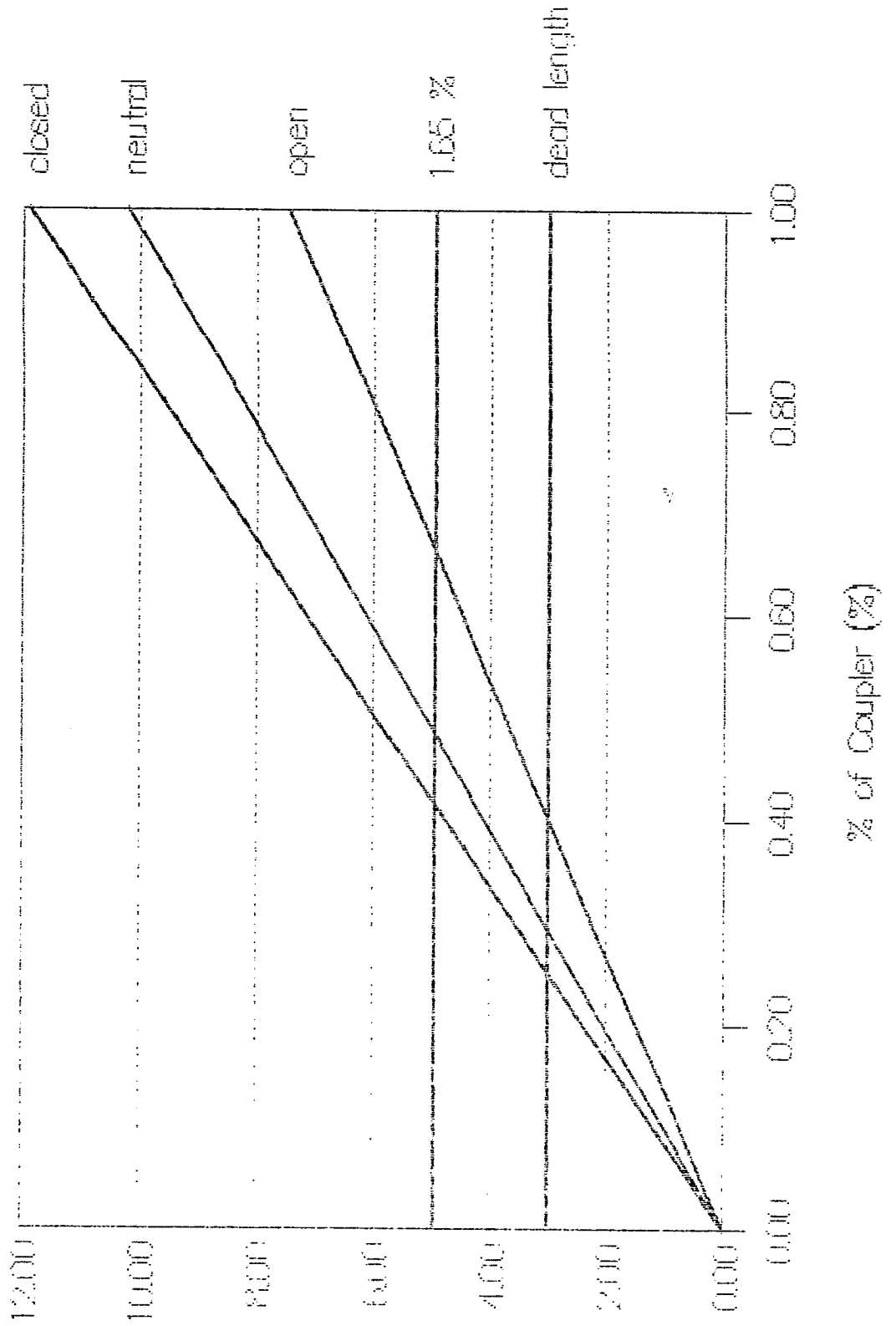

(a) length of coupler

# SELF-RIGHTING MECHANISM

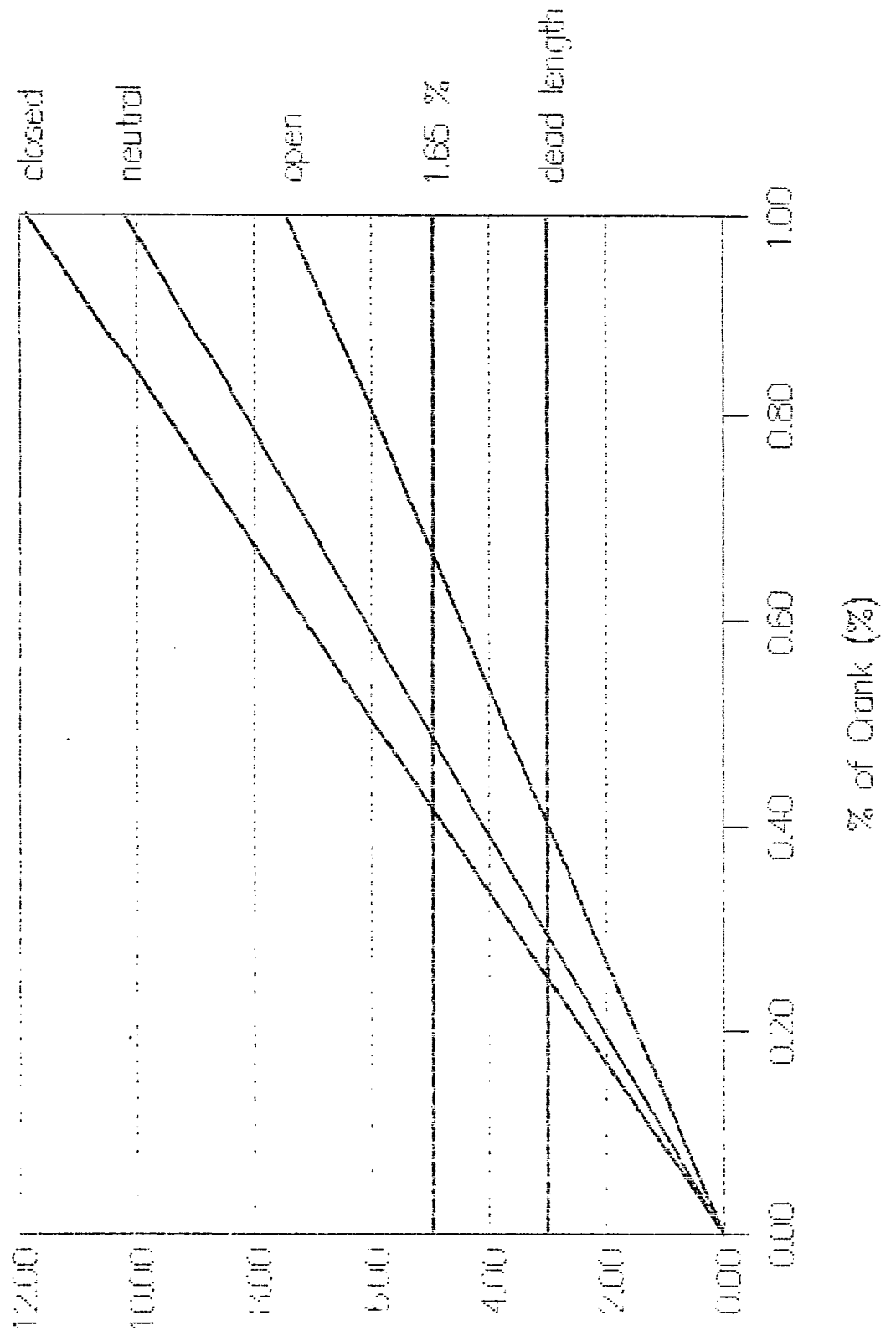

# SELF-RIGHTING MECHANISM - CRANK 15%

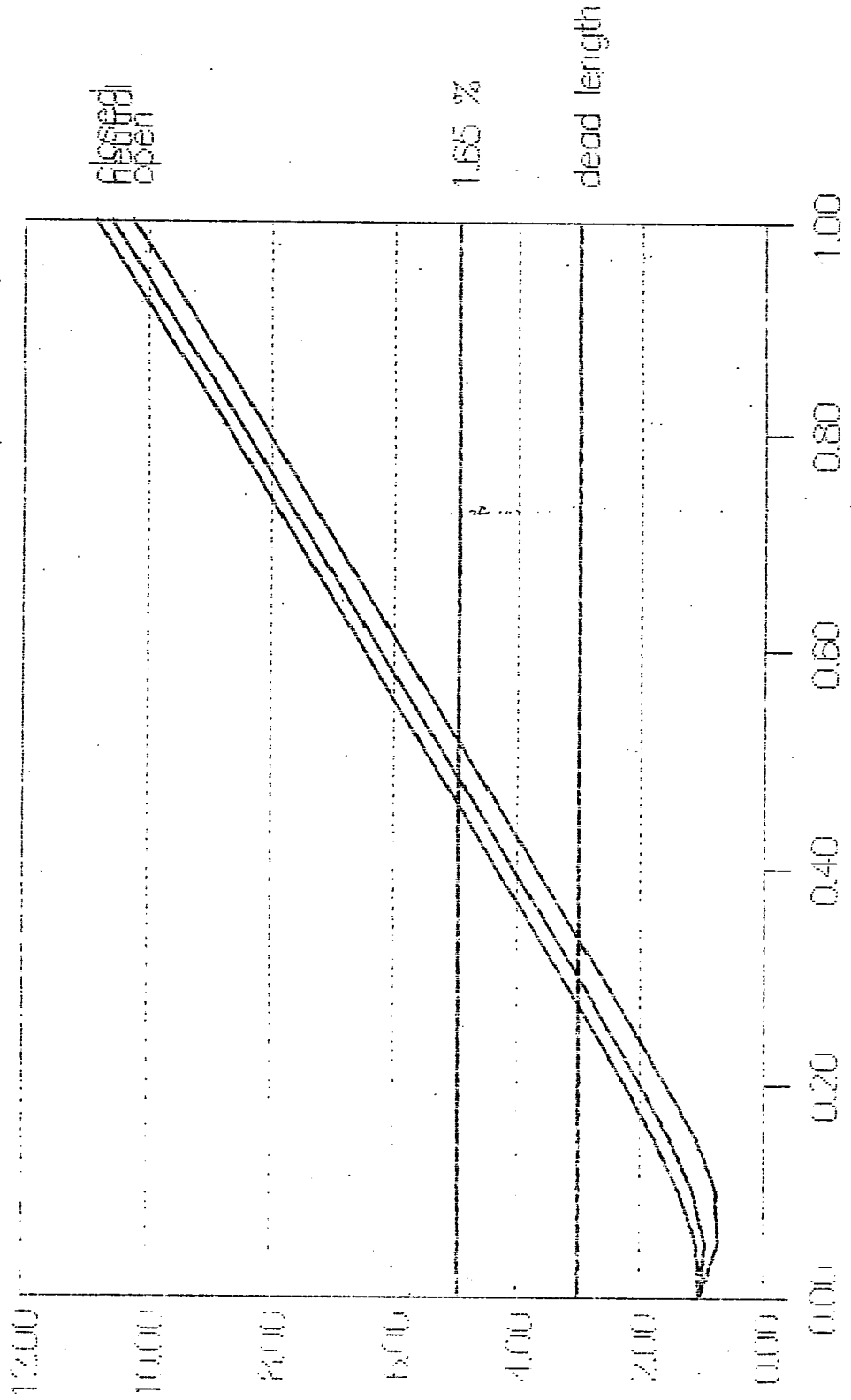

# SELF-RIGHTING MECHANISM - CRANK 30%

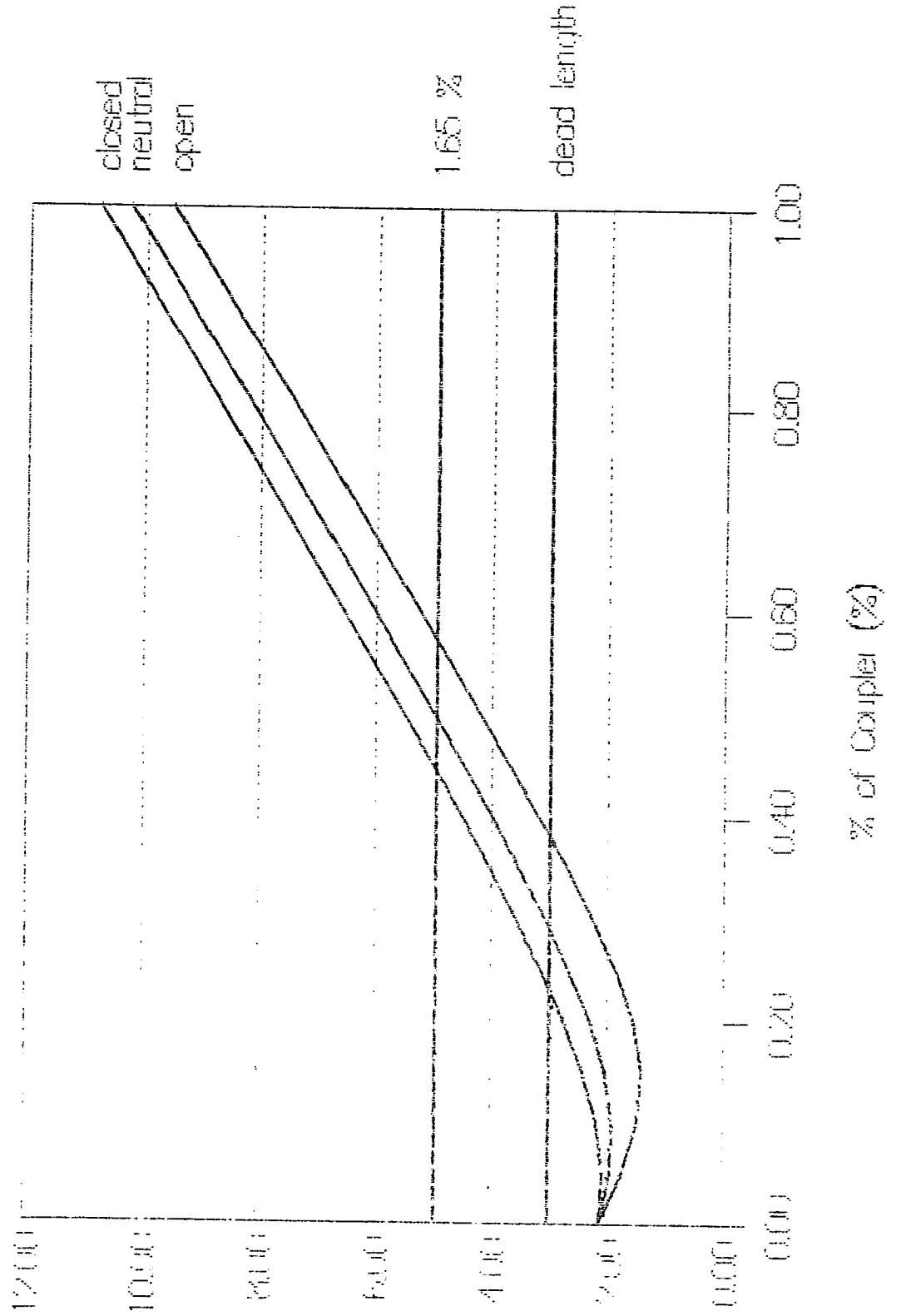

(1) 10/10/70 30 120/30

ORIGINAL PAGE IS  
OF POOR QUALITY

# SELF-RECTIFYING MECHANISM -- CRANK 50%

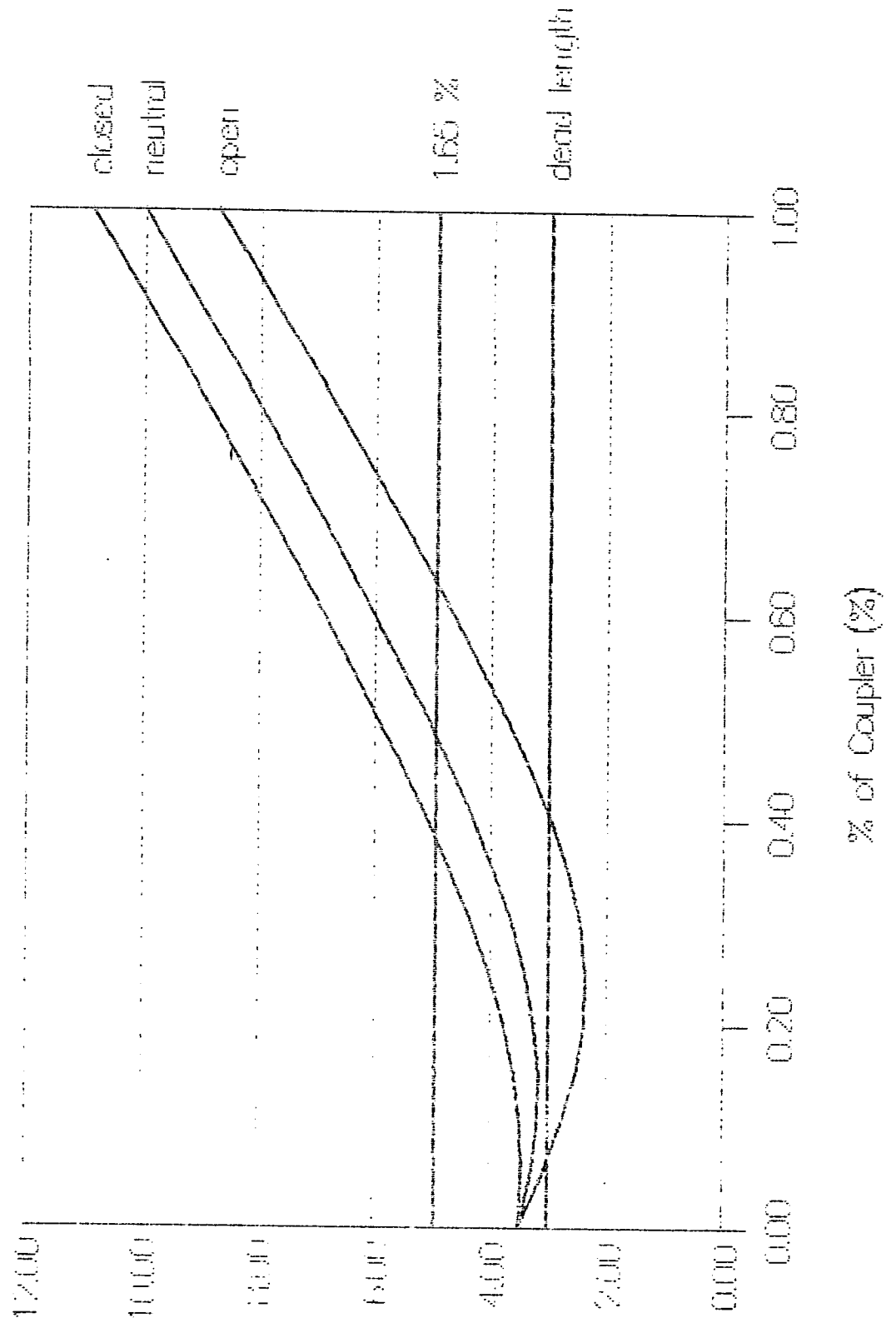

Length of Rod (ft)

ORIGINAL PAGE IS OF POOR QUALITY

# SELF-RIGHTING MECHANISM - CRANK 70%

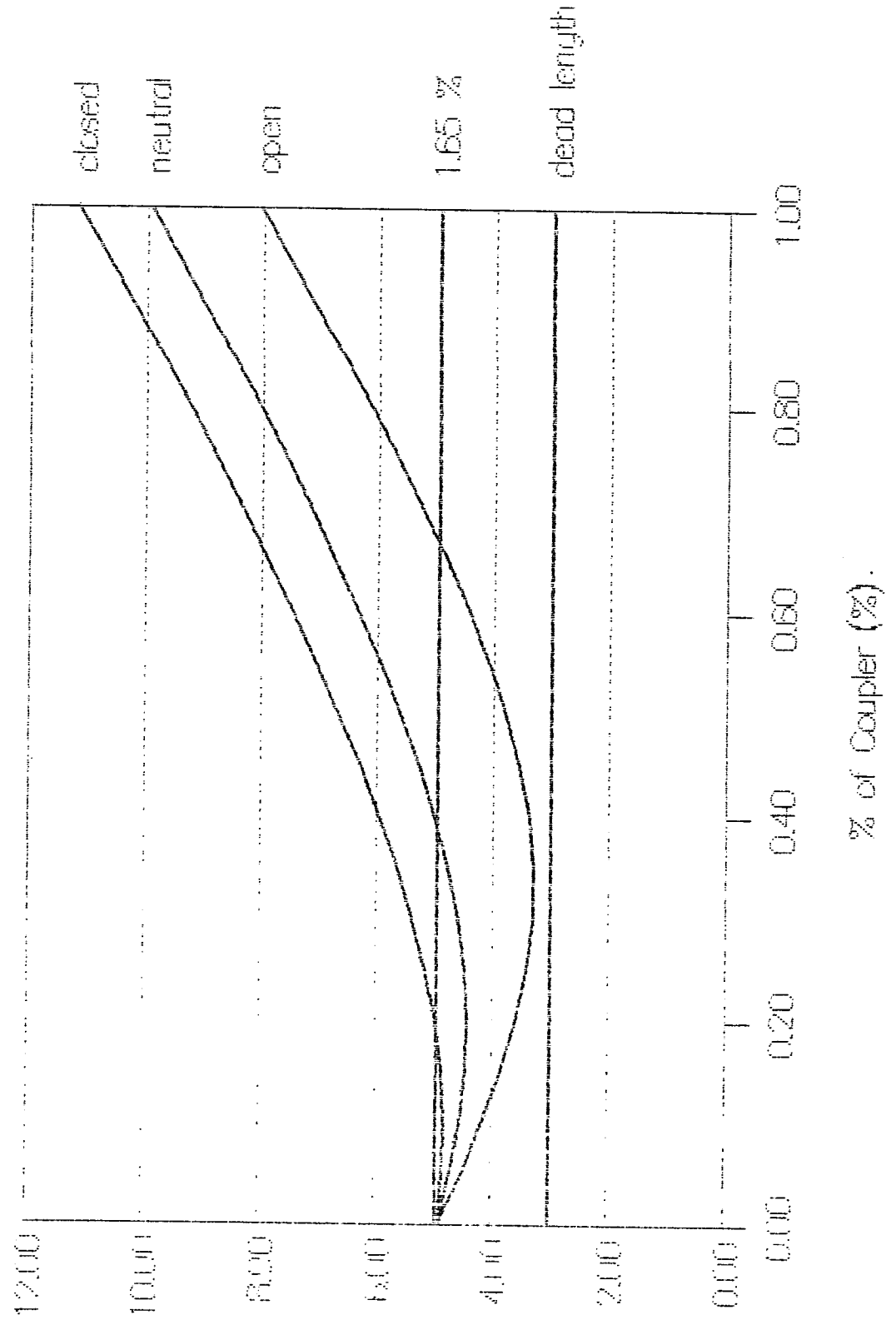

length of actuator (ft)

# SELF-RIGHTING MECHANISM - CRANK 90%

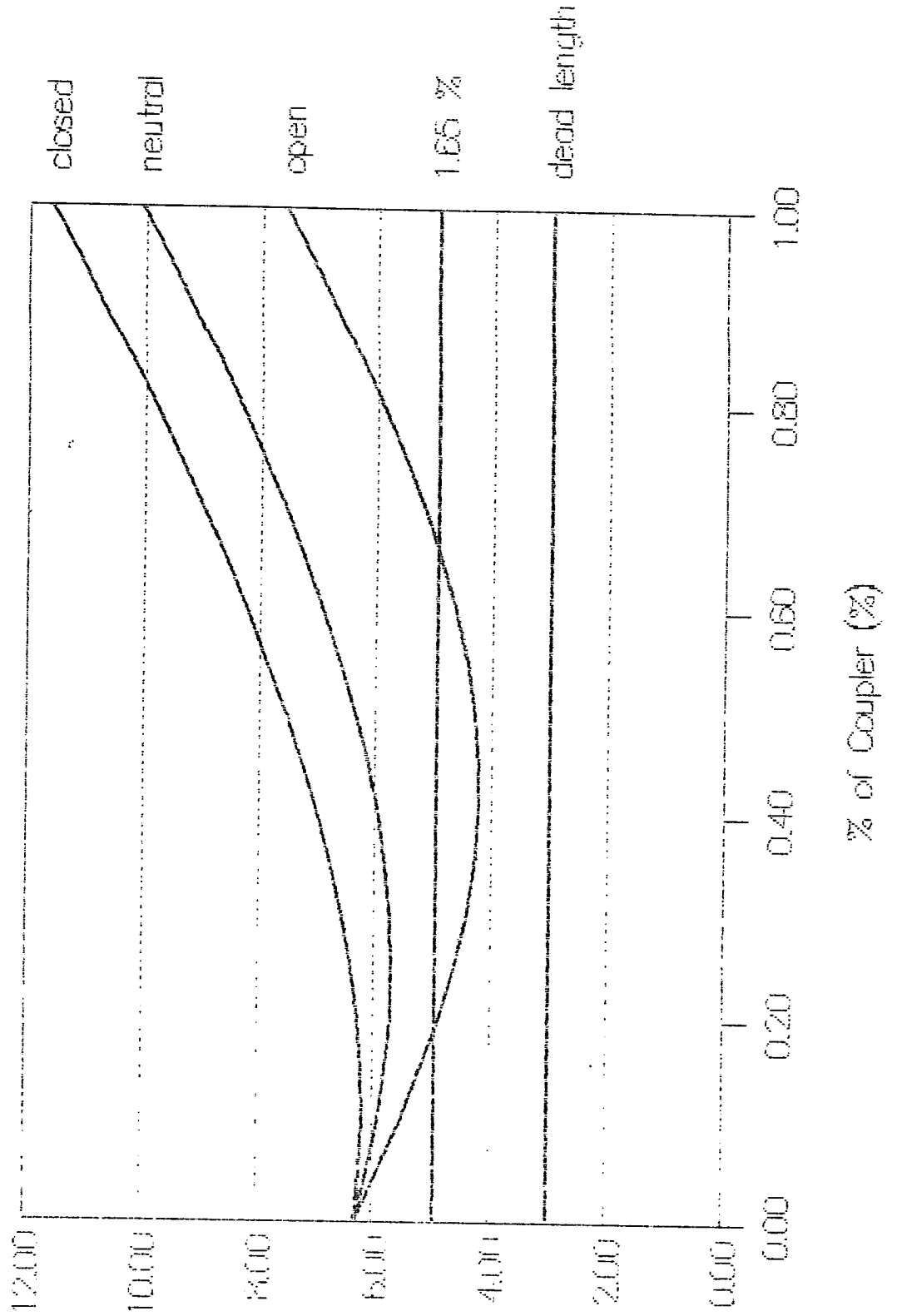

length of actuator (ft)

ORIGINAL PAGE IS  
OF POOR QUALITY

# **APPENDIX C**

## **PROGRESS REPORTS**



April 14, 1988

To: J. W. Brazell

From: M E 4182 Design Group Six

Subject: Progress Report

During the past week, general design ideas were discussed. The problem statement was also written.

Two ideas for movement are being considered. The first is the existing idea of a four-wheeled vehicle. The second is the possibility of using a bulldozer type vehicle, which would keep the center of gravity low and eliminate the need for ground clearance.

For the platform/payload bed constraint, an idea was discussed that would make one side of the piece a bowl and the other side flat. This would allow two separate interfaces for material transport with only one piece of equipment.

An additional proposal to the capsize-self-righting constraint was submitted that allowed the vehicle to move whether upside down or not.

A few questions arised that need to be answered: Do wheels have to be used, and if so, how many? Can items be made for a dual purpose (i.e. the platform-payload-bed as one piece) ? Can a train type design be made as opposed to a symmetrical body? What is the range of materials that will be carried? Does the design have to be symmetric?

Answers to these questions will be obtained at the team meeting this week when this progress report is submitted. A tentative project critical path has been agreed upon.

Progress Report

Group 6 - Bulk Transport Vehicle

ME 4182

4/21/88

Our original problem statement was revised and more clearly defined. The information included in it covered the three areas discussed at our previous group meeting; background, performance objectives and constraints.

Equipped with a clearer understanding of the project at hand, the group assigned Stewart Griner and Cody Platt to research information available through the Literature Searches available at the Georgia Tech Library. Steve Martiny and Doug Meyhoeffer were assigned to conduct an LPI search. The others in the group agreed to research information concerning the problem at hand through other sources.

The group meeting scheduled for later in the week will address the topics of work division and concept evaluation. Members will continue to conceptualize on their own until that point.

TO: Professor J.W. Brazell  
FROM: Team Six, Cody Platt (leader)  
SUBJ: Problem Statement  
DATE: April 21, 1988

A Bulk material transport vehicle has been designed twice previously. It is desired to refine prior designs for use in moving lunar work-station materials. A vehicle for lunar work stations is to be designed within the following performance specifications and constraints.

I. Performance

- A. Slope - The vehicle must be able to travel up and down a 20% grade whether loaded or unloaded.
- B. Traction - Optimal traction is to be obtained since the Moon's soil is loose and gravity is  $\frac{1}{6}$  that of Earth's.
- C. Speed - The vehicle must be able to travel at a top speed of 5-15 mph.
- D. Payload Capacity - The hauling capacity should be at least 50 cubic feet and 800 Moon pounds.
- E. Self-righting - In the event of capsize, the vehicle should be capable of self-righting.
- F. Reliability - In order to ensure maximum reliability, the vehicle should be as mechanically simple as possible.
- G. Power - The vehicle should operate on 5-15 horsepower.
- H. Center of Gravity - The center of gravity will be as low as possible to prevent capsizing.

- I. Ground Clearance - The ground clearance will be at least one foot.
  - J. Weight - To minimize shipping costs, the vehicle will be made as light as possible.
  - K. Control - The vehicle will be operated via remote control.
  - L. Braking - A regenerative braking system would be optimal if proven feasible.
- II. Constraints
- A. Wheel-Bucket Ratio - The wheel to bucket ratio must be constant.
  - B. Body Shape - Body should be symmetrical about a center pivot.
  - C. Operating Range - The range of operation is limited to the line of sight.
  - D. Thermal Range - Vehicle must operate between -120 C to 120 C
  - E. Environment - The vehicle components must be able to withstand the abrasive soil and must operate with gravity 1/6 that of the Earth's.

April 28, 1988

To: Professor J. W. Brazell

From: ME 4182 Design Group Six

Subject: Progress Report

At the team meeting of Monday, April 25, 1988, each team member was assigned a specific responsibility. The assignments were as follows:

Self-righting and dump mechanisms:

Cody Platt  
Doug Meyheofer

Center joint and steering mechanism:

Stewart Griner  
Stephen Martiny

Wheels and frame:

Chris Makorov  
Elizabeth Wheeler

Cameras and visual equipment:

Paul Daugherty

Connections to the bowl/plate:

John Sivak

Power and fuel cells:

Alan Hendrix

Chris and Libby went to the Department of Agriculture at Auburn and talked to Eddie Burt about tires for the LBMTV. He suggested ANS (all non skid) tires for where maximum traction is needed. Although this tire is pressurized, a solid tire could be made for this application. Also, he discussed the Mohr cohesion formula:

$$\tau = C + (\gamma) \tan(\phi) \quad \text{where}$$

$\tau$  is the shear stress in the soil,  $\gamma$  is the normal stress of the tire on the soil, and  $\phi$  is the angle of incline.  $C$  is the cohesion factor and it is zero for sand or moon dust. This means that there is virtually no resistance to the wheels' movement in the material. Mr. Burt also suggested a wheel width of about 12 inches to give a more concentrated normal force and thus better grip on an incline.

Cody and Doug worked on using a four bar linkage for the self-righting mechanism and for the dumping/bowl-flipover mechanism. Other possibilities are also being considered for the self-righting mechanism such as a mast type arrangement protruding from the top of the LBMTV.

Other members of the group worked on their individual assignments. At the meeting of Monday, May 2, each alternative for each assignment will be discussed by all team members and the compatibility of the different aspects of the LBMTV will be discussed. Also, our literature search should be complete very soon.

May 5, 1988

To: Professor J. W. Brazell

From: M E 4182 Design Group Six

Subject: Progress Report

Most work in the past week has been the preparation for the presentation of May 5, 1988. Much progress has been by each group member in his specific area of concentration for the LBMTV.

Doug and Cody have designed suitable mechanisms for the bowl's dumping and inversion and also for the self-righting of the vehicle. All that remains in these areas is a stress analysis for different lengths of each bar involved in each linkage. Doug is writing a program to optimize these lengths for the least force required and for a low weight requirement. Actuators will be sized when this process is complete.

Stewart and Steve have come up with a center joint that provides for articulated steering and allows for rotation about two axes at the middle of the LBMTV.

Chris and Libby have determined what type of tread would be most useful for the lunar surface. They are trying to determine if some type of substance might be used to stuff the inside of the tire with a surface made of a polymer. Also, Chris is working on a triangular space truss to form the frame of the LBMTV and to hold the fuel cells and other power supplies.

Paul has come up with a number of good ideas for camera location. He also has devised a scheme that would enable the lenses to be cleaned periodically should they become soiled by moon dust stirred up by the tires.

John has developed a method for attaching other implements to the flat plate. He will be contacting the group working on the SKITTER interfaces to try and make these ideas compatible.

Alan has been in contact with the Utah State University concerning fuel

cells and power supplies. These supplies will probably be stored inside the truss-like structure of the LBMTV.



May 12, 1988

To: Professor J. W. Brazell

From: M E 4182 Group Six

Subject: Progress Report

We have abandoned the idea of a single bowl and plate fixture due to the complexity of its rotation. Therefore, Doug has devised two new schemes for dumping from a detachable bowl. Also, Cody and Doug are looking into the positioning of the self-righting mechanism and the correct size actuator to use.

Chris is working on the frame structure and will begin working on a scale model of the LBMTV. Paul will be working with Chris on the model, also.

Paul will continue to do research on the camera system. He will also do research on the best insulation materials to house temperature sensitive components in.

Libby is researching tire materials and working on interfacing mechanisms.

Alan is still inquiring as to the best applicable power sources and their location.

Steve and Stewart are working on the steering mechanism and center joint. They are attempting to minimize the torque through the middle pin that would be created by the steering actuators. In addition, they are minimizing the wheel base by reducing the area necessary for the steering mechanism.

May 19, 1988

To: J. W. Brazell

From: M E 4182 Design Group Six

Subject: Progress Report

Douglas Meyhoefer and Cody Platt are finishing the design on the four bar linkage that will be used as the self-righting mechanism. The team has decided to use a single actuator device for the dump mechanism as opposed to the bowl inverting four bar linkage. The bowl inversion linkage was deemed to complicated because of the complexity of driving its rotation for the 180° rotation of the bowl.

Stewart Griner, Stephen Martiny, and Paul Daugherty are finishing design on the central pivot of the LBMTV. A worst possible case for maximum shear force on the central pivot pins was found by estimating a sudden deceleration time on the order of one ten thousandth of a second and using the estimate of the vehicle's mass. The analysis proved that the pin sizes are relatively small. Analysis will be furnished with the final report.

Alan Hendrix is sizing up the power requirements for the actuators and drive motors. Paul Daugherty has started looking into a general control schematic for the steering and dump actuators as well as the drive motors. Multi-layer insulation is also being investigated for protecting the electronic equipment from radiation. Insulation will probably be a combination of dimple boards layered with some type of fiberglass felt for best insulation.

Chris Makarov is doing a finite element analysis of the frame at critical areas. Frame design will be finished by the end of this week.

May 26, 1988

To: J. W. Brazell

From: M E 4182 Design Group Six

Subject: Progress Report

The design was completed and submitted for rough draft. The design was found to be too heavy, so it was necessary to re-design major structural components in order to reduce the total weight of the LBMTV.

The truss frame weight was reduced by using only .05" thickness tubing instead of 1/8".

The thermal control system heat sink housing was downsized as well. In addition the use of a thermo-electric convertor to utilize heat from radiation was scrapped for the use of a heat sink only.

The rough draft was submitted and work began for the final report.

# **APPENDIX D**

## **INVENTION DISCLOSURE**

GEORGIA INSTITUTE OF TECHNOLOGY

APPROVAL SHEET (Attach to DISCLOSURE OF INVENTION)

The following questions should be answered by the laboratory or school director, as applicable. The questions are designed to verify the ownership of the invention. This approval should be included when the Invention Disclosure form is submitted to the Office of Technology Transfer.

1. Title of Invention: LUNAR Bulk MATERIAL TRANSPORT VEHICLE (LBMTV)

2. List of Inventor(s):

CODY PLATT

ALAN HENDRIX

PAUL DAUGHERTY

STEWART GRINER

STEPHEN MARTINY

CHRIS MAKARON

ELIZABETH WHEELER

DOUGLAS MEYHOEFER

3. Ownership:

JOHN SJIAK

In my opinion this invention:

A. Is owned by the Institute in accordance with the Patent Policy.

B. Was developed by the inventor(s) without use of Institute time, facilities or materials, and is not related to the inventor's area of technical responsibility to the Institute and hence belongs to the inventor(s).

4. Research project advisor approval for student submissions (if applicable):

\_\_\_\_\_  
Advisor Date

Reviewed for Institute ownership by laboratory or school director.

\_\_\_\_\_  
Name Date

\_\_\_\_\_  
Title/Unit

GEORGIA INSTITUTE OF TECHNOLOGY  
DISCLOSURE OF INVENTION

Submit this disclosure to the Office of Technology Transfer (OTT) or contact that office for assistance. Disclosure must contain the following items: (1) title of invention, (2) a complete statement of invention and suggested scope, (3) results demonstrating that the concept is valid, (4) variations and alternate forms of the invention, (5) a statement of the novel features of the invention and how these features distinguish your invention from the state of the art as known to you, (6) applications of the technology, and (7) supporting information.

1. Title

Technical Title: LUNAR BULK MATERIAL TRANSPORT VEHICLE

Layman's Title (34 characters maximum, including spaces): LUNAR  
DAMP TRUCK

Inventor(s): (Correspondence, patent questions, etc. will be directed to the first named inventor)

- A. Signature Cody Platt Revenue Share% 0 Date 06-2-88  
Printed Name CODY CLAXTON PLATT Citizenship US  
First Middle Last  
Home Address 2965 CYNTHIA CT.  
City MARIETTA County COBB State GA Zip Code 30062  
Campus Unit/Mail Address P.O. 30820 Campus Phone 676-9236
- B. Signature Elizabeth O. Wheeler Revenue Share% 0 Date 06-2-88  
Printed Name Elizabeth Fitch Wheeler Citizenship USA  
First Middle Last  
Home Address 14 Billy Downs Court  
City Atlanta County Pulston State GA Zip Code 30318  
Campus Unit/Mail Address P.O. 31660 Campus Phone 842-2930
- C. Signature Douglas M. Hoefler Revenue Share% 0 Date 6/2/88  
Printed Name Douglas Ralph M-yhoefler Citizenship USA  
First Middle Last  
Home Address #7 SUNSET Blvd  
City MASSAPEQUA County NASSAU State NY Zip Code 11758  
Campus Unit/Mail Address P.O. 30442 Campus Phone 676-0597

DISCLOSURE OF INVENTION

2. Statement of Invention:

Give a complete description of the invention. If necessary, use additional pages, drawings, diagrams, etc. Description may be by reference to a separate document (copy of a report, a preprint, grant application, or the like) attached hereto. If so, identify the document positively. The description should include the best mode that you presently contemplate for making (the apparatus or material invented) or for carrying out the process invented.

The LBMTV IS VEHICLE THAT WILL TRANSPORT SOIL AND APPARATUS ON THE MOON. A MORE COMPLETE DESCRIPTION OF THE VEHICLE AND ITS SPECIFICATIONS IS ~~THE~~ STATED IN THE ATTACHED REPORT, THE LUNAR BULK MATERIAL TRANSPORT VEHICLE.

Inventor(s) Coly Platt Date 06-02-88  
Elizabeth D. Wheeler Date 06-02-88  
Douglas Myhr Date 6/2/88  
Witness\* Stephen Martiny Date 6/2/88  
Date \_\_\_\_\_

\*The witness should be technically competent and understand the invention.

DISCLOSURE OF INVENTION

3. Results Demonstrating the Concept is Valid:

Cite specific results to date. Indicate whether you have completed preliminary research, laboratory model, or prototype testing.

Only preliminary research has been done and a scale model has been made for as a visual aid. It is not a working model. At the present time all calculations are based on theory. There has not been any testing of materials, controls, or mechanisms.

4. Variations and Alternative Forms of the Invention:

State all of the alternate forms envisioned to be within the full scope of the invention. List all potential applications and forms of the invention, whether currently proven or not. (For example, chemical inventions should consider all derivatives, analogues, etc.) Be speculative in answering this section. Indicate what testing, if any, you have conducted on these alternate forms.

The vehicle is set in its shape and frame dimensions, however it can be fitted with any style of carrying mechanism or other interfaces, as long as these attachments do not exceed 400 million pounds.

Inventor(s) Coch Platt Date 06-02-88

Elizabeth D. Wheeler Date 06-02-88

Douglas Mylof Date 6/2/88

Witness\* Stephen Martiny Date 6/2/88  
(printed name)

\_\_\_\_\_  
(printed name) Date \_\_\_\_\_



DISCLOSURE OF INVENTION

5. Novel Features:

a. Specify the novel features of your invention. How does the invention differ from present technology?

A TRUSS STYLE FRAME, MOVIEABLE SELF-RIGHTING MECHANISM,  
THERMAL CONTROL SYSTEM

b. What deficiencies or limitations in the present technology does your invention overcome?

CURRENTLY, WE KNOW OF NO EXISTING TECHNOLOGY TO  
TRANSPORT BULK MATERIALS ON THE MOON.

c. Have you or an associate searched the scientific literature with respect to this invention? Yes X No \_\_\_\_\_. Have you done a patent search? Yes \_\_\_\_\_ No X \_\_\_\_\_. If yes in either case, or both, indicate what pertinent information you found and enclose copies if available. Also indicate any other art you are aware of (whatever the source of your information) that is pertinent to your invention. Enclose copies of descriptions if available. (Note: An inventor is under duty by law to disclose to the U.S. Patent and Trademark Office any prior art known to him or her.)

SEE REFERENCES FOR PERTINENT INFORMATION.

Inventor(s) Cody Platt Date 06-02-88  
Elizabeth D. Wheeler Date 06-02-88  
Douglas M. Wolfe Date 6/2/88  
Witness Stephen R. ... Date 6/2/88  
(printed name) \_\_\_\_\_  
Date \_\_\_\_\_  
(printed name) \_\_\_\_\_

DISCLOSURE OF INVENTION

6. Application of the Technology:

List all products you envision resulting from this invention. For each, indicate whether the product could be developed in the near term (less than 2 years) or would require long-term development (more than 2 years).

LUNAR DUMP TRUCK OR OTHER  
CARGO TRANSPORT VEHICLE.

LONG TERM

Inventor(s) Colby Platt Date 06-02-88  
Elizabeth D. Wheeler Date 06-02-88  
Douglas Myhr Date 6/2/88

Witness Stephan Martiny Date 6/2/88  
(printed name)  
(printed name) Date \_\_\_\_\_

*Col*

DISCLOSURE OF INVENTION  
SUPPORTING INFORMATION

1. Are there publications such as theses, reports, preprints, reprints, etc. pertaining to the invention? Please list with publication dates. Include manuscripts (submitted or not), news releases, feature articles and items from internal publications. Supply copies if possible.

THERE ARE ELEVEN COPIES, TWO COPIES WERE SUBMITTED TO J.W. BRAZELY, AND EACH INVENTOR HAS ONE COPY.

2. On what date was the invention first conceived? 3. Is this date documented? YES Where? SEE BELOW Are laboratory records and data available? Give reference numbers and physical location, but do not enclose.

GEORGIA INSTITUTE OF TECHNOLOGY/NASA SPONSORED  
ADVANCED DESIGN PROGRAM.

3. Give date, place, and circumstances of any disclosure. If disclosed to specific individuals, give names and dates.

SEE PREVIOUS REPORTS

4. Was the work that led to the invention sponsored by an entity external to Georgia Institute of Technology? Yes X No \_\_\_\_\_

a) If yes, has sponsor been notified? Yes X No \_\_\_\_\_

b) Sponsor Names: GIT Project Nos.

NASA

5. What firms do you think may be interested, in the invention and why. Name specific persons within the companies if possible.

NASA

DISCLOSURE OF INVENTION  
SUPPORTING INFORMATION

6. Setting aside your personal interest, what do you see as the greatest obstacles to the adoption of your invention?

*Not Fully Tested, Expensive to Ship*

7. Alternate Technology and Competition:

- a. Describe alternate technologies of which you are aware that accomplish the purpose of the invention.

*None*

- b. List the companies and their products currently on the market which make use of these alternate technologies.

- c. List any research groups currently engaged in research and development in this area.

*UNKNOWN*

8. Future Research Plans:

- a. What additional research is needed to complete development and testing of the invention? What time frame and estimated budget is needed for the completion of each step?

*ACTUAL BUILDING + SIMULATED TESTING.*

*10 YRS.*

- b. Is this additional research presently being undertaken? Yes \_\_\_ No X

- c. If yes, under whose sponsorship?

- d. If no, should corporate sponsorship be pursued? Yes X No \_\_\_

Suggested corporation(s) \_\_\_\_\_

9. Attach, sign and date additional sheets if necessary. Enclose sketches, drawings, photographs and other materials that help illustrate the description. (Rough artwork, flow sheets, Polaroid photographs and penciled graphs are satisfactory as long as they tell a clear and understandable story.)

# **APPENDIX E**

## **FIGURES**

THE BOWL

VALUE OF PIE:	3.14
DIAMETER OF MOUTH(FT):	4.12
DIAMETER OF BASE(FT):	2.06
TOTAL HEIGHT(FT):	2.06
UPPER HEIGHT(FT):	1.03
EDGE RADIUS @ BASE(FT):	1.03
SURFACE AREA OF BOWL(SQ.FT):	33.30
VOLUME OF BOWL(CU.FT):	25.25
DENSITY OF MOON SOIL(KG/CU.M):	1500.00
PAYLOAD OF MOON SOIL(EARTH LBS.)	2364.37
WEIGHT OF MOON SOIL(MOON LBS):	394.06
CENTER OF GRAVITY FROM BASE(FT):	1.02

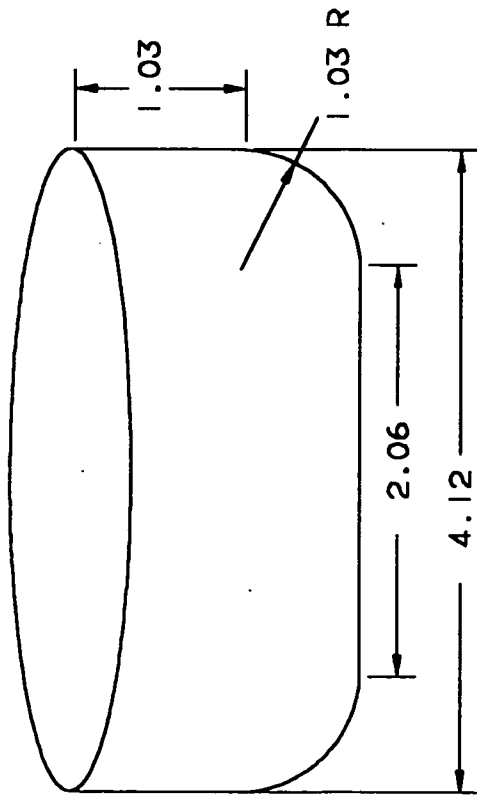

FIGURE B1

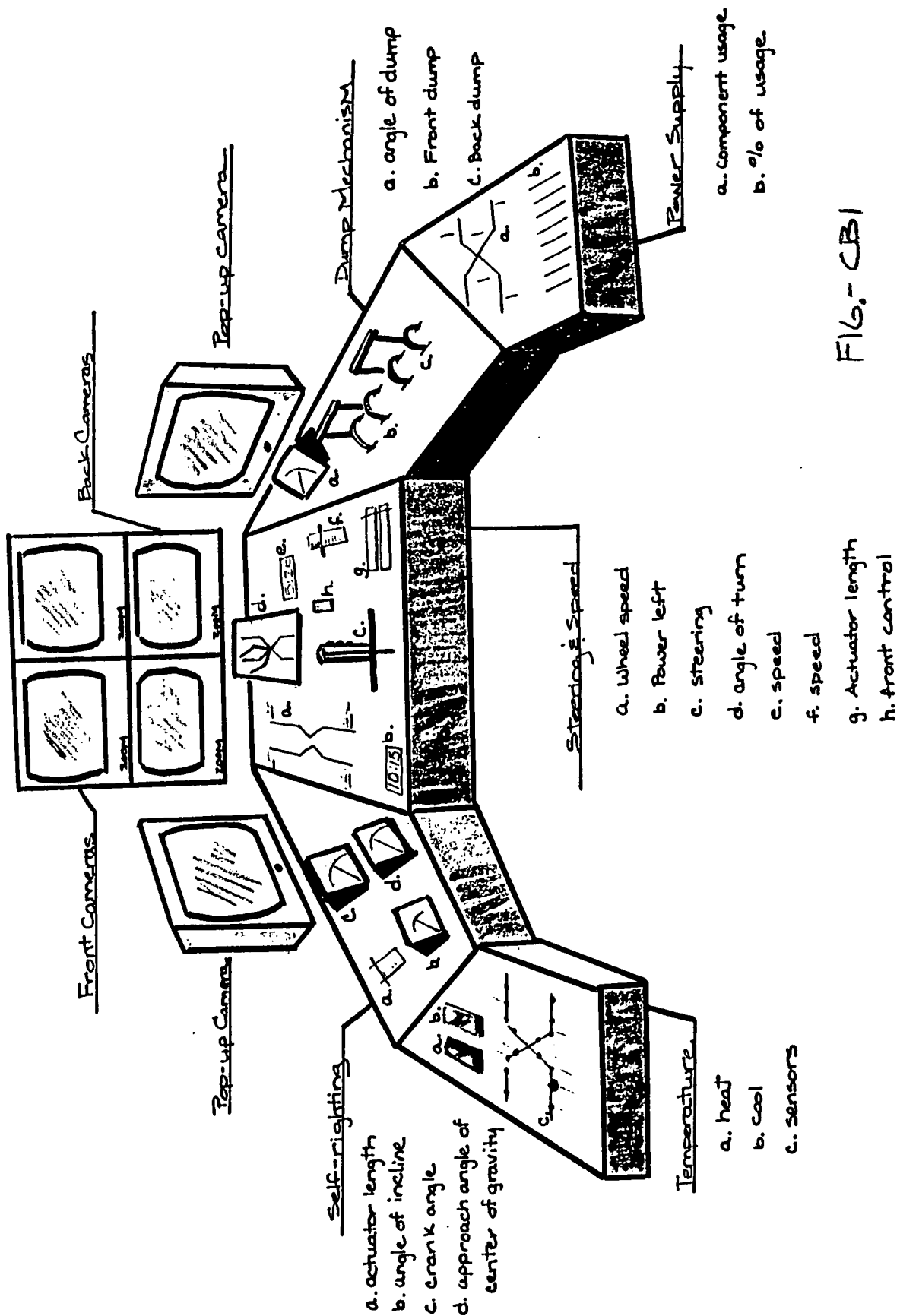

FIG.- CB1

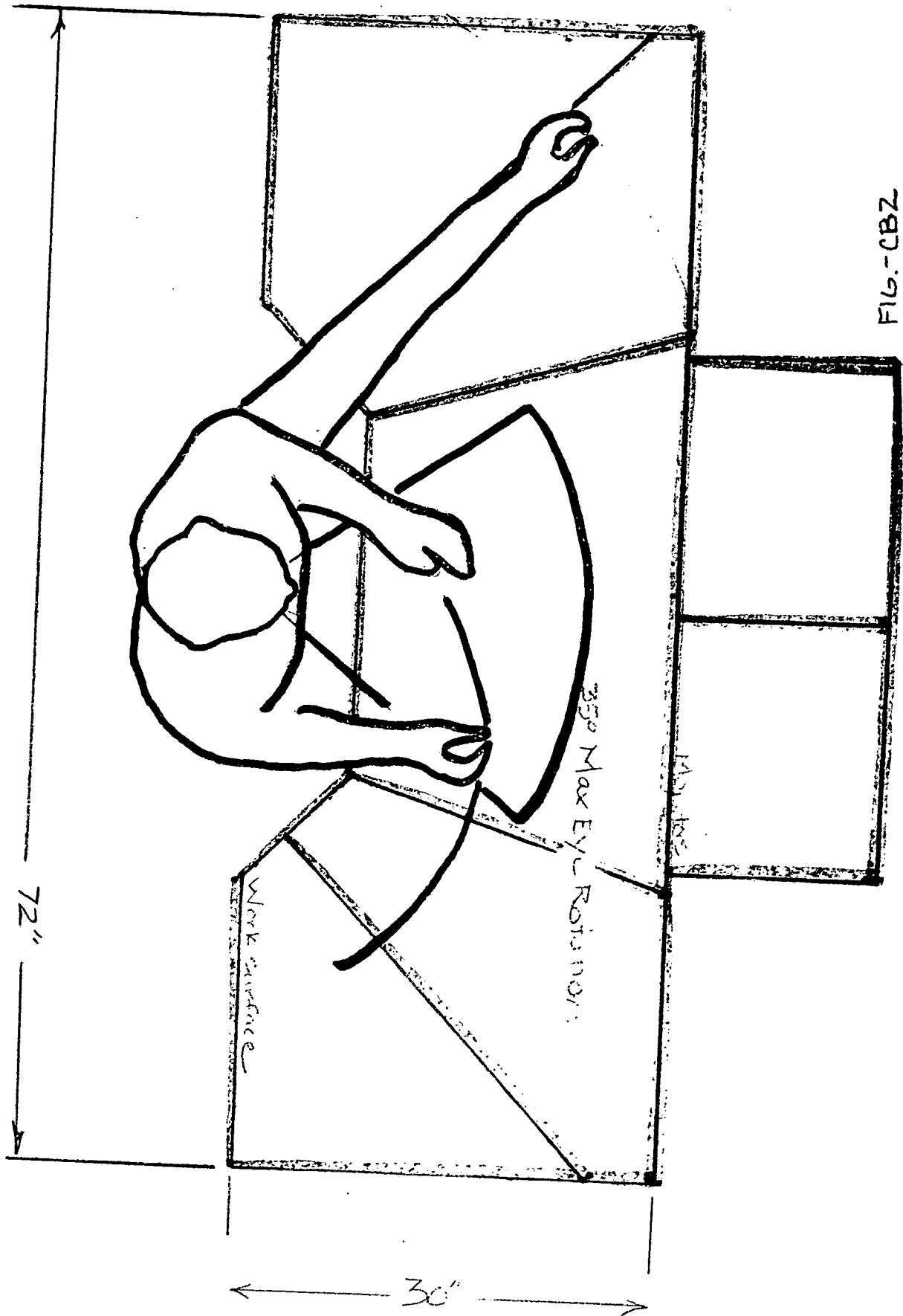
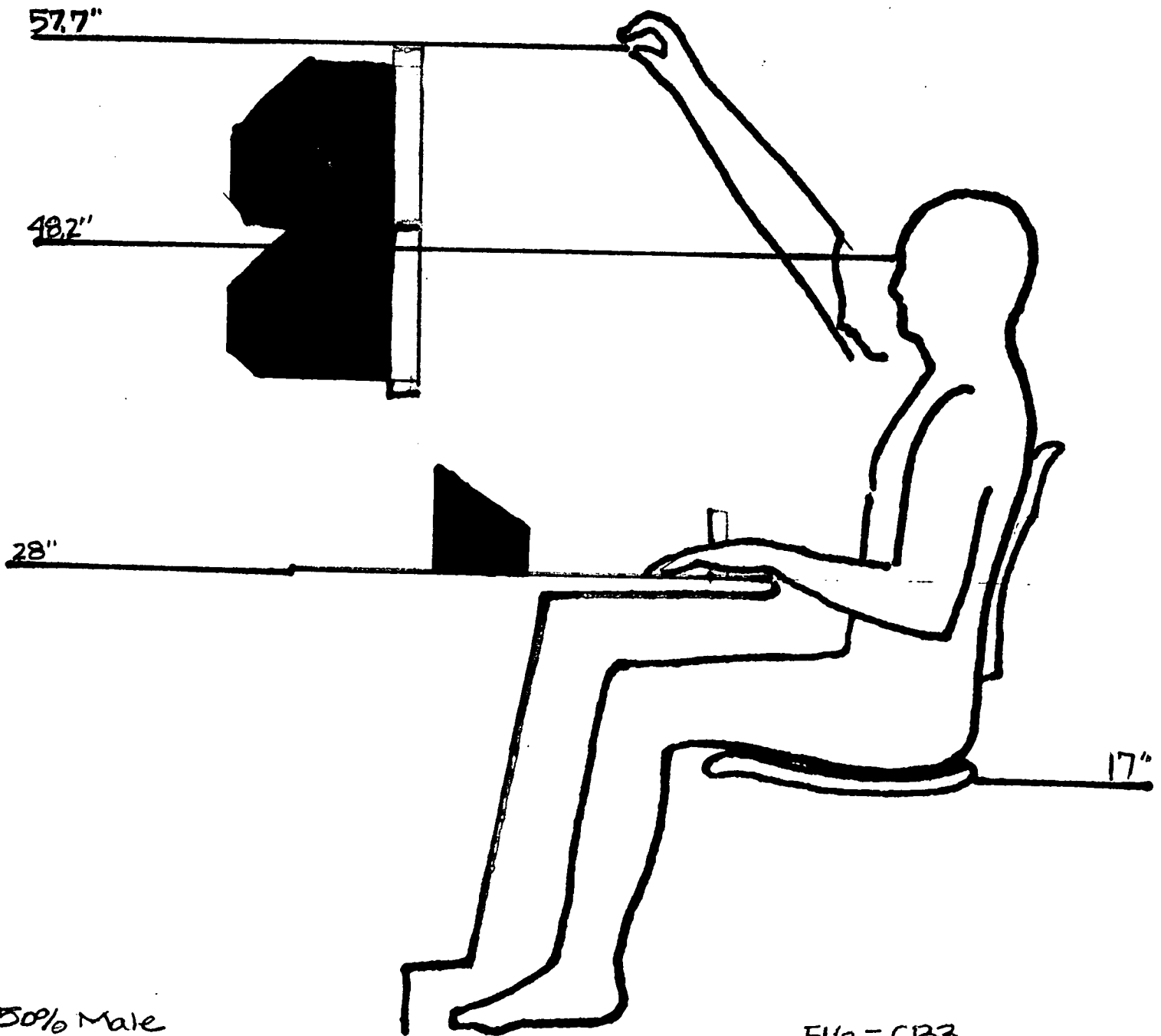

FIG.-CBZ





50% Male

FIG.-CB3

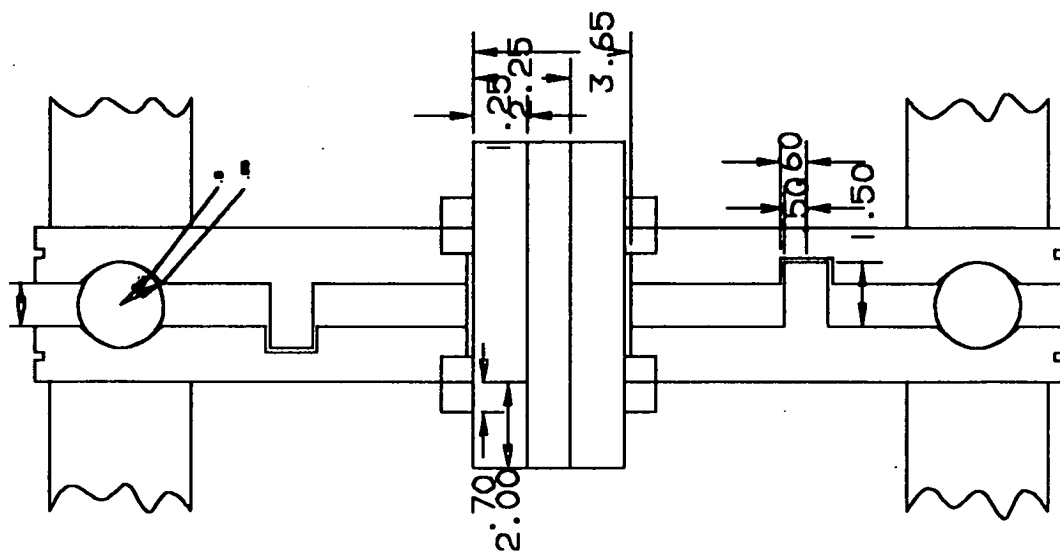
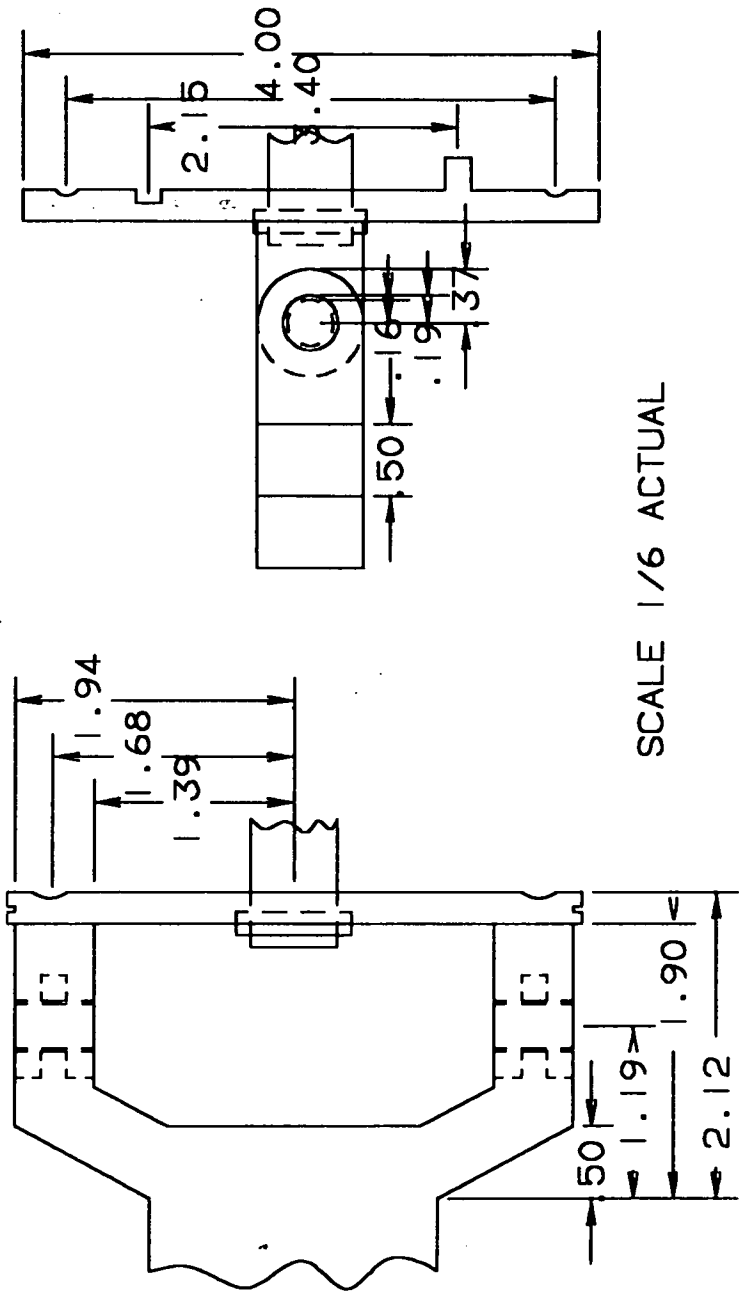
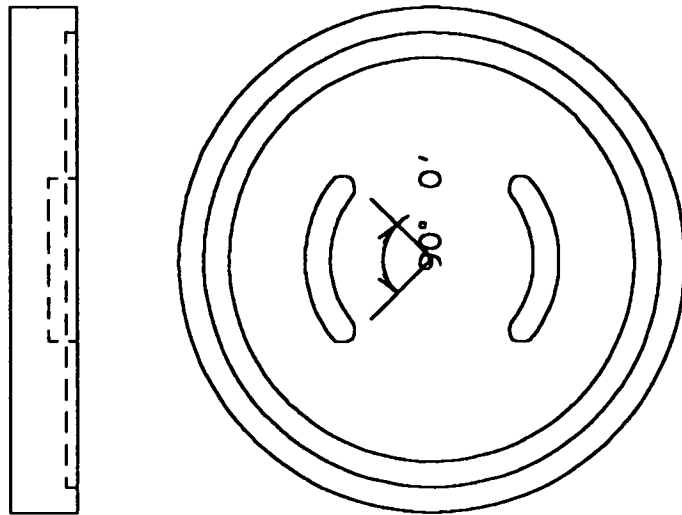

FIGURE CJI



SCALE 1/6 ACTUAL

FIGURE CJ2



BALL BEARING / PIN STOP SLOTS

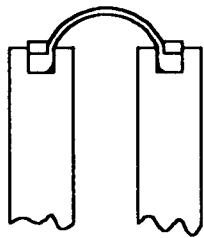

BALL BEARING SEALING  
RUBBER

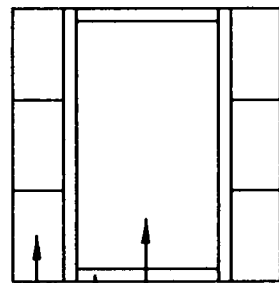

PIN  
PIN CAP  
HINGE BANDS

FIGURE CJ3

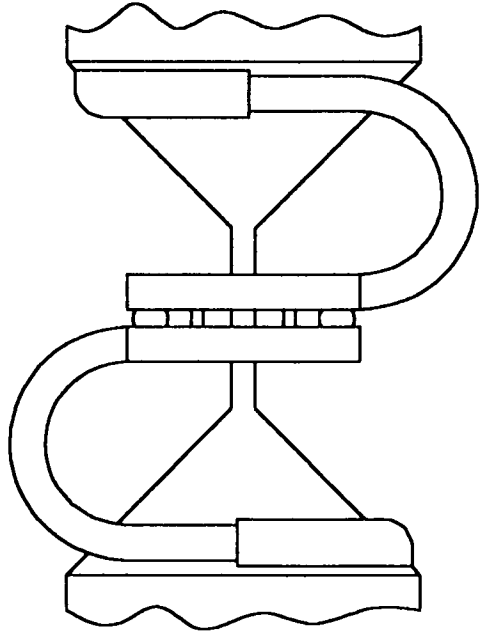
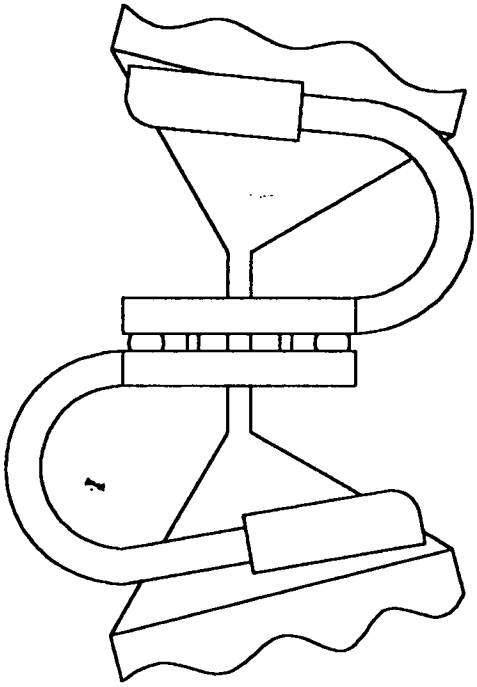

FIGURE CJ4

SWING ANGLE 90 DEG TO 100 DEG

SWING RADIUS 1 INCH

MAX FORCE 250 LBS(TENSION)

PIVOT POINT

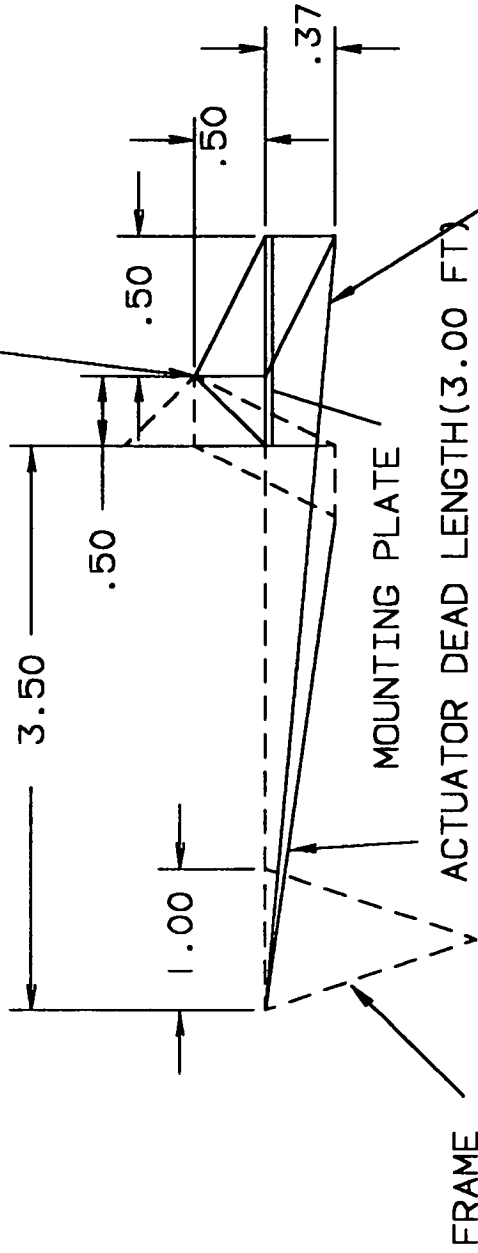

ACTUATOR EXTENDED(4.50 FT)

DUMP MECHANISM DIMENSIONS IN FT.

FIGURE DM 1

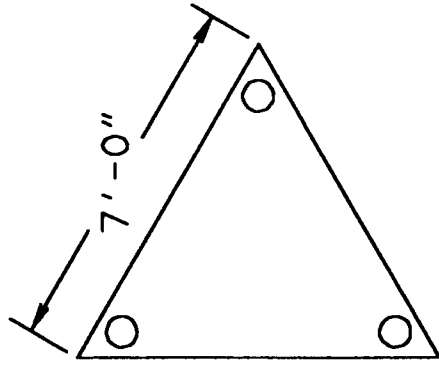

FIGURE IF1.SKITTER INTERFACE

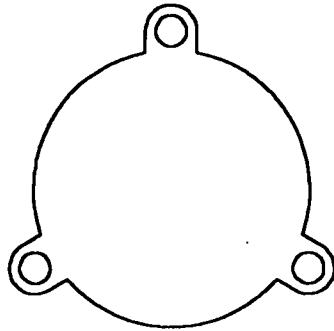

FIGURE IF2.BULK MATERIAL  
CONTAINER INTERFACE

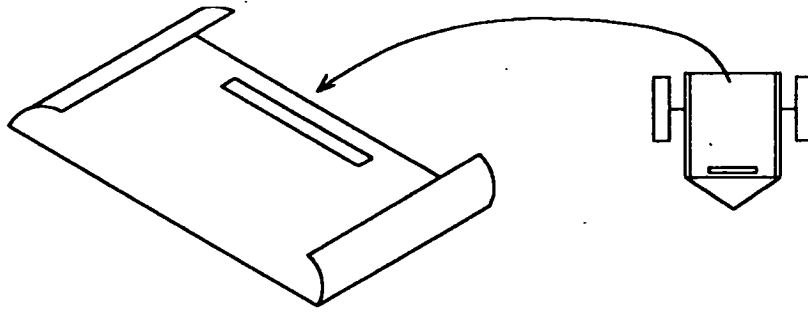

FIGURE IF3.BULK MATERIAL TRANSPORT  
VEHICLE INTERFACE

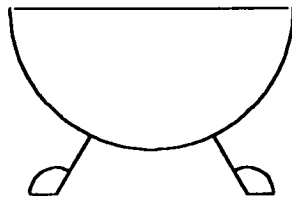

FIGURE IF4.CONTAINER TO  
VEHICLE INTERFACE



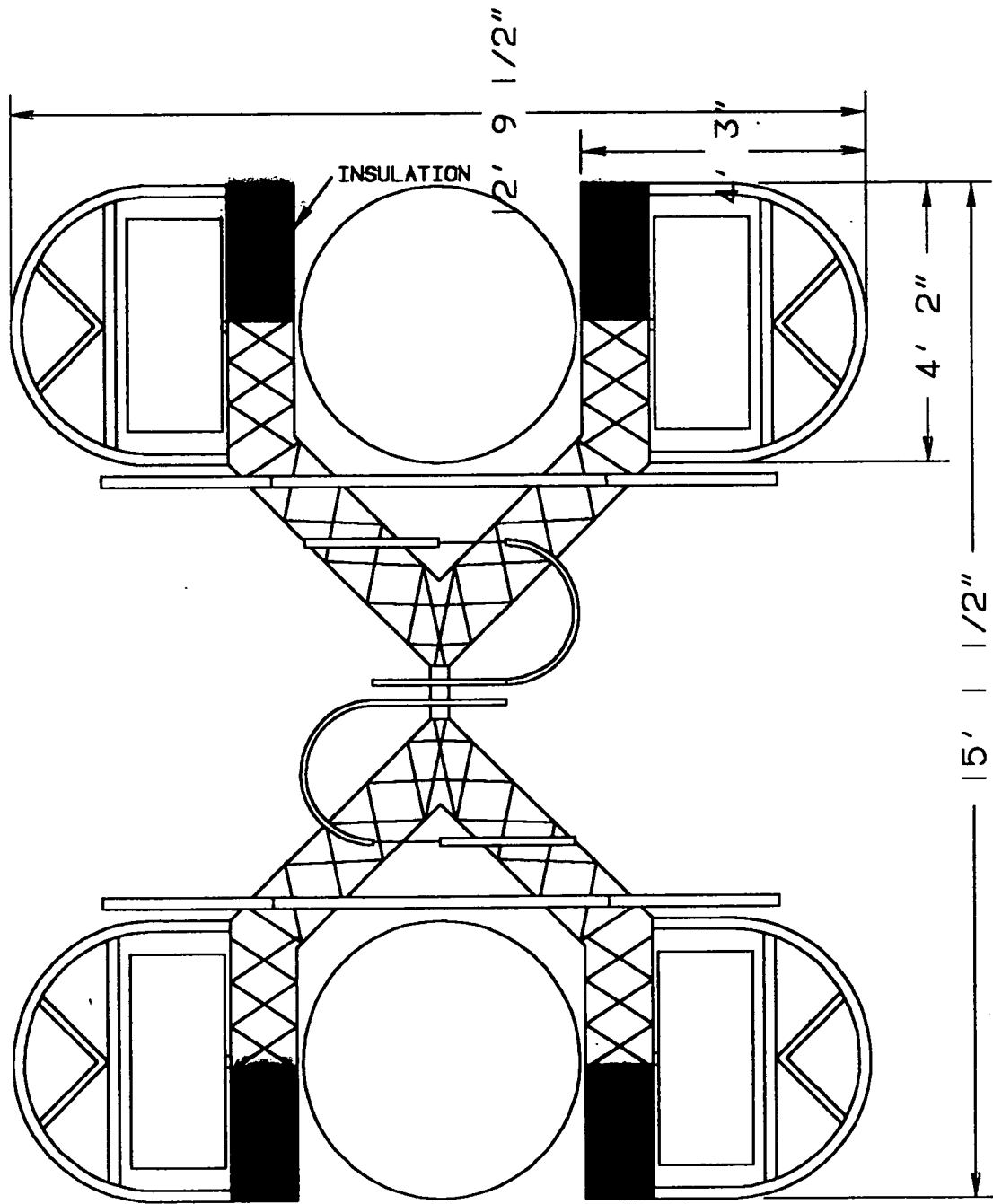

FIGURE 0A1. TOP VIEW-LUNAR  
BULK MATERIAL TRANSPORT VEHICLE

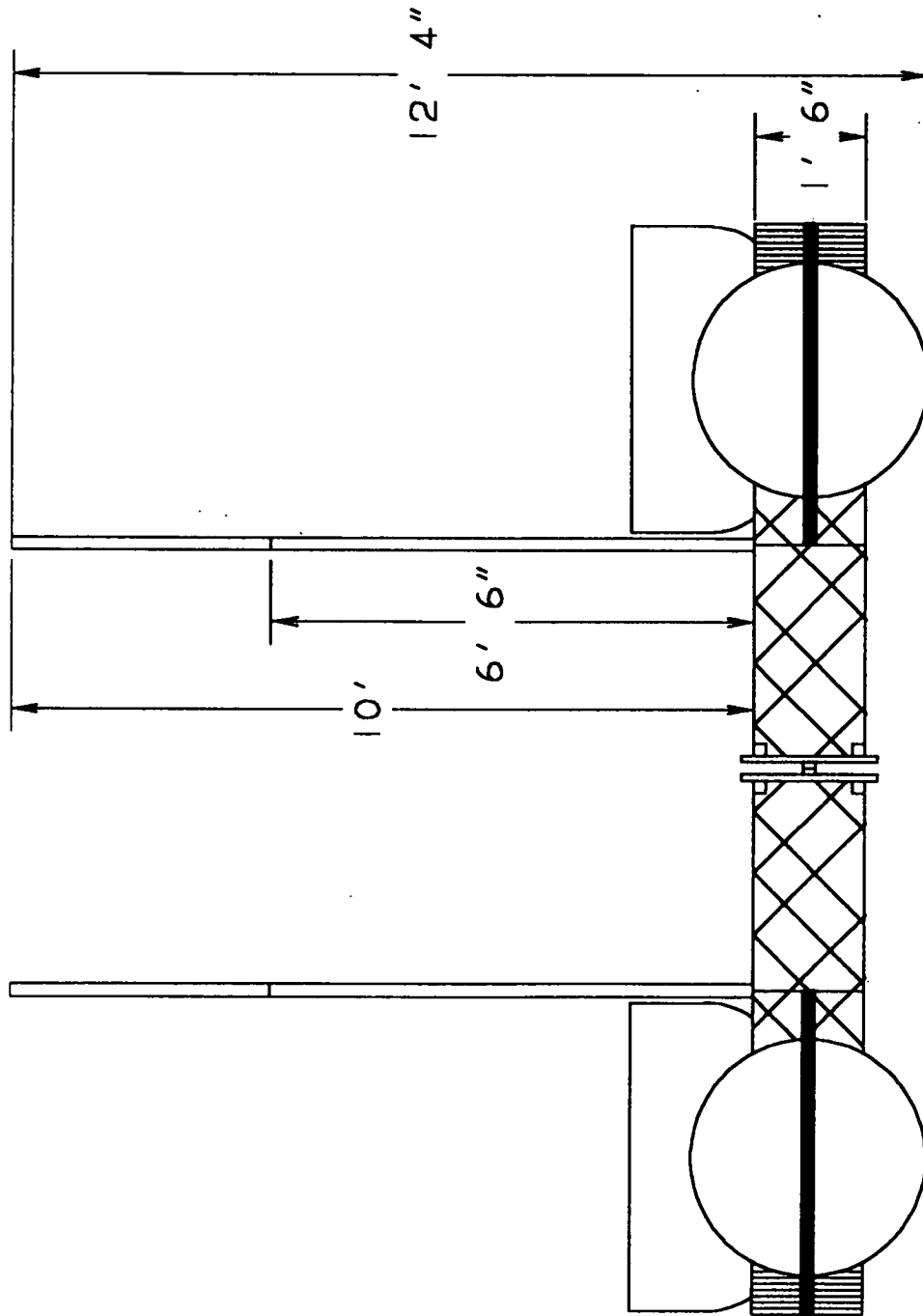

FIGURE OA2. SIDE VIEW-LUNAR BULK MATERIAL TRANSPORT VEHICLE

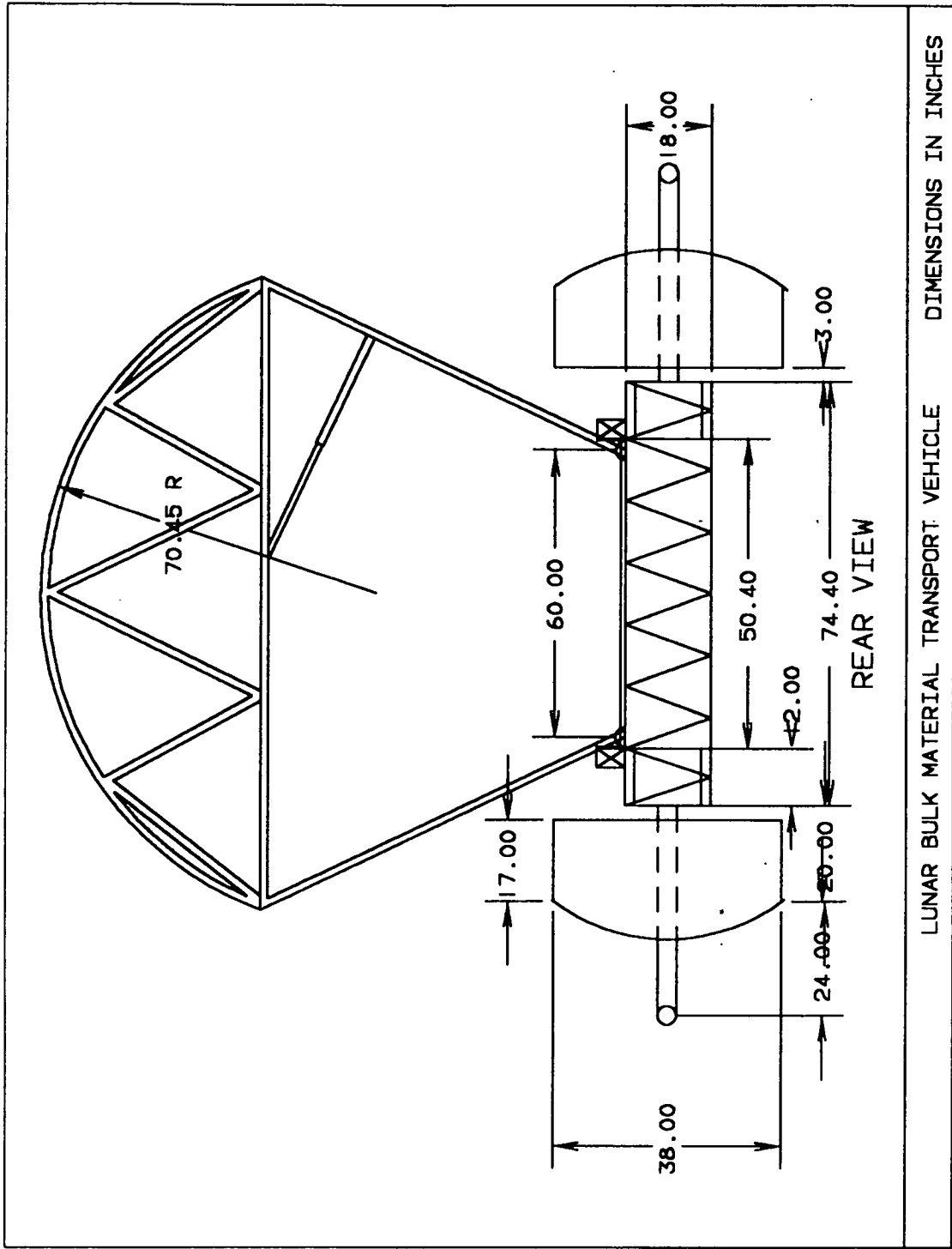
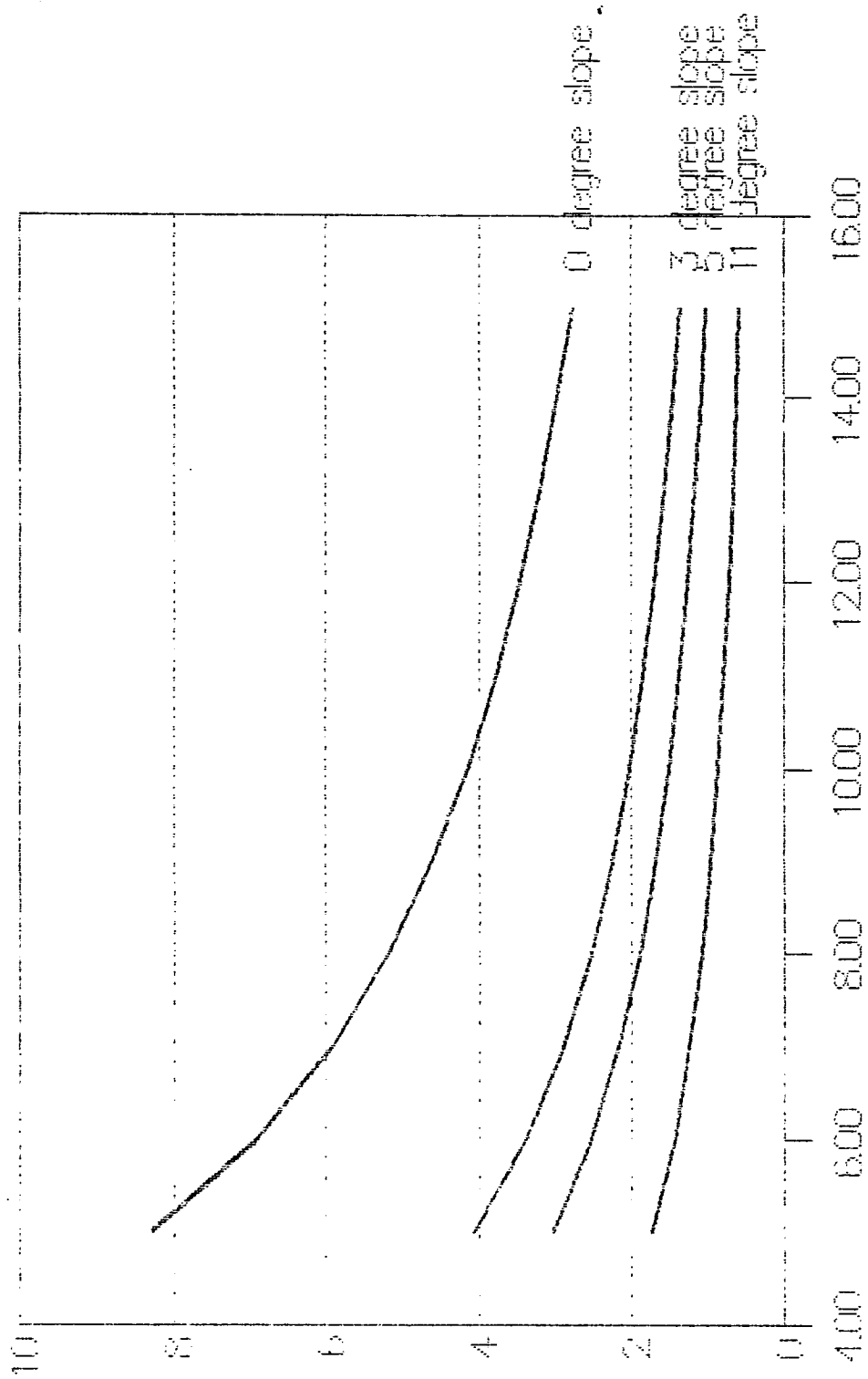

FIGURE O A 3

# TIME VS. VELOCITY AT VARIOUS SLOPE



Velocity (mph)

Fig. P5-1

# TIME vs. VELOCITY

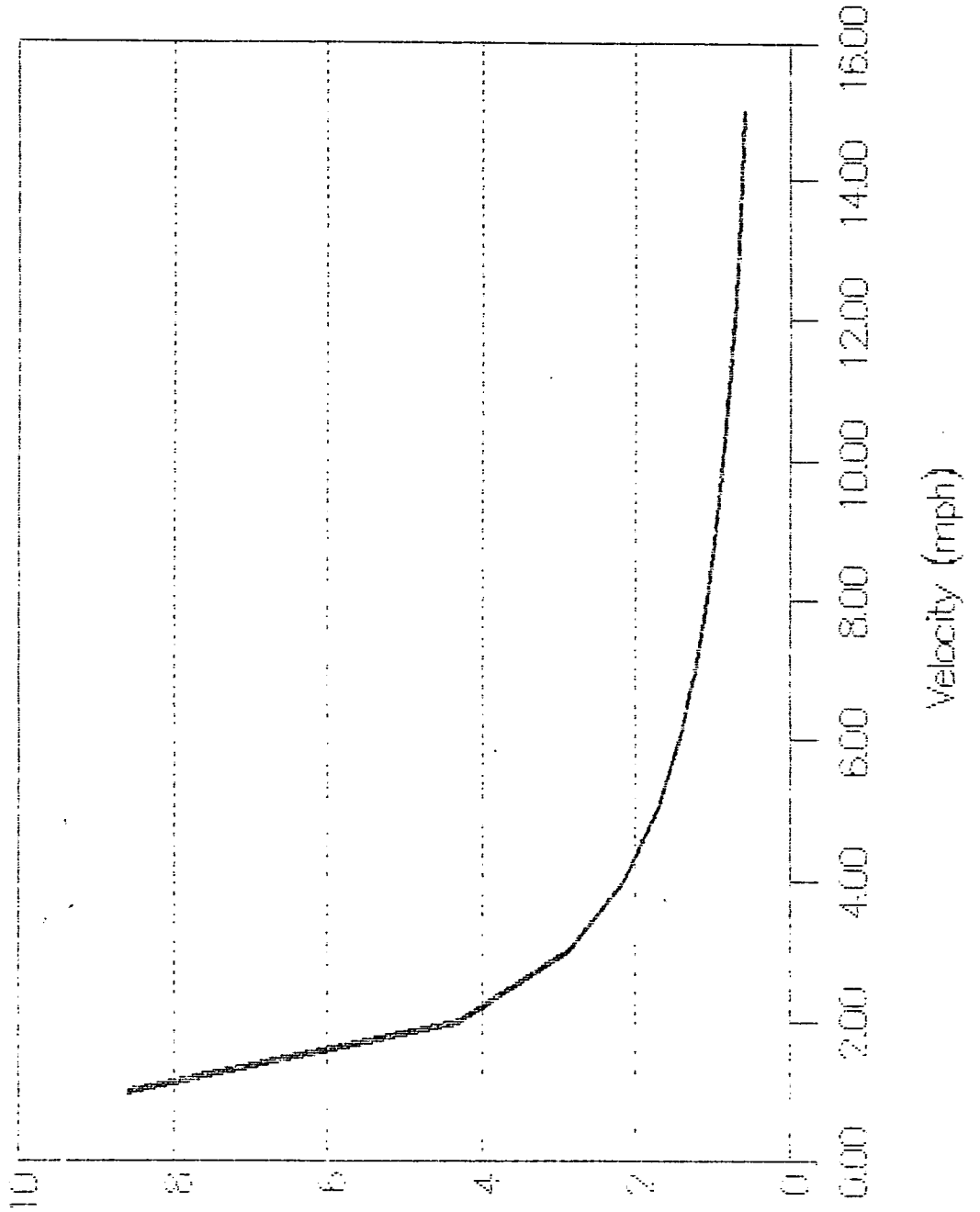

Velocity (mph)

Fig. Ps-2

Running Time (hours)

ORIGINAL PAGE IS  
OF POOR QUALITY

# BATTERY WEIGHT VS. VELOCITY

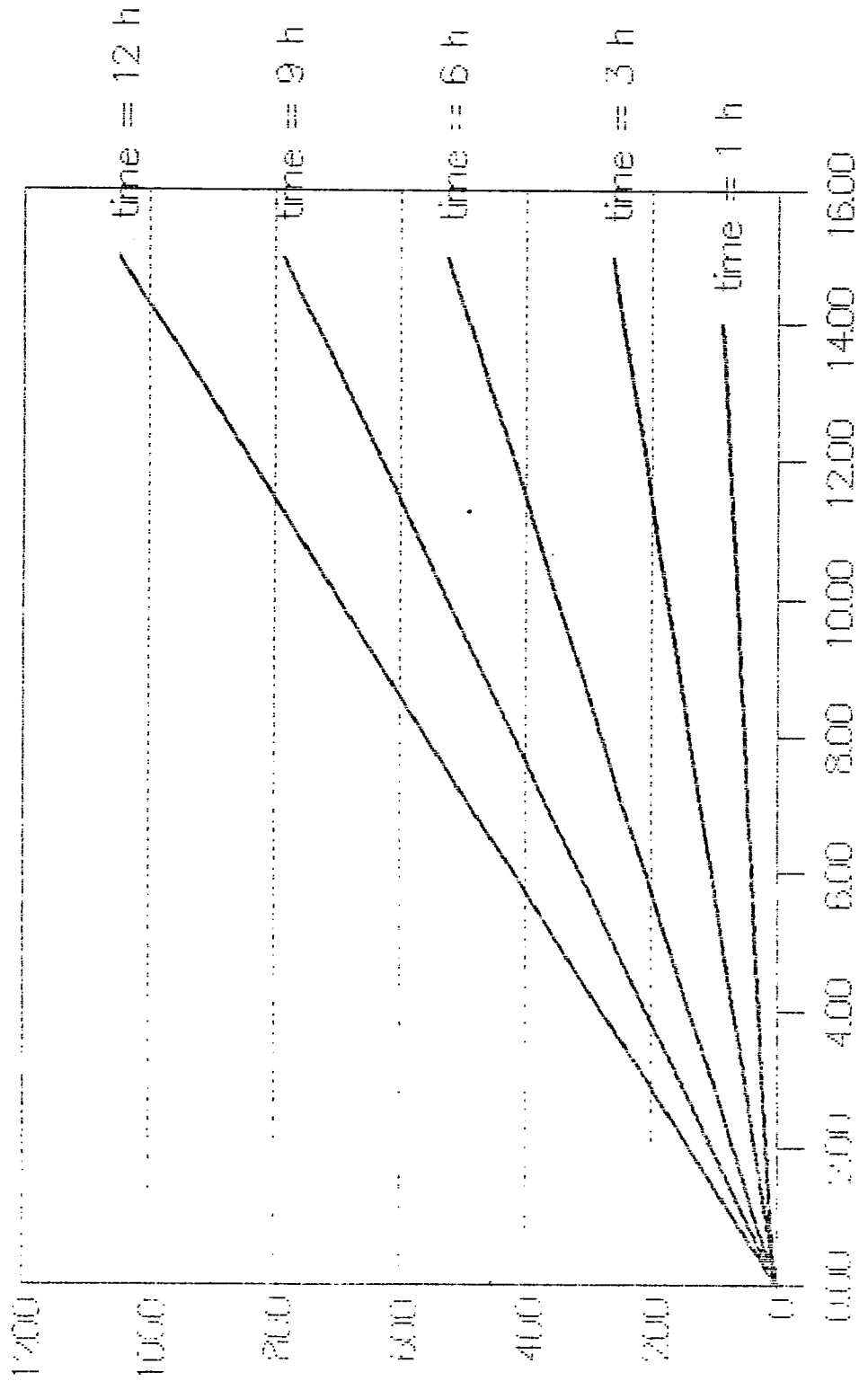

Velocity (mph)  
Fig. PS-3

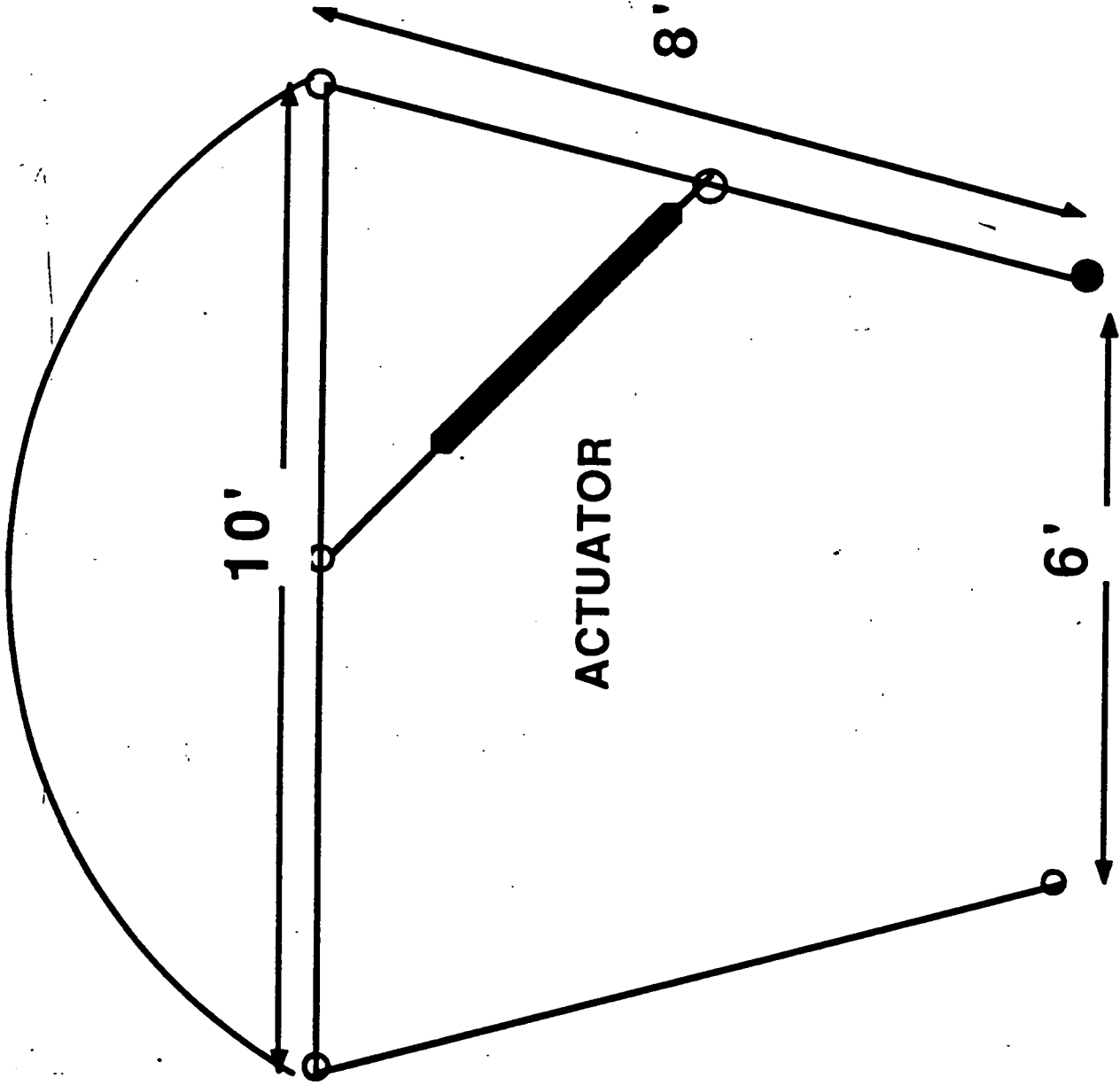

**ROLL-BAR: SELF-RIGHTING MECHANISM**

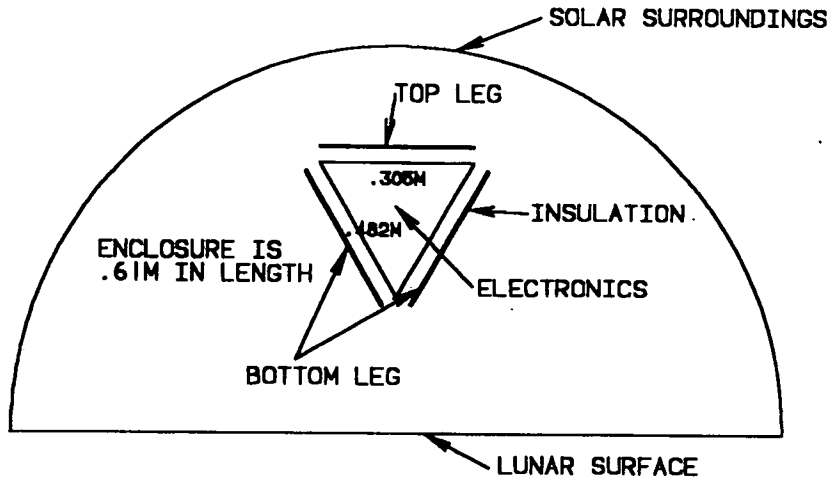

FIGURE TC1. SIMPLIFIED RADIATIVE SYSTEM

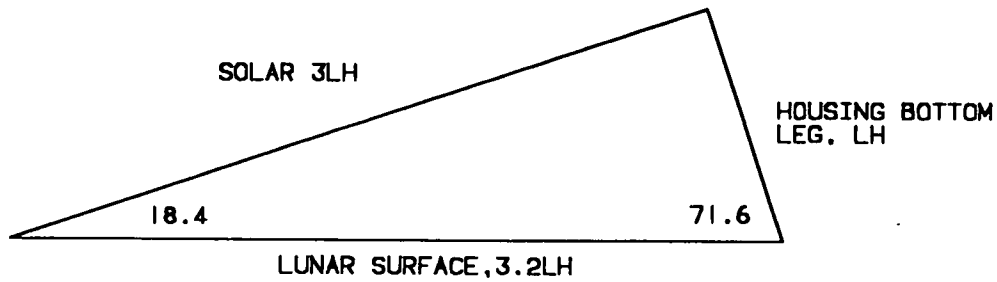

FIGURE TC2. PROJECTION OF BOTTOM LEG TO LUNAR SURFACE



# HOUSING WEIGHT VS. SATURATION TIME

(1 LUNAR NEWTON = 4.45 POUNDS)

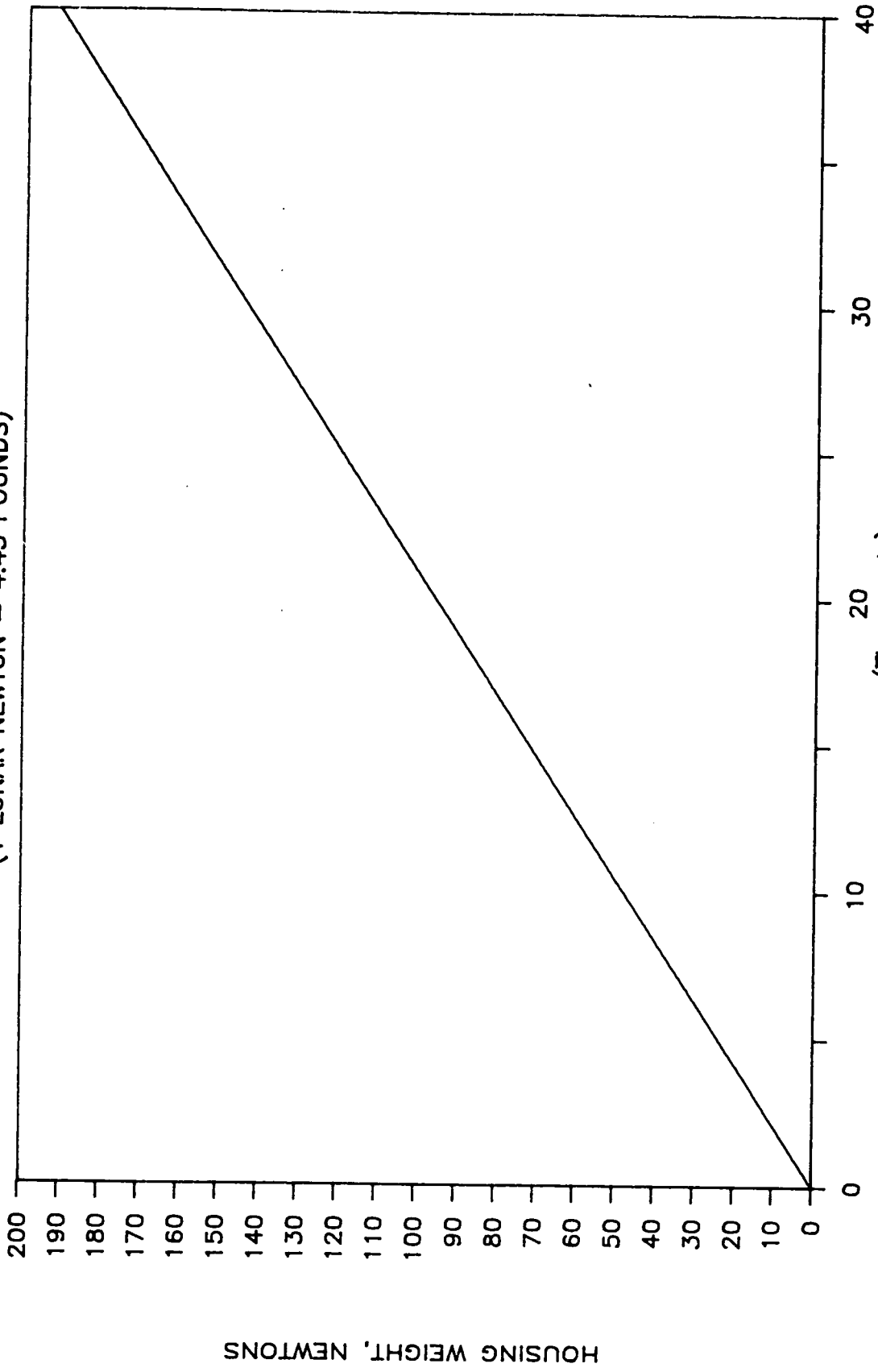

Figure TC3

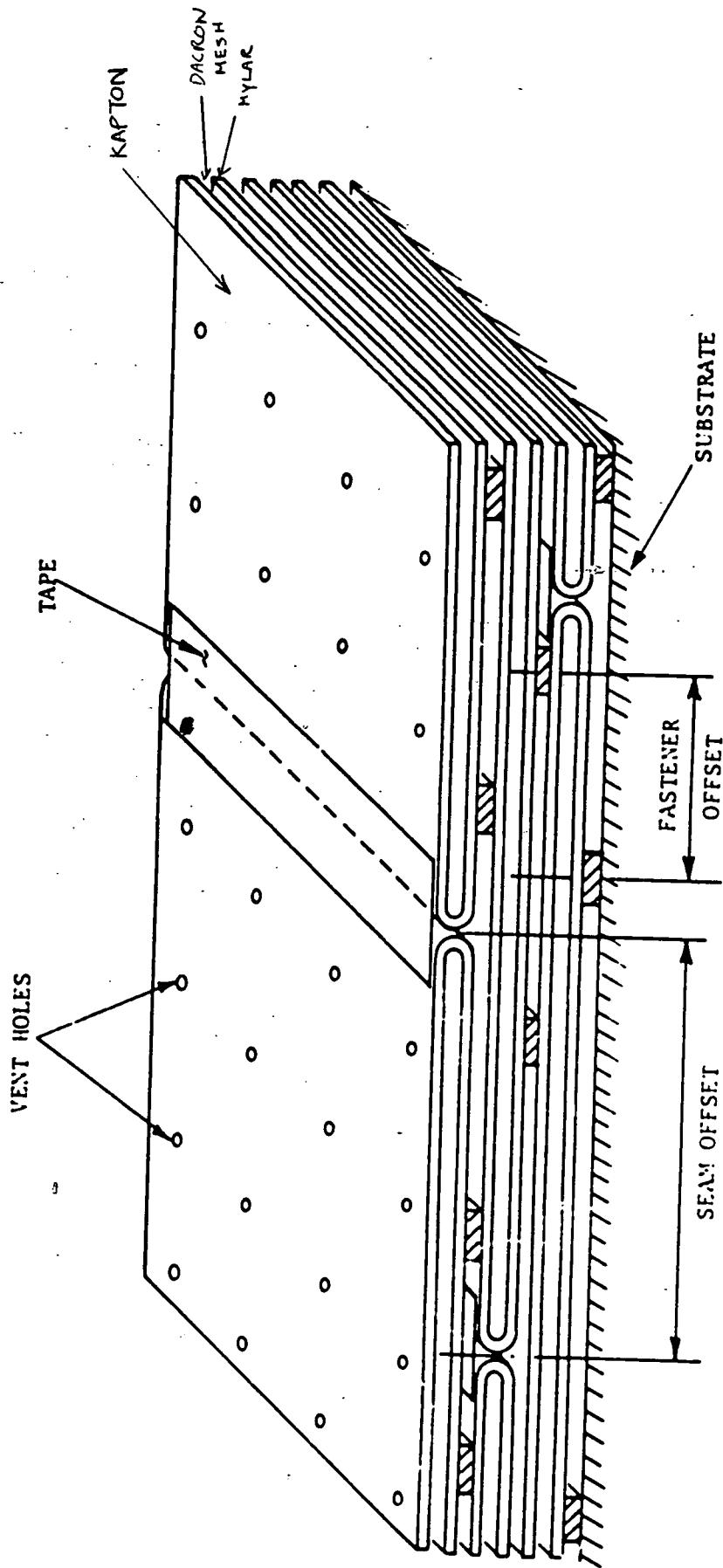

Figure TCH Schematic of Blanket Installation

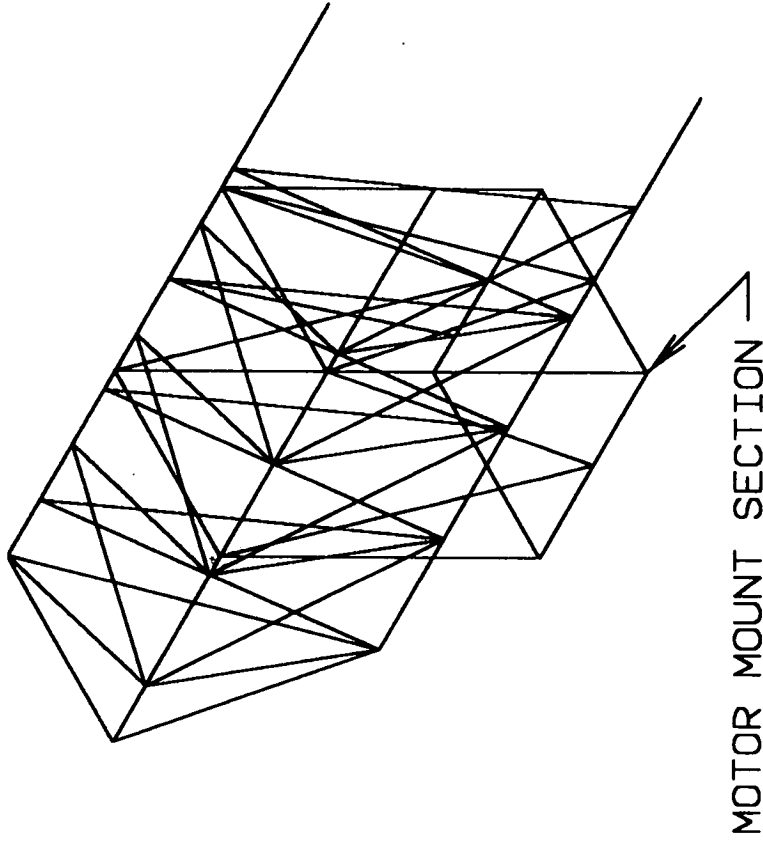
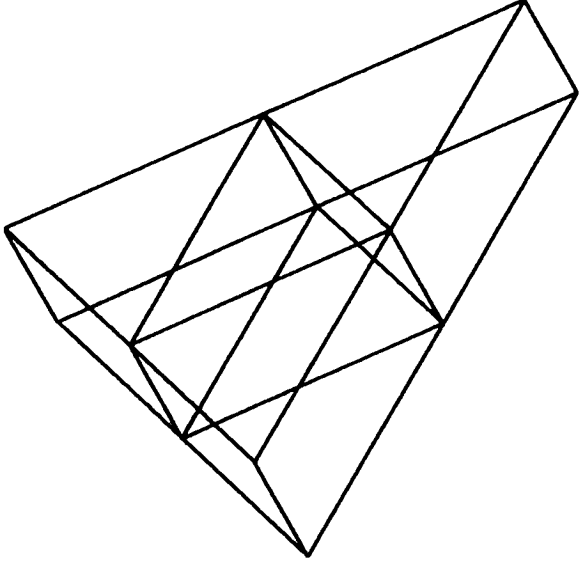

FIGURE TFI



BOWL MOUNT SECTION

FIGURE TF2

1

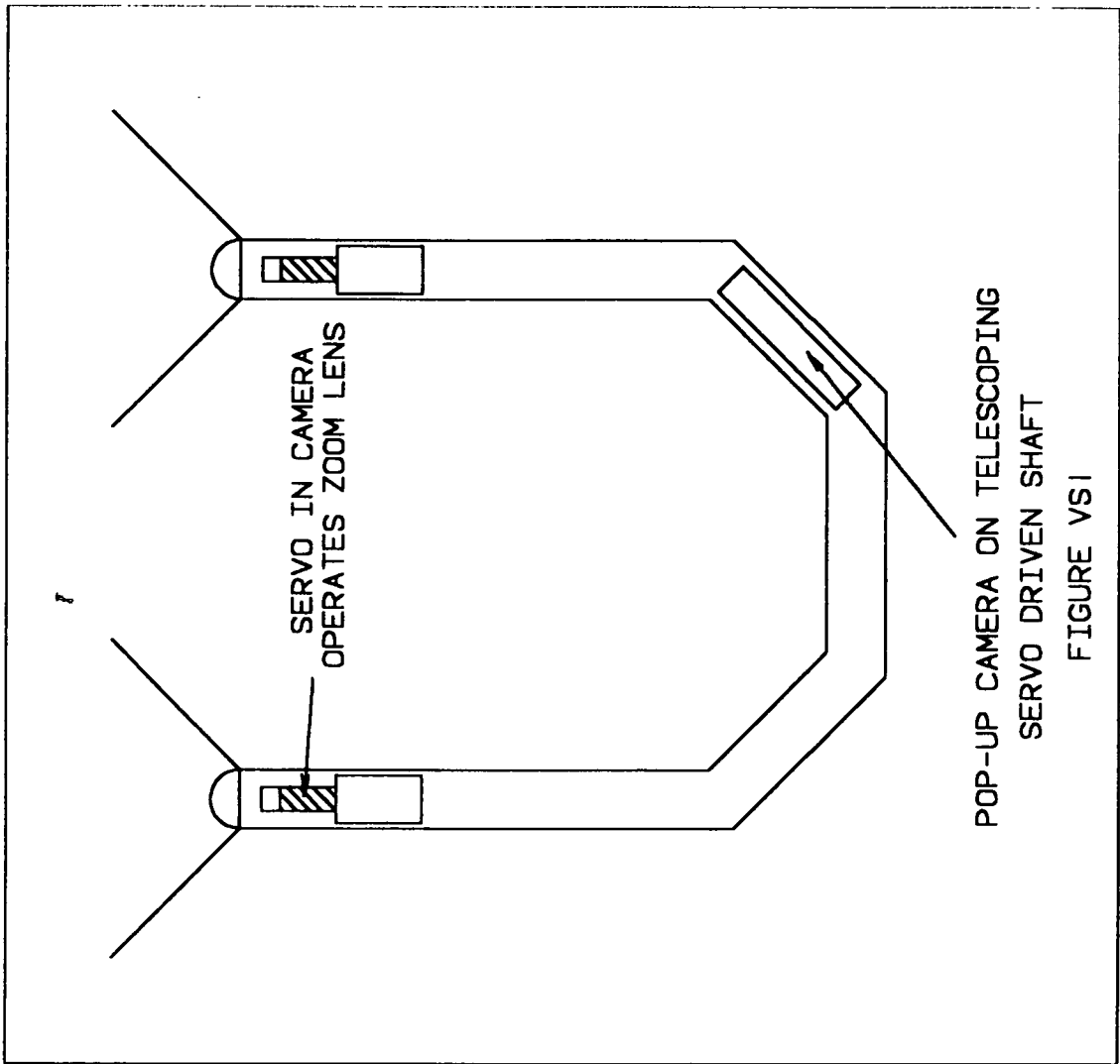

POP-UP CAMERA ON TELESCOPING  
SERVO DRIVEN SHAFT  
FIGURE VSI

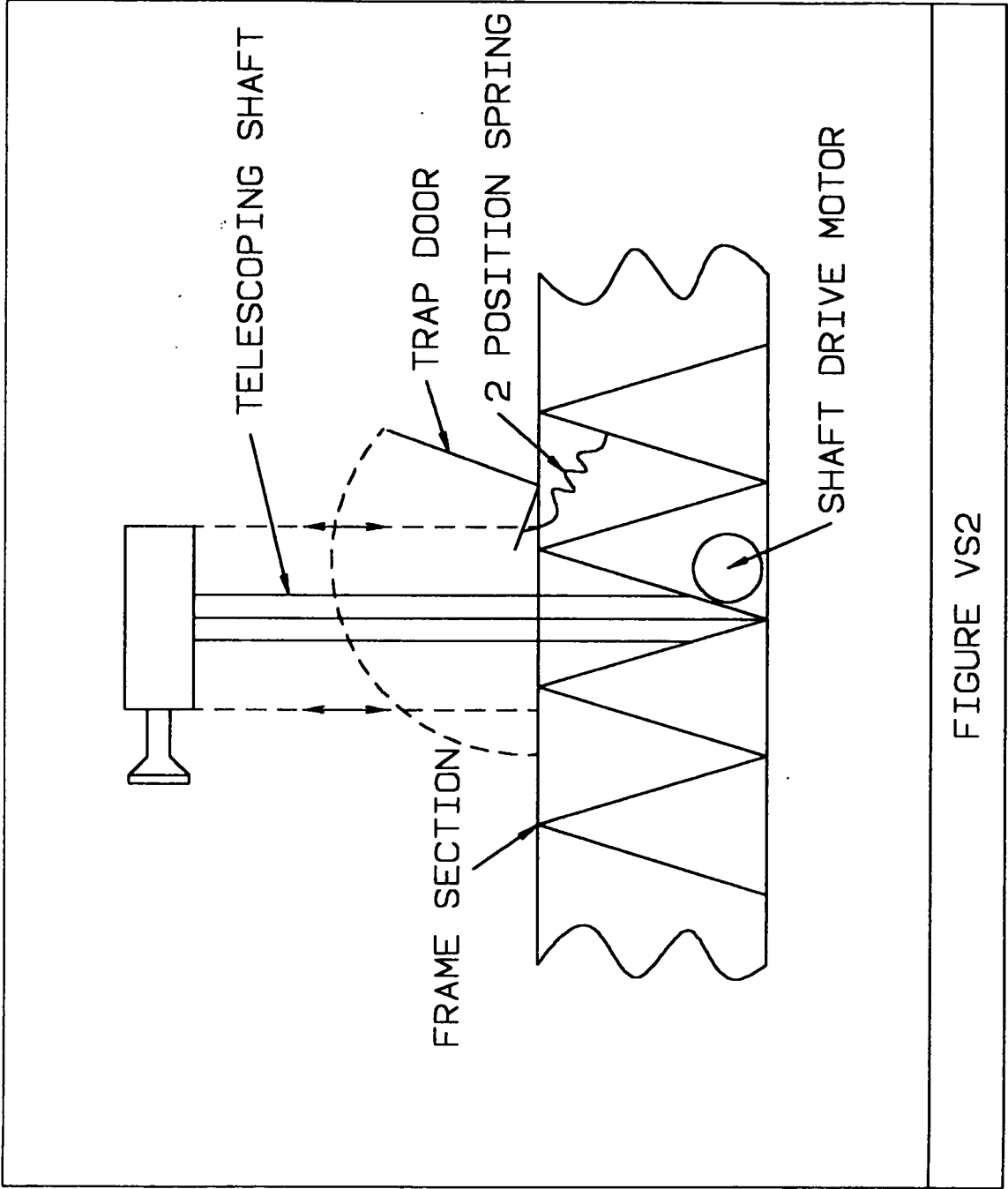

FIGURE VS2

# **APPENDIX F**

## **DRAWINGS**

REVISIONS			
DATE	REV	DESCRIPTION	APPROVE

2 ROTOR SYSTEM

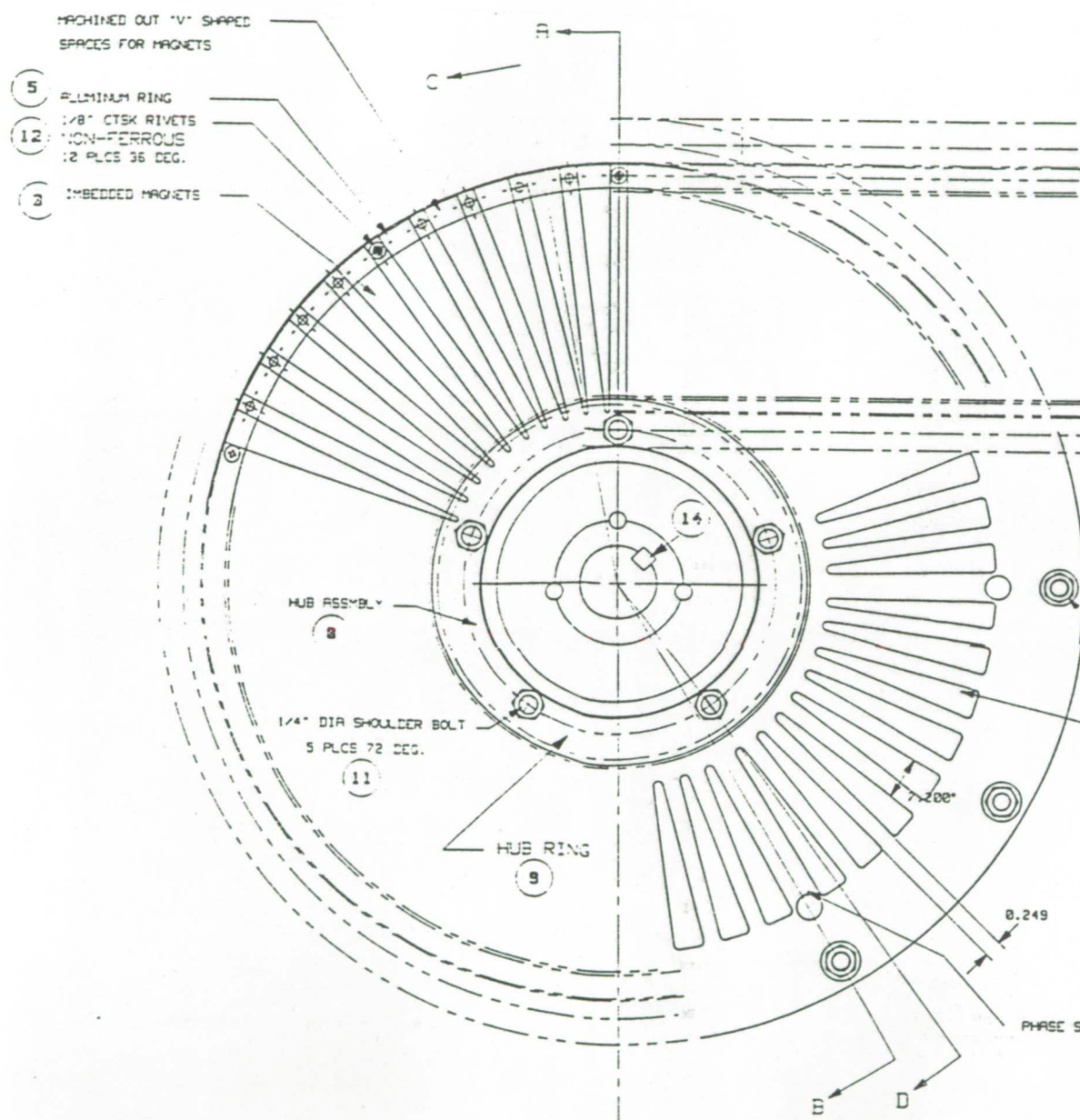

1 STATOR SYSTEM  
1/4" - 28 UNF 3 PLCS (30 DEG.) (13)  
RAISED SECT: - 3/16" HIGH  
7.2 DEG. APP. 1/4" BETWEEN

6 3/8" STEEL SPACERS

SECTION A

SECTION C

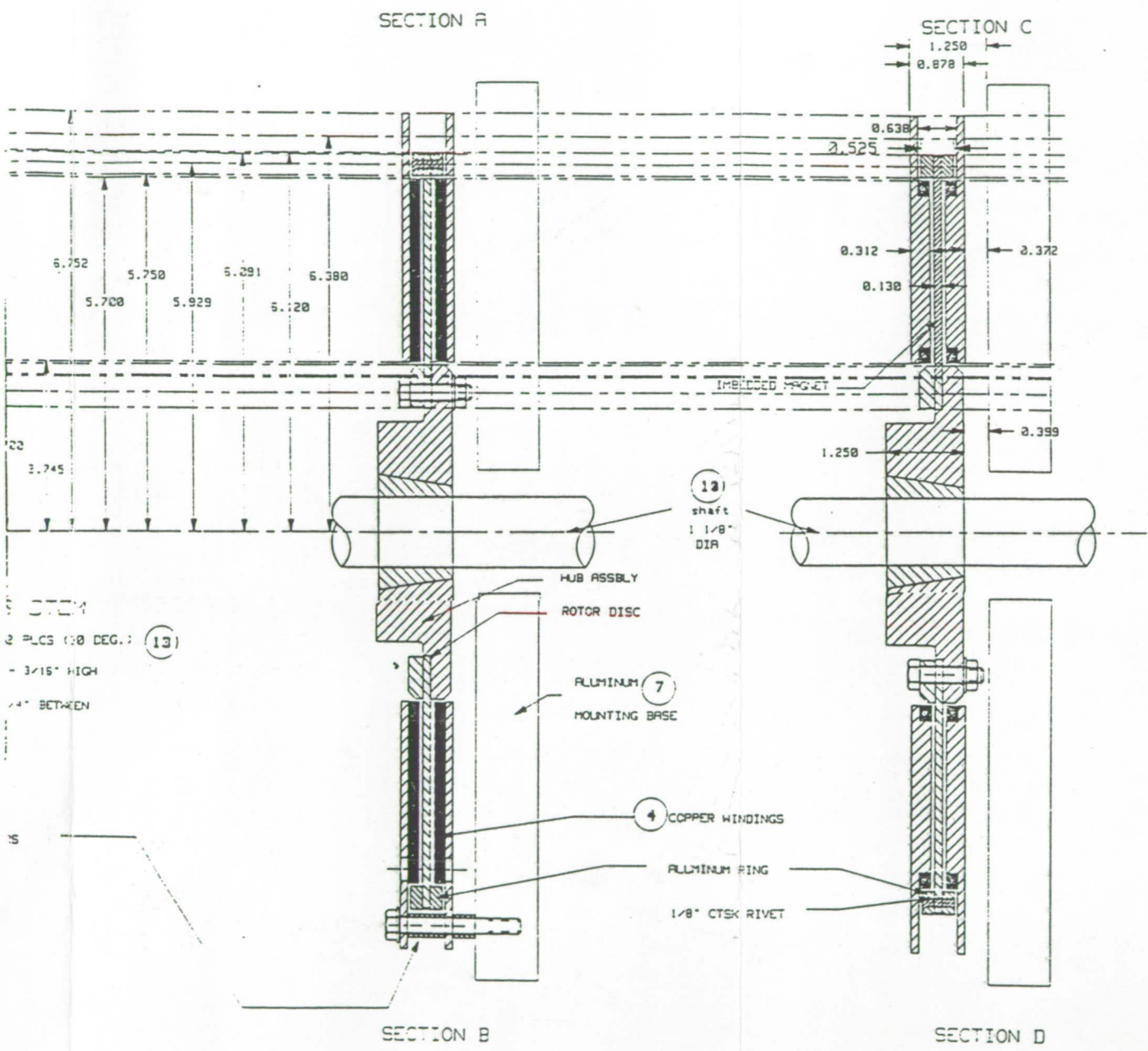

Fig. PS-4

ALL DIMENSIONS ARE REFERENCE

PARTS LIST

TOLERANCES			
.XX	±	0.010	UNLESS OTHERWISE STATED: DIMENSIONS IN INCHES.
.X	±	0.030	
.X	±	0.100	
.X	±	0.100	

CSM ASSEMBLY		
2 SIDED VERSION		
J. BRAZELL J. CRISCUOLO		
SIZE/ISSN NO.	DIG NO.	REV
D	CSMJMCSM	0
SCALE 3:4	DATE 3/29/88	SHEET

ORIGINAL PAGE IS OF POOR QUALITY

ORIGINAL PAGE IS OF POOR QUALITY