

NASA Contractor Report 181973

PLAN, EXECUTE, AND DISCUSS VIBRATION MEASUREMENTS AND CORRELATIONS TO EVALUATE A NASTRAN FINITE ELEMENT MODEL OF THE AH-64 HELICOPTER AIRFRAME

D. Ferg, L. Foote, G. Korkosz, F. Straub, M. Toossi, and R. Weisenburger

**MCDONNELL DOUGLAS HELICOPTER COMPANY
Mesa, Arizona**

**Contract NAS1-17498
January 1990**

(NASA-CR-181973) PLAN, EXECUTE, AND DISCUSS VIBRATION MEASUREMENTS AND CORRELATIONS TO EVALUATE A NASTRAN FINITE ELEMENT MODEL OF THE AH-64 HELICOPTER AIRFRAME
(McDonnell-Douglas Helicopter Co.) 215 p 63/59 0703474

NASA
National Aeronautics and Space Administration
Langley Research Center
Hampton, Virginia 23665-532



FOREWORD

McDonnell Douglas Helicopter Company (MDHC) has been conducting a study of finite element modeling of helicopter airframes to predict vibration. This work is being performed under U.S. Government Contract NAS1-17498. The contract is monitored by the NASA Langley Research Center, Structures Directorate.

This report presents the results of vibration testing and correlation with a dynamic finite element model of the AH-64A Helicopter airframe. Key NASA and MDHC personnel are listed below:

NASA LANGLEY

MCDONNELL DOUGLAS HELICOPTER COMPANY

Panice H. Clark, Contracting Officer

M. Toossi, Project Manager

Joseph W. Owens, Contract Specialist

R. King, Program Manager

John H. Cline, Technical Representative

D. Ferg, Structural Dynamics

Raymond G. Kvaternik, Leader,
Rotorcraft Structural Dynamics Group

L. Foote, Structural Vibration Testing

G. Korkosz, Structural Vibration Testing

F. Straub, Rotor Dynamics

R. Weisenburger, Structural Dynamics

CONTENTS

SECTION	PAGE
1. INTRODUCTION	1
2. VEHICLE DESCRIPTION	7
3. TEST VEHICLE	15
4. SHAKE TEST	21
5. SUMMARY OF TEST RESULTS	61
6. CORRELATION WITH NASTRAN	125
7. EXPERIENCES OF THE SHAKE TEST AND CORRELATION	183
8. SUGGESTIONS FOR FUTURE STUDY	211
9. CONCLUSIONS	227

ii INTENTIONALLY BLANK

1. INTRODUCTION

INTRODUCTION

The NASA Langley Research Center is sponsoring a rotorcraft structural dynamics program with the overall objective to establish in the United States a superior capability to utilize finite element analysis models for calculations to support industrial design of helicopter airframe structures. Viewed as a whole, the program is planned to include efforts by NASA, Universities, and the U.S. Helicopter Industry. In the initial phase of the program, teams from the major U.S. manufacturers of helicopter airframes will apply extant finite element analysis methods to calculate static internal loads and vibrations of helicopter airframes of both metal and composite construction, conduct laboratory measurements of the structural behavior of these airframes, and perform correlations between analysis and measurements to build up a basis upon which to evaluate the results of the applications. To maintain the necessary scientific observation and control, emphasis throughout these activities will be on advance planning, documentation of methods and procedures, and thorough discussion of results and experiences, all with industry-wide critique to allow maximum technology transfer between companies. The finite element models formed in this phase will then serve as the basis for the development, application, and evaluation of both improved modeling techniques and advanced analytical and computational techniques, all aimed at strengthening and enhancing the technology base which supports industrial design of helicopter airframe structures. Here again, procedures for mutual critique have been established, and these procedures call for a thorough discussion among the program participants of each method prior to the applications and of the results and experiences after the applications.

8 INTERNATIONALLY BLANK

The aforementioned rotorcraft structural dynamics program has been given the acronym DAMVIBS (Design Analysis Methods for VIBrations). As a major helicopter manufacturer, McDonnell Douglas Helicopter Company is a participant in this program. This report presents: (1) the test procedures and methods used in the ground vibration test of the fuselage of a production AH-64 Attack Helicopter, (2) the results of that shake test, and (3) the correlation of these results with a NASTRAN finite element analysis.

The main objective of the shake test was to obtain an experimental data base describing the vibration response of the test vehicle. This data base consisted mainly of frequency response functions for various measurement locations throughout the fuselage structure. These frequency response functions were then used for correlation with the NASTRAN finite element model which was developed under a different task of this contract. The correlation was performed to verify the accuracy of the dynamic finite element model and obtain further insight into usage of finite element analysis as a tool to eliminate vibration problems of helicopter airframes. Although the test was not a modal survey test, the major airframe modes were extracted from the test data. These modes provided insight into the basic vibration characteristics of the fuselage and aided in the correlation with NASTRAN model.

2. VEHICLE DESCRIPTION

VEHICLE DESCRIPTION

The AH-64A Apache is a twin engine, four bladed rotary wing aircraft operated by a tandem seated crew of two. It is intended for use by Army attack helicopter units. The airframe is a redundant semi-monocoque construction representing a fail-safe, damage tolerant design. The aircraft is equipped with main and tail landing gears which are functional for both normal landings and crash attenuation. Provisions are made for a nose mounted weapon system and for the carriage of wing mounted external stores.

The T700-GE-701 engines on the Apache are mounted high on the outside of the airframe. The engines are widely separated to reduce the risk of both engines sustaining combat damage. The rotor blades consist of multiple fiberglass spar tubes and stainless steel outer skin. This construction results in a ballistically survivable blade. The main rotor hub is fully articulated with redundant lead-lag dampers on each blade and stainless steel straps are used for blade retention. An M230 30mm chain gun is mounted on the bottom of the airframe between the crew stations. Hellfire missiles and/or 2.75 in. FFAR rockets can be carried on the wing mounted pylons. The sighting for the weapon systems is performed by the Target Acquisition and Designation System (TADS) and the Pilot Night Vision System (PNVS) located in the front of the airframe. The table below gives general data on the AH-64A.

**McDonnell
Douglas
Helicopter
Company**

VEHICLE DESCRIPTION

General Data:

Primary Mission Gross Weight 14,694 lb.
Basic Structural Design Gross Weight 14,660
Maximum Alternate Mission Gross Weight 17,650
Ferry Mission Gross Weight 21,000

Main Rotor RPM 289
Tail Rotor RPM 1,403

V_{ne} 204 kn
 V_h 164
 V_{lat} 45
 V_{clt} 45
Flight Maneuver Limits +3.5g to -0.5g

VEHICLE DESCRIPTION

The photograph below shows an AH-64A in primary mission configuration with 8 Hellfire missiles, 38 FFAR rockets, and 600 rounds of 30MM ammunition.

ORIGINAL PAGE
BLACK AND WHITE PHOTOGRAPH

VEHICLE DESCRIPTION

McDonnell
Douglas
Helicopter
Company



ORIGINAL PAGE
BLACK AND WHITE PHOTOGRAPH

OVERALL DIMENSIONS

The accompanying three view drawing shows the overall dimensions for the AH-64 aircraft.

McDonnell
Douglas
Helicopter
Company

OVERALL DIMENSIONS

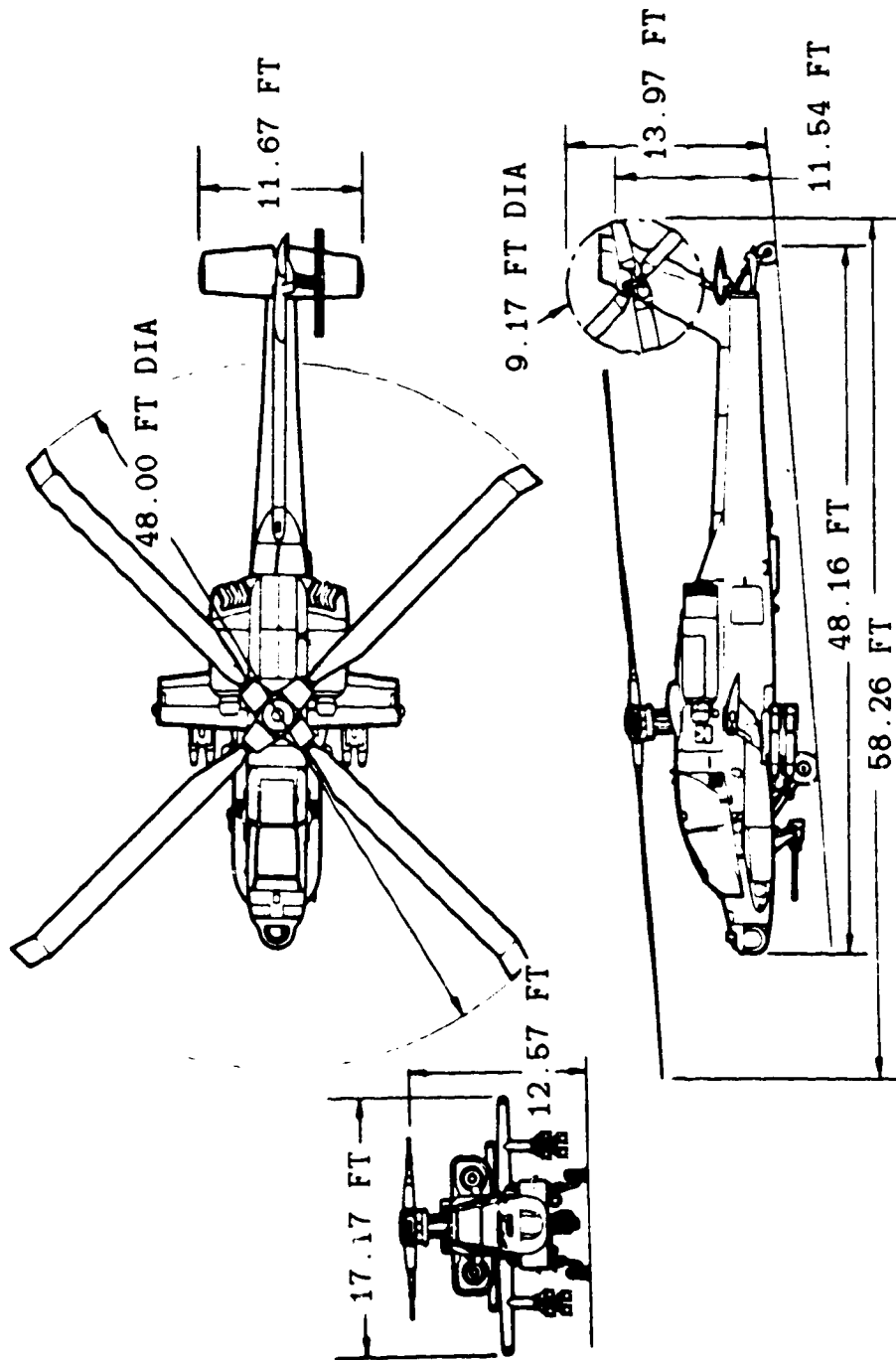

3. TEST VEHICLE

CONFIDENTIAL INTENTIONALLY BLANK

TEST VEHICLE

The test vehicle used was the first production vehicle (PVO1). This aircraft has been used for the production flight strain and vibration surveys as well as other engineering test programs to determine the characteristics of the production Apache. The testing was performed with the vehicle in the primary mission configuration. This included four dummy HELLFIRE missiles installed on each of the inboard pylons (no outboard pylons were installed), a dummy chain gun mounted under the cockpit and 1870 lbs of fuel. The main rotor hub and blades were replaced with a rigid steel fixture which was attached to the static mast in a manner similar to the actual hub. The dummy structure was equivalent to 100% of the weight of all of the actual items except for the rotor blades. The blade weight was reduced to 60% of the actual weight to more closely represent the dynamic equivalent of the rotating system. The equivalent blade weight, which was determined using an approximate rotor dynamic analysis, is accurate in all three directions up through 4 Per Rev (19.25 Hz). The center of gravity of this dummy component was located at the same position as that of the actual rotor system. It was not necessary to remove the tail rotor as it is small and stiff enough that its modes should not affect those of the aircraft. In addition, dummy masses were used to represent the pilot and copilot. These weights were isolated from the seat structure using foam rubber cushions to 'soft mount' them in a manner similar to that of the weights they replaced.

**McDonnell
Douglas
Helicopter
Company**

TEST VEHICLE

- FIRST PRODUCTION VEHICLE
- TESTING PERFORMED WITH VEHICLE IN PRIMARY MISSION CONFIG:
 - EIGHT DUMMY HELLFIRE MISSILES
 - 1870 LBS OF FUEL
- MAIN ROTOR HUB AND BLADES REPLACED WITH RIGID STEEL FIX-
TURE REPRESENTING:
 - 100% ROTOR HUB WEIGHT
 - 60% BLADE WEIGHT

WEIGHT STATEMENT

There were some differences between the actual weight of the PVO1 ship and of the standard production vehicle in the primary mission configuration due to the following. PVO1 does not have much of the avionics equipment installed and does not have the ammunition and flat pack. As a test vehicle, PVO1 contains extra flight recorders and test equipment. In addition, 150 lbs of ballast was added to the nose to bring the ship to a proper attitude for the testing. The measured gross weight of the ship at the time of testing was 14831 lbs, 137 lbs greater than the standard primary mission configuration weight. The NASTRAN finite element model developed under this contract was specifically for PVO1, incorporating these differences. A detailed weight statement is given in the following table. A minus sign indicates that the weight was removed. Also included in the table is a comparison of the total weight and C.G. actuals with those calculated by NASTRAN.

**McDonnell
Douglas
Helicopter
Company**

WEIGHT STATEMENT

ITEM	WEIGHT	F. S of C. G.
BASIC WEIGHT*	11528 LB.	208.3 IN.
CO-PILOT	200	82.2
PILOT	200	143.3
FUEL, FWD TANK	990	150.6
FUEL, AFT TANK	880	255.0
HUB TEST FIXTURE	1095	198.6
NOSE BALLAST	150	35.0
MLG X-TUBE BALLAST	-208	120.0
INSTRUM. (MLG FAB)	-4	135.0
ACTUAL TOTAL	14831 LB.	203.4 IN.
MASTRAN MODEL	14831 LB.	201.3 IN.
DIFFERENCE	0 LB.	2.1 IN.

NOTES:

* Basic weight includes inboard pylons, 8 dummy missiles and dummy gun. It does not include the M/R hub and blades.

4. SHAKE TEST

code INTENTIONALLY BLANK

SUSPENSION GANTRY

The test vehicle was suspended from an 'A' frame structure consisting of an 'I' beam at the top supported by tubular struts. The gantry support structure is shown in the figure below. Air bag suspension springs located at the top of the gantry provided vibration isolation in the vertical direction between the test vehicle and the gantry structure. The air springs provide a low spring rate required for isolation without large deflections. Link chain was used to attach the air spring system to the dummy main rotor hub. Sufficient length was used to insure low pendular frequencies of the aircraft. Using the link chain also removed the tendency for the aircraft to yaw.

When the vehicle was initially mounted, it was found that the C.G. was slightly offset from its normal position resulting in the aircraft assuming a slightly nose up attitude. Therefore, 150 lbs of ballast was added to the nose to bring the vehicle to the proper attitude.

This gantry and suspension system were the same as those used in earlier shake tests of prototype versions of the AH-64. To insure that the test vehicle was sufficiently isolated from the gantry, the rigid body frequencies of the suspended airframe were measured and recorded as follows:

VERTICAL SUSPENSION	0.6 Hz
LONGITUDINAL PENDULUM	0.5 Hz
LATERAL PENDULUM	1.2 Hz

McDonnell
Douglas
Helicopter
Company

SUSPENSION GANTRY



ORIGINAL PAGE
BLACK AND WHITE PHOTOGRAPH

EXCITATION METHODS

Sinusoidal excitation was applied at the main rotor mast through the dummy hub using an electrohydraulic servo actuator and to the tail rotor hub using an electrodynamic shaker. Three forces, longitudinal, lateral and vertical, were applied to the dummy main rotor hub, as well as two moments, pitch (lateral moment vector) and roll (longitudinal moment vector). These forces and moments were applied at a location equivalent to the intersection of the shaft axis with the hub plane. The force and moment levels were 200 lbs and 1000 in-lbs, respectively. Three forces were applied at the tail rotor location: longitudinal, lateral and vertical. The tail rotor excitation point was on the shaft axis half way between the two rotor planes. (The tail rotor consists of two teetering rotors offset axially by a few inches.) The tail rotor was on the aircraft during the entire shake test. Small blocks were attached to the tail rotor hub to facilitate excitation at that location. The force level applied to the tail rotor was 50 lbs.

**McDonnell
Douglas
Helicopter
Company**

EXCITATION METHODS

- MAIN ROTOR
 1. ELECTRO HYDRAULIC SERVO ACTUATOR
 2. THREE FORCE EXCITATIONS - P_x, P_y, P_z (200 LBS)
 3. TWO MOMENT EXCITATIONS - M_x, M_y (1000 IN-LBS)

- TAIL ROTOR
 1. ELECTRO DYNAMIC SERVO CONTROLLED SHAKER
 2. THREE FORCE EXCITATIONS - P_x, P_y, P_z (50 LBS)

FORCE EXCITATION AT MAIN ROTOR HUB

Excitation at the main rotor was produced by an electrohydraulic servo actuator system, which employed a large, high-performance servo valve. The actuator system was operated in closed loop servo control using a displacement transducer for the feedback element. The actuator was mounted on a seismic mass which reacted the vibratory load. The seismic mass was in turn suspended by a cable from a mobile crane, which allowed for quick and easy alignment with the dummy hub. The actuator was connected to the dummy hub by a linkage containing the following elements: (1) a coil spring for converting the relatively large actuator stroke to a force, (2) a tubular drive shaft, and (3) a load cell located close to the aircraft for measuring and controlling the input force.

ORIGINAL PAGE IS
OF POOR QUALITY

McDonnell
Douglas
Helicopter
Company

FORCE EXCITATION AT MAIN ROTOR HUB



MOMENT EXCITATION AT MAIN ROTOR HUB

Moment inputs were applied as follows. The servo actuator was attached to a lever arm to convert the actuator stroke into a rotation. The load was transmitted to the dummy hub by a torque tube. Bendix couplings were mounted on each end of the torque tube to preclude transmission of transverse shear forces to the aircraft. The torque tube was designed as a torsion spring and was instrumented near the aircraft end with a strain-gage bridge in a torsion arrangement. The bridge served to both measure and control the input torque. This method was used because it produced a pure vibratory couple that did not suffer from the difficulties of phase and amplitude matching associated with using two forces. This setup is shown in the photograph.

ORIGINAL PAGE IS
OF POOR QUALITY

MOMENT EXCITATION AT MAIN ROTOR HUB

McDonnell
Douglas
Helicopter
Company



FORCE EXCITATION AT TAIL ROTOR

Input forces were applied to the tail rotor by means of an electrodynamic shaker. The shaker was mounted on a seismic mass and connected to the point of load application in the same manner as with the main rotor force inputs. The seismic mass and shaker were supported by a fork lift truck. This setup is shown in the photogragh.

**McDonnell
Douglas
Helicopter
Company**

FORCE EXCITATION AT TAIL ROTOR

FIGURE 18
ASSEMBLY



ORIGINAL PAGE
BLACK AND WHITE PHOTOGRAPH

FORCE MEASUREMENT TRANSDUCERS

The load cells used were built for this test to MDHC specifications. The load cells for force excitation were fabricated from high-strength aluminum alloy and employed a ring design for a high level output with minimal size and weight. The load cell output was amplified using a Gould Universal Bridge Amplifier, which provided an essentially flat gain over the frequency range of 0 to 1000 Hz. The load cell capacities were 2000 lbs for the main rotor excitation and 50 lbs for the tail rotor excitation. For moment inputs, the torque tube in the drive linkage was instrumented with a torsion strain gage system.

FORCE MEASUREMENT TRANSDUCERS

- BUILT TO MDHC SPECIFICATIONS FOR THIS TEST
- EMPLOYED A RING DESIGN FOR HIGH OUTPUT LEVEL
- USED GOULD UNIVERSAL BRIDGE AMPLIFIER
- EXCITATION AT MAIN ROTOR:
 1. 2000 LB. CAPACITY LOAD CELL FOR FORCE INPUT
 2. TORSION BAR DRIVE LINKAGE WITH CALIBRATED STRAIN GAGE USED FOR MOMENT INPUTS
- EXCITATION AT TAIL ROTOR:
 1. 50 LB. CAPACITY LOAD CELL

ACCELEROMETERS

The accelerometers used in the test were low cost, good quality, quartz element transducers made by Dytran. These devices have a built in amplifier and a high output level of 100 mv/g. Each accelerometer was calibrated and verified in a mechanical system, using a load cell to drive a known free mass in the test frequency range. This produced a transfer function for each unit which was used during the actual shake test by the computer to convert voltage to acceleration and to adjust the phase at each frequency step.

**McDonnell
Douglas
Helicopter
Company**

ACCELEROMETERS

- MANUFACTURED BY DYTRAN
- VERY LOW COST
- QUARTZ ELEMENT WITH BUILT-IN AMPLIFIER
- GOOD OUTPUT LEVEL (100 mv/g)
- FLAT FREQUENCY RESPONSE IN THE TEST RANGE
- INDIVIDUALLY CALIBRATED AND VERIFIED BEFORE TESTING BEGAN

ACCELEROMETER LOCATIONS

A total of 102 accelerometers were mounted on the aircraft at 55 locations and four were mounted on the gantry and suspension system, for a total of 106 accelerometers. The accelerometer locations were chosen based on three criteria: (1) to identify the response at key locations such as pilot seats, wings, hubs, etc.; (2) to describe fundamental modes of the airframe; and (3) to identify as best as possible important local modes (e.g. engines, stabilator, etc.).

**McDonnell
Douglas
Helicopter
Company**

ACCELEROMETER LOCATIONS

- 102 ACCELEROMETERS INSTALLED AT 55 LOCATIONS
THROUGHOUT AIRFRAME
- 4 ON GANTRY AND SUSPENSION SYSTEM
- LOCATIONS CHOSEN TO BEST IDENTIFY
 1. KEY RESPONSES
 2. FUNDAMENTAL AIRFRAME MODES
 3. IMPORTANT LOCAL MODES

ACCELEROMETER LOCATIONS

The following list and figure present in detail the location of each of the 102 accelerometers mounted on the airframe. The direction of measurement is also indicated. In addition, three accelerometers were mounted on the center of the top cross beam of the gantry, giving the longitudinal, lateral and vertical response at that location. Finally, one accelerometer was mounted on the air bags giving the vertical response of the suspension system.

**McDonnell
Douglas
Helicopter
Company**

ACCELEROMETER LOCATIONS

LOCATION	FS	BL	WL	MEASUREMENT DIRECTIONS	MEASUREMENT ID NOS.
TADS/PNVS	6.5	0.0	127.5	Y,Z	24,25
FRAME 35.5	35.3	-21.25	129.2	Y,Z	55,57
FRAME 35.5	35.3	21.25	129.2	Z	59
COPILOT SEAT	85.3	0.0	118.9	X,Y,Z	100,101,102
GUN TURRETT	108.0	8.0	84.75	X,Y,Z	63,65,67
FRAME 115	115.0	-24.25	138.0	Y,Z	49,51
FRAME 115	115.0	24.25	138.0	Z	53
PILOT SEAT	145.6	0.0	137.0	X,Y,Z	95,97,99
MAIN GEAR	163.4	43.75	79.9	X,Y,Z	10,12,14
MAIN GEAR	163.4	-43.75	79.9	X,Y,Z	16,18,20
FRAME 176	176.0	-24.25	129.2	X,Y,Z	43,45
FRAME 176	176.0	24.25	129.2	Y,Z	47
RACK (FWD)	179.6	-65.0	102.5	Z	64,66,68
RACK (FWD)	179.6	65.0	102.5	X,Y,Z	70,72,74
M/R HUB	183.6	0.0	215.1	X,Y,Z	32,42
MAST BASE	188.63	0.0	172.4	X,Z	28,30
M/R HUB	198.6	-15.0	216.5	X,Y	34,38
M/R HUB	198.6	15.0	216.5	Y,Z	36
WING MID	200.4	60.0	142.0	Z	56
WING MID	200.4	-60.0	142.0	Z	58
WING TIP (FWD)	200.7	97.5	140.8	X,Z	44,46
WING TIP (FWD)	200.7	-97.5	140.8	X,Z	48,50
RACK (AFT)	205.1	-65.0	102.5	Y,Z	76,78
RACK (AFT)	205.1	65.0	102.5	Y,Z	80,82
WING TIP (AFT)	211.7	97.5	139.7	Z	52
WING TIP (AFT)	211.7	-97.5	139.7	Z	54
M/R HUB	213.6	0.0	217.75	Z	40
FRAME 230	230.0	-24.25	129.2	Y,Z	37,39
FRAME 230	230.0	24.25	129.2	Z	41

**McDonnell
Douglas
Helicopter
Company**

ACCELEROMETER LOCATIONS

LOCATION	COORDINATES			MEASUREMENT DIRECTIONS	MEASUREMENT ID NOS.
	FS	BL	WL		
ENGINE (FWD)	230.0	-47.5	160.25	X, Y, Z	69, 71, 73
ENGINE (FWD)	230.0	47.5	160.25	X, Y, Z	75, 77, 79
ENGINE (AFT)	260.0	-43.8	164.0	Y, Z	81, 83
ENGINE (AFT)	260.0	43.8	164.0	Y, Z	85, 87
FRAME 280	280.0	-24.25	129.2	Y, Z	31, 33
FRAME 280	280.0	24.25	129.2	Z	35
FRAME 320	320.0	21.36	129.2	Z	22
FRAME 320	320.0	-21.36	129.2	Y, Z	27, 29
FRAME 370	370.0	-18.9	129.2	Y, Z	21, 23
FRAME 370	370.0	18.9	129.2	Z	25
FRAME 396	396.6	-16.75	129.2	Y	17
FRAME 396	396.6	0.0	112.0	Z	19
FRAME 450	450.0	-14.1	129.2	Y, Z	11, 13
FRAME 450	450.0	14.1	129.2	Z	15
FRAME 489	489.9	-12.43	129.2	Y	7
FRAME 489	489.9	0.0	116.8	Z	9
FRAME 530	530.1	-11.7	129.2	Y, Z	1, 3
FRAME 530	530.1	11.7	129.2	Z	5
STABILATOR TIP	553.8	-63.5	150.6	X, Y, Z	84, 86, 88
STABILATOR TIP	553.8	63.5	150.6	X, Y, Z	90, 92, 94
STABILATOR MID	553.8	-40.0	150.5	Z	96
STABILATOR MID	553.8	40.0	150.5	Z	98
T/R HUB	554.7	-34.0	216.25	X, Y, Z	89, 91, 93
VERTICAL	569.6	-4.0	231.7	X, Y, Z	4, 6, 8
VERTICAL	569.6	4.5	231.7	X, Y	60, 62
TAIL GEAR	579.5	-5.25	108.9	Y, Z	2, 61

McDonnell
Douglas
Helicopter
Company

ACCELEROMETER LOCATIONS

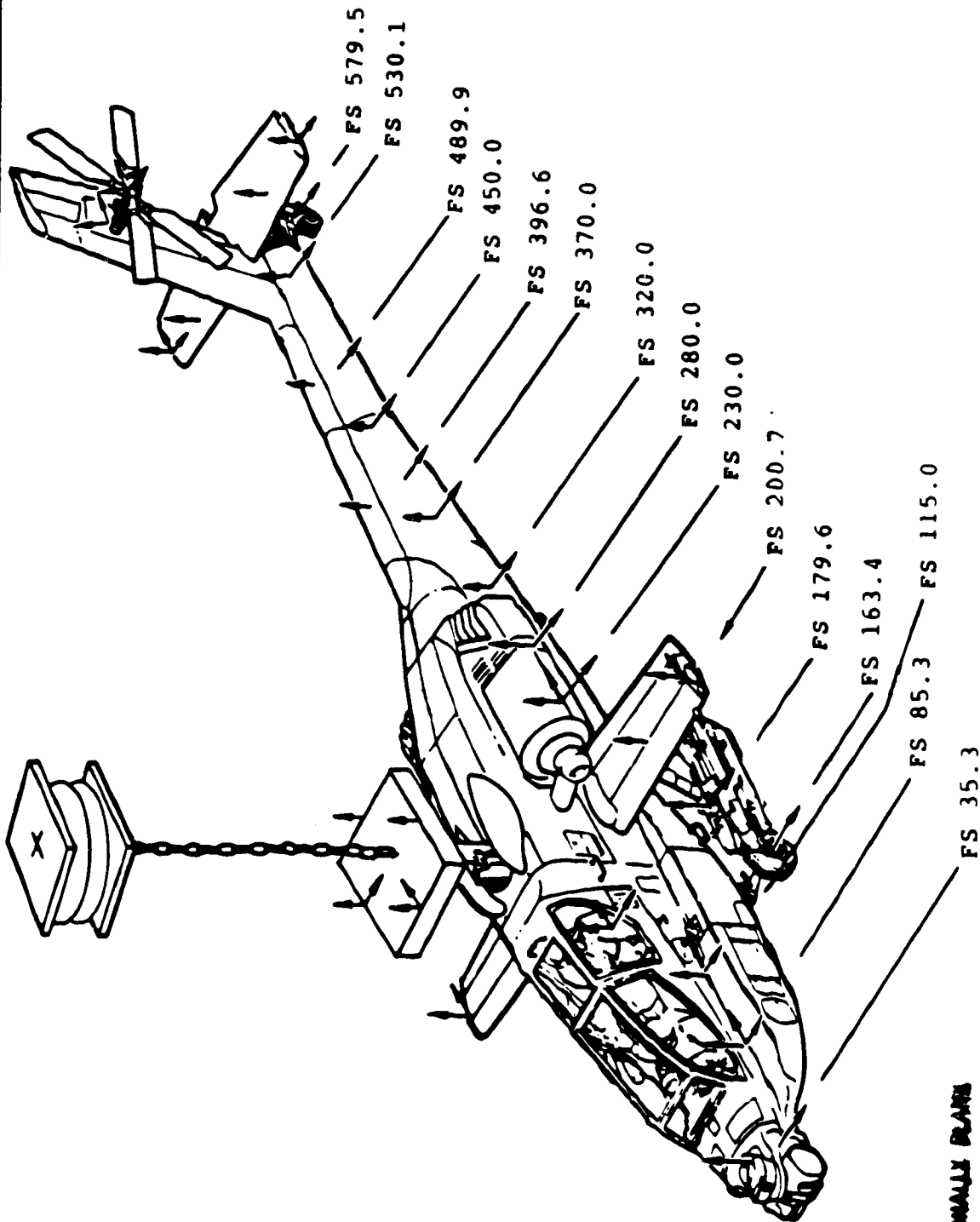

ACCELEROMETER INSTALLATION

The accelerometers were mounted on one inch cubic fiberglass blocks which were bonded to the airframe with epoxy. The blocks were shaped to fit the airframe contours so that their faces were aligned with three orthogonal axes of the ship. Each block had one to three accelerometers attached to it.

**McDonnell
Douglas
Helicopter
Company**

ACCELEROMETER INSTALLATION

- MOUNTED ON 1 INCH CUBIC FIBERGLASS BLOCKS WHICH WERE SHAPED TO FIT AIRFRAME CONTOUR AT LOCATION POINT
- BLOCKS WERE BONDED TO AIRFRAME WITH EPOXY
- ACCELEROMETERS MOUNTED ON UP TO 3 MUTUALLY PERPENDICULAR FACES OF EACH BLOCK WITH EPOXY

TYPICAL ACCELEROMETER INSTALLATION

The photograph below depicts a typical accelerometer mounting.

McDonnell
Douglas
Helicopter
Company

TYPICAL ACCELEROMETER INSTALLATION

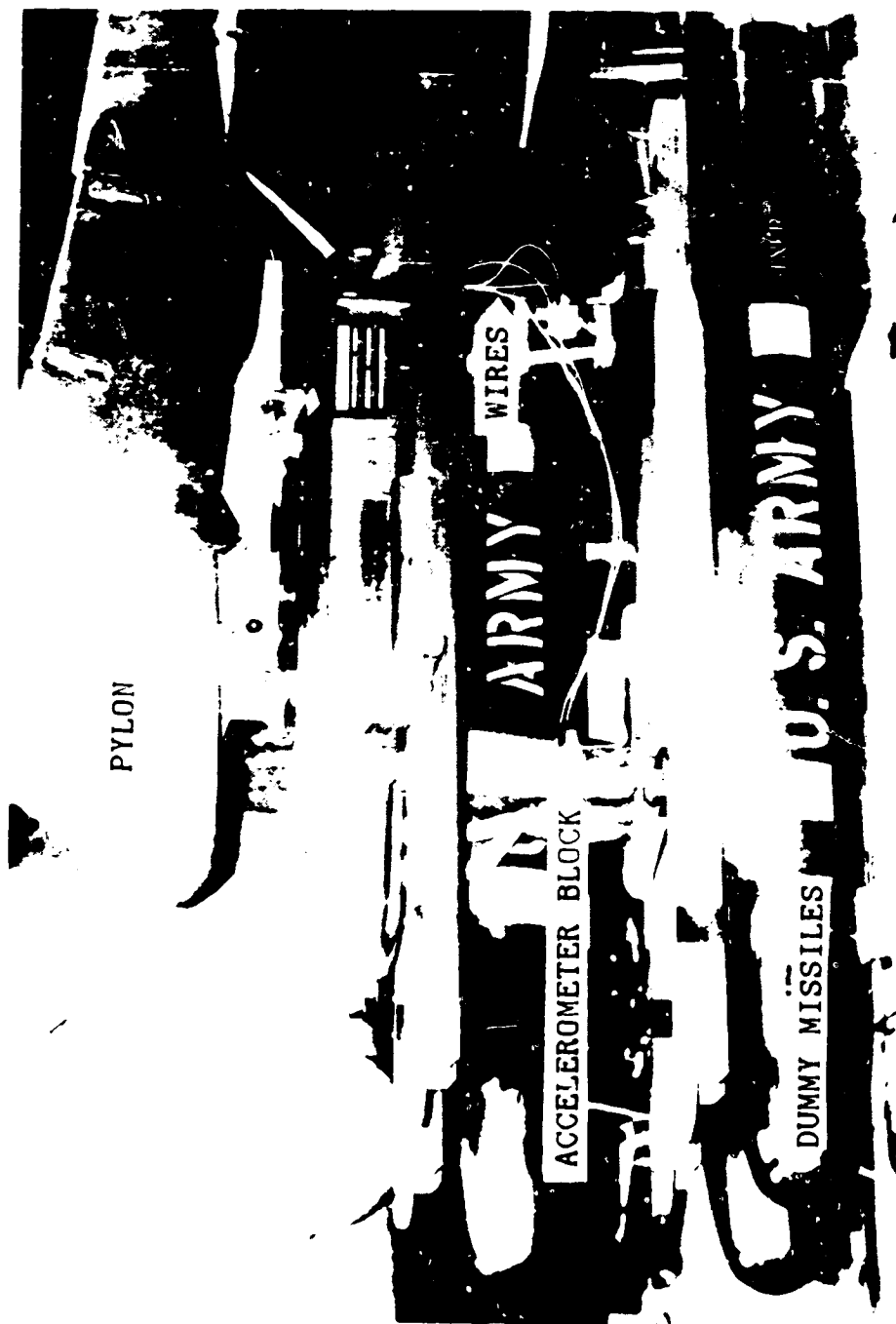

ORIGINAL PAGE IS
OF POOR QUALITY

DATA ACQUISITION AND CONTROL EQUIPMENT

The system used for data acquisition was completely controlled by the HP 9836 computer/system controller. The following two photographs show the data acquisition equipment mounted on mobile carts for easy movement.

McDonnell
Douglas
Helicopter
Company

DATA ACQUISITION AND CONTROL EQUIPMENT



McDonnell
Douglas
Helicopter
Company

DATA ACQUISITION AND CONTROL EQUIPMENT

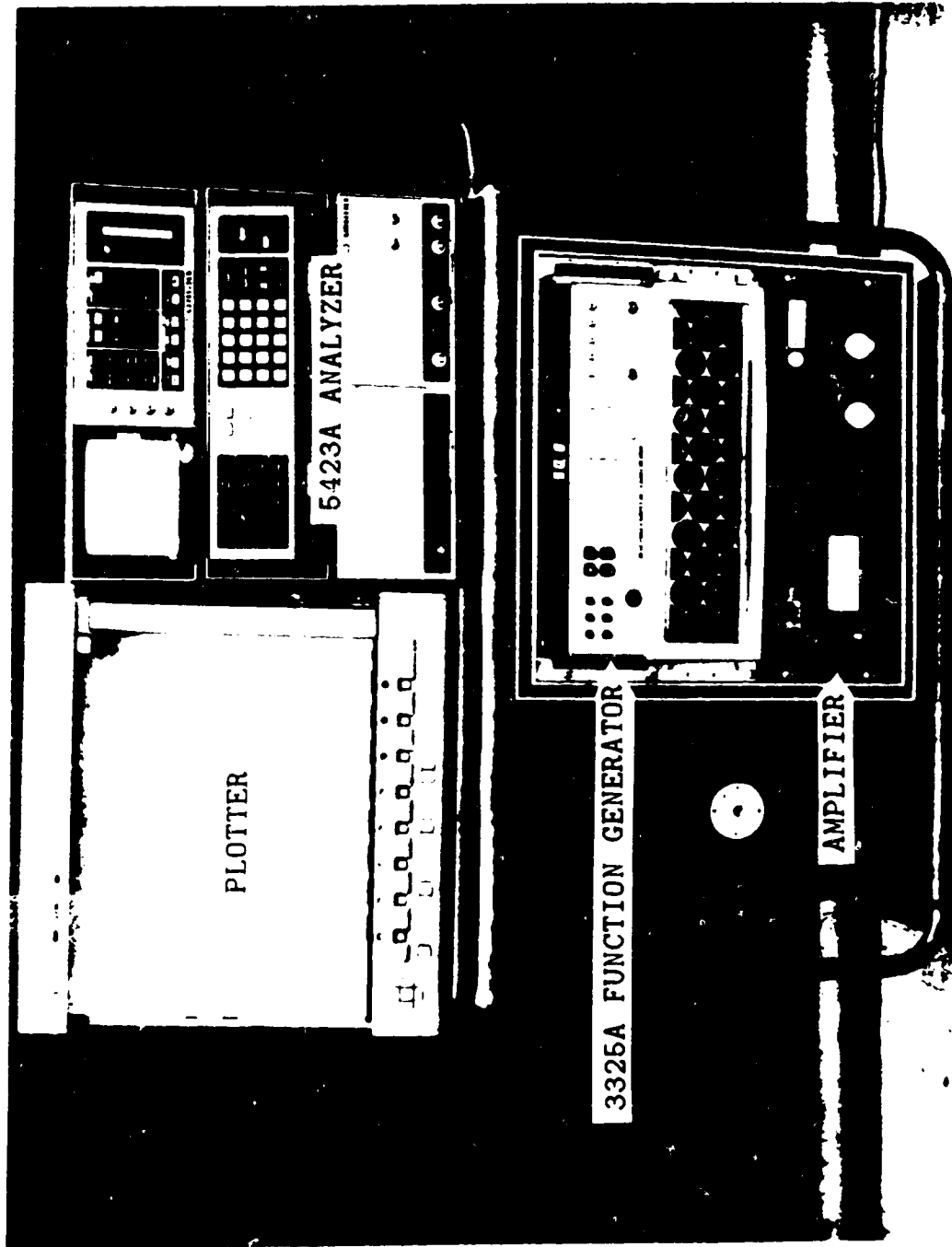

THIS PAGE IS
OF FOUR QUALITY

BLACK AND WHITE PHOTOGRAPH

50 INTENTIONALLY BLANK

BLOCK DIAGRAM OF DATA SYSTEM

The figure below is a block diagram indicating the various pieces of equipment used and the relationships between them. The instruments on the second row of the diagram were controlled via the HP-IB. This is Hewlett Packard's implementation of the IEEE 488 specification of 1978. Hewlett Packard has provided system firmware in the operating system ROM which is able to command all of these instruments to any of their programmable capabilities. Three of the instruments were crucial to the operation of the shake test. The 6942A multiprogrammer scanned and measured the data at a rate of 25000 readings per second. Data for all measurement locations at one frequency was stored here before passing it back to the computer for processing. The 3325A generated the desired sine program for input to the shakers. It was also used to modulate the sine amplitude which kept the desired load on track. The 3437A was used to generate precise timing pulses at each data acquisition point. It was programmed to trigger the 6942A at exactly the correct instant, 16 times in one period of vibration, at each frequency step. The other instruments in this row are self-explanatory. The lower section of the diagram indicates the analog systems used for force and acceleration voltages.

McDonnell
Douglas
Helicopter
Company

BLOCK DIAGRAM OF DATA SYSTEM

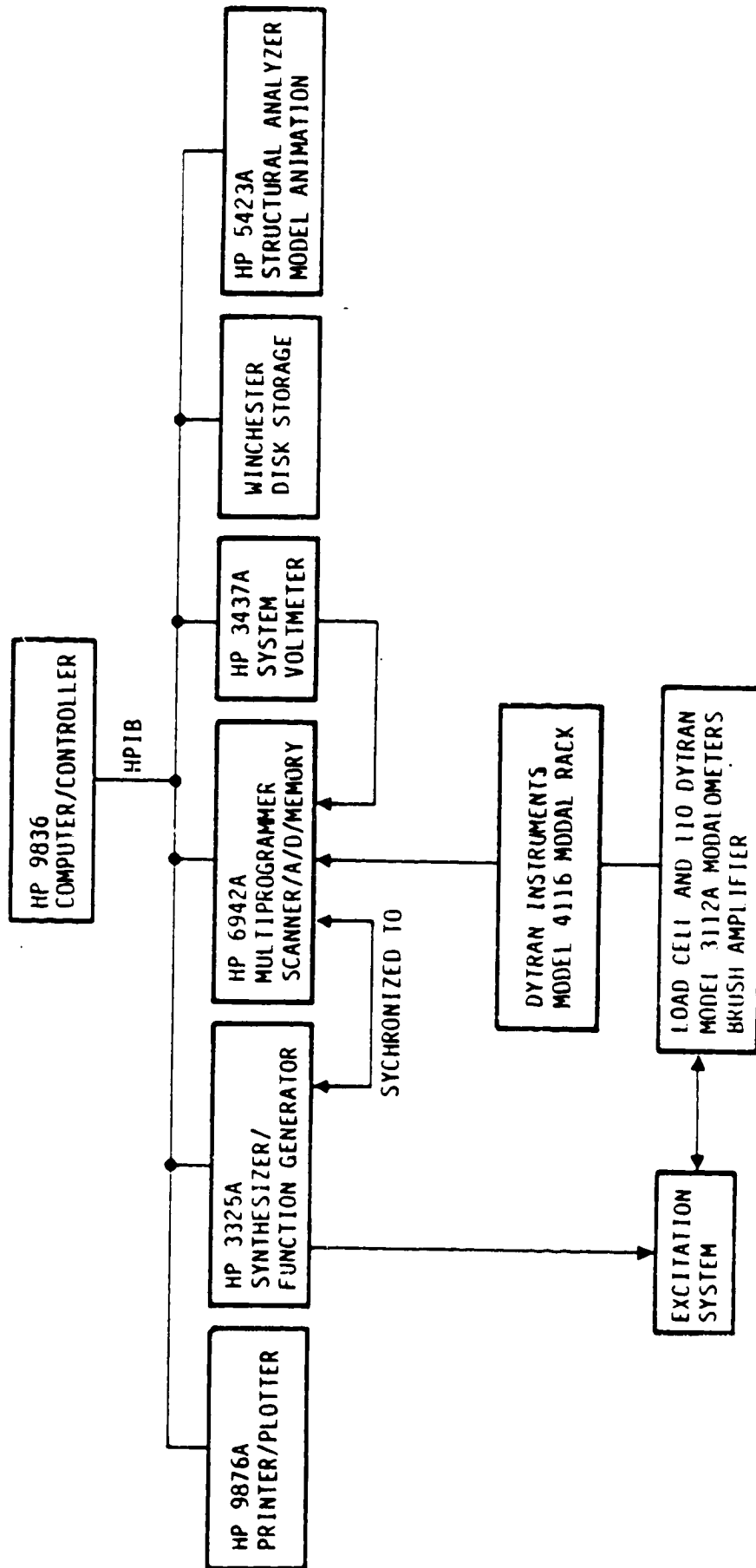

DATA PROCESSING

The program used to control the data processing was developed for this test at MDHC. The program was used to scan and measure data, to control the excitation, and to calibrate and verify the instrumentation. Hewlett Packard software was used in transforming the raw test data from the time domain to the frequency domain. This HP algorithm employed a Discrete Fourier Transform. The data acquisition was timed for exactly one cycle of vibration at the frequency of excitation. Sixteen (16) readings were taken at equally spaced intervals over this one cycle. These data points were then fitted with a sine wave at the frequency of excitation. Thus, the transform automatically tuned out all higher harmonics of the excitation frequency up to the 8th harmonic. This data processing system was verified by using the HP 5423A dynamics analyzer to animate and plot forced response mode shapes. Animated mode shapes demonstrated the validity of the response data on a global basis by showing smooth and continuous shapes.

- USED MDHC DEVELOPED SOFTWARE TO:
 - SCAN AND MEASURE DATA
 - CALIBRATE AND VERIFY INSTRUMENTATION
 - CONTROL THE EXCITATION FREQUENCY AND FORCE LEVEL
- USED HEWLETT PACKARD ALGORITHM TO TRANSFORM TEST DATA FROM TIME DOMAIN TO FREQUENCY DOMAIN (DISCRETE FOURIER TRANSFORM)
- USED HP5423A MODE SHAPE ANIMATION TO VERIFY THE DATA ON A GLOBAL BASIS

PROGRAM LOGIC FLOW

The diagram below shows the program logic flow. Each test run was begun by initializing the control program. This consisted of specifying the start and stop frequencies, force level, and frequency step options. Once initialized, the computer controlled the entire test. At each frequency step, all data channels were scanned and 16 readings were taken over one cycle of vibration. This data was then sent from the HP 6942A scanner to the HP 9836 computer where magnitude and phase data was extracted by means of a Discrete Fourier Transform. By this method the first harmonic was extracted while the higher harmonics, up to the 8th, were rejected. Each frequency step was approximately 5 seconds in duration: one second settling time and 4 seconds to scan and reduce the data. Using a frequency step of 0.5% of the current forcing frequency, each test run took about 45 minutes to complete. Two different frequency ranges were used, depending on the excitation location: 3.75 to 50 Hz at the main rotor and 3.75 to 200 Hz at the tail rotor. During the test it was possible to monitor the response at any measurement location. At the end of each test run, all of the data was stored on the Winchester Disk. Frequency response plots could then be examined on the screen and hardcopies of the data obtained. In addition, modes shapes could be animated using the HP 5423A analyzer and plotted on the HP plotter.

PROGRAM LOGIC FLOW

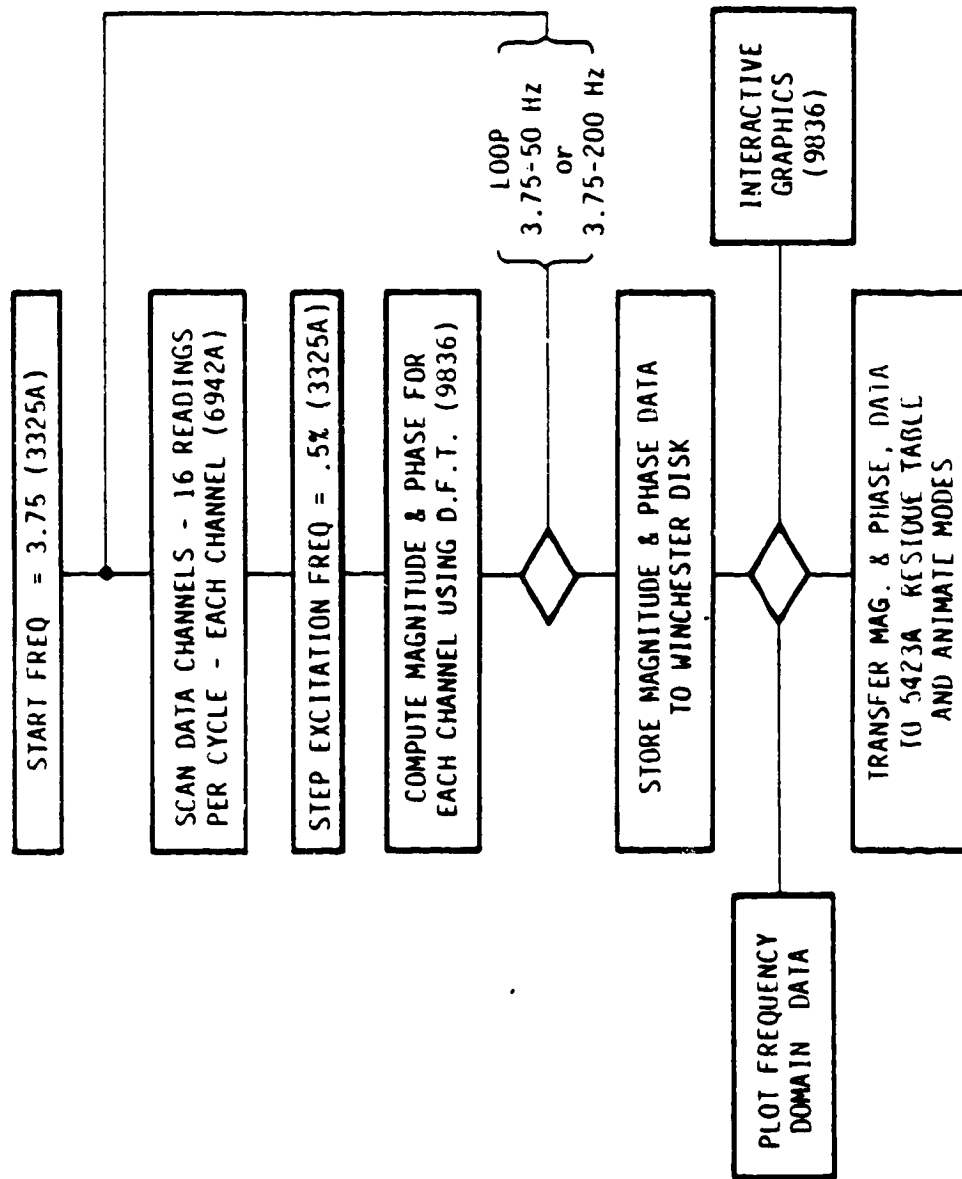

MODE SHAPE ANIMATION

The figure below shows the wire frame model used for animating and plotting the experimental mode shapes. This model was specifically generated for that purpose. The model includes many more points than were actually measured so that it would look more like the NASTRAN model. The motion of the extra points was determined by linear interpolation of the measured data points.

McDonnell
Douglas
Helicopter
Company

MODE SHAPE ANIMATION

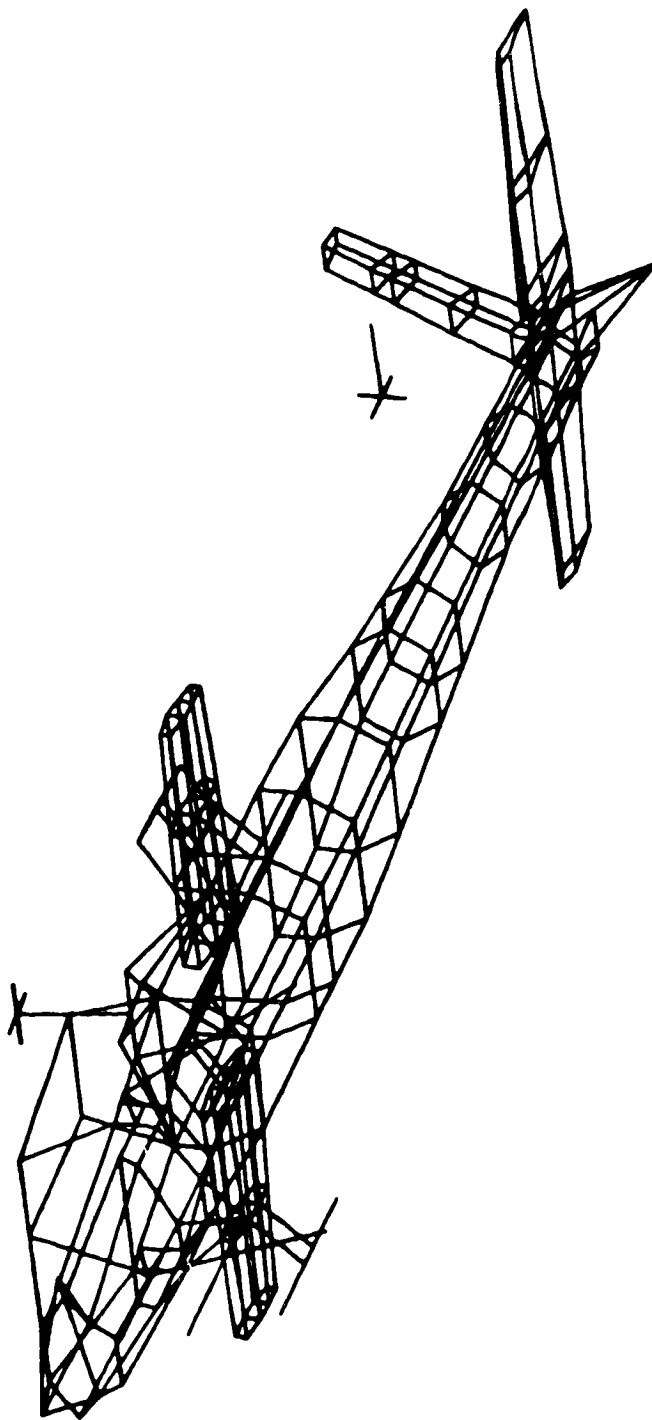

5. SUMMARY OF TEST RESULTS

61

PRECEDING PAGES HAVE NOT FILMED

PAGE 62 - INTENTIONALLY BLANK

FREQUENCY RESPONSES

The basic results of the shake test were the frequency response functions. The volume of this data is great and will not be presented here. The complete set of data is kept on Mag tape in the MDHC archive. The important aspects of the response data are summarized in the following pages. A sample frequency response is shown in the figure below. The lower curve is the magnitude of the response in g's/lb, while the upper curve is the phase (in degrees) of the response with respect to the excitation force. Both the magnitude and phase are plotted as a function of excitation frequency. In this case the response shown is that of the main rotor hub in the longitudinal direction. The excitation condition is a longitudinal force applied at the main rotor hub. A similar frequency response function was obtained for each measurement location and each excitation condition.

McDonnell
Douglas
Helicopter
Company

FREQUENCY RESPONSES

SAMPLE FREQUENCY RESPONSE FUNCTION

TEST CONDITION : LONGITUDINAL @ M-F MRET
FILE CODE : XHAST MERS. I.D. 32 MODEL S N 453

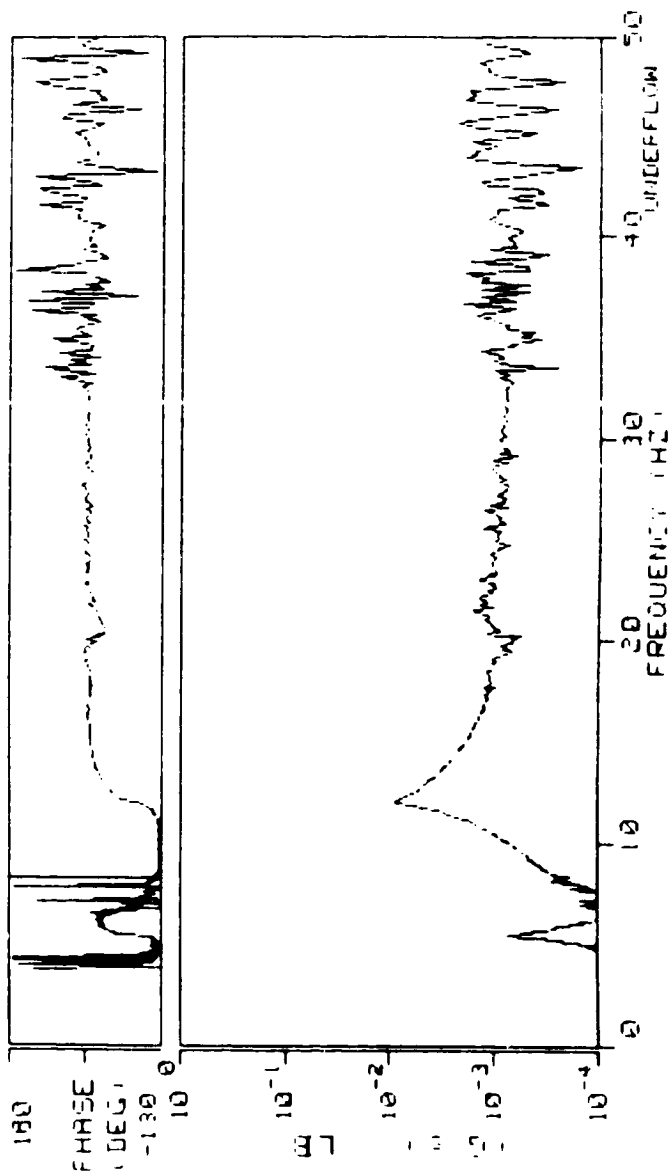

ORIGINAL PAGE IS
OF POOR QUALITY

INDICATOR FUNCTIONS

Natural frequencies were deduced from the data by means of two indicator functions, which are defined below. The first function is well known in the literature, though slightly modified here. The numerator is the sum of the amplitude squared times one minus the cosine of the phase angle. The denominator, which is the square of the magnitude of the response, normalizes the function so that a value between zero and one is obtained. Theoretically, at a natural mode, the phase angle is 90° , making the numerator and denominator of I_1 equal. Therefore, a mode is indicated if the function value approaches unity. A value of 0.6 or greater is a good indication of a global mode. (The typical indicator function found in the literature is identical to I_1 shown below except that the $1 - |\cos\phi_i|$ term is simply $\cos\phi_i$. This results in a function value of zero for a mode. Thus the function used here is merely the typically used function turned upside down so that when plotted modes are indicated by peaks instead of valleys.) The first function indicates all of the modes present in the response. The second function, which is simply a sum of the amplitudes over all locations, determines which of these modes dominate the response.

**McDonnell
Douglas
Helicopter
Company**

INDICATOR FUNCTIONS

- TWO INDICATOR FUNCTIONS WERE USED TO DETERMINE NATURAL FREQUENCIES FROM TEST DATA

$$I_1(f) = \frac{\sum_i A_i^2 (1 - |\cos \phi_i|)}{\sum_i A_i^2}$$

$$I_2(f) = \sum_i A_i$$

• WHERE:

A = AMPLITUDE
 ϕ = PHASE ANGLE
i = MEASUREMENT ID
f = FREQUENCY

INDICATOR FUNCTION RESULTS
LONGITUDINAL EXCITATION AT MAIN ROTOR HUB

The following two figures show the results of the application of the two indicator functions to the responses to longitudinal input at the main rotor hub. The two modes dominating the response to this input are at 5.45 Hz and 12.11 Hz. These are the first vertical bending mode of the fuselage and the longitudinal bending mode of the main rotor mast, respectively.

**McDonnell
Douglas
Helicopter
Company**

**INDICATOR FUNCTION RESULTS
LONGITUDINAL EXCITATION AT MAIN ROTOR HUB**

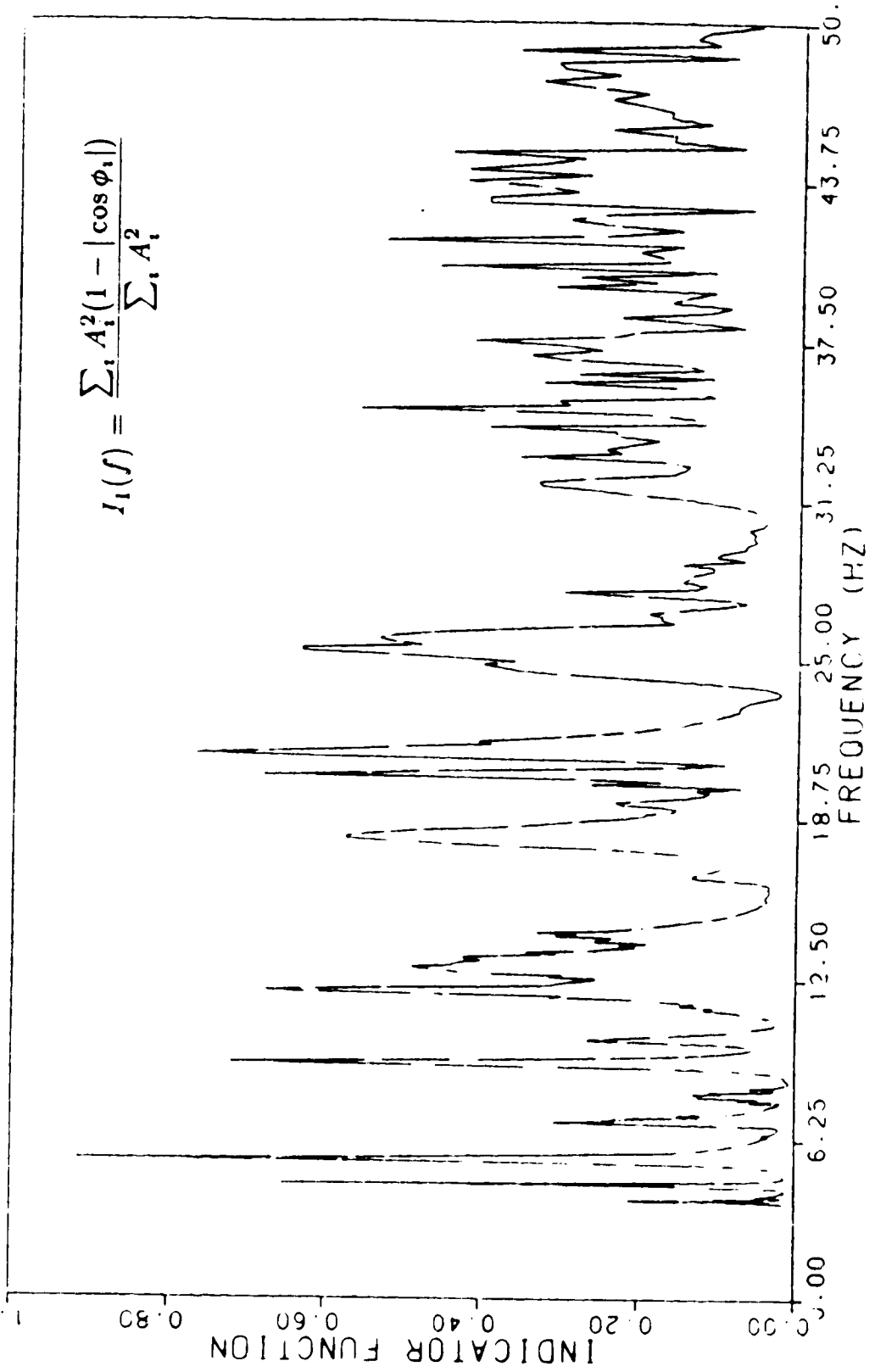

**McDonnell
Douglas
Helicopter
Company**

**INDICATOR FUNCTION RESULTS
LONGITUDINAL EXCITATION AT MAIN ROTOR HUB**

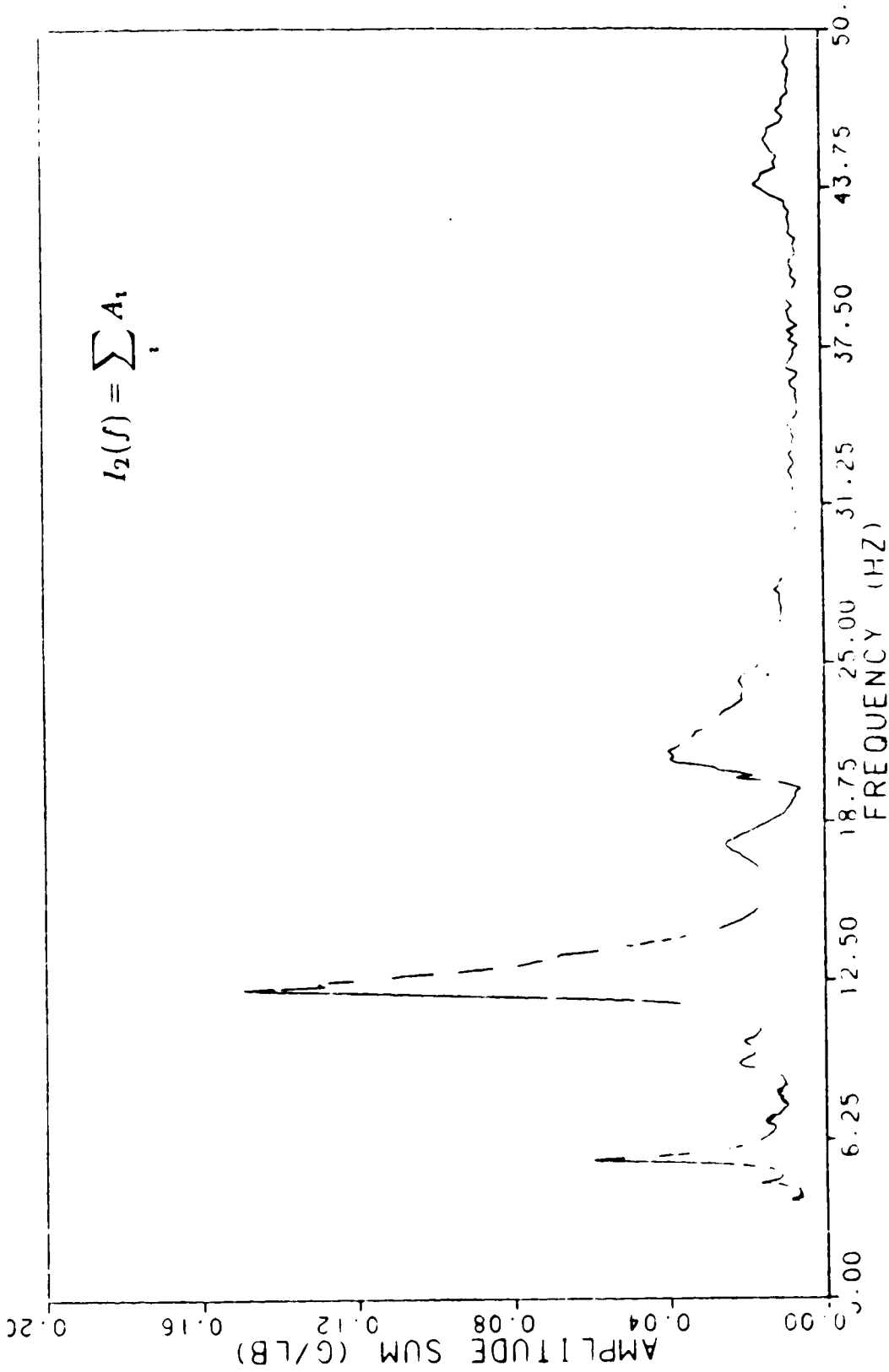

THIS VALUE IS
OF POOR QUALITY

68 INTENTIONALLY BLANK

INDICATOR FUNCTION RESULTS
LATERAL EXCITATION AT MAIN ROTOR HUB

The dominating responses for this excitation condition are at 4.42 Hz, 12.48 Hz and 13.85 Hz. These are the tailboom torsion mode, the lateral bending mode of the main rotor mast, and the anti-symmetric wing bending mode.

McDonnell
Douglas
Helicopter
Company

INDICATOR FUNCTION RESULTS
LATERAL EXCITATION AT MAIN ROTOR HUB

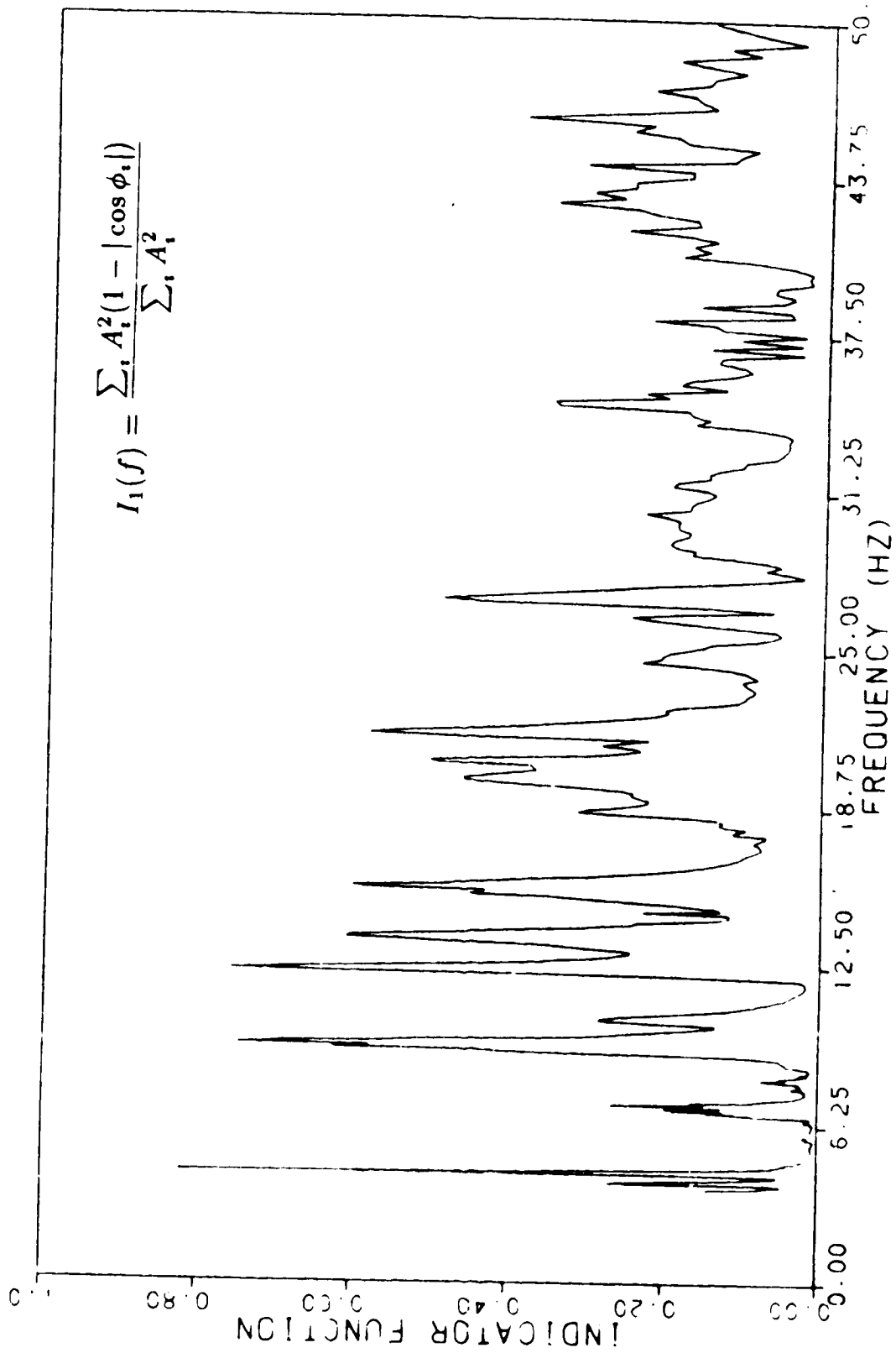

McDonnell
Douglas
Helicopter
Company

INDICATOR FUNCTION RESULTS
LATERAL EXCITATION AT MAIN ROTOR HUB

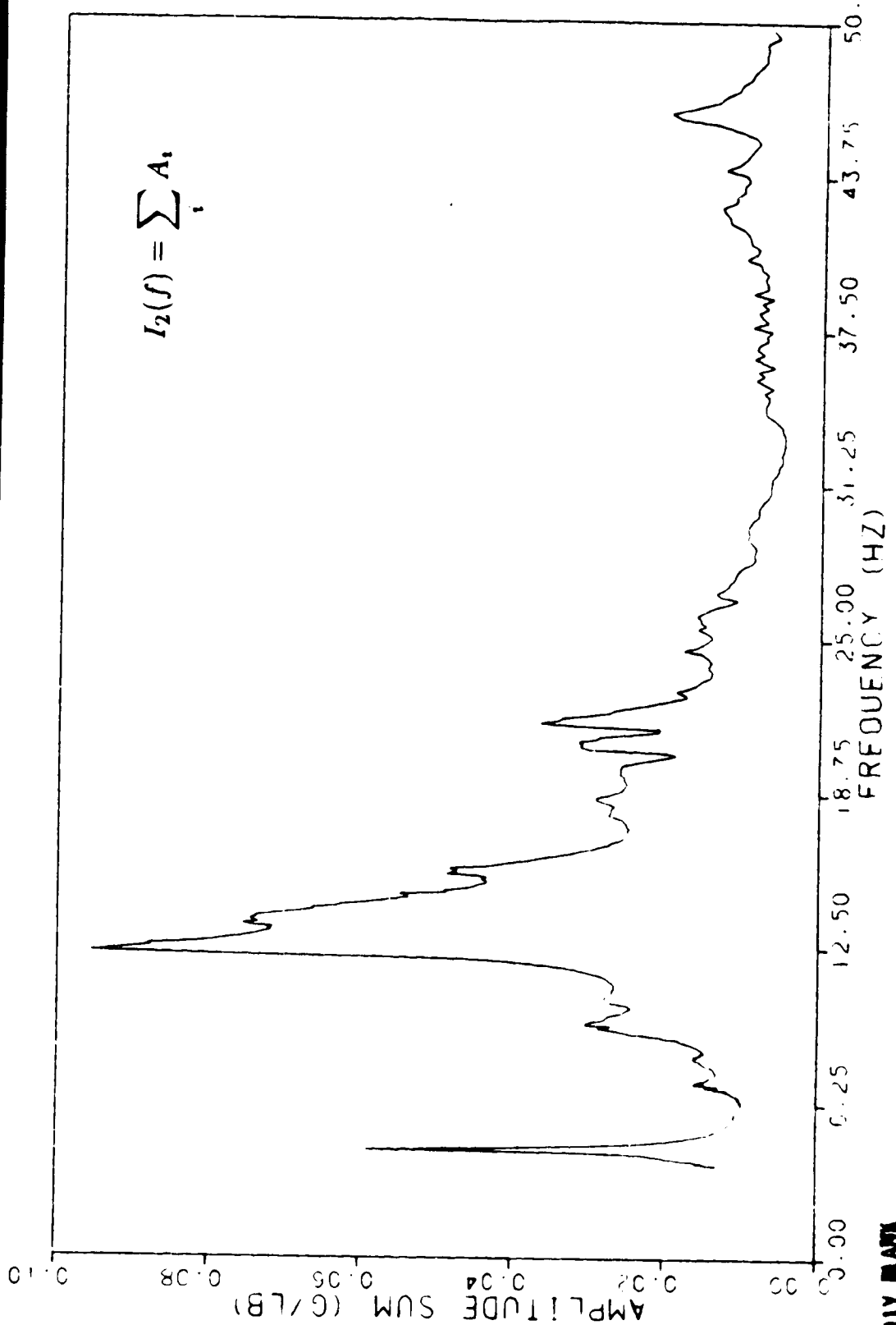

PRECEDING PAGE DATA NOT FILMED

73

THIS PAGE IS
OF POOR QUALITY

PAGE 72 INTENTIONALLY BLANK

INDICATOR FUNCTION RESULTS
VERTICAL EXCITATION AT MAIN ROTOR HUB

There are four modes dominating the response to vertical input at the main rotor hub. These are the first vertical bending of the fuselage at 5.45 Hz, longitudinal bending of the vertical stabilizer at 10.07 Hz, symmetric wing bending at 13.31 Hz, and second vertical bending of the fuselage at 17.51 Hz.

**McDonnell
Douglas
Helicopter
Company**

**INDICATOR FUNCTION RESULTS
VERTICAL EXCITATION AT MAIN ROTOR HUB**

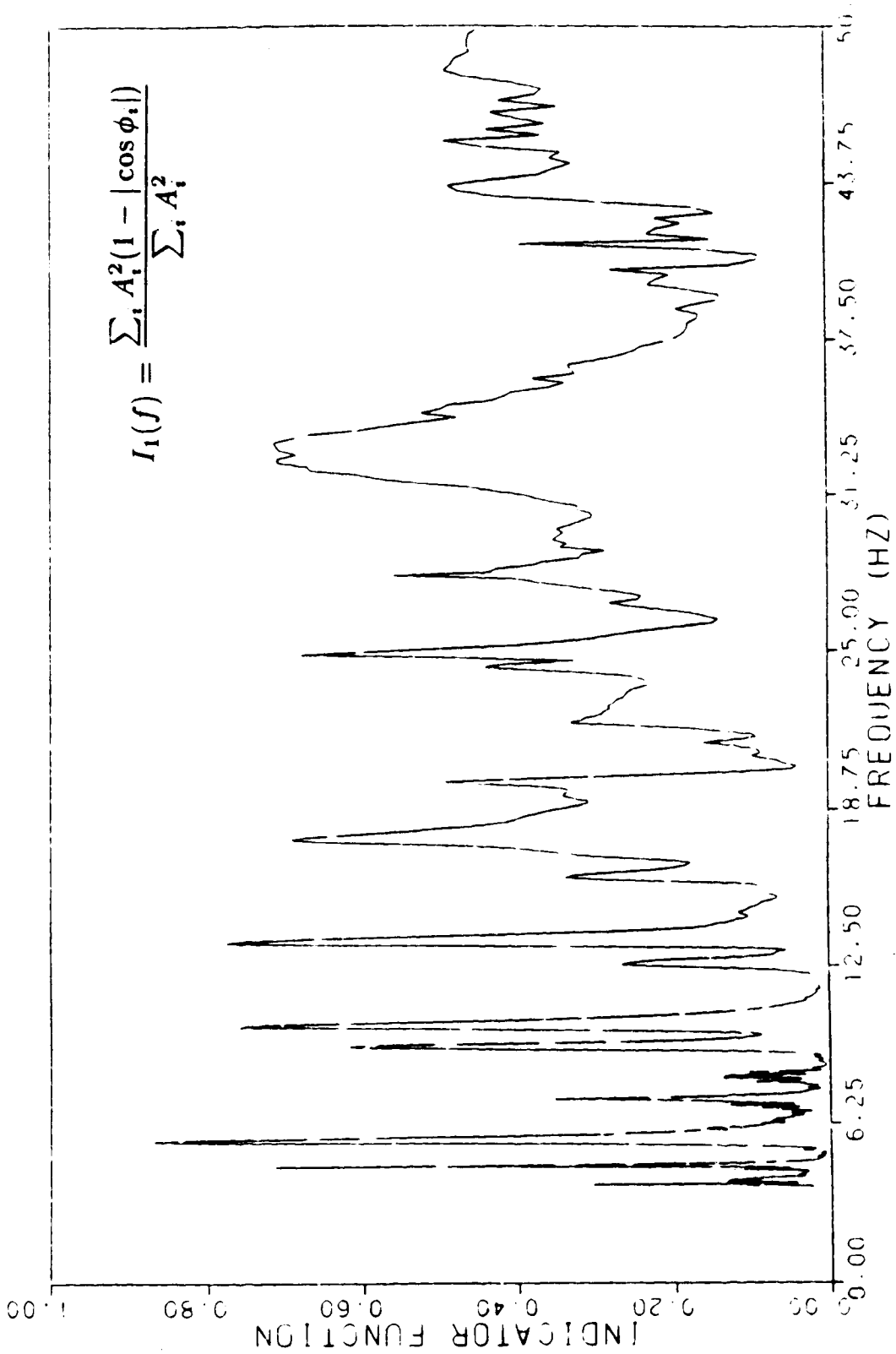

McDonnell
Douglas
Helicopter
Company

INDICATOR FUNCTION RESULTS
VERTICAL EXCITATION AT MAIN ROTOR HUB

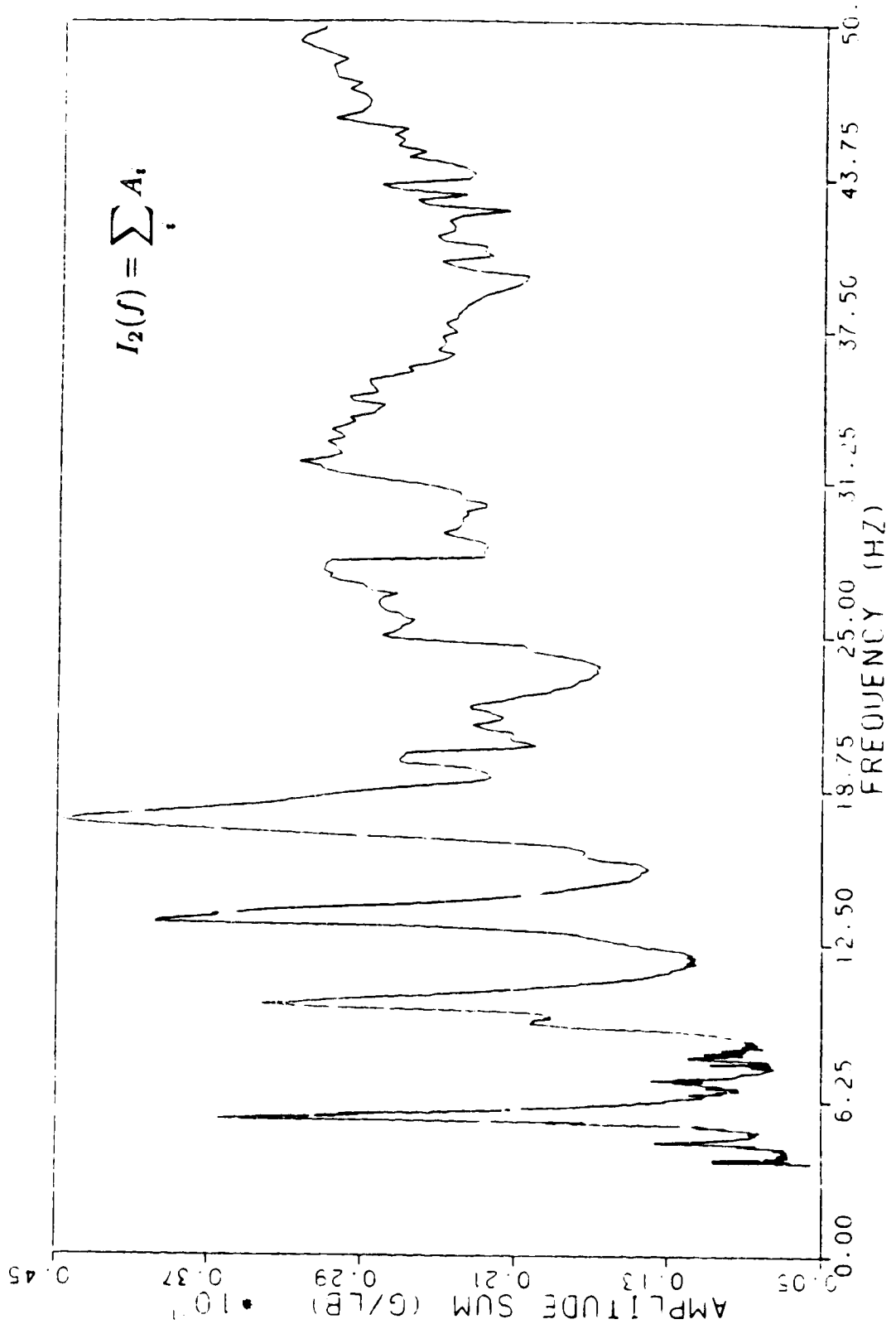

THIS PAGE IS
OF POOR QUALITY

PRECEDING PAGE BLANK NOT FILMED

76 INTENTIONALLY BLANK

INDICATOR FUNCTION RESULTS
MOMENT EXCITATION AT MAIN ROTOR HUB

Results from the moment excitation test conditions were generally of a lesser quality than those from force inputs. This was largely due to the low level of input moment used. The largest moment that could be applied with the available equipment was 1000 in-lbs. In order to record responses, it was necessary to increase the sensitivity of the instrumentation, thereby decreasing the signal to noise ratio. This increased noise is evident in many of the response plots and also in the results of the indicator functions for the moment inputs shown in the accompanying slides.

McDonnell
Douglas
Helicopter
Company

INDICATOR FUNCTION RESULTS
MOMENT EXCITATION AT MAIN ROTOR HUB

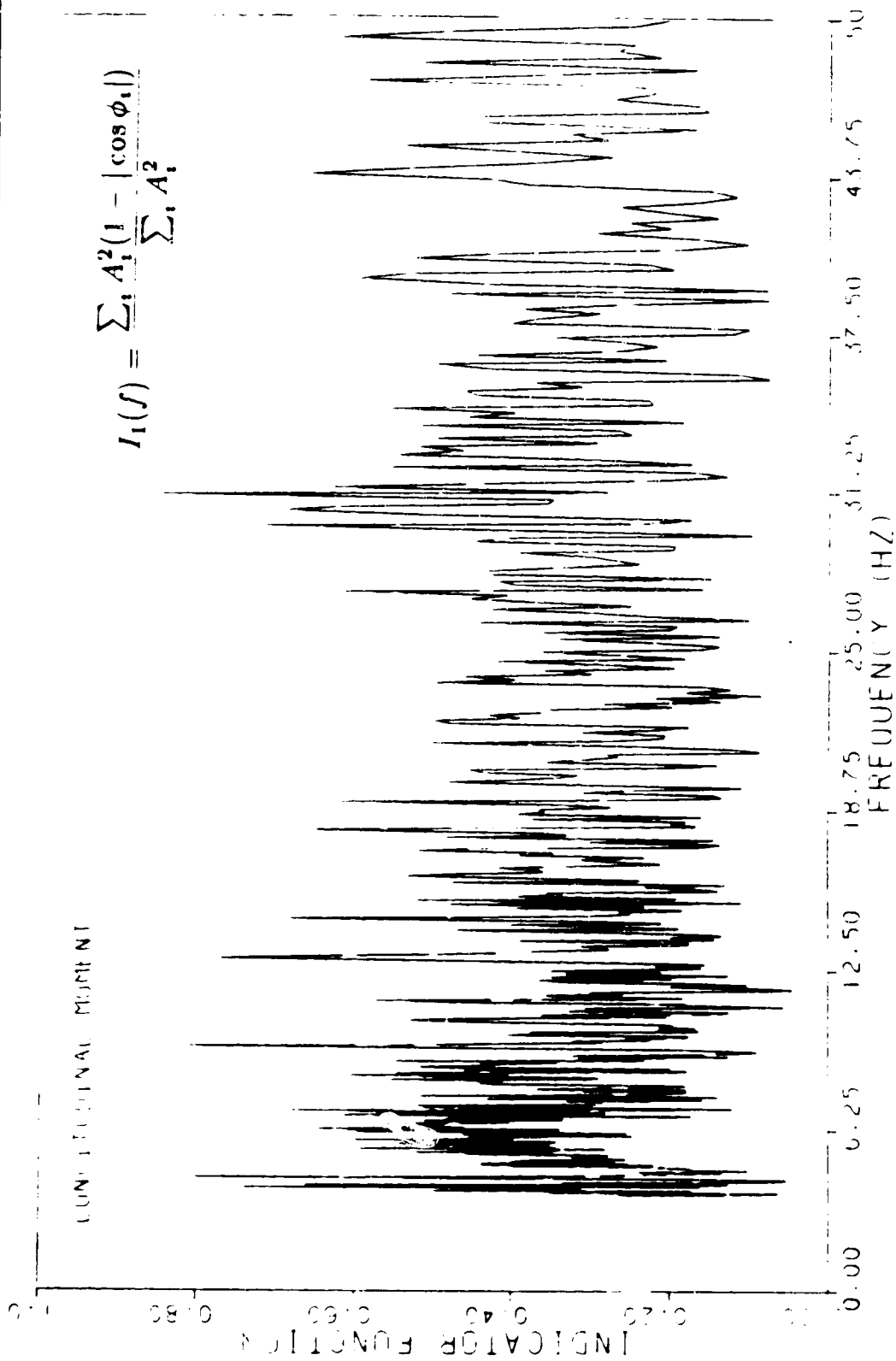

**McDonnell
Douglas
Helicopter
Company**

**INDICATOR FUNCTION RESULTS
MOMENT EXCITATION AT MAIN ROTOR HUB**

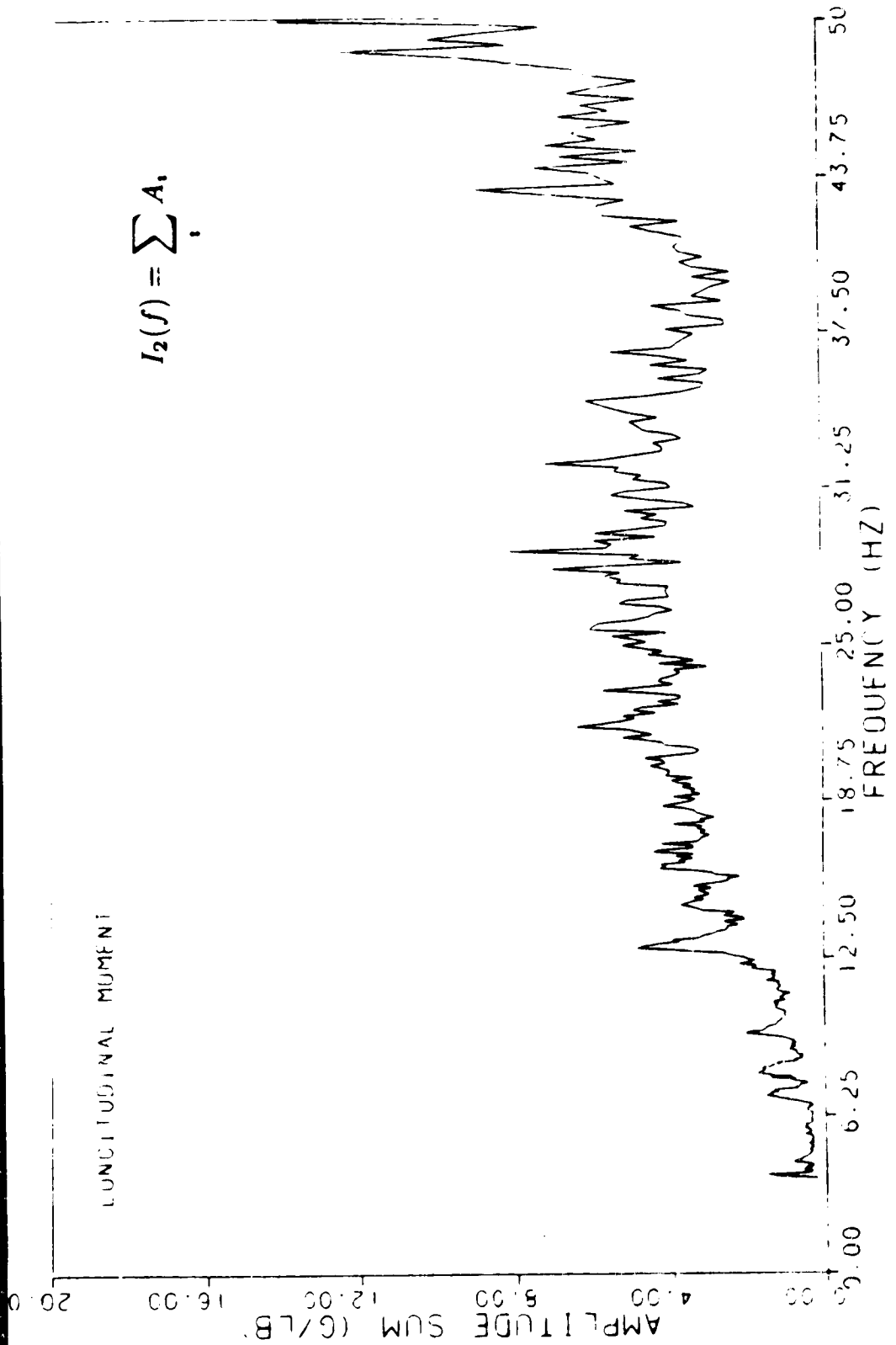

THIS PAGE IS
OF POOR QUALITY

McDonnell
Douglas
Helicopter
Company

INDICATOR FUNCTION RESULTS
MOMENT EXCITATION AT MAIN ROTOR HUB

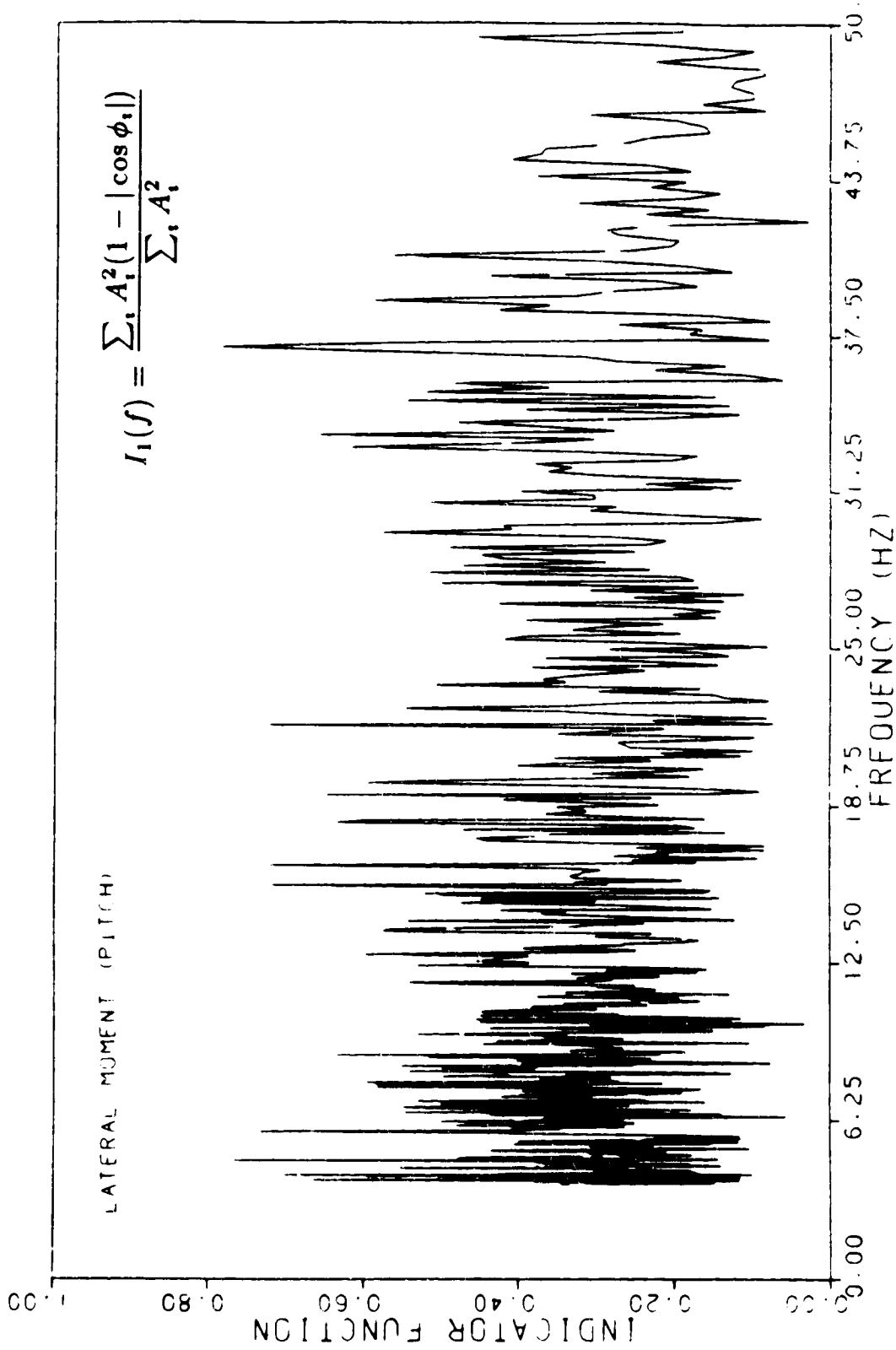

McDonnell
Douglas
Helicopter
Company

INDICATOR FUNCTION RESULTS
MOMENT EXCITATION AT MAIN ROTOR HUB

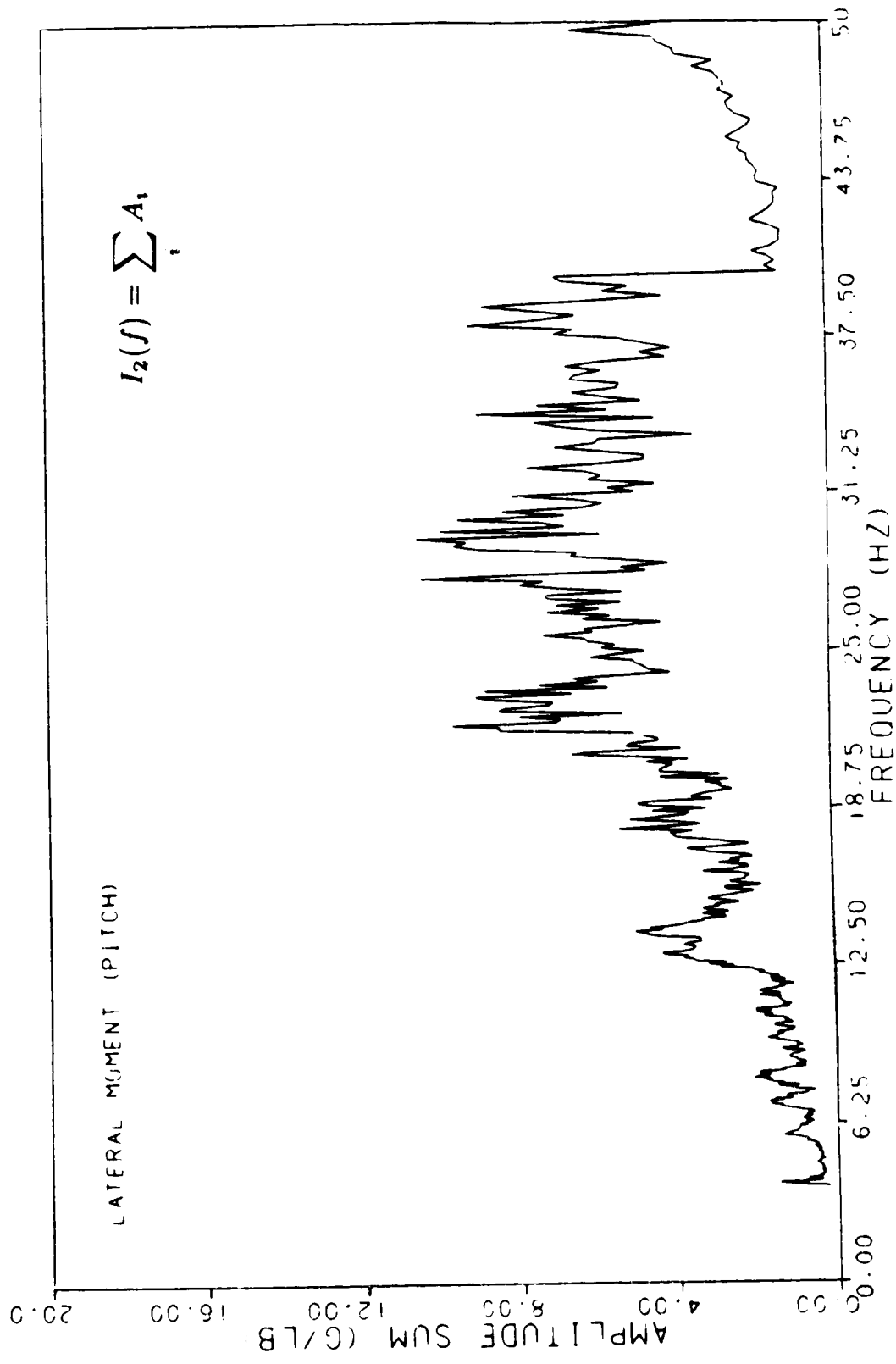

INTENTIONALLY BLANK

NATURAL FREQUENCIES

A summary of the estimated natural frequencies of the major airframe modes is given in the accompanying table. There was some variance of these frequencies depending on the point of application and direction of excitation. In most cases the range of variance was about 5%. The frequency estimates given in the table were all derived from force excitation at the main rotor hub. Response data from excitation at the tail rotor revealed the same major airframe modes as found in the responses to excitation at the main rotor hub. Note that the list only includes frequencies up to 25 Hz. At higher frequencies, mode identification was difficult due to the limited number of accelerometers. Forced response mode shapes are presented in the pages that follow.

**McDonnell
Douglas
Helicopter
Company**

NATURAL FREQUENCIES

<u>FREQUENCY (HZ)</u>	<u>DESCRIPTION</u>
4.42	TAILBOOM TORSION
5.45	FIRST VERTICAL BENDING
9.39	FIRST LATERAL BENDING
10.07	LONGITUDINAL BENDING OF VERTICAL
12.11	LONGITUDINAL BENDING OF M/R MAST
12.48	LATERAL BENDING OF M/R MAST
13.38	SYMMETRIC WING BENDING
13.85	ANTI-SYMMETRIC WING BENDING
14.20	SYMMETRIC ENGINE YAW
15.31	STABILATOR ROLL
15.93	ANTI-SYMMETRIC ENGINE PITCH, YAW
17.51	SYMMETRIC ENGINE PITCH/SECOND VERTICAL BENDING
20.44	STABILATOR YAW
22.14	LONGITUDINAL ANTI-SYMMETRIC WING BENDING
25.46	STABILATOR YAW, ROLL

FORCED RESPONSE MODE SHAPES
LATERAL EXCITATION AT M/R HUB - 4.42 HZ

This mode is a combination of torsion and lateral bending of the tailboom or aft portion of the fuselage. Since the forward part of the fuselage is so much more massive, there is little motion in this area. The primary motion is torsion, hence the name 'tailboom torsion'.

McDonnell
Douglas
Helicopter
Company

FORCED RESPONSE MODE SHAPES
LATERAL EXCITATION AT M/R HUB - 4.42 HZ

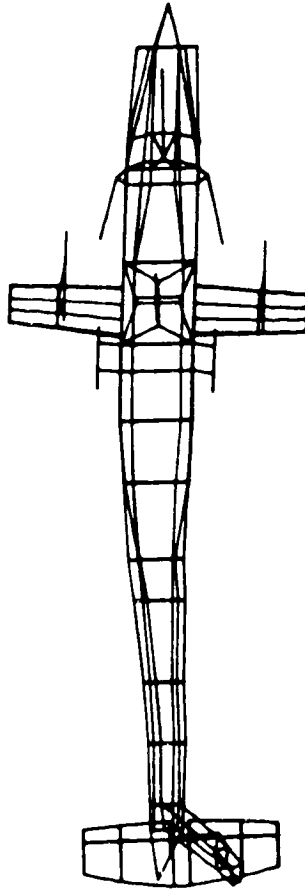
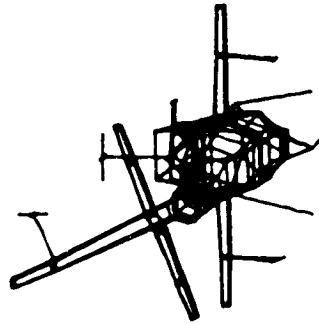

'TAILBOOM TORSION'

FORCED RESPONSE MODE SHAPES
LONGITUDINAL EXCITATION AT M/R HUB - 5.45 HZ

This is a classical first vertical bending mode.

McDonnell
Douglas
Helicopter
Company

FORCED RESPONSE MODE SHAPES
LONGITUDINAL EXCITATION AT M/R HUB - 5.45 HZ

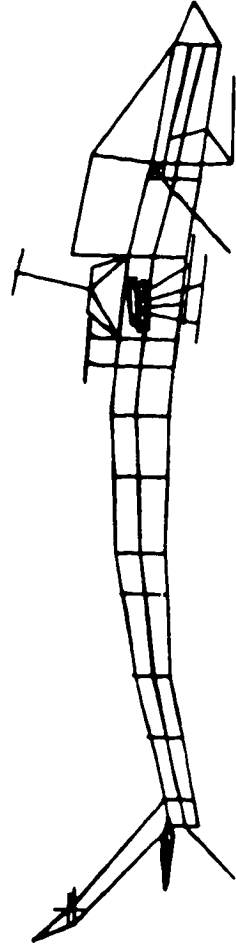
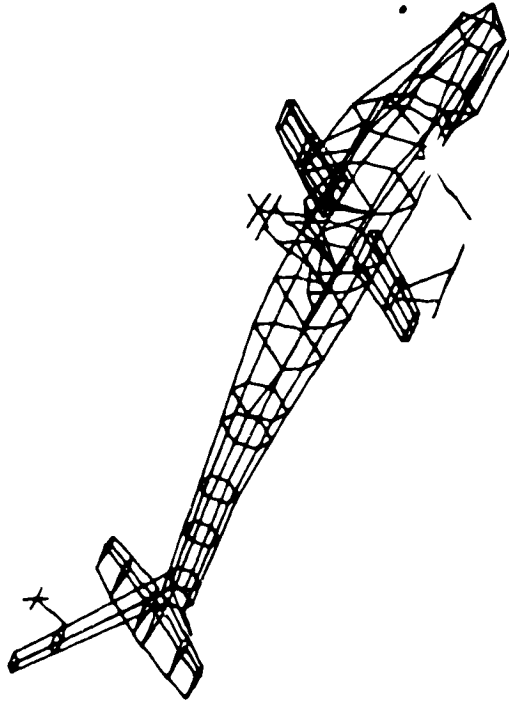

'FIRST VERTICAL BENDING'

FORCED RESPONSE MODE SHAPES
LATERAL EXCITATION AT M/R HUB - 9.39 HZ

This mode is very similar to the first mode at 4.42 Hz except that the torsion motion has reversed its phase with respect to the bending motion. Here, the primary motion is bending; therefore, the name 'first lateral bending' is used to describe this mode.

McDonnell
Douglas
Helicopter
Company

FORCED RESPONSE MODE SHAPES
LATERAL EXCITATION AT M/R HUB - 9.39 HZ

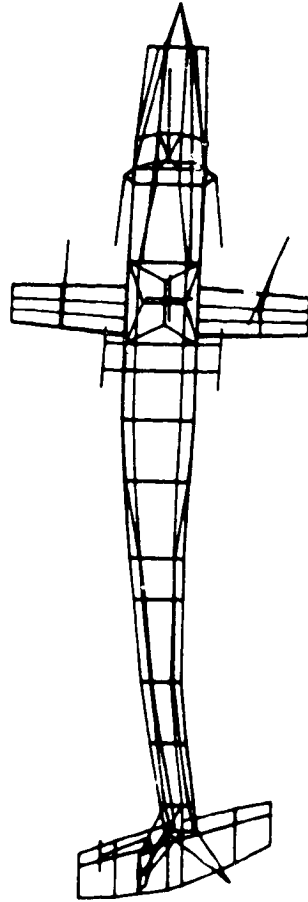
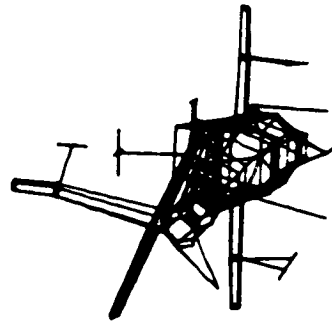

'FIRST LATERAL BENDING'

FORCED RESPONSE MODE SHAPES
VERTICAL EXCITATION AT M/R HUB - 10.07 HZ

The primary motion in this mode is a longitudinal motion of the vertical stabilizer. This motion is balanced by vertical bending of the fuselage. Although the fuselage bending appears to be a second mode it is not a true second bending mode. The true second vertical bending mode occurs at 17.51 Hz. This mode is called 'longitudinal bending of the vertical' indicating the principal motion. The figure shows the mode in both extremes of the motion for clarity of illustration.

McDonnell
Douglas
Helicopter
Company

FORCED RESPONSE MODE SHAPES
VERTICAL EXCITATION AT M/R HUB - 10.07 HZ

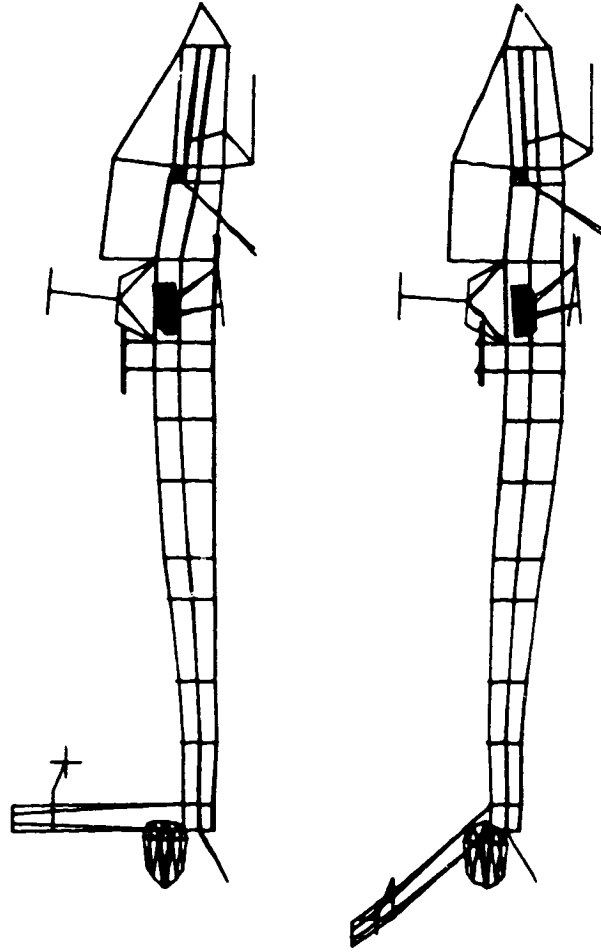

'LONGITUDINAL BENDING OF THE VERTICAL STABILIZER'

FORCED RESPONSE MODE SHAPES
LONGITUDINAL EXCITATION AT M/R HUB - 12.11 HZ

The mode shown here is dominated by bending of the main rotor mast in the longitudinal direction. The motion of the mast is balanced by a vertical motion of the front of the fuselage. Notice also the symmetric vertical wing bending motion. This mode is referred to as 'longitudinal bending of the M/R mast'.

McDonnell
Douglas
Helicopter
Company

FORCED RESPONSE MODE SHAPES
LONGITUDINAL EXCITATION AT M/R HUB - 12.11 HZ

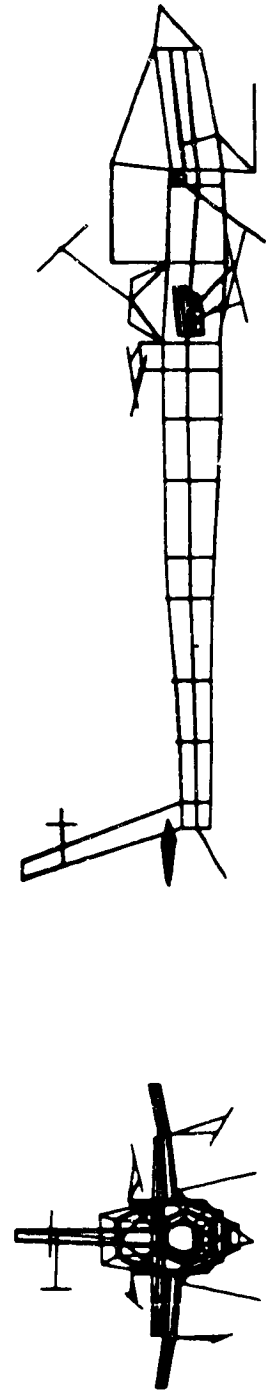
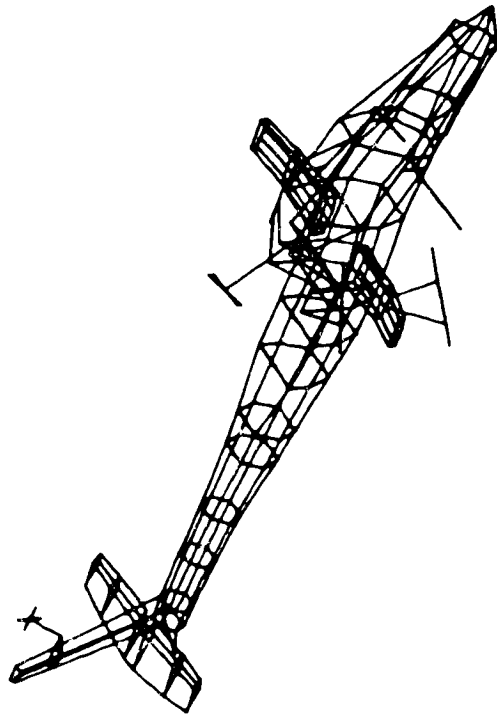

'LONGITUDINAL BENDING OF THE M/R MAST'

FORCED RESPONSE MODE SHAPES
LATERAL EXCITATION AT M/R HUB - 12.48 HZ

Very close in frequency to the previous mode, this is the 'lateral M/R mast bending' mode. There is significant coupling with the engines and wings, both of which move in a vertical, anti-symmetric motion.

McDonnell
Douglas
Helicopter
Company

FORCED RESPONSE MODE SHAPES
LATERAL EXCITATION AT M/R HUB - 12.48 HZ

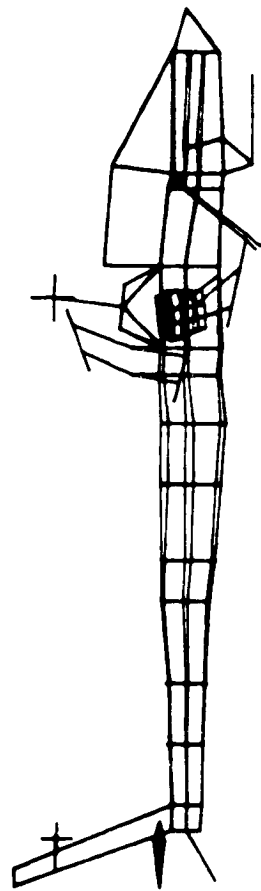
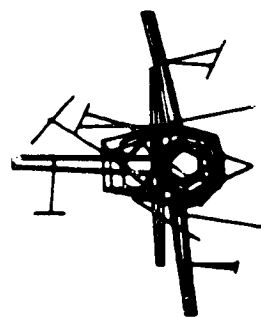
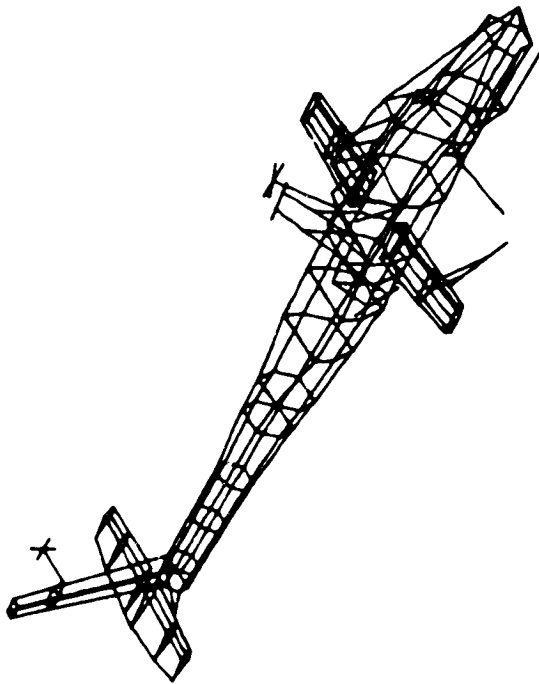

'LATERAL BENDING OF THE M/R MAST'

FORCED RESPONSE MODE SHAPES
VERTICAL EXCITATION AT M/R HUB - 13.38 HZ

Shown here is the 'symmetric wing bending' mode. Although the wing motion is symmetric, the rack and engine motion that couples with it is asymmetric.

McDonnell
Douglas
Helicopter
Company

FORCED RESPONSE MODE SHAPES
VERTICAL EXCITATION AT M/R HUB - 13.38 HZ

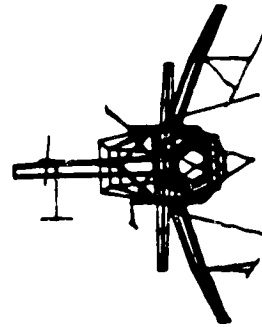
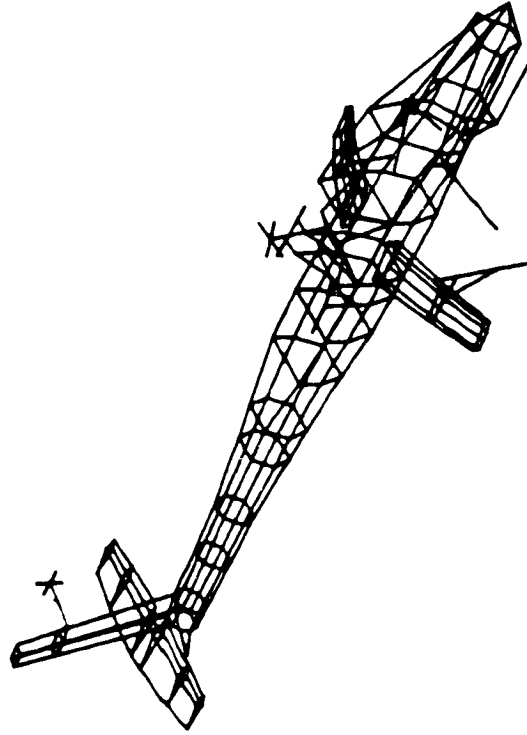

'SYMMETRIC WING BENDING'

FORCED RESPONSE MODE SHAPES
LATERAL EXCITATION AT M/R HUB - 13.85 HZ

This is the 'anti-symmetric wing bending' mode. Coupled with the wing motion there is significant anti-symmetric engine yaw motion. Notice also the anti-symmetric yaw motion of the rack.

McDonnell
Douglas
Helicopter
Company

FORCED RESPONSE MODE SHAPES
LATERAL EXCITATION AT M/R HUB - 13.85 HZ

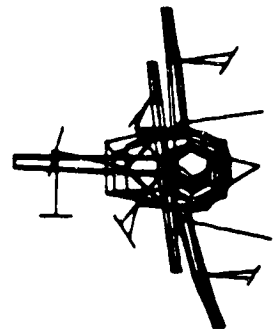
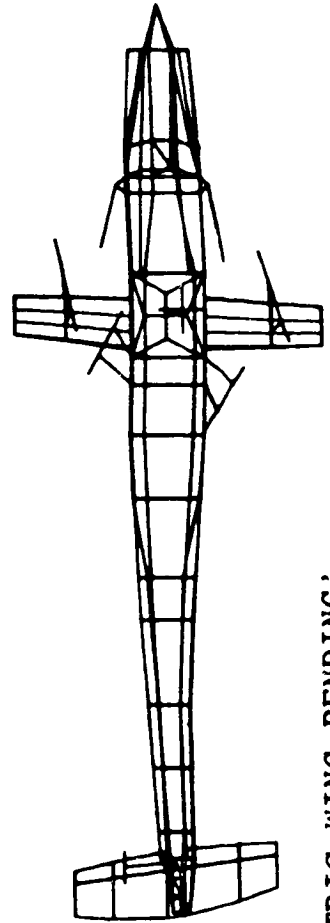
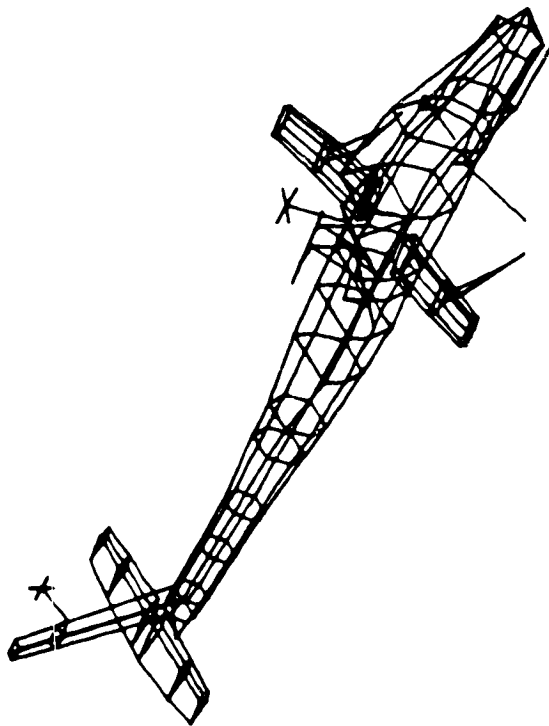

'ANTI-SYMMETRIC WING BENDING'

FORCED RESPONSE MODE SHAPES
LONGITUDINAL EXCITATION AT M/R HUB - 14.20 HZ

The mode shape shown here is a pure 'symmetric engine yaw' mode. Notice that almost all of the motion occurs in the engines.

McDonnell
Douglas
Helicopter
Company

FORCED RESPONSE MODE SHAPES
LONGITUDINAL EXCITATION AT M/R HUB - 14.20 HZ

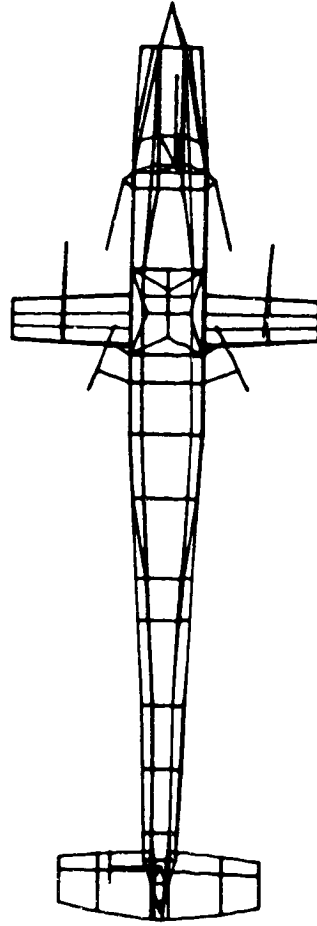

'SYMMETRIC ENGINE YAW'

FORCED RESPONSE MODE SHAPES
LATERAL EXCITATION AT M/R HUB - 15.31 HZ

This mode is called the 'stabilator roll' mode for obvious reasons. While there appears to be some torsion of the fuselage, most of the motion is in the stabilator.

McDonnell
Douglas
Helicopter
Company

FORCED RESPONSE MODE SHAPES
LATERAL EXCITATION AT M/R HUB - 15.31 HZ

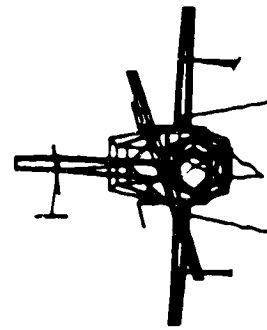
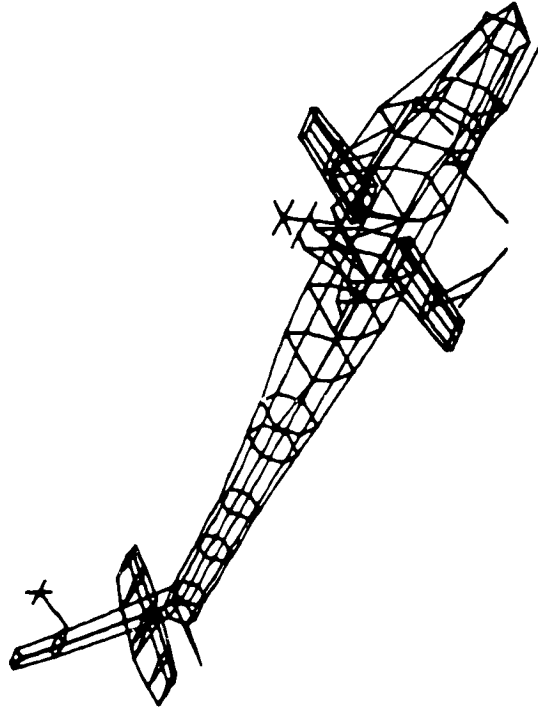

'STABILATOR ROLL'

FORCED RESPONSE MODE SHAPES
LATERAL EXCITATION AT M/R HUB - 15.93 HZ

There are many different parts of the ship participating in this mode. There is significant anti-symmetric motion of the wings and a stabilator rolling motion in the opposite direction. However, the predominant motion is an anti-symmetric engine pitch and yaw mode.

McDonnell
Douglas
Helicopter
Company

FORCED RESPONSE MODE SHAPES
LATERAL EXCITATION AT M/R HUB - 15.93 HZ

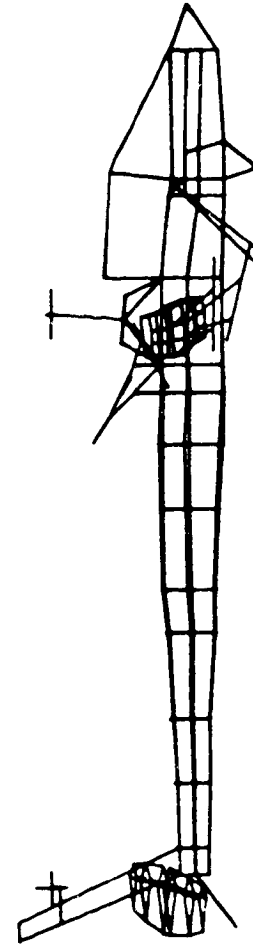
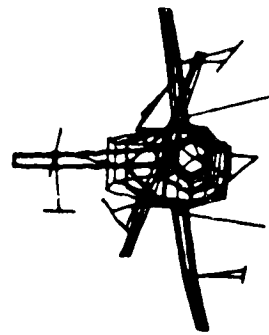
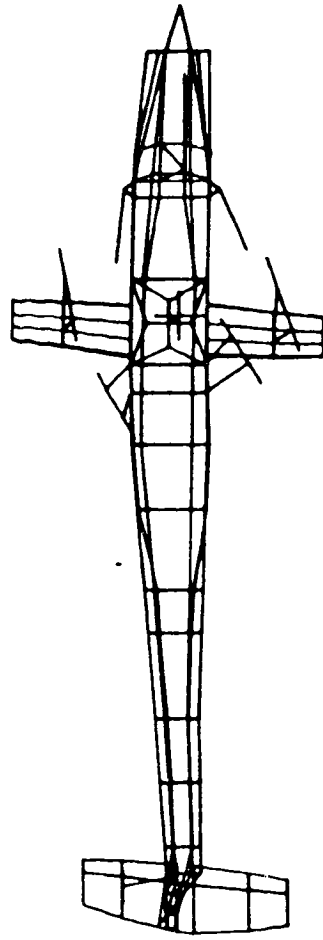

'ANTI-SYMMETRIC ENGINE PITCH AND YAW'

FORCED RESPONSE MODE SHAPES
VERTICAL EXCITATION AT M/R HUB - 17.51 HZ

The mode shape shown here is the true second vertical bending mode of the fuselage. Coupled with this there is the symmetric engine pitch mode.

McDonnell
Douglas
Helicopter
Company

FORCED RESPONSE MODE SHAPES
VERTICAL EXCITATION AT M/R HUB - 17.51 HZ

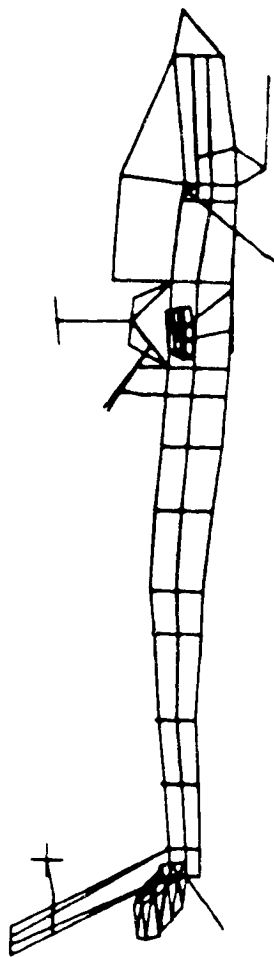
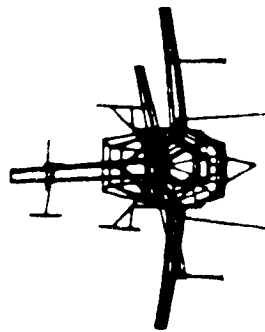
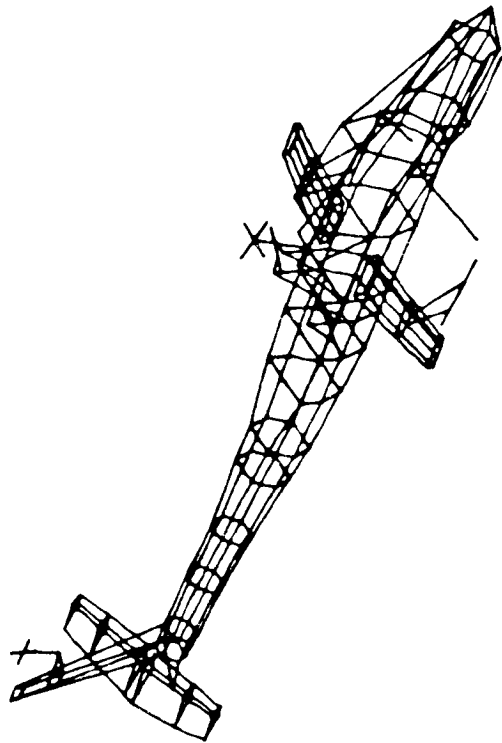

'SYMMETRIC ENGINE PITCH/SECOND VERTICAL BENDING'

FORCED RESPONSE MODE SHAPES
LONGITUDINAL EXCITATION AT M/R HUB - 20.44 HZ

The predominant motion of this mode is yaw of the stabilator.

McDonnell
Douglas
Helicopter
Company

FORCED RESPONSE MODE SHAPES
LONGITUDINAL EXCITATION AT M/R HUB - 20.44 HZ

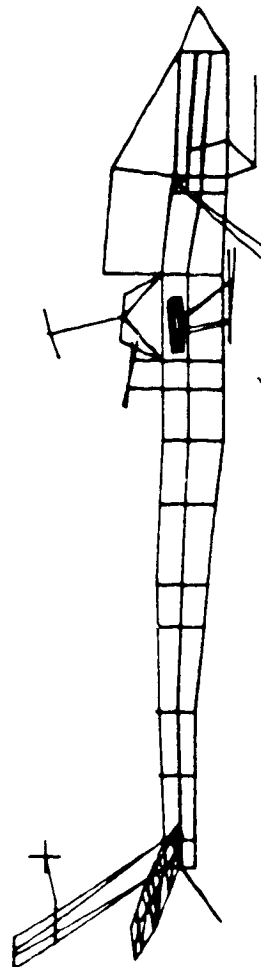
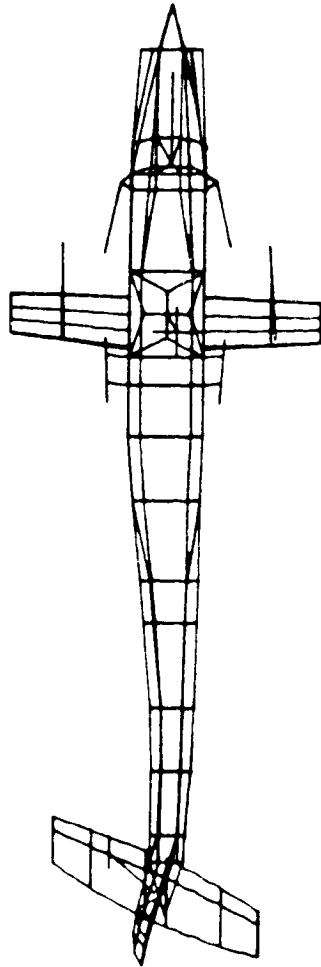

'STABILATOR YAW'

FORCED RESPONSE MODE SHAPES
LATERAL EXCITATION AT M/R HUB - 22.14 HZ

This mode is called 'anti-symmetric longitudinal wing bending' because most of the motion occurs in the wings. However, this mode might also be called the second lateral bending of the fuselage. Notice also the symmetric yawing motion of the racks.

McDonnell
Douglas
Helicopter
Company

FORCED RESPONSE MODE SHAPES
LATERAL EXCITATION AT M/R HUB - 22.14 HZ

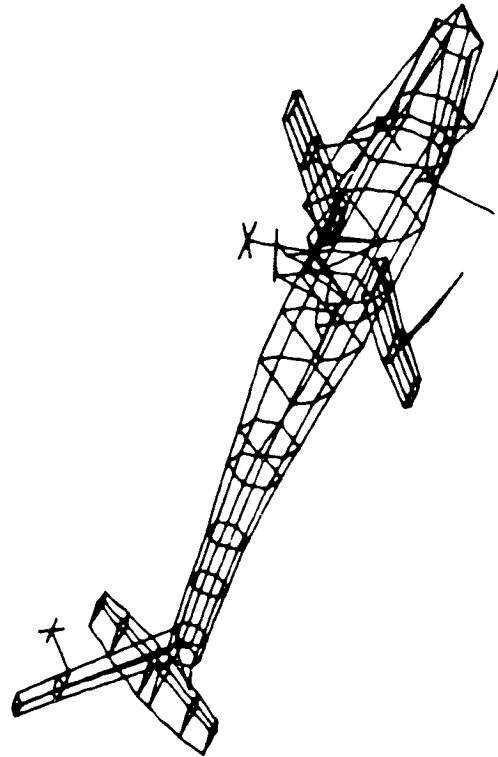

'ANTI-SYMMETRIC LONGITUDINAL WING BENDING'

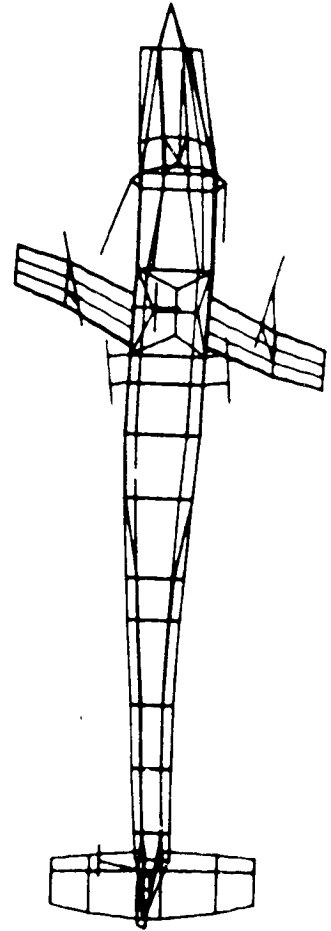

FORCED RESPONSE MODE SHAPES
LONGITUDINAL EXCITATION AT M/R HUB - 25.46 HZ

The mode shape shown here is a combination stabilator yaw and roll.



McDonnell
Douglas
Helicopter
Company

FORCED RESPONSE MODE SHAPES
LONGITUDINAL EXCITATION AT M/R HUB - 25.46 HZ

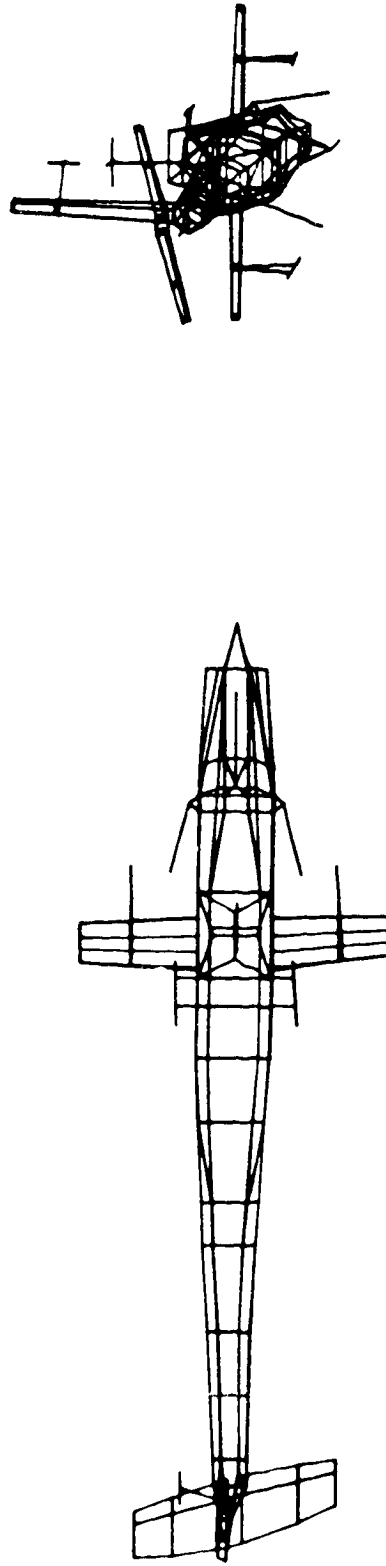

'STABILATOR YAW AND ROLL'

RESPONSE OF THE GANTRY AND SUSPENSION SYSTEM

It was the intention of the test to simulate as best as possible a free-free structure. This was accomplished by the gantry and suspension system previously described. As was mentioned earlier, the rigid body modes of the suspended aircraft were measured and were found to be sufficiently below the lowest excitation frequency of 3.75 Hz. To further insure proper isolation of the aircraft structure, one test case was run with the load applied directly to the gantry. The load was applied to one of the gantry legs at an angle so as to excite as many of the significant modes of the gantry as possible. The results of this test, presented on the following pages, indicate that the suspension system adequately isolated the aircraft from the gantry.

The plot shown below on the left is the vertical response at the center of the gantry cross beam due to excitation applied directly to the gantry. The peak responses are on the order of one hundredth of a g/lb. The sharp peaks indicate the low amount of damping in the gantry itself. The plot on the right shows the vertical response of the suspension system. Notice that the major responses occur above 20 Hz. Again, the order of magnitude of the responses is about one hundredth of a g/lb.

**McDonnell
Douglas
Helicopter
Company**

RESPONSE OF THE GANTRY AND SUSPENSION SYSTEM

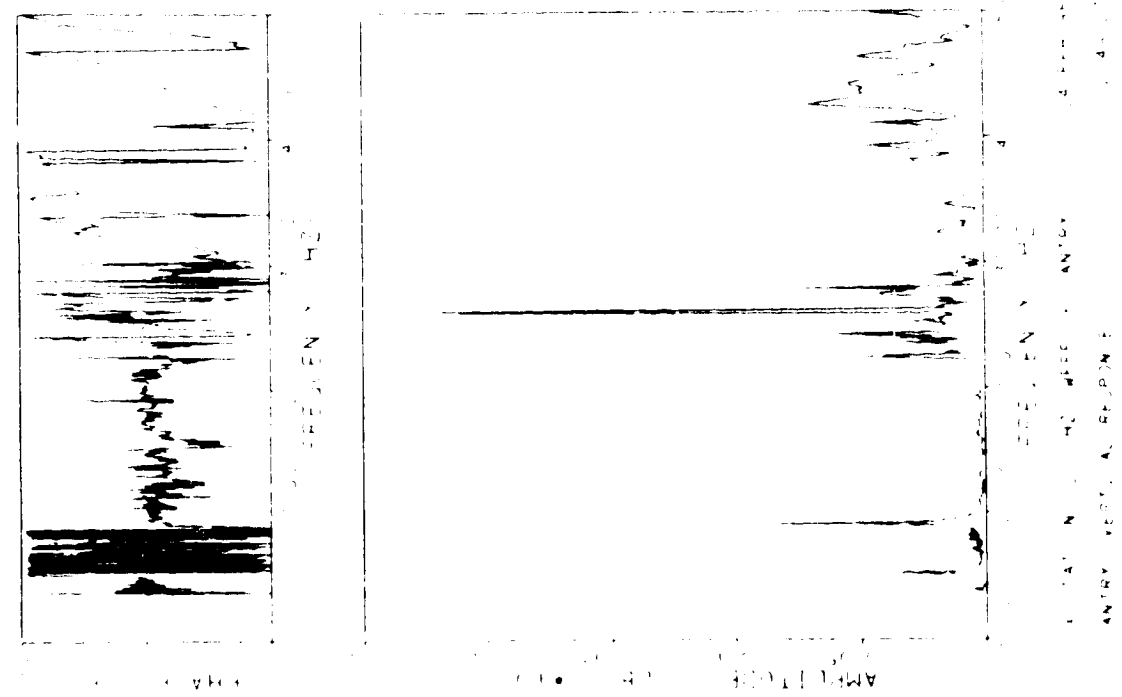
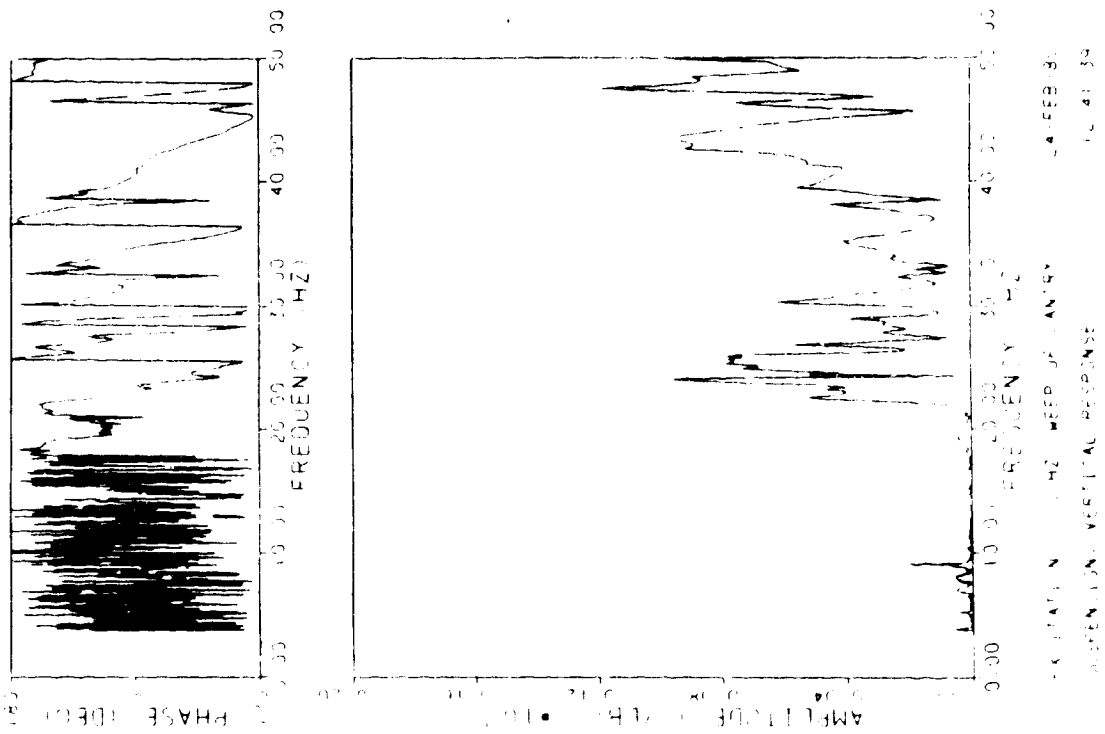

FUSELAGE RESPONSE TO EXCITATION AT GANTRY

The two figures shown below are the responses at the vertical stabilizer and at fuselage station 35 due to excitation applied to the gantry. These responses are typical of those measured at all locations on the ship. The important features are the flatness and the low magnitude of the response (at least two orders of magnitude lower than the response of the gantry and suspension). These results show that the test structure was sufficiently isolated from the gantry and suspension system.

McDonnell
Douglas
Helicopter
Company

FUSELAGE RESPONSE TO EXCITATION AT GANTRY

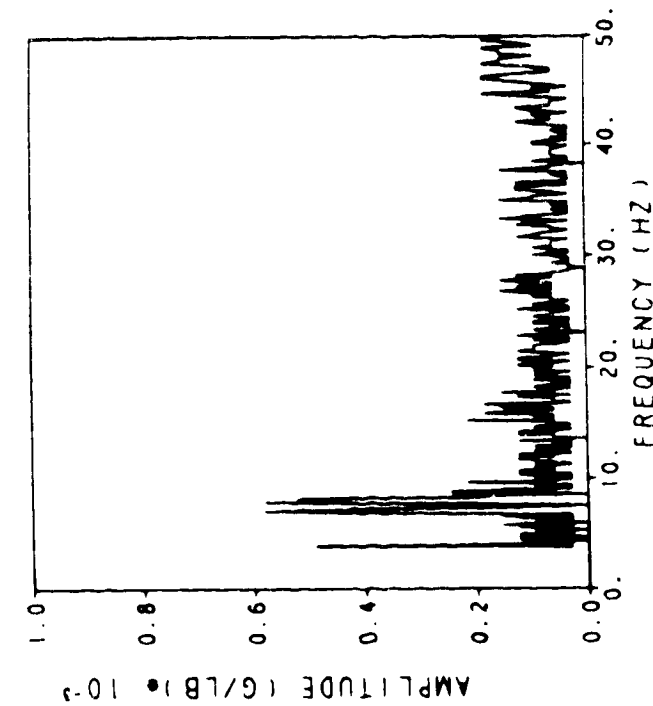
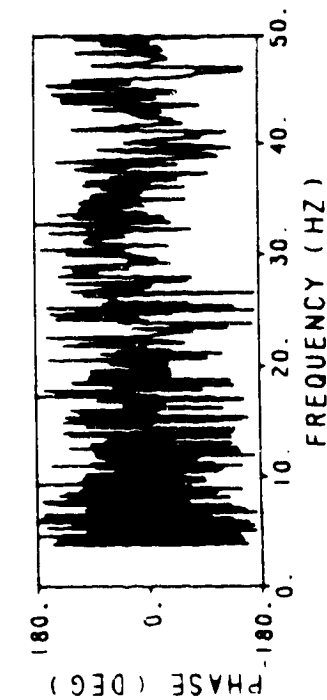

EXCITATION, 200 HZ SWEEP OF GANTRY
TOP OF VERTICAL, VERTICAL RESPONSE

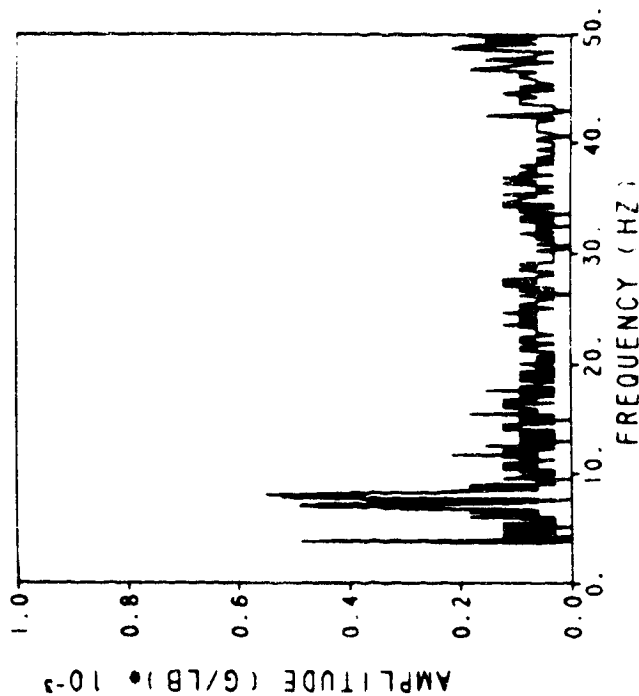
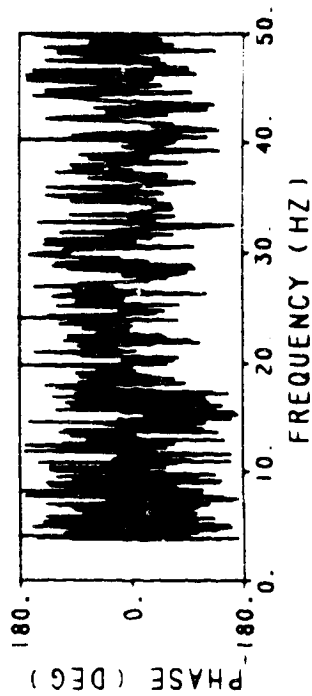

EXCITATION, 200 HZ SWEEP OF GANTRY
FUSELAGE STATION 35, VERTICAL RESPONSE

LINEARITY OF RESPONSES

Two test cases were run for a lateral load at the main rotor hub, one with a force of 100 lbs and the other with a force of 200 lbs. These results were used to investigate the linearity of the response to input force. It was found that at most measurement locations the transfer function peaks were significantly lower in magnitude (up to 36%) for the larger input force, although in some cases there was very little change in the response magnitude. The peak frequency was found to be slightly lower (about 0.5 to 1.5%) for most responses. In no instance was the magnitude or frequency significantly higher for the larger input force. This nonlinear effect is probably due mostly to the presence of frictional damping in the structure. Typical comparison plots are presented in the figures below.

**McDonnell
Douglas
Helicopter
Company**

LINEARITY OF RESPONSES

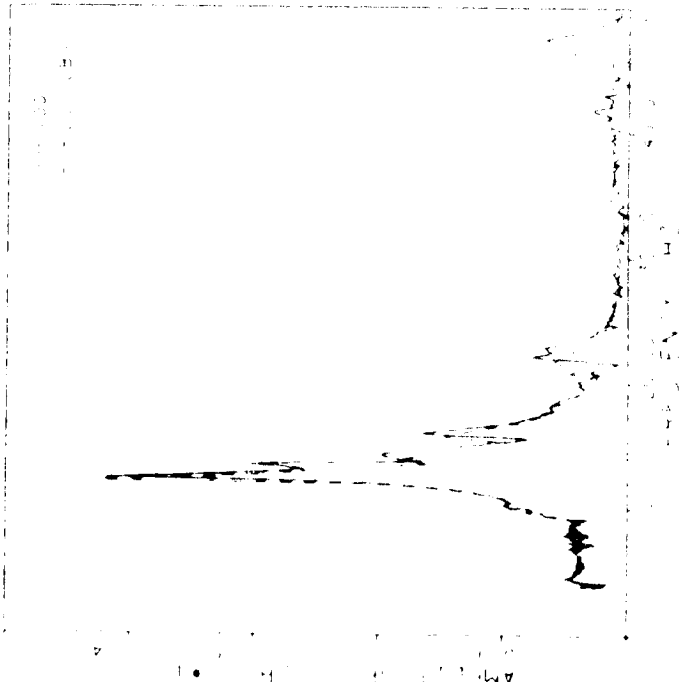
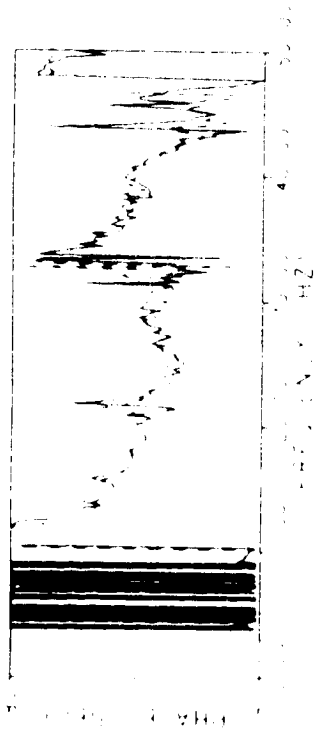

EXCITATION LATERAL • M/R MAST
STARBOARD WINCH LATERAL RESPONSE
8-MAY-86 09 43 13

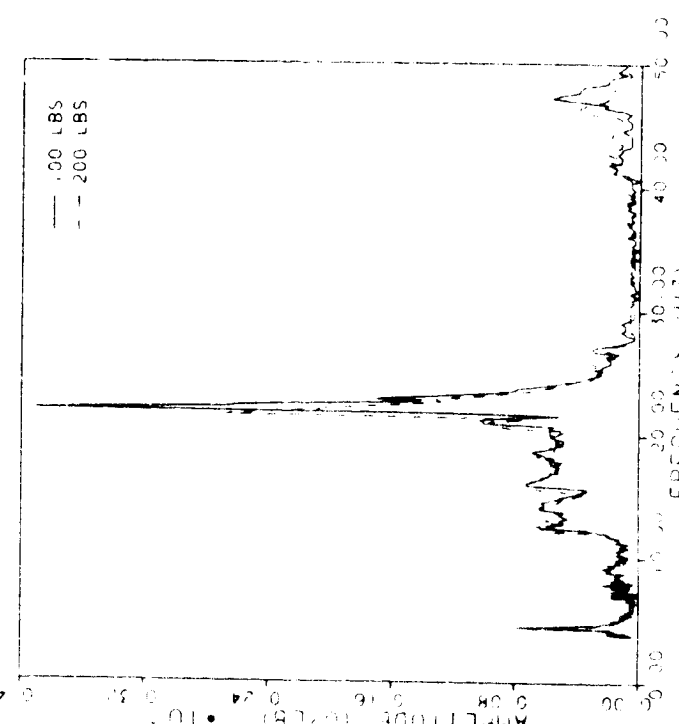
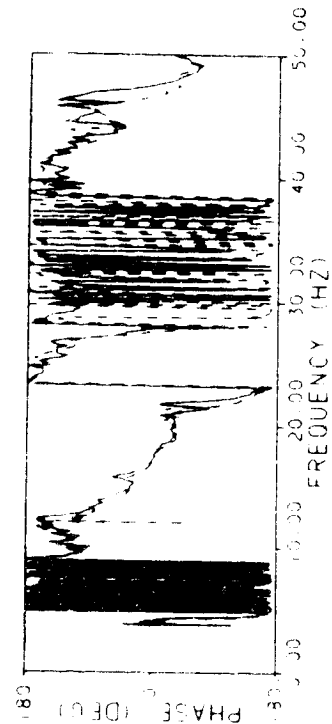

EXCITATION LATERAL • M/R MAST
STARBOARD WINCH LONGITUDINAL RESPONSE
8-MAY-86 09 43 13

6. CORRELATION WITH NASTRAN

125

PRELIMINARY

NOT FILMED

134 INTENTIONALLY BLANK

NASTRAN MODEL

The NASTRAN finite element model of the AH-64 airframe is described in detail in a separate report. The model shown and described below is slightly different. Some modifications were made to the model based on preliminary correlation results. These modifications are described in detail in the sections that follow. The test results have shown that adequate simulation of a free-free structure was obtained in the shake test. Therefore, the analysis does not include any of the supporting structure but assumes the aircraft to be free-free. The accompanying figure shows a hidden line removed plot of the model along with pertinent information.

McDonnell
Douglas
Helicopter
Company

NASTRAN MODEL

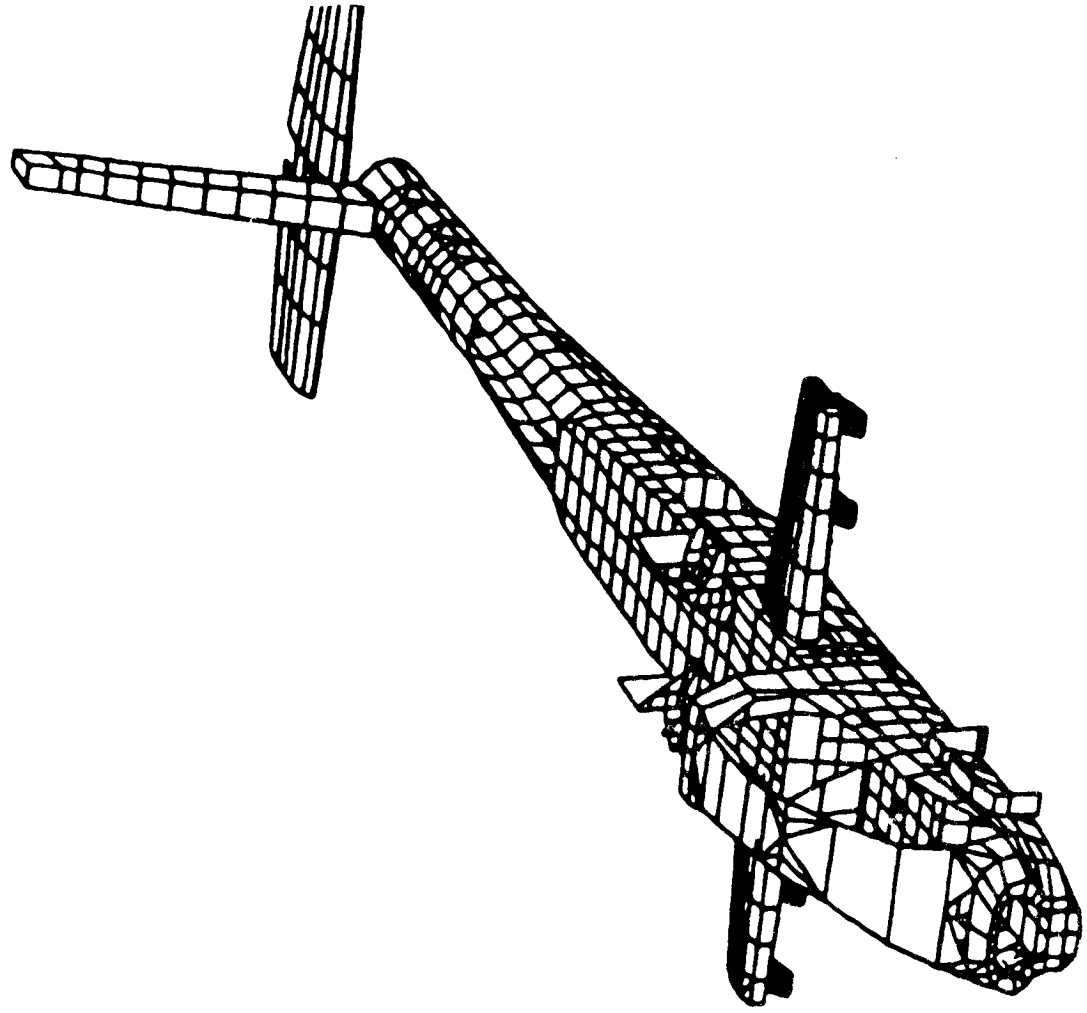

NASTRAN FINITE ELEMENT MODEL STATISTICS

GRID POINTS	2176
ELEMENTS	5772
CBAR	1148
CBEAM	54
CBEND	4
CELAS1	50
CELAS2	16
CONROD	911
CQUAD	188
CROD	1408
CSHEAR	1606
CTRIA3	226
RBAR	36
RBE1	1
RBE2	47
RBE3	78
MASS ELEMENTS	1685

CORRELATION OF THE FREQUENCY RESPONSES

The correlation results presented herein represent the current NASTRAN finite element model. Improvements have been made to the wing portion of the NASTRAN model based on the preliminary correlation. The changes that were implemented and their effects on the results are described in detail in section 7. Briefly, the changes involved making improvements to the mass modeling and rack/store representation, correcting errors in the element products of inertia, and incorporating the trailing edge in the wing.

The main objective of the correlation task was to compare the frequency responses obtained in the test with those predicted by NASTRAN. Responses were examined and compared for ten locations throughout the ship. These locations are given in the following table. Response correlation plots presented on the following pages are typical results which demonstrate both the strengths and deficiencies of the correlation. The NASTRAN analysis assumed a modal damping value of 2% for response calculations.

The correlation results show very good agreement between test and analysis up to 13 Hz for most locations investigated. Above 13 Hz the correlation tends to deteriorate. The best correlation was achieved at the main rotor mast and at points on the fuselage. The worst correlation was at the engines and stabilator, probably due to the difficulty in modeling these components.

**McDonnell
Douglas
Helicopter
Company**

CORRELATION OF THE FREQUENCY RESPONSES

LOCATIONS USED IN CORRELATION WITH NASTRAN

LOCATION	MEAS. DIRECTIONS	MEAS. ID NOS.	NASTRAN GRID NO.
TOP OF VERTICAL	X, Y, Z	4, 6, 8	55037
M/R HUB	X, Z	32, 42	900055
M/R HUB	Y, Z	34, 38	900056
STARBOARD WING TIP	X, Z	44, 46	20314
FUSELAGE STATION 35.5	Y, Z	55, 57	3519
PORT ENGINE (FWD)	X, Y, Z	69, 71, 73	24101
PORT ENGINE (AFT)	Y, Z	81, 83	24102
STABILATOR TIP	X, Y, Z	84, 86, 88	56044
PILOT SEAT	X, Y, Z	95, 97, 99	10017
COPILOT SEAT	X, Y, Z	100, 101, 102	10015

LONGITUDINAL EXCITATION AT M/R MAST
RESPONSE AT THE VERTICAL STABILIZER

These plots show the longitudinal and vertical response of the vertical stabilizer. Demonstrated is the close correlation in frequency between test and NASTRAN of the first vertical bending mode of the fuselage at 5.45 Hz. It is apparent that the amplitude correlation for this response could be improved by using a higher value for the damping factor.

**McDonnell
Douglas
Helicopter
Company**

**LONGITUDINAL EXCITATION AT M/R MAST
RESPONSE AT THE VERTICAL STABILIZER**

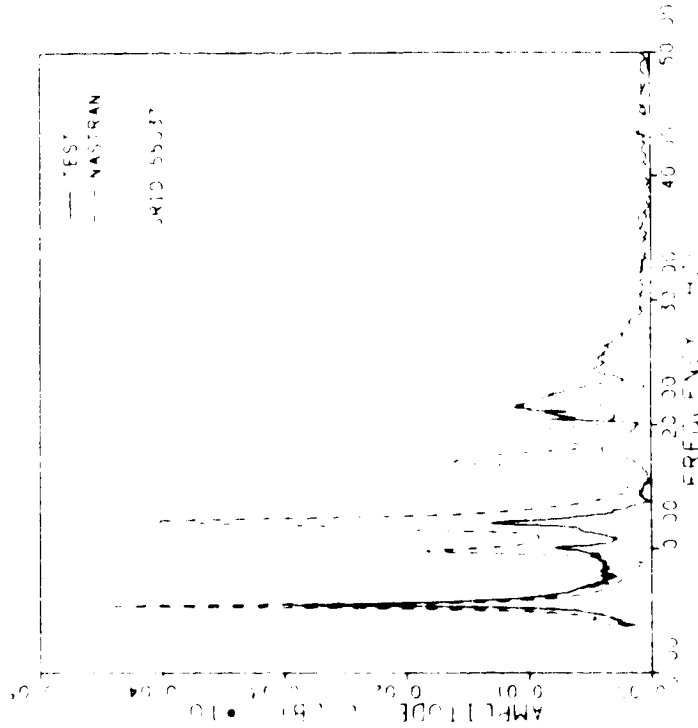
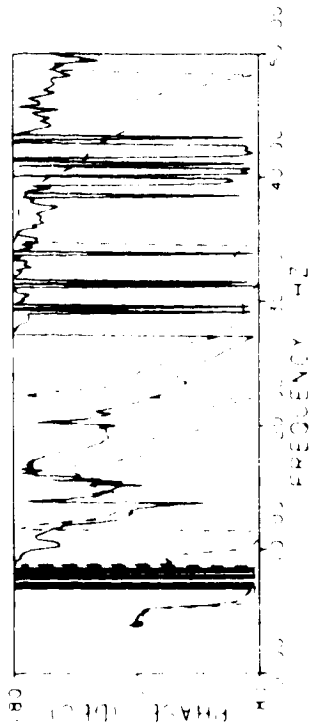

EXCITATION LONGITUDINAL M/R MAST
TOP OF VERTICAL LONGITUDINAL RESPONSE

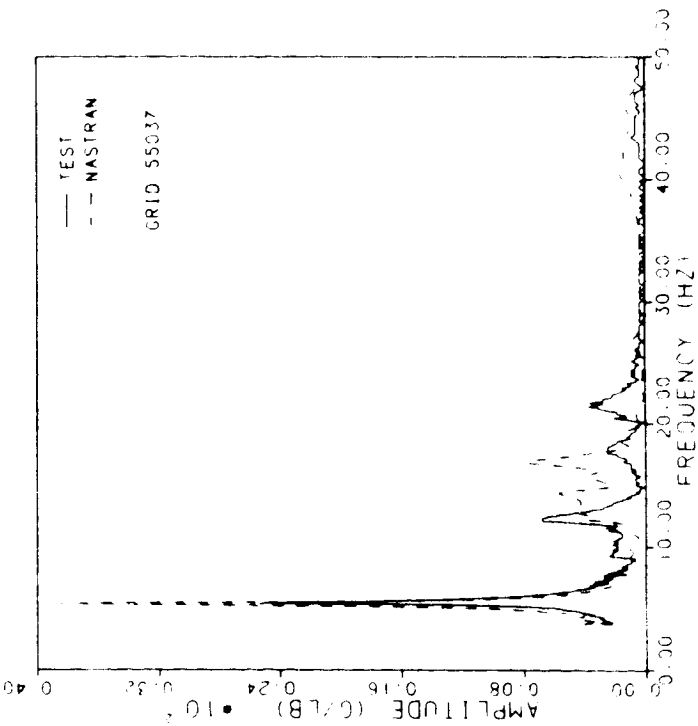
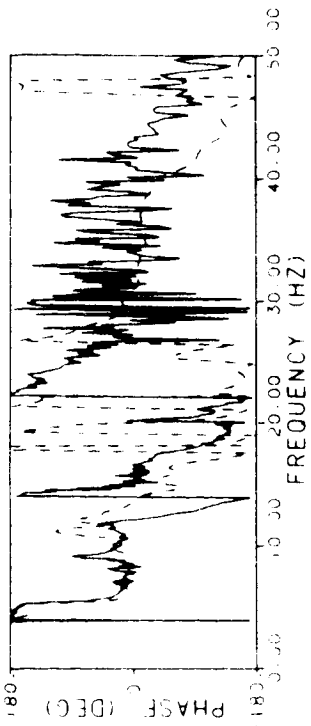

EXCITATION VERTICAL M/R MAST
TOP OF VERTICAL VERTICAL RESPONSE

LONGITUDINAL EXCITATION AT M/R MAST
RESPONSE AT THE MAIN ROTOR HUB

Excellent correlation was obtained for the main mast bending modes. Shown here are the longitudinal and vertical responses. The longitudinal mast bending mode at 12.11 Hz is dominant. This is typical of main rotor hub responses for force excitations. In this case, the damping used in the analysis seems to be appropriate. Although this shows the response measured at the point of the applied excitation, this response is dominated by a very important mode, namely the longitudinal M/R mast bending mode. This correlation demonstrates the accuracy of the NASTRAN analysis in the modeling of the mast and supporting structure, the dummy hub and the overall mass of the ship.

**McDonnell
Douglas
Helicopter
Company**

**LONGITUDINAL EXCITATION AT M/R MAST
RESPONSE AT THE MAIN ROTOR HUB**

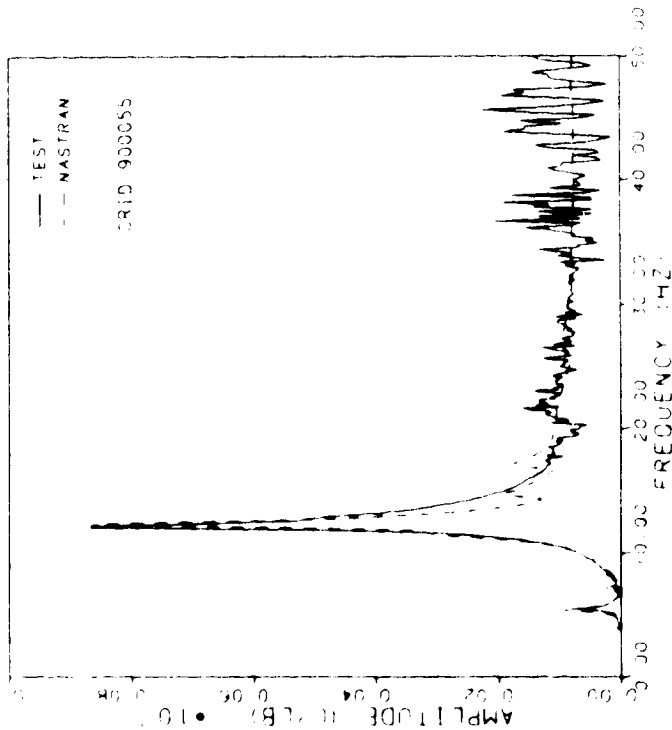
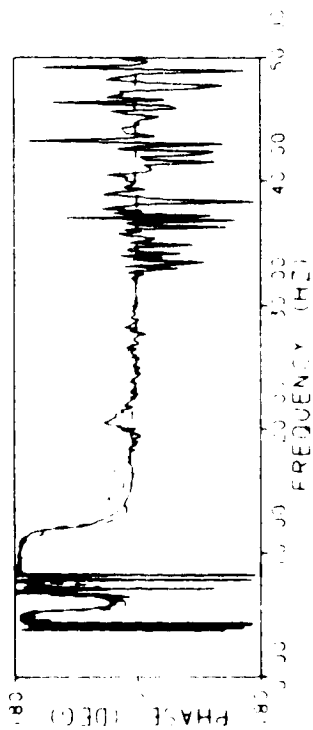

EXCITATION: LONGITUDINAL • M/R MAST 22 SEP 85
MAIN ROTOR HUB: LONGITUDINAL RESPONSE 11:04:15

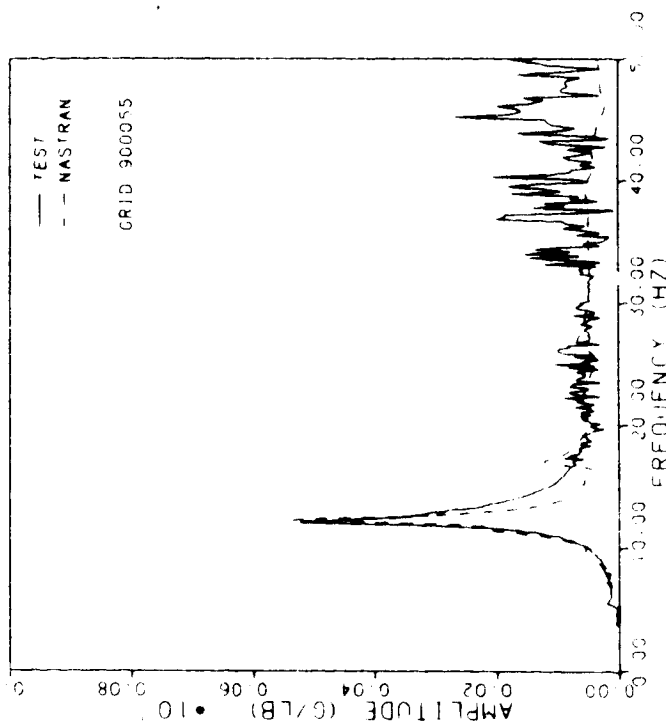
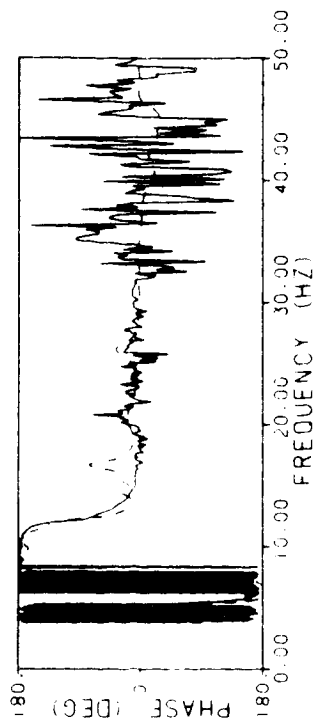

EXCITATION: LONGITUDINAL • M/R MAST 22 SEP 86
MAIN ROTOR HUB: VERTICAL RESPONSE 11:06:58

LONGITUDINAL EXCITATION AT M/R MAST
RESPONSE AT FUSELAGE STATION 35

The vertical response at the most forward bulkhead illustrates again the good correlation in frequency of the first vertical bending mode at 5.45 Hz and the longitudinal main mast bending mode at 12.11 Hz. The longitudinal mast bending mode also included significant vertical bending of the forward fuselage. The damping assumed analytically here also is insufficient.

McDonnell
Douglas
Helicopter
Company

LONGITUDINAL EXCITATION AT M/R MAST
RESPONSE AT FUSELAGE STATION 35

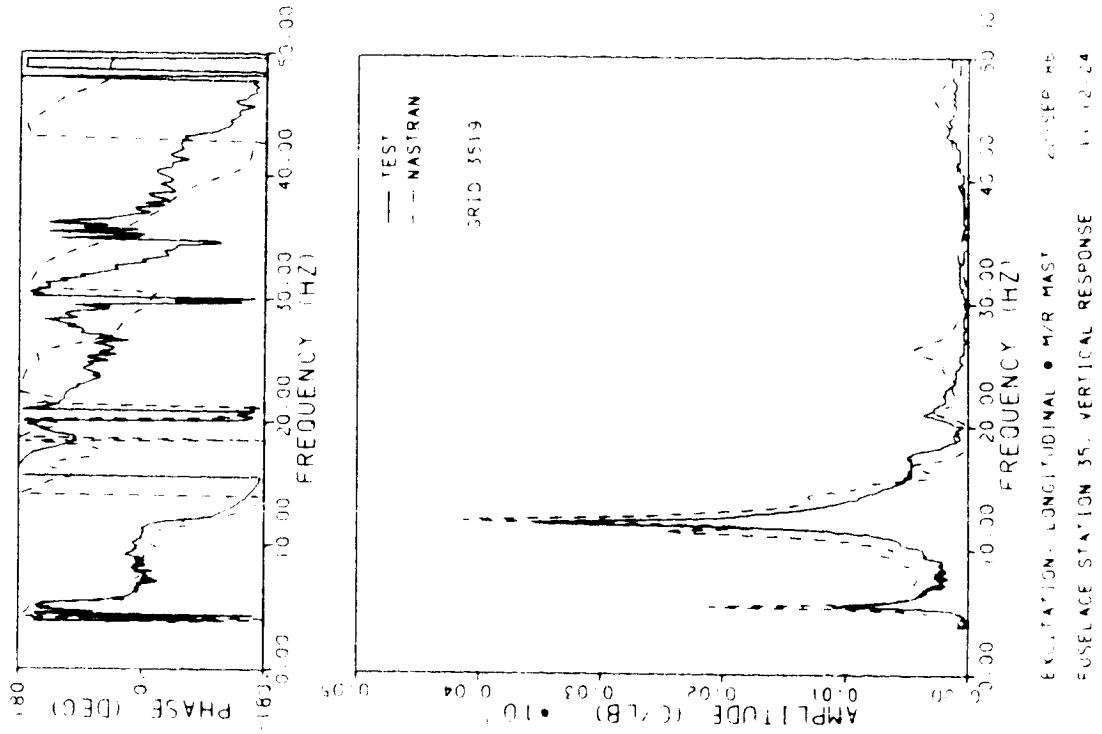

LONGITUDINAL EXCITATION AT M/R MAST
RESPONSE AT THE WING TIP

Shown here are the longitudinal and vertical response of the starboard wing tip. Dramatic improvement in the correlation of the vertical response was achieved due to the changes implemented in the wing model (see next section). There is excellent correspondence for the peak response occurring at 12.11 Hz, which is the longitudinal M/R mast bending mode. This is typical of the vertical wing response to other excitation conditions. The peak response predicted by NASTRAN at 15 Hz is the symmetric wing bending mode. In the test, the response of this mode is hidden in the response of the main mast bending mode. The longitudinal response of the wing does not compare quite so well. The NASTRAN model appears to be too flexible in this direction.

**McDonnell
Douglas
Helicopter
Company**

**LONGITUDINAL EXCITATION AT M/R MAST
RESPONSE AT THE WING TIP**

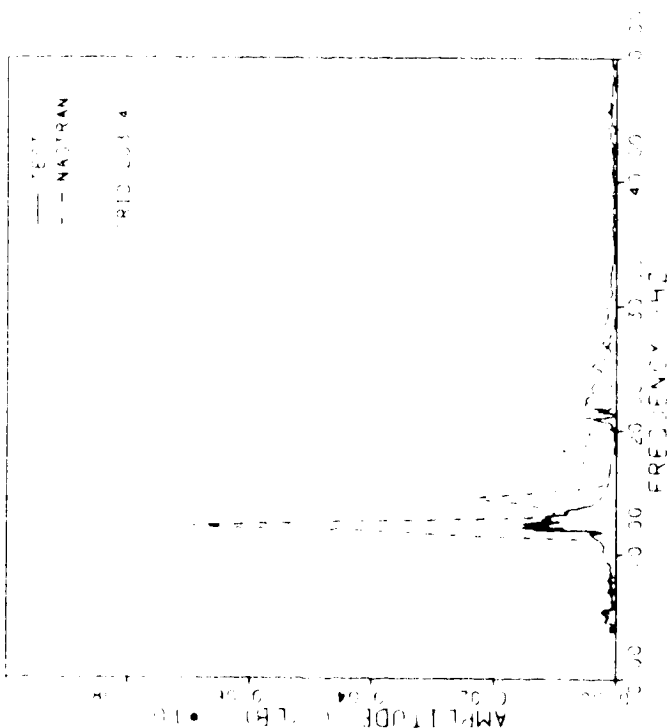
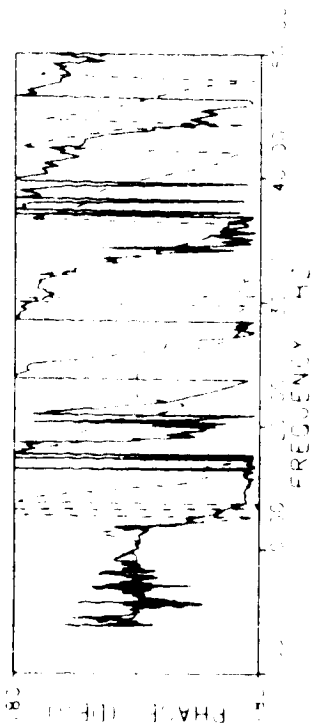

EXCITATION: LONGITUDINAL M/R MAST
STARBOARD WIND: LONGITUDINAL RESPONSE

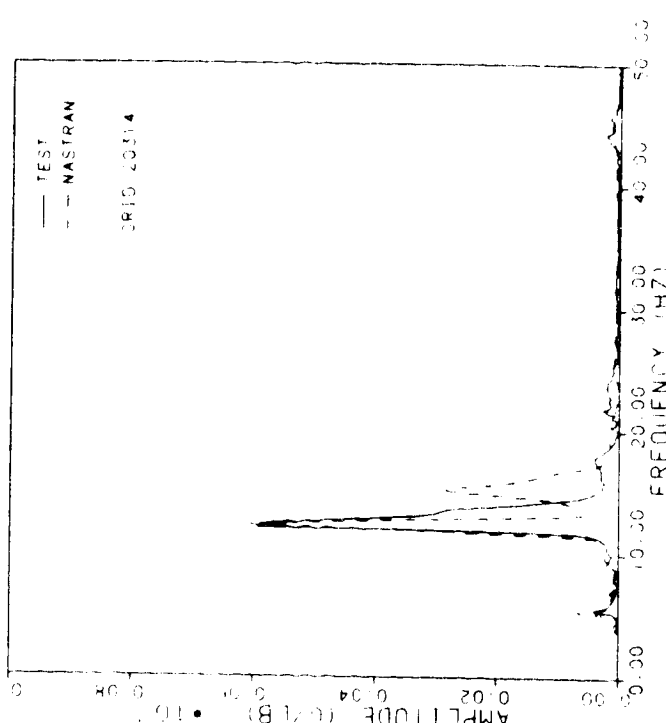
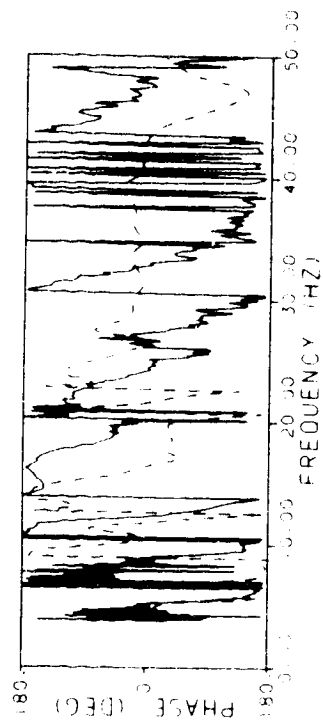

EXCITATION: LONGITUDINAL M/R MAST
STARBOARD WIND: VERTICAL RESPONSE

LONGITUDINAL EXCITATION AT M/R MAST
RESPONSE AT THE PILOT SEAT

Shown below are the longitudinal and vertical responses at the pilot seat. The dominant mode is the M/R mast longitudinal bending mode. The longitudinal response correlates well, but the vertical response calculated by NASTRAN is underdamped.

**McDonnell
Douglas
Helicopter
Company**

**LONGITUDINAL EXCITATION AT M/R MAST
RESPONSE AT THE PILOT SEAT**

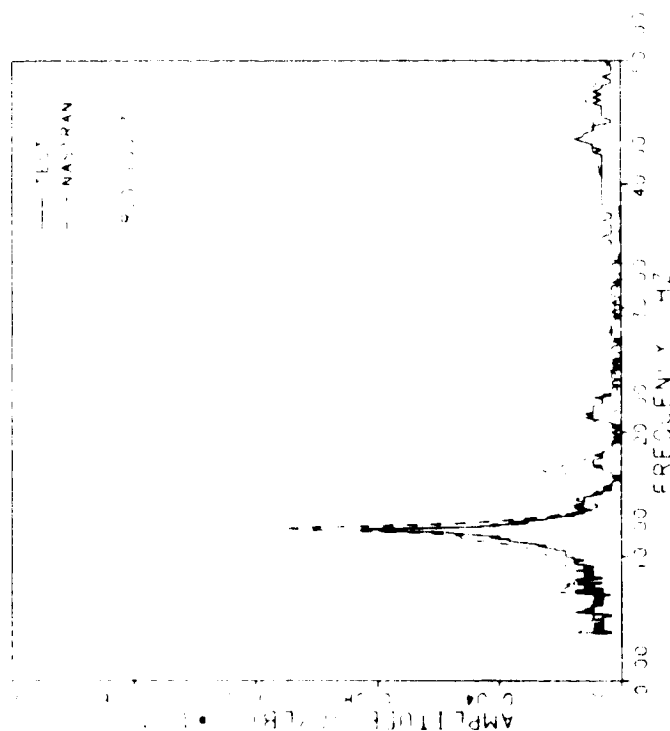
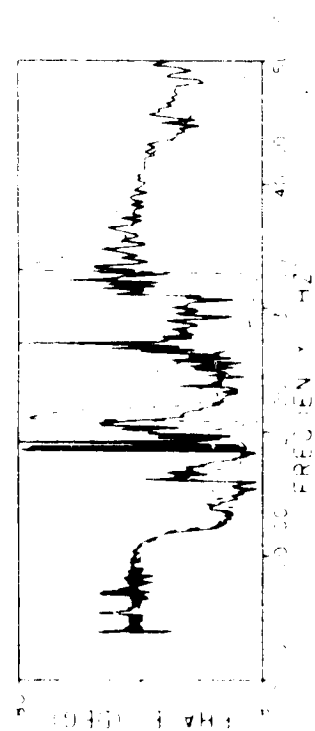

EXCITATION: LONGITUDINAL • M/R MAST 20-SEP-88
PILOT SEAT: LONGITUDINAL RESPONSE 12:52:10

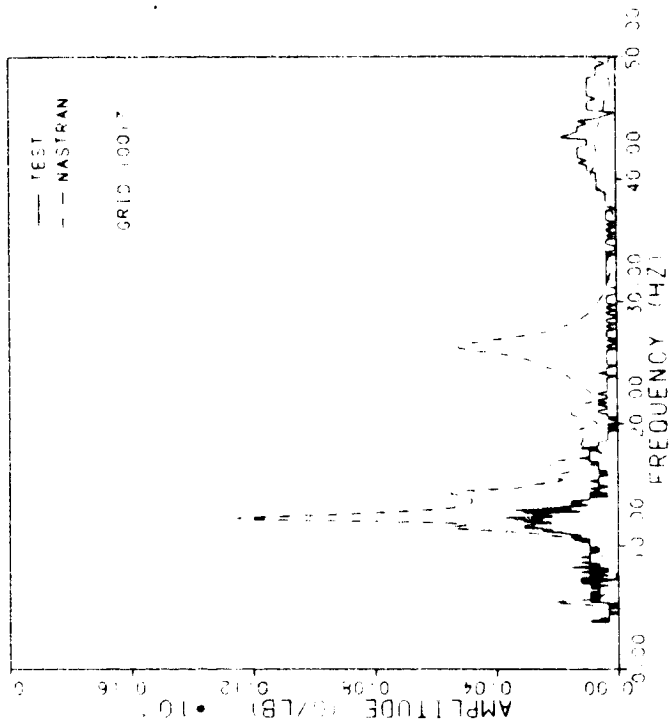
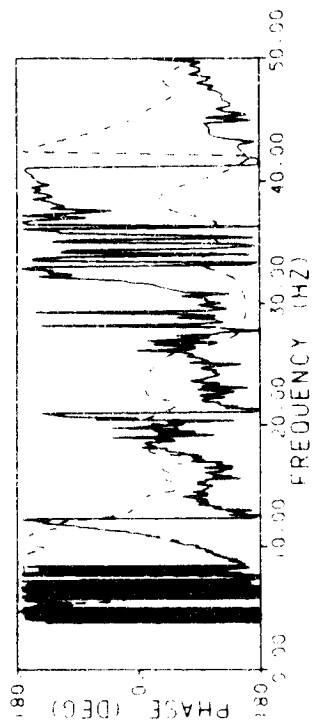

EXCITATION: LONGITUDINAL • M/R MAST 20-SEP-88
PILOT SEAT: VERTICAL RESPONSE 12:52:10

LATERAL EXCITATION AT M/R MAST
RESPONSE AT THE MAIN ROTOR HUB

Good correlation of the main rotor mast lateral bending mode is shown.

McDonnell
Douglas
Helicopter
Company

LATERAL EXCITATION AT M/R MAST
RESPONSE AT THE MAIN ROTOR HUB

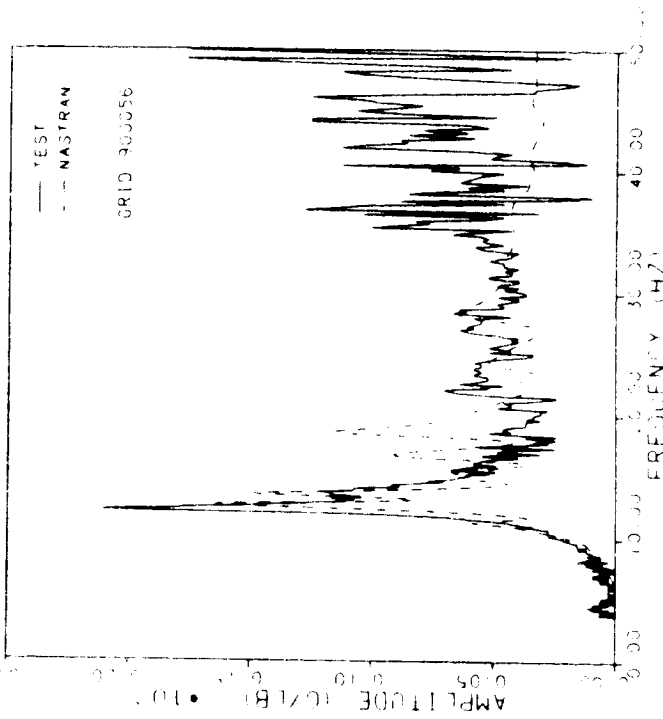
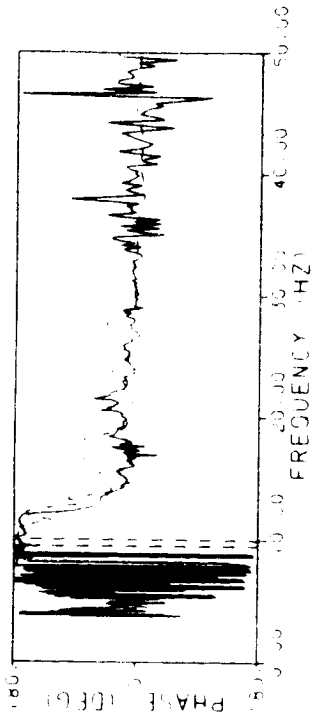
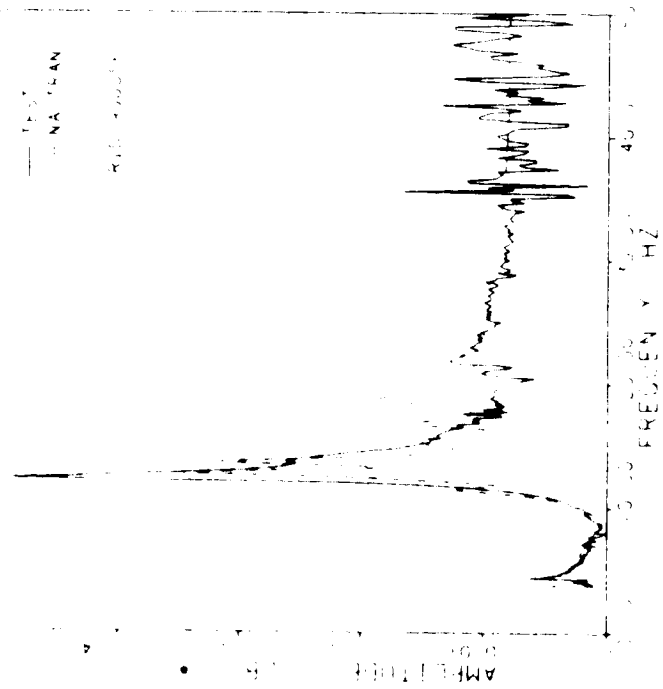
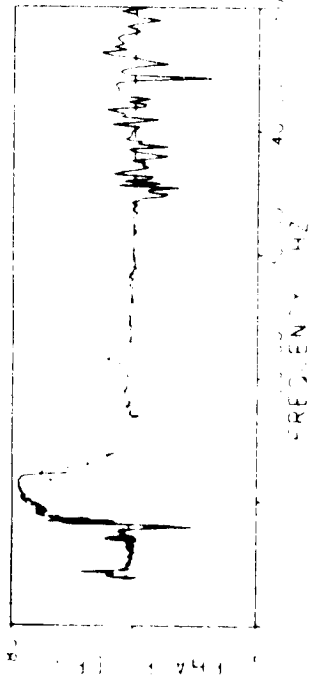

LATERAL EXCITATION AT M/R MAST
RESPONSE AT THE WING TIP

The longitudinal response of the wing tip shown at the left below indicates that the NASTRAN model is too flexible in this direction. The problem most likely resides in the connection of the wing to the fuselage or in the fuselage structure adjacent to the wing.

**McDonnell
Douglas
Helicopter
Company**

**LATERAL EXCITATION AT M/R MAST
RESPONSE AT THE WING TIP**

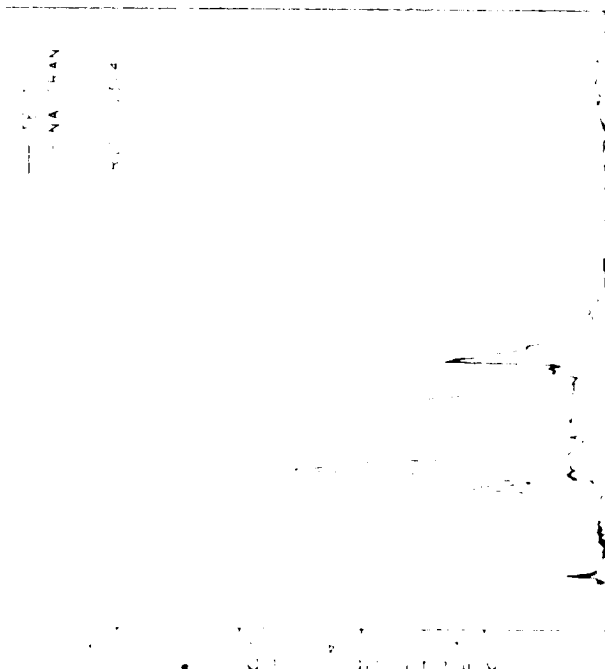
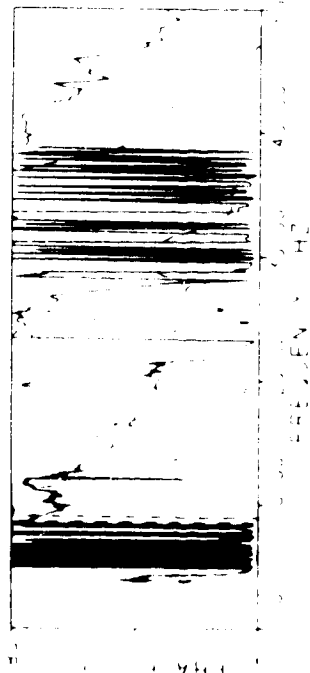

FIGURE 1. LATERAL EXCITATION AT M/R MAST
TABLE 1. WING TIP LATERAL RESPONSE

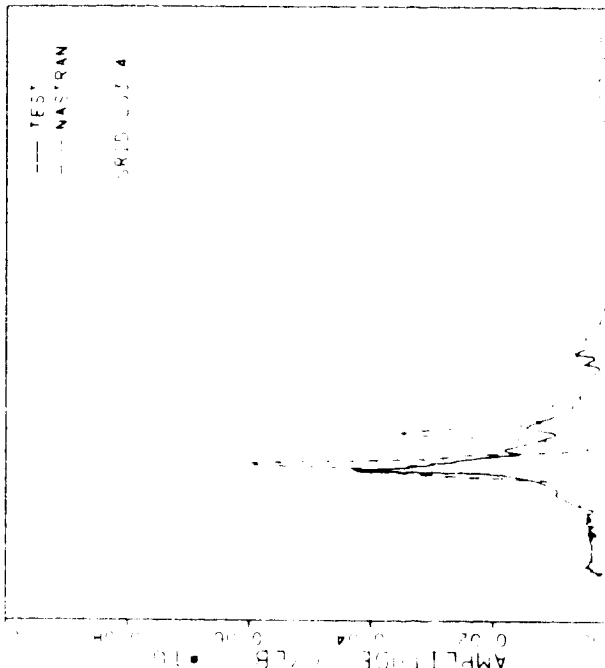
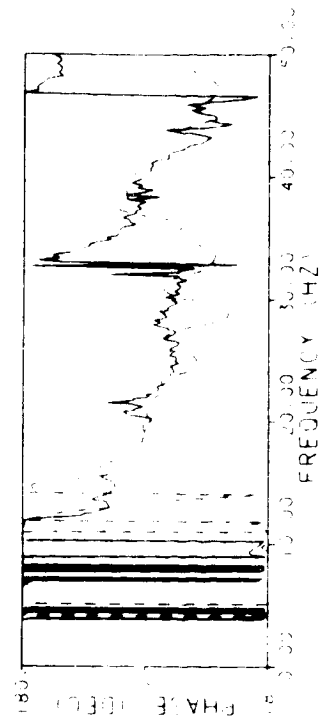

FIGURE 2. VERTICAL EXCITATION AT M/R MAST
TABLE 2. WING TIP VERTICAL RESPONSE

LATERAL EXCITATION AT M/R MAST
RESPONSE AT FUSELAGE STATION 35

This response plot shows good correlation of the tailboom torsion mode at
4.42 Hz.

McDonnell
Douglas
Helicopter
Company

LATERAL EXCITATION AT M/R MAST
RESPONSE AT FUSELAGE STATION 35

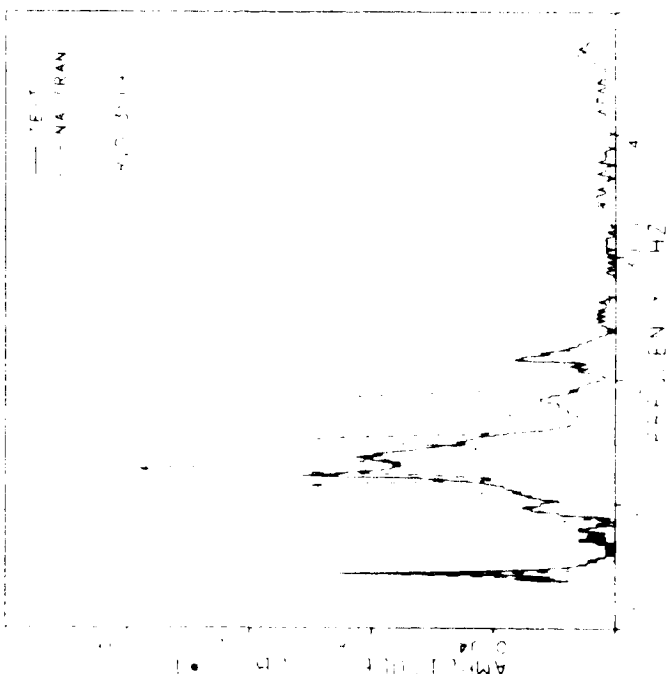
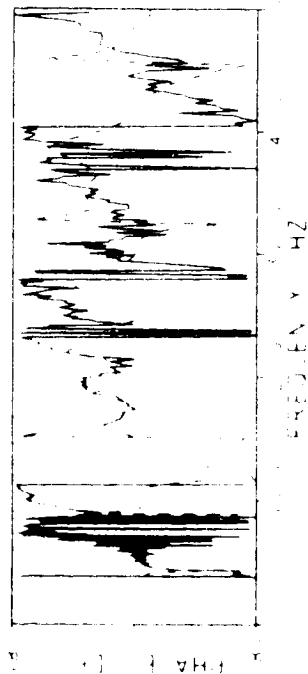

LATERAL EXCITATION AT M/R MAST
RESPONSE AT THE STABILATOR

These plots are typical of the stabilator responses. There is good correlation at the fundamental fuselage modes (in this case the tailboom torsion mode at 4.42 Hz) but the higher frequency responses do not correspond well. This is primarily due to the difficulty in properly modeling the joint which connects the stabilator to the vertical stabilizer.

McDonnell
Douglas
Helicopter
Company

LATERAL EXCITATION AT M/R MAST
RESPONSE AT THE STABILATOR

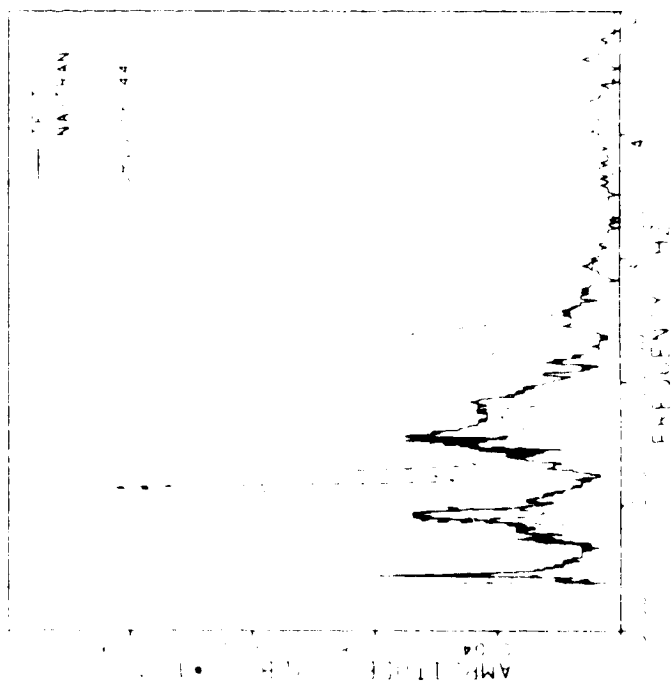
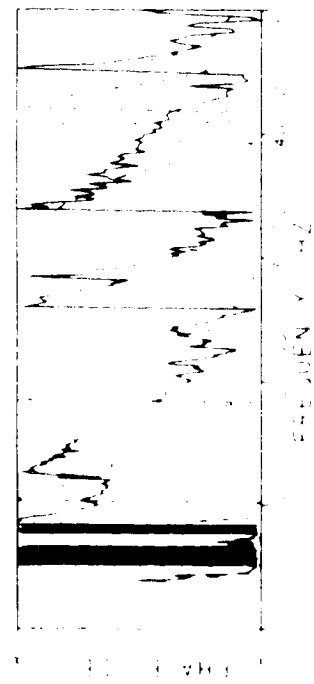

STABILATOR LATERAL RESPONSE

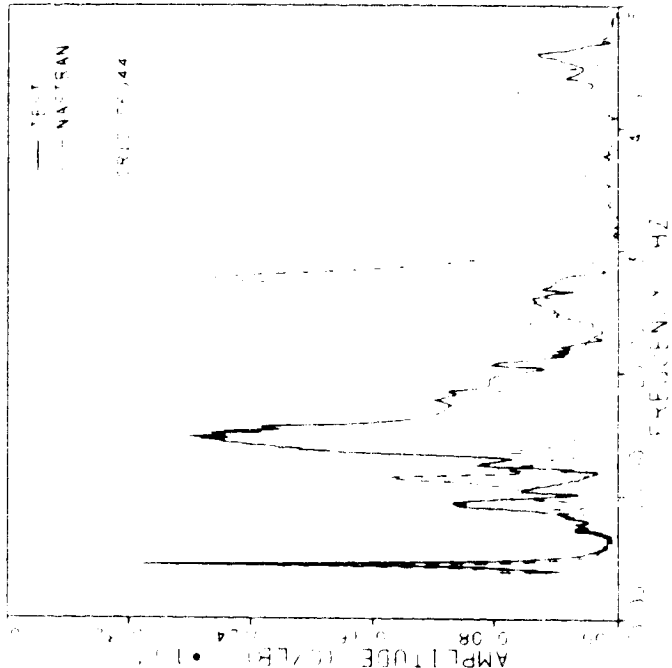
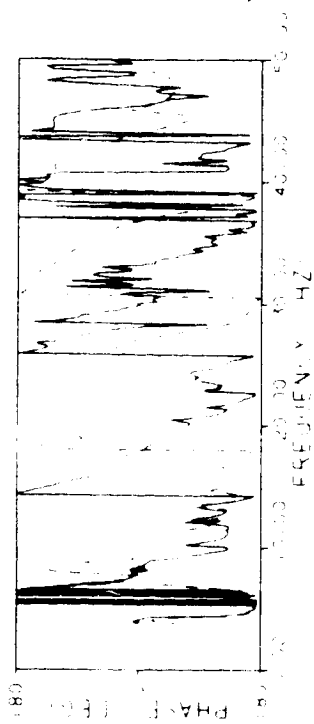

STABILATOR VERT. AL. RESPONSE

LATERAL EXCITATION AT M/R MAST
RESPONSE AT THE ENGINE

As was mentioned, the engine response was another difficult area to correlate. The engines seem to correlate well only in the coupling with the lateral main mast bending mode as shown here. Discrepancies in the responses of the engines, as with the stabilator, are probably due to simplifying assumptions in the modeling. At present, the engines are represented by rigid masses. While this approach represents well the effect of the engines on the rest of the ship, the motion of the engines themselves might not be accounted for properly.

**LATERAL EXCITATION AT M/R MAST
RESPONSE AT THE ENGINE**

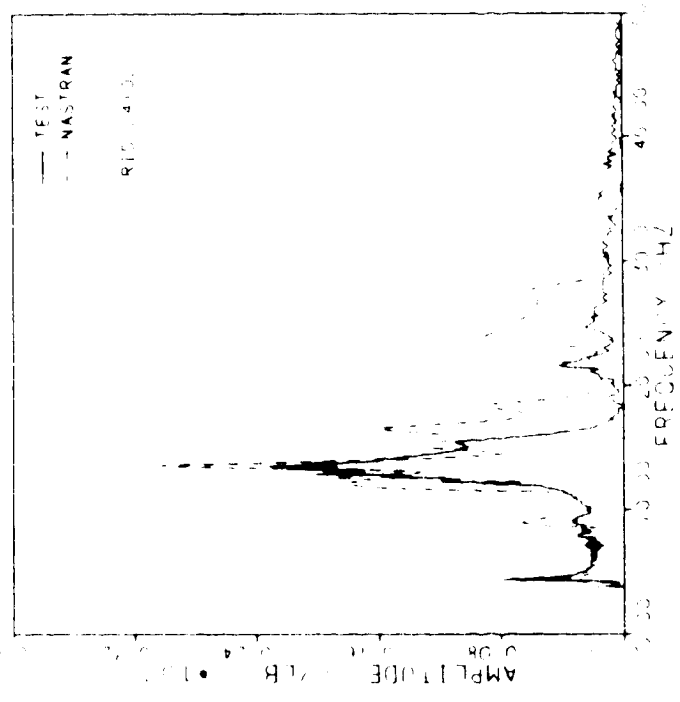
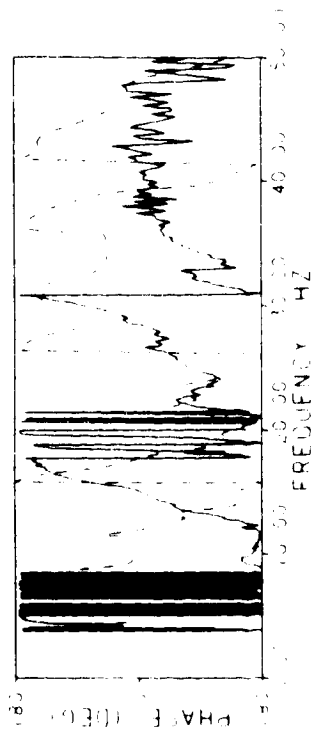

EXCITATION: LATERAL • M/R MAST • 100 LBS • 20 SECONDS
PORT ENGINE (AFT) LATERAL RESPONSE 15 58 27

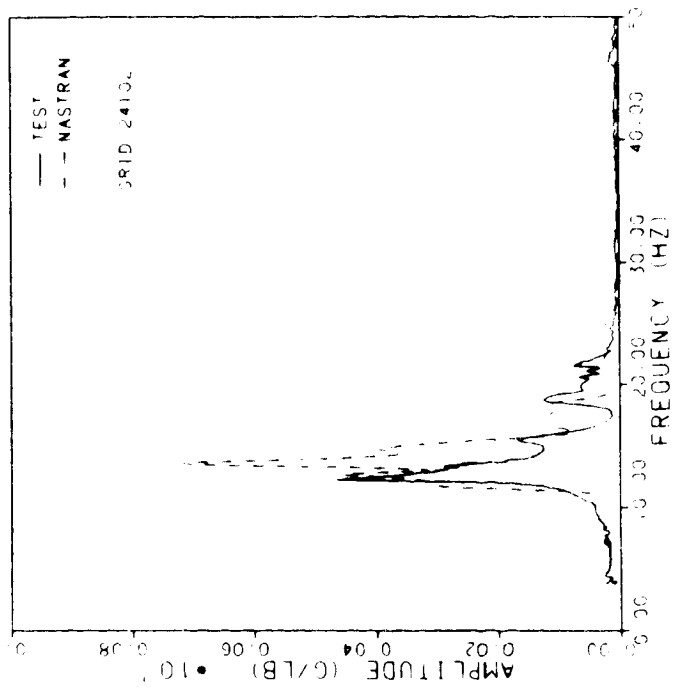
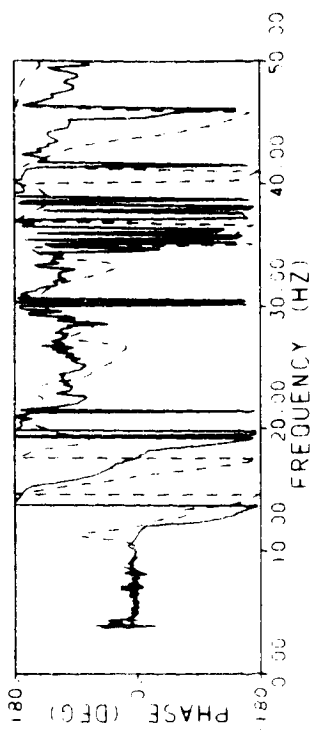

EXCITATION: LATERAL • M/R MAST • 100 LBS • 20 SECONDS
PORT ENGINE (AFT) VERTICAL RESPONSE 16 00 54

VERTICAL EXCITATION AT M/R MAST
RESPONSE AT THE VERTICAL STABILIZER

These responses show very good agreement for the first vertical bending mode and the longitudinal bending of the vertical stabilizer mode.

**McDonnell
Douglas
Helicopter
Company**

**VERTICAL EXCITATION AT M/R MAST
RESPONSE AT THE VERTICAL STABILIZER**

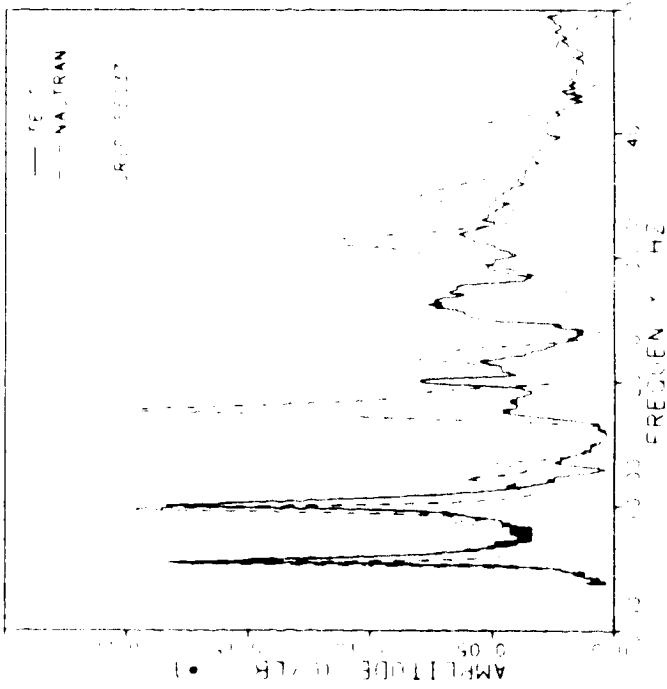
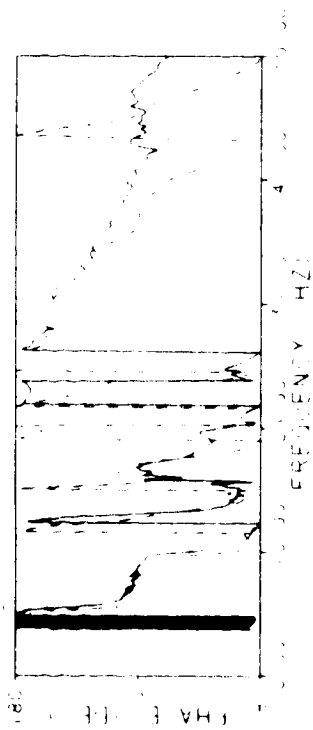

EXCITATION: VERTICAL • M/R MAST
RESPONSE: VERTICAL • VERTICAL STABILIZER

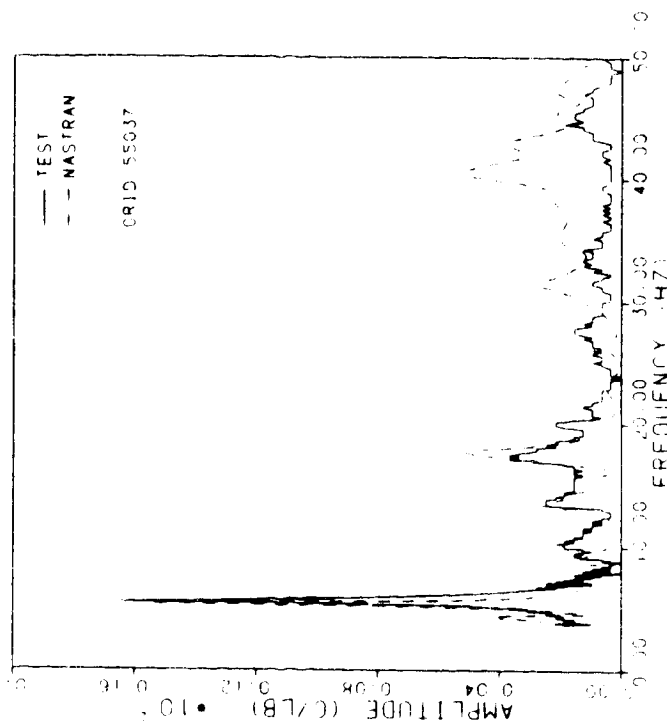
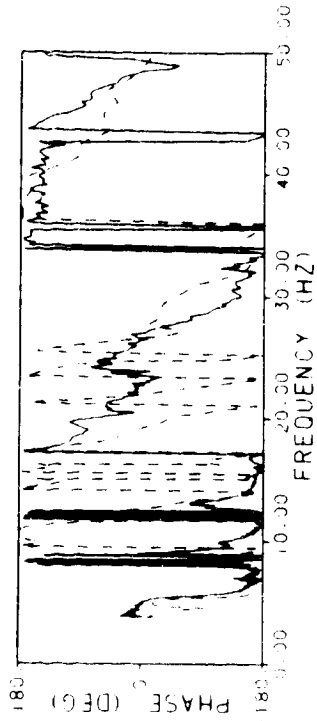

EXCITATION: VERTICAL • M/R MAST
RESPONSE: VERTICAL • VERTICAL STABILIZER

VERTICAL EXCITATION AT M/R MAST
RESPONSE AT THE MAIN ROTOR HUB

The longitudinal response shows good correlation of the longitudinal mast bending mode. While the correlation of the vertical response is not as good, the upward trend with increasing frequency is predicted by NASTRAN.

**McDonnell
Douglas
Helicopter
Company**

**VERTICAL EXCITATION AT M/R MAST
RESPONSE AT THE MAIN ROTOR HUB**

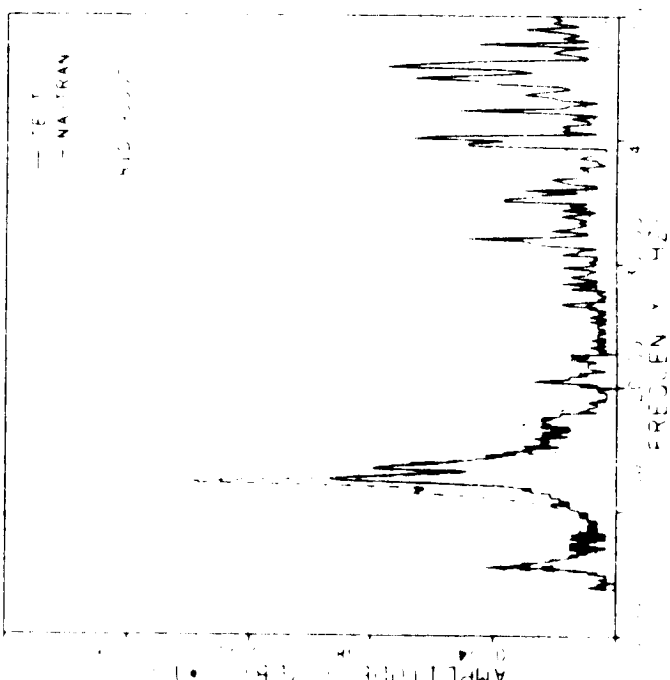
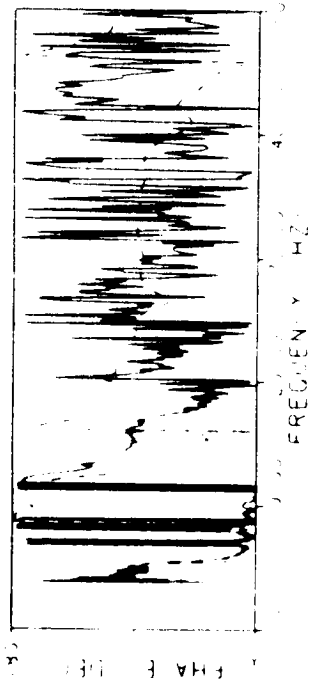

EXCITATION: VERTICAL M/R MAST
MAIN ROTOR HUB: ORIGINAL RESPONSE

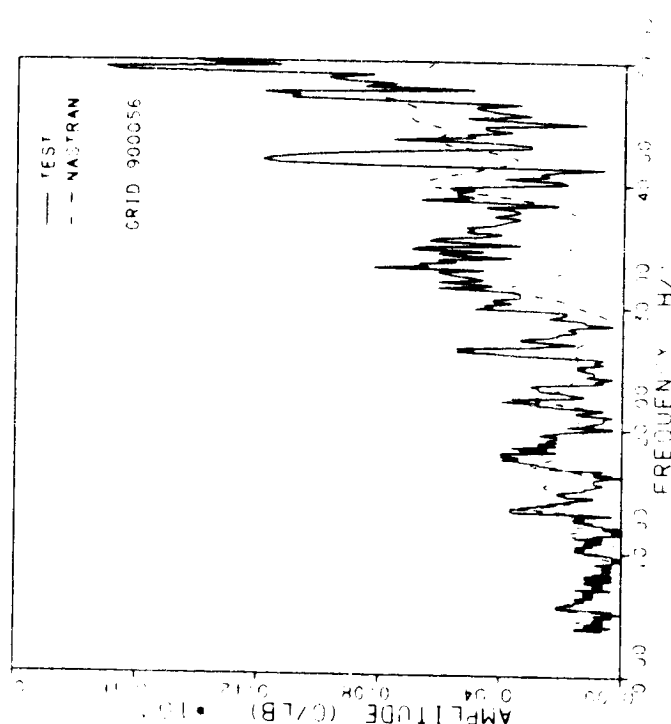
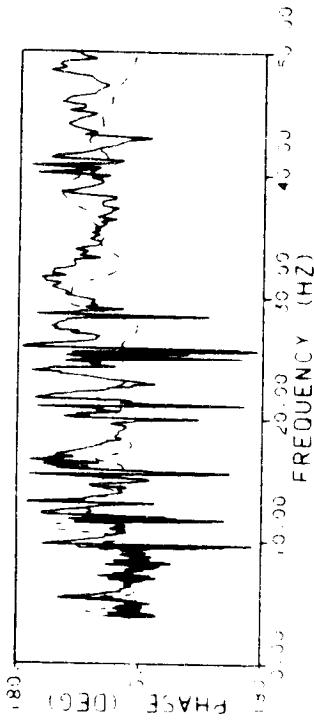

EXCITATION: VERTICAL M/R MAST
MAIN ROTOR HUB: VERTICAL RESPONSE

VERTICAL EXCITATION AT M/R MAST
RESPONSE AT THE WING TIP

Again, the wing is shown here to be too flexible in the longitudinal direction, while the vertical wing bending modes correlate well.

**McDonnell
Douglas
Helicopter
Company**

**VERTICAL EXCITATION AT M/R MAST
RESPONSE AT THE WING TIP**

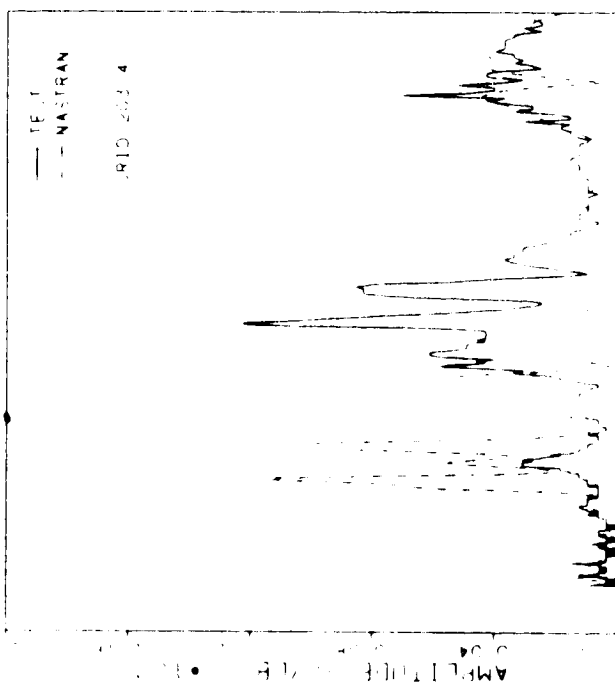
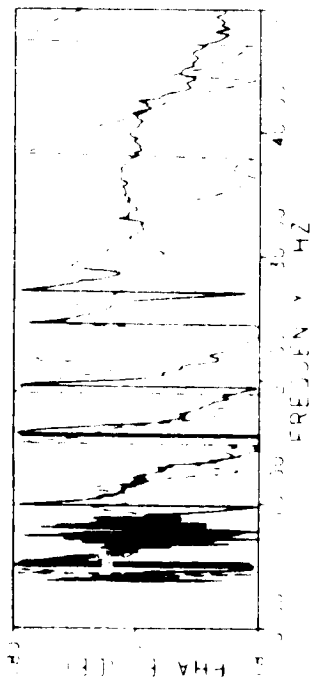

EXCITATION: VERTICAL • M/R MAST
STARBOARD WING: VERTICAL RESPONSE

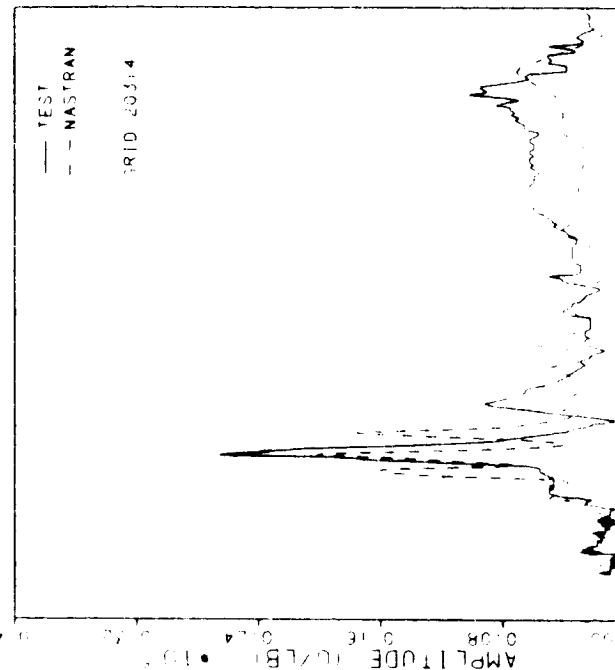
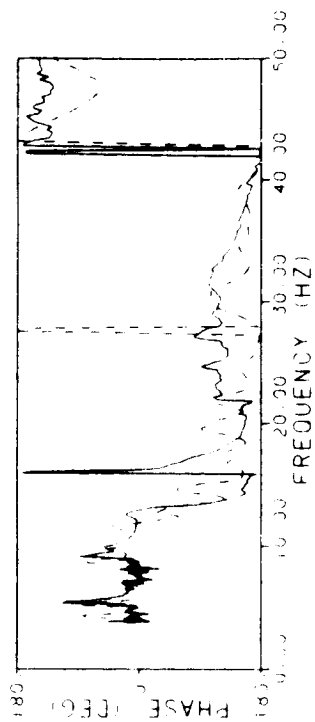

EXCITATION: VERTICAL • M/R MAST
STARBOARD WING: VERTICAL RESPONSE

VERTICAL EXCITATION AT M/R MAST
RESPONSE AT THE ENGINE

The plots shown here are more typical of the engine responses. The dominant mode in the test response is the symmetric engine pitch/second vertical bending mode which seems to have no corresponding mode in the NASTRAN analysis.

**VERTICAL EXCITATION AT M/R MAST
RESPONSE AT THE ENGINE**

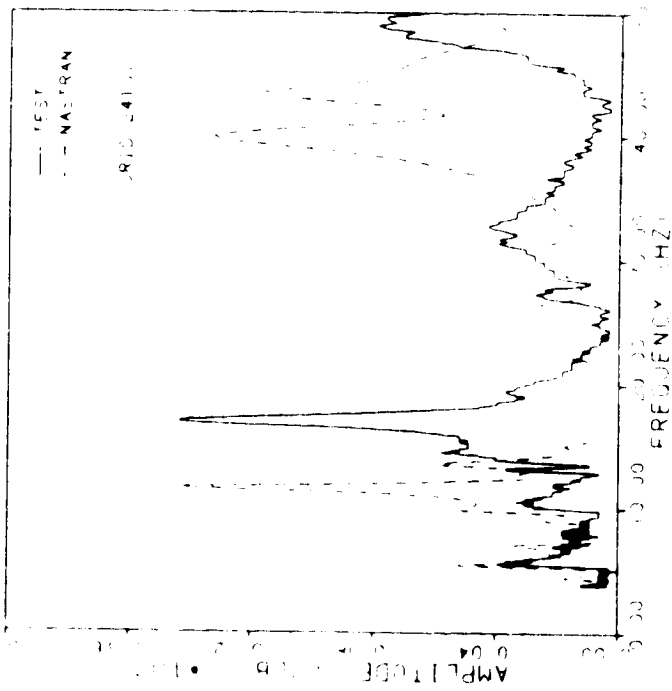
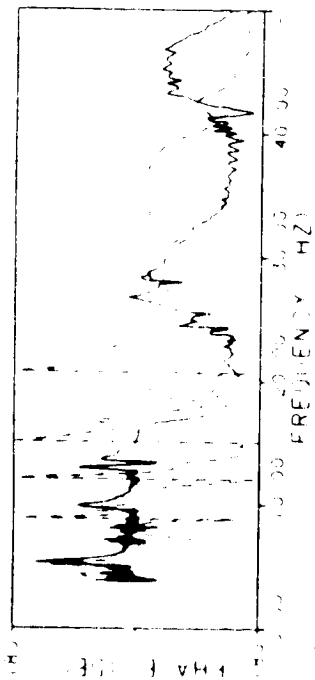

EXCITATION: VERTICAL • M/R MAST
PORT ENGINE FWD: VERTICAL RESPONSE

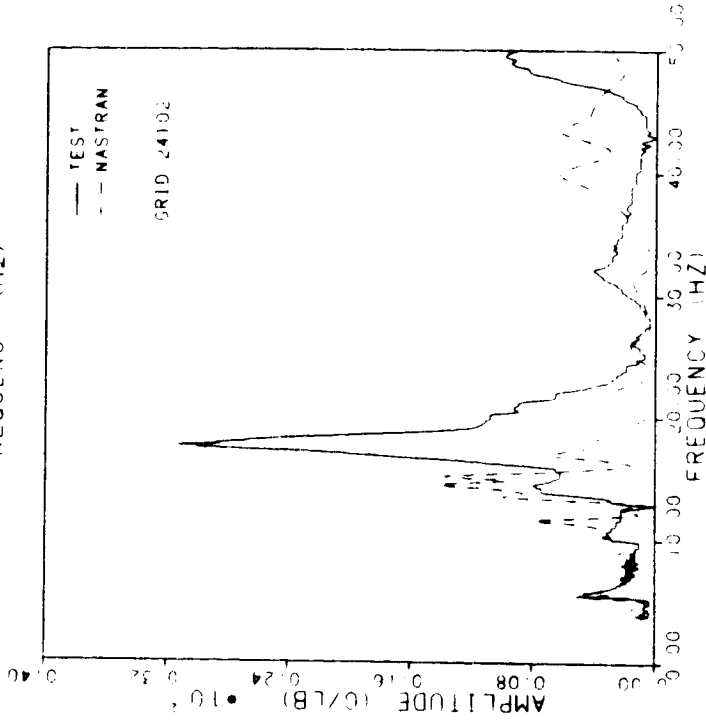
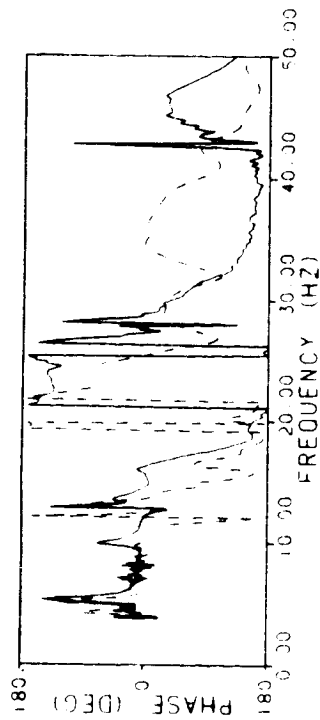

EXCITATION: VERTICAL • M/R MAST
PORT ENGINE AFT: VERTICAL RESPONSE

LATERAL EXCITATION AT TAIL ROTOR
RESPONSE AT THE VERTICAL STABILIZER AND FUSELAGE ST 35

These responses show good correlation and the dominance of the tailboom torsion mode for this excitation condition.

**McDonnell
Douglas
Helicopter
Company**

**LATERAL EXCITATION AT TAIL ROTOR
RESPONSE AT THE VERTICAL STABILIZER AND FUSELAGE ST 35**

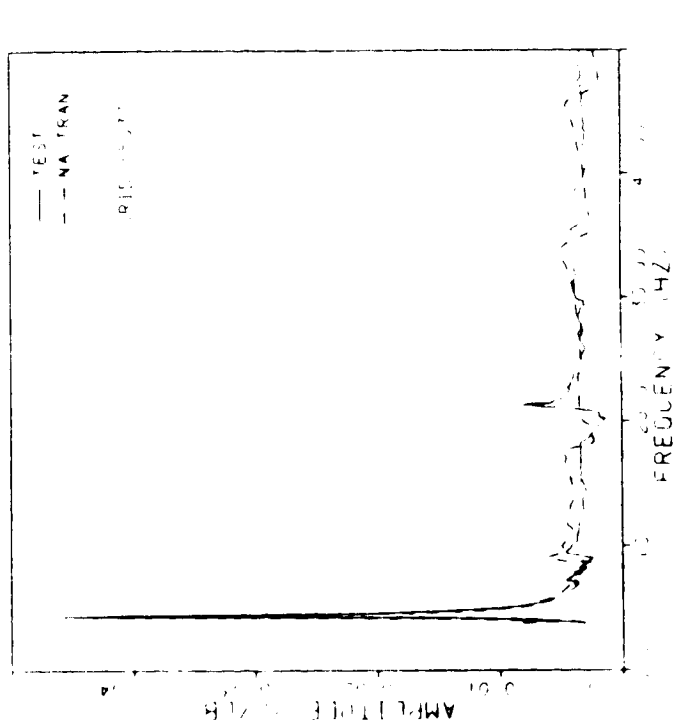
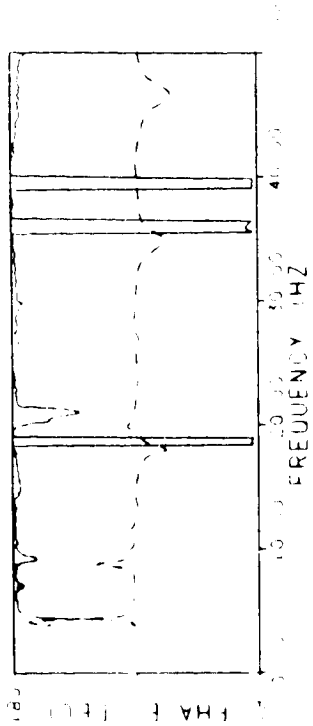

EXCITATION LATERAL • TAIL ROTOR
RESPONSE AT THE VERTICAL STABILIZER

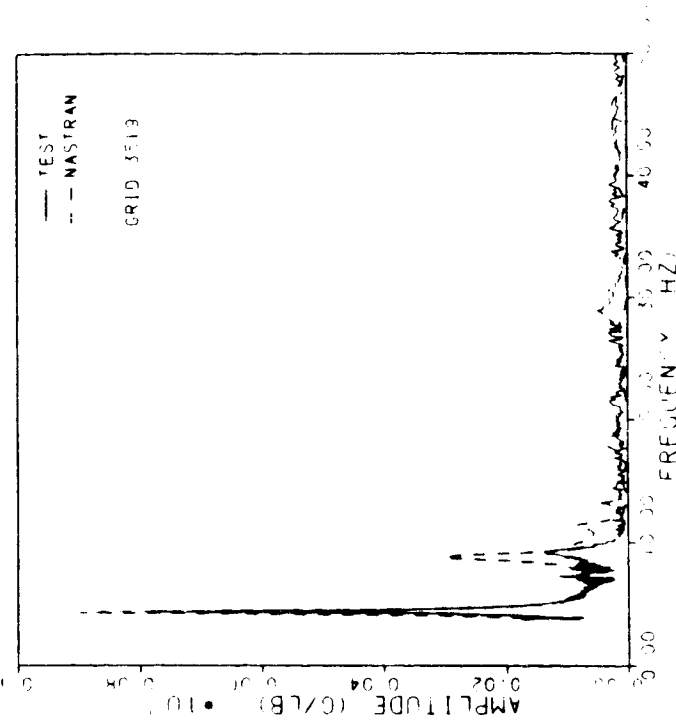
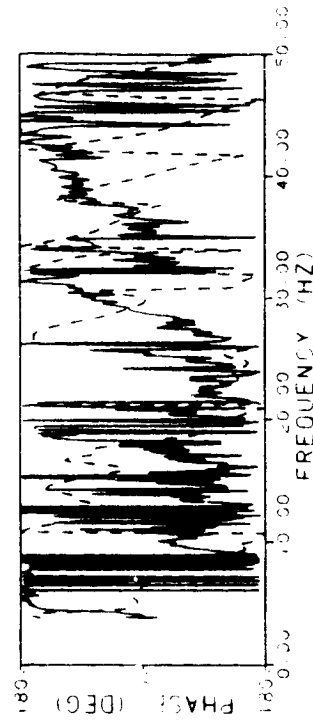

EXCITATION LATERAL • TAIL ROTOR
RESPONSE AT FUSELAGE STATION 35

VERTICAL EXCITATION AT TAIL ROTOR
RESPONSE AT THE VERTICAL STABILIZER

The longitudinal response of the vertical stabilizer is presented in the plot on the left. This response demonstrates excellent correlation of the longitudinal bending mode of the vertical stabilizer at 10.07 Hz. Both plots show very good correlation of the first vertical bending mode at 5.45 Hz.

**VERTICAL EXCITATION AT TAIL ROTOR
RESPONSE AT THE VERTICAL STABILIZER**

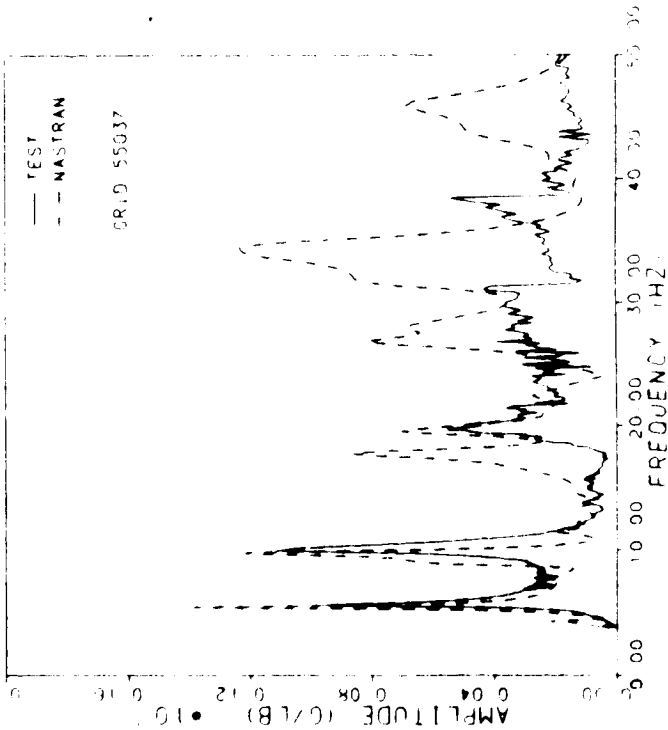
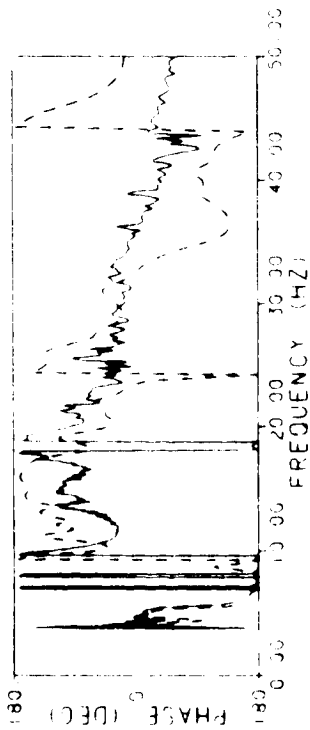

EXCITATION: VERTICAL • TAIL ROTOR 24-SEP-86
TOP OF VERTICAL: LONGITUDINAL RESPONSE 08 04 27

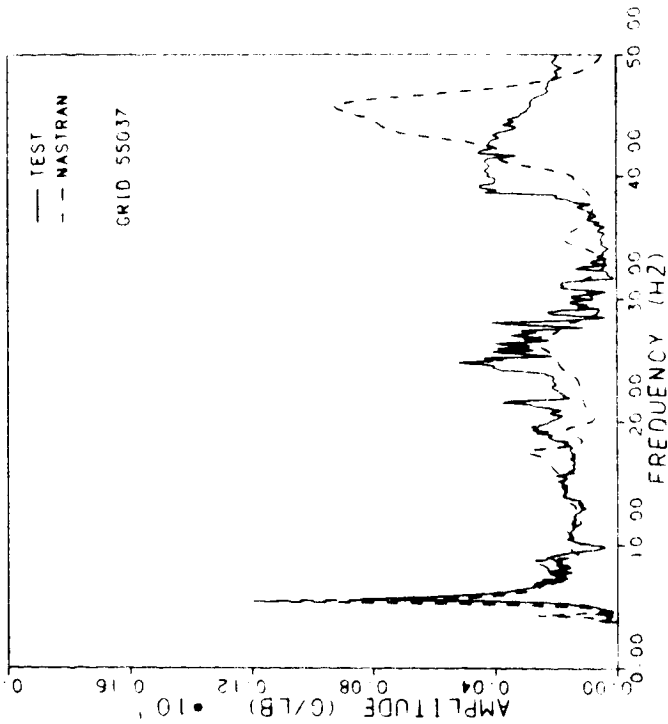
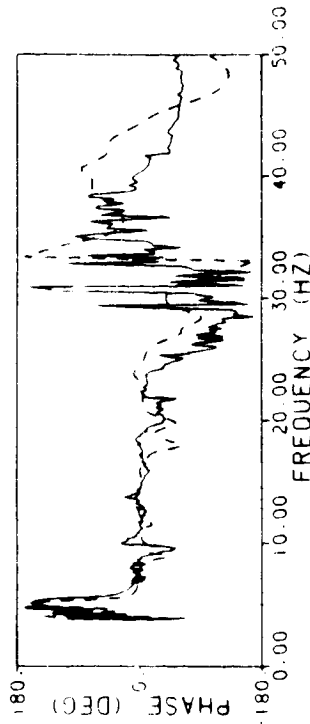

EXCITATION: VERTICAL • TAIL ROTOR 24-SEP-86
TOP OF VERTICAL: VERTICAL RESPONSE 08 10 04

CORRELATION OF NATURAL FREQUENCIES

There is very good agreement between test and analysis for the fundamental airframe modes up to 13 Hz. These are the first six modes found in the test. From 13 to 20 Hz, there is a good agreement in the two wing modes, symmetric and anti-symmetric vertical bending. This correlation was greatly improved by the modifications made to the model. The stabilator yaw mode from the test, at 20.44 Hz, corresponds well in shape to a NASTRAN mode at 17.55 Hz.

Above 20 Hz it becomes very difficult to match the analytical and experimental modes. These higher modes are more dependent on local effects and the mass density distribution which are not adequately represented in the NASTRAN model. Likewise, the test results are limited by the number and location of the accelerometers. The accompanying table gives a list of modes which have been correlated. Nine out of the fifteen modes found in the test were correlated with an analytical mode. The remaining six experimental modes were not found in the analysis. Following the table, plots are presented which compare the analytical and experimental mode shapes.

CORRELATION OF NATURAL FREQUENCIES

DESCRIPTION	FREQUENCY (HZ)	TEST	NASTRAN	Δ%
TAILBOOM TORSION	4.42	4.42	4.28	-3.2
1st VERTICAL BENDING	5.45	5.45	5.39	-1.1
1st LATERAL BENDING	9.39	9.39	8.79	-6.4
LONG BENDIGN OF VERTICAL	10.07	10.07	9.78	-2.9
LONG. M/R MAST BENDING	12.11	12.11	12.26	1.2
LAT. M/R MAST BENDING	12.48	12.48	12.74	2.1
SYMMETRIC WING BENDING	13.38	13.38	15.15	13.2
ANTI-SYMM. WING BENDING	13.85	13.85	15.37	11.0
SYMMETRIC ENGINE YAW	14.20	14.20	****	---
STABILATOR ROLL	15.31	15.31	****	---
ANTI-SYMM. ENGINE PITCH/YAW	15.93	15.93	****	---
SYMMETIRC ENGINE PITCH	17.51	17.51	****	---
STABILATOR YAW	20.44	20.44	17.78	-13.0
LONG. ANTI-SYMM. WING BENDING	22.14	22.14	****	---
STABILATOR YAW/ROLL	25.46	25.46	****	---

**** CORRESPONDING ANALYTICAL MODES WERE NOT FOUND FOR THESE EXPERIMENTAL MODES.

MODE SHAPE COMPARISON
TAILBOOM TORSION

The following slide shows a comparison between test and analysis for the tailboom torsion mode. There is excellent agreement in both shape and frequency. The end view for the NASTRAN plot is from the rear, while the test plot is viewed from the front. Hence the tail rotor appears to be reversed. Also, the front view of the test plot is at a slight angle to the longitudinal axis and the perspective is slightly exaggerated. Again, it should be noted that while the NASTRAN modes are true free vibration modes, the experimental modes are actually forced response mode shapes. However, these 'forced modes' closely approximate free vibration modes, especially at lower frequencies.

McDonnell
Douglas
Helicopter
Company

MODE SHAPE COMPARISON
TAILBOOM TORSION

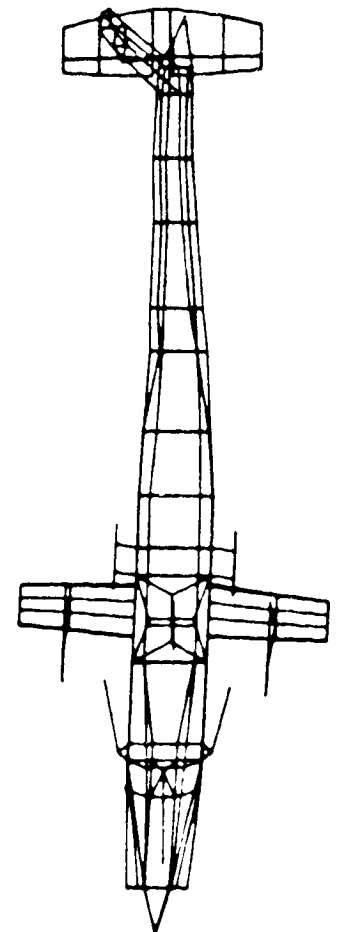
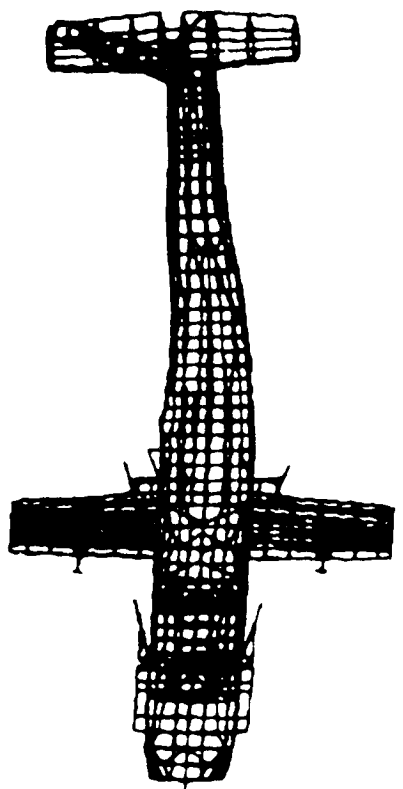
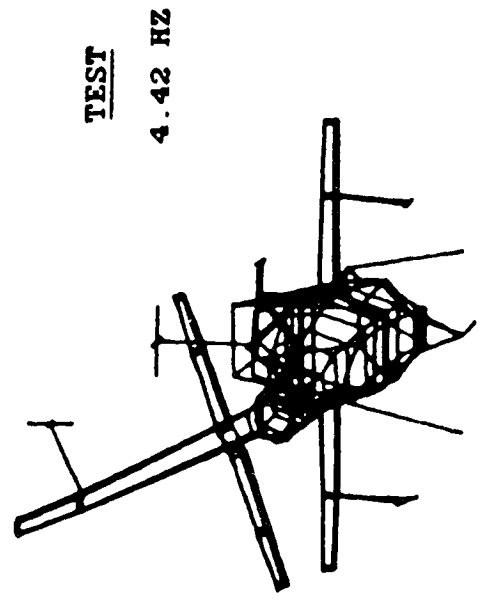
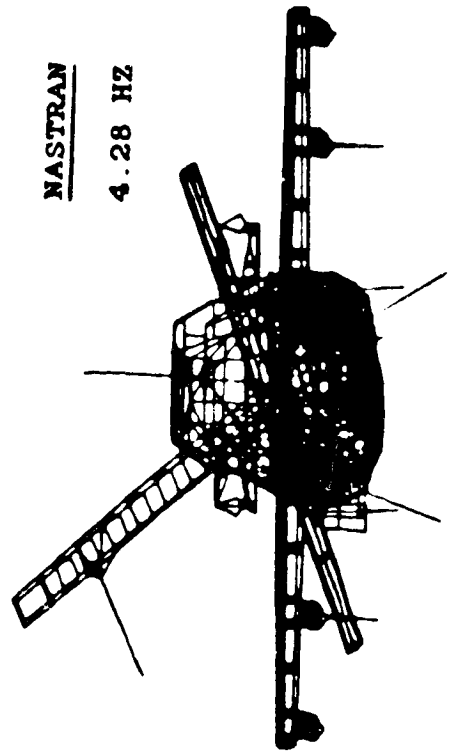

MODE SHAPE COMPARISON
FIRST VERTICAL BENDING

The comparison for the first vertical bending mode again shows excellent correspondence between test and analysis.

McDonnell
Douglas
Helicopter
Company

MODE SHAPE COMPARISON
FIRST VERTICAL BENDING

NASTRAN

5.39 HZ

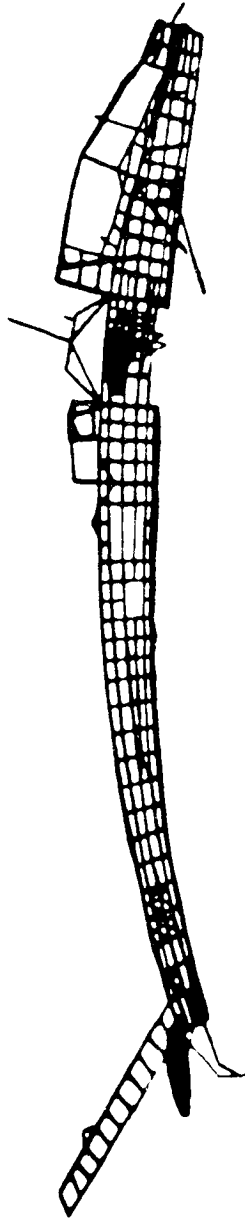

TEST

5.45 HZ

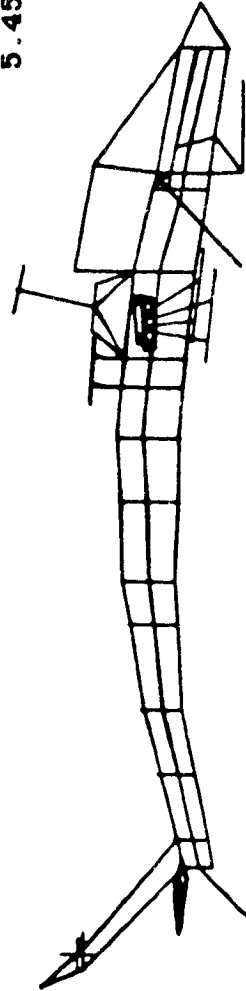

MODE SHAPE COMPARISON
FIRST LATERAL BENDING

The first lateral bending mode shown here compares well in every detail except for the engines. The NASTRAN model indicates significant lateral engine motion, while the test results show the engines to be motionless.

McDonnell
Douglas
Helicopter
Company

MODE SHAPE COMPARISON
FIRST LATERAL BENDING

NASTRAN

8.79 HZ

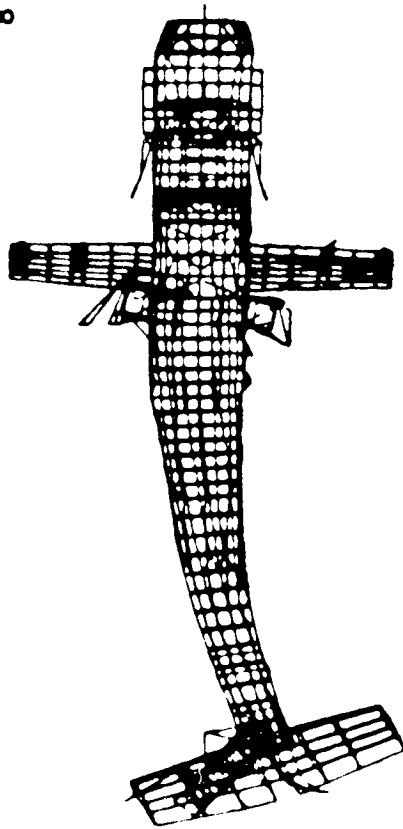

TEST

9.39 HZ

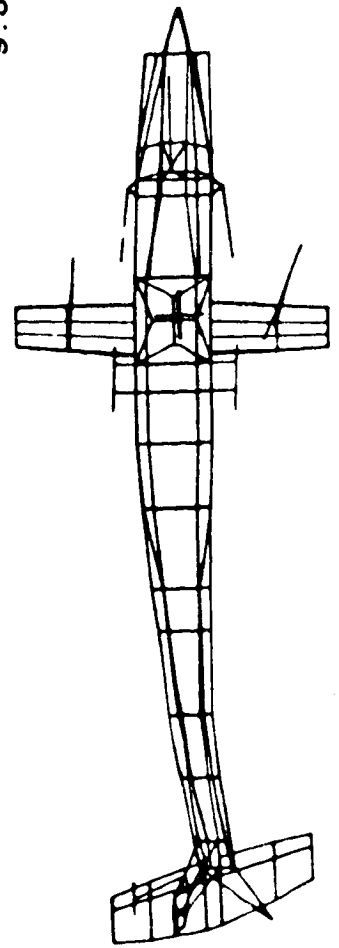

MODE SHAPE COMPARISON
LONGITUDINAL BENDING OF THE VERTICAL STABILIZER

The 'longitudinal bending of the vertical stabilizer' mode shape also compares quite well.

McDonnell
Douglas
Helicopter
Company

MODE SHAPE COMPARISON
LONGITUDINAL BENDING OF THE VERTICAL STABILIZER

NASTRAN
9.78 HZ

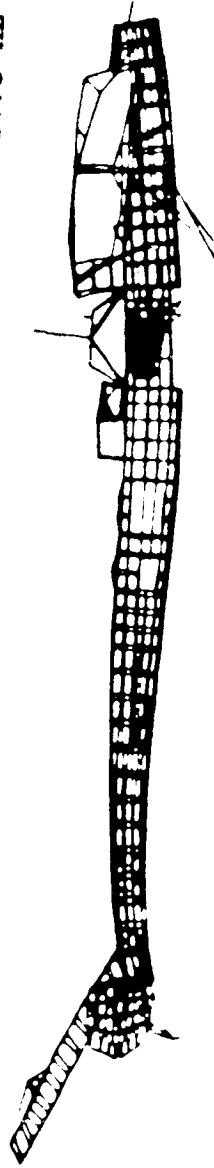

TEST
10.07 HZ

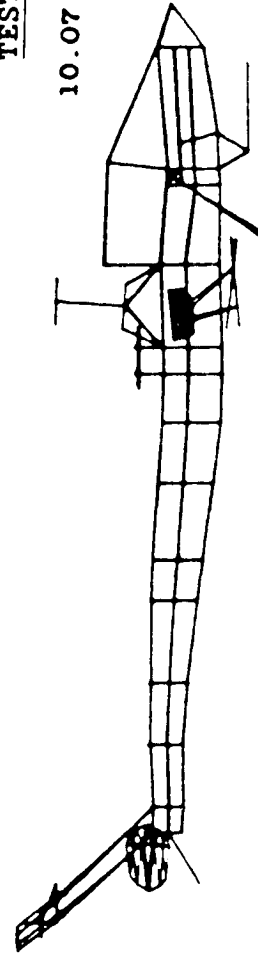

MODE SHAPE COMPARISON
LONGITUDINAL M/R MAST BENDING

Although shown 180 degrees out of phase, the good correspondence of the longitudinal M/R mast bending mode is still apparent. The major discrepancies are the longitudinal motions of the wings and the vertical stabilizer.

McDonnell
Douglas
Helicopter
Company

MODE SHAPE COMPARISON
LONGITUDINAL M/R MAST BENDING

NASTRAN
12.26 HZ

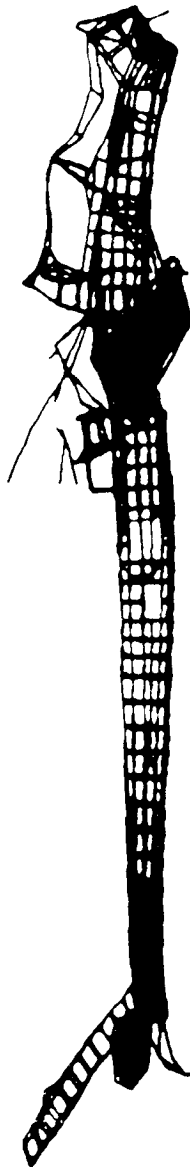

TEST
12.11 HZ

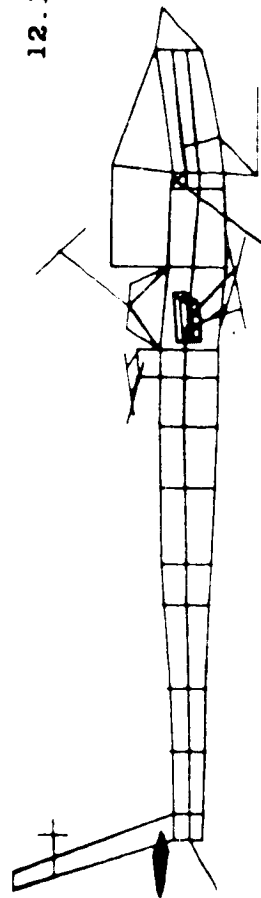

MODE SHAPE COMPARISON
LATERAL M/R MAST BENDING

This figure compares the lateral M/R mast bending mode as viewed from the rear. Good correspondence is seen in the mast and wing motion. Although it is difficult to discern, there is also good correspondence in the engine motion.

McDonnell
Douglas
Helicopter
Company

MODE SHAPE COMPARISON
LATERAL M/R MAST BENDING



MASTRAN
12.74 HZ

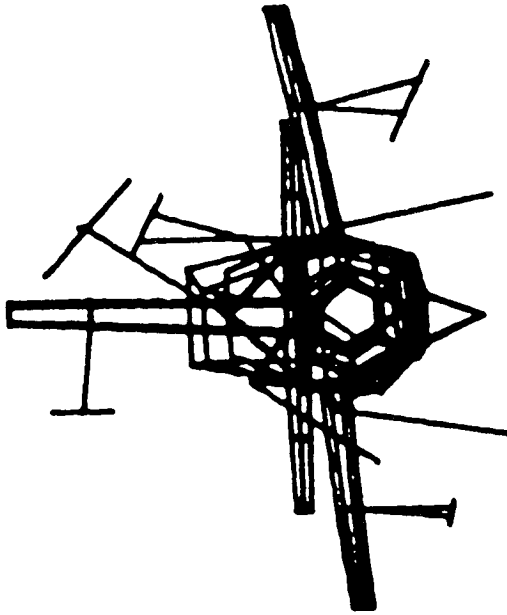

TEST
12.48 HZ

MODE SHAPE COMPARISON
SYMMETRIC WING BENDING

Shown in the following figure is the symmetric wing bending mode. Although NASTRAN indicates a somewhat higher frequency, there is good correlation of the mode shape.

McDonnell
Douglas
Helicopter
Company

MODE SHAPE COMPARISON
SYMMETRIC WING BENDING

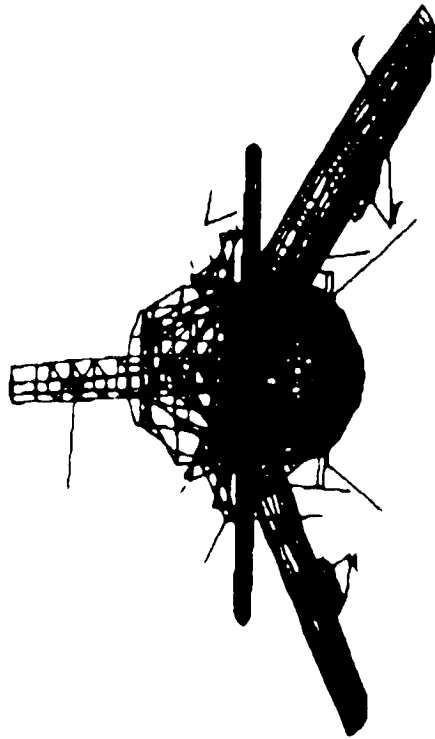

NASTRAN

15.15 HZ

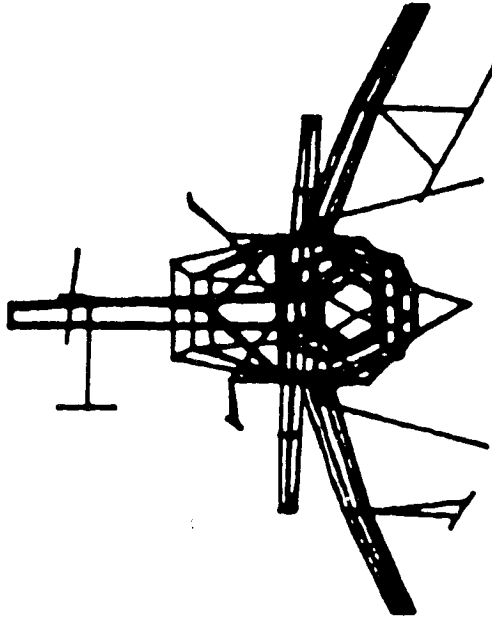

TEST

13.58 HZ

MODE SHAPE COMPARISON
ANTI-SYMMETRIC WING BENDING

As with the symmetric wing bending mode, the anti-symmetric wing bending mode compares well in shape although the analytical frequency is higher than that measured in the test.

McDonnell
Douglas
Helicopter
Company

MODE SHAPE COMPARISON
ANTI-SYMMETRIC WING BENDING



NASTRAN
15.37 HZ

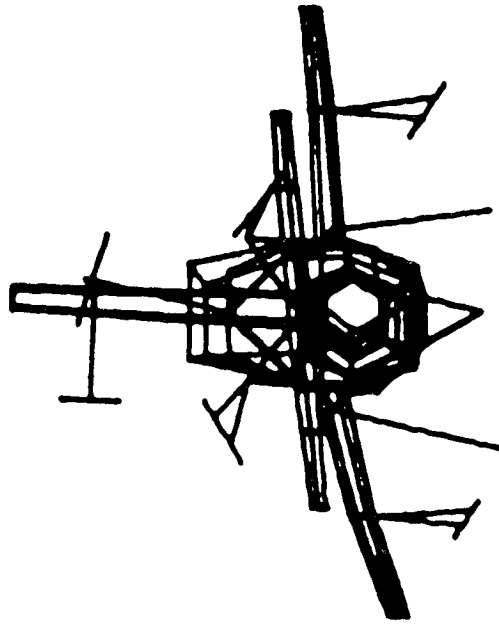

TEST
13.85 HZ

MUDE SHAPE COMPARISON
STABILATOR YAW

Finally, very good correlation was obtained for the stabilator yaw mode, at least in terms of shape. This is evident from the figure even though they are shown 180 degrees out of phase. Despite the good shape comparison, there is a significant discrepancy in the frequency.

McDonnell
Douglas
Helicopter
Company

MODE SHAPE COMPARISON
STABILATOR YAW

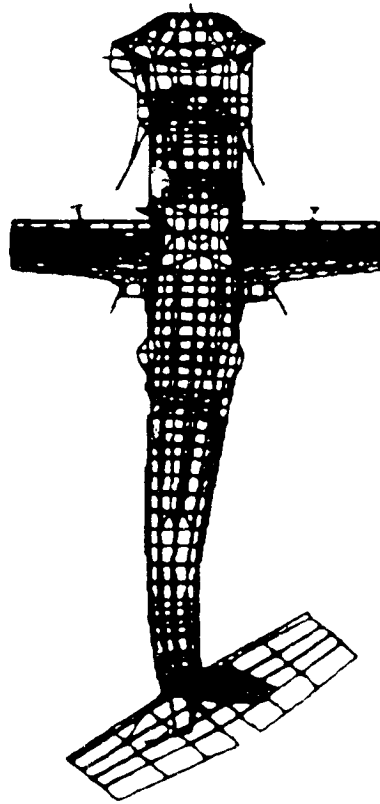

NASTRAN
17.78 HZ

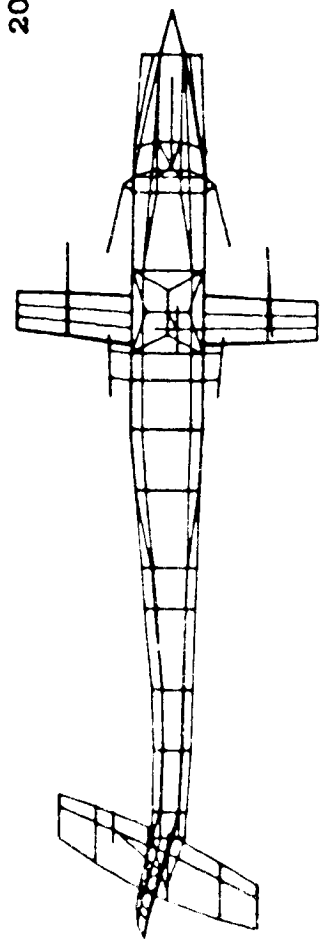

TEST
20.44 HZ

7. EXPERIENCES OF THE SHAKE TEST
AND CORRELATION

183

PROCEEDINGS OF THE SOCIETY FOR EXPERIMENTAL MECHANICS

PAGE 183 INTENTIONALLY BLANK

GENERAL EXPERIENCES

The experience gained from the shake test falls into two categories. The first category is the experience gained which was independent of the test results: that is, experience gained merely from planning and performing the test, as well as working with the finite element model. The shake test and correlation program provided the opportunity for gaining such experience. The second category is the experience which was gained by working with the experimental data. This second category can be further divided into two groups. The first group is related to the finite element model of the test vehicle and the second is applicable to any finite element model and dynamic analysis. The following pages provide some examples of each of these experiences.

**McDonnell
Douglas
Helicopter
Company**

GENERAL EXPERIENCES

- EXPERIENCES INDEPENDENT OF EXPERIMENTAL DATA.
- EXPERIENCES BASED ON TEST RESULTS.
- SPECIFIC EXPERIENCE APPLICABLE ONLY TO TEST VEHICLE
FINITE ELEMENT MODEL AND ITS DYNAMIC ANALYSIS.
- GENERAL EXPERIENCE APPLICABLE TO ANY DYNAMIC ANALYSIS
AND FUTURE PRACTICE.

EXPERIENCE GAINED INDEPENDENT FROM TEST RESULTS
LEVELS OF EXCITATION

The levels of excitation were chosen on the following basis. The magnitude of the excitation force or moment was held constant over the entire frequency range. It was therefore unfeasible to use forcing levels equivalent to actual 4/rev flight loads as this may have caused damage at the lower frequencies. On the other hand, it was necessary to use forcing levels sufficiently high to adequately excite the aircraft. For force excitation at both the main rotor and tail rotor locations, the force level used adequately satisfied these opposing requirements. For moment excitation, the excitation level used was somewhat on the low side. The responses obtained for the moment inputs were much lower than those obtained for the force inputs and therefore of a slightly lesser quality.

In the future, it is recommended that a shake test include a dwell test at 4/rev with forcing levels representative of actual flight loads. Results from such a test would be useful in correlating with flight test vibration surveys and in better gauging the nonlinearity of response to force level.

McDonnell
Douglas
Helicopter
Company

EXPERIENCE GAINED INDEPENDENT FROM TEST RESULTS
LEVELS OF EXCITATION

- LEVELS OF EXCITATION FOR FORCE INPUTS WERE GENERALLY ADEQUATE:
 - LOW ENOUGH TO AVOID CAUSING DAMAGE
 - HIGH ENOUGH TO OBTAIN GOOD RESULTS
- LEVELS OF EXCITATION FOR MOMENT INPUTS WERE LOW
- FOR FUTURE SHAKE TESTS: DWELL AT 4/REV WITH FORCE LEVELS REPRESENTATIVE OF ACTUAL FLIGHT LOADS

EXPERIENCE GAINED INDEPENDENT FROM TEST RESULTS
USING FIXED ACCELEROMETERS

The use of a large number of fixed accelerometers proved to be much more effective than a few roving accelerometers, as was previous practice at MDHC. The chief reasons for this are as follows. Accurate positioning was made possible in a minimum amount of time, and errors in mounting and polarity were minimized because the accelerometers remained fixed in position. The time required for testing was greatly reduced because only one frequency sweep was necessary for each test configuration. For these reasons, the cost of the accelerometers (\$20,000) was more than offset by savings in the labor costs.

**McDonnell
Douglas
Helicopter
Company**

**EXPERIENCE GAINED INDEPENDENT FROM TEST RESULTS
USING FIXED ACCELEROMETERS**

- USE OF A LARGE NUMBER OF FIXED ACCELEROMETERS
INSTEAD OF A FEW ROVING ACCELEROMETERS WAS
SUCCESSFUL.

- COST EFFECTIVE
- ACCURATE POSITIONING
- MINIMIZE ERROR IN MOUNTING AND POLARITY
- REDUCE TIME REQUIRED FOR TESTING
- COST OF ACCELEROMETERS (\$20,000) MORE THAN OFFSET BY
SAVINGS IN LABOR COSTS

EXPERIENCE GAINED INDEPENDENT FROM TEST RESULTS
FINITE ELEMENT ANALYSIS

The post processing medium should be considered when designing a system for finite element modeling. The numbering system used in preparing the finite element model of the AH-64A was not suitable for efficient use of PATRAM as a post processor, making the use of PATRAM much slower.

Errors which have a negligible effect on the static analysis may grossly affect the dynamic behavior. For example, the left wing was modeled and then the right wing model was produced from the left by symmetry. In this process the signs of the products of inertia of elements were not changed. Although the effect was small for statics, it caused non-symmetric dynamic behavior of the wings.

Documentation of changes to a finite element model is essential. Particularly in a large model, lack of proper documentation of alterations can create undetected errors. Usage of "difference files" appended to the beginning of the newer version is recommended.

**McDonnell
Douglas
Helicopter
Company**

EXPERIENCE GAINED INDEPENDENT FROM TEST RESULTS
FINITE ELEMENT ANALYSIS

- FINITE ELEMENT MODELING GUIDELINES SHOULD CONSIDER POST PROCESSING REQUIREMENTS.
- ERRORS WHICH HAVE NEGLIGIBLE EFFECT ON STATIC RESULTS MAY GROSSLY ALTER DYNAMIC BEHAVIOR.
- DOCUMENTATION OF ALTERATIONS MADE TO A FEM IS BEST DONE BY GENERATING AND APPENDING A DIFFERENCE FILE TO THE BEGINNING OF THE NEWER VERSION.

USING THE TEST RESULTS TO ENHANCE THE APACHE FINITE ELEMENT MODEL

Shake test results can be used to refine an existing finite element model. This can be done by using comparisons of experimental and analytical results. This comparison initially indicates that there are errors in the model and sometimes points to probable locations where modeling errors may reside. If the error has been caused by an incorrect assumption, then the comparison provides a clue as to the direction in which the modeling assumptions have to be modified. Finally, it provides a yard stick against which the degree of enhancement could be measured. The following pages provide some examples of each of these functions.

McDonnell
Douglas
Helicopter
Company

USING TEST RESULTS TO ENHANCE THE APACHE FINITE ELEMENT MODEL

TEST RESULTS ARE USED TO REFINE THE FINITE ELEMENT MODEL SINCE THEY:

- POINT OUT ERRORS IN THE FINITE ELEMENT MODEL.
- POINT TO LOCATION OF THE MODELING ERRORS.
- INDICATE DIRECTION IN WHICH THE MODELING ASSUMPTIONS SHOULD BE MODIFIED.
- PROVIDE A YARD STICK AGAINST WHICH THE DEGREE OF ENHANCEMENT COULD BE MEASURED.

USING THE TEST RESULTS TO ENHANCE THE APACHE FINITE ELEMENT MODEL
ERROR INDICATION

Initial comparison of the frequency response curves obtained from the test with those predicted by the analysis indicated that, for some cases, there were serious discrepancies between the two sets of results. The most severe problems appeared to be in the responses of the wings, the engines and the stabilator. Shown in the figure below is the response of the wing tip in the vertical direction.

McDonnell
Douglas
Helicopter
Company

USING THE TEST RESULTS TO ENHANCE THE APACHE FINITE ELEMENT MODEL
ERROR INDICATION

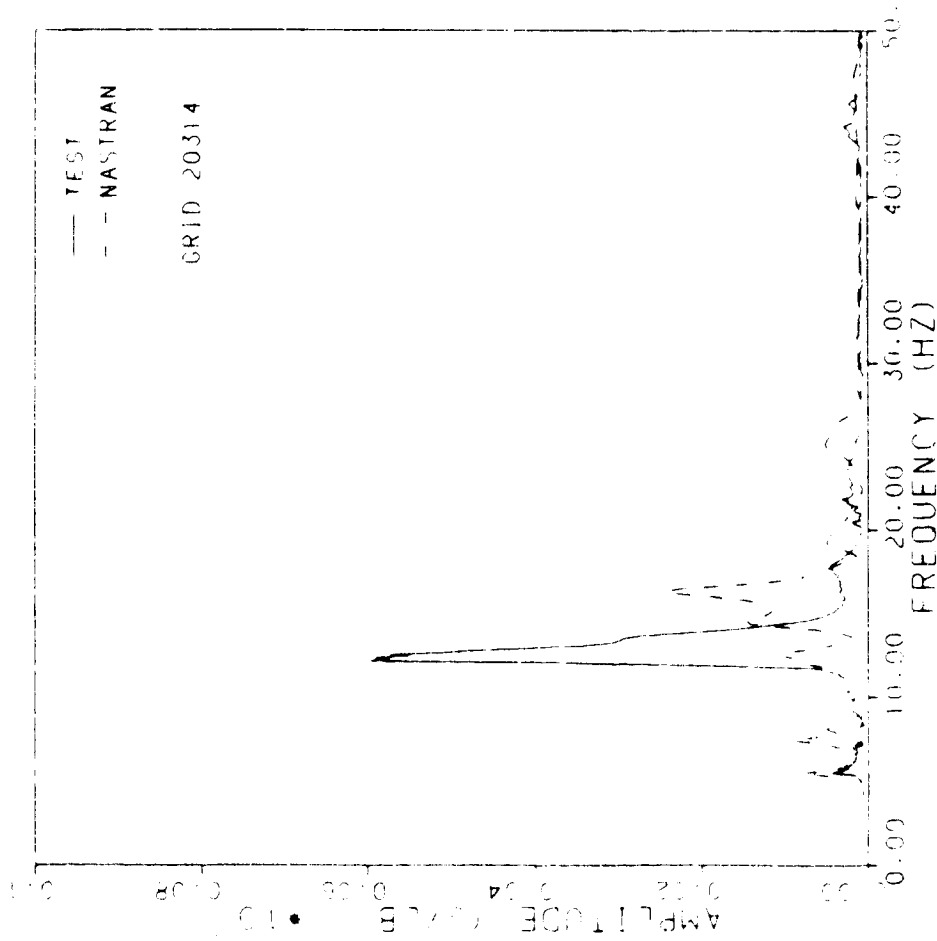

EXCITATION: LONGITUDINAL • M/R MAST
STANDARD WING: VERTICAL RESPONSE

USING THE TEST RESULTS TO ENHANCE THE APACHE FINITE ELEMENT MODEL
ERROR IDENTIFICATION

Examination of the deflected shapes obtained from test and analysis helped to further localize and identify errors in the model. In trying to identify an error, it is very helpful to have an idea of the effect of that error. For example, has it made the structure lighter or heavier, stiffer or more flexible. Studying the frequency response plots along with the mode shapes can provide such insight.

The following figure shows an analytical mode shape involving the wings which aided in locating and identifying errors. This mode shape indicates a highly non-symmetric wing motion which was not found experimentally. One of the wings is undergoing pure bending while the other wing shows a combination of torsion and bending. In addition, the frequency of this mode is significantly lower than that of the wing modes found in the test. Close study of this and other analytical wing modes lead to the identification and correction of errors and problems discussed on the following page.

McDonnell
Douglas
Helicopter
Company

USING THE TEST RESULTS TO ENHANCE THE APACHE FINITE ELEMENT MODEL
ERROR IDENTIFICATION

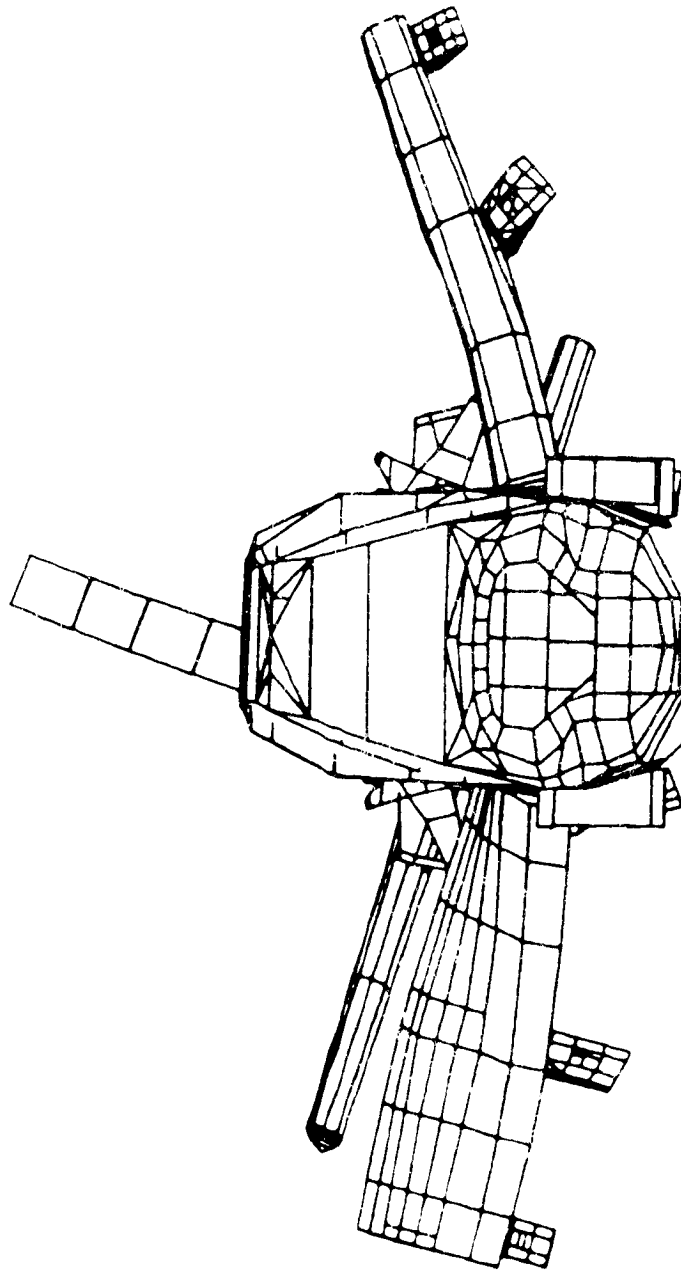

USING THE TEST RESULTS TO ENHANCE THE APACHE FINITE ELEMENT MODEL
CORRECTIONS TO THE WING MODEL

After close scrutiny of the wing portion of the model, several problems were identified and corrected. First, it was found that the concentrated mass items on the wings were not distributed symmetrically by the automatic mass lumping program. These mass items were then redistributed by hand. Second, the element products of inertia did not have the proper sign, as discussed previously. Third, the modeling philosophy of the racks and stores was suspect. The stores were previously modeled as extremely stiff bar elements extending to the C.G. of the Hellfire missile location. This area of the model was replaced by a more detailed model of the racks, stores, and the connections between them. Additionally, the pylon actuator location and constraints were corrected. Fourth, the trailing edge of the wing had been ignored in the static model because of its small load carrying capacity. However, further study indicated that this portion of the structure was important dynamically. Therefore, the trailing edge was added to the wing model.

McDonnell
Douglas
Helicopter
Company

USING TEST RESULTS TO ENHANCE THE APACHE FINITE ELEMENT MODEL
CORRECTIONS TO THE WING MODEL

- IMPROVED WING MASS REPRESENTATION
- CORRECTED ELEMENT PRODUCTS OF INERTIA
- IMPROVED RACK/STORE REPRESENTATION
- CORRECTED PYLON ACTUATOR LOCATION AND CONSTRAINTS
- ADDED TRAILING EDGE TO WING

USING THE TEST RESULTS TO ENHANCE THE APACHE FINITE ELEMENT MODEL
YARDSTICK . . . CHECK IMPROVEMENT

When the improvement is made, the analyst can use the whole inventory of test results such as frequency response plots, deflected shapes, and modal frequencies to examine the effect of the improvement. The figure below shows the improvement made in the vertical wing response as a result of the changes implemented in the model.

McDonnell
Douglas
Helicopter
Company

USING THE TEST RESULTS TO ENHANCE THE APACHE FINITE ELEMENT MODEL
YARDSTICK TO CHECK IMPROVEMENT

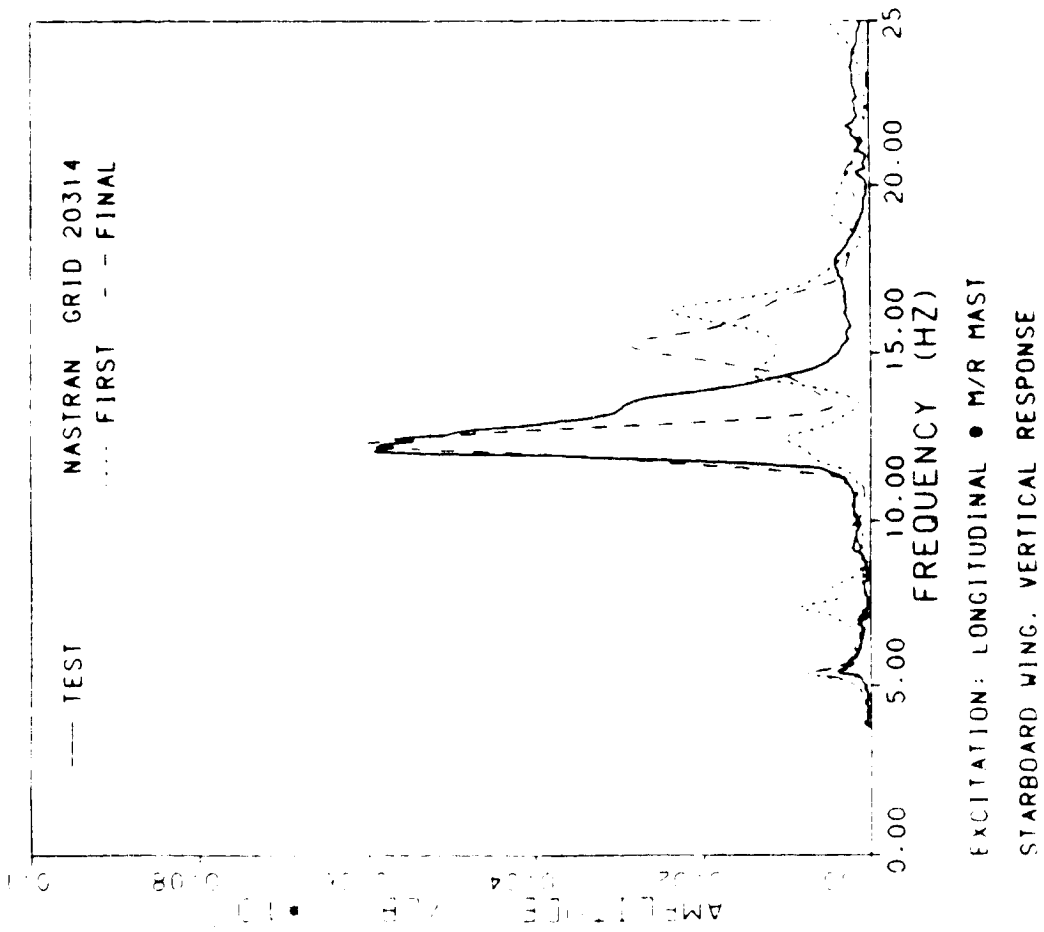

GENERAL APPLICATION OF TEST RESULTS

A comprehensive shake test, such as the one performed under this program, not only helps to enhance an existing finite element model of the test specimen, but also provides valuable guides for enhancing other finite element models and future modeling efforts. Test results may be used to verify modeling practices used in the past, to identify questionable assumptions and practices, and to provide a reasonable level of confidence with which the analysis results can be used. The following expounds on these topics in more detail.

McDonnell
Douglas
Helicopter
Company

GENERAL APPLICATION OF TEST RESULTS

- VERIFY CORRECTNESS OF ASSUMPTIONS AND PRACTICES USED
- IDENTIFY PRACTICES WHICH MAY RESULT IN ERRONEOUS RESULTS
- PROVIDE A REASONABLE LEVEL OF CONFIDENCE IN THE ANALYTICAL RESULTS

GENERAL APPLICATION OF TEST RESULTS
VERIFICATION OF ASSUMPTIONS AND PRACTICES

Analysts make many assumptions in preparing a finite element model. However, one is never sure of the degree of accuracy of these assumptions until they are verified against test results. In this particular case, test results confirmed many of our assumptions. For example, the assumption that stringers and longerons carry axial loads and skin and webs carry shear loads was verified. The effectiveness of using a static model for dynamic analysis with dynamic reduction was also confirmed. Good correlation associated with main rotor mast responses confirmed our modeling technique regarding the main rotor support structure and the overall representation of the airframe.

**McDonnell
Douglas
Helicopter
Company**

GENERAL APPLICATION OF TEST RESULTS
VERIFICATION OF ASSUMPTIONS AND PRACTICES

- VERIFIED ASSUMPTIONS REGARDING MODELING OF FRAMES, MACHINED FRAMES, BULKHEADS, RIBS, STRINGERS, LONGERONS, SKINS AND WEBS.
- VERIFIED EFFECTIVENESS OF USING STATIC FINITE ELEMENT MODEL FOR DYNAMIC ANALYSIS WITH DYNAMIC REDUCTION.
- VERIFIED MODELING TECHNIQUE FOR MAIN ROTOR MAST SUPPORT STRUCTURE.

GENERAL APPLICATION OF TEST RESULTS
IDENTIFY POOR MODELING PRACTICES

Correlation of test and analysis results pointed out some assumptions and practices which produce incorrect results. Here are some examples. Although using static model for dynamic analysis was generally successful, some of the assumptions made for statics were not good for a dynamic model. Two examples were ignoring the trailing edge structure of the wing and the frictional load carrying capability of bolts. Some assumptions made for statics were previously recognized and corrected to meet dynamics requirements. An example of this was the shear panel effectivity.

Regarding the mass distribution, some of the assumptions and methods were not strictly correct. For example, connectivity was not considered in the mass lumping. Moreover, the rotational mass moments of inertia were not accounted for properly.

**McDonnell
Douglas
Helicopter
Company**

**GENERAL APPLICATION OF TEST RESULTS
IDENTIFY POOR MODELING PRACTICES**

- STATIC MODELING ASSUMPTIONS WERE NOT NECESSARILY APPROPRIATE FOR DYNAMIC ANALYSIS.
- IGNORING STRUCTURALLY INEFFECTIVE PARTS
- IGNORING FRICTIONAL LOAD CARRYING CAPABILITY OF BOLTS
- AUTOMATIC MASS DISTRIBUTION TECHNIQUE HAD SOME PROBLEMS:
 - CONNECTIVITY WAS NOT CONSIDERED.
 - MASS MOMENTS OF INERTIA WERE NOT PROPERLY TREATED.

GENERAL APPLICATION OF TEST RESULTS
IDENTIFY LEVEL OF ACCURACY

Analysts and users alike, have a tendency to respect the "precision" of the analysis results more than is warranted. Although the analysis results may be precise to five significant figures their accuracy is much less. This is because of the necessary assumptions made in the analysis. The accuracy of results can only be confirmed by experimental data. The results of MDHC's shake test showed as much as 5% variation in modal frequencies calculated from different test cases. This means that the limit of accuracy of analysis predictions is at best 5%.

GENERAL APPLICATION OF TEST RESULTS
IDENTIFY LEVEL OF ACCURACY

- ACCURACY OF ANALYSIS RESULTS CAN ONLY BE VERIFIED BY TEST DATA.
- VARIATION OF MODAL FREQUENCIES OBTAINED FROM DIFFERENT TEST CASES WAS AS MUCH AS 5%.
- THE ANALYSIS RESULTS CAN BE REGARDED ACCURATE ONLY TO THIS RANGE.
- AT THIS TIME, IF ANALYSIS RESULTS FALL WITHIN THIS RANGE, THEY ARE AS ACCURATE AS IS POSSIBLE.

8. SUGGESTIONS FOR FUTURE STUDY

~~CONFIDENTIAL~~ INTENTIONALLY BLANK

(4)

SUGGESTIONS FOR FUTURE STUDY

As with any scientific study, the AH-64 correlation program uncovered as many or more questions as it answered. There are many questions and problems that must be answered if progress is to be made in the future. Some have specific application to the AH-64 correlation, while others have a general application to future programs. Proposed subjects for continued and future study are: (1) the modeling of difficult components, (2) the development of methods of post-processing which could enhance the finite element analysis, (3) dynamic optimization, (4) integrated kinetic-kinematic modeling, (5) the establishment of objective correlation criteria, and (6) component testing and modal synthesis. These subjects are presented in more detail in the pages that follow.

**McDonnell
Douglas
Helicopter
Company**

SUGGESTIONS FOR FUTURE STUDY

- DIFFICULT COMPONENTS
- METHODS OF FEA POST-PROCESSING
- DYNAMIC OPTIMIZATION
- INTEGRATED KINETIC-KINEMATIC MODELING
- CORRELATION CRITERIA
- COMPONENT TESTING AND MODAL SYNTHESIS

DIFFICULT COMPONENTS

In creating a large finite element model of a helicopter airframe, there are components and areas of the ship which cannot be easily modeled using standard techniques. The transmission housing and the tail rotor drive train are examples of components which are difficult to model. Currently, the load paths created by such components are ignored.

Non-linear connections present another modeling difficulty. These include the fitting looseness of the stabilator connection and the load carrying capacity of friction bolts in the wings and vertical stabilizer. Other areas of the ship such as the mast base are constructed with a deep beam but are modeled with standard beam elements. Another problem area to be addressed is the adequacy of using rigid elements and scaler springs to model large mass items such as the pilot, copilot and seats, the engines and the ammunition stores.

Presently, the analysis assumes that the damping is linear and uniformly distributed throughout the structure. In reality this is not true, and improving the assumptions made about the damping could greatly improve the correlation of the frequency responses. One possible approach might be to calculate the damping of the modes from the test data and assume that amount for the corresponding analytical modes.

In addition to structural modeling, there is the problem of mass lumping. Equivalent mass factors can be used for masses which are not rigidly connected to the vehicle, e.g. fuel and other fluids, cables, and fairings. Moreover, masses need only be distributed to points on the ship to which the masses are actually connected.

DIFFICULT COMPONENTS

- IGNORING PROPER LOAD PATHS
 - TRANSMISSION HOUSING
 - TAIL ROTOR DRIVE TRAIN
- NON-LINEAR CONNECTIONS
 - FITTING LOOSENESS ON STABILATOR
 - FRICTION CARRYING CAPABILITIES OF BOLTS
- DEEP BEAMS IN THE MAST BASE
- ADEQUACY OF USING RIGID ELEMENTS AND SCALER SPRINGS FOR MODELING:
 - PILOT, COPILOT AND SEATS
 - ENGINES
 - AMMUNITION STORES
- ASSUMPTION OF UNIFORM LINEAR DAMPING
- MASS MODELING
 - EQUIVELANT MASS FACTORS
 - MASS CONNECTIVITY

METHODS OF FEA POST-PROCESSING

After a large finite element model has been checked out and runs properly without error, tools are needed to reduce and interpret the analytical results. These tools will usually be a NASTRAN DMAP sequence. Such DMAPs can be used for modal identification. This can eliminate problems of deciding which modes are due to local effects and which ones are important. Once the insignificant local modes are identified, they may be eliminated from the analysis.

**McDonnell
Douglas
Helicopter
Company**

METHODS OF FEA POST-PROCESSING

- CREATE NASTRAN DMAP SEQUENCE DATA REDUCTION TOOLS FOR:
 - MODAL IDENTIFICATION
 - ELIMINATION OF INSIGNIFICANT LOCAL MODES

DYNAMIC OPTIMIZATION

Helicopter airframes are becoming increasingly more complex and the requirements for their vibration environment are becoming more stringent. In order to meet the vibration requirement, structural alterations and/or mass redistribution is often employed. The proper modification yielding the desired dynamic 'objective' without violating other 'constraints' cannot be easily decided upon using only one's experience and engineering judgement. It is practically imperative to utilize Computer-Aided-Engineering to achieve the goal in a cost effective manner. Optimization techniques are uniquely suited to address this type of problem.

New functional requirements for an existing helicopter call for new equipment. These additional masses may also require structural modifications. Although the basic requirements, both for mass and structural changes, are driven by requirements other than vibrations, alternative ways of mass placement and structural modifications often exist. The proper choice could be made in order to improve vibration environment or at least prevent it from becoming worse. Optimization techniques could be employed to address such problems.

It is during the design phase of a new helicopter, when many alternatives are being weighed, that the dynamist has the best opportunity to utilize dynamic optimization techniques in order to minimize vibrations of the airframe.

DYNAMIC OPTIMIZATION

DYNAMIC OPTIMIZATION TECHNIQUES MAY BE UTILIZED IN THE FOLLOWING CASES:

- WHEN THERE IS A VIBRATION PROBLEM, ELIMINATE THE PROBLEM WITHOUT VIOLATING OTHER REQUIREMENTS
- WHEN NEW FUNCTIONAL REQUIREMENTS NEED NEW EQUIPMENT, REDUCE VIBRATION LEVELS (OR AT LEAST PREVENT THEIR WORSENING) BY SELECTING THE OPTIMUM CHOICE OF LOCATION FOR NEW ADDITIONAL MASSES AND BY SELECTING THE BEST WAY TO MEET THE NEW STRUCTURAL REQUIREMENTS
- DURING THE DESIGN PHASE OF A NEW HELICOPTER

INTEGRATED KINETIC-KINEMATIC MODELING

There are helicopter components, such as the landing gears, stabilators, rotor blades, and the weapon system, whose functions require them to go through large rigid body deflections. In order to study their dynamic and vibrational behavior it is necessary to formulate appropriate kinematic mathematical models of such components. In order to study the combined behavior of these components and the fuselage, such as for landing and ground vibrations of the whole aircraft, it is necessary to integrate this model with the model of the fuselage. Therefore, the software used for kinematic modeling must be compatible with finite element analysis code.

**McDonnell
Douglas
Helicopter
Company**

INTEGRATED KINETIC-KINEMATIC MODELING

- USE KINEMATIC MODELING TO REPRESENT COMPONENTS WHICH GO THROUGH LARGE DEFLECTIONS, SUCH AS LANDING GEARS, STABILATORS, ROTOR BLADES AND WEAPON SYSTEMS.
- INTEGRATE THESE MODELS WITH FINITE ELEMENT MODELS OF THE FUSELAGE FOR STUDIES SUCH AS LANDING AND GROUND VIBRATIONS, WEAPON SYSTEM ACCURACY IMPROVEMENT

CORRELATION CRITERIA

There is no practical set of criteria which would objectively answer the following questions:

- How well do the analytical results correlate with test results?
- Is the analytical model 'accurate' or are further improvements warranted?
- How consistent are the test results within themselves?

The answer to these questions can save a great deal of time. Much effort might be needlessly spent if the subjective judgement on degree of correlation is wrong, or if the test results themselves are inconsistent, or in attempting to refine an already acceptable model. A practical and objective set of criteria would help to improve usage and application of test data and will accelerate refinement of finite element models.

McDonnell
Douglas
Helicopter
Company

CORRELATION CRITERIA

- AN OBJECTIVE AND PRACTICAL SET OF CRITERIA IS NEEDED TO HELP ADDRESS THE FOLLOWING QUESTIONS:
 - IS THE EXPERIMENTAL DATA CONSISTENT WITH ITSELF?
 - HOW ACCURATE IS THE EXPERIMENTAL DATA?
 - WHAT IS GOOD CORRELATION BETWEEN EXPERIMENTAL AND ANALYSIS RESULTS?
 - IS FURTHER IMPROVEMENT OF THE FEM OF THE TEST SPECIMEN WARRANTED OR HAS IT REACHED THE LIMIT OF ITS 'ACCURACY'?

COMPONENT TESTING AND MODAL SYNTHESSES

Developing finite element models of large airframes is expensive and requires a great deal of time. The model can be utilized only after proper verification and assuring that it is reliable. A finite element model is verified by correlating its results with experimental data. Presently in the helicopter industry, shake tests are performed for verification of the dynamic finite element analysis. The problem is that such tests are performed long after the design process is completed. During the design phase, the analytical model is not yet verified and its usefulness is limited.

In order to have the power of dynamic finite element analysis during the design modification phase, component testing and modal syntheses can be used. The model would be developed one component at a time (NASTRAN subelement analysis), and individually verified against a modal test of that component on the production line. Component finite element models and the modal synthesis methodology would then be used to generate a verified finite element model of the entire airframe. This relatively inexpensive procedure produces a verified model early enough making finite element analysis available during the final design phase.

COMPONENT TESTING AND MODAL SYNTHESSES

- MODEL THE AIRCRAFT ONE COMPONENT AT A TIME (NASTRAN SUPERELEMENT) AS THE PROTOTYPE IS BEING MANUFACTURED
- PERFORM MODAL TESTING OF COMPONENTS
- VERIFY MODEL OF EACH COMPONENT AGAINST ITS EXPERIMENTAL RESULTS
- USE MODAL SYNTHESIS TO DEVELOP FEM OF THE ENTIRE STRUCTURE.
- USE MODAL SYNTHESIS IN FINAL DESIGN AND DESIGN MODIFICATION STAGES.

9. CONCLUSIONS

CONCLUSIONS

A ground vibration test was performed on the AH-64 (Apache) helicopter to determine the frequency response of the airframe. The structure was excited at both the main and tail rotor hubs, separately, and response measurements were taken at 102 locations throughout the fuselage structure. These frequency responses were then compared and correlated with analytical results generated with NASTRAN. In addition, natural frequencies and mode shapes were estimated from the frequency response data to enhance understanding of the correlation.

Very good correlation was achieved at most locations up to about 13 Hz. Above the main mast bending modes, the correlation appears to deteriorate. The major problem areas are the engines, the stabilator, and the longitudinal response of the wings. Much improvement in the vertical response of the wings was accomplished by using preliminary correlation results to correct the model. Significant issues that still need to be resolved include the modeling of damping and the development of an objective correlation criteria.

McDonnell
Douglas
Helicopter
Company

CONCLUSIONS

- VERY GOOD CORRELATION UP TO 13 HZ AT MOST LOCATIONS
- IMPROVEMENT OF WING VERTICAL RESPONSE OBTAINED BY CORRECTING MODEL
- REMAINING PROBLEM AREAS:
 - ENGINES
 - STABILATOR
 - LONGITUDIAL RESPONSE OF WINGS
 - MODELING OF DAMPING
- AN OBJECTIVE AND PRACTICAL SET OF CORRELATION CRITERIA IS STILL NEEDED



Report Documentation Page

1. Report No. NASA CR-181973		2. Government Accession No.		3. Recipient's Catalog No.	
4. Title and Subtitle Plan, Execute, and Discuss Vibration Measurements and Correlations to Evaluate A NASTRAN Finite Element Model of the AH-64 Helicopter Airframe			5. Report Date January 1990		
			6. Performing Organization Code		
7. Author(s) D. Fery, L. Foote, G. Korkosz, F. Straub, M. Toossi, R. Weisenburger			8. Performing Organization Report No.		
			10. Work Unit No. 505-63-51-01		
9. Performing Organization Name and Address McDonnell Douglas Helicopter Co. 5000 E. McDowell Rd. Mesa AZ 85205-9797			11. Contract or Grant No. NAS1-17498		
			13. Type of Report and Period Covered Contractor Report		
12. Sponsoring Agency Name and Address NASA Langley Research Center Hampton VA 23665-5225			14. Sponsoring Agency Code		
			15. Supplementary Notes Langley Technical Monitor: Dr. Raymond G. Kvaternik		
16. Abstract A ground vibration test was performed on the AH-64 (Apache) helicopter to determine the frequency response of the airframe. The structure was excited at both the main and tail rotor hubs, separately, and response measurements were taken at 102 locations throughout the fuselage structure. Frequency responses were compared and correlated with results from a NASTRAN finite element model of the AH-64. In addition, natural frequencies and mode shapes were estimated from the frequency response data and were correlated with analytical results.					
17. Key Words (Suggested by Author(s)) Vibration, Correlation, NASTRAN, Finite Element Model, AH-64			18. Distribution Statement Unclassified - Unlimited Subject Category 39		
19. Security Classif (of this report) Unclassified		20. Security Classif (of this page) Unclassified		21. No of pages 235	22. Price A11

END

DATE

FILMED

NOV 6 1990