

N91-12419

## 20. CHARACTERIZING PERFORMANCE OF ULTRA-SENSITIVE ACCELEROMETERS

Dr. Henry Sebesta, Applied Technology Associates, Inc.

## ABSTRACT

This presentation gives an overview of methodology and test results pertaining to the characterization of ultra sensitive accelerometers. Two issues are of primary concern. The terminology ultra sensitive accelerometer is used to imply instruments whose noise floors and resolution are at the state of the art. Hence, the typical approach of verifying an instrument's performance by measuring it with a yet higher quality instrument (or standard) is not practical. Secondly, it is difficult to find or create an environment with sufficiently low background acceleration. The typical laboratory acceleration levels will be at several orders of magnitude above the noise floor of the most sensitive accelerometers. Furthermore, this background must be treated as unknown since the best instrument available is the one to be tested.

A test methodology has been developed in which two or more like instruments are subjected to the same but unknown background acceleration. Appropriately selected spectral analysis techniques were used to separate the sensors' output spectra into coherent components and incoherent components. The coherent part corresponds to the background acceleration being measured by the sensors being tested. The incoherent part is attributed to sensor noise and data acquisition and processing noise. The method works well for estimating noise floors that are 40-50 dB below the motion applied to the test accelerometers.

The accelerometers being tested are intended for use as feedback sensors in a system to actively stabilize an inertial guidance component test platform. The frequency band of interest for tests on the platform extends from a 90-day

period to 100 Hz. The residual motion on the platform is required to be below 10 nano-g's for translation and 10 nano-radians for rotation. Accelerometers used in controlling this platform are required to exhibit noise floors at or below a nano-g. The parallel test methodology has been used successfully to demonstrate availability of accelerometers which are capable of resolving nano-g level motion in the band 0.001 Hz to 100 Hz. No one instrument was found acceptable over the entire frequency bandwidth. Instruments were found which cover the mid-frequency band (0.001 to 1 Hz) and the high-frequency band (1 to 100 Hz).

Tests were conducted at the Advanced Inertial Test Laboratory, which is part of the Central Inertial Guidance Test Facility operated by Air Force's 6585 Test Group. Other tests were conducted in a mountain cave constructed for seismic instrument tests by the Albuquerque Seismological Laboratory. These facilities provide sufficiently quiet backgrounds so that the parallel method is able to extract accelerometer noise floors at or near the nano-g level.

In our discussions of accelerometers and the development of new accelerometer technology, we've heard about the problems of trying to characterize instruments. In order to characterize something, you normally think about having an instrument that's better than the one you're testing and evaluating, and if you're at the state of the art, that's a chicken and egg type situation. It turns out that there are some tools that come from the spectral analysis world that Keith Verges and a number of other speakers talked about, that allow you to extract noise floors considerably below the signal level. When you're trying to characterize an accelerometer that's capable of measuring nano-g and micro-g acceleration levels, the problem we face is finding a location that's quiet enough so that you can see the capability of the accelerometer.

I intend to talk about where our work comes from, and that agency in particular has much interest in accelerometers, not so much for space flight, but for guidance and control. This particular agency is the Central Inertial Guidance Test Facility at Holloman Air Force Base, which is a DoD-wide support agent for calibrating and certifying navigation and flight control systems. I plan to talk about the challenges associated with characterizing precision accelerometers and the methodology that can be brought to bear on the problem. Then, I will discuss some examples of results, and then a wrap-up.

Several years ago, we at Applied Technology Associates got involved with this particular work. The objective was to develop a laboratory facility, and the technology to support the evaluation of components for guidance and navigation systems, accelerometers and gyros in particular. (Figure 1) What we would like to be able to do is create an environment on the Earth, in the laboratory, where we can isolate and stabilize a test item down to nano-g and nanoradian levels. These are the levels that flow from certain performance requirements. The frequency band of interest is 90 days to 100 Hz. The general feeling was that as accelerometers improved for these new applications, and we got advances in the state of the art, that the capabilities and the facilities to support testing and calibration of these instruments needed to also move upward in their state of the art.

One of the things that we've been involved with also was supporting a Central Inertial Guidance Test Facility in identifying what are the trends associated with accelerometers. So about 6 to 8 months ago, we conducted a study program which had the purpose of identifying operational needs for advanced guidance test capability. We did this in response to the requirements of the agency by looking at performance capabilities associated with components in current DoD programs. We then looked at the vendor community and what they projected capabilities of new instruments to be, and then estimated what the current and projected test capability is (Figure 2).

## INTRODUCTION

- ◆ ACTIVE CONTROL SYSTEM FOR CIGTF SEISMICALLY STABLE PLATFORM
- GOAL: DESIGN, FABRICATE & DEMONSTRATE TECHNOLOGY
  - ISOLATION/STABILIZATION TO 10 NANO-G AND 10 NANO-RADIAN RMS LEVELS
  - FREQUENCY BAND OF  $1E-7$  TO 100 Hz
- ◆ STATE OF ART ACCELEROMETERS REQUIRE IMPROVED TEST CAPABILITY
- ◆ TRENDS ARE TOWARD EVEN BETTER ACCELEROMETERS

● **PURPOSE:** DETERMINE EXTENT/CRITICALITY OF OPERATIONAL NEED FOR AN ADVANCED GUIDANCE TEST CAPABILITY

● **DATA**

- PERFORMANCE CAPABILITIES OF CURRENT DOD PROGRAMS
- PROJECTED INSTRUMENT PERFORMANCE UP TO 2010
- CURRENT/PROJECTED TEST CAPABILITY

● **SPONSOR:** 6585TH TEST GROUP/CIGTF  
HOLLOMAN AFB, NEW MEXICO

Primarily, this was done by contacting the various agencies, first by telephone, then through a mail-out survey, and then some of the key vendors and key using agencies by actual site visits and interviews with people involved (shown in Figure 3).

We were very pleased to get participation by a large number of organizations, and Figure 4 summarizes the organization numbers that were involved. We certainly got a lot of very useful data and a feeling for where the guidance component industry and technology was going.

Figure 5 shows the noise floor, (scale is in  $G^2/Hz$ , for the PSD level) which also implies that there's a bandwidth, which we generally didn't try to deduce. The little dots represent actual respondees' current capabilities and then also capabilities that they expect to reach over the next couple of decades. This graph also shows the current capability for testing accelerometers, using the best available equipment and test methodologies. We identified that there is a problem in that as instruments get better our capability needs to improve also.

Figure 6 shows the threshold characteristics.

Figure 7 shows the methodology for testing an instrument where the environmental noise is considerably above the basic capability of the instrument. In other words, you're trying to deduce noise floors of an accelerometer and its performance at maybe 2 or 3 orders of magnitude below the background level of the facility in which you are operating. So the basic problem is: we don't have another sensor to determine what X is. X, in this case, is the unknown acceleration that you're subjecting the instrument to. The concept here is to utilize like instruments operating side by side at the same location and sensing the same unknown acceleration. Then theoretically, if the instruments had no noise, you would see the same output signals. The procedure is to record and process the data from these two instruments, and to look at that data using full knowledge of spectral analysis theory. We have a sensor, and we model that sensor as a device that gives an output signal proportional to the input acceleration plus some noise that's unknown. The same situation is true for the second sensor. The noise in sensor 1 and

- SURVEY OF DOD, NASA, AND VENDORS
  - TELEPHONE
  - MAIL
  - SITE VISITS
  
- LITERATURE SEARCH
  
- CIGTF CAPABILITIES REVIEW
  
- COMPILE RESULTS/DATA/TRIEVE
  
- ANALYSIS OF RESULTS
  
- DOCUMENT RESULTS (AFR57-1)

	<b>DOD</b>	<b>OTHER</b>	<b>TOTAL</b>
<b>TELEPHONE CONTACTS</b>	46	71	117
<b>QUESTIONNAIRES SENT</b>	25	32	57
<b>QUESTIONNAIRES RECEIVED</b>	10	17	27
<b>ORGANIZATIONS VISITED</b>	7	12	19

**FIGURE 4**



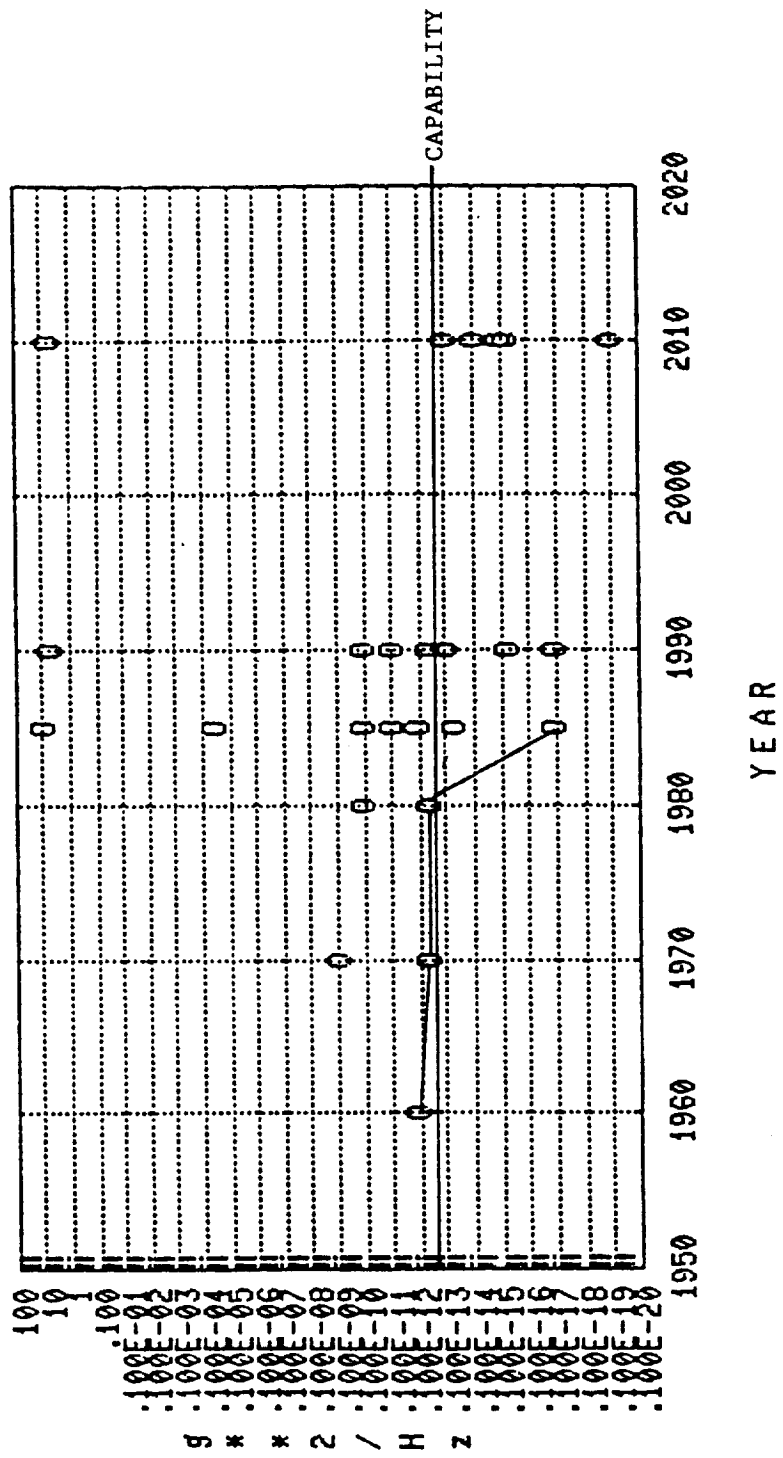

FIGURE 5

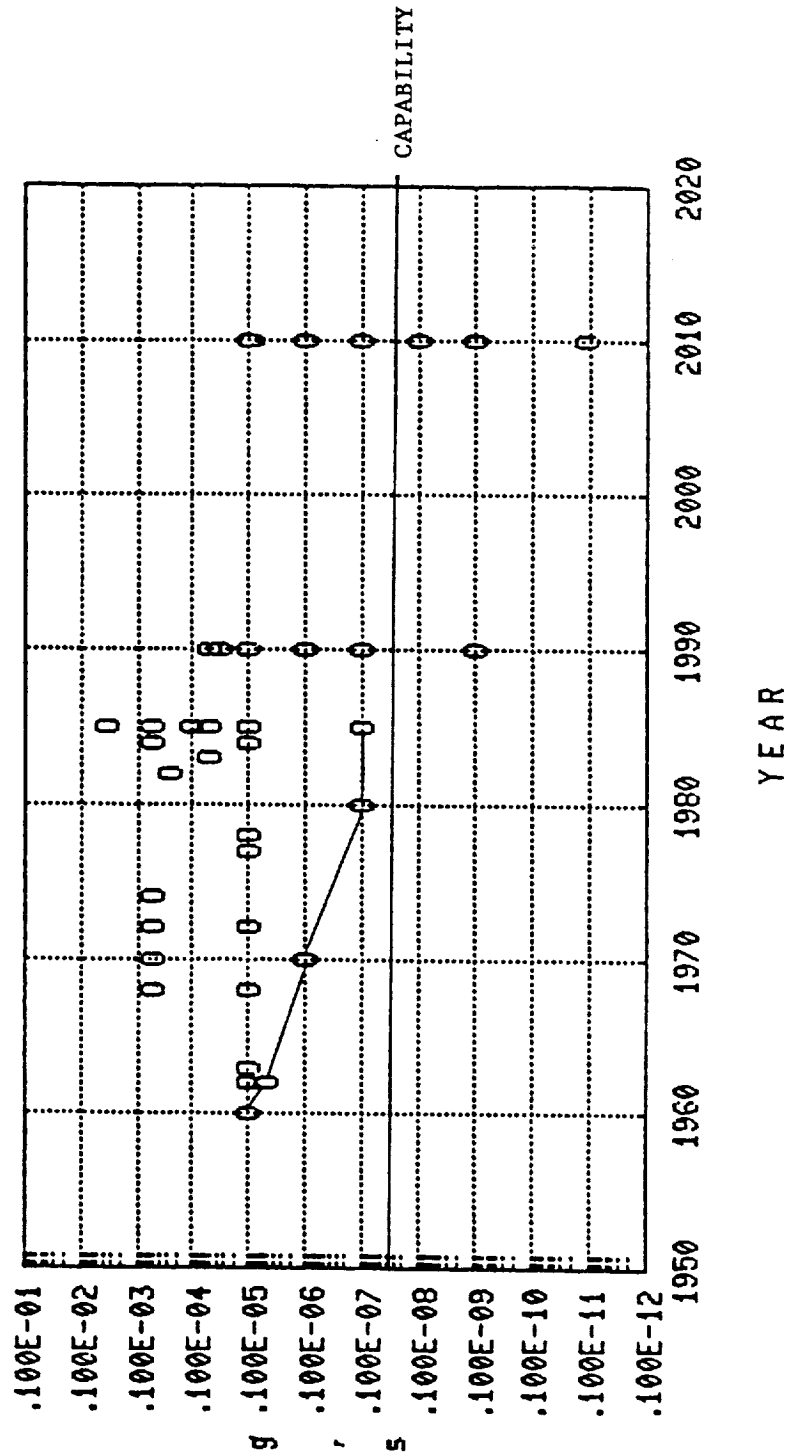
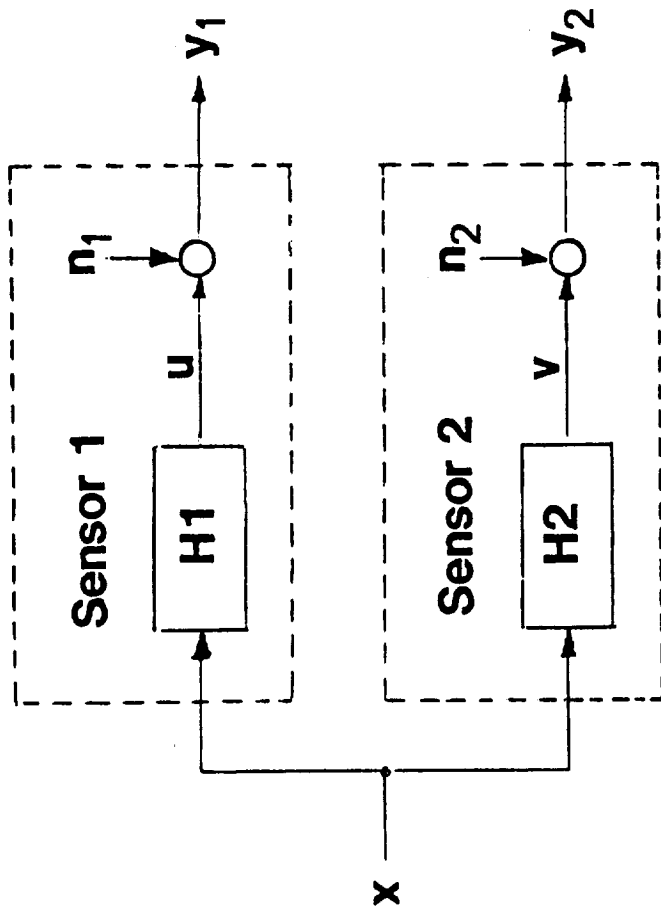

FIGURE 6



$$G_{11} = H1^* H1 G_{xx} + G_{n1 n1}$$

$$G_{22} = H2^* H2 G_{xx} + G_{n2 n2}$$

$$Y_{12}^2 = \frac{|G_{12}|^2}{G_{11} G_{22}}$$

$$G_{12} = G_{uv} = H1^* H2 G_{xx}$$

FIGURE 7

the noise in sensor 2 are typically uncorrelated. In other words, they're each independent of one another. Now the signals per se, the U and the V, we expect to be correlated. Both sensors are measuring the same thing, and should be responding in the same way. The processing involves calculating the auto spectrum for  $Y_1$ , which is the sensor output plus the noise, and the auto spectrum for  $Y_2$ , which is the other sensor's output, and these are defined in terms of a mathematical relationship. The important thing here is a frequency-dependent function called the coherence function that you can also calculate. That coherence function is the magnitude of the cross spectral density, which is the relationship between these two signals, divided by the auto spectrum signal of sensor 1 and the auto spectrum signal of sensor 2. This coherence function is a measure of how well these two signals,  $Y_1$  and  $Y_2$ , are correlated with one another.

Figure 8 shows one of the math relationships that describes that estimate. In other words we can make an estimate of the sensor noise or the unexplained part of the output. It can be thought of as the auto spectrum of sensor 1 minus the coherence function times the auto spectrum, or 1 minus the coherence times the auto spectrum. The basic premise of this particular relationship is that all of the noise is due to sensor 1, there's no noise on sensor 2. This is what you might call a worst-case assumption. Figure 9 shows other assumptions that can be used.

If you assume that the model for the sensor system at each input of the sensor has equal noise, you can calculate an estimate of the noise floor spectrum of the sensor as the auto spectrum minus the square root of the coherence function times the auto spectrum. This gives a better estimate of what the sensor noise might be: typically, for two sensors that are alike, you would expect the noise to be somewhat similar in character.

A little bit more complicated relationship is given in Figure 10, where you make the assumption that both of the output noises are the same. All these things can be easily calculated with digital signal processing tools. The typical digital signal analyzer that you might

$$\hat{G}_{n1n1} = G_{11} - Y_{12}^2 G_{11}$$

- ASSUMPTION : Other sensor noise zero
- EASY CALCULATION (2 keystrokes on HP5420)

$$\hat{G}_{n_1 n_1} = G_{11} - Y_{12} G_{11}$$

- **ASSUMPTION : Input noises equal**
- **REQUIRES  $\sqrt{\quad}$  FUNCTION**

$$\hat{G}_{nn} = \frac{(G_{11} + G_{22}) - \sqrt{(G_{11} - G_{22})^2 + 4|G_{12}|^2}}{2}$$

- **ASSUMPTION : Output noises equal**
- **DIFFICULT CALCULATION**

buy from HP or Nicolet will have buttons that you can push and generate these noise floor estimates. This enables you to generate the auto spectrum, the cross spectrum, coherence function, and calculate the noise spectral plot. And so you have an estimate of what the noise floor looks like as a function of frequency for the particular sensors that you're evaluating.

Figure 11 depicts power spectral density plots that represent results from sensors that we've tested. Our first job in developing an actively isolated platform was to find sensors that would do the job from 90 days to 100 Hz. It turns out that we were able to find sensors from about 0.001 Hz to 100 Hz, two different sensors, not the same sensor over the whole bandwidth. We were also able to find sensors that had PSD noise floors on the order of a nano-g squared per hertz. And that's the goal we set for ourselves, because we were trying to get an actively controlled system with a noise floor of 10 nano-g in translation. We set our sensor requirement for a feedback system 1 order of magnitude below that. Obviously if you try to control something with a noise on the feedback sensor, then the system response can't be better than your feedback sensor, so you have to have a feedback sensor that's better than the isolation goal of the system. We did a fairly comprehensive survey of the people that made sensors, both in the aerospace and the seismic community. We ended up with sensors from the seismic community that are capable of sensing nano-g accelerations. These sensors are manufactured by a little company called Streckeisen in Switzerland. What we're looking at in Figure 11 is the PSD of the motion that we measure on the floor of the Advanced Inertial Test Lab at Holloman. That particular lab is a facility that's designed to provide as quiet an environment as we know how to do. It includes special air-handling features, seismic pads, and then the active isolation system goes on top of that. The peak on the curve at about 0.1 Hz, or about a 10-sec period, is actually the ocean waves pounding on the continental shelves, so-called microseismic peaks. You can see this same character at any continental location, basically, as far as the PSD of the low-frequency end of the spectrum is concerned.



STS - 1V VERTICAL ACCELEROMETER MEASUREMENT'S  
AITL PIER ACCELERATION PSD

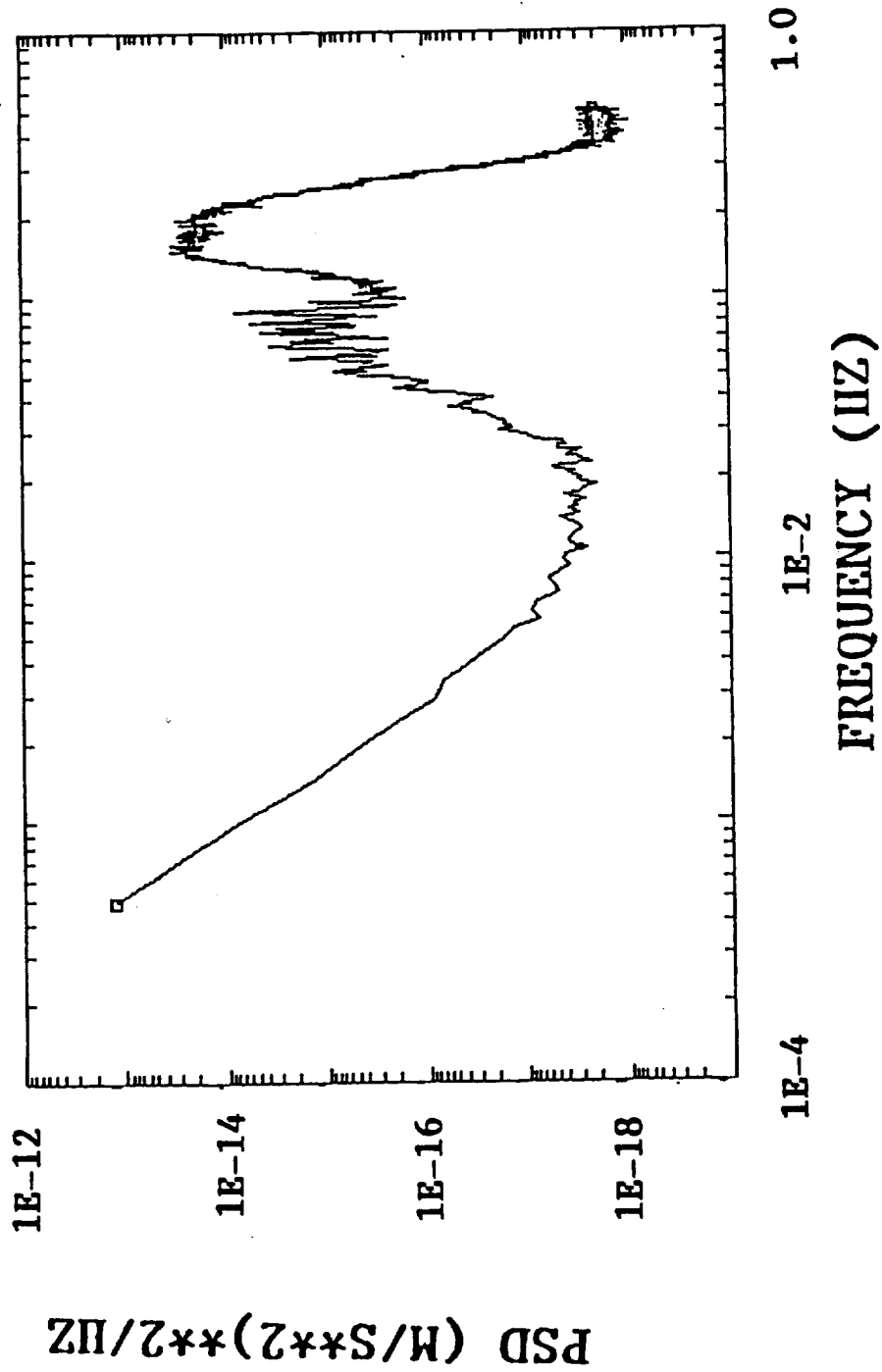

FIGURE 11

Figure 12 shows the noise PSD, or the incoherent power taken from two STSs measuring the same input, at the same location. This corresponds to a nano-g squared per hertz level of noise floor, and what we're able to see from this plot is that these sensors, their inherent noise floor, from something on the order of 0.002 Hz up to about 1 Hz, which is the bandwidth of the sensor, is below a nano-g squared per hertz, as a noise floor.

Figure 13 shows some of the Streckeisen-predicted noise or theoretical noise floors, and we found that they were very close to what we were able to measure.

Figures 14 and 15 are from instruments that are intended to work from about 0.1 Hz to 100 Hz. These happen to be Teledyne Geotech S-750s. This particular set of data was not obtained by us but by Sandia National Labs in some work that they were doing, to evaluate this particular seismometer. The PSD of sensor 1 and PSD of sensor 2 are the auto spectra, and we have the coherence function in Figure 16. The point to be made here is that the coherence is near to 1, which says that basically the outputs from each of these sensors are essentially correlated. The idea being that both are seeing the same input, so they should be showing the same output; and if there's not noise in the problem, then it will be the same. The coherence is a measure of how small that noise is. Noise can come from any of several sources. One source is the acquisition and processing algorithms themselves. There's a neat little trick that you use to verify that your acquisition electronics and amplifiers and all your algorithms are not dominating the noise. The procedure is accomplished by taking one sensor output and putting it into two parallel paths, and then looking at the incoherent power from that one sensor output through the two separate independent processing paths. That would be the equivalent of replacing the output signal of one of the instruments onto both of the processing channels. You can look at the coherence function for this setup and it should correspond to very low noise. Indeed, you expect that noise to be below the sensor noise. This is a technique that came from Teledyne Geotech. It's one of their standard processing tools to validate their acquisition and

**STS - 1V VERTICAL ACCELEROMETER MEASUREMENTS  
INCOHERENT COMPONENT PSD**

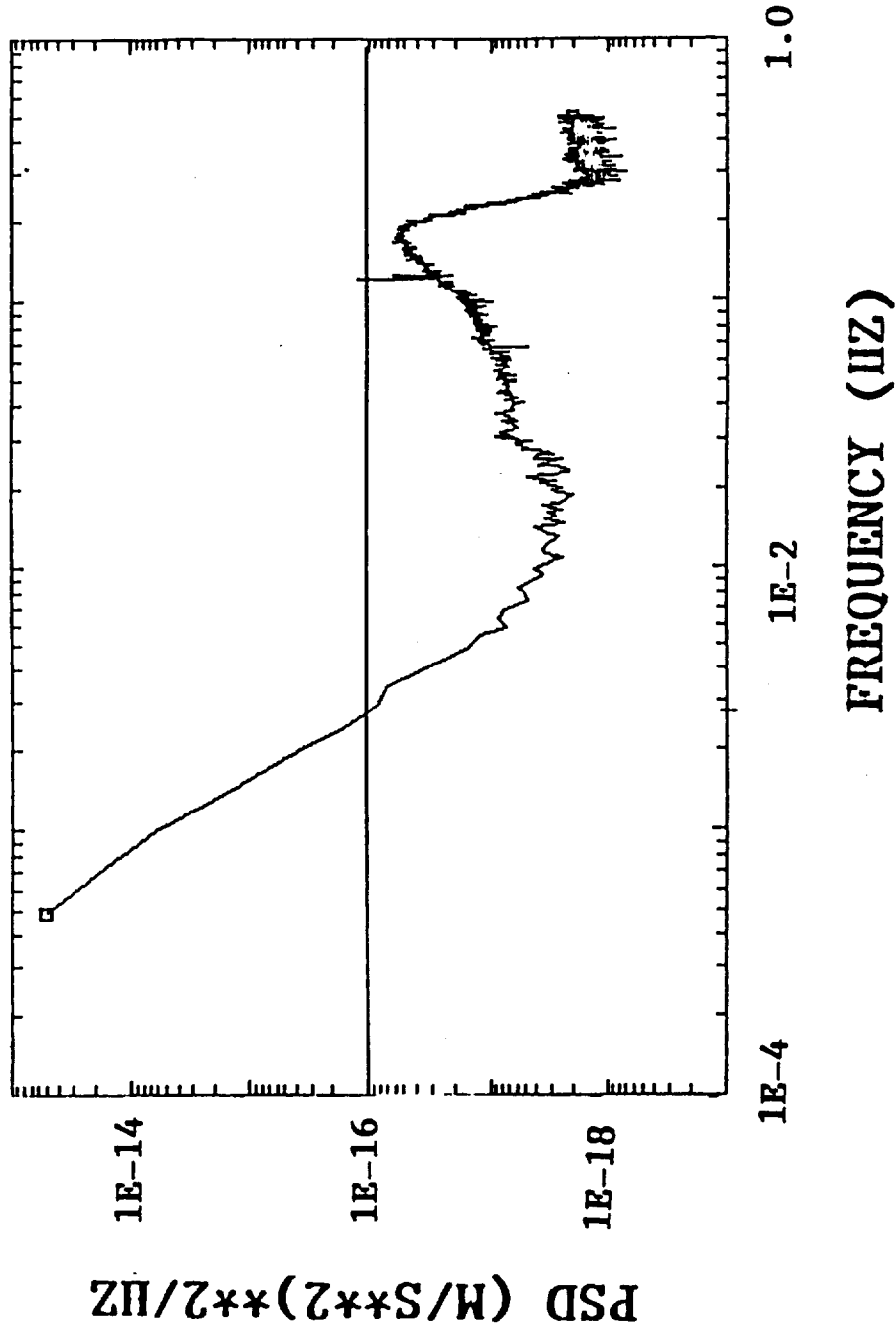

**FIGURE 12**

STRECKEISEN STS - PREDICTED ACCELEROMETER NOISE PSDS

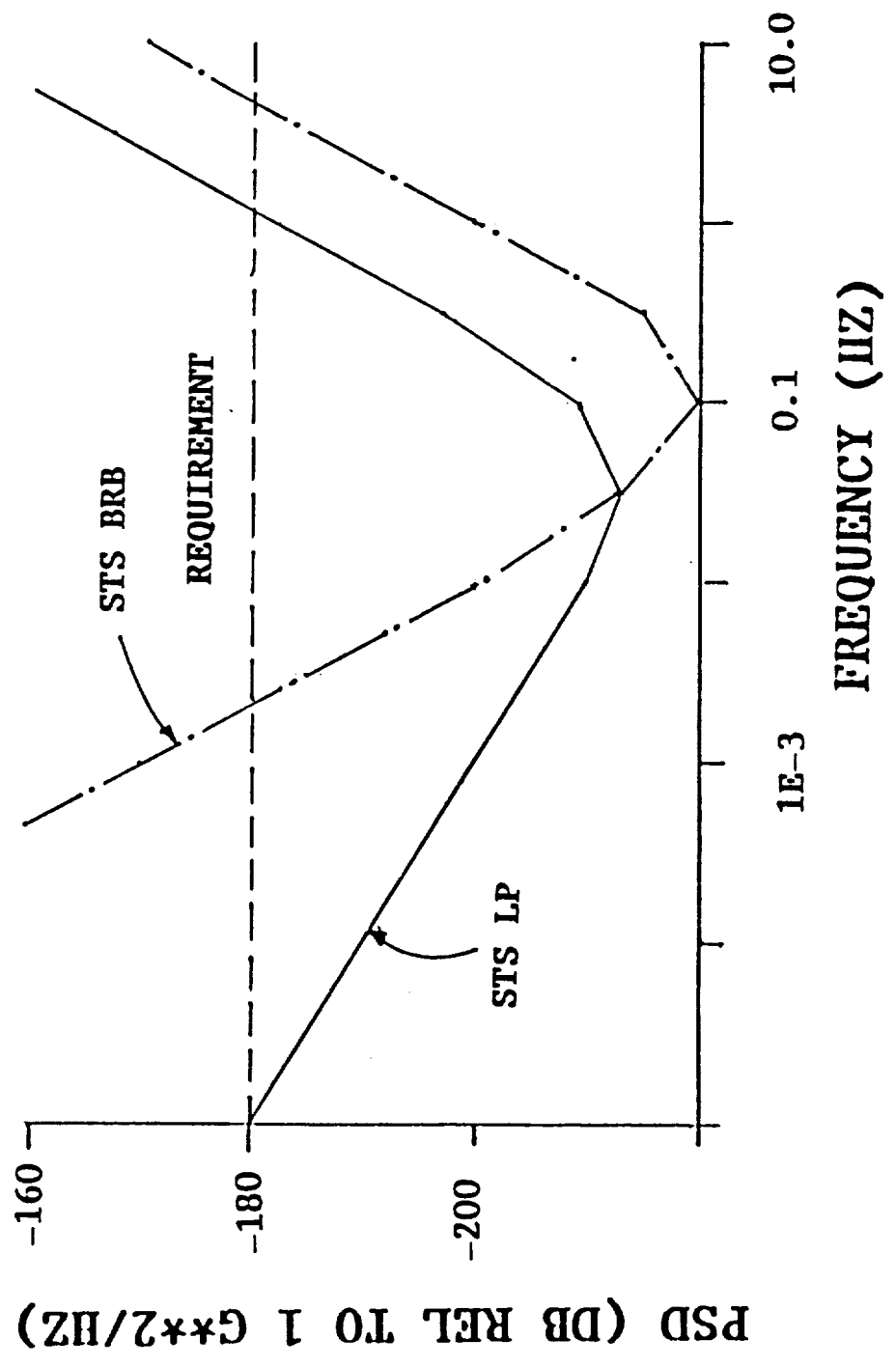

FIGURE 13

instrumentation system. The plot in Figure 17 is the incoherent part. Our requirement was to try to get to nano-g squared per hertz levels. We didn't quite get there with this particular instrument, but we were close enough that it would meet our requirements as far as the closed-loop stabilization system was concerned.

Figure 18 illustrates the active isolation system that is part of the Advanced Inertial Test Laboratory facility at Holloman. The whole thing is in a very quiet environment. The base is 20 ft below ground level, in a test cell that is also below ground level, sitting on a big concrete seismic mass. The apparatus that's sitting on top of it is equivalent to two optical benches. They're mounted on pneumatic airbag isolators, one mass on top of the other. So theoretically you're getting the equivalent of two inertial mass passive type of isolation system. At high frequency it works in a passive mode. At low frequency, we have actuators and the accelerometers, which we described earlier, as feedback sensors to actively suppress motions and forces that are acting on these masses.

A very busy overlay from a number of different sources is shown in Figure 19. In the low frequency range from 1 Hz down, we expect a seismic background that is pretty much similar in any location on the continent. You can get slight variations, if you live near the coastlines or a storm happens to be in the ocean or there is earthquake activity or something like that. But predominantly the low frequency characteristics will be the same. One of the things we noticed, is that some of these asymptotes are not quite the same. Our hypothesis is that the graphs include sensor noise that hasn't been eliminated from those measurements. As you get to lower and lower frequencies, you have other variables involved in the sensor output, such as barometric pressure and temperature variations, that may not be eliminated from the sensor output. If you can't control those variables, they influence the output and, as far as the measurement is concerned, it doesn't know the difference. Theoretically, we can look at analysis processes where we do a multiple coherence calculation that takes several variables, like temperature, pressure, and the combined parallel sensor outputs, and

# S750 ACCELEROMETER MEASUREMENTS (QUIET ENVIRONMENT)

SENSOR 1 PSD

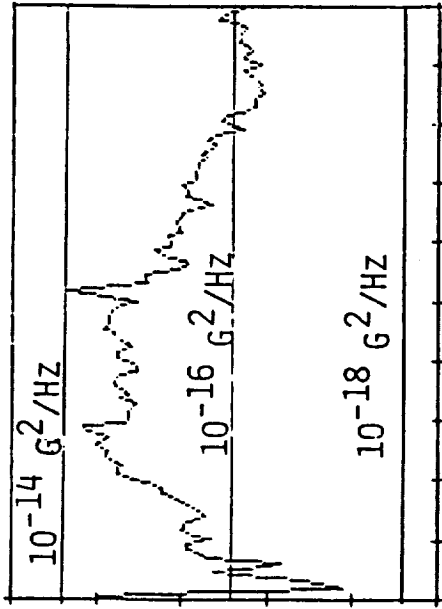

COHERENCE FUNCTION

FIGURE 14

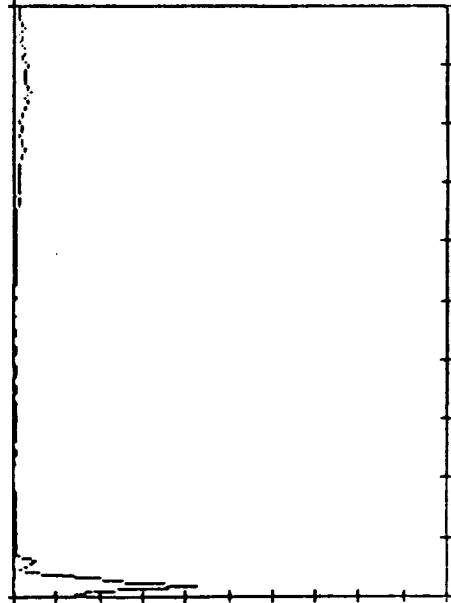

FREQUENCY (HZ) 100 HZ

FIGURE 16.

SENSOR 2 PSD

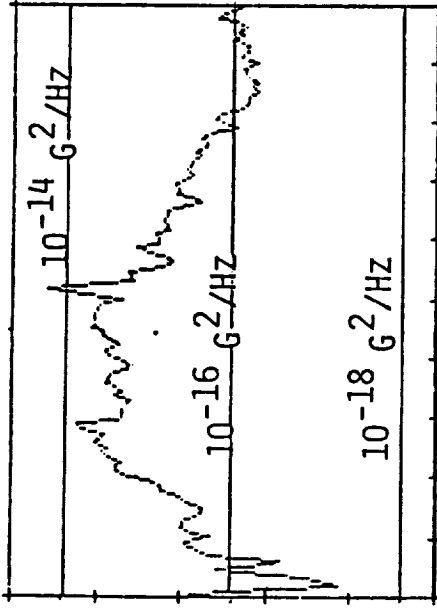

INCOHERENT COMPONENT (NOISE)

FIGURE 15

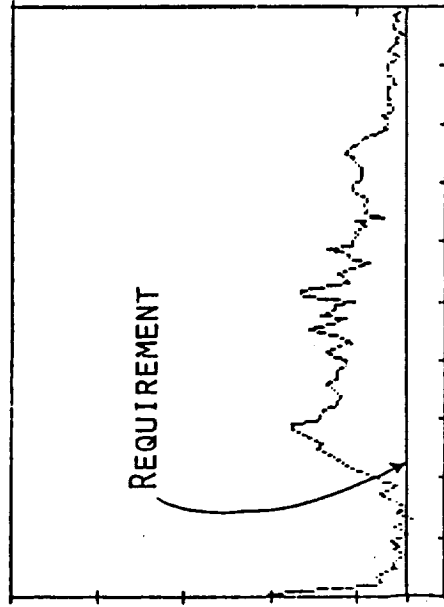

FREQUENCY (HZ) 100 HZ

FIGURE 17.

# ILLUSTRATION OF THE SEISMICALLY STABLE PLATFORM

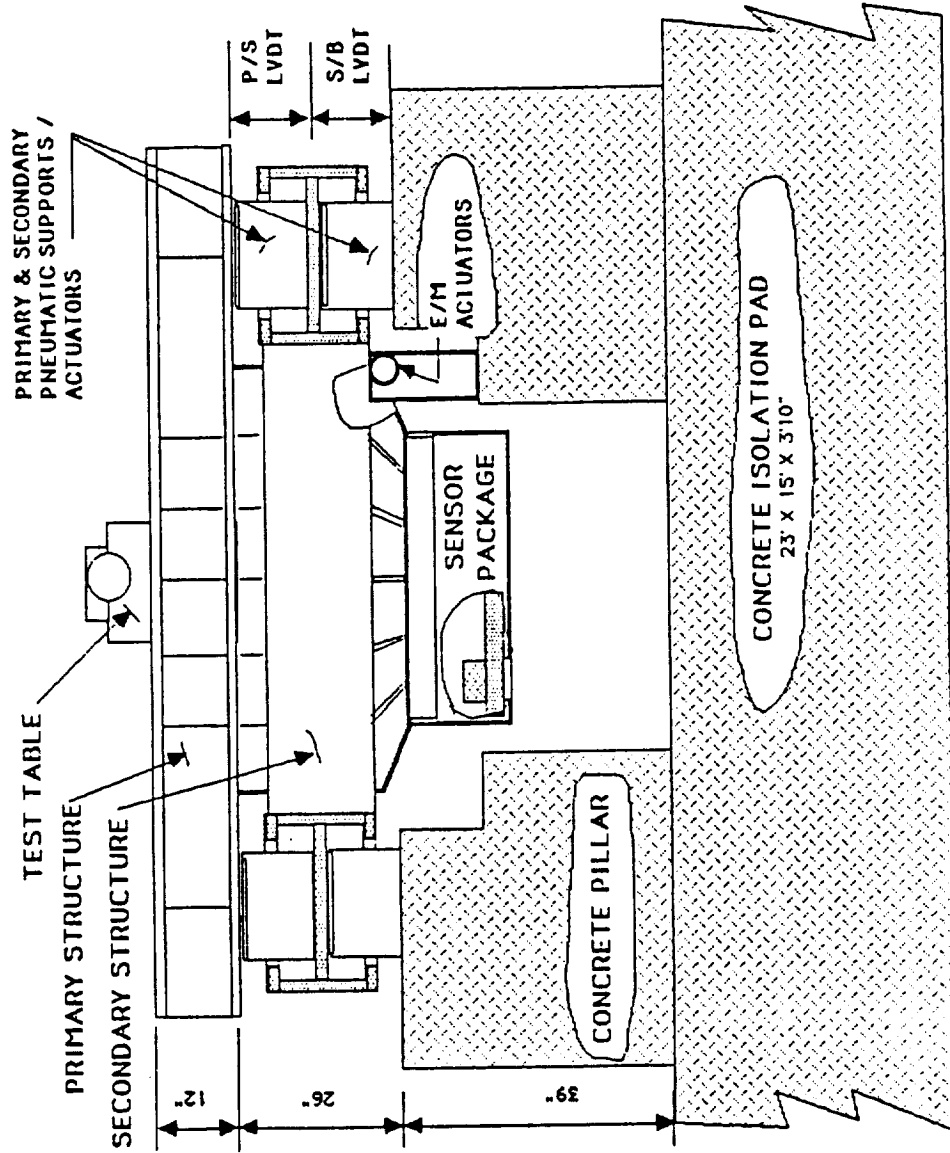

FIGURE 18.

# DISTURBANCE FOR THE VERTICAL TRANSLATION AXIS

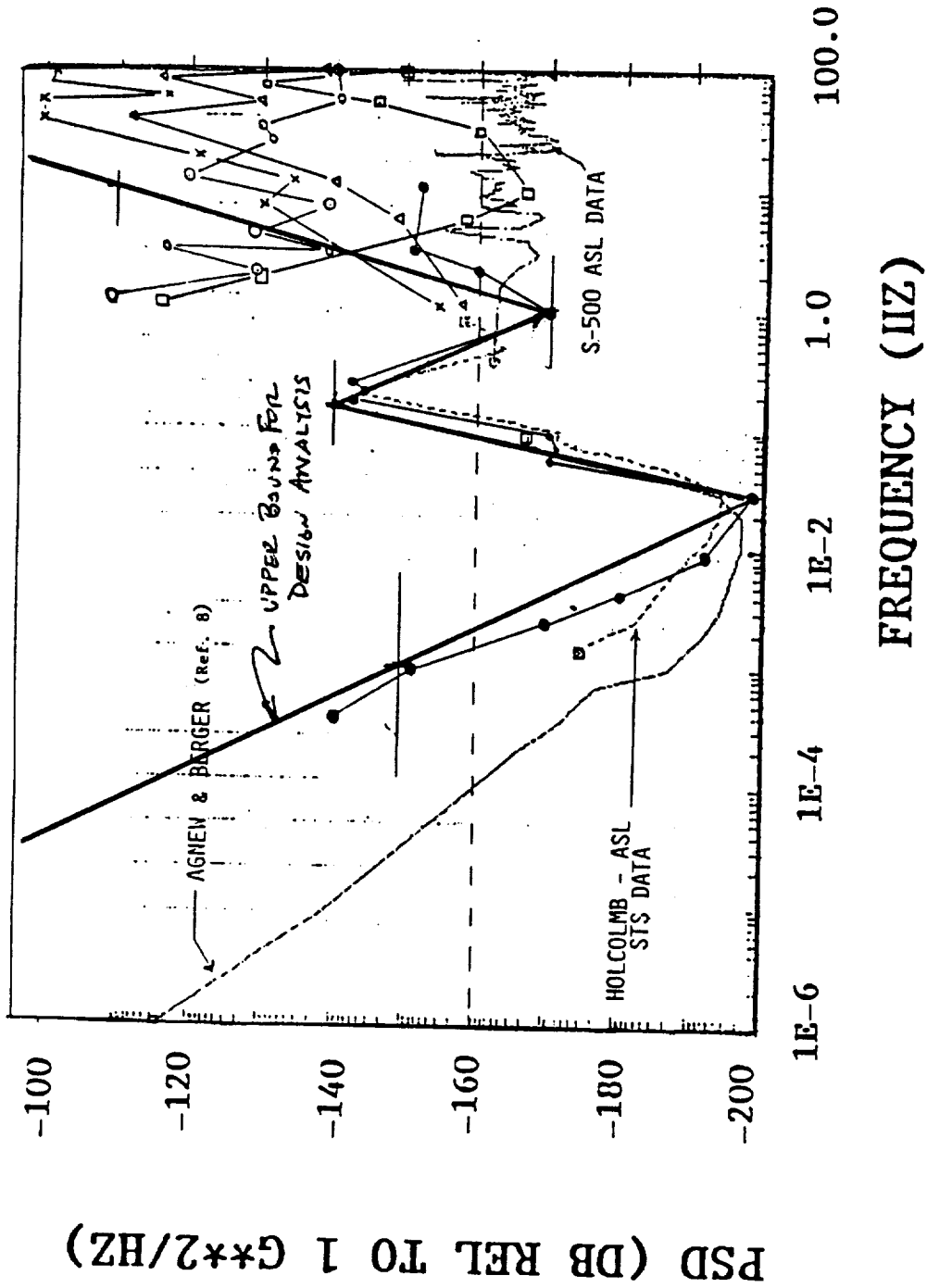

FIGURE 19.



explain their connection to the output. We can actually do a much better job than we have been doing as far as the low frequency end is concerned. In the upper end, what you really see is a wide variety of contributions that depend on your location. You have local machinery, local highways, rivers, and so on that contribute to the general spectra shape and levels from 1 Hz up. Figure 19 includes a curve that's down around 160 dB, which represents data that we took in a cave in the Monzano Mountains near Albuquerque. It's a part of a USGS facility where they do calibrations of seismic network instruments. It's a very quiet location. You can go to the back of the cave, about 60 meters into the mountain, and set up your instruments in parallel and establish the noise floors of an instrument fairly well.

The other data represent various conditions on top of the test platform with air conditioners on, air conditioners off, etc. But we basically took the solid dark line as an envelope that we're considering to be our disturbance input and designed our system to work against that.

The system that is being implemented currently involves basically two major loops: disturbance cancellation loops that actively control the pressure in the pressure bags, and an acceleration loop which actively controls some electromagnetic actuators to give us a high bandwidth control. The predicted performance is illustrated in Figure 20 by the lowest curve. The curve represents the residual acceleration, on top of the platform, with all the control loops working. What we're shooting for is the 10-nano-g residual environment.

I would like to summarize by saying that, if you want to characterize ultraprecise accelerometers, you have to find a quiet environment. Even with parallel testing, the best we were able to do is to see acceleration signals that might be 40, 50, or 60 dB below the inherent background. The inherent background in most places may range from micro-g's to tens of milli-g's. So if you're trying to characterize a sensor down to sub-micro-g level, you have to create a quiet environment. The parallel test methodology with this spectral analysis gives you the ability to do that with the current technology and current types

# PRIMARY MASS RESIDUAL ACCELERATION PSDS

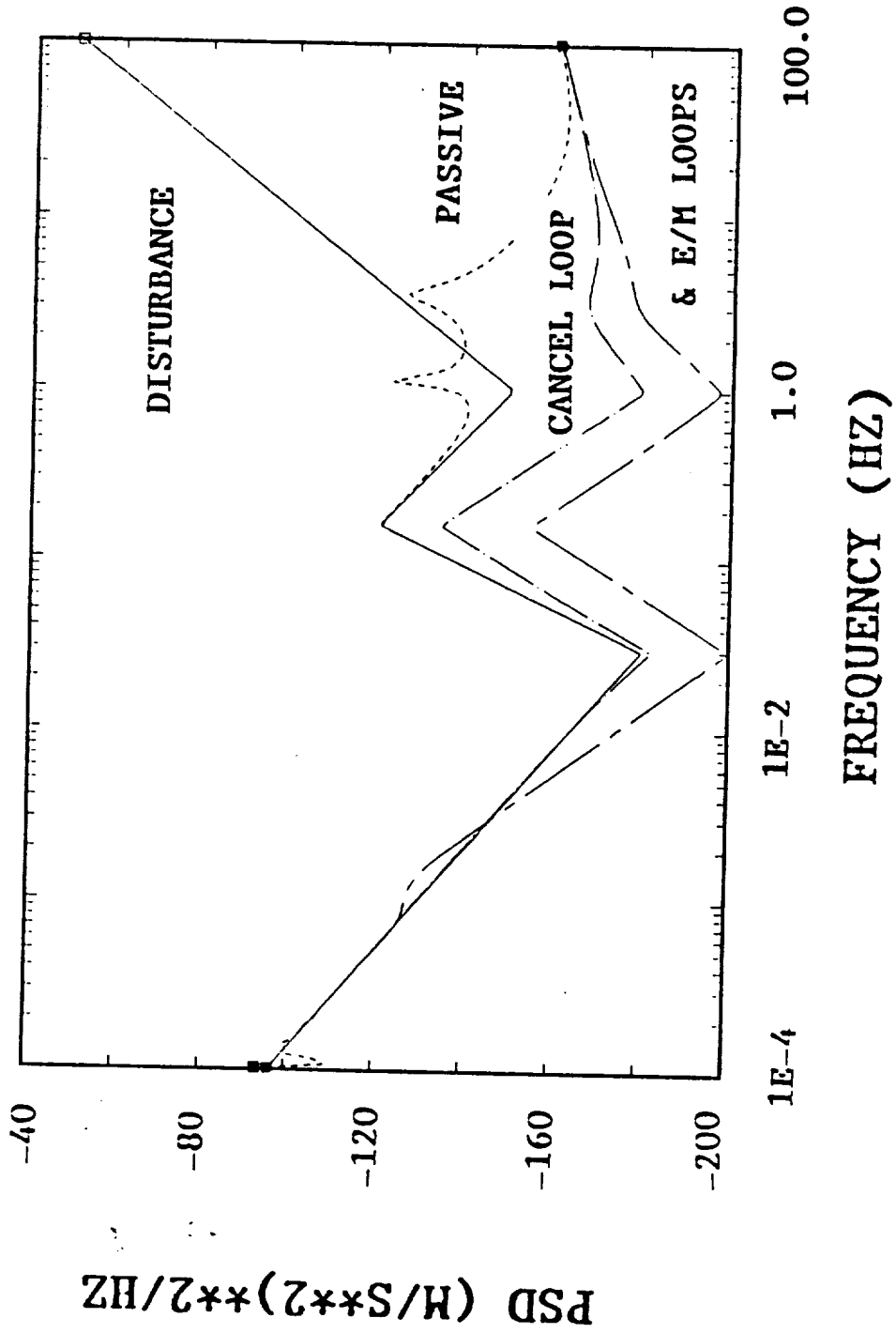

FIGURE 20.

of facilities. There are accelerometers available that can be used as calibration instruments that are capable of noise floors at 1 nano-g over a fairly broad bandwidth, at least from 0.001 Hz to 100 Hz.

**Question:** Are those seismic accelerometers flight-qualified?

**Sebesta:** The answer to that is no. As far as I know, none of the ones that we've been involved with have been designed for flight environments. Most of them are fragile instruments. But the technology is there, and they could probably be brought to that environment, but they haven't been. Keith Verges from Teledyne can talk about their particular applications.

