

N91-14383

Status of LWIR HgCdTe Infrared Detector Technology**M.B. Reine****Loral Infrared & Imaging Systems
Two Forbes Road
Lexington, Massachusetts 02173-7393**

Since its first synthesis in 1959, the HgCdTe semiconductor alloy system has proven to be a remarkably versatile intrinsic infrared detector material. A wide variety of high performance HgCdTe infrared detectors have been demonstrated and developed, including photoconductors, homojunction and heterojunction photodiodes, and metal-insulator-semiconductor photovoltaic devices. Controlled variations in HgCdTe alloy composition have enabled cutoff wavelengths to be tailored over the 2-25 μm wavelength region.

The success that HgCdTe has achieved is rooted in a unique set of semiconductor properties that make it a nearly ideal infrared detector material. Its large optical absorption coefficient enables (internal) quantum efficiencies approaching 100% to be achieved in devices that are 12-15 μm thick. Long carrier lifetimes allow the highest operating temperatures for achieving a given detectivity at a given cutoff wavelength.

This paper will review the status of LWIR HgCdTe detector technology for wavelengths between 8 and 17 μm , for application in NASA and DoD focal plane arrays (FPAs) operating at temperatures near 65 K with mission lifetimes of 5 to 10 years.

Linear arrays of LWIR HgCdTe photoconductors have been in production for the past ten years for DoD applications such as scanning thermal imaging systems and missile seekers. These arrays contain as many as 180 elements, operate at 77 K and cover the 8 to 12 μm wavelength region, which corresponds to a $\text{Hg}_{1-x}\text{Cd}_x\text{Te}$ alloy composition of $x=0.21$. These arrays are usually fabricated from bulk-grown n-type HgCdTe crystals having donor concentrations of 2-5 $\text{E}14 \text{ cm}^{-3}$. Detector sensitivity is typically background limited, with detectivities of 0.6-1.5 $\text{E}11 \text{ cm-Hz}^{1/2}/\text{W}$. Device resistances are typically 40 ohms per square at 77 K, with dc power dissipations of 0.1-0.5 mW. The total U.S. industry capacity for these units is about 2500-3000 deliveries per month.

LWIR HgCdTe photoconductors represent a mature established technology that will continue to play an important role in NASA and DoD applications that require relatively small numbers of elements (less than several hundred) which do not require a multiplexer on the focal plane. For example, Loral provided a large-area HgCdTe photoconductor with a detectivity of 3 $\text{E}10 \text{ cm-Hz}^{1/2}/\text{W}$ at 16 μm for the ATMOS interferometer.

Advanced DoD and NASA applications require orders of magnitude more detectors in a focal plane array. For these applications, HgCdTe photovoltaic (PV) devices are the detectors of choice because their higher impedance enables them to match into low-noise silicon CMOS input amplifiers. NxM arrays of HgCdTe photovoltaic detectors on IR-transparent substrates are bump interconnected to matching NxM arrays of input circuits on silicon CMOS multiplexer chips to form large focal

plane arrays. LWIR FPAs for scanning applications are typically 128 to 256 elements long, with 4, 8 or 16 elements in the scan direction for signal-to-noise enhancement, and have pixel sizes on the order of $50\ \mu\text{m} \times 50\ \mu\text{m}$. LWIR staring FPAs typically have 64×64 or 128×128 formats, with unit cells usually less than $50\ \mu\text{m} \times 50\ \mu\text{m}$.

These advanced LWIR FPAs place stringent performance requirements on the HgCdTe photovoltaic detector arrays in terms of zero-bias impedance, reverse-bias impedance and leakage current, quantum efficiency, fill factor, crosstalk, $1/f$ noise, uniformity of response and reliability.

Initial LWIR HgCdTe photovoltaic detectors were planar n-on-p devices made by mercury-diffusion and ion implantation. More recently, substantial improvements in device performance have been achieved with the use of a double-layer P-on-n LPE heterojunction photodiodes grown onto CdTe substrates. These LPE heterojunctions have demonstrated performance which approaches the theoretical limit set by n-side diffusion current at temperatures of 80 to 70 K over the 10-19 μm range.

Major improvements have been made over the years in HgCdTe materials technology. At Loral, uniformity of alloy composition in both bulk-grown and LPE HgCdTe is such that variations in detector cutoff wavelength are less than $\pm 1\%$ over the 2-12 μm range.

In this paper, the performance requirements that today's advanced LWIR focal plane arrays place on the HgCdTe photovoltaic detector array will be summarized. The theoretical performance limits for intrinsic LWIR HgCdTe detectors will be reviewed as functions of cutoff wavelength and operating temperature. The status of LWIR HgCdTe photovoltaic detectors will be reviewed and compared to the FPA requirements and to the theoretical limits. Emphasis will be placed on recent data for two-layer HgCdTe LPE heterojunction photodiodes grown at Loral with cutoff wavelengths ranging between 10 and 19 μm at temperatures of 70 - 80 K. Development trends in LWIR HgCdTe detector technology will be outlined, and conclusions will be drawn about the ability for photovoltaic HgCdTe detector arrays to satisfy a wide variety of advanced focal plane array applications.

Status of LWIR HgCdTe Infrared Detector Technology

M.B. Reine

**Loral Infrared & Imaging Systems
Lexington, Massachusetts 02173-7393**

Innovative Long Wavelength Infrared Detector Workshop

April 24 - 26, 1990

**Jet Propulsion Laboratory
California Institute of Technology
Pasadena, California 91109**

Status of LWIR HgCdTe Detector Technology

EMPHASIS

- **Wavelength: 10 to 17 μm**
- **Operating temperature: 60 K to 65 K**
- **Future NASA and DoD long-duration space applications**

TOPICS:

1. **HgCdTe material properties for infrared detectors**
 - **Uniformity of $\text{Hg}_{1-x}\text{Cd}_x\text{Te}$ alloy composition**
2. **Theoretical limits to HgCdTe detector performance and operating temperature**
 - **Thermal g-r noise**
 - **Background g-r noise**
3. **Detector requirements for advanced focal plane arrays**
4. **Status of HgCdTe infrared detectors:**
 - **Photoconductors**
 - **Photodiodes**
5. **Development trends in HgCdTe materials and devices**

Success of HgCdTe as an Infrared Detector Material Is Due to Its Energy Band Structure

- Adjustable energy band gap covers the 1-25 μm IR region
- Direct interband transitions give quantum efficiencies approaching 100% for 15 μm thick devices
- Intrinsic recombination mechanisms give long carrier lifetimes and high operating temperatures

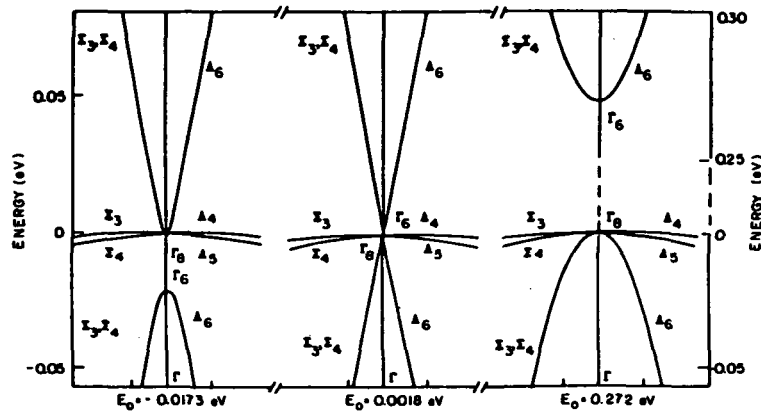

The $\text{Hg}_{1-x}\text{Cd}_x\text{Te}$ Semiconductor Alloy System Possesses Many Desirable Properties for an Infrared Detector Material

- Continuously adjustable energy gap from -0.3 eV to 1.6 eV
- Large absorption coefficient for high quantum efficiency
- Small lattice mismatch: 0.3% between HgTe and CdTe
- Amphoteric (can be made n-type or p-type):
 - Foreign atom donors and acceptors
 - Native defect acceptors
- Large electron-to-hole mobility ratio (400 for $x=0.2$ at 77K)
- Electrical purity levels of less than $1\text{E}14 \text{ cm}^{-3}$
- Surfaces are compatible with many passivation approaches:
 - ZnS, SiO_2
 - Native (anodic) oxide, sulphide or fluoride
 - Wide-gap HgCdTe

The Hg_{1-x}Cd_xTe Semiconductor Alloy System Possesses Many Desirable Properties for an Infrared Detector Material (continued)

- Long minority carrier lifetimes:
 - p-type: Shockley-Read, Auger 7
 - n-type: Auger 1, Shockley-Read
- Favorable thermal expansion coefficient:
 - Good match to silicon
 - Excellent match to GaAs, sapphire
- Low dielectric constant for low junction capacitance
- Compatible with many advanced crystal growth techniques:
 - Bulk: Honeywell's DME; THM
 - LPE: from Hg-rich and Te-rich solutions
 - VPE: MOCVD, MBE

Detector Cutoff Wavelength for Hg_{1-x}Cd_xTe Devices

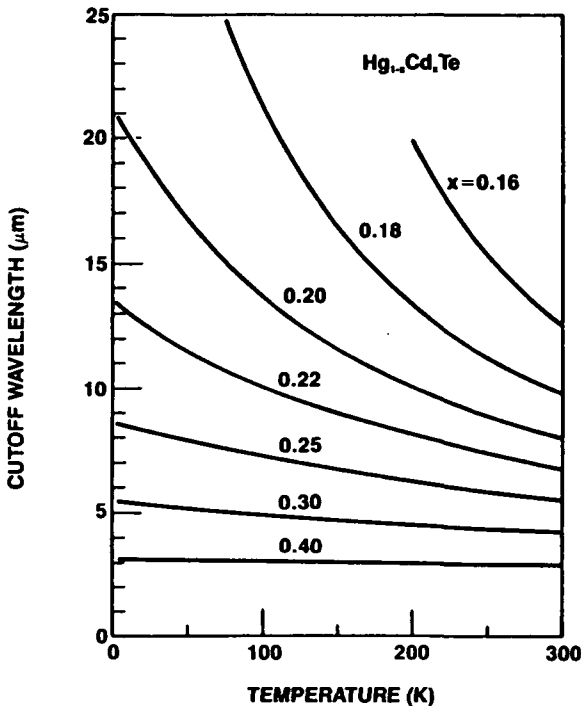

$$\lambda_{co} (\mu m) = \frac{1.24}{E_g(eV)}$$

$E_g(x, T)$ from:

Hansen, Schmit, Casselman
J. Appl. Phys. 53, 7099 (1982).

Today's $\text{Hg}_{1-x}\text{Cd}_x\text{Te}$ has Excellent Uniformity of Alloy Composition

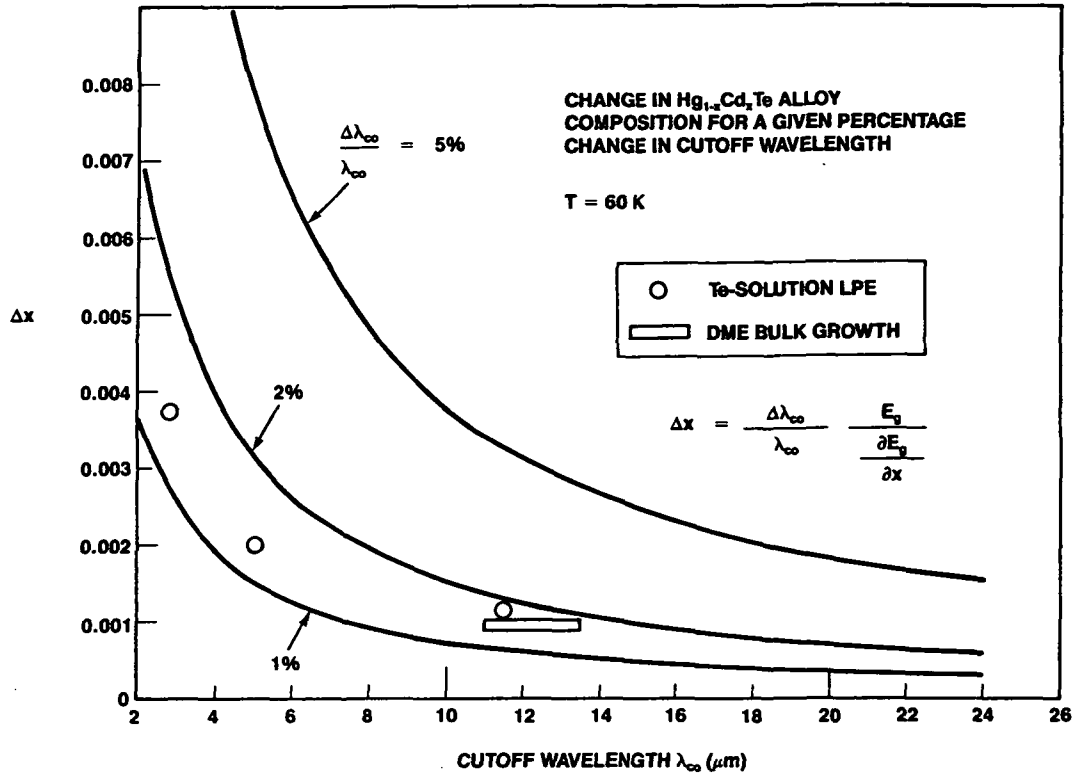

HgCdTe Device Technology

PHOTOCONDUCTORS

- n-type and p-type
- Signal PProcessing In The Element (SPRITE)
- Photo-JFET structures with gain enhancement

PHOTODIODES

- Homojunctions: n-on-p and p-on-n
- Heterojunctions: N-on-p and P-on-n
- Avalanche photodiode for 1.3 to 1.6 μm

PHOTOCAPACITORS

- n-channel and p-channel Charge Coupled Devices
- Charge Imaging Matrix

OTHER

- n-channel Insulated-Gate Field Effect Transistors
- Spin-flip Raman laser

Noise in A Two-Level Detector

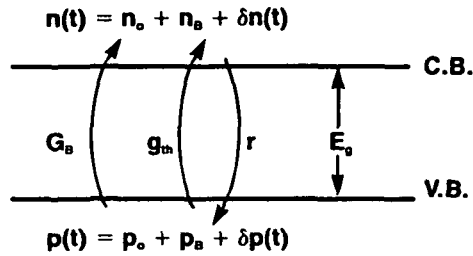

$$n_b = p_b = G_b \tau$$

$$\frac{1}{\tau} \approx \frac{\partial}{\partial n} (r-g)$$

$$\delta n(t) = \delta p(t)$$

g-r Theorem (Burgess, 1954):

$$\overline{\delta n(t)^2} = \frac{1}{Ad} [g_{th} + G_b] \tau$$

$$= \frac{1}{Ad} \left[\frac{n_o p_o}{n_o + p_o} \frac{1}{\tau} + \frac{\eta Q_b}{d} \right] \tau$$

$$= \frac{1}{Ad} \left[\frac{n_i^2}{n_o \tau} + \frac{\eta Q_b}{d} \right] \tau$$

$$n_o p_o = n_i^2 (E_g, T)$$

for $n_o \gg p_o$

LWIR PC HgCdTe Sensitivity vs Temperature

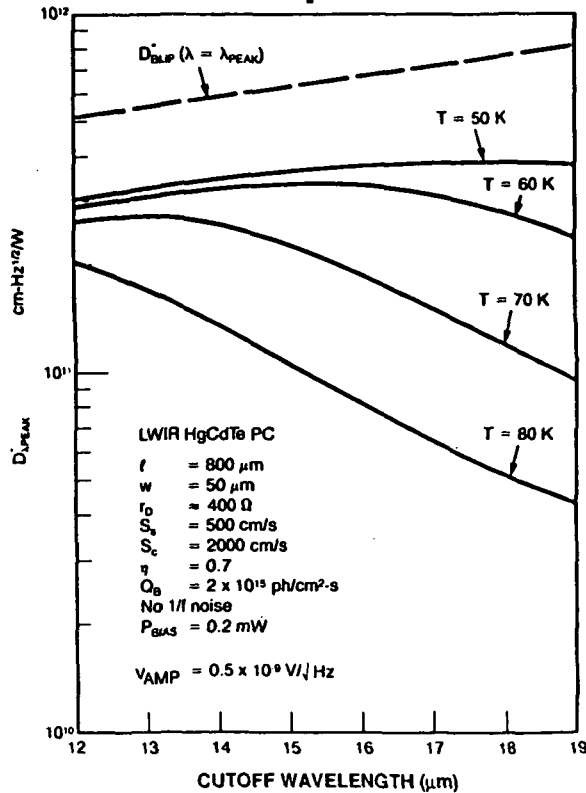

- Transit-limited response times of 0.5 μsec
- Photoconductive gain = 200
- DC bias power = 0.1-0.3 mW
- 60-180 element linear arrays in full production (capacity: 600 units/month):
 - T = 77 K
 - $\lambda_{\text{peak}} = 11.8 \mu\text{m}$
 - $\lambda_{\text{co}} = 13.0 \mu\text{m}$
 - $D_{\lambda}^* = 6 \times 10^{10} - 1.4 \times 10^{11} \text{ cm-Hz}^{1/2}/\text{W}$ (BLIP for $Q_b = 0.3 - 1 \times 10^{17} \text{ ph/cm}^2\text{-s}$)
 - 1/f noise knee frequencies less than 50 - 100 Hz
 - Area = 50 $\mu\text{m} \times 50 \mu\text{m}$
- DME bulk-grown $\text{Hg}_{1-x}\text{Cd}_x\text{Te}$ material:
 - x - uniformity: $\Delta x = \pm 0.0005 \rightarrow \Delta \lambda_{\text{co}} (77 \text{ K}, 12.5 \mu\text{m}) = \pm 0.1 \mu\text{m}$
 - Electrical purity: $1 \times 10^{14} \text{ cm}^{-3}$
- Passivation by anodic oxide surface accumulation:
 - Surface recombination velocity < 500 cm/s
 - Shunt resistance = 70 Ω/\square

Generalized Backside-Illuminated HgCdTe Focal Plane Array

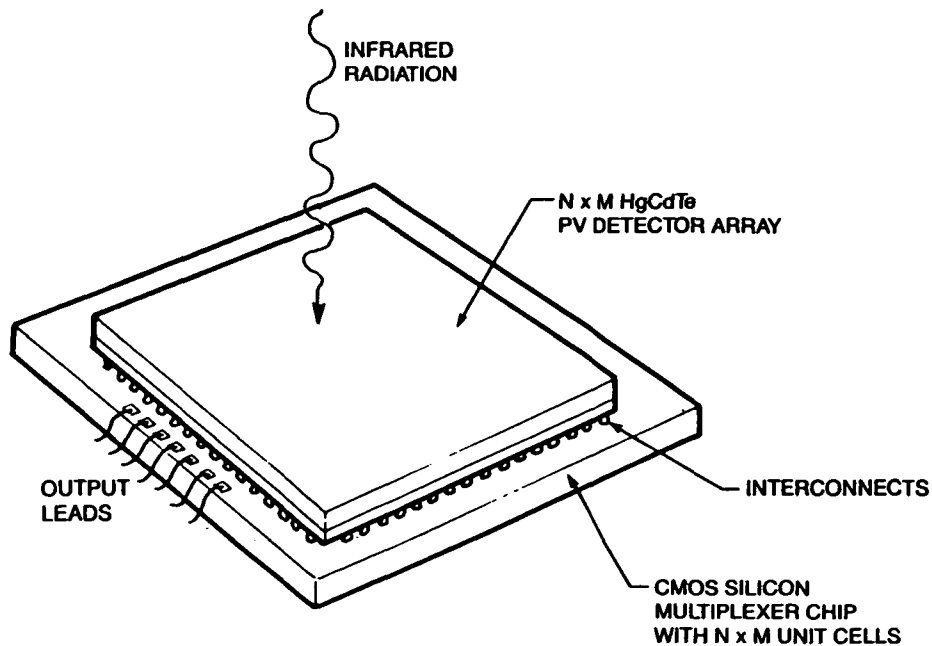

The Photon Detection Process in LWIR Focal Plane Arrays

1. Photoexcitation of electrons or electron-hole pairs
2. Transport and recombination of photoexcited carriers:
drift, diffusion, charge separation
3. Interaction with the external "input" circuit
4. Signal conditioning within each unit cell:
amplification, integration, filtering, sampling
5. Multiplexing
6. Signal processing with uncooled electronics off the focal
plane:
nonuniformity compensation, sub-frame integration

Detector Requirements for LWIR Focal Plane Arrays

1. Cutoff Wavelength:	Today: 10.5 - 12.0 μm Desired: out to 19 μm (e.g., AIRS)
2. Operating Temperature:	60-80 K (always as high as possible)
3. Detectivity:	Usually BLIP: $1\text{E}11 \text{ cm-Hz}^{1/2}/\text{W}$
4. Impedance:	High; 10 to 20 times larger than for BLIP
5. Quantum Efficiency:	> 70%
6. Active Area:	35 μm x 35 μm to 100 μm x 100 μm
7. 1/f Noise:	Critical for staring FPAs (BW=0.1 - 10 Hz)
8. Uniformity:	
cutoff wavelength:	$\pm 0.1 - 0.2 \mu\text{m}$
quantum efficiency:	$\pm 10\%$
impedance:	depends on input circuit design

Detector Requirements for LWIR Focal Plane Arrays (Continued)

9. Bias Voltage:	-10 mV to -40 mV for direct injection 0 ± 0.5 mV with active offset control
10. Crosstalk:	< 2 - 3%
11. Fill Factor:	> 80% for staring FPAs
12. Linearity:	± 2%
13. Dynamic Range:	1E4-1E5
14. Frequency Response:	Not an issue
15. Environmental Stability:	Thermal cycling; shock; vibration
16. Radiation Hardness:	Total dose; various particles

Simplified Input Coupling Model for Hybrid FPA

$$D^* = \frac{qn\lambda}{hc} \sqrt{A} \left(\overset{\text{BACKGROUND NOISE}}{\downarrow} 2q^2 \eta\phi A + \overset{\text{DETECTOR JOHNSON NOISE}}{\downarrow} \frac{4kT}{R} + \overset{\text{INPUT NOISE}}{\downarrow} \frac{e^2}{R^2} \right)^{-1/2}$$

e. = amplifier (or input gate) noise voltage

A = detector area

R = detector zero bias resistance

(Assumes coupling efficiency ≈ 1.0)

Key Focal Plane Requirements for AIRS Instrument



FPA SENSITIVITY REQUIREMENTS

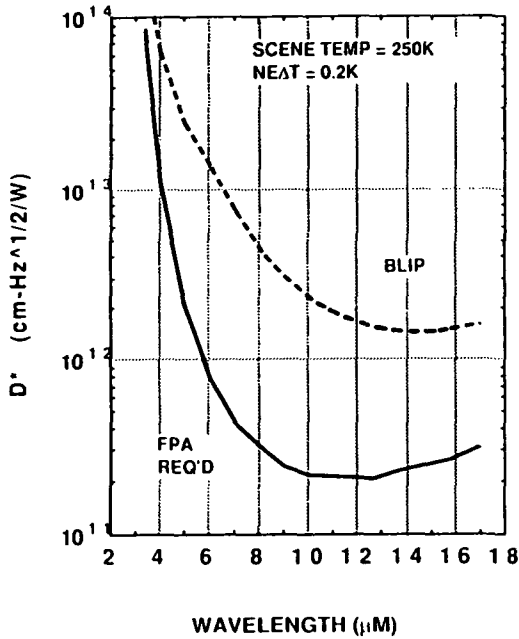

- Configuration
 - Multiple linear arrays
 - 8 SWIR Bands: 3.4 to 8.0 μm
 - 8 LWIR Bands: 8.0 to 15.4 μm (17.0 μm Goal)
- Pixel Size: 200 μm x 100 μm
- Total Pixel Count: 3950
- Background Flux Density: $\leq 2\text{E}15$ $\text{ph}/\text{cm}^2\text{-s}$ (LWIR)
- Minimum Operating Temp: 60 K
- Thermal Heat Load ≤ 500 mW
- Outages $\leq 2\%$
- Reliability ≥ 0.99 at 5 years
- Total Dose $\leq 2\text{E}4$ rads (Si)
- Technology Cutoff: 1992 1st instrument

REQUIRED R_oA PRODUCTS FOR AIRS PV DETECTORS

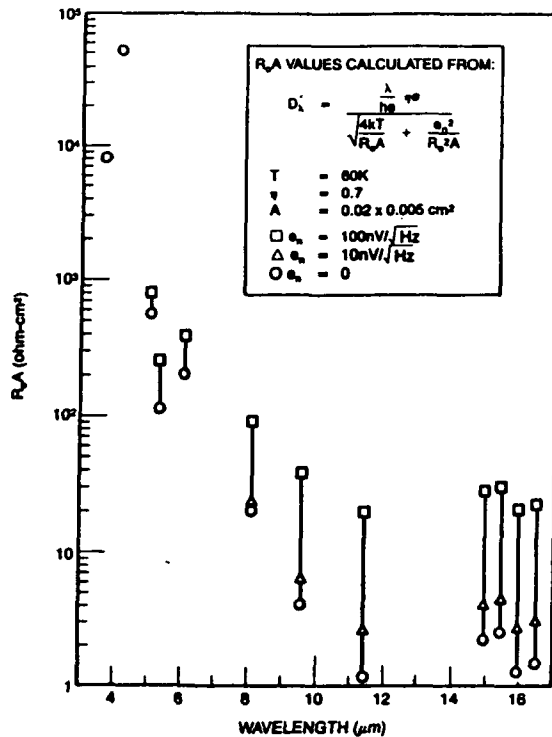

P-N Junction Formation in HgCdTe

- 1968 Hg-Diffused n⁻-on-p
 - Hg-vacancy acceptors
- 1975 Ion-implanted n⁺-on-p (n⁺-n⁻-on-p)
 - implant damage
 - native & foreign acceptors
- 1982 LPE grown heterojunctions
 - N-on-p
 - P-on-n
- 1987 Acceptor-diffused p-on-n
 - diffusion sources:
ion implant
Hg-solution
- 1990 MOCVD grown heterojunctions

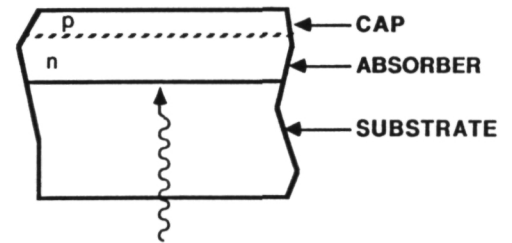
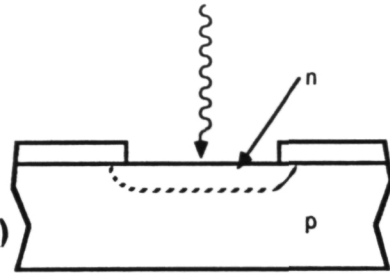

BACKSIDE-ILLUMINATED P-on-n LPE HgCdTe HETEROJUNCTION PHOTODIODES

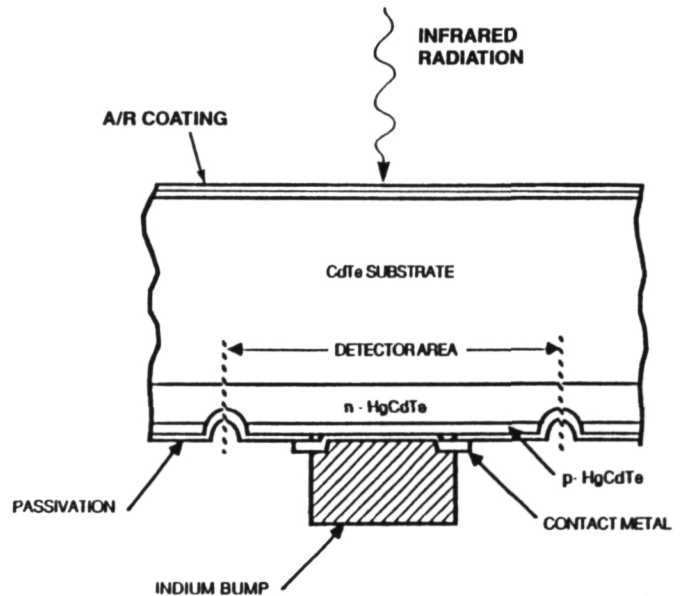
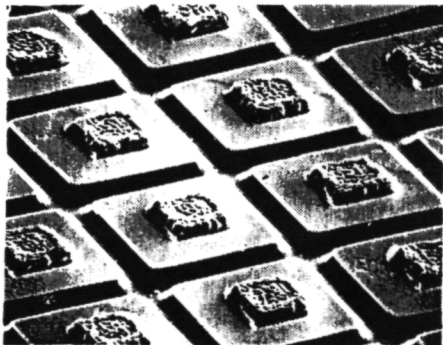

VLWIR P-on-n LPE HgCdTe Heterojunction Film Grown at Loral

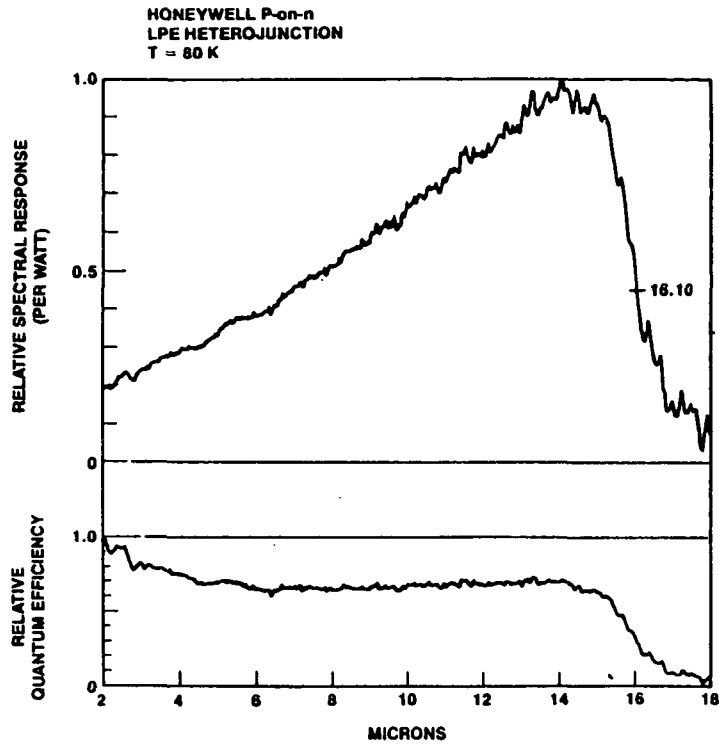

VLWIR P-on-n LPE HgCdTe Heterojunction Film Grown at Loral

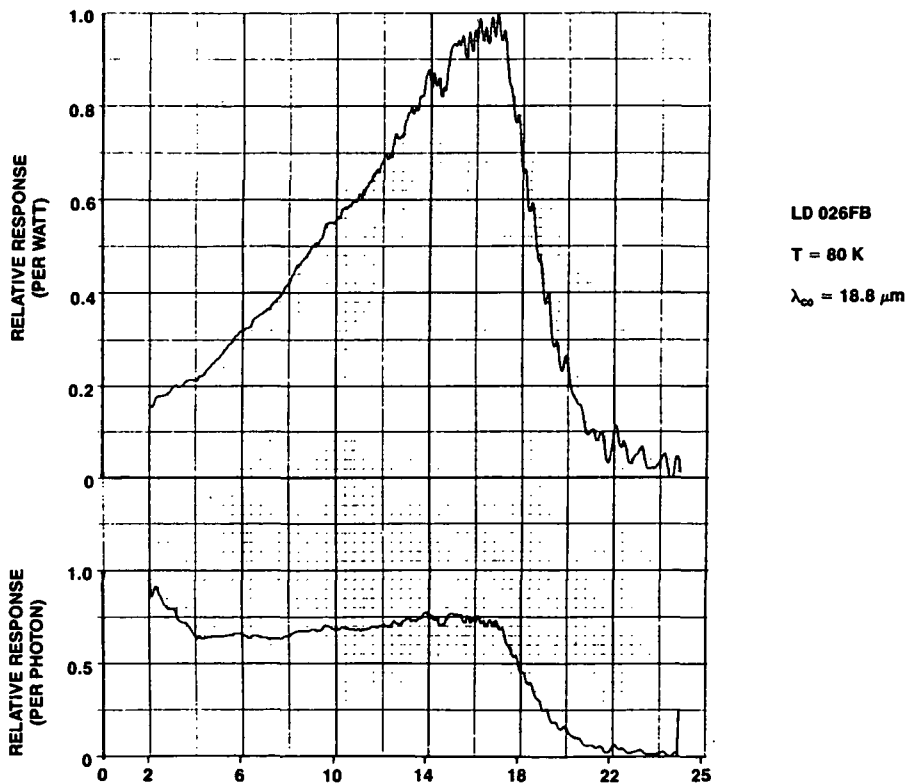

Dark Current Mechanisms in LWIR HgCdTe p-n Junction Photodiodes

I. INTRINSIC MECHANISMS

- Diffusion Current (Thermally Generated Current)
 - n-side
 - p-side
- Band-to-Band Tunneling current (Zener Tunneling)
 - Can be eliminated near zero bias by low doping

II. DEFECT-MEDIATED MECHANISMS

- Generation-Recombination (g-r) current
- Trap-Assisted Tunneling Current
- Defects may be at surface or within bulk

Dark Current Mechanisms in HgCdTe p-n Junction Photodiodes

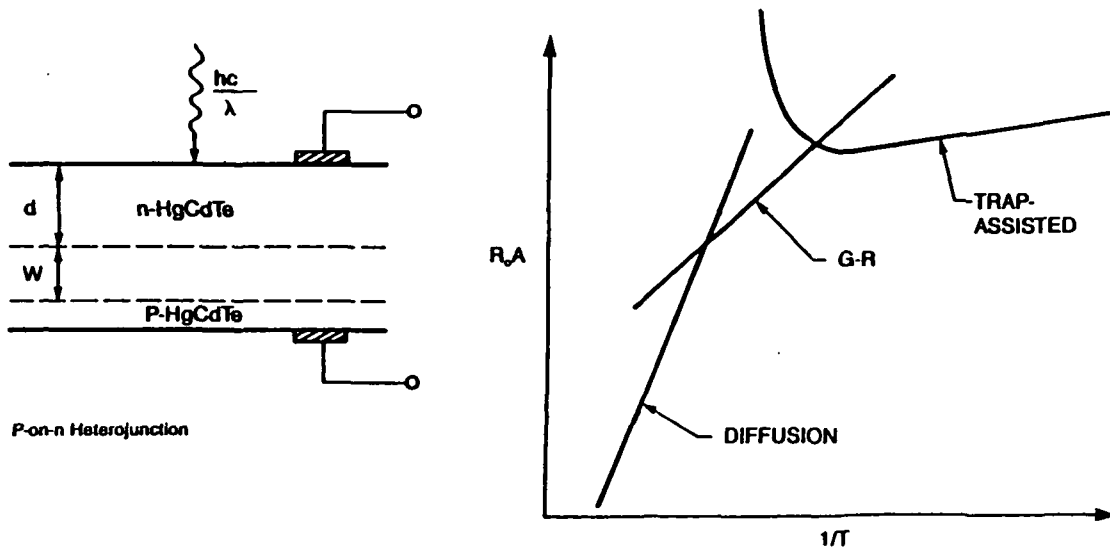

DIFFUSION CURRENT:

$$\frac{1}{R_d A} = \frac{e^2 n_i^2}{k T n_0} d$$

G-R CURRENT:

$$\frac{1}{R_d A} = \frac{e}{V_{bi}} \frac{n_i}{\tau_0} w$$

**LWIR LPE P-on-n HgCdTe
Photodiodes Grown at Loral**

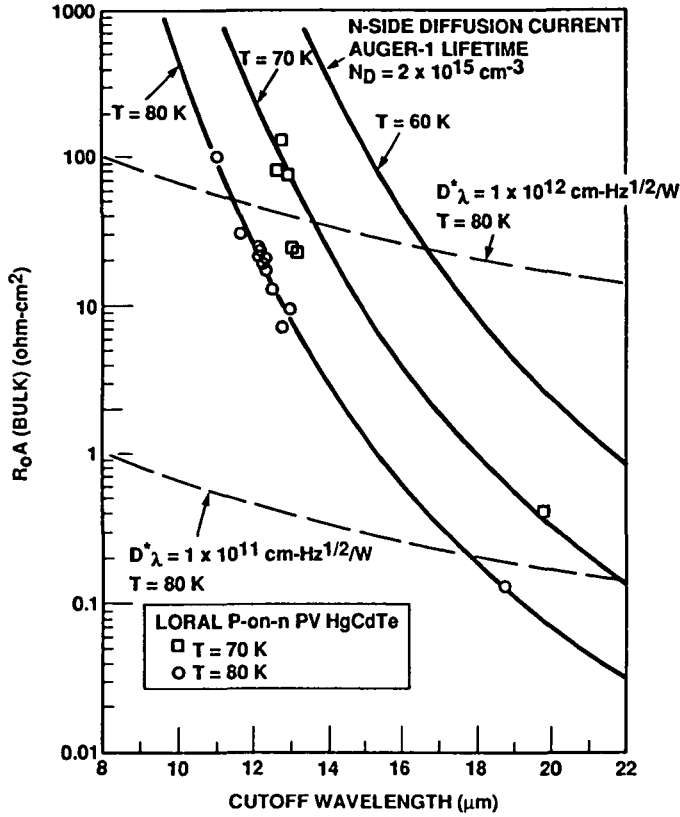

D_{λ}^* Limited by thermal noise:

$$D_{\lambda}^* = \frac{\lambda}{hc} \eta e \sqrt{\frac{R_{oA}}{4 kT}}$$

**Bilinear Array ER02C2
10.58 μm at 72 K**

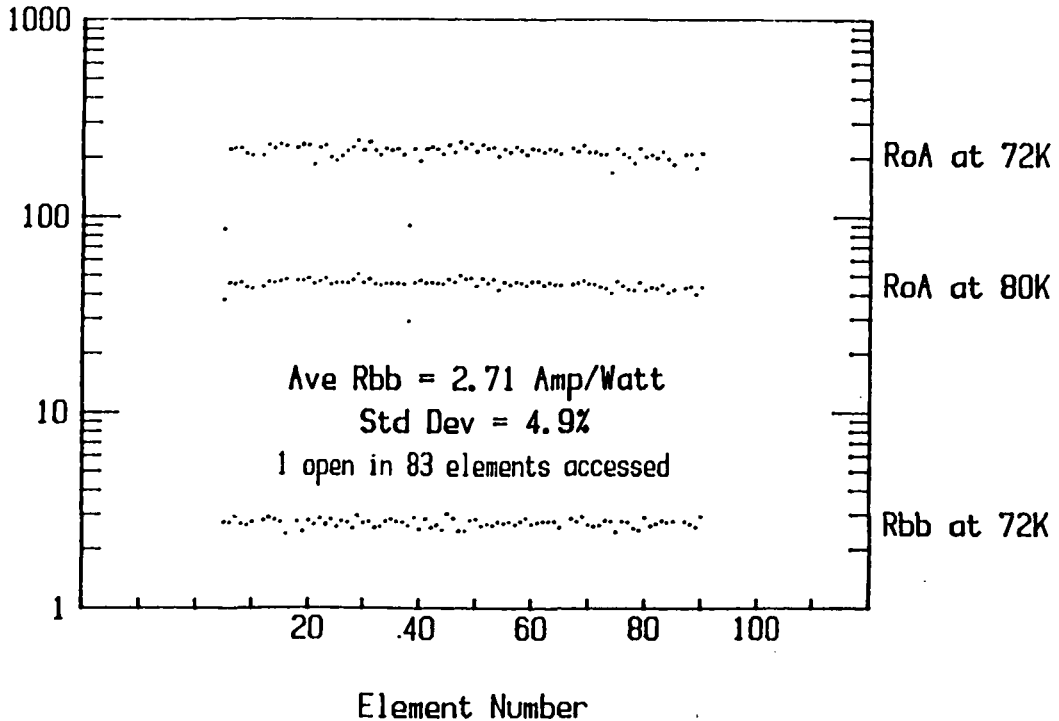

Bilinear Array ER02D4
10.68 μm at 72 K

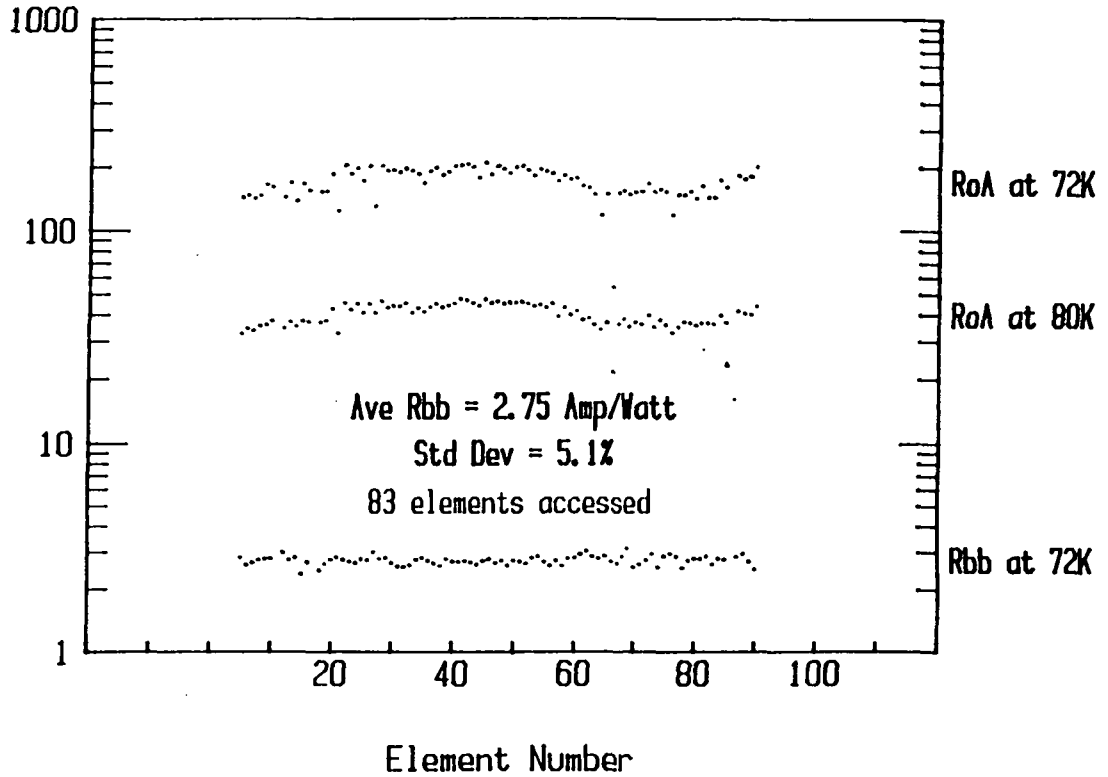

LWIR P-on-n HgCdTe PV Array

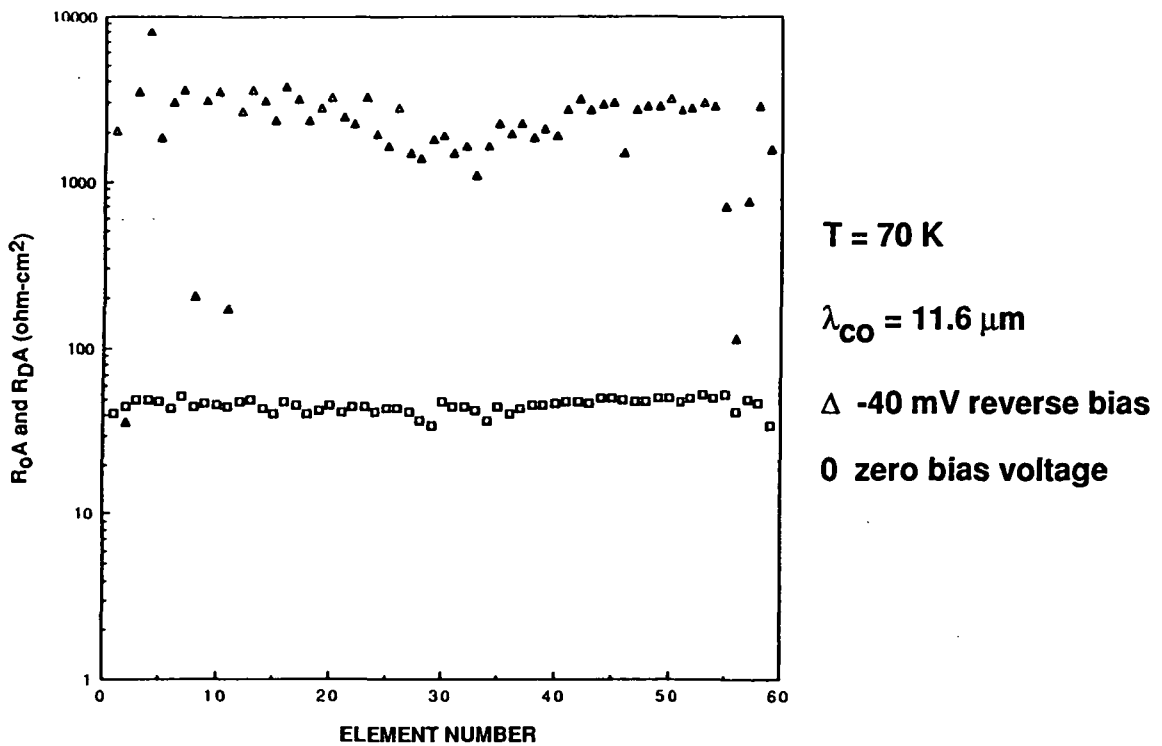

1. LOWER GROWTH TEMPERATURE AND LAYERED GROWTH:

Temperature	Technique	
700 °C	Bulk crystal growth: <ul style="list-style-type: none"> • Solid state recrystallization • Honeywell's DME • Traveling heater method 	} PC
400 °C - 500 °C	Liquid Phase Epitaxy <ul style="list-style-type: none"> • Te-Rich • Hg-Rich 	} PV
150 °C - 300 °C	MOCVD	
120 °C - 195 °C	MBE	

2. FOREIGN SUBSTRATES:

CdTe → CdTeSe → Sapphire → GaAs → GaAs on Si
CdZnTe

Conclusions

1. HgCdTe has nearly ideal semiconductor properties for LWIR detection
2. Alloy composition uniformity of today's bulk-grown and LPE HgCdTe is more than adequate
3. LWIR HgCdTe P-on-n LPE heterojunction photodiode performance is at the limit set by n-side diffusion current for Auger-1 lifetime for $T > 70$ K
4. Continued development of HgCdTe material and device technology will:
 - a. Improve performance:
 - Reduced leakage current and 1/f noise
 - Longer cutoff wavelengths
 - b. Increase producibility:
 - Low-cost large-area substrates
 - Improved screening techniques for material and arrays
 - c. Enable in situ VPE growth of advanced device structures:
 - p-n homojunctions and heterojunctions
 - Wide-gap passivation
 - Low-resistivity contact layers