

**NASA  
Technical  
Paper  
3048**

1991

**Parametric Experimental  
Investigation of a  
Scramjet Nozzle at Mach 6  
With Freon and Argon or Air  
Used for Exhaust Simulation**

James M. Cabbage  
*Vigyan Research Associates, Inc.*  
*Hampton, Virginia*

William J. Monta  
*Langley Research Center*  
*Hampton, Virginia*



National Aeronautics and  
Space Administration  
Office of Management  
Scientific and Technical  
Information Division



## Summary

A parametric experimental investigation of a scramjet nozzle has been conducted in the Langley 20-Inch Mach 6 Tunnel with a gas mixture used to simulate the scramjet engine exhaust flow at a free-stream Reynolds number of approximately  $6.5 \times 10^6$  per foot. External nozzle surface angles of  $16^\circ$ ,  $20^\circ$ , and  $24^\circ$  were tested with a fixed-length ramp and for cowl internal surface angles of  $6^\circ$  and  $12^\circ$ . Pressure data on the external nozzle surface were obtained for mixtures of Freon and argon gases with a ratio of specific heats of about 1.23, which matches that of a scramjet exhaust. Forces and moments were determined by integration of the pressure data.

Two nozzle configurations were also tested with air used to simulate the exhaust flow. On the external nozzle surface, lift and thrust forces for air exhaust simulation were approximately half of those for Freon-argon<sup>1</sup> exhaust simulation and the pitching moment was approximately a third. These differences were primarily due to the difference in the ratios of specific heats between the two exhaust simulation gases.

A  $20^\circ$  external surface angle produced the greatest thrust for a  $6^\circ$  cowl internal surface angle, but both the  $16^\circ$  and  $24^\circ$  external surface angles produced slightly more thrust than the  $20^\circ$  angle with the  $12^\circ$  cowl angle. An external nozzle flow fence that restricted lateral, or spanwise, expansion of the exhaust downstream of the cowl significantly increased lift and thrust forces over those for the nozzle without a flow fence. Calculated thrust for the internal portion of the nozzle was generally twice that measured for the external portion and the calculated internal lift was of opposite sign and approximately the same magnitude as that measured on the external nozzle surface.

## Introduction

The advent of the supersonic-combustion ramjet, or scramjet, engine opened the door to flight speeds well above Mach 6 for air-breathing propulsion systems. Because existing and proposed engine ground-test facilities could not provide data on engine performance in this flight regime, a flight research vehicle (X-24C) was proposed in the 1970's (refs. 1 and 2) to act as a scramjet test facility and to extend the aerodynamic flight data base beyond that obtained from the X-15 program. This new research vehicle program stimulated research at the Langley Research Center as well as at other Government research facilities, but the program was canceled in

the late 1970's with a resulting decline in research for air-breathing hypersonic vehicles. Recently, interest in these types of aircraft resurfaced as part of the National Aero-Space Plane Program (ref. 3), and although the technology requirements for this new program are more challenging than those of the previous program, many of the basic issues affecting scramjet-powered aircraft are unchanged. One of the most challenging issues concerning hypersonic, air-breathing aircraft is that of the efficient integration of the propulsion system with the airframe. Because of the large inlet compression and nozzle expansion ratios required for high Mach number flight, the entire undersurface of the airframe must be an integral part of the propulsion system.

The lower rear portion of the airframe is part of the nozzle expansion surface. The large thrust and pitching-moment contribution from the external nozzle could significantly affect overall vehicle stability and trim. Early analyses (1970) to determine the severity of this problem over Mach numbers of 6 to 10 were limited to two-dimensional solutions of flow in nozzles of arbitrary geometry, and impact theory aerodynamic programs were used to calculate aircraft longitudinal stability. This effort identified several nozzle geometries that had minimal effects on trim drag of a typical hypersonic configuration and generally established the effect of individual nozzle geometric parameters on forces and moments produced by the nozzle flow.

An experimental data base was established to confirm the trends of the two-dimensional analyses and to provide data for a three-dimensional flow field. Wind tunnel tests of a three-module scramjet nozzle and a vehicle afterbody were conducted in the Langley 20-Inch Mach 6 Tunnel in the mid-1970's with air used to simulate the scramjet exhaust. The unpublished data provided forces and moments produced by different portions of the nozzle and by the nozzle as a whole. The Freon-argon gas mixture used to simulate the scramjet exhaust flow for the present tests was developed to duplicate the Mach number, the static-pressure ratio, and the ratio of specific heats at the engine combustor exit (ref. 4). This technique was validated in a detonation tube for flight values of Reynolds number and enthalpy at Mach 6 and 8 (refs. 5 and 6) by comparing surface pressures on an external nozzle obtained for hydrogen-air combustion and for Freon-argon mixtures.

For the tests reported herein, Mach number, static pressure, and ratio of specific heats at the combustor exit were approximated for the X-24C scramjet operating in cruise flight at Mach 6 at dynamic pressures between 500 and 1000 lbf/ft<sup>2</sup>. These conditions are considerably different than the accelerating,

<sup>1</sup> Freon: Registered trade name of E. I. du Pont de Nemours Co.

high-dynamic-pressure flight proposed for the National Aero-Space Plane at Mach 6, and consequently engine combustor exit pressures would be greater than those originally contemplated for the experimental results reported herein. For these tests static pressure at the combustor exit was varied over a limited range for all nozzle configurations, and in all cases the exhaust flow was underexpanded at the cowl lip (i.e., the end of the internal portion of the scramjet nozzle). Data for one nozzle configuration with and without a flow fence with air used for the exhaust flow are included in appendix A.

## Symbols and Abbreviations

$A$	area, in <sup>2</sup>
c.g.	center of gravity
$F_N$	force normal to ramp surface, lbf
$F_R$	resultant gross thrust vector (see fig. 16), lb
F12	Freon 12 (CCl <sub>2</sub> F <sub>2</sub> )
F13B1	Freon 13B1 (CBrF <sub>3</sub> )
GLW	gross launch weight
$h$	combustor exit height, 0.60 in.
$L$	lift, lbf
$l$	distance along instrumented surface between station 3 and downstream end of integration area, in.
$M$	Mach number
$M_Y$	pitching moment, positive as defined in figure 4, lbf-in.
NPR	nozzle pressure ratio, $\frac{p_{t,j}}{p_\infty}$
$n$	static-pressure orifice number
$p_s$	surface pressure, psia (denoted as PS in table II)
$p_{t,j}$	jet total pressure, psia (denoted as PTJ in table II)
$p_3$	static pressure at station 3, psia (denoted as P <sub>3</sub> in table II)
$p_\infty$	free-stream static pressure, psia (denoted as PINF in table II)
$T$	thrust, lbf
$V$	velocity, ft/sec
$x$	axial distance along instrumented surface from station 3, in. (denoted as X in table II)

$y$	perpendicular distance from reflection plate, in. (denoted as Y in table II)
$z$	distance along model reference line from station 3 ( $z = x \cos \beta$ ), in.
$\alpha$	angle of attack, deg
$\beta$	angle between model reference line and instrumented ramp surface (see fig. 4), deg
$\gamma$	ratio of specific heats
$\epsilon$	angle between model reference line and internal cowl surface (see fig. 4), deg
$\Theta$	thrust resultant vector angle relative to model reference line, positive clockwise from thrust vector (see fig. 16), deg
$\rho$	density, slug/ft <sup>3</sup>
Subscripts:	
$ex$	external
$in$	internal
$j$	jet
$n$	orifice number
$s$	surface
$t$	total
2	conditions at throat of nozzle
3	conditions at combustor exit
4	conditions at cowl lip
$\infty$	free-stream conditions

Bar over symbol indicates arithmetic average. All data presented are based on measurements made in U.S. Customary Units.

## Apparatus and Methods

### Wind Tunnel

This investigation was conducted in the Langley 20-Inch Mach 6 Tunnel at a free-stream Reynolds number of approximately  $6.5 \times 10^6$  per foot. Tunnel stagnation conditions for all tests reported herein were 365+5 psia and 400°F to 425°F. Further details about this facility can be found in references 7 and 8.

### Model

The model for this investigation was a simplified version of the lower rear portion of a hypersonic research vehicle proposed in the 1970's. (See fig. 1.)

Also shown in this figure is the inverted position in which the model was mounted on a strut-supported reflection plate that, in turn, was attached to the tunnel floor. Through use of a half-span model of the vehicle afterbody a larger model could be constructed, and introduction of the simulant gas or air into the model was simplified. The external nozzle (ramp) was made long enough to assure fully expanded flow on the external nozzle for the range of NPR values tested. Photographs of the model appear in figure 2, and a three-view drawing of the model is shown in figure 3. Figure 4 shows the several geometry changes to the nozzle that were investigated as well as the coordinates for the internal nozzle that generated the combustor exit Mach number  $M_3$ .

The model was fabricated from aluminum except for the plenum, the nozzle used to generate  $M_3$ , and the cowl portion of the nozzle. (See fig. 3.) These parts were machined from stainless steel. The surface that formed the external part of the nozzle was instrumented with 124 0.060-in.-diameter orifices, with 120 of these integrated to determine forces and moments. (See fig. 5.) The orifices labeled "internal" in this figure were used to measure the static pressure at the combustor exit  $p_3$ . Pressure leads from all orifices were connected with jumpers to 0.090-in.-diameter tubing outside of the model to minimize pressure lag. All orifices for the gas mixture tests were connected to six 28-port scanivalves and each valve used a pressure transducer with a capacity of 5 psia. Two 48-port electronically scanned pressure modules were used for the air tests; one module had a range of 0 to 5 psia and the other had a range of 0 to 15 psia. All pressure instrumentation was calibrated prior to each series of data runs.

Total pressure and temperature in the model plenum and at the bottom of the reflection plate strut (where the piping from the gas system connected) were measured for each run. The pressure in the plenum  $p_{t,j}$  ranged from a minimum of 10 psia to a maximum of 34 psia, and the total temperature over this range of pressures was generally 385°F to 405°F. Corresponding conditions for the air tests were 13.9 to 25.8 psia and 85°F to 105°F. Because of space restrictions within the model and because the simulant gas entered the plenum perpendicular to the exhaust flow direction, the plenum total pressure was calibrated against total-pressure surveys at the throat (station 2) of the  $M_3$  nozzle. Pitot-pressure surveys were also made at the exit of this nozzle (station 3) to establish the experimental value of  $M_3$ . All  $p_{t,j}$  values reported have been corrected based on the pitot surveys, and this correction increased the measured values by about 10 percent.

The contour of the  $M_3$  nozzle was obtained from the code of reference 9 with the desired conditions for the nozzle known, that is,  $M_3 = 1.7$ ,  $h = 0.6$  in.,  $\gamma = 1.2$ , nozzle length, and the one-dimensional gas dynamic properties of the selected gas mixtures. The code of reference 10 was used to compute the flow in the nozzle, given the scaled, inviscid two-dimensional nozzle contour and a table for gas properties for each gas, to determine if any flow irregularities existed. The total-pressure survey at the nozzle exit indicated  $M_3$  was 1.72, for an average  $\gamma$  of 1.22. This same nozzle was used for expediency in the air tests, with the result that  $M_3$  increased to 1.78 and the static pressure at the cowl exit  $p_4$  decreased approximately 15 percent compared with that for the gas mixture for a given  $p_{t,j}$  value.

Discrete positive angles of attack (i.e., nose of model down as mounted in the tunnel) from 0° to 10° in 2° increments could be achieved by rotating the whole model about the hollow bushing through which the gas and air passed from the strut to the plenum. However, for this investigation, only angles of attack of 0° and 4° were used.

### Simulant-Gas System

Research reported in references 3 to 5 showed that Freon 12 or Freon 13B1 mixed with argon in the respective ratios of 40/60 or 50/50 by volume produced a gas mixture that duplicated the desired  $\gamma$  of a scramjet exhaust. Validation tests in a detonation tube at Mach 6 and 8 showed that surface pressures on a 20° inclined external nozzle were essentially identical for a gas mixture exhaust and for a hydrogen-air combustion exhaust flow.

Basically, the gas system fabricated for this investigation consisted of a heated storage vessel with a volume of 22 ft<sup>3</sup>, Freon and argon pumps, manifolds for the gas bottles, and control valves necessary for operating the system. The storage vessel contained about 220 lb of gas mixture when fully charged to a pressure of about 1500 psia at 500°F to 550°F. Further details of the system can be found in appendix B.

### Data Reduction

The normal force acting on the nozzle external surface for each test condition was obtained by summing the pressure-area product for each static-pressure orifice within the integration area depicted in figure 5. The pitching moment for each pressure-area product was determined about a point located as shown in figure 4. In equation form, for  $\alpha = 0^\circ$ ,

$$F_N = \sum_1^n (p_{s,n} - p_\infty) A_{s,n} \quad (1)$$

$$L = F_N \cos \beta \quad (2)$$

$$T = F_N \sin \beta = L \tan \beta \quad (3)$$

$$M_Y = - \sum_1^n (p_{s,n} - p_\infty) A_{s,n} x_n \quad (4)$$

In a similar manner, integrated forces representing shorter external nozzles were computed by omitting the orifices beyond the desired ramp length. The values of the forces and moments obtained from these equations were nondimensionalized by the ideal thrust  $T_3$  and moment  $M_{Y,3}$  calculated for the exhaust flow at the combustor exit for each test condition; that is,

$$\begin{aligned} T_3 &= (\rho_3 A_3 V_3) (V_3) + p_3 A_3 - p_\infty A_3 \\ &= p_3 A_3 \left( \gamma_3 M_3^2 + 1 - \frac{p_\infty}{p_3} \right) \end{aligned}$$

$$M_{Y,3} = T_3 \frac{h}{2}$$

where  $A_3 = 1.8 \text{ in}^2$  and  $M_3 = 1.72$ .

A two-dimensional Euler code called Seagull (ref. 11) was used to calculate forces and moments resulting from the exhaust flow acting on the internal portion of the nozzle between stations 3 and 4. These forces (which do not include  $T_3$ ) were then added to those determined experimentally on the external nozzle surface to arrive at the forces and moments for the complete scramjet nozzle (aft of the combustor exit, station 3).

The area represented by each orifice was determined by locating the boundaries of the area at half the distance to adjacent orifices. (See, e.g., orifice 27 at  $x = 7.5 \text{ in.}$  in fig. 5.) This approach resulted in a number of areas for which the orifice was not centrally located in the area and, because of varied orifice spacing, resulted in some relatively large areas at the rear of the model that were represented by a single orifice. The possible error in integration results introduced through use of one measured pressure to represent the pressure acting over a large area was investigated by fitting a cubic spline curve through the experimental data and then using a 91-step integration to obtain forces and moments. This effort yielded lift and thrust forces about 4 percent greater and moments about 3 percent greater than the summation of pressure-area and pressure-area-moment arm products used herein.

## Results and Discussion

Geometric parameters, angle of attack, and gas mixture ratios associated with each configuration are

presented in table I in order to condense the identification required for the data figures herein. Data for each configuration were obtained for several values of combustor exit static pressure  $p_3$ , and a listing of all pressure data recorded is given in table II.<sup>2</sup> The figures only present results for selected values of  $p_3$ .

### External Nozzle Surface Pressures

Figures 6 to 10 present sample distributions of  $p_s/p_3$  obtained for the nozzle external surface of configurations IV, V, VI, V-A, and II as a function of  $x$  and  $y$  for constant values of  $y$  and  $x$ , respectively, and as contour plots of constant values of  $p_s/p_3$ . A perspective view of the flow field for configuration V is shown in figure 7(d) and is representative of that for other configurations. The filled data symbols noted in figures 7, 9, and 10 represent an interpolated value of  $p_s$  that was used in the integration to obtain forces and moments. The pressures measured at these locations were judged to be in error, possibly because of leaking or plugged orifice leads. Interpolated values were used in the integration rather than deleting those orifices and distributing their areas to adjacent orifices.

A value for  $p_\infty/p_3$  is listed for these figures as a reference point. Local values of  $p_s/p_3$  less than this reference value produce negative lift and thrust. These regions can be clearly observed in the contour plots. All the contour plots were obtained by linear interpolation between adjacent orifices to obtain the isobars of  $p_s/p_3$ . Since these plots are presented to better visualize the flow over the external surface, any inaccuracies resulting from this method are not significant.

Although the value of  $p_3$  varies between 4.3 and 4.9 psia in figures 6 to 8, distributions for the different configurations can be compared because of the proportionality between  $p_{t,j}$  (and therefore  $p_3$ ) and orifice pressure, as indicated in figure 11. However, outside the exhaust flow boundary and at low exhaust total pressures ( $p_{t,j} \leq 10 \text{ psia}$ ), this proportionality is not necessarily true because of probable separation effects.

The lateral, or spanwise, expansion of the exhaust flow readily apparent in the contour plots is also shown in the distributions for constant  $x$  (fig. 6(b), for example) but is less apparent in the distributions for constant  $y$ . This expansion, or "pluming," of the

<sup>2</sup> The test data in digital form (recorded on personal computer disks) can be requested from the following source:  
NASA Langley Research Center Technical Library  
Attn: 185B/Special Documents Section  
Hampton, VA 23665-5225  
(804) 864-2362

exhaust flow at the end of the engine nacelle (i.e.,  $p_4 > p_\infty$ ) represents a loss in thrust and was of concern in early hypersonic aircraft designs not only because of thrust losses but also because of the possibility of plume impingement on rear control surfaces at high flight Mach numbers. Flow fences were considered to restrict the lateral expansion of the exhaust flow, but it was also realized that other factors, such as the structural strength required for fences to account for large stresses from both aerodynamic and acoustical forces, could negate any net thrust gain. Wind tunnel tests of a hypersonic configuration (having both turbojet and scramjet propulsion systems that used a common inlet) at transonic speeds showed that fences caused a significant loss in lift (ref. 12). This effect resulted from overexpansion of the turbojet exhaust causing lower than ambient pressures to exist over the aft undersurface between the fences. In addition, this pressure differential also acted on the normal projected area of the fences that were canted outward to conform with the elliptical cross section of the body and engine nacelle, thereby contributing to the loss in lift. If the overall negative impact of fences noted in reference 12 is generally applicable to other configurations at subsonic and transonic speeds, then a strong positive influence may be required at hypersonic speeds to justify their use.

The configuration with  $\beta = 20^\circ$  and  $\epsilon = 12^\circ$  was tested with a fence and the  $p_s/p_3$  distributions and contour plots obtained are shown in figure 9. The two-dimensionality of the exhaust flow between the fence and the reflection plate is apparent, and surface pressures outside the fence suggest that the external flow has separated from the surface in this region (i.e.,  $p_s/p_3 \approx p_\infty/p_3$ ). This separation of the free-stream flow at, or near, station 3 occurs for all three  $\beta$  angles investigated, as indicated in figure 12. In this figure,  $p_s/p_\infty$  is shown as a function of  $x$  for  $y = 3.75$  in. without exhaust flow. Also shown are distributions of  $p_s/p_\infty$  for the configuration with  $\beta = 20^\circ$  and  $\epsilon = 12^\circ$  with exhaust flow and with and without a flow fence. The notation "Prandtl-Meyer  $1 - (p_s/p_\infty)$ " indicates the surface pressure that would result if the tunnel flow was suddenly expanded isentropically to  $16^\circ$ ,  $20^\circ$ , or  $24^\circ$ . If we assume perfect calibration of the pressure transducers, the error introduced by the transducer alone ( $\pm 0.5$  percent of full scale) is  $\pm 0.05$  for a given value of  $p_s/p_\infty$  in this figure.

During the design of the model for this investigation, the decision was made to use Seagull to determine surface pressures as well as forces and moments for the internal portion of the nozzle so that all pressure instrumentation available could be used for the external surface. Distributions of  $p_s/p_3$  along

the surfaces of the complete nozzle as obtained from Seagull (ref. 11) are shown in figure 13, along with experimental data for three  $y$ -stations on the external surface of configuration V. The results shown in this figure are typical of those for other configurations without a fence. Although Seagull is a two-dimensional inviscid code, there is good agreement between the calculated and measured pressures on that portion of the external surface not affected by lateral expansion of the exhaust flow.

### Nozzle Forces and Moments

Results from the integration of surface pressures to obtain forces and moments acting on the external nozzle surface as well as on the complete nozzle are discussed in this section. Because the length of the instrumented portion of the external nozzle surface selected for this investigation ( $l = 11.0$  in., or  $l/h = 18.33$ ) was based on previous inviscid analytical studies that indicated the flow would be fully expanded for the range of NPR's tested, results for shorter lengths of external nozzle surface can be determined from the data by just integrating the pressure over a shorter length. Forces and moments for the internal surfaces of the nozzle were calculated with the Seagull program with experimental values for  $p_3$ ,  $p_\infty$ ,  $T_3$ , and  $M_3$  used as inputs. These results were then added algebraically to the experimental results for the external surface to obtain overall forces and moments for the complete nozzle.

**Effect of  $\beta$  on forces and moments.** Nondimensional forces and moments obtained from integration of pressures acting on the full-length nozzle external surface are presented in figure 14 as a function of  $\beta$  for two average values of  $p_3$  and for the two values of  $\epsilon$  tested. For this investigation, free-stream static pressure was always reached before the end of the ramp, and as a result the pressures on the rear-most area of that ramp do not make any contribution to the calculated forces. Forces reported for the maximum plate length are therefore the maximum attainable for that ramp angle, and consequently there are no NPR effects involved. There would, however, be NPR effects associated with the results for shorter ramp lengths for which surface pressures had not expanded to the level of free-stream (ambient) static pressure by the end of the ramp. The value of  $p_3$  was slightly different for each of the three  $\beta$  angles investigated; thus, an average of these three pressures was used as a nominal value for the figure. Although the maximum difference in  $p_3$  between values of  $\beta$  was 17 percent, this fact is not believed to be significant because the integrated forces and moments are generally proportional to  $p_3$  and are nondimensionalized

by  $T_3$  and  $M_{Y,3}$ , which are also directly proportional to  $p_3$ .

The effect of  $\beta$  on thrust is probably of primary interest in figure 14. For  $\epsilon = 6^\circ$  (fig. 14(a)), the  $20^\circ$  surface angle produces the greatest thrust of the three angles, although the difference in thrust between  $20^\circ$  and  $24^\circ$  decreases as  $p_3$  increases. However, for  $\epsilon = 12^\circ$  and  $\bar{p}_3 = 4.52$  psia (fig. 14(b)) the thrust actually increases when  $\beta$  increases from  $20^\circ$  to  $24^\circ$ . This trend is not noted for  $\bar{p}_3 = 2.93$  psia, however. The differences in results for the two cowl angles  $\epsilon$  are smaller than the influence of  $\beta$  on external nozzle forces. These data are only for the external part of the nozzle, so any conclusions on the effect of  $\beta$  on nozzle performance must be based on results for the complete nozzle.

Results for the complete nozzle are shown in figure 15, wherein the sum of experimental and calculated forces and moments is plotted as a function of  $\beta$  for the same average values of  $p_3$  as in figure 14. Comparison of either figures 14(a) and 15(a) or 14(b) and 15(b) shows relatively large changes in lift and thrust levels but only a small change in the moments because of the short moment arm of the internal nozzle. The thrust generated by the internal part of the nozzle is about twice that generated by the external part. Depending on  $\beta$  and  $\epsilon$  the lift for the complete nozzle can be reduced, canceled, or reversed in sign because of the contribution of the internal lift, a finding that would indicate nozzle geometry has a significant effect on thrust vector orientation.

Unpublished results from previous exploratory tests of a different model with air used to simulate the engine exhaust flow showed that the length of the cowl is also a factor. That is, those data confirmed predictions that lengthening the cowl produces more negative lift for the complete nozzle, but with only a minimal increase in thrust. Although internal nozzle forces are large relative to those for the external surface, they do not significantly affect the moment data because of the small moment arm these forces have and because moments for the upper and lower internal surfaces are opposite in sign.

Orientation of the resultant thrust vector with respect to the center of gravity of a specific hypersonic missile (ref. 13) for  $\beta = 16^\circ$ ,  $20^\circ$ , and  $24^\circ$  with  $\epsilon = 12^\circ$  is shown in figure 16. A detailed weight analysis of this vehicle was used to establish the relationship between the vehicle center of gravity and combustor exit location of the scramjet engine. Complete nozzle forces and moments were obtained from figure 15(b) for  $\bar{p}_3 = 4.52$  psia. Although the nose-up pitching moment increases with  $\beta$  for this particular set of circumstances, once again this may not be the true picture because drag and lift forces chargeable

to the engine, such as ram, inlet cowl lip, and spillage drag, are not accounted for here. In the extreme, if it is assumed that the moment due to combustor exit thrust is canceled by the moment and drag from inlet forces, then the net thrust resultant vector angle would range between  $28^\circ$  for  $\beta = 16^\circ$  to  $-11^\circ$  for  $\beta = 24^\circ$ . The actual angle of the net thrust vector for this particular vehicle with any one of the three  $\beta$  angles tested probably lies within these two extremes and serves to illustrate the complexity of determining the best nozzle geometry even for a fixed flight speed. Flight over a wide range of Mach numbers adds further complications and may require variable geometry nozzles to achieve minimum trim drag penalties.

**Effect of external nozzle length on nozzle forces and moments.** The length of the external nozzle surface selected for this investigation was based on unpublished inviscid analytical studies (similar to that in ref. 14 for a Mach 10 vehicle) that indicated a length of 11.0 in. ( $l/h = 18.33$ ) would be the maximum required for a Mach 6 vehicle. By using this length for the model, one can determine forces and moments for shorter lengths from the data by just integrating pressure over a desired length. Results obtained with this procedure for  $l/h = 10.00$  to 18.33 are shown in figure 17 for  $\beta = 20^\circ$  and  $\epsilon = 6^\circ$  and  $12^\circ$ . An essentially linear relationship exists between nozzle length and forces for  $\epsilon = 6^\circ$  and  $12^\circ$  and between nozzle length and moments for  $\epsilon = 12^\circ$ . Although the relationship between nozzle length and moments for  $\epsilon = 6^\circ$  is not linear, the trend of less negative values for shorter nozzle lengths is the same as that for  $\epsilon = 12^\circ$ . Since the calculated forces and moments for the internal nozzle are constant for a given value of  $p_3$ , total nozzle forces and moments would mirror the experimental data, but at different levels.

**Effects of flow fence on nozzle forces and moments.** The effect of a flow fence on the forces and moments for the nozzle with  $\beta = 20^\circ$  and  $\epsilon = 12^\circ$  is shown in figure 18 as a function of nozzle length. Although the data for the fence-on configuration in this figure are for  $p_3$  about 11 percent less than  $p_3$  for the fence-off data, the results for each configuration should be comparable because of the nondimensionalizing effect of  $T_3$  and  $M_{Y,3}$ . Besides the increase in lift and thrust and the more negative moment because of the fence, the lift, and therefore the moment, between  $l/h = 14.00$  and 18.33 is nonlinear. This result comes from the increasing pressure shown in the distributions of  $p_s/p_3$  in figure 9(a) for  $x > 7.5$  in. between the fence and reflection plate. Whether or not this result is peculiar to this model is not clear. Possibly the fence restricts dissipation of



higher than free-stream pressure flow from the bottom of the model. This flow may be bleeding into the region of separated exhaust flow downstream of  $x = 7.5$  in. ( $l/h = 12.50$ ).

### **Comparisons of Air Results With Freon-Argon Results for Pressures and Forces**

Appendix A presents results for air, including comparisons with present Freon-argon results. It is shown that the pressures on the expansion ramp are higher for the Freon-argon mixture ( $\gamma = 1.23$ ), the result being integrated forces (thrust and lift) for air that are only half of those for the Freon-argon mixture and pitching moments for air that are about one-third as large as those for Freon-argon. It is also concluded that although from past experience it is believed that air can be used to simulate the exhaust flow of a scramjet engine to determine the gross effect of changes in nozzle geometry on nozzle performance, these results reaffirm the need to simulate  $\gamma$  of the real scramjet exhaust to determine the effect on vehicle aerodynamic forces and moments and interference effects produced by the scramjet exhaust.

### **Summary of Results**

An investigation of the effects of nozzle geometry on the forces and moments produced by a scramjet nozzle at Mach 6 flight conditions yielded the following results:

1. An external nozzle surface angle of  $20^\circ$  produced the greatest thrust for a cowl surface angle of  $6^\circ$ , whereas a surface angle of  $16^\circ$  or  $24^\circ$  produced the greatest thrust for a cowl angle of  $12^\circ$ , depending on combustor exit static pressure.

2. Separation of the exhaust flow from the external surface generally occurred when the surface pressure equaled, or was slightly less than, free-stream static pressure followed by increasing pressure farther downstream. In general, the external flow on the body outside of the engine nacelle separated at the beginning of the external surface deflection.

3. Thrust and lift for the complete nozzle increased linearly with nozzle length, whereas the moment became more negative with increasing nozzle length.

4. Addition of a flow fence to restrict spanwise expansion of the exhaust flow downstream of the cowl increased lift and thrust forces over those for the nozzle without a fence.

5. Calculated thrust contributed by the internal portion of the nozzle was approximately twice that measured on the external portion of the nozzle, whereas the calculated lift of the internal nozzle was of opposite sign and approximately the same magnitude as the lift force measured on the external nozzle surface.

6. Although from past experience it is believed that air can be used to simulate the exhaust flow of a scramjet engine to determine the gross effect of changes in nozzle geometry on nozzle performance, these results reaffirm the need to simulate the ratio of specific heats of the real scramjet exhaust to determine the effect on vehicle aerodynamic forces and moments and interference effects produced by the scramjet exhaust.

NASA Langley Research Center  
Hampton, VA 23665-5225  
December 13, 1990

## Appendix A

### Data for Configurations V-D and V-E With Air Used to Simulate Engine Exhaust Flow

Tests of the nozzle model with air used as the exhaust flow medium were not conducted during the period of the Freon-argon tests because of the lack of time and other factors. Research in support of the National Aero-Space Plane project renewed interest in using the gas mixing apparatus and the still existing model to obtain further data on scramjet nozzles. Consequently, the gas system was recertified for use under present safety regulations. Since the pressure vessel was cleared for use first, the decision was made to obtain data for air while awaiting clearance to use the Freon and argon equipment. The pressure vessel was charged with dry, oil-free air and heated to 200°F for these tests. A comparison of results from these tests of configurations V-D and V-E with those for configurations V and V-A (see table I), which used a 40/60 Freon/argon mixture, is presented herein.

There were two primary differences between the gas tests and the air tests, one of which may affect the comparison of the two sets of data. The one difference that does not affect the comparison of data is the smaller pressure integration area for the air tests compared with that of the gas tests. (See fig. 5.) This reduction in area was necessary because fewer pressure channels were available at the time of these tests. Consequently, the Freon-argon data were converted to the smaller integration area by subtraction of those forces and moments contributed by pressures outside the reduced area from the original force and moment calculations. The remaining difference involves the nozzle within the model used to generate the combustor exit Mach number  $M_3$ . It was not practical to design and fabricate a new nozzle for  $\gamma = 1.4$  and  $M_3 = 1.72$  because of time restraints, so the nozzle used for the gas tests was also used for the air tests. Consequently,  $M_3$  increased to 1.78 for the air exhaust flow, and this increase, in turn, decreased  $p_4$  compared with that for the gas mixture for a given  $p_3$  value (i.e.,  $p_4/p_3 = 0.1128$  for air versus 0.1306 for the gas mixture). The two-dimensional Euler code Seagull (ref. 11) was used to see if any flow irregularities were generated by using air on the original nozzle, and the results for both exhaust flow mediums, in the form of isobars of  $p/p_2$ , are presented in figure 19. In this figure the flow field from the throat of the nozzle to the cowl lip is shown and it is evident that shocks are not present in the two flows. As a result, it was assumed the use of air flow in the nozzle would be acceptable for the determination of the

gross effect of exhaust-nozzle geometry changes such as cowl angle or expansion ramp angle.

### External Nozzle Surface Pressures

Distributions of the pressure ratio  $p_s/p_3$  on the external nozzle surface as a function of  $y$  for constant  $x$  and for the two exhaust flow mediums are shown for the nozzle with  $\beta = 20^\circ$  and  $\epsilon = 12^\circ$  without a fence (fig. 20) and with a fence (fig. 21). Distributions for each configuration are shown for similar values of  $p_3$  (figs. 20(a) and 21(a)) and for similar values of  $p_4$  (figs. 20(b) and 21(b)). This is done to illustrate any differences that exist between either of these pressures as a reference for comparison of surface pressures. Lack of sufficient data for configuration V prevented our obtaining  $p_3$  values closer than 25 percent of each other (fig. 20(a)) and for configuration V-A prevented our obtaining values within 8 percent of each other (fig. 21(b)).

The primary difference between the distributions for the two exhaust mediums in figures 20 and 21 is the greater surface pressures for the Freon-argon mixture flow over the first 4.0 in. of the nozzle surface. This difference increases when the constant  $p_4$  distributions are compared with the constant  $p_3$  distributions (with or without the fence). In general, the difference between the Freon-argon and air data becomes much smaller for  $x > 4.0$  in. The irregular distribution for the air data at  $x = 2.5$  in. in figure 20(a) is probably the result of erroneous pressure measurements, as this distribution should mirror that at  $x = 2.5$  in. in figure 20(b). It is believed that pressures measured for  $y = 1.125, 1.875,$  and  $2.625$  in. more nearly represent the actual pressures for this area of the nozzle surface. In any event, the pressures as measured were used in the integration for forces and moments. It is also shown in figure 21 that there is a significant difference between the air and Freon-argon data outside the flow fence at all values of  $x$ . The reason for this difference is believed to be the different flow fields outside of the fence for the two tests. That is, the external flow separated at station 3 for the Freon-argon tests and remained attached to the surface for a short distance downstream of station 3 for the air tests.

Pressure distributions from Seagull for the complete nozzle and those from the air tests at three  $y$  stations on the external surface are shown in figure 22. As in figure 13, note that the data are plotted as a function of  $z$  rather than  $x$ . The agreement of measured data with Seagull results in figure 22 is not as good as in figure 13. Considerable data scatter occurs between  $z = 2.35$  ( $x = 2.5$ ) and 5.17 in. ( $x = 5.5$  in.) in figure 22, although there are several

data points in this region that agree with the Seagull results. Beyond  $z = 6$ , pressures measured at all three  $y$  stations are very close to being equal and may indicate flow separation that begins somewhere between  $z = 5$  and  $6$  in. Since the region between  $z \approx 2$  and  $4$  in. experiences higher pressures than regions farther downstream, lower than expected pressures in the forward region would affect lift and thrust forces accordingly.

### Forces and Moments

Bar charts presented in figure 23 present lift, thrust, and moments obtained from the air and Freon-argon tests for comparable values of  $p_3$ . The top set of charts in this figure shows forces and moments on the external surface only, while the bottom set shows forces and moments for the complete nozzle.

It is apparent in figure 23(a) that there is a significant difference between the forces and moments calculated for the two exhaust mediums. On the external surface, lift and thrust forces for the air exhaust are approximately half of those for the Freon-argon exhaust, while the moment for air is only about

one-third of the moment for the Freon-argon mixture. Similar results are shown for the complete nozzle except for the lift force, which becomes essentially zero for the Freon-argon mixture and negative for the air exhaust. Similar results are noted for the fence-on configuration in figure 23(b) for the full integration area. Integrating pressures between the fence and the reflection plate results in forces and moments that differ only slightly from the full integration values for the Freon-argon mixture exhaust. The significant differences noted for the air exhaust are the direct result of lower than free-stream pressures acting on the external surface outside the fence, as discussed previously. That is, pressures below free-stream pressure result in negative lift and thrust and positive moment values.

Although from past experience it is believed that air can be used to simulate the exhaust flow of a scramjet engine to determine the gross effect of changes in nozzle geometry on nozzle performance, these results reaffirm the need to simulate  $\gamma$  of the real scramjet exhaust to determine the effect on vehicle aerodynamic forces and moments and interference effects produced by the scramjet exhaust.

## Appendix B

### Simulant-Gas System

A diagram of the system is shown in figure 24, and a photograph that shows the Freon and argon bottle manifolds, the heated storage vessel, the heated discharge pipe, the control valves, and a portion of the power panel that houses all electrical controls is presented as figure 25. The chiller, cryogenic pump, and vaporizer are located in the basement beneath the area shown in figure 20. The argon compressor and oil-in-gas detector are located at the far end of the storage vessel. A vacuum pump used to evacuate the system prior to charging the storage vessel can be seen alongside the vessel. A control panel located in the tunnel control room is used to arm the system, to remotely control the pressure in the model plenum, and to provide readouts of storage vessel and model plenum temperatures and pressures during a

test. These data, except for the vessel pressure, are recorded simultaneously by the tunnel data recording system.

Since the critical temperature of Freon 12 is 234°F (153°F for Freon 13B1), initial charging of the storage vessel was done with the vaporizer and vessel temperature set at 300°F to ensure that the Freon remained a gas at the full-charge pressure ( $\approx 1100$  psi) of the gas mixture. The storage vessel temperature was then increased to 500°F to obtain a final pressure of about 1500 psia. The higher values of  $p_{t,j}$  were set first during a test run to take advantage of the maximum vessel pressure because of the rather large pressure drop between the vessel and model at flow rates approaching 1.3 lb/sec. In general, the storage vessel was recharged when its pressure dropped below 500 psia. A gas chromatograph was used to continuously monitor the mixture ratio.

## References

1. Hearth, Donald P.; and Preyss, Albert E.: Hypersonic Technology - Approach to an Expanded Program. *Astronaut. & Aeronaut.*, vol. 14, no. 12, Dec. 1976, pp. 20-37.
2. Towards Hypersonics. *Flight Int.*, vol. 108, no. 3477, Oct. 30, 1975, pp. 657-658.
3. Colladay, Raymond S.: Rekindled Vision of Hypersonic Travel. *Aerosp. America*, vol. 25, no. 8, Aug. 1987, pp. 30-31, 34.
4. Oman, R. A.; Foreman, K. M.; Leng, J.; and Hopkins, H. B.: *Simulation of Hypersonic Scramjet Exhaust*. NASA CR-2494, 1975.
5. Hopkins, H. B.; Konopka, W.; and Leng, J.: *Validation of Scramjet Exhaust Simulation Technique*. NASA CR-2688, 1976.
6. Hopkins, H. B.; Konopka, W.; and Leng, J.: *Validation of Scramjet Exhaust Simulation Technique at Mach 6*. NASA CR-3003, 1979.
7. Sterrett, James R.; and Emery, James C.: *Extension of Boundary-Layer-Separation Criteria to a Mach Number of 6.5 by Utilizing Flat Plates With Forward-Facing Steps*. NASA TN D-618, 1960.
8. Keyes, J. Wayne: *Force Testing Manual for the Langley 20-Inch Mach 6 Tunnel*. NASA TM-74026, 1977.
9. Johnson, Charles B.; Boney, Lillian R.; Ellison, James C.; and Erickson, Wayne D.: *Real-Gas Effects on Hypersonic Nozzle Contours With a Method of Calculation*. NASA TN D-1622, 1963.
10. Ratliff, Alan W.; Smith, Sheldon D.; and Penny, Morris M.: *Rocket Exhaust Plume Computer Program Improvement. Volume I - Final Report*. NASA CR-125601, 1972.
11. Salas, Manuel D.: Shock Fitting Method for Complicated Two-Dimensional Supersonic Flows. *AIAA J.*, vol. 14, no. 5, May 1976, pp. 583-588.
12. Cabbage, James M.; and Mercer, Charles E.: *Investigation of Effect of Propulsion System Installation and Operation on Aerodynamics of an Airbreathing Hypersonic Airplane at Mach 0.3 to 1.2*. NASA TN D-8503, 1977.
13. Hunt, J. L.; Lawing, P. L.; Marcum, D. C.; and Cabbage, J. M.: Performance Potential and Research Needs of a Hypersonic, Airbreathing, Lifting Missile Concept. *J. Aircr.*, vol. 16, no. 10, Oct. 1979, pp. 666-673.
14. Small, William J.; Weidner, John P.; and Johnston, P. J.: *Scramjet Nozzle Design and Analysis as Applied to a Highly Integrated Hypersonic Research Airplane*. NASA TN D-8334, 1976.

Table I. Configuration Description and Gas Mixture Ratios

Configuration	$\beta$ , deg	$\epsilon$ , deg	$\alpha$ , deg	Fence	Freon*/argon
I	16	6	0	No	40/60
II	20	6	0	No	40/60
III	24	6	0	No	40/60
IV	16	12	0	No	40/60
V	20	12	0	No	40/60
VI	24	12	0	No	40/60
II-A	20	6	4	No	40/60
II-B	20	6	4	No	50/50
II-C	20	6	0	No	50/50
II-D	20	6	0	No	50/50 (F13B1)
V-A	20	12	0	Yes	40/60
V-B	20	12	0	No	50/50
V-C	20	12	0	Yes	50/50
V-D	20	12	0	No	Air
V-E	20	12	0	Yes	Air
VI-A	24	12	4	No	40/60

\*Freon 12 unless otherwise noted.

Table II. Listing of Test Conditions and Model Surface Pressures

(a) Configuration I:  $\beta = 16^\circ$ ;  $\epsilon = 6^\circ$ ;  $\alpha = 0^\circ$ ;  $\gamma = 1.23$ ; no fence

TEST RUN				6515	6515	6515	6515	6515
PTJ				11-1	11-2	11-3	13-1	13-2
P3				NO JET	10.732	15.275	24.07	16.84
PINF				NO JET	2.234	3.180	5.011	3.507
				0.2245	0.2225	0.2239	0.2230	0.2242
ORIFICE	X	Y	AREA	PS	PS	PS	PS	PS
1	2.5000	.3750	.4275	.3222	.7130	1.0886	1.6860	1.5670
5	2.5000	.7500	.2850	.2657	.6991	.9547	1.7118	1.1756
15	2.5000	1.1250	.2850	.2425	.7174	1.1138	1.7827	1.2174
19	2.5000	1.5000	.2850	.2419	.7212	1.1290	1.7827	1.2244
31	2.5000	1.8750	.2850	.2432	.7288	1.1164	1.8225	1.2522
35	2.5000	2.2500	.2850	.2419	.7338	1.1056	1.8055	1.2434
44	2.5000	2.6250	.2375	.2388	.7269	1.0576	1.7789	1.1991
52	2.5000	2.8750	.2375	.2356	.3728	.5448	.9399	.6439
55	2.5000	3.2500	.3325	.2255	.1104	.1180	.1533	.1135
70	2.5000	3.7500	.3800	.2046	.0554	.0560	.1381	.1065
84	2.5000	4.2500	.3800	.2246	.0917	.0865	.1063	.0961
94	2.5000	4.7500	.3800	.2109	.0630	.0592	.0667	.0667
6	3.0000	.7500	.5625	.2466	.5569	.7748	1.3993	.9509
20	3.0000	1.5000	.3750	.2365	.5974	.9375	1.2244	.9714
36	3.0000	2.2500	.2811	.2586	.6086	.8295	1.4973	1.0304
45	3.0000	2.6250	.1563	.2539	.4464	.5814	1.0106	.6654
53	3.0000	2.8750	.1562	.2973	.2931	.3741	.6527	.4668
56	3.0000	3.2500	.1562	.2918	.1847	.1717	.2664	.2067
64	3.0000	3.5000	.1250	.2210	.1300	.1262	.1135	.1122
71	3.0000	3.7500	.1875	.2355	.1308	.1623	.1943	.1783
85	3.0000	4.2500	.2500	.2156	.0751	.0674	.1041	.0862
120	3.0000	4.7500	.2500	.2186	.0959	.0942	.1249	.1053
2	3.5000	.3750	.2812	.2425	.4537	.6257	1.1473	.7875
7	3.5000	.7500	.1875	.2636	.4830	.7464	1.0654	.7127
16	3.5000	1.1250	.1875	.2400	.4588	.6061	1.1473	.7868
21	3.5000	1.5000	.1875	.2566	.4733	.7459	1.0891	.7186
32	3.5000	1.8750	.1875	.2523	.5259	.8023	.8497	.8497
37	3.5000	2.2500	.1875	.2556	.4722	.7083	1.0773	.7106
46	3.5000	2.6250	.1563	.2529	.3023	.4378	.6487	.4149
54	3.5000	2.8750	.1562	.2507	.1970	.2835	.3939	.2450
57	3.5000	3.2500	.1526	.2475	.1523	.1357	.1466	.0756
65	3.5000	3.5000	.1250	.2876	.2094	.1991	.1944	.1862
72	3.5000	3.7500	.1875	.2389	.1534	.1599	.0643	.0530
86	3.5000	4.2500	.2500	.2166	.0680	.0579	.1457	.1021
95	3.5000	4.7500	.2500	.2496	.2384	.2362	.1326	.1493
8	4.0000	.7500	.5625	.3007	.4345	.6430	.9806	.6994
22	4.0000	1.5000	.3750	.3000	.4331	.6478	.9964	.7028
38	4.0000	2.2500	.2811	.2966	.3720	.5243	.8345	.5937
47	4.0000	2.6250	.1563	.2938	.2664	.3604	.5731	.4139
121	4.0000	2.8750	.1562	.2931	.2074	.2712	.4304	.3165
58	4.0000	3.2500	.1562	.2911	.2108	.1840	.2712	.2088
66	4.0000	3.5000	.1250	.2432	.1658	.1550	.0638	.0503

Table II. Continued

(a) Continued

ORIFICE	X	Y	AREA	PS	PS	PS	PS	PS
73	4.0000	3.7500	.1250	.2863	.2108	.2060	.1971	.2019
80	4.0000	4.0000	.1250	.2192	.1281	.1426	.1318	.1375
87	4.0000	4.2500	.1875	.2394	.1039	.1128	.1873	.1487
122	4.0000	4.7500	.2500	.2849	.1600	.1292	.1670	.1477
3	4.5000	.3750	.2812	.3249	.3760	.5373	.7568	.5014
9	4.5000	.7500	.1875	.2507	.2808	.5412	.7922	.2993
17	4.5000	1.1250	.1875	.2534	.3405	.5244	.7412	.4815
23	4.5000	1.5000	.1875	.2554	.3382	.5328	.8352	.5700
33	4.5000	1.8750	.1875	.2507	.3228	.4878	.7111	.4611
39	4.5000	2.2500	.1875	.2516	.2451	.3639	.5995	.4120
48	4.5000	2.6250	.3125	.2503	.1745	.2490	.4152	.2855
59	4.5000	3.2500	.1562	.2451	.1726	.1469	.1963	.1359
67	4.5000	3.5000	.1250	.2883	.2245	.2115	.2040	.2047
74	4.5000	3.7500	.1250	.2432	.1783	.1636	.1263	.1519
81	4.5000	4.0000	.1250	.2413	.1790	.1700	.1404	.1577
88	4.5000	4.2500	.1875	.2405	.2222	.1846	.1094	.1288
123	4.5000	4.7500	.2500	.2419	.1276	.0917	.1397	.1070
10	5.0000	.7500	.5625	.2538	.2853	.4390	.7014	.4822
24	5.0000	1.5000	.2812	.2383	.2716	.4437	.7038	.4703
144	5.0000	1.8750	.2812	.2925	.2966	.4173	.6520	.4675
49	5.0000	2.6250	.4062	.2305	.1573	.1829	.3137	.2101
68	5.0000	3.5000	.2812	.2451	.2015	.1771	.1442	.1654
75	5.0000	3.7500	.1250	.2246	.1853	.1591	.0916	.1410
82	5.0000	4.0000	.1250	.2400	.2470	.1841	.1138	.1503
89	5.0000	4.2500	.1875	.2842	.2472	.2328	.1971	.2287
124	5.0000	4.7500	.2500	.2240	.1543	.1120	.1404	.1190
4	5.5000	.3750	.4218	.3281	.3158	.4331	.6527	.4784
11	5.5000	.7500	.2812	.2318	.2476	.3892	.6262	.4309
18	5.5000	1.1250	.2812	.2911	.3007	.4317	.6637	.4736
25	5.5000	1.5000	.2812	.2286	.2210	.3658	.5908	.3974
34	5.5000	1.8750	.2812	.2483	.2047	.3036	.4929	.3388
40	5.5000	2.2500	.2812	.2282	.1561	.2103	.3572	.2393
50	5.5000	2.6250	.4687	.2274	.1939	.1743	.2937	.2051
60	5.5000	3.2500	.2343	.2240	.1900	.1644	.1327	.1398
69	5.5000	3.5000	.1875	.2240	.1954	.1680	.1011	.1475
76	5.5000	3.7500	.1875	.2210	.2046	.1837	.1014	.1634
83	5.5000	4.0000	.1875	.2842	.2739	.2575	.1944	.2465
90	5.5000	4.2500	.2812	.2394	.2227	.2092	.1397	.1930
125	5.5000	4.7500	.3750	.2204	.1850	.1705	.1368	.1621
12	6.5000	.7500	1.1250	.2305	.1863	.2533	.4827	.3310
26	6.5000	1.5000	.7500	.2502	.2572	.3013	.3455	.2740
41	6.5000	2.2500	1.1875	.2242	.2154	.1717	.2797	.1969
61	6.5000	3.2500	.4375	.2223	.2299	.2078	.1179	.1912
77	6.5000	3.7500	.5000	.2419	.2490	.2394	.1654	.2264
91	6.5000	4.2500	.5000	.2216	.2234	.2174	.1636	.2083
126	6.5000	4.7500	.5000	.2210	.2192	.2156	.1827	.2125
127	7.5000	.3750	.5625	.3254	.2156	.2721	.3863	.2945
13	7.5000	.7500	.5625	.2480	.1652	.2362	.2831	.1713



Table II. Continued

(a) Concluded

ORIFICE	X	Y	AREA	PS	PS	PS	PS	PS
27	7.5000	1.5000	.7500	.2432	.2319	.1900	.2089	.1208
42	7.5000	2.2500	.5625	.2523	.2701	.2427	.1439	.1132
51	7.5000	2.6250	.6250	.2856	.3130	.3014	.2404	.2795
62	7.5000	3.2500	.4375	.2856	.3069	.3007	.2383	.2932
78	7.5000	3.7500	.5000	.2410	.2609	.1830	.1337	.1605
92	7.5000	4.2500	.5000	.2217	.2400	.2350	.2209	.2361
128	7.5000	4.7500	.5000	.2491	.2599	.2421	.1605	.1670
14	8.5000	.7500	1.1250	.2918	.2698	.2136	.3131	.2383
28	8.5000	1.5000	.7500	.2876	.3069	.2417	.2623	.2369
43	8.5000	2.2500	1.1875	.2421	.2744	.2712	.0982	.1681
63	8.5000	3.2500	.4375	.2443	.2658	.2690	.1605	.1826
79	8.5000	3.7500	.5000	.2897	.3123	.3089	.3124	.3179
93	8.5000	4.2500	.5000	.2458	.2708	.2638	.2650	.2630
129	8.5000	4.7500	.5000	.2883	.3165	.3082	.3172	.3158
130	9.5000	.3750	.5625	.3788	.3342	.2585	.2976	.2547
131	9.5000	.7500	.5625	.2567	.2618	.2072	.2110	.1905
29	9.5000	1.5000	.7500	.2483	.2644	.2580	.1699	.2547
132	9.5000	2.2500	.5625	.2870	.3123	.3226	.2623	.3337
133	9.5000	2.6250	.6250	.2432	.2733	.2824	.1740	.2030
134	9.5000	3.2500	.4375	.2952	.3130	.3213	.3254	.3344
135	9.5000	3.7500	.5000	.2548	.2760	.2753	.2784	.2791
136	9.5000	4.2500	.5000	.2502	.2873	.2824	.1955	.1976
137	9.5000	4.7500	.5000	.2483	.2901	.2837	.2823	.2842
138	10.5000	.7500	1.1250	.2502	.2454	.2609	.1636	.2655
30	10.5000	1.5000	.7500	.2389	.2436	.2615	.2023	.2696
139	10.5000	2.2500	1.1875	.2464	.2676	.2843	.2759	.2951
140	10.5000	3.2500	.4375	.2625	.2753	.2856	.2900	.2939
141	10.5000	3.7500	.5000	.2442	.2627	.2657	.2708	.2696
142	10.5000	4.2500	.5000	.3007	.3398	.3432	.3474	.3508
143	10.5000	4.7500	.5000	.2347	.2901	.2931	.2803	.2911

Table II. Continued

(b) Configuration II:  $\beta = 20^\circ$ ;  $\epsilon = 6^\circ$ ;  $\alpha = 0^\circ$ ;  $\gamma = 1.24$ ; no fence

TEST				6515	6515	6515	6515	6526	6526	6526
RUN				15-1	15-2	17-1	27-1	27-2	28-1	28-2
PTJ				25.82	18.41	19.10	NO JET	21.39	11.26	22.76
P3				5.357	3.834	3.977	NO JET	4.595	2.419	4.889
PINF				0.2232	0.2238	0.2255	0.2422	0.2422	0.2242	0.2422
ORIFICE	X	Y	AREA	PS	PS	PS	PS	PS	PS	PS
1	2.5000	.3750	.4275	1.5107	1.1142	.9820	.3207	1.2207	.6698	1.2508
5	2.5000	.7500	.2850	1.5934	1.1066	1.0725	.2953	1.2662	.6844	1.3101
15	2.5000	1.1250	.2850	1.7004	1.2236	1.1306	.2960	1.3016	.6998	1.3471
19	2.5000	1.5000	.2850	1.6985	1.2451	1.1185	.4101	1.3086	.6797	1.3363
31	2.5000	1.8750	.2850	1.7181	1.2362	1.1577	.3037	1.3690	.7098	1.3494
35	2.5000	2.2500	.2850	1.7219	1.2432	1.1704	.2999	1.3240	.7198	1.4404
44	2.5000	2.6250	.2375	1.6953	1.2040	1.1362	.2991	1.2685	.7291	1.4103
52	2.5000	2.8750	.2375	.8980	.6413	.6001	.2983	.7276	.4378	.7969
55	2.5000	3.2500	.3325	.1449	.1095	.1069	.2960	.2074	.1897	.2190
70	2.5000	3.7500	.3800	.0779	.0652	.0809	.2868	.1488	.1589	.1619
84	2.5000	4.2500	.3800	.0843	.0939	.1061	.2224	.0805	.1014	.0829
94	2.5000	4.7500	.3800	.3414	.0728	.0873	.2891	.1496	.1658	.1550
6	3.0000	.7500	.5625	1.2522	.8622	.8215	.2392	.9873	.5054	1.0291
20	3.0000	1.5000	.3750	1.2887	.9750	.9091	.2152	.9854	.4732	1.0088
36	3.0000	2.2500	.2811	1.3552	.9422	.9004	.2354	1.0151	.5231	1.1144
45	3.0000	2.6250	.1563	.9308	.6539	.6770	.2329	.7489	.4125	.8532
53	3.0000	2.8750	.1562	.6036	.4554	.4191	.2329	.4125	.2329	.4650
56	3.0000	3.2500	.1562	.2495	.2029	.1885	.2291	.1413	.1121	.1722
64	3.0000	3.5000	.1250	.0905	.1032	.1164	.2953	.1866	.2005	.1958
71	3.0000	3.7500	.1875	.1890	.1665	.1645	.2253	.1266	.1076	.1355
85	3.0000	4.2500	.2500	.0803	.0803	.0991	.1977	.0383	.0653	.0428
120	3.0000	4.7500	.2500	.1220	.1249	.1360	.2227	.0735	.1026	.0748
2	3.5000	.3750	.2812	1.0554	.7601	.7025	.2822	.8235	.4441	.8412
7	3.5000	.7500	.1875	.9684	.6910	.6990	.2410	.8267	.4228	.8537
16	3.5000	1.1250	.1875	1.0598	.7797	.6873	.2360	.8052	.4125	.8438
21	3.5000	1.5000	.1875	.9840	.7071	.7000	.2184	.8160	.3899	.8311
32	3.5000	1.8750	.1875	1.1849	.8408	.8324	.2316	.8393	.4308	.8722
37	3.5000	2.2500	.1875	.9926	.6915	.7360	.2378	.8267	.4255	.9055
46	3.5000	2.6250	.1563	.6050	.4050	.4750	.2351	.5220	.2869	.5851
54	3.5000	2.8750	.1562	.3420	.2189	.2960	.2346	.3306	.1882	.3699
57	3.5000	3.2500	.1526	.1044	.0506	.1400	.2340	.1607	.1278	.1806
65	3.5000	3.5000	.1250	.1802	.1899	.1995	.2284	.1114	.1361	.1140
72	3.5000	3.7500	.1875	.0195	.0329	.1430	.2292	.1278	.1337	.1289
86	3.5000	4.2500	.2500	.1013	.0848	.1005	.2929	.1650	.1704	.1820
95	3.5000	4.7500	.2500	.1560	.1614	.2560	.2292	.0944	.1213	.0825
8	4.0000	.7500	.5625	.9075	.6927	.6187	.2589	.6651	.3560	.6884
22	4.0000	1.5000	.3750	.9342	.7140	.6249	.2384	.6775	.3403	.6884
38	4.0000	2.2500	.2811	.8169	.6118	.5755	.2507	.5933	.3204	.6371
47	4.0000	2.6250	.1563	.5562	.4190	.3944	.2486	.3902	.2302	.4299
121	4.0000	2.8750	.1562	.4046	.3133	.2928	.2473	.2815	.1768	.3095
58	4.0000	3.2500	.1562	.2550	.2063	.1954	.2486	.1748	.1597	.1919
66	4.0000	3.5000	.1250	.0340	.0415	.1580	.2308	.1202	.1472	.1213

Table II. Continued

(b) Continued

ORIFICE	X	Y	AREA	PS	PS	PS	PS	PS	PS	PS
73	4.0000	3.7500	.1250	.1754	.2036	.2098	.2452	.1453	.1604	.1399
80	4.0000	4.0000	.1250	.1127	.1361	.1416	.2929	.2113	.2113	.2143
87	4.0000	4.2500	.1875	.1530	.1466	.1517	.2303	.1279	.1216	.1386
122	4.0000	4.7500	.2500	.1418	.1741	.1975	.2425	.1111	.1460	.1077
3	4.5000	.3750	.2812	.6625	.4732	.5120	.2788	.5970	.3338	.6013
9	4.5000	.7500	.1875	.7715	.2679	.5080	.2523	.5750	.2994	.5988
17	4.5000	1.1250	.1875	.6663	.4614	.5050	.2400	.5814	.3004	.6056
23	4.5000	1.5000	.1875	.7727	.5826	.4933	.2230	.5833	.2815	.5929
33	4.5000	1.8750	.1875	.6517	.4453	.5070	.2540	.5830	.2855	.6035
39	4.5000	2.2500	.1875	.5826	.4253	.3950	.2344	.4425	.2308	.4754
48	4.5000	2.6250	.3125	.4003	.2911	.2698	.2332	.3018	.1706	.3352
59	4.5000	3.2500	.1562	.1813	.1402	.1574	.2320	.1377	.1586	.1550
67	4.5000	3.5000	.1250	.1947	.2214	.2311	.2452	.1508	.1802	.1433
74	4.5000	3.7500	.1250	.1215	.1665	.1767	.2308	.1354	.1658	.1246
81	4.5000	4.0000	.1250	.1382	.1781	.1838	.2265	.1380	.1652	.1304
88	4.5000	4.2500	.1875	.0496	.1318	.1900	.2281	.1440	.1591	.1402
123	4.5000	4.7500	.2500	.1177	.1614	.1780	.2254	.0954	.1515	.0990
10	5.0000	.7500	.5625	.6359	.4697	.4130	.1983	.4470	.2169	.4631
24	5.0000	1.5000	.2812	.6514	.4900	.4010	.1726	.4406	.1951	.4477
144	5.0000	1.8750	.2812	.6276	.4746	.4431	.2479	.4497	.2520	.4634
49	5.0000	2.6250	.4062	.2958	.2113	.1950	.1880	.1957	.1533	.2497
68	5.0000	3.5000	.2812	.1421	.1890	.2005	.2326	.1544	.1902	.1348
75	5.0000	3.7500	.1250	.1142	.1714	.1831	.1835	.1006	.1430	.0852
82	5.0000	4.0000	.1250	.0517	.1566	.2170	.2281	.1558	.1952	.1429
89	5.0000	4.2500	.1875	.2187	.2722	.2736	.2432	.1761	.2090	.1590
124	5.0000	4.7500	.2500	.1434	.1988	.2045	.2022	.1533	.1430	.0865
4	5.5000	.3750	.4218	.6132	.4780	.4252	.2999	.4579	.2862	.4641
11	5.5000	.7500	.2812	.5799	.4345	.3876	.2991	.5187	.2085	.5395
18	5.5000	1.1250	.2812	.6159	.4718	.4259	.2527	.4401	.2459	.4586
25	5.5000	1.5000	.2812	.5572	.4225	.3471	.2814	.4825	.2744	.4918
34	5.5000	1.8750	.2812	.4715	.3476	.3186	.2350	.3578	.1944	.3698
40	5.5000	2.2500	.2812	.3352	.2411	.2206	.1861	.2266	.1135	.2426
50	5.5000	2.6250	.4687	.2916	.2132	.1967	.2968	.3076	.2637	.3322
60	5.5000	3.2500	.2343	.1178	.1583	.1801	.1842	.0981	.1527	.0807
69	5.5000	3.5000	.1875	.1124	.1791	.1968	.1848	.1122	.1565	.0865
76	5.5000	3.7500	.1875	.1449	.2081	.2169	.2914	.2351	.2775	.2213
83	5.5000	4.0000	.1875	.2427	.2914	.2942	.2445	.1946	.2315	.1761
90	5.5000	4.2500	.2812	.1993	.2404	.2409	.2296	.1759	.2087	.1527
125	5.5000	4.7500	.3750	.1923	.2208	.2302	.3053	.2529	.2775	.2305
12	6.5000	.7500	1.1250	.4661	.3428	.3094	.2398	.3720	.1981	.3922
26	6.5000	1.5000	.7500	.3512	.2474	.3260	.2133	.2828	.1823	.2847
41	6.5000	2.2500	1.1875	.2790	.2075	.1979	.2976	.3022	.2976	.3207
61	6.5000	3.2500	.4375	.1525	.2347	.2498	.2976	.2698	.3053	.2405
77	6.5000	3.7500	.5000	.2237	.2692	.2717	.2284	.2114	.2329	.1918
91	6.5000	4.2500	.5000	.2172	.2428	.2492	.1932	.1765	.1964	.1610
126	6.5000	4.7500	.5000	.2315	.2446	.2498	.2278	.2190	.2354	.2063
127	7.5000	.3750	.5625	.3810	.2994	.2679	.3065	.3298	.2189	.3304
13	7.5000	.7500	.5625	.2668	.1764	.2510	.2443	.2971	.1634	.3101

Table II. Continued

(b) Concluded

ORIFICE	X	Y	AREA	PS	PS	PS	PS	PS	PS	PS
27	7.5000	1.5000	.7500	.1759	.1286	.2060	.8181	.2104	.1834	.2175
42	7.5000	2.2500	.5625	.1227	.1437	.2760	.2329	.1918	.2544	.2069
51	7.5000	2.6250	.6250	.2468	.3435	.3498	.2310	.1993	.2544	.1892
62	7.5000	3.2500	.4375	.3051	.3428	.3436	.2360	.2227	.2436	.2133
78	7.5000	3.7500	.5000	.1705	.1829	.2940	.2362	.2335	.2497	.2281
92	7.5000	4.2500	.5000	.2587	.2720	.2782	.3022	.3099	.3199	.3053
128	7.5000	4.7500	.5000	.1625	.1721	.2720	.2330	.2405	.2551	.2303
14	8.5000	.7500	1.1250	.3230	.2612	.2427	.2630	.2452	.2302	.2514
28	8.5000	1.5000	.7500	.2722	.2578	.3086	.2397	.2165	.2596	.2158
43	8.5000	2.2500	1.1875	.1377	.2033	.3130	.2357	.2297	.2556	.1990
63	8.5000	3.2500	.4375	.2082	.1974	.3040	.2400	.2421	.2491	.2303
79	8.5000	3.7500	.5000	.3579	.3504	.3539	.2561	.2507	.2657	.2432
93	8.5000	4.2500	.5000	.3020	.3022	.2987	.2423	.2474	.2569	.2405
129	8.5000	4.7500	.5000	.3442	.3566	.3580	.2534	.2657	.2765	.2582
130	9.5000	.3750	.5625	.2607	.2178	.2462	.2420	.1739	.2343	.1700
131	9.5000	.7500	.5625	.2262	.2063	.2448	.2558	.1908	.2457	.1968
29	9.5000	1.5000	.7500	.2307	.2814	.2872	.2224	.2302	.2445	.2207
132	9.5000	2.2500	.5625	.3737	.3497	.3505	.2548	.2951	.2616	.2596
133	9.5000	2.6250	.6250	.2351	.2006	.3070	.2389	.2885	.2513	.2551
134	9.5000	3.2500	.4375	.3833	.3545	.3553	.2609	.2856	.2630	.2520
135	9.5000	3.7500	.5000	.3347	.3091	.3090	.2457	.2624	.2564	.2427
136	9.5000	4.2500	.5000	.2200	.2092	.3150	.2518	.2691	.2632	.2540
137	9.5000	4.7500	.5000	.3206	.3258	.3250	.2481	.2660	.2720	.2558
138	10.5000	.7500	1.1250	.2810	.3274	.3040	.2137	.2292	.1989	.1957
30	10.5000	1.5000	.7500	.3203	.2988	.2754	.1810	.2529	.2047	.2401
139	10.5000	2.2500	1.1875	.3380	.3097	.3006	.2421	.3036	.2493	.3006
140	10.5000	3.2500	.4375	.3457	.3142	.3083	.2457	.2887	.2558	.2743
141	10.5000	3.7500	.5000	.3262	.2941	.2962	.2009	.2439	.2137	.2317
142	10.5000	4.2500	.5000	.3936	.3696	.3731	.2616	.3006	.2780	.2876
143	10.5000	4.7500	.5000	.3244	.3161	.3147	.2037	.2426	.2394	.2356

Table II. Continued

(c) Configuration II-A:  $\beta = 20^\circ$ ;  $\epsilon = 6^\circ$ ;  $\alpha = 4^\circ$ ;  $\gamma = 1.23$ ; no fence

TEST RUN PTJ P3 PINF				6515	6515	6515	6526	6526	6526
				18-1	18-2	18-3	36-1	37-1	37-2
				24.45	18.45	11.80	33.35	22.86	14.07
				5.09	3.841	2.457	7.164	4.91	3.022
				0.2285	0.2281	0.2285	0.2376	0.2359	0.2359
ORIFICE	X	Y	AREA	PS	PS	PS	PS	PS	PS
1	2.5000	.3750	.4275	1.4284	1.1381	.7221			
5	2.5000	.7500	.2850	1.4861	1.0635	.6795			
15	2.5000	1.1250	.2850	1.6086	1.2507	.7777			
19	2.5000	1.5000	.2850	1.6124	1.2810	.8144			
31	2.5000	1.8750	.2850	1.6364	1.2614	.7961			
35	2.5000	2.2500	.2850	1.6484	1.2703	.8056			
44	2.5000	2.6250	.2375	1.6035	1.2191	.7651			
52	2.5000	2.8750	.2375	.8707	.6582	.4167			
55	2.5000	3.2500	.3325	.1631	.1518	.1391			
70	2.5000	3.7500	.3800	.0841	.0778	.0759			
84	2.5000	4.2500	.3800	.0785	.0752	.0714	.0789	.0843	.0867
94	2.5000	4.7500	.3800	.0702	.0702	.0677			
6	3.0000	.7500	.5625	1.1752	.8453	.5356	1.2853	.9925	.6598
20	3.0000	1.5000	.3750	1.2551	.9265	.6188	1.3080	.9963	.6908
36	3.0000	2.2500	.2811	1.2755	.9152	.5883	1.4567	1.0835	.6851
45	3.0000	2.6250	.1563	.9470	.6540	.4740	1.1012	.8198	.5081
53	3.0000	2.8750	.1562	.5755	.4369	.3107	.6036	.4486	.2817
56	3.0000	3.2500	.1562	.2475	.2071	.1892	.2102	.1729	.1419
64	3.0000	3.5000	.1250	.1612	.1537	.1404	.1465	.1786	.1440
71	3.0000	3.7500	.1875	.2172	.1671	.1138	.1862	.1628	.1096
85	3.0000	4.2500	.2500	.0658	.0640	.0616	.1206	.0923	.0891
120	3.0000	4.7500	.2500	.1366	.1170	.0961	.0698	.0749	.0818
2	3.5000	.3750	.2812	1.0136	.7341	.4692	1.0595	.8205	.5637
7	3.5000	.7500	.1875	1.0250	.8060	.5040	1.0768	.8142	.5391
16	3.5000	1.1250	.1875	.9864	.7107	.4856	1.0892	.8318	.5378
21	3.5000	1.5000	.1875	1.0220	.8290	.5420	1.0747	.8158	.5731
32	3.5000	1.8750	.1875	1.0880	.7860	.5188	1.1841	.8837	.5587
37	3.5000	2.2500	.1875	1.0410	.8040	.5060	1.1842	.8730	.5472
46	3.5000	2.6250	.1563	.6700	.5130	.3240	.7608	.5575	.3466
54	3.5000	2.8750	.1562	.4270	.3240	.2100	.4744	.3504	.2226
57	3.5000	3.2500	.1526	.2020	.1590	.1210	.2204	.1751	.1319
65	3.5000	3.5000	.1250	.2208	.2126	.2016	.1539	.1615	.1457
72	3.5000	3.7500	.1875	.1890	.1760	.1370	.1940	.1950	.1487
86	3.5000	4.2500	.2500	.0930	.0721	.0588			
95	3.5000	4.7500	.2500	.1350	.1640	.1680	.0753	.0775	.0807
8	4.0000	.7500	.5625	.8684	.7058	.4685	.8675	.6665	.4510
22	4.0000	1.5000	.3750	.8904	.7360	.5055	.8826	.6781	.4886
38	4.0000	2.2500	.2811	.7861	.6249	.4191	.8416	.6241	.4018
47	4.0000	2.6250	.1563	.5350	.4280	.2983	.5488	.4120	.2711
121	4.0000	2.8750	.1562	.4005	.3244	.2393	.3970	.3088	.2171
58	4.0000	3.2500	.1562	.2544	.2153	.1769	.2335	.1904	.1473
66	4.0000	3.5000	.1250	.1430	.1420	.1300	.4143	.1487	.1384

Table II. Continued

(c) Continued

ORIFICE	X	Y	AREA	PS	PS	PS	PS	PS	PS
73	4.0000	3.7500	.1250	.2283	.2215	.2009	.1850	.1891	.1679
80	4.0000	4.0000	.1250	.1846	.1537	.1069			
87	4.0000	4.2500	.1875	.1407	.1048	.0695	.1571	.1312	.0856
122	4.0000	4.7500	.2500	.1337	.1350	.1357	.0967	.1015	.1022
3	4.5000	.3750	.2812	.7350	.5910	.3860	.7565	.5855	.4140
9	4.5000	.7500	.1875	.7270	.5780	.3580	.7523	.5793	.3867
17	4.5000	1.1250	.1875	.7270	.5750	.3620	.7754	.5882	.3865
23	4.5000	1.5000	.1875	.7238	.5915	.3886	.7619	.5841	.4207
33	4.5000	1.8750	.1875	.7190	.5570	.3520	.8088	.6039	.3962
39	4.5000	2.2500	.1875	.5479	.4220	.2640	.6306	.4672	.2954
48	4.5000	2.6250	.3125	.3655	.2827	.1786	.4207	.3133	.2036
59	4.5000	3.2500	.1562	.1677	.1285	.0951	.1922	.1558	.1177
67	4.5000	3.5000	.1250	.1961	.1933	.1824	.1549	.1562	.1494
74	4.5000	3.7500	.1250	.1452	.1350	.1183	.1558	.1558	.1391
81	4.5000	4.0000	.1250	.1619	.1452	.1106	.1685	.1704	.1274
88	4.5000	4.2500	.1875	.1560	.1390	.1180	.1832	.1530	.1044
123	4.5000	4.7500	.2500	.0765	.0630	.0637	.0789	.0729	.0723
10	5.0000	.7500	.5625	.6071	.4796	.2950	.6495	.4940	.3288
24	5.0000	1.5000	.2812	.6166	.5076	.3367	.6309	.4856	.3661
144	5.0000	1.8750	.2812	.6091	.4884	.3347	.6179	.4674	.3081
49	5.0000	2.6250	.4062	.2938	.2301	.1527	.3661	.2871	.2074
68	5.0000	3.5000	.2812	.1195	.1106	.1041	.1368	.1314	.1260
75	5.0000	3.7500	.1250	.1140	.1045	.0932	.1405	.1470	.1238
82	5.0000	4.0000	.1250	.1500	.1430	.1210	.1551	.1541	.1293
89	5.0000	4.2500	.1875	.2297	.2043	.1673	.1891	.1747	.1330
124	5.0000	4.7500	.2500	.0932	.0753	.0658	.1425	.1071	.0936
4	5.5000	.3750	.4218	.5906	.4918	.3443	.5625	.4565	.3389
11	5.5000	.7500	.2812	.5609	.4572	.2890			
18	5.5000	1.1250	.2812	.5933	.4856	.3319	.5817	.4517	.3067
25	5.5000	1.5000	.2812	.5311	.4420	.2985			
34	5.5000	1.8750	.2812	.4432	.3417	.2152	.4929	.3706	.2382
40	5.5000	2.2500	.2812	.3278	.2539	.1622	.3822	.2890	.1913
50	5.5000	2.6250	.4687	.2909	.2289	.1511			
60	5.5000	3.2500	.2343	.1188	.0896	.0783	.1585	.1213	.0975
69	5.5000	3.5000	.1875	.0914	.1807	.0842	.1264	.1135	.1039
76	5.5000	3.7500	.1875	.1138	.1081	.1056			
83	5.5000	4.0000	.1875	.1988	.1947	.1789	.1528	.1576	.1426
90	5.5000	4.2500	.2812	.1440	.1253	.0958	.1463	.1433	.1051
125	5.5000	4.7500	.3750	.1138	.0873	.0651			
12	6.5000	.7500	1.1250	.4432	.3256	.2175	.4758	.3791	.2608
26	6.5000	1.5000	.7500	.3747	.2950	.2070	.3575	.2734	.2412
41	6.5000	2.2500	1.1875	.2776	.2232	.1461			
61	6.5000	3.2500	.4375	.1138	.0911	.1189	.1346	.1052	.0958
77	6.5000	3.7500	.5000	.1061	.1016	.1195	.1014	.1090	.1021
91	6.5000	4.2500	.5000	.0991	.0902	.0944	.1290	.1290	.1065
126	6.5000	4.7500	.5000	.1146	.0980	.0777	.1312	.1160	.0888
127	7.5000	.3750	.5625	.3565	.2961	.2037	.3843	.3223	.2507
13	7.5000	.7500	.5625	.3600	.2890	.1860	.3822	.2970	.2048

Table II. Continued

(c) Concluded

ORIFICE	X	Y	AREA	PS	PS	PS	PS	PS	PS
27	7.5000	1.5000	.7500	.2580	.2350	.1730	.2636	.1935	.1839
42	7.5000	2.2500	.5625	.2170	.1660	.1500	.2507	.2007	.1406
51	7.5000	2.6250	.6250	.2386	.1995	.2180	.2140	.1735	.1318
62	7.5000	3.2500	.4375	.1673	.1782	.2139	.1115	.0938	.1160
78	7.5000	3.7500	.5000	.0950	.1170	.1530	.0980	.1012	.1260
92	7.5000	4.2500	.5000	.0942	.1107	.1448			
128	7.5000	4.7500	.5000	.1340	.1520	.1650	.1195	.1082	.0985
14	8.5000	.7500	1.1250	.3189	.2729	.2009	.3006	.2445	.1795
28	8.5000	1.5000	.7500	.2551	.2393	.2016	.2137	.1822	.1685
43	8.5000	2.2500	1.1875	.1780	.1440	.1620	.2080	.1648	.1476
63	8.5000	3.2500	.4375	.0940	.1370	.1670	.1034	.0883	.1444
79	8.5000	3.7500	.5000	.1584	.2160	.2297	.1090	.1220	.1720
93	8.5000	4.2500	.5000	.0984	.1504	.1581	.0900	.0976	.1514
129	8.5000	4.7500	.5000	.1673	.2201	.2352	.1220	.1214	.1685
130	9.5000	.3750	.5625	.2534	.2248	.1759	.2549	.2125	.1662
131	9.5000	.7500	.5625	.2082	.1684	.1106	.2388	.1904	.1362
29	9.5000	1.5000	.7500	.1446	.1337	.1228	.1553	.1344	.1296
132	9.5000	2.2500	.5625	.1954	.1947	.2256	.1829	.1549	.1850
133	9.5000	2.6250	.6250	.1260	.1590	.1710	.1508	.1260	.1724
134	9.5000	3.2500	.4375	.1796	.2331	.2304	.1234	.1473	.1863
135	9.5000	3.7500	.5000	.1189	.1658	.1639	.0980	.1320	.1708
136	9.5000	4.2500	.5000	.1410	.1770	.1800	.1066	.1363	.1708
137	9.5000	4.7500	.5000	.1388	.1703	.1735	.0986	.1320	.1696
138	10.5000	.7500	1.1250	.1652	.1348	.1301	.1810	.1495	.1264
30	10.5000	1.5000	.7500	.1313	.1164	.1289	.1502	.1380	.1399
139	10.5000	2.2500	1.1875	.1138	.1459	.1555	.1391	.1320	.1714
140	10.5000	3.2500	.4375	.1465	.1587	.1613	.1266	.1684	.1809
141	10.5000	3.7500	.5000	.1474	.1509	.1533	.1328	.1695	.1785
142	10.5000	4.2500	.5000	.2338	.2489	.2496	.1597	.1863	.2000
143	10.5000	4.7500	.5000	.1479	.1747	.1747	.1495	.1765	.1920

Table II. Continued

(d) Configuration II-B:  $\beta = 20^\circ$ ;  $\epsilon = 6^\circ$ ;  $\alpha = 4^\circ$ ;  $\gamma = 1.21$ ; no fence

TEST RUN PTJ P3 PINF				6515 20-1 NO JET NO JET 0.2320	6515 20-2 25.59 5.461 0.2320	6515 20-3 18.50 3.948 0.2320	6515 20-4 10.44 2.228 0.2320	6526 39-1 34.33 7.326 0.2356	6526 39-2 23.18 4.947 0.2356
ORIFICE	X	Y	AREA	PS	PS	PS	PS	PS	PS
1	2.5000	.3750	.4275	.1742	1.6341	1.2377	.6402		
5	2.5000	.7500	.2850	.1552	1.6899	1.0317	.6573		
15	2.5000	1.1250	.2850	.1368	1.8105	1.3319	.6781		
19	2.5000	1.5000	.2850	.1179	1.8124	1.3622	.6958		
31	2.5000	1.8750	.2850	.1400	1.8339	1.3559	.7211		
35	2.5000	2.2500	.2850	.1394	1.8611	1.3736	.7350		
44	2.5000	2.6250	.2375	.1381	1.8188	1.3275	.7173		
52	2.5000	2.8750	.2375	.1381	1.0246	.7489	.4081		
55	2.5000	3.2500	.3325	.1368	.1716	.1413	.1179		
70	2.5000	3.7500	.3800	.1147	.1128	.0901	.0761		
84	2.5000	4.2500	.3800	.1185	.0864	.0845	.0762	.0825	.0825
94	2.5000	4.7500	.3800	.1040	.0629	.0622	.0597		
6	3.0000	.7500	.5625	.1327	1.3701	.9598	.5168	1.6453	1.0818
20	3.0000	1.5000	.3750	.7786	1.3591	1.1447	.9260	1.6699	1.1008
36	3.0000	2.2500	.2811	.1564	1.4703	1.0317	.5758	1.7310	1.1798
45	3.0000	2.6250	.1563	.1299	1.0982	.7541	.3729	1.3569	.9345
53	3.0000	2.8750	.1562	.2136	.7083	.5182	.3234	.7441	.5145
56	3.0000	3.2500	.1562	.2129	.2740	.2184	.1869	.2673	.1964
64	3.0000	3.5000	.1250	.1305	.1590	.1552	.1350		
71	3.0000	3.7500	.1875	.1423	.2528	.1995	.1224	.2382	.1882
85	3.0000	4.2500	.2500	.1118	.0701	.1660	.0600	.0990	.1324
120	3.0000	4.7500	.2500	.1142	.1398	.1166	.0898	.0763	.0738
2	3.5000	.3750	.2812	.1394	1.1523	.8159	.4498	1.3607	.8503
7	3.5000	.7500	.1875	.1277	1.1171	.8364	.4122	1.3575	.8872
16	3.5000	1.1250	.1875	.1381	1.1574	.8008	.4536	1.3512	.9161
21	3.5000	1.5000	.1875	.1046	1.1461	.8649	.4380	1.3791	.9088
32	3.5000	1.8750	.1875	.1299	.7842	.5111	.2557	1.3955	.9496
37	3.5000	2.2500	.1875	.1277	1.1703	.8504	.4401	1.3899	.9444
46	3.5000	2.6250	.1563	.1256	.7434	.5374	.2804	.9088	.6262
54	3.5000	2.8750	.1562	.1251	.5030	.3584	.1837	.5733	.3986
57	3.5000	3.2500	.1526	.1234	.2036	.1433	.0906	.2837	.2045
65	3.5000	3.5000	.1250	.2081	.2164	.2150	.1971	.1705	.1661
72	3.5000	3.7500	.1875	.1154	.1681	.1616	.1057	.2098	.2034
86	3.5000	4.2500	.2500	.1236	.1204	.0887	.0528		
95	3.5000	4.7500	.2500	.1299	.0869	.1272	.1396	.0772	.0766
8	4.0000	.7500	.5625	.2102	.9635	.7460	.4160	1.0944	.7202
22	4.0000	1.5000	.3750	.1965	1.0122	.7858	.4441	1.1299	.7510
38	4.0000	2.2500	.2811	.2122	.8867	.6692	.3927	.9582	.6621
47	4.0000	2.6250	.1563	.2109	.6067	.4633	.2877	.6518	.4569
121	4.0000	2.8750	.1562	.2164	.4729	.3669	.2376	.4891	.3700
58	4.0000	3.2500	.1562	.2095	.2726	.2225	.1759	.2880	.2155



Table II. Continued

(d) Continued

ORIFICE	X	Y	AREA	PS	PS	PS	PS	PS	PS
66	4.0000	3.5000	.1250	.1208	.1245	.1143	.0949	.1737	.1521
73	4.0000	3.7500	.1250	.2054	.2349	.2260	.1992	.2086	.1922
80	4.0000	4.0000	.1250	.1305	.2013	.1647	.1002		
87	4.0000	4.2500	.1875	.1526	.1815	.1301	.0768	.2021	.1503
122	4.0000	4.7500	.2500	.2047	.1402	.1327	.1313	.1047	.1019
3	4.5000	.3750	.2812	.1702	.7977	.6068	.3143	.9660	.6143
9	4.5000	.7500	.1875	.1320	.3665	.2745	.1799	.9593	.6229
17	4.5000	1.1250	.1875	.1261	.7934	.5875	.2885	.9660	.6596
23	4.5000	1.5000	.1875	.1430	.8448	.6445	.3401	.9939	.6521
33	4.5000	1.8750	.1875	.1251	.7869	.5788	.2907	.9487	.6521
39	4.5000	2.2500	.1875	.1590	.6349	.4666	.2508	.7279	.4976
48	4.5000	2.6250	.3125	.1590	.4377	.3221	.1783	.5078	.3485
59	4.5000	3.2500	.1562	.1539	.1937	.1436	.1019	.2387	.1719
67	4.5000	3.5000	.1250	.2088	.2102	.1920	.1793	.1909	.1567
74	4.5000	3.7500	.1250	.1539	.1603	.1474	.1256	.1719	.1576
81	4.5000	4.0000	.1250	.1558	.1853	.1693	.1185	.1908	.1775
88	4.5000	4.2500	.1875	.1251	.1423	.1245	.1148	.2185	.1705
123	4.5000	4.7500	.2500	.1539	.1051	.0807	.0672	.1063	.0759
10	5.0000	.7500	.5625	.1434	.6966	.5239	.2589	.8271	.5360
24	5.0000	1.5000	.2812	.1219	.1745	.5442	.2863	.8470	.5598
144	5.0000	1.8750	.2812	.2109	.6774	.5223	.3097	.7230	.5014
49	5.0000	2.6250	.4062	.1529	.3441	.2535	.1452	.4312	.3188
68	5.0000	3.5000	.2812	.1564	.1436	.1205	.1141	.1672	.1314
75	5.0000	3.7500	.1250	.1321	.1178	.1082	.0934	.1530	.1491
82	5.0000	4.0000	.1250	.1229	.1304	.1208	.1251	.1721	.1597
89	5.0000	4.2500	.1875	.2109	.2507	.2191	.1649	.2182	.1881
124	5.0000	4.7500	.2500	.1344	.1118	.0832	.0612	.1260	.1279
4	5.5000	.3750	.4218	.2266	.6589	.5217	.3151	.7216	.4754
11	5.5000	.7500	.2812	.1368	.6414	.4846	.2507		
18	5.5000	1.1250	.2812	.2095	.6726	.5210	.3028	.7250	.5014
25	5.5000	1.5000	.2812	.1179	.6010	.4631	.2494		
34	5.5000	1.8750	.2812	.1590	.5122	.3799	.2007	.5865	.3986
40	5.5000	2.2500	.2812	.1434	.3780	.2774	.1481	.4505	.3149
50	5.5000	2.6250	.4687	.1394	.3272	.2462	.1368		
60	5.5000	3.2500	.2343	.1285	.1338	.0939	.0886	.1947	.1414
69	5.5000	3.5000	.1875	.1297	.1047	.0803	.0904	.1575	.1202
76	5.5000	3.7500	.1875	.1381	.1116	.1084	.1052		
83	5.5000	4.0000	.1875	.2136	.2054	.1985	.1827	.1717	.1608
90	5.5000	4.2500	.2812	.1571	.1718	.1487	.1019	.1707	.1493
125	5.5000	4.7500	.3750	.1394	.1305	.0926	.0559		
12	6.5000	.7500	1.1250	.1368	.5017	.3619	.2051	.6132	.4228
26	6.5000	1.5000	.7500	.1294	.3745	.2778	.1740	.4987	.3457
41	6.5000	2.2500	1.1875	.1387	.3101	.2355	.1318		
61	6.5000	3.2500	.4375	.1432	.1242	.0920	.1236		
77	6.5000	3.7500	.5000	.1629	.1147	.1089	.1397	.1237	.1149
91	6.5000	4.2500	.5000	.1380	.1070	.0987	.1082	.1298	.1356
126	6.5000	4.7500	.5000	.1398	.1315	.0987	.0749	.1572	.1244

Table II. Continued

(d) Concluded

ORIFICE	X	Y	AREA	PS	PS	PS	PS	PS	PS
127	7.5000	.3750	.5625	.1975	.4062	.3215	.1937	.4905	.3318
13	7.5000	.7500	.5625	.1272	.3804	.2810	.1342	.4833	.3296
27	7.5000	1.5000	.7500	.1084	.2772	.2240	.1261	.3627	.2500
42	7.5000	2.2500	.5625	.1299	.2191	.1536	.1288	.3033	.2217
51	7.5000	2.6250	.6250	.2129	.2609	.2109	.2273	.2629	.1939
62	7.5000	3.2500	.4375	.2164	.1809	.1574	.2266	.1421	.1054
78	7.5000	3.7500	.5000	.1218	.0724	.0837	.1358	.1133	.1052
92	7.5000	4.2500	.5000	.1482	.0983	.0951	.1558		
128	7.5000	4.7500	.5000	.1315	.0912	.1197	.1407	.1392	.1182
14	8.5000	.7500	1.1250	.2205	.3495	.2850	.1834	.3721	.2654
28	8.5000	1.5000	.7500	.2040	.2822	.2472	.2061	.2893	.2216
43	8.5000	2.2500	1.1875	.1304	.1745	.1272	.1428	.2519	.1850
63	8.5000	3.2500	.4375	.1369	.0788	.0993	.1433	.1300	.0977
79	8.5000	3.7500	.5000	.2239	.1471	.2095	.2390	.1252	.1177
93	8.5000	4.2500	.5000	.1718	.1031	.1622	.1751	.1073	.0984
129	8.5000	4.7500	.5000	.2266	.1752	.2122	.2424	.1396	.1266
130	9.5000	.3750	.5625	.2291	.2774	.2315	.1666	.3207	.2256
131	9.5000	.7500	.5625	.1834	.2431	.1879	.1295	.2966	.2030
29	9.5000	1.5000	.7500	.1558	.1712	.1500	.1481	.2030	.1564
132	9.5000	2.2500	.5625	.2225	.2102	.1834	.2321	.2189	.1662
133	9.5000	2.6250	.6250	.1390	.1148	.1261	.1466	.1818	.1354
134	9.5000	3.2500	.4375	.2280	.1560	.2404	.2369	.1430	.1293
135	9.5000	3.7500	.5000	.1731	.1051	.1847	.1783	.0944	.1087
136	9.5000	4.2500	.5000	.1310	.0923	.1347	.1530	.1031	.1209
137	9.5000	4.7500	.5000	.1763	.1179	.1873	.1866	.1039	.1075
138	10.5000	.7500	1.1250	.1773	.1880	.1434	.1452	.2275	.1613
30	10.5000	1.5000	.7500	.1499	.1368	.1196	.1374	.1767	.1555
139	10.5000	2.2500	1.1875	.1815	.1340	.1558	.1693	.1672	.1224
140	10.5000	3.2500	.4375	.1789	.1352	.1789	.1751	.1105	.1385
141	10.5000	3.7500	.5000	.1559	.1404	.1612	.1595	.0938	.1592
142	10.5000	4.2500	.5000	.2356	.2362	.2561	.2541	.1286	.1785
143	10.5000	4.7500	.5000	.1589	.1523	.1797	.1797	.1125	.1665

Table II. Continued

(e) Configuration II-C:  $\beta = 20^\circ$ ;  $\epsilon = 6^\circ$ ;  $\alpha = 0^\circ$ ;  $\gamma = 1.21$ ; no fence

TEST				6515	6515	6515
RUN				21-1	21-2	21-3
PTJ				20.44	23.04	13.41
P3				4.362	4.917	2.862
PINF				0.2302	0.2302	0.2302
ORIFICE	X	Y	AREA	PS	PS	PS
1	2.5000	.3750	.4275	1.7019	1.6493	.7540
5	2.5000	.7500	.2850	1.7072	1.6591	1.0080
15	2.5000	1.1250	.2850	1.7391	1.7587	.8374
19	2.5000	1.5000	.2850	1.7171	1.7871	.8046
31	2.5000	1.8750	.2850	1.7460	1.8649	.9032
35	2.5000	2.2500	.2850	1.7344	1.8649	.9209
44	2.5000	2.6250	.2375	1.7699	1.7966	.9228
52	2.5000	2.8750	.2375	1.5531	.9784	.5150
55	2.5000	3.2500	.3325	.1725	.1754	.1248
70	2.5000	3.7500	.3800	.1361	.1021	.1021
84	2.5000	4.2500	.3800	.0974	.0762	.1019
94	2.5000	4.7500	.3800	.1019	.0686	.0957
6	3.0000	.7500	.5625	1.2766	1.3523	.8098
20	3.0000	1.5000	.3750	1.2835	1.3477	1.0720
36	3.0000	2.2500	.2811	1.3107	1.4389	.8673
45	3.0000	2.6250	.1563	1.1571	1.0891	.6305
53	3.0000	2.8750	.1562	.6056	.6445	.4290
56	3.0000	3.2500	.1562	.1743	.2712	.2013
64	3.0000	3.5000	.1250	.1658	.1116	.1444
71	3.0000	3.7500	.1875	.1389	.1937	.1609
85	3.0000	4.2500	.2500	.1015	.0898	.1047
120	3.0000	4.7500	.2500	.1016	.1315	.1279
2	3.5000	.3750	.2812	.8807	1.1523	.7021
7	3.5000	.7500	.1875	.9013	1.1364	.4971
16	3.5000	1.1250	.1875	.9079	1.1333	.6850
21	3.5000	1.5000	.1875	.9244	1.1337	.4939
32	3.5000	1.8750	.1875	.9218	.7514	.4450
37	3.5000	2.2500	.1875	.9288	1.1708	.5584
46	3.5000	2.6250	.1563	.6230	.7348	.3638
54	3.5000	2.8750	.1562	.3792	.4563	.2299
57	3.5000	3.2500	.1526	.1645	.2111	.1116
65	3.5000	3.5000	.1250	.1655	.2026	.2129
72	3.5000	3.7500	.1875	.1656	.1068	.1245
86	3.5000	4.2500	.2500	.1150	.1394	.1198
95	3.5000	4.7500	.2500	.1041	.2256	.2466
8	4.0000	.7500	.5625	.6450	.9841	.4853
22	4.0000	1.5000	.3750	.6874	1.0115	.4976
38	4.0000	2.2500	.2811	.6122	.8921	.4757
47	4.0000	2.6250	.1563	.4036	.6054	.3467
121	4.0000	2.8750	.1562	.2839	.4469	.2740

Table II. Continued

(e) Continued

ORIFICE	X	Y	AREA	PS	PS	PS
58	4.0000	3.2500	.1562	.1676	.2911	.2239
66	4.0000	3.5000	.1250	.1694	.1261	.1417
73	4.0000	3.7500	.1250	.1854	.1889	.2301
80	4.0000	4.0000	.1250	.1781	.1337	.1653
87	4.0000	4.2500	.1875	.1414	.1590	.1430
122	4.0000	4.7500	.2500	.1238	.1622	.1966
3	4.5000	.3750	.2812	.5421	.8068	.3643
9	4.5000	.7500	.1875	.5072	.4455	.3181
17	4.5000	1.1250	.1875	.5178	.7977	.3665
23	4.5000	1.5000	.1875	.5549	.8359	.3754
33	4.5000	1.8750	.1875	.5518	.8020	.3756
39	4.5000	2.2500	.1875	.4284	.6297	.3086
48	4.5000	2.6250	.3125	.2865	.4294	.2219
59	4.5000	3.2500	.1562	.1588	.1995	.1776
67	4.5000	3.5000	.1250	.1950	.2177	.2513
74	4.5000	3.7500	.1250	.1749	.1141	.1802
81	4.5000	4.0000	.1250	.1794	.1320	.1763
88	4.5000	4.2500	.1875	.1699	.1600	.1960
123	4.5000	4.7500	.2500	.1135	.1250	.1635
10	5.0000	.7500	.5625	.4120	.7038	.3173
24	5.0000	1.5000	.2812	.4467	.7234	.3262
144	5.0000	1.8750	.2812	.4097	.6939	.3755
49	5.0000	2.6250	.4062	.2166	.3351	.1690
68	5.0000	3.5000	.2812	.1934	.1468	.2040
75	5.0000	3.7500	.1250	.1832	.1035	.1952
82	5.0000	4.0000	.1250	.1937	.1681	.1982
89	5.0000	4.2500	.1875	.2066	.2074	.2836
124	5.0000	4.7500	.2500	.1658	.1404	.1994
4	5.5000	.3750	.4218	.4042	.6774	.3529
11	5.5000	.7500	.2812	.3862	.6534	.3101
18	5.5000	1.1250	.2812	.3618	.6747	.3604
25	5.5000	1.5000	.2812	.3673	.6250	.2918
34	5.5000	1.8750	.2812	.3121	.5167	.2521
40	5.5000	2.2500	.2812	.2429	.3828	.1833
50	5.5000	2.6250	.4687	.2007	.3348	.2039
60	5.5000	3.2500	.2343	.1857	.1428	.2035
69	5.5000	3.5000	.1875	.1909	.1112	.2101
76	5.5000	3.7500	.1875	.1955	.1331	.2342
83	5.5000	4.0000	.1875	.2223	.2184	.3049
90	5.5000	4.2500	.2812	.1946	.1500	.2335
125	5.5000	4.7500	.3750	.1918	.1672	.2285
12	6.5000	.7500	1.1250	.3343	.5188	.3234
26	6.5000	1.5000	.7500	.2591	.4342	.2955
41	6.5000	2.2500	1.1875	.2140	.3246	.2361
61	6.5000	3.2500	.4375	.2166	.1419	.2595
77	6.5000	3.7500	.5000	.2123	.1885	.2611
91	6.5000	4.2500	.5000	.2243	.1916	.2458

Table II. Continued

(e) Concluded

ORIFICE	X	Y	AREA	PS	PS	PS
126	6.5000	4.7500	.5000	.2287	.2148	.2404
127	7.5000	.3750	.5625	.2793	.4146	.2059
13	7.5000	.7500	.5625	.2589	.3848	.1670
27	7.5000	1.5000	.7500	.2183	.2869	.2143
42	7.5000	2.2500	.5625	.2616	.3041	.2778
51	7.5000	2.6250	.6250	.2875	.2658	.3392
62	7.5000	3.2500	.4375	.2597	.2520	.3302
78	7.5000	3.7500	.5000	.2465	.1788	.1998
92	7.5000	4.2500	.5000	.2405	.2437	.2810
128	7.5000	4.7500	.5000	.2476	.2283	.2493
14	8.5000	.7500	1.1250	.2168	.3597	.2843
28	8.5000	1.5000	.7500	.2353	.2953	.3344
43	8.5000	2.2500	1.1875	.2907	.1799	.2681
63	8.5000	3.2500	.4375	.2708	.2713	.2649
79	8.5000	3.7500	.5000	.2798	.3488	.3529
93	8.5000	4.2500	.5000	.2717	.2778	.2862
129	8.5000	4.7500	.5000	.2784	.3398	.3570
130	9.5000	.3750	.5625	.1960	.2875	.3149
131	9.5000	.7500	.5625	.2059	.2412	.2727
29	9.5000	1.5000	.7500	.2590	.1885	.2727
132	9.5000	2.2500	.5625	.2934	.3049	.3488
133	9.5000	2.6250	.6250	.2886	.2740	.2686
134	9.5000	3.2500	.4375	.2866	.3680	.3577
135	9.5000	3.7500	.5000	.2775	.3029	.2977
136	9.5000	4.2500	.5000	.2832	.2643	.2783
137	9.5000	4.7500	.5000	.2841	.2964	.3086
138	10.5000	.7500	1.1250	.2571	.2136	.2643
30	10.5000	1.5000	.7500	.2648	.2601	.2714
139	10.5000	2.2500	1.1875	.2733	.3003	.2849
140	10.5000	3.2500	.4375	.2829	.3086	.2971
141	10.5000	3.7500	.5000	.2847	.3042	.2958
142	10.5000	4.2500	.5000	.3051	.3913	.3790
143	10.5000	4.7500	.5000	.3066	.3095	.3125

Table II. Continued

(f) Configuration II-D:  $\beta = 20^\circ$ ;  $\epsilon = 6^\circ$ ;  $\alpha = 0^\circ$ ;  $\gamma = 1.18$ ; no fence

TEST				6526	6526	6526
RUN				31-1	31-2	33-1
PTJ				23.42	13.61	21.40
P3				5.304	3.083	4.960
PINF				0.2367	0.2367	0.2368
ORIFICE	X	Y	AREA	PS	PS	PS
1	2.5000	.3750	.4275	1.3276	.7497	1.3648
5	2.5000	.7500	.2850	1.4093	.7828	1.4134
15	2.5000	1.1250	.2850	1.4833	.8287	1.4542
19	2.5000	1.5000	.2850	1.4548	.8344	1.4596
31	2.5000	1.8750	.2850	1.5210	.8969	1.4604
35	2.5000	2.2500	.2850	1.5287	.9238	1.4635
44	2.5000	2.6250	.2375	1.4679	.9215	1.4619
52	2.5000	2.8750	.2375	.8514	.5801	.8532
55	2.5000	3.2500	.3325	.2665	.2542	.2891
70	2.5000	3.7500	.3800	.2064	.2118	.2351
84	2.5000	4.2500	.3800	.0813	.0956	.0811
94	2.5000	4.7500	.3800	.1987	.2210	.2290
6	3.0000	.7500	.5625	1.0723	.5335	1.0638
20	3.0000	1.5000	.3750	1.0622	.5367	1.0714
36	3.0000	2.2500	.2811	1.1488	.6461	1.0796
45	3.0000	2.6250	.1563	.8535	.4981	.8305
53	3.0000	2.8750	.1562	.4671	.2888	.4555
56	3.0000	3.2500	.1562	.1712	.1149	.1677
64	3.0000	3.5000	.1250	.2457	.2588	.2737
71	3.0000	3.7500	.1875	.1402	.1142	.1412
85	3.0000	4.2500	.2500	.1973	.0892	.2118
120	3.0000	4.7500	.2500	.0744	.0959	.0748
2	3.5000	.3750	.2812	.8820	.4564	.8899
7	3.5000	.7500	.1875	.8889	.4396	.8753
16	3.5000	1.1250	.1875	.8940	.4583	.8634
21	3.5000	1.5000	.1875	.8727	.4466	.8850
32	3.5000	1.8750	.1875	.9522	.5145	.8950
37	3.5000	2.2500	.1875	.9325	.5178	.8731
46	3.5000	2.6250	.1563	.5836	.3431	.5652
54	3.5000	2.8750	.1562	.3706	.2303	.3597
57	3.5000	3.2500	.1526	.1813	.1263	.1763
65	3.5000	3.5000	.1250	.1180	.1376	.1178
72	3.5000	3.7500	.1875	.1349	.1424	.1364
86	3.5000	4.2500	.2500	.2249	.2195	.2521
95	3.5000	4.7500	.2500	.0826	.1090	.0825
8	4.0000	.7500	.5625	.7182	.3687	.7103
22	4.0000	1.5000	.3750	.7223	.3878	.7335
38	4.0000	2.2500	.2811	.6655	.2783	.6234
47	4.0000	2.6250	.1563	.4350	.2688	.4217
121	4.0000	2.8750	.1562	.3140	.2073	.3054
58	4.0000	3.2500	.1562	.1950	.1560	.1905
66	4.0000	3.5000	.1250	.1214	.1516	.1202

Table II. Continued

(f) Continued

ORIFICE	X	Y	AREA	PS	PS	PS
73	4.0000	3.7500	.1250	.1457	.1649	.1474
80	4.0000	4.0000	.1250	.2673	.2788	.2968
87	4.0000	4.2500	.1875	.1383	.1212	.1367
122	4.0000	4.7500	.2500	.1081	.1361	.1084
3	4.5000	.3750	.2812	.6364	.3490	.6358
9	4.5000	.7500	.1875	.6253	.3103	.6209
17	4.5000	1.1250	.1875	.6375	.3290	.6180
23	4.5000	1.5000	.1875	.6229	.3270	.6388
33	4.5000	1.8750	.1875	.6559	.3700	.6170
39	4.5000	2.2500	.1875	.5024	.2763	.4706
48	4.5000	2.6250	.3125	.3419	.2012	.3286
59	4.5000	3.2500	.1562	.1546	.1552	.1509
67	4.5000	3.5000	.1250	.1471	.1826	.1474
74	4.5000	3.7500	.1250	.1284	.1624	.1288
81	4.5000	4.0000	.1250	.1338	.1617	.1367
88	4.5000	4.2500	.1875	.1424	.1597	.1450
123	4.5000	4.7500	.2500	.0992	.1338	.0990
10	5.0000	.7500	.5625	.5392	.2731	.5383
24	5.0000	1.5000	.2812	.5161	.2982	.5428
144	5.0000	1.8750	.2812	.5034	.2880	.4736
49	5.0000	2.6250	.4062	.3078	.2050	.2992
68	5.0000	3.5000	.2812	.1379	.1863	.1401
75	5.0000	3.7500	.1250	.1408	.1851	.1463
82	5.0000	4.0000	.1250	.1467	.1947	.1515
89	5.0000	4.2500	.1875	.1655	.2073	.1713
124	5.0000	4.7500	.2500	.2301	.2391	.2266
4	5.5000	.3750	.4218	.4863	.2887	.4901
11	5.5000	.7500	.2812	.6087	.3836	.5550
18	5.5000	1.1250	.2812	.4850	.2647	.4730
25	5.5000	1.5000	.2812	.5462	.3844	.5873
34	5.5000	1.8750	.2812	.4046	.2226	.3707
40	5.5000	2.2500	.2812	.3130	.1780	.2953
50	5.5000	2.6250	.4687	.3790	.3158	.3993
60	5.5000	3.2500	.2343	.1343	.1896	.1373
69	5.5000	3.5000	.1875	.1420	.1973	.1540
76	5.5000	3.7500	.1875	.2742	.3328	.3060
83	5.5000	4.0000	.1875	.1833	.2298	.1919
90	5.5000	4.2500	.2812	.1684	.2036	.1735
125	5.5000	4.7500	.3750	.2850	.3343	.3230
12	6.5000	.7500	1.1250	.4083	.2097	.4004
26	6.5000	1.5000	.7500	.2907	.2091	.3614
41	6.5000	2.2500	1.1875	.3744	.3482	.3885
61	6.5000	3.2500	.4375	.2996	.3598	.3369
77	6.5000	3.7500	.5000	.2097	.2300	.2152
91	6.5000	4.2500	.5000	.2204	.2410	.2349
126	6.5000	4.7500	.5000	.2287	.2350	.2310
127	7.5000	.3750	.5625	.3515	.2185	.3531

Table II. Continued

(f) Concluded

ORIFICE	X	Y	AREA	PS	PS	PS
13	7.5000	.7500	.5625	.3220	.1705	.3166
27	7.5000	1.5000	.7500	.2226	.2500	.2782
42	7.5000	2.2500	.5625	.2104	.2603	.2025
51	7.5000	2.6250	.6250	.1889	.2629	.1974
62	7.5000	3.2500	.4375	.2344	.2502	.2367
78	7.5000	3.7500	.5000	.2438	.2573	.2448
92	7.5000	4.2500	.5000	.3690	.3829	.3939
128	7.5000	4.7500	.5000	.2503	.2589	.2491
14	8.5000	.7500	1.1250	.2627	.2237	.2602
28	8.5000	1.5000	.7500	.2216	.2565	.2158
43	8.5000	2.2500	1.1875	.1991	.2676	.2081
63	8.5000	3.2500	.4375	.2395	.2643	.2362
79	8.5000	3.7500	.5000	.2572	.2777	.2575
93	8.5000	4.2500	.5000	.2553	.2654	.2550
129	8.5000	4.7500	.5000	.2770	.2852	.2753
130	9.5000	.3750	.5625	.2294	.2796	.2343
131	9.5000	.7500	.5625	.2053	.2471	.2028
29	9.5000	1.5000	.7500	.2310	.2441	.2147
132	9.5000	2.2500	.5625	.2839	.2736	.2944
133	9.5000	2.6250	.6250	.2843	.2654	.2912
134	9.5000	3.2500	.4375	.2825	.2784	.2849
135	9.5000	3.7500	.5000	.2650	.2698	.2642
136	9.5000	4.2500	.5000	.2729	.2767	.2750
137	9.5000	4.7500	.5000	.2745	.2853	.2755
138	10.5000	.7500	1.1250	.2661	.2487	.2735
30	10.5000	1.5000	.7500	.3143	.2635	.3249
139	10.5000	2.2500	1.1875	.3306	.2602	.3209
140	10.5000	3.2500	.4375	.3008	.2710	.2970
141	10.5000	3.7500	.5000	.2609	.2738	.2941
142	10.5000	4.2500	.5000	.3078	.2893	.3081
143	10.5000	4.7500	.5000	.2950	.2988	.3031



Table II. Continued

(g) Configuration III:  $\beta = 24^\circ$ ;  $\epsilon = 6^\circ$ ;  $\alpha = 0^\circ$ ;  $\gamma = 1.23$ ; no fence

TEST				6515	6515	6515	6515
RUN				9-1	9-2	9-3	9-4
PTJ				NO JET	15.340	10.020	26.93
P3				NO JET	3.194	2.087	5.606
PINF				0.2192	0.2227	0.2217	0.2207
ORIFICE	X	Y	AREA	PS	PS	PS	PS
1	2.5000	.3750	.4275	.2987	.7824	.5763	1.3426
5	2.5000	.7500	.2850	.2483	.7928	.5148	1.4299
15	2.5000	1.1250	.2850	.2361	.8457	.5554	1.4969
19	2.5000	1.5000	.2850	.2190	.8583	.5889	1.5007
31	2.5000	1.8750	.2850	.2304	.8558	.5674	1.5570
35	2.5000	2.2500	.2850	.2285	.8697	.5814	1.5703
44	2.5000	2.6250	.2375	.2273	.8532	.5586	1.5627
52	2.5000	2.8750	.2375	.2273	.4606	.3076	.8608
55	2.5000	3.2500	.3325	.2247	.1312	.1552	.1261
70	2.5000	3.7500	.3800	.2216	.1223	.1457	.0743
84	2.5000	4.2500	.3800	.2374	.1385	.1609	.0871
94	2.5000	4.7500	.3800	.2235	.1217	.1470	.0755
6	3.0000	.7500	.5625	.2262	.5835	.3786	1.0563
20	3.0000	1.5000	.3750	1.4160	.6581	.4589	1.3856
36	3.0000	2.2500	.2811	.2451	.6567	.4371	1.1961
45	3.0000	2.6250	.1563	.2667	.4503	.2783	.8514
53	3.0000	2.8750	.1562	.2911	.3234	.2417	.5347
56	3.0000	3.2500	.1562	.2898	.1779	.2006	.2150
64	3.0000	3.5000	.1250	.2260	.1267	.1508	.0894
71	3.0000	3.7500	.1875	.2393	.1584	.1699	.1558
85	3.0000	4.2500	.2500	.2184	.1225	.1446	.0862
120	3.0000	4.7500	.2500	.2202	.1362	.1493	.1404
2	3.5000	.3750	.2812	.2298	.4916	.3259	.9076
7	3.5000	.7500	.1875	.2622	.4686	.2966	.8735
16	3.5000	1.1250	.1875	.2285	.4992	.3196	.9000
21	3.5000	1.5000	.1875	.2464	.4579	.3288	.8482
32	3.5000	1.8750	.1875	.2651	.5146	.3803	1.0848
37	3.5000	2.2500	.1875	.2605	.4428	.2987	.8918
46	3.5000	2.6250	.1563	.2571	.2783	.1697	.5611
54	3.5000	2.8750	.1562	.2605	.1460	.0880	.3202
57	3.5000	3.2500	.1526	.2605	.0691	.0912	.1095
65	3.5000	3.5000	.1250	.2911	.1971	.2164	.1690
72	3.5000	3.7500	.1875	.2571	.0858	.0982	.0605
86	3.5000	4.2500	.2500	.2260	.1261	.1432	.1021
95	3.5000	4.7500	.2500	.2611	.1509	.1385	.1751
8	4.0000	.7500	.5625	.2918	.4743	.3398	.7769
22	4.0000	1.5000	.3750	.2822	.4812	.3762	.7968
38	4.0000	2.2500	.2811	.2891	.4448	.3206	.7515
47	4.0000	2.6250	.1563	.2850	.3069	.2314	.5093
121	4.0000	2.8750	.1562	.2891	.2294	.1903	.3666
58	4.0000	3.2500	.1562	.2898	.1951	.1992	.2253

Table II. Continued

(g) Continued

ORIFICE	X	Y	AREA	PS	PS	PS	PS
66	4.0000	3.5000	.1250	.2594	.0842	.0971	.0654
73	4.0000	3.7500	.1250	.2905	.2040	.2205	.1848
80	4.0000	4.0000	.1250	.2266	.1400	.1520	.1185
87	4.0000	4.2500	.1875	.2406	.1494	.1558	.1308
122	4.0000	4.7500	.2500	.2905	.1958	.2095	.1807
3	4.5000	.3750	.2812	.2450	.3632	.3014	.6380
9	4.5000	.7500	.1875	.2699	.1912	.1519	.3622
17	4.5000	1.1250	.1875	.2628	.3175	.1944	.6111
23	4.5000	1.5000	.1875	.2341	.3761	.2862	.6535
33	4.5000	1.8750	.1875	.2594	.3138	.1928	.6127
39	4.5000	2.2500	.1875	.2393	.2996	.2020	.5334
48	4.5000	2.6250	.3125	.2386	.2046	.1481	.3613
59	4.5000	3.2500	.1562	.2418	.1552	.1532	.1552
67	4.5000	3.5000	.1250	.2891	.2122	.2184	.1875
74	4.5000	3.7500	.1250	.2406	.1596	.1699	.1365
81	4.5000	4.0000	.1250	.2406	.1693	.1686	.1423
88	4.5000	4.2500	.1875	.2611	.1111	.1202	.1272
123	4.5000	4.7500	.2500	.2418	.1532	.1545	.1519
10	5.0000	.7500	.5625	.2339	.3143	.2238	.5525
24	5.0000	1.5000	.2812	.2131	.3065	.2428	.5584
144	5.0000	1.8750	.2812	.2843	.3495	.2589	.5759
49	5.0000	2.6250	.4062	.2166	.1475	.1505	.2714
68	5.0000	3.5000	.2812	.2451	.1776	.1821	.1436
75	5.0000	3.7500	.1250	.2190	.1595	.1666	.1333
82	5.0000	4.0000	.1250	.2594	.1105	.1202	.1267
89	5.0000	4.2500	.1875	.2891	.2438	.2253	.2184
124	5.0000	4.7500	.2500	.2220	.1583	.1464	.1654
4	5.5000	.3750	.4218	.3289	.3659	.3131	.5573
11	5.5000	.7500	.2812	.2279	.2867	.1950	.5118
18	5.5000	1.1250	.2812	.2891	.3344	.2486	.5416
25	5.5000	1.5000	.2812	.2146	.2646	.2121	.4764
34	5.5000	1.8750	.2812	.2438	.2451	.1686	.4294
40	5.5000	2.2500	.2812	.2166	.1660	.1511	.3065
50	5.5000	2.6250	.4687	.2235	.1691	.1887	.2728
60	5.5000	3.2500	.2343	.2190	.1690	.1773	.1213
69	5.5000	3.5000	.1875	.2196	.1749	.1809	.1333
76	5.5000	3.7500	.1875	.2260	.1881	.1938	.1539
83	5.5000	4.0000	.1875	.2911	.2575	.2527	.2342
90	5.5000	4.2500	.2812	.2425	.2085	.1828	.1802
125	5.5000	4.7500	.3750	.2374	.1836	.1558	.1805
12	6.5000	.7500	1.1250	.2298	.2209	.1482	.4144
26	6.5000	1.5000	.7500	.2644	.1912	.1525	.3546
41	6.5000	2.2500	1.1875	.2209	.1862	.2172	.2627
61	6.5000	3.2500	.4375	.2241	.2127	.2172	.1830
77	6.5000	3.7500	.5000	.2406	.2290	.2341	.2245
91	6.5000	4.2500	.5000	.2202	.2071	.2011	.2089

Table II. Continued

(g) Concluded

ORIFICE	X	Y	AREA	PS	PS	PS	PS
126	6.5000	4.7500	.5000	.2214	.2089	.1821	.2095
127	7.5000	.3750	.5625	.3260	.2907	.2791	.4088
13	7.5000	.7500	.5625	.2628	.1331	.0933	.2778
27	7.5000	1.5000	.7500	.2435	.1170	.1294	.1783
42	7.5000	2.2500	.5625	.2667	.1632	.1799	.1493
51	7.5000	2.6250	.6250	.2863	.2829	.2891	.2644
62	7.5000	3.2500	.4375	.2877	.2802	.2925	.2987
78	7.5000	3.7500	.5000	.2577	.1095	.1191	.1288
92	7.5000	4.2500	.5000	.2260	.2260	.2342	.2475
128	7.5000	4.7500	.5000	.2628	.1595	.1460	.1858
14	8.5000	.7500	1.1250	.2939	.2040	.2678	.3055
28	8.5000	1.5000	.7500	.2802	.2479	.2671	.2438
43	8.5000	2.2500	1.1875	.2480	.1724	.1691	.1600
63	8.5000	3.2500	.4375	.2549	.1589	.1826	.1955
79	8.5000	3.7500	.5000	.2877	.2850	.3076	.3110
93	8.5000	4.2500	.5000	.2412	.2444	.2547	.2573
129	8.5000	4.7500	.5000	.2898	.3083	.3083	.3254
130	9.5000	.3750	.5625	.3595	.3268	.4459	.4006
131	9.5000	.7500	.5625	.2611	.2091	.2579	.2123
29	9.5000	1.5000	.7500	.2322	.2277	.2341	.1841
132	9.5000	2.2500	.5625	.2788	.2671	.2870	.2870
133	9.5000	2.6250	.6250	.2497	.1579	.1718	.1912
134	9.5000	3.2500	.4375	.2891	.2795	.2994	.2959
135	9.5000	3.7500	.5000	.2431	.2412	.2540	.2470
136	9.5000	4.2500	.5000	.2605	.1509	.1380	.2057
137	9.5000	4.7500	.5000	.2406	.2688	.2643	.2874
138	10.5000	.7500	1.1250	.2333	.3226	.2678	.3202
30	10.5000	1.5000	.7500	.2095	.2619	.2482	.3524
139	10.5000	2.2500	1.1875	.2271	.2431	.2483	.3202
140	10.5000	3.2500	.4375	.2316	.2444	.2540	.2560
141	10.5000	3.7500	.5000	.2131	.2351	.2428	.2482
142	10.5000	4.2500	.5000	.2850	.3186	.3206	.3440
143	10.5000	4.7500	.5000	.2166	.2595	.2547	.2988

Table II. Continued

(h) Configuration IV:  $\beta = 16^\circ$ ;  $\epsilon = 12^\circ$ ;  $\alpha = 0^\circ$ ;  $\gamma = 1.23$ ; no fence

TEST				6526	6526	6526
RUN				20-1	21-1	22-1
PTJ				29.01	20.06	14.71
P3				6.231	4.309	3.16
PINF				0.2330	0.2339	0.2339
ORIFICE	X	Y	AREA	PS	PS	PS
1	2.5000	.3750	.4275	2.1323	1.7019	1.1937
5	2.5000	.7500	.2850	2.2260	1.7072	1.2338
15	2.5000	1.1250	.2850	2.2948	1.7391	1.1911
19	2.5000	1.5000	.2850	2.3680	1.7171	1.2118
31	2.5000	1.8750	.2850	2.3591	1.7460	1.1309
35	2.5000	2.2500	.2850	2.5444	1.7344	1.1845
44	2.5000	2.6250	.2375	2.5790	1.7699	1.2105
52	2.5000	2.8750	.2375	2.3904	1.5531	1.0354
55	2.5000	3.2500	.3325	.2230	.1725	.1532
70	2.5000	3.7500	.3800	.1559	.1361	.1204
84	2.5000	4.2500	.3800	.0926	.0974	.1027
94	2.5000	4.7500	.3800	.0894	.1019	.1089
6	3.0000	.7500	.5625	1.7363	1.2766	.9066
20	3.0000	1.5000	.3750	1.7831	1.2835	.9117
36	3.0000	2.2500	.2811	1.8780	1.3107	.9294
45	3.0000	2.6250	.1563	1.6807	1.1571	.8219
53	3.0000	2.8750	.1562	.8586	.6056	.4425
56	3.0000	3.2500	.1562	.2249	.1743	.1560
64	3.0000	3.5000	.1250	.1220	.1658	.1708
71	3.0000	3.7500	.1875	.1572	.1389	.1237
85	3.0000	4.2500	.2500	.1022	.1015	.1054
120	3.0000	4.7500	.2500	.0902	.1016	.1117
2	3.5000	.3750	.2812	1.1836	.8807	.6347
7	3.5000	.7500	.1875	1.2346	.9013	.6343
16	3.5000	1.1250	.1875	1.3025	.9079	.6499
21	3.5000	1.5000	.1875	1.2772	.9244	.6494
32	3.5000	1.8750	.1875	1.3215	.9218	.6594
37	3.5000	2.2500	.1875	1.3370	.9288	.6537
46	3.5000	2.6250	.1563	.8969	.6230	.4444
54	3.5000	2.8750	.1562	.5367	.3792	.2723
57	3.5000	3.2500	.1526	.2228	.1645	.1494
65	3.5000	3.5000	.1250	.1231	.1655	.1749
72	3.5000	3.7500	.1875	.1376	.1656	.1645
86	3.5000	4.2500	.2500	.1230	.1150	.1180
95	3.5000	4.7500	.2500	.0944	.1041	.1171
8	4.0000	.7500	.5625	.8632	.6450	.4685
22	4.0000	1.5000	.3750	.9316	.6874	.4911
38	4.0000	2.2500	.2811	.8639	.6122	.4425
47	4.0000	2.6250	.1563	.5616	.4036	.2989
121	4.0000	2.8750	.1562	.3830	.2839	.2182
58	4.0000	3.2500	.1562	.2114	.1676	.1868

Table II. Continued

(h) Continued

ORIFICE	X	Y	AREA	PS	PS	PS
66	4.0000	3.5000	.1250	.1295	.1694	.1726
73	4.0000	3.7500	.1250	.1498	.1854	.1861
80	4.0000	4.0000	.1250	.1381	.1781	.1850
87	4.0000	4.2500	.1875	.1610	.1414	.1345
122	4.0000	4.7500	.2500	.1136	.1238	.1423
3	4.5000	.3750	.2812	.7190	.5421	.3997
9	4.5000	.7500	.1875	.6831	.5072	.3646
17	4.5000	1.1250	.1875	.7362	.5178	.3695
23	4.5000	1.5000	.1875	.7553	.5549	.3885
33	4.5000	1.8750	.1875	.7826	.5518	.4013
39	4.5000	2.2500	.1875	.6121	.4284	.3073
48	4.5000	2.6250	.3125	.4028	.2865	.2131
59	4.5000	3.2500	.1562	.1648	.1588	.1827
67	4.5000	3.5000	.1250	.1491	.1950	.1991
74	4.5000	3.7500	.1250	.1421	.1749	.1821
81	4.5000	4.0000	.1250	.1446	.1794	.1870
88	4.5000	4.2500	.1875	.1602	.1699	.1662
123	4.5000	4.7500	.2500	.1039	.1135	.1451
10	5.0000	.7500	.5625	.5591	.4120	.2950
24	5.0000	1.5000	.2812	.6048	.4467	.3033
144	5.0000	1.8750	.2812	.5711	.4097	.3044
49	5.0000	2.6250	.4062	.3098	.2166	.1665
68	5.0000	3.5000	.2812	.1499	.1934	.1940
75	5.0000	3.7500	.1250	.1523	.1832	.1915
82	5.0000	4.0000	.1250	.1559	.1937	.1980
89	5.0000	4.2500	.1875	.1731	.2066	.2114
124	5.0000	4.7500	.2500	.1414	.1658	.1864
4	5.5000	.3750	.4218	.5144	.4042	.3153
11	5.5000	.7500	.2812	.4903	.3862	.2849
18	5.5000	1.1250	.2812	.4945	.3618	.2716
25	5.5000	1.5000	.2812	.4929	.3673	.2458
34	5.5000	1.8750	.2812	.4386	.3121	.2292
40	5.5000	2.2500	.2812	.3413	.2429	.1793
50	5.5000	2.6250	.4687	.2656	.2007	.1648
60	5.5000	3.2500	.2343	.1318	.1857	.1967
69	5.5000	3.5000	.1875	.1523	.1909	.1896
76	5.5000	3.7500	.1875	.1712	.1955	.2172
83	5.5000	4.0000	.1875	.1813	.2223	.2292
90	5.5000	4.2500	.2812	.1636	.1946	.2030
125	5.5000	4.7500	.3750	.1673	.1918	.2124
12	6.5000	.7500	1.1250	.4298	.3343	.2540
26	6.5000	1.5000	.7500	.3217	.2591	.1990
41	6.5000	2.2500	1.1875	.2657	.2140	.2228
61	6.5000	3.2500	.4375	.1643	.2166	.2339
77	6.5000	3.7500	.5000	.1908	.2123	.2388
91	6.5000	4.2500	.5000	.2024	.2243	.2294
126	6.5000	4.7500	.5000	.2059	.2287	.2407

Table II. Continued

(h) Concluded

ORIFICE	X	Y	AREA	PS	PS	PS
127	7.5000	.3750	.5625	.3425	.2793	.2286
13	7.5000	.7500	.5625	.3371	.2589	.1926
27	7.5000	1.5000	.7500	.2198	.2183	.2057
42	7.5000	2.2500	.5625	.2395	.2616	.2894
51	7.5000	2.6250	.6250	.2211	.2875	.2907
62	7.5000	3.2500	.4375	.2173	.2597	.2610
78	7.5000	3.7500	.5000	.2239	.2465	.2498
92	7.5000	4.2500	.5000	.2079	.2405	.2482
128	7.5000	4.7500	.5000	.2271	.2476	.2481
14	8.5000	.7500	1.1250	.2709	.2168	.2285
28	8.5000	1.5000	.7500	.2182	.2353	.2688
43	8.5000	2.2500	1.1875	.2802	.2907	.2762
63	8.5000	3.2500	.4375	.2266	.2708	.2562
79	8.5000	3.7500	.5000	.2394	.2798	.2716
93	8.5000	4.2500	.5000	.2401	.2717	.2711
129	8.5000	4.7500	.5000	.2531	.2784	.2770
130	9.5000	.3750	.5625	.2384	.1960	.2616
131	9.5000	.7500	.5625	.2149	.2059	.2525
29	9.5000	1.5000	.7500	.1910	.2590	.2537
132	9.5000	2.2500	.5625	.2634	.2934	.2777
133	9.5000	2.6250	.6250	.2724	.2886	.2665
134	9.5000	3.2500	.4375	.2592	.2866	.2729
135	9.5000	3.7500	.5000	.2399	.2775	.2644
136	9.5000	4.2500	.5000	.2551	.2832	.2708
137	9.5000	4.7500	.5000	.2554	.2841	.N769
138	10.5000	.7500	1.1250	.1748	.2571	.2436
30	10.5000	1.5000	.7500	.2346	.2648	.2468
139	10.5000	2.2500	1.1875	.2662	.2733	.2590
140	10.5000	3.2500	.4375	.2710	.2829	.2680
141	10.5000	3.7500	.5000	.2744	.2847	.2667
142	10.5000	4.2500	.5000	.2866	.3051	.2907
143	10.5000	4.7500	.5000	.2821	.3066	.2892

Table II. Continued

(i) Configuration V:  $\beta = 20^\circ$ ;  $\epsilon = 12^\circ$ ;  $\alpha = 0^\circ$ ;  $\gamma = 1.23$ ; no fence

TEST				6526	6526	6526
RUN				15-1	16-1	17-1
PTJ				22.02	19.56	13.97
P3				4.731	4.201	3.001
PINF				0.2327	0.2312	0.2312
ORIFICE	X	Y	AREA	PS	PS	PS
1	2.5000	.3750	.4275	1.5958	1.3145	1.0433
5	2.5000	.7500	.2850	1.6474	1.3299	1.0880
15	2.5000	1.1250	.2850	1.6628	1.3333	1.0787
19	2.5000	1.5000	.2850	1.6289	1.4028	1.0810
31	2.5000	1.8750	.2850	1.6420	1.4229	1.0787
35	2.5000	2.2500	.2850	1.6397	1.4338	1.0864
44	2.5000	2.6250	.2375	1.7044	1.3548	1.1149
52	2.5000	2.8750	.2375	1.6189	1.3297	.9323
55	2.5000	3.2500	.3325	.2488	.2018	.2788
70	2.5000	3.7500	.3800	.1756	.1859	.2226
84	2.5000	4.2500	.3800	.1224	.1338	.1642
94	2.5000	4.7500	.3800	.1879	.1777	.2357
6	3.0000	.7500	.5625	1.2627	1.1077	.8181
20	3.0000	1.5000	.3750	1.2494	1.1058	.7941
36	3.0000	2.2500	.2811	1.3095	1.1526	.8491
45	3.0000	2.6250	.1563	1.1817	.8812	.7605
53	3.0000	2.8750	.1562	.6069	.5538	.4007
56	3.0000	3.2500	.1562	.1648	.1699	.1749
64	3.0000	3.5000	.1250	.2018	.2054	.2357
71	3.0000	3.7500	.1875	.1389	.1547	.1749
85	3.0000	4.2500	.2500	.1292	.1337	.1594
120	3.0000	4.7500	.2500	.1319	.1478	.1768
2	3.5000	.3750	.2812	.8807	.7802	.5828
7	3.5000	.7500	.1875	.9137	.7955	.5787
16	3.5000	1.1250	.1875	.9338	.8295	.6119
21	3.5000	1.5000	.1875	.9266	.8133	.5744
32	3.5000	1.8750	.1875	.9515	.8485	.6233
37	3.5000	2.2500	.1875	.9633	.8376	.6073
46	3.5000	2.6250	.1563	.6483	.5750	.4159
54	3.5000	2.8750	.1562	.3905	.3517	.2508
57	3.5000	3.2500	.1526	.1597	.1527	.1683
65	3.5000	3.5000	.1250	.1604	.1749	.1933
72	3.5000	3.7500	.1875	.1559	.1618	.1705
86	3.5000	4.2500	.2500	.1964	.1982	.2311
95	3.5000	4.7500	.2500	.1732	.1586	.1645
8	4.0000	.7500	.5625	.6628	.5875	.4398
22	4.0000	1.5000	.3750	.6936	.6183	.4501
38	4.0000	2.2500	.2811	.6423	.5670	.4261
47	4.0000	2.6250	.1563	.4166	.2776	.2893
121	4.0000	2.8750	.1562	.2928	.2729	.2127
58	4.0000	3.2500	.1562	.1703	.1792	.2004
66	4.0000	3.5000	.1250	.1672	.1726	.1769

Table II. Continued

(i) Continued

ORIFICE	X	Y	AREA	PS	PS	PS
73	4.0000	3.7500	.1250	.1806	.1895	.2004
80	4.0000	4.0000	.1250	.2311	.2314	.2488
87	4.0000	4.2500	.1875	.1686	.1819	.1933
122	4.0000	4.7500	.2500	.1744	.1840	.1922
3	4.5000	.3750	.2812	.5475	.4849	.3684
9	4.5000	.7500	.1875	.5203	.4630	.3401
17	4.5000	1.1250	.1875	.5297	.4698	.3441
23	4.5000	1.5000	.1875	.5519	.4922	.3455
33	4.5000	1.8750	.1875	.5685	.5054	.3787
39	4.5000	2.2500	.1875	.4469	.3962	.2906
48	4.5000	2.6250	.3125	.2936	.2698	.2036
59	4.5000	3.2500	.1562	.1660	.1904	.1970
67	4.5000	3.5000	.1250	.2004	.2073	.2107
74	4.5000	3.7500	.1250	.1821	.1928	.1994
81	4.5000	4.0000	.1250	.1889	.1996	.2161
88	4.5000	4.2500	.1875	.1856	.1888	.1942
123	4.5000	4.7500	.2500	.1809	.1868	.1851
10	5.0000	.7500	.5625	.4222	.3676	.2693
24	5.0000	1.5000	.2812	.4293	.3766	.2629
144	5.0000	1.8750	.2812	.4220	.3810	.2941
49	5.0000	2.6250	.4062	.2262	.1979	.1632
68	5.0000	3.5000	.2812	.2000	.2095	.2101
75	5.0000	3.7500	.1250	.2012	.1954	.1979
82	5.0000	4.0000	.1250	.2050	.2061	.2125
89	5.0000	4.2500	.1875	.2223	.2257	.2346
124	5.0000	4.7500	.2500	.2114	.2057	.2050
4	5.5000	.3750	.4218	.4001	.3742	.2996
11	5.5000	.7500	.2812	.4322	.3675	.3944
18	5.5000	1.1250	.2812	.3612	.3276	.2592
25	5.5000	1.5000	.2812	.4021	.3025	.2996
34	5.5000	1.8750	.2812	.3199	.2888	.2179
40	5.5000	2.2500	.2812	.2526	.2192	.1697
50	5.5000	2.6250	.4687	.2912	.2304	.2490
60	5.5000	3.2500	.2343	.1986	.1947	.1999
69	5.5000	3.5000	.1875	.2089	.2024	.2031
76	5.5000	3.7500	.1875	.2765	.2619	.2835
83	5.5000	4.0000	.1875	.2374	.2374	.2415
90	5.5000	4.2500	.2812	.2161	.2167	.2203
125	5.5000	4.7500	.3750	.2881	.2889	.2881
12	6.5000	.7500	1.1250	.3286	.3090	.2426
26	6.5000	1.5000	.7500	.2439	.2325	.2078
41	6.5000	2.2500	1.1875	.2750	.2636	.3097
61	6.5000	3.2500	.4375	.2865	.2715	.3012
77	6.5000	3.7500	.5000	.2388	.2439	.2489
91	6.5000	4.2500	.5000	.2436	.2346	.2288
126	6.5000	4.7500	.5000	.2470	.2508	.2508



Table II. Continued

(i) Concluded

ORIFICE	X	Y	AREA	PS	PS	PS
127	7.5000	.3750	.5625	.2781	.2656	.2214
13	7.5000	.7500	.5625	.2514	.2298	.1813
27	7.5000	1.5000	.7500	.2284	.2020	.2022
42	7.5000	2.2500	.5625	.2704	.2831	.3004
51	7.5000	2.6250	.6250	.2964	.3021	.2831
62	7.5000	3.2500	.4375	.2553	.2635	.2584
78	7.5000	3.7500	.5000	.2508	.2492	.2417
92	7.5000	4.2500	.5000	.3212	.3016	.3166
128	7.5000	4.7500	.5000	.2595	.2525	.2411
14	8.5000	.7500	1.1250	.2141	.2059	.2394
28	8.5000	1.5000	.7500	.2476	.2565	.2634
43	8.5000	2.2500	1.1875	.2837	.2767	.2578
63	8.5000	3.2500	.4375	.2622	.2557	.2395
79	8.5000	3.7500	.5000	.2743	.2743	.2634
93	8.5000	4.2500	.5000	.2723	.2749	.2685
129	8.5000	4.7500	.5000	.2825	.2798	.2702
130	9.5000	.3750	.5625	.2031	.2114	.2629
131	9.5000	.7500	.5625	.2119	.2280	.2429
29	9.5000	1.5000	.7500	.2489	.2489	.2411
132	9.5000	2.2500	.5625	.2825	.2798	.2661
133	9.5000	2.6250	.6250	.2762	.2665	.2476
134	9.5000	3.2500	.4375	.2757	.2736	.2627
135	9.5000	3.7500	.5000	.2692	.2680	.2513
136	9.5000	4.2500	.5000	.2762	.2686	.2541
137	9.5000	4.7500	.5000	.2799	.2757	.2584
138	10.5000	.7500	1.1250	.2629	.2500	.2307
30	10.5000	1.5000	.7500	.2603	.2481	.2365
139	10.5000	2.2500	1.1875	.2632	.2614	.2483
140	10.5000	3.2500	.4375	.2662	.2704	.2584
141	10.5000	3.7500	.5000	.2783	.2661	.2481
142	10.5000	4.2500	.5000	.2948	.2907	.2791
143	10.5000	4.7500	.5000	.2943	.2802	.2609

Table II. Continued

(j) Configuration V-A:  $\beta = 20^\circ$ ;  $\epsilon = 12^\circ$ ;  $\alpha = 0^\circ$ ;  $\gamma = 1.22$ ; fence on

TEST RUN PTJ P3 PINF				6515 23-1 20.11 4.188 0.2245	6515 23-2 13.34 2.728 0.2245
ORIFICE	X	Y	AREA	PS	PS
1	2.5000	.3750	.4275	1.5729	1.0664
5	2.5000	.7500	.2850	1.5796	1.0857
15	2.5000	1.1250	.2850	1.6481	1.1101
19	2.5000	1.5000	.2850	1.6203	1.0879
31	2.5000	1.8750	.2850	1.6380	1.0968
35	2.5000	2.2500	.2850	1.6349	1.1018
44	2.5000	2.6250	.2375	1.6911	1.1404
52	2.5000	2.8750	.2375	1.7088	1.1537
55	2.5000	3.2500	.3325	.2546	.2381
70	2.5000	3.7500	.3800	.2033	.2046
84	2.5000	4.2500	.3800	.2291	.2259
94	2.5000	4.7500	.3800	.2059	.2052
6	3.0000	.7500	.5625	1.1994	.8141
20	3.0000	1.5000	.3750	1.2485	1.0601
36	3.0000	2.2500	.2811	1.2854	.8873
45	3.0000	2.6250	.1563	1.2860	.8650
53	3.0000	2.8750	.1562	1.2365	.8592
56	3.0000	3.2500	.1562	.2870	.2801
64	3.0000	3.5000	.1250	.2052	.2052
71	3.0000	3.7500	.1875	.2618	.2464
85	3.0000	4.2500	.2500	.2019	.2014
120	3.0000	4.7500	.2500	.2496	.2305
2	3.5000	.3750	.2812	.8350	.5694
7	3.5000	.7500	.1875	.9140	.6250
16	3.5000	1.1250	.1875	.9115	.6099
21	3.5000	1.5000	.1875	.9460	.6250
32	3.5000	1.8750	.1875	.6380	.4510
37	3.5000	2.2500	.1875	.9980	.6650
46	3.5000	2.6250	.1563	.9390	.6340
54	3.5000	2.8750	.1562	.9490	.6480
57	3.5000	3.2500	.1526	.2450	.2370
65	3.5000	3.5000	.1250	.2712	.2705
72	3.5000	3.7500	.1875	.2220	.2210
86	3.5000	4.2500	.2500	.2040	.2059
95	3.5000	4.7500	.2500	.2370	.2370
8	4.0000	.7500	.5625	.6938	.4976
22	4.0000	1.5000	.3750	.7418	.5120
38	4.0000	2.2500	.2811	.7542	.5257
47	4.0000	2.6250	.1563	.7425	.5243
121	4.0000	2.8750	.1562	.7480	.5415
58	4.0000	3.2500	.1562	.2822	.2794
66	4.0000	3.5000	.1250	.2260	.2270

Table II. Continued

(j) Continued

ORIFICE	X	Y	AREA	PS	PS
73	4.0000	3.7500	.1250	.2719	.2726
80	4.0000	4.0000	.1250	.2059	.2090
87	4.0000	4.2500	.1875	.2284	.2284
122	4.0000	4.7500	.2500	.2698	.2712
3	4.5000	.3750	.2812	.5450	.3870
9	4.5000	.7500	.1875	.3230	.4370
17	4.5000	1.1250	.1875	.5390	.3720
23	4.5000	1.5000	.1875	.5681	.3742
33	4.5000	1.8750	.1875	.5860	.3970
39	4.5000	2.2500	.1875	.5733	.3877
48	4.5000	2.6250	.3125	.5771	.3948
59	4.5000	3.2500	.1562	.2355	.2355
67	4.5000	3.5000	.1250	.2760	.2787
74	4.5000	3.7500	.1250	.2336	.2336
81	4.5000	4.0000	.1250	.2316	.2316
88	4.5000	4.2500	.1875	.2290	.2260
123	4.5000	4.7500	.2500	.2297	.2291
10	5.0000	.7500	.5625	.4092	.2853
24	5.0000	1.5000	.2812	.4378	.2835
144	5.0000	1.8750	.2812	.4990	.3611
49	5.0000	2.6250	.4062	.4449	.2984
68	5.0000	3.5000	.2812	.2381	.2394
75	5.0000	3.7500	.1250	.2115	.2121
82	5.0000	4.0000	.1250	.2310	.2310
89	5.0000	4.2500	.1875	.2760	.2774
124	5.0000	4.7500	.2500	.2067	.2073
4	5.5000	.3750	.4218	.4159	.3151
11	5.5000	.7500	.2812	.3728	.2621
18	5.5000	1.1250	.2812	.4009	.3021
25	5.5000	1.5000	.2812	.3633	.2388
34	5.5000	1.8750	.2812	.3864	.2715
40	5.5000	2.2500	.2812	.3711	.2490
50	5.5000	2.6250	.4687	.4120	.2874
60	5.5000	3.2500	.2343	.2180	.2186
69	5.5000	3.5000	.1875	.2156	.2168
76	5.5000	3.7500	.1875	.2179	.2210
83	5.5000	4.0000	.1875	.2808	.2815
90	5.5000	4.2500	.2812	.2361	.2342
125	5.5000	4.7500	.3750	.2122	.2141
12	6.5000	.7500	1.1250	.2912	.2046
26	6.5000	1.5000	.7500	.3090	.2550
41	6.5000	2.2500	1.1875	.3134	.2185
61	6.5000	3.2500	.4375	.2350	.2343
77	6.5000	3.7500	.5000	.2503	.2458
91	6.5000	4.2500	.5000	.2145	.2127
126	6.5000	4.7500	.5000	.2151	.2151

Table II. Continued

(j) Concluded

ORIFICE	X	Y	AREA	PS	PS
127	7.5000	.3750	.5625	.2593	.2092
13	7.5000	.7500	.5625	.2480	.1810
27	7.5000	1.5000	.7500	.2210	.2020
42	7.5000	2.2500	.5625	.2580	.1870
51	7.5000	2.6250	.6250	.3000	.2355
62	7.5000	3.2500	.4375	.3062	.2986
78	7.5000	3.7500	.5000	.2520	.2460
92	7.5000	4.2500	.5000	.2217	.2217
128	7.5000	4.7500	.5000	.2370	.2370
14	8.5000	.7500	1.1250	.2437	.3665
28	8.5000	1.5000	.7500	.2575	.3439
43	8.5000	2.2500	1.1875	.2150	.2740
63	8.5000	3.2500	.4375	.2690	.2560
79	8.5000	3.7500	.5000	.3007	.2959
93	8.5000	4.2500	.5000	.2445	.2426
129	8.5000	4.7500	.5000	.2856	.2863
130	9.5000	.3750	.5625	.3959	.3967
131	9.5000	.7500	.5625	.3678	.3742
29	9.5000	1.5000	.7500	.3087	.3659
132	9.5000	2.2500	.5625	.2828	.4063
133	9.5000	2.6250	.6250	.2530	.3730
134	9.5000	3.2500	.4375	.3144	.2986
135	9.5000	3.7500	.5000	.2599	.2580
136	9.5000	4.2500	.5000	.2410	.2420
137	9.5000	4.7500	.5000	.2471	.2458
138	10.5000	.7500	1.1250	.4312	.2853
30	10.5000	1.5000	.7500	.4235	.3478
139	10.5000	2.2500	1.1875	.4410	.3748
140	10.5000	3.2500	.4375	.2708	.2471
141	10.5000	3.7500	.5000	.2377	.2311
142	10.5000	4.2500	.5000	.2925	.2945
143	10.5000	4.7500	.5000	.2258	.2264

Table II. Continued

(k) Configuration V-B:  $\beta = 20^\circ$ ;  $\epsilon = 12^\circ$ ;  $\alpha = 0^\circ$ ;  $\gamma = 1.20$ ; no fence

TEST RUN				6526 12-1	6526 12-2	6526 12-3
PTJ				NO JET	15.060	12.910
P3				NO JET	3.213	2.756
PINF				0.2308	0.2308	0.2308
ORIFICE	X	Y	AREA	PS	PS	PS
1	2.5000	.3750	.4275	.3497	1.2020	1.3623
5	2.5000	.7500	.2850	.3282	1.2436	1.3507
15	2.5000	1.1250	.2850	.3389	1.2421	1.1373
19	2.5000	1.5000	.2850	.4599	1.2405	1.1481
31	2.5000	1.8750	.2850	.3490	1.2983	1.1126
35	2.5000	2.2500	.2850	.3451	1.3099	1.1234
44	2.5000	2.6250	.2375	.3451	1.3330	1.1442
52	2.5000	2.8750	.2375	.3389	1.2236	1.0340
55	2.5000	3.2500	.3325	.3251	.2996	.3097
70	2.5000	3.7500	.3800	.3212	.2557	.2788
84	2.5000	4.2500	.3800	.2012	.1367	.1475
94	2.5000	4.7500	.3800	.3312	.2565	.2827
6	3.0000	.7500	.5625	.2540	.9066	.8181
20	3.0000	1.5000	.3750	.2331	.8908	.8162
36	3.0000	2.2500	.2811	.2477	.9781	.8251
45	3.0000	2.6250	.1563	.2439	.8801	.7371
53	3.0000	2.8750	.1562	.2420	.4513	.3824
56	3.0000	3.2500	.1562	.2350	.1528	.1623
64	3.0000	3.5000	.1250	.3359	.2727	.2881
71	3.0000	3.7500	.1875	.2262	.1541	.1604
85	3.0000	4.2500	.2500	.2102	.1337	.1427
120	3.0000	4.7500	.2500	.2255	.1509	.1604
2	3.5000	.3750	.2812	.2945	.6271	.5828
7	3.5000	.7500	.1875	.2433	.6375	.5750
16	3.5000	1.1250	.1875	.2489	.6682	.6043
21	3.5000	1.5000	.1875	.2201	.6613	.6084
32	3.5000	1.8750	.1875	.2458	.7169	.6056
37	3.5000	2.2500	.1875	.2363	.7141	.5976
46	3.5000	2.6250	.1563	.2320	.4833	.4056
54	3.5000	2.8750	.1562	.2309	.2897	.2460
57	3.5000	3.2500	.1526	.2282	.1543	.1672
65	3.5000	3.5000	.1250	.2338	.1743	.1813
72	3.5000	3.7500	.1875	.2222	.1635	.1651
86	3.5000	4.2500	.2500	.3366	.2681	.2819
95	3.5000	4.7500	.2500	.2201	.1500	.1543
8	4.0000	.7500	.5625	.2572	.4720	.4296
22	4.0000	1.5000	.3750	.2442	.5116	.4767
38	4.0000	2.2500	.2811	.2490	.4843	.4104
47	4.0000	2.6250	.1563	.2469	.3208	.2763
121	4.0000	2.8750	.1562	.2463	.2292	.2011
58	4.0000	3.2500	.1562	.2449	.1868	.1929
66	4.0000	3.5000	.1250	.2255	.1753	.1764

Table II. Continued

(k) Continued

ORIFICE	X	Y	AREA	PS	PS	PS
73	4.0000	3.7500	.1250	.2415	.1902	.1929
80	4.0000	4.0000	.1250	.3397	.2973	.3081
87	4.0000	4.2500	.1875	.2363	.1844	.1838
122	4.0000	4.7500	.2500	.2380	.1833	.1840
3	4.5000	.3750	.2812	.2805	.4056	.3765
9	4.5000	.7500	.1875	.2453	.3640	.3276
17	4.5000	1.1250	.1875	.2363	.3787	.3436
23	4.5000	1.5000	.1875	.2238	.4022	.3741
33	4.5000	1.8750	.1875	.2541	.4358	.3738
39	4.5000	2.2500	.1875	.2304	.3288	.2751
48	4.5000	2.6250	.3125	.2286	.2220	.1892
59	4.5000	3.2500	.1562	.2256	.1833	.1815
67	4.5000	3.5000	.1250	.2435	.2038	.2038
74	4.5000	3.7500	.1250	.2250	.1851	.1851
81	4.5000	4.0000	.1250	.2331	.1983	.2040
88	4.5000	4.2500	.1875	.2228	.1920	.1910
123	4.5000	4.7500	.2500	.2197	.1773	.1737
10	5.0000	.7500	.5625	.2372	.2956	.2699
24	5.0000	1.5000	.2812	.2192	.3123	.2976
144	5.0000	1.8750	.2812	.2476	.3283	.2859
49	5.0000	2.6250	.4062	.2269	.1652	.1549
68	5.0000	3.5000	.2812	.2274	.1976	.1952
75	5.0000	3.7500	.1250	.2224	.1902	.1902
82	5.0000	4.0000	.1250	.2239	.2039	.2050
89	5.0000	4.2500	.1875	.2401	.2209	.2230
124	5.0000	4.7500	.2500	.2204	.1967	.1915
4	5.5000	.3750	.4218	.2955	.3146	.2976
11	5.5000	.7500	.2812	.3282	.4041	.7597
18	5.5000	1.1250	.2812	.2483	.2722	.2524
25	5.5000	1.5000	.2812	.3235	.3821	.3555
34	5.5000	1.8750	.2812	.2298	.2399	.2047
40	5.5000	2.2500	.2812	.2262	.1838	.1607
50	5.5000	2.6250	.4687	.3382	.3220	.3436
60	5.5000	3.2500	.2343	.2211	.1883	.1902
69	5.5000	3.5000	.1875	.2211	.1941	.1960
76	5.5000	3.7500	.1875	.3405	.3266	.3397
83	5.5000	4.0000	.1875	.2408	.2298	.2312
90	5.5000	4.2500	.2812	.2203	.2041	.2041
125	5.5000	4.7500	.3750	.2350	.2526	.3389
12	6.5000	.7500	1.1250	.2470	.2502	.2344
26	6.5000	1.5000	.7500	.2249	.1939	.1920
41	6.5000	2.2500	1.1875	.3359	.3366	.3574
61	6.5000	3.2500	.4375	.3389	.3405	.3544
77	6.5000	3.7500	.5000	.2331	.2319	.2350
91	6.5000	4.2500	.5000	.2198	.2237	.2198
126	6.5000	4.7500	.5000	.2350	.2401	.2363

Table II. Continued

(k) Concluded

ORIFICE	X	Y	AREA	PS	PS	PS
127	7.5000	.3750	.5625	.2978	.2232	.2083
13	7.5000	.7500	.5625	.2374	.1867	.1737
27	7.5000	1.5000	.7500	.8139	.1974	.1920
42	7.5000	2.2500	.5625	.2395	.2704	.2679
51	7.5000	2.6250	.6250	.2376	.2774	.2704
62	7.5000	3.2500	.4375	.2363	.2464	.2439
78	7.5000	3.7500	.5000	.2244	.2395	.2363
92	7.5000	4.2500	.5000	.3428	.3390	.3667
128	7.5000	4.7500	.5000	.2271	.2438	.2374
14	8.5000	.7500	1.1250	.2538	.2052	.2244
28	8.5000	1.5000	.7500	.2363	.2538	.2524
43	8.5000	2.2500	1.1875	.2303	.2627	.2535
63	8.5000	3.2500	.4375	.2276	.2427	.2374
79	8.5000	3.7500	.5000	.2435	.2586	.2531
93	8.5000	4.2500	.5000	.2338	.2584	.2515
129	8.5000	4.7500	.5000	.2435	.2661	.2586
130	9.5000	.3750	.5625	.2776	.2429	.2545
131	9.5000	.7500	.5625	.2441	.2298	.2298
29	9.5000	1.5000	.7500	.2214	.2352	.2298
132	9.5000	2.2500	.5625	.2490	.2647	.2565
133	9.5000	2.6250	.6250	.2320	.2508	.2444
134	9.5000	3.2500	.4375	.2490	.2565	.2531
135	9.5000	3.7500	.5000	.2304	.2453	.2381
136	9.5000	4.2500	.5000	.2287	.2557	.2481
137	9.5000	4.7500	.5000	.2238	.2537	.2435
138	10.5000	.7500	1.1250	.2468	.2301	.2262
30	10.5000	1.5000	.7500	.2217	.2346	.2288
139	10.5000	2.2500	1.1875	.2304	.2429	.2364
140	10.5000	3.2500	.4375	.2340	.2501	.2429
141	10.5000	3.7500	.5000	.2307	.2494	.2416
142	10.5000	4.2500	.5000	.2483	.2743	.2654
143	10.5000	4.7500	.5000	.2294	.2596	.2487

Table II. Continued

(1) Configuration V-C:  $\beta = 20^\circ$ ;  $\epsilon = 12^\circ$ ;  $\alpha = 0^\circ$ ;  $\gamma = 1.20$ ; fence on

TEST RUN				6526	6526	6526	6526
PTJ				11-1	11-2	11-3	11-4
P3				NO JET	13.00	21.10	26.45
PINF				NO JET	2.774	4.503	5.644
				0.2134	0.2134	0.2134	0.2266
ORIFICE	X	Y	AREA	PS	PS	PS	PS
1	2.5000	.3750	.4275	.3621	1.0934	1.7183	2.1768
5	2.5000	.7500	.2850	.3382	1.1111	1.7584	2.2177
15	2.5000	1.1250	.2850	.3605	1.1196	1.7830	2.2539
19	2.5000	1.5000	.2850	.4653	1.1157	1.7291	2.1683
31	2.5000	1.8750	.2850	.3520	1.1080	1.7445	2.1629
35	2.5000	2.2500	.2850	.3482	1.1172	1.7530	2.2022
44	2.5000	2.6250	.2375	.3490	1.1512	1.8015	2.2500
52	2.5000	2.8750	.2375	.3490	1.1356	1.8250	2.3271
55	2.5000	3.2500	.3325	.4029	.3883	.3636	.3675
70	2.5000	3.7500	.3800	.1879	.2788	.2703	.2678
84	2.5000	4.2500	.3800	.1177	.1857	.1737	.1719
94	2.5000	4.7500	.3800	.1879	.2619	.2264	.2341
6	3.0000	.7500	.5625	.2527	.7979	1.3114	1.6687
20	3.0000	1.5000	.3750	.2508	.7890	1.3044	1.6522
36	3.0000	2.2500	.2811	.2483	.8326	1.3493	1.7072
45	3.0000	2.6250	.1563	.2477	.8118	1.3095	1.6541
53	3.0000	2.8750	.1562	.2496	.7909	1.2797	1.6231
56	3.0000	3.2500	.1562	.1528	.2523	.2514	.2546
64	3.0000	3.5000	.1250	.2033	.2596	.2388	.2434
71	3.0000	3.7500	.1875	.1237	.1927	.1806	.1775
85	3.0000	4.2500	.2500	.1408	.1928	.1800	.1761
120	3.0000	4.7500	.2500	.1383	.1958	.1870	.1844
2	3.5000	.3750	.2812	.2919	.5721	.9085	1.1609
7	3.5000	.7500	.1875	.2587	.5771	.9508	1.2101
16	3.5000	1.1250	.1875	.2515	.5904	.9686	1.2304
21	3.5000	1.5000	.1875	.2476	.5884	.9795	1.2378
32	3.5000	1.8750	.1875	.2477	.7470	1.1771	1.4642
37	3.5000	2.2500	.1875	.2471	.6192	1.0075	1.2777
46	3.5000	2.6250	.1563	.2460	.5933	.9568	1.2097
54	3.5000	2.8750	.1562	.2481	.5965	.9611	1.2211
57	3.5000	3.2500	.1526	.1565	.2169	.2239	.2309
65	3.5000	3.5000	.1250	.1528	.2047	.1927	.1908
72	3.5000	3.7500	.1875	.1284	.1958	.1850	.1818
86	3.5000	4.2500	.2500	.1405	.1958	.1869	.1837
95	3.5000	4.7500	.2500	.1424	.1969	.1888	.1856
8	4.0000	.7500	.5625	.2654	.4323	.6881	.8700
22	4.0000	1.5000	.3750	.2640	.4528	.7380	.9261
38	4.0000	2.2500	.2811	.2599	.4562	.7257	.9158
47	4.0000	2.6250	.1563	.2599	.4603	.7216	.9063
121	4.0000	2.8750	.1562	.2613	.4617	.7291	.9179
58	4.0000	3.2500	.1562	.2025	.2292	.2333	.2394
66	4.0000	3.5000	.1250	.1635	.1996	.1899	.1888



Table II. Continued

(l) Continued

ORIFICE	X	Y	AREA	PS	PS	PS	PS
73	4.0000	3.7500	.1250	.1601	.2141	.2032	.2004
80	4.0000	4.0000	.1250	.4114	.4391	.3667	.3598
87	4.0000	4.2500	.1875	.1402	.2078	.1971	.1952
122	4.0000	4.7500	.2500	.1683	.2134	.2059	.2025
3	4.5000	.3750	.2812	.2859	.3733	.5755	.7271
9	4.5000	.7500	.1875	.2566	.3336	.5435	.6939
17	4.5000	1.1250	.1875	.2546	.3490	.5620	.7120
23	4.5000	1.5000	.1875	.3103	.4052	.6384	.7875
33	4.5000	1.8750	.1875	.2659	.3862	.6095	.7659
39	4.5000	2.2500	.1875	.2417	.3551	.5793	.7398
48	4.5000	2.6250	.3125	.2429	.3646	.5847	.7374
59	4.5000	3.2500	.1562	.1994	.2012	.1898	.1874
67	4.5000	3.5000	.1250	.2121	.2175	.2073	.2059
74	4.5000	3.7500	.1250	.1606	.1970	.1845	.1833
81	4.5000	4.0000	.1250	.1459	.2009	.1908	.1895
88	4.5000	4.2500	.1875	.1365	.2012	.1899	.1888
123	4.5000	4.7500	.2500	.1511	.1892	.1797	.1767
10	5.0000	.7500	.5625	.2545	.2789	.4434	.5636
24	5.0000	1.5000	.2812	.2519	.2854	.4820	.6028
144	5.0000	1.8750	.2812	.2579	.3064	.4761	.5971
49	5.0000	2.6250	.4062	.2455	.2995	.4749	.6003
68	5.0000	3.5000	.2812	.2167	.2024	.1916	.1904
75	5.0000	3.7500	.1250	.1934	.2012	.1864	.1825
82	5.0000	4.0000	.1250	.1662	.2050	.1942	.1926
89	5.0000	4.2500	.1875	.1710	.2182	.2080	.2052
124	5.0000	4.7500	.2500	.2069	.1979	.1902	.1838
4	5.5000	.3750	.4218	.3037	.2900	.4159	.5116
11	5.5000	.7500	.2812	.3405	.3598	.4977	.5909
18	5.5000	1.1250	.2812	.2606	.2538	.3871	.4856
25	5.5000	1.5000	.2812	.3428	.3467	.4938	.5886
34	5.5000	1.8750	.2812	.2423	.2483	.3879	.4958
40	5.5000	2.2500	.2812	.2455	.2494	.3991	.5051
50	5.5000	2.6250	.4687	.3459	.3829	.5223	.6264
60	5.5000	3.2500	.2343	.2365	.2082	.1934	.1883
69	5.5000	3.5000	.1875	.2365	.2069	.1902	.1851
76	5.5000	3.7500	.1875	.2270	.2951	.2790	.2664
83	5.5000	4.0000	.1875	.2189	.2230	.2121	.2100
90	5.5000	4.2500	.2812	.1749	.1964	.1845	.1833
125	5.5000	4.7500	.3750	.2069	.1964	.1845	.1850
12	6.5000	.7500	1.1250	.2489	.2205	.3463	.4323
26	6.5000	1.5000	.7500	.2451	.1977	.3002	.3742
41	6.5000	2.2500	1.1875	.3428	.3266	.4306	.5077
61	6.5000	3.2500	.4375	.2927	.2665	.2534	.2580
77	6.5000	3.7500	.5000	.2312	.2129	.2034	.2021
91	6.5000	4.2500	.5000	.2256	.2057	.1967	.1941
126	6.5000	4.7500	.5000	.2110	.2078	.1996	.1971

Table II. Continued

(1) Concluded

ORIFICE	X	Y	AREA	PS	PS	PS	PS
127	7.5000	.3750	.5625	.3037	.2089	.2811	.3395
13	7.5000	.7500	.5625	.4709	.3921	.2881	.3597
27	7.5000	1.5000	.7500	.8247	.2183	.2450	.3097
42	7.5000	2.2500	.5625	.2407	.1870	.2869	.3577
51	7.5000	2.6250	.6250	.2458	.1971	.2976	.3666
62	7.5000	3.2500	.4375	.4715	.1816	.1728	.1678
78	7.5000	3.7500	.5000	.2293	.2158	.2104	.2093
92	7.5000	4.2500	.5000	.4391	.3559	.3181	.3605
128	7.5000	4.7500	.5000	.2314	.2093	.2028	.1996
14	8.5000	.7500	1.1250	.2599	.2531	.2367	.2893
28	8.5000	1.5000	.7500	.2558	.2387	.2312	.2757
43	8.5000	2.2500	1.1875	.2390	.1985	.2384	.2945
63	8.5000	3.2500	.4375	.2341	.2233	.2222	.2206
79	8.5000	3.7500	.5000	.2463	.2326	.2298	.2292
93	8.5000	4.2500	.5000	.2363	.2135	.2104	.2129
129	8.5000	4.7500	.5000	.2517	.2251	.2216	.2175
130	9.5000	.3750	.5625	.2866	.3573	.2725	.2494
131	9.5000	.7500	.5625	.2572	.3366	.2208	.2387
29	9.5000	1.5000	.7500	.2352	.3264	.1952	.2191
132	9.5000	2.2500	.5625	.2531	.3427	.2141	.2599
133	9.5000	2.6250	.6250	.2390	.3328	.2039	.2454
134	9.5000	3.2500	.4375	.2517	.2380	.2435	.2422
135	9.5000	3.7500	.5000	.2304	.2149	.2143	.2167
136	9.5000	4.2500	.5000	.2379	.2136	.2136	.2169
137	9.5000	4.7500	.5000	.2346	.2012	.1988	.1982
138	10.5000	.7500	1.1250	.2545	.3355	.3734	.3419
30	10.5000	1.5000	.7500	.2416	.3278	.3663	.2629
139	10.5000	2.2500	1.1875	.2358	.3407	.3610	.2226
140	10.5000	3.2500	.4375	.2352	.2119	.2310	.2370
141	10.5000	3.7500	.5000	.2346	.2159	.2237	.2262
142	10.5000	4.2500	.5000	.2510	.2298	.2346	.2394
143	10.5000	4.7500	.5000	.2384	.2114	.2108	.2121

Table II. Continued

(m) Configuration V-D:  $\beta = 20^\circ$ ;  $\epsilon = 12^\circ$ ;  $\alpha = 0^\circ$ ;  $\gamma = 1.40$ ; no fence

TEST				6624	6624
RUN				3-50	3-53
PTJ				14.89	25.84
P3				3.408	5.530
PINF				0.2258	0.2264
ORIFICE	X	Y	AREA	PS	PS
1	2.5000	.3750	.4275	.8560	.9820
5	2.5000	.7500	.2850	.8310	.9630
15	2.5000	1.1250	.2850	.7440	1.0370
19	2.5000	1.5000	.2850	.7560	1.0610
31	2.5000	1.8750	.2850	.7400	1.1070
35	2.5000	2.2500	.2850	.8320	1.2530
44	2.5000	2.6250	.2375	.8260	1.2850
52	2.5000	2.8750	.2375	.7860	1.2310
55	2.5000	3.2500	.3325	.5030	.5230
70	2.5000	3.7500	.3800	.1080	.1010
84	2.5000	4.2500	.3800	.0940	.0870
6	3.0000	.7500	.5625	.6920	.7590
20	3.0000	1.5000	.3750	.7270	.7780
36	3.0000	2.2500	.2811	.7920	.9980
45	3.0000	2.6250	.1563	.7930	.9840
53	3.0000	2.8750	.1562	.4510	.6770
56	3.0000	3.2500	.1562	.1910	.2620
64	3.0000	3.5000	.1250	.1390	.1290
71	3.0000	3.7500	.1875	.1060	.1270
85	3.0000	4.2500	.2500	.1200	.1070
2	3.5000	.3750	.2812	.5350	.6960
7	3.5000	.7500	.1875	.5080	.6980
16	3.5000	1.1250	.1875	.6290	.6730
21	3.5000	1.5000	.1875	.5910	.6080
32	3.5000	1.8750	.1875	.6750	.7370
37	3.5000	2.2500	.1875	.6380	.8250
46	3.5000	2.6250	.1563	.4740	.6580
54	3.5000	2.8750	.1562	.2430	.3900
57	3.5000	3.2500	.1526	.0910	.1410
65	3.5000	3.5000	.1250	.1320	.1240
72	3.5000	3.7500	.1875	.1420	.1290
86	3.5000	4.2500	.2500	.1070	.1130
8	4.0000	.7500	.5625	.4350	.6070
22	4.0000	1.5000	.3750	.5270	.6320
38	4.0000	2.2500	.2811	.5110	.6440
47	4.0000	2.6250	.1563	.2950	.4330
121	4.0000	2.8750	.1562	.2100	.3100
58	4.0000	3.2500	.1562	.0110	.1410
66	4.0000	3.5000	.1250	.1240	.1140

Table II. Continued

(m) Continued

ORIFICE	X	Y	AREA	PS	PS
73	4.0000	3.7500	.1250	.1430	.1150
80	4.0000	4.0000	.1250	.1390	.1210
87	4.0000	4.2500	.1875	.1280	.1350
3	4.5000	.3750	.2812	.2910	.4250
9	4.5000	.7500	.1875	.3470	.4770
17	4.5000	1.1250	.1875	.4220	.5620
23	4.5000	1.5000	.1875	.3830	.5310
33	4.5000	1.8750	.1875	.4530	.5780
39	4.5000	2.2500	.1875	.3970	.4980
48	4.5000	2.6250	.3125	.2530	.3100
59	4.5000	3.2500	.1562	.1610	.1550
67	4.5000	3.5000	.1250	.1540	.1310
74	4.5000	3.7500	.1250	.1440	.1150
81	4.5000	4.0000	.1250	.1470	.1260
88	4.5000	4.2500	.1875	.1290	.1150
10	5.0000	.7500	.5625	.2990	.4170
24	5.0000	1.5000	.2812	.3020	.4530
144	5.0000	1.8750	.2812	.3750	.4840
49	5.0000	2.6250	.4062	.1540	.2170
68	5.0000	3.5000	.2812	.1000	.1190
75	5.0000	3.7500	.1250	.1550	.1250
82	5.0000	4.0000	.1250	.1460	.1200
89	5.0000	4.2500	.1875	.1360	.1140
4	5.5000	.3750	.4218	.2220	.3240
11	5.5000	.7500	.2812	.2180	.3210
18	5.5000	1.1250	.2812	.3030	.4300
25	5.5000	1.5000	.2812	.2800	.4240
34	5.5000	1.8750	.2812	.2940	.4000
40	5.5000	2.2500	.2812	.2360	.3130
50	5.5000	2.6250	.4687	.1600	.2030
60	5.5000	3.2500	.2343	.1460	.1140
69	5.5000	3.5000	.1875	.1520	.1120
76	5.5000	3.7500	.1875	.1590	.1270
83	5.5000	4.0000	.1875	.1760	.1450
90	5.5000	4.2500	.2812	.1760	.1450
12	6.5000	.7500	1.1250	.1930	.2750
26	6.5000	1.5000	.7500	.1850	.2710
41	6.5000	2.2500	1.1875	.1490	.1970
61	6.5000	3.2500	.4375	.1510	.1130
77	6.5000	3.7500	.5000	.1790	.1450
91	6.5000	4.2500	.5000	.1790	.1380

Table II. Continued

(m) Concluded

ORIFICE	X	Y	AREA	PS	PS
127	7.5000	.3750	.5625	.1960	.2560
13	7.5000	.7500	.5625	.1540	.2160
27	7.5000	1.5000	.7500	.1670	.2010
42	7.5000	2.2500	.5625	.1630	.1510
51	7.5000	2.6250	.6250	.1690	.1340
62	7.5000	3.2500	.4375	.1710	.1350
78	7.5000	3.7500	.5000	.1770	.1430
92	7.5000	4.2500	.5000	.2080	.1730
14	8.5000	.7500	1.1250	.1550	.1840
28	8.5000	1.5000	.7500	.1640	.1640
43	8.5000	2.2500	1.1875	.1830	.1280
63	8.5000	3.2500	.4375	.1960	.1500
79	8.5000	3.7500	.5000	.2740	.2570
93	8.5000	4.2500	.5000	.2310	.2040

Table II. Continued

(n) Configuration V-E:  $\beta = 20^\circ$ ;  $\epsilon = 12^\circ$ ;  $\alpha = 0^\circ$ ;  $\gamma = 1.40$ ; fence on

TEST				6624	6624	6624
RUN				4-76	4-79	5-226
PTJ				19.78	24.16	13.86
P3				4.256	5.155	2.905
PINF				0.2285	.2285	.2290
ORIFICE	X	Y	AREA	PS	PS	PS
1	2.5000	.3750	.4275	1.2440	1.4870	.8730
5	2.5000	.7500	.2850	1.2330	1.4760	.8600
15	2.5000	1.1250	.2850	1.2910	1.5430	.9090
19	2.5000	1.5000	.2850	1.3380	1.5920	.9450
31	2.5000	1.8750	.2850	1.3310	1.5860	.9340
35	2.5000	2.2500	.2850	1.2530	1.4950	.8900
44	2.5000	2.6250	.2375	1.1950	1.4330	.8640
52	2.5000	2.8750	.2375	1.1740	1.4040	.8560
55	2.5000	3.2500	.3325	.0850	.1030	.0980
70	2.5000	3.7500	.3800	.0980	.0960	.0980
84	2.5000	4.2500	.3800	.0820	.0790	.0800
6	3.0000	.7500	.5625	.9960	1.1930	.7000
20	3.0000	1.5000	.3750	1.0610	1.2580	.7590
36	3.0000	2.2500	.2811	1.0540	1.2630	.7560
45	3.0000	2.6250	.1563	1.0420	1.2570	.7400
53	3.0000	2.8750	.1562	1.0530	1.2540	.7500
56	3.0000	3.2500	.1562	.0850	.0870	.0790
64	3.0000	3.5000	.1250	.0980	.0950	.0850
71	3.0000	3.7500	.1875	.0910	.0870	.0800
85	3.0000	4.2500	.2500	.1050	.1020	.0920
2	3.5000	.3750	.2812	.7390	.8660	.5450
7	3.5000	.7500	.1875	.7560	.9050	.5320
16	3.5000	1.1250	.1875	.8540	1.0040	.6220
21	3.5000	1.5000	.1875	.7730	.9210	.5460
32	3.5000	1.8750	.1875	.8300	.9810	.5990
37	3.5000	2.2500	.1875	.8470	1.0060	.6040
46	3.5000	2.6250	.1563	.8340	.9840	.6000
54	3.5000	2.8750	.1562	.7640	.9150	.5410
57	3.5000	3.2500	.1526	.0850	.0770	.0870
65	3.5000	3.5000	.1250	.0910	.0890	.0880
72	3.5000	3.7500	.1875	.1030	.1000	.0910
86	3.5000	4.2500	.2500	.0910	.0890	.0810
8	4.0000	.7500	.5625	.6130	.7220	.4530
22	4.0000	1.5000	.3750	.6380	.7560	.4680
38	4.0000	2.2500	.2811	.6900	.8090	.5050
47	4.0000	2.6250	.1563	.6420	.7620	.4680
121	4.0000	2.8750	.1562	.6290	.7450	.4560
58	4.0000	3.2500	.1562	.0940	.0770	.0750
66	4.0000	3.5000	.1250	.0850	.0870	.0780

Table II. Continued

(n) Continued

ORIFICE	X	Y	AREA	PS	PS	PS
73	4.0000	3.7500	.1250	.0970	.0940	.0840
80	4.0000	4.0000	.1250	.0950	.0920	.0850
87	4.0000	4.2500	.1875	.1030	.1000	.0910
3	4.5000	.3750	.2812	.4260	.5100	.3050
9	4.5000	.7500	.1875	.4730	.5550	.3560
17	4.5000	1.1250	.1875	.5270	.6150	.3930
23	4.5000	1.5000	.1875	.4560	.5470	.3300
33	4.5000	1.8750	.1875	.5390	.6340	.4020
39	4.5000	2.2500	.1875	.5580	.6510	.4140
48	4.5000	2.6250	.3125	.5410	.6340	.4360
59	4.5000	3.2500	.1562	.1060	.1030	.0950
67	4.5000	3.5000	.1250	.1060	.1040	.0900
74	4.5000	3.7500	.1250	.1000	.0960	.0860
81	4.5000	4.0000	.1250	.1030	.1010	.0900
88	4.5000	4.2500	.1875	.0880	.0860	.0790
10	5.0000	.7500	.5625	.4030	.4770	.3100
24	5.0000	1.5000	.2812	.3640	.4380	.2630
144	5.0000	1.8750	.2812	.4620	.5290	.3480
49	5.0000	2.6250	.4062	.3800	.4570	.2770
68	5.0000	3.5000	.2812	.1100	.1030	.1040
75	5.0000	3.7500	.1250	.1110	.1080	.0940
82	5.0000	4.0000	.1250	.0960	.0930	.0840
89	5.0000	4.2500	.1875	.0800	.0790	.0750
4	5.5000	.3750	.4218	.3250	.3820	.2450
11	5.5000	.7500	.2812	.2920	.3510	.2210
18	5.5000	1.1250	.2812	.3770	.4340	.2960
25	5.5000	1.5000	.2812	.3560	.4150	.2800
34	5.5000	1.8750	.2812	.3960	.4570	.3240
40	5.5000	2.2500	.2812	.3870	.4510	.1590
50	5.5000	2.6250	.4687	.3580	.4220	.1160
60	5.5000	3.2500	.2343	.0850	.0870	.0780
69	5.5000	3.5000	.1875	.0980	.0950	.0870
76	5.5000	3.7500	.1875	.1100	.1070	.0940
83	5.5000	4.0000	.1875	.1190	.1160	.1020
90	5.5000	4.2500	.2812	.1150	.1130	.1030
12	6.5000	.7500	1.1250	.2450	.2870	.1870
26	6.5000	1.5000	.7500	.2400	.2850	.1870
41	6.5000	2.2500	1.1875	.2560	.3010	.1940
61	6.5000	3.2500	.4375	.0840	.0830	.0760
77	6.5000	3.7500	.5000	.1140	.1130	.1030
91	6.5000	4.2500	.5000	.1070	.1060	.0970

Table II. Continued

(n) Concluded

ORIFICE	X	Y	AREA	PS	PS	PS
127	7.5000	.3750	.5625	.2400	.2740	.2030
13	7.5000	.7500	.5625	.1920	.2260	.1500
27	7.5000	1.5000	.7500	.1970	.2300	.1550
42	7.5000	2.2500	.5625	.2030	.2400	.1580
51	7.5000	2.6250	.6250	.2070	.2440	.1620
62	7.5000	3.2500	.4375	.0980	.0960	.0930
78	7.5000	3.7500	.5000	.0990	.0980	.0970
92	7.5000	4.2500	.5000	.1300	.1280	.1180
14	8.5000	.7500	1.1250	.1710	.1990	.1370
28	8.5000	1.5000	.7500	.1530	.2060	.1390
43	8.5000	2.2500	1.1875	.1640	.1950	.1340
63	8.5000	3.2500	.4375	.1070	.1070	.1120
79	8.5000	3.7500	.5000	.2320	.2320	.2200
93	8.5000	4.2500	.5000	.1930	.1850	.1640



Table II. Continued

(o) Configuration VI:  $\beta = 24^\circ$ ;  $\epsilon = 12^\circ$ ;  $\alpha = 0^\circ$ ;  $\gamma = 1.22$ ; no fence

TEST RUN	6526						
PTJ	24-1	24-2	24-3	24-4			
P3	NO JET	12.21	22.67	27.15			
PINF	NO JET	2.623	4.870	5.832			
ORIFICE	X	Y	AREA	PS	PS	PS	PS
1	2.5000	.3750	.4275	.3274	.8606	1.5511	1.8823
5	2.5000	.7500	.2850	.3135	.8683	1.5750	1.9071
15	2.5000	1.1250	.2850	.3228	.8768	1.6058	1.9229
19	2.5000	1.5000	.2850	.4553	.9146	1.5912	1.9141
31	2.5000	1.8750	.2850	.3343	.8730	1.5758	1.9154
35	2.5000	2.2500	.2850	.3336	.8668	1.6443	1.9235
44	2.5000	2.6250	.2375	.3328	.8892	1.5927	2.0070
52	2.5000	2.8750	.2375	.3305	.8568	1.6482	1.2891
55	2.5000	3.2500	.3325	.3258	.3135	.2405	.2415
70	2.5000	3.7500	.3800	.3258	.2409	.2039	.1958
84	2.5000	4.2500	.3800	.2286	.1684	.1493	.1469
94	2.5000	4.7500	.3800	.3274	.2873	.2642	1.2883
6	3.0000	.7500	.5625	.2483	.6290	1.2197	1.4897
20	3.0000	1.5000	.3750	.2243	.6056	1.2001	1.4499
36	3.0000	2.2500	.2811	.2432	.6455	1.2348	1.4910
45	3.0000	2.6250	.1563	.2407	.6119	1.0494	1.2702
53	3.0000	2.8750	.1562	.2420	.3090	.5961	.6960
56	3.0000	3.2500	.1562	.2388	.1680	.1585	.1705
64	3.0000	3.5000	.1250	.3312	.2585	.2696	.2372
71	3.0000	3.7500	.1875	.2331	.1636	.1446	.1459
85	3.0000	4.2500	.2500	.2442	.1735	.1491	.1459
120	3.0000	4.7500	.2500	.2306	.1623	.1408	.1383
2	3.5000	.3750	.2812	.2932	.4766	.8839	1.0831
7	3.5000	.7500	.1875	.2508	.5022	.9735	1.1893
16	3.5000	1.1250	.1875	.2464	.4842	.9414	1.1444
21	3.5000	1.5000	.1875	.2201	.4757	.9455	1.1402
32	3.5000	1.8750	.1875	.2420	.4911	.9465	1.1476
37	3.5000	2.2500	.1875	.2492	.5133	.9973	1.2000
46	3.5000	2.6250	.1563	.2444	.3641	.6915	.8322
54	3.5000	2.8750	.1562	.2444	.2131	.4002	.4666
57	3.5000	3.2500	.1526	.2454	.1500	.1575	.1818
65	3.5000	3.5000	.1250	.2357	.1686	.1610	.1598
72	3.5000	3.7500	.1875	.2390	.1694	.1635	.1678
86	3.5000	4.2500	.2500	.3297	.2819	.2380	.2482
95	3.5000	4.7500	.2500	.2374	.1796	.1516	.1511
8	4.0000	.7500	.5625	.2675	.3769	.7011	.8488
22	4.0000	1.5000	.3750	.2490	.3783	.7257	.8700
38	4.0000	2.2500	.2811	.2579	.3700	.6860	.8201
47	4.0000	2.6250	.1563	.2592	.2510	.4439	.5287
121	4.0000	2.8750	.1562	.2565	.1792	.3030	.3509
58	4.0000	3.2500	.1562	.2565	.1744	.1751	.1915
66	4.0000	3.5000	.1250	.2411	.1710	.1796	.1780

Table II. Continued

(o) Continued

ORIFICE	X	Y	AREA	PS	PS	PS	PS
73	4.0000	3.7500	.1250	.2524	.1888	.1874	.1929
80	4.0000	4.0000	.1250	.3336	.2460	.2472	.2730
87	4.0000	4.2500	.1875	.2376	.1617	.1724	.1844
122	4.0000	4.7500	.2500	.2517	.1765	.1799	.1881
3	4.5000	.3750	.2812	.2913	.3258	.5680	.6855
9	4.5000	.7500	.1875	.2614	.2805	.5346	.6521
17	4.5000	1.1250	.1875	.2498	.3037	.5809	.7060
23	4.5000	1.5000	.1875	.2292	.2900	.5895	.7123
33	4.5000	1.8750	.1875	.2670	.3360	.6089	.7319
39	4.5000	2.2500	.1875	.2477	.2483	.4779	.5746
48	4.5000	2.6250	.3125	.2441	.1719	.3133	.3747
59	4.5000	3.2500	.1562	.5740	.1739	.1532	.1700
67	4.5000	3.5000	.1250	.2538	.2018	.2045	.2073
74	4.5000	3.7500	.1250	.2381	.1839	.1874	.1904
81	4.5000	4.0000	.1250	.2350	.1699	.1914	.1946
88	4.5000	4.2500	.1875	.2390	.1656	.2018	.2034
123	4.5000	4.7500	.2500	.2340	.1552	.1809	.1886
10	5.0000	.7500	.5625	.2577	.2339	.4306	.5244
24	5.0000	1.5000	.2812	.2359	.2487	.4775	.5823
144	5.0000	1.8750	.2812	.2572	.2558	.4535	.5410
49	5.0000	2.6250	.4062	.2487	.1877	.2359	.2815
68	5.0000	3.5000	.2812	.2399	.2161	.2006	.2006
75	5.0000	3.7500	.1250	.2468	.2172	.1986	.2005
82	5.0000	4.0000	.1250	.2400	.2012	.2088	.2125
89	5.0000	4.2500	.1875	.2524	.1956	.2271	.2305
124	5.0000	4.7500	.2500	.2494	.1722	.2076	.2172
4	5.5000	.3750	.4218	.3085	.2675	.4145	.4870
11	5.5000	.7500	.2812	.3228	.2833	.5046	.5458
18	5.5000	1.1250	.2812	.2699	.2182	.3776	.4549
25	5.5000	1.5000	.2812	.3043	.2820	.5046	.5629
34	5.5000	1.8750	.2812	.2477	.1874	.3431	.4129
40	5.5000	2.2500	.2812	.2481	.1832	.2648	.3149
50	5.5000	2.6250	.4687	.3343	.3004	.3520	.3104
60	5.5000	3.2500	.2343	.2468	.2224	.1954	.1992
69	5.5000	3.5000	.1875	.2416	.2301	.2057	.2082
76	5.5000	3.7500	.1875	.3336	.3161	.2573	.2922
83	5.5000	4.0000	.1875	.2524	.2449	.2374	.2469
90	5.5000	4.2500	.2812	.2459	.2047	.2143	.2232
125	5.5000	4.7500	.3750	.3405	.3120	.3382	1.2752
12	6.5000	.7500	1.1250	.2489	.1762	.3229	.3893
26	6.5000	1.5000	.7500	.2217	.1927	.2432	.2989
41	6.5000	2.2500	1.1875	.3328	.2930	.3382	.3432
61	6.5000	3.2500	.4375	.3343	.3269	.3012	.2825
77	6.5000	3.7500	.5000	.2357	.2350	.2293	.2553
91	6.5000	4.2500	.5000	.2468	.2378	.2397	.2532
126	6.5000	4.7500	.5000	.2363	.2230	.2395	.2502

Table II. Continued

(o) Concluded

ORIFICE	X	Y	AREA	PS	PS	PS	PS
127	7.5000	.3750	.5625	.3151	.2125	.2841	.3234
13	7.5000	.7500	.5625	.2519	.1861	.2605	.3118
27	7.5000	1.5000	.7500	.8667	.2212	.2138	.2317
42	7.5000	2.2500	.5625	.2420	.2572	.2546	.2388
51	7.5000	2.6250	.6250	.2407	.2565	.2894	.2837
62	7.5000	3.2500	.4375	.2420	.2401	.2572	.2515
78	7.5000	3.7500	.5000	.2417	.2454	.2562	.2616
92	7.5000	4.2500	.5000	.3351	.3598	.3264	.3317
128	7.5000	4.7500	.5000	.2422	.2411	.2632	.2697
14	8.5000	.7500	1.1250	.2661	.2558	.2182	.2551
28	8.5000	1.5000	.7500	.2504	.2661	.2456	.2168
43	8.5000	2.2500	1.1875	.2444	.2616	.2875	.2800
63	8.5000	3.2500	.4375	.2444	.2476	.2670	.2643
79	8.5000	3.7500	.5000	.2551	.2606	.2818	.2736
93	8.5000	4.2500	.5000	.2382	.2458	.2704	.2685
129	8.5000	4.7500	.5000	.2510	.2606	.2873	.2914
130	9.5000	.3750	.5625	.2956	.2854	.2044	.2172
131	9.5000	.7500	.5625	.2596	.2453	.2149	.1976
29	9.5000	1.5000	.7500	.2328	.2483	.2548	.2316
132	9.5000	2.2500	.5625	.2586	.2668	.2900	.2866
133	9.5000	2.6250	.6250	.2427	.2551	.2832	.2789
134	9.5000	3.2500	.4375	.2558	.2620	.2811	.2750
135	9.5000	3.7500	.5000	.2381	.2477	.2751	.2721
136	9.5000	4.2500	.5000	.2400	.2535	.2827	.2832
137	9.5000	4.7500	.5000	.2387	.2495	.2811	.2888
138	10.5000	.7500	1.1250	.2648	.2584	.2725	.2352
30	10.5000	1.5000	.7500	.2429	.2622	.2693	.2706
139	10.5000	2.2500	1.1875	.2453	.2537	.2721	.2775
140	10.5000	3.2500	.4375	.2459	.2698	.2877	.2793
141	10.5000	3.7500	.5000	.2378	.2564	.2789	.2821
142	10.5000	4.2500	.5000	.2510	.2675	.2976	.3030
143	10.5000	4.7500	.5000	.2468	.2603	.2911	.3001

Table II. Continued

(p) Configuration VI-A:  $\beta = 24^\circ$ ;  $\epsilon = 12^\circ$ ;  $\alpha = 4^\circ$ ;  $\gamma = 1.24$ ; no fence

TEST				6526	6526
RUN				25-1	25-2
PTJ				19.17	11.13
P3				4.118	2.391
PINF				0.2406	0.2406
ORIFICE	X	Y	AREA	PS	PS
1	2.5000	.3750	.4275	1.2914	.5927
5	2.5000	.7500	.2850	1.3384	.6688
15	2.5000	1.1250	.2850	1.3055	.6726
19	2.5000	1.5000	.2850	1.3110	.7040
31	2.5000	1.8750	.2850	1.3227	.7216
35	2.5000	2.2500	.2850	1.4185	.7788
44	2.5000	2.6250	.2375	1.3896	.7500
52	2.5000	2.8750	.2375	.9326	.5060
55	2.5000	3.2500	.3325	.1083	.0954
70	2.5000	3.7500	.3800	.0689	.0508
84	2.5000	4.2500	.3800	.0753	.0884
94	2.5000	4.7500	.3800	.4491	.0715
6	3.0000	.7500	.5625	1.0736	.5411
20	3.0000	1.5000	.3750	1.0375	.5304
36	3.0000	2.2500	.2811	1.1615	.6290
45	3.0000	2.6250	.1563	.9914	.5974
53	3.0000	2.8750	.1562	.5462	.3204
56	3.0000	3.2500	.1562	.1345	.1123
64	3.0000	3.5000	.1250	.0947	.1090
71	3.0000	3.7500	.1875	.0902	.0807
85	3.0000	4.2500	.2500	.0752	.0874
120	3.0000	4.7500	.2500	.0725	.0845
2	3.5000	.3750	.2812	.7764	.4039
7	3.5000	.7500	.1875	.8177	.4105
16	3.5000	1.1250	.1875	.8251	.4279
21	3.5000	1.5000	.1875	.8063	.4169
32	3.5000	1.8750	.1875	.8510	.4589
37	3.5000	2.2500	.1875	.9255	.4530
46	3.5000	2.6250	.1563	.6359	.3474
54	3.5000	2.8750	.1562	.3614	.2109
57	3.5000	3.2500	.1526	.1430	.1085
65	3.5000	3.5000	.1250	.1048	.1206
72	3.5000	3.7500	.1875	.1236	.1095
86	3.5000	4.2500	.2500	.0731	.0880
95	3.5000	4.7500	.2500	.0729	.0863
8	4.0000	.7500	.5625	.6033	.3302
22	4.0000	1.5000	.3750	.6610	.3454
38	4.0000	2.2500	.2811	.6395	.3523
47	4.0000	2.6250	.1563	.4152	.2428
121	4.0000	2.8750	.1562	.2900	.1922
58	4.0000	3.2500	.1562	.1594	.1443
66	4.0000	3.5000	.1250	.0987	.1279

Table II. Continued

(p) Continued

ORIFICE	X	Y	AREA	PS	PS
73	4.0000	3.7500	.1250	.1307	.1471
80	4.0000	4.0000	.1250	.1040	.1140
87	4.0000	4.2500	.1875	.0902	.0915
122	4.0000	4.7500	.2500	.0985	.1156
3	4.5000	.3750	.2812	.4968	.2767
9	4.5000	.7500	.1875	.4714	.2387
17	4.5000	1.1250	.1875	.4914	.2551
23	4.5000	1.5000	.1875	.5048	.2739
33	4.5000	1.8750	.1875	.4891	.2622
39	4.5000	2.2500	.1875	.4451	.2358
48	4.5000	2.6250	.3125	.2918	.1648
59	4.5000	3.2500	.1562	.1167	.1121
67	4.5000	3.5000	.1250	.1272	.1539
74	4.5000	3.7500	.1250	.1159	.1338
81	4.5000	4.0000	.1250	.1155	.1256
88	4.5000	4.2500	.1875	.1063	.1074
123	4.5000	4.7500	.2500	.0723	.0980
10	5.0000	.7500	.5625	.3734	.1934
24	5.0000	1.5000	.2812	.3895	.2352
144	5.0000	1.8750	.2812	.4036	.2353
49	5.0000	2.6250	.4062	.2237	.1363
68	5.0000	3.5000	.2812	.1224	.1481
75	5.0000	3.7500	.1250	.1150	.1369
82	5.0000	4.0000	.1250	.1203	.1403
89	5.0000	4.2500	.1875	.1409	.1553
124	5.0000	4.7500	.2500	.0893	.1885
4	5.5000	.3750	.4218	.3721	.2374
11	5.5000	.7500	.2812	.1381	.1739
18	5.5000	1.1250	.2812	.3372	.1929
25	5.5000	1.5000	.2812	.3169	.1959
34	5.5000	1.8750	.2812	.3014	.1666
40	5.5000	2.2500	.2812	.2423	.1414
50	5.5000	2.6250	.4687	.1969	.1412
60	5.5000	3.2500	.2343	.0983	.1427
69	5.5000	3.5000	.1875	.1131	.1427
76	5.5000	3.7500	.1875	.1024	.1387
83	5.5000	4.0000	.1875	.1457	.1744
90	5.5000	4.2500	.2812	.1147	.1433
125	5.5000	4.7500	.3750	.4368	.1421
12	6.5000	.7500	1.1250	.2913	.1598
26	6.5000	1.5000	.7500	.2078	.1617
41	6.5000	2.2500	1.1875	.1949	.1500
61	6.5000	3.2500	.4375	.0947	.1583
77	6.5000	3.7500	.5000	.1269	.1667
91	6.5000	4.2500	.5000	.1324	.1632
126	6.5000	4.7500	.5000	.1364	.1661

Table II. Concluded

(p) Concluded

ORIFICE	X	Y	AREA	PS	PS
127	7.5000	.3750	.5625	.2614	.1827
13	7.5000	.7500	.5625	.2287	.1333
27	7.5000	1.5000	.7500	.1464	.1377
42	7.5000	2.2500	.5625	.1699	.1908
51	7.5000	2.6250	.6250	.1863	.1983
62	7.5000	3.2500	.4375	.1395	.1756
78	7.5000	3.7500	.5000	.1451	.1753
92	7.5000	4.2500	.5000	.1390	.1610
128	7.5000	4.7500	.5000	.1505	.1748
14	8.5000	.7500	1.1250	.1970	.1690
28	8.5000	1.5000	.7500	.1690	.1799
43	8.5000	2.2500	1.1875	.1861	.1856
63	8.5000	3.2500	.4375	.1699	.1721
79	8.5000	3.7500	.5000	.1874	.1977
93	8.5000	4.2500	.5000	.1661	.1825
129	8.5000	4.7500	.5000	.1840	.2032
130	9.5000	.3750	.5625	.1710	.1915
131	9.5000	.7500	.5625	.1499	.1564
29	9.5000	1.5000	.7500	.1588	.1564
132	9.5000	2.2500	.5625	.2141	.1936
133	9.5000	2.6250	.6250	.2012	.1780
134	9.5000	3.2500	.4375	.1991	.1915
135	9.5000	3.7500	.5000	.1791	.1803
136	9.5000	4.2500	.5000	.1764	.1850
137	9.5000	4.7500	.5000	.1743	.1886
138	10.5000	.7500	1.1250	.1330	.1517
30	10.5000	1.5000	.7500	.1632	.1568
139	10.5000	2.2500	1.1875	.1863	.1690
140	10.5000	3.2500	.4375	.1994	.1952
141	10.5000	3.7500	.5000	.1825	.1812
142	10.5000	4.2500	.5000	.2066	.2114
143	10.5000	4.7500	.5000	.1915	.1979

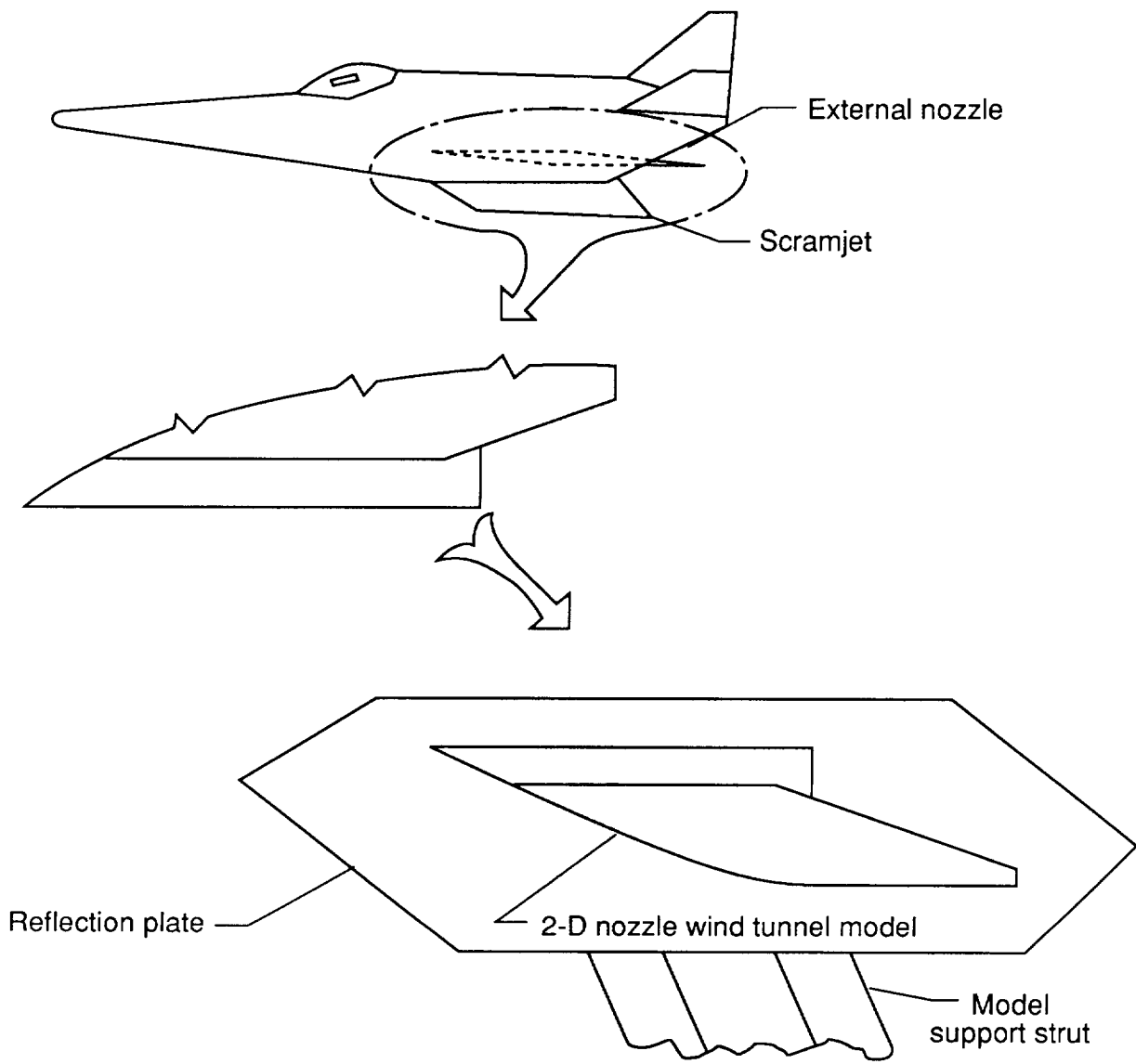
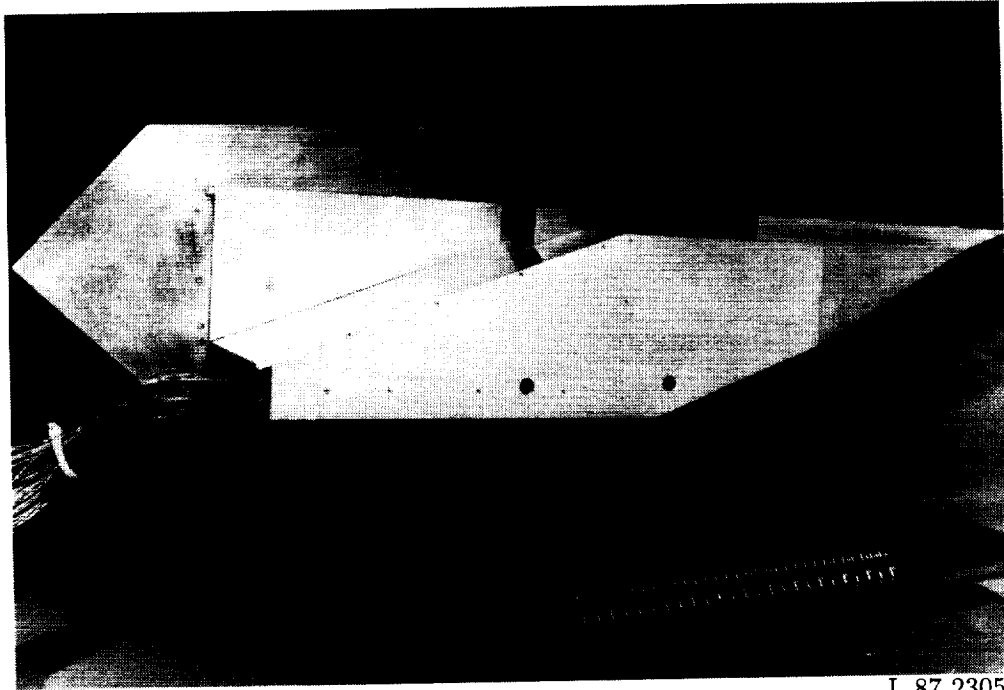

Figure 1. Genesis of two-dimensional wind tunnel model.

ORIGINAL PAGE  
BLACK AND WHITE PHOTOGRAPH



L-87-2305

(a) Model mounted on reflection plate;  $\alpha = 4^\circ$ .

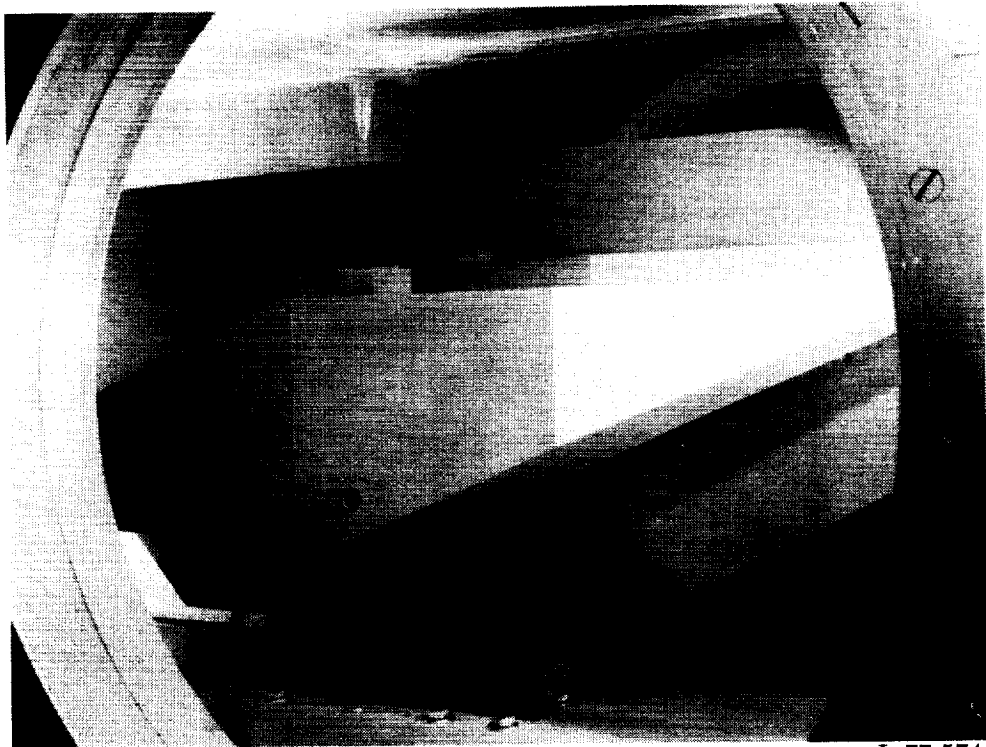

L-77-574

(b) Model mounted in tunnel;  $\alpha = 0^\circ$ .

Figure 2. Model mounted on reflection plate and in tunnel.



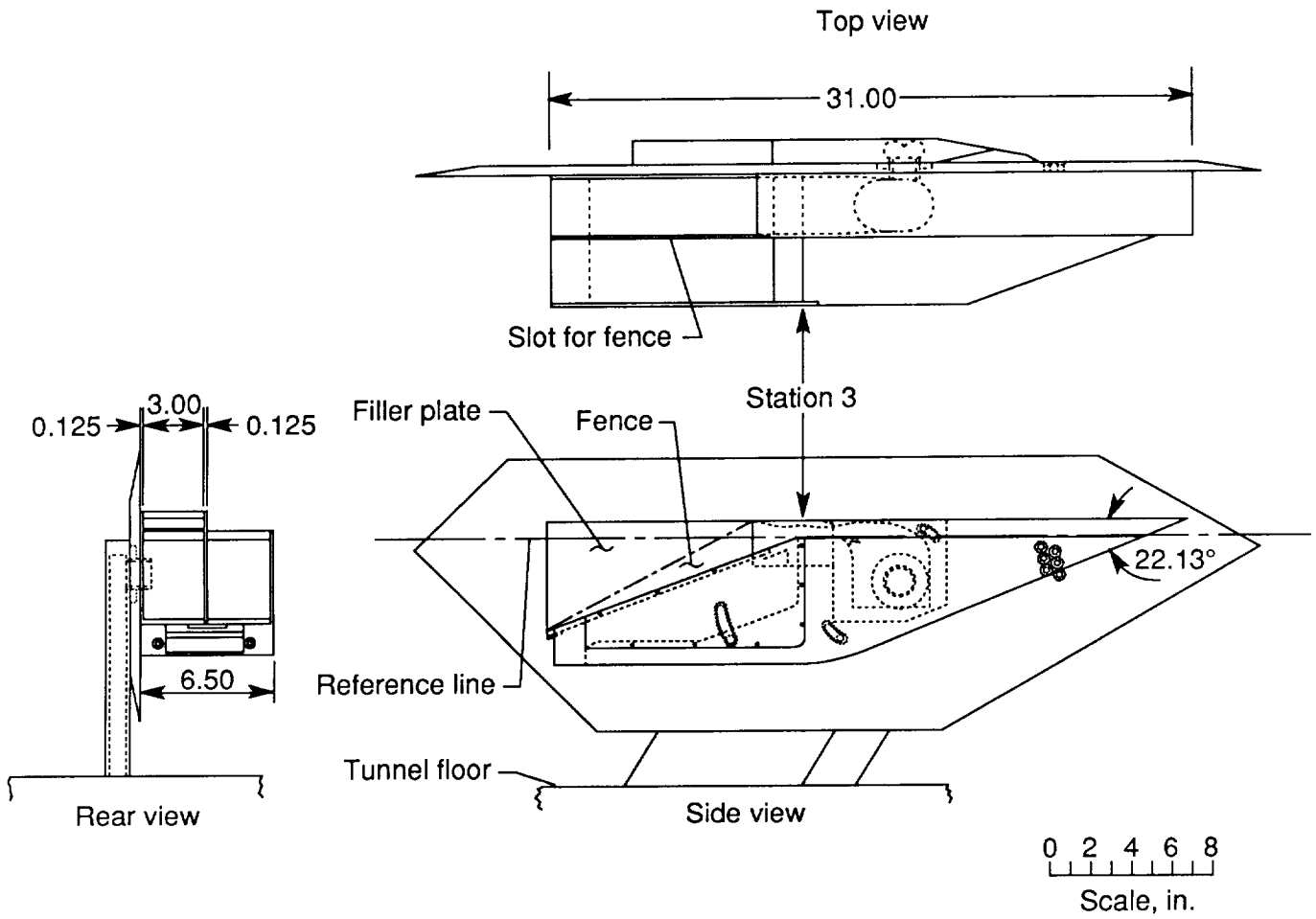
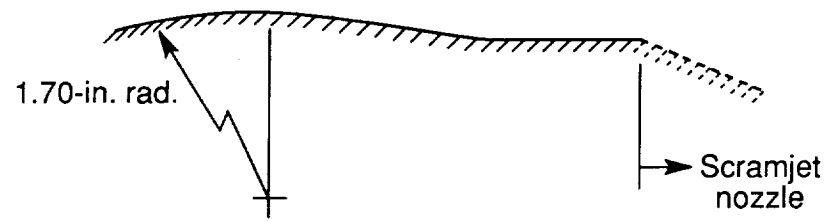
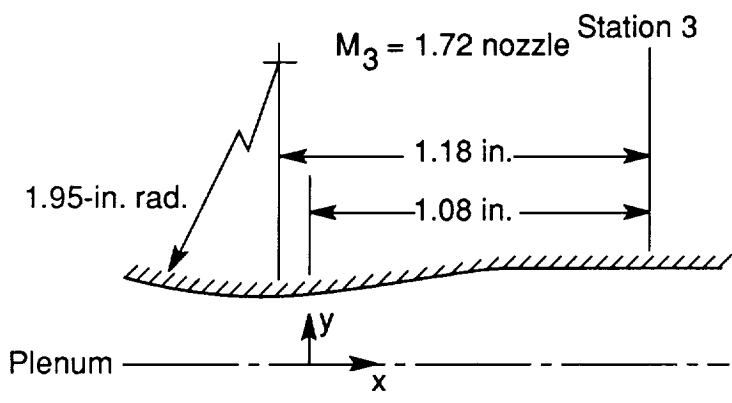
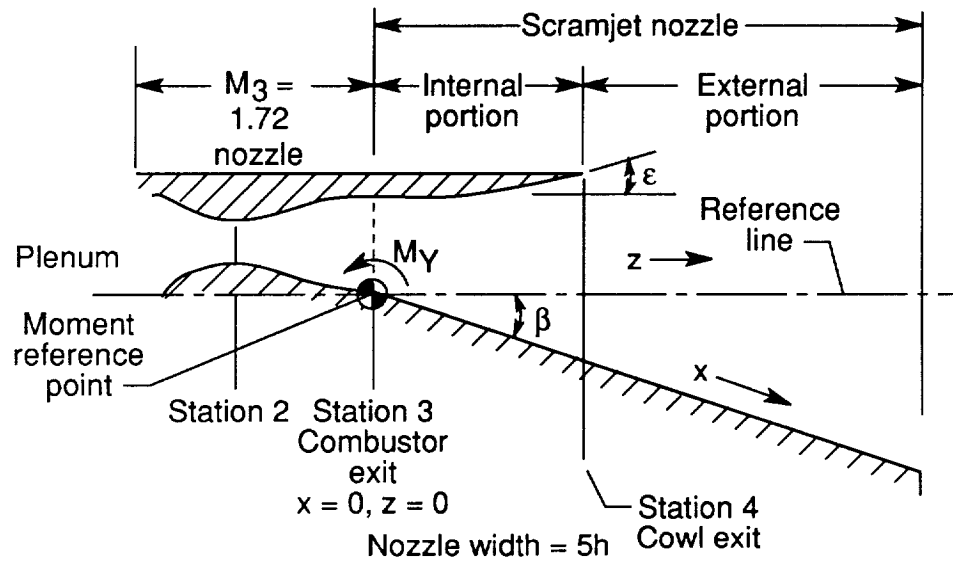

Figure 3. Three-view drawing of model. All linear dimensions are in inches.



x	0	0.050	0.101	0.140	0.180	0.241	0.279	0.337	0.407	0.492	0.576	0.728	0.874	1.080
y	0.212	0.216	0.221	0.226	0.232	0.242	0.248	0.256	0.266	0.275	0.283	0.293	0.298	0.300

Figure 4. Nozzle details.

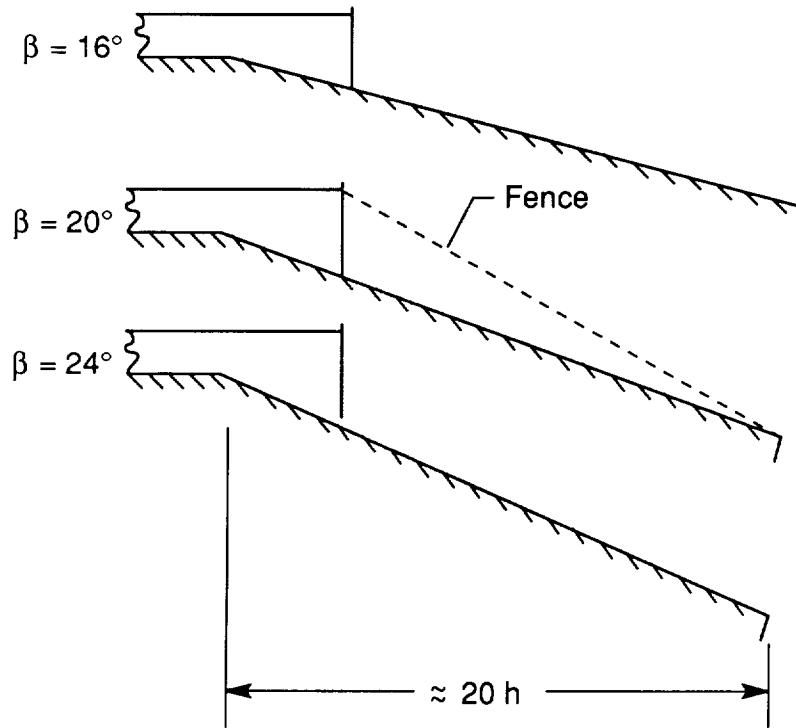
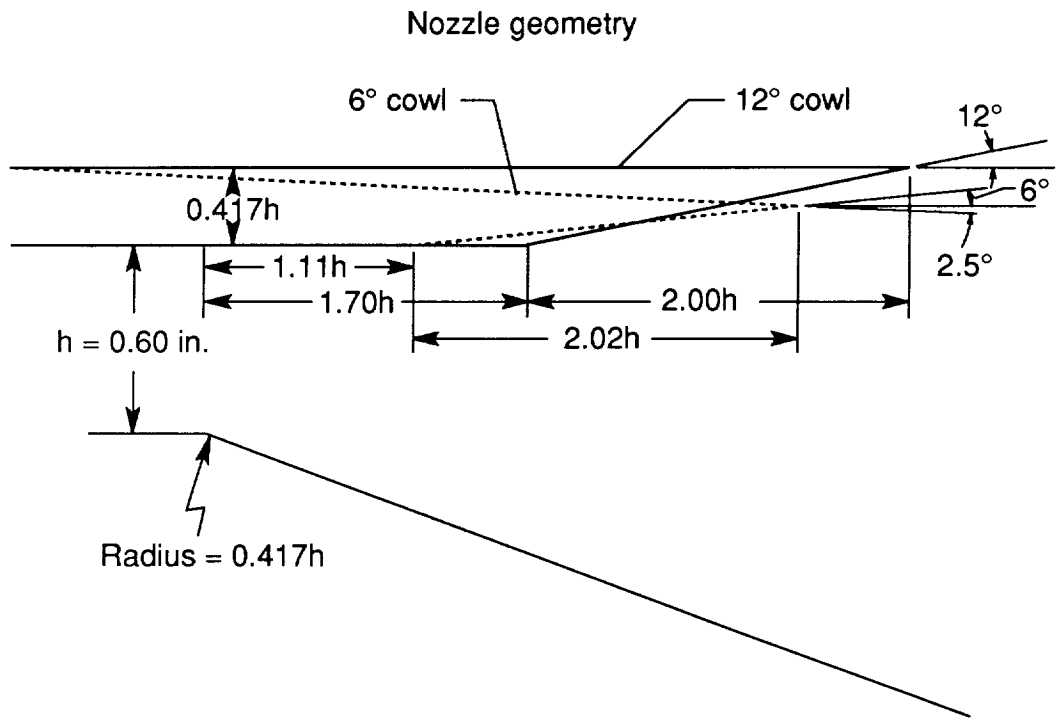
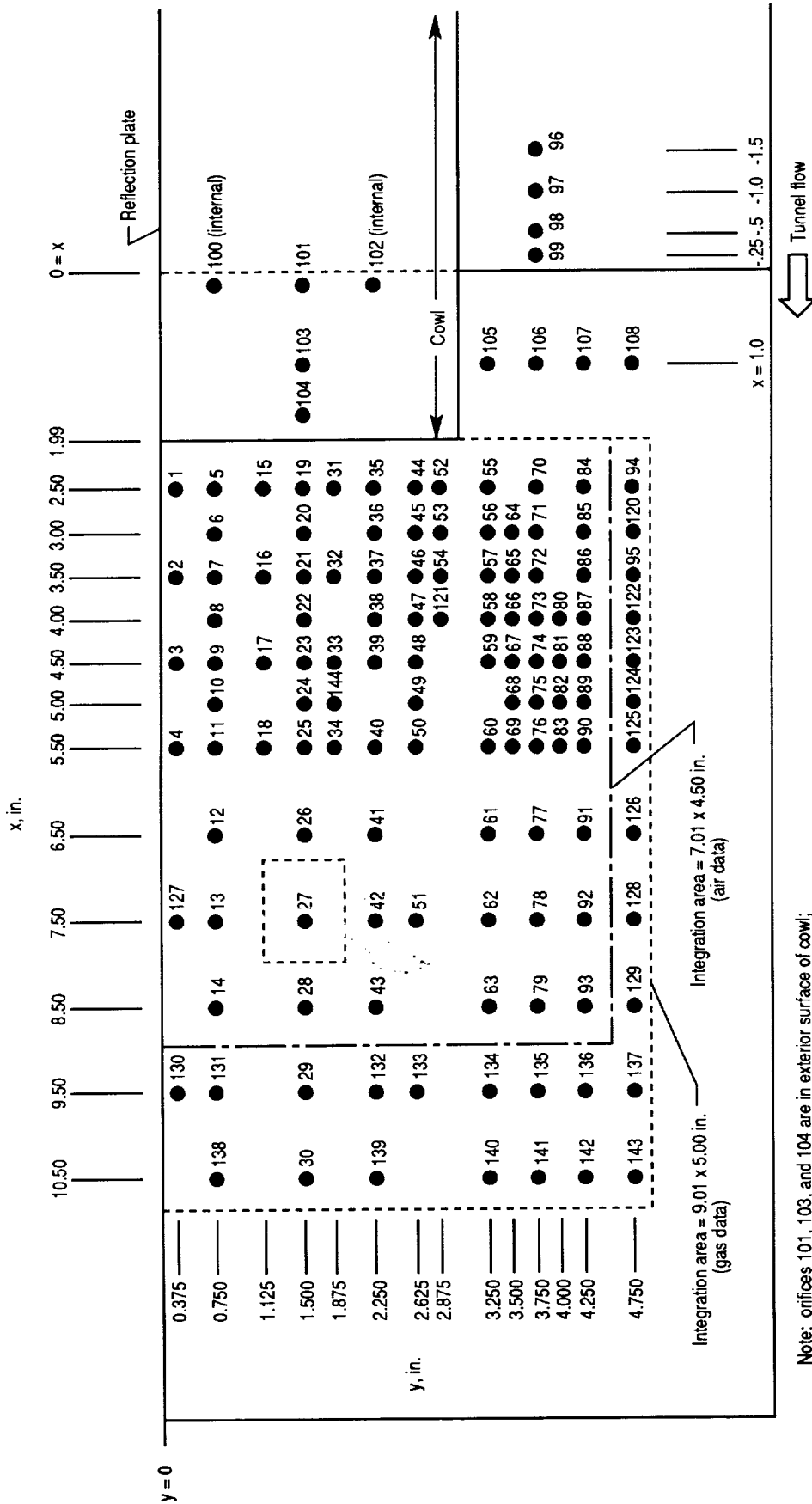
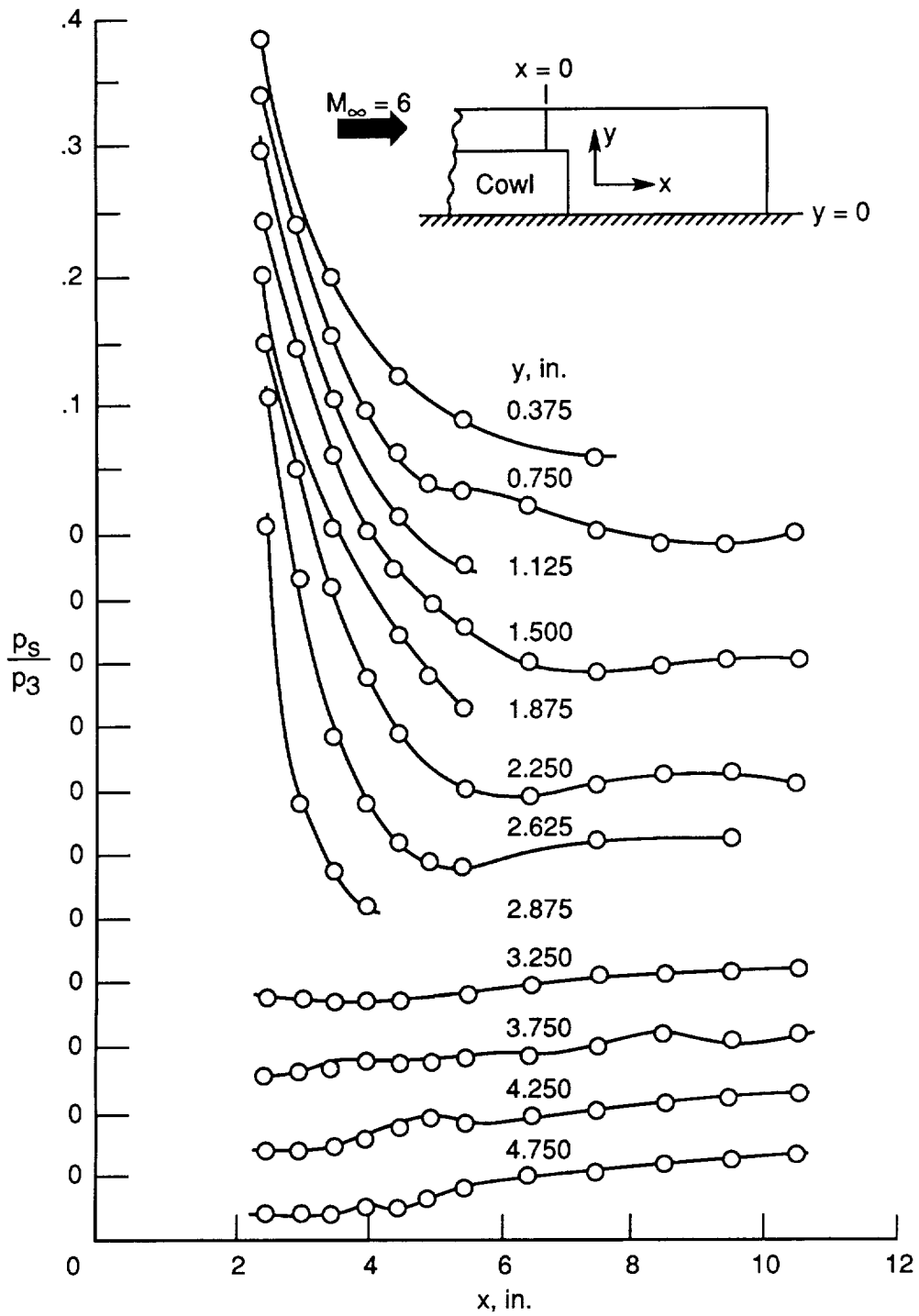

Figure 4. Concluded.



Note: orifices 101, 103, and 104 are in exterior surface of cowl; orifices 100 and 102 are in internal surface of cowl.

Figure 5. Orifice locations. Example of area represented by orifice shown by dotted line for  $n = 27$ .



(a) Constant  $y$ .

Figure 6. Configuration IV pressure distributions.  $p_3 = 4.309$  psia;  $p_\infty/p_3 = 0.0543$ .

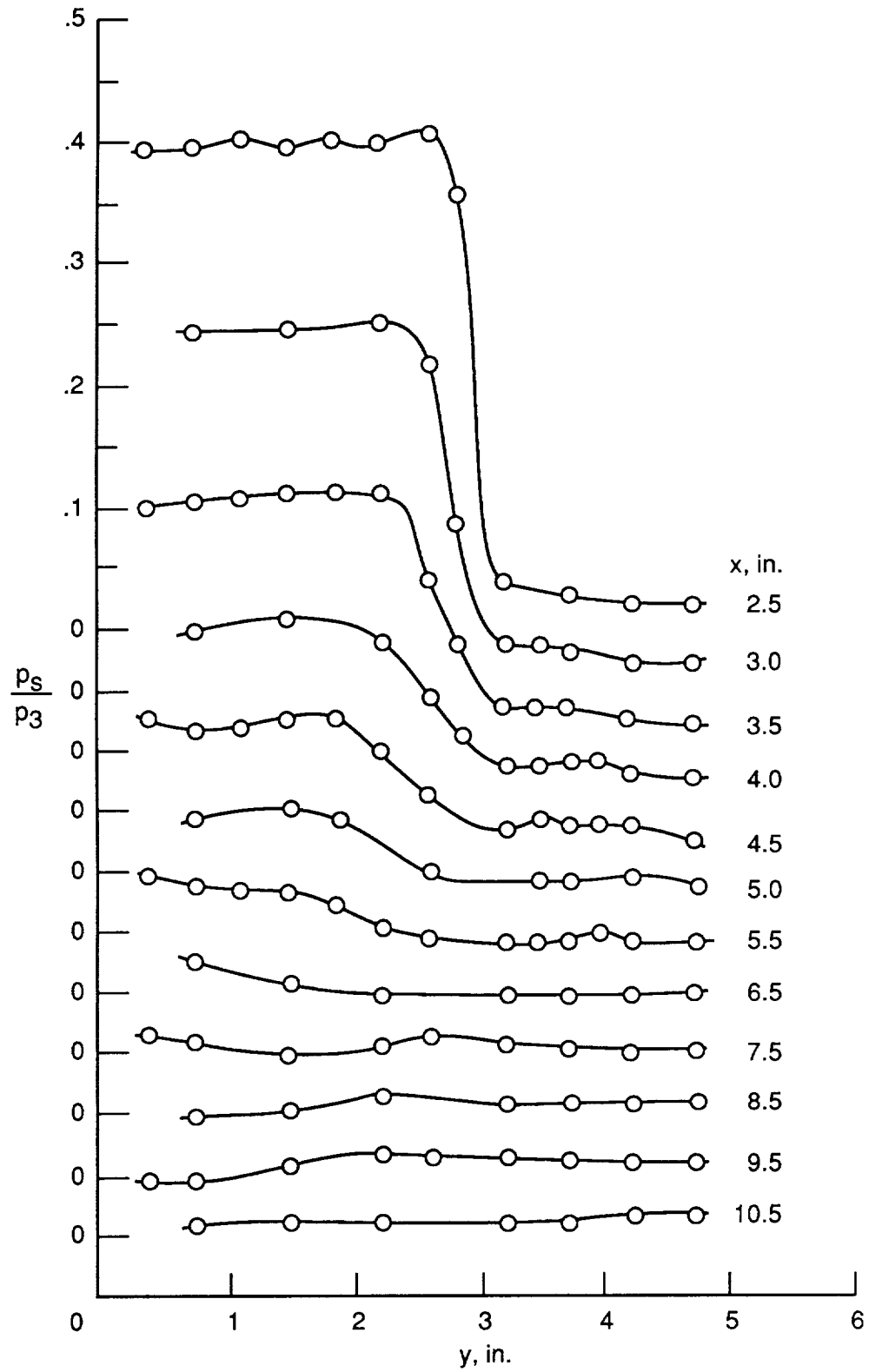

(b) Constant  $x$ .

Figure 6. Continued.

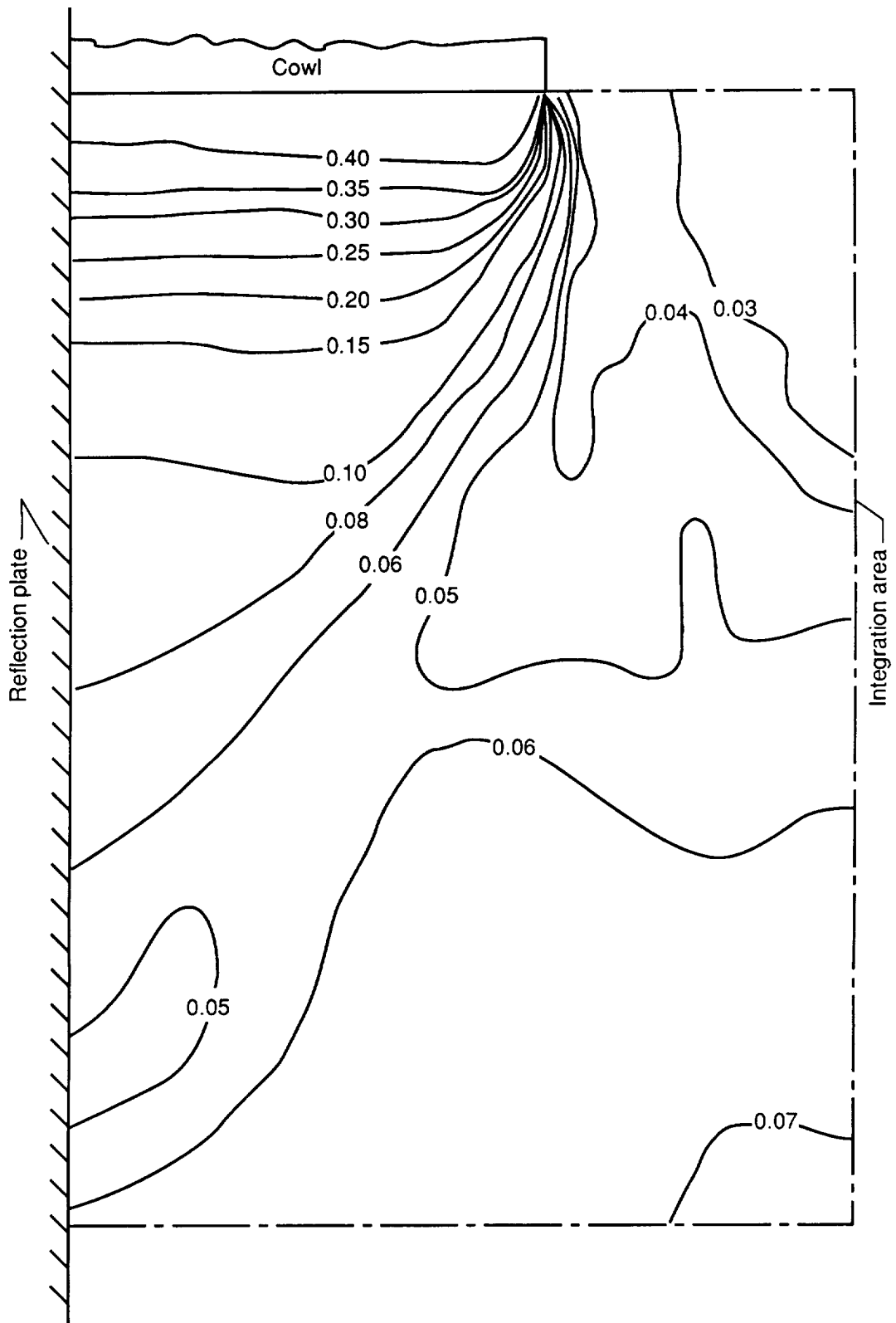

(c) Isobars of  $p_s/p_3$ .

Figure 6. Concluded.

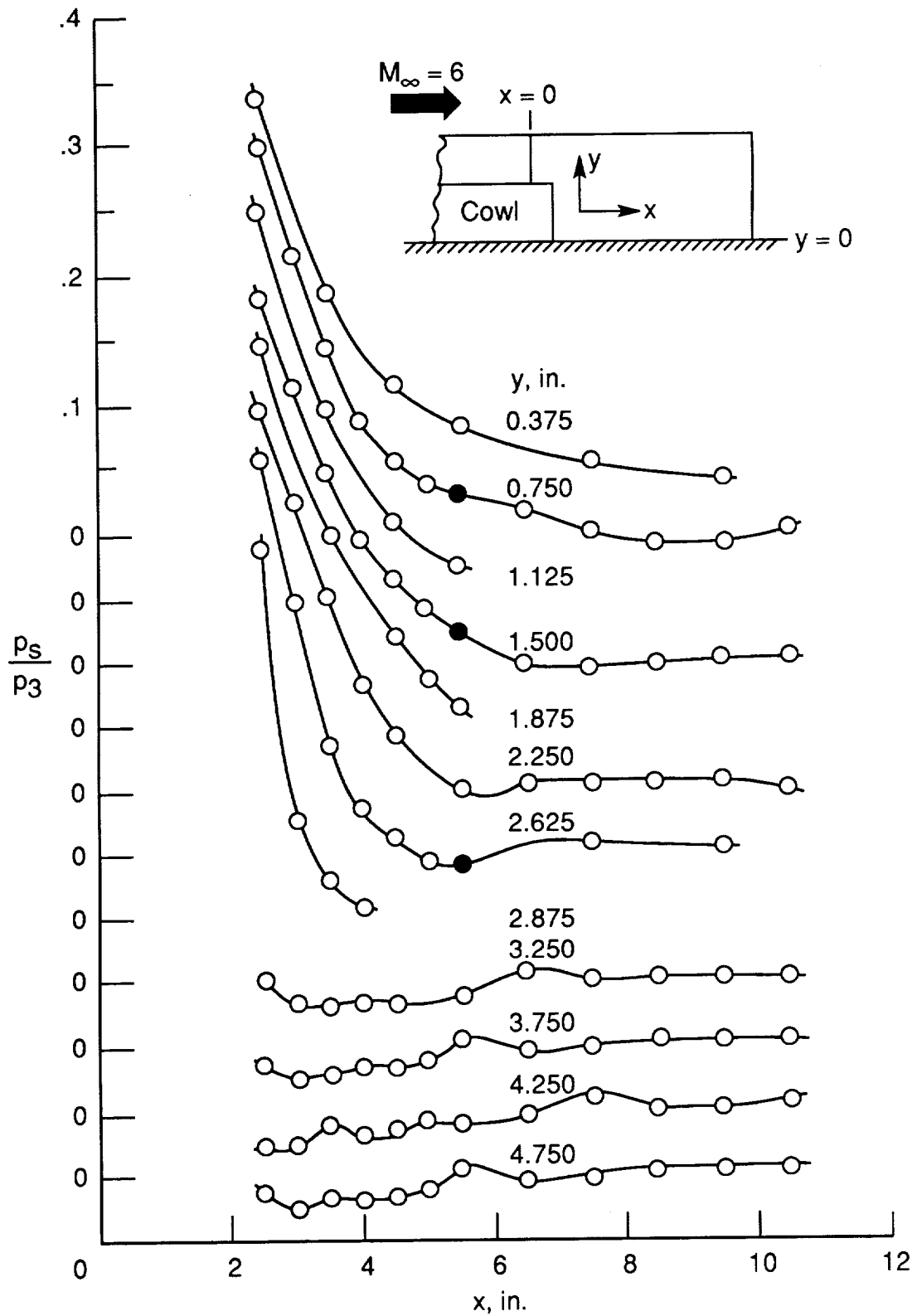

(a) Constant  $y$ .

Figure 7. Configuration V pressure distributions.  $p_3 = 4.731$  psia;  $p_\infty/p_3 = 0.0492$ .



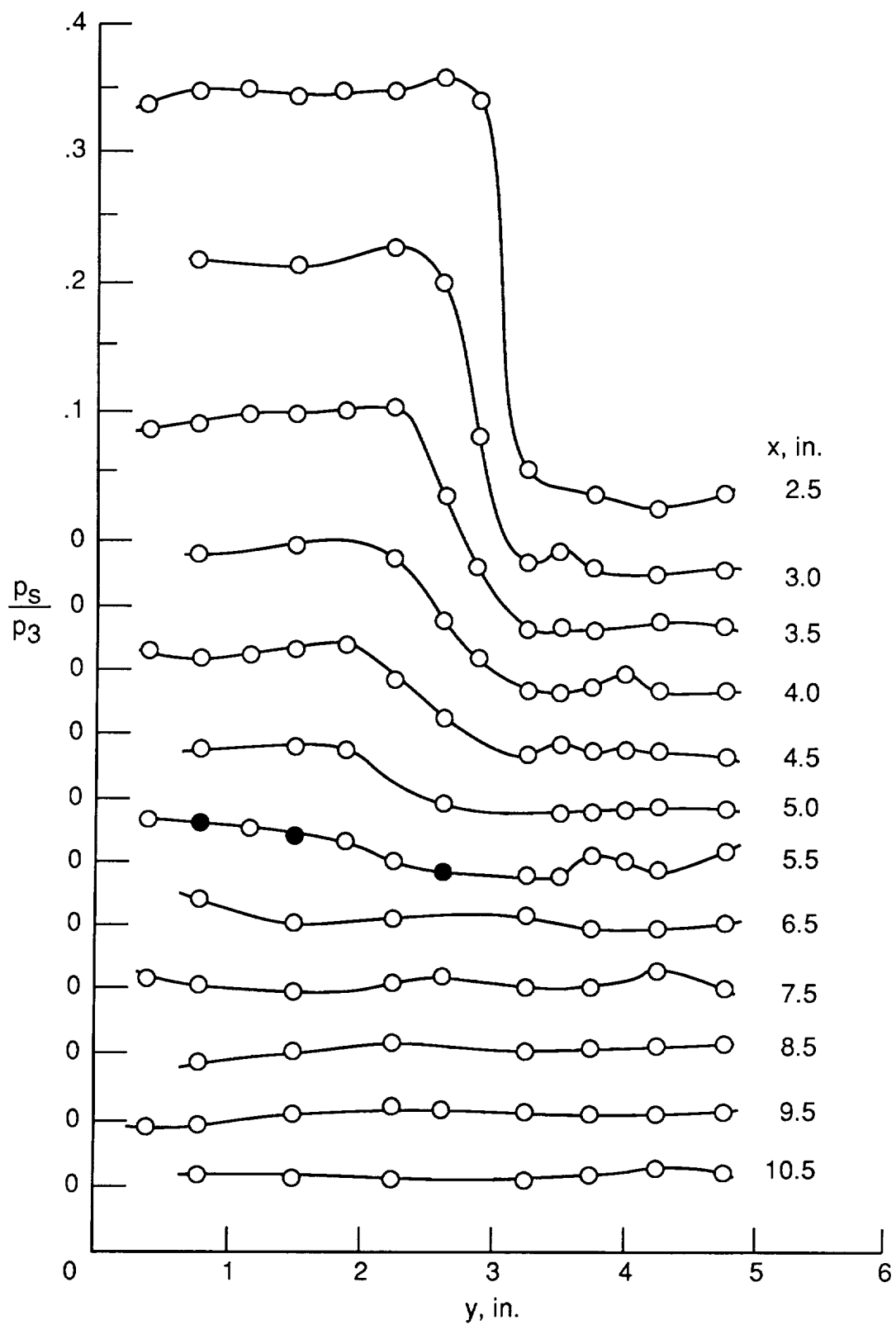

(b) Constant  $x$ .

Figure 7. Continued.

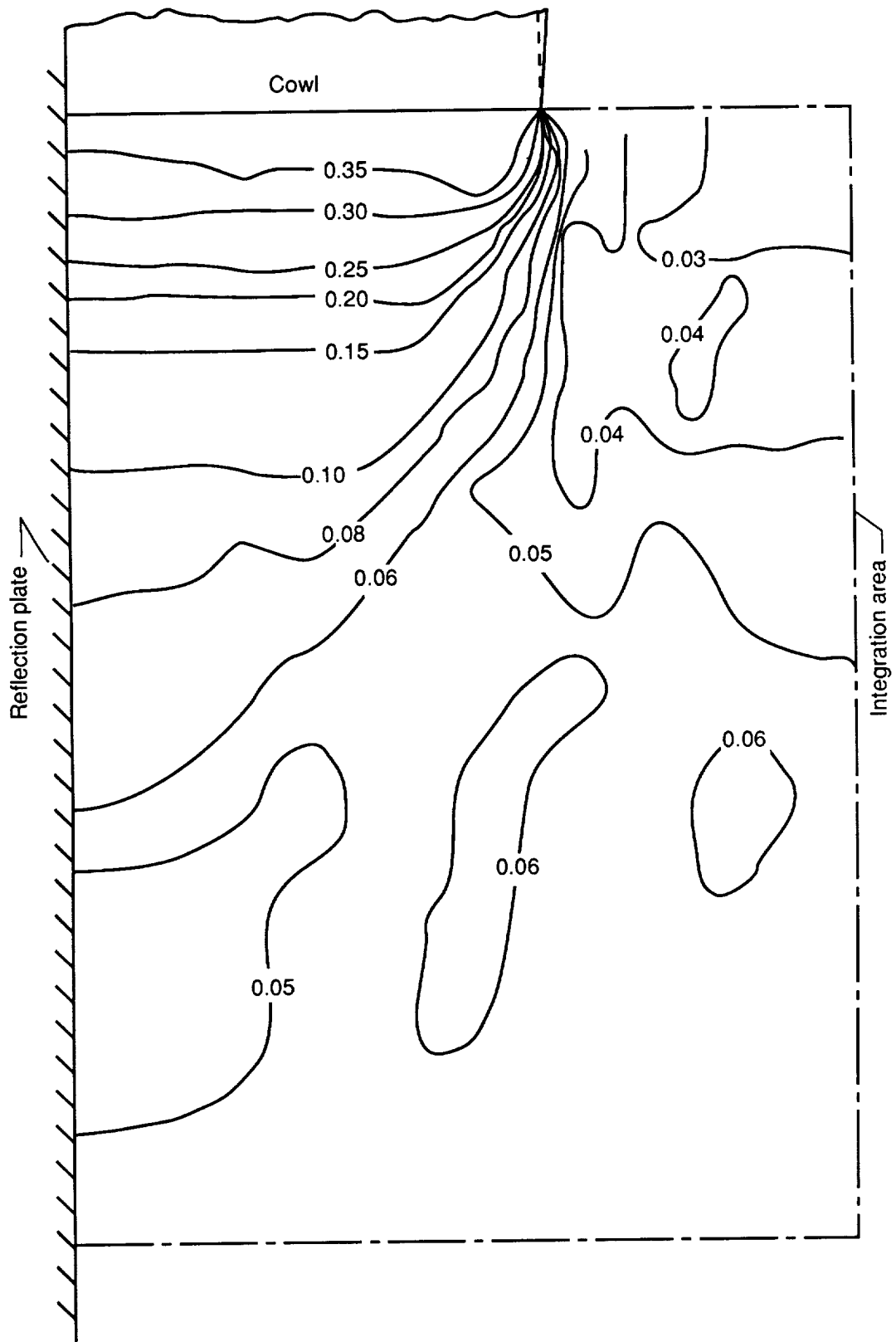

(c) Isobars of  $p_s/p_3$ .  
 Figure 7. Continued.

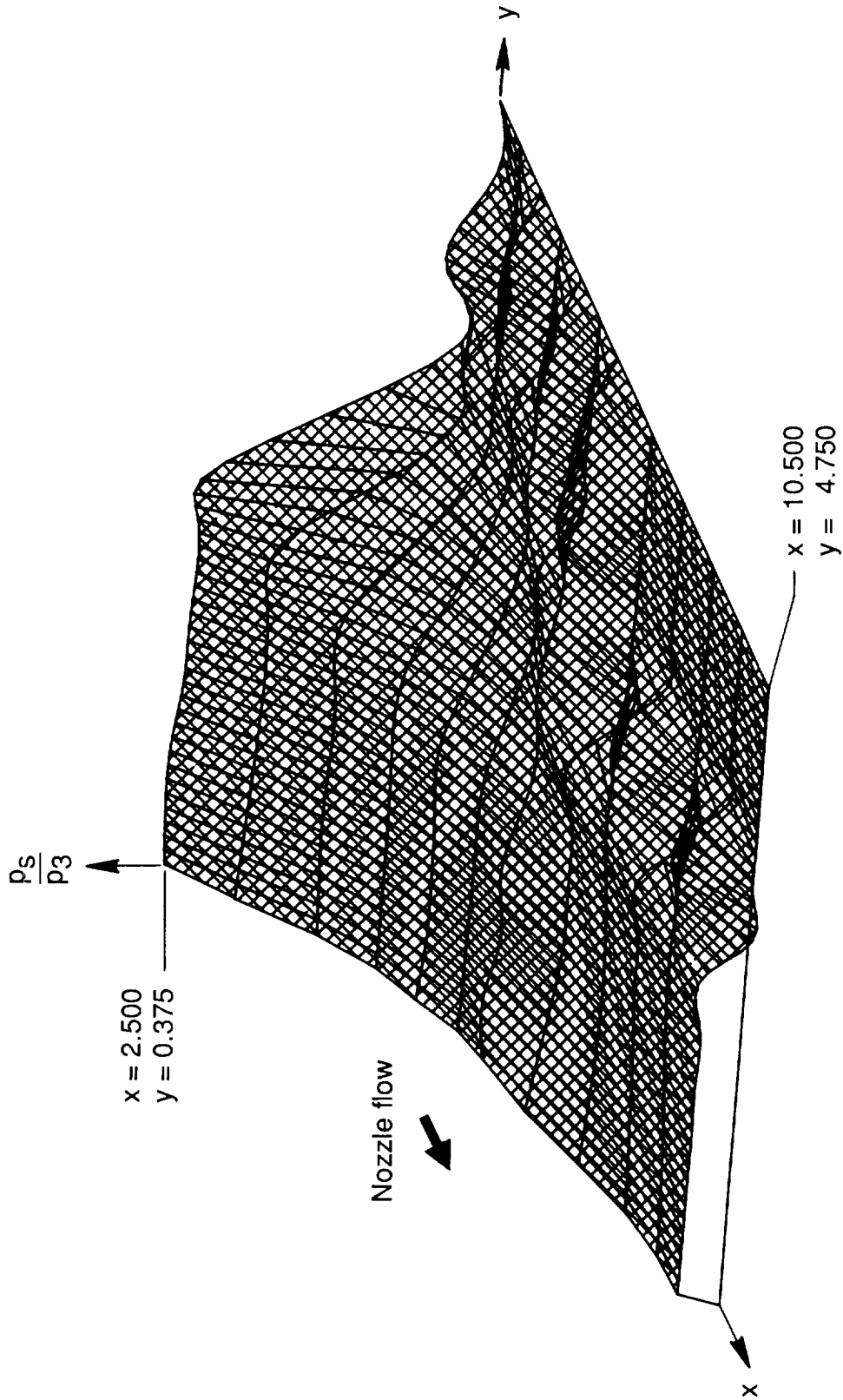

(d) Typical carpet plot of pressures on external nozzle surface.

Figure 7. Concluded.

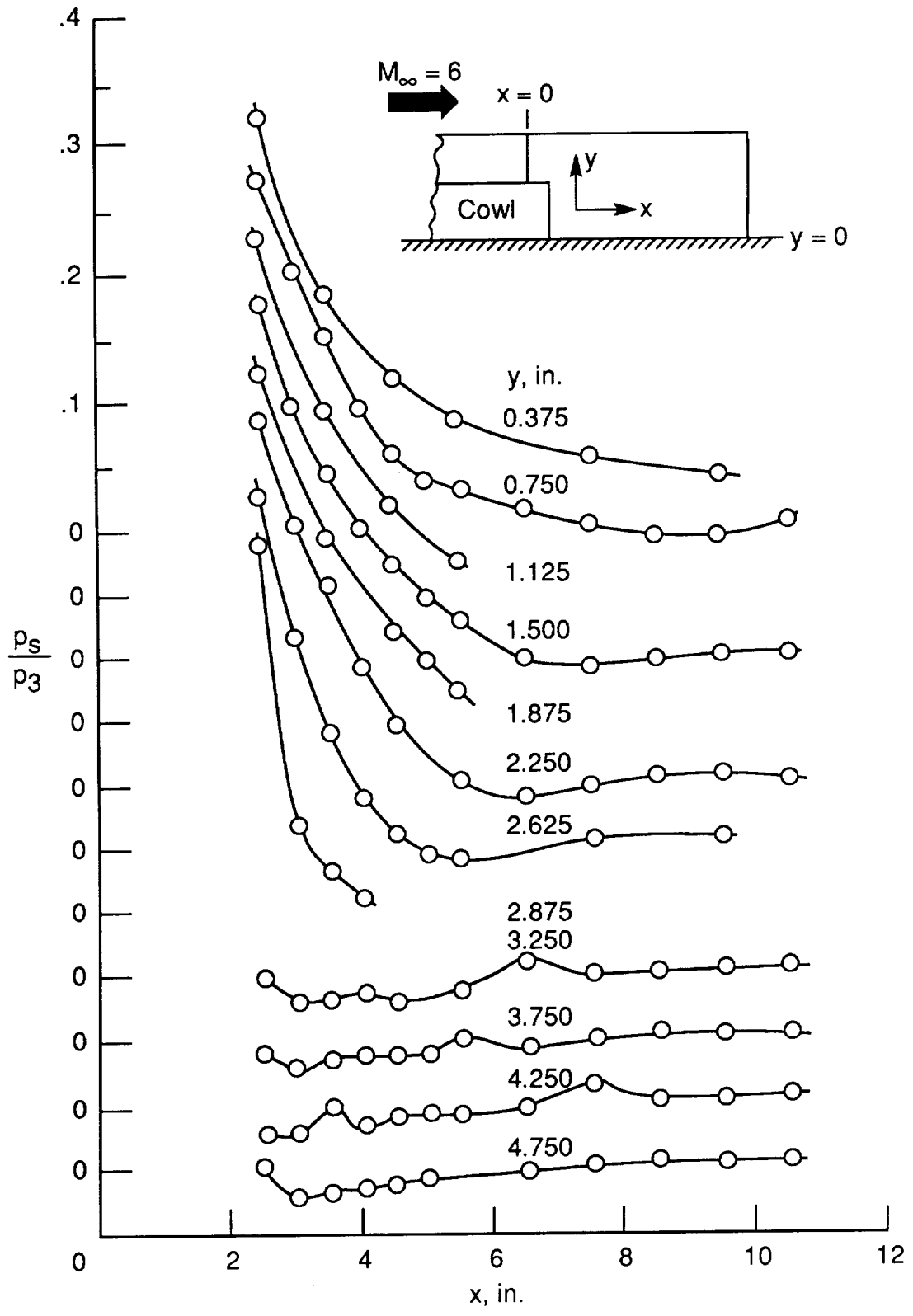

(a) Constant  $y$ .

Figure 8. Configuration VI pressure distributions.  $p_3 = 4.87$  psia;  $p_\infty/p_3 = 0.0484$ .

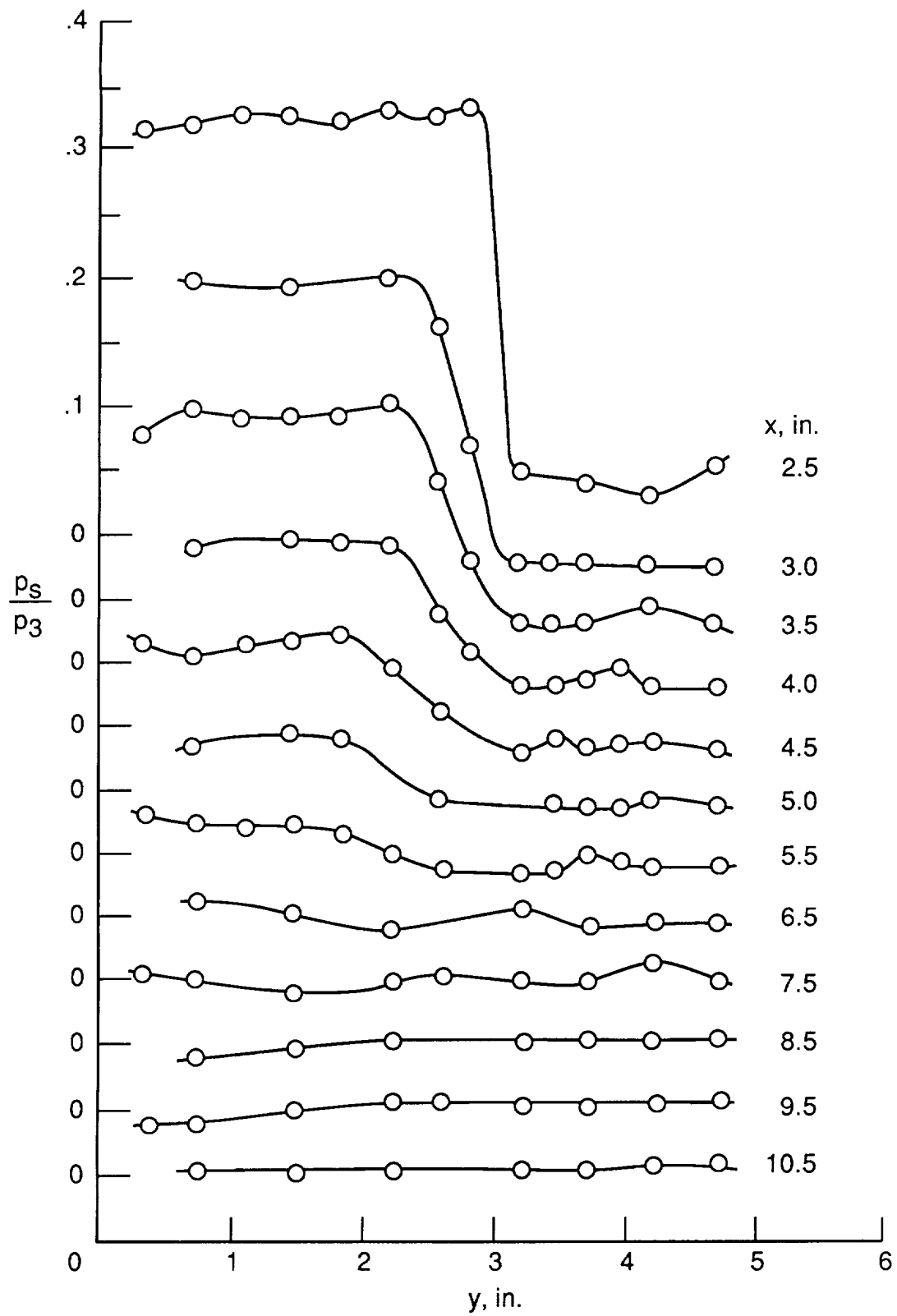

(b) Constant  $x$ .

Figure 8. Continued.

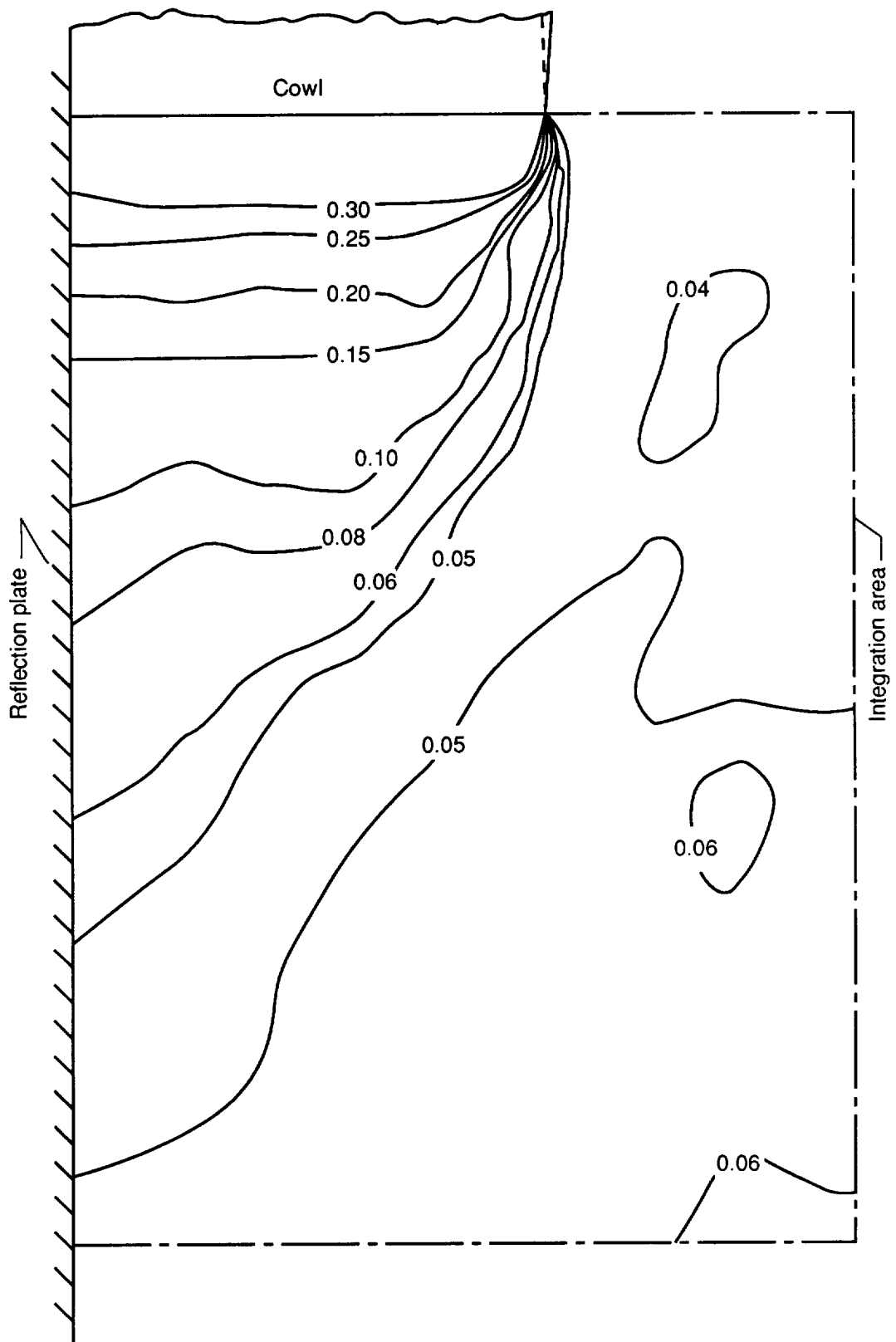

(c) Isobars of  $p_s/p_3$ .  
 Figure 8. Concluded.

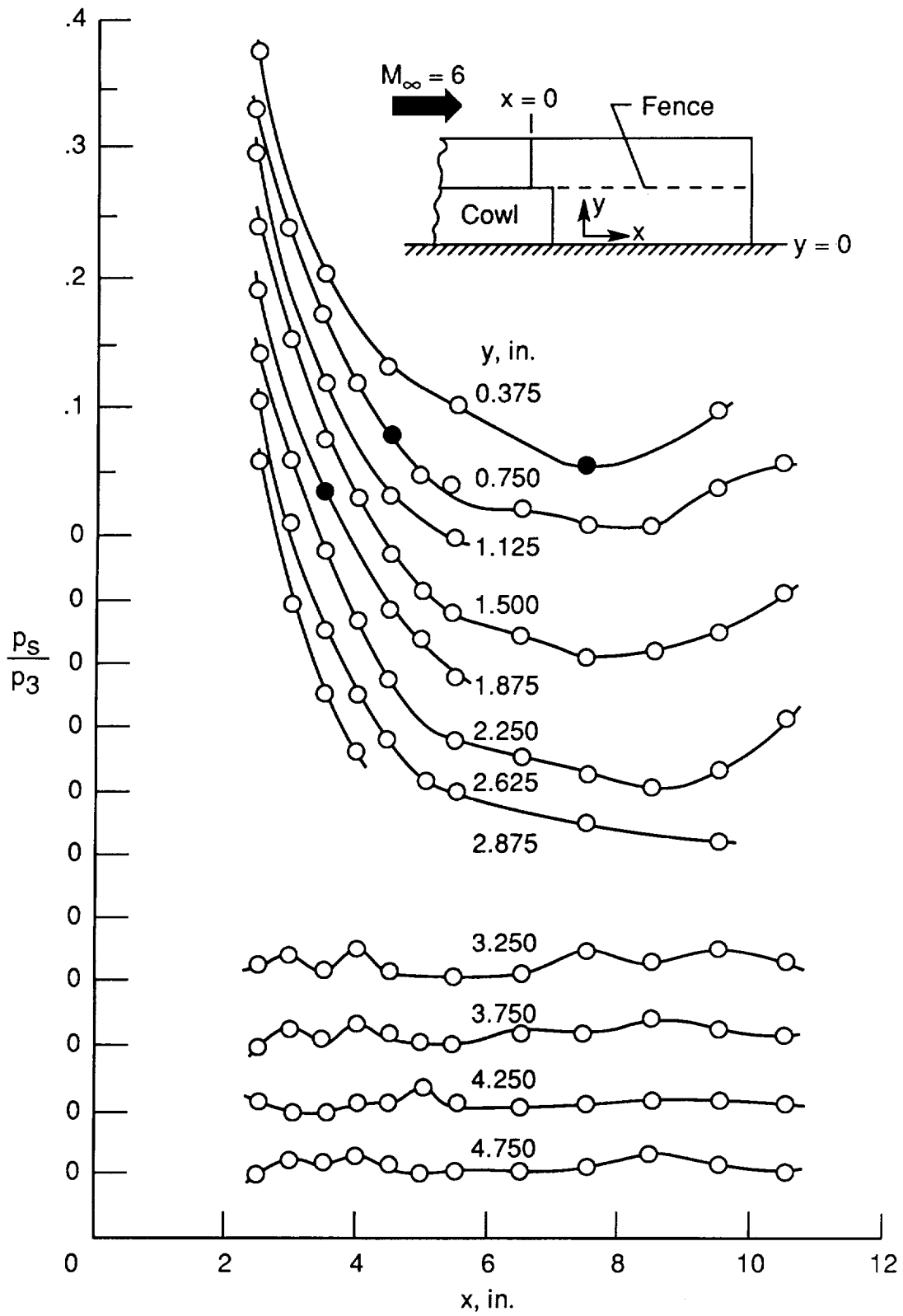

(a) Constant  $y$ .

Figure 9. Configuration V-A pressure distributions.  $p_3 = 4.188$  psia;  $p_\infty/p_3 = 0.0536$ .

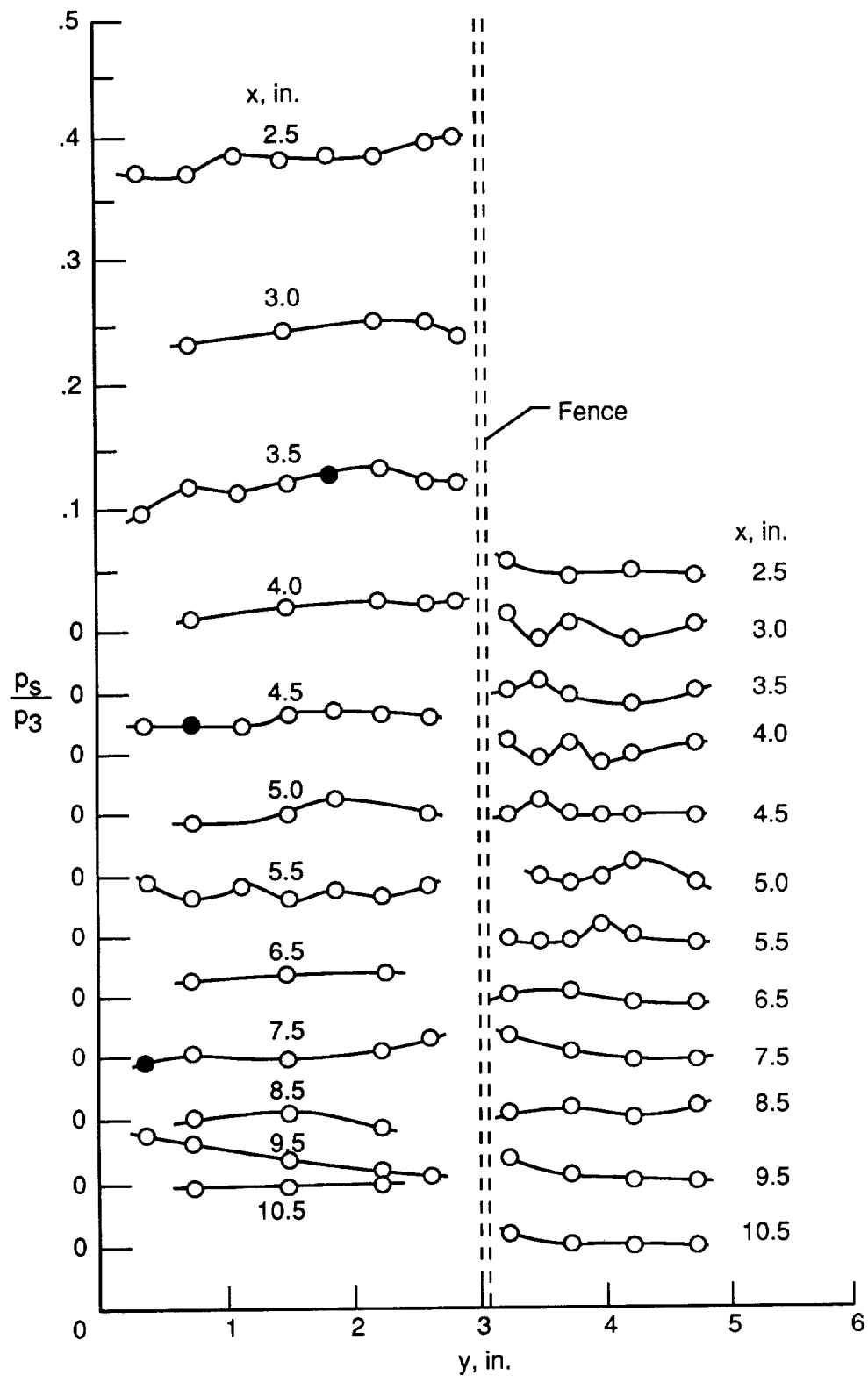

(b) Constant  $x$ .

Figure 9. Continued.



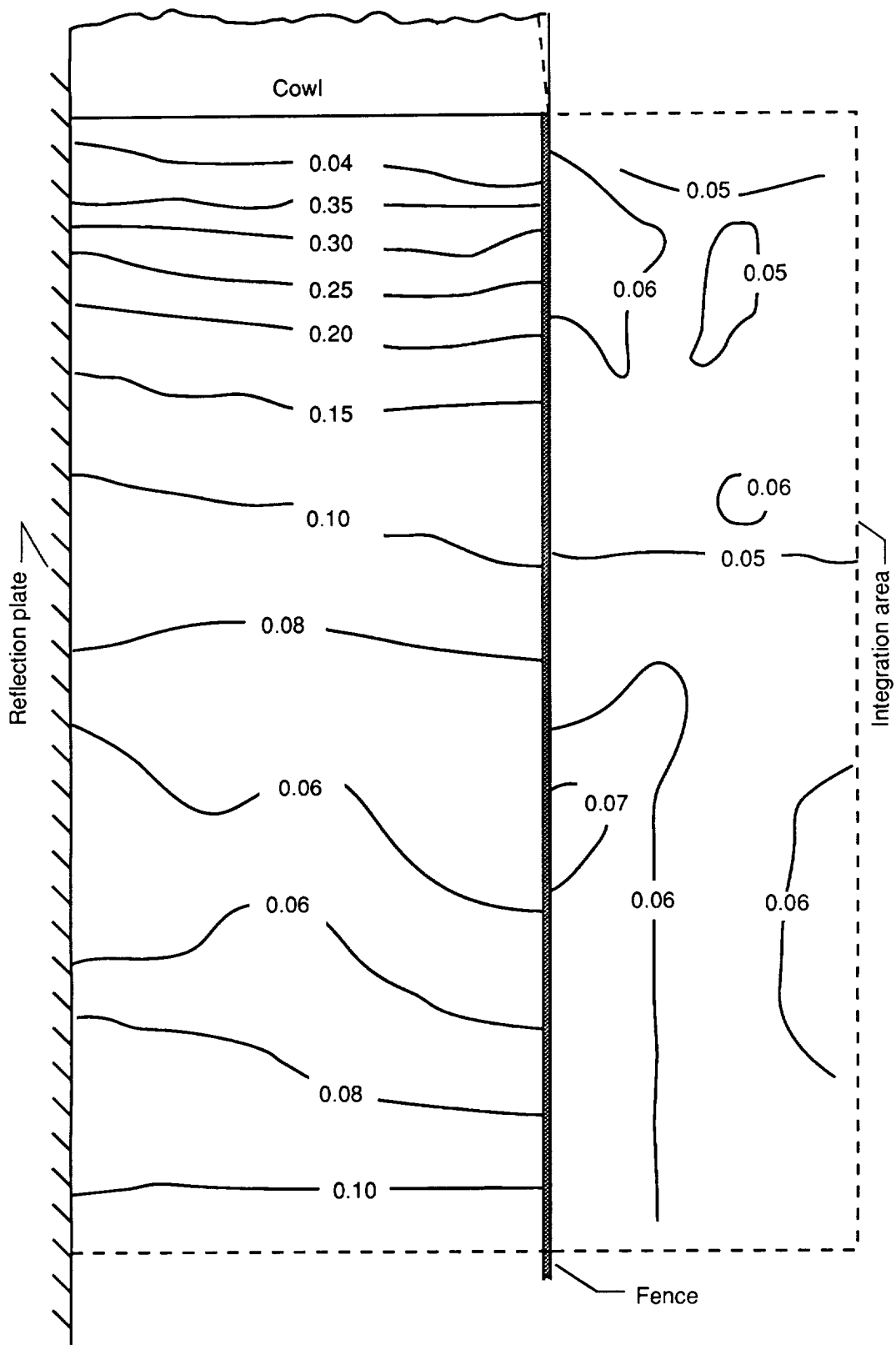

(c) Isobars of  $p_s/p_3$ .

Figure 9. Concluded.

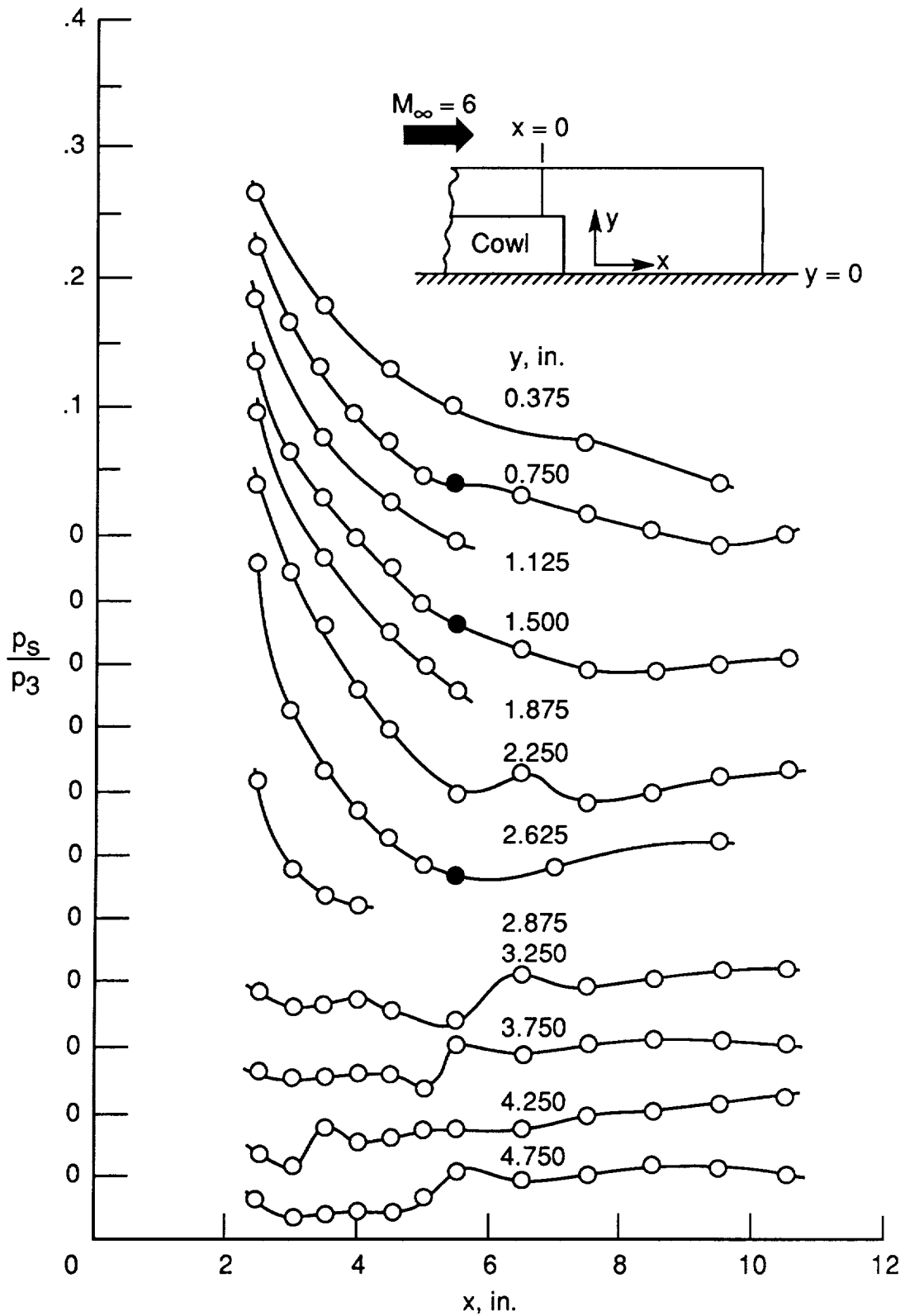

(a) Constant  $y$ .

Figure 10. Configuration II pressure distributions.  $p_3 = 4.595$  psia;  $p_\infty/p_3 = 0.0527$ .

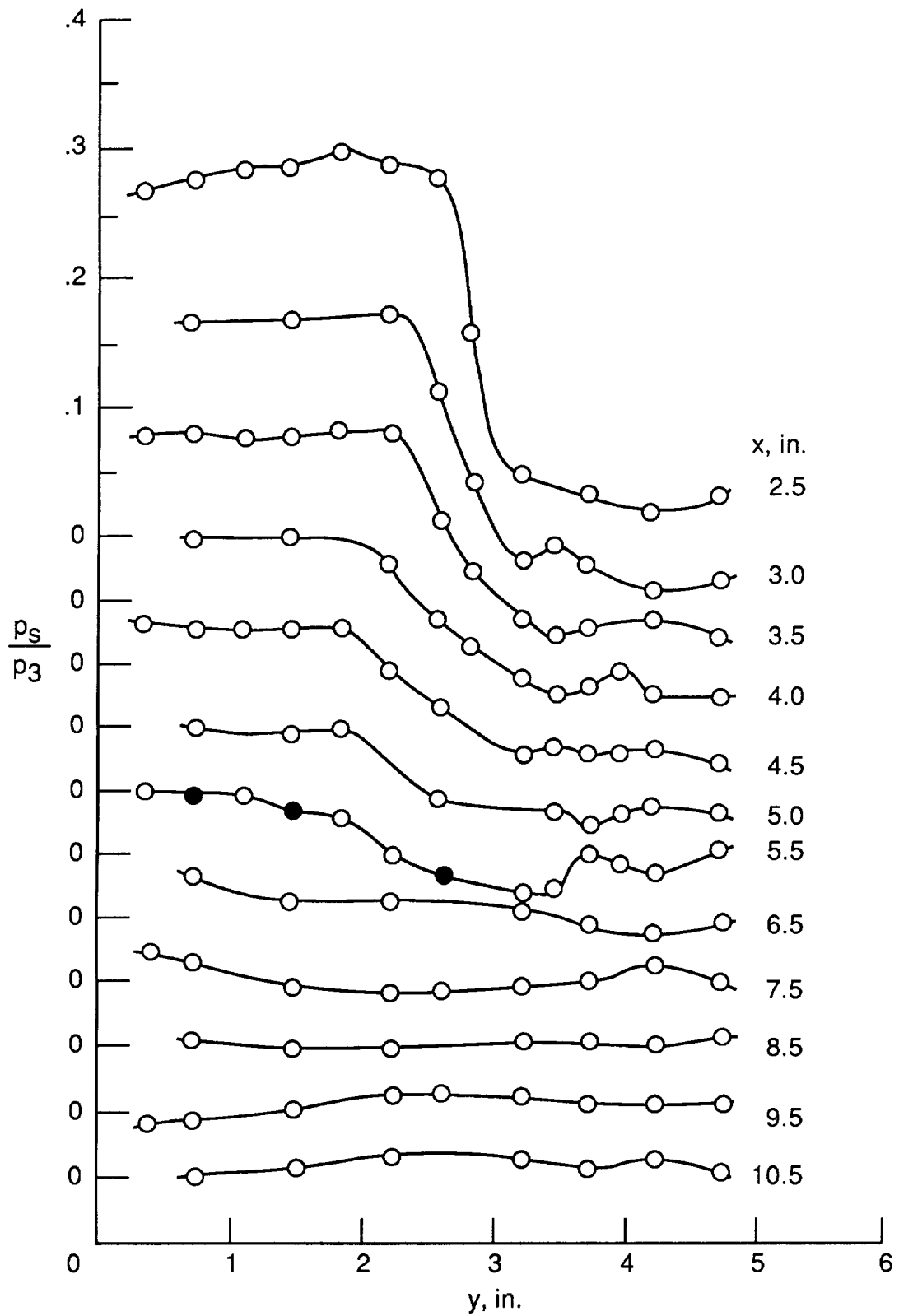

(b) Constant  $x$ .

Figure 10. Continued.

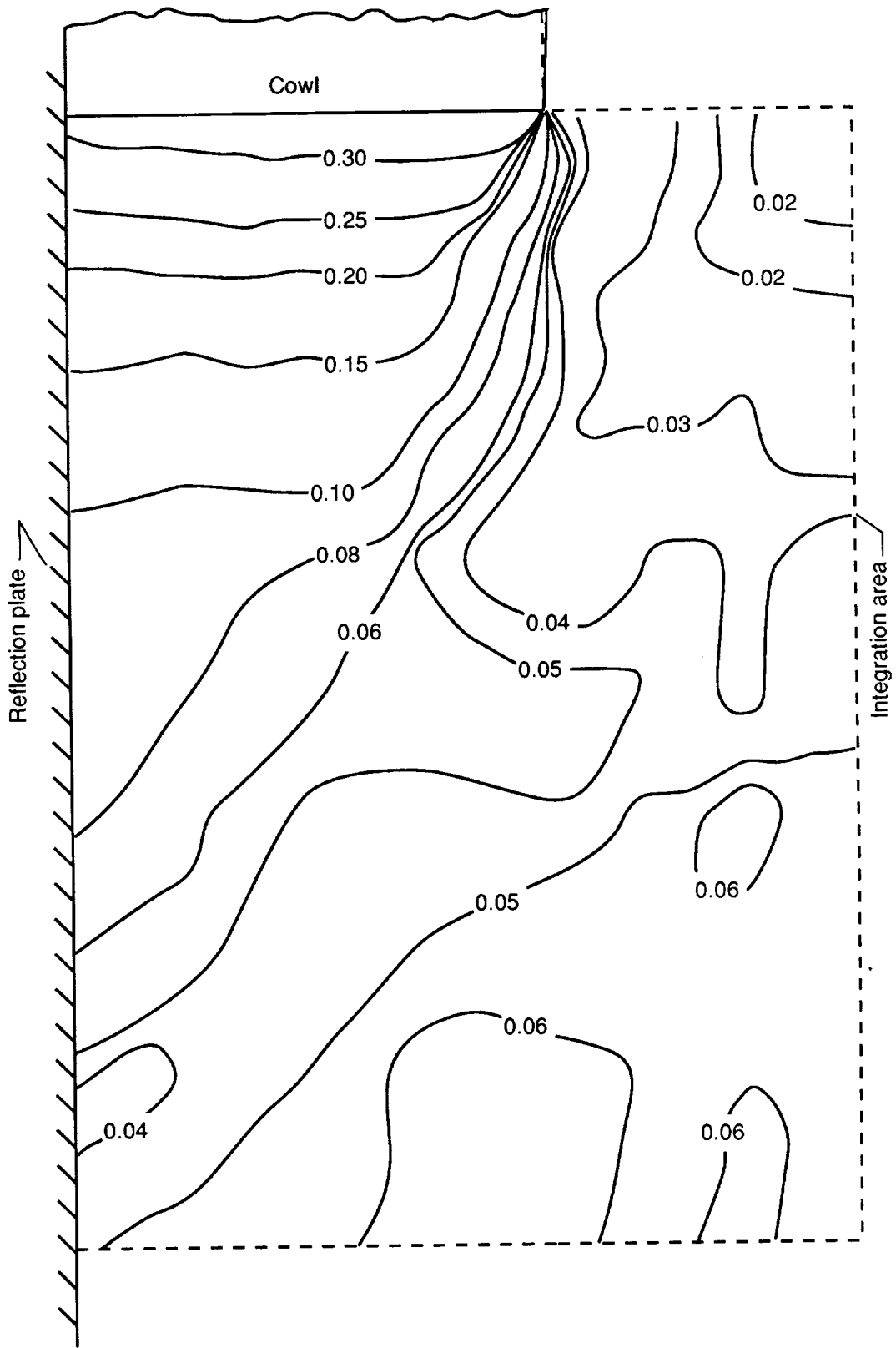

(c) Isobars of  $p_s/p_3$ .  
 Figure 10. Concluded.

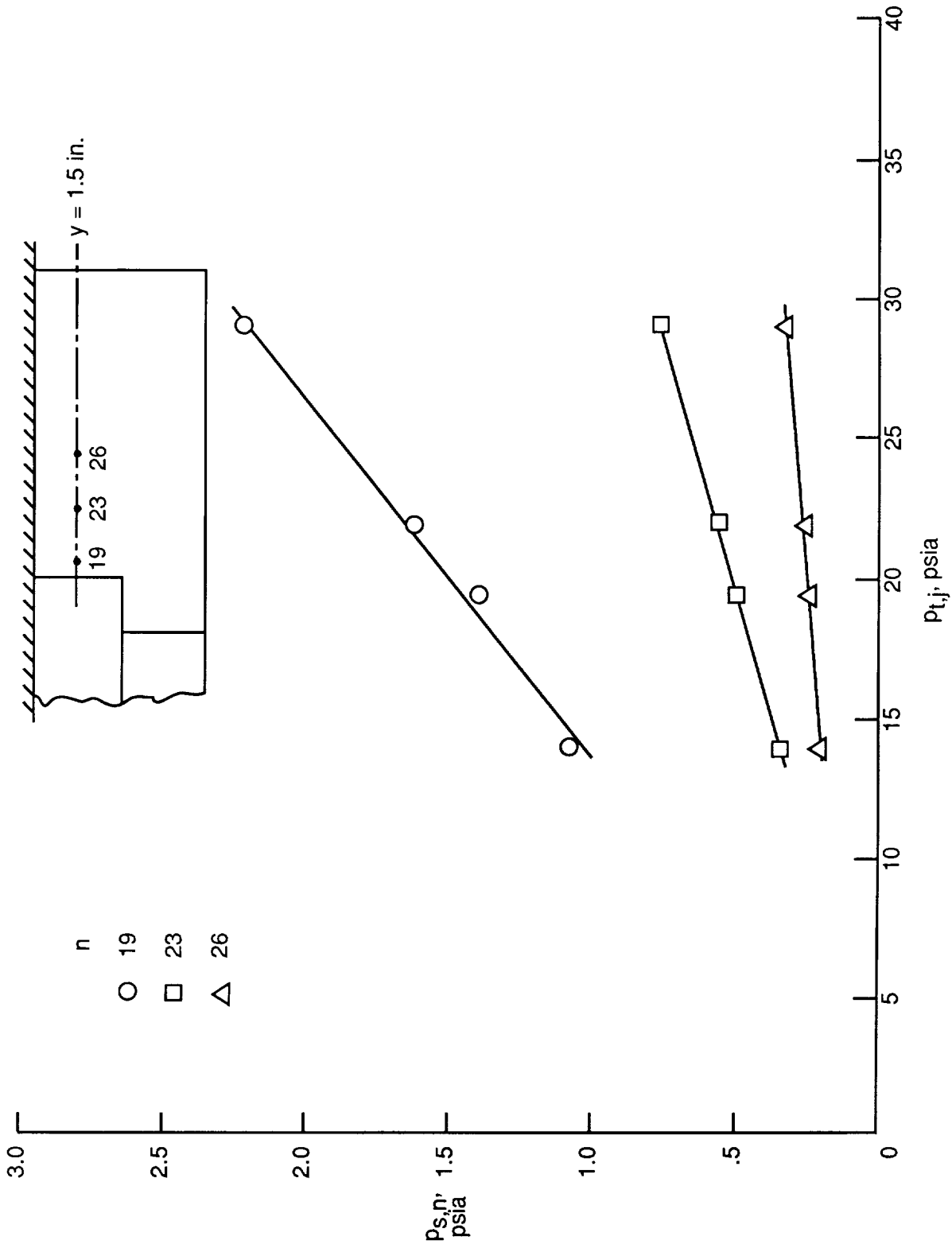

Figure 11. Proportionality of orifice pressure to jet total pressure.  $\beta = 20^\circ$ ;  $\epsilon = 12^\circ$ .

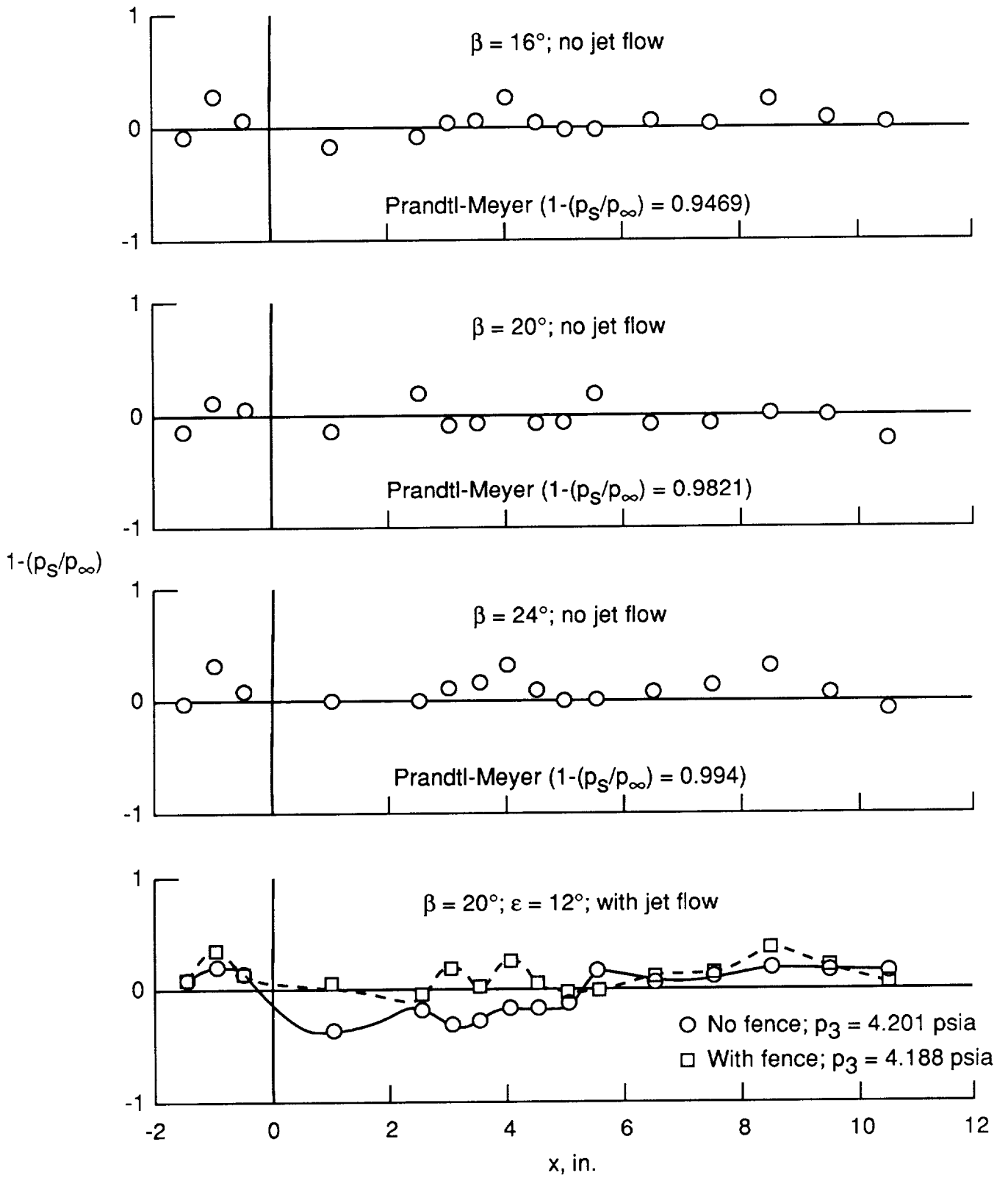

Figure 12. External surface pressures at  $y = 3.75$  in. with and without jet flow and with and without fence.

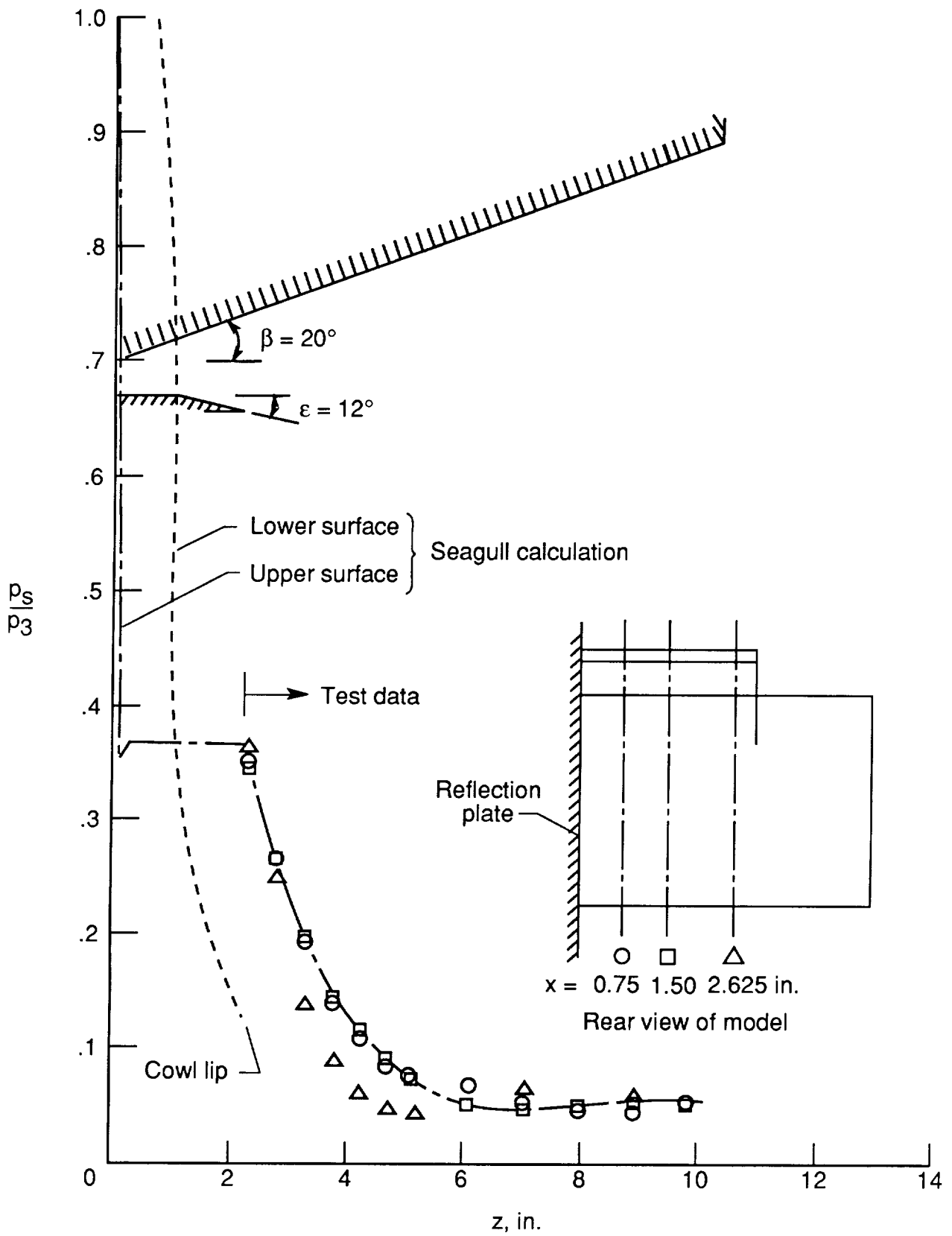
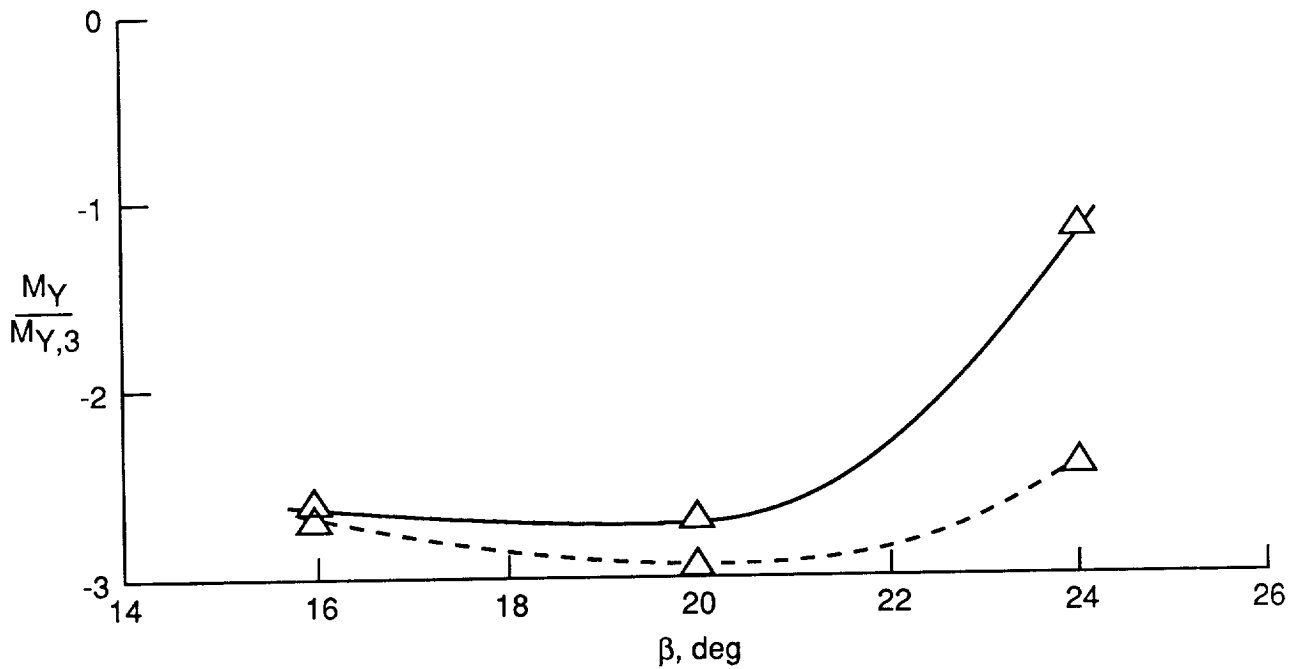
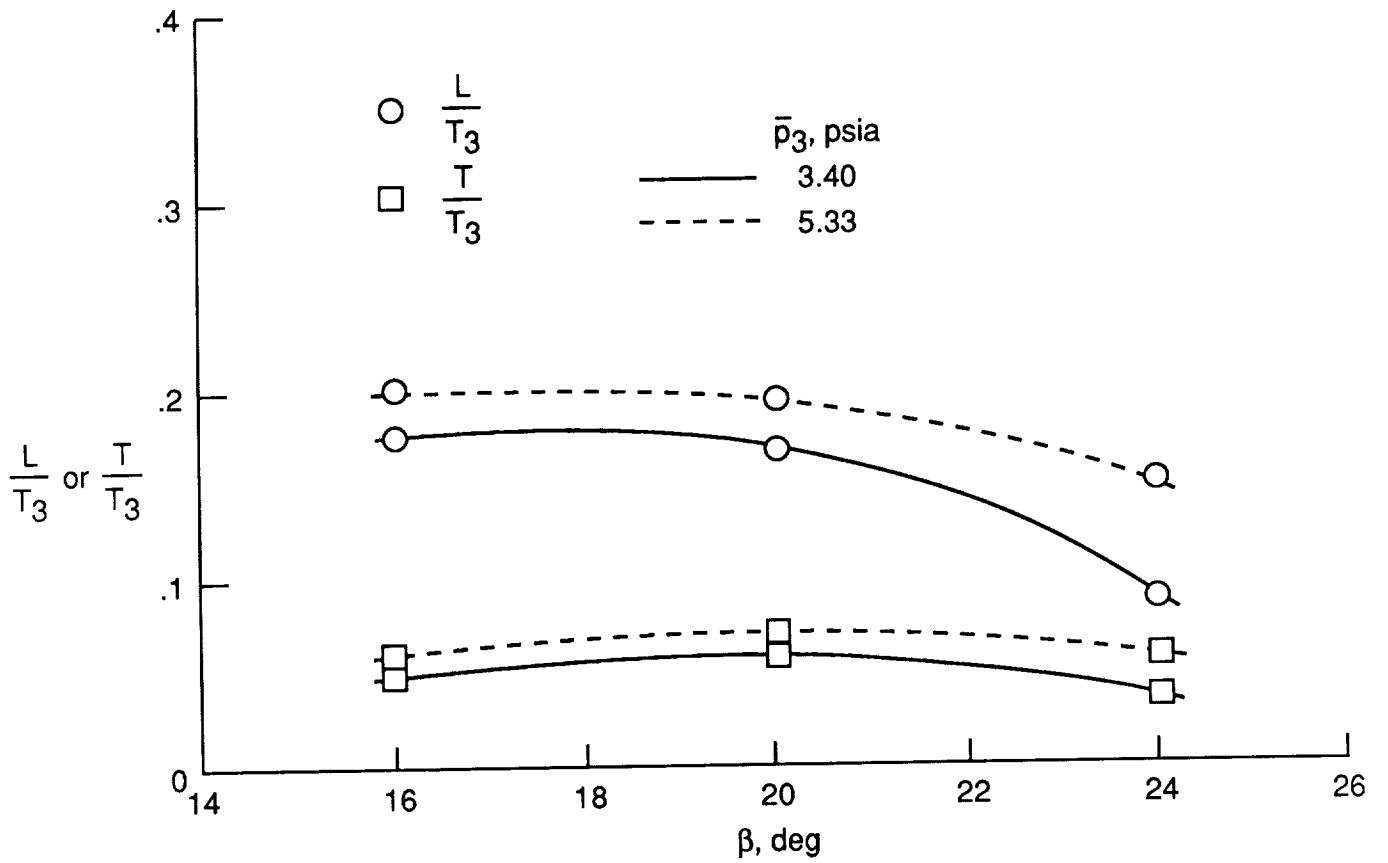

Figure 13. Pressure distributions from Seagull for complete nozzle and measured data for external surface of configuration V.  $p_3 = 4.731$  psia;  $p_4/p_\infty = 2.655$ .



(a)  $\epsilon = 6^\circ$ .

Figure 14. Effect of  $\beta$  on external nozzle forces and moments.  $\ell/h = 18.33$ .



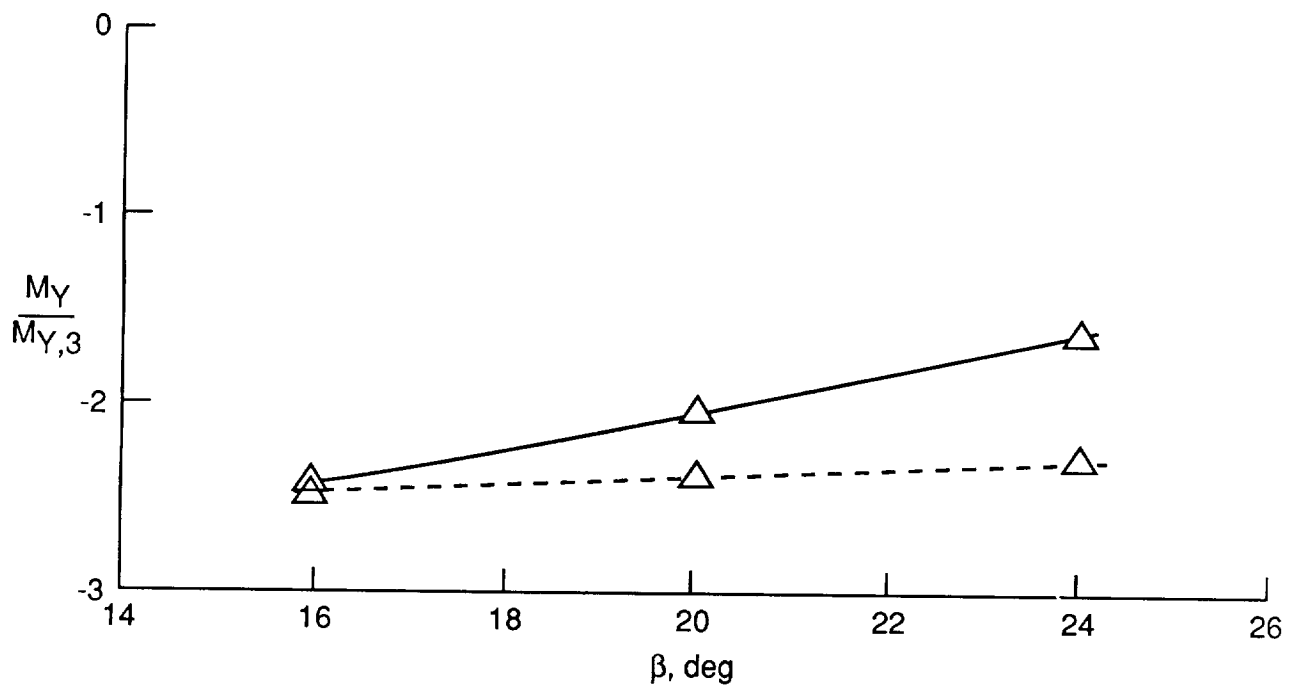
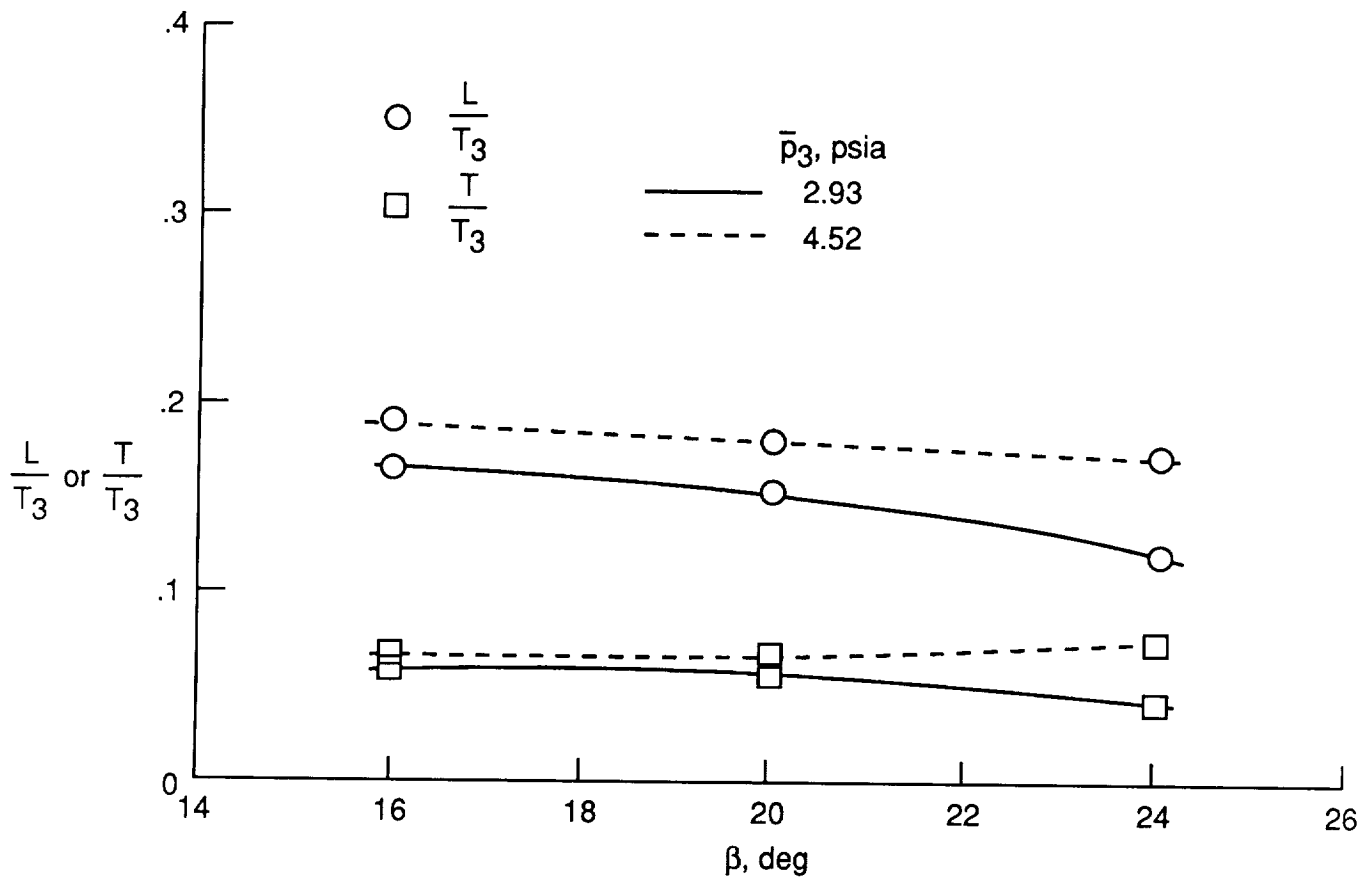

(b)  $\epsilon = 12^\circ$ .

Figure 14. Concluded.

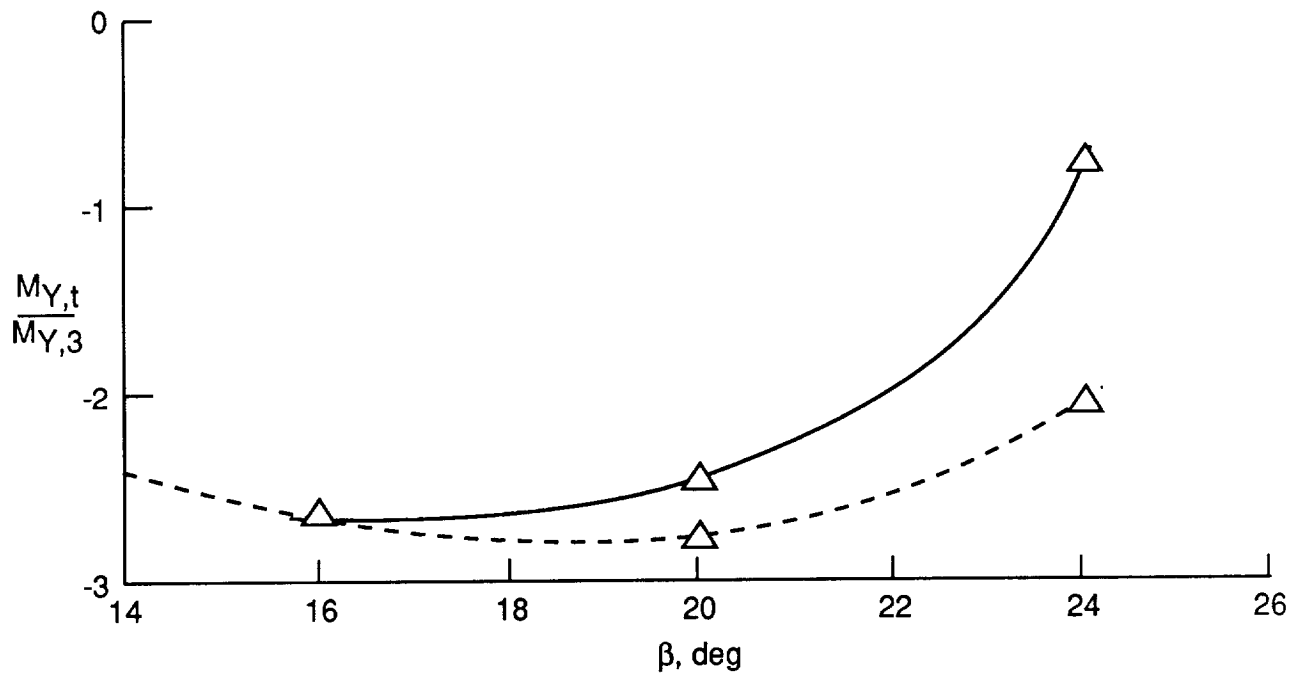
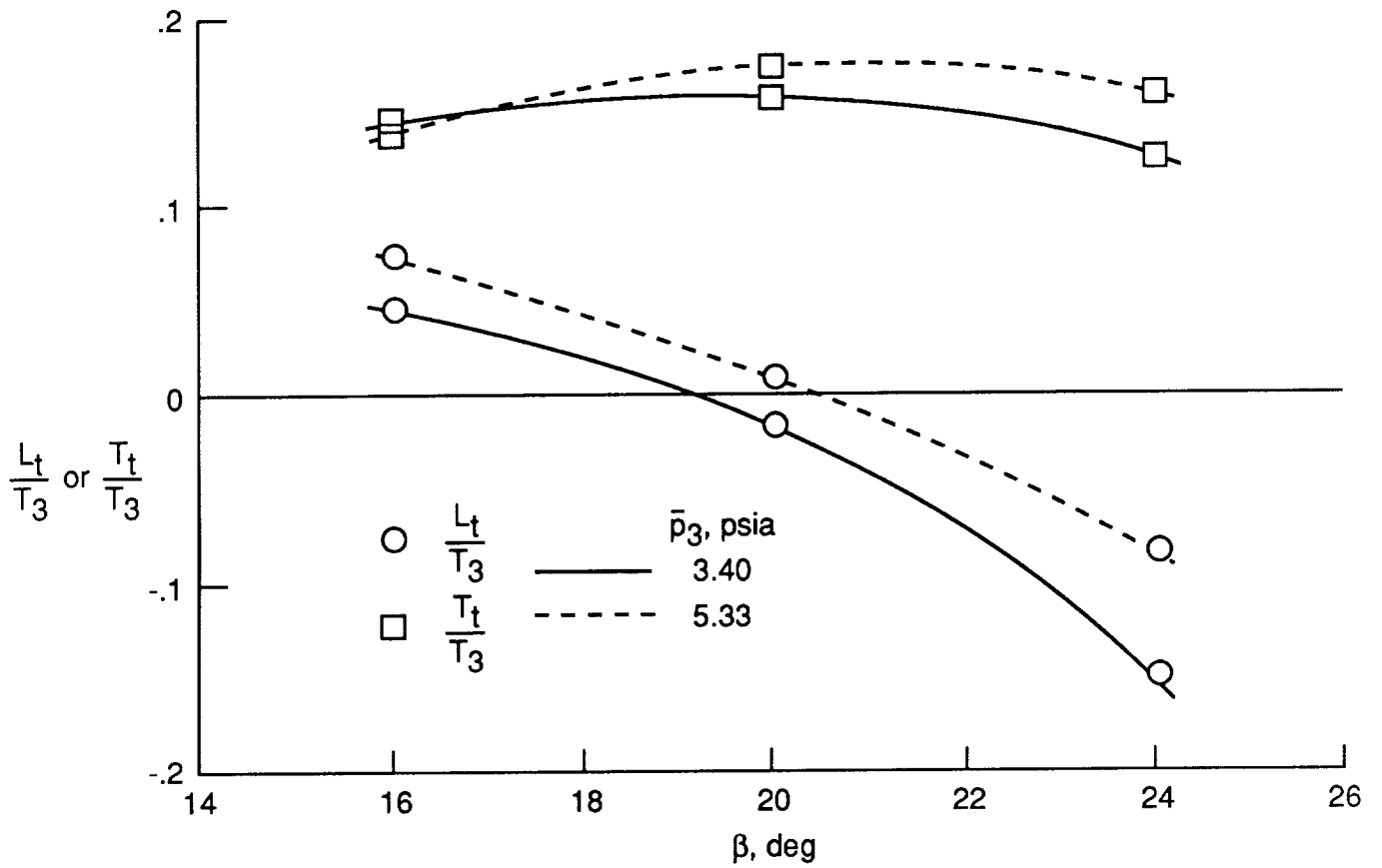

(a)  $\epsilon = 6^\circ$ .

Figure 15. Effect of  $\beta$  on total nozzle forces and moments.  $l/h = 18.33$ .

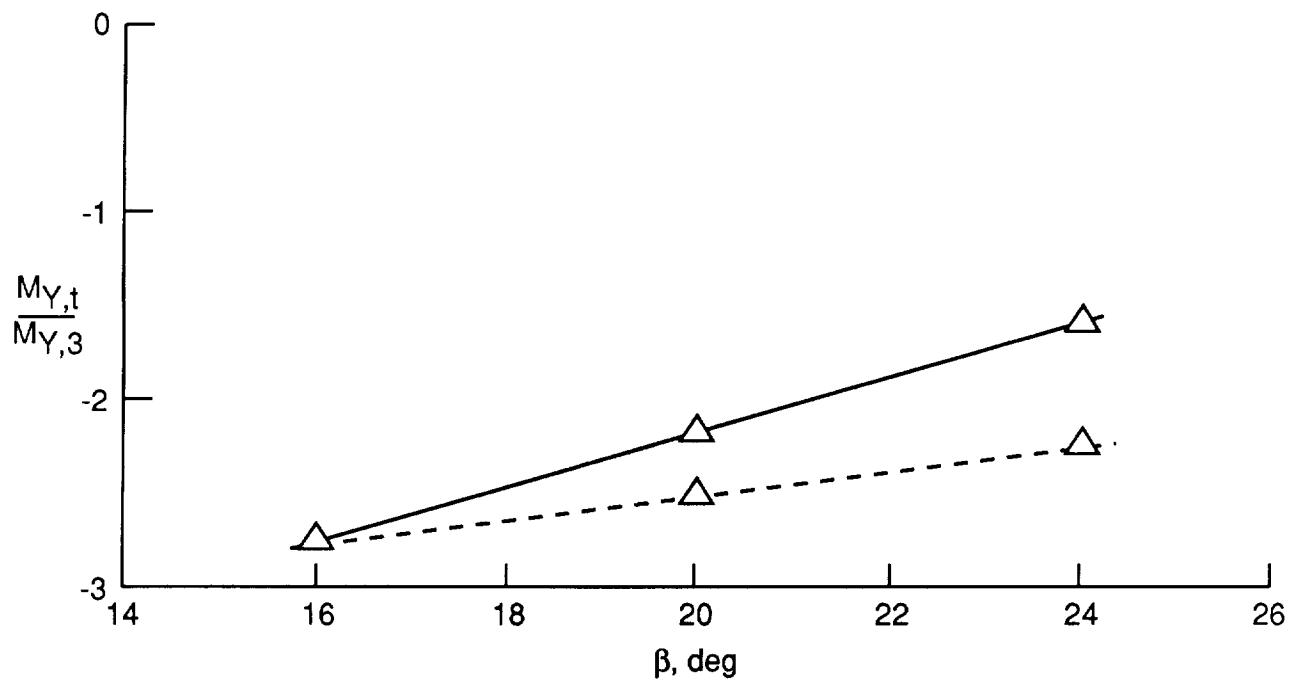
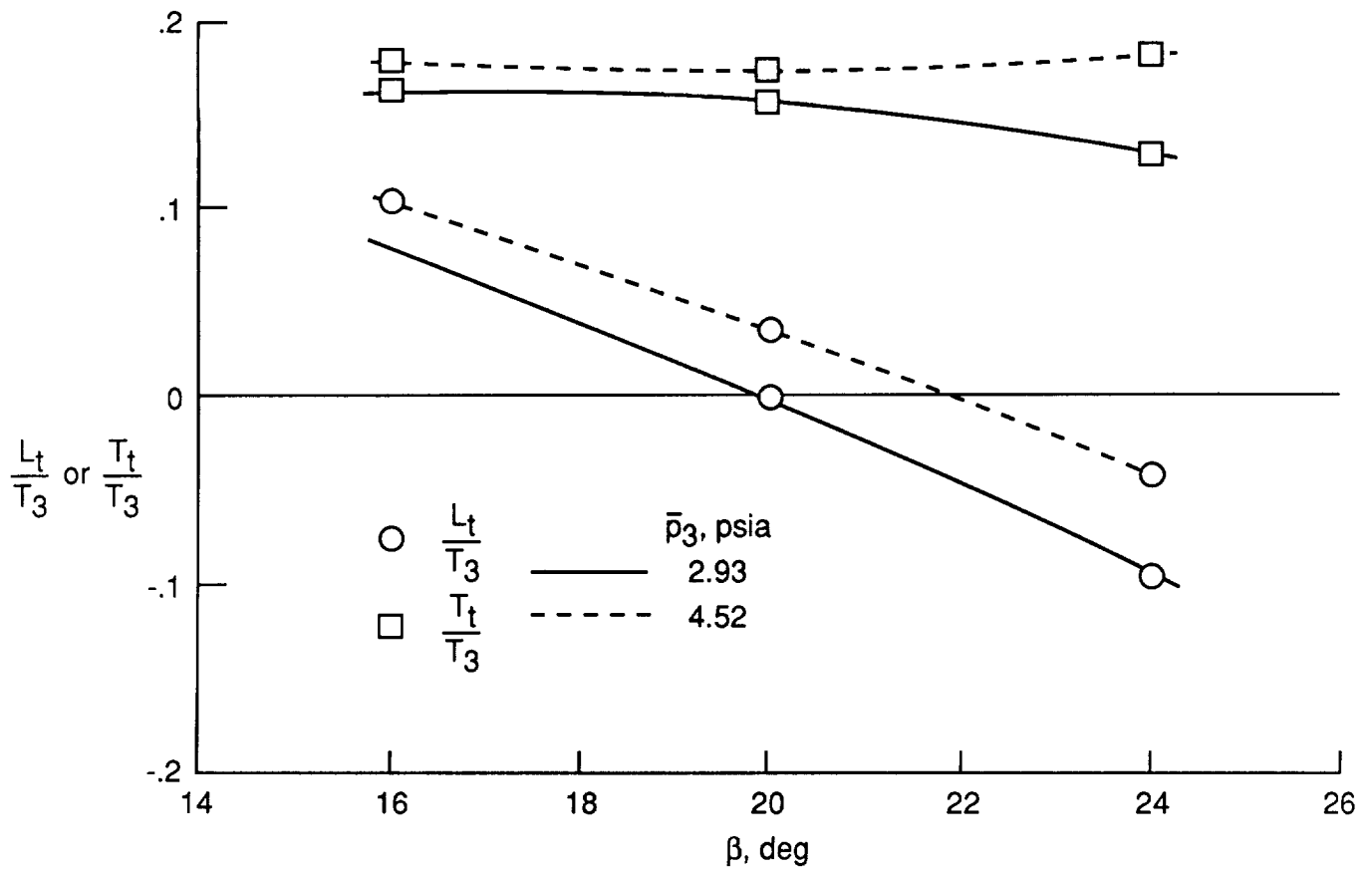

(b)  $\epsilon = 12^\circ$ .

Figure 15. Concluded.

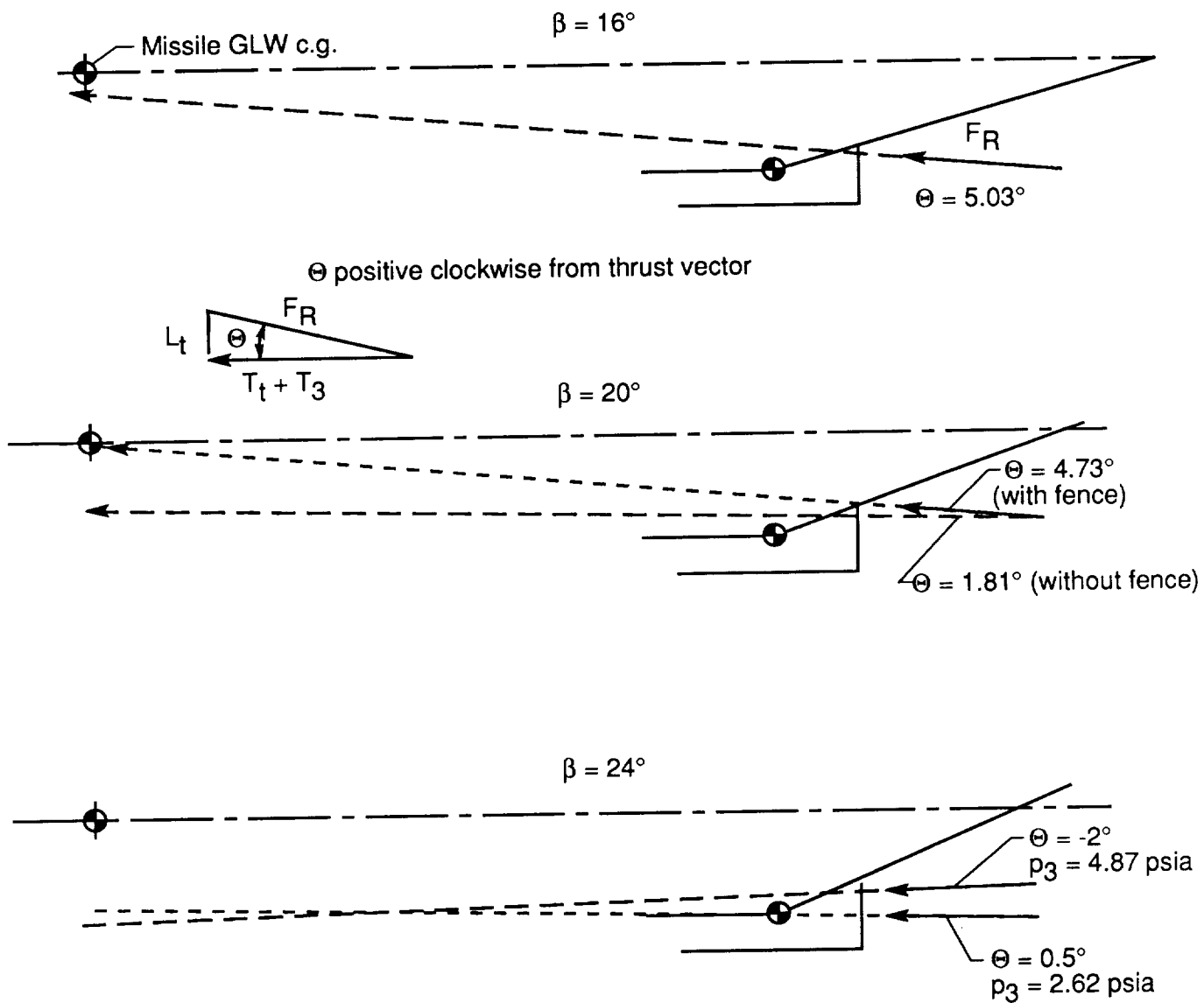
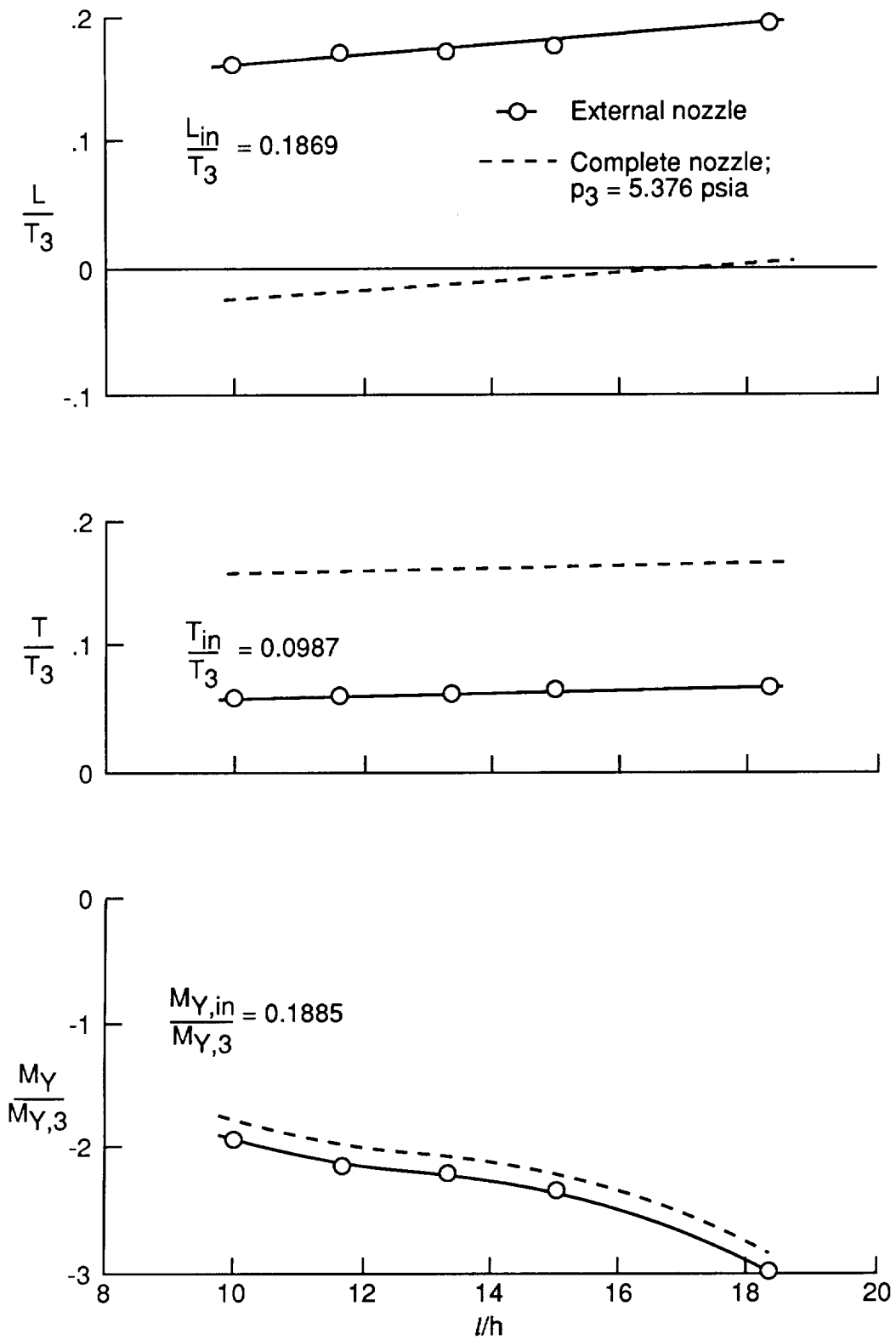
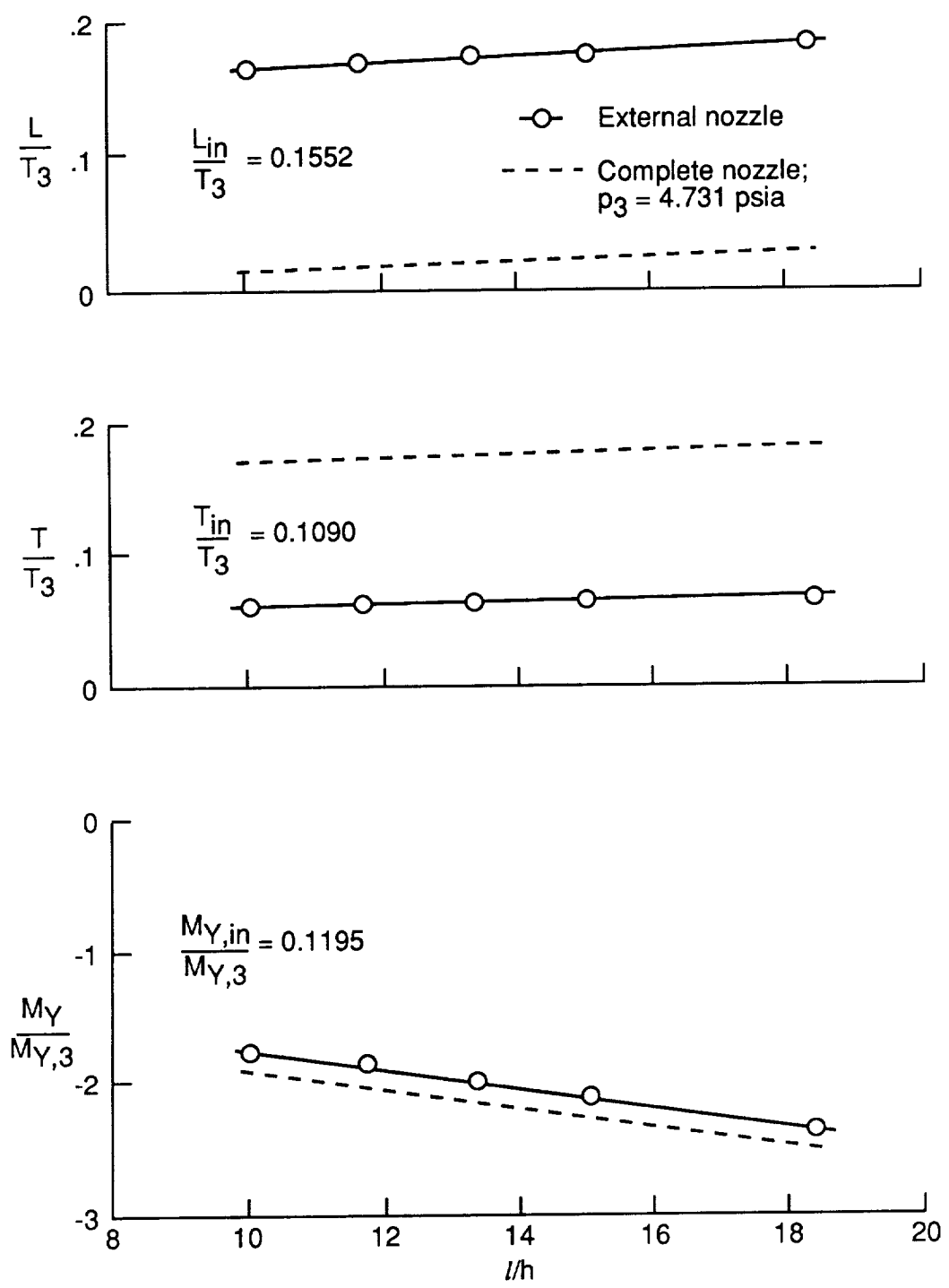

Figure 16. Orientation of gross thrust resultant vector with respect to center of gravity of scramjet-powered missile concept.  $\epsilon = 12^\circ$ .



(a)  $\epsilon = 6^\circ$ .

Figure 17. Effect of external nozzle length on nozzle forces and moments.  $\beta = 20^\circ$ .



(b)  $\epsilon = 12^\circ$ .

Figure 17. Concluded.

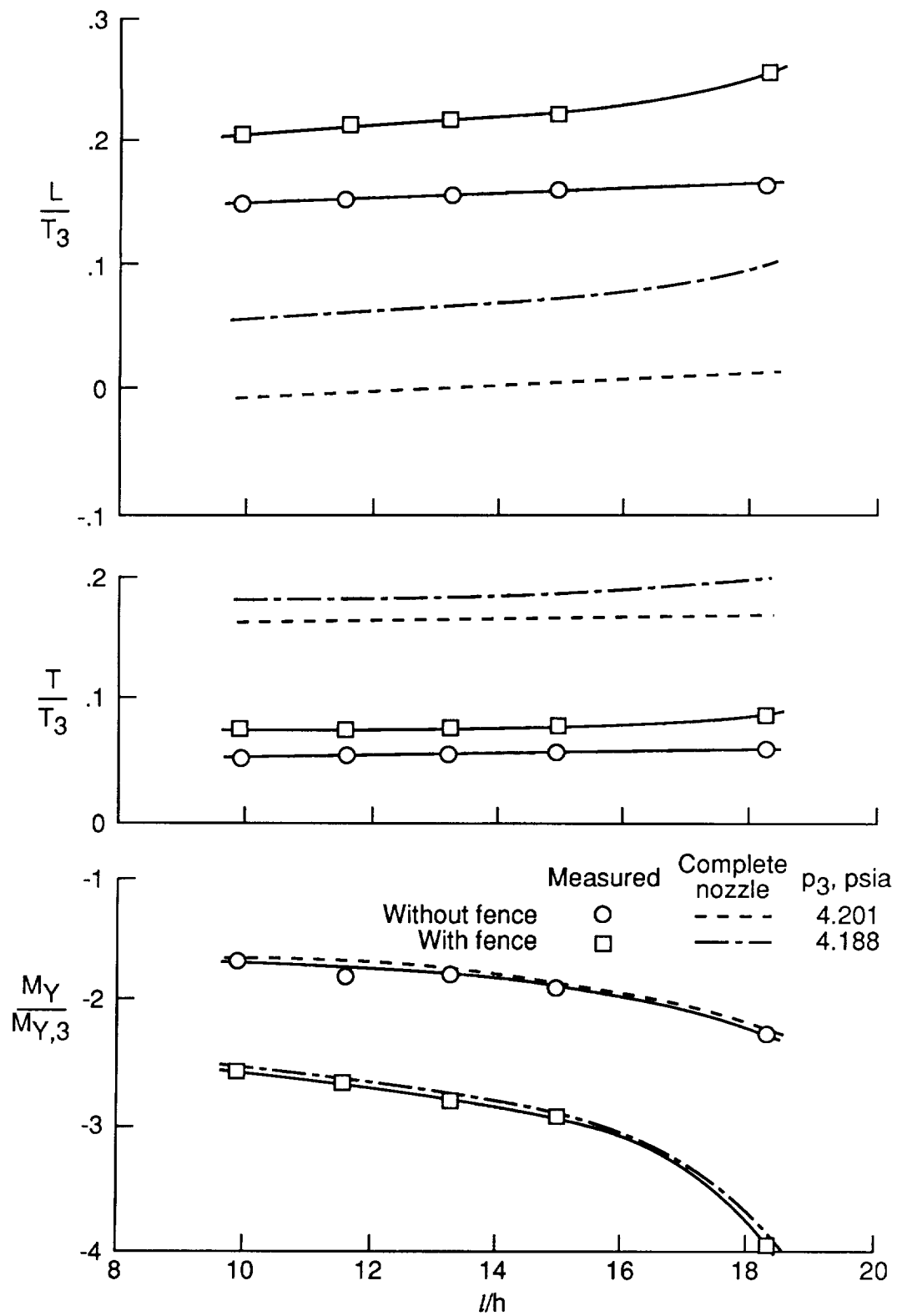

Figure 18. Effect of flow fence on nozzle forces and moments.  $\beta = 20^\circ$ ;  $\epsilon = 12^\circ$ .

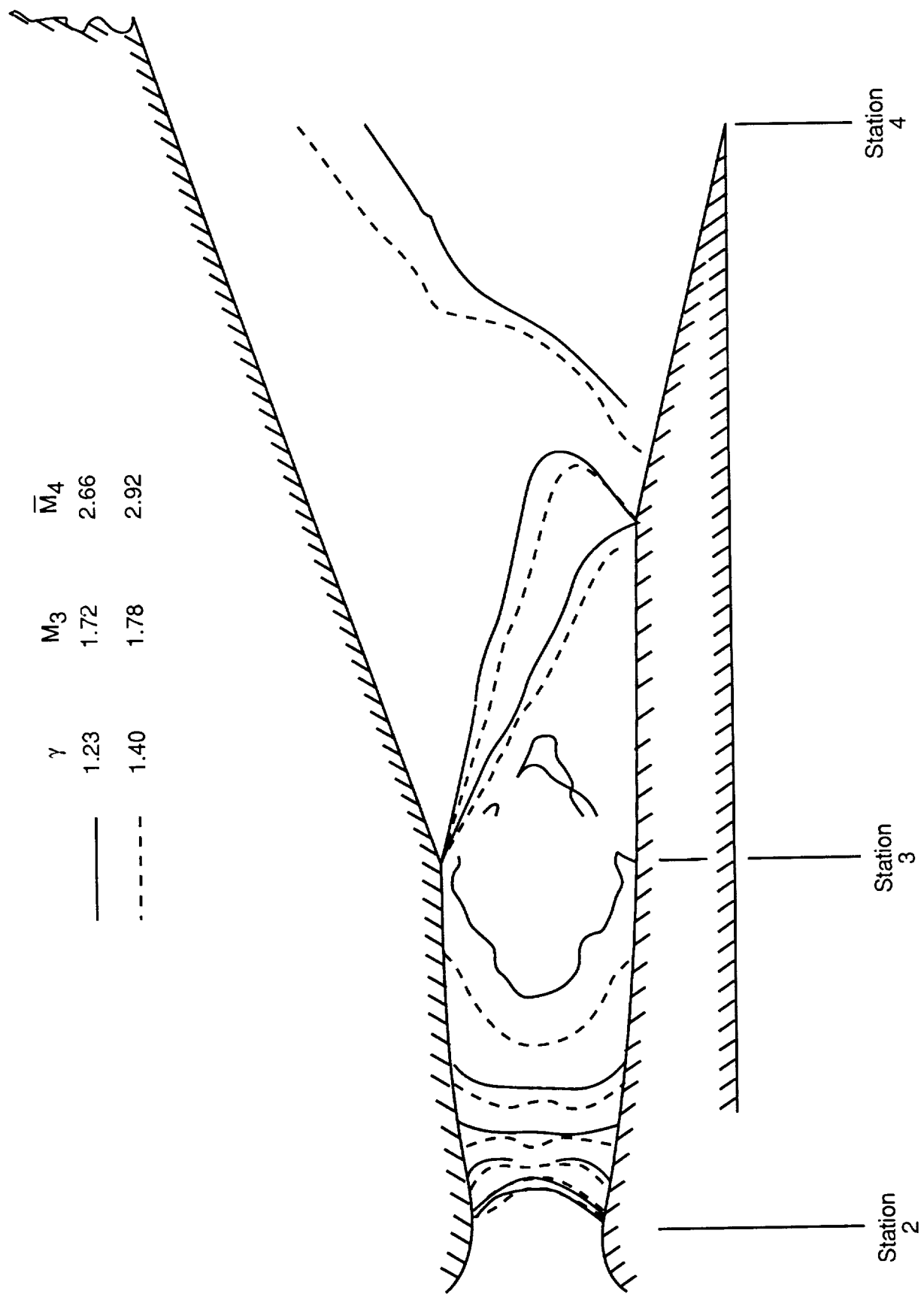
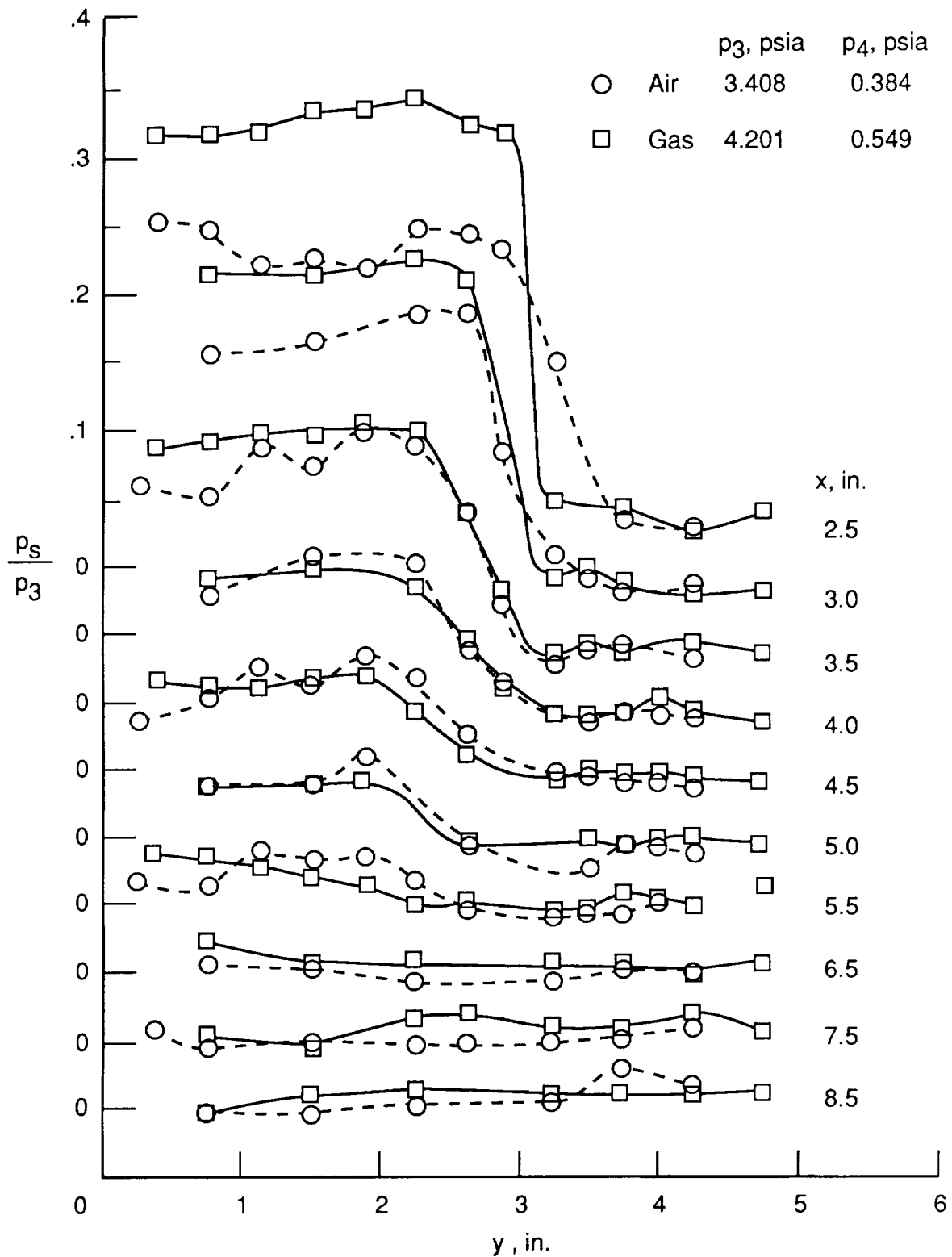

Figure 19. Contours of  $p/p_2$  for 40/60 F12/Ar and air exhaust flows.





(a) Similar  $p_3$  values.

Figure 20. Air and gas pressure distributions on external nozzle surface for configurations V and V-D.  $\beta = 20^\circ$ ;  $\epsilon = 12^\circ$ ; without fence.

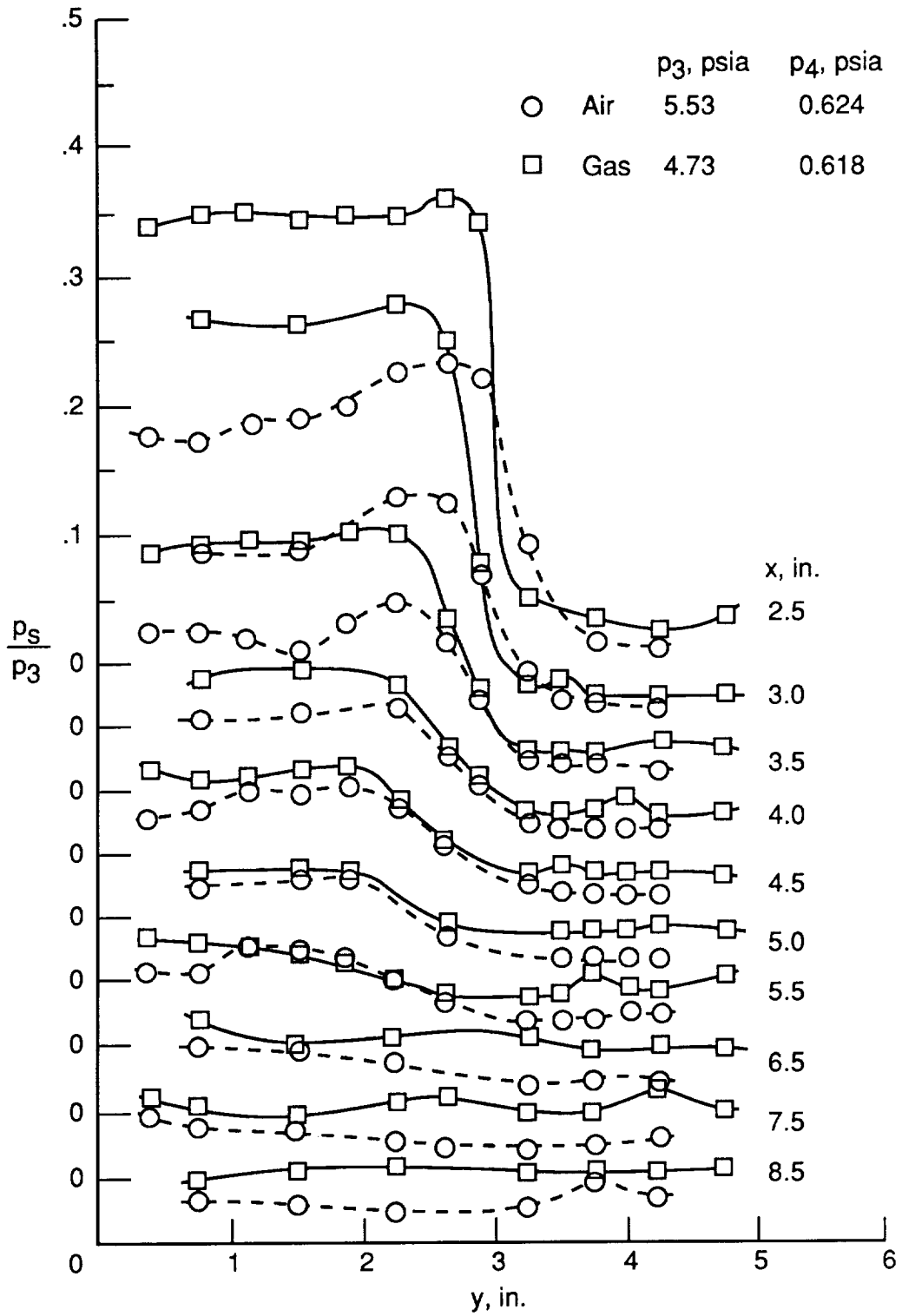

(b) Similar  $p_4$  values.  
 Figure 20. Concluded.

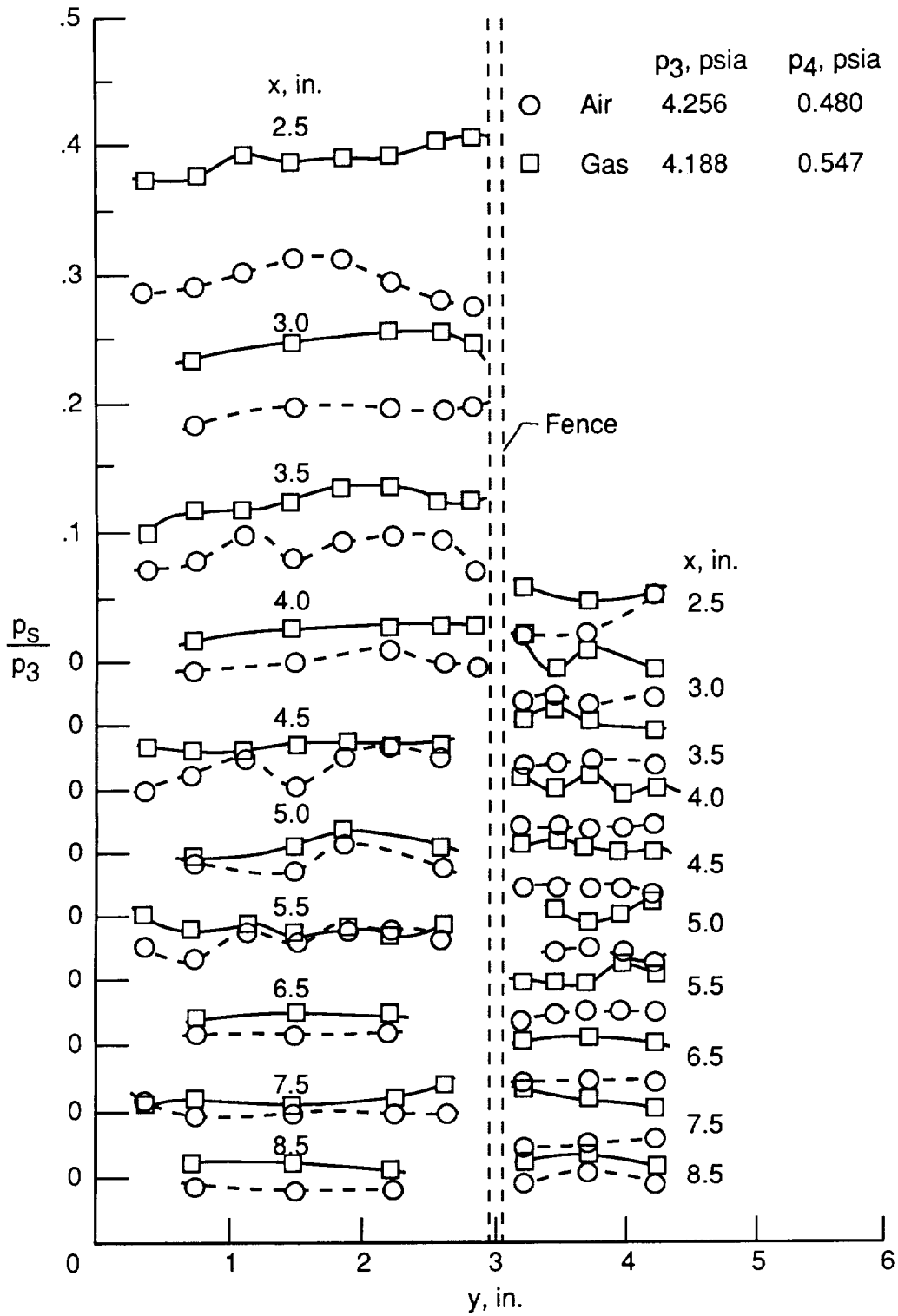

(a) Similar  $p_3$  values.

Figure 21. Air and gas pressure distributions on nozzle surface for configurations V-A and V-E.  $\beta = 20^\circ$ ;  $\epsilon = 12^\circ$ ; with fence.

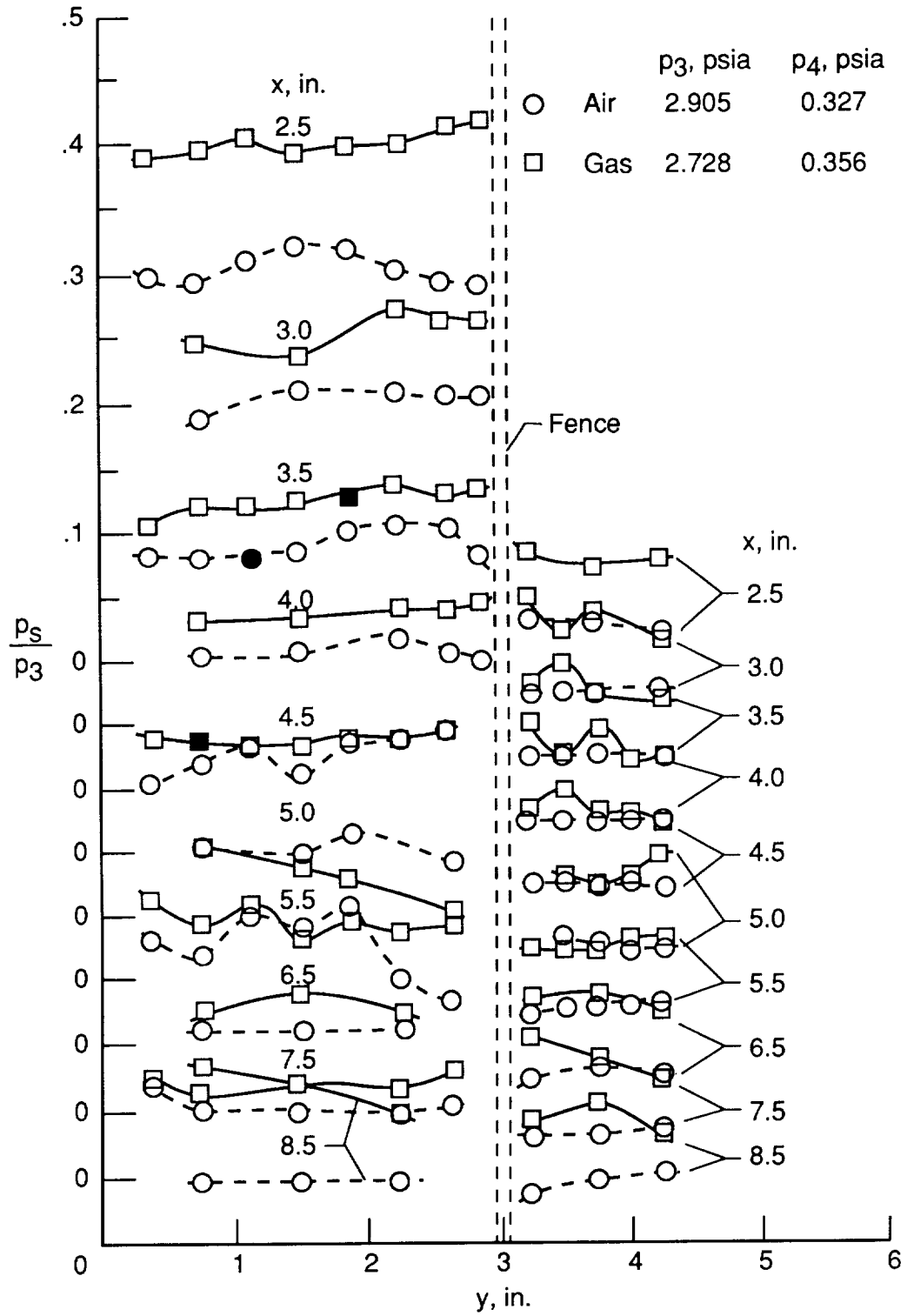

(b) Similar  $p_4$  values.  
Figure 21. Concluded.

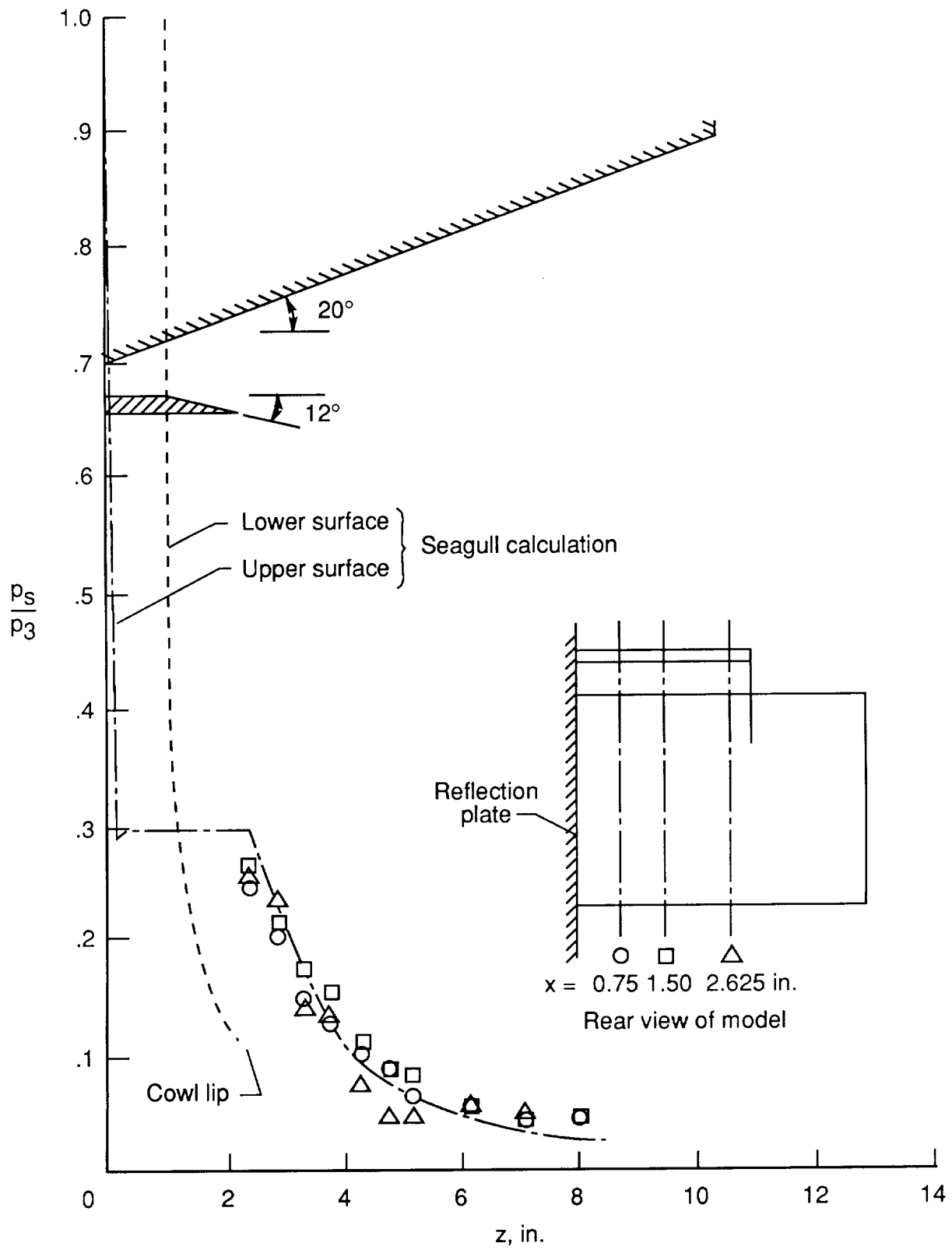
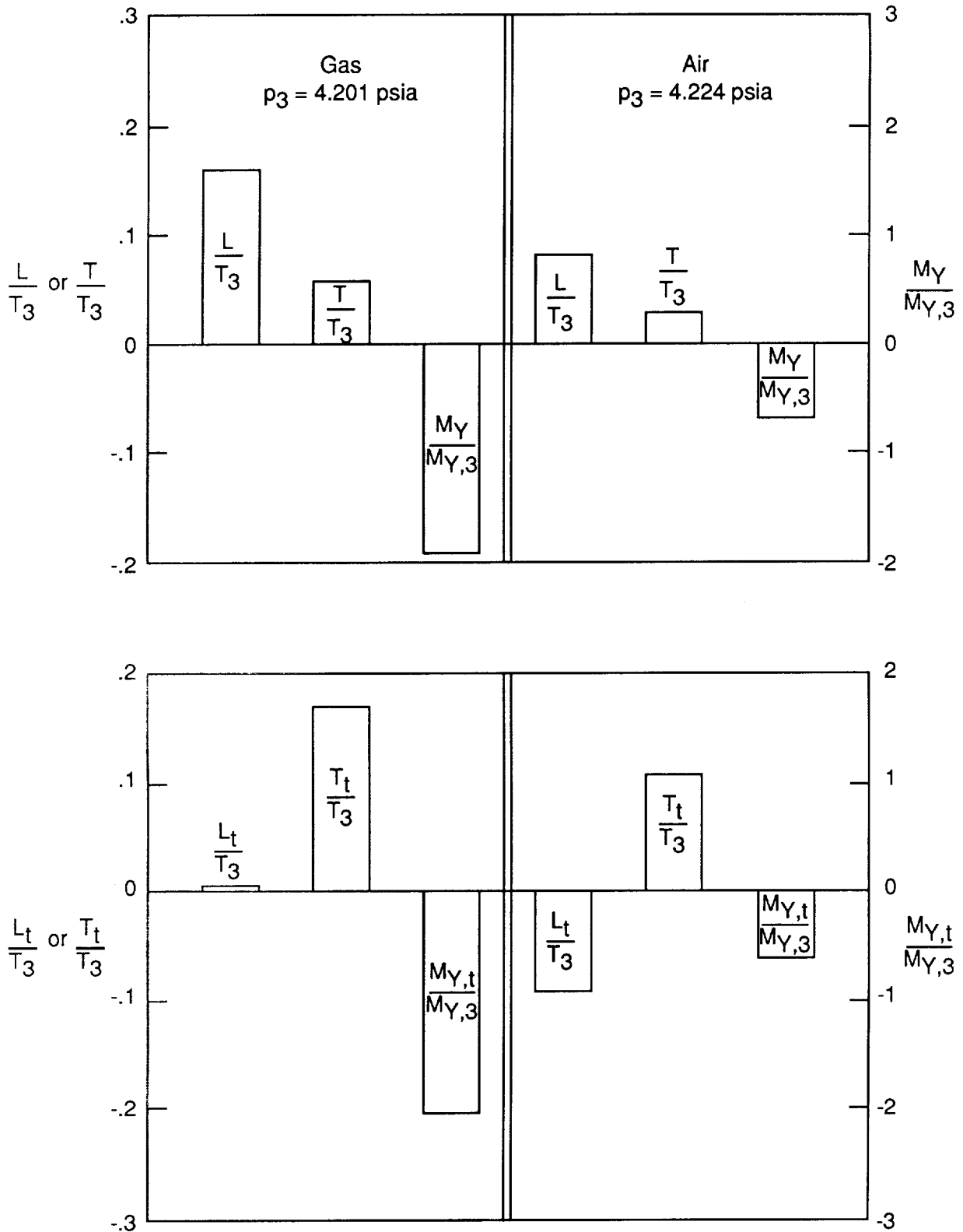
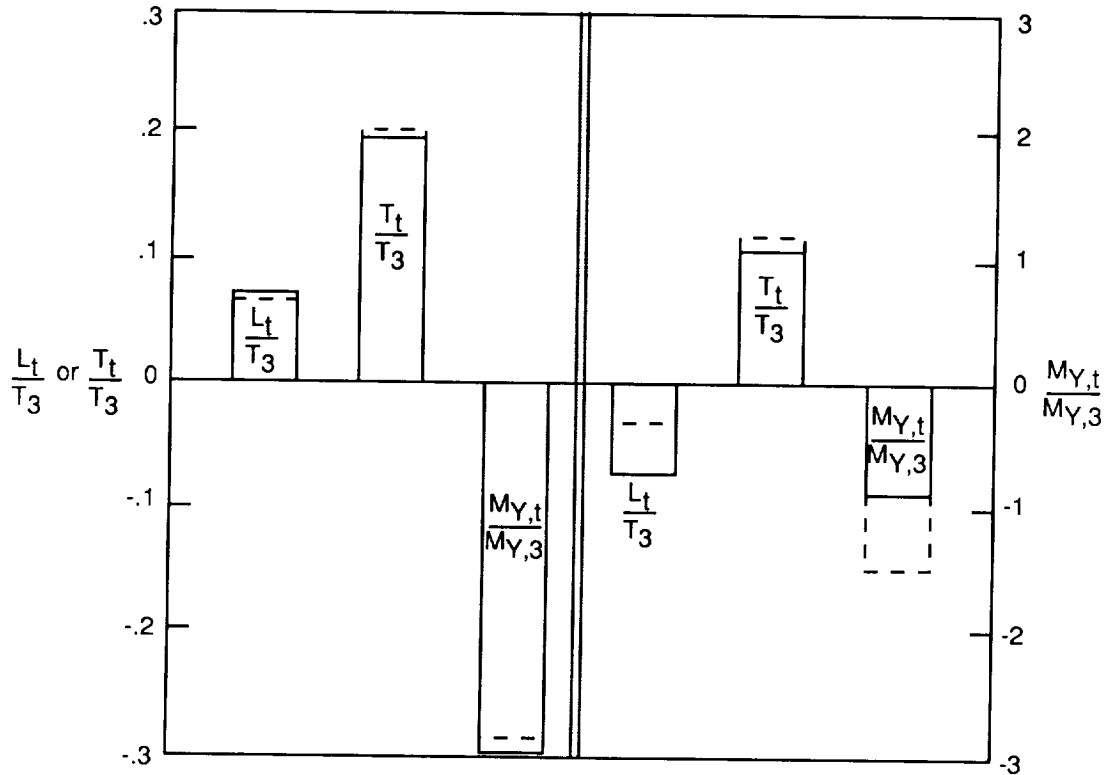
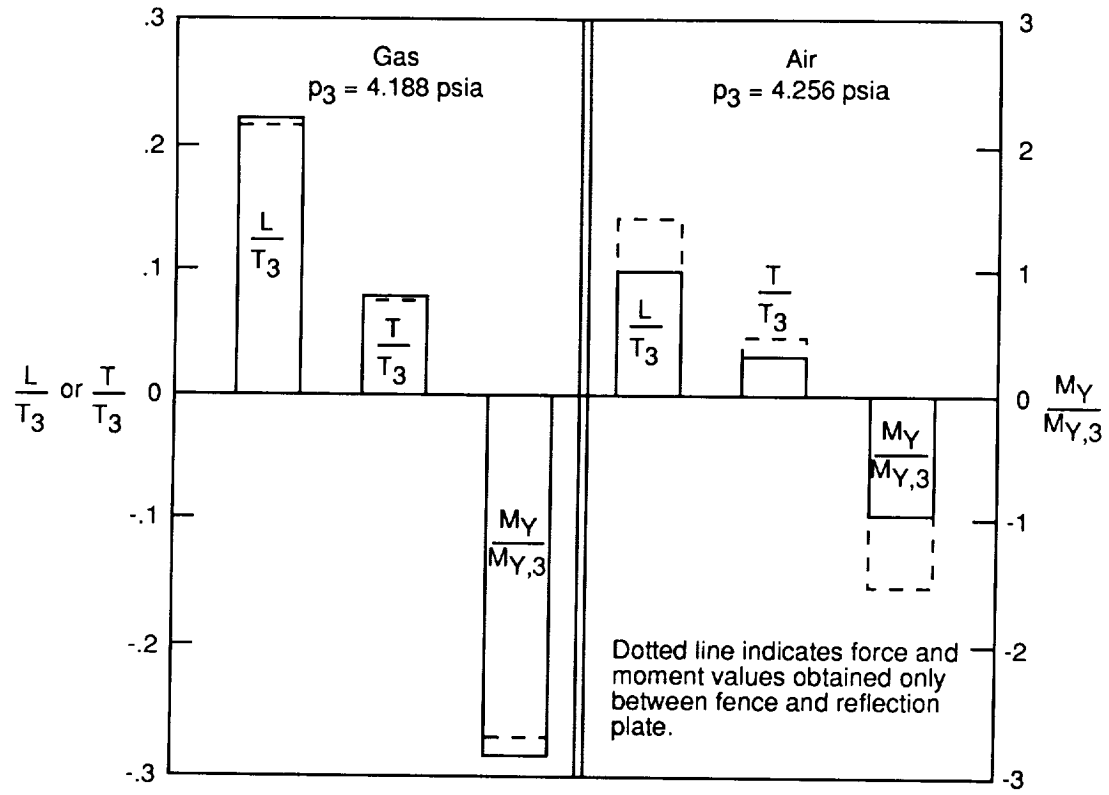

Figure 22. Pressure distributions from Seagull for complete nozzle and measured data for nozzle external surface with air used to simulate engine exhaust flow.  $p_3 = 3.408$ ;  $p_4/p_\infty = 1.702$ .



(a) Configurations V and V-D (without fence).

Figure 23. Exhaust forces and moments from air and Freon-argon tests for configurations V, V-D, V-A, and V-E.



(b) Configurations V-A and V-E (with fence).

Figure 23. Concluded.

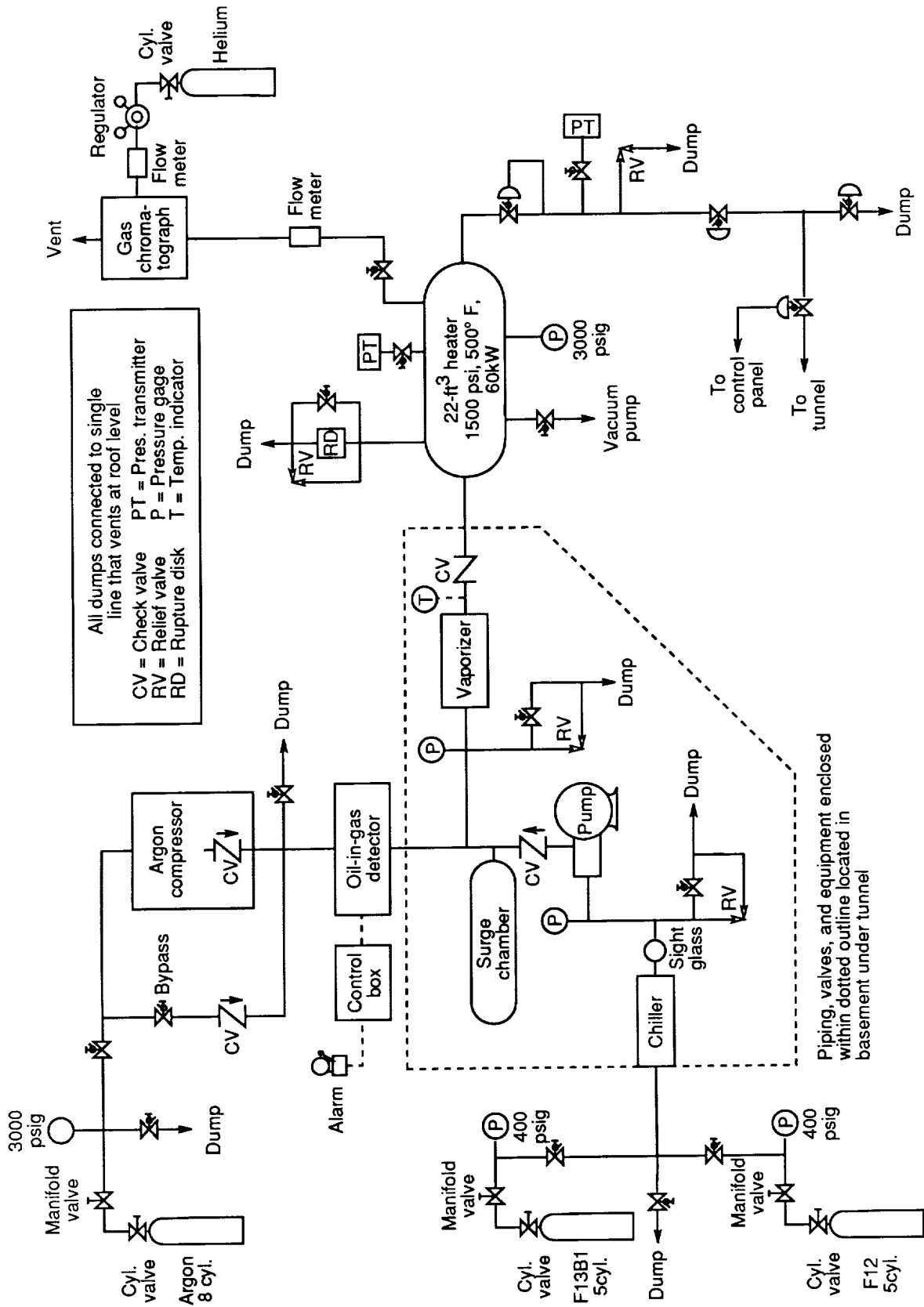
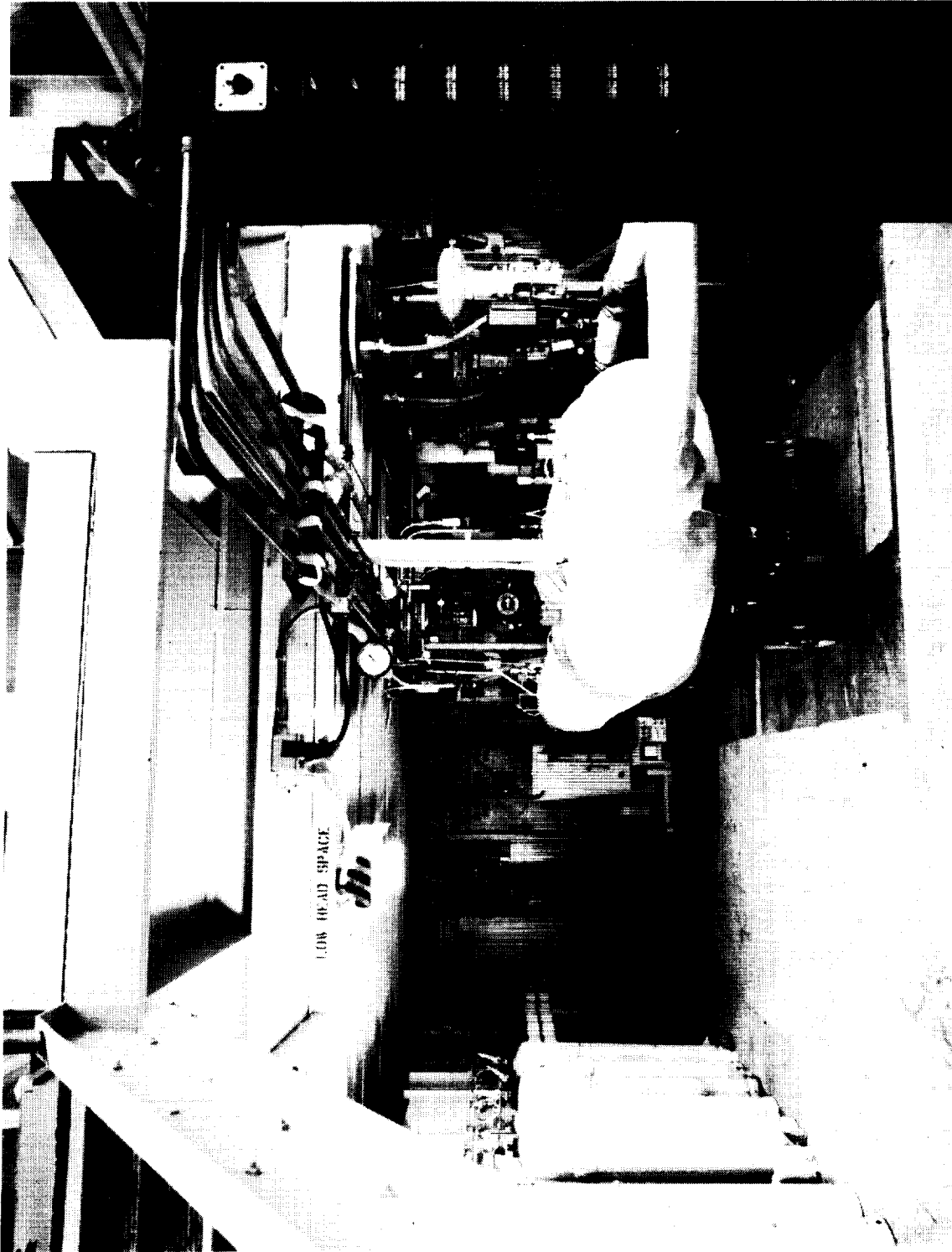

Figure 24. Diagram of simulant-gas system.



ORIGINAL PAGE  
BLACK AND WHITE PHOTOGRAPH



L-77-572

Figure 25. Simulant-gas system heated pressure vessel and related equipment.







# Report Documentation Page

1. Report No. NASA TP-3048	2. Government Accession No.	3. Recipient's Catalog No.	
4. Title and Subtitle Parametric Experimental Investigation of a Scramjet Nozzle at Mach 6 With Freon and Argon or Air Used for Exhaust Simulation		5. Report Date February 1991	6. Performing Organization Code
		8. Performing Organization Report No. L-16707	10. Work Unit No. 763-01-31-24
7. Author(s) James M. Cabbage and William J. Monta		11. Contract or Grant No.	
		13. Type of Report and Period Covered Technical Paper	
9. Performing Organization Name and Address NASA Langley Research Center Hampton, VA 23665-5225		14. Sponsoring Agency Code	
		12. Sponsoring Agency Name and Address National Aeronautics and Space Administration Washington, DC 20546-0001	
15. Supplementary Notes James M. Cabbage: Vigyan Research Associates, Inc., Hampton, Virginia. William J. Monta: Langley Research Center, Hampton, Virginia.			
16. Abstract A parametric experimental investigation of a scramjet nozzle has been conducted with a gas mixture used to simulate the scramjet engine exhaust flow at a free-stream Reynolds number of approximately $6.5 \times 10^6$ per foot. External nozzle surface angles of $16^\circ$ , $20^\circ$ , and $24^\circ$ were tested with a fixed-length ramp and for cowl internal surface angles of $6^\circ$ and $12^\circ$ . Pressure data on the external nozzle surface were obtained for mixtures of Freon and argon gases with a ratio of specific heats of about 1.23, which matches that of a scramjet exhaust. Forces and moments were determined by integration of the pressure data. Two nozzle configurations were also tested with air used to simulate the exhaust flow. On the external nozzle surface, lift and thrust forces for air exhaust simulation were approximately half of those for Freon-argon exhaust simulation and the pitching moment was approximately a third. These differences were primarily due to the difference in the ratios of specific heats between the two exhaust simulation gases. A $20^\circ$ external surface angle produced the greatest thrust for a $6^\circ$ cowl internal surface angle. A flow fence significantly increased lift and thrust forces over those for the nozzle without a flow fence.			
17. Key Words (Suggested by Authors(s)) Hypersonic speed Supersonic combustion ramjet engines Scramjet engine Nozzle exhaust flow		18. Distribution Statement Unclassified—Unlimited  Subject Category 02	
19. Security Classif. (of this report) Unclassified	20. Security Classif. (of this page) Unclassified	21. No. of Pages 104	22. Price A05