

NASA Technical Memorandum TM 103815

(NASA-TM-103815) DEBRIS/ICE/TPS ASSESSMENT
AND PHOTOGRAPHIC ANALYSIS FOR SHUTTLE
MISSION STS-38 (NASA) 180 p CSCI 22B

N91-17113

Unclas

G3/16 0332648

Debris/Ice/TPS Assessment And Photographic Analysis For Shuttle Mission STS-38

February 1991

NASA

National Aeronautics and
Space Administration

ORIGINAL CONTENTS
COLOR ILLUSTRATIONS

Debris/Ice/TPS Assessment And Photographic Analysis For Shuttle Mission STS-38

Gregory N. Katnik
NASA/Kennedy Space Center

Scott A. Higginbotham
NASA/Kennedy Space Center

J. Bradley Davis
NASA/Kennedy Space Center

February 1991

National Aeronautics and
Space Administration

John F. Kennedy Space Center



DEBRIS/ICE/TPS ASSESSMENT
AND
PHOTOGRAPHIC ANALYSIS
OF
SHUTTLE MISSION STS-38

November 15, 1990

Prepared By:

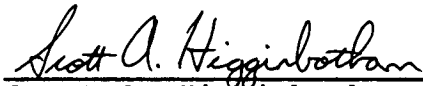

Scott A. Higginbotham
NASA/Kennedy Space Center
TV-MSD-22

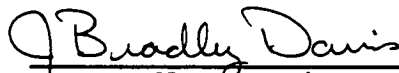

J. Bradley Davis
NASA/Kennedy Space Center
TV-MSD-22

Approved:



Gregory N. Katnik
Lead, Ice/Debris/Photo Analysis
NASA/Kennedy Space Center
TV-MSD-22



Pedro J. Rosado
Chief, ET Mechanical Sys.
NASA/Kennedy Space Center
TV-MSD-22

TABLE OF CONTENTS

1.0	Summary	2
2.0	KSC Ice/Frost/Debris Team Activities . .	5
3.0	Hydrogen Leak	10
3.1	Tanking Test #1	10
3.2	Tanking Test #2	12
3.3	Tanking Test #3	15
3.4	Tanking Test #4	20
4.0	Pre-Test Briefing	23
4.1	Pre-Launch SSV/Pad Debris Inspection . .	24
5.0	Launch	29
5.1	Ice/Frost Inspection	29
5.2	Orbiter	29
5.3	Solid Rocket Boosters	29
5.4	External Tank	32
5.5	Facility	36
6.0	Post Launch Pad Debris Inspection . . .	47
7.0	Film Review Summary/Problem Reports. . .	54
7.1	Launch Film and Video Data Review . . .	63
7.2	On-Orbit Film Data Review.	93
7.3	Landing Film and Data Review	94
8.0	SRB Post Flight/Retrieval Assessment . .	98
8.1	RH SRB Debris Inspection	98
8.2	LH SRB Debris Inspection	102
8.3	Recovered SRB Disassembly Findings . . .	106
9.0	Orbiter Post Landing Debris Assessment .	122
10.0	Debris Sample Lab Reports	148
11.0	Post Launch Anomalies	151
11.1	Post Launch Pad Inspection	151
11.2	Film Review	151
11.3	SRB Retrieval Inspection	151
11.4	Orbiter Post Landing	151
	Appendix A: Microchemical Analysis Report . .	152

FOREWORD

The Debris Team is continuing its effort to develop and implement measures to control damage from debris in the Shuttle operational environment and to make the control measures a part of routine processing and operations.

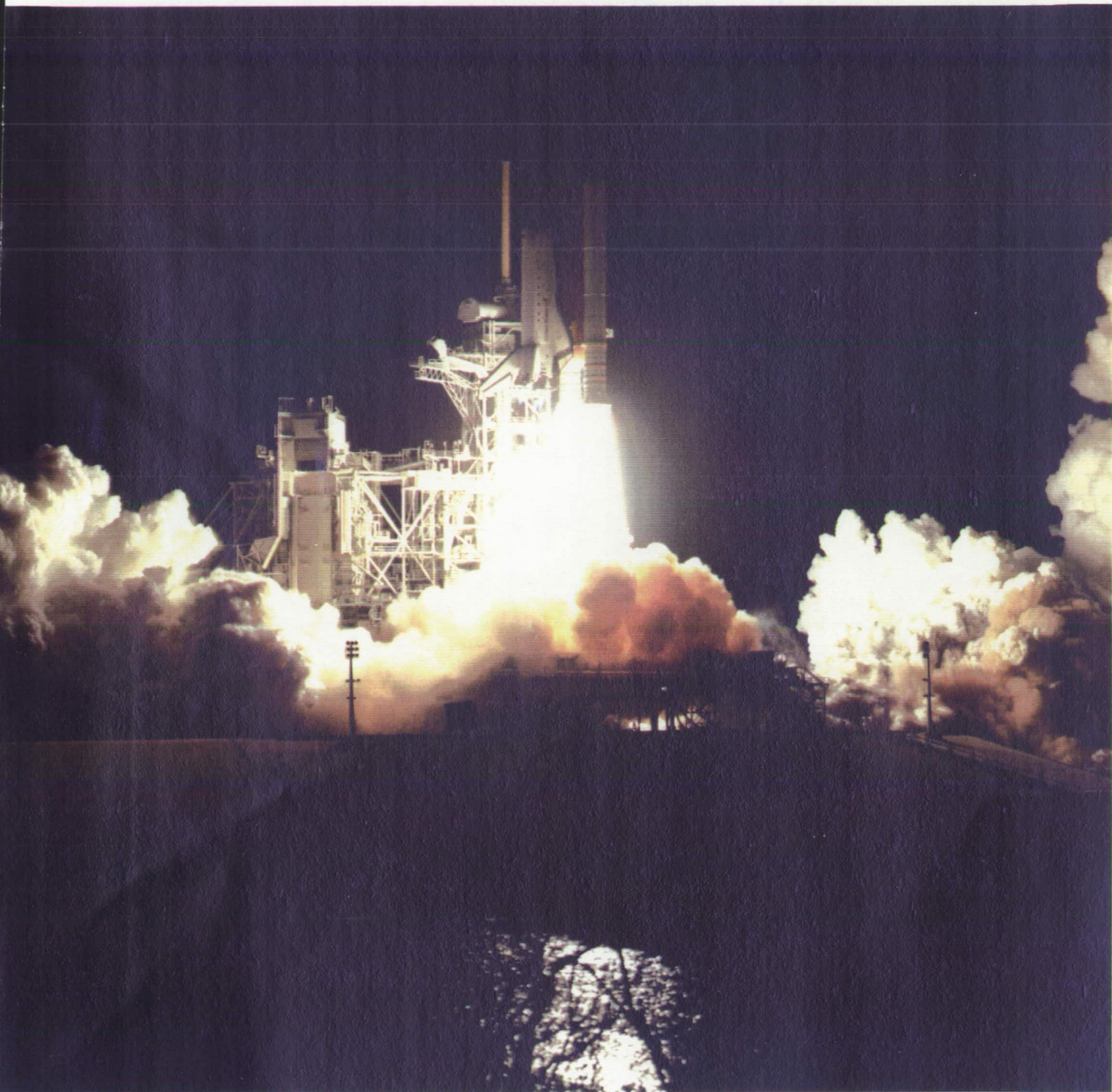

Shuttle mission STS-38 was launched at 6:48 p.m. EST 11/15/90

1.0 Summary

After a hydrogen leak had been detected in the aft compartment of OV-102 on STS-35, a tanking test was performed on STS-38 on 29 June 1990 to ensure a generic hydrogen leak would not occur on OV-104. However, external leak detectors registered concentrations of hydrogen greater than 4 percent around the ET/ORB LH2 umbilical during the tanking test. Tanking tests with additional sensors/instrumentation on 13 July and 25 July 1990 traced the hydrogen leak to the LH2 feedline flange area. On-pad repairs were not successful and the SSV stack was rolled back to the VAB on 7 August 1990. ET-37 was demated and replaced with ET-40, which included the new 6000 series LH2 ET/ORB umbilical. After rollout to pad 39A, a fourth tanking test was performed on 24 October 1990. This test was successful with no significant hydrogen leakage detected.

Debris and Photo Analysis Team activities for Mission STS-38 began with the pre-launch debris inspection of the launch pad and Shuttle vehicle on 14 November, 1990. No major anomalies were observed on OV-104 (Atlantis), BI039, or ET-40. Minor facility discrepancies were corrected prior to cryoloading the vehicle.

The vehicle was cryoloaded for flight on 15 November 1990. No LCC/OMRS violations were detected during the Ice Inspection. There were no Orbiter, ET, or SRB anomalies. No condensate, ice, or frost, was present on the acreage areas of the External Tank. Three Ice/Frost console observation anomalies were documented and found acceptable for launch per the LCC and NSTS-08303. The LH2 umbilical leak sensor detected no significant hydrogen during the cryo load. The ET/ORB hydrogen detection sensor tygon tubing was in proper position prior to removal. The tubing was successfully removed from the attach points on the pressurization line and ET EO-2 fitting. However, local high winds exerted additional pull on the velcro attach point on the ET/SRB upper strut fairing causing a premature release. The tygon tubing fell vertically and contacted the inboard sloped side of the LH SRB aft skirt. There was no impact to the holddown posts or SRB T-0 umbilical. Close examination revealed no damage to the aft skirt acreage. At launch, the ET ice condition was well within the data base for ice formation.

No significant flight hardware or TPS material was found during the post launch debris inspection of Pad 39A. Launch damage to the holddown posts was minimal, though the EPON shim material on all south holddown posts was debonded to some degree. No signs indicative of stud hang-up were visible. No fragments from HDP debris containers were found. The GH2 vent line had latched properly. Overall, the facility sustained minimal damage.

A total of 125 film and video items were analyzed as part of the post launch data review. No major vehicle damage or lost flight hardware was observed that would have affected the success of the mission. However, an IFA was taken against the suspected loss of LH SRB aft skirt thermal curtain material at 34 and 39 seconds MET. SSME ignition caused pieces of ice to fall from the LH2 ET/ORB umbilical. Some of the ice inside the Orbiter mold line contacted the umbilical cavity door sill and was deflected outward away from the Orbiter. No tile damage resulted. At least 40 light-colored particles fell out of the SRB plume just after the roll maneuver and another 24 particles fell out of the SRB plumes approximately 60-83 seconds into flight. Similar particles on previous flights have been attributed to either chunks of SRB propellant/inhibitor or pieces of aft skirt instafoam. Movement of the Orbiter body flap was visible after the roll maneuver and through most of the ascent. The motion appears to have an amplitude and frequency similar to that of previous missions. Orbiter performance, landing gear extension, wheel touchdown, and vehicle rollout after landing at the Kennedy Space Center were nominal. However, two pieces of SSME thermal blanket fell from the Orbiter as the vehicle rolled out onto final approach.

The Solid Rocket Boosters were inspected at Hanger AF after retrieval. Both frustums exhibited no missing TPS, but a total of 115 debonds over fasteners. The frustum severance rings, utilizing the new pin retainer clips, were missing no pins. An IFA was taken on two 8-inch divots on the forward face of the RH ETA ring. All eight DCS plungers were properly seated, though post flight disassembly revealed the loss of ordnance debris from HDP #1 and #7. EPON shim material was missing from HDP #4, 7, and 8 prior to water impact. The thermal curtain attach structure and aft skirt aft ring were inspected for damage caused by the suspected loss of thermal curtain material during ascent, but no unusual damage was visible. Water impact may have altered any remaining evidence.

Due to unacceptable weather at Edwards AFB, the first landing at KSC since return-to-flight occurred on 20 November 1990. A post landing inspection of OV-104 was performed on Runway 33. The Orbiter TPS sustained a total of 81 hits, of which 8 had a major dimension of one inch or greater. The Orbiter lower surface had a total of 70 hits, of which 7 had a major dimension of one inch or greater. Based on these numbers and comparison to statistics from previous missions of similar configuration, the number of hits on the lower surface was less than average. Also, based on the severity of damage as indicated by surface area and depth, this flight was better than average. Flight hardware found on the post landing inspection of Runway 33 consisted of one 3"x1/2" piece of Ames gap filler and four pieces of Cerachrome felt insulation from the SSME beta blankets.

White streaks/deposits were present on both wing leading edge RCC panels. Lab analysis revealed the streaks were caused by TPS materials and SRB separation products. The lower surface Orbiter tile samples indicated localized heating from re-entry, but the only materials recovered from the damage sites were tile TPS elements.

A total of 7 Post Launch Anomalies were documented during this mission assessment.

2.0 KSC ICE/FROST/DEBRIS TEAM ACTIVITIES

Team Composition: NASA KSC, NASA MSFC, NASA JSC,
LSOC SPC, RI - DOWNEY, MMMSS - MAF,
USBI - BPC, MTI - LSS

Team Activities:

1) Prelaunch Pad Debris Inspection

Objective: Identify and evaluate potential debris material/sources. Baseline debris and debris sources existing from previous launches.

Areas: MLP deck, ORB and SRB flame exhaust holes, FSS, Shuttle external surfaces

Time: L - 1 day

Requirements: OMRSD S00U00.030 - An engineering debris inspection team shall inspect the shuttle and launch pad to identify and resolve potential debris sources. The prelaunch vehicle and pad configuration shall be documented and photographed.

Documents: OMI S6444

Report: Generate PR's and recommend corrective actions to pad managers.

2) Launch Countdown Firing Room 2

Objective: Evaluate ice/frost accumulation on the Shuttle and/or any observed debris utilizing OTV cameras.

Areas: MLP deck, FSS, Shuttle external surfaces

Time: T - 6 hours to Launch + 1 hour or propellant drain

Requirements: OMRSD S00FB0.005 - Monitor and video tape record ET TPS surfaces during loading through prepressurization.

Documents: OMI S0007, OMI S6444

Report: OIS call to NTD, Launch Director, and Shuttle managers. Generate IPR's.

3) Ice/Frost TPS and Debris Inspection

Objective: Evaluate any ice formation as potential debris material. Identify and evaluate any ORB, ET, or SRB TPS anomaly which may be a debris source or safety of flight concern. Identify and evaluate any other possible facility or vehicle anomaly.

Areas: MLP deck, FSS, Shuttle external surfaces

Time: T - 3 hours (during 2 hour BIH)

Requirements: OMRSD S00U00.020 - An engineering debris inspection team shall inspect the Shuttle for ice/frost, TPS, and debris anomalies after cryo propellant loading. Evaluate, document, and photograph all anomalies. During the walkdown, inspect Orbiter aft engine compartment (externally) for water condensation and/or ice formation in or between aft compartment tiles. An IR scan is required during the vehicle inspection to verify ET surface temperatures. During the walkdown inspect ET TPS areas which cannot be observed by the OTV system.

Documents: OMI S0007, OMI S6444

Report: Briefing to NTD, Launch Director, Shuttle management; generate IPR's.

4) Post Launch Pad Debris Inspection

Objectives: Locate and identify debris that could have damaged the shuttle vehicle during launch.

Areas: MLP zero level, flame exhaust holes and trenches, FSS, pad surfaces and slopes, extension of trenches to the perimeter fence, walkdown of the beach from Playalinda to Complex 40, aerial overview of inaccessible areas.

Time: Launch + 1 hour (after pad safing, before washdown)

Requirements: OMRSD S00U00.010 - An engineering debris inspection team shall perform a post launch pad/area inspection to identify any lost flight or ground systems hardware and resultant debris sources. The post launch pad and area configuration shall be documented and photographed.

Documents: OMI S0007, OMI S6444

Report: Initial report to NTD and verbal briefing to Level II at L+8 hours; generate PR's.

5) Launch Data Review

Objective: Detailed review of high speed films video tapes, and photographs from pad cameras, range trackers, aircraft and vehicle onboard cameras to determine possible launch damage to the flight vehicle. Identify debris and debris sources.

Time: Launch + 1 day to Launch + 6 days

Requirements: OMRSD S00U00.011 - An engineering film review and analysis shall be performed on all engineering launch film as soon as possible to identify any debris damage to the Shuttle. Identify flight vehicle or ground system damage that could affect orbiter flight operations or future SSV launches.

Documents: OMI S6444

Report: Daily reports to Level II Mission Management Team starting on L+1 day through landing; generate PR's.

6) SRB Post Flight/Retrieval Inspection

Objective: Evaluate potential SRB debris sources. Data will be correlated with observed Orbiter post landing TPS damage.

Areas: SRB external surfaces (Hangar AF, CCAFS)

Time: Launch + 24 hours (after on-dock, before hydrolasing)

Requirements: OMRSD S00U00.013 - An engineering debris damage inspection team shall perform a post retrieval inspection of the SRB's to identify any damage caused by launch debris. Any anomalies must be documented/photographed and coordinated with the results of the post launch shuttle and pad area debris inspection.

Documents: OMI B8001

Report: Daily reports to Level II Mission Management Team. Preliminary report to SRB Disassembly Evaluation Team. Generate PR's.

7) Orbiter Post Landing Debris Damage Assessment

Objective: Identify and evaluate areas of damage to Orbiter TPS due to debris and correlate, if possible, source and time of occurrence. Additionally, runways are inspected for debris and sources of debris.

Areas: Orbiter TPS surfaces, runways

Time: After vehicle safing on runway, before towing

Requirements: OMRSD S00U00.040 - An engineering debris inspection team shall perform a prelanding runway inspection to identify, document, and collect debris that could result in orbiter damage. Runway debris and any facility anomalies which cannot be removed or corrected by the Team shall be documented and photographed; and the proper management shall be notified and corrective actions taken.

Requirements: OMRSD S00U00.050 - An engineering debris inspection team shall perform a post landing runway inspection to identify and resolve potential debris sources that may have caused vehicle damage but was not present or was not identified during pre-launch runway inspection. Obtain photographic documentation of any debris, debris sources, or flight hardware that may have been lost on landing.

Requirements: OMRSD S00U00.060 - An engineering debris inspection team shall map, document, and photograph debris-related Orbiter TPS damage and debris sources.

Requirements: OMRSD S00U00.012 - An engineering debris damage inspection team shall perform a post landing inspection of the orbiter vehicle to identify any damage caused by launch debris. Any anomalies must be documented/photographed and coordinated with the results of the post launch shuttle/pad area debris inspection.

Requirements: OMRSD V09AJ0.095 - An engineering debris inspection team shall perform temperature measurements of RCC nose cap and RCC RH Wing leading edge panels 9 and 17.

Documents: OMI S0026, OMI S0027, OMI S0028

Report: Briefing to NASA Convoy Commander

and generate PR's. Preliminary report to Level II on the day of landing followed by a preliminary update the next day.

8) Level II report

Objective:

Compile and correlate data from all inspections and analyses. Results of the debris assessment, along with recommendations for corrective actions, are presented directly to Level II via SIR and PRCB. Paper copy of complete report follows in 3 to 4 weeks. (Ref NASA Technical Memorandum series).

3.0 HYDROGEN LEAK

3.1 TANKING TEST #1

After a hydrogen leak had been detected in the aft compartment of OV-102 on STS-35, a tanking test was performed on STS-38 to ensure a generic hydrogen leak would not occur on OV-104. Tygon tubes, attached to LH2 ET/ORB umbilical plate gap and pyro canister external vent ports, were connected to sensors in order to more precisely characterize any leak. During the test, leak detectors 54 and 55 did detect concentrations of hydrogen greater than 4 percent around the ET/ORB LH2 umbilical. The LH2 tank had been filled slightly more than the 5% sensor-wet mark. A post-drain inspection of ET-37 was performed at Pad-39A from 1430 to 1530 hours on 29 June 1990.

There was no damage, such as divots or cracks, on the ET TPS acreage.

Ice still remained in the lower three L02 feedline support brackets.

A small amount of solid ice was present in the LH2 feedline lower bellows, LH2 recirculation line bellows, and both burst discs.

Closeout foam applied to the LH2 umbilical upper plate gap purge tube and the forward outboard pyro canister showed cracks. Ice had formed around these cracks and was associated with the amount of vapors in this area during the test (Ref Ice Console Observation anomaly 001 and IPR-38RV-0130). Anomaly 002 documented a frost spot emitting vapors at the feedline interface of the aft pyro canister closeout.

Ice was still present in the expansion joint of both ET/SRB cable trays near the upper strut fairings.

A small 1/2-inch diameter frost spot had formed on an aft dome PDL plug-pull repair.

All of these ice/frost conditions were acceptable per NSTS-08303.

All instrumentation tygon tubing was in the proper position.

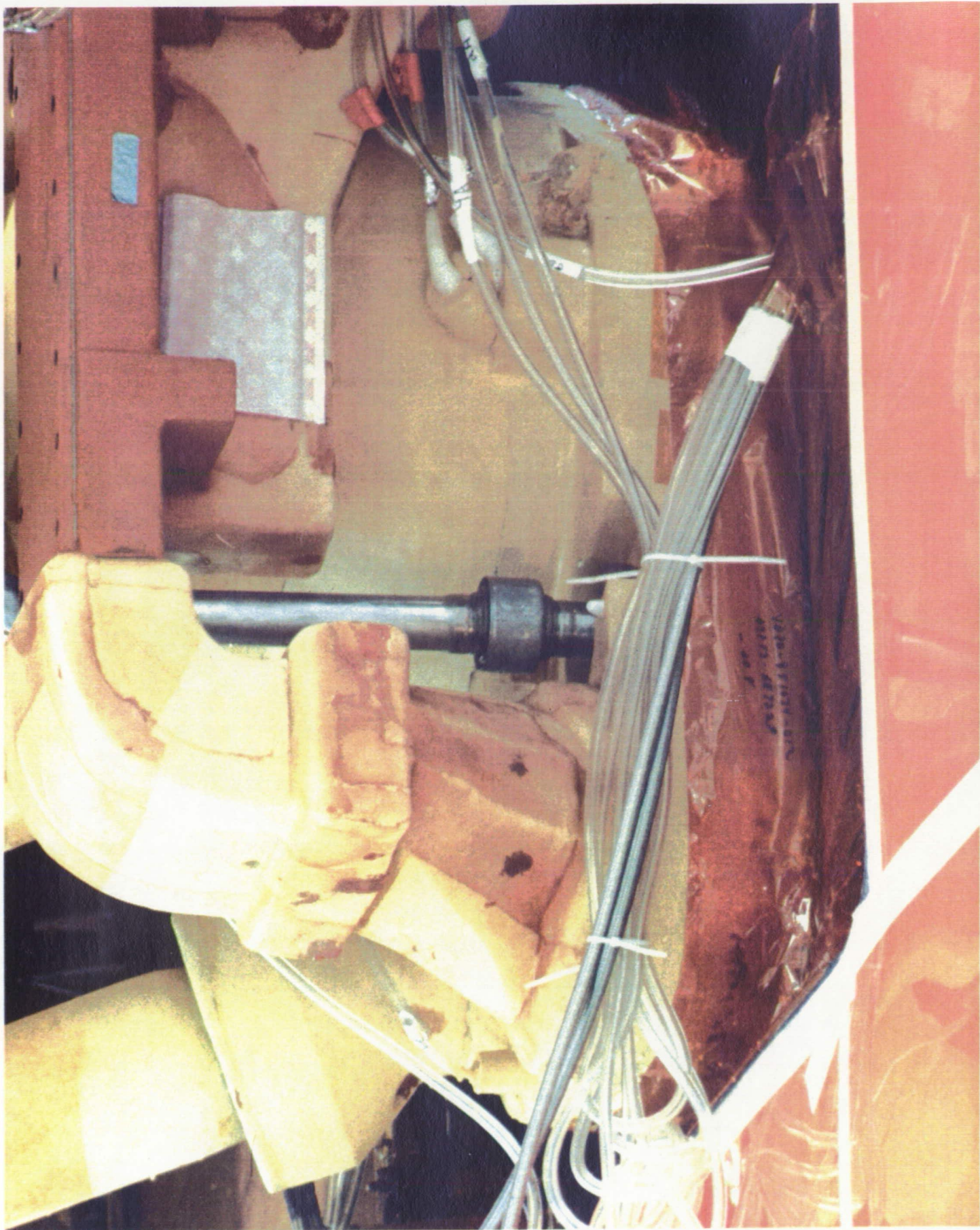

Post drain condition of the LH2 umbilical after Tanking Test 1.
Tygon tubes for sensing hydrogen leakage were positioned at
critical areas, such as plate gap and pyro canister purge vents

3.2 TANKING TEST #2

Data from Tanking Test #1 indicated the hydrogen leak occurred in the area of the ET/ORB umbilical LH2 feedline flange. TPS was removed and the 48 flange bolts were checked/torqued. A special test enclosure, or baggie, was taped around the LH2 feedline flange to detect and measure any hydrogen leakage. However, unacceptable concentrations of hydrogen were detected again during Tanking Test #2.

A post drain inspection of ET-37 was performed at Pad 39A from 1500 to 1615 hours on 13 July 1990. No major vehicle or facility anomalies were observed. The ET LH2 tank had been filled approximately 50-65 percent during the tanking test. Ice particles and liquid droplets were observed falling from the LH2 umbilical area at GMT 13:15:58.

Ice/frost in the LH2 feedline bellows and the upper bellows of the LH2 recirculation line had melted, but solid ice was still present in the recirculation line lower bellows. There was no ice/frost in the burst disks. Solid ice covered the tygon tubes where frost fingers typically form on the umbilical pyro canister and plate gap cavity purge vents. Small amounts of ice adhered to the top and sides of the Orbiter baggie and on the aluminum tape near the forward outboard pyro canister.

A 10-inch crack was visible on the LH2 feedline flange closeout (in the original TPS area) adjacent to the feedline support bracket at the 10 o'clock position (facing the tank). A 4-inch horizontal crack was also visible above the forward outboard pyro canister purge vent near the upper plate gap cavity purge vent. The crack may extend farther under the baggie/aluminum tape. A 2-inch crack occurred in the new TPS LH2 feedline flange closeout just below the forward outboard pyro canister. Ice/frost had formed along the new TPS LH2 feedline flange closeout-to-original TPS at three locations near the aft pyro canister (5 to 7 o'clock position on the umbilical).

OTV camera 052 surveillance of the LH2 feedline area during drain showed cryo pumping occurring from the LH2 feedline outboard area between the lower bellows and the tank interface. A crack or void was not visible to the inspection team on the MLP deck.

There was no visible TPS damage, such as divots or cracks, on the tank acreage. However, the +Y ET/SRB cable tray PAL ramp was debonded. (After ET-37 was demated from the STS-38 stack in the VAB, the PAL ramp was subjected to investigative evaluation by an engineering team. The foam exhibited an off-color appearance during ramp removal. Visual examination revealed the bonding layer component mix ratio was abnormal. The entire ramp and bondline were sent to MMC/MAF for laboratory analysis).

Ice still remained between the L02 feedline support bracket and the ice/frost ramp at stations XT 1871 and 1623.

Ice/Frost was present on both +Y and -Y ET/SRB diagonal strut fittings at EB-5 and EB-6.

Ice/Frost filled the expansion joint of both ET/SRB cable trays near the upper strut fairings.

OTV surveillance of the ET during drain showed 7 frost spots with some venting on the +Y longeron. The frost spots melted and the venting areas were not visible at the time of the inspection.

One small 1/2-inch frost spot formed on the LH2 tank siphon manhole cover closeout. Ice accumulation on EB-7 and EB-8 fittings was normal.

All instrumentation tygon tubing, umbilical baggies, wind streamers, and hydrogen detection system butcher paper were intact. Some aluminum tape was loose on the umbilical just below the 4-inch recirculation line and cable tray.

There were no Orbiter or SRB anomalies.

Three Ice Console Observation Anomalies were recorded during the tanking test.

Anomaly 001 documented ice/frost on the LH2 feedline -Y side at the support bracket foam interface. Vapors escaping from the test baggie were impinging on this area. This anomaly was specific to the tanking test and no PR was required.

Anomaly 002 recorded 7 areas of frost on the +Y longeron and TPS cracks in the thrust strut interface. These areas exhibited no debonding or visible cracks after the test.

One TPS crack appeared on the -Y side of the LH2 feedline near the tank interface. Another crack was visible on the LH2 recirculation line closeout near the tank interface (Anomaly 003).

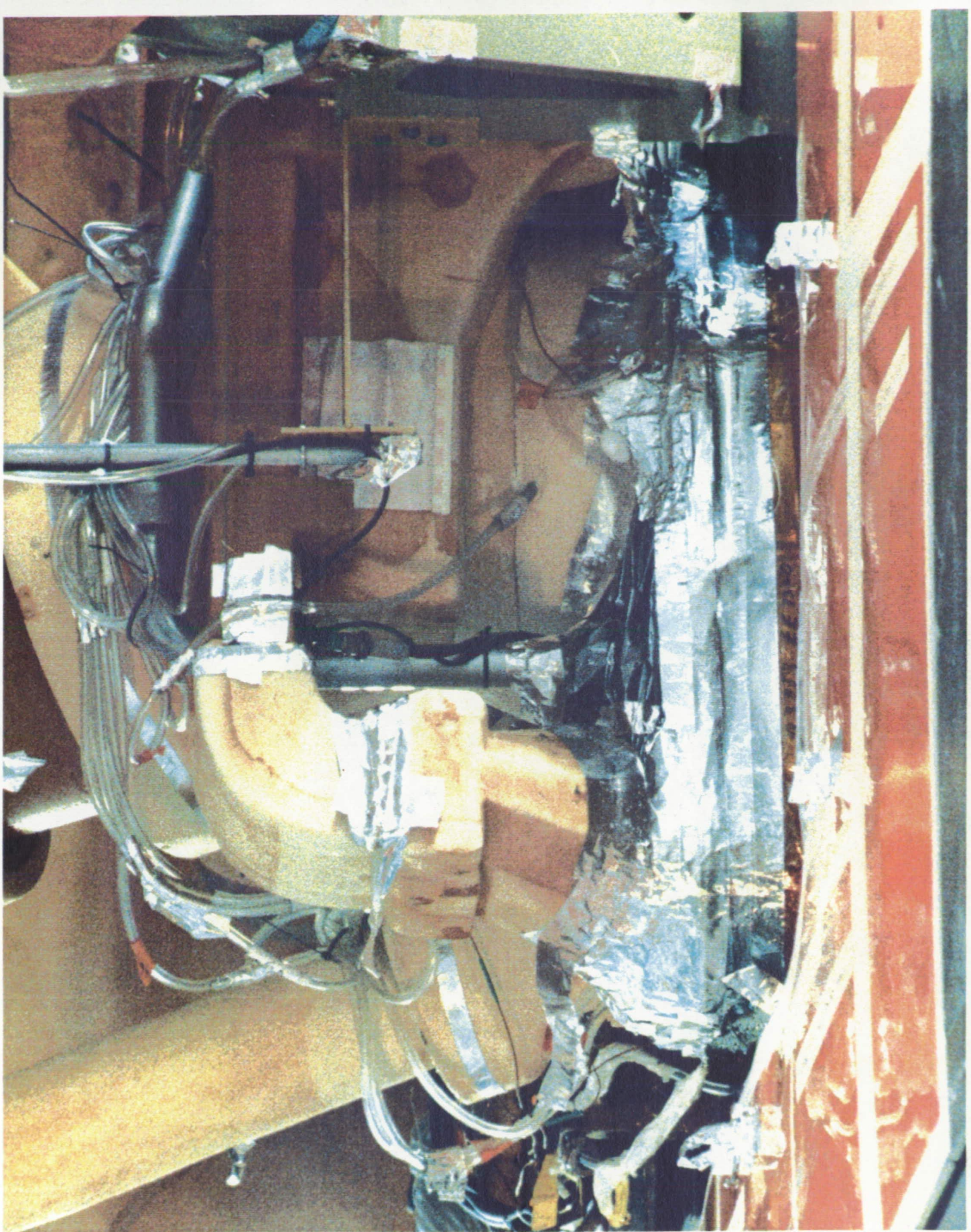

Post drain condition of the LH2 umbilical after Tanking Test 2.
Aluminum tape covers/seals in the area where the LH2 feedline
flange had been enclosed by a baggie to contain hydrogen leaks.

3.3 TANKING TEST #3

Data from Tanking Test #2 could not locate the exact origin of the hydrogen leak in the ET/ORB umbilical LH2 feedline flange area. The special test enclosure, or baggie, may have lost seal integrity during the tanking test and affected the data. A new test enclosure was installed and foamed over to make a tighter seal. The tanking test was repeated. However, hydrogen leakage was again detected during Tanking Test #3.

A post drain inspection of ET-37 was performed at Pad 39A from 1215 to 1310 hours on 25 July 1990. No major vehicle or facility anomalies were observed. The ET LH2 tank had been filled approximately 10-15 percent during the tanking test. At one point, LD 55, Rake #4, and Rake #11 had measured 4 percent hydrogen concentration.

The LH2 feedline bellows and the LH2 recirculation line bellows were filled with solid ice. There was ice/frost in the burst disks. Small amounts of ice covered the umbilical pyro canister and plate gap cavity purge vents. Small amounts of ice adhered to the top and sides of the Orbiter baggie.

A bondline delamination occurred on the LH2 feedline flange closeout interface with the LH2 umbilical foam from 2 to 6 o'clock position (facing the orbiter). An approximately 2-inch crack was visible in the umbilical foam just below the forward outboard pyro canister.

OTV camera 009 surveillance of the LH2 feedline area during drain showed cryo pumping occurring from the LH2 feedline test rework/repair between the lower bellows and the tank interface.

There was a divot/crack on the aft hardpoint closeout area at station XT-2020. The crack was approximately 18 inches long and 3/8 of an inch wide with offset.

Ice still remained between the LO2 feedline support bracket and the ice/frost ramp at stations XT-1871 and 1623.

Ice/frost was present on both +Y and -Y ET/SRB diagonal strut fittings EB-5 and EB-6.

Ice/frost filled the expansion joint of both ET/SRB cable trays near the upper strut fairings.

OTV surveillance of the ET during drain showed 3 frost spots with some venting on the +Y longeron. These areas had been observed during the second tanking test.

One small 1/2-inch frost spot formed on the LH2 tank siphon manhole cover closeout, a recurrence from the second tanking test. Ice accumulation on EB-7 and EB-8 fittings was normal.

The LH2 umbilical cable tray purge hole was taped over with LT-80 tape. Wind streamers were attached to this tape.

A piece of plastic wrapping was loose around the RH SRB IEA cover. Also a red tag was attached on the LH SRB aft center segment south of the systems tunnel cover. The red tag read "clean primer".

There were no Orbiter or SRB anomalies.

A hands-on inspection was performed on ET-37 at Pad A from 1230 to 1400 hours on 26 July 1990. Three cracks, one of which was considered major, occurred in the LH2 umbilical TPS. The large crack was located on the upper outboard pyro canister and joined a previous crack that was not repaired for the test. The new crack was five inches long and interfaced with the 17-inch feedline flange baggie. The second crack, also five inches long, was located on the upper inboard pyro canister orbiter interface and progressed towards the ET. The third crack, 1.5 inches long, was located on the top of the recirculation line BX-250 foam-to-umbilical foam interface above the 4-inch line flange baggie. There were some areas of delaminated foam in the BX-250 closeout, which were present before the tanking test. The areas where ice/frost had formed during the tanking test showed no evidence of delamination, but the foam felt softer than normal.

Five Ice Console Observation Anomalies had been recorded during the tanking test.

Anomaly 001 documented vapors at the LH2 feedline/umbilical flange foam closeout bondline (-Y side). A possible crack in the TPS was visible on cameras 49 and 52.

Anomaly 002 recorded a frost spot emitting vapors on the +Y longeron closeout.

Vapors originated from a PDL repair on the outboard side of the LH2 feedline (Anomaly 003).

Anomaly 004 documented vapors from the +X-Z side of the LH2 feedline flange.

Anomaly 005 recorded vapors emanating from a repair area on the inboard (+Y-Z) side of the LH2 recirculation line. Ice/frost had formed on the forward +Y side.

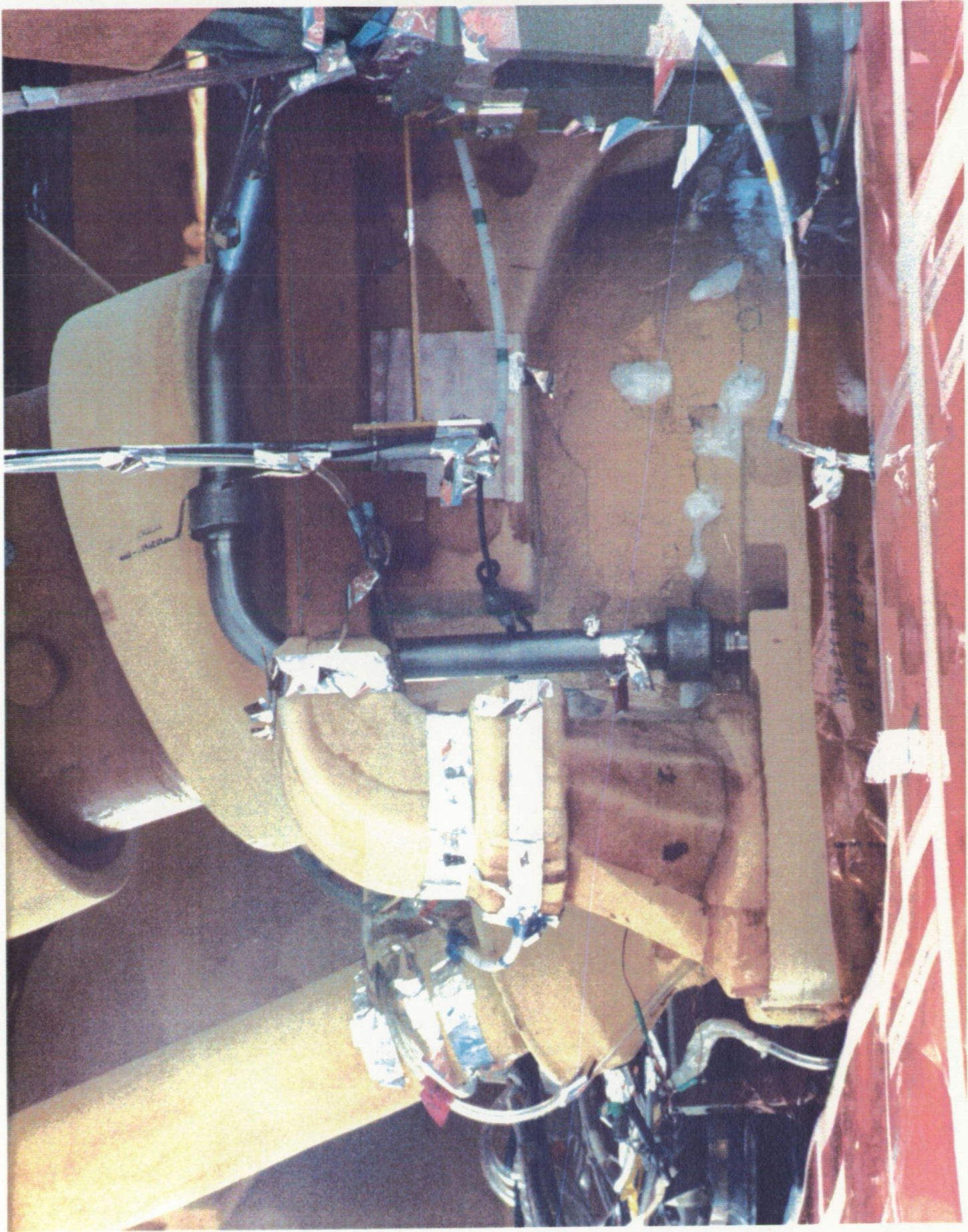

Post drain condition of the LH2 umbilical after Tanking Test 3. Special leak detection instrumentation, including tygon tube rakes, had been installed to map hydrogen leak flow fields.



Due to the changing test configurations, numerous TPS cracks and isochem bondline thermal shorts were revealed by the appearance of ice/frost formations.

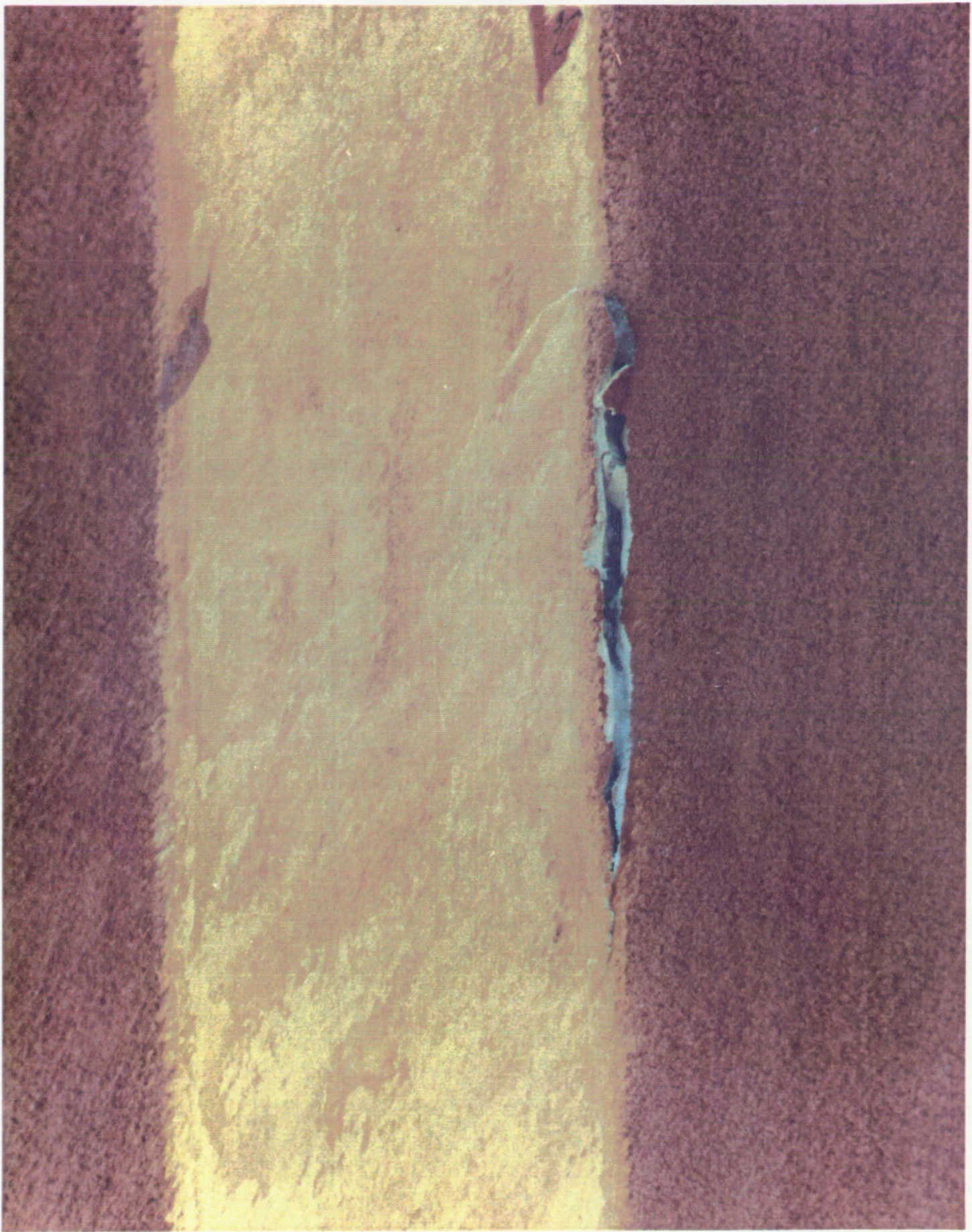

Tanking Test #3 post drain inspection revealed an 18-inch long crack 3/8-inch wide with offset on the aft hardpoint closeout.

3.4 TANKING TEST #4

Since the hydrogen leak at the LH2 feedline flange could not be repaired on the launch pad, the STS-38 SSV was rolled back to the VAB. ET-37 (LWT 30) was demated and replaced by ET-40 (LWT 33). After rollout to the pad, tanking test #4 was performed to ensure the hydrogen leak had been corrected. The LH2 tank was filled to approximately 25 percent and enough LO2 was used to accomplish MPS chilldown. The usual launch instrumentation, including Orbiter aft compartment sensors, LD54, and LD55, were utilized for the tanking test. The test was successful with readings of 175 ppm GH2 and 100 ppm GOX in the aft compartment. LD54 read 200 ppm and LD55 peaked at 700 ppm GH2. A post drain inspection was performed at Pad 39A from 1700 to 1800 hours on 24 October 1990. No major vehicle or facility anomalies were observed.

A small amount of solid ice remained in the LH2 feedline bellows and the LH2 recirculation line bellows. The lower burst disk on the recirculation line was covered by ice. Formation of ice/frost fingers on the purge vents and venting of the cold helium purge gas had been normal during the tanking test. Ice/frost was present at the aft pyro canister-to-umbilical closeout forward corner due to an exposed bondline. No anomalies were visible on the 17-inch flapper valve actuator access port plug closeout or on the cable tray clamshell foam repairs.

There was no ice/frost on the LO2 ET/ORB umbilical. There was no visible damage to the LO2 feedline support brackets.

Heavy ice was present on both +Y and -Y ET/SRB diagonal strut fittings EB-5/EB-6 and the lower strut fittings EB-7/EB-8. Two cracks were visible in the +Y thrust strut-to-longeron TPS interface.

Ice/frost filled both ET/SRB cable tray-to-upper strut fairing interfaces (expansion joints). Frost was present on both aft fairing flow restrictors.

Ice/frost appeared along the outside bondline of the LH2 tank aft dome siphon manhole cover for approximately 40 percent of the circumference. Small isolated frost spots occurred on the -Z manhole cover along the TPS closeout bondline.

There was no visible TPS damage, such as divots or cracks, on the tank acreage. There were no Orbiter or SRB anomalies. All of the above ice/frost conditions have been observed previously and are acceptable per the NSTS-08303 ice criteria.

Although a frost spot 1-inch in diameter had appeared on the umbilical TPS acreage near the forward outboard pyro canister during the tanking test, no sign of TPS damage was visible (Anomaly 001).

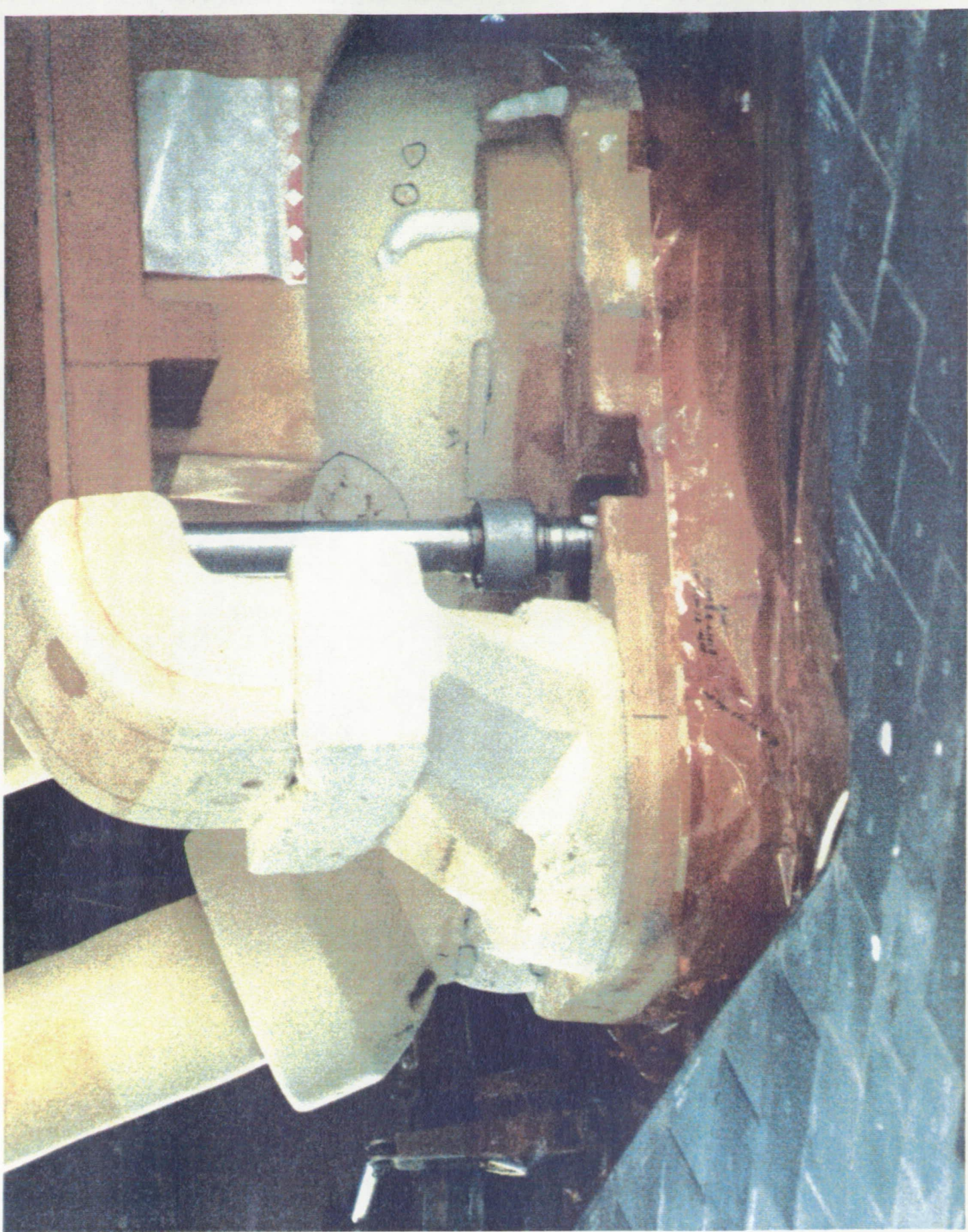

Post drain condition of the LH2 umbilical after Tanking Test 4.
Ice/frost formations on the plate gap and pyrotechnic canister
purge vents were normal.

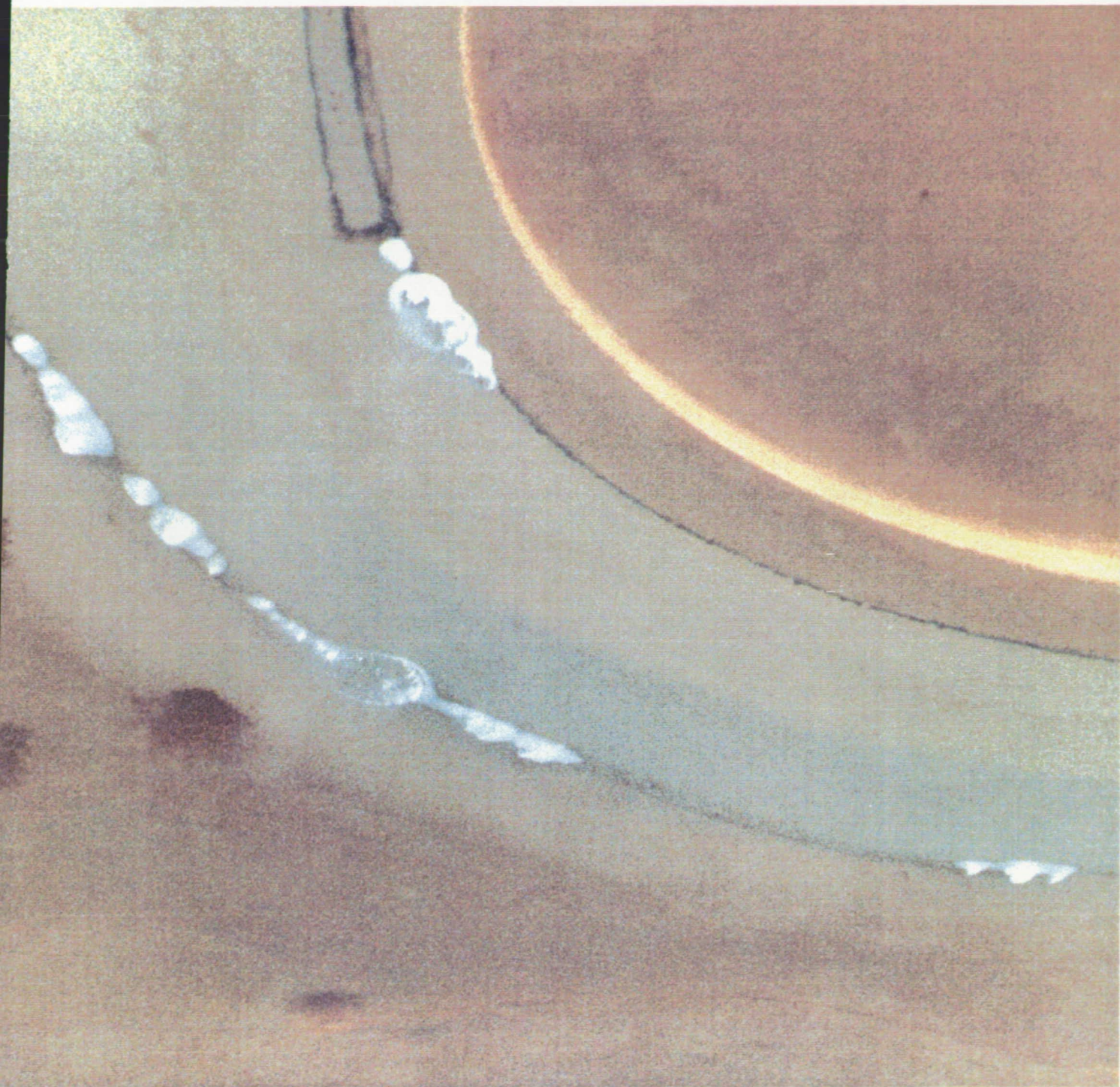

Ice/frost appeared on the outside bondline of the LH2 tank aft dome siphon manhole cover - approximately 40 percent of the circumference.

4.0 PRE-TEST BRIEFING

The Ice/Frost/Debris Team briefing for launch activities was conducted on 14 November 1990 at 1330 hours with the following key personnel present:

J. Rivera	NASA - KSC	ET Processing, Debris Assess
P. Rosado	NASA - KSC	Chief, ET Mechanical Systems
G. Katnik	NASA - KSC	Lead, Ice/Debris Assess Team
S. Higginbotham	NASA - KSC	STI, Ice/Debris Assessment
B. Davis	NASA - KSC	STI, Ice/Debris Assessment
R. Speece	NASA - KSC	ET Processing, Ice/Debris
B. Bowen	NASA - KSC	ET Processing, Ice/Debris
K. Tenbusch	NASA - KSC	ET Processing, Ice/Debris
M. Bassignani	NASA - KSC	ET Processing, Debris Assess
A. Oliu	NASA - KSC	ET Processing, Ice/Debris
J. Hoffmann	LSOC - SPC	ET Processing, Ice Assess
J. Blue	LSOC - SPC	ET Processing, Ice Assess
R. Seale	LSOC - SPC	ET Processing, Ice Assess
M. Jaime	LSOC - SPC	ET Processing, Ice Assess
Z. Byrns	NASA - JSC	Level II Integration
C. Gray	MMC - MAF	ET TPS & Materials Design
S. Copsey	MMC - MAF	ET TPS Testing/Certif
J. McClymonds	RI - Downey	Debris Assess, LVL II Integ
K. Mayer	RI - LSS	Vehicle Integration
C. Curtis	MMC - LSS	ET Processing
W. Nelson	USBI - EI	SRB Processing
K. Parsons	MTI - LSS	SRM Processing
J. Cook	MTI - LSS	SRM Processing

These personnel participated in various team activities, assisted in the collection and evaluation of data, and contributed to the reports contained in this document.

4.1 PRE-LAUNCH SSV/PAD DEBRIS INSPECTION

The pre-launch debris inspection of the pad and Shuttle vehicle was conducted on 14 November 1990 from 1430 to 1545 hours. The detailed walkdown of Launch Pad 39A and MLP-1 also included the primary flight elements OV-104 Atlantis (7th flight), ET-40 (LWT-33), and BI039. Documentary photographs were taken of facility anomalies, potential sources of vehicle damaging debris, and new vehicle configurations.

There were no major vehicle anomalies.

A reddish-brown liquid had dripped onto the LH SRB aft skirt (below the IEA) and adjacent MLP deck. The material had dried and could not be removed by hand.

The new Field Joint Protection System (FJPS) closeout had been applied to the RH SRB aft field joint. According to the original plan, STS-38 would have flown a test FJPS closeout at this one location and would have prevented Orbiter damage in the event of a FJPS failure. STS-41, which was the first vehicle to fully incorporate the new configuration, flew before STS-38 due to the rearranged launch schedule and Ulysses payload priority. STS-41 post flight assessment of the new FJPS closeout revealed no anomalies.

Due to the continued concern over potential hydrogen leakage from the ET/ORB LH2 umbilical interface area during cryoload/launch, temporary hydrogen leak detectors LD54 and LD55 were installed at the ET/ORB LH2 umbilical until a permanent sensor could be designed and installed. The tygon tubes are intended to remain in place during cryoloading and be removed by the Ice Inspection Team during the T-3 hour hold. The tygon tubes were properly positioned since the initial installation on Nov 12th.

The SRB sound suppression water troughs were configured properly and filled with water.

MLP deck discrepancies included a loose plug at the MLP east fire alarm standoff, loose bolts/disconnected tether chains on the portable purge unit electrical covers in the northwest corner of the MLP, and a handrail ground strap still present on the MLP deck near holddown post #6.

Trash and debris was visible on the MLP deck between the SRB's and in the SRB holddown post haunches. These areas were vacuumed prior to cryoload.

Cleanup of the MLP deck and pad surface was almost complete at the time of the inspection. The facility discrepancies were entered in S0007 Appendix K and transferred to the pad leader for resolution prior to vehicle tanking.

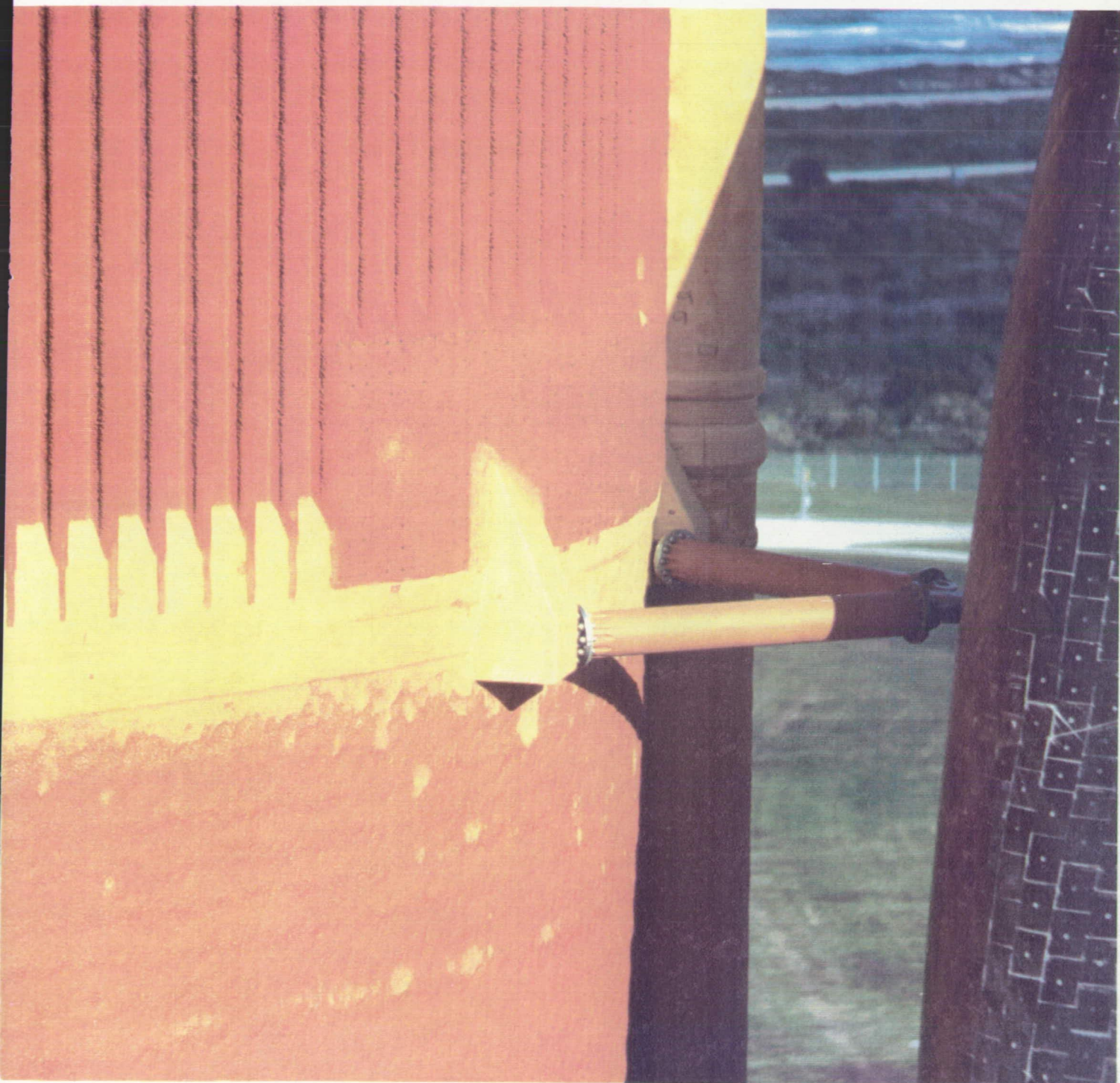

Pre-launch configuration of ET intertank/upper LH2 tank TPS.
Note pattern of vent holes drilled in TPS to vent possible
substrate voids and preclude divots during ascent.

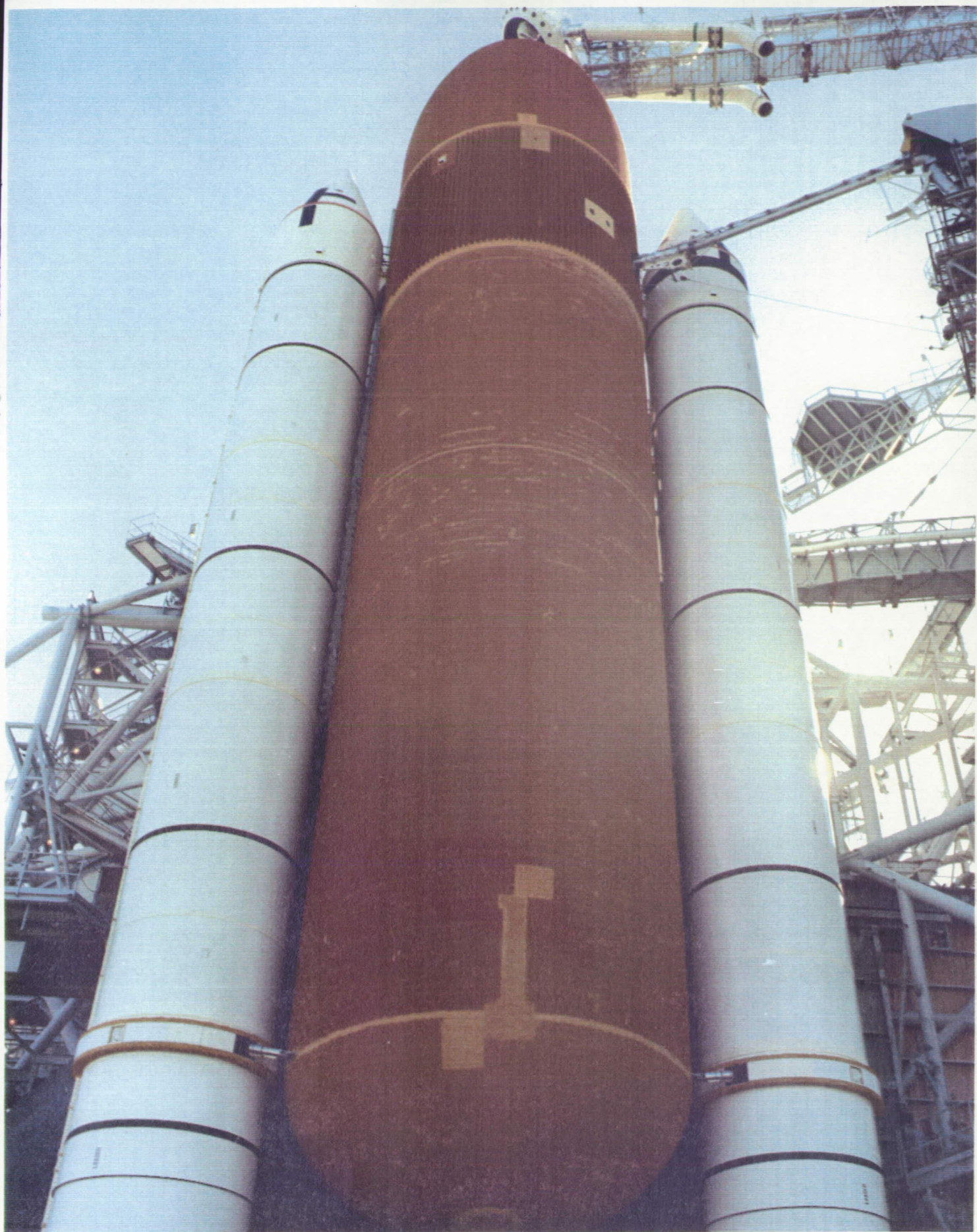

Overall view of ET-40 (LWT 33) and SRB BIO39 -Z side

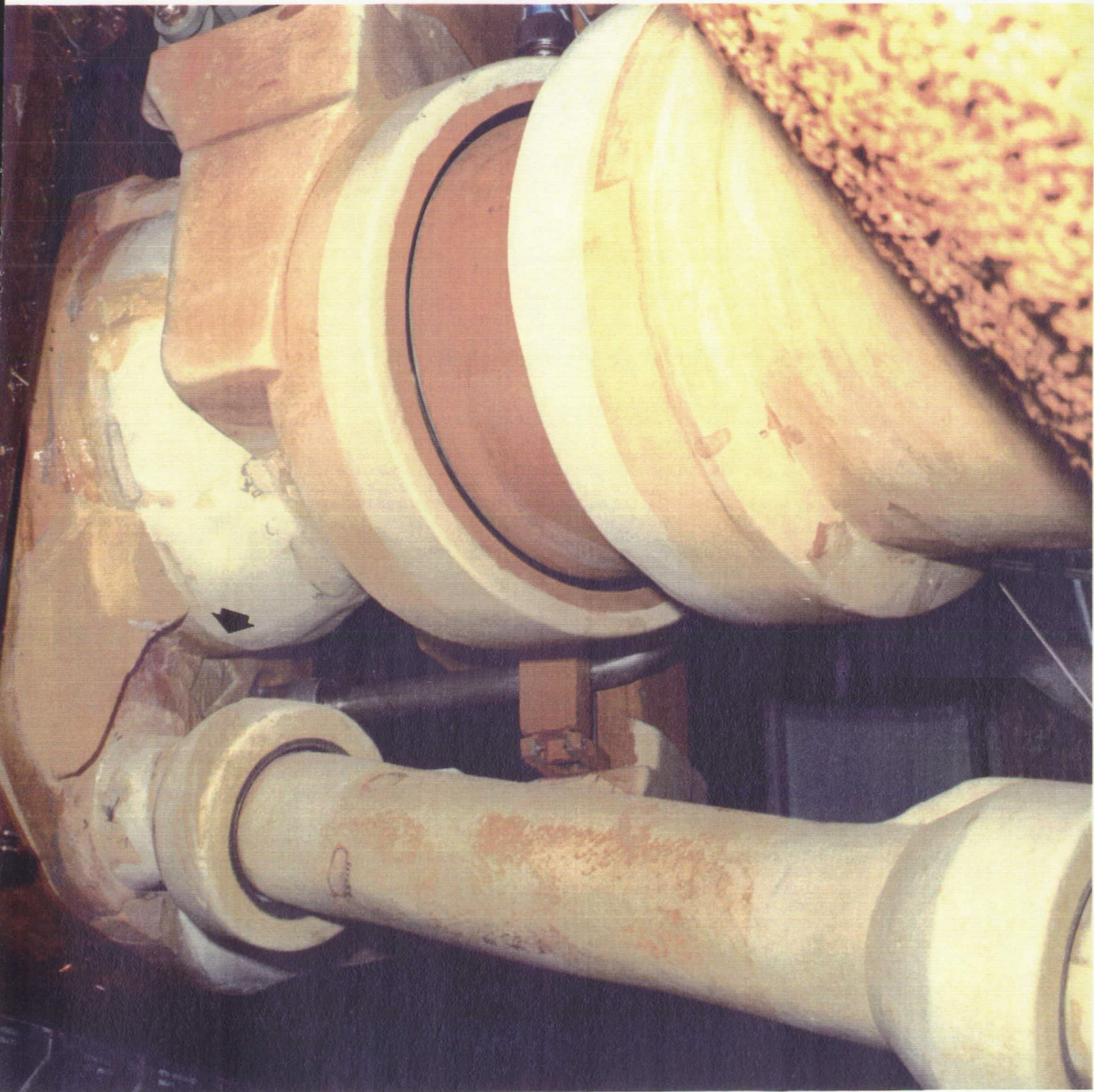

ET/ORB LH2 umbilical prior to loading of cryogenic propellants. Note configuration of 17-inch flapper valve tool access port foam plug closeout.



Reddish-brown liquid had dripped onto LH SRB aft skirt from the IEA area during pad closeout operations

5.0 LAUNCH

STS-38 was launched at 18:48:15 EST on 15 November 1990.

5.1 ICE/FROST INSPECTION

The Ice/Frost Inspection of the cryoloaded vehicle was performed on 15 November 1990 from 1320 to 1530 hours during the two hour built-in-hold at T-3 hours in the countdown. There were no LCC/OMRS violations or IPR conditions.

Ambient weather conditions at the time of the inspection were:

Temperature:	75.0 F
Relative Humidity:	59.8 %
Wind Speed:	13 Knots
Wind Direction:	077 Degrees

The portable STI infrared scanner was utilized to obtain vehicle surface temperature measurements for an overall thermal assessment of the vehicle, as shown in Figure 1 and 2.

5.2 ORBITER OBSERVATIONS

No Orbiter tile anomalies were observed. All forward and aft RCS thruster paper covers were intact. The average Orbiter surface temperature as measured by the STI was 74 degrees F in sunlight and 68 degrees F in the shade. A small amount of ice/frost had accumulated along 60 percent of the engine mounted heat shield interface on SSME #1 and from the 4 to 10 o'clock position on SSME #2. SSME #3 heat shield was dry. STI measured average engine mounted heat shield temperatures of 71, 66, and 71 degrees F on SSME #1, 2, and 3, respectively. Aft compartment hydrogen detection sensors had measured 100-150 ppm during tanking. LD 54 and 55 had read virtually zero.

5.3 SRB OBSERVATIONS

No SRB anomalies or loose ablator/cork were observed. There were no discrepancies on the new RH aft field joint protection system (FJPS) closeout. The STI portable infrared scanner recorded RH and LH SRB case surface temperatures between 73-76 degrees F, compared to a range of 74-78 degrees F as measured by the SRB GEI. STI confirmed that the joint heaters were operating. The predicted Propellant Mean Bulk Temperature (PMBT) supplied by MTI was 73 degrees F. There were no over-pressure spikes recorded in the exhaust holes during launch.

FIGURE 1. SSV INFRARED SCANNER SURFACE TEMPERATURE SUMMARY DATA

TIME: 1320 - 1530
 DATE: 11/15/90
 VEH. STS- 38

Notes: All temperatures
 are degrees F.
 S.T. 76.5
 E.O. 0.85

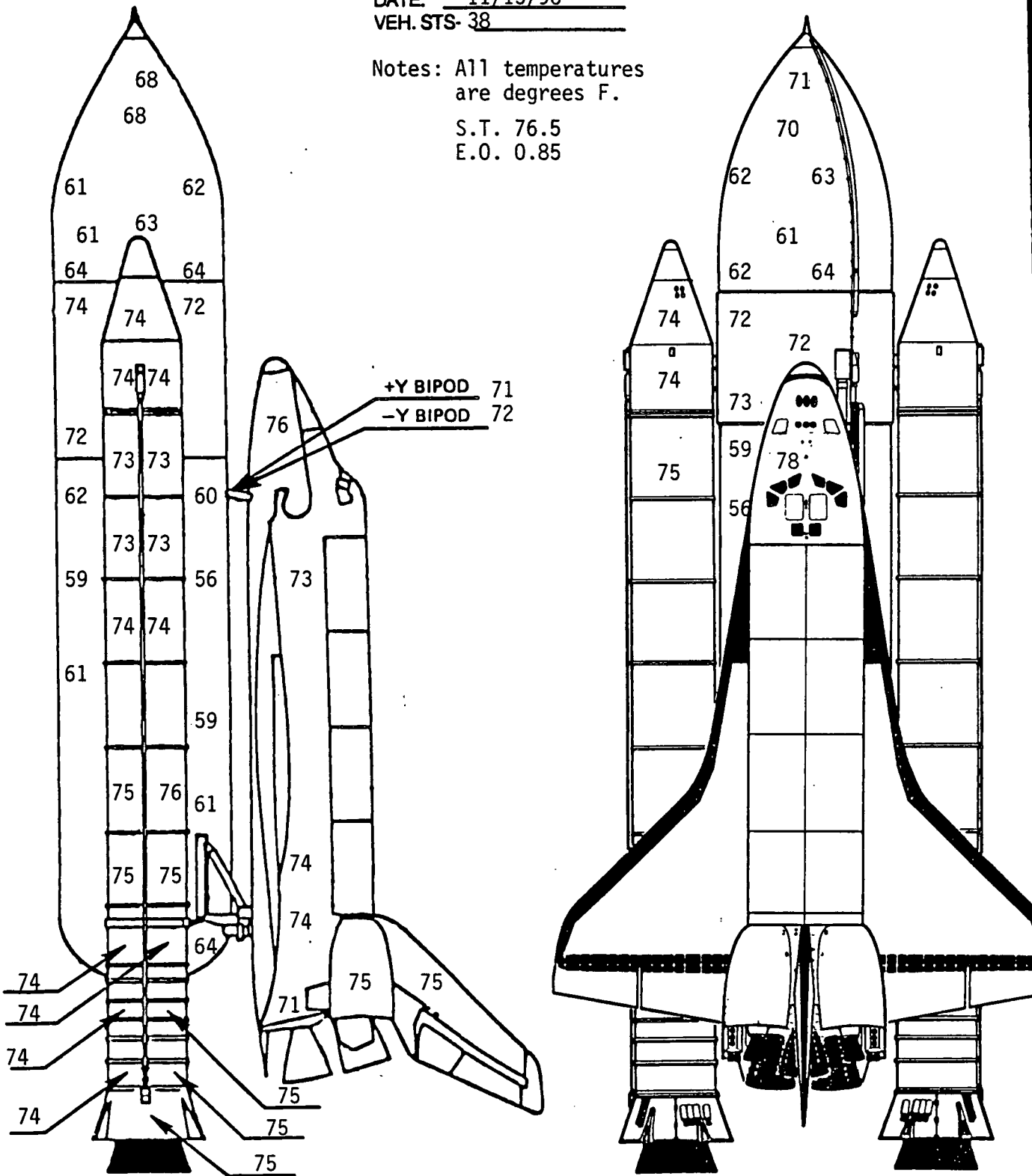

**FIGURE 2. SSV INFRARED SCANNER
SURFACE TEMPERATURE
SUMMARY DATA**

TIME: 1320 - 1530
 DATE: 11/15/90
 VEH. STS- 38

Notes: All temperatures
are degrees F.

S.T. 76.5
 E.O. 0.85

Most spot measurements
had decreased by 3-5
degrees F while the
Ice Team was taking
data during a 2 hour
interval.

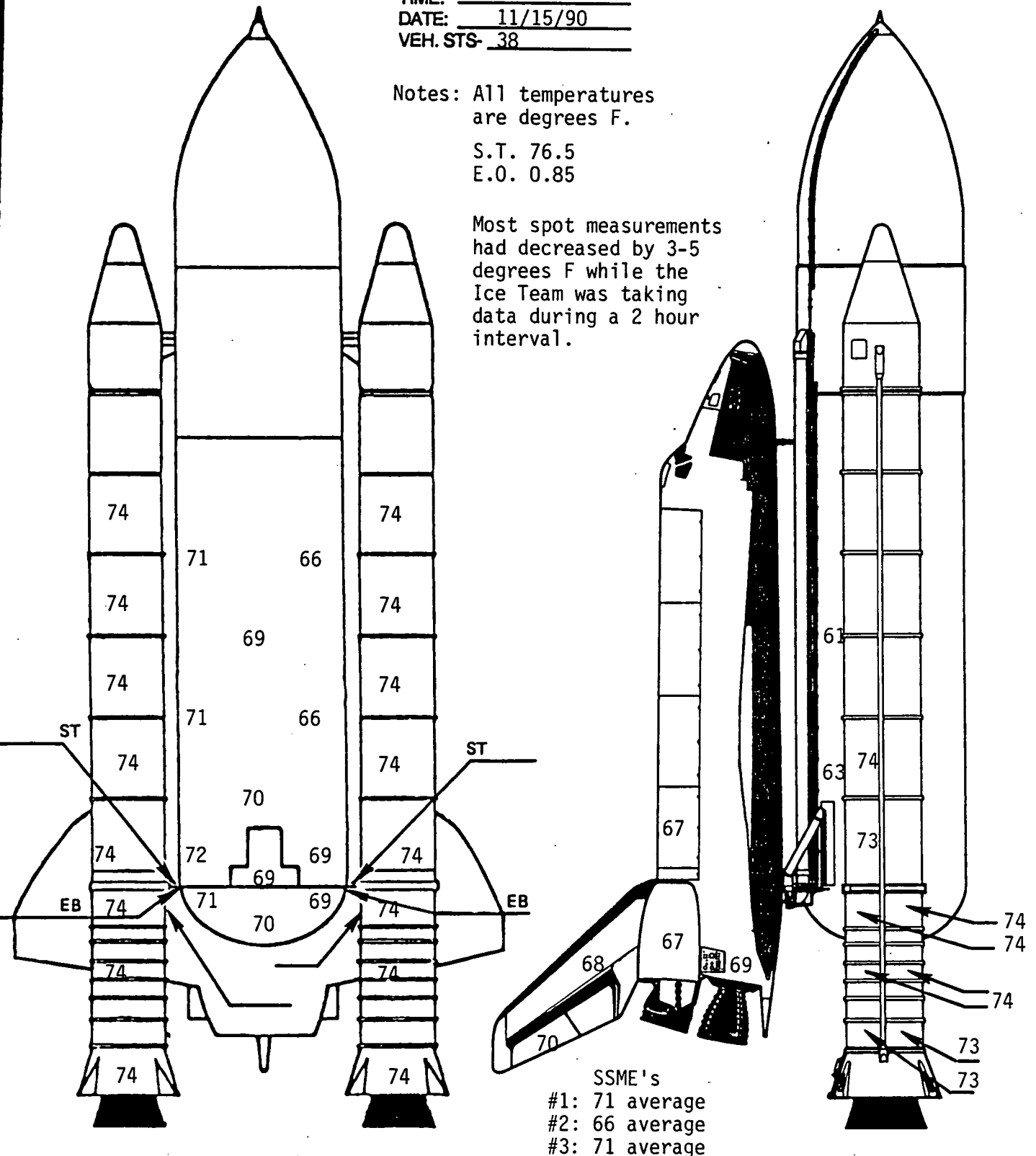

5.4 EXTERNAL TANK OBSERVATIONS

The ice/frost prediction computer program was run from 1100 to 1900 hours and the results tabulated in Figures 3 and 4. The program predicted no ice/frost or condensate accumulation on the TPS acreage surfaces.

The LO2 tank TPS acreage was dry. There was no ice/frost or condensate on the ogive or barrel sections. There were no TPS anomalies. The tumble valve cover was intact. The STI infrared scanner measured an average surface temperature of 69 degrees F on the ogive and 62 degrees F on the barrel section. This compares to Mikron IR instrument readings of 70 and 69 degrees F, respectively. SURFICE predicted 64 degrees F on the ogive and 60 degrees F on the barrel section.

The intertank TPS acreage was dry with no condensate. There were no TPS anomalies. Very small 1/2-inch diameter frost spots appeared in the stringer valleys on the -Y-Z side of the tank. The STI IR scanner measured an average surface temperature of 73 degrees F. There were no anomalies on the bipods.

The LH2 tank and aft dome TPS acreage was dry with no run-off condensate. There was no acreage ice/frost and no TPS anomalies. The average surface temperatures as measured by the STI IR scanner were 58 degrees F on the upper LH2 tank and 62 degrees F on the lower LH2 tank. This compares to 67 and 66 degrees F, respectively, as measured by the Mikron instrument. SURFICE predicted 59 degrees F on the upper LH2 tank and 60 degrees F on the lower LH2 tank.

There were no anomalies on the PAL ramp, cable tray/press line ice/frost ramps, thrust struts, longerons, aft dome apex, or manhole covers. Ice/frost was present in the ET/SRB cable tray-to-upper strut fairing expansion joint. Ice/frost covered the lower EB fittings outboard to the strut pin hole with condensate on the rest of the fitting. The struts were dry.

Normal amounts of ice were present in all L02 feedline bellows. Less than usual amounts of ice/frost were present in the L02 feedline support brackets.

There were no anomalies on the L02 ET/ORB umbilical. The baggie was configured properly and was holding positive purge pressure. A small amount of ice/frost covered the inboard and aft areas of the baggie. There was no ice/frost accumulation on the acreage areas of the umbilical. Ice/frost fingers 4-6 inches in length had formed on the three pyro canister purge vents. Normal venting of nitrogen purge gas was occurring.

STS- 38		TEST S0007 LAUNCH														DATE: 15 Nov. 1990				T-0 TIME: 18:48:15 EST						
ORBITER 104		ET 40	SRB BI-039	MLP 1	PAD A	LO2										LH2										
						CHILLDOWN TIME: 15:40					FAST FILL TIME: 16:19					CHILLDOWN TIME: 15:27					FAST FILL TIME: 16:03					
						SLOW FILL TIME: 16:02					REPLENISH TIME: 18:21					SLOW FILL TIME: 15:38					REPLENISH TIME: 18:04					
TIME (EDT)	CONDITIONS						LO2 TANK STA 370 TO 540					LO2 TANK STA 550 TO 852					LH2 TANK STA 1130 TO 1380					LH2 TANK STA 1380 TO 2058				
	TEMP F	REL. HUM. %	DEW PT F	WIND VEL KNTS	WIND DIR DEG	REG	LOCAL VEL KNTS	SOFI TEMP	COND RATE IN/HR	ICE RATE IN/HR	REG	LOCAL VEL KNTS	SOFI TEMP	COND RATE IN/HR	ICE RATE IN/HR	REG	LOCAL VEL KNTS	SOFI TEMP	COND RATE IN/HR	ICE RATE IN/HR	REG	LOCAL VEL KNTS	SOFI TEMP	COND RATE IN/HR	ICE RATE IN/HR	
1100	76.80	54.20	59.55	13	71	I	7.67	63.77	0.0000	-0.2319	I	7.67	58.39	0.0007	-0.2014	I	7.15	57.41	0.0012	-0.1828	I	15.86	63.61	0.0000	-0.4046	
1115	77.00	56.60	60.95	16	82	I	9.44	65.56	0.0000	-0.2890	I	9.44	60.35	0.0005	-0.2575	I	8.80	59.52	0.0011	-0.2352	I	19.52	65.67	0.0000	-0.5158	
1130	78.00	54.00	60.61	13	77	I	7.67	64.97	0.0000	-0.2429	I	7.67	59.52	0.0007	-0.2121	I	7.15	58.55	0.0012	-0.1929	I	15.86	64.78	0.0000	-0.4236	
1145	78.20	51.20	59.33	15	80	I	8.85	66.13	0.0000	-0.2674	I	8.85	59.86	0.0000	-0.2364	I	8.25	58.72	0.0004	-0.2157	I	18.30	66.21	0.0000	-0.4729	
1200	78.80	52.80	60.76	10	85	I	5.90	63.69	0.0000	-0.1974	I	5.90	58.46	0.0012	-0.1673	I	5.50	57.30	0.0016	-0.1511	I	12.20	62.95	0.0000	-0.3331	
1215	77.60	52.40	59.39	13	90	I	7.67	64.50	0.0000	-0.2341	I	7.67	58.63	0.0005	-0.2036	I	7.15	57.66	0.0010	-0.1849	I	15.86	64.37	0.0000	-0.4080	
1230	77.80	54.80	60.82	13	86	I	7.67	64.79	0.0000	-0.2434	I	7.67	59.56	0.0008	-0.2125	I	7.15	58.60	0.0013	-0.1933	I	15.86	64.58	0.0000	-0.4247	
1245	78.00	55.60	61.42	12	91	I	7.08	64.42	0.0000	-0.2312	I	7.08	59.57	0.0011	-0.2005	I	6.60	58.53	0.0016	-0.1821	I	14.64	64.04	0.0000	-0.4001	
1300	77.80	57.40	62.11	11	80	I	6.49	63.60	0.0000	-0.2176	I	6.49	59.39	0.0016	-0.1871	I	6.05	58.29	0.0020	-0.1694	I	13.42	63.01	0.0000	-0.3731	
1315	75.80	59.80	61.31	14	78	I	8.26	63.49	0.0000	-0.2544	I	8.26	59.41	0.0013	-0.2234	I	7.70	58.47	0.0018	-0.2032	I	17.08	63.38	0.0000	-0.4489	
1330	74.40	60.60	60.32	11	84	I	6.49	60.31	0.0000	-0.1960	I	6.49	56.80	0.0019	-0.1660	I	6.05	55.64	0.0023	-0.1493	I	13.42	60.11	0.0002	-0.3367	
1345	74.40	60.00	60.04	11	86	I	6.49	60.25	0.0000	-0.1946	I	6.49	56.64	0.0018	-0.1646	I	6.05	55.48	0.0022	-0.1480	I	13.42	59.94	0.0001	-0.3341	
1400	75.00	60.80	60.99	13	78	I	7.67	62.16	0.0000	-0.2334	I	7.67	58.47	0.0016	-0.2026	I	7.15	57.47	0.0021	-0.1837	I	15.86	61.95	0.0000	-0.4087	
1415	75.40	59.00	60.55	15	76	I	8.85	63.55	0.0000	-0.2635	I	8.85	59.15	0.0010	-0.2323	I	8.25	58.25	0.0016	-0.2115	I	18.30	63.59	0.0000	-0.4679	
1445	75.20	59.00	60.35	17	66	I	10.03	64.24	0.0000	-0.2920	I	10.03	59.56	0.0007	-0.2605	I	11.90	59.93	0.0004	-0.3030	I	20.57	64.37	0.0000	-0.5207	
1500	75.20	60.20	60.91	16	72	I	9.44	63.86	0.0000	-0.2807	I	9.44	59.61	0.0010	-0.2493	I	8.80	58.75	0.0016	-0.2273	I	19.52	63.95	0.0000	-0.5019	
1515	74.60	60.00	60.23	15	78	I	8.85	62.79	0.0000	-0.2579	I	8.85	58.63	0.0012	-0.2269	I	8.25	57.71	0.0017	-0.2064	I	18.30	62.83	0.0000	-0.4584	
1530	75.40	58.80	60.45	16	73	I	9.44	64.02	0.0000	-0.2783	I	9.44	59.41	0.0008	-0.2470	I	8.80	58.55	0.0014	-0.2252	I	19.52	64.14	0.0000	-0.4973	
1545	75.20	59.00	60.35	17	76	I	10.03	64.24	0.0000	-0.2920	I	10.03	59.56	0.0007	-0.2605	I	9.35	58.74	0.0012	-0.2379	I	20.74	64.43	0.0000	-0.5249	
1600	74.80	59.40	60.15	15	80	I	8.85	62.97	0.0000	-0.2582	I	8.85	58.66	0.0011	-0.2272	I	8.25	57.75	0.0016	-0.2067	I	18.30	63.01	0.0000	-0.4588	
1615	74.40	59.40	59.76	15	76	I	8.85	62.57	0.0000	-0.2539	I	8.85	58.26	0.0011	-0.2230	I	8.25	57.34	0.0016	-0.2027	I	18.30	62.63	0.0000	-0.4512	
1630	74.20	59.80	59.75	16	76	I	9.44	62.83	0.0000	-0.2680	I	9.44	58.50	0.0010	-0.2369	I	8.80	57.62	0.0015	-0.2157	I	19.52	62.97	0.0000	-0.4793	
1645	73.80	59.60	59.27	16	81	I	9.44	62.43	0.0000	-0.2629	I	9.44	58.05	0.0009	-0.2319	I	8.80	57.16	0.0015	-0.2110	I	19.52	62.58	0.0000	-0.4701	
1700	73.80	59.00	58.99	15	77	I	8.85	61.95	0.0000	-0.2464	I	8.85	57.55	0.0010	-0.2157	I	8.25	56.62	0.0015	-0.1958	I	18.30	62.04	0.0000	-0.4377	
1715	73.40	59.80	58.97	15	78	I	8.85	61.58	0.0000	-0.2445	I	8.85	57.37	0.0011	-0.2139	I	8.25	56.44	0.0016	-0.1940	I	18.30	61.66	0.0000	-0.4346	
1730	73.20	59.40	58.59	14	81	I	8.26	60.85	0.0000	-0.2268	I	8.26	56.68	0.0012	-0.1965	I	7.70	55.70	0.0017	-0.1777	I	17.08	60.86	0.0000	-0.4003	
1745	73.60	58.40	58.51	16	80	I	9.44	62.21	0.0000	-0.2569	I	9.44	57.52	0.0007	-0.2261	I	8.80	56.63	0.0013	-0.2055	I	19.52	62.39	0.0000	-0.4592	
1800	73.60	58.00	58.32	13	85	I	7.67	60.66	0.0000	-0.2124	I	7.67	56.28	0.0012	-0.1823	I	7.15	55.25	0.0017	-0.1645	I	15.86	60.56	0.0000	-0.3715	

FIGURE 3. 'SURFICE' Computer Predictions

STS- 38		TEST S0007 LAUNCH																		DATE: 15 Nov. 1990				T-0 TIME: 18:48:15 EST			
ORBITER 104		ET 40	SRB BI-039	MLP 1	PAD A	LO2 CHILLDOWN TIME: 15:40 FAST FILL TIME: 16:19 SLOW FILL TIME: 16:02 REPLENISH TIME: 18:21										LH2 CHILLDOWN TIME: 15:27 FAST FILL TIME: 16:03 SLOW FILL TIME: 15:38 REPLENISH TIME: 18:04											
TIME (EDT)	CONDITIONS					LO2 TANK STA 370 TO 540					LO2 TANK STA 550 TO 852					LH2 TANK STA 1130 TO 1380					LH2 TANK STA 1380 TO 2058						
	TEMP F	REL. HUM. %	DEW PT F	WIND VEL KNTS	WIND DIR DEG	REG	LOCAL VEL KNTS	SOFI TEMP	COND RATE IN/HR	ICE RATE IN/HR	REG	LOCAL VEL KNTS	SOFI TEMP	COND RATE IN/HR	ICE RATE IN/HR	REG	LOCAL VEL KNTS	SOFI TEMP	COND RATE IN/HR	ICE RATE IN/HR	REG	LOCAL VEL KNTS	SOFI TEMP	COND RATE IN/HR	ICE RATE IN/HR		
1815	73.20	60.20	58.96	16	78	I	9.44	61.85	0.0000	-0.2581	I	9.44	57.61	0.0010	-0.2272	I	8.80	56.72	0.0015	-0.2065	I	19.52	62.01	0.0000	-0.4618		
1830	73.20	61.40	59.51	16	84	I	9.44	61.88	0.0000	-0.2619	I	9.44	57.94	0.0012	-0.2309	I	8.80	57.06	0.0017	-0.2099	I	19.52	62.03	0.0000	-0.4687		
1845	73.20	62.60	60.05	18	85	I	10.62	62.72	0.0000	-0.2953	I	10.62	58.83	0.0010	-0.2637	I	9.90	58.03	0.0016	-0.2407	I	21.96	62.97	0.0000	-0.5344		
1900	73.00	62.60	59.85	16	85	I	9.44	61.71	0.0000	-0.2633	I	9.44	58.06	0.0014	-0.2323	I	8.80	57.18	0.0019	-0.2112	I	19.52	61.84	0.0000	-0.4716		

AVG 67.94 47.84 50.55 12.4 E 7.17 59.31

7.57 55.06

7.13 52.65

15.65 55.98

 Period of Ice Team Inspection

FIGURE 4. 'SURFICE' Computer Predictions

Ice/frost had formed in the LH2 feedline bellows, LH2 recirculation line bellows, and on both burst disks. The top and sides of the LH2 ET/ORB umbilical were covered by heavy, but typical, ice/frost. Ice/frost accumulation on the inboard and aft areas of the baggie was light. Frost had formed around the closeout line of the aft pyro canister. Ice/frost fingers 5-7 inches in length had formed on the pyro canister purge vents. Normal venting of helium purge gas was occurring. There were no unusual vapors emanating from the umbilicals nor any evidence of hydrogen leakage. No frost was visible on the cable tray vent hole. All the TPS repairs/closeouts performed on the LH2 umbilical/feedline/cable tray exhibited no ice/frost problems. The 17-inch flapper valve actuator access port foam plug was properly closed out, though a small 1/2-inch frost spot had formed at the 6 o'clock position of the plug bondline due to a thermal short.

The ET/ORB hydrogen detection sensor tygon tubing was in proper position prior to removal. The tubing was successfully removed from the attach points on the pressurization line and ET EO-2 fitting. However, local high winds exerted additional pull on the velcro attach point on the ET/SRB upper strut fairing causing a premature release. The tygon tubing fell vertically and contacted the inboard sloped side of the LH SRB aft skirt. There was no impact to the holddown posts or SRB T-0 umbilical. Close examination revealed no damage to the aft skirt acreage.

The summary of ice/frost team observation anomalies consists of 3 OTV recorded items:

Anomaly 001 documented ice/frost formations on the ET/ORB LH2 umbilical purge vents, a repair/closeout bondline on the -Y side of the LH2 recirculation line-to-LH2 aft dome closeout, the LH2 feedline bellows, and the LH2 recirculation line bellows and burst disks. These ice/frost accumulations were acceptable per NSTS-08303.

Anomaly 002 recorded 4-6 inch ice/frost fingers on the ET/ORB LO2 umbilical purge vents, and on the aft/inboard sides of the baggie. These accumulations were acceptable per NSTS-08303.

Ice/frost accumulation in the LO2 feedline bellows and support brackets (Anomaly 003) were acceptable per NSTS-08303.

5.5 FACILITY OBSERVATIONS

Two new debris concerns had been identified during the ice/frost inspection of the vehicle. Foam had been tie-wrapped to two firex nozzles on the southeast and southwest corners of the SSME exhaust hole to protect personnel during prelaunch activities. The foam and tie-wraps were removed by the Ice Team. A safety sign hanging by one attach point was removed from the roof of the RSS.

All SRB sound suppression water troughs were filled and properly configured for launch.

No leaks were observed on either the LO2 or LH2 Orbiter T-0 umbilicals, though typical accumulations of ice/frost were present on the cryogenic lines. There was also no apparent leakage anywhere on the GH2 vent line or GUCP. The modification to the GH2 vent line prevented ice from forming on the line but some ice/frost, which was expected, had accumulated on the GUCP legs and on the uninsulated parts of the umbilical carrier plate.

Visual and infrared observations of the GOX seals confirmed no leakage. There were no icicles on the GOX vent ducts.

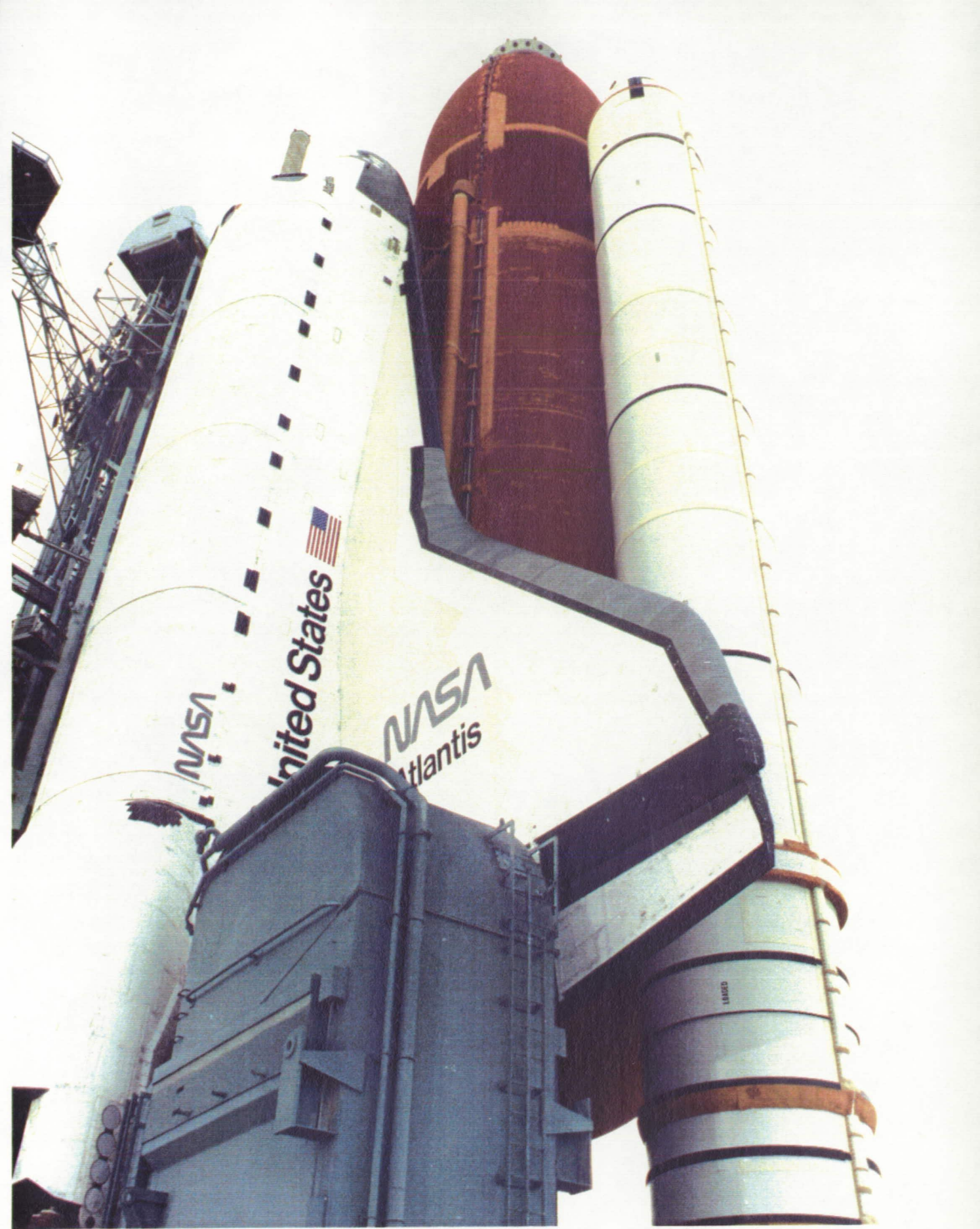

Overall view of OV-104, ET-40, and RH SRB B1039. No ice/frost had formed on the External Tank TPS acreage.

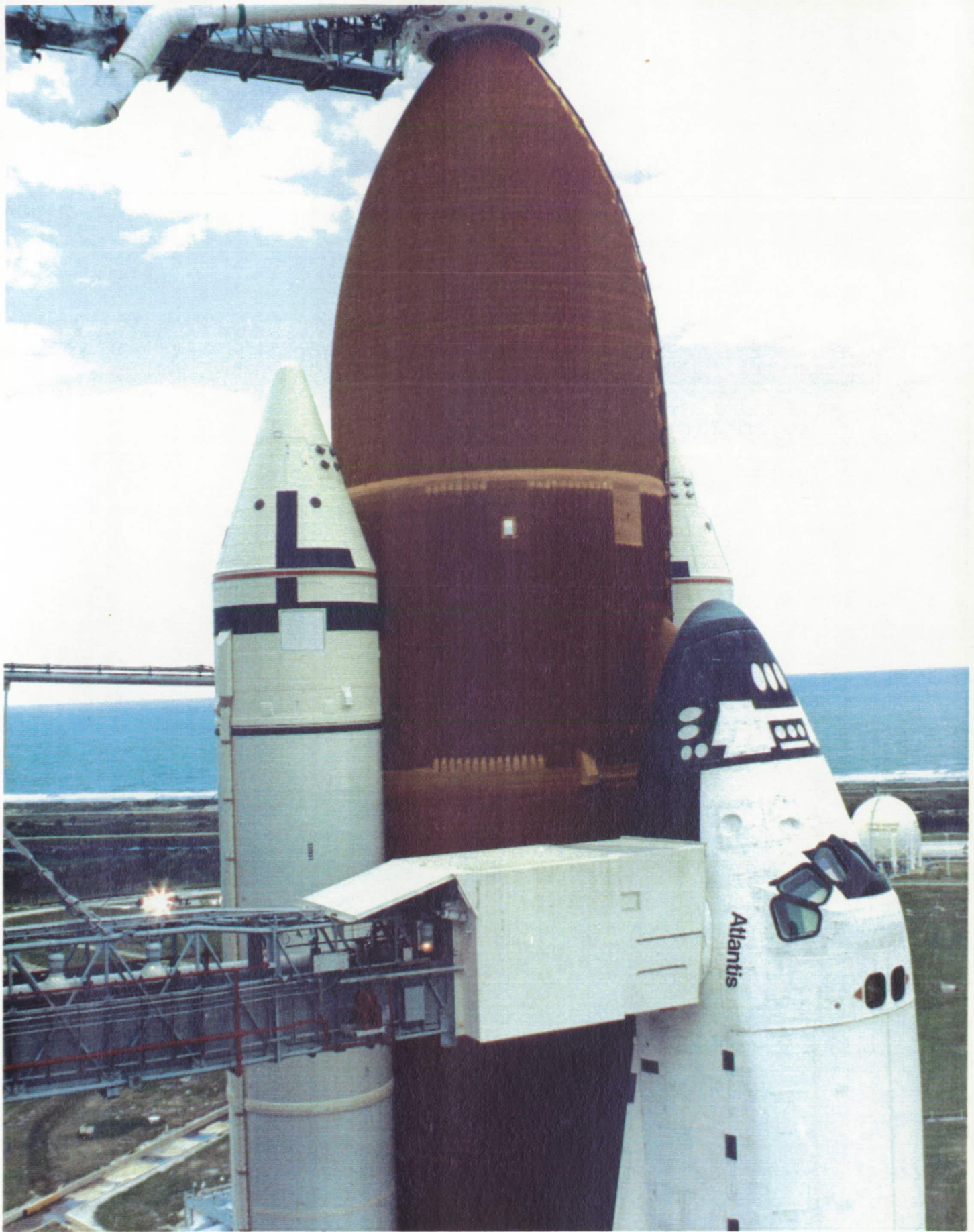

Overall view of ET-40 L02 tank and upper LH2 tank -Y+Z side. No ice/frost had formed on the ET TPS acreage.



Overall view of OV-104 and +Z side of ET-40 and SRB BI039

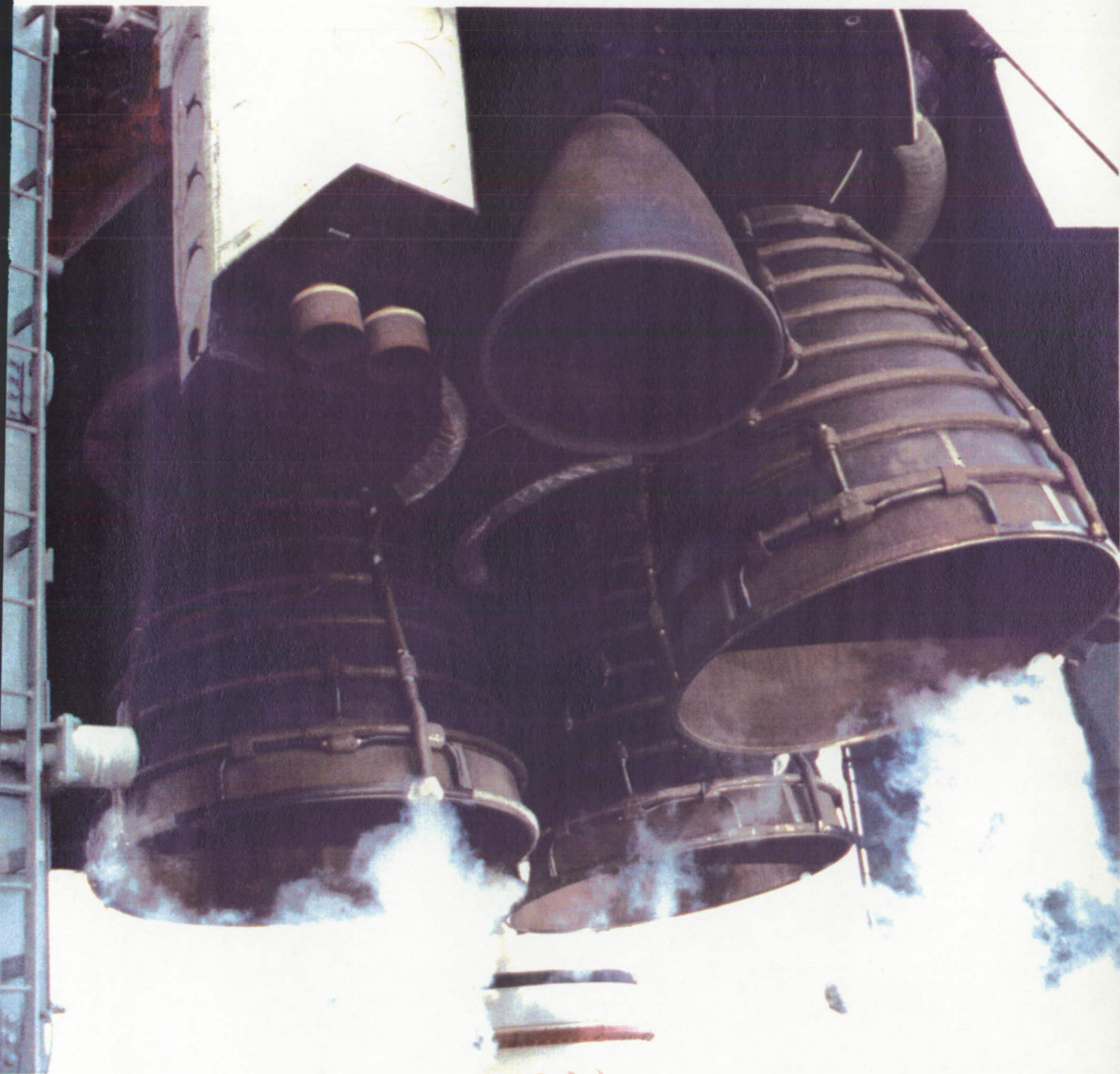

Overall view of SSME's. A small amount of ice/frost had formed on the SSME #1 and #2 engine mounted heat shield interfaces.

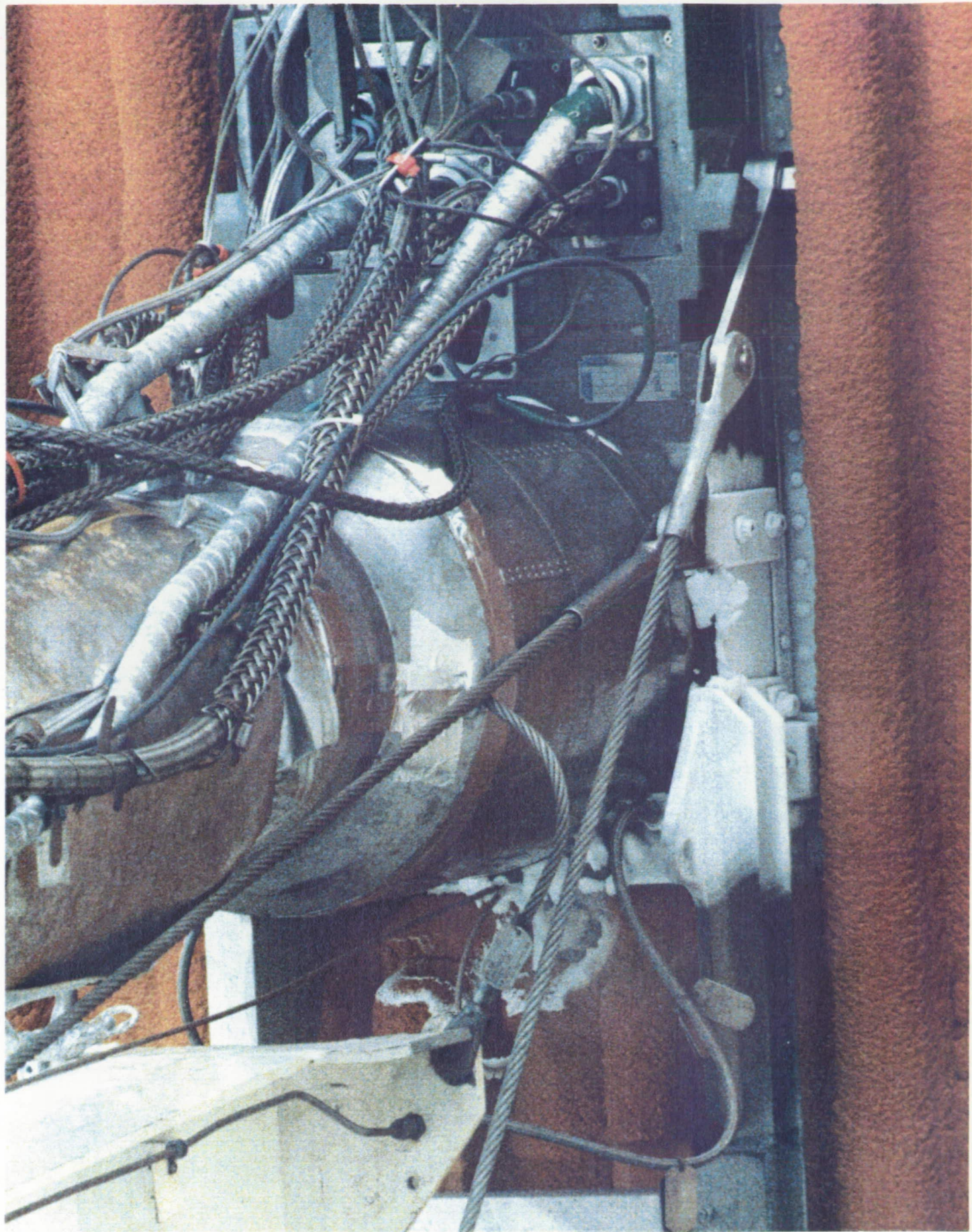

Typical ice/frost had accumulated on the GUCP legs and in the
TPS cut-out below the GH2 vent line

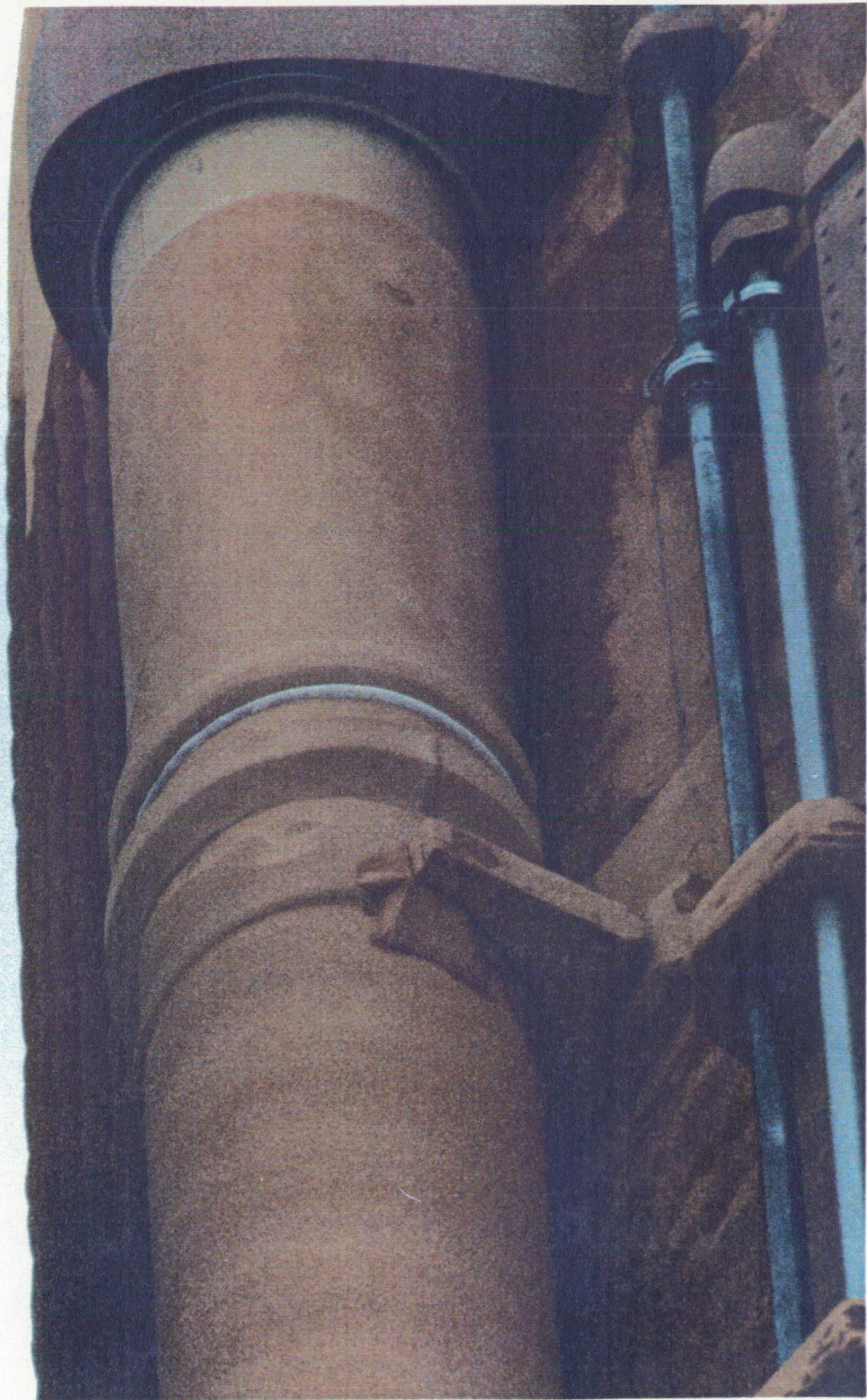

Typical ice/frost accumulation in the L02 feedline upper bellows and less-than-usual ice/frost in the support bracket

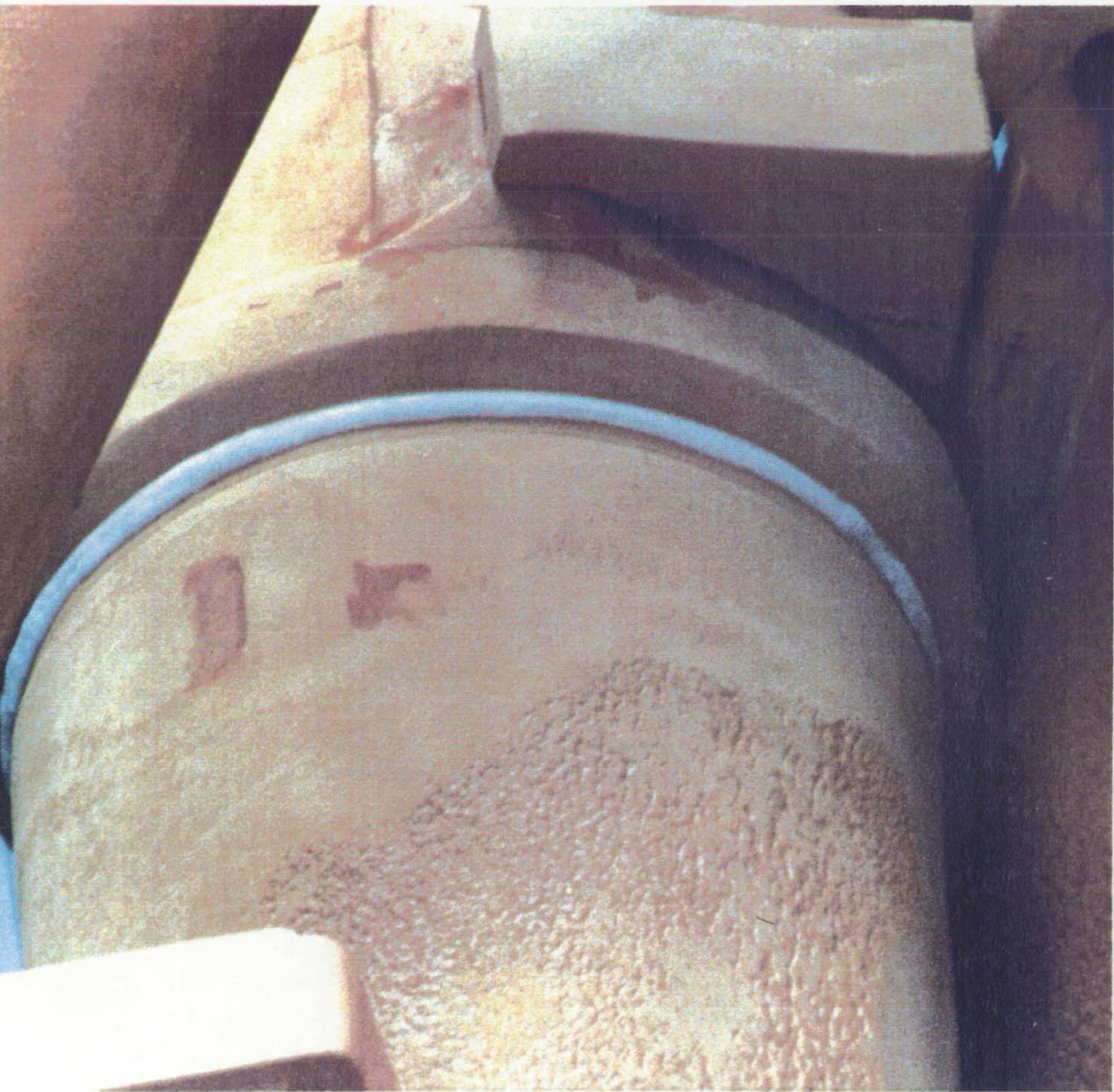

Typical ice/frost accumulation in the L02 feedline lower bellows and less-than-usual ice/frost in the support brackets

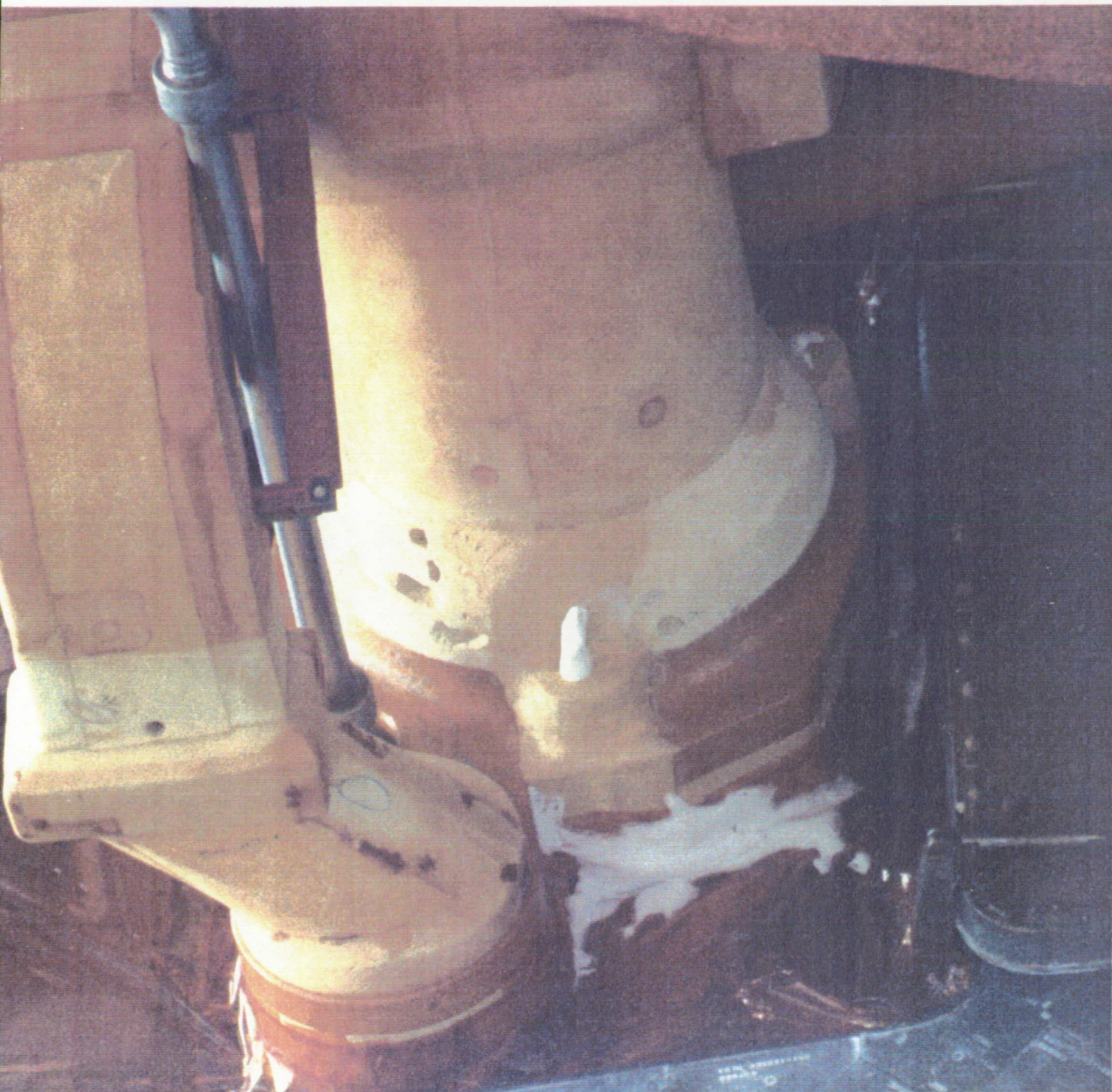

Typical ice/frost formations on the ET/ORB L02 umbilical purge barrier and pyro canister purge vents. Venting of nitrogen purge gas through the purge vents was normal.



Typical ice/frost formations on the ET/ORB LH2 umbilical purge barrier top and outboard sides, the upper plate gap purge vent, and the forward outboard pyrotechnic canister purge vent.

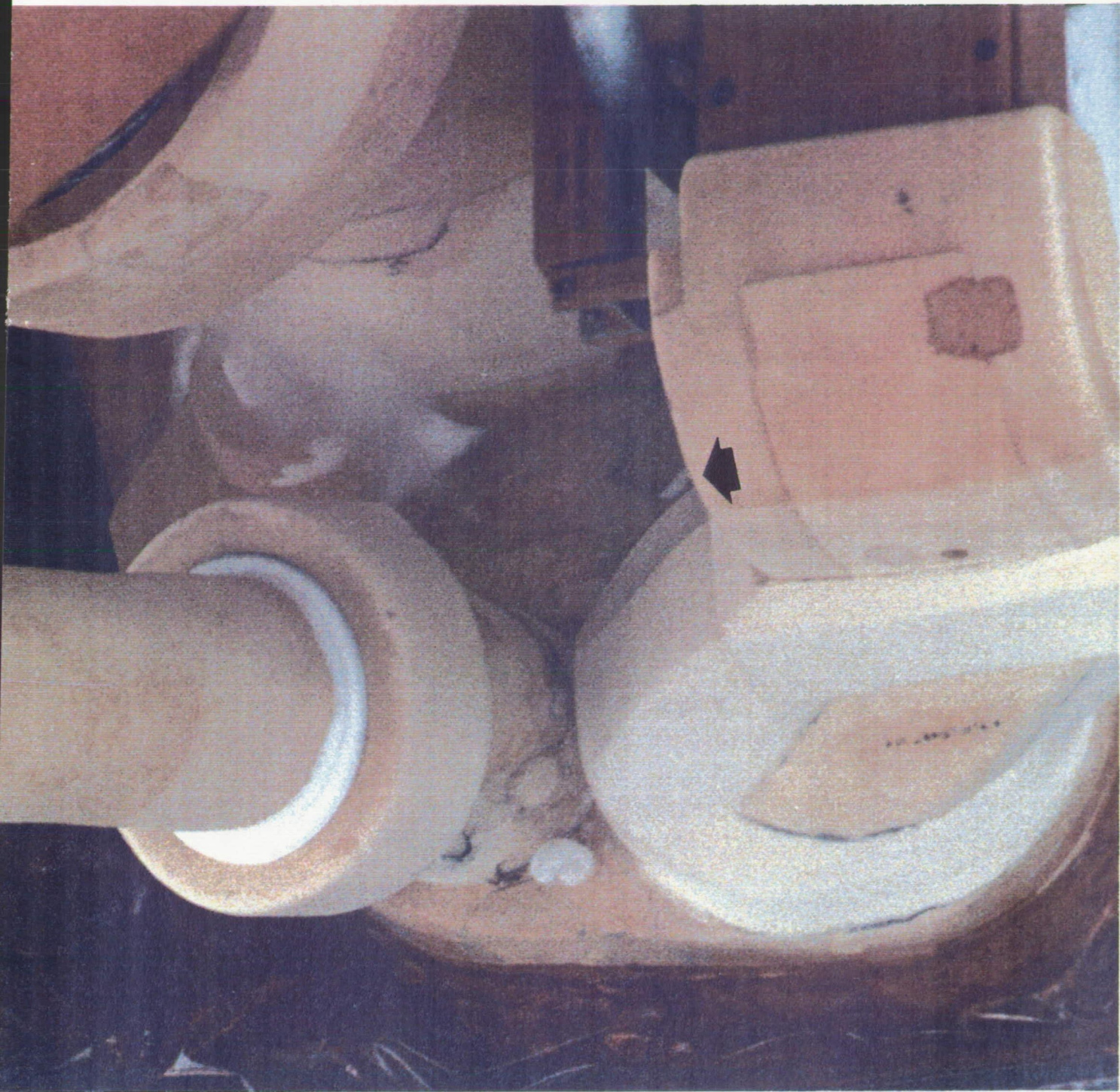

Typical ice/frost formations on the ET/ORB LH2 umbilical lower plate gap purge vent, lower pyro canister purge vent, and LH2 recirculation line upper bellows. Venting of cold helium purge gas from the pyro canister purge vent was normal. Note small frost spot on 17-inch flapper valve tool access port foam plug closeout bondline. Small frost spots also formed on lower pyro can TPS bondlines due to thermal shorts.

6.0 POST LAUNCH PAD DEBRIS INSPECTION

The post launch inspection of the pad and surrounding area began on 15 November 1990 from launch + 3 to 4-1/2 hours. Only the MLP and FSS were inspected immediately after launch due to the night (dark) conditions. No flight hardware or TPS materials were found. A less than usual amount of SRB throat plug material (foam and RTV) and sound suppression water trough material from the SRB exhaust holes was found.

South SRB holddown post erosion was typical. All south holddown post shim material was intact, but the sidewall shims for all posts were slightly debonded. North holddown post doghouse blast covers were in the closed position and exhibited greater-than-normal erosion. All four blast covers were eroded on the inboard corner and the lost material averaged 1-1/2" x 1-1/2" in size. A 1-inch diameter hole was visible on the south face of HDP #3 cover. The SRB aft skirt nitrogen purge lines and T-0 (joint heater) umbilicals sustained minor damage. Post flight inspection of the sandboxes inside the holddown posts revealed no significant debris.

A metal plate on the MLP deck just north of the LH SRB exhaust hole was raised up 1/2-inch at one corner and was missing one bolt. This 0.5 inch diameter bolt had loosened and 'walked' out of the bolt hole during SRB plume impingement.

The OAA, TSM's, and GOX vent arm showed typical, but minor, launch damage. The GH2 vent arm appeared to have retracted nominally, with the exception of the north latch hitting and riding against the north saddle stabilizer. This has occurred on previous launches. The GH2 vent arm was latched on the sixth tooth of the latching mechanism and had no loose cables.

All seven emergency egress slidewire baskets were secured on the FSS 195 foot level.

Ground teams continued the post launch debris inspection on Friday 11/16/90 by searching the pad acreage and beach from the northern KSC boundary to the Titan complex. The NASA helicopter was utilized to cover the water areas around the pad, the beach from Complex 40 to a point 10 miles north of the pad, and the ocean area under the flight path. No flight hardware was found.

Approximately 25 sections of north pad perimeter chain link fence had been torn loose from the support posts.

There were no FSS/RSS cable tray covers found. Post launch inspection of Pad B after the STS-41 launch had revealed 7 lost covers and numerous loose covers on the facility. The covers on Pad A had been modified during pad refurbishment with a new trapeze type fastener. This modification is currently in work at Pad B.

Patrick AFB and MILA radars were configured in a mode for increased sensitivity for the purpose of observing any debris falling from the vehicle during ascent but after SRB separation (due to the masking effect of the SRB exhaust plume). Although most of the signal registrations were very weak and often barely detectable, which generally compares with the types of particles detected on previous Shuttle flights, a total of 49 particles were imaged in the T+139 to 390 second time period. Four of the particles at T+143-165 seconds had slightly stronger signals. 23 of the particles were imaged by only one radar, 23 particles were imaged by two radars, and 8 particles were imaged by all three radars.

Post launch pad inspection anomalies are listed in Section 11.1

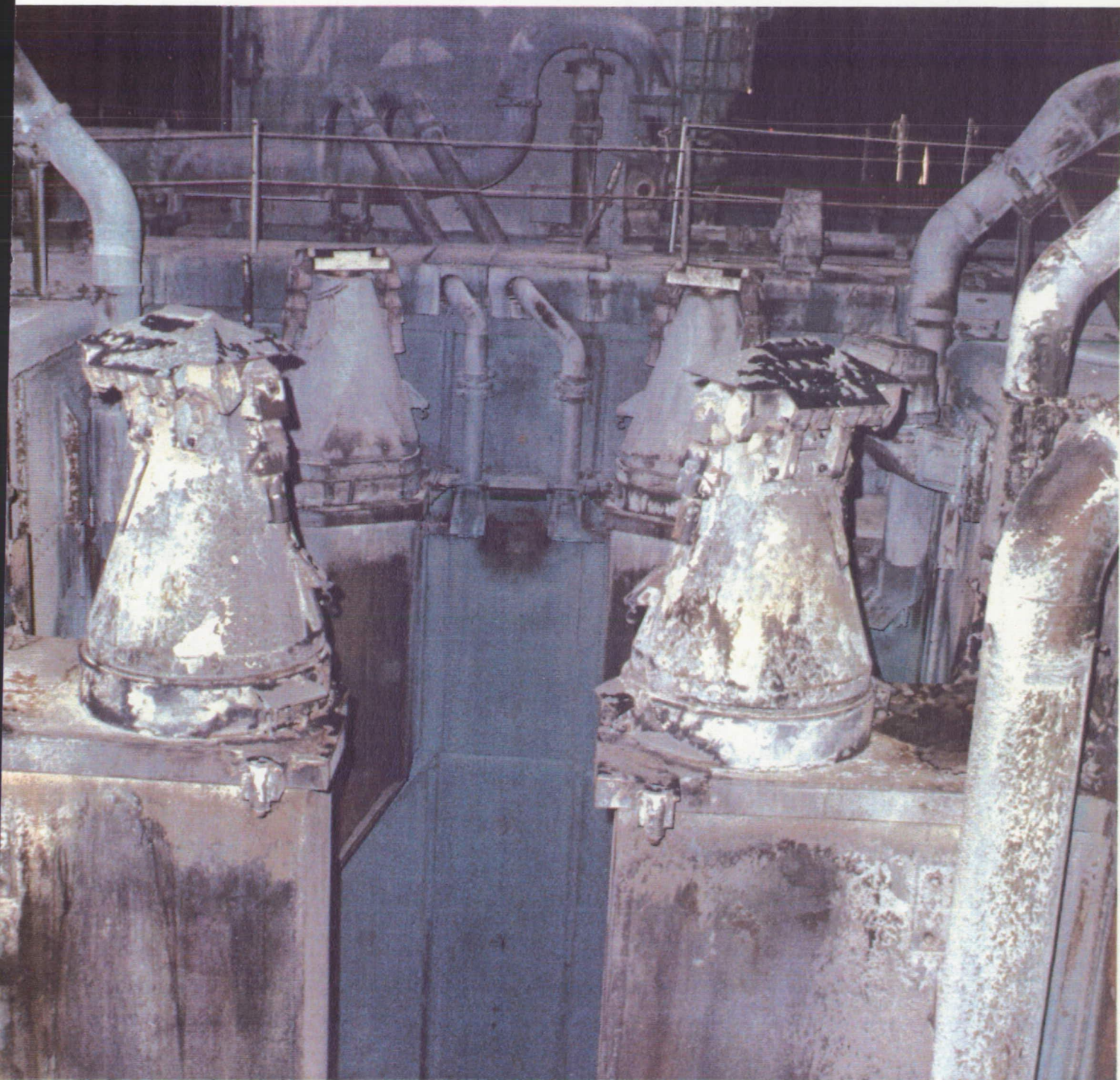

Post launch condition of RH SRB holddown posts. Note SRB plume effects on north posts compared to little effect on south posts



Typical SRB plume erosion on north holddown posts. All doghouse
blast covers had closed properly.

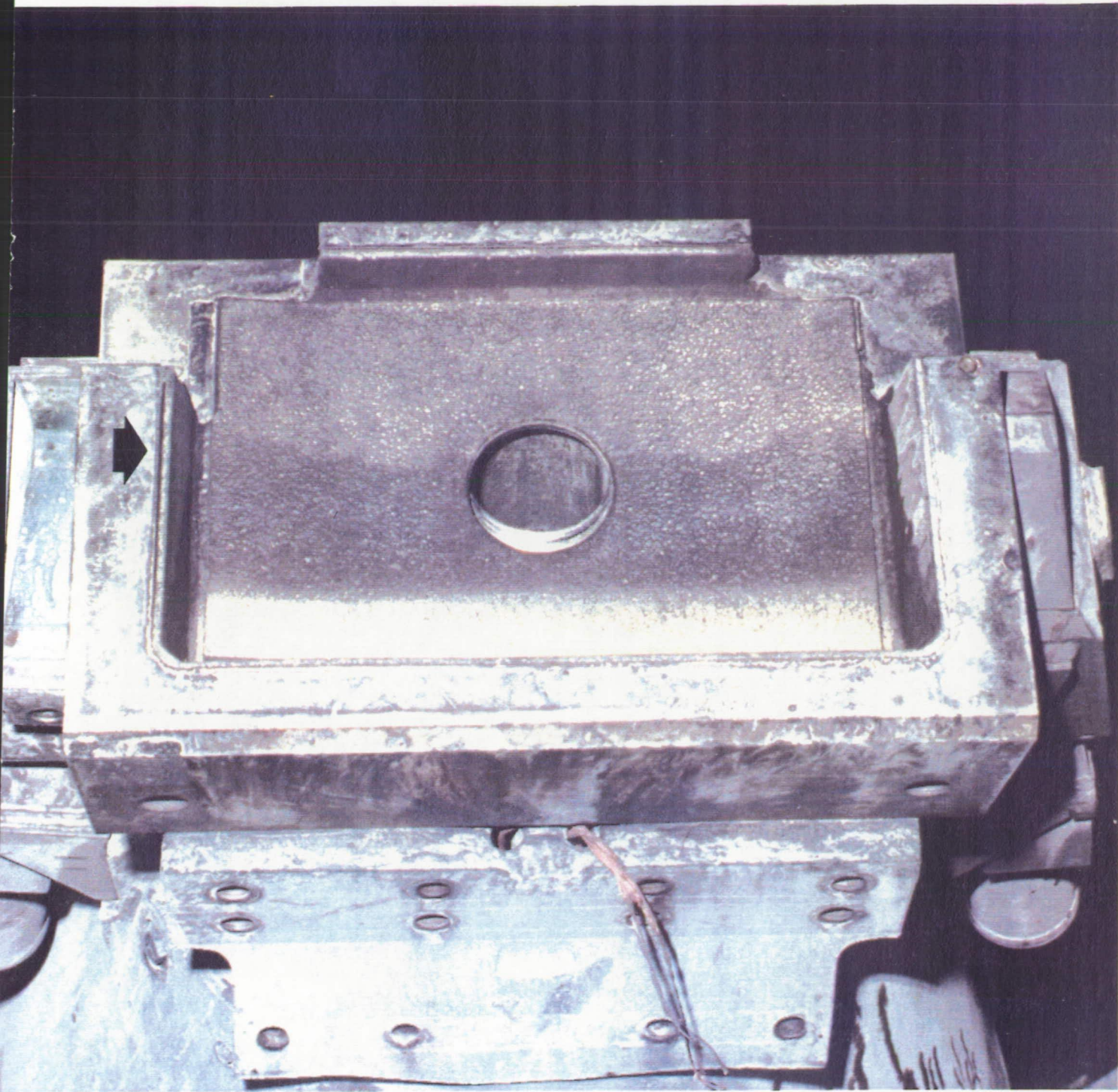

Holddown post shoe sidewall shim material was debonded

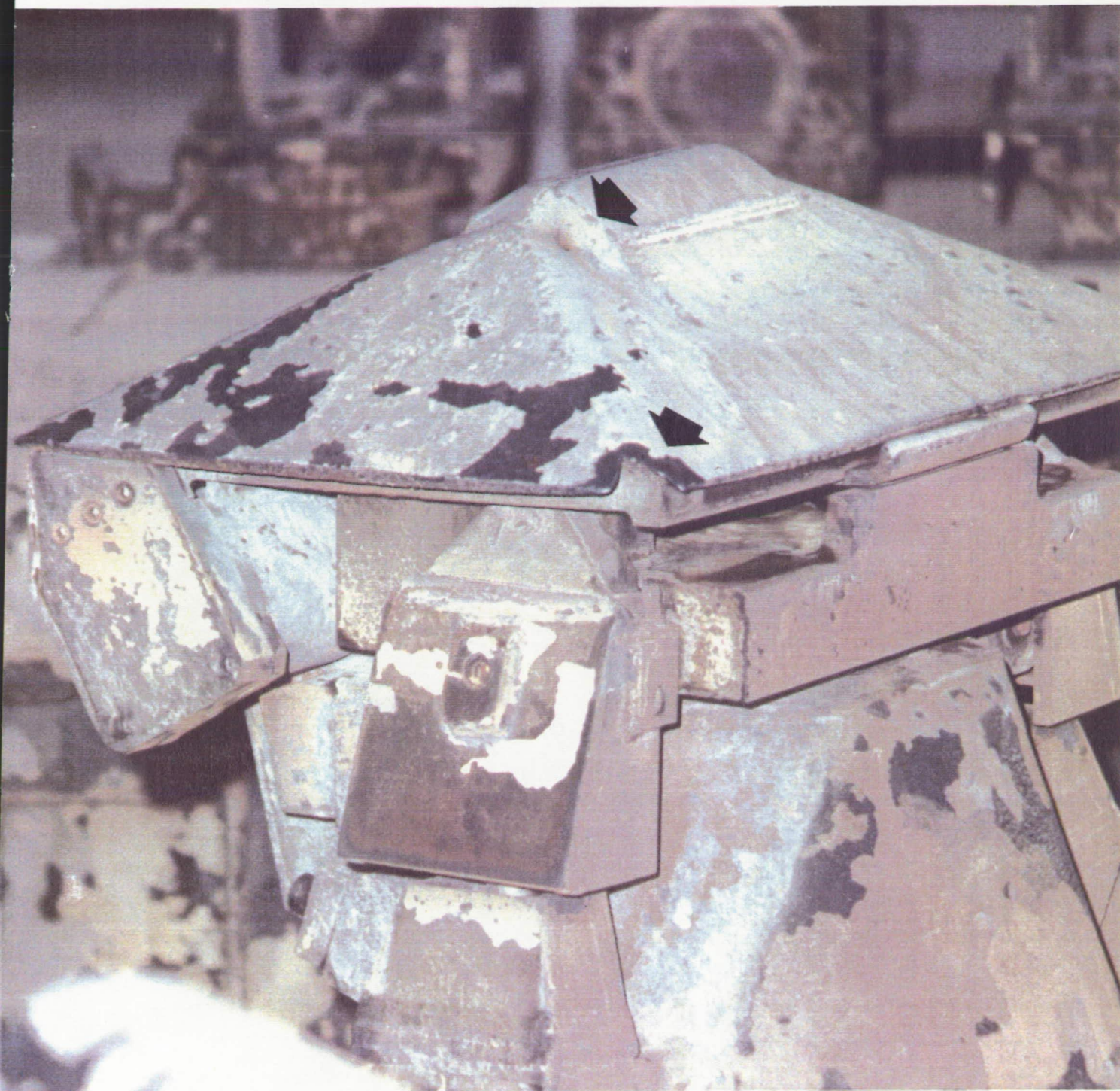

Erosion/heating effects from SRB plume was visible on top and corner of doghouse blast cover



SRB exhaust plume from the pad flame trench caused damage to
the north pad perimeter fence

7.0 FILM REVIEW SUMMARY/PROBLEM REPORT DISPOSITION

A total of 125 film and video data items, which included 35 videos, 43 16mm films, 39 35mm films, and 8 70mm films were reviewed during the STS-38 mission.

No major vehicle damage or lost flight hardware was observed that would have affected the mission. However, an IFA was taken against the possible loss of LH SRB aft skirt thermal curtain material at 34 and 39 seconds MET.

SSME ignition caused pieces of ice to fall from the LH2 ET/ORB umbilical. Some of the ice inside the Orbiter mold line contacted the umbilical cavity door sill/thermal barrier and was deflected outward away from the Orbiter. No tile damage resulted. SSME ignition vibration/acoustics caused the loss of small pieces of tile surface coating material from tiles on the base heatshield and LH RCS stinger.

Helium purge vapors and ice build-up on the LH2 umbilical had been typical during tanking, stable replenish, and launch. There were no unusual vapors or liquid drops during liftoff.

There were no major facility anomalies. No swing arms or other pad structures contacted the vehicle during liftoff. All T-0 umbilicals separated cleanly. The GH2 vent line latched properly. However, excessive slack caused the static retract lanyard to impact the underside of the ET intertank access structure, rebound, and contact the GUCP (E-33, 42, 50). The lanyard modification, successfully utilized on STS-41, had not yet been incorporated on Pad A.

Three ordnance fragments fell from HDP #1 aft skirt stud hole shortly after liftoff (E-9). Small pieces of aft skirt instafoam and a sliver of holddown post shim material/putty were pulled loose from the HDP #5 shoe area by vehicle liftoff (E-12). A piece of EPON shim material, which should remain bonded to the RH SRB aft skirt HDP #4, was loose but still attached to the vehicle shortly after liftoff (E-7, 15, 27).

Numerous particles were ejected out of the SRB exhaust holes after T-0 as the vehicle attained 30 feet altitude. Five of the particles trailed smoke and are believed to be pieces of burning SRB throat plug material (E-61, 62, 63, 64). Charred pieces of throat plug material are commonly found after launch. Many film and video items recorded various amounts of flying debris on and around the pad after the vehicle cleared the tower. This debris is SRB throat plug material and shredded sound suppression water troughs - an expected occurrence.

At least 40 light-colored particles fell out of the SRB plume just after the roll maneuver and another 24 particles fell out of the SRB plumes approximately 60-83 seconds into flight. Similar particles on previous flights have been attributed to either chunks of SRB propellant/inhibitor or pieces of SRB aft skirt instafoam.

Movement of the Orbiter body flap was clearly visible during flight and appeared to have magnitude/frequency similar to previous flights (E-207). Orbiter LO2 umbilical purge barrier (baggie) separated from the vehicle, fell aft, and was caught in the plume recirculation at 42 seconds MET in film E-218.

A light-colored object, most likely SRB thermal blanket material, fell from the -Z side of the LH SRB aft skirt 34 seconds into flight. The object appeared to come loose near the nozzle extension, moved toward the aft ring, and finally separated from the aft skirt. The object seemed to be flexible, rather than a more rigid-like piece of instafoam. The size and behavior of the object in the air flow ruled out the possibility of thermal curtain tape. A second similar object fell aft from the same general area at 39 seconds MET.

There was no on-orbit photography of the External Tank due to the DOD mission and time of launch (dark conditions).

Orbiter performance, landing gear extension, wheel touchdown, and vehicle rollout after landing at the Kennedy Space Center were nominal. However, two pieces of SSME thermal blanket fell from the Orbiter as the vehicle came out of the Heading Alignment Circle (HAC).

No PR's or IPR's were generated as a result of the film and video data review. However, the Post Launch Anomalies observed in the Film Review were presented to the Mission Management Team, Shuttle managers, and vehicle systems engineers. These anomalies are listed in Section 11.2.



SSME ignition vibration/acoustics caused pieces of tile surface coating material to fall from rudder/speed brake trailing edge tiles (arrows)

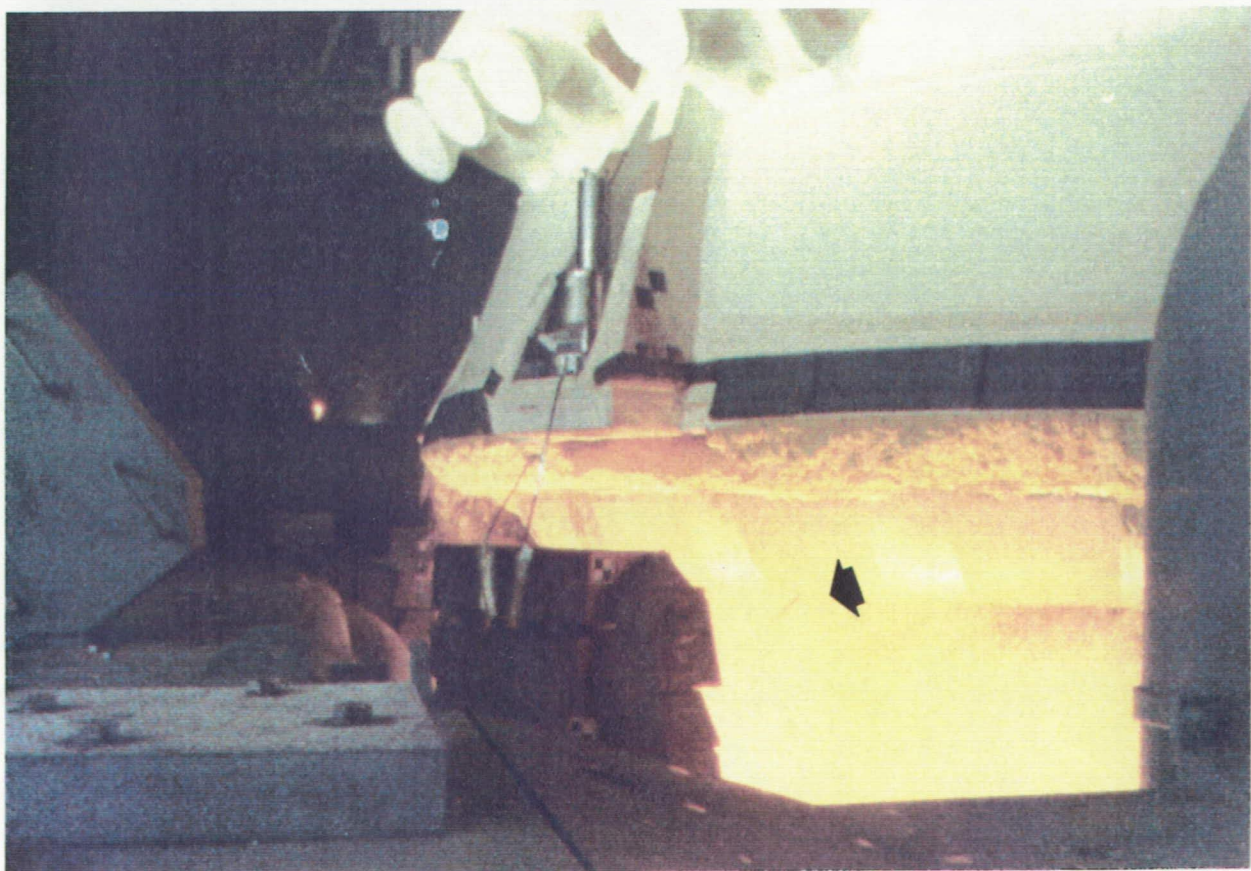
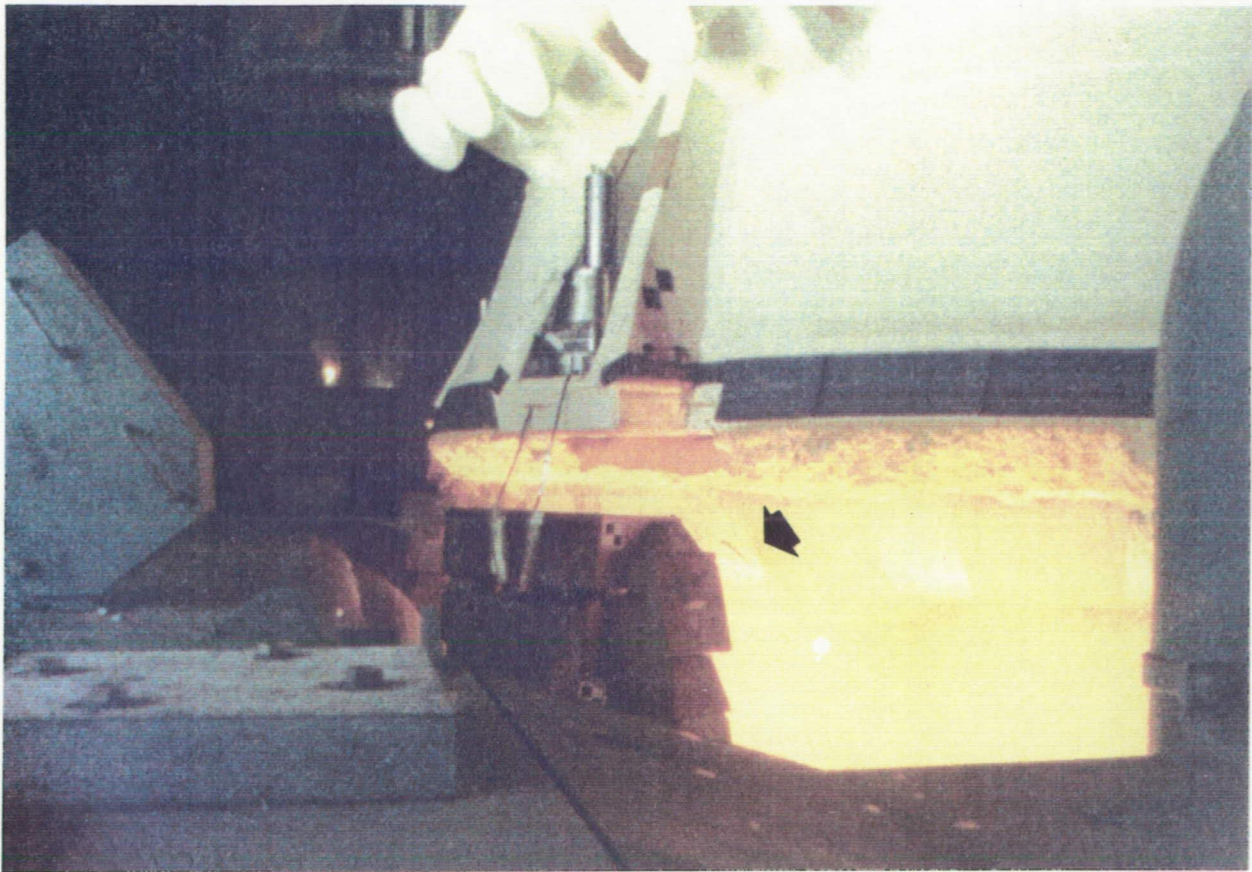

Small pieces of aft skirt instafoam and a sliver of HDP shim material/putty were pulled loose from the HDP #5 area at T-0

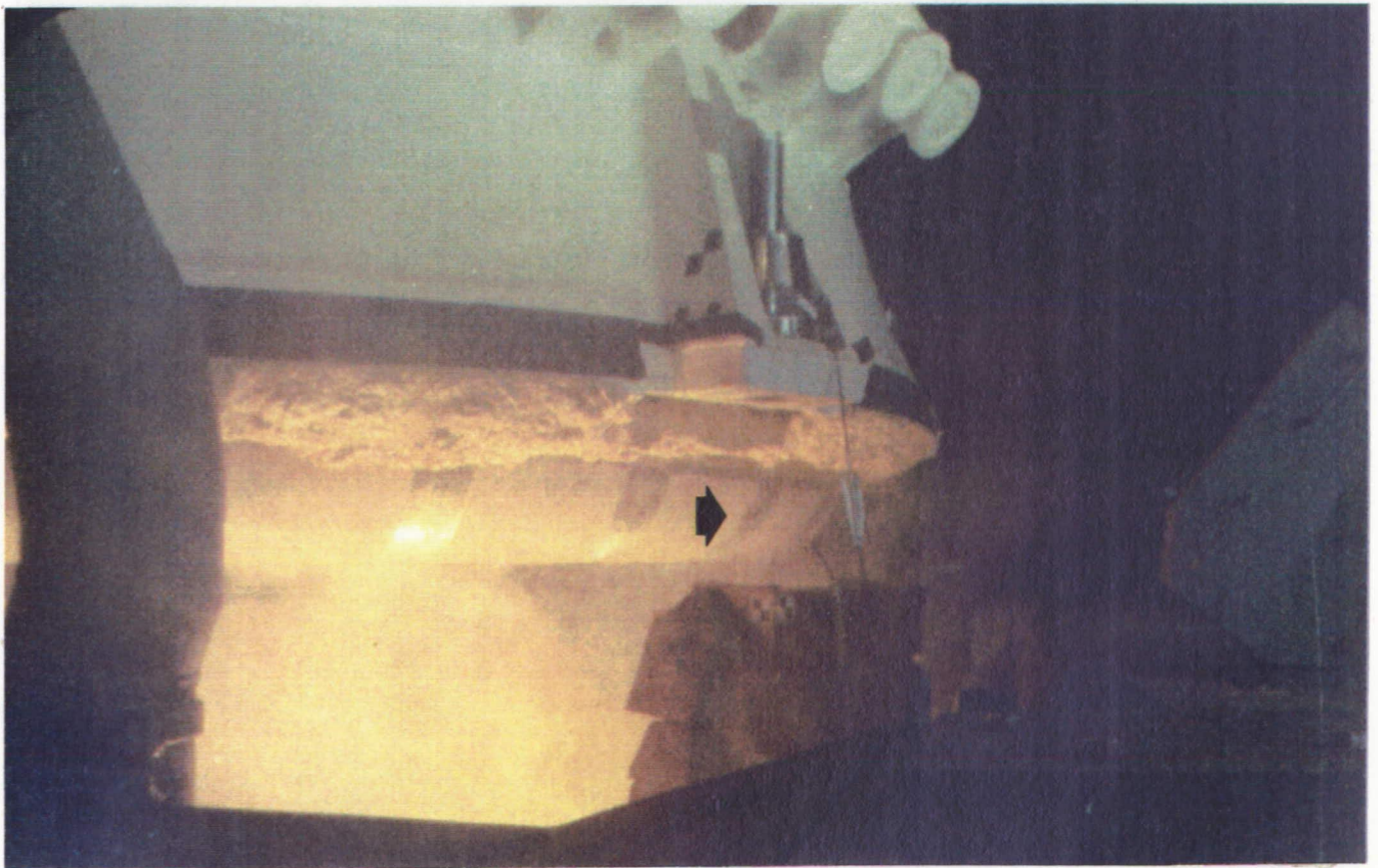
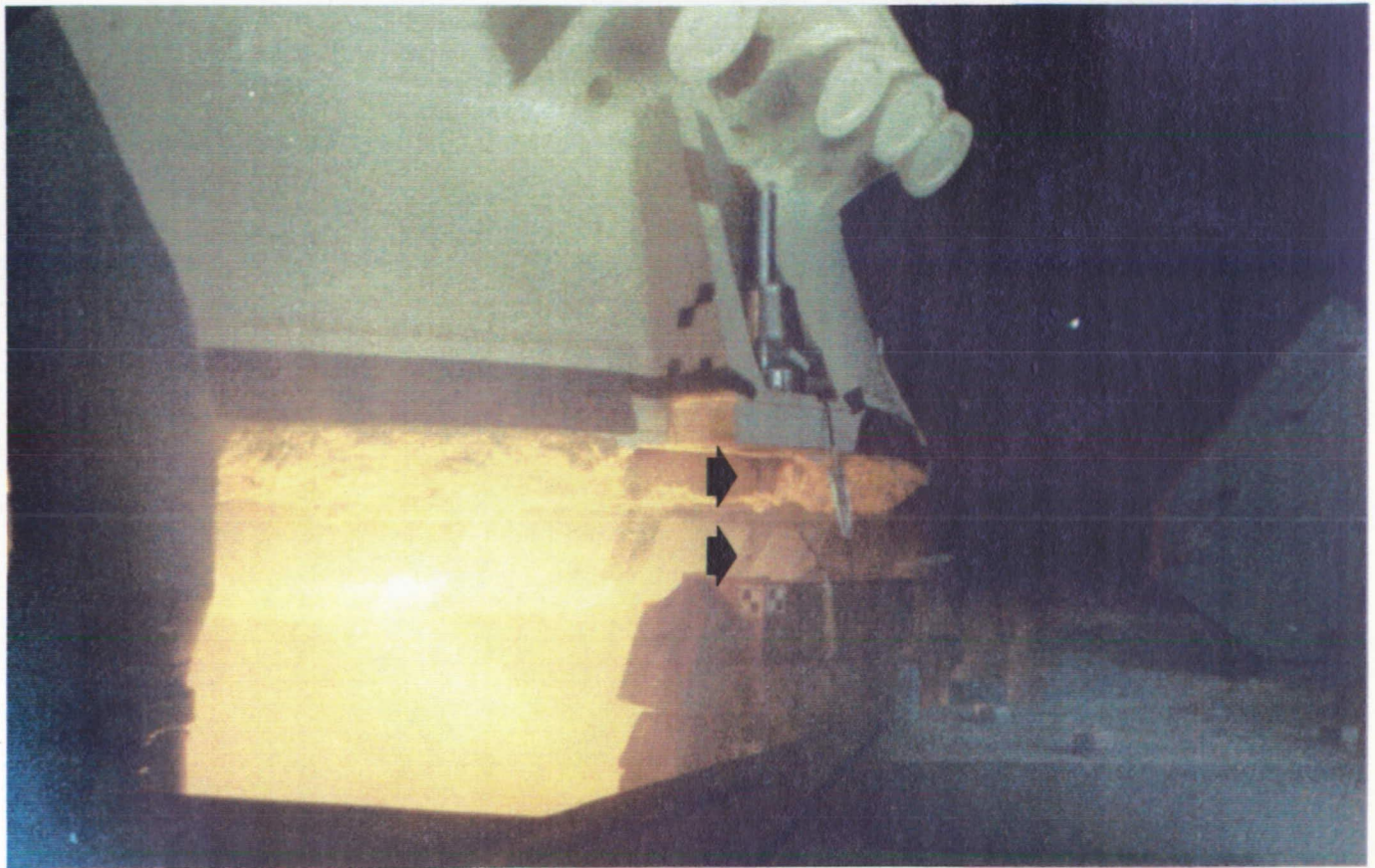

Three ordnance fragments fell from the RH SRB aft skirt HDP #1
DCS/stud hole shortly after liftoff



Numerous particles were ejected out of the SRB exhaust holes after T-0 as the vehicle attained 30 feet altitude. Five of the particles trailed smoke and may be pieces of burning SRB throat plug material. Charred pieces of throat plug are commonly found on the pad after launch.

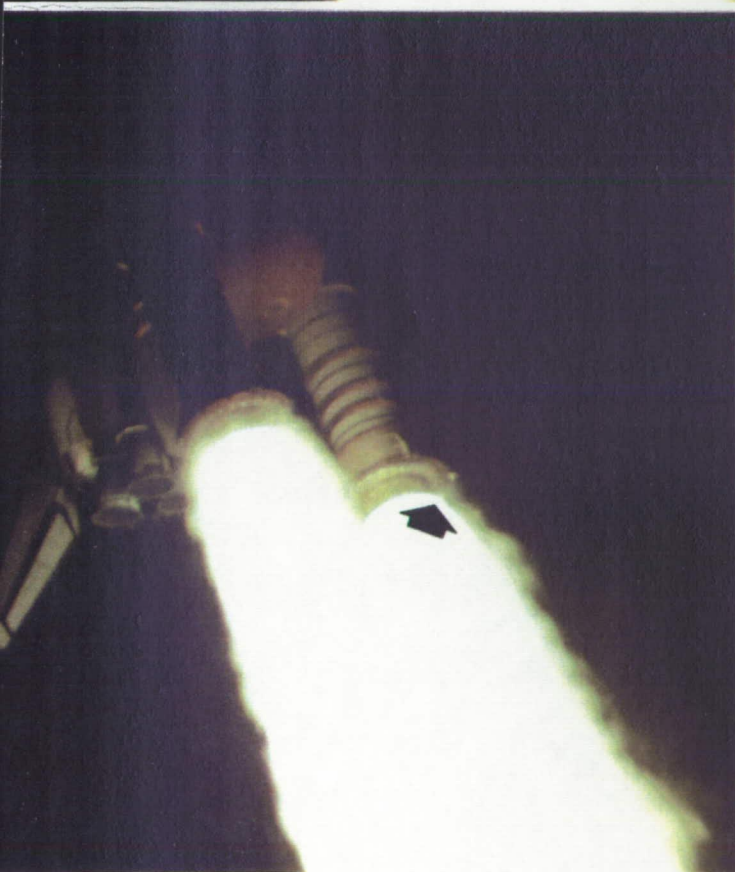

Possible loss of thermal curtain material from the LH SRB aft skirt -Z side. Tracking footage shows the piece of material appeared to come loose near the nozzle extension, moved out toward the aft ring, and then separated from the aft skirt.

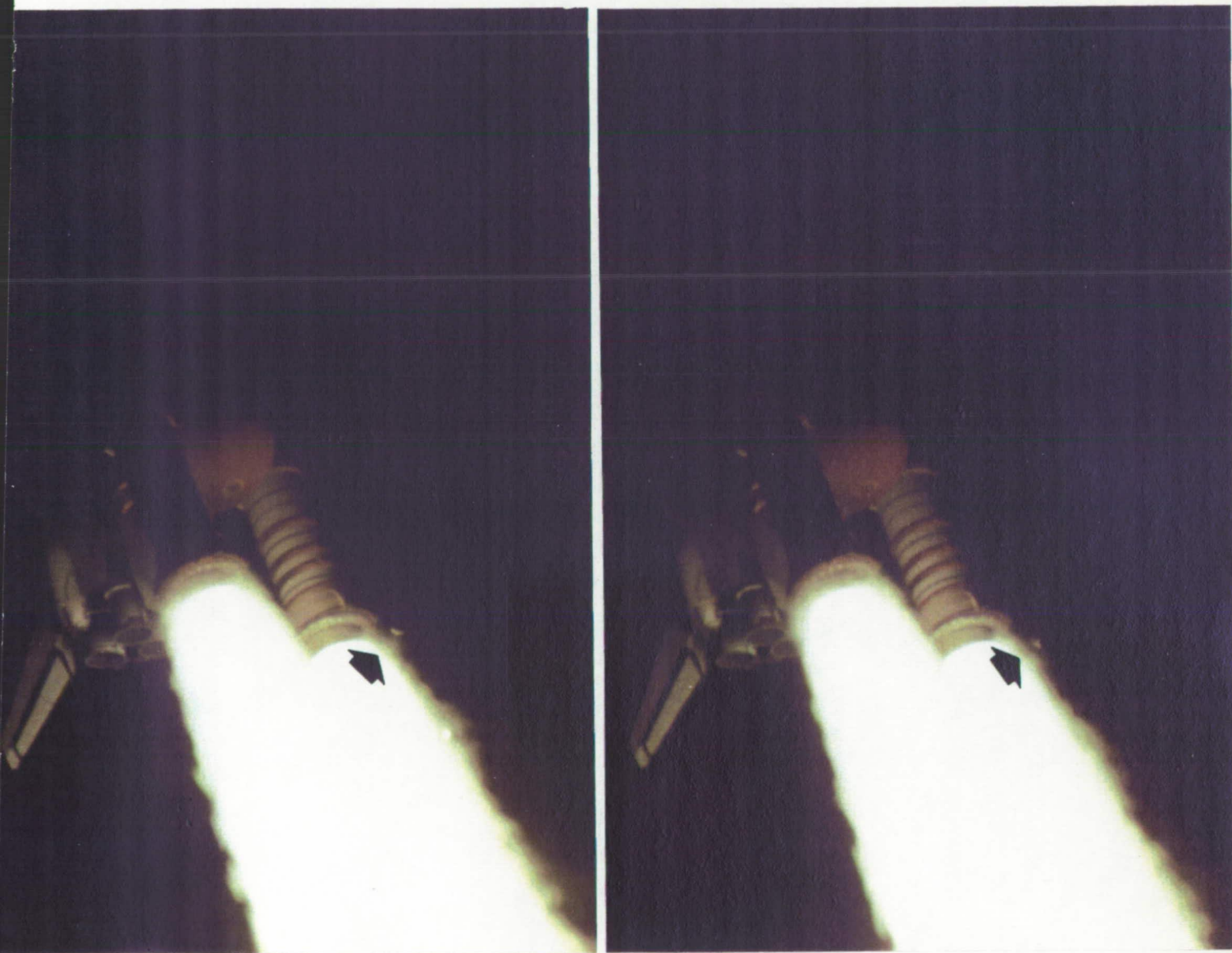

Possible loss of thermal curtain material from the LH SRB aft skirt -Z side at 34 seconds MET. The piece of material was lost against the SRB exhaust plume and could not be tracked further.

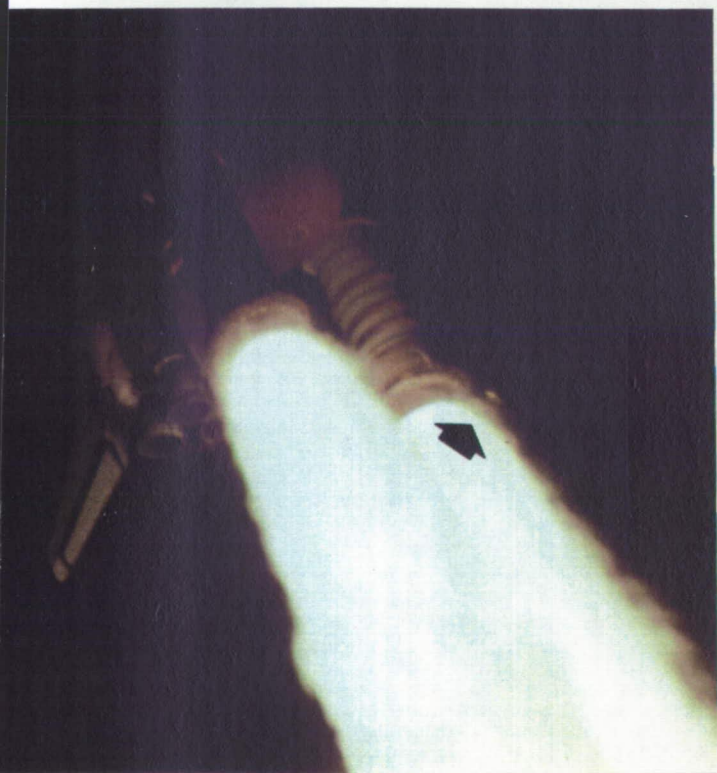
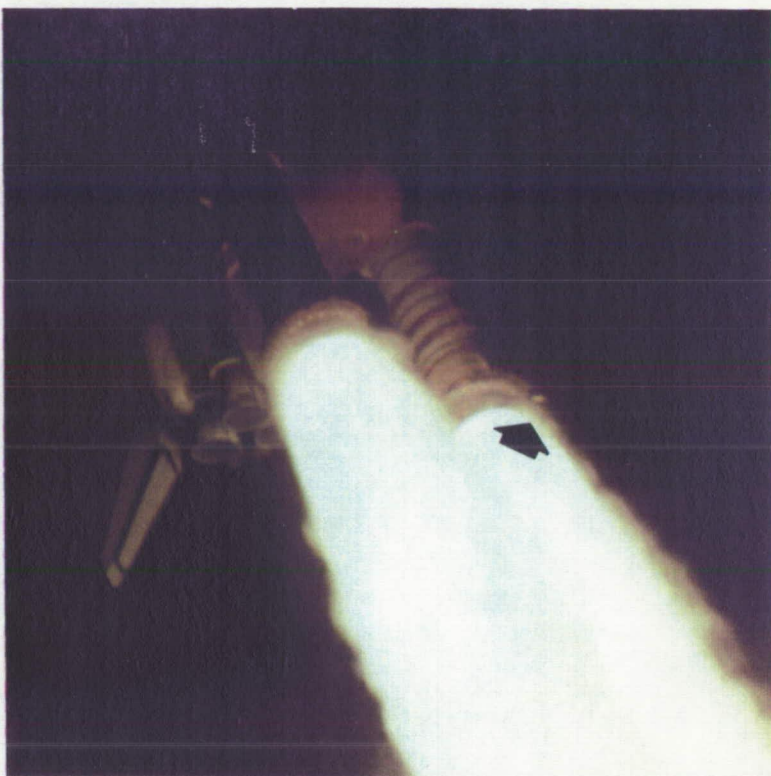

Possible loss of second piece of LH SRB aft skirt thermal curtain material at 39 seconds MET. Both objects' apparent size, mass, and behavior tend to preclude the possibility of SRB thermal curtain tape.

7.1 LAUNCH FILM AND VIDEO DATA REVIEW

FILM ITEMS

EX1 Camera is located on MLP deck south of RH SRB
400 FPS exhaust duct and looks north to view SRB Heater
16mm Umbilical during ignition and liftoff.

Comments: Deleted for STS-38 due to low lighting conditions.

EX2 Camera is located on the MLP deck west of RH SRB
400 FPS flame duct and looks east to view SRB Heater
16mm Umbilical during ignition and liftoff.

Focus : O.K.
F. O. V.: O.K.
Exposure: O.K.

Comments: T-0 umbilical separation nominal. Numerous particles of throat plug material were ejected out of SRB exhaust hole after T-0.

EX3 Camera is located on the MLP deck east of LH SRB
400 FPS flame duct and looks west to view SRB Heater
16mm Umbilical during ignition and liftoff.

Focus : O.K.
F. O. V.: Cuts off part umbilical.
Exposure: O.K.

Comments: T-0 umbilical separation nominal. One piece of throat plug material ejected out of SRB exhaust hole after T-0.

EX4 Camera is located on MLP deck south of LH SRB
400 FPS flame duct and looks north to view LH SRB Heater
16mm Umbilical during ignition and liftoff.

Comments: Deleted for STS-38 due to low lighting conditions.

E-1 Camera is located on the NE corner of the MLP deck
400 FPS and views the lower ET, SRB's, and Orbiter.
16mm

Focus : Soft
F. O. V.: O.K.
Exposure: O.K.

Comments: Numerous flashes in SSME plume were caused by pieces of RCS paper covers. Ice particles fell from LH2 umbilical at SSME ignition and T-0. No tile damage visible. Numerous pieces of SRB throat plug material were ejected upward out of SRB exhaust hole.

E-2 Camera is located on the SE corner of the MLP deck
400 FPS and views Orbiter SSME and OMS engine nozzles.
16mm

Focus : O.K.
F. O. V.: O.K.
Exposure: O.K.

Comments: SSME ignition nominal. Pieces of RCS paper covers were torn loose and pulled into SSME plume at SSME ignition and T-0. Vapors were visible from LO2 TSM T-0 prior to disconnect. Foam on ET aft dome and SRB stiffener rings outgassed during early ascent.

E-3 Camera is located on the SW corner of the MLP deck
400 FPS and views Orbiter SSME and OMS engine nozzles.
16mm

Focus : O.K.
F. O. V.: O.K.
Exposure: O.K.

Comments: SSME ignition nominal. RCS paper covers were drawn into SSME plume. LO2 TSM door rebounded momentarily before full closure. A dark particle first appeared behind LH2 TSM moving toward FSS (frame 4466). Residual LO2 vapor from T-0 disconnect was drawn into plume.

E-4 Camera is located on the NW corner of the MLP deck
400 FPS and views lower ET, SRB's, and Orbiter.
16mm

Focus : O.K.
F. O. V.: O.K.
Exposure: Underexposed.

Comments: Shortly after T-0, an 8"x8" piece of ice fell past body flap from LH2 ORB/ET umbilical, no vehicle impact. Residual vapors were visible from Orbiter LO2 T-0 umbilical after disconnect. Two particles passed in front of LH wing during early ascent, but did not contact the vehicle. Numerous particles were ejected out of the SRB exhaust hole, one particle trailing smoke.

E-5 Camera is located on the east side of the MLP
400 FPS deck and views the Orbiter RH wing, body flap,
16mm and lower ET/SRB.

Focus : O.K.
F. O. V.: O.K.
Exposure: O.K.

Comments: SSME ignition caused ice to fall from ET/ORB umbilicals. No tile damage visible. No unusual vapors in the vicinity of the umbilical during liftoff. Ice particles fell from LH2 feedline/recirculation line bellows. Residual LO2 vapors were visible in Orbiter T-0 disconnect.

E-6 Camera is located on the east side of the MLP deck
200 FPS and views the RH lower Orbiter wing, body flap, ET
16mm lower LOX feedline, and ET/Orbiter umbilical area.

Focus : O.K.
F. O. V.: O.K.
Exposure: O.K.

Comments: Ice particles fell from ET/ORB umbilicals at SSME ignition and T-0.

E-7 Camera is located on the MLP deck and views the
400 FPS RH SRB northeast holddown post (HDP #4).
16mm

Focus : O.K.
F. O. V.: O.K.
Exposure: O.K.

Comments: Piece of EPON shim material was loose on RH SRB aft skirt HDP #4. SRB holddown post blast covers closure was nominal. No vehicle anomalies.

E-8 Camera is located on the MLP deck and views the
400 FPS RH SRB southeast holddown post (HDP #2).
16mm

Focus : O.K.
F. O. V.: O.K.
Exposure: O.K.

Comments: Numerous pieces of throat plug material were ejected out of the SRB exhaust hole after T-0. When vehicle was approximately 6 feet above MLP deck, a small particle - probably SRB instafoam - crossed FOV, frame 4543.

E-9 Camera is located on the MLP deck and views the
400 FPS RH SRB southwest holddown post (HDP #1).
16mm

Focus : O.K.
F. O. V.: Camera shaky.
Exposure: O.K.

Comments: At frame 3940, the first of three ordnance debris fragments fell from the HDP #1 DCS/stud hole.

E-10 Camera is located on the MLP deck and views the
400 FPS RH SRB northwest holddown post (HDP #3).
16mm

Focus : O.K.
F. O. V.: O.K.
Exposure: O.K.

Comments: SRB instafoam and throat plug material were ejected out of SRB exhaust hole after T-0. SRB holddown post blast cover closure was nominal.

E-11 Camera is located on the MLP deck and views the
400 FPS LH SRB northeast holddown post (HDP #7).
16mm

Focus : O.K.
F. O. V.: O.K.
Exposure: O.K.

Comments: SRB instafoam and throat plug material were ejected out of SRB exhaust hole after T-0. SRB holddown post blast cover closure was nominal.

E-12 Camera is located on the MLP deck and views the
400 FPS LH SRB southeast holddown post (HDP #5).
16mm

Focus : O.K.
F. O. V.: O.K.
Exposure: O.K.

Comments: Free burning hydrogen was blown under body flap. Deck debris was blown across deck during SSME ignition. Large quantity of ice particles fell from ET/ORB umbilicals. Small pieces of aft skirt instafoam and one sliver of holddown post shim material/putty near the shoe were pulled loose by vehicle liftoff. No debris fell from aft skirt stud hole. Small pieces of K5NA behind DCS came into view.

E-13 Camera is located on the MLP deck and views the
400 FPS LH SRB southwest holddown post (HDP #6).
16mm

Focus : O.K.
F. O. V.: O.K.
Exposure: O.K.

Comments: Light colored debris objects that appeared in FOV are pieces of SRB throat plug material. Some facility debris passed in front/vicinity of HDP #5.

E-14 Camera is located on the MLP deck and views the
400 FPS LH SRB northwest holddown post (HDP #8).
16mm

Focus : O.K.
F. O. V.: O.K.
Exposure: O.K.

Comments: SRB throat plug material was ejected out of the SRB exhaust hole at T-0. SRB holddown post blast covers closure was nominal.

E-15 Camera is located on the MLP deck and views the RH
400 FPS SRB skirt, sound suppression water troughs, and RH
16mm lower Orbiter body flap.

Focus : O.K.
F. O. V.: O.K.
Exposure: Slightly underexposed.

Comments: ET/ORB umbilical and T-0 umbilical ice particles fell during SSME ignition. A piece of EPON shim material was loose on SRB aft skirt HDP #4. SRB blast covers closed nominally. Pieces of throat plug material were ejected out of SRB exhaust hole moving diagonally left to right.

E-16 Camera is located on the MLP deck and views the LH
400 FPS SRB skirt, sound suppression water troughs, and LH
16mm lower Orbiter body flap.

Focus : O.K.
F. O. V.: O.K.
Exposure: O.K.

Comments: SSME ignition nominal. Free burning hydrogen drifted upward. Ice particles fell from LH2 umbilical. SRB throat plug material and sound suppression trough water ejected upward at T-0. No debris fell from aft skirt stud hole. SRB holddown post blast covers closed nominally. SRB plume deflected upward and momentarily impinged on aft skirt instafoam.

E-17 Camera is located on the MLP deck and views the
400 FPS -Z side of the LO2 T-0 Umbilical and TSM.
16mm

Focus : O.K.
F. O. V.: O.K.
Exposure: O.K.

Comments: Numerous ice/frost particles fell from cryo lines during SSME ignition. Aft RCS paper covers were torn loose and pulled into plume. After retraction, six particles fell from TSM door are and were probably ice particles. A particle moved downward as vehicle cleared FOV. No contact visible.

E-18 Camera is located on the MLP deck and views the
400 FPS -Z side of the LH2 T-0 umbilical and TSM.
16mm

Focus : O.K.
F. O. V.: O.K.
Exposure: O.K.

Comments: Free burning hydrogen drifted upward. Ice particles fell from LH2 T-0 umbilical during ignition. Vapors, most likely frost subliming from cold freon supply lines, appeared after SSME ignition and were drawn downward by aspiration. Body flap moved slightly during ignition. T-0 disconnect and retraction nominal. Residual vapors were drawn into plume.

E-19 Camera is located on the SE side of the MLP deck
400 FPS and views the SSME/OMS nozzles and Orbiter aft
16mm heat shield area.

Focus : O.K.
F. O. V.: O.K.
Exposure: O.K.

Comments: SSME ignition was nominal. Aft RCS paper covers were torn loose during SSME ignition and pulled into plume. Ice/frost particles fell from LO2 T-0 umbilical during ignition and retraction. Residual vapors were visible from both LO2 and LH2 T-0 QD's

E-20 Camera is located on the SW side of the MLP deck
400 FPS and views the SSME/OMS nozzles and Orbiter aft
16mm heat shield area.

Focus : O.K.
F. O. V.: O.K.
Exposure: O.K.

Comments: Free burning hydrogen drifted up to LH RCS stinger. SSME ignition nominal. LH2 T-0 disconnect nominal. LO2 TSM door rebounded during closure. Residual vapors were drawn into plume. Two small pieces of tile surface coating material broke loose from aft face of LH stinger and one piece from base heat shield.

E-21 Camera is located inside the LO2 TSM and views
200 FPS the disconnection of the T-0 umbilical.
16mm

Focus : O.K.
F. O. V.: O.K.
Exposure: O.K.

Comments: Vehicle twang nominal. T-0 carrier plate disconnection and retraction nominal. TSM door rebounded 2-3 inches before final closure.

E-22 Camera is located inside the LH2 TSM and views
200 FPS the disconnection of the T-0 umbilical.
16mm

Focus : O.K.
F. O. V.: O.K.
Exposure: O.K.

Comments: SSME ignition caused purge barrier to pull away from top of TSM. T-0 carrier plate disconnect and retraction nominal. TSM door did not rebound.

E-23 Camera is located on the MLP deck and views the
400 FPS RH OMS engine nozzle.
16mm

Focus : O.K.
F. O. V.: O.K.
Exposure: O.K.

Comments: Ice particles fell from LOX TSM umbilical during SSME ignition and T-0. RCS paper covers were torn loose and pulled into SSME plume by aspiration. Residual vapors were visible from LOX T-0 umbilical after separation. SRB stiffener ring foam out-gassed at T-0 and during early ascent.

E-24 Camera is located on the MLP deck and views the
400 FPS LH OMS engine nozzle.
16mm

Comments: No data, camera malfunction.

E-25 Camera is located on the east side of the MLP and
400 FPS views between Orbiter and ET/SRB during liftoff.
16mm

Focus : O.K.
F. O. V.: O.K.
Exposure: Slightly underexposed.

Comments: Three pieces of ice fell from ET/ORB umbilical. RH SRB HPU exhaust was visible during early ascent.

E-26 Camera is located on the west side of the MLP and
400 FPS views between Orbiter and ET/SRB during liftoff.
16mm

Focus : O.K.
F. O. V.: O.K.
Exposure: O.K.

Comments: Ice particles fell from umbilicals and LH2 feedline bellows. No tile impacts visible. No unusual vapors occurred in area of umbilicals. One particle fell into FOV from above -Y ET/SRB cable tray.

E-27 Camera is located on the MLP deck and views RH SRB
400 FPS northwest holddown post (HDP #3) blast cover.
16mm

Focus : O.K.
F. O. V.: O.K.
Exposure: O.K.

Comments: SRB throat plug instafoam and SRB sound suppression water trough material was ejected out of SRB exhaust hole at T-0. A piece of EPON shim material was loose on SRB aft skirt HDP #4 after liftoff. SRB holddown post blast cover closure was nominal.

E-28 Camera is located on the MLP deck and views LH SRB
400 FPS northeast holddown post (HDP #7) blast cover.
16mm

Focus : O.K.
F. O. V.: O.K.
Exposure: O.K.

Comments: SRB throat plug material was ejected out of SRB ex-
haust hole at T-0. SRB holddown post blast cover closure was
nominal.

E-30 Camera is located on the FSS 195 foot level and
400 FPS views LH SRB and sound suppression water troughs.
16mm

Focus : O.K.
F. O. V.: O.K.
Exposure: O.K.

Comments: Free burning hydrogen was blown under the Orbiter body
flap by east winds. A large ice particle fell from LH2 ET/ORB
umbilical at T-0.

E-31 Camera is located on the FSS 95 foot level and
100 FPS views the LH Orbiter wing, body flap, and
16mm ET/Orbiter LH2 umbilical area.

Focus : O.K.
F. O. V.: O.K.
Exposure: O.K.

Comments: At SSME ignition, ice particles fell from ET/ORB um-
bilical area, GSE strut attach points and recirculation bellows.
No tile damage was visible. LH inboard and outboard elevons moved
at SSME ignition. Four particles, probably ice from LOX feedline
bellows, fell from area above vertical strut. After SRB ignition,
an ice particle fell from Orbiter umbilical purge barrier baggie
and bounced off Orbiter umbilical thermal barrier on the cavity
sill. No damage resulted.

E-33 Camera is located on the FSS 235 foot level and
400 FPS views the ET GH2 vent line and GUCP.
16mm

Focus : O.K.
F. O. V.: O.K.
Exposure: O.K.

Comments: Ice particles fell from ET/GUCP interface at SSME ignition and T-0. Residual vapors were visible in the Umbilical Carrier Plate after separation.

E-34 Camera is located on FSS at 255 foot level and
400 FPS views upper Orbiter tile surfaces.
16mm

Focus : O.K.
F. O. V.: O.K.
Exposure: O.K.

Comments: GH2 vent line disconnect and retraction nominal. Four small pieces of ice fell from GUCP after release.

E-35 Camera is located on the FSS 255 foot level and
400 FPS views the mid-Orbiter/ET/SRB area.
16mm

Focus : Soft
F. O. V.: O.K.
Exposure: Slightly underexposed.

Comments: Several particles of ice fell from LH2 ET/ORB umbilical. SSME ignition nominal. LH2 T-0 umbilical retraction nominal. Two pieces of ice fell from ET umbilical carrier plate after retraction.

E-36 Camera is located on the FSS 255 foot level and
400 FPS views lower Orbiter, ET, SRB's, and water trough.
16mm

Focus : O.K.
F. O. V.: O.K.
Exposure: Overexposed during liftoff.

Comments: Free burning hydrogen was blown under body flap. SSME ignition nominal. Ice particles fell from LH2 umbilical. LH2 T-0 disconnect and separation nominal.

E-40 Camera is located on the FSS 275 foot level and
400 FPS views the ET ogive, SRB nosecone, and Orbiter
16mm tiled surfaces.

Focus : O.K.
F. O. V.: O.K.
Exposure: O.K.

Comments: Forward RCS paper covers were still intact at tower clear. No vehicle anomalies. ET aft dome and SRB stiffener ring foam outgassed after T-0. No unusual vapors in area of ET/ORB umbilicals.

E-41 Camera is located on the FSS 255 foot level and
400 FPS views the GH2 vent line during rotation. Also
16mm shows clearance between structure and SRB aft skirt.

Focus :
F. O. V.:
Exposure:

Comments: Due to modifications on the FSS, the camera location cannot be used. The camera will be relocated at a future date.

E-42 Camera is located on the FSS 185 foot level and
400 FPS views the GH2 vent line drop, deceleration, and
16mm latchback.

Focus : O.K.
F. O. V.: O.K.
Exposure: O.K.

Comments: Excess slack occurred in the GH2 vent line static lanyard. The lanyard contacted the underside of the ET intertank access structure, rebounded, and appeared to strike the GUCP. Ice particles from the GUCP were shaken loose during retraction.

E-43 Camera is located on the SW side of pad apron
200 FPS and views the underside of the SSME exhaust hole
16mm during ignition and liftoff.

Focus : O.K.
F. O. V.: O.K.
Exposure: O.K.

Comments: SSME exhaust plume blown by east wind quickly obscured FOV.

E-44 Camera is located on the FSS 155 foot level and
400 FPS views the LH OMS Pod leading edge tiles during
16mm ignition and liftoff.

Focus : O.K.
F. O. V.: O.K.
Exposure: O.K.

Comments: A particle, probably a water droplet, fell alongside
the vehicle at T-0. After liftoff, residual vapors were visible
from the LH2 TSM.

E-48 Camera is located on the FSS 215 foot level (ET
400 FPS Intertank access arm structure) and views the GH2
16mm vent line during GUCP disconnection, rotation, and
latchback

Focus : O.K.
F. O. V.: O.K.
Exposure: O.K.

Comments: SSME ignition caused small pieces of ice/frost to fall
from GUCP. GH2 vent line/GUCP disconnected and retracted
nominally. GH2 vent line latched properly and did not rebound.

E-50 Camera is located at camera site 1 at NE pad
400 FPS perimeter and views entire GH2 vent line and
16mm GUCP during rotation and latchback.

Focus : O.K.
F. O. V.: Low
Exposure: O.K.

Comments: Several ice particles fell from GUCP interface at T-0.
GH2 vent arm retraction and latchback was nominal. Static retract
lanyard exhibited excessive slack during retraction.

E-52 Camera is located at camera site 2 on the east pad
96 FPS perimeter. Remote tracking of lower one-third of
35mm launch vehicle from ignition to 1200 feet.

Focus : O.K.
F. O. V.: O.K.
Exposure: O.K.

Comments: See comments in film item E-54.

E-53 Camera is located at camera site 2 on the east pad
96 FPS perimeter. Remote tracking of middle one-third of
35mm launch vehicle from ignition to 1200 feet.

Focus : O.K.
F. O. V.: O.K.
Exposure: O.K.

Comments: See comments in film item E-54.

E-54 Camera is located at camera site 2 on the east pad
96 FPS perimeter. Remote tracking of upper one-third of
35mm launch vehicle from ignition to 1200 feet.

Focus : O.K.
F. O. V.: O.K.
Exposure: O.K.

Comments: A bird was visible above the FSS hammerhead crane heading away from vehicle. ET aft dome and SRB stiffener ring outgassed at T-0 and during early ascent. After vehicle cleared TSM's, vapors were visible trailing the Orbiter speed brake. Charring was visible on ET aft dome shortly after roll maneuver. Forward RCS paper covers were torn loose and entered the SSME plume. Numerous bright particles fell out of SRB plume after roll maneuver.

E-57 Camera is located at camera site 6 on the NW pad
96 FPS perimeter. Remote tracking of lower one-third of
35mm launch vehicle from ignition to 1200 feet.

Focus : O.K.
F. O. V.: O.K.
Exposure: O.K.

Comments: See comments in film item E-59.

E-58 Camera is located at camera site 6 on the NW pad
96 FPS perimeter. Remote tracking of center one-third of
35mm launch vehicle from ignition to 1200 feet.

Focus : O.K.
F. O. V.: O.K.
Exposure: O.K.

Comments: See comments in film item E-59.

E-59 Camera is located at camera site 6 on the NW pad
96 FPS perimeter. Remote tracking of upper one-third of
35mm launch vehicle from ignition to 1200 feet.

Focus : O.K.
F. O. V.: O.K.
Exposure: O.K.

Comments: A bird west of the FSS headed toward the southwest. FSS water deluge system was activated properly. Ice particles fell from GUCP at T-0. ET aft dome foam outgassed. ET aft dome charring was visible after roll maneuver. Numerous particles fell out of SRB plume shortly after roll maneuver.

E-60 Camera is located on north pad perimeter at camera
96 FPS site 1 and views the entire launch vehicle, FSS,
35mm and MLP zero level.

Focus : O.K.
F. O. V.: O.K.
Exposure: O.K.

Comments: Ice particles fell from LO2 T-0 umbilical. GH2 vent line retraction and latchback was nominal. RH stinger RCS paper cover was torn loose and pulled into SSME plume creating an orange flash as the vehicle cleared the tower. ET aft dome and SRB stiffener ring foam outgassed after T-0.

E-61 Camera is located at camera site 2 on the east pad
100 FPS perimeter and views the launch vehicle, FSS, and
35mm MLP.

Focus : O.K.
F. O. V.: O.K.
Exposure: O.K.

Comments: Ice particles fell from ET/ORB umbilicals during SSME ignition and T-0. Numerous particles, probably SRB throat plug or aft skirt instafoam, were ejected out of SRB exhaust hole. Several pieces trailed smoke. ET aft dome foam outgassed after T-0. Vapors trailed the orbiter split rudder/speed brake when vehicle was approximately 30-40 feet above the MLP. RH stinger RCS paper cover was torn loose and pulled into the SSME plume. A bird was visible south of the pad well after the vehicle had cleared the tower.

E-62 Camera is located on the SE pad perimeter at
96 FPS camera site 3 and views entire vehicle, FSS, and
35mm MLP.

Focus : O.K.
F. O. V.: O.K.
Exposure: O.K.

Comments: Free burning hydrogen was blown west and up the LH2 TSM. ET/ORB umbilical ice particles fell at SSME ignition, T-0 and early ascent. Ice particles fell from LOX T-0 umbilical at SSME ignition and T-0 retraction. Residual vapors emanated from Orbiter LOX T-0 umbilical after separation. Numerous pieces of SRB throat plug material were ejected out of SRB exhaust hole and away from vehicle. ET aft dome and SRB stiffener ring foam outgassed after T-0. As vehicle gained altitude vapors were visible trailing the orbiter speed brake.

E-63 Camera is located on SW pad perimeter at camera
96 FPS site 4 and views entire launch vehicle, FSS, and
35mm MLP.

Focus : O.K.
F. O. V.: O.K.
Exposure: O.K.

Comments: Free burning hydrogen was blown west. Residual vapors emanated from LH2 T-0 disconnect. SRB throat plug material was ejected out of the SRB exhaust hole. Particles were visible on the east side of the FSS and to the northeast - possibly debris from the RSS/FSS. A bird to the southwest was not near the vehicle.

E-64 Camera is located on NW pad perimeter at camera
96 FPS site 6 and views entire launch vehicle, FSS, and
35mm MLP.

Focus : O.K.
F. O. V.: O.K.
Exposure: O.K.

Comments: ET aft dome and SRB stiffener ring foam outgassed after T-0. Numerous burning particles were ejected out of SRB exhaust hole. RH RCS stinger paper cover was torn loose and entered the plume when the vehicle was approximately 30-40 feet above the MLP.

E-65 Camera is located on east pad perimeter at camera
100 FPS site 2 and views ET LO2 feedline, ET intertank,
16mm and RH SRB as vehicle passes through the frame.

Focus : O.K.
F. O. V.: O.K.
Exposure: O.K.

Comments: No vehicle anomalies.

E-76 Camera is located on SE pad perimeter at camera
96 FPS site 3 and views SSME engines #1 and #3 and the RH
35mm OMS engine nozzle.

Focus : O.K.
F. O. V.: O.K.
Exposure: O.K.

Comments: Free burning hydrogen was blown east by local winds. ET/ORB umbilical ice particles fell during SSME ignition, T-0 and early ascent. LO2 TSM ice particles fell after during SSME ignition, T-0 and early ascent. During SSME ignition aft RCS paper covers were torn loose and entered the SSME plume. LO2 T-0 disconnected and retracted properly. Residual GOX from LO2 T-0 disconnect emanated during retraction.

E-77 Camera is located on SW pad perimeter at camera-
96 FPS site 4 and views SSME engines #1 and #2 and the LH
35mm OMS engine nozzle.

Focus : O.K.
F. O. V.: O.K.
Exposure: O.K.

Comments: Ice particles fell from LO2 T-0 disconnect. LH2 T-0 disconnect retraction was nominal. SSME ignition and associated acoustics caused four tile chips on the LH trailing edge of the vertical stabilizer near the base structure.

E-78 Camera is located on SE pad perimeter at camera
400 FPS site 3 and views RH OMS Pod leading edge.
16mm

Comments: Deleted for STS-38 due to lighting conditions

E-79 Camera is located on east pad perimeter at
100 FPS camera site 2 and views the ET nosecone, louver,
16mm and ogive.

Focus : O.K.
F. O. V.: O.K.
Exposure: O.K.

Comments: ET twang was nominal. No vehicle anomalies.

E-201 UCS-9 IFLOT tracking of launch vehicle from
30 FPS ignition and early flight through LOV.
70mm

Focus : O.K.
F. O. V.: O.K.
Exposure: O.K.

Comments: No vehicle/plume anomalies.

E-202 UCS-15 IFLOT tracking of launch vehicle from
30 FPS ignition and early flight through LOV.
70mm

Focus : O.K.
F. O. V.: O.K.
Exposure: O.K.

Comments: No vehicle anomalies. Flashes in SSME plume were caused by FWD RCS paper covers being torn loose and pulled into plume.

E-203 UCS-6 IFLOT tracking of launch vehicle from
30 FPS ignition and early flight through LOV.
70mm

Focus : O.K.
F. O. V.: O.K.
Exposure: O.K.

Comments: No vehicle/plume anomalies.

E-204 PAFB IGOR tracking of launch vehicle from
48 FPS acquisition to SRB separation. Tracks ET/ORB
35mm after SRB separation to LOV.

Focus : O.K.
F. O. V.: O.K.
Exposure: O.K.

Comments: Plume recirculation on ET aft dome was normal. SRB separation was nominal.

E-205 Shiloh IFLOT tracking of launch vehicle from
48 FPS acquisition to SRB separation. Tracks ET/ORB
35mm after SRB separation to LOV.

Focus : O.K.
F. O. V.: O.K.
Exposure: O.K.

Comments: No details visible due to atmospheric conditions.

E-206 Melbourne Beach ROTI tracking of launch vehicle
48 FPS from acquisition to SRB separation. Tracks ET/ORB
35mm after SRB separation to LOV.

Focus : O.K.
F. O. V.: O.K.
Exposure: O.K.

Comments: Plume recirculation on ET aft dome was normal. SRB separation was nominal.

E-207 UCS-10 MIGOR tracking of launch vehicle from
96 FPS acquisition to SRB separation. Tracks ET/ORB
35mm after SRB separation to LOV.

Focus : O.K.
F. O. V.: O.K.
Exposure: O.K.

Comments: ET aft dome charring began shortly after roll maneuver. Body flap motion was similar in amplitude and frequency to previous flights. Forward RCS paper covers were torn loose and pulled into the SSME plume causing orange flashes in frames 520 and 1971. Two light colored objects originated under the LH SRB aft skirt area and fell aft into the SRB plume at 34 seconds MET

(GMT 48:49) and 39 seconds MET (GMT 48:54). The objects, visible at frames 1240 and 1695, were believed to be pieces of an SRB thermal curtain. Loose SRB thermal curtain tape is visible in the 20-40 second MET time frame. Several clusters of particles (SRB aft skirt instafoam or propellant chunks) fell out of the SRB plume at frames 3705, 3893, and 4014. SRB slag particles fell from the SRBs after separation.

E-208 Cocoa Beach DOAMS tracking of launch vehicle
48 FPS from acquisition to SRB separation. Tracks ET/ORB
35mm after SRB separation to LOV.

Focus : O.K.
F. O. V.: O.K.
Exposure: O.K.

Comments: ET aft dome charring occurred shortly after roll maneuver. Numerous particles, probably SRB aft skirt instafoam or propellant particles, fell out of plume several times during ascent. Plume recirculation was typical. SRB slag was present just prior to and after SRB separation. SRB separation was nominal.

E-209 SHILOH IFLOT intermediate tracking of
30 FPS launch vehicle from acquisition to LOV.
70mm

Focus : O.K.
F. O. V.: O.K.
Exposure: O.K.

Comments: No vehicle anomalies. Flashes in SSME plume were caused by FWD RCS paper covers being torn loose and pulled into plume.

E-210 UCS-26 IFLOT intermediate tracking of
30 FPS launch vehicle from acquisition to LOV.
70mm

Focus : O.K.
F. O. V.: O.K.
Exposure: O.K.

Comments: No vehicle/plume anomalies.

E-211 UCS-13 IFLOT intermediate tracking of forward
96 FPS portion of ORB and ET from acquisition to LOV.
35mm

Focus : O.K.
F. O. V.: O.K.
Exposure: O.K.

Comments: Vehicle acquired shortly before roll maneuver. No detail visible at low altitude due to atmospheric effects. ET aft dome outgassing and charring was normal. SRB instafoam or propellant slag exited the SRB plume during ascent.

E-212 UCS-23 MIGOR tracking of launch vehicle
64 FPS from acquisition to LOV.
35mm

Focus : O.K.
F. O. V.: O.K.
Exposure: O.K.

Comments: Numerous particles fell out of the SRB plume several times during ascent. Orange flashes occurred in SSME plume due to forward RCS paper covers tearing loose and entering SSME plume at frames 31-06/10/11, 83-11, 106-11, 125-13. Two light colored objects originated from the LH SRB aft skirt area and fell into the SRB plume at 34 and 39 seconds MET. A piece of ET/ORB purge barrier (baggie) fell aft and got caught in the plume recirculation. Plume recirculation effects on ET aft dome was typical. Multiple optical linear distortions were visible moving in both directions. SRB separation was nominal.

E-213 UCS-7 MOTS tracking of forward portion of ORB and
96 FPS ET from acquisition to LOV.
35mm

Focus : O.K.
F. O. V.: O.K.
Exposure: O.K.

Comments: Residual GOX from T-0 umbilical was drawn aft. Vapors trailed from Orbiter speed brake during early ascent. ET aft dome and SRB stiffener ring foam outgassed early in flight. Charring on ET aft dome is visible shortly after roll program. Forward RCS paper covers were torn loose and entered the SSME plume. Orange flashes occurred in SSME plume, probably from FWD RCS paper covers, in frame 151-03. Light colored particles, possible pieces of instafoam, fell from the RH SRB aft skirt area at 26 seconds MET.

E-217 Beach Road IFLOT close-in tracking of launch
30 FPS vehicle during ignition, liftoff, and early
70mm portion of flight through LOV.

Focus : O.K.
F. O. V.: O.K.
Exposure: O.K.

Comments: No vehicle anomalies. Flashes in SSME plume were caused by FWD RCS paper covers being torn loose and pulled into plume.

E-218 UCS-26 IFLOT intermediate tracking of
96 FPS launch vehicle from acquisition through LOV.
35mm

Focus : O.K.
F. O. V.: O.K.
Exposure: O.K.

Comments: ET aft dome charring was visible shortly after roll maneuver. Plume recirculation on ET aft dome was typical. Body flap motion was similar in magnitude and frequency to previous flights. Forward RCS paper covers were torn loose and entered SSME plume causing orange streaks in frames 53-12, 93-15, 145-09. In frames 165-00 to 166-00 LH2 umbilical baggie material fell aft past body flap. In frame 186-04 LH2 baggie material was torn loose and caused orange flashes in SSME plume. Numerous particles fell out of the SRB plume. SRB slag material was visible after SRB separation.

E-219 UCS-3 IFLOT close-in tracking of launch
30 FPS vehicle during ignition, liftoff, and early
70mm portion of flight through LOV.

Comments: Deleted for STS-38 due to depleted ETR resources.

E-220 UCS-15 IFLOT close-in tracking of forward
96 FPS portion of ORB and ET during ignition, liftoff,
35mm and early portion of flight through LOV.

Focus : O.K.
F. O. V.: O.K.
Exposure: O.K.

Comments: ET aft dome and SRB stiffener ring foam outgassed at T-0 and early ascent. Forward RCS paper covers were torn loose and pulled into SSME plume during early ascent and after roll maneuver. ET aft dome charring was visible. Two light colored objects, believed to be pieces of SRB thermal curtain material, originated from the LH SRB aft skirt area and fell aft into the SRB plume at 34 and 39 seconds MET. Debris below Orbiter body flap was most likely a piece of the ET/ORB purge barrier caught in the plume recirculation. Body flap motion was similar in magnitude and frequency to previous flights. Several particles, probably SRB instafoam or chunks of propellant, fell from the SRB plume in frames 271-06, 304-02, 343-04.

E-221 UCS-3 IFLOT close-in tracking of forward portion
96 FPS of ORB and ET during ignition, liftoff, and early
35mm portion of flight through LOV.

Comments: Deleted for STS-38 due to deplete ETR resources.

E-222 Beach Road IFLOT close-in tracking of forward
96 FPS portion of ORB and ET during ignition, liftoff,
35mm and early portion of flight through LOV.

Focus : O.K.
F. O. V.: O.K.
Exposure: O.K.

Comments: ET aft dome and SRB stiffener ring foam outgassed on ascent. Numerous particles ejected from SRB exhaust hole, several trailing smoke, were probably SRB throat plug material. Orange flashes in SSME plume were caused by forward RCS paper covers coming loose and falling aft into SSME plume at frame 242-12. ET aft dome charring occurred shortly after roll program. A light colored particle, probably SRB aft skirt instafoam, fell out of the plume at 26 seconds MET (frame 2868).

E-223 UCS-9 IFLOT intermediate tracking of forward
96 FPS portion of ORB and ET during ignition, liftoff,
35mm and early portion of flight through LOV.

Focus : O.K.
F. O. V.: O.K.
Exposure: O.K.

Comments: ET aft dome and SRB stiffener ring foam outgassed after T-0. Aft dome charring occurred shortly after roll maneuver. Orange flashes in the SSME plume were caused by forward RCS paper covers being torn loose and pulled into the plume (frame 134-09 and 276-00). Numerous clusters of particles fell out of the SRB plume (frames 385-11 and 398-11).

E-224 UCS-6 IFLOT close-in tracking of entire launch
100 FPS vehicle during ignition, liftoff, and early flight
. 35mm through LOV.

Comments: Camera malfunction - no data.

E-233,234 Castglance airborne tracking
35mm

Comments: Did not run due to dark conditions.

E-301,302 Castglance airborne tracking
16mm

Comments: Did not run due to dark conditions.

VIDEO ITEMS

OTV 001 Views aft end of Orbiter from the FSS 255 foot
B/W M-II level.

Comments: Facility water deluge and TSM camera light activation were normal. Ignition of SSME #2 was nominal. The LH2 T-0 disconnected and retracted properly.

OTV 003 Views GUCP and GH2 vent line.
B/W M-II

Comments: Vehicle twang appeared normal. Pieces of ice fell from the GUCP during SSME ignition and lift-off. Disconnect and separation of the GUCP was normal.

OTV-009 Views ET/Orbiter LH2 umbilical area from the 95
B/W M-II foot level of the FSS.

Comments: SSME ignition caused ice/frost to fall from ET/ORB LH2 umbilical. No TPS damage.

OTV 041 Views and tracks vehicle from camera site 2.
B/W

Comments: SSME ignition appeared nominal. Ice/frost fell from umbilicals. Vehicle twang was typical. Haunch water was properly activated. Outgassing from foam on ET aft dome and SRB stiffener rings occurred after liftoff.

OTV 043 Views east side of launch vehicle and pad from
B/W camera site 2.

Comments: Facility was deluged activated properly. SSME ignition appeared nominal. GH2 vent arm retraction and latchback was normal. No vehicle anomalies.

OTV 048 Launch and tracking view from camera site 6.
B/W

Comments: SSME ignition nominal. Haunch water was flowing. Vehicle twang typical. ET aft dome and SRB stiffener ring foam outgassed after liftoff.

OTV 049 Views Orbiter LO2 T-0 umbilical from MLP deck.
B/W M-II

Comments: SSME ignition caused pieces of ice to shake loose from LO2 T-0 umbilical. Separation and retraction of the carrier plate was nominal. Residual vapors were visible at T-0.

OTV 050 Views Orbiter LH2 T-0 umbilical from SW MLP deck.
B/W M-II

Comments: Ice fell from the high point bleed line purge shroud during SSME ignition. LH2 T-0 umbilical disconnect and retraction appeared normal. Some residual vapors emanated from the flight QD. No vehicle anomalies.

OTV 051 Views main engine cluster.
B/W M-II

Comments: SSME ignition nominal. All RCS paper covers on RH stinger tear and pieces fell aft. LH2 TSM door closed properly.

OTV 054 Views ET/Orbiter LO2 umbilical and Orbiter RH wing.
B/W M-II

Comments: SSME ignition caused ice to fall from both ET/ORB umbilicals - no Orbiter tile damage. Glare from the SRB plumes wiped out additional video data.

OTV 055 Views RH SRB and underside of Orbiter RH wing.
B/W M-II

Comments: Not available for this launch.

OTV 056 Views LH SRB and underside of Orbiter LH wing.
B/W M-II

Comments: SSME ignition appeared nominal. Ice fell from the ET/ORB umbilicals. No vehicle anomalies.

OTV 060 Views ET nosecone and NE louver from water tower.
Color M-II

Comments: Camera not configured correctly. Facility water was activated properly. GH2 vent line separation and retraction nominal.

OTV 061 Views ET nosecone and SW louver from the FSS.
Color M-II

Comments: Frost coated louvers. Tumble valve cover and fairing nominal. Nose cone footprint area okay. Vehicle twang typical. Ice particles fell from LO2 feedline bellows, but no vehicle impacts visible.

OTV 063 Views ET/Orbiter umbilical and Orbiter T-0
Color M-II umbilical from the FSS.

Comments: Free burning hydrogen blown under body flap. SSME ignition caused ice/frost to fall from umbilicals, but east wind blew pieces away from body flap. One large piece hit LH2 umbilical cavity door sill/thermal barrier and was deflected outward away from orbiter. No damage to vehicle. LH2 T-0 umbilical/retraction was nominal. Residual vapors emanated from T-0 umbilical. Wing motion occurred at T-0.

OTV 070 Views overall vehicle from SE direction.
Color M-II

Comments: Facility water activated properly. SSME ignition was nominal.

OTV 071 Views overall vehicle from SW direction.
Color M-II

Comments: SSME ignition nominal. Free burning H2 rises to LH OMS pod. RCS paper covers were torn loose and drawn into plume.

STI (C/S 2) Infrared view from camera site 2.
B/W M-II

Comments: APU start and run appeared normal. No unusually cold or hot areas were apparent in the nosecone area after GOX hood retraction.

SSME ignition was nominal. Free burning hydrogen was blown under the body but quickly dissipated. Radiative heating effects from the exhaust plumes were visible on the ET aft dome and the Orbiter body flap lower surface as the vehicle ascended. No facility fires were detected after launch.

STI (RSS) Infrared view from RSS roof.
B/W M-II

Comments: APU start and run appeared normal. No unusually cold or hot areas were apparent in the nosecone area after GOX hood retraction. SSME ignition was nominal. Some free burning hydrogen, which quickly dissipated, was visible. No facility fires were detected after launch.

TV-2 Views launch from convoy position at SLF midfield.
Color M-II

Comments: Too distant for detail. No vehicle/plume anomalies.

TV-3A Views Pad A launch from UCS-4 north of Pad B.
Color M-II

Comments: Too distant for detail. No plume anomalies.

TV-4A Views Pad A launch from Beach Road IFLOT site
Color M-II north of complex 41.

Comments: SSME ignition nominal. Facility water was activated properly. ET aft dome and SRB stiffener rings outgassed. Roll maneuver appeared nominal. One flash in SSME plume just after roll. SRB separation nominal. Numerous clinkers fell out of plume.

TV-5 Views launch from VAB roof.
Color M-II

Comments: Too distant for detail. No plume anomalies. Twenty-four particles fell out of plume at T+60 through 83 seconds. SRB separation nominal. Numerous clinkers fell out of plumes after separation.

TV-7 Views launch vehicle from camera site 2 east
Color M-II of pad.

Comments: SSME ignition nominal. Facility water was activated properly. ET aft dome and SRB stiffener rings outgassed. Roll appeared nominal. One flash in SSME plume just after roll. SRB separation nominal. Numerous clinkers fell out of plume.

TV-11 Views launch from TV Tower #1 east of SLF.
Color M-II

Comments: Too distant for detail. No vehicle anomalies.

TV-13 Cocoa Beach DOAMS long range tracker.
Color M-II

Comments: Plume recirculation nominal. SRB separation nominal.

TV-16 Views launch from helicopter orbiting west of VAB.
Color M-II

Comments: Too distant for detail. No vehicle anomalies.

TV-18 Malabar ITEK long range tracker.
Color M-II

Comments: Intermittently obscured by clouds. No vehicle anomalies.

TV-21A Views Pad A launch from UCS-15 north of Pad A.
Color M-II

Comments: SSME plume obscured liftoff. Roll maneuver appeared nominal.

ET-204 Patrick IGOR video. Tracks launch vehicle from
Color M-II acquisition to LOV.

Comments: One SSME flash during ascent. Plume recirculation nominal. SRB separation nominal.

ET-206 Melbourne Beach ROTI video. Tracks launch vehicle
Color M-II from acquisition to LOV.

Comments: Plume recirculation appeared typical. SRB separation nominal.

ET-207 UCS-10 MIGOR video. Tracks launch vehicle from
Color M-II acquisition to LOV.

Comments: Large white particle was visible at T+34 seconds from LH SRB, possibly a piece of SRB thermal blanket. Large piece of slag fell out of plume near tailoff. SRB separation nominal. Numerous clinkers fell out of plume after separation.

ET-208 Cocoa Beach DOAMS video. Tracks launch vehicle
Color M-II from acquisition to LOV.

Comments: Plume recirculation nominal. Slag fell from SRBs near tailoff. SRB separation nominal. Numerous clinkers fell out of SRB plume after separation.

ET-212 UCS-23 MIGOR video. Tracks launch vehicle from
Color M-II acquisition to LOV.

Comments: Plume recirculation nominal. Slag fell from SRBs near tailoff. SRB separation nominal. Numerous clinkers fell out of SRB plume after separation.

ET-213 UCS-3 MOTS video. Tracks launch vehicle from
Color M-II acquisition to LOV.

Comments: ET aft dome outgassed early due to dry tank. No vehicle anomalies.

7.2 ON-ORBIT FILM DATA REVIEW

There was no on-orbit photography of the ET after separation from the orbiter. OV-104 is not configured to carry umbilical cameras and the crew photo DTO was not performed due to dark conditions.

7.3 LANDING FILM/VIDEO DATA REVIEW

E-702 KSC Tracking Site B IFLOT close-in tracking of
35mm Orbiter from final flare through rollout.

Focus : O.K.
F. O. V.: O.K.
Exposure: O.K.

Comments: Landing gear deployment nominal. MLG touchdown nominal with left side first. NLG touchdown smooth. Vehicle too distant for TPS analysis.

E-703 KSC Tracking Site C tracking of Orbiter from final
35mm flare through rollout.

Focus : O.K.
F. O. V.: O.K.
Exposure: O.K.

Comments: Trees obscured view of MLG and NLG touchdown. Vehicle too distant for detail. No vehicle anomalies.

E-706 KSC Tracking Site B tracking of Orbiter from final
16mm flare through rollout.

Focus : O.K.
F. O. V.: O.K.
Exposure: O.K.

Comments: Landing gear deployment nominal. MLG touchdown nominal with left side first. No vehicle anomalies.

E-712 KSC Tracking Site B IFLOT close-in tracking of
16mm Orbiter from final flare through rollout.

Focus : O.K.
F. O. V.: O.K.
Exposure: O.K.

Comments: Landing gear deployment nominal. MLG touchdown nominal with left side first. No vehicle anomalies.

E-713 KSC Tracking Site C tracking of Orbiter from final
16mm flare through rollout.

Focus : O.K.
F. O. V.: O.K.
Exposure: O.K.

Comments: Trees obscured view of MLG and NLG touchdown. Vehicle too distant for detail. No vehicle anomalies.

E-716 KSC Tracking Site F tracking of Orbiter from final
16mm flare through rollout.

Focus : O.K.
F. O. V.: O.K.
Exposure: O.K.

Comments: Landing gear deployment nominal. MLG touchdown nominal with left side first. NLG touchdown smooth. Vehicle too distant for TPS analysis.

UCS-1 Tracking coverage from UCS-1.
35mm

Focus : OK
F. O. V.: OK
Exposure: Slightly underexposed

Comments: Orbiter acquired while passing overhead. Speed brake used in Heading Alignment Circle (HAC). Orbiter passed close to camera position - good view of lower surface tiles and tile damage areas. Two pieces of SSME blanket were first visible near SSME #2 and fell aft of the Orbiter (frame 7162 and 7500) after coming out of the HAC/on final approach. Trees obscured view prior to landing gear extension.

UCS-10 Tracking coverage from UCS-10.
35mm

Focus : OK
F. O. V.: Tracking problems at beginning and end of film.
Exposure: Slightly underexposed

Comments: Body flap was deflected in 'down' position. No Orbiter anomalies visible in this film item.

TV-2 View from convoy position at SLF midfield.
Video

Comments: Landing gear deployment appeared nominal. Left main landing gear touched down first just ahead of RH MLG. Nose landing gear touchdown was smooth. No anomalies during rollout. Wheel stop was normal.

TV-5 View from VAB roof.
Video

Comments: No anomalies during final approach. Landing gear deployment was nominal. Smooth touchdown of all landing gear. No anomalies during rollout.

TV-6 View from top of Mate Demate Device at SLF.
Video

Comments: Too distant for detail.

TV-11 View from Shuttle Landing Facility TV Tower #1
Video east of the runway.

Comments: Smooth touchdown and rollout. Too distant for detail.

TV-14 UCS-7 MIGOR long range tracker.
Video

Comments: Not available for this landing.

TV-15 View from Shuttle Landing Facility TV Tower #2
Video west of the runway.

Comments: Provided landing coverage on Orbiter left side. Smooth touchdown and rollout. Too distant for detail.

TV-16 View from Helicopter orbiting west of SLF.
Video

Comments: Not available for this landing.

TV-18
Video

Malabar ITEK long range tracker.

Comments: Orbiter acquired in Heading Alignment Circle (HAC). No vehicle anomalies.

TV-20
Video

UCS-3 Infrared Tracker.

Comments: Not available for this landing.

8.0 SRB POST FLIGHT/RETRIEVAL DEBRIS ASSESSMENT

Both Solid Rocket Boosters were inspected for debris damage and debris sources at CCAFS Hangar AF on 18 November 1990 from 1500 to 1830 hours. In general, the SRB's appeared to be in good condition.

8.1 RH SOLID ROCKET BOOSTER DEBRIS INSPECTION

The nose cap was not recovered. The RH frustum had no areas of missing TPS but had 56 debonds over fasteners (Figure 5). The Hypalon paint was blistered slightly in localized areas. All BSM covers were fully opened and locked in the 180 degree position.

The RH forward skirt exhibited no debonds or missing TPS (Figure 6). The frustum severance ring, utilizing the new pin retainer clips, was missing no pins. Separation of the forward attach bolt and electrical cables appeared normal.

Generally, the field joint closeouts were in good condition. The right aft field joint had been the first flight assembly/closeout of the redesigned field joint protection system. No significant anomalies occurred on this new FJPS, though one small crack and two spongy areas (less than 0.6 inches) were visible in the K5NA. Minor trailing edge damage to the FJPS and the GEI cork runs were attributed to debris hits from nozzle extension severance.

Separation of the aft ET/SRB struts appeared nominal. The stiffener rings were damaged by water impact. There was no structural damage to the ETA ring or IEA. K5NA closeouts on the IEA covers were intact. However, instafoam was missing from the forward face of the ETA ring: 8-inch diameter depression at 260 degrees, 8-inch diameter depression with another 8 inches of delamination at 170 degrees. Voids were found in the foam adjacent to these divots and were probably caused by a processing anomaly. Remaining foam in these areas was removed for laboratory testing.

The TPS over the aft skirt acreage was generally in good condition with localized blistering of the Hypalon paint (Figure 7). The TVC system appeared to be undamaged. The phenolic material on the kick ring delaminated in several locations. K5NA protective domes were missing prior to water impact at 5 locations. K5NA was missing from all aft BSM nozzles. Instafoam was missing from the aft ring around the aft skirt feet, HPU exhaust horns, and the SRB T-0 umbilical. All four Debris Containment System (DCS) plungers were properly seated. Some Epon shim material was missing from the aft skirt HDP #4 foot and the substrate was sooted. This condition coincides with the piece of EPON shim material that came loose after liftoff (ref Film Item E-7).

FIGURE 5. RIGHT SRB FRUSTUM

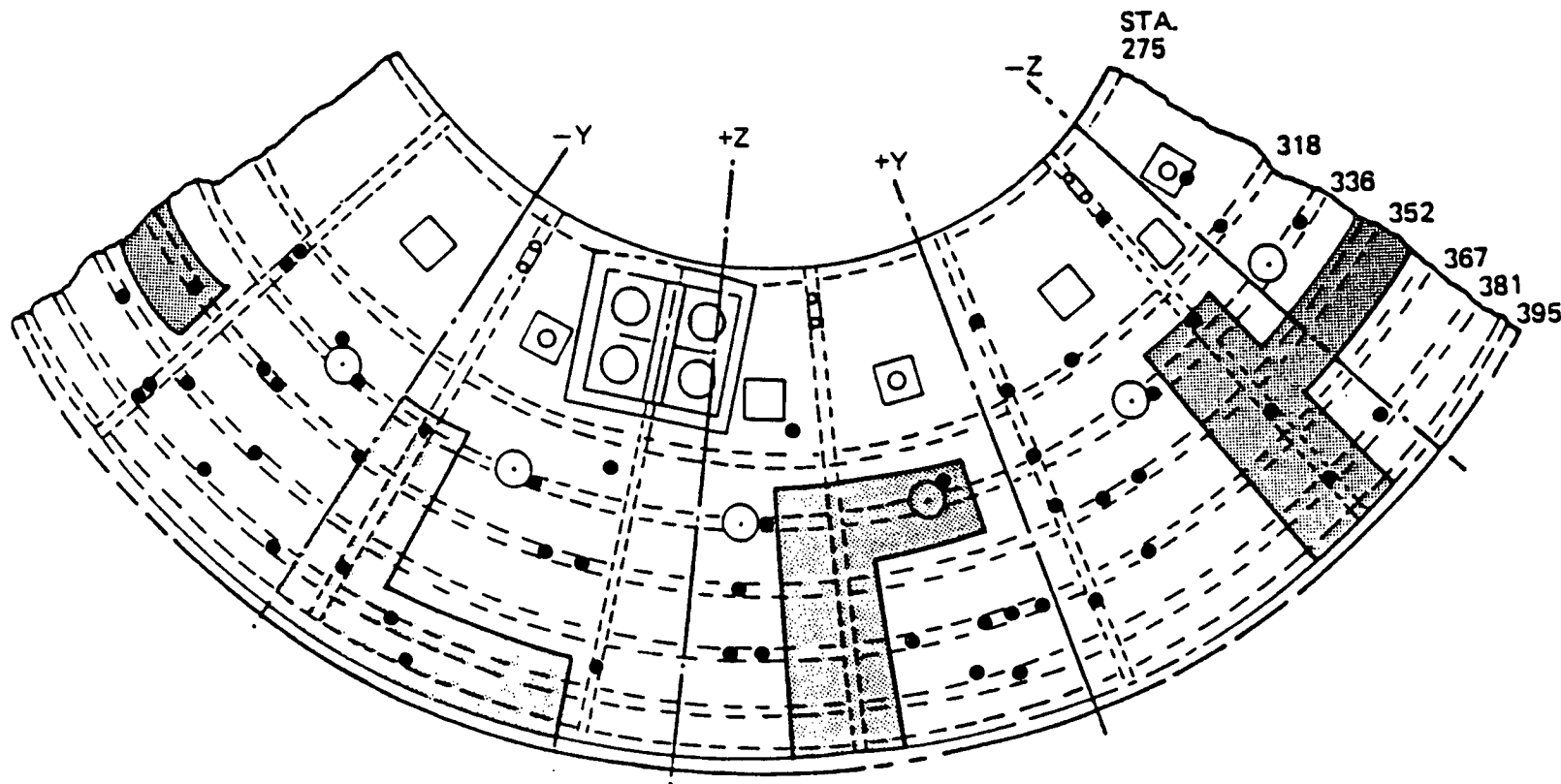

66

MISSING TPS

NONE

DEBONDS

56 DEBONDS

FIGURE 6. RIGHT SRB FWD SKIRT

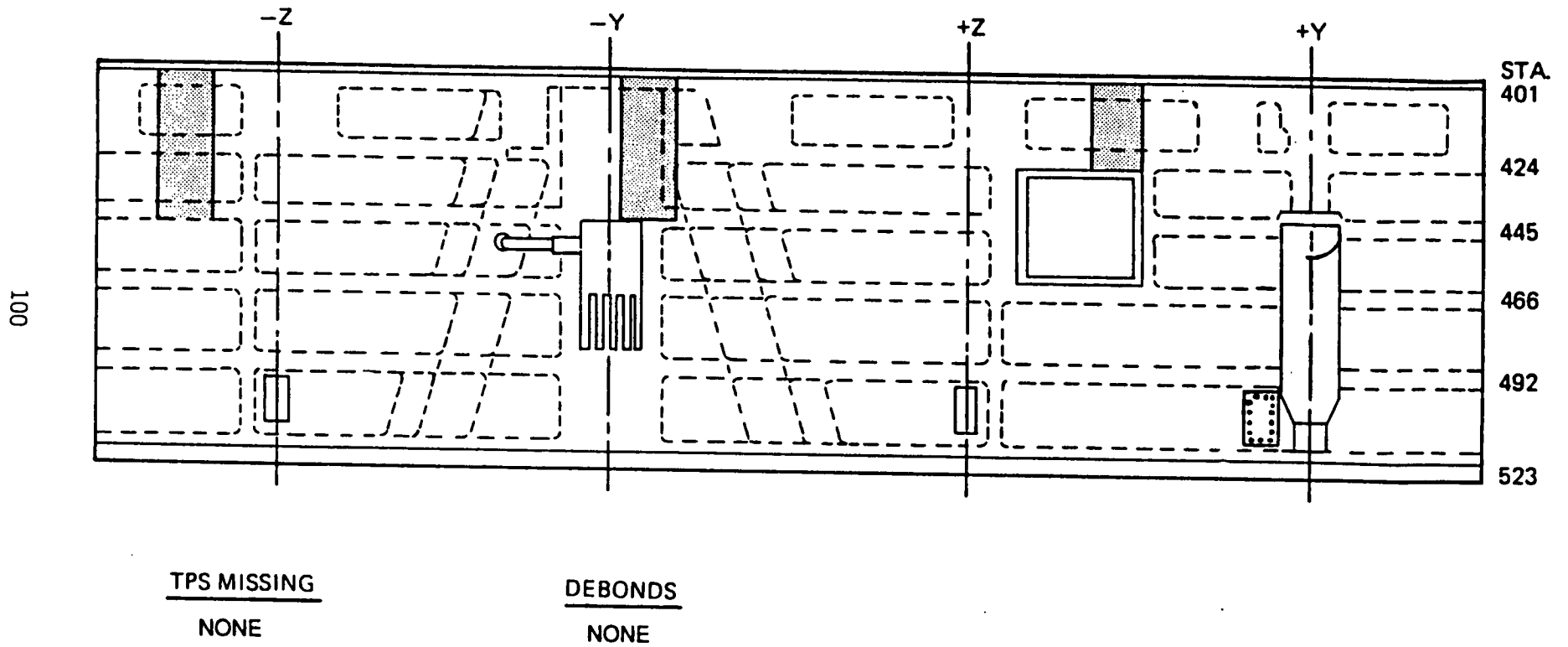
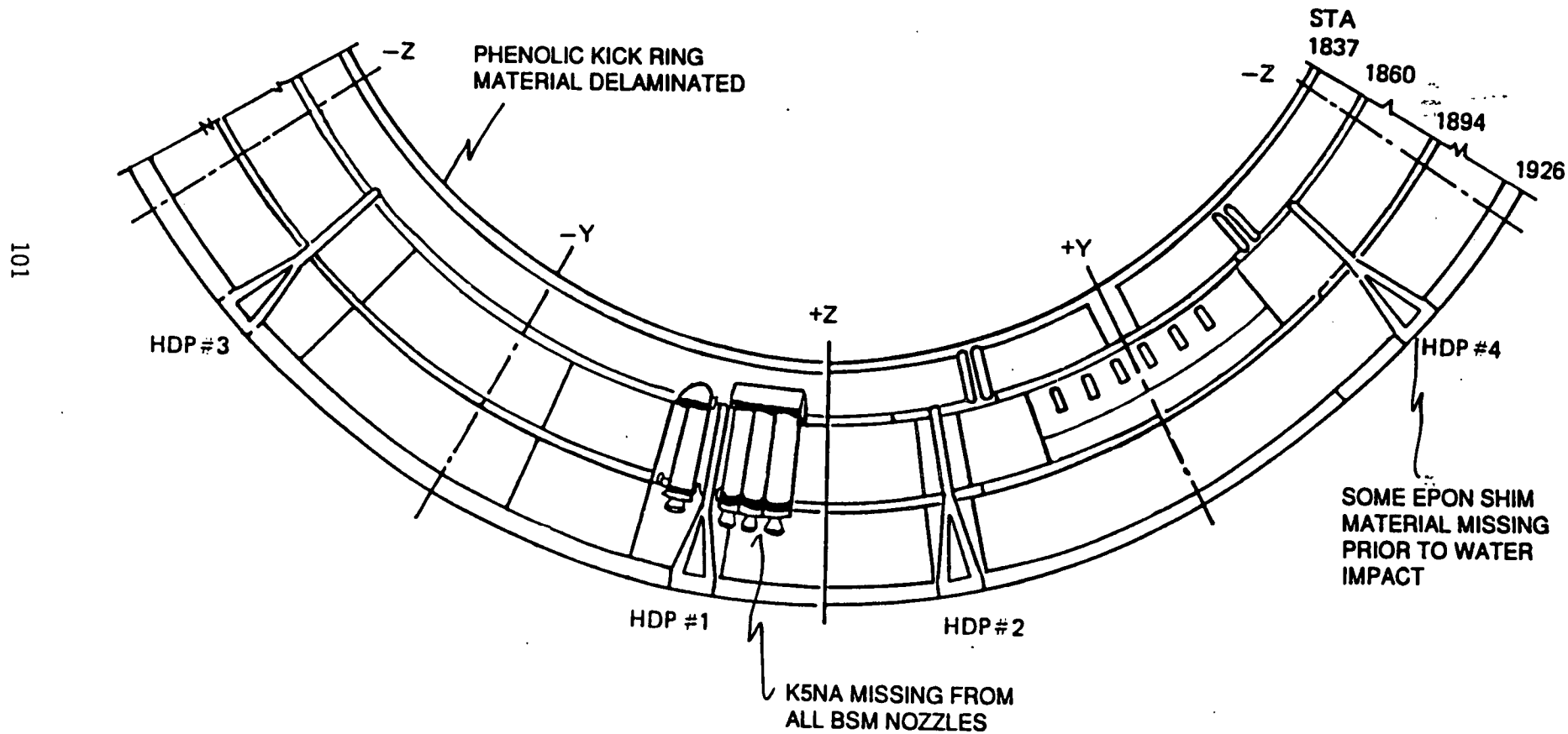

FIGURE 7. RIGHT SRB AFT SKIRT EXTERIOR TPS



ALL DCS PLUNGERS
WERE PROPERLY SEATED

8.2 LH SOLID ROCKET BOOSTER DEBRIS INSPECTION

The nosecap was not recovered. The LH frustum exhibited no missing TPS but had 54 debonds over fasteners (Figure 8). All of the BSM covers were fully opened and locked in the 180 degree position.

The LH forward skirt exhibited no debonds or missing TPS (Figure 9). Blistering of the Hypalon paint had occurred around the forward attach point. The frustum severance ring, utilizing the new pin retainer clips, was missing no pins. Separation of the forward attach bolt and electrical cables appeared normal.

The field joint closeouts were generally in good condition. Two cracks in the left aft field joint K5NA occurred. The cracks, 2.6 inches long at 270 degrees and 0.5 inches long at 30 degrees, were located at trunnion locations. Minor trailing edge damage to the FJPS and the GEI cork runs were attributed to debris hits from the nozzle extension severance.

Separation of the aft ET/SRB struts appeared nominal. There was no structural damage to the ETA ring or IEA. K5NA closeouts on the IEA covers were intact. The stiffener rings were damaged at the 180-200 degree location by water impact.

The TPS over the aft skirt acreage was generally in good condition (Figure 10). The phenolic material on the kick ring delaminated in several locations. K5NA was missing from all aft BSM nozzles. The TVC system appeared undamaged.

All DCS plungers were properly seated. Aft skirt HDP #7 was missing Epon shim from the inboard side of the foot and the substrate was sooted. A 9"x2" piece of HDP #8 aft face shim material was missing prior to water impact. The thermal curtain attach structure and aft skirt aft ring were inspected for damage caused by the suspected loss of a thermal curtain 34 seconds into flight, but no unusual damage was visible. Water impact may have altered any remaining evidence. Instafoam was missing from the aft ring around the aft skirt feet, HPU exhaust horns, and the SRB T-0 umbilical.

FIGURE 8. LEFT SRB FRUSTUM

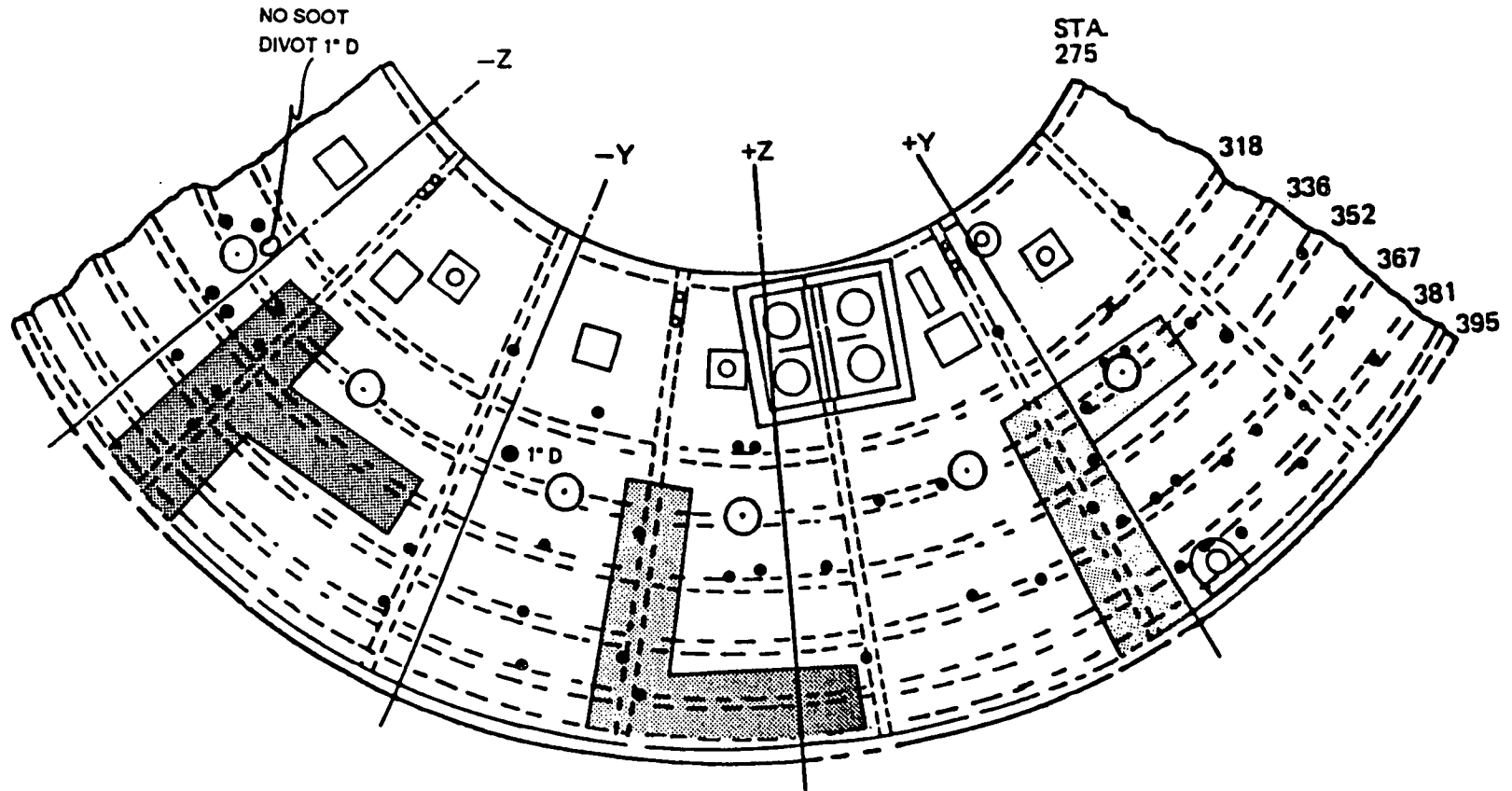

103

MISSING TPS
NONE

DEBONDS
54 DEBONDS

FIGURE 9. LEFT SRB FWD SKIRT

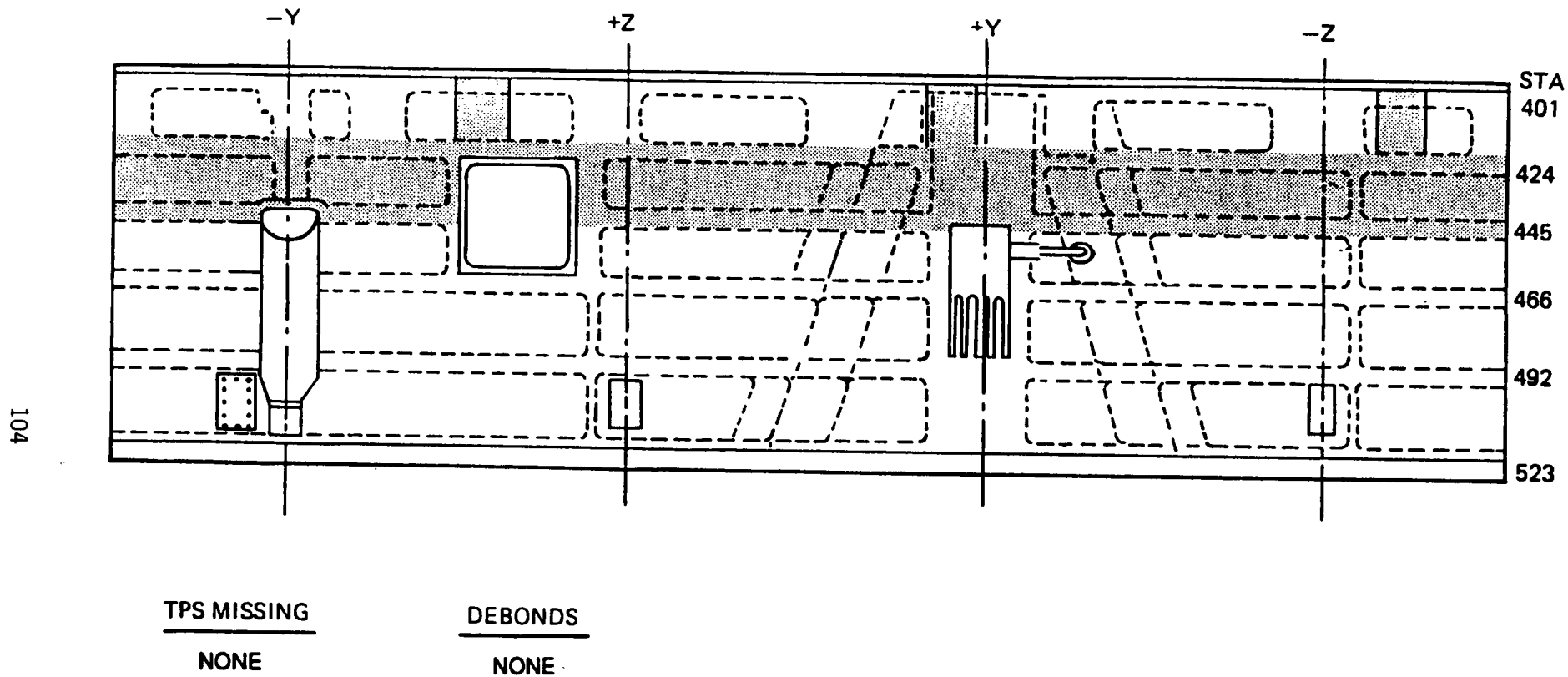
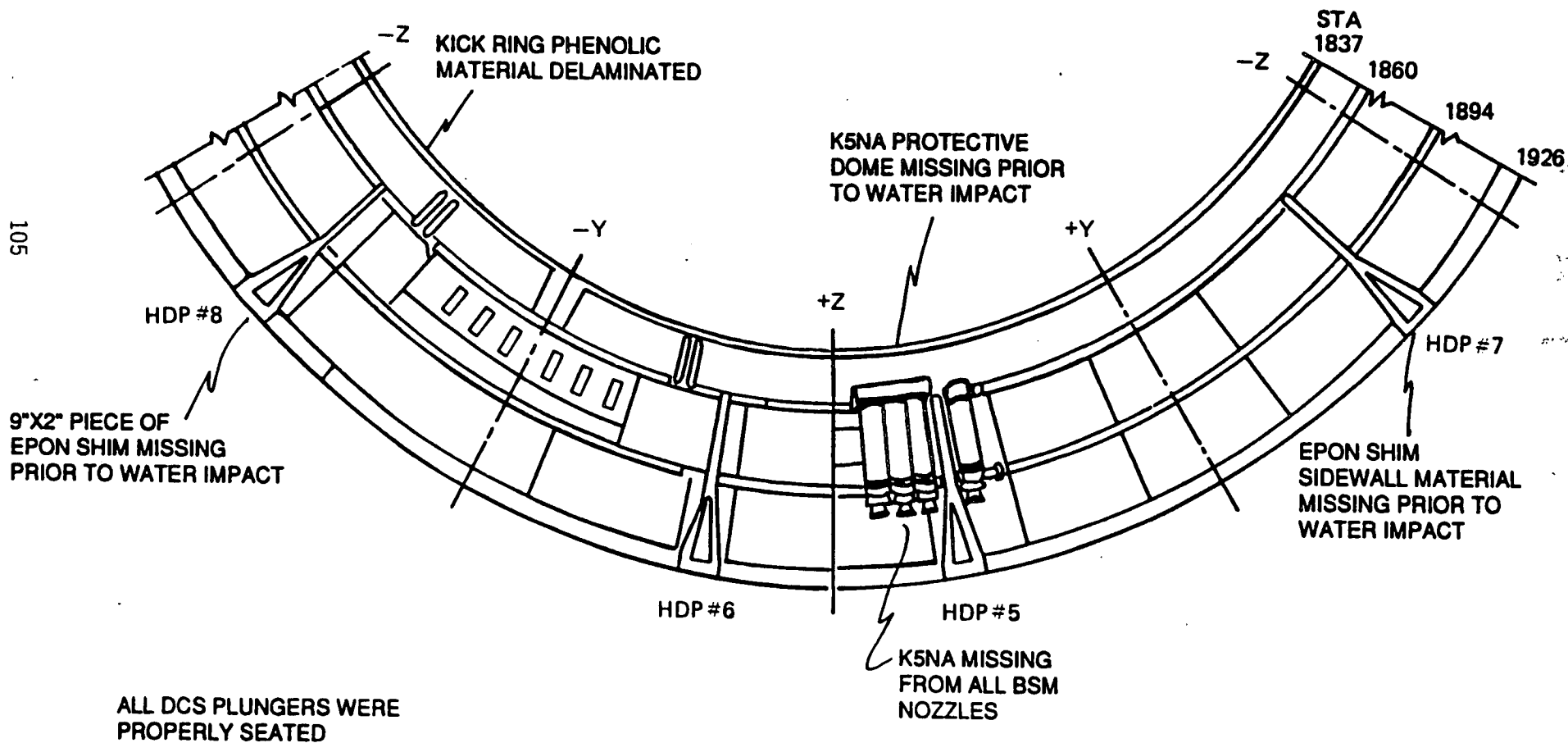

FIGURE 10. LEFT SRB AFT SKIRT EXTERIOR TPS



8.3 RECOVERED SRB DISASSEMBLY FINDINGS

Ignitor blowholes occurred on both ignitors and resulted in the loss of cadmium plating from the gask-o-seals. The cadmium plating loss was less than previously documented.

Post flight disassembly of the Debris Containment System (DCS) housings revealed an overall system retention of 89% and individual holddown post retention percentages as listed:

HDP #	Overall %	% of Nut without 2 large halves	% of Ordnance
1	69	81	46
2	99	99	94
3	99	96	99
4	99	97	99
5	99	94	99
6	99	97	99
7	47	53	33
8	99	97	99

The minimum allowable retention per NSTS-07700 is 90 percent. Loss of ordnance fragments from the HDP #1 DCS was visible in the film review, but no debris was observed falling from the HDP #7 DCS. All DCS plungers had been fully seated when inspected at Hangar AF. Disassembly of the DCS's revealed no installation anomalies.

SRB post flight/retrieval debris anomalies are listed in Section 11.3.

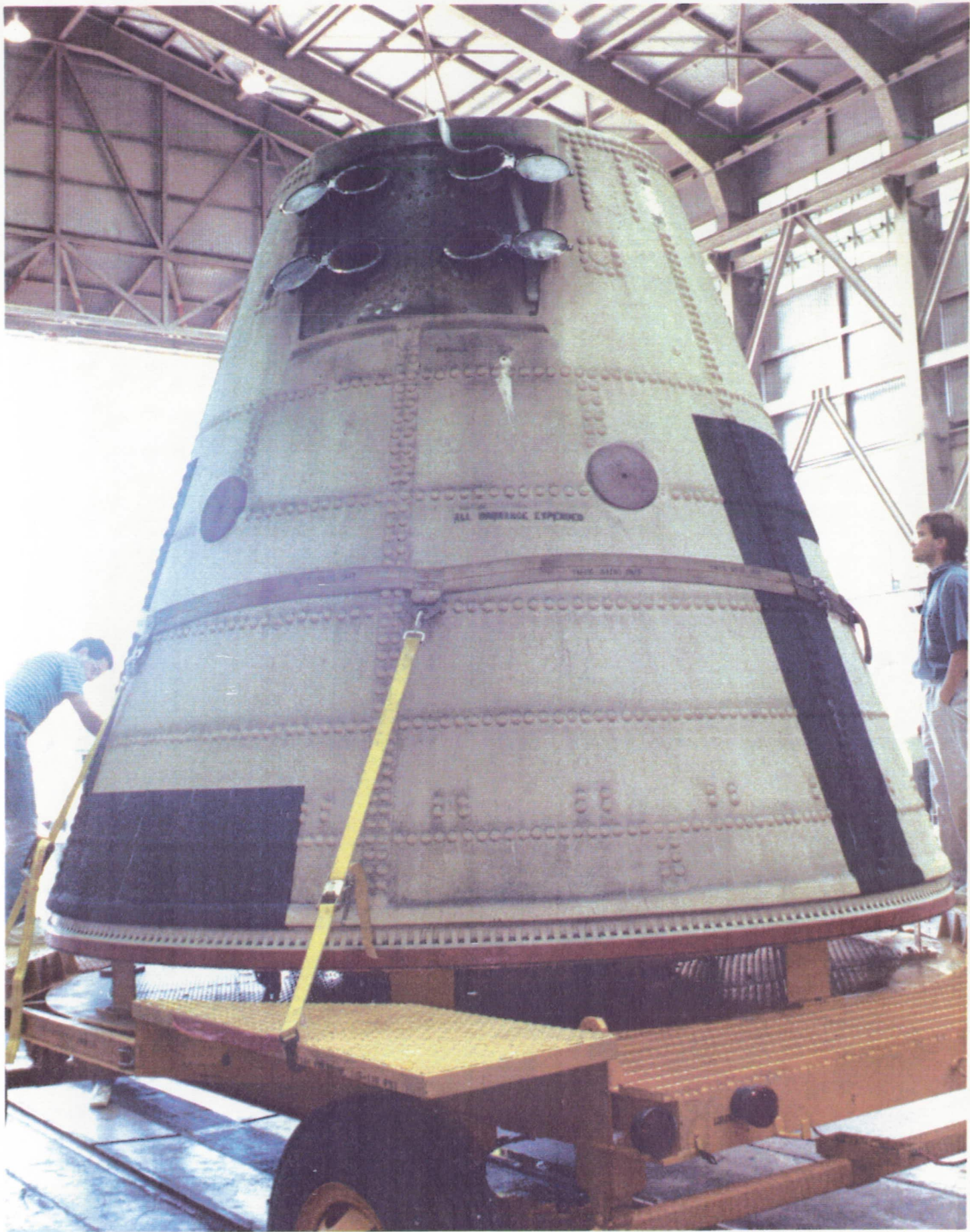

Post flight condition of the RH SRB frustum. There were 56 MSA-2 debonds over fasteners, but no areas of missing TPS

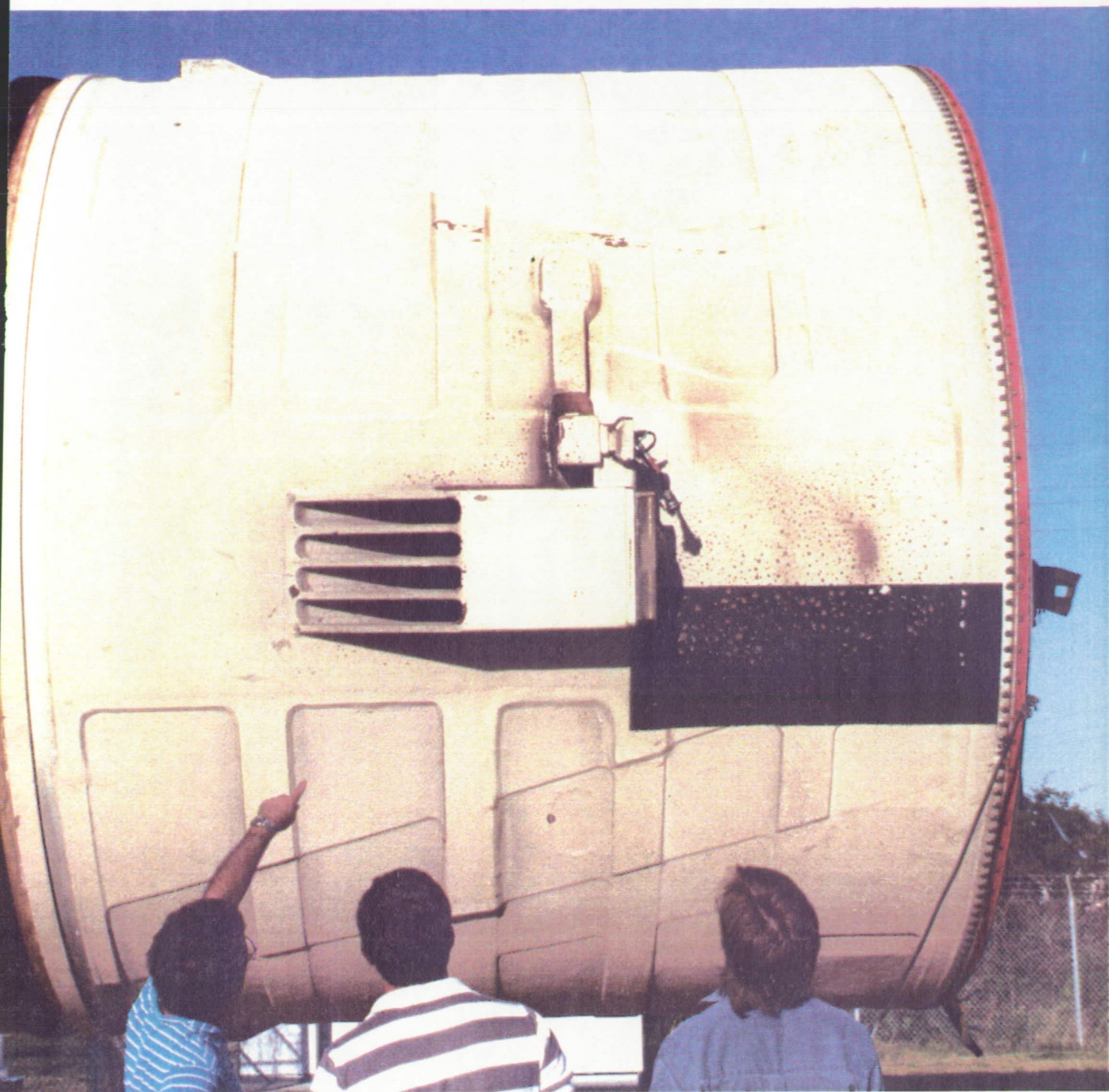

Post flight condition of the RH SRB forward skirt. There were no MSA-2 debonds or areas of missing TPS

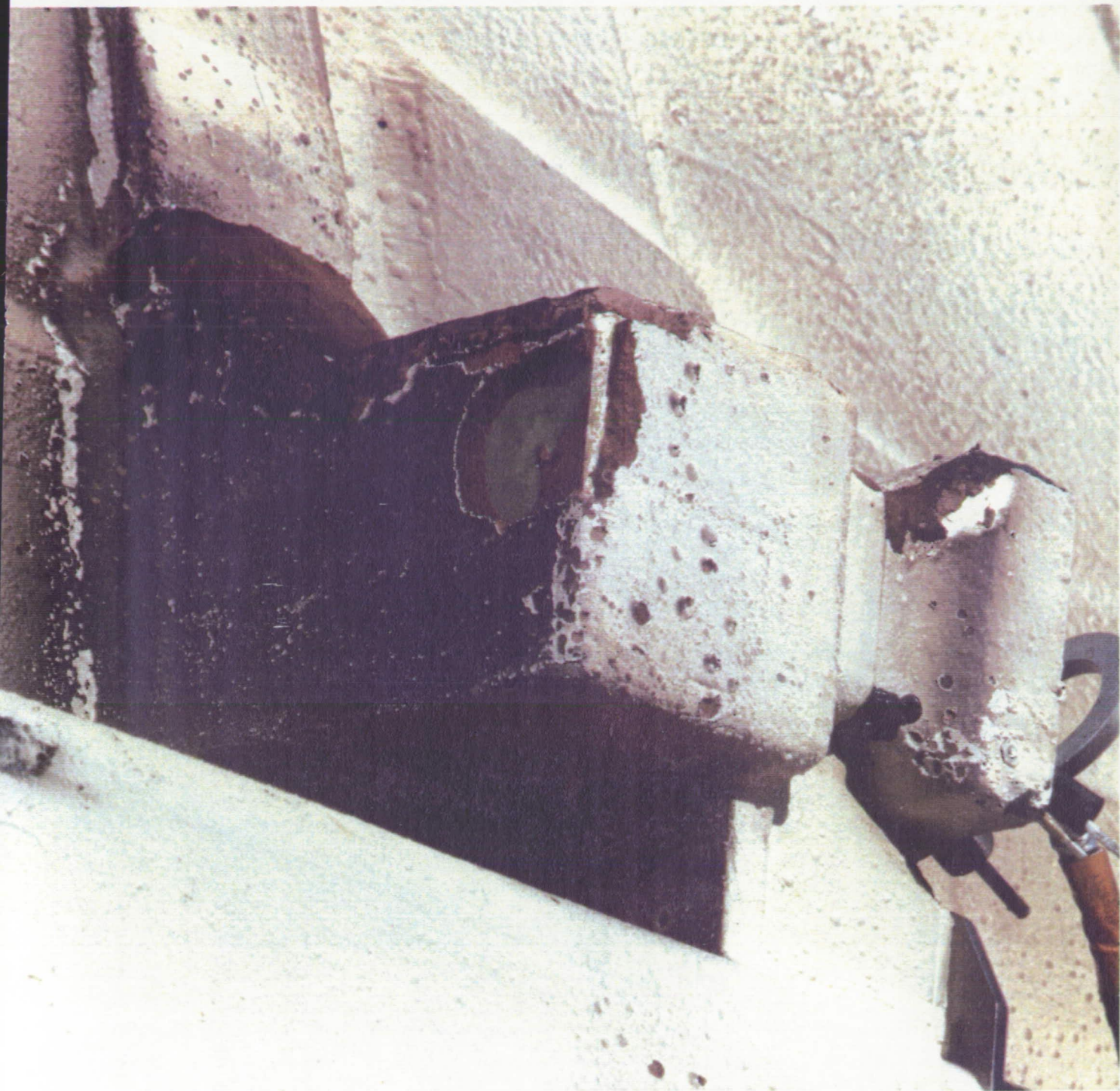

K5NA was missing from the aft face of the electrical
feed-through box

109

ORIGINAL PAGE
COLOR PHOTOGRAPH

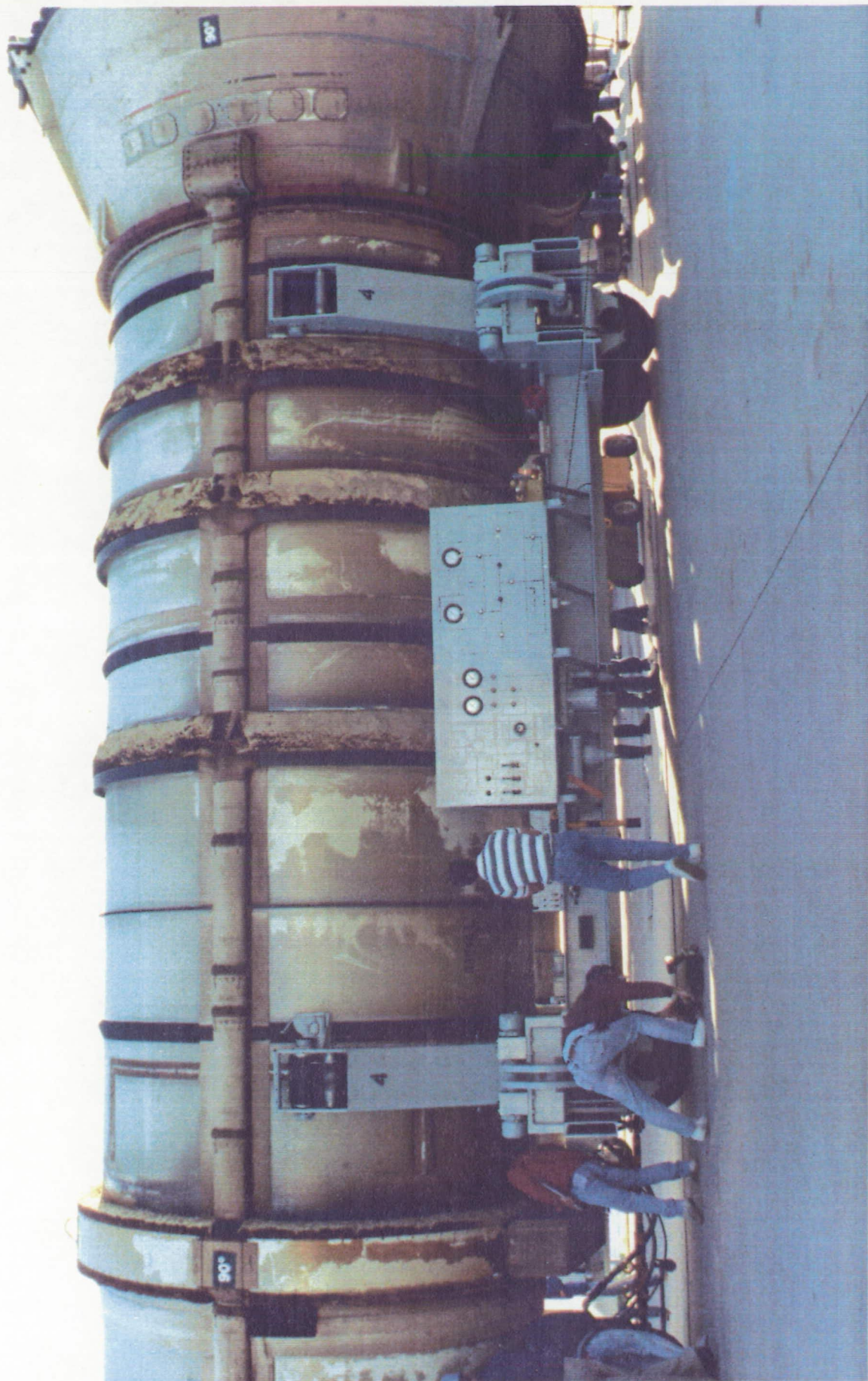

Post flight condition of the RH SRB aft booster. Stiffener rings were damaged by water impact, but there was no structural damage to the ETA ring or IEA.



An IFA was taken against an 8-inch instafoam divot on the forward side of the ETA ring near the lower EB strut

111

ORIGINAL PAGE
COLOR PHOTOGRAPH



An IFA was taken against a second 8-inch instafoam divot with another 8 inches of delamination on the ETA ring forward side

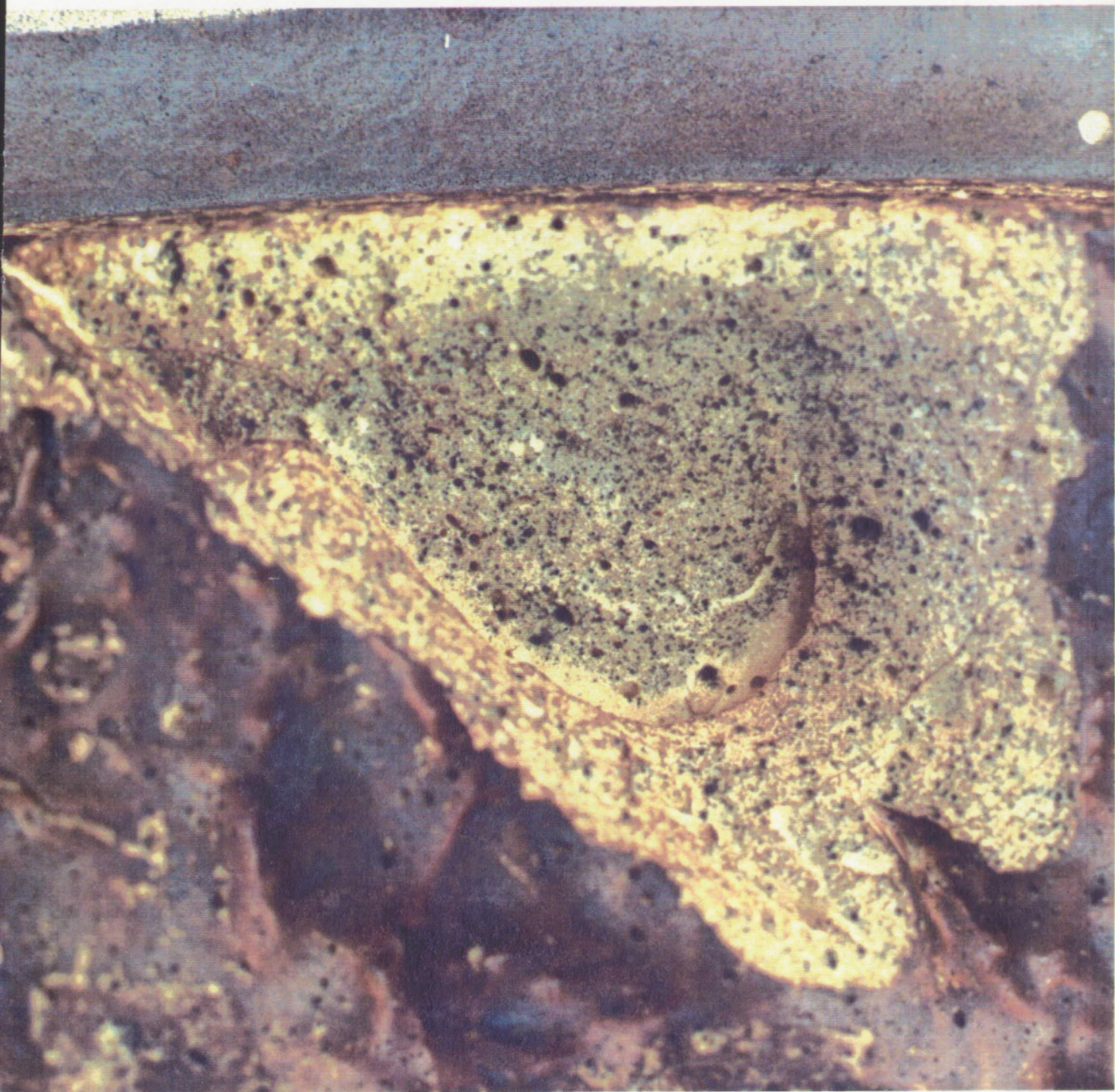

Close-in view of instafoam divot on the ETA ring forward side

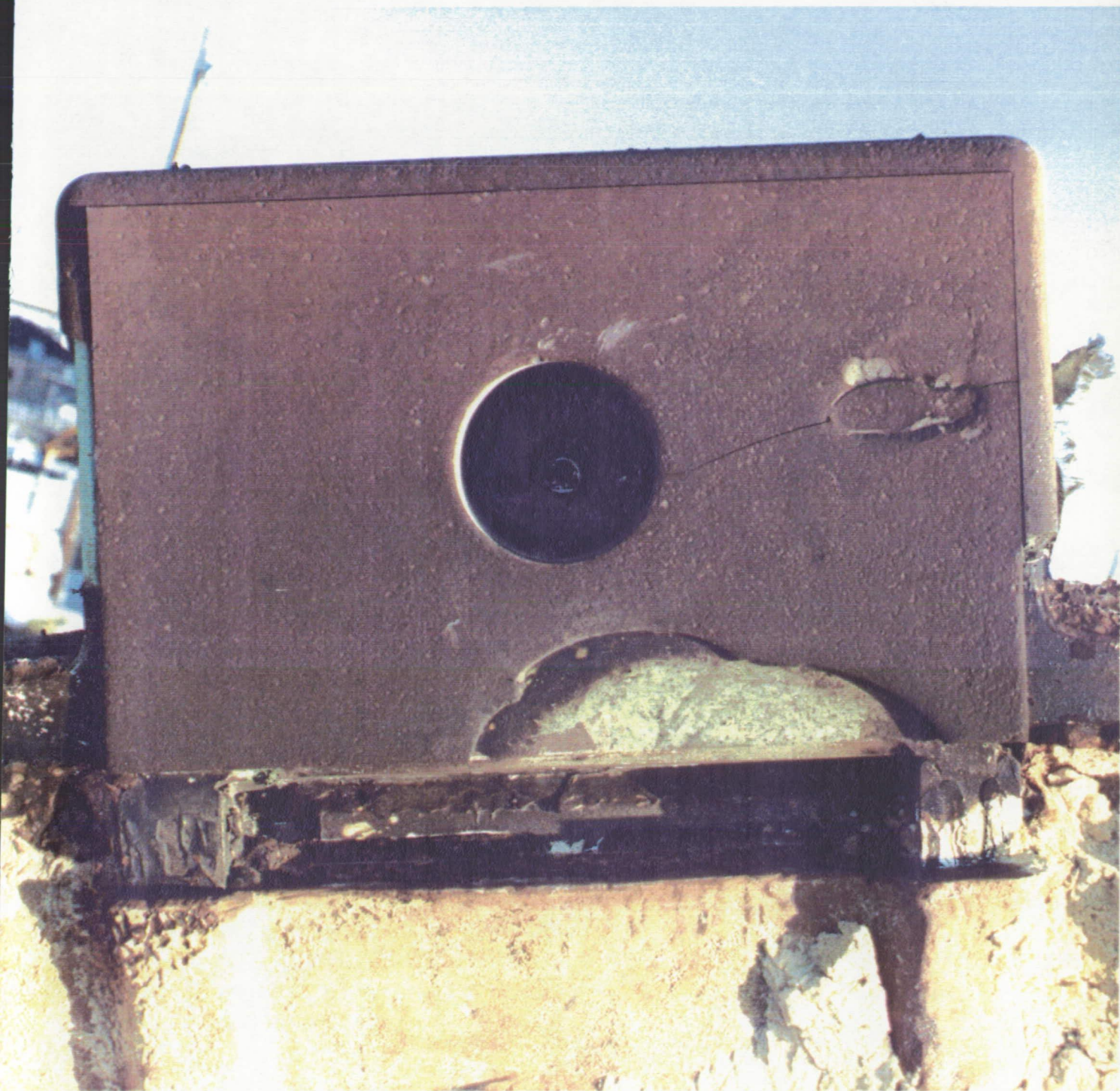

EPON shim material was missing from the aft skirt HDP #4 foot and the substrate was sooted. This condition coincided with the piece of EPON shim material that came loose at liftoff and was visible in the film review (film items E-7, 15, 27).

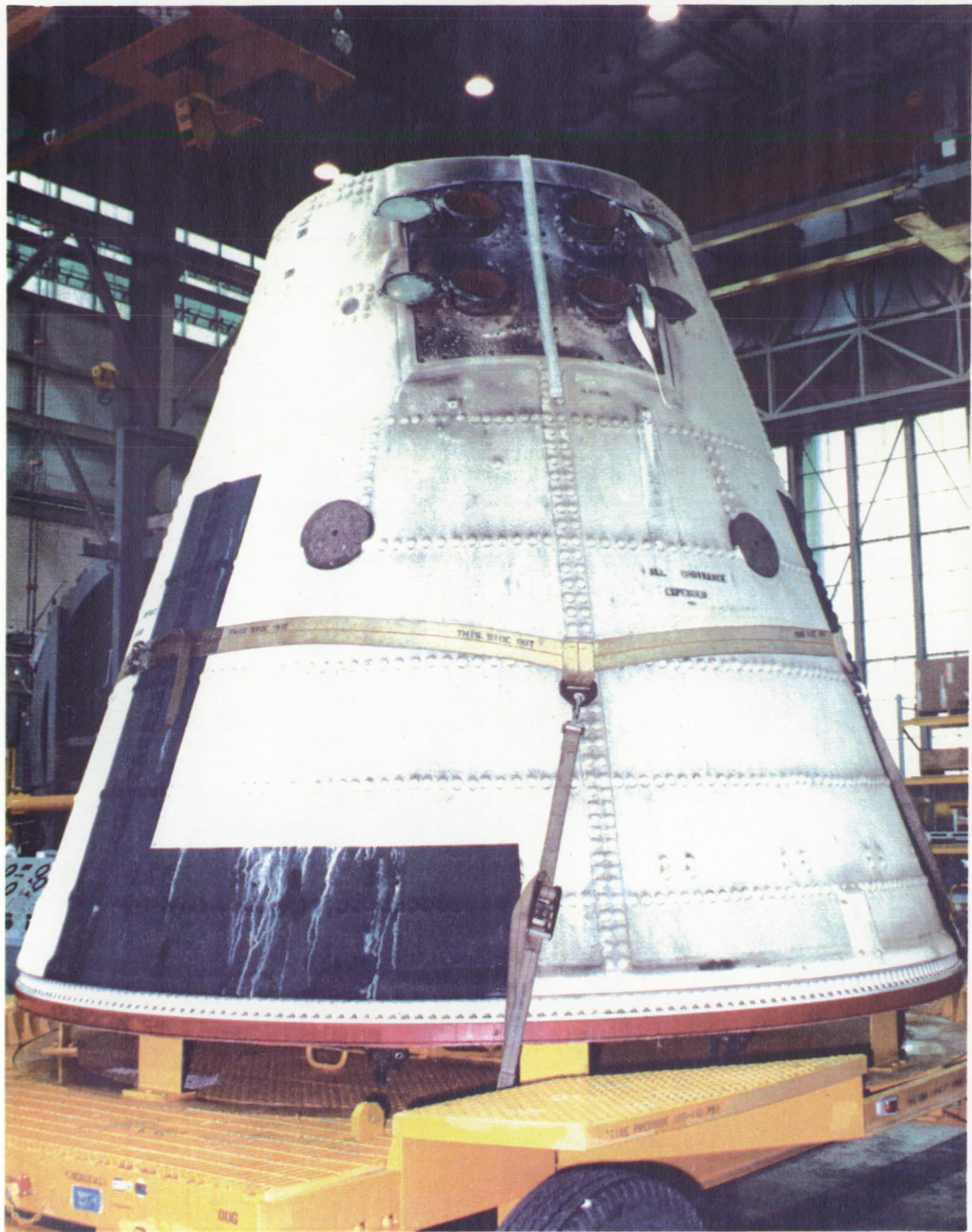

Post flight condition of LH SRB frustum. There were 54 MSA-2 debonds over fasteners, but no areas of missing TPS.

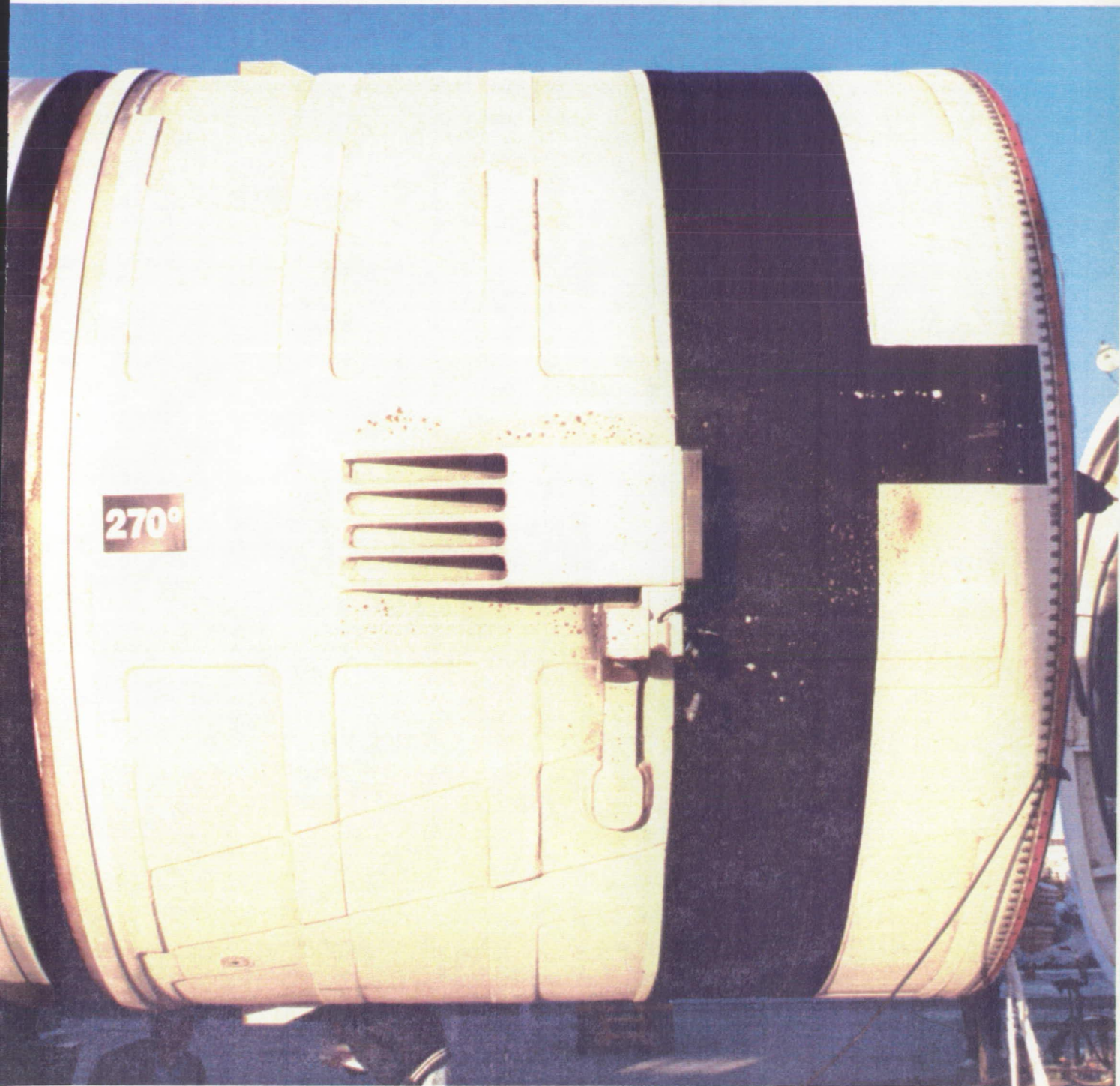

Post flight condition of LH forward skirt. There were no
MSA-2 debonds or areas of missing TPS.



A 2.6-inch crack occurred in the K5NA closeout on the left
aft field joint trunnion

117

ORIGINAL PAGE
COLOR PHOTOGRAPH



Post flight condition of the LH aft booster. There was no structural damage to the ETA ring or IEA.

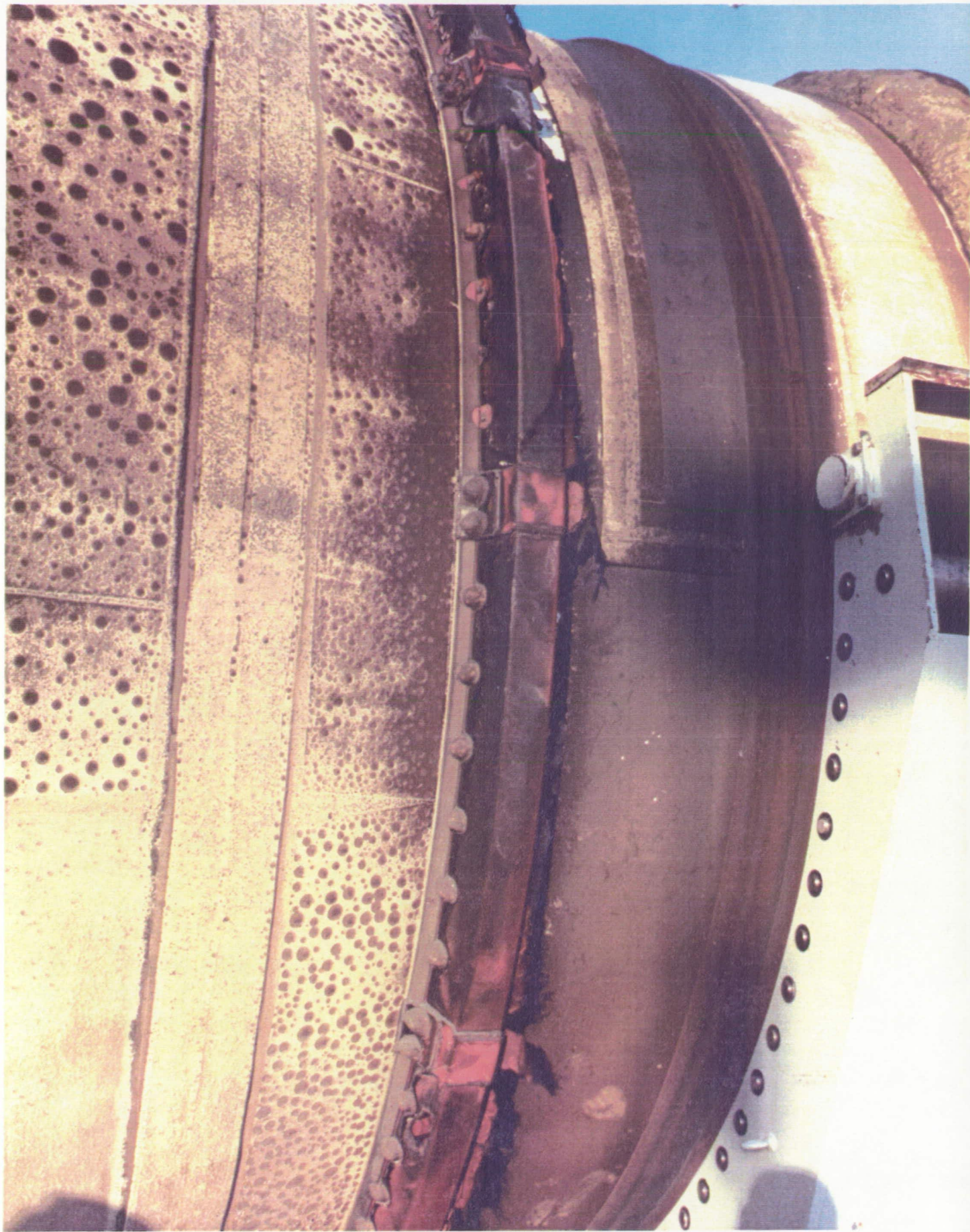

Some K5NA protective domes were missing from the aft side
of the phenolic kick ring prior to water impact



No damage other than typical water impact damage was visible in the -Z area of the LH aft skirt. Analysis of launch films revealed the possible loss of thermal curtain material during ascent at 34 and 39 seconds MET.

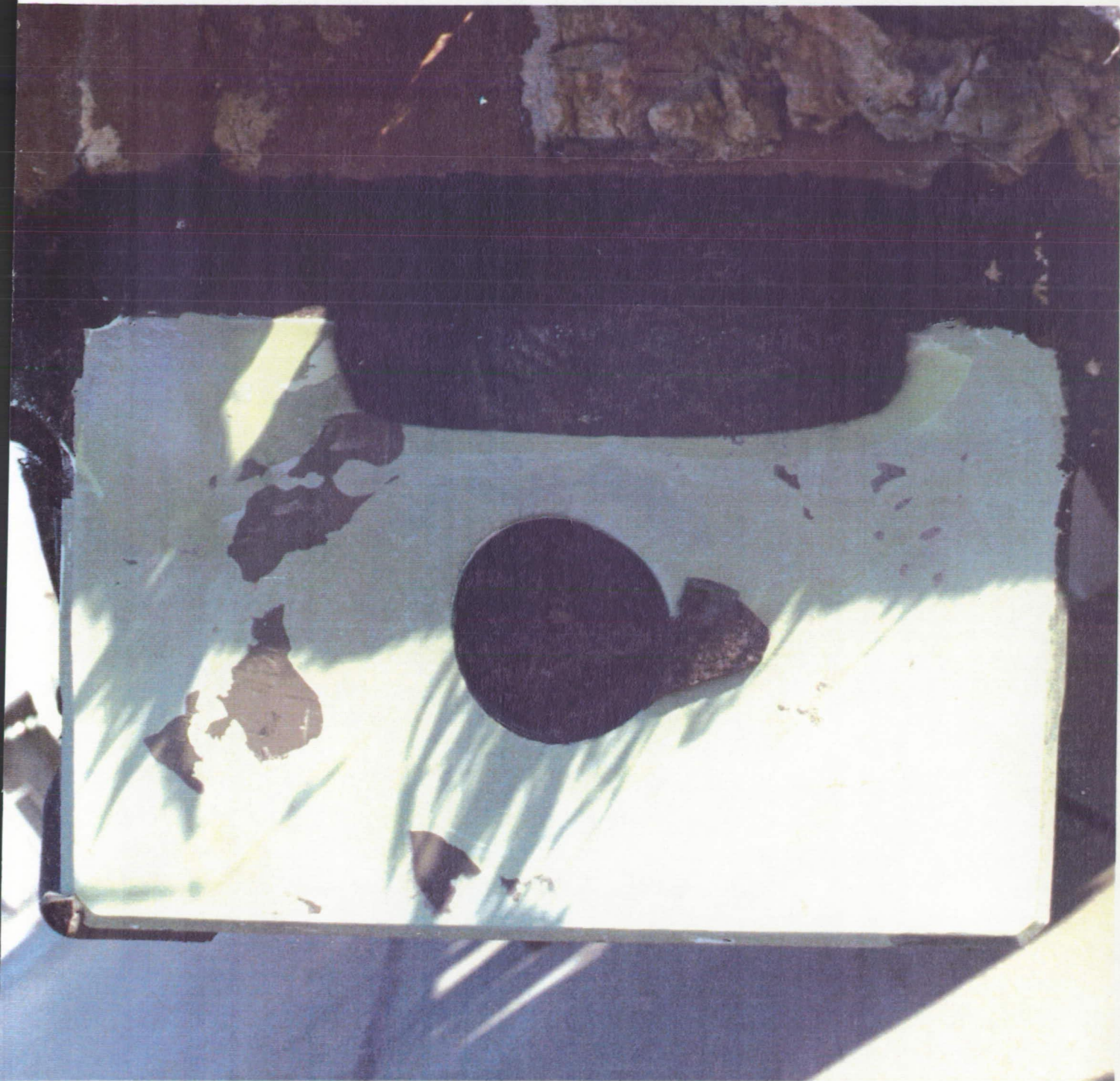

A 9" x 2" piece of HDP #8 aft face EPON shim material was
missing prior to water impact

121

ORIGINAL PAGE
COLOR PHOTOGRAPH

9.0 ORBITER POST LANDING DEBRIS ASSESSMENT

A detailed post landing inspection of OV-104 (Atlantis) was conducted on November 20-21, 1990, at the Kennedy Space Center on Runway 33 and in the Orbiter Processing Facility to identify debris impact damage, and if possible, debris sources. The Orbiter TPS sustained a total of 81 hits, of which 8 had a major dimension of one inch or greater. This total does not include the approximately 150 hits on the base heat shield.

The Orbiter lower surface had a total of 70 hits of which 7 had a major dimension of one inch or greater. A comparison of these numbers to statistics from 23 previous missions of similar configuration (excluding missions STS-24, 25, 26, 26R, 27R, and 30R, which had damage from known debris sources), indicates the total number of hits on the lower surface was less than average. Figures 11-14 show the TPS debris damage assessment for STS-38.

The Orbiter lower surface tile damage sites had an approximate equal distribution about the vehicle centerline. A cluster of 10 hits (two larger than one-inch) occurred just aft of the LH2 ET/ORB umbilical cavity. Similar clusters of hits have occurred in this area on previous flights and are attributed to ice/debris impacts during ET separation. There was no damage to the LH2 umbilical cavity sill/thermal barrier by ice shaken loose at SSME ignition (as seen during the post launch film review). A total of 18 hits occurred on the body flap lower surface.

Damage to the base heatshield tiles was average with approximately 150 sites. All three main engine closeout beta blankets were frayed in localized areas: 5-7 o'clock on SSME #1, 1-2 and 4-5 o'clock on SSME #2, and 10-12 o'clock on SSME #3. Approximately 1-1/2 feet of blanket and insulation was missing from SSME #1.

A few small pieces of gap filler sleeving material were slightly protruding from the RH OMS pod leading edge. No detectable damage to adjacent tiles resulted from these gap fillers. The overall condition of the OMS pods was better than average.

Speed brake trailing edge tile damage occurred in 7 locations on the LH side and one location on the RH side.

Windows #2 and #5 were slightly hazed. The hazing was moderate on windows #3 and #4.

The separation ordnance devices appeared to have functioned properly. The debris plungers in EO-2 and EO-3 were seated. No ordnance fragments were found on the runway beneath the ET/ORB umbilical cavities. The EO-1 bipod yoke bolt piston was flush with the outer mold line. Upon disassembly of the EO-1

FIGURE 11. DEBRIS DAMAGE LOCATIONS

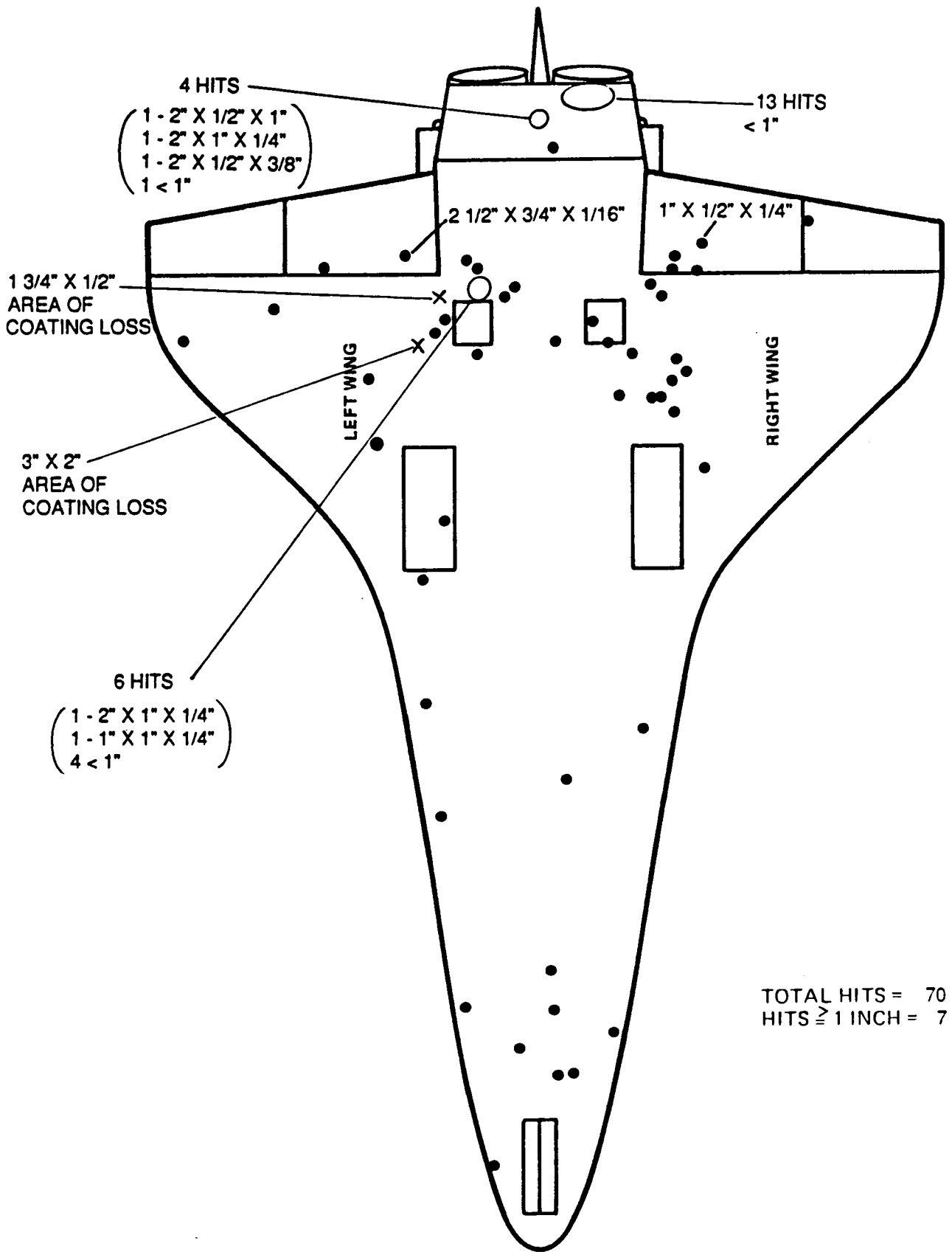

FIGURE 12. DEBRIS DAMAGE LOCATIONS

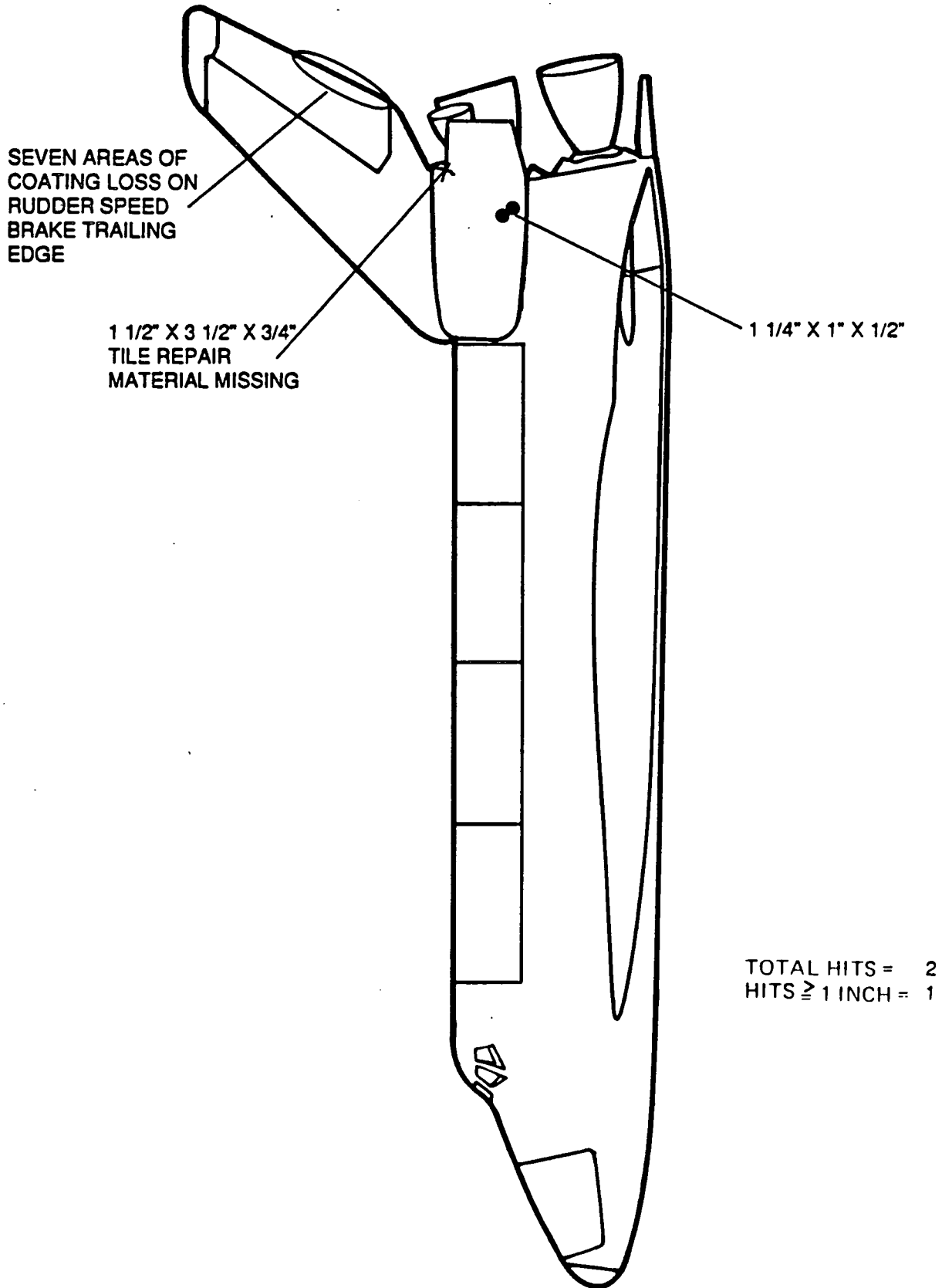
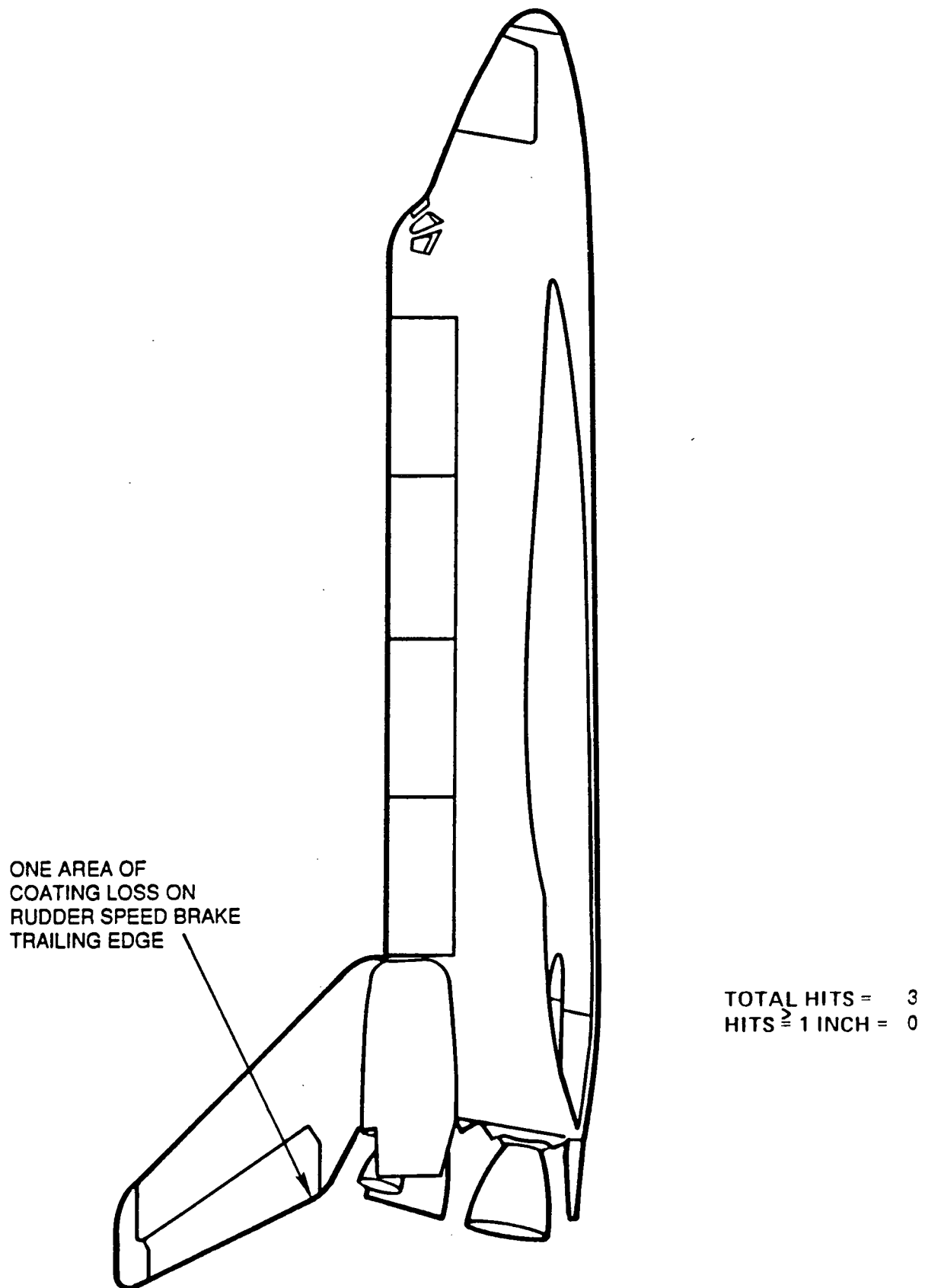
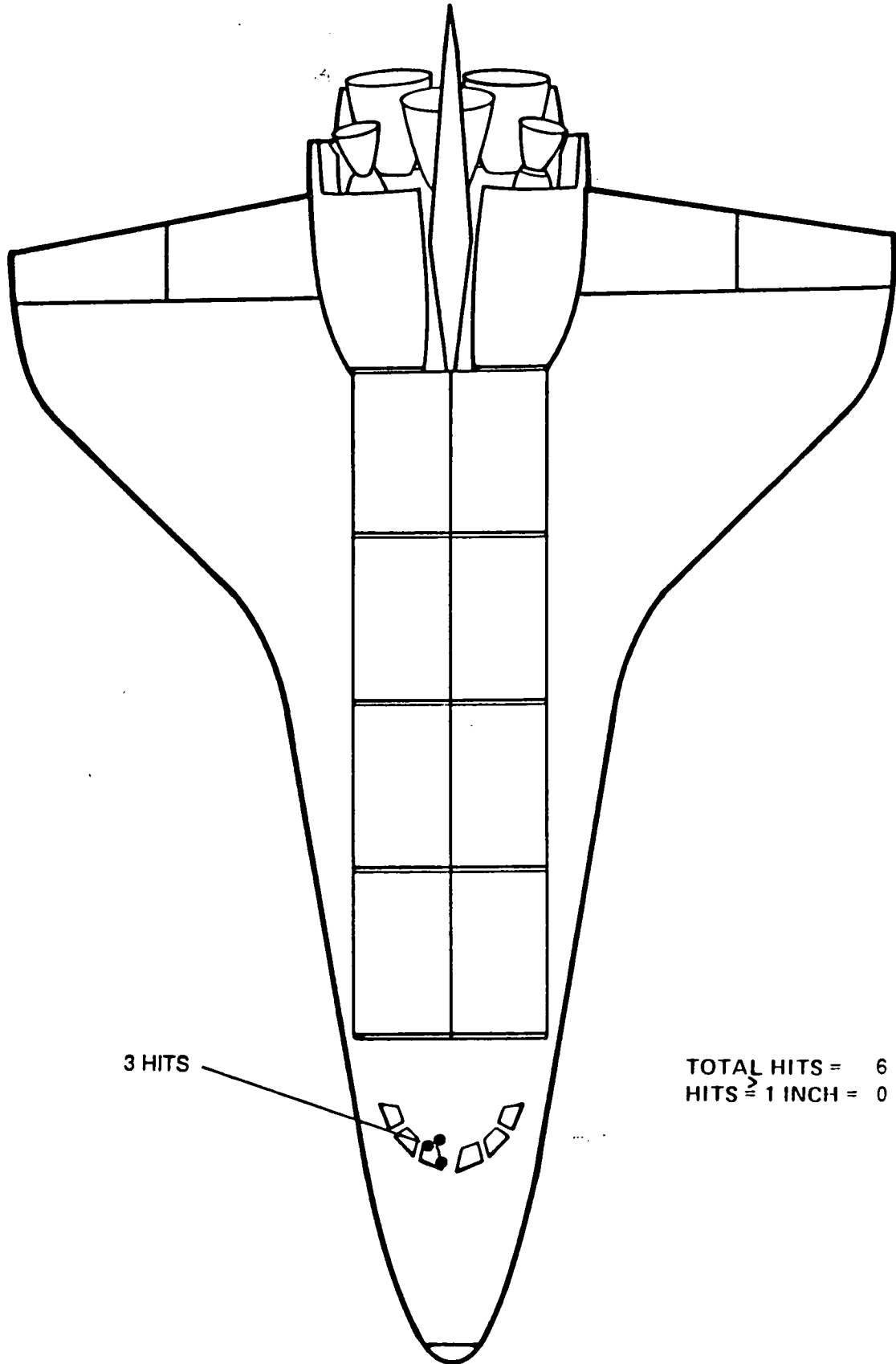

FIGURE 13. DEBRIS DAMAGE LOCATIONS



EGG/V

FIGURE 14. DEBRIS DAMAGE LOCATIONS



assembly, the RH centering ring stop bolt was found to be bent. The bending of this bolt was declared an IFA and, after extensive analysis, was dispositioned as an "Unexplained Anomaly".

Damage to the tires appeared minimal after landing on the KSC concrete runway. A 12-inch length of thermal barrier on the aft outboard corner of the RH landing gear well was frayed.

After arrival in the OPF, samples were taken from the selected damage sites (Figure 15) for laboratory analysis. The results of all debris sample chemical analysis are presented in Section 10.0.

The KSC Shuttle Thermal Imager (STI) was used to record the surface temperatures of several areas (Figure 16). Twenty-eight minutes after landing, the nose cap RCC measured 148 degrees F. The RH wing RCC panel #9 and #17 measured 82 and 78 degrees F, respectively.

SLF Runway 33/15 was swept and inspected by LSOC personnel on 20 November 1990 prior to Orbiter landing. The runway was found to be in good condition.

The post landing inspection of Runway 33 was performed 1/2 hour after landing. One 3"x1/2" piece of Ames gap filler was found 50 yards south of Marker 14 and four pieces of Cerachrome felt insulation (from the SSME beta blankets) were found 50 yards north of the runway threshold.

In summary, the total number of lower surface Orbiter TPS debris hits was less than average when compared to previous flights as shown in the comparison chart (Figure 17). The distribution of hits on the Orbiter does not point to a single source for ascent debris, but indicates a shedding of ice and TPS debris from random sources.

There were no Orbiter Post Launch Anomalies.

FIGURE 15. DEBRIS DAMAGE CHEMICAL SAMPLE LOCATIONS

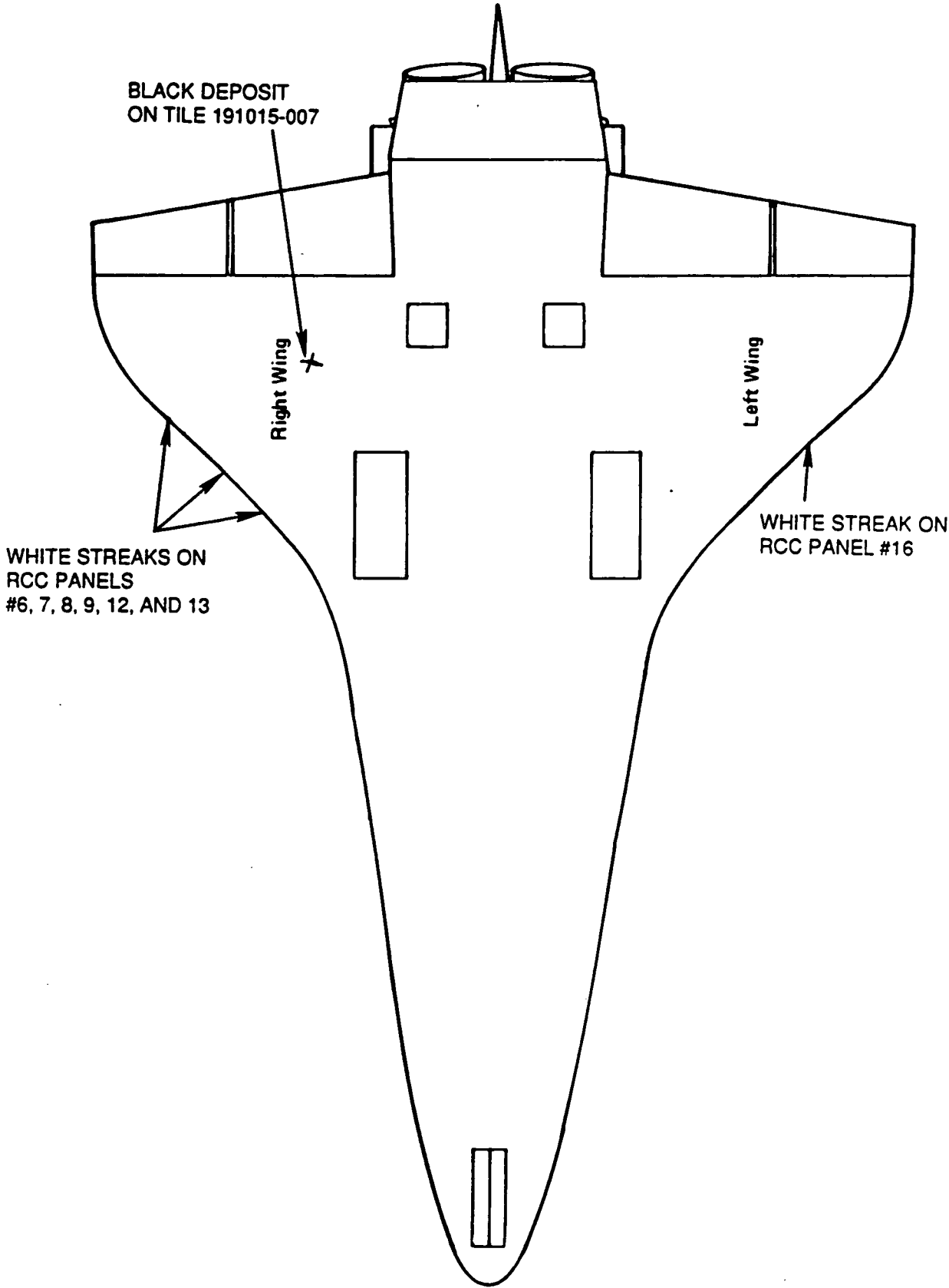

FIGURE 16. TEMPERATURE MEASUREMENTS

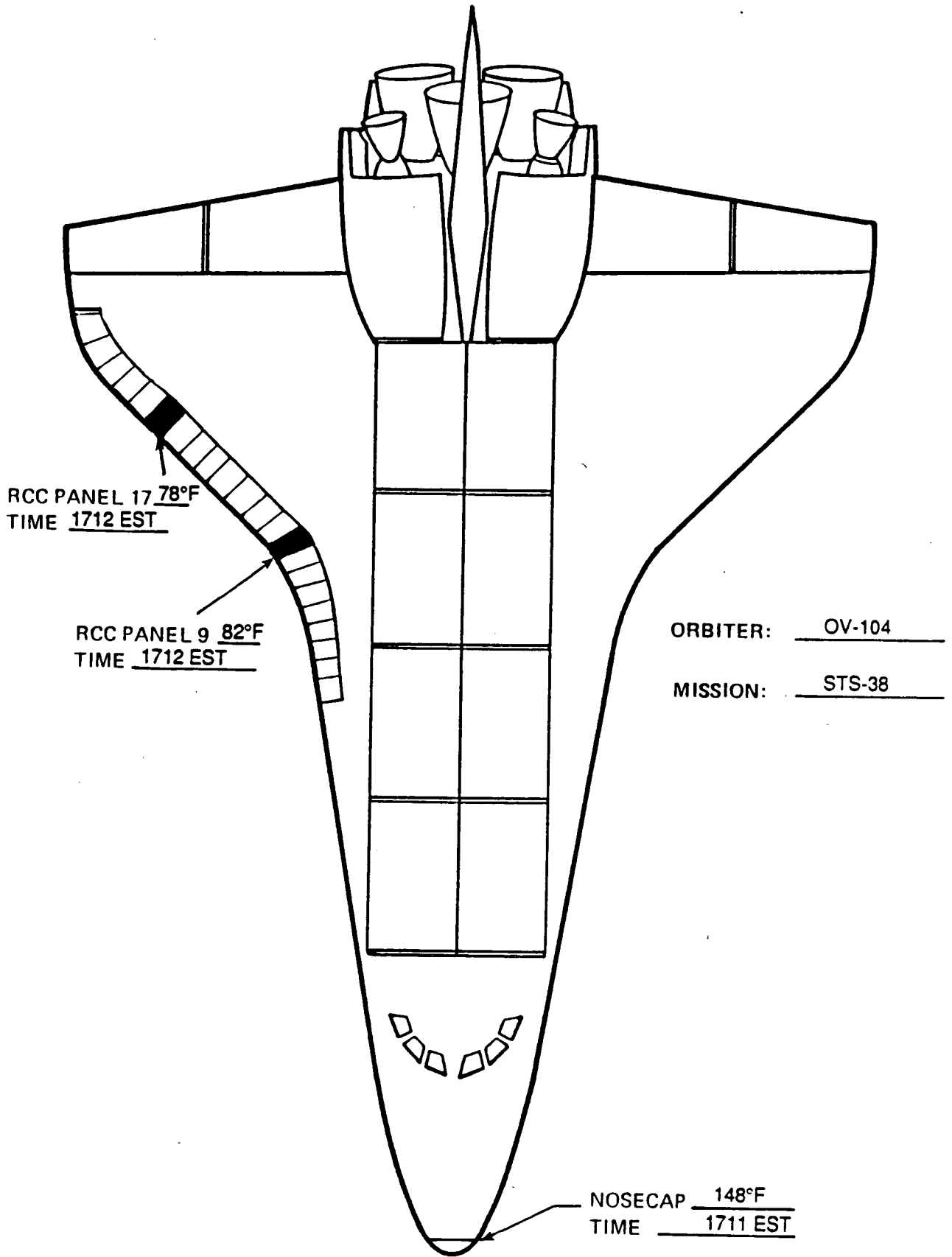

FIGURE 17. STS-38 DEBRIS DAMAGE ASSESSMENT SUMMARY

	<u>Hits > or = 1"</u>	<u>Total Hits</u>
Lower Surface	7	70
Upper Surface	0	6
Right Side	0	3
Left Side	0	0
Right OMS Pod	0	0
Left OMS Pod	1	2
TOTALS	8	81

COMPARISON TABLE

STS-6	36	120
STS-7	48	253
STS-8	7	56
STS-9 (41-A)	14	58
STS-11 (41-B)	34	63
STS-13 (41-C)	8	36
STS-14 (41-D)	30	111
STS-17 (41-G)	36	154
STS-19 (51-A)	20	87
STS-20 (51-C)	28	81
STS-23 (51-D)	46	152
STS-24 (51-B)	63	140
STS-25 (51-G)	144	315
STS-26 (51-F)	226	553
STS-27 (51-I)	33	141
STS-28 (51-J)	17	111
STS-30 (61-A)	34	183
STS-31 (61-B)	55	257
STS-32 (61-C)	39	193
STS-26R	55	411
STS-27R	298	707
STS-29R	23	132
STS-30R	56	151
STS-28R	20	76
STS-34	18	53
STS-33R	21	118
STS-32R	15	120
STS-36	20	62
STS-31R	14	63
STS-41	16	76
STS-38	8	81

FIGURE 18
COMPARISON TABLE

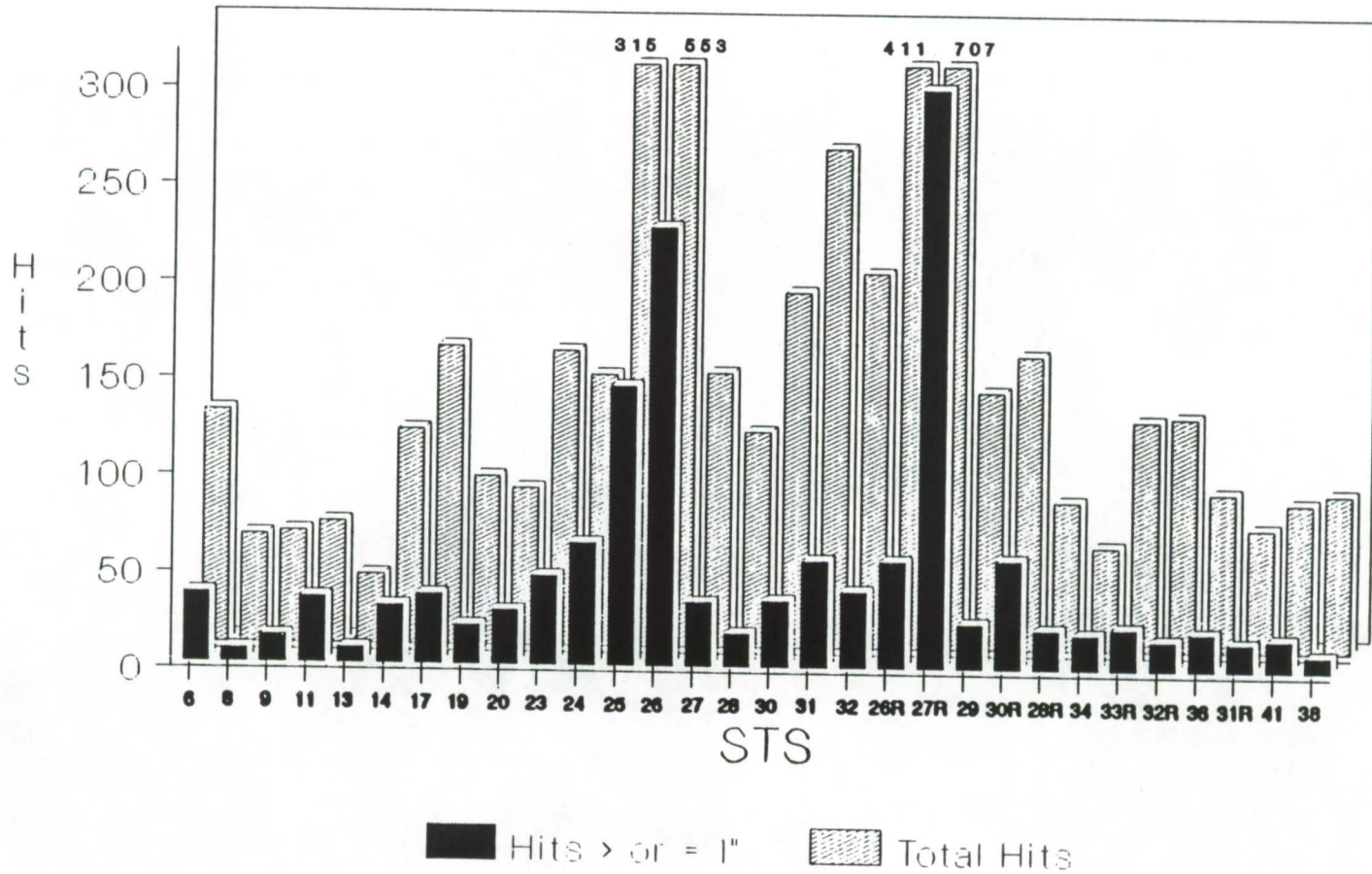
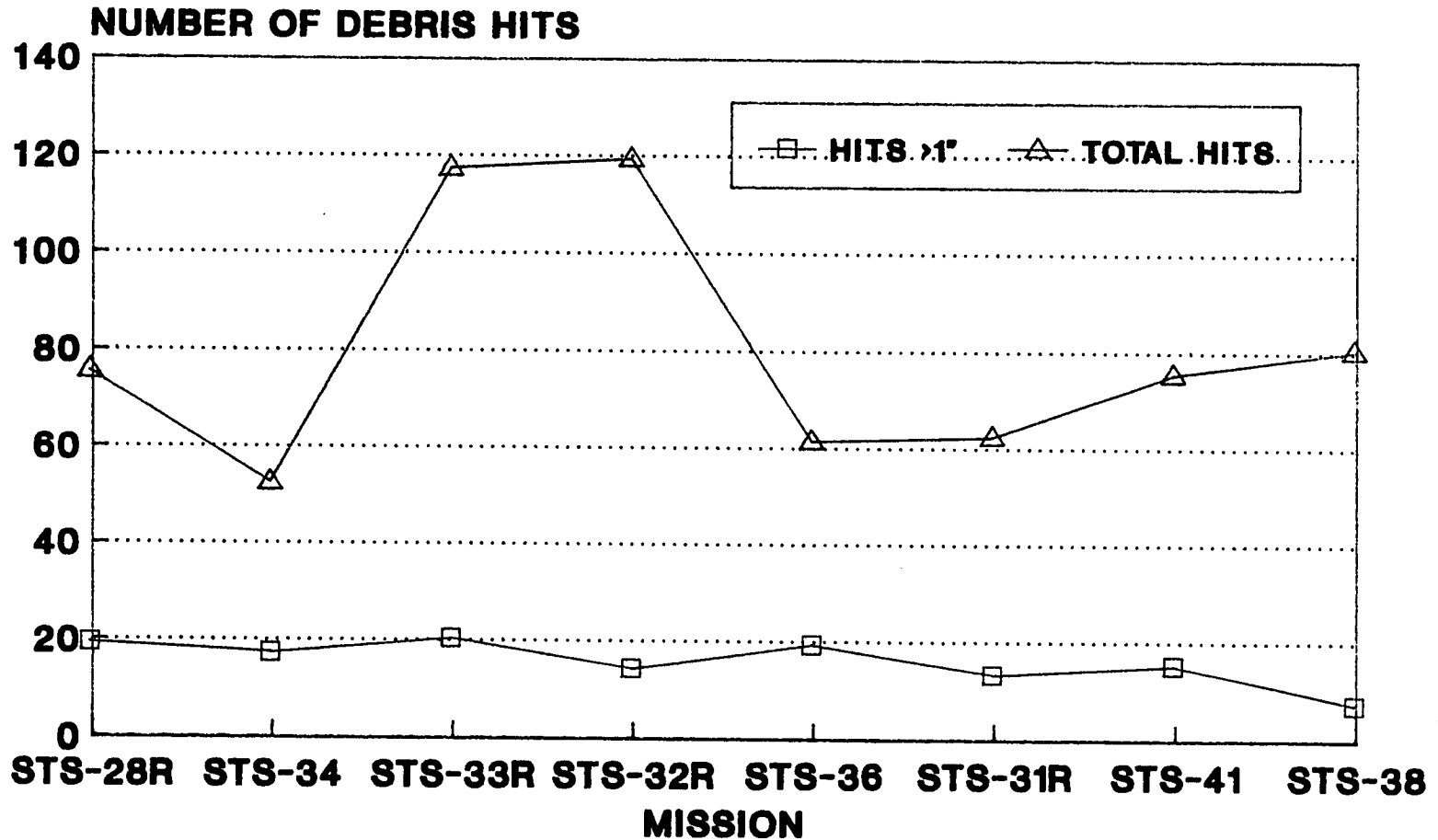

FIGURE 19

ORBITER TPS DEBRIS DAMAGE STS-28R THROUGH STS-38





OV-104 in the Heading Alignment Circle (HAC) prior to landing at KSC. No vehicle anomalies were visible.

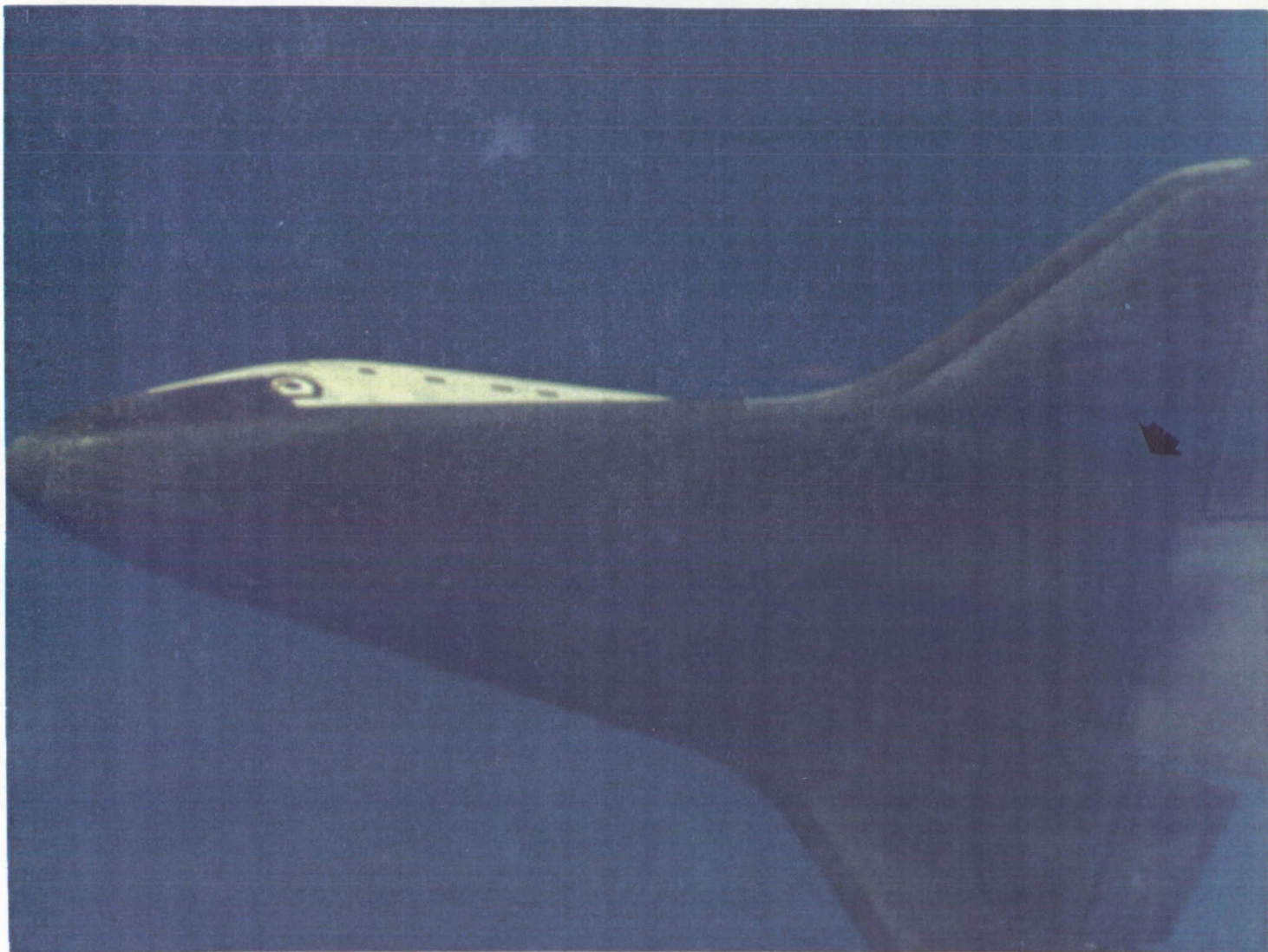

Overall view of lower surface tiles as Orbiter passes over the camera position. Note tile damage just visible near the ET/ORB LH2 umbilical area

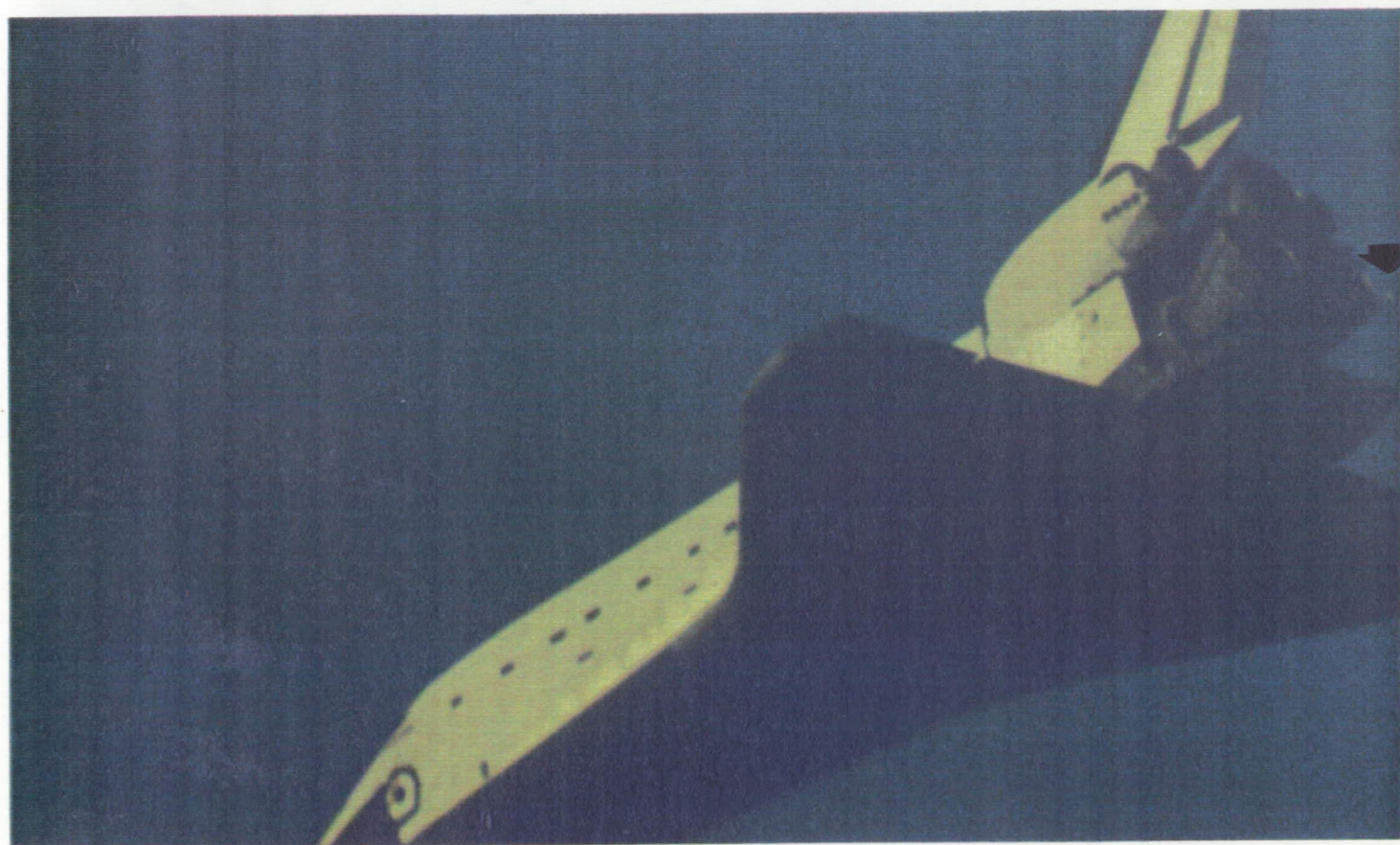
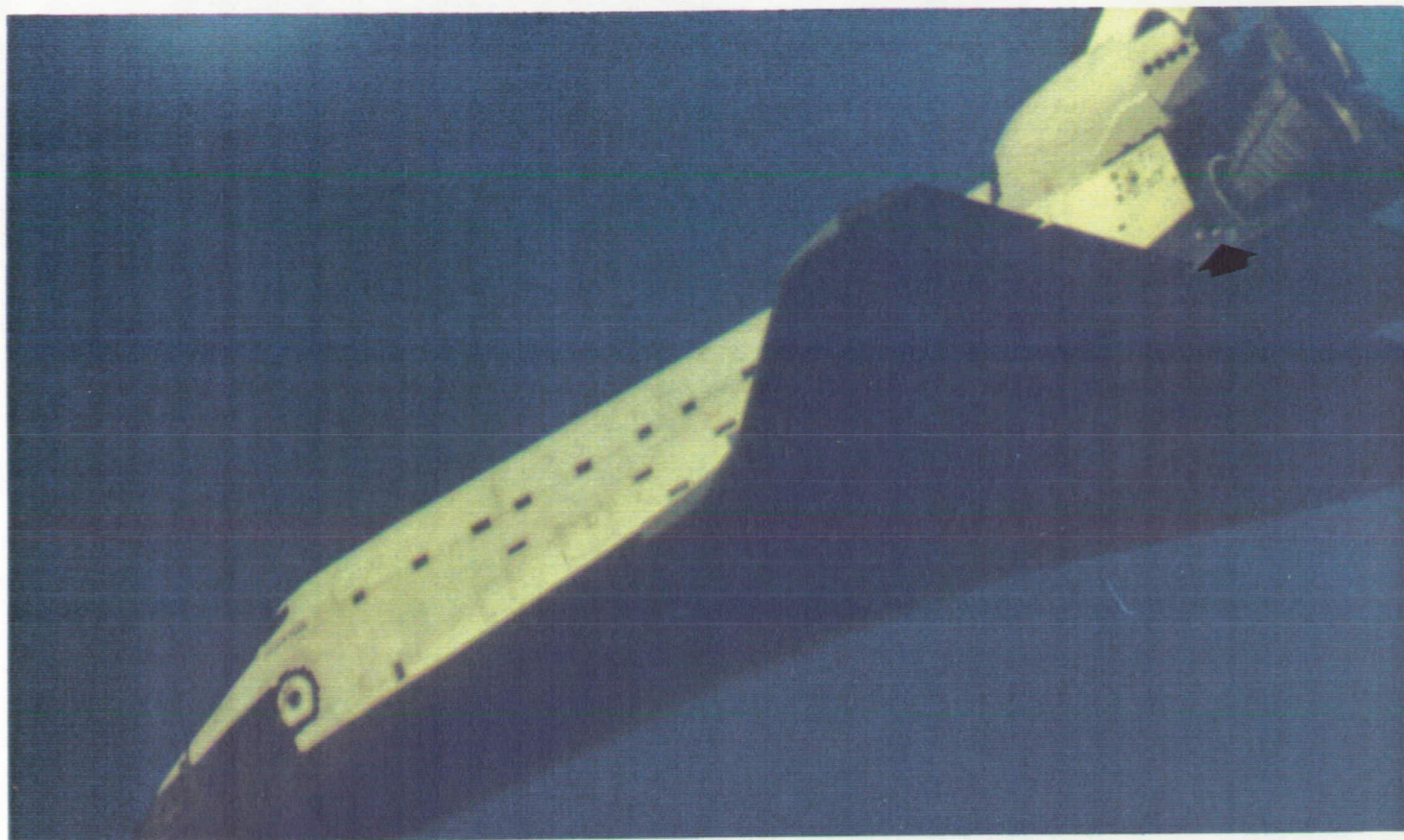

Two pieces of SSME closeout blanket, above the body flap near SSME #2 and outboard of SSME #3, fell aft during final approach



OV-104 Atlantis made the 6th landing at the Kennedy Space
Center on 20 November 1990 at 4:42 p.m. EST



Overall view of OV-104 left side



Overall view of OV-104 right side

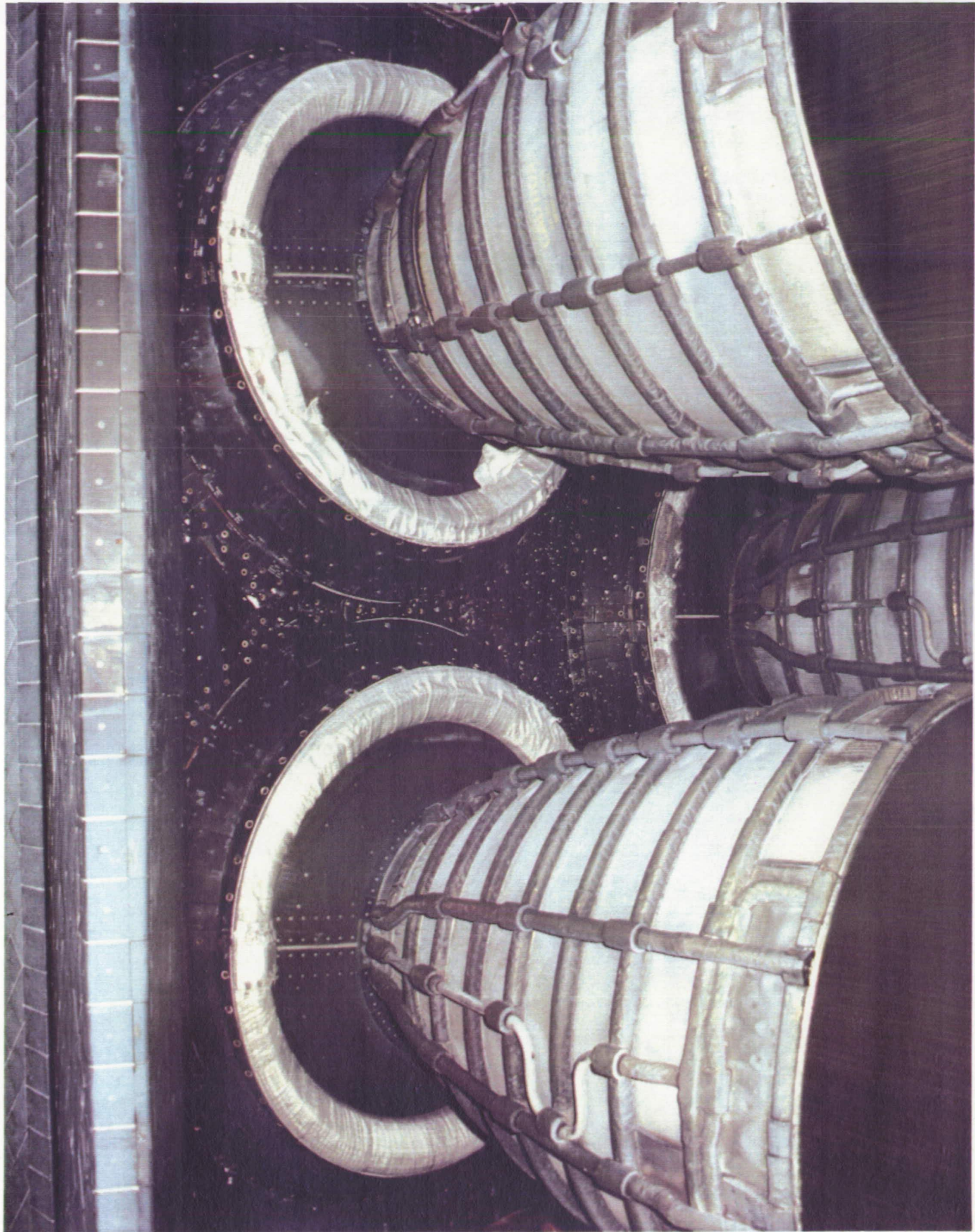

Overall view of SSME's. Damage to the base heat shield tiles was average with approximately 150 sites. All three SSME closeout beta blankets were frayed in localized areas.

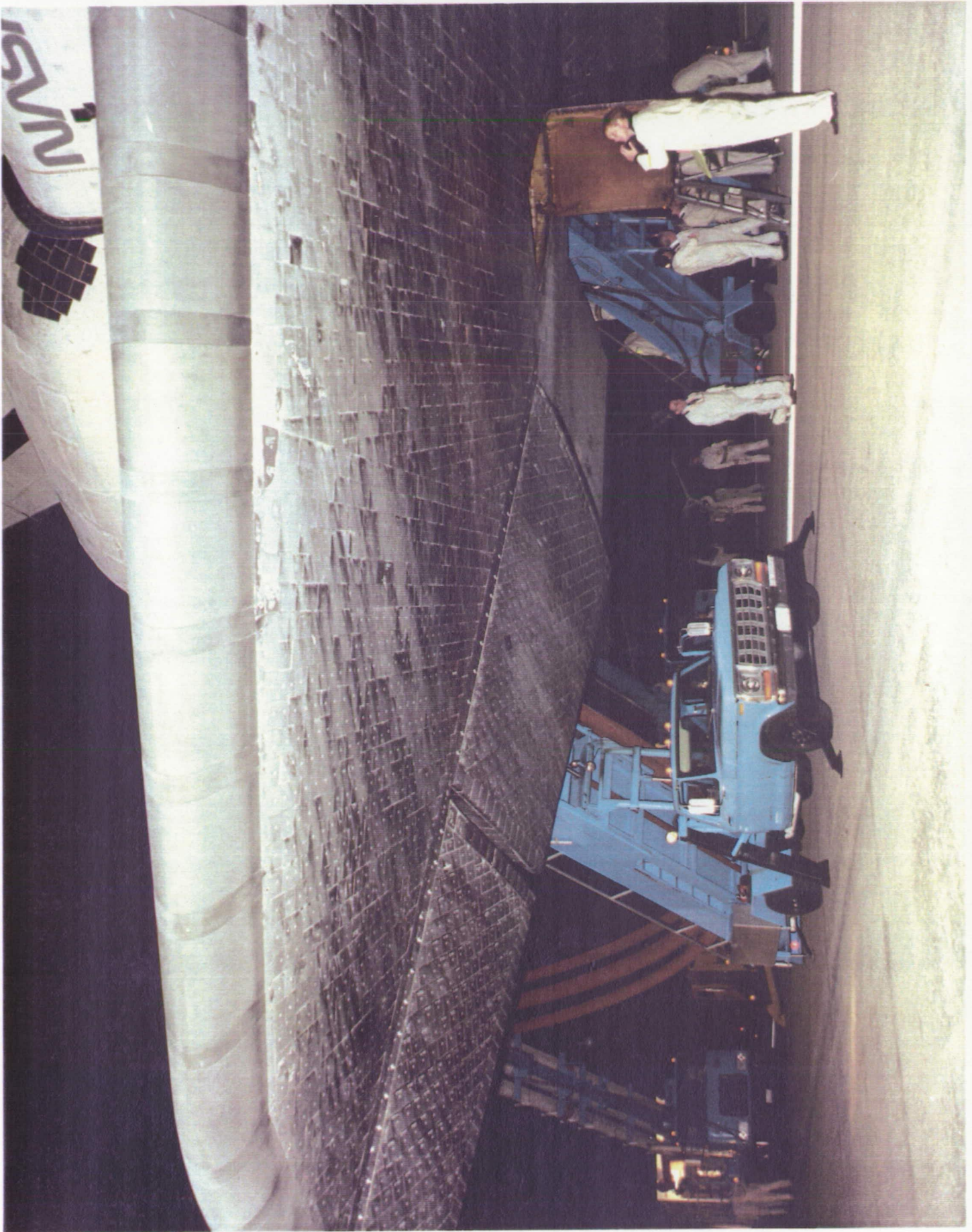

Lower surface tiles sustained a total of 70 hits with 7 of those damage sites measuring greater than or equal to 1 inch.
140

ORIGINAL PAGE
COLOR PHOTOGRAPH

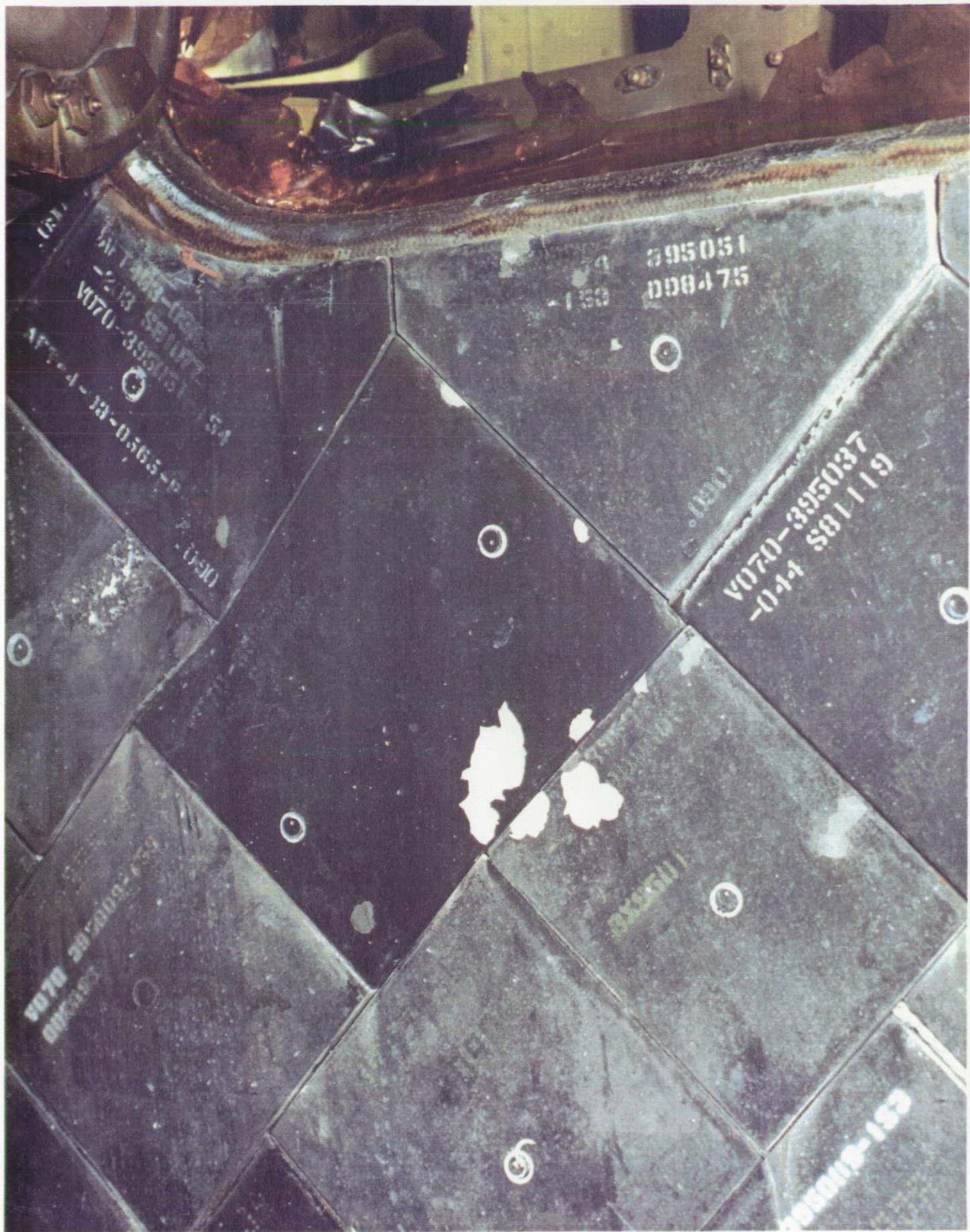

Typical debris impact damage to lower surface tiles near the
ET/ORB LH2 umbilical

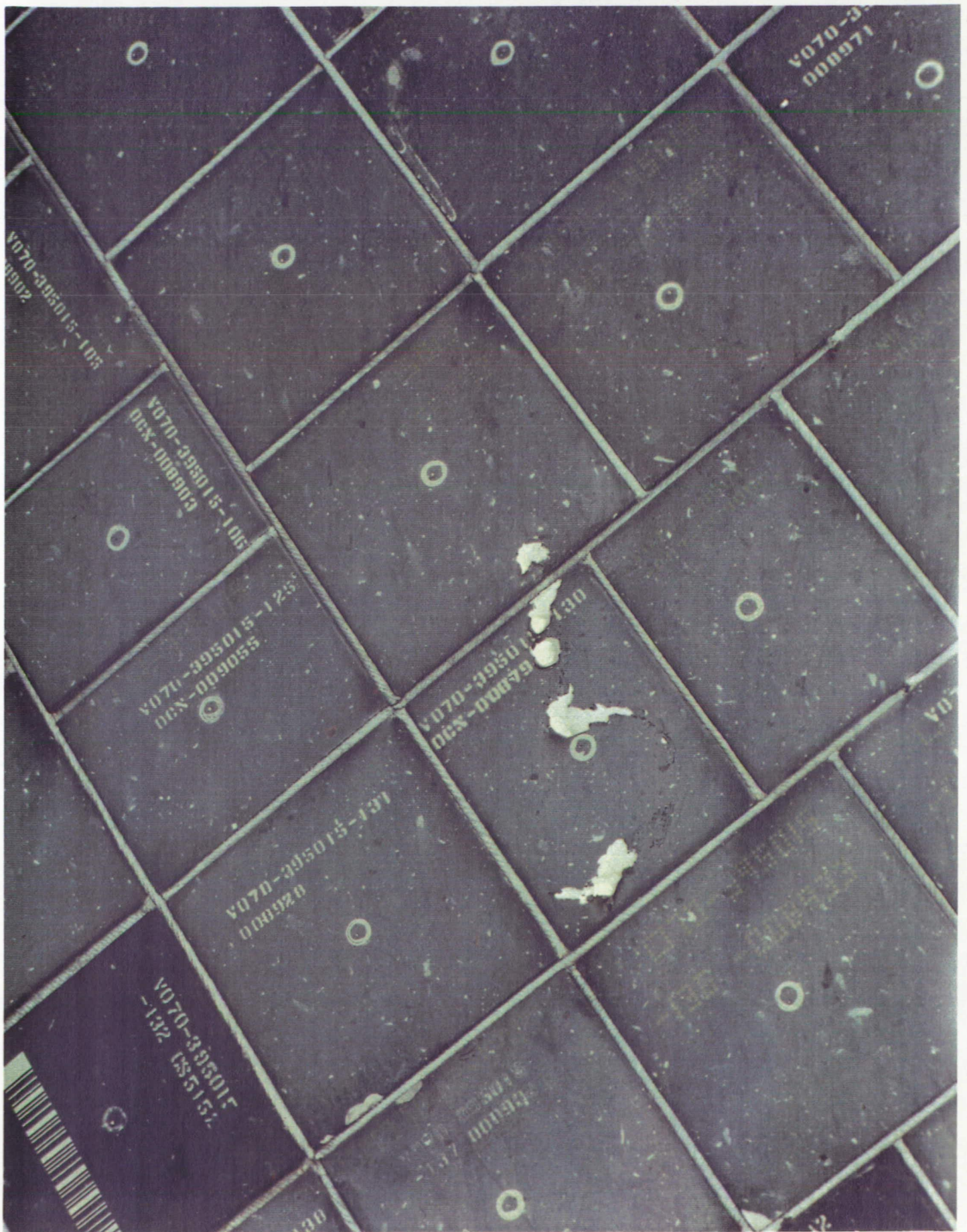

A total of 18 hits occurred on the body flap lower surface.
Some of the damage sites reached depths of 1/4 to 1 inch.



Typical debris impact damage to lower surface tiles

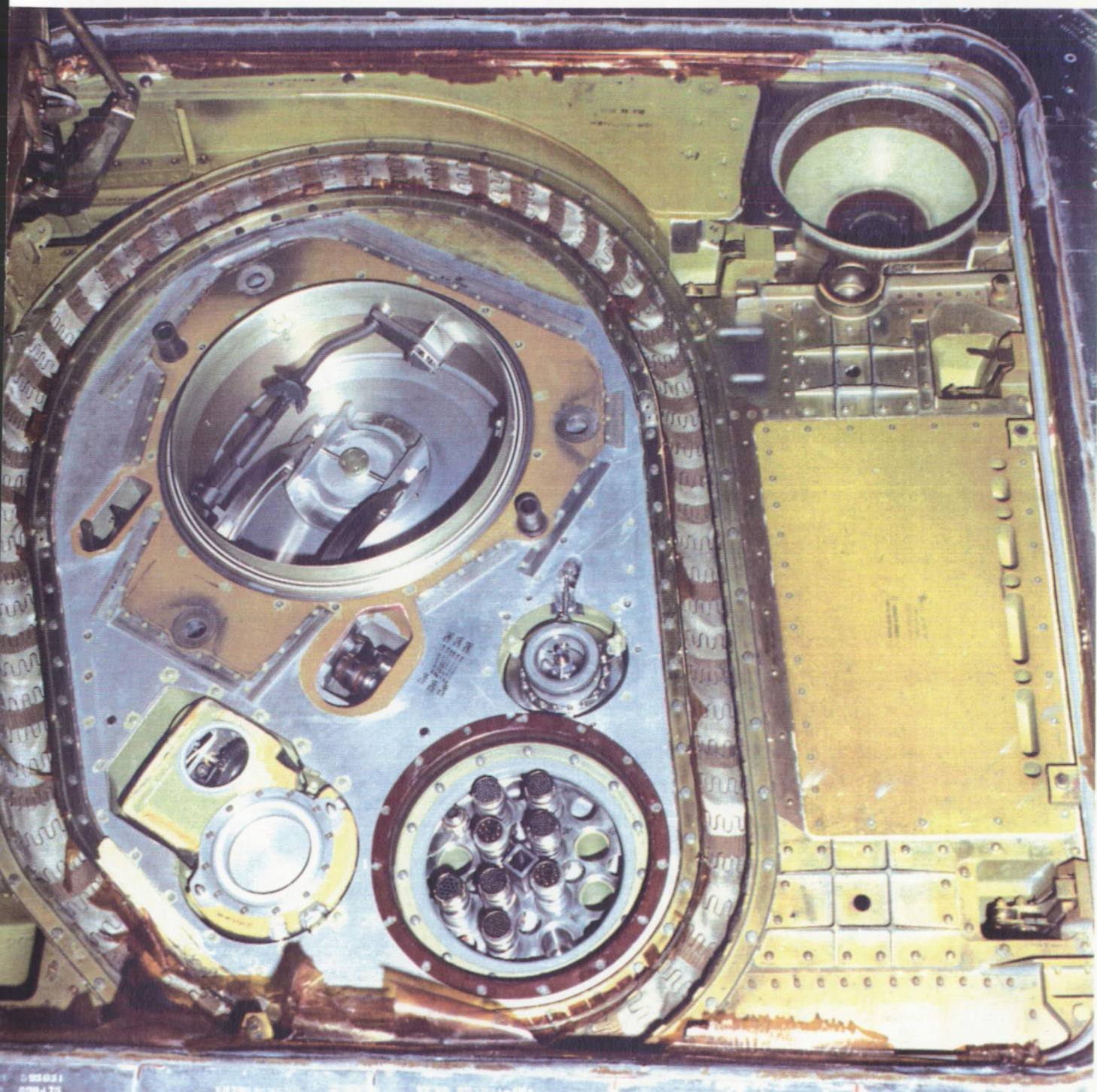

Post flight condition of the LH2 ET/ORB umbilical. The debris plunger in EO-2 was properly seated.

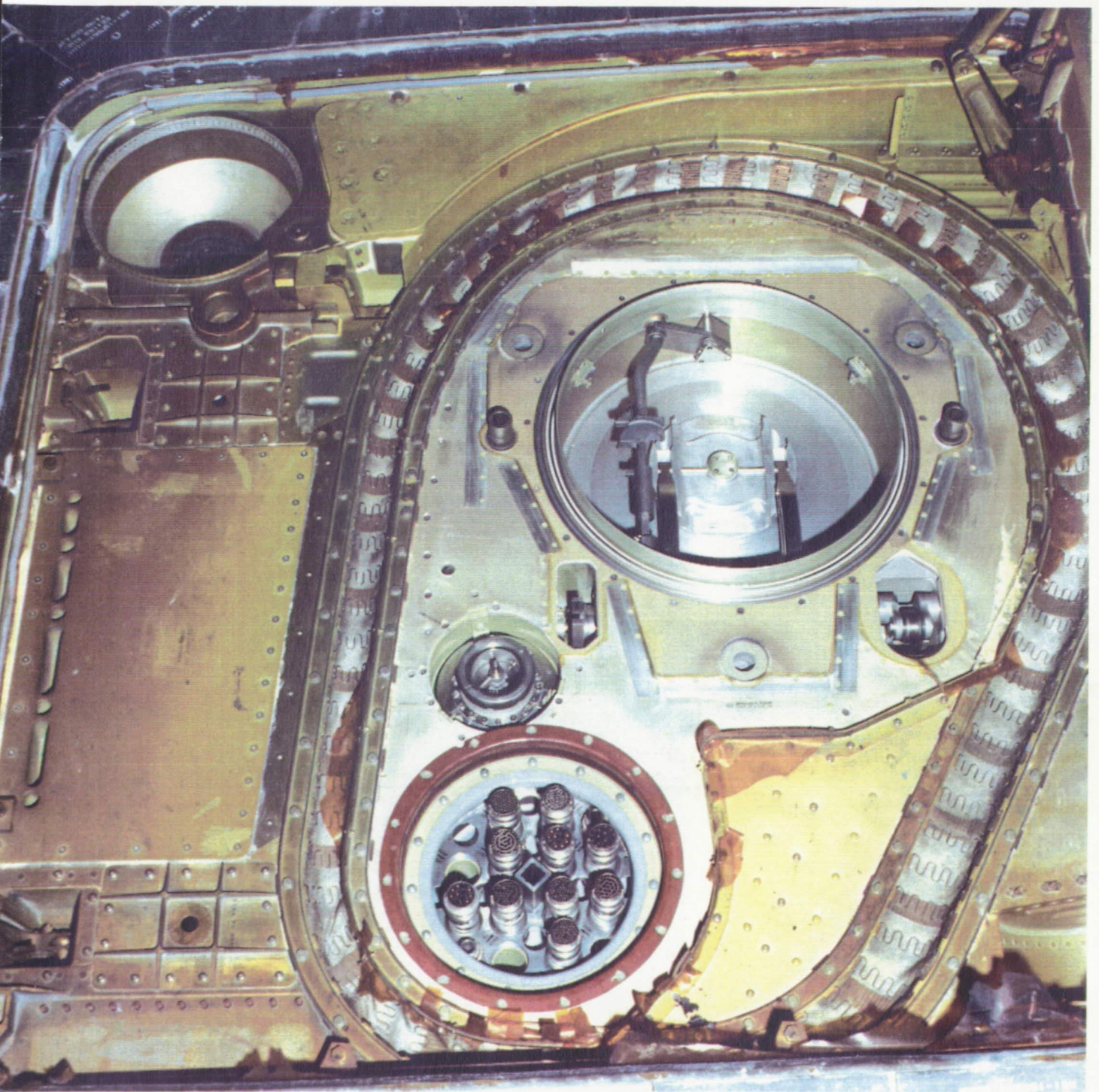

Post flight condition of the LO2 ET/ORB umbilical. The debris plunger in EO-3 was properly seated.



One 3" x 1/2" piece of Ames gap filler was found on the runway
50 yards south of Marker 14 near the runway threshold

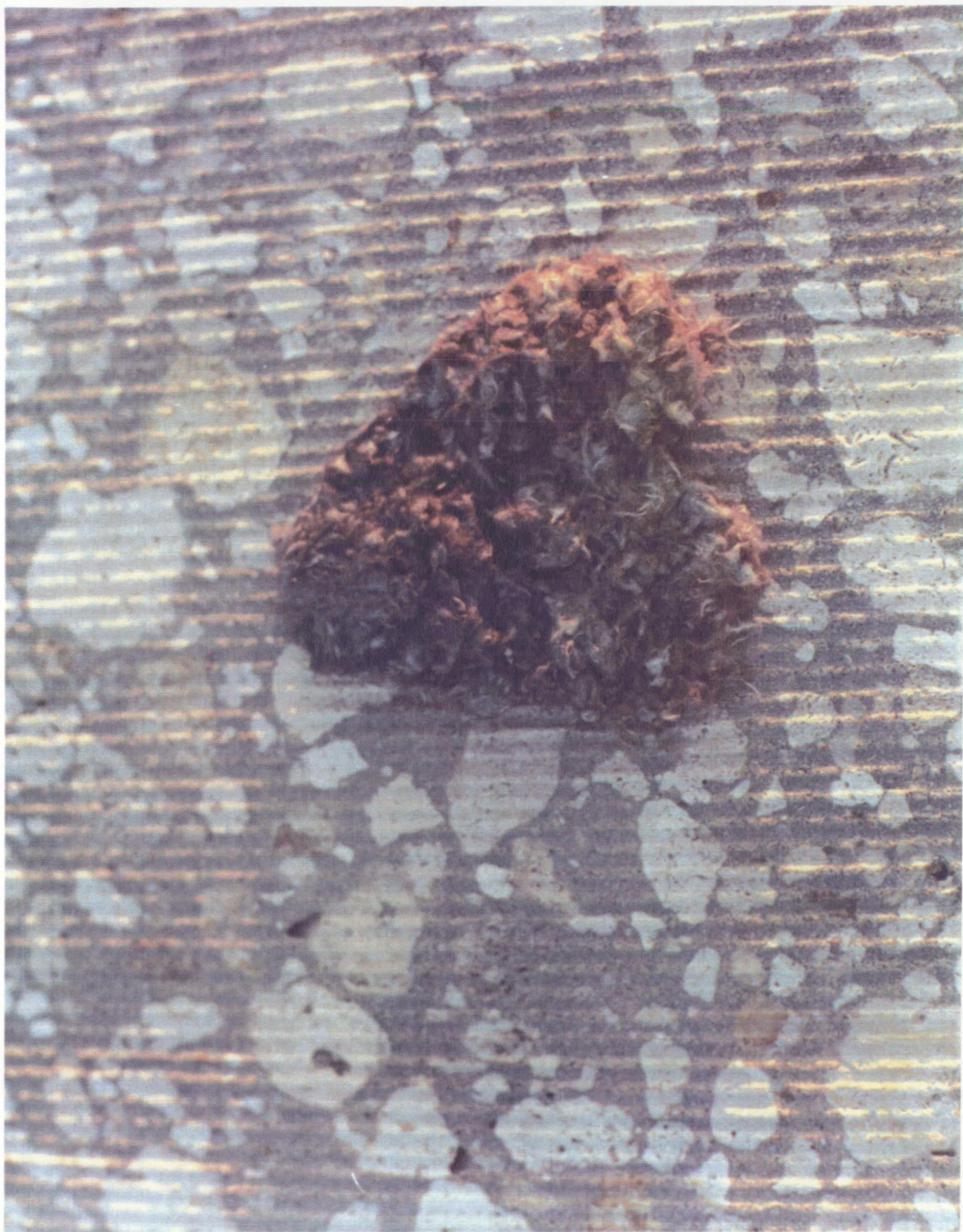

Four pieces of Cerachrome felt insulation from the SSME beta blankets were found on the runway near the threshold

10.0 DEBRIS SAMPLE LAB REPORTS

A total of 10 samples were obtained from Orbiter OV-104 during the STS-38 post landing debris assessment at Kennedy Space Center, Florida (Figure 15). The 10 submitted samples consisted of 7 wing leading edge RCC samples (6RH, 1LH), 1 tile residue sample, and reference samples: (1) foam "padding" used in wing leading edge RCC protective covers and (2) hypalon paint used in SRB processing. The samples were analyzed by the NASA KSC Microchemical Analysis Branch (MAB) for material composition and comparison to known STS materials. The specific elemental analysis is shown in the appended MAB report. Debris analysis involves the placing and correlating of particles with respect to composition, availability, and thermal (mission) effects. Debris samples and analyses are provided by Orbiter location in the following summaries.

Orbiter wing RCC panels

Results of the wing leading edge RCC samples indicated the presence of the following materials:

1. Black, white and grey silicon-rich materials
2. RTV
3. "Elephant hide"-ensolite foam
4. Hypalon paint

Debris analysis provides the following correlations:

1. Black, white and grey silicon-rich particles originate from Orbiter thermal protection system (TPS).
2. RTV is used for bonding/sealing Orbiter TPS.
3. "Elephant hide"-ensolite foam is used as padding for RCC protective covers.
4. Hypalon paint is a topcoat on SRB thermal protection system (TPS) surfaces.

Orbiter tile

Results of the tile sample chemical analysis revealed the presence of the following materials:

1. Silicon-rich TPS materials (Black pumaceous)

Debris analysis provides the following correlation:

1. Silicon-rich TPS materials (Black pumaceous) originate from the Orbiter thermal protection system (TPS).

Reference samples

Results of the reference samples indicated the following:

1. Hypalon paint - provided similar results to the RCC white streak samples. A Hypalon paint sample was heated in a laboratory oven to characterize the effect of re-entry heating, and when comparatively analyzed to the RCC white streak, the sample was discovered to be very similar. This data suggests Hypalon paint as the origin of the RCC white streaks.
2. Initial laboratory results of the RCC samples provided indications of materials not normally associated with landing debris samples. In an effort to discover the source, a sample of elephant hide material was submitted to the laboratory for analysis. This request was based on observations from MAB and debris team personnel that the RCC protective covers, lined with elephant hide foam, had been installed prior to post-landing debris sampling in the OPF. The results of the "elephant hide"-ensolite foam sample, when comparatively analyzed with RCC samples taken after landing, indicates residual elephant hide-ensolite foam material is present in RCC samples.

Conclusions

The STS-38 mission, as evidenced by the debris analysis report, was successful in minimizing damage from debris. This is also shown to be true by the chemical analysis that was performed on post flight samples. The STS-38 mission landing at Kennedy Space Center provided an opportunity for Microchemical Analysis Branch (MAB) personnel to provide on-site support for sampling. This assistance provided for understanding/improving current sampling techniques.

The Orbiter wing leading edge samples provided results that indicated exposure to Orbiter thermal protection system (TPS), RTV, and Hypalon paint. The samples also showed exposure to "elephant hide"-ensolite foam, which was discovered to originate from the RCC panel protective covers.

The submitted Orbiter tile sample was a residue, and not a tile damage site. The sample results indicated only black pumaceous tile material, which may have been caused by re-entry heating effects.

The reference samples of Hypalon paint and "elephant hide"-ensolite foam provided categorical data as follows:

(1) The Hypalon paint comparative analysis suggested the RCC panel white streaks may be caused by the paint. Additional tests and analyses will be performed to more positively identify the effects of heat on Hypalon paint (at re-entry temperatures) and compare the results to RCC samples.

(2) The "elephant hide"-ensolite foam testing has characterized the residue from the material. Continued testing will verify that samples from the RCC panels are not affected by the use of the RCC panel protective covers.

This samples taken for this mission provided no evidence of orbital debris impacts.

11.0 POST LAUNCH ANOMALIES

Based on the debris inspections and film review, 7 Post Launch Anomalies were observed for STS-38.

11.1 POST LAUNCH PAD INSPECTION

1. All south holddown post shim material was intact, but the sidewall shims for all posts were slightly debonded. All shim material should remain completely bonded. (Project item).

11.2 FILM REVIEW

1. Three ordnance fragments fell from the HDP #1 aft skirt stud hole shortly after liftoff. Loss of material indicates a problem with the plunger in the DCS. (Project item).

2. Small pieces of aft skirt instafoam and a sliver of holddown post shim material/putty were pulled loose from the HDP #5 area by vehicle liftoff. Should be no loss of instafoam from the vehicle and shim material/putty from the facility during launch. (Project item).

3. Suspect the loss of thermal curtain material from the -Z side of the LH SRB aft skirt 34 seconds into flight. It appeared to come loose near the nozzle extension first, moved toward the aft ring, and finally separated from the aft skirt. A second piece fell from the same general area at 39 seconds MET. Although film review does not conclusively prove the loss of thermal curtain material, SRB project should investigate to preclude a generic problem (IFA candidate).

11.3 SRB POST FLIGHT/RETRIEVAL INSPECTION

1. The RH frustum had 56 MSA-2 debonds over fasteners. The LH frustum had 59 debonds over fasteners. If too many debonds are clustered together, a sizable area of debond could result in the loss of material in flight. (Project item).

2. Instafoam was missing from two places on the forward face of the RH ETA ring. Potential causes could be voids or material failure. Instafoam should not be lost from this location. (IFA candidate).

3. Some Epon shim material was missing from HDP #4, 7, and 8 prior to water impact. Shim material bonded to the north feet of the aft skirts should not separate from the vehicle prior to water impact (Project item).

11.4 ORBITER POST LANDING INSPECTION

There were no Orbiter post landing anomalies.

APPENDIX A.

MICROCHEMICAL ANALYSIS BRANCH
DM-MSL-1, ROOM 1274, O&C BUILDING
NASA/KSC
JANUARY 9 , 1991

SUBJECT: Orbiter Debris Samples from STS-38 Landing

LABORATORY REQUEST NO: MCB-0955-90

RELATED DOCUMENTATION: Intercenter Debris Team Requirements

1.0 FOREWORD:

1.1 REQUESTER: R. F. Speece/TV-MSD-22/1-2946

1.2 REQUESTER'S SAMPLE DESCRIPTION: The samples were from OV-104, STS-38, Orbiter, and were identified as:

1. R/H RCC #6, white streaks.
2. R/H RCC #7, white streaks.
3. R/H RCC #8, white streaks.
4. R/H RCC #9, white streaks.
5. R/H RCC #12, white streaks.
6. R/H RCC #13, "T".
7. L/H 191015-007 tile.
8. L/H #16.
9. Elephant hide ensolite foam.

1.3 REQUESTED: Perform chemical/material identification analysis and compare results to known STS materials.

2.0 CHEMICAL ANALYSIS AND RESULTS:

2.1 Procedure:

The samples were analyzed by means of optical microscopy (OM), x-ray diffraction (XRD) and electron microprobe with energy dispersive spectrometry (EDS).

2.2 Results:

2.2.1 The particulates were classified into components on the basis of color and texture by OM and the analytical results are listed in Table 1.

Table 1

Component ID	Elemental Analysis By EDS*	
	Major	Minor
<u>1.RCC#6</u>		
a.white mtls(65)	Si, Al, Ti	Na,Ca,Fe
b.lgt grey mtls(35)	Si	Fe,Ti,Ca,Al
c.red mtls(T)	Fe, Si	Mg,S,Ca,Ti
<u>2.RCC#7</u>		
a.wht mtls(55)	Si	Ti, Al
b.lgt grey mtls(45)	Si	Fe, Ti, Al
<u>3.RCC#8</u>		
a.wht mtls(70)	Si	Al, Ti
b.lgt grey mtls(30)	Si	Ti,Ca,Fe,Al,Mg
<u>4.RCC#9</u>		
a.wht mtls(95)	Si	Ti,Al,
b.blk mtls(5)	Si	Na,Mg,Al,Ca,Ti
<u>5.RCC#12</u>		
a.wht mtls(100)	Ca, Cl	Ti,Si,S
<u>6.RCC#13 "T"</u>		
a.wht mtls(100)	Zn, Si	Ca, Fe
<u>7.191015-007 tile</u>		
a.blk puma mtls	Si	
<u>8.#16</u>		
a.wht mtls(100)	Si, Al	Fe
<u>9.elephant hide</u>		
a.foam(100)	Ca, Cl, Ti	Zn,Al,S,Fe,Si

(5): Estimated Volume Percent.

*: O, C, H, and B are not detectable by using this technique.

2.2.2 The XRD data from samples 1, 2, and 3, indicated the presence of silicon dioxide (SiO_2) in the form of cristobalite, and possibly silicon carbide (SiC). The XRD pattern of sample 6 indicated the presence of zinc oxide, ZnO (zincite). Sample 9 contained CaCO_3 (calcite), TiO_2 (rutile), and possibly SiC. The presence of Sb_2O_3 (senarmontite) from Sample 9 was noted by XRD technique although the EDS pattern did not show any Sb element.

2.2.3 Figures 1, 2, and 3 are low and high magnification SEM photomicrographs of white particles from sample #3 to show the morphological features. Figures 4, 5, and 6 are SEM photomicrographs of white particles from sample #4.

- 2.2.4 Figures 7 and 8 are low and high magnification SEM photomicrographs of Ca-Cl rich particles from sample #5. Figures 9 and 10 are SEM photomicrographs of the Zn-Si rich materials to show the pumaceous surface appearance.
- 2.2.5 Figures 11 (#7) and 12 (#8) are low and high magnification SEM photomicrographs of black and white materials, respectively, to show the black pumaceous and fused appearance of surfaces.
- 2.2.6 Figures 13 and 14 are EDS patterns of white and light grey materials, respectively, from sample 1. Figures 15 and 16 are EDS patterns of white and light grey materials from sample 2. Figures 17 and 18 are EDS patterns of white glossy and light grey materials from samples 3 and 4.
- 2.2.7 Figures 19 and 20 are EDS patterns of the Ca-Cl rich and Zn-Si rich materials from samples 5 and 6, respectively. Figures 21 and 22 are EDS patterns of black and white materials, respectively, from samples 7 and 8.
- 2.2.8 Figures 23, 24, and 25 are EDS patterns of elephant hide foam, hypalon paints, and hypalon paints heated to 1350 F degree for an hour, and are included as comparison.

3.0 CONCLUSIONS:

- 3.1 The samples 1, 2, and 3 contained white materials and light grey materials. The sample 1 contained red materials. The white materials from sample 1, 2, 3 and 4 were composed of Si-Al-Ti rich materials. The light grey materials from samples 1, 2, and 3 were composed of Si rich materials. The red material in sample 1 was composed of RTV. The white materials from samples 1, 2, and 3 contained alpha-cristobalite (SiO_2). The alpha-cristobalite was formed at conversion temperature of 1470 degree C.
- 3.2 The white material from sample 5 was composed of Ca-Cl rich materials, and the white material from sample 6 was composed of Zn-Si rich material. The XRD data indicted the presence of ZnO (zincite).

- 3.3 The black pumaceous materials from sample 7 were composed of Si-rich materials. The surface of black pumaceous materials show the melted or fused appearance which might have been at high temperature during reentry (Figures 11 and 12).
- 3.4 The white materials from sample 8 were composed of Si-Al rich TPS. The fused appearance of the particle surface can be seen from Figure 12.
- 3.5 Sample 9, "Elephant hide" ensolite foam, was composed of unknown organics with calcite (CaCO_3), rutile (TiO_2), senarmonite (Sb_2O_3) and possibly SiC.
- 3.6 The EDS data suggested that the white streaks could be originated from the hypalon paints.

CHEMIST: H. S. Kim
H. S. Kim

APPROVED: J. E. Jones
J. E. Jones

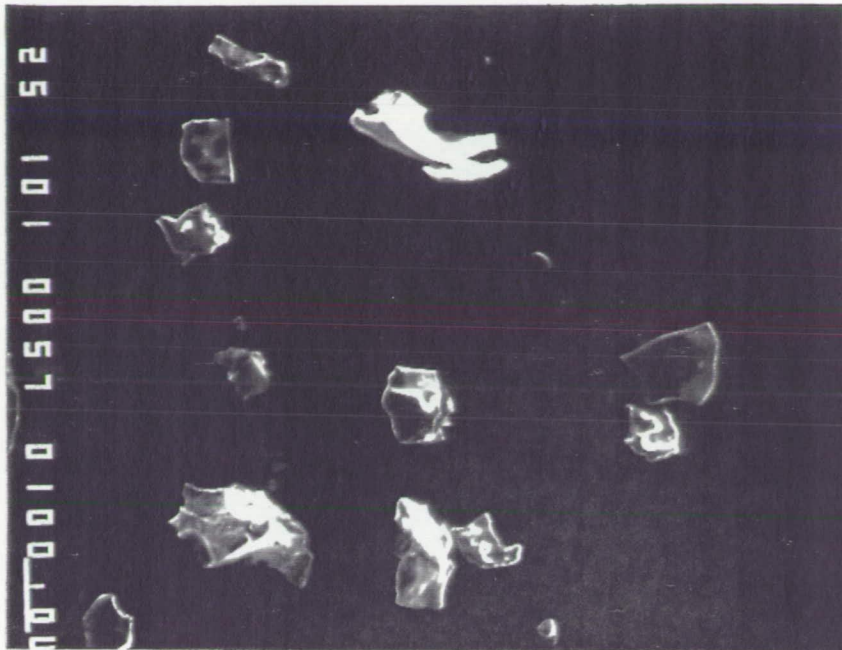

Figure 1. Low magnification SEM photomicrograph of white particles. #3, 100x.



Figure 2. High magnification SEM photomicrograph of white particle from Figure 1. #3. 320x.

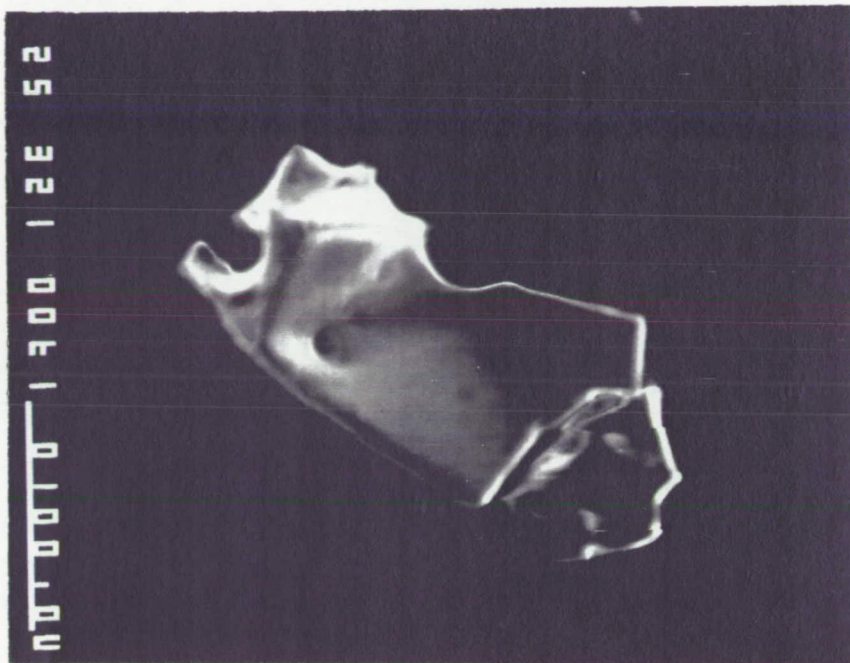

Figure 3. SEM photomicrograph of white particle from Figure 1. #3. 320x. Note the presence of the glossy surface texture.

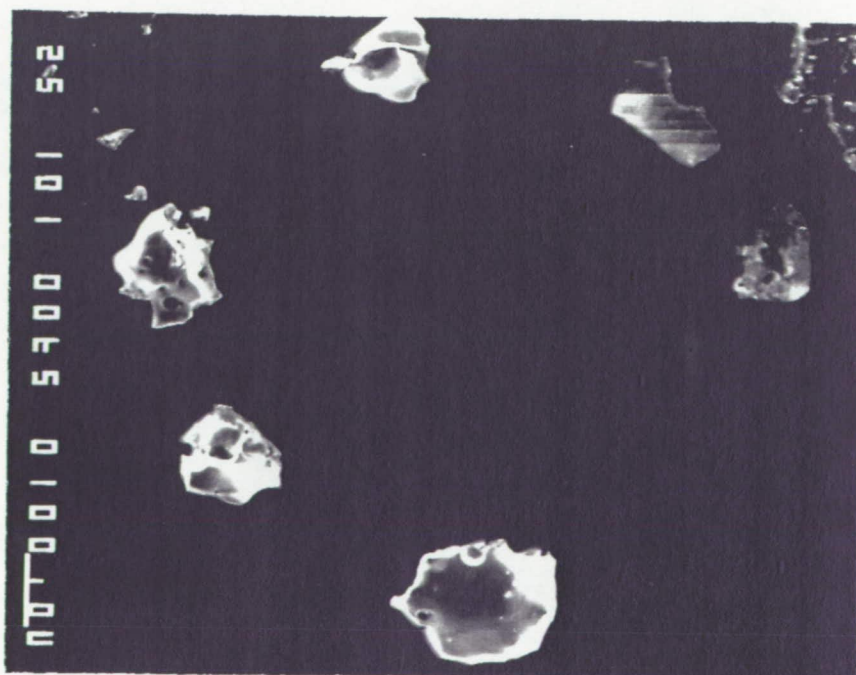

Figure 4. Low magnification SEM photomicrograph of white particles. #4. 100x.

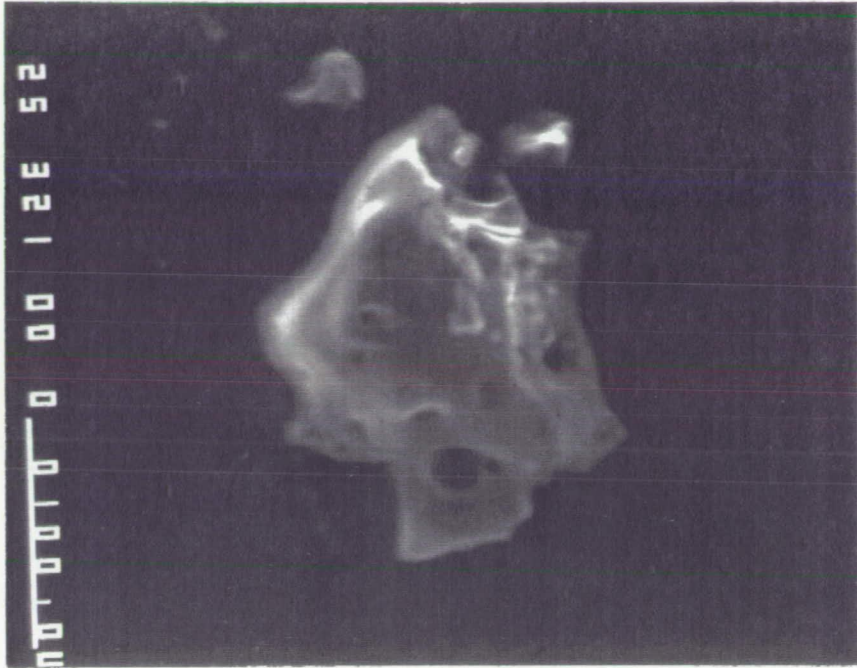

Figure 5. High magnification SEM photomicrograph of white particles to show the morphological characteristics. #4. 320x.

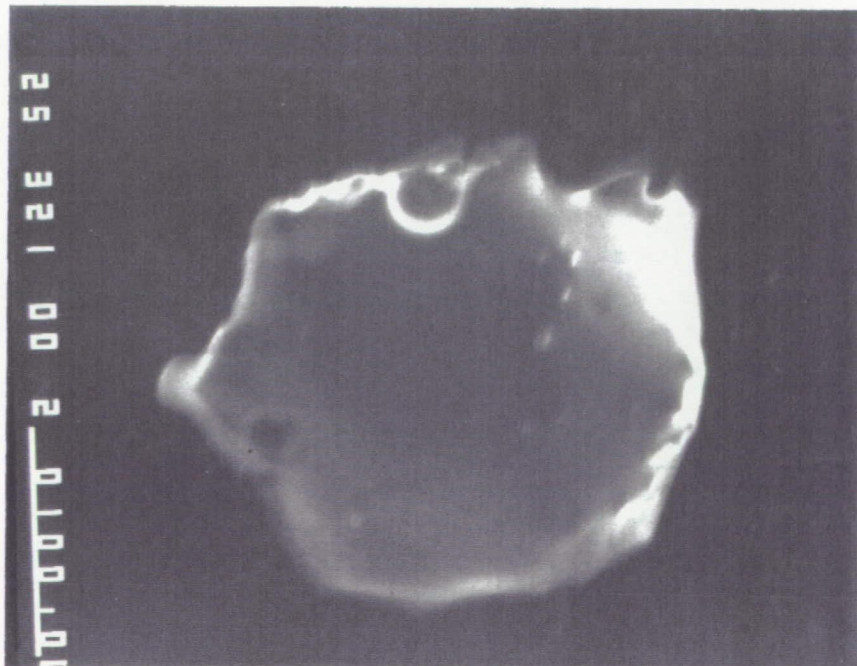

Figure 6. SEM photomicrograph of white particles. #4. 320x.

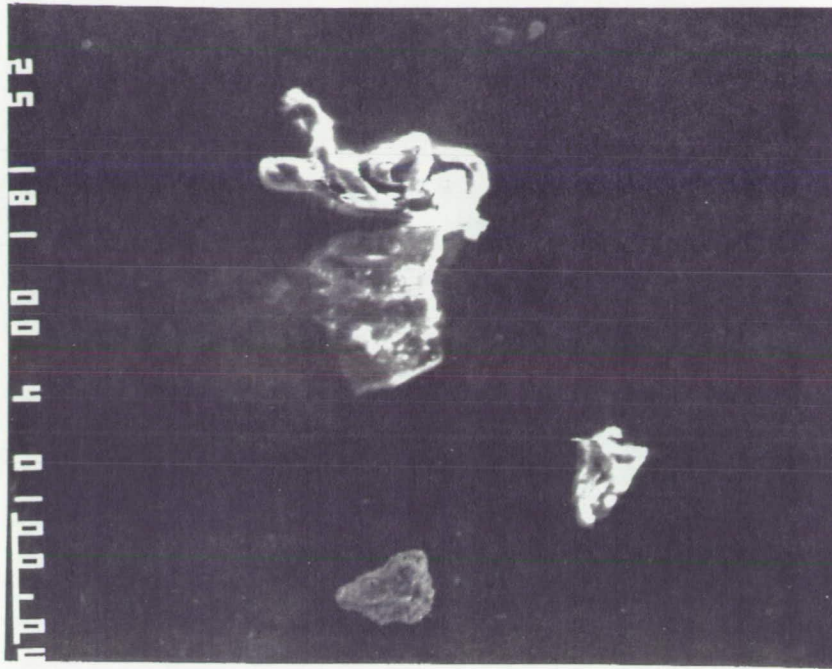

Figure 7. Low magnification SEM photomicrograph of Ca-Cl rich materials. #5. 180x.

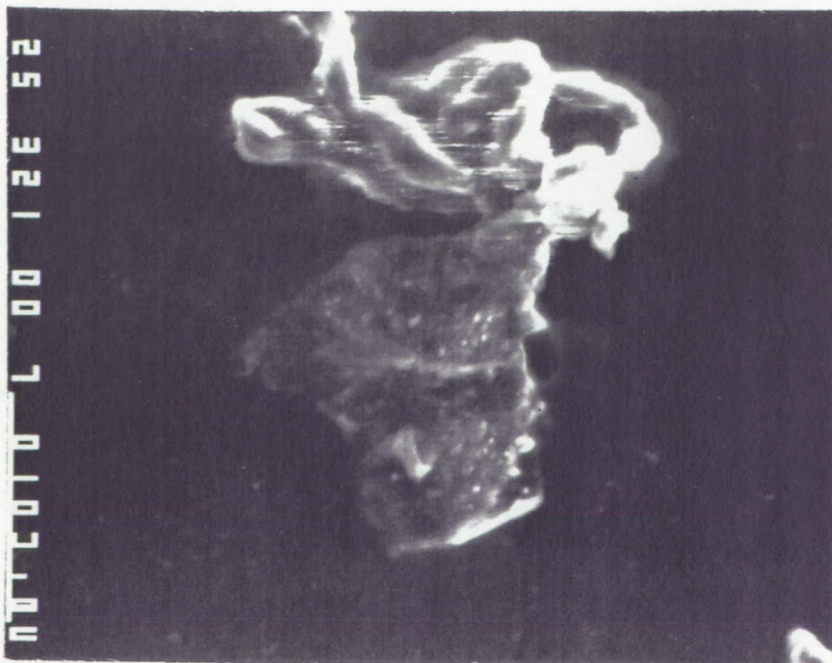

Figure 8. High magnification SEM photomicrograph of the white Ca-Cl rich materials. #5. 360x.



Figure 9. Low magnification SEM photomicrograph of white Zn-Si rich materials. #6. 100x.

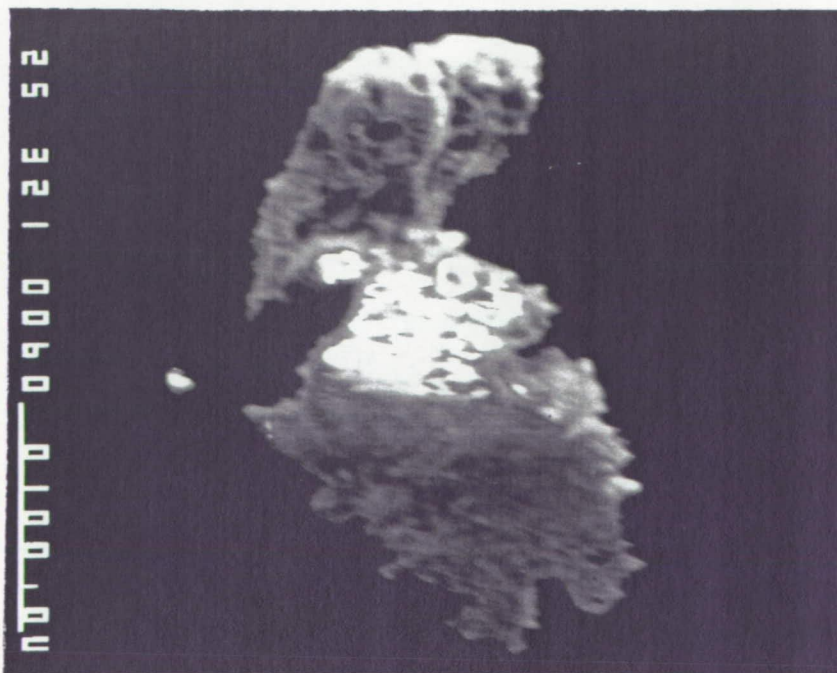

Figure 10. High magnification SEM photomicrograph of the white Zn-Si rich materials. #6. 320x. Note the pumaceous surface appearance.

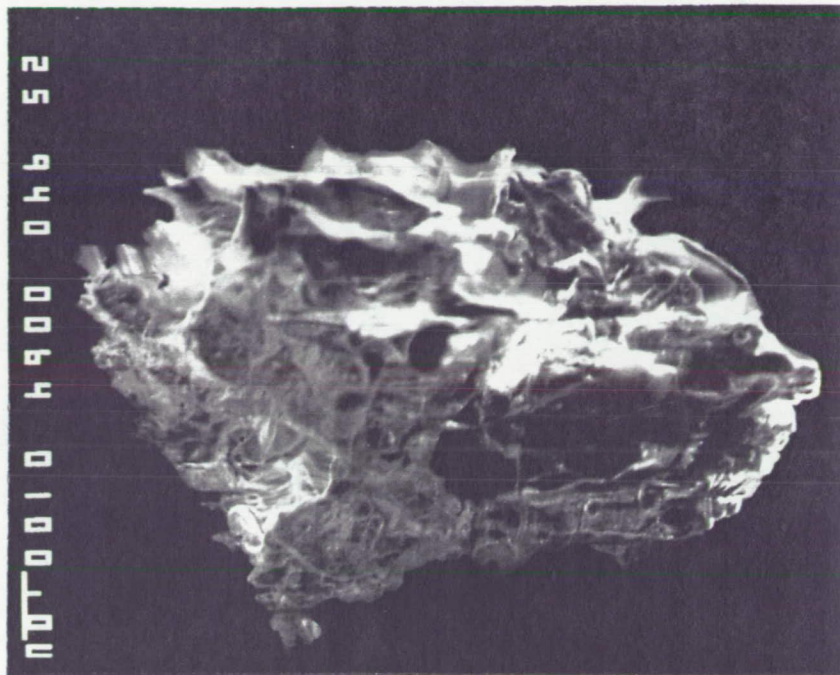
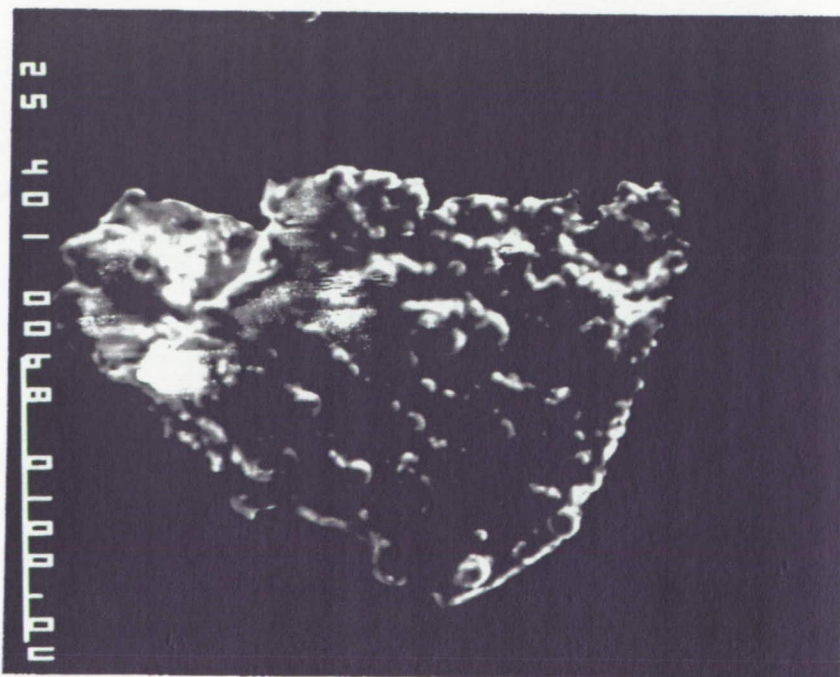

Figure 11. Low magnification SEM photomicrograph of the black pumaceous Si rich materials. #7. 94x.



ORIGINAL PAGE IS
OF POOR QUALITY

Figure 12. High magnification SEM photomicrograph of white particles. #8. 400x. Note the fused surface appearance.

Figure 13. WHITE, 1,955-90

SPECTRUM LABEL



SPECTRUM FILE NAME

3190

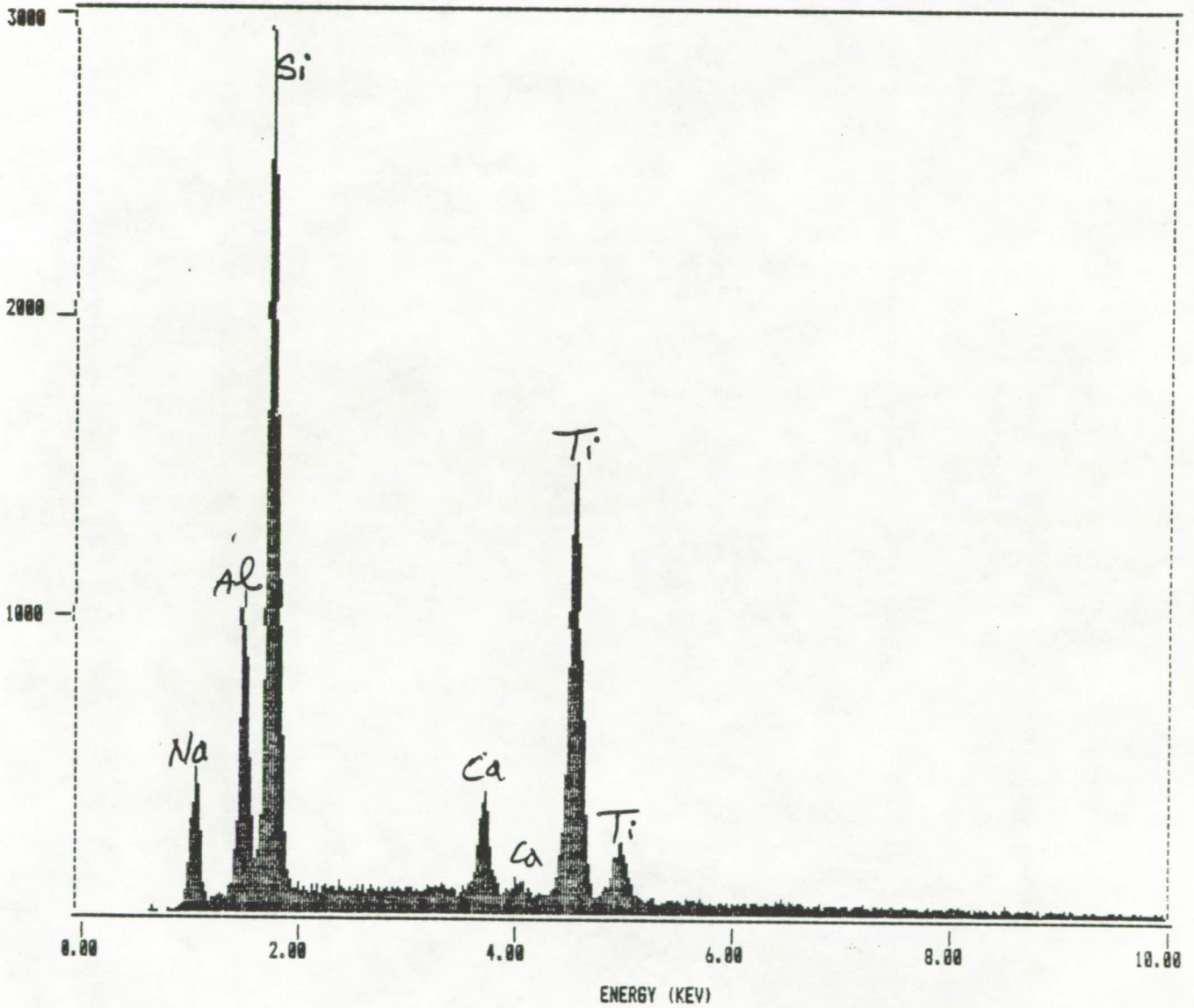

γ PIGIT I

Figure 14. LGT GREY MTLs, 1,955-90

SPECTRUM LABEL



SPECTRUM FILE NAME

3198

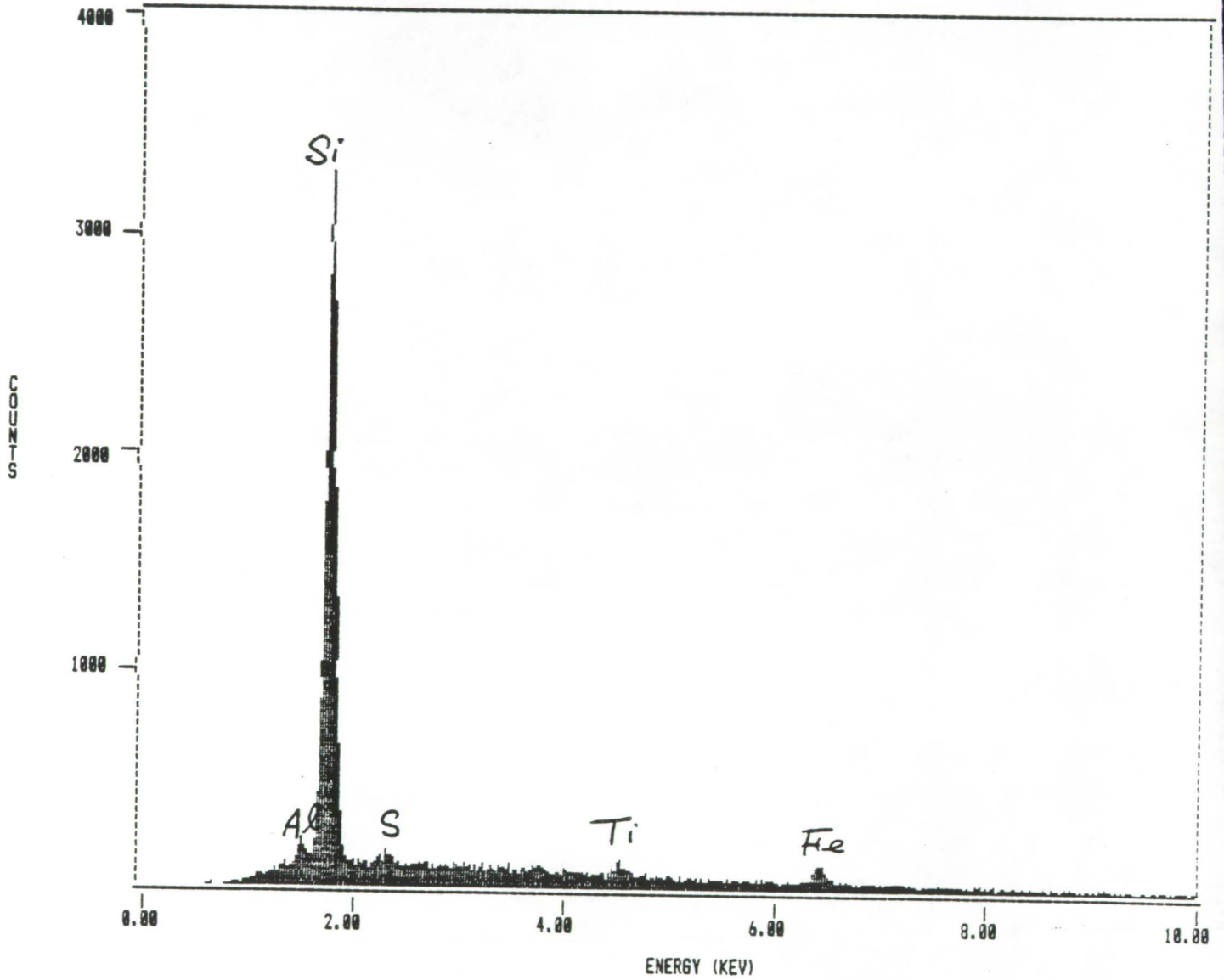

γ PIGITI

Figure 15.

WHITE MTL, 2,955-90

SPECTRUM LABEL



SPECTRUM FILE NAME

3190

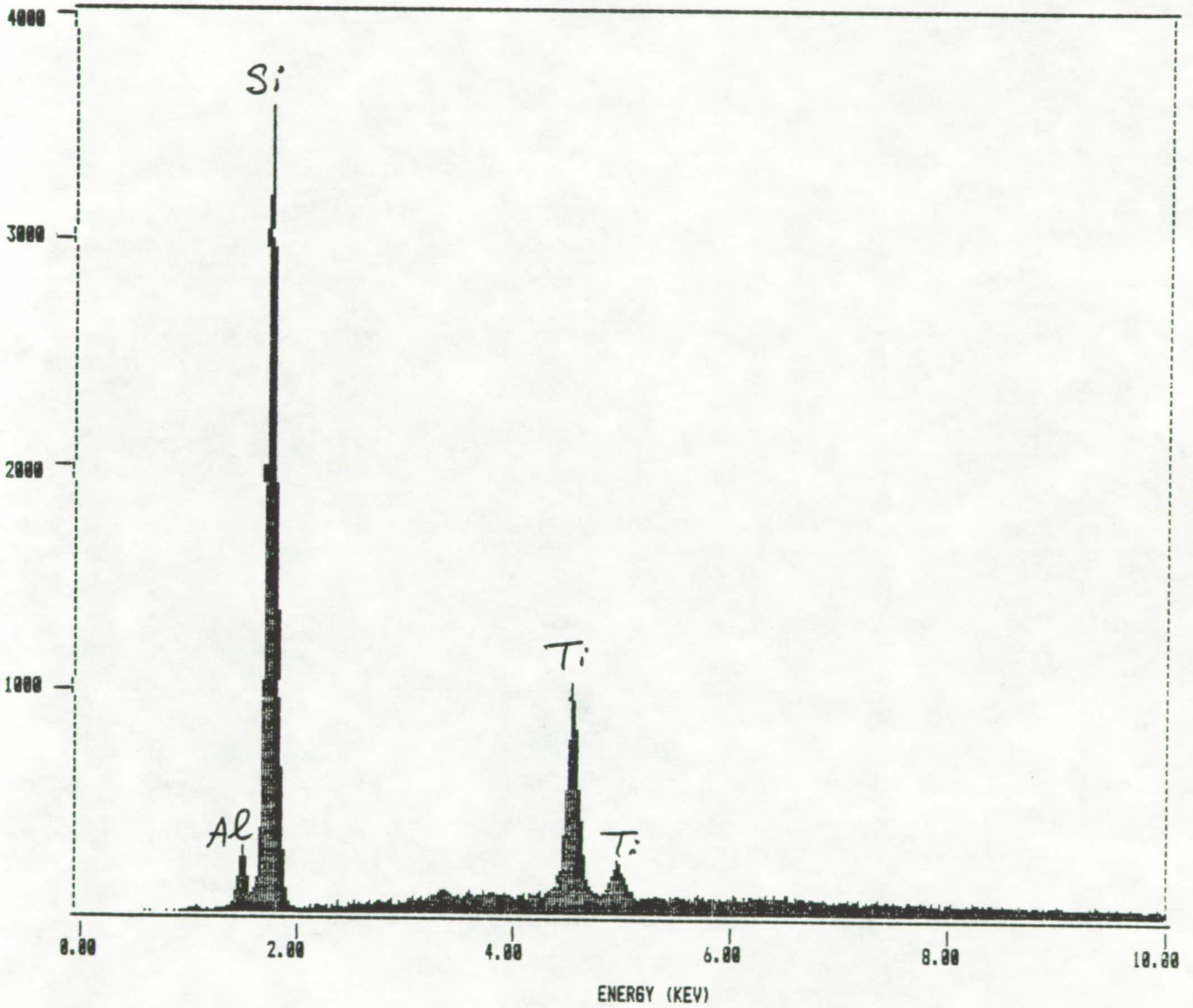

8 PIGIT I

Figure 16.

LGT GREY MTL, 2,955-90

SPECTRUM LABEL



SPECTRUM FILE NAME

3190

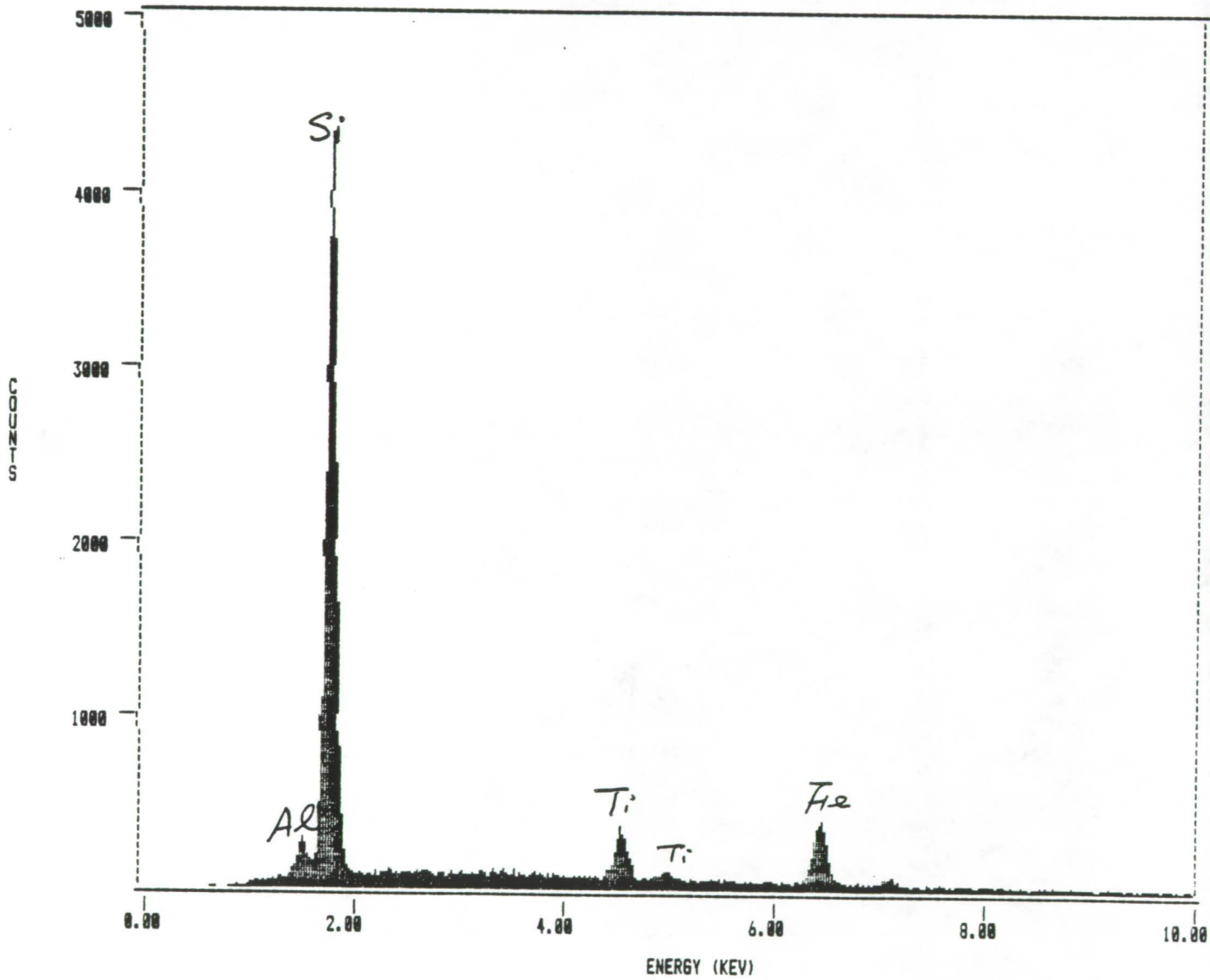

Y PIGIT I

Figure 17. WHT GLOSSY, 3,955-90

SPECTRUM LABEL



SPECTRUM FILE NAME

3198

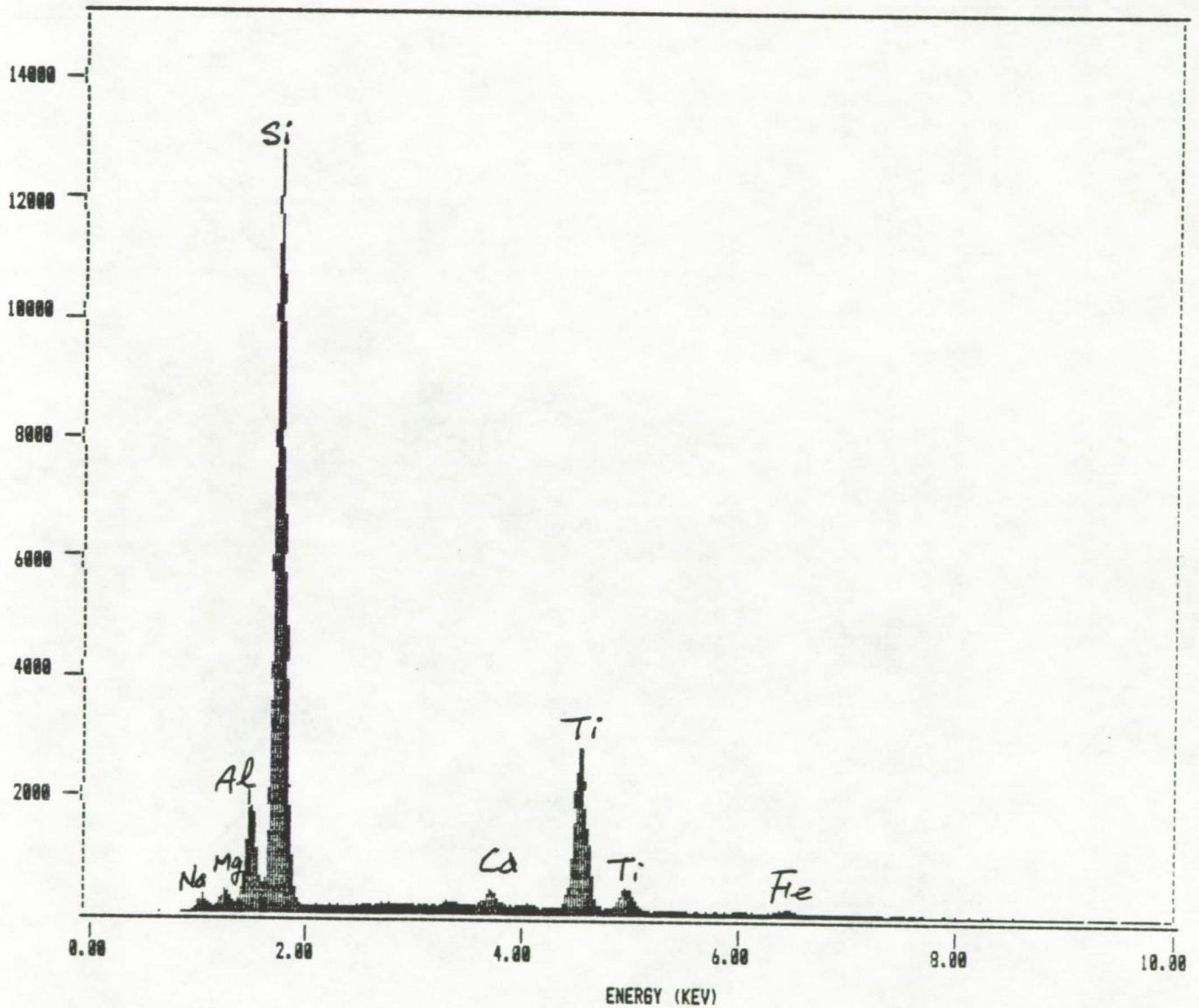

8 PIGITI

Figure 18.

LGT GREY, 4,955-90

SPECTRUM LABEL

SPECTRUM FILE NAME

■

■ 3190

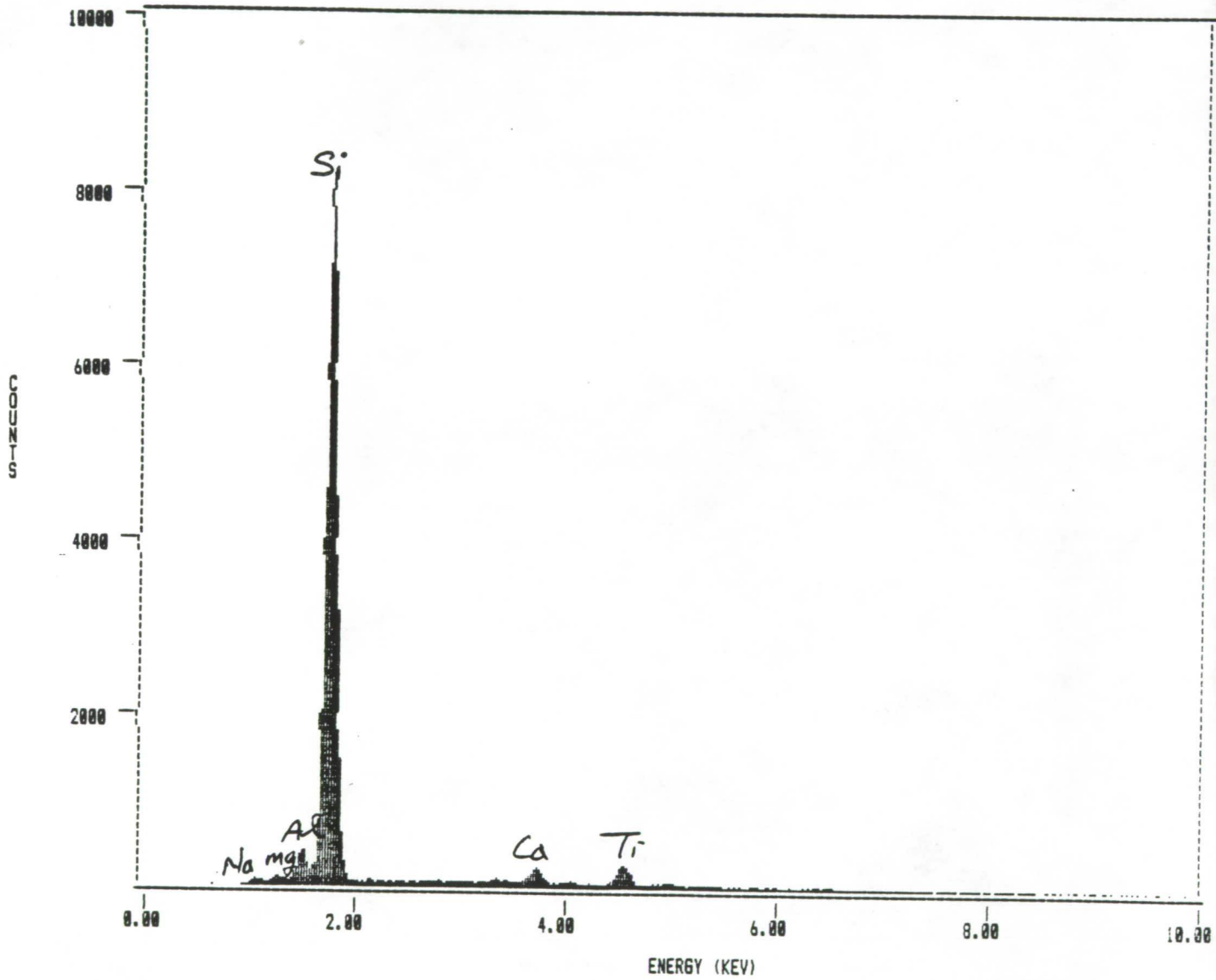

γ PIGITI

Figure 19.

WHITE MTLs, 5,955-90

SPECTRUM LABEL

SPECTRUM FILE NAME



3190

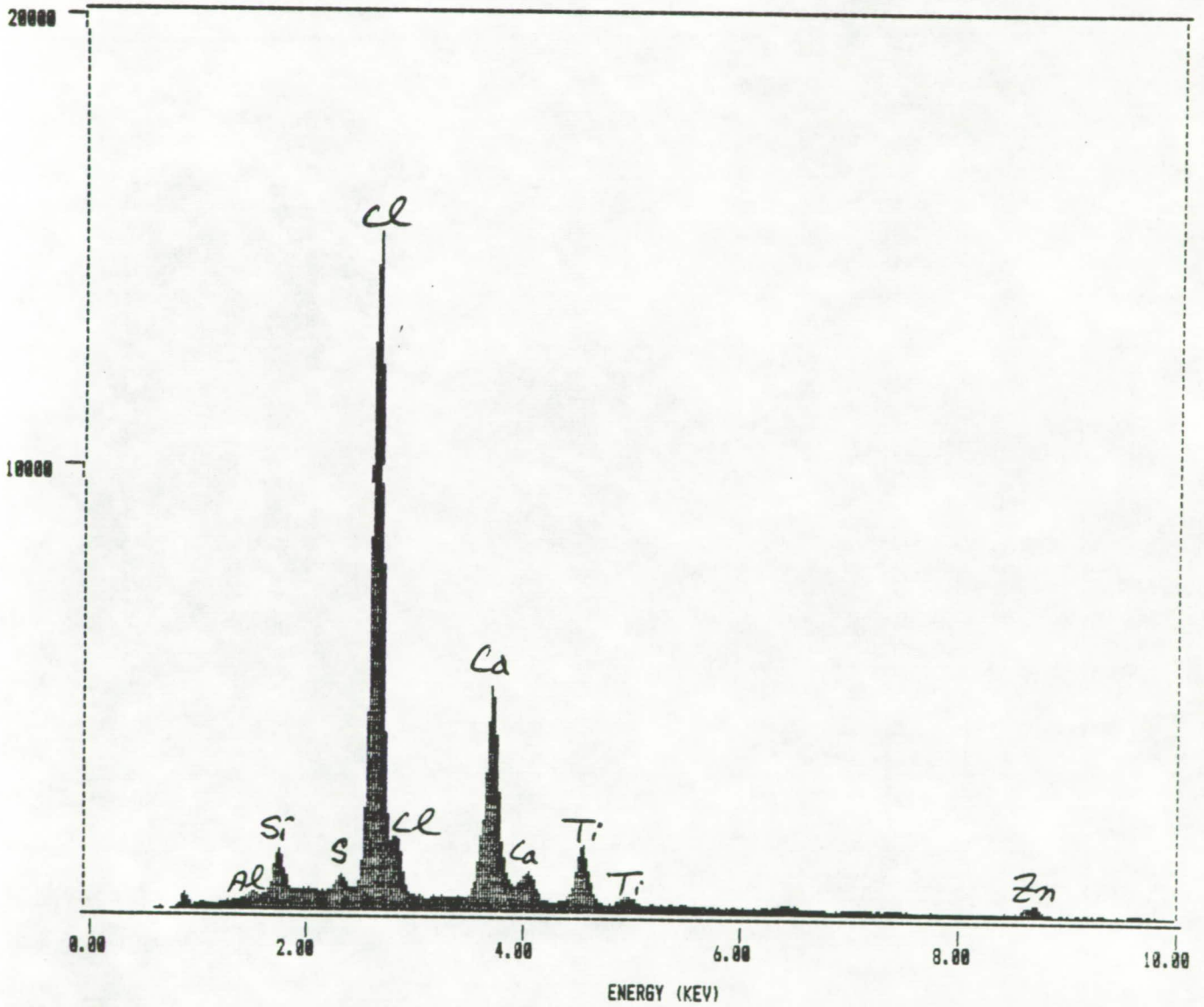

γ PIGITI

Figure 20.

WHITE, 6, 955-90

SPECTRUM LABEL



SPECTRUM FILE NAME

3190

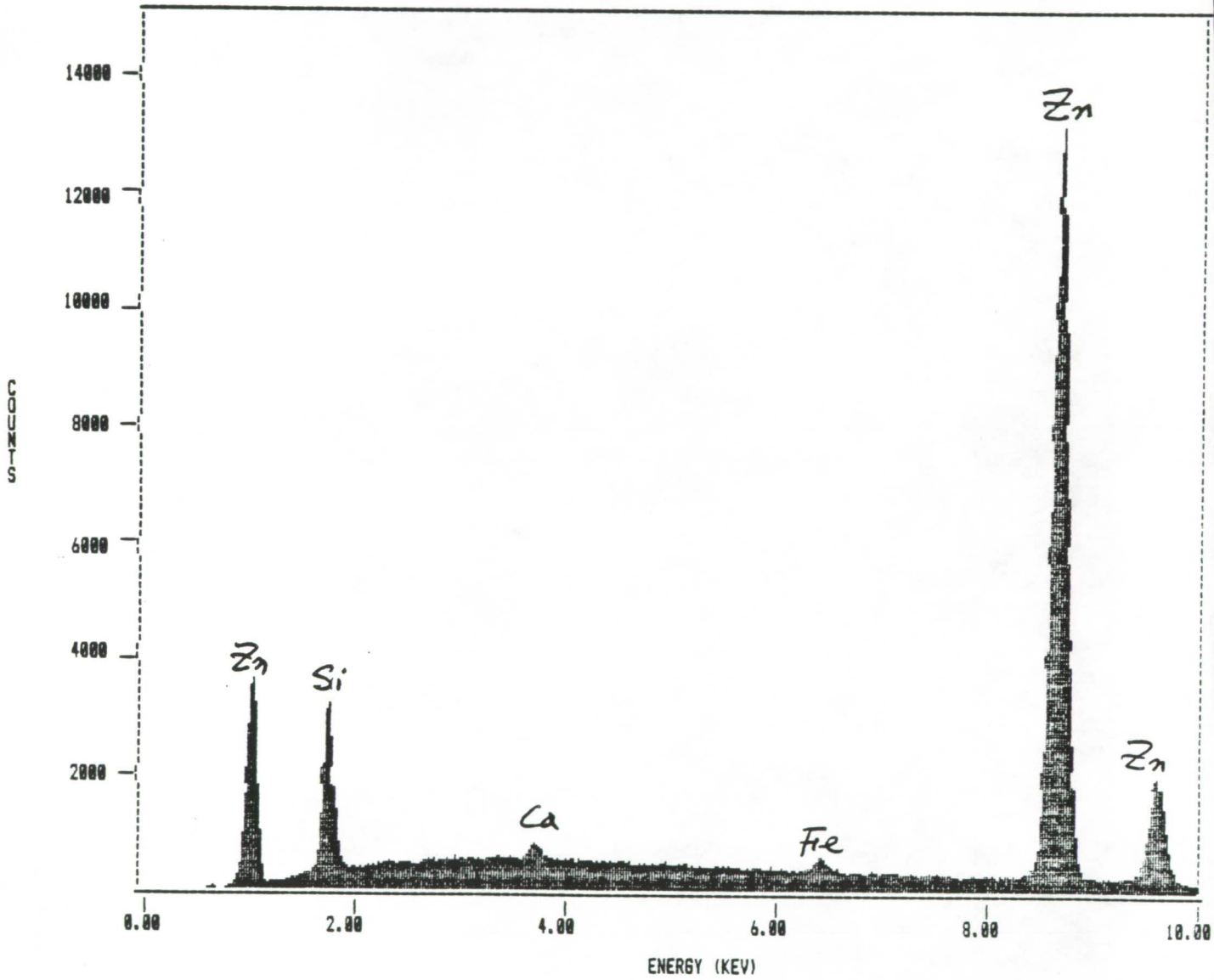

γ PIGITI

Figure 21. BLK MTL5,7,955-90

SPECTRUM LABEL



SPECTRUM FILE NAME

3190

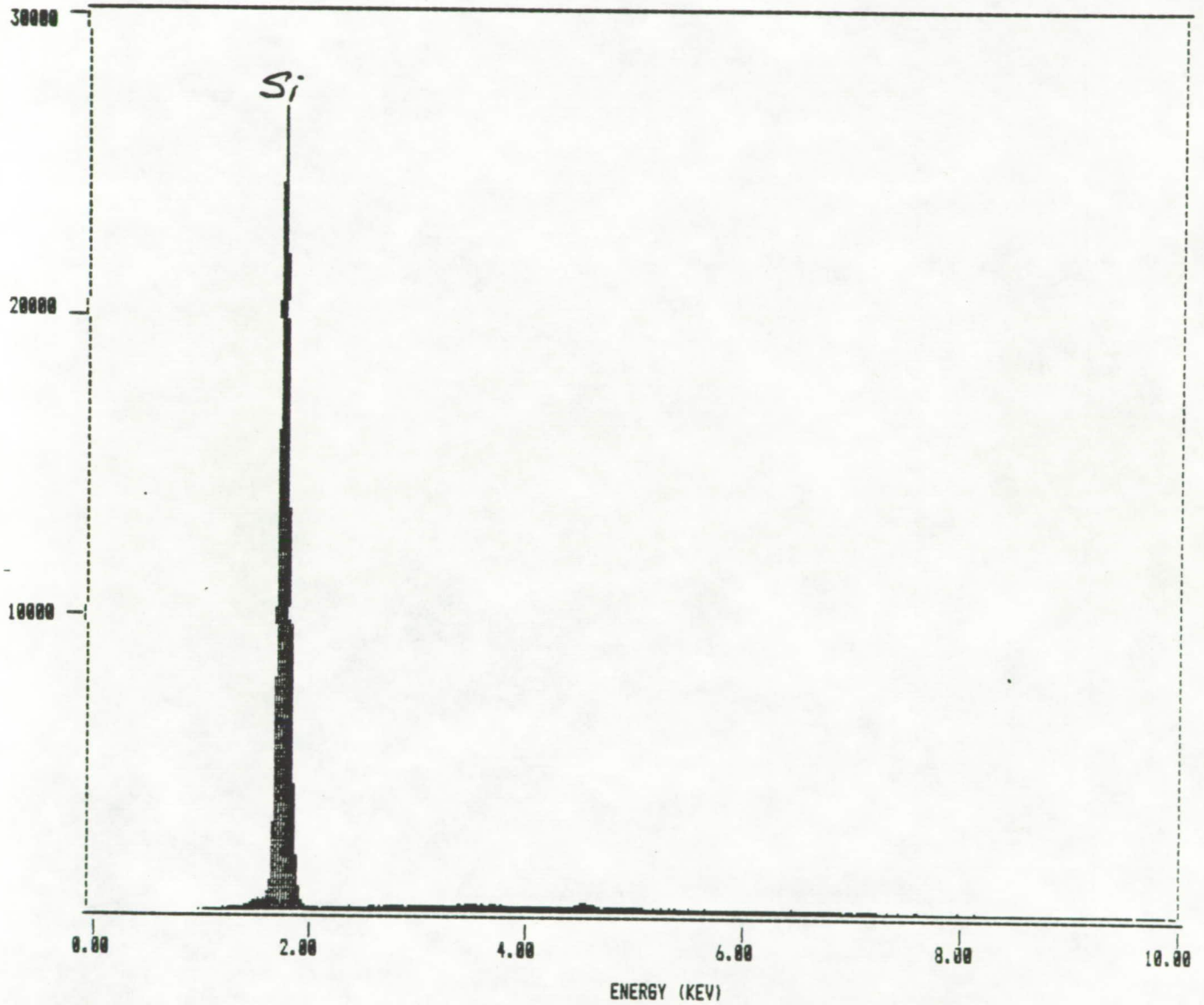

γ PIGITI

Figure 22.

WHITE MTLs, 8,955-90

SPECTRUM LABEL



SPECTRUM FILE NAME

3190

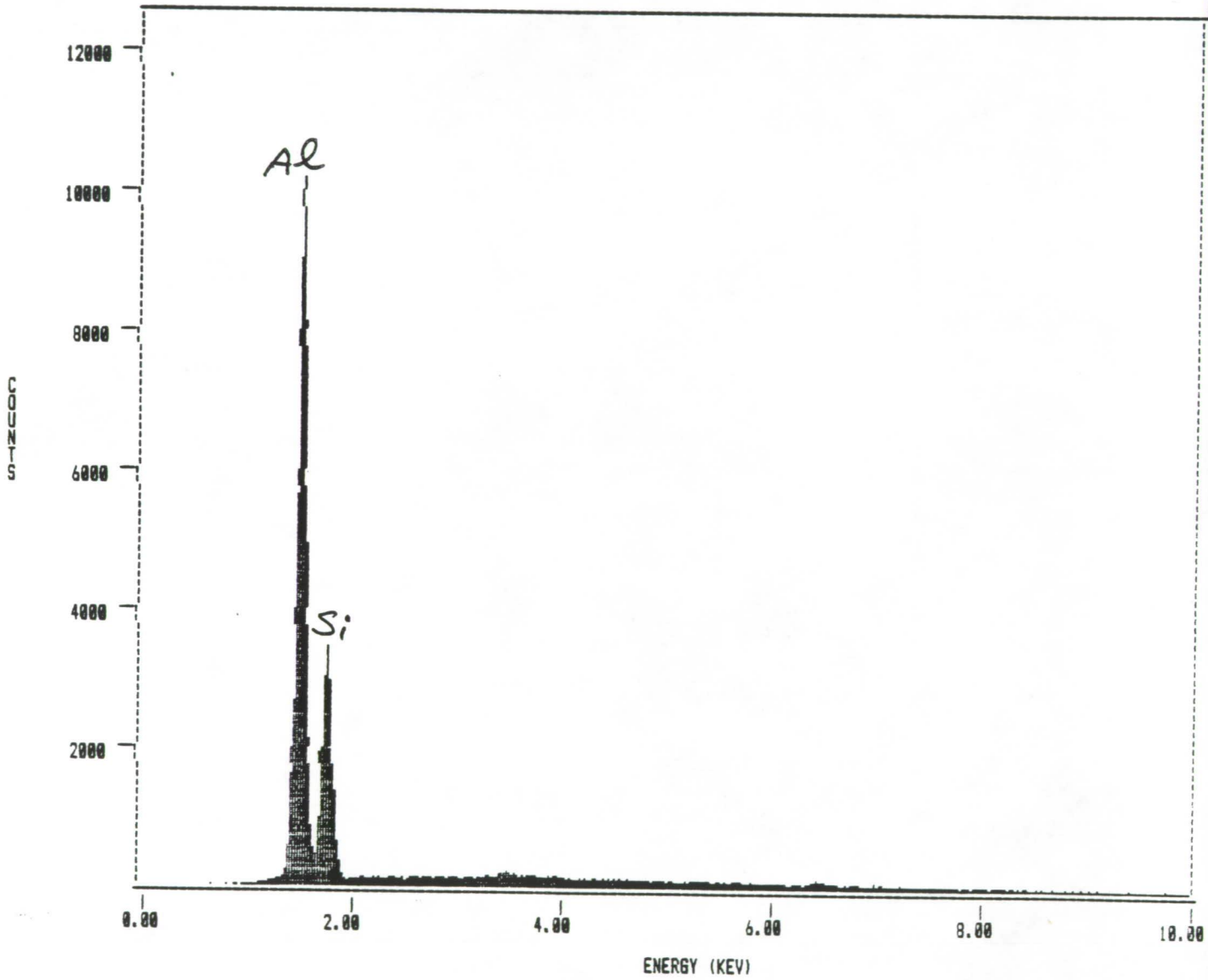

γ PIGTI

Figure 23. WHITE ELE, 9, 955-90

SPECTRUM LABEL

SPECTRUM FILE NAME



3198

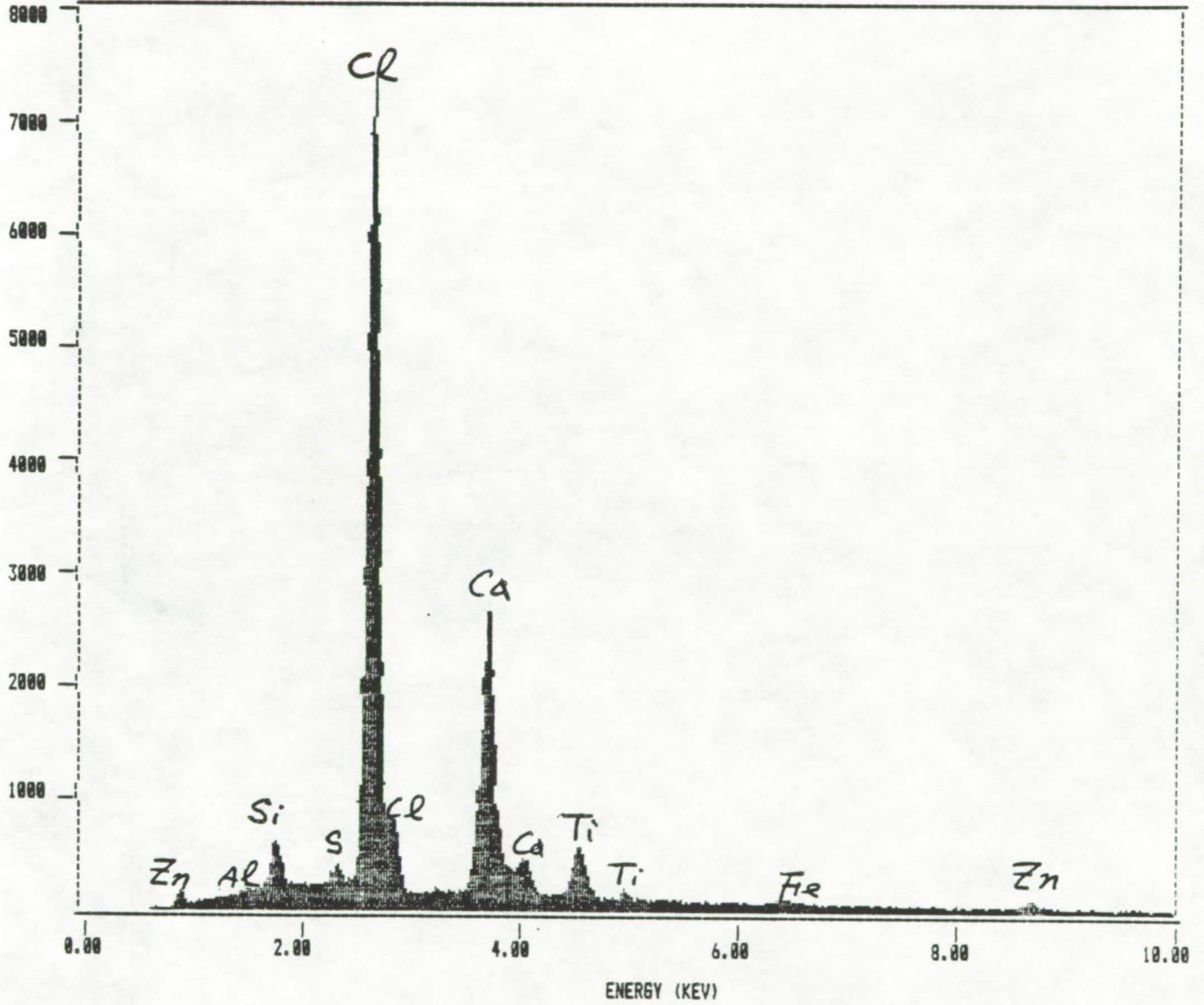

Y PIGITI

Figure 24.

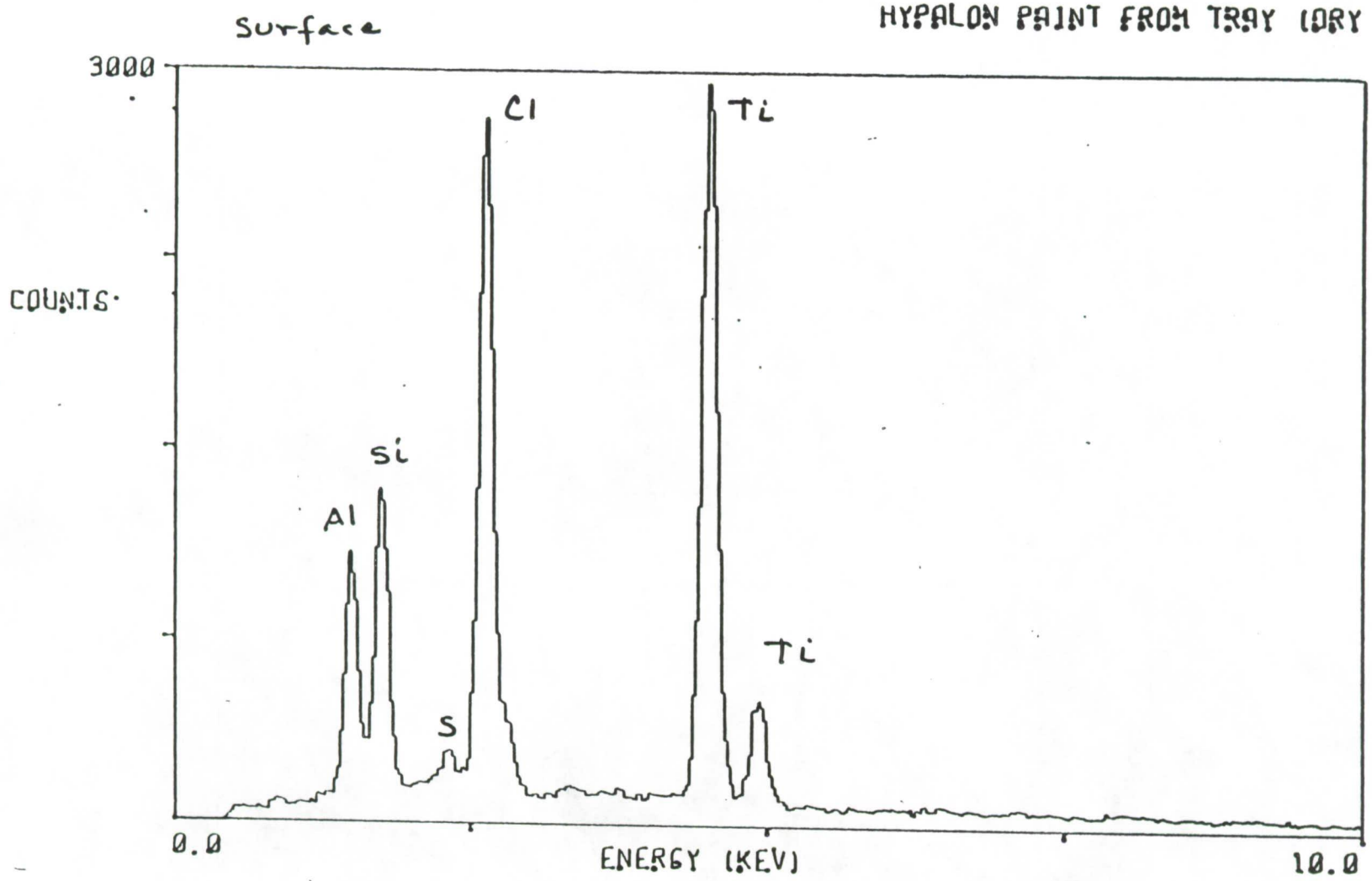
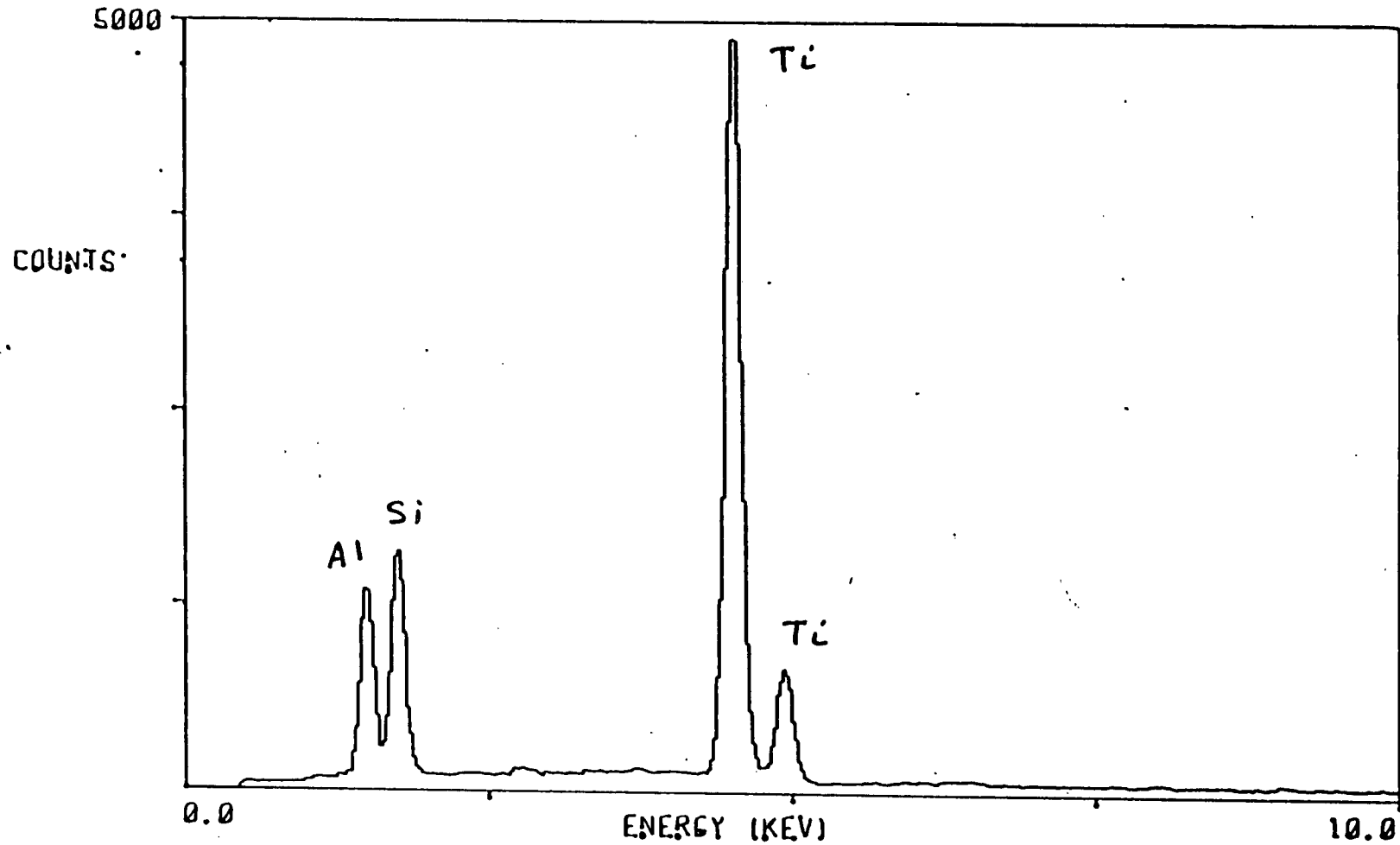

Figure 25.

1350 DEGREES - 1 HOUR ISPT C)

CHARGED HYPALON PAINT CHIP



174



Report Documentation Page

1. Report No.		2. Government Accession No.		3. Recipient's Catalog No.	
4. Title and Subtitle Debris/Ice/TPS Assessment and Photographic Analysis for Shuttle Mission STS-38				5. Report Date February 1991	
				6. Performing Organization Code	
7. Author(s) Gregory N. Katnik Scott A. Higginbotham J. Bradley Davis				8. Performing Organization Report No.	
				10. Work Unit No.	
9. Performing Organization Name and Address NASA External Tank Mechanical Systems Division Mail Code: TV-MSD-22 Kennedy Space Center, Florida 32899				11. Contract or Grant No.	
				13. Type of Report and Period Covered	
12. Sponsoring Agency Name and Address				14. Sponsoring Agency Code	
				15. Supplementary Notes	
16. Abstract A Debris/Ice/TPS assessment and photographic analysis was conducted for Space Shuttle Mission STS-38. Debris inspections of the flight elements and launch pad were performed before and after launch. Ice/frost conditions on the External Tank were assessed by the use of computer programs, nomographs, and infrared scanner data during cryogenic loading of the vehicle followed by on-pad visual inspection. High speed photography was analyzed after launch to identify ice/debris sources and evaluate potential vehicle damage and/or in-flight anomalies. This report documents the debris/ice/TPS conditions and photographic analysis of Mission STS-38, and their overall effect on the Space Shuttle Program.					
17. Key Words (Suggested by Author(s)) STS-38 Frost Thermal Protection System (TPS) Photographic Analysis			18. Distribution Statement Ice Debris Publicly Available Unclassified - Unlimited		
19. Security Classif. (of this report) Unclassified		20. Security Classif. (of this page) Unclassified		21. No. of pages	22. Price