

N91-17727

OBSERVATIONS OF THERMAL ION INFLUXES ABOUT THE SPACE SHUTTLE

J. M. Grebowsky

NASA/Goddard Space Flight Center, Planetary Atmospheres Branch,
Code 614, Greenbelt, Maryland 20771

A. Schaefer

Marquette University, Physics Department
Milwaukee, WI 53233

Abstract. Ion mass spectrometer measurements made, as part of the University of Iowa's Plasma Diagnostic Package, on the STS-3 and Spacelab 2 Space Shuttle missions sampled a variety of ion composition and collected ion current responses to gas emissions from the vehicle. The only other shuttle ion measurements were made by an AFGL quadrupole spectrometer flown on STS-4. Gas emissions change the distribution of the incoming plasma through scattering and charge transfer processes. A background flux of contaminant ion species (mostly relating to water) always exists in the near vicinity of the shuttle with a magnitude which is dependent on the look direction of the spectrometer but which varies differently with changes in the angle of attack than that of the ambient ions. There is a near shuttle wake cavity in the contaminant ion distributions which has a different spatial configuration than the wake of the ambient ions. Although water dumps produce the most persistent ion perturbations, the sources for ion current modification were best delineated from measurements made when only one or two of the Reaction Control System thrusters fired for a relatively long duration. Contaminant ion perturbations associated with such firings were observed to persist for the order of a second after the cessation of the firings. The dense thruster plumes are efficient collisional, charge exchange barriers to the passage of ambient ions. Collected ion current perturbations were more evident for firings of the rear verniers, whose plumes scatter off projecting surfaces, than for the nose thrusters. The effect of the Vernier firings was found to depend not only on the location and attitude of the spectrometer with respect to the shuttle and thruster plume direction, but also on the orientation of the local magnetic field with respect to the shuttle velocity.

Background

Several space shuttle missions carried experiments to measure the concentrations and thermal properties of the low energy plasma in the near vicinity of the vehicle. These observations have shown that the thermal ion distributions and the ambient ion influxes to collectors in the vicinity of the spacecraft are affected by gases emitted from the spacecraft. The exact manner in which the incoming ion fluxes are modulated depend upon the properties of the gas releases (such as their composition, source locations and durations), the attitude of the moving

spacecraft, the local magnetic field direction and of course the location of the ion current detector with respect to the shuttle and payloads. In this paper features of this interaction between incoming ion fluxes and the shuttle's "contaminant" neutral gas environment will be highlighted by using ion mass spectrometer measurements taken in the immediate vicinity of the space shuttle. These measurements serve as a means of tracing the dynamics of plasma perturbations in the vicinity of large space vehicles as well as providing a background for predicting consequences in the vicinity of even larger gas emitting space structures such as the space station.

Ion Spectrometer Experiments

Ion composition measurements were made by ion mass spectrometers on three space shuttle missions. An ion-neutral quadrupole mass spectrometer was flown by the Ionospheric Disturbances and Modification Branch of the Air Force Geophysics Laboratory on the STS-4 mission in June-July 1982. A Bennett RF ion mass spectrometer supplied from Goddard Space Flight Center was flown as part of the University of Iowa's Plasma Diagnostic Package (PDP) within the NASA Office of Space Science-1 (OSS-1) payload on the STS-3 flight in May 1982 and was then reflown as part of the Spacelab 2 (SL-2) payload on the STS-51F mission in July-August 1985.

The ion mode of the ion-neutral spectrometer as described by Narcisi et al. (1983) provided high temporal and good mass resolution of ion species from within the near vicinity of the shuttle's open payload bay. The Bennett ion mass spectrometer although more limited in temporal and mass resolution was flown for a longer period of time under a more varied complement of positions- particularly on the SL-2 mission where a concentrated period of Shuttle operations was focused on Plasma Diagnostic Package (PDP) science objectives with planned attitude changes, remote manipulator system (RMS) movement of the PDP and even a brief PDP free flight away from the shuttle. In this paper only observations made while the instruments were secured within the open cargo bay or on the RMS will be considered. The general range of altitudes of the shuttle orbits on these three missions fell between approximately 240 and 320 kilometers, i.e. within the F2 region of the ionosphere.

One characteristic of these ion spectrometers is the directionality of their field of view and the resultant dependence of the collected ion flux on the average direction and magnitude of the incident ion velocity with respect to the spectrometer orifice as well as on the incident ion concentrations. The angle of attack response of the PDP spectrometer followed that shown in Figure 1 for the same type of instrument that was flown on Atmosphere Explorers C and E. This dependence on angle of attack plays a significant role in studies from the shuttle since ion measurements are most frequently made when shuttle operations and attitudes are dedicated to other experiments resulting in other than an optimum ram pointing configuration for the spectrometer. Further, as will be seen, ions may be flowing relative to the shuttle from a direction different from that of ram. Hence one must be aware of the

orientation of the spectrometers with respect to the vehicle's coordinate system. The ion spectrometer look directions are indicated in Figure 2 for the 3 shuttle missions when the experiments were anchored in the bay. On STS-3 (OSS-1) the PDP was secured within the bay on the rear pallet with its ion spectrometer facing directly toward the port side of the bay; on STS-4 the spectrometer (as described by Narcisi et al., 1983) looked over the starboard side wing but was pitched up by 12° ; and on SL-2 the PDP again was on the rear pallet this time with the spectrometer looking forward. Because of complexities in the spectrometer response due to off ram angles it is not feasible to routinely convert the measured ion currents into number densities, so only raw measured currents of the ion species are used to explore the vehicle environment.

It is to be noted also that the Bennett ion mass spectrometer flown on the shuttle missions cycled through 4 sensitivity level mass scans. These levels were produced by the application of a sequence of 4 retarding potentials on a grid positioned in front of the current collector to eliminate ion species which have not been resonantly accelerated in the RF mass selecting portion of the instrument. This is described more fully in the paper by Grebowsky et al. (1987). The choice of the step or level of the data to be studied is made based on whether high mass resolution or high sensitivity is sought - the mass resolution increases with decreasing sensitivity. In the subsequent plots of these measurements the sensitivity level will be cited on the plot without further elaboration. For reference: Level 1 corresponds to the least sensitive mode with sensitivity increasing to a maximum on Level 4.

Quiescent Ion Environment Near the Shuttle

The most notable feature of the near-shuttle thermal ion environment is the persistence throughout the duration of all the flights of ion species that are not ambient in origin - most prominently the species H_2O^+ with lower influxes of H_3O^+ . Figure 3 shows observations made during the STS-4 mission when the ion-neutral spectrometer orifice pointed nearly into the ram direction. A relative influx of water ions was detected that was consistently about two orders of magnitude below that of the incoming ambient O^+ ion fluxes. It was noted by Narcisi et al. (1983) that earlier in this mission, background levels of the water ions were of the order of 10% indicating a significant falloff with mission elapsed time.

The SL-2 ion spectrometer observations in the ram direction detected a similar relative background of incoming water ion currents. One of the better examples of this was obtained on a PDP dedicated operation in which the shuttle flew perpendicular to its X axis (i.e., the tail-nose line) rolling about this axis, while the PDP extended on the RMS away from the shuttle was synchronously twisted to maintain a fixed orientation of the PDP to the oncoming ambient plasma velocity. A few of these twist sequences maintained an ion spectrometer look direction into ram. These measurements made during the second day of the mission are depicted in Figure 3. On the ram side of the shuttle where ambient

ions have unimpeded access to the spectrometer, the measured water ion currents were of the order of two magnitudes below that of the ambients. The other prominent ion displayed, NO^+ , is common to the bottomside of the F-layer and in this instance may not be a contaminant ion. A further survey of the SL data showed a tendency for a decrease of the fractional occurrence of water ion with time through the mission, but even at the end of a week's observations the contaminant fluxes were still between two and three orders of magnitude of those of the ambient O^+ ions.

These observations demonstrate the general presence of a relatively stable influx of ions around the shuttle which decreases with mission duration but never disappears. The source of the water ions is accepted to be a water bearing gas cloud traveling with the shuttle which charge exchanges with the ambient O^+ . If the water molecule concentration in the cloud is dense enough the production of H_3O^+ will also become very prominent due to charge transfer reactions between the neutral and ionized water molecules as described by Narcisi (1983) and Narcisi et al. (1983). The existence of such a cloud has been directly detected by neutral spectrometers flown on several missions (e.g., Carignan and Miller, 1983; Narcisi et al., 1983; Wulf and von Zahn, 1986). These water related ion-neutral reactions are rapid enough to lead to prominent depletions of local ambient plasma concentrations around space vehicles (e.g., Mendillo, 1981). It is difficult without a mother-daughter type of experiment from the space shuttle to determine quantitatively the magnitude by which the incoming ram flux of ambient ions is significantly reduced in passing through the quiescent gas cloud. The occurrence of only a relatively small fractional percentage of incident water ion fluxes under nominal conditions appears to argue against a significant depletion of the fluxes impinging upon the vehicle although Hunton and Calo (1985) have demonstrated that the ion-neutral collision rates may be rapid enough to produce a change in the incoming ambient O^+ velocity distribution function. Disturbed conditions however, as will be shown, do exist under which the incoming ion fluxes are notably perturbed. The observed decrease of the average water ion influx with mission elapsed time is anticipated due to the degassing of the spacecraft. The STS-4 mission apparently had the largest contaminant fluxes initially due to the fact that it was launched following a severe rainstorm which dampened the spacecraft tiles.

Ion spectrometer measurements on the STS-3 mission could not be used to evaluate the average ram influx toward the shuttle because the spectrometer never had the ideal low angle of attack configuration. However its position on the rear pallet within the bay provided a unique perspective for exploring ion fluxes generated or scattered low within the bay. Figure 5 shows the ion measurements made during part of one STS-3 orbit while the PDP was stowed in the bay. This type of profile was repeatedly seen on this mission because of the persistence employment of the same shuttle attitude configuration which was a nose-to-sun attitude with a shuttle roll period twice the orbital period. Within the bay the spectrometer was facing directly toward the side of the shuttle which would effectively shadow part or all of the incoming ion fluxes to the spectrometer. The only ions with unimpeded access to

the spectrometer are those incident from the port side from the topside of the bay. The ion currents collected in this bay configuration did not increase with decreasing spectrometer angle of attack but maximized when the incoming ion flow was from behind the spectrometer (negative azimuth angles in the figure correspond to shuttle motion in the starboard direction). All the ion species currents tended to track the variation of the shuttle's pitch angle with the maximum currents seen when the bay (and not the spectrometer orifice) was facing most directly into the shuttle velocity direction. In this situation the relative percentage of water ion current to that of the ambient ions, which is the order of 10%, cannot be compared to the previously discussed examples of unobstructed incoming ion fluxes. The buildup of the ion distributions seen in the bay on the STS-3 mission instead occur in association with the measured neutral gas pressure buildup in the bay that is observed as the bay faces more directly into the shuttle velocity direction (Shawhan et al., 1984).

The STS-3 measurements seen in Figure 5 also demonstrate that in addition to water related contaminant ion species occurring in the vicinity of the shuttle, ions such as NO^+ and O_2^+ also have a local production source. These ions can readily be produced by charge exchange reactions of ambient O^+ ions with neutral molecules of oxygen and nitrogen which are enhanced in concentration at the shuttle (Wulf and von Zahn, 1986). It is to be noted also that an analysis of the position of mass peaks in the sweep spectra of the instrument in this STS-3 example indicates that ions are formed or scattered by collisions within the plasma sheath of the -10 volt potential that exists on a guard ring surrounding the entrance aperture of the instrument. Hence the observations are consistent with the presence of not only water species ions but also molecular oxygen and nitric oxide ions of near shuttle origin as part of the usual shuttle background generated ion population. This was also noted from measurements of the spherical retarding potential analyzer flown on the same mission (Raitt et al., 1984 and Siskind et al., 1984). Previously Grebowsky et al. (1983) noted evidence of CO_2^+ ions also, but a further analysis of the spectrometer response indicated that an instrument harmonic of O^+ occurs at the same telemetry mass location and may have dominated over the background presence of carbon dioxide ions.

Directional Dependence of Shuttle Ion Influxes

The shuttle ion measurements taken with the instruments pointing in different directions with respect to the vehicle's velocity show distinctly different responses between ambient and contaminant ion species. Narcisi et al. (1983) showed that observations made with the STS-4 spectrometer off ram did not detect the same relative ambient/contaminant ion current influxes as were discussed previously for near ram conditions. At pointing angles from ram between 30 and 40° for example they noted comparable current magnitudes for both the dominant and ambient ions. It was noted that the collected number fluxes of the water ions varied less with changes in angle of attack than did the ambient O^+ - an indication that the H_2O^+ ions had higher thermal velocities than the ambient plasma.

The angle of attack variation of the Bennett spectrometer (as shown in Figure 1) is not as predominantly affected by the thermal velocity of the incoming ions as is the quadrupole spectrometer, the field of view of the former is 180° compared to the latter's 30° . The angle of attack sensitivity of the Bennett device for supersonic incident ion flows is more dependent on the average component of the incident velocity perpendicular to the longitudinal axis of the cylindrical spectrometer compared to the rf resonant velocity along the tube axis. Nevertheless the relative current ratio of the contaminant and ambient ions measured with the Bennett rf spectrometer was observed to vary significantly with the angle of attack of the instrument from the shuttle ram direction. This is seen for example in Figure 6 which presents SL measurements during a period when the shuttle was flipping tail-over-nose along its orbital path as depicted in the inset. The O^+ current increased with a decreasing angle between the shuttle velocity and the outward normal to the spectrometer orifice (which points forward in the bay) until the instrument was shadowed from the incoming ambient plasma by the front of the shuttle. The ion species NO^+ followed a similar trend insofar as its current peaked coincidentally with that of the ambient O^+ , but its overall current variation did not parallel that of the oxygen. This was particularly evident when the bay initially emerged from the shuttle wake and turned directly into the ram direction. This behavior supports the conclusion previously arrived at from the in-bay STS-3 observations that there is a contaminant NO^+ source in addition to an ambient influx of the same ion species. The other contaminant ion detected on the orbit depicted in Figure 6, the water ion species, shows a definite maximum occurring before the ambient O^+ influx into the spectrometer maximized. This water ion behavior is consistent with a direction of motion different from that of the ambient ionospheric plasma.

The different behavior of the water and oxygen ions with varying instrument angle of attack is a common feature of the shuttle environment. Its explanation lays apparently in the presence of the ambient magnetic field. Water ions formed by the charge exchange between ambient O^+ ions with water molecules in the cloud moving with the shuttle have the shuttle velocity at the moment of their origin. The Lorentz force exerted on these ions due to the presence of the earth's magnetic field causes them to gyrate about the local magnetic field line rather than moving along with the shuttle. Those contaminant ions produced upstream of the shuttle can be subsequently intercepted by the vehicle since these pick-up ions in the shuttle frame of reference will have an average flow velocity corresponding to their guiding center velocity perpendicular to B . This will in general result in their incidence on the shuttle obliquely from the ram direction as depicted schematically in Figure 7. The effect will be to produce a wake configuration behind the shuttle that is different for contaminant and ambient ions. A similar situation may prevail for other contaminant moleculars such as NO^+ although the dynamics will differ due to differing masses and velocities at their origin.

Eccles (1988) has provided further evidence for the existence of differing wake configurations for ambient and contaminant ions by doing

an extensive model calculation of the contaminant ion distributions incident upon the shuttle. This study applied a model neutral cloud which charge exchanged with ambient oxygen ions to produce water ions whose trajectories were electrodynamically modelled in the shuttle frame of reference. The calculation also included a simple model of the payload bay configuration to approximate important shadowing effects. Figure 8 shows the result of one such set of this model's calculations for conditions characteristic of a particular sequence of three SL-2 shuttle orbits. The ion mass spectrometer measurements made from within the bay show distinct differences between the ambient and contaminant ion variations with changing attitude. Using a very approximate angle of attack and energy dependence for the spectrometer, the study of Eccles modeled the variations in the relative ion currents that should be collected by the spectrometer. The model produced water ion current variations that have a wake boundary offset from that of O^+ ions which is similar to the observations. Although the calculation, not surprisingly due to the complexity of both the instrument response and spacecraft environment, does not reproduce all aspects of the measurements it does convincingly demonstrate that the contaminant water ions form an ion source that flows on the average toward the shuttle not from the ram direction but from a direction normal to the local magnetic field. Enhanced temperatures of the water ions also are required to explain the measured relative amplitudes of the current variations.

Water Dump Effects

Excess water generated on the shuttle has to be released periodically. This is done predominantly by a water relief vent near the forward bulkhead on the port side of the vehicle. The dump durations last for the greater part of an hour and release water amounts typically in the range of 50 to 100 kg. The Flash Evaporator System is another method used to release water, but will not be considered here since it has less of an impact on the overall thermal ion distributions detected by the spectrometer than does a water dump. A further discussion of details of these operations and their effect on the spacecraft environment can be found in the study of Pickett et al. (1983).

Since the quiescent ion environment about the shuttle consists predominantly of ion species that relate to charge transfer processes with neutral water molecules, it is anticipated that water dumps will significantly perturb the thermal ion influxes in the vicinity of the spacecraft. One example of a dump on the STS-3 mission is presented in Figure 9. In this example the water was released throughout the night until shortly after dawn along the orbit. The effect of the dump was only dramatically evident near sunrise when the collected water ion currents within the bay had magnitudes comparable to those of the ambient O^+ ions. That this is an effect of the dump is clearly established by the abrupt drop of the water ion current at the moment of termination of the dump. An effect on the ambient ions is not clearly evident from the measurements on this one orbit. However, if it is compared to measurements made predawn on the preceding shuttle orbit which had the same attitude configuration and which was previously

considered in Figure 5, it appears that the prominent predawn maximum in the O^+ current is reduced in magnitude during the dump. The choppy nature of the predawn currents in Figure 9 is the result of the periodic firing of an electron gun experiment during this time resulting in the periodic positive charging of the PDP and its spectrometer that repelled incoming positive ions. One anticipates on the basis of the earlier discussion that the introduction of more water molecules to the cloud about the shuttle would lead to a reduction of the incoming ionospheric oxygen ion fluxes due to scattering and charge transfer reactions. Another pervasive effect of the cloud of water emitted is also apparent in the appearance of quantities of H_2O^+ ion currents that are comparable to those of H_2O^+ - the 18AMU ions associated with the water dump depicted in Figure 9 occurred coincidentally with nearly identical currents of 19 AMU ions, the latter of which then fell below the sensitivity threshold of the instrument after the cessation of the dump.

Another example of a water dump effect is seen in Figure 10 which shows ion spectrometer measurements made from within the payload bay on the SL-2 mission. In this instance the water ion currents during the dump were almost an order of magnitude greater than those of O^+ when the spectrometer was clearly within the geometrical wake of the shuttle. A calculation of the direction of influx of water ions in the shuttle frame of reference perpendicular to the magnetic field showed that they have a flow direction into the spectrometer. Hence the large differences in the two species currents can be explained not only as an enhancement in water ion production but also by differing ambient, contaminant ion wake configurations. The perturbation by the water release ceased abruptly after the dusk terminator was crossed and the attitude of the shuttle was such that the spectrometer orifice was pointed directly into the spacecraft ram direction. The effects of the water dump on the ambient ion influx is not clearly evident in this example since the spectrometer turned away from the ram direction at the onset of the dump and then rapidly turned into ram near the cessation. Hence no fixed attitude frame was available to compare before and after effects - the previous and following orbits could not be used because the attitude configurations were different.

The extra water added to the shuttle environment by the dumps does have a significant impact on the ion fluxes and composition in the near vicinity of the shuttle. However the contaminant ions still appear to have the same trajectories as those produced under quiescent conditions so that ambient and contaminant ion wake configurations can be similarly offset from one another in either environment. This is demonstrated in the last water dump example to be considered which is shown in Figure 11. The onset of the dump was associated with an abrupt increase in the water ion currents but as noted above it is difficult from one orbit to determine in detail changes brought about by the water release. The water ion currents dropped off out of step with the ambient O^+ currents as the bay turned into the shuttle's wake. This is characteristic of the behavior in the quiescent state. Indeed this orbit is the central orbit of the sequence of 3 plotted in Figure 8. The preceding and following orbits were characterized by nearly identical shuttle

attitudes so the effects of the water dump can be singled out to be a factor of 2-3 reduction in observed O^+ currents produced by collisions within the water cloud that occurs in association with a definitely observed enhancement of water ion currents during the entire dump period except in the deep wake of the shuttle. However the extra water added around the shuttle had no pronounced effect on the location of the contaminant ion or ambient ion wake boundaries.

Thruster Effects

The Reaction Control System (RCS) shuttle engine firings in orbit have been noted to have an impact on many shuttle plasma measurements (e.g., Pickett et al., 1983). Unlike the water dumps however, which occur for prolonged periods of time, the thrusters (particularly the attitude tweaking verniers) typically fire for fractions of a second and release directed beams of effluents with velocities of the order of a few km/s in different directions from the shuttle depending on the particular thrusters being fired. Because sequences of different combinations of multiple thruster firings of varying durations are typically executed it is not a straightforward task to sort out the details of how an individual thruster firing affects the ion fluxes in the vicinity of the shuttle. However the thrusters do have a more prominent impact on the local ionization than the water dumps. Even though they are short in duration compared to the water releases they release gases at a rate of the order of 5000 kg/hr from the primary engines and 150 kg/hr from the verniers. These rates are large in comparison to the release rates of 50-100kg/hr and 10 kg/hr that are typical of water dumps and flash evaporator releases respectively.

The effects of the RCS firings on the thermal ion distributions are multifaceted. For example reductions in the ambient O^+ number fluxes in the vicinity of the shuttle analogous to the effects of the previously discussed water dumps are sometimes observed simultaneously with impulsive enhancements in the measured currents of contaminant ion species such as H_2O^+ (and/or) NO^+ . Figure 12 shows such an example from SL-2 data. Figure 13 on the other hand shows an example from STS-4 where depletions of the O^+ currents are observed with corresponding reductions in the H_2O^+ currents during thruster firings (from Narcisi et al., 1983). There are also times when the measurements detect ambient ion current enhancements above their quiescent levels such as those labeled in the earlier discussed Figure 9 and times when no noticeable effect is detectable in the ion measurements during thruster firings. In order to isolate the causes of some of these effects, a comprehensive analysis of SL-2 ion spectrometer measurements was made restricting attention to only vernier engine firings in which one or at most 2 of the verniers fired simultaneously. The firing events were further restricted to those with duration greater than 1 second. The latter criterium was established because the ion spectrometer took 2.4 seconds to sweep through all ion masses and it was desired to insure that there was a high probability that at least one of the ion species associated with a thruster perturbation was sampled by the instrument during the firing.

Figure 14 depicts the locations of the 3 vernier thrusters on the port side of the shuttle. There is a symmetric trio on the starboard side the names of which correspond to the port side nomenclature with the L's replaced by R's. One of the significant features of their locations is the positioning of the rear verniers near prominent projections of the shuttle in contrast to the the shuttle topology near the two forward verniers, F5L and F5L. Due to the expansion of the exhaust plumes, the rearward thrusters will be partially scattered off shuttle shuttle surfaces but the forward ones will not. This has been noted by Wulf and von Zahn (1986) to account for the detection of neutral molecule concentration enhancements in the bay during rear thruster firings and the absence of such effects with the firing of the thrusters on the nose. Isolating attention to the verniers rather than all RCS thrusters considerably simplifies the number of thrusters to keep track of - i.e., only 6 verniers compared to 38 main thrusters.

The combustion within a thrust chamber results in the formation of ions as well as the predominantly neutral hot thrust gases and it is possible that such ions could produce an enhancement in contaminant ion number fluxes near the shuttle in association with the firings. Since water, nitric oxide and molecular hydrogen are produced in the nitrogen tetroxide - monomethyl hydrazine reaction similar ion species could appear in measurable concentrations. However the predominant constituents of the thruster jet are neutral molecules of high concentration that enhance, albeit in a complex geometrical fashion, the cloud of gases moving with the shuttle. These neutral effluents will, through collisional reactions with the ambient plasma, result in the production of contaminant ion species. This is clearly seen by taking a model of the molecular concentration variations in a steady state vernier exhaust plume and computing the mean free path distribution for an ambient O^+ ion moving through it. The results of such a computation (depicted in Figure 15) demonstrate that the thruster plumes in the near vicinity of the spacecraft are essentially opaque to the passage of ambient ions which through charge exchange will yield their charge to the neutral thruster jet effluents.

Considering all ion spectrometer observations made while the PDP was secured in the SL-2 bay, a search was made for all individual and paired firings of the verniers. The appended Table lists the number of occurrences of each set of Vernier firings, the number and percentage of firings which caused observable ion perturbations, and the average duration of the firings ignoring the few extremely long ones. Enhancements in ion species currents were the dominant effects observed. The number of events for which depletions in one or more species currents were the result of the firings were infrequent and are listed in parentheses in the Table. The forward verniers although not impacting any prominent scattering surfaces were still at times detectable in the ion measurements taken from within the shuttle payload bay. On the other hand there is evidence that the scattering of the plumes off spacecraft surfaces has a significant impact on the thermal ion distributions - there were significantly more detections of perturbations by the rear thruster firings - particularly for the downward thrusters which skirt past the wings.

The observations at first look seem consistent with the detection of ionization that is produced in the combustion and streams out with the neutral products. For example Figure 16 shows a continuous time segment of SL-2 measurements when the PDP was held out over the port side and the spectrometer was facing rearward and the two opposing rear downward thrusters fired. All contaminant ions anticipated - i.e., 18, 19, 28 and 30 AMU species- were enhanced in current magnitude in association with the firing compared to conditions in the following cycle of sensitivity sweeps when the thrusters were off. However the 1 and 16 AMU ions are ambient in origin and are not from the thruster chamber and yet their collected currents are enhanced relative to the quiescent conditions existing on the sweeps before and after the thruster sequence. This is evidence that the neutral effluents of the thrusters are modifying the ambient ion distributions and perhaps through charge exchange are responsible for the contaminant ions observed rather than ions produced in the thrust reaction. The measured effect lasts approximately for the duration of the firing and appears to endure after the firing ceases - the latter behavior may not be a persistence of the effect however since there was a lack of total synchronization of the PDP data record time and that of the spacecraft clock on this mission. This resulted in unresolvable varying time differences between the recorded thruster firing times and the times of PDP measurements of as much as a few seconds (personal communication, R. L. Brechwald, U. Iowa, 1988).

Evidence that charge exchange between ambients and thruster plume neutral molecules plays a significant role in contaminant ion production was found in several instances in which the observed ion perturbation duration was the order of a second longer than the duration of the thruster firing. Although absolute times of thruster firings and instrument sampling times might be offset, shuttle time intervals given for the thruster firings can validly be compared to intervals of time determined from the ion spectrometer mass sweep scans which are set by internal oscillators. One such example of the persistence of the observed ion effect beyond the duration of the thruster firing is depicted in Figure 17. This again is an example of SL-2 ion measurements taken with the PDP on the extended RMS arm. The thruster perturbations of the ions are in evidence by the obvious difference in the amplitudes and ion species of the ion peaks near the time of the firing from those detected for the same sensitivity levels on the cycle of sweeps before and after the firing. The peaks labeled H correspond to instrument harmonics of 18 AMU ions - these will vary in amplitude in step with the 18 AMU influx occurring at the same time and can be used to denote the presence of the water ions. Such harmonics are natural to the RF response of this type of instrument. The observations in the figure show that the enhanced ionization resulting from the thrusters lasts for over a second longer than the duration of the firings. Since the thruster cutoff times are extremely rapid these observations cannot be accounted for by thruster chamber produced ions.

Finally, it is inherent to the thruster effects that they are dependent upon the ambient magnetic field direction with respect to the moving vehicle. Figure 18 gives an example of measurements during 2

segments of the same orbit during which the same two rear vernier thrusters fired for similar times and during similar sensitivity level scans of the spectrometer - in one instance ion perturbations were definitely detected from within the bay, but in the other nothing was measured above the instrument sensitivity. Comparing the spacecraft velocity vector directions in X,Y,Z body axis coordinate that are listed in the figure shows that the shuttle's attitude with respect to its velocity was identical in both instances. However the magnetic field direction angles in the same coordinate system were distinctly different. Indeed calculating the pickup ion guiding center velocity for the two segments reveals that the thruster related ions were not measured when the pickup velocity was large and directed predominantly into the belly of the spacecraft - i.e., the contaminant ions were shadowed strongly by the shuttle and prevented from encountering the spectrometer within the bay. When the thruster ion effect was detected the corresponding pickup ion flow velocity was relatively low in magnitude and its dominant spatial direction was not toward the belly - hence contaminant ions could more readily have paths that take them to the spectrometer than in the previously discussed instance. Hence just as for the quiescent state and water dump ion contaminant distributions, some of the thruster effects are consistent with charge exchange production and interactions with the shuttle that are characterized by a plasma wake configuration different from that of the ambient ions.

Comment

The thermal ion environment of large gas emitting bodies like the shuttle and the space station is always characterized by the presence of ions not of ambient origin. These ions are due predominantly to charge exchange interactions between the ambient ionospheric positive ions and the extended gas cloud moving with the vehicle. After the initial period of degassing of the spacecraft the effects on the ion currents collected near the vehicle are relatively small under quiescent conditions. However for impulsive gas releases such as thruster firings or water releases there are pronounced perturbations in the incoming number fluxes and energy distribution of the thermal ions that need to be fully modeled in order to determine the ramifications for current collecting devices.

References

- Carignan, G. R., and E. R. Miller, Mass spectrometer, in STS-2,3,4, Induced Environment Contamination Monitor (IECM), Summary Report, edited by E. R. Miller, NASA TM-82524, 1983.
- Eccles, J. V., The electrodynamics of plasma within the outgas cloud of the Space Shuttle orbiter, Ph.D. Dissertation, Center for Atmospheric and Space Sciences, Utah State University, 1988.
- Grebowsky, J. M., M. W. Pharo III, H. A. Taylor, Jr., and I. J. Eberstein, Measured thermal environment of STS-3, paper presented at the Shuttle Environment and Operations Meeting, Am. Inst. of Aeronaut. and Astronautics, Washington, D.C., October 31, 1983.

- Grebowsky, J. M., H. A. Taylor, Jr., M. W. Pharo, and N. Reese, Thermal ion complexities observed within the Spacelab 2 bay, Planet. Space Sci., 35, 1463, 1987.
- Grebowsky, J. M., H. A. Taylor, Jr., M. W. Pharo, III and N. Reese, Thermal ion perturbations observed in the vicinity of the Space Shuttle, Planet. Space Sci., 35, 501, 1987.
- Hunton, D. E., and J. M. Calo, Low energy ions in the shuttle environment evidence for strong ambient-contaminant interactions, Planet. Space Sci., 33, 945, 1985.
- Mendillo, Michael, The effect of rocket launches on the ionosphere, Advances in Space Res., 1, 275, 1981.
- Murphy, G. R., S. D. Shawhan, and J. S. Pickett, Perturbations in the plasma environment induced by the orbiter's maneuvering thrusters, Am. Inst. of Aeronaut. and Astronautics, paper 83-2599, 1983.
- Narcisi, R. E., Trzcinski, G. Frederico, L. Wyodyka and D. Delorey, The gaseous and plasma environment around space shuttle, paper presented at the Shuttle Environment and Operations Meeting, Am. Inst. of Aeronaut. and Astronautics, Washington, D.C., November 2, 1983.
- Narcisi, R. E., Quantitative determination of the outgassing water vapor concentrations surrounding space vehicles from ion mass spectrometer measurements, Adv. Space Res., 2, 283, 1983.
- Pickett, J. S., G. B. Murphy, W. S. Kurth, C. K. Goertz and S. D. Shawhan, Effects of chemical releases by the STS 3 orbiter on the ionosphere, J. Geophys. Res., 90, 3487, 1985.
- Raitt, W. J., D. E. Siskind, P. M. Banks, and P. R. Williamson, Measurements of the thermal plasma environment of the space shuttle, Planet. Space Sci., 32, 457, 1984.
- Shawhan, S. D., G. B. Murphy, and J. S. Pickett, Plasma Diagnostics Package initial assessment of the shuttle orbiter plasma environment, J. Spacecraft, 21, 387, 1984.
- Siskind, D. E., W. J. Raitt, P. M. Banks, and P. R. Williamson, Interactions between the orbiting space shuttle and the ionosphere, Planet. Space Sci., 32, 881, 1984.
- Smith, S. D., Improvements in rocket engine nozzle and high altitude plume computations, presented as paper 83-1547 at the AIAA Thermophysics Conference, Montreal, Canada, June 1983.
- Wulf, E. and U. von Zahn, The shuttle environment effects of thruster firings on gas density and composition in the payload bay, J. Geophys. Res., 91, 3270, 1986.

TABLE

1-2 VERNIER PAIR FIRINGS
Longer Than 1 Second

<u>PAIR</u>	<u>FIRINGS</u>	<u>ION EFFECT (DROP)</u>	<u>% SEEN</u>	<u>AVERAGE DURATION (SEC.)</u>
F5L	7	0	0	1.6
F5R	3	0	0	1.3
F5R, F5L	46	19(3)	41	1.7
F5R, R5R	22	13(2)	59	2.0
F5R, L5L	13	8	62	1.9
L5L, L5D	13	13(4)	100	1.7
R5R, R5D	9	9(2)	100	1.6
L5D, R5D	118	100(7)	85	3.5

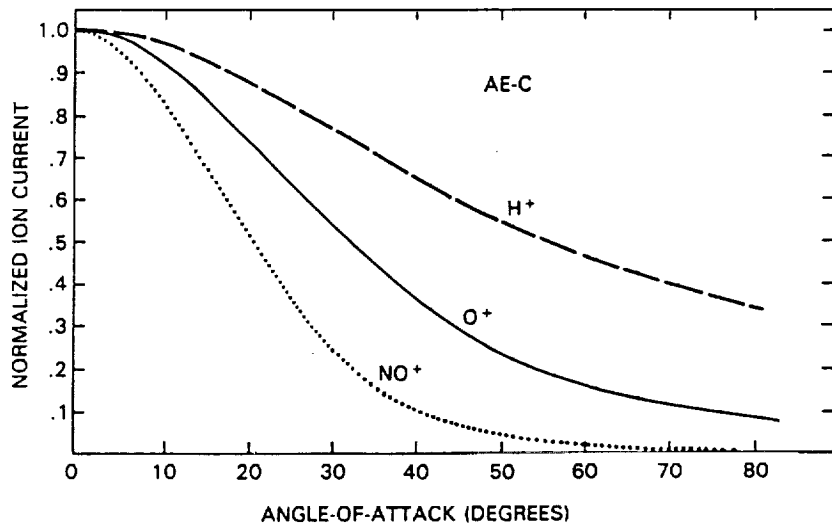

Figure 1. The variation of the collected ion current as a function of angle of attack empirically determined for the Atmosphere Explorer C Bennett RF ion mass spectrometer is plotted for measured ion species.

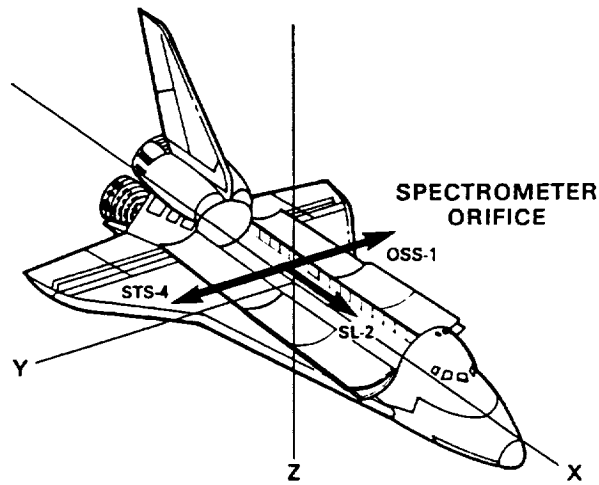

Figure 2. The arrows indicate the directions in which the Bennett RF ion mass spectrometer (on SL-2 and OSS-1 missions) and the ion-neutral quadrupole spectrometer (on STS-4) orifices faced when secured within the shuttle bay.

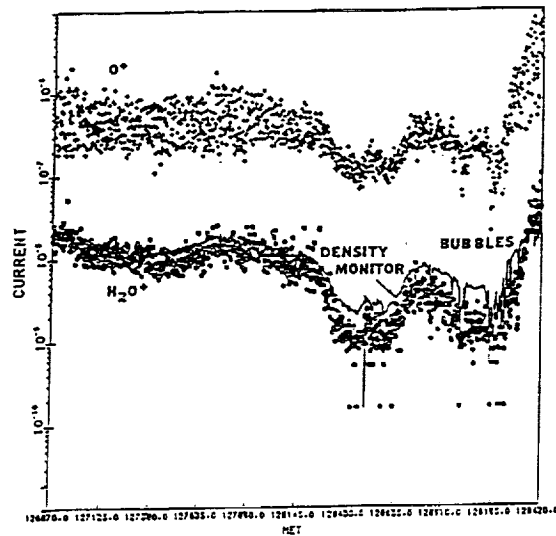

Figure 3. STS-4 ion measurements for a period of time beginning on orbit 24 when the spectrometer was facing into the ram direction show a characteristic H_2O^+/O^+ ratio of about 2%. This plot is taken from Narcisi et al. (1983). MET refers to mission elapsed time.

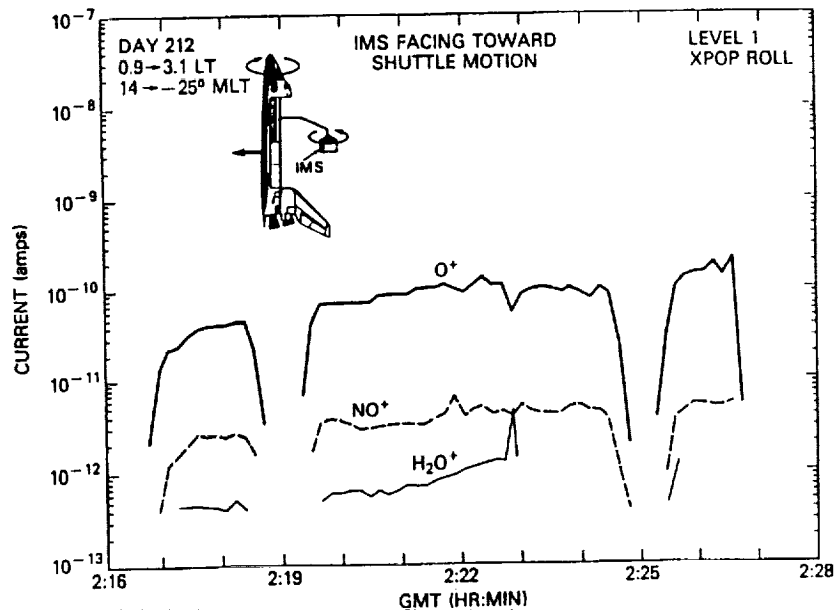

Figure 4. SL-2 measurements of ion composition taken during several X Perpendicular-to-Orbital plane rolls in which the ion spectrometer orifice was maintained in the shuttle ram direction.

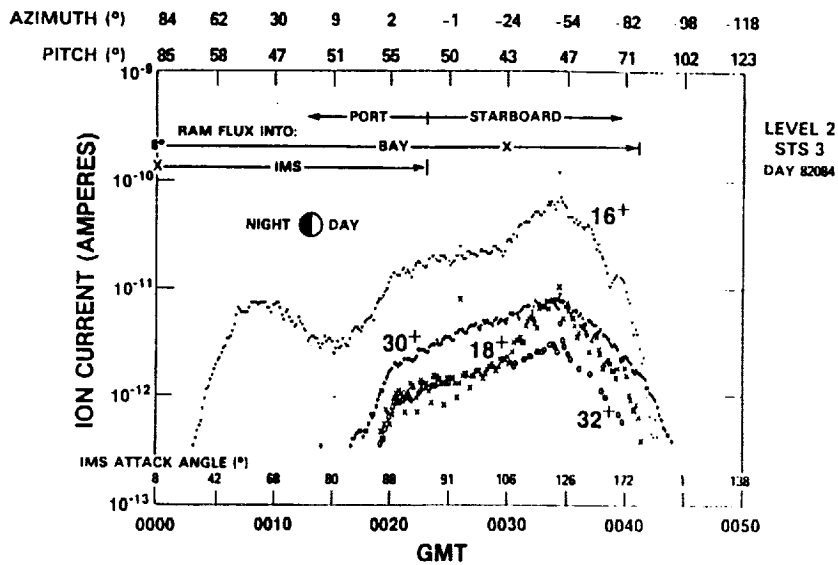

Figure 5. An example of ion composition measurements in the bay on STS-3. The pitch refers to the angle between the spacecraft velocity and the outward normal to the Bay (i.e., the -Z axis); azimuth is the velocity angle projected into the X-Y plane from the X axis; and the IMS angle refers to the angle the velocity makes with the outward normal to the orifice.

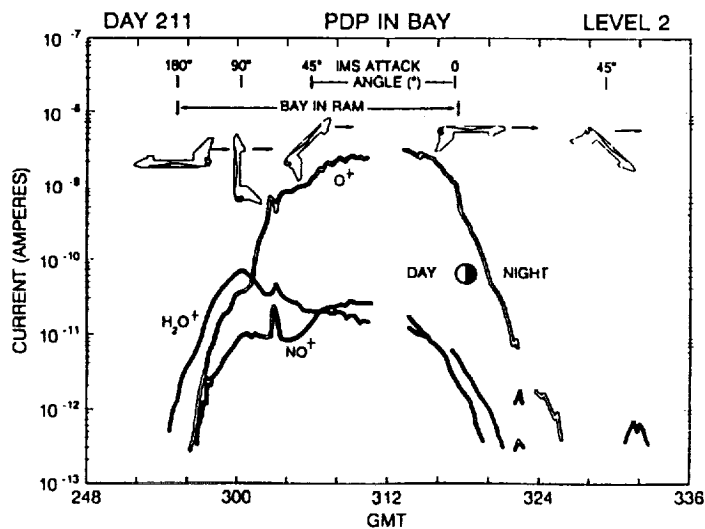

Figure 6. Spacelab 2 observations made from within the payload bay when the spacecraft was flipping end-over-end along the orbit.

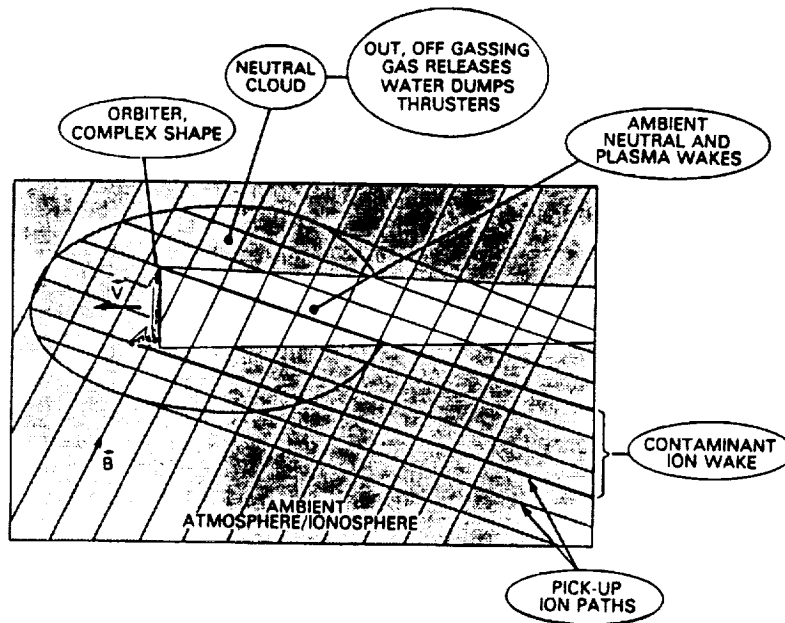

Figure 7. A schematic model of the average environment about the shuttle. Water ions formed by charge exchange follow guiding center paths perpendicular to B that are oblique, in the shuttle frame of reference, to the streamlines of ambient ions. This results in a contaminant ion influx and resultant depleted plasma wake behind the shuttle that differs from the corresponding ambient ion behavior.

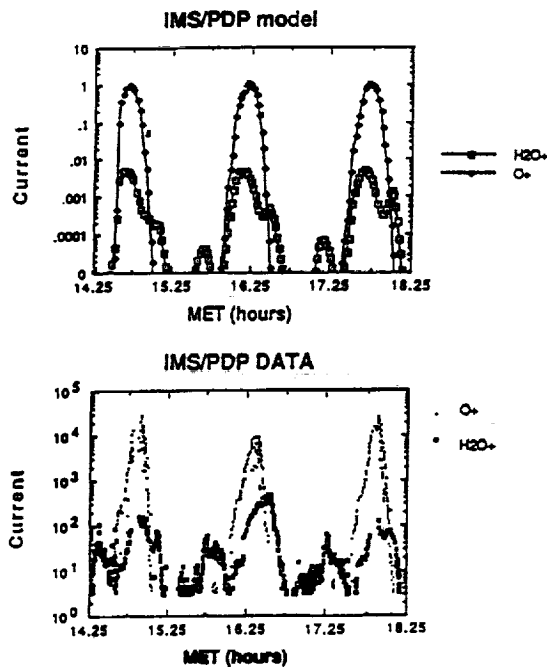

Figure 8. SL-2 ion measurements made within the wake on three consecutive orbits showing differing contaminant and ambient ion behavior are shown on the bottom. Model calculations of currents to be expected for these orbits shown at the top reproduce the differing wake behaviors. This figure is from Eccles (1988).

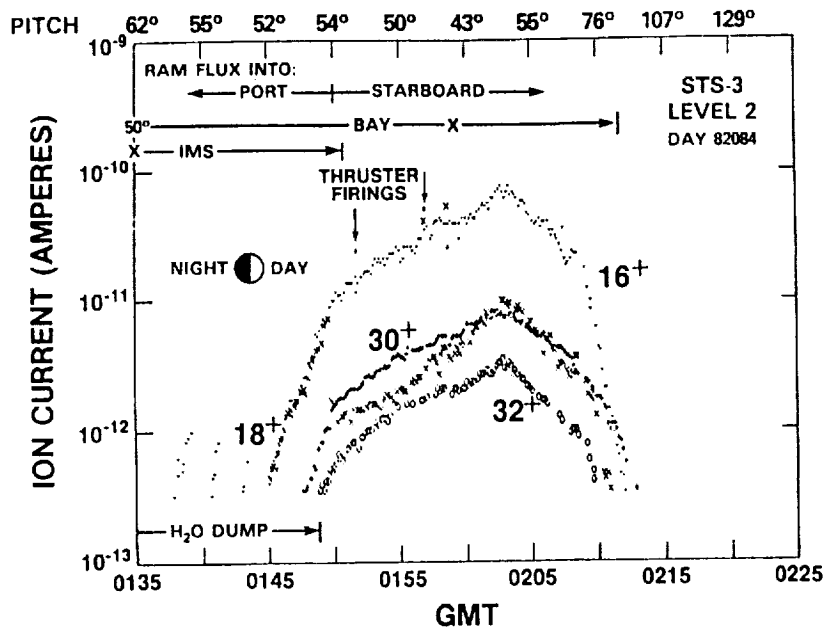

Figure 9. Ion spectrometer measurements taken within the bay of STS-3 during and after a water dump. The regions delineated at the top of the figure denote the direction of motion of ambient ions as viewed from the shuttle. The crosses on the lines indicate the points where the outward normal to the bay and spectrometer orifice were closest to the ram direction and the vertical bars indicate when the angles were 90°. This orbit followed that described in Figure 5 on which no water dump took place.

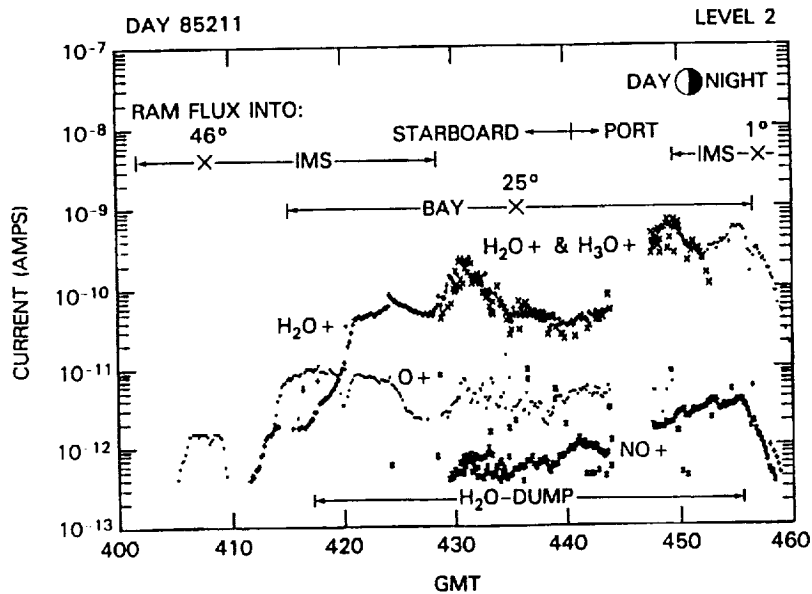

Figure 10. Ion measurements from within the shuttle bay on SL-2 during a water dump show an extreme case where water related ion currents dominate the ambient ion species currents by a factor of 10.

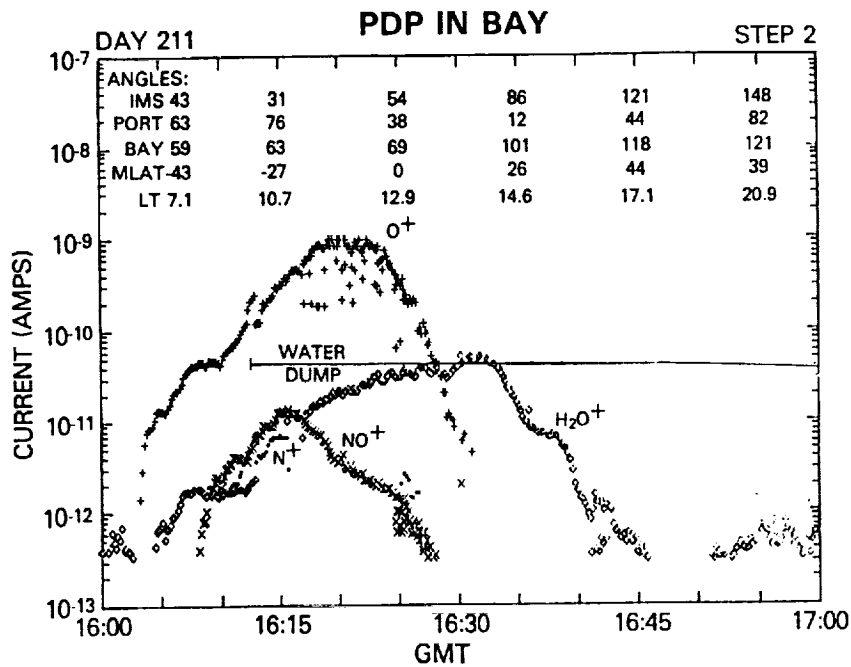

Figure 11. Another SL-2 in-bay example of the effects of a water dump. The crossings of the ambient and contaminant ion wakes still occur at different times. The water dump does not fill in the ion wake. This is the second orbit of the sequence plotted in Figure 8 (bottom).

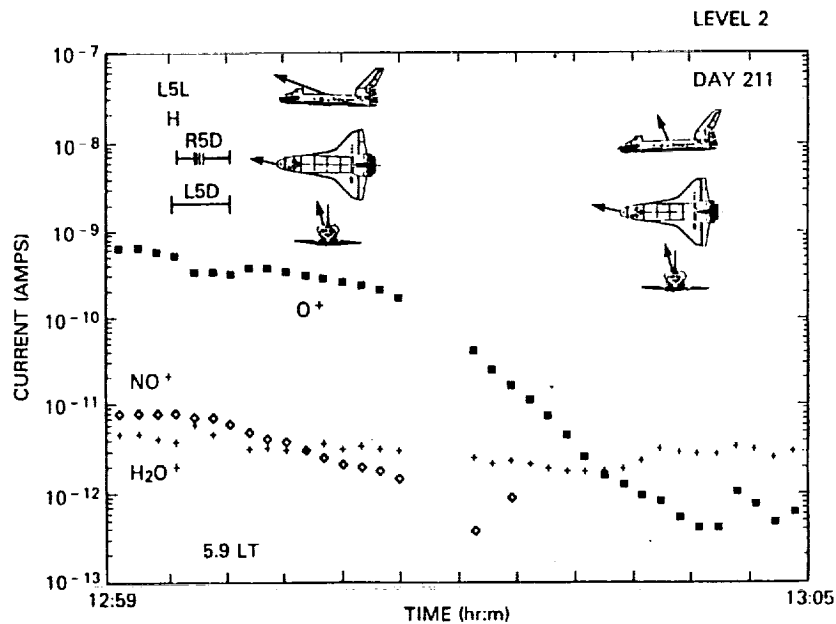

Figure 12. A SL-2 set of measurements from within the bay when a decrease in the ambient ions is detected during thruster firings while the water ion currents are enhanced. Note that the ion spectrometer is directed into the spacecraft direction of motion

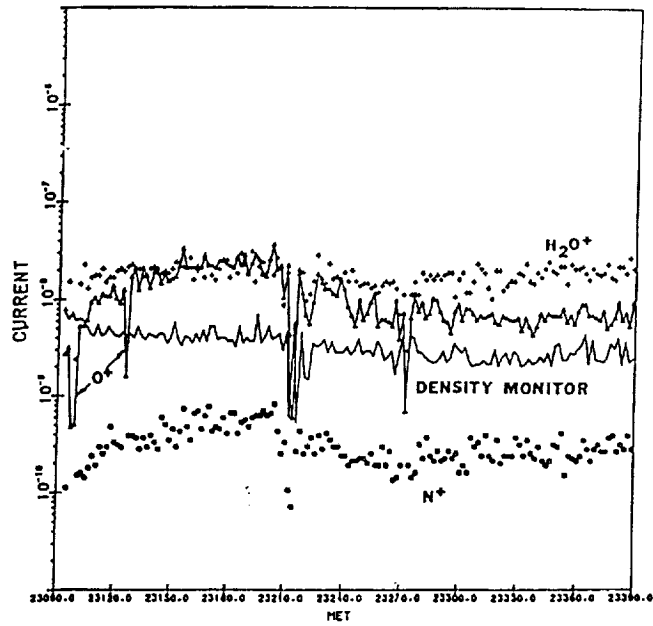

Figure 13. An example of large momentary decreases in O^+ currents incident on the STS-4 spectrometer during thruster firings were detected on orbit 5 along with simultaneous decreases in the water ion currents. This figure is from Narcisi et al. (1983).

SPACE SHUTTLE VERNIER THRUSTERS

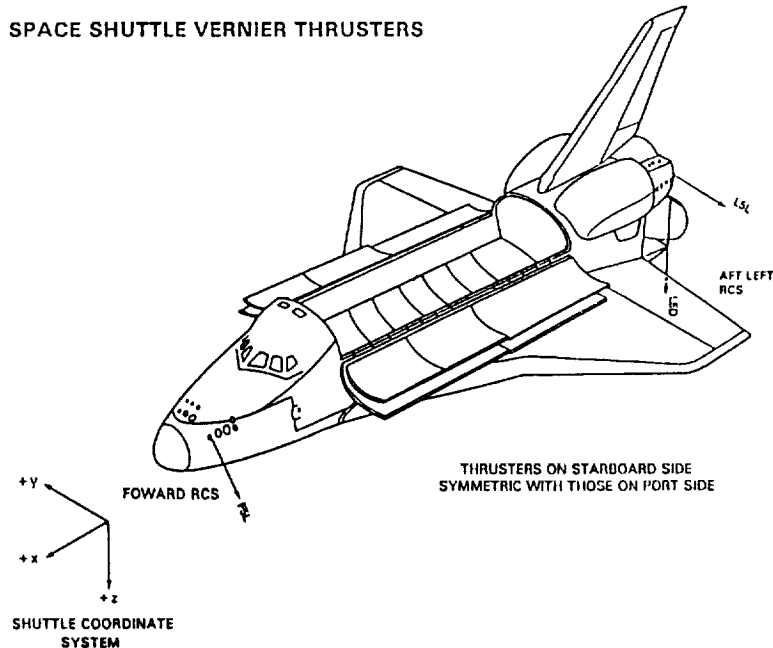

Figure 14. There are 6 vernier thrusters on the shuttle. The three on the port (left) side (F5L, L5L, L5D) are delineated while a similar set (F5R, R5R, R5D) are located symmetrically on the starboard (right) side of the vehicle.

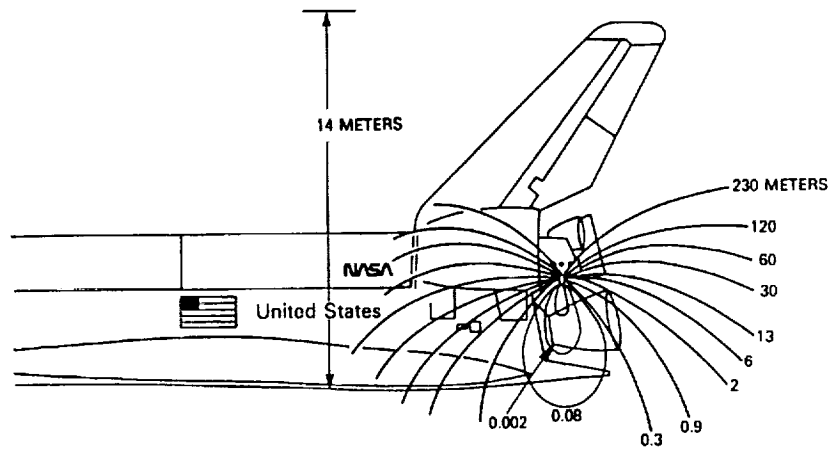

Figure 15. The RCS plume concentration configuration computed by Smith (1983) with the ramp code was simply scaled to the vernier effluent rate and then used to compute the mean free path of ambient O^+ ions moving through it. The thruster plume is depicted as directed downward in the figure - the exact orientation of course is dependent upon which thruster is considered. The angles in the parentheses at the top rate are the angles of the shuttle's velocity in the spacecraft X, Y, Z coordinate system.

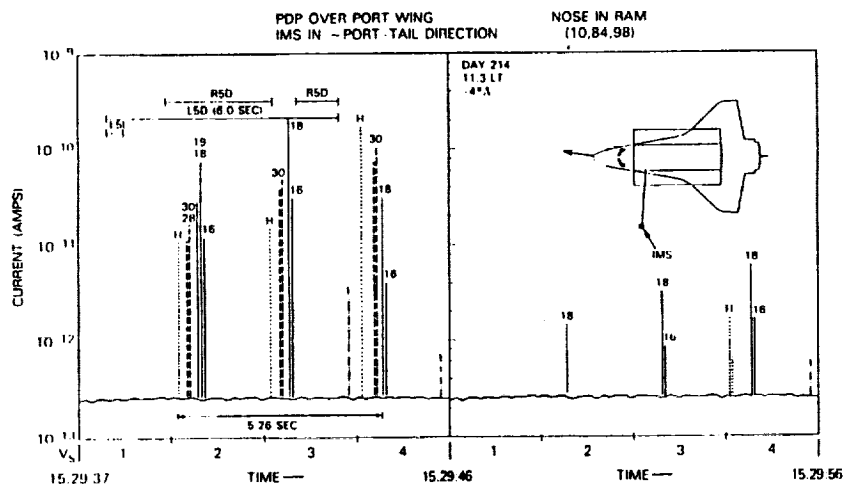

Figure 16. An example from SL-2 of the detection of ion perturbations from a pair of rear firing thrusters. The PDP was on the RMS as shown with the IMS directed tailward and away from the port side. The masses are swept on each cycle from low to high AMU's with each sensitivity level mass scan duration of approximately 2.4 seconds. The current peak variations seen in the background measurements after the firing demonstrate the sensitivity level increases of the instrument from step 1 to 4. The dotted H curves refer to harmonics of the 18 and/or 16 AMU species produced by the RF resonance in the instrument. These vary in amplitude with the fundamental current.

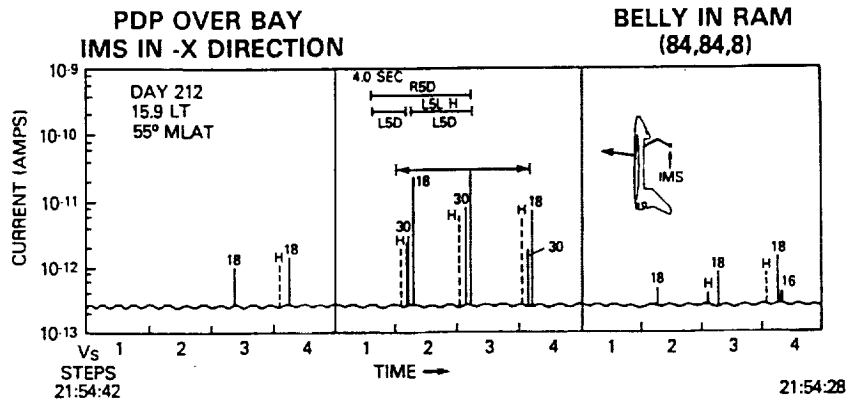

Figure 17. A SL-2 example of thruster ion perturbation duration exceeding the duration of the firing. The time of the observed perturbation is obtained from the known sweep cycle periods of the instrument.

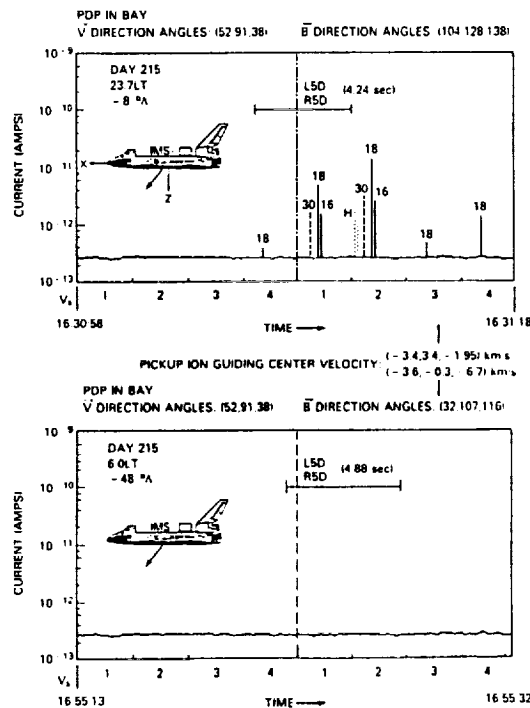

Figure 18. Two sequences of similar SL-2 thruster firings at the same shuttle attitude on the same orbit have different consequences at the ion spectrometer location within the bay. The differences in the magnetic field orientation with respect to the shuttle will produce distinctly different pick-up ion trajectories that could explain the differences.