

11-247
3357
P-85

**NASA
Technical
Memorandum**

NASA TM - 103527

**EVALUATION OF BEARING CONFIGURATIONS USING
THE SINGLE BEARING TESTER IN LIQUID NITROGEN**

By T. Jett, P. Hall, and R. Thom

Materials and Processes Laboratory
Science and Engineering Directorate

March 1991

(NASA-TM-103527) EVALUATION OF BEARING
CONFIGURATIONS USING THE SINGLE BEARING
TESTER IN LIQUID NITROGEN (NASA) 85 p

N91-21532

CSCS 13I

Unclass

G3/37

0003357



National Aeronautics and
Space Administration

George C. Marshall Space Flight Center



4

•

1

•

TABLE OF CONTENTS

	Page
I. INTRODUCTION	1
II. EXPERIMENTAL PROCEDURE	1
A. Test Equipment	1
B. Bearing Configurations	2
C. Test Objective	3
D. Bearing Testing Procedure	3
III. TEST RESULTS AND DISCUSSION	4
IV. CONCLUSIONS	6
REFERENCES	7
APPENDIX	27

LIST OF ILLUSTRATIONS

Figure	Title	Page
1.	Single bearing tester.....	8
2.	Cross section of the single bearing tester.....	9
3.	Isometric drawing of the single bearing tester.....	10
4.	Schematic of the single bearing tester system.....	11
5.	Test number N949-3, baseline configuration.....	12
6.	Test number N949-5, Salox/M cage configuration.....	13
7.	Test number N949-6, Salox/M cage configuration.....	14
8.	Test number N949-7, Salox/M cage configuration.....	15
9.	Test number N949-9, baseline configuration.....	16
10.	Test number N949-10, elongated cage configuration.....	17
11.	Test number N949-11, silicon nitride balls configuration.....	18
12.	Test number N949-12, Bray 601 grease configuration.....	19
13.	Test number N949-13, Salox/M cage configuration.....	20
14.	Summary of critical flowrate test results of various bearing configurations.....	21
15.	Inner race after complete test series.....	22
16.	Outer race after complete test series.....	22
17.	440C balls used in all tests except test number N949-11.....	23
18.	Silicon nitride balls after test number N949-11.....	23
19.	Baseline Armalon cage after test number N949-12.....	24
20.	Armalon cage with elongated ball pockets after test number N949-10.....	24
21.	Salox/M cage used in test numbers N949-4, N949-5, N949-7, and N949-13.....	25

LIST OF TABLES

Table	Title	Page
1.	Summary of individual tests	25
2.	Summary of bearing configurations.....	26
3.	Wear measurements of test balls	26

TECHNICAL MEMORANDUM

EVALUATION OF BEARING CONFIGURATIONS USING THE SINGLE BEARING TESTER IN LIQUID NITROGEN

I. INTRODUCTION

Presently, the space shuttle main engine (SSME) is not meeting its target design life of 7.5 hours. One limiting factor is the performance and life of the high pressure oxidizer turbopump (HPOTP). To meet the life requirements, an improved bearing configuration (i.e., an improved bearing design and/or an improved bearing material) is needed. To evaluate potentially improved bearing configurations, a simple and easy-to-manage cryogenic single bearing tester was designed and built in-house at Marshall Space Flight Center (MSFC) [1]. This bearing tester, known as the single bearing tester, is used to do comparative screening tests of potentially improved bearing configurations versus the baseline design. The baseline is one Rocketdyne phase I HPOTP pump end 45 mm bore bearing that is made of 440C stainless steel.

In this study, the single bearing tester was used to evaluate the performance of several different bearing configurations. These configurations included the following:

1. Baseline configuration (440C races, 440C balls, and Armalon cage)
2. Salox cage configuration (440C races, 440C balls, and Battelle-designed cage with Salox/M inserts)
3. Silicon nitride balls configuration (440C races, silicon nitride balls, and Armalon cage)
4. Elongated cage configuration (440C races, 440C balls, and Armlon cage with elongated ball pockets)
5. Bray 601 grease configuration (440C races, 440C balls, and Armalon cage with Bray 601 grease coated ball pockets)

A series of tests in liquid nitrogen was performed to compare these configurations, and the results are provided in this report.

II. EXPERIMENTAL PROCEDURE

A. Test Equipment

In this study, one standard 45-mm phase I Rocketdyne SSME turbopump bearing was tested using the single bearing tester as shown in figure 1. This bearing tester was designed, fabricated,

and built in-house at MSFC. This basic tester has a 304 stainless steel housing that is rubber mounted on a modified heavy duty Walker Turner drill press. The inner race of the bearing is press fitted (0.020-mm interference fit at room temperature) on a 440C stainless steel drill press arbor adapter, and the outer race is mounted loosely (0.203-mm loose fit at room temperature) in the bearing housing. The bearing is loaded axially via a simple dead-weight loading mechanism. A cross section of the tester is shown in figure 2, and an isometric drawing of the tester is shown in figure 3. This tester is installed in test cell 1 of the lox impact test facility (building 4623). A schematic of the tester system is shown in figure 4. The tester is instrumented to measure coolant inlet temperature, coolant outlet temperature, bearing outer race temperature, coolant flow rate, and the change in pressure across the bearing. The coolant supply line is pressurized to 140 kPa (20 psi) using gaseous nitrogen, then the pressurized coolant goes through a heat exchanger that is filled with liquid nitrogen at atmosphere pressure. This provides 5 K of subcooling to the liquid nitrogen coolant. During testing, an IBM AT computer and a Fluke Helios are used to monitor and record data.

B. Bearing Configurations

The baseline configuration for this test series was a phase I design Rocketdyne SSME turbo-pump HPOTP bearing (Rocketdyne design number R0015850). This bearing is a 45-mm angular contact ball bearing with 11.1125-mm (0.4375-in) balls. All components of this bearing are made of 440C stainless steel except for the cage. The cage is made of Armalon, which is a glass-reinforced polytetrafluorethylene (PTFE) self-lubricating composite. This cage had 13 circular-shaped ball pockets. With a load of 2,220 N (500 lb), the Hertz stress on the bearing inner race was 1.46 GPa (212 ksi) as calculated using the Shaberth bearing analysis computer program. (See appendix for Shaberth results.)

The second bearing configuration used the same components as the previously tested baseline bearing except for the Armalon cage. A Battelle-designed Salox/M cage was used. This cage had a phosphorus bronze shroud for structural strength with Salox/M ball pocket inserts for lubrication. The Salox/M is a self-lubricating composite that is made of 60-percent bronze and 40-percent PTFE by weight [2]. This cage had only 11 ball pockets; two fewer than the baseline Armalon cage. This resulted in 1.56-GPa (225-ksi) Hertz stress on the inner race with the 2,220 N axial load.

In the third bearing configuration, all components of the baseline bearing were used except the 440C balls. Silicon nitride balls (11.1125 mm, grade 5) from Norton were used in this bearing configuration. Silicon nitride is a ceramic bearing material that is harder than steel and more wear resistant. This bearing configuration resulted in contact stress of 1.74 GPa (252 ksi) with the 2,220 N axial load. This higher contact stress is due to the higher elastic modulus of silicon nitride as compared to the baseline 440C balls.

In the fourth bearing configuration, all components of the original baseline bearing were used except for the Armalon cage. For this configuration, an Armalon cage with elongated cage pockets was used. This cage had 12 cage pockets (one fewer than the baseline) that were elongated for increased clearance. This bearing configuration had 1.50-GPa (218-ksi) contact stress on the inner race with 2,220 N axial load.

In the final bearing configuration, all components of the baseline bearing including the cage were used. In this configuration, a small amount of Bray 601 grease (approximately 0.25 mm thick) was smeared into each ball pocket of the baseline Armalon cage. Bray 601 grease is a perfluoroalkylpolyether base grease that is lox compatible [3].

C. Test Objective

The following is a list of the test objectives:

1. To determine and define a critical flowrate for the baseline bearing configuration using LN₂ as the coolant. To determine this critical flowrate, incrementally decrease the flowrate every 50 seconds until the bearing outer race temperature increases by 10 K from the steady-state condition. Establish a statistical confidence in this critical flowrate by repeating this process several times.
2. Determine and define a critical flowrate for alternate bearing configurations in LN₂ using the same method as used for the baseline.
3. Compare the critical flowrate between the different configurations. The bearings with low flow critical flowrates are likely candidates for subsequent testing in the MSFC bearing and seal material tester.

D. Bearing Testing Procedure

In this study, all testing was done using the single bearing tester, which was previously described. All the tests were run in liquid nitrogen using components from the same baseline 45 mm bearing (Rocketdyne SN No. 8548949). The various bearing configurations were formed by substituting components or modifying the baseline as previously described, however, all tests used the same inner and outer raceways. In this study, 10 tests were performed and are described below.

<u>Test Number</u>	<u>Bearing Configuration</u>
N949-3	Baseline
N949-4	Baseline
N949-5	Salox/M cage
N949-6	Salox/M cage
N949-7	Salox/M cage
N949-9	Baseline
N949-10	Elongated cage
N949-11	Silicon nitride balls
N949-12	Bray 601 grease
N949-13	Salox/M cage

These tests were done under identical test conditions. These test conditions were as follows:

1. Load – 2,220 N (axial), no applied radial load
2. Speed – 10,000 rpm
3. Coolant – liquid nitrogen
4. Coolant pressure – 140 kPa
5. Coolant flowrate – variable
6. Outer race temperature cutoff – 90 K.

During testing, the coolant inlet temperature, coolant outlet temperature, bearing outer race temperature, coolant flowrate, and delta pressure across the bearing were monitored and recorded. The objective of an individual test was to determine the critical flowrate which caused the bearing to go into a thermal excursion. The coolant flowrate was determined using the flow control valve position. This measurement technique was used because the turbine flowmeter gave erratic and unreliable data, possibly due to two-phase coolant flow.

Each test consisted of a series of runs to determine the critical flowrate for that bearing configuration. Before each test, all bearing components were ultrasonically cleaned in freon. To perform a test, the bearing was loaded into the housing, then a 2,220 N axial load was applied. The heat exchanger was filled with LN₂ and the LN₂ supply dewars were pressurized to 140 kPa using GN₂. This pressure was kept constant throughout testing. Next, LN₂ coolant flow was initiated to cool the tester and bearing by fully opening the flow control valve. The bearing outer race was cooled down to 80 K for at least 5 minutes. With the tester sufficiently cooled, the flowrate was adjusted to a predetermined high flowrate and rotation was initiated. Next, the coolant flowrate was incrementally lowered from the initial high flowrate in discrete time steps (usually every 50 seconds). Lowering of the flowrate continued until the bearing outer race increased to 90 K which was an indication of the start of a thermal excursion. The flowrate where the temperature excursion occurred was deemed the critical flowrate. The individual run was then terminated by stopping rotation and increasing the LN₂ coolant flowrate to cool the bearing back down. The bearing outer race temperature was cooled back down to below 80 K and held for approximately 5 minutes, then another run was made. This process was repeated several times to achieve confidence in determining the critical flowrate. After testing, the bearing was removed from the housing and the housing was cleaned with freon in preparation for the next test. Between tests of various bearing configurations, the bearing components were microscopically examined and recleaned.

III. TEST RESULTS AND DISCUSSIONS

The primary objective of this study was to compare the difference in heat generation between various bearing configurations running in LN₂ using the single bearing tester. The differences in

heat generation were evaluated by determining a critical flowrate at which a given bearing configuration would just start to thermally runaway. In this study, five different bearing configurations were evaluated and comparisons were made to the baseline configuration, which was a phase I 45-mm Rocketdyne HPOTP turbopump bearing.

In this study, a total of 10 tests were performed. The baseline configuration was tested three times, and the Salox/M cage configuration was tested four times. The remaining bearing configurations were tested once. Each individual test consisted of a series of runs to determine the critical flowrate. The data from the tests are shown in figures 5 to 13 (Note: the computer data for test N949-4 was accidentally overwritten and is not shown). The critical flowrate from individual runs was averaged, and the standard deviation was computed. A student's T analysis was performed and the 95-percent bands were determined. These results were summarized in table 1. To compare the bearing configurations, the multiple tests of Armalon and Salox/M were averaged, and the results are given in table 2 and are shown graphically in figure 14.

The results showed that the baseline configuration bearing would thermally runaway at an average flowrate valve position of 26-percent open (standard deviation 7.5). The elongated cage configuration was approximately equal from the heat generation standpoint (25.3-percent open, standard deviation 4.5). The silicon nitride bearing configuration had the highest heat generation with a critical flowrate of 28.4-percent open, standard deviation 3.43. This flowrate is 9 percent greater than the baseline configuration. From a heat generation viewpoint, the Salox/M cage and Bray 601 grease configurations were superior. The Salox/M cage had a critical flowrate of 18-percent open, standard deviation 4.4, which was 28 percent less than the critical flowrate that was required by the baseline bearing. This indicates that the Salox/M cage bearing requires less coolant because it is producing less heat, due to lower friction; even though it has two fewer balls and a subsequent higher contact stress. The Bray 601 grease configuration was even better than Salox/M. This configuration required a flowrate of 14-percent open, standard deviation 1.2 percent before it began to thermally run away. This flowrate is 44 percent less than the baseline configuration required. This indicates the grease is providing some lubrication to the contacts despite the cryogenic environment.

Another interesting observation about differences in heat generation between the Salox/M cage and the baseline Armalon cage occurred during a side experiment. During testing, it was observed that when the outer race temperature started to increase in the baseline bearing configurations, no amount of increased coolant flow could cool the bearing back down while the bearing was still rotating. This behavior was not observed with the Salox/M cage. Several times during testing, it was demonstrated that the temperature increase due to coolant starvation could be reversed by increasing the coolant flowrate a moderate amount. This, in effect, quenched the thermal runaway processes, turning the temperature increase around, decreasing the outer race temperature to nominal. This side experiment was not done on the other bearing configurations, but will be investigated in future studies.

Optical microscopy inspection of the bearing components was made after each test. In general, these inspections showed no significant damage to the test components. The bearing races (shown in figs. 15 and 16) had light wear tracks with no sign of surface distress or discoloration. The balls (both 440C and silicon nitride) were in excellent condition. The 440C balls are shown in figure 17, and the silicon nitride balls are shown in figure 18. The balls were measured with a

Pratt and Whitney Supermic before and after each test, and these results are given in table 3. The results show essentially no wear of the balls. Four of the 440C balls showed a slight decrease in the average diameter (0.0004- to 0.0007-mm decrease), but this is within measurement uncertainty of the Supermic. The only component that showed significant wear was the cage. Each of the three cages had light scarring in each ball pocket. Overall, the baseline Armalon cage appeared to be in the worst condition (i.e., larger and heavier wear scars), but it was used in the most number of tests. Photographs of the tested cages are shown in figures 19 to 21. Optical microscopy of the bearing components after tests using the Salox/M cage showed only a hint of bronze color on the balls and raceways, indicating a small amount of lubricant transfer from cage to the active bearing elements. The inspection of the bearing components after the test using the Bray 601 showed that a good quantity of grease was still intact in the ball pockets and a grease film was observed on the balls and raceways.

The overall results from this test series showed that bearing components were not significantly damaged during testing. This was expected due to the nature of this bearing tester (low load and speed) and of the test procedure. The axial load and speed of this tester are less than those in the SSME turbopump. Also, the tester was immediately shut down upon any indication of thermal excursion (i.e., 90 K redline). The purpose of this test series and of the single bearing tester is only to perform screening tests of potentially improved bearing configurations. Bearing configurations, which show promising results from this tester, need to be further evaluated on more advanced bearing testers, such as MSFC's Bearing and Seal Materials Tester, that better simulate actual turbopump conditions.

IV. CONCLUSIONS

Test results using the single bearing tester with LN₂ coolant lead to the following conclusions:

1. An Armalon cage with 12 elongated ball pockets is not statistically better than the baseline phase I cage.
2. A phase I bearing with silicon nitride balls will tend to generate more heat than the same bearing with 440C balls.
3. The Salox/M cage offers a statistically significant improvement (as shown by the 95-percent confidence bands) in heat generation rate over the baseline bearing configurations. A small amount of lubricant transfer was observed on the tested bearing components.
4. The addition of Bray 601 to the cage pockets significantly reduces the heat generation in a baseline bearing. A good quantity of grease remains on the cage after testing.
5. Optical microscopy showed no significant damage or surface distress to the bearing components during testing.

REFERENCES

1. Dolan, F.J., Gibson H.G., and Cannon, J.L.: "Cryogenic High Speed Turbopump Bearing Cooling Requirements." 1988 Conference on Advanced Earth-to-Orbit Propulsion Technology, MSFC, Huntsville, AL, May 1988.
2. Gleeson, J.B., and Kannel, J.W.: "Evaluation of Transfer Films From Fluoroloy-C to 440C for HPOTP Bearing Cage Applications." NASA Contract Task Report 2, Contract No. NAS8-37813, 1989.
3. McMurtrey, E.L.: "Lubrication for the Space Industry." NASA Technical Memorandum, TM-86556, December 1985.

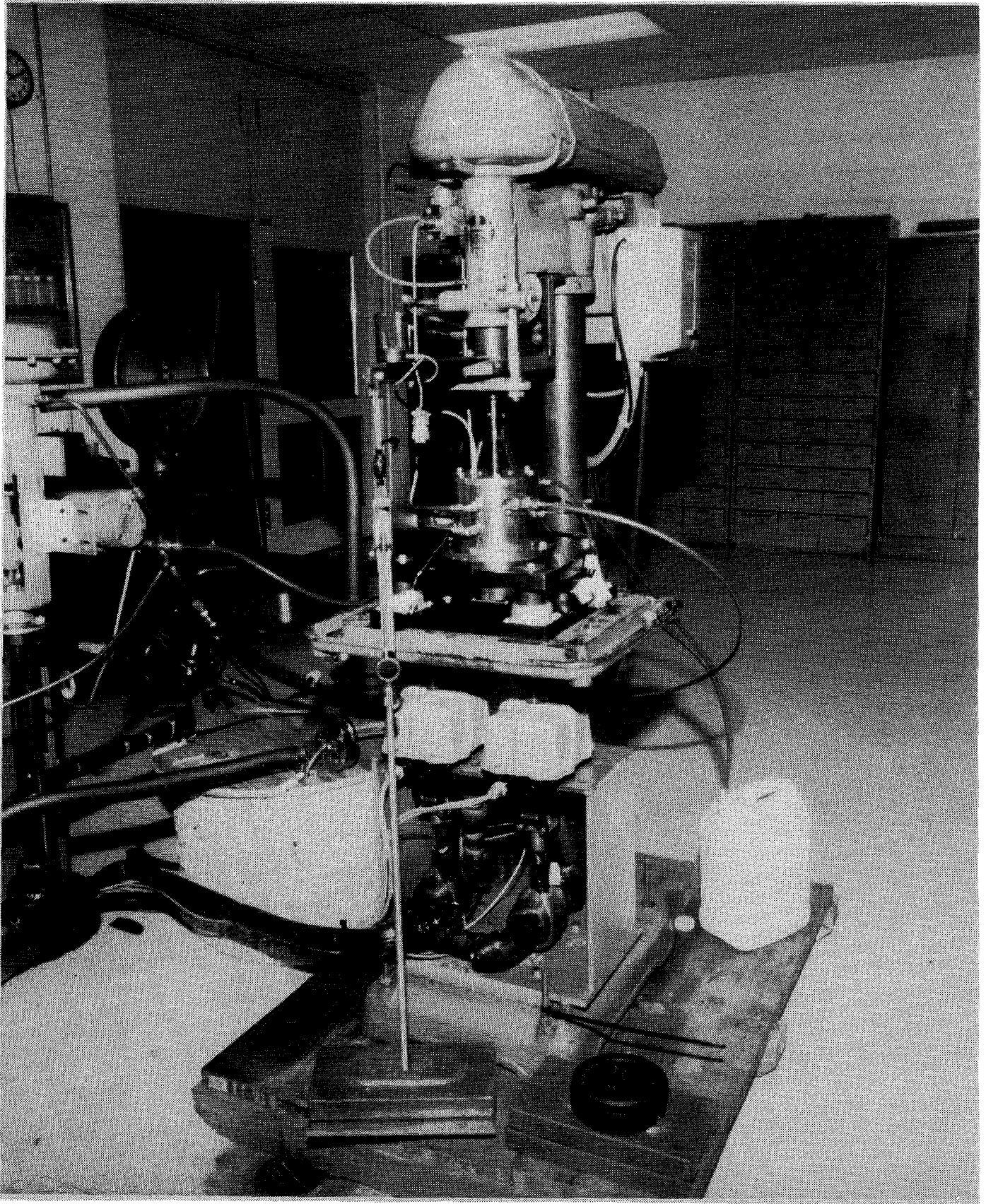

Figure 1. Single bearing tester.

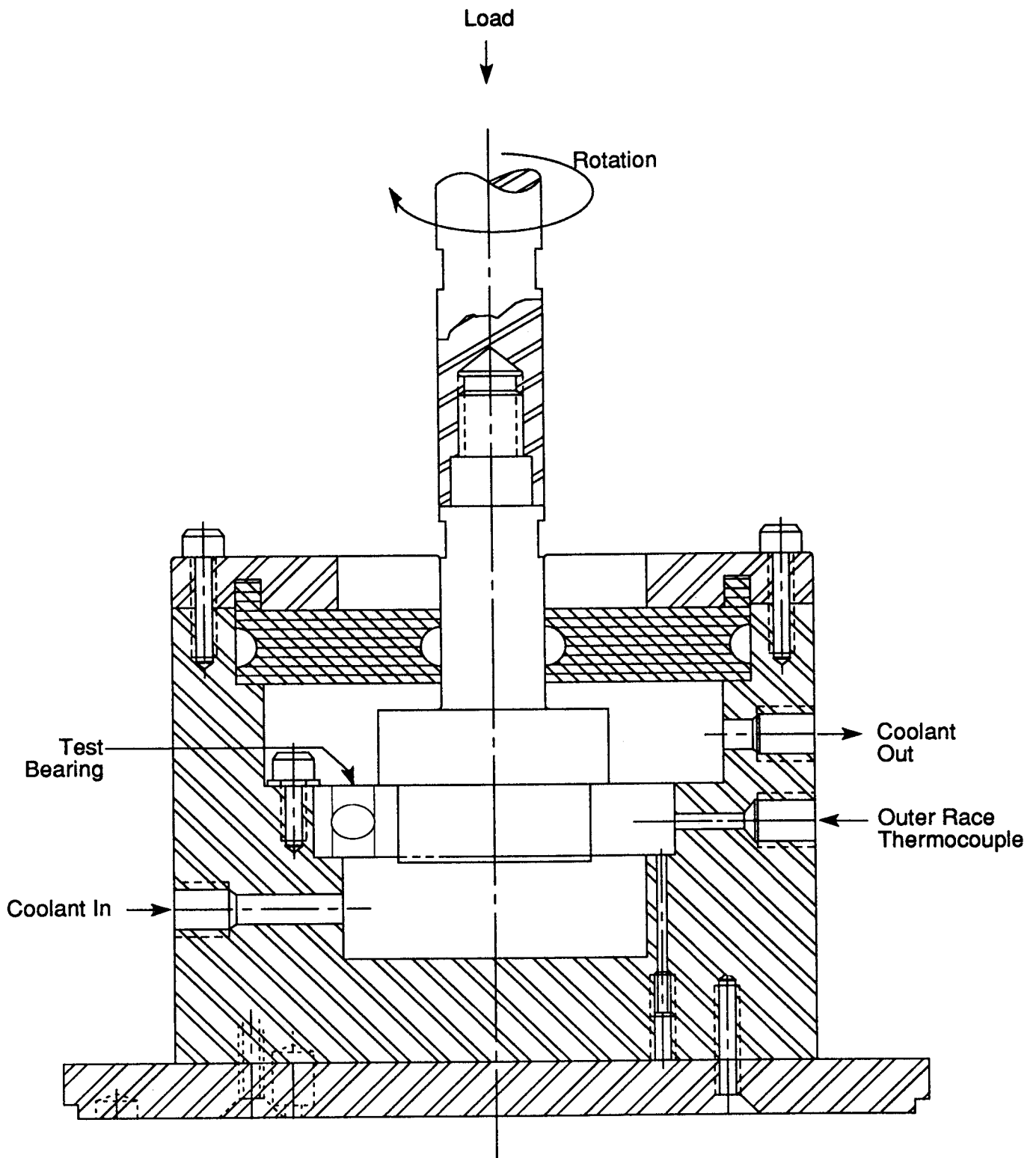

Figure 2. Cross section of the single bearing tester.

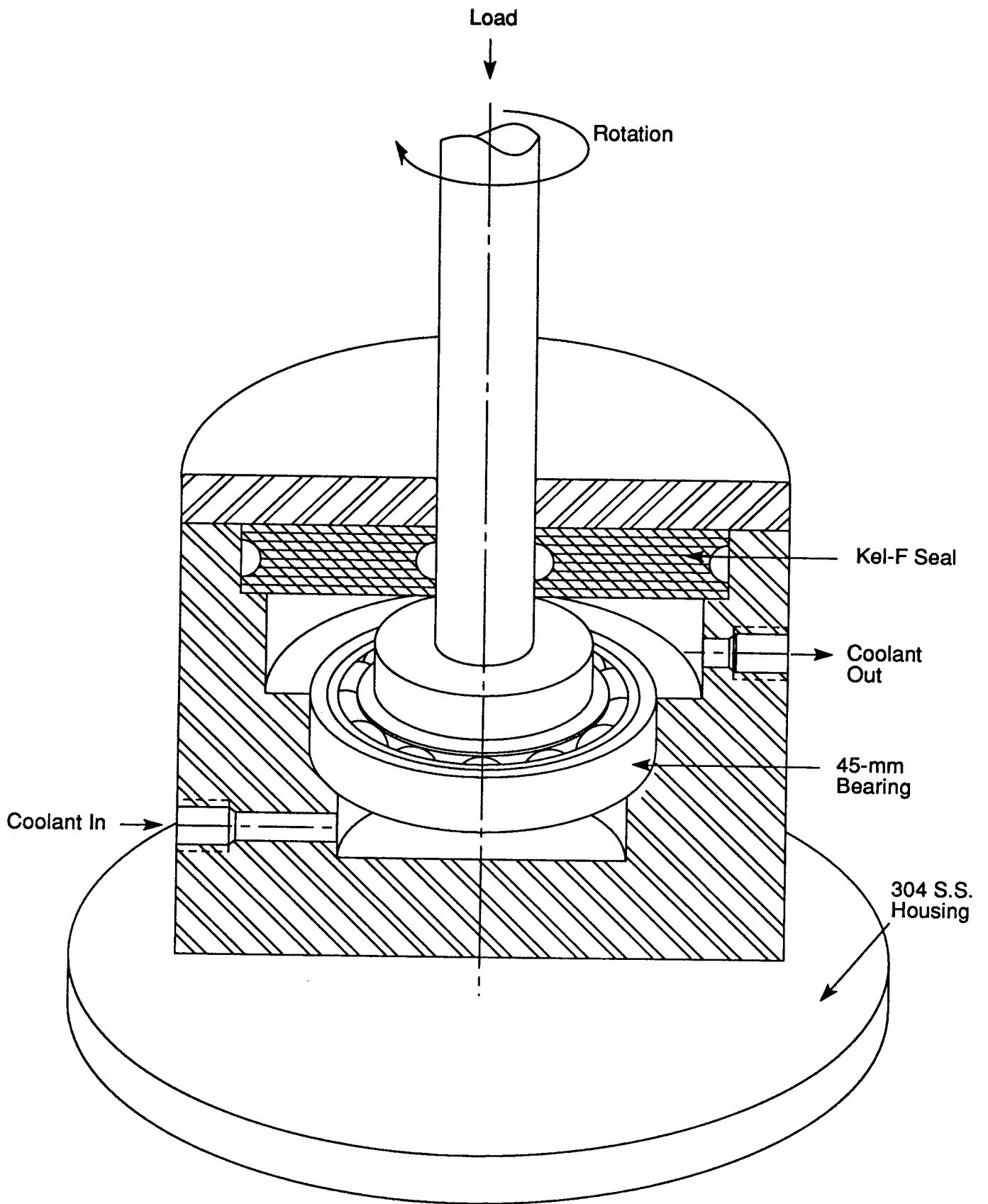

Figure 3. Isometric drawing of the single bearing tester.

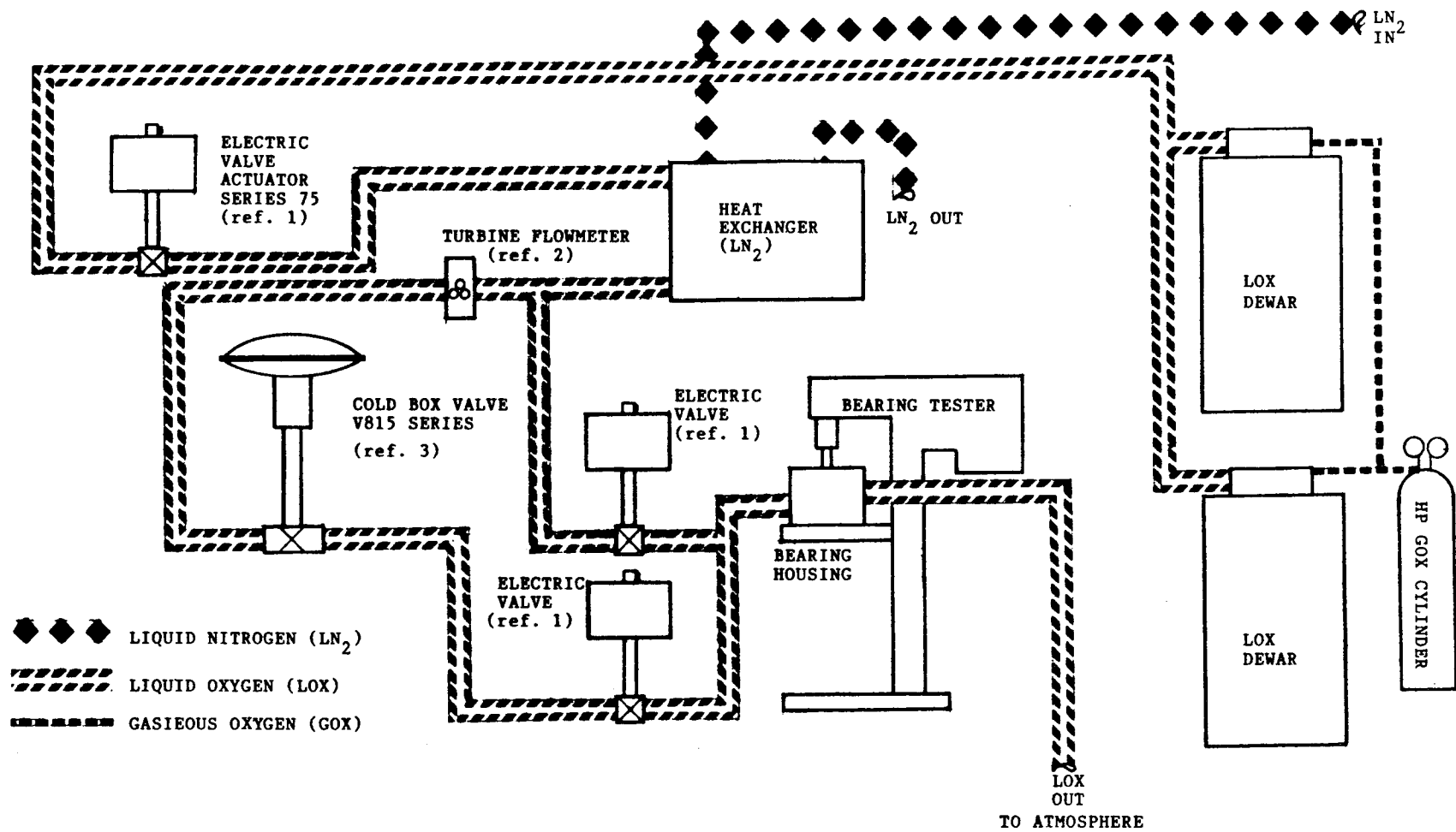

Figure 4. Schematic of the single bearing tester system.

N949-3
ARMALON CAGE

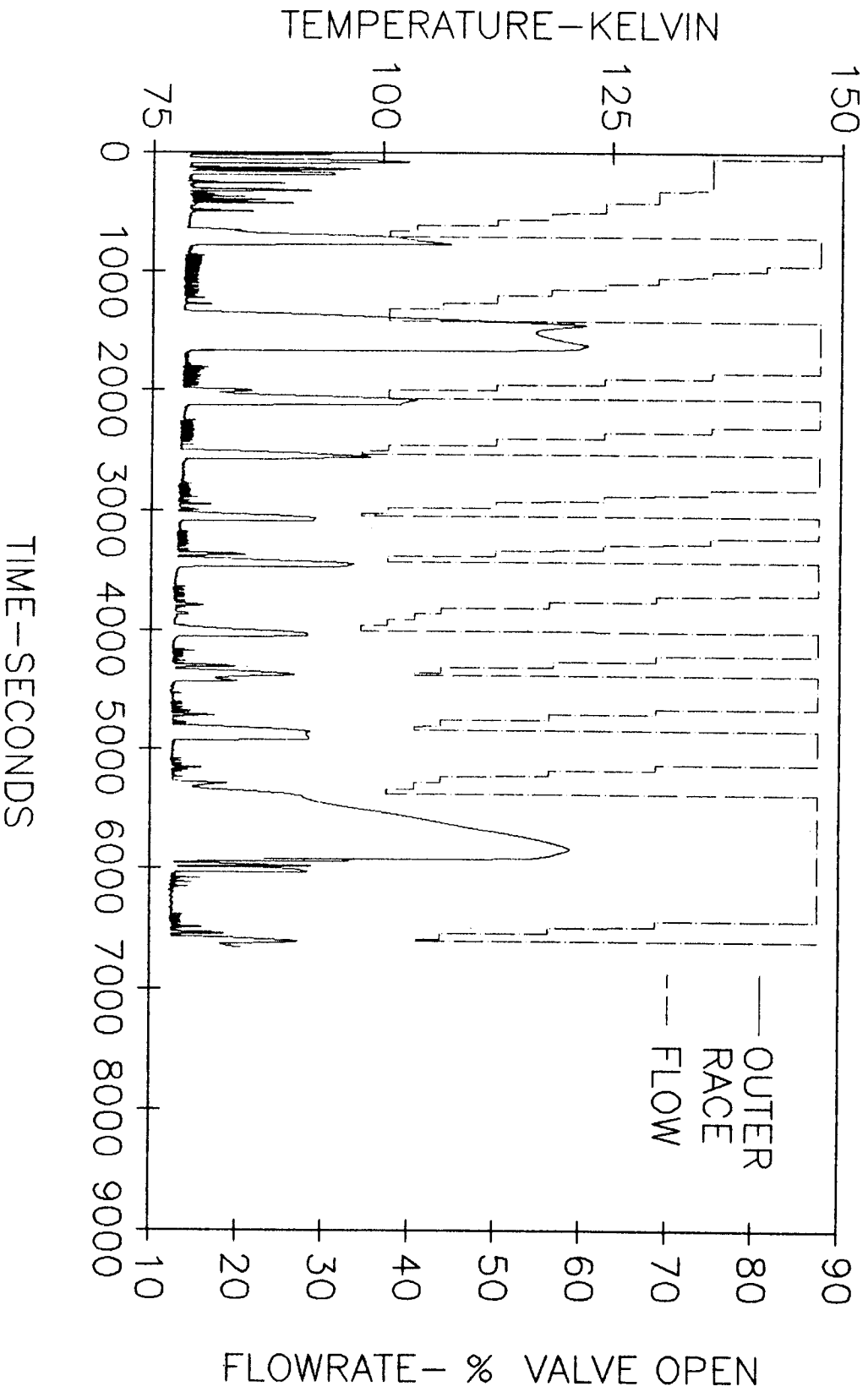

Figure 5. Test number N949-3, baseline configuration.

N949-5
SALOX/M CAGE

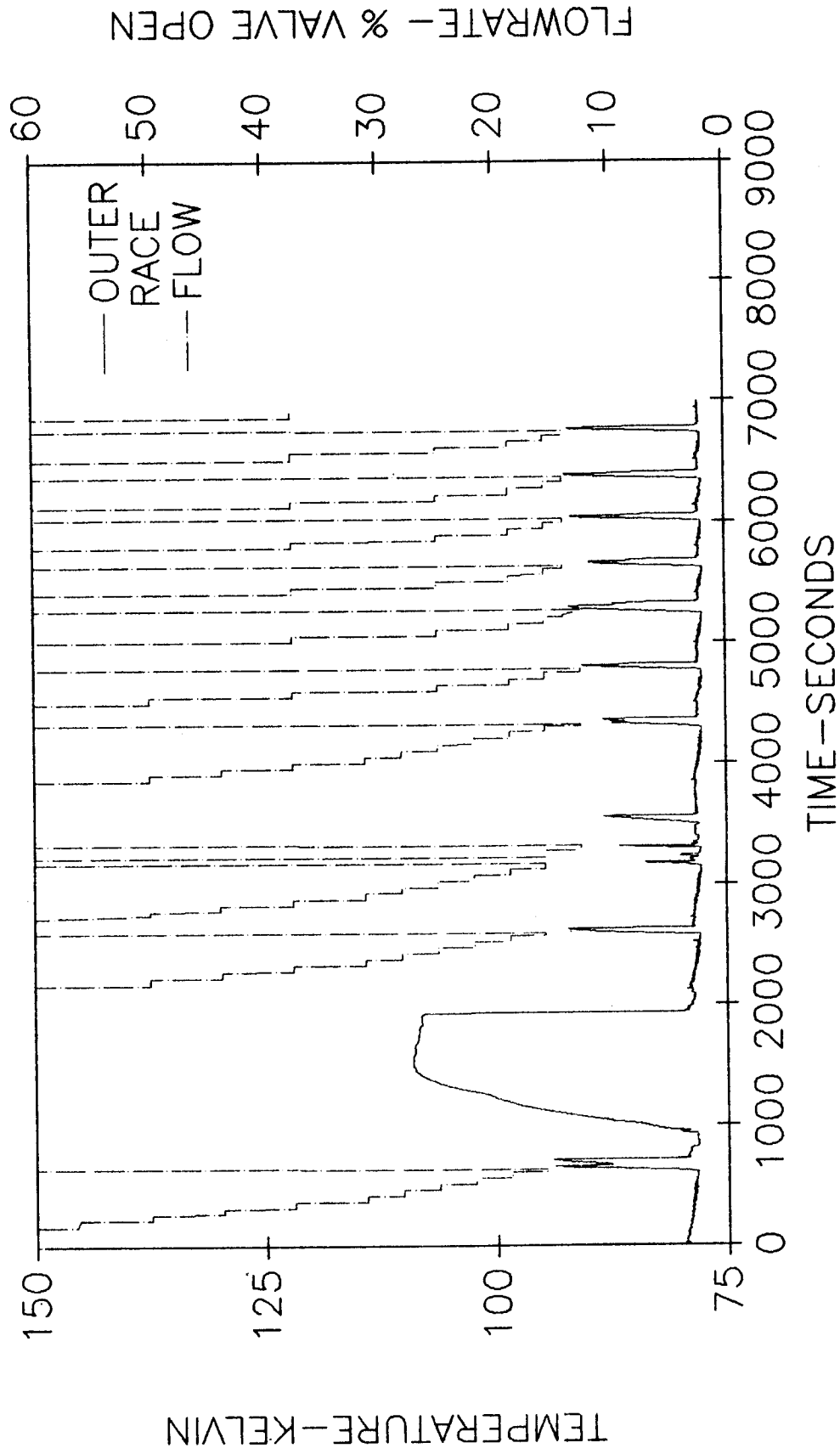

Figure 6. Test number N949-5, Salox/M cage configuration.

N949-6
SALOX/M CAGE

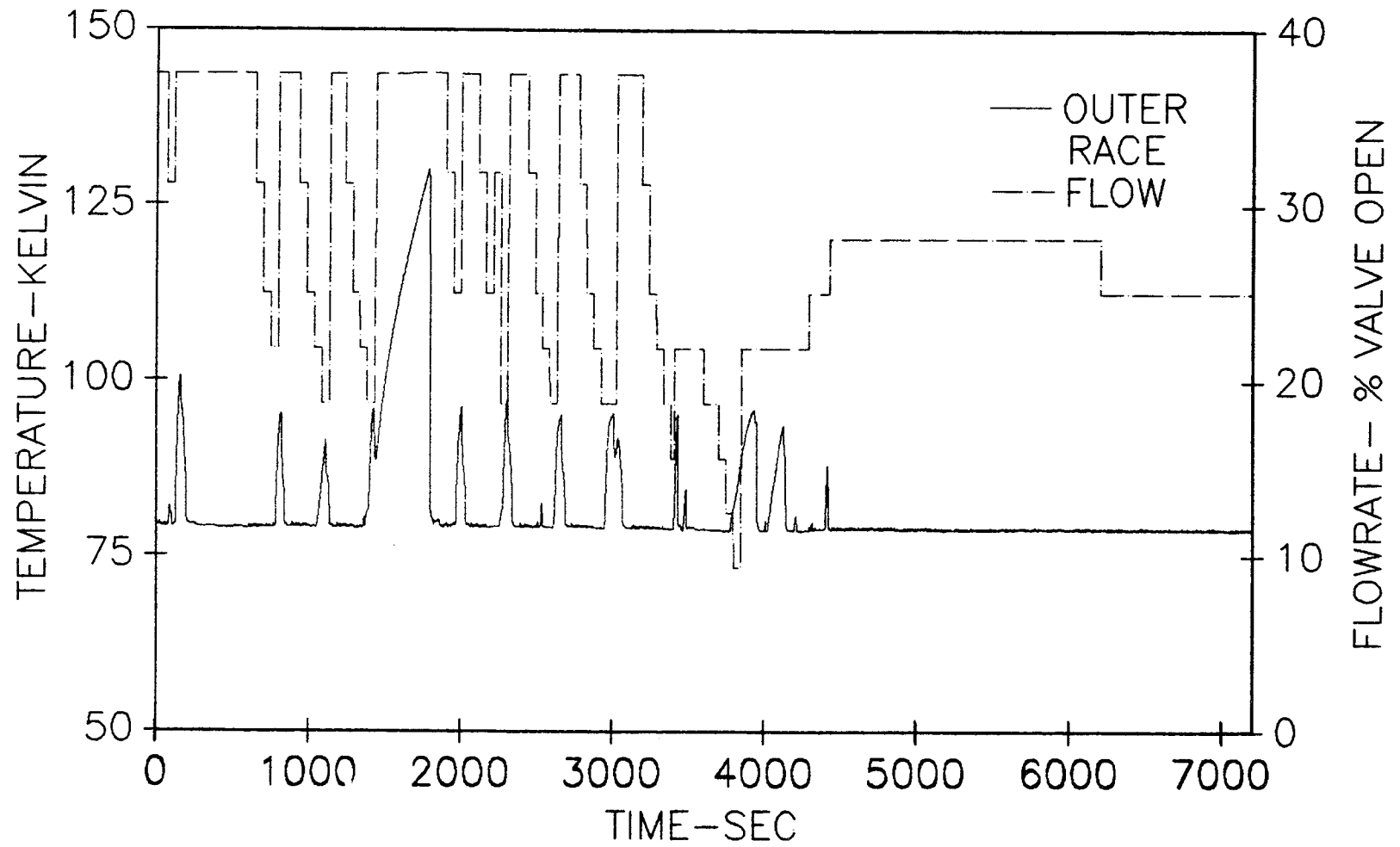

Figure 7. Test number N949-6, Salox/M cage configuration.

N949-7
SALOX/M CAGE

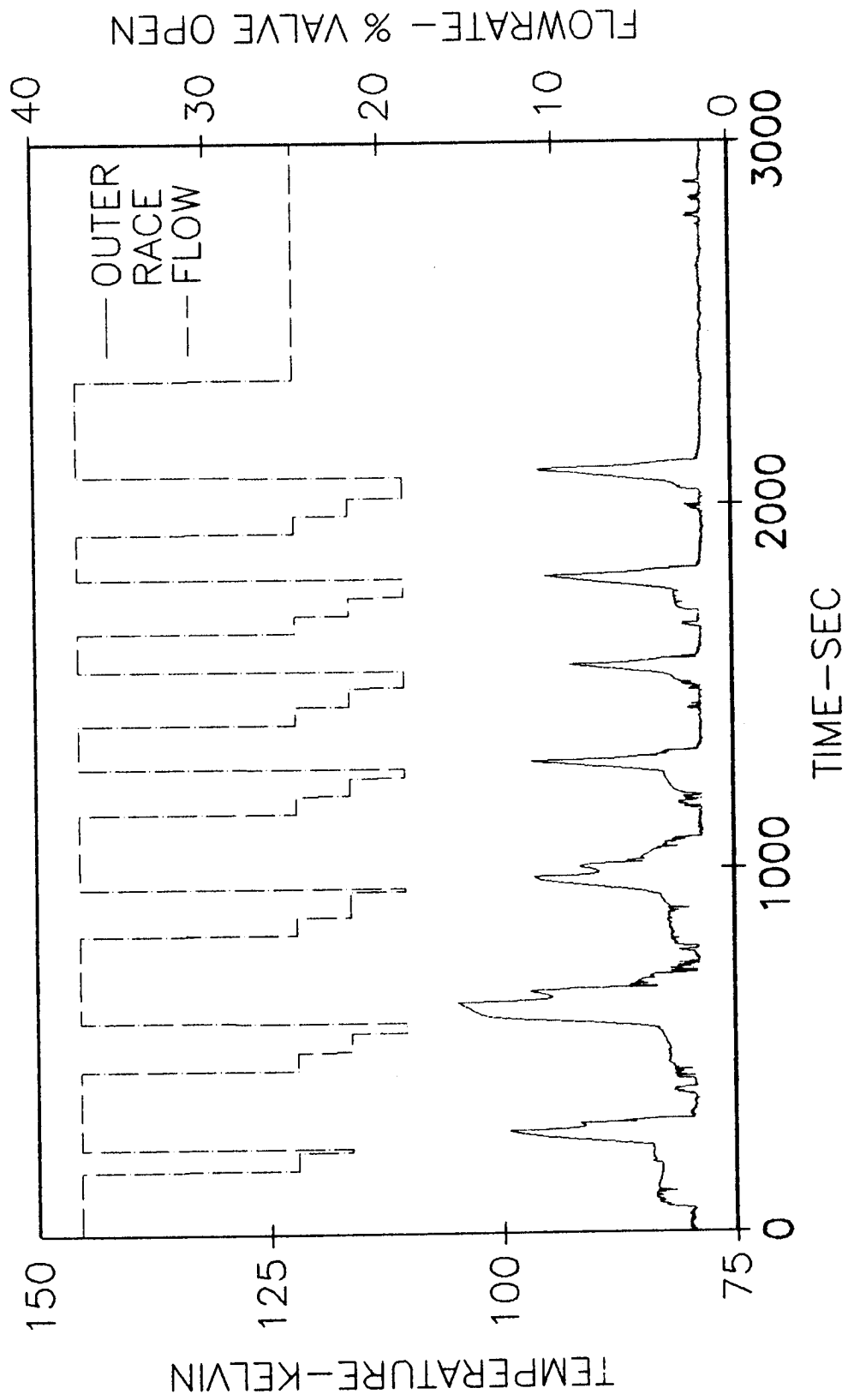

Figure 8. Test number N949-7, Salox/M cage configuration.

N949-9
ARMALON CAGE

Figure 9. Test number N949-9, baseline configuration.

N949-10
ARMALON CAGE WITH ELONGATED BALL POCKETS

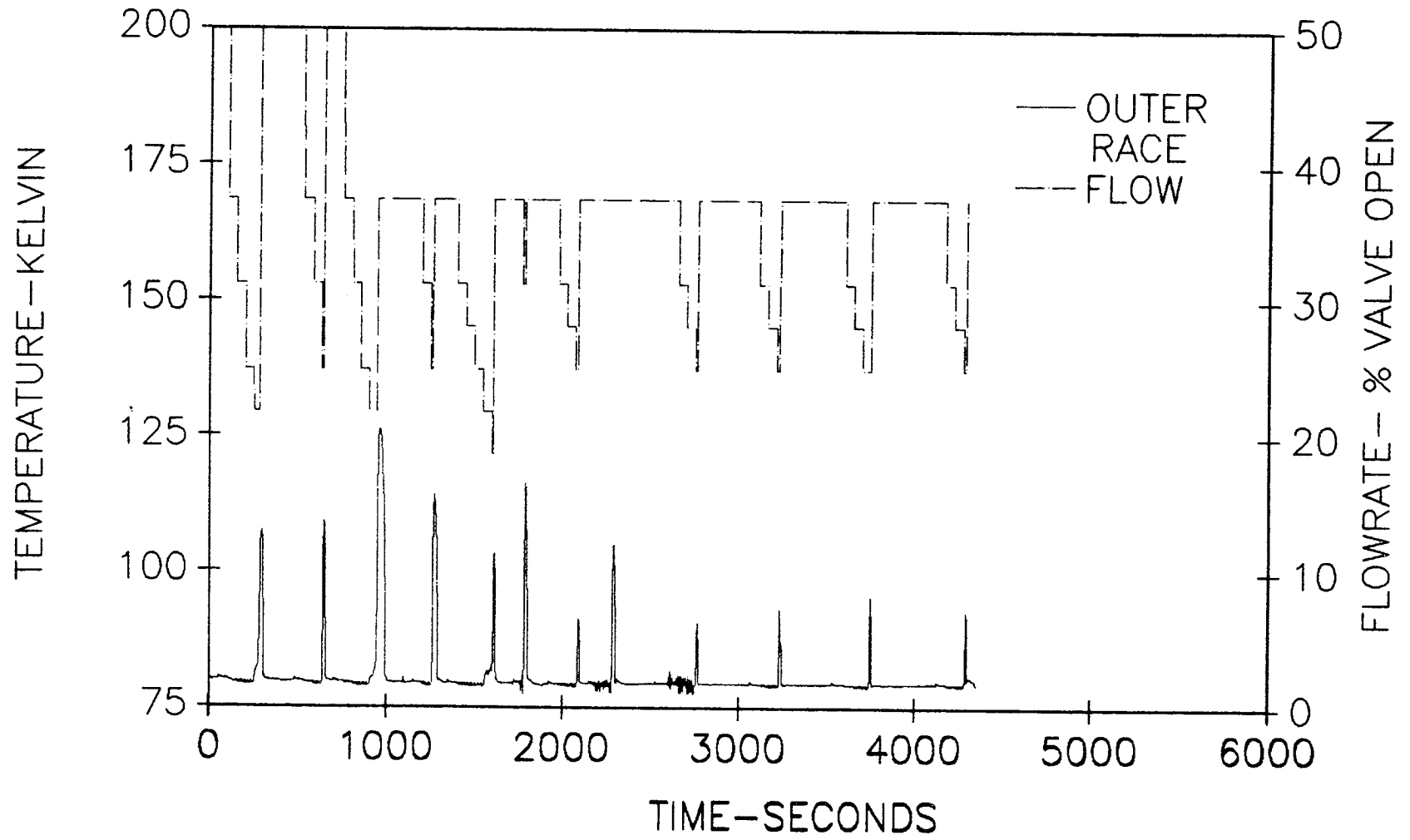
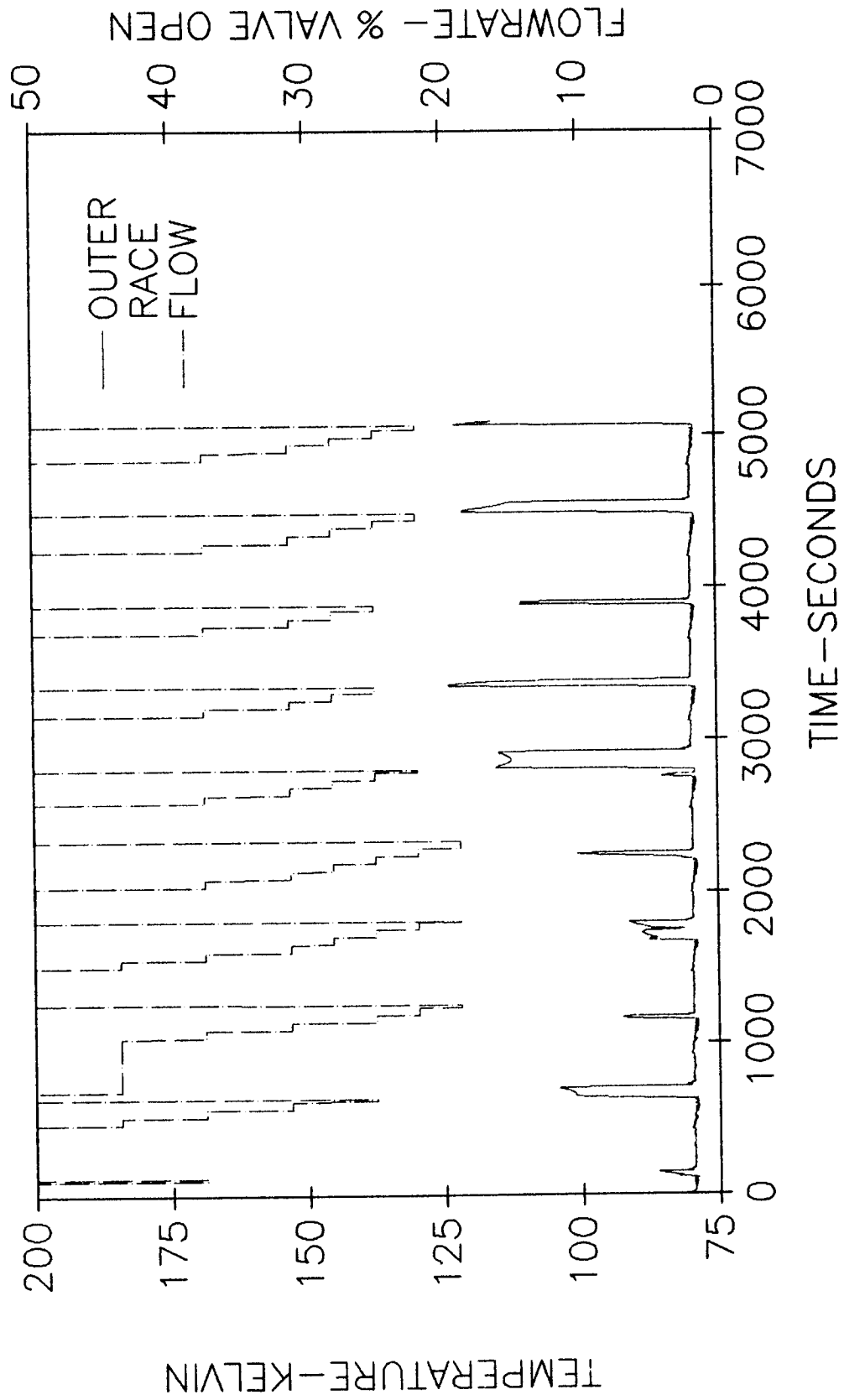

Figure 10. Test number N949-10, elongated cage configuration.

N949-11
ARMALON CAGE WITH SILICON NITRIDE BALLS

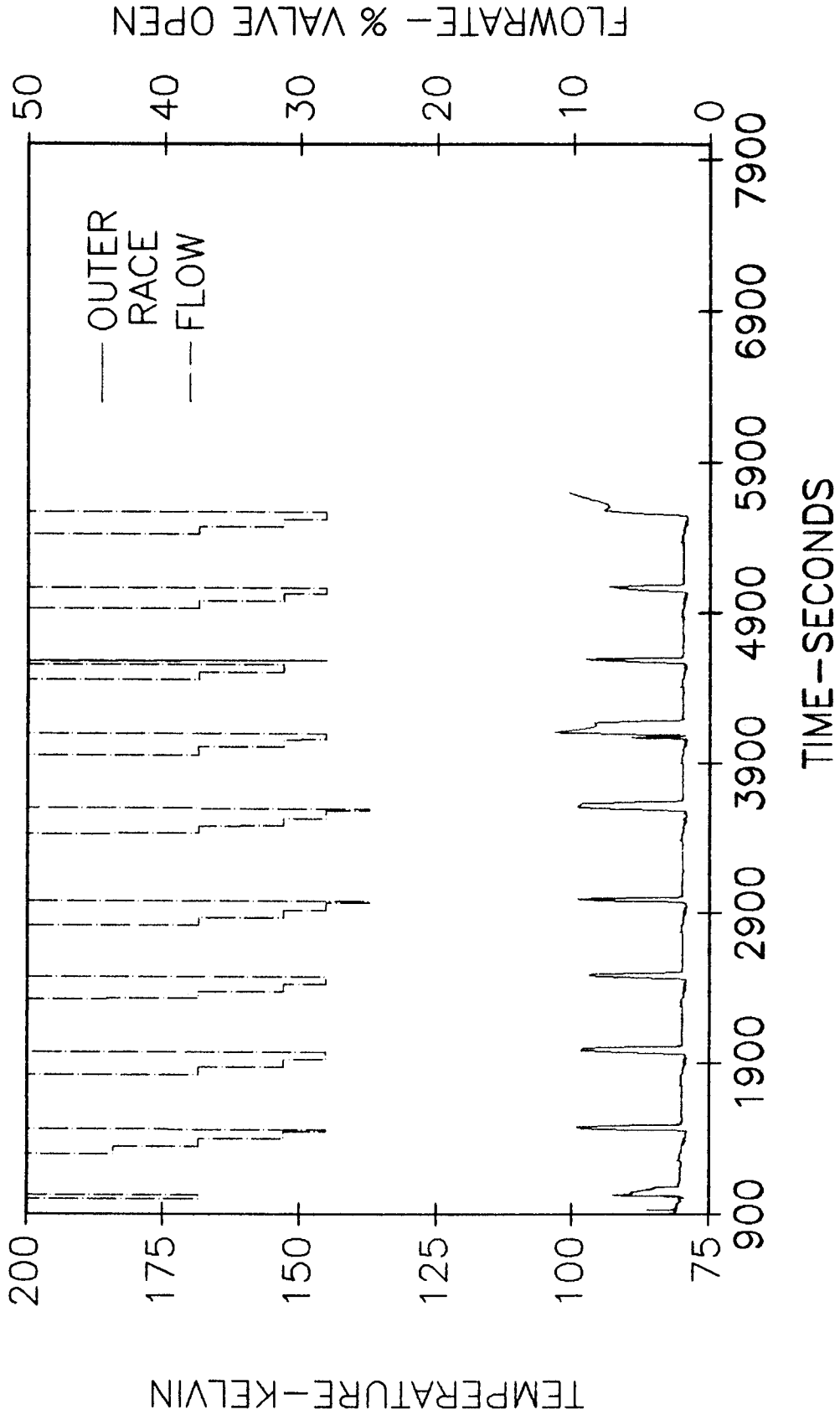

Figure 11. Test number N949-11, silicon nitride balls configuration.

N949-12
ARMALON CAGE WITH BRAY 601 GREASE

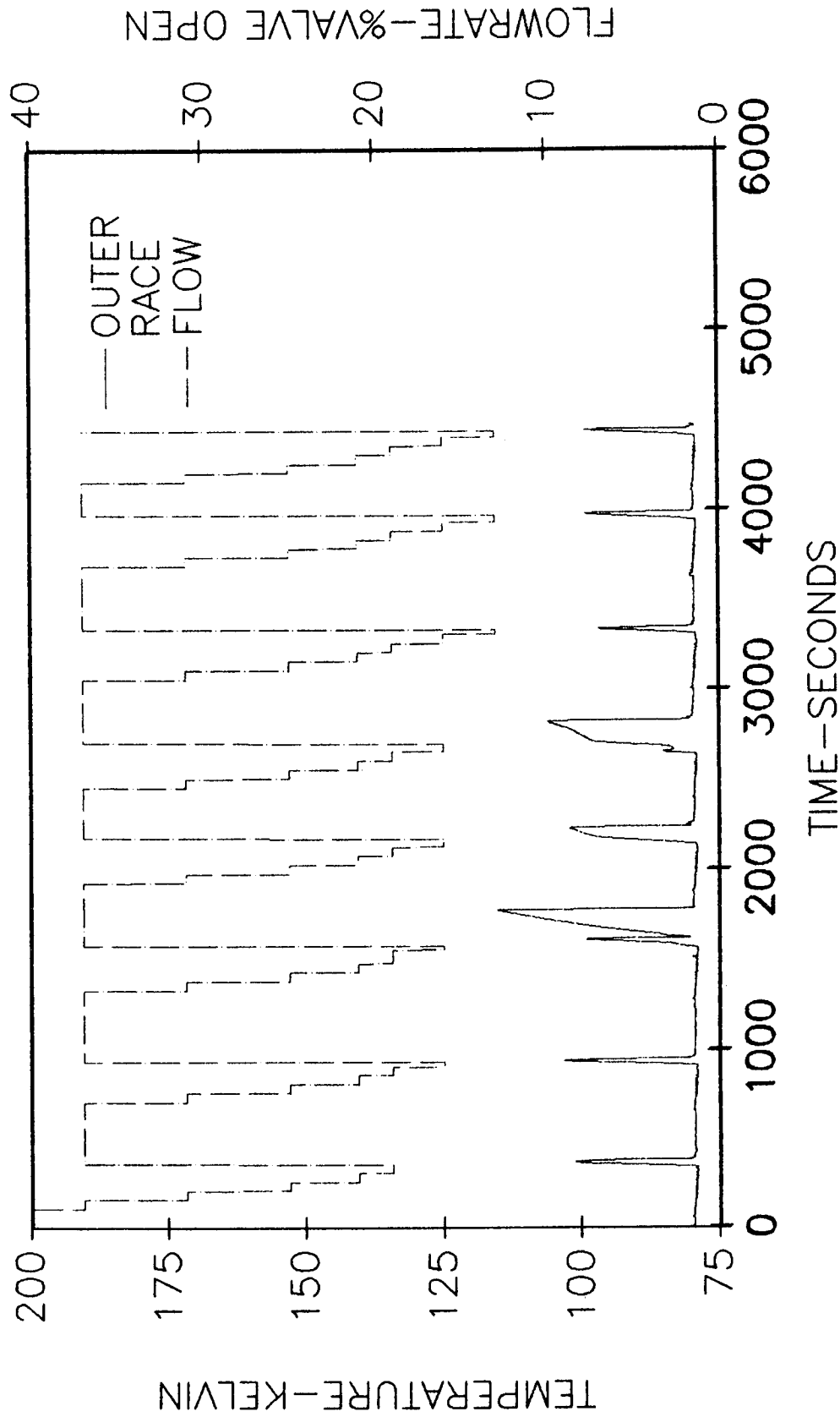

Figure 12. Test number N949-12, Bray 601 grease configuration.

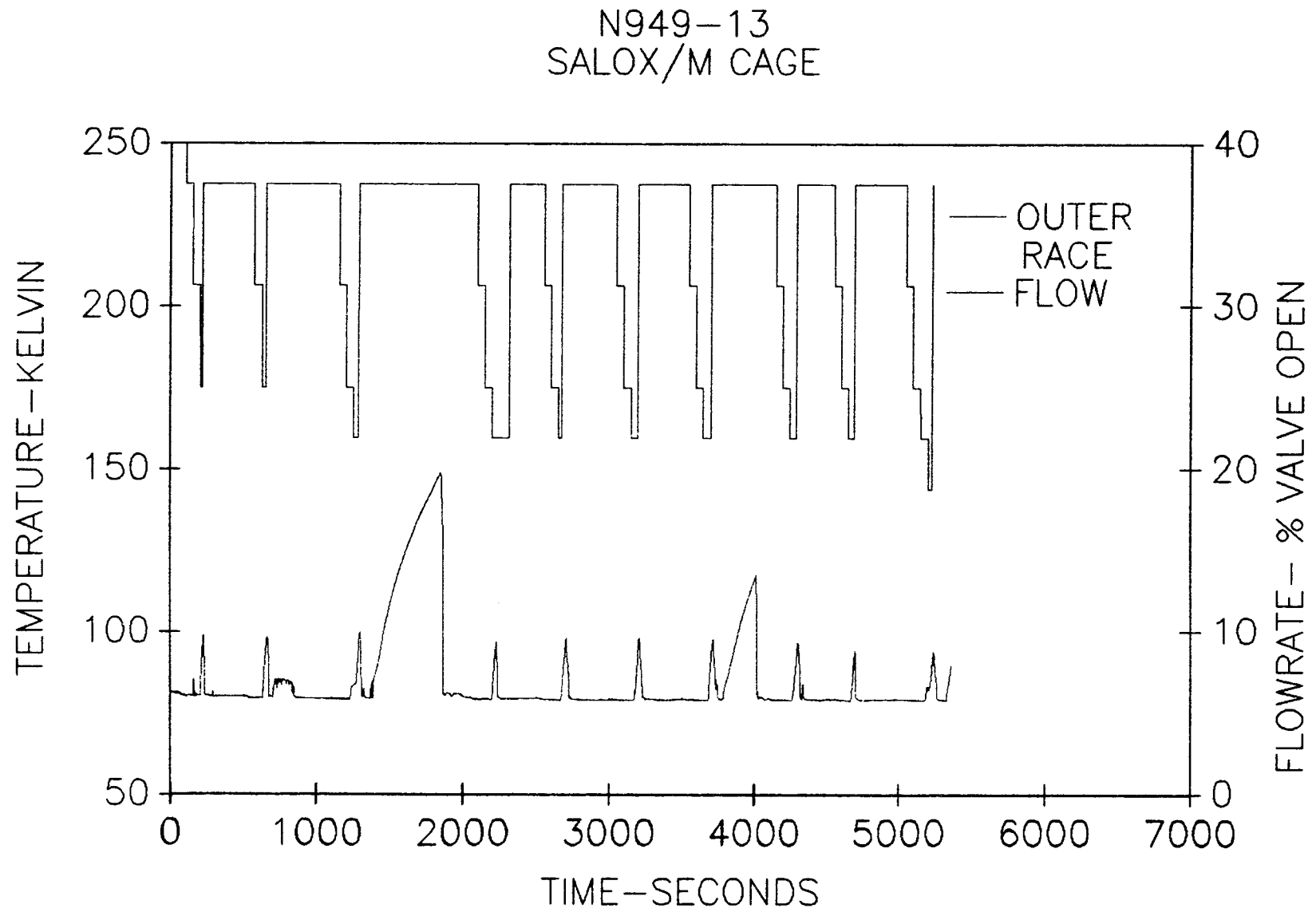

Figure 13. Test number N949-13, Salox/M cage configuration.

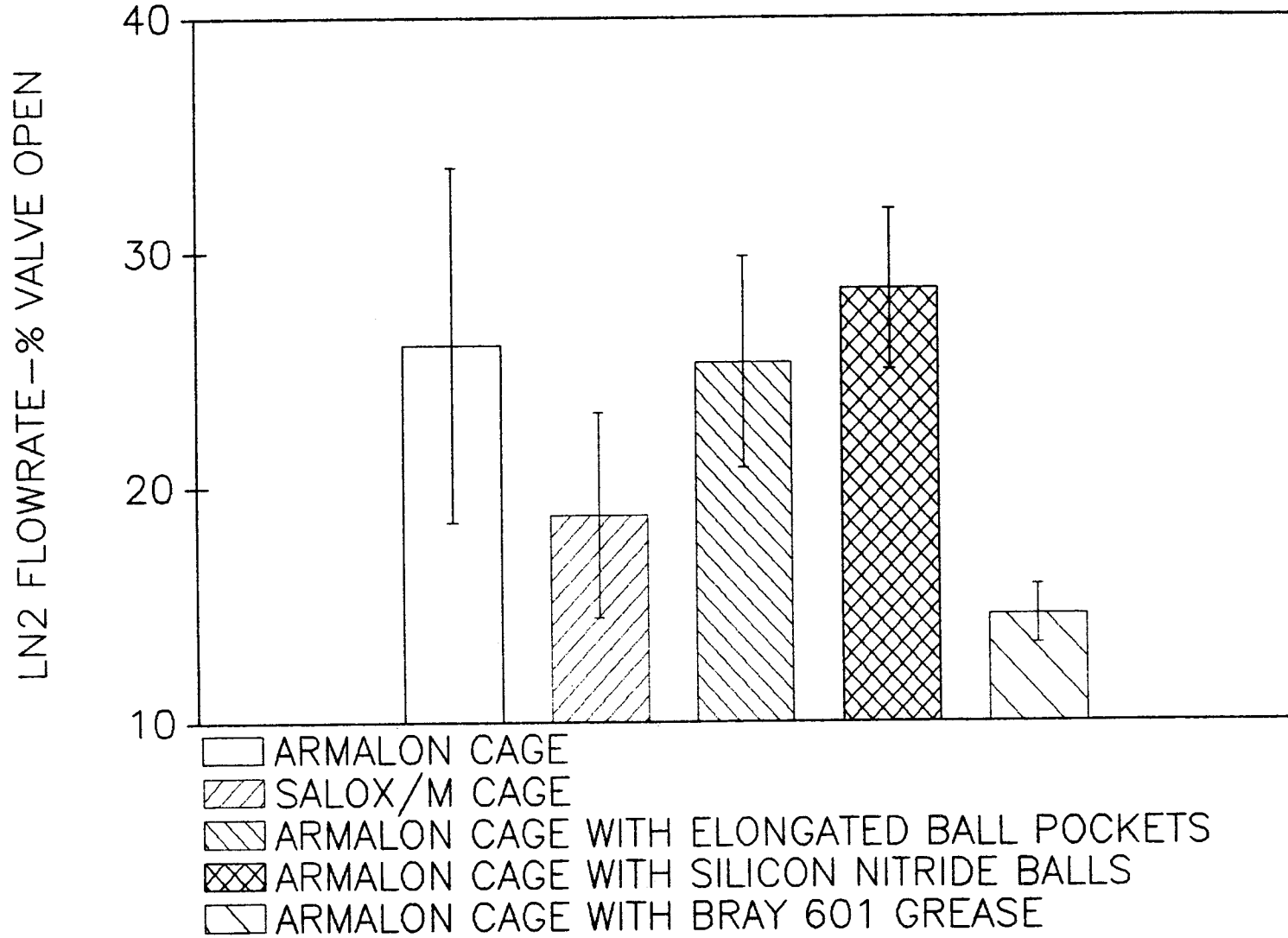

Figure 14. Summary of critical flowrate test results of various bearing configurations.
 (Armalon cage with Bray 601 grease performed the best.)

ORIGINAL PAGE
BLACK AND WHITE PHOTOGRAPH

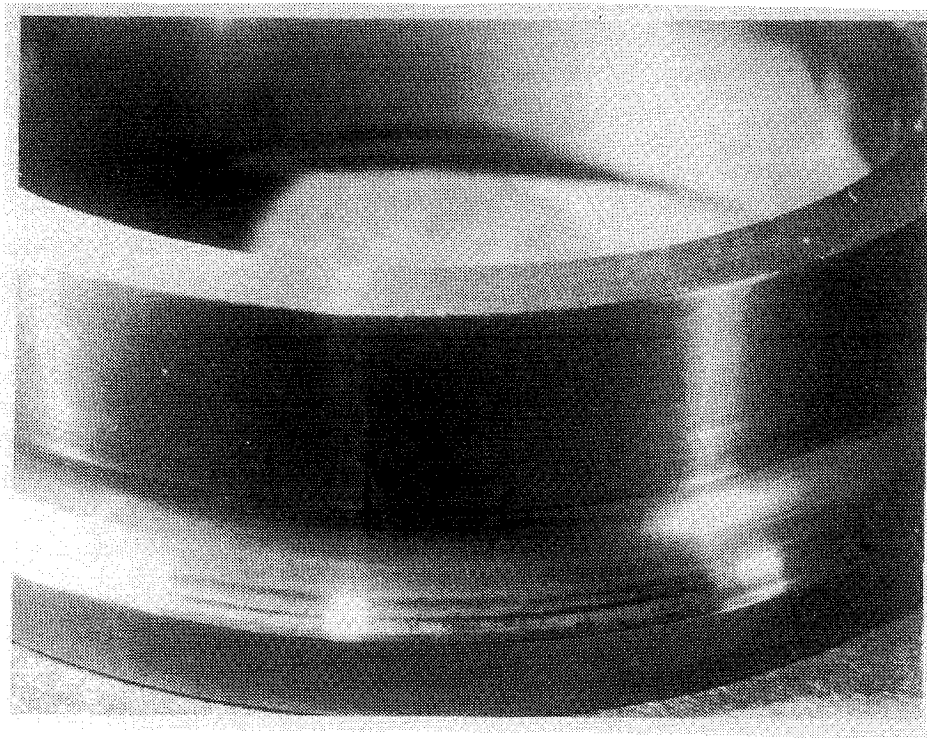

Figure 15. Inner race after complete test series.

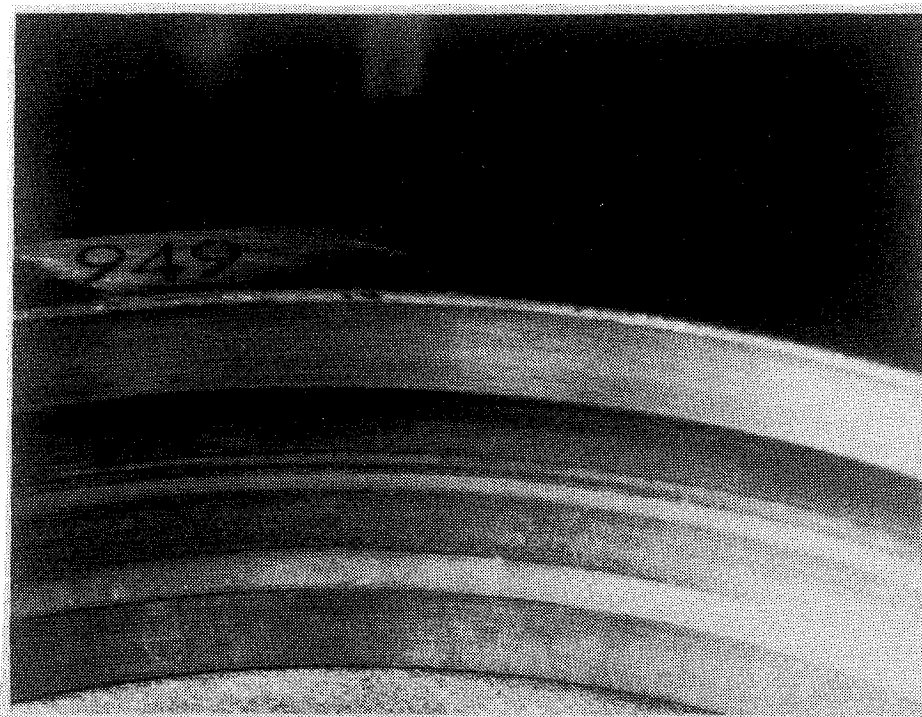

Figure 16. Outer race after complete test series.

ORIGINAL PAGE
BLACK AND WHITE PHOTOGRAPH

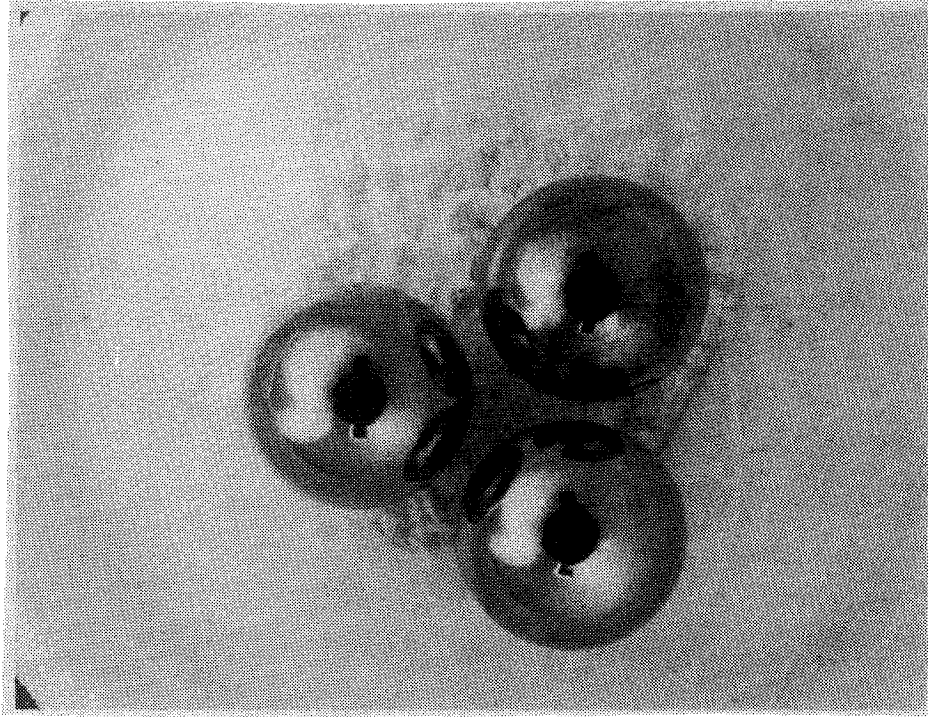

Figure 17. 440C balls used in all tests except test number N949-11.

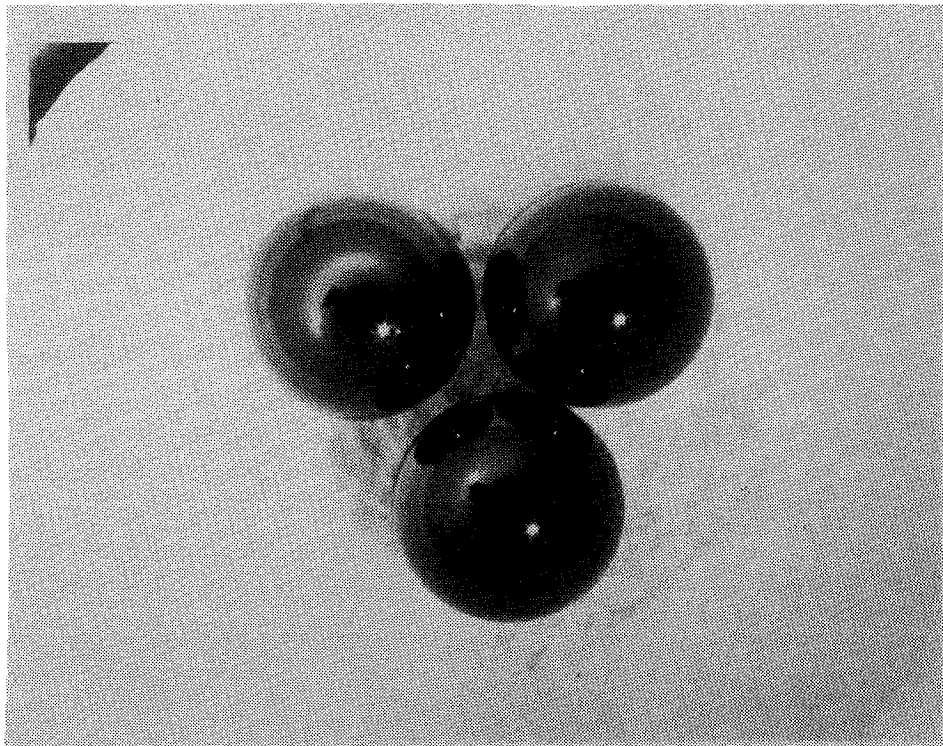

Figure 18. Silicon nitride balls after test number N949-11.

ORIGINAL PAGE
BLACK AND WHITE PHOTOGRAPH

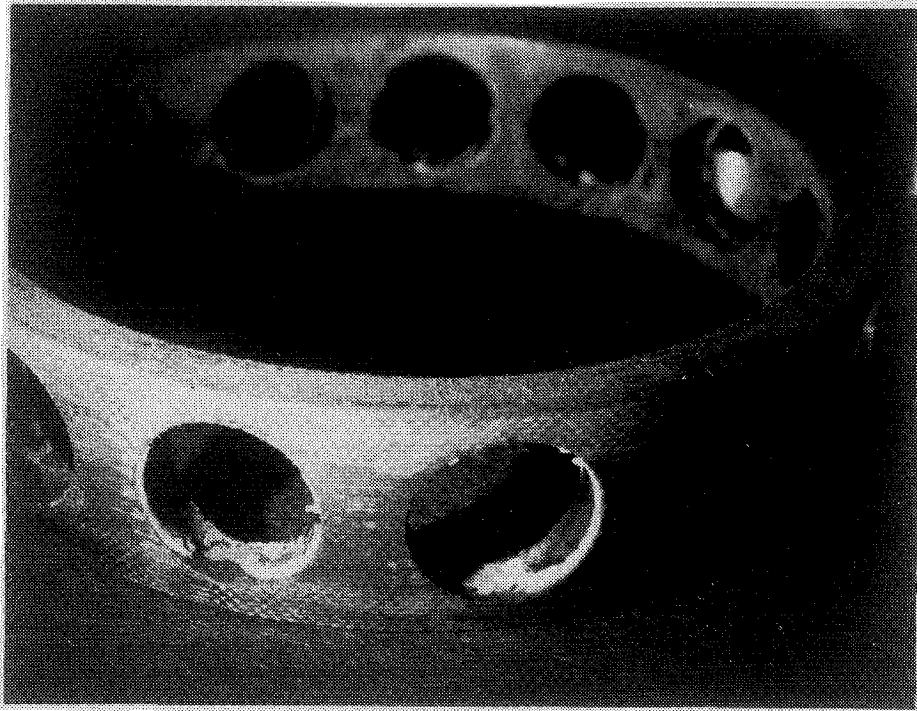

Figure 19. Baseline Armalon cage after test number N949-12 (notice the grease that remains in ball pockets).

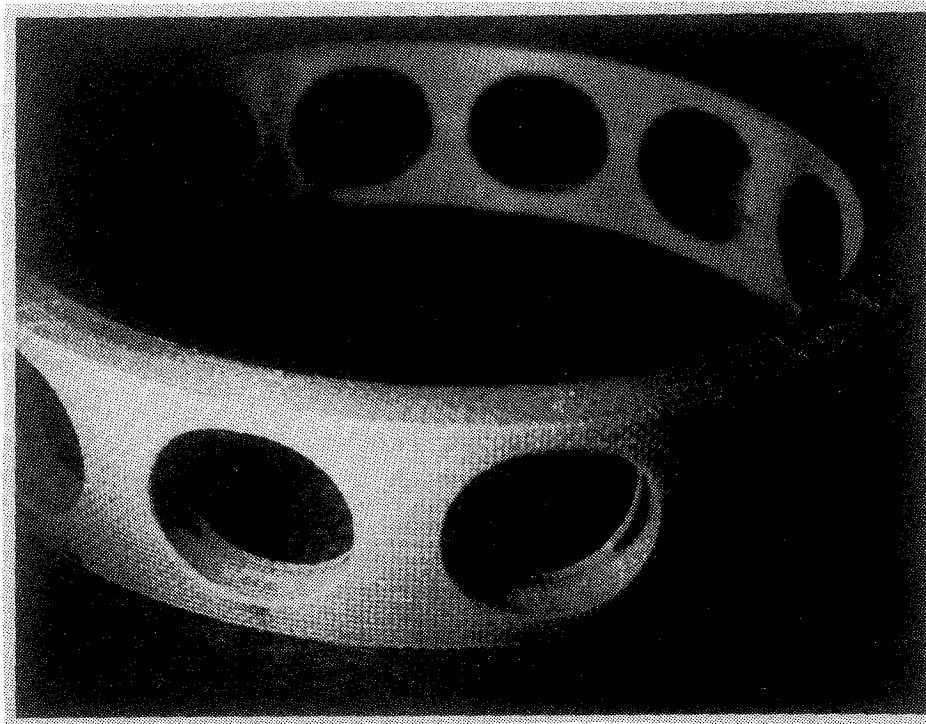

Figure 20. Armalon cage with elongated ball pockets after test number N949-10 (notice the mild wear scars in the ball pockets).

ORIGINAL PAGE
BLACK AND WHITE PHOTOGRAPH

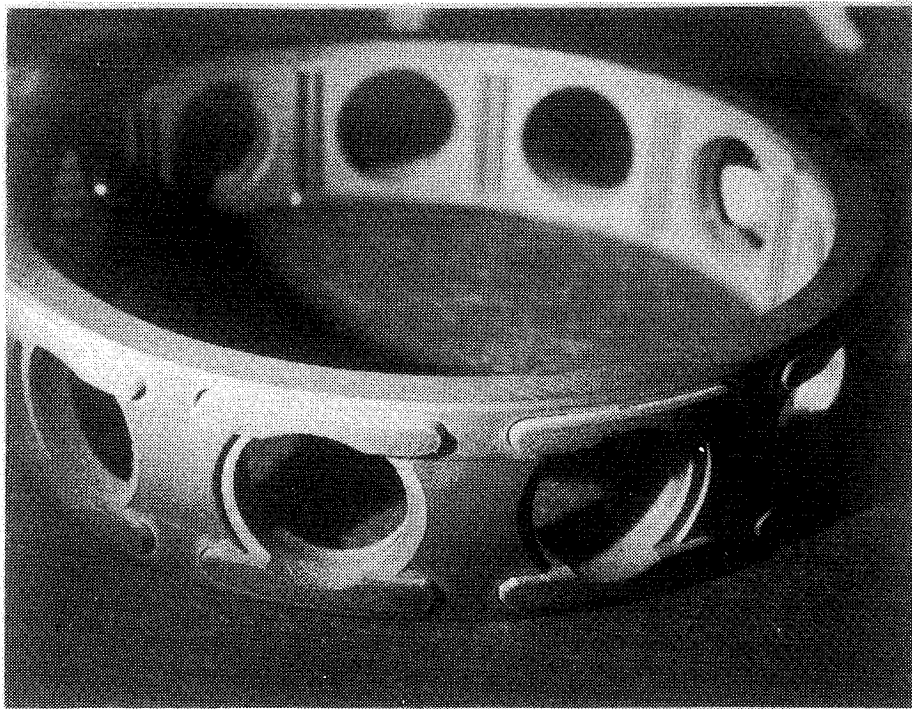

Figure 21. Salox/M cage used in test numbers N949-4, N949-5, N949-7, and N949-13 (notice the mild wear scar in the ball pocket).

Table 1. Summary of individual tests.

<u>Rank</u>	<u>Test No.</u>	<u>Bearing Configuration</u>	<u>Flowrate Percent Open</u>	<u>Standard Deviation</u>
1	N949-5	Salox/M cage	13.7	1.2
2	N949-12	Bray 601 grease	14.6	1.6
3	N949-7	Salox/M cage	19.2	1.2
4	N949-6	Salox/M cage	21.1	4.3
5	N949-13	Salox/M cage	21.9	2.0
6	N949-9	Baseline	24.5	3.5
7	N949-10	Elongated cage	25.3	4.5
8	N949-3	Baseline	25.5	8.5
9	N949-4	Baseline	27.9	9.2
10	N949-11	Silicon nitride ball	28.4	3.4

Table 2. Summary of bearing configurations.

<u>Rank</u>	<u>Bearing Configurations</u>	<u>Flowrate Percent Open</u>	<u>Standard Deviation</u>
1	Bray 601 grease	14.6	1.2
2	Salox/M cage	18.8	4.4
3	Elongated cage	25.3	4.5
4	Baseline	26.0	7.6
5	Silicon nitride ball	28.4	3.4

Table 3. Wear measurements of test balls.

<u>Ball No.</u>	440C Balls Average Diameter (mm)		Silicon Nitride Balls Average Diameter (mm)	
	<u>Before</u>	<u>After</u>	<u>Before</u>	<u>After</u>
1	11.1120	11.1120	11.1150	11.1168
2	11.1120	11.1120	11.1150	11.1168
3	11.1120	11.1120	11.1152	11.1165
4	11.1120	11.1120	11.1155	11.1168
5	11.1120	11.1120	11.1153	11.1168
6	11.1120	11.1114	11.1153	11.1168
7	11.1120	11.1120	11.1120	11.1168
8	11.1127	11.1120	11.1158	11.1165
9	11.1122	11.1118	11.1150	11.1165
10	11.1120	11.1120	11.1153	11.1168
11	11.1127	11.1122	11.1153	11.1168
12	11.1127	11.1127	11.1153	11.1165
13	11.1127	11.1127	11.1158	11.1168

APPENDIX

*** PC-SHABERTH, a personal computer program of SKF AEROSPACE BEARINGS ***

Single Bearing Tester - Elongated Ball Pockets

INPUT PREPARED BY : Jett

DATE OF EXECUTION : 8/23/90

THIS DATA SET CONTAINS 1 BEARING

BEARING NO. (1) - BALL BEARING

SOLUTION LEVEL = 1

*** PC-SHABERTH, a personal computer program of SKF AEROSPACE BEARINGS ***

Single Bearing Tester - Elongated Ball Pockets

UNLESS OTHERWISE STATED, LINEAR DIMENSIONS ARE SPECIFIED IN INCHES, TEMPERATURES IN DEGREES FAHRENHEIT, FORCES AND WEIGHTS IN POUNDS, PRESSURES AND ELASTIC MODULI IN POUNDS PER SQUARE INCH, ANGLES AND SLOPES IN DEGREES, SURFACE ROUGHNESS IN MICROINCHES, SPEEDS IN REVOLUTIONS PER MINUTE, DENSITY IN POUNDS PER CUBIC INCH, KINEMATIC VISCOSITY IN INCHES SQUARED PER SECOND AND THERMAL CONDUCTIVITY IN BRITISH THERMAL UNITS PER HOUR-FOOT-DEGREE FAHRENHEIT

BEARING NUMBER	NUMBER OF ROLLING ELEMENTS	AZIMUTH ANGLE ORIENTATION	PITCH DIAMETER	DIAMETRAL CLEARANCE	CONTACT ANGLE	INNER RING SPEED	OUTER RING SPEED
1	12	30.000	3.3000	.00400	15.000	10000.	0.

C A G E D A T A

BEARING NUMBER	CAGE TYPE	CAGE POCKET CLEARANCE	RAIL-LAND WIDTH	RAIL-LAND DIAMETER	RAIL-LAND CLEARANCE	WEIGHT
1	OUTER RING LAND RIDING	.024500	.0850	2.8260	.009000	.041000

S T E E L D A T A

BRG.NO.	INNER RING TYPE	LIFE FACTOR	OUTER RING TYPE	LIFE FACTOR
1	STANDARD BRG STEEL	1.000	STANDARD BRG STEEL	1.000

*** PC-SHABERTH, a personal computer program of SKF AEROSPACE BEARINGS ***

Single Bearing Tester - Elongated Ball Pockets

ROLLING ELEMENT DATA

BEARING NUMBER (1) TYPE - BALL BEARING

BALL DIAMETER	OUTER RACEWAY CURVATURE	INNER RACEWAY CURVATURE
.4375	.5200	.5300

*** PC-SHABERTH, a personal computer program of SKF AEROSPACE BEARINGS ***

Single Bearing Tester - Elongated Ball Pockets

S U R F A C E D A T A

BEARING NUMBER	CLA ROUGHNESS			RMS ASPERITY SLOPE		
	OUTER	INNER	ROLL. ELM.	OUTER	INNER	ROLL. ELM.
1	1.00	1.00	1.00	2.000	2.000	2.000

L U B R I C A T I O N A N D F R I C T I O N D A T A

BEARING 1 IS OPERATING DRY WITH FRICTION COEFFICIENTS OF, RACE/R.E. .200 CAGE/R.E. AND CAGE/RING .200

*** PC-SHABERTH, a personal computer program of SKF AEROSPACE BEARINGS ***

Single Bearing Tester - Elongated Ball Pockets

FIT DATA AND MATERIAL PROPERTIES

BEARING NUMBER	COLD FITS (MM TIGHT)		EFFECTIVE WIDTHS			
	SHAFT	HOUSING	SHAFT	INNER RING	OUTER RING	HOUSING
1	.0002	.0002	1.3340	.6670	.6670	1.3340

BEARING NUMBER	SHAFT I.D.	BEARING BORE	EFFECTIVE DIAMETERS			
			INNER RING AVE. O.D.	OUTER RING AVE. I.D.	BEARING O.D.	HOUSING O.D.
1	.000	1.771	2.045	3.064	3.303	6.000

BEARING NUMBER (1)	SHAFT	INNER RING	ROLL. ELEM.	OUTER RING	HOUSING
MODULUS OF ELASTICITY	29600000.	29600000.	29600000.	29600000.	29600000.
POISSONS RATIO	.3000	.3000	.3000	.3000	.3000
WEIGHT DENSITY	.2820	.2820	.2820	.2820	.2820
COEFF. OF THERMAL EXP.	.00000680	.00000680	.00000680	.00000680	.00000680

UNLESS OTHERWISE STATED, ENGLISH UNITS ARE USED

GIVEN TEMPERATURES

BRG	O.RACE	I.RACE	BULK OIL	FLNG.1	FLNG.2	FLNG.3	FLNG.4	CAGE	SHAFT	I.RING	ROLL.EL.	O.RING	HSG.
1	-310.00	-310.00	-320.00	.00	.00	.00	.00	-310.00	-300.00	-310.00	-300.00	-320.00	-300.00

*** PC-SHABERTH, a personal computer program of SKF AEROSPACE BEARINGS ***

Single Bearing Tester - Elongated Ball Pockets

SHAFT GEOMETRY, BEARING LOCATIONS AND SHAFT LOAD, PLANE X - Y.

2 GEOMETRIC SECTIONS 1 LOAD SECTION(S), 1 BEARINGS. MODULUS OF ELASTICITY = 2.960E+07

POSITION	INNER DIAM.		OUTER DIAM.		POINT FORCE	POINT MOMENT	LOAD INTENSITY		BEARING SEAT				
	LEFT	RIGHT	LEFT	RIGHT			LEFT	RIGHT	POS.ERR	DEFL/FOR	ANG.ERR	DEFL/MOM	
1	.00	.00	.00	1.77	1.77				1	.00000	.00E+00	.0000	.00E+00
2	1.33	.00	.00	1.77	1.77				2				

*** PC-SHABERTH, a personal computer program of SKF AEROSPACE BEARINGS ***

Single Bearing Tester - Elongated Ball Pockets

SHAFT GEOMETRY, BEARING LOCATIONS AND SHAFT LOAD, PLANE X - Z.

2 GEOMETRIC SECTIONS 1 LOAD SECTION(S), 1 BEARINGS. MODULUS OF ELASTICITY = 2.960E+07

THRUST LOAD = 5.000E+02

	POSITION	INNER DIAM.		OUTER DIAM.		POINT FORCE	POINT MOMENT	LOAD INTENSITY		BEARING SEAT				
		LEFT	RIGHT	LEFT	RIGHT			LEFT	RIGHT	POS.ERR	DEFL/FOR	ANG.ERR	DEFL/MOM	
1	.00	.00	.00	1.77	1.77					1	.00000	.00E+00	.0000	.00E+00
2	1.33	.00	.00	1.77	1.77					2				

*** PC-SHABERTH, a personal computer program of SKF AEROSPACE BEARINGS ***

Single Bearing Tester - Elongated Ball Pockets

BEARING SYSTEM OUTPUT ENGLISH UNITS

LINEAR (IN) AND ANGULAR (RADIAN) DEFLECTIONS

REACTION FORCES (LB) AND MOMENTS (IN-LB)

BRG.	DX	DY	DZ	GY	GZ	FX	FY	FZ	MY	MZ
1	5.453E-03	.000E+00	.000E+00	.000E+00	.000E+00	4.998E+02	.000E+00	.000E+00	.000E+00	.000E+00

FATIGUE LIFE (HOURS)

H/SIGMA

LUBE-LIFE FACTOR

MATERIAL FACTOR

BRG.	O. RACE	I. RACE	BEARING	O. RACE	I. RACE	O. RACE	I. RACE	O. RACE	I. RACE
1	1.324E+04	1.743E+03	1.593E+03	.000E+00	.000E+00	1.000E+00	1.000E+00	1.000E+00	1.000E+00

TEMPERATURES RELEVANT TO BEARING PERFORMANCE (DEGREES FAHRENHEIT)

BRG	O.RACE	I.RACE	BULK OIL	FLNG.1	FLNG.2	FLNG.3	FLNG.4	CAGE	SHAFT	I.RING	ROLL.EL.	O.RING	HSG.
1	-310.00	-310.00	-320.00	.00	.00	.00	.00	-310.00	-300.00	-310.00	-300.00	-320.00	-300.00

*** PC-SHABERTH, a personal computer program of SKF AEROSPACE BEARINGS ***

Single Bearing Tester - Elongated Ball Pockets

BEARING SYSTEM OUTPUT ENGLISH UNITS

BEARING STIFFNESSES (LB/IN, IN-LB/RAD, AND LB/RAD)

BEARING 1	DFY	DFZ	DMY	DMZ	DFX
DY	.0000E+00	.0000E+00	.0000E+00	.0000E+00	.0000E+00
DZ	.0000E+00	.0000E+00	.0000E+00	.0000E+00	.0000E+00
DGY	.0000E+00	.0000E+00	.0000E+00	.0000E+00	.0000E+00
DGZ	.0000E+00	.0000E+00	.0000E+00	.0000E+00	.0000E+00
DX	.0000E+00	.0000E+00	.0000E+00	.0000E+00	.9369E+06

*** PC-SHABERTH, a personal computer program of SKF AEROSPACE BEARINGS ***

Single Bearing Tester - Elongated Ball Pockets

BEARING SYSTEM OUTPUT ENGLISH UNITS

FRICIONAL HEAT GENERATION RATE (BTU/HR) AND FRICTION TORQUE (LB-IN)

BRG.	O. RACE	O. FLNGS.	I. RACE	I. FLNGS.	R.E.DRAG	R.E.-CAGE	CAGE-LAND	TOTAL	TORQUE
1	1.581E+02	.000E+00	6.795E+02	.000E+00	.000E+00	.000E+00	2.075E+00	8.397E+02	2.079E+00

EHD FILM THICKNESS, FILM REDUCTION FACTORS AND HEAT CONDUCTIVITY DATA FOR THE OUTER AND INNER RACEWAYS RESPECTIVELY

BRG.	FILM (MICRO IN)	STARVATION FACTOR	THERMAL FACTOR	MENISCUS DIST. (IN)	CONDUCTIVITY (B/HR/DEG.F)
1	.000E+00	.000E+00	.000E+00	.000E+00	1.120E+01 9.175E+00

FIT PRESSURES (PSI) BEARING CLEARANCES (IN) SPEED GIVING ZERO FIT PRESSURE

BRG.	SHAFT-COLD, OPER.	HSG.-COLD, OPER.	ORIGINAL	CHANGE	OPERATING	SHAFT-INNER RING (RPM)
1	4.369E+02	9.616E+02	1.269E+02	.000E+00	4.000E-03 -4.141E-04	3.586E-03 3.409E+04

CAGE DATA ENGLISH UNITS

CAGE RAIL - RING LAND DATA

CAGE SPEED DATA

BRG.	TORQUE (IN-LB)	HEAT RATE (BTU/HR)	SEP.FORCE (POUNDS)	ECCENTRICITY RATIO	EPICYCLIC SPEED (RAD/SEC)	(RPM)	CALCULATED SPEED (RAD/SEC)	(RPM)	CALC/EPIC RATIO	CAGE/SHAFT RATIO
1	-1.159E-02	2.075E+00	4.181E-02	3.414E-01	4.649E+02	4.439E+03	4.649E+02	4.439E+03	1.000E+00	4.439E-01

** PC-SHABERTH, a personal computer program of SKF AEROSPACE BEARINGS ***

Single Bearing Tester - Elongated Ball Pockets

R O L L I N G E L E M E N T O U T P U T F O R B E A R I N G N U M B E R 1 E N G L I S H U N I T S

AZIMUTH	ANGULAR SPEEDS (RADIAN/SECOND)				SPEED VECTOR ANGLES (DEGREES)				
ANGLE (DEG.)	WX	WY	WZ	TOTAL	ORBITAL	TAN-1(WY/WX)	TAN-1(WZ/WX)	SPIN TO ROLL OR / IR	
30.00	-3571.737	1625.562	.000	3924.252	464.868	155.53	-180.00	.0000	/ .1771

*** PC-SHABERTH, a personal computer program of SKF AEROSPACE BEARINGS ***

Single Bearing Tester - Elongated Ball Pockets

ROLLING ELEMENT OUTPUT FOR BEARING NUMBER 1 ENGLISH UNITS

AZIMUTH ANGLE (DEG.)	NORMAL FORCES (POUNDS)			HZ STRESS (LB/IN**2)		LOAD RATIO QASP/QTOT		CONTACT ANGLES (DEG.)	
	CAGE	OUTER	INNER	OUTER	INNER	OUTER	INNER	OUTER	INNER
30.00	.000	89.842	79.906	184989.000	218239.200	1.0000	1.0000	27.62	31.42

*** PC-SHABERTH, a personal computer program of SKF AEROSPACE BEARINGS ***

Single Bearing Tester - Elongated Ball Pockets

R O L L I N G E L E M E N T O U T P U T F O R B E A R I N G N U M B E R 1 E N G L I S H U N I T S

	<===== OUTER RACE CONTACT =====>			<===== INNER RACE CONTACT =====>		
AZIMUTH	REQUIRED			REQUIRED		
ANGLE	SEMI-MAJOR	SEMI-MINOR	RACEWAY	SEMI-MAJOR	SEMI-MINOR	RACEWAY
(DEG.)	AXIS (IN)	AXIS (IN)	DEPTH (IN)	AXIS (IN)	AXIS (IN)	DEPTH (IN)
30.00	.4189E-01	.5535E-02	.4879E-01	.3486E-01	.5014E-02	.5441E-01

*** PC-SHABERTH, a personal computer program of SKF AEROSPACE BEARINGS ***

Single Bearing Tester - baseline armalon cage

INPUT PREPARED BY : Jett

DATE OF EXECUTION : 8/23/90

THIS DATA SET CONTAINS 1 BEARING

BEARING NO. (1) - BALL BEARING

SOLUTION LEVEL = 1

*** PC-SHABERTH, a personal computer program of SKF AEROSPACE BEARINGS ***

Single Bearing Tester - baseline armalon cage

UNLESS OTHERWISE STATED, LINEAR DIMENSIONS ARE SPECIFIED IN INCHES, TEMPERATURES IN DEGREES FAHRENHEIT, FORCES AND WEIGHTS IN POUNDS, PRESSURES AND ELASTIC MODULI IN POUNDS PER SQUARE INCH, ANGLES AND SLOPES IN DEGREES, SURFACE ROUGHNESS IN MICROINCHES, SPEEDS IN REVOLUTIONS PER MINUTE, DENSITY IN POUNDS PER CUBIC INCH, KINEMATIC VISCOSITY IN INCHES SQUARED PER SECOND AND THERMAL CONDUCTIVITY IN BRITISH THERMAL UNITS PER HOUR-FOOT-DEGREE FAHRENHEIT

BEARING NUMBER	NUMBER OF ROLLING ELEMENTS	AZIMUTH ANGLE ORIENTATION	PITCH DIAMETER	DIAMETRICAL CLEARANCE	CONTACT ANGLE	INNER RING SPEED	OUTER RING SPEED
1	13	30.000	3.3000	.00400	15.000	10000.	0.

C A G E D A T A

BEARING NUMBER	CAGE TYPE	CAGE POCKET CLEARANCE	RAIL-LAND WIDTH	RAIL-LAND DIAMETER	RAIL-LAND CLEARANCE	WEIGHT
1	OUTER RING LAND RIDING	.024500	.0850	2.8260	.009000	.041000

S T E E L D A T A

BRG.NO.	INNER RING TYPE	LIFE FACTOR	OUTER RING TYPE	LIFE FACTOR
1	STANDARD BRG STEEL	1.000	STANDARD BRG STEEL	1.000

*** PC-SHABERTH, a personal computer program of SKF AEROSPACE BEARINGS ***

Single Bearing Tester - baseline armalon cage

ROLLING ELEMENT DATA

BEARING NUMBER (1) TYPE - BALL BEARING

BALL DIAMETER	OUTER RACEWAY CURVATURE	INNER RACEWAY CURVATURE
.4375	.5200	.5300

*** PC-SHABERTH, a personal computer program of SKF AEROSPACE BEARINGS ***

Single Bearing Tester - baseline armalon cage

S U R F A C E D A T A

BEARING NUMBER	CLA ROUGHNESS			RMS ASPERITY SLOPE		
	OUTER	INNER	ROLL. ELM.	OUTER	INNER	ROLL. ELM.
1	1.00	1.00	1.00	2.000	2.000	2.000

L U B R I C A T I O N A N D F R I C T I O N D A T A

BEARING 1 IS OPERATING DRY WITH FRICTION COEFFICIENTS OF, RACE/R.E. .200 CAGE/R.E. AND CAGE/RING .200

*** PC-SHABERTH, a personal computer program of SKF AEROSPACE BEARINGS ***

Single Bearing Tester - baseline armalon cage

F I T D A T A A N D M A T E R I A L P R O P E R T I E S

BEARING NUMBER	COLD FITS (MM TIGHT)		EFFECTIVE WIDTHS			
	SHAFT	HOUSING	SHAFT	INNER RING	OUTER RING	HOUSING
1	.0002	.0002	1.3340	.6670	.6670	1.3340

BEARING NUMBER	EFFECTIVE DIAMETERS					
	SHAFT I.D.	BEARING BORE	INNER RING AVE. O.D.	OUTER RING AVE. I.D.	BEARING O.D.	HOUSING O.D.
1	.000	1.771	2.045	3.064	3.303	6.000

BEARING NUMBER (1)	SHAFT	INNER RING	ROLL. ELEM.	OUTER RING	HOUSING
MODULUS OF ELASTICITY	29600000.	29600000.	29600000.	29600000.	29600000.
POISSONS RATIO	.3000	.3000	.3000	.3000	.3000
WEIGHT DENSITY	.2820	.2820	.2820	.2820	.2820
COEFF. OF THERMAL EXP.	.00000680	.00000680	.00000680	.00000680	.00000680

UNLESS OTHERWISE STATED, ENGLISH UNITS ARE USED

GIVEN TEMPERATURES

BRG	O.RACE	I.RACE	BULK OIL	FLNG.1	FLNG.2	FLNG.3	FLNG.4	CAGE	SHAFT	I.RING	ROLL.EL.	O.RING	HSG.
1	-310.00	-310.00	-320.00	.00	.00	.00	.00	-310.00	-300.00	-310.00	-300.00	-320.00	-300.00

*** PC-SHABERTH, a personal computer program of SKF AEROSPACE BEARINGS ***

Single Bearing Tester - baseline armalon cage

SHAFT GEOMETRY, BEARING LOCATIONS AND SHAFT LOAD, PLANE X - Y.

2 GEOMETRIC SECTIONS 1 LOAD SECTION(S), 1 BEARINGS. MODULUS OF ELASTICITY = 2.960E+07

	POSITION	INNER DIAM.		OUTER DIAM.		POINT FORCE	POINT MOMENT	LOAD INTENSITY		BEARING SEAT				
		LEFT	RIGHT	LEFT	RIGHT			LEFT	RIGHT	POS.ERR	DEFL/FOR	ANG.ERR	DEFL/MOM	
1	.00	.00	.00	1.77	1.77					1	.00000	.00E+00	.0000	.00E+00
2	1.33	.00	.00	1.77	1.77					2				

*** PC-SHABERTH, a personal computer program of SKF AEROSPACE BEARINGS ***

Single Bearing Tester - baseline armalon cage

SHAFT GEOMETRY, BEARING LOCATIONS AND SHAFT LOAD, PLANE X - Z.

2 GEOMETRIC SECTIONS 1 LOAD SECTION(S), 1 BEARINGS. MODULUS OF ELASTICITY = 2.960E+07

THRUST LOAD = 5.000E+02

	POSITION	INNER DIAM.		OUTER DIAM.		POINT FORCE	POINT MOMENT	LOAD INTENSITY		BEARING SEAT				
		LEFT	RIGHT	LEFT	RIGHT			LEFT	RIGHT	POS.ERR	DEFL/FOR	ANG.ERR	DEFL/MOM	
1	.00	.00	.00	1.77	1.77					1	.00000	.00E+00	.0000	.00E+00
2	1.33	.00	.00	1.77	1.77					2				

*** PC-SHABERTH, a personal computer program of SKF AEROSPACE BEARINGS ***

Single Bearing Tester - baseline armalon cage

BEARING SYSTEM OUTPUT ENGLISH UNITS

LINEAR (IN) AND ANGULAR (RADIAN) DEFLECTIONS

REACTION FORCES (LB) AND MOMENTS (IN-LB)

BRG.	DX	DY	DZ	GY	GZ	FX	FY	FZ	MY	MZ
1	5.408E-03	.000E+00	.000E+00	.000E+00	.000E+00	4.997E+02	.000E+00	.000E+00	.000E+00	.000E+00

FATIGUE LIFE (HOURS)

H/SIGMA

LUBE-LIFE FACTOR

MATERIAL FACTOR

BRG.	O. RACE	I. RACE	BEARING	O. RACE	I. RACE	O. RACE	I. RACE	O. RACE	I. RACE
1	1.513E+04	2.049E+03	1.867E+03	.000E+00	.000E+00	1.000E+00	1.000E+00	1.000E+00	1.000E+00

TEMPERATURES RELEVANT TO BEARING PERFORMANCE (DEGREES FAHRENHEIT)

BRG	O.RACE	I.RACE	BULK OIL	FLNG.1	FLNG.2	FLNG.3	FLNG.4	CAGE	SHAFT	I.RING	ROLL.EL.	O.RING	HSG.
1	-310.00	-310.00	-320.00	.00	.00	.00	.00	-310.00	-300.00	-310.00	-300.00	-320.00	-300.00

*** PC-SHABERTH, a personal computer program of SKF AEROSPACE BEARINGS ***

Single Bearing Tester - baseline armalon cage

B E A R I N G S Y S T E M O U T P U T E N G L I S H U N I T S

BEARING STIFFNESSES (LB/IN, IN-LB/RAD, AND LB/RAD)

BEARING 1	DFY	DFZ	DMY	DMZ	DFX
DY	.0000E+00	.0000E+00	.0000E+00	.0000E+00	.0000E+00
DZ	.0000E+00	.0000E+00	.0000E+00	.0000E+00	.0000E+00
DGY	.0000E+00	.0000E+00	.0000E+00	.0000E+00	.0000E+00
DGZ	.0000E+00	.0000E+00	.0000E+00	.0000E+00	.0000E+00
DX	.0000E+00	.0000E+00	.0000E+00	.0000E+00	.9756E+06

** PC-SHABERTH, a personal computer program of SKF AEROSPACE BEARINGS ***

Single Bearing Tester - baseline armalon cage

ROLLING ELEMENT OUTPUT FOR BEARING NUMBER 1 ENGLISH UNITS

AZIMUTH	ANGULAR SPEEDS (RADIAN/SECOND)				SPEED VECTOR ANGLES (DEGREES)			
ANGLE (DEG.)	WX	WY	WZ	TOTAL	ORBITAL	TAN-1(WY/WX)	TAN-1(WZ/WX)	SPIN TO ROLL OR / IR
30.00	-3580.034	1611.210	.000	3925.893	464.956	155.77	-180.00	.0000 / .1811

*** PC-SHABERTH, a personal computer program of SKF AEROSPACE BEARINGS ***

Single Bearing Tester - baseline armalon cage

ROLLING ELEMENT OUTPUT FOR BEARING NUMBER 1 ENGLISH UNITS

AZIMUTH ANGLE (DEG.)	NORMAL FORCES (POUNDS)			HZ STRESS (LB/IN**2)		LOAD RATIO QASP/QTOT		CONTACT ANGLES (DEG.)	
	CAGE	OUTER	INNER	OUTER	INNER	OUTER	INNER	OUTER	INNER
30.00	.000	83.677	73.723	180657.100	212458.800	1.0000	1.0000	27.35	31.43

*** PC-SHABERTH, a personal computer program of SKF AEROSPACE BEARINGS ***

Single Bearing Tester - baseline armalon cage

ROLLING ELEMENT OUTPUT FOR BEARING NUMBER 1 ENGLISH UNITS

	<===== OUTER RACE CONTACT =====>			<===== INNER RACE CONTACT =====>		
AZIMUTH	REQUIRED			REQUIRED		
ANGLE	SEMI-MAJOR	SEMI-MINOR	RACEWAY	SEMI-MAJOR	SEMI-MINOR	RACEWAY
(DEG.)	AXIS (IN)	AXIS (IN)	DEPTH (IN)	AXIS (IN)	AXIS (IN)	DEPTH (IN)
30.00	.4091E-01	.5406E-02	.4752E-01	.3394E-01	.4881E-02	.5385E-01

*** PC-SHABERTH, a personal computer program of SKF AEROSPACE BEARINGS ***

Single Bearing Tester - Silicon Nitride Balls

INPUT PREPARED BY : Jett

DATE OF EXECUTION : 8/23/90

THIS DATA SET CONTAINS 1 BEARING

BEARING NO. (1) - BALL BEARING

SOLUTION LEVEL = 1

*** PC-SHABERTH, a personal computer program of SKF AEROSPACE BEARINGS ***

Single Bearing Tester - Silicon Nitride Balls

UNLESS OTHERWISE STATED, LINEAR DIMENSIONS ARE SPECIFIED IN INCHES, TEMPERATURES IN DEGREES FAHRENHEIT, FORCES AND WEIGHTS IN POUNDS, PRESSURES AND ELASTIC MODULI IN POUNDS PER SQUARE INCH, ANGLES AND SLOPES IN DEGREES, SURFACE ROUGHNESS IN MICROINCHES, SPEEDS IN REVOLUTIONS PER MINUTE, DENSITY IN POUNDS PER CUBIC INCH, KINEMATIC VISCOSITY IN INCHES SQUARED PER SECOND AND THERMAL CONDUCTIVITY IN BRITISH THERMAL UNITS PER HOUR-FOOT-DEGREE FAHRENHEIT

BEARING NUMBER	NUMBER OF ROLLING ELEMENTS	AZIMUTH ANGLE ORIENTATION	PITCH DIAMETER	DIAMETRAL CLEARANCE	CONTACT ANGLE	INNER RING SPEED	OUTER RING SPEED
1	13	30.000	3.3000	.00400	15.000	10000.	0.

C A G E D A T A

BEARING NUMBER	CAGE TYPE	CAGE POCKET CLEARANCE	RAIL-LAND WIDTH	RAIL-LAND DIAMETER	RAIL-LAND CLEARANCE	WEIGHT
1	OUTER RING LAND RIDING	.024500	.0850	2.8260	.009000	.041000

S T E E L D A T A

BRG.NO.	INNER RING TYPE	LIFE FACTOR	OUTER RING TYPE	LIFE FACTOR
1	STANDARD BRG STEEL	1.000	STANDARD BRG STEEL	1.000

*** PC-SHABERTH, a personal computer program of SKF AEROSPACE BEARINGS ***

Single Bearing Tester - Silicon Nitride Balls

ROLLING ELEMENT DATA

BEARING NUMBER (1) TYPE - BALL BEARING

BALL DIAMETER	OUTER RACEWAY CURVATURE	INNER RACEWAY CURVATURE
.4375	.5200	.5300

*** PC-SHABERTH, a personal computer program of SKF AEROSPACE BEARINGS ***

Single Bearing Tester - Silicon Nitride Balls

S U R F A C E D A T A

BEARING NUMBER	CLA ROUGHNESS			RMS ASPERITY SLOPE		
	OUTER	INNER	ROLL. ELM.	OUTER	INNER	ROLL. ELM.
1	1.00	1.00	1.00	2.000	2.000	2.000

L U B R I C A T I O N A N D F R I C T I O N D A T A

BEARING 1 IS OPERATING DRY WITH FRICTION COEFFICIENTS OF, RACE/R.E. .200 CAGE/R.E. AND CAGE/RING .200

*** PC-SHABERTH, a personal computer program of SKF AEROSPACE BEARINGS ***

Single Bearing Tester - Silicon Nitride Balls

FIT DATA AND MATERIAL PROPERTIES

BEARING NUMBER	COLD FITS (MM TIGHT)		EFFECTIVE WIDTHS			
	SHAFT	HOUSING	SHAFT	INNER RING	OUTER RING	HOUSING
1	.0002	.0002	1.3340	.6670	.6670	1.3340

BEARING NUMBER	EFFECTIVE DIAMETERS					
	SHAFT I.D.	BEARING BORE	INNER RING AVE. O.D.	OUTER RING AVE. I.D.	BEARING O.D.	HOUSING O.D.
1	.000	1.771	2.045	3.064	3.303	6.000

BEARING NUMBER (1)	SHAFT	INNER RING	ROLL. ELEM.	OUTER RING	HOUSING
MODULUS OF ELASTICITY	29600000.	29600000.	45000000.	29600000.	29600000.
POISSONS RATIO	.3000	.3000	.2500	.3000	.3000
WEIGHT DENSITY	.2820	.2820	.1990	.2820	.2820
COEFF. OF THERMAL EXP.	.00000680	.00000680	.00000190	.00000680	.00000680

UNLESS OTHERWISE STATED, ENGLISH UNITS ARE USED

GIVEN TEMPERATURES

BRG	O.RACE	I.RACE	BULK OIL	FLNG.1	FLNG.2	FLNG.3	FLNG.4	CAGE	SHAFT	I.RING	ROLL.EL.	O.RING	HSG.
1	-310.00	-310.00	-320.00	.00	.00	.00	.00	-310.00	-300.00	-310.00	-300.00	-320.00	-300.00

*** PC-SHABERTH, a personal computer program of SKF AEROSPACE BEARINGS ***

Single Bearing Tester - Silicon Nitride Balls

SHAFT GEOMETRY, BEARING LOCATIONS AND SHAFT LOAD, PLANE X - Y.

2 GEOMETRIC SECTIONS 1 LOAD SECTION(S), 1 BEARINGS. MODULUS OF ELASTICITY = 2.960E+07

	POSITION	INNER DIAM.		OUTER DIAM.		POINT FORCE	POINT MOMENT	LOAD INTENSITY		BEARING SEAT				
		LEFT	RIGHT	LEFT	RIGHT			LEFT	RIGHT	POS.ERR	DEFL/FOR	ANG.ERR	DEFL/MOM	
1	.00	.00	.00	1.77	1.77					1	.00000	.00E+00	.0000	.00E+00
2	1.33	.00	.00	1.77	1.77					2				

*** PC-SHABERTH, a personal computer program of SKF AEROSPACE BEARINGS ***

Single Bearing Tester - Silicon Nitride Balls

SHAFT GEOMETRY, BEARING LOCATIONS AND SHAFT LOAD, PLANE X - Z.

2 GEOMETRIC SECTIONS 1 LOAD SECTION(S), 1 BEARINGS. MODULUS OF ELASTICITY = 2.960E+07

THRUST LOAD = 5.000E+02

	POSITION	INNER DIAM.		OUTER DIAM.		POINT FORCE	POINT MOMENT	LOAD INTENSITY		BEARING SEAT				
		LEFT	RIGHT	LEFT	RIGHT			LEFT	RIGHT	POS.ERR	DEFL/FOR	ANG.ERR	DEFL/MOM	
1	.00	.00	.00	1.77	1.77					1	.00000	.00E+00	.0000	.00E+00
2	1.33	.00	.00	1.77	1.77					2				

*** PC-SHABERTH, a personal computer program of SKF AEROSPACE BEARINGS ***

Single Bearing Tester - Silicon Nitride Balls

BEARING SYSTEM OUTPUT ENGLISH UNITS

LINEAR (IN) AND ANGULAR (RADIAN) DEFLECTIONS

REACTION FORCES (LB) AND MOMENTS (IN-LB)

BRG.	DX	DY	DZ	GY	GZ	FX	FY	FZ	MY	MZ
1	3.934E-03	.000E+00	.000E+00	.000E+00	.000E+00	4.999E+02	.000E+00	.000E+00	.000E+00	.000E+00

FATIGUE LIFE (HOURS)

H/SIGMA

LUBE-LIFE FACTOR

MATERIAL FACTOR

BRG.	O. RACE	I. RACE	BEARING	O. RACE	I. RACE	O. RACE	I. RACE	O. RACE	I. RACE
1	3.558E+03	4.587E+02	4.201E+02	.900E+00	.000E+00	1.000E+00	1.000E+00	1.000E+00	1.000E+00

TEMPERATURES RELEVANT TO BEARING PERFORMANCE (DEGREES FAHRENHEIT)

BRG	O.RACE	I.RACE	BULK OIL	FLNG.1	FLNG.2	FLNG.3	FLNG.4	CAGE	SHAFT	I.RING	ROLL.EL.	O.RING	HSG.
1	-310.00	-310.00	-320.00	.00	.00	.00	.00	-310.00	-300.00	-310.00	-300.00	-320.00	-300.00

*** PC-SHABERTH, a personal computer program of SKF AEROSPACE BEARINGS ***

Single Bearing Tester - Silicon Nitride Balls

B E A R I N G S Y S T E M O U T P U T E N G L I S H U N I T S

BEARING STIFFNESSES (LB/IN, IN-LB/RAD, AND LB/RAD)

BEARING 1	DFY	DFZ	DMY	DMZ	DFX
DY	.0000E+00	.0000E+00	.0000E+00	.0000E+00	.0000E+00
DZ	.0000E+00	.0000E+00	.0000E+00	.0000E+00	.0000E+00
DGY	.0000E+00	.0000E+00	.0000E+00	.0000E+00	.0000E+00
DGZ	.0000E+00	.0000E+00	.0000E+00	.0000E+00	.0000E+00
DX	.0000E+00	.0000E+00	.0000E+00	.0000E+00	.8845E+06

*** PC-SHABERTH, a personal computer program of SKF AEROSPACE BEARINGS ***

Single Bearing Tester - Silicon Nitride Balls

BEARING SYSTEM OUTPUT ENGLISH UNITS

FRICTIONAL HEAT GENERATION RATE (BTU/HR) AND FRICTION TORQUE (LB-IN)

BRG.	O. RACE	O. FLNGS.	I. RACE	I. FLNGS.	R.E.DRAG	R.E.-CAGE	CAGE-LAND	TOTAL	TORQUE
1	1.506E+02	.000E+00	5.640E+02	.000E+00	.000E+00	.000E+00	2.061E+00	7.167E+02	1.775E+00

EHD FILM THICKNESS, FILM REDUCTION FACTORS AND HEAT CONDUCTIVITY DATA FOR THE OUTER AND INNER RACEWAYS RESPECTIVELY

BRG.	FILM (MICRO IN)	STARVATION FACTOR	THERMAL FACTOR	MENISCUS DIST. (IN)	CONDUCTIVITY (B/HR/DEG.F)
1	.000E+00	.000E+00	.000E+00	.000E+00	1.175E+01 9.898E+00

FIT PRESSURES (PSI) BEARING CLEARANCES (IN) SPEED GIVING ZERO FIT PRESSURE

BRG.	SHAFT-COLD, OPER.	HSG.-COLD, OPER.	ORIGINAL	CHANGE	OPERATING	SHAFT-INNER RING (RPM)
1	4.369E+02	1.045E+03	1.269E+02	-4.872E+00	4.000E-03	-1.954E-03 2.046E-03 3.538E+04

CAGE DATA ENGLISH UNITS

CAGE RAIL - RING LAND DATA

CAGE SPEED DATA

BRG.	TORQUE (IN-LB)	HEAT RATE (BTU/HR)	SEP.FORCE (POUNDS)	ECCENTRICITY RATIO	EPICYCLIC SPEED (RAD/SEC)	(RPM)	CALCULATED SPEED (RAD/SEC)	(RPM)	CALC/EPIC RATIO	CAGE/SHAFT RATIO
1	-1.159E-02	2.061E+00	4.181E-02	3.414E-01	4.616E+02	4.408E+03	4.616E+02	4.408E+03	1.000E+00	4.408E-01

*** PC-SHABERTH, a personal computer program of SKF AEROSPACE BEARINGS ***

Single Bearing Tester - Silicon Nitride Balls

ROLLING ELEMENT OUTPUT FOR BEARING NUMBER 1 ENGLISH UNITS

AZIMUTH	ANGULAR SPEEDS (RADIAN/SECOND)				SPEED VECTOR ANGLES (DEGREES)			
ANGLE (DEG.)	WX	WY	WZ	TOTAL	ORBITAL	TAN-1(WY/WX)	TAN-1(WZ/WX)	SPIN TO ROLL OR / IR
30.00	-3636.653	1428.386	.000	3907.113	461.573	158.56	-180.00	.0000 / .1350

*** PC-SHABERTH, a personal computer program of SKF AEROSPACE BEARINGS ***

Single Bearing Tester - Silicon Nitride Balls

ROLLING ELEMENT OUTPUT FOR BEARING NUMBER 1 ENGLISH UNITS

AZIMUTH	NORMAL FORCES (POUNDS)			HZ STRESS (LB/IN**2)		LOAD RATIO QASP/QTOT		CONTACT ANGLES (DEG.)	
ANGLE (DEG.)	CAGE	OUTER	INNER	OUTER	INNER	OUTER	INNER	OUTER	INNER
30.00	.000	93.729	86.552	210942.100	251990.200	1.0000	1.0000	24.22	26.38

*** PC-SHABERTH, a personal computer program of SKF AEROSPACE BEARINGS ***

Single Bearing Tester - Silicon Nitride Balls

ROLLING ELEMENT OUTPUT FOR BEARING NUMBER 1 ENGLISH UNITS

	<===== OUTER RACE CONTACT =====>			<===== INNER RACE CONTACT =====>		
AZIMUTH	REQUIRED			REQUIRED		
ANGLE	SEMI-MAJOR	SEMI-MINOR	RACEWAY	SEMI-MAJOR	SEMI-MINOR	RACEWAY
(DEG.)	AXIS (IN)	AXIS (IN)	DEPTH (IN)	AXIS (IN)	AXIS (IN)	DEPTH (IN)
30.00	.4007E-01	.5295E-02	.3971E-01	.3377E-01	.4857E-02	.4136E-01

*** PC-SHABERTH, a personal computer program of SKF AEROSPACE BEARINGS ***

Single Bearing Tester - Salox-m cage

INPUT PREPARED BY : Jett

DATE OF EXECUTION : 9/4/90

THIS DATA SET CONTAINS 1 BEARING

BEARING NO. (1) - BALL BEARING

SOLUTION LEVEL = 1

*** PC-SHABERTH, a personal computer program of SKF AEROSPACE BEARINGS ***

Single Bearing Tester - Salox-m cage

UNLESS OTHERWISE STATED, LINEAR DIMENSIONS ARE SPECIFIED IN INCHES, TEMPERATURES IN DEGREES FAHRENHEIT, FORCES AND WEIGHTS IN POUNDS, PRESSURES AND ELASTIC MODULI IN POUNDS PER SQUARE INCH, ANGLES AND SLOPES IN DEGREES, SURFACE ROUGHNESS IN MICROINCHES, SPEEDS IN REVOLUTIONS PER MINUTE, DENSITY IN POUNDS PER CUBIC INCH, KINEMATIC VISCOSITY IN INCHES SQUARED PER SECOND AND THERMAL CONDUCTIVITY IN BRITISH THERMAL UNITS PER HOUR-FOOT-DEGREE FAHRENHEIT

BEARING NUMBER	NUMBER OF ROLLING ELEMENTS	AZIMUTH ANGLE ORIENTATION	PITCH DIAMETER	DIAMETRAL CLEARANCE	CONTACT ANGLE	INNER RING SPEED	OUTER RING SPEED
1	11	30.000	3.3000	.00400	15.000	10000.	0.

C A G E D A T A

BEARING NUMBER	CAGE TYPE	CAGE POCKET CLEARANCE	RAIL-LAND WIDTH	RAIL-LAND DIAMETER	RAIL-LAND CLEARANCE	WEIGHT
1	OUTER RING LAND RIDING	.024500	.0850	2.8260	.009000	.118000

S T E E L D A T A

BRG.NO.	INNER RING TYPE	LIFE FACTOR	OUTER RING TYPE	LIFE FACTOR
1	STANDARD BRG STEEL	1.000	STANDARD BRG STEEL	1.000

*** PC-SHABERTH, a personal computer program of SKF AEROSPACE BEARINGS ***

Single Bearing Tester - Salox-m cage

ROLLING ELEMENT DATA

BEARING NUMBER (1) TYPE - BALL BEARING

BALL DIAMETER	OUTER RACEWAY CURVATURE	INNER RACEWAY CURVATURE
.4375	.5200	.5300

*** PC-SHABERTH, a personal computer program of SKF AEROSPACE BEARINGS ***

Single Bearing Tester - Salox-m cage

S U R F A C E D A T A

BEARING NUMBER	CLA ROUGHNESS			RMS ASPERITY SLOPE		
	OUTER	INNER	ROLL. ELM.	OUTER	INNER	ROLL. ELM.
1	1.00	1.00	1.00	2.000	2.000	2.000

L U B R I C A T I O N A N D F R I C T I O N D A T A

BEARING 1 IS OPERATING DRY WITH FRICTION COEFFICIENTS OF, RACE/R.E. .200 CAGE/R.E. AND CAGE/RING .200

*** PC-SHABERTH, a personal computer program of SKF AEROSPACE BEARINGS ***

Single Bearing Tester - Salox-m cage

FIT DATA AND MATERIAL PROPERTIES

BEARING NUMBER	COLD FITS (MM TIGHT)		EFFECTIVE WIDTHS			
	SHAFT	HOUSING	SHAFT	INNER RING	OUTER RING	HOUSING
1	.0002	.0002	1.3340	.6670	.6670	1.3340

BEARING NUMBER	EFFECTIVE DIAMETERS					
	SHAFT I.D.	BEARING BORE	INNER RING AVE. O.D.	OUTER RING AVE. I.D.	BEARING O.D.	HOUSING O.D.
1	.000	1.771	2.045	3.064	3.303	6.000

BEARING NUMBER (1)	SHAFT	INNER RING	ROLL. ELEM.	OUTER RING	HOUSING
MODULUS OF ELASTICITY	29600000.	29600000.	29600000.	29600000.	29600000.
POISSONS RATIO	.3000	.3000	.3000	.3000	.3000
WEIGHT DENSITY	.2820	.2820	.2820	.2820	.2820
COEFF. OF THERMAL EXP.	.00000680	.00000680	.00000680	.00000680	.00000680

UNLESS OTHERWISE STATED, ENGLISH UNITS ARE USED

GIVEN TEMPERATURES

BRG	O.RACE	I.RACE	BULK OIL	FLNG.1	FLNG.2	FLNG.3	FLNG.4	CAGE	SHAFT	I.RING	ROLL.EL.	O.RING	HSG.
1	-310.00	-310.00	-320.00	.00	.00	.00	.00	-310.00	-300.00	-310.00	-300.00	-320.00	-300.00

*** PC-SHABERTH, a personal computer program of SKF AEROSPACE BEARINGS ***

Single Bearing Tester - Salox-m cage

SHAFT GEOMETRY, BEARING LOCATIONS AND SHAFT LOAD, PLANE X - Y.

2 GEOMETRIC SECTIONS 1 LOAD SECTION(S), 1 BEARINGS. MODULUS OF ELASTICITY = 2.960E+07

	POSITION	INNER DIAM.		OUTER DIAM.		POINT FORCE	POINT MOMENT	LOAD INTENSITY		BEARING SEAT				
		LEFT	RIGHT	LEFT	RIGHT			LEFT	RIGHT	POS.ERR	DEFL/FOR	ANG.ERR	DEFL/MOM	
1	.00	.00	.00	1.77	1.77					1	.00000	.00E+00	.0000	.00E+00
2	1.33	.00	.00	1.77	1.77					2				

*** PC-SHABERTH, a personal computer program of SKF AEROSPACE BEARINGS ***

Single Bearing Tester - Salox-m cage

SHAFT GEOMETRY, BEARING LOCATIONS AND SHAFT LOAD, PLANE X - Z.

2 GEOMETRIC SECTIONS 1 LOAD SECTION(S), 1 BEARINGS. MODULUS OF ELASTICITY = 2.960E+07

THRUST LOAD = 5.000E+02

	POSITION	INNER DIAM.		OUTER DIAM.		POINT FORCE	POINT MOMENT	LOAD INTENSITY		BEARING SEAT				
		LEFT	RIGHT	LEFT	RIGHT			LEFT	RIGHT	POS.ERR	DEFL/FOR	ANG.ERR	DEFL/MOM	
1	.00	.00	.00	1.77	1.77					1	.00000	.00E+00	.0000	.00E+00
2	1.33	.00	.00	1.77	1.77					2				

*** PC-SHABERTH, a personal computer program of SKF AEROSPACE BEARINGS ***

Single Bearing Tester - Salox-m cage

BEARING SYSTEM OUTPUT ENGLISH UNITS

LINEAR (IN) AND ANGULAR (RADIAN) DEFLECTIONS

REACTION FORCES (LB) AND MOMENTS (IN-LB)

BRG.	DX	DY	DZ	GY	GZ	FX	FY	FZ	MY	MZ
1	5.505E-03	.000E+00	.000E+00	.000E+00	.000E+00	4.998E+02	.000E+00	.000E+00	.000E+00	.000E+00

FATIGUE LIFE (HOURS)

H/SIGMA

LUBE-LIFE FACTOR

MATERIAL FACTOR

BRG.	O. RACE	I. RACE	BEARING	O. RACE	I. RACE	O. RACE	I. RACE	O. RACE	I. RACE
1	1.145E+04	1.465E+03	1.342E+03	.000E+00	.000E+00	1.000E+00	1.000E+00	1.000E+00	1.000E+00

TEMPERATURES RELEVANT TO BEARING PERFORMANCE (DEGREES FAHRENHEIT)

BRG	O.RACE	I.RACE	BULK OIL	FLNG.1	FLNG.2	FLNG.3	FLNG.4	CAGE	SHAFT	I.RING	ROLL.EL.	O.RING	HSG.
1	-310.00	-310.00	-320.00	.00	.00	.00	.00	-310.00	-300.00	-310.00	-300.00	-320.00	-300.00

*** PC-SHABERTH, a personal computer program of SKF AEROSPACE BEARINGS ***

Single Bearing Tester - Salox-m cage

BEARING SYSTEM OUTPUT ENGLISH UNITS

BEARING STIFFNESSES (LB/IN, IN-LB/RAD, AND LB/RAD)

BEARING 1	DFY	DFZ	DMY	DMZ	DFX
DY	.0000E+00	.0000E+00	.0000E+00	.0000E+00	.0000E+00
DZ	.0000E+00	.0000E+00	.0000E+00	.0000E+00	.0000E+00
DGY	.0000E+00	.0000E+00	.0000E+00	.0000E+00	.0000E+00
DGZ	.0000E+00	.0000E+00	.0000E+00	.0000E+00	.0000E+00
DX	.0000E+00	.0000E+00	.0000E+00	.0000E+00	.8951E+06

*** PC-SHABERTH, a personal computer program of SKF AEROSPACE BEARINGS ***

Single Bearing Tester - Salox-m cage

B E A R I N G S Y S T E M O U T P U T E N G L I S H U N I T S

FRICTIONAL HEAT GENERATION RATE (BTU/HR) AND FRICTION TORQUE (LB-IN)

BRG.	O. RACE	O. FLNGS.	I. RACE	I. FLNGS.	R.E.DRAG	R.E.-CAGE	CAGE-LAND	TOTAL	TORQUE
1	1.689E+02	.000E+00	6.844E+02	.000E+00	.000E+00	.000E+00	5.972E+00	8.593E+02	2.128E+00

EHD FILM THICKNESS, FILM REDUCTION FACTORS AND HEAT CONDUCTIVITY DATA FOR THE OUTER AND INNER RACEWAYS RESPECTIVELY

BRG.	FILM (MICRO IN)	STARVATION FACTOR	THERMAL FACTOR	MENISCUS DIST. (IN)	CONDUCTIVITY (B/HR/DEG.F)
1	.000E+00	.000E+00	.000E+00	.000E+00	1.084E+01 8.938E+00

FIT PRESSURES (PSI) BEARING CLEARANCES (IN) SPEED GIVING ZERO FIT PRESSURE

BRG.	SHAFT-COLD, OPER.	HSG.-COLD, OPER.	ORIGINAL	CHANGE	OPERATING SHAFT-INNER RING (RPM)
1	4.369E+02	9.616E+02	1.269E+02	.000E+00 4.000E-03	-4.162E-04 3.584E-03 3.409E+04

C A G E D A T A E N G L I S H U N I T S

CAGE RAIL - RING LAND DATA

CAGE SPEED DATA

BRG.	TORQUE (IN-LB)	HEAT RATE (BTU/HR)	SEP.FORCE (POUNDS)	ECCENTRICITY RATIO	EPICYCLIC SPEED (RAD/SEC)	(RPM)	CALCULATED SPEED (RAD/SEC)	(RPM)	CALC/EPIC RATIO	CAGE/SHAFT RATIO
1	-3.335E-02	5.972E+00	1.203E-01	9.825E-01	4.648E+02	4.438E+03	4.648E+02	4.438E+03	1.000E+00	4.438E-01

*** PC-SHABERTH, a personal computer program of SKF AEROSPACE BEARINGS ***

Single Bearing Tester - Salox-m cage

ROLLING ELEMENT OUTPUT FOR BEARING NUMBER 1 ENGLISH UNITS

	<===== OUTER RACE CONTACT =====>			<===== INNER RACE CONTACT =====>		
AZIMUTH	REQUIRED			REQUIRED		
ANGLE	SEMI-MAJOR	SEMI-MINOR	RACEWAY	SEMI-MAJOR	SEMI-MINOR	RACEWAY
(DEG.)	AXIS (IN)	AXIS (IN)	DEPTH (IN)	AXIS (IN)	AXIS (IN)	DEPTH (IN)
30.00	.4299E-01	.5680E-02	.5019E-01	.3589E-01	.5162E-02	.5508E-01

*** PC-SHABERTH, a personal computer program of SKF AEROSPACE BEARINGS ***

Single Bearing Tester - Salox-m cage

ROLLING ELEMENT OUTPUT FOR BEARING NUMBER 1 ENGLISH UNITS

AZIMUTH	ANGULAR SPEEDS (RADIAN/SECOND)				SPEED VECTOR ANGLES (DEGREES)			
ANGLE (DEG.)	WX	WY	WZ	TOTAL	ORBITAL	TAN-1(WY/WX)	TAN-1(WZ/WX)	SPIN TO ROLL OR / IR
30.00	-3563.071	1640.676	.000	3922.664	464.794	155.28	-180.00	.0000 / .1731

** PC-SHABERTH, a personal computer program of SKF AEROSPACE BEARINGS ***

Single Bearing Tester - Salox-m cage

ROLLING ELEMENT OUTPUT FOR BEARING NUMBER 1 ENGLISH UNITS

AZIMUTH ANGLE (DEG.)	NORMAL FORCES (POUNDS)			HZ STRESS (LB/IN**2)		LOAD RATIO QASP/QTOT		CONTACT ANGLES (DEG.)	
	CAGE	OUTER	INNER	OUTER	INNER	OUTER	INNER	OUTER	INNER
30.00	.000	97.095	87.176	189838.700	224666.700	1.0000	1.0000	27.90	31.41

APPROVAL

EVALUATION OF BEARING CONFIGURATIONS USING THE SINGLE BEARING TESTER IN LIQUID NITROGEN

By T. Jett, P. Hall, and R. Thom

The information in this report has been reviewed for technical content. Review of any information concerning Department of Defense or nuclear energy activities or programs has been made by the MSFC Security Classification Officer. This report, in its entirety, has been determined to be unclassified.

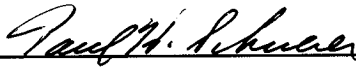

PAUL H. SCHUERER

Director, Materials and Processes Laboratory

1. Report No. NASA TM - 103527		2. Government Accession No.		3. Recipient's Catalog No.	
4. Title and Subtitle Evaluation of Bearing Configurations Using the Single Bearing Tester in Liquid Nitrogen				5. Report Date March 1991	
				6. Performing Organization Code	
7. Author(s) T. Jett, P. Hall, and R. Thom				8. Performing Organization Report No.	
				10. Work Unit No.	
9. Performing Organization Name and Address George C. Marshall Space Flight Center Marshall Space Flight Center, Alabama 35812				11. Contract or Grant No.	
				13. Type of Report and Period Covered Technical Memorandum	
12. Sponsoring Agency Name and Address National Aeronautics and Space Administration Washington, DC 20546				14. Sponsoring Agency Code NASA	
15. Supplementary Notes Prepared by Materials and Processes Laboratory, Science and Engineering Directorate					
16. Abstract Various bearing configurations were tested using the Marshall Space Flight Center single bearing tester with LN₂ as the cryogenic coolant. The baseline was one Rocketdyne phase I high pressure oxidizer turbopump (HPOTP) pump end 45-mm bore bearing. The bearing configurations that were tested included a Salox/M cage configuration, a silicon nitride ball configuration, an elongated cage configurations, and a Bray 601 grease configuration.					
17. Key Words (Suggested by Author(s)) bearings, cryogenic, silicon nitride, liquid nitrogen, Salox/m, Braycote grease, Armalon				18. Distribution Statement Unclassified - Unlimited	
19. Security Classif. (of this report) Unclassified		20. Security Classif. (of this page) Unclassified		21. No. of pages 85	22. Price NTIS