

1N-47
30316
P-388

NASA Contractor Report 187589

(NASA-CR-187589) RADIOMETER OFFSETS AND
COUNT CONVERSION COEFFICIENTS FOR THE EARTH
RADIATION BUDGET EXPERIMENT (ERBE)
SPACECRAFT FOR THE YEARS 1984, 1985, AND
1986 Final Report (ST Systems Corp.) 388 p GB/47

N91-27702

Unclas
0030670

Radiometer Offsets and Count Conversion Coefficients for the Earth Radiation Budget Experiment (ERBE) Spacecraft for the Years 1984, 1985, and 1986

Jack Paden, Dhirendra K. Pandey,
Netra D. Shivakumar, Joseph C. Stassi,
Robert Wilson, William Bolden,
Susan Thomas, M. Alan Gibson

ST Systems Corporation (STX)
28 Research Drive
Hampton, Virginia 23666

Contract NAS1-18460
May 1991



National Aeronautics and
Space Administration

Langley Research Center
Hampton, Virginia 23665-5225



NASA Contractor Report 187589

**Radiometer Offsets and Count Conversion Coefficients for
the Earth Radiation Budget Experiment (ERBE) Spacecraft for
the Years 1984, 1985, and 1986**

**Jack Paden, Dhirendra K. Pandey,
Netra D. Shivakumar, Joseph C. Stassi,
Robert Wilson, William Bolden,
Susan Thomas, M. Alan Gibson**

**ST Systems Corporation (STX)
28 Research Drive
Hampton, Virginia 23666**

Contract Number NAS1-18460

May 1991

TABLE OF CONTENTS

	<u>Page</u>
1.0 Introduction	1
2.0 Scanning Radiometers	1
2.1 Ground Offsets and Scanner Count Conversion Algorithm	1
2.2 ERBS Scanner Offset Procedures	3
2.3 NOAA Scanner Offset Procedures	3
2.3.1 NOAA-9 Scanner Offset Procedures	3
2.3.2 NOAA-10 Scanner Offset Procedures	4
2.4 Significant Events	4
2.4.1 Significant Events ERBS	4
2.4.2 Significant Events NOAA-9	4
2.4.3 Significant Events NOAA-10	4
3.0 Nonscanning Radiometers	5
3.1 Count Conversion Algorithms	5
3.1.1 Dome Degradation Corrections	5
3.2 Ground Offsets	7
3.3 In-Flight Offsets	8
3.3.1 Total Channels	8
3.3.2 Shortwave Channels	9
3.4 Final Count Conversion Offsets	9
REFERENCES	10
APPENDIX A: ERBS Scanner Offset Tables	13
APPENDIX B: NOAA-9 Scanner Offset Tables	21
APPENDIX C: NOAA-10 Scanner Offset Tables	161
APPENDIX D: ERBS Scanner Offset Plots	169
APPENDIX E: NOAA-9 Scanner Offset Surface Plots	177
APPENDIX F: NOAA-10 Scanner Offset Plots	249
APPENDIX G: ERBS Nonscanner Offset Calibration Plots	255
APPENDIX H: NOAA-9 Nonscanner Offset Calibration Plots	261
APPENDIX I: NOAA-10 Nonscanner Offset Calibration Plots	267
APPENDIX J: ERBS Nonscanner Offsets (Merge)	273
APPENDIX K: NOAA-9 Nonscanner Offsets (Merge)	327
APPENDIX L: NOAA-10 Nonscanner Offsets (Merge)	375

LIST OF FIGURES

<u>Figure</u>	<u>Page</u>
1. ERBE Scanner Elevation Angles	2
2. ERBE Nonscanner Sensor Module	6

LIST OF TABLES

<u>Table</u>	<u>Page</u>
1. ERBE Nonscanner Ground Coefficients	8

LISTS OF OFFSETS AND SURFACE PLOTS

ERBS Cross-Track Offsets, October 1984 - December 1985	15
ERBS Along-Track Offsets, January and August 1985	16
ERBS Scanner Offsets, January through December 1986	17
NOAA-9 Scanner Offsets for February 1985	23
NOAA-9 Scanner Offsets for March 1985	29
NOAA-9 Scanner Offsets for April 1985	35
NOAA-9 Scanner Offsets for May 1985	41
NOAA-9 Scanner Offsets for June 1985	47
NOAA-9 Scanner Offsets for July 1985	53
NOAA-9 Scanner Offsets for August 1985	59
NOAA-9 Scanner Offsets for September 1985	65
NOAA-9 Scanner Offsets for October 1985	71
NOAA-9 Scanner Offsets for November 1985	77
NOAA-9 Scanner Offsets for December 1985	83
NOAA-9 Scanner Offsets for January 1986	89
NOAA-9 Scanner Offsets for February 1986	95
NOAA-9 Scanner Offsets for March 1986	101
NOAA-9 Scanner Offsets for April 1986	107
NOAA-9 Scanner Offsets for May 1986	113
NOAA-9 Scanner Offsets for June 1986	119
NOAA-9 Scanner Offsets for July 1986	125
NOAA-9 Scanner Offsets for August 1986	131
NOAA-9 Scanner Offsets for September 1986	137
NOAA-9 Scanner Offsets for October 1986	143
NOAA-9 Scanner Offsets for November 1986	149
NOAA-9 Scanner Offsets for December 1986	155
NOAA-10 Scanner Offsets for October, November, December 1986	163
ERBS Cross Track, October 1984 - December 1985	171
ERBS Along Track, January and August 1985	174

OFFSETS AND SURFACE PLOTS (continued)

	<u>Page</u>
NOAA-9 Scanner Offset Surface Plots, February 1985	179
NOAA-9 Scanner Offset Surface Plots, March 1985	182
NOAA-9 Scanner Offset Surface Plots, April 1985	185
NOAA-9 Scanner Offset Surface Plots, May 1985	188
NOAA-9 Scanner Offset Surface Plots, June 1985	191
NOAA-9 Scanner Offset Surface Plots, July 1985	194
NOAA-9 Scanner Offset Surface Plots, August 1985	197
NOAA-9 Scanner Offset Surface Plots, September 1985	200
NOAA-9 Scanner Offset Surface Plots, October 1985	203
NOAA-9 Scanner Offset Surface Plots, November 1985	206
NOAA-9 Scanner Offset Surface Plots, December 1985	209
NOAA-9 Scanner Offset Surface Plots, January 1986	212
NOAA-9 Scanner Offset Surface Plots, February 1986	215
NOAA-9 Scanner Offset Surface Plots, March 1986	218
NOAA-9 Scanner Offset Surface Plots, April 1986	221
NOAA-9 Scanner Offset Surface Plots, May 1986	224
NOAA-9 Scanner Offset Surface Plots, June 1986	227
NOAA-9 Scanner Offset Surface Plots, July 1986	230
NOAA-9 Scanner Offset Surface Plots, August 1986	233
NOAA-9 Scanner Offset Surface Plots, September 1986	236
NOAA-9 Scanner Offset Surface Plots, October 1986	239
NOAA-9 Scanner Offset Surface Plots, November 1986	242
NOAA-9 Scanner Offset Surface Plots, December 1986	245
NOAA-10 Scanner Offset Surface Plots, October, November, December 1986	249
ERBS Nonscanner Offsets (Calibration Days), Total Channel, WFOV	257
ERBS Nonscanner Offsets (Calibration Days), Total Channel, MFOV	258
ERBS Nonscanner Offsets (Calibration Days), Shortwave Channel, WFOV	259
ERBS Nonscanner Offsets (Calibration Days), Shortwave Channel, MFOV	260
NOAA-9 Nonscanner Offsets (Calibration Days), Total Channel, WFOV	263
NOAA-9 Nonscanner Offsets (Calibration Days), Total Channel, MFOV	264
NOAA-9 Nonscanner Offsets (Calibration Days), Shortwave Channel, WFOV	265
NOAA-9 Nonscanner Offsets (Calibration Days), Shortwave Channel, MFOV	266
NOAA-10 Nonscanner Offsets (Calibration Days), Total Channel, WFOV	269
NOAA-10 Nonscanner Offsets (Calibration Days), Total Channel, MFOV	270
NOAA-10 Nonscanner Offsets (Calibration Days), Shortwave Channel, WFOV	271
NOAA-10 Nonscanner Offsets (Calibration Days), Shortwave Channel, MFOV	272

LIST OF TABLES (continued)

	<u>Page</u>
ERBS Nonscanner Offsets (Merge) November 1984	275
ERBS Nonscanner Offsets (Merge) December 1984	277
ERBS Nonscanner Offsets (Merge) January 1985	279
ERBS Nonscanner Offsets (Merge) February 1985	281
ERBS Nonscanner Offsets (Merge) March 1985	283
ERBS Nonscanner Offsets (Merge) April 1985	285
ERBS Nonscanner Offsets (Merge) May 1985	287
ERBS Nonscanner Offsets (Merge) June 1985	289
ERBS Nonscanner Offsets (Merge) July 1985	291
ERBS Nonscanner Offsets (Merge) August 1985	293
ERBS Nonscanner Offsets (Merge) September 1985	295
ERBS Nonscanner Offsets (Merge) October 1985	297
ERBS Nonscanner Offsets (Merge) November 1985	299
ERBS Nonscanner Offsets (Merge) December 1985	301
ERBS Nonscanner Offsets (Merge) January 1986	303
ERBS Nonscanner Offsets (Merge) February 1986	305
ERBS Nonscanner Offsets (Merge) March 1986	307
ERBS Nonscanner Offsets (Merge) April 1986	309
ERBS Nonscanner Offsets (Merge) May 1986	311
ERBS Nonscanner Offsets (Merge) June 1986	313
ERBS Nonscanner Offsets (Merge) July 1986	315
ERBS Nonscanner Offsets (Merge) August 1986	317
ERBS Nonscanner Offsets (Merge) September 1986	319
ERBS Nonscanner Offsets (Merge) October 1986	321
ERBS Nonscanner Offsets (Merge) November 1986	323
ERBS Nonscanner Offsets (Merge) December 1986	325
NOAA-9 Nonscanner Offsets (Merge) February 1985	329
NOAA-9 Nonscanner Offsets (Merge) March 1985	331
NOAA-9 Nonscanner Offsets (Merge) April 1985	333
NOAA-9 Nonscanner Offsets (Merge) May 1985	335
NOAA-9 Nonscanner Offsets (Merge) June 1985	337
NOAA-9 Nonscanner Offsets (Merge) July 1985	339
NOAA-9 Nonscanner Offsets (Merge) August 1985	341
NOAA-9 Nonscanner Offsets (Merge) September 1985	343
NOAA-9 Nonscanner Offsets (Merge) October 1985	345
NOAA-9 Nonscanner Offsets (Merge) November 1985	347
NOAA-9 Nonscanner Offsets (Merge) December 1985	349
NOAA-9 Nonscanner Offsets (Merge) January 1986	351
NOAA-9 Nonscanner Offsets (Merge) February 1986	353
NOAA-9 Nonscanner Offsets (Merge) March 1986	355
NOAA-9 Nonscanner Offsets (Merge) April 1986	357
NOAA-9 Nonscanner Offsets (Merge) May 1986	359
NOAA-9 Nonscanner Offsets (Merge) June 1986	361
NOAA-9 Nonscanner Offsets (Merge) July 1986	363
NOAA-9 Nonscanner Offsets (Merge) August 1986	365
NOAA-9 Nonscanner Offsets (Merge) September 1986	367

OFFSETS AND SURFACE PLOTS (concluded)

	<u>Page</u>
NOAA-9 Nonscanner Offsets (Merge) October 1986	369
NOAA-9 Nonscanner Offsets (Merge) November 1986	371
NOAA-9 Nonscanner Offsets (Merge) December 1986	373
NOAA-10 Nonscanner Offsets (Merge) October 1986	377
NOAA-10 Nonscanner Offsets (Merge) November 1986	379
NOAA-10 Nonscanner Offsets (Merge) December 1986	381

LIST OF ACRONYMS

<u>Acronym</u>	<u>Definition</u>
ERBE	Earth Radiation Budget Experiment
ERBS	Earth Radiation Budget Satellite
FOV	Field-Of-View
FOVL	Field-Of-View Limiter
IBB	Internal Blackbody
IVT	Instrument Validation Tape
LaRC	Langley Research Center (NASA, Hampton, VA)
LW	Longwave
MFOV	Medium Field-Of-View
N.A.	Not Applicable
NASA	National Aeronautics and Space Administration
NOAA	National Oceanic and Atmospheric Administration
SW	Shortwave
SWICS	Shortwave Internal Calibration Source
T	Total
WFOV	Wide Field-Of-View

LIST OF SYMBOLS

<u>Symbol</u>	<u>Definition</u>
A_E	Gain due to LW heating of SW filter dome and longwave radiation leaks beyond 60 micrometers
A_F	Gain due to FOVL temperature
A_V	Instrument Gain
A_R	Amplification Gain due to reference cavity
B	Offsets
E_{LW}	The radiance measured by the longwave channel
E_{SW}	The radiance measured by the shortwave channel
E_T	The radiance measured by the total channel
T_F	The FOVL temperature
V	The detector voltage

This page has been intentionally left blank

1.0 INTRODUCTION

The NASA Earth Radiation Budget Satellite (ERBS) spacecraft, which was launched into a 57-degree inclination orbit on October 5, 1984, became operational on November 1, 1984, and was the only operational ERBE spacecraft during that year. The National Oceanographic and Atmospheric Administration NOAA-9 spacecraft was launched into a polar, Sun-synchronous "noon/midnight" orbit on December 12, 1984. The NOAA-9 did not become operational until February of 1985. The NOAA-10 satellite was launched into a polar, Sun-synchronous "terminator" orbit in October 1986 and became operational in that month.

2.0 SCANNING RADIOMETERS

The relative positions of the scanner at various elevation angles are shown in Figure 1. The sector from 14 to 22 degrees is sometimes called the "space look before scan," the sector from 22 to 158 degrees is called "Earth-viewing," and the sector from 158 to 163 degrees is called "space after scan." The complete design and method of operation of the scanners was described by Carman¹ and Kopia². Data for scanner offsets are obtained from pre-Processed Archival Tapes (also called pre-PAT's or ID-3's) produced by the ERBE Merge Subsystem. The Merge Subsystem and the ERBE scanner count conversion process is fully described by Stassi et al.³. The ERBE scanners complete one scan every 4 seconds; hence, there are four scans in each telemetry record. A space-view is obtained every scan and is the source of the "space clamp" offset, which is applied to all measurements in a scan to adjust for drift. The scan position offsets are scan position specific, and these are the offsets listed in this report. The units associated are Watts per square meter per steradian. It is important to mention here that the scan positions referred to in this report, which range from 1 to 60, are known as the "Earth-viewing" scan positions, and they differ from the sample numbers listed in other documents (e.g., Section 4, Reference 4), which range from 1 to 74. The conversion from the "Earth-viewing" scan position to sample number is performed by adding 8 to the scan position. Thus, sample numbers 1 to 8 are the "space-viewing" positions, 9 to 68 are "Earth-viewing," 69 and 70 are "space-viewing," and 71 to 74 are the "internal blackbody (IBB) viewing" positions. The nadir position in the "Earth-viewing" system is scan position 34, while it is sample number 42.

2.1 GROUND OFFSETS AND THE SCANNER COUNT CONVERSION ALGORITHM

Halyo et al.⁵, modeled and determined the count conversion coefficients using the TRW ground calibration data documentation^{4,6,7} for all ERBE scanning sensors. A more detailed description of the scanner count conversion process is given by Lee et al.⁸. The accuracy of the ERBE scanners was shown by Lee et al.⁹, to be within 1 percent. Stassi et al.³, detailed the software applications of the count conversion algorithms as they are used by the ERBE Merge Subsystem. In abbreviated form, the following equation characterizes the scanner count conversion algorithm used:

$$E_{scan} = GAIN * (raw\ counts - (scan\ position + space\ clamp\ count\ offset)) \\ + scan\ offset\ for\ the\ record + drift\ offset\ for\ the\ scan$$

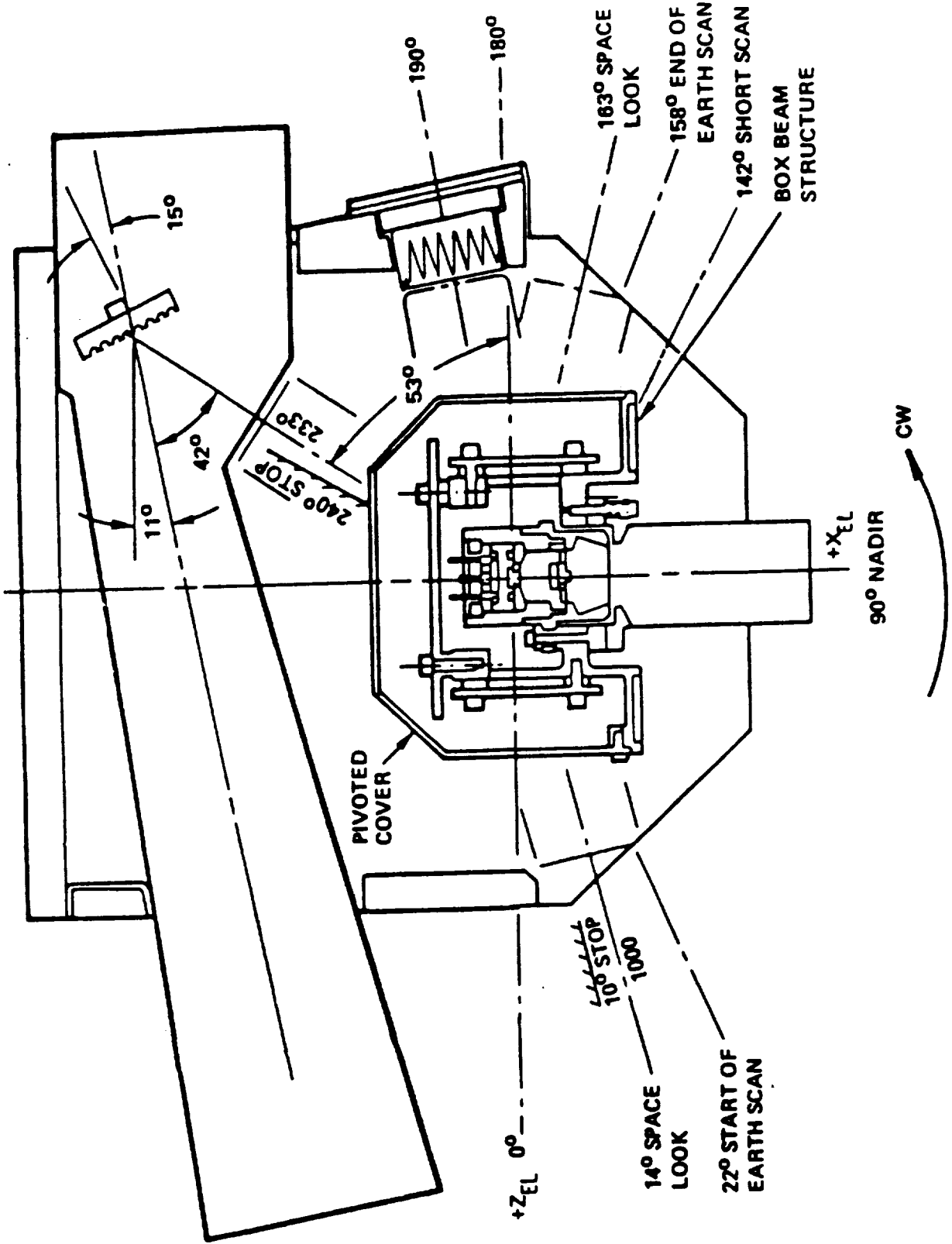

Figure 1. ERBE Scanner Elevation Angles

where: $GAIN = (AV/VB) * CVLT$ and
AV - a constant for the channel determined from ground calibration data.
VB - bias voltage counts for the channel
CVLT - a counts to voltage conversion factor (-1/409.5)

2.2 ERBS SCANNER OFFSET PROCEDURES

Halyo et al.⁵ determined the ERBS ground count conversion coefficients (gains). The ERBS zero-radiance offsets (by scan position) were derived by B.R. Barkstrom, using space-view data from the 1984 pitch-up maneuvers. The 1985 pitch-up maneuvers were used to verify that the ERBS in-flight scanner offsets had not changed. Major differences were found, however, between the scanner offsets, when operated at the along-track azimuth position and those found when operated at the cross-track position. Appendix A contains the ERBS cross-track and along-track scanner offsets. X

2.3 NOAA SCANNER OFFSET PROCEDURES

Halyo et al.⁵, determined the NOAA-9 and NOAA-10 ground count conversion coefficients and generated the corresponding offsets using the ground-calibration data reported by Hendricks^{4,7}. Data acquired by the NOAA-9 spacecraft in orbit indicated that ground and in-flight offsets were significantly different. The procedures used in the determination of the in-flight offsets for the ERBE NOAA satellites were developed by Mr. Lee Avis¹⁰ of the Atmospheric Sciences Division at the NASA Langley Research Center (LaRC). They consist, basically, of presuming that the ERBS satellite measurements are without error, and then making the necessary adjustments to the NOAA-9 data to make them equivalent to the ERBS data. The NOAA-9 and NOAA-10 offsets are produced only for scan positions 5 through 60, because of the difference in operational spacecraft altitudes.

2.3.1 NOAA-9 SCANNER OFFSET PROCEDURES

For selected days during the month, when the ERBS averaged radiance profile is approximately Lambertian and the ERBS and NOAA-9 satellite orbits intersect in darkness, averages of the differences in the two readings for each scan position (corrected for differences in satellite altitude) are determined. These "offsets" are called the "benchmark" offsets and represent the amount by which the NOAA-9 measured radiances must be corrected to produce the "corrected to ERBS" values. The NOAA-9 offsets for each day, or for a group of days, are determined by applying the "benchmark" offsets to the NOAA-9 readings for the "benchmark" day or days, averaging if more than one day is involved, and taking the difference between these "corrected to ERBS" NOAA-9 radiances and the measured NOAA-9 radiances on the day in question. The NOAA-9 scanner offsets, generated using the "Avis" method just described, are shown in Appendix B of this report. In the listings contained in Appendix B, there are occasional columns which are filled with asterisks. In those cases, there either were no data for the day in question, or the data were not reduced. As with the nonscanner, NOAA-9 scanner offsets begin in February 1985.

2.3.2 NOAA-10 SCANNER OFFSET PROCEDURES

In the case of the NOAA-10 satellite, scanner offsets are necessarily produced in a different manner than those for NOAA-9. There are two reasons for this: first, because of NOAA-10's terminator orbit, there are few intersections in darkness; and second, the NOAA-10 offsets have been found to be sensitive to scanner azimuth angle, which is alternately either 0 or 35 degrees. Therefore, to determine NOAA-10 offsets, an extension of Mr. Avis' procedures was developed by STX. The modified procedure uses the same software developed for the NOAA-9 to determine an average of all offsets for days which contain nighttime intersection data during the period under consideration (i.e., the period when the scanner azimuth angle remains fixed at either 0 or 35 degrees). These averaged data are then used as the NOAA-10 offsets for each day of the entire period. The NOAA-10 scanner offsets for 1986, which were generated using the "STX" method, are shown in Appendix C of this report.

2.4 SIGNIFICANT EVENTS

During the lifetimes of the three ERBE satellites, there have been periods of time when the satellites have not been functioning in their "normal" or Earth viewing mode. Some of these events, such as the bi-weekly internal calibrations and operations in the along-track (or pushbroom) mode were planned; others were not. A list of the most significant of these events follows.

2.4.1 SIGNIFICANT EVENTS: ERBS

The ERBS satellite was launched into a 57-degree inclination orbit on October 5, 1984, and became operational on November 1, 1984. During the month of January 1985, from the 16th to the 28th, and during the month of August 1985, from the 7th to the 14th, the ERBS scanner was operated in the along-track (or pushbroom) mode, as opposed to the normal cross-track (or whiskbroom) mode.

2.4.2 SIGNIFICANT EVENTS: NOAA-9

The NOAA-9 satellite was launched into a polar, Sun-synchronous, "noon/midnight" orbit on December 12, 1984. During the month of August 1985, from the 2nd to the 9th, the NOAA-9 scanner was operated in the along-track mode, as opposed to the normal cross-track mode.

Thus, for a period of 2 days, from August 7 to 9, 1985, both the ERBS and NOAA-9 scanners were functioning in an along-track mode.

2.4.3 SIGNIFICANT EVENTS: NOAA-10

The NOAA-10 satellite was launched into a polar, Sun-synchronous, "terminator" orbit on October 22, 1986. Because of the orientation of the Sun in relation to the NOAA-10 scanning plane in this terminator orbit, the scanner azimuth angle must be changed periodically to prevent scanning of the solar disk. From its launch until December 31, 1986, the NOAA-10 scanner azimuth angle remained fixed at 35 degrees.

3.0 NONSCANNING RADIOMETERS

The ERBE nonscanning sensor module is illustrated in Figure 2. The hemispherical shortwave dome, which is shown covering the active cavity in the illustration, is used only for the shortwave channels and is not present on the total instruments. Also, the distance separating the primary aperture and the field limiting aperture is much less on the WFOV instrument than on the MFOV. The complete design and method of operation for the nonscanners was described by Carman¹¹ and Luther et al.^{12,13}. The TRW ground calibration data for the ERBS, NOAA-9, and NOAA-10 nonscanners was documented by Fellner et al.^{14,15,16}. Halyo et al.⁵ designed, modeled, and validated count conversion equations to represent the TRW ground calibration data. They also produced the final count conversion coefficients for all nonscanning sensors. For the most part, nonscanner offsets were produced for every usable calibration day. The normal nonscanner calibration frequency was once every 2 weeks. As mentioned in the Introduction, NOAA-9 offsets start in February 1985, and NOAA-10 offsets start in October 1986.

3.1 NONSCANNER COUNT CONVERSION ALGORITHMS

The equations used in the determination of nonscanner offsets were developed by members of the ERBS Science Team, and are described by Halyo et al.⁵ They are used as follows:

TOTAL CHANNELS (WFOV & MFOV)

$$E_T = A_V \cdot V^2 + A_T \cdot T_T + A_R \cdot V_R^2 + B_T$$

SHORTWAVE CHANNELS (WFOV & MFOV)

$$E_{SW} = A_V \cdot V^2 + A_T \cdot T_T + A_R \cdot E_T + A_R \cdot V_R^2 + B_{SW}$$

The in-flight total channel count conversion coefficients, except for the B_T offset term, remain the same as the ground coefficients. The offset term, B_T , is recalculated using in-flight calibration data. However, because of degradation of the transmissivity of the Suprasil dome used to block longwave radiation from entering the active cavity of the shortwave channel, each count conversion coefficient for the shortwave channel is modified as described in the next paragraph. The shortwave offset term, B_{SW} , is then recalculated using the in-flight data.

3.1.1 DOME DEGRADATION CORRECTION

The transmissivity degradation caused by solar exposure of the dome is computed for each calibration day. The method of correction of the shortwave data to compensate for this dome degradation is accomplished by using the relationship:

$$A(t) = (s(t_0)/s(t)) * A = (C_0 / s(t)) * A$$

where: $A(t)$ = "corrected" in-flight shortwave coefficient

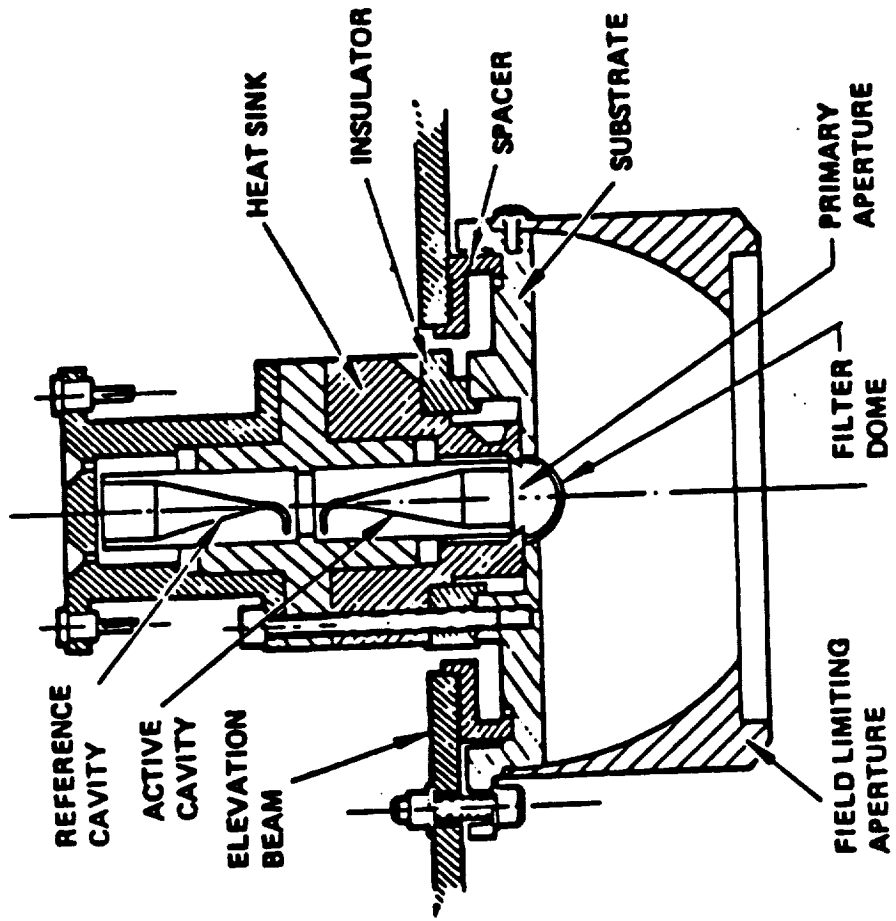

Figure 2. ERBE Nonscanner Sensor Module

$s(t_0)$ - measured solar irradiance on day 0
 $s(t)$ - measured solar irradiance on day t
 C_0 - offset calculated on day 0
A - ground coefficient for the term in question

The factor $(C_0/s(t))$ is sometimes referred to as the dome degradation factor. It is a number (normally greater than 1) which represents the amount by which the ground coefficient, A, must be increased to compensate for degradation of the dome. These comments apply to all "A" coefficients in the shortwave equation. For the coefficients and offsets listed in this document, the value of $s(t)$ was calculated from a second order fit to solar calibration data both before and after the data days. The offset term, B_{SW} , was computed by assuming zero shortwave energy present in the nighttime in-flight data. The procedures used for revising the coefficients and offsets are described by Paden et al.¹⁷.

3.2 GROUND OFFSETS

The TRW ground calibrations for the ERBE nonscanners are described by Fellner, et al.^{14,15,16}, at the TRW facility in Redondo Beach, California. The TRW calibration data were used by Information & Control Systems, Inc. (ICS), Hampton, Virginia⁵, to define count conversion coefficients. A summary of the applicable coefficients, which were generated through the combined efforts of ICS and NASA, is shown in Table 1. The radiometric fluxes, or "E" terms in the above equations, are calculated based on the coefficients, or "A" terms in Table 1, and the following variables:

V - Instrument output (volts)
 T_f - Field-of-view limiter temperature (degrees K)
 V_R - Calibration heater voltage (volts)

Table 1. ERBE Nonscanner Ground Coefficients

SAT	COEF.		A_V	A_F	A_R	B	A_E
ERBS	T O T	WFOV	-22.7873	-1.3968	26.1161	1703.700	N.A.
		MFOV	-22.7093	-0.9230	25.1276	1273.547	N.A.
	S / W	WFOV	-25.5824	-0.6434	26.5454	1311.386	-0.03051
		MFOV	-25.5337	1.2227	29.0431	1014.669	-0.03751
NOAA-9	T O T	WFOV	-22.8621	-0.3977	24.7635	1475.430	N.A.
		MFOV	-22.5566	-0.5274	23.9133	1211.540	N.A.
	S / W	WFOV	-25.9880	-0.3540	30.1311	1359.474	-0.03465
		MFOV	-25.4599	0.7092	28.9870	841.703	-0.03604
NOAA-10	T O T	WFOV	-22.5230	-0.4216	23.8202	1432.85	N.A.
		MFOV	-23.2215	-1.9825	22.4009	1668.74	N.A.
	S / W	WFOV	-24.3501	-1.3074	28.6683	1417.18	-0.03032
		MFOV	-25.0633	-3.3751	29.1677	1942.58	-0.02270

3.3 IN-FLIGHT OFFSETS

The ERBE Merge Subsystem, described by Stassi et al.³, was used to produce Instrument Validation Tape (IVT) for each calibration day in question. This tape was used as the source for nonscanner in-flight calibration data. Appendices G, H, and I contain figures depicting the offsets derived on the calibration days for the ERBS, NOAA-9, and NOAA-10 satellites, respectively. Monthly tables of nonscanner offsets, as they were used by the Merge Subsystem, are reproduced in their original memoranda format in Appendices J, K, and L, for the ERBS, NOAA-9, and NOAA-10 satellites, respectively.

3.3.1 TOTAL CHANNELS

Two data sets are used to independently determine total channel offsets (i.e., the B_T terms). These are referred to as "B-soak" and "internal cal." The "B-soak" data set is the set of 60 IVT records beginning 90 records before the "go to nadir" command preceding the elevation of the instrument to the internal sources

nadir" command preceding the elevation of the instrument to the internal sources for the internal calibration sequence. The "internal cal" data set is the data set comprised of records collected during the internal calibration sequence when both the Shortwave Internal Calibration Source (SWICS) and the calibration heater voltages are zero. Total channel offsets are independently determined from both of these data sets, using the temperature and voltage data supplied by the IVT records. If the "B-soak" offset is present, it is the preferred offset and is the final total channel offset. If the "B-soak" offset is not available, then the "Internal Cal" offset is used.

3.3.2 SHORTWAVE CHANNELS

Four data sets are defined for use in the independent determination of shortwave channel offsets. The "B-soak" and "internal cal" data sets, as described for the total channels; the "nighttime" data set; and the "solar cal" data set. The "nighttime" data set is the aggregate of all data records collected when the solar zenith angle is greater than a specified value. The specified value is normally 123 degrees. The "solar cal" data set is the collection of "space-look" records (about 24) following solar exposure while the instrument is returning to nadir. During the "nighttime" and "solar cal" periods, the incident shortwave flux is assumed to be zero. If there are data for the "nighttime" offset, this is the preferred offset. If not, then the second choice is the "internal cal" offset determined by using the IVT data (and using the SWICS temperature to determine the total channel flux reading, if it were observing the SWICS) adjusted by the appropriate "delta" (e.g., the fitted difference between the "nighttime" and the "internal cal" shortwave offsets). Failing either of these options, we then resort to using interpolated "nighttime" (first choice) or "internal cal" (second choice) data from the calibration days immediately preceding and succeeding the day in question. The "solar cal" offsets are not currently used. Deltas for shortwave channel correction to "nighttime" equivalents are determined from least squares linear fits to historical shortwave calibration data.

3.4 FINAL COUNT CONVERSION COEFFICIENTS

Appendices G, H, and I contain tables of nonscanner offsets for the ERBS, NOAA-9, and NOAA-10 satellites, respectively, for the years 1984, 1985, and 1986. These offsets were generated using data acquired on internal calibration days, which are shown in the plots in Appendices J, K, and L and are presented as they were used by the ERBE Merge Subsystem. For the most part, nonscanner offsets were produced for every useable calibration day, and the nonscanner internal calibration frequency was approximately once every 2 weeks. As mentioned in the Introduction, NOAA-9 offsets commence in February 1985, and NOAA-10 offsets commence in October 1986.

REFERENCES

1. S. L. Carman, "ERBE Scanner Instrument Operations Manual," TRW Document No. D04607A, 1982.
2. L. P. Kopla, "The Earth Radiation Budget Experiment Scanner Instrument", Rev. Geophys., Vol. 24, No. 2, 400-406, May 1986.
3. J. C. Stassi, L. H. Hoffman, and I. J. Walker, "Earth Radiation Budget Experiment (ERBE) Data Management System Reference Manual", Volume IV - Merge, FOV Calculations, Count Conversion, NASA LaRC, ERBE 3-3-9-4-87-8-0, 1987.
4. C. K. Hendricks, "Final Calibration Report on ERBE Flight Model One Scanner Instrument", TRW Document No. D06903, 1984.
5. N. Halyo, D. K. Pandey, and D. B. Taylor, "Modelling and Characterization of the Earth Radiation Budget Experiment (ERBE) Nonscanner and Scanner Sensors," NASA Contractor Report 181818, March 1989.
6. C. K. Hendricks, "Final Calibration Report on ERBE Protoflight Model Scanner Instrument", TRW Document No. D06905, 1984.
7. C. K. Hendricks, "Final Calibration Report on ERBE Flight Model Two Scanner Instrument", TRW Document No. D06907, 1984.
8. Robert B. Lee III, Bruce R. Barkstrom, Nesim Halyo, Michael A. Gibson, and Lee M. Avis, "Characterizations of the Earth Radiation Budget Experiment (ERBE) Scanning Radiometers," SPIE Proc., 1109, 186-194, 1989.
9. R. B. Lee III, M. A. Gibson, S. Thomas, J. R. Mahan, J. L. Meekins, and N. E. Tira, "Earth Radiation Budget Experiment Scanner Radiometric Calibration Results," SPIE Proc., Vol. 1299, 80-91, 1990.
10. L. M. Avis, W. C. Bolden, R. B. Lee III, J. Paden, D. K. Pandey, J. C. Stassi, C. J. Tolson, and R. S. Wilson, "NOAA-9 Earth Radiation Budget Experiment (ERBE): Scanner Offsets Determination," to be published, 1991.
11. S. L. Carman, "ERBE Nonscanner Instrument Operations Manual," TRW Document No. D04608A, 1982.
12. M. R. Luther, T. A. Evert, R. J. Hesser, W. D. Potter, and A. Castinerias, "Performance Characteristics of Active Cavity Radiometers in Unshuttered Applications," Applied Optics, Vol. 25, No. 20, 3705-3709, 1986.
13. M. R. Luther, J. E. Cooper, and G. R. Taylor, "The Earth Radiation Budget Experiment Nonscanner Instrument," Rev. Geophys. and Space Physics, Vol. 24, No. 2, 391-399, May 1986.
14. R. Fellner, T. Evert, and R. Hesser, "Final Calibration Report on ERBE Flight Model One Nonscanner Instrument", TRW Document No. D06904, 1984.

15. R. Fellner, T. Evert, and R. Hesser, "Final Calibration Report on ERBE Flight Model Two Nonscanner Instrument", TRW Document No. D06906, 1984.
16. R. Fellner, T. Evert, and R. Hesser, "Final Calibration Report on ERBE Protoflight Model Nonscanner Instrument", TRW Document No. D06908, 1984.
17. J. Paden, D. K. Pandey, R. S. Wilson, S. Thomas, M. A. Gibson, and R. B. Lee III, "Ground and In-flight Calibrations for the Earth Radiation Budget Experiment (ERBE) Nonscanning Radiometers," SPIE Proc., 1300, 190-201, 1990.

This page has been intentionally left blank

APPENDIX A

ERBS SCANNER OFFSET TABLES



APPENDIX A: ERBS SCANNER OFFSET TABLES

The following pages contain the ERBS scanner offset tables, both cross-track and along-track for the period from November 1984 until December 1986. As previously mentioned, the ERBS did not become operational until late October 1984.

During the periods from January 16 to 28, 1985, and from August 7 to 14, 1985, the ERBS spacecraft was operated in an along-track mode. Scanner offsets for these days are listed as "along-track" offsets. Offsets for all other days are listed as "cross-track" offsets. In reality, for all days in 1985, only one set of scanner (cross-track) offsets was used. The differences for each individual month were only in the offset for scan position 1 of the shortwave set.

The units used for all scanner offsets in these tables are watts per square meter per steradian.

	Table
ERBS Cross-Track Offsets, October 1984 - December 1985	A-1
ERBS Along-Track Offsets, January and August 1985	A-2
ERBS Scanner Offsets, January - December 1986	A-3

This page has been intentionally left blank

ERBS CROSS-TRACK SCANNER OFFSETS NOVEMBER 1984 THROUGH DECEMBER 1985

S.P.	TOTAL	LONGWAVE	SHORTWAVE
1	.12	.13	-.23
2	.09	.06	-.70
3	.00	.03	-.58
4	-.04	-.06	-.49
5	-.56	-.45	-1.13
6	-.36	-.26	-.88
7	.14	.14	-.63
8	.15	.22	-1.04
9	.24	.25	-.77
10	-.45	-.34	-.81
11	-.37	-.25	-1.23
12	-.45	-.31	-.97
13	-.28	-.14	-.68
14	.33	.39	-.91
15	.34	.40	-.76
16	.35	.43	-.54
17	.38	.42	-.95
18	.45	.50	-.68
19	.46	.49	-.45
20	.52	.56	-.77
21	.55	.60	-.61
22	.50	.46	-.53
23	.48	.49	-.97
24	.52	.54	-.78
25	-.04	.02	-.72
26	.18	.28	-.97
27	.79	.81	-.58
28	.82	.86	-.37
29	.92	.97	-.68
30	.26	.32	-.73
31	.33	.41	-.52
32	.33	.43	-.84
33	.52	.56	-.53
34	1.12	1.16	-.19
35	1.14	1.18	-.59
36	1.20	1.22	-.32
37	1.14	1.17	-.20
38	1.19	1.25	-.60
39	1.25	1.30	-.37
40	1.25	1.25	-.18
41	1.25	1.31	-.61
42	1.16	1.23	-.44
43	1.20	1.18	-.30
44	1.21	1.28	-.67
45	.62	.70	-.62
46	.79	.82	-.40
47	1.45	1.48	-.56
48	1.47	1.51	-.29
49	1.51	1.56	-.08
50	.82	.84	-.72
51	.91	.93	-.49
52	1.02	1.17	-.12
53	1.09	1.17	-.63
54	1.65	1.73	-.29
55	1.58	1.65	-.17
56	1.56	1.62	-.63
57	1.52	1.60	-.44
58	1.45	1.49	-.32
59	1.42	1.51	-.74
60	1.40	1.51	-.51
61	1.38	1.43	-.41
62	1.31	1.41	-1.19

14 INTENTIONALLY BLANK

PRECEDING PAGE BLANK NOT FILMED

ERBS SCANNER OFFSETS (ALONG-TRACK) FOR 16-28 JANUARY 1985
AND 7-14 AUGUST 1985

S.P.	TOTAL	LONGWAVE	SHORTWAVE
1	0.26	0.25	-0.15
2	0.22	0.22	-0.62
3	0.13	0.18	-0.55
4	0.13	0.13	-0.44
5	-0.43	-0.33	-1.12
6	-0.21	-0.13	-0.91
7	0.3	0.27	-0.67
8	0.26	0.31	-1.12
9	0.34	0.33	-0.88
10	-0.32	-0.27	-0.93
11	-0.26	-0.16	-1.32
12	-0.34	-0.23	-1.08
13	-0.14	-0.07	-0.81
14	0.46	0.46	-1.06
15	0.45	0.48	-0.9
16	0.49	0.52	-0.71
17	0.54	0.51	-1.09
18	0.56	0.57	-0.82
19	0.59	0.56	-0.58
20	0.67	0.63	-0.92
21	0.75	0.7	-0.73
22	0.7	0.62	-0.61
23	0.7	0.62	-1.03
24	0.73	0.67	-0.87
25	0.14	0.1	-0.87
26	0.4	0.37	-1.14
27	1.02	0.89	-0.72
28	1.01	0.86	-0.56
29	1.09	0.99	-0.86
30	0.4	0.31	-0.96
31	0.49	0.42	-0.76
32	0.49	0.43	-1.08
33	0.65	0.56	-0.78
34	1.31	1.17	-0.44
35	1.36	1.19	-0.81
36	1.39	1.25	-0.58
37	1.32	1.17	-0.47
38	1.39	1.24	-0.82
39	1.44	1.3	-0.61
40	1.45	1.27	-0.4
41	1.48	1.34	-0.8
42	1.45	1.33	-0.56
43	1.48	1.3	-0.4
44	1.53	1.38	-0.8
45	0.88	0.75	-0.81
46	1.07	0.88	-0.56
47	1.74	1.54	-0.71
48	1.74	1.53	-0.49
49	1.76	1.55	-0.3
50	1.05	0.85	-0.96
51	1.15	0.92	-0.71
52	1.24	1.16	-0.3
53	1.32	1.14	-0.85
54	1.88	1.72	-0.56
55	1.82	1.63	-0.44
56	1.77	1.6	-0.88
57	1.71	1.54	-0.76
58	1.61	1.43	-0.63
59	1.58	1.43	-1.08
60	1.52	1.4	-0.97
61	1.52	1.33	-0.87
62	1.5	1.34	-1.6

ERBS SCANNER OFFSETS FOR 1986: TOTAL CHANNEL

S.P.	MONTH -->											
	JAN	FEB	MAR	APR	MAY	JUN	JUL	AUG	SEP	OCT	NOV	DEC
1	.12	.12	.12	.12	.12	.12	.12	.12	.12	.12	.12	.12
2	.09	.09	.09	.09	.09	.09	.09	.09	.09	.09	.09	.09
3	.00	.00	.00	.00	.00	.00	.00	.00	.00	.00	.00	.00
4	-.04	-.04	-.04	-.04	-.04	-.04	-.04	-.04	-.04	-.04	-.04	-.04
5	-.56	-.56	-.56	-.56	-.56	-.56	-.56	-.56	-.56	-.56	-.56	-.56
6	-.36	-.36	-.36	-.36	-.36	-.36	-.36	-.36	-.36	-.36	-.36	-.36
7	.14	.14	.14	.14	.14	.14	.14	.14	.14	.14	.14	.14
8	.15	.15	.15	.15	.15	.15	.15	.15	.15	.15	.15	.15
9	.24	.24	.24	.24	.24	.24	.24	.24	.24	.24	.24	.24
10	-.45	-.45	-.45	-.45	-.45	-.45	-.45	-.45	-.45	-.45	-.45	-.45
11	-.37	-.37	-.37	-.37	-.37	-.37	-.37	-.37	-.37	-.37	-.37	-.37
12	-.45	-.45	-.45	-.45	-.45	-.45	-.45	-.45	-.45	-.45	-.45	-.45
13	-.28	-.28	-.28	-.28	-.28	-.28	-.28	-.28	-.28	-.28	-.28	-.28
14	.33	.33	.33	.33	.33	.33	.33	.33	.33	.33	.33	.33
15	.34	.34	.34	.34	.34	.34	.34	.34	.34	.34	.34	.34
16	.35	.35	.35	.35	.35	.35	.35	.35	.35	.35	.35	.35
17	.38	.38	.38	.38	.38	.38	.38	.38	.38	.38	.38	.38
18	.45	.45	.45	.45	.45	.45	.45	.45	.45	.45	.45	.45
19	.46	.46	.46	.46	.46	.46	.46	.46	.46	.46	.46	.46
20	.52	.52	.52	.52	.52	.52	.52	.52	.52	.52	.52	.52
21	.55	.55	.55	.55	.55	.55	.55	.55	.55	.55	.55	.55
22	.50	.50	.50	.50	.50	.50	.50	.50	.50	.50	.50	.50
23	.48	.48	.48	.48	.48	.48	.48	.48	.48	.48	.48	.48
24	.52	.52	.52	.52	.52	.52	.52	.52	.52	.52	.52	.52
25	-.04	-.04	-.04	-.04	-.04	-.04	-.04	-.04	-.04	-.04	-.04	-.04
26	.18	.18	.18	.18	.18	.18	.18	.18	.18	.18	.18	.18
27	.79	.79	.79	.79	.79	.79	.79	.79	.79	.79	.79	.79
28	.82	.82	.82	.82	.82	.82	.82	.82	.82	.82	.82	.82
29	.92	.92	.92	.92	.92	.92	.92	.92	.92	.92	.92	.92
30	.26	.26	.26	.26	.26	.26	.26	.26	.26	.26	.26	.26
31	.33	.33	.33	.33	.33	.33	.33	.33	.33	.33	.33	.33
32	.33	.33	.33	.33	.33	.33	.33	.33	.33	.33	.33	.33
33	.52	.52	.52	.52	.52	.52	.52	.52	.52	.52	.52	.52
34	1.12	1.12	1.12	1.12	1.12	1.12	1.12	1.12	1.12	1.12	1.12	1.12
35	1.14	1.14	1.14	1.14	1.14	1.14	1.14	1.14	1.14	1.14	1.14	1.14
36	1.20	1.20	1.20	1.20	1.20	1.20	1.20	1.20	1.20	1.20	1.20	1.20
37	1.14	1.14	1.14	1.14	1.14	1.14	1.14	1.14	1.14	1.14	1.14	1.14
38	1.19	1.19	1.19	1.19	1.19	1.19	1.19	1.19	1.19	1.19	1.19	1.19
39	1.25	1.25	1.25	1.25	1.25	1.25	1.25	1.25	1.25	1.25	1.25	1.25
40	1.25	1.25	1.25	1.25	1.25	1.25	1.25	1.25	1.25	1.25	1.25	1.25
41	1.25	1.25	1.25	1.25	1.25	1.25	1.25	1.25	1.25	1.25	1.25	1.25
42	1.16	1.16	1.16	1.16	1.16	1.16	1.16	1.16	1.16	1.16	1.16	1.16
43	1.20	1.20	1.20	1.20	1.20	1.20	1.20	1.20	1.20	1.20	1.20	1.20
44	1.21	1.21	1.21	1.21	1.21	1.21	1.21	1.21	1.21	1.21	1.21	1.21
45	.62	.62	.62	.62	.62	.62	.62	.62	.62	.62	.62	.62
46	.79	.79	.79	.79	.79	.79	.79	.79	.79	.79	.79	.79
47	1.45	1.45	1.45	1.45	1.45	1.45	1.45	1.45	1.45	1.45	1.45	1.45
48	1.47	1.47	1.47	1.47	1.47	1.47	1.47	1.47	1.47	1.47	1.47	1.47
49	1.51	1.51	1.51	1.51	1.51	1.51	1.51	1.51	1.51	1.51	1.51	1.51
50	.82	.82	.82	.82	.82	.82	.82	.82	.82	.82	.82	.82
51	.91	.91	.91	.91	.91	.91	.91	.91	.91	.91	.91	.91
52	1.02	1.02	1.02	1.02	1.02	1.02	1.02	1.02	1.02	1.02	1.02	1.02
53	1.09	1.09	1.09	1.09	1.09	1.09	1.09	1.09	1.09	1.09	1.09	1.09
54	1.65	1.65	1.65	1.65	1.65	1.65	1.65	1.65	1.65	1.65	1.65	1.65
55	1.58	1.58	1.58	1.58	1.58	1.58	1.58	1.58	1.58	1.58	1.58	1.58
56	1.56	1.56	1.56	1.56	1.56	1.56	1.56	1.56	1.56	1.56	1.56	1.56
57	1.52	1.52	1.52	1.52	1.52	1.52	1.52	1.52	1.52	1.52	1.52	1.52
58	1.45	1.45	1.45	1.45	1.45	1.45	1.45	1.45	1.45	1.45	1.45	1.45
59	1.42	1.42	1.42	1.42	1.42	1.42	1.42	1.42	1.42	1.42	1.42	1.42
60	1.40	1.40	1.40	1.40	1.40	1.40	1.40	1.40	1.40	1.40	1.40	1.40
61	1.38	1.38	1.38	1.38	1.38	1.38	1.38	1.38	1.38	1.38	1.38	1.38
62	1.31	1.31	1.31	1.31	1.31	1.31	1.31	1.31	1.31	1.31	1.31	1.31

ERBS SCANNER OFFSETS FOR 1966: LONGWAVE CHANNEL

S.P.	MONTH -->											
	JAN	FEB	MAR	APR	MAY	JUN	JUL	AUG	SEP	OCT	NOV	DEC
1	.13	.13	.13	.13	.13	.13	.13	.13	.13	.13	.13	.13
2	.06	.06	.06	.06	.06	.06	.06	.06	.06	.06	.06	.06
3	.03	.03	.03	.03	.03	.03	.03	.03	.03	.03	.03	.03
4	-.06	-.06	-.06	-.06	-.06	-.06	-.06	-.06	-.06	-.06	-.06	-.06
5	-.45	-.45	-.45	-.45	-.45	-.45	-.45	-.45	-.45	-.45	-.45	-.45
6	-.26	-.26	-.26	-.26	-.26	-.26	-.26	-.26	-.26	-.26	-.26	-.26
7	.14	.14	.14	.14	.14	.14	.14	.14	.14	.14	.14	.14
8	.22	.22	.22	.22	.22	.22	.22	.22	.22	.22	.22	.22
9	.25	.25	.25	.25	.25	.25	.25	.25	.25	.25	.25	.25
10	-.34	-.34	-.34	-.34	-.34	-.34	-.34	-.34	-.34	-.34	-.34	-.34
11	-.25	-.25	-.25	-.25	-.25	-.25	-.25	-.25	-.25	-.25	-.25	-.25
12	-.31	-.31	-.31	-.31	-.31	-.31	-.31	-.31	-.31	-.31	-.31	-.31
13	-.14	-.14	-.14	-.14	-.14	-.14	-.14	-.14	-.14	-.14	-.14	-.14
14	.39	.39	.39	.39	.39	.39	.39	.39	.39	.39	.39	.39
15	.40	.40	.40	.40	.40	.40	.40	.40	.40	.40	.40	.40
16	.43	.43	.43	.43	.43	.43	.43	.43	.43	.43	.43	.43
17	.42	.42	.42	.42	.42	.42	.42	.42	.42	.42	.42	.42
18	.50	.50	.50	.50	.50	.50	.50	.50	.50	.50	.50	.50
19	.49	.49	.49	.49	.49	.49	.49	.49	.49	.49	.49	.49
20	.56	.56	.56	.56	.56	.56	.56	.56	.56	.56	.56	.56
21	.60	.60	.60	.60	.60	.60	.60	.60	.60	.60	.60	.60
22	.46	.46	.46	.46	.46	.46	.46	.46	.46	.46	.46	.46
23	.49	.49	.49	.49	.49	.49	.49	.49	.49	.49	.49	.49
24	.54	.54	.54	.54	.54	.54	.54	.54	.54	.54	.54	.54
25	.02	.02	.02	.02	.02	.02	.02	.02	.02	.02	.02	.02
26	.28	.28	.28	.28	.28	.28	.28	.28	.28	.28	.28	.28
27	.81	.81	.81	.81	.81	.81	.81	.81	.81	.81	.81	.81
28	.86	.86	.86	.86	.86	.86	.86	.86	.86	.86	.86	.86
29	.97	.97	.97	.97	.97	.97	.97	.97	.97	.97	.97	.97
30	.32	.32	.32	.32	.32	.32	.32	.32	.32	.32	.32	.32
31	.41	.41	.41	.41	.41	.41	.41	.41	.41	.41	.41	.41
32	.43	.43	.43	.43	.43	.43	.43	.43	.43	.43	.43	.43
33	.56	.56	.56	.56	.56	.56	.56	.56	.56	.56	.56	.56
34	1.16	1.16	1.16	1.16	1.16	1.16	1.16	1.16	1.16	1.16	1.16	1.16
35	1.18	1.18	1.18	1.18	1.18	1.18	1.18	1.18	1.18	1.18	1.18	1.18
36	1.22	1.22	1.22	1.22	1.22	1.22	1.22	1.22	1.22	1.22	1.22	1.22
37	1.17	1.17	1.17	1.17	1.17	1.17	1.17	1.17	1.17	1.17	1.17	1.17
38	1.25	1.25	1.25	1.25	1.25	1.25	1.25	1.25	1.25	1.25	1.25	1.25
39	1.30	1.30	1.30	1.30	1.30	1.30	1.30	1.30	1.30	1.30	1.30	1.30
40	1.25	1.25	1.25	1.25	1.25	1.25	1.25	1.25	1.25	1.25	1.25	1.25
41	1.31	1.31	1.31	1.31	1.31	1.31	1.31	1.31	1.31	1.31	1.31	1.31
42	1.23	1.23	1.23	1.23	1.23	1.23	1.23	1.23	1.23	1.23	1.23	1.23
43	1.18	1.18	1.18	1.18	1.18	1.18	1.18	1.18	1.18	1.18	1.18	1.18
44	1.28	1.28	1.28	1.28	1.28	1.28	1.28	1.28	1.28	1.28	1.28	1.28
45	.70	.70	.70	.70	.70	.70	.70	.70	.70	.70	.70	.70
46	.82	.82	.82	.82	.82	.82	.82	.82	.82	.82	.82	.82
47	1.48	1.48	1.48	1.48	1.48	1.48	1.48	1.48	1.48	1.48	1.48	1.48
48	1.51	1.51	1.51	1.51	1.51	1.51	1.51	1.51	1.51	1.51	1.51	1.51
49	1.56	1.56	1.56	1.56	1.56	1.56	1.56	1.56	1.56	1.56	1.56	1.56
50	.84	.84	.84	.84	.84	.84	.84	.84	.84	.84	.84	.84
51	.93	.93	.93	.93	.93	.93	.93	.93	.93	.93	.93	.93
52	1.17	1.17	1.17	1.17	1.17	1.17	1.17	1.17	1.17	1.17	1.17	1.17
53	1.17	1.17	1.17	1.17	1.17	1.17	1.17	1.17	1.17	1.17	1.17	1.17
54	1.73	1.73	1.73	1.73	1.73	1.73	1.73	1.73	1.73	1.73	1.73	1.73
55	1.65	1.65	1.65	1.65	1.65	1.65	1.65	1.65	1.65	1.65	1.65	1.65
56	1.62	1.62	1.62	1.62	1.62	1.62	1.62	1.62	1.62	1.62	1.62	1.62
57	1.60	1.60	1.60	1.60	1.60	1.60	1.60	1.60	1.60	1.60	1.60	1.60
58	1.49	1.49	1.49	1.49	1.49	1.49	1.49	1.49	1.49	1.49	1.49	1.49
59	1.51	1.51	1.51	1.51	1.51	1.51	1.51	1.51	1.51	1.51	1.51	1.51
60	1.51	1.51	1.51	1.51	1.51	1.51	1.51	1.51	1.51	1.51	1.51	1.51
61	1.43	1.43	1.43	1.43	1.43	1.43	1.43	1.43	1.43	1.43	1.43	1.43
62	1.41	1.41	1.41	1.41	1.41	1.41	1.41	1.41	1.41	1.41	1.41	1.41

ERBS SCANNER OFFSETS FOR 1986: SHORTWAVE CHANNEL

S.P.	MONTH -->											
	JAN	FEB	MAR	APR	MAY	JUN	JUL	AUG	SEP	OCT	NOV	DEC
1	-.23	-.23	-.23	-.23	-.58	-.56	-.63	-.55	-.46	-.23	-.56	-.23
2	-.70	-.70	-.70	-.70	-.70	-.70	-.70	-.70	-.70	-.70	-.70	-.70
3	-.58	-.58	-.58	-.58	-.58	-.58	-.58	-.58	-.58	-.58	-.58	-.58
4	-.49	-.49	-.49	-.49	-.49	-.49	-.49	-.49	-.49	-.49	-.49	-.49
5	-1.13	-1.13	-1.13	-1.13	-1.13	-1.13	-1.13	-1.13	-1.13	-1.13	-1.13	-1.13
6	-.88	-.88	-.88	-.88	-.88	-.88	-.88	-.88	-.88	-.88	-.88	-.88
7	-.63	-.63	-.63	-.63	-.63	-.63	-.63	-.63	-.63	-.63	-.63	-.63
8	-1.04	-1.04	-1.04	-1.04	-1.04	-1.04	-1.04	-1.04	-1.04	-1.04	-1.04	-1.04
9	-.77	-.77	-.77	-.77	-.77	-.77	-.77	-.77	-.77	-.77	-.77	-.77
10	-.81	-.81	-.81	-.81	-.81	-.81	-.81	-.81	-.81	-.81	-.81	-.81
11	-1.23	-1.23	-1.23	-1.23	-1.23	-1.23	-1.23	-1.23	-1.23	-1.23	-1.23	-1.23
12	-.97	-.97	-.97	-.97	-.97	-.97	-.97	-.97	-.97	-.97	-.97	-.97
13	-.68	-.68	-.68	-.68	-.68	-.68	-.68	-.68	-.68	-.68	-.68	-.68
14	-.91	-.91	-.91	-.91	-.91	-.91	-.91	-.91	-.91	-.91	-.91	-.91
15	-.76	-.76	-.76	-.76	-.76	-.76	-.76	-.76	-.76	-.76	-.76	-.76
16	-.54	-.54	-.54	-.54	-.54	-.54	-.54	-.54	-.54	-.54	-.54	-.54
17	-.95	-.95	-.95	-.95	-.95	-.95	-.95	-.95	-.95	-.95	-.95	-.95
18	-.68	-.68	-.68	-.68	-.68	-.68	-.68	-.68	-.68	-.68	-.68	-.68
19	-.45	-.45	-.45	-.45	-.45	-.45	-.45	-.45	-.45	-.45	-.45	-.45
20	-.77	-.77	-.77	-.77	-.77	-.77	-.77	-.77	-.77	-.77	-.77	-.77
21	-.61	-.61	-.61	-.61	-.61	-.61	-.61	-.61	-.61	-.61	-.61	-.61
22	-.53	-.53	-.53	-.53	-.53	-.53	-.53	-.53	-.53	-.53	-.53	-.53
23	-.97	-.97	-.97	-.97	-.97	-.97	-.97	-.97	-.97	-.97	-.97	-.97
24	-.78	-.78	-.78	-.78	-.78	-.78	-.78	-.78	-.78	-.78	-.78	-.78
25	-.72	-.72	-.72	-.72	-.72	-.72	-.72	-.72	-.72	-.72	-.72	-.72
26	-.97	-.97	-.97	-.97	-.97	-.97	-.97	-.97	-.97	-.97	-.97	-.97
27	-.58	-.58	-.58	-.58	-.58	-.58	-.58	-.58	-.58	-.58	-.58	-.58
28	-.37	-.37	-.37	-.37	-.37	-.37	-.37	-.37	-.37	-.37	-.37	-.37
29	-.68	-.68	-.68	-.68	-.68	-.68	-.68	-.68	-.68	-.68	-.68	-.68
30	-.73	-.73	-.73	-.73	-.73	-.73	-.73	-.73	-.73	-.73	-.73	-.73
31	-.52	-.52	-.52	-.52	-.52	-.52	-.52	-.52	-.52	-.52	-.52	-.52
32	-.84	-.84	-.84	-.84	-.84	-.84	-.84	-.84	-.84	-.84	-.84	-.84
33	-.53	-.53	-.53	-.53	-.53	-.53	-.53	-.53	-.53	-.53	-.53	-.53
34	-.19	-.19	-.19	-.19	-.19	-.19	-.19	-.19	-.19	-.19	-.19	-.19
35	-.59	-.59	-.59	-.59	-.59	-.59	-.59	-.59	-.59	-.59	-.59	-.59
36	-.32	-.32	-.32	-.32	-.32	-.32	-.32	-.32	-.32	-.32	-.32	-.32
37	-.20	-.20	-.20	-.20	-.20	-.20	-.20	-.20	-.20	-.20	-.20	-.20
38	-.60	-.60	-.60	-.60	-.60	-.60	-.60	-.60	-.60	-.60	-.60	-.60
39	-.37	-.37	-.37	-.37	-.37	-.37	-.37	-.37	-.37	-.37	-.37	-.37
40	-.18	-.18	-.18	-.18	-.18	-.18	-.18	-.18	-.18	-.18	-.18	-.18
41	-.61	-.61	-.61	-.61	-.61	-.61	-.61	-.61	-.61	-.61	-.61	-.61
42	-.44	-.44	-.44	-.44	-.44	-.44	-.44	-.44	-.44	-.44	-.44	-.44
43	-.30	-.30	-.30	-.30	-.30	-.30	-.30	-.30	-.30	-.30	-.30	-.30
44	-.67	-.67	-.67	-.67	-.67	-.67	-.67	-.67	-.67	-.67	-.67	-.67
45	-.62	-.62	-.62	-.62	-.62	-.62	-.62	-.62	-.62	-.62	-.62	-.62
46	-.40	-.40	-.40	-.40	-.40	-.40	-.40	-.40	-.40	-.40	-.40	-.40
47	-.56	-.56	-.56	-.56	-.56	-.56	-.56	-.56	-.56	-.56	-.56	-.56
48	-.29	-.29	-.29	-.29	-.29	-.29	-.29	-.29	-.29	-.29	-.29	-.29
49	-.08	-.08	-.08	-.08	-.08	-.08	-.08	-.08	-.08	-.08	-.08	-.08
50	-.72	-.72	-.72	-.72	-.72	-.72	-.72	-.72	-.72	-.72	-.72	-.72
51	-.49	-.49	-.49	-.49	-.49	-.49	-.49	-.49	-.49	-.49	-.49	-.49
52	-.12	-.12	-.12	-.12	-.12	-.12	-.12	-.12	-.12	-.12	-.12	-.12
53	-.63	-.63	-.63	-.63	-.63	-.63	-.63	-.63	-.63	-.63	-.63	-.63
54	-.29	-.29	-.29	-.29	-.29	-.29	-.29	-.29	-.29	-.29	-.29	-.29
55	-.17	-.17	-.17	-.17	-.17	-.17	-.17	-.17	-.17	-.17	-.17	-.17
56	-.63	-.63	-.63	-.63	-.63	-.63	-.63	-.63	-.63	-.63	-.63	-.63
57	-.44	-.44	-.44	-.44	-.44	-.44	-.44	-.44	-.44	-.44	-.44	-.44
58	-.32	-.32	-.32	-.32	-.32	-.32	-.32	-.32	-.32	-.32	-.32	-.32
59	-.74	-.74	-.74	-.74	-.74	-.74	-.74	-.74	-.74	-.74	-.74	-.74
60	-.51	-.51	-.51	-.51	-.51	-.51	-.51	-.51	-.51	-.51	-.51	-.51
61	-.41	-.41	-.41	-.41	-.41	-.41	-.41	-.41	-.41	-.41	-.41	-.41
62	-1.19	-1.19	-1.19	-1.19	-1.19	-1.19	-1.19	-1.19	-1.19	-1.19	-1.19	-1.19

APPENDIX B

NOAA-9 SCANNER OFFSET TABLES

APPENDIX B: NOAA-9 SCANNER OFFSET TABLES

The following pages contain the scanner offset tables for the NOAA-9 spacecraft for the period from February to December 1986. As previously mentioned, the NOAA-9 did not become operational until late January 1985.

During the period from August 2 until 9, the NOAA-9 spacecraft was operated in the "along-track" mode. Scanner offsets listed for these days are those appropriate for the scanner operational mode on that day. Only one set of scanner offsets was used for each day.

The units used for all scanner offsets in these tables are watts per square meter per steradian.

	Table
February 1985	B-1
March 1985	B-2
April 1985	B-3
May 1985	B-4
June 1985	B-5
July 1985	B-6
August 1985	B-7
September 1985	B-8
October 1985	B-9
November 1985	B-10
December 1985	B-11
January 1986	B-12
February 1986	B-13
March 1986	B-14
April 1986	B-15
May 1986	B-16
June 1986	B-17
July 1986	B-18
August 1986	B-19
September 1986	B-20
October 1986	B-21
November 1986	B-22
December 1986	B-23

This page has been intentionally left blank

NOAA-9 SCANNER OFFSETS FOR FEBRUARY 1985: TOTAL CHANNEL
 DAY OF MONTH -->

S.P.	1	2	3	4	5	6	7	8	9	10	11	12	13	14	15
1	.36	.36	.36	.36	.36	.36	.36	.36	.36	.36	.36	.36	.36	.36	.36
2	1.04	1.04	1.04	1.04	1.04	1.04	1.04	1.04	1.04	1.04	1.04	1.04	1.04	1.04	1.04
3	1.93	1.93	1.93	1.93	1.93	1.93	1.93	1.93	1.93	1.93	1.93	1.93	1.93	1.93	1.93
4	-9.64	-9.64	-9.64	-9.64	-9.64	-9.64	-9.64	-9.64	-9.64	-9.64	-9.64	-9.64	-9.64	-9.64	-9.64
5	-17.37	-17.23	-19.35	-17.02	-18.00	-18.13	-18.64	-17.88	-17.57	-17.47	-17.87	-17.74	-17.44	-17.74	-18.03
6	-1.33	-1.33	-3.76	-.78	-1.97	-2.78	-2.98	-1.66	-.91	-.98	-1.26	-1.51	-1.10	-1.13	-1.26
7	-1.49	-.95	-2.84	-.11	-1.43	-2.26	-1.95	-.93	-.71	-.47	-.18	-.93	-.80	-.48	-.89
8	-.97	.06	-1.56	1.09	-.47	-.68	-.23	-.10	.04	.56	.92	.32	.31	.54	.44
9	-.76	.13	-1.19	1.44	.00	-.09	.53	.24	.41	.87	1.36	.91	.88	.85	.91
10	-.88	-.05	-1.13	1.43	.22	-.01	.58	.13	.29	.72	1.25	.83	1.11	.50	.84
11	-.95	-.15	-1.26	1.19	.33	-.22	.61	.14	.23	.51	.96	.68	1.50	.30	.92
12	-1.07	-.28	-1.43	.92	.22	-.25	.76	.18	.17	.34	.88	.81	1.88	.33	.99
13	-1.30	-.56	-1.55	.67	-.34	-.31	.47	-.16	-.37	.01	.48	.68	1.86	.01	.63
14	-1.28	-.61	-1.71	.77	-.66	-.11	.29	-.30	-.55	.02	.16	.47	2.08	-.28	.16
15	-1.27	-.78	-2.15	.71	-.87	.07	.20	-.41	-.47	-.02	-.20	.30	2.38	-.57	-.25
16	-1.29	-.88	-2.60	.71	-1.05	.06	.13	-.42	-.45	-.03	-.47	.30	2.51	-.87	-.46
17	-1.50	-.97	-2.75	.43	-1.23	.01	-.18	-.42	-.49	-.16	-.65	.25	2.45	-1.11	-.69
18	-1.50	-1.14	-2.69	.43	-1.21	-.05	-.40	-.37	-.57	-.36	-.70	.22	2.42	-.92	-.77
19	-1.47	-1.30	-2.81	-.02	-1.22	-.20	-.66	-.31	-.73	-.52	-.83	.13	2.22	-.66	-.78
20	-1.51	-1.47	-2.77	-.27	-1.35	-.40	-.89	-.33	-.92	-.68	-1.10	-.12	1.89	-.54	-.79
21	-1.37	-1.54	-2.46	-.22	-1.45	-.33	-.85	-.27	-.94	-.63	-1.12	-.13	1.76	-.48	-.68
22	-1.45	-1.58	-2.25	-.06	-1.52	-.36	-.88	-.24	-1.07	-.59	-1.11	-.03	1.55	-.49	-.71
23	-1.60	-1.66	-2.18	-.32	-1.58	-.43	-.90	-.22	-1.18	-.67	-1.04	.01	1.38	-.42	-.73
24	-1.69	-1.63	-2.12	-.16	-1.50	-.46	-.65	-.14	-1.09	-.71	-.93	.09	1.41	-.25	-.63
25	-1.71	-1.47	-2.08	-.16	-1.35	-.44	-.36	-.13	-.99	-.72	-.77	.30	1.40	.06	-.53
26	-1.51	-1.19	-1.90	-.01	-1.23	-.34	-.16	-.13	-.84	-.64	-.64	.46	1.47	.38	-.39
27	-1.25	-.77	-1.59	.22	-1.01	-.11	.01	.04	-.62	-.36	-.49	.59	1.74	.69	-.12
28	-.99	-.43	-1.32	.15	-.73	-.06	.13	.16	-.58	-.10	-.31	.63	1.85	.84	.13
29	-.79	-.18	-1.23	.28	-.58	-.07	.17	.09	-.60	-.10	-.28	.54	1.89	.84	.31
30	-.59	.05	-1.21	.49	-.41	.03	.16	.15	-.47	-.08	-.27	.63	2.16	.96	.50
31	-.50	.03	-1.31	.50	-.42	-.10	.05	.10	-.50	-.11	-.27	.49	2.31	.94	.54
32	-.11	.22	-1.13	.72	-.25	-.04	.19	.31	-.46	.13	-.01	.59	2.59	1.18	.79
33	.33	.48	-.88	.94	.01	.12	.35	.48	-.28	.37	.24	.84	2.78	1.48	1.14
34	.68	.71	-.64	1.18	.34	.34	.60	.65	.09	.75	.60	1.13	2.92	1.88	1.46
35	1.03	.99	-.26	1.56	.79	.56	.88	.87	.50	1.15	1.03	1.38	3.15	2.28	1.76
36	1.45	1.43	.30	1.86	1.25	.86	1.23	1.06	.93	1.51	1.48	1.70	3.48	2.58	2.09
37	1.82	1.84	.82	2.13	1.51	1.22	1.40	1.18	1.22	1.77	1.89	1.99	3.76	2.75	2.38
38	2.13	2.13	1.26	2.33	1.61	1.50	1.38	1.32	1.38	1.91	2.27	2.17	3.97	2.87	2.64
39	2.46	2.42	1.65	2.63	1.72	1.72	1.36	1.45	1.59	2.06	2.58	2.35	4.23	3.01	2.79
40	2.58	2.37	1.86	2.71	1.64	1.78	1.18	1.26	1.63	2.08	2.63	2.37	4.23	3.13	2.66
41	2.47	2.18	1.89	2.54	1.51	1.82	.97	1.10	1.63	2.03	2.54	2.31	4.16	3.16	2.49
42	2.34	2.06	2.00	2.32	1.54	1.79	.90	1.01	1.62	2.04	2.39	2.30	4.04	3.11	2.40
43	2.25	1.90	1.90	1.95	1.67	1.65	.79	.85	1.45	1.97	2.27	2.17	3.86	3.01	2.20
44	2.23	1.80	1.77	1.82	1.69	1.56	.67	.73	1.35	1.96	2.23	2.14	3.79	3.00	2.11
45	2.38	1.79	1.70	1.81	1.70	1.51	.66	.66	1.51	2.06	2.23	2.24	3.79	3.07	2.21
46	2.46	1.71	1.46	1.77	1.68	1.40	.54	.63	1.71	2.12	2.06	2.26	3.71	2.93	2.26
47	2.49	1.63	1.14	1.74	1.65	1.18	.39	.71	1.86	2.01	1.90	2.12	3.51	2.57	2.31
48	2.58	1.64	.93	1.61	1.66	.90	.24	.74	1.95	1.98	1.95	2.10	3.39	2.57	2.28
49	2.50	1.47	.76	1.26	1.31	.61	-.21	.40	1.72	1.80	1.87	1.96	3.03	2.53	2.01
50	2.39	1.18	.75	.90	.89	.25	-.54	.08	1.36	1.57	1.82	1.80	2.62	2.43	1.76
51	2.23	.72	.46	.78	.66	-.08	-.71	-.19	.93	1.18	1.70	1.64	2.14	2.18	1.37
52	1.83	.20	.01	.83	.29	-.55	-1.01	-.66	.47	.60	1.22	1.19	1.44	1.46	.71
53	1.38	-.29	-.11	.82	.08	-1.03	-1.18	-1.04	.32	-.07	.89	.63	1.11	.84	.31
54	.68	-.88	-.24	.52	-.44	-1.43	-1.20	-1.40	-.03	-.69	.36	-.05	.75	.38	-.01
55	-.09	-1.39	-.51	.19	-1.13	-1.59	-1.15	-1.69	-.63	-1.16	-.31	-.66	.14	-.02	-.31
56	-.92	-1.87	-.97	-.22	-1.62	-1.67	-1.22	-1.70	-1.24	-1.54	-.82	-1.09	-.22	-.54	-.52
57	-1.32	-2.29	-1.34	-.26	-1.44	-1.35	-1.16	-1.48	-1.05	-1.26	-.82	-1.10	.47	-.63	-.44
58	-2.07	-3.16	-2.17	-.43	-1.77	-1.69	-1.54	-1.85	-1.31	-1.75	-1.64	-1.74	.64	-1.45	-1.06
59	-5.59	-6.62	-5.68	-3.83	-5.38	-4.86	-4.95	-5.09	-5.18	-5.51	-5.22	-4.97	-2.75	-5.43	-4.98
60	-14.09	-14.77	-14.29	-13.34	-14.41	-14.21	-14.36	-14.30	-15.01	-15.17	-15.16	-15.05	-13.85	-15.49	-14.95
61	11.19	11.19	11.19	11.19	11.19	11.19	11.19	11.19	11.19	11.19	11.19	11.19	11.19	11.19	11.19
62	3.13	3.13	3.13	3.13	3.13	3.13	3.13	3.13	3.13	3.13	3.13	3.13	3.13	3.13	3.13

NOAA-9 SCANNER OFFSETS FOR FEBRUARY 1985: TOTAL CHANNEL													
S.P.	DAY OF MONTH -->												
	16	17	18	19	20	21	22	23	24	25	26	27	28
1	.36	.36	.36	.36	.36	.36	.36	.36	.36	.36	.36	.36	.36
2	1.04	1.04	1.04	1.04	1.04	1.04	1.04	1.04	1.04	1.04	1.04	1.04	1.04
3	1.93	1.93	1.93	1.93	1.93	1.93	1.93	1.93	1.93	1.93	1.93	1.93	1.93
4	-9.64	-9.64	-9.64	-9.64	-9.64	-9.64	-9.64	-9.64	-9.64	-9.64	-9.64	-9.64	-9.64
5	-18.66	-18.31	-17.96	-19.11	-19.06	-19.18	-19.48	-20.04	-20.40	-20.79	-20.76	-20.63	-21.12
6	-1.71	-1.09	-.47	-1.90	-1.91	-1.29	-1.35	-2.45	-2.40	-2.30	-2.00	-2.26	-2.66
7	-.61	-.12	.36	-.72	-1.21	-.59	-.43	-1.45	-1.51	-1.16	-.65	-1.21	-2.11
8	.64	.98	1.31	.66	-.23	.40	.79	-.31	-.34	.14	.73	-.16	-.86
9	1.04	1.23	1.41	1.23	.21	.63	1.14	.07	.20	.51	1.04	-.06	-.14
10	1.10	1.18	1.26	1.34	.31	.33	1.14	.19	.34	.25	.95	-.54	.32
11	1.17	1.19	1.21	1.29	.51	-.08	.96	.40	.58	.15	.82	-.79	.53
12	1.26	1.24	1.22	1.09	.92	-.37	.70	.46	.84	.14	.70	-1.06	.67
13	.97	.90	.82	.52	.80	-.94	.22	.05	.75	-.15	.35	-1.44	.51
14	.90	.75	.59	.24	.76	-1.24	.08	-.06	.68	-.29	.38	-1.58	.43
15	.86	.65	.44	.12	.76	-1.38	.08	-.03	.55	-.25	.31	-1.69	.32
16	.81	.58	.36	.05	.72	-1.44	.15	-.03	.40	-.23	.03	-1.75	.24
17	.69	.43	.18	-.11	.51	-1.47	.10	-.15	.15	-.35	-.27	-1.80	.17
18	.52	.30	.08	-.16	.40	-1.33	-.05	-.27	-.02	-.41	-.54	-1.63	.17
19	.33	.14	-.05	-.18	.23	-1.17	-.20	-.31	-.17	-.53	-.81	-1.46	.10
20	.05	-.12	-.30	-.17	.07	-.94	-.39	-.36	-.33	-.72	-1.09	-1.28	-.09
21	-.11	-.23	-.36	-.16	.15	-.73	-.46	-.30	-.29	-.69	-1.15	-1.11	-.16
22	-.31	-.35	-.38	-.34	.09	-.78	-.60	-.36	-.31	-.66	-1.15	-1.06	-.36
23	-.43	-.40	-.36	-.45	-.09	-.79	-.74	-.42	-.40	-.71	-1.10	-1.16	-.43
24	-.37	-.25	-.14	-.45	-.18	-.70	-.71	-.43	-.35	-.65	-.90	-1.25	-.31
25	-.27	-.10	.07	-.50	-.29	-.68	-.62	-.34	-.16	-.57	-.78	-1.23	-.16
26	-.14	.06	.26	-.55	-.36	-.54	-.52	-.06	.12	-.49	-.62	-1.08	.12
27	.05	.29	.54	-.39	-.21	-.24	-.21	.26	.41	-.36	-.40	-.92	.40
28	.12	.39	.67	-.30	-.23	.01	.09	.44	.55	-.36	-.09	-.72	.54
29	-.01	.34	.68	-.37	-.33	.20	.22	.54	.55	-.39	-.03	-.57	.62
30	.07	.44	.80	-.43	-.35	.41	.33	.75	.61	-.35	.12	-.38	.71
31	.16	.47	.78	-.66	-.55	.47	.21	.81	.50	-.32	.09	-.28	.48
32	.36	.71	1.07	-.49	-.37	.67	.37	1.07	.68	-.04	.29	-.04	.49
33	.55	1.00	1.46	-.12	-.25	.90	.77	1.40	.99	.30	.66	.32	.57
34	.58	1.13	1.69	.21	-.08	1.07	.98	1.58	1.16	.59	.92	.62	.60
35	.66	1.28	1.89	.51	.24	1.24	1.27	1.79	1.32	.95	1.26	1.00	.88
36	.95	1.62	2.28	.83	.70	1.59	1.70	2.05	1.45	1.28	1.75	1.49	1.19
37	1.26	2.01	2.75	1.10	1.10	1.92	2.01	2.18	1.53	1.54	2.11	1.89	1.42
38	1.42	2.32	3.21	1.31	1.32	2.16	2.31	2.28	1.49	1.84	2.23	2.18	1.57
39	1.56	2.62	3.68	1.58	1.41	2.32	2.65	2.39	1.49	2.18	2.36	2.39	1.81
40	1.58	2.74	3.89	1.59	1.32	2.35	2.79	2.33	1.37	2.23	2.43	2.40	1.73
41	1.63	2.78	3.93	1.38	1.19	2.36	2.74	2.24	1.38	2.10	2.47	2.34	1.54
42	1.73	2.79	3.85	1.17	1.10	2.43	2.66	2.22	1.44	2.02	2.52	2.25	1.53
43	1.69	2.72	3.74	.96	1.02	2.42	2.47	2.02	1.49	1.89	2.43	2.13	1.45
44	1.53	2.56	3.59	.86	1.05	2.33	2.30	1.69	1.53	1.72	2.31	2.09	1.40
45	1.39	2.42	3.44	1.01	1.18	2.39	2.23	1.41	1.66	1.67	2.26	2.13	1.51
46	1.29	2.29	3.29	1.17	1.42	2.34	2.08	1.20	1.59	1.68	2.04	2.04	1.56
47	1.25	2.24	3.22	1.27	1.48	2.17	2.09	.95	1.40	1.80	1.86	1.79	1.50
48	1.32	2.28	3.24	1.46	1.44	2.11	2.33	.79	1.32	2.02	1.88	1.64	1.62
49	1.16	2.11	3.06	1.25	1.24	1.90	2.16	.49	1.06	1.96	1.79	1.51	1.59
50	1.00	1.92	2.84	1.01	1.00	1.61	1.76	.34	.80	1.69	1.62	1.38	1.26
51	.91	1.70	2.49	.82	.68	1.16	1.38	.24	.62	1.12	1.47	1.01	.65
52	.59	1.27	1.95	.42	.26	.39	.90	-.05	.10	.29	1.04	.36	-.04
53	.51	.97	1.43	.22	.00	-.11	.76	-.28	-.31	-.18	.87	.02	-.74
54	.48	.67	.86	-.06	-.37	-.46	.40	-.77	-.56	-.48	.53	-.40	-1.43
55	.23	.19	.14	-.32	-.90	-1.26	-.23	-1.43	-.89	-1.09	-.06	-1.04	-1.99
56	-.30	-.40	-.50	-.36	-1.22	-2.04	-.66	-1.86	-1.23	-1.77	-.81	-1.57	-2.25
57	-.26	-.33	-.40	.04	-1.00	-2.32	-.59	-1.55	-1.12	-1.67	-.92	-1.60	-1.81
58	-.31	-.68	-1.05	-.48	-1.21	-2.96	-1.07	-1.67	-1.11	-1.87	-1.69	-2.40	-1.74
59	-4.09	-4.44	-4.80	-4.74	-4.59	-5.84	-4.72	-4.97	-4.61	-5.51	-5.78	-6.22	-5.20
60	-14.81	-14.85	-14.89	-15.43	-14.92	-14.58	-14.63	-14.50	-14.66	-15.11	-15.38	-15.42	-14.99
61	11.19	11.19	11.19	11.19	11.19	11.19	11.19	11.19	11.19	11.19	11.19	11.19	11.19
62	3.13	3.13	3.13	3.13	3.13	3.13	3.13	3.13	3.13	3.13	3.13	3.13	3.13

NOAA-9 SCANNER OFFSETS FOR FEBRUARY 1985: LONGVALE CHANNEL

S.P.	DAY OF MONTH -->														
	1	2	3	4	5	6	7	8	9	10	11	12	13	14	15
1	.29	.29	.29	.29	.29	.29	.29	.29	.29	.29	.29	.29	.29	.29	.29
2	.59	.59	.59	.59	.59	.59	.59	.59	.59	.59	.59	.59	.59	.59	.59
3	.63	.63	.63	.63	.63	.63	.63	.63	.63	.63	.63	.63	.63	.63	.63
4	.27	.27	.27	.27	.27	.27	.27	.27	.27	.27	.27	.27	.27	.27	.27
5	-10.55	-10.51	-11.85	-10.33	-11.09	-11.07	-11.32	-10.92	-10.67	-10.71	-10.92	-10.95	-10.63	-10.85	-10.95
6	-1.02	-1.10	-2.66	-.67	-1.63	-2.01	-2.03	-1.29	-.76	-.94	-1.03	-1.35	-1.04	-1.02	-1.02
7	-1.33	-1.09	-2.30	-.47	-1.49	-1.90	-1.59	-1.04	-.86	-.83	-.56	-1.22	-1.16	-.84	-1.05
8	-1.20	-.63	-1.64	.11	-1.05	-1.06	-.66	-.56	-.57	-.35	-.03	-.62	-.68	-.40	-.39
9	-1.30	-.82	-1.62	.11	-.97	-.90	-.42	-.70	-.57	-.36	.01	-.45	-.54	-.46	-.33
10	-1.57	-1.11	-1.75	-.08	-1.01	-1.03	-.60	-.94	-.85	-.62	-.25	-.67	-.55	-.88	-.57
11	-1.77	-1.29	-1.96	-.37	-1.05	-1.29	-.74	-1.04	-1.03	-.87	-.57	-.87	-.38	-1.14	-.66
12	-1.95	-1.46	-2.17	-.65	-1.21	-1.39	-.75	-1.09	-1.14	-1.04	-.73	-.85	-.17	-1.21	-.71
13	-2.17	-1.72	-2.33	-.90	-1.65	-1.49	-1.02	-1.36	-1.55	-1.28	-1.04	-.98	-.20	-1.46	-1.01
14	-2.28	-1.90	-2.57	-.98	-2.00	-1.50	-1.29	-1.58	-1.78	-1.40	-1.39	-1.23	-.17	-1.76	-1.45
15	-2.41	-2.16	-3.02	-1.17	-2.28	-1.94	-1.49	-1.82	-1.87	-1.55	-1.77	-1.48	-.11	-2.08	-1.86
16	-2.64	-2.42	-3.52	-1.38	-2.59	-1.75	-1.74	-2.05	-2.03	-1.75	-2.14	-1.68	-.21	-2.46	-2.18
17	-2.95	-2.66	-3.80	-1.75	-2.89	-1.96	-2.13	-2.24	-2.22	-2.00	-2.44	-1.88	-.42	-2.78	-2.49
18	-3.15	-2.97	-3.94	-1.96	-3.05	-2.20	-2.49	-2.42	-2.46	-2.34	-2.68	-2.08	-.63	-2.84	-2.72
19	-3.37	-3.31	-4.24	-2.49	-3.27	-2.53	-2.88	-2.59	-2.79	-2.69	-2.99	-2.35	-.98	-2.86	-2.94
20	-3.63	-3.63	-4.42	-2.89	-3.60	-2.88	-3.26	-2.81	-3.11	-3.03	-3.38	-2.73	-1.41	-2.98	-3.17
21	-3.78	-3.87	-4.42	-3.06	-3.87	-3.06	-3.46	-2.99	-3.35	-3.22	-3.61	-2.96	-1.72	-3.15	-3.31
22	-4.05	-4.10	-4.48	-3.16	-4.11	-3.28	-3.69	-3.18	-3.62	-3.40	-3.80	-3.09	-2.06	-3.36	-3.53
23	-4.30	-4.31	-4.58	-3.49	-4.30	-3.48	-3.85	-3.34	-3.85	-3.61	-3.91	-3.23	-2.32	-3.46	-3.68
24	-4.49	-4.42	-4.69	-3.51	-4.37	-3.63	-3.81	-3.43	-3.95	-3.77	-3.96	-3.32	-2.44	-3.46	-3.75
25	-4.61	-4.44	-4.78	-3.63	-4.39	-3.74	-3.74	-3.54	-4.04	-3.90	-3.97	-3.32	-2.57	-3.37	-3.79
26	-4.54	-4.30	-4.71	-3.57	-4.36	-3.73	-3.67	-3.59	-4.00	-3.89	-3.95	-3.26	-2.56	-3.19	-3.75
27	-4.39	-4.04	-4.53	-3.43	-4.24	-3.61	-3.59	-3.47	-3.88	-3.72	-3.89	-3.21	-2.41	-3.01	-3.58
28	-4.21	-3.80	-4.34	-3.46	-4.05	-3.57	-3.50	-3.38	-3.87	-3.55	-3.79	-3.20	-2.35	-2.91	-3.43
29	-4.02	-3.59	-4.23	-3.31	-3.90	-3.52	-3.42	-3.34	-3.83	-3.48	-3.72	-3.21	-2.27	-2.85	-3.28
30	-3.78	-3.32	-4.10	-3.07	-3.67	-3.35	-3.30	-3.17	-3.66	-3.36	-3.63	-3.05	-1.99	-2.68	-3.08
31	-3.56	-3.18	-4.01	-2.90	-3.53	-3.29	-3.19	-3.01	-3.52	-3.23	-3.48	-2.99	-1.75	-2.55	-2.92
32	-3.07	-2.80	-3.66	-2.52	-3.17	-3.01	-2.83	-2.61	-3.23	-2.79	-3.05	-2.67	-1.30	-2.13	-2.50
33	-2.48	-2.34	-3.22	-2.10	-2.71	-2.63	-2.41	-2.20	-2.80	-2.29	-2.57	-2.20	-.88	-1.62	-2.00
34	-2.03	-1.96	-2.86	-1.72	-2.27	-2.26	-2.02	-1.89	-2.34	-1.80	-2.11	-1.80	-.57	-1.12	-1.58
35	-1.50	-1.47	-2.30	-1.16	-1.66	-1.82	-1.53	-1.43	-1.75	-1.24	-1.50	-1.33	-.13	-.55	-1.09
36	-.95	-.91	-1.66	-.68	-1.07	-1.34	-1.02	-1.04	-1.19	-.72	-.92	-.85	.37	-.08	-.59
37	-.41	-.33	-1.00	-.20	-.58	-.81	-.60	-.67	-.69	-.26	-.34	-.36	.86	.31	-1.10
38	.12	.20	-.37	.27	-.19	-.28	-.29	-.25	-.25	.16	.25	.10	1.34	.70	.40
39	.64	.69	.21	.79	.21	.19	.01	.15	.21	.58	.77	.54	1.83	1.12	.81
40	1.02	.95	.65	1.14	.46	.52	.19	.32	.53	.90	1.09	.83	2.12	1.48	1.01
41	1.25	1.13	.98	1.34	.68	.85	.34	.52	.83	1.18	1.32	1.08	2.36	1.78	1.19
42	1.45	1.33	1.31	1.47	.99	1.10	.55	.75	1.10	1.49	1.50	1.34	2.56	2.01	1.41
43	1.62	1.45	1.47	1.46	1.32	1.24	.70	.87	1.22	1.69	1.66	1.48	2.67	2.16	1.50
44	1.82	1.60	1.60	1.58	1.56	1.39	.82	1.01	1.36	1.90	1.86	1.67	2.85	2.33	1.66
45	2.07	1.76	1.69	1.73	1.74	1.52	.96	1.13	1.63	2.15	2.03	1.88	3.02	2.51	1.88
46	2.28	1.86	1.68	1.86	1.90	1.59	1.03	1.27	1.91	2.33	2.07	2.04	3.11	2.53	2.05
47	2.43	1.96	1.59	1.98	2.02	1.58	1.07	1.47	2.15	2.39	2.10	2.08	3.12	2.43	2.20
48	2.57	2.07	1.54	1.97	2.13	1.49	1.08	1.58	2.30	2.44	2.24	2.15	3.15	2.53	2.27
49	2.57	2.00	1.50	1.77	1.97	1.34	.85	1.44	2.20	2.37	2.26	2.12	2.98	2.56	2.14
50	2.55	1.87	1.57	1.60	1.76	1.17	.70	1.31	2.02	2.28	2.30	2.07	2.78	2.57	2.04
51	2.47	1.60	1.44	1.56	1.65	1.00	.66	1.20	1.78	2.08	2.28	2.00	2.53	2.47	1.84
52	2.25	1.28	1.18	1.64	1.43	.72	.53	.95	1.51	1.72	2.02	1.71	2.12	2.05	1.43
53	1.63	.64	.80	1.34	.96	.05	.10	.37	1.06	.94	1.48	.96	1.54	1.29	.82
54	1.03	.14	.60	1.03	.50	-.34	-.03	.01	.70	.39	1.03	.41	1.19	.87	.47
55	.46	-.22	.39	.79	.03	-.49	-.04	-.24	.26	.03	.57	-.02	.76	.60	.23
56	-.20	-.63	-.03	.40	-.40	-.65	-.23	-.39	-.26	-.32	.14	-.40	.42	.16	-.03
57	-.67	-1.09	-.48	.19	-.48	-.65	-.42	-.48	-.35	-.32	-.04	-.59	.73	-.09	-.18
58	-1.38	-1.85	-1.23	-.11	-.88	-1.04	-.85	-.93	-.67	-.80	-.74	-1.18	.69	-.85	-.78
59	-3.89	-4.33	-3.76	-2.55	-3.46	-3.35	-3.28	-3.27	-3.40	-3.49	-3.30	-3.50	-1.75	-3.71	-3.51
60	-9.05	-9.32	-9.05	-8.36	-9.01	-9.06	-9.04	-8.92	-9.43	-9.44	-9.40	-9.54	-8.60	-9.79	-9.53
61	.83	.83	.83	.83	.83	.83	.83	.83	.83	.83	.83	.83	.83	.83	.83
62	.97	.97	.97	.97	.97	.97	.97	.97	.97	.97	.97	.97	.97	.97	.97

NOAA-9 SCANNER OFFSETS FOR FEBRUARY 1985: LONGJAVE CHANNEL

S.P.	DAY OF MONTH -->												
	16	17	18	19	20	21	22	23	24	25	26	27	28
1	.29	.29	.29	.29	.29	.29	.29	.29	.29	.29	.29	.29	.29
2	.59	.59	.59	.59	.59	.59	.59	.59	.59	.59	.59	.59	.59
3	.63	.63	.63	.63	.63	.63	.63	.63	.63	.63	.63	.63	.63
4	.27	.27	.27	.27	.27	.27	.27	.27	.27	.27	.27	.27	.27
5	-11.30	-11.12	-10.94	-11.57	-11.75	-11.70	-11.79	-12.14	-12.32	-12.47	-12.53	-12.50	-12.73
6	-1.27	-.92	-.57	-1.30	-1.68	-1.13	-1.07	-1.76	-1.66	-1.48	-1.40	-1.63	-1.82
7	-.78	-.52	-.27	-.86	-1.51	-.91	-.71	-1.34	-1.30	-.96	-.77	-1.16	-1.66
8	-.17	-.02	.12	-.22	-1.12	-.50	-.14	-.80	-.77	-.37	-.10	-.67	-1.03
9	-.18	-.13	-.09	-.11	-1.09	-.61	-.17	-.83	-.70	-.43	-.17	-.88	-.79
10	-.34	-.37	-.39	-.25	-1.23	-1.02	-.37	-.97	-.83	-.83	-.41	-1.41	-.67
11	-.44	-.50	-.55	-.42	-1.22	-1.43	-.62	-.97	-.83	-1.06	-.63	-1.73	-.67
12	-.46	-.54	-.62	-.67	-1.03	-1.72	-.89	-1.03	-.76	-1.18	-.82	-2.02	-.68
13	-.70	-.82	-.93	-1.12	-1.15	-2.13	-1.23	-1.32	-.84	-1.39	-1.10	-2.31	-.79
14	-.85	-1.03	-1.21	-1.48	-1.30	-2.45	-1.45	-1.51	-1.01	-1.61	-1.22	-2.52	-.93
15	-1.02	-1.24	-1.46	-1.73	-1.45	-2.68	-1.61	-1.64	-1.24	-1.72	-1.34	-2.71	-1.15
16	-1.25	-1.47	-1.70	-1.99	-1.66	-2.91	-1.75	-1.82	-1.52	-1.90	-1.66	-2.92	-1.39
17	-1.49	-1.73	-1.98	-2.28	-1.98	-3.11	-1.97	-2.07	-1.85	-2.15	-2.04	-3.11	-1.62
18	-1.79	-2.02	-2.26	-2.52	-2.23	-3.20	-2.27	-2.34	-2.16	-2.38	-2.46	-3.19	-1.81
19	-2.14	-2.37	-2.60	-2.76	-2.54	-3.31	-2.60	-2.59	-2.47	-2.70	-2.91	-3.28	-2.10
20	-2.55	-2.76	-2.97	-2.98	-2.86	-3.36	-2.93	-2.84	-2.79	-3.05	-3.33	-3.37	-2.43
21	-2.84	-3.03	-3.22	-3.16	-3.02	-3.43	-3.18	-3.04	-2.99	-3.26	-3.58	-3.48	-2.68
22	-3.15	-3.28	-3.42	-3.44	-3.21	-3.65	-3.47	-3.31	-3.22	-3.46	-3.78	-3.66	-3.02
23	-3.36	-3.44	-3.53	-3.64	-3.46	-3.81	-3.71	-3.53	-3.44	-3.66	-3.91	-3.89	-3.24
24	-3.47	-3.49	-3.51	-3.77	-3.66	-3.89	-3.82	-3.70	-3.56	-3.81	-3.95	-4.11	-3.31
25	-3.55	-3.50	-3.46	-3.90	-3.86	-4.01	-3.87	-3.78	-3.56	-3.91	-4.02	-4.26	-3.37
26	-3.54	-3.44	-3.35	-3.97	-3.95	-3.97	-3.86	-3.68	-3.45	-3.94	-3.97	-4.26	-3.27
27	-3.45	-3.32	-3.20	-3.88	-3.87	-3.81	-3.70	-3.53	-3.31	-3.93	-3.83	-4.23	-3.13
28	-3.41	-3.26	-3.12	-3.81	-3.86	-3.66	-3.52	-3.43	-3.25	-3.96	-3.66	-4.13	-3.08
29	-3.45	-3.26	-3.07	-3.80	-3.86	-3.48	-3.39	-3.32	-3.20	-3.94	-3.61	-3.99	-2.99
30	-3.32	-3.11	-2.90	-3.75	-3.76	-3.24	-3.23	-3.10	-3.05	-3.82	-3.49	-3.77	-2.86
31	-3.12	-2.94	-2.76	-3.76	-3.72	-3.06	-3.17	-2.92	-2.95	-3.67	-3.39	-3.57	-2.86
32	-2.73	-2.53	-2.33	-3.42	-3.34	-2.69	-2.83	-2.50	-2.59	-3.24	-3.04	-3.16	-2.62
33	-2.33	-2.07	-1.81	-2.90	-2.96	-2.22	-2.25	-1.98	-2.09	-2.70	-2.49	-2.61	-2.28
34	-2.10	-1.78	-1.45	-2.48	-2.65	-1.89	-1.86	-1.63	-1.76	-2.27	-2.09	-2.18	-2.06
35	-1.75	-1.38	-1.01	-1.98	-2.16	-1.46	-1.34	-1.17	-1.35	-1.71	-1.53	-1.61	-1.58
36	-1.29	-.88	-.47	-1.50	-1.60	-.94	-.75	-.69	-.95	-1.16	-.92	-.99	-1.10
37	-.78	-.32	.14	-1.02	-1.06	-.40	-.21	-.28	-.56	-.64	-.36	-.49	-.63
38	-.33	.23	.79	-.55	-.61	.11	.34	.15	-.24	-.09	.12	.13	-.20
39	.08	.74	1.41	-.06	-.24	.55	.91	.57	.08	.46	.57	.60	.27
40	.39	1.11	1.84	.23	-.01	.89	1.31	.83	.29	.80	.93	.91	.51
41	.72	1.44	2.15	.37	.20	1.21	1.60	1.08	.59	1.02	1.23	1.18	.66
42	1.06	1.72	2.38	.50	.41	1.55	1.81	1.35	.93	1.26	1.50	1.39	.91
43	1.25	1.89	2.53	.58	.60	1.78	1.91	1.45	1.23	1.44	1.68	1.55	1.09
44	1.35	1.99	2.63	.72	.84	1.96	2.01	1.44	1.49	1.57	1.84	1.72	1.29
45	1.41	2.04	2.68	.98	1.10	2.16	2.13	1.40	1.74	1.71	1.97	1.90	1.52
46	1.48	2.09	2.71	1.24	1.43	2.28	2.18	1.42	1.87	1.85	2.00	2.00	1.69
47	1.58	2.19	2.79	1.45	1.61	2.29	2.30	1.38	1.89	2.06	2.00	1.97	1.81
48	1.71	2.31	2.90	1.66	1.66	2.34	2.54	1.37	1.92	2.31	2.09	1.95	1.99
49	1.65	2.24	2.83	1.56	1.56	2.25	2.46	1.24	1.79	2.34	2.08	1.93	2.04
50	1.62	2.18	2.74	1.45	1.43	2.11	2.24	1.19	1.66	2.22	2.06	1.91	1.91
51	1.60	2.07	2.54	1.37	1.25	1.84	2.02	1.15	1.57	1.86	2.01	1.71	1.53
52	1.43	1.83	2.22	1.13	.97	1.32	1.72	.99	1.23	1.34	1.73	1.30	1.09
53	1.03	1.30	1.57	.63	.43	.62	1.25	.47	.60	.67	1.21	.69	.24
54	.87	.97	1.07	.31	.02	.22	.88	-.02	.27	.29	.79	.24	-.40
55	.68	.61	.55	.12	-.41	-.35	.41	-.51	.02	-.16	.34	-.27	-.83
56	.23	.13	.03	.00	-.76	-1.00	-.03	-.91	-.34	-.75	-.27	-.75	-1.13
57	.05	-.03	-.10	-.09	-.86	-1.43	-.22	-.91	-.49	-.92	-.59	-.97	-1.09
58	-.16	-.43	-.70	-.38	-1.22	-2.04	-.72	-1.18	-.69	-1.29	-1.32	-1.68	-1.28
59	-2.84	-3.10	-3.35	-3.31	-3.63	-4.10	-3.28	-3.55	-3.20	-3.86	-4.18	-4.40	-3.73
60	-9.37	-9.42	-9.47	-9.82	-9.78	-9.34	-9.30	-9.33	-9.36	-9.69	-9.97	-9.99	-9.66
61	.83	.83	.83	.83	.83	.83	.83	.83	.83	.83	.83	.83	.83
62	.97	.97	.97	.97	.97	.97	.97	.97	.97	.97	.97	.97	.97

NOAA-9 SCANNER OFFSETS FOR FEBRUARY 1985: SHORTWAVE CHANNEL
 DAY OF MONTH -->

S.P.	1	2	3	4	5	6	7	8	9	10	11	12	13	14	15
1	-.11	-.11	-.11	-.11	-.11	-.11	-.11	-.11	-.11	-.11	-.11	-.11	-.11	-.11	-.11
2	.32	.32	.32	.32	.32	.32	.32	.32	.32	.32	.32	.32	.32	.32	.32
3	.49	.49	.49	.49	.49	.49	.49	.49	.49	.49	.49	.49	.49	.49	.49
4	-4.09	-4.09	-4.09	-4.09	-4.09	-4.09	-4.09	-4.09	-4.09	-4.09	-4.09	-4.09	-4.09	-4.09	-4.09
5	.56	.42	.50	.52	.49	.49	.54	.47	.48	.51	.55	.58	.60	.57	.58
6	1.06	.99	1.01	1.03	1.00	1.01	1.06	.99	1.01	1.02	1.06	1.09	1.11	1.09	1.09
7	.61	.57	.59	.61	.57	.59	.64	.56	.58	.60	.64	.68	.68	.66	.66
8	.59	.54	.58	.59	.55	.57	.62	.55	.56	.57	.63	.66	.67	.65	.65
9	1.07	1.00	1.05	1.06	1.03	1.05	1.10	1.03	1.03	1.04	1.11	1.15	1.15	1.13	1.14
10	.61	.53	.58	.60	.57	.60	.65	.57	.57	.58	.65	.70	.70	.68	.68
11	.54	.47	.52	.55	.52	.55	.59	.50	.52	.52	.59	.65	.66	.63	.62
12	.98	.88	.94	.96	.92	.97	.99	.89	.90	.91	.98	1.03	1.06	1.02	1.01
13	.12	.02	.10	.14	.06	.09	.14	.00	-.01	.00	.07	.10	.15	.10	.06
14	.06	-.08	.01	.05	-.04	.01	.05	-.09	-.11	-.09	-.01	.02	.05	.01	-.03
15	.54	.43	.51	.55	.46	.52	.55	.41	.39	.40	.47	.51	.55	.50	.46
16	.07	-.01	.05	.10	.00	.05	.09	-.04	-.07	-.05	.01	.04	.09	.03	-.02
17	.03	-.05	.01	.06	-.04	.01	.05	-.07	-.11	-.09	-.03	.00	.04	-.02	-.07
18	.52	.43	.49	.54	.45	.49	.53	.41	.38	.38	.45	.48	.52	.47	.41
19	.07	-.01	.04	.10	.01	.04	.09	-.03	-.07	-.06	.01	.04	.09	.03	-.03
20	.06	-.03	.02	.08	-.02	.01	.07	-.05	-.09	-.08	-.02	.02	.06	.01	-.05
21	.55	.45	.48	.55	.45	.47	.54	.41	.38	.39	.45	.50	.54	.48	.41
22	.07	.00	.04	.11	.01	.03	.09	-.04	-.07	-.06	.00	.04	.09	.01	-.08
23	.07	-.01	.03	.10	.00	.01	.08	-.05	-.08	-.07	-.01	.03	.08	.00	-.09
24	.56	.49	.54	.59	.49	.50	.57	.44	.42	.42	.48	.53	.58	.50	.41
25	.12	.07	.11	.17	.07	.07	.15	.02	-.01	.00	.06	.10	.15	.09	-.03
26	.12	.05	.10	.16	.06	.07	.15	.01	-.02	-.01	.05	.09	.15	.08	-.03
27	.61	.54	.59	.65	.55	.55	.62	.49	.46	.47	.53	.57	.63	.55	.44
28	.18	.10	.16	.21	.12	.12	.19	.06	.03	.05	.11	.14	.20	.12	.00
29	.20	.10	.15	.21	.13	.12	.19	.07	.05	.06	.11	.14	.21	.13	.02
30	.73	.61	.64	.72	.63	.62	.71	.57	.55	.57	.62	.65	.72	.64	.53
31	.30	.21	.24	.32	.23	.22	.30	.17	.14	.16	.21	.24	.31	.23	.11
32	.25	.14	.18	.26	.17	.17	.24	.11	.05	.08	.13	.17	.25	.18	.05
33	.56	.42	.46	.55	.46	.45	.52	.38	.30	.33	.39	.43	.52	.47	.36
34	.14	-.01	.02	.12	.02	.02	.10	-.05	-.14	-.09	-.03	.01	.09	.04	-.06
35	.14	.01	.05	.14	.04	.04	.12	-.03	-.13	-.09	-.02	.01	.09	.05	-.05
36	.65	.53	.57	.66	.56	.56	.64	.49	.39	.43	.49	.53	.61	.57	.47
37	.26	.15	.19	.27	.19	.19	.26	.11	.01	.04	.11	.14	.22	.18	.09
38	.29	.18	.21	.30	.22	.22	.29	.13	.03	.07	.14	.16	.25	.21	.12
39	.80	.70	.72	.80	.72	.72	.79	.64	.54	.58	.65	.68	.76	.71	.62
40	.40	.30	.34	.41	.33	.32	.41	.26	.16	.19	.26	.29	.38	.33	.23
41	.44	.32	.36	.44	.35	.34	.44	.29	.20	.22	.29	.32	.40	.36	.28
42	.96	.84	.89	.96	.87	.85	.96	.80	.70	.72	.78	.82	.90	.86	.78
43	.54	.43	.48	.55	.47	.44	.54	.37	.28	.32	.37	.41	.48	.45	.36
44	.52	.41	.45	.53	.44	.42	.52	.35	.26	.29	.35	.39	.46	.42	.33
45	.99	.88	.93	1.00	.92	.89	.99	.82	.73	.75	.81	.85	.92	.88	.78
46	.55	.45	.50	.58	.49	.47	.56	.39	.30	.32	.37	.42	.49	.45	.35
47	.55	.43	.50	.57	.48	.47	.54	.38	.29	.30	.36	.40	.48	.43	.35
48	1.06	.94	.99	1.05	.98	.96	1.03	.87	.78	.79	.85	.89	.97	.92	.83
49	.63	.49	.54	.62	.54	.52	.59	.42	.34	.35	.42	.45	.53	.49	.39
50	.66	.48	.52	.60	.53	.50	.58	.42	.33	.34	.42	.45	.53	.48	.40
51	1.13	.97	1.01	1.08	1.00	.97	1.06	.90	.79	.79	.88	.91	.99	.93	.84
52	.77	.62	.66	.73	.65	.62	.70	.54	.43	.44	.52	.55	.63	.58	.49
53	1.20	1.04	1.04	1.11	1.07	1.04	1.11	.98	.89	.92	.99	1.05	1.10	1.10	1.04
54	1.92	1.75	1.76	1.81	1.78	1.77	1.83	1.72	1.63	1.64	1.71	1.77	1.82	1.83	1.78
55	1.49	1.35	1.37	1.41	1.39	1.37	1.42	1.31	1.22	1.23	1.29	1.36	1.41	1.42	1.37
56	1.46	1.33	1.34	1.39	1.36	1.35	1.40	1.29	1.20	1.21	1.27	1.33	1.40	1.40	1.34
57	1.92	1.79	1.79	1.85	1.81	1.81	1.85	1.74	1.65	1.65	1.71	1.78	1.85	1.85	1.79
58	1.46	1.36	1.37	1.41	1.38	1.39	1.41	1.30	1.21	1.21	1.28	1.35	1.42	1.42	1.36
59	1.41	1.32	1.33	1.38	1.33	1.35	1.37	1.26	1.16	1.16	1.23	1.30	1.38	1.39	1.32
60	1.81	1.72	1.72	1.78	1.73	1.73	1.76	1.66	1.55	1.55	1.62	1.70	1.77	1.78	1.72
61	3.05	3.05	3.05	3.05	3.05	3.05	3.05	3.05	3.05	3.05	3.05	3.05	3.05	3.05	3.05
62	.45	.45	.45	.45	.45	.45	.45	.45	.45	.45	.45	.45	.45	.45	.45

NOAA-9 SCANNER OFFSETS FOR FEBRUARY 1985: SHORTWAVE CHANNEL

S.P.	DAY OF MONTH -->												
	16	17	18	19	20	21	22	23	24	25	26	27	28
1	-.11	-.11	-.11	-.11	-.11	-.11	-.11	-.11	-.11	-.11	-.11	-.11	-.11
2	.32	.32	.32	.32	.32	.32	.32	.32	.32	.32	.32	.32	.32
3	.49	.49	.49	.49	.49	.49	.49	.49	.49	.49	.49	.49	.49
4	-4.09	-4.09	-4.09	-4.09	-4.09	-4.09	-4.09	-4.09	-4.09	-4.09	-4.09	-4.09	-4.09
5	.56	.66	.61	.63	.65	.70	.64	.62	.63	.64	.71	.71	.77
6	1.08	1.19	1.11	1.12	1.18	1.17	1.12	1.10	1.07	1.08	1.17	1.19	1.22
7	.65	.77	.68	.68	.73	.69	.66	.65	.61	.62	.76	.76	.77
8	.65	.76	.66	.68	.72	.66	.63	.63	.58	.59	.77	.72	.77
9	1.14	1.23	1.16	1.16	1.21	1.15	1.11	1.13	1.08	1.08	1.19	1.18	1.23
10	.68	.75	.71	.71	.76	.71	.66	.66	.64	.62	.70	.69	.75
11	.63	.67	.64	.64	.69	.63	.58	.59	.57	.55	.61	.58	.62
12	1.02	1.05	1.04	1.05	1.07	1.01	.99	.99	.99	.96	1.00	.94	.95
13	.06	.05	.11	.13	.14	.08	.09	.06	.11	.06	.09	.01	-.02
14	-.03	.00	.02	.05	.07	-.01	.01	-.03	.01	-.04	.01	-.10	-.15
15	.46	.49	.49	.51	.56	.46	.48	.45	.47	.44	.43	.36	.33
16	-.02	-.05	.01	.04	.10	-.01	.01	-.02	.00	-.03	-.07	-.12	-.13
17	-.06	-.09	-.03	.00	.08	-.05	-.04	-.06	-.04	-.08	-.16	-.18	-.15
18	.43	.44	.46	.49	.57	.45	.44	.42	.44	.39	.35	.31	.31
19	-.03	.07	.02	.05	.10	.01	-.02	-.03	.00	-.05	-.01	-.13	-.14
20	-.05	.11	.01	.04	.09	.00	-.04	-.04	-.01	-.07	-.02	-.15	-.21
21	.42	.59	.49	.51	.57	.46	.44	.43	.46	.39	.44	.32	.23
22	-.08	.11	.00	.02	.07	-.03	-.05	-.07	-.03	-.09	-.04	-.18	-.28
23	-.09	.08	-.01	.01	.06	-.03	-.06	-.09	-.05	-.10	-.08	-.21	-.32
24	.40	.58	.50	.51	.57	.47	.45	.40	.44	.39	.41	.26	.16
25	-.04	.15	.07	.08	.15	.02	.02	-.03	.01	-.05	-.02	-.18	-.28
26	-.04	.18	.06	.08	.15	.01	.01	-.03	-.01	-.06	-.05	-.20	-.31
27	.45	.67	.55	.56	.65	.50	.49	.45	.47	.42	.37	.27	.15
28	.01	.20	.12	.14	.22	.08	.05	.00	.04	-.02	-.07	-.17	-.29
29	.03	.25	.14	.17	.25	.11	.07	.02	.06	-.01	-.08	-.19	-.29
30	.55	.78	.66	.68	.78	.62	.58	.54	.57	.49	.46	.32	.21
31	.12	.32	.23	.24	.32	.19	.15	.11	.14	.07	.07	-.11	-.22
32	.07	.25	.17	.20	.27	.13	.10	.05	.09	.02	.02	-.16	-.27
33	.39	.59	.49	.54	.57	.43	.43	.35	.41	.33	.32	.16	.05
34	-.03	.20	.08	.13	.15	.01	.03	-.07	-.01	-.10	-.12	-.26	-.39
35	-.03	.21	.08	.13	.16	.00	.02	-.07	-.02	-.10	-.16	-.29	-.39
36	.50	.78	.60	.65	.71	.53	.55	.46	.50	.42	.37	.23	.14
37	.12	.41	.21	.27	.34	.15	.16	.07	.12	.05	.02	-.15	-.22
38	.15	.47	.24	.32	.37	.18	.19	.10	.15	.08	.01	-.13	-.20
39	.65	.94	.75	.83	.88	.69	.70	.61	.64	.58	.48	.37	.28
40	.26	.56	.38	.45	.50	.32	.32	.24	.27	.20	.08	-.02	-.09
41	.30	.57	.42	.48	.53	.36	.35	.26	.29	.22	.15	.00	-.08
42	.80	1.04	.91	.96	1.02	.84	.83	.74	.77	.70	.71	.49	.43
43	.38	.64	.49	.55	.59	.41	.41	.32	.35	.28	.28	.06	.01
44	.36	.63	.47	.52	.57	.39	.38	.30	.33	.26	.22	.03	-.03
45	.82	1.11	.92	.97	1.03	.84	.84	.74	.78	.71	.68	.48	.41
46	.39	.68	.49	.54	.60	.41	.40	.31	.35	.27	.21	.04	-.02
47	.38	.68	.47	.54	.58	.38	.38	.29	.32	.25	.18	.00	-.05
48	.88	1.15	.96	1.02	1.05	.86	.86	.78	.79	.73	.69	.48	.43
49	.43	.75	.53	.60	.63	.44	.44	.36	.37	.31	.26	.05	-.02
50	.43	.72	.53	.60	.63	.45	.44	.36	.36	.30	.23	.05	-.05
51	.88	1.17	.98	1.04	1.08	.90	.89	.80	.81	.75	.65	.48	.39
52	.52	.81	.61	.67	.72	.52	.52	.42	.44	.37	.26	.10	.02
53	1.06	1.35	1.15	1.18	1.22	1.03	1.05	.95	.94	.89	.80	.62	.51
54	1.82	2.10	1.91	1.93	1.98	1.81	1.80	1.73	1.70	1.65	1.62	1.37	1.29
55	1.41	1.70	1.50	1.52	1.58	1.40	1.40	1.32	1.30	1.25	1.20	.97	.86
56	1.37	1.67	1.46	1.49	1.55	1.36	1.37	1.29	1.26	1.22	1.14	.93	.82
57	1.82	2.14	1.91	1.94	1.99	1.80	1.81	1.74	1.71	1.66	1.59	1.37	1.25
58	1.39	1.69	1.48	1.50	1.56	1.36	1.37	1.30	1.28	1.23	1.14	.91	.82
59	1.35	1.65	1.45	1.47	1.52	1.33	1.33	1.26	1.23	1.19	1.12	.87	.75
60	1.75	2.03	1.85	1.87	1.90	1.73	1.73	1.65	1.63	1.59	1.53	1.27	1.14
61	3.05	3.05	3.05	3.05	3.05	3.05	3.05	3.05	3.05	3.05	3.05	3.05	3.05
62	.45	.45	.45	.45	.45	.45	.45	.45	.45	.45	.45	.45	.45

NOAA-9 SCANNER OFFSETS FOR MARCH 1985: TOTAL CHANNEL

S.P.	DAY OF MONTH -->														
	1	2	3	4	5	6	7	8	9	10	11	12	13	14	15
1	.36	.36	.36	.36	.36	.36	.36	.36	.36	.36	.36	.36	.36	.36	.36
2	1.04	1.04	1.04	1.04	1.04	1.04	1.04	1.04	1.04	1.04	1.04	1.04	1.04	1.04	1.04
3	1.93	1.93	1.93	1.93	1.93	1.93	1.93	1.93	1.93	1.93	1.93	1.93	1.93	1.93	1.93
4	-9.64	-9.64	-9.64	-9.64	-9.64	-9.64	-9.64	-9.64	-9.64	-9.64	-9.64	-9.64	-9.64	-9.64	-9.64
5	-4.13	-3.40	-1.71	-1.74	-1.74	-2.45	-3.40	-2.45	-3.40	-4.13	-3.63	-4.13	-3.40	-3.61	-3.40
6	-.88	-1.31	.50	.89	.89	-.10	-1.31	-.10	-.96	-.88	-1.47	-.88	-1.31	-1.59	-1.31
7	-.39	-1.10	.03	1.04	1.04	-.01	-1.10	-.01	-.48	-.39	-.81	-.39	-1.10	-1.68	-1.10
8	.60	-.53	.30	1.60	1.60	.48	-.53	.48	.22	.60	.05	.60	-.53	-1.48	-.53
9	1.01	-.44	.37	1.72	1.72	.63	-.44	.63	.42	1.01	.40	1.01	-.44	-1.58	-.44
10	.87	-.74	.12	1.49	1.49	.36	-.74	.36	.33	.87	.23	.87	-.74	-1.66	-.74
11	-.15	-1.58	-.72	.65	.65	-.48	-1.58	-.48	-.26	-.15	-.79	-.15	-1.58	-2.25	-1.58
12	-1.22	-2.48	-1.64	-.15	-.15	-1.28	-2.48	-1.28	-.94	-1.22	-1.69	-1.22	-2.48	-2.84	-2.48
13	-1.08	-2.26	-1.30	.05	.05	-1.05	-2.26	-1.05	-.73	-1.08	-1.42	-1.08	-2.26	-2.42	-2.26
14	-1.32	-2.30	-1.09	-.05	-.05	-1.18	-2.30	-1.18	-.76	-1.32	-1.45	-1.32	-2.30	-2.32	-2.30
15	-1.79	-2.57	-1.12	-.41	-.41	-1.51	-2.57	-1.51	-1.06	-1.79	-1.82	-1.79	-2.57	-2.34	-2.57
16	-1.99	-2.60	-.84	-.50	-.50	-1.55	-2.60	-1.55	-1.03	-1.99	-1.91	-1.99	-2.60	-2.01	-2.60
17	-2.38	-2.88	-.96	-.79	-.79	-1.84	-2.88	-1.84	-1.13	-2.38	-2.21	-2.38	-2.88	-1.89	-2.88
18	-2.30	-2.74	-.73	-.56	-.56	-1.66	-2.74	-1.66	-.89	-2.30	-2.08	-2.30	-2.74	-1.33	-2.74
19	-2.69	-3.04	-.97	-1.00	-1.00	-2.05	-3.04	-2.05	-1.23	-2.69	-2.52	-2.69	-3.04	-1.43	-3.04
20	-3.27	-3.50	-1.39	-1.74	-1.74	-2.62	-3.50	-2.62	-1.80	-3.27	-3.18	-3.27	-3.50	-1.88	-3.50
21	-3.07	-3.15	-1.01	-1.59	-1.59	-2.32	-3.15	-2.32	-1.49	-3.07	-2.88	-3.07	-3.15	-1.48	-3.15
22	-2.72	-2.87	-.56	-1.25	-1.25	-1.99	-2.87	-1.99	-1.07	-2.72	-2.46	-2.72	-2.87	-1.15	-2.87
23	-2.21	-2.51	-.02	-.78	-.78	-1.50	-2.51	-1.50	-.43	-2.21	-2.02	-2.21	-2.51	-.75	-2.51
24	-1.89	-2.20	.25	-.57	-.57	-1.23	-2.20	-1.23	-.19	-1.89	-1.84	-1.89	-2.20	-.53	-2.20
25	-1.99	-2.27	.03	-.83	-.83	-1.48	-2.27	-1.48	-.56	-1.99	-2.10	-1.99	-2.27	-.78	-2.27
26	-1.85	-2.04	.25	-.69	-.69	-1.25	-2.04	-1.25	-.41	-1.85	-1.90	-1.85	-2.04	-.67	-2.04
27	-1.44	-1.52	.75	-.17	-.17	-.74	-1.52	-.74	.01	-1.44	-1.35	-1.44	-1.52	-.15	-1.52
28	-1.52	-1.53	.77	-.17	-.17	-.74	-1.53	-.74	-.18	-1.52	-1.33	-1.52	-1.53	-.17	-1.53
29	-1.25	-1.18	1.06	.16	.16	-.47	-1.18	-.47	.01	-1.25	-1.02	-1.25	-1.18	.06	-1.18
30	-1.33	-1.17	1.04	.16	.16	-.56	-1.17	-.56	-.11	-1.33	-1.09	-1.33	-1.17	.04	-1.17
31	-1.23	-1.06	1.16	.31	.31	-.56	-1.06	-.56	-.17	-1.23	-1.04	-1.23	-1.06	.12	-1.06
32	-1.10	-.95	1.33	.44	.44	-.47	-.95	-.47	-.14	-1.10	-1.06	-1.10	-.95	.19	-.95
33	-.53	-.37	1.86	1.01	1.01	-.03	-.37	-.03	.21	-.53	-.68	-.53	-.37	.65	-.37
34	.11	.29	2.49	1.68	1.68	.49	.29	.49	.58	.11	-.21	.11	.29	1.14	.29
35	.60	.76	2.94	2.12	2.12	.83	.76	.83	.87	.60	.14	.60	.76	1.48	.76
36	.92	1.08	3.15	2.39	2.39	1.08	1.08	1.08	1.06	.92	.34	.92	1.08	1.78	1.08
37	1.00	1.22	3.21	2.46	2.46	1.17	1.22	1.17	1.12	1.00	.35	1.00	1.22	1.86	1.22
38	1.00	1.33	3.20	2.44	2.44	1.19	1.33	1.19	1.31	1.00	.36	1.00	1.33	1.73	1.33
39	1.29	1.74	3.50	2.71	2.71	1.50	1.74	1.50	1.67	1.29	.68	1.29	1.74	1.82	1.74
40	1.45	1.94	3.65	2.86	2.86	1.70	1.94	1.70	1.83	1.45	.86	1.45	1.94	1.88	1.94
41	.62	1.12	2.79	1.95	1.95	.92	1.12	.92	1.01	.62	.03	.62	1.12	.91	1.12
42	.92	1.39	3.22	2.26	2.26	1.33	1.39	1.33	1.23	.92	.37	.92	1.39	1.09	1.39
43	.69	1.19	3.08	2.04	2.04	1.15	1.19	1.15	.90	.69	.14	.69	1.19	.81	1.19
44	.59	.92	2.94	1.78	1.78	.92	.92	.92	.66	.59	-.12	.59	.92	.56	.92
45	.74	.93	3.00	1.87	1.87	1.06	.93	1.06	.72	.74	-.07	.74	.93	.54	.93
46	.98	1.05	3.02	1.99	1.99	1.11	1.05	1.11	.81	.98	.04	.98	1.05	.37	1.05
47	.98	.99	2.84	1.90	1.90	.93	.99	.93	.91	.98	.10	.98	.99	.18	.99
48	.75	.66	2.44	1.73	1.73	.59	.66	.59	.87	.75	.07	.75	.66	-.09	.66
49	.89	.68	2.24	2.02	2.02	.58	.68	.58	1.08	.89	.28	.89	.68	.11	.68
50	1.07	.76	1.78	2.19	2.19	.48	.76	.48	1.23	1.07	.29	1.07	.76	.26	.76
51	1.71	1.20	1.66	2.61	2.61	.82	1.20	.82	1.58	1.71	.75	1.71	1.20	.79	1.20
52	1.64	.85	1.08	2.42	2.42	.70	.85	.70	1.10	1.64	.56	1.64	.85	.45	.85
53	1.49	.69	.82	2.28	2.28	.67	.69	.67	.82	1.49	.46	1.49	.69	-.03	.69
54	1.81	1.02	1.10	2.52	2.52	.94	1.02	.94	1.23	1.81	.87	1.81	1.02	-.06	1.02
55	2.37	1.33	1.37	2.86	2.86	1.25	1.33	1.25	1.78	2.37	1.46	2.37	1.33	.15	1.33
56	1.79	.38	.73	2.11	2.11	.61	.38	.61	1.34	1.79	.93	1.79	.38	-.77	.38
57	1.16	-.45	.32	1.50	1.50	.11	-.45	.11	.91	1.16	.24	1.16	-.45	-1.70	-.45
58	.01	-1.42	.22	.52	.52	-.58	-1.42	-.58	-.30	.01	-.68	.01	-1.42	-2.37	-1.42
59	-2.11	-3.18	-1.04	-1.72	-1.72	-2.25	-3.18	-2.25	-1.49	-2.11	-2.89	-2.11	-3.18	-3.40	-3.18
60	-8.51	-9.10	-7.40	-8.04	-8.04	-8.53	-9.10	-8.53	-8.16	-8.51	-9.43	-8.51	-9.10	-9.12	-9.10
61	11.19	11.19	11.19	11.19	11.19	11.19	11.19	11.19	11.19	11.19	11.19	11.19	11.19	11.19	11.19
62	3.13	3.13	3.13	3.13	3.13	3.13	3.13	3.13	3.13	3.13	3.13	3.13	3.13	3.13	3.13

NOAA-9 SCANNER OFFSETS FOR MARCH 1985: TOTAL CHANNEL
 DAY OF MONTH -->

S.P.	16	17	18	19	20	21	22	23	24	25	26	27	28	29	30	31
1	.36	.36	.36	.36	.36	.36	.36	.36	.36	.36	.36	.36	.36	.36	.36	.36
2	1.04	1.04	1.04	1.04	1.04	1.04	1.04	1.04	1.04	1.04	1.04	1.04	1.04	1.04	1.04	1.04
3	1.93	1.93	1.93	1.93	1.93	1.93	1.93	1.93	1.93	1.93	1.93	1.93	1.93	1.93	1.93	1.93
4	-9.64	-9.64	-9.64	-9.64	-9.64	-9.64	-9.64	-9.64	-9.64	-9.64	-9.64	-9.64	-9.64	-9.64	-9.64	-9.64
5	-3.82	-3.63	-3.63	-4.13	-3.58	-3.04	-5.77	-5.26	-5.77	-5.77	-5.26	-4.96	-3.40	-3.63	-3.40	-3.40
6	-1.84	-1.47	-1.47	-.88	-.84	-.81	-1.82	-1.80	-1.82	-1.82	-1.80	-1.99	-.96	-1.47	-.96	-.96
7	-1.26	-.81	-.81	-.39	-.67	-.94	-1.47	-1.60	-1.47	-1.47	-1.60	-1.81	-.48	-.81	-.48	-.48
8	-.31	.05	.05	.60	.19	-.23	-.91	-1.14	-.91	-.91	-1.14	-.84	.22	.05	.22	.22
9	-.04	.40	.40	1.01	.75	.49	-.80	-1.04	-.80	-.80	-1.04	-.29	.42	.40	.42	.42
10	-.31	.23	.23	.87	.92	.96	-1.17	-1.12	-1.17	-1.17	-1.12	-.15	.33	.23	.33	.33
11	-1.20	-.79	-.79	-.15	.22	.58	-1.82	-1.60	-1.82	-1.82	-1.60	-.61	-.26	-.79	-.26	-.26
12	-2.12	-1.69	-1.69	-1.22	-.66	-.10	-2.49	-2.22	-2.49	-2.49	-2.22	-1.13	-.94	-1.69	-.94	-.94
13	-1.89	-1.42	-1.42	-1.08	-.46	.16	-1.97	-1.77	-1.97	-1.97	-1.77	-.66	-.73	-1.42	-.73	-.73
14	-1.90	-1.45	-1.45	-1.32	-.63	.05	-1.86	-1.53	-1.86	-1.86	-1.53	-.32	-.76	-1.45	-.76	-.76
15	-2.22	-1.82	-1.82	-1.79	-1.16	-.54	-2.16	-1.72	-2.16	-2.16	-1.72	-.45	-1.06	-1.82	-1.06	-1.06
16	-2.32	-1.91	-1.91	-1.99	-1.38	-.76	-1.94	-1.75	-1.94	-1.94	-1.75	-.49	-1.03	-1.91	-1.03	-1.03
17	-2.69	-2.21	-2.21	-2.38	-1.66	-.94	-1.78	-1.85	-1.78	-1.78	-1.85	-.62	-1.13	-2.21	-1.13	-1.13
18	-2.66	-2.08	-2.08	-2.30	-1.56	-.81	-1.39	-1.55	-1.39	-1.39	-1.55	-.49	-.89	-2.08	-.89	-.89
19	-3.07	-2.52	-2.52	-2.69	-2.03	-1.36	-1.63	-1.90	-1.63	-1.63	-1.90	-.91	-1.23	-2.52	-1.23	-1.23
20	-3.65	-3.18	-3.18	-3.27	-2.58	-1.90	-2.07	-2.36	-2.07	-2.07	-2.36	-1.53	-1.80	-3.18	-1.80	-1.80
21	-3.42	-2.88	-2.88	-3.07	-2.33	-1.59	-1.74	-2.09	-1.74	-1.74	-2.09	-1.45	-1.49	-2.88	-1.49	-1.49
22	-3.11	-2.46	-2.46	-2.72	-2.00	-1.27	-1.32	-1.86	-1.32	-1.32	-1.86	-1.26	-1.07	-2.46	-1.07	-1.07
23	-2.66	-2.02	-2.02	-2.21	-1.49	-.78	-.72	-1.44	-.72	-.72	-1.44	-1.05	-.43	-2.02	-.43	-.43
24	-2.32	-1.84	-1.84	-1.89	-1.30	-.72	-.36	-1.47	-.36	-.36	-1.47	-1.17	-.19	-1.84	-.19	-.19
25	-2.41	-2.10	-2.10	-1.99	-1.57	-1.15	-.53	-1.89	-.53	-.53	-1.89	-1.63	-.56	-2.10	-.56	-.56
26	-2.14	-1.90	-1.90	-1.85	-1.45	-1.05	-.26	-1.66	-.26	-.26	-1.66	-1.58	-.41	-1.90	-.41	-.41
27	-1.59	-1.35	-1.35	-1.44	-1.10	-.76	.12	-1.15	.12	.12	-1.15	-1.36	.01	-1.35	.01	.01
28	-1.46	-1.33	-1.33	-1.52	-1.19	-.87	-.04	-1.13	-.04	-.04	-1.13	-1.49	-.18	-1.33	-.18	-.18
29	-1.05	-1.02	-1.02	-1.25	-.90	-.55	.26	-.78	.26	.26	-.78	-1.12	.01	-1.02	.01	.01
30	-1.05	-1.09	-1.09	-1.33	-.99	-.65	.18	-.84	.18	.18	-.84	-1.15	-.11	-1.09	-.11	-.11
31	-.98	-1.04	-1.04	-1.23	-.91	-.59	.27	-.80	.27	.27	-.80	-1.14	-.17	-1.04	-.17	-.17
32	-.89	-1.06	-1.06	-1.10	-.74	-.38	.49	-.61	.49	.49	-.61	-1.00	-.14	-1.06	-.14	-.14
33	-.44	-.68	-.68	-.53	-.17	.20	.95	-.04	.95	.95	-.04	-.47	.21	-.68	.21	.21
34	.03	-.21	-.21	.11	.49	.87	1.47	.57	1.47	1.47	.57	.01	.58	-.21	.58	.58
35	.29	.14	.14	.60	1.02	1.44	1.93	1.05	1.93	1.93	1.05	.49	.87	.14	.87	.87
36	.47	.34	.34	.92	1.33	1.74	2.08	1.26	2.08	2.08	1.26	.80	1.06	.34	1.06	1.06
37	.55	.35	.35	1.00	1.44	1.88	2.04	1.36	2.04	2.04	1.36	.99	1.12	.35	1.12	1.12
38	.61	.36	.36	1.00	1.57	2.13	2.07	1.55	2.07	2.07	1.55	1.25	1.31	.36	1.31	1.31
39	.98	.68	.68	1.29	1.86	2.42	2.33	1.91	2.33	2.33	1.91	1.60	1.67	.68	1.67	1.67
40	1.17	.86	.86	1.45	1.98	2.52	2.48	2.13	2.48	2.48	2.13	1.78	1.83	.86	1.83	1.83
41	.32	.03	.03	.62	1.20	1.77	1.78	1.38	1.78	1.78	1.38	1.08	1.01	.03	1.01	1.01
42	.68	.37	.37	.92	1.54	2.17	2.08	1.73	2.08	2.08	1.73	1.40	1.23	.37	1.23	1.23
43	.41	.14	.14	.69	1.34	2.00	1.78	1.58	1.78	1.78	1.58	1.18	.90	.14	.90	.90
44	.11	-.12	-.12	.59	1.33	2.08	1.72	1.52	1.72	1.72	1.52	1.12	.66	-.12	.66	.66
45	.15	-.07	-.07	.74	1.50	2.26	1.69	1.61	1.69	1.69	1.61	1.09	.72	-.07	.72	.72
46	.18	.04	.04	.98	1.61	2.24	1.61	1.72	1.61	1.61	1.72	1.07	.81	.04	.81	.81
47	.12	.10	.10	.98	1.60	2.22	1.53	1.74	1.53	1.53	1.74	1.12	.91	.10	.91	.91
48	-.10	.07	.07	.75	1.28	1.81	1.11	1.46	1.11	1.11	1.46	.89	.87	.07	.87	.87
49	-.01	.28	.28	.89	1.31	1.72	1.00	1.51	1.00	1.00	1.51	.71	1.08	.28	1.08	1.08
50	-.04	.29	.29	1.07	1.39	1.70	.97	1.49	.97	.97	1.49	.52	1.23	.29	1.23	1.23
51	.36	.75	.75	1.71	1.79	1.88	1.22	1.57	1.22	1.22	1.57	.64	1.58	.75	1.58	1.58
52	.16	.56	.56	1.64	1.45	1.27	.52	1.01	.52	.52	1.01	.23	1.10	.56	1.10	1.10
53	.23	.46	.46	1.49	1.21	.93	.06	.49	.06	.06	.49	-.02	.82	.46	.82	.82
54	.73	.87	.87	1.81	1.53	1.26	.34	.37	.34	.34	.37	.31	1.23	.87	1.23	1.23
55	1.20	1.46	1.46	2.37	2.05	1.73	.80	.60	.80	.80	.60	.99	1.78	1.46	1.78	1.78
56	.33	.93	.93	1.79	1.50	1.20	.18	-.07	.18	.18	-.07	.89	1.34	.93	1.34	1.34
57	-.57	.24	.24	1.16	1.03	.90	-.38	-.76	-.38	-.38	-.76	.72	.91	.24	.91	.91
58	-1.58	-.68	-.68	.01	.23	.45	-.70	-1.40	-.70	-.70	-1.40	.45	.30	-.68	.30	.30
59	-3.44	-2.89	-2.89	-2.11	-1.91	-1.71	-1.95	-2.78	-1.95	-1.95	-2.78	-1.53	-1.49	-2.89	-1.49	-1.49
60	-9.74	-9.43	-9.43	-8.51	-8.54	-8.57	-6.19	-7.31	-6.19	-6.19	-7.31	-7.69	-8.16	-9.43	-8.16	-8.16
61	11.19	11.19	11.19	11.19	11.19	11.19	11.19	11.19	11.19	11.19	11.19	11.19	11.19	11.19	11.19	11.19
62	3.13	3.13	3.13	3.13	3.13	3.13	3.13	3.13	3.13	3.13	3.13	3.13	3.13	3.13	3.13	3.13

NOAA-9 SCANNER OFFSETS FOR MARCH 1985: LONGWAVE CHANNEL
 DAY OF MONTH -->

S.P.	1	2	3	4	5	6	7	8	9	10	11	12	13	14	15
1	-.11	-.11	-.11	-.11	-.11	-.11	-.11	-.11	-.11	-.11	-.11	-.11	-.11	-.11	-.11
2	.32	.32	.32	.32	.32	.32	.32	.32	.32	.32	.32	.32	.32	.32	.32
3	.49	.49	.49	.49	.49	.49	.49	.49	.49	.49	.49	.49	.49	.49	.49
4	-4.09	-4.09	-4.09	-4.09	-4.09	-4.09	-4.09	-4.09	-4.09	-4.09	-4.09	-4.09	-4.09	-4.09	-4.09
5	-3.68	-3.26	-2.15	-2.25	-2.25	-2.70	-3.26	-2.70	-3.23	-3.68	-3.37	-3.68	-3.26	-3.36	-3.26
6	-.72	-1.05	.18	.36	.36	-.33	-1.05	-.33	-.71	-.72	-1.10	-.72	-1.05	-1.14	-1.05
7	-.74	-1.19	-.47	.16	.16	-.63	-1.19	-.63	-.77	-.74	-.94	-.74	-1.19	-1.50	-1.19
8	.15	-.59	-.19	.65	.65	-.20	-.59	-.20	-.20	.15	-.20	.15	-.59	-1.22	-.59
9	.39	-.62	-.26	.64	.64	-.19	-.62	-.19	-.08	.39	-.04	.39	-.62	-1.35	-.62
10	.11	-1.00	-.55	.38	.38	-.48	-1.00	-.48	-.31	.11	-.30	.11	-1.00	-1.48	-1.00
11	-.73	-1.75	-1.26	-.34	-.34	-1.20	-1.75	-1.20	-.86	-.73	-1.12	-.73	-1.75	-2.02	-1.75
12	-1.50	-2.40	-1.92	-.92	-.92	-1.80	-2.40	-1.80	-1.36	-1.50	-1.76	-1.50	-2.40	-2.46	-2.40
13	-1.71	-2.50	-1.97	-1.10	-1.10	-1.97	-2.50	-1.97	-1.49	-1.71	-1.84	-1.71	-2.50	-2.47	-2.50
14	-1.85	-2.55	-1.85	-1.22	-1.22	-2.11	-2.55	-2.11	-1.56	-1.85	-1.88	-1.85	-2.55	-2.42	-2.55
15	-2.28	-2.86	-2.00	-1.60	-1.60	-2.48	-2.86	-2.48	-1.84	-2.28	-2.25	-2.28	-2.86	-2.58	-2.86
16	-2.58	-3.09	-2.04	-1.87	-1.87	-2.72	-3.09	-2.72	-2.06	-2.58	-2.52	-2.58	-3.09	-2.61	-3.09
17	-3.00	-3.46	-2.28	-2.23	-2.23	-3.06	-3.46	-3.06	-2.35	-3.00	-2.88	-3.00	-3.46	-2.70	-3.46
18	-3.12	-3.53	-2.29	-2.25	-2.25	-3.10	-3.53	-3.10	-2.36	-3.12	-2.95	-3.12	-3.53	-2.51	-3.53
19	-3.58	-3.93	-2.66	-2.73	-2.73	-3.56	-3.93	-3.56	-2.72	-3.58	-3.43	-3.58	-3.93	-2.78	-3.93
20	-4.14	-4.45	-3.16	-3.41	-3.41	-4.12	-4.45	-4.12	-3.23	-4.14	-4.10	-4.14	-4.45	-3.28	-4.45
21	-4.22	-4.44	-3.16	-3.52	-3.52	-4.13	-4.44	-4.13	-3.25	-4.22	-4.14	-4.22	-4.44	-3.24	-4.44
22	-4.18	-4.38	-3.07	-3.47	-3.47	-4.07	-4.38	-4.07	-3.20	-4.18	-4.03	-4.18	-4.38	-3.20	-4.38
23	-4.14	-4.41	-3.02	-3.44	-3.44	-4.01	-4.41	-4.01	-3.16	-4.14	-3.99	-4.14	-4.41	-3.20	-4.41
24	-4.13	-4.40	-3.00	-3.46	-3.46	-3.98	-4.40	-3.98	-3.13	-4.13	-4.02	-4.13	-4.40	-3.19	-4.40
25	-4.50	-4.68	-3.35	-3.84	-3.84	-4.34	-4.68	-4.34	-3.51	-4.50	-4.39	-4.50	-4.68	-3.55	-4.68
26	-4.55	-4.65	-3.37	-3.90	-3.90	-4.34	-4.65	-4.34	-3.56	-4.55	-4.41	-4.55	-4.65	-3.65	-4.65
27	-4.39	-4.49	-3.23	-3.73	-3.73	-4.15	-4.49	-4.15	-3.47	-4.39	-4.24	-4.39	-4.49	-3.51	-4.49
28	-4.42	-4.48	-3.21	-3.72	-3.72	-4.14	-4.48	-4.14	-3.58	-4.42	-4.25	-4.42	-4.48	-3.56	-4.48
29	-4.27	-4.24	-3.00	-3.52	-3.52	-3.93	-4.24	-3.93	-3.48	-4.27	-4.07	-4.27	-4.24	-3.42	-4.24
30	-4.34	-4.19	-2.95	-3.45	-3.45	-3.94	-4.19	-3.94	-3.52	-4.34	-4.06	-4.34	-4.19	-3.40	-4.19
31	-4.16	-4.04	-2.74	-3.23	-3.23	-3.82	-4.04	-3.82	-3.45	-4.16	-3.91	-4.16	-4.04	-3.24	-4.04
32	-3.78	-3.69	-2.34	-2.85	-2.85	-3.48	-3.69	-3.48	-3.17	-3.78	-3.62	-3.78	-3.69	-2.91	-3.69
33	-3.10	-3.02	-1.67	-2.16	-2.16	-2.90	-3.02	-2.90	-2.64	-3.10	-3.09	-3.10	-3.02	-2.30	-3.02
34	-2.55	-2.45	-1.13	-1.56	-1.56	-2.44	-2.45	-2.44	-2.23	-2.55	-2.65	-2.55	-2.45	-1.84	-2.45
35	-1.92	-1.88	-.94	-.97	-.97	-1.91	-1.88	-1.91	-1.81	-1.92	-2.11	-1.92	-1.88	-1.29	-1.88
36	-1.40	-1.36	-.10	-.47	-.47	-1.43	-1.36	-1.43	-1.39	-1.40	-1.67	-1.40	-1.36	-.81	-1.36
37	-1.03	-.95	.27	-.11	-.11	-1.06	-.95	-1.06	-.93	-1.03	-1.36	-1.03	-.95	-.46	-.95
38	-.66	-.50	.64	.23	.23	-.69	-.50	-.69	-.49	-.66	-1.01	-.66	-.50	-.20	-.50
39	-.18	.07	1.17	.70	.70	-.17	.07	-.17	.01	-.18	-.50	-.18	.07	.13	.07
40	.21	.51	1.58	1.08	1.08	.25	.51	.25	.34	.21	-.11	.21	.51	.44	.51
41	.28	.58	1.66	1.11	1.11	.36	.58	.36	.41	.28	-.04	.28	.58	.43	.58
42	.64	.99	2.11	1.48	1.48	.81	.99	.81	.73	.64	.36	.64	.99	.69	.99
43	.73	1.05	2.21	1.53	1.53	.90	1.05	.90	.70	.73	.40	.73	1.05	.70	1.05
44	.89	1.08	2.32	1.58	1.58	.96	1.08	.96	.74	.89	.44	.89	1.08	.74	1.08
45	1.13	1.23	2.52	1.78	1.78	1.20	1.23	1.20	.92	1.13	.61	1.13	1.23	.88	1.23
46	1.41	1.47	2.69	2.03	2.03	1.39	1.47	1.39	1.14	1.41	.86	1.41	1.47	.93	1.47
47	1.56	1.57	2.69	2.10	2.10	1.40	1.57	1.40	1.32	1.56	1.02	1.56	1.57	.92	1.57
48	1.46	1.40	2.48	2.03	2.03	1.21	1.40	1.21	1.34	1.46	1.04	1.46	1.40	.80	1.40
49	1.55	1.41	2.34	2.22	2.22	1.22	1.41	1.22	1.51	1.55	1.17	1.55	1.41	.94	1.41
50	1.62	1.39	1.97	2.27	2.27	1.08	1.39	1.08	1.57	1.62	1.12	1.62	1.39	.98	1.39
51	2.14	1.77	1.97	2.63	2.63	1.38	1.77	1.38	1.93	2.14	1.49	2.14	1.77	1.39	1.77
52	2.13	1.56	1.63	2.55	2.55	1.34	1.56	1.34	1.66	2.13	1.40	2.13	1.56	1.20	1.56
53	1.71	1.13	1.14	2.15	2.15	1.00	1.13	1.00	1.14	1.71	1.02	1.71	1.13	.58	1.13
54	1.78	1.15	1.20	2.15	2.15	1.05	1.15	1.05	1.24	1.78	1.15	1.78	1.15	.42	1.15
55	1.98	1.19	1.22	2.19	2.19	1.08	1.19	1.08	1.43	1.98	1.34	1.98	1.19	.39	1.19
56	1.49	.49	.73	1.60	1.60	.55	.49	.55	1.00	1.49	.81	1.49	.49	-.31	.49
57	.80	-.23	.28	1.03	1.03	.05	-.23	.05	.54	.80	.16	.80	-.23	-1.09	-.23
58	.17	-.86	.20	.41	.41	-.42	-.86	-.42	.13	.17	-.43	.17	-.86	-1.52	-.86
59	-1.37	-2.10	-.69	-1.15	-1.15	-1.62	-2.10	-1.62	-1.15	-1.37	-1.94	-1.37	-2.10	-2.28	-2.10
60	-4.90	-5.37	-4.22	-4.72	-4.72	-5.08	-5.37	-5.08	-4.84	-4.90	-5.66	-4.90	-5.37	-5.42	-5.37
61	3.05	3.05	3.05	3.05	3.05	3.05	3.05	3.05	3.05	3.05	3.05	3.05	3.05	3.05	3.05
62	.45	.45	.45	.45	.45	.45	.45	.45	.45	.45	.45	.45	.45	.45	.45

NOAA-9 SCANNER OFFSETS FOR MARCH 1965: LONGVALE CHANNEL

S.P.	DAY OF MONTH -->											26	27	28	29	30	31
	16	17	18	19	20	21	22	23	24	25	26						
1	-.11	-.11	-.11	-.11	-.11	-.11	-.11	-.11	-.11	-.11	-.11	-.11	-.11	-.11	-.11	-.11	
2	.32	.32	.32	.32	.32	.32	.32	.32	.32	.32	.32	.32	.32	.32	.32	.32	
3	.49	.49	.49	.49	.49	.49	.49	.49	.49	.49	.49	.49	.49	.49	.49	.49	
4	-4.09	-4.09	-4.09	-4.09	-4.09	-4.09	-4.09	-4.09	-4.09	-4.09	-4.09	-4.09	-4.09	-4.09	-4.09	-4.09	
5	-3.55	-3.37	-3.37	-3.68	-3.41	-3.14	-4.76	-4.37	-4.76	-4.76	-4.37	-4.19	-3.23	-3.37	-3.23	-3.23	
6	-1.33	-1.10	-1.10	-.72	-.75	-.78	-1.43	-1.31	-1.43	-1.43	-1.31	-1.39	-.71	-1.10	-.71	-.71	
7	-1.23	-.94	-.94	-.74	-.93	-1.13	-1.48	-1.47	-1.48	-1.48	-1.47	-1.54	-.77	-.94	-.77	-.77	
8	-.45	-.20	-.20	.15	-.20	-.55	-.97	-1.06	-.97	-.97	-1.06	-.78	-.20	-.20	-.20	-.20	
9	-.33	-.04	-.04	.39	.12	-.16	-.95	-1.08	-.95	-.95	-1.08	-.51	-.08	-.04	-.08	-.08	
10	-.62	-.30	-.30	.11	.07	.03	-1.27	-1.22	-1.27	-1.27	-1.22	-1.22	-.50	-.31	-.31	-.31	
11	-1.37	-1.12	-1.12	-.73	-.57	-.42	-1.89	-1.71	-1.89	-1.89	-1.71	-.99	-.86	-1.12	-.86	-.86	
12	-2.02	-1.76	-1.76	-1.50	-1.22	-.95	-2.42	-2.18	-2.42	-2.42	-2.18	-1.43	-1.36	-1.76	-1.36	-1.36	
13	-2.15	-1.84	-1.84	-1.71	-1.39	-1.06	-2.45	-2.16	-2.45	-2.45	-2.16	-1.42	-1.49	-1.84	-1.49	-1.49	
14	-2.20	-1.88	-1.88	-1.85	-1.52	-1.18	-2.43	-2.06	-2.43	-2.43	-2.06	-1.26	-1.56	-1.88	-1.56	-1.56	
15	-2.55	-2.25	-2.25	-2.28	-2.00	-1.72	-2.71	-2.32	-2.71	-2.71	-2.32	-1.51	-1.84	-2.25	-1.84	-1.84	
16	-2.82	-2.52	-2.52	-2.58	-2.34	-2.09	-2.77	-2.55	-2.77	-2.77	-2.55	-1.77	-2.06	-2.52	-2.06	-2.06	
17	-3.24	-2.88	-2.88	-3.00	-2.70	-2.40	-2.86	-2.81	-2.86	-2.86	-2.81	-2.05	-2.35	-2.88	-2.35	-2.35	
18	-3.39	-2.95	-2.95	-3.12	-2.81	-2.49	-2.77	-2.80	-2.77	-2.77	-2.80	-2.13	-2.36	-2.95	-2.36	-2.36	
19	-3.85	-3.43	-3.43	-3.58	-3.32	-3.05	-3.14	-3.21	-3.14	-3.14	-3.21	-2.61	-2.72	-3.43	-2.72	-2.72	
20	-4.43	-4.10	-4.10	-4.14	-3.89	-3.64	-3.65	-3.73	-3.65	-3.65	-3.73	-3.26	-3.23	-4.10	-3.23	-3.23	
21	-4.49	-4.14	-4.14	-4.22	-3.94	-3.66	-3.65	-3.77	-3.65	-3.65	-3.77	-3.42	-3.25	-4.14	-3.25	-3.25	
22	-4.45	-4.03	-4.03	-4.18	-3.89	-3.61	-3.54	-3.78	-3.54	-3.54	-3.78	-3.45	-3.20	-4.03	-3.20	-3.20	
23	-4.41	-3.99	-3.99	-4.14	-3.87	-3.60	-3.44	-3.81	-3.44	-3.44	-3.81	-3.59	-3.16	-3.99	-3.16	-3.16	
24	-4.32	-4.02	-4.02	-4.13	-3.92	-3.71	-3.45	-4.01	-3.45	-3.45	-4.01	-3.83	-3.13	-4.02	-3.13	-3.13	
25	-4.57	-4.39	-4.39	-4.50	-4.34	-4.18	-3.75	-4.49	-3.75	-3.75	-4.49	-4.32	-3.51	-4.39	-3.51	-3.51	
26	-4.56	-4.41	-4.41	-4.55	-4.42	-4.29	-3.69	-4.51	-3.69	-3.69	-4.51	-4.47	-3.56	-4.41	-3.56	-3.56	
27	-4.38	-4.24	-4.24	-4.39	-4.33	-4.27	-3.58	-4.37	-3.58	-3.58	-4.37	-4.50	-3.47	-4.24	-3.47	-3.47	
28	-4.32	-4.25	-4.25	-4.42	-4.38	-4.34	-3.68	-4.35	-3.68	-3.68	-4.35	-4.58	-3.58	-4.25	-3.58	-3.58	
29	-4.06	-4.07	-4.07	-4.27	-4.20	-4.14	-3.52	-4.15	-3.52	-3.52	-4.15	-4.36	-3.48	-4.07	-3.48	-3.48	
30	-4.00	-4.06	-4.06	-4.34	-4.24	-4.14	-3.51	-4.14	-3.51	-3.51	-4.14	-4.32	-3.52	-4.06	-3.52	-3.52	
31	-3.85	-3.91	-3.91	-4.16	-4.06	-3.96	-3.33	-3.97	-3.33	-3.33	-3.97	-4.18	-3.45	-3.91	-3.45	-3.45	
32	-3.52	-3.62	-3.62	-3.78	-3.66	-3.54	-2.94	-3.58	-2.94	-2.94	-3.58	-3.84	-3.17	-3.62	-3.17	-3.17	
33	-2.93	-3.09	-3.09	-3.10	-2.97	-2.84	-2.28	-2.92	-2.28	-2.28	-2.92	-3.21	-2.64	-3.09	-2.64	-2.64	
34	-2.48	-2.65	-2.65	-2.55	-2.40	-2.25	-1.77	-2.35	-1.77	-1.77	-2.35	-2.73	-2.23	-2.65	-2.23	-2.23	
35	-2.02	-2.11	-2.11	-1.92	-1.75	-1.58	-1.19	-1.76	-1.19	-1.19	-1.76	-2.12	-1.81	-2.11	-1.81	-1.81	
36	-1.61	-1.67	-1.67	-1.40	-1.23	-1.07	-.78	-1.32	-.78	-.78	-1.32	-1.60	-1.39	-1.67	-1.39	-1.39	
37	-1.27	-1.36	-1.36	-1.03	-.83	-.64	-.51	-.93	-.51	-.51	-.93	-1.13	-.93	-1.36	-.93	-.93	
38	-.88	-1.01	-1.01	-.66	-.40	-.13	-.10	-.44	-.10	-.10	-.44	-.60	-.49	-1.01	-.49	-.49	
39	-.35	-.50	-.50	-.18	.09	.36	.40	.10	.40	.40	.10	-.04	.01	-.50	.01	.01	
40	.04	-.11	-.11	.21	.47	.73	.76	.56	.76	.76	.56	.39	.34	-.11	.34	.34	
41	.11	-.04	-.04	.28	.57	.86	.88	.69	.88	.88	.69	.56	.41	-.04	.41	.41	
42	.50	.36	.36	.64	.97	1.30	1.30	1.10	1.30	1.30	1.10	.94	.73	.36	.73	.73	
43	.52	.40	.40	.73	1.07	1.41	1.41	1.21	1.41	1.41	1.21	1.02	.70	.40	.70	.70	
44	.53	.44	.44	.89	1.28	1.66	1.58	1.38	1.58	1.58	1.38	1.18	.74	.44	.74	.74	
45	.69	.61	.61	1.13	1.53	1.93	1.69	1.59	1.69	1.69	1.59	1.34	.92	.61	.92	.92	
46	.88	.86	.86	1.41	1.76	2.11	1.82	1.86	1.82	1.82	1.86	1.53	1.14	.86	1.14	1.14	
47	.98	1.02	1.02	1.56	1.88	2.21	1.88	1.98	1.88	1.88	1.98	1.67	1.32	1.02	1.32	1.32	
48	.88	1.04	1.04	1.46	1.73	2.00	1.67	1.84	1.67	1.67	1.84	1.57	1.34	1.04	1.34	1.34	
49	.93	1.17	1.17	1.55	1.76	1.96	1.61	1.89	1.61	1.61	1.89	1.46	1.51	1.17	1.51	1.51	
50	.84	1.12	1.12	1.62	1.74	1.87	1.52	1.80	1.52	1.52	1.80	1.25	1.57	1.12	1.57	1.57	
51	1.18	1.49	1.49	2.14	2.11	2.08	1.79	1.94	1.79	1.79	1.94	1.43	1.93	1.49	1.93	1.93	
52	1.08	1.40	1.40	2.13	1.94	1.75	1.40	1.64	1.40	1.40	1.64	1.23	1.66	1.40	1.66	1.66	
53	.81	1.02	1.02	1.71	1.46	1.20	.79	.99	.79	.79	.99	.78	1.14	1.02	1.14	1.14	
54	1.00	1.15	1.15	1.78	1.52	1.26	.79	.73	.79	.79	.73	.89	1.24	1.15	1.24	1.24	
55	1.11	1.34	1.34	1.98	1.69	1.40	.97	.70	.97	.97	.70	1.21	1.43	1.34	1.43	1.43	
56	.43	.81	.81	1.49	1.20	.91	.45	.13	.45	.45	.13	1.01	1.00	.81	1.00	1.00	
57	-.34	-.16	-.16	.80	.67	.55	-.08	-.48	-.08	-.08	-.48	.72	.54	-.16	.54	.54	
58	-1.01	-.43	-.43	.17	.22	.28	-.29	-.87	-.29	-.29	-.87	.51	.13	-.43	.13	.13	
59	-2.32	-1.94	-1.94	-1.37	-1.31	-1.26	-1.22	-1.88	-1.22	-1.22	-1.88	-.99	-1.15	-1.94	-1.15	-1.15	
60	-5.82	-5.66	-5.66	-4.90	-5.04	-5.18	-3.60	-4.37	-3.60	-3.60	-4.37	-4.48	-4.84	-5.66	-4.84	-4.84	
61	3.05	3.05	3.05	3.05	3.05	3.05	3.05	3.05	3.05	3.05	3.05	3.05	3.05	3.05	3.05	3.05	
62	.45	.45	.45	.45	.45	.45	.45	.45	.45	.45	.45	.45	.45	.45	.45	.45	

NOAA-9 SCANNER OFFSETS FOR MARCH 1985: SHORTRAVE CHANNEL
 DAY OF MONTH -->

S.P.	1	2	3	4	5	6	7	8	9	10	11	12	13	14	15
1	.29	.29	.29	.29	.29	.29	.29	.29	.29	.29	.29	.29	.29	.29	.29
2	.59	.59	.59	.59	.59	.59	.59	.59	.59	.59	.59	.59	.59	.59	.59
3	.63	.63	.63	.63	.63	.63	.63	.63	.63	.63	.63	.63	.63	.63	.63
4	.27	.27	.27	.27	.27	.27	.27	.27	.27	.27	.27	.27	.27	.27	.27
5	.67	.67	.73	.73	.73	.73	.73	.73	.73	.73	.73	.73	.73	.67	.73
6	1.15	1.15	1.21	1.21	1.21	1.21	1.21	1.21	1.21	1.21	1.21	1.21	1.15	1.15	1.21
7	.73	.73	.79	.79	.79	.79	.79	.79	.79	.79	.79	.79	.73	.73	.79
8	.71	.71	.78	.78	.78	.78	.78	.78	.78	.78	.78	.78	.71	.71	.78
9	1.18	1.18	1.28	1.28	1.28	1.28	1.28	1.28	1.28	1.28	1.28	1.28	1.18	1.18	1.28
10	.72	.72	.84	.84	.84	.84	.84	.84	.84	.84	.84	.84	.72	.72	.84
11	.64	.64	.75	.75	.75	.75	.75	.75	.75	.75	.75	.75	.64	.64	.75
12	1.03	1.03	1.15	1.15	1.15	1.15	1.15	1.15	1.15	1.15	1.15	1.15	1.03	1.03	1.15
13	.08	.08	.20	.20	.20	.20	.20	.20	.20	.20	.20	.20	.08	.08	.20
14	-.06	-.06	.09	.09	.09	.09	.09	.09	.09	.09	.09	.09	-.06	-.06	.09
15	.40	.40	.54	.54	.54	.54	.54	.54	.54	.54	.54	.54	.40	.40	.54
16	-.06	-.06	.09	.09	.09	.09	.09	.09	.09	.09	.09	.09	-.06	-.06	.09
17	-.11	-.11	.03	.03	.03	.03	.03	.03	.03	.03	.03	.03	-.11	-.11	.03
18	.37	.37	.52	.52	.52	.52	.52	.52	.52	.52	.52	.52	.37	.37	.52
19	-.05	-.05	.09	.09	.09	.09	.09	.09	.09	.09	.09	.09	-.05	-.05	.09
20	-.07	-.07	.08	.08	.08	.08	.08	.08	.08	.08	.08	.08	-.07	-.07	.08
21	.38	.38	.55	.55	.55	.55	.55	.55	.55	.55	.55	.55	.38	.38	.55
22	-.12	-.12	.01	.01	.01	.01	.01	.01	.01	.01	.01	.01	-.12	-.12	.01
23	-.19	-.19	-.04	-.04	-.04	-.04	-.04	-.04	-.04	-.04	-.04	-.04	-.19	-.19	-.04
24	.24	.24	.42	.42	.42	.42	.42	.42	.42	.42	.42	.42	.24	.24	.42
25	-.20	-.20	-.03	-.03	-.03	-.03	-.03	-.03	-.03	-.03	-.03	-.03	-.20	-.20	-.03
26	-.22	-.22	-.04	-.04	-.04	-.04	-.04	-.04	-.04	-.04	-.04	-.04	-.22	-.22	-.04
27	.27	.27	.44	.44	.44	.44	.44	.44	.44	.44	.44	.44	.27	.27	.44
28	-.16	-.16	.00	.00	.00	.00	.00	.00	.00	.00	.00	.00	-.16	-.16	.00
29	-.15	-.15	.02	.02	.02	.02	.02	.02	.02	.02	.02	.02	-.15	-.15	.02
30	.35	.35	.54	.54	.54	.54	.54	.54	.54	.54	.54	.54	.35	.35	.54
31	-.07	-.07	.10	.10	.10	.10	.10	.10	.10	.10	.10	.10	-.07	-.07	.10
32	-.12	-.12	.06	.06	.06	.06	.06	.06	.06	.06	.06	.06	-.12	-.12	.06
33	-.19	-.19	.38	.38	.38	.38	.38	.38	.38	.38	.38	.38	-.19	-.19	.38
34	-.24	-.24	-.06	-.06	-.06	-.06	-.06	-.06	-.06	-.06	-.06	-.06	-.24	-.24	-.06
35	-.26	-.26	-.08	-.08	-.08	-.08	-.08	-.08	-.08	-.08	-.08	-.08	-.26	-.26	-.08
36	.24	.24	.44	.44	.44	.44	.44	.44	.44	.44	.44	.44	.24	.24	.44
37	-.13	-.13	.07	.07	.07	.07	.07	.07	.07	.07	.07	.07	-.13	-.13	.07
38	-.07	-.07	.11	.11	.11	.11	.11	.11	.11	.11	.11	.11	-.07	-.07	.11
39	.43	.43	.62	.62	.62	.62	.62	.62	.62	.62	.62	.62	.43	.43	.62
40	.06	.06	.25	.25	.25	.25	.25	.25	.25	.25	.25	.25	.06	.06	.25
41	.08	.08	.28	.28	.28	.28	.28	.28	.28	.28	.28	.28	.08	.08	.28
42	.56	.56	.77	.77	.77	.77	.77	.77	.77	.77	.77	.77	.56	.56	.77
43	.13	.13	.34	.34	.34	.34	.34	.34	.34	.34	.34	.34	.13	.13	.34
44	.10	.10	.30	.30	.30	.30	.30	.30	.30	.30	.30	.30	.10	.10	.30
45	.54	.54	.74	.74	.74	.74	.74	.74	.74	.74	.74	.74	.54	.54	.74
46	.09	.09	.28	.28	.28	.28	.28	.28	.28	.28	.28	.28	.09	.09	.28
47	.06	.06	.26	.26	.26	.26	.26	.26	.26	.26	.26	.26	.06	.06	.26
48	.55	.55	.76	.76	.76	.76	.76	.76	.76	.76	.76	.76	.55	.55	.76
49	.14	.14	.35	.35	.35	.35	.35	.35	.35	.35	.35	.35	.14	.14	.35
50	.14	.14	.37	.37	.37	.37	.37	.37	.37	.37	.37	.37	.14	.14	.37
51	.58	.58	.82	.82	.82	.82	.82	.82	.82	.82	.82	.82	.58	.58	.82
52	.22	.22	.45	.45	.45	.45	.45	.45	.45	.45	.45	.45	.22	.22	.45
53	.69	.69	.92	.92	.92	.92	.92	.92	.92	.92	.92	.92	.69	.69	.92
54	1.46	1.46	1.67	1.67	1.67	1.67	1.67	1.67	1.67	1.67	1.67	1.67	1.46	1.46	1.67
55	1.04	1.04	1.26	1.26	1.26	1.26	1.26	1.26	1.26	1.26	1.26	1.26	1.04	1.04	1.26
56	1.00	1.00	1.21	1.21	1.21	1.21	1.21	1.21	1.21	1.21	1.21	1.21	1.00	1.00	1.21
57	1.43	1.43	1.66	1.66	1.66	1.66	1.66	1.66	1.66	1.66	1.66	1.66	1.43	1.43	1.66
58	.99	.99	1.23	1.23	1.23	1.23	1.23	1.23	1.23	1.23	1.23	1.23	.99	.99	1.23
59	.93	.93	1.20	1.20	1.20	1.20	1.20	1.20	1.20	1.20	1.20	1.20	.93	.93	1.20
60	1.32	1.32	1.60	1.60	1.60	1.60	1.60	1.60	1.60	1.60	1.60	1.60	1.32	1.32	1.60
61	.83	.83	.83	.83	.83	.83	.83	.83	.83	.83	.83	.83	.83	.83	.83
62	.97	.97	.97	.97	.97	.97	.97	.97	.97	.97	.97	.97	.97	.97	.97

NOAA-9 SCANNER OFFSETS FOR MARCH 1985: SHORTWAVE CHANNEL

S.P.	DAY OF MONTH -->															
	16	17	18	19	20	21	22	23	24	25	26	27	28	29	30	31
1	.29	.29	.29	.29	.29	.29	.29	.29	.29	.29	.29	.29	.29	.29	.29	.29
2	.59	.59	.59	.59	.59	.59	.59	.59	.59	.59	.59	.59	.59	.59	.59	.59
3	.63	.63	.63	.63	.63	.63	.63	.63	.63	.63	.63	.63	.63	.63	.63	.63
4	.27	.27	.27	.27	.27	.27	.27	.27	.27	.27	.27	.27	.27	.27	.27	.27
5	.87	.87	.67	.67	.83	.83	.83	.85	.83	.85	.83	.83	.83	.83	.83	.99
6	1.32	1.32	1.15	1.15	.89	.89	.89	.85	.89	.91	.89	.89	.89	.89	1.03	.93
7	.85	.85	.73	.73	.50	.50	.50	.45	.50	.53	.50	.50	.50	.50	.60	.43
8	.83	.83	.71	.71	.85	.85	.85	.82	.85	.84	.85	.85	.85	.85	.98	.83
9	1.35	1.35	1.18	1.18	.90	.90	.90	.89	.90	.89	.90	.90	.90	.90	1.01	.92
10	.92	.92	.72	.72	.51	.51	.51	.50	.51	.53	.51	.51	.51	.51	.61	.52
11	.88	.88	.64	.64	.82	.82	.82	.81	.82	.79	.82	.82	.82	.82	.94	.81
12	1.28	1.28	1.03	1.03	.80	.80	.80	.79	.80	.77	.80	.80	.80	.80	.94	.70
13	.35	.35	.08	.08	-.09	-.09	-.09	-.08	-.09	-.08	-.09	-.09	-.09	-.09	.07	-.28
14	.22	.22	-.06	-.06	.18	.18	.18	.18	.18	.14	.18	.18	.18	.18	.37	.05
15	.70	.70	.40	.40	.20	.20	.20	.17	.20	.13	.20	.20	.20	.20	.33	.12
16	.23	.23	-.06	-.06	-.18	-.18	-.18	-.21	-.18	-.21	-.18	-.18	-.18	-.18	-.12	-.28
17	.17	.17	-.11	-.11	.18	.18	.18	.16	.18	.16	.18	.18	.18	.18	.21	.03
18	.68	.68	.37	.37	.20	.20	.20	.18	.20	.16	.20	.20	.20	.20	.16	.00
19	.26	.26	-.05	-.05	-.20	-.20	-.20	-.20	-.20	-.20	-.20	-.20	-.20	-.20	-.29	-.41
20	.26	.26	-.07	-.07	.17	.17	.17	.17	.17	.17	.17	.17	.17	.17	.04	-.06
21	.73	.73	.38	.38	.19	.19	.19	.17	.19	.22	.19	.19	.19	.19	.03	-.09
22	.22	.22	-.12	-.12	-.25	-.25	-.25	-.30	-.25	-.21	-.25	-.25	-.25	-.25	-.45	-.60
23	.13	.13	-.19	-.19	.10	.10	.10	.05	.10	.12	.10	.10	.10	.10	-.07	-.25
24	.57	.57	.24	.24	.11	.11	.11	.04	.11	.13	.11	.11	.11	.11	-.03	-.23
25	.10	.10	-.20	-.20	-.28	-.28	-.28	-.36	-.28	-.24	-.28	-.28	-.28	-.28	-.44	-.64
26	.11	.11	-.22	-.22	.13	.13	.13	.06	.13	.14	.13	.13	.13	.13	-.04	-.26
27	.61	.61	.27	.27	.16	.16	.16	.11	.16	.19	.16	.16	.16	.16	-.02	-.23
28	.18	.18	-.16	-.16	-.23	-.23	-.23	-.24	-.23	-.14	-.23	-.23	-.23	-.23	-.40	-.62
29	.18	.18	-.15	-.15	.16	.16	.16	.13	.16	.23	.16	.16	.16	.16	-.04	-.22
30	.71	.71	.35	.35	.23	.23	.23	.19	.23	.29	.23	.23	.23	.23	.00	-.16
31	.29	.29	-.07	-.07	-.13	-.13	-.13	-.16	-.13	-.06	-.13	-.13	-.13	-.13	-.38	-.53
32	.23	.23	-.12	-.12	.20	.20	.20	.20	.20	.28	.20	.20	.20	.20	.00	-.18
33	.55	.55	.19	.19	.11	.11	.11	.07	.11	.19	.11	.11	.11	.11	-.12	-.25
34	.09	.09	-.24	-.24	-.27	-.27	-.27	-.33	-.27	-.18	-.27	-.27	-.27	-.27	-.48	-.60
35	.07	.07	-.26	-.26	.13	.13	.13	.03	.13	.17	.13	.13	.13	.13	-.04	-.14
36	.56	.56	.24	.24	.18	.18	.18	.09	.18	.24	.18	.18	.18	.18	.04	-.05
37	.20	.20	-.13	-.13	-.14	-.14	-.14	-.22	-.14	-.04	-.14	-.14	-.14	-.14	-.27	-.41
38	.25	.25	-.07	-.07	.31	.31	.31	.22	.31	.38	.31	.31	.31	.31	.15	-.01
39	.79	.79	.43	.43	.38	.38	.38	.32	.38	.46	.38	.38	.38	.38	.21	.01
40	.42	.42	.06	.06	.05	.05	.05	.00	.05	.18	.05	.05	.05	.05	-.12	-.30
41	.44	.44	.08	.08	.47	.47	.47	.39	.47	.58	.47	.47	.47	.47	.35	.17
42	.95	.95	.56	.56	.51	.51	.51	.41	.51	.61	.51	.51	.51	.51	.42	.22
43	.51	.51	.13	.13	.14	.14	.14	.05	.14	.27	.14	.14	.14	.14	.03	-.16
44	.46	.46	.10	.10	.51	.51	.51	.39	.51	.61	.51	.51	.51	.51	.37	.22
45	.89	.89	.54	.54	.52	.52	.52	.39	.52	.63	.52	.52	.52	.52	.32	.23
46	.42	.42	.09	.09	.13	.13	.13	.00	.13	.27	.13	.13	.13	.13	-.07	-.14
47	.37	.37	.06	.06	.49	.49	.49	.37	.49	.60	.49	.49	.49	.49	.31	.24
48	.86	.86	.55	.55	.53	.53	.53	.41	.53	.65	.53	.53	.53	.53	.35	.26
49	.45	.45	.14	.14	.17	.17	.17	.02	.17	.33	.17	.17	.17	.17	-.03	-.17
50	.47	.47	.14	.14	.58	.58	.58	.43	.58	.73	.58	.58	.58	.58	.39	.23
51	.97	.97	.58	.58	.60	.60	.60	.45	.60	.77	.60	.60	.60	.60	.42	.25
52	.61	.61	.22	.22	.27	.27	.27	.12	.27	.47	.27	.27	.27	.27	.11	-.05
53	1.08	1.08	.69	.69	1.07	1.07	1.07	.95	1.07	1.23	1.07	1.07	1.07	1.07	.94	.81
54	1.82	1.82	1.46	1.46	1.46	1.46	1.46	1.30	1.46	1.68	1.46	1.46	1.46	1.46	1.23	1.19
55	1.40	1.40	1.04	1.04	1.13	1.13	1.13	.96	1.13	1.37	1.13	1.13	1.13	1.13	.87	.83
56	1.34	1.34	1.00	1.00	1.45	1.45	1.45	1.28	1.45	1.68	1.45	1.45	1.45	1.45	1.17	1.14
57	1.76	1.76	1.43	1.43	1.50	1.50	1.50	1.29	1.50	1.71	1.50	1.50	1.50	1.50	1.17	1.13
58	1.30	1.30	.99	.99	1.10	1.10	1.10	.91	1.10	1.35	1.10	1.10	1.10	1.10	.80	.70
59	1.26	1.26	.93	.93	1.41	1.41	1.41	1.22	1.41	1.64	1.41	1.41	1.41	1.41	1.15	.99
60	1.66	1.66	1.32	1.32	1.40	1.40	1.40	1.18	1.40	1.64	1.40	1.40	1.40	1.40	1.09	.93
61	.83	.83	.83	.83	.83	.83	.83	.83	.83	.83	.83	.83	.83	.83	.83	.83
62	.97	.97	.97	.97	.97	.97	.97	.97	.97	.97	.97	.97	.97	.97	.97	.97

NOAA-9 SCANNER OFFSETS FOR APRIL 1985: SHORTWAVE CHANNEL
 DAY OF MONTH -->

S.P.	1	2	3	4	5	6	7	8	9	10	11	12	13	14	15
1	.29	.29	.29	.29	.29	.29	.29	.29	.29	.29	.29	.29	.29	.29	.29
2	.59	.59	.59	.59	.59	.59	.59	.59	.59	.59	.59	.59	.59	.59	.59
3	.63	.63	.63	.63	.63	.63	.63	.63	.63	.63	.63	.63	.63	.63	.63
4	.27	.27	.27	.27	.27	.27	.27	.27	.27	.27	.27	.27	.27	.27	.27
5	.62	.62	.62	.62	.62	.62	.62	.62	.62	.62	.62	.62	.62	.62	.62
6	.68	.68	.68	.68	.68	.68	.68	.68	.68	.68	.68	.68	.68	.68	.68
7	.31	.31	.31	.31	.31	.31	.31	.31	.31	.31	.31	.31	.31	.31	.31
8	.64	.64	.64	.64	.64	.64	.64	.64	.64	.64	.64	.64	.64	.64	.64
9	.69	.69	.69	.69	.69	.69	.69	.69	.69	.69	.69	.69	.69	.69	.69
10	.31	.31	.31	.31	.31	.31	.31	.31	.31	.31	.31	.31	.31	.31	.31
11	.57	.57	.57	.57	.57	.57	.57	.57	.57	.57	.57	.57	.57	.57	.57
12	.57	.57	.57	.57	.57	.57	.57	.57	.57	.57	.57	.57	.57	.57	.57
13	-.28	-.28	-.28	-.28	-.28	-.28	-.28	-.28	-.28	-.28	-.28	-.28	-.28	-.28	-.28
14	-.05	-.05	-.05	-.05	-.05	-.05	-.05	-.05	-.05	-.05	-.05	-.05	-.05	-.05	-.05
15	-.06	-.06	-.06	-.06	-.06	-.06	-.06	-.06	-.06	-.06	-.06	-.06	-.06	-.06	-.06
16	-.46	-.46	-.46	-.46	-.46	-.46	-.46	-.46	-.46	-.46	-.46	-.46	-.46	-.46	-.46
17	-.15	-.15	-.15	-.15	-.15	-.15	-.15	-.15	-.15	-.15	-.15	-.15	-.15	-.15	-.15
18	-.14	-.14	-.14	-.14	-.14	-.14	-.14	-.14	-.14	-.14	-.14	-.14	-.14	-.14	-.14
19	-.50	-.50	-.50	-.50	-.50	-.50	-.50	-.50	-.50	-.50	-.50	-.50	-.50	-.50	-.50
20	-.12	-.12	-.12	-.12	-.12	-.12	-.12	-.12	-.12	-.12	-.12	-.12	-.12	-.12	-.12
21	-.08	-.08	-.08	-.08	-.08	-.08	-.08	-.08	-.08	-.08	-.08	-.08	-.08	-.08	-.08
22	-.52	-.52	-.52	-.52	-.52	-.52	-.52	-.52	-.52	-.52	-.52	-.52	-.52	-.52	-.52
23	-.16	-.16	-.16	-.16	-.16	-.16	-.16	-.16	-.16	-.16	-.16	-.16	-.16	-.16	-.16
24	-.12	-.12	-.12	-.12	-.12	-.12	-.12	-.12	-.12	-.12	-.12	-.12	-.12	-.12	-.12
25	-.49	-.49	-.49	-.49	-.49	-.49	-.49	-.49	-.49	-.49	-.49	-.49	-.49	-.49	-.49
26	-.12	-.12	-.12	-.12	-.12	-.12	-.12	-.12	-.12	-.12	-.12	-.12	-.12	-.12	-.12
27	-.10	-.10	-.10	-.10	-.10	-.10	-.10	-.10	-.10	-.10	-.10	-.10	-.10	-.10	-.10
28	-.45	-.45	-.45	-.45	-.45	-.45	-.45	-.45	-.45	-.45	-.45	-.45	-.45	-.45	-.45
29	-.04	-.04	-.04	-.04	-.04	-.04	-.04	-.04	-.04	-.04	-.04	-.04	-.04	-.04	-.04
30	.05	.05	.05	.05	.05	.05	.05	.05	.05	.05	.05	.05	.05	.05	.05
31	-.27	-.27	-.27	-.27	-.27	-.27	-.27	-.27	-.27	-.27	-.27	-.27	-.27	-.27	-.27
32	.10	.10	.10	.10	.10	.10	.10	.10	.10	.10	.10	.10	.10	.10	.10
33	.03	.03	.03	.03	.03	.03	.03	.03	.03	.03	.03	.03	.03	.03	.03
34	-.32	-.32	-.32	-.32	-.32	-.32	-.32	-.32	-.32	-.32	-.32	-.32	-.32	-.32	-.32
35	.04	.04	.04	.04	.04	.04	.04	.04	.04	.04	.04	.04	.04	.04	.04
36	.10	.10	.10	.10	.10	.10	.10	.10	.10	.10	.10	.10	.10	.10	.10
37	-.19	-.19	-.19	-.19	-.19	-.19	-.19	-.19	-.19	-.19	-.19	-.19	-.19	-.19	-.19
38	.20	.20	.20	.20	.20	.20	.20	.20	.20	.20	.20	.20	.20	.20	.20
39	.25	.25	.25	.25	.25	.25	.25	.25	.25	.25	.25	.25	.25	.25	.25
40	-.06	-.06	-.06	-.06	-.06	-.06	-.06	-.06	-.06	-.06	-.06	-.06	-.06	-.06	-.06
41	.33	.33	.33	.33	.33	.33	.33	.33	.33	.33	.33	.33	.33	.33	.33
42	.40	.40	.40	.40	.40	.40	.40	.40	.40	.40	.40	.40	.40	.40	.40
43	.07	.07	.07	.07	.07	.07	.07	.07	.07	.07	.07	.07	.07	.07	.07
44	.42	.42	.42	.42	.42	.42	.42	.42	.42	.42	.42	.42	.42	.42	.42
45	.44	.44	.44	.44	.44	.44	.44	.44	.44	.44	.44	.44	.44	.44	.44
46	.10	.10	.10	.10	.10	.10	.10	.10	.10	.10	.10	.10	.10	.10	.10
47	.42	.42	.42	.42	.42	.42	.42	.42	.42	.42	.42	.42	.42	.42	.42
48	.45	.45	.45	.45	.45	.45	.45	.45	.45	.45	.45	.45	.45	.45	.45
49	.09	.09	.09	.09	.09	.09	.09	.09	.09	.09	.09	.09	.09	.09	.09
50	.43	.43	.43	.43	.43	.43	.43	.43	.43	.43	.43	.43	.43	.43	.43
51	.45	.45	.45	.45	.45	.45	.45	.45	.45	.45	.45	.45	.45	.45	.45
52	.16	.16	.16	.16	.16	.16	.16	.16	.16	.16	.16	.16	.16	.16	.16
53	.92	.92	.92	.92	.92	.92	.92	.92	.92	.92	.92	.92	.92	.92	.92
54	1.37	1.37	1.37	1.37	1.37	1.37	1.37	1.37	1.37	1.37	1.37	1.37	1.37	1.37	1.37
55	1.07	1.07	1.07	1.07	1.07	1.07	1.07	1.07	1.07	1.07	1.07	1.07	1.07	1.07	1.07
56	1.37	1.37	1.37	1.37	1.37	1.37	1.37	1.37	1.37	1.37	1.37	1.37	1.37	1.37	1.37
57	1.40	1.40	1.40	1.40	1.40	1.40	1.40	1.40	1.40	1.40	1.40	1.40	1.40	1.40	1.40
58	1.03	1.03	1.03	1.03	1.03	1.03	1.03	1.03	1.03	1.03	1.03	1.03	1.03	1.03	1.03
59	1.31	1.31	1.31	1.31	1.31	1.31	1.31	1.31	1.31	1.31	1.31	1.31	1.31	1.31	1.31
60	1.31	1.31	1.31	1.31	1.31	1.31	1.31	1.31	1.31	1.31	1.31	1.31	1.31	1.31	1.31
61	.83	.83	.83	.83	.83	.83	.83	.83	.83	.83	.83	.83	.83	.83	.83
62	.97	.97	.97	.97	.97	.97	.97	.97	.97	.97	.97	.97	.97	.97	.97

NOAA-9 SCANNER OFFSETS FOR APRIL 1985: SHORTWAVE CHANNEL
 DAY OF MONTH -->

S.P.	16	17	18	19	20	21	22	23	24	25	26	27	28	29	30
1	.29	.29	.29	.29	.29	.29	.29	.29	.29	.29	.29	.29	.29	.29	.29
2	.59	.59	.59	.59	.59	.59	.59	.59	.59	.59	.59	.59	.59	.59	.59
3	.63	.63	.63	.63	.63	.63	.63	.63	.63	.63	.63	.63	.63	.63	.63
4	.27	.27	.27	.27	.27	.27	.27	.27	.27	.27	.27	.27	.27	.27	.27
5	.62	.62	.62	.62	.62	.62	.62	.62	.62	.62	.62	.62	.62	.62	.62
6	.68	.68	.68	.68	.68	.68	.68	.68	.68	.68	.68	.68	.68	.68	.68
7	.31	.31	.31	.31	.31	.31	.31	.31	.31	.31	.31	.31	.31	.31	.31
8	.64	.64	.64	.64	.64	.64	.64	.64	.64	.64	.64	.64	.64	.64	.64
9	.69	.69	.69	.69	.69	.69	.69	.69	.69	.69	.69	.69	.69	.69	.69
10	.31	.31	.31	.31	.31	.31	.31	.31	.31	.31	.31	.31	.31	.31	.31
11	.57	.57	.57	.57	.57	.57	.57	.57	.57	.57	.57	.57	.57	.57	.57
12	.57	.57	.57	.57	.57	.57	.57	.57	.57	.57	.57	.57	.57	.57	.57
13	-.28	-.28	-.28	-.28	-.28	-.28	-.28	-.28	-.28	-.28	-.28	-.28	-.28	-.28	-.28
14	-.05	-.05	-.05	-.05	-.05	-.05	-.05	-.05	-.05	-.05	-.05	-.05	-.05	-.05	-.05
15	-.06	-.06	-.06	-.06	-.06	-.06	-.06	-.06	-.06	-.06	-.06	-.06	-.06	-.06	-.06
16	-.46	-.46	-.46	-.46	-.46	-.46	-.46	-.46	-.46	-.46	-.46	-.46	-.46	-.46	-.46
17	-.15	-.15	-.15	-.15	-.15	-.15	-.15	-.15	-.15	-.15	-.15	-.15	-.15	-.15	-.15
18	-.14	-.14	-.14	-.14	-.14	-.14	-.14	-.14	-.14	-.14	-.14	-.14	-.14	-.14	-.14
19	-.50	-.50	-.50	-.50	-.50	-.50	-.50	-.50	-.50	-.50	-.50	-.50	-.50	-.50	-.50
20	-.12	-.12	-.12	-.12	-.12	-.12	-.12	-.12	-.12	-.12	-.12	-.12	-.12	-.12	-.12
21	-.08	-.08	-.08	-.08	-.08	-.08	-.08	-.08	-.08	-.08	-.08	-.08	-.08	-.08	-.08
22	-.52	-.52	-.52	-.52	-.52	-.52	-.52	-.52	-.52	-.52	-.52	-.52	-.52	-.52	-.52
23	-.16	-.16	-.16	-.16	-.16	-.16	-.16	-.16	-.16	-.16	-.16	-.16	-.16	-.16	-.16
24	-.12	-.12	-.12	-.12	-.12	-.12	-.12	-.12	-.12	-.12	-.12	-.12	-.12	-.12	-.12
25	-.49	-.49	-.49	-.49	-.49	-.49	-.49	-.49	-.49	-.49	-.49	-.49	-.49	-.49	-.49
26	-.12	-.12	-.12	-.12	-.12	-.12	-.12	-.12	-.12	-.12	-.12	-.12	-.12	-.12	-.12
27	-.10	-.10	-.10	-.10	-.10	-.10	-.10	-.10	-.10	-.10	-.10	-.10	-.10	-.10	-.10
28	-.45	-.45	-.45	-.45	-.45	-.45	-.45	-.45	-.45	-.45	-.45	-.45	-.45	-.45	-.45
29	-.04	-.04	-.04	-.04	-.04	-.04	-.04	-.04	-.04	-.04	-.04	-.04	-.04	-.04	-.04
30	.05	.05	.05	.05	.05	.05	.05	.05	.05	.05	.05	.05	.05	.05	.05
31	-.27	-.27	-.27	-.27	-.27	-.27	-.27	-.27	-.27	-.27	-.27	-.27	-.27	-.27	-.27
32	.10	.10	.10	.10	.10	.10	.10	.10	.10	.10	.10	.10	.10	.10	.10
33	.03	.03	.03	.03	.03	.03	.03	.03	.03	.03	.03	.03	.03	.03	.03
34	-.32	-.32	-.32	-.32	-.32	-.32	-.32	-.32	-.32	-.32	-.32	-.32	-.32	-.32	-.32
35	.04	.04	.04	.04	.04	.04	.04	.04	.04	.04	.04	.04	.04	.04	.04
36	.10	.10	.10	.10	.10	.10	.10	.10	.10	.10	.10	.10	.10	.10	.10
37	-.19	-.19	-.19	-.19	-.19	-.19	-.19	-.19	-.19	-.19	-.19	-.19	-.19	-.19	-.19
38	.20	.20	.20	.20	.20	.20	.20	.20	.20	.20	.20	.20	.20	.20	.20
39	.25	.25	.25	.25	.25	.25	.25	.25	.25	.25	.25	.25	.25	.25	.25
40	-.06	-.06	-.06	-.06	-.06	-.06	-.06	-.06	-.06	-.06	-.06	-.06	-.06	-.06	-.06
41	.33	.33	.33	.33	.33	.33	.33	.33	.33	.33	.33	.33	.33	.33	.33
42	.40	.40	.40	.40	.40	.40	.40	.40	.40	.40	.40	.40	.40	.40	.40
43	.07	.07	.07	.07	.07	.07	.07	.07	.07	.07	.07	.07	.07	.07	.07
44	.42	.42	.42	.42	.42	.42	.42	.42	.42	.42	.42	.42	.42	.42	.42
45	.44	.44	.44	.44	.44	.44	.44	.44	.44	.44	.44	.44	.44	.44	.44
46	.10	.10	.10	.10	.10	.10	.10	.10	.10	.10	.10	.10	.10	.10	.10
47	.42	.42	.42	.42	.42	.42	.42	.42	.42	.42	.42	.42	.42	.42	.42
48	.45	.45	.45	.45	.45	.45	.45	.45	.45	.45	.45	.45	.45	.45	.45
49	.09	.09	.09	.09	.09	.09	.09	.09	.09	.09	.09	.09	.09	.09	.09
50	.43	.43	.43	.43	.43	.43	.43	.43	.43	.43	.43	.43	.43	.43	.43
51	.45	.45	.45	.45	.45	.45	.45	.45	.45	.45	.45	.45	.45	.45	.45
52	.16	.16	.16	.16	.16	.16	.16	.16	.16	.16	.16	.16	.16	.16	.16
53	.92	.92	.92	.92	.92	.92	.92	.92	.92	.92	.92	.92	.92	.92	.92
54	1.37	1.37	1.37	1.37	1.37	1.37	1.37	1.37	1.37	1.37	1.37	1.37	1.37	1.37	1.37
55	1.07	1.07	1.07	1.07	1.07	1.07	1.07	1.07	1.07	1.07	1.07	1.07	1.07	1.07	1.07
56	1.37	1.37	1.37	1.37	1.37	1.37	1.37	1.37	1.37	1.37	1.37	1.37	1.37	1.37	1.37
57	1.40	1.40	1.40	1.40	1.40	1.40	1.40	1.40	1.40	1.40	1.40	1.40	1.40	1.40	1.40
58	1.03	1.03	1.03	1.03	1.03	1.03	1.03	1.03	1.03	1.03	1.03	1.03	1.03	1.03	1.03
59	1.31	1.31	1.31	1.31	1.31	1.31	1.31	1.31	1.31	1.31	1.31	1.31	1.31	1.31	1.31
60	1.31	1.31	1.31	1.31	1.31	1.31	1.31	1.31	1.31	1.31	1.31	1.31	1.31	1.31	1.31
61	.83	.83	.83	.83	.83	.83	.83	.83	.83	.83	.83	.83	.83	.83	.83
62	.97	.97	.97	.97	.97	.97	.97	.97	.97	.97	.97	.97	.97	.97	.97

NOAA-9 SCANNER OFFSETS FOR MAY 1985: TOTAL CHANNEL
 DAY OF MONTH -->

S.P.	1	2	3	4	5	6	7	8	9	10	11	12	13	14	15
1	.36	.36	.36	.36	.36	.36	.36	.36	.36	.36	*****	.36	.36	.36	.36
2	1.04	1.04	1.04	1.04	1.04	1.04	1.04	1.04	1.04	1.04	*****	1.04	1.04	1.04	1.04
3	1.93	1.93	1.93	1.93	1.93	1.93	1.93	1.93	1.93	1.93	*****	1.93	1.93	1.93	1.93
4	-9.64	-9.64	-9.64	-9.64	-9.64	-9.64	-9.64	-9.64	-9.64	-9.64	*****	-9.64	-9.64	-9.64	-9.64
5	3.68	2.95	3.90	3.36	4.53	4.13	4.22	3.62	5.26	5.26	*****	5.26	4.22	3.53	3.35
6	4.60	3.59	2.84	3.96	4.66	3.59	3.76	3.80	4.94	4.94	*****	4.94	3.76	4.95	4.69
7	.59	-.36	-2.02	-.29	.33	-.72	-.17	.72	.79	.79	*****	.79	-.17	1.03	1.09
8	-.47	-1.32	-2.68	-1.11	-.71	-1.61	-.43	.16	.00	.00	*****	.00	-.43	-.29	.03
9	-.58	-1.44	-2.27	-1.07	-.78	-1.57	-.16	.07	-.32	-.32	*****	-.32	-.16	-.81	-.11
10	.46	-.15	-.46	.14	.41	-.19	1.17	1.46	.60	.60	*****	.60	1.17	-.25	.96
11	-.66	-.85	-.99	-.72	-.38	-.52	.15	.59	-.31	-.31	*****	-.31	.15	-1.59	.19
12	-.61	-.47	-.78	-.66	-.05	.12	.13	.83	.05	.05	*****	.05	-.13	-1.54	.60
13	-.84	-.55	-.95	-1.03	-.17	.00	-.21	.66	.01	.01	*****	.01	-.21	-1.56	.50
14	-1.73	-1.40	-1.61	-1.98	-.99	-1.08	-1.17	-.13	-.62	-.62	*****	-.62	-1.17	-2.52	-.46
15	-2.22	-1.97	-1.89	-2.30	-1.40	-1.87	-1.76	-.42	-.98	-.98	*****	-.98	-1.76	-3.13	-1.00
16	-2.33	-2.05	-1.66	-2.10	-1.35	-2.03	-1.85	-.51	-1.05	-1.05	*****	-1.05	-1.85	-3.22	-1.02
17	-3.02	-2.58	-2.03	-2.50	-1.79	-2.54	-2.31	-1.15	-1.62	-1.62	*****	-1.62	-2.31	-3.64	-1.45
18	-3.05	-2.67	-1.93	-2.42	-1.65	-2.53	-2.26	-1.20	-1.55	-1.55	*****	-1.55	-2.26	-3.45	-1.38
19	-2.86	-2.48	-1.47	-2.21	-1.45	-2.50	-2.08	-1.17	-1.12	-1.12	*****	-1.12	-2.08	-2.96	-1.21
20	-3.05	-2.24	-1.16	-2.11	-1.46	-2.75	-2.05	-1.29	-1.01	-1.01	*****	-1.01	-2.05	-2.59	-1.17
21	-3.18	-2.09	-1.08	-2.03	-1.41	-3.02	-2.10	-1.42	-1.15	-1.15	*****	-1.15	-2.10	-2.36	-1.24
22	-3.50	-2.32	-1.43	-2.31	-1.66	-3.66	-2.38	-1.83	-1.54	-1.54	*****	-1.54	-2.38	-2.53	-1.80
23	-3.62	-2.38	-1.50	-2.37	-1.74	-3.91	-2.41	-1.98	-1.63	-1.63	*****	-1.63	-2.41	-2.51	-2.26
24	-3.82	-2.51	-1.79	-2.53	-1.95	-4.14	-2.50	-2.11	-2.02	-2.02	*****	-2.02	-2.50	-2.55	-2.72
25	-3.73	-2.50	-1.91	-2.58	-2.08	-4.05	-2.37	-2.10	-2.37	-2.37	*****	-2.37	-2.37	-2.44	-2.92
26	-3.46	-2.32	-1.80	-2.43	-2.03	-3.88	-2.10	-1.91	-2.39	-2.39	*****	-2.39	-2.10	-2.09	-2.98
27	-2.76	-1.82	-1.53	-1.89	-1.52	-3.47	-1.59	-1.48	-2.00	-2.00	*****	-2.00	-1.59	-1.47	-2.62
28	-2.95	-2.23	-2.19	-2.25	-1.82	-3.90	-1.93	-1.88	-2.39	-2.39	*****	-2.39	-1.93	-1.79	-3.00
29	-2.54	-2.17	-1.92	-1.85	-1.52	-3.75	-1.68	-1.73	-2.11	-2.11	*****	-2.11	-1.68	-1.57	-2.89
30	-2.18	-2.03	-1.46	-1.48	-1.31	-3.49	-1.44	-1.81	-1.80	-1.80	*****	-1.80	-1.44	-1.55	-2.80
31	-1.75	-1.66	-.93	-1.00	-1.08	-2.91	-1.07	-1.81	-1.36	-1.36	*****	-1.36	-1.07	-1.44	-2.49
32	-1.19	-1.08	-.13	-.28	-.69	-2.01	-.55	-1.52	-.80	-.80	*****	-.80	-.55	-1.13	-1.96
33	-.82	-.67	.55	.23	-.36	-1.39	-.20	-1.33	-.53	-.53	*****	-.53	-.20	-.96	-1.62
34	-.67	-.45	.89	.57	-.23	-.92	.08	-1.30	-.32	-.32	*****	-.32	.08	-.93	-1.27
35	-.60	-.46	.85	.51	-.37	-.88	.05	-1.39	-.16	-.16	*****	-.16	.05	-1.08	-.92
36	-.68	-.72	.63	.32	-.72	-.92	-.07	-1.63	-.17	-.17	*****	-.17	-.07	-1.23	-.83
37	-.91	-1.03	.32	.16	-1.04	-.98	-.16	-1.90	-.30	-.30	*****	-.30	-.16	-1.34	-.99
38	-.71	-.76	.63	.44	-.84	-.75	.27	-1.55	.00	.00	*****	.00	.27	-1.11	-.66
39	-1.17	-1.16	.18	-.09	-1.39	-1.35	.02	-1.78	-.46	-.46	*****	-.46	.02	-1.47	-.96
40	-1.46	-1.49	-.32	-.57	-1.94	-1.87	-.31	-2.01	-.80	-.80	*****	-.80	-.31	-1.63	-1.22
41	-1.07	-1.21	-.23	-.35	-1.78	-1.74	-.19	-1.81	-.56	-.56	*****	-.56	-.19	-1.31	-1.07
42	-.87	-1.03	-.17	-.36	-1.60	-1.67	-.18	-1.57	-.38	-.38	*****	-.38	-.18	-1.03	-1.31
43	-.86	-.92	-.22	-.56	-1.41	-1.55	-.12	-1.24	-.22	-.22	*****	-.22	-.12	-.80	-1.62
44	-.85	-.90	-.39	-.73	-1.26	-1.46	.05	-.95	-.10	-.10	*****	-.10	.05	-.71	-1.48
45	.20	.06	.31	.10	-.19	-.57	1.28	.02	.97	.97	*****	.97	1.28	.28	-.19
46	-.11	-.36	-.44	-.34	-.54	-1.00	1.06	-.45	.72	.72	*****	.72	1.06	-.02	-.42
47	-.34	-.67	-.92	-.62	-.71	-1.27	.86	-.67	.60	.60	*****	.60	.86	-.21	-.37
48	-.49	-.99	-1.28	-.80	-.89	-1.46	.67	-.85	.43	.43	*****	.43	.67	-.36	-.30
49	-.68	-1.57	-1.91	-1.02	-1.28	-1.79	.17	-1.04	.29	.29	*****	.29	.17	-.51	-.48
50	-.36	-1.70	-2.07	-.81	-1.24	-1.68	-.02	-.86	.49	.49	*****	.49	-.02	-.20	-.29
51	.06	-1.57	-1.88	-.68	-.88	-1.61	-.11	-.77	.68	.68	*****	.68	-.11	.42	.11
52	-.47	-2.15	-2.40	-1.29	-1.10	-2.08	-.89	-1.34	.22	.22	*****	.22	-.89	.18	-.19
53	-.13	-1.90	-1.88	-.91	-.51	-1.38	-.63	-.31	.79	.79	*****	.79	-.63	.57	.31
54	.31	-1.37	-1.50	-.33	-.05	-.85	.01	1.03	1.24	1.24	*****	1.24	.01	1.17	.92
55	.14	-1.52	-2.04	-.62	-.54	-1.18	.04	1.43	.87	.87	*****	.87	.04	1.10	.75
56	-.66	-2.33	-2.87	-1.46	-1.39	-2.02	-.60	.93	.08	.08	*****	.08	-.60	.10	-.24
57	-.86	-2.42	-2.64	-1.37	-1.25	-2.11	-.53	.70	-.22	-.22	*****	-.22	-.53	-.62	-.60
58	-.52	-1.49	-1.66	-.66	-.37	-1.33	-.06	1.08	.02	.02	*****	.02	-.06	-1.09	.07
59	-4.04	-4.21	-4.30	-3.89	-3.15	-4.17	-3.84	-2.46	-3.21	-3.21	*****	-3.21	-3.84	-5.00	-2.79
60	-14.79	-14.26	-15.23	-13.95	-13.97	-15.39	-14.62	-14.73	-14.53	-14.53	*****	-14.53	-14.62	-14.30	-12.79
61	11.19	11.19	11.19	11.19	11.19	11.19	11.19	11.19	11.19	11.19	*****	11.19	11.19	11.19	11.19
62	3.13	3.13	3.13	3.13	3.13	3.13	3.13	3.13	3.13	3.13	*****	3.13	3.13	3.13	3.13

NOAA-9 SCANNER OFFSETS FOR MAY 1985: TOTAL CHANNEL

S.P.	DAY OF MONTH -->															
	16	17	18	19	20	21	22	23	24	25	26	27	28	29	30	31
1	.36	.36	.36	.36	.36	.36	.36	.36	.36	.36	.36	.36	.36	.36	.36	.36
2	1.04	1.04	1.04	1.04	1.04	1.04	1.04	1.04	1.04	1.04	1.04	1.04	1.04	1.04	1.04	1.04
3	1.93	1.93	1.93	1.93	1.93	1.93	1.93	1.93	1.93	1.93	1.93	1.93	1.93	1.93	1.93	1.93
4	-9.64	-9.64	-9.64	-9.64	-9.64	-9.64	-9.64	-9.64	-9.64	-9.64	-9.64	-9.64	-9.64	-9.64	-9.64	-9.64
5	4.45	4.86	3.36	1.61	3.37	4.53	4.37	3.68	2.08	3.37	3.68	5.10	2.95	3.68	2.17	4.75
6	3.84	4.99	3.96	3.39	3.55	4.66	4.25	4.60	4.44	3.55	4.60	5.32	3.59	4.60	3.84	5.65
7	-.64	.81	-.29	-.82	-.27	.33	1.07	.59	.72	-.27	.59	.73	-.36	.59	-.53	.97
8	-1.67	-.13	-1.11	-2.05	-.94	-.71	1.14	-.47	-.36	-.94	-.47	-.36	-1.32	-.47	-1.24	-.04
9	-1.70	-.54	-1.07	-2.16	-1.03	-.78	1.09	-.58	-.38	-1.03	-.58	-.49	-1.44	-.58	-1.31	-.19
10	-.33	.33	.14	-.76	.16	.41	1.77	.46	.74	.16	.46	.45	-.15	.46	-.24	.82
11	-1.12	-.66	-.72	-1.37	-.73	-.38	.46	-.66	-.16	-.73	-.66	-.51	-.85	-.66	-1.05	.19
12	-.83	-.44	-.66	-1.01	-.28	-.05	.52	-.61	-.13	-.28	-.61	-.22	-.47	-.61	-.61	.61
13	-1.17	-.62	-1.03	-.69	-.21	-.17	.32	-.84	-.29	-.21	-.84	-.55	-.55	-.84	-.43	.59
14	-2.21	-1.49	-1.98	-1.29	-.91	-.99	-.82	-1.73	-1.15	-.91	-1.73	-1.77	-1.40	-1.73	-1.11	-.18
15	-2.60	-2.22	-2.30	-1.75	-1.27	-1.40	-1.42	-2.22	-1.69	-1.27	-2.22	-2.59	-1.97	-2.22	-1.63	-.48
16	-2.53	-2.43	-2.10	-1.82	-1.31	-1.35	-1.49	-2.33	-1.82	-1.31	-2.33	-2.75	-2.05	-2.33	-1.88	-.25
17	-2.84	-3.04	-2.50	-2.40	-1.92	-1.79	-2.04	-3.02	-2.61	-1.92	-3.02	-3.27	-2.58	-3.02	-2.31	-.65
18	-2.60	-3.20	-2.42	-2.41	-2.01	-1.65	-1.97	-3.05	-2.92	-2.01	-3.05	-3.20	-2.67	-3.05	-2.07	-.63
19	-2.27	-3.16	-2.21	-2.19	-1.97	-1.45	-1.62	-2.86	-2.92	-1.97	-2.86	-2.76	-2.48	-2.86	-1.92	-.54
20	-2.07	-3.38	-2.11	-2.37	-2.25	-1.46	-1.61	-3.05	-3.09	-2.25	-3.05	-2.54	-2.24	-3.05	-1.88	-.73
21	-1.88	-3.67	-2.03	-2.68	-2.59	-1.41	-1.77	-3.18	-3.25	-2.59	-3.18	-2.50	-2.09	-3.18	-1.89	-.88
22	-1.98	-4.17	-2.31	-3.10	-3.07	-1.66	-2.20	-3.50	-3.66	-3.07	-3.50	-2.82	-2.32	-3.50	-2.33	-1.39
23	-1.85	-4.36	-2.37	-3.02	-3.28	-1.74	-2.32	-3.62	-3.93	-3.28	-3.62	-2.96	-2.38	-3.62	-2.43	-1.77
24	-1.82	-4.63	-2.53	-3.02	-3.48	-1.95	-2.47	-3.82	-4.33	-3.48	-3.82	-3.14	-2.51	-3.82	-2.60	-2.02
25	-1.60	-4.67	-2.58	-3.06	-3.45	-2.08	-2.45	-3.73	-4.33	-3.45	-3.73	-3.11	-2.50	-3.73	-2.64	-1.99
26	-1.18	-4.42	-2.43	-2.89	-3.21	-2.03	-2.30	-3.46	-3.97	-3.21	-3.46	-2.91	-2.32	-3.46	-2.46	-1.83
27	-.45	-3.71	-1.89	-2.36	-2.67	-1.52	-1.77	-2.76	-3.38	-2.67	-2.76	-2.22	-1.82	-2.76	-2.04	-1.46
28	-.73	-3.95	-2.25	-2.45	-3.07	-1.82	-2.18	-2.95	-3.82	-3.07	-2.95	-2.55	-2.23	-2.95	-2.44	-1.87
29	-.47	-3.71	-1.85	-1.81	-2.90	-1.52	-1.91	-2.54	-3.71	-2.90	-2.54	-2.41	-2.17	-2.54	-2.07	-1.62
30	-.22	-3.42	-1.48	-1.18	-2.62	-1.31	-1.66	-2.18	-3.67	-2.62	-2.18	-2.13	-2.03	-2.18	-1.62	-1.47
31	.11	-2.75	-1.00	-.70	-2.20	-1.08	-1.28	-1.75	-3.28	-2.20	-1.75	-1.60	-1.66	-1.75	-1.08	-1.11
32	.50	-1.89	-.28	-.27	-1.67	-.69	-.69	-1.19	-2.77	-1.67	-1.19	-.97	-1.08	-1.19	-.43	-.42
33	.68	-1.32	.23	.17	-1.22	-.36	-.35	-.82	-2.50	-1.22	-.82	-.56	-.67	-.82	.13	.20
34	.74	-1.01	.57	.39	-.86	-.23	-.21	-.67	-2.34	-.86	-.67	-.23	-.45	-.67	.48	.72
35	.74	-.95	.51	.28	-.61	-.37	-.14	-.60	-2.15	-.61	-.60	-.10	-.46	-.60	.67	.95
36	.60	-.87	.32	.05	-.55	-.72	.03	-.68	-2.10	-.55	-.68	-.19	-.72	-.68	.77	1.00
37	.18	-.81	.16	-.23	-.69	-1.04	-.01	-.91	-2.15	-.69	-.91	-.44	-1.03	-.91	.80	.81
38	.30	-.33	.44	-.03	-.36	-.84	.31	-.71	-1.74	-.36	-.71	-.30	-.76	-.71	1.22	1.11
39	-.11	-.57	-.09	-.54	-.79	-1.39	-.06	-1.17	-2.06	-.79	-1.17	-.75	-1.16	-1.17	.96	.64
40	-.40	-.79	-.57	-.98	-1.34	-1.94	-.45	-1.46	-2.31	-1.34	-1.46	-1.12	-1.49	-1.46	.65	.16
41	-.13	-.46	-.35	-.63	-1.35	-1.78	-.34	-1.07	-1.91	-1.35	-1.07	-.85	-1.21	-1.07	.87	.34
42	.23	-.16	-.36	-.36	-1.26	-1.60	-.41	-.87	-1.64	-1.26	-.87	-.49	-1.03	-.87	.93	.46
43	.55	.10	-.56	-.35	-1.21	-1.41	-.62	-.86	-1.75	-1.21	-.86	-.34	-.92	-.86	1.01	.35
44	.79	.38	-.73	-.37	-1.21	-1.26	-.70	-.85	-1.78	-1.21	-.85	-.24	-.90	-.85	1.25	.27
45	2.03	1.43	.10	.63	-.31	-.19	.17	.20	-.70	-.31	.20	.93	.06	.20	2.30	1.22
46	1.73	1.16	-.34	.14	-.82	-.54	-.25	-.11	-.75	-.82	-.11	.89	-.36	-.11	1.62	.77
47	1.48	.99	-.62	-.20	-1.18	-.71	-.64	-.34	-.50	-1.18	-.34	.69	-.67	-.34	.98	.55
48	1.17	.76	-.80	-.46	-1.47	-.89	-1.07	-.49	-.43	-1.47	-.49	.43	-.99	-.49	.42	.36
49	.74	.42	-1.02	-.82	-1.72	-1.28	-1.50	-.68	-.65	-1.72	-.68	.09	-1.57	-.68	-.08	.00
50	.78	.37	-.81	-.76	-1.43	-1.24	-1.58	-.36	-.49	-1.43	-.36	.16	-1.70	-.36	-.02	.23
51	.90	.40	-.68	-.76	-1.08	-.88	-1.56	.06	-.24	-1.08	.06	.49	-1.57	.06	.14	.69
52	.30	-.35	-1.29	-1.37	-1.48	-1.10	-2.23	-.47	-.69	-1.48	-.47	-.03	-2.15	-.47	-.50	.24
53	.50	-.06	-.91	-1.12	-.91	-.51	-1.84	-.13	.10	-.91	-.13	.14	-1.90	-.13	-.14	.61
54	.75	.38	-.33	-.93	-.27	-.05	-.81	.31	.96	-.27	.31	.25	-1.37	.31	.50	1.04
55	.25	.41	-.62	-1.41	-.27	-.54	-.23	.14	.40	-.27	.14	-.14	-1.52	.14	.23	.79
56	-.79	-.05	-1.46	-2.46	-1.05	-1.39	-.06	-.66	-.67	-1.05	-.66	-.89	-2.33	-.66	-.51	.01
57	-.87	-.43	-1.37	-2.48	-.91	-1.25	.38	-.86	-.64	-.91	-.86	-.99	-2.42	-.86	-.59	-.35
58	-.19	-.43	-.66	-1.65	-.02	-.37	.80	-.52	.20	-.02	-.52	-.48	-1.49	-.52	-.05	.03
59	-3.52	-4.18	-3.89	-3.88	-3.17	-3.15	-2.88	-4.04	-2.71	-3.17	-4.04	-3.85	-4.21	-4.04	-3.01	-2.83
60	-14.52	-14.89	-13.95	-11.58	-13.44	-13.97	-13.46	-14.79	-11.83	-13.44	-14.79	-14.33	-14.26	-14.79	-11.34	-12.56
61	11.19	11.19	11.19	11.19	11.19	11.19	11.19	11.19	11.19	11.19	11.19	11.19	11.19	11.19	11.19	11.19
62	3.13	3.13	3.13	3.13	3.13	3.13	3.13	3.13	3.13	3.13	3.13	3.13	3.13	3.13	3.13	3.13

NOAA-9 SCANNER OFFSETS FOR MAY 1985: LONGWAVE CHANNEL
 DAY OF MONTH -->

S.P.	1	2	3	4	5	6	7	8	9	10	11	12	13	14	15
1	-.11	-.11	-.11	-.11	-.11	-.11	-.11	-.11	-.11	-.11	*****	-.11	-.11	-.11	-.11
2	.32	.32	.32	.32	.32	.32	.32	.32	.32	.32	*****	.32	.32	.32	.32
3	.49	.49	.49	.49	.49	.49	.49	.49	.49	.49	*****	.49	.49	.49	.49
4	-4.09	-4.09	-4.09	-4.09	-4.09	-4.09	-4.09	-4.09	-4.09	-4.09	*****	-4.09	-4.09	-4.09	-4.09
5	.83	.45	1.05	.71	1.44	1.21	1.21	1.15	1.24	2.00	*****	2.00	1.15	1.98	1.84
6	1.55	1.05	.59	1.30	1.75	1.15	1.15	1.24	2.00	2.00	*****	2.00	1.15	1.98	1.84
7	-.55	-1.10	-2.15	-1.06	-.67	-1.23	-1.00	-.35	-.27	-.27	*****	-.27	-1.00	-.18	-.11
8	-1.34	-1.80	-2.62	-1.65	-1.42	-1.85	-1.24	-.75	-.84	-.84	*****	-.84	-1.24	-1.11	-.88
9	-1.60	-1.90	-2.35	-1.66	-1.49	-1.86	-1.09	-.84	-1.09	-1.09	*****	-1.09	-1.09	-1.50	-1.08
10	-.85	-1.05	-1.15	-.85	-.71	-.96	-.22	.04	-.50	-.50	*****	-.50	-.22	-1.15	-.45
11	-1.68	-1.70	-1.69	-1.61	-1.42	-1.40	-1.10	-.73	-1.30	-1.30	*****	-1.30	-1.10	-2.21	-1.16
12	-1.80	-1.57	-1.68	-1.70	-1.29	-1.08	-1.23	-.68	-1.18	-1.18	*****	-1.18	-1.23	-2.29	-.98
13	-2.01	-1.61	-1.79	-1.93	-1.34	-1.11	-1.44	-.77	-1.17	-1.17	*****	-1.17	-1.44	-2.29	-1.02
14	-2.80	-2.42	-2.48	-2.79	-2.11	-2.05	-2.33	-1.52	-1.83	-1.83	*****	-1.83	-2.33	-3.16	-1.89
15	-3.41	-3.06	-2.92	-3.24	-2.63	-2.81	-2.97	-1.96	-2.31	-2.31	*****	-2.31	-2.97	-3.82	-2.49
16	-3.77	-3.32	-2.95	-3.30	-2.79	-3.06	-3.21	-2.20	-2.56	-2.56	*****	-2.56	-3.21	-4.07	-2.67
17	-4.51	-3.94	-3.47	-3.84	-3.36	-3.62	-3.77	-2.90	-3.22	-3.22	*****	-3.22	-3.77	-4.63	-3.21
18	-4.77	-4.23	-3.65	-4.03	-3.52	-3.84	-3.96	-3.19	-3.42	-3.42	*****	-3.42	-3.96	-4.74	-3.41
19	-4.91	-4.36	-3.61	-4.15	-3.65	-4.08	-4.09	-3.43	-3.39	-3.39	*****	-3.39	-4.09	-4.68	-3.56
20	-5.30	-4.50	-3.67	-4.36	-3.94	-4.53	-4.34	-3.80	-3.58	-3.58	*****	-3.58	-4.34	-4.70	-3.80
21	-5.57	-4.62	-3.84	-4.54	-4.15	-4.96	-4.58	-4.13	-3.91	-3.91	*****	-3.91	-4.58	-4.79	-4.09
22	-5.99	-4.99	-4.31	-4.96	-4.55	-5.63	-4.96	-4.65	-4.39	-4.39	*****	-4.39	-4.96	-5.12	-4.68
23	-6.25	-5.23	-4.55	-5.17	-4.77	-5.99	-5.18	-4.92	-4.62	-4.62	*****	-4.62	-5.18	-5.29	-5.16
24	-6.57	-5.51	-4.93	-5.48	-5.09	-6.37	-5.42	-5.19	-5.06	-5.06	*****	-5.06	-5.42	-5.50	-5.66
25	-6.68	-5.65	-5.16	-5.68	-5.34	-6.49	-5.50	-5.34	-5.45	-5.45	*****	-5.45	-5.50	-5.60	-5.97
26	-6.54	-5.57	-5.09	-5.62	-5.34	-6.41	-5.36	-5.24	-5.50	-5.50	*****	-5.50	-5.36	-5.40	-6.04
27	-6.21	-5.31	-4.97	-5.34	-5.08	-6.20	-5.09	-5.02	-5.33	-5.33	*****	-5.33	-5.09	-5.05	-5.88
28	-6.29	-5.60	-5.40	-5.57	-5.27	-6.49	-5.31	-5.30	-5.59	-5.59	*****	-5.59	-5.31	-5.26	-6.13
29	-5.94	-5.53	-5.18	-5.24	-5.01	-6.33	-5.08	-5.14	-5.35	-5.35	*****	-5.35	-5.08	-5.06	-5.99
30	-5.65	-5.41	-4.83	-4.94	-4.81	-6.10	-4.87	-5.14	-5.09	-5.09	*****	-5.09	-4.87	-5.00	-5.87
31	-5.21	-5.00	-4.31	-4.46	-4.50	-5.58	-4.46	-4.97	-4.63	-4.63	*****	-4.63	-4.46	-4.75	-5.48
32	-4.62	-4.40	-3.58	-3.77	-4.04	-4.80	-3.89	-4.57	-4.03	-4.03	*****	-4.03	-3.89	-4.35	-4.92
33	-4.03	-3.82	-2.80	-3.10	-3.53	-4.11	-3.35	-4.14	-3.53	-3.53	*****	-3.53	-3.35	-3.90	-4.34
34	-3.52	-3.34	-2.26	-2.57	-3.12	-3.50	-2.86	-3.79	-3.08	-3.08	*****	-3.08	-2.86	-3.56	-3.78
35	-3.17	-2.97	-1.94	-2.26	-2.87	-3.13	-2.55	-3.51	-2.63	-2.63	*****	-2.63	-2.55	-3.33	-3.21
36	-2.93	-2.76	-1.73	-2.05	-2.76	-2.84	-2.31	-3.33	-2.30	-2.30	*****	-2.30	-2.31	-3.10	-2.82
37	-2.66	-2.53	-1.52	-1.74	-2.57	-2.48	-1.98	-3.11	-1.98	-1.98	*****	-1.98	-1.98	-2.78	-2.52
38	-2.11	-1.99	-.98	-1.20	-2.06	-2.00	-1.34	-2.53	-1.42	-1.42	*****	-1.42	-1.34	-2.27	-1.95
39	-2.04	-1.87	-.90	-1.18	-2.04	-2.03	-1.14	-2.30	-1.36	-1.36	*****	-1.36	-1.14	-2.13	-1.77
40	-1.87	-1.72	-.90	-1.15	-2.05	-2.06	-1.01	-2.12	-1.22	-1.22	*****	-1.22	-1.01	-1.89	-1.59
41	-1.29	-1.18	-.51	-.67	-1.62	-1.67	-.59	-1.66	-.73	-.73	*****	-.73	-.59	-1.34	-1.14
42	-.89	-.79	-.21	-.40	-1.22	-1.35	-.32	-1.23	-.34	-.34	*****	-.34	-.32	-.87	-1.01
43	-.55	-.40	.08	-.23	-.77	-.97	.02	-.70	.08	.08	*****	.08	.02	-.41	-.89
44	-.32	-.14	.18	-.11	-.44	-.68	-.36	-.28	.40	.40	*****	.40	.36	-.12	-.56
45	.47	.62	.77	.57	.40	.03	1.29	.49	1.23	1.23	*****	1.23	1.29	.66	.40
46	.44	.56	.48	.49	.36	-.07	1.36	.37	1.27	1.27	*****	1.27	1.36	.66	.44
47	.46	.52	.34	.48	.41	-.08	1.38	.39	1.36	1.36	*****	1.36	1.38	.70	.63
48	.50	.46	.25	.51	.43	-.05	1.40	.41	1.39	1.39	*****	1.39	1.40	.75	.82
49	.40	.11	-.14	.38	.20	-.22	1.09	.31	1.31	1.31	*****	1.31	1.09	.68	.74
50	.68	.07	-.21	.57	.26	-.09	1.00	.50	1.50	1.50	*****	1.50	1.00	.95	.94
51	1.12	.32	.08	.84	.69	.16	1.13	.76	1.79	1.79	*****	1.79	1.13	1.55	1.40
52	.69	-.19	-.39	.31	.42	-.28	.48	.27	1.35	1.35	*****	1.35	.48	1.26	1.06
53	.62	-.32	-.38	.27	.48	-.17	.36	.63	1.40	1.40	*****	1.40	.36	1.22	1.08
54	.60	-.24	-.36	.43	.54	-.05	.54	1.29	1.45	1.45	*****	1.45	.54	1.37	1.24
55	.44	-.35	-.73	.27	.21	-.25	.52	1.55	1.20	1.20	*****	1.20	.52	1.31	1.11
56	-.08	-.97	-1.38	-.34	-.44	-.87	.01	1.12	.58	.58	*****	.58	.01	.57	.37
57	-.38	-1.22	-1.41	-.47	-.55	-1.09	-.11	.76	.18	.18	*****	.18	-.11	-.09	-.09
58	-.29	-.74	-.89	-.13	-.09	-.70	.13	.88	.22	.22	*****	.22	.13	-.50	.22
59	-2.79	-2.76	-2.84	-2.46	-2.12	-2.79	-2.52	-1.69	-2.12	-2.12	*****	-2.12	-2.52	-3.27	-1.87
60	-9.02	-8.62	-9.20	-8.34	-8.45	-9.36	-8.85	-8.92	-8.75	-8.75	*****	-8.75	-8.85	-8.64	-7.71
61	3.05	3.05	3.05	3.05	3.05	3.05	3.05	3.05	3.05	3.05	*****	3.05	3.05	3.05	3.05
62	.45	.45	.45	.45	.45	.45	.45	.45	.45	.45	*****	.45	.45	.45	.45

NOAA-9 SCANNER OFFSETS FOR MAY 1985: LONGHAVE CHANNEL
DAY OF MONTH -->

S.P.	16	17	18	19	20	21	22	23	24	25	26	27	28	29	30	31
1	-.11	-.11	-.11	-.11	-.11	-.11	-.11	-.11	-.11	-.11	-.11	-.11	-.11	-.11	-.11	-.11
2	.32	.32	.32	.32	.32	.32	.32	.32	.32	.32	.32	.32	.32	.32	.32	.32
3	.49	.49	.49	.49	.49	.49	.49	.49	.49	.49	.49	.49	.49	.49	.49	.49
4	-4.09	-4.09	-4.09	-4.09	-4.09	-4.09	-4.09	-4.09	-4.09	-4.09	-4.09	-4.09	-4.09	-4.09	-4.09	-4.09
5	1.31	1.61	.71	-.25	.53	1.44	1.17	.83	-.23	.53	.83	1.62	.45	-.59	-.22	1.28
6	1.20	1.98	1.30	.97	.88	1.75	1.38	1.55	1.45	.88	1.55	2.03	1.05	.91	1.00	2.09
7	-1.30	-.31	-1.06	-1.35	-1.15	-.67	-.27	-.55	-.53	-1.15	-.55	-.53	-1.10	-1.05	-1.42	-.52
8	-2.02	-.98	-1.65	-2.18	-1.61	-1.42	-.27	-1.34	-1.28	-1.61	-1.34	-1.29	-1.80	-1.72	-1.92	-1.24
9	-2.07	-1.28	-1.66	-2.28	-1.72	-1.49	-.34	-1.60	-1.36	-1.72	-1.60	-1.43	-1.90	-2.03	-1.96	-1.37
10	-1.19	-.71	-.85	-1.37	-.99	-.71	.09	-.85	-.65	-.99	-.85	-.83	-1.05	-1.41	-1.24	-.71
11	-1.89	-1.54	-1.61	-1.99	-1.77	-1.42	-.97	-1.68	-1.45	-1.77	-1.68	-1.68	-1.70	-2.27	-1.96	-1.31
12	-1.81	-1.49	-1.70	-1.90	-1.59	-1.29	-1.06	-1.80	-1.58	-1.59	-1.80	-1.61	-1.57	-2.42	-1.79	-1.13
13	-2.01	-1.58	-1.93	-1.68	-1.51	-1.34	-1.18	-2.01	-1.69	-1.51	-2.01	-1.83	-1.61	-2.55	-1.62	-1.10
14	-2.93	-2.41	-2.79	-2.29	-2.22	-2.11	-2.18	-2.80	-2.50	-2.22	-2.80	-2.88	-2.42	-3.20	-2.24	-1.84
15	-3.42	-3.14	-3.24	-2.83	-2.74	-2.63	-2.83	-3.41	-3.11	-2.74	-3.41	-3.69	-3.06	-3.68	-2.80	-2.26
16	-3.53	-3.46	-3.30	-3.05	-3.01	-2.79	-3.06	-3.77	-3.39	-3.01	-3.77	-3.99	-3.32	-4.00	-3.13	-2.27
17	-4.03	-4.13	-3.84	-3.73	-3.69	-3.36	-3.71	-4.51	-4.20	-3.69	-4.51	-4.62	-3.94	-4.58	-3.69	-2.77
18	-4.12	-4.48	-4.03	-3.99	-3.97	-3.52	-3.91	-4.77	-4.67	-3.97	-4.77	-4.81	-4.23	-4.67	-3.75	-2.96
19	-4.17	-4.69	-4.15	-4.10	-4.21	-3.65	-3.93	-4.91	-4.94	-4.21	-4.91	-4.80	-4.36	-4.78	-3.88	-3.12
20	-4.34	-5.11	-4.36	-4.50	-4.67	-3.94	-4.20	-5.30	-5.35	-4.67	-5.30	-4.94	-4.50	-4.97	-4.09	-3.46
21	-4.45	-5.53	-4.54	-4.95	-5.13	-4.15	-4.55	-5.57	-5.71	-5.13	-5.57	-5.16	-4.62	-5.14	-4.28	-3.75
22	-4.74	-6.10	-4.96	-5.45	-5.68	-4.55	-5.06	-5.99	-6.24	-5.68	-5.99	-5.61	-4.99	-5.56	-4.76	-4.26
23	-4.83	-6.41	-5.17	-5.58	-6.01	-4.77	-5.32	-6.25	-6.60	-6.01	-6.25	-5.88	-5.23	-5.77	-4.97	-4.65
24	-5.00	-6.77	-5.48	-5.76	-6.34	-5.09	-5.60	-6.57	-7.06	-6.34	-6.57	-6.20	-5.51	-5.97	-5.22	-4.95
25	-5.02	-6.96	-5.68	-5.96	-6.49	-5.34	-5.76	-6.68	-7.24	-6.49	-6.68	-6.35	-5.65	-6.08	-5.39	-5.07
26	-4.78	-6.82	-5.62	-5.88	-6.38	-5.34	-5.69	-6.54	-7.05	-6.38	-6.54	-6.26	-5.57	-5.95	-5.29	-4.97
27	-4.36	-6.43	-5.34	-5.59	-6.11	-5.08	-5.42	-6.21	-6.75	-6.11	-6.21	-5.90	-5.31	-5.64	-5.03	-4.78
28	-4.55	-6.60	-5.57	-5.66	-6.39	-5.27	-5.70	-6.29	-7.06	-6.39	-6.29	-6.16	-5.60	-5.93	-5.29	-5.05
29	-4.33	-6.39	-5.24	-5.19	-6.22	-5.01	-5.48	-5.94	-6.95	-6.22	-5.94	-6.04	-5.53	-5.81	-5.01	-4.83
30	-4.10	-6.15	-4.94	-4.72	-5.98	-4.81	-5.27	-5.65	-6.87	-5.98	-5.65	-5.81	-5.41	-5.78	-4.67	-4.69
31	-3.70	-5.53	-4.46	-4.24	-5.54	-4.50	-4.85	-5.21	-6.43	-5.54	-5.21	-5.30	-5.00	-5.55	-4.19	-4.33
32	-3.24	-4.76	-3.77	-3.76	-5.00	-4.04	-4.26	-4.62	-5.90	-5.00	-4.62	-4.65	-4.40	-5.06	-3.62	-3.72
33	-2.80	-4.07	-3.10	-3.17	-4.41	-3.53	-3.71	-4.03	-5.41	-4.41	-4.03	-4.05	-3.82	-4.53	-3.01	-3.04
34	-2.45	-3.55	-2.57	-2.71	-3.84	-3.12	-3.30	-3.52	-4.97	-3.84	-3.52	-3.49	-3.34	-4.05	-2.53	-2.43
35	-2.13	-3.17	-2.26	-2.45	-3.33	-2.87	-2.91	-3.17	-4.49	-3.33	-3.17	-3.04	-2.97	-3.68	-2.12	-1.99
36	-1.88	-2.79	-2.05	-2.26	-2.94	-2.76	-2.46	-2.93	-4.10	-2.94	-2.93	-2.72	-2.76	-3.48	-1.77	-1.67
37	-1.75	-2.34	-1.74	-2.04	-2.61	-2.57	-2.07	-2.66	-3.69	-2.61	-2.66	-2.45	-2.53	-3.22	-1.42	-1.44
38	-1.31	-1.67	-1.20	-1.57	-2.01	-2.06	-1.50	-2.11	-3.03	-2.01	-2.11	-1.98	-1.99	-2.52	-.85	-.94
39	-1.19	-1.45	-1.18	-1.52	-1.92	-2.04	-1.37	-2.04	-2.83	-1.92	-2.04	-1.88	-1.87	-2.27	-.69	-.91
40	-1.02	-1.25	-1.15	-1.45	-1.93	-2.05	-1.31	-1.87	-2.62	-1.93	-1.87	-1.75	-1.72	-2.10	-.60	-.90
41	-.50	-.70	-.67	-.87	-1.59	-1.62	-.92	-1.29	-1.99	-1.59	-1.29	-1.21	-1.18	-1.58	-.18	-.47
42	.03	-.23	-.40	-.41	-1.25	-1.22	-.70	-.89	-1.52	-1.25	-.89	-.68	-.79	-1.15	.10	-.13
43	.56	.24	-.23	-.11	-.90	-.77	-.52	-.55	-1.26	-.90	-.55	-.25	-.40	-.71	.45	.09
44	.94	.64	-.11	.11	-.65	-.44	-.34	-.32	-1.02	-.65	-.32	.06	-.14	-.25	.81	.26
45	1.88	1.48	.57	.91	.10	.40	.36	.47	-.15	.10	.47	.98	.62	.64	1.64	1.02
46	1.88	1.51	.49	.81	-.02	.36	.29	.44	.02	-.02	.44	1.16	.56	.56	1.37	.94
47	1.89	1.56	.48	.76	-.10	.41	.21	.46	.36	-.10	.46	1.20	.52	.50	1.12	.96
48	1.83	1.54	.51	.74	-.15	.43	.07	.50	.56	-.15	.50	1.16	.46	.33	.91	.98
49	1.57	1.32	.38	.53	-.29	.20	-.20	.40	.43	-.29	.40	.95	.11	.10	.59	.78
50	1.65	1.34	.57	.65	-.02	.26	-.20	.68	.60	-.02	.68	1.05	.07	.10	.69	1.01
51	1.92	1.51	.84	.84	.42	.69	-.01	1.12	.94	.42	1.12	1.42	.32	.43	1.01	1.51
52	1.38	.86	.31	.30	.04	.42	-.57	.69	.50	.04	.69	.94	-.19	.16	.49	1.08
53	1.15	.71	.27	.22	.13	.48	-.61	.62	.74	.13	.62	.73	-.32	.52	.48	1.02
54	1.06	.78	.43	.10	.33	.54	-.16	.60	1.04	.33	.60	.56	-.24	.96	.65	1.05
55	.72	.78	.27	-.22	.32	.21	.23	.44	.65	.32	.44	.28	-.35	1.06	.51	.88
56	-.03	.36	-.34	-.98	-.29	-.44	.26	-.08	-.14	-.29	-.08	-.30	-.97	.71	.00	.30
57	-.25	-.06	-.47	-1.15	-.39	-.55	.39	-.38	-.31	-.39	-.38	-.54	-1.22	.60	-.21	-.10
58	.08	-.14	-.13	-.69	.07	-.09	.55	-.29	.12	.07	-.29	-.34	-.74	.97	.06	.05
59	-2.31	-2.80	-2.46	-2.40	-2.21	-2.12	-2.06	-2.79	-2.02	-2.21	-2.79	-2.78	-2.76	-1.03	-2.05	-2.02
60	-8.73	-9.01	-8.34	-6.91	-8.21	-8.45	-8.22	-9.02	-7.32	-8.21	-9.02	-8.91	-8.62	-6.04	-6.88	-7.66
61	3.05	3.05	3.05	3.05	3.05	3.05	3.05	3.05	3.05	3.05	3.05	3.05	3.05	3.05	3.05	3.05
62	.45	.45	.45	.45	.45	.45	.45	.45	.45	.45	.45	.45	.45	.45	.45	.45

NOAA-9 SCANNER OFFSETS FOR MAY 1985: SHORTWAVE CHANNEL
 DAY OF MONTH -->

S.P.	1	2	3	4	5	6	7	8	9	10	11	12	13	14	15
1	.29	.29	.29	.29	.29	.29	.29	.29	.29	.29	*****	.29	.29	.29	.29
2	.59	.59	.59	.59	.59	.59	.59	.59	.59	.59	*****	.59	.59	.59	.59
3	.63	.63	.63	.63	.63	.63	.63	.63	.63	.63	*****	.63	.63	.63	.63
4	.27	.27	.27	.27	.27	.27	.27	.27	.27	.27	*****	.27	.27	.27	.27
5	.59	.59	.59	.59	.59	.59	.43	.59	.59	.59	*****	.43	.43	.36	.43
6	.65	.65	.65	.65	.65	.65	.48	.65	.65	.65	*****	.48	.48	.40	.48
7	.29	.29	.29	.29	.29	.29	.11	.29	.29	.29	*****	.11	.11	.02	.11
8	.64	.64	.64	.64	.64	.64	.43	.64	.64	.64	*****	.43	.43	.34	.43
9	.70	.70	.70	.70	.70	.70	.48	.70	.70	.70	*****	.48	.48	.40	.48
10	.32	.32	.32	.32	.32	.32	.10	.32	.32	.32	*****	.10	.10	.01	.10
11	.60	.60	.60	.60	.60	.60	.38	.60	.60	.60	*****	.38	.38	.28	.38
12	.59	.59	.59	.59	.59	.59	.39	.59	.59	.59	*****	.39	.39	.28	.39
13	-.23	-.23	-.23	-.23	-.23	-.23	-.41	-.23	-.23	-.23	*****	-.41	-.41	-.51	-.41
14	.03	.03	.03	.03	.03	.03	-.16	.03	.03	.03	*****	-.16	-.16	-.28	-.16
15	.03	.03	.03	.03	.03	.03	-.16	.03	.03	.03	*****	-.16	-.16	-.28	-.16
16	-.37	-.37	-.37	-.37	-.37	-.37	-.55	-.37	-.37	-.37	*****	-.55	-.55	-.66	-.55
17	-.05	-.05	-.05	-.05	-.05	-.05	-.24	-.05	-.05	-.05	*****	-.24	-.24	-.35	-.24
18	-.03	-.03	-.03	-.03	-.03	-.03	-.22	-.03	-.03	-.03	*****	-.22	-.22	-.33	-.22
19	-.41	-.41	-.41	-.41	-.41	-.41	-.59	-.41	-.41	-.41	*****	-.59	-.59	-.70	-.59
20	-.05	-.05	-.05	-.05	-.05	-.05	-.24	-.05	-.05	-.05	*****	-.24	-.24	-.34	-.24
21	-.03	-.03	-.03	-.03	-.03	-.03	-.23	-.03	-.03	-.03	*****	-.23	-.23	-.32	-.23
22	-.46	-.46	-.46	-.46	-.46	-.46	-.65	-.46	-.46	-.46	*****	-.65	-.65	-.74	-.65
23	-.10	-.10	-.10	-.10	-.10	-.10	-.30	-.10	-.10	-.10	*****	-.30	-.30	-.39	-.30
24	-.07	-.07	-.07	-.07	-.07	-.07	-.26	-.07	-.07	-.07	*****	-.26	-.26	-.35	-.26
25	-.43	-.43	-.43	-.43	-.43	-.43	-.62	-.43	-.43	-.43	*****	-.62	-.62	-.70	-.62
26	-.07	-.07	-.07	-.07	-.07	-.07	-.26	-.07	-.07	-.07	*****	-.26	-.26	-.34	-.26
27	-.04	-.04	-.04	-.04	-.04	-.04	-.22	-.04	-.04	-.04	*****	-.22	-.22	-.31	-.22
28	-.40	-.40	-.40	-.40	-.40	-.40	-.58	-.40	-.40	-.40	*****	-.58	-.58	-.66	-.58
29	-.01	-.01	-.01	-.01	-.01	-.01	-.20	-.01	-.01	-.01	*****	-.20	-.20	-.28	-.20
30	.05	.05	.05	.05	.05	.05	-.13	.05	.05	.05	*****	-.13	-.13	-.22	-.13
31	-.30	-.30	-.30	-.30	-.30	-.30	-.48	-.30	-.30	-.30	*****	-.48	-.48	-.55	-.48
32	.05	.05	.05	.05	.05	.05	-.13	.05	.05	.05	*****	-.13	-.13	-.21	-.13
33	-.03	-.03	-.03	-.03	-.03	-.03	-.21	-.03	-.03	-.03	*****	-.21	-.21	-.27	-.21
34	-.40	-.40	-.40	-.40	-.40	-.40	-.56	-.40	-.40	-.40	*****	-.56	-.56	-.63	-.56
35	-.04	-.04	-.04	-.04	-.04	-.04	-.21	-.04	-.04	-.04	*****	-.21	-.21	-.27	-.21
36	.03	.03	.03	.03	.03	.03	-.13	.03	.03	.03	*****	-.13	-.13	-.19	-.13
37	-.26	-.26	-.26	-.26	-.26	-.26	-.42	-.26	-.26	-.26	*****	-.42	-.42	-.48	-.42
38	.12	.12	.12	.12	.12	.12	-.03	.12	.12	.12	*****	-.03	-.03	-.10	-.03
39	.18	.18	.18	.18	.18	.18	.03	.18	.18	.18	*****	.03	.03	-.02	.03
40	-.12	-.12	-.12	-.12	-.12	-.12	-.27	-.12	-.12	-.12	*****	-.27	-.27	-.32	-.27
41	.27	.27	.27	.27	.27	.27	.12	.27	.27	.27	*****	.12	.12	.07	.12
42	.32	.32	.32	.32	.32	.32	.17	.32	.32	.32	*****	.17	.17	.12	.17
43	-.03	-.03	-.03	-.03	-.03	-.03	-.18	-.03	-.03	-.03	*****	-.18	-.18	-.22	-.18
44	.31	.31	.31	.31	.31	.31	.16	.31	.31	.31	*****	.16	.16	.12	.16
45	.33	.33	.33	.33	.33	.33	.18	.33	.33	.33	*****	.18	.18	.14	.18
46	-.03	-.03	-.03	-.03	-.03	-.03	-.17	-.03	-.03	-.03	*****	-.17	-.17	-.21	-.17
47	.31	.31	.31	.31	.31	.31	.16	.31	.31	.31	*****	.16	.16	.12	.16
48	.35	.35	.35	.35	.35	.35	.21	.35	.35	.35	*****	.21	.21	.17	.21
49	.00	.00	.00	.00	.00	.00	-.13	.00	.00	.00	*****	-.13	-.13	-.17	-.13
50	.35	.35	.35	.35	.35	.35	.22	.35	.35	.35	*****	.22	.22	.17	.22
51	.37	.37	.37	.37	.37	.37	.23	.37	.37	.37	*****	.23	.23	.18	.23
52	.07	.07	.07	.07	.07	.07	-.07	.07	.07	.07	*****	-.07	-.07	-.13	-.07
53	.88	.88	.88	.88	.88	.88	.69	.88	.88	.88	*****	.69	.69	.57	.69
54	1.26	1.26	1.26	1.26	1.26	1.26	1.11	1.26	1.26	1.26	*****	1.11	1.11	1.04	1.11
55	.94	.94	.94	.94	.94	.94	.79	.94	.94	.94	*****	.79	.79	.74	.79
56	1.25	1.25	1.25	1.25	1.25	1.25	1.10	1.25	1.25	1.25	*****	1.10	1.10	1.04	1.10
57	1.29	1.29	1.29	1.29	1.29	1.29	1.15	1.29	1.29	1.29	*****	1.15	1.15	1.08	1.15
58	.92	.92	.92	.92	.92	.92	.78	.92	.92	.92	*****	.78	.78	.73	.78
59	1.22	1.22	1.22	1.22	1.22	1.22	1.08	1.22	1.22	1.22	*****	1.08	1.08	1.02	1.08
60	1.22	1.22	1.22	1.22	1.22	1.22	1.10	1.22	1.22	1.22	*****	1.10	1.10	1.03	1.10
61	.83	.83	.83	.83	.83	.83	.83	.83	.83	.83	*****	.83	.83	.83	.83
62	.97	.97	.97	.97	.97	.97	.97	.97	.97	.97	*****	.97	.97	.97	.97

NOAA-9 SCANNER OFFSETS FOR MAY 1985: SHORTWAVE CHANNEL
 DAY OF MONTH -->

S.P.	16	17	18	19	20	21	22	23	24	25	26	27	28	29	30	31
1	.29	.29	.29	.29	.29	.29	.29	.29	.29	.29	.29	.29	.29	.29	.29	.29
2	.59	.59	.59	.59	.59	.59	.59	.59	.59	.59	.59	.59	.59	.59	.59	.59
3	.63	.63	.63	.63	.63	.63	.63	.63	.63	.63	.63	.63	.63	.63	.63	.63
4	.27	.27	.27	.27	.27	.27	.27	.27	.27	.27	.27	.27	.27	.27	.27	.27
5	.59	.59	.36	.36	.43	.43	.36	.23	.11	.23	.23	.43	.36	.36	.43	.47
6	.65	.65	.40	.40	.48	.48	.40	.27	.15	.27	.27	.48	.40	.40	.48	.54
7	.29	.29	.02	.02	.11	.11	.02	-.11	-.22	-.11	-.11	.11	.02	.02	.11	.16
8	.64	.64	.34	.34	.43	.43	.34	.21	.10	.21	.21	.43	.34	.34	.43	.50
9	.70	.70	.40	.40	.48	.48	.40	.26	.15	.26	.26	.48	.40	.40	.48	.56
10	.32	.32	.01	.01	.10	.10	.01	-.12	-.23	-.12	-.12	.10	.01	.01	.10	.17
11	.60	.60	.28	.28	.38	.38	.28	.14	.02	.14	.14	.38	.28	.28	.38	.46
12	.59	.59	.28	.28	.39	.39	.28	.14	.02	.14	.14	.39	.28	.28	.39	.46
13	-.23	-.23	-.51	-.51	-.41	-.41	-.51	-.67	-.77	-.67	-.67	-.41	-.51	-.51	-.41	-.34
14	.03	.03	-.28	-.28	-.16	-.16	-.28	-.43	-.54	-.43	-.43	-.16	-.28	-.28	-.16	-.06
15	.03	.03	-.28	-.28	-.16	-.16	-.28	-.43	-.55	-.43	-.43	-.16	-.28	-.28	-.16	-.07
16	-.37	-.37	-.66	-.66	-.55	-.55	-.66	-.81	-.92	-.81	-.81	-.55	-.66	-.66	-.55	-.45
17	-.05	-.05	-.35	-.35	-.24	-.24	-.35	-.49	-.62	-.49	-.49	-.24	-.35	-.35	-.24	-.12
18	-.03	-.03	-.33	-.33	-.22	-.22	-.33	-.48	-.62	-.48	-.48	-.22	-.33	-.33	-.22	-.11
19	-.41	-.41	-.70	-.70	-.59	-.59	-.70	-.85	-.98	-.85	-.85	-.59	-.70	-.70	-.59	-.49
20	-.05	-.05	-.34	-.34	-.24	-.24	-.34	-.50	-.63	-.50	-.50	-.24	-.34	-.34	-.24	-.11
21	-.03	-.03	-.32	-.32	-.23	-.23	-.32	-.48	-.62	-.48	-.48	-.23	-.32	-.32	-.23	-.09
22	-.46	-.46	-.74	-.74	-.65	-.65	-.74	-.90	-1.04	-.90	-.90	-.65	-.74	-.74	-.65	-.52
23	-.10	-.10	-.39	-.39	-.30	-.30	-.39	-.54	-.69	-.54	-.54	-.30	-.39	-.39	-.30	-.15
24	-.07	-.07	-.35	-.35	-.26	-.26	-.35	-.50	-.65	-.50	-.50	-.26	-.35	-.35	-.26	-.11
25	-.43	-.43	-.70	-.70	-.62	-.62	-.70	-.85	-1.00	-.85	-.85	-.62	-.70	-.70	-.62	-.47
26	-.07	-.07	-.34	-.34	-.26	-.26	-.34	-.49	-.64	-.49	-.49	-.26	-.34	-.34	-.26	-.09
27	-.04	-.04	-.31	-.31	-.22	-.22	-.31	-.45	-.61	-.45	-.45	-.22	-.31	-.31	-.22	-.06
28	-.40	-.40	-.66	-.66	-.58	-.58	-.66	-.80	-.95	-.80	-.80	-.58	-.66	-.66	-.58	-.42
29	-.01	-.01	-.28	-.28	-.20	-.20	-.28	-.42	-.57	-.42	-.42	-.20	-.28	-.28	-.20	-.02
30	.05	.05	-.22	-.22	-.13	-.13	-.22	-.35	-.51	-.35	-.35	-.13	-.22	-.22	-.13	.03
31	-.30	-.30	-.55	-.55	-.48	-.48	-.55	-.69	-.84	-.69	-.69	-.48	-.55	-.55	-.48	-.33
32	.05	.05	-.21	-.21	-.13	-.13	-.21	-.32	-.49	-.32	-.32	-.13	-.21	-.21	-.13	.01
33	-.03	-.03	-.27	-.27	-.21	-.21	-.27	-.38	-.55	-.38	-.38	-.21	-.27	-.27	-.21	-.09
34	-.40	-.40	-.63	-.63	-.56	-.56	-.63	-.74	-.90	-.74	-.74	-.56	-.63	-.63	-.56	-.47
35	-.04	-.04	-.27	-.27	-.21	-.21	-.27	-.37	-.54	-.37	-.37	-.21	-.27	-.27	-.21	-.10
36	.03	.03	-.19	-.19	-.13	-.13	-.19	-.28	-.45	-.28	-.28	-.13	-.19	-.19	-.13	-.04
37	-.26	-.26	-.48	-.48	-.42	-.42	-.48	-.57	-.73	-.57	-.57	-.42	-.48	-.48	-.42	-.36
38	.12	.12	-.10	-.10	-.03	-.03	-.10	-.18	-.34	-.18	-.18	-.03	-.10	-.10	-.03	.03
39	.18	.18	-.02	-.02	.03	.03	-.02	-.10	-.27	-.10	-.10	.03	-.02	-.02	.03	.08
40	-.12	-.12	-.32	-.32	-.27	-.27	-.32	-.41	-.56	-.41	-.41	-.27	-.32	-.32	-.27	-.23
41	.27	.27	.07	.07	.12	.12	.07	-.02	-.18	-.02	-.02	.12	.07	.07	.12	.16
42	.32	.32	.12	.12	.17	.17	.12	.04	-.13	.04	.04	.17	.12	.12	.17	.20
43	-.03	-.03	-.22	-.22	-.18	-.18	-.22	-.31	-.46	-.31	-.31	-.18	-.22	-.22	-.18	-.16
44	.31	.31	.12	.12	.16	.16	.12	.04	-.13	.04	.04	.16	.12	.12	.16	.19
45	.33	.33	.14	.14	.18	.18	.14	.07	-.11	.07	.07	.18	.14	.14	.18	.21
46	-.03	-.03	-.21	-.21	-.17	-.17	-.21	-.29	-.46	-.29	-.29	-.17	-.21	-.21	-.17	-.16
47	.31	.31	.12	.12	.16	.16	.12	.05	-.13	.05	.05	.16	.12	.12	.16	.19
48	.35	.35	.17	.17	.21	.21	.17	.10	-.08	.10	.10	.21	.17	.17	.21	.23
49	.00	.00	-.17	-.17	-.13	-.13	-.17	-.25	-.42	-.25	-.25	-.13	-.17	-.17	-.13	-.13
50	.35	.35	.17	.17	.22	.22	.17	.10	-.08	.10	.10	.22	.17	.17	.22	.23
51	.37	.37	.18	.18	.23	.23	.18	.12	-.06	.12	.12	.23	.18	.18	.23	.24
52	.07	.07	-.13	-.13	-.07	-.07	-.13	-.18	-.36	-.18	-.18	-.07	-.13	-.13	-.07	-.08
53	.88	.88	.57	.57	.69	.69	.57	.56	.36	.56	.56	.69	.57	.57	.69	.68
54	1.26	1.26	1.04	1.04	1.11	1.11	1.04	.98	.81	.98	.98	1.11	1.04	1.04	1.11	1.08
55	.94	.94	.74	.74	.79	.79	.74	.67	.51	.67	.67	.79	.74	.74	.79	.76
56	1.25	1.25	1.04	1.04	1.10	1.10	1.04	.97	.81	.97	.97	1.10	1.04	1.04	1.10	1.09
57	1.29	1.29	1.08	1.08	1.15	1.15	1.08	1.02	.85	1.02	1.02	1.15	1.08	1.08	1.15	1.12
58	.92	.92	.73	.73	.78	.78	.73	.66	.50	.66	.66	.78	.73	.73	.78	.75
59	1.22	1.22	1.02	1.02	1.08	1.08	1.02	.95	.79	.95	.95	1.08	1.02	1.02	1.08	1.07
60	1.22	1.22	1.03	1.03	1.10	1.10	1.03	.96	.81	.96	.96	1.10	1.03	1.03	1.10	1.07
61	.83	.83	.83	.83	.83	.83	.83	.83	.83	.83	.83	.83	.83	.83	.83	.83
62	.97	.97	.97	.97	.97	.97	.97	.97	.97	.97	.97	.97	.97	.97	.97	.97

S.P.	NOAA-9 SCANNER OFFSETS FOR														TOTAL CHANNEL		
	DAY OF MONTH -->																
	1	2	3	4	5	6	7	8	9	10	11	12	13	14	15		
136	.36	.36	.36	.36	.36	.36	.36	.36	.36	.36	.36	.36	.36	.36
2	1.04	1.04	1.04	1.04	1.04	1.04	1.04	1.04	1.04	1.04	1.04	1.04	1.04	1.04	1.04
3	1.93	1.93	1.93	1.93	1.93	1.93	1.93	1.93	1.93	1.93	1.93	1.93	1.93	1.93	1.93
4	-9.64	-9.64	-9.64	-9.64	-9.64	-9.64	-9.64	-9.64	-9.64	-9.64	-9.64	-9.64	-9.64	-9.64	-9.64
5	-6.65	-3.93	-5.11	-4.42	-2.77	-1.28	-3.57	-4.23	-4.80	-6.02	-7.46	-12.51	-14.81	-6.26	-6.91
6	-3.37	-2.99	-4.36	-2.93	-1.92	-1.43	-3.29	-4.04	-3.59	-4.13	-5.21	-6.67	-4.08	-4.09	-4.09
7	-1.83	-2.90	-4.16	-1.62	-1.21	-.87	-2.88	-3.29	-2.69	-3.01	-4.67	-3.65	-2.81	-2.76	-2.76
8	-.87	-2.36	-3.85	-.66	-1.09	-.39	-1.98	-1.98	-1.67	-1.69	-1.69	-2.73	-2.21	-2.18	-2.18
9	-.66	-1.97	-4.27	-.33	-1.38	-.57	-1.48	-1.29	-1.68	-.53	-2.01	-2.10	-2.10	-2.25	-2.25
10	-.22	-1.65	-4.65	-.23	-1.37	-.34	-.96	-.77	-1.68	-.24	-1.42	-2.01	-2.43	-2.43	-2.43
1130	-1.58	-4.58	-.38	-1.25	.09	-.44	-.57	-1.50	-.76	-1.83	-2.43	-3.03	-2.65	-3.06
12	-.01	-2.21	-4.68	-1.16	-1.62	-.11	-.71	-1.24	-2.12	-1.15	-2.07	-2.65	-2.98	-2.64	-2.98
13	-.13	-2.56	-4.40	-1.51	-1.74	-.09	-.98	-1.60	-2.35	-1.15	-2.07	-2.64	-2.55	-2.64	-2.55
1407	-2.42	-4.05	-1.64	-1.41	.14	-.69	-1.61	-2.40	-1.12	-1.74	-2.64	-2.55	-2.64	-2.55
1561	-1.94	-3.38	-1.45	-.79	.37	.08	-1.26	-2.16	-1.12	-1.74	-2.64	-2.55	-2.64	-2.55
1649	-1.89	-2.97	-1.55	-.67	.24	.42	-1.32	-2.18	-1.02	-1.70	-2.72	-2.36	-2.21	-2.21
1710	-2.01	-2.87	-1.54	-.64	.39	.51	-1.31	-2.16	-1.05	-1.70	-2.78	-2.21	-2.21	-2.21
18	-.44	-2.26	-2.98	-1.81	-.74	.22	.09	-1.41	-2.44	-1.22	-1.93	-2.93	-2.21	-2.21	-2.21
19	-.88	-2.53	-3.04	-1.99	-.92	-.14	-.64	-1.68	-2.73	-1.44	-2.06	-3.03	-2.31	-2.31	-2.31
20	-1.12	-2.53	-2.85	-1.86	-.99	-.34	-1.20	-1.90	-2.66	-1.35	-2.02	-3.10	-2.26	-2.26	-2.26
21	-1.30	-2.47	-2.54	-1.91	-1.18	-.45	-1.64	-2.08	-2.61	-1.16	-1.97	-3.24	-2.12	-2.12	-2.12
22	-1.75	-2.67	-2.54	-2.19	-1.54	-.74	-2.16	-2.26	-2.77	-1.21	-2.23	-3.47	-2.19	-2.19	-2.19
23	-1.86	-2.52	-2.19	-2.23	-1.50	-.64	-2.30	-2.08	-2.64	-1.12	-2.09	-3.39	-2.01	-2.01	-2.01
24	-1.90	-2.41	-2.10	-2.30	-1.44	-.71	-2.51	-2.29	-2.66	-1.13	-2.11	-3.41	-1.95	-1.95	-1.95
25	-1.79	-2.14	-2.07	-2.33	-1.14	-.65	-2.65	-2.61	-2.54	-.71	-2.00	-3.31	-1.77	-1.77	-1.77
26	-1.74	-1.80	-1.94	-2.44	-.89	-.56	-2.78	-2.88	-2.50	-.44	-1.95	-3.20	-1.76	-1.76	-1.76
27	-1.66	-1.39	-1.65	-2.33	-.71	-.32	-2.75	-2.76	-2.21	-.30	-1.89	-3.01	-1.70	-1.70	-1.70
28	-1.46	-1.09	-1.25	-2.12	-.57	-.16	-2.67	-2.53	-1.85	-.03	-1.80	-2.58	-1.48	-1.48	-1.48
29	-1.22	-.91	-.81	-1.81	-.36	.04	-2.48	-2.32	-1.52	.22	-1.53	-2.13	-1.09	-1.09	-1.09
30	-1.01	-.86	-.67	-1.73	-.24	.13	-2.39	-2.18	-1.44	.33	-1.22	-1.64	-.78	-.78	-.78
31	-.87	-.81	-.85	-1.82	-.36	.11	-2.24	-2.21	-1.34	.40	-1.08	-1.23	-.73	-.73	-.73
32	-.58	-.33	-.65	-1.47	-.17	.47	-1.79	-1.96	-.80	.85	-.67	-.65	-.52	-.52	-.52
3308	.43	-.15	-.81	.31	.99	-1.12	-1.24	-.02	1.47	-.04	.22	.13	.13	.13
3467	.97	.11	-.48	.67	1.39	-.74	-.68	.59	1.95	.42	.92	.67	.67	.67
3599	1.45	.32	-.23	.79	1.62	-.39	-.26	1.00	2.08	.71	1.43	1.05	1.05	1.05
36	1.11	1.85	.49	-.08	.75	1.74	-.24	-.15	1.12	1.89	.83	1.68	1.13	1.13	1.13
37	1.11	2.15	.61	.07	.68	1.87	-.26	-.03	1.14	1.71	.76	1.61	1.12	1.12	1.12
38	1.21	2.57	.81	.36	.91	2.13	-.19	.27	1.32	1.77	.83	1.73	1.38	1.38	1.38
3987	2.66	.44	.24	.76	1.95	-.64	.14	1.01	1.53	.50	1.45	1.13	1.13	1.13
4076	2.67	.35	.15	.81	1.87	-.78	.16	.83	1.31	.35	1.37	1.03	1.03	1.03
41	1.03	2.86	.68	.23	1.18	2.06	-.35	.41	1.18	1.36	.44	1.74	1.24	1.24	1.24
42	1.10	2.84	.71	.11	1.34	2.01	-.19	.32	1.33	1.34	.24	1.78	1.14	1.14	1.14
4369	2.37	.23	-.53	.96	1.37	-.64	-.20	.85	.95	-.37	1.35	.50	.50	.50
4475	2.35	.32	-.72	.94	1.27	-.60	-.17	.90	1.07	-.43	1.45	.41	.41	.41
4566	2.07	.04	-.82	.76	.96	-.96	-.35	.82	.91	-.68	1.35	.10	.10	.10
4676	1.95	-.17	-.73	.83	.74	-1.33	-.45	.67	.99	-.71	1.23	-.09	-.09	-.09
47	1.25	2.07	.04	-.20	1.30	.93	-1.08	-.23	.68	1.35	-.34	1.21	-.03	-.03	-.03
48	1.25	1.76	-.19	-.05	1.34	.78	-1.24	-.50	.43	1.18	-.25	.80	-.39	-.39	-.39
49	1.24	1.47	-.06	-.02	1.37	.46	-1.27	-.64	.32	1.15	-.33	.61	-.45	-.45	-.45
50	1.13	1.00	-.07	-.03	1.36	-.11	-1.27	-.94	.19	.80	-.93	.35	-.57	-.57	-.57
51	1.15	.65	-.03	.13	1.61	-.29	-1.12	-.86	.38	.42	-1.21	.30	-.42	-.42	-.42
5289	.26	-.08	.29	1.83	-.35	-1.24	-.83	.74	-.06	-1.52	.07	-.36	-.36	-.36
53	1.01	.11	.41	.94	2.31	.21	-1.00	-.45	.67	.12	-1.49	.16	-.25	-.25	-.25
54	1.09	.28	.51	1.52	2.27	.50	-.85	-.19	.80	.31	-1.54	.43	-.05	-.05	-.05
5584	.39	.43	1.53	1.71	.33	-.72	-.24	.50	.65	-1.67	.45	-.04	-.04	-.04
5654	.14	-.29	1.09	.81	.02	-.62	-.40	.24	.72	-1.52	.34	-.20	-.20	-.20
5707	-.69	-1.91	.27	-.55	-.57	-.79	-.59	-.55	.13	-1.67	.05	-.54	-.54	-.54
5898	-.54	-2.14	.25	-1.03	-.07	.01	.04	-.32	.46	-.94	.20	-.39	-.39	-.39
59	3.63	1.42	.32	1.35	.57	2.12	1.85	1.77	1.70	2.52	1.39	2.10	1.74	1.74	1.74
60	6.12	3.65	3.03	1.95	.93	1.58	1.48	1.48	2.33	3.83	3.52	7.23	9.26	9.26	9.26
61	11.19	11.19	11.19	11.19	11.19	11.19	11.19	11.19	11.19	11.19	11.19	11.19	11.19	11.19	11.19
62	3.13	3.13	3.13	3.13	3.13	3.13	3.13	3.13	3.13	3.13	3.13	3.13	3.13	3.13	3.13

NOAA-9 SCANNER OFFSETS FOR JUNE 1985:													TOTAL CHANNEL						
S.P.	DAY OF MONTH -->												24	25	26	27	28	29	30
	16	17	18	19	20	21	22	23											
1	.36	.36	.36	.36	.36	.36	.36	.36	.36	.36	.36	.36	.36	.36	.36	.36	.36		
2	1.04	1.04	1.04	1.04	1.04	1.04	1.04	1.04	1.04	1.04	1.04	1.04	1.04	1.04	1.04	1.04	1.04		
3	1.93	1.93	1.93	1.93	1.93	1.93	1.93	1.93	1.93	1.93	1.93	1.93	1.93	1.93	1.93	1.93	1.93		
4	-9.64	-9.64	-9.64	-9.64	-9.64	-9.64	-9.64	-9.64	-9.64	-9.64	-9.64	-9.64	-9.64	-9.64	-9.64	-9.64	-9.64		
5	-13.81	-14.45	-4.42	-6.65	-14.81	-4.23	-4.80	-13.11	-4.42	-4.80	-4.80	-4.80	-4.80	-4.23	-4.42	-4.42	-4.42		
6	-6.56	-6.97	-6.40	-5.65	-6.25	-7.08	-6.41	-5.81	-6.89	-7.37	-8.18	-7.37	-7.55	-7.08	-8.33	-7.08	-8.33		
7	-3.99	-4.37	-3.19	-2.61	-3.66	-4.03	-3.56	-3.45	-3.12	-3.55	-3.32	-3.55	-3.65	-4.03	-3.46	-3.46	-3.46		
8	-2.74	-3.32	-1.38	-1.56	-2.72	-2.94	-2.30	-2.38	-1.74	-2.31	-2.66	-2.31	-2.31	-2.94	-2.12	-2.12	-2.12		
9	-2.50	-3.08	-.40	-1.23	-2.50	-2.29	-1.69	-2.04	-1.12	-1.62	-2.80	-1.62	-1.74	-2.29	-1.66	-1.66	-1.66		
10	-2.16	-2.67	.09	-.89	-2.24	-1.62	-1.44	-1.76	-1.13	-1.28	-2.43	-1.28	-1.47	-1.62	-1.48	-1.48	-1.48		
11	-1.81	-2.21	.18	-.56	-1.92	-.96	-1.21	-1.68	-1.25	-.96	-1.78	-.96	-1.51	-.96	-1.37	-1.37	-1.37		
12	-2.16	-2.65	-.60	-1.09	-2.38	-1.24	-1.78	-2.22	-1.92	-1.49	-1.96	-1.49	-2.43	-1.24	-1.82	-1.82	-1.82		
13	-2.29	-2.89	-.91	-1.12	-2.44	-1.30	-1.93	-2.46	-2.17	-1.78	-2.04	-1.78	-2.75	-1.30	-2.08	-2.08	-2.08		
14	-2.23	-2.82	-1.06	-.79	-2.35	-1.24	-1.96	-2.23	-2.26	-2.02	-2.19	-2.02	-2.71	-1.24	-2.32	-2.32	-2.32		
15	-1.66	-2.08	-.77	-.28	-1.85	-.90	-1.51	-1.60	-1.80	-1.91	-1.78	-1.91	-2.25	-.90	-2.13	-2.13	-2.13		
16	-1.34	-1.78	-.79	-.40	-1.47	-.98	-1.39	-1.54	-1.50	-2.08	-1.63	-2.08	-2.21	-.98	-2.30	-2.30	-2.30		
17	-1.12	-1.66	-1.01	-.63	-1.31	-1.15	-1.39	-1.79	-1.44	-2.29	-1.48	-2.29	-2.30	-1.15	-2.46	-2.46	-2.46		
18	-1.24	-1.91	-1.35	-.86	-1.39	-1.44	-1.65	-2.14	-1.60	-2.50	-1.55	-2.50	-2.46	-1.44	-2.71	-2.71	-2.71		
19	-1.50	-2.34	-1.64	-1.07	-1.48	-1.59	-2.02	-2.36	-1.76	-2.61	-1.67	-2.61	-2.59	-1.59	-3.07	-3.07	-3.07		
20	-1.65	-2.42	-1.68	-1.18	-1.50	-1.59	-2.32	-2.30	-1.68	-2.57	-1.60	-2.57	-2.65	-1.59	-3.19	-3.19	-3.19		
21	-1.73	-2.35	-1.70	-1.32	-1.63	-1.57	-2.52	-2.12	-1.48	-2.49	-1.48	-2.49	-2.71	-1.57	-3.17	-3.17	-3.17		
22	-1.99	-2.50	-1.90	-1.57	-1.82	-1.78	-2.80	-2.14	-1.66	-2.60	-1.70	-2.60	-2.86	-1.78	-3.35	-3.35	-3.35		
23	-2.00	-2.38	-1.78	-1.50	-1.57	-1.70	-2.76	-1.96	-1.57	-2.37	-1.68	-2.37	-2.71	-1.70	-3.23	-3.23	-3.23		
24	-2.09	-2.35	-1.80	-1.65	-1.58	-1.71	-2.78	-1.92	-1.57	-2.37	-1.79	-2.37	-2.74	-1.71	-3.16	-3.16	-3.16		
25	-2.01	-2.28	-1.78	-1.67	-1.38	-1.67	-2.68	-1.71	-1.47	-2.33	-1.75	-2.33	-2.73	-1.67	-3.02	-3.02	-3.02		
26	-1.86	-2.38	-1.78	-1.75	-1.11	-1.69	-2.60	-1.41	-1.53	-2.29	-1.71	-2.29	-2.67	-1.69	-2.96	-2.96	-2.96		
27	-1.54	-2.43	-1.65	-1.57	-.81	-1.58	-2.42	-1.04	-1.45	-2.07	-1.55	-2.07	-2.46	-1.58	-2.75	-2.75	-2.75		
28	-1.27	-2.41	-1.45	-1.32	-.67	-1.36	-2.17	-.72	-1.43	-1.90	-1.41	-1.90	-2.09	-1.36	-2.60	-2.60	-2.60		
29	-.95	-2.13	-1.04	-1.02	-.50	-1.08	-1.75	-.21	-1.36	-1.73	-1.22	-1.73	-1.62	-1.08	-2.31	-2.31	-2.31		
30	-.69	-2.05	-.77	-.88	-.40	-.99	-1.41	.11	-1.27	-1.62	-1.21	-1.62	-1.37	-.99	-2.30	-2.30	-2.30		
31	-.48	-2.12	-.80	-.82	-.33	-1.07	-1.34	.22	-1.21	-1.64	-1.15	-1.64	-1.32	-1.07	-2.42	-2.42	-2.42		
32	.01	-1.86	-.52	-.48	-.08	-.86	-1.16	.61	-.95	-1.32	-.70	-1.32	-1.09	-.86	-2.17	-2.17	-2.17		
33	.72	-1.34	.21	.30	.59	-.27	-.54	1.22	-.44	-.48	.13	-.48	-.44	-.27	-1.58	-1.58	-1.58		
34	1.16	-1.06	.54	.84	1.13	.04	.00	1.47	-.04	.15	.59	.15	-.03	.04	-1.17	-1.17	-1.17		
35	1.40	-.84	.63	1.09	1.47	.25	.23	1.59	.26	.47	.57	.47	.19	.25	-.86	-.86	-.86		
36	1.43	-.72	.52	1.04	1.72	.25	.22	1.60	.33	.51	.47	.51	.25	.25	-.68	-.68	-.68		
37	1.33	-.61	.36	1.08	1.77	.11	.23	1.60	.22	.55	.34	.55	.34	.11	-.71	-.71	-.71		
38	1.38	-.31	.52	1.37	1.86	.24	.47	1.82	.33	.80	.35	.80	.65	.24	-.58	-.58	-.58		
39	1.08	-.34	.38	1.19	1.40	.09	.34	1.58	.04	.63	.08	.63	.50	.09	-.85	-.85	-.85		
40	1.00	-.40	.28	1.10	1.15	.07	.42	1.39	-.11	.53	.03	.53	.44	.07	-.98	-.98	-.98		
41	1.33	-.19	.53	1.29	1.35	.39	.85	1.54	.17	.80	.37	.80	.65	.39	-.75	-.75	-.75		
42	1.37	-.19	.57	1.28	1.21	.40	1.15	1.48	.29	.87	.42	.87	.69	.40	-.71	-.71	-.71		
43	.86	-.70	.07	.87	.57	-.06	.82	.86	.02	.62	-.20	.62	.34	-.06	-1.19	-1.19	-1.19		
44	.62	-.70	.00	.92	.42	-.07	.78	.69	.11	.91	-.28	.91	.52	-.07	-1.13	-1.13	-1.13		
45	.09	-.77	-.18	.75	.08	-.29	.53	.41	.08	.81	-.39	.81	.55	-.29	-1.34	-1.34	-1.34		
46	-.28	-.58	-.03	.66	-.07	-.37	.45	.40	.29	.85	-.29	.85	.67	-.37	-1.38	-1.38	-1.38		
47	-.37	-.08	.42	1.01	.21	-.18	.81	.63	.55	1.24	.17	1.24	1.03	-.18	-.89	-.89	-.89		
48	-.90	-.17	.34	.95	.21	-.32	.80	.23	.34	1.15	.30	1.15	.99	-.32	-.72	-.72	-.72		
49	-1.52	-.26	.23	.74	.13	-.29	.75	-.18	.34	1.04	.54	1.04	1.05	-.29	-.39	-.39	-.39		
50	-2.02	-.63	-.14	.27	-.32	-.48	.51	-.52	.22	.63	.55	.63	.77	-.48	-.17	-.17	-.17		
51	-1.91	-.70	-.22	.12	-.51	-.41	.43	-.49	.31	.65	.83	.65	.54	-.41	.26	.26	.26		
52	-1.64	-.68	-.17	.05	-.60	-.50	.30	-.29	.35	.67	1.04	.67	.26	-.50	.60	.60	.60		
53	-1.02	-.30	.19	.29	-.43	-.37	.60	.35	.60	.89	1.34	.89	.25	-.37	.96	.96	.96		
54	-.55	-.03	.44	.67	-.18	-.13	.87	.86	.91	1.03	1.65	1.03	.48	-.13	1.20	1.20	1.20		
55	-.13	-.15	.55	.83	-.14	-.23	.97	1.02	.87	.77	1.33	.77	.56	-.23	1.06	1.06	1.06		
56	.06	-.16	.70	.87	-.32	-.40	1.08	.71	.88	.49	.51	.49	.64	-.40	.88	.88	.88		
57	-.48	-.67	.60	.32	-.98	-.73	.86	-.02	.60	-.03	-.56	-.03	.14	-.73	.17	.17	.17		
58	.00	-.38	1.50	.65	-.60	.07	1.25	.29	.95	.44	-.06	.44	.41	.07	.38	.38	.38		
59	2.51	1.96	3.94	3.09	2.17	2.86	3.57	2.76	2.82	2.50	2.74	2.50	2.19	2.86	2.40	2.40	2.40		
60	8.91	8.24	10.26	9.20	9.12	9.17	9.60	8.14	9.19	9.05	10.29	9.05	8.60	9.17	8.88	8.88	8.88		
61	11.19	11.19	11.19	11.19	11.19	11.19	11.19	11.19	11.19	11.19	11.19	11.19	11.19	11.19	11.19	11.19	11.19		
62	3.13	3.13	3.13	3.13	3.13	3.13	3.13	3.13	3.13	3.13	3.13	3.13	3.13	3.13	3.13	3.13	3.13		

NOAA-9 SCANNER OFFSETS FOR JUNE 1985: LONGVALE CHANNEL
 DAY OF MONTH -->

S.P.	1	2	3	4	5	6	7	8	9	10	11	12	13	14	15
1	*****	*****	-.11	-.11	-.11	-.11	-.11	-.11	-.11	-.11	-.11	-.11	-.11	-.11	-.11
2	*****	*****	.32	.32	.32	.32	.32	.32	.32	.32	.32	.32	.32	.32	.32
3	*****	*****	.49	.49	.49	.49	.49	.49	.49	.49	.49	.49	.49	.49	.49
4	*****	*****	-4.09	-4.09	-4.09	-4.09	-4.09	-4.09	-4.09	-4.09	-4.09	-4.09	-4.09	-4.09	-4.09
5	*****	*****	-5.10	-3.47	-4.28	-3.80	-2.82	-2.03	-3.38	-3.70	-4.05	-4.72	-5.58	-8.79	-9.90
6	*****	*****	-2.71	-2.60	-3.53	-2.56	-2.00	-1.82	-2.94	-3.29	-3.04	-3.30	-3.97	-4.91	-4.93
7	*****	*****	-1.60	-2.44	-3.29	-1.59	-1.45	-1.36	-2.57	-2.66	-2.36	-2.45	-3.50	-3.27	-2.96
8	*****	*****	-1.12	-2.19	-3.17	-1.03	-1.46	-1.13	-2.06	-1.87	-1.79	-1.63	-2.87	-2.53	-2.18
9	*****	*****	-1.22	-2.14	-3.62	-.99	-1.82	-1.42	-1.89	-1.61	-2.01	-1.36	-2.46	-2.42	-2.00
10	*****	*****	-1.17	-2.14	-4.06	-1.11	-1.98	-1.47	-1.74	-1.49	-2.20	-1.31	-2.22	-2.62	-2.25
11	*****	*****	-1.01	-2.20	-4.15	-1.34	-2.01	-1.32	-1.52	-1.51	-2.22	-1.32	-1.98	-2.78	-2.51
12	*****	*****	-1.35	-2.70	-4.33	-1.96	-2.34	-1.57	-1.79	-2.06	-2.74	-1.77	-2.38	-3.29	-3.08
13	*****	*****	-1.44	-2.90	-4.11	-2.16	-2.39	-1.55	-1.91	-2.28	-2.91	-2.00	-2.54	-3.43	-3.08
14	*****	*****	-1.51	-2.98	-4.04	-2.42	-2.34	-1.56	-1.88	-2.49	-3.12	-2.38	-2.77	-3.68	-3.20
15	*****	*****	-1.39	-2.85	-3.78	-2.49	-2.12	-1.56	-1.56	-2.47	-3.16	-2.33	-2.77	-3.73	-3.14
16	*****	*****	-1.61	-2.95	-3.64	-2.69	-2.18	-1.76	-1.46	-2.66	-3.33	-2.43	-2.94	-3.91	-3.22
17	*****	*****	-2.03	-3.21	-3.75	-2.88	-2.34	-1.86	-1.59	-2.87	-3.50	-2.68	-3.18	-4.16	-3.38
18	*****	*****	-2.58	-3.57	-4.02	-3.25	-2.61	-2.19	-2.06	-3.14	-3.88	-3.03	-3.60	-4.52	-3.65
19	*****	*****	-3.08	-3.95	-4.26	-3.58	-2.94	-2.62	-2.77	-3.53	-4.28	-3.40	-3.95	-4.84	-4.00
20	*****	*****	-3.47	-4.17	-4.34	-3.71	-3.20	-2.97	-3.35	-3.88	-4.49	-3.60	-4.24	-5.13	-4.27
21	*****	*****	-3.72	-4.27	-4.28	-3.89	-3.47	-3.18	-3.78	-4.15	-4.62	-3.63	-4.43	-5.45	-4.42
22	*****	*****	-4.22	-4.62	-4.48	-4.29	-3.92	-3.56	-4.34	-4.49	-4.94	-3.89	-4.91	-5.92	-4.76
23	*****	*****	-4.43	-4.67	-4.42	-4.47	-4.04	-3.61	-4.57	-4.53	-5.02	-4.00	-5.03	-6.12	-4.89
24	*****	*****	-4.58	-4.73	-4.48	-4.64	-4.13	-3.75	-4.83	-4.78	-5.18	-4.14	-5.25	-6.30	-5.05
25	*****	*****	-4.60	-4.65	-4.57	-4.78	-4.05	-3.79	-5.04	-5.10	-5.22	-3.98	-5.34	-6.39	-5.10
26	*****	*****	-4.61	-4.51	-4.56	-4.93	-3.97	-3.77	-5.21	-5.33	-5.26	-3.85	-5.39	-6.41	-5.21
27	*****	*****	-4.58	-4.27	-4.39	-4.90	-3.87	-3.63	-5.23	-5.27	-5.08	-3.81	-5.39	-6.30	-5.21
28	*****	*****	-4.44	-4.08	-4.13	-4.76	-3.78	-3.54	-5.20	-5.13	-4.83	-3.64	-5.33	-6.06	-5.07
29	*****	*****	-4.25	-3.93	-3.82	-4.52	-3.63	-3.44	-5.08	-4.98	-4.61	-3.45	-5.11	-5.77	-4.79
30	*****	*****	-4.05	-3.84	-3.68	-4.41	-3.50	-3.32	-4.97	-4.84	-4.50	-3.30	-4.49	-5.40	-4.49
31	*****	*****	-3.84	-3.69	-3.68	-4.35	-3.48	-3.18	-4.77	-4.77	-4.31	-3.10	-4.49	-4.99	-4.28
32	*****	*****	-3.49	-3.21	-3.38	-3.95	-3.18	-2.75	-4.32	-4.43	-3.78	-2.62	-3.98	-4.44	-3.95
33	*****	*****	-2.76	-2.42	-2.76	-3.22	-2.59	-2.12	-3.63	-3.67	-2.94	-1.90	-3.17	-3.55	-3.15
34	*****	*****	-2.15	-1.83	-2.36	-2.77	-2.13	-1.60	-3.16	-3.07	-2.32	-1.32	-2.55	-2.82	-2.49
35	*****	*****	-1.68	-1.25	-1.96	-2.35	-1.78	-1.17	-2.68	-2.53	-1.76	-.95	-2.01	-2.13	-1.90
36	*****	*****	-1.32	-.70	-1.56	-1.96	-1.52	-.80	-2.29	-2.20	-1.41	-.76	-1.56	-1.57	-1.48
37	*****	*****	-1.02	-.21	-1.19	-1.56	-1.26	-.43	-2.01	-1.81	-1.07	-.54	-1.24	-1.18	-1.11
38	*****	*****	-.67	.38	-.76	-1.06	-.79	.03	-1.65	-1.29	-.65	-.18	-.82	-.75	-.55
39	*****	*****	-.63	.73	-.72	-.86	-.60	.17	-1.67	-1.12	-.55	-.05	-.69	-.62	-.36
40	*****	*****	-.41	1.04	-.47	-.61	-.26	.41	-1.47	-.84	-.37	.13	-.42	-.32	-.06
41	*****	*****	.07	1.46	.06	-.27	.31	.84	-.88	-.39	.18	.48	-.02	.26	.43
42	*****	*****	.40	1.69	.33	-.11	.66	1.06	-.53	-.23	.58	.74	.17	.59	.68
43	*****	*****	.44	1.65	.29	-.26	.67	.88	-.57	-.38	.55	.77	.08	.62	.57
44	*****	*****	.66	1.83	.54	-.19	.84	.99	-.37	-.22	.78	1.05	.26	.91	.73
45	*****	*****	.81	1.83	.53	-.08	.89	.96	-.43	-.20	.90	1.12	.30	1.07	.74
46	*****	*****	1.10	1.94	.58	.18	1.11	1.01	-.51	-.09	.99	1.37	.47	1.20	.82
47	*****	*****	1.55	2.12	.81	.63	1.52	1.25	-.24	.15	1.08	1.70	.84	1.32	.97
48	*****	*****	1.63	2.00	.76	.82	1.63	1.23	-.24	.06	1.00	1.71	1.00	1.17	.84
49	*****	*****	1.65	1.86	.90	.90	1.71	1.02	-.20	.02	.97	1.74	1.00	1.11	.85
50	*****	*****	1.60	1.58	.94	.93	1.73	.68	-.16	-.13	.93	1.54	.61	1.01	.80
51	*****	*****	1.73	1.44	1.05	1.11	1.96	.65	.03	.00	1.15	1.35	.50	1.05	.99
52	*****	*****	1.55	1.18	1.12	1.21	2.10	.64	-.07	.04	1.40	.99	.26	.84	.98
53	*****	*****	1.36	.80	1.05	1.33	2.07	.65	-.25	-.02	1.02	.82	-.03	.65	.87
54	*****	*****	1.26	.74	.94	1.53	1.88	.65	-.31	.02	.89	.77	-.27	.56	.68
55	*****	*****	1.09	.75	.80	1.45	1.43	.46	-.31	-.09	.59	.91	-.43	.50	.56
56	*****	*****	.86	.49	.21	1.05	.72	.17	-.34	-.31	.24	.84	-.46	.37	.31
57	*****	*****	.43	-.15	-.97	.39	-.29	-.28	-.56	-.52	-.46	.32	-.69	.08	-.03
58	*****	*****	.91	-.09	-1.16	.33	-.66	.03	-.09	-.16	-.36	.41	-.25	.14	.01
59	*****	*****	2.48	1.13	.37	.99	.32	1.40	1.08	.86	.90	1.62	1.21	1.32	1.28
60	*****	*****	4.24	2.73	2.30	1.57	.81	1.34	1.11	.96	1.59	2.66	2.76	4.71	6.06
61	*****	*****	3.05	3.05	3.05	3.05	3.05	3.05	3.05	3.05	3.05	3.05	3.05	3.05	3.05
62	*****	*****	.45	.45	.45	.45	.45	.45	.45	.45	.45	.45	.45	.45	.45

NOAA-9 SCANNER OFFSETS FOR JUNE 1985: LONGHAVE CHANNEL
 DAY OF MONTH -->

S.P.	16	17	18	19	20	21	22	23	24	25	26	27	28	29	30
1	-.11	-.11	-.11	-.11	-.11	-.11	-.11	-.11	-.11	-.11	-.11	-.11	-.11	-.11	-.11
2	.32	.32	.32	.32	.32	.32	.32	.32	.32	.32	.32	.32	.32	.32	.32
3	.49	.49	.49	.49	.49	.49	.49	.49	.49	.49	.49	.49	.49	.49	.49
4	-4.09	-4.09	-4.09	-4.09	-4.09	-4.09	-4.09	-4.09	-4.09	-4.09	-4.09	-4.09	-4.09	-4.09	-4.09
5	-9.31	-9.66	-3.80	-5.10	-9.90	-3.70	-4.05	-8.87	-3.80	-4.05	-4.05	-4.05	-4.05	-3.70	-3.80
6	-4.72	-4.85	-4.63	-4.14	-4.53	-5.02	-4.62	-4.27	-4.85	-5.25	-5.85	-5.25	-5.27	-5.02	-5.80
7	-2.92	-3.02	-2.39	-1.97	-2.70	-2.87	-2.61	-2.60	-2.28	-2.61	-2.58	-2.61	-2.57	-2.87	-2.48
8	-2.18	-2.43	-1.27	-1.32	-2.16	-2.24	-1.86	-1.98	-1.42	-1.86	-2.21	-1.86	-1.74	-2.24	-1.65
9	-2.22	-2.49	-.83	-1.32	-2.21	-2.02	-1.67	-1.98	-1.22	-1.63	-2.56	-1.63	-1.60	-2.02	-1.60
10	-2.21	-2.45	-.72	-1.34	-2.26	-1.82	-1.73	-2.00	-1.43	-1.63	-2.55	-1.63	-1.64	-1.82	-1.74
11	-2.13	-2.29	-.81	-1.29	-2.19	-1.55	-1.74	-2.08	-1.63	-1.57	-2.25	-1.57	-1.82	-1.55	-1.84
12	-2.52	-2.75	-1.51	-1.84	-2.66	-1.91	-2.29	-2.60	-2.23	-2.11	-2.51	-2.11	-2.60	-1.91	-2.33
13	-2.58	-2.89	-1.72	-1.91	-2.70	-1.95	-2.38	-2.74	-2.38	-2.31	-2.55	-2.31	-2.80	-1.95	-2.49
14	-2.72	-3.02	-2.00	-1.91	-2.82	-2.09	-2.57	-2.77	-2.62	-2.64	-2.77	-2.64	-2.93	-2.09	-2.80
15	-2.57	-2.79	-2.05	-1.80	-2.73	-2.12	-2.51	-2.59	-2.56	-2.79	-2.70	-2.79	-2.83	-2.12	-2.89
16	-2.56	-2.79	-2.26	-2.06	-2.68	-2.37	-2.62	-2.74	-2.57	-3.09	-2.77	-3.09	-2.99	-2.37	-3.17
17	-2.68	-2.98	-2.66	-2.44	-2.83	-2.74	-2.87	-3.17	-2.79	-3.47	-2.92	-3.47	-3.30	-2.74	-3.51
18	-3.02	-3.40	-3.14	-2.83	-3.15	-3.20	-3.31	-3.67	-3.16	-3.88	-3.21	-3.88	-3.67	-3.20	-3.94
19	-3.48	-3.95	-3.61	-3.23	-3.48	-3.56	-3.83	-4.08	-3.53	-4.21	-3.53	-4.21	-4.02	-3.56	-4.43
20	-3.89	-4.28	-3.93	-3.59	-3.79	-3.84	-4.33	-4.33	-3.77	-4.46	-3.77	-4.46	-4.32	-3.84	-4.78
21	-4.17	-4.45	-4.15	-3.90	-4.09	-4.05	-4.69	-4.43	-3.85	-4.62	-3.89	-4.62	-4.55	-4.05	-4.97
22	-4.63	-4.83	-4.55	-4.35	-4.49	-4.45	-5.16	-4.72	-4.22	-4.95	-4.28	-4.95	-4.90	-4.45	-5.34
23	-4.87	-4.97	-4.68	-4.51	-4.53	-4.59	-5.34	-4.81	-4.34	-4.98	-4.45	-4.98	-4.99	-4.59	-5.44
24	-5.11	-5.14	-4.87	-4.79	-4.70	-4.75	-5.50	-4.94	-4.49	-5.12	-4.65	-5.12	-5.16	-4.75	-5.54
25	-5.22	-5.26	-5.01	-4.98	-4.72	-4.85	-5.57	-4.95	-4.57	-5.24	-4.74	-5.24	-5.28	-4.85	-5.58
26	-5.24	-5.46	-5.11	-5.15	-4.64	-4.95	-5.61	-4.84	-4.69	-5.30	-4.79	-5.30	-5.33	-4.95	-5.61
27	-5.07	-5.55	-5.05	-5.08	-4.45	-4.90	-5.51	-4.62	-4.65	-5.16	-4.70	-5.16	-5.21	-4.90	-5.47
28	-4.90	-5.52	-4.91	-4.93	-4.35	-4.74	-5.31	-4.39	-4.61	-5.03	-4.59	-5.03	-4.95	-4.74	-5.33
29	-4.65	-5.30	-4.60	-4.70	-4.21	-4.50	-4.99	-4.01	-4.52	-4.87	-4.41	-4.87	-4.60	-4.50	-5.08
30	-4.39	-5.14	-4.33	-4.53	-4.04	-4.33	-4.67	-3.70	-4.36	-4.69	-4.34	-4.69	-4.33	-4.33	-4.97
31	-4.08	-5.01	-4.16	-4.33	-3.83	-4.21	-4.45	-3.46	-4.16	-4.54	-4.17	-4.54	-4.13	-4.21	-4.87
32	-3.56	-4.66	-3.79	-3.91	-3.49	-3.89	-4.15	-3.03	-3.81	-4.15	-3.71	-4.15	-3.79	-3.89	-4.53
33	-2.72	-3.94	-2.93	-3.00	-2.68	-3.15	-3.41	-2.28	-3.12	-3.23	-2.80	-3.23	-3.01	-3.15	-3.80
34	-2.13	-3.43	-2.40	-2.34	-2.01	-2.64	-2.76	-1.82	-2.55	-2.50	-2.16	-2.50	-2.43	-2.64	-3.24
35	-1.64	-2.94	-2.01	-1.87	-1.46	-2.18	-2.28	-1.41	-2.04	-1.96	-1.85	-1.96	-1.96	-2.18	-2.72
36	-1.26	-2.50	-1.74	-1.56	-.96	-1.84	-1.95	-1.06	-1.65	-1.60	-1.58	-1.60	-1.59	-1.84	-2.29
37	-.95	-2.04	-1.49	-1.15	-.57	-1.58	-1.60	-.70	-1.37	-1.23	-1.33	-1.23	-1.19	-1.58	-1.98
38	-.55	-1.47	-1.02	-.57	-.16	-1.14	-1.07	-.19	-.94	-.71	-1.00	-.71	-.64	-1.14	-1.55
39	-.40	-1.15	-.77	-.33	-.13	-.90	-.82	.00	-.80	-.48	-.87	-.48	-.41	-.90	-1.41
40	-.08	-.83	-.48	.00	.06	-.55	-.41	.24	-.54	-.20	-.55	-.20	-.09	-.55	-1.15
41	.50	-.35	.03	.49	.54	.01	.23	.70	-.02	.33	.03	.33	.39	.01	-.67
42	.84	-.05	.36	.77	.75	.32	.73	.96	.36	.67	.36	.67	.70	.32	-.34
43	.81	-.10	.32	.80	.63	.32	.82	.86	.47	.80	.24	.80	.75	.32	-.37
44	.87	.12	.50	1.06	.76	.52	1.01	.98	.75	1.21	.41	1.21	1.07	.52	-.11
45	.72	.28	.59	1.16	.73	.57	1.04	.99	.94	1.36	.54	1.36	1.29	.57	-.06
46	.67	.60	.89	1.30	.83	.71	1.19	1.18	1.26	1.59	.79	1.59	1.56	.71	.11
47	.73	1.06	1.29	1.64	1.13	.94	1.54	1.45	1.55	1.95	1.19	1.95	1.89	.94	.55
48	.48	1.11	1.36	1.74	1.24	.97	1.64	1.30	1.53	2.01	1.39	2.01	1.98	.97	.78
49	.13	1.09	1.34	1.67	1.24	1.04	1.67	1.08	1.60	1.99	1.60	1.99	2.06	1.04	1.06
50	-.16	.88	1.13	1.42	.98	.95	1.55	.89	1.56	1.76	1.66	1.76	1.92	.95	1.25
51	-.02	.91	1.15	1.43	.91	1.07	1.56	.98	1.69	1.84	1.92	1.84	1.84	1.07	1.61
52	.11	.87	1.13	1.37	.80	.96	1.42	1.07	1.67	1.81	2.02	1.81	1.59	.96	1.79
53	.31	.92	1.18	1.34	.70	.87	1.42	1.26	1.66	1.78	2.09	1.78	1.40	.87	1.87
54	.32	.80	1.04	1.26	.56	.70	1.29	1.28	1.53	1.54	1.96	1.54	1.21	.70	1.68
55	.49	.59	1.00	1.26	.48	.54	1.25	1.27	1.38	1.27	1.64	1.27	1.16	.54	1.48
56	.49	.39	.96	1.17	.24	.31	1.19	.92	1.26	.96	.98	.96	1.07	.31	1.24
57	.02	-.11	.77	.67	-.31	-.07	.92	.32	.93	.49	.17	.49	.60	-.07	.66
58	.29	.04	1.30	.83	-.12	.39	1.11	.46	1.03	.76	.46	.76	.71	.39	.73
59	1.86	1.52	2.79	2.32	1.60	2.10	2.53	1.99	2.11	2.00	2.19	2.00	1.75	2.10	1.94
60	5.95	5.57	6.81	6.20	6.05	6.13	6.36	5.47	6.20	6.15	6.93	6.15	5.80	6.13	6.05
61	3.05	3.05	3.05	3.05	3.05	3.05	3.05	3.05	3.05	3.05	3.05	3.05	3.05	3.05	3.05
62	.45	.45	.45	.45	.45	.45	.45	.45	.45	.45	.45	.45	.45	.45	.45

NOAA-9 SCANNER OFFSETS FOR JUNE 1985: SHORTWAVE CHANNEL
 DAY OF MONTH -->

S.P.	1	2	3	4	5	6	7	8	9	10	11	12	13	14	15
1	.29	.29	.29	.29	.29	.29	.29	.29	.29	.29	.29	.29	.29	.29	.29
2	.59	.59	.59	.59	.59	.59	.59	.59	.59	.59	.59	.59	.59	.59	.59
3	.63	.63	.63	.63	.63	.63	.63	.63	.63	.63	.63	.63	.63	.63	.63
4	.27	.27	.27	.27	.27	.27	.27	.27	.27	.27	.27	.27	.27	.27	.27
5	.36	.51	.51	.51	.51	.71	.78	.71	.59	.43	.37	.38	.46	.54	.54
6	.44	.55	.55	.55	.76	.83	.76	.66	.51	.46	.44	.56	.60	.27	.27
7	.09	.19	.19	.19	.38	.44	.38	.27	.16	.11	.09	.23	.27	.27	.27
8	.42	.52	.52	.52	.73	.81	.73	.62	.48	.43	.43	.55	.58	.58	.58
9	.48	.59	.59	.59	.78	.85	.78	.67	.53	.49	.50	.61	.65	.65	.65
10	.10	.22	.22	.22	.40	.47	.40	.29	.14	.11	.13	.24	.30	.30	.30
11	.37	.50	.50	.50	.70	.78	.70	.58	.43	.38	.39	.50	.54	.54	.54
12	.39	.52	.52	.52	.71	.78	.71	.59	.44	.39	.40	.53	.58	.58	.58
13	-.42	-.24	-.24	-.24	-.03	.03	-.03	-.20	-.42	-.44	-.42	-.29	-.13	-.13	-.13
14	-.16	.03	.03	.03	.27	.34	.27	.09	-.19	-.21	-.21	-.09	-.04	-.04	-.04
15	-.15	.03	.03	.03	.27	.33	.27	.09	-.20	-.22	-.22	-.09	-.06	-.06	-.06
16	-.35	-.35	-.35	-.35	-.12	-.06	-.12	-.30	-.56	-.58	-.59	-.46	-.41	-.41	-.41
17	-.21	-.02	-.02	-.02	.22	.29	.22	.03	-.24	-.27	-.29	-.15	-.12	-.12	-.12
18	-.19	-.01	-.01	-.01	.23	.30	.23	.05	-.23	-.25	-.29	-.14	-.12	-.12	-.12
19	-.56	-.38	-.38	-.38	-.16	-.10	-.16	-.34	-.60	-.62	-.66	-.51	-.48	-.48	-.48
20	-.21	.00	.00	.00	.23	.31	.23	.05	-.24	-.26	-.30	-.16	-.15	-.15	-.15
21	-.19	.03	.03	.03	.25	.32	.25	.06	-.23	-.25	-.29	-.15	-.14	-.14	-.14
22	-.60	-.39	-.39	-.39	-.19	-.12	-.19	-.38	-.63	-.66	-.71	-.56	-.55	-.55	-.55
23	-.23	-.02	-.02	-.02	.19	.27	.19	.00	-.26	-.29	-.36	-.20	-.23	-.23	-.23
24	-.19	.02	.02	.02	.23	.31	.23	.04	-.23	-.26	-.33	-.18	-.20	-.20	-.20
25	-.54	-.34	-.34	-.34	-.14	-.07	-.14	-.34	-.58	-.61	-.68	-.53	-.55	-.55	-.55
26	-.17	.03	.03	.03	.24	.32	.24	.04	-.22	-.25	-.33	-.17	-.22	-.22	-.22
27	-.13	.06	.06	.06	.27	.35	.27	.07	-.18	-.21	-.30	-.14	-.18	-.18	-.18
28	-.49	-.30	-.30	-.30	-.11	-.02	-.11	-.30	-.54	-.56	-.64	-.49	-.52	-.52	-.52
29	-.10	.10	.10	.10	.29	.40	.29	.09	-.16	-.18	-.25	-.12	-.17	-.17	-.17
30	-.05	.16	.16	.16	.34	.45	.34	.14	-.11	-.13	-.19	-.06	-.10	-.10	-.10
31	-.39	-.21	-.21	-.21	-.03	.07	-.03	-.23	-.45	-.47	-.52	-.40	-.43	-.43	-.43
32	-.04	.15	.15	.15	.33	.44	.33	.13	-.10	-.12	-.17	-.05	-.08	-.08	-.08
33	-.12	.07	.07	.07	.24	.34	.24	.03	-.21	-.23	-.25	-.14	-.14	-.14	-.14
34	-.51	-.30	-.30	-.30	-.14	-.05	-.14	-.37	-.59	-.62	-.61	-.51	-.52	-.52	-.52
35	-.16	.05	.05	.05	.23	.33	.23	.00	-.23	-.26	-.25	-.17	-.19	-.19	-.19
36	-.08	.12	.12	.12	.28	.37	.28	.06	-.16	-.19	-.17	-.08	-.10	-.10	-.10
37	-.38	-.20	-.20	-.20	-.06	.03	-.06	-.28	-.46	-.49	-.45	-.38	-.39	-.39	-.39
38	-.02	.19	.19	.19	.34	.44	.34	.12	-.09	-.12	-.07	-.02	-.04	-.04	-.04
39	.05	.24	.24	.24	.38	.48	.38	.16	-.03	-.06	.00	.06	.05	.05	.05
40	-.26	-.08	-.08	-.08	.06	.16	.06	-.17	-.34	-.36	-.28	-.24	-.24	-.24	-.24
41	.12	.32	.32	.32	.46	.58	.46	.22	.04	.02	.11	.14	.12	.12	.12
42	.17	.36	.36	.36	.49	.60	.49	.26	.09	.07	.16	.19	.18	.18	.18
43	-.17	-.01	-.01	-.01	.13	.24	.13	-.11	-.26	-.27	-.18	-.15	-.15	-.15	-.15
44	-.16	.34	.34	.34	.49	.61	.49	.24	.07	.05	.16	.18	.18	.18	.18
45	-.18	.36	.36	.36	.49	.61	.49	.25	.09	.07	.18	.20	.20	.20	.20
46	-.18	-.01	-.01	-.01	.10	.22	.10	-.13	-.27	-.29	-.17	-.15	-.14	-.14	-.14
47	.16	.33	.33	.33	.47	.59	.47	.22	.06	.04	.16	.17	.16	.16	.16
48	.20	.38	.38	.38	.50	.62	.50	.26	.10	.09	.21	.22	.22	.22	.22
49	-.15	.02	.02	.02	.13	.24	.13	-.11	-.24	-.26	-.13	-.12	-.12	-.12	-.12
50	.20	.38	.38	.38	.51	.62	.51	.25	.10	.08	.22	.22	.20	.20	.20
51	.21	.39	.39	.39	.51	.62	.51	.26	.11	.10	.23	.22	.21	.21	.21
52	-.10	.07	.07	.07	.18	.30	.18	-.05	-.20	-.21	-.07	-.10	-.14	-.14	-.14
53	.67	.81	.81	.81	.94	1.08	.94	.75	.58	.53	.70	.61	.43	.43	.43
54	1.12	1.22	1.22	1.22	1.32	1.44	1.32	1.14	1.04	1.00	1.17	1.13	1.07	1.07	1.07
55	.80	.89	.89	.89	.97	1.10	.97	.81	.73	.70	.87	.83	.79	.79	.79
56	1.12	1.21	1.21	1.21	1.31	1.44	1.31	1.14	1.04	1.01	1.15	1.13	1.08	1.08	1.08
57	1.16	1.24	1.24	1.24	1.33	1.45	1.33	1.17	1.08	1.05	1.20	1.17	1.12	1.12	1.12
58	.81	.86	.86	.86	.95	1.07	.95	.80	.73	.70	.85	.82	.77	.77	.77
59	1.11	1.18	1.18	1.18	1.28	1.41	1.28	1.13	1.03	1.00	1.13	1.11	1.05	1.05	1.05
60	1.11	1.17	1.17	1.17	1.00	1.38	1.00	1.12	1.03	1.00	1.16	1.11	1.07	1.07	1.07
61	.83	.83	.83	.83	.83	.83	.83	.83	.83	.83	.83	.83	.83	.83	.83
62	.97	.97	.97	.97	.97	.97	.97	.97	.97	.97	.97	.97	.97	.97	.97

NOAA-9 SCANNER OFFSETS FOR JUNE 1985: SHORTWAVE CHANNEL

S.P.	DAY OF MONTH -->														
	16	17	18	19	20	21	22	23	24	25	26	27	28	29	30
1	.29	.29	.29	.29	.29	.29	.29	.29	.29	.29	.29	.29	.29	.29	.29
2	.59	.59	.59	.59	.59	.59	.59	.59	.59	.59	.59	.59	.59	.59	.59
3	.63	.63	.63	.63	.63	.63	.63	.63	.63	.63	.63	.63	.63	.63	.63
4	.27	.27	.27	.27	.27	.27	.27	.27	.27	.27	.27	.27	.27	.27	.27
5	.61	.54	.50	.58	.58	.58	.58	.51	.50	.50	.33	.42	.32	.32	.32
6	.68	.60	.57	.65	.65	.65	.65	.58	.57	.57	.36	.46	.34	.34	.34
7	.34	.27	.25	.33	.33	.33	.33	.26	.25	.25	.03	.15	.01	.01	.01
8	.66	.58	.56	.64	.64	.64	.64	.58	.56	.56	.34	.46	.33	.33	.33
9	.73	.65	.63	.71	.71	.71	.71	.66	.63	.63	.41	.53	.40	.40	.40
10	.38	.30	.28	.36	.36	.36	.36	.32	.28	.28	.07	.20	.06	.06	.06
11	.62	.54	.52	.61	.61	.61	.61	.55	.52	.52	.31	.43	.30	.30	.30
12	.66	.58	.56	.64	.64	.64	.64	.60	.56	.56	.34	.48	.34	.34	.34
13	-.07	-.13	-.15	-.08	-.08	-.08	-.08	-.08	-.15	-.15	-.33	-.18	-.31	-.31	-.31
14	.05	-.04	-.07	.02	.02	.02	.02	.05	-.07	-.07	-.29	-.17	-.24	-.24	-.24
15	.02	-.06	-.09	.00	.00	.00	.00	.04	-.09	-.09	-.32	-.19	-.25	-.25	-.25
16	-.33	-.41	-.44	-.35	-.35	-.35	-.35	-.32	-.44	-.44	-.66	-.54	-.61	-.61	-.61
17	-.03	-.12	-.16	-.06	-.06	-.06	-.06	-.03	-.16	-.16	-.38	-.26	-.32	-.32	-.32
18	-.04	-.12	-.15	-.06	-.06	-.06	-.06	-.02	-.15	-.15	-.38	-.27	-.32	-.32	-.32
19	-.40	-.48	-.51	-.42	-.42	-.42	-.42	-.38	-.51	-.51	-.73	-.62	-.67	-.67	-.67
20	-.06	-.15	-.18	-.08	-.08	-.08	-.08	-.05	-.18	-.18	-.39	-.29	-.34	-.34	-.34
21	-.05	-.14	-.16	-.07	-.07	-.07	-.07	-.02	-.16	-.16	-.38	-.28	-.32	-.32	-.32
22	-.47	-.55	-.56	-.47	-.47	-.47	-.47	-.44	-.56	-.56	-.78	-.68	-.72	-.72	-.72
23	-.15	-.23	-.25	-.16	-.16	-.16	-.16	-.12	-.25	-.25	-.47	-.38	-.41	-.41	-.41
24	-.12	-.20	-.22	-.13	-.13	-.13	-.13	-.09	-.22	-.22	-.44	-.36	-.37	-.37	-.37
25	-.47	-.55	-.56	-.47	-.47	-.47	-.47	-.43	-.56	-.56	-.78	-.70	-.71	-.71	-.71
26	-.13	-.22	-.23	-.14	-.14	-.14	-.14	-.09	-.23	-.23	-.45	-.37	-.37	-.37	-.37
27	-.09	-.18	-.19	-.10	-.10	-.10	-.10	-.05	-.19	-.19	-.41	-.34	-.33	-.33	-.33
28	-.44	-.52	-.54	-.45	-.45	-.45	-.45	-.40	-.54	-.54	-.75	-.68	-.68	-.68	-.68
29	-.09	-.17	-.18	-.09	-.09	-.09	-.09	-.04	-.18	-.18	-.40	-.34	-.32	-.32	-.32
30	-.01	-.10	-.11	-.02	-.02	-.02	-.02	-.04	-.11	-.11	-.33	-.26	-.25	-.25	-.25
31	-.35	-.43	-.44	-.36	-.36	-.36	-.36	-.30	-.44	-.44	-.66	-.59	-.58	-.58	-.58
32	.01	-.08	-.10	-.02	-.02	-.02	-.02	.04	-.10	-.10	-.31	-.24	-.23	-.23	-.23
33	-.03	-.14	-.15	-.05	-.05	-.05	-.05	.03	-.15	-.15	-.36	-.27	-.25	-.25	-.25
34	-.40	-.52	-.53	-.43	-.43	-.43	-.43	-.34	-.53	-.53	-.75	-.64	-.64	-.64	-.64
35	-.07	-.19	-.20	-.10	-.10	-.10	-.10	-.02	-.20	-.20	-.42	-.33	-.32	-.32	-.32
36	.01	-.10	-.12	-.01	-.01	-.01	-.01	.07	-.12	-.12	-.35	-.24	-.24	-.24	-.24
37	-.27	-.39	-.41	-.30	-.30	-.30	-.30	-.22	-.41	-.41	-.64	-.53	-.53	-.53	-.53
38	.09	-.04	-.05	.06	.06	.06	.06	.13	-.05	-.05	-.27	-.17	-.17	-.17	-.17
39	.16	.05	.02	.13	.13	.13	.13	.22	.02	.02	-.20	-.08	-.09	-.09	-.09
40	-.12	-.24	-.26	-.16	-.16	-.16	-.16	-.08	-.26	-.26	-.49	-.37	-.39	-.39	-.39
41	.25	.12	.10	.20	.20	.20	.20	.28	.10	.10	-.13	-.01	-.03	-.03	-.03
42	.30	.18	.16	.26	.26	.26	.26	.34	.16	.16	-.07	.05	.03	.03	.03
43	-.03	-.15	-.17	-.08	-.08	-.08	-.08	.01	-.17	-.17	-.39	-.27	-.29	-.29	-.29
44	.29	.18	.16	.25	.25	.25	.25	.34	.16	.16	-.07	.06	.04	.04	.04
45	.32	.20	.19	.28	.28	.28	.28	.37	.19	.19	-.04	.09	.07	.07	.07
46	-.02	-.14	-.16	-.06	-.06	-.06	-.06	.03	-.16	-.16	-.38	-.24	-.27	-.27	-.27
47	.28	.16	.16	.25	.25	.25	.25	.34	.16	.16	-.08	.05	.04	.04	.04
48	.33	.22	.20	.29	.29	.29	.29	.39	.20	.20	-.03	.10	.08	.08	.08
49	.00	-.12	-.12	-.03	-.03	-.03	-.03	.06	-.12	-.12	-.36	-.22	-.25	-.25	-.25
50	.32	.20	.20	.29	.29	.29	.29	.39	.20	.20	-.04	.10	.08	.08	.08
51	.33	.21	.20	.29	.29	.29	.29	.39	.20	.20	-.02	.10	.09	.09	.09
52	-.02	-.14	-.15	-.06	-.06	-.06	-.06	.04	-.15	-.15	-.38	-.27	-.27	-.27	-.27
53	.59	.43	.40	.53	.53	.53	.53	.62	.40	.40	.15	.23	.29	.29	.29
54	1.20	1.07	1.04	1.15	1.15	1.15	1.15	1.23	1.04	1.04	.79	.92	.91	.91	.91
55	.92	.79	.77	.87	.87	.87	.87	.93	.77	.77	.54	.67	.64	.64	.64
56	1.21	1.08	1.05	1.14	1.14	1.14	1.14	1.22	1.05	1.05	.82	.94	.93	.93	.93
57	1.24	1.12	1.10	1.19	1.19	1.19	1.19	1.27	1.10	1.10	.86	.98	.97	.97	.97
58	.89	.77	.75	.83	.83	.83	.83	.91	.75	.75	.51	.63	.62	.62	.62
59	1.18	1.05	1.01	1.10	1.10	1.10	1.10	1.19	1.01	1.01	.78	.89	.89	.89	.89
60	1.20	1.07	1.04	1.14	1.14	1.14	1.14	1.22	1.04	1.04	.81	.92	.92	.92	.92
61	.83	.83	.83	.83	.83	.83	.83	.83	.83	.83	.83	.83	.83	.83	.83
62	.97	.97	.97	.97	.97	.97	.97	.97	.97	.97	.97	.97	.97	.97	.97

S.P.	NOAA-9 SCANNER OFFSETS FOR JULY 1985: TOTAL CHANNEL														
	DAY OF MONTH -->														
	1	2	3	4	5	6	7	8	9	10	11	12	13	14	15
1	.36	.36	.36	.36	.36	.36	.36	.36	.36	.36	.36	.36	.36	.36	.36
2	1.04	1.04	1.04	1.04	1.04	1.04	1.04	1.04	1.04	1.04	1.04	1.04	1.04	1.04	1.04
3	1.93	1.93	1.93	1.93	1.93	1.93	1.93	1.93	1.93	1.93	1.93	1.93	1.93	1.93	1.93
4	-9.64	-9.64	-9.64	-9.64	-9.64	-9.64	-9.64	-9.64	-9.64	-9.64	-9.64	-9.64	-9.64	-9.64	-9.64
5	-8.36	-8.36	-8.36	-8.36	-8.36	-8.36	-8.36	-8.36	-8.36	-8.36	-8.36	-8.36	-8.36	-8.36	-8.36
6	-7.07	-7.07	-7.07	-7.07	-7.07	-7.07	-7.07	-7.07	-7.07	-7.07	-7.07	-7.07	-7.07	-7.07	-7.07
7	-3.44	-3.44	-3.44	-3.44	-3.44	-3.44	-3.44	-3.44	-3.44	-3.44	-3.44	-3.44	-3.44	-3.44	-3.44
8	-1.66	-1.66	-1.66	-1.66	-1.66	-1.66	-1.66	-1.66	-1.66	-1.66	-1.66	-1.66	-1.66	-1.66	-1.66
9	-1.82	-1.82	-1.82	-1.82	-1.82	-1.82	-1.82	-1.82	-1.82	-1.82	-1.82	-1.82	-1.82	-1.82	-1.82
10	-1.71	-1.71	-1.71	-1.71	-1.71	-1.71	-1.71	-1.71	-1.71	-1.71	-1.71	-1.71	-1.71	-1.71	-1.71
11	-.98	-.98	-.98	-.98	-.98	-.98	-.98	-.98	-.98	-.98	-.98	-.98	-.98	-.98	-.98
12	-.73	-.73	-.73	-.73	-.73	-.73	-.73	-.73	-.73	-.73	-.73	-.73	-.73	-.73	-.73
13	-1.16	-1.16	-1.16	-1.16	-1.16	-1.16	-1.16	-1.16	-1.16	-1.16	-1.16	-1.16	-1.16	-1.16	-1.16
14	-.72	-.72	-.72	-.72	-.72	-.72	-.72	-.72	-.72	-.72	-.72	-.72	-.72	-.72	-.72
15	-.95	-.95	-.95	-.95	-.95	-.95	-.95	-.95	-.95	-.95	-.95	-.95	-.95	-.95	-.95
16	-1.08	-1.08	-1.08	-1.08	-1.08	-1.08	-1.08	-1.08	-1.08	-1.08	-1.08	-1.08	-1.08	-1.08	-1.08
17	-1.56	-1.56	-1.56	-1.56	-1.56	-1.56	-1.56	-1.56	-1.56	-1.56	-1.56	-1.56	-1.56	-1.56	-1.56
18	-.93	-.93	-.93	-.93	-.93	-.93	-.93	-.93	-.93	-.93	-.93	-.93	-.93	-.93	-.93
19	-.88	-.88	-.88	-.88	-.88	-.88	-.88	-.88	-.88	-.88	-.88	-.88	-.88	-.88	-.88
20	-1.03	-1.03	-1.03	-1.03	-1.03	-1.03	-1.03	-1.03	-1.03	-1.03	-1.03	-1.03	-1.03	-1.03	-1.03
21	-.83	-.83	-.83	-.83	-.83	-.83	-.83	-.83	-.83	-.83	-.83	-.83	-.83	-.83	-.83
22	-.59	-.59	-.59	-.59	-.59	-.59	-.59	-.59	-.59	-.59	-.59	-.59	-.59	-.59	-.59
23	-.77	-.77	-.77	-.77	-.77	-.77	-.77	-.77	-.77	-.77	-.77	-.77	-.77	-.77	-.77
24	-1.38	-1.38	-1.38	-1.38	-1.38	-1.38	-1.38	-1.38	-1.38	-1.38	-1.38	-1.38	-1.38	-1.38	-1.38
25	-.62	-.62	-.62	-.62	-.62	-.62	-.62	-.62	-.62	-.62	-.62	-.62	-.62	-.62	-.62
26	-.85	-.85	-.85	-.85	-.85	-.85	-.85	-.85	-.85	-.85	-.85	-.85	-.85	-.85	-.85
27	-.42	-.42	-.42	-.42	-.42	-.42	-.42	-.42	-.42	-.42	-.42	-.42	-.42	-.42	-.42
28	-.50	-.50	-.50	-.50	-.50	-.50	-.50	-.50	-.50	-.50	-.50	-.50	-.50	-.50	-.50
29	-.15	-.15	-.15	-.15	-.15	-.15	-.15	-.15	-.15	-.15	-.15	-.15	-.15	-.15	-.15
30	-.35	-.35	-.35	-.35	-.35	-.35	-.35	-.35	-.35	-.35	-.35	-.35	-.35	-.35	-.35
31	-.74	-.74	-.74	-.74	-.74	-.74	-.74	-.74	-.74	-.74	-.74	-.74	-.74	-.74	-.74
32	-1.27	-1.27	-1.27	-1.27	-1.27	-1.27	-1.27	-1.27	-1.27	-1.27	-1.27	-1.27	-1.27	-1.27	-1.27
33	.12	.12	.12	.12	.12	.12	.12	.12	.12	.12	.12	.12	.12	.12	.12
34	.71	.71	.71	.71	.71	.71	.71	.71	.71	.71	.71	.71	.71	.71	.71
35	.49	.49	.49	.49	.49	.49	.49	.49	.49	.49	.49	.49	.49	.49	.49
36	.60	.60	.60	.60	.60	.60	.60	.60	.60	.60	.60	.60	.60	.60	.60
37	.33	.33	.33	.33	.33	.33	.33	.33	.33	.33	.33	.33	.33	.33	.33
38	.64	.64	.64	.64	.64	.64	.64	.64	.64	.64	.64	.64	.64	.64	.64
39	.80	.80	.80	.80	.80	.80	.80	.80	.80	.80	.80	.80	.80	.80	.80
40	.80	.80	.80	.80	.80	.80	.80	.80	.80	.80	.80	.80	.80	.80	.80
41	1.12	1.12	1.12	1.12	1.12	1.12	1.12	1.12	1.12	1.12	1.12	1.12	1.12	1.12	1.12
42	.54	.54	.54	.54	.54	.54	.54	.54	.54	.54	.54	.54	.54	.54	.54
43	.61	.61	.61	.61	.61	.61	.61	.61	.61	.61	.61	.61	.61	.61	.61
44	.40	.40	.40	.40	.40	.40	.40	.40	.40	.40	.40	.40	.40	.40	.40
45	.74	.74	.74	.74	.74	.74	.74	.74	.74	.74	.74	.74	.74	.74	.74
46	.66	.66	.66	.66	.66	.66	.66	.66	.66	.66	.66	.66	.66	.66	.66
47	-.09	-.09	-.09	-.09	-.09	-.09	-.09	-.09	-.09	-.09	-.09	-.09	-.09	-.09	-.09
48	-.35	-.35	-.35	-.35	-.35	-.35	-.35	-.35	-.35	-.35	-.35	-.35	-.35	-.35	-.35
49	-.98	-.98	-.98	-.98	-.98	-.98	-.98	-.98	-.98	-.98	-.98	-.98	-.98	-.98	-.98
50	-.78	-.78	-.78	-.78	-.78	-.78	-.78	-.78	-.78	-.78	-.78	-.78	-.78	-.78	-.78
51	-.52	-.52	-.52	-.52	-.52	-.52	-.52	-.52	-.52	-.52	-.52	-.52	-.52	-.52	-.52
52	-.26	-.26	-.26	-.26	-.26	-.26	-.26	-.26	-.26	-.26	-.26	-.26	-.26	-.26	-.26
53	-.29	-.29	-.29	-.29	-.29	-.29	-.29	-.29	-.29	-.29	-.29	-.29	-.29	-.29	-.29
54	.93	.93	.93	.93	.93	.93	.93	.93	.93	.93	.93	.93	.93	.93	.93
55	.19	.19	.19	.19	.19	.19	.19	.19	.19	.19	.19	.19	.19	.19	.19
56	.80	.80	.80	.80	.80	.80	.80	.80	.80	.80	.80	.80	.80	.80	.80
57	.46	.46	.46	.46	.46	.46	.46	.46	.46	.46	.46	.46	.46	.46	.46
58	.60	.60	.60	.60	.60	.60	.60	.60	.60	.60	.60	.60	.60	.60	.60
59	.89	.89	.89	.89	.89	.89	.89	.89	.89	.89	.89	.89	.89	.89	.89
60	-4.35	-4.35	-4.35	-4.35	-4.35	-4.35	-4.35	-4.35	-4.35	-4.35	-4.35	-4.35	-4.35	-4.35	-4.35
61	11.19	11.19	11.19	11.19	11.19	11.19	11.19	11.19	11.19	11.19	11.19	11.19	11.19	11.19	11.19
62	3.13	3.13	3.13	3.13	3.13	3.13	3.13	3.13	3.13	3.13	3.13	3.13	3.13	3.13	3.13

NOAA-9 SCANNER OFFSETS FOR JULY 1985: TOTAL CHANNEL
 DAY OF MONTH -->

S.P.	16	17	18	19	20	21	22	23	24	25	26	27	28	29	30	31
1	.36	.36	.36	.36	.36	.36	.36	.36	.36	.36	.36	.36	.36	.36	.36	.36
2	1.04	1.04	1.04	1.04	1.04	1.04	1.04	1.04	1.04	1.04	1.04	1.04	1.04	1.04	1.04	1.04
3	1.93	1.93	1.93	1.93	1.93	1.93	1.93	1.93	1.93	1.93	1.93	1.93	1.93	1.93	1.93	1.93
4	-9.64	-9.64	-9.64	-9.64	-9.64	-9.64	-9.64	-9.64	-9.64	-9.64	-9.64	-9.64	-9.64	-9.64	-9.64	-9.64
5	-8.36	-8.36	-8.36	-8.36	-8.36	-8.36	-8.36	-8.36	-8.36	-8.36	-8.36	-8.36	-8.36	-8.36	-8.36	-8.36
6	-7.07	-4.34	-4.34	-4.34	-4.34	-4.34	-4.34	-4.34	-4.34	-4.34	-4.34	-4.34	-4.34	-4.34	-4.34	-4.34
7	-3.44	-3.42	-3.42	-3.42	-3.42	-3.42	-3.42	-3.42	-3.42	-3.42	-3.42	-3.42	-3.42	-3.42	-3.42	-3.42
8	-1.66	-2.56	-2.56	-2.56	-2.56	-2.56	-2.56	-2.56	-2.56	-2.56	-2.56	-2.56	-2.56	-2.56	-2.56	-2.56
9	-1.82	-2.50	-2.50	-2.50	-2.50	-2.50	-2.50	-2.50	-2.50	-2.50	-2.50	-2.50	-2.50	-2.50	-2.50	-2.50
10	-1.71	-2.23	-2.23	-2.23	-2.23	-2.23	-2.23	-2.23	-2.23	-2.23	-2.23	-2.23	-2.23	-2.23	-2.23	-2.23
11	-.98	-1.96	-1.96	-1.96	-1.96	-1.96	-1.96	-1.96	-1.96	-1.96	-1.96	-1.96	-1.96	-1.96	-1.96	-1.96
12	-.73	-1.50	-1.50	-1.50	-1.50	-1.50	-1.50	-1.50	-1.50	-1.50	-1.50	-1.50	-1.50	-1.50	-1.50	-1.50
13	-1.16	-1.74	-1.74	-1.74	-1.74	-1.74	-1.74	-1.74	-1.74	-1.74	-1.74	-1.74	-1.74	-1.74	-1.74	-1.74
14	-.72	-1.78	-1.78	-1.78	-1.78	-1.78	-1.78	-1.78	-1.78	-1.78	-1.78	-1.78	-1.78	-1.78	-1.78	-1.78
15	-.95	-1.61	-1.61	-1.61	-1.61	-1.61	-1.61	-1.61	-1.61	-1.61	-1.61	-1.61	-1.61	-1.61	-1.61	-1.61
16	-1.08	-2.14	-2.14	-2.14	-2.14	-2.14	-2.14	-2.14	-2.14	-2.14	-2.14	-2.14	-2.14	-2.14	-2.14	-2.14
17	-1.56	-2.13	-2.13	-2.13	-2.13	-2.13	-2.13	-2.13	-2.13	-2.13	-2.13	-2.13	-2.13	-2.13	-2.13	-2.13
18	-.93	-2.16	-2.16	-2.16	-2.16	-2.16	-2.16	-2.16	-2.16	-2.16	-2.16	-2.16	-2.16	-2.16	-2.16	-2.16
19	-.88	-2.34	-2.34	-2.34	-2.34	-2.34	-2.34	-2.34	-2.34	-2.34	-2.34	-2.34	-2.34	-2.34	-2.34	-2.34
20	-1.03	-2.06	-2.06	-2.06	-2.06	-2.06	-2.06	-2.06	-2.06	-2.06	-2.06	-2.06	-2.06	-2.06	-2.06	-2.06
21	-.83	-1.71	-1.71	-1.71	-1.71	-1.71	-1.71	-1.71	-1.71	-1.71	-1.71	-1.71	-1.71	-1.71	-1.71	-1.71
22	-.59	-1.57	-1.57	-1.57	-1.57	-1.57	-1.57	-1.57	-1.57	-1.57	-1.57	-1.57	-1.57	-1.57	-1.57	-1.57
23	-.77	-1.49	-1.49	-1.49	-1.49	-1.49	-1.49	-1.49	-1.49	-1.49	-1.49	-1.49	-1.49	-1.49	-1.49	-1.49
24	-1.38	-1.32	-1.32	-1.32	-1.32	-1.32	-1.32	-1.32	-1.32	-1.32	-1.32	-1.32	-1.32	-1.32	-1.32	-1.32
25	-.62	-1.53	-1.53	-1.53	-1.53	-1.53	-1.53	-1.53	-1.53	-1.53	-1.53	-1.53	-1.53	-1.53	-1.53	-1.53
26	-.85	-1.40	-1.40	-1.40	-1.40	-1.40	-1.40	-1.40	-1.40	-1.40	-1.40	-1.40	-1.40	-1.40	-1.40	-1.40
27	-.42	-1.29	-1.29	-1.29	-1.29	-1.29	-1.29	-1.29	-1.29	-1.29	-1.29	-1.29	-1.29	-1.29	-1.29	-1.29
28	-.50	-1.27	-1.27	-1.27	-1.27	-1.27	-1.27	-1.27	-1.27	-1.27	-1.27	-1.27	-1.27	-1.27	-1.27	-1.27
29	-.15	-1.29	-1.29	-1.29	-1.29	-1.29	-1.29	-1.29	-1.29	-1.29	-1.29	-1.29	-1.29	-1.29	-1.29	-1.29
30	-.35	-1.14	-1.14	-1.14	-1.14	-1.14	-1.14	-1.14	-1.14	-1.14	-1.14	-1.14	-1.14	-1.14	-1.14	-1.14
31	-.74	-1.05	-1.05	-1.05	-1.05	-1.05	-1.05	-1.05	-1.05	-1.05	-1.05	-1.05	-1.05	-1.05	-1.05	-1.05
32	-1.27	-.78	-.78	-.78	-.78	-.78	-.78	-.78	-.78	-.78	-.78	-.78	-.78	-.78	-.78	-.78
33	.12	-.62	-.62	-.62	-.62	-.62	-.62	-.62	-.62	-.62	-.62	-.62	-.62	-.62	-.62	-.62
34	.71	-.25	-.25	-.25	-.25	-.25	-.25	-.25	-.25	-.25	-.25	-.25	-.25	-.25	-.25	-.25
35	.49	.09	.09	.09	.09	.09	.09	.09	.09	.09	.09	.09	.09	.09	.09	.09
36	.60	.18	.18	.18	.18	.18	.18	.18	.18	.18	.18	.18	.18	.18	.18	.18
37	.33	.13	.13	.13	.13	.13	.13	.13	.13	.13	.13	.13	.13	.13	.13	.13
38	.64	.28	.28	.28	.28	.28	.28	.28	.28	.28	.28	.28	.28	.28	.28	.28
39	.80	.03	.03	.03	.03	.03	.03	.03	.03	.03	.03	.03	.03	.03	.03	.03
40	.80	-.01	-.01	-.01	-.01	-.01	-.01	-.01	-.01	-.01	-.01	-.01	-.01	-.01	-.01	-.01
41	1.12	.14	.14	.14	.14	.14	.14	.14	.14	.14	.14	.14	.14	.14	.14	.14
42	.54	.21	.21	.21	.21	.21	.21	.21	.21	.21	.21	.21	.21	.21	.21	.21
43	.61	.05	.05	.05	.05	.05	.05	.05	.05	.05	.05	.05	.05	.05	.05	.05
44	.40	-.26	-.26	-.26	-.26	-.26	-.26	-.26	-.26	-.26	-.26	-.26	-.26	-.26	-.26	-.26
45	.74	-.32	-.32	-.32	-.32	-.32	-.32	-.32	-.32	-.32	-.32	-.32	-.32	-.32	-.32	-.32
46	.66	-.46	-.46	-.46	-.46	-.46	-.46	-.46	-.46	-.46	-.46	-.46	-.46	-.46	-.46	-.46
47	-.09	-.52	-.52	-.52	-.52	-.52	-.52	-.52	-.52	-.52	-.52	-.52	-.52	-.52	-.52	-.52
48	-.35	-.63	-.63	-.63	-.63	-.63	-.63	-.63	-.63	-.63	-.63	-.63	-.63	-.63	-.63	-.63
49	-.98	-.81	-.81	-.81	-.81	-.81	-.81	-.81	-.81	-.81	-.81	-.81	-.81	-.81	-.81	-.81
50	-.78	-.42	-.42	-.42	-.42	-.42	-.42	-.42	-.42	-.42	-.42	-.42	-.42	-.42	-.42	-.42
51	-.52	-.48	-.48	-.48	-.48	-.48	-.48	-.48	-.48	-.48	-.48	-.48	-.48	-.48	-.48	-.48
52	-.26	-.99	-.99	-.99	-.99	-.99	-.99	-.99	-.99	-.99	-.99	-.99	-.99	-.99	-.99	-.99
53	-.29	-.43	-.43	-.43	-.43	-.43	-.43	-.43	-.43	-.43	-.43	-.43	-.43	-.43	-.43	-.43
54	.93	-.37	-.37	-.37	-.37	-.37	-.37	-.37	-.37	-.37	-.37	-.37	-.37	-.37	-.37	-.37
55	.19	-.65	-.65	-.65	-.65	-.65	-.65	-.65	-.65	-.65	-.65	-.65	-.65	-.65	-.65	-.65
56	.80	-.84	-.84	-.84	-.84	-.84	-.84	-.84	-.84	-.84	-.84	-.84	-.84	-.84	-.84	-.84
57	.46	-.69	-.69	-.69	-.69	-.69	-.69	-.69	-.69	-.69	-.69	-.69	-.69	-.69	-.69	-.69
58	.60	-.70	-.70	-.70	-.70	-.70	-.70	-.70	-.70	-.70	-.70	-.70	-.70	-.70	-.70	-.70
59	.89	-.68	-.68	-.68	-.68	-.68	-.68	-.68	-.68	-.68	-.68	-.68	-.68	-.68	-.68	-.68
60	-4.35	-4.35	-4.35	-4.35	-4.35	-4.35	-4.35	-4.35	-4.35	-4.35	-4.35	-4.35	-4.35	-4.35	-4.35	-4.35
61	11.19	11.19	11.19	11.19	11.19	11.19	11.19	11.19	11.19	11.19	11.19	11.19	11.19	11.19	11.19	11.19
62	3.13	3.13	3.13	3.13	3.13	3.13	3.13	3.13	3.13	3.13	3.13	3.13	3.13	3.13	3.13	3.13

NOAA-9 SCANNER OFFSETS FOR JULY 1985: LONGHAVE CHANNEL
 DAY OF MONTH -->

S.P.	16	17	18	19	20	21	22	23	24	25	26	27	28	29	30	31
1	-.11	-.11	-.11	-.11	-.11	-.11	-.11	-.11	-.11	-.11	-.11	-.11	-.11	-.11	-.11	-.11
2	.32	.32	.32	.32	.32	.32	.32	.32	.32	.32	.32	.32	.32	.32	.32	.32
3	.49	.49	.49	.49	.49	.49	.49	.49	.49	.49	.49	.49	.49	.49	.49	.49
4	-4.09	-4.09	-4.09	-4.09	-4.09	-4.09	-4.09	-4.09	-4.09	-4.09	-4.09	-4.09	-4.09	-4.09	-4.09	-4.09
5	-6.44	-6.44	-6.44	-6.44	-6.44	-6.44	-6.44	-6.44	-6.44	-6.44	-6.44	-6.44	-6.44	-6.44	-6.44	-6.44
6	-5.32	-3.71	-3.71	-3.71	-3.71	-3.71	-3.71	-3.71	-3.71	-3.71	-3.71	-3.71	-3.71	-3.71	-3.71	-3.71
7	-2.81	-2.89	-2.89	-2.89	-2.89	-2.89	-2.89	-2.89	-2.89	-2.89	-2.89	-2.89	-2.89	-2.89	-2.89	-2.89
8	-1.80	-2.38	-2.38	-2.38	-2.38	-2.38	-2.38	-2.38	-2.38	-2.38	-2.38	-2.38	-2.38	-2.38	-2.38	-2.38
9	-2.10	-2.49	-2.49	-2.49	-2.49	-2.49	-2.49	-2.49	-2.49	-2.49	-2.49	-2.49	-2.49	-2.49	-2.49	-2.49
10	-2.30	-2.49	-2.49	-2.49	-2.49	-2.49	-2.49	-2.49	-2.49	-2.49	-2.49	-2.49	-2.49	-2.49	-2.49	-2.49
11	-1.88	-2.53	-2.53	-2.53	-2.53	-2.53	-2.53	-2.53	-2.53	-2.53	-2.53	-2.53	-2.53	-2.53	-2.53	-2.53
12	-1.96	-2.38	-2.38	-2.38	-2.38	-2.38	-2.38	-2.38	-2.38	-2.38	-2.38	-2.38	-2.38	-2.38	-2.38	-2.38
13	-2.27	-2.50	-2.50	-2.50	-2.50	-2.50	-2.50	-2.50	-2.50	-2.50	-2.50	-2.50	-2.50	-2.50	-2.50	-2.50
14	-2.10	-2.65	-2.65	-2.65	-2.65	-2.65	-2.65	-2.65	-2.65	-2.65	-2.65	-2.65	-2.65	-2.65	-2.65	-2.65
15	-2.45	-2.80	-2.80	-2.80	-2.80	-2.80	-2.80	-2.80	-2.80	-2.80	-2.80	-2.80	-2.80	-2.80	-2.80	-2.80
16	-2.68	-3.28	-3.28	-3.28	-3.28	-3.28	-3.28	-3.28	-3.28	-3.28	-3.28	-3.28	-3.28	-3.28	-3.28	-3.28
17	-3.19	-3.52	-3.52	-3.52	-3.52	-3.52	-3.52	-3.52	-3.52	-3.52	-3.52	-3.52	-3.52	-3.52	-3.52	-3.52
18	-2.98	-3.77	-3.77	-3.77	-3.77	-3.77	-3.77	-3.77	-3.77	-3.77	-3.77	-3.77	-3.77	-3.77	-3.77	-3.77
19	-3.08	-4.13	-4.13	-4.13	-4.13	-4.13	-4.13	-4.13	-4.13	-4.13	-4.13	-4.13	-4.13	-4.13	-4.13	-4.13
20	-3.51	-4.15	-4.15	-4.15	-4.15	-4.15	-4.15	-4.15	-4.15	-4.15	-4.15	-4.15	-4.15	-4.15	-4.15	-4.15
21	-3.52	-4.08	-4.08	-4.08	-4.08	-4.08	-4.08	-4.08	-4.08	-4.08	-4.08	-4.08	-4.08	-4.08	-4.08	-4.08
22	-3.53	-4.22	-4.22	-4.22	-4.22	-4.22	-4.22	-4.22	-4.22	-4.22	-4.22	-4.22	-4.22	-4.22	-4.22	-4.22
23	-3.81	-4.22	-4.22	-4.22	-4.22	-4.22	-4.22	-4.22	-4.22	-4.22	-4.22	-4.22	-4.22	-4.22	-4.22	-4.22
24	-4.16	-4.26	-4.26	-4.26	-4.26	-4.26	-4.26	-4.26	-4.26	-4.26	-4.26	-4.26	-4.26	-4.26	-4.26	-4.26
25	-3.86	-4.60	-4.60	-4.60	-4.60	-4.60	-4.60	-4.60	-4.60	-4.60	-4.60	-4.60	-4.60	-4.60	-4.60	-4.60
26	-3.83	-4.32	-4.32	-4.32	-4.32	-4.32	-4.32	-4.32	-4.32	-4.32	-4.32	-4.32	-4.32	-4.32	-4.32	-4.32
27	-3.79	-4.42	-4.42	-4.42	-4.42	-4.42	-4.42	-4.42	-4.42	-4.42	-4.42	-4.42	-4.42	-4.42	-4.42	-4.42
28	-3.80	-4.36	-4.36	-4.36	-4.36	-4.36	-4.36	-4.36	-4.36	-4.36	-4.36	-4.36	-4.36	-4.36	-4.36	-4.36
29	-3.50	-4.16	-4.16	-4.16	-4.16	-4.16	-4.16	-4.16	-4.16	-4.16	-4.16	-4.16	-4.16	-4.16	-4.16	-4.16
30	-3.54	-3.88	-3.88	-3.88	-3.88	-3.88	-3.88	-3.88	-3.88	-3.88	-3.88	-3.88	-3.88	-3.88	-3.88	-3.88
31	-3.61	-3.87	-3.87	-3.87	-3.87	-3.87	-3.87	-3.87	-3.87	-3.87	-3.87	-3.87	-3.87	-3.87	-3.87	-3.87
32	-3.80	-3.54	-3.54	-3.54	-3.54	-3.54	-3.54	-3.54	-3.54	-3.54	-3.54	-3.54	-3.54	-3.54	-3.54	-3.54
33	-2.55	-3.16	-3.16	-3.16	-3.16	-3.16	-3.16	-3.16	-3.16	-3.16	-3.16	-3.16	-3.16	-3.16	-3.16	-3.16
34	-1.90	-2.62	-2.62	-2.62	-2.62	-2.62	-2.62	-2.62	-2.62	-2.62	-2.62	-2.62	-2.62	-2.62	-2.62	-2.62
35	-1.79	-2.15	-2.15	-2.15	-2.15	-2.15	-2.15	-2.15	-2.15	-2.15	-2.15	-2.15	-2.15	-2.15	-2.15	-2.15
36	-1.43	-1.78	-1.78	-1.78	-1.78	-1.78	-1.78	-1.78	-1.78	-1.78	-1.78	-1.78	-1.78	-1.78	-1.78	-1.78
37	-1.17	-1.51	-1.51	-1.51	-1.51	-1.51	-1.51	-1.51	-1.51	-1.51	-1.51	-1.51	-1.51	-1.51	-1.51	-1.51
38	-.75	-1.08	-1.08	-1.08	-1.08	-1.08	-1.08	-1.08	-1.08	-1.08	-1.08	-1.08	-1.08	-1.08	-1.08	-1.08
39	-.29	-.89	-.89	-.89	-.89	-.89	-.89	-.89	-.89	-.89	-.89	-.89	-.89	-.89	-.89	-.89
40	-.07	-.62	-.62	-.62	-.62	-.62	-.62	-.62	-.62	-.62	-.62	-.62	-.62	-.62	-.62	-.62
41	.43	-.05	-.05	-.05	-.05	-.05	-.05	-.05	-.05	-.05	-.05	-.05	-.05	-.05	-.05	-.05
42	.32	-.06	-.06	-.06	-.06	-.06	-.06	-.06	-.06	-.06	-.06	-.06	-.06	-.06	-.06	-.06
43	.62	.06	.06	.06	.06	.06	.06	.06	.06	.06	.06	.06	.06	.06	.06	.06
44	.69	.11	.11	.11	.11	.11	.11	.11	.11	.11	.11	.11	.11	.11	.11	.11
45	1.12	.22	.22	.22	.22	.22	.22	.22	.22	.22	.22	.22	.22	.22	.22	.22
46	1.16	.29	.29	.29	.29	.29	.29	.29	.29	.29	.29	.29	.29	.29	.29	.29
47	.55	.34	.34	.34	.34	.34	.34	.34	.34	.34	.34	.34	.34	.34	.34	.34
48	.89	.43	.43	.43	.43	.43	.43	.43	.43	.43	.43	.43	.43	.43	.43	.43
49	.51	.33	.33	.33	.33	.33	.33	.33	.33	.33	.33	.33	.33	.33	.33	.33
50	.59	.58	.58	.58	.58	.58	.58	.58	.58	.58	.58	.58	.58	.58	.58	.58
51	.97	.76	.76	.76	.76	.76	.76	.76	.76	.76	.76	.76	.76	.76	.76	.76
52	1.20	.16	.16	.16	.16	.16	.16	.16	.16	.16	.16	.16	.16	.16	.16	.16
53	.94	.40	.40	.40	.40	.40	.40	.40	.40	.40	.40	.40	.40	.40	.40	.40
54	1.39	.10	.10	.10	.10	.10	.10	.10	.10	.10	.10	.10	.10	.10	.10	.10
55	.87	-.14	-.14	-.14	-.14	-.14	-.14	-.14	-.14	-.14	-.14	-.14	-.14	-.14	-.14	-.14
56	1.23	-.37	-.37	-.37	-.37	-.37	-.37	-.37	-.37	-.37	-.37	-.37	-.37	-.37	-.37	-.37
57	.84	-.38	-.38	-.38	-.38	-.38	-.38	-.38	-.38	-.38	-.38	-.38	-.38	-.38	-.38	-.38
58	1.11	-.50	-.50	-.50	-.50	-.50	-.50	-.50	-.50	-.50	-.50	-.50	-.50	-.50	-.50	-.50
59	1.66	-.72	-.72	-.72	-.72	-.72	-.72	-.72	-.72	-.72	-.72	-.72	-.72	-.72	-.72	-.72
60	-2.73	-2.73	-2.73	-2.73	-2.73	-2.73	-2.73	-2.73	-2.73	-2.73	-2.73	-2.73	-2.73	-2.73	-2.73	-2.73
61	3.05	3.05	3.05	3.05	3.05	3.05	3.05	3.05	3.05	3.05	3.05	3.05	3.05	3.05	3.05	3.05
62	.45	.45	.45	.45	.45	.45	.45	.45	.45	.45	.45	.45	.45	.45	.45	.45

NOAA-9 SCANNER OFFSETS FOR AUGUST 1985: TOTAL CHANNEL															
S.P.	DAY OF MONTH -->														
	1	2	3	4	5	6	7	8	9	10	11	12	13	14	15
1	.36	.36	.36	.36	.36	.36	.36	.36	.36	.36	.36	.36	.36	.36	.36
2	1.04	1.04	1.04	1.04	1.04	1.04	1.04	1.04	1.04	1.04	1.04	1.04	1.04	1.04	1.04
3	1.93	1.93	1.93	1.93	1.93	1.93	1.93	1.93	1.93	1.93	1.93	1.93	1.93	1.93	1.93
4	-9.64	-9.64	-9.64	-9.64	-9.64	-9.64	-9.64	-9.64	-9.64	-9.64	-9.64	-9.64	-9.64	-9.64	-9.64
5	*****	*****	-.81	-.81	-.81	-.81	-.81	-.81	-.81	-8.48	-8.80	-8.24	-8.58	-7.90	-9.46
6	*****	*****	-6.10	-6.10	-6.44	-5.10	-6.10	-7.93	-7.50	-3.47	-3.12	-2.36	-2.43	-2.12	-3.14
7	*****	*****	-2.24	-2.24	-2.34	-1.43	-2.24	-4.12	-4.17	-2.26	-1.72	-1.14	-1.13	-1.62	-1.41
8	*****	*****	-1.04	-1.04	-.92	-.04	-1.04	-3.08	-3.00	-1.05	-.73	.00	-.38	-.65	-.21
9	*****	*****	.99	.99	1.10	2.07	.99	-1.21	-1.07	-2.07	-1.59	-.98	-1.82	-1.29	-1.26
10	*****	*****	1.53	1.53	1.61	2.63	1.53	-.79	-.65	-2.42	-1.64	-1.00	-1.99	-1.06	-1.48
11	*****	*****	1.12	1.12	1.25	2.27	1.12	-1.26	-1.29	-2.72	-1.77	-1.26	-1.94	-1.04	-1.76
12	*****	*****	1.33	1.33	1.40	2.44	1.33	-1.12	-1.33	-2.88	-1.95	-1.59	-2.09	-1.29	-2.02
13	*****	*****	.40	.40	.37	1.47	.40	-2.12	-2.26	-3.37	-2.49	-2.05	-2.61	-1.91	-2.48
14	*****	*****	.48	.48	.41	1.53	.48	-2.01	-2.02	-3.79	-2.99	-2.38	-3.09	-2.48	-2.89
15	*****	*****	.87	.87	.76	1.95	.87	-1.68	-1.63	-3.60	-2.88	-2.23	-3.11	-2.54	-2.87
16	*****	*****	1.37	1.37	1.23	2.43	1.37	-1.23	-1.08	-3.44	-2.89	-2.12	-3.11	-2.55	-2.74
17	*****	*****	1.27	1.27	1.09	2.36	1.27	-1.28	-1.24	-3.61	-3.24	-2.30	-3.26	-2.83	-2.86
18	*****	*****	1.20	1.20	1.05	2.32	1.20	-1.25	-1.39	-3.71	-3.22	-2.38	-3.24	-3.02	-3.02
19	*****	*****	1.07	1.07	.94	2.24	1.07	-1.46	-1.53	-3.89	-3.30	-2.76	-3.45	-3.52	-3.38
20	*****	*****	1.56	1.56	1.29	2.76	1.56	-1.01	-.96	-3.73	-3.20	-3.11	-3.53	-3.64	-3.35
21	*****	*****	1.44	1.44	1.16	2.81	1.44	-.96	-1.00	-3.84	-3.47	-3.69	-3.97	-3.99	-3.56
22	*****	*****	2.01	2.01	1.80	3.44	2.01	-.35	-.51	-3.99	-3.73	-4.18	-4.35	-4.36	-3.91
23	*****	*****	1.59	1.59	1.49	3.06	1.59	-.70	-.88	-3.69	-3.53	-4.32	-4.20	-4.23	-3.81
24	*****	*****	1.73	1.73	1.62	3.16	1.73	-.65	-.91	-3.41	-3.31	-4.47	-4.10	-3.96	-3.55
25	*****	*****	1.74	1.74	1.54	3.17	1.74	-.68	-1.14	-3.07	-3.17	-4.67	-4.07	-3.73	-3.29
26	*****	*****	2.08	2.08	1.96	3.57	2.08	-.30	-.83	-2.48	-2.82	-4.38	-3.65	-3.25	-2.81
27	*****	*****	2.14	2.14	2.02	3.73	2.14	-.15	-.58	-2.57	-3.01	-4.53	-3.55	-3.30	-2.83
28	*****	*****	2.01	2.01	1.92	3.60	2.01	-.24	-.50	-2.54	-2.96	-4.45	-3.32	-3.14	-2.64
29	*****	*****	2.09	2.09	2.09	3.60	2.09	-.20	-.23	-2.36	-2.69	-4.20	-3.12	-2.96	-2.45
30	*****	*****	2.10	2.10	2.11	3.58	2.10	-.28	-.16	-2.38	-2.67	-4.11	-3.10	-3.06	-2.52
31	*****	*****	2.34	2.34	2.33	3.87	2.34	-.01	-.03	-2.31	-2.65	-3.84	-3.00	-2.92	-2.49
32	*****	*****	2.38	2.38	2.37	3.97	2.38	.05	.21	-2.38	-2.75	-3.70	-3.18	-2.94	-2.65
33	*****	*****	2.25	2.25	2.22	3.77	2.25	-.10	.35	-1.62	-1.87	-2.74	-2.55	-2.10	-1.90
34	*****	*****	1.99	1.99	1.95	3.52	1.99	-.35	.41	-1.65	-1.87	-2.74	-2.63	-2.07	-1.90
35	*****	*****	2.52	2.52	2.63	4.01	2.52	.16	1.01	-1.39	-1.72	-2.53	-2.41	-1.77	-1.64
36	*****	*****	2.61	2.61	2.84	4.04	2.61	.16	1.32	-.96	-1.52	-2.19	-2.08	-1.25	-1.33
37	*****	*****	2.56	2.56	2.80	3.99	2.56	.20	1.52	-1.04	-1.77	-2.20	-2.26	-1.22	-1.47
38	*****	*****	2.18	2.18	2.40	3.69	2.18	-.11	1.20	-.62	-1.46	-1.58	-2.00	-.79	-1.03
39	*****	*****	2.07	2.07	2.22	3.45	2.07	-.35	1.08	-.57	-1.55	-1.19	-1.97	-.73	-.91
40	*****	*****	1.75	1.75	1.98	3.13	1.75	-.59	.98	-.46	-1.71	-.87	-1.99	-.60	-.82
41	*****	*****	1.84	1.84	2.22	3.29	1.84	-.56	1.20	-.30	-1.80	-.58	-1.80	-.32	-.62
42	*****	*****	2.53	2.53	3.00	4.03	2.53	.01	1.82	-.43	-1.87	-.55	-1.66	-.22	-.71
43	*****	*****	2.24	2.24	2.79	3.80	2.24	-.30	1.78	-.72	-1.89	-.57	-1.67	-.15	-.84
44	*****	*****	2.21	2.21	2.80	3.86	2.21	-.34	1.98	-.02	-1.05	.34	-.72	.77	-.06
45	*****	*****	1.70	1.70	2.34	3.32	1.70	-.86	1.58	-.16	-.96	.40	-.76	.79	-.19
46	*****	*****	1.74	1.74	2.48	3.25	1.74	-.90	1.55	-.62	-1.02	.16	-1.11	.57	-.43
47	*****	*****	2.02	2.02	2.89	3.52	2.02	-.75	1.70	-.45	-.47	.58	-.82	.89	-.10
48	*****	*****	2.23	2.23	3.16	3.74	2.23	-.52	1.75	-.64	-.49	.54	-.88	.75	-.12
49	*****	*****	1.63	1.63	2.52	3.11	1.63	-1.12	1.14	-.85	-.61	.42	-.85	.49	-.21
50	*****	*****	1.51	1.51	2.54	3.03	1.51	-1.10	1.04	-.95	-.57	.37	-.79	.23	-.19
51	*****	*****	1.53	1.53	2.69	3.08	1.53	-.86	.76	-.90	-.39	.44	-.45	.33	-.11
52	*****	*****	1.96	1.96	3.09	3.43	1.96	-.27	1.15	-.64	-.24	.66	.10	.46	.56
53	*****	*****	1.74	1.74	2.74	3.20	1.74	-.35	.81	-.10	.23	1.20	.85	.69	1.16
54	*****	*****	1.95	1.95	2.95	3.43	1.95	-.09	.58	.16	.78	1.78	1.46	.94	1.68
55	*****	*****	2.47	2.47	3.46	3.80	2.47	.52	.55	-.35	.67	1.67	1.36	.58	1.41
56	*****	*****	1.81	1.81	2.70	3.24	1.81	-.14	-.14	-.16	1.01	1.85	1.42	.79	1.56
57	*****	*****	.73	.73	1.74	2.19	.73	-1.25	-1.58	-1.02	.35	.87	.35	-.05	.90
58	*****	*****	-.09	-.09	1.12	1.59	-.09	-1.84	-2.64	-.85	.38	.96	.27	.13	1.07
59	*****	*****	-.92	-.92	-1.13	.82	-.92	-2.47	-3.48	-1.30	-.75	-.48	-1.05	-.52	-.30
60	*****	*****	-7.88	-7.88	-7.27	-7.27	-7.88	-9.88	-9.43	-6.05	-6.30	-6.63	-6.48	-6.00	-5.06
61	11.19	11.19	11.19	11.19	11.19	11.19	11.19	11.19	11.19	11.19	11.19	11.19	11.19	11.19	11.19
62	3.13	3.13	3.13	3.13	3.13	3.13	3.13	3.13	3.13	3.13	3.13	3.13	3.13	3.13	3.13

NOAA-9 SCANNER OFFSETS FOR AUGUST 1985: TOTAL CHANNEL																
S.P.	DAY OF MONTH -->															
	16	17	18	19	20	21	22	23	24	25	26	27	28	29	30	31
1	.36	.36	.36	.36	.36	.36	.36	.36	.36	.36	.36	.36	.36	.36	.36	.36
2	1.04	1.04	1.04	1.04	1.04	1.04	1.04	1.04	1.04	1.04	1.04	1.04	1.04	1.04	1.04	1.04
3	1.93	1.93	1.93	1.93	1.93	1.93	1.93	1.93	1.93	1.93	1.93	1.93	1.93	1.93	1.93	1.93
4	-9.64	-9.64	-9.64	-9.64	-9.64	-9.64	-9.64	-9.64	-9.64	-9.64	-9.64	-9.64	-9.64	-9.64	-9.64	-9.64
5	-8.06	-10.16	-10.08	-8.16	-9.08	-8.24	-7.80	-6.17	-6.25	-5.19	-6.27	-6.55	-8.16	-6.29	-5.28	-4.43
6	-2.32	-4.21	-4.17	-2.50	-3.13	-2.96	-3.19	-1.92	-2.37	-2.65	-2.56	-1.94	-2.77	-2.34	-1.42	-1.26
7	-1.61	-2.65	-1.88	-1.50	-2.37	-2.10	-2.31	-1.47	-1.95	-2.30	-1.94	-1.15	-1.69	-1.72	-.72	-1.06
8	-1.11	-1.37	-.32	-.62	-.73	-1.22	-1.03	-.88	-.88	-1.29	-.95	-.24	-.86	-.47	.24	-.39
9	-2.40	-1.97	-1.06	-1.86	-1.40	-2.33	-1.76	-1.83	-1.81	-1.97	-2.00	-1.32	-2.20	-1.52	-1.04	-1.69
10	-2.31	-1.78	-1.10	-1.93	-1.17	-2.29	-1.64	-1.57	-1.65	-1.62	-2.18	-1.17	-2.21	-1.77	-1.20	-1.82
11	-2.32	-1.87	-1.28	-2.12	-1.20	-2.23	-1.72	-1.67	-1.62	-1.58	-2.28	-1.16	-2.13	-1.88	-1.48	-1.99
12	-2.29	-2.03	-1.50	-2.51	-1.52	-2.28	-1.84	-1.95	-1.75	-1.76	-2.25	-1.43	-2.25	-1.94	-1.86	-2.12
13	-2.49	-2.22	-2.01	-3.26	-2.14	-2.71	-2.29	-2.52	-1.89	-2.18	-2.59	-2.04	-2.67	-2.29	-2.42	-2.45
14	-2.76	-2.46	-2.55	-3.94	-2.78	-3.28	-2.93	-2.84	-2.13	-2.64	-3.06	-2.75	-3.09	-2.67	-2.77	-2.91
15	-2.44	-2.30	-2.52	-4.02	-2.91	-3.40	-3.05	-2.73	-2.18	-2.66	-3.02	-2.89	-3.04	-2.69	-2.68	-2.78
16	-2.13	-2.25	-2.57	-4.02	-3.15	-3.47	-3.07	-2.66	-2.42	-2.63	-3.01	-2.94	-3.12	-2.65	-2.70	-2.67
17	-2.30	-2.47	-2.90	-4.30	-3.18	-3.71	-3.40	-2.89	-2.80	-2.92	-3.19	-3.32	-3.43	-2.87	-2.89	-2.85
18	-2.48	-2.35	-3.19	-4.44	-3.55	-3.81	-3.56	-3.11	-2.97	-3.14	-3.33	-3.63	-3.67	-2.97	-2.88	-2.94
19	-2.87	-2.47	-3.66	-4.66	-4.02	-4.19	-3.78	-3.53	-3.34	-3.58	-3.66	-4.04	-4.07	-3.26	-3.08	-3.26
20	-2.88	-2.45	-3.77	-4.41	-3.81	-4.18	-3.66	-3.59	-3.41	-3.73	-3.55	-4.09	-4.06	-3.22	-3.14	-3.24
21	-3.10	-2.79	-4.15	-4.59	-3.99	-4.40	-3.73	-3.91	-3.51	-4.11	-3.74	-4.53	-4.29	-3.40	-3.49	-3.56
22	-3.41	-3.19	-4.69	-4.99	-4.36	-4.68	-3.81	-4.25	-3.61	-4.50	-4.02	-5.00	-4.51	-3.63	-3.92	-3.98
23	-3.22	-3.08	-4.70	-4.83	-4.38	-4.36	-3.44	-4.02	-3.32	-4.34	-3.72	-4.91	-4.34	-3.44	-3.80	-3.77
24	-3.12	-2.94	-4.65	-4.73	-4.12	-4.04	-3.11	-3.61	-3.11	-4.12	-3.38	-4.81	-4.15	-3.28	-3.53	-3.56
25	-3.03	-2.83	-4.64	-4.57	-3.92	-3.74	-2.90	-3.24	-3.02	-3.82	-2.97	-4.65	-3.87	-3.15	-3.27	-3.39
26	-2.59	-2.36	-4.17	-3.92	-3.47	-3.18	-2.41	-2.64	-2.54	-3.10	-2.40	-4.16	-3.26	-2.65	-2.81	-2.80
27	-2.51	-2.42	-4.14	-3.83	-3.37	-3.20	-2.41	-2.59	-2.49	-3.05	-2.43	-4.16	-3.23	-2.73	-2.84	-2.78
28	-2.30	-2.39	-3.93	-3.66	-3.31	-3.13	-2.21	-2.41	-2.32	-2.89	-2.32	-3.97	-3.14	-2.56	-2.71	-2.67
29	-2.07	-2.39	-3.78	-3.40	-3.17	-3.03	-2.08	-2.21	-2.14	-2.71	-2.17	-3.67	-3.06	-2.36	-2.55	-2.44
30	-2.07	-2.58	-3.84	-3.40	-3.24	-3.23	-2.29	-2.25	-2.17	-2.80	-2.23	-3.65	-3.14	-2.35	-2.65	-2.45
31	-1.98	-2.59	-3.68	-3.19	-3.17	-3.25	-2.29	-2.10	-2.12	-2.74	-2.16	-3.50	-2.97	-2.22	-2.60	-2.30
32	-2.14	-2.73	-3.80	-3.16	-3.33	-3.31	-2.44	-2.20	-2.23	-2.84	-2.37	-3.43	-2.97	-2.25	-2.68	-2.36
33	-1.42	-1.91	-2.97	-2.28	-2.54	-2.50	-1.79	-1.47	-1.45	-2.24	-1.61	-2.44	-2.01	-1.35	-1.95	-1.51
34	-1.45	-1.84	-2.96	-2.24	-2.54	-2.53	-2.04	-1.62	-1.58	-2.43	-1.70	-2.39	-1.86	-1.39	-2.18	-1.48
35	-1.22	-1.56	-2.74	-2.02	-2.37	-2.23	-2.10	-1.52	-1.54	-2.28	-1.63	-2.12	-1.57	-1.20	-2.10	-1.36
36	-.85	-1.35	-2.36	-1.76	-2.25	-1.91	-1.93	-1.33	-1.38	-2.00	-1.54	-1.70	-1.27	-.88	-1.83	-1.16
37	-1.03	-1.68	-2.43	-1.92	-2.43	-2.05	-2.01	-1.53	-1.56	-2.17	-1.84	-1.70	-1.45	-.96	-2.02	-1.35
38	-.69	-1.51	-2.04	-1.60	-1.96	-1.77	-1.56	-1.12	-1.25	-1.95	-1.67	-1.20	-1.21	-.59	-1.81	-1.07
39	-.66	-1.64	-2.04	-1.51	-1.71	-1.82	-1.54	-1.04	-1.30	-2.08	-1.76	-.99	-1.28	-.52	-1.89	-1.06
40	-.72	-1.70	-2.02	-1.37	-1.51	-1.87	-1.67	-.98	-1.26	-2.23	-1.72	-.87	-1.30	-.47	-1.87	-.95
41	-.65	-1.61	-1.93	-1.13	-1.21	-1.86	-1.72	-.83	-1.09	-2.23	-1.59	-.74	-1.21	-.28	-1.61	-.81
42	-.66	-1.70	-2.01	-1.00	-1.14	-2.06	-1.89	-.83	-1.11	-2.30	-1.67	-.79	-1.18	-.26	-1.58	-.82
43	-.65	-1.79	-2.13	-.93	-1.17	-2.27	-2.06	-.90	-1.05	-2.34	-1.72	-.92	-1.15	-.30	-1.55	-1.00
44	.14	-1.11	-1.49	-.01	-.31	-1.48	-1.43	-.19	-.04	-1.51	-.90	-.07	-.23	.48	-.55	-.28
45	.01	-1.34	-1.76	-.03	-.36	-1.52	-1.57	-.42	.08	-1.56	-1.10	-.02	-.24	.25	-.47	-.29
46	-.23	-1.58	-2.09	-.24	-.64	-1.81	-1.64	-.83	-.11	-1.77	-1.45	-.25	-.48	-.16	-.64	-.49
47	-.16	-1.20	-1.73	.18	-.33	-1.64	-1.14	-.58	.15	-1.34	-1.16	.03	-.12	.17	-.27	-.21
48	.04	-1.34	-1.75	.27	-.67	-1.84	-1.20	-.65	-.04	-1.53	-1.36	-.22	-.18	.10	-.43	-.35
49	-.03	-1.64	-1.76	.19	-.57	-1.95	-1.39	-.75	-.39	-1.78	-1.71	-.45	-.25	-.27	-.80	-.51
50	-.02	-1.77	-1.67	-.02	-.65	-1.95	-1.44	-.74	-.80	-1.91	-1.86	-.56	-.35	-.58	-1.04	-.54
51	.12	-1.55	-1.33	-.01	-.69	-1.68	-1.14	-.38	-.97	-1.79	-1.60	-.37	-.05	-.56	-.69	-.26
52	.31	-1.18	-.85	.05	-.15	-1.14	-.63	-.12	-.75	-1.53	-1.07	.02	.44	-.49	.05	.07
53	.59	-.90	-.12	.42	.20	-.38	.02	.75	-.12	-1.12	-.42	.64	1.07	-.15	.84	.52
54	.98	-.46	.73	.87	.81	.35	.45	1.31	.32	-.73	.13	1.32	1.55	.43	1.21	.78
55	.70	-.40	.88	.62	.52	.20	.18	.78	.13	-.76	.06	1.30	1.20	.69	.96	.41
56	.80	.20	1.39	.69	.61	.17	.56	.50	.28	-.18	.34	1.49	1.27	1.13	1.12	.52
57	.08	.17	1.08	-.11	-.22	-.60	-.07	-.26	-.35	-.52	-.04	.79	.23	.15	.28	-.33
58	.17	.88	1.43	.17	.45	-.14	-.01	.05	.08	.09	.33	.85	-.14	.14	.27	-.29
59	-.61	.36	.20	-1.10	-.11	-.79	-1.25	-1.07	-.89	-.78	-.60	-.73	-1.44	-.90	-.58	-1.41
60	-5.44	-3.62	-4.21	-6.24	-4.25	-5.77	-6.32	-7.05	-6.59	-7.79	-6.44	-6.32	-5.18	-6.01	-6.32	-7.10
61	11.19	11.19	11.19	11.19	11.19	11.19	11.19	11.19	11.19	11.19	11.19	11.19	11.19	11.19	11.19	11.19
62	3.13	3.13	3.13	3.13	3.13	3.13	3.13	3.13	3.13	3.13	3.13	3.13	3.13	3.13	3.13	3.13

NOAA-9 SCANNER OFFSETS FOR AUGUST 1985: LONGVALE CHANNEL

S.P.	DAY OF MONTH -->														
	1	2	3	4	5	6	7	8	9	10	11	12	13	14	15
1	.29	.29	.29	.29	.29	.29	.29	.29	.29	.29	.29	.29	.29	.29	.29
2	.59	.59	.59	.59	.59	.59	.59	.59	.59	.59	.59	.59	.59	.59	.59
3	.63	.63	.63	.63	.63	.63	.63	.63	.63	.63	.63	.63	.63	.63	.63
4	.27	.27	.27	.27	.27	.27	.27	.27	.27	.27	.27	.27	.27	.27	.27
5	*****	*****	-1.84	-1.84	-1.84	-1.84	-1.84	-1.84	-1.84	-6.69	-6.92	-6.58	-6.76	-6.32	-7.26
6	*****	*****	-3.75	-3.75	-4.15	-2.95	-3.75	-4.47	-5.16	-3.51	-3.33	-2.81	-2.87	-2.65	-3.27
7	*****	*****	-1.32	-1.32	-1.51	-.64	-1.32	-2.37	-2.89	-2.23	-1.93	-1.50	-1.54	-1.83	-1.65
8	*****	*****	-.58	-.58	-.69	.04	-.58	-1.75	-2.26	-1.62	-1.47	-.95	-1.21	-1.38	-1.04
9	*****	*****	.60	.60	.52	1.24	.60	-.63	-1.18	-2.47	-2.21	-1.76	-2.31	-1.97	-1.91
10	*****	*****	.89	.89	.80	1.47	.89	-.42	-1.07	-2.91	-2.42	-1.95	-2.60	-2.02	-2.25
11	*****	*****	.69	.69	.65	1.28	.69	-.68	-1.48	-3.32	-2.71	-2.31	-2.77	-2.20	-2.62
12	*****	*****	.81	.81	.76	1.40	.81	-.58	-1.58	-3.62	-3.02	-2.71	-3.05	-2.55	-2.96
13	*****	*****	.53	.53	.43	1.09	.53	-.91	-1.93	-3.97	-3.41	-3.03	-3.41	-2.98	-3.27
14	*****	*****	.55	.55	.45	1.10	.55	-.91	-1.96	-4.44	-3.93	-3.46	-3.93	-3.55	-3.72
15	*****	*****	.78	.78	.69	1.33	.78	-.71	-1.81	-4.47	-4.02	-3.54	-4.10	-3.74	-3.88
16	*****	*****	1.19	1.19	1.08	1.74	1.19	-.33	-1.45	-4.45	-4.11	-3.57	-4.19	-3.83	-3.89
17	*****	*****	1.14	1.14	1.02	1.71	1.14	-.41	-1.63	-4.75	-4.53	-3.88	-4.49	-4.21	-4.16
18	*****	*****	1.14	1.14	1.02	1.71	1.14	-.39	-1.77	-4.98	-4.68	-4.09	-4.63	-4.50	-4.42
19	*****	*****	1.10	1.10	1.02	1.69	1.10	-.47	-1.89	-5.28	-4.92	-4.54	-4.96	-5.02	-4.86
20	*****	*****	1.44	1.44	1.33	2.06	1.44	-.15	-1.61	-5.41	-5.09	-4.99	-5.24	-5.32	-5.08
21	*****	*****	1.50	1.50	1.35	2.10	1.50	-.08	-1.69	-5.62	-5.42	-5.51	-5.67	-5.70	-5.35
22	*****	*****	1.79	1.79	1.66	2.41	1.79	.22	-1.52	-5.90	-5.77	-6.01	-6.09	-6.11	-5.77
23	*****	*****	1.60	1.60	1.52	2.22	1.60	.03	-1.77	-5.83	-5.76	-6.20	-6.11	-6.14	-5.82
24	*****	*****	1.60	1.60	1.57	2.23	1.60	.03	-1.88	-5.77	-5.74	-6.41	-6.16	-6.08	-5.77
25	*****	*****	1.56	1.56	1.51	2.19	1.56	-.02	-2.07	-5.68	-5.77	-6.66	-6.26	-6.05	-5.73
26	*****	*****	1.77	1.77	1.72	2.41	1.77	.19	-1.93	-5.34	-5.59	-6.48	-6.01	-5.77	-5.47
27	*****	*****	1.79	1.79	1.74	2.45	1.79	.26	-1.81	-5.41	-5.74	-6.61	-5.95	-5.81	-5.52
28	*****	*****	1.66	1.66	1.62	2.31	1.66	.14	-1.79	-5.37	-5.69	-6.57	-5.78	-5.67	-5.38
29	*****	*****	1.72	1.72	1.75	2.35	1.72	.17	-1.58	-5.17	-5.42	-6.31	-5.55	-5.46	-5.18
30	*****	*****	1.62	1.62	1.68	2.26	1.62	.04	-1.61	-5.13	-5.36	-6.21	-5.47	-5.47	-5.18
31	*****	*****	1.65	1.65	1.69	2.30	1.65	.09	-1.51	-4.92	-5.19	-5.89	-5.25	-5.23	-5.02
32	*****	*****	1.65	1.65	1.64	2.31	1.65	.10	-1.30	-4.83	-5.11	-5.69	-5.22	-5.10	-5.00
33	*****	*****	1.68	1.68	1.60	2.32	1.68	.12	-1.01	-4.04	-4.24	-4.77	-4.52	-4.28	-4.23
34	*****	*****	1.59	1.59	1.47	2.24	1.59	.04	-.80	-3.77	-3.94	-4.46	-4.28	-3.96	-3.94
35	*****	*****	1.75	1.75	1.68	2.38	1.75	.19	-.40	-3.33	-3.58	-4.05	-3.86	-3.49	-3.51
36	*****	*****	1.72	1.72	1.76	2.35	1.72	.13	-.13	-2.76	-3.16	-3.53	-3.37	-2.87	-3.02
37	*****	*****	1.63	1.63	1.66	2.24	1.63	.09	.05	-2.50	-3.02	-3.23	-3.19	-2.55	-2.81
38	*****	*****	1.45	1.45	1.45	2.10	1.45	-.08	.03	-1.96	-2.54	-2.54	-2.75	-1.99	-2.24
39	*****	*****	1.24	1.24	1.18	1.89	1.24	-.32	-.01	-1.64	-2.31	-1.99	-2.46	-1.67	-1.88
40	*****	*****	1.09	1.09	1.02	1.73	1.09	-.46	.06	-1.28	-2.12	-1.48	-2.19	-1.29	-1.51
41	*****	*****	1.17	1.17	1.15	1.79	1.17	-.42	.30	-.87	-1.88	-.99	-1.78	-.82	-1.08
42	*****	*****	1.54	1.54	1.56	2.15	1.54	-.10	.75	-.71	-1.68	-.72	-1.45	-.51	-.89
43	*****	*****	1.37	1.37	1.39	2.00	1.37	-.29	.81	-.62	-1.41	-.46	-1.18	-.19	-.70
44	*****	*****	1.32	1.32	1.33	1.96	1.32	-.31	1.00	-.25	-.93	.06	-.64	.33	-.26
45	*****	*****	1.01	1.01	1.02	1.62	1.01	-.65	.86	.09	-.44	.53	-.23	.78	.10
46	*****	*****	1.12	1.12	1.16	1.72	1.12	-.59	1.04	-.06	-.32	.54	-.32	.79	.09
47	*****	*****	1.31	1.31	1.43	1.89	1.31	-.47	1.21	.30	.29	1.07	.12	1.24	.57
48	*****	*****	1.47	1.47	1.60	2.09	1.47	-.27	1.31	.30	.40	1.17	.20	1.27	.69
49	*****	*****	1.07	1.07	1.13	1.62	1.07	-.70	.88	.15	.30	1.05	.20	1.08	.61
50	*****	*****	1.14	1.14	1.23	1.66	1.14	-.66	.92	.11	.36	1.04	.29	.94	.65
51	*****	*****	1.21	1.21	1.34	1.76	1.21	-.59	.85	.27	.61	1.21	.64	1.14	.98
52	*****	*****	1.31	1.31	1.45	1.87	1.31	-.46	.96	.34	.61	1.27	.90	1.12	1.16
53	*****	*****	1.00	1.00	1.14	1.47	1.00	-.78	.60	.52	.72	1.44	1.20	1.06	1.35
54	*****	*****	.83	.83	1.01	1.37	.83	-.88	.25	.43	.83	1.57	1.34	.97	1.43
55	*****	*****	1.11	1.11	1.32	1.61	1.11	-.61	.30	.05	.71	1.45	1.22	.68	1.20
56	*****	*****	.59	.59	.85	1.18	.59	-1.04	-.12	.09	.85	1.49	1.17	.72	1.21
57	*****	*****	-.36	-.36	-.01	.24	-.36	-1.97	-1.08	-.62	.27	.71	.31	.02	.63
58	*****	*****	-1.10	-1.10	-.67	-.50	-1.10	-2.69	-1.82	-.53	.28	.75	.23	.11	.69
59	*****	*****	-2.23	-2.23	-2.14	-1.68	-2.23	-3.73	-2.62	-.84	-.48	-.18	-.65	-.34	-.25
60	*****	*****	-7.64	-7.64	-7.03	-7.03	-7.64	-9.07	-6.73	-3.64	-3.77	-3.87	-3.88	-3.58	-3.09
61	.83	.83	.83	.83	.83	.83	.83	.83	.83	.83	.83	.83	.83	.83	.83
62	.97	.97	.97	.97	.97	.97	.97	.97	.97	.97	.97	.97	.97	.97	.97

NOAA-9 SCANNER OFFSETS FOR AUGUST 1985: LONGMAYE CHANNEL

S.P.	DAY OF MONTH -->															
	16	17	18	19	20	21	22	23	24	25	26	27	28	29	30	31
1	.29	.29	.29	.29	.29	.29	.29	.29	.29	.29	.29	.29	.29	.29	.29	.29
2	.59	.59	.59	.59	.59	.59	.59	.59	.59	.59	.59	.59	.59	.59	.59	.59
3	.63	.63	.63	.63	.63	.63	.63	.63	.63	.63	.63	.63	.63	.63	.63	.63
4	.27	.27	.27	.27	.27	.27	.27	.27	.27	.27	.27	.27	.27	.27	.27	.27
5	-6.40	-7.69	-7.68	-6.50	-7.06	-6.50	-6.10	-5.13	-5.18	-4.59	-5.20	-5.39	-6.34	-5.22	-4.62	-4.14
6	-2.75	-3.97	-3.96	-2.89	-3.31	-3.11	-3.13	-2.35	-2.65	-2.83	-2.74	-2.37	-2.88	-2.59	-2.00	-1.92
7	-1.80	-2.48	-1.96	-1.73	-2.31	-2.05	-2.06	-1.55	-1.88	-2.07	-1.84	-1.34	-1.66	-1.67	-1.01	-1.26
8	-1.66	-1.83	-1.11	-1.37	-1.43	-1.67	-1.40	-1.35	-1.38	-1.56	-1.36	-.92	-1.30	-1.04	-.56	-1.00
9	-2.67	-2.38	-1.76	-2.36	-2.04	-2.57	-2.06	-2.14	-2.18	-2.18	-2.21	-1.81	-2.35	-1.90	-1.58	-2.02
10	-2.82	-2.43	-1.97	-2.58	-2.08	-2.74	-2.20	-2.20	-2.30	-2.19	-2.56	-1.94	-2.58	-2.29	-1.92	-2.34
11	-3.02	-2.67	-2.27	-2.88	-2.31	-2.89	-2.47	-2.49	-2.49	-2.40	-2.88	-2.15	-2.77	-2.60	-2.33	-2.67
12	-3.18	-2.96	-2.61	-3.31	-2.72	-3.12	-2.76	-2.87	-2.76	-2.72	-3.07	-2.53	-3.06	-2.84	-2.79	-2.95
13	-3.33	-3.11	-2.96	-3.82	-3.15	-3.45	-3.09	-3.28	-2.90	-3.07	-3.33	-2.98	-3.39	-3.11	-3.21	-3.22
14	-3.71	-3.46	-3.51	-4.48	-3.78	-4.05	-3.76	-3.73	-3.29	-3.63	-3.89	-3.68	-3.90	-3.61	-3.69	-3.76
15	-3.66	-3.52	-3.68	-4.71	-4.05	-4.32	-4.06	-3.86	-3.51	-3.85	-4.08	-3.98	-4.08	-3.82	-3.84	-3.89
16	-3.55	-3.59	-3.84	-4.81	-4.30	-4.50	-4.22	-3.96	-3.80	-3.97	-4.20	-4.15	-4.28	-3.94	-3.99	-3.96
17	-3.86	-3.95	-4.26	-5.20	-4.53	-4.88	-4.69	-4.35	-4.29	-4.41	-4.56	-4.64	-4.73	-4.32	-4.36	-4.32
18	-4.15	-4.04	-4.60	-5.45	-4.92	-5.14	-5.00	-4.71	-4.61	-4.75	-4.85	-5.05	-5.10	-4.60	-4.57	-4.59
19	-4.61	-4.32	-5.10	-5.79	-5.41	-5.60	-5.39	-5.22	-5.09	-5.29	-5.58	-5.50	-5.60	-5.04	-4.95	-5.04
20	-4.84	-4.55	-5.41	-5.85	-5.49	-5.85	-5.59	-5.54	-5.42	-5.68	-5.52	-5.90	-5.88	-5.30	-5.27	-5.32
21	-5.13	-4.92	-5.80	-6.11	-5.75	-6.17	-5.83	-5.96	-5.68	-6.14	-5.85	-6.39	-6.23	-5.62	-5.72	-5.74
22	-5.51	-5.38	-6.32	-6.55	-6.17	-6.58	-6.13	-6.44	-5.99	-6.64	-6.28	-6.95	-6.61	-6.02	-6.27	-6.28
23	-5.51	-5.43	-6.44	-6.57	-6.30	-6.53	-6.06	-6.47	-5.99	-6.72	-6.27	-7.10	-6.69	-6.08	-6.36	-6.32
24	-5.57	-5.47	-6.54	-6.61	-6.22	-6.47	-6.01	-6.37	-6.03	-6.73	-6.22	-7.21	-6.73	-6.16	-6.36	-6.35
25	-5.64	-5.52	-6.63	-6.62	-6.21	-6.42	-6.04	-6.28	-6.15	-6.70	-6.13	-7.27	-6.72	-6.24	-6.37	-6.41
26	-5.39	-5.26	-6.36	-6.23	-5.97	-6.11	-5.81	-5.95	-5.92	-6.31	-5.83	-6.99	-6.41	-6.01	-6.14	-6.13
27	-5.35	-5.32	-6.34	-6.19	-5.92	-6.15	-5.84	-5.97	-5.94	-6.33	-5.90	-7.01	-6.45	-6.12	-6.22	-6.18
28	-5.20	-5.28	-6.19	-6.07	-5.88	-6.09	-5.71	-5.85	-5.84	-6.23	-5.86	-6.88	-6.40	-6.02	-6.14	-6.11
29	-4.96	-5.20	-6.01	-5.83	-5.70	-5.93	-5.54	-5.62	-5.64	-6.03	-5.70	-6.61	-6.28	-5.82	-5.98	-5.90
30	-4.91	-5.29	-6.00	-5.77	-5.70	-5.99	-5.60	-5.59	-5.60	-6.03	-5.69	-6.55	-6.28	-5.76	-5.99	-5.85
31	-4.70	-5.16	-5.75	-5.49	-5.52	-5.83	-5.42	-5.32	-5.39	-5.82	-5.48	-6.31	-6.00	-5.50	-5.78	-5.58
32	-4.66	-5.12	-5.70	-5.33	-5.49	-5.71	-5.32	-5.21	-5.27	-5.69	-5.43	-6.11	-5.82	-5.34	-5.65	-5.43
33	-3.88	-4.31	-4.90	-4.49	-4.71	-4.87	-4.56	-4.41	-4.43	-4.97	-4.60	-5.17	-4.85	-4.42	-4.82	-4.52
34	-3.61	-3.97	-4.60	-4.17	-4.41	-4.56	-4.37	-4.14	-4.15	-4.74	-4.30	-4.76	-4.40	-4.07	-4.60	-4.14
35	-3.19	-3.53	-4.20	-3.76	-4.04	-4.06	-4.06	-3.74	-3.77	-4.30	-3.90	-4.24	-3.86	-3.61	-4.22	-3.71
36	-2.66	-3.10	-3.67	-3.30	-3.67	-3.53	-3.59	-3.24	-3.30	-3.74	-3.47	-3.61	-3.30	-3.03	-3.68	-3.21
37	-2.47	-3.02	-3.41	-3.10	-3.49	-3.29	-3.28	-2.98	-3.03	-3.46	-3.27	-3.21	-3.03	-2.70	-3.42	-2.95
38	-1.97	-2.63	-2.88	-2.61	-2.90	-2.80	-2.63	-2.36	-2.48	-2.96	-2.81	-2.52	-2.52	-2.10	-2.92	-2.40
39	-1.67	-2.43	-2.60	-2.27	-2.46	-2.52	-2.26	-1.95	-2.16	-2.69	-2.51	-2.02	-2.20	-1.69	-2.61	-2.03
40	-1.40	-2.16	-2.30	-1.88	-2.02	-2.22	-1.99	-1.55	-1.78	-2.42	-2.12	-1.57	-1.85	-1.29	-2.22	-1.59
41	-1.07	-1.80	-1.94	-1.43	-1.53	-1.89	-1.68	-1.10	-1.32	-2.07	-1.68	-1.13	-1.43	-.81	-1.70	-1.14
42	-.83	-1.61	-1.74	-1.12	-1.25	-1.76	-1.51	-.82	-1.04	-1.83	-1.43	-.87	-1.12	-.51	-1.37	-.86
43	-.55	-1.39	-1.55	-.80	-1.02	-1.60	-1.30	-.55	-.69	-1.54	-1.14	-.64	-.79	-.22	-1.03	-.66
44	-.11	-1.02	-1.21	-.28	-.53	-1.14	-.95	-.15	-.08	-1.06	-.66	-.14	-.23	.24	-.43	-.25
45	.25	-.73	-.94	.14	-.14	-.72	-.59	.15	.46	-.64	-.34	.34	.22	.55	.06	.21
46	.24	-.73	-.99	.17	-.16	-.74	-.46	.04	.50	-.60	-.40	.36	.23	.45	.10	.24
47	.75	-.22	-.49	.70	.30	-.35	.13	.46	.93	-.07	.03	.78	.72	.92	.60	.69
48	.80	-.18	-.37	.89	.21	-.35	.23	.55	.93	-.07	.02	.74	.81	1.00	.62	.72
49	.73	-.40	-.39	.82	.26	-.42	.09	.47	.69	-.25	-.25	.58	.75	.74	.35	.61
50	.77	-.45	-.30	.71	.25	-.38	.11	.51	.48	-.30	-.32	.55	.72	.57	.22	.63
51	1.00	-.17	.05	.85	.37	-.07	.44	.88	.50	-.10	-.04	.81	1.05	.70	.59	.95
52	1.02	-.02	.26	.78	.62	.18	.66	1.09	.55	-.03	.19	.97	1.25	.64	.99	1.06
53	1.00	.00	.59	.82	.67	.47	.86	1.25	.73	.01	.39	1.15	1.47	.66	1.30	1.16
54	1.01	.02	.87	.86	.79	.68	.87	1.36	.74	.04	.51	1.34	1.53	.80	1.33	1.10
55	.78	.01	.91	.64	.55	.50	.63	.93	.55	-.04	.40	1.26	1.23	.91	1.10	.84
56	.77	.32	1.15	.60	.51	.36	.75	.63	.55	.22	.49	1.27	1.14	1.09	1.11	.75
57	.16	.16	.79	-.07	-.18	-.31	.16	-.04	-.03	-.19	.05	.62	.28	.27	.38	.01
58	.21	.60	.99	.10	.23	-.07	.16	.12	.22	.16	.24	.59	-.01	.21	.34	.01
59	-.32	.23	.18	-.76	-.15	-.59	-.69	-.63	-.43	-.44	-.40	-.47	-.92	-.52	-.26	-.71
60	-3.18	-2.15	-2.45	-3.83	-2.58	-3.54	-3.70	-4.19	-3.85	-4.63	-3.88	-3.81	-3.13	-3.58	-3.70	-4.11
61	.83	.83	.83	.83	.83	.83	.83	.83	.83	.83	.83	.83	.83	.83	.83	.83
62	.97	.97	.97	.97	.97	.97	.97	.97	.97	.97	.97	.97	.97	.97	.97	.97

NOAA-9 SCANNER OFFSETS FOR AUGUST 1985: SHORTWAVE CHANNEL

S.P.	DAY OF MONTH -->														
	1	2	3	4	5	6	7	8	9	10	11	12	13	14	15
1	-.11	-.11	-.11	-.11	-.11	-.11	-.11	-.11	-.11	-.11	-.11	-.11	-.11	-.11	-.11
2	.32	.32	.32	.32	.32	.32	.32	.32	.32	.32	.32	.32	.32	.32	.32
3	.49	.49	.49	.49	.49	.49	.49	.49	.49	.49	.49	.49	.49	.49	.49
4	-4.09	-4.09	-4.09	-4.09	-4.09	-4.09	-4.09	-4.09	-4.09	-4.09	-4.09	-4.09	-4.09	-4.09	-4.09
5	*****	*****	.31	.31	.31	.31	.31	.31	.26	.25	.25	.33	.25	.33	.25
6	*****	*****	.40	.40	.40	.40	.40	.40	.34	.32	.32	.40	.32	.40	.32
7	*****	*****	.05	.05	.05	.05	.05	.05	.00	-.02	-.02	.06	-.02	.06	-.02
8	*****	*****	.38	.38	.38	.38	.38	.38	.32	.29	.29	.37	.29	.37	.29
9	*****	*****	.42	.42	.42	.42	.42	.42	.38	.37	.37	.45	.37	.45	.37
10	*****	*****	-.03	-.03	-.03	-.03	-.03	-.03	-.02	.02	.02	.10	.02	.10	.02
11	*****	*****	.40	.40	.40	.40	.40	.40	.32	.28	.28	.37	.28	.37	.28
12	*****	*****	.42	.42	.42	.42	.42	.42	.35	.31	.31	.40	.31	.40	.31
13	*****	*****	-.65	-.65	-.65	-.65	-.65	-.65	-.59	-.43	-.43	-.36	-.43	-.36	-.43
14	*****	*****	-.61	-.61	-.61	-.61	-.61	-.61	-.51	-.25	-.25	-.18	-.25	-.18	-.25
15	*****	*****	-.42	-.42	-.42	-.42	-.42	-.42	-.40	-.26	-.26	-.18	-.26	-.18	-.26
16	*****	*****	-.74	-.74	-.74	-.74	-.74	-.74	-.73	-.61	-.61	-.53	-.61	-.53	-.61
17	*****	*****	-.42	-.42	-.42	-.42	-.42	-.42	-.42	-.31	-.31	-.22	-.31	-.22	-.31
18	*****	*****	-.38	-.38	-.38	-.38	-.38	-.38	-.40	-.30	-.30	-.22	-.30	-.22	-.30
19	*****	*****	-.72	-.72	-.72	-.72	-.72	-.72	-.75	-.65	-.65	-.57	-.65	-.57	-.65
20	*****	*****	-.41	-.41	-.41	-.41	-.41	-.41	-.42	-.30	-.30	-.22	-.30	-.22	-.30
21	*****	*****	-.50	-.50	-.50	-.50	-.50	-.50	-.47	-.29	-.29	-.20	-.29	-.20	-.29
22	*****	*****	-.73	-.73	-.73	-.73	-.73	-.73	-.77	-.69	-.69	-.61	-.69	-.61	-.69
23	*****	*****	-.36	-.36	-.36	-.36	-.36	-.36	-.42	-.35	-.35	-.26	-.35	-.26	-.35
24	*****	*****	-.32	-.32	-.32	-.32	-.32	-.32	-.38	-.31	-.31	-.23	-.31	-.23	-.31
25	*****	*****	-.67	-.67	-.67	-.67	-.67	-.67	-.72	-.65	-.65	-.57	-.65	-.57	-.65
26	*****	*****	-.32	-.32	-.32	-.32	-.32	-.32	-.38	-.30	-.30	-.22	-.30	-.22	-.30
27	*****	*****	-.30	-.30	-.30	-.30	-.30	-.30	-.35	-.27	-.27	-.19	-.27	-.19	-.27
28	*****	*****	-.66	-.66	-.66	-.66	-.66	-.66	-.70	-.62	-.62	-.54	-.62	-.54	-.62
29	*****	*****	-.36	-.36	-.36	-.36	-.36	-.36	-.38	-.25	-.25	-.16	-.25	-.16	-.25
30	*****	*****	-.44	-.44	-.44	-.44	-.44	-.44	-.40	-.20	-.20	-.11	-.20	-.11	-.20
31	*****	*****	-.64	-.64	-.64	-.64	-.64	-.64	-.66	-.53	-.53	-.45	-.53	-.45	-.53
32	*****	*****	-.37	-.37	-.37	-.37	-.37	-.37	-.35	-.20	-.20	-.11	-.20	-.11	-.20
33	*****	*****	-.82	-.82	-.82	-.82	-.82	-.82	-.86	-.28	-.28	-.19	-.28	-.19	-.28
34	*****	*****	-1.40	-1.40	-1.40	-1.40	-1.40	-1.40	-1.17	-.67	-.67	-.58	-.67	-.58	-.67
35	*****	*****	-.95	-.95	-.95	-.95	-.95	-.95	-.77	-.34	-.34	-.25	-.34	-.25	-.34
36	*****	*****	-.89	-.89	-.89	-.89	-.89	-.89	-.71	-.27	-.27	-.18	-.27	-.18	-.27
37	*****	*****	-1.23	-1.23	-1.23	-1.23	-1.23	-1.23	-1.03	-.57	-.57	-.48	-.57	-.48	-.57
38	*****	*****	-.91	-.91	-.91	-.91	-.91	-.91	-.70	-.22	-.22	-.12	-.22	-.12	-.22
39	*****	*****	-.88	-.88	-.88	-.88	-.88	-.88	-.66	-.16	-.16	-.06	-.16	-.06	-.16
40	*****	*****	-1.28	-1.28	-1.28	-1.28	-1.28	-1.28	-1.01	-.46	-.46	-.37	-.46	-.37	-.46
41	*****	*****	-1.07	-1.07	-1.07	-1.07	-1.07	-1.07	-.74	-.10	-.10	-.01	-.10	-.01	-.10
42	*****	*****	-.87	-.87	-.87	-.87	-.87	-.87	-.61	-.04	-.04	.05	-.04	.05	-.04
43	*****	*****	-1.23	-1.23	-1.23	-1.23	-1.23	-1.23	-.94	-.38	-.38	-.28	-.38	-.28	-.38
44	*****	*****	-.92	-.92	-.92	-.92	-.92	-.92	-.64	-.05	-.05	.05	-.05	.05	-.05
45	*****	*****	-.90	-.90	-.90	-.90	-.90	-.90	-.61	-.02	-.02	.08	-.02	.08	-.02
46	*****	*****	-1.27	-1.27	-1.27	-1.27	-1.27	-1.27	-.97	-.37	-.37	-.27	-.37	-.27	-.37
47	*****	*****	-.97	-.97	-.97	-.97	-.97	-.97	-.67	-.05	-.05	.04	-.05	.04	-.05
48	*****	*****	-.94	-.94	-.94	-.94	-.94	-.94	-.63	-.01	-.01	.09	-.01	.09	-.01
49	*****	*****	-1.35	-1.35	-1.35	-1.35	-1.35	-1.35	-1.02	-.34	-.34	-.25	-.34	-.25	-.34
50	*****	*****	-1.16	-1.16	-1.16	-1.16	-1.16	-1.16	-.77	-.01	-.01	.08	-.01	.08	-.01
51	*****	*****	-.98	-.98	-.98	-.98	-.98	-.98	-.66	.00	.00	.10	.00	.10	.00
52	*****	*****	-1.30	-1.30	-1.30	-1.30	-1.30	-1.30	-.99	-.33	-.33	-.23	-.33	-.23	-.33
53	*****	*****	-.56	-.56	-.56	-.56	-.56	-.56	-.26	.31	.31	.43	.31	.43	.31
54	*****	*****	-.08	-.08	-.08	-.08	-.08	-.08	.23	.84	.84	.94	.84	.94	.84
55	*****	*****	-.21	-.21	-.21	-.21	-.21	-.21	.04	.55	.55	.65	.55	.65	.55
56	*****	*****	.15	.15	.15	.15	.15	.15	.36	.85	.85	.95	.85	.95	.85
57	*****	*****	.25	.25	.25	.25	.25	.25	.44	.89	.89	.99	.89	.99	.89
58	*****	*****	-.04	-.04	-.04	-.04	-.04	-.04	.14	.54	.54	.65	.54	.65	.54
59	*****	*****	.33	.33	.33	.33	.33	.33	.46	.83	.83	.94	.83	.94	.83
60	*****	*****	.36	.36	.36	.36	.36	.36	.50	.85	.85	.98	.85	.98	.85
61	3.05	3.05	3.05	3.05	3.05	3.05	3.05	3.05	3.05	3.05	3.05	3.05	3.05	3.05	3.05
62	.45	.45	.45	.45	.45	.45	.45	.45	.45	.45	.45	.45	.45	.45	.45

NOAA-9 SCANNER OFFSETS FOR AUGUST 1985: SHORTWAVE CHANNEL

S.P.	DAY OF MONTH -->															
	16	17	18	19	20	21	22	23	24	25	26	27	28	29	30	31
1	-.11	-.11	-.11	-.11	-.11	-.11	-.11	-.11	-.11	-.11	-.11	-.11	-.11	-.11	-.11	-.11
2	.32	.32	.32	.32	.32	.32	.32	.32	.32	.32	.32	.32	.32	.32	.32	.32
3	.49	.49	.49	.49	.49	.49	.49	.49	.49	.49	.49	.49	.49	.49	.49	.49
4	-4.09	-4.09	-4.09	-4.09	-4.09	-4.09	-4.09	-4.09	-4.09	-4.09	-4.09	-4.09	-4.09	-4.09	-4.09	-4.09
5	.12	.10	.15	.31	.36	.28	.15	.29	.29	.36	.36	.42	.32	.41	.39	.41
6	.19	.17	.21	.39	.43	.35	.21	.36	.36	.44	.44	.49	.39	.49	.47	.49
7	-.15	-.17	-.12	.05	.10	.00	-.14	.01	.01	.10	.10	.15	.05	.15	.14	.15
8	.16	.15	.20	.37	.41	.31	.18	.31	.33	.41	.41	.46	.37	.46	.45	.46
9	.23	.22	.28	.45	.49	.40	.26	.39	.40	.48	.49	.54	.45	.54	.53	.55
10	-.12	-.12	-.06	.10	.15	.06	-.08	.05	.05	.13	.14	.20	.11	.19	.18	.20
11	.13	.13	.19	.36	.41	.32	.18	.31	.32	.40	.40	.47	.37	.46	.45	.47
12	.16	.17	.22	.39	.44	.35	.20	.34	.34	.42	.43	.49	.41	.49	.47	.49
13	-.60	-.56	-.51	-.38	-.30	-.40	-.56	-.42	-.43	-.38	-.33	-.26	-.35	-.29	-.33	-.31
14	-.42	-.42	-.36	-.19	-.14	-.23	-.38	-.22	-.22	-.17	-.12	-.07	-.19	-.10	-.13	-.10
15	-.42	-.42	-.37	-.19	-.13	-.23	-.38	-.22	-.23	-.16	-.13	-.08	-.19	-.11	-.13	-.10
16	-.76	-.77	-.71	-.55	-.49	-.58	-.74	-.58	-.59	-.53	-.49	-.44	-.56	-.47	-.49	-.47
17	-.46	-.47	-.42	-.24	-.18	-.27	-.44	-.28	-.29	-.23	-.19	-.14	-.25	-.16	-.19	-.17
18	-.45	-.45	-.41	-.23	-.17	-.27	-.43	-.27	-.28	-.22	-.18	-.13	-.25	-.16	-.18	-.15
19	-.80	-.80	-.76	-.58	-.53	-.63	-.79	-.62	-.63	-.58	-.54	-.49	-.61	-.51	-.54	-.52
20	-.45	-.46	-.42	-.23	-.19	-.28	-.45	-.29	-.29	-.24	-.19	-.15	-.27	-.17	-.20	-.18
21	-.43	-.44	-.40	-.22	-.17	-.27	-.44	-.27	-.28	-.23	-.18	-.14	-.26	-.17	-.19	-.17
22	-.84	-.83	-.80	-.61	-.57	-.67	-.84	-.68	-.69	-.64	-.59	-.55	-.67	-.58	-.60	-.58
23	-.50	-.51	-.47	-.27	-.23	-.34	-.50	-.35	-.35	-.30	-.26	-.22	-.34	-.24	-.26	-.24
24	-.46	-.47	-.43	-.24	-.20	-.31	-.47	-.31	-.32	-.27	-.23	-.19	-.31	-.21	-.24	-.21
25	-.80	-.82	-.77	-.58	-.54	-.65	-.82	-.66	-.67	-.63	-.58	-.54	-.67	-.57	-.59	-.57
26	-.45	-.47	-.43	-.23	-.19	-.30	-.47	-.31	-.33	-.27	-.24	-.20	-.32	-.22	-.25	-.22
27	-.42	-.44	-.39	-.20	-.16	-.27	-.44	-.28	-.29	-.24	-.21	-.17	-.29	-.20	-.22	-.19
28	-.75	-.79	-.74	-.54	-.51	-.61	-.78	-.62	-.64	-.59	-.55	-.52	-.64	-.55	-.57	-.54
29	-.39	-.43	-.37	-.17	-.15	-.24	-.41	-.25	-.26	-.22	-.18	-.14	-.27	-.17	-.19	-.16
30	-.33	-.37	-.32	-.12	-.08	-.19	-.34	-.18	-.20	-.16	-.12	-.09	-.21	-.12	-.14	-.11
31	-.66	-.71	-.66	-.46	-.42	-.52	-.68	-.52	-.54	-.49	-.46	-.43	-.55	-.45	-.47	-.44
32	-.33	-.38	-.32	-.13	-.09	-.18	-.34	-.17	-.19	-.15	-.10	-.08	-.20	-.11	-.13	-.10
33	-.42	-.45	-.40	-.20	-.15	-.25	-.39	-.22	-.25	-.24	-.13	-.12	-.26	-.17	-.21	-.17
34	-.80	-.84	-.78	-.58	-.54	-.64	-.76	-.58	-.61	-.60	-.50	-.49	-.64	-.54	-.58	-.53
35	-.47	-.52	-.47	-.26	-.22	-.30	-.42	-.25	-.27	-.26	-.16	-.16	-.30	-.21	-.24	-.19
36	-.40	-.45	-.39	-.18	-.14	-.23	-.34	-.16	-.18	-.17	-.08	-.07	-.21	-.12	-.15	-.10
37	-.70	-.75	-.70	-.49	-.45	-.53	-.63	-.44	-.47	-.46	-.36	-.36	-.50	-.41	-.44	-.39
38	-.34	-.40	-.35	-.13	-.10	-.17	-.26	-.07	-.10	-.09	.00	.00	-.14	-.05	-.07	-.02
39	-.28	-.34	-.28	-.07	-.03	-.11	-.18	.00	-.03	-.03	.07	.07	-.06	.03	.00	.06
40	-.57	-.64	-.58	-.38	-.34	-.40	-.48	-.29	-.32	-.32	-.22	-.22	-.36	-.26	-.29	-.24
41	-.21	-.27	-.23	-.01	.03	-.04	-.10	.08	.06	.06	.15	.15	.01	.10	.08	.13
42	-.15	-.22	-.17	.05	.09	.02	-.04	.14	.12	.12	.21	.21	.07	.17	.13	.19
43	-.48	-.55	-.50	-.28	-.24	-.31	-.37	-.18	-.21	-.22	-.12	-.12	-.26	-.17	-.20	-.14
44	-.15	-.22	-.16	.05	.09	.02	-.04	.14	.12	.12	.21	.21	.07	.16	.13	.18
45	-.12	-.19	-.14	.08	.12	.04	-.01	.17	.15	.14	.23	.23	.10	.19	.16	.21
46	-.46	-.53	-.49	-.27	-.23	-.29	-.35	-.17	-.20	-.21	-.12	-.12	-.25	-.16	-.19	-.14
47	-.16	-.23	-.18	.03	.07	.01	-.03	.14	.12	.10	.20	.19	.06	.15	.12	.17
48	-.10	-.18	-.13	.08	.12	.05	.01	.18	.16	.14	.24	.23	.10	.19	.17	.22
49	-.44	-.51	-.46	-.26	-.22	-.29	-.33	-.16	-.19	-.20	-.10	-.10	-.23	-.14	-.17	-.12
50	-.11	-.18	-.13	.07	.11	.04	.00	.17	.15	.14	.23	.23	.09	.18	.16	.22
51	-.08	-.17	-.11	.08	.12	.05	.01	.18	.15	.15	.24	.23	.11	.20	.18	.23
52	-.42	-.51	-.46	-.25	-.22	-.29	-.32	-.15	-.18	-.18	-.09	-.10	-.23	-.14	-.15	-.09
53	.25	.10	.16	.45	.42	.38	.37	.55	.51	.53	.65	.63	.40	.53	.55	.62
54	.76	.66	.71	.94	.96	.89	.85	1.02	.99	1.00	1.10	1.09	.93	1.04	1.04	1.10
55	.47	.37	.42	.64	.66	.59	.55	.71	.68	.68	.79	.79	.63	.73	.73	.79
56	.75	.67	.72	.94	.96	.88	.83	.99	.96	.97	1.07	1.08	.93	1.03	1.03	1.08
57	.81	.73	.77	.99	1.00	.93	.88	1.04	1.01	1.02	1.12	1.12	.97	1.07	1.07	1.13
58	.47	.39	.43	.64	.66	.58	.53	.69	.66	.67	.77	.76	.61	.72	.72	.78
59	.76	.66	.71	.92	.94	.86	.80	.96	.93	.94	1.04	1.05	.90	1.00	1.00	1.05
60	.78	.70	.73	.95	.97	.89	.83	.99	.96	.97	1.07	1.06	.92	1.02	1.02	1.07
61	3.05	3.05	3.05	3.05	3.05	3.05	3.05	3.05	3.05	3.05	3.05	3.05	3.05	3.05	3.05	3.05
62	.45	.45	.45	.45	.45	.45	.45	.45	.45	.45	.45	.45	.45	.45	.45	.45

NOAA-9 SCANNER OFFSETS FOR SEPTEMBER 1985:

TOTAL CHANNEL

S.P.	DAY OF MONTH -->														
	1	2	3	4	5	6	7	8	9	10	11	12	13	14	15
1	.36	.36	.36	.36	.36	.36	.36	.36	.36	.36	.36	.36	.36	.36	.36
2	1.04	1.04	1.04	1.04	1.04	1.04	1.04	1.04	1.04	1.04	1.04	1.04	1.04	1.04	1.04
3	1.93	1.93	1.93	1.93	1.93	1.93	1.93	1.93	1.93	1.93	1.93	1.93	1.93	1.93	1.93
4	-9.64	-9.64	-9.64	-9.64	-9.64	-9.64	-9.64	-9.64	-9.64	-9.64	-9.64	-9.64	-9.64	-9.64	-9.64
5	-2.25	-4.72	-5.66	-1.79	-.87	-.20	-.24	1.76	2.30	1.15	1.84	1.06	-.72	-3.74	-3.91
6	.20	-.67	-1.53	.27	1.33	.80	.96	1.47	1.45	.84	.85	.83	.66	-.31	-.14
7	-1.59	-1.81	-2.79	-1.63	-.75	-.83	-1.09	-.56	-.85	-1.26	-1.84	-1.69	-1.02	-1.76	-1.54
8	-1.60	-1.53	-2.77	-1.48	-.75	-.69	-1.17	-.25	-1.00	-1.20	-1.88	-2.02	-.72	-1.75	-1.91
9	-1.62	-1.71	-2.79	-1.30	-.90	-.68	-1.49	-.26	-1.23	-1.21	-2.03	-2.20	-.85	-2.02	-2.27
10	-1.56	-1.99	-2.66	-1.05	-1.08	-.73	-1.85	-.44	-1.27	-1.09	-2.23	-2.38	-1.22	-2.31	-2.18
11	-1.13	-1.74	-1.93	-.61	-.63	-.59	-1.59	-.08	-1.07	-.66	-1.95	-1.93	-1.07	-2.24	-1.62
12	-1.57	-2.31	-2.05	-1.24	-1.01	-.92	-1.88	-.49	-1.62	-1.01	-2.43	-1.94	-1.47	-3.04	-1.80
13	-2.02	-2.70	-2.24	-1.70	-1.53	-1.22	-2.06	-.92	-1.87	-1.33	-2.78	-2.09	-1.80	-3.76	-1.98
14	-1.96	-2.50	-2.09	-1.62	-1.47	-1.32	-1.74	-.82	-1.46	-1.21	-2.49	-1.89	-1.77	-3.73	-1.76
15	-1.66	-2.21	-1.91	-1.47	-1.36	-1.47	-1.44	-.81	-1.18	-1.42	-2.20	-1.63	-1.67	-3.37	-1.44
16	-1.59	-2.28	-2.07	-1.43	-1.47	-1.69	-1.35	-1.20	-1.27	-1.96	-2.12	-1.53	-1.79	-3.17	-1.33
17	-1.59	-2.39	-2.31	-1.34	-1.58	-1.59	-1.23	-1.56	-1.43	-2.41	-2.20	-1.52	-2.01	-3.01	-1.41
18	-1.76	-2.56	-2.59	-1.45	-1.73	-1.77	-1.30	-1.76	-1.69	-2.78	-2.41	-1.65	-2.19	-3.04	-1.64
19	-2.18	-2.80	-2.79	-1.69	-1.79	-1.81	-1.55	-2.03	-1.93	-3.15	-2.57	-1.88	-2.33	-3.06	-1.86
20	-2.58	-3.07	-2.87	-1.88	-1.81	-1.64	-1.67	-2.33	-2.04	-3.44	-2.59	-2.10	-2.42	-3.03	-2.00
21	-2.69	-3.23	-2.89	-1.89	-1.70	-1.56	-1.70	-2.55	-2.01	-3.61	-2.62	-2.28	-2.52	-3.00	-2.11
22	-2.76	-3.37	-2.94	-2.07	-1.79	-1.71	-1.83	-2.69	-2.13	-3.68	-2.77	-2.55	-2.58	-3.03	-2.35
23	-2.59	-3.30	-2.84	-2.02	-1.64	-1.64	-1.81	-2.52	-2.09	-3.54	-2.58	-2.63	-2.40	-2.95	-2.41
24	-2.45	-3.29	-2.78	-2.01	-1.36	-1.66	-1.80	-2.35	-2.06	-3.42	-2.36	-2.61	-2.30	-2.94	-2.50
25	-2.32	-3.29	-2.81	-2.03	-1.19	-1.56	-1.74	-2.24	-2.19	-3.34	-2.17	-2.38	-2.22	-2.83	-2.48
26	-1.99	-3.07	-2.56	-1.83	-.97	-1.32	-1.48	-1.98	-2.15	-3.07	-1.88	-2.06	-2.05	-2.58	-2.28
27	-1.82	-3.00	-2.40	-1.80	-1.03	-1.44	-1.40	-1.91	-2.15	-3.00	-1.80	-1.96	-2.20	-2.58	-2.18
28	-1.81	-2.98	-2.25	-1.91	-1.00	-1.56	-1.55	-1.92	-2.23	-3.09	-1.76	-1.95	-2.44	-2.32	-2.12
29	-1.47	-2.59	-1.86	-1.73	-.66	-1.47	-1.33	-1.55	-1.95	-3.05	-1.47	-1.73	-2.39	-1.83	-1.86
30	-1.07	-2.25	-1.54	-1.54	-.56	-1.37	-.98	-1.24	-1.62	-3.15	-1.29	-1.54	-2.21	-1.53	-1.67
31	-.67	-1.91	-1.28	-1.33	-.55	-1.26	-.76	-1.10	-1.29	-3.20	-1.14	-1.26	-1.90	-1.34	-1.54
32	-.32	-1.46	-.87	-.98	-.27	-1.06	-.44	-.85	-.88	-2.88	-.72	-.83	-1.38	-1.07	-1.24
33	.12	-.81	-.23	-.49	.41	-.62	.13	-.35	-.35	-2.31	-.07	-.32	-.72	-.58	-.69
34	.24	-.45	.04	-.31	.89	-.38	.46	-.05	-.06	-2.07	.27	-.14	-.45	-.23	-.37
35	.47	-.08	.39	-.06	1.38	.03	.84	.34	.16	-1.57	.70	.17	-.08	.05	-.05
36	.38	-.08	.37	-.09	1.45	.12	.87	.34	-.02	-1.31	.91	.22	-.08	-.25	-.08
37	.14	-.17	.09	-.19	1.33	.13	.58	.11	-.32	-1.25	.84	-.08	-.37	-.57	-.29
38	.11	-.03	-.11	-.19	1.22	.18	.49	.04	-.43	-1.06	.81	-.29	-.43	-.72	-.34
39	.11	.06	-.28	-.34	1.03	.15	.35	-.03	-.63	-.90	.71	-.31	-.48	-.86	-.43
40	-.04	.11	-.47	-.46	.81	.11	.15	-.01	-.87	-.91	.59	-.34	-.54	-1.01	-.65
41	.09	.51	-.35	-.23	.93	.39	.21	.37	-.81	-.62	.72	-.18	-.34	-.88	-.60
42	.78	1.48	.41	.59	1.67	1.33	.72	1.20	-.18	.18	1.24	.45	.41	-.21	.03
43	-.08	.82	-.42	-.13	.94	.63	-.29	.34	-1.02	-.57	.18	-.43	-.42	-1.07	-.80
44	.87	1.77	.43	1.00	1.97	1.70	.59	1.08	.03	.50	.86	.49	.41	-.18	.25
45	.84	1.57	.23	.99	1.95	1.86	.63	.86	.02	.44	.61	.37	.26	-.23	.31
46	.81	1.25	.15	.88	2.01	2.04	.65	.68	-.04	.31	.53	.24	.13	-.16	.37
47	.90	1.20	.19	.90	2.31	2.32	.96	.68	.07	.29	.80	.28	.25	.22	.66
48	.99	1.30	.23	1.10	2.63	2.57	1.39	.99	.27	.43	1.08	.42	.53	.61	1.02
49	.75	.90	-.08	1.02	2.53	2.44	1.40	.93	.07	.02	.89	.21	.35	.46	.93
50	1.06	1.07	.20	1.46	2.82	2.85	1.91	1.33	.37	.03	1.12	.73	.79	.73	1.34
51	1.03	1.01	.20	1.46	2.57	2.86	1.86	1.37	.44	.07	.90	.77	.97	.69	1.36
52	.44	.55	-.26	.94	1.82	2.46	1.06	.87	.03	-.19	.18	.11	.56	.22	.82
53	.46	.54	.01	.91	1.61	2.68	.83	1.03	.14	.16	.10	.02	.68	.30	.87
54	.48	.60	.09	1.04	1.65	2.82	.77	1.07	.33	.54	.06	-.19	.77	.46	1.01
55	.01	.32	-.23	1.00	1.56	2.58	.52	.74	.48	.65	-.36	-.84	.53	.15	.74
56	-.22	.19	-.04	1.29	1.42	2.49	.39	.87	.65	.70	-.40	-1.04	.50	.15	.54
57	-.28	-.04	.04	1.43	1.07	2.24	.17	1.16	.47	.39	-.25	-.91	.49	.02	.15
58	-.16	.24	.56	1.82	1.35	1.72	.34	1.37	.61	.19	.26	-.10	.82	.08	.49
59	-.28	.50	.64	1.71	1.65	1.08	.34	.67	.36	-.54	.13	.32	.58	-.04	.88
60	-5.66	-3.08	-2.96	-3.74	-3.65	-5.03	-5.45	-7.36	-7.90	-7.85	-7.12	-6.68	-5.54	-3.35	-1.96
61	11.19	11.19	11.19	11.19	11.19	11.19	11.19	11.19	11.19	11.19	11.19	11.19	11.19	11.19	11.19
62	3.13	3.13	3.13	3.13	3.13	3.13	3.13	3.13	3.13	3.13	3.13	3.13	3.13	3.13	3.13

NOAA-9 SCANNER OFFSETS FOR SEPTEMBER 1985:

TOTAL CHANNEL

S.P.	DAY OF MONTH -->														
	16	17	18	19	20	21	22	23	24	25	26	27	28	29	30
1	.36	.36	.36	.36	.36	.36	.36	.36	.36	.36	.36	.36	.36	.36	.36
2	1.04	1.04	1.04	1.04	1.04	1.04	1.04	1.04	1.04	1.04	1.04	1.04	1.04	1.04	1.04
3	1.93	1.93	1.93	1.93	1.93	1.93	1.93	1.93	1.93	1.93	1.93	1.93	1.93	1.93	1.93
4	-9.64	-9.64	-9.64	-9.64	-9.64	-9.64	-9.64	-9.64	-9.64	-9.64	-9.64	-9.64	-9.64	-9.64	-9.64
5	-6.36	-4.86	-.93	1.51	-1.83	-1.91	.83	-.24	2.24	1.90	1.90	4.13	4.13	4.71	4.51
6	-1.42	-1.14	.81	1.73	-.58	-.26	.15	.14	1.09	.43	.43	1.08	1.08	1.48	1.83
7	-2.37	-2.12	-1.14	-.31	-2.20	-1.78	-2.18	-1.99	-1.64	-1.87	-1.87	-2.16	-2.16	-1.23	-.62
8	-2.33	-1.96	-1.16	-.75	-2.17	-1.51	-2.51	-1.88	-1.97	-1.81	-1.81	-2.50	-2.50	-1.16	-.57
9	-2.21	-2.18	-1.17	-1.38	-2.19	-1.82	-3.08	-2.00	-2.22	-1.95	-1.95	-2.67	-2.67	-1.41	-.98
10	-2.15	-2.72	-1.44	-1.92	-2.35	-2.38	-3.37	-2.32	-2.17	-2.04	-2.04	-2.48	-2.48	-1.52	-1.30
11	-1.77	-2.56	-1.29	-1.54	-1.93	-2.41	-3.15	-2.25	-1.39	-1.55	-1.55	-1.99	-1.99	-.94	-.96
12	-2.33	-3.01	-1.58	-1.84	-2.25	-3.24	-3.67	-2.87	-1.57	-1.91	-1.91	-2.22	-2.22	-1.19	-1.52
13	-2.78	-3.41	-1.81	-2.26	-2.38	-3.83	-4.02	-3.27	-1.94	-2.38	-2.38	-2.34	-2.34	-1.71	-2.09
14	-2.60	-3.49	-1.65	-2.13	-2.28	-3.49	-4.02	-3.02	-1.67	-2.25	-2.25	-2.05	-2.05	-1.39	-2.04
15	-2.40	-3.54	-1.57	-1.90	-2.30	-2.89	-3.97	-2.69	-1.15	-2.07	-2.07	-1.84	-1.84	-1.18	-1.87
16	-2.69	-3.55	-1.76	-1.93	-2.25	-2.69	-3.97	-2.51	-.91	-2.06	-2.06	-1.92	-1.92	-1.29	-2.05
17	-2.93	-3.44	-1.80	-2.00	-2.01	-2.64	-3.79	-2.37	-.89	-1.97	-1.97	-2.07	-2.07	-1.24	-2.21
18	-3.12	-3.48	-1.93	-2.06	-2.14	-2.65	-3.61	-2.32	-1.17	-1.97	-1.97	-2.21	-2.21	-1.65	-2.44
19	-3.45	-3.55	-2.15	-2.28	-2.45	-2.67	-3.55	-2.48	-1.52	-2.19	-2.19	-2.32	-2.32	-2.14	-2.77
20	-3.73	-3.43	-2.40	-2.46	-2.62	-2.63	-3.58	-2.64	-1.78	-2.33	-2.33	-2.44	-2.44	-2.48	-2.92
21	-3.82	-3.18	-2.57	-2.53	-2.93	-2.48	-3.38	-2.67	-1.84	-2.13	-2.13	-2.45	-2.45	-2.86	-2.86
22	-4.10	-3.10	-2.85	-2.67	-3.38	-2.40	-3.18	-2.75	-2.14	-2.01	-2.01	-2.27	-2.27	-3.25	-2.82
23	-4.07	-2.69	-2.97	-2.64	-3.55	-2.25	-2.85	-2.67	-2.02	-1.82	-1.82	-1.93	-1.93	-3.23	-2.68
24	-4.06	-2.33	-2.91	-2.60	-3.48	-2.18	-2.76	-2.61	-2.22	-1.71	-1.71	-1.83	-1.83	-3.07	-2.63
25	-4.17	-2.12	-2.79	-2.35	-3.12	-2.15	-2.39	-2.53	-2.16	-1.45	-1.45	-1.72	-1.72	-2.94	-2.55
26	-3.91	-1.73	-2.51	-1.90	-2.61	-1.95	-1.90	-2.27	-1.82	-1.11	-1.11	-1.31	-1.31	-2.58	-2.38
27	-3.69	-1.62	-2.51	-1.68	-2.49	-1.90	-1.57	-2.17	-1.73	-1.11	-1.11	-1.08	-1.08	-2.39	-2.39
28	-3.59	-1.59	-2.53	-1.57	-2.43	-1.81	-1.42	-2.05	-1.61	-1.22	-1.22	-.97	-.97	-2.28	-2.38
29	-3.20	-1.27	-2.27	-1.16	-2.15	-1.48	-1.13	-1.61	-1.36	-1.11	-1.11	-.58	-.58	-1.91	-2.21
30	-2.90	-1.16	-2.02	-.90	-1.95	-1.24	-.91	-1.36	-1.30	-1.07	-1.07	-.22	-.22	-1.61	-2.14
31	-2.66	-.99	-1.72	-.65	-1.84	-.99	-.62	-1.21	-1.30	-1.11	-1.11	.08	.08	-1.40	-2.01
32	-2.28	-.64	-1.24	-.26	-1.53	-.65	-.13	-.95	-1.12	-.80	-.80	.49	.49	-.96	-1.73
33	-1.73	-.17	-.51	.16	-1.02	-.17	.37	-.48	-.68	-.18	-.18	.80	.80	-.39	-1.36
34	-1.45	.07	-.03	.40	-.77	.03	.71	-.11	-.54	.28	.28	.92	.92	-.12	-1.06
35	-1.18	.38	.46	.74	-.44	.22	1.20	.32	-.48	.63	.63	1.20	1.20	.11	-.64
36	-1.33	.30	.49	.59	-.47	.10	1.32	.27	-.65	.49	.49	1.15	1.15	.07	-.68
37	-1.64	-.05	.41	.10	-.60	-.23	1.30	-.08	-.99	.15	.15	.87	.87	-.12	-.90
38	-1.70	-.14	.41	-.03	-.60	-.41	1.40	-.06	-.98	-.02	-.02	.78	.78	-.13	-.82
39	-1.72	-.19	.39	-.07	-.47	-.54	1.38	-.02	-.89	-.15	-.15	.70	.70	-.22	-.85
40	-1.77	-.32	.30	-.16	-.47	-.61	1.20	.05	-.92	-.45	-.45	.55	.55	-.56	-.94
41	-1.52	-.16	.34	.03	-.25	-.35	1.22	.40	-.65	-.42	-.42	.70	.70	-.48	-.59
42	-.73	.53	.94	.79	.52	.31	1.82	1.13	-.19	.21	.21	1.30	1.30	.19	.42
43	-1.35	-.36	.05	-.01	-.38	-.83	.83	.12	-.46	-.68	-.68	.29	.29	-.78	-.23
44	-.20	.51	.99	.95	.46	-.17	1.41	.81	.60	.15	.15	1.07	1.07	.04	.66
45	-.06	.43	.99	.97	.19	-.47	1.05	.55	.65	.03	.03	.81	.81	-.13	.56
46	.03	.41	1.02	1.03	-.17	-.73	.84	.33	.75	.08	.08	.54	.54	-.19	.61
47	.31	.42	1.18	1.16	-.21	-.67	.89	.38	.95	.31	.31	.59	.59	-.32	.94
48	.80	.57	1.38	1.30	-.02	-.49	1.11	.71	1.20	.54	.54	.77	.77	-.36	1.35
49	.85	.53	1.19	1.03	-.17	-.67	.87	.87	1.12	.46	.46	.51	.51	-.64	1.35
50	1.31	1.06	1.55	1.34	.21	-.21	1.10	1.59	1.43	.85	.85	.79	.79	-.48	1.89
51	1.27	1.01	1.63	1.49	.20	-.24	1.02	1.72	1.18	.67	.67	.55	.55	-.48	1.92
52	.67	.45	1.22	1.30	-.30	-.92	.41	1.40	.59	.25	.25	-.02	-.02	-.73	1.28
53	.43	.56	1.10	1.50	-.38	-1.04	.19	1.32	.41	.45	.45	-.25	-.25	-.71	1.07
54	.47	.72	.94	1.45	-.40	-.91	.05	1.18	.22	.76	.76	-.55	-.55	-.83	.93
55	.30	.66	.73	.90	-.87	-1.01	-.04	.78	-.10	.76	.76	-.75	-.75	-1.07	.75
56	.45	.63	.76	.46	-.98	-.90	-.05	.68	.05	.76	.76	-.66	-.66	-1.18	.65
57	.52	.41	.65	-.11	-.74	-1.02	-.40	.42	.28	.84	.84	-.71	-.71	-1.22	-.01
58	.75	.53	.88	-.14	-.07	-1.08	-.05	.34	.76	1.13	1.13	-.31	-.31	-.64	-.20
59	.71	.23	.91	-.12	.24	-1.05	.43	.40	.52	.85	.85	-.30	-.30	-1.01	-1.08
60	-1.47	-2.60	-3.91	-6.18	-4.77	-4.58	-5.84	-5.36	-7.19	-6.96	-6.96	-8.90	-8.90	-10.21	-10.42
61	11.19	11.19	11.19	11.19	11.19	11.19	11.19	11.19	11.19	11.19	11.19	11.19	11.19	11.19	11.19
62	3.13	3.13	3.13	3.13	3.13	3.13	3.13	3.13	3.13	3.13	3.13	3.13	3.13	3.13	3.13

NOAA-9 SCANNER OFFSETS FOR SEPTEMBER 1985: LONGWAVE CHANNEL

S.P.	DAY OF MONTH -->														
	1	2	3	4	5	6	7	8	9	10	11	12	13	14	15
1	-.11	-.11	-.11	-.11	-.11	-.11	-.11	-.11	-.11	-.11	-.11	-.11	-.11	-.11	-.11
2	.32	.32	.32	.32	.32	.32	.32	.32	.32	.32	.32	.32	.32	.32	.32
3	.49	.49	.49	.49	.49	.49	.49	.49	.49	.49	.49	.49	.49	.49	.49
4	-4.09	-4.09	-4.09	-4.09	-4.09	-4.09	-4.09	-4.09	-4.09	-4.09	-4.09	-4.09	-4.09	-4.09	-4.09
5	-2.70	-4.16	-4.74	-2.44	-1.88	-1.47	-1.49	-.31	-.03	-.66	-.26	-.73	-1.78	-3.59	-3.71
6	-.91	-1.44	-2.01	-.92	-.25	-.50	-.45	-.13	-.17	-.50	-.53	-.52	-.61	-1.25	-1.16
7	-1.71	-1.79	-2.48	-1.82	-1.25	-1.20	-1.41	-1.10	-1.30	-1.49	-1.93	-1.78	-1.36	-1.84	-1.75
8	-1.75	-1.63	-2.49	-1.78	-1.31	-1.16	-1.48	-.93	-1.46	-1.49	-2.00	-2.01	-1.21	-1.88	-2.05
9	-1.96	-1.93	-2.70	-1.87	-1.62	-1.39	-1.88	-1.13	-1.81	-1.70	-2.29	-2.31	-1.49	-2.26	-2.49
10	-2.16	-2.35	-2.85	-1.95	-2.00	-1.67	-2.36	-1.49	-2.08	-1.87	-2.67	-2.68	-1.97	-2.68	-2.68
11	-2.08	-2.41	-2.59	-1.86	-1.90	-1.76	-2.41	-1.46	-2.15	-1.79	-2.69	-2.59	-2.08	-2.82	-2.51
12	-2.55	-2.98	-2.87	-2.45	-2.33	-2.16	-2.79	-1.90	-2.66	-2.17	-3.16	-2.77	-2.50	-3.52	-2.83
13	-2.88	-3.27	-3.01	-2.80	-2.71	-2.36	-2.93	-2.22	-2.84	-2.39	-3.41	-2.88	-2.74	-4.02	-2.96
14	-3.08	-3.38	-3.13	-2.97	-2.90	-2.65	-2.94	-2.39	-2.80	-2.56	-3.44	-2.96	-2.95	-4.22	-3.03
15	-3.08	-3.39	-3.20	-3.05	-3.01	-2.93	-2.92	-2.57	-2.80	-2.89	-3.44	-2.97	-3.08	-4.18	-3.01
16	-3.17	-3.60	-3.45	-3.18	-3.24	-3.21	-2.99	-2.96	-3.01	-3.39	-3.53	-3.05	-3.31	-4.18	-3.09
17	-3.41	-3.94	-3.87	-3.36	-3.55	-3.38	-3.16	-3.44	-3.37	-3.93	-3.83	-3.29	-3.69	-4.32	-3.38
18	-3.77	-4.29	-4.30	-3.66	-3.87	-3.72	-3.45	-3.81	-3.79	-4.41	-4.21	-3.61	-4.06	-4.58	-3.75
19	-4.30	-4.69	-4.68	-4.07	-4.16	-3.99	-3.87	-4.24	-4.22	-4.91	-4.57	-4.02	-4.41	-4.85	-4.14
20	-4.84	-5.12	-5.00	-4.43	-4.42	-4.14	-4.22	-4.71	-4.55	-5.37	-4.85	-4.44	-4.74	-5.12	-4.51
21	-5.12	-5.41	-5.19	-4.60	-4.52	-4.44	-5.06	-4.75	-5.68	-5.08	-4.77	-5.01	-5.31	-4.79	-5.19
22	-5.44	-5.75	-5.46	-4.95	-4.81	-4.58	-4.78	-5.39	-5.09	-5.98	-5.43	-5.22	-5.30	-5.58	-5.19
23	-5.52	-5.87	-5.55	-5.07	-4.85	-4.69	-4.92	-5.43	-5.22	-6.03	-5.47	-5.45	-5.34	-5.71	-5.41
24	-5.60	-6.02	-5.66	-5.19	-4.80	-4.82	-5.08	-5.47	-5.36	-6.12	-5.49	-5.60	-5.43	-5.87	-5.64
25	-5.68	-6.18	-5.83	-5.34	-4.82	-4.89	-5.19	-5.53	-5.59	-6.21	-5.52	-5.61	-5.55	-5.95	-5.79
26	-5.55	-6.08	-5.72	-5.25	-4.71	-4.77	-5.06	-5.40	-5.62	-6.08	-5.38	-5.43	-5.49	-5.85	-5.70
27	-5.52	-6.09	-5.66	-5.28	-4.80	-4.91	-5.05	-5.41	-5.68	-6.08	-5.38	-5.40	-5.63	-5.90	-5.70
28	-5.52	-6.08	-5.57	-5.35	-4.78	-4.99	-5.13	-5.38	-5.70	-6.12	-5.33	-5.37	-5.79	-5.71	-5.65
29	-5.26	-5.76	-5.25	-5.16	-4.50	-4.86	-4.91	-5.06	-5.44	-6.02	-5.06	-5.16	-5.69	-5.31	-5.41
30	-4.94	-5.47	-4.97	-4.98	-4.40	-4.75	-4.62	-4.78	-5.14	-6.02	-4.86	-4.96	-5.49	-5.04	-5.21
31	-4.49	-5.06	-4.60	-4.66	-4.22	-4.48	-4.28	-4.49	-4.72	-5.85	-4.56	-4.59	-5.08	-4.72	-4.91
32	-4.08	-4.62	-4.16	-4.24	-3.86	-4.16	-3.90	-4.13	-4.25	-5.45	-4.09	-4.14	-4.56	-4.37	-4.54
33	-3.46	-3.87	-3.40	-3.57	-3.07	-3.54	-3.19	-3.46	-3.56	-4.74	-3.32	-3.47	-3.77	-3.69	-3.84
34	-3.02	-3.29	-2.87	-3.09	-2.38	-3.03	-2.61	-2.90	-3.02	-4.23	-2.73	-3.01	-3.24	-3.11	-3.27
35	-2.51	-2.72	-2.31	-2.58	-1.69	-2.42	-2.03	-2.30	-2.54	-3.55	-2.10	-2.49	-2.66	-2.58	-2.73
36	-2.22	-2.37	-2.00	-2.27	-1.30	-2.02	-1.67	-1.96	-2.33	-3.04	-1.62	-2.13	-2.32	-2.44	-2.42
37	-1.99	-2.06	-1.83	-1.97	-1.01	-1.65	-1.49	-1.74	-2.16	-2.63	-1.29	-1.95	-2.13	-2.27	-2.18
38	-1.65	-1.62	-1.62	-1.64	-.77	-1.29	-1.21	-1.45	-1.88	-2.16	-.97	-1.76	-1.82	-2.02	-1.88
39	-1.28	-1.19	-1.39	-1.42	-.57	-.96	-.95	-1.15	-1.64	-1.70	-.66	-1.41	-1.50	-1.75	-1.58
40	-.99	-.80	-1.16	-1.17	-.39	-.64	-.72	-.78	-1.42	-1.34	-.37	-1.06	-1.17	-1.50	-1.36
41	-.57	-.21	-.76	-.69	.02	-.14	-.36	-.20	-1.05	-.83	.04	-.63	-.70	-1.09	-.99
42	.20	.72	.04	.15	.80	.76	.27	.64	-.34	.00	.68	.08	.10	-.35	-.28
43	-.08	.55	-.23	-.03	.60	.57	-.13	.35	-.62	-.23	.25	-.22	-.17	-.65	-.56
44	.75	1.38	.54	.96	1.52	1.49	.67	1.05	.28	.69	.91	.59	.58	.16	.34
45	.94	1.45	.62	1.15	1.72	1.79	.90	1.11	.47	.86	.95	.72	.68	.34	.60
46	1.12	1.44	.76	1.29	1.97	2.11	1.12	1.19	.65	.97	1.10	.84	.80	.58	.85
47	1.39	1.61	1.02	1.52	2.40	2.51	1.54	1.40	.94	1.18	1.49	1.09	1.10	1.03	1.28
48	1.48	1.69	1.08	1.66	2.64	2.69	1.85	1.64	1.10	1.31	1.72	1.21	1.32	1.31	1.57
49	1.33	1.45	.89	1.62	2.59	2.62	1.88	1.62	.98	1.05	1.60	1.10	1.21	1.23	1.53
50	1.60	1.62	1.15	1.95	2.82	2.94	2.28	1.94	1.23	1.11	1.80	1.50	1.55	1.47	1.86
51	1.73	1.73	1.30	2.09	2.79	3.08	2.39	2.11	1.41	1.27	1.79	1.67	1.81	1.59	2.02
52	1.26	1.33	.89	1.66	2.19	2.71	1.76	1.68	1.04	1.00	1.22	1.14	1.43	1.18	1.56
53	1.06	1.16	.86	1.41	1.79	2.57	1.35	1.51	.81	.91	.88	.81	1.24	1.03	1.39
54	.85	.94	.65	1.26	1.60	2.44	1.08	1.33	.72	.95	.64	.47	1.07	.86	1.20
55	.47	.69	.37	1.16	1.47	2.21	.86	1.06	.75	.96	.31	-.03	.84	.59	.95
56	.22	.49	.38	1.25	1.29	2.06	.68	1.04	.75	.89	.18	-.27	.71	.48	.72
57	.04	.19	.27	1.19	.93	1.74	.40	1.09	.48	.53	.13	-.33	.57	.26	.33
58	-.02	.22	.47	1.32	.98	1.28	.37	1.10	.43	.27	.35	.08	.66	.19	.43
59	.02	.47	.62	1.35	1.29	.98	.48	.75	.35	-.10	.38	.45	.62	.22	.77
60	-3.23	-1.70	-1.58	-1.97	-1.94	-2.74	-3.03	-4.14	-4.64	-4.53	-4.00	-3.79	-3.11	-1.80	-.97
61	3.05	3.05	3.05	3.05	3.05	3.05	3.05	3.05	3.05	3.05	3.05	3.05	3.05	3.05	3.05
62	.45	.45	.45	.45	.45	.45	.45	.45	.45	.45	.45	.45	.45	.45	.45

NOAA-9 SCANNER OFFSETS FOR SEPTEMBER 1985: LONGHAYE CHANNEL

S.P.	DAY OF MONTH -->														
	16	17	18	19	20	21	22	23	24	25	26	27	28	29	30
1	-.11	-.11	-.11	-.11	-.11	-.11	-.11	-.11	-.11	-.11	-.11	-.11	-.11	-.11	-.11
2	.32	.32	.32	.32	.32	.32	.32	.32	.32	.32	.32	.32	.32	.32	.32
3	.49	.49	.49	.49	.49	.49	.49	.49	.49	.49	.49	.49	.49	.49	.49
4	-4.09	-4.09	-4.09	-4.09	-4.09	-4.09	-4.09	-4.09	-4.09	-4.09	-4.09	-4.09	-4.09	-4.09	-4.09
5	-5.21	-4.36	-2.07	-.46	-2.51	-2.51	-1.02	-1.68	-.16	-.40	-.40	1.08	1.08	1.53	1.41
6	-2.02	-1.88	-.72	.02	-1.48	-1.26	-1.13	-1.16	-.52	-.97	-.97	-.40	-.40	-.06	-.14
7	-2.29	-2.17	-1.64	-.97	-2.19	-1.92	-2.33	-2.22	-1.98	-2.16	-2.16	-2.19	-2.19	-1.49	-1.15
8	-2.29	-2.10	-1.69	-1.28	-2.19	-1.77	-2.61	-2.20	-2.24	-2.18	-2.18	-2.45	-2.45	-1.50	-1.18
9	-2.41	-2.43	-1.87	-1.86	-2.37	-2.15	-3.18	-2.48	-2.59	-2.46	-2.46	-2.74	-2.74	-1.83	-1.62
10	-2.60	-2.98	-2.27	-2.42	-2.68	-2.75	-3.61	-2.91	-2.80	-2.76	-2.76	-2.82	-2.82	-2.12	-2.03
11	-2.55	-3.07	-2.36	-2.34	-2.59	-2.99	-3.68	-3.08	-2.48	-2.63	-2.63	-2.66	-2.66	-1.90	-1.96
12	-3.13	-3.55	-2.72	-2.68	-2.96	-3.73	-4.23	-3.70	-2.79	-3.04	-3.04	-2.96	-2.96	-2.21	-2.46
13	-3.49	-3.86	-2.95	-3.00	-3.07	-4.14	-4.56	-4.07	-3.12	-3.42	-3.42	-3.08	-3.08	-2.61	-2.90
14	-3.61	-4.16	-3.09	-3.17	-3.24	-4.14	-4.80	-4.16	-3.21	-3.58	-3.58	-3.14	-3.14	-2.64	-3.10
15	-3.66	-4.40	-3.22	-3.22	-3.45	-3.93	-4.95	-4.13	-3.06	-3.65	-3.65	-3.19	-3.19	-2.69	-3.17
16	-3.99	-4.57	-3.51	-3.40	-3.58	-3.95	-5.11	-4.16	-3.06	-3.81	-3.81	-3.40	-3.40	-2.92	-3.46
17	-4.40	-4.77	-3.81	-3.70	-3.70	-4.17	-5.25	-4.31	-3.31	-4.01	-4.01	-3.76	-3.76	-3.17	-3.87
18	-4.79	-5.06	-4.15	-4.00	-4.04	-4.43	-5.39	-4.52	-3.74	-4.27	-4.27	-4.11	-4.11	-3.72	-4.29
19	-5.30	-5.36	-4.58	-4.43	-4.52	-4.71	-5.61	-4.87	-4.22	-4.68	-4.68	-4.46	-4.46	-4.33	-4.78
20	-5.77	-5.55	-5.03	-4.82	-4.91	-4.96	-5.91	-5.23	-4.67	-5.05	-5.05	-4.82	-4.82	-4.87	-5.14
21	-6.02	-5.58	-5.34	-5.07	-5.33	-5.08	-5.98	-5.43	-4.91	-5.14	-5.14	-5.05	-5.05	-5.34	-5.30
22	-6.45	-5.78	-5.79	-5.42	-5.90	-5.29	-6.08	-5.70	-5.34	-5.31	-5.31	-5.19	-5.19	-5.85	-5.47
23	-6.59	-5.69	-6.05	-5.58	-6.19	-5.36	-6.03	-5.78	-5.43	-5.35	-5.35	-5.15	-5.15	-6.02	-5.55
24	-6.76	-5.62	-6.19	-5.73	-6.32	-5.48	-6.13	-5.89	-5.73	-5.45	-5.45	-5.27	-5.27	-6.08	-5.69
25	-7.00	-5.65	-6.28	-5.73	-6.25	-5.63	-6.06	-5.98	-5.82	-5.44	-5.44	-5.37	-5.37	-6.14	-5.81
26	-6.89	-5.47	-6.16	-5.48	-5.96	-5.57	-5.80	-5.86	-5.67	-5.28	-5.28	-5.17	-5.17	-5.94	-5.77
27	-6.78	-5.46	-6.22	-5.40	-5.93	-5.59	-5.66	-5.87	-5.67	-5.35	-5.35	-5.11	-5.11	-5.89	-5.84
28	-6.70	-5.45	-6.23	-5.33	-5.88	-5.52	-5.55	-5.79	-5.58	-5.41	-5.41	-5.04	-5.04	-5.82	-5.83
29	-6.37	-5.19	-5.98	-4.99	-5.63	-5.24	-5.29	-5.44	-5.35	-5.28	-5.28	-4.74	-4.74	-5.53	-5.66
30	-6.09	-5.06	-5.76	-4.77	-5.43	-5.00	-5.06	-5.20	-5.23	-5.17	-5.17	-4.43	-4.43	-5.26	-5.54
31	-5.72	-4.74	-5.35	-4.41	-5.17	-4.64	-4.64	-4.90	-5.01	-4.97	-4.97	-4.03	-4.03	-4.93	-5.25
32	-5.32	-4.32	-4.84	-3.96	-4.79	-4.24	-4.12	-4.55	-4.70	-4.56	-4.56	-3.55	-3.55	-4.44	-4.85
33	-4.63	-3.68	-4.01	-3.35	-4.12	-3.60	-3.47	-3.93	-4.11	-3.82	-3.82	-3.02	-3.02	-3.74	-4.30
34	-4.09	-3.16	-3.31	-2.82	-3.60	-3.10	-2.89	-3.33	-3.67	-3.15	-3.15	-2.59	-2.59	-3.20	-3.75
35	-3.58	-2.59	-2.60	-2.23	-3.03	-2.63	-2.20	-2.68	-3.27	-2.56	-2.56	-2.03	-2.03	-2.68	-3.12
36	-3.35	-2.29	-2.23	-1.98	-2.69	-2.36	-1.77	-2.37	-3.04	-2.31	-2.31	-1.72	-1.72	-2.36	-2.80
37	-3.19	-2.14	-1.89	-1.92	-2.39	-2.19	-1.39	-2.22	-2.87	-2.15	-2.15	-1.51	-1.51	-2.11	-2.55
38	-2.88	-1.84	-1.52	-1.66	-2.03	-1.94	-.97	-1.86	-2.50	-1.91	-1.91	-1.21	-1.21	-1.78	-2.15
39	-2.52	-1.51	-1.17	-1.31	-1.57	-1.65	-.61	-1.45	-2.05	-1.63	-1.63	-.89	-.89	-1.48	-1.82
40	-2.17	-1.21	-.85	-1.01	-1.19	-1.32	-.36	-1.04	-1.70	-1.47	-1.47	-.63	-.63	-1.36	-1.57
41	-1.67	-.76	-.48	-.54	-.71	-.81	.00	-.48	-1.17	-1.09	-1.09	-.20	-.20	-.99	-1.03
42	-.84	.02	.23	.28	.10	-.06	.71	.33	-.29	-.36	-.36	.49	.49	-.27	-.07
43	-.97	-.26	-.07	.04	-.21	-.54	.33	-.07	-.45	-.68	-.68	.09	.09	-.65	-.20
44	.01	.55	.78	.89	.54	.10	.91	.61	.47	.10	.10	.82	.82	.14	.60
45	.32	.73	.99	1.12	.56	.12	.89	.66	.74	.27	.27	.88	.88	.26	.70
46	.60	.94	1.23	1.36	.53	.16	.97	.72	1.05	.54	.54	.93	.93	.44	.91
47	1.03	1.17	1.56	1.68	.73	.42	1.22	.98	1.42	.92	.92	1.17	1.17	.62	1.34
48	1.40	1.30	1.71	1.79	.87	.57	1.40	1.23	1.63	1.11	1.11	1.37	1.37	.56	1.61
49	1.46	1.28	1.60	1.62	.78	.46	1.25	1.35	1.59	1.07	1.07	1.24	1.24	.41	1.64
50	1.82	1.66	1.88	1.86	1.07	.81	1.45	1.88	1.86	1.39	1.39	1.52	1.52	.65	2.11
51	1.93	1.77	2.08	2.10	1.21	.92	1.56	2.13	1.84	1.43	1.43	1.52	1.52	.72	2.34
52	1.42	1.29	1.71	1.88	.77	.37	1.07	1.83	1.34	1.05	1.05	1.05	1.05	.45	1.83
53	1.05	1.19	1.41	1.74	.46	.04	.66	1.55	.94	.87	.87	.60	.60	.23	1.36
54	.77	1.04	1.08	1.49	.21	-.12	.34	1.25	.61	.87	.87	.21	.21	.02	1.02
55	.54	.93	.88	1.05	-.17	-.26	.21	.90	.33	.79	.79	.03	.03	-.17	.74
56	.52	.81	.80	.67	-.34	-.30	.09	.69	.31	.66	.66	-.03	-.03	-.41	.55
57	.43	.53	.61	.19	-.31	-.51	-.25	.36	.30	.53	.53	-.22	-.22	-.66	-.13
58	.49	.46	.65	.07	.01	-.67	-.14	.18	.47	.55	.55	-.06	-.06	-.44	-.52
59	.66	.34	.76	.19	.32	-.55	.27	.33	.42	.46	.46	.08	.08	-.51	-.98
60	-.68	-1.41	-2.16	-3.49	-2.70	-2.67	-3.53	-3.19	-4.29	-4.31	-4.31	-5.14	-5.14	-6.12	-6.56
61	3.05	3.05	3.05	3.05	3.05	3.05	3.05	3.05	3.05	3.05	3.05	3.05	3.05	3.05	3.05
62	.45	.45	.45	.45	.45	.45	.45	.45	.45	.45	.45	.45	.45	.45	.45

NOAA-9 SCANNER OFFSETS FOR SEPTEMBER 1985: SHORTWAVE CHANNEL

S.P.	DAY OF MONTH -->														
	1	2	3	4	5	6	7	8	9	10	11	12	13	14	15
1	.29	.29	.29	.29	.29	.29	.29	.29	.29	.29	.29	.29	.29	.29	.29
2	.59	.59	.59	.59	.59	.59	.59	.59	.59	.59	.59	.59	.59	.59	.59
3	.63	.63	.63	.63	.63	.63	.63	.63	.63	.63	.63	.63	.63	.63	.63
4	.27	.27	.27	.27	.27	.27	.27	.27	.27	.27	.27	.27	.27	.27	.27
5	.33	.16	.06	-.13	-.12	-.04	.11	.07	.33	.24	.24	.24	.24	.13	.10
6	.41	.24	.13	-.07	-.06	-.03	.19	.14	.41	.31	.31	.31	.31	.21	.18
7	.06	-.11	-.22	-.43	-.43	-.34	-.17	-.23	.06	-.05	-.05	-.03	-.03	-.14	-.16
8	.38	.20	.09	-.13	-.13	-.03	.13	.08	.38	.26	.26	.28	.28	.17	.13
9	.46	.28	.16	-.07	-.08	.04	.21	.15	.46	.34	.34	.36	.36	.24	.21
10	.11	-.06	-.18	-.42	-.42	-.31	-.13	-.20	.11	-.02	-.02	.00	.00	-.10	-.13
11	.38	.20	.08	-.16	-.16	-.06	.11	.05	.38	.24	.24	.26	.26	.14	.11
12	.39	.23	.10	-.15	-.15	-.04	.14	.06	.39	.25	.25	.28	.28	.17	.14
13	-.39	-.52	-.66	-.97	-.96	-.80	-.64	-.71	-.39	-.55	-.55	-.51	-.51	-.62	-.61
14	-.17	-.36	-.50	-.77	-.77	-.58	-.42	-.47	-.17	-.33	-.33	-.29	-.29	-.46	-.45
15	-.17	-.37	-.51	-.79	-.78	-.59	-.43	-.47	-.17	-.33	-.33	-.30	-.30	-.47	-.47
16	-.53	-.72	-.86	-1.13	-1.13	-.94	-.79	-.83	-.53	-.70	-.70	-.66	-.66	-.82	-.82
17	-.24	-.42	-.56	-.83	-.83	-.64	-.49	-.53	-.24	-.40	-.40	-.36	-.36	-.53	-.53
18	-.22	-.42	-.56	-.82	-.82	-.62	-.48	-.51	-.22	-.38	-.38	-.35	-.35	-.53	-.52
19	-.59	-.78	-.91	-1.16	-1.16	-.97	-.83	-.87	-.59	-.74	-.74	-.71	-.71	-.88	-.88
20	-.24	-.43	-.56	-.82	-.81	-.61	-.48	-.52	-.24	-.39	-.39	-.37	-.37	-.54	-.54
21	-.23	-.42	-.55	-.83	-.82	-.59	-.46	-.50	-.23	-.38	-.38	-.36	-.36	-.53	-.52
22	-.65	-.84	-.96	-1.25	-1.24	-1.00	-.88	-.91	-.65	-.79	-.79	-.76	-.76	-.94	-.93
23	-.31	-.50	-.62	-.91	-.90	-.65	-.54	-.57	-.31	-.44	-.44	-.43	-.43	-.61	-.60
24	-.27	-.47	-.59	-.88	-.87	-.62	-.50	-.53	-.27	-.40	-.40	-.39	-.39	-.58	-.57
25	-.63	-.82	-.94	-1.22	-1.21	-.96	-.84	-.87	-.63	-.75	-.75	-.74	-.74	-.92	-.91
26	-.28	-.47	-.59	-.87	-.86	-.61	-.49	-.52	-.28	-.40	-.40	-.39	-.39	-.58	-.57
27	-.25	-.43	-.55	-.83	-.82	-.57	-.46	-.48	-.25	-.36	-.36	-.36	-.36	-.55	-.54
28	-.60	-.77	-.89	-1.16	-1.14	-.90	-.79	-.81	-.60	-.70	-.70	-.70	-.70	-.88	-.87
29	-.22	-.41	-.52	-.78	-.76	-.51	-.42	-.43	-.22	-.32	-.32	-.33	-.33	-.51	-.50
30	-.16	-.33	-.45	-.69	-.66	-.43	-.35	-.35	-.16	-.26	-.26	-.26	-.26	-.45	-.44
31	-.49	-.67	-.78	-1.00	-.95	-.75	-.67	-.68	-.49	-.59	-.59	-.59	-.59	-.77	-.76
32	-.15	-.31	-.41	-.65	-.59	-.39	-.32	-.33	-.15	-.24	-.24	-.25	-.25	-.42	-.42
33	-.21	-.35	-.43	-.68	-.64	-.43	-.35	-.38	-.21	-.29	-.29	-.30	-.30	-.47	-.45
34	-.56	-.72	-.80	-1.03	-1.00	-.78	-.70	-.73	-.56	-.65	-.65	-.65	-.65	-.83	-.82
35	-.22	-.38	-.46	-.69	-.66	-.43	-.36	-.38	-.22	-.30	-.30	-.32	-.32	-.50	-.48
36	-.14	-.30	-.39	-.61	-.58	-.35	-.28	-.30	-.14	-.21	-.21	-.22	-.22	-.42	-.40
37	-.43	-.59	-.67	-.89	-.86	-.63	-.57	-.58	-.43	-.49	-.49	-.51	-.51	-.70	-.68
38	-.05	-.22	-.30	-.51	-.47	-.26	-.20	-.20	-.05	-.12	-.12	-.14	-.14	-.33	-.31
39	.02	-.15	-.23	-.42	-.38	-.19	-.13	-.13	.02	-.05	-.05	-.07	-.07	-.26	-.24
40	-.27	-.43	-.51	-.68	-.64	-.46	-.41	-.41	-.27	-.33	-.33	-.36	-.36	-.54	-.51
41	.11	-.06	-.14	-.30	-.26	-.08	-.03	-.03	.11	.05	.05	.01	.01	-.18	-.15
42	.16	.00	-.08	-.23	-.19	-.02	.03	.03	.16	.11	.11	.08	.08	-.11	-.09
43	-.18	-.32	-.40	-.55	-.50	-.34	-.30	-.30	-.18	-.22	-.22	-.25	-.25	-.43	-.41
44	.16	.01	-.07	-.24	-.19	-.01	.03	.03	.16	.11	.11	.08	.08	-.11	-.08
45	.19	.04	-.04	-.20	-.16	.02	.07	.07	.19	.14	.14	.11	.11	-.08	-.05
46	-.16	-.31	-.38	-.53	-.48	-.31	-.27	-.27	-.16	-.20	-.20	-.24	-.24	-.41	-.38
47	-.16	.00	-.07	-.21	-.17	.02	.05	.05	.16	.12	.12	.08	.08	-.10	-.08
48	.20	.06	-.01	-.14	-.10	.07	.10	.11	.20	.17	.17	.13	.13	-.05	-.02
49	-.14	-.28	-.35	-.46	-.43	-.26	-.23	-.23	-.14	-.16	-.16	-.21	-.21	-.38	-.35
50	.20	.05	-.02	-.13	-.09	.08	.10	.11	.20	.17	.17	.13	.13	-.06	-.03
51	.21	.07	.00	-.10	-.06	.10	.12	.12	.21	.18	.18	.14	.14	-.04	-.01
52	-.11	-.27	-.33	-.42	-.37	-.22	-.21	-.19	-.11	-.14	-.14	-.19	-.19	-.37	-.34
53	.62	.40	.37	.36	.38	.49	.51	.54	.62	.64	.64	.52	.52	.29	.32
54	1.07	.92	.89	.83	.85	.95	.97	.95	1.07	1.08	1.08	.99	.99	.83	.84
55	.74	.62	.60	.53	.55	.64	.66	.63	.74	.76	.76	.67	.67	.53	.54
56	1.03	.90	.89	.81	.82	.91	.93	.91	1.03	1.03	1.03	.94	.94	.81	.82
57	1.08	.95	.93	.86	.87	.96	.98	.96	1.08	1.09	1.09	.99	.99	.85	.86
58	.72	.60	.58	.52	.52	.61	.63	.61	.72	.74	.74	.64	.64	.50	.51
59	.99	.87	.86	.80	.79	.88	.90	.88	.99	1.01	1.01	.91	.91	.78	.78
60	1.02	.90	.88	.82	.81	.90	.93	.90	1.02	1.03	1.03	.94	.94	.80	.81
61	.83	.83	.83	.83	.83	.83	.83	.83	.83	.83	.83	.83	.83	.83	.83
62	.97	.97	.97	.97	.97	.97	.97	.97	.97	.97	.97	.97	.97	.97	.97

NOAA-9 SCANNER OFFSETS FOR SEPTEMBER 1985: SHORTWAVE CHANNEL

S.P.	DAY OF MONTH -->														
	16	17	18	19	20	21	22	23	24	25	26	27	28	29	30
1	.29	.29	.29	.29	.29	.29	.29	.29	.29	.29	.29	.29	.29	.29	.29
2	.59	.59	.59	.59	.59	.59	.59	.59	.59	.59	.59	.59	.59	.59	.59
3	.63	.63	.63	.63	.63	.63	.63	.63	.63	.63	.63	.63	.63	.63	.63
4	.27	.27	.27	.27	.27	.27	.27	.27	.27	.27	.27	.27	.27	.27	.27
5	-.10	-.07	.01	.16	.20	.20	.17	.07	.25	.33	.27	.48	.72	.97	1.01
6	-.04	-.02	.07	.23	.29	.29	.26	.16	.33	.41	.33	.54	.78	1.06	1.04
7	-.38	-.37	-.30	-.13	-.05	-.05	-.09	-.18	-.03	.06	-.05	.15	.40	.70	.64
8	-.09	-.08	-.01	.18	.26	.26	.23	.14	.30	.40	.28	.52	.78	1.06	1.00
9	-.02	-.02	.04	.25	.34	.34	.30	.22	.37	.48	.33	.58	.84	1.09	1.07
10	-.36	-.36	-.30	-.11	.00	.00	-.04	-.11	.05	.15	-.03	.21	.51	.69	.74
11	-.13	-.11	-.05	.15	.25	.25	.27	.21	.36	.44	.24	.53	.88	1.02	1.14
12	-.10	-.07	-.04	.15	.28	.28	.30	.26	.40	.46	.25	.54	.92	1.01	1.16
13	-.84	-.83	-.84	-.66	-.51	-.51	-.51	-.51	-.38	-.33	-.56	-.27	.13	.17	.31
14	-.70	-.65	-.64	-.44	-.31	-.31	-.24	-.24	-.08	-.04	-.29	.07	.47	.53	.61
15	-.72	-.65	-.63	-.44	-.32	-.32	-.19	-.16	-.03	-.01	-.28	.10	.51	.57	.64
16	-1.06	-.99	-.97	-.79	-.68	-.68	-.51	-.46	-.36	-.34	-.67	-.31	.11	.18	.20
17	-.77	-.68	-.67	-.49	-.38	-.38	-.17	-.09	.01	.01	-.35	.02	.45	.52	.50
18	-.76	-.67	-.65	-.48	-.38	-.38	-.11	-.01	.08	.07	-.33	.02	.48	.53	.49
19	-1.11	-1.02	-1.00	-.83	-.74	-.74	-.41	-.32	-.24	-.26	-.70	-.37	.10	.10	.09
20	-.76	-.69	-.65	-.48	-.40	-.40	-.02	.07	.17	.11	-.35	-.01	.49	.41	.49
21	-.76	-.70	-.64	-.47	-.39	-.39	.05	.16	.27	.17	-.33	.02	.52	.36	.53
22	-1.17	-1.10	-1.03	-.88	-.80	-.80	-.28	-.15	-.07	-.20	-.78	-.40	.11	-.09	.16
23	-.85	-.76	-.68	-.53	-.47	-.47	.09	.25	.33	.17	-.43	-.02	.50	.29	.53
24	-.83	-.73	-.64	-.50	-.44	-.44	.14	.34	.41	.23	-.36	.00	.55	.40	.56
25	-1.17	-1.05	-.97	-.84	-.79	-.79	-.19	.06	.12	-.10	-.72	-.36	.17	.09	.17
26	-.83	-.70	-.61	-.49	-.44	-.44	.20	.47	.54	.29	-.38	.07	.57	.52	.56
27	-.79	-.66	-.57	-.45	-.41	-.41	.26	.52	.61	.33	-.35	.16	.61	.57	.62
28	-1.12	-.99	-.89	-.78	-.76	-.76	-.07	.19	.29	-.02	-.71	-.15	.28	.23	.29
29	-.75	-.62	-.52	-.41	-.39	-.39	.30	.55	.66	.36	-.32	.29	.70	.67	.71
30	-.68	-.52	-.44	-.33	-.33	-.33	.39	.61	.74	.45	-.21	.40	.81	.78	.81
31	-1.00	-.85	-.75	-.65	-.66	-.66	.08	.28	.40	.14	-.54	.10	.52	.47	.50
32	-.65	-.51	-.41	-.31	-.32	-.32	.40	.58	.69	.47	-.17	.50	.91	.82	.86
33	-.68	-.55	-.45	-.38	-.37	-.37	.30	.48	.59	.40	-.21	.37	.80	.69	.72
34	-1.05	-.91	-.81	-.73	-.73	-.73	-.06	.13	.25	.06	-.57	-.01	.45	.32	.35
35	-.71	-.57	-.47	-.39	-.40	-.40	.30	.49	.59	.42	-.22	.36	.85	.71	.75
36	-.63	-.47	-.37	-.31	-.32	-.32	.38	.58	.66	.50	-.12	.42	.90	.75	.81
37	-.90	-.74	-.64	-.59	-.60	-.60	.11	.29	.36	.20	-.42	.09	.57	.39	.46
38	-.53	-.36	-.26	-.21	-.24	-.24	.51	.67	.74	.56	-.04	.48	.97	.78	.84
39	-.45	-.28	-.17	-.14	-.17	-.17	.59	.74	.83	.62	-.02	.50	1.01	.81	.84
40	-.73	-.55	-.44	-.42	-.46	-.46	.33	.44	.53	.30	-.26	.13	.65	.43	.42
41	-.35	-.18	-.07	-.04	-.09	-.09	.70	.82	.92	.66	.14	.50	1.03	.78	.75
42	-.29	-.11	.01	.03	-.03	-.03	.78	.91	.97	.71	.21	.50	1.06	.80	.74
43	-.60	-.44	-.30	-.30	-.36	-.36	.45	.57	.64	.38	-.12	.07	.67	.34	.22
44	-.27	-.12	.01	.03	-.03	-.03	.78	.88	.96	.68	.20	.38	.99	.58	.52
45	-.23	-.08	.05	.06	.00	.00	.79	.89	.97	.67	.22	.30	.90	.49	.60
46	-.57	-.41	-.27	-.28	-.35	-.35	.45	.58	.60	.28	-.16	-.14	.40	.11	.27
47	-.26	-.10	.05	.04	-.04	-.04	.78	.92	.92	.59	.18	-.01	.78	.37	.62
48	-.20	-.03	.12	.10	.01	.01	.85	1.01	.99	.65	.24	.07	.78	.49	.66
49	-.52	-.36	-.20	-.24	-.32	-.32	.51	.67	.62	.28	-.11	-.09	.30	.10	.17
50	-.20	-.03	.14	.10	.01	.01	.84	.98	.97	.63	.25	.30	.58	.27	.39
51	-.18	.00	.17	.13	.02	.02	.88	1.03	1.00	.64	.27	.25	.56	.36	.28
52	-.52	-.33	-.14	-.18	-.31	-.31	.55	.70	.72	.34	-.03	-.22	.21	.07	.15
53	.13	.31	.58	.58	.41	.41	1.28	1.37	1.50	1.15	.81	.46	.94	.80	.62
54	.70	.85	1.07	1.04	.91	.91	1.69	1.78	1.90	1.53	1.16	.96	1.25	1.00	.93
55	.41	.56	.78	.73	.59	.59	1.37	1.44	1.57	1.23	.85	.68	.89	.56	.66
56	.70	.85	1.06	1.00	.88	.88	1.62	1.71	1.82	1.50	1.13	.94	1.15	.83	.91
57	.74	.90	1.10	1.06	.92	.92	1.62	1.75	1.84	1.55	1.18	.89	1.08	.91	.90
58	.39	.56	.75	.70	.57	.57	1.24	1.40	1.46	1.21	.82	.45	.65	.50	.58
59	.68	.84	1.03	.98	.84	.84	1.53	1.65	1.73	1.50	1.13	.84	.92	.72	.87
60	.70	.86	1.05	1.00	.87	.87	1.54	1.64	1.71	1.50	1.13	.79	.83	.64	.74
61	.83	.83	.83	.83	.83	.83	.83	.83	.83	.83	.83	.83	.83	.83	.83
62	.97	.97	.97	.97	.97	.97	.97	.97	.97	.97	.97	.97	.97	.97	.97

NOAA-9 SCANNER OFFSETS FOR OCTOBER 1985:

TOTAL CHANNEL

S.P.	DAY OF MONTH -->														
	1	2	3	4	5	6	7	8	9	10	11	12	13	14	15
1	.36	.36	.36	.36	.36	.36	.36	.36	.36	.36	.36	.36	.36	.36	.36
2	1.04	1.04	1.04	1.04	1.04	1.04	1.04	1.04	1.04	1.04	1.04	1.04	1.04	1.04	1.04
3	1.93	1.93	1.93	1.93	1.93	1.93	1.93	1.93	1.93	1.93	1.93	1.93	1.93	1.93	1.93
4	-9.64	-9.64	-9.64	-9.64	-9.64	-9.64	-9.64	-9.64	-9.64	-9.64	-9.64	-9.64	-9.64	-9.64	-9.64
5	7.08	4.98	7.08	7.08	7.08	7.08	7.08	7.08	4.98	7.08	4.98	6.50	4.98	4.98	8.70
6	2.97	.27	2.97	1.76	2.97	2.97	2.97	3.06	2.97	.27	.69	.27	.27	3.51	3.15
7	-.49	.41	-.34	-.15	-.34	-.34	-.34	-.34	-2.64	-.34	.41	-.35	.41	-.65	-3.24
8	3.35	.03	-1.68	-2.69	-1.68	-1.68	-1.68	-3.05	-1.68	.03	-1.20	.03	.03	-1.98	-6.45
9	2.10	.75	-1.01	-3.22	-1.01	-1.01	-1.01	-2.49	-1.01	.75	-.88	.75	.75	-4.34	-6.52
10	2.04	-.35	-2.62	-2.46	-2.62	-2.62	-2.62	-.60	-2.62	-.35	-.95	-.35	-.35	-2.00	-2.59
11	-.70	-1.17	-3.01	-1.55	-3.01	-3.01	-3.01	-1.85	-3.01	-1.17	-1.16	-1.17	-1.17	-3.40	-2.58
12	-1.52	-1.79	-2.04	-2.29	-2.04	-2.04	-2.04	-1.68	-2.04	-1.79	-1.74	-1.79	-1.79	-3.89	-2.96
13	.70	-2.20	-2.07	-1.99	-2.07	-2.07	-2.07	-1.13	-2.07	-2.20	-2.12	-2.20	-2.20	-4.51	-3.87
14	-3.17	-2.58	-1.79	-2.42	-1.79	-1.79	-1.79	-.92	-1.79	-2.58	-1.88	-2.58	-2.58	-3.47	-4.60
15	-2.21	-2.84	-1.64	-2.01	-1.64	-1.64	-1.64	-1.41	-1.64	-2.84	-1.87	-2.84	-2.84	-2.15	-3.90
16	-2.58	-2.73	-1.72	-1.62	-1.72	-1.72	-1.72	-2.22	-1.72	-2.73	-1.77	-2.73	-2.73	-1.90	-2.48
17	-3.61	-2.66	-1.85	-.87	-1.85	-1.85	-1.85	-3.57	-1.85	-2.66	-1.83	-2.66	-2.66	-1.86	-2.44
18	-3.86	-3.01	-1.30	-1.67	-1.30	-1.30	-1.30	-4.34	-1.30	-3.01	-2.33	-3.01	-3.01	-1.35	-3.14
19	-3.75	-3.43	-1.13	-3.95	-1.13	-1.13	-1.13	-5.67	-1.13	-3.43	-2.94	-3.43	-3.43	-1.57	-2.51
20	-3.58	-4.08	-1.01	-3.04	-1.01	-1.01	-1.01	-5.86	-1.01	-4.08	-3.11	-4.08	-4.08	-1.47	-2.28
21	-4.39	-4.76	-.72	-2.69	-.72	-.72	-.72	-5.55	-.72	-4.76	-3.46	-4.76	-4.76	-1.14	-1.50
22	-3.62	-5.73	-.56	-2.14	-.56	-.56	-.56	-5.66	-.56	-5.73	-3.91	-5.73	-5.73	-2.16	.14
23	-.77	-4.77	-.34	-2.26	-.34	-.34	-.34	-3.62	-.34	-4.77	-3.69	-4.77	-4.77	-3.57	-2.53
24	-2.71	-4.76	-1.18	-2.62	-1.18	-1.18	-1.18	-4.77	-1.18	-4.76	-3.58	-4.76	-4.76	-3.50	-2.50
25	.07	-4.66	-1.30	-2.52	-1.30	-1.30	-1.30	-4.86	-1.30	-4.66	-3.79	-4.66	-4.66	-3.76	-2.89
26	.49	-3.57	-1.01	-2.63	-1.01	-1.01	-1.01	-2.30	-1.01	-3.57	-3.49	-3.57	-3.57	-3.81	-2.58
27	-.11	-3.12	-.42	-2.23	-.42	-.42	-.42	-3.09	-.42	-3.12	-1.44	-3.12	-3.12	-2.86	-1.88
28	-1.30	-3.24	-.22	-1.97	-.22	-.22	-.22	-2.30	-.22	-3.24	-1.76	-3.24	-3.24	-2.46	-1.63
29	-1.03	-3.16	-.04	-.86	-.04	-.04	-.04	-.12	-.04	-3.16	-1.51	-3.16	-3.16	-1.74	-1.47
30	-.80	-3.31	-.12	-.66	-.12	-.12	-.12	.83	-.12	-3.31	-1.42	-3.31	-3.31	-1.19	-1.26
31	-1.01	-3.04	-.03	-.14	-.03	-.03	-.03	-.62	-.03	-3.04	-1.33	-3.04	-3.04	-1.51	-1.25
32	.06	-2.40	.21	.34	.21	.21	.21	.12	.21	-2.40	-1.05	-2.40	-2.40	-1.43	-1.21
33	.20	-1.95	.68	1.12	.68	.68	.68	-.83	.68	-1.95	-.44	-1.95	-1.95	-.90	-1.43
34	-.47	-1.91	.77	1.48	.77	.77	.77	-.18	.77	-1.91	-.15	-1.91	-1.91	-.68	-1.77
35	-.13	-1.34	.95	1.63	.95	.95	.95	.12	.95	-1.34	-.10	-1.34	-1.34	-.55	-1.83
36	.25	-1.16	.50	1.78	.50	.50	.50	.04	.50	-1.16	.05	-1.16	-1.16	-.52	-1.75
37	.71	-1.17	.32	1.72	.32	.32	.32	.57	.32	-1.17	.05	-1.17	-1.17	-.47	-1.52
38	-.13	-1.13	.17	1.78	.17	.17	.17	-.10	.17	-1.13	.68	-1.13	-1.13	-.16	-1.70
39	1.67	-1.57	.82	1.75	.82	.82	.82	-.32	.82	-1.57	1.18	-1.57	-1.57	-.13	-2.56
40	-.67	-1.90	1.08	1.49	1.08	1.08	1.08	-2.11	1.08	-1.90	1.58	-1.90	-1.90	-.03	-2.49
41	.50	-1.89	1.20	1.39	1.20	1.20	1.20	.33	1.20	-1.89	2.05	-1.89	-1.89	.59	-2.90
42	1.98	-1.75	.89	2.55	.89	.89	.89	2.57	.89	-1.75	2.09	-1.75	-1.75	1.54	-2.52
43	2.54	-1.74	.56	2.14	.56	.56	.56	4.30	.56	-1.74	2.17	-1.74	-1.74	1.60	-2.31
44	2.84	.15	.43	1.66	.43	.43	.43	2.30	.43	.15	2.28	.15	.15	2.05	-2.59
45	3.09	.37	1.51	1.65	1.51	1.51	1.51	3.64	1.51	.37	1.75	.37	.37	.05	-2.66
46	3.09	.45	1.46	1.77	1.46	1.46	1.46	2.04	1.46	.45	1.36	.45	.45	.63	-1.37
47	1.68	.62	1.22	1.71	.91	1.22	1.22	1.44	1.22	.62	1.19	.62	.62	.10	.32
48	3.29	.24	.91	1.12	.91	.91	.91	1.46	.91	.24	1.74	.24	.24	-.15	-.96
49	3.01	-.23	.50	.83	.50	.50	.50	1.59	.50	-.23	.85	-.23	-.23	.55	-1.96
50	2.57	-.19	-.12	.65	-.12	-.12	-.12	.93	-.12	-.19	.23	-.19	-.19	.28	-2.49
51	1.50	-.12	-.05	.40	-.05	-.05	-.05	1.30	-.05	-.12	.09	-.12	-.12	.16	-2.83
52	1.29	-.86	-.35	-.22	-.35	-.35	-.35	-6.04	-.35	-.86	-.42	-.86	-.86	-.15	-3.14
53	.86	.53	-.30	-.18	-.30	-.30	-.30	-5.08	-.30	.53	.12	.53	.53	-.23	-2.92
54	1.03	.93	-.40	-.07	-.40	-.40	-.40	-2.90	-.40	.93	-.86	.93	.93	-.72	-4.03
55	1.52	.87	-.21	-.11	-.21	-.21	-.21	-3.24	-.21	.87	-.65	.87	.87	-1.50	-4.48
56	1.32	1.14	-.36	-.32	-.36	-.36	-.36	-2.70	-.36	1.14	-1.57	1.14	1.14	-.26	-1.33
57	.94	1.11	-.96	-1.98	-.96	-.96	-.96	-2.95	-.96	1.11	-2.56	1.11	1.11	-1.23	-.90
58	-1.05	-.10	-.99	2.00	-.99	-.99	-.99	-2.65	-.99	-.10	-2.32	-.10	-.10	-2.07	-2.32
59	-1.00	-2.12	-1.14	.34	-1.14	-1.14	-1.14	-2.74	-1.14	-2.12	-2.43	-2.12	-2.12	-3.15	-3.31
60	-10.82	-10.08	-10.82	-7.90	-10.82	-10.82	-10.82	-12.55	-10.82	-10.08	-9.49	-10.08	-10.08	-10.38	-11.38
61	11.19	11.19	11.19	11.19	11.19	11.19	11.19	11.19	11.19	11.19	11.19	11.19	11.19	11.19	11.19
62	3.13	3.13	3.13	3.13	3.13	3.13	3.13	3.13	3.13	3.13	3.13	3.13	3.13	3.13	3.13

NOAA-9 SCANNER OFFSETS FOR OCTOBER 1985:

TOTAL CHANNEL

S.P.	DAY OF MONTH -->													29	30	31
	16	17	18	19	20	21	22	23	24	25	26	27	28			
1	.36	.36	.36	.36	.36	.36	.36	.36	.36	.36	.36	.36	.36	*****	.36	.36
2	1.04	1.04	1.04	1.04	1.04	1.04	1.04	1.04	1.04	1.04	1.04	1.04	1.04	*****	1.04	1.04
3	1.93	1.93	1.93	1.93	1.93	1.93	1.93	1.93	1.93	1.93	1.93	1.93	1.93	*****	1.93	1.93
4	-9.64	-9.64	-9.64	-9.64	-9.64	-9.64	-9.64	-9.64	-9.64	-9.64	-9.64	-9.64	-9.64	*****	-9.64	-9.64
5	8.70	8.70	8.70	6.50	4.98	8.70	4.98	4.98	8.70	8.70	7.97	4.98	4.98	*****	8.70	8.70
6	3.90	7.09	3.51	.69	.27	9.07	.27	.27	9.07	9.07	7.79	.27	.27	*****	9.07	-1.41
7	2.46	1.04	-.65	-.35	.41	5.90	.41	.41	5.90	5.90	4.66	.41	.41	*****	5.90	1.11
8	-.11	1.63	-1.98	-1.20	.03	1.66	.03	.03	1.66	1.66	.88	.03	.03	*****	1.66	-.11
9	-2.67	1.91	-4.34	-.88	.75	-.93	.75	.75	-.93	-.93	-.86	.75	.75	*****	-.93	.52
10	-3.69	1.54	-2.00	-.95	-.35	-1.61	-.35	-.35	-1.61	-1.61	-1.30	-.35	-.35	*****	-1.61	-.97
11	-4.01	2.46	-3.40	-1.16	-1.17	-1.40	-1.17	-1.17	-1.40	-1.40	-1.24	-1.17	-1.17	*****	-1.40	1.86
12	-4.55	2.02	-3.89	-1.74	-1.79	-1.83	-1.79	-1.79	-1.83	-1.83	-1.68	-1.79	-1.79	*****	-1.83	-1.84
13	-4.77	-1.01	-4.51	-2.12	-2.20	-4.31	-2.20	-2.20	-4.31	-4.31	-4.13	-2.20	-2.20	*****	-4.31	-.78
14	-5.04	-2.10	-3.47	-1.88	-2.58	-5.24	-2.58	-2.58	-5.24	-5.24	-5.04	-2.58	-2.58	*****	-5.24	-2.23
15	-4.30	-2.90	-2.15	-1.87	-2.84	-3.63	-2.84	-2.84	-3.63	-3.63	-3.52	-2.84	-2.84	*****	-3.63	-.87
16	-2.40	-2.87	-1.90	-1.77	-2.73	-3.17	-2.73	-2.73	-3.17	-3.17	-3.19	-2.73	-2.73	*****	-3.17	-1.68
17	-1.18	-3.59	-1.86	-1.83	-2.66	-2.44	-2.66	-2.66	-2.44	-2.44	-2.73	-2.66	-2.66	*****	-2.44	-2.08
18	-1.18	-3.51	-1.35	-2.33	-3.01	-1.18	-3.01	-3.01	-1.18	-1.18	-1.58	-3.01	-3.01	*****	-1.18	-2.13
19	-.78	-3.33	-1.57	-2.94	-3.43	-.78	-3.43	-3.43	-.78	-.78	-1.13	-3.43	-3.43	*****	-.78	-1.07
20	-.43	-5.42	-1.47	-3.11	-4.08	.54	-4.08	-4.08	.54	.54	.23	-4.08	-4.08	*****	.54	-2.26
21	-.16	-6.06	-1.14	-3.46	-4.76	-.23	-4.76	-4.76	-.23	-.23	-.57	-4.76	-4.76	*****	-.23	-1.21
22	-1.19	-6.19	-2.16	-3.91	-5.73	-.33	-5.73	-5.73	-.33	-.33	-.86	-5.73	-5.73	*****	-.33	-1.16
23	-2.56	-5.85	-3.57	-3.69	-4.77	-.46	-4.77	-4.77	-.46	-.46	-1.28	-4.77	-4.77	*****	-.46	-2.08
24	-3.00	-4.87	-3.50	-3.58	-4.76	-.03	-4.76	-4.76	-.03	-.03	-1.20	-4.76	-4.76	*****	-.03	-1.22
25	-2.71	-2.79	-3.76	-3.79	-4.66	-.83	-4.66	-4.66	-.83	-.83	-2.34	-4.66	-4.66	*****	-.83	-1.22
26	-2.39	-1.29	-3.81	-3.49	-3.57	-.16	-3.57	-3.57	-.16	-.16	-1.56	-3.57	-3.57	*****	-.16	-.06
27	-2.49	-1.21	-2.86	-1.44	-3.12	.05	-3.12	-3.12	.05	.05	-1.12	-3.12	-3.12	*****	.05	.30
28	-2.37	-1.70	-2.46	-1.76	-3.24	-.40	-3.24	-3.24	-.40	-.40	-1.66	-3.24	-3.24	*****	-.40	-.02
29	-3.36	-1.19	-1.74	-1.51	-3.16	.21	-3.16	-3.16	.21	.21	-1.24	-3.16	-3.16	*****	-.21	-.14
30	-2.88	-1.27	-1.19	-1.42	-3.31	.28	-3.31	-3.31	.28	.28	-1.10	-3.31	-3.31	*****	-.28	.40
31	-2.16	-.83	-1.51	-1.33	-3.04	.28	-3.04	-3.04	.28	.28	-.99	-3.04	-3.04	*****	-.28	.82
32	-1.46	-.23	-1.43	-1.05	-2.40	.73	-2.40	-2.40	.73	.73	-.64	-2.40	-2.40	*****	-.64	1.41
33	-.74	-.31	-.90	-.44	-1.95	.84	-1.95	-1.95	.84	.84	-.56	-1.95	-1.95	*****	-.74	1.75
34	-.31	-.51	-.68	-.15	-1.91	-.27	-1.91	-1.91	-.27	-.27	-1.65	-1.91	-1.91	*****	-.31	-.62
35	-.38	-.44	-.55	-.10	-1.34	-.64	-1.34	-1.34	-.64	-.64	-2.05	-1.34	-1.34	*****	-.38	-.57
36	-.64	-.35	-.52	.05	-1.16	-.29	-1.16	-1.16	-.29	-.29	-1.78	-1.16	-1.16	*****	-.64	-.64
37	-.78	-.31	-.47	.05	-1.17	.50	-1.17	-1.17	.50	.50	-1.11	-1.17	-1.17	*****	-.78	-.89
38	-.34	.22	-.16	.68	-1.13	.86	-1.13	-1.13	.86	.86	-.87	-1.13	-1.13	*****	-.34	-.64
39	.20	1.39	-.13	1.18	-1.57	1.38	-1.57	-1.57	1.38	1.38	-.56	-1.57	-1.57	*****	.20	-.04
40	.49	1.19	-.03	1.58	-1.90	1.45	-1.90	-1.90	1.45	1.45	-.74	-1.90	-1.90	*****	.49	.04
41	-3.00	1.36	.59	2.05	-1.89	1.12	-1.89	-1.89	1.12	1.12	-1.30	-1.89	-1.89	*****	-3.00	-.25
42	.29	1.36	1.54	2.09	-1.75	1.25	-1.75	-1.75	1.25	1.25	-1.59	-1.75	-1.75	*****	.29	2.57
43	-2.76	1.81	1.60	2.17	-1.74	-1.54	-1.74	-1.74	-1.54	-1.54	-4.57	-1.74	-1.74	*****	-2.76	.19
44	-.83	1.55	2.05	2.28	.15	-.72	.15	.15	-.72	-.72	-3.63	.15	.15	*****	-.83	.54
45	-2.76	1.45	.05	1.75	.37	.64	.37	.37	.64	.64	-2.23	.37	.37	*****	-2.76	.38
46	-2.32	1.21	.63	1.36	.45	1.04	.45	1.02	1.04	1.04	-1.83	.45	.45	*****	-2.32	-.39
47	-3.30	.34	.10	1.19	.62	1.70	.62	2.18	1.70	1.70	-.90	.62	.62	*****	-3.30	-.38
48	-1.86	.18	-.15	1.74	.24	1.91	.24	2.16	1.91	1.91	-.46	.24	.24	*****	-1.86	-.34
49	-4.09	.37	.55	.85	-.23	2.13	-.23	.55	2.13	2.13	-.09	-.23	-.23	*****	-4.09	-.42
50	-4.05	.62	.28	.23	-.19	2.70	-.19	.28	2.70	2.70	.69	-.19	-.19	*****	-4.05	.58
51	-4.70	-.19	.16	.09	-.12	-.73	-.12	.16	-.73	-.73	-2.29	-.12	-.12	*****	-4.70	-1.29
52	-5.53	1.24	-.15	-.42	-.86	-.11	-.86	-.15	-.11	-.11	-1.55	-.86	-.86	*****	-5.53	-.31
53	-5.13	.94	-.23	.12	.53	-.76	.53	-.23	-.76	-.76	-2.43	.53	.53	*****	-5.13	.91
54	-6.54	-.09	-.72	-.86	.93	-.43	.93	-.72	-.43	-.43	-1.78	.93	.93	*****	-6.54	1.23
55	-5.09	-1.17	-1.50	-.65	.87	.35	.87	-1.50	.35	.35	-.73	.87	.87	*****	-5.09	-.17
56	-5.98	-2.76	-.26	-1.57	1.14	-.07	1.14	-.26	-.07	-.07	-1.11	1.14	1.14	*****	-5.98	.64
57	-5.27	-4.48	-1.23	-2.56	1.11	-4.48	1.11	-1.23	-4.48	-4.48	-5.04	1.11	1.11	*****	-5.27	-5.27
58	-4.71	-3.87	-2.07	-2.32	-.10	-3.87	-.10	-2.07	-3.87	-3.87	-3.73	-.10	-.10	*****	-4.71	-4.71
59	-7.49	-2.79	-3.15	-2.43	-2.12	-2.79	-2.12	-3.15	-2.79	-2.79	-2.45	-2.12	-2.12	*****	-7.49	-7.49
60	-14.67	-14.67	-10.38	-9.49	-10.08	-14.67	-10.08	-10.38	-14.67	-14.67	-14.67	-10.08	-10.08	*****	-14.67	-14.67
61	11.19	11.19	11.19	11.19	11.19	11.19	11.19	11.19	11.19	11.19	11.19	11.19	11.19	*****	11.19	11.19
62	3.13	3.13	3.13	3.13	3.13	3.13	3.13	3.13	3.13	3.13	3.13	3.13	3.13	*****	3.13	3.13

NOAA-9 SCANNER OFFSETS FOR OCTOBER 1985: LONGHAYE CHANNEL
 DAY OF MONTH -->

S.P.	1	2	3	4	5	6	7	8	9	10	11	12	13	14	15
1	-1.11	-1.11	-1.11	-1.11	-1.11	-1.11	-1.11	-1.11	-1.11	-1.11	-1.11	-1.11	-1.11	-1.11	-1.11
2	.32	.32	.32	.32	.32	.32	.32	.32	.32	.32	.32	.32	.32	.32	.32
3	.49	.49	.49	.49	.49	.49	.49	.49	.49	.49	.49	.49	.49	.49	.49
4	-4.09	-4.09	-4.09	-4.09	-4.09	-4.09	-4.09	-4.09	-4.09	-4.09	-4.09	-4.09	-4.09	-4.09	-4.09
5	2.85	1.43	2.85	2.85	2.85	2.85	2.85	1.43	2.85	1.43	2.45	1.43	1.43	3.73	2.74
6	.50	-.84	.50	-.07	.50	.50	.50	.16	.50	-.84	-.57	-.84	-.84	.91	.66
7	-1.07	-.61	-1.36	-1.07	-1.36	-1.36	-1.36	-3.02	-1.36	-.61	-1.03	-.61	-.61	-1.51	-3.21
8	1.30	-.92	-2.25	-2.80	-2.25	-2.25	-2.25	-3.17	-2.25	-.92	-1.55	-.92	-.92	-2.43	-5.34
9	.33	-.34	-1.91	-3.22	-1.91	-1.91	-1.91	-2.77	-1.91	-.34	-1.50	-.34	-.34	-3.99	-5.49
10	.11	-.77	-2.79	-2.74	-2.79	-2.79	-2.79	-1.76	-2.79	-.77	-1.63	-.77	-.77	-2.55	-2.91
11	-1.90	-1.71	-3.25	-2.25	-3.25	-3.25	-3.25	-2.69	-3.25	-1.71	-1.92	-1.71	-1.71	-3.68	-3.12
12	-2.56	-2.38	-2.89	-2.85	-2.89	-2.89	-2.89	-2.69	-2.89	-2.38	-2.05	-2.38	-2.38	-4.10	-3.51
13	-1.13	-2.79	-2.95	-2.85	-2.95	-2.95	-2.95	-2.34	-2.95	-2.79	-2.46	-2.79	-2.79	-4.48	-4.10
14	-3.90	-3.32	-2.97	-3.17	-2.97	-2.97	-2.97	-2.42	-2.97	-3.32	-2.68	-3.32	-3.32	-3.92	-4.70
15	-3.46	-3.85	-3.06	-3.09	-3.06	-3.06	-3.06	-2.98	-3.06	-3.85	-3.04	-3.85	-3.85	-3.26	-4.48
16	-3.94	-4.04	-3.30	-3.00	-3.30	-3.30	-3.30	-3.76	-3.30	-4.04	-3.24	-4.04	-4.04	-3.33	-3.76
17	-4.86	-4.23	-3.62	-2.68	-3.62	-3.62	-3.62	-4.93	-3.62	-4.23	-3.52	-4.23	-4.23	-3.57	-3.97
18	-5.29	-4.72	-3.75	-3.56	-3.75	-3.75	-3.75	-5.73	-3.75	-4.72	-4.18	-4.72	-4.72	-3.52	-4.70
19	-5.49	-5.17	-3.83	-5.75	-3.83	-3.83	-3.83	-6.89	-3.83	-5.17	-4.84	-5.17	-5.17	-3.93	-4.53
20	-5.68	-5.82	-3.97	-5.43	-3.97	-3.97	-3.97	-7.16	-3.97	-5.82	-5.24	-5.82	-5.82	-4.14	-4.63
21	-4.30	-6.38	-3.94	-5.37	-3.94	-3.94	-3.94	-7.23	-3.94	-6.38	-5.63	-6.38	-6.38	-4.09	-4.28
22	-6.07	-6.55	-3.97	-5.05	-3.97	-3.97	-3.97	-7.55	-3.97	-6.55	-6.11	-6.55	-6.55	-5.01	-3.42
23	-4.36	-6.75	-4.02	-5.26	-4.02	-4.02	-4.02	-6.29	-4.02	-6.75	-6.16	-6.75	-6.75	-6.07	-5.41
24	-5.81	-6.86	-4.66	-5.65	-4.66	-4.66	-4.66	-7.41	-4.66	-6.86	-6.23	-6.86	-6.86	-6.15	-5.53
25	-4.23	-6.97	-4.85	-5.71	-4.85	-4.85	-4.85	-7.57	-4.85	-6.97	-6.55	-6.97	-6.97	-6.47	-5.96
26	-4.00	-6.24	-4.67	-5.81	-4.67	-4.67	-4.67	-5.94	-4.67	-6.24	-5.22	-6.24	-6.24	-6.50	-5.75
27	-4.44	-5.97	-4.30	-5.56	-4.30	-4.30	-4.30	-6.34	-4.30	-5.97	-4.88	-5.97	-5.97	-5.88	-5.28
28	-5.22	-6.13	-4.15	-5.37	-4.15	-4.15	-4.15	-5.86	-4.15	-6.13	-5.12	-6.13	-6.13	-5.59	-5.09
29	-5.00	-6.01	-3.95	-4.51	-3.95	-3.95	-3.95	-4.63	-3.95	-6.01	-4.86	-6.01	-6.01	-5.00	-4.88
30	-4.82	-6.07	-3.99	-4.37	-3.99	-3.99	-3.99	-4.01	-3.99	-6.07	-4.79	-6.07	-6.07	-4.59	-4.69
31	-4.68	-5.65	-3.69	-3.79	-3.69	-3.69	-3.69	-4.55	-3.69	-5.65	-4.52	-5.65	-5.65	-4.59	-4.43
32	-3.72	-4.97	-3.31	-3.24	-3.31	-3.31	-3.31	-3.84	-3.31	-4.97	-4.07	-4.97	-4.97	-4.29	-4.22
33	-3.26	-4.37	-2.69	-2.37	-2.69	-2.69	-2.69	-3.97	-2.69	-4.37	-3.26	-4.37	-4.37	-3.59	-4.04
34	-3.30	-3.94	-2.25	-1.78	-2.25	-2.25	-2.25	-3.25	-2.25	-3.94	-2.67	-3.94	-3.94	-3.07	-3.89
35	-2.76	-3.29	-1.82	-1.37	-1.82	-1.82	-1.82	-2.76	-1.82	-3.29	-2.34	-3.29	-3.29	-2.67	-3.63
36	-2.17	-2.84	-1.79	-.95	-1.79	-1.79	-1.79	-2.46	-1.79	-2.84	-1.95	-2.84	-2.84	-2.30	-3.24
37	-1.52	-2.53	-1.54	-.63	-1.54	-1.54	-1.54	-1.73	-1.54	-2.53	-1.58	-2.53	-2.53	-1.93	-2.73
38	-1.81	-2.16	-1.30	-.27	-1.30	-1.30	-1.30	-1.81	-1.30	-2.16	-.82	-2.16	-2.16	-1.40	-2.48
39	-.21	-2.12	-.55	.03	-.55	-.55	-.55	-1.62	-.55	-2.12	-.16	-2.12	-2.12	-1.02	-2.71
40	-1.48	-2.05	-.03	.22	-.03	-.03	-.03	-2.25	-.03	-2.05	.40	-2.05	-2.05	-.59	-2.35
41	-.33	-1.66	.42	.52	.42	.42	.42	-.49	.42	-1.66	1.07	-1.66	-1.66	.20	-2.25
42	.82	-1.33	.44	1.51	.44	.44	.44	.98	.44	-1.33	1.28	-1.33	-1.33	1.06	-1.75
43	1.45	-1.17	.44	1.53	.44	.44	.44	2.29	.44	-1.17	1.61	-1.17	-1.17	1.34	-1.30
44	1.87	.34	.58	1.44	.58	.58	.58	1.46	.58	.34	1.89	.34	.34	1.85	-1.29
45	2.19	.62	1.40	1.60	1.40	1.40	1.40	2.23	1.40	.62	1.67	.62	.62	.67	-1.18
46	2.40	.90	1.60	1.96	1.60	1.60	1.60	1.42	1.60	.90	1.65	.90	.90	1.30	-.12
47	1.61	1.15	1.58	2.05	1.58	1.58	1.58	1.18	1.58	1.15	1.63	1.15	1.15	1.09	1.11
48	2.83	.98	1.54	1.79	1.54	1.54	1.54	1.53	1.54	.98	2.10	.98	.98	1.09	.45
49	2.58	.64	1.27	1.62	1.27	1.27	1.27	1.69	1.27	.64	1.47	.64	.64	1.49	-.24
50	2.25	.68	.84	1.49	.84	.84	.84	1.09	.84	.68	1.03	.68	.68	1.29	-.61
51	1.57	.93	1.12	1.57	1.12	1.12	1.12	1.56	1.12	.93	1.16	.93	.93	1.43	-.62
52	1.28	.25	.81	1.03	.81	.81	.81	-3.16	.81	.25	.64	.25	.25	1.05	-1.03
53	.86	.88	.59	.84	.59	.59	.59	-2.82	.59	.88	.69	.88	.88	.71	-1.11
54	.81	.91	.35	.68	.35	.35	.35	-1.38	.35	.91	-.14	.91	.91	.22	-2.03
55	1.05	.69	.38	.53	.38	.38	.38	-1.53	.38	.69	-.21	.69	.69	-.37	-2.38
56	.54	.84	.16	.19	.16	.16	.16	-.92	.16	.84	-1.03	.84	.84	.39	-.50
57	.21	.67	-.32	-1.10	-.32	-.32	-.32	-1.37	-.32	.67	-1.65	.67	.67	-.39	-1.38
58	-1.12	-.38	-.55	1.56	-.55	-.55	-.55	-1.35	-.55	-.38	-1.56	-.38	-.38	-1.02	-1.39
59	-1.10	-1.73	-.74	.37	-.74	-.74	-.74	-1.77	-.74	-1.73	-1.73	-1.73	-1.73	-1.80	-2.01
60	-6.65	-6.16	-6.65	-4.47	-6.65	-6.65	-6.65	-7.74	-6.65	-6.16	-5.60	-6.16	-6.16	-6.07	-6.94
61	3.05	3.05	3.05	3.05	3.05	3.05	3.05	3.05	3.05	3.05	3.05	3.05	3.05	3.05	3.05
62	.45	.45	.45	.45	.45	.45	.45	.45	.45	.45	.45	.45	.45	.45	.45

NOAA-9 SCANNER OFFSETS FOR OCTOBER 1985: LONGWAVE CHANNEL

S.P.	DAY OF MONTH -->																														
	16	17	18	19	20	21	22	23	24	25	26	27	28	29	30	31															
1	-.11	-.11	-.11	-.11	-.11	-.11	-.11	-.11	-.11	-.11	-.11	-.11	-.11	-.11	-.11	-.11															
2	.32	.32	.32	.32	.32	.32	.32	.32	.32	.32	.32	.32	.32	.32	.32	.32															
3	.49	.49	.49	.49	.49	.49	.49	.49	.49	.49	.49	.49	.49	.49	.49	.49															
4	-4.09	-4.09	-4.09	-4.09	-4.09	-4.09	-4.09	-4.09	-4.09	-4.09	-4.09	-4.09	-4.09	-4.09	-4.09	-4.09															
5	3.73	3.73	3.73	2.45	1.43	3.73	1.43	1.43	3.73	3.73	3.23	1.43	1.43	1.43	3.73	3.73															
6	1.03	3.03	.91	-.57	-.84	4.28	-.84	-.84	4.28	4.28	3.36	-.84	-.84	1.43	4.28	-2.46															
7	.47	-.47	-1.51	-1.03	-.61	2.61	-.61	-.61	2.61	2.61	1.70	-.61	-.61	1.43	2.61	-.42															
8	-1.09	-.08	-2.43	-1.55	-.92	-.26	-.92	-.92	-.26	-.26	-.84	-.92	-.92	1.43	-.26	-1.30															
9	-2.83	-.10	-3.99	-1.50	-.34	-1.98	-.34	-.34	-1.98	-1.98	-1.98	-.34	-.34	1.43	-1.98	-.97															
10	-3.58	-.24	-2.55	-1.63	-.77	-2.52	-.77	-.77	-2.52	-2.52	-2.36	-.77	-.77	1.43	-2.52	-2.00															
11	-4.03	-.19	-3.68	-1.92	-1.71	-2.59	-1.71	-1.71	-2.59	-2.59	-2.53	-1.71	-1.71	1.43	-2.59	-.34															
12	-4.57	-.24	-4.10	-2.05	-2.38	-3.44	-2.38	-2.38	-3.44	-3.44	-3.40	-2.38	-2.38	1.43	-3.44	-2.90															
13	-4.76	-2.27	-4.48	-2.46	-2.79	-4.61	-2.79	-2.79	-4.61	-4.61	-4.59	-2.79	-2.79	1.43	-4.61	-2.26															
14	-5.06	-3.15	-3.92	-2.68	-3.32	-5.27	-3.32	-3.32	-5.27	-5.27	-5.26	-3.32	-3.32	1.43	-5.27	-3.24															
15	-4.71	-3.91	-3.26	-3.04	-3.85	-4.40	-3.85	-3.85	-4.40	-4.40	-4.45	-3.85	-3.85	1.43	-4.40	-2.72															
16	-3.60	-4.05	-3.33	-3.24	-6.04	-4.13	-4.04	-4.04	-4.13	-4.13	-6.28	-4.04	-4.04	1.43	-4.13	-3.44															
17	-3.03	-4.80	-3.57	-3.52	-4.23	-3.80	-4.23	-4.23	-3.80	-3.80	-4.13	-4.23	-4.23	1.43	-3.80	-3.99															
18	-3.22	-4.99	-3.52	-4.18	-4.72	-3.55	-4.72	-4.72	-3.55	-3.55	-3.95	-4.72	-4.72	1.43	-3.55	-4.30															
19	-3.17	-5.11	-3.93	-4.84	-5.17	-3.41	-5.17	-5.17	-3.41	-3.41	-3.78	-5.17	-5.17	1.43	-3.41	-3.89															
20	-3.23	-6.79	-4.14	-5.24	-5.82	-3.01	-5.82	-5.82	-3.01	-3.01	-3.35	-5.82	-5.82	1.43	-3.01	-4.80															
21	-3.24	-7.38	-4.09	-5.63	-6.38	-3.19	-6.38	-6.38	-3.19	-3.19	-3.54	-6.38	-6.38	1.43	-3.19	-4.34															
22	-4.18	-7.66	-5.01	-6.11	-6.55	-3.49	-6.55	-6.55	-3.49	-3.49	-3.95	-6.55	-6.55	1.43	-3.49	-4.60															
23	-5.38	-7.59	-6.07	-6.16	-6.75	-3.77	-6.75	-6.75	-3.77	-3.77	-4.41	-6.75	-6.75	1.43	-3.77	-5.31															
24	-5.77	-7.07	-6.15	-6.23	-6.86	-3.85	-6.86	-6.86	-3.85	-3.85	-4.71	-6.86	-6.86	1.43	-3.85	-4.85															
25	-5.72	-5.78	-6.47	-6.55	-6.97	-4.87	-6.97	-6.97	-4.87	-4.87	-5.92	-6.97	-6.97	1.43	-4.87	-4.95															
26	-5.58	-4.81	-6.50	-5.22	-6.24	-4.22	-6.24	-6.24	-4.22	-4.22	-5.17	-6.24	-6.24	1.43	-4.22	-4.28															
27	-5.66	-4.79	-5.88	-4.88	-5.97	-4.13	-5.97	-5.97	-4.13	-4.13	-4.91	-5.97	-5.97	1.43	-4.13	-4.04															
28	-5.61	-5.10	-5.59	-5.12	-6.13	-4.54	-6.13	-6.13	-4.54	-4.54	-5.34	-6.13	-6.13	1.43	-4.54	-4.18															
29	-6.21	-4.67	-5.00	-4.86	-6.01	-3.99	-6.01	-6.01	-3.99	-3.99	-4.92	-6.01	-6.01	1.43	-3.99	-4.09															
30	-5.88	-4.63	-4.59	-4.79	-6.07	-3.87	-6.07	-6.07	-3.87	-3.87	-4.75	-6.07	-6.07	1.43	-3.87	-3.67															
31	-5.14	-4.12	-4.59	-4.52	-5.65	-3.63	-5.65	-5.65	-3.63	-3.63	-4.42	-5.65	-5.65	1.43	-3.63	-3.14															
32	-4.42	-3.49	-4.29	-4.07	-4.97	-3.11	-4.97	-4.97	-3.11	-3.11	-3.95	-4.97	-4.97	1.43	-3.11	-2.54															
33	-3.59	-3.19	-3.59	-3.26	-4.37	-2.77	-4.37	-4.37	-2.77	-2.77	-3.61	-4.37	-4.37	1.43	-2.77	-2.06															
34	-3.00	-2.95	-3.07	-2.67	-3.94	-3.05	-3.94	-3.94	-3.05	-3.05	-3.89	-3.94	-3.94	1.43	-3.05	-3.08															
35	-2.75	-2.01	-2.67	-2.34	-3.29	-2.96	-3.29	-3.29	-2.96	-2.96	-3.81	-3.29	-3.29	1.43	-2.96	-2.78															
36	-2.63	-1.71	-2.30	-1.95	-2.84	-2.19	-2.84	-2.84	-2.19	-2.19	-3.10	-2.84	-2.84	1.43	-2.19	-2.50															
37	-2.33	-1.78	-1.93	-1.58	-2.53	-1.42	-2.53	-2.53	-1.42	-1.42	-2.40	-2.53	-2.53	1.43	-1.42	-2.29															
38	-1.72	-1.09	-1.40	-.82	-2.16	-.81	-2.16	-2.16	-.81	-.81	-1.87	-2.16	-2.16	1.43	-.81	-1.83															
39	-1.06	-.01	-1.02	-.16	-2.12	-.09	-2.12	-2.12	-.09	-.09	-1.30	-2.12	-2.12	1.43	-.09	-1.12															
40	-.52	.19	-.59	.40	-2.05	.33	-2.05	-2.05	.33	.33	-1.04	-2.05	-2.05	1.43	.33	-.77															
41	-2.64	.64	.20	1.07	-1.66	.49	-1.66	-1.66	.49	.49	-1.04	-1.66	-1.66	1.43	.49	-.47															
42	-.05	.84	1.06	1.28	-1.33	.77	-1.33	-1.33	.77	.77	-1.04	-1.33	-1.33	1.43	.77	-.05															
43	-1.95	1.39	1.34	1.61	-1.17	-.69	-1.17	-1.17	-.69	-.69	-2.65	-1.17	-1.17	1.43	-.69	-.95															
44	-.21	1.43	1.85	1.89	.34	.03	.34	.34	.03	.03	-1.85	.34	.34	1.43	.03	-.21															
45	-1.27	1.55	.67	1.67	.62	1.08	.62	.62	1.08	1.08	-.77	.62	.62	1.43	.62	-.79															
46	-.77	1.56	1.30	1.65	.90	1.51	.90	1.52	1.51	1.51	-.32	.90	.90	1.43	.90	-.42															
47	-1.32	1.11	1.09	1.63	1.15	1.71	1.15	2.41	1.71	1.71	.05	1.15	1.15	1.43	1.15	-.32															
48	-.13	1.14	1.09	2.10	.98	2.34	.98	2.50	2.34	2.34	.86	.98	.98	1.43	.98	-.13															
49	-1.85	1.25	1.49	1.47	.64	2.41	.64	1.49	2.41	2.41	1.04	.64	.64	1.43	.64	-1.85															
50	-1.67	1.42	1.29	1.03	.68	2.68	.68	1.29	2.68	2.68	1.45	.68	.68	1.43	.68	-1.67															
51	-1.65	1.12	1.43	1.16	.93	.79	.93	1.43	.79	.79	-.13	.93	.93	1.43	.93	-.13															
52	-2.31	1.88	1.05	.64	.25	.84	.25	1.05	.84	.84	.00	.25	.25	1.43	.25	-2.31															
53	-2.34	1.32	.71	.69	.88	.12	.88	.71	.12	.12	-.86	.88	.88	1.43	.88	-2.34															
54	-3.74	.43	.22	-.14	.91	.16	.91	.22	.16	.16	-.60	.91	.91	1.43	.91	-3.74															
55	-2.79	-.38	-.37	-.21	.69	.60	.69	-.37	.60	.60	.04	.69	.69	1.43	.69	-2.79															
56	-2.46	-1.57	.39	-1.03	.84	.36	.84	.39	.36	.36	-.16	.84	.84	1.43	.84	-2.46															
57	-3.03	-2.78	-.39	-1.65	.67	-2.72	.67	-.39	-2.72	-2.72	-2.95	.67	.67	1.43	.67	-3.03															
58	-2.16	-2.57	-1.02	-1.56	-.38	-2.57	-.38	-1.02	-2.57	-2.57	-2.34	-.38	-.38	1.43	-.38	-2.16															
59	-4.85	-1.85	-1.80	-1.75	-1.73	-1.85	-1.73	-1.80	-1.85	-1.85	-1.50	-1.73	-1.73	1.43	-1.73	-4.85															
60	-9.16	-9.16	-6.07	-5.60	-6.16	-9.16	-6.16	-6.07	-9.16	-9.16	-9.16	-6.16	-6.16	1.43	-6.16	-9.16															
61	3.05	3.05	3.05	3.05	3.05	3.05	3.05	3.05	3.05	3.05	3.05	3.05	3.05	1.43	3.05	3.05															
62	.45	.45	.45	.45	.45	.45	.45	.45	.45	.45	.45	.45	.45	1.43	.45	.45															

NOAA-9 SCANNER OFFSETS FOR OCTOBER 1985: SHORTHAVE CHANNEL

S.P.	DAY OF MONTH -->														
	1	2	3	4	5	6	7	8	9	10	11	12	13	14	15
1	.35	.30	-.13	-.23	-.13	.03	.03	-.13	-.13	-.19	-.13	-.19	-.19	-.31	-.19
2	.76	.65	.17	.07	.17	.33	.33	.17	.17	.11	.17	.11	.11	-.04	.11
3	.85	.70	.22	.11	.22	.37	.37	.22	.22	.16	.22	.16	.16	.00	.16
4	.53	.35	-.12	-.23	-.12	.04	.04	-.12	-.12	-.18	-.12	-.18	-.18	-.35	-.18
5	.99	.77	.27	.13	.27	.43	.43	.27	.27	.21	.27	.21	.21	.03	.21
6	1.05	.85	.37	.22	.37	.52	.52	.37	.37	.30	.37	.30	.30	.11	.30
7	.67	.47	.03	-.12	.03	.16	.16	.03	.03	-.05	.03	-.05	-.05	-.24	-.05
8	.98	.82	.35	.19	.35	.50	.50	.35	.35	.28	.35	.28	.28	.07	.28
9	1.00	.89	.44	.25	.44	.59	.59	.44	.44	.37	.44	.37	.37	.16	.37
10	.62	.51	.09	-.09	.09	.23	.23	.09	.09	.01	.09	.01	.01	-.21	.01
11	1.01	.85	.36	.18	.36	.51	.51	.36	.36	.28	.36	.28	.28	.06	.28
12	1.02	.84	.36	.18	.36	.51	.51	.36	.36	.28	.36	.28	.28	.07	.28
13	.26	.02	-.45	-.63	-.45	-.31	-.31	-.45	-.45	-.54	-.45	-.54	-.54	-.75	-.54
14	.58	.31	-.21	-.42	-.21	-.06	-.06	-.21	-.21	-.30	-.21	-.30	-.30	-.53	-.30
15	.62	.33	-.20	-.41	-.20	-.06	-.06	-.20	-.20	-.29	-.20	-.29	-.29	-.52	-.29
16	.20	-.10	-.58	-.79	-.58	-.44	-.44	-.58	-.58	-.67	-.58	-.67	-.67	-.89	-.67
17	.52	.22	-.28	-.50	-.28	-.14	-.14	-.28	-.28	-.37	-.28	-.37	-.37	-.58	-.37
18	.48	.22	-.26	-.48	-.26	-.12	-.12	-.26	-.26	-.35	-.26	-.35	-.35	-.57	-.35
19	.03	-.18	-.63	-.84	-.63	-.50	-.50	-.63	-.63	-.73	-.63	-.73	-.73	-.92	-.73
20	.36	.18	-.29	-.51	-.29	-.16	-.16	-.29	-.29	-.39	-.29	-.39	-.39	-.57	-.39
21	.45	.21	-.28	-.49	-.28	-.14	-.14	-.28	-.28	-.37	-.28	-.37	-.37	-.56	-.37
22	.10	-.22	-.69	-.89	-.69	-.56	-.56	-.69	-.69	-.79	-.69	-.79	-.79	-.97	-.79
23	.49	.16	-.35	-.55	-.35	-.22	-.22	-.35	-.35	-.45	-.35	-.45	-.45	-.63	-.45
24	.53	.20	-.32	-.51	-.32	-.18	-.18	-.32	-.32	-.41	-.32	-.41	-.41	-.59	-.41
25	.15	-.20	-.67	-.85	-.67	-.54	-.54	-.67	-.67	-.77	-.67	-.77	-.77	-.94	-.77
26	.52	.16	-.32	-.49	-.32	-.20	-.20	-.32	-.32	-.42	-.32	-.42	-.42	-.58	-.42
27	.57	.17	-.29	-.45	-.29	-.15	-.15	-.29	-.29	-.39	-.29	-.39	-.39	-.54	-.39
28	.22	-.20	-.64	-.79	-.64	-.51	-.51	-.64	-.64	-.74	-.64	-.74	-.74	-.88	-.74
29	.65	.23	-.27	-.42	-.27	-.13	-.13	-.27	-.27	-.36	-.27	-.36	-.36	-.50	-.36
30	.75	.29	-.20	-.34	-.20	-.06	-.06	-.20	-.20	-.29	-.20	-.29	-.29	-.42	-.29
31	.44	-.06	-.54	-.66	-.54	-.41	-.41	-.54	-.54	-.64	-.54	-.64	-.64	-.76	-.64
32	.80	.30	-.20	-.31	-.20	-.08	-.08	-.20	-.20	-.31	-.20	-.31	-.31	-.42	-.31
33	.68	.19	-.27	-.37	-.27	-.15	-.15	-.27	-.27	-.37	-.27	-.37	-.37	-.49	-.37
34	.30	-.19	-.62	-.71	-.62	-.51	-.51	-.62	-.62	-.73	-.62	-.73	-.73	-.84	-.73
35	.68	.20	-.28	-.37	-.28	-.17	-.17	-.28	-.28	-.39	-.28	-.39	-.39	-.51	-.39
36	.71	.25	-.20	-.27	-.20	-.09	-.09	-.20	-.20	-.31	-.20	-.31	-.31	-.43	-.31
37	.36	-.08	-.50	-.56	-.50	-.39	-.39	-.50	-.50	-.61	-.50	-.61	-.61	-.73	-.61
38	.76	.32	-.13	-.20	-.13	-.02	-.02	-.13	-.13	-.23	-.13	-.23	-.23	-.35	-.23
39	.78	.36	-.07	-.12	-.07	.04	.04	-.07	-.07	-.17	-.07	-.17	-.17	-.27	-.17
40	.37	.01	-.37	-.41	-.37	-.25	-.25	-.37	-.37	-.47	-.37	-.47	-.47	-.57	-.47
41	.64	.39	.02	-.03	.02	.13	.13	.02	.02	-.08	.02	-.08	-.08	-.18	-.08
42	.59	.44	.07	.05	.07	.18	.18	.07	.07	-.03	.07	-.03	-.03	-.11	-.03
43	.19	.07	-.27	-.29	-.27	-.17	-.17	-.27	-.27	-.37	-.27	-.37	-.37	-.45	-.37
44	.43	.36	.06	.05	.06	.16	.16	.06	.06	-.05	.06	-.05	-.05	-.12	-.05
45	.36	.35	.08	.08	.08	.19	.19	.08	.08	-.02	.08	-.02	-.02	-.09	-.02
46	.06	.04	-.27	-.25	-.27	-.17	-.17	-.27	-.27	-.37	-.27	-.37	-.37	-.45	-.37
47	.50	.39	.05	.07	.05	.16	.16	.05	.05	-.05	.05	-.05	-.05	-.13	-.05
48	.61	.42	.09	.11	.09	.20	.20	.09	.09	-.01	.09	-.01	-.01	-.07	-.01
49	.25	.06	-.25	-.21	-.25	-.15	-.15	-.25	-.25	-.35	-.25	-.35	-.35	-.40	-.35
50	.54	.38	.10	.13	.10	.20	.20	.10	.10	.00	.10	.00	.00	-.06	.00
51	.41	.32	.10	.16	.10	.20	.20	.10	.10	.00	.10	.00	.00	-.05	.00
52	-.06	-.06	-.22	-.16	-.22	-.12	-.12	-.22	-.22	-.33	-.22	-.33	-.33	-.38	-.33
53	.76	.83	.58	.63	.58	.68	.68	.58	.58	.48	.58	.48	.48	.42	.48
54	1.09	1.16	.98	1.05	.98	1.07	1.07	.98	.98	.87	.98	.87	.87	.85	.87
55	.60	.82	.65	.72	.65	.73	.73	.65	.65	.55	.65	.55	.55	.51	.55
56	.97	1.19	.92	1.00	.92	1.02	1.02	.92	.92	.83	.92	.83	.83	.79	.83
57	1.02	1.20	.96	1.05	.96	1.05	1.05	.96	.96	.86	.96	.86	.86	.82	.86
58	.48	.78	.59	.69	.59	.68	.68	.59	.59	.48	.59	.48	.48	.45	.48
59	.84	1.10	.86	.95	.86	.95	.95	.86	.86	.76	.86	.76	.76	.73	.76
60	.85	1.06	.86	.95	.86	.95	.95	.86	.86	.76	.86	.76	.76	.73	.76
61	.35	.53	.40	.50	.40	.48	.48	.40	.40	.29	.40	.29	.29	.28	.29
62	.45	.68	.52	.61	.52	.61	.61	.52	.52	.42	.52	.42	.42	.40	.42

NOAA-9 SCANNER OFFSETS FOR OCTOBER 1985: SHORTWAVE CHANNEL

S.P.	DAY OF MONTH -->															
	16	17	18	19	20	21	22	23	24	25	26	27	28	29	30	31
1	-.19	-.19	-.13	.03	.03	-.13	.03	.03	.16	.16	.16	.16	.16	*****	.16	.16
2	.11	.11	.17	.33	.33	.17	.33	.33	.46	.46	.46	.46	.46	*****	.46	.46
3	.16	.16	.22	.37	.37	.22	.37	.37	.50	.50	.50	.50	.50	*****	.50	.50
4	-.18	-.18	-.12	.04	.04	-.12	.04	.04	.15	.15	.15	.15	.15	*****	.15	.15
5	.21	.21	.27	.43	.43	.27	.43	.43	.54	.54	.54	.54	.54	*****	.54	.54
6	.30	.30	.37	.52	.52	.37	.52	.52	.62	.62	.62	.62	.62	*****	.62	.62
7	-.05	-.05	.03	.16	.16	.03	.16	.16	.27	.27	.27	.27	.27	*****	.27	.27
8	.28	.28	.35	.50	.50	.35	.50	.50	.61	.61	.61	.61	.61	*****	.61	.61
9	.37	.37	.44	.59	.59	.44	.59	.59	.68	.68	.68	.68	.68	*****	.68	.68
10	.01	.01	.09	.23	.23	.09	.23	.23	.32	.32	.32	.32	.32	*****	.32	.32
11	.28	.28	.36	.51	.51	.36	.51	.51	.61	.61	.61	.61	.61	*****	.61	.61
12	.28	.28	.36	.51	.51	.36	.51	.51	.60	.60	.60	.60	.60	*****	.60	.60
13	-.54	-.54	-.45	-.31	-.31	-.45	-.31	-.31	-.22	-.22	-.22	-.22	-.22	*****	-.22	-.22
14	-.30	-.30	-.21	-.06	-.06	-.21	-.06	-.06	.04	.04	.04	.04	.04	*****	.04	.04
15	-.29	-.29	-.20	-.06	-.06	-.20	-.06	-.06	.05	.05	.05	.05	.05	*****	.05	.05
16	-.67	-.67	-.58	-.44	-.44	-.58	-.44	-.44	-.35	-.35	-.35	-.35	-.35	*****	-.35	-.35
17	-.37	-.37	-.28	-.14	-.14	-.28	-.14	-.14	-.05	-.05	-.05	-.05	-.05	*****	-.05	-.05
18	-.35	-.35	-.26	-.12	-.12	-.26	-.12	-.12	-.03	-.03	-.03	-.03	-.03	*****	-.03	-.03
19	-.73	-.73	-.63	-.50	-.50	-.63	-.50	-.50	-.40	-.40	-.40	-.40	-.40	*****	-.40	-.40
20	-.39	-.39	-.29	-.16	-.16	-.29	-.16	-.16	-.07	-.07	-.07	-.07	-.07	*****	-.07	-.07
21	-.37	-.37	-.28	-.14	-.14	-.28	-.14	-.14	-.04	-.04	-.04	-.04	-.04	*****	-.04	-.04
22	-.79	-.79	-.69	-.56	-.56	-.69	-.56	-.56	-.47	-.47	-.47	-.47	-.47	*****	-.47	-.47
23	-.45	-.45	-.35	-.22	-.22	-.35	-.22	-.22	-.13	-.13	-.13	-.13	-.13	*****	-.13	-.13
24	-.41	-.41	-.32	-.18	-.18	-.32	-.18	-.18	-.08	-.08	-.08	-.08	-.08	*****	-.08	-.08
25	-.77	-.77	-.67	-.54	-.54	-.67	-.54	-.54	-.44	-.44	-.44	-.44	-.44	*****	-.44	-.44
26	-.42	-.42	-.32	-.20	-.20	-.32	-.20	-.20	-.09	-.09	-.09	-.09	-.09	*****	-.09	-.09
27	-.39	-.39	-.29	-.15	-.15	-.29	-.15	-.15	-.06	-.06	-.06	-.06	-.06	*****	-.06	-.06
28	-.74	-.74	-.64	-.51	-.51	-.64	-.51	-.51	-.41	-.41	-.41	-.41	-.41	*****	-.41	-.41
29	-.36	-.36	-.27	-.13	-.13	-.27	-.13	-.13	-.04	-.04	-.04	-.04	-.04	*****	-.04	-.04
30	-.29	-.29	-.20	-.06	-.06	-.20	-.06	-.06	.03	.03	.03	.03	.03	*****	.03	.03
31	-.64	-.64	-.54	-.41	-.41	-.54	-.41	-.41	-.32	-.32	-.32	-.32	-.32	*****	-.32	-.32
32	-.31	-.31	-.20	-.08	-.08	-.20	-.08	-.08	.01	.01	.01	.01	.01	*****	.01	.01
33	-.37	-.37	-.27	-.15	-.15	-.27	-.15	-.15	-.07	-.07	-.07	-.07	-.07	*****	-.07	-.07
34	-.73	-.73	-.62	-.51	-.51	-.62	-.51	-.51	-.43	-.43	-.43	-.43	-.43	*****	-.43	-.43
35	-.39	-.39	-.28	-.17	-.17	-.28	-.17	-.17	-.08	-.08	-.08	-.08	-.08	*****	-.08	-.08
36	-.31	-.31	-.20	-.09	-.09	-.20	-.09	-.09	-.01	-.01	-.01	-.01	-.01	*****	-.01	-.01
37	-.61	-.61	-.50	-.39	-.39	-.50	-.39	-.39	-.31	-.31	-.31	-.31	-.31	*****	-.31	-.31
38	-.23	-.23	-.13	-.02	-.02	-.13	-.02	-.02	.06	.06	.06	.06	.06	*****	.06	.06
39	-.17	-.17	-.07	.04	.04	-.07	.04	.04	.12	.12	.12	.12	.12	*****	.12	.12
40	-.47	-.47	-.37	-.25	-.25	-.37	-.25	-.25	-.18	-.18	-.18	-.18	-.18	*****	-.18	-.18
41	-.08	-.08	.02	.13	.13	.02	.13	.13	.20	.20	.20	.20	.20	*****	.20	.20
42	-.03	-.03	.07	.18	.18	.07	.18	.18	.25	.25	.25	.25	.25	*****	.25	.25
43	-.37	-.37	-.27	-.17	-.17	-.27	-.17	-.17	-.09	-.09	-.09	-.09	-.09	*****	-.09	-.09
44	-.05	-.05	.06	.16	.16	.06	.16	.16	.24	.24	.24	.24	.24	*****	.24	.24
45	-.02	-.02	.08	.19	.19	.08	.19	.19	.26	.26	.26	.26	.26	*****	.26	.26
46	-.37	-.37	-.27	-.17	-.17	-.27	-.17	-.17	-.09	-.09	-.09	-.09	-.09	*****	-.09	-.09
47	-.05	-.05	.05	.16	.16	.05	.16	.16	.24	.24	.24	.24	.24	*****	.24	.24
48	-.01	-.01	.09	.20	.20	.09	.20	.20	.29	.29	.29	.29	.29	*****	.29	.29
49	-.35	-.35	-.25	-.15	-.15	-.25	-.15	-.15	-.06	-.06	-.06	-.06	-.06	*****	-.06	-.06
50	.00	.00	.10	.20	.20	.10	.20	.20	.29	.29	.29	.29	.29	*****	.29	.29
51	.00	.00	.10	.20	.20	.10	.20	.20	.31	.31	.31	.31	.31	*****	.31	.31
52	-.33	-.33	-.22	-.12	-.12	-.22	-.12	-.12	-.01	-.01	-.01	-.01	-.01	*****	-.01	-.01
53	.48	.48	.58	.68	.68	.58	.68	.68	.85	.85	.85	.85	.85	*****	.85	.85
54	.87	.87	.98	1.07	1.07	.98	1.07	1.07	1.21	1.21	1.21	1.21	1.21	*****	1.21	1.21
55	.55	.55	.65	.73	.73	.65	.73	.73	.89	.89	.89	.89	.89	*****	.89	.89
56	.83	.83	.92	1.02	1.02	.92	1.02	1.02	1.18	1.18	1.18	1.18	1.18	*****	1.18	1.18
57	.86	.86	.96	1.05	1.05	.96	1.05	1.05	1.22	1.22	1.22	1.22	1.22	*****	1.22	1.22
58	.48	.48	.59	.68	.68	.59	.68	.68	.85	.85	.85	.85	.85	*****	.85	.85
59	.76	.76	.86	.95	.95	.86	.95	.95	1.13	1.13	1.13	1.13	1.13	*****	1.13	1.13
60	.76	.76	.86	.95	.95	.86	.95	.95	1.12	1.12	1.12	1.12	1.12	*****	1.12	1.12
61	.29	.29	.40	.48	.48	.40	.48	.48	.66	.66	.66	.66	.66	*****	.66	.66
62	.42	.42	.52	.61	.61	.52	.61	.61	.81	.81	.81	.81	.81	*****	.81	.81

NOAA-9 SCANNER OFFSETS FOR NOVEMBER 1985:											TOTAL	CHANNEL				
DAY OF MONTH --->																
S.P.	1	2	3	4	5	6	7	8	9	10	11	12	13	14	15	
1	.36	.36	.36	.36	.36	.36	.36	.36	.36	.36	.36	.36	.36	.36	.36	
2	1.04	1.04	1.04	1.04	1.04	1.04	1.04	1.04	1.04	1.04	1.04	1.04	1.04	1.04	1.04	
3	1.93	1.93	1.93	1.93	1.93	1.93	1.93	1.93	1.93	1.93	1.93	1.93	1.93	1.93	1.93	
4	-9.64	-9.64	-9.64	-9.64	-9.64	-9.64	-9.64	-9.64	-9.64	-9.64	-9.64	-9.64	-9.64	-9.64	-9.64	
5	-7.61	-7.29	-8.12	-7.38	-7.81	-7.63	-8.04	-7.64	-8.78	-8.25	-7.67	-7.83	-8.47	-8.30	-8.14	
6	3.91	3.51	3.85	3.73	3.51	3.66	3.69	4.21	3.71	3.63	4.59	3.57	4.21	4.16	3.45	
7	3.59	3.03	3.94	2.70	2.62	2.57	3.63	3.68	3.78	3.43	4.15	2.70	1.55	3.57	2.95	
8	3.01	2.16	2.95	1.10	1.78	1.46	2.85	2.59	3.08	2.41	2.89	1.88	.91	2.16	2.12	
9	2.44	1.35	1.94	-.31	1.10	.58	2.09	1.25	2.13	1.25	1.84	1.05	.61	.74	1.09	
10	1.93	.88	1.32	-1.02	.58	.31	1.83	.40	1.43	.54	1.32	.87	-.10	.26	.68	
11	1.49	.24	.77	-1.29	.38	.47	1.60	.17	1.20	.41	1.00	.95	.06	.28	.50	
12	1.24	-.16	.73	-1.26	.61	.79	1.46	.12	1.22	.77	1.13	.68	-.15	.38	.79	
13	.90	-.78	.29	-1.49	.48	.76	1.29	-.26	.96	.68	.90	-.10	-.48	.04	.69	
14	.92	-1.10	.24	-1.42	.47	.83	1.58	-.39	.74	.70	.65	-.58	-.87	.07	.43	
15	.80	-1.27	.19	-1.24	.20	.75	1.64	-.64	.45	.60	.32	-.81	-1.32	.03	.13	
16	.57	-1.41	-.08	-1.03	-.21	.42	1.52	-.80	-.08	.51	-.02	-1.23	-1.23	-.23	-.13	
17	.46	-1.53	-.13	-.93	-.15	.25	1.47	-.74	-.08	.45	-.12	-1.14	-1.40	-.25	-.38	
18	.31	-1.65	-.15	-.97	.04	.17	1.31	-.64	-.16	.27	-.12	-1.18	-1.44	-.21	-.62	
19	.17	-1.64	-.16	-1.18	.12	-.14	1.02	-.85	-.36	-.02	-.32	-1.38	-1.47	-.13	-.84	
20	.02	-1.56	-.10	-1.49	.33	-.30	.93	-.92	-.44	-.26	-.37	-1.27	-1.07	-.12	-.68	
21	-.21	-1.67	-.19	-1.67	.28	-.43	.79	-.96	-.53	-.44	.51	-1.14	-1.46	-.11	-.68	
22	-.41	-1.75	-.51	-1.77	.05	-.84	.65	-.99	-.65	-.58	-.68	-1.29	-1.61	-.39	-.67	
23	-.56	-1.61	-.72	-1.65	.07	-1.07	.77	-.94	-.67	-.56	-.75	-1.40	-1.42	-.51	-.44	
24	-.75	-1.46	-.77	-1.50	.17	-1.38	.81	-.72	-.65	-.58	-.80	-1.40	-1.07	-.55	-.39	
25	-.84	-1.22	-.75	-1.24	.15	-1.67	.83	-.46	-.49	-.58	-.87	-1.21	-1.20	-.31	-.43	
26	-.67	-.93	-.52	-.72	.25	-1.78	1.02	-.07	-.06	-.37	-.78	-.91	-.44	.08	-.19	
27	-.41	-.69	-.45	-.40	.45	-1.70	1.07	.25	.24	-.16	-.66	-.77	-.03	.28	.05	
28	-.30	-.59	-.51	-.23	.66	-1.52	1.07	.39	.32	-.15	-.60	-.70	.07	.48	.24	
29	-.35	-.43	-.51	-.16	.93	-1.44	1.08	.38	.32	-.31	-.59	-.65	.18	.69	.35	
30	-.62	-.36	-.44	-.32	1.00	-1.40	.99	.24	.19	-.47	-.69	-.52	.00	.64	.37	
31	-.73	-.41	-.40	-.39	.81	-1.37	.92	.07	-.10	-.75	-.85	-.52	-.53	.37	.37	
32	-.37	-.17	-.07	-.06	.97	-1.07	1.20	.30	-.17	-.65	-.67	-.17	-.34	.47	.77	
33	.00	.20	.41	.46	1.38	-.58	1.64	.77	-.07	-.36	-.38	.24	-.01	.83	1.22	
34	.06	.48	.69	.92	1.61	-.23	1.87	1.21	.03	-.29	-.33	.51	.52	.94	1.43	
35	.21	.88	1.08	1.34	1.89	.18	2.06	1.61	.42	-.06	-.16	1.05	1.06	1.33	1.70	
36	.23	1.23	1.31	1.66	2.01	.51	2.14	1.74	.66	.00	-.05	1.37	1.10	1.50	1.64	
37	.21	1.31	1.40	1.85	1.84	.65	2.19	1.70	.76	-.10	-.14	1.33	1.01	1.36	1.47	
38	.39	1.41	1.50	1.96	1.74	.78	2.26	1.71	.83	-.02	-.02	1.33	.88	1.28	1.45	
39	.58	1.40	1.54	1.94	1.64	.97	2.28	1.68	.78	.09	.12	1.44	.75	1.23	1.41	
40	.72	1.42	1.64	1.86	1.55	.99	2.26	1.64	.59	.19	.21	1.49	1.21	1.30	1.25	
41	.84	1.55	1.77	1.84	1.62	.92	2.41	1.81	.52	.43	.36	1.44	1.58	1.45	1.15	
42	.88	1.78	1.73	1.70	1.76	.93	2.55	1.77	.37	.55	.36	1.33	1.70	1.48	1.30	
43	.81	1.98	1.61	1.54	1.90	.89	2.30	1.52	.21	.57	.34	1.25	1.69	1.39	1.35	
44	.79	2.05	1.61	1.57	1.98	.89	2.19	1.45	.22	.59	.33	1.01	1.11	1.46	1.22	
45	.87	2.02	1.64	1.34	1.94	.80	2.10	1.43	.31	.58	.33	.61	1.09	1.45	1.08	
46	.93	1.86	1.61	.95	1.92	.76	1.83	1.28	.37	.60	.14	.40	1.11	1.15	.97	
47	.96	1.56	1.58	.75	1.96	.57	1.54	1.07	.41	.64	-.04	.50	1.05	.88	.78	
48	.92	1.16	1.45	.66	1.94	.01	1.21	.69	.39	.56	-.31	.60	.86	.71	.36	
49	.63	.48	1.24	.42	1.63	-.55	.63	.20	.18	.15	-.54	.28	.43	.57	-.21	
50	.41	-.08	1.07	.48	1.18	-.87	.21	-.23	.06	-.06	-.40	.06	-.32	.30	-.54	
51	.10	-.43	.82	.33	.58	-1.27	.03	-.62	.13	-.24	-.25	-.22	-.23	-.03	-.79	
52	-.20	-.80	.56	.01	.07	-1.70	.00	-.93	.19	-.36	-.29	-.73	-.73	-.27	-1.11	
53	.00	-.74	.92	.01	.05	-1.27	.54	-.77	.47	.25	-.03	-.41	-.56	-.25	-.98	
54	.02	-.57	1.15	-.10	-.16	-.88	.71	-.51	.76	.47	.15	-.34	-.17	-.49	-.95	
55	-.21	-.38	1.29	-.41	-.39	-.77	.43	-.55	.95	.22	-.06	-.61	-.30	-.72	-.81	
56	-.06	-.04	1.49	-.67	-.28	-.51	.16	-.25	1.09	.09	-.26	-.67	-1.01	-.52	-.53	
57	-.09	-.07	1.40	-1.00	-.53	-.66	-.03	-.19	.27	-.38	-.21	-.72	-1.69	-.46	-.42	
58	-.42	-.16	.85	-1.24	-.77	-.78	-.28	-.09	-.31	-.72	.21	-.76	-1.13	-.22	-.04	
59	-3.29	-3.22	-2.88	-3.72	-2.89	-3.77	-3.04	-2.42	-2.84	-3.35	-2.36	-3.49	-3.52	-3.04	-2.81	
60	-13.27	-13.85	-13.75	-13.68	-13.04	-13.90	-13.85	-12.99	-13.46	-14.17	-13.91	-15.19	-14.41	-15.06	-14.99	
61	11.19	11.19	11.19	11.19	11.19	11.19	11.19	11.19	11.19	11.19	11.19	11.19	11.19	11.19	11.19	
62	3.13	3.13	3.13	3.13	3.13	3.13	3.13	3.13	3.13	3.13	3.13	3.13	3.13	3.13	3.13	

S.P.	NOAA-9 SCANNER OFFSETS FOR NOVEMBER 1985: TOTAL CHANNEL														
	16	17	18	19	20	21	22	23	24	25	26	27	28	29	30
	DAY OF MONTH --->														
1	.36	.36	.36	.36	.36	.36	.36	.36	.36	.36	.36	.36	.36	.36	.36
2	1.04	1.04	1.04	1.04	1.04	1.04	1.04	1.04	1.04	1.04	1.04	1.04	1.04	1.04	1.04
3	1.93	1.93	1.93	1.93	1.93	1.93	1.93	1.93	1.93	1.93	1.93	1.93	1.93	1.93	1.93
4	-9.64	-9.64	-9.64	-9.64	-9.64	-9.64	-9.64	-9.64	-9.64	-9.64	-9.64	-9.64	-9.64	-9.64	-9.64
5	-7.84	-8.87	-9.47	-8.18	-7.91	-8.70	-8.82	-9.00	-8.64	-8.69	-9.12	-9.29	-9.25	-8.69	-9.27
6	3.73	3.03	2.32	3.40	4.42	2.69	3.48	3.18	4.06	3.63	2.77	3.14	3.73	3.72	3.52
7	3.06	3.07	1.99	2.22	1.08	.08	3.60	3.27	4.01	3.58	-.35	.45	3.71	3.61	2.97
8	2.02	2.43	1.28	.60	.15	.22	3.18	2.95	2.82	2.51	-.47	.18	2.54	2.42	1.92
9	1.08	1.64	.75	-.46	-.08	.68	2.42	2.21	1.49	1.18	.05	.69	1.40	.92	1.18
10	.60	.93	.49	-.72	-.85	.19	2.00	1.61	.67	.18	-.06	.41	.76	.10	.80
11	.36	.74	.85	-.45	-.54	.42	1.88	1.19	.47	-.33	.42	.79	.08	-.25	.41
12	.53	1.06	1.13	.21	.00	.75	1.91	.78	.59	-.44	.47	.81	-.35	-.38	.27
13	.61	.75	.78	.23	.16	.67	1.61	.33	.29	-.94	.05	.50	-.97	-.77	-.11
14	.68	.24	.54	.44	-.02	.43	1.42	.26	.06	-1.09	-.09	.15	-1.24	-.96	-.32
15	.28	-.18	.37	.51	-.34	-.03	1.34	.22	.02	-1.08	-.16	-.39	-1.56	-1.14	-.66
16	-.09	-.45	.26	.50	-.35	-.24	1.16	.10	-.09	-1.07	-.63	-.69	-2.03	-1.37	-1.13
17	-.20	-.57	.30	.66	-.58	-.64	.96	.10	-.14	-.92	-1.18	-1.42	-2.10	-1.70	-1.22
18	-.37	-.72	.21	.68	-.51	-.73	.91	.03	-.28	-1.00	-1.06	-1.70	-2.13	-1.73	-1.12
19	-.68	-.95	.00	.50	-.45	-.68	-.02	-.08	-.57	-1.25	-1.09	-1.66	-2.37	-1.64	-1.14
20	-.78	-1.15	-.04	.47	-.26	-.56	-.33	-.13	-.82	-1.49	-1.09	-1.49	-2.41	-1.47	-1.15
21	-.91	-1.35	-.09	.33	-.91	-1.44	-.54	-.33	-1.17	-1.72	-1.24	-2.04	-2.34	-1.44	-1.14
22	-1.15	-1.39	-.20	.15	-1.19	-1.84	-.65	-.54	-1.51	-2.00	-1.29	-2.29	-2.17	-1.20	-1.19
23	-1.46	-1.33	-.40	.04	-1.16	-1.68	-.67	-.60	-1.75	-2.22	-1.49	-2.29	-2.01	-1.33	-1.25
24	-1.51	-1.18	-.45	.20	-1.12	-1.53	-.82	-.77	-2.03	-2.35	-1.41	-2.22	-1.79	-1.46	-1.20
25	-1.35	-1.01	-.35	.42	-1.51	-1.66	-.83	-.82	-2.15	-2.22	-1.39	-2.51	-1.48	-1.24	-1.12
26	-1.02	-.68	-.09	.69	-1.10	-.96	-.72	-.64	-1.96	-1.96	-.75	-1.84	-1.17	-.98	-.94
27	-.93	-.42	-.11	.83	-.87	-.64	-.64	-.45	-1.78	-1.81	-.93	-1.46	-1.01	-.74	-.71
28	-.99	-.35	-.34	.84	-.88	-.65	-.84	-.47	-1.82	-1.96	-1.15	-1.34	-.97	-.69	-.59
29	-.87	-.35	-.55	.81	-.86	-.61	-1.06	-.44	-1.82	-2.14	-.93	-1.14	-1.05	-.81	-.58
30	-.73	-.47	-.70	.66	-1.04	-.77	-1.17	-.42	-1.94	-2.35	-1.53	-1.04	-1.22	-.72	-.57
31	-.80	-.63	-.86	.37	-1.58	-1.44	-1.39	-.58	-2.02	-2.55	-2.16	-1.48	-1.57	-.66	-.59
32	-.59	-.47	-.79	.47	-1.38	-1.30	-1.31	-.44	-1.82	-2.40	-2.08	-1.30	-1.46	-.03	-.25
33	-.26	-.29	-.62	.82	-.90	-.88	-1.01	-.23	-1.44	-1.85	-1.70	-.72	-1.10	-.49	-.28
34	-.12	-.21	-.60	.90	-.34	-.30	-.81	-.11	-1.10	-1.55	-1.14	-.10	-.83	.72	.79
35	.22	.20	-.37	1.06	.35	.43	-.12	.36	-.56	-.96	-.72	.39	-.43	1.18	1.26
36	.49	.34	-.23	1.09	.44	.53	.29	.53	-.15	-.53	-.75	.41	-.29	1.63	1.56
37	.51	.31	-.45	1.08	.41	.49	.38	.42	.08	-.39	-.78	.36	-.24	1.96	1.79
38	.48	.41	-.47	1.05	.42	.34	.42	.29	.20	-.26	-.75	.25	-.03	2.20	2.00
39	.38	.51	-.53	.93	.21	.31	.60	.40	.16	-.15	-.87	.08	.19	2.39	2.03
40	.32	.47	-.61	.94	.31	.50	.81	.45	.01	-.09	-.59	.25	.36	2.48	2.04
41	.33	.42	-.53	.92	.46	.64	.89	.58	.02	.08	-.32	.37	.57	2.25	2.19
42	.35	.33	-.52	.78	.51	.67	.81	.78	.03	.21	-.24	.37	.68	2.37	2.24
43	.26	.16	-.59	.60	.63	.70	.66	.86	-.02	.29	-.24	.26	.60	2.01	2.19
44	.25	.06	-.70	.44	.34	.34	.46	.76	.04	.29	-.63	-.24	.56	1.69	2.15
45	.27	-.06	-.89	.37	.54	.58	.57	.68	.08	.18	-.52	-.15	.50	1.38	2.07
46	.24	-.26	-1.05	.38	.58	.55	.60	.49	.04	.06	-.45	-.07	.45	1.01	1.91
47	.22	-.33	-1.09	.47	.63	.35	.61	.39	.09	.16	-.48	-.21	.71	.69	1.69
48	.02	-.38	-1.18	.44	.58	.07	.47	.18	.09	.26	-.51	-.30	1.00	.66	1.32
49	-.25	-.60	-1.16	-.02	.28	-.15	.18	-.17	-.10	.12	-.77	-.37	.90	.41	.80
50	-.47	-.77	-1.22	-.47	-.48	-.84	.08	-.42	-.39	-.07	-1.37	-.99	.47	.00	.39
51	-.70	-1.16	-1.42	-.87	-.44	-.76	-.02	-.55	-.49	-.11	-1.38	-.85	-.09	-.48	.22
52	-.69	-1.47	-1.56	-1.17	-1.01	-1.34	-.02	-.68	-.44	-.09	-1.70	-1.23	-.39	-.64	.13
53	-.26	-1.21	-1.05	-1.02	-.80	-1.08	.18	-.55	-.31	.16	-1.41	-.98	-.30	-.19	.48
54	-.16	-1.23	-.46	-1.08	-.50	-.45	.28	-.65	-.57	-.09	-.93	-.59	-.52	.12	.60
55	-.38	-1.39	-.17	-1.26	-.70	-.34	.48	-.59	-1.05	-.51	-.75	-.86	-.70	.42	.49
56	-.70	-1.01	.21	-.96	-1.17	-.84	.61	-.26	-1.19	-.61	-.92	-1.39	-.72	1.05	.45
57	-.92	-.62	.20	-.69	-1.43	-.99	.66	-.32	-1.18	-.87	-.83	-1.66	-1.01	.67	-.07
58	-.74	-.61	.00	-.26	-.85	-.53	.56	-.76	-1.06	-1.04	.04	-1.33	-1.34	-.24	-.69
59	-3.26	-3.73	-2.90	-2.85	-3.62	-3.11	-2.49	-3.82	-3.60	-3.49	-2.93	-3.91	-4.60	-4.37	-4.07
60	-15.02	-15.55	-14.88	-15.02	-15.45	-15.01	-15.21	-16.03	-15.74	-15.47	-15.36	-16.35	-16.51	-16.04	-16.27
61	11.19	11.19	11.19	11.19	11.19	11.19	11.19	11.19	11.19	11.19	11.19	11.19	11.19	11.19	11.19
62	3.13	3.13	3.13	3.13	3.13	3.13	3.13	3.13	3.13	3.13	3.13	3.13	3.13	3.13	3.13

NOAA-9 SCANNER OFFSETS FOR NOVEMBER 1985: LONGWAVE CHANNEL

S.P.	DAY OF MONTH -->														
	1	2	3	4	5	6	7	8	9	10	11	12	13	14	15
1	.29	.29	.29	.29	.29	.29	.29	.29	.29	.29	.29	.29	.29	.29	.29
2	.59	.59	.59	.59	.59	.59	.59	.59	.59	.59	.59	.59	.59	.59	.59
3	.63	.63	.63	.63	.63	.63	.63	.63	.63	.63	.63	.63	.63	.63	.63
4	.27	.27	.27	.27	.27	.27	.27	.27	.27	.27	.27	.27	.27	.27	.27
5	-5.72	-5.51	-6.05	-5.56	-5.83	-5.75	-6.10	-5.75	-6.52	-6.21	-5.82	-5.96	-6.32	-6.25	-6.20
6	1.40	1.16	1.37	1.25	1.13	1.20	1.13	1.55	1.11	1.10	1.72	1.06	1.48	1.44	.96
7	1.35	.98	1.57	.69	.67	.64	1.23	1.31	1.28	1.11	1.54	.61	.05	1.18	.77
8	.93	.36	.90	-.41	.05	-.15	.65	.52	.78	.36	.65	-.04	-.48	-.17	.15
9	.52	-.22	.20	-1.40	-.45	-.78	.09	-.43	.06	-.48	-.12	-.68	-.86	-.85	-.58
10	.07	-.65	-.32	-2.01	-.90	-1.10	-.22	-1.11	-.55	-1.06	-.59	-.98	-1.54	-1.29	-.98
11	-.37	-1.22	-.84	-2.29	-1.17	-1.16	-.52	-1.41	-.85	-1.30	-.96	-1.18	-1.59	-1.42	-1.25
12	-.64	-1.59	-.97	-2.36	-1.10	-1.04	-.72	-1.54	-.95	-1.19	-.98	-1.51	-1.82	-1.45	-1.17
13	-.89	-2.02	-1.29	-2.55	-1.23	-1.09	-.90	-1.83	-1.22	-1.33	-1.18	-2.03	-2.08	-1.76	-1.31
14	-1.07	-2.42	-1.51	-2.69	-1.44	-1.24	-.92	-2.13	-1.57	-1.51	-1.56	-2.63	-2.59	-1.94	-1.69
15	-1.35	-2.72	-1.74	-2.76	-1.81	-1.48	-1.07	-2.50	-1.94	-1.74	-1.96	-3.00	-3.01	-2.14	-2.10
16	-1.70	-3.02	-2.13	-2.81	-2.29	-1.91	-1.36	-2.81	-2.36	-1.98	-2.39	-3.45	-3.21	-2.52	-2.49
17	-1.95	-3.31	-2.36	-2.96	-2.47	-2.21	-1.57	-2.98	-2.62	-2.22	-2.65	-3.58	-3.57	-2.74	-2.83
18	-2.27	-3.60	-2.59	-3.24	-2.58	-2.48	-1.89	-3.15	-2.86	-2.53	-2.87	-3.82	-3.75	-2.95	-3.20
19	-2.57	-3.79	-2.80	-3.59	-2.73	-2.88	-2.28	-3.51	-3.19	-2.91	-3.21	-4.18	-4.00	-3.13	-3.57
20	-2.90	-3.93	-2.98	-3.96	-2.80	-3.20	-2.55	-3.76	-3.43	-3.28	-3.45	-4.39	-4.06	-3.19	-3.68
21	-3.26	-4.23	-3.26	-4.28	-3.04	-3.51	-2.84	-3.99	-3.67	-3.59	-3.75	-4.51	-4.40	-3.58	-3.90
22	-3.57	-4.47	-3.65	-4.50	-3.36	-3.96	-3.09	-4.18	-3.92	-3.83	-4.02	-4.70	-4.70	-3.94	-4.07
23	-3.86	-4.54	-3.98	-4.63	-3.54	-4.27	-3.17	-4.30	-4.08	-3.96	-4.24	-4.92	-4.84	-4.19	-4.08
24	-4.11	-4.60	-4.15	-4.67	-3.61	-4.60	-3.27	-4.29	-4.19	-4.10	-4.40	-5.01	-4.73	-4.33	-4.18
25	-4.28	-4.54	-4.24	-4.61	-3.72	-4.89	-3.36	-4.19	-4.19	-4.19	-4.54	-5.03	-4.83	-4.25	-4.27
26	-4.24	-4.42	-4.16	-4.34	-3.73	-5.04	-3.29	-4.04	-3.97	-4.08	-4.52	-4.83	-4.34	-4.05	-4.18
27	-4.10	-4.30	-4.16	-4.18	-3.64	-5.04	-3.30	-3.91	-3.80	-3.97	-4.49	-4.78	-4.20	-3.97	-4.05
28	-4.01	-4.23	-4.18	-4.08	-3.51	-4.93	-3.33	-3.81	-3.74	-3.99	-4.45	-4.73	-4.09	-3.83	-3.91
29	-4.01	-4.11	-4.16	-4.02	-3.31	-4.84	-3.28	-3.79	-3.75	-4.10	-4.42	-4.62	-4.01	-3.66	-3.82
30	-4.09	-3.97	-4.01	-4.02	-3.15	-4.73	-3.22	-3.77	-3.74	-4.11	-4.39	-4.65	-4.05	-3.59	-3.69
31	-4.00	-3.84	-3.81	-3.90	-3.11	-4.54	-3.08	-3.70	-3.76	-4.13	-4.33	-4.29	-4.16	-3.60	-3.52
32	-3.53	-3.44	-3.35	-3.44	-2.76	-4.09	-2.64	-3.31	-3.57	-3.81	-3.95	-3.82	-3.79	-3.28	-2.98
33	-2.97	-2.88	-2.71	-2.76	-2.16	-3.44	-2.00	-2.61	-3.14	-3.26	-3.41	-3.17	-3.25	-2.67	-2.32
34	-2.66	-2.43	-2.25	-2.16	-1.71	-2.92	-1.56	-2.03	-2.76	-2.92	-3.09	-2.71	-2.57	-2.31	-1.91
35	-2.24	-1.86	-1.67	-1.56	-1.21	-2.31	-1.11	-1.43	-2.14	-2.42	-2.64	-1.99	-1.88	-1.70	-1.42
36	-1.92	-1.30	-1.18	-1.03	-.82	-1.77	-.73	-1.02	-1.67	-2.08	-2.23	-1.46	-1.55	-1.29	-1.17
37	-1.58	-.89	-.78	-.55	-.58	-1.33	-.36	-.70	-1.26	-1.80	-1.94	-1.13	-1.26	-1.05	-.95
38	-1.14	-.49	-.38	-.14	-.32	-.92	-.02	-.37	-.88	-1.41	-1.53	-.77	-1.02	-.78	-.63
39	-.68	-.17	-.02	.19	-.05	-.48	.37	-.04	-.59	-1.00	-1.09	-.25	-.77	-.48	-.31
40	-.25	.18	.38	.46	.22	-.13	.71	.28	-.38	-.61	-.70	.11	-.13	-.10	-.08
41	.13	.57	.78	.74	.56	.12	1.12	.68	-.14	-.14	-.32	.36	.43	.29	.14
42	.44	1.01	1.07	.94	.94	.43	1.52	.95	.06	.24	-.02	.58	.82	.61	.53
43	.66	1.40	1.25	1.10	1.30	.69	1.62	1.05	.22	.52	.25	.78	1.10	.81	.82
44	.85	1.65	1.48	1.35	1.59	.91	1.77	1.24	.46	.77	.47	.85	.87	1.06	.93
45	1.07	1.80	1.67	1.41	1.76	1.05	1.90	1.42	.69	.95	.65	.79	1.03	1.24	1.01
46	1.26	1.85	1.82	1.31	1.91	1.19	1.89	1.48	.90	1.14	.68	.85	1.23	1.19	1.07
47	1.40	1.80	1.94	1.32	2.08	1.20	1.82	1.48	1.05	1.27	.70	1.06	1.31	1.14	1.06
48	1.49	1.65	1.95	1.38	2.17	.92	1.70	1.32	1.15	1.31	.63	1.23	1.32	1.14	.91
49	1.38	1.28	1.88	1.31	2.05	.63	1.39	1.09	1.05	1.11	.57	1.09	1.05	1.13	.63
50	1.28	.96	1.79	1.39	1.81	.46	1.15	.85	1.01	.99	.71	1.01	.59	.98	.49
51	1.11	.76	1.63	1.31	1.44	.23	1.04	.60	1.09	.87	.82	.83	.80	.80	.36
52	.96	.55	1.47	1.12	1.15	-.02	1.07	.41	1.15	.80	.80	.50	.29	.69	.16
53	.76	.24	1.34	.75	.81	-.08	1.10	.17	.97	.84	.63	.38	.14	.35	-.09
54	.60	.15	1.32	.50	.53	.03	1.06	.20	.94	.81	.59	.27	.24	.02	-.24
55	.37	.20	1.34	.22	.33	.04	.82	.14	.97	.58	.38	.05	.07	-.17	-.21
56	.35	.29	1.32	-.08	.28	.07	.51	.24	.90	.34	.11	-.14	-.54	-.18	-.18
57	.20	.12	1.09	-.46	.00	-.17	.21	.17	.18	-.13	-.03	-.37	-1.19	-.29	-.26
58	-.15	-.09	.53	-.77	-.27	-.36	-.11	.11	-.38	-.51	.09	-.59	-.92	-.26	-.15
59	-2.10	-2.15	-1.99	-2.45	-1.71	-2.29	-1.96	-1.47	-2.10	-2.33	-1.65	-2.47	-2.51	-2.18	-2.02
60	-8.06	-8.49	-8.49	-8.37	-7.74	-8.29	-8.43	-7.81	-8.38	-8.82	-8.59	-9.45	-9.01	-9.37	-9.32
61	.83	.83	.83	.83	.83	.83	.83	.83	.83	.83	.83	.83	.83	.83	.83
62	.97	.97	.97	.97	.97	.97	.97	.97	.97	.97	.97	.97	.97	.97	.97

NOAA-9 SCANNER OFFSETS FOR NOVEMBER 1985: LONGMAVE CHANNEL

S.P.	DAY OF MONTH -->														
	16	17	18	19	20	21	22	23	24	25	26	27	28	29	30
1	.29	.29	.29	.29	.29	.29	.29	.29	.29	.29	.29	.29	.29	.29	.29
2	.59	.59	.59	.59	.59	.59	.59	.59	.59	.59	.59	.59	.59	.59	.59
3	.63	.63	.63	.63	.63	.63	.63	.63	.63	.63	.63	.63	.63	.63	.63
4	.27	.27	.27	.27	.27	.27	.27	.27	.27	.27	.27	.27	.27	.27	.27
5	-5.97	-6.67	-7.02	-6.27	-6.01	-6.49	-6.53	-6.60	-6.42	-6.37	-6.71	-6.80	-6.76	-6.37	-6.77
6	1.14	.61	.20	.82	1.58	.47	1.02	.88	1.44	1.23	.58	.80	1.22	1.26	1.08
7	.84	.75	.09	.12	-.28	-.93	1.20	1.05	1.51	1.33	-1.15	-.66	1.33	1.27	.85
8	.08	.26	-.47	-1.03	-.99	-.95	.85	.75	.62	.54	-1.33	-.94	.49	.39	.09
9	-.62	-.35	-.89	-1.80	-1.32	-.77	.34	.21	-.33	-.38	-1.15	-.76	-.32	-.66	-.47
10	-1.06	-.97	-1.16	-2.09	-2.02	-1.26	-.01	-.31	-.99	-1.16	-1.40	-1.09	-.86	-1.31	-.83
11	-1.37	-1.26	-1.07	-2.05	-1.96	-1.26	-.22	-.75	-1.25	-1.64	-1.24	-.97	-1.45	-1.69	-1.23
12	-1.36	-1.16	-.98	-1.69	-1.66	-1.07	-.25	-1.06	-1.24	-1.79	-1.25	-1.03	-1.80	-1.85	-1.40
13	-1.35	-1.39	-1.28	-1.73	-1.54	-1.09	-.45	-1.39	-1.47	-2.14	-1.50	-1.23	-2.21	-2.11	-1.67
14	-1.49	-1.93	-1.66	-1.82	-1.92	-1.46	-.77	-1.58	-1.80	-2.38	-1.81	-1.70	-2.56	-2.40	-1.99
15	-1.94	-2.40	-1.98	-1.97	-2.27	-1.87	-.99	-1.79	-1.99	-2.55	-2.12	-2.17	-2.94	-2.71	-2.39
16	-2.39	-2.77	-2.26	-2.19	-2.54	-2.25	-1.30	-2.06	-2.25	-2.72	-2.51	-2.61	-3.43	-3.05	-2.91
17	-2.65	-3.05	-2.46	-2.29	-2.90	-2.74	-1.63	-2.26	-2.46	-2.81	-3.13	-3.35	-3.68	-3.32	-3.17
18	-2.99	-3.36	-2.74	-2.50	-3.00	-2.97	-2.19	-2.55	-2.79	-3.10	-3.35	-3.70	-3.91	-3.54	-3.31
19	-3.43	-3.72	-3.11	-2.85	-3.21	-3.21	-2.79	-2.86	-3.21	-3.50	-3.62	-3.91	-4.29	-3.73	-3.53
20	-3.70	-4.10	-3.35	-3.09	-3.44	-3.49	-3.27	-3.14	-3.62	-3.91	-3.79	-4.08	-4.54	-3.87	-3.76
21	-4.00	-4.47	-3.60	-3.39	-3.96	-4.16	-3.66	-3.51	-4.07	-4.30	-4.20	-4.49	-4.70	-4.06	-3.96
22	-4.34	-4.67	-3.88	-3.67	-4.38	-4.64	-3.93	-3.85	-4.46	-4.68	-4.42	-4.88	-4.74	-4.18	-4.18
23	-4.73	-4.80	-4.21	-3.92	-4.62	-4.81	-4.12	-4.09	-4.84	-5.03	-4.55	-5.13	-4.81	-4.43	-4.41
24	-4.88	-4.79	-4.36	-3.93	-4.71	-4.83	-4.32	-4.32	-5.16	-5.24	-4.63	-5.21	-4.80	-4.65	-4.50
25	-4.86	-4.76	-4.36	-3.88	-4.97	-4.90	-4.40	-4.42	-5.34	-5.24	-4.90	-5.39	-4.69	-4.60	-4.55
26	-4.70	-4.59	-4.22	-3.76	-4.72	-4.44	-4.40	-4.37	-5.30	-5.13	-4.52	-4.94	-4.55	-4.50	-4.51
27	-4.67	-4.44	-4.27	-3.70	-4.71	-4.39	-4.38	-4.30	-5.23	-5.09	-4.57	-4.89	-4.51	-4.38	-4.42
28	-4.71	-4.36	-4.40	-3.68	-4.71	-4.41	-4.57	-4.36	-5.28	-5.22	-4.71	-4.80	-4.50	-4.36	-4.33
29	-4.60	-4.31	-4.50	-3.66	-4.68	-4.39	-4.71	-4.33	-5.27	-5.34	-4.57	-4.65	-4.54	-4.42	-4.29
30	-4.39	-4.29	-4.48	-3.64	-4.74	-4.44	-4.68	-4.22	-5.25	-5.40	-4.90	-4.51	-4.56	-4.27	-4.19
31	-4.26	-4.24	-4.41	-3.66	-4.89	-4.71	-4.67	-4.20	-5.16	-5.40	-5.11	-4.60	-4.64	-3.94	-4.05
32	-3.87	-3.89	-4.13	-3.32	-4.55	-4.41	-4.37	-3.87	-4.80	-5.05	-4.83	-4.27	-4.31	-3.41	-3.59
33	-3.30	-3.45	-3.70	-2.74	-3.90	-3.85	-3.85	-3.44	-4.24	-4.36	-4.27	-3.58	-3.74	-2.74	-2.89
34	-2.93	-3.09	-3.39	-2.39	-3.16	-3.10	-3.41	-3.04	-3.70	-3.85	-3.56	-2.86	-3.27	-2.30	-2.26
35	-2.36	-2.45	-2.87	-1.94	-2.36	-2.25	-2.57	-2.37	-2.99	-3.11	-2.95	-2.22	-2.68	-1.66	-1.64
36	-1.85	-2.03	-2.42	-1.61	-1.97	-1.86	-1.97	-1.92	-2.39	-2.48	-2.66	-1.93	-2.30	-1.05	-1.14
37	-1.49	-1.71	-2.21	-1.24	-1.64	-1.54	-1.59	-1.67	-1.89	-2.05	-2.33	-1.65	-1.93	-.49	-.66
38	-1.17	-1.30	-1.87	-.92	-1.34	-1.35	-1.26	-1.44	-1.49	-1.63	-2.02	-1.46	-1.47	-.01	-.19
39	-.90	-.89	-1.57	-.65	-1.16	-1.04	-.80	-1.04	-1.18	-1.24	-1.78	-1.24	-.99	.43	.16
40	-.61	-.57	-1.29	-.30	-.75	-.58	-.32	-.67	-.97	-.88	-1.27	-.80	-.57	.81	.48
41	-.30	-.33	-.94	-.01	-.32	-.22	.02	-.31	-.69	-.48	-.79	-.42	-.15	1.10	.88
42	.00	-.13	-.66	.18	.00	.07	.24	.10	-.41	-.12	-.46	-.14	.21	1.30	1.19
43	.19	.00	-.46	.31	.33	.35	.40	.40	-.18	.19	-.17	.05	.41	1.30	1.43
44	.39	.16	-.32	.40	.31	.30	.50	.56	.06	.42	-.26	-.10	.59	1.31	1.60
45	.59	.29	-.27	.53	.64	.69	.80	.73	.28	.55	.00	.15	.73	1.29	1.72
46	.73	.33	-.22	.71	.87	.87	.98	.77	.41	.63	.23	.38	.85	1.21	1.76
47	.85	.41	-.10	.93	1.02	.84	1.12	.83	.59	.81	.31	.41	1.15	1.12	1.74
48	.85	.49	-.04	1.04	1.13	.78	1.12	.79	.70	.99	.43	.48	1.43	1.36	1.60
49	.75	.44	.03	.81	.98	.69	.99	.61	.64	.97	.30	.49	1.45	1.27	1.34
50	.64	.38	.02	.54	.51	.27	.97	.48	.45	.86	-.05	.10	1.19	.89	1.11
51	.50	.14	-.08	.27	.69	.47	.91	.42	.41	.86	.09	.34	.83	.75	1.02
52	.52	-.07	-.15	.10	.16	-.08	.91	.37	.50	.88	-.29	-.09	.66	.46	.98
53	.46	-.26	-.19	-.16	.02	-.20	.65	.09	.26	.71	-.38	-.20	.37	.37	.88
54	.34	-.45	-.01	-.37	.05	.05	.53	-.14	-.13	.35	-.23	-.11	.02	.53	.77
55	.13	-.64	.10	-.56	-.16	.07	.62	-.14	-.52	.02	-.18	-.35	-.19	.67	.63
56	-.22	-.54	.23	-.48	-.62	-.40	.58	-.06	-.76	-.18	-.40	-.84	-.35	.81	.47
57	-.50	-.44	.09	-.44	-.99	-.68	.47	-.25	-.90	-.46	-.53	-1.22	-.70	.41	-.01
58	-.50	-.55	-.20	-.31	-.72	-.49	.21	-.70	-1.00	-.71	-.10	-1.13	-1.07	-.33	-.56
59	-2.19	-2.64	-2.16	-2.11	-2.58	-2.21	-1.85	-2.79	-2.74	-2.38	-2.08	-2.83	-3.27	-3.07	-2.81
60	-9.20	-9.67	-9.30	-9.37	-9.64	-9.32	-9.46	-10.09	-9.97	-9.50	-9.48	-10.20	-10.32	-9.98	-10.06
61	.83	.83	.83	.83	.83	.83	.83	.83	.83	.83	.83	.83	.83	.83	.83
62	.97	.97	.97	.97	.97	.97	.97	.97	.97	.97	.97	.97	.97	.97	.97

NOAA-9 SCANNER OFFSETS FOR NOVEMBER 1985: SHORTWAVE CHANNEL

S.P.	DAY OF MONTH -->														
	1	2	3	4	5	6	7	8	9	10	11	12	13	14	15
1	-.11	-.11	-.11	-.11	-.11	-.11	-.11	-.11	-.11	-.11	-.11	-.11	-.11	-.11	-.11
2	.32	.32	.32	.32	.32	.32	.32	.32	.32	.32	.32	.32	.32	.32	.32
3	.49	.49	.49	.49	.49	.49	.49	.49	.49	.49	.49	.49	.49	.49	.49
4	-4.09	-4.09	-4.09	-4.09	-4.09	-4.09	-4.09	-4.09	-4.09	-4.09	-4.09	-4.09	-4.09	-4.09	-4.09
5	.54	.56	.43	.32	.40	.30	.34	.33	.26	.28	.33	.36	.34	.42	.46
6	.61	.64	.50	.39	.48	.37	.39	.39	.33	.35	.39	.40	.37	.44	.45
7	.25	.28	.15	.03	.12	.01	.02	.02	-.03	-.02	.03	.01	-.01	.04	.06
8	.58	.62	.47	.35	.45	.33	.34	.34	.29	.30	.35	.34	.33	.36	.41
9	.66	.69	.55	.42	.52	.40	.40	.41	.36	.36	.41	.40	.41	.40	.48
10	.30	.32	.19	.06	.17	.04	.05	.05	.01	-.01	.05	.04	.05	.03	.12
11	.58	.61	.47	.32	.44	.33	.33	.33	.30	.30	.34	.36	.38	.36	.47
12	.57	.60	.46	.29	.43	.31	.32	.32	.27	.27	.32	.33	.36	.35	.44
13	-.25	-.22	-.37	-.56	-.38	-.51	-.50	-.52	-.56	-.57	-.50	-.52	-.49	-.50	-.40
14	.01	.05	-.12	-.30	-.12	-.25	-.23	-.25	-.30	-.30	-.22	-.25	-.23	-.23	-.13
15	.01	.05	-.11	-.29	-.11	-.23	-.21	-.24	-.28	-.28	-.21	-.22	-.20	-.21	-.10
16	-.38	-.35	-.49	-.67	-.50	-.61	-.59	-.63	-.67	-.67	-.60	-.62	-.59	-.61	-.50
17	-.09	-.05	-.19	-.37	-.19	-.31	-.29	-.33	-.37	-.37	-.29	-.31	-.28	-.30	-.19
18	-.08	-.03	-.18	-.34	-.17	-.29	-.27	-.31	-.34	-.33	-.26	-.28	-.24	-.26	-.16
19	-.45	-.41	-.55	-.70	-.53	-.65	-.63	-.66	-.70	-.68	-.61	-.62	-.59	-.61	-.52
20	-.12	-.08	-.22	-.37	-.19	-.32	-.29	-.32	-.36	-.35	-.26	-.28	-.27	-.28	-.19
21	-.10	-.06	-.21	-.34	-.17	-.29	-.27	-.30	-.34	-.32	-.24	-.25	-.24	-.25	-.17
22	-.52	-.48	-.63	-.77	-.59	-.71	-.70	-.73	-.75	-.74	-.66	-.67	-.65	-.65	-.56
23	-.18	-.14	-.29	-.44	-.26	-.39	-.37	-.39	-.40	-.39	-.31	-.33	-.30	-.29	-.21
24	-.13	-.10	-.25	-.40	-.22	-.35	-.32	-.35	-.36	-.34	-.27	-.29	-.26	-.24	-.15
25	-.48	-.45	-.61	-.75	-.57	-.71	-.68	-.70	-.71	-.68	-.62	-.65	-.62	-.61	-.50
26	-.14	-.11	-.26	-.40	-.23	-.36	-.33	-.36	-.37	-.32	-.27	-.29	-.26	-.26	-.13
27	-.10	-.08	-.22	-.35	-.19	-.32	-.28	-.31	-.33	-.28	-.23	-.24	-.23	-.21	-.11
28	-.46	-.44	-.58	-.70	-.54	-.66	-.63	-.65	-.67	-.63	-.58	-.60	-.59	-.56	-.48
29	-.10	-.07	-.21	-.32	-.15	-.28	-.25	-.28	-.30	-.25	-.19	-.22	-.21	-.19	-.11
30	-.03	.00	-.13	-.24	-.09	-.21	-.18	-.20	-.22	-.17	-.11	-.15	-.13	-.13	-.06
31	-.38	-.35	-.49	-.59	-.45	-.57	-.55	-.56	-.58	-.53	-.47	-.50	-.48	-.48	-.41
32	-.05	-.03	-.17	-.28	-.11	-.24	-.21	-.24	-.26	-.21	-.15	-.20	-.19	-.17	-.11
33	-.12	-.11	-.26	-.38	-.18	-.33	-.29	-.34	-.35	-.33	-.23	-.33	-.33	-.34	-.27
34	-.47	-.48	-.62	-.74	-.53	-.68	-.64	-.71	-.71	-.69	-.58	-.69	-.69	-.72	-.64
35	-.13	-.11	-.27	-.41	-.19	-.35	-.30	-.36	-.38	-.34	-.24	-.33	-.32	-.36	-.27
36	-.05	-.04	-.19	-.32	-.11	-.26	-.22	-.27	-.29	-.25	-.16	-.24	-.25	-.28	-.18
37	-.35	-.35	-.49	-.62	-.41	-.57	-.51	-.57	-.60	-.55	-.47	-.54	-.55	-.59	-.49
38	.02	.02	-.11	-.23	-.03	-.19	-.13	-.18	-.21	-.17	-.08	-.15	-.17	-.20	-.10
39	.08	.08	-.05	-.16	.03	-.11	-.06	-.12	-.15	-.10	-.02	-.09	-.11	-.13	-.04
40	-.22	-.22	-.34	-.46	-.26	-.41	-.37	-.42	-.45	-.41	-.32	-.41	-.43	-.45	-.36
41	.17	.15	.04	-.07	.13	-.03	.02	-.04	-.07	-.02	.08	-.02	-.04	-.07	.03
42	.22	.22	.10	.00	.19	.04	.08	.04	.00	.06	.15	.07	.04	.02	.12
43	-.12	-.12	-.24	-.34	-.15	-.30	-.26	-.30	-.34	-.28	-.19	-.28	-.31	-.33	-.22
44	.22	.22	.10	.00	.18	.04	.08	.04	.00	.05	.15	.08	.05	.03	.14
45	.25	.26	.13	.03	.21	.07	.11	.06	.03	.08	.18	.11	.09	.06	.18
46	-.09	-.09	-.21	-.31	-.13	-.28	-.24	-.29	-.32	-.27	-.17	-.24	-.26	-.29	-.16
47	.25	.24	.13	.03	.21	.06	.10	.05	.02	.08	.17	.10	.09	.07	.21
48	.30	.30	.19	.09	.27	.12	.16	.11	.08	.14	.22	.16	.14	.14	.27
49	-.04	-.05	-.15	-.24	-.06	-.22	-.18	-.23	-.26	-.21	-.13	-.19	-.22	-.23	-.10
50	.32	.30	.21	.12	.30	.15	.17	.13	.10	.16	.23	.16	.13	.14	.25
51	.33	.33	.23	.15	.32	.18	.20	.16	.12	.20	.27	.18	.16	.19	.29
52	.01	.01	-.08	-.16	.00	-.13	-.11	-.16	-.19	-.12	-.05	-.14	-.15	-.14	-.03
53	.87	.86	.80	.71	.83	.73	.72	.68	.65	.72	.79	.75	.71	.72	.87
54	1.25	1.23	1.17	1.11	1.21	1.10	1.08	1.05	1.03	1.08	1.14	1.10	1.08	1.10	1.22
55	.93	.92	.85	.80	.90	.79	.76	.73	.72	.76	.82	.78	.76	.76	.90
56	1.22	1.21	1.15	1.09	1.18	1.07	1.05	1.01	1.01	1.06	1.10	1.06	1.04	1.05	1.20
57	1.27	1.25	1.20	1.14	1.23	1.13	1.10	1.06	1.05	1.10	1.15	1.10	1.08	1.10	1.24
58	.90	.89	.83	.78	.87	.77	.73	.69	.68	.73	.77	.71	.70	.73	.86
59	1.18	1.18	1.11	1.05	1.14	1.05	1.01	.97	.96	1.02	1.04	1.00	.98	1.01	1.16
60	1.19	1.17	1.11	1.07	1.15	1.06	1.00	.98	.96	1.02	1.03	1.00	.98	1.01	1.16
61	3.05	3.05	3.05	3.05	3.05	3.05	3.05	3.05	3.05	3.05	3.05	3.05	3.05	3.05	3.05
62	.45	.45	.45	.45	.45	.45	.45	.45	.45	.45	.45	.45	.45	.45	.45

NOAA-9 SCANNER OFFSETS FOR NOVEMBER 1985: SHORTWAVE CHANNEL

S.P.	DAY OF MONTH -->														
	16	17	18	19	20	21	22	23	24	25	26	27	28	29	30
1	-.11	-.11	-.11	-.11	-.11	-.11	-.11	-.11	-.11	-.11	-.11	-.11	-.11	-.11	-.11
2	.32	.32	.32	.32	.32	.32	.32	.32	.32	.32	.32	.32	.32	.32	.32
3	.49	.49	.49	.49	.49	.49	.49	.49	.49	.49	.49	.49	.49	.49	.49
4	-4.09	-4.09	-4.09	-4.09	-4.09	-4.09	-4.09	-4.09	-4.09	-4.09	-4.09	-4.09	-4.09	-4.09	-4.09
5	.40	.35	.34	.35	.41	.38	.36	.36	.40	.35	.37	.41	.40	.35	.46
6	.44	.42	.42	.40	.46	.45	.42	.43	.45	.42	.43	.47	.47	.41	.53
7	.06	.05	.06	.02	.07	.09	.06	.07	.08	.04	.04	.09	.08	.03	.15
8	.40	.39	.40	.37	.40	.42	.40	.41	.42	.38	.36	.43	.41	.35	.47
9	.46	.44	.47	.44	.47	.46	.46	.46	.49	.43	.42	.47	.46	.42	.54
10	.08	.06	.11	.08	.11	.09	.10	.09	.12	.05	.04	.09	.08	.04	.16
11	.40	.37	.41	.40	.43	.42	.42	.41	.44	.36	.35	.40	.39	.34	.47
12	.37	.34	.38	.37	.41	.40	.40	.38	.41	.34	.32	.37	.36	.32	.44
13	-.49	-.47	-.43	-.45	-.41	-.41	-.45	-.44	-.42	-.48	-.51	-.48	-.49	-.54	-.39
14	-.24	-.21	-.16	-.17	-.14	-.15	-.16	-.16	-.13	-.19	-.25	-.21	-.22	-.29	-.12
15	-.20	-.19	-.14	-.15	-.12	-.14	-.17	-.15	-.11	-.18	-.23	-.18	-.20	-.28	-.10
16	-.61	-.58	-.55	-.55	-.52	-.54	-.57	-.56	-.52	-.59	-.62	-.57	-.59	-.67	-.49
17	-.30	-.27	-.25	-.23	-.23	-.24	-.27	-.26	-.23	-.29	-.31	-.25	-.28	-.37	-.17
18	-.27	-.25	-.23	-.21	-.22	-.21	-.25	-.23	-.21	-.26	-.29	-.21	-.26	-.34	-.15
19	-.63	-.62	-.58	-.56	-.57	-.56	-.60	-.58	-.56	-.61	-.64	-.56	-.62	-.70	-.52
20	-.30	-.27	-.24	-.21	-.22	-.21	-.24	-.23	-.22	-.26	-.29	-.23	-.27	-.35	-.18
21	-.28	-.22	-.21	-.18	-.17	-.14	-.19	-.19	-.19	-.22	-.25	-.22	-.25	-.32	-.16
22	-.68	-.62	-.62	-.60	-.57	-.53	-.57	-.59	-.59	-.62	-.66	-.62	-.67	-.75	-.58
23	-.32	-.27	-.27	-.24	-.23	-.18	-.22	-.24	-.23	-.27	-.31	-.26	-.32	-.41	-.24
24	-.28	-.24	-.22	-.20	-.20	-.14	-.17	-.19	-.18	-.21	-.28	-.20	-.27	-.36	-.19
25	-.64	-.61	-.59	-.56	-.57	-.54	-.57	-.58	-.55	-.60	-.64	-.56	-.63	-.72	-.56
26	-.30	-.26	-.25	-.20	-.22	-.20	-.23	-.25	-.21	-.27	-.28	-.22	-.27	-.37	-.20
27	-.25	-.21	-.21	-.15	-.18	-.16	-.19	-.21	-.19	-.23	-.22	-.16	-.22	-.31	-.15
28	-.60	-.57	-.57	-.50	-.53	-.50	-.52	-.53	-.53	-.57	-.57	-.50	-.56	-.66	-.51
29	-.23	-.19	-.19	-.12	-.15	-.11	-.11	-.13	-.15	-.17	-.19	-.13	-.18	-.27	-.13
30	-.17	-.12	-.12	-.05	-.06	-.02	-.04	-.06	-.08	-.08	-.11	-.08	-.11	-.19	-.06
31	-.52	-.45	-.47	-.39	-.40	-.36	-.38	-.39	-.41	-.41	-.47	-.43	-.45	-.54	-.41
32	-.21	-.11	-.11	-.05	-.06	-.02	-.05	-.06	-.07	-.07	-.14	-.11	-.14	-.21	-.08
33	-.36	-.21	-.19	-.16	-.16	-.10	-.15	-.17	-.19	-.18	-.25	-.24	-.28	-.34	-.20
34	-.73	-.58	-.54	-.53	-.53	-.47	-.51	-.54	-.56	-.54	-.62	-.60	-.66	-.71	-.57
35	-.37	-.22	-.19	-.16	-.18	-.14	-.19	-.22	-.23	-.22	-.28	-.25	-.30	-.36	-.21
36	-.29	-.15	-.13	-.07	-.11	-.08	-.14	-.16	-.16	-.16	-.19	-.17	-.21	-.27	-.12
37	-.60	-.45	-.44	-.39	-.41	-.39	-.44	-.48	-.48	-.48	-.49	-.47	-.51	-.57	-.43
38	-.21	-.05	-.05	-.01	-.03	.00	-.05	-.08	-.10	-.08	-.11	-.07	-.12	-.19	-.03
39	-.14	.01	.01	.05	.04	.07	.03	.00	-.04	-.01	-.04	.00	-.06	-.11	.03
40	-.45	-.30	-.29	-.26	-.26	-.24	-.29	-.32	-.35	-.32	-.35	-.32	-.36	-.41	-.28
41	-.07	.10	.10	.14	.14	.17	.11	.08	.06	.09	.05	.07	.04	-.03	.12
42	.02	.19	.18	.22	.23	.27	.21	.18	.15	.18	.15	.15	.12	.05	.19
43	-.32	-.15	-.16	-.13	-.11	-.06	-.12	-.16	-.20	-.16	-.20	-.18	-.22	-.28	-.16
44	.04	.20	.20	.25	.25	.29	.24	.19	.17	.21	.16	.17	.12	.07	.19
45	.07	.22	.23	.29	.27	.29	.23	.19	.19	.21	.18	.19	.15	.09	.22
46	-.28	-.14	-.13	-.06	-.08	-.06	-.13	-.17	-.17	-.15	-.17	-.15	-.20	-.28	-.13
47	.07	.22	.22	.29	.28	.28	.23	.19	.17	.20	.19	.20	.15	.07	.22
48	.12	.29	.26	.32	.34	.36	.30	.25	.23	.26	.25	.27	.20	.13	.26
49	-.24	-.07	-.09	-.04	-.01	.01	-.03	-.08	-.13	-.08	-.10	-.12	-.15	-.22	-.10
50	.12	.28	.29	.34	.35	.37	.33	.29	.26	.30	.25	.24	.21	.13	.25
51	.16	.30	.31	.39	.39	.40	.36	.32	.32	.33	.29	.27	.24	.15	.28
52	-.15	-.03	-.03	.07	.07	.09	.04	-.01	-.03	.01	-.02	-.04	-.10	-.18	-.06
53	.73	.82	.83	.94	.92	.94	.91	.84	.85	.90	.84	.83	.74	.68	.78
54	1.10	1.19	1.20	1.29	1.29	1.30	1.28	1.22	1.21	1.27	1.21	1.20	1.12	1.09	1.16
55	.78	.85	.88	.96	.95	.96	.94	.87	.87	.93	.88	.84	.79	.75	.82
56	1.08	1.15	1.16	1.25	1.24	1.25	1.22	1.16	1.17	1.22	1.16	1.13	1.08	1.03	1.11
57	1.13	1.19	1.20	1.28	1.28	1.28	1.26	1.19	1.19	1.25	1.22	1.16	1.12	1.07	1.15
58	.75	.81	.81	.88	.90	.91	.88	.81	.79	.88	.84	.79	.72	.68	.76
59	1.04	1.10	1.10	1.18	1.19	1.19	1.17	1.10	1.09	1.18	1.13	1.06	1.00	.97	1.04
60	1.04	1.09	1.10	1.17	1.18	1.19	1.16	1.09	1.09	1.19	1.11	1.04	.99	.96	1.03
61	3.05	3.05	3.05	3.05	3.05	3.05	3.05	3.05	3.05	3.05	3.05	3.05	3.05	3.05	3.05
62	.45	.45	.45	.45	.45	.45	.45	.45	.45	.45	.45	.45	.45	.45	.45

NOAA-9 SCANNER OFFSETS FOR DECEMBER 1985: TOTAL CHANNEL															
S.P.	DAY OF MONTH -->														
	1	2	3	4	5	6	7	8	9	10	11	12	13	14	15
1	.36	.36	.36	.36	.36	.36	.36	.36	.36	.36	.36	.36	.36	.36	.36
2	1.04	1.04	1.04	1.04	1.04	1.04	1.04	1.04	1.04	1.04	1.04	1.04	1.04	1.04	1.04
3	1.93	1.93	1.93	1.93	1.93	1.93	1.93	1.93	1.93	1.93	1.93	1.93	1.93	1.93	1.93
4	-9.64	-9.64	-9.64	-9.64	-9.64	-9.64	-9.64	-9.64	-9.64	-9.64	-9.64	-9.64	-9.64	-9.64	-9.64
5	2.39	1.86	2.40	2.28	1.90	2.06	2.06	2.43	1.81	1.69	2.95	2.76	3.37	2.78	2.21
6	.22	-.68	-.44	-.02	-.69	-.63	-.48	-.57	-1.46	-1.52	.11	-.34	.63	-.35	-.98
7	1.34	.64	.77	1.26	.81	.69	.53	.72	-.11	-.08	.99	.95	1.12	.56	.12
8	-1.15	-1.64	-1.22	-1.26	-1.13	-1.21	-1.74	-1.55	-2.10	-1.72	-1.86	-1.31	-1.61	-1.70	-2.16
9	-1.91	-2.21	-1.28	-1.61	-1.45	-1.53	-2.00	-1.95	-2.10	-1.80	-2.88	-1.62	-2.33	-1.93	-2.45
10	-2.27	-2.23	-1.36	-1.55	-1.76	-1.58	-2.13	-2.09	-1.85	-1.93	-3.21	-1.66	-2.63	-1.81	-2.38
11	-2.59	-2.45	-1.58	-1.90	-1.96	-1.66	-2.40	-2.36	-1.73	-2.26	-2.94	-1.92	-3.19	-2.12	-2.52
12	-2.81	-2.79	-1.82	-2.39	-2.06	-2.08	-2.76	-2.76	-1.87	-2.79	-3.04	-2.43	-3.92	-2.72	-2.80
13	-3.13	-3.36	-2.48	-3.06	-2.45	-2.84	-3.25	-3.34	-2.25	-3.47	-3.45	-3.00	-4.68	-3.74	-3.41
14	-2.76	-3.26	-2.68	-3.09	-2.35	-3.10	-2.96	-3.19	-2.16	-3.48	-3.49	-2.82	-4.86	-4.04	-3.60
15	-2.35	-2.86	-2.65	-2.90	-2.03	-3.10	-2.64	-2.95	-1.95	-3.14	-2.88	-2.53	-4.79	-3.86	-3.62
16	-2.15	-2.48	-2.67	-2.68	-1.71	-2.83	-2.54	-2.80	-1.79	-2.93	-2.71	-2.22	-4.55	-3.74	-3.56
17	-1.86	-2.04	-2.47	-2.21	-1.40	-2.45	-2.41	-2.59	-1.60	-2.71	-2.63	-1.81	-4.13	-3.58	-3.39
18	-1.74	-1.74	-2.00	-1.89	-1.33	-2.22	-2.32	-2.47	-1.63	-2.51	-2.28	-1.60	-3.59	-3.46	-3.15
19	-1.72	-1.45	-1.64	-1.68	-1.49	-2.20	-2.15	-2.46	-1.59	-2.40	-2.04	-1.65	-3.05	-3.26	-3.15
20	-1.59	-1.12	-1.28	-1.33	-1.51	-1.96	-1.99	-2.36	-1.34	-2.27	-1.60	-1.42	-2.66	-2.86	-2.73
21	-1.35	-.93	-.85	-.88	-1.25	-1.53	-1.83	-2.15	-1.13	-2.09	-1.23	-1.08	-2.18	-2.49	-2.28
22	-1.41	-.80	-.68	-.63	-1.09	-1.12	-1.69	-1.77	-1.05	-1.98	-1.10	-.84	-1.74	-2.12	-1.96
23	-1.67	-.86	-.70	-.56	-1.18	-.85	-1.53	-1.51	-.96	-1.81	-1.24	-.80	-1.48	-1.91	-1.78
24	-1.89	-1.15	-.88	-.74	-1.32	-.90	-1.59	-1.67	-1.09	-1.97	-1.50	-.96	-1.37	-2.01	-1.93
25	-2.03	-1.27	-.88	-.93	-1.34	-.94	-1.75	-1.82	-1.15	-2.07	-1.48	-1.06	-1.34	-2.21	-2.15
26	-1.81	-1.01	-.60	-.84	-1.16	-.68	-1.58	-1.78	-.90	-1.82	-1.24	-.98	-1.20	-2.10	-2.08
27	-1.61	-.65	-.38	-.63	-.93	-.31	-1.26	-1.67	-.72	-1.45	-.94	-.76	-.91	-1.84	-1.86
28	-1.52	-.43	-.31	-.42	-.68	-.08	-.99	-1.60	-.60	-1.12	-.66	-.61	-.78	-1.62	-1.66
29	-1.39	-.11	-.14	-.21	-.43	.08	-.65	-1.41	-.41	-.92	-.51	-.46	-.70	-1.25	-1.39
30	-1.21	.21	.06	-.15	-.30	.16	-.49	-1.22	-.30	-.83	-.44	-.36	-.65	-.86	-1.05
31	-1.09	.31	.12	-.35	-.28	.28	-.37	-1.09	-.31	-.80	-.46	-.34	-.70	-.56	-.84
32	-.56	.80	.47	-.14	-.03	.70	-.06	-.59	.07	-.33	.02	.18	-.23	.12	-.36
33	.17	1.33	.93	.23	.30	1.31	.34	-.11	.43	.29	.55	.87	.40	.84	.21
34	.58	1.59	1.29	.52	.58	1.76	.60	.04	.68	.69	.78	1.21	.68	1.26	.53
35	.86	1.65	1.46	.60	.79	1.98	.79	.08	.87	.92	.92	1.36	.88	1.48	.74
36	.93	1.49	1.35	.51	.79	2.08	.74	-.02	.84	.87	.89	1.32	.98	1.46	.76
37	.77	1.18	1.19	.37	.62	1.88	.59	-.11	.63	.63	.67	1.09	1.00	1.21	.66
38	.83	1.20	1.30	.50	.64	1.81	.67	-.02	.59	.48	.61	1.15	1.23	1.20	.71
39	.67	1.15	1.18	.51	.51	1.63	.62	.02	.38	.23	.46	1.06	1.30	1.15	.60
40	.62	1.11	1.05	.48	.42	1.49	.45	.15	.19	.11	.44	.83	1.28	1.28	.52
41	.61	1.06	.95	.39	.35	1.36	.22	.25	.11	.01	.49	.73	1.24	1.31	.41
42	.72	.98	.93	.40	.24	1.30	.29	.39	.19	-.11	.59	.68	1.30	1.22	.28
43	.62	.72	.54	.31	-.02	1.16	.15	.23	.01	-.36	.60	.45	1.11	.73	-.08
44	.62	.74	.22	.38	-.05	1.16	.12	.19	-.12	-.41	.75	.41	1.12	.48	-.13
45	.78	.89	.27	.78	.07	1.19	.24	.30	-.34	-.39	.91	.46	1.38	.62	.09
46	.95	.87	.51	1.14	-.03	1.22	.25	.31	-.58	-.38	.96	.54	1.53	.75	.18
47	.96	.75	.54	1.19	-.31	1.23	.25	.00	-.78	-.54	.94	.71	1.52	.72	.12
48	.74	.43	.22	.99	-.51	1.11	.12	-.43	-1.10	-.84	.75	.57	1.39	.37	-.25
49	.30	-.03	-.34	.55	-.70	.73	-.27	-.86	-1.46	-1.29	.36	.04	1.10	-.12	-.88
50	-.03	-.24	-.94	.26	-.97	.48	-.57	-1.17	-1.64	-1.67	-.05	-.35	.94	-.47	-1.18
51	-.25	-.39	-1.55	-.14	-1.24	.19	-.88	-1.47	-1.71	-2.07	-.71	-.76	.29	-.85	-1.49
52	-.72	-.78	-2.21	-.73	-1.32	-.40	-1.22	-1.87	-1.97	-2.48	-1.36	-1.35	-.54	-1.38	-1.89
53	-1.15	-1.02	-2.58	-.92	-1.20	-.59	-1.27	-1.72	-2.09	-2.18	-1.54	-1.64	-.86	-1.31	-1.95
54	-1.79	-1.17	-3.09	-1.48	-1.56	-1.06	-1.66	-1.64	-2.27	-2.20	-1.88	-2.06	-1.56	-1.57	-2.49
55	-2.09	-1.35	-3.16	-2.05	-1.75	-1.66	-2.03	-1.80	-2.33	-2.23	-2.33	-2.21	-2.15	-1.90	-2.97
56	-1.87	-1.49	-2.78	-2.27	-1.56	-2.09	-2.05	-1.82	-2.06	-1.84	-2.69	-2.13	-2.17	-2.06	-2.96
57	-1.64	-1.33	-2.59	-2.39	-1.57	-2.63	-2.08	-1.72	-1.72	-1.54	-3.15	-1.98	-2.08	-2.18	-2.77
58	-1.08	-.75	-2.05	-2.12	-1.40	-2.73	-1.66	-1.36	-.96	-1.04	-2.82	-1.60	-1.79	-1.55	-2.00
59	-2.68	-2.38	-3.32	-3.30	-3.39	-4.11	-3.62	-3.46	-2.60	-2.68	-3.72	-3.09	-3.50	-2.88	-3.16
60	-15.81	-15.52	-16.29	-15.91	-16.57	-16.48	-16.17	-16.66	-15.87	-15.97	-16.24	-16.34	-16.51	-16.10	-15.99
61	11.19	11.19	11.19	11.19	11.19	11.19	11.19	11.19	11.19	11.19	11.19	11.19	11.19	11.19	11.19
62	3.13	3.13	3.13	3.13	3.13	3.13	3.13	3.13	3.13	3.13	3.13	3.13	3.13	3.13	3.13

S.P.	NOAA-9 SCANNER OFFSETS FOR DECEMBER 1985: TOTAL CHANNEL															
	16	17	18	19	20	21	22	23	24	25	26	27	28	29	30	31
1	.36	.36	.36	.36	.36	.36	.36	.36	.36	.36	.36	.36	.36	.36	.36	.36
2	1.04	1.04	1.04	1.04	1.04	1.04	1.04	1.04	1.04	1.04	1.04	1.04	1.04	1.04	1.04	1.04
3	1.93	1.93	1.93	1.93	1.93	1.93	1.93	1.93	1.93	1.93	1.93	1.93	1.93	1.93	1.93	1.93
4	-9.64	-9.64	-9.64	-9.64	-9.64	-9.64	-9.64	-9.64	-9.64	-9.64	-9.64	-9.64	-9.64	-9.64	-9.64	-9.64
5	2.86	2.79	2.94	2.16	3.07	3.07	3.37	3.38	4.00	4.01	4.44	4.84	4.72	4.65	4.57	4.35
6	-.22	-.27	-.50	-1.14	-.47	-.22	.33	.04	.03	.83	.58	.91	.64	.73	.62	.11
7	1.06	1.55	.57	.22	.81	.88	2.01	1.70	1.24	2.10	1.74	1.78	1.47	1.58	1.60	1.16
8	-.99	-.12	-1.60	-.97	-1.11	-1.37	.11	-.20	-.97	.17	-.17	-.66	-.87	-.84	-.49	-1.24
9	-1.26	-.35	-1.97	-.65	-1.51	-1.93	-.22	-.54	-1.66	-.04	-.33	-1.41	-1.09	-1.43	-1.14	-1.92
10	-1.40	-.50	-2.32	-.68	-1.57	-2.25	-.21	-.78	-1.83	-.16	-.29	-1.89	-.97	-1.72	-1.70	-2.13
11	-2.06	-.85	-2.51	-.79	-1.68	-2.48	-.48	-.89	-1.90	-.47	-.42	-2.21	-.98	-2.10	-1.89	-2.18
12	-2.71	-1.50	-2.96	-1.08	-1.93	-2.82	-1.05	-1.17	-2.11	-.86	-.61	-2.61	-1.12	-2.25	-2.18	-2.41
13	-3.52	-2.37	-3.48	-1.76	-2.45	-2.91	-1.83	-1.92	-2.65	-1.56	-1.21	-3.09	-1.54	-2.86	-2.81	-2.93
14	-3.81	-2.53	-3.53	-1.86	-2.44	-2.70	-1.84	-2.07	-2.63	-1.73	-1.13	-2.96	-1.47	-2.84	-2.80	-2.75
15	-3.86	-2.51	-3.47	-1.54	-2.44	-2.53	-1.65	-2.03	-2.40	-1.77	-.94	-2.57	-1.42	-2.54	-2.67	-2.54
16	-3.78	-2.65	-3.31	-1.20	-2.46	-2.27	-1.45	-1.91	-2.19	-1.73	-.76	-2.22	-1.32	-2.29	-2.47	-2.27
17	-3.41	-2.71	-3.14	-.78	-2.42	-1.90	-1.23	-1.68	-1.98	-1.52	-.58	-1.85	-1.18	-2.11	-2.17	-1.94
18	-3.00	-2.56	-3.01	-.51	-2.34	-1.71	-1.16	-1.68	-1.87	-1.29	-.44	-1.75	-1.17	-1.96	-1.91	-1.81
19	-2.58	-2.33	-3.03	-.52	-2.30	-1.62	-1.08	-1.80	-1.74	-1.23	-.43	-1.80	-1.12	-1.80	-1.78	-1.88
20	-2.22	-1.88	-2.79	-.47	-2.25	-1.53	-.82	-1.74	-1.33	-1.01	-.18	-1.47	-.90	-1.62	-1.46	-1.77
21	-1.92	-1.43	-2.33	-.25	-2.01	-1.19	-.40	-1.56	-.86	-.67	.21	-.95	-.54	-1.35	-1.06	-1.60
22	-1.61	-1.07	-1.92	-.05	-1.70	-1.13	-.20	-1.44	-.81	-.45	.45	-.57	-.24	-1.17	-.69	-1.47
23	-1.51	-1.01	-1.78	-.10	-1.52	-1.01	-.05	-1.39	-.96	-.39	.47	-.38	-.23	-1.00	-.48	-1.45
24	-1.68	-1.25	-1.97	-.46	-1.78	-1.14	-.18	-1.61	-1.30	-.50	.10	-.51	-.54	-1.12	-.61	-1.81
25	-1.83	-1.41	-2.00	-.59	-1.92	-1.23	-.50	-1.83	-1.51	-.58	-.37	-.60	-.73	-1.31	-.63	-2.01
26	-1.89	-1.37	-1.67	-.51	-1.58	-.87	-.52	-1.63	-1.24	-.32	-.53	-.32	-.56	-1.11	-.44	-1.75
27	-1.69	-1.21	-1.20	-.22	-1.09	-.33	-.44	-1.26	-.85	.11	-.39	.21	-.22	-.80	-.11	-1.28
28	-1.58	-1.13	-.86	.04	-.79	.01	-.43	-1.00	-.55	.43	-.24	.53	.11	-.51	.10	-.88
29	-1.36	-1.05	-.54	.44	-.48	.31	-.22	-.64	-.27	.74	-.01	.68	.40	-.25	.30	-.46
30	-1.15	-.88	-.40	.76	-.35	.50	-.06	-.27	-.09	.84	.13	.71	.49	-.09	.43	-.18
31	-1.06	-.75	-.38	.82	-.34	.75	.02	-.13	.05	.77	.14	.72	.43	-.18	.44	-.07
32	-.59	-.40	.21	1.11	.12	1.31	.60	.29	.55	1.19	.52	1.26	.83	.21	.87	.37
33	-.09	-.02	.99	1.47	.81	1.90	1.36	.81	1.11	1.79	1.23	1.81	1.44	.97	1.51	.81
34	.16	.28	1.28	1.59	1.14	2.22	1.81	1.19	1.45	2.09	1.60	2.10	1.85	1.43	1.89	.99
35	.34	.50	1.28	1.58	1.24	2.22	2.07	1.39	1.65	2.28	1.82	2.33	2.09	1.77	2.00	1.13
36	.24	.46	1.03	1.53	1.20	1.99	2.05	1.32	1.75	2.27	1.85	2.29	2.10	1.91	1.85	1.14
37	-.08	.24	.77	1.38	.91	1.80	1.81	1.06	1.68	2.06	1.66	2.11	2.09	1.76	1.61	.97
38	-.21	.22	.74	1.39	.85	1.82	1.79	1.02	1.92	2.07	1.64	2.22	2.10	1.79	1.66	1.02
39	-.38	.17	.64	1.43	.83	1.66	1.66	.91	1.89	2.05	1.56	2.28	1.95	1.64	1.72	1.13
40	-.30	.20	.58	1.42	.85	1.55	1.68	.92	1.87	2.05	1.48	2.25	1.74	1.65	1.71	1.21
41	-.23	.21	.56	1.25	.85	1.42	1.52	.85	1.90	1.96	1.41	2.17	1.42	1.70	1.62	1.17
42	-.13	.28	.55	1.07	.89	1.42	1.42	.87	1.86	1.80	1.38	1.99	1.06	1.81	1.47	1.07
43	-.15	.21	.46	.83	.87	1.22	1.26	.72	1.61	1.63	1.26	1.73	.85	1.86	1.45	.96
44	-.02	.36	.54	.81	.94	1.35	1.33	.85	1.72	1.43	1.38	1.64	.92	2.00	1.70	1.06
45	.32	.61	.69	.93	1.20	1.39	1.52	.86	1.70	1.37	1.45	1.55	.95	2.00	1.85	1.16
46	.50	.76	.75	.92	1.32	1.28	1.63	.91	1.53	1.27	1.59	1.46	.97	2.01	1.83	1.15
47	.31	.67	.72	1.01	1.21	1.06	1.54	.96	1.35	1.29	1.81	1.54	.94	2.07	1.84	1.20
48	-.28	.45	.49	.97	.84	.85	1.33	.89	.98	1.05	1.86	1.64	.87	1.86	1.84	1.08
49	-.79	.25	.05	.67	.41	.50	.91	.49	.47	.59	1.62	1.61	.65	1.53	1.64	.60
50	-.89	.14	-.07	.41	.14	.23	.66	.19	.12	.44	1.42	1.60	.53	1.32	1.38	.22
51	-1.19	-.08	-.34	.08	-.08	-.15	.44	-.16	-.28	.19	1.10	1.47	.44	.94	.99	-.28
52	-1.47	-.35	-.92	-.66	-.65	-.81	-.06	-.80	-.97	-.44	.52	.91	.18	.35	.30	-.84
53	-1.31	-.36	-1.02	-.94	-.96	-.95	-.15	-.88	-1.20	-.63	.38	.68	.25	.27	.28	-.96
54	-1.60	-.76	-1.57	-1.36	-1.50	-1.36	-.43	-1.12	-1.73	-1.13	.28	.16	.03	-.20	-.08	-1.17
55	-1.73	-1.28	-2.46	-1.73	-2.09	-1.91	-.67	-1.48	-2.27	-1.30	.06	-.44	-.29	-.88	-.73	-1.35
56	-1.58	-1.37	-2.87	-1.73	-2.35	-1.99	-.58	-1.27	-2.15	-1.03	-.04	-.55	-.15	-1.04	-.94	-1.36
57	-1.68	-1.41	-2.94	-1.82	-2.71	-1.85	-.70	-1.12	-1.89	-.74	-.12	-.65	-.19	-1.35	-.96	-1.54
58	-1.37	-1.33	-2.44	-1.84	-2.32	-1.65	-.85	-.68	-.84	-.24	-.08	-.42	.14	-1.02	-.78	-1.05
59	-3.06	-3.23	-4.02	-3.76	-3.37	-3.43	-2.94	-2.12	-2.02	-1.81	-1.82	-1.88	-1.21	-2.15	-2.22	-2.46
60	-16.26	-16.34	-16.72	-16.12	-15.75	-15.93	-15.91	-14.98	-14.99	-14.87	-14.40	-14.11	-13.80	-14.20	-13.60	-14.54
61	11.19	11.19	11.19	11.19	11.19	11.19	11.19	11.19	11.19	11.19	11.19	11.19	11.19	11.19	11.19	11.19
62	3.13	3.13	3.13	3.13	3.13	3.13	3.13	3.13	3.13	3.13	3.13	3.13	3.13	3.13	3.13	3.13

NOAA-9 SCANNER OFFSETS FOR DECEMBER 1985: LONGMAVE CHANNEL

S.P.	DAY OF MONTH -->														
	1	2	3	4	5	6	7	8	9	10	11	12	13	14	15
1	.29	.29	.29	.29	.29	.29	.29	.29	.29	.29	.29	.29	.29	.29	.29
2	.59	.59	.59	.59	.59	.59	.59	.59	.59	.59	.59	.59	.59	.59	.59
3	.63	.63	.63	.63	.63	.63	.63	.63	.63	.63	.63	.63	.63	.63	.63
4	.27	.27	.27	.27	.27	.27	.27	.27	.27	.27	.27	.27	.27	.27	.27
5	-.10	-.45	-.07	-.16	-.40	-.35	-.33	-.12	-.52	-.60	.15	.02	.41	.04	-.40
6	-.81	-1.40	-1.15	-.92	-1.37	-1.37	-1.24	-1.34	-1.91	-1.94	-.97	-1.25	-.66	-1.27	-1.73
7	-.09	-.55	-.37	-.10	-.42	-.54	-.60	-.52	-1.04	-1.03	-.43	-.43	-.38	-.70	-1.02
8	-1.70	-2.02	-1.67	-1.74	-1.67	-1.77	-2.09	-1.99	-2.30	-2.07	-2.30	-1.90	-2.17	-2.16	-2.47
9	-2.31	-2.53	-1.84	-2.11	-1.98	-2.10	-2.37	-2.37	-2.39	-2.25	-3.07	-2.21	-2.76	-2.43	-2.77
10	-2.69	-2.70	-2.05	-2.24	-2.36	-2.28	-2.61	-2.60	-2.35	-2.47	-3.44	-2.37	-3.10	-2.49	-2.86
11	-3.08	-3.05	-2.40	-2.66	-2.69	-2.54	-2.97	-2.96	-2.43	-2.89	-3.44	-2.73	-3.64	-2.88	-3.13
12	-3.35	-3.37	-2.69	-3.10	-2.87	-2.93	-3.33	-3.33	-2.66	-3.36	-3.63	-3.19	-4.22	-3.39	-3.45
13	-3.63	-3.83	-3.20	-3.61	-3.18	-3.50	-3.72	-3.78	-3.02	-3.90	-3.97	-3.64	-4.12	-4.12	-3.95
14	-3.58	-3.98	-3.54	-3.84	-3.33	-3.88	-3.74	-3.89	-3.19	-4.14	-4.23	-3.75	-5.78	-4.55	-4.30
15	-3.52	-3.92	-3.75	-3.94	-3.35	-4.11	-3.76	-3.97	-3.30	-4.15	-4.04	-3.81	-5.33	-4.70	-4.56
16	-3.58	-3.87	-3.95	-3.98	-3.33	-4.12	-3.88	-4.08	-3.38	-4.19	-4.16	-3.82	-5.39	-4.85	-4.72
17	-3.59	-3.75	-4.00	-3.84	-3.29	-4.04	-3.98	-4.15	-3.44	-4.24	-4.30	-3.78	-5.33	-4.98	-4.83
18	-3.72	-3.75	-3.88	-3.82	-3.44	-4.08	-4.13	-4.27	-3.67	-4.33	-4.29	-3.87	-5.18	-5.12	-5.00
19	-3.94	-3.78	-3.88	-3.91	-3.79	-4.33	-4.25	-4.48	-3.88	-4.50	-4.36	-4.14	-5.06	-5.20	-5.10
20	-4.08	-3.79	-3.85	-3.91	-4.02	-4.37	-4.37	-4.62	-3.92	-4.63	-4.29	-4.20	-5.02	-5.14	-5.02
21	-4.14	-3.90	-3.79	-3.85	-4.06	-4.29	-4.47	-4.68	-3.99	-4.72	-4.24	-4.17	-4.90	-5.10	-4.93
22	-4.35	-3.97	-3.85	-3.87	-4.14	-4.18	-4.53	-4.58	-4.12	-4.83	-4.29	-4.17	-4.77	-4.99	-4.86
23	-4.68	-4.18	-4.02	-3.97	-4.35	-4.14	-4.57	-4.56	-4.22	-4.85	-4.54	-4.30	-4.76	-4.98	-4.91
24	-4.91	-4.50	-4.27	-4.22	-4.57	-4.33	-4.74	-4.79	-4.41	-5.06	-4.86	-4.52	-4.80	-5.16	-5.14
25	-5.07	-4.65	-4.37	-4.44	-4.68	-4.42	-4.95	-4.98	-4.56	-5.24	-4.94	-4.66	-4.86	-5.39	-5.38
26	-5.05	-4.57	-4.27	-4.45	-4.62	-4.34	-4.92	-5.03	-4.50	-5.16	-4.82	-4.67	-4.86	-5.42	-5.46
27	-4.94	-4.35	-4.16	-4.35	-4.47	-4.12	-4.74	-4.99	-4.41	-4.94	-4.64	-4.54	-4.70	-5.28	-5.33
28	-4.86	-4.17	-4.09	-4.16	-4.27	-3.94	-4.54	-4.92	-4.31	-4.72	-4.44	-4.42	-4.60	-5.12	-5.17
29	-4.72	-3.88	-3.89	-3.94	-4.02	-3.80	-4.24	-4.75	-4.13	-4.51	-4.30	-4.26	-4.48	-4.80	-4.91
30	-4.48	-3.54	-3.64	-3.80	-3.86	-3.64	-4.03	-4.52	-3.96	-4.31	-4.13	-4.06	-4.29	-4.38	-4.55
31	-4.23	-3.32	-3.44	-3.77	-3.69	-3.38	-3.78	-4.24	-3.80	-4.13	-3.97	-3.83	-4.12	-3.97	-4.23
32	-3.61	-2.74	-2.97	-3.38	-3.29	-2.86	-3.34	-3.66	-3.29	-3.59	-3.35	-3.19	-3.53	-3.25	-3.66
33	-2.77	-2.03	-2.31	-2.78	-2.71	-2.06	-2.69	-2.97	-2.71	-2.79	-2.62	-2.35	-2.75	-2.39	-2.92
34	-2.18	-1.54	-1.73	-2.26	-2.20	-1.43	-2.19	-2.56	-2.20	-2.20	-2.14	-1.78	-2.26	-1.78	-2.36
35	-1.67	-1.15	-1.28	-1.88	-1.73	-.95	-1.73	-2.20	-1.75	-1.73	-1.72	-1.34	-1.79	-1.30	-1.88
36	-1.30	-.95	-1.03	-1.62	-1.40	-.56	-1.44	-1.93	-1.45	-1.44	-1.42	-1.04	-1.39	-.99	-1.55
37	-1.10	-.85	-.83	-1.41	-1.19	-.36	-1.23	-1.69	-1.29	-1.28	-1.24	-.88	-1.06	-.86	-1.32
38	-.75	-.53	-.46	-1.02	-.87	-.10	-.87	-1.33	-1.03	-1.07	-.99	-.55	-.59	-.56	-.99
39	-.53	-.23	-.22	-.68	-.64	.10	-.58	-.99	-.84	-.91	-.78	-.29	-.23	-.28	-.74
40	-.25	.07	.01	-.37	-.38	.31	-.40	-.61	-.64	-.67	-.47	-.13	.07	.13	-.48
41	.03	.33	.23	-.15	-.15	.51	-.26	-.24	-.42	-.44	-.14	.12	.37	.46	-.25
42	.34	.52	.47	.10	.03	.71	.03	.10	-.11	-.26	.18	.34	.67	.67	-.08
43	.53	.59	.47	.30	.13	.88	.18	.23	.04	-.15	.47	.46	.80	.58	-.08
44	.74	.80	.45	.54	.31	1.09	.36	.42	.18	.04	.78	.66	1.02	.62	.12
45	1.03	1.10	.68	1.00	.59	1.29	.64	.71	.24	.26	1.09	.90	1.41	.95	.49
46	1.32	1.29	1.02	1.44	.71	1.51	.84	.91	.27	.48	1.29	1.14	1.69	1.23	.73
47	1.47	1.33	1.17	1.59	.66	1.64	.98	.84	.26	.50	1.41	1.39	1.81	1.34	.81
48	1.43	1.19	1.04	1.54	.60	1.67	.97	.64	.14	.38	1.39	1.38	1.80	1.17	.63
49	1.21	.94	.75	1.32	.53	1.50	.78	.42	-.04	.14	1.17	1.07	1.66	.89	.28
50	1.04	.86	.39	1.17	.39	1.36	.60	.25	-.15	-.10	.92	.82	1.58	.71	.12
51	.92	.79	.00	.90	.21	1.18	.40	.06	-.20	-.37	.47	.54	1.15	.46	-.08
52	.63	.55	-.42	.53	.16	.79	.20	-.18	-.35	-.64	.06	.18	.60	.14	-.32
53	.00	.04	-1.00	.06	-.10	.31	-.15	-.42	-.74	-.77	-.41	-.38	.04	-.16	-.69
54	-.60	-.25	-1.52	-.48	-.52	-.19	-.60	-.56	-1.03	-.96	-.83	-.86	-.59	-.52	-1.22
55	-.84	-.39	-1.62	-.90	-.69	-.64	-.89	-.69	-1.11	-1.03	-1.16	-.99	-1.03	-.77	-1.57
56	-.83	-.61	-1.52	-1.17	-.70	-1.07	-1.03	-.85	-1.09	-.92	-1.52	-1.07	-1.18	-1.01	-1.69
57	-.84	-.66	-1.52	-1.38	-.86	-1.57	-1.19	-.92	-1.02	-.88	-1.95	-1.13	-1.28	-1.23	-1.70
58	-.61	-.42	-1.33	-1.34	-.92	-1.78	-1.07	-.84	-.69	-.73	-1.88	-1.04	-1.24	-.97	-1.35
59	-1.73	-1.55	-2.24	-2.18	-2.30	-2.74	-2.23	-2.29	-1.85	-1.92	-2.55	-2.10	-2.44	-1.91	-2.18
60	-9.61	-9.46	.00	-9.71	-10.19	-10.10	-9.92	-10.19	-9.81	-9.87	-10.01	-10.03	-10.22	-9.84	-9.84
61	.83	.83	.83	.83	.83	.83	.83	.83	.83	.83	.83	.83	.83	.83	.83
62	.97	.97	.97	.97	.97	.97	.97	.97	.97	.97	.97	.97	.97	.97	.97

NOAA-9 SCANNER OFFSETS FOR DECEMBER 1985: LONGMAYE CHANNEL

S.P.	DAY OF MONTH -->															
	16	17	18	19	20	21	22	23	24	25	26	27	28	29	30	31
1	.29	.29	.29	.29	.29	.29	.29	.29	.29	.29	.29	.29	.29	.29	.29	.29
2	.59	.59	.59	.59	.59	.59	.59	.59	.59	.59	.59	.59	.59	.59	.59	.59
3	.63	.63	.63	.63	.63	.63	.63	.63	.63	.63	.63	.63	.63	.63	.63	.63
4	.27	.27	.27	.27	.27	.27	.27	.27	.27	.27	.27	.27	.27	.27	.27	.27
5	.04	-.02	.14	-.30	.23	.11	.44	.42	.77	.73	.95	1.21	1.12	1.10	1.06	.90
6	-1.23	-1.26	-1.34	-1.68	-1.29	-1.19	-.75	-.95	-1.00	-.56	-.76	-.56	-.75	-.67	-.75	-1.07
7	-.41	-.10	-.66	-.78	-.47	-.40	.33	.13	-.24	.22	-.07	-.04	-.26	-.17	-.17	-.43
8	-1.70	-1.16	-2.04	-1.53	-1.71	-1.79	-.88	-1.10	-1.67	-1.03	-1.30	-1.64	-1.78	-1.75	-1.55	-2.00
9	-1.99	-1.41	-2.39	-1.43	-2.09	-2.26	-1.20	-1.44	-2.25	-1.31	-1.56	-2.28	-2.09	-2.29	-2.15	-2.60
10	-2.22	-1.66	-2.78	-1.61	-2.29	-2.60	-1.35	-1.76	-2.53	-1.55	-1.72	-2.79	-2.20	-2.68	-2.69	-2.93
11	-2.82	-2.06	-3.11	-1.89	-2.54	-2.98	-1.70	-2.00	-2.75	-1.93	-1.98	-3.16	-2.37	-3.12	-2.98	-3.13
12	-3.37	-2.61	-3.54	-2.24	-2.83	-3.24	-2.20	-2.30	-3.01	-2.32	-2.24	-3.56	-2.58	-3.33	-3.31	-3.43
13	-4.00	-3.27	-3.97	-2.82	-3.30	-3.55	-2.82	-2.90	-3.48	-2.86	-2.76	-3.98	-2.95	-3.82	-3.83	-3.88
14	-4.43	-3.63	-4.25	-3.12	-3.53	-3.68	-3.07	-3.25	-3.71	-3.22	-2.95	-4.12	-3.12	-4.05	-4.06	-3.98
15	-4.71	-3.86	-4.42	-3.17	-3.78	-3.80	-3.19	-3.45	-3.80	-3.47	-3.04	-4.11	-3.34	-4.08	-4.21	-4.08
16	-4.88	-4.16	-4.52	-3.14	-3.99	-3.81	-3.26	-3.56	-3.86	-3.67	-3.11	-4.07	-3.48	-4.12	-4.29	-4.10
17	-4.85	-4.43	-4.61	-3.06	-4.20	-3.77	-3.32	-3.62	-3.93	-3.74	-3.21	-4.04	-3.62	-4.23	-4.30	-4.10
18	-4.79	-4.55	-4.75	-3.11	-4.36	-3.86	-3.49	-3.84	-4.07	-3.83	-3.34	-4.20	-3.84	-4.37	-4.35	-4.24
19	-4.73	-4.61	-4.99	-3.37	-4.56	-4.05	-3.69	-4.17	-4.24	-4.05	-3.60	-4.51	-4.09	-4.55	-4.53	-4.56
20	-4.67	-4.51	-5.07	-3.57	-4.76	-4.23	-3.76	-4.37	-4.21	-4.15	-3.71	-4.54	-4.21	-4.70	-4.58	-4.75
21	-4.70	-4.43	-4.99	-3.66	-4.83	-4.22	-3.71	-4.48	-4.13	-4.18	-3.66	-4.45	-4.22	-4.76	-4.56	-4.89
22	-4.62	-4.33	-4.88	-3.69	-4.80	-4.35	-3.76	-4.59	-4.30	-4.17	-3.69	-4.38	-4.21	-4.85	-4.50	-5.00
23	-4.69	-4.42	-4.94	-3.89	-4.86	-4.43	-3.85	-4.71	-4.58	-4.29	-3.84	-4.42	-4.38	-4.91	-4.56	-5.18
24	-4.91	-4.69	-5.22	-4.31	-5.20	-4.66	-4.10	-5.01	-4.97	-4.52	-4.22	-4.67	-4.75	-5.13	-4.80	-5.61
25	-5.14	-4.91	-5.38	-4.50	-5.43	-4.85	-4.46	-5.30	-5.23	-4.71	-4.66	-4.85	-5.00	-5.38	-4.93	-5.87
26	-5.31	-5.03	-5.22	-4.54	-5.30	-4.72	-4.58	-5.28	-5.14	-4.58	-4.82	-4.76	-4.95	-5.33	-4.92	-5.80
27	-5.18	-4.97	-4.95	-4.36	-4.99	-4.40	-4.57	-5.11	-4.90	-4.30	-4.73	-4.40	-4.74	-5.16	-4.69	-5.50
28	-5.10	-4.89	-4.71	-4.16	-4.76	-4.24	-4.54	-4.92	-4.67	-4.05	-4.57	-4.13	-4.49	-4.93	-4.49	-5.19
29	-4.89	-4.77	-4.42	-3.81	-4.47	-4.01	-4.34	-4.61	-4.41	-3.75	-4.32	-3.95	-4.22	-4.67	-4.30	-4.84
30	-4.59	-4.51	-4.21	-3.48	-4.26	-3.78	-4.12	-4.25	-4.14	-3.57	-4.10	-3.81	-4.04	-4.41	-4.08	-4.52
31	-4.32	-4.21	-4.01	-3.24	-4.06	-3.42	-3.88	-3.98	-3.84	-3.42	-3.90	-3.60	-3.87	-4.27	-3.85	-4.24
32	-3.74	-3.73	-3.33	-2.78	-3.49	-2.79	-3.23	-3.45	-3.21	-2.83	-3.34	-2.93	-3.30	-3.70	-3.26	-3.64
33	-3.02	-3.13	-2.45	-2.16	-2.67	-2.05	-2.35	-2.73	-2.44	-2.00	-2.42	-2.13	-2.48	-2.78	-2.42	-2.94
34	-2.51	-2.59	-1.94	-1.76	-2.13	-1.50	-1.73	-2.14	-1.87	-1.45	-1.83	-1.59	-1.85	-2.12	-1.81	-2.48
35	-2.06	-2.08	-1.62	-1.45	-1.74	-1.17	-1.22	-1.65	-1.38	-1.06	-1.30	-1.04	-1.29	-1.51	-1.36	-2.00
36	-1.84	-1.79	-1.47	-1.17	-1.45	-1.01	-.89	-1.35	-.96	-.62	-.90	-.67	-.90	-1.04	-1.08	-1.62
37	-1.77	-1.65	-1.31	-.95	-1.32	-.82	-.72	-1.20	-.67	-.41	-.66	-.43	-.53	-.76	-.88	-1.36
38	-1.55	-1.36	-1.04	-.63	-1.05	-.50	-.41	-.89	-.19	-.09	-.36	-.02	-.18	-.40	-.50	-.97
39	-1.32	-1.06	-.78	-.25	-.70	-.22	-.14	-.61	.14	.24	-.06	.40	.10	-.13	-.09	-.51
40	-.96	-.72	-.50	.06	-.37	.07	.21	-.26	.47	.56	.25	.73	.32	.24	.26	-.10
41	-.61	-.40	-.22	.25	-.10	.26	.40	.00	.80	.80	.49	1.01	.43	.58	.54	.19
42	-.28	-.10	.05	.40	.20	.49	.61	.29	1.05	.96	.75	1.15	.47	.93	.71	.40
43	-.05	.12	.29	.52	.47	.65	.77	.46	1.15	1.14	.96	1.28	.63	1.27	1.01	.64
44	.24	.46	.58	.75	.73	.90	1.04	.78	1.49	1.22	1.29	1.47	.92	1.60	1.40	.94
45	.70	.85	.89	1.06	1.13	1.14	1.37	.99	1.66	1.38	1.52	1.61	1.15	1.80	1.71	1.20
46	1.00	1.14	1.11	1.24	1.42	1.29	1.67	1.25	1.74	1.49	1.82	1.74	1.36	2.00	1.88	1.38
47	.97	1.18	1.22	1.42	1.47	1.36	1.72	1.41	1.76	1.66	2.10	1.95	1.49	2.16	2.03	1.55
48	.62	1.08	1.17	1.47	1.31	1.33	1.68	1.46	1.61	1.60	2.25	2.12	1.53	2.12	2.12	1.56
49	.34	1.03	.92	1.32	1.08	1.17	1.47	1.27	1.33	1.35	2.14	2.15	1.44	1.95	2.04	1.28
50	.32	.98	.85	1.17	.91	1.03	1.30	1.08	1.08	1.25	2.03	2.15	1.36	1.81	1.88	1.04
51	.12	.83	.67	.93	.74	.78	1.13	.82	.77	1.04	1.81	2.03	1.26	1.52	1.58	.69
52	-.05	.66	.26	.41	.34	.32	.77	.32	.25	.59	1.36	1.60	1.03	1.05	1.07	.29
53	-.26	.32	-.16	-.12	-.22	-.14	.37	-.12	-.26	-.10	.89	1.07	.70	.65	.70	-.15
54	-.62	-.13	-.70	-.56	-.75	-.60	.00	-.47	-.80	-.41	.67	.55	.39	.16	.27	-.47
55	-.74	-.52	-1.34	-.86	-1.19	-1.00	-.20	-.77	-1.21	-.57	.47	.14	.16	-.33	-.17	-.61
56	-.74	-.70	-1.73	-1.00	-1.48	-1.15	-.22	-.71	-1.21	-.48	.36	-.02	.18	-.51	-.40	-.74
57	-.94	-.86	-1.91	-1.20	-1.85	-1.17	-.41	-.71	-1.14	-.40	.19	-.21	.05	-.84	-.52	-1.00
58	-.88	-.96	-1.74	-1.37	-1.75	-1.19	-.65	-.56	-.59	-.20	.11	-.18	.15	-.75	-.52	-.82
59	-2.06	-2.30	-2.84	-2.71	-2.50	-2.49	-2.08	-1.57	-1.42	-1.31	-1.09	-1.17	-.79	-1.52	-1.50	-1.78
60	-9.99	-10.17	-10.43	-10.11	-9.89	-9.96	-9.85	-9.29	-9.19	-9.17	-8.65	-8.48	-8.36	-8.73	-8.30	-9.03
61	.83	.83	.83	.83	.83	.83	.83	.83	.83	.83	.83	.83	.83	.83	.83	.83
62	.97	.97	.97	.97	.97	.97	.97	.97	.97	.97	.97	.97	.97	.97	.97	.97

NOAA-9 SCANNER OFFSETS FOR DECEMBER 1985: SHORTWAVE CHANNEL
 DAY OF MONTH --->

S.P.	1	2	3	4	5	6	7	8	9	10	11	12	13	14	15
1	-.11	-.11	-.11	-.11	-.11	-.11	-.11	-.11	-.11	-.11	-.11	-.11	-.11	-.11	-.11
2	.32	.32	.32	.32	.32	.32	.32	.32	.32	.32	.32	.32	.32	.32	.32
3	.49	.49	.49	.49	.49	.49	.49	.49	.49	.49	.49	.49	.49	.49	.49
4	-4.09	-4.09	-4.09	-4.09	-4.09	-4.09	-4.09	-4.09	-4.09	-4.09	-4.09	-4.09	-4.09	-4.09	-4.09
5	.43	.43	.54	.51	.52	.50	.48	.43	.54	.49	.53	.52	.50	.46	.47
6	.50	.50	.61	.58	.59	.56	.54	.50	.61	.57	.61	.57	.54	.49	.50
7	.12	.11	.22	.20	.21	.18	.16	.11	.25	.21	.22	.19	.14	.08	.11
8	.43	.43	.55	.52	.54	.51	.49	.43	.58	.54	.55	.52	.47	.40	.43
9	.50	.50	.61	.58	.60	.56	.53	.48	.64	.60	.60	.57	.52	.45	.50
10	.12	.12	.23	.20	.22	.17	.15	.09	.26	.22	.21	.17	.14	.07	.12
11	.42	.42	.54	.52	.53	.48	.46	.39	.57	.53	.52	.48	.45	.38	.42
12	.39	.39	.51	.49	.50	.44	.43	.35	.53	.49	.49	.44	.42	.34	.39
13	-.45	-.44	-.33	-.36	-.36	-.40	-.40	-.50	-.28	-.38	-.34	-.40	-.38	-.48	-.41
14	-.18	-.18	-.06	-.10	-.09	-.14	-.14	-.23	.00	-.10	-.07	-.12	-.08	-.19	-.11
15	-.15	-.15	-.03	-.08	-.07	-.10	-.11	-.20	.03	-.08	-.04	-.09	-.05	-.15	-.07
16	-.55	-.55	-.43	-.47	-.46	-.50	-.49	-.59	-.37	-.48	-.43	-.48	-.44	-.52	-.45
17	-.25	-.24	-.12	-.16	-.15	-.18	-.18	-.26	-.06	-.17	-.12	-.15	-.10	-.17	-.10
18	-.22	-.22	-.11	-.15	-.14	-.15	-.16	-.22	-.04	-.15	-.09	-.13	-.08	-.15	-.08
19	-.59	-.59	-.48	-.52	-.51	-.52	-.53	-.59	-.42	-.53	-.46	-.50	-.46	-.53	-.47
20	-.25	-.25	-.13	-.18	-.16	-.16	-.18	-.24	-.08	-.20	-.12	-.16	-.12	-.21	-.15
21	-.22	-.22	-.11	-.15	-.14	-.13	-.16	-.23	-.07	-.19	-.10	-.16	-.10	-.19	-.13
22	-.64	-.63	-.53	-.57	-.56	-.55	-.58	-.65	-.50	-.61	-.54	-.60	-.53	-.62	-.56
23	-.29	-.28	-.18	-.22	-.21	-.21	-.24	-.30	-.15	-.26	-.20	-.25	-.17	-.27	-.21
24	-.25	-.22	-.13	-.17	-.17	-.17	-.20	-.26	-.10	-.22	-.14	-.20	-.13	-.23	-.16
25	-.61	-.61	-.51	-.55	-.54	-.54	-.57	-.62	-.47	-.58	-.51	-.57	-.49	-.58	-.51
26	-.27	-.24	-.15	-.19	-.19	-.19	-.21	-.26	-.11	-.22	-.15	-.20	-.11	-.19	-.13
27	-.22	-.19	-.10	-.15	-.14	-.14	-.17	-.21	-.07	-.18	-.11	-.15	-.05	-.13	-.07
28	-.58	-.55	-.46	-.50	-.49	-.49	-.52	-.55	-.43	-.54	-.47	-.50	-.41	-.46	-.40
29	-.20	-.17	-.09	-.13	-.11	-.10	-.13	-.16	-.05	-.16	-.07	-.10	-.01	-.06	-.03
30	-.13	-.11	-.03	-.07	-.05	-.01	-.06	-.09	.01	-.10	.00	-.03	.04	-.02	.02
31	-.49	-.46	-.38	-.42	-.39	-.36	-.40	-.44	-.34	-.45	-.35	-.38	-.33	-.39	-.35
32	-.17	-.12	-.05	-.10	-.06	-.02	-.07	-.12	-.02	-.14	-.04	-.07	.01	-.06	-.02
33	-.26	-.24	-.16	-.21	-.18	-.15	-.20	-.24	-.14	-.28	-.17	-.19	-.09	-.16	-.11
34	-.63	-.61	-.54	-.59	-.57	-.54	-.59	-.62	-.52	-.67	-.55	-.56	-.46	-.53	-.48
35	-.28	-.26	-.19	-.24	-.21	-.18	-.23	-.26	-.17	-.30	-.18	-.19	-.09	-.17	-.12
36	-.19	-.18	-.12	-.15	-.13	-.10	-.15	-.18	-.09	-.21	-.10	-.11	-.01	-.08	-.02
37	-.50	-.49	-.43	-.47	-.45	-.42	-.46	-.49	-.39	-.53	-.41	-.41	-.31	-.37	-.31
38	-.11	-.09	-.02	-.07	-.06	-.02	-.07	-.09	.01	-.13	-.01	.00	.10	.04	.09
39	-.04	-.02	.05	.00	.01	.05	.01	-.02	.07	-.06	.07	.08	.17	.13	.16
40	-.35	-.33	-.27	-.32	-.30	-.26	-.31	-.31	-.24	-.37	-.24	-.23	-.13	-.17	-.15
41	.04	.06	.13	.09	.10	.14	.09	.08	.15	.03	.15	.16	.26	.22	.24
42	.13	.15	.21	.16	.18	.22	.17	.16	.23	.11	.23	.23	.32	.29	.32
43	-.22	-.20	-.15	-.19	-.18	-.13	-.17	-.19	-.13	-.25	-.13	-.12	-.03	-.05	-.03
44	.13	.16	.22	.17	.18	.23	.17	.17	.22	.10	.22	.23	.33	.31	.34
45	.17	.19	.25	.20	.21	.25	.20	.18	.24	.12	.23	.24	.34	.31	.33
46	-.19	-.18	-.13	-.17	-.17	-.12	-.18	-.18	-.13	-.25	-.13	-.12	-.03	-.07	-.04
47	.16	.19	.23	.19	.18	.23	.17	.17	.23	.09	.23	.23	.33	.29	.33
48	.21	.25	.29	.24	.24	.27	.22	.22	.27	.15	.27	.29	.39	.36	.41
49	-.14	-.11	-.07	-.12	-.12	-.09	-.14	-.13	-.08	-.21	-.09	-.07	.04	.01	.05
50	.21	.25	.29	.24	.24	.27	.21	.23	.29	.16	.28	.30	.41	.37	.40
51	.24	.28	.32	.27	.28	.31	.26	.27	.32	.19	.32	.34	.43	.40	.43
52	-.09	-.04	-.01	-.06	-.04	-.02	-.07	-.06	.00	-.13	-.01	.02	.09	.07	.10
53	.82	.84	.88	.81	.80	.87	.78	.82	.83	.77	.85	.91	.94	.94	.95
54	1.17	1.18	1.22	1.16	1.15	1.21	1.12	1.18	1.18	1.11	1.18	1.24	1.26	1.27	1.26
55	.84	.84	.87	.80	.81	.87	.79	.84	.82	.76	.82	.90	.91	.93	.92
56	1.11	1.11	1.15	1.08	1.09	1.15	1.06	1.11	1.11	1.04	1.11	1.18	1.21	1.21	1.21
57	1.16	1.14	1.17	1.11	1.11	1.16	1.09	1.14	1.14	1.07	1.14	1.20	1.23	1.24	1.24
58	.78	.74	.78	.72	.72	.77	.71	.75	.75	.68	.75	.82	.84	.86	.86
59	1.05	1.03	1.07	1.01	1.01	1.06	1.00	1.04	1.04	.98	1.06	1.11	1.15	1.15	1.15
60	1.05	1.01	1.06	1.00	.99	1.05	.99	1.02	1.03	.96	1.06	1.10	1.14	1.15	1.15
61	3.05	3.05	3.05	3.05	3.05	3.05	3.05	3.05	3.05	3.05	3.05	3.05	3.05	3.05	3.05
62	.45	.45	.45	.45	.45	.45	.45	.45	.45	.45	.45	.45	.45	.45	.45

NOAA-9 SCANNER OFFSETS FOR DECEMBER 1985: SHORTWAVE CHANNEL

S.P.	DAY OF MONTH -->															
	16	17	18	19	20	21	22	23	24	25	26	27	28	29	30	31
1	-.11	-.11	-.11	-.11	-.11	-.11	-.11	-.11	-.11	-.11	-.11	-.11	-.11	-.11	-.11	-.11
2	.32	.32	.32	.32	.32	.32	.32	.32	.32	.32	.32	.32	.32	.32	.32	.32
3	.49	.49	.49	.49	.49	.49	.49	.49	.49	.49	.49	.49	.49	.49	.49	.49
4	-4.09	-4.09	-4.09	-4.09	-4.09	-4.09	-4.09	-4.09	-4.09	-4.09	-4.09	-4.09	-4.09	-4.09	-4.09	-4.09
5	.55	.55	.55	.56	.67	.63	.64	.61	.61	.55	.46	.49	.54	.55	.56	.56
6	.59	.59	.61	.64	.73	.70	.70	.65	.64	.58	.46	.50	.56	.57	.57	.59
7	.19	.19	.24	.26	.37	.34	.34	.29	.26	.18	.06	.08	.15	.17	.16	.18
8	.52	.53	.57	.61	.72	.69	.69	.65	.61	.54	.40	.42	.49	.50	.49	.51
9	.58	.60	.63	.67	.78	.76	.76	.72	.68	.62	.46	.47	.55	.56	.54	.56
10	.20	.22	.25	.29	.41	.39	.40	.35	.30	.24	.07	.08	.19	.19	.16	.17
11	.50	.52	.56	.60	.71	.69	.70	.66	.61	.54	.38	.37	.49	.50	.45	.48
12	.47	.50	.52	.56	.68	.65	.66	.62	.55	.48	.31	.33	.44	.44	.41	.43
13	-.35	-.32	-.33	-.28	-.12	-.18	-.16	-.26	-.30	-.38	-.55	-.54	-.39	-.37	-.44	-.44
14	-.05	-.01	-.04	.00	.18	.11	.14	.03	.00	-.10	-.25	-.25	-.10	-.07	-.15	-.15
15	-.01	.03	-.01	.03	.19	.13	.16	.05	.02	-.07	-.24	-.23	-.09	-.07	-.14	-.14
16	-.39	-.35	-.41	-.37	-.22	-.29	-.24	-.36	-.38	-.47	-.64	-.63	-.49	-.48	-.55	-.56
17	-.04	.00	-.10	-.06	.10	.03	.08	-.03	-.06	-.15	-.31	-.30	-.15	-.15	-.21	-.22
18	-.03	.01	-.09	-.05	.10	.05	.09	-.01	-.04	-.13	-.28	-.27	-.13	-.13	-.19	-.20
19	-.43	-.38	-.47	-.44	-.29	-.35	-.30	-.40	-.43	-.50	-.66	-.65	-.50	-.51	-.57	-.58
20	-.10	-.04	-.12	-.09	.06	.00	.06	-.04	-.07	-.14	-.28	-.27	-.13	-.14	-.20	-.21
21	-.08	-.03	-.11	-.07	.08	.01	.08	-.03	-.04	-.11	-.25	-.24	-.10	-.10	-.16	-.18
22	-.51	-.46	-.55	-.51	-.36	-.43	-.36	-.47	-.48	-.53	-.68	-.65	-.53	-.54	-.59	-.61
23	-.15	-.11	-.19	-.16	-.01	-.08	-.01	-.11	-.12	-.19	-.31	-.29	-.17	-.17	-.24	-.25
24	-.11	-.06	-.13	-.10	.04	-.04	.03	-.07	-.07	-.13	-.27	-.23	-.12	-.13	-.18	-.20
25	-.46	-.41	-.48	-.45	-.30	-.39	-.32	-.43	-.41	-.48	-.60	-.57	-.47	-.48	-.53	-.56
26	-.07	-.02	-.11	-.08	.07	-.01	.06	-.04	-.02	-.10	-.20	-.17	-.07	-.10	-.15	-.18
27	-.01	.04	-.09	-.05	.08	.01	.09	-.02	.00	-.07	-.16	-.14	-.04	-.05	-.11	-.14
28	-.36	-.30	-.45	-.42	-.28	-.37	-.28	-.39	-.36	-.43	-.52	-.50	-.40	-.42	-.49	-.51
29	.04	.10	-.06	-.04	.10	.02	.11	.01	.04	-.03	-.12	-.09	.01	-.01	-.08	-.11
30	.07	.14	.00	.03	.18	.08	.18	.07	.11	.07	-.03	.02	.11	.08	.01	-.02
31	-.31	-.23	-.36	-.33	-.19	-.27	-.18	-.28	-.24	-.27	-.35	-.31	-.23	-.27	-.34	-.37
32	.02	.10	-.03	.00	.14	.05	.15	.06	.08	.06	.00	.03	.12	.09	.01	-.04
33	-.10	-.02	-.16	-.14	.02	-.08	.03	-.09	-.05	-.09	-.16	-.11	.00	-.02	-.11	-.09
34	-.47	-.39	-.54	-.52	-.35	-.46	-.34	-.48	-.41	-.47	-.53	-.47	-.36	-.38	-.47	-.55
35	-.10	-.02	-.17	-.15	.02	-.09	.02	-.11	-.04	-.09	-.15	-.08	.02	.00	-.09	-.16
36	.00	.07	-.08	-.05	.11	.00	.11	-.03	.04	-.02	-.08	.00	.09	.07	-.01	-.08
37	-.29	-.22	-.39	-.36	-.20	-.32	-.20	-.34	-.27	-.33	-.38	-.31	-.21	-.23	-.32	-.39
38	.11	.20	.02	.05	.20	.09	.21	.08	.15	.09	.04	.12	.22	.19	.10	.03
39	.18	.27	.09	.11	.27	.16	.28	.15	.22	.16	.12	.20	.29	.26	.17	.10
40	-.14	-.05	-.21	-.20	-.04	-.16	-.04	-.17	-.10	-.14	-.19	-.10	-.02	-.05	-.13	-.21
41	.26	.36	.19	.21	.38	.27	.39	.24	.33	.27	.23	.31	.41	.38	.29	.21
42	.34	.42	.28	.29	.46	.33	.45	.32	.40	.35	.32	.40	.48	.45	.36	.29
43	-.02	.08	-.09	-.07	.09	-.01	.10	-.02	.05	-.01	-.03	.06	.13	.10	.01	-.06
44	.36	.44	.26	.28	.45	.34	.46	.34	.40	.35	.33	.42	.50	.46	.38	.31
45	.36	.44	.26	.28	.46	.36	.47	.35	.42	.36	.35	.44	.51	.47	.40	.32
46	-.02	.06	-.10	-.10	.07	-.03	.08	-.03	.05	-.01	-.01	.08	.14	.10	.03	-.04
47	.36	.44	.27	.27	.43	.33	.44	.32	.42	.36	.35	.45	.51	.47	.40	.33
48	.44	.51	.31	.31	.47	.38	.49	.37	.46	.40	.40	.49	.56	.52	.45	.37
49	.08	.14	-.05	-.04	.11	.01	.11	.00	.09	.03	.04	.14	.20	.15	.09	.01
50	.43	.51	.33	.33	.49	.39	.50	.37	.48	.41	.43	.52	.58	.54	.48	.39
51	.46	.54	.36	.36	.51	.41	.53	.40	.51	.46	.46	.56	.61	.57	.50	.42
52	.13	.20	.04	.04	.19	.09	.20	.08	.22	.16	.16	.26	.32	.27	.20	.10
53	.98	1.04	.94	.95	1.03	.98	1.07	1.01	1.17	1.08	1.09	1.21	1.23	1.17	1.12	1.03
54	1.29	1.36	1.25	1.26	1.33	1.28	1.37	1.34	1.45	1.39	1.40	1.52	1.53	1.47	1.45	1.35
55	.94	1.01	.89	.90	.96	.93	1.03	1.01	1.11	1.03	1.06	1.18	1.19	1.13	1.10	1.01
56	1.24	1.31	1.19	1.19	1.27	1.23	1.32	1.30	1.40	1.34	1.35	1.49	1.50	1.43	1.42	1.32
57	1.25	1.32	1.20	1.20	1.27	1.23	1.32	1.28	1.39	1.33	1.36	1.50	1.50	1.44	1.42	1.34
58	.86	.93	.82	.82	.88	.84	.93	.88	1.00	.94	.96	1.11	1.11	1.05	1.04	.96
59	1.17	1.25	1.14	1.13	1.21	1.17	1.25	1.21	1.33	1.26	1.29	1.44	1.44	1.38	1.37	1.30
60	1.16	1.23	1.12	1.12	1.19	1.14	1.22	1.18	1.30	1.24	1.27	1.42	1.41	1.35	1.35	1.28
61	3.05	3.05	3.05	3.05	3.05	3.05	3.05	3.05	3.05	3.05	3.05	3.05	3.05	3.05	3.05	3.05
62	.45	.45	.45	.45	.45	.45	.45	.45	.45	.45	.45	.45	.45	.45	.45	.45

NOAA-9 SCANNER OFFSETS FOR JANUARY 1986:

TOTAL CHANNEL

S.P.	DAY OF MONTH -->														
	1	2	3	4	5	6	7	8	9	10	11	12	13	14	15
1	.36	.36	.36	.36	.36	.36	.36	.36	.36	.36	.36	.36	.36	.36	.36
2	1.04	1.04	1.04	1.04	1.04	1.04	1.04	1.04	1.04	1.04	1.04	1.04	1.04	1.04	1.04
3	1.93	1.93	1.93	1.93	1.93	1.93	1.93	1.93	1.93	1.93	1.93	1.93	1.93	1.93	1.93
4	-9.64	-9.64	-9.64	-9.64	-9.64	-9.64	-9.64	-9.64	-9.64	-9.64	-9.64	-9.64	-9.64	-9.64	-9.64
5	-.81	-.81	-.81	-.81	-.81	-.81	-.81	-.81	-.81	-.81	-.81	-.81	-.81	-.81	-.81
6	3.10	3.00	13.29	13.29	2.90	1.16	3.10	1.16	2.15	3.22	2.90	13.29	1.16	3.10	4.30
7	-.60	-.43	5.06	5.06	-.15	.11	-.26	.11	-1.53	-.46	-.09	4.51	.11	-.60	.53
8	-1.29	-1.03	1.91	1.91	-.57	-2.87	-.89	-2.87	-1.80	-1.35	-.30	1.94	-2.87	-1.29	-.81
9	-.83	-.51	1.06	1.06	-.13	-2.55	.10	-2.55	-.67	-.46	.55	.50	-2.55	-.83	-.84
10	-.27	-.19	1.49	1.49	.11	-1.65	.83	-1.65	.18	.43	1.17	.69	-1.65	-.27	-.28
11	-.91	-.02	1.22	1.22	-.69	-2.43	.42	-2.43	-.03	-.09	.43	.49	-2.43	-.91	-.78
12	-1.29	-.15	.46	.46	-1.02	-2.63	.13	-2.63	-.01	-.60	-.11	.17	-2.63	-1.29	-1.03
13	-1.11	.09	-1.24	-1.24	-.76	-1.16	.16	-1.16	.46	-.60	-.14	-.90	-1.16	-1.11	-.78
14	.26	1.39	-1.64	-1.64	.57	-1.25	1.32	-1.25	1.89	.62	1.07	-1.17	-1.25	.26	.53
15	-.31	.69	-2.00	-2.00	-.02	-1.35	.44	-1.35	1.24	.00	.50	-1.40	-1.35	-.31	-.09
16	-.28	.63	-1.85	-1.85	.01	-.45	.25	-.45	1.18	-.06	.59	-1.26	-.45	-.28	-.09
17	-.07	.73	-1.99	-1.99	.18	-.54	.26	-.54	1.39	.07	.69	-1.25	-.54	-.07	.17
18	.33	.99	-2.39	-2.39	.30	-.46	.30	-.46	1.46	.28	.79	-1.38	-.46	.33	.52
19	-2.12	-1.60	-2.82	-2.82	-2.50	-.19	-2.65	-.19	-1.27	-2.59	-1.91	-1.88	-.19	-2.12	-1.89
20	-2.62	-1.94	-1.16	-1.16	-2.90	-.34	-3.16	-.34	-1.69	-2.95	-2.49	-.83	-.34	-2.62	-2.30
21	-2.88	-1.96	-1.33	-1.33	-2.97	-.03	-3.21	-.03	-1.88	-2.95	-2.71	-.98	-.03	-2.88	-2.52
22	-2.76	-1.70	-1.98	-1.98	-2.71	-.29	-2.82	-.29	-1.61	-2.59	-2.62	-1.19	-.29	-2.76	-2.37
23	-3.22	-2.28	-2.07	-2.07	-3.19	.46	-3.22	.46	-2.00	-2.94	-3.21	-.80	.46	-3.22	-3.00
24	-2.80	-2.05	-2.31	-2.31	-2.85	.82	-2.71	.82	-1.56	-2.40	-2.90	-.90	.82	-2.80	-2.52
25	-2.58	-1.91	-2.22	-2.22	-2.66	.98	-2.44	.98	-1.32	-2.13	-2.69	-1.07	.98	-2.58	-2.06
26	-2.47	-1.62	-1.61	-1.61	-2.29	1.77	-2.16	1.77	-1.14	-1.68	-2.45	-.64	1.77	-2.47	-1.60
27	-2.26	-1.25	-.96	-.96	-1.96	2.32	-1.77	2.32	-.97	-1.18	-2.22	.00	2.32	-2.26	-1.26
28	-2.47	-1.36	-.57	-.57	-2.22	1.39	-1.89	1.39	-1.38	-1.50	-2.52	.35	1.39	-2.47	-1.49
29	-3.02	-1.81	.20	.20	-2.88	1.19	-2.37	1.19	-2.08	-2.20	-3.08	.90	1.19	-3.02	-2.03
30	-3.30	-2.15	.38	.38	-3.28	.85	-2.67	.85	-2.53	-2.49	-3.51	.88	.85	-3.30	-2.28
31	-3.29	-2.16	.55	.55	-3.34	.82	-2.76	.82	-2.61	-2.56	-3.80	.85	.82	-3.29	-2.33
32	-3.12	-2.10	.31	.31	-3.18	1.48	-2.62	1.48	-2.54	-2.35	-3.86	.85	1.48	-3.12	-2.32
33	-2.69	-1.72	.66	.66	-2.70	2.46	-2.25	2.46	-2.11	-1.78	-3.59	1.20	2.46	-2.69	-1.96
34	-1.97	-.94	1.13	1.13	-1.94	1.39	-1.52	1.39	-1.28	-.84	-2.91	1.59	1.39	-1.97	-1.27
35	-1.28	-.22	1.48	1.48	-1.26	1.16	-.78	1.16	-.64	-.09	-2.28	1.81	1.16	-1.28	-.60
36	-1.50	-.41	1.89	1.89	-1.55	1.02	-.87	1.02	-.97	-.34	-2.46	2.06	1.02	-1.50	-.76
37	-1.36	-.32	1.82	1.82	-1.46	.84	-.57	.84	-.95	-.33	-2.21	1.97	.84	-1.36	-.55
38	-1.34	-.25	1.48	1.48	-1.36	.84	-.34	.84	-1.08	-.41	-2.06	1.92	.84	-1.34	-.45
39	-1.05	-.06	1.47	1.47	-1.00	1.04	.02	1.04	-.92	-.16	-1.73	1.96	1.04	-1.05	-.16
40	-1.27	-.41	1.18	1.18	-1.05	1.11	-.08	1.11	-1.15	-.30	-1.84	1.68	1.11	-1.27	-.30
41	-1.16	-.25	1.23	1.23	-.86	1.40	-.01	1.40	-1.25	-.23	-1.56	1.58	1.40	-1.16	.00
42	-.87	-.06	-.05	-.05	-.77	1.44	.01	1.44	-1.43	-.18	-1.38	.80	1.44	-.87	.34
43	-.77	.03	.37	.37	-.61	1.93	.25	1.93	-1.33	-.07	-1.33	.86	1.93	-.77	.52
44	-.88	.09	-.22	-.22	-.58	2.18	.39	2.18	-1.23	-.12	-1.45	.47	2.18	-.88	.49
45	-.79	.31	-.41	-.41	-.46	3.38	.56	3.38	-1.08	-.04	-1.27	.00	3.38	-.79	.61
46	-.79	.15	-2.07	-2.07	-.44	3.57	.65	3.57	-.99	-.17	-1.16	-1.33	3.57	-.79	.59
47	-.70	.04	-2.26	-2.26	-.19	2.76	.96	2.76	-.97	-.17	-.87	-1.44	2.76	-.70	.75
48	-.78	-.14	-2.48	-2.48	-.21	2.00	1.05	2.00	-1.11	-.53	-.67	-1.98	2.00	-.78	.70
49	-1.19	-.73	-2.99	-2.99	-.74	1.41	.63	1.41	-1.48	-1.32	-.96	-2.64	1.41	-1.19	.14
50	-1.51	-1.31	-1.60	-1.60	-1.20	1.05	.10	1.05	-1.80	-1.73	-1.22	-2.02	1.05	-1.51	-.37
51	-1.46	-1.33	-1.27	-1.27	-1.30	.82	-.11	.82	-1.97	-1.82	-1.22	-1.64	.82	-1.46	-.52
52	-.94	-.83	-1.51	-1.51	-.69	.36	.04	.36	-1.66	-1.32	-.82	-1.65	.36	-.94	-.32
53	.25	.26	-.75	-.75	.56	.36	.94	.36	-.85	-.19	.35	-1.05	.36	.25	.55
54	.67	.77	-1.54	-1.54	1.26	.12	1.46	.12	-.40	.31	.97	-1.18	.12	.67	.91
55	.76	1.25	-2.18	-2.18	1.77	.08	1.82	.08	.16	.67	1.53	-1.35	.08	.76	1.20
56	.17	1.43	-2.35	-2.35	1.59	.04	1.53	.04	.27	.39	1.48	-1.30	.04	.17	.77
57	.40	1.91	-3.06	-3.06	1.80	.10	1.69	.10	1.02	.36	1.82	-2.15	.10	.40	.80
58	.02	1.79	-3.07	-3.07	1.23	.62	1.12	.62	1.22	.06	1.33	-2.51	.62	.02	.48
59	-1.44	-.36	-3.79	-3.79	-.64	.56	-.26	.56	.14	-1.11	-.33	-3.35	.56	-1.44	-.77
60	-16.35	-15.30	-15.99	-15.99	-16.76	-12.53	-15.23	-12.53	-15.66	-16.74	-15.66	-15.71	-12.53	-16.35	-15.96
61	11.19	11.19	11.19	11.19	11.19	11.19	11.19	11.19	11.19	11.19	11.19	11.19	11.19	11.19	11.19
62	3.13	3.13	3.13	3.13	3.13	3.13	3.13	3.13	3.13	3.13	3.13	3.13	3.13	3.13	3.13

NOAA-9 SCANNER OFFSETS FOR JANUARY 1986:

TOTAL CHANNEL

S.P.	DAY OF MONTH -->															
	16	17	18	19	20	21	22	23	24	25	26	27	28	29	30	31
1	.36	.36	.36	.36	.36	.36	.36	.36	.36	.36	.36	.36	.36	.36	.36	.36
2	1.04	1.04	1.04	1.04	1.04	1.04	1.04	1.04	1.04	1.04	1.04	1.04	1.04	1.04	1.04	1.04
3	1.93	1.93	1.93	1.93	1.93	1.93	1.93	1.93	1.93	1.93	1.93	1.93	1.93	1.93	1.93	1.93
4	-9.64	-9.64	-9.64	-9.64	-9.64	-9.64	-9.64	-9.64	-9.64	-9.64	-9.64	-9.64	-9.64	-9.64	-9.64	-9.64
5	-.81	-.81	-.81	-.81	-.81	-.81	-.81	-.81	-.81	-.81	-.81	-.81	-.81	-.81	-.81	-.81
6	1.16	3.00	2.90	2.90	2.90	13.59	13.80	13.29	16.64	13.89	13.29	13.29	12.99	17.16	16.64	16.89
7	.11	-.43	-.09	-.09	-.09	3.71	4.00	4.51	5.49	5.20	5.06	4.51	4.98	6.33	5.49	5.41
8	-2.87	-1.03	-.30	-.30	-.30	.96	1.53	1.94	1.93	2.10	1.91	1.94	1.87	2.47	1.93	1.58
9	-2.55	-.51	.55	.55	.55	-1.07	-1.66	.50	-.04	1.51	1.06	.50	1.01	.48	-.04	-.37
10	-1.65	.19	1.17	1.17	1.17	-1.07	-1.44	.69	-.52	2.19	1.49	.69	1.65	-.28	-.52	-.59
11	-2.43	-.02	.43	.43	.43	-.88	-1.25	.49	-1.41	1.72	1.22	.49	1.53	-1.36	-1.41	-.97
12	-2.63	-.15	-.11	-.11	-.11	-.20	-.69	.17	-2.32	.79	.46	.17	.84	-2.39	-2.32	-1.76
13	-1.16	.09	-.14	-.14	-.14	-.01	-.61	-.90	-2.88	-1.73	-1.24	-.90	-1.01	-2.98	-2.88	-2.11
14	-1.25	1.39	1.07	1.07	1.07	-.14	-1.30	-1.17	-1.87	-1.83	-1.64	-1.17	-1.51	-1.92	-1.87	-1.15
15	-1.35	.69	.50	.50	.50	-.47	-1.84	-1.40	-1.71	-2.22	-2.00	-1.40	-2.00	-1.67	-1.71	-.81
16	-.45	.63	.59	.59	.59	-.72	-2.08	-1.26	-1.32	-2.09	-1.85	-1.26	-2.16	-1.07	-1.32	-.43
17	-.54	.73	.69	.69	.69	-.70	-2.10	-1.25	-.84	-2.23	-1.99	-1.25	-2.64	-.63	-.84	-.03
18	-.46	.99	.79	.79	.79	-.54	-1.94	-1.38	-.90	-2.40	-2.39	-1.38	-3.14	-.99	-.90	-.28
19	-.19	-1.60	-1.91	-1.91	-1.91	-1.34	-2.68	-1.88	-1.45	-2.54	-2.82	-1.88	-3.47	-1.51	-1.45	-.85
20	-.34	-1.94	-2.49	-2.49	-2.49	-1.08	-2.30	-.83	-1.49	-.73	-1.16	-.83	-1.75	-1.36	-1.49	-.90
21	-.03	-1.96	-2.71	-2.71	-2.71	-1.23	-2.29	-.98	-1.68	-.96	-1.33	-.98	-1.95	-1.36	-1.68	-1.18
22	-.29	-1.70	-2.62	-2.62	-2.62	-1.18	-2.07	-1.19	-1.68	-1.53	-1.98	-1.19	-2.36	-1.08	-1.68	-1.18
23	.46	-2.28	-3.21	-3.21	-3.21	-.42	-1.32	-.80	-1.47	-1.49	-2.07	-.80	-2.31	-.97	-1.47	-1.09
24	.82	-2.05	-2.90	-2.90	-2.90	-.42	-1.44	-.90	-1.81	-1.75	-2.31	-.90	-2.56	-1.40	-1.81	-1.52
25	.98	-1.91	-2.69	-2.69	-2.69	-.89	-1.94	-1.07	-2.84	-1.70	-2.22	-1.07	-2.54	-2.37	-2.84	-2.37
26	1.77	-1.62	-2.45	-2.45	-2.45	-.60	-1.79	-.64	-2.76	-1.11	-1.61	-.64	-2.00	-2.29	-2.76	-2.32
27	2.32	-1.25	-2.22	-2.22	-2.22	-.08	-1.39	.00	-2.47	-.31	-.96	.00	-1.27	-2.13	-2.47	-1.93
28	1.39	-1.36	-2.52	-2.52	-2.52	.10	-1.67	.35	-2.32	.20	-.57	.35	-.67	-2.07	-2.32	-1.75
29	1.19	-1.81	-3.08	-3.08	-3.08	.37	-1.40	.90	-1.83	1.12	.20	.90	.10	-1.67	-1.83	-1.34
30	.85	-2.15	-3.51	-3.51	-3.51	.14	-1.63	.88	-1.78	1.28	.38	.88	.16	-1.72	-1.78	-1.30
31	.82	-2.16	-3.80	-3.80	-3.80	.19	-1.74	.85	-1.31	1.51	.55	.85	.18	-1.36	-1.31	-.93
32	1.48	-2.10	-3.86	-3.86	-3.86	.67	-1.46	.85	-.38	1.41	.31	.85	-.24	-.65	-.38	-.25
33	2.46	-1.72	-3.59	-3.59	-3.59	1.22	-.95	1.20	.26	1.81	.66	1.20	.04	-.02	.26	.30
34	1.39	-.94	-2.91	-2.91	-2.91	1.52	-.52	1.59	.94	2.26	1.13	1.59	.46	.78	.94	1.08
35	1.16	-.22	-2.28	-2.28	-2.28	1.82	-.11	1.81	1.53	2.58	1.48	1.81	.68	1.40	1.53	1.78
36	1.02	-.41	-2.46	-2.46	-2.46	2.06	.02	2.06	1.99	3.03	1.89	2.06	1.13	2.24	1.99	2.46
37	.84	-.32	-2.21	-2.21	-2.21	2.10	.32	1.97	2.43	3.16	1.82	1.97	1.17	2.93	2.43	2.88
38	.84	-.25	-2.06	-2.06	-2.06	2.54	.59	1.92	2.93	3.01	1.48	1.92	.84	3.40	2.93	3.24
39	1.04	-.06	-1.73	-1.73	-1.73	2.73	.77	1.96	2.64	3.13	1.47	1.96	.88	2.99	2.64	2.82
40	1.11	-.41	-1.84	-1.84	-1.84	2.52	.28	1.68	2.12	2.89	1.18	1.68	.55	2.56	2.12	2.36
41	1.40	-.25	-1.56	-1.56	-1.56	2.38	.77	1.58	2.28	2.83	1.23	1.58	.51	2.84	2.28	2.54
42	1.44	-.06	-1.38	-1.38	-1.38	2.09	.67	.80	2.47	1.51	-.05	.80	-.72	2.93	2.47	2.75
43	1.93	.03	-1.33	-1.33	-1.33	1.95	.25	.86	2.60	1.79	.37	.86	-.34	2.96	2.60	2.90
44	2.18	.09	-1.45	-1.45	-1.45	2.19	.56	.47	1.60	.96	-.22	.47	-.88	1.90	1.60	1.97
45	3.38	.31	-1.27	-1.27	-1.27	1.75	.12	.00	1.81	.49	-.41	.00	-.99	2.01	1.81	2.25
46	3.57	.15	-1.16	-1.16	-1.16	.96	-.67	-1.33	1.81	-1.28	-2.07	-1.33	-2.59	1.94	1.81	2.05
47	2.76	.04	-.87	-.87	-.87	1.11	-.58	-1.44	1.20	-1.50	-2.26	-1.44	-2.64	1.52	1.20	1.31
48	2.00	-.14	-.67	-.67	-.67	.44	-1.05	-1.98	2.10	-1.75	-2.48	-1.98	-2.61	2.89	2.10	2.39
49	1.41	-.73	-.96	-.96	-.96	-.35	-1.34	-2.64	.70	-2.29	-2.99	-2.64	-2.99	1.47	.70	.94
50	1.05	-1.31	-1.22	-1.22	-1.22	-.47	-1.14	-2.02	.10	-1.09	-1.60	-2.02	-1.70	.85	.10	-.04
51	.82	-1.33	-1.22	-1.22	-1.22	-.28	-.58	-1.64	-.23	-.91	-1.27	-1.64	-1.47	.73	-.23	-.66
52	.36	-.83	-.82	-.82	-.82	-.36	-.34	-1.65	-.61	-1.35	-1.51	-1.65	-2.07	.50	-.61	-1.28
53	.36	.26	.35	.35	.35	-.42	-.23	-1.05	-1.27	-.58	-.75	-1.05	-1.60	-.27	-1.27	-2.00
54	.12	.77	.97	.97	.97	-.64	-.52	-1.18	-.44	-1.26	-1.54	-1.18	-2.39	.28	-.44	-1.28
55	.08	1.25	1.53	1.53	1.53	-.70	-.97	-1.35	.13	-1.78	-2.18	-1.35	-2.77	.41	.13	-.75
56	.04	1.43	1.48	1.48	1.48	-.63	-1.08	-1.30	-3.00	-2.01	-2.35	-1.30	-2.84	-2.56	-3.00	-2.87
57	.10	1.91	1.82	1.82	1.82	-1.67	-2.50	-2.15	-2.53	-2.89	-3.06	-2.15	-3.56	-1.85	-2.53	-1.49
58	.62	1.79	1.33	1.33	1.33	-2.28	-3.52	-2.51	-3.29	-2.80	-3.07	-2.51	-3.35	-2.95	-3.29	-2.50
59	.56	.36	-.33	-.33	-.33	-3.12	-4.70	-3.35	-3.96	-3.09	-3.79	-3.35	-3.37	-3.51	-3.96	-3.55
60	-12.53	-15.30	-15.66	-15.66	-15.66	-15.09	-16.74	-15.71	-16.27	-15.47	-15.99	-15.71	-14.73	-15.55	-16.27	-16.14
61	11.19	11.19	11.19	11.19	11.19	11.19	11.19	11.19	11.19	11.19	11.19	11.19	11.19	11.19	11.19	11.19
62	3.13	3.13	3.13	3.13	3.13	3.13	3.13	3.13	3.13	3.13	3.13	3.13	3.13	3.13	3.13	3.13

NOAA-9 SCANNER OFFSETS FOR JANUARY 1986: LONGHAYE CHANNEL
 DAY OF MONTH -->

S.P.	1	2	3	4	5	6	7	8	9	10	11	12	13	14	15
1	-.11	-.11	-.11	-.11	-.11	-.11	-.11	-.11	-.11	-.11	-.11	-.11	-.11	-.11	-.11
2	.32	.32	.32	.32	.32	.32	.32	.32	.32	.32	.32	.32	.32	.32	.32
3	.49	.49	.49	.49	.49	.49	.49	.49	.49	.49	.49	.49	.49	.49	.49
4	-4.09	-4.09	-4.09	-4.09	-4.09	-4.09	-4.09	-4.09	-4.09	-4.09	-4.09	-4.09	-4.09	-4.09	-4.09
5	-1.84	-1.84	-1.84	-1.84	-1.84	-1.84	-1.84	-1.84	-1.84	-1.84	-1.84	-1.84	-1.84	-1.84	-1.84
6	-.11	.08	6.47	6.47	.13	-.79	.17	-.79	-.51	.20	.08	6.31	-.79	.11	.84
7	-1.92	-1.82	1.67	1.67	-1.50	-1.51	-1.70	-1.51	-2.58	-1.86	-1.51	1.11	-1.51	-1.92	-1.27
8	-2.47	-2.30	-.18	-.18	-1.83	-3.39	-2.15	-3.39	-2.81	-2.49	-1.71	-.40	-3.39	-2.47	-2.23
9	-2.18	-1.98	-.78	-.78	-1.51	-3.27	-1.48	-3.27	-2.06	-1.90	-1.15	-1.35	-3.27	-2.18	-2.28
10	-2.04	-1.74	-.62	-.62	-1.61	-2.78	-1.24	-2.78	-1.72	-1.57	-.98	-1.33	-2.78	-2.04	-2.15
11	-2.61	-2.03	-.98	-.98	-2.25	-3.53	-1.65	-3.53	-2.01	-2.06	-1.63	-1.65	-3.53	-2.61	-2.63
12	-3.03	-2.28	-1.63	-1.63	-2.60	-3.75	-2.00	-3.75	-2.18	-2.56	-2.17	-2.03	-3.75	-3.03	-2.97
13	-2.93	-2.18	-2.80	-2.80	-2.43	-2.87	-1.98	-2.87	-1.90	-2.60	-2.26	-2.79	-2.87	-2.93	-2.84
14	-2.31	-1.60	-3.27	-3.27	-1.79	-3.09	-1.47	-3.09	-1.23	-2.07	-1.74	-3.17	-3.09	-2.31	-2.26
15	-2.93	-2.31	-3.76	-3.76	-2.41	-3.37	-2.31	-3.37	-1.92	-2.74	-2.35	-3.58	-3.37	-2.93	-2.91
16	-3.14	-2.59	-3.90	-3.90	-2.58	-3.52	-2.64	-3.52	-2.16	-2.97	-2.48	-3.70	-3.52	-3.14	-3.12
17	-3.27	-2.80	-4.27	-4.27	-2.72	-3.55	-2.88	-3.55	-2.27	-3.12	-2.66	-3.96	-3.55	-3.27	-3.22
18	-3.24	-2.83	-4.78	-4.78	-2.86	-3.55	-3.11	-3.55	-2.46	-3.20	-2.82	-4.29	-3.55	-3.24	-3.21
19	-5.21	-4.94	-5.36	-5.36	-5.09	-3.55	-5.45	-3.55	-4.61	-5.45	-4.96	-4.88	-3.55	-5.21	-5.16
20	-5.74	-5.39	-4.41	-4.41	-5.54	-3.98	-5.97	-3.98	-5.06	-5.84	-5.53	-4.38	-3.98	-5.74	-5.65
21	-6.03	-5.51	-4.73	-4.73	-5.69	-3.98	-6.13	-3.98	-5.27	-5.94	-5.77	-4.66	-3.98	-6.03	-5.91
22	-6.18	-5.57	-5.40	-5.40	-5.78	-4.51	-6.14	-4.51	-5.31	-5.92	-5.93	-5.01	-4.51	-6.18	-6.06
23	-6.68	-6.16	-5.72	-5.72	-6.31	-4.31	-6.60	-4.31	-5.74	-6.32	-6.50	-4.99	-4.31	-6.68	-6.67
24	-6.52	-6.14	-6.03	-6.03	-6.20	-4.32	-6.38	-4.32	-5.54	-6.05	-6.39	-.20	-4.32	-6.52	-6.47
25	-6.48	-6.18	-6.18	-6.18	-6.24	-4.43	-6.33	-4.43	-5.45	-5.97	-6.35	-5.51	-4.43	-6.48	-6.28
26	-6.34	-5.95	-5.81	-5.81	-5.95	-3.91	-6.10	-3.91	-5.26	-5.59	-6.11	-5.24	-3.91	-6.34	-5.92
27	-6.08	-5.60	-5.38	-5.38	-5.64	-3.53	-5.74	-3.53	-5.02	-5.11	-5.81	-4.78	-3.53	-6.08	-5.56
28	-6.08	-5.53	-5.09	-5.09	-5.71	-4.15	-5.71	-4.15	-5.14	-5.16	-5.86	-4.49	-4.15	-6.08	-5.57
29	-6.37	-5.74	-4.48	-4.48	-6.11	-4.16	-5.98	-4.16	-5.49	-5.51	-6.11	-4.04	-4.16	-6.37	-5.83
30	-6.46	-5.90	-4.32	-4.32	-6.36	-4.29	-6.13	-4.29	-5.71	-5.63	-6.33	-3.98	-4.29	-6.46	-5.91
31	-6.21	-5.64	-3.94	-3.94	-6.19	-4.04	-5.99	-4.04	-5.53	-5.43	-6.32	-3.73	-4.04	-6.21	-5.69
32	-5.81	-5.31	-3.88	-3.88	-5.83	-3.30	-5.61	-3.30	-5.19	-5.02	-6.09	-3.50	-3.30	-5.81	-5.39
33	-5.14	-4.64	-3.31	-3.31	-5.13	-2.26	-4.96	-2.26	-4.51	-4.28	-5.50	-2.93	-2.26	-5.14	-4.76
34	-4.24	-3.66	-2.58	-2.58	-4.18	-2.52	-4.03	-2.52	-3.52	-3.26	-4.63	-2.25	-2.52	-4.24	-3.87
35	-3.42	-2.79	-1.98	-1.98	-3.36	-2.29	-3.16	-2.29	-2.76	-2.44	-3.88	-1.76	-2.29	-3.42	-3.06
36	-3.24	-2.58	-1.32	-1.32	-3.20	-1.98	-2.87	-1.98	-2.67	-2.30	-3.69	-1.18	-1.98	-3.24	-2.84
37	-2.74	-2.08	-.96	-.96	-2.74	-1.64	-2.25	-1.64	-2.28	-1.93	-3.11	-.84	-1.64	-2.74	-2.29
38	-2.36	-1.62	-.77	-.77	-2.27	-1.21	-1.69	-1.21	-2.03	-1.63	-2.63	-.46	-1.21	-2.36	-1.83
39	-1.84	-1.18	-.39	-.39	-1.71	-.64	-1.12	-.64	-1.63	-1.18	-2.11	-.04	-.64	-1.84	-1.31
40	-1.62	-1.03	-.18	-.18	-1.33	-.17	-.77	-.17	-1.42	-.91	-1.80	.20	-.17	-1.62	-1.03
41	-1.20	-.54	.23	.23	-.85	.42	-.37	.42	-1.19	-.51	-1.25	.52	.42	-1.20	-.47
42	-.64	-.07	-.31	-.31	-.47	.72	-.04	.72	-1.00	-.17	-.81	.29	.72	-.64	.10
43	-.30	.29	.19	.19	-.08	1.33	.43	1.33	-.66	.17	-.51	.57	1.33	-.30	.48
44	-.10	.61	-.01	-.01	.24	1.71	.81	1.71	-.31	.42	-.31	.47	1.71	-.10	.73
45	.19	1.00	.05	.05	.54	2.68	1.17	2.68	.02	.69	.03	.33	2.68	.19	1.04
46	.48	1.20	-.73	-.73	.84	3.05	1.52	3.05	.38	.90	.38	-.30	3.05	.48	1.31
47	.68	1.26	-.72	-.72	1.13	2.79	1.87	2.79	.53	1.03	.72	-.23	2.79	.68	1.56
48	.78	1.27	-.73	-.73	1.26	2.41	2.06	2.41	.57	.94	.98	-.45	2.41	.78	1.66
49	.55	.90	-1.10	-1.10	.96	1.92	1.82	1.92	.37	.46	.81	-.92	1.92	.55	1.31
50	.43	.61	-.21	-.21	.75	1.60	1.57	1.60	.29	.30	.74	-.51	1.60	.43	1.06
51	.77	.90	.25	.25	.95	1.66	1.70	1.66	.47	.52	1.03	-.01	1.66	.77	1.24
52	.84	.97	-.02	-.02	1.07	1.15	1.53	1.15	.43	.58	1.01	-.13	1.15	.84	1.10
53	1.37	1.42	.11	.11	1.61	1.14	1.84	1.14	.73	1.07	1.47	-.11	1.14	1.37	1.39
54	1.61	1.76	-.57	-.57	2.05	.75	2.17	.75	1.05	1.43	1.84	-.36	.75	1.61	1.61
55	1.27	1.67	-1.05	-1.05	2.00	.58	2.02	.58	1.07	1.29	1.82	-.52	.58	1.27	1.39
56	.76	1.71	-1.26	-1.26	1.76	.44	1.74	.44	1.04	1.00	1.67	-.58	.44	.76	.98
57	.84	1.97	-1.86	-1.86	1.81	.33	1.76	.33	1.46	.92	1.81	-1.31	.33	.84	.91
58	.54	1.85	-2.00	-2.00	1.38	.89	1.35	.89	1.56	.67	1.45	-1.68	.89	.54	.64
59	-.78	.56	-2.50	-2.50	-.19	.73	.09	.73	.50	-.45	.01	-2.24	.73	-.78	-.54
60	-9.86	-9.01	-9.89	-9.89	-10.05	-7.23	-9.04	-7.23	-9.11	-9.97	-9.35	-9.77	-7.23	-9.86	-9.79
61	3.05	3.05	3.05	3.05	3.05	3.05	3.05	3.05	3.05	3.05	3.05	3.05	3.05	3.05	3.05
62	.45	.45	.45	.45	.45	.45	.45	.45	.45	.45	.45	.45	.45	.45	.45

NOAA-9 SCANNER OFFSETS FOR JANUARY 1986: LONGWAVE CHANNEL

S.P.	DAY OF MONTH -->															
	16	17	18	19	20	21	22	23	24	25	26	27	28	29	30	31
1	-.11	-.11	-.11	-.11	-.11	-.11	-.11	-.11	-.11	-.11	-.11	-.11	-.11	-.11	-.11	-.11
2	.32	.32	.32	.32	.32	.32	.32	.32	.32	.32	.32	.32	.32	.32	.32	.32
3	.49	.49	.49	.49	.49	.49	.49	.49	.49	.49	.49	.49	.49	.49	.49	.49
4	-4.09	-4.09	-4.09	-4.09	-4.09	-4.09	-4.09	-4.09	-4.09	-4.09	-4.09	-4.09	-4.09	-4.09	-4.09	-4.09
5	-1.84	-1.84	-1.84	-1.84	-1.84	-1.84	-1.84	-1.84	-1.84	-1.84	-1.84	-1.84	-1.84	-1.84	-1.84	-1.84
6	-.79	.08	.08	.08	.08	6.52	6.63	6.31	8.40	6.78	6.47	6.31	6.19	8.73	8.40	8.52
7	-1.51	-1.82	-1.51	-1.51	-1.51	.59	.76	1.11	1.81	1.67	1.67	1.11	1.48	2.32	1.81	1.74
8	-3.39	-2.30	-1.71	-1.71	-1.71	-1.07	-1.12	-.40	-.38	-.15	-.18	-.40	-.41	-.07	-.38	-.64
9	-3.27	-1.98	-1.15	-1.15	-1.15	-2.39	-2.80	-1.35	-1.73	-.55	-.78	-1.35	-1.04	-1.44	-1.73	-1.98
10	-2.78	-1.74	-.98	-.98	-.98	-2.46	-2.73	-1.33	-2.21	-.23	-.62	-1.33	-.75	-2.07	-2.21	-2.26
11	-3.53	-2.03	-1.63	-1.63	-1.63	-2.51	-3.12	-1.65	-2.87	-.75	-.98	-1.65	-1.01	-2.87	-2.87	-2.58
12	-3.75	-2.28	-2.17	-2.17	-2.17	-2.25	-2.94	-2.03	-3.66	-1.50	-1.63	-2.03	-1.60	-3.78	-3.66	-3.28
13	-2.87	-2.18	-2.26	-2.26	-2.26	-2.25	-2.97	-2.79	-4.09	-2.81	-2.80	-2.79	-2.85	-4.27	-4.09	-3.59
14	-3.09	-1.60	-1.74	-1.74	-1.74	-2.58	-3.66	-3.17	-3.64	-3.47	-3.27	-3.17	-3.39	-3.78	-3.64	-3.16
15	-3.37	-2.31	-2.35	-2.35	-2.35	-3.04	-4.30	-3.58	-3.85	-3.98	-3.76	-3.58	-4.00	-3.95	-3.85	-3.27
16	-3.52	-2.59	-2.48	-2.48	-2.48	-3.41	-4.67	-3.70	-3.78	-4.13	-3.90	-3.70	-4.35	-3.75	-3.78	-3.22
17	-3.35	-2.80	-2.66	-2.66	-2.66	-3.65	-4.93	-3.96	-3.72	-4.47	-4.27	-3.96	-4.95	-3.72	-3.72	-3.22
18	-3.55	-2.83	-2.82	-2.82	-2.82	-3.83	-5.08	-4.29	-4.01	-4.81	-4.78	-4.29	-5.51	-4.19	-4.01	-3.64
19	-3.55	-4.94	-4.96	-4.96	-4.96	-4.61	-5.81	-4.88	-4.65	-5.20	-5.36	-4.88	-5.99	-4.79	-4.65	-4.29
20	-3.98	-5.39	-5.53	-5.53	-5.53	-4.65	-5.76	-4.38	-4.94	-4.14	-4.41	-4.38	-4.99	-4.93	-4.94	-4.60
21	-3.98	-5.51	-5.77	-5.77	-5.77	-4.89	-5.90	-4.66	-5.26	-4.52	-4.73	-4.66	-5.32	-5.08	-5.26	-4.99
22	-4.51	-5.57	-5.93	-5.93	-5.93	-5.05	-5.98	-5.01	-5.49	-5.16	-5.40	-5.01	-5.79	-5.12	-5.49	-5.26
23	-4.31	-6.16	-6.50	-6.50	-6.50	-4.77	-5.71	-4.99	-5.52	-5.37	-5.72	-4.99	-5.96	-5.26	-5.52	-5.41
24	-4.32	-6.14	-6.39	-6.39	-6.39	-4.89	-5.87	-5.20	-5.85	-5.69	-6.03	-5.20	-6.23	-5.64	-5.85	-5.80
25	-4.43	-6.18	-6.35	-6.35	-6.35	-5.36	-6.36	-5.51	-6.71	-5.84	-6.18	-5.51	-6.41	-6.45	-6.71	-6.54
26	-3.91	-5.95	-6.11	-6.11	-6.11	-5.17	-6.28	-5.24	-6.71	-5.47	-5.81	-5.24	-6.07	-6.46	-6.71	-6.56
27	-3.53	-5.60	-5.81	-5.81	-5.81	-4.77	-5.97	-4.78	-6.51	-6.92	-5.38	-4.78	-5.55	-6.34	-6.51	-6.28
28	-4.15	-5.53	-5.86	-5.86	-5.86	-4.56	-5.76	-4.49	-6.39	-4.58	-5.09	-4.49	-5.13	-6.28	-6.39	-6.13
29	-4.16	-5.74	-6.11	-6.11	-6.11	-4.28	-5.50	-4.04	-5.96	-3.89	-4.48	-4.04	-4.50	-5.92	-5.96	-5.76
30	-4.29	-5.90	-6.33	-6.33	-6.33	-4.37	-5.58	-3.98	-5.84	-3.72	-4.32	-3.98	-4.40	-5.86	-5.84	-5.63
31	-4.04	-5.64	-6.32	-6.32	-6.32	-4.08	-5.38	-3.73	-5.25	-3.31	-3.94	-3.73	-4.13	-5.34	-5.25	-5.14
32	-3.30	-5.31	-6.09	-6.09	-6.09	-3.50	-4.94	-3.50	-4.39	-3.16	-3.88	-3.50	-4.21	-4.64	-4.39	-4.43
33	-2.26	-4.64	-5.50	-5.50	-5.50	-2.77	-4.28	-2.93	-3.64	-2.57	-3.31	-2.93	-3.68	-3.87	-3.64	-3.71
34	-2.52	-3.66	-4.63	-4.63	-4.63	-2.15	-3.58	-2.25	-2.83	-1.85	-2.58	-2.25	-2.99	-3.00	-2.83	-2.83
35	-2.29	-2.79	-3.88	-3.88	-3.88	-1.61	-2.97	-1.76	-2.09	-1.28	-1.98	-1.76	-2.51	-2.27	-2.09	-2.03
36	-1.98	-2.58	-3.69	-3.69	-3.69	-1.09	-2.52	-1.18	-1.39	-.59	-1.32	-1.18	-1.83	-1.31	-1.39	-1.18
37	-1.64	-2.08	-3.11	-3.11	-3.11	-.65	-2.19	-.84	-.73	-.08	-.96	-.84	-1.40	-.50	-.73	-.51
38	-1.21	-1.62	-2.63	-2.63	-2.63	.02	-1.62	-.46	-.05	.24	-.77	-.46	-1.20	.15	-.05	.08
39	-.64	-1.18	-2.11	-2.11	-2.11	.53	-1.12	-.04	.12	.71	-.39	-.04	-.79	.23	.12	.18
40	-.17	-1.03	-1.80	-1.80	-1.80	.84	-.71	.20	.16	.95	-.18	.20	-.64	.32	.16	.27
41	.42	-.54	-1.25	-1.25	-1.25	1.13	-.26	.52	.68	1.30	.23	.52	-.26	.89	.68	.79
42	.72	-.07	-.81	-.81	-.81	1.19	-.07	.29	1.07	.73	-.31	.29	-.77	1.21	1.07	1.20
43	1.33	.29	-.51	-.51	-.51	1.36	.23	.57	1.43	1.15	.19	.57	-.29	1.50	1.43	1.56
44	1.71	.61	-.31	-.31	-.31	1.67	.61	.47	.99	.81	-.01	.47	-.45	1.05	.99	1.17
45	2.68	1.00	.03	.03	.03	1.55	.49	.33	1.31	.69	.05	.33	-.32	1.30	1.31	1.52
46	3.05	1.20	.38	.38	.38	1.24	.20	-.30	1.54	-.19	-.73	-.30	-1.08	1.46	1.54	1.58
47	2.79	1.26	.72	.72	.72	1.46	.37	-.23	1.24	-.21	-.72	-.23	-1.00	1.32	1.24	1.22
48	2.41	1.27	.98	.98	.98	1.16	.20	-.45	2.02	-.22	-.73	-.45	-.85	2.41	2.02	2.11
49	1.92	.90	.81	.81	.81	.60	-.04	-.92	1.00	-.60	-1.10	-.92	-1.16	1.36	1.00	1.05
50	1.60	.61	.74	.74	.74	.52	.08	-.51	.55	.19	-.21	-.51	-.30	.92	.55	.35
51	1.66	.90	1.03	1.03	1.03	.86	.68	-.01	.54	.53	.25	-.01	.08	1.05	.54	.15
52	1.15	.97	1.01	1.01	1.01	.73	.75	-.13	.22	.12	-.02	-.13	-.46	.77	.22	-.33
53	1.14	1.42	1.47	1.47	1.47	.37	.49	-.11	-.61	.25	.11	-.11	-.58	-.12	-.61	-1.19
54	.75	1.76	1.84	1.84	1.84	.05	.13	-.36	-.23	-.35	-.57	-.36	-1.28	.06	-.23	-.89
55	.58	1.67	1.82	1.82	1.82	-.03	-.22	-.52	.01	-.73	-1.05	-.52	-1.63	.03	.01	-.63
56	.44	1.71	1.67	1.67	1.67	-.05	-.39	-.58	-2.14	-.97	-1.26	-.58	-1.81	-1.99	-2.14	-2.09
57	.33	1.97	1.81	1.81	1.81	-.97	-1.60	-1.31	-1.96	-1.67	-1.86	-1.31	-2.43	-1.69	-1.96	-1.30
58	.89	1.85	1.45	1.45	1.45	-1.48	-2.40	-1.68	-2.62	-1.75	-2.00	-1.68	-2.41	-2.60	-2.62	-2.09
59	.73	.56	.01	.01	.01	-2.02	-3.16	-2.24	-3.07	-1.95	-2.50	-2.24	-2.45	-3.00	-3.07	-2.78
60	-7.23	-9.01	-9.35	-9.35	-9.35	-9.31	-10.50	-9.77	-10.55	-9.44	-9.89	-9.77	-9.33	-10.27	-10.55	-10.43
61	3.05	3.05	3.05	3.05	3.05	3.05	3.05	3.05	3.05	3.05	3.05	3.05	3.05	3.05	3.05	3.05
62	.45	.45	.45	.45	.45	.45	.45	.45	.45	.45	.45	.45	.45	.45	.45	.45

NOAA-9 SCANNER OFFSETS FOR JANUARY 1986: SHORTWAVE CHANNEL
DAY OF MONTH -->

S.P.	1	2	3	4	5	6	7	8	9	10	11	12	13	14	15
1	.23	.23	.10	.23	.33	.23	.33	.23	.23	.23	.23	.23	.33	.41	.41
2	.52	.53	.44	.53	.62	.52	.62	.52	.52	.52	.52	.52	.63	.69	.69
3	.53	.51	.44	.51	.63	.53	.63	.53	.53	.53	.53	.53	.66	.71	.71
4	.15	.11	.06	.11	.23	.15	.23	.15	.15	.15	.15	.15	.27	.33	.33
5	.55	.55	.51	.55	.63	.55	.63	.55	.55	.55	.55	.55	.66	.72	.72
6	.60	.60	.54	.60	.67	.60	.67	.60	.60	.60	.60	.60	.73	.77	.77
7	.19	.21	.16	.21	.26	.19	.26	.19	.19	.19	.19	.19	.26	.35	.35
8	.54	.57	.51	.57	.62	.54	.62	.54	.54	.54	.54	.54	.66	.72	.72
9	.62	.63	.55	.63	.68	.62	.68	.62	.62	.62	.62	.62	.76	.80	.80
10	.27	.23	.17	.23	.32	.27	.32	.27	.27	.27	.27	.27	.40	.44	.44
11	.59	.57	.51	.57	.65	.59	.65	.59	.59	.59	.59	.59	.72	.76	.76
12	.57	.55	.47	.55	.63	.57	.63	.57	.57	.57	.57	.57	.70	.74	.74
13	-.20	-.24	-.40	-.24	-.12	-.20	-.12	-.20	-.20	-.20	-.20	-.20	-.05	-.03	-.03
14	.08	.06	-.10	.06	.19	.08	.19	.08	.08	.08	.08	.08	.22	.26	.26
15	.10	.09	-.06	.09	.21	.10	.21	.10	.10	.10	.10	.10	.24	.27	.27
16	-.29	-.32	-.46	-.32	-.19	-.29	-.19	-.29	-.29	-.29	-.29	-.29	-.15	-.14	-.14
17	.03	.03	-.11	.03	.15	.03	.15	.03	.03	.03	.03	.03	.17	.19	.19
18	.07	.05	-.10	.05	.18	.07	.18	.07	.07	.07	.07	.07	.18	.22	.22
19	-.29	-.31	-.46	-.31	-.19	-.29	-.19	-.29	-.29	-.29	-.29	-.29	-.21	-.16	-.16
20	.05	.07	-.09	.07	.18	.05	.18	.05	.05	.05	.05	.05	.13	.19	.19
21	.07	.10	-.06	.10	.20	.07	.20	.07	.07	.07	.07	.07	.15	.22	.22
22	-.35	-.33	-.47	-.33	-.23	-.35	-.23	-.35	-.35	-.35	-.35	-.35	-.26	-.21	-.21
23	.01	.05	-.08	.05	.14	.01	.14	.01	.01	.01	.01	.01	.09	.14	.14
24	.05	.11	-.03	.11	.18	.05	.18	.05	.05	.05	.05	.05	.12	.18	.18
25	-.32	-.26	-.39	-.26	-.19	-.32	-.19	-.32	-.32	-.32	-.32	-.32	-.25	-.20	-.20
26	.06	.13	.00	.13	.19	.06	.19	.06	.06	.06	.06	.06	.12	.17	.17
27	.10	.17	.03	.17	.22	.10	.22	.10	.10	.10	.10	.10	.15	.20	.20
28	-.27	-.19	-.32	-.19	-.14	-.27	-.14	-.27	-.27	-.27	-.27	-.27	-.22	-.17	-.17
29	.12	.23	.10	.23	.28	.12	.28	.12	.12	.12	.12	.12	.17	.24	.24
30	.19	.30	.17	.30	.35	.19	.35	.19	.19	.19	.19	.19	.22	.30	.30
31	-.16	-.04	-.17	-.04	-.01	-.16	-.01	-.16	-.16	-.16	-.16	-.16	-.12	-.07	-.07
32	.19	.33	.19	.33	.35	.19	.35	.19	.19	.19	.19	.19	.21	.28	.28
33	.10	.23	.05	.23	.28	.10	.28	.10	.10	.10	.10	.10	.11	.20	.20
34	-.27	-.15	-.32	-.15	-.08	-.27	-.08	-.27	-.27	-.27	-.27	-.27	-.25	-.16	-.16
35	.11	.27	.08	.27	.30	.11	.30	.11	.11	.11	.11	.11	.12	.21	.21
36	.19	.34	.16	.34	.37	.19	.37	.19	.19	.19	.19	.19	.19	.28	.28
37	-.13	.03	-.15	.03	.05	-.13	.05	-.13	-.13	-.13	-.13	-.13	-.12	-.04	-.04
38	.28	.46	.28	.46	.48	.28	.48	.28	.28	.28	.28	.28	.28	.36	.36
39	.34	.53	.36	.53	.54	.34	.54	.34	.34	.34	.34	.34	.32	.42	.42
40	.02	.22	.05	.22	.24	.02	.24	.02	.02	.02	.02	.02	.00	.11	.11
41	.43	.64	.48	.64	.65	.43	.65	.43	.43	.43	.43	.43	.40	.51	.51
42	.49	.71	.54	.71	.70	.49	.70	.49	.49	.49	.49	.49	.44	.57	.57
43	.13	.35	.19	.35	.34	.13	.34	.13	.13	.13	.13	.13	.09	.20	.20
44	.49	.75	.56	.75	.70	.49	.70	.49	.49	.49	.49	.49	.45	.57	.57
45	.51	.76	.59	.76	.71	.51	.71	.51	.51	.51	.51	.51	.45	.57	.57
46	.13	.38	.22	.38	.34	.13	.34	.13	.13	.13	.13	.13	.08	.20	.20
47	.49	.75	.58	.75	.70	.49	.70	.49	.49	.49	.49	.49	.43	.55	.55
48	.54	.78	.62	.78	.75	.54	.75	.54	.54	.54	.54	.54	.46	.58	.58
49	.17	.41	.26	.41	.38	.17	.38	.17	.17	.17	.17	.17	.10	.22	.22
50	.55	.80	.66	.80	.76	.55	.76	.55	.55	.55	.55	.55	.47	.60	.60
51	.57	.82	.70	.82	.77	.57	.77	.57	.57	.57	.57	.57	.48	.61	.61
52	.23	.50	.36	.50	.44	.23	.44	.23	.23	.23	.23	.23	.14	.26	.26
53	1.06	1.40	1.31	1.40	1.28	1.06	1.28	1.06	1.06	1.06	1.06	1.06	.92	1.11	1.11
54	1.38	1.70	1.64	1.70	1.57	1.38	1.57	1.38	1.38	1.38	1.38	1.38	1.23	1.41	1.41
55	1.03	1.34	1.27	1.34	1.23	1.03	1.23	1.03	1.03	1.03	1.03	1.03	.89	1.06	1.06
56	1.35	1.68	1.59	1.68	1.57	1.35	1.57	1.35	1.35	1.35	1.35	1.35	1.20	1.39	1.39
57	1.37	1.69	1.60	1.69	1.57	1.37	1.57	1.37	1.37	1.37	1.37	1.37	1.21	1.40	1.40
58	.99	1.30	1.20	1.30	1.18	.99	1.18	.99	.99	.99	.99	.99	.83	1.02	1.02
59	1.31	1.62	1.54	1.62	1.51	1.31	1.51	1.31	1.31	1.31	1.31	1.31	1.14	1.34	1.34
60	1.29	1.59	1.50	1.59	1.48	1.29	1.48	1.29	1.29	1.29	1.29	1.29	1.12	1.31	1.31
61	.82	1.13	1.05	1.13	1.02	.82	1.02	.82	.82	.82	.82	.82	.66	.85	.85
62	.98	1.29	1.20	1.29	1.19	.98	1.19	.98	.98	.98	.98	.98	.82	1.02	1.02

NOAA-9 SCANNER OFFSETS FOR JANUARY 1986: SHORTWAVE CHANNEL
 DAY OF MONTH -->

S.P.	16	17	18	19	20	21	22	23	24	25	26	27	28	29	30	31
1	.33	.33	.33	.41	.41	.41	.41	.41	.41	.23	.23	.33	.41	.43	.43	.43
2	.62	.62	.62	.69	.69	.69	.69	.69	.69	.52	.52	.62	.69	.73	.73	.73
3	.63	.63	.63	.71	.71	.71	.71	.71	.71	.53	.53	.63	.71	.76	.76	.76
4	.23	.23	.23	.33	.33	.33	.33	.33	.33	.15	.15	.23	.33	.37	.37	.37
5	.63	.63	.63	.72	.72	.72	.72	.72	.72	.55	.55	.63	.72	.78	.78	.78
6	.67	.67	.67	.77	.77	.77	.77	.77	.77	.60	.60	.67	.77	.83	.83	.83
7	.26	.26	.26	.35	.35	.35	.35	.35	.35	.19	.19	.26	.35	.43	.43	.43
8	.62	.62	.62	.72	.72	.72	.72	.72	.72	.54	.54	.62	.72	.79	.79	.79
9	.68	.68	.68	.80	.80	.80	.80	.80	.80	.62	.62	.68	.80	.84	.84	.84
10	.32	.32	.32	.44	.44	.44	.44	.44	.44	.27	.27	.32	.44	.50	.50	.50
11	.65	.65	.65	.76	.76	.76	.76	.76	.76	.59	.59	.65	.76	.86	.86	.86
12	.63	.63	.63	.74	.74	.74	.74	.74	.74	.57	.57	.63	.74	.86	.86	.86
13	-.12	-.12	-.12	-.03	-.03	-.03	-.03	-.03	-.03	-.20	-.20	-.12	-.03	.12	.12	.12
14	.19	.19	.19	.26	.26	.26	.26	.26	.26	.08	.08	.19	.26	.44	.44	.44
15	.21	.21	.21	.27	.27	.27	.27	.27	.27	.10	.10	.21	.27	.47	.47	.47
16	-.19	-.19	-.19	-.14	-.14	-.14	-.14	-.14	-.14	-.29	-.29	-.19	-.14	.06	.06	.06
17	.15	.15	.15	.19	.19	.19	.19	.19	.19	.03	.03	.15	.19	.39	.39	.39
18	.18	.18	.18	.22	.22	.22	.22	.22	.22	.07	.07	.18	.22	.42	.42	.42
19	-.19	-.19	-.19	-.16	-.16	-.16	-.16	-.16	-.16	-.29	-.29	-.19	-.16	.06	.06	.06
20	.18	.18	.18	.19	.19	.19	.19	.19	.19	.05	.05	.18	.19	.44	.44	.44
21	.20	.20	.20	.22	.22	.22	.22	.22	.22	.07	.07	.20	.22	.47	.47	.47
22	-.23	-.23	-.23	-.21	-.21	-.21	-.21	-.21	-.21	-.35	-.35	-.23	-.21	.06	.06	.06
23	.14	.14	.14	.14	.14	.14	.14	.14	.14	.01	.01	.14	.14	.43	.43	.43
24	.18	.18	.18	.18	.18	.18	.18	.18	.18	.05	.05	.18	.18	.46	.46	.46
25	-.19	-.19	-.19	-.20	-.20	-.20	-.20	-.20	-.20	-.32	-.32	-.19	-.20	.10	.10	.10
26	.19	.19	.19	.17	.17	.17	.17	.17	.17	.06	.06	.19	.17	.48	.48	.48
27	.22	.22	.22	.20	.20	.20	.20	.20	.20	.10	.10	.22	.20	.52	.52	.52
28	-.14	-.14	-.14	-.17	-.17	-.17	-.17	-.17	-.17	-.27	-.27	-.14	-.17	.15	.15	.15
29	.28	.28	.28	.24	.24	.24	.24	.24	.24	.12	.12	.28	.24	.55	.55	.55
30	.35	.35	.35	.30	.30	.30	.30	.30	.30	.19	.19	.35	.30	.63	.63	.63
31	-.01	-.01	-.01	-.07	-.07	-.07	-.07	-.07	-.07	-.16	-.16	-.01	-.07	.29	.29	.29
32	.35	.35	.35	.28	.28	.28	.28	.28	.28	.19	.19	.35	.28	.65	.65	.65
33	.28	.28	.28	.20	.20	.20	.20	.20	.20	.10	.10	.28	.20	.55	.55	.55
34	-.08	-.08	-.08	-.16	-.16	-.16	-.16	-.16	-.16	-.27	-.27	-.08	-.16	.18	.18	.18
35	.30	.30	.30	.21	.21	.21	.21	.21	.21	.11	.11	.30	.21	.59	.59	.59
36	.37	.37	.37	.28	.28	.28	.28	.28	.28	.19	.19	.37	.28	.66	.66	.66
37	.05	.05	.05	-.04	-.04	-.04	-.04	-.04	-.04	-.13	-.13	.05	-.04	.33	.33	.33
38	.48	.48	.48	.36	.36	.36	.36	.36	.36	.28	.28	.48	.36	.75	.75	.75
39	.54	.54	.54	.42	.42	.42	.42	.42	.42	.34	.34	.54	.42	.82	.82	.82
40	.24	.24	.24	.11	.11	.11	.11	.11	.11	.02	.02	.24	.11	.50	.50	.50
41	.65	.65	.65	.51	.51	.51	.51	.51	.51	.43	.43	.65	.51	.92	.92	.92
42	.70	.70	.70	.57	.57	.57	.57	.57	.57	.49	.49	.70	.57	.99	.99	.99
43	.34	.34	.34	.20	.20	.20	.20	.20	.20	.13	.13	.34	.20	.64	.64	.64
44	.70	.70	.70	.57	.57	.57	.57	.57	.57	.49	.49	.70	.57	1.01	1.01	1.01
45	.71	.71	.71	.57	.57	.57	.57	.57	.57	.51	.51	.71	.57	1.03	1.03	1.03
46	.34	.34	.34	.20	.20	.20	.20	.20	.20	.13	.13	.34	.20	.65	.65	.65
47	.70	.70	.70	.55	.55	.55	.55	.55	.55	.49	.49	.70	.55	1.02	1.02	1.02
48	.75	.75	.75	.58	.58	.58	.58	.58	.58	.54	.54	.75	.58	1.06	1.06	1.06
49	.38	.38	.38	.22	.22	.22	.22	.22	.22	.17	.17	.38	.22	.68	.68	.68
50	.76	.76	.76	.60	.60	.60	.60	.60	.60	.55	.55	.76	.60	1.06	1.06	1.06
51	.77	.77	.77	.61	.61	.61	.61	.61	.61	.57	.57	.77	.61	1.07	1.07	1.07
52	.44	.44	.44	.26	.26	.26	.26	.26	.26	.23	.23	.44	.26	.73	.73	.73
53	1.28	1.28	1.28	1.11	1.11	1.11	1.11	1.11	1.11	1.06	1.06	1.28	1.11	1.56	1.56	1.56
54	1.57	1.57	1.57	1.41	1.41	1.41	1.41	1.41	1.41	1.38	1.38	1.57	1.41	1.82	1.82	1.82
55	1.23	1.23	1.23	1.06	1.06	1.06	1.06	1.06	1.06	1.03	1.03	1.23	1.06	1.50	1.50	1.50
56	1.57	1.57	1.57	1.39	1.39	1.39	1.39	1.39	1.39	1.35	1.35	1.57	1.39	1.85	1.85	1.85
57	1.57	1.57	1.57	1.40	1.40	1.40	1.40	1.40	1.40	1.37	1.37	1.57	1.40	1.86	1.86	1.86
58	1.18	1.18	1.18	1.02	1.02	1.02	1.02	1.02	1.02	.99	.99	1.18	1.02	1.48	1.48	1.48
59	1.51	1.51	1.51	1.34	1.34	1.34	1.34	1.34	1.34	1.31	1.31	1.51	1.34	1.81	1.81	1.81
60	1.48	1.48	1.48	1.31	1.31	1.31	1.31	1.31	1.31	1.29	1.29	1.48	1.31	1.78	1.78	1.78
61	1.02	1.02	1.02	.85	.85	.85	.85	.85	.85	.82	.82	1.02	.85	1.29	1.29	1.29
62	1.19	1.19	1.19	1.02	1.02	1.02	1.02	1.02	1.02	.98	.98	1.19	1.02	1.49	1.49	1.49

NOAA-9 SCANNER OFFSETS FOR FEBRUARY 1986:											TOTAL CHANNEL				
S.P.	DAY OF MONTH -->										11	12	13	14	15
	1	2	3	4	5	6	7	8	9	10					
1	.36	.36	.36	.36	.36	.36	.36	.36	.36	.36	.36	.36	.36	.36	.36
2	1.04	1.04	1.04	1.04	1.04	1.04	1.04	1.04	1.04	1.04	1.04	1.04	1.04	1.04	1.04
3	1.93	1.93	1.93	1.93	1.93	1.93	1.93	1.93	1.93	1.93	1.93	1.93	1.93	1.93	1.93
4	-9.64	-9.64	-9.64	-9.64	-9.64	-9.64	-9.64	-9.64	-9.64	-9.64	-9.64	-9.64	-9.64	-9.64	-9.64
5	-7.11	-7.36	-7.09	-7.10	-7.14	-7.42	-7.42	-7.42	-7.42	-7.42	-8.70	-6.99	-6.62	-9.54	-9.77
6	-4.73	-4.62	-5.29	-5.45	-5.28	-5.57	-5.57	-5.57	-5.57	-5.57	-4.92	-3.93	-3.13	-5.56	-5.56
7	-3.15	-2.78	-3.57	-4.56	-4.12	-4.19	-4.19	-4.19	-4.19	-4.19	-2.74	-2.02	-1.50	-3.55	-3.62
8	-1.63	-.99	-2.20	-3.63	-2.70	-2.70	-2.70	-2.70	-2.70	-2.70	-1.21	-.70	-.44	-1.80	-1.87
9	-1.06	-.09	-1.71	-3.39	-2.14	-2.14	-2.14	-2.14	-2.14	-2.14	-.75	-.40	-.32	-.91	-1.33
10	-.87	-.15	-1.21	-2.99	-1.89	-1.90	-1.90	-1.90	-1.90	-1.90	-.68	-.35	-.52	-.42	-1.19
11	-.70	-.52	-1.11	-2.58	-1.81	-1.57	-1.57	-1.57	-1.57	-1.57	-.50	-.36	-.53	-.05	-1.03
12	-.53	-.81	-1.36	-2.49	-1.86	-1.22	-1.22	-1.22	-1.22	-1.22	-.21	-.56	-.69	-.06	-.94
13	-.66	-1.12	-1.95	-2.96	-2.23	-1.17	-1.17	-1.17	-1.17	-1.17	-.32	-1.08	-1.06	-.51	-1.09
14	-.62	-1.20	-2.11	-3.13	-2.28	-1.00	-1.00	-1.00	-1.00	-1.00	-.24	-1.30	-1.19	-.69	-1.06
15	-.66	-1.25	-2.30	-3.33	-2.43	-1.26	-1.26	-1.26	-1.26	-1.26	-.27	-1.50	-1.29	-.89	-1.07
16	-1.18	-1.56	-2.65	-3.57	-2.64	-1.74	-1.74	-1.74	-1.74	-1.74	-.57	-1.72	-1.51	-1.46	-1.18
17	-1.47	-1.89	-2.79	-3.65	-2.68	-1.97	-1.97	-1.97	-1.97	-1.97	-.92	-1.75	-1.73	-2.02	-1.33
18	-1.81	-2.31	-3.06	-3.83	-2.73	-2.11	-2.11	-2.11	-2.11	-2.11	-1.35	-1.92	-2.07	-2.39	-1.66
19	-2.08	-2.71	-3.32	-4.08	-2.96	-2.27	-2.27	-2.27	-2.27	-2.27	-1.81	-2.25	-2.54	-2.64	-1.99
20	-2.22	-2.86	-3.41	-4.17	-3.16	-2.35	-2.35	-2.35	-2.35	-2.35	-2.10	-2.37	-2.83	-2.73	-2.08
21	-2.12	-2.80	-3.45	-4.14	-3.15	-2.37	-2.37	-2.37	-2.37	-2.37	-2.08	-2.27	-2.88	-2.76	-2.03
22	-2.06	-2.57	-3.35	-4.18	-3.16	-2.44	-2.44	-2.44	-2.44	-2.44	-2.10	-2.31	-2.85	-2.71	-1.88
23	-1.81	-2.38	-3.07	-3.95	-2.95	-2.26	-2.26	-2.26	-2.26	-2.26	-2.07	-2.18	-2.62	-2.37	-1.65
24	-1.60	-2.12	-2.91	-3.35	-2.74	-2.16	-2.16	-2.16	-2.16	-2.16	-1.95	-1.85	-2.34	-2.01	-1.37
25	-1.43	-1.95	-2.75	-3.45	-2.54	-2.03	-2.03	-2.03	-2.03	-2.03	-1.84	-1.50	-2.10	-1.74	-1.10
26	-1.06	-1.70	-2.42	-3.14	-2.06	-1.64	-1.64	-1.64	-1.64	-1.64	-1.53	-1.06	-1.68	-1.30	-.63
27	-.81	-1.52	-1.97	-2.83	-1.64	-1.42	-1.42	-1.42	-1.42	-1.42	-1.21	-.71	-1.32	-.89	-.22
28	-.50	-1.30	-1.54	-2.54	-1.33	-1.25	-1.25	-1.25	-1.25	-1.25	-.99	-.47	-1.10	-.56	-.10
29	-.21	-.94	-1.19	-2.20	-.98	-1.01	-1.01	-1.01	-1.01	-1.01	-.89	-.23	-.84	-.21	.37
30	-.13	-.67	-.87	-1.87	-.57	-.75	-.75	-.75	-.75	-.75	-.69	.03	-.43	.19	.61
31	.32	-.53	-.65	-1.67	-.39	-.75	-.75	-.75	-.75	-.75	-.52	.16	-.10	.48	.77
32	.68	-.21	-.15	-1.18	-.03	-.49	-.49	-.49	-.49	-.49	-.10	.57	.33	.88	1.14
33	.94	.03	.23	-.66	.31	-.36	-.36	-.36	-.36	-.36	.25	.93	.64	1.17	1.42
34	.93	-.03	.22	-.29	.46	-.45	-.45	-.45	-.45	-.45	.29	1.09	.77	1.25	1.50
35	.94	-.04	.29	-.05	.58	-.49	-.49	-.49	-.49	-.49	.41	1.30	1.02	1.55	1.65
36	.75	-.19	.25	.14	.66	-.54	-.54	-.54	-.54	-.54	.44	1.28	1.19	1.72	1.65
37	.51	-.32	.17	.17	.70	-.76	-.76	-.76	-.76	-.76	.44	1.22	1.22	1.72	1.53
38	.43	-.32	.03	.20	.75	-1.01	-1.01	-1.01	-1.01	-1.01	.40	1.23	1.11	1.64	1.44
39	.20	-.42	-.12	.16	.75	-1.33	-1.33	-1.33	-1.33	-1.33	.28	1.16	.94	1.34	1.30
40	-.31	-.64	-.29	-.05	.59	-1.63	-1.63	-1.63	-1.63	-1.63	-.04	.87	.75	1.01	1.04
41	-.62	-.72	-.14	-.04	.64	-1.62	-1.62	-1.62	-1.62	-1.62	-.04	.80	.75	.88	.95
42	-.75	-.72	-.06	-.18	.57	-1.65	-1.65	-1.65	-1.65	-1.65	-.05	.74	.79	.65	.89
43	-1.04	-.71	-.10	-.36	.28	-1.78	-1.78	-1.78	-1.78	-1.78	-.25	.53	.59	.23	.60
44	-1.21	-.53	-.15	-.36	.07	-1.85	-1.85	-1.85	-1.85	-1.85	-.18	.46	.50	.00	.32
45	-1.30	-.49	-.19	-.29	-.16	-1.95	-1.95	-1.95	-1.95	-1.95	-.12	.39	.49	-.09	-.06
46	-1.25	-.51	-.33	-.30	-.42	-1.96	-1.96	-1.96	-1.96	-1.96	-.14	.36	.46	-.17	-.44
47	-1.00	-.36	-.30	-.23	-.55	-1.58	-1.58	-1.58	-1.58	-1.58	-.07	.49	.68	-.26	-.64
48	-.82	-.21	-.36	-.21	-.66	-1.34	-1.34	-1.34	-1.34	-1.34	-.07	.49	.80	-.29	-.77
49	-.91	-.34	-.65	-.26	-.93	-1.49	-1.49	-1.49	-1.49	-1.49	-.20	.32	.59	-.48	-1.09
50	-.77	-.31	-.75	-.07	-.90	-1.17	-1.17	-1.17	-1.17	-1.17	-.16	.43	.54	-.48	-1.15
51	-.48	-.14	-.88	.02	-.92	-.91	-.91	-.91	-.91	-.91	-.04	.60	.66	-.28	-1.02
52	-.36	.05	-.75	-.04	-1.08	-.75	-.75	-.75	-.75	-.75	.22	.78	.83	-.20	-.91
53	-.07	.20	-.21	.23	-.81	-.40	-.40	-.40	-.40	-.40	.68	1.07	1.17	-.14	-.57
54	.08	.21	-.23	.07	-.70	-.21	-.21	-.21	-.21	-.21	.70	1.02	1.20	-.20	-.32
55	.36	.09	-.50	-.53	-.92	-.18	-.18	-.18	-.18	-.18	.48	.83	1.02	-.13	-.26
56	.61	.27	-.35	-.82	-.90	-.07	-.07	-.07	-.07	-.07	.45	.88	.79	.16	-.07
57	1.10	1.18	.12	-.60	-.46	.48	.48	.48	.48	.48	.97	1.20	.93	.70	.43
58	2.54	2.82	1.23	.13	.57	1.57	1.57	1.57	1.57	1.57	2.32	1.97	1.95	2.08	1.98
59	2.66	2.80	1.52	-.30	.91	1.74	1.74	1.74	1.74	1.74	2.45	1.79	2.04	2.30	2.51
60	-4.99	-5.32	-6.51	-7.47	-6.12	-6.46	-6.46	-6.46	-6.46	-6.46	-4.24	-5.64	-5.36	-4.05	-3.67
61	11.19	11.19	11.19	11.19	11.19	11.19	11.19	11.19	11.19	11.19	11.19	11.19	11.19	11.19	11.19
62	3.13	3.13	3.13	3.13	3.13	3.13	3.13	3.13	3.13	3.13	3.13	3.13	3.13	3.13	3.13

NOAA-9 SCANNER OFFSETS FOR FEBRUARY 1986:												TOTAL	CHANNEL		
S.P.	DAY OF MONTH -->											26	27	28	
	16	17	18	19	20	21	22	23	24	25					
1	.36	.36	.36	.36	.36	.36	.36	.36	.36	.36	.36	.36	.36	.36	.36
2	1.04	1.04	1.04	1.04	1.04	1.04	1.04	1.04	1.04	1.04	1.04	1.04	1.04	1.04	1.04
3	1.93	1.93	1.93	1.93	1.93	1.93	1.93	1.93	1.93	1.93	1.93	1.93	1.93	1.93	1.93
4	-9.64	-9.64	-9.64	-9.64	-9.64	-9.64	-9.64	-9.64	-9.64	-9.64	-9.64	-9.64	-9.64	-9.64	-9.64
5	-11.63	-11.47	-14.25	-12.73	-9.07	-9.28	-8.35	-8.46	-7.16	-7.18	-6.62	-7.13	-6.94	-6.94	-6.94
6	-5.88	-5.83	-6.57	-6.14	-5.28	-5.12	-4.57	-4.91	-3.99	-4.28	-4.30	-4.03	-3.65	-3.65	-3.65
7	-3.59	-3.44	-3.73	-3.56	-3.57	-3.16	-2.89	-3.26	-2.07	-2.37	-2.79	-2.03	-1.74	-1.74	-1.74
8	-1.68	-1.62	-1.94	-1.54	-2.08	-1.41	-1.39	-2.09	-.14	-.48	-.92	-.19	-.23	-.23	-.23
9	-.75	-.77	-1.09	-.69	-1.19	-.59	-.74	-1.46	.66	.54	-.13	.89	.45	.45	.45
10	-.43	-.27	-.68	-.44	-.60	-.19	-.49	-.88	.74	.98	.08	1.26	.53	.53	.53
11	-.35	.03	-.43	-.34	-.38	-.17	-.47	-.49	.82	.94	.37	1.22	.35	.35	.35
12	-.51	-.19	-.41	-.32	-.28	-.15	-.46	-.37	.58	.90	.54	1.40	.46	.46	.46
13	-.92	-.03	-.71	-.40	-.33	-.36	-.75	-.52	.13	.83	.30	1.16	.29	.29	.29
14	-1.03	-.17	-.77	-.49	-.29	-.45	-.83	-.52	.07	.92	.26	1.16	.29	.29	.29
15	-.97	-.30	-.89	-.79	-.46	-.53	-.86	-.53	-.06	.67	.20	1.06	.20	.20	.20
16	-.98	-.58	-1.19	-1.36	-.95	-.87	-1.05	-.55	-.41	.37	.12	.88	-.06	-.06	-.06
17	-.93	-.78	-1.52	-1.78	-1.42	-1.22	-1.15	-.61	-.70	-.04	.20	.49	-.27	-.27	-.27
18	-1.04	-1.03	-1.79	-2.17	-1.89	-1.52	-1.29	-.84	-1.06	-.62	.14	.12	-.60	-.60	-.60
19	-1.31	-1.29	-2.09	-2.53	-2.25	-1.78	-1.48	-1.11	-1.48	-1.19	-.04	-.33	-.97	-.97	-.97
20	-1.49	-1.48	-2.25	-2.75	-2.44	-1.97	-1.72	-1.29	-1.72	-1.41	-.15	-.63	-1.12	-1.12	-1.12
21	-1.50	-1.44	-2.28	-2.76	-2.44	-1.94	-1.83	-1.25	-1.69	-1.45	-.14	-.85	-1.04	-1.04	-1.04
22	-1.47	-1.41	-2.31	-2.77	-2.29	-1.96	-1.80	-1.06	-1.57	-1.54	-.07	-1.03	-.99	-.99	-.99
23	-1.22	-1.37	-2.27	-2.63	-2.11	-1.90	-1.61	-.63	-1.10	-1.51	.28	-.97	-.75	-.75	-.75
24	-.97	-1.33	-2.22	-2.38	-1.88	-1.76	-1.48	-.31	-.61	-1.46	.53	-.99	-.57	-.57	-.57
25	-.69	-1.25	-2.04	-2.11	-1.52	-1.64	-1.40	-.03	-.33	-1.33	.73	-.91	-.34	-.34	-.34
26	-.25	-.97	-1.68	-1.75	-1.00	-1.29	-1.10	.29	-.04	-1.07	1.03	-.54	-.14	-.14	-.14
27	.20	-.71	-1.36	-1.42	-.54	-.87	-.82	.52	.30	-.83	1.20	-.16	-.03	-.03	-.03
28	.59	-.46	-1.16	-1.14	-.09	-.48	-.43	.85	.51	-.49	1.43	.08	.14	.14	.14
29	.91	-.20	-.88	-.92	.37	-.07	.01	1.20	.77	-.05	1.71	.58	.48	.48	.48
30	1.16	.05	-.54	-.71	.76	.32	.40	1.49	1.07	.36	1.92	.76	.73	.73	.73
31	1.35	.24	-.20	-.50	.89	.53	.81	1.66	1.24	.63	2.05	.64	.89	.89	.89
32	1.74	.59	.25	-.07	1.32	.89	1.47	2.15	1.68	1.25	2.48	.83	1.28	1.28	1.28
33	2.04	.85	.67	.35	1.67	1.22	1.91	2.49	1.93	1.62	2.87	.96	1.51	1.51	1.51
34	2.16	.94	.77	.55	1.69	1.41	1.95	2.64	1.99	1.77	2.90	1.00	1.54	1.54	1.54
35	2.33	1.16	.89	.75	1.65	1.60	2.11	2.78	2.16	1.96	3.03	1.15	1.81	1.81	1.81
36	2.34	1.25	.80	.79	1.44	1.63	2.15	2.68	2.22	2.11	2.98	1.15	1.90	1.90	1.90
37	2.27	1.11	.55	.73	1.29	1.53	2.01	2.49	2.14	1.99	2.81	1.00	1.80	1.80	1.80
38	2.20	1.02	.39	.64	1.21	1.45	1.92	2.30	2.05	2.05	2.71	.97	1.66	1.66	1.66
39	1.95	.85	.22	.42	1.04	1.26	1.78	2.00	1.92	1.94	2.51	.94	1.46	1.46	1.46
40	1.61	.63	.01	.11	.77	.91	1.39	1.54	1.71	1.64	2.19	.74	1.11	1.11	1.11
41	1.52	.62	-.05	.09	.72	.81	1.27	1.35	1.75	1.48	2.03	.76	.98	.98	.98
42	1.35	.71	.01	.15	.65	.69	1.14	1.27	1.75	1.45	1.85	.77	.94	.94	.94
43	.98	.57	.00	.19	.39	.42	.79	1.19	1.63	1.21	1.41	.45	.80	.80	.80
44	.84	.48	-.02	.25	.14	.27	.58	1.12	1.53	1.06	1.00	.32	.62	.62	.62
45	.64	.38	-.08	.06	-.07	.12	.50	.97	1.42	.99	.75	.18	.28	.28	.28
46	.30	.19	-.10	-.17	-.23	-.04	.39	.85	1.33	.89	.62	.11	.05	.05	.05
47	-.13	.11	.08	-.13	-.10	.02	.31	.93	1.38	1.16	.65	.16	.11	.11	.11
48	-.03	-.08	.10	-.03	-.14	.07	.18	.70	1.17	1.11	.55	.22	.08	.08	.08
49	-.36	-.42	-.13	-.19	-.55	-.05	-.11	.23	.72	.77	.12	.05	-.06	-.06	-.06
50	-.45	-.44	.01	.04	-.70	-.07	-.18	.02	.68	.66	.07	.31	.26	.26	.26
51	-.34	-.38	-.04	.28	-.82	.09	-.22	.03	.75	.83	.11	.60	.67	.67	.67
52	-.31	-.07	-.19	.28	-1.00	.27	-.14	-.01	.62	.97	.06	.56	1.05	1.05	1.05
53	-.12	.40	.07	.46	-.90	.50	.24	.19	.79	1.40	.32	.80	1.46	1.46	1.46
54	-.12	.62	.29	.62	-.92	.46	.20	.37	.95	1.59	.23	.86	1.47	1.47	1.47
55	-.10	.70	.13	.67	-.97	.26	.04	.24	.78	1.48	.23	.73	1.31	1.31	1.31
56	.24	.80	.00	.83	-.52	.39	.34	.04	.88	1.65	.39	1.01	1.40	1.40	1.40
57	.87	1.13	.56	1.26	.40	1.15	1.00	.70	1.45	2.19	1.06	1.88	1.80	1.80	1.80
58	2.22	2.50	2.24	2.20	1.98	2.44	2.32	2.18	2.97	3.03	2.50	3.35	2.90	2.90	2.90
59	2.72	3.09	2.78	2.13	2.21	2.41	2.54	2.26	3.00	2.57	2.56	2.98	2.38	2.38	2.38
60	-2.19	-2.33	-.48	-2.08	-4.80	-4.99	-4.99	-5.63	-6.67	-7.17	-7.40	-7.80	-8.12	-8.12	-8.12
61	11.19	11.19	11.19	11.19	11.19	11.19	11.19	11.19	11.19	11.19	11.19	11.19	11.19	11.19	11.19
62	3.13	3.13	3.13	3.13	3.13	3.13	3.13	3.13	3.13	3.13	3.13	3.13	3.13	3.13	3.13

NOAA-9 SCANNER OFFSETS FOR FEBRUARY 1986: LONGHARVE CHANNEL

S.P.	DAY OF MONTH -->														
	1	2	3	4	5	6	7	8	9	10	11	12	13	14	15
1	.29	.29	.29	.29	.29	.29	.29	.29	.29	.29	.29	.29	.29	.29	.29
2	.59	.59	.59	.59	.59	.59	.59	.59	.59	.59	.59	.59	.59	.59	.59
3	.63	.63	.63	.63	.63	.63	.63	.63	.63	.63	.63	.63	.63	.63	.63
4	.27	.27	.27	.27	.27	.27	.27	.27	.27	.27	.27	.27	.27	.27	.27
5	-4.62	-4.72	-4.65	-4.58	-4.63	-4.81	-4.81	-4.81	-4.81	-4.81	-5.55	-4.53	-4.23	-5.98	-6.23
6	-4.05	-3.92	-4.45	-4.51	-4.42	-4.61	-4.61	-4.61	-4.61	-4.61	-4.21	-3.57	-2.99	-4.52	-4.65
7	-3.13	-2.82	-3.44	-4.05	-3.81	-3.82	-3.82	-3.82	-3.82	-3.82	-2.91	-2.46	-2.05	-3.34	-3.54
8	-2.40	-1.93	-2.80	-3.72	-3.15	-3.14	-3.14	-3.14	-3.14	-3.14	-2.18	-1.86	-1.65	-2.48	-2.70
9	-2.22	-1.52	-2.67	-3.73	-2.95	-2.93	-2.93	-2.93	-2.93	-2.93	-2.08	-1.84	-1.78	-2.09	-2.54
10	-2.26	-1.73	-2.53	-3.64	-2.95	-2.90	-2.90	-2.90	-2.90	-2.90	-2.19	-2.00	-2.08	-1.94	-2.61
11	-2.31	-2.14	-2.61	-3.54	-3.08	-2.85	-2.85	-2.85	-2.85	-2.85	-2.25	-2.21	-2.24	-1.90	-2.65
12	-2.35	-2.44	-2.89	-3.61	-3.26	-2.71	-2.71	-2.71	-2.71	-2.71	-2.18	-2.47	-2.48	-2.06	-2.74
13	-2.54	-2.73	-3.40	-4.02	-3.58	-2.78	-2.78	-2.78	-2.78	-2.78	-2.33	-2.90	-2.85	-2.48	-2.96
14	-2.75	-3.00	-3.74	-4.36	-3.85	-2.95	-2.95	-2.95	-2.95	-2.95	-2.50	-3.30	-3.17	-2.86	-3.18
15	-3.03	-3.25	-4.08	-4.74	-4.16	-3.34	-3.34	-3.34	-3.34	-3.34	-2.74	-3.68	-3.49	-3.25	-3.44
16	-3.62	-3.72	-4.54	-5.16	-4.55	-3.89	-3.89	-3.89	-3.89	-3.89	-3.19	-4.07	-3.89	-3.86	-3.75
17	-4.05	-4.16	-4.89	-5.47	-4.81	-4.30	-4.30	-4.30	-4.30	-4.30	-3.66	-4.33	-4.27	-4.44	-4.08
18	-4.50	-4.68	-5.30	-5.84	-5.10	-4.65	-4.65	-4.65	-4.65	-4.65	-4.17	-4.69	-4.74	-4.92	-4.52
19	-4.93	-5.21	-5.72	-6.27	-5.52	-5.00	-5.00	-5.00	-5.00	-5.00	-4.70	-5.14	-5.28	-5.32	-4.96
20	-5.30	-5.55	-6.10	-6.62	-5.91	-5.34	-5.34	-5.34	-5.34	-5.34	-5.16	-5.47	-5.72	-5.64	-5.26
21	-5.46	-5.76	-6.38	-6.87	-6.18	-5.59	-5.59	-5.59	-5.59	-5.59	-5.37	-5.63	-5.97	-5.85	-5.42
22	-5.63	-5.83	-6.51	-7.10	-6.39	-5.84	-5.84	-5.84	-5.84	-5.84	-5.56	-5.84	-6.13	-5.97	-5.45
23	-5.67	-5.93	-6.52	-7.15	-6.45	-5.95	-5.95	-5.95	-5.95	-5.95	-5.70	-5.91	-6.15	-5.90	-5.42
24	-5.68	-5.92	-6.55	-7.11	-6.45	-6.03	-6.03	-6.03	-6.03	-6.03	-5.74	-5.81	-6.08	-5.78	-5.37
25	-5.71	-5.94	-6.60	-7.15	-6.47	-6.10	-6.10	-6.10	-6.10	-6.10	-5.76	-5.70	-6.04	-5.71	-5.29
26	-5.55	-5.87	-6.46	-7.05	-6.26	-5.92	-5.92	-5.92	-5.92	-5.92	-5.60	-5.46	-5.81	-5.44	-5.06
27	-5.41	-5.79	-6.21	-6.89	-6.01	-5.79	-5.79	-5.79	-5.79	-5.79	-5.37	-5.22	-5.56	-5.15	-4.78
28	-5.19	-5.63	-5.90	-6.67	-5.75	-5.65	-5.65	-5.65	-5.65	-5.65	-5.17	-4.99	-5.34	-4.86	-4.52
29	-4.92	-5.34	-5.61	-6.38	-5.45	-5.44	-5.44	-5.44	-5.44	-5.44	-5.03	-4.74	-5.07	-4.53	-4.29
30	-4.57	-5.03	-5.30	-6.04	-5.06	-5.12	-5.12	-5.12	-5.12	-5.12	-4.76	-4.42	-4.66	-4.13	-4.02
31	-4.25	-4.73	-4.96	-5.71	-4.74	-4.89	-4.89	-4.89	-4.89	-4.89	-4.47	-4.12	-4.25	-3.75	-3.75
32	-3.75	-4.27	-4.38	-5.12	-4.24	-4.48	-4.48	-4.48	-4.48	-4.48	-3.96	-3.58	-3.70	-3.23	-3.26
33	-3.27	-3.81	-3.83	-4.44	-3.71	-4.10	-4.10	-4.10	-4.10	-4.10	-3.40	-2.97	-3.16	-2.72	-2.75
34	-2.96	-3.52	-3.51	-3.87	-3.27	-3.84	-3.84	-3.84	-3.84	-3.84	-3.05	-2.55	-2.76	-2.35	-2.39
35	-2.58	-3.15	-3.09	-3.29	-2.81	-3.46	-3.46	-3.46	-3.46	-3.46	-2.64	-2.06	-2.23	-1.84	-1.96
36	-2.34	-2.89	-2.76	-2.80	-2.37	-3.11	-3.11	-3.11	-3.11	-3.11	-2.27	-1.74	-1.76	-1.40	-1.62
37	-2.12	-2.61	-2.42	-2.39	-1.94	-2.83	-2.83	-2.83	-2.83	-2.83	-1.93	-1.42	-1.39	-1.05	-1.33
38	-1.80	-2.23	-2.10	-1.99	-1.51	-2.59	-2.59	-2.59	-2.59	-2.59	-1.60	-1.06	-1.10	-.74	-1.02
39	-1.50	-1.85	-1.75	-1.59	-1.08	-2.36	-2.36	-2.36	-2.36	-2.36	-1.28	-.70	-.82	-.53	-.71
40	-1.43	-1.57	-1.43	-1.33	-.77	-2.13	-2.13	-2.13	-2.13	-2.13	-1.10	-.50	-.57	-.36	-.52
41	-1.24	-1.19	-.92	-.92	-.33	-1.73	-1.73	-1.73	-1.73	-1.73	-.72	-.17	-.18	-.05	-.20
42	-1.05	-.90	-.56	-.71	-.09	-1.47	-1.47	-1.47	-1.47	-1.47	-.45	.05	.12	.06	.01
43	-1.01	-.66	-.37	-.58	-.04	-1.31	-1.31	-1.31	-1.31	-1.31	-.36	.16	.23	.00	.03
44	-.95	-.36	-.24	-.42	-.02	-1.20	-1.20	-1.20	-1.20	-1.20	-.18	.28	.33	.02	-.01
45	-.84	-.18	-.11	-.23	-.02	-1.10	-1.10	-1.10	-1.10	-1.10	.02	.39	.48	.15	-.10
46	-.65	-.04	-.04	-.09	-.03	-.92	-.92	-.92	-.92	-.92	.16	.53	.63	.28	-.19
47	-.36	.17	.10	.05	.01	-.54	-.54	-.54	-.54	-.54	.33	.74	.91	.36	-.18
48	-.15	.36	.15	.12	.04	-.31	-.31	-.31	-.31	-.31	.40	.83	1.08	.42	-.14
49	-.19	.32	-.01	.10	-.11	-.37	-.37	-.37	-.37	-.37	.34	.77	.99	.35	-.27
50	-.08	.34	-.06	.22	-.08	-.15	-.15	-.15	-.15	-.15	.39	.86	.97	.36	-.28
51	.13	.45	-.10	.30	-.07	.05	.05	.05	.05	.05	.50	.97	1.03	.49	-.19
52	.22	.57	.00	.28	-.17	.18	.18	.18	.18	.18	.72	1.11	1.16	.57	-.07
53	.09	.29	.01	.11	-.33	.13	.13	.13	.13	.13	.73	1.00	1.11	.33	-.11
54	.05	.12	-.14	-.13	-.38	.10	.10	.10	.10	.10	.63	.84	1.01	.16	-.08
55	.18	-.03	-.36	-.54	-.56	.06	.06	.06	.06	.06	.46	.66	.86	.18	-.07
56	.22	-.04	-.38	-.83	-.68	.04	.04	.04	.04	.04	.34	.56	.60	.30	-.03
57	.36	.40	-.24	-.83	-.55	.24	.24	.24	.24	.24	.24	.61	.52	.54	.17
58	1.13	1.33	.29	-.51	-.02	.79	.79	.79	.79	.79	1.27	.95	1.03	1.25	1.01
59	.98	1.08	.24	-1.05	-.01	.65	.65	.65	.65	.65	1.13	.60	.86	1.13	1.11
60	-3.27	-3.46	-4.15	-4.93	-3.78	-3.85	-3.85	-3.85	-3.85	-3.85	-2.51	-3.44	-3.14	-2.31	-2.22
61	.83	.83	.83	.83	.83	.83	.83	.83	.83	.83	.83	.83	.83	.83	.83
62	.97	.97	.97	.97	.97	.97	.97	.97	.97	.97	.97	.97	.97	.97	.97

NOAA-9 SCANNER OFFSETS FOR FEBRUARY 1986: LONGVALE CHANNEL

S.P.	DAY OF MONTH -->												
	16	17	18	19	20	21	22	23	24	25	26	27	28
1	.29	.29	.29	.29	.29	.29	.29	.29	.29	.29	.29	.29	.29
2	.59	.59	.59	.59	.59	.59	.59	.59	.59	.59	.59	.59	.59
3	.63	.63	.63	.63	.63	.63	.63	.63	.63	.63	.63	.63	.63
4	.27	.27	.27	.27	.27	.27	.27	.27	.27	.27	.27	.27	.27
5	-7.24	-7.12	-8.84	-7.92	-5.68	-5.82	-5.23	-5.26	-4.58	-4.71	-4.17	-4.59	-4.38
6	-4.77	-4.65	-5.20	-4.93	-4.35	-4.23	-3.88	-4.02	-3.57	-3.81	-3.58	-3.56	-3.25
7	-3.42	-3.22	-3.46	-3.38	-3.38	-3.11	-2.94	-3.09	-2.48	-2.68	-2.69	-2.30	-2.05
8	-2.48	-2.34	-2.60	-2.35	-2.70	-2.25	-2.24	-2.63	-1.54	-1.73	-1.76	-1.34	-1.30
9	-2.09	-2.00	-2.25	-2.00	-2.34	-1.93	-2.03	-2.43	-1.21	-1.27	-1.46	-.80	-1.02
10	-2.06	-1.84	-2.16	-1.99	-2.16	-1.85	-2.04	-2.21	-1.31	-1.11	-1.48	-.62	-1.06
11	-2.19	-1.81	-2.19	-2.09	-2.19	-2.00	-2.19	-2.11	-1.39	-1.25	-1.44	-.75	-1.27
12	-2.45	-1.87	-2.35	-2.23	-2.26	-2.12	-2.31	-2.12	-1.58	-1.35	-1.45	-.81	-1.31
13	-2.80	-2.12	-2.64	-2.36	-2.39	-2.35	-2.58	-2.29	-1.94	-1.51	-1.70	-1.04	-1.50
14	-3.09	-2.45	-2.90	-2.65	-2.58	-2.63	-2.86	-2.51	-2.24	-1.68	-1.98	-1.30	-1.71
15	-3.30	-2.77	-3.23	-3.10	-2.92	-2.93	-3.09	-2.75	-2.52	-2.04	-2.25	-1.62	-2.00
16	-3.55	-3.21	-3.64	-3.74	-3.48	-3.41	-3.45	-3.03	-2.95	-2.51	-2.59	-2.01	-2.43
17	-3.77	-3.58	-4.11	-4.23	-4.03	-3.88	-3.76	-3.26	-3.35	-3.00	-2.83	-2.46	-2.81
18	-4.09	-3.97	-4.53	-4.73	-4.57	-4.32	-4.10	-3.65	-3.83	-3.59	-3.09	-3.01	-3.29
19	-4.51	-4.40	-5.02	-5.22	-5.07	-4.74	-4.48	-4.09	-4.35	-4.25	-3.45	-3.54	-3.78
20	-4.89	-4.79	-5.40	-5.60	-5.46	-5.12	-4.93	-4.52	-4.75	-4.71	-3.76	-3.99	-4.14
21	-5.11	-4.97	-5.62	-5.79	-5.68	-5.33	-5.24	-4.77	-4.97	-5.00	-3.95	-4.28	-4.30
22	-5.26	-5.11	-5.78	-5.94	-5.75	-5.53	-5.43	-4.88	-5.06	-5.22	-4.09	-4.57	-4.40
23	-5.27	-5.21	-5.88	-6.00	-5.77	-5.67	-5.49	-4.81	-4.91	-5.40	-4.06	-4.71	-4.37
24	-5.23	-5.32	-5.95	-5.97	-5.75	-5.73	-5.57	-4.76	-4.79	-5.48	-4.03	-4.82	-4.43
25	-5.13	-5.39	-5.96	-5.90	-5.64	-5.79	-5.65	-4.77	-4.79	-5.50	-4.06	-4.83	-4.51
26	-4.88	-5.25	-5.78	-5.69	-5.37	-5.60	-5.53	-4.66	-4.66	-5.40	-3.98	-4.68	-4.52
27	-4.59	-5.03	-5.54	-5.47	-5.07	-5.32	-5.34	-4.51	-4.50	-5.32	-3.87	-4.49	-4.48
28	-4.27	-4.79	-5.32	-5.21	-4.70	-5.03	-5.05	-4.24	-4.33	-5.14	-3.71	-4.44	-4.38
29	-3.99	-4.50	-5.04	-4.97	-4.31	-4.70	-4.67	-3.94	-4.12	-4.81	-3.51	-4.23	-4.14
30	-3.67	-4.19	-4.65	-4.68	-3.92	-4.31	-4.24	-3.60	-3.87	-4.45	-3.29	-4.03	-3.89
31	-3.36	-3.89	-4.25	-4.36	-3.63	-3.96	-3.75	-3.30	-3.58	-4.10	-3.01	-3.89	-3.60
32	-2.84	-3.41	-3.72	-3.83	-3.10	-3.45	-3.05	-2.72	-3.01	-3.42	-2.43	-3.47	-3.06
33	-2.28	-2.92	-3.10	-3.20	-2.58	-2.89	-2.43	-2.16	-2.46	-2.85	-1.81	-3.07	-2.56
34	-1.89	-2.57	-2.71	-2.73	-2.24	-2.43	-2.06	-1.74	-2.08	-2.45	-1.43	-2.70	-2.20
35	-1.44	-2.09	-2.28	-2.25	-1.91	-1.94	-1.58	-1.26	-1.54	-1.93	-.96	-2.20	-1.63
36	-1.10	-1.70	-2.00	-1.89	-1.69	-1.55	-1.19	-.95	-1.12	-1.39	-.58	-1.77	-1.20
37	-.80	-1.45	-1.81	-1.60	-1.42	-1.24	-.91	-.69	-.77	-1.04	-.29	-1.43	-.91
38	-.50	-1.15	-1.58	-1.34	-1.10	-.91	-.59	-.38	-.45	-.66	.02	-1.10	-.62
39	-.26	-.89	-1.31	-1.10	-.80	-.62	-.27	-.10	-.09	-.29	.31	-.73	-.36
40	-.09	-.66	-1.08	-.92	-.59	-.47	-.12	.04	.20	-.03	.50	-.46	-.18
41	.24	-.28	-.71	-.54	-.23	-.14	.19	.31	.63	.33	.78	-.09	.14
42	.39	.03	-.40	-.23	.00	.07	.38	.55	.95	.61	.95	.18	.41
43	.38	.15	-.21	.02	.06	.14	.38	.73	1.12	.71	.94	.23	.57
44	.43	.23	-.05	.22	.05	.22	.41	.86	1.22	.84	.87	.33	.62
45	.46	.34	.08	.27	.08	.30	.53	.95	1.32	1.02	.88	.40	.55
46	.38	.37	.24	.28	.14	.37	.62	1.04	1.41	1.13	.97	.54	.53
47	.37	.45	.48	.42	.36	.54	.69	1.20	1.57	1.37	1.14	.72	.69
48	.34	.45	.60	.59	.40	.66	.68	1.12	1.50	1.42	1.16	.83	.75
49	.17	.26	.50	.53	.17	.62	.52	.84	1.20	1.17	.96	.75	.67
50	.13	.26	.63	.69	.09	.63	.48	.70	1.15	1.11	.97	.90	.87
51	.21	.31	.60	.84	.00	.73	.44	.69	1.22	1.26	1.03	1.07	1.13
52	.26	.53	.46	.83	-.11	.85	.49	.69	1.14	1.39	1.02	1.10	1.37
53	.12	.59	.36	.65	-.37	.67	.41	.49	.88	1.31	.81	.96	1.27
54	-.03	.59	.33	.58	-.52	.48	.25	.49	.83	1.29	.61	.88	1.12
55	-.05	.62	.20	.57	-.59	.30	.12	.36	.70	1.14	.57	.75	.97
56	.09	.61	.02	.59	-.38	.27	.23	.17	.64	1.10	.55	.78	.90
57	.39	.71	.24	.72	.09	.61	.53	.46	.85	1.33	.81	1.16	.94
58	1.15	1.46	1.19	1.16	.96	1.31	1.22	1.30	1.70	1.82	1.57	1.97	1.45
59	1.25	1.61	1.32	.89	.92	1.11	1.15	1.18	1.51	1.30	1.39	1.49	.85
60	-1.34	-1.29	-.27	-1.25	-2.87	-2.88	-2.93	-3.14	-3.85	-4.12	-4.10	-4.56	-4.98
61	.83	.83	.83	.83	.83	.83	.83	.83	.83	.83	.83	.83	.83
62	.97	.97	.97	.97	.97	.97	.97	.97	.97	.97	.97	.97	.97

NOAA-9 SCANNER OFFSETS FOR FEBRUARY 1986: SHORTWAVE CHANNEL
 DAY OF MONTH --->

S.P.	1	2	3	4	5	6	7	8	9	10	11	12	13	14	15
1	-.11	-.11	-.11	-.11	-.11	-.11	-.11	-.11	-.11	-.11	-.11	-.11	-.11	-.11	-.11
2	.32	.32	.32	.32	.32	.32	.32	.32	.32	.32	.32	.32	.32	.32	.32
3	.49	.49	.49	.49	.49	.49	.49	.49	.49	.49	.49	.49	.49	.49	.49
4	-4.09	-4.09	-4.09	-4.09	-4.09	-4.09	-4.09	-4.09	-4.09	-4.09	-4.09	-4.09	-4.09	-4.09	-4.09
5	.80	.76	.73	.73	.70	.71	.71	.71	.71	.71	.77	.84	.80	.61	.60
6	.87	.85	.77	.79	.78	.82	.82	.82	.82	.82	.86	.91	.88	.69	.70
7	.50	.46	.41	.43	.39	.44	.44	.44	.44	.44	.48	.53	.48	.31	.32
8	.87	.84	.79	.80	.78	.83	.83	.83	.83	.83	.83	.89	.83	.66	.65
9	.92	.91	.85	.88	.85	.89	.89	.89	.89	.89	.89	.94	.88	.70	.69
10	.53	.50	.49	.53	.48	.48	.48	.48	.48	.48	.51	.55	.50	.31	.30
11	.89	.89	.82	.88	.81	.83	.83	.83	.83	.83	.85	.94	.86	.69	.66
12	.90	.88	.79	.86	.83	.78	.78	.78	.78	.78	.86	.92	.85	.69	.66
13	.08	.05	.01	.06	.03	-.08	-.08	-.08	-.08	-.08	-.01	.01	.03	-.15	-.15
14	.38	.36	.34	.39	.39	.31	.31	.31	.31	.31	.29	.30	.33	-.15	.13
15	.42	.38	.36	.40	.36	.32	.32	.32	.32	.32	.31	.36	.38	.20	.18
16	.00	-.01	-.08	-.02	-.05	-.12	-.12	-.12	-.12	-.12	-.11	-.05	-.03	-.21	-.22
17	.34	.31	.29	.35	.28	.24	.24	.24	.24	.24	.25	.27	.28	.10	.09
18	.35	.33	.29	.39	.32	.28	.28	.28	.28	.28	.28	.26	.31	.13	.13
19	-.04	-.04	-.11	.00	-.07	-.12	-.12	-.12	-.12	-.12	-.13	-.09	-.09	-.27	-.25
20	.35	.32	.28	.37	.31	.25	.25	.25	.25	.25	.25	.26	.26	.10	.12
21	.35	.30	.30	.42	.36	.28	.28	.28	.28	.28	.25	.26	.26	.10	.12
22	-.08	-.09	-.12	-.03	-.10	-.19	-.19	-.19	-.19	-.19	-.16	-.16	-.16	-.30	-.29
23	.31	.30	.26	.33	.26	.18	.18	.18	.18	.18	.20	.19	.21	.05	.06
24	.32	.33	.26	.37	.29	.24	.24	.24	.24	.24	.25	.24	.27	.11	.12
25	-.09	-.08	-.11	-.03	-.12	-.15	-.15	-.15	-.15	-.15	-.14	-.14	-.13	-.26	-.26
26	.29	.28	.24	.33	.32	.23	.23	.23	.23	.23	.23	.23	.25	.09	.12
27	.29	.31	.27	.39	.36	.23	.23	.23	.23	.23	.23	.26	.28	.31	.12
28	-.08	-.05	-.09	.00	-.04	-.14	-.14	-.14	-.14	-.14	-.13	-.10	-.08	-.26	-.21
29	.30	.35	.28	.42	.36	.28	.28	.28	.28	.28	.25	.30	.29	.11	.16
30	.36	.39	.35	.48	.46	.37	.37	.37	.37	.37	.31	.36	.36	.16	.22
31	.01	.02	.00	.10	.09	-.03	-.03	-.03	-.03	-.03	-.05	.00	.01	-.18	-.11
32	.38	.36	.37	.48	.47	.32	.32	.32	.32	.32	.30	.34	.34	.16	.24
33	.29	.29	.29	.43	.42	.26	.26	.26	.26	.26	.21	.21	.25	.07	.14
34	-.08	-.10	-.08	.10	.09	-.07	-.07	-.07	-.07	-.07	-.18	-.18	-.14	-.32	-.25
35	.35	.34	.33	.46	.45	.31	.31	.31	.31	.31	.22	.22	.27	.09	.16
36	.43	.41	.40	.51	.55	.39	.39	.39	.39	.39	.29	.30	.34	.17	.23
37	.12	.11	.09	.21	.21	.04	.04	.04	.04	.04	-.02	-.03	.01	-.15	-.10
38	.56	.56	.50	.64	.62	.44	.44	.44	.44	.44	.39	.39	.43	.28	.30
39	.62	.62	.54	.73	.68	.50	.50	.50	.50	.50	.44	.45	.49	.32	.35
40	.26	.27	.19	.38	.35	.17	.17	.17	.17	.17	.10	.09	.15	-.02	.02
41	.67	.64	.64	.86	.78	.60	.60	.60	.60	.60	.51	.50	.56	.38	.43
42	.76	.71	.67	.88	.83	.64	.64	.64	.64	.64	.58	.59	.65	.47	.52
43	.37	.33	.31	.52	.44	.27	.27	.27	.27	.27	.21	.21	.27	.11	.17
44	.75	.69	.69	.87	.81	.64	.64	.64	.64	.64	.57	.57	.63	.48	.52
45	.72	.68	.71	.90	.82	.64	.64	.64	.64	.64	.60	.58	.66	.47	.54
46	.35	.33	.34	.51	.45	.24	.24	.24	.24	.24	.23	.20	.26	.09	.16
47	.72	.69	.70	.90	.82	.60	.60	.60	.60	.60	.57	.57	.62	.44	.50
48	.74	.73	.74	.94	.85	.63	.63	.63	.63	.63	.61	.62	.67	.49	.54
49	.34	.32	.35	.57	.44	.25	.25	.25	.25	.25	.24	.22	.26	.08	.13
50	.71	.70	.76	.98	.87	.67	.67	.67	.67	.67	.61	.59	.63	.44	.48
51	.76	.75	.74	.98	.85	.67	.67	.67	.67	.67	.64	.64	.67	.51	.54
52	.38	.38	.39	.60	.47	.33	.33	.33	.33	.33	.27	.29	.35	.16	.17
53	1.23	1.21	1.24	1.46	1.33	1.15	1.15	1.15	1.15	1.15	1.08	1.18	1.16	.94	.94
54	1.48	1.52	1.54	1.76	1.65	1.44	1.44	1.44	1.44	1.44	1.40	1.48	1.43	1.26	1.27
55	1.16	1.20	1.18	1.41	1.30	1.14	1.14	1.14	1.14	1.14	1.05	1.16	1.10	.94	.94
56	1.51	1.55	1.54	1.72	1.65	1.50	1.50	1.50	1.50	1.50	1.38	1.48	1.42	1.28	1.27
57	1.54	1.58	1.56	1.76	1.68	1.53	1.53	1.53	1.53	1.53	1.39	1.51	1.44	1.28	1.28
58	1.17	1.17	1.17	1.39	1.30	1.13	1.13	1.13	1.13	1.13	1.02	1.11	1.06	.89	.90
59	1.48	1.48	1.52	1.73	1.64	1.49	1.49	1.49	1.49	1.49	1.33	1.42	1.38	1.23	1.24
60	1.44	1.46	1.48	1.66	1.59	1.45	1.45	1.45	1.45	1.45	1.31	1.39	1.35	1.19	1.20
61	3.05	3.05	3.05	3.05	3.05	3.05	3.05	3.05	3.05	3.05	3.05	3.05	3.05	3.05	3.05
62	.45	.45	.45	.45	.45	.45	.45	.45	.45	.45	.45	.45	.45	.45	.45

NOAA-9 SCANNER OFFSETS FOR FEBRUARY 1986: SHORTWAVE CHANNEL

S.P.	DAY OF MONTH -->												
	16	17	18	19	20	21	22	23	24	25	26	27	28
1	-.11	-.11	-.11	-.11	-.11	-.11	-.11	-.11	-.11	-.11	-.11	-.11	-.11
2	.32	.32	.32	.32	.32	.32	.32	.32	.32	.32	.32	.32	.32
3	.49	.49	.49	.49	.49	.49	.49	.49	.49	.49	.49	.49	.49
4	-4.09	-4.09	-4.09	-4.09	-4.09	-4.09	-4.09	-4.09	-4.09	-4.09	-4.09	-4.09	-4.09
5	.37	.48	.32	.32	.72	.65	.66	.71	.82	.94	.85	.87	.86
6	.47	.35	.39	.39	.80	.73	.73	.77	.91	.96	.86	.96	.99
7	.10	.18	.01	.03	.43	.36	.36	.41	.56	.61	.46	.52	.52
8	.46	.53	.36	.36	.78	.71	.71	.77	.90	.91	.84	.85	.84
9	.51	.58	.39	.40	.81	.75	.75	.81	.99	.99	.91	.90	.88
10	.14	.22	.03	.02	.45	.36	.37	.38	.53	.54	.49	.46	.46
11	.50	.57	.38	.38	.79	.72	.72	.73	.94	.86	.83	.73	.81
12	.52	.59	.44	.40	.82	.73	.75	.72	.80	.77	.76	.79	.79
13	-.32	-.25	-.37	-.43	.03	-.14	-.07	-.15	-.17	-.13	-.13	-.05	-.09
14	-.08	.01	-.12	-.21	.31	.15	.23	.15	.19	.25	.19	.30	.25
15	-.05	.05	-.08	-.14	.36	.19	.27	.19	.22	.24	.21	.33	.28
16	-.44	-.35	-.45	-.53	-.06	-.23	-.16	-.19	-.25	-.17	-.20	-.03	-.12
17	-.13	-.02	-.13	-.21	.27	.11	.18	.14	.08	.17	.18	.24	.24
18	-.09	.00	-.10	-.18	.29	.13	.20	.17	.11	.14	.21	.35	.28
19	-.50	-.38	-.49	-.55	-.11	-.26	-.19	-.23	-.31	-.27	-.24	-.05	-.11
20	-.14	-.03	-.14	-.21	.24	.09	.15	.12	.08	.15	.13	.32	.23
21	-.13	-.02	-.12	-.20	.25	.10	.17	.16	.10	.22	.08	.26	.23
22	-.54	-.44	-.56	-.63	-.18	-.32	-.25	-.26	-.36	-.25	-.37	-.24	-.21
23	-.19	-.10	-.23	-.28	.18	.05	.12	.13	.03	.11	.05	.16	.15
24	-.14	-.06	-.21	-.25	.22	.10	.16	.15	.09	.14	.09	.16	.14
25	-.50	-.43	-.60	-.60	-.16	-.29	-.23	-.20	-.29	-.29	-.33	-.27	-.17
26	-.14	-.05	-.22	-.23	.22	.09	.15	.20	.09	.08	.10	.09	.24
27	-.09	-.03	-.17	-.19	.27	.13	.19	.22	.13	.11	.13	.11	.26
28	-.46	-.39	-.56	-.55	-.10	-.23	-.18	-.17	-.26	-.18	-.28	-.26	-.14
29	-.09	-.03	-.18	-.17	.29	.18	.22	.22	.18	.29	.18	.40	.32
30	-.03	.02	-.13	-.12	.37	.24	.29	.27	.29	.38	.30	.51	.38
31	-.37	-.31	-.47	-.46	.03	-.10	-.06	-.09	-.06	.03	-.07	.09	.02
32	-.02	.07	-.09	-.08	.40	.25	.31	.30	.34	.43	.29	.42	.35
33	-.14	-.05	-.17	-.20	.34	.15	.23	.20	.25	.35	.19	.31	.22
34	-.52	-.41	-.56	-.59	-.02	-.23	-.14	-.16	-.11	.02	-.22	-.07	-.19
35	-.13	.00	-.17	-.19	.38	.18	.27	.28	.27	.43	.22	.35	.24
36	-.06	.07	-.10	-.12	.45	.26	.36	.36	.34	.52	.28	.41	.29
37	-.38	-.24	-.43	-.45	.12	-.07	.04	.06	.00	.10	-.10	-.01	-.04
38	.03	.16	-.02	-.05	.53	.34	.45	.45	.44	.59	.38	.42	.39
39	.08	.22	.05	.02	.58	.40	.52	.47	.49	.66	.45	.51	.47
40	-.26	-.11	-.27	-.31	.25	.07	.18	.11	.13	.30	.11	.15	.12
41	.13	.29	.12	.08	.65	.48	.59	.52	.57	.60	.51	.59	.55
42	.21	.38	.21	.17	.72	.56	.67	.59	.61	.67	.61	.72	.63
43	-.16	.02	-.14	-.18	.36	.20	.31	.22	.20	.29	.19	.32	.25
44	.20	.39	.23	.18	.72	.56	.66	.59	.58	.64	.53	.65	.60
45	.21	.40	.23	.18	.72	.57	.67	.60	.55	.59	.52	.63	.60
46	-.17	.01	-.14	-.20	.35	.18	.29	.20	.18	.13	.12	.25	.20
47	.18	.38	.21	.17	.71	.55	.65	.58	.54	.59	.45	.56	.58
48	.23	.39	.25	.21	.75	.59	.69	.61	.57	.60	.48	.58	.61
49	-.15	.01	-.15	-.19	.36	.20	.30	.22	.18	.23	.03	.17	.20
50	.21	.38	.23	.19	.72	.57	.67	.60	.61	.62	.41	.56	.57
51	.25	.41	.25	.22	.75	.61	.71	.66	.62	.66	.49	.65	.63
52	-.12	.06	-.11	-.13	.40	.26	.36	.32	.28	.28	.15	.32	.28
53	.66	.82	.64	.63	1.18	1.09	1.16	1.14	1.20	1.17	1.10	1.11	1.17
54	1.02	1.20	1.06	1.03	1.48	1.41	1.45	1.42	1.53	1.46	1.40	1.40	1.46
55	.71	.87	.72	.71	1.16	1.09	1.13	1.13	1.19	1.13	1.07	1.05	1.12
56	1.04	1.19	1.06	1.05	1.48	1.42	1.46	1.46	1.54	1.60	1.44	1.41	1.46
57	1.05	1.19	1.06	1.06	1.50	1.46	1.49	1.47	1.58	1.65	1.47	1.48	1.49
58	.67	.81	.68	.68	1.13	1.08	1.11	1.10	1.21	1.22	1.08	1.07	1.10
59	.99	1.14	1.01	1.00	1.46	1.40	1.44	1.42	1.53	1.50	1.42	1.37	1.42
60	.95	1.10	.97	.98	1.43	1.36	1.40	1.38	1.50	1.46	1.36	1.29	1.36
61	3.05	3.05	3.05	3.05	3.05	3.05	3.05	3.05	3.05	3.05	3.05	3.05	3.05
62	.45	.45	.45	.45	.45	.45	.45	.45	.45	.45	.45	.45	.45

NOAA-9 SCANNER OFFSETS FOR MARCH 1986: TOTAL CHANNEL															
S.P.	DAY OF MONTH -->														
	1	2	3	4	5	6	7	8	9	10	11	12	13	14	15
1	.36	.36	.36	.36	.36	.36	.36	.36	.36	.36	.36	.36	.36	.36	.36
2	1.04	1.04	1.04	1.04	1.04	1.04	1.04	1.04	1.04	1.04	1.04	1.04	1.04	1.04	1.04
3	1.93	1.93	1.93	1.93	1.93	1.93	1.93	1.93	1.93	1.93	1.93	1.93	1.93	1.93	1.93
4	-9.64	-9.64	-9.64	-9.64	-9.64	-9.64	-9.64	-9.64	-9.64	-9.64	-9.64	-9.64	-9.64	-9.64	-9.64
5	3.18	3.07	1.42	1.85	2.42	2.85	3.21	4.01	4.22	2.76	2.05	1.16	1.68	1.68	1.68
6	2.27	2.31	1.58	1.21	1.74	1.60	1.70	2.70	3.02	2.81	2.90	1.89	1.16	1.16	1.16
7	-1.03	-1.09	-2.06	-2.19	-1.92	-2.08	-1.72	-.58	-.45	-.73	-.57	-1.32	-2.39	-.39	-.39
8	-.92	-1.05	-2.05	-1.66	-1.59	-2.03	-1.20	-.04	-.30	-1.12	-.76	-1.13	-2.37	-.37	-.37
9	-.91	-1.08	-1.80	-1.68	-1.43	-1.86	-.89	.22	-.17	-1.21	-1.01	-1.11	-2.17	-.17	-.17
10	-1.59	-1.68	-2.12	-2.46	-2.06	-2.26	-1.39	-.29	-.63	-1.55	-1.49	-1.73	-2.15	-.15	-.15
11	-2.09	-1.76	-2.05	-2.52	-2.17	-2.14	-1.43	-.24	-.48	-1.36	-1.43	-1.79	-1.59	-.59	-.59
12	-2.46	-1.61	-1.83	-2.64	-2.54	-2.07	-1.48	-.51	-.67	-1.14	-1.43	-1.82	-1.16	-.16	-.16
13	-2.65	-1.53	-1.58	-2.74	-2.76	-2.09	-1.59	-.76	-.70	-1.01	-1.44	-1.91	-.85	-.85	-.85
14	-2.37	-1.33	-1.24	-2.71	-2.56	-2.01	-1.40	-.81	-.72	-.75	-1.32	-1.69	-.45	-.45	-.45
15	-2.09	-1.39	-1.01	-2.72	-2.44	-2.08	-1.24	-.96	-.98	-.73	-1.33	-1.73	-.26	-.26	-.26
16	-2.22	-1.52	-1.14	-2.87	-2.62	-2.25	-1.37	-1.20	-1.29	-1.04	-1.52	-2.01	-.34	-.34	-.34
17	-2.33	-1.66	-1.40	-3.05	-2.67	-2.36	-1.43	-1.30	-1.32	-1.13	-1.36	-2.06	-.45	-.45	-.45
18	-2.04	-1.22	-1.17	-2.60	-2.07	-1.87	-.98	-.88	-.82	-.73	-.62	-1.59	-.09	-.09	-.09
19	-2.42	-1.54	-1.60	-2.84	-2.17	-2.16	-1.27	-1.20	-1.05	-.93	-.72	-1.84	-.38	-.38	-.38
20	-2.77	-2.03	-1.92	-3.01	-2.32	-2.54	-1.46	-1.56	-1.35	-1.09	-1.01	-2.13	-.63	-.63	-.63
21	-2.62	-2.00	-1.83	-2.92	-2.12	-2.53	-1.21	-1.52	-1.25	-1.12	-.90	-1.97	-.52	-.52	-.52
22	-2.64	-2.07	-1.98	-2.99	-2.19	-2.64	-1.43	-1.86	-1.26	-1.28	-.96	-1.93	-.54	-.54	-.54
23	-2.71	-2.12	-2.26	-3.04	-2.41	-2.84	-1.58	-2.12	-1.39	-1.45	-1.15	-2.09	-.66	-.66	-.66
24	-2.62	-1.87	-2.22	-2.84	-2.35	-2.70	-1.42	-1.91	-1.26	-1.29	-1.13	-1.87	-.64	-.64	-.64
25	-2.68	-1.97	-2.37	-2.95	-2.37	-2.83	-1.59	-2.08	-1.44	-1.38	-1.39	-1.90	-.89	-.89	-.89
26	-2.16	-1.71	-1.98	-2.55	-1.84	-2.27	-1.17	-1.71	-.80	-.79	-.93	-1.34	-.51	-.51	-.51
27	-1.82	-1.45	-1.81	-2.18	-1.32	-1.72	-.95	-1.43	-.35	-.37	-.69	-.97	-.31	-.31	-.31
28	-1.48	-1.14	-1.63	-1.78	-.74	-1.26	-.66	-1.12	.09	.04	-.66	-.63	-.09	-.09	-.09
29	-1.08	-.81	-1.38	-1.40	-.42	-.85	-.43	-.88	.56	.42	-.57	-.20	.21	.21	.21
30	-.93	-.62	-1.39	-1.29	-.50	-.71	-.23	-.76	.55	.42	-.73	-.17	.15	.15	.15
31	-.44	-.04	-.85	-.45	.00	-.27	.23	-.26	.99	.88	-.33	.28	.56	.56	.56
32	.05	.41	-.44	.18	.31	.12	.54	.03	1.56	1.33	.10	.74	.85	.85	.85
33	.17	.54	-.34	.41	.43	.27	.54	.18	1.67	1.51	.30	.97	.79	.79	.79
34	-.06	.28	-.67	.22	.33	.12	.30	.11	1.35	1.39	.25	.91	.46	.46	.46
35	-.01	.22	-.84	.23	.50	.04	.27	.19	1.20	1.40	.37	1.05	.38	.38	.38
36	.36	.59	-.63	.43	.84	.25	.53	.51	1.46	1.66	.82	1.47	.60	.60	.60
37	.31	.36	-.77	.12	.58	-.04	.30	.33	1.23	1.40	.74	1.36	.37	.37	.37
38	.63	.58	-.64	.25	.63	.03	.42	.52	1.35	1.57	.95	1.68	.56	.56	.56
39	.39	.46	-.96	-.26	.22	-.32	-.01	.31	.85	1.32	.58	1.43	.28	.28	.28
40	.49	.68	-.89	-.40	.16	-.26	-.21	.55	.69	1.32	.61	1.42	.33	.33	.33
41	.36	.49	-1.05	-.90	-.22	-.38	-.51	.38	.31	1.07	.33	1.12	.14	.14	.14
42	.81	.73	-.64	-.70	.06	.08	-.21	.61	.64	1.43	.63	1.29	.51	.51	.51
43	.51	.19	-1.04	-1.15	-.44	-.21	-.66	.04	.17	1.14	.22	.74	.02	.02	.02
44	.47	.09	-.96	-1.13	-.46	-.24	-.62	-.08	.16	1.24	.23	.68	-.13	-.13	-.13
45	.03	-.30	-1.27	-1.51	-.69	-.66	-.99	-.35	-.18	1.10	-.01	.41	-.62	-.62	-.62
46	-.21	-.46	-1.23	-1.71	-.75	-.76	-1.14	-.32	-.33	1.11	.04	.41	-.83	-.83	-.83
47	-.38	-.55	-1.16	-1.79	-.90	-.85	-1.15	-.52	-.40	.95	.17	.35	-1.02	-1.02	-1.02
48	-1.20	-1.28	-1.76	-2.48	-1.87	-1.63	-1.97	-1.40	-1.18	.17	-.37	-.39	-1.84	-.84	-.84
49	-1.35	-1.20	-1.81	-2.47	-2.05	-1.59	-2.09	-1.41	-1.28	.02	-.39	-.25	-1.88	-.88	-.88
50	-1.83	-1.35	-2.24	-2.63	-2.46	-1.68	-2.26	-1.52	-1.77	-.42	-.68	-.40	-2.26	-.26	-.26
51	-1.99	-1.20	-2.35	-2.28	-2.45	-1.48	-2.08	-1.41	-1.93	-.55	-.42	-.22	-2.28	-.28	-.28
52	-2.55	-1.70	-2.67	-2.44	-2.69	-1.71	-2.36	-1.98	-2.33	-1.21	-.79	-.52	-2.51	-.51	-.51
53	-1.79	-1.20	-1.98	-1.62	-1.83	-.96	-1.46	-1.39	-1.48	-1.00	-.37	.00	-1.52	-.52	-.52
54	-1.75	-1.49	-2.20	-1.77	-2.01	-1.06	-1.44	-1.60	-1.55	-1.62	-.77	-.40	-1.54	-.54	-.54
55	-1.09	-1.17	-1.53	-1.18	-1.64	-.44	-1.16	-1.10	-1.12	-1.30	-.36	-.17	-1.11	-.11	-.11
56	-1.09	-1.50	-1.28	-1.02	-1.37	-.38	-1.43	-.94	-1.16	-1.46	-.47	-.34	-.95	-.95	-.95
57	-.71	-1.44	-.77	-.61	-.55	.09	-1.25	-.41	-.82	-1.37	-.26	-.26	-.39	-.39	-.39
58	-.82	-1.54	-.66	-.93	-.27	-.13	-1.47	-.63	-.75	-1.20	-.35	-.72	-.17	-.17	-.17
59	-1.21	-1.49	-.58	-1.52	-.54	-1.18	-2.01	-1.64	-1.36	-1.09	-.82	-1.06	-.71	-.71	-.71
60	-12.28	-11.75	-10.36	-11.73	-11.65	-13.49	-14.19	-14.29	-14.27	-12.77	-11.98	-11.42	-12.94	-.94	-.94
61	11.19	11.19	11.19	11.19	11.19	11.19	11.19	11.19	11.19	11.19	11.19	11.19	11.19	11.19	11.19
62	3.13	3.13	3.13	3.13	3.13	3.13	3.13	.00	.00	3.13	3.13	3.13	3.13	3.13	3.13

NOAA-9 SCANNER OFFSETS FOR MARCH 1986:														TOTAL	CHANNEL					
S.P.	DAY OF MONTH -->														26	27	28	29	30	31
	16	17	18	19	20	21	22	23	24	25										
1	.36	.36	.36	.36	.36	.36	.36	.36	.36	.36	.36	.36	.36	.36	.36	.36	.36	.36	.36	.36
2	1.04	1.04	1.04	1.04	1.04	1.04	1.04	1.04	1.04	1.04	1.04	1.04	1.04	1.04	1.04	1.04	1.04	1.04	1.04	1.04
3	1.93	1.93	1.93	1.93	1.93	1.93	1.93	1.93	1.93	1.93	1.93	1.93	1.93	1.93	1.93	1.93	1.93	1.93	1.93	1.93
4	-9.64	-9.64	-9.64	-9.64	-9.64	-9.64	-9.64	-9.64	-9.64	-9.64	-9.64	-9.64	-9.64	-9.64	-9.64	-9.64	-9.64	-9.64	-9.64	-9.64
5	-5.33	-1.19	-5.24	-6.28	-7.13	-6.77	-6.01	-2.39	-2.77	.43	.98	.84	1.73	1.53	1.58	2.56				
6	-1.77	.02	-1.31	-1.92	-1.76	-1.65	-1.53	.46	1.17	2.10	1.39	.67	1.36	1.41	1.82	2.48				
7	-3.45	-2.27	-3.04	-3.43	-2.63	-2.79	-3.34	-2.03	-1.25	-1.04	-2.21	-2.55	-1.77	-1.31	-1.49	-.79				
8	-2.92	-1.70	-2.09	-2.74	-1.81	-1.96	-2.99	-1.35	-.76	-1.16	-2.17	-1.97	-1.67	-.68	-1.01	-.48				
9	-2.45	-1.57	-1.28	-1.93	-1.38	-1.49	-2.68	-.77	-.48	-1.10	-1.89	-1.47	-1.77	-.35	-.78	-.55				
10	-2.77	-2.14	-1.25	-1.98	-1.85	-1.89	-2.97	-1.07	-1.16	-1.44	-2.00	-1.80	-2.28	-.61	-1.28	-1.37				
11	-2.43	-2.31	-1.23	-1.78	-1.69	-1.81	-2.63	-.93	-1.29	-1.36	-1.45	-1.80	-1.99	-.39	-1.31	-1.41				
12	-2.02	-2.47	-1.41	-1.93	-1.68	-2.02	-2.34	-.78	-1.70	-1.37	-1.35	-1.78	-1.80	-.64	-1.57	-1.51				
13	-1.55	-2.41	-1.41	-2.01	-1.67	-2.16	-1.94	-.58	-1.95	-1.27	-1.66	-1.62	-1.97	-.91	-1.71	-1.80				
14	-1.12	-1.94	-1.23	-2.02	-1.79	-2.11	-1.68	-.24	-1.92	-.99	-1.58	-1.20	-1.88	-.58	-1.36	-1.66				
15	-.95	-1.77	-1.20	-2.00	-2.06	-1.97	-1.70	-.35	-2.07	-.90	-1.54	-.95	-2.10	-.46	-1.26	-1.63				
16	-1.23	-2.05	-1.57	-2.25	-2.29	-2.13	-1.93	-.67	-2.57	-1.10	-1.55	-.99	-2.48	-.71	-1.44	-1.79				
17	-1.25	-2.15	-1.89	-2.34	-2.20	-2.21	-1.87	-.81	-2.65	-1.09	-1.42	-.95	-2.60	-.88	-1.43	-1.68				
18	-.65	-1.66	-1.46	-1.69	-1.52	-1.70	-1.39	-.38	-2.12	-.64	-.71	-.53	-2.27	-.55	-.78	-.95				
19	-.85	-1.55	-1.60	-1.73	-1.58	-2.02	-1.64	-.64	-2.27	-1.05	-.79	-1.08	-2.63	-.96	-.82	-.94				
20	-1.12	-1.72	-1.84	-1.85	-1.60	-2.35	-1.84	-.85	-2.35	-1.38	-.91	-1.47	-2.82	-1.41	-.98	-.99				
21	-1.12	-1.38	-1.74	-1.63	-1.26	-2.27	-1.70	-.66	-2.11	-1.25	-.80	-1.39	-2.71	-1.43	-.95	-.82				
22	-1.20	-1.40	-1.74	-1.55	-1.18	-2.21	-1.59	-.73	-1.99	-1.13	-.86	-1.63	-2.94	-1.66	-1.18	-.94				
23	-1.37	-1.56	-1.86	-1.67	-1.27	-2.32	-1.56	-.89	-1.95	-1.11	-1.07	-1.87	-3.06	-1.92	-1.46	-1.01				
24	-1.25	-1.41	-1.76	-1.60	-1.09	-2.18	-1.43	-.70	-1.76	-.91	-1.11	-1.83	-2.84	-1.86	-1.38	-.71				
25	-1.27	-1.50	-1.97	-1.66	-1.17	-2.29	-1.60	-.80	-1.92	-1.01	-1.37	-2.02	-3.04	-2.00	-1.56	-.66				
26	-.75	-.91	-1.49	-1.18	-.62	-1.79	-1.25	-.33	-1.54	-.50	-.93	-1.64	-2.58	-1.56	-1.22	-.07				
27	-.36	-.37	-1.06	-.92	-.21	-1.48	-1.02	-.02	-1.35	-.25	-.67	-1.43	-2.27	-1.28	-.95	.23				
28	-.07	-.02	-.67	-.46	.08	-1.26	-.85	.27	-1.13	-.06	-.41	-1.17	-2.09	-1.03	-.57	.47				
29	.18	.28	-.29	-.48	.28	-.96	-.60	.58	-.83	.16	-.05	-.97	-1.85	-.62	-.12	.84				
30	.14	.21	-.24	-.82	-.03	-1.01	-.62	.38	-.93	-.01	-.08	-1.08	-1.92	-.69	-.16	.85				
31	.63	.66	.26	-.62	.14	-.63	-.20	.72	-.48	.28	.29	-.73	-1.61	-.48	.27	1.21				
32	1.00	1.10	.67	-.40	.35	-.35	.07	1.02	-.17	.65	.63	-.30	-1.29	-.16	.66	1.54				
33	1.22	1.31	.89	-.40	.41	-.31	.10	1.11	-.18	.67	.75	-.20	-1.29	-.15	.65	1.59				
34	1.05	1.24	.74	-.62	.25	-.55	-.17	.82	-.40	.35	.80	-.48	-1.50	-.36	.30	1.38				
35	.89	1.26	.68	-.60	.27	-.68	-.21	.78	-.32	.33	.87	-.80	-1.57	-.43	.23	1.27				
36	1.02	1.57	.96	-.23	.36	-.56	-.11	.98	.08	.65	1.10	-.79	-1.26	-.20	.38	1.41				
37	.67	1.25	.76	-.36	.02	-.82	-.07	.68	-.09	.49	.82	-1.21	-1.43	-.40	-.05	1.16				
38	.67	1.26	.87	-.31	.18	-.68	.07	.92	.12	.80	.99	-1.13	-1.20	-.08	-.06	1.36				
39	.32	.90	.58	-.72	-.12	-1.02	-.32	.61	-.16	.64	.59	-1.44	-1.33	-.32	-.38	1.04				
40	.43	.89	.59	-.75	-.17	-1.06	-.28	.61	-.14	.80	.56	-1.29	-1.19	-.21	-.26	.91				
41	.24	.58	.34	-1.15	-.53	-1.46	-.55	.44	-.41	.67	.33	-1.32	-1.50	-.47	-.29	.59				
42	.53	.80	.72	-.98	-.21	-1.20	-.31	.79	-.08	1.00	.67	-.94	-1.31	-.25	-.16	.88				
43	.12	.36	.30	-1.59	-.70	-1.70	-.89	.27	-.57	.64	.26	-1.33	-1.69	-.82	-.27	.35				
44	.24	.23	.14	-1.70	-.80	-1.77	-.90	.21	-.51	.69	.27	-1.22	-1.69	-.99	-.26	.20				
45	-.06	-.23	-.34	-1.97	-1.17	-2.06	-1.17	-.07	-.63	.41	-.07	-1.34	-1.97	-1.42	-.51	-.37				
46	-.03	-.29	-.45	-1.86	-1.21	-2.06	-1.26	-.14	-.57	.43	-.15	-1.36	-1.94	-1.64	-.43	-.62				
47	-.08	-.31	-.63	-1.67	-1.26	-2.11	-1.37	-.39	-.48	.42	-.23	-1.58	-1.81	-1.87	-.46	-.80				
48	-.94	-1.01	-1.64	-2.25	-2.06	-2.84	-2.18	-1.43	-1.04	-.31	-1.01	-2.67	-2.47	-2.84	-1.33	-1.70				
49	-.89	-1.00	-1.73	-2.04	-2.26	-2.76	-2.22	-1.78	-.89	-.39	-1.15	-2.88	-2.34	-2.96	-1.53	-1.77				
50	-1.13	-1.36	-1.93	-2.12	-2.70	-2.85	-2.50	-2.30	-1.27	-.76	-1.43	-3.27	-2.41	-3.31	-1.89	-2.13				
51	-1.13	-1.39	-1.69	-1.92	-2.59	-2.62	-2.39	-2.20	-1.32	-.84	-1.49	-3.26	-2.20	-3.10	-1.63	-2.14				
52	-1.55	-1.61	-2.05	-2.26	-2.73	-2.76	-2.81	-2.46	-1.85	-1.39	-1.92	-3.62	-2.44	-3.22	-1.89	-2.45				
53	-1.11	-.82	-1.34	-1.68	-1.87	-1.92	-2.09	-1.62	-1.28	-.90	-1.20	-2.85	-1.51	-2.48	-.93	-1.55				
54	-1.35	-.92	-1.14	-1.80	-1.86	-1.87	-2.21	-1.61	-1.41	-1.33	-1.50	-2.86	-1.67	-2.91	-1.12	-1.65				
55	-.98	-.54	-.35	-1.15	-1.33	-1.19	-1.65	-1.12	-.75	-1.28	-1.31	-2.01	-1.41	-2.26	-.68	-1.14				
56	-1.21	-.80	-.21	-1.00	-1.50	-1.16	-1.62	-1.02	-.66	-1.64	-1.78	-1.74	-1.79	-1.97	-.83	-1.31				
57	-.96	-1.10	-.06	-.43	-1.37	-.99	-1.21	-.51	-.40	-1.71	-1.89	-.99	-1.73	-1.59	-.74	-1.01				
58	-.55	-1.15	-.36	-.27	-1.41	-1.08	-.77	-.34	-.57	-1.69	-2.09	-.63	-1.80	-1.74	-.73	-1.03				
59	-.13	-1.49	-.39	-.29	-1.10	-.71	-.43	-.53	-.85	-1.85	-2.22	-1.14	-2.61	-2.86	-1.57	-1.41				
60	-5.59	-11.10	-7.24	-6.06	-5.23	-6.39	-7.12	-10.21	-10.13	-13.04	-14.02	-14.05	-16.21	-16.09	-14.83	-15.14				
61	11.19	11.19	11.19	11.19	11.19	11.19	11.19	11.19	11.19	11.19	11.19	11.19	11.19	11.19	11.19	11.19				
62	3.13	3.13	3.13	3.13	3.13	3.13	3.13	.00	3.13	.00	3.13	3.13	.00	.00	.00	.00				

NOAA-9 SCANNER OFFSETS FOR MARCH 1986: LONGVALE CHANNEL

S.P.	DAY OF MONTH -->														
	1	2	3	4	5	6	7	8	9	10	11	12	13	14	15
1	.29	.29	.29	.29	.29	.29	.29	.29	.29	.29	.29	.29	.29	.29	.29
2	.59	.59	.59	.59	.59	.59	.59	.59	.59	.59	.59	.59	.59	.59	.59
3	.63	.63	.63	.63	.63	.63	.63	.63	.63	.63	.63	.63	.63	.63	.63
4	.27	.27	.27	.27	.27	.27	.27	.27	.27	.27	.27	.27	.27	.27	.27
5	1.77	1.49	.63	.81	1.15	1.59	1.59	2.23	2.70	1.76	1.33	.86	1.10	.27	.27
6	-.34	.12	-.21	-.52	-.24	-.14	-.29	.48	.95	.82	.93	.38	-.13	.27	.27
7	-1.85	-2.19	-2.62	-2.79	-2.69	-2.65	-2.60	-1.76	-1.44	-1.56	-1.38	-1.82	-2.52	.27	.27
8	-1.85	-2.24	-2.66	-2.53	-2.51	-2.73	-2.37	-1.52	-1.41	-1.94	-1.59	-1.84	-2.62	.27	.27
9	-2.00	-2.37	-2.60	-2.65	-2.50	-2.77	-2.28	-1.43	-1.40	-2.18	-1.91	-1.99	-2.65	.27	.27
10	-2.57	-2.88	-2.92	-3.31	-3.09	-3.22	-2.76	-1.89	-1.84	-2.59	-2.40	-2.58	-2.80	.27	.27
11	-2.98	-3.01	-2.96	-3.48	-3.29	-3.23	-2.85	-1.96	-1.87	-2.61	-2.51	-2.76	-2.61	.27	.27
12	-3.31	-2.97	-2.86	-3.58	-3.54	-3.15	-2.85	-2.07	-1.89	-2.45	-2.52	-2.81	-2.37	.27	.27
13	-3.59	-3.08	-2.82	-3.78	-3.73	-3.21	-3.01	-2.28	-1.91	-2.35	-2.55	-2.93	-2.22	.27	.27
14	-3.72	-3.28	-2.91	-4.03	-3.82	-3.38	-3.08	-2.50	-2.05	-2.30	-2.62	-2.95	-2.14	.27	.27
15	-3.73	-3.53	-3.07	-4.27	-3.91	-3.56	-3.17	-2.75	-2.30	-2.35	-2.73	-3.07	-2.10	.27	.27
16	-3.94	-3.77	-3.38	-4.57	-4.17	-3.77	-3.39	-3.07	-2.68	-2.68	-2.99	-3.38	-2.28	.27	.27
17	-4.15	-3.97	-3.76	-4.86	-4.34	-4.02	-3.61	-3.31	-2.95	-2.93	-3.11	-3.64	-2.58	.27	.27
18	-4.15	-3.85	-3.73	-4.73	-4.07	-3.87	-3.51	-3.20	-2.86	-2.89	-2.84	-3.57	-2.57	.27	.27
19	-4.65	-4.33	-4.26	-5.16	-4.38	-4.29	-3.95	-3.62	-3.22	-3.24	-3.14	-3.97	-3.01	.27	.27
20	-5.17	-4.97	-4.86	-5.58	-4.82	-4.85	-4.40	-4.15	-3.65	-3.60	-3.60	-4.44	-3.45	.27	.27
21	-5.28	-5.17	-5.02	-5.69	-4.90	-5.10	-4.44	-4.31	-3.78	-3.82	-3.73	-4.53	-3.60	.27	.27
22	-5.51	-5.43	-5.29	-5.88	-5.11	-5.35	-4.64	-4.61	-3.98	-4.17	-4.00	-4.72	-3.85	.27	.27
23	-5.76	-5.64	-5.66	-6.11	-5.42	-5.66	-4.94	-4.95	-4.24	-4.50	-4.35	-4.99	-4.13	.27	.27
24	-5.81	-5.57	-5.76	-6.13	-5.52	-5.70	-4.94	-4.94	-4.24	-4.53	-4.48	-5.03	-4.25	.27	.27
25	-5.98	-5.69	-6.00	-6.37	-5.70	-5.96	-5.17	-5.21	-4.48	-4.76	-4.85	-5.26	-4.59	.27	.27
26	-5.64	-5.46	-5.68	-6.02	-5.31	-5.66	-4.92	-5.00	-4.10	-4.42	-4.62	-4.97	-4.39	.27	.27
27	-5.41	-5.26	-5.55	-5.77	-4.98	-5.32	-4.82	-4.86	-3.84	-4.21	-4.53	-4.78	-4.29	.27	.27
28	-5.15	-4.99	-5.39	-5.46	-4.59	-5.01	-4.62	-4.66	-3.54	-3.97	-4.53	-4.55	-4.12	.27	.27
29	-4.86	-4.74	-5.15	-5.15	-4.33	-4.71	-4.49	-4.50	-3.18	-3.69	-4.45	-4.23	-3.89	.27	.27
30	-4.66	-4.55	-5.11	-5.10	-4.43	-4.55	-4.41	-4.47	-3.10	-3.59	-4.46	-4.14	-3.85	.27	.27
31	-4.08	-3.94	-4.53	-4.41	-3.94	-4.04	-3.88	-3.93	-2.66	-3.09	-4.00	-3.63	-3.37	.27	.27
32	-3.56	-3.44	-4.05	-3.82	-3.53	-3.60	-3.46	-3.51	-2.15	-2.61	-3.54	-3.14	-2.98	.27	.27
33	-3.17	-3.06	-3.68	-3.37	-3.14	-3.26	-3.16	-3.15	-1.81	-2.22	-3.13	-2.71	-2.74	.27	.27
34	-2.96	-2.83	-3.49	-3.08	-2.84	-3.02	-2.96	-2.86	-1.68	-1.97	-2.83	-2.43	-2.63	.27	.27
35	-2.54	-2.47	-3.16	-2.68	-2.34	-2.68	-2.61	-2.48	-1.41	-1.58	-2.38	-1.95	-2.30	.27	.27
36	-1.94	-1.90	-2.68	-2.24	-1.76	-2.17	-2.09	-1.94	-.95	-1.08	-1.75	-1.33	-1.81	.27	.27
37	-1.54	-1.64	-2.40	-2.07	-1.53	-1.96	-1.79	-1.62	-.71	-.87	-1.41	-1.01	-1.55	.27	.27
38	-.95	-1.09	-1.91	-1.57	-1.09	-1.53	-1.28	-1.01	-.22	-.39	-.90	-.43	-1.06	.27	.27
39	-.67	-.74	-1.64	-1.36	-.88	-1.30	-1.09	-.65	-.03	-.10	-.68	-.15	-.78	.27	.27
40	-.29	-.28	-1.26	-1.11	-.59	-.92	-.88	-.14	.24	.23	-.34	.16	-.41	.27	.27
41	-.06	-.04	-.98	-1.05	-.45	-.64	-.72	.14	.37	.43	-.14	.32	-.16	.27	.27
42	.46	.34	-.46	-.69	-.02	-.07	-.30	.53	.82	.91	.32	.69	.34	.27	.27
43	.53	.27	-.47	-.76	-.09	.02	-.34	.42	.80	1.00	.33	.60	.32	.27	.27
44	.69	.41	-.22	-.58	.07	.20	-.16	.52	.98	1.28	.51	.75	.42	.27	.27
45	.67	.43	-.08	-.52	.20	.19	-.11	.62	1.01	1.46	.63	.85	.37	.27	.27
46	.67	.49	.10	-.46	.35	.30	-.04	.82	1.06	1.63	.85	1.02	.40	.27	.27
47	.63	.49	.20	-.45	.31	.31	-.01	.76	1.07	1.59	1.01	1.07	.34	.27	.27
48	.28	.19	-.04	-.72	-.16	-.03	-.39	.37	.74	1.24	.84	.77	-.03	.27	.27
49	.08	.15	-.16	-.79	-.35	-.12	-.56	.27	.58	1.04	.74	.78	-.13	.27	.27
50	-.33	-.05	-.54	-.99	-.71	-.27	-.72	.14	.19	.66	.49	.61	-.47	.27	.27
51	-.26	-.24	-.39	-.53	-.50	.10	-.36	.47	.34	.80	.90	.95	-.27	.27	.27
52	-.83	-.24	-.78	-.80	-.85	-.25	-.73	-.07	-.10	.18	.48	.56	-.62	.27	.27
53	-.57	-.15	-.53	-.50	-.52	-.02	-.37	.07	.23	.09	.54	.67	-.21	.27	.27
54	-.64	-.46	-.80	-.73	-.74	-.18	-.50	-.16	.13	-.39	.19	.30	-.29	.27	.27
55	-.26	-.37	-.45	-.49	-.57	.15	-.39	.09	.40	-.22	.41	.39	-.05	.27	.27
56	-.45	-.84	-.50	-.62	-.61	-.01	-.79	.03	.22	-.47	.16	.09	-.16	.27	.27
57	-.37	-.97	-.34	-.51	-.26	.12	-.79	.27	.32	-.52	.16	-.02	-.04	.27	.27
58	-.73	-1.27	-.53	-.95	-.26	-.29	-1.12	-.04	.15	-.63	-.13	-.56	-.05	.27	.27
59	-.94	-1.18	-.44	-1.24	-.32	-.91	-1.35	-.61	-.16	-.49	-.37	-.72	-.34	.27	.27
60	-7.30	-6.97	-6.09	-7.07	-6.74	-8.00	-8.34	-8.01	-7.73	-7.23	-6.86	-6.68	-7.45	.27	.27
61	.83	.83	.83	.83	.83	.83	.83	.83	.83	.83	.83	.83	.83	.27	.27
62	.97	.97	.97	.97	.97	.97	.97	.97	.00	.97	.97	.97	.97	.27	.27

NOAA-9 SCANNER OFFSETS FOR MARCH 1986: LONGMERE CHANNEL

S.P.	DAY OF MONTH -->															
	16	17	18	19	20	21	22	23	24	25	26	27	28	29	30	31
1	.29	.29	.29	.29	.29	.29	.29	.29	.29	.29	.29	.29	.29	.29	.29	.29
2	.59	.59	.59	.59	.59	.59	.59	.59	.59	.59	.59	.59	.59	.59	.59	.59
3	.63	.63	.63	.63	.63	.63	.63	.63	.63	.63	.63	.63	.63	.63	.63	.63
4	.27	.27	.27	.27	.27	.27	.27	.27	.27	.27	.27	.27	.27	.27	.27	.27
5	-2.83	-.64	-3.07	-3.74	-4.19	-3.99	-3.62	-1.52	-1.66	.28	.45	.35	1.31	1.16	1.15	1.47
6	-1.79	-.89	-1.64	-2.16	-2.07	-1.95	-1.99	-.76	-.34	.39	-.28	-.71	.22	.21	.39	.52
7	-3.02	-2.48	-2.84	-3.26	-2.74	-2.77	-3.25	-2.49	-2.07	-1.74	-2.70	-2.91	-1.89	-1.61	-1.87	-1.71
8	-2.81	-2.24	-2.33	-2.95	-2.32	-2.35	-3.12	-2.20	-1.96	-1.95	-2.83	-2.63	-1.95	-1.29	-1.74	-1.69
9	-2.70	-2.32	-1.97	-2.59	-2.24	-2.23	-3.11	-1.97	-1.98	-2.10	-2.80	-2.46	-2.17	-1.22	-1.76	-1.92
10	-3.09	-2.87	-2.11	-2.78	-2.71	-2.68	-3.49	-2.32	-2.59	-2.48	-3.03	-2.81	-2.67	-1.57	-2.24	-2.63
11	-3.02	-3.11	-2.24	-2.82	-2.79	-2.82	-3.44	-2.41	-2.84	-2.55	-2.82	-2.93	-2.63	-1.58	-2.41	-2.82
12	-2.83	-3.27	-2.45	-2.98	-2.91	-3.09	-3.37	-2.40	-2.84	-2.58	-2.78	-2.98	-2.55	-1.82	-2.64	-2.95
13	-2.57	-3.31	-2.54	-3.11	-3.04	-3.32	-3.22	-2.36	-3.43	-2.57	-3.09	-3.01	-2.74	-2.09	-2.87	-3.28
14	-2.43	-3.19	-2.61	-3.29	-3.32	-3.33	-3.26	-2.34	-3.63	-2.55	-3.24	-2.95	-2.88	-2.12	-2.88	-3.47
15	-2.37	-3.14	-2.68	-3.38	-3.61	-3.58	-3.36	-2.48	-3.83	-2.58	-3.29	-2.86	-3.09	-2.14	-2.90	-3.60
16	-2.64	-3.42	-3.03	-3.65	-3.88	-3.82	-3.61	-2.74	-4.29	-2.82	-3.42	-2.96	-3.44	-2.42	-3.13	-3.85
17	-2.81	-3.68	-3.45	-3.93	-4.02	-4.09	-3.75	-2.99	-4.53	-3.00	-3.54	-3.12	-3.72	-2.76	-3.32	-3.99
18	-2.60	-3.58	-3.37	-3.71	-3.76	-3.98	-3.62	-2.87	-4.34	-2.89	-3.30	-3.04	-3.72	-2.78	-3.13	-3.74
19	-2.94	-3.97	-3.67	-3.93	-4.00	-4.39	-3.98	-3.23	-4.59	-3.37	-3.57	-3.64	-4.18	-3.29	-3.42	-3.95
20	-3.38	-4.08	-4.07	-4.23	-4.25	-4.83	-4.38	-3.62	-4.84	-3.84	-3.90	-4.18	-4.57	-3.87	-3.81	-4.22
21	-3.56	-4.03	-4.16	-4.20	-4.17	-4.90	-4.45	-3.64	-4.79	-3.95	-4.00	-4.33	-4.69	-4.09	-3.99	-4.23
22	-3.83	-4.20	-4.34	-4.29	-4.29	-5.02	-4.57	-3.84	-4.86	-4.03	-4.21	-4.66	-5.05	-4.40	-4.33	-4.45
23	-4.14	-4.48	-4.60	-4.51	-4.51	-5.25	-4.71	-4.13	-5.02	-4.19	-4.55	-5.00	-5.33	-4.72	-4.71	-4.68
24	-4.18	-4.49	-4.65	-4.55	-4.49	-5.23	-4.74	-4.16	-5.02	-4.18	-4.71	-5.09	-5.33	-4.81	-4.84	-4.58
25	-4.35	-4.69	-4.95	-4.72	-4.68	-5.43	-5.01	-4.39	-5.25	-4.38	-5.06	-5.39	-5.65	-5.11	-5.12	-4.71
26	-4.03	-4.30	-4.65	-4.46	-4.33	-5.11	-4.81	-4.08	-5.00	-4.07	-4.81	-5.18	-5.43	-4.88	-4.91	-4.39
27	-3.80	-3.94	-4.38	-4.30	-4.07	-4.90	-4.68	-3.86	-4.87	-3.93	-4.67	-5.08	-5.26	-4.72	-4.75	-4.17
28	-3.60	-3.67	-4.09	-4.09	-3.86	-4.72	-4.53	-3.61	-4.68	-3.78	-4.46	-4.89	-5.12	-4.55	-4.47	-3.97
29	-3.38	-3.40	-3.78	-3.93	-3.67	-4.46	-4.29	-3.32	-4.41	-3.58	-4.17	-4.71	-4.92	-4.27	-4.10	-3.68
30	-3.32	-3.35	-3.64	-4.05	-3.76	-4.38	-4.18	-3.32	-4.37	-3.58	-4.11	-4.70	-4.87	-4.22	-4.01	-3.59
31	-2.81	-2.84	-3.12	-3.73	-3.45	-3.92	-3.71	-2.90	-3.90	-3.18	-3.64	-4.25	-4.45	-3.87	-3.50	-3.14
32	-2.42	-2.37	-2.70	-3.43	-3.19	-3.59	-3.38	-2.54	-3.54	-2.76	-3.22	-3.75	-4.02	-3.47	-3.00	-2.73
33	-2.03	-1.97	-2.29	-3.18	-2.90	-3.31	-3.05	-2.24	-3.32	-2.49	-2.86	-3.37	-3.72	-3.14	-2.66	-2.38
34	-1.84	-1.71	-2.09	-3.04	-2.71	-3.16	-2.91	-2.12	-3.14	-2.36	-2.50	-3.22	-3.52	-2.93	-2.56	-2.15
35	-1.63	-1.35	-1.80	-2.71	-2.37	-2.92	-2.59	-1.79	-2.71	-1.98	-2.04	-3.03	-3.16	-2.59	-2.22	-1.81
36	-1.25	-.83	-1.31	-2.17	-2.01	-2.52	-2.06	-1.34	-2.10	-1.43	-1.53	-2.66	-2.60	-2.13	-1.78	-1.35
37	-1.15	-.68	-1.09	-1.89	-1.88	-2.34	-1.81	-1.17	-1.84	-1.16	-1.32	-2.53	-2.30	-1.86	-1.67	-1.11
38	-.82	-.34	-.70	-1.52	-1.44	-1.91	-1.38	-.70	-1.35	-.62	-.85	-2.09	-1.74	-1.29	-1.27	-.56
39	-.63	-.16	-.46	-1.37	-1.22	-1.71	-1.21	-.47	-1.05	-.25	-.66	-1.83	-1.35	-.96	-1.01	-.28
40	-.27	.14	-.17	-1.10	-.95	-1.46	-.92	-.18	-.72	.18	-.38	-1.43	-.94	-.55	-.62	-.03
41	-.06	.27	.01	-1.01	-.84	-1.37	-.76	.04	-.53	.43	-.17	-1.09	-.77	-.36	-.32	.08
42	.38	.64	.50	-.66	-.40	-.98	-.35	.54	-.06	.91	.32	-.56	-.40	.03	.19	.50
43	.39	.61	.48	-.79	-.45	-1.05	-.43	.52	-.09	.96	.34	-.54	-.38	-.07	.17	.43
44	.68	.71	.56	-.65	-.31	-.91	-.25	.69	.17	1.19	.54	-.26	-.20	.01	.36	.53
45	.78	.68	.52	-.55	-.26	-.84	-.15	.80	.36	1.29	.57	-.06	-.14	.00	.44	.47
46	.98	.82	.61	-.30	-.11	-.66	-.03	.94	.59	1.48	.70	.10	.05	.07	.64	.47
47	1.02	.74	.56	-.10	-.06	-.62	-.03	.85	.71	1.56	.73	.02	.21	.04	.68	.41
48	.65	.44	.08	-.28	-.40	-.93	-.37	.36	.53	1.27	.40	-.51	-.05	-.40	.26	-.01
49	.61	.51	-.07	-.21	-.60	-.95	-.48	.06	.54	1.13	.24	-.75	-.06	-.54	.04	-.15
50	.39	.18	-.26	-.33	-.93	-1.05	-.73	-.35	.22	.81	-.02	-1.08	-.19	-.80	-.27	-.45
51	.62	.38	.13	.03	-.63	-.65	-.44	-.07	.41	.99	.18	-.84	.19	-.43	.12	-.27
52	.14	.03	-.29	-.39	-.92	-.94	-.93	-.44	-.14	.43	-.28	-1.27	-.17	-.72	-.24	-.66
53	.30	.30	-.02	-.17	-.49	-.54	-.66	-.08	.00	.51	-.05	-1.01	.18	-.50	.13	-.36
54	-.02	.10	-.05	-.42	-.65	-.67	-.91	-.19	-.24	.12	-.33	-1.11	.00	-.87	-.04	-.49
55	.16	.33	.42	-.06	-.37	-.29	-.59	.10	.16	.14	-.25	-.61	.13	-.55	.22	-.18
56	-.17	-.03	.34	-.15	-.65	-.45	-.74	.01	.04	-.25	-.74	-.60	-.29	-.61	-.05	-.46
57	-.13	-.37	.30	.08	-.71	-.48	-.60	.24	.04	-.40	-.97	-.25	-.37	-.50	-.11	-.42
58	-.07	-.61	-.13	-.06	-.97	-.77	-.57	.12	-.35	-.58	-1.31	-.25	-.66	-.82	-.31	-.67
59	.25	-.76	-.09	-.05	-.74	-.48	-.31	.05	-.50	-.62	-1.34	-.52	-1.12	-1.51	-.76	-.82
60	-2.90	-6.35	-4.06	-3.40	-3.10	-3.77	-4.21	-5.64	-5.94	-7.18	-8.17	-8.03	-9.09	-9.30	-8.54	-8.88
61	.83	.83	.83	.83	.83	.83	.83	.83	.83	.83	.83	.83	.83	.83	.83	.83
62	.97	.97	.97	.97	.97	.97	.97	.97	.97	.97	.97	.97	.97	.97	.97	.97

NOAA-9 SCANNER OFFSETS FOR MARCH 1986: SHORTWAVE CHANNEL
 DAY OF MONTH --->

S.P.	1	2	3	4	5	6	7	8	9	10	11	12	13	14	15
1	-.11	-.11	-.11	-.11	-.11	-.11	-.11	-.11	-.11	-.11	-.11	-.11	-.11	*****	*****
2	.32	.32	.32	.32	.32	.32	.32	.32	.32	.32	.32	.32	.32	*****	*****
3	.49	.49	.49	.49	.49	.49	.49	.49	.49	.49	.49	.49	.49	*****	*****
4	-4.09	-4.09	-4.09	-4.09	-4.09	-4.09	-4.09	-4.09	-4.09	-4.09	-4.09	-4.09	-4.09	*****	*****
5	.96	1.09	1.09	1.09	1.03	.79	1.08	1.04	.88	.70	.74	.59	.72	*****	*****
6	1.03	1.08	1.09	1.15	1.06	.85	1.19	1.24	1.18	.88	.83	.68	.79	*****	*****
7	.67	.72	.72	.77	.70	.50	.83	.92	.95	.54	.44	.31	.41	*****	*****
8	.93	.97	1.02	1.07	.94	.82	1.15	1.26	1.29	.88	.79	.67	.76	*****	*****
9	.93	.98	.94	.99	.90	.85	1.16	1.24	1.20	.88	.81	.68	.76	*****	*****
10	.49	.56	.51	.57	.51	.50	.69	.72	.74	.46	.41	.29	.36	*****	*****
11	.77	.83	.78	.90	.91	.87	.99	1.13	1.19	.88	.81	.68	.77	*****	*****
12	.72	.75	.73	.82	.82	.79	.85	.96	.97	.88	.82	.68	.79	*****	*****
13	-.13	-.10	-.19	-.05	-.07	-.07	.00	.00	.06	-.01	-.07	-.19	-.10	*****	*****
14	.22	.30	.08	.27	.23	.25	.29	.28	.31	.25	.23	.12	.23	*****	*****
15	.30	.38	.24	.36	.30	.30	.43	.36	.26	.24	.25	.14	.26	*****	*****
16	-.11	.04	-.05	.08	-.06	-.09	.07	.04	-.08	-.18	-.15	-.28	-.16	*****	*****
17	.18	.23	.26	.36	.23	.22	.39	.44	.34	.20	.20	.07	.18	*****	*****
18	.12	.15	.17	.26	.15	.21	.35	.41	.43	.21	.24	.09	.20	*****	*****
19	-.28	-.25	-.35	-.19	-.27	-.22	-.11	-.05	.04	-.20	-.17	-.31	-.20	*****	*****
20	.10	.14	.10	.22	.11	.17	.33	.36	.34	.17	.19	.05	.16	*****	*****
21	.12	.22	.18	.31	.22	.29	.50	.46	.38	.17	.21	.08	.17	*****	*****
22	-.30	-.22	-.31	-.17	-.25	-.20	-.13	-.12	-.05	-.27	-.24	-.37	-.27	*****	*****
23	.11	.19	.03	.17	.09	.14	.21	.19	.31	.14	.15	.01	.12	*****	*****
24	.11	.21	.08	.19	.12	.17	.22	.23	.32	.17	.18	.05	.16	*****	*****
25	-.26	-.15	-.27	-.14	-.24	-.23	-.19	-.19	-.18	-.25	-.22	-.35	-.23	*****	*****
26	.09	.11	.05	.17	.09	.13	.18	.18	.22	.13	.17	.04	.16	*****	*****
27	.13	.13	.05	.17	.09	.17	.20	.20	.22	.15	.20	.07	.18	*****	*****
28	-.25	-.24	-.33	-.20	-.27	-.22	-.18	-.18	-.17	-.23	-.19	-.32	-.20	*****	*****
29	.16	.13	.03	.15	.07	.18	.16	.18	.22	.17	.20	.09	.20	*****	*****
30	.30	.32	.15	.30	.20	.30	.44	.40	.29	.23	.27	.16	.27	*****	*****
31	-.06	-.01	-.10	.07	-.04	-.07	.13	.13	-.09	-.13	-.10	-.21	-.08	*****	*****
32	.29	.33	.25	.43	.28	.28	.47	.41	.33	.24	.27	.16	.28	*****	*****
33	.18	.27	.18	.41	.20	.22	.35	.31	.27	.15	.20	.08	.19	*****	*****
34	-.24	-.13	-.25	-.03	-.22	-.13	-.08	-.10	-.16	-.23	-.18	-.29	-.20	*****	*****
35	.17	.22	.11	.33	.18	.25	.33	.31	.25	.19	.24	.12	.24	*****	*****
36	.24	.29	.13	.40	.24	.33	.43	.39	.37	.26	.32	.19	.31	*****	*****
37	-.10	-.02	-.15	.09	-.09	.01	.10	.09	.05	-.06	.00	-.13	-.02	*****	*****
38	.29	.33	.24	.50	.30	.41	.45	.41	.43	.37	.42	.29	.40	*****	*****
39	.36	.37	.25	.45	.34	.47	.47	.38	.41	.42	.47	.35	.46	*****	*****
40	.01	.03	-.10	.09	-.02	.14	.11	.02	.00	.07	.12	.00	.12	*****	*****
41	.43	.43	.29	.46	.35	.58	.51	.40	.36	.49	.54	.43	.54	*****	*****
42	.52	.50	.34	.53	.42	.62	.58	.46	.43	.55	.61	.50	.62	*****	*****
43	.16	.15	-.02	.18	.06	.25	.20	.09	.04	.19	.25	.13	.25	*****	*****
44	.50	.49	.39	.59	.45	.62	.59	.47	.39	.56	.62	.50	.62	*****	*****
45	.48	.49	.35	.59	.47	.63	.59	.48	.38	.56	.62	.51	.63	*****	*****
46	.09	.12	-.03	.17	.07	.24	.17	.07	-.01	.17	.24	.12	.24	*****	*****
47	.47	.50	.34	.54	.43	.62	.57	.45	.39	.55	.62	.50	.62	*****	*****
48	.50	.53	.38	.58	.46	.66	.60	.48	.40	.59	.66	.54	.66	*****	*****
49	.09	.11	-.06	.14	.04	.26	.18	.06	-.02	.18	.26	.14	.25	*****	*****
50	.47	.49	.32	.51	.40	.69	.57	.45	.37	.58	.65	.53	.64	*****	*****
51	.52	.56	.35	.57	.44	.70	.61	.48	.38	.62	.69	.56	.67	*****	*****
52	.16	.20	-.01	.19	.09	.35	.25	.11	.02	.26	.34	.20	.31	*****	*****
53	1.00	.95	.82	.98	.94	1.23	1.13	1.04	.89	1.12	1.19	1.04	1.15	*****	*****
54	1.33	1.23	1.15	1.26	1.23	1.50	1.38	1.30	1.15	1.44	1.52	1.37	1.47	*****	*****
55	.99	.91	.86	.98	.93	1.19	1.09	1.00	.79	1.09	1.17	1.04	1.13	*****	*****
56	1.34	1.28	1.19	1.34	1.27	1.55	1.48	1.37	1.12	1.44	1.52	1.38	1.47	*****	*****
57	1.36	1.34	1.22	1.34	1.29	1.56	1.49	1.38	1.12	1.46	1.53	1.39	1.49	*****	*****
58	.96	.91	.82	.94	.91	1.16	1.05	.94	.72	1.07	1.14	1.00	1.09	*****	*****
59	1.28	1.20	1.13	1.22	1.22	1.49	1.36	1.26	1.06	1.43	1.48	1.35	1.44	*****	*****
60	1.22	1.15	1.08	1.17	1.17	1.42	1.29	1.18	.98	1.37	1.42	1.29	1.38	*****	*****
61	3.05	3.05	3.05	3.05	3.05	3.05	3.05	3.05	3.05	3.05	3.05	3.05	3.05	*****	*****
62	.45	.45	.45	.45	.45	.45	.45	.00	.00	.45	.45	.45	.45	*****	*****

NOAA-9 SCANNER OFFSETS FOR MARCH 1986: SHORTWAVE CHANNEL

S.P.	DAY OF MONTH -->															
	16	17	18	19	20	21	22	23	24	25	26	27	28	29	30	31
1	-.11	-.11	-.11	-.11	-.11	-.11	-.11	-.11	-.11	-.11	-.11	-.11	-.11	-.11	-.11	-.11
2	.32	.32	.32	.32	.32	.32	.32	.32	.32	.32	.32	.32	.32	.32	.32	.32
3	.49	.49	.49	.49	.49	.49	.49	.49	.49	.49	.49	.49	.49	.49	.49	.49
4	-4.09	-4.09	-4.09	-4.09	-4.09	-4.09	-4.09	-4.09	-4.09	-4.09	-4.09	-4.09	-4.09	-4.09	-4.09	-4.09
5	.68	.54	.36	.29	.22	.32	.28	.57	.51	.71	.72	.74	.78	1.00	.59	.85
6	.73	.59	.43	.38	.32	.40	.40	.62	.62	.81	.82	.83	.87	1.10	.73	.96
7	.42	.22	.07	.03	-.01	.05	.05	.31	.32	.45	.45	.51	.51	.74	.41	.62
8	.76	.58	.42	.38	.35	.41	.40	.71	.73	.83	.80	.83	.90	1.12	.84	1.03
9	.79	.62	.44	.40	.37	.44	.43	.72	.81	.89	.90	.88	.96	1.19	.88	1.06
10	.43	.24	.05	.01	-.02	.04	.04	.27	.37	.54	.46	.47	.58	.83	.45	.62
11	.79	.59	.43	.40	.36	.41	.43	.66	.75	.85	.80	.75	.93	1.17	.80	.97
12	.83	.59	.46	.45	.41	.45	.47	.69	.70	.79	.76	.66	.89	1.14	.72	.91
13	.05	-.27	-.37	-.34	-.36	-.34	-.42	-.20	-.21	-.05	-.12	-.25	.01	.28	-.18	.03
14	.27	.02	-.13	-.13	-.19	-.15	-.22	.04	.06	.23	.25	.10	.34	.61	.15	.41
15	.29	.07	-.08	-.10	-.16	-.10	-.16	.05	.07	.29	.25	.11	.30	.59	.16	.44
16	-.11	-.35	-.47	-.50	-.54	-.49	-.60	-.38	-.33	-.11	-.16	-.32	-.12	.22	-.25	.03
17	.21	-.01	-.13	-.17	-.21	-.16	-.28	-.06	.04	.24	.18	.02	.25	.58	.10	.37
18	.21	.01	-.12	-.16	-.20	-.15	-.26	-.04	.04	.23	.21	.03	.27	.59	.10	.36
19	-.19	-.40	-.51	-.55	-.58	-.54	-.67	-.42	-.35	-.17	-.20	-.39	-.16	.19	-.26	-.04
20	.17	-.02	-.15	-.19	-.23	-.19	-.31	-.06	-.01	.17	.16	.01	.22	.56	.10	.32
21	.18	-.01	-.15	-.18	-.23	-.20	-.28	-.03	-.05	-.17	.17	.05	.24	.59	.11	.29
22	-.24	-.45	-.57	-.60	-.63	-.61	-.69	-.48	-.49	-.27	-.30	-.45	-.23	.06	-.37	-.24
23	.13	-.07	-.19	-.25	-.28	-.25	-.31	-.12	-.13	.07	.07	-.07	.14	.35	-.06	.09
24	.15	-.04	-.17	-.23	-.26	-.23	-.30	-.08	-.08	.08	.11	-.06	.18	.33	-.02	.09
25	-.23	-.43	-.55	-.61	-.64	-.60	-.70	-.43	-.50	-.33	-.30	-.45	-.22	-.01	-.39	-.30
26	.14	-.03	-.16	-.23	-.27	-.23	-.34	-.06	-.14	.04	.08	-.08	.15	.38	-.06	.16
27	.17	-.01	-.13	-.21	-.24	-.20	-.31	-.07	-.13	.06	.12	-.04	.17	.36	-.07	.17
28	-.22	-.39	-.51	-.59	-.62	-.58	-.70	-.47	-.52	-.32	-.28	-.43	-.25	-.08	-.49	-.25
29	.17	.01	-.13	-.21	-.25	-.21	-.32	-.12	-.15	.07	.13	-.01	.13	.38	-.09	.17
30	.22	.08	-.07	-.17	-.21	-.17	-.29	-.11	-.11	.14	.21	.09	.17	.45	-.06	.31
31	-.14	-.28	-.42	-.51	-.55	-.51	-.62	-.45	-.43	-.23	-.16	-.28	-.22	.01	-.43	-.05
32	.25	.11	-.02	-.13	-.17	-.13	-.25	-.07	-.04	.14	.20	.07	.13	.38	-.09	.30
33	.17	.03	-.12	-.23	-.28	-.23	-.37	-.16	-.12	.06	.13	-.01	.02	.26	-.25	.19
34	-.24	-.34	-.53	-.64	-.69	-.64	-.81	-.58	-.52	-.33	-.21	-.38	-.34	-.16	-.65	-.20
35	.17	.05	-.11	-.22	-.27	-.22	-.38	-.16	-.11	.05	.16	.00	.03	.26	-.20	.21
36	.23	.11	-.05	-.16	-.22	-.17	-.31	-.10	-.04	.12	.23	.07	.07	.33	-.13	.26
37	-.10	-.22	-.37	-.49	-.55	-.49	-.65	-.44	-.38	-.23	-.10	-.27	-.28	-.01	-.44	-.05
38	.30	.20	.02	-.10	-.16	-.10	-.23	-.02	.05	.21	.32	.17	.09	.41	-.03	.34
39	.37	.25	.09	-.04	-.09	-.03	-.17	.07	.11	.26	.38	.22	.11	.40	-.01	.33
40	.02	-.08	-.25	-.39	-.44	-.37	-.50	-.29	-.24	-.10	.06	-.10	-.22	-.01	-.36	-.05
41	.44	.36	.15	.00	-.04	.02	-.09	.10	.15	.32	.50	.35	.18	.35	.09	.39
42	.52	.40	.23	.09	.04	.11	.01	.20	.22	.35	.54	.38	.21	.39	.20	.49
43	.14	.04	-.12	-.27	-.30	-.24	-.38	-.21	-.16	-.03	.17	.00	-.17	-.01	-.12	.12
44	.52	.41	.25	.10	.07	.13	-.01	.12	.19	.32	.53	.37	.18	.34	.24	.49
45	.51	.41	.24	.09	.06	.12	-.01	.12	.19	.32	.54	.37	.20	.30	.25	.43
46	.13	.03	-.13	-.29	-.32	-.25	-.40	-.28	-.20	-.07	.16	-.02	-.21	-.18	-.11	.02
47	.50	.41	.24	.08	.04	.11	-.04	.09	.17	.28	.54	.36	.15	.12	.26	.42
48	.54	.45	.27	.11	.08	.15	.01	.12	.20	.31	.57	.39	.16	.08	.32	.43
49	.15	.06	-.11	-.27	-.31	-.24	-.39	-.28	-.19	-.08	.18	-.01	-.26	-.37	-.08	.05
50	.52	.47	.25	.09	.04	.11	-.05	.06	.17	.31	.60	.38	.14	-.07	.28	.41
51	.55	.47	.29	.13	.09	.16	.03	.11	.20	.30	.59	.40	.15	-.07	.32	.49
52	.17	.11	-.07	-.23	-.27	-.19	-.34	-.23	-.16	-.06	.24	.06	-.20	-.43	-.04	.13
53	.86	.99	.68	.44	.40	.50	.43	.56	.64	.77	1.13	.99	.67	.43	.83	1.01
54	1.32	1.36	1.09	.87	.84	.91	.85	.91	1.02	1.12	1.44	1.29	.94	.68	1.09	1.30
55	1.00	1.01	.79	.57	.56	.63	.57	.59	.66	.77	1.11	.98	.60	.39	.74	.93
56	1.35	1.35	1.13	.92	.91	.98	.92	.93	1.00	1.10	1.45	1.33	.95	.86	1.08	1.25
57	1.36	1.36	1.13	.92	.92	.98	.91	.93	1.01	1.10	1.46	1.35	.93	.89	1.13	1.28
58	.97	.97	.73	.53	.52	.58	.52	.55	.62	.72	1.08	.96	.51	.47	.73	.93
59	1.32	1.31	1.09	.88	.87	.93	.87	.88	.96	1.05	1.42	1.31	.85	.79	1.03	1.26
60	1.28	1.27	1.05	.84	.82	.88	.83	.86	.92	1.01	1.38	1.25	.77	.73	.97	1.19
61	3.05	3.05	3.05	3.05	3.05	3.05	3.05	3.05	3.05	3.05	3.05	3.05	3.05	3.05	3.05	3.05
62	.45	.45	.45	.45	.45	.45	.45	.00	.45	.00	.45	.45	.00	.00	.00	.00

NOAA-9 SCANNER OFFSETS FOR APRIL 1986: TOTAL CHANNEL																
S.P.	DAY OF MONTH -->										11	12	13	14	15	
	1	2	3	4	5	6	7	8	9	10						
1	.36	.36	.36	.36	.36	.36	.36	.36	.36	.36	.36	.36	.36	.36	.36	.36
2	1.04	1.04	1.04	1.04	1.04	1.04	1.04	1.04	1.04	1.04	1.04	1.04	1.04	1.04	1.04	1.04
3	1.93	1.93	1.93	1.93	1.93	1.93	1.93	1.93	1.93	1.93	1.93	1.93	1.93	1.93	1.93	1.93
4	-9.64	-9.64	-9.64	-9.64	-9.64	-9.64	-9.64	-9.64	-9.64	-9.64	-9.64	-9.64	-9.64	-9.64	-9.64	-9.64
5	-4.46	-4.19	-4.13	-5.18	-6.17	-11.89	-8.30	-9.02	-10.55	-8.15	-6.32	-3.63	-3.83	-4.81	-3.43	
6	.13	.15	.02	.09	-.15	-2.06	.07	-.43	-.65	-.42	.14	.54	.18	-.16	.72	
7	-.47	1.01	-.15	.72	.55	.31	1.41	1.21	1.32	.74	1.23	1.07	.84	.44	.99	
8	-1.31	-.52	-2.75	-1.65	-1.54	-1.35	-.62	-.77	-.72	-1.45	-.86	-.82	-1.13	-1.69	-1.30	
9	-1.75	-.99	-3.44	-2.39	-2.24	-1.65	-.93	-1.41	-1.18	-2.03	-1.28	-1.37	-1.56	-2.27	-1.90	
10	-2.02	-1.28	-3.57	-2.45	-2.48	-1.90	-.79	-1.65	-1.33	-2.04	-1.27	-1.28	-1.52	-2.12	-2.30	
11	-1.65	-.81	-2.84	-1.92	-2.07	-1.68	-.10	-1.10	-.96	-1.23	-.77	-.82	-.98	-1.18	-2.01	
12	-2.28	-1.18	-3.17	-2.65	-2.67	-2.41	-.59	-1.41	-1.58	-1.23	-1.38	-1.47	-1.21	-1.34	-2.51	
13	-2.99	-2.04	-3.64	-3.63	-3.75	-3.25	-1.43	-2.06	-2.26	-1.74	-2.18	-2.27	-1.89	-2.08	-3.37	
14	-2.60	-2.02	-3.18	-3.61	-3.84	-3.25	-1.48	-1.99	-2.14	-1.57	-2.20	-2.16	-1.88	-2.10	-3.30	
15	-2.32	-2.11	-2.68	-3.59	-3.75	-3.19	-1.29	-1.81	-1.98	-1.20	-2.18	-2.18	-1.81	-2.04	-3.19	
16	-2.15	-2.33	-2.41	-3.80	-3.57	-3.27	-1.03	-1.67	-1.89	-.98	-2.28	-2.21	-1.95	-2.08	-3.13	
17	-1.61	-2.22	-1.80	-3.74	-3.18	-3.01	-.57	-1.41	-1.58	-.81	-2.06	-1.90	-1.79	-1.97	-2.81	
18	-1.54	-2.49	-1.62	-4.21	-3.32	-3.14	-1.01	-1.80	-1.80	-1.04	-2.32	-2.19	-2.21	-2.31	-3.06	
19	-.84	-2.00	-1.04	-3.98	-2.82	-2.74	-.93	-1.52	-1.46	-.70	-1.92	-1.91	-2.00	-2.00	-2.69	
20	-.43	-1.57	-.74	-3.77	-2.53	-2.61	-.86	-1.54	-1.33	-.65	-1.60	-1.78	-1.90	-1.90	-2.62	
21	.21	-.82	-.34	-3.16	-1.91	-2.18	-.34	-1.20	-1.06	-.27	-.99	-1.35	-1.45	-1.54	-2.27	
22	.51	-.41	-.14	-2.85	-1.64	-2.01	-.03	-.97	-.98	-.19	-.75	-1.29	-1.16	-1.59	-2.20	
23	-.05	-.90	-.82	-3.35	-2.23	-2.74	-.65	-1.66	-1.65	-.70	-1.20	-1.87	-1.64	-2.39	-2.85	
24	.49	-.32	-.36	-2.73	-1.68	-2.15	-.16	-1.30	-1.26	-.06	-.48	-1.17	-.97	-1.94	-2.17	
25	.21	-.61	-.85	-3.06	-1.97	-2.42	-.54	-1.74	-1.78	-.21	-.64	-1.33	-1.19	-2.15	-2.37	
26	.59	-.26	-.46	-2.61	-1.46	-1.92	-.12	-1.37	-1.57	.15	-.24	-.69	-.79	-1.61	-2.01	
27	1.21	.43	.26	-1.96	-.67	-1.03	.61	-.74	-.95	.63	.48	.21	.00	-.75	-1.41	
28	1.12	.40	.21	-2.03	-.52	-.94	.61	-.70	-1.01	.44	.45	.31	.03	-.65	-1.53	
29	1.26	.64	.43	-1.75	-.23	-.77	.92	-.40	-.90	.57	.64	.70	.22	-.30	-1.34	
30	1.29	.48	.36	-1.68	-.37	-.98	.98	-.49	-1.07	.38	.53	.74	.07	-.44	-1.41	
31	1.49	.55	.32	-1.61	-.58	-1.01	1.12	-.45	-1.00	.28	.49	.81	.04	-.47	-1.40	
32	1.82	.92	.57	-1.39	-.57	-.78	1.42	-.32	-.87	.36	.74	1.05	.17	-.28	-1.13	
33	2.15	1.14	.74	-1.14	-.43	-.53	1.75	-.05	-.76	.46	1.00	1.12	.42	.06	-.89	
34	2.22	1.22	.62	-1.14	-.47	-.42	1.84	.03	-.75	.29	.98	.99	.38	.13	-.82	
35	2.38	1.38	.69	-1.01	-.43	-.05	2.12	.29	-.44	.47	1.04	1.10	.43	.44	-.47	
36	2.50	1.38	.61	-1.03	-.53	.11	2.16	.34	-.22	.47	.99	1.16	.48	.57	-.24	
37	2.95	1.81	1.07	-.45	-.16	.63	2.65	.77	.46	.96	1.58	1.83	.99	1.09	.46	
38	2.31	1.41	.60	-.88	-.66	.22	2.21	.39	.19	.53	1.37	1.37	.61	.63	.14	
39	2.01	1.38	.35	-1.04	-.76	.20	2.03	.44	.19	.38	1.33	1.25	.60	.49	.10	
40	1.77	1.08	-.17	-1.30	-1.06	.09	1.65	.15	-.10	-.02	1.12	1.06	.32	.02	-.19	
41	1.95	1.19	-.30	-1.27	-1.07	.28	1.66	.13	-.12	-.17	1.16	1.05	.27	-.20	-.21	
42	2.58	1.59	-.05	-.83	-.76	.78	2.04	.61	.28	.11	1.43	1.34	.50	-.01	.09	
43	2.56	1.49	-.22	-.77	-.70	.67	1.97	.64	.34	.08	1.20	1.21	.35	-.19	.04	
44	2.19	1.12	-.74	-1.10	-.93	.19	1.67	.49	-.02	-.34	.89	.76	.03	-.53	-.23	
45	1.91	.70	-1.12	-1.29	-1.19	-.22	1.53	.35	-.39	-.86	.70	.27	-.20	-.75	-.42	
46	1.54	.32	-1.50	-1.46	-1.49	-.58	1.41	.03	-.69	-1.32	.47	-.23	-.62	-.99	-.72	
47	.62	-.42	-2.34	-2.15	-2.18	-1.38	.81	-.68	-1.29	-2.15	-.20	-.97	-1.52	-1.74	-1.46	
48	-.21	-.93	-3.09	-2.60	-2.68	-1.90	.40	-1.25	-1.72	-2.63	-.87	-1.52	-2.21	-2.47	-1.83	
49	-1.17	-1.52	-3.97	-3.27	-3.32	-2.43	-.10	-1.95	-2.25	-3.17	-1.61	-2.03	-2.91	-3.35	-2.38	
50	-1.55	-1.50	-4.00	-3.27	-3.24	-2.42	-.12	-2.01	-2.19	-3.13	-1.75	-1.90	-2.80	-3.69	-2.40	
51	-1.70	-1.52	-3.74	-3.02	-2.90	-2.44	-.18	-1.75	-2.09	-2.83	-1.74	-1.80	-2.41	-4.05	-2.38	
52	-2.12	-1.81	-3.72	-3.33	-3.05	-2.80	-.77	-1.80	-2.40	-3.00	-2.07	-1.91	-2.48	-4.55	-2.91	
53	-.62	-.35	-2.20	-2.23	-1.79	-1.43	.09	-.60	-1.10	-1.74	-.74	-.49	-.97	-3.20	-1.93	
54	-.24	.23	-1.71	-1.93	-1.37	-.95	.28	-.26	-.52	-1.15	-.34	-.45	-.50	-2.73	-1.73	
55	-.41	.09	-1.58	-1.99	-1.33	-1.15	.05	-.34	-.49	-.91	-.46	-.78	-.58	-2.51	-1.99	
56	-.55	-.02	-1.61	-1.93	-1.42	-1.12	-.28	-.51	-.55	-.73	-.32	-.69	-.53	-2.06	-2.01	
57	-1.37	-1.04	-2.65	-2.72	-2.41	-1.64	-1.27	-1.58	-1.45	-1.42	-.84	-1.19	-1.33	-2.55	-3.03	
58	-1.43	-1.50	-2.45	-3.02	-2.85	-1.88	-1.29	-2.09	-1.75	-1.26	-.95	-1.24	-1.70	-2.70	-3.93	
59	-.60	-1.45	-1.84	-3.06	-2.44	-1.32	-.24	-1.43	-1.26	-.34	-.62	-1.48	-1.86	-2.29	-3.97	
60	-8.15	-9.58	-10.63	-11.56	-9.14	-3.64	-4.10	-5.35	-4.23	-5.28	-7.16	-10.08	-10.11	-9.55	-11.34	
61	11.19	11.19	11.19	11.19	11.19	11.19	11.19	11.19	11.19	11.19	11.19	11.19	11.19	11.19	11.19	11.19
62	.00	.00	.00	.00	.00	.00	.00	.00	.00	.00	.00	.00	.00	.00	.00	.00

MOAA-9 SCANNER OFFSETS FOR APRIL 1986: TOTAL CHANNEL															
S.P.	DAY OF MONTH -->														
	16	17	18	19	20	21	22	23	24	25	26	27	28	29	30
1	.36	.36	.36	.36	.36	.36	.36	.36	.36	.36	.36	.36	.36	.36	.36
2	1.04	1.04	1.04	1.04	1.04	1.04	1.04	1.04	1.04	1.04	1.04	1.04	1.04	1.04	1.04
3	1.93	1.93	1.93	1.93	1.93	1.93	1.93	1.93	1.93	1.93	1.93	1.93	1.93	1.93	1.93
4	-9.64	-9.64	-9.64	-9.64	-9.64	-9.64	-9.64	-9.64	-9.64	-9.64	-9.64	-9.64	-9.64	-9.64	-9.64
5	-3.26	-2.85	-2.64	-3.49	-3.54	-3.01	-4.77	-10.26	-9.94	-8.50	-7.60	-5.43	-3.89	-3.16	-2.09
6	.21	1.24	1.63	.84	.45	.66	-.65	-1.81	-1.60	-.70	-.60	-.06	.45	.51	.96
7	.90	1.79	2.17	1.81	.89	1.14	.42	.00	.14	.96	.30	.72	1.16	1.19	1.22
8	-1.03	-.06	-.22	.02	-1.22	-.84	-1.13	-1.68	-1.27	-.62	-1.92	-1.20	-.43	-.46	-.67
9	-1.66	-.30	-.72	-.76	-1.73	-1.61	-1.29	-1.67	-1.20	-.99	-2.75	-1.83	-1.06	-.82	-.86
10	-1.71	-.34	-.82	-1.37	-1.73	-2.26	-1.35	-1.33	-.81	-1.16	-3.12	-2.27	-1.49	-1.13	-.86
11	-1.22	.31	-.34	-.95	-1.27	-2.01	-1.00	-.77	.05	-.69	-2.66	-2.11	-1.15	-.99	-.42
12	-1.94	-.14	-.92	-1.35	-1.97	-2.67	-1.49	-1.38	-.36	-1.37	-2.86	-2.65	-1.79	-1.74	-.75
13	-2.90	-1.03	-1.84	-2.19	-2.89	-3.79	-2.37	-2.29	-1.17	-2.30	-3.29	-3.27	-2.78	-2.87	-1.35
14	-2.81	-.89	-1.92	-2.01	-2.67	-3.83	-2.31	-2.46	-1.17	-2.31	-2.94	-3.04	-2.92	-3.09	-1.16
15	-2.70	-.77	-1.62	-1.85	-2.49	-3.44	-2.25	-2.51	-1.12	-2.21	-2.66	-2.84	-3.14	-3.30	-1.12
16	-2.85	-.78	-1.41	-1.71	-2.49	-2.96	-2.22	-2.74	-1.22	-2.18	-2.35	-2.65	-3.45	-3.43	-1.32
17	-2.65	-.63	-1.00	-1.22	-2.14	-2.29	-1.98	-2.56	-1.08	-1.71	-1.78	-2.24	-3.32	-3.11	-1.15
18	-3.08	-.95	-1.13	-1.20	-2.30	-2.17	-2.18	-2.69	-1.40	-1.73	-1.82	-2.56	-3.49	-3.18	-1.32
19	-2.93	-.70	-.73	-.72	-1.94	-1.46	-1.83	-2.03	-1.03	-1.22	-1.36	-2.36	-3.03	-2.66	-.76
20	-2.87	-.52	-.63	-.61	-1.76	-.87	-1.85	-1.44	-.84	-1.13	-1.23	-2.12	-2.78	-2.22	-.43
21	-2.40	-.05	-.21	-.22	-1.31	-.13	-1.49	-.70	-.49	-.73	-.83	-1.50	-2.13	-1.54	.13
22	-2.25	.19	-.05	-.08	-1.12	.09	-1.21	-.48	-.49	-.57	-.63	-1.25	-1.95	-1.25	.43
23	-2.91	-.34	-.66	-.73	-1.75	-.62	-1.58	-1.07	-1.20	-1.25	-1.13	-1.76	-2.58	-1.59	-.13
24	-2.23	.26	-.15	-.34	-1.24	.03	-.90	-.41	-.62	-.66	-.46	-1.14	-2.05	-.77	.43
25	-2.26	-.04	-.46	-.82	-1.59	-.19	-1.07	-.70	-.92	-.82	-.59	-1.47	-2.39	-.93	.15
26	-1.64	.31	-.10	-.66	-1.07	.13	-.58	-.27	-.62	-.45	-.08	-1.11	-1.90	-.45	.55
27	-.78	.95	.57	-.16	-.37	.67	.08	.49	.03	.18	.53	-.37	-1.23	.13	1.23
28	-.71	.92	.66	-.33	-.38	.51	-.13	.35	-.25	.26	.48	-.34	-1.21	.04	1.08
29	-.43	1.11	.86	-.07	-.17	.59	.06	.39	-.27	.63	.63	-.02	-.78	.38	1.19
30	-.47	.86	.67	-.17	-.30	.38	-.06	.17	-.58	.47	.48	.03	-.75	.37	1.01
31	-.63	.77	.64	-.12	-.25	.25	-.16	.01	-.73	.35	.38	.09	-.79	.42	.94
32	-.52	.91	.75	.11	.10	.50	-.02	-.12	-.56	.35	.58	.44	-.58	.68	1.19
33	-.23	1.01	.96	.21	.41	.93	.24	-.13	-.38	.49	.80	.84	-.25	.88	1.54
34	-.18	.85	1.00	.13	.40	1.16	.12	-.20	-.47	.54	.71	1.02	-.16	.94	1.60
35	.02	.82	1.14	.31	.58	1.52	.10	-.07	-.32	.80	.78	1.13	.16	1.10	1.77
36	.27	.77	1.20	.47	.57	1.63	-.04	-.09	-.28	.99	.94	1.14	.38	1.14	1.90
37	.99	1.45	1.81	1.14	1.18	2.23	.40	.34	.15	1.51	1.65	1.63	.93	1.55	2.47
38	.69	1.16	1.54	.87	.81	1.89	.00	-.07	-.31	1.17	1.36	1.21	.64	.95	2.15
39	.63	1.02	1.40	.91	.70	1.77	-.11	-.29	-.53	1.20	1.26	1.12	.61	.77	2.02
40	.42	.75	.98	.70	.47	1.42	-.20	-.69	-1.00	.90	.94	.94	.32	.60	1.50
41	.41	.73	.73	.68	.48	1.28	-.08	-.91	-.87	.78	.85	1.01	.14	.59	1.30
42	.80	1.00	.99	1.02	.84	1.43	.29	-.96	-.43	.95	1.08	1.31	.20	.85	1.47
43	.78	.80	.79	.90	.75	1.29	.18	-1.33	-.60	.83	.94	1.32	.05	.82	1.27
44	.65	.38	.40	.52	.39	1.12	-.37	-1.85	-.98	.58	.45	1.07	-.32	.51	.94
45	.30	.02	-.01	.32	.07	1.01	-.80	-2.14	-1.27	.39	.01	.87	-.40	.13	.58
46	-.04	-.36	-.56	.02	-.24	.59	-1.22	-2.36	-1.59	.14	-.49	.37	-.52	-.40	.13
47	-.99	-1.01	-1.45	-.78	-1.07	-.16	-2.04	-2.99	-2.12	-.60	-1.30	-.75	-1.20	-1.27	-.56
48	-2.16	-1.31	-2.07	-1.25	-1.67	-.77	-2.73	-3.52	-2.48	-1.25	-1.83	-1.52	-1.82	-1.95	-1.17
49	-3.19	-1.80	-2.71	-1.80	-2.49	-1.61	-3.49	-4.03	-3.02	-1.96	-2.31	-2.40	-2.48	-2.81	-1.99
50	-3.18	-1.61	-2.69	-1.69	-2.39	-1.69	-3.41	-3.83	-2.92	-2.05	-2.11	-2.35	-2.52	-3.00	-2.17
51	-2.72	-1.38	-2.60	-1.51	-2.08	-1.72	-3.17	-3.47	-2.73	-2.10	-1.89	-2.06	-2.62	-2.92	-2.15
52	-2.83	-1.62	-2.67	-1.78	-2.27	-2.32	-3.23	-3.61	-2.95	-2.27	-2.10	-2.09	-3.19	-3.27	-2.23
53	-1.35	-.18	-1.05	-.31	-.80	-1.11	-1.47	-2.43	-1.77	-.64	-.63	-.41	-1.88	-2.00	-.54
54	-.54	.24	-.48	.20	-.31	-.53	-.75	-2.05	-1.30	.11	-.02	.09	-1.27	-1.72	-.06
55	.08	.21	-.43	.16	-.50	-.36	-.71	-1.93	-1.15	.01	.16	-.09	-.82	-1.75	.28
56	.23	.05	-.53	.24	-.78	-.36	-.52	-1.64	-.84	.13	.01	-.16	-.48	-1.64	.90
57	-.79	-.78	-1.37	-.89	-1.58	-1.54	-1.40	-2.16	-1.52	-.43	-1.16	-1.04	-1.27	-2.14	.63
58	-1.84	-1.09	-1.57	-1.44	-2.00	-2.48	-2.26	-1.78	-1.37	-.71	-1.57	-1.29	-1.75	-2.36	.71
59	-2.20	-1.19	-1.34	-1.39	-1.85	-2.35	-2.06	-.78	-.43	-.22	-.46	-.44	-1.43	-1.87	.86
60	-10.37	-9.33	-9.43	-8.70	-8.85	-8.80	-8.45	-3.27	-2.74	-3.24	-3.23	-5.23	-6.78	-7.29	-6.23
61	11.19	11.19	11.19	11.19	11.19	11.19	11.19	11.19	11.19	11.19	11.19	11.19	11.19	11.19	11.19
62	.00	.00	.00	.00	.00	.00	.00	.00	.00	.00	.00	.00	.00	.00	.00

NOAA-9 SCANNER OFFSETS FOR APRIL 1986: LONGWAVE CHANNEL

S.P.	DAY OF MONTH -->														
	1	2	3	4	5	6	7	8	9	10	11	12	13	14	15
1	.29	.29	.29	.29	.29	.29	.29	.29	.29	.29	.29	.29	.29	.29	.29
2	.59	.59	.59	.59	.59	.59	.59	.59	.59	.59	.59	.59	.59	.59	.59
3	.63	.63	.63	.63	.63	.63	.63	.63	.63	.63	.63	.63	.63	.63	.63
4	.27	.27	.27	.27	.27	.27	.27	.27	.27	.27	.27	.27	.27	.27	.27
5	-3.18	-2.66	-2.50	-3.04	-3.79	-7.12	-5.11	-5.50	-6.50	-5.31	-4.08	-2.40	-2.38	-2.87	-2.12
6	-.87	-.47	-.38	-.22	-.56	-1.73	-.56	-.83	-1.06	-1.14	-.63	-.29	-.40	-.52	-.03
7	-.80	-.06	-.64	.07	-.22	-.37	.14	.07	.05	-.54	-.10	-.11	-.15	-.32	-.03
8	-1.81	-.91	-2.19	-1.30	-1.43	-1.33	-1.05	-1.09	-1.16	-1.81	-1.33	-1.21	-1.27	-1.57	-1.37
9	-2.35	-1.45	-2.89	-1.98	-2.12	-1.82	-1.52	-1.77	-1.75	-2.45	-1.87	-1.83	-1.78	-2.18	-2.00
10	-2.79	-1.90	-3.22	-2.24	-2.51	-2.22	-1.64	-2.17	-2.11	-2.69	-2.09	-2.03	-1.99	-2.30	-2.49
11	-2.88	-1.91	-3.03	-2.18	-2.52	-2.37	-1.50	-2.13	-2.20	-2.46	-2.06	-2.03	-1.93	-2.08	-2.90
12	-3.29	-2.12	-3.19	-2.65	-2.88	-2.84	-1.80	-2.34	-2.61	-2.46	-2.46	-2.42	-2.05	-2.08	-2.90
13	-3.64	-2.57	-3.38	-3.21	-3.44	-3.23	-2.22	-2.58	-2.88	-2.61	-2.86	-2.81	-2.35	-2.44	-3.32
14	-3.79	-2.98	-3.46	-3.57	-3.88	-3.58	-2.61	-2.88	-3.11	-2.81	-3.25	-3.11	-2.71	-2.81	-3.65
15	-3.78	-3.23	-3.30	-3.70	-3.98	-3.70	-2.64	-2.93	-3.11	-2.72	-3.43	-3.30	-2.84	-2.88	-3.72
16	-3.82	-3.53	-3.30	-4.05	-4.04	-3.90	-2.61	-2.97	-3.15	-2.71	-3.68	-3.49	-3.08	-3.03	-3.79
17	-3.72	-3.67	-3.15	-4.32	-3.99	-3.96	-2.53	-3.00	-3.13	-2.80	-3.77	-3.52	-3.23	-3.16	-3.77
18	-3.92	-4.05	-3.28	-4.92	-6.30	-4.26	-3.02	-3.44	-3.46	-3.15	-4.17	-3.94	-3.71	-3.58	-4.12
19	-3.69	-3.96	-3.13	-5.03	-4.16	-4.21	-3.17	-3.45	-3.41	-3.11	-4.15	-3.97	-3.78	-3.59	-4.05
20	-3.68	-3.92	-3.22	-5.20	-4.24	-4.39	-3.37	-3.71	-3.55	-3.37	-4.23	-4.16	-4.01	-3.79	-4.26
21	-3.43	-3.59	-3.15	-4.95	-3.99	-4.23	-3.14	-3.60	-3.49	-3.26	-3.99	-4.01	-3.90	-3.74	-4.18
22	-3.47	-3.57	-3.24	-4.94	-3.99	-4.32	-3.13	-3.66	-3.65	-3.43	-4.07	-4.19	-3.97	-4.01	-4.36
23	-4.07	-4.14	-3.94	-5.50	-4.61	-4.99	-3.72	-4.29	-4.27	-4.04	-4.62	-4.81	-4.54	-4.78	-5.05
24	-3.80	-3.85	-3.73	-5.15	-4.33	-4.64	-3.41	-4.08	-3.97	-3.72	-4.24	-4.42	-4.20	-4.58	-4.70
25	-4.27	-4.31	-4.32	-5.60	-4.77	-5.00	-3.85	-4.58	-4.45	-4.06	-4.58	-4.77	-4.61	-5.00	-5.07
26	-4.12	-4.16	-4.11	-5.38	-4.53	-4.69	-3.58	-4.33	-4.31	-3.84	-4.37	-4.41	-4.42	-4.71	-4.91
27	-3.77	-3.76	-3.66	-5.00	-4.07	-4.07	-3.06	-3.87	-3.89	-3.48	-3.92	-3.84	-3.92	-4.19	-4.54
28	-3.77	-3.76	-3.64	-5.01	-3.97	-3.98	-2.99	-3.76	-3.86	-3.53	-3.87	-3.74	-3.87	-4.11	-4.59
29	-3.61	-3.55	-3.47	-4.76	-3.77	-3.83	-2.72	-3.49	-3.74	-3.41	-3.68	-3.47	-3.73	-3.83	-4.44
30	-3.49	-3.55	-3.49	-4.63	-3.81	-3.88	-2.57	-3.43	-3.75	-3.43	-3.65	-3.41	-3.76	-3.81	-4.40
31	-3.13	-3.27	-3.26	-4.32	-3.72	-3.69	-2.26	-3.16	-3.48	-3.25	-3.40	-3.12	-3.53	-3.57	-4.13
32	-2.71	-2.79	-2.88	-3.96	-3.49	-3.39	-1.87	-2.89	-3.22	-2.97	-2.96	-2.71	-3.20	-3.20	-3.73
33	-2.17	-2.34	-2.50	-3.51	-3.11	-2.92	-1.36	-2.42	-2.86	-2.55	-2.42	-2.34	-2.74	-2.65	-3.28
34	-1.74	-1.95	-2.23	-3.15	-2.77	-2.50	-.95	-2.02	-2.52	-2.25	-2.03	-2.03	-2.38	-2.22	-2.85
35	-1.25	-1.46	-1.80	-2.69	-2.31	-1.88	-.42	-1.51	-1.96	-1.73	-1.56	-1.56	-1.94	-1.62	-2.24
36	-.82	-1.13	-1.53	-2.36	-1.99	-1.44	-.08	-1.18	-1.49	-1.39	-1.27	-1.17	-1.59	-1.23	-1.76
37	-.14	-.53	-.91	-1.63	-1.36	-.79	.57	-.58	-.74	-.72	-.59	-.40	-.92	-.58	-.97
38	-.18	-.40	-.86	-1.53	-1.31	-.73	.65	-.49	-.61	-.62	-.42	-.36	-.81	-.55	-.82
39	-.01	-.03	-.68	-1.27	-1.01	-.38	.91	-.12	-.30	-.36	-.09	-.11	-.47	-.27	-.47
40	.20	.12	-.63	-1.08	-.85	-.07	1.02	.04	-.15	-.28	.11	.12	-.28	-.20	-.28
41	.69	.50	-.40	-.72	-.53	.42	1.38	.34	.18	-.02	.48	.45	.03	-.01	.04
42	1.39	1.03	.04	-.14	-.02	1.03	1.91	.94	.72	.44	.97	.93	.47	.36	.49
43	1.74	1.30	.24	.20	.34	1.25	2.17	1.27	1.06	.72	1.13	1.15	.65	.47	.72
44	1.74	1.26	.11	.22	.40	1.14	2.20	1.40	1.02	.66	1.15	1.06	.61	.39	.72
45	1.74	1.16	.05	.30	.42	1.06	2.30	1.53	.99	.54	1.24	.94	.63	.39	.76
46	1.66	1.05	-.06	.35	.36	.98	2.38	1.48	.95	.39	1.25	.75	.50	.37	.73
47	1.15	.65	-.59	-.03	-.02	.51	2.05	1.09	.64	-.06	.88	.36	-.01	-.03	.34
48	.75	.40	-.98	-.21	-.22	.30	1.92	.86	.51	-.25	.59	.14	-.30	-.33	.22
49	.14	.00	-1.55	-.66	-.63	-.04	1.61	.41	.18	-.60	.12	-.17	-.72	-.92	-.15
50	-.12	.03	-1.56	-.65	-.57	-.03	1.60	.36	.23	-.59	.03	-.08	-.65	-1.18	-.17
51	-.13	.16	-1.23	-.37	-.25	.05	1.64	.62	.38	-.32	.12	.10	-.29	-1.34	-.09
52	-.47	-.08	-1.24	-.63	-.40	-.26	1.18	.53	.10	-.50	-.18	-.06	-.40	-1.79	-.54
53	.19	.59	-.48	-.18	.12	.41	1.48	1.07	.71	.05	.36	.52	.26	-1.25	-.23
54	.33	.89	-.22	-.08	.28	.54	1.45	1.14	.91	.29	.49	.46	.46	-1.10	-.23
55	.18	.82	-.17	-.16	.26	.35	1.25	1.02	.86	.38	.38	.20	.34	-1.03	-.48
56	.04	.70	-.24	-.17	.15	.30	.98	.86	.77	.44	.41	.19	.28	-.82	-.58
57	-.61	-.02	-.99	-.77	-.57	-.13	.24	.08	.10	-.07	-.02	-.23	-.35	-1.26	-1.36
58	-1.03	-.66	-1.22	-1.30	-1.20	-.62	-.12	-.60	-.47	-.30	-.42	-.60	-.97	-1.71	-2.33
59	-.44	-.59	-.78	-1.28	-.88	-.22	.61	-.15	-.19	.36	-.14	-.69	-1.02	-1.41	-2.32
60	-4.92	-5.42	-6.01	-6.32	-4.86	-1.71	-1.71	-2.52	-2.07	-2.62	-4.05	-5.82	-5.94	-5.71	-6.65
61	.83	.83	.83	.83	.83	.83	.83	.83	.83	.83	.83	.83	.83	.83	.83
62	.00	.00	.00	.00	.00	.00	.00	.00	.00	.00	.00	.00	.00	.00	.00

NOAA-9 SCANNER OFFSETS FOR APRIL 1986: LONGWAVE CHANNEL

S.P.	DAY OF MONTH -->														
	16	17	18	19	20	21	22	23	24	25	26	27	28	29	30
1	.29	.29	.29	.29	.29	.29	.29	.29	.29	.29	.29	.29	.29	.29	.29
2	.59	.59	.59	.59	.59	.59	.59	.59	.59	.59	.59	.59	.59	.59	.59
3	.63	.63	.63	.63	.63	.63	.63	.63	.63	.63	.63	.63	.63	.63	.63
4	.27	.27	.27	.27	.27	.27	.27	.27	.27	.27	.27	.27	.27	.27	.27
5	-2.20	-1.89	-1.74	-2.28	-2.29	-1.93	-3.00	-6.28	-6.13	-5.33	-4.78	-3.46	-2.55	-2.10	-1.54
6	-.54	.16	.45	-.08	-.33	-.15	-.96	-1.71	-1.63	-1.13	-1.07	-.69	-.37	-.34	-.18
7	-.26	.34	.61	.30	-.22	-.02	-.43	-.70	-.68	-.23	-.67	-.36	-.09	-.09	-.24
8	-1.37	-.73	-.82	-.78	-1.45	-1.17	-1.30	-1.65	-1.46	-1.13	-1.97	-1.49	-1.00	-1.04	-1.34
9	-2.07	-1.14	-1.42	-1.54	-2.01	-1.93	-1.65	-1.93	-1.66	-1.64	-2.77	-2.18	-1.69	-1.55	-1.69
10	-2.35	-1.42	-1.73	-2.14	-2.24	-2.61	-1.95	-1.95	-1.62	-2.01	-3.25	-2.72	-2.21	-2.00	-1.93
11	-2.33	-1.32	-1.73	-2.14	-2.24	-2.77	-2.03	-1.87	-1.35	-2.02	-3.27	-2.93	-2.31	-2.21	-1.95
12	-2.76	-1.56	-2.06	-2.33	-2.67	-3.18	-2.32	-2.28	-1.62	-2.46	-3.41	-3.27	-2.72	-2.68	-2.14
13	-3.23	-1.98	-2.54	-2.70	-3.13	-3.79	-2.75	-2.75	-1.99	-2.90	-3.54	-3.53	-3.24	-3.31	-2.42
14	-3.52	-2.26	-2.99	-2.98	-3.39	-4.21	-3.12	-3.24	-2.39	-3.27	-3.70	-3.79	-3.76	-3.88	-2.71
15	-3.58	-2.33	-2.98	-3.05	-3.46	-4.14	-3.28	-3.45	-2.56	-3.36	-3.67	-3.82	-4.10	-4.21	-2.86
16	-3.78	-2.50	-3.00	-3.11	-3.63	-3.97	-3.45	-3.74	-2.79	-3.50	-3.62	-3.85	-4.49	-4.47	-3.14
17	-3.87	-2.63	-2.96	-3.00	-3.62	-3.74	-3.52	-3.83	-2.95	-3.41	-3.48	-3.80	-4.65	-4.48	-3.27
18	-4.39	-3.08	-3.27	-3.21	-3.95	-3.87	-3.87	-4.15	-3.43	-3.63	-3.74	-4.24	-4.99	-4.74	-3.61
19	-4.52	-3.14	-3.23	-3.11	-3.92	-3.64	-3.86	-3.94	-3.41	-3.50	-3.64	-4.31	-4.90	-4.60	-3.44
20	-4.74	-3.26	-3.40	-3.32	-4.06	-3.50	-4.16	-3.81	-3.56	-3.69	-3.82	-4.42	-4.97	-4.56	-3.48
21	-4.58	-3.09	-3.26	-3.21	-3.90	-3.16	-4.07	-3.46	-3.48	-3.56	-3.69	-4.16	-4.67	-4.26	-3.28
22	-4.69	-3.18	-3.39	-3.36	-4.03	-3.24	-4.11	-3.53	-3.70	-3.67	-3.79	-4.22	-4.74	-4.27	-3.30
23	-5.38	-3.78	-4.04	-4.05	-4.71	-3.96	-4.58	-4.16	-4.39	-4.38	-4.35	-4.80	-5.41	-4.75	-3.93
24	-5.02	-3.47	-3.77	-3.87	-4.47	-3.62	-4.18	-3.79	-4.07	-4.04	-3.97	-4.47	-5.21	-4.31	-3.69
25	-5.31	-3.92	-4.21	-4.46	-4.95	-4.00	-4.53	-4.20	-4.46	-4.35	-4.29	-4.92	-5.69	-4.67	-4.13
26	-4.98	-3.76	-4.02	-4.43	-4.68	-3.85	-4.26	-3.96	-4.28	-4.13	-4.04	-4.75	-5.45	-4.45	-3.93
27	-4.44	-3.36	-3.59	-4.12	-4.24	-3.52	-3.83	-3.47	-3.83	-3.71	-3.67	-4.28	-5.01	-4.12	-3.50
28	-4.35	-3.35	-3.48	-4.16	-4.21	-3.59	-3.91	-3.50	-3.95	-3.60	-3.67	-4.22	-4.95	-4.16	-3.57
29	-4.11	-3.19	-3.31	-3.93	-4.02	-3.47	-3.73	-3.42	-3.87	-3.29	-3.51	-3.95	-4.61	-3.91	-3.46
30	-4.08	-3.27	-3.36	-3.91	-4.02	-3.51	-3.66	-3.48	-3.92	-3.29	-3.51	-3.84	-4.50	-3.83	-3.49
31	-3.96	-3.08	-3.15	-3.63	-3.73	-3.37	-3.49	-3.32	-3.75	-3.13	-3.33	-3.56	-4.28	-3.56	-3.28
32	-3.67	-2.77	-2.83	-3.24	-3.29	-2.99	-3.21	-3.18	-3.44	-2.92	-3.01	-3.12	-3.92	-3.15	-2.90
33	-3.18	-2.41	-2.36	-2.83	-2.77	-2.37	-2.76	-2.86	-2.97	-2.54	-2.56	-2.55	-3.39	-2.67	-2.32
34	-2.77	-2.14	-1.92	-2.51	-2.39	-1.84	-2.49	-2.57	-2.64	-2.15	-2.27	-2.08	-2.97	-2.28	-1.91
35	-2.23	-1.75	-1.40	-1.97	-1.88	-1.19	-2.12	-2.13	-2.12	-1.59	-1.85	-1.64	-2.38	-1.78	-1.41
36	-1.74	-1.43	-1.00	-1.49	-1.51	-.73	-1.88	-1.82	-1.69	-1.12	-1.40	-1.29	-1.88	-1.39	-.95
37	-.92	-.67	-.28	-.70	-.75	.01	-1.25	-1.20	-1.06	-.43	-.56	-.63	-1.17	-.74	-.21
38	-.77	-.53	-.11	-.51	-.61	.16	-1.17	-1.11	-1.03	-.31	-.39	-.58	-1.01	-.77	-.03
39	-.49	-.28	.15	-.12	-.31	.43	-.89	-.88	-.83	.04	-.12	-.30	-.68	-.54	.24
40	-.29	-.09	.24	.06	-.10	.54	-.62	-.77	-.82	.18	.01	-.07	-.53	-.30	.25
41	.05	.24	.42	.36	.24	.77	-.20	-.56	-.46	.39	.24	.28	-.35	.02	.45
42	.59	.70	.86	.87	.75	1.17	.31	-.28	.13	.79	.67	.74	-.03	.47	.84
43	.89	.87	1.03	1.09	1.00	1.38	.55	-.24	.39	1.05	.88	1.05	.17	.75	1.02
44	1.01	.80	.98	1.01	.99	1.50	.42	-.37	.43	1.14	.76	1.09	.14	.77	1.01
45	.99	.75	.91	1.02	.97	1.61	.32	-.36	.47	1.20	.67	1.14	.29	.70	.98
46	.91	.66	.70	.92	.90	1.48	.17	-.34	.42	1.18	.49	.97	.36	.50	.83
47	.35	.31	.18	.42	.42	1.05	-.32	-.68	.15	.77	.03	.29	-.03	-.03	.44
48	-.30	.26	-.09	.26	.15	.77	-.66	-.92	.03	.46	-.17	-.10	-.33	-.38	.16
49	-.97	-.03	-.47	-.02	-.34	.25	-1.13	-1.25	-.34	-.01	-.46	-.65	-.76	-.94	-.36
50	-.95	.11	-.43	.11	-.25	.20	-1.06	-1.13	-.32	-.09	-.31	-.63	-.79	-1.07	-.48
51	-.55	.36	-.26	.36	.08	.29	-.80	-.83	-.12	-.03	-.07	-.32	-.76	-.93	-.38
52	-.69	.12	-.35	.15	-.11	-.15	-.90	-1.00	-.37	-.22	-.29	-.40	-1.21	-1.21	-.50
53	-.05	.74	.39	.75	.54	.33	-.10	-.51	.12	.52	.38	.39	-.67	-.71	.26
54	.37	.92	.63	.92	.75	.60	.24	-.48	.19	.82	.61	.58	-.39	-.68	.45
55	.71	.85	.59	.83	.57	.68	.21	-.49	.18	.67	.66	.41	-.14	-.73	.61
56	.71	.67	.45	.82	.34	.62	.24	-.38	.27	.65	.49	.27	.01	-.72	.93
57	-.08	.05	-.19	.03	-.27	-.25	-.45	-.83	-.29	.15	-.38	-.42	-.61	-1.13	.67
58	-1.12	-.49	-.66	-.65	-.90	-1.23	-1.38	-.98	-.60	-.43	-1.03	-.96	-1.30	-1.62	.35
59	-1.31	-.51	-.48	-.59	-.80	-1.12	-1.24	-.32	.00	-.11	-.31	-.41	-1.07	-1.26	.43
60	-6.14	-5.37	-5.31	-5.00	-4.98	-4.94	-5.06	-1.90	-1.46	-1.97	-1.99	-3.29	-4.27	-4.47	-3.89
61	.83	.83	.83	.83	.83	.83	.83	.83	.83	.83	.83	.83	.83	.83	.83
62	.00	.00	.00	.00	.00	.00	.00	.00	.00	.00	.00	.00	.00	.00	.00

NOAA-9 SCANNER OFFSETS FOR APRIL 1986: SHORTWAVE CHANNEL
 DAY OF MONTH -->

S.P.	1	2	3	4	5	6	7	8	9	10	11	12	13	14	15
1	-.11	-.11	-.11	-.11	-.11	-.11	-.11	-.11	-.11	-.11	-.11	-.11	-.11	-.11	-.11
2	.32	.32	.32	.32	.32	.32	.32	.32	.32	.32	.32	.32	.32	.32	.32
3	.49	.49	.49	.49	.49	.49	.49	.49	.49	.49	.49	.49	.49	.49	.49
4	-4.09	-4.09	-4.09	-4.09	-4.09	-4.09	-4.09	-4.09	-4.09	-4.09	-4.09	-4.09	-4.09	-4.09	-4.09
5	.84	.60	.66	.71	.93	.94	.76	.82	1.06	1.02	.87	.92	1.04	1.24	1.20
6	.90	.66	.71	.80	1.03	1.09	.87	.97	1.18	1.10	.99	1.02	1.20	1.39	1.32
7	.47	.26	.34	.42	.62	.79	.54	.64	.86	.72	.64	.68	.86	1.05	.97
8	.81	.65	.72	.82	.98	1.19	.90	1.01	1.27	1.03	1.01	1.07	1.25	1.45	1.36
9	.82	.69	.79	.84	.98	1.24	.91	1.05	1.33	1.05	1.08	1.14	1.31	1.49	1.40
10	.44	.27	.40	.45	.58	.88	.50	.65	.98	.67	.71	.78	.92	1.09	1.00
11	.80	.66	.78	.85	.97	1.21	.85	1.03	1.33	1.02	1.07	1.14	1.28	1.49	1.39
12	.75	.60	.72	.81	.93	1.20	.82	1.07	1.32	1.07	1.06	1.10	1.27	1.49	1.37
13	-.15	-.32	-.20	-.10	.00	.36	.05	.26	.46	.25	.25	.28	.47	.69	.56
14	.17	-.01	.10	.22	.28	.56	.30	.50	.66	.47	.52	.61	.79	1.02	.92
15	.20	.04	.12	.20	.28	.57	.30	.53	.64	.51	.54	.58	.80	1.01	.97
16	-.25	-.38	-.32	-.23	-.14	.15	-.09	.12	.25	.12	.12	.17	.38	.61	.52
17	.08	-.07	.00	.13	.19	.45	.23	.40	.54	.41	.42	.52	.75	.94	.83
18	.10	-.08	.02	.18	.19	.43	.21	.35	.55	.41	.41	.51	.75	.89	.80
19	-.31	-.50	-.42	-.25	-.25	-.02	-.22	-.08	.11	-.02	.00	.08	.29	.45	.35
20	.05	-.15	-.06	.09	.08	.32	.11	.26	.45	.34	.36	.47	.67	.79	.66
21	.06	-.16	-.09	.04	.09	.31	.10	.24	.43	.38	.38	.49	.67	.82	.63
22	-.39	-.60	-.55	-.50	-.38	-.12	-.32	-.20	.02	-.07	-.05	.01	.24	.36	.14
23	-.04	-.22	-.24	-.19	-.05	.19	.02	.12	.35	.30	.33	.35	.59	.69	.48
24	-.04	-.22	-.26	-.19	-.05	.20	.03	.12	.30	.35	.36	.35	.59	.65	.51
25	-.39	-.61	-.70	-.67	-.49	-.21	-.39	-.28	-.17	.00	-.01	-.01	.18	.22	.12
26	.03	-.23	-.34	-.32	-.15	.13	-.02	.05	.14	.36	.37	.39	.52	.54	.45
27	.14	-.20	-.36	-.33	-.14	.10	-.01	.05	.14	.35	.39	.40	.51	.54	.42
28	-.24	-.59	-.81	-.77	-.55	-.30	-.39	-.35	-.27	-.06	-.02	-.01	.08	.15	-.01
29	.13	-.21	-.45	-.42	-.19	.04	-.04	.00	.09	.30	.35	.41	.49	.52	.36
30	.14	-.19	-.42	-.40	-.17	.06	.00	.03	.11	.34	.37	.49	.55	.48	.38
31	-.22	-.58	-.86	-.82	-.57	-.33	-.35	-.33	-.25	-.02	-.03	.06	.13	.07	-.04
32	-.17	-.22	-.55	-.50	-.26	.02	.01	-.01	.09	.31	.27	.37	.41	.35	.25
33	.08	-.37	-.65	-.63	-.39	-.11	-.10	-.12	-.05	.16	.08	.20	.28	.17	.12
34	-.34	-.73	-1.05	-1.05	-.82	-.57	-.51	-.56	-.48	-.29	-.35	-.24	-.14	-.30	-.34
35	.07	-.31	-.64	-.65	-.44	-.21	-.12	-.16	-.09	.10	.00	.12	.25	.08	.06
36	.16	-.25	-.59	-.61	-.42	-.19	-.06	-.09	-.06	.16	.07	.18	.32	.12	.12
37	-.21	-.58	-.92	-.96	-.80	-.56	-.37	-.43	-.42	-.18	-.22	-.11	.04	-.17	-.23
38	.20	-.20	-.51	-.57	-.43	-.17	.00	-.05	-.04	.19	.26	.34	.45	.25	.16
39	.22	-.22	-.48	-.55	-.41	-.15	.01	-.03	-.01	.21	.31	.42	.48	.25	.16
40	-.16	-.60	-.91	-.95	-.81	-.58	-.38	-.43	-.40	-.17	-.02	.09	.07	-.20	-.28
41	.21	-.16	-.53	-.58	-.43	-.24	-.01	-.06	-.07	.18	.36	.48	.43	.12	.05
42	.35	-.05	-.45	-.52	-.37	-.20	.05	.00	-.02	.28	.37	.47	.43	.17	.09
43	-.05	-.46	-.85	-.91	-.78	-.60	-.32	-.40	-.42	-.11	-.05	.08	.05	-.18	-.29
44	.25	-.08	-.53	-.57	-.43	-.26	.01	-.07	-.10	.26	.30	.42	.44	.18	.07
45	.25	-.09	-.55	-.60	-.45	-.28	-.01	-.13	-.14	.23	.28	.39	.42	.18	.05
46	-.13	-.48	-.98	-1.03	-.85	-.69	-.40	-.53	-.57	-.16	-.13	-.02	-.01	-.24	-.39
47	.22	-.14	-.58	-.66	-.49	-.35	-.05	-.20	-.25	.17	.22	.30	.30	.05	-.09
48	.23	-.12	-.55	-.65	-.46	-.34	-.03	-.19	-.26	.17	.19	.27	.25	-.03	-.12
49	-.22	-.51	-.99	-1.08	-.89	-.76	-.43	-.61	-.70	-.23	-.20	-.15	-.24	-.55	-.57
50	.13	-.15	-.59	-.72	-.54	-.41	-.09	-.27	-.39	.12	.15	.22	.11	-.20	-.23
51	.23	-.19	-.62	-.72	-.52	-.38	-.06	-.23	-.37	.15	.14	.23	.13	-.23	-.25
52	-.09	-.57	-1.02	-1.08	-.90	-.77	-.42	-.60	-.76	-.20	-.19	-.10	-.23	-.59	-.61
53	.82	.32	-.17	-.21	-.07	-.04	.31	.12	-.03	.53	.63	.78	.54	.23	.20
54	1.12	.60	.10	.05	.22	.34	.61	.42	.36	.84	.96	1.01	.80	.50	.46
55	.78	.18	-.29	-.29	-.11	.01	.30	.10	.04	.49	.55	.65	.42	.10	.06
56	1.08	.52	.06	.04	.22	.34	.62	.42	.36	.83	.88	.97	.76	.41	.38
57	1.06	.53	.04	.05	.22	.34	.62	.41	.35	.83	.90	.99	.75	.38	.35
58	.72	.10	-.37	-.35	-.18	-.06	.24	.02	-.05	.42	.49	.57	.33	-.05	-.06
59	1.05	.45	-.01	-.01	.17	.25	.56	.33	.28	.73	.77	.86	.59	.24	.25
60	.99	.36	-.05	-.07	.10	.20	.50	.27	.22	.65	.70	.75	.50	.12	.15
61	3.05	3.05	3.05	3.05	3.05	3.05	3.05	3.05	3.05	3.05	3.05	3.05	3.05	3.05	3.05
62	.00	.00	.00	.00	.00	.00	.00	.00	.00	.00	.00	.00	.00	.00	.00

NOAA-9 SCANNER OFFSETS FOR APRIL 1986: SHORTWAVE CHANNEL

S.P.	DAY OF MONTH -->														
	16	17	18	19	20	21	22	23	24	25	26	27	28	29	30
1	-.11	-.11	-.11	-.11	-.11	-.11	-.11	-.11	-.11	-.11	-.11	-.11	-.11	-.11	-.11
2	.32	.32	.32	.32	.32	.32	.32	.32	.32	.32	.32	.32	.32	.32	.32
3	.49	.49	.49	.49	.49	.49	.49	.49	.49	.49	.49	.49	.49	.49	.49
4	-4.09	-4.09	-4.09	-4.09	-4.09	-4.09	-4.09	-4.09	-4.09	-4.09	-4.09	-4.09	-4.09	-4.09	-4.09
5	1.03	1.01	.98	.94	.97	.88	1.09	.98	1.09	.98	.73	.85	.85	.87	.79
6	1.15	1.14	1.08	1.06	1.08	.98	1.22	1.10	1.27	1.11	.86	.96	.95	.98	.89
7	.80	.78	.74	.74	.71	.63	.89	.79	.95	.77	.52	.62	.58	.62	.54
8	1.18	1.18	1.15	1.13	1.07	1.01	1.29	1.20	1.35	1.14	.89	1.00	.97	1.00	.92
9	1.26	1.24	1.23	1.18	1.13	1.06	1.37	1.29	1.40	1.19	.96	1.07	1.03	1.06	.99
10	.87	.85	.84	.79	.76	.67	1.00	.96	1.05	.85	.61	.71	.62	.67	.64
11	1.25	1.22	1.22	1.18	1.13	1.06	1.37	1.30	1.44	1.18	.93	1.03	.96	1.00	.98
12	1.22	1.17	1.20	1.17	1.10	1.03	1.35	1.32	1.48	1.19	.94	1.00	.92	.95	.94
13	.42	.33	.38	.33	.28	.21	.50	.55	.70	.36	.15	.18	.06	.07	.08
14	.75	.65	.71	.66	.62	.56	.83	.78	.92	.63	.45	.52	.41	.42	.42
15	.78	.64	.74	.68	.65	.58	.85	.78	.93	.64	.44	.51	.41	.42	.39
16	.34	.25	.33	.25	.27	.19	.44	.33	.49	.24	.03	.11	.00	.02	-.03
17	.70	.61	.68	.61	.64	.54	.78	.63	.84	.58	.38	.44	.38	.38	.33
18	.71	.68	.71	.64	.66	.57	.79	.64	.92	.60	.40	.47	.42	.42	.34
19	.31	.28	.31	.23	.26	.18	.39	.29	.55	.23	.01	.06	.03	.02	-.07
20	.67	.66	.66	.60	.63	.57	.76	.67	.94	.60	.40	.44	.37	.41	.33
21	.63	.67	.66	.57	.60	.58	.76	.67	.95	.63	.42	.47	.41	.44	.36
22	.20	.22	.23	.12	.13	.12	.28	.20	.53	.20	-.02	.00	-.08	-.05	-.12
23	.59	.60	.62	.52	.53	.48	.64	.58	.88	.57	.35	.37	.32	.33	.24
24	.65	.62	.62	.53	.58	.52	.64	.64	.90	.62	.39	.40	.36	.37	.26
25	.29	.20	.20	.12	.19	.12	.23	.23	.55	.22	.00	.00	-.08	-.04	-.12
26	.66	.55	.55	.51	.59	.50	.61	.59	.93	.58	.38	.35	.26	.32	.23
27	.68	.55	.56	.52	.59	.52	.58	.61	.94	.61	.39	.35	.25	.32	.23
28	.28	.14	.18	.07	.18	.10	.13	.18	.49	.19	-.02	-.06	-.18	-.12	-.17
29	.67	.56	.59	.44	.59	.47	.51	.52	.80	.56	.38	.33	.20	.25	.26
30	.73	.59	.65	.50	.61	.49	.53	.53	.78	.62	.43	.38	.28	.29	.31
31	.29	.16	.31	.15	.19	.08	.12	.09	.37	.23	.00	-.03	-.16	-.11	-.12
32	.60	.47	.60	.50	.55	.44	.46	.37	.74	.57	.38	.32	.14	.21	.24
33	.49	.34	.45	.35	.47	.33	.36	.20	.61	.46	.29	.22	.03	.06	.13
34	.06	-.08	.02	-.03	.06	-.08	-.04	-.22	.18	.04	-.10	-.13	-.35	-.33	-.25
35	.43	.29	.40	.38	.46	.33	.35	.16	.54	.36	.25	.19	.00	.07	.11
36	.49	.33	.44	.42	.48	.38	.40	.23	.55	.42	.31	.24	.06	.11	.15
37	.17	.04	.15	.11	.17	.08	.04	-.12	.15	.04	-.04	-.11	-.29	-.25	-.20
38	.57	.52	.66	.53	.62	.52	.45	.29	.56	.43	.38	.29	.17	.17	.22
39	.62	.56	.73	.55	.64	.57	.49	.30	.61	.49	.43	.34	.22	.24	.27
40	.27	.21	.36	.19	.30	.24	.14	-.10	.25	.14	.09	-.02	-.12	-.09	-.09
41	.66	.59	.72	.58	.70	.63	.52	.27	.70	.58	.51	.39	.26	.31	.31
42	.69	.62	.75	.58	.73	.67	.55	.23	.72	.59	.50	.39	.23	.33	.33
43	.28	.22	.33	.16	.33	.28	.12	-.16	.27	.16	.10	-.02	-.12	-.08	-.07
44	.62	.57	.64	.48	.66	.63	.42	.16	.50	.47	.42	.32	.21	.27	.27
45	.58	.56	.62	.47	.63	.62	.40	.13	.41	.44	.40	.32	.21	.26	.25
46	.15	.14	.17	.10	.24	.20	.01	-.31	-.02	.02	-.02	-.10	-.19	-.16	-.15
47	.50	.46	.53	.44	.58	.54	.36	.02	.28	.35	.32	.23	.15	.18	.22
48	.51	.44	.51	.42	.57	.51	.35	.01	.29	.35	.34	.24	.15	.17	.23
49	.05	-.01	.03	-.04	.10	.05	-.11	-.39	-.13	-.03	-.05	-.18	-.29	-.25	-.19
50	.39	.32	.37	.27	.39	.38	.21	-.04	.26	.36	.31	.20	.05	.09	.15
51	.39	.31	.36	.23	.37	.38	.17	-.05	.23	.30	.31	.21	.06	.10	.16
52	.04	-.02	-.03	-.17	.00	-.01	-.21	-.43	-.15	-.10	-.06	-.15	-.30	-.30	-.19
53	.88	.81	.79	.71	.87	.87	.66	.27	.60	.73	.76	.67	.52	.55	.66
54	1.14	1.06	1.10	1.04	1.14	1.16	.95	.65	.99	1.10	1.10	.98	.80	.87	.96
55	.75	.69	.75	.65	.77	.77	.56	.29	.61	.74	.74	.62	.46	.52	.61
56	1.09	1.04	1.10	.97	1.09	1.09	.89	.61	.96	1.06	1.05	.95	.81	.87	.94
57	1.10	1.05	1.10	.95	1.07	1.09	.87	.60	.91	1.05	1.05	.97	.84	.89	.93
58	.66	.59	.64	.52	.66	.67	.44	.20	.49	.65	.64	.57	.43	.50	.54
59	.97	.90	.92	.84	1.01	.99	.74	.50	.78	.95	.95	.88	.73	.81	.87
60	.86	.83	.87	.76	.94	.90	.63	.42	.68	.85	.90	.80	.71	.74	.80
61	3.05	3.05	3.05	3.05	3.05	3.05	3.05	3.05	3.05	3.05	3.05	3.05	3.05	3.05	3.05
62	.00	.00	.00	.00	.00	.00	.00	.00	.00	.00	.00	.00	.00	.00	.00

S.P.	NOAA-9 SCANNER OFFSETS FOR MAY 1986: TOTAL CHANNEL														
	DAY OF MONTH -->														
	1	2	3	4	5	6	7	8	9	10	11	12	13	14	15
1	.36	.36	.36	.36	.36	.36	.36	.36	.36	.36	.36	.36	.36	.36	.36
2	1.04	1.04	1.04	1.04	1.04	1.04	1.04	1.04	1.04	1.04	1.04	1.04	1.04	1.04	1.04
3	1.93	1.93	1.93	1.93	1.93	1.93	1.93	1.93	1.93	1.93	1.93	1.93	1.93	1.93	1.93
4	-9.64	-9.64	-9.64	-9.64	-9.64	-9.64	-9.64	-9.64	-9.64	-9.64	-9.64	-9.64	-9.64	-9.64	-9.64
5	.30	.33	-1.24	-.90	-.19	.11	-.36	.38	-.41	.39	-.08	.05	.08	.28	-.19
6	12.99	13.12	12.44	12.55	12.98	12.92	12.34	12.87	12.55	13.04	12.72	12.66	12.47	12.84	12.67
7	3.71	3.31	3.55	3.72	3.75	3.38	3.35	3.34	3.45	4.04	3.81	3.60	3.08	3.70	4.21
8	3.47	2.39	3.62	3.63	3.22	3.18	3.14	2.79	3.21	3.82	3.28	3.00	2.65	3.34	4.22
9	1.20	.16	1.47	1.44	.80	1.13	1.01	.29	.97	1.20	.59	.70	.57	1.14	1.82
10	.39	-.25	.58	.44	-.24	.25	.23	-.67	-.09	.15	-.39	-.31	.19	.60	.85
11	-.39	-.38	.06	-.31	-1.25	-.23	-.29	-1.18	-.45	-.64	-1.11	-1.28	-.03	.18	.25
12	-1.04	-.66	-.58	-.69	-2.08	-.42	-.57	-1.25	-.76	-1.27	-1.83	-1.69	-.22	-.23	-.19
13	-1.75	-1.20	-1.55	-1.13	-2.94	-.95	-1.07	-1.45	-1.48	-1.93	-2.82	-2.27	-.89	-.86	-.92
14	-1.71	-.94	-1.87	-1.10	-3.08	-.98	-.98	-1.16	-1.71	-2.06	-3.17	-2.20	-1.04	-.81	-1.20
15	-1.62	-.74	-2.14	-1.33	-3.18	-.96	-.94	-.93	-1.98	-2.05	-3.42	-2.00	-1.06	-.73	-1.33
16	-1.60	-.51	-2.26	-1.49	-3.13	-.96	-.94	-.89	-2.26	-1.92	-3.47	-1.96	-1.13	-.82	-1.49
17	-1.84	-.50	-2.24	-1.54	-2.84	-1.16	-.72	-.88	-2.48	-1.97	-3.44	-1.94	-1.21	-1.03	-1.70
18	-2.29	-.69	-2.32	-1.67	-2.70	-1.45	-.69	-1.15	-2.69	-2.20	-3.47	-1.92	-1.34	-1.27	-2.08
19	-2.61	-.94	-2.68	-1.97	-2.76	-1.69	-1.05	-1.58	-2.98	-2.52	-3.64	-1.99	-1.62	-1.59	-2.52
20	-2.59	-1.05	-2.94	-2.01	-2.59	-1.71	-1.27	-1.75	-3.02	-2.64	-3.63	-1.96	-1.79	-1.74	-2.71
21	-2.42	-1.14	-2.93	-2.06	-2.32	-1.75	-1.40	-1.68	-2.99	-2.83	-3.46	-1.93	-1.71	-1.74	-2.95
22	-2.21	-1.25	-2.92	-2.05	-2.16	-1.83	-1.56	-1.63	-2.94	-3.02	-3.28	-2.01	-1.71	-1.82	-3.24
23	-1.88	-1.13	-2.59	-1.81	-1.74	-1.65	-1.41	-1.42	-2.75	-2.98	-2.94	-1.96	-1.43	-1.69	-3.14
24	-1.72	-.92	-2.09	-1.50	-1.28	-1.28	-1.22	-1.12	-2.57	-2.91	-2.69	-1.77	-1.17	-1.48	-2.93
25	-1.63	-.82	-1.52	-1.05	-.88	-.91	-1.07	-.98	-2.46	-2.82	-2.44	-1.52	-1.06	-1.26	-2.81
26	-1.10	-.80	-1.05	-.52	-.50	-.61	-.88	-.67	-2.15	-2.67	-2.00	-1.26	-.81	-.94	-2.55
27	-.90	-.66	-1.05	-.15	-.28	-.50	-.77	-.45	-2.01	-2.69	-1.75	-1.14	-.71	-.80	-2.46
28	-.94	-.61	-1.12	.10	-.16	-.53	-.68	-.41	-1.99	-2.63	-1.65	-1.08	-.80	-.85	-2.50
29	-.82	-.39	-.84	.44	-.01	-.38	-.50	-.27	-1.85	-2.36	-1.31	-.91	-.70	-.79	-2.34
30	-.66	-.12	-.54	.74	.20	-.07	-.32	-.01	-1.77	-2.09	-1.02	-.58	-.53	-.54	-2.16
31	-.38	-.01	-.49	.75	.38	.09	-.33	.16	-1.67	-1.85	-.90	-.37	-.53	-.35	-2.04
32	-.30	.52	-.07	1.10	.89	.46	-.01	.77	-1.18	-1.15	-.34	.11	-.17	.15	-1.43
33	.92	.97	.50	1.63	1.20	.70	.31	1.29	-.79	-.62	.19	.51	.16	.44	-.87
34	1.32	1.15	.86	2.12	1.47	.76	.52	1.56	-.56	-.32	.48	.79	.29	.55	-.63
35	1.67	1.34	1.23	2.62	1.84	.86	.76	1.79	-.36	.16	.73	1.06	.59	.88	-.32
36	1.79	1.58	1.43	2.96	2.05	.96	.92	1.97	-.22	.55	.91	1.23	.77	1.22	.01
37	1.81	1.71	1.50	3.06	1.97	.92	.96	1.81	-.22	.70	.97	1.18	.62	1.29	-.05
38	1.88	1.74	1.40	3.11	1.85	.84	.93	1.58	-.12	.84	1.09	1.14	.48	1.30	-.16
39	1.73	1.55	1.13	2.92	1.59	.62	.74	1.24	-.15	.86	.87	.91	.28	1.14	-.23
40	1.45	1.27	.86	2.56	1.34	.24	.55	.80	-.36	.74	.64	.61	.05	.75	-.38
41	1.38	1.18	.91	2.27	1.40	.12	.60	.70	-.20	.90	.84	.60	.15	.52	-.33
42	1.18	.93	.94	1.86	1.36	.06	.47	.50	-.15	.94	.80	.41	.11	.26	-.48
43	.86	.44	.89	1.37	1.03	-.12	.22	.26	-.17	.86	.43	.18	-.03	.04	-.68
44	.56	.15	.83	1.05	.70	-.20	-.11	.12	.00	.90	.10	.04	-.19	.05	-.71
45	.51	.00	.85	.93	.42	-.18	-.38	.02	-.07	1.09	-.05	-.17	-.54	-.10	-.72
46	.50	-.15	.88	.86	.10	-.33	-.67	-.14	-.33	1.11	-.32	-.49	-1.00	-.36	-.85
47	.45	-.17	1.02	.82	-.08	-.50	-.84	-.25	-.54	.99	-.59	-.70	-1.35	-.60	-.94
48	.31	-.28	1.15	.74	-.03	-.63	-1.04	-.34	-.72	.73	-.72	-.94	-1.69	-.86	-1.11
49	.27	-.41	1.10	.61	-.07	-.72	-1.21	-.42	-.74	.49	-.88	-1.12	-1.92	-1.19	-1.37
50	.37	-.37	1.11	.66	.00	-.67	-1.25	-.31	-.57	.35	-.83	-.84	-1.59	-1.38	-1.41
51	.19	-.29	.96	.47	.15	-.72	-1.21	-.10	-.59	.15	-.76	-.60	-1.26	-1.59	-1.46
52	-.23	-.29	.59	.00	.07	-1.10	-1.24	-.19	-.62	-.30	-.87	-.60	-1.27	-1.75	-1.60
53	-.04	.00	.51	-.05	.25	-.86	-.81	-.17	-.14	-.16	-.44	-.10	-.88	-1.18	-1.37
54	-.15	.02	.37	-.22	.17	-.64	-.64	-.45	-.17	-.24	-.58	-.14	-.83	-.92	-1.35
55	-.59	-.08	.26	-.49	-.13	-.43	-.68	-.37	-.33	-.32	-.93	-.69	-1.07	-1.01	-1.00
56	-.77	-.17	.33	-.40	-.42	-.02	-.59	.12	-.10	-.19	-.97	-1.23	-1.26	-.99	-.46
57	-1.38	-.61	.12	-.35	-.88	-.20	-.88	.12	-.08	-.36	-1.31	-1.78	-1.65	-1.02	-.19
58	-1.76	-1.28	-1.00	-.95	-1.45	-1.11	-1.14	-.57	-.59	-1.37	-2.53	-2.39	-2.22	-1.55	-.40
59	-3.15	-3.30	-3.35	-2.52	-3.47	-3.28	-2.62	-2.70	-2.85	-4.10	-4.66	-3.84	-3.96	-3.50	-2.81
60	-19.60	-19.23	-17.94	-17.24	-19.04	-18.74	-18.18	-18.07	-18.57	-19.04	-18.82	-18.18	-18.51	-18.08	-18.35
61	11.19	11.19	11.19	11.19	11.19	11.19	11.19	11.19	11.19	11.19	11.19	11.19	11.19	11.19	11.19
62	.00	.00	.00	.00	.00	.00	.00	.00	.00	.00	.00	.00	.00	.00	.00

S.P.	NOAA-9 SCANNER OFFSETS FOR MAY 1986: TOTAL CHANNEL															
	16	17	18	19	20	21	22	23	24	25	26	27	28	29	30	31
1	.36	.36	.36	.36	.36	.36	.36	.36	.36	.36	.36	.36	.36	.36	.36	.36
2	1.04	1.04	1.04	1.04	1.04	1.04	1.04	1.04	1.04	1.04	1.04	1.04	1.04	1.04	1.04	1.04
3	1.93	1.93	1.93	1.93	1.93	1.93	1.93	1.93	1.93	1.93	1.93	1.93	1.93	1.93	1.93	1.93
4	-9.64	-9.64	-9.64	-9.64	-9.64	-9.64	-9.64	-9.64	-9.64	-9.64	-9.64	-9.64	-9.64	-9.64	-9.64	-9.64
5	.37	.90	1.61	1.63	1.98	2.18	2.08	2.47	2.39	2.15	1.84	1.88	1.13	2.26	1.91	1.85
6	13.11	13.42	13.03	12.89	13.41	13.25	13.63	14.11	13.79	13.52	13.25	13.43	12.67	14.12	13.71	13.92
7	3.88	3.86	3.18	3.54	3.55	3.54	4.25	4.28	4.04	3.75	3.78	4.01	3.39	4.38	4.07	4.24
8	3.49	3.10	2.62	3.57	2.82	3.48	4.07	3.75	3.62	3.08	3.47	3.77	3.56	3.69	3.66	3.37
9	1.03	.97	.24	1.54	.20	1.36	1.99	1.56	1.44	.93	1.35	1.43	1.58	1.34	1.59	.53
10	.16	.47	-.47	.65	-.63	.73	1.12	.73	.63	.27	.63	.51	.71	.51	.85	-.89
11	-.52	.02	-.90	-.07	-1.10	.01	.56	.25	.14	-.04	.03	-.15	.02	.07	.26	-1.69
12	-.99	-.26	-1.53	-.73	-1.52	-.88	-.39	-.31	-.20	-.44	-.60	-.72	-.54	-.31	-.18	-2.04
13	-1.76	-.95	-2.48	-1.72	-2.12	-2.01	-.67	-1.16	-.67	-1.14	-1.53	-1.62	-1.51	-1.06	-.92	-2.71
14	-1.92	-1.27	-2.89	-2.01	-2.06	-2.33	-.67	-1.34	-.62	-1.27	-1.81	-1.77	-1.83	-1.17	-1.00	-2.77
15	-1.86	-1.50	-3.15	-2.06	-2.04	-2.55	-1.04	-1.41	-.57	-1.30	-1.93	-1.75	-1.85	-1.05	-.92	-2.75
16	-1.75	-1.74	-3.20	-2.05	-2.09	-2.88	-1.09	-1.42	-.55	-1.33	-2.04	-1.88	-1.89	-.88	-.84	-2.69
17	-1.77	-1.97	-3.20	-2.09	-2.26	-2.97	-1.23	-1.43	-.52	-1.18	-2.05	-2.10	-1.95	-.85	-.71	-2.50
18	-1.99	-2.28	-3.35	-2.17	-2.60	-3.11	-1.36	-1.57	-.49	-1.12	-2.04	-2.46	-2.09	-.97	-.86	-2.58
19	-2.23	-2.59	-3.54	-2.31	-2.84	-3.13	-1.51	-1.84	-.55	-1.09	-2.19	-2.93	-2.31	-1.26	-1.19	-2.82
20	-2.34	-2.67	-3.44	-2.41	-2.93	-2.93	-1.72	-1.90	-.63	-1.00	-2.26	-3.13	-2.35	-1.44	-1.38	-2.82
21	-2.45	-2.79	-3.38	-2.39	-2.96	-2.82	-2.35	-1.81	-.84	-1.07	-2.45	-3.13	-2.26	-1.59	-1.63	-2.71
22	-2.57	-2.89	-3.34	-2.26	-2.95	-2.76	-2.90	-1.65	-1.03	-1.07	-2.52	-3.08	-2.24	-1.69	-1.89	-2.73
23	-2.43	-2.69	-2.97	-1.93	-2.68	-2.47	-3.08	-1.33	-.94	-.88	-2.30	-2.93	-2.02	-1.63	-1.76	-2.55
24	-2.28	-2.60	-2.58	-1.54	-2.40	-1.97	-2.90	-1.09	-.80	-.60	-2.03	-2.59	-1.74	-1.55	-1.33	-2.31
25	-2.16	-2.46	-2.20	-1.29	-2.16	-1.83	-2.20	-.86	-.74	-.30	-1.84	-2.17	-1.45	-1.34	-1.00	-2.19
26	-1.94	-2.03	-1.74	-1.04	-1.81	-1.48	-1.70	-.52	-.59	.04	-1.58	-1.84	-1.23	-.93	-.59	-1.94
27	-1.84	-1.81	-1.46	-.83	-1.71	-1.35	-2.09	-.37	-.47	.14	-1.42	-1.72	-1.16	-.67	-.44	-1.60
28	-1.79	-1.94	-1.37	-.67	-1.73	-1.31	-2.23	-.44	-.51	.19	-1.34	-1.66	-1.21	-.70	-.43	-1.45
29	-1.48	-1.80	-1.30	-.44	-1.49	-1.12	-1.85	-.33	-.43	.40	-1.06	-1.43	-1.10	-.60	-.26	-1.26
30	-1.12	-1.57	-1.04	-.21	-1.22	-.85	-1.32	-.14	-.30	.61	-.87	-1.10	-.92	-.36	-.15	-.96
31	-1.02	-1.59	-.89	-.09	-1.03	-.76	-1.39	.03	-.19	.79	-.79	-.78	-.84	-.24	-.15	-.76
32	-.64	-1.15	-.48	.48	-.51	-.38	-.39	.59	.38	1.27	-.37	-.23	-.32	.19	.27	-.24
33	-.29	-.61	-.07	.97	.02	.06	-.22	1.13	.95	1.64	-.01	.22	.29	.63	.55	.25
34	-.07	-.19	.20	1.26	.44	.44	.57	1.37	1.30	1.88	.27	.45	.70	.86	.67	.53
35	.23	.18	.64	1.63	.87	.85	1.10	1.56	1.71	2.26	.56	.78	1.22	1.19	.92	.72
36	.60	.36	1.00	1.87	1.09	.96	.92	1.71	1.85	2.49	.77	.96	1.64	1.46	1.00	.76
37	.73	.34	1.07	1.83	1.17	.86	1.40	1.83	1.75	2.42	.95	.95	1.87	1.50	.94	.79
38	.81	.42	1.15	1.74	1.23	.93	1.85	1.90	1.83	2.37	1.11	.86	1.98	1.40	.87	.77
39	.90	.70	1.20	1.60	1.17	.90	.82	1.92	1.79	2.24	1.11	.79	1.87	1.21	.69	.65
40	.82	.76	1.05	1.39	1.03	.73	1.77	1.82	1.45	1.86	.94	.62	1.57	.98	.54	.38
41	.84	.90	1.03	1.36	1.19	.82	1.97	1.78	1.22	1.76	.98	.75	1.43	.93	.67	.29
42	.76	.88	1.01	1.15	1.24	.93	1.95	1.59	1.12	1.66	.87	.78	1.20	.81	.71	.15
43	.57	.68	.82	.77	1.05	.97	1.27	1.24	.85	1.33	.49	.43	.92	.70	.50	-.13
44	.53	.53	.59	.46	1.04	.96	1.03	1.07	.62	1.03	.30	.23	.80	.68	.41	-.20
45	.54	.31	.53	.18	1.00	.85	1.45	.92	.50	.74	.22	.20	.73	.58	.34	-.19
46	.47	.11	.42	-.06	.76	.97	2.09	.70	.37	.41	.04	.08	.54	.35	.22	-.20
47	.34	.04	.38	-.19	.51	.95	1.66	.67	.39	.22	.01	.00	.30	.14	.17	-.13
48	.17	-.23	.21	-.47	.38	.62	1.71	.57	.41	-.08	-.01	-.08	.00	-.09	.07	-.17
49	-.20	-.51	-.05	-.77	.28	.21	1.72	.40	.24	-.27	-.04	-.23	-.13	-.31	.03	-.25
50	-.19	-.49	-.07	-.93	.22	.27	2.22	.44	.03	-.28	.16	-.08	.00	-.25	.15	-.09
51	-.08	-.50	-.19	-1.20	.07	.03	1.33	.37	-.22	-.40	.44	.22	.04	-.22	.24	-.01
52	-.26	-.72	-.52	-1.51	-.26	-.35	.78	-.03	-.58	-.71	.40	.32	-.06	-.33	.12	-.19
53	-.18	-.46	-.51	-1.43	-.15	-.47	.90	-.22	-.47	-.61	.61	.67	.21	-.15	.27	-.21
54	-.69	-.34	-.91	-1.69	-.53	-1.02	-.29	-.75	-.49	-.79	.41	.35	-.04	-.22	-.09	-.54
55	-1.15	-.44	-1.53	-1.79	-1.08	-1.48	-.44	-1.24	-.45	-1.20	.07	-.24	-.69	-.34	-.63	-.72
56	-1.05	-.44	-1.92	-1.54	-1.28	-1.79	.29	-1.20	-.40	-1.56	-.15	-.61	-1.32	-.20	-.81	-.62
57	-1.13	-.54	-2.08	-1.68	-2.08	-1.82	-.19	-1.17	-.74	-2.17	-.74	-1.02	-1.93	-.19	-1.08	-.96
58	-1.64	-.91	-2.48	-2.26	-3.19	-2.60	-1.16	-1.66	-1.84	-2.69	-2.07	-1.89	-2.62	-.82	-1.50	-2.10
59	-3.56	-3.04	-4.71	-4.34	-4.89	-4.72	-3.58	-3.48	-4.30	-4.28	-4.29	-4.41	-4.38	-3.04	-3.47	-4.41
60	-17.95	-18.00	-19.59	-19.96	-19.81	-20.02	-18.83	-18.85	-19.42	-18.95	-18.93	-19.55	-18.63	-18.53	-18.27	-18.95
61	11.19	11.19	11.19	11.19	11.19	11.19	11.19	11.19	11.19	11.19	11.19	11.19	11.19	11.19	11.19	11.19
62	.00	.00	.00	.00	.00	.00	.00	.00	.00	.00	.00	.00	.00	.00	.00	.00

NOAA-9 SCANNER OFFSETS FOR MAY 1986: LONGWAVE CHANNEL
 DAY OF MONTH -->

S.P.	1	2	3	4	5	6	7	8	9	10	11	12	13	14	15
1	.29	.29	.29	.29	.29	.29	.29	.29	.29	.29	.29	.29	.29	.29	.29
2	.59	.59	.59	.59	.59	.59	.59	.59	.59	.59	.59	.59	.59	.59	.59
3	.63	.63	.63	.63	.63	.63	.63	.63	.63	.63	.63	.63	.63	.63	.63
4	.27	.27	.27	.27	.27	.27	.27	.27	.27	.27	.27	.27	.27	.27	.27
5	.33	.29	-.66	-.40	-.03	.16	-.12	.35	-.23	.27	-.04	.05	.04	.22	-.07
6	6.82	6.81	6.38	6.51	6.78	6.73	6.37	6.66	6.39	6.74	6.50	6.46	6.31	6.64	6.51
7	1.35	.96	1.14	1.29	1.33	1.07	1.06	.95	1.00	1.42	1.25	1.10	.72	1.24	1.56
8	1.09	.24	1.08	1.10	.88	.84	.77	.44	.72	1.15	.79	.59	.33	.88	1.45
9	-.34	-1.18	-.27	-.30	-.67	-.46	-.60	-1.17	-.72	-.94	-.94	-.88	-.98	-.54	-.07
10	-.93	-1.53	-.90	-1.02	-1.44	-1.10	-1.18	-1.84	-1.48	-1.32	-1.67	-1.62	-1.30	-.98	-.80
11	-1.49	-1.70	-1.32	-1.59	-2.19	-1.50	-1.60	-2.24	-1.80	-1.93	-2.22	-2.33	-1.55	-1.35	-1.30
12	-1.95	-1.94	-1.79	-1.89	-2.82	-1.72	-1.84	-2.33	-2.06	-2.40	-2.74	-2.65	-1.74	-1.69	-1.65
13	-2.44	-2.30	-2.45	-2.18	-3.43	-2.11	-2.17	-2.47	-2.57	-2.85	-3.40	-3.01	-2.16	-2.12	-2.17
14	-2.64	-2.30	-2.86	-2.34	-3.73	-2.34	-2.28	-2.46	-2.93	-3.14	-3.84	-3.15	-2.41	-2.28	-2.57
15	-2.76	-2.33	-3.24	-2.69	-3.97	-2.49	-2.41	-2.46	-3.31	-3.31	-4.16	-3.19	-2.57	-2.41	-2.84
16	-2.95	-2.35	-3.56	-3.02	-4.18	-2.65	-2.58	-2.61	-3.70	-3.40	-4.37	-3.35	-2.80	-2.66	-3.12
17	-3.32	-2.94	-3.77	-3.28	-4.21	-2.94	-2.59	-2.80	-4.05	-3.63	-4.55	-3.54	-3.06	-2.99	-3.43
18	-3.84	-2.88	-4.07	-3.62	-4.35	-3.33	-2.78	-3.21	-4.40	-3.99	-4.79	-3.75	-3.37	-3.34	-3.87
19	-4.27	-3.26	-4.54	-4.07	-4.56	-3.71	-3.25	-3.75	-4.80	-4.40	-5.13	-4.01	-3.77	-3.72	-4.36
20	-4.47	-3.58	-4.96	-4.35	-4.63	-3.94	-3.63	-4.09	-5.02	-4.69	-5.37	-4.21	-4.12	-4.01	-4.71
21	-4.57	-3.88	-5.16	-4.59	-4.65	-4.16	-3.93	-4.22	-5.19	-5.00	-5.46	-4.41	-4.30	-4.21	-5.07
22	-4.61	-4.14	-5.30	-4.72	-4.71	-4.39	-4.22	-4.33	-5.33	-5.30	-5.54	-4.65	-4.50	-4.45	-5.43
23	-4.56	-4.26	-5.23	-4.69	-4.59	-4.48	-4.29	-4.40	-5.39	-5.46	-5.50	-4.81	-4.54	-4.54	-5.50
24	-4.57	-4.26	-5.01	-4.57	-4.36	-4.38	-4.29	-4.32	-5.40	-5.54	-5.47	-4.84	-4.53	-4.55	-5.51
25	-4.49	-4.33	-4.73	-4.34	-4.20	-4.25	-4.31	-4.35	-5.46	-5.61	-5.42	-4.79	-4.59	-4.54	-5.57
26	-4.31	-4.40	-4.50	-4.03	-4.04	-4.15	-4.29	-4.25	-5.36	-5.59	-5.23	-4.72	-4.53	-4.43	-5.47
27	-4.23	-4.38	-4.57	-3.83	-3.97	-4.13	-4.29	-4.16	-5.32	-5.65	-5.13	-4.69	-4.54	-4.41	-5.46
28	-4.26	-4.36	-4.63	-3.67	-3.90	-4.15	-4.25	-4.14	-5.32	-5.63	-5.06	-4.67	-4.58	-4.46	-5.46
29	-4.16	-4.16	-4.38	-3.40	-3.76	-4.01	-4.10	-4.01	-5.18	-5.44	-4.80	-4.53	-4.44	-4.36	-5.25
30	-3.91	-3.87	-4.08	-3.09	-3.49	-3.69	-3.88	-3.74	-4.98	-5.11	-4.48	-4.21	-4.20	-4.06	-5.01
31	-3.61	-3.58	-3.83	-2.91	-3.16	-3.39	-3.72	-3.47	-4.70	-4.75	-4.19	-3.89	-3.99	-3.73	-4.72
32	-2.88	-2.94	-3.29	-2.42	-2.57	-2.88	-3.28	-2.80	-4.12	-4.04	-3.56	-3.32	-3.47	-3.12	-4.07
33	-2.11	-2.28	-2.57	-1.75	-2.05	-2.41	-2.74	-2.11	-3.55	-3.36	-2.87	-2.73	-2.91	-2.58	-3.36
34	-1.55	-1.83	-1.99	-1.13	-1.60	-2.08	-2.29	-1.60	-3.10	-2.85	-2.35	-2.23	-2.48	-2.19	-2.87
35	-.99	-1.34	-1.35	-.41	-1.00	-1.66	-1.75	-1.05	-2.60	-2.15	-1.80	-1.67	-1.89	-1.59	-2.26
36	-.57	-.82	-.83	.21	-.51	-1.23	-1.27	-.57	-2.17	-1.52	-1.33	-1.18	-1.39	-1.03	-1.70
37	-.17	-.37	-.40	.66	-.20	-.90	-.88	-.32	-1.81	-1.05	-.93	-.82	-1.08	-.61	-1.39
38	.23	.01	-.09	1.07	.08	-.59	-.54	-.10	-1.36	-.61	-.49	-.50	-.78	-.23	-1.12
39	.47	.25	.07	1.30	.24	-.37	-.32	.00	-1.02	-.25	-.27	-.29	-.56	.01	-.85
40	.61	.43	.20	1.36	.41	-.29	-.10	.02	-.80	.02	-.08	-.12	-.36	.07	-.62
41	.86	.70	.53	1.46	.78	-.06	.23	.24	-.38	.44	.36	.19	.01	.22	-.27
42	1.03	.82	.85	1.44	1.07	.19	.44	.41	-.05	.76	.63	.37	.28	.36	-.07
43	1.09	.77	1.05	1.35	1.13	.34	.53	.52	.22	.98	.67	.50	.44	.47	.07
44	1.11	.81	1.25	1.37	1.15	.51	.54	.69	.56	1.25	.69	.64	.53	.69	.28
45	1.20	.89	1.51	1.50	1.15	.71	.56	.83	.70	1.56	.77	.70	.46	.75	.45
46	1.29	.97	1.76	1.69	1.13	.79	.55	.93	.69	1.74	.75	.65	.30	.74	.52
47	1.34	1.08	1.99	1.83	1.17	.86	.63	1.04	.69	1.80	.70	.64	.19	.71	.56
48	1.33	1.09	2.15	1.89	1.27	.87	.61	1.12	.67	1.73	.72	.58	.05	.63	.52
49	1.33	1.08	2.19	1.87	1.31	.86	.55	1.11	.69	1.63	.66	.53	-.05	.47	.41
50	1.40	1.16	2.22	1.95	1.39	.96	.57	1.23	.85	1.59	.73	.77	.19	.36	.43
51	1.31	1.26	2.14	1.84	1.51	.96	.63	1.38	.88	1.50	.81	.97	.44	.25	.44
52	1.03	1.24	1.86	1.47	1.44	.67	.59	1.27	.79	1.20	.72	.94	.39	.11	.34
53	.70	1.01	1.39	.96	1.14	.38	.41	.82	.66	.84	.53	.83	.17	.03	.06
54	.40	.84	1.08	.62	.90	.36	.30	.43	.46	.60	.23	.60	-.02	-.01	-.08
55	-.08	.73	.98	.39	.70	.48	.22	.47	.36	.56	-.02	.24	-.22	-.12	.13
56	-.09	.59	.98	.38	.43	.67	.21	.75	.48	.62	-.09	-.17	-.44	-.19	.40
57	-.32	.24	.81	.37	.07	.45	-.04	.69	.46	.45	-.38	-.58	-.78	-.28	.51
58	-.65	-.27	.03	-.04	-.38	-.25	-.28	.18	.02	-.28	-1.26	-1.03	-1.24	-.71	.29
59	-1.70	-1.57	-1.47	-.99	-1.68	-1.64	-1.23	-1.17	-1.51	-2.04	-2.64	-1.96	-2.37	-1.96	-1.29
60	-11.56	-11.12	-10.23	-9.80	-11.04	-10.92	-10.59	-10.40	-10.96	-11.03	-11.09	-10.54	-11.10	-10.72	-10.67
61	.83	.83	.83	.83	.83	.83	.83	.83	.83	.83	.83	.83	.83	.83	.83
62	.00	.00	.00	.00	.00	.00	.00	.00	.00	.00	.00	.00	.00	.00	.00

NOAA-9 SCANNER OFFSETS FOR MAY 1986: LONGWAVE CHANNEL

S.P.	DAY OF MONTH -->															
	16	17	18	19	20	21	22	23	24	25	26	27	28	29	30	31
1	.29	.29	.29	.29	.29	.29	.29	.29	.29	.29	.29	.29	.29	.29	.29	.29
2	.59	.59	.59	.59	.59	.59	.59	.59	.59	.59	.59	.59	.59	.59	.59	.59
3	.63	.63	.63	.63	.63	.63	.63	.63	.63	.63	.63	.63	.63	.63	.63	.63
4	.27	.27	.27	.27	.27	.27	.27	.27	.27	.27	.27	.27	.27	.27	.27	.27
5	.31	.64	.99	.86	1.20	1.44	1.23	1.47	1.44	1.30	1.13	1.16	.66	1.34	1.12	1.10
6	6.84	7.01	6.70	6.50	6.91	7.00	7.03	7.33	7.15	7.00	6.82	6.97	6.42	7.31	7.07	7.23
7	1.42	1.33	.84	1.02	1.02	1.22	1.47	1.48	1.36	1.18	1.20	1.38	.91	1.50	1.34	1.46
8	1.07	.75	.37	.94	.43	1.02	1.23	1.02	.99	.65	.88	1.11	.91	.93	.97	.80
9	-.51	-.60	-1.14	-.34	-1.24	-.36	-.10	-.38	-.38	-.72	-.47	-.38	-.34	-.56	-.33	-1.01
10	-1.20	-.98	-1.69	-.99	-1.86	-.99	-.75	-.99	-.98	-1.22	-1.02	-1.07	-.98	-1.16	-.88	-2.00
11	-1.76	-1.35	-2.09	-1.54	-2.27	-1.54	-1.23	-1.40	-1.40	-1.53	-1.51	-1.61	-1.53	-1.56	-1.38	-2.63
12	-2.14	-1.59	-2.56	-2.03	-2.61	-2.17	-1.41	-1.83	-1.67	-1.86	-1.97	-2.05	-1.96	-1.85	-1.72	-2.87
13	-2.67	-2.08	-3.21	-2.71	-3.04	-2.92	-2.16	-2.42	-2.01	-2.36	-2.61	-2.65	-2.60	-2.31	-2.21	-3.27
14	-2.99	-2.54	-3.70	-3.16	-3.21	-3.36	-2.37	-2.75	-2.19	-2.67	-3.00	-2.95	-3.00	-2.55	-2.46	-3.45
15	-3.13	-2.92	-4.09	-3.48	-3.40	-3.74	-2.82	-3.01	-2.37	-2.89	-3.27	-3.12	-3.19	-2.63	-2.59	-3.59
16	-3.24	-3.30	-4.35	-3.76	-3.63	-4.17	-3.06	-3.22	-2.58	-3.12	-3.54	-3.41	-3.41	-2.69	-2.72	-3.72
17	-3.44	-3.65	-4.58	-4.05	-3.96	-4.47	-3.39	-3.43	-2.79	-3.25	-3.76	-3.75	-3.65	-2.84	-2.81	-3.77
18	-3.77	-4.09	-4.94	-4.35	-4.41	-4.73	-3.69	-3.75	-3.01	-3.45	-3.97	-4.18	-3.94	-3.11	-3.09	-4.40
19	-4.11	-4.52	-5.32	-4.67	-4.79	-4.98	-4.01	-4.15	-3.30	-3.66	-4.28	-4.66	-4.29	-3.51	-3.50	-4.63
20	-4.40	-4.81	-5.51	-4.98	-5.08	-5.07	-4.40	-4.42	-3.60	-3.83	-4.54	-4.99	-4.51	-3.86	-3.82	-4.63
21	-4.69	-5.05	-5.70	-5.18	-5.32	-5.23	-5.03	-4.58	-3.98	-4.09	-4.87	-5.19	-4.66	-4.17	-4.16	-4.77
22	-4.94	-5.28	-5.88	-5.30	-5.51	-5.41	-5.61	-4.67	-4.32	-4.29	-5.11	-5.35	-4.84	-4.44	-4.50	-4.98
23	-4.98	-5.29	-5.85	-5.27	-5.51	-5.36	-5.88	-4.64	-4.45	-4.35	-5.14	-5.42	-4.85	-4.59	-4.56	-5.05
24	-5.00	-5.35	-5.74	-5.12	-5.45	-5.26	-5.94	-4.61	-4.49	-4.30	-5.10	-5.34	-4.79	-4.68	-4.62	-5.04
25	-5.04	-5.36	-5.59	-5.05	-5.41	-5.16	-5.58	-4.58	-4.56	-4.21	-5.09	-5.18	-4.69	-4.66	-4.32	-5.08
26	-4.97	-5.14	-5.35	-4.99	-5.27	-4.99	-5.34	-4.43	-4.54	-4.07	-5.01	-5.06	-4.63	-4.48	-4.17	-5.02
27	-5.00	-5.03	-5.19	-4.98	-5.26	-4.93	-5.65	-4.37	-4.51	-4.05	-4.97	-5.05	-4.64	-4.36	-4.15	-4.86
28	-5.00	-5.09	-5.11	-4.91	-5.29	-4.91	-5.71	-4.41	-4.52	-4.00	-4.92	-5.02	-4.66	-4.38	-4.15	-4.77
29	-4.73	-4.91	-5.01	-4.71	-5.08	-4.70	-5.39	-4.27	-4.39	-3.80	-4.69	-4.82	-4.53	-4.26	-3.99	-4.60
30	-4.35	-4.62	-4.70	-4.43	-4.78	-4.42	-4.90	-4.00	-4.16	-3.52	-4.43	-4.49	-4.28	-3.98	-3.80	-4.29
31	-4.05	-4.41	-4.39	-4.14	-4.45	-4.16	-4.72	-3.68	-3.86	-3.19	-4.19	-4.09	-4.04	-3.71	-3.60	-3.97
32	-3.51	-3.87	-3.81	-3.46	-3.82	-3.61	-3.76	-3.01	-3.18	-2.57	-3.62	-3.45	-3.41	-3.15	-3.05	-3.35
33	-2.95	-3.20	-3.16	-2.74	-3.09	-2.94	-3.25	-2.28	-2.43	-1.95	-3.03	-2.81	-2.66	-2.51	-2.52	-2.68
34	-2.48	-2.59	-2.63	-2.19	-2.46	-2.34	-2.38	-1.78	-1.84	-1.44	-2.52	-2.34	-2.06	-2.02	-2.11	-2.17
35	-1.90	-1.98	-1.95	-1.55	-1.80	-1.68	-1.65	-1.27	-1.18	-.81	-1.94	-1.75	-1.35	-1.42	-1.58	-1.68
36	-1.30	-1.49	-1.34	-1.02	-1.27	-1.21	-1.38	-.79	-.69	-.27	-1.41	-1.26	-.69	-.87	-1.14	-1.28
37	-.85	-1.14	-.91	-.66	-.84	-.89	-.66	-.32	-.36	.08	-.89	-.90	-.17	-.46	-.80	-.90
38	-.44	-.76	-.46	-.30	-.41	-.45	.02	.11	.08	.43	-.40	-.57	.28	-.15	-.48	-.55
39	-.07	-.25	-.05	.00	-.06	-.08	-.26	.50	.44	.72	-.02	-.24	.57	.09	-.23	-.26
40	.20	.14	.23	.23	.24	.19	.72	.82	.58	.85	.24	.01	.71	.31	.03	-.07
41	.52	.55	.55	.54	.68	.58	1.20	1.12	.76	1.11	.60	.44	.94	.61	.45	.19
42	.76	.83	.84	.75	1.03	.95	1.48	1.30	.99	1.36	.84	.77	1.07	.83	.77	.40
43	.91	.97	1.00	.81	1.19	1.16	1.31	1.35	1.09	1.43	.88	.83	1.17	1.05	.91	.50
44	1.12	1.10	1.08	.88	1.42	1.37	1.43	1.47	1.18	1.47	.99	.93	1.32	1.27	1.08	.69
45	1.31	1.14	1.22	.92	1.60	1.60	1.90	1.57	1.29	1.47	1.13	1.10	1.45	1.39	1.22	.89
46	1.42	1.17	1.33	.96	1.61	1.79	2.49	1.60	1.38	1.43	1.19	1.19	1.48	1.41	1.31	1.06
47	1.44	1.22	1.44	1.02	1.58	1.95	2.33	1.70	1.52	1.42	1.30	1.27	1.45	1.39	1.40	1.23
48	1.40	1.12	1.42	.94	1.59	1.87	2.45	1.72	1.62	1.31	1.40	1.31	1.34	1.32	1.42	1.30
49	1.23	1.01	1.33	.82	1.60	1.68	2.54	1.69	1.58	1.25	1.45	1.28	1.33	1.26	1.46	1.33
50	1.28	1.08	1.36	.78	1.62	1.75	2.92	1.77	1.49	1.30	1.64	1.43	1.48	1.34	1.59	1.49
51	1.37	1.11	1.33	.65	1.55	1.71	2.37	1.76	1.35	1.25	1.86	1.66	1.54	1.38	1.67	1.57
52	1.24	.95	1.08	.47	1.32	1.43	1.98	1.48	1.09	1.03	1.83	1.69	1.44	1.27	1.55	1.42
53	.83	.68	.64	.13	.98	.92	1.60	.89	.72	.66	1.51	1.44	1.15	.92	1.17	.95
54	.32	.59	.19	-.16	.58	.38	.67	.36	.55	.39	1.21	1.04	.78	.68	.75	.57
55	.00	.51	-.21	-.21	.27	-.03	.55	.04	.57	.10	.97	.62	.33	.58	.39	.44
56	-.04	.46	-.49	-.11	.14	-.15	.97	.02	.55	-.18	.78	.34	-.16	.62	.18	.44
57	-.14	.33	-.61	-.22	-.40	-.35	.59	-.02	.26	-.65	.34	.00	-.65	.57	-.06	.15
58	-.54	.02	-.92	-.65	-1.21	-.93	-.13	-.40	-.54	-1.04	-.58	-.64	-1.16	.08	-.41	-.66
59	-1.79	-1.36	-2.36	-2.07	-2.33	-2.38	-1.69	-1.57	-2.12	-2.04	-2.01	-2.30	-2.28	-1.37	-1.68	-2.17
60	-10.43	-10.36	-11.26	-11.55	-11.28	-11.54	-10.88	-10.82	-11.21	-10.83	-10.80	-11.42	-10.82	-10.69	-10.57	-10.89
61	.83	.83	.83	.83	.83	.83	.83	.83	.83	.83	.83	.83	.83	.83	.83	.83
62	.00	.00	.00	.00	.00	.00	.00	.00	.00	.00	.00	.00	.00	.00	.00	.00

NOAA-9 SCANNER OFFSETS FOR MAY 1986: SHORTWAVE CHANNEL

S.P.	DAY OF MONTH -->														
	1	2	3	4	5	6	7	8	9	10	11	12	13	14	15
1	-.11	-.11	-.11	-.11	-.11	-.11	-.11	-.11	-.11	-.11	-.11	-.11	-.11	-.11	-.11
2	.32	.32	.32	.32	.32	.32	.32	.32	.32	.32	.32	.32	.32	.32	.32
3	.49	.49	.49	.49	.49	.49	.49	.49	.49	.49	.49	.49	.49	.49	.49
4	-4.09	-4.09	-4.09	-4.09	-4.09	-4.09	-4.09	-4.09	-4.09	-4.09	-4.09	-4.09	-4.09	-4.09	-4.09
5	.74	.60	.60	.55	.67	.63	.62	.51	.74	.74	.75	.75	.73	.77	.85
6	.85	.69	.69	.64	.77	.75	.71	.61	.85	.84	.85	.85	.84	.90	.97
7	.49	.33	.32	.28	.42	.38	.34	.24	.50	.47	.49	.48	.47	.53	.61
8	.86	.70	.68	.65	.78	.75	.71	.62	.87	.85	.86	.86	.84	.90	.98
9	.95	.75	.70	.67	.84	.80	.76	.65	.93	.92	.94	.93	.90	.97	1.04
10	.60	.39	.32	.28	.47	.41	.35	.25	.53	.53	.57	.57	.54	.61	.68
11	.92	.73	.65	.59	.76	.70	.65	.52	.83	.84	.86	.87	.87	.93	1.01
12	.88	.68	.62	.55	.70	.67	.59	.47	.79	.78	.82	.84	.82	.91	1.00
13	.06	-.18	-.22	-.28	-.16	-.14	-.23	-.33	-.02	-.07	-.02	.00	-.05	.09	.21
14	.41	.16	.11	.05	.17	.21	.11	.01	.30	.26	.33	.35	.28	.43	.53
15	.38	.15	.10	.05	.15	.19	.10	.02	.34	.27	.33	.33	.24	.43	.54
16	-.04	-.27	-.31	-.37	-.30	-.25	-.32	-.40	-.09	-.14	-.10	-.10	-.20	.00	.11
17	.30	.08	.06	-.03	.02	.07	.00	-.07	.24	.20	.23	.24	.13	.33	.45
18	.32	.10	.09	.02	.06	.08	.00	-.04	.26	.21	.26	.25	.12	.34	.46
19	-.08	-.30	-.30	-.36	-.35	-.29	-.38	-.43	-.14	-.20	-.14	-.15	-.30	-.07	.05
20	.31	.10	.08	.03	.02	.08	-.01	-.04	.21	.16	.22	.22	.09	.29	.44
21	.34	.14	.11	.07	.04	.08	-.01	-.06	.17	.13	.22	.24	.13	.31	.45
22	-.17	-.35	-.37	-.42	-.46	-.40	-.50	-.52	-.31	-.34	-.27	-.24	-.35	-.15	-.06
23	.19	.03	-.02	-.07	-.11	-.04	-.15	-.16	.05	.01	.08	.12	.03	.20	.26
24	.22	.05	.00	-.05	-.10	-.01	-.14	-.14	.06	.02	.08	.15	.05	.20	.25
25	-.19	-.34	-.39	-.44	-.48	-.41	-.55	-.56	-.35	-.37	-.34	-.25	-.37	-.19	-.16
26	.17	.01	-.01	-.08	-.11	-.04	-.17	-.18	.04	.02	.04	.13	.00	.19	.21
27	.15	.02	.03	-.06	-.09	-.03	-.14	-.16	.06	.03	.06	.14	.02	.19	.21
28	-.28	-.39	-.34	-.44	-.50	-.45	-.54	-.58	-.37	-.39	-.35	-.27	-.44	-.24	-.22
29	.12	.01	.06	-.03	-.09	-.07	-.14	-.18	.01	.01	.05	.13	-.06	.10	.16
30	.22	.08	.13	.04	-.04	.01	-.06	-.13	.05	.02	.09	.17	-.05	.13	.21
31	-.17	-.34	-.29	-.37	-.46	-.39	-.44	-.49	-.34	-.41	-.35	-.27	-.47	-.29	-.24
32	.17	-.01	.07	.00	-.10	-.02	-.06	-.10	.05	-.02	.00	.08	-.11	.07	.08
33	.10	-.11	-.02	-.09	-.21	-.12	-.16	-.21	-.05	-.13	-.11	-.03	-.21	-.04	.02
34	-.26	-.49	-.36	-.40	-.53	-.47	-.52	-.57	-.42	-.52	-.49	-.41	-.63	-.43	-.36
35	.10	-.09	.02	-.02	-.15	-.10	-.17	-.24	-.09	-.17	-.14	-.08	-.28	-.10	-.04
36	.12	-.01	.05	.00	-.12	-.04	-.12	-.16	-.03	-.12	-.07	-.02	-.23	-.04	.05
37	-.24	-.32	-.29	-.36	-.47	-.40	-.46	-.50	-.38	-.47	-.42	-.40	-.62	-.39	-.29
38	.19	.12	.10	.04	-.08	-.01	-.07	-.10	.00	-.06	.01	.03	-.25	-.03	.11
39	.22	.17	.15	.08	-.03	.05	.00	-.04	.06	-.01	.06	.07	-.21	.02	.23
40	-.13	-.19	-.16	-.24	-.36	-.28	-.33	-.35	-.29	-.34	-.28	-.30	-.57	-.27	-.05
41	.28	.20	.27	.19	.05	.14	.12	.13	.15	.10	.16	.16	-.13	.14	.38
42	.30	.25	.33	.28	.08	.21	.19	.15	.17	.13	.20	.20	-.07	.16	.38
43	-.09	-.13	-.01	-.06	-.30	-.15	-.16	-.20	-.20	-.24	-.20	-.17	-.42	-.21	-.03
44	.24	.22	.36	.30	.04	.21	.22	.17	.16	.11	.15	.18	-.02	.15	.31
45	.20	.22	.32	.29	.04	.20	.21	.15	.14	.11	.14	.17	-.05	.14	.29
46	-.18	-.18	-.13	-.16	-.35	-.16	-.19	-.24	-.26	-.31	-.28	-.25	-.47	-.28	-.13
47	.18	.18	.23	.15	-.08	.12	.08	.06	.03	-.02	.02	.06	-.16	.03	.21
48	.20	.20	.29	.19	-.04	.10	.02	.02	.01	-.02	.02	.06	-.20	.01	.21
49	-.22	-.20	-.10	-.19	-.39	-.24	-.32	-.33	-.32	-.37	-.34	-.31	-.60	-.38	-.23
50	.12	.15	.26	.21	.01	.13	.06	.07	.07	.02	.04	.07	-.21	-.01	.13
51	.11	.16	.30	.23	.05	.17	.08	.07	.05	.00	.03	.06	-.23	-.05	.08
52	-.24	-.19	-.06	-.09	-.26	-.14	-.22	-.23	-.28	-.34	-.32	-.30	-.59	-.41	-.30
53	.65	.71	.74	.77	.65	.72	.70	.72	.64	.59	.59	.58	.36	.50	.61
54	.93	.96	1.03	1.08	.94	.98	.99	.98	.94	.89	.86	.87	.64	.76	.82
55	.56	.62	.71	.76	.61	.65	.65	.64	.55	.51	.50	.52	.29	.39	.48
56	.88	.97	1.06	1.11	.96	1.01	1.00	1.00	.89	.84	.82	.85	.61	.72	.85
57	.88	.99	1.08	1.12	.97	1.03	1.02	1.01	.92	.88	.86	.86	.61	.76	.87
58	.48	.60	.66	.70	.57	.62	.61	.61	.54	.50	.51	.47	.21	.37	.56
59	.80	.92	.97	.97	.86	.91	.92	.91	.87	.83	.83	.80	.53	.70	.94
60	.72	.89	.94	.93	.81	.82	.84	.84	.82	.79	.78	.76	.46	.65	.89
61	3.05	3.05	3.05	3.05	3.05	3.05	3.05	3.05	3.05	3.05	3.05	3.05	3.05	3.05	3.05
62	.00	.00	.00	.00	.00	.00	.00	.00	.00	.00	.00	.00	.00	.00	.00

NOAA-9 SCANNER OFFSETS FOR MAY 1986: SHORTWAVE CHANNEL

S.P.	DAY OF MONTH -->															
	16	17	18	19	20	21	22	23	24	25	26	27	28	29	30	31
1	-.11	-.11	-.11	-.11	-.11	-.11	-.11	-.11	-.11	-.11	-.11	-.11	-.11	-.11	-.11	-.11
2	.32	.32	.32	.32	.32	.32	.32	.32	.32	.32	.32	.32	.32	.32	.32	.32
3	.49	.49	.49	.49	.49	.49	.49	.49	.49	.49	.49	.49	.49	.49	.49	.49
4	-4.09	-4.09	-4.09	-4.09	-4.09	-4.09	-4.09	-4.09	-4.09	-4.09	-4.09	-4.09	-4.09	-4.09	-4.09	-4.09
5	.86	.87	.78	.75	.79	.78	.80	.80	.82	.78	.77	.78	.78	.79	.79	.79
6	.99	.99	.89	.85	.88	.88	.91	.90	.92	.88	.86	.88	.88	.89	.90	.90
7	.62	.63	.53	.49	.52	.51	.55	.53	.56	.53	.50	.52	.52	.52	.53	.54
8	.98	.98	.89	.86	.89	.89	.92	.91	.94	.89	.87	.89	.89	.89	.90	.90
9	1.04	1.05	.95	.93	.94	.93	.97	.96	1.00	.95	.93	.95	.95	.94	.95	.95
10	.70	.69	.58	.55	.56	.54	.57	.56	.60	.55	.53	.55	.56	.55	.56	.56
11	1.04	.99	.92	.90	.93	.91	.93	.93	.97	.92	.90	.92	.91	.92	.93	.93
12	1.02	1.00	.87	.86	.87	.85	.88	.87	.91	.86	.85	.86	.88	.88	.88	.90
13	.24	.21	.04	.02	.03	-.01	.03	.00	.04	.00	-.03	-.01	.06	.06	.05	.06
14	.55	.56	.39	.36	.37	.33	.36	.33	.36	.32	.29	.33	.39	.39	.38	.39
15	.56	.55	.37	.35	.37	.32	.36	.34	.37	.34	.31	.33	.39	.39	.39	.40
16	-.14	.11	-.06	-.07	-.04	-.10	-.07	-.09	-.05	-.08	-.11	-.09	-.03	-.02	-.02	-.01
17	.49	.43	.28	.27	.29	.24	.28	.26	.30	.27	.24	.25	.32	.33	.33	.34
18	.51	.45	.30	.28	.30	.26	.30	.27	.31	.28	.25	.26	.33	.34	.35	.35
19	.11	.07	-.11	-.13	-.11	-.15	-.11	-.14	-.09	-.12	-.15	-.14	-.07	-.06	-.05	-.05
20	.50	.47	.29	.25	.28	.25	.27	.24	.29	.26	.24	.26	.33	.33	.34	.34
21	.51	.49	.30	.25	.29	.26	.27	.24	.28	.25	.24	.26	.33	.33	.34	.34
22	.02	.01	-.18	-.21	-.17	-.21	-.18	-.21	-.17	-.19	-.21	-.21	-.12	-.13	-.12	-.11
23	.35	.33	.20	.17	.20	.17	.19	.17	.21	.18	.17	.19	.20	.28	.27	.29
24	.32	.31	.22	.21	.23	.20	.22	.20	.23	.21	.19	.20	.28	.27	.27	.29
25	-.11	-.12	-.20	-.18	-.16	-.20	-.17	-.19	-.16	-.17	-.20	-.19	-.11	-.12	-.12	-.11
26	.24	.24	.17	.20	.22	.19	.21	.20	.22	.21	.18	.19	.27	.26	.25	.27
27	.23	.26	.16	.23	.25	.21	.24	.23	.24	.23	.20	.20	.29	.28	.27	.29
28	-.18	-.19	-.24	-.17	-.15	-.19	-.16	-.17	-.15	-.17	-.20	-.19	-.11	-.11	-.13	-.10
29	.21	.17	.18	.25	.27	.23	.26	.24	.27	.25	.22	.23	.31	.30	.29	.31
30	.23	.23	.24	.32	.32	.29	.30	.28	.30	.28	.25	.27	.35	.35	.34	.35
31	-.19	-.23	-.16	-.10	-.08	-.11	-.09	-.09	-.07	-.09	-.12	-.11	-.03	-.04	-.05	-.02
32	.12	.10	.16	.23	.24	.22	.25	.23	.26	.23	.22	.23	.34	.33	.31	.33
33	.07	.02	.06	.12	.13	.11	.13	.11	.13	.10	.11	.13	.27	.25	.23	.23
34	-.30	-.34	-.31	-.27	-.28	-.29	-.26	-.29	-.26	-.29	-.29	-.27	-.12	-.14	-.17	-.16
35	.00	.01	.06	.12	.13	.11	.14	.11	.13	.10	.10	.12	.27	.25	.22	.22
36	.10	.06	.12	.18	.18	.16	.20	.15	.17	.15	.16	.17	.33	.31	.28	.27
37	-.24	-.30	-.22	-.18	-.16	-.18	-.15	-.19	-.18	-.20	-.19	-.17	-.01	-.03	-.06	-.07
38	.18	.13	.17	.19	.25	.24	.27	.23	.23	.21	.23	.23	.40	.38	.35	.34
39	.29	.26	.22	.23	.27	.28	.31	.27	.27	.26	.27	.28	.43	.41	.38	.37
40	.02	-.03	-.12	-.09	-.08	-.06	-.03	-.07	-.05	-.08	-.06	-.07	.09	.08	.05	.04
41	.44	.41	.30	.34	.31	.34	.36	.33	.36	.32	.34	.32	.48	.47	.44	.43
42	.45	.42	.33	.38	.38	.38	.40	.37	.40	.36	.37	.38	.52	.52	.48	.47
43	.05	.01	-.05	.01	.01	.00	.03	-.01	.02	-.02	-.02	-.01	.14	.14	.10	.08
44	.37	.34	.30	.37	.38	.36	.39	.35	.38	.34	.34	.36	.49	.49	.46	.44
45	.35	.32	.30	.37	.36	.35	.38	.34	.38	.34	.34	.36	.49	.49	.46	.44
46	-.07	-.11	-.11	-.03	-.03	-.05	-.01	-.05	-.03	-.06	-.06	-.04	.09	.10	.06	.05
47	.27	.23	.24	.33	.33	.32	.35	.32	.34	.31	.31	.32	.45	.45	.43	.41
48	.27	.22	.27	.35	.35	.35	.38	.34	.36	.33	.33	.34	.47	.47	.45	.43
49	-.16	-.22	-.13	-.04	-.04	-.04	-.01	-.04	-.02	-.06	-.05	-.05	.09	.09	.06	.05
50	.19	.12	.23	.31	.32	.32	.35	.33	.35	.32	.33	.32	.46	.46	.43	.42
51	.15	.10	.23	.32	.32	.32	.34	.32	.33	.30	.32	.31	.45	.44	.42	.40
52	-.24	-.26	-.13	-.06	-.03	-.06	-.04	-.05	-.04	-.07	-.03	-.05	.09	.09	.06	.03
53	.64	.64	.72	.78	.85	.80	.81	.87	.85	.79	.89	.88	.95	.98	.96	.89
54	.88	.87	.97	.97	1.06	1.02	1.02	1.12	1.07	1.02	1.15	1.13	1.20	1.23	1.16	1.15
55	.47	.53	.57	.52	.59	.55	.61	.69	.67	.61	.76	.71	.76	.82	.72	.75
56	.87	.85	.88	.80	.82	.82	.94	1.00	1.00	.96	1.08	1.00	1.05	1.14	1.09	1.10
57	.92	.91	.86	.77	.75	.85	.95	.97	.99	.97	1.09	.98	1.05	1.11	1.07	1.10
58	.60	.60	.46	.38	.34	.43	.53	.53	.58	.53	.66	.54	.64	.71	.67	.72
59	.97	.97	.83	.72	.69	.78	.85	.84	.88	.85	.97	.87	.96	1.03	1.02	1.06
60	.95	.93	.79	.69	.69	.77	.86	.83	.85	.83	.95	.84	.92	.99	1.02	1.04
61	3.05	3.05	3.05	3.05	3.05	3.05	3.05	3.05	3.05	3.05	3.05	3.05	3.05	3.05	3.05	3.05
62	.00	.00	.00	.00	.00	.00	.00	.00	.00	.00	.00	.00	.00	.00	.00	.00

S.P.	NOAA-9 SCANNER OFFSETS FOR JUNE 1986:									TOTAL	CHANNEL				
	DAY OF MONTH -->										12	13	14	15	
	1	2	3	4	5	6	7	8	9	10	11				
1	.36	.36	.36	.36	.36	.36	.36	.36	.36	.36	.36	.36	.36	.36	.36
2	1.04	1.04	1.04	1.04	1.04	1.04	1.04	1.04	1.04	1.04	1.04	1.04	1.04	1.04	1.04
3	1.93	1.93	1.93	1.93	1.93	1.93	1.93	1.93	1.93	1.93	1.93	1.93	1.93	1.93	1.93
4	-9.64	-9.64	-9.64	-9.64	-9.64	-9.64	-9.64	-9.64	-9.64	-9.64	-9.64	-9.64	-9.64	-9.64	-9.64
5	4.49	2.96	3.51	3.81	4.63	4.90	4.41	4.47	5.22	4.75	5.16	4.60	4.65	5.09	5.17
6	.66	.92	1.08	.39	.51	1.07	1.03	.77	2.00	1.26	2.25	1.37	1.51	2.47	2.26
7	-1.94	-1.07	-1.50	-2.43	-2.08	-1.62	-1.41	-1.32	-.45	-1.22	.02	-.78	-1.04	-.23	-.29
8	-1.99	-1.78	-1.84	-2.57	-1.93	-1.94	-2.00	-1.45	-.85	-1.50	-.23	-.89	-1.14	-.03	-.78
9	-1.75	-2.09	-1.67	-2.12	-1.66	-1.76	-2.09	-1.42	-.85	-1.09	-.14	-.70	-.74	-.26	-.89
10	-1.63	-1.68	-1.27	-1.36	-1.14	-1.20	-1.50	-.89	-.43	-.38	.31	-.31	-.21	-.14	-.67
11	-1.81	-1.61	-1.36	-1.13	-.81	-1.40	-1.13	-.75	-.40	-.47	.10	-.43	-.17	-.26	-.80
12	-2.65	-2.68	-2.52	-1.87	-1.37	-2.54	-1.89	-1.64	-1.28	-1.52	-1.21	-1.43	-1.09	-1.18	-1.71
13	-2.75	-3.05	-2.88	-2.12	-1.55	-2.69	-2.09	-1.63	-1.36	-1.87	-1.76	-1.64	-1.33	-1.39	-1.97
14	-2.73	-3.14	-2.95	-2.04	-1.61	-2.49	-1.72	-1.39	-1.21	-1.89	-1.81	-1.54	-1.05	-1.42	-2.01
15	-2.58	-2.86	-2.51	-1.66	-1.44	-2.19	-1.17	-1.11	-1.00	-1.53	-1.71	-1.36	-.63	-1.41	-1.90
16	-2.73	-2.98	-2.50	-1.79	-1.64	-2.45	-1.39	-1.45	-1.44	-1.47	-2.07	-1.43	-.92	-1.85	-2.27
17	-2.68	-3.07	-2.51	-1.91	-1.71	-2.65	-1.51	-2.05	-1.82	-1.57	-2.38	-1.56	-1.22	-2.11	-2.63
18	-2.41	-2.93	-2.25	-1.63	-1.54	-2.54	-1.45	-2.38	-1.75	-1.53	-2.14	-1.42	-1.15	-1.92	-2.57
19	-2.67	-3.06	-2.38	-1.80	-1.65	-2.67	-1.71	-2.76	-2.05	-1.73	-2.27	-1.59	-1.43	-2.05	-2.76
20	-2.68	-2.64	-2.37	-1.70	-1.43	-2.36	-1.55	-2.61	-2.08	-1.58	-2.29	-1.37	-1.44	-1.81	-2.56
21	-2.63	-2.38	-2.44	-1.71	-1.34	-2.12	-1.45	-2.51	-2.02	-1.61	-2.15	-1.13	-1.41	-1.66	-2.24
22	-2.51	-2.27	-2.30	-1.76	-1.35	-1.79	-1.31	-2.27	-1.98	-1.52	-1.90	-.84	-1.39	-1.48	-1.93
23	-2.58	-2.37	-2.29	-1.93	-1.56	-1.68	-1.43	-2.44	-2.28	-1.42	-1.79	-.75	-1.59	-1.47	-1.86
24	-2.65	-2.38	-2.23	-2.05	-1.56	-1.59	-1.50	-2.54	-2.34	-1.20	-1.62	-.59	-1.75	-1.39	-1.79
25	-2.72	-2.40	-2.20	-2.25	-1.53	-1.57	-1.55	-2.59	-2.40	-.90	-1.51	-.59	-2.06	-1.36	-1.64
26	-2.40	-2.11	-1.82	-2.17	-1.21	-1.24	-1.30	-2.47	-2.18	-.47	-1.15	-.42	-2.09	-1.11	-1.16
27	-1.98	-1.80	-1.38	-1.87	-.82	-.93	-1.02	-2.35	-1.98	-.17	-.84	-.26	-2.03	-.83	-.80
28	-1.75	-1.65	-1.13	-1.67	-.54	-.84	-.85	-2.40	-2.03	-.11	-.77	-.32	-2.00	-.65	-.66
29	-1.45	-1.44	-.91	-1.46	-.19	-.70	-.65	-2.37	-1.97	-.01	-.58	-.15	-1.80	-.33	-.44
30	-1.13	-1.22	-.62	-1.05	-.14	-.45	-.41	-2.16	-1.62	.11	-.46	.14	-1.58	.02	-.30
31	-1.04	-1.07	-.54	-.86	.26	-.27	-.11	-2.09	-1.52	.18	-.42	.27	-1.43	.19	-.25
32	-.85	-.87	-.48	-.54	.41	-.06	.14	-1.84	-1.42	.32	-.19	.51	-1.18	.50	-.03
33	-.73	-.71	-.49	-.29	.43	.11	.25	-1.64	-1.14	.38	.11	.62	-1.11	.72	.02
34	-.48	-.43	-.30	-.02	.56	.43	.59	-1.16	-.63	.64	.49	.58	-1.00	.94	.14
35	-.13	-.12	-.12	.34	.72	.70	.83	-.82	-.10	.97	.88	.70	-.68	1.23	.30
36	.14	.14	.15	.70	.93	.91	.82	-.55	.29	1.18	1.28	.75	-.56	1.41	.51
37	.16	.20	.20	.78	1.02	.92	.64	-.43	.26	1.13	1.40	.63	-.49	1.47	.62
38	.28	.34	.27	.94	1.13	.98	.53	-.13	.31	1.13	1.61	.71	-.38	1.72	.76
39	.46	.58	.36	1.07	1.17	1.09	.52	.17	.31	1.22	1.77	.82	-.25	1.94	.91
40	.51	.70	.36	.99	1.06	1.21	.47	.18	.25	1.26	1.65	.64	-.24	1.94	.93
41	.87	.86	.66	1.16	1.16	1.58	.56	.41	.41	1.50	1.73	.62	-.04	2.19	1.12
42	1.04	.72	.78	1.04	1.04	1.55	.45	.52	.37	1.54	1.68	.48	.01	2.19	1.05
43	.91	.30	.65	.72	.68	1.31	.25	.49	.27	1.34	1.44	.20	-.15	1.86	.78
44	.21	-.60	.02	.09	-.08	.60	-.35	-.02	-.37	.78	.88	-.42	-.66	1.31	.12
45	-.08	-1.17	-.25	-.16	-.53	.03	-.58	-.34	-.73	.49	.60	-.65	-.81	1.21	-.17
46	-.58	-1.72	-.69	-.57	-1.16	-.62	-.96	-.85	-1.16	-.03	.14	-.93	-1.19	.74	-.49
47	-.68	-1.99	-.96	-.77	-1.34	-.89	-1.11	-1.06	-1.24	-.50	-.02	-.93	-1.24	.60	-.55
48	-.60	-2.10	-1.04	-.92	-1.48	-1.00	-1.16	-.94	-1.25	-.84	-.02	-.80	-1.10	.74	-.60
49	-.67	-2.04	-1.15	-1.07	-1.87	-1.34	-1.32	-.92	-1.43	-1.16	-.15	-.68	-.84	.68	-.73
50	-.75	-1.99	-1.26	-1.02	-2.18	-1.68	-1.41	-1.02	-1.66	-1.47	-.18	-.62	-.43	.52	-.75
51	-.98	-1.91	-1.46	-1.34	-2.52	-2.09	-1.65	-1.14	-1.98	-2.02	-.25	-.74	-.32	.33	-.82
52	-1.46	-2.13	-1.73	-1.90	-2.90	-2.59	-2.07	-1.51	-2.40	-2.77	-.57	-1.00	-.71	-.09	-1.02
53	-1.22	-1.82	-1.49	-1.83	-2.63	-2.41	-1.59	-1.41	-2.08	-2.78	-.35	-.62	-.44	.13	-.67
54	-1.81	-2.19	-2.09	-2.70	-3.21	-2.79	-1.95	-2.10	-2.10	-3.16	-1.06	-1.00	-.97	-.28	-1.11
55	-2.04	-2.27	-2.43	-3.18	-3.16	-2.68	-2.10	-2.23	-1.70	-2.92	-1.15	-.77	-1.17	-.35	-1.18
56	-2.10	-2.32	-2.19	-2.93	-2.67	-2.23	-1.86	-1.98	-1.05	-2.59	-1.04	-.52	-1.07	-.28	-.99
57	-2.51	-2.64	-2.20	-2.80	-2.41	-2.44	-1.97	-1.93	-.88	-2.26	-1.22	-.74	-1.06	-.46	-1.10
58	-2.84	-2.64	-2.51	-2.74	-2.28	-2.97	-2.28	-2.27	-1.12	-1.87	-1.16	-.83	-.83	-1.00	-1.56
59	-2.86	-2.08	-2.27	-2.41	-1.86	-3.23	-2.03	-2.55	-1.52	-1.73	-.95	-.81	-.59	-.93	-2.19
60	-9.24	-7.14	-7.98	-8.10	-8.68	-9.60	-8.88	-9.68	-9.27	-8.98	-8.31	-8.15	-8.38	-8.32	-9.87
61	11.19	11.19	11.19	11.19	11.19	11.19	11.19	11.19	11.19	11.19	11.19	11.19	11.19	11.19	11.19
62	.00	.00	.00	.00	.00	.00	.00	.00	.00	.00	.00	.00	.00	.00	.00

S.P.	NOAA-9 SCANNER OFFSETS FOR JUNE 1986:										TOTAL CHANNEL				
	DAY OF MONTH -->										26	27	28	29	30
	16	17	18	19	20	21	22	23	24	25					
1	.36	.36	.36	.36	.36	.36	.36	.36	.36	.36	.36	.36	.36	.36	.36
2	1.04	1.04	1.04	1.04	1.04	1.04	1.04	1.04	1.04	1.04	1.04	1.04	1.04	1.04	1.04
3	1.93	1.93	1.93	1.93	1.93	1.93	1.93	1.93	1.93	1.93	1.93	1.93	1.93	1.93	1.93
4	-9.64	-9.64	-9.64	-9.64	-9.64	-9.64	-9.64	-9.64	-9.64	-9.64	-9.64	-9.64	-9.64	-9.64	-9.64
5	4.55	4.37	4.19	4.54	4.27	4.14	4.78	4.97	4.60	4.66	4.04	4.33	4.21	2.73	3.49
6	1.73	1.27	.74	1.25	1.03	1.53	2.33	2.39	1.93	2.10	1.64	1.96	1.98	1.17	.66
7	-.21	-.93	-1.59	-1.31	-1.31	-.85	-.22	-.13	-.48	-.65	-.29	-.53	-.59	-.86	-1.60
8	-.49	-1.05	-1.43	-1.44	-1.45	-1.16	-.84	-.39	-.61	-1.00	-.27	-1.16	-.72	-1.06	-1.70
9	-.74	-.93	-1.34	-1.19	-1.36	-.92	-.92	-.28	-.48	-.97	-.15	-1.29	-.25	-1.02	-1.23
10	-.76	-.83	-1.18	-.78	-.90	-.70	-.56	-.12	-.30	-.61	.08	-1.10	.14	-.83	-.59
11	-1.14	-1.00	-1.42	-.88	-.65	-1.08	-.70	-.25	-.35	-.70	-.25	-1.19	-.25	-.94	-.70
12	-2.30	-1.97	-2.39	-1.92	-1.56	-2.33	-1.70	-1.30	-1.11	-1.53	-1.46	-2.09	-1.48	-1.91	-1.81
13	-2.63	-2.26	-2.54	-2.12	-1.80	-2.71	-1.94	-1.65	-1.16	-1.49	-1.79	-2.26	-1.83	-2.04	-1.90
14	-2.54	-2.21	-2.29	-1.97	-1.68	-2.69	-1.97	-1.56	-.92	-1.38	-1.76	-2.22	-1.67	-1.70	-1.67
15	-2.33	-1.79	-1.90	-1.68	-1.54	-2.47	-1.85	-1.35	-.63	-1.25	-1.44	-2.02	-1.36	-1.36	-1.46
16	-2.57	-1.90	-2.07	-1.82	-1.90	-2.73	-1.96	-1.53	-.80	-1.54	-1.53	-2.30	-1.53	-1.50	-1.84
17	-2.70	-2.02	-2.29	-2.05	-2.23	-2.86	-1.86	-1.58	-.95	-1.71	-1.53	-2.41	-1.70	-1.54	-1.97
18	-2.47	-1.88	-2.00	-1.81	-2.17	-2.68	-1.59	-1.32	-.80	-1.64	-1.30	-2.21	-1.62	-1.40	-1.69
19	-2.56	-2.19	-2.07	-2.00	-2.49	-2.82	-1.77	-1.52	-1.07	-1.99	-1.53	-2.45	-1.83	-1.71	-1.86
20	-2.40	-2.13	-2.08	-1.93	-2.45	-2.48	-1.57	-1.23	-.89	-1.92	-1.47	-2.35	-1.71	-1.62	-1.68
21	-2.19	-1.92	-2.11	-1.81	-2.45	-2.30	-1.28	-1.02	-.74	-1.82	-1.38	-2.24	-1.54	-1.62	-1.48
22	-1.98	-1.68	-2.11	-1.57	-2.46	-2.14	-1.00	-.86	-.64	-1.73	-1.31	-2.12	-1.38	-1.62	-1.24
23	-1.96	-1.63	-2.36	-1.71	-2.78	-2.10	-1.02	-.85	-.79	-1.71	-1.46	-2.27	-1.34	-1.60	-1.16
24	-1.92	-1.58	-2.48	-1.82	-2.98	-1.90	-.82	-.75	-.86	-1.53	-1.52	-2.34	-1.24	-1.40	-1.04
25	-1.96	-1.55	-2.48	-1.90	-2.98	-1.93	-.81	-.75	-1.02	-1.55	-1.58	-2.30	-1.33	-1.32	-.98
26	-1.73	-1.26	-2.08	-1.70	-2.68	-1.81	-.60	-.53	-.83	-1.25	-1.35	-1.90	-1.06	-.97	-.74
27	-1.36	-.91	-1.63	-1.48	-2.30	-1.68	-.30	-.41	-.57	-.94	-1.08	-1.55	-.68	-.77	-.46
28	-1.13	-.79	-1.36	-1.44	-2.09	-1.57	-.06	-.39	-.32	-.70	-.83	-1.37	-.37	-.70	-.30
29	-.82	-.67	-1.09	-1.33	-1.83	-1.33	.16	-.24	.02	-.42	-.39	-1.11	.00	-.40	-.05
30	-.54	-.43	-.82	-1.17	-1.58	-1.03	.37	-.02	.26	-.25	.13	-.84	.26	-.10	.25
31	-.58	-.39	-.73	-1.14	-1.54	-.96	.34	.16	.27	-.29	.35	-.69	.29	-.09	.27
32	-.52	-.41	-.59	-.99	-1.49	-.86	.49	.46	.51	-.27	.46	-.43	.41	-.01	.32
33	-.56	-.66	-.57	-.95	-1.51	-.96	.51	.55	.63	-.27	.43	-.31	.42	.08	.14
34	-.37	-.90	-.38	-.76	-1.12	-1.01	.64	.78	.87	.07	.57	-.09	.56	.28	.17
35	.08	-.68	-.07	-.47	-.75	-.83	1.01	1.15	1.25	.65	.77	.16	.76	.56	.40
36	.41	-.37	.09	-.16	-.32	-.61	1.00	1.20	1.26	.97	.90	.37	1.16	.94	.63
37	.62	-.18	-.17	-.06	-.14	-.51	.99	1.30	1.39	1.20	.84	.29	1.37	1.09	.72
38	.89	.01	-.32	.14	.14	-.26	1.06	1.52	1.49	1.40	1.01	.41	1.57	1.22	.94
39	1.11	.06	-.35	.34	.45	.07	1.03	1.56	1.62	1.48	1.24	.58	1.73	1.38	1.11
40	1.13	-.01	-.34	.40	.50	.30	.84	1.58	1.73	1.49	1.20	.54	1.71	1.43	1.06
41	1.21	.09	-.05	.68	.70	.54	.75	1.63	1.98	1.69	1.28	.76	1.89	1.58	1.21
42	1.01	-.12	.15	.67	.65	.74	.64	1.61	2.13	1.71	1.14	.83	1.95	1.43	1.10
43	.70	-.17	.21	.39	.41	.60	.41	1.40	1.86	1.42	.86	.63	1.85	1.20	.77
44	.02	-.96	-.17	-.22	-.11	-.03	-.22	.80	1.22	.74	.27	.23	1.35	.65	.14
45	-.28	-1.27	-.30	-.47	-.37	-.17	-.17	.81	1.19	.62	.07	.26	1.19	.33	-.14
46	-.67	-1.63	-.63	-.85	-.75	-.61	-.44	.51	.86	.26	-.28	.05	.75	-.04	-.76
47	-.72	-1.59	-.72	-.95	-.84	-.78	-.53	.62	.66	.17	-.36	.11	.52	-.07	-1.20
48	-.57	-1.54	-.71	-.75	-.73	-.67	-.62	.96	.48	-.01	-.32	.17	.50	-.09	-1.45
49	-.51	-1.63	-.75	-.69	-.94	-.78	-.71	.98	.11	-.49	-.30	.20	.46	-.17	-1.75
50	-.60	-1.69	-.77	-.54	-1.26	-.85	-.61	.94	-.11	-.50	-.36	.23	.38	-.29	-1.93
51	-.75	-1.71	-.82	-.49	-1.40	-.85	-.58	.78	-.39	-.35	-.54	.09	.26	-.46	-2.09
52	-.91	-1.94	-1.12	-.81	-1.50	-1.10	-.57	.39	-.78	-.51	-.87	-.29	-.05	-.81	-2.25
53	-.50	-1.49	-.75	-.57	-1.02	-.62	-.05	.42	-.54	-.22	-.49	-.02	.24	-.57	-1.83
54	-.89	-1.78	-1.24	-1.12	-1.48	-1.05	-.70	-.57	-1.12	-.61	-.85	-.47	-.12	-1.00	-2.19
55	-1.01	-1.60	-1.32	-1.41	-1.69	-1.33	-1.05	-1.13	-1.47	-.77	-.95	-.68	-.10	-.99	-2.07
56	-.97	-1.15	-1.32	-1.53	-1.59	-1.43	-1.06	-1.03	-1.46	-.41	-.86	-.77	.16	-.74	-1.64
57	-1.29	-1.21	-1.82	-2.14	-1.67	-1.60	-1.36	-1.12	-1.56	-.45	-1.15	-1.23	-.11	-.73	-1.67
58	-1.79	-1.74	-2.71	-2.59	-2.10	-2.06	-1.74	-1.20	-1.48	-1.13	-1.56	-1.90	-.63	-1.47	-2.13
59	-2.55	-2.09	-2.80	-2.66	-2.55	-2.25	-1.93	-1.03	-.85	-1.60	-1.73	-2.31	-1.06	-2.29	-2.65
60	-9.82	-9.72	-10.02	-10.52	-10.41	-9.93	-9.51	-8.97	-8.99	-9.88	-9.98	-10.71	-9.27	-10.36	-11.44
61	11.19	11.19	11.19	11.19	11.19	11.19	11.19	11.19	11.19	11.19	11.19	11.19	11.19	11.19	11.19
62	.00	.00	.00	.00	.00	.00	.00	.00	.00	.00	.00	.00	.00	.00	.00

NOAA-9 SCANNER OFFSETS FOR JUNE 1986: LONGWAVE CHANNEL
 DAY OF MONTH -->

S.P.	1	2	3	4	5	6	7	8	9	10	11	12	13	14	15
1	.29	.29	.29	.29	.29	.29	.29	.29	.29	.29	.29	.29	.29	.29	.29
2	.59	.59	.59	.59	.59	.59	.59	.59	.59	.59	.59	.59	.59	.59	.59
3	.63	.63	.63	.63	.63	.63	.63	.63	.63	.63	.63	.63	.63	.63	.63
4	.27	.27	.27	.27	.27	.27	.27	.27	.27	.27	.27	.27	.27	.27	.27
5	1.08	.12	.47	.69	1.19	1.37	.99	1.08	1.61	1.21	1.40	1.05	1.16	1.48	1.53
6	-.62	-.50	-.41	-.80	-.74	-.36	-.49	-.60	.26	-.31	.29	-.28	-.13	.51	.38
7	-2.05	-1.53	-1.83	-2.38	-2.17	-1.87	-1.81	-1.70	-1.08	-1.65	-.88	-1.40	-1.53	-.69	-1.02
8	-2.04	-1.96	-2.03	-2.45	-2.05	-2.08	-2.19	-1.76	-1.31	-1.80	-1.01	-1.45	-1.57	-.85	-1.33
9	-2.00	-2.35	-2.09	-2.33	-2.02	-2.11	-2.42	-1.90	-1.46	-1.70	-1.13	-1.50	-1.48	-1.19	-1.58
10	-2.08	-2.27	-2.02	-2.01	-1.86	-1.92	-2.20	-1.76	-1.39	-1.42	-1.03	-1.44	-1.34	-1.32	-1.63
11	-2.37	-2.40	-2.27	-2.04	-1.83	-2.23	-2.13	-1.86	-1.55	-1.68	-1.37	-1.71	-1.50	-1.59	-1.91
12	-2.98	-3.19	-3.13	-2.61	-2.27	-3.05	-2.71	-2.52	-2.22	-2.47	-2.31	-2.47	-2.19	-2.29	-2.61
13	-3.04	-3.45	-3.41	-2.79	-2.41	-3.17	-2.89	-2.55	-2.33	-2.76	-2.73	-2.67	-2.40	-2.50	-2.84
14	-3.25	-3.71	-3.69	-2.97	-2.68	-3.26	-2.92	-2.66	-2.51	-3.05	-3.03	-2.90	-2.48	-2.81	-3.16
15	-3.31	-3.69	-3.59	-2.87	-2.71	-3.21	-2.76	-2.68	-2.60	-3.02	-3.17	-2.99	-2.40	-3.00	-3.29
16	-3.57	-3.91	-3.74	-3.11	-2.97	-3.52	-3.08	-3.11	-3.09	-3.17	-3.59	-3.19	-2.76	-3.47	-3.71
17	-3.77	-4.19	-3.95	-3.39	-3.20	-3.86	-3.40	-3.78	-3.60	-3.49	-4.04	-3.51	-3.19	-3.88	-4.21
18	-3.85	-4.34	-3.99	-3.44	-3.32	-4.02	-3.65	-4.29	-3.83	-3.75	-4.15	-3.68	-3.41	-4.02	-4.44
19	-4.29	-4.66	-4.26	-3.80	-3.64	-4.34	-4.04	-4.81	-4.30	-4.17	-4.53	-4.07	-3.87	-4.37	-4.85
20	-4.53	-4.61	-4.47	-3.95	-3.71	-4.34	-4.15	-4.96	-4.57	-4.34	-4.78	-4.17	-4.11	-4.43	-4.96
21	-4.69	-4.61	-4.71	-4.15	-3.85	-4.36	-4.27	-5.10	-4.74	-4.58	-4.87	-4.21	-4.27	-4.52	-4.92
22	-4.87	-4.77	-4.85	-4.41	-4.11	-4.39	-4.41	-5.22	-4.97	-4.78	-4.95	-4.26	-4.49	-4.63	-4.92
23	-5.08	-4.99	-4.99	-4.68	-4.41	-4.47	-4.64	-5.50	-5.34	-4.87	-5.05	-4.34	-4.77	-4.77	-5.03
24	-5.29	-5.14	-5.09	-4.88	-4.57	-4.57	-4.82	-5.73	-5.55	-4.90	-5.09	-4.35	-5.02	-4.85	-5.11
25	-5.51	-5.29	-5.24	-5.20	-4.74	-4.74	-5.00	-5.95	-5.79	-4.89	-5.20	-4.51	-5.39	-4.97	-5.14
26	-5.31	-5.06	-4.97	-5.14	-4.54	-4.55	-4.83	-5.88	-5.66	-4.60	-4.97	-4.38	-5.40	-4.78	-4.80
27	-5.06	-4.88	-4.69	-4.98	-4.33	-4.39	-4.66	-5.83	-5.57	-4.42	-4.78	-4.28	-5.38	-4.59	-4.56
28	-4.88	-4.77	-4.52	-4.84	-4.17	-4.32	-4.50	-5.79	-5.56	-4.32	-4.69	-4.28	-5.33	-4.43	-4.43
29	-4.55	-4.52	-4.22	-4.60	-3.83	-4.13	-4.23	-5.60	-5.35	-4.09	-4.42	-4.03	-5.07	-4.08	-4.14
30	-4.27	-4.35	-3.95	-4.26	-3.56	-3.89	-4.02	-5.33	-4.97	-3.89	-4.24	-3.77	-4.84	-3.76	-3.96
31	-4.01	-4.05	-3.70	-3.94	-3.28	-3.53	-3.59	-5.02	-4.60	-3.58	-3.99	-3.46	-4.52	-3.42	-3.68
32	-3.62	-3.68	-3.43	-3.51	-2.94	-3.12	-3.16	-4.56	-4.18	-3.22	-3.55	-3.04	-4.08	-2.94	-3.27
33	-3.22	-3.26	-3.12	-3.03	-2.61	-2.69	-2.73	-4.10	-3.67	-2.82	-3.01	-2.64	-3.72	-2.47	-2.90
34	-2.67	-2.71	-2.62	-2.47	-2.15	-2.11	-2.14	-3.41	-2.98	-2.26	-2.38	-2.30	-3.27	-1.95	-2.46
35	-2.05	-2.14	-2.12	-1.85	-1.67	-1.55	-1.60	-2.80	-2.27	-1.65	-1.74	-1.83	-2.64	-1.35	-1.96
36	-1.50	-1.60	-1.57	-1.24	-1.15	-1.05	-1.24	-2.24	-1.66	-1.17	-1.11	-1.44	-2.22	-.88	-1.45
37	-1.10	-1.19	-1.17	-.81	-.72	-.67	-.97	-1.75	-1.31	-.84	-.66	-1.11	-1.75	-.44	-.97
38	-.66	-.74	-.78	-.33	-.28	-.28	-.68	-1.16	-.91	-.46	-.15	-.68	-1.30	.12	-.50
39	-.19	-.24	-.38	.10	.10	.15	-.33	-.62	-.56	-.01	.29	-.24	-.85	.62	-.05
40	.23	.20	-.01	.42	.41	.60	.00	-.24	-.22	.41	.59	.02	-.48	.99	.33
41	.80	.64	.50	.87	.83	1.18	.38	.26	.24	.91	.97	.35	.00	1.49	.79
42	1.20	.83	.90	1.10	1.05	1.46	.62	.63	.50	1.22	1.23	.56	.33	1.79	1.04
43	1.39	.83	1.10	1.18	1.10	1.58	.77	.89	.71	1.36	1.34	.64	.48	1.84	1.13
44	1.12	.45	.89	.97	.81	1.31	.57	.74	.48	1.18	1.17	.44	.34	1.66	.86
45	1.09	.24	.89	.98	.69	1.10	.59	.69	.41	1.18	1.15	.47	.41	1.78	.85
46	.92	.06	.77	.89	.44	.83	.50	.51	.29	1.00	1.01	.47	.34	1.65	.81
47	.94	-.01	.68	.85	.42	.74	.49	.47	.33	.79	1.00	.58	.41	1.65	.87
48	1.11	.03	.75	.86	.43	.76	.57	.66	.43	.67	1.11	.79	.62	1.86	.94
49	1.04	.05	.65	.74	.16	.51	.44	.65	.29	.43	1.01	.86	.78	1.81	.84
50	.98	.10	.60	.78	-.03	.31	.40	.62	.18	.26	1.02	.92	1.07	1.73	.84
51	.95	.27	.60	.72	-.11	.17	.36	.68	.16	.05	1.11	.98	1.27	1.74	.93
52	.54	.04	.34	.27	-.44	-.24	.01	.37	-.17	-.49	.83	.72	.95	1.38	.72
53	.29	-.09	.13	-.04	-.61	-.48	-.05	.08	-.28	-.85	.62	.61	.76	1.17	.58
54	-.25	-.49	-.42	-.74	-1.12	-.87	-.41	-.48	-.43	-1.23	.01	.22	.27	.73	.16
55	-.50	-.62	-.67	-1.08	-1.14	-.86	-.57	-.59	-.23	-1.12	-.10	.32	.08	.61	.05
56	-.64	-.73	-.55	-.97	-.88	-.65	-.50	-.47	.16	-.93	-.09	.42	.08	.57	.10
57	-1.06	-1.07	-.68	-1.01	-.85	-.90	-.72	-.57	.17	-.82	-.32	.15	-.06	.33	-.10
58	-1.20	-1.01	-.79	-.87	-.68	-1.17	-.85	-.71	.14	-.46	-.20	.16	.17	.06	-.32
59	-1.17	-.64	-.61	-.63	-.40	-1.32	-.67	-.84	-.07	-.32	-.04	.20	.34	.12	-.73
60	-4.90	-3.59	-3.99	-3.97	-4.43	-5.05	-4.70	-5.04	-4.65	-4.58	-4.35	-4.10	-4.26	-4.24	-5.24
61	.83	.83	.83	.83	.83	.83	.83	.83	.83	.83	.83	.83	.83	.83	.83
62	.00	.00	.00	.00	.00	.00	.00	.00	.00	.00	.00	.00	.00	.00	.00

NOAA-9 SCANNER OFFSETS FOR JUNE 1986: LONGHAVE CHANNEL
 DAY OF MONTH -->

S.P.	16	17	18	19	20	21	22	23	24	25	26	27	28	29	30
1	.29	.29	.29	.29	.29	.29	.29	.29	.29	.29	.29	.29	.29	.29	.29
2	.59	.59	.59	.59	.59	.59	.59	.59	.59	.59	.59	.59	.59	.59	.59
3	.63	.63	.63	.63	.63	.63	.63	.63	.63	.63	.63	.63	.63	.63	.63
4	.27	.27	.27	.27	.27	.27	.27	.27	.27	.27	.27	.27	.27	.27	.27
5	1.08	1.04	.89	1.15	.98	.88	1.30	1.38	1.11	1.32	.85	1.01	.89	.09	.49
6	-.01	-.25	-.62	-.24	-.39	-.09	.44	.44	.16	.34	.02	.20	.14	-.25	-.63
7	-.99	-1.41	-1.88	-1.64	-1.67	-1.37	-.95	-.94	-1.11	-1.25	-.96	-1.14	-1.25	-1.29	-1.82
8	-1.16	-1.46	-1.75	-1.70	-1.73	-1.55	-1.36	-1.11	-1.19	-1.49	-.92	-1.53	-1.32	-1.40	-1.85
9	-1.50	-1.54	-1.85	-1.71	-1.84	-1.56	-1.57	-1.21	-1.27	-1.63	-1.02	-1.78	-1.19	-1.53	-1.70
10	-1.71	-1.66	-1.94	-1.63	-1.73	-1.60	-1.51	-1.29	-1.29	-1.53	-1.06	-1.84	-1.12	-1.58	-1.47
11	-2.15	-1.96	-2.30	-1.90	-1.74	-2.03	-1.78	-1.56	-1.51	-1.73	-1.46	-2.06	-1.56	-1.82	-1.72
12	-3.02	-2.67	-3.02	-2.68	-2.43	-2.94	-2.52	-2.34	-2.06	-2.30	-2.32	-2.69	-2.44	-2.50	-2.51
13	-3.31	-2.91	-3.18	-2.89	-2.67	-3.22	-2.69	-2.59	-2.05	-2.24	-2.54	-2.80	-2.67	-2.56	-2.58
14	-3.53	-3.14	-3.28	-3.06	-2.88	-3.49	-2.95	-2.80	-2.14	-2.36	-2.73	-2.99	-2.77	-2.54	-2.64
15	-3.59	-3.04	-3.22	-3.08	-2.99	-3.56	-3.07	-2.87	-2.16	-2.42	-2.65	-3.01	-2.71	-2.46	-2.68
16	-3.91	-3.29	-3.51	-3.36	-3.44	-3.91	-3.30	-3.15	-2.41	-2.71	-2.85	-3.34	-2.96	-2.70	-3.08
17	-4.23	-3.59	-3.90	-3.75	-3.92	-4.24	-3.46	-3.41	-2.73	-2.97	-3.04	-3.62	-3.30	-2.97	-3.39
18	-4.33	-3.72	-3.97	-3.87	-4.18	-4.40	-3.54	-3.52	-2.91	-3.15	-3.12	-3.73	-3.49	-3.14	-3.44
19	-4.65	-4.19	-4.28	-4.27	-4.69	-4.78	-3.92	-3.93	-3.38	-3.64	-3.53	-4.15	-3.89	-3.61	-3.79
20	-4.78	-4.38	-4.52	-4.48	-4.93	-4.77	-4.02	-3.96	-3.51	-3.85	-3.74	-4.33	-4.05	-3.79	-3.90
21	-4.83	-4.44	-4.74	-4.60	-5.14	-4.84	-4.03	-4.02	-3.61	-4.02	-3.90	-4.46	-4.14	-3.99	-3.95
22	-4.92	-4.53	-4.97	-4.67	-5.37	-4.96	-4.09	-4.17	-3.79	-4.24	-4.10	-4.63	-4.29	-4.24	-4.04
23	-5.04	-4.65	-5.30	-4.90	-5.74	-5.07	-4.27	-4.32	-4.07	-4.44	-4.37	-4.91	-4.42	-4.39	-4.16
24	-5.13	-4.76	-5.51	-5.11	-6.00	-5.05	-4.25	-4.38	-4.26	-4.46	-4.57	-5.12	-4.51	-4.41	-4.23
25	-5.29	-4.91	-5.66	-5.32	-6.10	-5.24	-4.37	-4.52	-4.54	-4.65	-4.78	-5.25	-4.75	-4.51	-4.36
26	-5.13	-4.71	-5.39	-5.18	-5.85	-5.16	-4.24	-4.37	-4.44	-4.48	-4.64	-4.99	-4.59	-4.29	-4.22
27	-4.90	-4.51	-5.11	-5.06	-5.61	-5.11	-4.09	-4.32	-4.36	-4.34	-4.51	-4.81	-4.37	-4.20	-4.07
28	-4.72	-4.41	-4.90	-5.00	-5.44	-5.01	-3.93	-4.26	-4.21	-4.17	-4.35	-4.71	-4.13	-4.15	-3.95
29	-4.38	-4.21	-4.58	-4.80	-5.12	-4.72	-3.66	-4.00	-3.88	-3.88	-3.95	-4.45	-3.79	-3.84	-3.66
30	-4.12	-3.99	-4.33	-4.61	-4.89	-4.46	-3.47	-3.81	-3.68	-3.71	-3.58	-4.22	-3.58	-3.61	-3.41
31	-3.92	-3.76	-4.06	-4.36	-4.61	-4.20	-3.30	-3.50	-3.53	-3.53	-3.24	-3.94	-3.37	-3.42	-3.16
32	-3.60	-3.51	-3.69	-3.98	-4.30	-3.85	-2.94	-3.04	-3.15	-3.23	-2.91	-3.54	-3.02	-3.11	-2.86
33	-3.28	-3.31	-3.32	-3.61	-4.00	-3.58	-2.60	-2.65	-2.79	-2.90	-2.60	-3.12	-2.66	-2.72	-2.66
34	-2.78	-3.12	-2.83	-3.10	-3.31	-3.23	-2.14	-2.11	-2.29	-2.31	-2.12	-2.58	-2.17	-2.20	-2.27
35	-2.08	-2.57	-2.25	-2.53	-2.69	-2.70	-1.48	-1.45	-1.67	-1.53	-1.61	-2.04	-1.65	-1.65	-1.74
36	-1.50	-2.00	-1.75	-1.95	-2.01	-2.23	-1.19	-1.12	-1.37	-1.04	-1.17	-1.55	-1.04	-1.06	-1.26
37	-.98	-1.49	-1.53	-1.49	-1.51	-1.78	-.77	-.64	-.83	-.51	-.86	-1.24	-.54	-.61	-.85
38	-.42	-1.01	-1.28	-.99	-.97	-1.25	-.37	-.14	-.40	-.06	-.40	-.82	-.07	-.19	-.37
39	.07	-.64	-.95	-.52	-.42	-.70	-.06	.23	.08	.32	.10	-.37	.38	.25	.06
40	.44	-.31	-.58	-.12	-.05	-.18	.21	.64	.55	.70	.44	-.03	.74	.66	.39
41	.82	.08	-.05	.42	.43	.29	.44	.98	1.01	1.13	.82	.45	1.23	1.10	.83
42	.99	.40	.37	.70	.69	.72	.67	1.28	1.42	1.44	1.01	.80	1.58	1.29	1.05
43	1.04	.49	.67	.77	.77	.90	.81	1.42	1.50	1.52	1.08	.94	1.80	1.41	1.11
44	.78	.18	.63	.59	.64	.66	.56	1.19	1.26	1.27	.87	.87	1.67	1.23	.87
45	.77	.14	.72	.61	.65	.77	.80	1.42	1.46	1.38	.91	1.06	1.74	1.19	.85
46	.68	.07	.67	.53	.58	.65	.80	1.40	1.42	1.28	.85	1.09	1.63	1.12	.60
47	.71	.20	.69	.56	.62	.65	.86	1.59	1.44	1.32	.89	1.23	1.57	1.18	.39
48	.90	.33	.80	.79	.79	.82	.92	1.92	1.44	1.30	1.03	1.37	1.67	1.28	.31
49	.92	.22	.75	.81	.62	.71	.83	1.90	1.13	.94	1.02	1.36	1.63	1.19	.06
50	.89	.19	.75	.92	.40	.67	.92	1.90	1.02	1.00	.99	1.39	1.60	1.12	-.05
51	.93	.30	.83	1.08	.44	.80	1.07	1.92	1.00	1.24	1.00	1.44	1.65	1.14	-.03
52	.74	.06	.55	.81	.28	.54	1.00	1.59	.67	1.01	.73	1.11	1.37	.81	-.23
53	.64	-.01	.41	.60	.26	.47	.96	1.22	.50	.82	.62	.92	1.22	.61	-.32
54	.22	-.35	-.07	.11	-.17	.06	.42	.46	.00	.39	.24	.48	.84	.18	-.70
55	.07	-.30	-.18	-.13	-.37	-.18	.14	.04	-.29	.18	.11	.28	.81	.13	-.69
56	.03	-.07	-.24	-.27	-.34	-.30	.10	.06	-.32	.35	.09	.14	.92	.28	-.48
57	-.32	-.24	-.67	-.76	-.51	-.52	-.18	-.09	-.46	.20	-.23	-.29	.62	.16	-.63
58	-.59	-.51	-1.13	-.92	-.65	-.69	-.33	-.06	-.31	-.13	-.42	-.66	.37	-.25	-.85
59	-1.07	-.72	-1.15	-.93	-.86	-.76	-.42	.07	.08	-.31	-.50	-.88	.15	-.77	-1.13
60	-5.34	-5.21	-5.37	-5.53	-5.49	-5.23	-4.84	-4.56	-4.66	-5.09	-5.32	-5.79	-4.64	-5.50	-6.26
61	.83	.83	.83	.83	.83	.83	.83	.83	.83	.83	.83	.83	.83	.83	.83
62	.00	.00	.00	.00	.00	.00	.00	.00	.00	.00	.00	.00	.00	.00	.00

NOAA-9 SCANNER OFFSETS FOR JUNE 1986: SHORTWAVE CHANNEL

S.P.	DAY OF MONTH -->														
	1	2	3	4	5	6	7	8	9	10	11	12	13	14	15
1	-.11	-.11	-.11	-.11	-.11	-.11	-.11	-.11	-.11	-.11	-.11	-.11	-.11	-.11	-.11
2	.32	.32	.32	.32	.32	.32	.32	.32	.32	.32	.32	.32	.32	.32	.32
3	.49	.49	.49	.49	.49	.49	.49	.49	.49	.49	.49	.49	.49	.49	.49
4	-4.09	-4.09	-4.09	-4.09	-4.09	-4.09	-4.09	-4.09	-4.09	-4.09	-4.09	-4.09	-4.09	-4.09	-4.09
5	.79	.82	.84	.75	.82	.86	.80	.82	.84	.80	.71	.64	.76	.63	.74
6	.89	.91	.95	.86	.94	.97	.91	.95	.96	.90	.81	.76	.88	.74	.86
7	.53	.55	.59	.50	.58	.62	.55	.61	.61	.54	.45	.40	.51	.37	.48
8	.89	.90	.95	.87	.94	.99	.94	1.00	1.01	.93	.78	.76	.87	.73	.84
9	.95	.95	1.01	.94	1.00	1.05	1.00	1.06	1.08	.98	.84	.82	.93	.78	.90
10	.56	.57	.62	.59	.63	.65	.62	.67	.68	.62	.48	.42	.54	.39	.50
11	.93	.93	.98	.92	.98	1.03	.99	1.02	1.02	.97	.84	.75	.89	.73	.85
12	.89	.90	.96	.89	.94	.98	.94	.95	.96	.90	.74	.69	.83	.66	.78
13	.04	.09	.13	.06	.10	.13	.10	.11	.12	.06	-.17	-.18	-.03	-.21	-.08
14	.37	.38	.43	.40	.45	.45	.44	.44	.46	.40	.16	.17	.31	.14	.27
15	.37	.38	.45	.39	.44	.47	.45	.46	.47	.40	.14	.16	.30	.12	.26
16	-.05	-.03	.04	-.03	.02	.07	.04	.05	.06	-.01	-.28	-.27	-.11	-.30	-.16
17	.30	.32	.39	.32	.38	.42	.38	.40	.41	.35	.06	.08	.24	.06	.20
18	.32	.33	.41	.34	.40	.45	.40	.41	.43	.36	.09	.10	.26	.09	.23
19	-.08	-.06	.02	-.05	.01	.05	-.01	-.02	.00	-.05	-.29	-.31	-.14	-.31	-.18
20	.31	.32	.40	.34	.40	.44	.37	.35	.38	.32	.06	.09	.25	.09	.23
21	.32	.33	.40	.38	.43	.44	.38	.35	.39	.34	.07	.12	.28	.12	.25
22	-.14	-.12	-.03	-.10	-.05	-.01	-.07	-.10	-.09	-.14	-.41	-.36	-.20	-.37	-.23
23	.23	.25	.34	.27	.32	.36	.29	.24	.24	.22	-.04	.01	.17	.01	.14
24	.26	.28	.37	.29	.35	.38	.32	.29	.31	.24	-.01	.04	.21	.05	.17
25	-.14	-.11	-.02	-.11	-.04	.00	-.08	-.09	-.07	-.15	-.41	-.36	-.18	-.33	-.23
26	.25	.27	.35	.27	.33	.39	.29	.26	.31	.21	-.06	.03	.19	.07	.16
27	.27	.28	.37	.30	.35	.40	.29	.25	.30	.21	-.03	.05	.22	.11	.19
28	-.13	-.11	-.01	-.11	-.04	-.01	-.15	-.23	-.14	-.25	-.45	-.35	-.18	-.29	-.21
29	.28	.28	.37	.30	.37	.39	.19	.08	.17	.10	-.05	.08	.24	.14	.22
30	.32	.32	.40	.36	.43	.40	.26	.08	.13	.11	-.02	.15	.29	.21	.26
31	-.06	-.04	-.01	-.04	.03	-.02	-.09	-.31	-.35	-.31	-.41	-.26	-.10	-.20	-.16
32	.29	.31	.30	.30	.36	.29	.26	.04	-.12	.06	-.07	.10	.23	.13	.19
33	.19	.20	.19	.21	.26	.18	.14	-.02	-.19	-.02	-.13	.03	.16	.03	.11
34	-.19	-.19	-.15	-.15	-.12	-.16	-.20	-.31	-.45	-.36	-.49	-.35	-.21	-.33	-.25
35	.20	.19	.23	.22	.27	.26	.22	.18	.11	.13	-.08	.05	.18	.09	.15
36	.25	.23	.29	.28	.32	.32	.28	.26	.25	.21	-.02	.11	.25	.17	.22
37	-.10	-.12	-.04	-.07	-.02	-.02	-.08	-.08	-.04	-.13	-.35	-.23	-.09	-.17	-.11
38	.31	.28	.36	.33	.39	.40	.33	.32	.37	.26	.05	.18	.31	.23	.29
39	.35	.34	.40	.37	.43	.44	.35	.37	.40	.28	.08	.21	.34	.26	.33
40	.01	.02	.06	.04	.10	.11	.00	.02	.03	-.06	-.29	-.13	.00	-.09	-.01
41	.41	.42	.46	.47	.49	.51	.43	.40	.40	.34	.09	.27	.40	.30	.37
42	.45	.45	.49	.48	.52	.52	.45	.41	.40	.39	.11	.31	.43	.35	.40
43	.06	.08	.09	.08	.13	.12	.04	.01	.01	.00	-.29	-.06	.05	-.03	.00
44	.42	.42	.44	.44	.48	.47	.38	.34	.34	.34	.08	.30	.41	.34	.36
45	.42	.42	.44	.44	.47	.45	.37	.32	.30	.33	.08	.29	.40	.34	.34
46	.01	.03	.05	.03	.07	.04	-.05	-.09	-.12	-.07	-.30	-.10	-.01	-.07	-.06
47	.38	.38	.39	.38	.44	.40	.32	.24	.24	.28	.06	.27	.34	.29	.30
48	.40	.40	.40	.39	.45	.42	.32	.22	.24	.28	.10	.29	.36	.30	.32
49	.00	.02	.02	-.01	.05	.00	-.08	-.19	-.17	-.11	-.28	-.09	-.02	-.10	-.08
50	.37	.38	.38	.36	.40	.34	.31	.14	.13	.23	.11	.28	.36	.25	.28
51	.34	.37	.34	.33	.38	.29	.30	.12	.06	.19	.12	.29	.35	.25	.26
52	-.03	-.01	-.03	-.05	.00	-.08	-.08	-.22	-.33	-.17	-.21	-.05	-.01	-.10	-.13
53	.85	.79	.85	.84	.88	.82	.84	.75	.57	.71	.75	.94	.97	.85	.80
54	1.14	1.10	1.16	1.09	1.15	1.11	1.11	1.01	.91	1.02	1.04	1.23	1.26	1.16	1.11
55	.76	.72	.74	.72	.78	.73	.74	.60	.59	.66	.67	.86	.88	.80	.71
56	1.10	1.05	1.05	1.01	1.12	1.09	1.07	.92	.98	.99	1.02	1.20	1.22	1.14	1.04
57	1.09	1.05	1.06	1.03	1.11	1.06	1.08	.95	.99	1.00	1.03	1.21	1.23	1.14	1.02
58	.68	.65	.65	.61	.71	.61	.67	.54	.55	.58	.64	.82	.82	.72	.59
59	1.03	.99	.96	.96	1.04	.92	.99	.84	.81	.87	.98	1.15	1.15	1.02	.91
60	.99	.96	.91	.90	.98	.87	.95	.81	.74	.81	.97	1.13	1.10	1.00	.86
61	3.05	3.05	3.05	3.05	3.05	3.05	3.05	3.05	3.05	3.05	3.05	3.05	3.05	3.05	3.05
62	.00	.00	.00	.00	.00	.00	.00	.00	.00	.00	.00	.00	.00	.00	.00

NOAA-9 SCANNER OFFSETS FOR JUNE 1986: SHORTWAVE CHANNEL

S.P.	DAY OF MONTH -->															
	16	17	18	19	20	21	22	23	24	25	26	27	28	29	30	
1	-.11	-.11	-.11	-.11	-.11	-.11	-.11	-.11	-.11	-.11	-.11	-.11	-.11	-.11	-.11	
2	.32	.32	.32	.32	.32	.32	.32	.32	.32	.32	.32	.32	.32	.32	.32	
3	.49	.49	.49	.49	.49	.49	.49	.49	.49	.49	.49	.49	.49	.49	.49	
4	-4.09	-4.09	-4.09	-4.09	-4.09	-4.09	-4.09	-4.09	-4.09	-4.09	-4.09	-4.09	-4.09	-4.09	-4.09	
5	.78	.83	.75	.72	.64	.64	.51	.48	.55	.69	.72	.79	.58	.76	.88	
6	.89	.95	.87	.83	.75	.75	.61	.57	.65	.79	.84	.89	.68	.87	1.01	
7	.52	.59	.50	.47	.39	.39	.24	.19	.29	.42	.47	.53	.30	.52	.66	
8	.88	.96	.87	.84	.76	.75	.59	.55	.65	.77	.84	.88	.64	.88	1.02	
9	.93	1.01	.92	.89	.82	.80	.64	.59	.70	.82	.88	.93	.66	.92	1.06	
10	.52	.62	.52	.49	.42	.40	.25	.19	.32	.43	.50	.53	.26	.54	.65	
11	.87	.97	.87	.84	.76	.74	.59	.54	.67	.78	.85	.89	.60	.89	1.03	
12	.81	.90	.80	.78	.69	.69	.54	.48	.63	.72	.79	.84	.53	.85	.97	
13	-.06	.03	-.07	-.09	-.17	-.13	-.29	-.34	-.20	-.11	-.07	-.01	-.33	.00	.12	
14	.27	.37	.28	.27	.17	.22	.06	.01	.15	.24	.29	.32	.03	.34	.46	
15	.27	.35	.27	.24	.15	.20	.04	.00	.14	.22	.27	.32	.01	.32	.47	
16	-.15	-.07	-.15	-.17	-.27	-.20	-.36	-.40	-.27	-.18	-.15	-.09	-.40	-.09	.06	
17	.22	.28	.21	.19	.08	.15	.00	-.05	.07	.17	.22	.27	-.04	.27	.41	
18	.25	.29	.23	.20	.10	.17	.02	-.02	.10	.20	.24	.29	-.01	.28	.43	
19	-.16	-.12	-.18	-.20	-.30	-.22	-.36	-.40	-.28	-.19	-.15	-.10	-.40	-.12	.02	
20	.25	.30	.22	.21	.11	.18	.05	.01	.13	.21	.26	.30	.01	.28	.40	
21	.28	.34	.24	.24	.14	.21	.09	.05	.16	.25	.30	.31	.04	.30	.41	
22	-.17	-.11	-.24	-.25	-.35	-.26	-.38	-.41	-.31	-.22	-.19	-.16	-.42	-.17	-.05	
23	.21	.26	.14	.12	.02	.11	.00	-.03	.07	.16	.18	.21	-.04	.20	.33	
24	.25	.29	.17	.15	.05	.14	.03	.00	.09	.18	.21	.24	.01	.23	.36	
25	-.14	-.10	-.23	-.24	-.34	-.26	-.37	-.38	-.31	-.20	-.19	-.15	-.37	-.16	-.04	
26	.25	.28	.15	.13	.03	.12	.01	-.01	.06	.19	.19	.23	.02	.22	.35	
27	.28	.30	.17	.14	.04	.14	.03	.02	.06	.20	.21	.24	.06	.23	.36	
28	-.11	-.09	-.23	-.27	-.37	-.28	-.36	-.41	-.35	-.22	-.18	-.17	-.32	-.18	-.03	
29	.31	.33	.19	.15	.04	.12	.05	-.03	.02	.18	.24	.24	.12	.23	.37	
30	.35	.39	.23	.18	.09	.18	.11	.03	.05	.23	.31	.28	.19	.28	.40	
31	-.08	-.03	-.17	-.24	-.35	-.24	-.30	-.34	-.22	-.10	-.12	-.22	-.14	-.05	-.05	
32	.21	.27	.13	.06	-.03	.09	.06	.01	-.02	.07	.20	.21	.08	.13	.22	
33	.06	.12	.00	-.02	-.11	-.01	-.02	-.09	-.13	-.07	.04	.05	-.08	-.06	.04	
34	-.34	-.31	-.39	-.42	-.51	-.40	-.38	-.44	-.49	-.44	-.37	-.40	-.49	-.48	-.38	
35	.07	.08	.01	.00	-.08	.01	.02	-.05	-.07	-.02	.03	-.01	-.09	-.08	.02	
36	.14	.13	.08	.08	-.01	.10	.11	.09	.08	.11	.09	.04	-.01	.03	.11	
37	-.17	-.20	-.26	-.26	-.34	-.20	-.22	-.21	-.19	-.20	-.22	-.29	-.27	-.25	-.18	
38	.25	.17	.16	.17	.10	.22	.17	.20	.21	.21	.24	.15	.19	.20	.27	
39	.30	.18	.18	.20	.15	.29	.25	.24	.27	.28	.29	.21	.27	.26	.33	
40	-.04	-.16	-.17	-.14	-.18	-.04	-.10	-.11	-.09	-.06	-.05	-.10	-.06	-.08	.01	
41	.37	.23	.23	.25	.21	.35	.29	.28	.32	.34	.34	.31	.34	.31	.41	
42	.39	.28	.30	.29	.24	.40	.35	.34	.36	.41	.39	.36	.39	.36	.43	
43	.00	-.11	-.07	-.08	-.14	.00	-.05	-.05	-.05	.03	.02	-.04	.02	-.02	.04	
44	.37	.23	.30	.28	.21	.35	.31	.31	.30	.26	.36	.38	.31	.41	.31	
45	.35	.23	.29	.26	.18	.33	.31	.30	.26	.36	.38	.31	.41	.31	.36	
46	-.06	-.16	-.12	-.15	-.22	-.08	-.10	-.12	-.16	-.07	-.02	-.08	.01	-.10	-.05	
47	.32	.23	.23	.20	.12	.27	.25	.24	.19	.27	.35	.28	.38	.26	.30	
48	.38	.28	.25	.21	.13	.28	.27	.26	.21	.29	.36	.29	.40	.27	.31	
49	-.03	-.10	-.15	-.18	-.26	-.11	-.13	-.13	-.18	-.11	-.04	-.11	.01	-.13	-.08	
50	.29	.25	.21	.17	.10	.24	.23	.23	.17	.24	.31	.26	.37	.22	.27	
51	.22	.23	.21	.18	.09	.25	.25	.24	.18	.22	.28	.22	.36	.21	.23	
52	-.17	-.15	-.16	-.18	-.25	-.11	-.10	-.11	-.18	-.13	-.12	-.16	.01	-.16	-.15	
53	.76	.77	.74	.75	.70	.78	.79	.81	.69	.78	.81	.78	.90	.74	.77	
54	1.05	1.05	1.03	1.03	.97	1.03	1.02	1.04	.94	1.05	1.12	1.09	1.23	1.04	1.07	
55	.65	.62	.63	.62	.59	.64	.61	.66	.54	.69	.77	.70	.87	.68	.71	
56	.97	.94	.94	.94	.92	.97	.93	1.00	.85	1.00	1.12	1.03	1.23	.98	1.06	
57	.98	.94	.89	.88	.91	.93	.88	.97	.84	.97	1.12	1.02	1.25	.99	1.06	
58	.59	.52	.41	.40	.44	.47	.47	.55	.45	.52	.72	.60	.84	.54	.61	
59	.94	.84	.73	.69	.72	.76	.79	.89	.74	.79	1.02	.90	1.14	.81	.88	
60	.90	.81	.71	.66	.70	.70	.81	.85	.69	.67	.94	.82	1.01	.68	.73	
61	3.05	3.05	3.05	3.05	3.05	3.05	3.05	3.05	3.05	3.05	3.05	3.05	3.05	3.05	3.05	
62	.00	.00	.00	.00	.00	.00	.00	.00	.00	.00	.00	.00	.00	.00	.00	

S.P.	NOAA-9 SCANNER OFFSETS FOR JULY 1986: DAY OF MONTH -->										TOTAL	CHANNEL				
	1	2	3	4	5	6	7	8	9	10	11	12	13	14	15	
1	.36	.36	.36	.36	.36	.36	.36	.36	.36	.36	.36	.36	.36	.36	.36	
2	1.04	1.04	1.04	1.04	1.04	1.04	1.04	1.04	1.04	1.04	1.04	1.04	1.04	1.04	1.04	
3	1.93	1.93	1.93	1.93	1.93	1.93	1.93	1.93	1.93	1.93	1.93	1.93	1.93	1.93	1.93	
4	-9.64	-9.64	-9.64	-9.64	-9.64	-9.64	-9.64	-9.64	-9.64	-9.64	-9.64	-9.64	-9.64	-9.64	-9.64	
5	.88	1.14	1.20	1.27	1.25	.56	1.04	1.36	.11	-.41	-.09	-.87	-1.41	-1.41	.21	
6	1.50	2.19	1.95	2.24	2.21	1.69	2.68	2.67	1.32	1.91	1.90	1.19	1.66	1.20	2.25	
7	-1.59	-1.04	-1.33	-.94	-1.06	-1.31	-.08	-.58	-1.40	-1.18	-1.31	-1.80	-1.12	-1.74	-.65	
8	-1.65	-1.54	-1.80	-1.75	-1.66	-1.84	-.69	-1.16	-1.36	-1.77	-1.64	-2.28	-1.63	-2.27	-1.25	
9	-1.99	-2.49	-2.26	-2.70	-2.41	-2.73	-1.83	-2.00	-1.78	-2.55	-2.28	-2.81	-2.31	-3.10	-2.12	
10	-.99	-1.81	-1.26	-1.84	-1.63	-2.02	-.95	-1.04	-.86	-1.74	-1.36	-1.71	-1.48	-2.36	-1.51	
11	-.84	-1.73	-1.32	-1.89	-1.59	-1.83	-.81	-.89	-.87	-2.00	-1.45	-1.53	-1.37	-2.41	-1.75	
12	-.76	-1.89	-1.50	-2.02	-1.66	-1.62	-1.04	-.79	-1.05	-2.04	-1.50	-1.54	-1.26	-2.37	-1.92	
13	-1.31	-2.62	-1.99	-2.55	-2.39	-1.91	-1.77	-1.30	-1.85	-2.31	-2.10	-2.16	-1.93	-2.82	-2.40	
14	-1.12	-2.31	-1.64	-2.08	-2.20	-1.55	-1.79	-1.11	-1.73	-1.82	-1.85	-1.88	-1.86	-2.50	-1.95	
15	-.85	-1.96	-1.44	-1.83	-1.78	-1.48	-2.00	-1.03	-1.52	-1.44	-1.66	-1.82	-1.75	-2.21	-1.60	
16	-.80	-1.83	-1.56	-1.81	-1.55	-1.59	-2.16	-1.05	-1.37	-1.23	-1.58	-1.94	-1.95	-2.05	-1.47	
17	-.70	-1.73	-1.79	-1.77	-1.40	-1.60	-2.16	-.99	-1.19	-1.12	-1.47	-1.93	-2.15	-2.04	-1.45	
18	-2.27	-1.33	-1.79	-1.56	-.96	-1.23	-1.89	-.60	-.75	-.81	-1.18	-1.71	-1.94	-1.85	-1.22	
19	-.34	-1.37	-1.88	-1.58	-.95	-1.25	-1.95	-.41	-.70	-.85	-1.14	-1.91	-1.99	-1.80	-1.21	
20	-.81	-1.67	-2.05	-1.74	-1.29	-1.68	-2.42	-.55	-.93	-1.22	-1.32	-2.27	-2.32	-2.02	-1.44	
21	-.70	-1.40	-1.66	-1.32	-1.05	-1.58	-2.24	-.30	-.64	-1.05	-1.05	-1.90	-2.00	-1.83	-1.09	
22	-.89	-1.48	-1.71	-1.28	-1.14	-1.65	-2.25	-.34	-.64	-1.16	-1.11	-1.92	-2.02	-1.92	-1.03	
23	-.09	-.60	-.91	-.19	-.19	-.68	-1.13	.70	.49	-.05	-.12	-.89	-.93	-.89	.16	
24	.01	-.52	-.85	.09	-.01	-.51	-.76	1.15	.74	.31	.11	-.63	-.56	-.68	.59	
25	-.12	-.61	-.96	.05	-.13	-.59	-.81	1.30	.66	.37	.01	-.63	-.43	-.88	.65	
26	-.04	-.45	-.80	.28	.04	-.48	-.63	1.64	.73	.62	.06	-.34	-.10	-.73	.93	
27	-.08	-.49	-.81	.35	.08	-.47	-.51	1.71	.60	.71	-.07	-.23	.03	-.53	1.02	
28	.22	-.32	-.68	.51	.40	-.26	-.18	1.89	.60	1.01	.04	.06	.25	-.19	1.39	
29	.25	-.20	-.52	.53	.65	-.11	.06	1.95	.55	1.24	.22	.29	.29	.10	1.58	
30	.23	-.19	-.21	.65	.84	-.12	.34	2.12	.53	1.34	.40	.50	.33	.38	1.56	
31	.35	-.04	.21	.90	1.15	.02	.77	2.53	.67	1.51	.65	.81	.55	.62	1.62	
32	.45	.03	.68	1.19	1.40	.27	1.25	2.98	.90	1.82	1.07	1.30	.84	.95	1.83	
33	.76	.22	1.24	1.46	1.60	.55	1.72	3.41	1.25	2.22	1.45	1.85	1.23	1.52	2.16	
34	.64	-.01	1.12	1.17	1.19	.24	1.69	3.30	1.08	1.77	1.10	1.68	1.03	1.36	1.73	
35	.82	.05	1.20	1.03	1.11	.31	1.88	3.32	1.21	1.43	1.02	1.61	1.10	1.36	1.67	
36	1.16	.27	1.44	1.11	1.19	.55	2.04	3.44	1.48	1.27	1.10	1.70	1.21	1.56	1.82	
37	.64	-.32	.79	.52	.43	-.14	1.34	2.86	.87	.36	.42	.99	.40	.89	1.11	
38	.70	-.24	.83	.66	.49	-.06	1.31	2.96	.90	.31	.45	.95	.40	.89	1.23	
39	.45	-.58	.52	.49	.25	-.33	1.07	2.79	.74	.01	.27	.56	.19	.63	1.09	
40	.55	-.59	.56	.58	.19	-.30	1.30	2.94	.89	-.04	.40	.55	.32	.72	1.23	
41	.63	-.40	.66	.73	.23	-.09	1.55	3.16	1.04	-.01	.59	.56	.51	.84	1.32	
42	.48	-.44	.78	.69	.09	-.09	1.69	3.10	.97	-.08	.59	.39	.44	.82	1.25	
43	.19	-.61	.83	.56	-.01	-.15	1.66	2.80	.56	-.24	.53	-.06	.22	.71	1.08	
44	.05	-.72	.93	.62	.13	-.13	1.76	2.51	.35	-.17	.64	-.30	.14	.77	1.07	
45	-.23	-.92	.78	.50	.01	-.40	1.66	2.13	.09	-.32	.51	-.48	-.10	.68	.91	
46	-.69	-1.04	.50	.42	-.13	-.62	1.50	1.93	-.14	-.47	.26	-.56	-.34	.69	.80	
47	-1.14	-1.08	.29	.41	-.23	-.80	1.39	1.59	-.41	-.44	.01	-.64	-.57	.80	.68	
48	-1.56	-1.09	.11	.33	-.56	-1.03	1.38	1.11	-.65	-.46	-.21	-.80	-.79	.64	.37	
49	-1.76	-.83	-.20	.32	-.86	-1.19	1.43	.67	-.73	-.53	-.26	-.80	-.91	.38	-.01	
50	-1.85	-.47	-.59	.34	-.99	-1.40	1.28	.33	-.87	-.63	-.13	-.88	-.92	.18	-.35	
51	-2.04	-.45	-1.23	-.01	-1.26	-1.88	.89	-.15	-1.39	-1.00	-.30	-1.13	-.99	-.07	-.90	
52	-2.30	-.83	-2.09	-.77	-1.78	-2.42	.38	-1.05	-2.03	-1.40	-.81	-1.62	-1.32	-.46	-1.55	
53	-1.74	-.84	-2.29	-.95	-1.72	-2.13	.40	-1.45	-2.12	-1.12	-.64	-1.49	-1.07	-.29	-1.48	
54	-1.89	-1.45	-2.89	-1.78	-1.95	-2.34	-.24	-2.21	-2.70	-1.55	-1.10	-1.88	-1.53	-.99	-1.93	
55	-1.85	-1.59	-2.97	-2.12	-1.82	-2.14	-.62	-2.46	-2.78	-1.63	-1.32	-2.14	-1.68	-1.09	-2.02	
56	-1.95	-2.04	-3.21	-2.48	-2.22	-2.35	-1.32	-2.69	-3.14	-2.00	-1.96	-2.72	-2.01	-1.73	-2.46	
57	-1.97	-2.40	-3.15	-2.67	-2.59	-2.62	-1.81	-2.68	-2.79	-2.23	-2.45	-2.78	-2.30	-2.35	-2.46	
58	-1.89	-2.71	-2.71	-2.30	-2.36	-2.40	-2.30	-2.10	-1.83	-1.71	-2.14	-2.43	-2.14	-2.35	-1.73	
59	-1.81	-3.03	-2.52	-2.12	-2.12	-2.53	-2.83	-1.50	-1.49	-1.07	-2.00	-2.15	-1.73	-2.30	-1.31	
60	-14.82	-15.77	-15.51	-15.21	-15.05	-15.71	-15.21	-14.56	-14.59	-13.48	-14.77	-14.51	-13.99	-14.66	-14.88	
61	11.19	11.19	11.19	11.19	11.19	11.19	11.19	11.19	11.19	11.19	11.19	11.19	11.19	11.19	11.19	
62	.00	.00	.00	.00	.00	.00	.00	.00	.00	.00	.00	.00	.00	.00	.00	

S.P.	NOAA-9 SCANNER OFFSETS FOR JULY 1986: TOTAL CHANNEL															
	DAY OF MONTH -->															
	16	17	18	19	20	21	22	23	24	25	26	27	28	29	30	31
1	.36	.36	.36	.36	.36	.36	.36	.36	.36	.36	.36	.36	.36	.36	.36	.36
2	1.04	1.04	1.04	1.04	1.04	1.04	1.04	1.04	1.04	1.04	1.04	1.04	1.04	1.04	1.04	1.04
3	1.93	1.93	1.93	1.93	1.93	1.93	1.93	1.93	1.93	1.93	1.93	1.93	1.93	1.93	1.93	1.93
4	-9.64	-9.64	-9.64	-9.64	-9.64	-9.64	-9.64	-9.64	-9.64	-9.64	-9.64	-9.64	-9.64	-9.64	-9.64	-9.64
5	-.17	-.19	-.06	-.02	-.09	.41	-.07	-.68	-.29	-.34	-.24	-.57	-.88	-.93	-.65	-.65
6	1.82	1.87	1.56	1.93	1.84	1.97	2.19	1.60	1.77	1.69	1.80	1.24	.55	1.08	1.32	1.56
7	-1.18	-1.24	-1.07	-1.01	-1.42	-1.08	-1.24	-1.29	-.84	-1.39	-1.20	-1.40	-2.53	-2.11	-1.81	-1.33
8	-1.92	-1.70	-1.27	-1.69	-1.86	-1.08	-1.90	-1.74	-1.15	-1.76	-1.95	-1.33	-2.93	-2.83	-2.44	-1.87
9	-2.82	-2.36	-2.06	-2.47	-2.20	-1.38	-2.52	-2.61	-1.84	-2.22	-2.90	-1.81	-3.49	-3.56	-3.20	-2.67
10	-1.80	-1.46	-.93	-1.57	-.85	-.54	-1.52	-1.77	-.98	-1.02	-2.21	-.88	-2.18	-2.37	-2.32	-2.10
11	-1.54	-1.38	-.42	-1.44	-.44	-.60	-1.50	-1.55	-.88	-.84	-2.43	-.88	-1.67	-1.94	-2.17	-2.36
12	-1.49	-1.37	-.49	-1.48	-.22	-.73	-1.54	-1.39	-.82	-.80	-2.76	-1.06	-1.58	-1.88	-2.25	-2.64
13	-2.39	-1.91	-1.20	-1.91	-.70	-1.43	-2.28	-1.83	-1.38	-1.27	-3.59	-1.55	-2.02	-2.40	-3.12	-3.20
14	-2.31	-1.77	-1.25	-1.49	-.65	-1.28	-2.30	-1.47	-1.12	-.97	-3.35	-1.26	-1.69	-2.28	-3.26	-2.88
15	-2.12	-1.70	-1.36	-1.30	-.57	-.99	-2.30	-1.30	-.96	-.83	-2.85	-.94	-1.42	-2.02	-3.15	-2.77
16	-2.12	-1.84	-1.40	-1.32	-.71	-.89	-2.42	-1.26	-1.07	-1.00	-2.27	-.82	-1.44	-1.80	-3.14	-2.85
17	-2.11	-1.98	-1.47	-1.30	-.83	-.88	-2.47	-1.26	-1.14	-1.36	-1.70	-.79	-1.55	-1.66	-3.17	-2.95
18	-1.79	-1.84	-1.33	-1.05	-.51	-.60	-2.21	-1.01	-.92	-1.31	-.99	-.57	-1.30	-1.42	-2.96	-2.83
19	-1.65	-2.03	-1.51	-1.15	-.33	-.58	-2.20	-1.01	-1.09	-1.39	-.70	-.75	-1.36	-1.58	-3.11	-2.90
20	-1.92	-2.43	-1.92	-1.56	-.33	-.89	-2.74	-1.32	-1.46	-1.79	-.82	-1.27	-1.76	-2.05	-3.47	-3.15
21	-1.82	-2.12	-1.81	-1.45	.10	-.68	-2.66	-1.06	-1.28	-1.72	-.59	-1.11	-1.72	-1.94	-3.17	-2.99
22	-1.98	-1.97	-2.08	-1.54	.12	-.74	-2.71	-.99	-1.45	-1.78	-.63	-1.06	-1.95	-2.07	-3.11	-3.09
23	-1.06	-.91	-1.29	-.53	1.14	.28	-1.86	.09	-.55	-.76	.48	.07	-1.05	-1.20	-2.00	-2.11
24	-.88	-.65	-1.19	-.28	1.47	.53	-1.58	.30	-.43	-.48	1.02	.37	-.76	-1.10	-1.65	-1.73
25	-.91	-.71	-1.28	-.22	1.60	.41	-1.61	.28	-.62	-.53	1.13	.34	-.77	-1.12	-1.61	-1.65
26	-.72	-.56	-1.06	.05	1.88	.45	-1.36	.52	-.47	-.40	1.31	.44	-.53	-.93	-1.26	-1.42
27	-.79	-.45	-1.07	.10	1.90	.34	-.96	.45	-.39	-.39	1.36	.48	-.39	-.78	-.99	-1.21
28	-.58	-.12	-.89	.27	2.01	.55	-.68	.59	-.12	-.19	1.58	.83	-.02	-.44	-.58	-.79
29	-.37	.12	-.76	.35	2.10	.75	-.41	.68	.16	-.11	1.69	1.05	.13	-.21	-.26	-.55
30	-.23	.27	-.55	.43	2.10	.90	-.32	.73	.47	-.01	1.81	1.14	.33	.02	.06	-.30
31	-.02	.58	-.23	.79	2.15	1.12	.02	.94	.91	.38	2.06	1.39	.73	.33	.57	.16
32	.27	.96	.06	1.31	2.26	1.45	.47	1.27	1.30	.74	2.27	1.75	1.08	.63	1.11	.64
33	.63	1.45	.38	1.83	2.62	1.89	1.02	1.62	1.78	1.14	2.57	2.17	1.52	.94	1.64	1.09
34	.50	1.41	.16	1.75	2.58	1.81	.95	1.39	1.68	.99	2.32	2.02	1.31	.68	1.53	1.05
35	.65	1.65	.21	1.86	2.76	1.94	1.04	1.33	1.83	1.11	2.31	2.02	1.17	.66	1.48	1.18
36	1.01	1.90	.33	2.07	2.98	2.16	1.19	1.36	1.99	1.26	2.41	2.13	1.14	.86	1.56	1.31
37	.45	1.19	-.32	1.49	2.20	1.52	.51	.63	1.28	.57	1.64	1.33	.27	.23	.83	.55
38	.55	1.19	-.21	1.49	1.99	1.58	.57	.57	1.21	.55	1.46	1.23	.17	.29	.79	.44
39	.30	.89	-.35	1.13	1.57	1.34	.25	.26	.78	.29	1.01	.84	-.25	.07	.45	.20
40	.40	.96	-.15	1.14	1.52	1.43	.31	.30	.75	.36	.92	.80	-.40	.11	.61	.44
41	.67	1.06	.14	1.19	1.46	1.61	.48	.40	.92	.47	1.01	.90	-.30	.32	.88	.83
42	.74	1.01	.21	1.03	1.20	1.62	.47	.23	.96	.36	.75	.76	-.49	.45	.79	1.05
43	.67	.88	.05	.84	.84	1.60	.46	-.07	.91	.20	.33	.54	-.84	.44	.59	1.02
44	.68	.90	.00	.82	.85	1.71	.56	-.13	1.03	.24	.12	.51	-.94	.58	.64	1.03
45	.47	.78	-.16	.62	.86	1.58	.41	-.28	.90	.18	-.16	.40	-1.10	.61	.43	.94
46	.25	.53	-.34	.44	.80	1.44	.19	-.41	.73	.11	-.42	.14	-1.22	.53	.11	.80
47	.03	.23	-.44	.09	.63	1.39	.12	-.53	.64	.01	-.66	-.08	-1.26	.34	-.13	.54
48	-.21	.07	-.41	-.32	.45	1.16	.06	-.68	.55	-.07	-.92	-.28	-1.38	.09	-.38	.34
49	-.40	-.03	-.27	-.59	.36	.96	.02	-.77	.46	-.09	-1.14	-.58	-1.55	-.20	-.57	.18
50	-.61	-.09	-.21	-.67	.23	.70	-.04	-1.00	.39	-.17	-1.37	-.82	-1.60	-.33	-.70	-.05
51	-1.06	-.55	-.57	-.96	-.15	.18	-.27	-1.26	-.04	-.45	-1.72	-1.39	-1.94	-.66	-1.09	-.35
52	-1.66	-1.32	-1.12	-1.37	-.64	-.46	-.77	-1.53	-.64	-.89	-2.20	-2.08	-2.44	-1.27	-1.67	-.84
53	-1.40	-1.35	-.93	-1.07	-.44	-.27	-.80	-1.18	-.47	-.69	-1.94	-1.79	-2.04	-1.40	-1.62	-.93
54	-1.82	-1.79	-1.13	-1.39	-.85	-.59	-1.48	-1.46	-.98	-1.18	-2.16	-2.10	-2.13	-2.34	-2.23	-1.40
55	-1.87	-1.87	-.92	-1.30	-.97	-.68	-1.86	-1.42	-1.18	-1.48	-2.19	-2.10	-2.13	-3.00	-2.41	-1.72
56	-2.15	-2.48	-1.05	-1.72	-1.55	-1.04	-2.34	-1.77	-1.82	-2.23	-2.49	-2.42	-2.53	-3.73	-2.83	-2.49
57	-2.30	-2.87	-1.57	-2.07	-2.01	-1.07	-2.64	-2.18	-2.36	-2.37	-2.86	-2.29	-2.50	-4.03	-2.92	-2.97
58	-2.07	-2.14	-2.10	-1.93	-1.40	-.58	-2.42	-2.23	-1.84	-1.77	-2.59	-1.85	-1.80	-3.48	-2.85	-2.92
59	-2.00	-1.64	-2.51	-2.03	-1.31	-.45	-2.26	-2.38	-1.55	-1.72	-2.22	-2.03	-2.03	-2.97	-3.41	-3.04
60	-15.94	-15.80	-16.38	-16.33	-15.40	-14.80	-16.62	-16.43	-16.40	-16.30	-16.50	-16.55	-16.90	-17.08	-17.49	-17.20
61	11.19	11.19	11.19	11.19	11.19	11.19	11.19	11.19	11.19	11.19	11.19	11.19	11.19	11.19	11.19	11.19
62	.00	.00	.00	.00	.00	.00	.00	.00	.00	.00	.00	.00	.00	.00	.00	.00

NOAA-9 SCANNER OFFSETS FOR JULY 1986: LONGWAVE CHANNEL

S.P.	DAY OF MONTH -->														
	1	2	3	4	5	6	7	8	9	10	11	12	13	14	15
1	.29	.29	.29	.29	.29	.29	.29	.29	.29	.29	.29	.29	.29	.29	.29
2	.59	.59	.59	.59	.59	.59	.59	.59	.59	.59	.59	.59	.59	.59	.59
3	.63	.63	.63	.63	.63	.63	.63	.63	.63	.63	.63	.63	.63	.63	.63
4	.27	.27	.27	.27	.27	.27	.27	.27	.27	.27	.27	.27	.27	.27	.27
5	.12	.30	.35	.35	.32	-.12	.21	.36	-.49	-.79	-.62	-1.10	-1.37	-1.38	-.33
6	-.28	.16	.03	.17	.13	-.23	.44	.39	-.57	-.19	-.20	-.66	-.30	-.60	-.12
7	-1.90	-1.54	-1.71	-1.52	-1.62	-1.80	-.97	-1.33	-1.97	-1.82	-1.91	-2.21	-1.71	-2.12	-1.38
8	-2.00	-1.93	-2.08	-2.12	-2.08	-2.22	-1.44	-1.77	-2.02	-2.28	-2.21	-2.58	-2.10	-2.53	-1.84
9	-2.28	-2.63	-2.46	-2.82	-2.65	-2.88	-2.28	-2.39	-2.38	-2.89	-2.71	-3.01	-2.64	-3.17	-2.49
10	-1.73	-2.29	-1.90	-2.36	-2.26	-2.51	-1.81	-1.88	-1.88	-2.48	-2.23	-2.40	-2.21	-2.81	-2.18
11	-1.79	-2.41	-2.11	-2.57	-2.42	-2.54	-1.89	-1.97	-2.06	-2.84	-2.47	-2.46	-2.32	-3.02	-2.51
12	-1.77	-2.56	-2.29	-2.71	-2.51	-2.45	-2.10	-1.96	-2.25	-2.94	-2.58	-2.55	-2.34	-3.07	-2.68
13	-2.14	-3.08	-2.63	-3.08	-3.02	-2.67	-2.63	-2.34	-2.82	-3.15	-3.01	-3.00	-2.83	-3.40	-3.04
14	-2.22	-3.12	-2.60	-3.12	-2.99	-3.12	-2.69	-2.90	-2.48	-3.01	-3.07	-3.08	-3.06	-3.45	-3.01
15	-2.24	-3.10	-2.66	-3.01	-3.03	-2.88	-3.25	-2.65	-3.10	-3.01	-3.13	-3.25	-3.20	-3.49	-3.03
16	-2.38	-3.18	-2.90	-3.16	-3.04	-3.15	-3.54	-2.84	-3.17	-3.02	-3.22	-3.52	-3.54	-3.59	-3.17
17	-2.51	-3.31	-3.25	-3.32	-3.11	-3.36	-3.74	-2.97	-3.23	-3.11	-3.33	-3.72	-3.92	-3.81	-3.39
18	-2.44	-3.23	-3.44	-3.36	-3.00	-3.30	-3.73	-2.87	-3.12	-3.08	-3.32	-3.78	-3.99	-3.89	-3.47
19	-2.68	-3.43	-3.68	-3.53	-3.15	-3.45	-3.91	-2.89	-3.26	-3.28	-3.44	-4.10	-4.22	-4.06	-3.67
20	-3.26	-3.89	-4.05	-3.92	-3.61	-3.97	-4.44	-3.23	-3.68	-3.80	-3.83	-4.61	-4.72	-4.48	-4.10
21	-3.39	-3.89	-3.98	-3.84	-3.63	-4.06	-4.49	-3.24	-3.67	-3.90	-3.84	-4.56	-4.70	-4.56	-4.07
22	-3.74	-4.16	-4.25	-4.03	-3.91	-4.32	-4.69	-3.49	-3.88	-4.19	-4.09	-4.74	-4.92	-4.86	-4.26
23	-3.45	-3.82	-3.99	-3.55	-3.52	-3.91	-4.19	-3.06	-3.37	-3.66	-3.67	-4.29	-4.43	-4.42	-3.71
24	-3.55	-3.93	-4.15	-3.54	-3.57	-3.96	-4.08	-2.94	-3.36	-3.58	-3.69	-4.27	-4.33	-4.45	-3.58
25	-3.80	-4.16	-4.41	-3.74	-3.83	-4.19	-4.28	-3.01	-3.59	-3.72	-3.96	-4.43	-4.40	-4.74	-3.70
26	-3.80	-4.10	-4.36	-3.64	-3.77	-4.18	-4.23	-2.86	-3.58	-3.61	-3.97	-4.31	-4.20	-4.67	-3.55
27	-3.83	-4.14	-4.35	-3.61	-3.76	-4.19	-4.17	-2.83	-3.67	-3.57	-4.06	-4.22	-4.10	-4.52	-3.45
28	-3.65	-4.03	-4.27	-3.52	-3.58	-4.08	-3.98	-2.74	-3.66	-3.39	-4.00	-4.02	-3.95	-4.29	-3.18
29	-3.55	-3.88	-4.10	-3.43	-3.35	-3.92	-3.76	-2.63	-3.61	-3.14	-3.80	-3.78	-3.84	-4.00	-2.95
30	-3.50	-3.79	-3.82	-3.28	-3.16	-3.86	-3.51	-2.44	-3.54	-2.99	-3.60	-3.55	-3.72	-3.73	-2.86
31	-3.20	-3.50	-3.30	-2.90	-2.76	-3.56	-3.02	-1.96	-3.23	-2.65	-3.21	-3.10	-3.34	-3.35	-2.59
32	-2.84	-3.18	-2.73	-2.49	-2.38	-3.17	-2.48	-1.43	-2.85	-2.24	-2.69	-2.54	-2.90	-2.88	-2.19
33	-2.31	-2.68	-2.02	-2.00	-1.96	-2.69	-1.85	-.80	-2.30	-1.68	-2.10	-1.83	-2.29	-2.16	-1.65
34	-2.04	-2.48	-1.77	-1.87	-1.95	-2.58	-1.54	-.57	-2.06	-1.70	-2.02	-1.61	-2.08	-1.91	-1.62
35	-1.60	-2.11	-1.40	-1.63	-1.68	-2.21	-1.09	-.22	-1.64	-1.59	-1.74	-1.32	-1.68	-1.55	-1.30
36	-1.02	-1.63	-.89	-1.21	-1.28	-1.70	-.62	.23	-1.12	-1.33	-1.33	-.91	-1.24	-1.05	-.81
37	-1.03	-1.69	-.96	-1.24	-1.41	-1.78	-.73	.22	-1.14	-1.54	-1.40	-1.01	-1.40	-1.12	-.90
38	-.70	-1.35	-.66	-.85	-1.05	-1.43	-.46	.57	-.83	-1.26	-1.06	-.73	-1.09	-.81	-.50
39	-.51	-1.21	-.51	-.62	-.84	-1.25	-.27	.83	-.56	-1.06	-.80	-.61	-.85	-.60	-.22
40	-.07	-.85	-.12	-.19	-.53	-.87	.23	1.30	-.08	-.72	-.34	-.24	-.40	-.17	.23
41	.34	-.38	.28	.26	-.15	-.36	.73	1.79	.38	-.35	.14	.12	.08	.25	.63
42	.53	-.11	.65	.52	.07	-.04	1.13	2.07	.63	-.08	.45	.33	.34	.55	.88
43	.61	.05	.96	.72	.30	.21	1.39	2.15	.65	.12	.70	.32	.49	.76	1.07
44	.70	.16	1.22	.95	.61	.43	1.65	2.16	.71	.38	.98	.37	.64	1.00	1.25
45	.69	.21	1.32	1.07	.73	.44	1.79	2.11	.75	.49	1.10	.45	.68	1.14	1.32
46	.54	.29	1.28	1.19	.80	.44	1.85	2.15	.78	.55	1.10	.58	.70	1.31	1.41
47	.37	.39	1.29	1.33	.87	.47	1.93	2.07	.76	.72	1.08	.67	.70	1.54	1.49
48	.21	.51	1.29	1.40	.79	.45	2.06	1.91	.73	.84	1.07	.71	.70	1.58	1.41
49	-.01	.60	1.02	1.33	.52	.28	2.03	1.54	.60	.72	.97	.64	.56	1.33	1.08
50	-.05	.85	.78	1.35	.46	.17	1.95	1.34	.53	.67	1.08	.62	.59	1.22	.87
51	-.02	1.04	.54	1.28	.43	.02	1.87	1.23	.34	.59	1.14	.62	.74	1.22	.66
52	-.31	.67	-.10	.67	-.04	-.44	1.43	.54	-.20	.20	.69	.19	.43	.85	.11
53	-.29	.30	-.54	.20	-.32	-.61	1.09	-.06	-.63	.03	.43	-.06	.27	.60	-.23
54	-.45	-.15	-.99	-.40	-.52	-.79	.62	-.64	-1.06	-.32	.05	-.39	-.10	.03	-.61
55	-.42	-.24	-1.04	-.59	-.41	-.62	.37	-.79	-1.09	-.36	-.09	-.53	-.18	.01	-.64
56	-.57	-.61	-1.28	-.89	-.72	-.79	-.15	-.99	-1.37	-.62	-.57	-.97	-.44	-.46	-.99
57	-.73	-.99	-1.40	-1.15	-1.10	-1.10	-.61	-1.09	-1.26	-.87	-1.00	-1.13	-.74	-.99	-1.11
58	-.70	-1.22	-1.15	-.93	-.97	-.99	-.96	-.69	-.63	-.53	-.80	-.91	-.64	-1.01	-.64
59	-.58	-1.35	-.95	-.76	-.77	-1.02	-1.24	-.20	-.35	-.03	-.62	-.66	-.30	-.87	-.30
60	-8.32	-8.88	-8.67	-8.54	-8.46	-8.87	-8.56	-7.97	-8.13	-7.39	-8.17	-7.96	-7.59	-8.16	-8.30
61	.83	.83	.83	.83	.83	.83	.83	.83	.83	.83	.83	.83	.83	.83	.83
62	.00	.00	.00	.00	.00	.00	.00	.00	.00	.00	.00	.00	.00	.00	.00

NOAA-9 SCANNER OFFSETS FOR JULY 1986: LONGHAVE CHANNEL
 DAY OF MONTH -->

S.P.	16	17	18	19	20	21	22	23	24	25	26	27	28	29	30	31
1	.29	.29	.29	.29	.29	.29	.29	.29	.29	.29	.29	.29	.29	.29	.29	.29
2	.59	.59	.59	.59	.59	.59	.59	.59	.59	.59	.59	.59	.59	.59	.59	.59
3	.63	.63	.63	.63	.63	.63	.63	.63	.63	.63	.63	.63	.63	.63	.63	.63
4	.27	.27	.27	.27	.27	.27	.27	.27	.27	.27	.27	.27	.27	.27	.27	.27
5	-.36	-.35	-.51	-.47	-.48	-.23	-.51	-.90	-.68	-.71	-.58	-.78	-.99	-1.04	-.83	-.87
6	-.14	-.12	-.32	-.06	-.22	-.09	.04	-.30	-.21	-.27	-.13	-.48	-.92	-.60	-.43	-.31
7	-1.69	-1.75	-1.63	-1.57	-1.94	-1.64	-1.81	-1.78	-1.51	-1.87	-1.68	-1.79	-2.52	-2.27	-2.07	-1.78
8	-2.23	-2.12	-1.82	-2.08	-2.29	-1.74	-2.38	-2.16	-1.78	-2.17	-2.24	-1.81	-2.83	-2.81	-2.55	-2.21
9	-2.91	-2.63	-2.40	-2.67	-2.58	-2.03	-2.94	-2.82	-2.32	-2.55	-2.94	-2.19	-3.29	-3.38	-3.14	-2.83
10	-2.35	-2.14	-1.75	-2.19	-1.79	-1.59	-2.44	-2.37	-1.87	-1.87	-2.59	-1.67	-2.53	-2.69	-2.66	-2.56
11	-2.37	-2.26	-1.60	-2.28	-1.69	-1.82	-2.47	-2.39	-1.98	-1.93	-2.92	-1.85	-2.38	-2.58	-2.73	-2.91
12	-2.38	-2.31	-1.69	-2.36	-1.60	-1.96	-2.52	-2.33	-2.02	-1.97	-3.20	-2.03	-2.40	-2.62	-2.85	-3.16
13	-3.00	-2.69	-2.19	-2.67	-1.96	-2.46	-2.99	-2.66	-2.42	-2.32	-3.79	-2.41	-2.76	-3.03	-3.46	-3.59
14	-3.21	-2.85	-2.47	-2.64	-2.15	-2.61	-3.20	-2.66	-2.49	-2.37	-3.87	-2.46	-2.79	-3.19	-3.81	-3.63
15	-3.33	-3.03	-2.77	-2.73	-2.30	-2.63	-3.39	-2.74	-2.58	-2.47	-3.74	-2.48	-2.83	-3.23	-3.96	-3.78
16	-3.54	-3.30	-2.99	-2.94	-2.56	-2.73	-3.63	-2.88	-2.82	-2.73	-3.52	-2.58	-3.01	-3.29	-4.14	-4.04
17	-3.77	-3.60	-3.25	-3.14	-2.82	-2.93	-3.85	-3.09	-3.04	-3.14	-3.33	-2.75	-3.27	-3.40	-4.37	-4.31
18	-3.78	-3.71	-3.36	-3.18	-2.78	-2.93	-3.87	-3.12	-3.08	-3.28	-3.04	-2.78	-3.29	-3.44	-4.42	-4.44
19	-3.90	-4.02	-3.67	-3.44	-2.83	-3.10	-4.17	-3.30	-3.35	-3.50	-3.02	-3.08	-3.49	-3.71	-4.70	-4.68
20	-4.36	-4.56	-4.22	-3.98	-3.09	-3.57	-4.79	-3.75	-3.85	-4.03	-3.38	-3.69	-3.96	-4.30	-5.20	-5.12
21	-4.50	-4.55	-4.35	-4.10	-2.93	-3.61	-4.90	-3.76	-3.89	-4.18	-3.42	-3.78	-4.16	-4.42	-5.18	-5.21
22	-4.83	-4.67	-4.76	-4.39	-3.15	-3.85	-5.15	-3.91	-4.22	-4.45	-3.67	-3.98	-4.56	-4.73	-5.35	-5.51
23	-4.46	-4.20	-4.48	-3.97	-2.70	-3.40	-4.71	-3.42	-3.84	-4.03	-3.19	-3.47	-4.21	-4.39	-4.86	-5.10
24	-4.48	-4.18	-4.57	-3.96	-2.71	-3.38	-4.64	-3.44	-3.90	-4.01	-3.00	-3.44	-4.17	-4.47	-4.79	-5.01
25	-4.65	-4.39	-4.80	-4.09	-2.79	-3.61	-4.78	-3.61	-4.22	-4.20	-3.09	-3.63	-4.34	-4.66	-4.94	-5.04
26	-4.56	-4.32	-4.69	-3.95	-2.66	-3.62	-4.63	-3.50	-4.19	-4.16	-3.03	-3.62	-4.22	-4.57	-4.75	-4.91
27	-4.59	-4.27	-4.69	-3.92	-2.66	-3.69	-4.50	-3.56	-4.16	-4.17	-3.01	-3.61	-4.12	-4.48	-4.59	-4.81
28	-4.46	-4.07	-4.59	-3.83	-2.58	-3.55	-4.25	-3.49	-4.00	-4.05	-2.88	-3.40	-3.90	-4.27	-4.34	-4.56
29	-4.22	-3.83	-4.42	-3.70	-2.44	-3.34	-4.05	-3.37	-3.75	-3.92	-2.74	-3.18	-3.72	-4.04	-4.07	-4.35
30	-4.03	-3.65	-4.19	-3.56	-2.36	-3.17	-3.92	-3.25	-3.47	-3.78	-2.58	-3.04	-3.54	-3.81	-3.79	-4.10
31	-3.66	-3.24	-3.74	-3.10	-2.11	-2.80	-3.49	-2.90	-2.98	-3.32	-2.20	-2.68	-3.07	-3.38	-3.26	-3.58
32	-3.23	-2.76	-3.32	-2.52	-1.80	-2.34	-2.98	-2.47	-2.49	-2.85	-1.84	-2.21	-2.61	-2.95	-2.67	-3.01
33	-2.69	-2.12	-2.80	-1.86	-1.26	-1.71	-2.30	-1.93	-1.86	-2.26	-1.33	-1.59	-1.99	-2.40	-1.98	-2.37
34	-2.45	-1.81	-2.60	-1.57	-.96	-1.41	-2.01	-1.75	-1.60	-2.02	-1.16	-1.36	-1.80	-2.23	-1.73	-2.06
35	-2.01	-1.31	-2.23	-1.15	-.50	-.96	-1.60	-1.46	-1.16	-1.60	-.83	-1.02	-1.56	-1.90	-1.41	-1.63
36	-1.37	-.77	-1.78	-.63	.01	-.42	-1.13	-1.08	-.69	-1.14	-.41	-.58	-1.23	-1.41	-.99	-1.18
37	-1.35	-.87	-1.84	-.64	-.14	-.46	-1.22	-1.21	-.80	-1.23	-.55	-.74	-1.44	-1.46	-1.11	-1.31
38	-.98	-.58	-1.47	-.34	.01	-.11	-.90	-.97	-.55	-.96	-.38	-.52	-1.22	-1.13	-.84	-1.09
39	-.78	-.43	-1.20	-.22	.09	.11	-.75	-.83	-.48	-.77	-.32	-.42	-1.15	-.92	-.71	-.89
40	-.35	-.02	-.71	.15	.42	.54	-.35	-.45	-.14	-.37	-.02	-.08	-.89	-.53	-.24	-.36
41	.18	.40	-.17	.53	.74	1.02	.11	-.04	.32	.04	.38	.34	-.48	-.06	.28	.24
42	.53	.65	.17	.71	.86	1.33	.40	.14	.66	.28	.51	.55	-.32	.32	.52	.68
43	.76	.84	.34	.87	.90	1.60	.68	.22	.90	.45	.52	.68	-.27	.59	.67	.94
44	.97	1.06	.50	1.05	1.11	1.88	.95	.38	1.18	.68	.58	.86	-.14	.88	.90	1.14
45	1.01	1.17	.59	1.11	1.32	2.00	1.04	.46	1.29	.83	.59	.98	-.05	1.09	.95	1.27
46	1.03	1.17	.64	1.15	1.44	2.09	1.10	.53	1.35	.96	.59	.97	.04	1.19	.91	1.34
47	1.03	1.12	.73	1.07	1.49	2.21	1.17	.60	1.43	1.04	.59	.98	.16	1.22	.90	1.31
48	1.00	1.15	.89	.93	1.50	2.20	1.23	.65	1.51	1.12	.55	.98	.22	1.18	.88	1.31
49	.80	1.03	.91	.69	1.37	2.00	1.16	.53	1.38	1.03	.34	.73	.05	.92	.70	1.14
50	.69	1.02	.97	.67	1.33	1.86	1.17	.42	1.36	1.00	.21	.60	.05	.85	.65	1.02
51	.56	.88	.91	.66	1.26	1.71	1.18	.42	1.25	.98	.16	.41	.01	.81	.59	1.00
52	.05	.26	.43	.29	.85	1.18	.73	.13	.75	.58	-.26	-.16	-.42	.30	.13	.57
53	-.14	-.12	.18	.13	.62	.97	.37	.02	.52	.36	-.43	-.31	-.50	-.12	-.17	.16
54	-.48	-.47	-.01	-.14	.30	.72	-.19	-.19	.12	-.03	-.64	-.58	-.61	-.81	-.63	-.21
55	-.51	-.51	.13	-.07	.22	.69	-.50	-.13	.00	-.23	-.64	-.58	-.59	-1.24	-.73	-.41
56	-.76	-.97	-.03	-.40	-.22	.41	-.94	-.42	-.48	-.78	-.89	-.85	-.93	-1.80	-1.07	-.98
57	-.98	-1.35	-.51	-.77	-.64	.27	-1.33	-.82	-.95	-1.01	-1.27	-.90	-1.03	-2.13	-1.26	-1.43
58	-.86	-.89	-.89	-.70	-.27	.56	-1.18	-.88	-.63	-.64	-1.12	-.64	-.59	-1.77	-1.23	-1.42
59	-.74	-.50	-1.11	-.70	-.13	.71	-.92	-.93	-.37	-.55	-.82	-.68	-.68	-1.36	-1.52	-1.42
60	-8.99	-8.88	-9.31	-9.18	-8.47	-7.78	-9.32	-9.22	-9.19	-9.20	-9.26	-9.29	-9.50	-9.68	-9.84	-9.78
61	.83	.83	.83	.83	.83	.83	.83	.83	.83	.83	.83	.83	.83	.83	.83	.83
62	.00	.00	.00	.00	.00	.00	.00	.00	.00	.00	.00	.00	.00	.00	.00	.00

NOAA-9 SCANNER OFFSETS FOR JULY 1986: SHORTWAVE CHANNEL
 DAY OF MONTH -->

S.P.	1	2	3	4	5	6	7	8	9	10	11	12	13	14	15
1	-.11	-.11	-.11	-.11	-.11	-.11	-.11	-.11	-.11	-.11	-.11	-.11	-.11	-.11	-.11
2	.32	.32	.32	.32	.32	.32	.32	.32	.32	.32	.32	.32	.32	.32	.32
3	.49	.49	.49	.49	.49	.49	.49	.49	.49	.49	.49	.49	.49	.49	.49
4	-4.09	-4.09	-4.09	-4.09	-4.09	-4.09	-4.09	-4.09	-4.09	-4.09	-4.09	-4.09	-4.09	-4.09	-4.09
5	.88	.88	.88	.77	.75	.76	.75	.70	.75	.71	.72	.72	.70	.72	.78
6	1.00	1.01	1.00	.89	.86	.88	.87	.80	.87	.83	.83	.82	.81	.84	.90
7	.66	.66	.66	.54	.51	.53	.52	.45	.53	.48	.47	.46	.45	.48	.54
8	1.03	1.02	1.03	.90	.88	.90	.88	.81	.89	.84	.83	.82	.81	.83	.92
9	1.07	1.06	1.08	.95	.92	.94	.92	.84	.94	.90	.89	.87	.86	.89	.96
10	.67	.65	.67	.55	.50	.52	.52	.44	.55	.52	.49	.49	.47	.52	.55
11	1.04	1.02	1.03	.90	.86	.88	.87	.79	.88	.83	.82	.81	.79	.81	.89
12	.99	.97	.98	.84	.80	.82	.80	.72	.82	.77	.76	.76	.74	.77	.84
13	.15	.13	.14	-.02	-.05	-.04	-.06	-.14	-.05	-.09	-.10	-.11	-.12	-.03	.01
14	.48	.46	.49	.33	.29	.30	.28	.20	.30	.25	.24	.23	.20	.32	.35
15	.49	.48	.49	.31	.28	.29	.26	.18	.27	.22	.21	.21	.18	.28	.34
16	.07	.07	.07	-.11	-.13	-.12	-.16	-.23	-.15	-.20	-.20	-.21	-.24	-.14	-.08
17	.43	.43	.43	.25	.23	.23	.20	.13	.21	.15	.15	.14	.11	.21	.27
18	.44	.45	.45	.26	.24	.25	.22	.14	.23	.17	.17	.15	.12	.23	.29
19	.04	.04	.05	-.14	-.16	-.15	-.18	-.25	-.17	-.23	-.23	-.25	-.28	-.17	-.11
20	.43	.43	.44	.26	.24	.25	.22	.15	.24	.17	.16	.14	.12	.23	.28
21	.43	.44	.45	.28	.27	.27	.24	.19	.27	.20	.19	.17	.15	.27	.30
22	-.02	-.01	-.02	-.20	-.21	-.21	-.24	-.29	-.22	-.29	-.29	-.31	-.33	-.23	-.17
23	.35	.36	.32	.17	.15	.17	.13	.07	.15	.07	.08	.06	.04	.13	.20
24	.37	.38	.33	.19	.18	.19	.16	.10	.17	.10	.10	.09	.07	.16	.22
25	-.02	-.01	-.06	-.22	-.22	-.21	-.24	-.29	-.22	-.30	-.29	-.31	-.33	-.24	-.17
26	.36	.37	.32	.16	.16	.17	.14	.09	.16	.08	.09	.07	.05	.13	.22
27	.37	.38	.35	.18	.17	.18	.15	.11	.18	.10	.10	.10	.07	.15	.23
28	-.03	-.04	-.04	-.23	-.23	-.22	-.25	-.29	-.21	-.29	-.29	-.30	-.32	-.24	-.17
29	.36	.35	.35	.19	.19	.19	.17	.12	.21	.13	.13	.13	.10	.18	.25
30	.38	.35	.37	.24	.24	.23	.21	.15	.28	.21	.19	.19	.16	.27	.30
31	-.06	-.03	-.04	-.17	-.17	-.17	-.21	-.25	-.14	-.22	-.22	-.22	-.26	-.16	-.08
32	.15	.18	.28	.16	.15	.15	.12	.09	.19	.13	.11	.11	.08	.23	.28
33	-.01	-.04	.17	.03	-.02	.02	.00	-.02	.07	.05	-.01	.00	-.04	.20	.18
34	-.42	-.43	-.21	-.39	-.49	-.45	-.38	-.38	-.33	-.36	-.39	-.38	-.42	-.17	-.25
35	-.03	.00	.18	-.03	-.15	-.07	.00	.03	.05	.05	-.02	-.03	-.01	.18	.12
36	.09	.11	.23	.00	-.07	-.02	.04	.07	.10	.04	.03	.05	.01	.24	.21
37	-.18	-.16	-.12	-.32	-.36	-.35	-.30	-.26	-.23	-.31	-.32	-.30	-.34	-.10	-.11
38	.28	.29	.29	.12	.09	.09	.10	.16	.20	.12	.10	.11	.07	.29	.29
39	.32	.34	.32	.18	.15	.14	.14	.20	.26	.18	.15	.16	.12	.33	.32
40	.00	.00	-.02	-.15	-.19	-.21	-.18	-.14	-.07	-.15	-.18	-.19	-.22	.00	-.02
41	.43	.41	.37	.24	.19	.20	.22	.25	.33	.26	.20	.20	.18	.41	.38
42	.43	.42	.39	.27	.23	.22	.25	.29	.37	.29	.25	.26	.22	.43	.41
43	.03	.02	-.01	-.12	-.16	-.17	-.14	-.09	-.01	-.09	-.13	-.13	-.16	.05	.00
44	.36	.37	.34	.23	.20	.19	.21	.26	.34	.26	.23	.23	.20	.40	.30
45	.33	.34	.34	.22	.18	.18	.21	.24	.33	.26	.23	.24	.20	.41	.36
46	-.09	-.08	-.07	-.18	-.22	-.22	-.18	-.15	-.08	-.14	-.17	-.16	-.19	.01	-.03
47	.26	.27	.28	.18	.13	.14	.19	.22	.28	.21	.19	.20	.17	.37	.32
48	.25	.27	.30	.20	.13	.16	.22	.24	.30	.23	.21	.23	.20	.40	.33
49	-.15	-.13	-.11	-.20	-.26	-.23	-.17	-.14	-.10	-.15	-.18	-.16	-.19	.02	-.05
50	.23	.25	.25	.17	.09	.14	.21	.23	.26	.21	.18	.20	.18	.39	.33
51	.18	.20	.18	.12	.07	.11	.20	.22	.26	.21	.19	.22	.20	.39	.30
52	-.17	-.16	-.23	-.29	-.32	-.25	-.15	-.13	-.11	-.15	-.16	-.14	-.16	.05	-.06
53	.82	.80	.67	.65	.57	.70	.82	.82	.82	.78	.76	.77	.72	.98	.86
54	1.11	1.06	.97	.96	.87	1.00	1.13	1.12	1.10	1.09	1.05	1.08	1.04	1.26	1.17
55	.71	.69	.62	.57	.51	.61	.74	.74	.75	.73	.69	.71	.70	.89	.77
56	1.04	1.02	1.01	.93	.87	.95	1.07	1.09	1.10	1.08	1.03	1.05	1.04	1.23	1.11
57	1.06	1.04	1.04	.95	.90	.97	1.08	1.11	1.11	1.09	1.04	1.07	1.05	1.23	1.12
58	.60	.59	.62	.56	.51	.56	.67	.71	.72	.70	.65	.67	.66	.84	.72
59	.87	.84	.93	.89	.83	.89	1.00	1.05	1.05	1.03	.98	1.01	.99	1.17	1.06
60	.77	.70	.87	.86	.80	.86	.98	1.02	1.02	1.00	.96	.99	.96	1.15	1.04
61	3.05	3.05	3.05	3.05	3.05	3.05	3.05	3.05	3.05	3.05	3.05	3.05	3.05	3.05	3.05
62	.00	.00	.00	.00	.00	.00	.00	.00	.00	.00	.00	.00	.00	.00	.00

NOAA-9 SCANNER OFFSETS FOR JULY 1986: SHORHWAVE CHANNEL

S.P.	DAY OF MONTH -->															
	16	17	18	19	20	21	22	23	24	25	26	27	28	29	30	31
1	-.11	-.11	-.11	-.11	-.11	-.11	-.11	-.11	-.11	-.11	-.11	-.11	-.11	-.11	-.11	-.11
2	.32	.32	.32	.32	.32	.32	.32	.32	.32	.32	.32	.32	.32	.32	.32	.32
3	.49	.49	.49	.49	.49	.49	.49	.49	.49	.49	.49	.49	.49	.49	.49	.49
4	-4.09	-4.09	-4.09	-4.09	-4.09	-4.09	-4.09	-4.09	-4.09	-4.09	-4.09	-4.09	-4.09	-4.09	-4.09	-4.09
5	.82	.77	.77	.78	.63	.46	.73	.71	.75	.72	.76	.77	.76	.76	.74	.74
6	.92	.88	.88	.88	.72	.53	.82	.81	.86	.83	.87	.88	.87	.88	.85	.86
7	.56	.52	.52	.53	.34	.14	.47	.45	.49	.46	.51	.52	.50	.51	.49	.49
8	.93	.88	.89	.88	.68	.48	.82	.80	.85	.81	.86	.88	.87	.87	.86	.85
9	.97	.93	.93	.92	.71	.49	.86	.84	.89	.85	.90	.93	.91	.92	.90	.89
10	.56	.52	.51	.52	.29	.08	.46	.45	.49	.46	.50	.54	.51	.51	.49	.48
11	.92	.87	.87	.86	.63	.41	.81	.79	.84	.81	.85	.89	.87	.87	.86	.84
12	.88	.83	.82	.82	.58	.36	.75	.74	.77	.75	.79	.84	.81	.81	.80	.77
13	.07	.02	-.02	.01	-.24	-.48	-.08	-.12	-.09	-.10	-.05	.02	-.01	-.01	-.07	-.09
14	.40	.36	.32	.34	.09	-.13	.26	.22	.25	.24	.27	.35	.32	.32	.25	.23
15	.40	.35	.31	.34	.08	-.12	.25	.20	.23	.22	.28	.36	.32	.31	.26	.23
16	-.01	-.06	-.11	-.08	-.33	-.52	-.16	-.21	-.18	-.19	-.13	-.06	-.09	-.10	-.15	-.18
17	.34	.29	.25	.28	.03	-.15	.19	.14	.17	.16	.23	.29	.26	.25	.20	.17
18	.35	.31	.25	.29	.06	-.12	.21	.16	.19	.18	.24	.30	.27	.26	.21	.18
19	-.05	-.10	-.15	-.11	-.33	-.49	-.20	-.23	-.21	-.22	-.16	-.10	-.14	-.14	-.19	-.22
20	.33	.30	.24	.29	.07	-.08	.20	.17	.19	.17	.23	.28	.24	.24	.19	.16
21	.33	.31	.25	.30	.10	-.04	.22	.20	.21	.19	.23	.29	.25	.25	.19	.16
22	-.12	-.16	-.22	-.17	-.36	-.49	-.25	-.28	-.27	-.28	-.23	-.17	-.21	-.21	-.26	-.30
23	.25	.21	.15	.20	.02	-.09	.12	.08	.10	.08	.14	.20	.16	.16	.11	.07
24	.27	.23	.17	.22	.06	-.05	.14	.11	.12	.10	.16	.22	.18	.17	.13	.09
25	-.12	-.17	-.22	-.18	-.33	-.43	-.26	-.29	-.28	-.30	-.23	-.18	-.22	-.23	-.27	-.30
26	.25	.21	.15	.19	.07	-.03	.12	.08	.10	.08	.14	.20	.16	.15	.10	.07
27	.26	.22	.16	.21	.09	.01	.13	.10	.11	.09	.16	.21	.17	.16	.11	.08
28	-.14	-.18	-.24	-.20	-.30	-.37	-.27	-.30	-.29	-.30	-.24	-.20	-.23	-.24	-.29	-.32
29	.27	.23	.17	.22	.12	.07	.14	.11	.13	.12	.16	.21	.18	.17	.11	.09
30	.31	.28	.21	.25	.18	.14	.19	.16	.18	.17	.20	.25	.22	.21	.15	.12
31	-.08	-.12	-.19	-.14	-.21	-.23	-.21	-.25	-.22	-.23	-.19	-.15	-.18	-.19	-.24	-.26
32	.28	.24	.16	.21	.15	.15	.14	.09	.12	.11	.15	.20	.17	.16	.09	.07
33	.21	.18	.06	.12	.07	.07	.06	-.02	.02	.02	.05	.13	.09	.08	-.02	-.05
34	-.19	-.20	-.33	-.26	-.30	-.29	-.32	-.40	-.37	-.37	-.33	-.25	-.29	-.30	-.41	-.43
35	.16	.16	.04	.11	.09	.11	.05	-.03	.01	.01	.03	.11	.07	.06	-.05	-.06
36	.23	.21	.10	.16	.14	.17	.10	.02	.06	.07	.09	.16	.11	.11	.01	.00
37	-.11	-.13	-.24	-.18	-.19	-.16	-.24	-.32	-.27	-.28	-.26	-.19	-.23	-.23	-.34	-.35
38	.31	.28	.17	.23	.23	.26	.16	.09	.13	.13	.15	.22	.18	.18	.08	.06
39	.35	.32	.20	.27	.28	.31	.20	.13	.17	.17	.18	.26	.21	.21	.11	.10
40	.01	-.02	-.13	-.07	-.05	-.01	-.13	-.21	-.17	-.17	-.15	-.08	-.12	-.13	-.23	-.24
41	.45	.40	.28	.35	.37	.41	.27	.18	.23	.24	.26	.35	.30	.29	.20	.18
42	.44	.40	.29	.36	.39	.44	.29	.21	.26	.26	.27	.34	.29	.29	.21	.20
43	.05	.02	-.09	-.02	.02	.07	-.10	-.17	-.12	-.12	-.12	-.05	-.09	-.09	-.18	-.19
44	.41	.38	.27	.34	.39	.44	.26	.19	.23	.24	.24	.31	.27	.27	.18	.17
45	.41	.38	.27	.34	.40	.45	.26	.19	.23	.24	.24	.32	.27	.27	.18	.18
46	.01	-.02	-.13	-.06	.01	.08	-.13	-.20	-.16	-.15	-.15	-.08	-.12	-.12	-.22	-.22
47	.37	.35	.25	.30	.38	.46	.24	.16	.20	.21	.21	.29	.24	.24	.15	.14
48	.40	.38	.27	.33	.42	.49	.27	.19	.23	.23	.24	.32	.27	.27	.18	.18
49	.02	.01	-.10	-.04	.06	.14	-.10	-.19	-.15	-.14	-.13	-.05	-.09	-.09	-.19	-.20
50	.43	.40	.29	.36	.46	.54	.29	.19	.23	.24	.27	.36	.32	.31	.21	.20
51	.38	.37	.27	.33	.45	.53	.27	.18	.22	.22	.24	.32	.28	.28	.19	.18
52	.02	.02	-.08	-.03	.10	.20	-.07	-.17	-.14	-.13	-.12	-.02	-.06	-.06	-.15	-.17
53	.96	.97	.90	.91	1.06	1.18	.88	.79	.83	.81	.84	.97	.92	.89	.86	.83
54	1.26	1.26	1.20	1.23	1.38	1.49	1.19	1.12	1.15	1.13	1.17	1.26	1.22	1.19	1.17	1.15
55	.86	.87	.81	.83	.99	1.12	.79	.75	.76	.74	.77	.87	.82	.79	.79	.76
56	1.21	1.21	1.16	1.18	1.35	1.48	1.14	1.09	1.11	1.08	1.12	1.23	1.17	1.13	1.13	1.10
57	1.23	1.23	1.17	1.19	1.36	1.50	1.15	1.10	1.12	1.09	1.13	1.24	1.19	1.15	1.14	1.11
58	.83	.82	.76	.79	.97	1.11	.75	.70	.72	.69	.72	.84	.78	.74	.74	.71
59	1.16	1.16	1.09	1.11	1.31	1.46	1.08	1.03	1.05	1.02	1.05	1.17	1.10	1.07	1.07	1.04
60	1.14	1.13	1.07	1.08	1.29	1.44	1.05	1.00	1.02	.99	1.03	1.13	1.08	1.05	1.04	1.01
61	3.05	3.05	3.05	3.05	3.05	3.05	3.05	3.05	3.05	3.05	3.05	3.05	3.05	3.05	3.05	3.05
62	.00	.00	.00	.00	.00	.00	.00	.00	.00	.00	.00	.00	.00	.00	.00	.00

NOAA-9 SCANNER OFFSETS FOR AUGUST 1986:											TOTAL	CHANNEL			
S.P.	DAY OF MONTH -->														
	1	2	3	4	5	6	7	8	9	10	11	12	13	14	15
1	.36	.36	.36	.36	.36	.36	.36	.36	.36	.36	.36	.36	.36	.36	.36
2	1.04	1.04	1.04	1.04	1.04	1.04	1.04	1.04	1.04	1.04	1.04	1.04	1.04	1.04	1.04
3	1.93	1.93	1.93	1.93	1.93	1.93	1.93	1.93	1.93	1.93	1.93	1.93	1.93	1.93	1.93
4	-9.64	-9.64	-9.64	-9.64	-9.64	-9.64	-9.64	-9.64	-9.64	-9.64	-9.64	-9.64	-9.64	-9.64	-9.64
5	-12.65	-12.50	-11.63	-11.54	-11.92	-11.98	-12.69	-12.36	-12.11	-12.10	-12.67	-12.01	-12.95	-12.59	-13.02
6	-3.84	-3.35	-2.54	-2.71	-2.81	-3.37	-3.92	-3.40	-3.64	-3.36	-4.29	-3.02	-3.87	-3.50	-3.92
7	-1.22	-.97	-.65	-.78	-.49	-1.13	-1.58	-.98	-1.30	-1.19	-1.70	-.64	-1.76	-1.02	-1.63
8	-.45	-.22	-.81	-.53	-.05	-.69	-1.08	-.31	-.82	-.95	-.79	-.11	-1.42	-.35	-1.01
9	-.86	-.69	-1.57	-1.06	-.78	-1.10	-1.36	-.69	-1.40	-1.44	-.96	-.67	-1.99	-.88	-1.23
10	-.99	-1.23	-1.69	-1.34	-1.30	-1.25	-1.44	-1.00	-1.72	-1.70	-1.03	-1.25	-2.36	-1.19	-1.22
11	-.81	-1.40	-1.30	-1.40	-1.35	-1.06	-1.24	-1.04	-1.77	-1.68	-1.04	-1.60	-2.30	-1.29	-.98
12	-1.24	-1.91	-1.62	-1.86	-1.62	-1.22	-1.70	-1.42	-2.17	-2.14	-1.38	-2.06	-2.67	-1.78	-1.24
13	-2.09	-2.69	-2.26	-2.50	-2.37	-1.85	-2.63	-2.36	-2.88	-3.00	-2.13	-2.80	-3.36	-2.62	-1.87
14	-2.66	-3.06	-2.63	-2.76	-2.89	-2.11	-3.28	-3.03	-3.23	-3.36	-2.72	-3.38	-3.82	-3.15	-2.26
15	-3.08	-3.13	-2.71	-2.85	-3.14	-2.21	-3.61	-3.43	-3.36	-3.38	-3.00	-3.72	-3.99	-3.47	-2.52
16	-3.93	-3.60	-3.11	-3.46	-3.87	-2.88	-4.22	-4.18	-3.95	-3.68	-3.63	-4.36	-4.58	-4.15	-3.14
17	-4.34	-3.76	-3.24	-3.80	-4.16	-3.35	-4.55	-4.59	-4.31	-3.82	-3.92	-4.62	-5.03	-4.39	-3.42
18	-4.03	-3.31	-2.80	-3.24	-3.63	-2.98	-4.14	-4.39	-3.87	-3.36	-3.45	-4.23	-4.62	-3.86	-2.96
19	-4.10	-3.34	-2.77	-2.98	-3.58	-3.07	-4.05	-4.65	-3.89	-3.32	-3.29	-4.22	-4.42	-3.86	-3.01
20	-4.18	-3.42	-2.62	-2.65	-3.53	-3.08	-3.94	-4.84	-3.94	-3.29	-3.16	-4.12	-4.29	-3.78	-3.08
21	-3.68	-2.94	-1.92	-1.87	-2.91	-2.52	-3.20	-4.36	-3.38	-2.69	-2.61	-3.51	-3.55	-3.05	-2.56
22	-3.39	-2.63	-1.60	-1.44	-2.57	-2.20	-2.77	-3.99	-3.10	-2.27	-2.38	-3.08	-3.13	-2.50	-2.29
23	-3.16	-2.57	-1.36	-1.24	-2.31	-1.93	-2.44	-3.70	-2.98	-2.00	-2.25	-2.75	-2.79	-2.11	-2.12
24	-2.95	-2.50	-1.14	-1.05	-2.15	-1.80	-2.10	-3.57	-2.86	-1.78	-2.23	-2.56	-2.55	-1.84	-2.06
25	-2.58	-2.41	-.78	-.83	-1.99	-1.67	-1.75	-3.45	-2.69	-1.63	-2.17	-2.40	-2.39	-1.49	-2.03
26	-2.19	-2.10	-.37	-.59	-1.65	-1.37	-1.37	-3.08	-2.32	-1.38	-2.00	-2.12	-2.10	-1.21	-1.89
27	-2.19	-2.06	-.23	-.67	-1.62	-1.32	-1.23	-2.97	-2.29	-1.40	-2.09	-2.09	-2.11	-1.22	-2.05
28	-2.59	-2.42	-.54	-1.12	-1.91	-1.75	-1.41	-3.25	-2.66	-1.80	-2.56	-2.39	-2.50	-1.57	-2.52
29	-2.24	-2.16	-.22	-.89	-1.56	-1.59	-1.01	-2.85	-2.34	-1.53	-2.50	-2.06	-2.25	-1.26	-2.38
30	-2.27	-2.16	-.16	-.95	-1.59	-1.68	-1.00	-2.75	-2.38	-1.58	-2.76	-2.08	-2.38	-1.25	-2.51
31	-2.10	-1.89	.02	-.81	-1.44	-1.53	-.86	-2.40	-2.23	-1.49	-2.69	-1.78	-2.38	-1.02	-2.37
32	-1.79	-1.42	.32	-.50	-1.08	-1.11	-.71	-1.89	-1.87	-1.18	-2.48	-1.34	-2.06	-.70	-2.10
33	-1.18	-.69	.80	.06	-.39	-.53	-.48	-1.28	-1.30	-.62	-2.00	-.67	-1.52	-.26	-1.53
34	-.83	-.40	.80	.20	-.05	-.40	-.50	-1.24	-1.09	-.34	-1.85	-.47	-1.30	-.24	-1.34
35	-.62	-.06	.89	.36	.23	-.19	-.39	-1.27	-.81	.01	-1.71	-.41	-1.14	-.14	-1.20
36	-.49	.18	.91	.37	.31	-.11	-.59	-1.28	-.58	.16	-1.57	-.54	-1.13	-.13	-1.20
37	.12	.86	1.38	.79	.72	.38	-.29	-.80	.05	.70	-.90	-.18	-.64	.37	-.68
38	.29	1.15	1.56	.86	.78	.55	-.24	-.59	.30	.83	-.66	-.09	-.51	.42	-.41
39	.41	1.29	1.66	.93	.80	.64	-.16	-.30	.55	.97	-.50	.01	-.48	.45	-.29
40	.40	1.08	1.46	.64	.69	.44	-.36	-.26	.44	.78	-.51	-.15	-.61	.26	-.47
41	.61	1.07	1.48	.64	.84	.53	-.30	.06	.51	.83	-.34	-.06	-.26	.30	-.26
42	.65	1.03	1.38	.58	.78	.61	-.31	.32	.58	.78	-.23	-.07	-.08	.23	-.12
43	.33	.58	.89	-.05	.27	.24	-.79	.09	.25	.24	-.49	-.40	-.36	-.26	-.60
44	.68	.74	1.15	-.02	.46	.46	-.63	.40	.46	.32	-.20	.01	-.05	-.17	-.51
45	1.25	1.17	1.62	.37	.95	.77	-.27	.94	.94	.62	.24	.64	.46	.25	-.13
46	.97	.93	1.23	-.04	.57	.19	-.63	.77	.61	.18	-.13	.28	.15	-.14	-.50
47	.73	.96	.93	-.18	.39	-.10	-.69	.80	.51	.13	-.17	.16	-.12	-.36	-.71
48	.70	1.11	.73	-.06	.58	-.11	-.47	1.04	.73	.40	.04	.38	-.05	-.38	-.72
49	.05	.37	-.12	-.62	.12	-.64	-1.13	.48	.32	-.13	-.51	-.08	-.59	-1.01	-1.40
50	-.53	-.31	-.78	-.88	-.40	-1.12	-1.71	-.02	-.23	-.74	-.95	-.46	-1.23	-1.45	-1.94
51	-.72	-.64	-1.12	-1.05	-.70	-1.32	-1.99	-.22	-.46	-1.04	-1.16	-.52	-1.63	-1.56	-2.08
52	-2.27	-2.22	-2.78	-2.78	-2.33	-2.91	-3.62	-1.79	-1.85	-2.69	-2.70	-1.90	-3.34	-2.88	-3.41
53	-1.97	-1.92	-2.48	-2.38	-2.15	-2.64	-3.21	-1.32	-1.45	-2.34	-2.13	-1.39	-3.03	-2.21	-2.69
54	-1.15	-1.38	-1.85	-1.72	-1.77	-2.13	-2.41	-.62	-1.05	-1.88	-1.17	-.67	-2.34	-1.33	-1.85
55	-.90	-1.52	-1.76	-1.67	-2.12	-2.15	-2.24	-.87	-1.28	-2.47	-1.10	-.71	-2.41	-1.24	-1.72
56	-1.25	-1.61	-1.69	-1.54	-2.55	-2.39	-2.04	-1.37	-1.71	-3.11	-1.29	-1.01	-2.66	-1.47	-1.61
57	-1.57	-1.76	-1.80	-1.69	-2.52	-2.64	-1.86	-1.96	-2.20	-3.27	-1.69	-1.43	-2.89	-2.03	-1.54
58	-3.44	-3.39	-3.45	-3.44	-3.75	-3.93	-3.50	-3.66	-4.00	-4.12	-3.43	-3.58	-4.56	-3.80	-2.71
59	-1.41	-1.02	-.87	-.79	-1.03	-1.42	-1.15	-1.53	-1.56	-.89	-1.34	-1.77	-1.76	-.93	-.21
60	-1.15	-.61	-.75	-.77	-1.11	-1.34	-1.12	-1.44	-1.57	-.82	-1.36	-1.35	-.71	.31	.36
61	11.19	11.19	11.19	11.19	11.19	11.19	11.19	11.19	11.19	11.19	11.19	11.19	11.19	11.19	11.19
62	1.99	1.99	1.99	1.99	1.99	1.99	1.99	1.99	1.99	1.99	1.99	1.99	1.99	1.99	1.99

S.P.	NOAA-9 SCANNER OFFSETS FOR AUGUST 1986: TOTAL CHANNEL															
	16	17	18	19	20	21	22	23	24	25	26	27	28	29	30	31
1	.36	.36	.36	.36	.36	.36	.36	.36	.36	.36	.36	.36	.36	.36	.36	.36
2	1.04	1.04	1.04	1.04	1.04	1.04	1.04	1.04	1.04	1.04	1.04	1.04	1.04	1.04	1.04	1.04
3	1.93	1.93	1.93	1.93	1.93	1.93	1.93	1.93	1.93	1.93	1.93	1.93	1.93	1.93	1.93	1.93
4	-9.64	-9.64	-9.64	-9.64	-9.64	-9.64	-9.64	-9.64	-9.64	-9.64	-9.64	-9.64	-9.64	-9.64	-9.64	-9.64
5	-12.25	-11.90	-12.26	-12.06	-11.78	-12.12	-11.27	-11.54	-11.54	-10.92	-10.80	-10.50	-11.19	-10.73	-10.96	-10.10
6	-3.12	-3.09	-3.21	-3.26	-2.94	-2.83	-2.50	-3.17	-2.61	-2.43	-2.20	-2.46	-3.06	-2.85	-3.43	-2.24
7	-.77	-.77	-.63	-.98	-.79	-.29	-.76	-1.27	-.18	-.46	-.23	-.61	-1.05	-.76	-1.26	-.42
8	-.16	-.45	-.30	-.86	-.47	-.27	-.77	-.92	-.26	-.34	-.04	-.39	-.54	-.79	-.71	-.19
9	-.60	-1.28	-.95	-1.70	-1.24	-.39	-1.33	-1.45	-.22	-.95	-.67	-1.00	-1.13	-1.64	-1.08	-.79
10	-.55	-1.74	-1.36	-2.41	-1.76	-.92	-1.41	-1.59	-.54	-1.31	-1.02	-1.05	-1.24	-2.09	-1.25	-1.17
11	-.21	-1.85	-1.51	-2.86	-1.81	-1.15	-1.31	-1.26	-.55	-1.07	-.93	-1.01	-1.06	-2.13	-.89	-1.29
12	-.67	-2.31	-2.14	-3.67	-2.31	-1.81	-1.45	-1.49	-.76	-1.37	-1.48	-1.50	-1.44	-2.50	-1.09	-1.61
13	-1.44	-3.24	-3.05	-4.57	-2.91	-2.61	-1.84	-2.29	-1.34	-2.18	-2.44	-2.21	-2.22	-3.27	-1.70	-2.23
14	-1.85	-3.81	-3.58	-5.09	-3.24	-2.95	-2.14	-2.69	-1.73	-2.75	-2.98	-2.75	-2.75	-3.90	-2.08	-2.77
15	-2.01	-4.02	-3.95	-5.25	-3.48	-2.97	-2.27	-2.79	-2.02	-2.93	-3.04	-2.91	-3.05	-4.07	-2.39	-3.13
16	-2.71	-4.49	-4.55	-5.81	-4.09	-3.45	-3.04	-3.20	-2.72	-3.49	-3.49	-3.50	-3.77	-4.57	-3.02	-3.67
17	-3.03	-4.92	-4.71	-6.11	-4.32	-3.67	-3.58	-3.29	-3.18	-3.85	-3.58	-3.88	-4.00	-4.76	-3.22	-3.98
18	-2.65	-4.68	-4.25	-5.48	-3.71	-3.29	-3.15	-2.61	-2.89	-3.42	-2.91	-3.35	-3.55	-4.09	-2.66	-3.66
19	-2.74	-4.72	-4.31	-5.19	-3.57	-3.33	-3.04	-2.42	-2.90	-3.39	-2.66	-3.34	-3.56	-3.77	-2.45	-3.73
20	-2.82	-4.76	-4.32	-4.84	-3.46	-3.37	-2.83	-2.20	-2.86	-3.41	-2.41	-3.31	-3.53	-3.52	-2.33	-3.67
21	-2.27	-4.26	-3.84	-4.14	-2.61	-2.86	-1.89	-1.39	-2.29	-2.81	-1.57	-2.76	-3.01	-2.70	-1.76	-2.95
22	-2.00	-3.89	-3.60	-3.73	-1.96	-2.48	-1.41	-.84	-2.05	-2.31	-.95	-2.55	-2.66	-2.03	-1.47	-2.60
23	-1.81	-3.69	-3.49	-3.27	-1.62	-2.28	-1.14	-.43	-1.97	-1.95	-.55	-2.35	-2.30	-1.60	-1.32	-2.37
24	-1.68	-3.50	-3.40	-2.97	-1.39	-2.18	-.93	-.28	-1.82	-1.69	-.25	-2.17	-2.08	-1.42	-1.31	-2.25
25	-1.59	-3.22	-3.29	-2.77	-1.13	-2.01	-.93	-.20	-1.61	-1.35	-.05	-1.99	-1.91	-1.22	-1.34	-2.03
26	-1.50	-2.74	-2.87	-2.49	-.78	-1.77	-.72	-.01	-1.31	-.88	.19	-1.72	-1.73	-.83	-1.30	-1.68
27	-1.84	-2.53	-2.61	-2.48	-.72	-1.71	-.60	-.07	-1.28	-.75	.17	-1.76	-1.75	-.73	-1.49	-1.71
28	-2.35	-2.78	-2.68	-2.72	-1.03	-2.27	-.93	-.46	-1.68	-1.02	-.17	-2.14	-1.95	-1.08	-1.91	-2.13
29	-2.10	-2.45	-2.35	-2.15	-.70	-1.88	-.77	-.12	-1.53	-.69	.19	-1.91	-1.57	-.82	-1.53	-1.85
30	-2.21	-2.49	-2.31	-1.86	-.69	-1.68	-1.02	-.15	-1.67	-.63	.13	-2.02	-1.58	-.91	-1.50	-1.79
31	-2.13	-2.26	-2.06	-1.48	-.50	-1.41	-.93	-.02	-1.54	-.42	.21	-1.89	-1.48	-.84	-1.36	-1.54
32	-1.82	-1.87	-1.77	-1.04	-.16	-1.02	-.59	.26	-1.19	-.17	.41	-1.56	-1.29	-.72	-1.00	-1.05
33	-1.45	-1.25	-1.29	-.48	.37	-.42	.04	.79	-.67	.21	.80	-.96	-.81	-.38	-.47	-.49
34	-1.31	-1.05	-.98	-.27	.54	-.30	.16	.93	-.51	.19	.87	-.58	-.64	-.44	-.38	-.34
35	-1.06	-.82	-.76	-.04	.81	-.12	.36	1.02	-.23	.25	1.06	-.24	-.44	-.42	-.21	-.05
36	-.95	-.58	-.74	-.10	.94	-.10	.53	1.04	-.12	.26	1.13	-.16	-.35	-.40	-.21	.06
37	-.45	.18	-.16	.37	1.49	.44	1.15	1.55	.49	.82	1.69	.43	.19	.15	.23	.55
38	-.28	.53	.04	.57	1.69	.54	1.31	1.55	.76	.94	1.93	.77	.30	.33	.31	.66
39	-.11	.85	.12	.80	1.87	.60	1.39	1.39	.95	.99	2.08	.99	.35	.55	.38	.72
40	-.26	.85	-.13	.91	1.80	.33	1.18	1.11	.85	.84	1.76	.91	.24	.50	.17	.47
41	-.08	.96	-.08	1.31	1.89	.15	1.34	1.14	1.12	.90	1.72	1.16	.59	.71	.19	.47
42	.09	1.04	-.25	1.37	1.83	-.19	1.37	1.01	1.26	.87	1.62	1.23	.83	.79	.11	.36
43	-.26	.72	-.82	.89	1.39	-.42	.87	.53	.87	.44	.96	.77	.60	.42	-.31	-.10
44	-.03	.97	-.68	1.03	1.53	.24	1.01	.69	1.05	.57	.98	.94	.88	.61	-.05	.04
45	.53	1.26	-.28	1.43	1.86	1.14	1.32	1.09	1.53	1.00	1.29	1.28	1.29	1.01	.48	.40
46	.37	.66	-.53	1.08	1.53	.80	.90	.75	1.35	.74	.91	.84	.93	.66	.37	.21
47	.39	.36	-.58	.92	1.36	.52	.72	.73	1.31	.58	.67	.72	.88	.45	.45	.29
48	.69	.45	-.41	.87	1.52	.76	.84	.91	1.29	.43	.60	1.13	1.08	.56	.67	.59
49	.37	-.23	-1.00	.11	.91	.35	.34	.37	.48	-.38	-.06	.90	.55	-.06	-.02	.19
50	-.09	-.82	-1.40	-.45	.35	-.18	-.06	-.14	-.08	-.94	-.66	.69	.19	-.71	-.52	-.24
51	-.38	-1.08	-1.52	-.58	.21	-.39	-.18	-.52	-.22	-1.20	-.96	.58	.07	-1.02	-.62	-.45
52	-2.02	-2.60	-3.14	-2.16	-1.35	-1.87	-1.78	-2.17	-1.70	-2.81	-2.54	-1.02	-1.47	-2.68	-2.17	-2.01
53	-1.66	-2.17	-2.88	-1.92	-1.09	-1.47	-1.52	-1.82	-1.39	-2.74	-2.08	-.73	-1.24	-2.48	-1.90	-1.49
54	-1.04	-1.55	-2.30	-1.33	-.64	-.82	-1.02	-1.27	-.80	-2.21	-1.13	-.28	-.74	-1.85	-1.31	-.64
55	-1.01	-1.74	-2.61	-1.53	-.73	-1.02	-1.40	-1.55	-.97	-2.25	-.76	-.48	-1.06	-1.79	-1.36	-.56
56	-.95	-2.12	-3.34	-2.17	-1.19	-1.53	-1.81	-1.93	-1.16	-2.03	-.41	-.89	-1.51	-2.10	-1.52	-.80
57	-.50	-2.63	-3.49	-2.95	-1.69	-1.93	-2.01	-1.97	-1.10	-1.77	-.11	-.99	-1.68	-2.41	-1.63	-1.33
58	-1.69	-4.23	-4.68	-5.01	-3.70	-3.99	-3.44	-3.02	-2.56	-3.21	-1.59	-2.46	-3.14	-3.71	-3.28	-3.25
59	.11	-1.61	-1.83	-2.12	-1.52	-1.64	-.44	.28	-.02	-.36	.93	-.04	-.61	-.96	-.64	-.96
60	.02	-.79	-.75	-.59	-.34	-.26	.79	1.70	1.05	.88	1.69	.97	1.06	.26	.68	.61
61	11.19	11.19	11.19	11.19	11.19	11.19	11.19	11.19	11.19	11.19	11.19	11.19	11.19	11.19	11.19	11.19
62	1.99	1.99	1.99	1.99	1.99	1.99	1.99	1.99	1.99	1.99	1.99	1.99	1.99	1.99	1.99	1.99

NOAA-9 SCANNER OFFSETS FOR AUGUST 1986: LONGWAVE CHANNEL

S.P.	DAY OF MONTH -->														
	1	2	3	4	5	6	7	8	9	10	11	12	13	14	15
1	.29	.29	.29	.29	.29	.29	.29	.29	.29	.29	.29	.29	.29	.29	.29
2	.59	.59	.59	.59	.59	.59	.59	.59	.59	.59	.59	.59	.59	.59	.59
3	.63	.63	.63	.63	.63	.63	.63	.63	.63	.63	.63	.63	.63	.63	.63
4	.27	.27	.27	.27	.27	.27	.27	.27	.27	.27	.27	.27	.27	.27	.27
5	-8.43	-8.30	-7.82	-7.78	-7.99	-8.04	-8.48	-8.21	-8.04	-8.05	-8.42	-7.99	-8.50	-8.39	-8.67
6	-2.79	-2.46	-2.01	-2.12	-2.16	-2.51	-2.88	-2.46	-2.60	-2.48	-3.04	-2.23	-2.71	-2.60	-2.88
7	-1.28	-1.13	-.99	-1.09	-.86	-1.25	-1.57	-1.10	-1.31	-1.30	-1.57	-.90	-1.56	-1.20	-1.61
8	-1.04	-.91	-1.35	-1.18	-.83	-1.22	-1.48	-.91	-1.26	-1.42	-1.23	-.81	-1.61	-1.02	-1.46
9	-1.57	-1.48	-2.10	-1.79	-1.57	-1.76	-1.92	-1.41	-1.90	-2.01	-1.60	-1.45	-2.25	-1.63	-1.87
10	-1.84	-2.03	-2.35	-2.13	-2.09	-2.05	-2.14	-1.78	-2.27	-2.35	-1.82	-2.02	-2.65	-2.01	-2.05
11	-1.92	-2.35	-2.28	-2.36	-2.32	-2.12	-2.20	-1.99	-2.49	-2.52	-2.02	-2.44	-2.80	-2.26	-2.09
12	-2.24	-2.73	-2.53	-2.71	-2.54	-2.30	-2.54	-2.26	-2.78	-2.87	-2.28	-2.77	-3.06	-2.61	-2.30
13	-2.89	-3.32	-3.05	-3.23	-3.11	-2.80	-3.21	-2.92	-3.29	-3.47	-2.82	-3.29	-3.54	-3.19	-2.77
14	-3.54	-3.80	-3.52	-3.64	-3.67	-3.20	-3.82	-3.57	-3.76	-3.90	-3.41	-3.90	-4.05	-3.73	-3.25
15	-4.00	-4.01	-3.75	-3.87	-4.00	-3.40	-4.15	-3.97	-4.01	-4.01	-3.72	-4.28	-4.31	-4.06	-3.56
16	-4.70	-4.46	-4.16	-4.43	-4.61	-3.95	-4.66	-4.57	-4.54	-4.29	-4.26	-4.85	-4.81	-4.61	-4.08
17	-5.19	-4.79	-4.46	-4.88	-5.02	-4.44	-5.07	-5.03	-4.97	-4.53	-4.64	-5.23	-5.30	-4.97	-4.45
18	-5.24	-4.75	-4.43	-4.77	-4.91	-4.42	-5.03	-5.14	-4.91	-4.43	-4.57	-5.20	-5.25	-4.86	-4.37
19	-5.54	-5.01	-4.65	-4.84	-5.10	-4.68	-5.21	-5.53	-5.12	-4.61	-4.68	-5.41	-5.32	-5.09	-4.61
20	-5.88	-5.37	-4.85	-4.92	-5.35	-4.94	-5.42	-5.94	-5.40	-4.86	-4.86	-5.59	-5.50	-5.32	-4.93
21	-5.74	-5.19	-4.56	-4.58	-5.13	-4.74	-5.12	-5.79	-5.19	-4.62	-4.67	-5.34	-5.18	-5.01	-4.78
22	-5.75	-5.12	-4.54	-4.49	-5.09	-4.73	-5.03	-5.75	-5.18	-4.53	-4.71	-5.22	-5.09	-4.82	-4.80
23	-5.84	-5.29	-4.61	-4.60	-5.16	-4.81	-5.06	-5.79	-5.33	-4.56	-4.86	-5.22	-5.11	-4.77	-4.89
24	-5.88	-5.42	-4.65	-4.66	-5.23	-4.96	-5.01	-5.90	-5.43	-4.61	-5.02	-5.26	-5.13	-4.77	-5.04
25	-5.78	-5.52	-4.56	-4.65	-5.25	-5.03	-4.92	-5.99	-5.46	-4.66	-5.14	-5.29	-5.19	-4.70	-5.18
26	-5.60	-5.39	-4.37	-4.58	-5.13	-4.92	-4.76	-5.84	-5.31	-4.60	-5.12	-5.20	-5.10	-4.62	-5.19
27	-5.63	-5.42	-4.30	-4.66	-5.13	-4.91	-4.71	-5.81	-5.34	-4.68	-5.24	-5.23	-5.15	-4.68	-5.35
28	-5.90	-5.67	-4.50	-4.94	-5.34	-5.21	-4.88	-6.02	-5.62	-5.01	-5.57	-5.46	-5.43	-4.98	-5.68
29	-5.63	-5.48	-4.24	-4.75	-5.09	-5.07	-4.61	-5.74	-5.40	-4.85	-5.52	-5.22	-5.27	-4.78	-5.57
30	-5.55	-5.37	-4.10	-4.70	-5.02	-5.05	-4.54	-5.60	-5.36	-4.84	-5.63	-5.18	-5.28	-4.71	-5.58
31	-5.22	-4.98	-3.76	-4.37	-4.71	-4.76	-4.25	-5.19	-5.07	-4.60	-5.40	-4.78	-5.05	-4.37	-5.26
32	-4.76	-4.44	-3.34	-3.91	-4.21	-4.24	-3.92	-4.62	-4.63	-4.20	-5.03	-4.27	-4.61	-3.94	-4.87
33	-3.97	-3.62	-2.69	-3.18	-3.39	-3.50	-3.43	-3.88	-3.94	-3.51	-4.36	3.49	-3.95	-3.30	-4.17
34	-3.39	-3.09	-2.37	-2.76	-2.83	-3.08	-3.12	-3.52	-3.49	-3.02	-3.98	3.03	-3.51	-2.97	-3.73
35	-2.89	-2.51	-1.92	-2.28	-2.28	-2.61	-2.70	-3.20	-2.95	-2.44	-3.51	-2.64	-3.07	-2.57	-3.29
36	-2.43	-1.98	-1.51	-1.88	-1.86	-2.20	-2.47	-2.84	-2.43	-1.97	-3.03	-2.35	-2.70	-2.19	-2.92
37	-1.60	-1.10	-.77	-1.18	-1.17	-1.50	-1.86	-2.12	-1.61	-1.20	-2.19	-1.71	-1.97	-1.46	-2.16
38	-1.11	-.51	-.26	-.74	-.74	-1.02	-1.45	-1.59	-1.06	-.74	-1.65	-.28	-1.52	-1.05	-1.60
39	-.66	-.05	.18	-.33	-.36	-.59	-1.03	-1.05	-.54	-.29	-1.11	-.87	-1.14	-.67	-1.16
40	-.32	.15	.40	-.17	-.09	-.37	-.81	-.68	-.27	-.06	-.85	-.64	-.89	-.46	-.94
41	.14	.44	.73	.15	.33	.00	-.46	-.16	.10	.29	-.41	-.28	-.35	-.11	-.48
42	.47	.70	.96	.40	.57	.35	-.17	.31	.44	.56	-.05	.01	.08	.15	-.07
43	.52	.65	.88	.24	.49	.37	-.23	.41	.47	.46	.02	.04	.14	.06	-.13
44	.92	.93	1.23	.43	.78	.70	.05	.79	.77	.68	.37	.48	.51	.28	.10
45	1.47	1.40	1.71	.86	1.28	1.08	.46	1.32	1.26	1.05	.82	1.07	1.01	.73	.53
46	1.38	1.34	1.54	.68	1.11	.77	.31	1.30	1.13	.84	.66	.93	.88	.59	.38
47	1.30	1.45	1.43	.68	1.09	.66	.36	1.41	1.14	.90	.73	.94	.79	.54	.32
48	1.40	1.68	1.42	.90	1.34	.80	.63	1.68	1.42	1.20	.99	1.22	.96	.66	.43
49	.98	1.21	.88	.54	1.07	.48	.20	1.32	1.16	.87	.64	.94	.61	.27	-.01
50	.59	.78	.45	.39	.73	.17	-.17	1.00	.83	.48	.36	.70	.20	.01	-.35
51	.52	.65	.30	.34	.61	.11	-.29	.94	.75	.35	.29	.71	.01	.01	-.38
52	-.55	-.45	-.83	-.84	-.53	-1.00	-1.41	-.15	-.22	-.80	-.78	-.25	-1.17	-.91	-1.31
53	-.72	-.63	-1.00	-.93	-.79	-1.25	-1.50	-.24	-.35	-.98	-.81	-.33	-1.37	-.84	-1.21
54	-.33	-.42	-.73	-.64	-.69	-1.08	-1.12	.07	-.25	-.87	-.34	-.02	-1.08	-.42	-.83
55	-.19	-.52	-.67	-.61	-.93	-1.07	-1.03	-.12	-.42	-1.30	-.33	-.07	-1.16	-.38	-.75
56	-.59	-.75	-.78	-.67	-1.38	-1.36	-1.08	-.65	-.87	-1.90	-.64	-.44	-1.51	-.70	-.85
57	-.88	-.91	-.92	-.82	-1.42	-1.56	-1.05	-1.11	-1.26	-2.09	-.98	-.79	-1.75	-1.12	-.87
58	-2.26	-2.13	-2.16	-2.11	-2.37	-2.59	-2.30	-2.41	-2.60	-2.82	-2.30	-2.37	-3.01	-2.42	-1.80
59	-.83	-.45	-.37	-.27	-.47	-.83	-.66	-.92	-.91	-.61	-.82	-1.07	-1.06	-.42	-.07
60	-.74	-.27	-.36	-.32	-.57	-.86	-.72	-.92	-1.01	-.64	-.92	-.87	-.47	.26	.17
61	.83	.83	.83	.83	.83	.83	.83	.83	.83	.83	.83	.83	.83	.83	.83
62	.97	.97	.97	.97	.97	.97	.97	.97	.97	.97	.97	.97	.97	.97	.97

NOAA-9 SCANNER OFFSETS FOR AUGUST 1986: LONGWAVE CHANNEL

S.P.	DAY OF MONTH -->															
	16	17	18	19	20	21	22	23	24	25	26	27	28	29	30	31
1	.29	.29	.29	.29	.29	.29	.29	.29	.29	.29	.29	.29	.29	.29	.29	.29
2	.59	.59	.59	.59	.59	.59	.59	.59	.59	.59	.59	.59	.59	.59	.59	.59
3	.63	.63	.63	.63	.63	.63	.63	.63	.63	.63	.63	.63	.63	.63	.63	.63
4	.27	.27	.27	.27	.27	.27	.27	.27	.27	.27	.27	.27	.27	.27	.27	.27
5	-8.09	-7.91	-8.17	-8.02	-7.83	-8.09	-7.50	-7.66	-7.68	-7.29	-7.27	-7.02	-7.43	-7.23	-7.36	-6.82
6	-2.27	-2.27	-2.37	-2.37	-2.17	-2.09	-1.87	-2.29	-1.93	-1.83	-1.74	-1.83	-2.19	-2.14	-2.48	-1.73
7	-.95	-1.01	-.92	-1.11	-.99	-.63	-.94	-1.27	-.56	-.76	-.66	-.86	-1.11	-1.01	-1.31	-.76
8	-.82	-1.09	-.98	-1.29	-1.04	-.54	-1.19	-1.29	-.52	-.93	-.80	-.98	-1.04	-1.28	-1.21	-.87
9	-1.37	-1.93	-1.69	-2.10	-1.82	-1.26	-1.82	-1.88	-1.08	-1.59	-1.47	-1.65	-1.70	-2.09	-1.71	-1.52
10	-1.51	-2.43	-2.14	-2.75	-2.33	-1.83	-2.05	-2.15	-1.47	-2.00	-1.88	-1.85	-1.95	-2.56	-1.98	-1.94
11	-1.49	-2.71	-2.47	-3.28	-2.56	-2.22	-2.15	-2.13	-1.66	-2.03	-2.04	-2.02	-2.01	-2.77	-1.91	-2.21
12	-1.87	-3.04	-2.96	-3.87	-2.93	-2.72	-2.28	-2.34	-1.85	-2.28	-2.46	-2.38	-2.31	-3.02	-2.03	-2.62
13	-2.45	-3.73	-3.63	-4.56	-3.40	-3.31	-2.60	-2.95	-2.30	-2.89	-3.18	-2.94	-2.89	-3.55	-2.45	-2.83
14	-2.96	-4.33	-4.18	-5.11	-3.86	-3.77	-3.04	-3.46	-2.81	-3.51	-3.79	-3.53	-3.47	-4.15	-2.89	-3.35
15	-3.21	-4.62	-4.59	-5.38	-4.17	-3.95	-3.30	-3.70	-3.18	-3.81	-4.02	-3.81	-3.84	-4.40	-3.23	-3.72
16	-3.78	-5.05	-5.12	-5.87	-4.71	-4.42	-3.97	-4.12	-3.81	-4.34	-4.47	-4.34	-4.44	-4.86	-3.77	-4.21
17	-4.19	-5.54	-5.45	-6.31	-5.09	-4.80	-4.56	-4.41	-4.34	-4.81	-4.75	-4.79	-4.81	-5.19	-4.12	-4.63
18	-4.17	-5.64	-5.38	-6.17	-4.94	-4.79	-4.54	-4.21	-4.42	-4.78	-4.56	-4.72	-4.75	-4.99	-4.00	-4.67
19	-4.44	-5.91	-5.67	-6.23	-5.08	-5.08	-4.71	-4.32	-4.67	-4.99	-4.62	-4.91	-4.97	-5.02	-4.10	-4.95
20	-4.77	-6.23	-5.97	-6.30	-5.29	-5.38	-4.87	-4.46	-4.93	-5.28	-4.74	-5.15	-5.23	-5.13	-4.31	-5.19
21	-4.56	-6.07	-5.83	-6.02	-4.90	-5.20	-4.41	-4.11	-4.74	-5.04	-4.32	-4.92	-5.06	-4.76	-4.12	-4.92
22	-4.52	-6.00	-5.84	-5.93	-4.63	-5.14	-4.26	-3.93	-4.77	-4.88	-4.06	-4.94	-5.00	-4.51	-4.13	-4.87
23	-4.62	-6.08	-5.98	-5.85	-4.62	-5.24	-4.25	-3.90	-4.96	-4.87	-3.98	-5.01	-4.99	-4.47	-4.27	-4.93
24	-4.73	-6.10	-6.09	-5.82	-4.64	-5.33	-4.31	-3.97	-5.03	-4.86	-3.92	-5.04	-5.01	-4.53	-4.45	-5.05
25	-4.80	-6.02	-6.16	-5.81	-4.60	-5.34	-4.51	-4.07	-5.04	-4.78	-3.92	-5.04	-5.02	-4.55	-4.62	-5.08
26	-4.83	-5.75	-5.97	-5.71	-4.45	-5.27	-4.46	-4.04	-4.92	-4.55	-3.83	-4.94	-4.96	-4.39	-4.69	-4.95
27	-5.12	-5.62	-5.79	-5.73	-4.46	-5.29	-4.43	-4.12	-4.94	-4.50	-3.87	-4.99	-5.01	-4.37	-4.87	-5.01
28	-5.49	-5.79	-5.82	-5.88	-4.68	-5.71	-4.67	-4.39	-5.21	-4.69	-4.08	-5.25	-5.16	-4.62	-5.17	-5.31
29	-5.30	-5.54	-5.56	-5.47	-4.44	-5.38	-4.56	-4.14	-5.07	-4.45	-3.80	-5.06	-4.90	-4.43	-4.90	-5.10
30	-5.30	-5.49	-5.43	-5.18	-4.35	-5.15	-4.68	-4.07	-5.08	-4.32	-3.76	-5.05	-4.83	-4.42	-4.79	-4.99
31	-5.08	-5.15	-5.05	-4.72	-4.02	-4.77	-4.41	-3.78	-4.77	-3.97	-3.49	-4.75	-4.56	-4.17	-4.49	-4.62
32	-4.67	-4.67	-4.62	-4.19	-3.56	-4.25	-3.96	-3.35	-4.28	-3.55	-3.11	-4.27	-4.21	-3.86	-4.02	-4.06
33	-4.12	-3.91	-3.98	-3.49	-2.87	-3.47	-3.20	-2.65	-3.57	-2.94	-2.48	-3.50	-3.54	-3.29	-3.32	-3.34
34	-3.70	-3.46	-3.45	-3.04	-2.43	-3.06	-2.81	-2.23	-3.13	-2.62	-2.09	-2.90	-3.10	-3.00	-2.94	-2.92
35	-3.17	-2.95	-2.98	-2.55	-1.90	-2.57	-2.32	-1.82	-2.59	-2.23	-1.60	-2.31	-2.62	-2.64	-2.48	-2.38
36	-2.71	-2.40	-2.61	-2.21	-1.45	-2.20	-1.83	-1.43	-2.14	-1.85	-1.16	-1.87	-2.19	-2.26	-2.11	-1.94
37	-1.98	-1.47	-1.81	-1.48	-.68	-1.43	-1.01	-.68	-1.32	-1.07	-.36	-1.06	-1.43	-1.49	-1.41	-1.21
38	-1.48	-.84	-1.29	-.97	-.17	-.99	-.54	-.29	-.76	-.62	.19	-.46	-.97	-.99	-.98	-.76
39	-1.00	-.28	-.87	-.46	.31	-.59	-.13	-.04	-.26	-.22	.67	.05	-.57	-.48	-.57	-.36
40	-.76	.05	-.69	-.04	.59	-.47	.09	.13	.03	.02	.82	.35	-.30	-.16	-.37	-.18
41	-.35	.42	-.35	.54	.95	-.31	.50	.46	.51	.38	1.11	.83	.24	.29	-.04	.13
42	.05	.76	-.16	.89	1.19	-.16	.82	.67	.90	.65	1.36	1.18	.70	.64	.21	.35
43	.08	.79	-.30	.81	1.15	-.02	.73	.61	.90	.62	1.18	1.13	.80	.65	.19	.30
44	.40	1.13	-.04	1.06	1.43	.58	.99	.89	1.18	.88	1.38	1.42	1.15	.94	.53	.57
45	.93	1.49	.39	1.49	1.83	1.38	1.38	1.33	1.67	1.33	1.77	1.82	1.59	1.37	1.06	.98
46	.90	1.16	.30	1.35	1.70	1.20	1.22	1.19	1.64	1.25	1.62	1.62	1.44	1.22	1.07	.94
47	1.02	1.05	.34	1.33	1.66	1.10	1.19	1.26	1.70	1.22	1.57	1.64	1.50	1.17	1.21	1.08
48	1.34	1.26	.56	1.42	1.89	1.43	1.40	1.50	1.80	1.24	1.65	2.04	1.75	1.37	1.46	1.40
49	1.16	.85	-.18	.93	1.50	1.16	1.08	1.16	1.28	.71	1.23	1.90	1.41	.97	1.02	1.15
50	.88	.48	-.02	.58	1.15	.81	.82	.84	.92	.35	.86	1.78	1.18	.55	.68	.88
51	.77	.37	-.01	.57	1.12	.78	.82	.66	.90	.24	.75	1.78	1.18	.41	.68	.81
52	-.35	-.69	-1.13	-.51	.05	-.23	-.23	-.46	-.13	-.86	-.32	.67	.11	-.74	-.39	-.29
53	-.48	-.81	-1.34	-.74	-.16	-.34	-.40	-.58	-.31	-1.20	-.39	.48	-.12	-.99	-.60	-.35
54	-.23	-.61	-1.10	-.50	-.02	-.06	-.22	-.37	-.09	-1.00	.10	.62	.04	-.74	-.38	.03
55	-.23	-.79	-1.32	-.64	-.08	-.24	-.44	-.57	-.23	-1.04	.34	.48	-.20	-.72	-.45	.05
56	-.37	-1.23	-1.97	-1.23	-.54	-.79	-.83	-.97	-.53	-1.05	.41	.04	-.67	-1.12	-.75	-.30
57	-.14	-1.63	-2.15	-1.82	-.93	-1.14	-1.00	-1.07	-.56	-.93	.54	-.09	-.86	-1.40	-.91	-.74
58	-1.08	-2.82	-3.12	-3.36	-2.42	-2.70	-2.11	-1.94	-1.68	-2.04	-.61	-1.22	-1.98	-2.42	-2.16	-2.20
59	.19	-.99	-1.12	-1.39	-.90	-1.14	-.06	.30	.07	-.08	1.13	.47	-.22	-.52	-.34	-.59
60	.00	-.52	-.49	-.49	-.27	-.31	.53	1.04	.58	.57	1.46	.97	.67	.11	.34	.27
61	.83	.83	.83	.83	.83	.83	.83	.83	.83	.83	.83	.83	.83	.83	.83	.83
62	.97	.97	.97	.97	.97	.97	.97	.97	.97	.97	.97	.97	.97	.97	.97	.97

NOAA-9 SCANNER OFFSETS FOR AUGUST 1986: SHORTWAVE CHANNEL

S.P.	DAY OF MONTH -->														
	1	2	3	4	5	6	7	8	9	10	11	12	13	14	15
1	-.11	-.11	-.11	-.11	-.11	-.11	-.11	-.11	-.11	-.11	-.11	-.11	-.11	-.11	-.11
2	.32	.32	.32	.32	.32	.32	.32	.32	.32	.32	.32	.32	.32	.32	.32
3	.49	.49	.49	.49	.49	.49	.49	.49	.49	.49	.49	.49	.49	.49	.49
4	-4.09	-4.09	-4.09	-4.09	-4.09	-4.09	-4.09	-4.09	-4.09	-4.09	-4.09	-4.09	-4.09	-4.09	-4.09
5	.76	.77	.80	.79	.80	.74	.71	.71	.76	.77	.76	.69	.75	.77	.76
6	.87	.87	.91	.90	.89	.86	.82	.81	.87	.87	.88	.80	.87	.88	.87
7	.51	.51	.54	.53	.53	.49	.45	.45	.51	.51	.53	.45	.51	.53	.52
8	.87	.87	.90	.88	.89	.85	.81	.81	.89	.87	.90	.81	.87	.90	.89
9	.92	.92	.94	.93	.94	.89	.86	.86	.93	.92	.95	.85	.91	.95	.95
10	.52	.51	.55	.52	.53	.50	.47	.46	.53	.52	.53	.44	.51	.55	.56
11	.87	.85	.89	.86	.88	.84	.81	.82	.89	.88	.90	.79	.86	.89	.90
12	.81	.77	.82	.80	.81	.78	.75	.76	.84	.83	.84	.74	.81	.84	.85
13	-.02	-.08	-.02	-.04	-.05	-.06	-.10	-.09	.02	.01	-.01	-.09	-.03	-.02	.00
14	.30	.25	.31	.28	.27	.28	.24	.25	.36	.36	.32	.24	.31	.32	.34
15	.30	.26	.31	.29	.28	.27	.22	.25	.35	.35	.32	.24	.31	.31	.32
16	-.11	-.14	-.09	-.11	-.13	-.14	-.19	-.16	-.06	-.07	-.10	-.17	-.11	-.11	-.10
17	.24	.21	.25	.24	.22	.21	.16	.19	.29	.29	.25	.19	.24	.24	.25
18	.25	.22	.27	.25	.22	.22	.18	.20	.30	.30	.26	.21	.26	.26	.27
19	-.15	-.18	-.13	-.15	-.18	-.17	-.22	-.20	-.09	-.10	-.14	-.19	-.15	-.15	-.14
20	.24	.21	.25	.24	.21	.22	.17	.19	.30	.30	.25	.21	.24	.24	.25
21	.24	.23	.27	.24	.22	.23	.19	.20	.31	.32	.26	.22	.25	.27	.27
22	-.22	-.23	-.20	-.22	-.24	-.24	-.29	-.27	-.15	-.15	-.20	-.24	-.21	-.21	-.20
23	.15	.14	.17	.14	.13	.13	.08	.10	.22	.22	.17	.13	.16	.16	.16
24	.17	.16	.18	.15	.15	.16	.10	.13	.24	.25	.19	.15	.18	.18	.19
25	-.22	-.23	-.21	-.24	-.25	-.23	-.29	-.27	-.16	-.14	-.20	-.25	-.22	-.21	-.20
26	.16	.13	.16	.12	.13	.14	.09	.11	.22	.23	.18	.13	.16	.16	.17
27	.17	.14	.18	.14	.14	.15	.10	.13	.23	.24	.19	.14	.18	.17	.19
28	-.23	-.26	-.21	-.26	-.26	-.26	-.29	-.27	-.17	-.16	-.21	-.25	-.22	-.23	-.20
29	.18	.14	.19	.15	.15	.14	.13	.15	.24	.24	.19	.16	.18	.19	.21
30	.22	.19	.24	.19	.19	.17	.18	.19	.27	.29	.22	.21	.22	.24	.27
31	-.16	-.20	-.15	-.19	-.21	-.24	-.23	-.20	-.12	-.11	-.16	-.17	-.17	-.16	-.14
32	.18	.14	.19	.15	.12	.10	.11	.15	.23	.25	.17	.18	.17	.19	.21
33	.09	.06	.13	.09	.04	.01	.03	.06	.13	.14	.07	.09	.08	.11	.13
34	-.29	-.32	-.25	-.30	-.34	-.37	-.37	-.32	-.25	-.26	-.32	-.30	-.31	-.28	-.26
35	.09	.05	.12	.07	.03	.01	.01	.05	.12	.12	.05	.08	.07	.10	.12
36	.15	.12	.17	.13	.09	.08	.07	.10	.17	.18	.10	.12	.12	.15	.17
37	-.20	-.23	-.19	-.23	-.25	-.26	-.28	-.25	-.17	-.16	-.24	-.22	-.22	-.19	-.16
38	.21	.19	.22	.18	.16	.15	.14	.17	.24	.25	.17	.19	.18	.21	.24
39	.24	.22	.25	.22	.19	.18	.18	.20	.28	.30	.21	.22	.22	.24	.28
40	-.10	-.13	-.10	-.13	-.15	-.18	-.16	-.13	-.05	-.03	-.13	-.11	-.12	-.09	-.05
41	.31	.28	.31	.29	.25	.22	.24	.28	.37	.38	.28	.30	.28	.30	.34
42	.32	.30	.33	.30	.27	.23	.26	.30	.37	.39	.29	.32	.30	.33	.37
43	-.07	-.11	-.08	-.11	-.14	-.17	-.12	-.09	-.02	.00	-.09	-.06	-.08	-.06	-.02
44	.29	.26	.28	.25	.22	.18	.23	.27	.34	.36	.26	.30	.27	.29	.33
45	.30	.28	.29	.27	.23	.18	.23	.27	.33	.35	.26	.30	.27	.29	.33
46	-.10	-.12	-.12	-.13	-.17	-.20	-.16	-.12	-.07	-.05	-.14	-.10	-.12	-.10	-.06
47	.27	.24	.24	.23	.19	.17	.20	.24	.30	.32	.22	.27	.24	.26	.30
48	.30	.28	.27	.26	.22	.21	.23	.27	.32	.34	.25	.25	.24	.29	.33
49	-.08	-.11	-.11	-.12	-.15	-.15	-.15	-.10	-.05	-.04	-.12	-.08	-.11	-.09	-.05
50	.32	.28	.28	.28	.23	.23	.23	.29	.35	.34	.27	.32	.27	.29	.33
51	.29	.27	.26	.26	.21	.22	.22	.27	.32	.32	.25	.30	.26	.28	.32
52	-.06	-.07	-.09	-.09	-.13	-.12	-.11	-.08	-.02	-.03	-.10	-.04	-.09	-.06	-.02
53	.88	.90	.88	.86	.86	.86	.89	.91	.97	.91	.90	.93	.85	.89	.95
54	1.20	1.20	1.18	1.17	1.16	1.14	1.17	1.22	1.26	1.22	1.20	1.23	1.17	1.20	1.26
55	.81	.81	.79	.78	.77	.75	.79	.83	.87	.82	.82	.84	.78	.83	.88
56	1.16	1.16	1.14	1.12	1.11	1.09	1.13	1.18	1.22	1.17	1.16	1.19	1.12	1.17	1.22
57	1.16	1.17	1.14	1.13	1.12	1.10	1.15	1.19	1.23	1.18	1.17	1.19	1.13	1.17	1.23
58	.77	.77	.75	.74	.72	.72	.75	.78	.83	.79	.77	.79	.73	.77	.84
59	1.09	1.10	1.08	1.07	1.05	1.06	1.08	1.11	1.15	1.12	1.10	1.11	1.06	1.10	1.17
60	1.07	1.06	1.05	1.05	1.03	1.03	1.05	1.08	1.12	1.08	1.06	1.08	1.04	1.08	1.15
61	3.05	3.05	3.05	3.05	3.05	3.05	3.05	3.05	3.05	3.05	3.05	3.05	3.05	3.05	3.05
62	.45	.45	.45	.45	.45	.45	.45	.45	.45	.45	.45	.45	.45	.45	.45

NOAA-9 SCANNER OFFSETS FOR AUGUST 1986: SHORTWAVE CHANNEL

S.P.	DAY OF MONTH -->															
	16	17	18	19	20	21	22	23	24	25	26	27	28	29	30	31
1	-.11	-.11	-.11	-.11	-.11	-.11	-.11	-.11	-.11	-.11	-.11	-.11	-.11	-.11	-.11	-.11
2	.32	.32	.32	.32	.32	.32	.32	.32	.32	.32	.32	.32	.32	.32	.32	.32
3	.49	.49	.49	.49	.49	.49	.49	.49	.49	.49	.49	.49	.49	.49	.49	.49
4	-4.09	-4.09	-4.09	-4.09	-4.09	-4.09	-4.09	-4.09	-4.09	-4.09	-4.09	-4.09	-4.09	-4.09	-4.09	-4.09
5	.73	.65	.74	.77	.67	.64	.77	.77	.82	.82	.52	.56	.79	.80	.79	.78
6	.83	.76	.85	.88	.78	.79	.89	.88	.92	.93	.61	.64	.89	.90	.89	.88
7	.47	.42	.49	.52	.41	.48	.52	.52	.57	.57	.23	.26	.52	.54	.53	.52
8	.84	.79	.86	.89	.79	.88	.89	.88	.93	.98	.98	.60	.65	.94	.95	.93
9	.89	.83	.91	.94	.84	.93	.94	.93	.98	.98	.60	.65	.94	.95	.93	.93
10	.48	.42	.50	.54	.43	.52	.53	.52	.57	.56	.16	.23	.53	.54	.53	.52
11	.84	.79	.86	.89	.78	.87	.88	.87	.92	.91	.51	.58	.89	.90	.90	.88
12	.80	.71	.82	.85	.72	.80	.82	.81	.87	.85	.44	.52	.83	.83	.84	.83
13	-.05	-.16	-.02	.00	-.15	-.04	-.03	-.04	.02	.00	-.42	-.33	-.04	-.02	-.02	-.03
14	.27	.16	.28	.31	.18	.30	.31	.29	.35	.31	-.10	-.01	.28	.30	.30	.29
15	.29	.16	.27	.32	.18	.30	.30	.27	.34	.33	-.08	.02	.29	.31	.30	.29
16	-.13	-.26	-.15	-.10	-.23	-.13	-.11	-.15	-.07	-.09	-.49	-.38	-.13	-.11	-.11	-.13
17	.22	.09	.20	.24	.12	.21	.24	.20	.27	.26	-.12	-.02	.22	.24	.24	.22
18	.24	.12	.20	.25	.14	.21	.25	.22	.28	.27	-.09	.01	.23	.25	.25	.23
19	-.16	-.28	-.21	-.16	-.26	-.19	-.14	-.18	-.12	-.13	-.48	-.37	-.17	-.15	-.15	-.17
20	.24	.12	.17	.22	.13	.18	.24	.21	.27	.25	-.08	.03	.22	.24	.24	.21
21	.25	.13	.18	.22	.14	.19	.26	.23	.28	.27	-.05	.05	.23	.24	.25	.22
22	-.21	-.32	-.27	-.23	-.31	-.28	-.20	-.24	-.19	-.19	-.48	-.38	-.22	-.21	-.21	-.23
23	.16	.04	.10	.15	.05	.10	.17	.13	.18	.18	-.09	.01	.15	.17	.16	.14
24	.18	.06	.13	.17	.07	.11	.19	.15	.20	.21	-.04	.05	.17	.19	.18	.16
25	-.22	-.34	-.26	-.23	-.33	-.28	-.21	-.25	-.20	-.19	-.42	-.33	-.23	-.21	-.21	-.24
26	.16	.03	.12	.15	.05	.09	.16	.12	.18	.18	-.02	.07	.15	.17	.16	.14
27	.17	.05	.12	.16	.07	.11	.18	.13	.19	.20	.02	.10	.16	.19	.18	.16
28	-.23	-.35	-.30	-.25	-.33	-.29	-.22	-.27	-.21	-.20	-.36	-.28	-.23	-.21	-.22	-.25
29	.18	.06	.10	.15	.08	.11	.18	.14	.20	.21	.07	.15	.17	.19	.19	.16
30	.22	.11	.14	.19	.12	.16	.23	.19	.24	.25	.13	.20	.21	.23	.23	.20
31	-.17	-.26	-.25	-.20	-.26	-.23	-.17	-.21	-.15	-.13	-.23	-.16	-.18	-.15	-.16	-.18
32	.18	.10	.09	.13	.07	.11	.17	.14	.19	.20	.12	.19	.15	.17	.16	.15
33	.08	.00	-.02	.01	-.04	.01	.09	.06	.09	.09	.03	.09	.05	.06	.05	.04
34	-.29	-.37	-.40	-.37	-.43	-.38	-.31	-.33	-.30	-.30	-.35	-.28	-.34	-.32	-.34	-.35
35	.07	.02	-.03	.00	-.06	-.01	.06	.05	.08	.07	.05	.11	.03	.05	.04	.02
36	.12	.06	.04	.06	.00	.05	.12	.10	.14	.12	.12	.17	.09	.10	.09	.07
37	-.22	-.29	-.32	-.29	-.34	-.29	-.22	-.24	-.20	-.22	-.21	-.16	-.26	-.25	-.26	-.27
38	.18	.11	.08	.11	.07	.12	.18	.16	.21	.19	.21	.26	.15	.16	.15	.13
39	.22	.15	.12	.14	.10	.15	.21	.19	.24	.22	.26	.31	.18	.20	.18	.17
40	-.10	-.18	-.22	-.19	-.23	-.18	-.13	-.14	-.10	-.11	-.06	-.01	-.16	-.14	-.16	-.17
41	.32	.25	.19	.23	.19	.25	.28	.26	.32	.30	.36	.42	.26	.28	.25	.24
42	.35	.28	.20	.24	.22	.21	.30	.28	.33	.31	.39	.44	.27	.29	.26	.25
43	-.03	-.10	-.18	-.15	-.17	-.22	-.08	-.11	-.05	-.07	.02	.06	-.11	-.09	-.12	-.13
44	.32	.26	.18	.21	.19	.21	.27	.26	.31	.29	.39	.43	.25	.27	.24	.23
45	.32	.27	.19	.22	.19	.25	.28	.26	.31	.29	.41	.44	.25	.27	.24	.23
46	-.06	-.12	-.20	-.17	-.21	-.10	-.12	-.14	-.08	-.10	.03	.06	-.15	-.12	-.15	-.16
47	.30	.26	.17	.19	.16	.25	.24	.23	.28	.26	.41	.43	.22	.25	.22	.21
48	.33	.28	.21	.22	.19	.26	.27	.26	.31	.29	.44	.46	.24	.28	.24	.24
49	-.05	-.10	-.15	-.15	-.18	-.10	-.10	-.11	-.07	-.08	.09	.10	-.13	-.10	-.13	-.13
50	.35	.29	.24	.25	.21	.31	.29	.28	.33	.32	.50	.51	.28	.30	.26	.26
51	.34	.27	.20	.23	.19	.27	.28	.26	.31	.30	.49	.49	.25	.27	.24	.24
52	.00	-.06	-.15	-.12	-.15	-.08	-.06	-.09	-.04	-.05	.15	.16	-.09	-.07	-.10	-.11
53	.97	.97	.84	.85	.84	.90	.89	.87	.92	.91	1.11	1.15	.91	.91	.88	.88
54	1.30	1.29	1.16	1.18	1.17	1.19	1.20	1.19	1.23	1.22	1.44	1.46	1.22	1.22	1.19	1.19
55	.92	.92	.77	.79	.78	.80	.81	.80	.84	.83	1.07	1.08	.83	.84	.80	.81
56	1.27	1.27	1.12	1.13	1.12	1.13	1.16	1.14	1.18	1.17	1.42	1.43	1.17	1.19	1.14	1.15
57	1.28	1.29	1.14	1.14	1.13	1.14	1.16	1.15	1.19	1.18	1.44	1.45	1.19	1.20	1.16	1.16
58	.87	.87	.76	.75	.72	.73	.76	.75	.79	.78	1.05	1.05	.79	.80	.75	.75
59	1.19	1.19	1.09	1.09	1.05	1.04	1.10	1.08	1.11	1.11	1.38	1.38	1.11	1.13	1.08	1.08
60	1.16	1.16	1.04	1.06	1.03	1.01	1.07	1.06	1.09	1.08	1.36	1.35	1.09	1.09	1.05	1.05
61	3.05	3.05	3.05	3.05	3.05	3.05	3.05	3.05	3.05	3.05	3.05	3.05	3.05	3.05	3.05	3.05
62	.45	.45	.45	.45	.45	.45	.45	.45	.45	.45	.45	.45	.45	.45	.45	.45

NOAA-9 SCANNER OFFSETS FOR SEPTEMBER 1986:											TOTAL	CHANNEL				
S.P.	DAY OF MONTH -->										11	12	13	14	15	
	1	2	3	4	5	6	7	8	9	10						
1	.36	.36	.36	.36	.36	.36	.36	.36	.36	.36	.36	.36	.36	.36	.36	
2	1.04	1.04	1.04	1.04	1.04	1.04	1.04	1.04	1.04	1.04	1.04	1.04	1.04	1.04	1.04	
3	1.93	1.93	1.93	1.93	1.93	1.93	1.93	1.93	1.93	1.93	1.93	1.93	1.93	1.93	1.93	
4	-9.64	-9.64	-9.64	-9.64	-9.64	-9.64	-9.64	-9.64	-9.64	-9.64	-9.64	-9.64	-9.64	-9.64	-9.64	
5	2.21	1.20	1.08	1.97	2.23	1.64	.81	1.79	.86	.94	-.45	2.23	-1.69	-3.26	-6.41	
6	-.30	-1.02	-.79	-.49	-1.03	-1.04	-.46	-.32	-.29	-.42	-.95	.03	-1.52	-1.40	-3.18	
7	-2.06	-2.16	-1.05	-1.58	-2.39	-1.96	-.91	-.79	-.77	-.92	-1.56	-.98	-1.45	-1.33	-3.19	
8	-2.31	-2.12	-.88	-1.57	-2.45	-1.64	-.51	-.32	-.67	-.75	-1.18	-.93	-.83	-1.26	-2.42	
9	-3.90	-3.80	-2.55	-3.05	-3.97	-3.16	-2.17	-1.78	-2.63	-2.39	-2.75	-2.69	-1.98	-2.77	-3.55	
10	-3.73	-3.40	-2.53	-2.71	-3.59	-2.83	-2.03	-1.57	-2.73	-2.09	-2.67	-2.63	-1.56	-2.62	-3.11	
11	-3.93	-3.51	-2.97	-2.72	-3.57	-2.90	-2.04	-1.87	-2.80	-1.97	-3.06	-2.82	-1.74	-2.83	-3.08	
12	-4.16	-3.39	-3.29	-2.97	-3.53	-2.91	-1.94	-2.32	-2.71	-2.26	-3.66	-2.82	-2.00	-3.21	-2.94	
13	-4.46	-3.48	-3.70	-3.56	-3.70	-3.15	-2.16	-2.94	-2.85	-3.06	-4.34	-3.24	-2.43	-3.93	-3.16	
14	-4.03	-2.86	-3.19	-3.24	-3.00	-2.58	-1.84	-2.49	-2.28	-3.04	-4.08	-2.79	-1.91	-3.63	-2.68	
15	-4.29	-2.94	-3.35	-3.53	-3.18	-2.66	-2.04	-2.57	-2.35	-3.44	-4.38	-3.17	-2.12	-3.87	-2.89	
16	-4.14	-2.94	-3.36	-3.67	-3.38	-2.72	-1.92	-2.62	-2.42	-3.36	-4.30	-3.38	-2.17	-3.69	-3.01	
17	-3.42	-2.44	-2.77	-3.22	-2.92	-2.27	-1.42	-2.23	-2.02	-2.72	-3.61	-2.95	-1.79	-3.53	-2.66	
18	-2.86	-2.16	-2.42	-2.99	-2.49	-2.02	-1.26	-1.97	-1.78	-2.32	-3.24	-2.57	-1.57	-3.23	-2.42	
19	-2.74	-2.25	-2.46	-3.06	-2.40	-1.92	-1.50	-1.89	-1.93	-2.14	-3.24	-2.72	-1.68	-3.36	-2.41	
20	-2.06	-1.98	-1.93	-2.52	-1.86	-1.31	-1.28	-1.26	-1.53	-1.35	-2.76	-2.17	-1.34	-2.98	-1.86	
21	-1.68	-1.80	-1.68	-2.19	-1.58	-.98	-1.23	-.95	-1.27	-.70	-2.48	-1.71	-1.24	-2.41	-1.69	
22	-1.35	-1.51	-1.50	-1.87	-1.28	-.65	-.89	-.67	-.99	-.38	-2.19	-1.30	-.97	-2.25	-1.75	
23	-1.13	-1.54	-1.47	-1.71	-1.11	-.56	-.70	-.48	-.92	-.23	-2.13	-1.11	-.81	-2.58	-2.11	
24	-.86	-1.48	-1.36	-1.59	-.83	-.27	-.38	-.11	-.73	.12	-1.85	-.69	-.78	-2.40	-2.32	
25	-1.02	-1.61	-1.58	-1.82	-.91	-.31	-.35	-.15	-.76	.13	-1.81	-.60	-1.14	-2.25	-2.51	
26	-.71	-1.21	-1.40	-1.55	-.62	.11	-.02	.08	-.30	.34	-1.41	-.17	-.90	-1.59	-2.15	
27	-.14	-.42	-1.03	-.96	-.16	.65	.43	.45	.32	.78	-.79	.27	-.42	-.73	-1.51	
28	.26	.09	-.77	-.38	.28	1.03	.61	.81	.85	1.16	-.22	.60	-.19	-.15	-1.09	
29	.90	.60	-.33	.47	1.06	1.59	.94	1.43	1.59	1.63	.57	1.12	.22	.68	-.45	
30	1.43	1.00	.06	1.19	1.71	2.04	1.13	1.90	2.14	2.01	1.20	1.54	.54	1.25	.02	
31	1.83	1.21	.26	1.53	1.98	2.27	1.07	2.26	2.28	2.08	1.58	1.66	.79	1.38	.17	
32	2.56	1.79	.74	2.14	2.49	2.74	1.36	2.90	2.55	2.20	2.21	1.93	1.29	1.74	.74	
33	2.86	2.05	.82	2.35	2.67	2.82	1.50	3.15	2.60	1.98	2.47	1.96	1.59	2.09	1.08	
34	3.03	2.17	.74	2.39	2.72	2.79	1.50	3.31	2.75	2.07	2.63	2.02	1.80	2.36	1.36	
35	3.17	2.21	.68	2.35	2.65	2.76	1.47	3.44	3.04	2.31	2.77	2.35	2.00	2.80	1.60	
36	3.22	2.25	.82	2.39	2.58	2.73	1.63	3.49	3.37	2.44	2.95	2.51	2.32	3.24	1.94	
37	3.04	1.88	.80	2.27	2.29	2.44	1.62	3.26	3.37	2.25	2.86	2.32	2.26	3.32	2.02	
38	2.89	1.45	.73	2.11	1.96	2.15	1.54	3.00	3.11	1.95	2.52	2.23	2.02	3.40	2.19	
39	2.49	1.02	.51	1.78	1.52	1.70	1.40	2.67	2.63	1.63	2.03	1.97	1.61	3.15	2.19	
40	2.21	.88	.52	1.68	1.37	1.42	1.38	2.64	2.26	1.31	1.86	1.97	1.28	3.07	2.17	
41	2.10	.62	.51	1.54	1.26	1.13	1.31	2.60	2.07	1.38	1.76	2.03	.83	3.02	1.91	
42	1.84	.16	.41	1.28	.97	.77	1.12	2.32	1.55	.87	1.51	1.91	.43	2.63	1.45	
43	1.28	-.22	.28	.85	.53	.49	.92	1.92	1.04	.63	.95	1.61	.24	2.34	.99	
44	.96	-.25	.28	.56	.18	.32	.97	1.89	1.08	.71	.74	1.53	.43	2.43	.73	
45	.25	-.57	.06	.16	-.41	-.28	.68	1.61	.87	.54	.55	1.24	.43	2.12	.44	
46	-.30	-1.10	-.27	-.17	-.86	-.92	.39	1.17	.45	.48	.41	.92	.18	1.67	.06	
47	-.43	-1.55	-.60	-.26	-1.07	-1.39	.22	.76	.12	.36	.19	.69	-.19	1.24	-.27	
48	-.82	-2.07	-1.07	-.53	-1.53	-1.96	-.08	.02	-.31	-.14	-.23	.09	-.92	.51	-1.00	
49	-1.20	-2.39	-1.38	-.79	-1.86	-2.25	-.31	-.61	-.51	-.67	-.64	-.28	-1.34	-.02	-1.38	
50	-1.41	-2.27	-1.38	-.97	-1.95	-2.39	-.35	-.81	-.66	-.97	-.84	-.52	-1.36	-.46	-1.52	
51	-1.40	-2.00	-1.14	-.92	-1.82	-2.30	-.33	-.61	-.69	-1.02	-.77	-.42	-1.23	-.44	-1.24	
52	-1.68	-2.06	-1.03	-.84	-1.67	-2.22	-.68	-.54	-.67	-1.05	-1.01	-.38	-1.28	-.49	-1.07	
53	-1.68	-1.48	-.30	-.35	-.99	-1.55	-.39	.10	-.02	-.45	-.76	-.13	-.75	-.13	-.86	
54	-2.07	-1.35	-.35	-.73	-1.03	-1.46	-.45	.05	-.06	-.25	-.93	-.49	-.58	.16	-.93	
55	-2.68	-1.71	-1.05	-1.46	-1.75	-1.93	-.91	-.40	-.62	-.63	-1.17	-1.35	-1.02	-.30	-1.47	
56	-3.09	-2.24	-1.62	-1.92	-2.30	-2.26	-1.32	-.66	-1.01	-1.16	-1.51	-1.97	-1.19	-.93	-1.88	
57	-3.06	-2.33	-1.77	-1.96	-2.58	-2.21	-1.53	-.83	-1.13	-1.30	-1.92	-2.17	-1.22	-1.06	-1.55	
58	-2.21	-1.76	-1.46	-1.56	-2.29	-1.98	-1.02	-.81	-.87	-.66	-1.89	-2.20	-1.03	-.85	-.59	
59	-2.67	-2.75	-2.90	-3.24	-3.44	-3.08	-2.03	-2.44	-1.97	-1.69	-2.80	-3.38	-2.38	-1.96	-.96	
60	-14.21	-14.21	-14.66	-15.24	-15.21	-14.05	-12.55	-13.39	-12.05	-11.52	-11.20	-12.95	-10.66	-8.01	-5.26	
61	11.19	11.19	11.19	11.19	11.19	11.19	11.19	11.19	11.19	11.19	11.19	11.19	11.19	11.19	11.19	
62	.00	.00	.00	.00	.00	.00	.00	.00	.00	.00	.00	.00	.00	.00	.00	

S.P.	NOAA-9 SCANNER OFFSETS FOR SEPTEMBER 1986:														
	DAY OF MONTH -->														
	16	17	18	19	20	21	22	23	24	25	26	27	28	29	30
1	-1.27	.36	.36	-1.27	-1.27	.36	.36	.36	.36	.36	.36	.36	.36	.36	.36
2	1.04	1.04	1.04	1.04	1.04	1.04	1.04	1.04	1.04	1.04	1.04	1.04	1.04	1.04	1.04
3	1.93	1.93	1.93	1.93	1.93	1.93	1.93	1.93	1.93	1.93	1.93	1.93	1.93	1.93	1.93
4	-9.64	-9.64	-9.64	-9.64	-9.64	-9.64	-9.64	-9.64	-9.64	-9.64	-9.64	-9.64	-9.64	-9.64	-9.64
5	-6.31	-1.53	-.28	1.32	1.78	.26	-1.14	2.40	2.81	4.25	3.98	3.03	2.69	3.75	1.56
6	-3.34	-1.17	-.83	-.51	-.04	-.55	-1.37	-.01	.48	1.25	.71	-1.63	-1.25	.18	-.72
7	-2.98	-1.08	-1.35	-1.60	-.55	-.96	-1.93	-.49	-.63	.01	-.08	-2.95	-2.67	-1.16	-1.45
8	-2.23	-.58	-1.47	-1.49	-.16	-.42	-1.40	-.04	-.82	.13	.08	-2.39	-2.22	-1.27	-1.38
9	-2.87	-2.15	-3.47	-3.07	-1.62	-1.64	-2.47	-1.72	-2.46	-1.35	-1.53	-3.39	-3.31	-2.65	-2.66
10	-2.25	-2.09	-3.42	-2.61	-1.26	-1.25	-1.92	-1.55	-2.19	-1.75	-1.33	-2.73	-2.59	-2.03	-2.31
11	-2.28	-2.47	-3.72	-2.72	-1.27	-1.53	-2.25	-1.83	-2.30	-2.38	-1.41	-2.55	-2.30	-1.82	-2.49
12	-2.70	-2.65	-3.82	-2.75	-1.35	-1.47	-2.15	-2.08	-2.45	-2.89	-1.73	-2.67	-2.00	-1.76	-2.53
13	-3.37	-3.39	-4.09	-3.06	-1.94	-1.76	-2.30	-2.58	-2.95	-3.76	-2.40	-3.19	-2.05	-2.27	-2.91
14	-3.22	-3.33	-3.52	-2.66	-2.01	-1.67	-1.91	-2.39	-2.68	-3.59	-2.03	-2.77	-1.53	-1.91	-2.49
15	-3.89	-3.66	-3.75	-3.09	-2.79	-2.17	-2.32	-2.86	-3.09	-3.89	-2.12	-2.60	-1.91	-2.36	-2.77
16	-4.38	-3.91	-3.76	-3.40	-3.46	-2.14	-2.65	-3.04	-3.25	-4.03	-2.05	-2.37	-2.25	-2.60	-2.93
17	-4.24	-3.63	-3.42	-3.13	-3.46	-1.30	-2.30	-2.62	-2.99	-3.54	-1.66	-1.84	-2.11	-2.46	-2.58
18	-4.16	-3.49	-3.28	-3.01	-2.66	-.59	-2.09	-2.35	-2.69	-3.18	-1.47	-1.59	-2.05	-2.32	-2.31
19	-4.15	-3.54	-3.28	-3.09	-2.27	-.54	-2.12	-2.40	-2.64	-3.18	-1.62	-1.69	-2.04	-2.44	-2.32
20	-3.48	-3.14	-2.85	-2.63	-1.60	-.25	-1.65	-1.93	-2.15	-2.61	-1.17	-1.17	-1.66	-2.13	-1.84
21	-2.91	-2.76	-2.57	-2.27	-1.15	.11	-1.44	-1.67	-1.71	-2.19	-.89	-.94	-1.30	-1.91	-1.51
22	-2.38	-2.27	-2.40	-1.80	-.74	.49	-1.45	-1.50	-1.45	-1.74	-.47	-.78	-1.03	-1.61	-1.29
23	-2.05	-2.13	-2.38	-1.60	-.56	.40	-1.19	-1.43	-1.34	-1.49	-.20	-.83	-.93	-1.57	-1.18
24	-1.67	-2.06	-2.10	-1.44	-.36	.09	-.77	-1.13	-.99	-1.16	.03	-.58	-.60	-1.45	-.91
25	-1.68	-2.02	-2.00	-1.51	-.41	.05	-.53	-1.07	-.98	-1.15	.02	-.52	-.54	-1.64	-.97
26	-1.41	-1.64	-1.44	-1.15	-.10	.45	.23	-.55	-.59	-.76	.41	-.17	-.03	-1.36	-.64
27	-.77	-1.21	-.69	-.67	.43	.61	1.04	.18	-.10	-.25	.77	.29	.64	-.86	-.05
28	-.61	-.95	-.13	-.40	.88	.55	1.38	.71	.33	.25	1.07	.68	1.15	-.57	.35
29	.04	-.44	.57	.07	1.43	.68	1.90	1.35	.93	1.09	1.70	1.28	1.82	-.02	.89
30	.47	.04	1.04	.58	1.90	.84	2.44	1.83	1.38	1.69	2.18	1.64	2.31	.51	1.37
31	.78	.15	1.20	.89	2.23	1.02	2.71	1.91	1.54	1.94	2.37	1.74	2.40	.55	1.49
32	1.46	.59	1.77	1.47	2.64	1.54	3.14	2.38	2.16	2.62	2.93	2.34	2.71	1.05	2.03
33	1.77	.73	2.10	1.78	2.69	1.92	3.31	2.59	2.57	2.96	3.16	2.70	2.90	1.39	2.38
34	1.83	.78	2.27	1.99	2.58	2.45	3.26	2.56	2.65	3.06	3.25	2.84	3.04	1.46	2.55
35	1.80	.94	2.41	2.08	2.46	2.92	2.87	2.41	2.69	3.13	3.18	2.90	3.08	1.31	2.56
36	2.05	1.23	2.44	2.04	2.44	3.22	2.39	2.40	2.83	3.31	3.23	3.06	3.07	1.48	2.61
37	2.02	1.23	2.18	1.81	2.38	3.24	1.76	2.14	2.77	3.14	3.15	2.93	2.86	1.53	2.39
38	1.37	1.27	2.11	1.72	2.43	3.21	1.30	1.82	2.72	2.92	2.92	2.77	2.60	1.44	2.18
39	.71	1.29	1.99	1.75	2.61	2.90	.88	1.41	2.55	2.56	2.57	2.55	2.24	1.28	1.86
40	.54	1.67	1.94	2.07	2.72	2.93	.82	1.31	2.58	2.49	2.56	2.41	2.08	1.23	1.54
41	.58	2.04	1.80	2.17	2.74	2.89	.71	1.26	2.51	2.46	2.50	2.27	2.04	1.20	1.27
42	.54	2.17	1.58	1.93	2.53	2.51	.49	1.02	2.19	2.20	2.20	2.16	1.74	1.00	.96
43	.46	1.92	1.37	1.42	1.97	2.03	.20	.67	1.87	1.94	1.79	1.87	1.17	.69	.53
44	.55	1.80	1.39	1.21	1.59	1.81	.01	.56	1.87	1.98	1.80	1.82	.94	.70	.54
45	.02	1.56	1.11	.77	1.18	1.45	-.25	.16	1.40	1.70	1.50	1.38	.39	.44	.27
46	-.93	1.24	.84	.34	.82	.72	-.21	-.17	.91	1.32	1.20	.76	-.10	.27	.01
47	-1.50	1.12	.61	-.02	.47	-.16	-.24	-.25	.65	1.11	1.10	.38	-.53	.32	-.31
48	-2.20	.89	.06	-.51	-.01	-.92	-.44	-.60	.11	.56	.80	-.21	-1.22	-.02	-.92
49	-2.37	.59	-.51	-.85	-.39	-1.14	-.58	-.76	-.31	.06	.51	-.65	-1.79	-.37	-1.39
50	-2.28	.20	-.95	-1.11	-.68	-1.48	-.78	-.83	-.41	-.28	.39	-1.02	-2.11	-.59	-1.54
51	-1.93	.02	-.99	-1.23	-.79	-1.76	-.83	-.63	-.27	-.34	.49	-1.29	-2.17	-.56	-1.24
52	-1.78	-.25	-.99	-1.45	-1.04	-1.89	-.85	-.51	-.42	-.26	.50	-1.60	-2.47	-.39	-.88
53	-1.62	-.01	-.70	-1.13	-.98	-1.38	-.54	.02	-.14	.44	1.00	-1.26	-2.18	-.08	-.09
54	-1.52	.00	-.84	-1.42	-1.19	-.87	-.89	-.10	-.33	.18	.91	-1.40	-2.28	-.49	-.04
55	-1.66	-.38	-1.61	-2.12	-1.45	-1.16	-1.79	-.51	-.86	-.60	.53	-1.86	-2.67	-1.04	-.54
56	-1.71	-.84	-2.41	-2.61	-1.74	-1.53	-2.18	-.78	-1.32	-1.19	.06	-2.18	-2.85	-1.28	-1.11
57	-1.46	-1.05	-2.77	-2.56	-1.56	-1.19	-2.10	-.83	-1.42	-1.51	-.31	-2.07	-2.53	-1.34	-1.31
58	-.96	-.62	-2.49	-1.83	-.92	.06	-1.60	-.54	-.96	-1.60	-.19	-1.37	-1.51	-1.13	-.88
59	-1.83	-1.94	-3.33	-2.61	-1.90	-.31	-2.61	-1.85	-2.19	-2.98	-1.47	-2.30	-2.16	-2.77	-2.08
60	-5.86	-9.26	-10.78	-11.09	-10.05	-.75	-9.26	-11.11	-11.05	-11.92	-11.09	-11.48	-11.00	-12.55	-10.14
61	11.19	11.19	11.19	11.19	11.19	11.19	11.19	11.19	11.19	11.19	11.19	11.19	11.19	11.19	11.19
62	.00	.00	.00	.00	.00	.00	.00	.00	.00	.00	.00	.00	.00	.00	.00

NOAA-9 SCANNER OFFSETS FOR SEPTEMBER 1986: LONGNAVE CHANNEL

S.P.	DAY OF MONTH -->														
	1	2	3	4	5	6	7	8	9	10	11	12	13	14	15
1	.29	.29	.29	.29	.29	.29	.29	.29	.29	.29	.29	.29	.29	.29	.29
2	.59	.59	.59	.59	.59	.59	.59	.59	.59	.59	.59	.59	.59	.59	.59
3	.63	.63	.63	.63	.63	.63	.63	.63	.63	.63	.63	.63	.63	.63	.63
4	.27	.27	.27	.27	.27	.27	.27	.27	.27	.27	.27	.27	.27	.27	.27
5	.39	-.31	-.36	.22	.35	-.03	-.53	.07	-.52	-.47	-1.33	.35	-2.06	-2.91	-4.80
6	-1.05	-1.60	-1.40	-1.18	-1.57	-1.59	-1.22	-1.11	-1.12	-1.22	-1.57	-.88	-1.89	-1.73	-2.89
7	-2.20	-2.34	-1.57	-1.89	-2.46	-2.20	-1.53	-1.42	-1.42	-1.52	-1.97	-1.54	-1.80	-1.68	-2.86
8	-2.78	-2.72	-1.85	-2.28	-2.89	-2.41	-1.68	-1.52	-1.76	-1.81	-2.14	-1.91	-1.78	-2.08	-2.81
9	-3.44	-3.46	-2.60	-2.90	-3.52	-3.06	-2.42	-2.13	-2.70	-2.55	-2.81	-2.72	-2.19	-2.74	-3.22
10	-3.62	-3.48	-2.91	-2.98	-3.59	-3.16	-2.63	-2.32	-3.08	-2.68	-3.06	-3.02	-2.25	-2.96	-3.24
11	-3.95	-3.75	-3.42	-3.20	-3.79	-3.40	-2.82	-2.72	-3.32	-2.82	-3.52	-3.34	-2.59	-3.34	-3.42
12	-4.21	-3.77	-3.72	-3.45	-3.85	-3.49	-2.80	-3.06	-3.36	-3.16	-4.05	-3.46	-2.89	-3.77	-3.52
13	-4.40	-3.83	-3.98	-3.84	-3.92	-3.61	-2.86	-3.39	-3.42	-3.74	-4.50	-3.77	-3.18	-4.26	-3.70
14	-4.34	-3.65	-3.86	-3.85	-3.66	-3.45	-2.85	-3.30	-3.24	-3.95	-4.59	-3.72	-3.08	-4.30	-3.61
15	-4.64	-3.85	-4.12	-4.17	-3.92	-3.65	-3.12	-3.49	-3.41	-4.31	-4.96	-4.14	-3.41	-4.61	-3.93
16	-4.66	-3.97	-4.26	-4.39	-4.18	-3.83	-3.18	-3.64	-3.56	-4.33	-5.04	-4.39	-3.60	-4.57	-4.15
17	-4.40	-3.86	-4.08	-4.32	-4.11	-3.74	-3.09	-3.60	-3.53	-4.09	-4.79	-4.32	-3.61	-4.78	-4.19
18	-4.22	-3.85	-4.01	-4.34	-4.00	-3.76	-3.18	-3.63	-3.55	-4.00	-4.70	-4.22	-3.62	-4.73	-4.22
19	-4.37	-4.15	-4.25	-4.59	-4.17	-3.92	-3.57	-3.81	-3.88	-4.09	-4.89	-4.53	-3.89	-5.14	-4.44
20	-4.21	-4.26	-4.17	-4.52	-4.10	-3.81	-3.71	-3.69	-3.89	-3.84	-4.80	-4.40	-3.95	-5.11	-4.32
21	-4.18	-4.34	-4.21	-4.52	-4.13	-3.80	-3.90	-3.72	-3.94	-3.60	-4.78	-4.28	-4.06	-4.90	-4.40
22	-4.22	-4.39	-4.34	-4.57	-4.20	-3.84	-3.94	-3.79	-4.02	-3.63	-4.80	-4.24	-4.06	-5.03	-4.73
23	-4.23	-4.56	-4.46	-4.63	-4.25	-3.94	-3.96	-3.82	-4.12	-3.67	-4.92	-4.27	-4.10	-5.37	-5.16
24	-4.27	-4.73	-4.60	-4.76	-4.28	-3.96	-3.98	-3.79	-4.20	-3.66	-4.97	-4.21	-4.31	-5.45	-5.45
25	-4.56	-5.01	-4.91	-5.06	-4.52	-4.17	-4.14	-4.00	-4.40	-3.84	-5.14	-4.32	-4.72	-5.51	-5.64
26	-4.43	-4.81	-4.85	-4.95	-4.40	-3.95	-4.00	-3.91	-4.17	-3.77	-4.92	-4.10	-4.59	-5.09	-5.41
27	-4.10	-4.34	-4.66	-4.65	-4.16	-3.65	-3.77	-3.74	-3.82	-3.55	-4.55	-3.87	-4.33	-4.58	-5.08
28	-3.83	-3.99	-4.46	-4.27	-3.86	-3.39	-3.65	-3.51	-3.48	-3.31	-4.15	-3.66	-4.19	-4.16	-4.87
29	-3.34	-3.58	-4.12	-3.67	-3.29	-2.97	-3.39	-3.05	-2.94	-2.94	-3.60	-3.28	-3.90	-3.57	-4.43
30	-2.95	-3.27	-3.83	-3.15	-2.82	-2.63	-3.23	-2.69	-2.54	-2.66	-3.18	-2.97	-3.64	-3.20	-4.08
31	-2.49	-2.94	-3.51	-2.73	-2.44	-2.28	-3.08	-2.27	-2.26	-2.45	-2.72	-2.72	-3.29	-2.93	-3.77
32	-1.78	-2.31	-2.98	-2.11	-1.89	-1.76	-2.68	-1.63	-1.87	-2.24	-2.11	-2.37	-2.76	-2.50	-3.23
33	-1.25	-1.77	-2.62	-1.65	-1.47	-1.40	-2.28	-1.16	-1.52	-2.09	-1.65	-2.07	-2.23	-1.96	-2.68
34	-.81	-1.36	-2.35	-1.30	-1.11	-1.09	-1.95	-.73	-1.11	-1.68	-1.23	-1.67	-1.79	-1.44	-2.18
35	-.37	-.98	-2.04	-.98	-.81	-.76	-1.61	-.28	-.55	-1.14	-.79	-1.05	-1.32	-.77	-1.67
36	.03	-.59	-1.59	-.58	-.49	-.40	-1.12	.12	.04	-.69	-.31	-.57	-.72	-.11	-1.10
37	.26	-.49	-1.24	-.31	-.33	-.23	-.78	.33	.40	-.46	-.01	-.35	-.39	.30	-.69
38	.52	-.41	-.93	-.06	-.19	-.06	-.46	.51	.58	-.28	.10	-.06	-.19	.71	-.20
39	.61	-.34	-.72	.08	-.12	.01	-.20	.66	.60	-.13	.15	.13	-.12	.93	.18
40	.81	-.06	-.34	.39	.16	.20	.17	1.02	.66	.01	.41	.54	-.03	1.28	.54
41	1.10	.16	.03	.67	.47	.40	.52	1.38	.90	.53	.75	.95	.03	1.64	.76
42	1.23	.14	.26	.79	.58	.47	.70	1.51	.81	.47	.86	1.19	.12	1.68	.78
43	1.12	.15	.42	.77	.55	.55	.84	1.51	.75	.59	.73	1.26	.29	1.75	.74
44	1.10	.33	.61	.76	.50	.63	1.06	1.68	1.01	.86	.80	1.41	.63	1.99	.77
45	.85	.34	.67	.70	.32	.44	1.08	1.71	1.13	.98	.92	1.43	.88	2.01	.81
46	.67	.16	.63	.67	.20	.20	1.06	1.60	1.06	1.13	1.02	1.40	.91	1.88	.72
47	.49	-.25	.31	.51	-.04	-.21	.84	1.23	.75	.97	.79	1.14	.57	1.51	.40
48	.55	-.29	.31	.65	-.03	-.27	.95	1.06	.79	.97	.85	1.05	.38	1.33	.25
49	.32	-.49	.12	.51	-.22	-.43	.83	.66	.68	.63	.60	.82	.14	.99	.00
50	.22	-.38	.16	.43	-.25	-.47	.85	.58	.64	.46	.53	.69	.22	.73	-.01
51	.37	-.06	.47	.61	-.02	-.26	1.01	.86	.78	.59	.74	.92	.47	.92	.37
52	.08	-.23	.43	.57	-.03	-.31	.68	.80	.70	.48	.49	.82	.37	.79	.38
53	-.27	-.19	.56	.56	.07	-.21	.53	.86	.80	.54	.35	.62	.45	.81	.34
54	-.63	-.20	.43	.23	-.04	-.23	.39	.74	.68	.60	.14	.33	.47	.90	.15
55	-1.05	-.46	-.06	-.25	-.53	-.55	.07	.45	.31	.35	.01	-.24	.20	.61	-.16
56	-1.37	-.85	-.48	-.60	-.94	-.83	-.25	.25	-.04	-.04	-.25	-.69	.07	.20	-.42
57	-1.58	-1.14	-.80	-.85	-1.36	-1.03	-.59	-.08	-.37	-.34	-.71	-.98	-.14	-.07	-.38
58	-1.05	-.76	-.59	-.58	-1.19	-.89	-.26	-.07	-.19	.07	-.69	-.97	-.06	.12	.25
59	-1.19	-1.26	-1.35	-1.52	-1.81	-1.45	-.75	-.97	-.71	-.45	-1.12	-1.54	-.82	-.45	.18
60	-8.02	-8.07	-8.31	-8.63	-8.77	-7.93	-6.99	-7.46	-6.68	-6.29	-6.08	-7.18	-5.75	-4.07	-2.41
61	.83	.83	.83	.83	.83	.83	.83	.83	.83	.83	.83	.83	.83	.83	.83
62	.00	.00	.00	.00	.00	.00	.00	.00	.00	.00	.00	.00	.00	.00	.00

NOAA-9 SCANNER OFFSETS FOR SEPTEMBER 1986: LONGWAVE CHANNEL

S.P.	DAY OF MONTH -->														
	16	17	18	19	20	21	22	23	24	25	26	27	28	29	30
1	.29	.29	.29	.29	.29	.29	.29	.29	.29	.29	.29	.29	.29	.29	.29
2	.59	.59	.59	.59	.59	.59	.59	.59	.59	.59	.59	.59	.59	.59	.59
3	.63	.63	.63	.63	.63	.63	.63	.63	.63	.63	.63	.63	.63	.63	.63
4	.27	.27	.27	.27	.27	.27	.27	.27	.27	.27	.27	.27	.27	.27	.27
5	-4.82	-1.91	-1.11	-.20	-.11	-.75	-1.56	.52	.78	1.67	1.45	.84	.63	1.30	-.01
6	-3.08	-1.70	-1.35	-1.17	-.87	-1.15	-1.75	-.83	-.54	-.06	-.45	-1.96	-1.71	-.78	-1.31
7	-2.82	-1.66	-1.69	-1.88	-1.17	-1.42	-2.10	-1.16	-1.26	-.88	-.98	-2.83	-2.67	-1.68	-1.80
8	-2.76	-1.75	-2.18	-2.24	-1.33	-1.44	-2.16	-1.27	-1.81	-1.25	-1.32	-2.89	-2.76	-2.18	-2.19
9	-2.89	-2.44	-3.15	-2.93	-1.94	-1.88	-2.47	-2.02	-2.52	-1.82	-1.97	-3.16	-3.12	-2.66	-2.65
10	-2.83	-2.75	-3.45	-2.96	-2.04	-1.95	-2.40	-2.23	-2.66	-2.40	-2.18	-3.05	-2.93	-2.56	-2.74
11	-3.05	-3.20	-3.87	-3.25	-2.29	-2.40	-2.83	-2.62	-2.94	-3.01	-2.43	-3.16	-2.96	-2.62	-3.07
12	-3.53	-3.47	-4.09	-3.41	-2.49	-2.54	-2.90	-2.91	-3.16	-3.44	-2.73	-3.34	-2.87	-2.67	-3.19
13	-4.03	-4.01	-4.30	-3.64	-2.94	-2.82	-3.02	-3.29	-3.53	-4.02	-3.16	-3.70	-2.94	-3.05	-3.47
14	-4.22	-4.22	-4.20	-3.69	-3.33	-3.07	-3.05	-3.45	-3.68	-4.15	-3.16	-3.68	-2.88	-3.10	-3.46
15	-4.78	-4.58	-4.52	-4.17	-4.09	-3.58	-3.51	-3.96	-4.08	-4.51	-3.36	-3.71	-3.30	-3.58	-3.82
16	-5.17	-4.89	-4.67	-4.52	-4.75	-3.70	-3.88	-4.26	-4.34	-4.73	-3.44	-3.67	-3.68	-3.88	-4.05
17	-5.26	-4.95	-4.67	-4.54	-4.98	-3.33	-3.86	-4.23	-4.41	-4.65	-3.42	-3.55	-3.81	-4.05	-4.08
18	-5.36	-5.06	-4.78	-4.64	-4.59	-2.95	-3.91	-4.25	-4.39	-4.61	-3.48	-3.55	-3.95	-4.14	-4.08
19	-5.55	-5.30	-5.00	-4.88	-4.50	-3.13	-4.15	-4.52	-4.58	-4.83	-3.80	-3.84	-4.15	-4.47	-4.29
20	-5.34	-5.33	-4.99	-4.80	-4.25	-3.23	-4.10	-4.50	-4.54	-4.74	-3.78	-3.78	-4.20	-4.54	-4.25
21	-5.12	-5.27	-5.02	-4.75	-4.06	-3.15	-4.24	-4.54	-4.47	-4.69	-3.82	-3.84	-4.14	-4.61	-4.24
22	-5.00	-5.17	-5.15	-4.68	-4.01	-3.13	-4.45	-4.67	-4.54	-4.63	-3.78	-3.97	-4.22	-4.64	-4.33
23	-4.96	-5.24	-5.29	-4.70	-4.05	-3.39	-4.32	-4.76	-4.62	-4.62	-3.75	-4.15	-4.29	-4.75	-4.41
24	-4.95	-5.37	-5.31	-4.81	-4.14	-3.88	-4.16	-4.76	-4.59	-4.62	-3.81	-4.19	-4.27	-4.87	-4.44
25	-5.14	-5.46	-5.41	-5.02	-4.33	-4.00	-4.15	-4.89	-4.76	-4.77	-3.98	-4.29	-4.41	-5.15	-4.65
26	-4.99	-5.25	-5.10	-4.88	-4.16	-3.76	-3.69	-4.59	-4.55	-4.57	-3.78	-4.10	-4.13	-5.01	-4.49
27	-4.66	-4.97	-4.65	-4.65	-3.81	-3.77	-3.21	-4.14	-4.28	-4.28	-3.59	-3.85	-3.75	-4.71	-4.16
28	-4.52	-4.79	-4.27	-4.50	-3.54	-3.85	-3.04	-3.78	-3.97	-3.93	-3.38	-3.60	-3.39	-4.48	-3.89
29	-4.04	-4.40	-3.75	-4.14	-3.20	-3.75	-2.66	-3.28	-3.52	-3.31	-2.91	-3.15	-2.89	-4.06	-3.47
30	-3.72	-3.98	-3.40	-3.77	-2.84	-3.60	-2.29	-2.91	-3.17	-2.86	-2.55	-2.87	-2.53	-3.66	-3.13
31	-3.31	-3.68	-3.10	-3.36	-2.39	-3.26	-1.91	-2.65	-2.87	-2.51	-2.24	-2.64	-2.30	-3.47	-2.88
32	-2.71	-3.22	-2.52	-2.75	-1.91	-2.70	-1.43	-2.10	-2.21	-1.81	-1.63	-1.99	-1.86	-2.87	-2.29
33	-2.20	-2.86	-1.95	-2.21	-1.55	-2.09	-1.02	-1.62	-1.60	-1.25	-1.13	-1.40	-1.38	-2.30	-1.72
34	-1.91	-2.54	-1.52	-1.74	-1.30	-1.38	-.80	-1.32	-1.21	-.85	-.74	-.98	-.96	-1.92	-1.28
35	-1.61	-2.05	-1.08	-1.33	-1.05	-.71	-.77	-1.05	-.83	-.46	-.43	-.59	-.58	-1.67	-.92
36	-1.08	-1.50	-.70	-.96	-.67	-.12	-.76	-.67	-.36	.04	-.02	-.11	-.22	-1.18	-.52
37	-.76	-1.13	-.54	-.76	-.32	.26	-.82	-.49	-.03	.29	.30	.17	.01	-.78	-.30
38	-.88	-.73	-.21	-.44	.10	.58	-.74	-.34	.29	.50	.49	.41	.19	-.50	-.11
39	-.89	-.36	.12	-.01	.66	.76	-.65	-.25	.54	.61	.62	.61	.32	-.25	.04
40	-.58	.25	.47	.63	1.13	1.24	-.34	.07	.94	.95	1.00	.89	.58	.09	.20
41	-.13	.87	.77	1.10	1.55	1.61	.02	.42	1.28	1.32	1.35	1.19	.95	.46	.40
42	.16	1.25	.94	1.25	1.72	1.62	.25	.57	1.38	1.44	1.45	1.42	1.06	.62	.48
43	.38	1.33	1.08	1.18	1.60	1.55	.36	.61	1.43	1.53	1.44	1.48	.93	.68	.45
44	.62	1.49	1.29	1.23	1.52	1.56	.42	.73	1.63	1.76	1.65	1.65	.98	.90	.69
45	.49	1.56	1.33	1.18	1.47	1.58	.47	.69	1.55	1.79	1.68	1.58	.84	.96	.76
46	.11	1.51	1.34	1.09	1.41	1.22	.73	.65	1.42	1.73	1.66	1.37	.72	1.04	.78
47	-.33	1.33	1.10	.74	1.06	.45	.62	.50	1.15	1.50	1.52	1.03	.33	.98	.49
48	-.42	1.50	1.06	.75	1.07	.27	.81	.60	1.12	1.47	1.65	.97	.21	1.09	.41
49	-.51	1.31	.70	.54	.85	.17	.76	.52	.87	1.16	1.48	.70	-.13	.89	.14
50	-.41	1.12	.47	.42	.67	-.07	.68	.53	.85	1.00	1.47	.51	-.30	.80	.10
51	-.02	1.16	.61	.47	.72	-.13	.82	.83	1.10	1.10	1.69	.49	-.17	.96	.46
52	-.01	.91	.54	.21	.44	-.27	.71	.82	.92	1.07	1.61	.21	-.46	.98	.63
53	-.06	.84	.45	.06	.15	-.16	.62	.87	.82	1.23	1.63	.12	-.58	.87	.86
54	-.10	.74	.25	-.26	-.08	.15	.24	.74	.62	1.01	1.51	-.03	-.71	.54	.80
55	-.20	.48	-.26	-.73	-.20	.03	-.39	.51	.31	.52	1.28	-.29	-.93	.20	.51
56	-.28	.14	-.83	-1.10	-.42	-.24	-.71	.32	.00	.11	.96	-.51	-1.05	.02	.12
57	-.29	-.18	-1.25	-1.27	-.47	-.20	-.85	.10	-.26	-.29	.52	-.63	-1.01	-.18	-.19
58	.06	.11	-1.05	-.77	-.05	.67	-.58	.28	.03	-.34	.59	-.19	-.35	-.05	.09
59	-.30	-.58	-1.44	-1.15	-.53	.61	-1.03	-.42	-.61	-1.08	-.09	-.62	-.61	-.95	-.53
60	-2.68	-4.99	-5.86	-6.15	-5.31	-3.72	-4.97	-5.96	-5.89	-6.37	-5.81	-6.06	-5.86	-6.76	-5.34
61	.83	.83	.83	.83	.83	.83	.83	.83	.83	.83	.83	.83	.83	.83	.83
62	.00	.00	.00	.00	.00	.00	.00	.00	.00	.00	.00	.00	.00	.00	.00

NOAA-9 SCANNER OFFSETS FOR SEPTEMBER 1986: SHORTWAVE CHANNEL

S.P.	DAY OF MONTH -->														
	1	2	3	4	5	6	7	8	9	10	11	12	13	14	15
1	-.11	-.11	-.11	-.11	-.11	-.11	-.11	-.11	-.11	-.11	-.11	-.11	-.11	-.11	-.11
2	.32	.32	.32	.32	.32	.32	.32	.32	.32	.32	.32	.32	.32	.32	.32
3	.49	.49	.49	.49	.49	.49	.49	.49	.49	.49	.49	.49	.49	.49	.49
4	-4.09	-4.09	-4.09	-4.09	-4.09	-4.09	-4.09	-4.09	-4.09	-4.09	-4.09	-4.09	-4.09	-4.09	-4.09
5	.81	.74	.75	.81	.79	.78	.83	.82	.85	.77	.75	.81	.76	.29	.25
6	.91	.84	.86	.92	.88	.88	.92	.91	.94	.86	.82	.90	.87	.40	.42
7	.55	.47	.50	.56	.52	.52	.56	.56	.59	.49	.46	.54	.51	.05	.03
8	.92	.84	.87	.93	.89	.88	.92	.92	.95	.85	.83	.90	.88	.40	.45
9	.97	.89	.92	.97	.94	.94	.97	.97	.99	.90	.89	.95	.94	.42	.48
10	.56	.48	.52	.56	.53	.54	.58	.58	.58	.49	.51	.55	.56	.06	.12
11	.91	.83	.86	.91	.88	.89	.94	.93	.94	.82	.83	.88	.88	.38	.46
12	.86	.77	.81	.85	.84	.85	.92	.90	.91	.78	.80	.83	.85	.38	.52
13	-.01	-.09	-.03	.01	.02	.02	.07	.07	.06	-.10	-.06	-.03	-.03	-.50	-.32
14	.32	.25	.30	.35	.36	.34	.39	.40	.38	.19	.26	.31	.27	-.24	-.12
15	.33	.24	.29	.35	.36	.35	.39	.39	.38	.18	.22	.29	.25	-.25	-.06
16	-.09	-.17	-.12	-.07	-.05	-.06	-.03	-.02	-.04	-.20	-.20	-.12	-.17	-.64	-.47
17	.26	.18	.23	.28	.30	.29	.32	.32	.31	.19	.14	.23	.17	-.27	-.13
18	.27	.19	.25	.30	.31	.30	.33	.34	.32	.21	.16	.25	.18	-.31	-.16
19	-.13	-.21	-.15	-.10	-.09	-.10	-.07	-.07	-.08	-.18	-.26	-.15	-.21	-.64	-.55
20	.26	.18	.25	.29	.30	.29	.31	.32	.29	.21	.14	.23	.18	-.29	-.20
21	.27	.20	.27	.31	.31	.30	.33	.34	.31	.24	.18	.27	.19	-.26	-.20
22	-.19	-.27	-.20	-.16	-.15	-.15	-.14	-.12	-.15	-.23	-.30	-.21	-.31	-.70	-.63
23	.19	.10	.17	.21	.22	.22	.23	.24	.22	.14	.08	.16	.07	-.35	-.30
24	.21	.12	.19	.23	.24	.24	.26	.27	.24	.17	.10	.19	.13	-.38	-.32
25	-.19	-.27	-.21	-.17	-.16	-.15	-.14	-.12	-.16	-.23	-.30	-.21	-.28	-.76	-.76
26	.19	.12	.17	.21	.22	.22	.24	.25	.21	.14	.07	.16	.08	-.38	-.42
27	.21	.15	.19	.23	.25	.24	.26	.27	.24	.16	.07	.19	.12	-.32	-.36
28	-.19	-.24	-.21	-.17	-.15	-.15	-.14	-.12	-.16	-.23	-.32	-.21	-.28	-.71	-.74
29	.22	.17	.20	.25	.26	.25	.27	.29	.24	.18	.09	.20	.13	-.30	-.36
30	.26	.21	.24	.29	.30	.30	.31	.34	.28	.23	.15	.26	.17	-.21	-.29
31	-.12	-.16	-.15	-.10	-.09	-.09	-.08	-.06	-.11	-.16	-.26	-.14	-.22	-.61	-.69
32	.22	.19	.21	.25	.28	.27	.28	.30	.24	.22	.10	.22	.14	-.26	-.35
33	.10	.09	.14	.17	.21	.20	.20	.23	.14	.09	.03	.13	.03	-.34	-.42
34	-.29	-.30	-.24	-.21	-.16	-.18	-.18	-.15	-.25	-.32	-.38	-.29	-.36	-.76	-.82
35	.08	.07	.11	.16	.20	.18	.18	.21	.11	.08	-.01	.10	.01	-.40	-.46
36	.14	.12	.16	.20	.24	.23	.23	.26	.16	.18	.04	.16	.07	-.31	-.37
37	-.21	-.22	-.18	-.14	-.10	-.12	-.11	-.09	-.18	-.14	-.30	-.17	-.28	-.65	-.71
38	.20	.19	.23	.27	.31	.28	.28	.31	.21	.24	.09	.23	.12	-.24	-.34
39	.24	.23	.26	.30	.34	.32	.32	.35	.25	.31	.13	.26	.15	-.18	-.30
40	-.10	-.10	-.07	-.03	.00	-.02	-.01	.02	-.07	-.02	-.21	-.08	-.17	-.54	-.64
41	.32	.31	.35	.38	.42	.40	.40	.43	.35	.39	.18	.32	.21	-.15	-.23
42	.33	.33	.35	.39	.42	.40	.41	.43	.36	.41	.23	.34	.21	-.11	-.22
43	-.06	-.05	-.03	.01	.04	.01	.02	.05	-.04	.01	-.15	-.05	-.17	-.50	-.60
44	.30	.30	.33	.37	.39	.37	.38	.40	.31	.37	.20	.29	.19	-.15	-.26
45	.30	.30	.34	.37	.39	.37	.38	.41	.32	.40	.18	.29	.22	-.14	-.27
46	-.09	-.09	-.06	-.02	.00	-.02	-.01	.02	-.07	.01	-.18	-.11	-.16	-.52	-.62
47	.27	.27	.31	.35	.37	.34	.35	.37	.29	.35	.18	.25	.20	-.17	-.25
48	.31	.30	.34	.38	.40	.37	.38	.40	.31	.37	.22	.27	.23	-.15	-.21
49	-.07	-.07	-.03	.01	.03	.01	.01	.03	-.06	-.01	-.14	-.10	-.15	-.52	-.57
50	.33	.32	.37	.41	.44	.41	.41	.43	.34	.38	.24	.28	.21	-.12	-.18
51	.31	.30	.34	.38	.40	.38	.39	.40	.31	.35	.23	.26	.21	-.12	-.18
52	-.05	-.05	.00	.04	.06	.04	.03	.05	-.05	-.01	-.12	-.09	-.16	-.46	-.52
53	.90	.91	.98	1.00	1.02	1.00	.97	.98	.89	.96	.77	.87	.72	.33	.26
54	1.23	1.23	1.29	1.31	1.33	1.33	1.32	1.32	1.24	1.29	1.14	1.20	1.11	.74	.75
55	.85	.85	.90	.92	.94	.95	.94	.94	.85	.91	.77	.81	.75	.44	.43
56	1.19	1.19	1.24	1.26	1.29	1.29	1.28	1.28	1.19	1.25	1.11	1.16	1.09	.75	.77
57	1.20	1.20	1.26	1.28	1.30	1.31	1.29	1.29	1.20	1.26	1.12	1.17	1.10	.78	.78
58	.80	.79	.85	.87	.89	.89	.89	.89	.80	.86	.73	.77	.71	.40	.40
59	1.14	1.13	1.18	1.20	1.22	1.24	1.23	1.22	1.13	1.19	1.06	1.10	1.06	.72	.74
60	1.11	1.11	1.16	1.17	1.20	1.21	1.20	1.20	1.10	1.17	1.04	1.08	1.02	.70	.72
61	3.05	3.05	3.05	3.05	3.05	3.05	3.05	3.05	3.05	3.05	3.05	3.05	3.05	3.05	3.05
62	.00	.00	.00	.00	.00	.00	.00	.00	.00	.00	.00	.00	.00	.00	.00

NOAA-9 SCANNER OFFSETS FOR SEPTEMBER 1986: SHORTWAVE CHANNEL

S.P.	DAY OF MONTH -->														
	16	17	18	19	20	21	22	23	24	25	26	27	28	29	30
1	-.11	-.11	-.11	-.11	-.11	-.11	-.11	-.11	-.11	-.11	-.11	-.11	-.11	-.11	-.11
2	.32	.32	.32	.32	.32	.32	.32	.32	.32	.32	.32	.32	.32	.32	.32
3	.49	.49	.49	.49	.49	.49	.49	.49	.49	.49	.49	.49	.49	.49	.49
4	-4.09	-4.09	-4.09	-4.09	-4.09	-4.09	-4.09	-4.09	-4.09	-4.09	-4.09	-4.09	-4.09	-4.09	-4.09
5	.60	.71	.68	.73	.69	.70	.75	.67	.69	.78	.59	.66	.64	.65	.60
6	.68	.83	.79	.83	.80	.78	.84	.77	.79	.88	.66	.74	.72	.73	.68
7	.29	.48	.43	.47	.44	.40	.47	.42	.43	.50	.28	.37	.36	.36	.31
8	.66	.86	.79	.83	.79	.76	.84	.78	.79	.86	.64	.73	.71	.73	.67
9	.75	.92	.85	.89	.84	.82	.91	.84	.85	.90	.67	.77	.76	.76	.71
10	.40	.54	.47	.51	.45	.45	.55	.46	.46	.48	.25	.35	.37	.35	.32
11	.72	.83	.76	.80	.74	.74	.84	.74	.75	.81	.59	.69	.67	.69	.63
12	.73	.80	.73	.76	.70	.71	.83	.68	.70	.74	.52	.61	.61	.60	.58
13	-.14	-.07	-.12	-.10	-.16	-.11	-.01	-.19	-.17	-.13	-.35	-.27	-.26	-.26	-.27
14	.10	.19	.19	.22	.16	.15	.28	.14	.16	.19	-.02	.06	.08	.07	.05
15	.05	.18	.16	.20	.11	.08	.25	.10	.13	.19	-.03	.05	.04	.05	.02
16	-.43	-.24	-.25	-.21	-.30	-.30	-.17	-.31	-.28	-.23	-.43	-.36	-.37	-.36	-.39
17	-.10	.10	.10	.10	-.01	.07	.17	.02	.06	.12	-.08	-.01	-.01	.00	-.05
18	-.11	.14	.11	.12	.01	.12	.20	.04	.08	.15	-.05	.02	.00	.02	-.02
19	-.46	-.23	-.27	-.26	-.31	-.23	-.18	-.36	-.32	-.25	-.45	-.38	-.40	-.38	-.42
20	-.11	.14	.11	.14	.10	.17	.18	.03	.07	.14	-.05	.01	.00	.01	-.03
21	-.07	.21	.14	.17	.15	.20	.26	.07	.11	.17	-.02	.03	.04	.04	.01
22	-.45	-.20	-.33	-.31	-.32	-.27	-.23	-.42	-.38	-.29	-.47	-.43	-.46	-.43	-.48
23	-.03	.20	.03	.05	.05	.09	.10	-.07	-.02	.07	-.10	-.07	-.09	-.06	-.11
24	.05	.22	.05	.08	.08	.12	.09	-.04	.01	.11	-.05	-.02	-.06	-.02	-.08
25	-.26	-.18	-.35	-.31	-.30	-.29	-.27	-.43	-.38	-.28	-.44	-.41	-.45	-.41	-.47
26	.05	.20	.03	.05	.07	.09	.14	-.06	-.01	.10	-.05	-.04	-.07	-.03	-.09
27	.15	.21	.05	.07	.10	.12	.19	-.04	.02	.13	-.01	.00	-.04	.00	-.06
28	-.32	-.18	-.34	-.31	-.28	-.27	-.17	-.43	-.37	-.26	-.40	-.39	-.43	-.39	-.45
29	.06	.23	.07	.09	.13	.11	.23	-.01	.05	.16	.02	.03	-.01	.02	-.03
30	.11	.30	.14	.16	.19	.12	.29	.07	.12	.21	.08	.08	.05	.07	.04
31	-.29	-.11	-.27	-.25	-.20	-.27	-.14	-.36	-.29	-.17	-.29	-.30	-.35	-.30	-.36
32	.09	.23	.08	.09	.15	.10	.19	-.01	.06	.19	.07	.05	.00	.05	.01
33	.02	.17	-.01	.01	.07	-.02	.10	-.08	-.02	.11	-.01	-.05	-.09	-.05	-.06
34	-.37	-.24	-.39	-.37	-.33	-.38	-.27	-.45	-.40	-.28	-.40	-.44	-.48	-.44	-.46
35	.01	.14	-.04	.01	.06	.03	.07	-.10	-.03	.10	-.01	-.06	-.11	-.06	-.09
36	.08	.21	.02	.07	.13	.11	.13	-.03	.03	.16	.06	.01	-.05	-.01	-.02
37	-.24	-.14	-.31	-.29	-.23	-.23	-.25	-.38	-.31	-.18	-.28	-.33	-.39	-.35	-.36
38	.18	.22	.07	.11	.19	.18	.11	.02	.09	.23	.14	.08	.02	.06	.05
39	.17	.26	.11	.17	.29	.23	.14	.07	.14	.27	.18	.12	.07	.11	.11
40	-.22	-.08	-.23	-.16	-.03	-.12	-.17	-.27	-.20	-.07	-.15	-.21	-.27	-.23	-.23
41	.17	.34	.18	.24	.37	.26	.24	.13	.20	.33	.26	.20	.13	.19	.18
42	.26	.41	.20	.27	.40	.28	.27	.17	.23	.36	.29	.21	.16	.21	.21
43	-.10	.05	-.18	-.11	.02	-.11	-.13	-.21	-.14	-.02	-.08	-.15	-.21	-.16	-.15
44	.30	.37	.17	.24	.38	.23	.22	.14	.21	.33	.27	.19	.14	.19	.20
45	.34	.33	.17	.24	.37	.20	.24	.15	.21	.34	.27	.19	.14	.18	.18
46	-.11	-.05	-.22	-.15	-.03	-.19	-.14	-.25	-.18	-.06	-.12	-.20	-.25	-.21	-.21
47	.24	.31	.13	.20	.33	.17	.24	.11	.18	.31	.25	.16	.11	.16	.15
48	.25	.35	.15	.23	.35	.17	.27	.14	.21	.34	.29	.19	.14	.19	.18
49	-.14	.01	-.23	-.15	-.03	-.22	-.12	-.23	-.17	-.03	-.08	-.17	-.23	-.18	-.19
50	.28	.40	.15	.22	.35	.17	.23	.14	.20	.36	.32	.21	.14	.20	.18
51	.33	.39	.15	.23	.36	.20	.21	.16	.22	.34	.31	.20	.15	.20	.20
52	-.01	.03	-.21	-.13	.02	-.19	-.18	-.14	-.00	-.04	-.15	-.21	-.14	-.14	-.15
53	.73	.86	.69	.80	.89	.65	.72	.78	.78	.95	.92	.82	.73	.81	.76
54	1.21	1.25	1.05	1.13	1.22	1.03	1.09	1.09	1.11	1.28	1.26	1.16	1.07	1.14	1.10
55	.88	.93	.71	.76	.87	.67	.73	.73	.74	.89	.87	.77	.69	.76	.74
56	1.28	1.29	1.05	1.10	1.21	1.01	1.09	1.07	1.08	1.23	1.22	1.11	1.04	1.10	1.09
57	1.31	1.29	1.05	1.11	1.24	1.04	1.07	1.08	1.09	1.25	1.23	1.13	1.06	1.12	1.11
58	.95	.89	.65	.72	.88	.67	.67	.70	.71	.85	.84	.74	.68	.73	.73
59	1.25	1.23	.98	1.05	1.21	1.00	1.00	1.02	1.04	1.19	1.18	1.08	1.01	1.07	1.06
60	1.22	1.20	.95	1.03	1.17	.97	.93	1.00	1.02	1.17	1.15	1.07	1.01	1.04	1.04
61	3.05	3.05	3.05	3.05	3.05	3.05	3.05	3.05	3.05	3.05	3.05	3.05	3.05	3.05	3.05
62	.00	.00	.00	.00	.00	.00	.00	.00	.00	.00	.00	.00	.00	.00	.00

NOAA-9 SCANNER OFFSETS FOR OCTOBER 1986:

TOTAL CHANNEL

S.P.	DAY OF MONTH -->														
	1	2	3	4	5	6	7	8	9	10	11	12	13	14	15
1	.36	.36	.36	.36	.36	.36	.36	.36	.36	.36	.36	.36	.36	.36	.36
2	1.04	1.04	1.04	1.04	1.04	1.04	1.04	1.04	1.04	1.04	1.04	1.04	1.04	1.04	1.04
3	1.93	1.93	1.93	1.93	1.93	1.93	1.93	1.93	1.93	1.93	1.93	1.93	1.93	1.93	1.93
4	-9.64	-9.64	-9.64	-9.64	-9.64	-9.64	-9.64	-9.64	-9.64	-9.64	-9.64	-9.64	-9.64	-9.64	-9.64
5	-2.58	-1.90	-2.38	-1.56	-1.78	-.11	-.11	.79	-.21	.18	.24	-2.92	1.04	1.14	-1.77
6	-2.64	-2.75	-3.34	-2.22	-2.67	-1.87	-1.87	-1.25	-2.38	-1.84	-2.00	-2.17	-1.67	-2.54	-3.24
7	-2.95	-3.33	-3.51	-2.54	-2.70	-2.30	-2.30	-2.05	-2.94	-2.90	-3.35	-1.89	-1.67	-2.99	-2.72
8	-3.55	-3.65	-3.48	-2.70	-2.30	-2.31	-2.31	-2.03	-2.89	-2.97	-3.64	-1.50	-2.00	-3.16	-2.55
9	-3.84	-3.87	-3.56	-3.21	-2.45	-1.99	-1.99	-1.99	-2.19	-2.78	-3.19	-3.50	-1.33	-2.24	-2.12
10	-3.07	-3.25	-2.31	-2.14	-1.36	-.78	-.78	-1.06	-1.61	-2.17	-2.46	-.62	-1.42	-2.12	-1.65
11	-2.87	-2.96	-1.62	-1.63	-.90	-.36	-.36	-.66	-1.00	-1.98	-2.20	-.67	-1.01	-1.47	-1.28
12	-2.90	-2.73	-1.46	-1.48	-.94	.08	.08	-.46	-.56	-2.28	-1.91	-.37	-.89	-1.07	-1.17
13	-3.36	-2.94	-1.64	-1.60	-1.30	.18	.18	-.44	-.99	-1.94	-1.75	-.17	-.87	-1.20	-1.41
14	-3.23	-2.63	-1.34	-1.24	-1.17	.64	.64	-.08	-.92	-1.64	-1.10	.36	-.39	-1.05	-1.13
15	-3.55	-2.78	-1.28	-1.17	-1.39	.50	.50	-.17	-1.00	-1.80	-.80	.34	-.53	-1.29	-1.13
16	-3.89	-2.96	-1.24	-1.12	-1.48	.41	.41	-.30	-1.18	-1.77	-.54	.13	-.70	-1.67	-1.41
17	-3.84	-2.96	-1.25	-.81	-1.16	.72	.72	.11	-1.26	-1.35	-.20	.12	-.57	-1.62	-1.40
18	-3.92	-3.30	-1.62	-1.11	-1.41	.46	.46	-.18	-1.35	-1.19	-.41	-.15	-.79	-1.81	-1.69
19	-3.36	-2.60	-1.47	-1.19	-1.34	.87	.87	-.14	-1.19	-.58	-.29	-.01	-.53	-1.32	-1.63
20	-3.21	-2.35	-1.53	-1.35	-1.50	1.18	1.18	-.10	-1.55	-.25	-.31	-.09	-.47	-1.37	-1.71
21	-2.86	-2.06	-1.06	-1.16	-1.38	1.45	1.45	.18	-1.60	.38	-.08	.02	-.31	-1.37	-1.50
22	-2.54	-1.71	-.45	-1.19	-1.23	1.31	1.31	.19	-1.87	.51	-.11	-.10	-.51	-1.32	-1.50
23	-2.52	-1.54	-.21	-1.11	-1.11	1.20	1.20	.15	-2.16	.56	-.07	-.29	-.73	-1.16	-1.39
24	-1.68	-.51	.72	-.07	-.06	2.12	2.12	1.11	-1.42	1.91	1.30	.86	.13	-.18	-.37
25	-1.98	-.53	.38	-.17	-.31	1.95	1.95	.87	-1.74	1.82	1.50	.88	-.26	-.38	-.59
26	-1.99	-.28	.35	-.10	-.17	2.02	2.02	1.05	-1.48	1.91	1.70	1.19	-.50	-.08	-.43
27	-1.92	-.08	.46	.01	.15	2.34	2.34	1.40	-1.13	2.04	2.03	1.39	-.75	.18	-.16
28	-2.25	-.23	.21	-.16	.12	2.11	2.11	1.48	-1.31	1.84	1.88	.90	-1.36	-.03	-.34
29	-2.21	.06	.17	-.01	.31	2.16	2.16	1.74	-1.11	1.88	1.76	.72	-1.34	.09	-.17
30	-2.01	.33	.17	.20	.55	2.22	2.22	1.91	-.94	1.99	1.91	.71	-.97	.45	-.08
31	-2.40	.22	-.08	.16	.63	1.98	1.98	1.80	-.86	1.79	1.79	.40	-.92	.49	-.32
32	-2.09	.59	.16	.47	1.08	2.34	2.34	2.11	-.40	1.95	2.11	.51	-.36	.99	-.06
33	-1.52	1.07	.52	.68	1.49	2.72	2.72	2.41	.01	2.19	2.21	.80	.06	1.45	.20
34	-1.20	1.40	.73	.84	1.74	2.98	2.98	2.62	.21	2.31	2.10	1.05	.23	1.70	.16
35	-1.31	1.25	.49	.59	1.72	2.82	2.82	2.56	.05	2.23	1.70	.95	.35	1.45	-.21
36	-1.19	1.19	.51	.40	1.71	2.88	2.88	2.65	.20	2.57	1.57	1.15	.76	1.30	-.19
37	-1.08	1.26	.36	.11	1.45	2.96	2.96	2.57	.14	2.49	1.59	1.29	.93	1.20	-.10
38	-.84	1.51	.45	.23	1.56	2.94	2.94	2.48	.08	2.61	1.85	1.44	1.11	1.46	-.04
39	-.81	1.37	.60	.42	1.69	2.74	2.74	2.34	.17	2.50	1.99	1.27	1.19	1.72	-.29
40	-1.01	.96	.30	.17	1.46	2.30	2.30	2.13	-.22	2.07	1.66	.75	1.07	1.71	-.74
41	-1.25	.61	-.01	-.10	1.09	1.87	1.87	1.99	-.63	1.72	1.21	.36	1.18	1.69	-.97
42	-.52	1.25	.64	.40	1.64	2.43	2.43	2.76	-.19	2.27	1.53	1.12	2.15	2.57	-.27
43	-.34	1.20	.51	.22	1.57	2.30	2.30	2.75	-.39	2.03	1.13	1.12	2.24	2.45	-.57
44	-.19	1.03	.34	.31	1.34	2.25	2.25	2.77	-.40	1.89	.91	1.09	2.25	2.31	-.97
45	-.85	.30	-.28	-.02	.65	1.72	1.72	2.17	-.76	1.29	.34	.72	1.80	1.73	-1.68
46	-1.30	-.37	-.60	-.30	.30	1.35	1.35	1.68	-.92	.84	-.11	.46	1.52	1.28	-2.08
47	-1.81	-1.05	-.92	-.54	-.14	.94	.94	1.32	-1.18	.21	-.42	.17	1.04	.66	-2.64
48	-2.35	-1.51	-1.21	-.71	-.65	.55	.55	1.24	-1.50	-.09	-.44	-.13	.68	.04	-3.02
49	-2.78	-2.13	-1.68	-.99	-1.13	.02	.02	.88	-2.09	-.37	-.80	-.72	.26	-.71	-3.47
50	-2.73	-2.43	-1.92	-.97	-1.07	-.28	-.28	.59	-2.42	-.62	-1.01	-.90	.14	-.89	-3.42
51	-2.49	-2.44	-2.09	-.86	-1.01	-.57	-.57	.27	-2.47	-.79	-1.32	-.88	-.10	-.97	-3.31
52	-2.03	-2.41	-2.39	-1.10	-1.43	-.83	-.83	-.11	-2.23	-.94	-1.95	-1.13	-.55	-1.47	-3.49
53	-.90	-1.45	-1.77	-.38	-.74	.17	.17	.63	-1.61	-.55	-1.37	-.34	.12	-.69	-2.25
54	-1.02	-1.67	-1.91	-.77	-.91	.20	.20	.19	-1.91	-1.10	-1.88	-.25	-.14	-.84	-1.80
55	-1.78	-2.72	-2.55	-1.44	-1.31	-.27	-.27	-.39	-2.36	-1.90	-2.83	-.74	-.91	-1.62	-1.96
56	-1.72	-2.70	-2.02	-1.09	-.55	.33	.33	.07	-1.54	-1.28	-2.41	-.22	-.41	-1.42	-1.38
57	-1.51	-2.26	-1.30	-.61	.29	1.05	1.05	.62	-.34	-.24	-1.47	.74	.31	-.76	-.68
58	-1.94	-2.42	-1.40	-.87	.44	1.02	1.02	.37	.12	-.36	-1.08	.94	.51	-.47	-.69
59	-1.68	-1.62	-.77	-.27	.94	1.47	1.47	.72	.64	.29	.33	1.87	.90	.17	-.02
60	-3.68	-3.23	-2.62	-2.73	-1.50	-1.76	-1.76	-2.36	-2.71	-1.87	-1.88	1.35	-2.79	-3.45	-2.15
61	11.19	11.19	11.19	11.19	11.19	11.19	11.19	11.19	11.19	11.19	11.19	11.19	11.19	11.19	11.19
62	3.13	3.13	3.13	3.13	3.13	3.13	3.13	3.13	3.13	3.13	3.13	3.13	3.13	3.13	3.13

NOAA-9 SCANNER OFFSETS FOR OCTOBER 1986: LONGWAVE CHANNEL

S.P.	DAY OF MONTH -->														
	1	2	3	4	5	6	7	8	9	10	11	12	13	14	15
1	-.11	-.11	-.11	-.11	-.11	-.11	-.11	-.11	-.11	-.11	-.11	-.11	-.11	-.11	-.11
2	.32	.32	.32	.32	.32	.32	.32	.32	.32	.32	.32	.32	.32	.32	.32
3	.49	.49	.49	.49	.49	.49	.49	.49	.49	.49	.49	.49	.49	.49	.49
4	-4.09	-4.09	-4.09	-4.09	-4.09	-4.09	-4.09	-4.09	-4.09	-4.09	-4.09	-4.09	-4.09	-4.09	-4.09
5	-3.15	-2.78	-3.10	-2.66	-2.76	-1.81	-1.81	-1.20	-1.75	-1.60	-1.51	-3.26	-.92	-.92	-2.67
6	-2.68	-2.81	-3.20	-2.52	-2.81	-2.31	-2.31	-1.90	-2.59	-2.35	-2.43	-2.38	-1.48	-1.83	-3.12
7	-2.74	-3.03	-3.13	-2.53	-2.65	-2.47	-2.47	-2.29	-2.78	-2.89	-3.19	-2.10	-1.98	-2.54	-2.93
8	-3.29	-3.36	-3.25	-2.81	-2.53	-2.66	-2.66	-2.47	-2.87	-3.09	-3.60	-2.03	-2.35	-2.99	-2.73
9	-3.61	-3.71	-3.50	-3.34	-2.83	-2.59	-2.59	-2.79	-3.05	-3.47	-3.72	-2.14	-2.69	-3.26	-2.78
10	-3.27	-3.41	-2.82	-2.78	-2.23	-1.95	-1.95	-2.17	-2.46	-2.93	-3.18	-1.83	-2.32	-2.72	-2.35
11	-3.58	-3.43	-2.57	-2.66	-2.12	-1.92	-1.92	-2.13	-2.24	-3.01	-3.26	-2.10	-2.26	-2.51	-2.35
12	-3.54	-3.43	-2.61	-2.69	-2.27	-1.78	-1.78	-2.14	-2.08	-3.36	-3.23	-2.03	-2.30	-2.40	-2.43
13	-3.90	-3.64	-2.79	-2.82	-2.54	-1.78	-1.78	-2.22	-2.47	-3.17	-3.19	-1.90	-2.34	-2.55	-2.64
14	-4.02	-3.65	-2.83	-2.83	-2.70	-1.71	-1.71	-2.22	-2.69	-3.23	-2.91	-1.67	-2.21	-2.64	-2.64
15	-4.41	-3.95	-2.99	-3.01	-3.10	-2.01	-2.01	-2.45	-2.91	-3.49	-2.88	-1.84	-2.47	-3.00	-2.83
16	-4.79	-4.25	-3.20	-3.16	-3.36	-2.21	-2.21	-2.68	-3.22	-3.62	-2.85	-2.11	-2.74	-3.42	-3.20
17	-5.01	-4.54	-3.46	-3.19	-3.34	-2.22	-2.22	-2.59	-3.51	-3.55	-2.80	-2.31	-2.86	-3.54	-3.40
18	-5.26	-4.97	-3.93	-3.66	-3.75	-2.64	-2.64	-3.02	-3.76	-3.61	-3.17	-2.74	-3.26	-3.90	-3.80
19	-5.08	-4.62	-4.03	-3.92	-3.95	-2.57	-2.57	-3.17	-3.90	-3.42	-3.30	-2.89	-3.30	-3.71	-3.99
20	-5.22	-4.72	-4.27	-4.22	-4.27	-2.57	-2.57	-3.34	-4.37	-3.41	-3.51	-3.18	-3.42	-3.93	-4.24
21	-5.19	-4.71	-4.13	-4.28	-4.37	-2.56	-2.56	-3.33	-4.56	-3.14	-3.52	-3.27	-3.46	-4.06	-4.28
22	-5.17	-4.63	-3.93	-4.51	-4.50	-2.89	-2.89	-3.56	-4.99	-3.34	-3.77	-3.58	-3.83	-4.27	-4.52
23	-5.35	-4.65	-3.95	-4.56	-4.59	-3.15	-3.15	-3.77	-5.35	-3.51	-3.91	-3.86	-4.14	-4.33	-4.62
24	-4.94	-4.10	-3.44	-3.97	-3.97	-2.67	-2.67	-3.25	-4.93	-2.71	-3.12	-3.16	-3.68	-3.81	-4.05
25	-5.29	-4.30	-3.81	-4.17	-4.28	-2.92	-2.92	-3.56	-5.26	-2.93	-3.14	-3.23	-4.08	-4.10	-4.35
26	-5.40	-4.24	-3.91	-4.23	-4.29	-2.99	-2.99	-3.54	-5.16	-2.96	-3.09	-3.09	-4.35	-3.99	-4.34
27	-5.35	-4.09	-3.83	-4.14	-4.08	-2.75	-2.75	-3.32	-4.96	-2.89	-2.84	-2.96	-4.52	-3.85	-4.18
28	-5.60	-4.21	-4.01	-4.24	-4.09	-2.91	-2.91	-3.26	-5.06	-3.00	-2.96	-3.34	-4.97	-4.05	-4.32
29	-5.53	-4.03	-4.01	-4.12	-3.93	-2.84	-2.84	-3.06	-4.87	-2.96	-3.04	-3.48	-4.93	-3.94	-4.19
30	-5.33	-3.79	-3.92	-3.89	-3.67	-2.72	-2.72	-2.90	-4.73	-2.83	-2.87	-3.50	-4.62	-3.63	-4.03
31	-5.46	-3.71	-3.93	-3.76	-3.44	-2.72	-2.72	-2.81	-4.53	-2.81	-2.80	-3.60	-4.41	-3.47	-4.04
32	-5.01	-3.25	-3.54	-3.31	-2.91	-2.24	-2.24	-2.38	-4.00	-2.50	-2.36	-3.32	-3.79	-2.92	-3.63
33	-4.30	-2.60	-2.95	-2.85	-2.32	-1.64	-1.64	-1.84	-3.38	-2.01	-1.98	-2.76	-3.19	-2.31	-3.14
34	-3.78	-2.07	-2.50	-2.45	-1.86	-1.13	-1.13	-1.39	-2.94	-1.62	-1.73	-2.27	-2.84	-1.89	-2.87
35	-3.51	-1.83	-2.33	-2.27	-1.51	-.88	-.88	-1.08	-2.69	-1.34	-1.65	-1.96	-2.46	-1.74	-2.77
36	-3.08	-1.55	-1.94	-2.03	-1.14	-.49	-.49	-.63	-2.19	-.69	-1.36	-1.40	-1.86	-1.50	-2.38
37	-2.64	-1.15	-1.70	-1.88	-.98	-.06	-.06	-.33	-1.88	-.44	-.96	-.91	-1.46	-1.21	-1.96
38	-2.14	-.62	-1.26	-1.44	-.57	.24	.24	-.05	-1.61	.02	-.43	-.46	-1.01	-.65	-1.58
39	-1.77	-.37	-.78	-.94	-.11	.47	.47	.23	-1.16	.32	.05	-.20	-.58	-.08	-1.38
40	-1.53	-.27	-.62	-.73	.10	.55	.55	.45	-1.07	.38	.17	-.24	-.30	.28	-1.33
41	-1.37	-.19	-.52	-.61	.18	.56	.56	.64	-1.04	.45	.14	-.26	.11	.59	-1.16
42	-.59	.57	.22	.03	.87	1.26	1.26	1.46	-.43	1.13	.64	.53	1.09	1.48	-.38
43	-.12	.84	.48	.27	1.18	1.52	1.52	1.80	-.27	1.28	.70	.84	1.48	1.72	-.25
44	.24	.98	.61	.56	1.23	1.75	1.75	2.06	-.01	1.44	.76	1.05	1.69	1.85	-.31
45	.01	.71	.39	.56	.99	1.61	1.61	1.88	-.04	1.26	.58	1.00	1.57	1.63	-.60
46	-.08	.51	.42	.61	1.00	1.60	1.60	1.82	.14	1.24	.51	1.06	1.62	1.56	-.64
47	-.29	.18	.34	.59	.86	1.49	1.49	1.73	.13	.98	.47	1.06	1.44	1.24	-.88
48	-.50	.01	.28	.63	.68	1.37	1.37	1.82	.02	.91	.64	1.06	1.32	.94	-1.01
49	-.71	-.35	.01	.50	.40	1.04	1.04	1.61	-.34	.74	.49	.73	1.06	.46	-1.27
50	-.64	-.53	-.16	.49	.42	.87	.87	1.41	-.59	.52	.37	.67	1.00	.36	-1.21
51	-.35	-.41	-.16	.70	.58	.78	.78	1.30	-.53	.50	.27	.81	.94	.41	-1.02
52	-.07	-.41	-.38	.46	.25	.57	.57	1.01	-.36	.41	-.23	.56	.57	.04	-1.18
53	.32	-.11	-.33	.61	.40	.92	.92	1.18	-.40	.31	-.19	.73	.66	.19	-.70
54	.05	-.43	-.59	.22	.16	.85	.85	.79	-.70	-.15	-.64	.64	.39	-.01	-.51
55	-.51	-1.21	-1.05	-.25	-.14	.58	.58	.42	-1.02	-.68	-1.25	.31	-.09	-.52	-.60
56	-.61	-1.29	-.81	-.17	.24	.90	.90	.66	-.48	-.34	-1.02	.57	.20	-.44	-.29
57	-.49	-1.02	-.33	.10	.72	1.37	1.37	1.00	.37	.38	-.39	1.23	.66	.01	.17
58	-.69	-1.10	-.31	-.09	.83	1.40	1.40	.89	.66	.32	-.07	1.44	.81	.23	.16
59	-.55	-.57	.09	.29	1.12	1.66	1.66	1.11	.99	.72	.84	2.04	1.01	.56	.54
60	-1.60	-1.30	-.86	-1.07	-.26	-.19	-.19	-.61	-.88	-.39	-.34	1.82	-1.09	-1.49	-.64
61	3.05	3.05	3.05	3.05	3.05	3.05	3.05	3.05	3.05	3.05	3.05	3.05	3.05	3.05	3.05
62	.45	.45	.45	.45	.45	.45	.45	.45	.45	.45	.45	.45	.45	.45	.45

NOAA-9 SCANNER OFFSETS FOR OCTOBER 1986: LONGHAVE CHANNEL

S.P.	DAY OF MONTH -->													30	31		
	16	17	18	19	20	21	22	23	24	25	26	27	28			29	
1	-.11	-.11	-.11	-.11	-.11	-.11	-.11	-.11	-.11	-.11	-.11	-.11	-.11	-.11	-.11	-.11	-.11
2	.32	.32	.32	.32	.32	.32	.32	.32	.32	.32	.32	.32	.32	.32	.32	.32	.32
3	.49	.49	.49	.49	.49	.49	.49	.49	.49	.49	.49	.49	.49	.49	.49	.49	.49
4	-4.09	-4.09	-4.09	-4.09	-4.09	-4.09	-4.09	-4.09	-4.09	-4.09	-4.09	-4.09	-4.09	-4.09	-4.09	-4.09	-4.09
5	-1.84	-1.20	-1.87	-1.54	-1.39	-1.46	-1.87	-2.06	-2.48	-2.48	-3.05	-2.18	-1.93	-2.93	-2.11	-2.56	-2.56
6	-2.52	-2.02	-2.49	-2.30	-2.43	-2.45	-2.80	-2.27	-2.67	-2.67	-2.91	-2.47	-2.23	-3.18	-2.56	-2.90	-3.00
7	-2.63	-2.16	-2.30	-2.72	-2.61	-2.69	-2.81	-2.15	-2.49	-2.49	-2.81	-2.48	-2.32	-3.36	-2.84	-3.57	-3.57
8	-2.78	-2.32	-2.12	-3.11	-2.65	-2.65	-2.74	-2.14	-2.51	-2.51	-2.88	-2.62	-2.23	-3.77	-3.02	-3.52	-3.52
9	-3.07	-2.59	-2.33	-3.30	-2.73	-2.78	-2.76	-2.24	-2.60	-2.60	-3.41	-2.86	-2.47	-3.98	-3.18	-3.88	-3.88
10	-2.67	-2.26	-2.23	-2.85	-2.41	-2.56	-2.23	-1.92	-2.27	-2.27	-3.33	-2.64	-2.36	-3.56	-2.84	-3.57	-3.57
11	-2.66	-2.36	-2.47	-2.90	-2.53	-2.66	-2.12	-2.07	-2.31	-2.31	-3.48	-3.09	-2.72	-3.64	-3.08	-3.61	-3.61
12	-2.56	-2.39	-2.63	-2.93	-2.47	-2.50	-1.99	-2.10	-2.19	-2.19	-3.17	-3.29	-3.12	-3.74	-3.15	-3.60	-3.60
13	-2.58	-2.39	-2.82	-3.09	-2.65	-2.56	-2.06	-2.32	-2.26	-2.26	-2.73	-3.36	-3.53	-3.94	-3.20	-3.68	-3.68
14	-2.53	-2.36	-2.73	-3.04	-2.82	-2.55	-2.06	-2.35	-2.26	-2.26	-2.64	-3.22	-3.67	-3.95	-3.08	-3.51	-3.51
15	-2.66	-2.71	-2.94	-3.14	-3.33	-2.90	-2.27	-2.74	-2.73	-2.73	-2.97	-3.32	-3.95	-4.11	-3.08	-3.63	-3.63
16	-2.91	-3.17	-3.34	-3.31	-3.72	-3.29	-2.59	-3.21	-3.09	-3.09	-3.25	-3.52	-4.19	-4.34	-3.22	-3.91	-3.91
17	-3.02	-3.32	-3.51	-3.43	-3.77	-3.53	-2.86	-3.38	-3.36	-3.36	-3.58	-3.67	-4.12	-4.40	-3.42	-4.01	-4.01
18	-3.44	-3.67	-3.82	-3.88	-4.01	-3.93	-3.27	-3.68	-3.75	-3.75	-3.77	-3.83	-4.32	-4.75	-3.90	-4.33	-4.33
19	-3.65	-3.74	-3.91	-4.07	-3.95	-3.58	-3.27	-3.57	-3.90	-3.90	-3.65	-3.80	-4.38	-4.73	-4.07	-4.36	-4.36
20	-3.86	-4.00	-4.20	-4.26	-4.06	-3.62	-3.41	-3.71	-4.25	-4.25	-3.95	-4.04	-4.56	-4.84	-4.22	-4.52	-4.52
21	-3.93	-4.11	-4.23	-4.29	-4.18	-3.79	-3.42	-3.95	-4.37	-4.37	-4.04	-4.26	-4.70	-4.94	-4.16	-4.52	-4.52
22	-4.37	-4.45	-4.46	-4.59	-4.52	-4.14	-3.61	-4.51	-4.84	-4.84	-4.57	-4.63	-5.11	-5.36	-4.42	-4.69	-4.69
23	-4.39	-4.69	-4.63	-4.81	-4.61	-4.20	-3.68	-4.80	-5.18	-5.18	-4.75	-4.72	-5.26	-5.64	-4.60	-4.84	-4.84
24	-3.74	-4.09	-4.05	-4.27	-3.93	-3.48	-3.06	-4.23	-4.92	-4.92	-3.91	-3.94	-4.65	-5.20	-4.04	-4.27	-4.27
25	-3.92	-4.33	-4.24	-4.53	-4.21	-3.66	-3.41	-4.57	-5.47	-5.47	-3.91	-4.08	-4.96	-5.56	-4.37	-4.57	-4.57
26	-3.99	-4.36	-4.12	-4.55	-4.31	-3.60	-3.54	-4.64	-5.77	-5.77	-4.06	-4.09	-5.07	-5.63	-4.36	-4.62	-4.62
27	-3.90	-4.27	-3.88	-4.42	-4.15	-3.39	-3.46	-4.53	-5.90	-5.90	-4.49	-4.04	-4.86	-5.43	-4.09	-4.44	-4.44
28	-4.08	-4.51	-4.06	-4.61	-4.30	-3.45	-3.63	-4.63	-5.94	-5.94	-5.31	-4.07	-4.91	-5.63	-4.16	-4.62	-4.62
29	-4.01	-4.37	-3.94	-4.47	-4.25	-3.29	-3.67	-4.53	-5.69	-5.69	-5.46	-4.07	-4.70	-5.57	-4.02	-4.52	-4.52
30	-3.84	-4.06	-3.66	-4.23	-4.04	-3.06	-3.61	-4.33	-5.26	-5.26	-5.24	-3.75	-4.28	-5.22	-3.83	-4.24	-4.24
31	-3.83	-3.93	-3.53	-4.11	-3.99	-2.85	-3.58	-4.21	-4.93	-4.93	-5.09	-3.59	-4.03	-4.94	-3.72	-4.11	-4.11
32	-3.49	-3.51	-3.16	-3.60	-3.59	-2.40	-3.22	-3.69	-4.19	-4.19	-4.42	-3.15	-3.55	-4.43	-3.22	-3.68	-3.68
33	-3.17	-3.06	-2.79	-3.15	-3.13	-1.95	-2.79	-3.17	-3.46	-3.46	-3.45	-2.63	-3.01	-3.85	-2.55	-3.21	-3.21
34	-2.96	-2.71	-2.60	-2.84	-2.83	-1.59	-2.50	-2.80	-2.94	-2.94	-2.69	-2.24	-2.58	-3.53	-1.99	-2.87	-2.87
35	-2.96	-2.57	-2.56	-2.63	-2.63	-1.40	-2.61	-2.54	-2.68	-2.68	-2.58	-1.99	-2.42	-3.53	-1.69	-2.60	-2.60
36	-2.71	-2.17	-2.28	-2.18	-2.24	-1.15	-2.03	-2.15	-2.30	-2.30	-2.35	-1.62	-2.10	-3.38	-1.23	-2.11	-2.11
37	-2.41	-1.74	-2.05	-1.61	-1.89	-.75	-1.72	-1.76	-1.94	-1.94	-1.93	-1.27	-1.76	-3.07	-.86	-1.66	-1.66
38	-1.98	-1.24	-1.75	-.98	-1.42	-.23	-1.26	-1.29	-1.57	-1.57	-1.30	-.89	-1.35	-2.61	-.48	-1.22	-1.22
39	-1.61	-.84	-1.43	-.60	-1.02	.00	-.82	-.94	-1.31	-1.31	-.82	-.59	-.92	-2.14	-.12	-.89	-.89
40	-1.54	-.61	-1.23	-.40	-.90	.01	-.75	-.78	-1.13	-1.13	-.75	-.42	-.71	-1.85	.06	-.70	-.70
41	-1.37	-.32	-1.06	-.15	-.79	.07	-.64	-.65	-.86	-.86	-.73	-.25	-.38	-1.55	.31	-.46	-.46
42	-.65	.50	-.32	.72	.03	.83	.12	.05	.01	.01	-.01	.44	.49	-.62	1.16	.35	.35
43	-.53	.77	-.16	.98	.36	.90	.21	.16	.32	.32	.34	.65	.82	-.26	1.29	.58	.58
44	-.31	.90	-.01	1.03	.52	.79	.17	.07	.43	.43	.28	.59	.93	-.08	1.28	.68	.68
45	-.33	.76	-.17	.77	.31	.51	-.05	-.19	.11	.11	-.20	.12	.73	-.26	.97	.54	.54
46	-.37	.78	-.13	.60	.14	.29	-.07	-.20	.09	.09	-.25	.05	.85	-.30	.87	.49	.49
47	-.46	.71	-.28	.30	-.08	-.06	-.19	-.41	-.01	-.01	-.72	.18	.88	-.46	.51	.21	.21
48	-.33	.70	-.36	.15	-.14	-.14	-.16	-.57	-.10	-.10	-1.00	.37	.78	-.55	.26	-.01	-.01
49	-.44	.42	-.46	-.06	-.37	-.44	-.36	-.68	-.26	-.26	-1.06	.14	.49	-.76	-.17	-.32	-.32
50	-.47	.31	-.45	.02	-.40	-.64	-.54	-.57	-.21	-.21	-.78	.04	.26	-.86	-.45	-.49	-.49
51	-.32	.28	-.33	.19	-.32	-.59	-.57	-.27	.00	.00	-.53	.02	.10	-.82	-.60	-.44	-.44
52	-.58	-.15	-.41	.01	-.56	-.82	-.87	-.24	-.19	-.19	-.85	-.18	-.26	-1.04	-.92	-.58	-.58
53	-.30	-.12	.08	.13	-.36	-.53	-.77	.21	.18	.18	-.73	.12	-.20	-.79	-.74	-.31	-.31
54	-.44	-.40	.22	-.24	-.55	-.64	-.84	.27	.36	.36	-.72	.01	-.33	-.88	-.95	-.53	-.53
55	-.70	-.65	.11	-.77	-.78	-1.09	-1.03	.17	.24	.24	-.77	-.52	-.43	-1.17	-1.09	-1.16	-1.16
56	-.58	-.29	.24	-.82	-.47	-.90	-.63	.46	.46	.46	-.55	-.52	.08	-.92	-.73	-1.24	-1.24
57	-.19	.12	.53	-.62	.09	-.38	.01	.82	.99	.99	-.39	-.32	.39	-.53	-.32	-.97	-.97
58	-.38	.15	.21	-.56	.16	-.37	.04	.69	.87	.87	-.54	-.51	-.14	-.75	-.39	-1.10	-1.10
59	.00	.39	.18	-.21	.30	.10	.35	.79	.87	.87	-.04	-.16	-.32	-.71	.10	-.60	-.60
60	-1.85	-1.96	-1.80	-2.35	-2.11	-1.59	-1.49	-1.01	-1.23	-1.23	-1.15	-1.58	-2.01	-2.03	-1.44	-1.68	-1.68
61	3.05	3.05	3.05	3.05	3.05	3.05	3.05	3.05	3.05	3.05	3.05	3.05	3.05	3.05	3.05	3.05	3.05
62	.45	.45	.45	.45	.45	.45	.45	.45	.45	.45	.45	.45	.45	.45	.45	.45	.45

NOAA-9 SCANNER OFFSETS FOR OCTOBER 1986: SHORTWAVE CHANNEL

S.P.	DAY OF MONTH -->														
	1	2	3	4	5	6	7	8	9	10	11	12	13	14	15
1	.29	.29	.29	.29	.29	.29	.29	.29	.29	.29	.29	.29	.29	.29	.29
2	.59	.59	.59	.59	.59	.59	.59	.59	.59	.59	.59	.59	.59	.59	.59
3	.63	.63	.63	.63	.63	.63	.63	.63	.63	.63	.63	.63	.63	.63	.63
4	.27	.27	.27	.27	.27	.27	.27	.27	.27	.27	.27	.27	.27	.27	.27
5	.56	.61	.57	.51	.43	.51	.56	.57	.61	.69	.61	.75	.61	.61	.61
6	.63	.69	.61	.55	.47	.55	.61	.61	.69	.61	.75	.61	.61	.61	.61
7	.25	.32	.24	.15	.06	.15	.22	.24	.32	.22	.37	.24	.22	.22	.22
8	.61	.67	.60	.51	.43	.51	.58	.60	.67	.58	.72	.60	.58	.58	.58
9	.63	.69	.63	.51	.47	.51	.61	.63	.69	.61	.74	.63	.61	.61	.61
10	.23	.27	.21	.10	.04	.10	.18	.21	.27	.18	.33	.21	.18	.18	.18
11	.55	.58	.55	.45	.37	.45	.52	.55	.58	.52	.66	.55	.52	.52	.52
12	.50	.53	.52	.40	.33	.40	.48	.52	.53	.48	.63	.52	.48	.48	.48
13	-.35	-.31	-.33	-.47	-.56	-.47	-.39	-.33	-.31	-.39	-.23	-.33	-.39	-.39	-.39
14	-.04	.02	-.05	-.16	-.26	-.16	-.09	-.05	.02	-.09	.08	-.05	-.09	-.09	-.09
15	-.05	.02	-.04	-.15	-.27	-.15	-.08	-.04	.02	-.08	.11	-.04	-.08	-.08	-.08
16	-.46	-.41	-.45	-.57	-.69	-.57	-.49	-.45	-.41	-.49	-.29	-.45	-.49	-.49	-.49
17	-.11	-.05	-.10	-.22	-.34	-.22	-.14	-.10	-.05	-.14	.06	-.10	-.14	-.14	-.14
18	-.10	-.08	-.10	-.21	-.33	-.21	-.12	-.10	-.08	-.12	.08	-.10	-.12	-.12	-.12
19	-.49	-.53	-.51	-.67	-.73	-.67	-.52	-.51	-.53	-.52	-.31	-.51	-.52	-.52	-.52
20	-.09	-.09	-.15	-.31	-.35	-.31	-.14	-.15	-.09	-.14	.08	-.15	-.14	-.14	-.14
21	-.08	-.08	-.12	-.29	-.34	-.29	-.12	-.12	-.08	-.12	.10	-.12	-.12	-.12	-.12
22	-.56	-.55	-.50	-.72	-.80	-.72	-.57	-.50	-.55	-.57	-.35	-.50	-.57	-.57	-.57
23	-.18	-.17	-.10	-.34	-.42	-.34	-.20	-.10	-.17	-.20	.02	-.10	-.20	-.20	-.20
24	-.13	-.13	-.05	-.25	-.39	-.25	-.16	-.05	-.13	-.16	.06	-.05	-.16	-.16	-.16
25	-.52	-.52	-.45	-.60	-.78	-.60	-.56	-.45	-.52	-.56	-.34	-.45	-.56	-.56	-.56
26	-.14	-.14	-.07	-.20	-.38	-.20	-.16	-.07	-.14	-.16	.05	-.07	-.16	-.16	-.16
27	-.12	-.11	-.04	-.18	-.36	-.18	-.14	-.04	-.11	-.14	.08	-.04	-.14	-.14	-.14
28	-.51	-.52	-.45	-.57	-.75	-.57	-.53	-.45	-.52	-.53	-.31	-.45	-.53	-.53	-.53
29	-.10	-.17	-.05	-.16	-.35	-.16	-.13	-.05	-.17	-.13	.10	-.05	-.13	-.13	-.13
30	-.03	-.13	.04	-.10	-.28	-.10	-.06	.04	-.13	-.06	.17	.04	-.06	-.06	-.06
31	-.42	-.52	-.32	-.45	-.65	-.45	-.43	-.32	-.52	-.43	-.20	-.32	-.43	-.43	-.43
32	-.05	-.15	.05	-.11	-.28	-.11	-.06	.05	-.15	-.06	.16	.05	-.06	-.06	-.06
33	-.14	-.17	-.06	-.20	-.36	-.20	-.14	-.06	-.17	-.14	.09	-.06	-.14	-.14	-.14
34	-.54	-.54	-.44	-.58	-.74	-.58	-.51	-.44	-.54	-.51	-.28	-.44	-.51	-.51	-.51
35	-.16	-.16	-.06	-.22	-.35	-.22	-.13	-.06	-.16	-.13	.09	-.06	-.13	-.13	-.13
36	-.09	-.09	-.01	-.15	-.29	-.15	-.07	-.01	-.09	-.07	.15	-.01	-.07	-.07	-.07
37	-.43	-.45	-.36	-.48	-.62	-.48	-.40	-.36	-.45	-.40	-.19	-.36	-.40	-.40	-.40
38	-.01	-.05	.02	-.07	-.20	-.07	.01	.02	-.05	.01	.22	.02	.01	.01	.01
39	.05	.00	.10	.00	.16	.00	.04	.10	.00	.04	.24	.10	.04	.04	.04
40	-.29	-.35	-.22	-.33	-.49	-.33	-.29	-.22	-.35	-.29	-.08	-.22	-.29	-.29	-.29
41	.12	.05	.23	.10	-.07	.10	.14	.23	.05	.14	.36	.23	.14	.14	.14
42	.16	.11	.29	.17	-.03	.17	.19	.29	.11	.19	.40	.29	.19	.19	.19
43	-.20	-.27	-.08	-.23	-.42	-.23	-.20	-.08	-.27	-.20	.03	-.08	-.20	-.20	-.20
44	-.14	.09	.28	.11	-.05	.11	.17	.28	.09	.17	.39	.28	.17	.17	.17
45	.13	.07	.29	.12	-.07	.12	.17	.29	.07	.17	.41	.29	.17	.17	.17
46	-.25	-.33	-.11	-.27	-.45	-.27	-.22	-.11	-.33	-.22	.02	-.11	-.22	-.22	-.22
47	.12	.06	.25	.10	-.07	.10	.15	.25	.06	.15	.37	.25	.15	.15	.15
48	.16	.07	.28	.15	-.02	.15	.19	.28	.07	.19	.41	.28	.19	.19	.19
49	-.21	-.29	-.08	-.21	-.39	-.21	-.18	-.08	-.29	-.18	.03	-.08	-.18	-.18	-.18
50	.18	.14	.33	.20	.03	.20	.24	.33	.14	.24	.45	.33	.24	.24	.24
51	.20	.18	.35	.22	.05	.22	.24	.35	.18	.24	.44	.35	.24	.24	.24
52	-.14	-.17	.01	-.11	-.29	-.11	-.08	.01	-.17	-.08	.14	.01	-.08	-.08	-.08
53	.78	.80	.96	.83	.67	.83	.90	.96	.80	.90	1.13	.96	.90	.90	.90
54	1.17	1.16	1.35	1.18	1.02	1.18	1.25	1.35	1.16	1.25	1.47	1.35	1.25	1.25	1.25
55	.82	.82	1.00	.83	.67	.83	.89	1.00	.82	.89	1.12	1.00	.89	.89	.89
56	1.16	1.15	1.34	1.16	1.02	1.16	1.25	1.34	1.15	1.25	1.47	1.34	1.25	1.25	1.25
57	1.18	1.15	1.38	1.20	1.04	1.20	1.27	1.38	1.15	1.27	1.49	1.38	1.27	1.27	1.27
58	.76	.77	.96	.82	.66	.82	.88	.96	.77	.88	1.11	.96	.88	.88	.88
59	1.11	1.09	1.28	1.13	.99	1.13	1.20	1.28	1.09	1.20	1.42	1.28	1.20	1.20	1.20
60	1.12	1.09	1.26	1.11	1.00	1.11	1.20	1.26	1.09	1.20	1.41	1.26	1.20	1.20	1.20
61	.83	.83	.83	.83	.83	.83	.83	.83	.83	.83	.83	.83	.83	.83	.83
62	.97	.97	.97	.97	.97	.97	.97	.97	.97	.97	.97	.97	.97	.97	.97

NOAA-9 SCANNER OFFSETS FOR OCTOBER 1986: SHORTWAVE CHANNEL
DAY OF MONTH -->

S.P.	16	17	18	19	20	21	22	23	24	25	26	27	28	29	30	31
1	.29	.29	.29	.29	.29	.29	.29	.29	.29	.29	.29	.29	.29	.29	.29	.29
2	.59	.59	.59	.59	.59	.59	.59	.59	.59	.59	.59	.59	.59	.59	.59	.59
3	.63	.63	.63	.63	.63	.63	.63	.63	.63	.63	.63	.63	.63	.63	.63	.63
4	.27	.27	.27	.27	.27	.27	.27	.27	.27	.27	.27	.27	.27	.27	.27	.27
5	.71	.71	.71	.71	.71	.71	.71	.71	.71	.76	.76	.71	.71	.71	.71	.71
6	.80	.80	.80	.80	.80	.80	.80	.80	.80	.88	.88	.80	.80	.80	.80	.80
7	.44	.44	.44	.44	.44	.44	.44	.44	.44	.54	.54	.44	.44	.44	.44	.44
8	.80	.80	.80	.80	.80	.80	.80	.80	.80	.89	.89	.80	.80	.80	.80	.80
9	.85	.85	.85	.85	.85	.85	.85	.85	.85	.94	.94	.85	.85	.85	.85	.85
10	.46	.46	.46	.46	.46	.46	.46	.46	.46	.55	.55	.46	.46	.46	.46	.46
11	.78	.78	.78	.78	.78	.78	.78	.78	.78	.84	.84	.78	.78	.78	.78	.78
12	.75	.75	.75	.75	.75	.75	.75	.75	.75	.79	.79	.75	.75	.75	.75	.75
13	-.09	-.09	-.09	-.09	-.09	-.09	-.09	-.09	-.09	.00	.00	-.09	-.09	-.09	-.09	-.09
14	.22	.22	.22	.22	.22	.22	.22	.22	.22	.33	.33	.22	.22	.22	.22	.22
15	.22	.22	.22	.22	.22	.22	.22	.22	.22	.32	.32	.22	.22	.22	.22	.22
16	-.19	-.19	-.19	-.19	-.19	-.19	-.19	-.19	-.19	-.10	-.10	-.19	-.19	-.19	-.19	-.19
17	.16	.16	.16	.16	.16	.16	.16	.16	.16	.25	.25	.16	.16	.16	.16	.16
18	.17	.17	.17	.17	.17	.17	.17	.17	.17	.21	.21	.17	.17	.17	.17	.17
19	-.23	-.23	-.23	-.23	-.23	-.23	-.23	-.23	-.23	-.25	-.25	-.23	-.23	-.23	-.23	-.23
20	.15	.15	.15	.15	.15	.15	.15	.15	.15	.19	.19	.15	.15	.15	.15	.15
21	.16	.16	.16	.16	.16	.16	.16	.16	.16	.20	.20	.16	.16	.16	.16	.16
22	-.30	-.30	-.30	-.30	-.30	-.30	-.30	-.30	-.30	-.27	-.27	-.30	-.30	-.30	-.30	-.30
23	.07	.07	.07	.07	.07	.07	.07	.07	.07	.10	.10	.07	.07	.07	.07	.07
24	.09	.09	.09	.09	.09	.09	.09	.09	.09	.13	.13	.09	.09	.09	.09	.09
25	-.30	-.30	-.30	-.30	-.30	-.30	-.30	-.30	-.30	-.27	-.27	-.30	-.30	-.30	-.30	-.30
26	.07	.07	.07	.07	.07	.07	.07	.07	.07	.09	.09	.07	.07	.07	.07	.07
27	.09	.09	.09	.09	.09	.09	.09	.09	.09	.12	.12	.09	.09	.09	.09	.09
28	-.30	-.30	-.30	-.30	-.30	-.30	-.30	-.30	-.30	-.29	-.29	-.30	-.30	-.30	-.30	-.30
29	.10	.10	.10	.10	.10	.10	.10	.10	.10	.06	.06	.10	.10	.10	.10	.10
30	.14	.14	.14	.14	.14	.14	.14	.14	.14	.07	.07	.14	.14	.14	.14	.14
31	-.24	-.24	-.24	-.24	-.24	-.24	-.24	-.24	-.24	-.33	-.33	-.24	-.24	-.24	-.24	-.24
32	.11	.11	.11	.11	.11	.11	.11	.11	.11	.02	.02	.11	.11	.11	.11	.11
33	.01	.01	.01	.01	.01	.01	.01	.01	.01	-.02	-.02	.01	.01	.01	.01	.01
34	-.37	-.37	-.37	-.37	-.37	-.37	-.37	-.37	-.37	-.40	-.40	-.37	-.37	-.37	-.37	-.37
35	.00	.00	.00	.00	.00	.00	.00	.00	.00	-.03	-.03	.00	.00	.00	.00	.00
36	.05	.05	.05	.05	.05	.05	.05	.05	.05	.03	.03	.05	.05	.05	.05	.05
37	-.29	-.29	-.29	-.29	-.29	-.29	-.29	-.29	-.29	-.33	-.33	-.29	-.29	-.29	-.29	-.29
38	.12	.12	.12	.12	.12	.12	.12	.12	.12	.06	.06	.12	.12	.12	.12	.12
39	.15	.15	.15	.15	.15	.15	.15	.15	.15	.11	.11	.15	.15	.15	.15	.15
40	-.18	-.18	-.18	-.18	-.18	-.18	-.18	-.18	-.18	-.24	-.24	-.18	-.18	-.18	-.18	-.18
41	.24	.24	.24	.24	.24	.24	.24	.24	.24	.15	.15	.24	.24	.24	.24	.24
42	.25	.25	.25	.25	.25	.25	.25	.25	.25	.18	.18	.25	.25	.25	.25	.25
43	-.14	-.14	-.14	-.14	-.14	-.14	-.14	-.14	-.14	-.22	-.22	-.14	-.14	-.14	-.14	-.14
44	.22	.22	.22	.22	.22	.22	.22	.22	.22	.14	.14	.22	.22	.22	.22	.22
45	.24	.24	.24	.24	.24	.24	.24	.24	.24	.14	.14	.24	.24	.24	.24	.24
46	-.15	-.15	-.15	-.15	-.15	-.15	-.15	-.15	-.15	-.26	-.26	-.15	-.15	-.15	-.15	-.15
47	.22	.22	.22	.22	.22	.22	.22	.22	.22	.13	.13	.22	.22	.22	.22	.22
48	.26	.26	.26	.26	.26	.26	.26	.26	.26	.14	.14	.26	.26	.26	.26	.26
49	-.10	-.10	-.10	-.10	-.10	-.10	-.10	-.10	-.10	-.22	-.22	-.10	-.10	-.10	-.10	-.10
50	.30	.30	.30	.30	.30	.30	.30	.30	.30	.20	.20	.30	.30	.30	.30	.30
51	.28	.28	.28	.28	.28	.28	.28	.28	.28	.22	.22	.28	.28	.28	.28	.28
52	-.08	-.08	-.08	-.08	-.08	-.08	-.08	-.08	-.08	-.17	-.17	-.08	-.08	-.08	-.08	-.08
53	.90	.90	.90	.90	.90	.90	.90	.90	.90	.81	.81	.90	.90	.90	.90	.90
54	1.25	1.25	1.25	1.25	1.25	1.25	1.25	1.25	1.25	1.16	1.16	1.25	1.25	1.25	1.25	1.25
55	.87	.87	.87	.87	.87	.87	.87	.87	.87	.80	.80	.87	.87	.87	.87	.87
56	1.22	1.22	1.22	1.22	1.22	1.22	1.22	1.22	1.22	1.12	1.12	1.22	1.22	1.22	1.22	1.22
57	1.24	1.24	1.24	1.24	1.24	1.24	1.24	1.24	1.24	1.12	1.12	1.24	1.24	1.24	1.24	1.24
58	.83	.83	.83	.83	.83	.83	.83	.83	.83	.72	.72	.83	.83	.83	.83	.83
59	1.15	1.15	1.15	1.15	1.15	1.15	1.15	1.15	1.15	1.04	1.04	1.15	1.15	1.15	1.15	1.15
60	1.14	1.14	1.14	1.14	1.14	1.14	1.14	1.14	1.14	1.02	1.02	1.14	1.14	1.14	1.14	1.14
61	.83	.83	.83	.83	.83	.83	.83	.83	.83	.83	.83	.83	.83	.83	.83	.83
62	.97	.97	.97	.97	.97	.97	.97	.97	.97	.97	.97	.97	.97	.97	.97	.97

NOAA-9 SCANNER OFFSETS FOR NOVEMBER 1986:										TOTAL	CHANNEL				
S.P.	DAY OF MONTH -->										11	12	13	14	15
	1	2	3	4	5	6	7	8	9	10					
1	.36	.36	.36	.36	.36	.36	.36	.36	.36	.36	.36	.36	-1.27	-1.27	.36
2	1.04	1.04	1.04	1.04	1.04	1.04	1.04	1.04	1.04	1.04	1.04	1.04	1.04	1.04	1.04
3	1.93	1.93	1.93	1.93	1.93	1.93	1.93	1.93	1.93	1.93	1.93	1.93	1.93	1.93	1.93
4	-9.64	-9.64	-9.64	-9.64	-9.64	-9.64	-9.64	-9.64	-9.64	-9.64	-9.64	-9.64	-9.64	-9.64	-9.64
5	-.41	-2.47	-6.35	-4.87	-.34	-2.14	-2.54	-7.11	-5.24	-5.53	-4.39	-5.99	-12.41	-9.18	-3.01
6	-.21	-1.14	-2.12	-2.44	-.26	-1.80	-2.02	-2.66	-2.38	-2.39	-2.41	-2.28	-4.31	-3.81	-1.26
7	-.37	-1.10	-1.81	-2.58	-1.34	-2.03	-2.65	-1.81	-1.61	-2.37	-2.28	-1.93	-2.92	-3.03	-.60
8	-.06	-.90	-1.60	-2.48	-1.98	-1.93	-2.71	-1.15	-1.26	-2.31	-1.78	-1.60	-2.31	-2.48	-.17
9	-.17	-.69	-1.93	-2.42	-2.09	-1.88	-2.57	-1.01	-1.22	-2.23	-1.41	-1.49	-1.96	-2.27	-.21
10	-.64	-.76	-2.30	-2.18	-2.12	-2.04	-2.28	-1.09	-1.27	-2.21	-1.11	-1.43	-1.95	-2.24	-.30
11	-.87	-.71	-2.33	-1.94	-1.94	-2.09	-1.89	-1.23	-1.12	-2.34	-1.10	-1.22	-1.61	-1.87	-.52
12	-1.60	-1.25	-3.01	-2.50	-2.38	-2.67	-2.35	-2.15	-1.71	-2.85	-1.77	-1.89	-1.98	-2.16	-1.66
13	-2.29	-1.65	-3.42	-2.76	-2.54	-2.69	-2.28	-2.71	-1.98	-2.83	-1.98	-2.43	-2.07	-2.32	-2.47
14	-2.38	-2.12	-3.38	-2.66	-2.32	-2.14	-2.38	-2.78	-2.18	-2.70	-2.06	-2.53	-2.18	-2.52	-2.85
15	-2.13	-2.37	-2.90	-2.38	-1.96	-1.54	-2.57	-2.44	-2.29	-2.46	-2.22	-2.46	-2.18	-2.32	-2.98
16	-1.77	-2.29	-2.32	-2.10	-1.42	-1.19	-2.44	-2.01	-2.16	-2.07	-2.40	-2.52	-2.24	-2.01	-2.84
17	-1.55	-2.24	-2.10	-2.10	-1.01	-1.10	-2.10	-1.67	-2.28	-1.85	-2.48	-2.53	-2.39	-1.94	-2.68
18	-1.51	-2.32	-2.29	-2.29	-.73	-1.34	-2.12	-1.73	-2.54	-1.82	-2.77	-2.55	-2.28	-2.05	-2.62
19	-1.51	-2.50	-2.70	-2.49	-.77	-1.71	-2.48	-2.06	-2.79	-1.93	-3.35	-2.94	-2.30	-2.20	-2.59
20	-1.20	-2.31	-2.76	-2.44	-.71	-1.67	-2.84	-2.17	-2.65	-1.90	-3.32	-2.53	-1.70	-2.02	-2.32
21	-.91	-1.97	-2.44	-2.14	-.67	-1.64	-3.14	-2.20	-2.33	-1.77	-3.04	-2.15	-.88	-1.72	-2.24
22	-.45	-1.54	-1.85	-1.46	-.51	-1.54	-2.88	-2.04	-1.91	-1.59	-2.42	-1.68	-.08	-1.22	-1.99
23	-.23	-1.34	-1.36	-.88	-.44	-1.73	-2.58	-1.94	-1.74	-1.60	-1.89	-1.40	.27	-.92	-1.73
24	-.16	-1.17	-.96	-.45	-.52	-1.70	-2.11	-1.78	-1.77	-1.36	-1.56	-1.04	.51	-.78	-1.37
25	-.27	-1.14	-.80	-.32	-1.12	-2.01	-1.96	-1.87	-2.00	-1.19	-1.48	-.85	.55	-.84	-1.32
26	-.23	-1.05	-.57	-.19	-1.31	-2.09	-1.62	-1.81	-2.09	-.87	-1.36	-.66	.55	-.84	-1.21
27	.16	-.77	-.13	.19	-1.07	-1.75	-1.02	-1.40	-1.77	-.14	-1.01	-.31	.81	-.55	-.83
28	.51	-.58	.32	.52	-.76	-1.08	-.79	-.97	-1.43	.29	-.86	-.09	.97	-.31	-.46
29	.68	-.62	.64	.64	-.38	-.90	-.66	-.83	-1.28	.37	-1.02	-.09	.71	-.31	-.39
30	.95	-.55	1.00	.85	.17	-.73	-.48	-.64	-.90	.51	-.80	.03	.43	-.14	-.25
31	.74	-.72	1.05	.78	.24	-1.05	-.31	-.72	-.86	.31	-.78	-.11	.38	-.14	-.26
32	.78	-.47	1.47	.88	.56	-.65	.33	-.48	-.56	.42	-.51	.10	.53	.10	.09
33	.91	-.18	1.90	.98	.90	.10	.63	-.14	-.33	.54	-.24	.19	.92	.30	.52
34	1.00	-.02	2.19	1.08	1.02	.32	.68	-.09	-.25	.49	-.10	.09	1.27	.16	.80
35	.91	.08	2.30	1.10	.82	.27	.47	-.22	-.31	.35	-.29	.08	1.22	-.03	.92
36	.77	.12	2.41	.98	.56	.07	.13	-.34	-.39	.17	-.71	.09	1.10	-.21	1.01
37	.42	-.25	2.12	.28	.11	-.38	-.67	-.85	-.83	-.23	-1.31	-.31	.86	-.70	.72
38	.53	-.15	2.09	.27	.27	-.23	-.97	-.90	-.99	-.04	-1.30	-.21	.93	-.68	.67
39	.67	-.09	2.02	.17	.45	-.06	-1.08	-.80	-1.15	.02	-1.21	.05	.98	-.57	.63
40	.68	.13	1.93	-.01	.52	-.09	-1.20	-.71	-1.33	-.15	-1.21	.42	1.07	-.47	.84
41	.55	.18	1.81	-.24	.29	-.56	-1.58	-.77	-1.70	-.46	-1.46	.38	.88	-.57	.99
42	.47	.10	1.69	-.24	.04	-.95	-1.73	-.69	-1.85	-.73	-1.62	.33	.79	-.50	1.12
43	.36	-.06	1.52	-.24	-.33	-1.37	-1.64	-.64	-1.97	-.80	1.51	.26	.72	-.29	1.13
44	.09	-.18	1.34	-.47	-.88	-1.74	-1.70	-.64	-1.93	-.68	-1.36	.19	.51	-.33	.99
45	.04	-.08	1.27	-.63	-1.32	-1.93	-1.56	-.37	-1.53	-.18	-1.00	.33	.45	-.34	.96
46	-.01	-.16	1.10	-.86	-1.67	-1.95	-1.54	-.40	-1.12	-.19	-1.02	.28	.12	-.61	.66
47	-.02	-.28	.90	-.94	-1.77	-2.04	-1.44	-.42	-1.09	-.50	-1.11	.03	-.13	-.94	.30
48	-.21	-.50	.59	-1.07	-1.58	-1.81	-1.36	-.58	-1.43	-.83	-1.25	-.34	-.23	-1.23	-.03
49	-.34	-.76	.37	-1.18	-1.41	-1.23	-1.53	-.73	-1.64	-1.03	-1.32	-.56	-.20	-1.19	-.27
50	-.28	-.95	.20	-1.24	-1.21	-1.07	-1.75	-.78	-1.69	-1.19	-1.39	-.65	.03	-1.17	-.28
51	-.11	-.81	.21	-1.25	-.97	-1.03	-2.04	-.76	-1.32	-1.23	-1.50	-.60	.22	-1.17	-.16
52	-.07	-.68	.05	-1.58	-1.12	-1.28	-2.48	-.85	-1.04	-1.27	-1.64	-.57	-.13	-1.47	-.18
53	.54	.08	.38	-1.42	-.84	-.87	-2.25	-.29	-.21	-.56	-.95	-.14	-.19	-1.27	.49
54	-.02	-.27	-.29	-2.01	-1.52	-1.36	-2.96	-.74	-.47	-.72	-1.25	-.73	-.97	-1.80	.11
55	-.49	-.48	-.84	-2.24	-2.00	-1.43	-3.01	-.83	-.64	-.93	-1.44	-.95	-1.16	-1.76	.26
56	-1.35	-1.38	-1.92	-3.16	-2.93	-2.04	-3.44	-1.50	-1.45	-1.86	-2.44	-1.59	-1.83	-2.09	-.28
57	-1.11	-.87	-1.88	-3.06	-2.55	-1.83	-2.54	-1.12	-1.28	-1.72	-2.11	-1.24	-1.42	-1.70	-.32
58	-1.34	-.74	-1.82	-2.86	-2.55	-1.60	-2.05	-1.08	-1.44	-1.93	-2.04	-1.36	-.96	-1.31	-.83
59	-2.49	-1.76	-2.00	-2.80	-2.76	-2.26	-2.62	-1.84	-2.24	-2.47	-2.48	-1.99	-.59	-1.40	-1.90
60	-9.61	-8.24	-4.62	-6.89	-9.39	-9.71	-9.91	-5.79	-7.50	-6.93	-8.14	-6.33	-.45	-3.73	-8.12
61	11.19	11.19	11.19	11.19	11.19	11.19	11.19	11.19	11.19	11.19	11.19	11.19	11.19	11.19	11.19
62	-1.63	-1.63	-1.63	-1.63	-1.63	-1.63	-1.63	-1.63	-1.63	-1.63	-1.63	-1.63	-1.63	-1.63	-1.63

S.P.	NOAA-9 SCANNER OFFSETS FOR NOVEMBER 1986: TOTAL CHANNEL														
	DAY OF MONTH -->														
	16	17	18	19	20	21	22	23	24	25	26	27	28	29	30
1	.36	.36	.36	.36	.36	.36	.36	.36	.36	.36	.36	.36	.36	.36	.36
2	1.04	1.04	1.04	1.04	1.04	1.04	1.04	1.04	1.04	1.04	1.04	1.04	1.04	1.04	1.04
3	1.93	1.93	1.93	1.93	1.93	1.93	1.93	1.93	1.93	1.93	1.93	1.93	1.93	1.93	1.93
4	-9.64	-9.64	-9.64	-9.64	-9.64	-9.64	-9.64	-9.64	-9.64	-9.64	-9.64	-9.64	-9.64	-9.64	-9.64
5	-1.10	-.98	-.99	-1.40	-2.54	-2.46	-5.14	-5.91	-10.00	-4.41	-7.97	-9.50	-8.12	-10.33	-7.93
6	-1.13	-.53	-.74	-1.05	-1.94	-1.71	-3.14	-3.68	-4.30	-2.47	-3.97	-3.17	-3.79	-5.16	-4.58
7	-1.62	-1.03	-1.24	-1.29	-2.05	-1.66	-2.73	-3.10	-3.23	-2.11	-3.75	-2.06	-3.85	-4.77	-5.01
8	-1.35	-1.27	-1.21	-1.16	-1.30	-1.22	-2.10	-2.33	-3.07	-1.73	-3.34	-1.83	-3.83	-4.87	-4.74
9	-.90	-1.46	-1.16	-1.20	-.60	-1.00	-1.64	-1.92	-2.98	-1.92	-2.88	-1.91	-3.55	-4.80	-3.94
10	-.74	-1.48	-1.11	-1.34	-.34	-1.04	-1.36	-1.84	-3.12	-2.28	-2.74	-2.40	-3.34	-4.71	-3.15
11	-.46	-1.49	-.94	-1.29	-.17	-1.25	-1.18	-1.57	-3.13	-2.42	-2.61	-2.52	-2.98	-4.27	-2.32
12	-.93	-1.94	-1.40	-1.83	-.66	-2.25	-2.18	-2.01	-3.57	-3.18	-3.03	-3.07	-3.21	-4.61	-2.44
13	-1.26	-2.04	-1.55	-2.13	-.95	-2.77	-2.88	-2.28	-3.78	-3.68	-3.17	-3.33	-3.55	-5.08	-2.59
14	-1.18	-1.87	-1.41	-2.01	-.98	-2.78	-2.97	-2.49	-3.84	-3.73	-3.24	-3.37	-3.79	-5.13	-2.41
15	-1.11	-1.75	-1.30	-1.85	-.82	-2.57	-2.72	-2.65	-3.69	-3.63	-3.25	-3.00	-3.38	-4.59	-2.07
16	-1.00	-1.40	-.97	-1.44	-.52	-2.25	-2.33	-2.56	-3.27	-3.21	-3.12	-2.37	-2.97	-4.02	-1.76
17	-.91	-1.28	-.76	-1.23	-.51	-2.10	-2.09	-2.52	-3.07	-2.93	-3.16	-2.15	-3.01	-3.71	-1.71
18	-1.07	-1.33	-.76	-1.22	-.76	-2.25	-2.11	-2.67	-3.32	-2.82	-3.32	-2.36	-3.18	-3.80	-2.00
19	-1.45	-1.50	-.89	-1.30	-1.01	-2.50	-2.38	-3.09	-3.77	-3.65	-3.45	-2.77	-3.67	-3.90	-2.22
20	-1.42	-1.39	-.62	-1.10	-.93	-2.49	-2.41	-3.15	-3.91	-3.64	-3.43	-2.94	-3.75	-4.02	-1.92
21	-1.11	-1.06	-.36	-.78	-.80	-2.33	-2.23	-3.00	-3.73	-3.45	-3.14	-2.82	-3.54	-3.63	-1.40
22	-.66	-.57	-.10	-.28	-.47	-2.07	-1.88	-2.68	-3.26	-2.78	-2.68	-2.15	-2.88	-3.15	-.95
23	-.40	-.31	-.08	-.05	-.25	-2.02	-1.61	-2.56	-2.91	-2.35	-2.12	-1.58	-2.34	-2.86	-.86
24	-.09	.00	.06	.17	-.14	-1.89	-1.34	-2.45	-2.63	-2.02	-1.66	-1.33	-1.86	-2.52	-.76
25	-.10	.13	.06	.11	-.29	-1.94	-1.42	-2.50	-2.65	-1.93	-1.46	-1.42	-1.78	-2.52	-.93
26	-.03	.30	.16	.06	-.39	-2.01	-1.43	-2.30	-2.57	-1.84	-1.17	-1.25	-1.70	-2.60	-1.03
27	.27	.79	.57	.24	-.37	-1.87	-1.09	-1.84	-2.04	-1.56	-.96	-.88	-1.25	-2.21	-.89
28	.53	1.15	.94	.32	-.36	-1.74	-.85	-1.58	-1.50	-1.25	-.75	-.76	-.86	-1.69	-.69
29	.61	1.31	1.02	.27	-.44	-1.73	-.86	-1.48	-1.34	-1.10	-.77	-.94	-.87	-1.66	-.63
30	.93	1.66	1.14	.39	-.19	-1.72	-.77	-1.24	-1.12	-.91	-.81	-1.17	-.79	-1.57	-.61
31	.90	1.66	.97	.10	-.25	-1.98	-.94	-1.40	-1.22	-.99	-.86	-1.61	-.86	-1.88	-.94
32	1.12	1.99	1.30	.24	-.12	-1.64	-.73	-1.24	-.99	-.53	-.73	-1.51	-.81	-1.99	-.86
33	1.26	2.26	1.46	.46	-.05	-1.34	-.60	-1.08	-.68	-.14	-.51	-1.38	-.79	-1.95	-.45
34	1.26	2.22	1.50	.57	-.14	-1.18	-.67	-1.06	-.60	-.07	-.60	-1.30	-.68	-1.59	-.21
35	1.25	2.03	1.53	.46	-.24	-1.12	-.80	-1.23	-.68	-.18	-.36	-1.25	-.58	-1.12	-.41
36	1.15	1.87	1.48	.38	-.48	-1.07	-.84	-1.34	-.75	-.45	-.24	-1.33	-.38	-.91	-.55
37	.68	1.37	1.17	-.05	-1.11	-1.34	-1.16	-1.75	-1.19	-.97	-.65	-1.83	-.64	-1.25	-.97
38	.77	1.35	1.24	-.01	-1.19	-1.12	-1.17	-1.60	-1.22	-1.16	-.61	-1.76	-.53	-1.08	-1.02
39	.80	1.36	1.18	.13	-1.10	-.83	-1.20	-1.48	-1.06	-1.32	-.46	-1.48	-.58	-.62	-1.17
40	.80	1.37	1.15	.23	-.96	-.65	-1.21	-1.36	-1.06	-1.42	-.46	-.95	-.66	-.28	-1.24
41	.49	1.11	.94	-.06	-1.20	-.72	-1.38	-1.46	-1.36	-1.68	-.57	-.71	-.81	-.41	-1.46
42	.35	.92	.87	-.16	-1.37	-.77	-1.48	-1.52	-1.86	-1.79	-.69	-.58	-.95	-.80	-1.78
43	.31	.83	.81	-.19	-1.43	-.83	-1.70	-1.44	-1.77	-1.74	-.94	-.32	-1.03	-1.29	-2.27
44	.24	.75	.68	-.23	-1.22	-.90	-1.77	-1.48	-1.69	-1.60	-1.20	-.23	-1.04	-1.62	-2.71
45	.15	.94	.74	-.18	-.84	-.65	-1.44	-1.46	-1.53	-1.60	-1.53	-.18	-.94	-1.69	-2.78
46	-.19	.89	.43	-.30	-.92	-.71	-1.48	-1.68	-1.55	-1.80	-1.76	-.36	-.99	-1.91	-3.05
47	-.44	.68	.15	-.54	-1.27	-.95	-1.58	-1.87	-1.58	-2.06	-1.75	-.36	-1.06	-1.98	-3.21
48	-.80	.36	-.10	-.79	-1.62	-1.15	-1.84	-2.09	-1.86	-2.35	-1.96	-.40	-1.30	-2.35	-3.54
49	-1.13	.17	-.23	-.76	-1.61	-1.20	-1.88	-2.14	-1.85	-2.48	-2.05	-.42	-1.39	-2.56	-3.81
50	-1.10	.00	-.28	-.66	-1.61	-1.32	-1.82	-2.19	-1.64	-2.43	-1.85	-.33	-1.66	-2.78	-3.89
51	-.85	-.18	-.20	-.60	-1.69	-1.56	-1.64	-2.27	-1.55	-2.17	-1.69	-.25	-2.05	-3.06	-3.89
52	-.67	-.57	-.51	-.78	-1.87	-1.75	-1.46	-2.49	-1.72	-1.94	-1.82	-.25	-2.35	-3.47	-3.91
53	.05	-.20	-.25	-.37	-1.17	-1.26	-.55	-2.00	-1.39	-1.08	-1.32	.24	-1.96	-3.22	-3.40
54	-.45	-.70	-1.10	-1.08	-1.36	-1.71	-.83	-2.32	-2.04	-1.26	-1.86	-.20	-2.43	-3.42	-3.87
55	-.78	-.81	-1.48	-1.48	-1.33	-1.69	-1.09	-2.37	-2.28	-1.24	-2.27	-.91	-2.91	-3.59	-4.23
56	-1.39	-1.66	-2.49	-2.08	-1.80	-2.09	-2.25	-2.90	-3.04	-1.92	-2.82	-2.04	-3.86	-4.24	-4.68
57	-.86	-1.37	-2.26	-1.66	-1.08	-1.44	-2.02	-2.42	-2.60	-1.83	-2.24	-1.90	-3.48	-4.08	-3.49
58	-.87	-1.21	-1.82	-1.75	-1.01	-1.46	-1.95	-2.18	-2.32	-2.73	-2.06	-2.05	-3.28	-4.08	-2.72
59	-1.81	-1.97	-2.34	-2.59	-2.43	-2.92	-2.77	-3.10	-2.81	-4.07	-2.70	-2.64	-3.42	-4.28	-2.83
60	-10.77	-10.94	-11.41	-11.95	-12.02	-12.18	-10.35	-10.55	-7.10	-12.35	-8.82	-7.03	-9.04	-8.15	-8.95
61	11.19	11.19	11.19	11.19	11.19	11.19	11.19	11.19	11.19	11.19	11.19	11.19	11.19	11.19	11.19
62	-1.63	-1.63	-1.63	-1.63	-1.63	-1.63	-1.63	-1.63	-1.63	-1.63	-1.63	-1.63	-1.63	-1.63	-1.63

NOAA-9 SCANNER OFFSETS FOR NOVEMBER 1986: LONGWAVE CHANNEL

S.P.	DAY OF MONTH -->														
	1	2	3	4	5	6	7	8	9	10	11	12	13	14	15
1	.29	.29	.29	.29	.29	.29	.29	.29	.29	.29	.29	.29	.29	.29	.29
2	.59	.59	.59	.59	.59	.59	.59	.59	.59	.59	.59	.59	.59	.59	.59
3	.63	.63	.63	.63	.63	.63	.63	.63	.63	.63	.63	.63	.63	.63	.63
4	.27	.27	.27	.27	.27	.27	.27	.27	.27	.27	.27	.27	.27	.27	.27
5	-1.13	-2.41	-4.68	-3.82	-1.14	-2.42	-2.62	-5.24	-4.20	-4.38	-3.65	-4.60	-8.38	-6.45	-2.74
6	-1.04	-1.67	-2.24	-2.42	-1.16	-2.24	-2.35	-2.69	-2.60	-2.60	-2.57	-2.48	-3.72	-3.33	-1.75
7	-.93	-1.41	-1.79	-2.27	-1.67	-2.14	-2.59	-1.93	-1.87	-2.36	-2.29	-2.03	-2.56	-2.59	-1.16
8	-.76	-1.29	-1.68	-2.26	-2.12	-2.04	-2.69	-1.55	-1.67	-2.35	-2.00	-1.85	-2.19	-2.30	-.92
9	-.99	-1.31	-2.08	-2.42	-2.34	-2.17	-2.80	-1.65	-1.81	-2.47	-1.92	-1.97	-2.16	-2.37	-1.13
10	-1.51	-1.56	-2.53	-2.48	-2.55	-2.54	-2.83	-1.93	-2.06	-2.67	-1.95	-2.15	-2.39	-2.57	-1.42
11	-1.84	-1.71	-2.74	-2.50	-2.63	-2.81	-2.74	-2.22	-2.15	-2.94	-2.12	-2.19	-2.39	-2.55	-1.75
12	-2.42	-2.16	-3.31	-2.95	-3.00	-3.31	-3.10	-2.94	-2.65	-3.38	-2.66	-2.75	-2.84	-2.89	-2.61
13	-2.86	-2.43	-3.58	-3.13	-3.12	-3.32	-3.05	-3.31	-2.82	-3.37	-2.80	-3.12	-2.93	-3.01	-3.17
14	-3.16	-2.98	-3.78	-3.31	-3.23	-3.15	-3.35	-3.58	-3.20	-3.51	-3.10	-3.44	-3.26	-3.38	-3.66
15	-3.17	-3.32	-3.64	-3.31	-3.15	-2.89	-3.67	-3.51	-3.45	-3.53	-3.41	-3.64	-3.50	-3.45	-3.94
16	-3.16	-3.48	-3.47	-3.35	-2.99	-2.86	-3.80	-3.43	-3.56	-3.47	-3.79	-3.93	-3.86	-3.47	-4.06
17	-3.33	-3.77	-3.66	-3.71	-3.03	-3.12	-3.84	-3.51	-3.94	-3.63	-4.16	-4.25	-4.31	-3.74	-4.27
18	-3.49	-4.01	-4.00	-4.12	-3.03	-3.47	-4.02	-3.73	-4.28	-3.78	-4.57	-4.48	-4.43	-3.98	-4.42
19	-3.72	-4.36	-4.55	-4.48	-3.29	-3.94	-4.48	-4.14	-4.64	-4.05	-5.20	-4.99	-4.64	-4.32	-4.62
20	-3.77	-4.48	-4.86	-4.68	-3.51	-4.18	-4.99	-4.46	-4.81	-4.28	-5.39	-4.84	-4.30	-4.46	-4.67
21	-3.79	-4.44	-4.86	-4.66	-3.72	-4.44	-5.44	-4.67	-4.80	-4.41	-5.39	-4.75	-3.85	-4.44	-4.83
22	-3.74	-4.43	-4.68	-4.41	-3.91	-4.71	-5.46	-4.80	-4.76	-4.57	-5.16	-4.68	-3.53	-4.35	-4.91
23	-3.75	-4.48	-4.49	-4.17	-4.07	-5.04	-5.44	-4.88	-4.74	-4.74	-4.94	-4.66	-3.48	-4.35	-4.96
24	-3.86	-4.53	-4.38	-4.02	-4.34	-5.21	-5.28	-4.92	-4.86	-4.75	-4.86	-4.55	-3.48	-4.43	-4.85
25	-4.12	-4.67	-4.43	-4.09	-4.95	-5.52	-5.27	-5.12	-5.14	-4.74	-4.99	-4.56	-3.62	-4.63	-4.97
26	-4.17	-4.69	-4.36	-4.07	-5.15	-5.55	-5.06	-5.16	-5.29	-4.58	-4.98	-4.53	-3.72	-4.73	-4.96
27	-3.96	-4.55	-4.12	-3.86	-4.99	-5.29	-4.77	-4.95	-5.09	-4.09	-4.79	-4.34	-3.62	-4.58	-4.74
28	-3.70	-4.40	-3.81	-3.66	-4.65	-4.78	-4.60	-4.65	-4.84	-3.80	-4.67	-4.15	-3.49	-4.41	-4.46
29	-3.52	-4.36	-3.55	-3.52	-4.27	-4.59	-4.45	-4.50	-4.70	-3.69	-4.68	-4.08	-3.65	-4.35	-4.32
30	-3.26	-4.24	-3.25	-3.32	-3.80	-4.43	-4.18	-4.33	-4.39	-3.52	-4.45	-3.93	-3.85	-4.16	-4.12
31	-3.21	-4.15	-3.04	-3.18	-3.55	-4.50	-3.88	-4.19	-4.25	-3.48	-4.25	-3.83	-3.72	-4.01	-3.92
32	-2.96	-3.77	-2.59	-2.92	-3.10	-3.97	-3.23	-3.84	-3.87	-3.20	-3.85	-3.50	-3.47	-3.64	-3.45
33	-2.52	-3.22	-1.94	-2.50	-2.51	-3.07	-2.66	-3.24	-3.34	-2.75	-3.26	-3.11	-2.83	-3.10	-2.78
34	-2.15	-2.80	-1.47	-2.13	-2.13	-2.62	-2.34	-2.91	-3.00	-2.49	-2.90	-2.91	-2.26	-2.88	-2.26
35	-1.84	-2.37	-1.06	-1.77	-1.93	-2.32	-2.17	-2.65	-2.69	-2.22	-2.70	-2.54	-2.01	-2.63	-1.81
36	-1.53	-1.95	-.59	-1.47	-1.70	-2.06	-2.00	-2.35	-2.35	-1.94	-2.59	-2.12	-1.75	-2.33	-1.34
37	-1.40	-1.83	-.42	-1.62	-1.63	-2.01	-2.22	-2.33	-2.29	-1.85	-2.64	-2.02	-1.48	-2.28	-1.16
38	-.96	-1.40	-.07	-1.21	-1.16	-1.55	-2.07	-1.99	-2.04	-1.37	-2.25	-1.56	-1.02	-1.90	-.82
39	-.48	-.97	.25	-.92	-.67	-1.08	-1.79	-1.54	-1.80	-1.04	-1.79	-.99	-.55	-1.43	-.45
40	-.11	-.47	.54	-.69	-.28	-.84	-1.52	-1.13	-1.61	-.85	-1.43	-.38	-.09	-1.00	.06
41	.13	-.11	.81	-.52	-.15	-.90	-1.45	-.83	-1.57	-.74	-1.26	-.09	.13	-.75	.49
42	.34	.10	1.02	-.22	-.11	-.91	-1.25	-.50	-1.42	-.62	-1.10	.18	.36	-.40	.87
43	.57	.29	1.21	.12	-.15	-.86	-.83	-.18	-1.19	-.35	-.68	.44	.62	.06	1.18
44	.60	.41	1.29	.20	-.36	-.82	-.63	.04	-.90	-.01	-.33	.60	.67	.24	1.30
45	.73	.65	1.43	.26	-.38	-.70	-.36	.42	-.42	.57	.11	.89	.82	.42	1.47
46	.89	.78	1.50	.30	-.34	-.49	-.18	.60	.09	.80	.29	1.04	.78	.42	1.46
47	.99	.81	1.49	.36	-.28	-.46	-.01	.70	.24	.72	.34	.98	.75	.32	1.34
48	.98	.80	1.42	.41	-.02	-.19	.14	.74	.16	.63	.38	.86	.84	.29	1.25
49	.90	.62	1.29	.34	.10	.18	.05	.63	.01	.50	.33	.71	.88	.34	1.09
50	.98	.53	1.23	.34	.28	.29	-.02	.65	.00	.43	.34	.72	1.07	.41	1.12
51	1.24	.75	1.38	.49	.59	.47	-.06	.80	.39	.55	.40	.90	1.37	.60	1.34
52	1.19	.77	1.22	.22	.43	.30	-.43	.68	.51	.46	.25	.87	1.12	.35	1.27
53	1.15	.85	1.10	-.07	.19	.16	-.69	.69	.69	.56	.30	.78	.78	.17	1.32
54	.75	.60	.58	-.54	-.27	-.19	-1.17	.31	.47	.40	.07	.33	.06	-.29	1.04
55	.33	.36	.12	-.81	-.69	-.36	-1.31	.12	.25	.15	-.16	.08	-.13	-.37	1.04
56	-.28	-.27	-.64	-1.51	-1.36	-.80	-1.68	-.37	-.35	-.52	-.89	-.40	-.62	-.61	.63
57	-.21	-.02	-.71	-1.51	-1.22	-.75	-1.17	-.22	-.34	-.52	-.77	-.25	-.49	-.41	.52
58	-.29	.15	-.61	-1.33	-1.15	-.54	-.77	-.13	-.37	-.61	-.67	-.24	-.07	-.07	.26
59	-1.23	-.71	-.93	-1.47	-1.45	-1.17	-1.34	-.79	-1.04	-1.18	-1.17	-.83	.02	-.31	-.63
60	-5.68	-4.82	-2.62	-4.03	-5.57	-5.82	-5.87	-3.30	-4.33	-3.98	-4.67	-3.57	-.04	-1.83	-4.47
61	.83	.83	.83	.83	.83	.83	.83	.83	.83	.83	.83	.83	.83	.83	.83
62	.00	.00	.00	.00	.00	.00	.00	.00	.00	.00	.00	.00	.00	.00	.00

NOAA-9 SCANNER OFFSETS FOR NOVEMBER 1986: LONGVALE CHANNEL

S.P.	DAY OF MONTH -->														
	16	17	18	19	20	21	22	23	24	25	26	27	28	29	30
1	.29	.29	.29	.29	.29	.29	.29	.29	.29	.29	.29	.29	.29	.29	.29
2	.59	.59	.59	.59	.59	.59	.59	.59	.59	.59	.59	.59	.59	.59	.59
3	.63	.63	.63	.63	.63	.63	.63	.63	.63	.63	.63	.63	.63	.63	.63
4	.27	.27	.27	.27	.27	.27	.27	.27	.27	.27	.27	.27	.27	.27	.27
5	-1.66	-1.57	-1.55	-1.83	-2.57	-2.50	-4.10	-4.61	-7.00	-3.77	-5.86	-6.82	-5.92	-7.28	-5.83
6	-1.75	-1.35	-1.45	-1.67	-2.28	-2.11	-3.01	-3.38	-3.75	-2.63	-3.60	-3.11	-3.50	-4.42	-4.04
7	-1.86	-1.46	-1.57	-1.62	-2.14	-1.88	-2.53	-2.80	-2.85	-2.17	-3.25	-2.14	-3.32	-3.95	-4.12
8	-1.72	-1.67	-1.60	-1.57	-1.68	-1.62	-2.16	-2.34	-2.79	-1.95	-3.03	-2.05	-3.36	-4.04	-3.99
9	-1.60	-1.98	-1.75	-1.77	-1.40	-1.65	-2.04	-2.27	-2.93	-2.27	-2.94	-2.33	-3.38	-4.17	-3.63
10	-1.72	-2.22	-1.94	-2.08	-1.44	-1.91	-2.08	-2.45	-3.24	-2.74	-3.07	-2.91	-3.45	-4.29	-3.30
11	-1.72	-2.40	-2.01	-2.22	-1.52	-2.24	-2.16	-2.47	-3.44	-3.01	-3.20	-3.17	-3.39	-4.18	-2.94
12	-2.10	-2.76	-2.38	-2.65	-1.91	-2.97	-2.90	-2.86	-3.85	-3.57	-3.56	-3.66	-3.68	-4.54	-3.12
13	-2.35	-2.86	-2.51	-2.88	-2.11	-3.32	-3.35	-3.03	-3.96	-3.89	-3.63	-3.80	-3.92	-4.90	-3.22
14	-2.56	-3.01	-2.68	-3.07	-2.39	-3.58	-3.66	-3.41	-4.21	-4.22	-3.90	-4.07	-4.32	-5.14	-3.32
15	-2.71	-3.11	-2.78	-3.14	-2.47	-3.61	-3.67	-3.69	-4.26	-4.38	-4.12	-3.95	-4.20	-4.93	-3.27
16	-2.86	-3.10	-2.78	-3.08	-2.49	-3.61	-3.61	-3.84	-4.19	-4.34	-4.29	-3.73	-4.11	-4.74	-3.29
17	-3.12	-3.35	-2.96	-3.26	-2.80	-3.82	-3.76	-4.13	-4.38	-4.43	-4.66	-3.95	-4.45	-4.87	-3.61
18	-3.41	-3.54	-3.16	-3.45	-3.16	-4.10	-3.96	-4.41	-4.73	-4.56	-4.95	-4.34	-4.74	-5.13	-4.00
19	-3.88	-3.89	-3.49	-3.73	-3.55	-4.45	-4.37	-4.86	-5.28	-5.41	-5.26	-4.90	-5.32	-5.37	-4.38
20	-4.11	-4.11	-3.57	-3.86	-3.75	-4.68	-4.62	-5.13	-5.63	-5.64	-5.54	-5.31	-5.65	-5.76	-4.45
21	-4.11	-4.08	-3.62	-3.86	-3.86	-4.76	-4.65	-5.22	-5.70	-5.70	-5.57	-5.43	-5.71	-5.64	-4.22
22	-4.07	-3.99	-3.71	-3.75	-3.90	-4.83	-4.61	-5.26	-5.65	-5.40	-5.49	-5.19	-5.49	-5.61	-4.15
23	-4.06	-3.96	-3.86	-3.76	-3.91	-5.00	-4.58	-5.34	-5.54	-5.24	-5.28	-4.88	-5.27	-5.55	-4.24
24	-4.01	-3.89	-3.92	-3.76	-3.98	-5.06	-4.53	-5.47	-5.49	-5.16	-5.11	-4.86	-5.11	-5.52	-4.37
25	-4.15	-3.96	-4.06	-3.95	-4.23	-5.22	-4.74	-5.70	-5.67	-5.25	-5.14	-5.09	-5.22	-5.69	-4.65
26	-4.17	-3.92	-4.05	-4.06	-4.37	-5.33	-4.92	-5.64	-5.77	-5.26	-5.02	-5.05	-5.25	-5.82	-4.79
27	-4.01	-3.65	-3.80	-4.01	-4.37	-5.26	-4.77	-5.37	-5.47	-5.12	-4.93	-4.93	-4.99	-5.60	-4.74
28	-3.78	-3.37	-3.51	-3.89	-4.33	-5.15	-4.61	-5.16	-5.08	-4.89	-4.74	-4.84	-4.71	-5.19	-4.57
29	-3.64	-3.18	-3.37	-3.82	-4.30	-5.01	-4.53	-5.01	-4.89	-4.71	-4.69	-4.89	-4.64	-5.13	-4.47
30	-3.34	-2.85	-3.21	-3.65	-4.05	-4.94	-4.38	-4.76	-4.67	-4.53	-4.69	-5.01	-4.52	-5.01	-4.41
31	-3.16	-2.64	-3.11	-3.64	-3.89	-4.98	-4.30	-4.65	-4.54	-4.42	-4.54	-5.13	-4.40	-5.08	-4.46
32	-2.76	-2.20	-2.65	-3.32	-3.56	-4.56	-3.95	-4.32	-4.18	-3.89	-4.27	-4.86	-4.18	-4.99	-4.20
33	-2.30	-1.64	-2.16	-2.82	-3.14	-4.02	-3.50	-3.83	-3.61	-3.28	-3.71	-4.40	-3.83	-4.62	-3.53
34	-1.98	-1.35	-1.82	-2.43	-2.87	-3.60	-3.24	-3.51	-3.24	-2.91	-3.45	-4.00	-3.42	-4.09	-3.03
35	-1.62	-1.11	-1.43	-2.13	-2.58	-3.19	-2.95	-3.25	-2.94	-2.60	-2.86	-3.59	-2.97	-3.40	-2.80
36	-1.27	-.83	-1.05	-1.78	-2.33	-2.72	-2.57	-2.91	-2.58	-2.38	-2.39	-3.25	-2.41	-2.82	-2.48
37	-1.21	-.79	-.89	-1.68	-2.37	-2.53	-2.41	-2.81	-2.54	-2.36	-2.27	-3.17	-2.21	-2.68	-2.40
38	-.77	-.43	-.47	-1.27	-2.04	-2.01	-2.04	-2.34	-2.18	-2.12	-1.83	-2.71	-1.76	-2.21	-2.05
39	-.36	-.03	-.12	-.78	-1.59	-1.43	-1.66	-1.86	-1.67	-1.85	-1.34	-2.11	-1.42	-1.52	-1.76
40	.01	.34	.23	-.35	-1.12	-.95	-1.30	-1.42	-1.33	-1.55	-1.02	-1.37	-1.10	-.93	-1.46
41	.13	.49	.42	-.22	-.95	-.68	-1.09	-1.18	-1.21	-1.42	-.76	-.83	-.88	-.72	-1.29
42	.31	.63	.65	-.02	-.80	-.44	-.89	-.95	-1.27	-1.24	-.57	-.45	-.68	-.73	-1.24
43	.58	.87	.91	.25	-.53	-.19	-.73	-.59	-.86	-.89	-.41	.01	-.43	-.77	-1.31
44	.73	1.01	1.02	.42	-.20	-.04	-.57	-.40	-.61	-.55	-.45	.26	-.24	-.77	-1.45
45	.84	1.31	1.24	.63	.23	.30	-.19	-.21	-.33	-.38	-.47	.47	.02	-.60	-1.35
46	.81	1.47	1.23	.75	.37	.44	-.01	-.16	-.12	-.29	-.40	.54	.17	-.52	-1.31
47	.76	1.45	1.15	.70	.25	.40	.04	-.16	.02	-.34	-.25	.64	.23	-.40	-1.20
48	.65	1.36	1.12	.66	.14	.40	.00	-.18	-.03	-.41	-.25	.75	.20	-.50	-1.26
49	.44	1.23	1.04	.68	.14	.36	-.03	-.21	-.03	-.50	-.28	.72	.14	-.65	-1.45
50	.49	1.16	1.04	.80	.18	.30	.05	-.20	.15	-.43	-.09	.83	-.01	-.79	-1.44
51	.79	1.18	1.23	.98	.27	.29	.30	-.12	.35	-.13	.16	1.05	-.15	-.87	-1.31
52	.84	.86	.96	.81	.07	.09	.36	-.33	.16	-.07	.00	.98	-.41	-1.21	-1.40
53	.89	.68	.71	.66	.11	-.03	.54	-.40	-.01	.09	-.08	.94	-.52	-1.38	-1.47
54	.56	.35	.14	.19	-.02	-.32	.32	-.66	-.53	-.06	-.51	.55	-.90	-1.62	-1.85
55	.24	.17	-.21	-.18	-.10	-.40	.04	-.82	-.81	-.15	-.92	-.07	-1.34	-1.88	-2.23
56	-.21	-.43	-.93	-.63	-.46	-.71	-.76	-1.22	-1.36	-.67	-1.35	-.89	-2.02	-2.35	-2.62
57	.06	-.33	-.88	-.46	-.09	-.38	-.71	-1.01	-1.16	-.71	-1.10	-.88	-1.90	-2.40	-1.92
58	.13	-.15	-.52	-.45	.04	-.32	-.58	-.77	-.89	-.13	-.91	-.88	-1.72	-2.35	-1.29
59	-.67	-.82	-1.04	-1.19	-1.07	-1.46	-1.30	-1.55	-1.40	-2.38	-1.51	-1.43	-1.97	-2.70	-1.54
60	-6.18	-6.33	-6.61	-6.92	-6.98	-7.17	-6.00	-6.16	-4.11	-7.44	-5.36	-4.17	-5.41	-5.07	-5.33
61	.83	.83	.83	.83	.83	.83	.83	.83	.83	.83	.83	.83	.83	.83	.83
62	.00	.00	.00	.00	.00	.00	.00	.00	.00	.00	.00	.00	.00	.00	.00

NOAA-9 SCANNER OFFSETS FOR NOVEMBER 1986: SHORTWAVE CHANNEL

S.P.	DAY OF MONTH -->														
	1	2	3	4	5	6	7	8	9	10	11	12	13	14	15
1	-.11	-.11	-.11	-.11	-.11	-.11	-.11	-.11	-.11	-.11	-.11	-.11	-.11	-.11	-.11
2	.32	.32	.32	.32	.32	.32	.32	.32	.32	.32	.32	.32	.32	.32	.32
3	.49	.49	.49	.49	.49	.49	.49	.49	.49	.49	.49	.49	.49	.49	.49
4	-4.09	-4.09	-4.09	-4.09	-4.09	-4.09	-4.09	-4.09	-4.09	-4.09	-4.09	-4.09	-4.09	-4.09	-4.09
5	.76	.76	.55	.52	.80	.83	.64	.32	.43	.24	.20	.22	-.04	.02	.27
6	.87	.87	.66	.63	.90	.91	.78	.42	.54	.32	.29	.32	.06	.11	.35
7	.51	.51	.30	.27	.53	.57	.43	.08	.19	-.02	-.06	-.02	-.29	-.23	-.01
8	.87	.87	.66	.63	.89	.95	.78	.43	.53	.34	.29	.33	.05	.13	.33
9	.92	.92	.72	.69	.95	1.03	.82	.48	.59	.39	.35	.39	.09	.18	.39
10	.52	.52	.36	.32	.56	.65	.42	.12	.22	.02	-.01	.03	-.31	-.22	.01
11	.85	.85	.64	.61	.88	.97	.74	.40	.51	.31	.27	.30	-.01	.10	.30
12	.80	.82	.64	.60	.85	.92	.71	.40	.50	.30	.24	.29	.01	.12	.26
13	-.04	-.04	-.20	-.25	-.01	.04	-.14	-.42	-.33	-.55	-.60	-.55	-.78	-.68	-.56
14	.27	.27	.05	.03	.31	.34	.20	-.17	-.06	-.28	-.32	-.30	-.63	-.50	-.30
15	.25	.24	.01	.00	.29	.35	.16	-.20	-.09	-.31	-.35	-.31	-.60	-.46	-.31
16	-.16	-.17	-.39	-.41	-.13	-.07	-.27	-.60	-.50	-.71	-.73	-.71	-.97	-.86	-.72
17	.18	.17	-.05	-.07	.21	.26	.06	-.26	-.16	-.37	-.41	-.40	-.69	-.55	-.38
18	.19	.19	-.04	-.02	.23	.27	.08	-.24	-.15	-.36	-.37	-.34	-.65	-.53	-.35
19	-.20	-.20	-.43	-.42	-.17	-.14	-.33	-.63	-.54	-.74	-.75	-.74	-.97	-.91	-.73
20	.18	.18	-.08	-.08	.22	.22	.05	-.25	-.15	-.36	-.40	-.39	-.69	-.54	-.35
21	.20	.20	-.04	-.05	.24	.24	.06	-.20	-.11	-.31	-.33	-.34	-.65	-.53	-.32
22	-.27	-.27	-.51	-.52	-.22	-.23	-.40	-.68	-.58	-.77	-.83	-.80	-1.06	-.97	-.76
23	.10	.08	-.15	-.13	.13	.09	-.06	-.33	-.22	-.45	-.47	-.45	-.70	-.61	-.40
24	.12	.11	-.11	-.10	.17	.08	-.01	-.30	-.17	-.40	-.43	-.42	-.67	-.58	-.36
25	-.28	-.29	-.50	-.49	-.24	-.29	-.43	-.69	-.55	-.78	-.79	-.81	-1.06	-.97	-.74
26	.09	.08	-.13	-.11	.11	.00	-.12	-.32	-.19	-.41	-.43	-.46	-.69	-.61	-.36
27	.12	.10	-.11	-.10	.13	-.06	-.03	-.29	-.19	-.39	-.41	-.43	-.67	-.58	-.32
28	-.28	-.30	-.51	-.50	-.31	-.43	-.43	-.69	-.59	-.77	-.79	-.83	-1.06	-.97	-.70
29	.13	.11	-.11	-.09	.10	.02	-.01	-.30	-.19	-.37	-.40	-.44	-.65	-.59	-.29
30	.18	.16	-.05	-.03	.20	.13	.02	-.22	-.12	-.30	-.34	-.38	-.62	-.57	-.22
31	-.21	-.24	-.48	-.45	-.16	-.25	-.40	-.64	-.54	-.72	-.76	-.79	-1.02	-.92	-.60
32	.13	.11	-.11	-.10	.17	.02	-.03	-.27	-.19	-.37	-.42	-.44	-.63	-.56	-.25
33	.05	.02	-.20	-.20	.06	-.06	-.12	-.34	-.27	-.47	-.52	-.53	-.73	-.69	-.33
34	-.34	-.37	-.60	-.60	-.33	-.46	-.52	-.72	-.65	-.85	-.88	-.90	-1.17	-1.11	-.70
35	.03	.00	-.24	-.23	.03	-.10	-.14	-.37	-.30	-.50	-.52	-.57	-.80	-.73	-.35
36	.08	.06	-.18	-.18	.06	-.08	-.12	-.31	-.25	-.46	-.47	-.52	-.71	-.66	-.28
37	-.26	-.28	-.53	-.49	-.31	-.45	-.47	-.64	-.60	-.79	-.81	-.85	-1.05	-1.01	-.61
38	.14	.12	-.13	-.12	.06	-.08	-.09	-.26	-.21	-.40	-.42	-.46	-.67	-.62	-.21
39	.16	.15	-.09	-.06	.07	-.07	-.05	-.21	-.16	-.33	-.36	-.42	-.64	-.57	-.16
40	-.17	-.19	-.42	-.41	-.30	-.41	-.44	-.53	-.47	-.64	-.69	-.77	-.98	-.91	-.48
41	.24	.21	-.03	-.02	.09	-.02	-.03	-.15	-.06	-.24	-.31	-.35	-.58	-.51	-.06
42	.25	.23	-.01	.02	.11	-.01	.00	-.11	-.02	-.21	-.26	-.33	-.56	-.47	-.05
43	-.13	-.15	-.39	-.36	-.26	-.44	-.41	-.47	-.39	-.58	-.64	-.71	-.94	-.86	-.41
44	.22	.21	-.03	-.02	.13	-.11	-.06	-.12	-.08	-.27	-.29	-.35	-.56	-.50	-.05
45	.22	.21	-.02	-.02	.07	-.17	-.07	-.12	-.08	-.24	-.28	-.34	-.55	-.49	-.04
46	-.16	-.18	-.41	-.41	-.39	-.57	-.44	-.51	-.46	-.63	-.67	-.73	-.93	-.87	-.42
47	.19	.17	-.06	-.05	-.05	-.17	-.07	-.17	-.12	-.28	-.32	-.38	-.60	-.53	-.06
48	.22	.20	-.02	-.02	.02	-.11	.00	-.14	-.09	-.25	-.28	-.34	-.57	-.51	-.03
49	-.14	-.17	-.39	-.40	-.31	-.41	-.37	-.51	-.46	-.63	-.65	-.71	-.90	-.86	-.39
50	.25	.22	-.03	-.04	.08	.00	-.02	-.15	-.09	-.27	-.29	-.33	-.51	-.47	-.01
51	.23	.21	-.01	-.03	.08	-.01	-.02	-.15	-.08	-.26	-.27	-.33	-.53	-.49	-.01
52	-.12	-.15	-.38	-.41	-.28	-.41	-.39	-.52	-.46	-.64	-.63	-.69	-.91	-.86	-.37
53	.86	.77	.41	.45	.62	.49	.55	.29	.36	.20	.24	.14	-.19	-.08	.51
54	1.18	1.14	.87	.84	.95	.83	.86	.69	.72	.59	.61	.57	.42	.43	.88
55	.79	.76	.54	.49	.56	.44	.48	.35	.37	.24	.27	.23	.08	.08	.55
56	1.13	1.09	.89	.85	.88	.77	.83	.70	.70	.59	.61	.59	.42	.43	.89
57	1.15	1.10	.90	.87	.87	.76	.85	.72	.72	.60	.64	.60	.45	.44	.91
58	.75	.70	.51	.48	.47	.36	.46	.33	.34	.20	.26	.21	.06	.06	.52
59	1.08	1.03	.84	.81	.78	.68	.79	.65	.65	.54	.60	.53	.38	.39	.85
60	1.11	1.06	.84	.80	.78	.68	.78	.66	.66	.55	.58	.54	.38	.39	.85
61	3.05	3.05	3.05	3.05	3.05	3.05	3.05	3.05	3.05	3.05	3.05	3.05	3.05	3.05	3.05
62	.00	.00	.00	.00	.00	.00	.00	.00	.00	.00	.00	.00	.00	.00	.00

NOAA-9 SCANNER OFFSETS FOR NOVEMBER 1986: SHORTWAVE CHANNEL

S.P.	DAY OF MONTH -->														
	16	17	18	19	20	21	22	23	24	25	26	27	28	29	30
1	-.11	-.11	-.11	-.11	-.11	-.11	-.11	-.11	-.11	-.11	-.11	-.11	-.11	-.11	-.11
2	.32	.32	.32	.32	.32	.32	.32	.32	.32	.32	.32	.32	.32	.32	.32
3	.49	.49	.49	.49	.49	.49	.49	.49	.49	.49	.49	.49	.49	.49	.49
4	-4.09	-4.09	-4.09	-4.09	-4.09	-4.09	-4.09	-4.09	-4.09	-4.09	-4.09	-4.09	-4.09	-4.09	-4.09
5	.73	.74	.76	.73	.72	.67	.39	.56	.55	.72	.43	.31	.40	.26	.27
6	.84	.84	.86	.83	.83	.79	.50	.66	.65	.83	.53	.41	.51	.39	.40
7	.47	.47	.50	.46	.47	.42	.16	.32	.30	.48	.20	.08	.16	.06	.06
8	.82	.83	.85	.82	.83	.78	.52	.68	.66	.83	.56	.45	.52	.41	.41
9	.89	.90	.92	.90	.90	.85	.58	.74	.72	.90	.63	.51	.58	.47	.45
10	.51	.52	.56	.52	.52	.47	.20	.37	.36	.53	.25	.11	.20	.07	.05
11	.82	.81	.84	.81	.82	.76	.49	.65	.64	.82	.57	.44	.50	.39	.37
12	.75	.75	.77	.75	.77	.72	.47	.63	.66	.78	.55	.44	.49	.40	.36
13	-.11	-.11	-.08	-.12	-.09	-.11	-.35	-.20	-.14	-.05	-.27	-.38	-.34	-.41	-.48
14	.23	.22	.25	.21	.25	.20	-.06	.10	.09	.27	-.02	-.17	-.10	-.22	-.24
15	.19	.18	.21	.18	.20	.19	-.07	.07	.09	.25	-.02	-.17	-.08	-.19	-.22
16	-.23	-.23	-.20	-.24	-.21	-.22	-.48	-.34	-.31	-.15	-.43	-.57	-.48	-.59	-.62
17	.11	.11	.14	.10	.14	.12	-.15	-.01	.03	.14	-.11	-.25	-.15	-.26	-.28
18	.13	.13	.16	.12	.15	.14	-.13	.01	.04	.18	-.12	-.23	-.13	-.27	-.27
19	-.26	-.27	-.24	-.27	-.24	-.26	-.53	-.38	-.35	-.18	-.51	-.62	-.51	-.67	-.68
20	.12	.12	.15	.12	.15	.12	-.15	.00	.03	.16	-.14	-.26	-.16	-.31	-.29
21	.16	.16	.19	.16	.18	.14	-.13	.03	.05	.17	-.11	-.27	-.16	-.34	-.29
22	-.32	-.33	-.30	-.32	-.30	-.32	-.59	-.44	-.40	-.30	-.59	-.72	-.58	-.74	-.72
23	.04	.04	.06	.04	.07	.04	-.23	-.09	-.05	.09	-.21	-.37	-.21	-.42	-.38
24	.07	.06	.09	.07	.10	.07	-.20	-.06	-.02	.10	-.18	-.33	-.19	-.38	-.34
25	-.31	-.33	-.30	-.32	-.30	-.33	-.60	-.46	-.41	-.29	-.57	-.72	-.58	-.76	-.72
26	.05	.05	.08	.05	.08	.04	-.23	-.09	-.04	.07	-.19	-.38	-.22	-.43	-.35
27	.08	.07	.10	.07	.10	.07	-.20	-.05	-.01	.09	-.17	-.35	-.20	-.41	-.33
28	-.30	-.32	-.29	-.32	-.30	-.32	-.60	-.44	-.41	-.32	-.59	-.75	-.59	-.79	-.73
29	.12	.10	.13	.09	.12	.08	-.20	-.04	-.01	.07	-.20	-.37	-.21	-.41	-.35
30	-.18	-.17	-.20	-.16	-.19	.15	-.14	.04	.05	.14	-.14	-.33	-.17	-.38	-.29
31	-.23	-.24	-.22	-.26	-.22	-.25	-.54	-.38	-.36	-.27	-.53	-.71	-.54	-.74	-.68
32	.11	.10	.11	.08	.12	.10	-.18	-.02	.01	.06	-.15	-.38	-.19	-.41	-.35
33	.03	.03	.02	-.02	.05	.04	-.25	-.07	-.07	-.03	-.26	-.47	-.31	-.57	-.49
34	-.35	-.35	-.35	-.38	-.33	-.33	-.61	-.44	-.46	-.41	-.67	-.90	-.71	-.99	-.85
35	.02	.01	.02	-.02	.04	.01	-.28	-.10	-.13	-.08	-.36	-.51	-.36	-.59	-.50
36	.08	.07	.08	.04	.10	.07	-.22	-.04	-.07	-.02	-.29	-.42	-.30	-.54	-.46
37	-.25	-.27	-.26	-.30	-.24	-.27	-.55	-.38	-.40	-.36	-.63	-.77	-.64	-.88	-.79
38	.15	.13	.14	.10	.16	.13	-.16	.02	.01	.04	-.25	-.40	-.25	-.49	-.41
39	.19	.17	.18	.14	.20	.17	-.12	.06	.05	.08	-.22	-.35	-.20	-.44	-.37
40	-.15	-.17	-.16	-.19	-.14	-.16	-.44	-.27	-.28	-.24	-.54	-.70	-.54	-.78	-.70
41	.23	.21	.23	.19	.25	.25	-.02	.15	.15	.18	-.16	-.32	-.13	-.40	-.30
42	.27	.25	.27	.23	.28	.26	-.02	.17	.17	.20	-.12	-.28	-.12	-.36	-.30
43	-.11	-.13	-.11	-.15	-.10	-.12	-.40	-.21	-.23	-.17	-.52	-.65	-.50	-.74	-.68
44	.24	.23	.25	.21	.26	.24	-.05	.14	.13	.17	-.12	-.30	-.15	-.42	-.32
45	.25	.24	.25	.22	.27	.24	-.03	.14	.16	.18	-.12	-.29	-.14	-.42	-.30
46	-.14	-.15	-.14	-.17	-.12	-.14	-.42	-.24	-.24	-.21	-.53	-.69	-.53	-.84	-.69
47	.21	.20	.22	.18	.23	.21	-.07	.11	.10	.14	-.18	-.36	-.18	-.52	-.38
48	.24	.23	.24	.21	.26	.24	-.04	.14	.12	.18	-.14	-.35	-.15	-.49	-.36
49	-.14	-.15	-.13	-.16	-.12	-.13	-.41	-.23	-.25	-.18	-.53	-.72	-.51	-.86	-.71
50	.22	.21	.23	.20	.25	.25	-.02	.15	.14	.20	-.16	-.36	-.11	-.48	-.32
51	.23	.22	.25	.21	.26	.25	-.03	.15	.13	.22	-.16	-.37	-.13	-.49	-.35
52	-.13	-.14	-.10	-.14	-.09	-.09	-.38	-.21	-.25	-.13	-.52	-.75	-.48	-.86	-.71
53	.80	.78	.83	.79	.85	.86	.52	.66	.55	.78	.31	.05	.39	-.08	.15
54	1.11	1.09	1.13	1.11	1.15	1.14	.85	1.01	.99	1.09	.71	.50	.79	.40	.59
55	.73	.73	.77	.75	.79	.81	.52	.67	.67	.77	.38	.15	.45	.05	.24
56	1.07	1.06	1.10	1.07	1.13	1.14	.85	1.01	1.01	1.11	.72	.49	.79	.38	.58
57	1.08	1.07	1.11	1.09	1.14	1.16	.87	1.03	1.02	1.11	.74	.51	.80	.39	.60
58	.69	.69	.73	.69	.75	.78	.48	.64	.64	.76	.37	.14	.43	.01	.22
59	1.02	1.02	1.05	1.02	1.08	1.10	.80	.97	.96	1.09	.68	.46	.76	.35	.54
60	1.01	1.01	1.04	1.00	1.06	1.08	.78	.95	.94	1.06	.68	.48	.75	.34	.52
61	3.05	3.05	3.05	3.05	3.05	3.05	3.05	3.05	3.05	3.05	3.05	3.05	3.05	3.05	3.05
62	.00	.00	.00	.00	.00	.00	.00	.00	.00	.00	.00	.00	.00	.00	.00

NOAA-9 SCANNER OFFSETS FOR DECEMBER 1986:

TOTAL CHANNEL

S.P.	DAY OF MONTH -->														
	1	2	3	4	5	6	7	8	9	10	11	12	13	14	15
1	.36	.36	.36	.36	.36	.36	.36	.36	.36	.36	.36	.36	.36	.36	.36
2	1.04	1.04	1.04	1.04	1.04	1.04	1.04	1.04	1.04	1.04	1.04	1.04	1.04	1.04	1.04
3	1.93	1.93	1.93	1.93	1.93	1.93	1.93	1.93	1.93	1.93	1.93	1.93	1.93	1.93	1.93
4	-9.64	-9.64	-9.64	-9.64	-9.64	-9.64	-9.64	-9.64	-9.64	-9.64	-9.64	-9.64	-9.64	-9.64	-9.64
5	-7.35	-10.08	-5.92	-4.29	-4.29	-4.29	-5.92	-5.51	-6.70	-6.05	-5.51	-5.51	-5.51	-5.51	-5.51
6	-2.48	-3.56	-3.72	-4.08	-4.44	-4.44	-6.51	-3.72	-1.81	-2.33	-1.95	-1.81	-1.81	-1.81	-1.81
7	-2.15	-2.36	-2.86	-1.78	-2.72	-3.02	-2.86	-1.54	-1.83	-1.64	-1.54	-1.54	-1.54	-1.54	-1.54
8	-1.77	-1.70	-2.01	-1.01	-2.32	-2.25	-2.01	-.92	-1.15	-.62	-.92	-.92	-.92	-.92	-.92
9	-1.89	-1.74	-2.02	-1.33	-2.61	-2.67	-2.02	-1.36	-1.09	-.64	-1.36	-1.36	-1.36	-1.36	-1.36
10	-1.19	-1.12	-1.33	-.87	-2.00	-2.06	-1.33	-.89	-.48	-.14	-.89	-.89	-.89	-.89	-.89
11	-1.38	-1.15	-1.25	-1.29	-2.12	-2.04	-1.25	-.99	-.60	-.89	-.99	-.99	-.99	-.99	-.99
12	-2.69	-2.45	-2.19	-2.78	-3.23	-3.42	-2.19	-2.10	-1.73	-2.08	-2.10	-2.10	-2.10	-2.10	-2.10
13	-3.63	-3.78	-3.00	-3.97	-4.05	-4.52	-3.00	-3.09	-2.98	-2.97	-3.09	-3.09	-3.09	-3.09	-3.09
14	-3.19	-3.86	-2.80	-3.84	-3.92	-4.58	-2.80	-2.78	-3.04	-2.42	-2.78	-2.78	-2.78	-2.78	-2.78
15	-2.69	-3.81	-2.61	-3.64	-3.85	-4.60	-2.61	-2.55	-2.89	-2.25	-2.55	-2.55	-2.55	-2.55	-2.55
16	-2.96	-4.27	-3.13	-4.22	-4.36	-5.19	-3.13	-3.07	-3.49	-2.86	-3.07	-3.07	-3.07	-3.07	-3.07
17	-2.48	-3.66	-2.80	-3.91	-3.90	-4.69	-2.80	-2.75	-3.06	-2.51	-2.75	-2.75	-2.75	-2.75	-2.75
18	-2.50	-3.58	-3.05	-4.21	-4.15	-4.74	-3.05	-2.94	-3.15	-2.43	-2.94	-2.94	-2.94	-2.94	-2.94
19	-2.23	-3.08	-2.92	-4.06	-4.10	-4.45	-2.92	-2.74	-2.84	-1.90	-2.74	-2.74	-2.74	-2.74	-2.74
20	-1.98	-2.65	-2.79	-3.77	-3.71	-4.10	-2.79	-2.47	-2.65	-1.56	-2.47	-2.47	-2.47	-2.47	-2.47
21	-1.67	-2.13	-2.49	-3.34	-3.32	-3.80	-2.49	-2.14	-2.18	-1.18	-2.14	-2.14	-2.14	-2.14	-2.14
22	-1.46	-1.54	-2.20	-2.92	-3.00	-3.49	-2.20	-1.74	-1.79	-.41	-1.74	-1.74	-1.74	-1.74	-1.74
23	-.85	-.66	-1.64	-2.22	-2.30	-2.79	-1.64	-1.05	-1.15	-.07	-1.05	-1.05	-1.05	-1.05	-1.05
24	-.24	.03	-1.12	-1.45	-1.53	-2.03	-1.12	-.44	-.38	.90	-.44	-.44	-.44	-.44	-.44
25	.05	.38	-.94	-.97	-1.12	-1.70	-.94	-.03	.07	1.31	-.03	-.03	-.03	-.03	-.03
26	-.61	-.06	-1.60	-1.46	-1.62	-2.35	-1.60	-.57	-.74	.92	-.57	-.57	-.57	-.57	-.57
27	-.76	-.04	-1.64	-1.45	-1.57	-2.52	-1.64	-.75	-.97	.30	-.75	-.75	-.75	-.75	-.75
28	-.60	.12	-1.32	-1.14	-1.19	-2.36	-1.32	-.66	-.92	.71	-.66	-.66	-.66	-.66	-.66
29	-.08	.57	-.66	-.57	-.58	-1.97	-.66	-.20	-.56	1.60	-.20	-.20	-.20	-.20	-.20
30	.16	.73	-.35	-.40	-.35	-1.89	-.35	.01	-.31	1.49	.01	.01	.01	.01	.01
31	.35	.93	-.16	-.27	-.14	-1.69	-.16	.23	.02	1.30	.23	.23	.23	.23	.23
32	.57	1.15	.10	-.09	.04	-1.56	.10	.59	.32	2.12	.59	.59	.59	.59	.59
33	1.06	1.60	.61	.47	.57	-.95	.61	1.20	.87	2.72	1.20	1.20	1.20	1.20	1.20
34	1.62	2.17	1.11	1.14	1.26	-.10	1.11	1.86	1.52	3.34	1.86	1.86	1.86	1.86	1.86
35	2.08	2.70	1.42	1.72	1.85	.60	1.42	2.32	1.97	3.75	2.32	2.32	2.32	2.32	2.32
36	1.84	2.56	1.12	1.64	1.77	.54	1.12	2.16	1.89	3.14	2.16	2.16	2.16	2.16	2.16
37	1.60	2.40	.90	1.47	1.70	.46	.90	2.16	1.85	2.97	2.16	2.16	2.16	2.16	2.16
38	1.98	2.67	1.27	1.72	2.25	1.07	1.27	2.65	2.29	3.33	2.65	2.65	2.65	2.65	2.65
39	2.00	2.59	1.40	1.65	2.42	1.19	1.40	2.77	2.45	3.33	2.77	2.77	2.77	2.77	2.77
40	1.94	2.64	1.60	1.53	2.42	1.17	1.60	2.88	2.64	3.43	2.88	2.88	2.88	2.88	2.88
41	2.20	3.01	1.98	1.63	2.53	1.57	1.98	3.18	3.02	3.87	3.18	3.18	3.18	3.18	3.18
42	2.27	3.10	2.19	1.61	2.45	1.87	2.19	3.27	3.17	4.09	3.27	3.27	3.27	3.27	3.27
43	2.18	2.93	2.13	1.47	2.31	1.91	2.13	3.14	3.28	4.46	3.14	3.14	3.14	3.14	3.14
44	1.84	2.52	1.82	1.10	1.93	1.71	1.82	2.67	3.08	4.05	2.67	2.67	2.67	2.67	2.67
45	1.26	1.94	1.52	.61	1.37	1.40	1.52	2.19	2.74	3.49	2.19	2.19	2.19	2.19	2.19
46	1.32	2.00	1.80	.72	1.42	1.77	1.80	2.43	3.11	3.66	2.43	2.43	2.43	2.43	2.43
47	-.10	.45	.40	-.67	-.13	.47	.40	1.13	1.97	2.44	1.13	1.13	1.13	1.13	1.13
48	-.42	.22	.05	-.77	-.44	.17	.05	1.01	2.01	2.59	1.01	1.01	1.01	1.01	1.01
49	-.56	.33	.02	-.57	-.41	.04	.02	1.16	2.27	2.22	1.16	1.16	1.16	1.16	1.16
50	-.26	.65	.39	-.14	.12	.32	.39	1.75	2.85	2.99	1.75	1.75	1.75	1.75	1.75
51	-.21	.50	.37	-.13	.23	.49	.37	1.85	2.87	2.72	1.85	1.85	1.85	1.85	1.85
52	-.43	.02	-.11	-.47	-.09	.40	-.11	1.44	2.52	2.34	1.44	1.44	1.44	1.44	1.44
53	-.51	-.18	-.35	-.60	-.34	.08	-.35	1.41	2.52	2.15	1.41	1.41	1.41	1.41	1.41
54	-1.04	-.48	-.78	-.87	-.69	-.36	-.78	.89	2.05	1.14	.89	.89	.89	.89	.89
55	-.60	.08	-.32	-.11	-.49	.11	-.32	1.08	2.16	1.95	1.08	1.08	1.08	1.08	1.08
56	.96	1.40	.94	1.84	.46	1.56	.94	2.28	3.22	3.27	2.28	2.28	2.28	2.28	2.28
57	.38	.37	.02	1.10	-.43	.57	.02	1.39	2.08	2.23	1.39	1.39	1.39	1.39	1.39
58	-.85	-1.31	-1.15	-.34	-1.44	-1.22	-1.15	-.31	.08	.31	-.31	-.31	-.31	-.31	-.31
59	-1.50	-1.78	-1.59	-.86	-1.45	-1.76	-1.59	-1.76	-1.10	-.80	-1.76	-1.76	-1.76	-1.76	-1.76
60	-2.94	-.38	-1.40	1.08	2.24	-6.18	-1.40	-6.17	-4.07	-4.15	-6.17	-6.17	-6.17	-6.17	-6.17
61	11.19	11.19	11.19	11.19	11.19	11.19	11.19	11.19	11.19	11.19	11.19	11.19	11.19	11.19	11.19
62	3.13	3.13	3.13	3.13	3.13	3.13	3.13	3.13	3.13	3.13	3.13	3.13	3.13	3.13	3.13

MOAA-9 SCANNER OFFSETS FOR DECEMBER 1986: LONGMAVE CHANNEL

S.P.	DAY OF MONTH -->														
	1	2	3	4	5	6	7	8	9	10	11	12	13	14	15
1	-.11	-.11	-.11	-.11	-.11	-.11	-.11	-.11	-.11	-.11	-.11	-.11	-.11	-.11	-.11
2	.32	.32	.32	.32	.32	.32	.32	.32	.32	.32	.32	.32	.32	.32	.32
3	.49	.49	.49	.49	.49	.49	.49	.49	.49	.49	.49	.49	.49	.49	.49
4	-4.09	-4.09	-4.09	-4.09	-4.09	-4.09	-4.09	-4.09	-4.09	-4.09	-4.09	-4.09	-4.09	-4.09	-4.09
5	-5.95	-7.33	-5.15	-4.22	-4.22	-4.22	-5.15	-4.92	-4.22	-4.94	-4.92	-4.92	-4.92	-4.92	-4.92
6	-2.58	-3.24	-3.31	-3.52	-3.75	-5.14	-3.31	-2.35	-2.70	-2.27	-2.35	-2.35	-2.35	-2.35	-2.35
7	-2.36	-2.57	-2.73	-2.04	-2.63	-2.87	-2.73	-2.08	-2.24	-2.19	-2.08	-2.08	-2.08	-2.08	-2.08
8	-2.33	-2.36	-2.37	-1.76	-2.59	-2.55	-2.37	-1.95	-1.88	-2.01	-1.95	-1.95	-1.95	-1.95	-1.95
9	-2.56	-2.58	-2.55	-2.15	-2.96	-3.01	-2.55	-2.32	-1.91	-2.23	-2.32	-2.32	-2.32	-2.32	-2.32
10	-2.31	-2.45	-2.29	-2.07	-2.78	-2.83	-2.29	-2.18	-1.66	-2.16	-2.18	-2.18	-2.18	-2.18	-2.18
11	-2.70	-2.83	-2.51	-2.62	-3.13	-3.12	-2.51	-2.54	-2.02	-2.68	-2.54	-2.54	-2.54	-2.54	-2.54
12	-3.33	-3.46	-2.91	-3.40	-3.66	-3.90	-2.91	-3.08	-2.60	-3.26	-3.08	-3.08	-3.08	-3.08	-3.08
13	-4.03	-4.37	-3.53	-4.26	-4.26	-4.73	-3.53	-3.90	-3.66	-4.00	-3.90	-3.90	-3.90	-3.90	-3.90
14	-3.94	-4.60	-3.60	-4.35	-4.37	-4.93	-3.60	-3.85	-4.01	-4.12	-3.85	-3.85	-3.85	-3.85	-3.85
15	-3.76	-4.71	-3.65	-4.40	-4.51	-5.11	-3.65	-3.82	-4.17	-4.21	-3.82	-3.82	-3.82	-3.82	-3.82
16	-4.19	-5.28	-4.26	-5.00	-5.07	-5.72	-4.26	-4.48	-4.88	-4.91	-4.48	-4.48	-4.48	-4.48	-4.48
17	-4.14	-5.20	-4.34	-5.06	-5.00	-5.62	-4.34	-4.55	-4.94	-4.96	-4.55	-4.55	-4.55	-4.55	-4.55
18	-4.35	-5.41	-4.70	-5.43	-5.38	-5.78	-4.70	-4.84	-5.17	-5.11	-4.84	-4.84	-4.84	-4.84	-4.84
19	-4.40	-5.35	-4.86	-5.56	-5.61	-5.80	-4.86	-4.86	-5.14	-4.94	-4.86	-4.86	-4.86	-4.86	-4.86
20	-4.52	-5.36	-5.06	-5.65	-5.57	-5.83	-5.06	-4.98	-5.25	-4.95	-4.98	-4.98	-4.98	-4.98	-4.98
21	-4.54	-5.18	-5.07	-5.60	-5.52	-5.81	-5.07	-4.99	-5.14	-4.89	-4.99	-4.99	-4.99	-4.99	-4.99
22	-4.66	-4.97	-5.14	-5.59	-5.57	-5.83	-5.14	-5.02	-5.13	-4.85	-5.02	-5.02	-5.02	-5.02	-5.02
23	-4.38	-4.48	-4.89	-5.25	-5.20	-5.47	-4.89	-4.73	-4.87	-4.45	-4.73	-4.73	-4.73	-4.73	-4.73
24	-4.20	-4.24	-4.78	-4.98	-4.88	-5.20	-4.78	-4.59	-4.74	-4.18	-4.59	-4.59	-4.59	-4.59	-4.59
25	-4.24	-4.22	-4.91	-4.91	-4.85	-5.24	-4.91	-4.65	-4.85	-4.23	-4.65	-4.65	-4.65	-4.65	-4.65
26	-4.55	-4.33	-5.22	-5.11	-5.05	-5.56	-5.22	-4.98	-5.37	-4.64	-4.98	-4.98	-4.98	-4.98	-4.98
27	-4.56	-4.19	-5.16	-5.03	-4.95	-5.58	-5.16	-5.05	-5.48	-4.79	-5.05	-5.05	-5.05	-5.05	-5.05
28	-4.40	-4.04	-4.88	-4.78	-4.66	-5.42	-4.88	-4.92	-5.40	-4.76	-4.92	-4.92	-4.92	-4.92	-4.92
29	-3.99	-3.70	-4.38	-4.33	-4.20	-5.13	-4.38	-4.54	-5.05	-4.42	-4.54	-4.54	-4.54	-4.54	-4.54
30	-3.80	-3.59	-4.15	-4.18	-4.04	-5.08	-4.15	-4.31	-4.75	-4.27	-4.31	-4.31	-4.31	-4.31	-4.31
31	-3.47	-3.27	-3.81	-3.88	-3.71	-4.78	-3.81	-3.89	-4.22	-3.93	-3.89	-3.89	-3.89	-3.89	-3.89
32	-3.18	-2.99	-3.51	-3.64	-3.49	-4.61	-3.51	-3.48	-3.83	-3.52	-3.48	-3.48	-3.48	-3.48	-3.48
33	-2.49	-2.34	-2.80	-2.87	-2.73	-3.82	-2.80	-2.72	-3.06	-2.77	-2.72	-2.72	-2.72	-2.72	-2.72
34	-1.87	-1.79	-2.23	-2.18	-2.05	-3.03	-2.23	-2.08	-2.43	-2.09	-2.08	-2.08	-2.08	-2.08	-2.08
35	-1.27	-1.20	-1.74	-1.49	-1.36	-2.29	-1.74	-1.48	-1.88	-1.51	-1.48	-1.48	-1.48	-1.48	-1.48
36	-.98	-.88	-1.53	-1.10	-.98	-1.90	-1.53	-1.19	-1.59	-1.26	-1.19	-1.19	-1.19	-1.19	-1.19
37	-.76	-.61	-1.29	-.83	-.67	-1.60	-1.29	-.88	-1.37	-1.08	-.88	-.88	-.88	-.88	-.88
38	-.13	-.04	-.69	-.28	-.07	-.84	-.69	-.27	-.81	-.51	-.27	-.27	-.27	-.27	-.27
39	.25	.33	-.22	.04	.54	-.42	-.22	.16	-.41	-.15	.16	.16	.16	.16	.16
40	.48	.73	.20	.22	.78	-.18	.20	.56	-.02	.17	.56	.56	.56	.56	.56
41	.97	1.39	.78	.61	1.15	.40	.78	1.16	.64	.75	1.16	1.16	1.16	1.16	1.16
42	1.30	1.74	1.18	.88	1.40	.89	1.18	1.58	1.10	1.13	1.58	1.58	1.58	1.58	1.58
43	1.50	1.89	1.37	1.06	1.60	1.17	1.37	1.81	1.38	1.32	1.81	1.81	1.81	1.81	1.81
44	1.41	1.74	1.28	.97	1.50	1.19	1.28	1.68	1.30	1.14	1.68	1.68	1.68	1.68	1.68
45	1.25	1.63	1.34	.91	1.39	1.29	1.34	1.60	1.25	1.06	1.60	1.60	1.60	1.60	1.60
46	1.46	1.84	1.70	1.14	1.59	1.72	1.70	1.86	1.54	1.37	1.86	1.86	1.86	1.86	1.86
47	.71	.95	.96	.39	.75	1.04	.96	1.10	.79	.73	1.10	1.10	1.10	1.10	1.10
48	.77	1.04	1.00	.59	.81	1.13	1.00	1.24	.93	1.07	1.24	1.24	1.24	1.24	1.24
49	.55	1.01	.83	.58	.70	.91	.83	1.11	.84	1.00	1.11	1.11	1.11	1.11	1.11
50	.80	1.30	1.10	.92	1.09	1.11	1.10	1.45	1.18	1.27	1.45	1.45	1.45	1.45	1.45
51	1.02	1.39	1.26	1.12	1.33	1.36	1.26	1.69	1.42	1.40	1.69	1.69	1.69	1.69	1.69
52	.78	.94	.83	.77	1.00	1.17	.83	1.40	1.21	1.02	1.40	1.40	1.40	1.40	1.40
53	.49	.56	.44	.47	.66	.78	.44	1.09	.97	.59	1.09	1.09	1.09	1.09	1.09
54	-.20	-.05	-.22	-.10	-.02	-.01	-.22	.35	.38	-.10	.35	.35	.35	.35	.35
55	-.03	.12	-.08	.28	-.01	.12	-.08	.31	.47	.13	.31	.31	.31	.31	.31
56	.32	.25	.05	.88	-.06	.33	.05	.42	.54	.41	.42	.42	.42	.42	.42
57	.24	-.09	-.21	.71	-.33	-.08	-.21	.11	.03	-.02	.11	.11	.11	.11	.11
58	-.49	-1.07	-.88	-.15	-.89	-1.21	-.88	-1.04	-1.31	-1.15	-1.04	-1.04	-1.04	-1.04	-1.04
59	-.75	-1.20	-1.00	-.36	-.73	-1.57	-1.00	-1.40	-1.99	-1.58	-1.40	-1.40	-1.40	-1.40	-1.40
60	-4.03	-4.03	-4.03	-4.03	-4.03	-4.03	-4.03	-4.03	-4.03	-4.03	-4.03	-4.03	-4.03	-4.03	-4.03
61	3.05	3.05	3.05	3.05	3.05	3.05	3.05	3.05	3.05	3.05	3.05	3.05	3.05	3.05	3.05
62	.45	.45	.45	.45	.45	.45	.45	.45	.45	.45	.45	.45	.45	.45	.45

NOAA-9 SCANNER OFFSETS FOR DECEMBER 1986: LONGWAVE CHANNEL

S.P.	DAY OF MONTH -->															
	16	17	18	19	20	21	22	23	24	25	26	27	28	29	30	31
1	-.11	-.11	-.11	-.11	-.11	-.11	-.11	-.11	-.11	-.11	-.11	-.11	-.11	-.11	-.11	-.11
2	.32	.32	.32	.32	.32	.32	.32	.32	.32	.32	.32	.32	.32	.32	.32	.32
3	.49	.49	.49	.49	.49	.49	.49	.49	.49	.49	.49	.49	.49	.49	.49	.49
4	-4.09	-4.09	-4.09	-4.09	-4.09	-4.09	-4.09	-4.09	-4.09	-4.09	-4.09	-4.09	-4.09	-4.09	-4.09	-4.09
5	-4.92	-4.92	-4.92	-4.92	-4.92	-4.92	-4.92	-4.92	-4.92	-4.92	-4.92	-4.92	-4.92	-4.92	-4.55	-5.95
6	-2.35	-2.35	-2.35	-2.35	-2.35	-2.35	-2.35	-2.35	-2.35	-2.35	-2.35	-2.35	-2.35	-2.35	-2.10	-2.58
7	-2.08	-2.08	-2.08	-2.08	-2.08	-2.08	-2.08	-2.08	-2.08	-2.08	-2.08	-2.08	-2.08	-2.08	-2.19	-2.36
8	-1.95	-1.95	-1.95	-1.95	-1.95	-1.95	-1.95	-1.95	-1.95	-1.95	-1.95	-1.95	-1.95	-1.95	-2.21	-2.33
9	-2.32	-2.32	-2.32	-2.32	-2.32	-2.32	-2.32	-2.32	-2.32	-2.32	-2.32	-2.32	-2.32	-2.32	-2.55	-2.56
10	-2.18	-2.18	-2.18	-2.18	-2.18	-2.18	-2.18	-2.18	-2.18	-2.18	-2.18	-2.18	-2.18	-2.18	-2.44	-2.31
11	-2.54	-2.54	-2.54	-2.54	-2.54	-2.54	-2.54	-2.54	-2.54	-2.54	-2.54	-2.54	-2.54	-2.54	-2.78	-2.70
12	-3.08	-3.08	-3.08	-3.08	-3.08	-3.08	-3.08	-3.08	-3.08	-3.08	-3.08	-3.08	-3.08	-3.08	-3.24	-3.33
13	-3.90	-3.90	-3.90	-3.90	-3.90	-3.90	-3.90	-3.90	-3.90	-3.90	-3.90	-3.90	-3.90	-3.90	-3.97	-4.03
14	-3.85	-3.85	-3.85	-3.85	-3.85	-3.85	-3.85	-3.85	-3.85	-3.85	-3.85	-3.85	-3.85	-3.85	-4.00	-3.94
15	-3.82	-3.82	-3.82	-3.82	-3.82	-3.82	-3.82	-3.82	-3.82	-3.82	-3.82	-3.82	-3.82	-3.82	-3.98	-3.76
16	-4.48	-4.48	-4.48	-4.48	-4.48	-4.48	-4.48	-4.48	-4.48	-4.48	-4.48	-4.48	-4.48	-4.48	-4.64	-4.19
17	-4.55	-4.55	-4.55	-4.55	-4.55	-4.55	-4.55	-4.55	-4.55	-4.55	-4.55	-4.55	-4.55	-4.55	-4.73	-4.14
18	-4.84	-4.84	-4.84	-4.84	-4.84	-4.84	-4.84	-4.84	-4.84	-4.84	-4.84	-4.84	-4.84	-4.84	-5.08	-4.35
19	-4.86	-4.86	-4.86	-4.86	-4.86	-4.86	-4.86	-4.86	-4.86	-4.86	-4.86	-4.86	-4.86	-4.86	-5.15	-4.40
20	-4.98	-4.98	-4.98	-4.98	-4.98	-4.98	-4.98	-4.98	-4.98	-4.98	-4.98	-4.98	-4.98	-4.98	-5.25	-4.52
21	-4.99	-4.99	-4.99	-4.99	-4.99	-4.99	-4.99	-4.99	-4.99	-4.99	-4.99	-4.99	-4.99	-4.99	-5.26	-4.54
22	-5.02	-5.02	-5.02	-5.02	-5.02	-5.02	-5.02	-5.02	-5.02	-5.02	-5.02	-5.02	-5.02	-5.02	-5.23	-4.66
23	-4.73	-4.73	-4.73	-4.73	-4.73	-4.73	-4.73	-4.73	-4.73	-4.73	-4.73	-4.73	-4.73	-4.73	-4.78	-4.38
24	-4.59	-4.59	-4.59	-4.59	-4.59	-4.59	-4.59	-4.59	-4.59	-4.59	-4.59	-4.59	-4.59	-4.59	-4.52	-4.20
25	-4.65	-4.65	-4.65	-4.65	-4.65	-4.65	-4.65	-4.65	-4.65	-4.65	-4.65	-4.65	-4.65	-4.65	-4.52	-4.24
26	-4.98	-4.98	-4.98	-4.98	-4.98	-4.98	-4.98	-4.98	-4.98	-4.98	-4.98	-4.98	-4.98	-4.98	-4.84	-4.55
27	-5.05	-5.05	-5.05	-5.05	-5.05	-5.05	-5.05	-5.05	-5.05	-5.05	-5.05	-5.05	-5.05	-5.05	-4.85	-4.56
28	-4.92	-4.92	-4.92	-4.92	-4.92	-4.92	-4.92	-4.92	-4.92	-4.92	-4.92	-4.92	-4.92	-4.92	-4.63	-4.40
29	-4.54	-4.54	-4.54	-4.54	-4.54	-4.54	-4.54	-4.54	-4.54	-4.54	-4.54	-4.54	-4.54	-4.54	-4.18	-3.99
30	-4.31	-4.31	-4.31	-4.31	-4.31	-4.31	-4.31	-4.31	-4.31	-4.31	-4.31	-4.31	-4.31	-4.31	-4.01	-3.80
31	-3.89	-3.89	-3.89	-3.89	-3.89	-3.89	-3.89	-3.89	-3.89	-3.89	-3.89	-3.89	-3.89	-3.89	-3.73	-3.47
32	-3.48	-3.48	-3.48	-3.48	-3.48	-3.48	-3.48	-3.48	-3.48	-3.48	-3.48	-3.48	-3.48	-3.48	-3.38	-3.18
33	-2.72	-2.72	-2.72	-2.72	-2.72	-2.72	-2.72	-2.72	-2.72	-2.72	-2.72	-2.72	-2.72	-2.72	-2.60	-2.49
34	-2.08	-2.08	-2.08	-2.08	-2.08	-2.08	-2.08	-2.08	-2.08	-2.08	-2.08	-2.08	-2.08	-2.08	-1.91	-1.87
35	-1.48	-1.48	-1.48	-1.48	-1.48	-1.48	-1.48	-1.48	-1.48	-1.48	-1.48	-1.48	-1.48	-1.48	-1.25	-1.27
36	-1.19	-1.19	-1.19	-1.19	-1.19	-1.19	-1.19	-1.19	-1.19	-1.19	-1.19	-1.19	-1.19	-1.19	-.93	-.98
37	-.88	-.88	-.88	-.88	-.88	-.88	-.88	-.88	-.88	-.88	-.88	-.88	-.88	-.88	-.66	-.76
38	-.27	-.27	-.27	-.27	-.27	-.27	-.27	-.27	-.27	-.27	-.27	-.27	-.27	-.27	-.06	-.13
39	.16	.16	.16	.16	.16	.16	.16	.16	.16	.16	.16	.16	.16	.16	.31	.25
40	.56	.56	.56	.56	.56	.56	.56	.56	.56	.56	.56	.56	.56	.56	.57	.48
41	1.16	1.16	1.16	1.16	1.16	1.16	1.16	1.16	1.16	1.16	1.16	1.16	1.16	1.16	1.09	.97
42	1.58	1.58	1.58	1.58	1.58	1.58	1.58	1.58	1.58	1.58	1.58	1.58	1.58	1.58	1.43	1.30
43	1.81	1.81	1.81	1.81	1.81	1.81	1.81	1.81	1.81	1.81	1.81	1.81	1.81	1.81	1.59	1.50
44	1.68	1.68	1.68	1.68	1.68	1.68	1.68	1.68	1.68	1.68	1.68	1.68	1.68	1.68	1.48	1.41
45	1.60	1.60	1.60	1.60	1.60	1.60	1.60	1.60	1.60	1.60	1.60	1.60	1.60	1.60	1.42	1.25
46	1.86	1.86	1.86	1.86	1.86	1.86	1.86	1.86	1.86	1.86	1.86	1.86	1.86	1.86	1.62	1.46
47	1.10	1.10	1.10	1.10	1.10	1.10	1.10	1.10	1.10	1.10	1.10	1.10	1.10	1.10	.79	.71
48	1.24	1.24	1.24	1.24	1.24	1.24	1.24	1.24	1.24	1.24	1.24	1.24	1.24	1.24	.87	.77
49	1.11	1.11	1.11	1.11	1.11	1.11	1.11	1.11	1.11	1.11	1.11	1.11	1.11	1.11	.77	.55
50	1.45	1.45	1.45	1.45	1.45	1.45	1.45	1.45	1.45	1.45	1.45	1.45	1.45	1.45	1.13	.80
51	1.69	1.69	1.69	1.69	1.69	1.69	1.69	1.69	1.69	1.69	1.69	1.69	1.69	1.69	1.39	1.02
52	1.40	1.40	1.40	1.40	1.40	1.40	1.40	1.40	1.40	1.40	1.40	1.40	1.40	1.40	1.05	.78
53	1.09	1.09	1.09	1.09	1.09	1.09	1.09	1.09	1.09	1.09	1.09	1.09	1.09	1.09	.62	.49
54	.35	.35	.35	.35	.35	.35	.35	.35	.35	.35	.35	.35	.35	.35	-.23	-.20
55	.31	.31	.31	.31	.31	.31	.31	.31	.31	.31	.31	.31	.31	.31	-.16	-.03
56	.42	.42	.42	.42	.42	.42	.42	.42	.42	.42	.42	.42	.42	.42	.13	.32
57	.11	.11	.11	.11	.11	.11	.11	.11	.11	.11	.11	.11	.11	.11	-.14	-.24
58	-1.04	-1.04	-1.04	-1.04	-1.04	-1.04	-1.04	-1.04	-1.04	-1.04	-1.04	-1.04	-1.04	-1.04	-.83	-.49
59	-1.40	-1.40	-1.40	-1.40	-1.40	-1.40	-1.40	-1.40	-1.40	-1.40	-1.40	-1.40	-1.40	-1.40	-1.10	-.75
60	-4.03	-4.03	-4.03	-4.03	-4.03	-4.03	-4.03	-4.03	-4.03	-4.03	-4.03	-4.03	-4.03	-4.03	-4.03	-4.03
61	3.05	3.05	3.05	3.05	3.05	3.05	3.05	3.05	3.05	3.05	3.05	3.05	3.05	3.05	3.05	3.05
62	.45	.45	.45	.45	.45	.45	.45	.45	.45	.45	.45	.45	.45	.45	.45	.45

NOAA-9 SCANNER OFFSETS FOR DECEMBER 1986: SHORTWAVE CHANNEL

S.P.	DAY OF MONTH -->														
	1	2	3	4	5	6	7	8	9	10	11	12	13	14	15
1	.29	.29	.29	.29	.29	.29	.29	.29	.29	.29	.29	.29	.29	.29	.29
2	.59	.59	.59	.59	.59	.59	.59	.59	.59	.59	.59	.59	.59	.59	.59
3	.63	.63	.63	.63	.63	.63	.63	.63	.63	.63	.63	.63	.63	.63	.63
4	.27	.27	.27	.27	.27	.27	.27	.27	.27	.27	.27	.27	.27	.27	.27
5	.12	.23	.45	.25	.19	.17	.38	.50	.69	.50	.50	.50	.50	.50	.50
6	.21	.32	.53	.33	.29	.26	.48	.61	.80	.61	.61	.61	.61	.61	.61
7	-.12	-.03	.18	-.01	-.05	-.05	.14	.26	.44	.26	.26	.26	.26	.26	.26
8	.23	.32	.53	.34	.31	.30	.49	.60	.79	.60	.60	.60	.60	.60	.60
9	.28	.38	.59	.40	.36	.34	.54	.65	.84	.65	.65	.65	.65	.65	.65
10	-.12	-.02	.22	.01	-.03	-.04	.15	.26	.46	.26	.26	.26	.26	.26	.26
11	.19	.29	.50	.30	.27	.26	.46	.57	.76	.57	.57	.57	.57	.57	.57
12	.18	.28	.48	.31	.28	.29	.47	.54	.73	.54	.54	.54	.54	.54	.54
13	-.66	-.56	-.38	-.50	-.51	-.48	-.36	-.29	-.12	-.29	-.29	-.29	-.29	-.29	-.29
14	-.43	-.33	-.09	-.29	-.33	-.35	-.14	.01	.21	.01	.01	.01	.01	.01	.01
15	-.43	-.33	-.11	-.29	-.32	-.35	-.14	.03	.23	.03	.03	.03	.03	.03	.03
16	-.83	-.74	-.53	-.69	-.73	-.75	-.54	-.38	-.19	-.38	-.38	-.38	-.38	-.38	-.38
17	-.50	-.41	-.19	-.36	-.41	-.44	-.20	-.06	.11	-.06	-.06	-.06	-.06	-.06	-.06
18	-.48	-.38	-.17	-.34	-.37	-.42	-.19	-.05	.12	-.05	-.05	-.05	-.05	-.05	-.05
19	-.88	-.79	-.58	-.74	-.77	-.80	-.58	-.46	-.31	-.46	-.46	-.46	-.46	-.46	-.46
20	-.51	-.43	-.19	-.38	-.41	-.43	-.22	-.10	.05	-.10	-.10	-.10	-.10	-.10	-.10
21	-.50	-.42	-.16	-.37	-.40	-.43	-.20	-.09	.06	-.09	-.09	-.09	-.09	-.09	-.09
22	-.95	-.86	-.64	-.82	-.84	-.88	-.63	-.54	-.40	-.54	-.54	-.54	-.54	-.54	-.54
23	-.59	-.49	-.28	-.47	-.49	-.53	-.28	-.19	-.06	-.19	-.19	-.19	-.19	-.19	-.19
24	-.55	-.46	-.25	-.44	-.46	-.48	-.26	-.15	-.02	-.15	-.15	-.15	-.15	-.15	-.15
25	-.94	-.85	-.64	-.83	-.85	-.86	-.63	-.53	-.40	-.53	-.53	-.53	-.53	-.53	-.53
26	-.57	-.49	-.27	-.46	-.50	-.51	-.29	-.15	-.02	-.15	-.15	-.15	-.15	-.15	-.15
27	-.55	-.46	-.25	-.43	-.46	-.49	-.26	-.11	.02	-.11	-.11	-.11	-.11	-.11	-.11
28	-.95	-.85	-.65	-.83	-.87	-.89	-.65	-.50	-.36	-.50	-.50	-.50	-.50	-.50	-.50
29	-.57	-.47	-.26	-.45	-.50	-.53	-.28	-.12	.02	-.12	-.12	-.12	-.12	-.12	-.12
30	-.51	-.41	-.18	-.39	-.46	-.48	-.23	-.08	.05	-.08	-.08	-.08	-.08	-.08	-.08
31	-.88	-.78	-.58	-.77	-.84	-.87	-.60	-.48	-.38	-.48	-.48	-.48	-.48	-.48	-.48
32	-.53	-.44	-.23	-.41	-.48	-.52	-.26	-.13	-.08	-.13	-.13	-.13	-.13	-.13	-.13
33	-.65	-.57	-.32	-.50	-.58	-.63	-.39	-.20	-.21	-.20	-.20	-.20	-.20	-.20	-.20
34	-1.07	-.98	-.68	-.90	-1.01	-1.07	-.82	-.57	-.59	-.57	-.57	-.57	-.57	-.57	-.57
35	-.70	-.61	-.34	-.55	-.65	-.70	-.44	-.21	-.23	-.21	-.21	-.21	-.21	-.21	-.21
36	-.63	-.55	-.27	-.48	-.58	-.64	-.38	-.15	-.16	-.15	-.15	-.15	-.15	-.15	-.15
37	-.96	-.88	-.60	-.81	-.92	-.98	-.72	-.48	-.48	-.48	-.48	-.48	-.48	-.48	-.48
38	-.58	-.49	-.20	-.42	-.53	-.62	-.33	-.09	-.07	-.09	-.09	-.09	-.09	-.09	-.09
39	-.53	-.44	-.16	-.37	-.47	-.53	-.30	-.04	-.02	-.04	-.04	-.04	-.04	-.04	-.04
40	-.86	-.77	-.48	-.70	-.80	-.89	-.65	-.36	-.35	-.36	-.36	-.36	-.36	-.36	-.36
41	-.47	-.38	-.06	-.29	-.39	-.52	-.29	.05	.03	.05	.05	.05	.05	.05	.05
42	-.44	-.34	-.06	-.28	-.37	-.47	-.22	.06	.02	.06	.06	.06	.06	.06	.06
43	-.81	-.71	-.43	-.65	-.75	-.84	-.59	-.31	-.39	-.31	-.31	-.31	-.31	-.31	-.31
44	-.46	-.36	-.07	-.29	-.39	-.49	-.24	.05	-.06	.05	.05	.05	.05	.05	.05
45	-.44	-.35	-.06	-.28	-.38	-.48	-.24	.05	-.06	.05	.05	.05	.05	.05	.05
46	-.81	-.72	-.43	-.66	-.75	-.86	-.64	-.32	-.43	-.32	-.32	-.32	-.32	-.32	-.32
47	-.48	-.37	-.07	-.30	-.40	-.52	-.30	.04	.06	.04	.04	.04	.04	.04	.04
48	-.46	-.33	-.04	-.26	-.36	-.47	-.28	.08	-.01	.08	.08	.08	.08	.08	.08
49	-.81	-.68	-.40	-.61	-.70	-.83	-.65	-.26	-.36	-.26	-.26	-.26	-.26	-.26	-.26
50	-.43	-.30	-.01	-.21	-.31	-.47	-.30	.13	.03	.13	.13	.13	.13	.13	.13
51	-.44	-.30	-.02	-.23	-.32	-.44	-.28	.13	.04	.13	.13	.13	.13	.13	.13
52	-.79	-.65	-.37	-.60	-.68	-.81	-.64	-.22	-.33	-.22	-.22	-.22	-.22	-.22	-.22
53	.04	.17	.52	.21	.08	-.15	.14	.69	.53	.69	.69	.69	.69	.69	.69
54	.52	.65	.92	.71	.61	.44	.60	1.02	.86	1.02	1.02	1.02	1.02	1.02	1.02
55	.17	.31	.59	.37	.27	.13	.28	.67	.51	.67	.67	.67	.67	.67	.67
56	.53	.66	.94	.73	.63	.48	.63	1.00	.84	1.00	1.00	1.00	1.00	1.00	1.00
57	.56	.69	.97	.76	.66	.53	.65	1.01	.85	1.01	1.01	1.01	1.01	1.01	1.01
58	.18	.31	.58	.37	.27	.16	.27	.62	.45	.62	.62	.62	.62	.62	.62
59	.55	.69	.96	.74	.64	.52	.63	.96	.84	.96	.96	.96	.96	.96	.96
60	.81	.95	1.17	.99	.91	.77	.87	.93	1.04	.93	.93	.93	.93	.93	.93
61	.83	.83	.83	.83	.83	.83	.83	.83	.83	.83	.83	.83	.83	.83	.83
62	.97	.97	.97	.97	.97	.97	.97	.97	.97	.97	.97	.97	.97	.97	.97

APPENDIX C

NOAA-10 SCANNER OFFSET TABLES

APPENDIX C: NOAA-10 SCANNER OFFSET TABLES

The following pages contain the scanner offset tables for the NOAA-10 spacecraft for the period from October to December 1986. Only one set of scanner offsets was used for each day. As previously mentioned, the NOAA-10 did not become operational until October 1986.

The units used for all scanner offsets in these tables are watts per square meter per steradian.

This page has been intentionally left blank

S.P.	NOAA-10 SCANNER OFFSETS FOR OCTOBER, NOVEMBER, DECEMBER 1986:										TOTAL	CHANNEL (AZIMUTH=35 DEGREES)				
	1	2	3	4	5	6	7	8	9	10		11	12	13	14	15
1	.66	.66	.66	.66	.66	.66	.66	.66	.66	.66	.66	.66	.66	.66	.66	
2	.62	.62	.62	.62	.62	.62	.62	.62	.62	.62	.62	.62	.62	.62	.62	
3	.77	.77	.77	.77	.77	.77	.77	.77	.77	.77	.77	.77	.77	.77	.77	
4	1.00	1.00	1.00	1.00	1.00	1.00	1.00	1.00	1.00	1.00	1.00	1.00	1.00	1.00	1.00	
5	-1.16	-1.16	-1.16	-1.16	-1.16	-1.16	-1.16	-1.16	-1.16	-1.16	-1.16	-1.16	-1.16	-1.16	-1.16	
6	-.23	-.23	-.23	-.23	-.23	-.23	-.23	-.23	-.23	-.23	-.23	-.23	-.23	-.23	-.23	
7	.40	.40	.40	.40	.40	.40	.40	.40	.40	.40	.40	.40	.40	.40	.40	
8	1.04	1.04	1.04	1.04	1.04	1.04	1.04	1.04	1.04	1.04	1.04	1.04	1.04	1.04	1.04	
9	1.64	1.64	1.64	1.64	1.64	1.64	1.64	1.64	1.64	1.64	1.64	1.64	1.64	1.64	1.64	
10	1.55	1.55	1.55	1.55	1.55	1.55	1.55	1.55	1.55	1.55	1.55	1.55	1.55	1.55	1.55	
11	1.60	1.60	1.60	1.60	1.60	1.60	1.60	1.60	1.60	1.60	1.60	1.60	1.60	1.60	1.60	
12	1.57	1.57	1.57	1.57	1.57	1.57	1.57	1.57	1.57	1.57	1.57	1.57	1.57	1.57	1.57	
13	1.42	1.42	1.42	1.42	1.42	1.42	1.42	1.42	1.42	1.42	1.42	1.42	1.42	1.42	1.42	
14	.96	.96	.96	.96	.96	.96	.96	.96	.96	.96	.96	.96	.96	.96	.96	
15	1.11	1.11	1.11	1.11	1.11	1.11	1.11	1.11	1.11	1.11	1.11	1.11	1.11	1.11	1.11	
16	.85	.85	.85	.85	.85	.85	.85	.85	.85	.85	.85	.85	.85	.85	.85	
17	.74	.74	.74	.74	.74	.74	.74	.74	.74	.74	.74	.74	.74	.74	.74	
18	1.08	1.08	1.08	1.08	1.08	1.08	1.08	1.08	1.08	1.08	1.08	1.08	1.08	1.08	1.08	
19	.31	.31	.31	.31	.31	.31	.31	.31	.31	.31	.31	.31	.31	.31	.31	
20	.07	.07	.07	.07	.07	.07	.07	.07	.07	.07	.07	.07	.07	.07	.07	
21	.05	.05	.05	.05	.05	.05	.05	.05	.05	.05	.05	.05	.05	.05	.05	
22	-.47	-.47	-.47	-.47	-.47	-.47	-.47	-.47	-.47	-.47	-.47	-.47	-.47	-.47	-.47	
23	-.51	-.51	-.51	-.51	-.51	-.51	-.51	-.51	-.51	-.51	-.51	-.51	-.51	-.51	-.51	
24	-.38	-.38	-.38	-.38	-.38	-.38	-.38	-.38	-.38	-.38	-.38	-.38	-.38	-.38	-.38	
25	-.56	-.56	-.56	-.56	-.56	-.56	-.56	-.56	-.56	-.56	-.56	-.56	-.56	-.56	-.56	
26	-.54	-.54	-.54	-.54	-.54	-.54	-.54	-.54	-.54	-.54	-.54	-.54	-.54	-.54	-.54	
27	-.29	-.29	-.29	-.29	-.29	-.29	-.29	-.29	-.29	-.29	-.29	-.29	-.29	-.29	-.29	
28	-.34	-.34	-.34	-.34	-.34	-.34	-.34	-.34	-.34	-.34	-.34	-.34	-.34	-.34	-.34	
29	-.29	-.29	-.29	-.29	-.29	-.29	-.29	-.29	-.29	-.29	-.29	-.29	-.29	-.29	-.29	
30	-.20	-.20	-.20	-.20	-.20	-.20	-.20	-.20	-.20	-.20	-.20	-.20	-.20	-.20	-.20	
31	-.44	-.44	-.44	-.44	-.44	-.44	-.44	-.44	-.44	-.44	-.44	-.44	-.44	-.44	-.44	
32	-.48	-.48	-.48	-.48	-.48	-.48	-.48	-.48	-.48	-.48	-.48	-.48	-.48	-.48	-.48	
33	-.20	-.20	-.20	-.20	-.20	-.20	-.20	-.20	-.20	-.20	-.20	-.20	-.20	-.20	-.20	
34	-.13	-.13	-.13	-.13	-.13	-.13	-.13	-.13	-.13	-.13	-.13	-.13	-.13	-.13	-.13	
35	-.12	-.12	-.12	-.12	-.12	-.12	-.12	-.12	-.12	-.12	-.12	-.12	-.12	-.12	-.12	
36	.16	.16	.16	.16	.16	.16	.16	.16	.16	.16	.16	.16	.16	.16	.16	
37	-.07	-.07	-.07	-.07	-.07	-.07	-.07	-.07	-.07	-.07	-.07	-.07	-.07	-.07	-.07	
38	-.11	-.11	-.11	-.11	-.11	-.11	-.11	-.11	-.11	-.11	-.11	-.11	-.11	-.11	-.11	
39	.38	.38	.38	.38	.38	.38	.38	.38	.38	.38	.38	.38	.38	.38	.38	
40	.08	.08	.08	.08	.08	.08	.08	.08	.08	.08	.08	.08	.08	.08	.08	
41	-.01	-.01	-.01	-.01	-.01	-.01	-.01	-.01	-.01	-.01	-.01	-.01	-.01	-.01	-.01	
42	.15	.15	.15	.15	.15	.15	.15	.15	.15	.15	.15	.15	.15	.15	.15	
43	.05	.05	.05	.05	.05	.05	.05	.05	.05	.05	.05	.05	.05	.05	.05	
44	-.18	-.18	-.18	-.18	-.18	-.18	-.18	-.18	-.18	-.18	-.18	-.18	-.18	-.18	-.18	
45	.09	.09	.09	.09	.09	.09	.09	.09	.09	.09	.09	.09	.09	.09	.09	
46	.41	.41	.41	.41	.41	.41	.41	.41	.41	.41	.41	.41	.41	.41	.41	
47	.29	.29	.29	.29	.29	.29	.29	.29	.29	.29	.29	.29	.29	.29	.29	
48	.65	.65	.65	.65	.65	.65	.65	.65	.65	.65	.65	.65	.65	.65	.65	
49	.60	.60	.60	.60	.60	.60	.60	.60	.60	.60	.60	.60	.60	.60	.60	
50	.38	.38	.38	.38	.38	.38	.38	.38	.38	.38	.38	.38	.38	.38	.38	
51	.32	.32	.32	.32	.32	.32	.32	.32	.32	.32	.32	.32	.32	.32	.32	
52	.36	.36	.36	.36	.36	.36	.36	.36	.36	.36	.36	.36	.36	.36	.36	
53	.11	.11	.11	.11	.11	.11	.11	.11	.11	.11	.11	.11	.11	.11	.11	
54	.35	.35	.35	.35	.35	.35	.35	.35	.35	.35	.35	.35	.35	.35	.35	
55	.26	.26	.26	.26	.26	.26	.26	.26	.26	.26	.26	.26	.26	.26	.26	
56	.38	.38	.38	.38	.38	.38	.38	.38	.38	.38	.38	.38	.38	.38	.38	
57	.56	.56	.56	.56	.56	.56	.56	.56	.56	.56	.56	.56	.56	.56	.56	
58	.25	.25	.25	.25	.25	.25	.25	.25	.25	.25	.25	.25	.25	.25	.25	
59	.73	.73	.73	.73	.73	.73	.73	.73	.73	.73	.73	.73	.73	.73	.73	
60	1.19	1.19	1.19	1.19	1.19	1.19	1.19	1.19	1.19	1.19	1.19	1.19	1.19	1.19	1.19	
61	1.26	1.26	1.26	1.26	1.26	1.26	1.26	1.26	1.26	1.26	1.26	1.26	1.26	1.26	1.26	
62	2.55	2.55	2.55	2.55	2.55	2.55	2.55	2.55	2.55	2.55	2.55	2.55	2.55	2.55	2.55	

162
 UNIDENTIFIED SCANNED

S.P.	NOAA-10 SCANNER OFFSETS FOR OCTOBER, NOVEMBER, DECEMBER 1986:											TOTAL				CHANNEL (AZIMUTH=35 DEGREES)			
	DAY OF MONTH -->											26	27	28	29	30			
	16	17	18	19	20	21	22	23	24	25	26	27	28	29	30				
1	.66	.66	.66	.66	.66	.66	.66	.66	.66	.66	.66	.66	.66	.66	.66				
2	.62	.62	.62	.62	.62	.62	.62	.62	.62	.62	.62	.62	.62	.62	.62				
3	.77	.77	.77	.77	.77	.77	.77	.77	.77	.77	.77	.77	.77	.77	.77				
4	1.00	1.00	1.00	1.00	1.00	1.00	1.00	1.00	1.00	1.00	1.00	1.00	1.00	1.00	1.00				
5	-1.16	-1.16	-1.16	-1.16	-1.16	-1.16	-1.16	-1.16	-1.16	-1.16	-1.16	-1.16	-1.16	-1.16	-1.16				
6	-.23	-.23	-.23	-.23	-.23	-.23	-.23	-.23	-.23	-.23	-.23	-.23	-.23	-.23	-.23				
7	.40	.40	.40	.40	.40	.40	.40	.40	.40	.40	.40	.40	.40	.40	.40				
8	1.04	1.04	1.04	1.04	1.04	1.04	1.04	1.04	1.04	1.04	1.04	1.04	1.04	1.04	1.04				
9	1.64	1.64	1.64	1.64	1.64	1.64	1.64	1.64	1.64	1.64	1.64	1.64	1.64	1.64	1.64				
10	1.55	1.55	1.55	1.55	1.55	1.55	1.55	1.55	1.55	1.55	1.55	1.55	1.55	1.55	1.55				
11	1.60	1.60	1.60	1.60	1.60	1.60	1.60	1.60	1.60	1.60	1.60	1.60	1.60	1.60	1.60				
12	1.57	1.57	1.57	1.57	1.57	1.57	1.57	1.57	1.57	1.57	1.57	1.57	1.57	1.57	1.57				
13	1.42	1.42	1.42	1.42	1.42	1.42	1.42	1.42	1.42	1.42	1.42	1.42	1.42	1.42	1.42				
14	.96	.96	.96	.96	.96	.96	.96	.96	.96	.96	.96	.96	.96	.96	.96				
15	1.11	1.11	1.11	1.11	1.11	1.11	1.11	1.11	1.11	1.11	1.11	1.11	1.11	1.11	1.11				
16	.85	.85	.85	.85	.85	.85	.85	.85	.85	.85	.85	.85	.85	.85	.85				
17	.74	.74	.74	.74	.74	.74	.74	.74	.74	.74	.74	.74	.74	.74	.74				
18	1.08	1.08	1.08	1.08	1.08	1.08	1.08	1.08	1.08	1.08	1.08	1.08	1.08	1.08	1.08				
19	.31	.31	.31	.31	.31	.31	.31	.31	.31	.31	.31	.31	.31	.31	.31				
20	.07	.07	.07	.07	.07	.07	.07	.07	.07	.07	.07	.07	.07	.07	.07				
21	.05	.05	.05	.05	.05	.05	.05	.05	.05	.05	.05	.05	.05	.05	.05				
22	-.47	-.47	-.47	-.47	-.47	-.47	-.47	-.47	-.47	-.47	-.47	-.47	-.47	-.47	-.47				
23	-.51	-.51	-.51	-.51	-.51	-.51	-.51	-.51	-.51	-.51	-.51	-.51	-.51	-.51	-.51				
24	-.38	-.38	-.38	-.38	-.38	-.38	-.38	-.38	-.38	-.38	-.38	-.38	-.38	-.38	-.38				
25	-.56	-.56	-.56	-.56	-.56	-.56	-.56	-.56	-.56	-.56	-.56	-.56	-.56	-.56	-.56				
26	-.54	-.54	-.54	-.54	-.54	-.54	-.54	-.54	-.54	-.54	-.54	-.54	-.54	-.54	-.54				
27	-.29	-.29	-.29	-.29	-.29	-.29	-.29	-.29	-.29	-.29	-.29	-.29	-.29	-.29	-.29				
28	-.34	-.34	-.34	-.34	-.34	-.34	-.34	-.34	-.34	-.34	-.34	-.34	-.34	-.34	-.34				
29	-.29	-.29	-.29	-.29	-.29	-.29	-.29	-.29	-.29	-.29	-.29	-.29	-.29	-.29	-.29				
30	-.20	-.20	-.20	-.20	-.20	-.20	-.20	-.20	-.20	-.20	-.20	-.20	-.20	-.20	-.20				
31	-.44	-.44	-.44	-.44	-.44	-.44	-.44	-.44	-.44	-.44	-.44	-.44	-.44	-.44	-.44				
32	-.48	-.48	-.48	-.48	-.48	-.48	-.48	-.48	-.48	-.48	-.48	-.48	-.48	-.48	-.48				
33	-.20	-.20	-.20	-.20	-.20	-.20	-.20	-.20	-.20	-.20	-.20	-.20	-.20	-.20	-.20				
34	-.13	-.13	-.13	-.13	-.13	-.13	-.13	-.13	-.13	-.13	-.13	-.13	-.13	-.13	-.13				
35	-.12	-.12	-.12	-.12	-.12	-.12	-.12	-.12	-.12	-.12	-.12	-.12	-.12	-.12	-.12				
36	.16	.16	.16	.16	.16	.16	.16	.16	.16	.16	.16	.16	.16	.16	.16				
37	-.07	-.07	-.07	-.07	-.07	-.07	-.07	-.07	-.07	-.07	-.07	-.07	-.07	-.07	-.07				
38	-.11	-.11	-.11	-.11	-.11	-.11	-.11	-.11	-.11	-.11	-.11	-.11	-.11	-.11	-.11				
39	.38	.38	.38	.38	.38	.38	.38	.38	.38	.38	.38	.38	.38	.38	.38				
40	.08	.08	.08	.08	.08	.08	.08	.08	.08	.08	.08	.08	.08	.08	.08				
41	-.01	-.01	-.01	-.01	-.01	-.01	-.01	-.01	-.01	-.01	-.01	-.01	-.01	-.01	-.01				
42	.15	.15	.15	.15	.15	.15	.15	.15	.15	.15	.15	.15	.15	.15	.15				
43	.05	.05	.05	.05	.05	.05	.05	.05	.05	.05	.05	.05	.05	.05	.05				
44	-.18	-.18	-.18	-.18	-.18	-.18	-.18	-.18	-.18	-.18	-.18	-.18	-.18	-.18	-.18				
45	.09	.09	.09	.09	.09	.09	.09	.09	.09	.09	.09	.09	.09	.09	.09				
46	.41	.41	.41	.41	.41	.41	.41	.41	.41	.41	.41	.41	.41	.41	.41				
47	.29	.29	.29	.29	.29	.29	.29	.29	.29	.29	.29	.29	.29	.29	.29				
48	.65	.65	.65	.65	.65	.65	.65	.65	.65	.65	.65	.65	.65	.65	.65				
49	.60	.60	.60	.60	.60	.60	.60	.60	.60	.60	.60	.60	.60	.60	.60				
50	.38	.38	.38	.38	.38	.38	.38	.38	.38	.38	.38	.38	.38	.38	.38				
51	.32	.32	.32	.32	.32	.32	.32	.32	.32	.32	.32	.32	.32	.32	.32				
52	.36	.36	.36	.36	.36	.36	.36	.36	.36	.36	.36	.36	.36	.36	.36				
53	.11	.11	.11	.11	.11	.11	.11	.11	.11	.11	.11	.11	.11	.11	.11				
54	.35	.35	.35	.35	.35	.35	.35	.35	.35	.35	.35	.35	.35	.35	.35				
55	.26	.26	.26	.26	.26	.26	.26	.26	.26	.26	.26	.26	.26	.26	.26				
56	.38	.38	.38	.38	.38	.38	.38	.38	.38	.38	.38	.38	.38	.38	.38				
57	.56	.56	.56	.56	.56	.56	.56	.56	.56	.56	.56	.56	.56	.56	.56				
58	.25	.25	.25	.25	.25	.25	.25	.25	.25	.25	.25	.25	.25	.25	.25				
59	.73	.73	.73	.73	.73	.73	.73	.73	.73	.73	.73	.73	.73	.73	.73				
60	1.19	1.19	1.19	1.19	1.19	1.19	1.19	1.19	1.19	1.19	1.19	1.19	1.19	1.19	1.19				
61	1.26	1.26	1.26	1.26	1.26	1.26	1.26	1.26	1.26	1.26	1.26	1.26	1.26	1.26	1.26				
62	2.55	2.55	2.55	2.55	2.55	2.55	2.55	2.55	2.55	2.55	2.55	2.55	2.55	2.55	2.55				

NOAA-10 SCANNER OFFSETS FOR OCTOBER, NOVEMBER, DECEMBER 1986: SHORTWAVE CHANNEL (AZIMUTH=35 DEGREES)
 DAY OF MONTH -->

S.P.	1	2	3	4	5	6	7	8	9	10	11	12	13	14	15
1	.29	.29	.29	.29	.29	.29	.29	.29	.29	.29	.29	.29	.29	.29	.29
2	.58	.58	.58	.58	.58	.58	.58	.58	.58	.58	.58	.58	.58	.58	.58
3	.70	.70	.70	.70	.70	.70	.70	.70	.70	.70	.70	.70	.70	.70	.70
4	.82	.82	.82	.82	.82	.82	.82	.82	.82	.82	.82	.82	.82	.82	.82
5	.08	.08	.08	.08	.08	.08	.08	.08	.08	.08	.08	.08	.08	.08	.08
6	.16	.16	.16	.16	.16	.16	.16	.16	.16	.16	.16	.16	.16	.16	.16
7	1.01	1.01	1.01	1.01	1.01	1.01	1.01	1.01	1.01	1.01	1.01	1.01	1.01	1.01	1.01
8	.41	.41	.41	.41	.41	.41	.41	.41	.41	.41	.41	.41	.41	.41	.41
9	.43	.43	.43	.43	.43	.43	.43	.43	.43	.43	.43	.43	.43	.43	.43
10	1.26	1.26	1.26	1.26	1.26	1.26	1.26	1.26	1.26	1.26	1.26	1.26	1.26	1.26	1.26
11	.52	.52	.52	.52	.52	.52	.52	.52	.52	.52	.52	.52	.52	.52	.52
12	.54	.54	.54	.54	.54	.54	.54	.54	.54	.54	.54	.54	.54	.54	.54
13	1.36	1.36	1.36	1.36	1.36	1.36	1.36	1.36	1.36	1.36	1.36	1.36	1.36	1.36	1.36
14	.62	.62	.62	.62	.62	.62	.62	.62	.62	.62	.62	.62	.62	.62	.62
15	.51	.51	.51	.51	.51	.51	.51	.51	.51	.51	.51	.51	.51	.51	.51
16	1.19	1.19	1.19	1.19	1.19	1.19	1.19	1.19	1.19	1.19	1.19	1.19	1.19	1.19	1.19
17	.41	.41	.41	.41	.41	.41	.41	.41	.41	.41	.41	.41	.41	.41	.41
18	.35	.35	.35	.35	.35	.35	.35	.35	.35	.35	.35	.35	.35	.35	.35
19	1.07	1.07	1.07	1.07	1.07	1.07	1.07	1.07	1.07	1.07	1.07	1.07	1.07	1.07	1.07
20	.30	.30	.30	.30	.30	.30	.30	.30	.30	.30	.30	.30	.30	.30	.30
21	.09	.09	.09	.09	.09	.09	.09	.09	.09	.09	.09	.09	.09	.09	.09
22	.68	.68	.68	.68	.68	.68	.68	.68	.68	.68	.68	.68	.68	.68	.68
23	-.06	-.06	-.06	-.06	-.06	-.06	-.06	-.06	-.06	-.06	-.06	-.06	-.06	-.06	-.06
24	-.08	-.08	-.08	-.08	-.08	-.08	-.08	-.08	-.08	-.08	-.08	-.08	-.08	-.08	-.08
25	.81	.81	.81	.81	.81	.81	.81	.81	.81	.81	.81	.81	.81	.81	.81
26	.01	.01	.01	.01	.01	.01	.01	.01	.01	.01	.01	.01	.01	.01	.01
27	-.02	-.02	-.02	-.02	-.02	-.02	-.02	-.02	-.02	-.02	-.02	-.02	-.02	-.02	-.02
28	.87	.87	.87	.87	.87	.87	.87	.87	.87	.87	.87	.87	.87	.87	.87
29	.10	.10	.10	.10	.10	.10	.10	.10	.10	.10	.10	.10	.10	.10	.10
30	.08	.08	.08	.08	.08	.08	.08	.08	.08	.08	.08	.08	.08	.08	.08
31	.84	.84	.84	.84	.84	.84	.84	.84	.84	.84	.84	.84	.84	.84	.84
32	.11	.11	.11	.11	.11	.11	.11	.11	.11	.11	.11	.11	.11	.11	.11
33	.08	.08	.08	.08	.08	.08	.08	.08	.08	.08	.08	.08	.08	.08	.08
34	.84	.84	.84	.84	.84	.84	.84	.84	.84	.84	.84	.84	.84	.84	.84
35	.07	.07	.07	.07	.07	.07	.07	.07	.07	.07	.07	.07	.07	.07	.07
36	.07	.07	.07	.07	.07	.07	.07	.07	.07	.07	.07	.07	.07	.07	.07
37	.89	.89	.89	.89	.89	.89	.89	.89	.89	.89	.89	.89	.89	.89	.89
38	.14	.14	.14	.14	.14	.14	.14	.14	.14	.14	.14	.14	.14	.14	.14
39	.12	.12	.12	.12	.12	.12	.12	.12	.12	.12	.12	.12	.12	.12	.12
40	.91	.91	.91	.91	.91	.91	.91	.91	.91	.91	.91	.91	.91	.91	.91
41	.00	.00	.00	.00	.00	.00	.00	.00	.00	.00	.00	.00	.00	.00	.00
42	-.15	-.15	-.15	-.15	-.15	-.15	-.15	-.15	-.15	-.15	-.15	-.15	-.15	-.15	-.15
43	.66	.66	.66	.66	.66	.66	.66	.66	.66	.66	.66	.66	.66	.66	.66
44	-.07	-.07	-.07	-.07	-.07	-.07	-.07	-.07	-.07	-.07	-.07	-.07	-.07	-.07	-.07
45	.04	.04	.04	.04	.04	.04	.04	.04	.04	.04	.04	.04	.04	.04	.04
46	.80	.80	.80	.80	.80	.80	.80	.80	.80	.80	.80	.80	.80	.80	.80
47	.04	.04	.04	.04	.04	.04	.04	.04	.04	.04	.04	.04	.04	.04	.04
48	.11	.11	.11	.11	.11	.11	.11	.11	.11	.11	.11	.11	.11	.11	.11
49	.87	.87	.87	.87	.87	.87	.87	.87	.87	.87	.87	.87	.87	.87	.87
50	.11	.11	.11	.11	.11	.11	.11	.11	.11	.11	.11	.11	.11	.11	.11
51	.06	.06	.06	.06	.06	.06	.06	.06	.06	.06	.06	.06	.06	.06	.06
52	.84	.84	.84	.84	.84	.84	.84	.84	.84	.84	.84	.84	.84	.84	.84
53	.09	.09	.09	.09	.09	.09	.09	.09	.09	.09	.09	.09	.09	.09	.09
54	-.03	-.03	-.03	-.03	-.03	-.03	-.03	-.03	-.03	-.03	-.03	-.03	-.03	-.03	-.03
55	.72	.72	.72	.72	.72	.72	.72	.72	.72	.72	.72	.72	.72	.72	.72
56	-.04	-.04	-.04	-.04	-.04	-.04	-.04	-.04	-.04	-.04	-.04	-.04	-.04	-.04	-.04
57	.03	.03	.03	.03	.03	.03	.03	.03	.03	.03	.03	.03	.03	.03	.03
58	.79	.79	.79	.79	.79	.79	.79	.79	.79	.79	.79	.79	.79	.79	.79
59	.43	.43	.43	.43	.43	.43	.43	.43	.43	.43	.43	.43	.43	.43	.43
60	.96	.96	.96	.96	.96	.96	.96	.96	.96	.96	.96	.96	.96	.96	.96
61	1.31	1.31	1.31	1.31	1.31	1.31	1.31	1.31	1.31	1.31	1.31	1.31	1.31	1.31	1.31
62	-2.15	-2.15	-2.15	-2.15	-2.15	-2.15	-2.15	-2.15	-2.15	-2.15	-2.15	-2.15	-2.15	-2.15	-2.15

NOAA-10 SCANNER OFFSETS FOR OCTOBER, NOVEMBER, DECEMBER 1986: SHORTWAVE CHANNEL (AZIMUTH=35 DEGREES)
 DAY OF MONTH -->

S.P.	16	17	18	19	20	21	22	23	24	25	26	27	28	29	30
1	.29	.29	.29	.29	.29	.29	.29	.29	.29	.29	.29	.29	.29	.29	.29
2	.58	.58	.58	.58	.58	.58	.58	.58	.58	.58	.58	.58	.58	.58	.58
3	.70	.70	.70	.70	.70	.70	.70	.70	.70	.70	.70	.70	.70	.70	.70
4	.82	.82	.82	.82	.82	.82	.82	.82	.82	.82	.82	.82	.82	.82	.82
5	.08	.08	.08	.08	.08	.08	.08	.08	.08	.08	.08	.08	.08	.08	.08
6	.16	.16	.16	.16	.16	.16	.16	.16	.16	.16	.16	.16	.16	.16	.16
7	1.01	1.01	1.01	1.01	1.01	1.01	1.01	1.01	1.01	1.01	1.01	1.01	1.01	1.01	1.01
8	.41	.41	.41	.41	.41	.41	.41	.41	.41	.41	.41	.41	.41	.41	.41
9	.43	.43	.43	.43	.43	.43	.43	.43	.43	.43	.43	.43	.43	.43	.43
10	1.26	1.26	1.26	1.26	1.26	1.26	1.26	1.26	1.26	1.26	1.26	1.26	1.26	1.26	1.26
11	.52	.52	.52	.52	.52	.52	.52	.52	.52	.52	.52	.52	.52	.52	.52
12	.54	.54	.54	.54	.54	.54	.54	.54	.54	.54	.54	.54	.54	.54	.54
13	1.36	1.36	1.36	1.36	1.36	1.36	1.36	1.36	1.36	1.36	1.36	1.36	1.36	1.36	1.36
14	.62	.62	.62	.62	.62	.62	.62	.62	.62	.62	.62	.62	.62	.62	.62
15	.51	.51	.51	.51	.51	.51	.51	.51	.51	.51	.51	.51	.51	.51	.51
16	1.19	1.19	1.19	1.19	1.19	1.19	1.19	1.19	1.19	1.19	1.19	1.19	1.19	1.19	1.19
17	.41	.41	.41	.41	.41	.41	.41	.41	.41	.41	.41	.41	.41	.41	.41
18	.35	.35	.35	.35	.35	.35	.35	.35	.35	.35	.35	.35	.35	.35	.35
19	1.07	1.07	1.07	1.07	1.07	1.07	1.07	1.07	1.07	1.07	1.07	1.07	1.07	1.07	1.07
20	.30	.30	.30	.30	.30	.30	.30	.30	.30	.30	.30	.30	.30	.30	.30
21	.09	.09	.09	.09	.09	.09	.09	.09	.09	.09	.09	.09	.09	.09	.09
22	.68	.68	.68	.68	.68	.68	.68	.68	.68	.68	.68	.68	.68	.68	.68
23	-.06	-.06	-.06	-.06	-.06	-.06	-.06	-.06	-.06	-.06	-.06	-.06	-.06	-.06	-.06
24	-.08	-.08	-.08	-.08	-.08	-.08	-.08	-.08	-.08	-.08	-.08	-.08	-.08	-.08	-.08
25	.81	.81	.81	.81	.81	.81	.81	.81	.81	.81	.81	.81	.81	.81	.81
26	.01	.01	.01	.01	.01	.01	.01	.01	.01	.01	.01	.01	.01	.01	.01
27	-.02	-.02	-.02	-.02	-.02	-.02	-.02	-.02	-.02	-.02	-.02	-.02	-.02	-.02	-.02
28	.87	.87	.87	.87	.87	.87	.87	.87	.87	.87	.87	.87	.87	.87	.87
29	.10	.10	.10	.10	.10	.10	.10	.10	.10	.10	.10	.10	.10	.10	.10
30	.08	.08	.08	.08	.08	.08	.08	.08	.08	.08	.08	.08	.08	.08	.08
31	.84	.84	.84	.84	.84	.84	.84	.84	.84	.84	.84	.84	.84	.84	.84
32	.11	.11	.11	.11	.11	.11	.11	.11	.11	.11	.11	.11	.11	.11	.11
33	.08	.08	.08	.08	.08	.08	.08	.08	.08	.08	.08	.08	.08	.08	.08
34	.84	.84	.84	.84	.84	.84	.84	.84	.84	.84	.84	.84	.84	.84	.84
35	.07	.07	.07	.07	.07	.07	.07	.07	.07	.07	.07	.07	.07	.07	.07
36	.07	.07	.07	.07	.07	.07	.07	.07	.07	.07	.07	.07	.07	.07	.07
37	.89	.89	.89	.89	.89	.89	.89	.89	.89	.89	.89	.89	.89	.89	.89
38	.14	.14	.14	.14	.14	.14	.14	.14	.14	.14	.14	.14	.14	.14	.14
39	.12	.12	.12	.12	.12	.12	.12	.12	.12	.12	.12	.12	.12	.12	.12
40	.91	.91	.91	.91	.91	.91	.91	.91	.91	.91	.91	.91	.91	.91	.91
41	.00	.00	.00	.00	.00	.00	.00	.00	.00	.00	.00	.00	.00	.00	.00
42	-.15	-.15	-.15	-.15	-.15	-.15	-.15	-.15	-.15	-.15	-.15	-.15	-.15	-.15	-.15
43	.66	.66	.66	.66	.66	.66	.66	.66	.66	.66	.66	.66	.66	.66	.66
44	-.07	-.07	-.07	-.07	-.07	-.07	-.07	-.07	-.07	-.07	-.07	-.07	-.07	-.07	-.07
45	.04	.04	.04	.04	.04	.04	.04	.04	.04	.04	.04	.04	.04	.04	.04
46	.80	.80	.80	.80	.80	.80	.80	.80	.80	.80	.80	.80	.80	.80	.80
47	.04	.04	.04	.04	.04	.04	.04	.04	.04	.04	.04	.04	.04	.04	.04
48	.11	.11	.11	.11	.11	.11	.11	.11	.11	.11	.11	.11	.11	.11	.11
49	.87	.87	.87	.87	.87	.87	.87	.87	.87	.87	.87	.87	.87	.87	.87
50	.11	.11	.11	.11	.11	.11	.11	.11	.11	.11	.11	.11	.11	.11	.11
51	.06	.06	.06	.06	.06	.06	.06	.06	.06	.06	.06	.06	.06	.06	.06
52	.84	.84	.84	.84	.84	.84	.84	.84	.84	.84	.84	.84	.84	.84	.84
53	.09	.09	.09	.09	.09	.09	.09	.09	.09	.09	.09	.09	.09	.09	.09
54	-.03	-.03	-.03	-.03	-.03	-.03	-.03	-.03	-.03	-.03	-.03	-.03	-.03	-.03	-.03
55	.72	.72	.72	.72	.72	.72	.72	.72	.72	.72	.72	.72	.72	.72	.72
56	-.04	-.04	-.04	-.04	-.04	-.04	-.04	-.04	-.04	-.04	-.04	-.04	-.04	-.04	-.04
57	.03	.03	.03	.03	.03	.03	.03	.03	.03	.03	.03	.03	.03	.03	.03
58	.79	.79	.79	.79	.79	.79	.79	.79	.79	.79	.79	.79	.79	.79	.79
59	.43	.43	.43	.43	.43	.43	.43	.43	.43	.43	.43	.43	.43	.43	.43
60	.96	.96	.96	.96	.96	.96	.96	.96	.96	.96	.96	.96	.96	.96	.96
61	1.31	1.31	1.31	1.31	1.31	1.31	1.31	1.31	1.31	1.31	1.31	1.31	1.31	1.31	1.31
62	-2.15	-2.15	-2.15	-2.15	-2.15	-2.15	-2.15	-2.15	-2.15	-2.15	-2.15	-2.15	-2.15	-2.15	-2.15

APPENDIX D

ERBS SCANNER OFFSET PLOTS

APPENDIX D: ERBS SCANNER OFFSET PLOTS

The plots in this section are standard "x,y" plots of scan position vs. offset for the total, longwave, and shortwave sensors. The scanner offsets for the ERBS are invariant over time; but they vary with scanner azimuth position, and, thus, there is a set for the "cross-track" (or "normal" mode) and a set for the "along-track" mode.

Figure

ERBS Cross-Track, October 1984 - December 1985	D-1
ERBS Along-Track, January and August 1985	D-2

This page has been intentionally left blank

ERBS TOTAL CHANNEL SCANNER OFFSETS (CROSS-TRACK)
 16-28 JANUARY & 7-14 AUGUST 1985

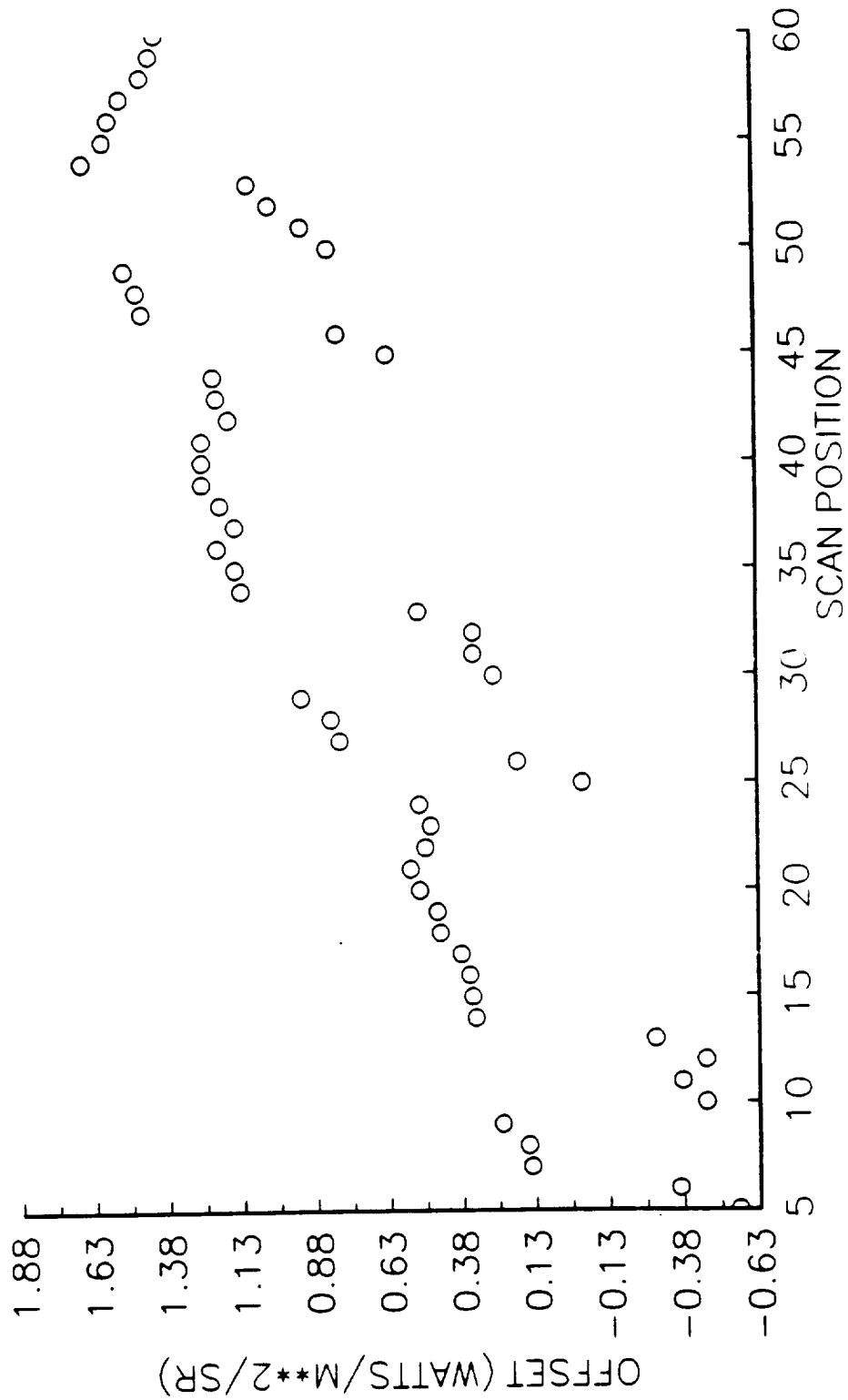

ERBS LONGWAVE CHANNEL SCANNER OFFSETS (CROSS-TRACK)
 (EXCLUDING 16-28 JANUARY & 7-14 AUGUST 1985)

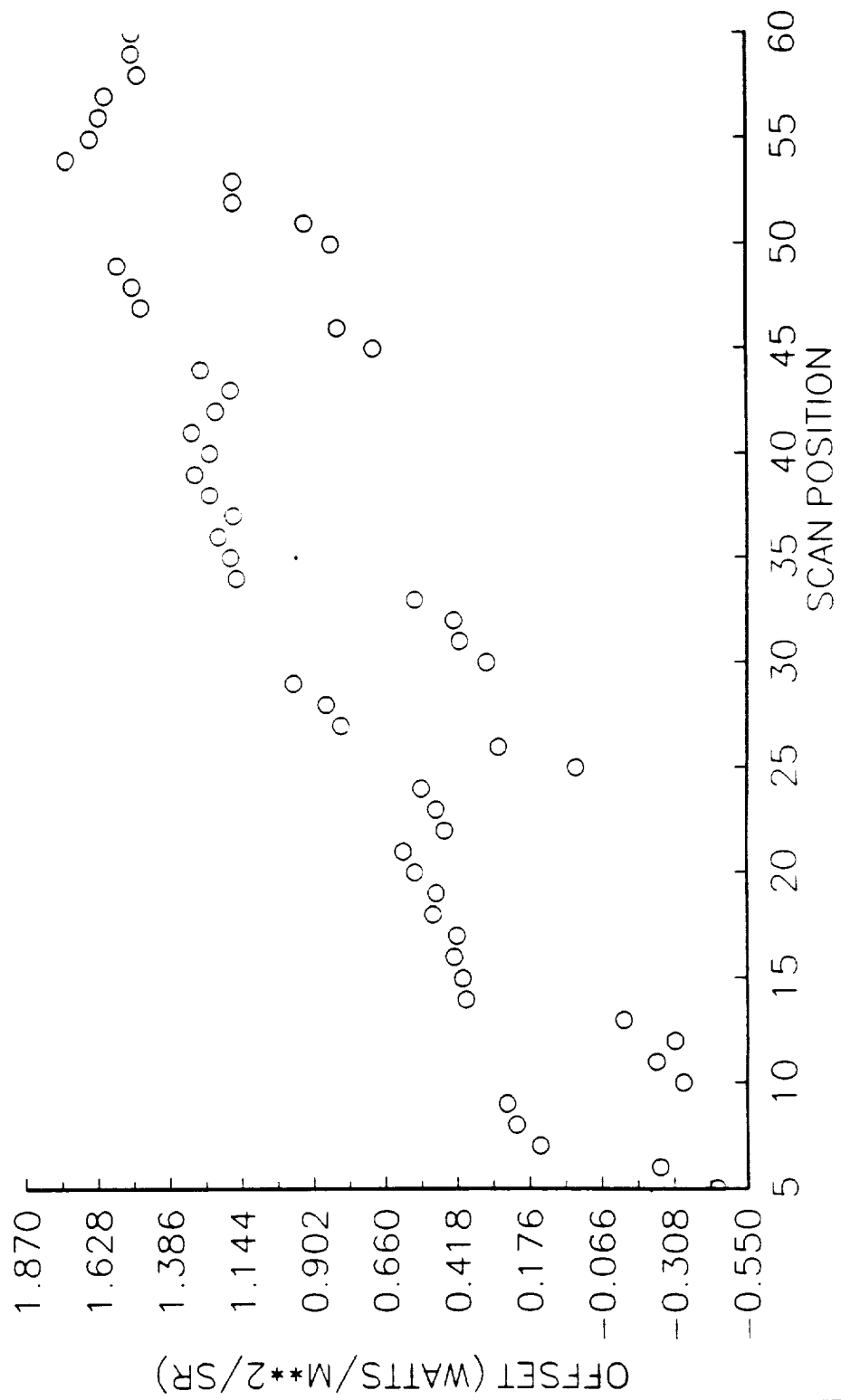

ERBS SHORTWAVE CHANNEL SCANNER OFFSETS (CROSS-TRACK)
(EXCLUDING 16-28 JANUARY & 7-14 AUGUST 1985)

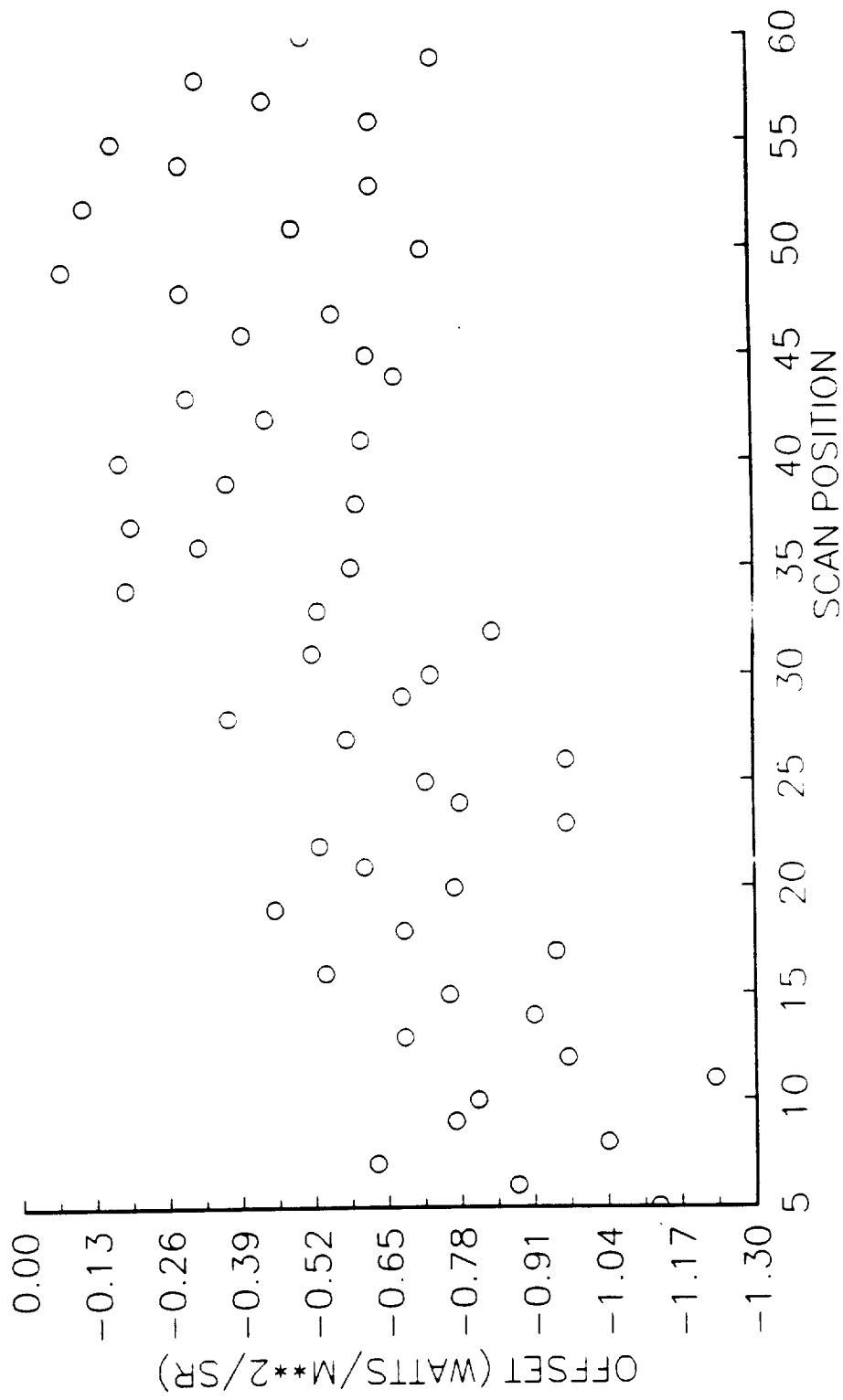

ERBS TOTAL CHANNEL SCANNER OFFSETS (ALONG - TRACK)
16-28 JANUARY & 7-14 AUGUST 1985

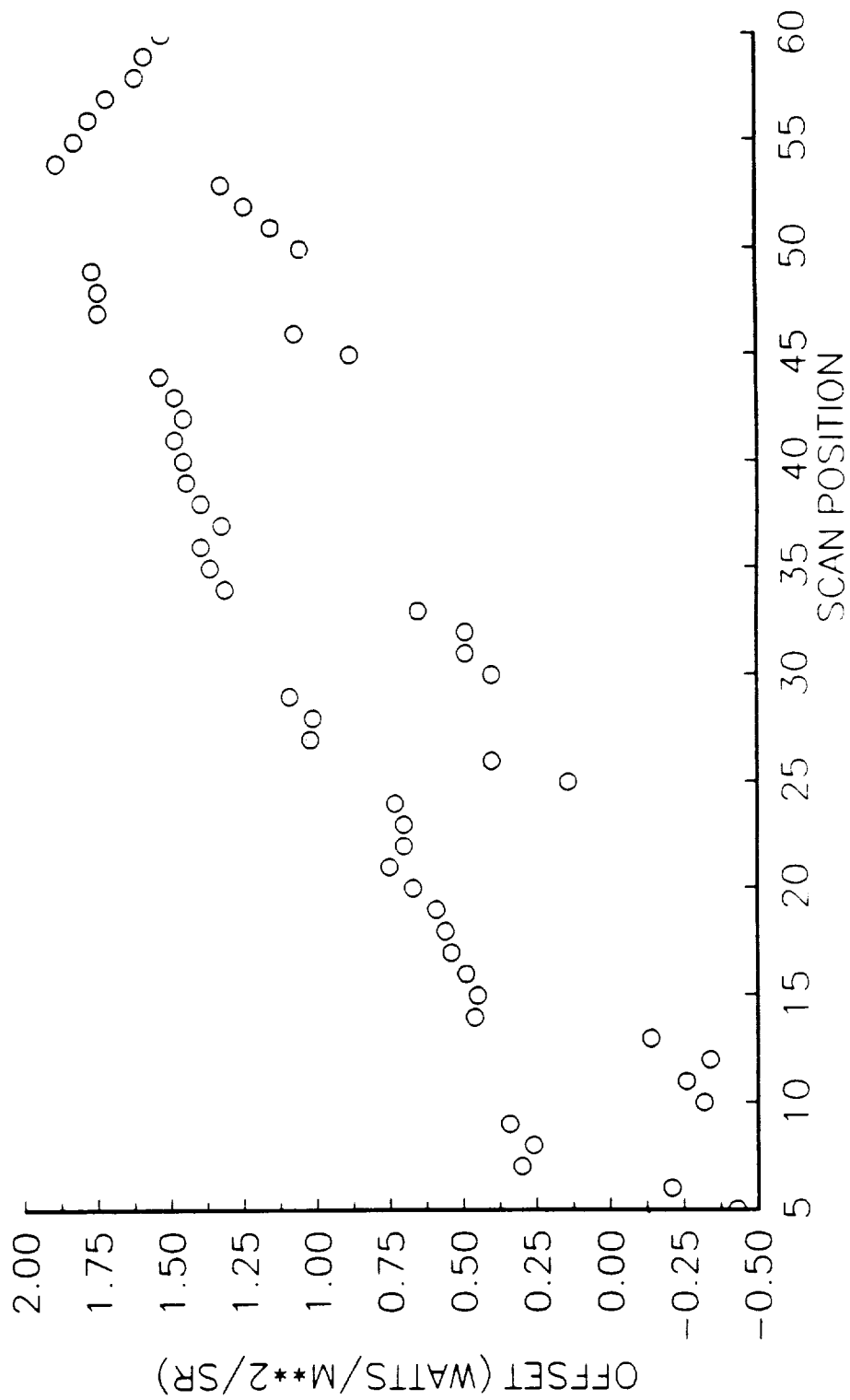

ERBS LONGWAVE CHANNEL SCANNER OFFSETS (ALONG-TRACK)
16-28 JANUARY & 7-14 AUGUST 1985

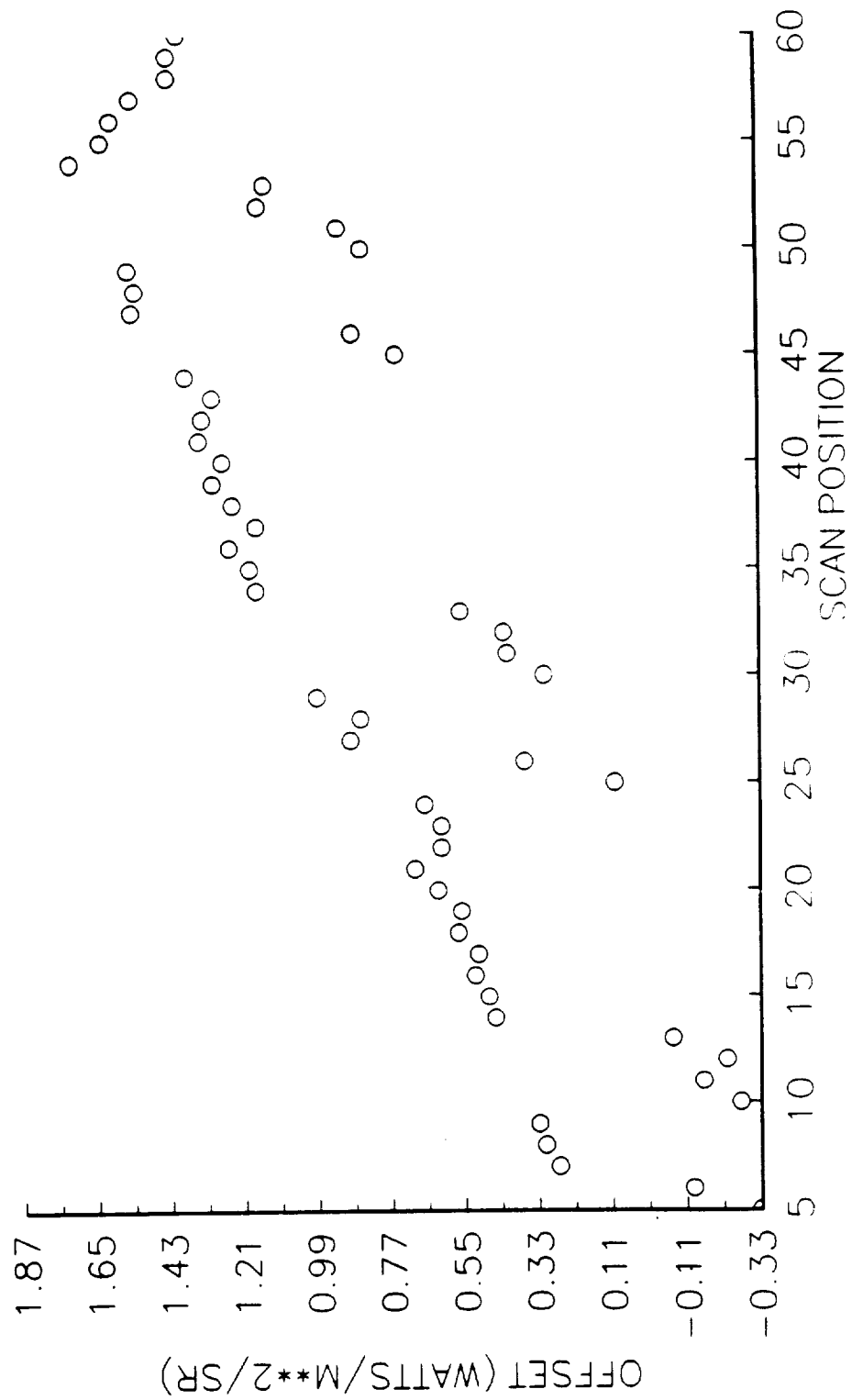

ERBS SHORTWAVE CHANNEL SCANNER OFFSETS (ALONG-TRACK)
16-28 JANUARY & 7-14 AUGUST 1985

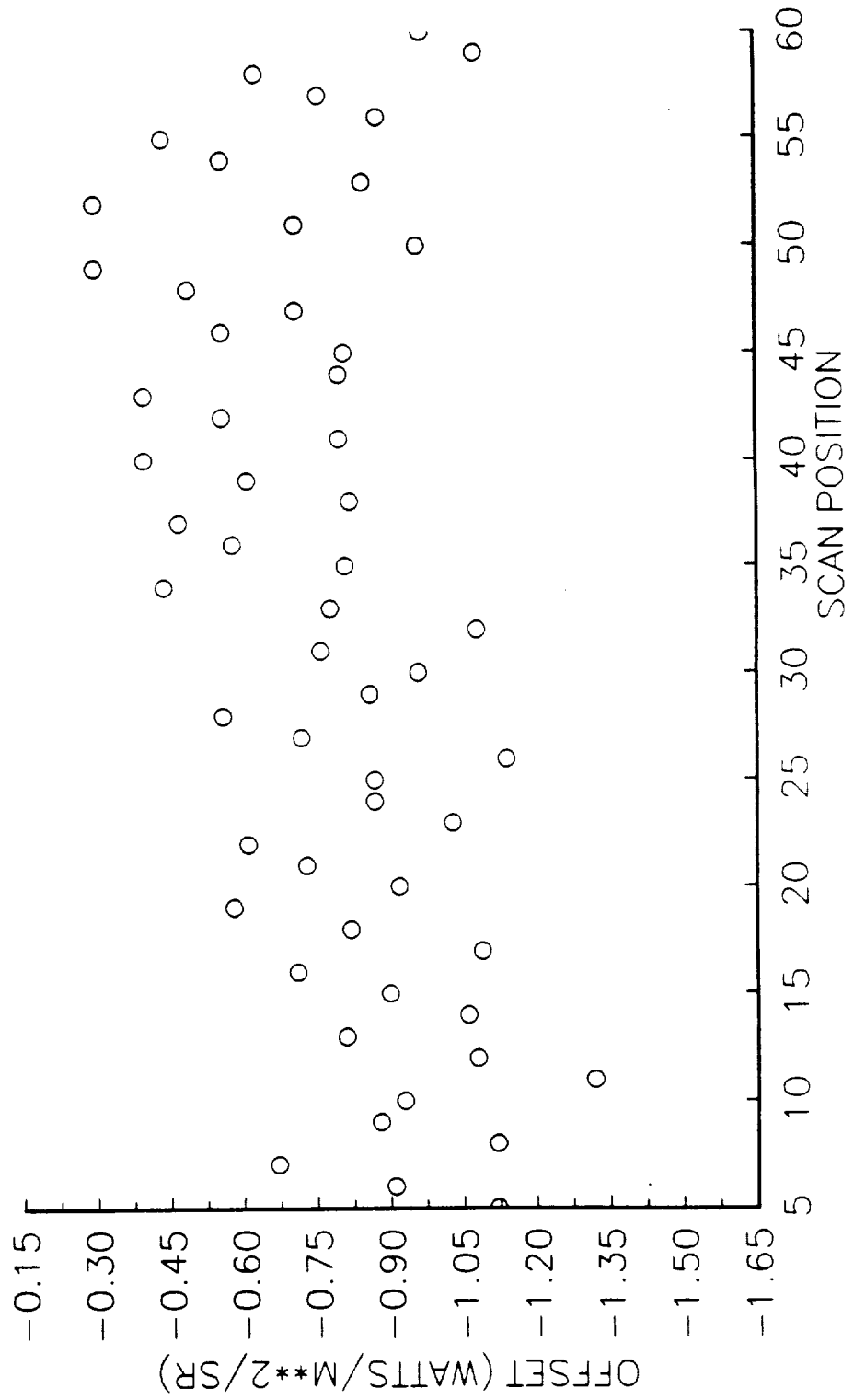

APPENDIX E

NOAA-9 SCANNER OFFSET SURFACE PLOTS

APPENDIX E: NOAA-9 SCANNER OFFSET SURFACE PLOTS

The following plots show the total, longwave, and shortwave NOAA-9 scanner offsets used during each applicable month of 1985 and 1986. The x-axis is in units of Earth-viewing scan position. The y-axis is in units of day-of-month, and the z-axis is in units of Watts/m²/steradian. Missing data are plotted as zero.

Figure

February 1985	E-1
March 1985	E-2
April 1985	E-3
May 1985	E-4
June 1985	E-5
July 1985	E-6
August 1985	E-7
September 1985	E-8
October 1985	E-9
November 1985	E-10
December 1985	E-11
January 1986	E-12
February 1986	E-13
March 1986	E-14
April 1986	E-15
May 1986	E-16
June 1986	E-17
July 1986	E-18
August 1986	E-19
September 1986	E-20
October 1986	E-21
November 1986	E-22
December 1986	E-23

This page has been intentionally left blank

TOTAL OFFSETS
NOAA-9, FEBRUARY 1985

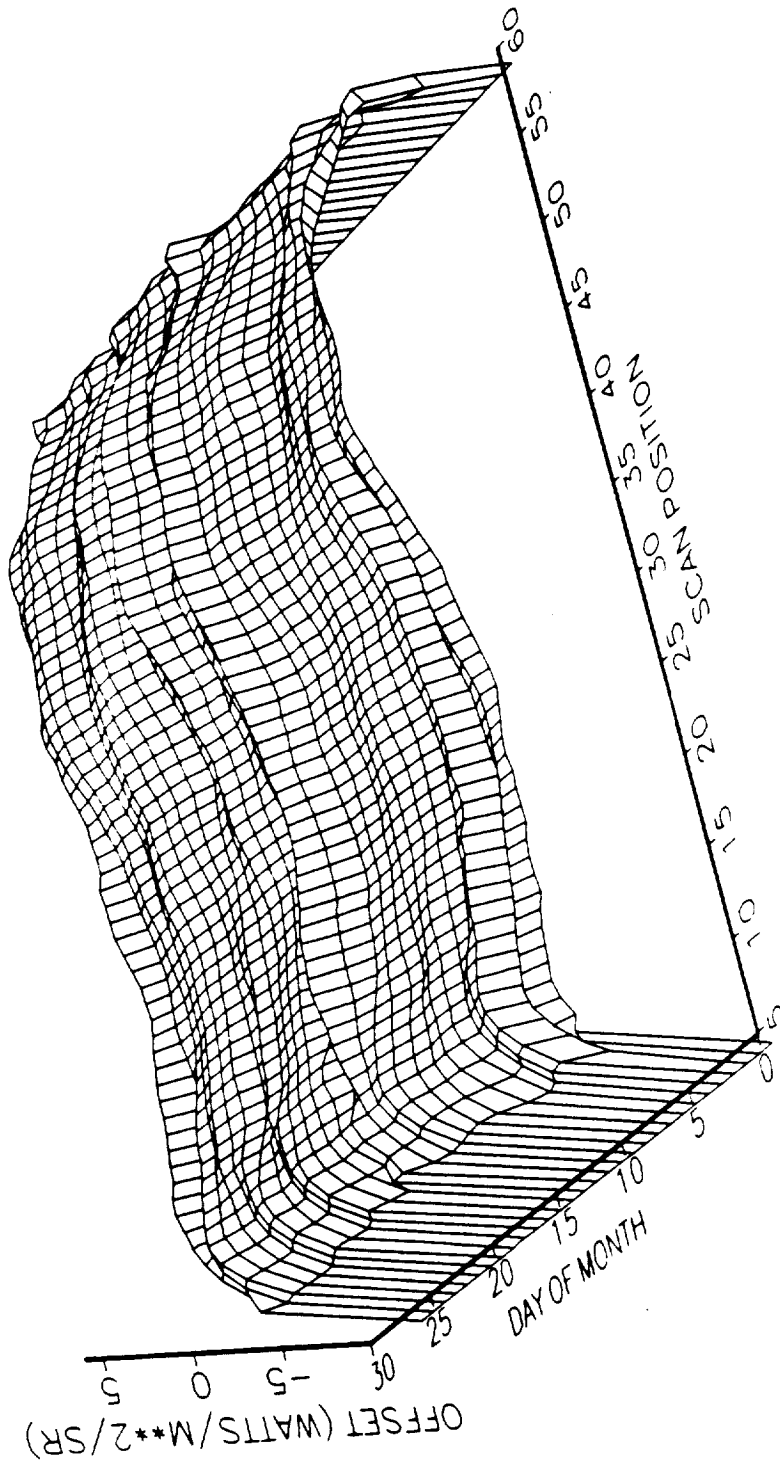

LONGWAVE OFFSETS
NOAA - 9, FEBRUARY 1985

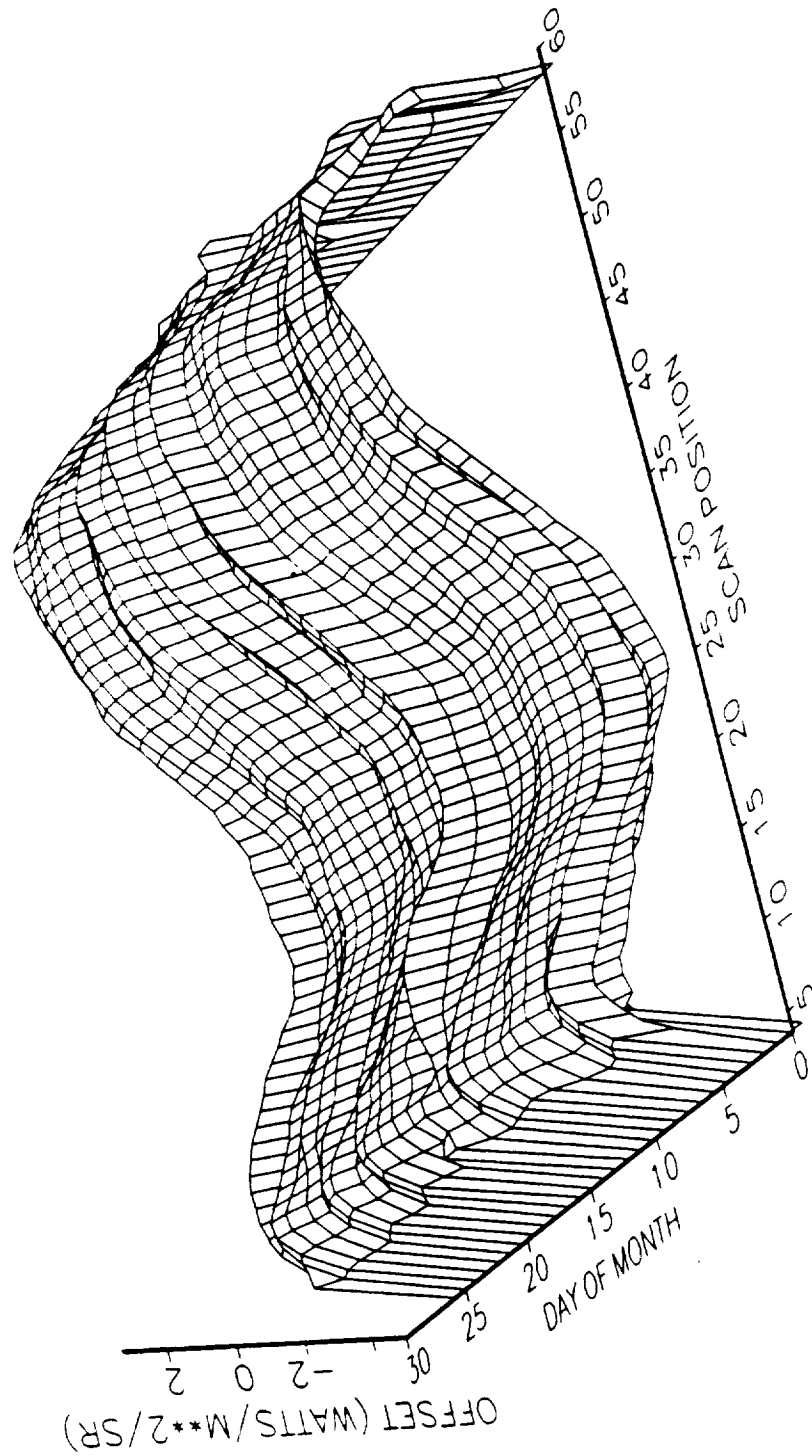

SHORTWAVE OFFSETS
NOMA-9, FEBRUARY 1985

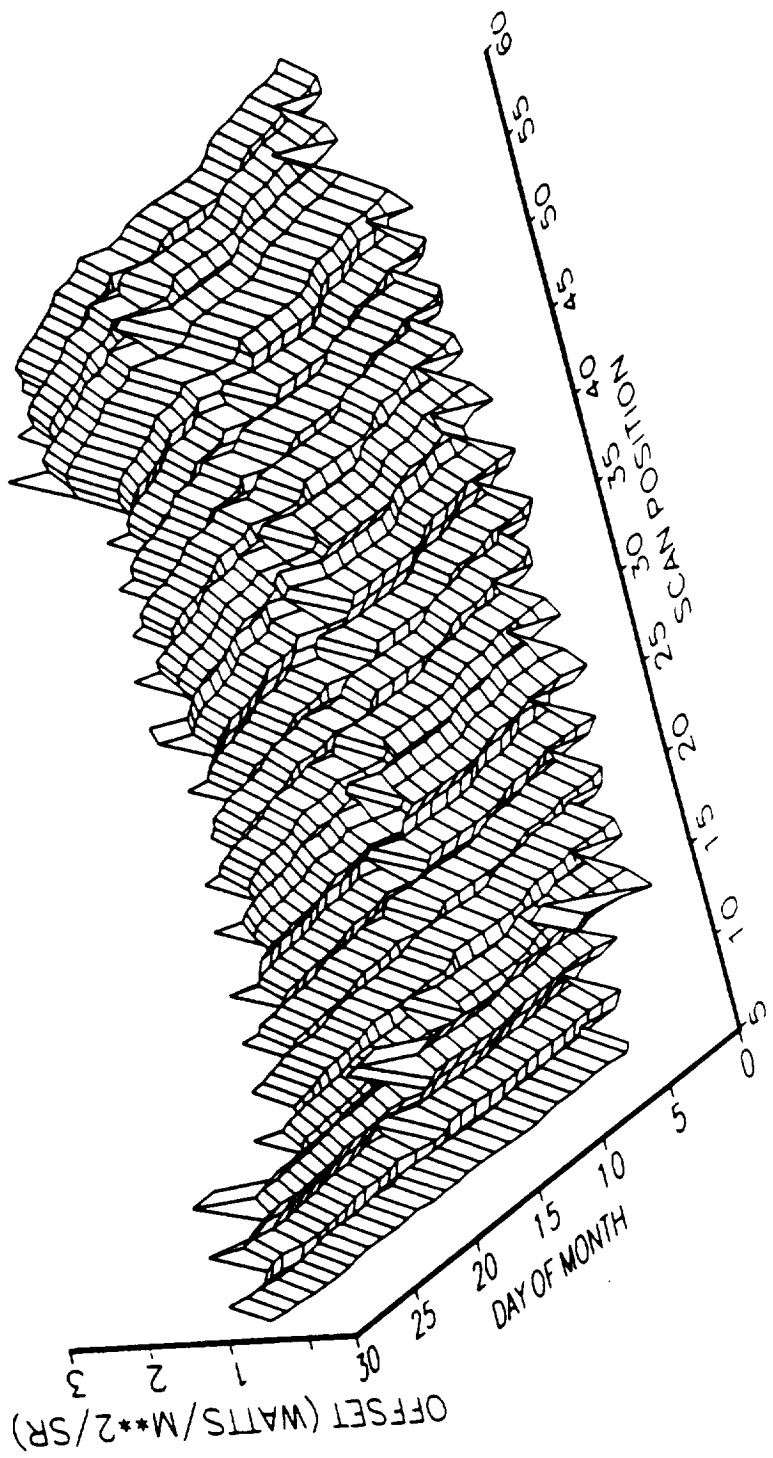

TOTAL OFFSETS
NOAA-9, MARCH 1985

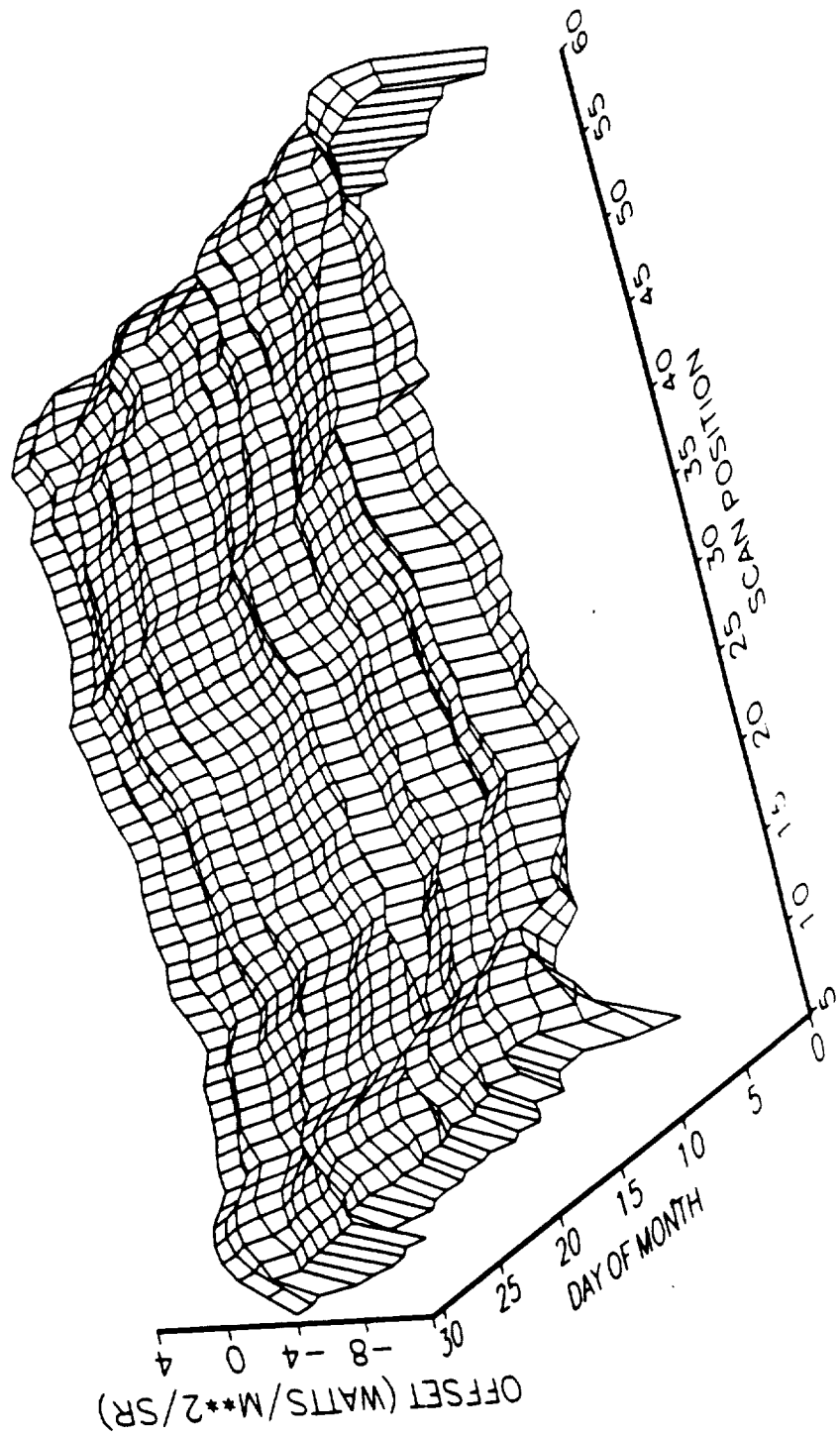

LONGWAVE OFFSETS
NOAA-9, MARCH 1985

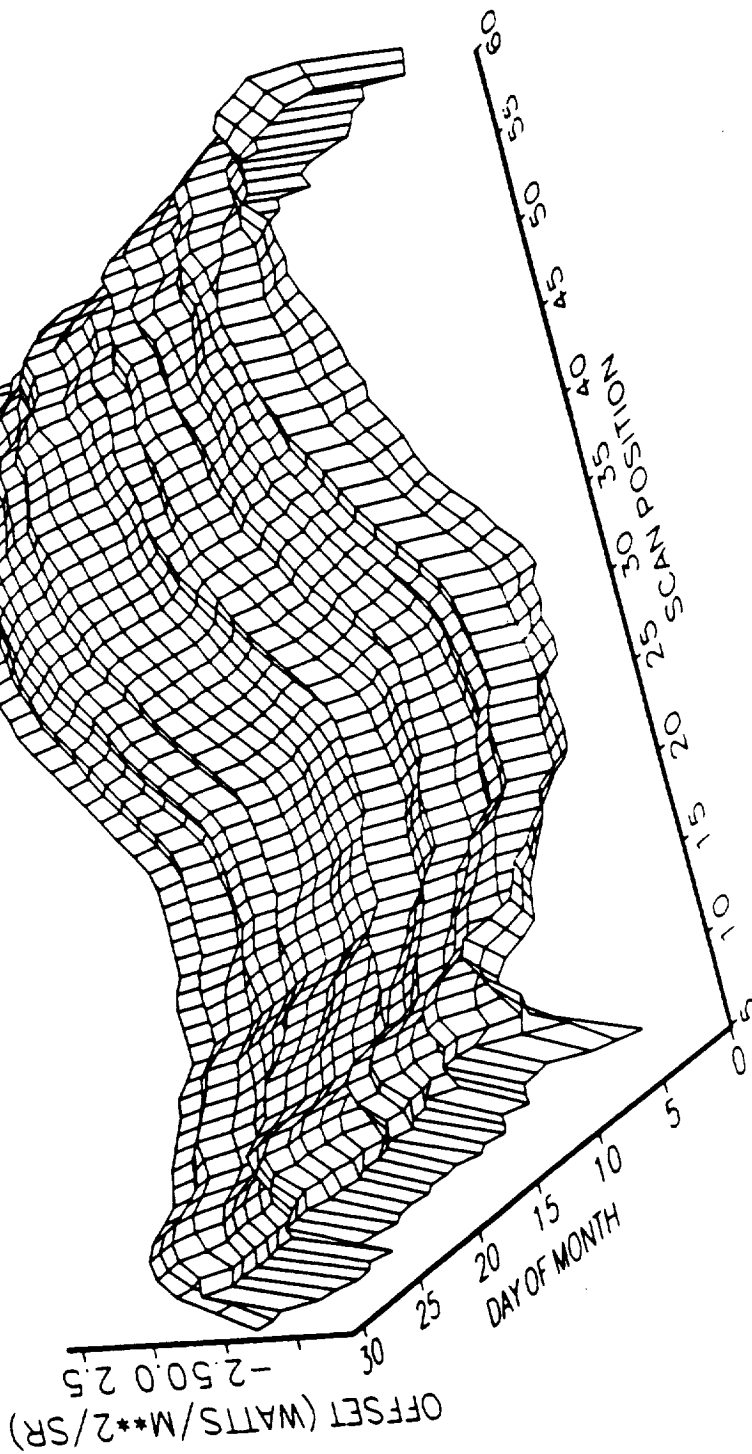

SHORTWAVE OFFSETS
NOAA-9, MARCH 1985

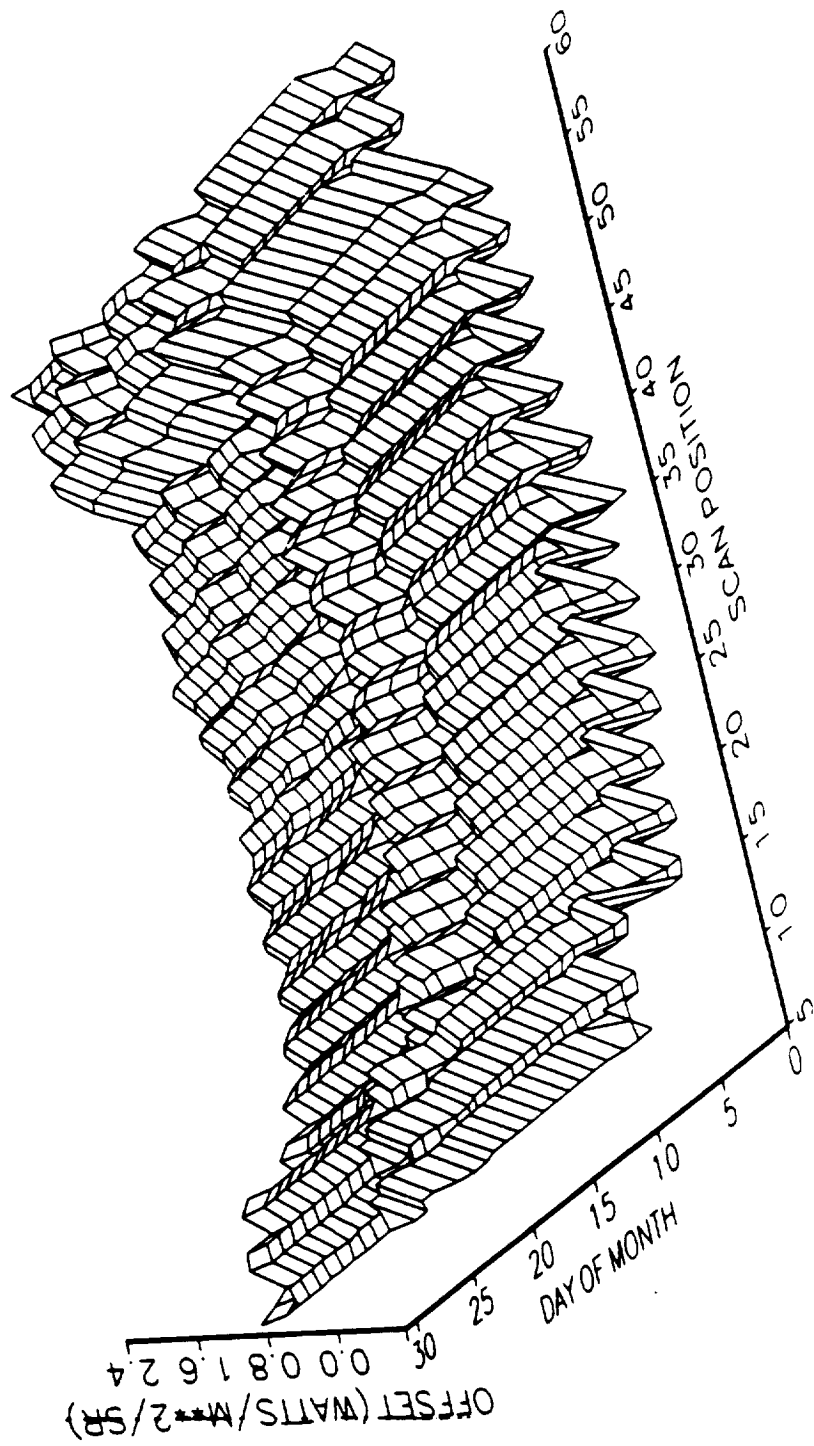

TOTAL OFFSETS
NOAA-9, APRIL 1985

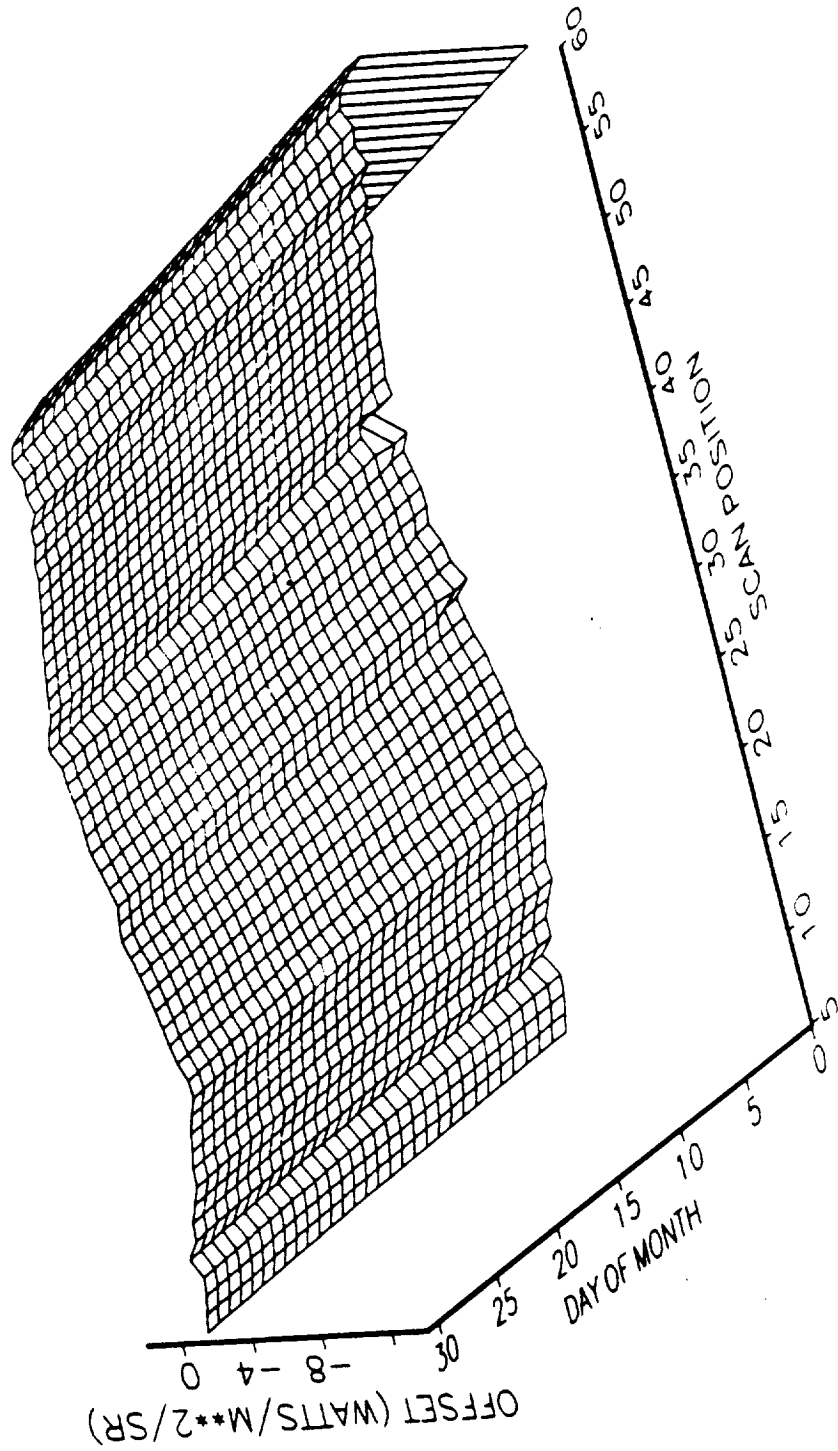

LONGWAVE OFFSETS
NOAA-9, APRIL 1985

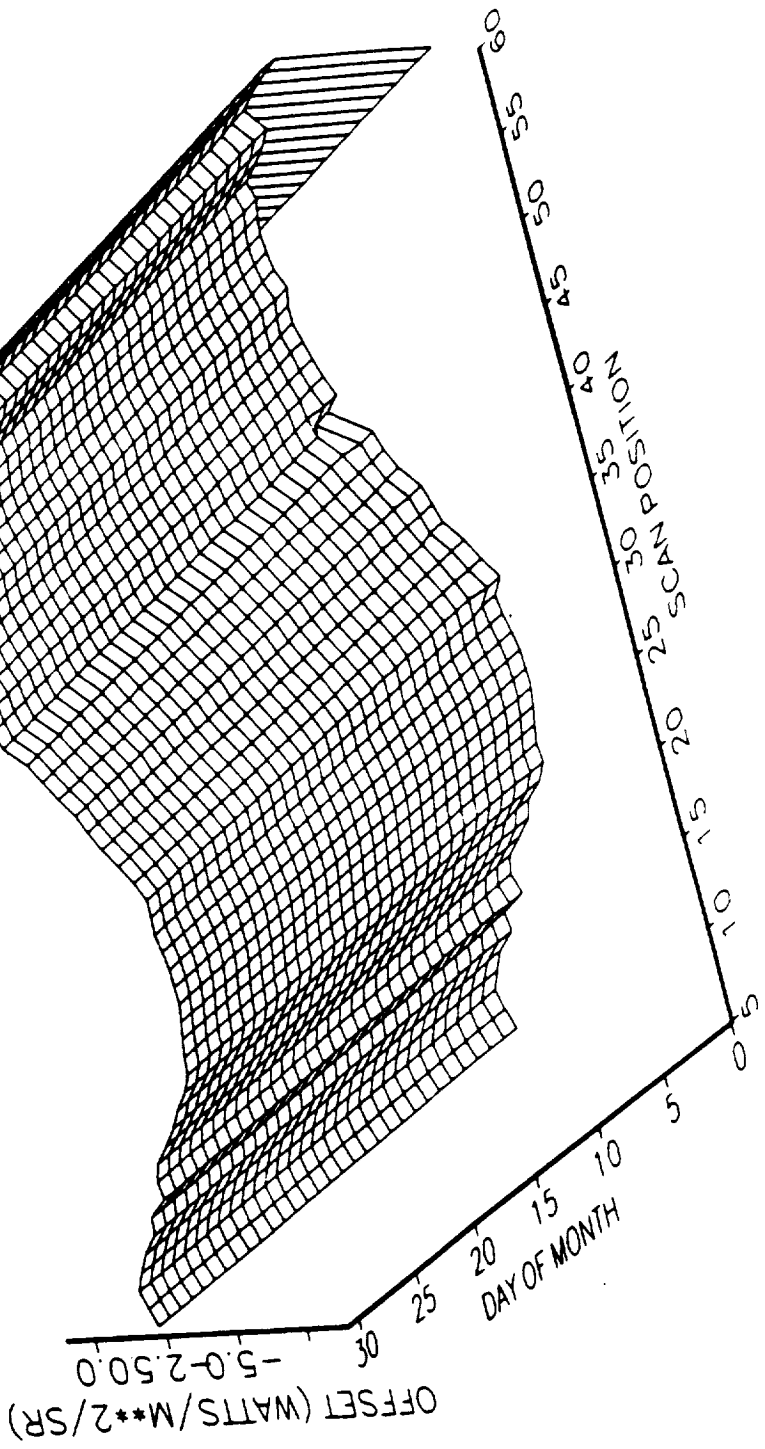

SHORTWAVE OFFSETS
NOAA-9, APRIL 1985

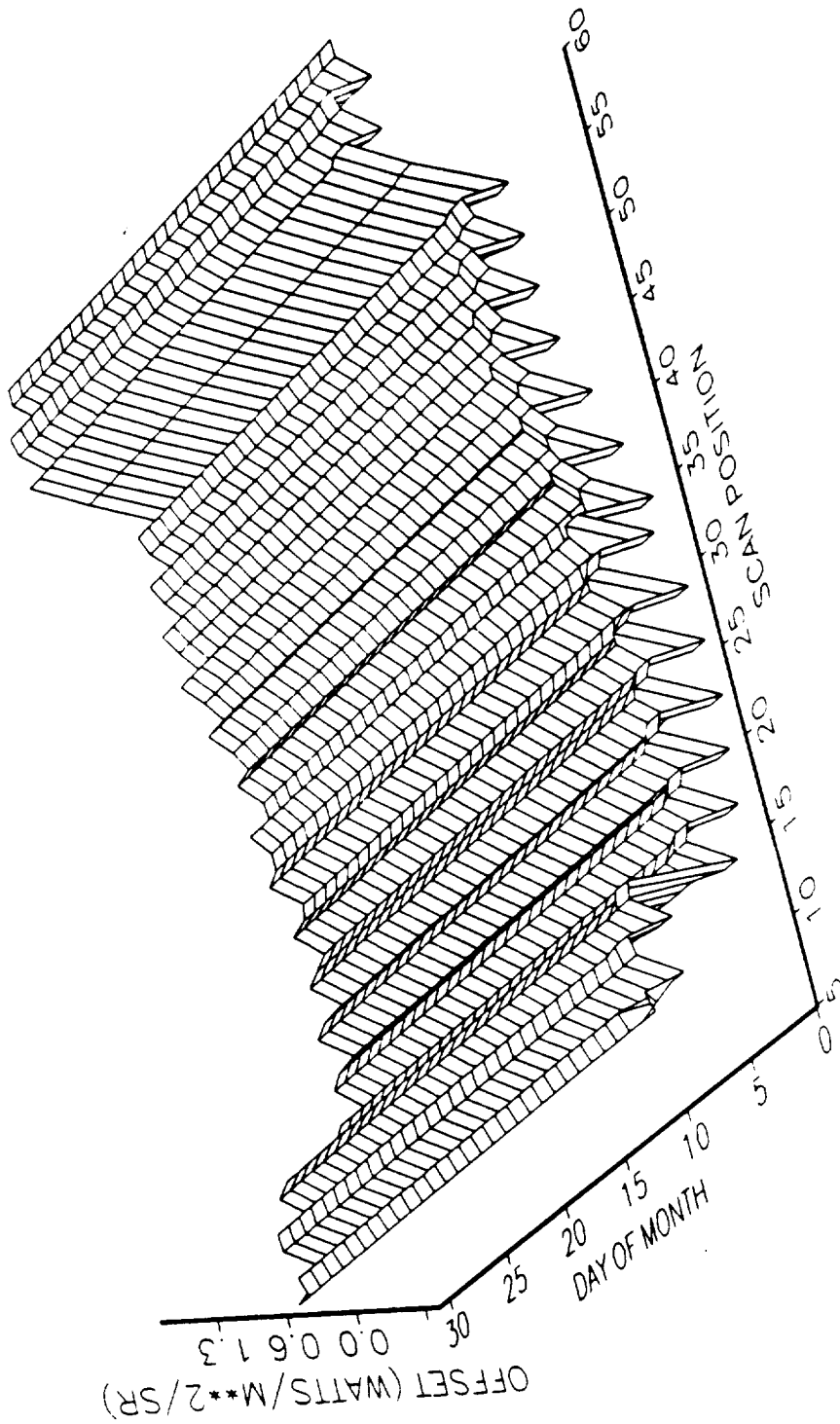

TOTAL OFFSETS
NOAA-9, MAY 1985

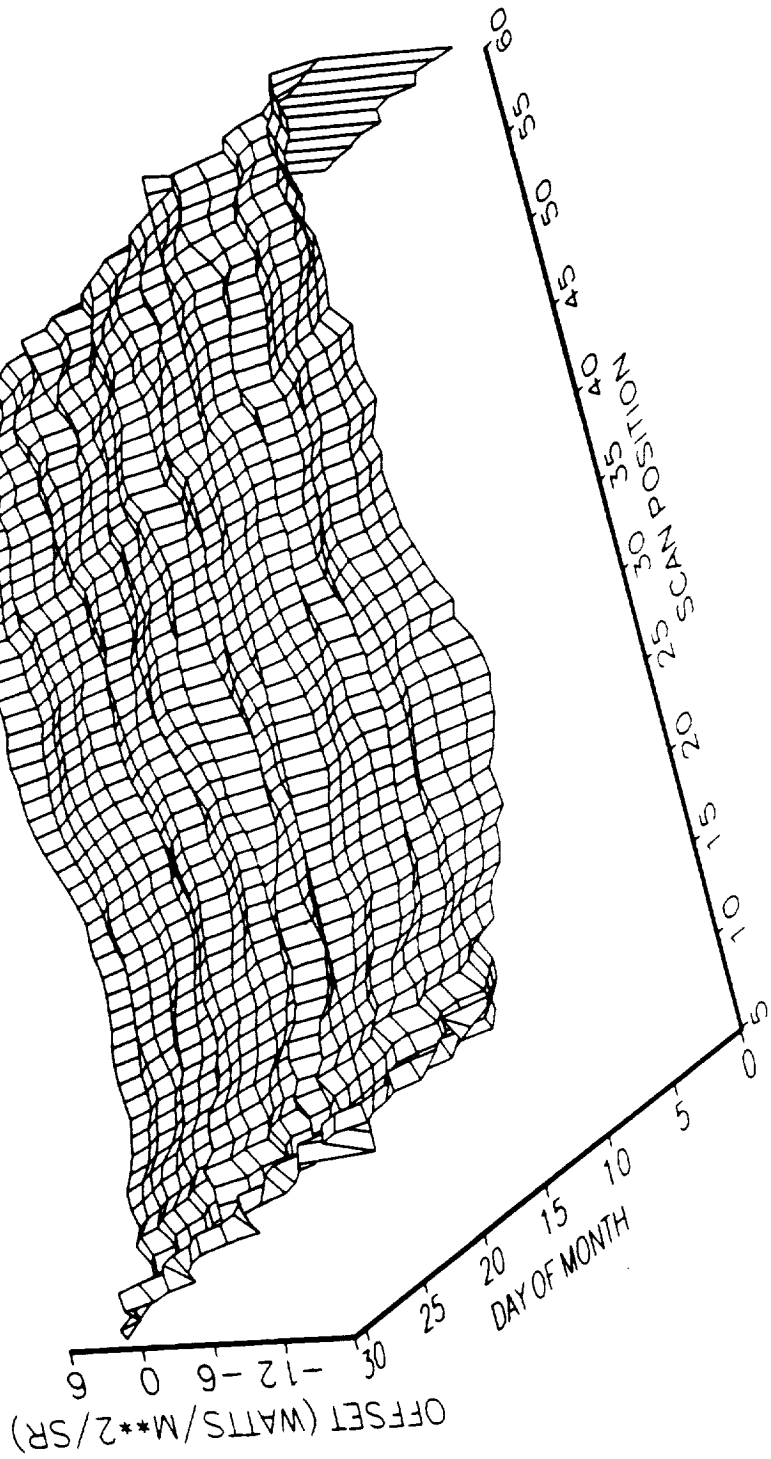

LONGWAVE OFFSETS
NOAA-9, MAY 1985

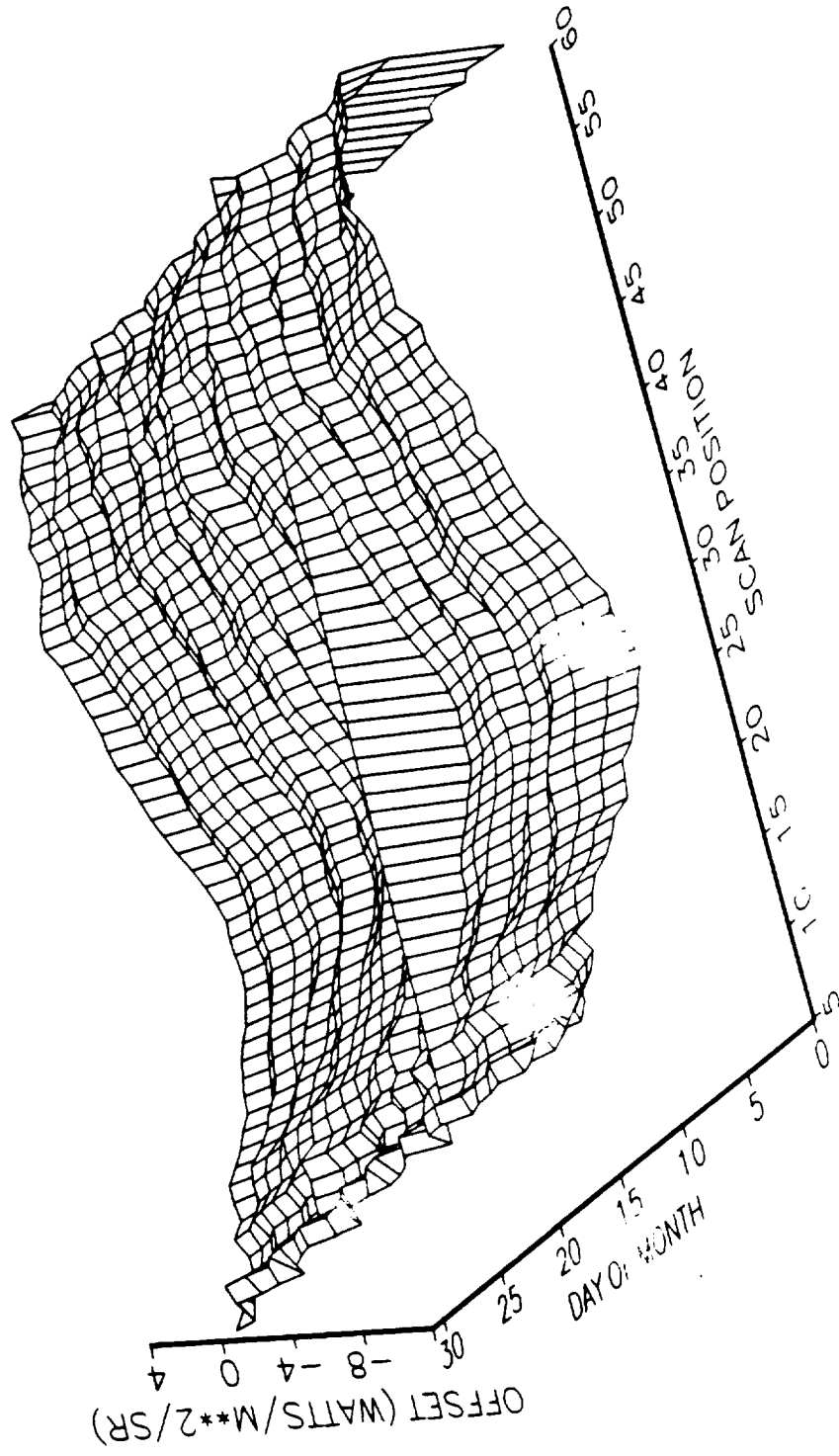

SHORTWAVE OFFSETS
NOAA-9, MAY 1985

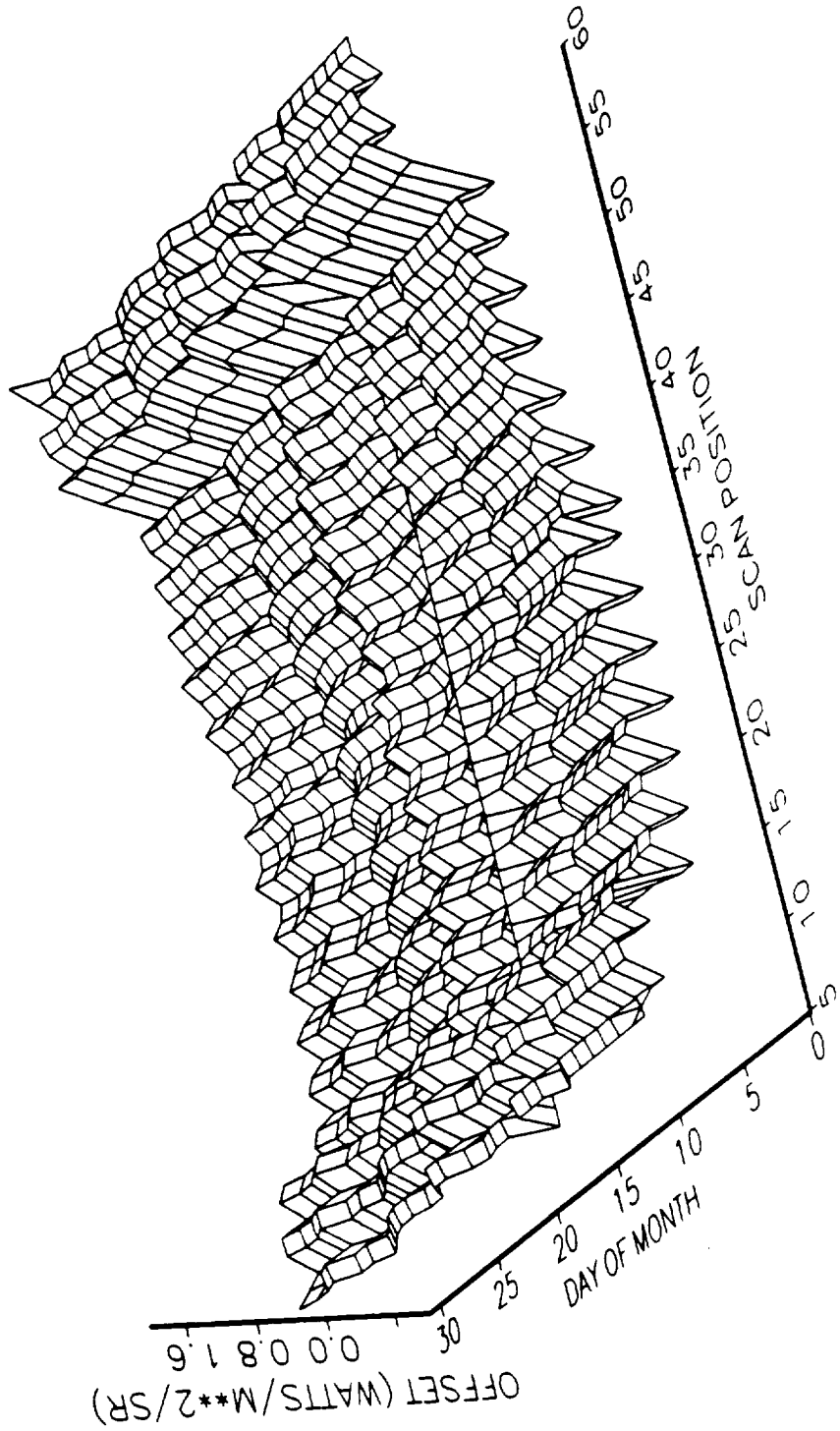

TOTAL OFFSETS
NOAA-9, JUNE 1985

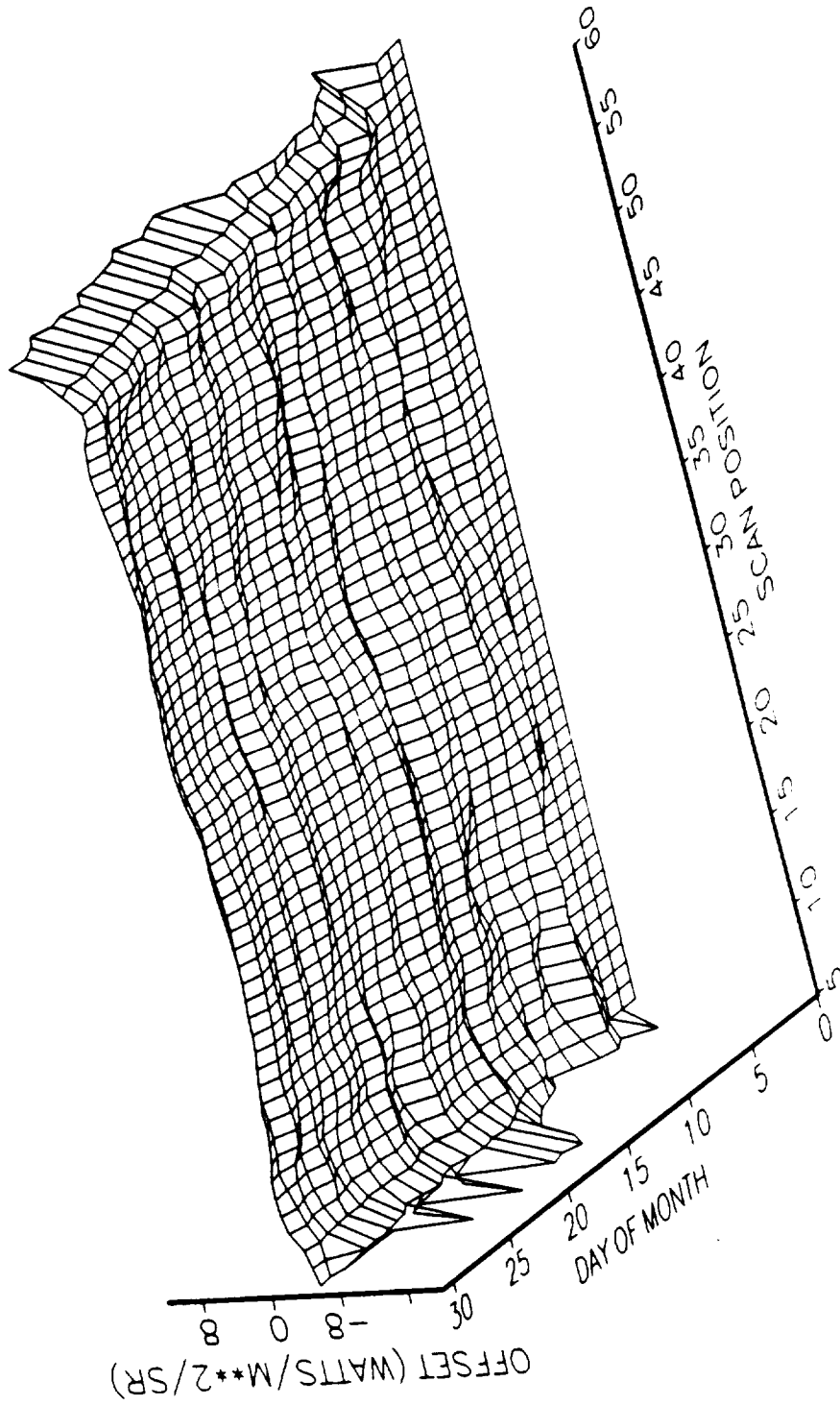

LONGWAVE OFFSETS
NOAA-9, JUNE 1985

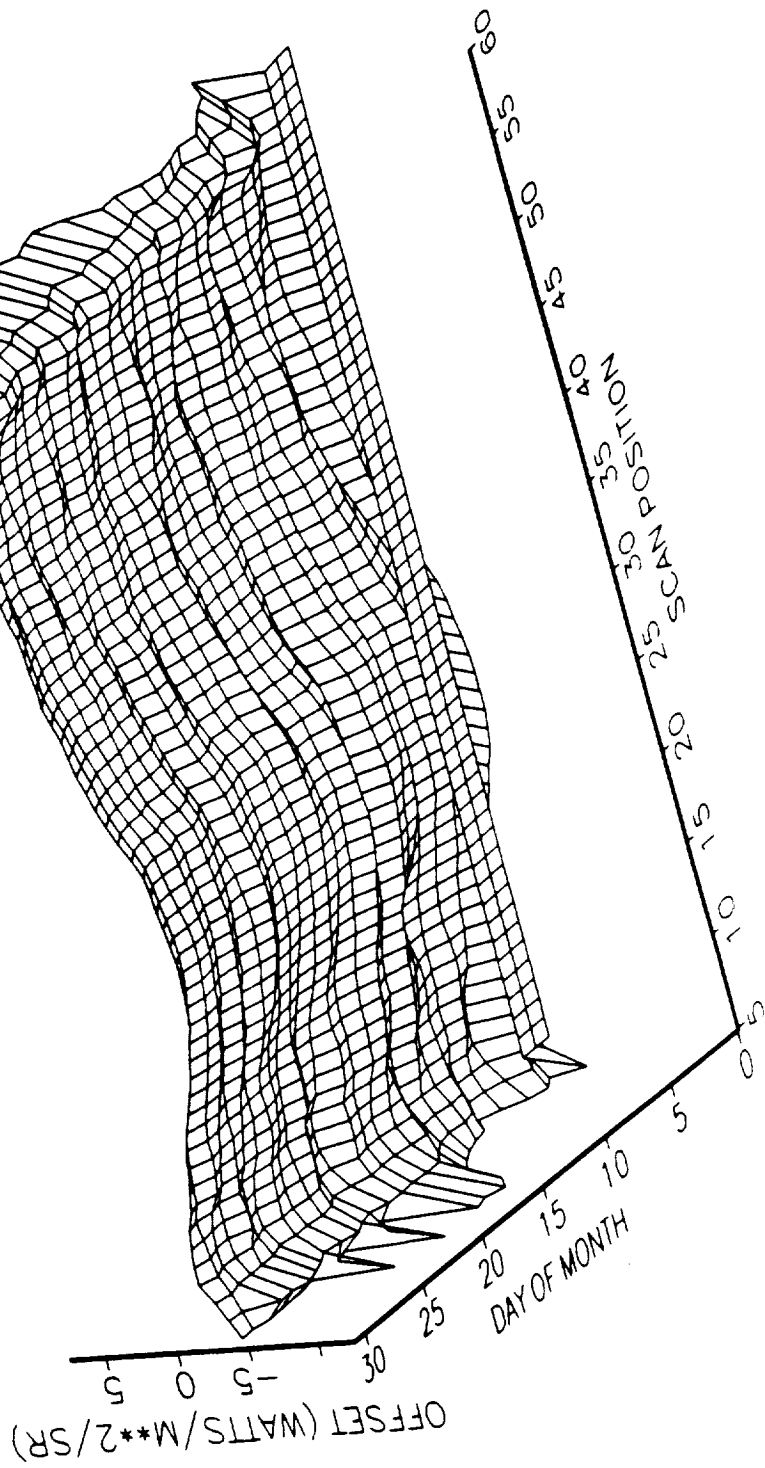

SHORTWAVE OFFSETS
NOAA-9, JUNE 1985

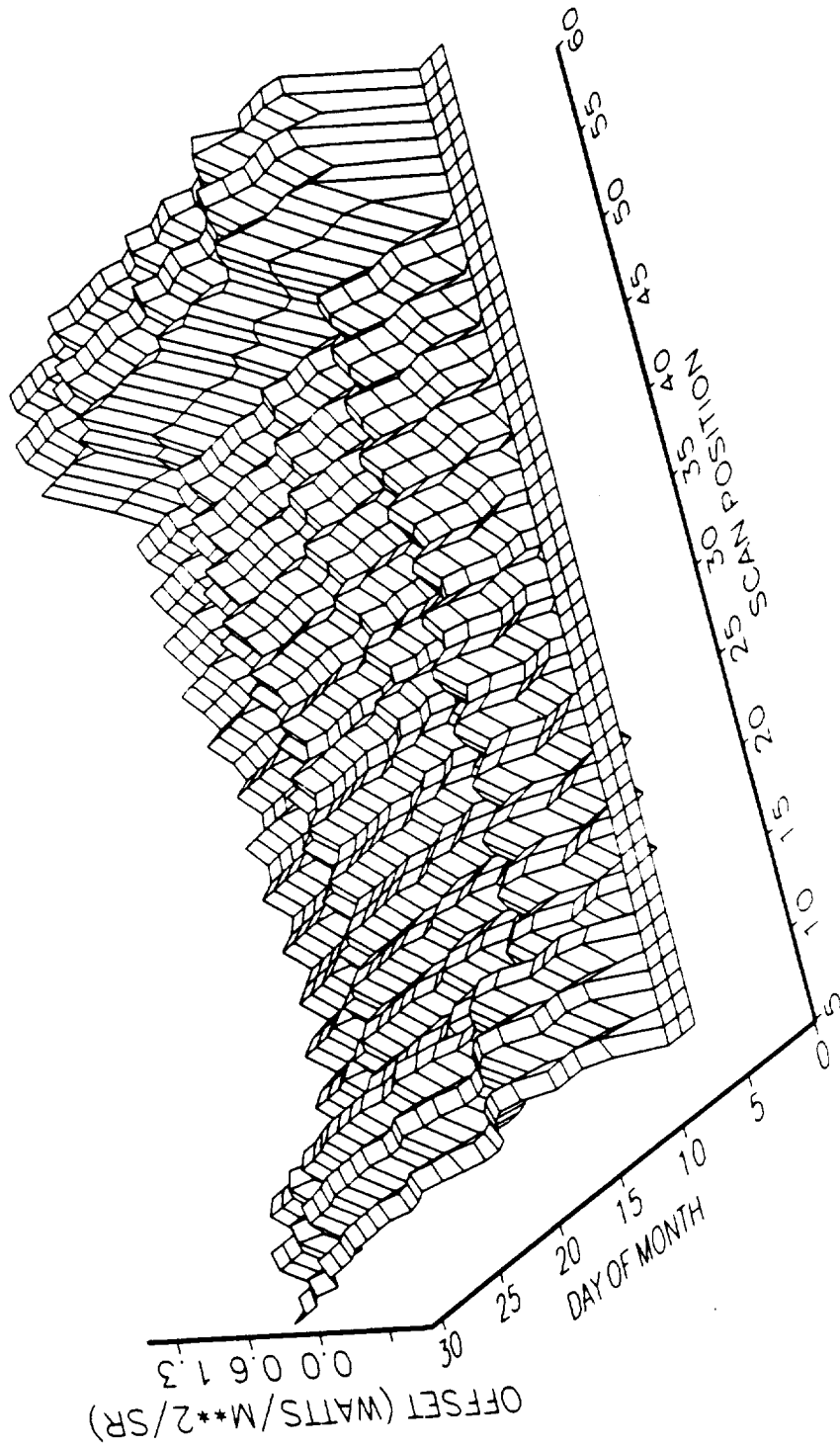

TOTAL OFFSETS
NOAA-9, JULY 1985

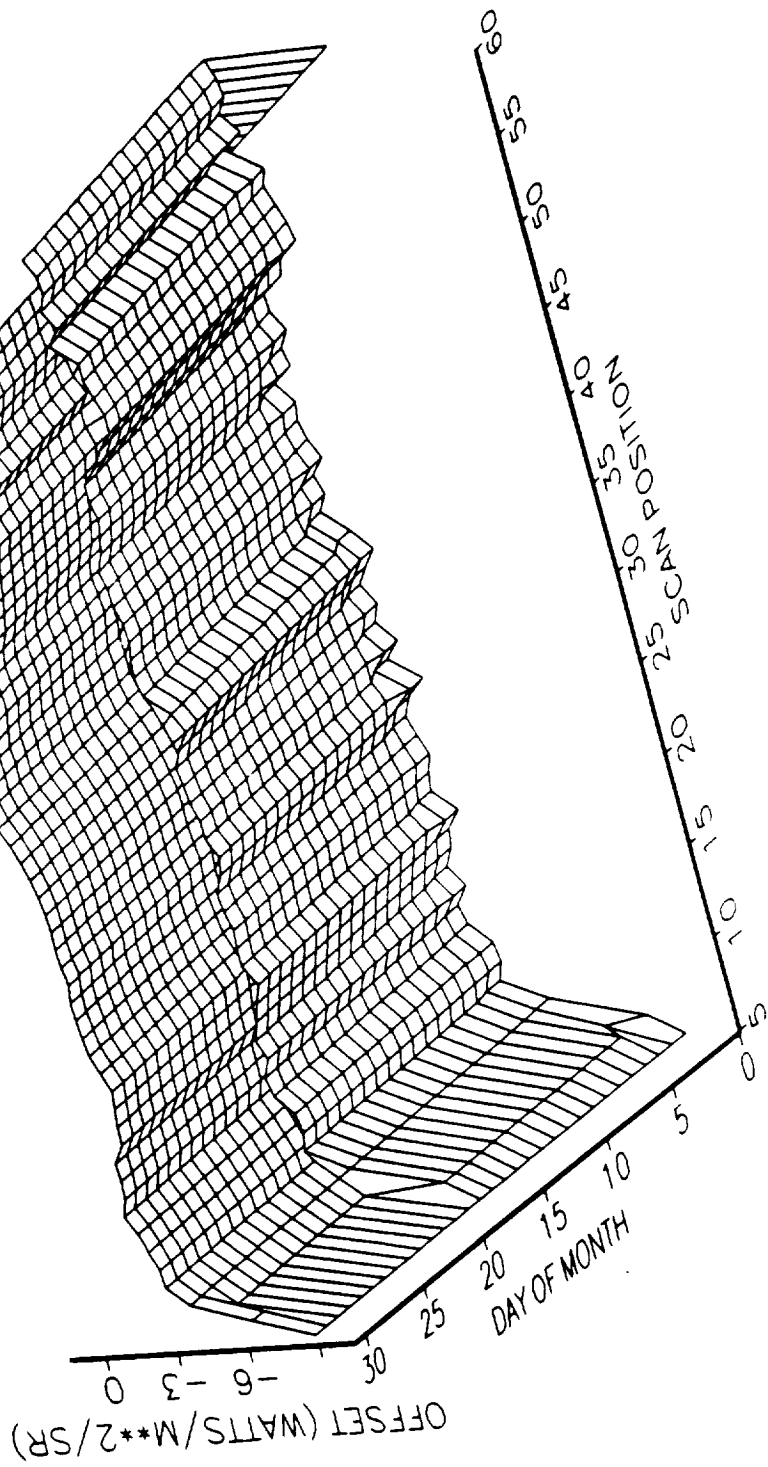

LONGWAVE OFFSETS
NOAA-9, JULY 1985

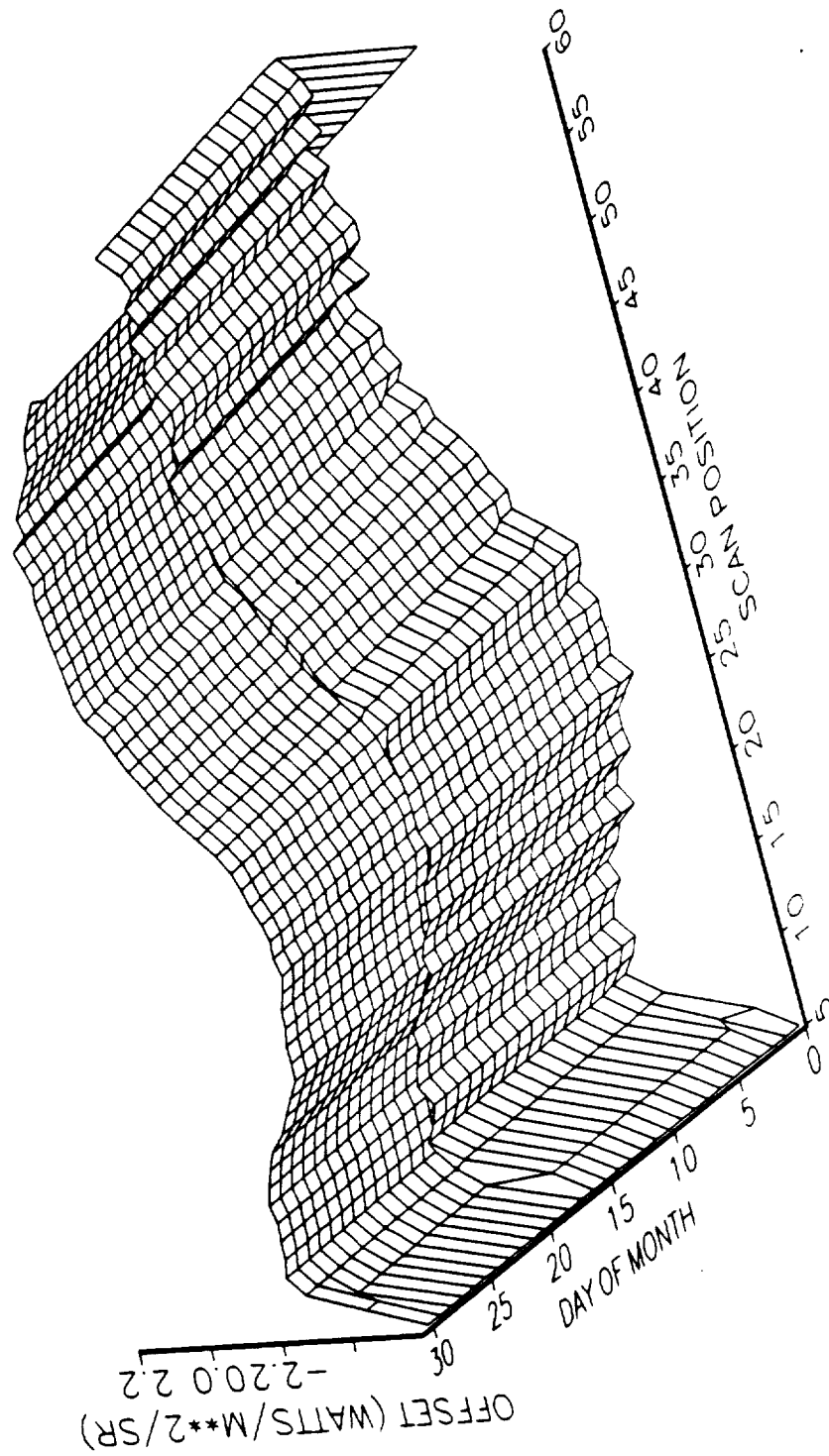

SHORTWAVE OFFSETS
NOAA-9, JULY 1985

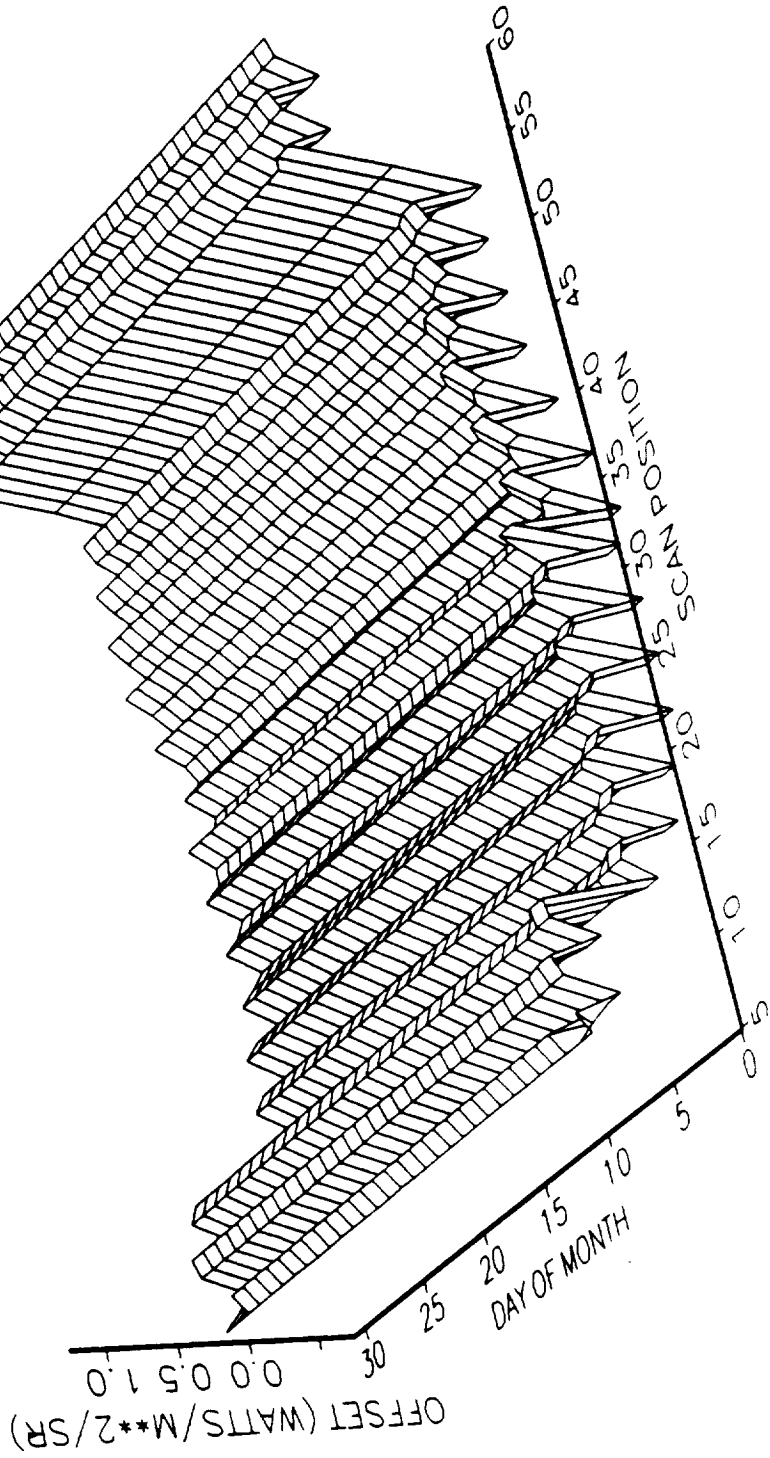

TOTAL OFFSETS
NOAA-9, AUGUST 1985

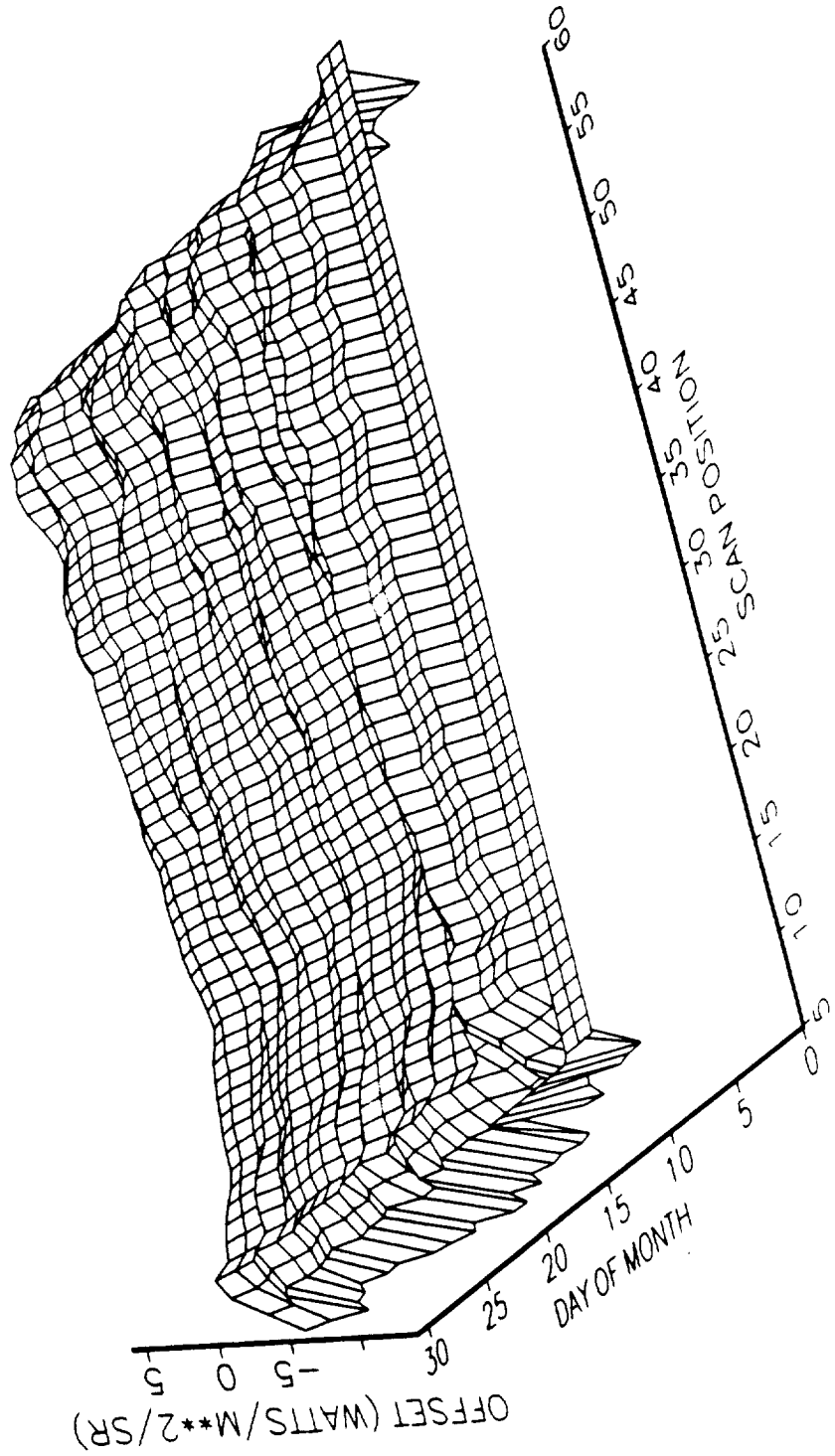

LONGWAVE OFFSETS
NOAA-9, AUGUST 1985

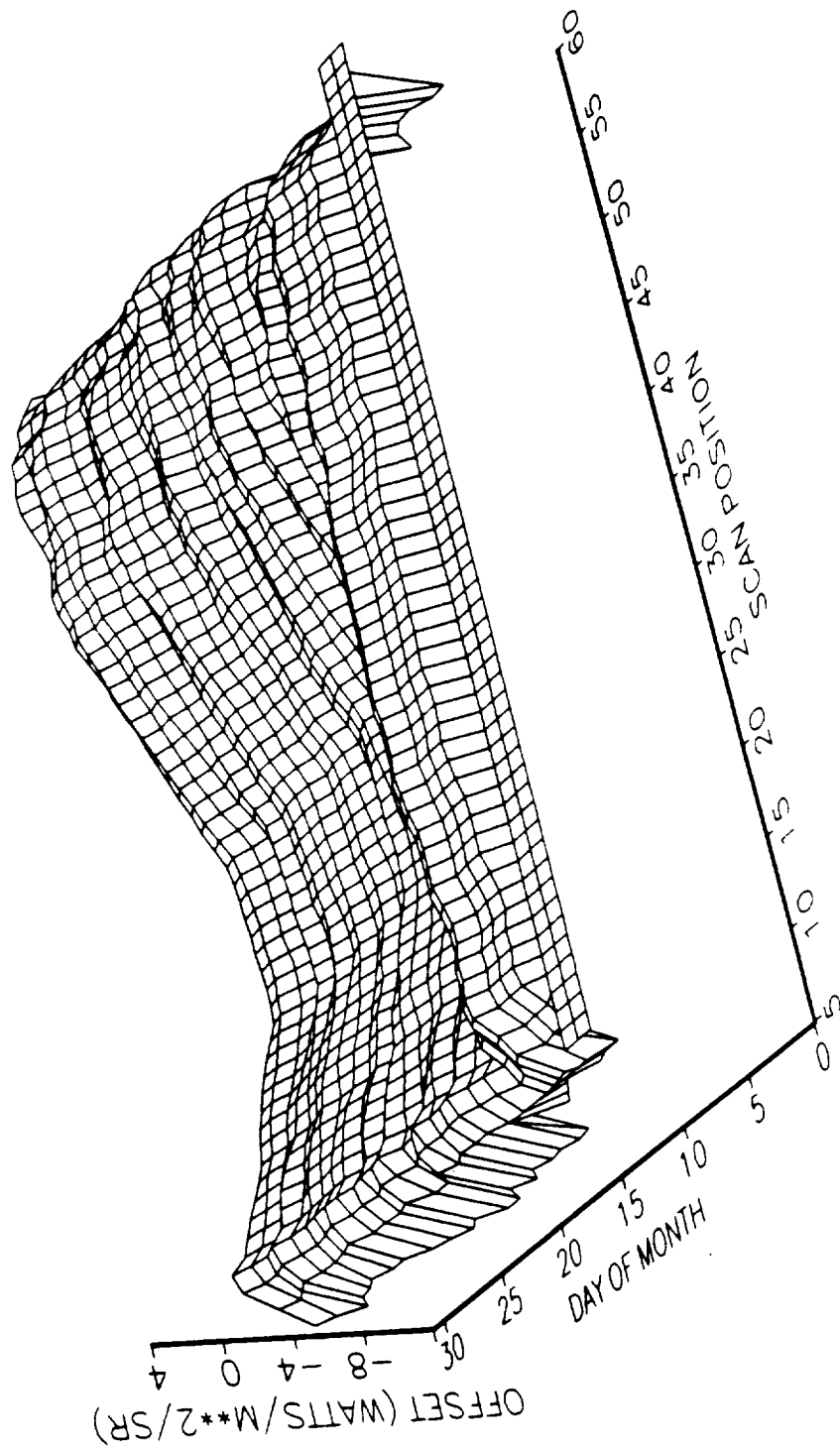

SHORTWAVE OFFSETS
NOAA-9, AUGUST 1985

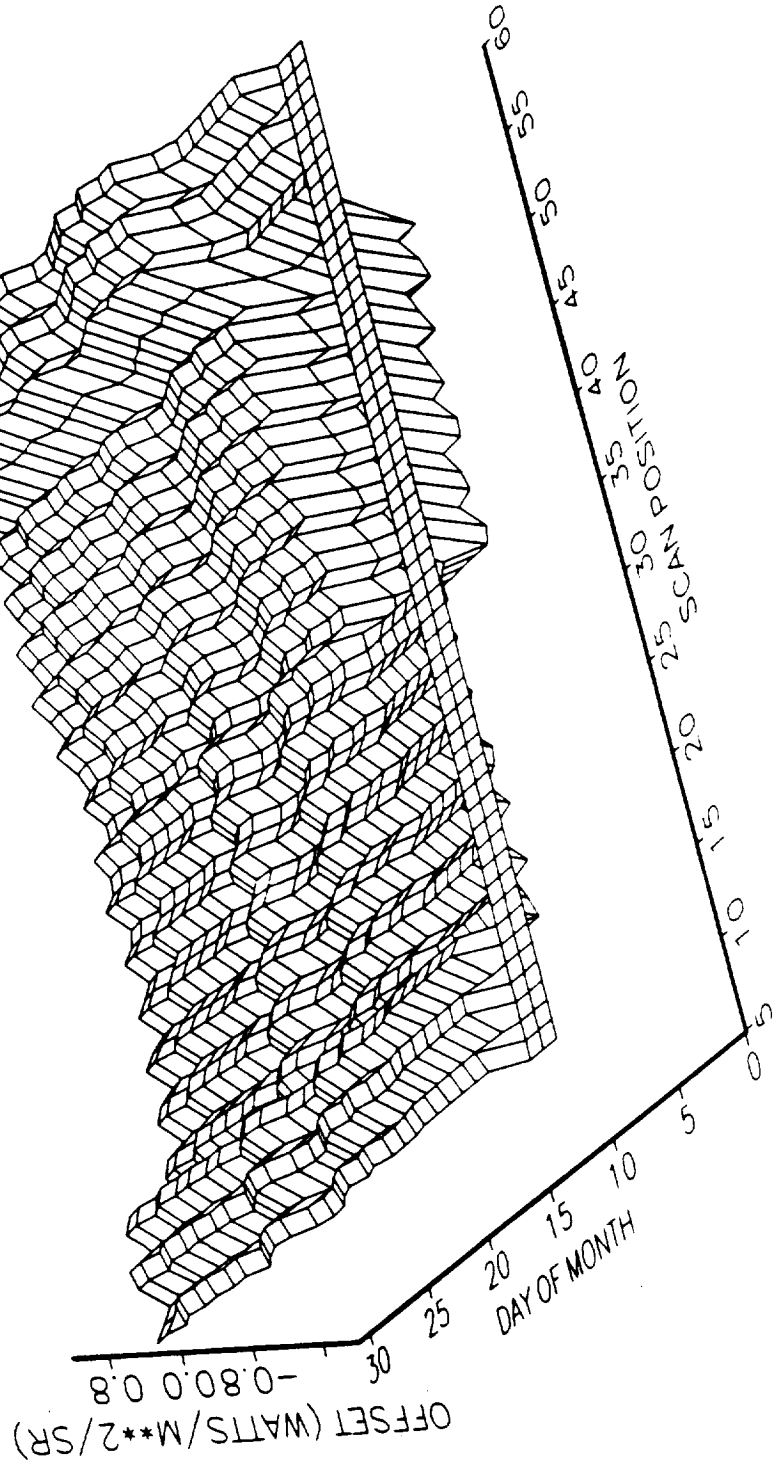

TOTAL OFFSETS
NOAA-9, SEPTEMBER 1985

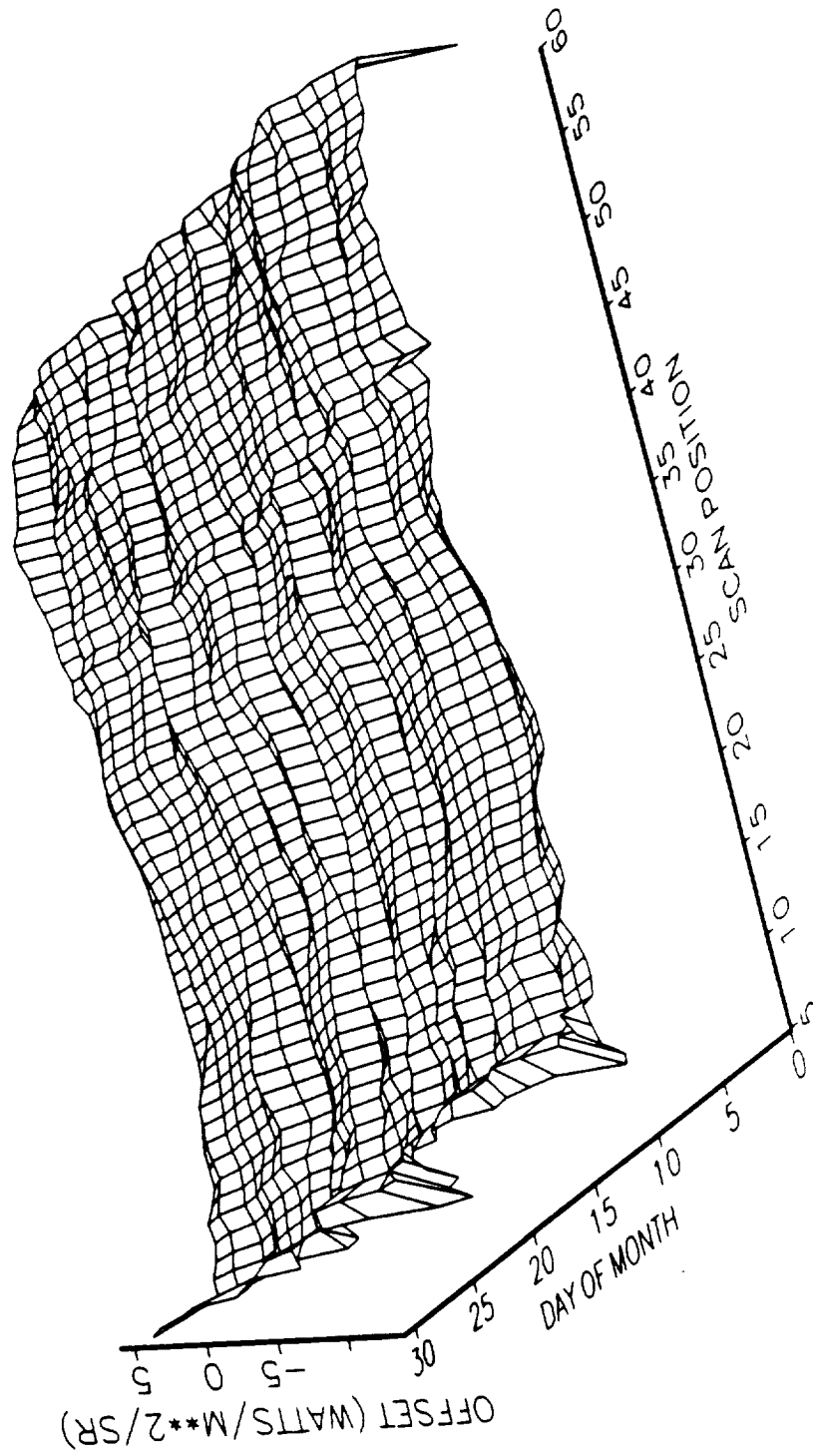

LONGWAVE OFFSETS
NOAA-9, SEPTEMBER 1985

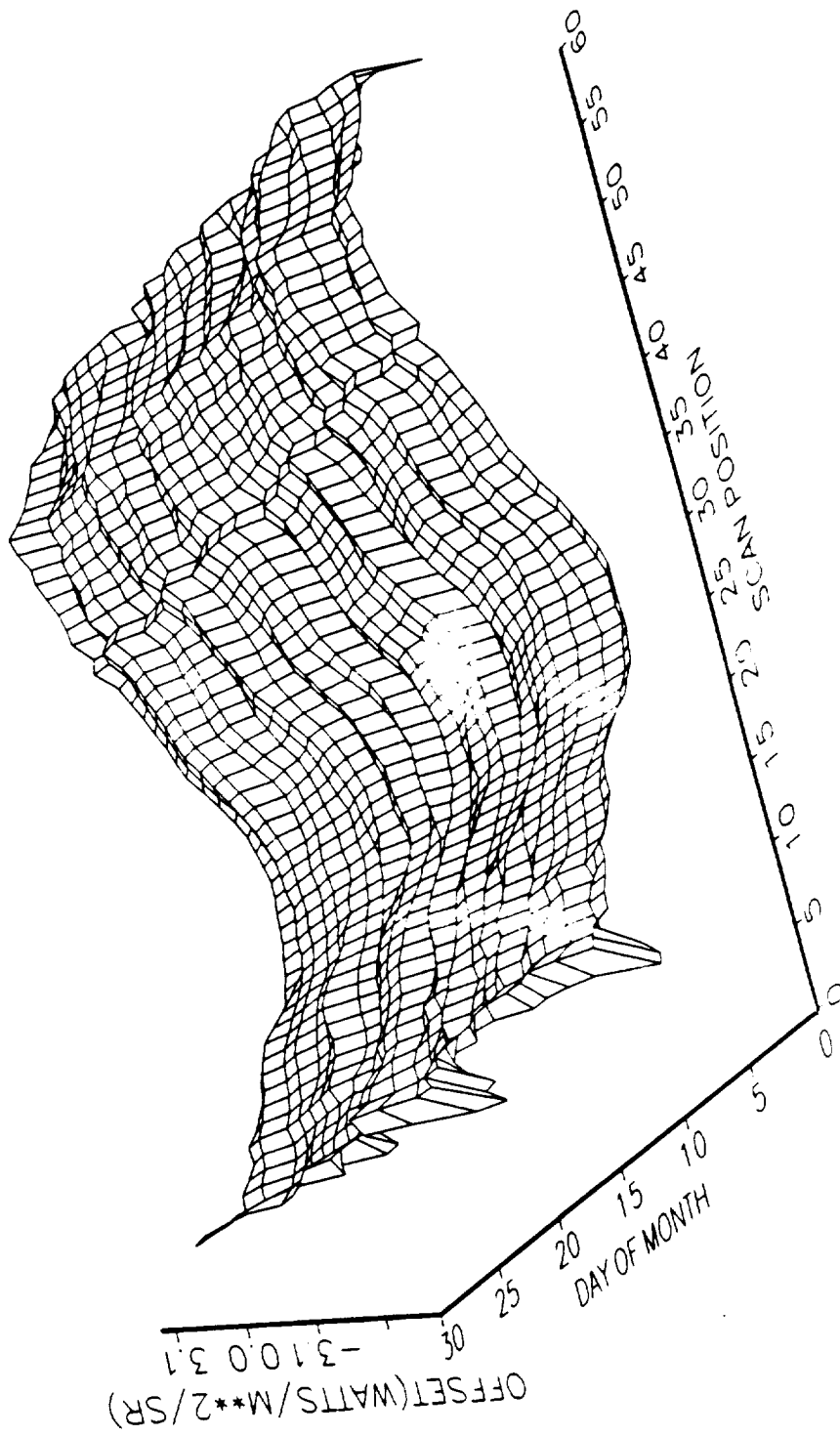

SHORTWAVE OFFSETS
NOAA-9, SEPTEMBER 1985

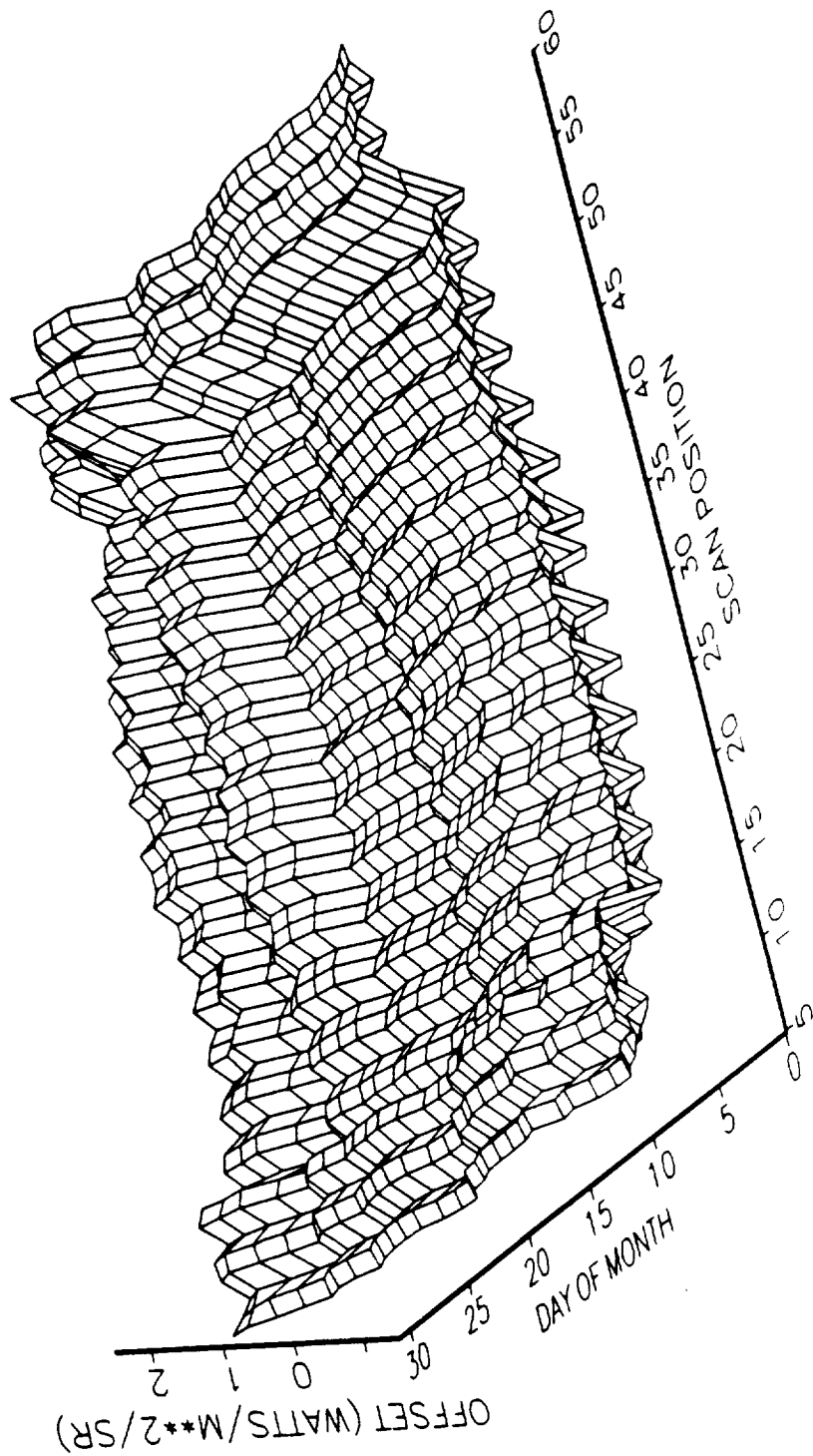

TOTAL OFFSETS
NOAA-9, OCTOBER 1985

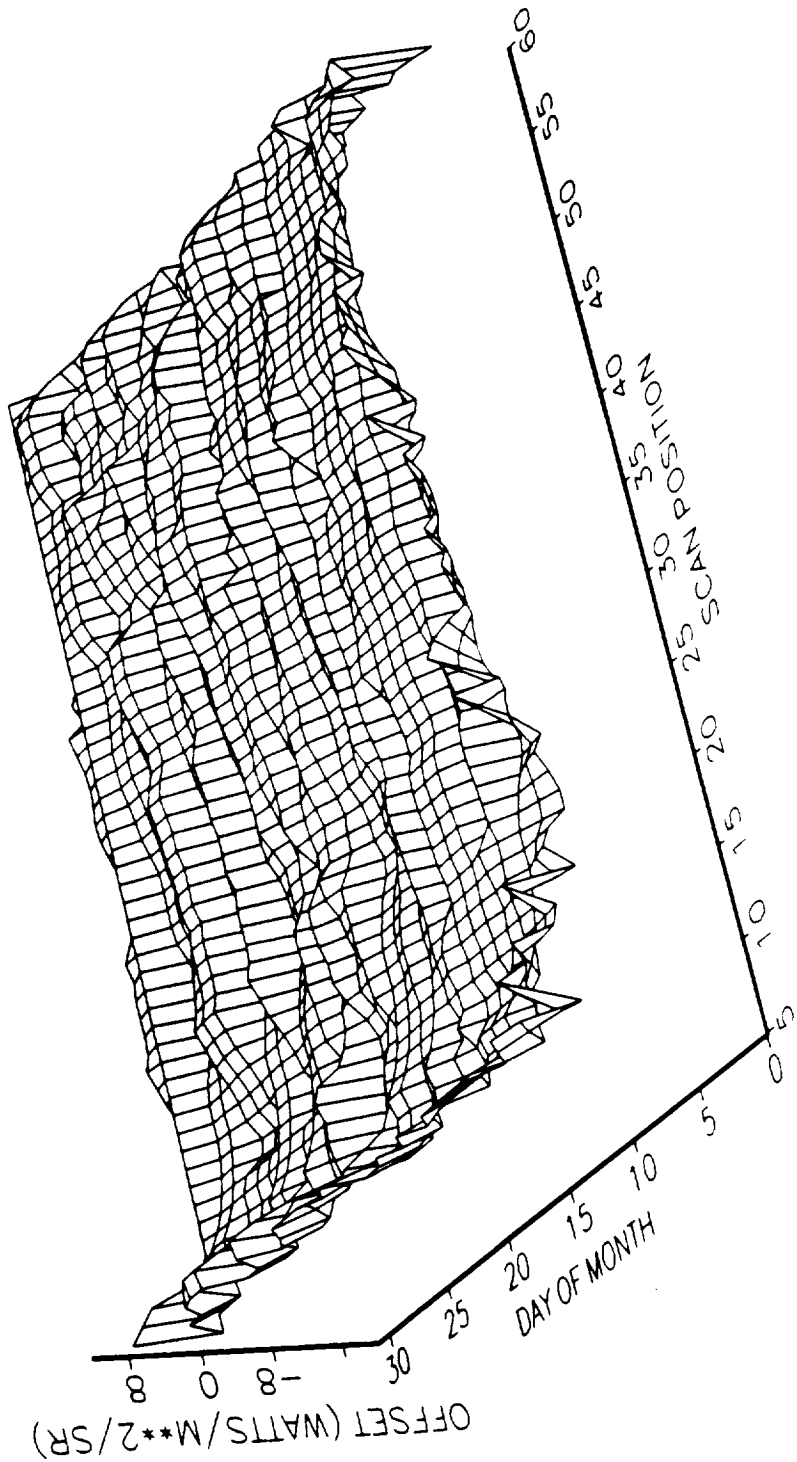

LONGWAVE OFFSETS
NOAA-9, OCTOBER 1985

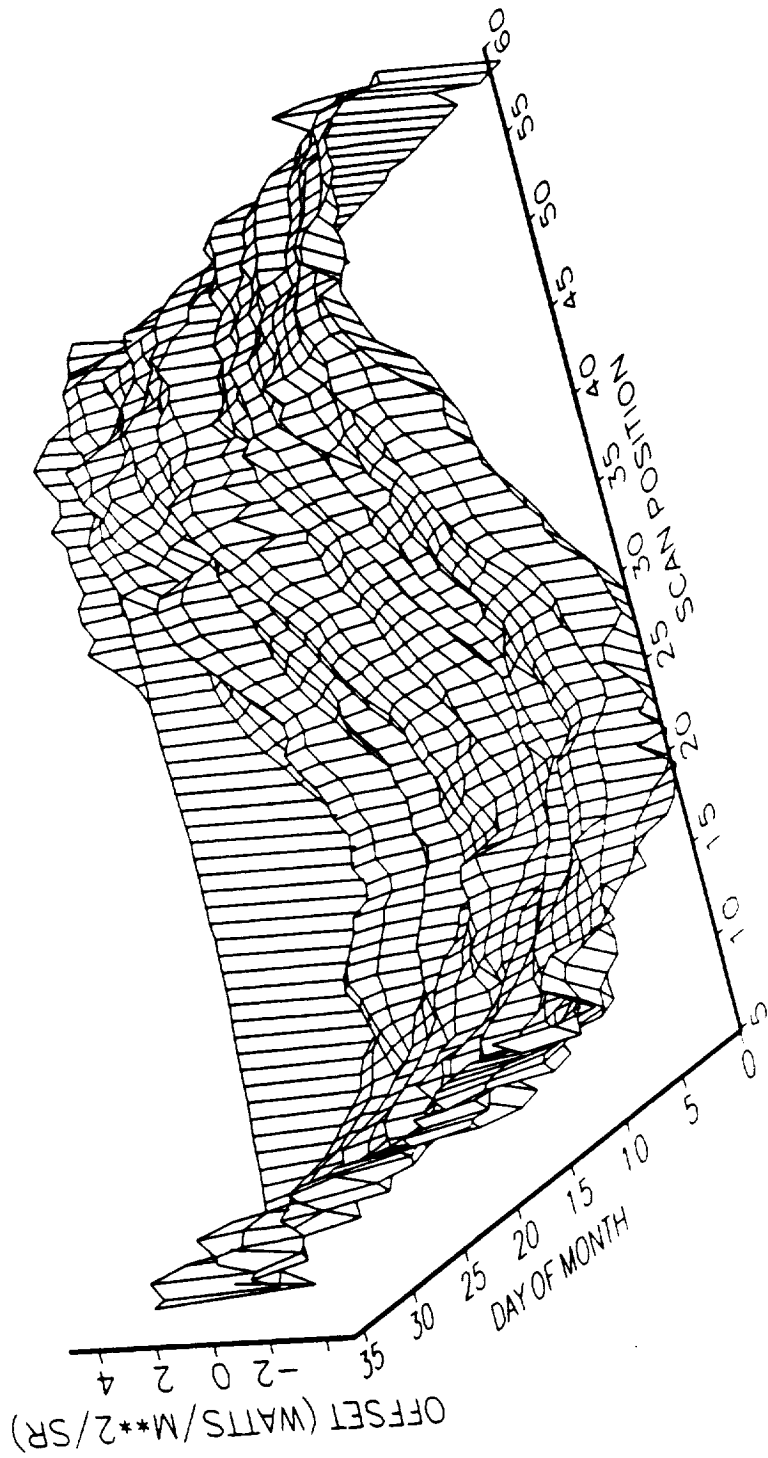

SHORTWAVE OFFSETS
NOAA-9, OCTOBER 1985

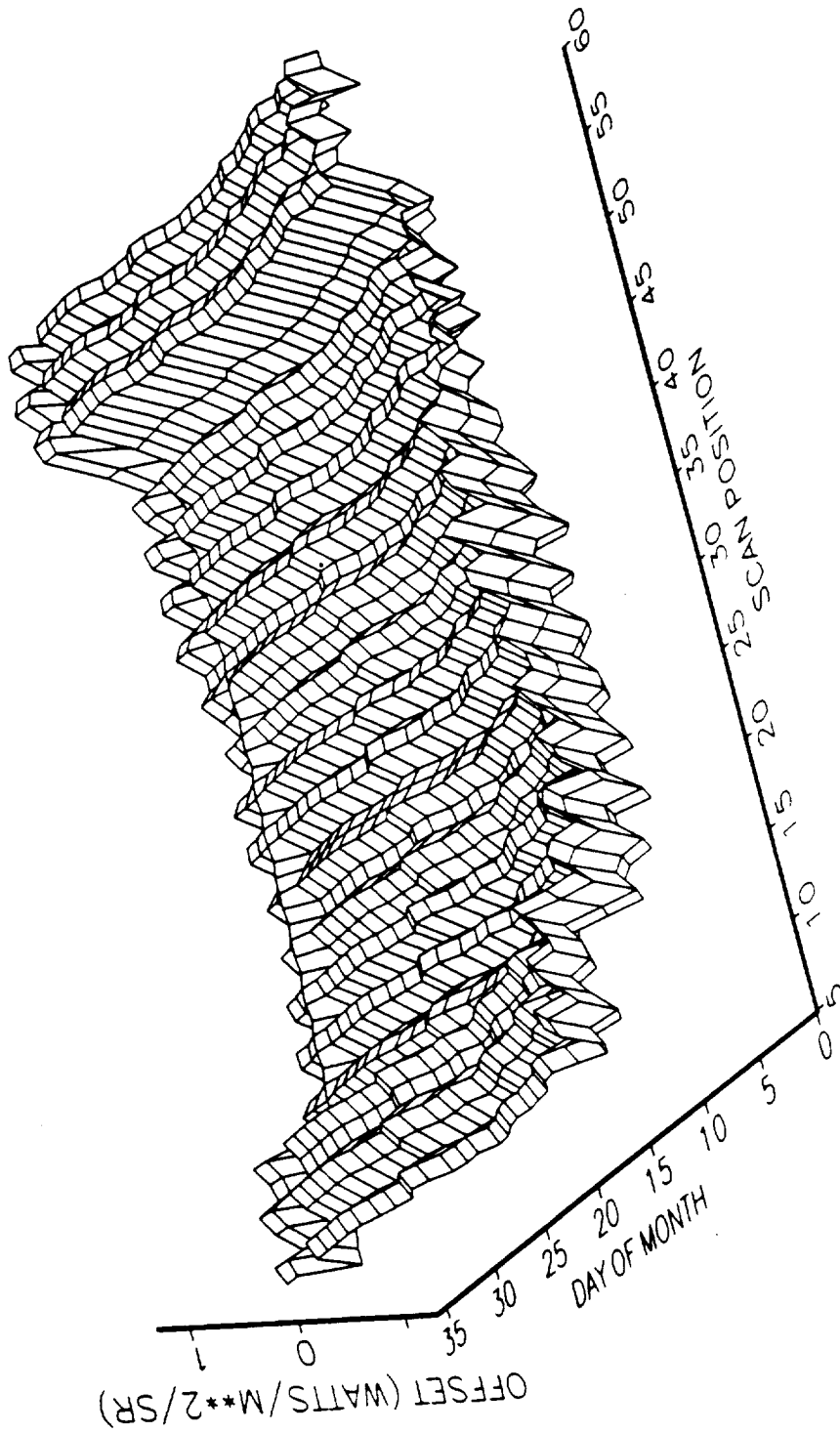

TOTAL OFFSETS
NOAA-9, NOVEMBER 1985

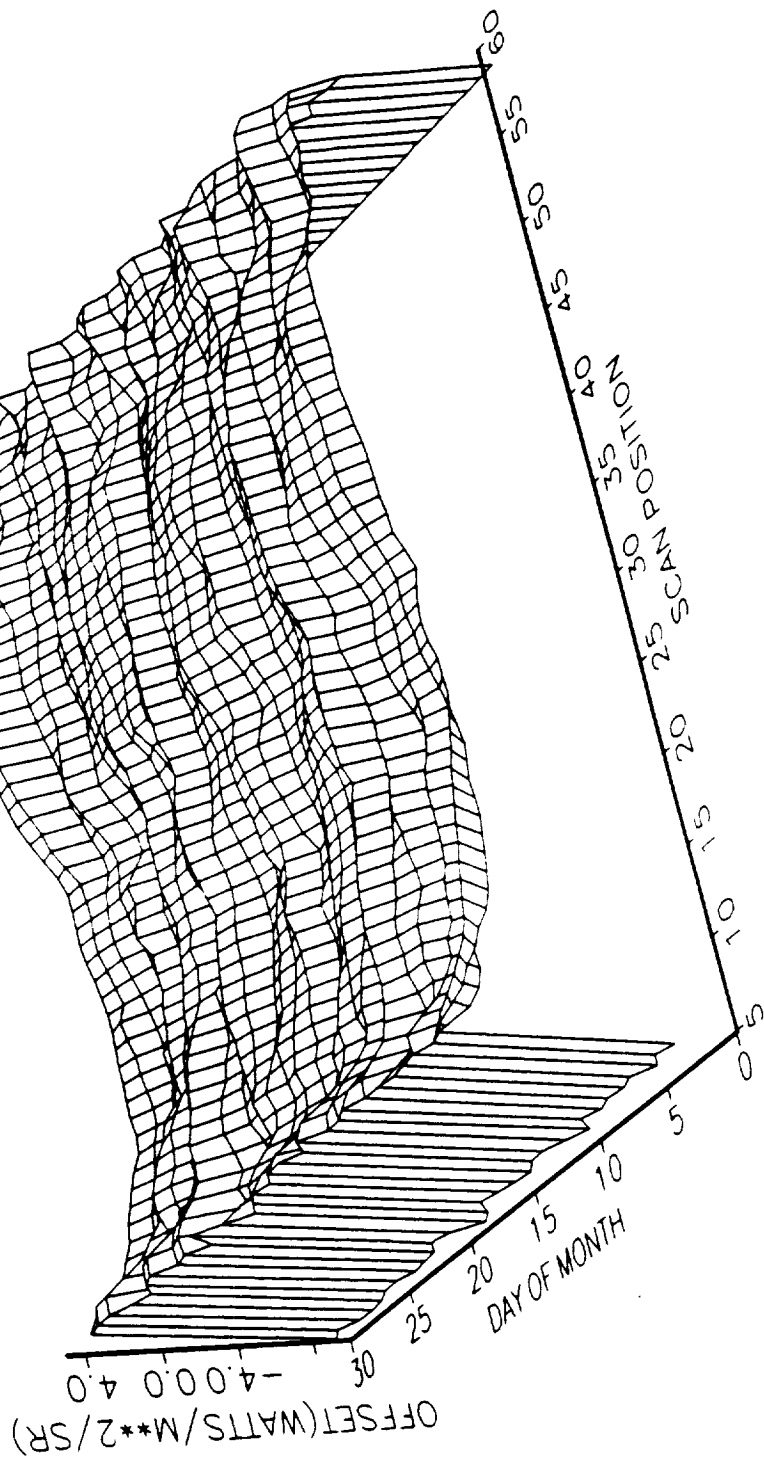

LONGWAVE OFFSETS
NOAA-9, NOVEMBER 1985

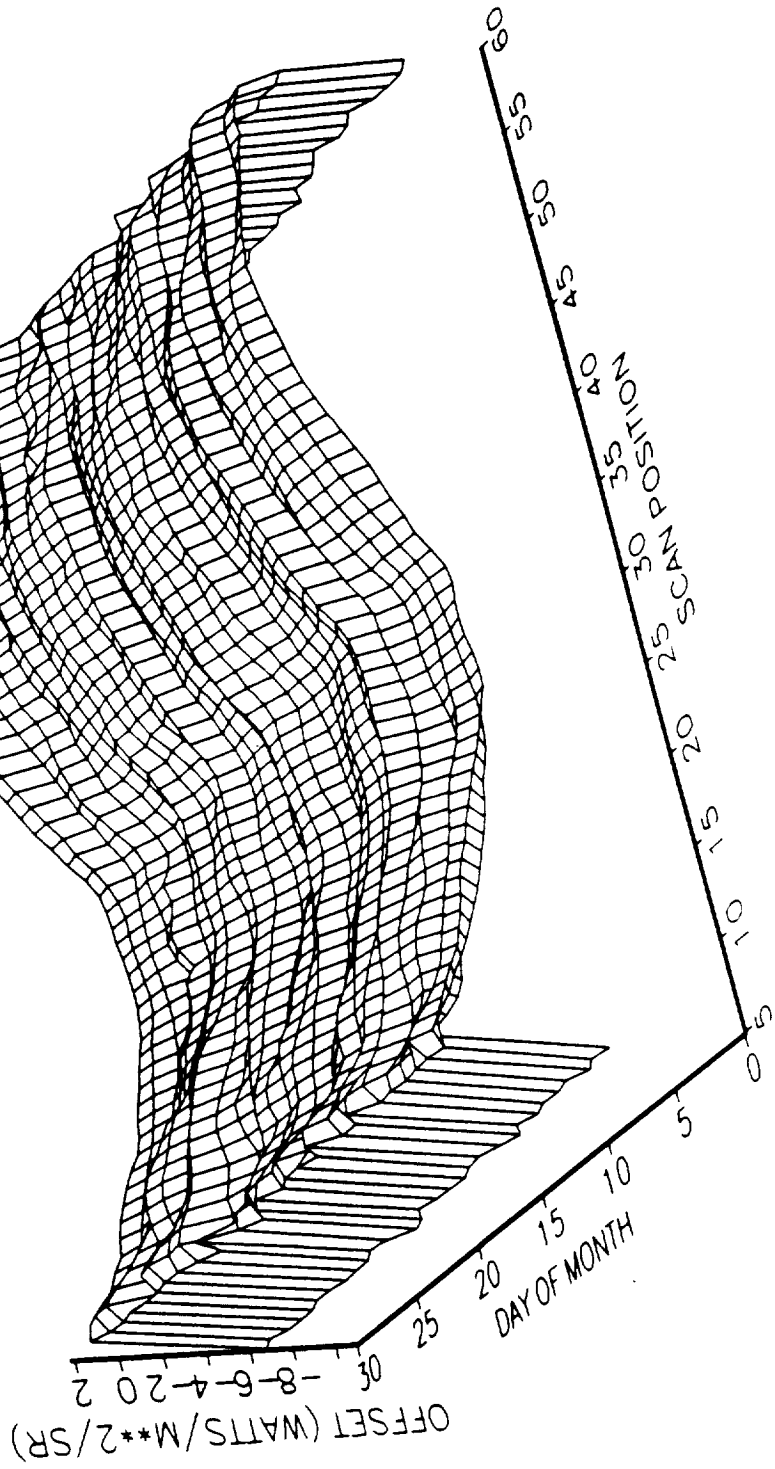

SHORTWAVE OFFSETS
NOAA-9, NOVEMBER 1985

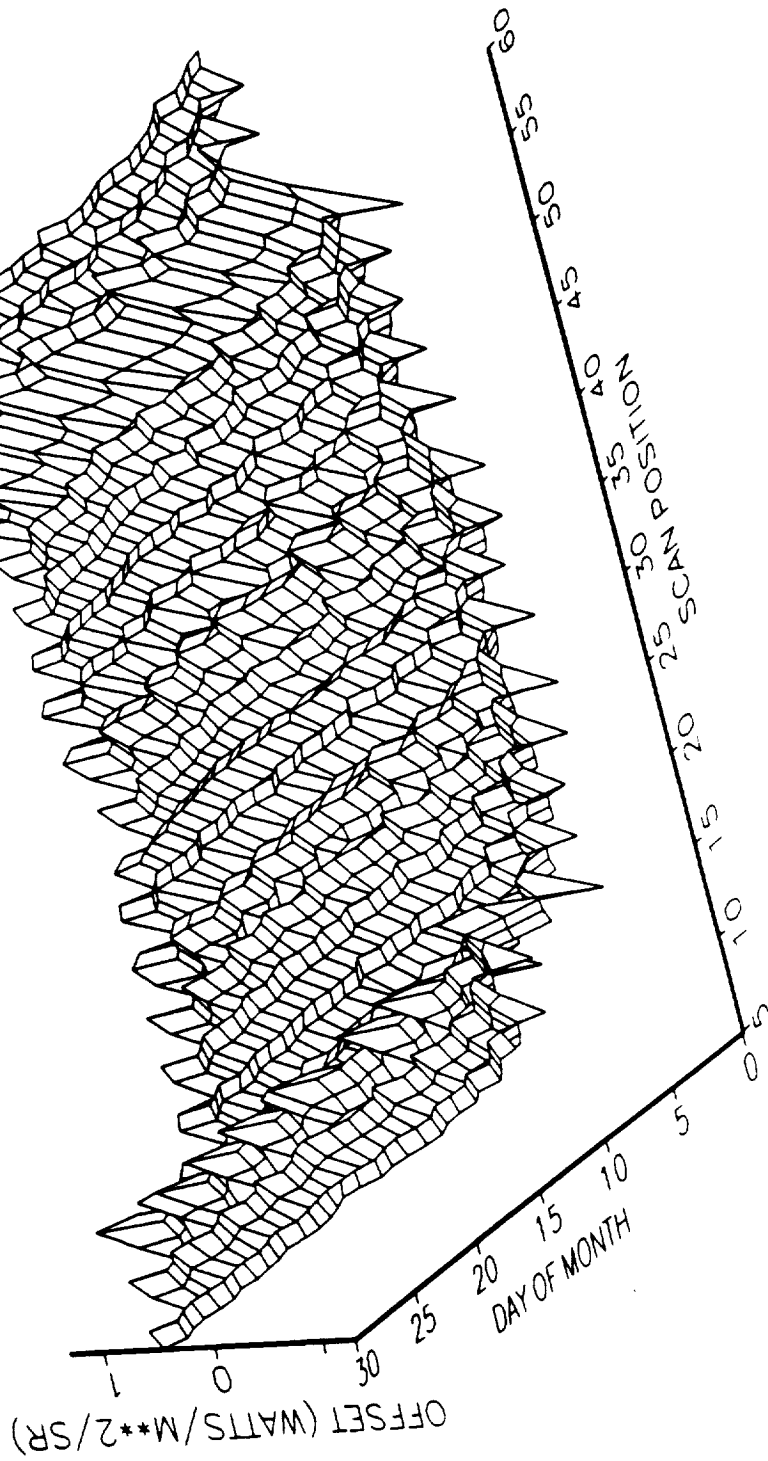

TOTAL OFFSETS
NOAA-9, DECEMBER 1985

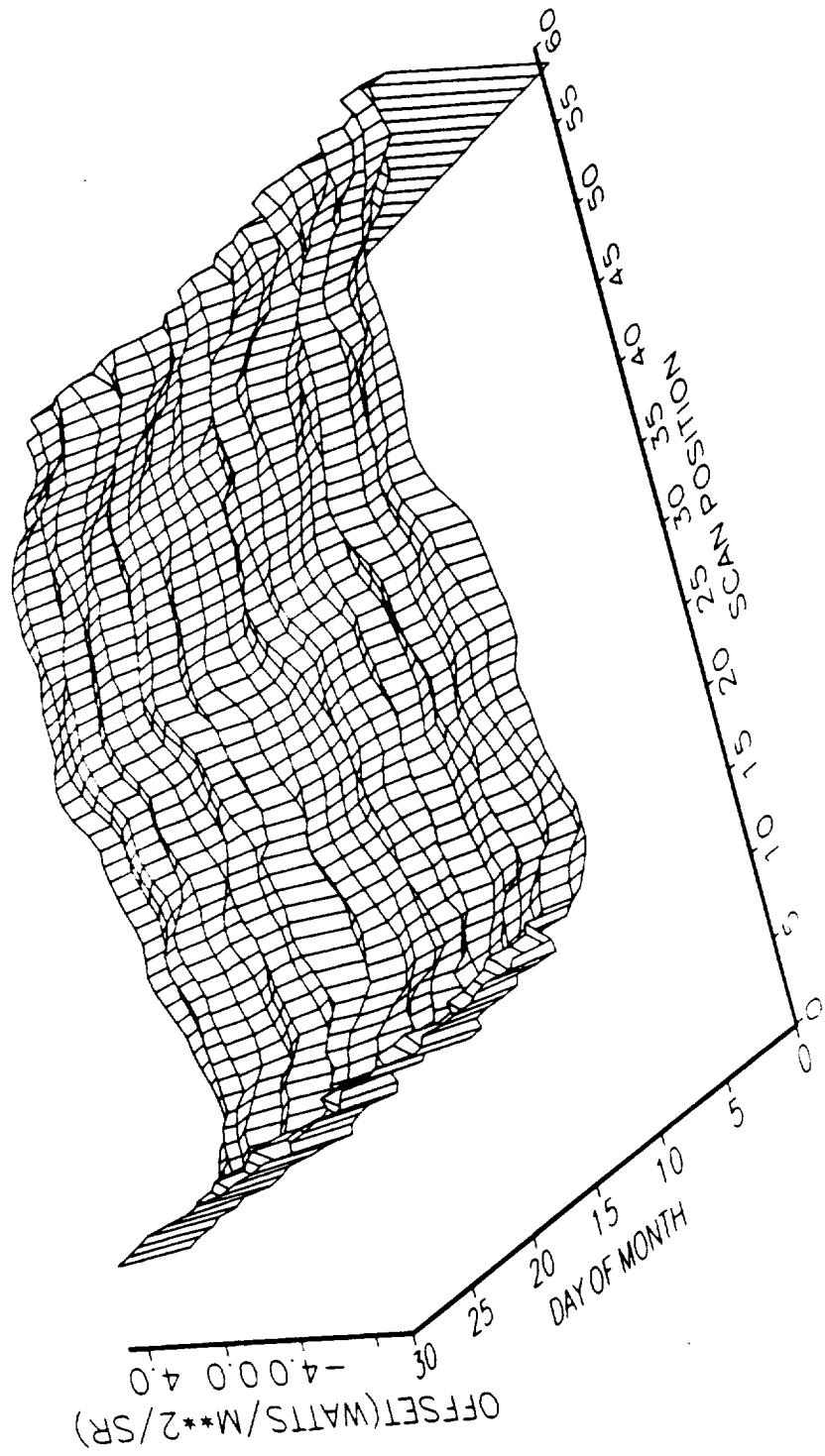

LONGWAVE OFFSETS
NOAA-9, DECEMBER 1985

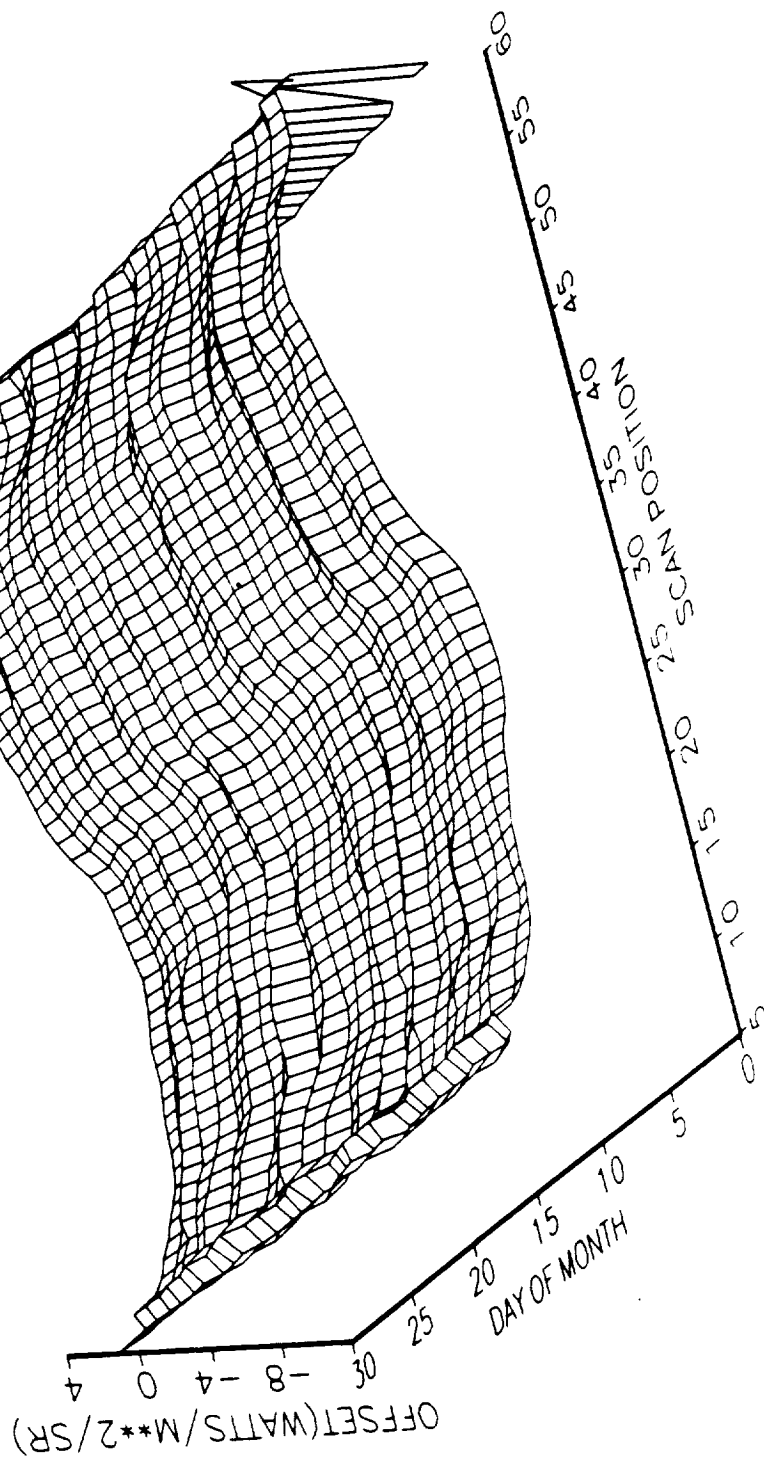

SHORTWAVE OFFSETS
NOAA-9, DECEMBER 1985

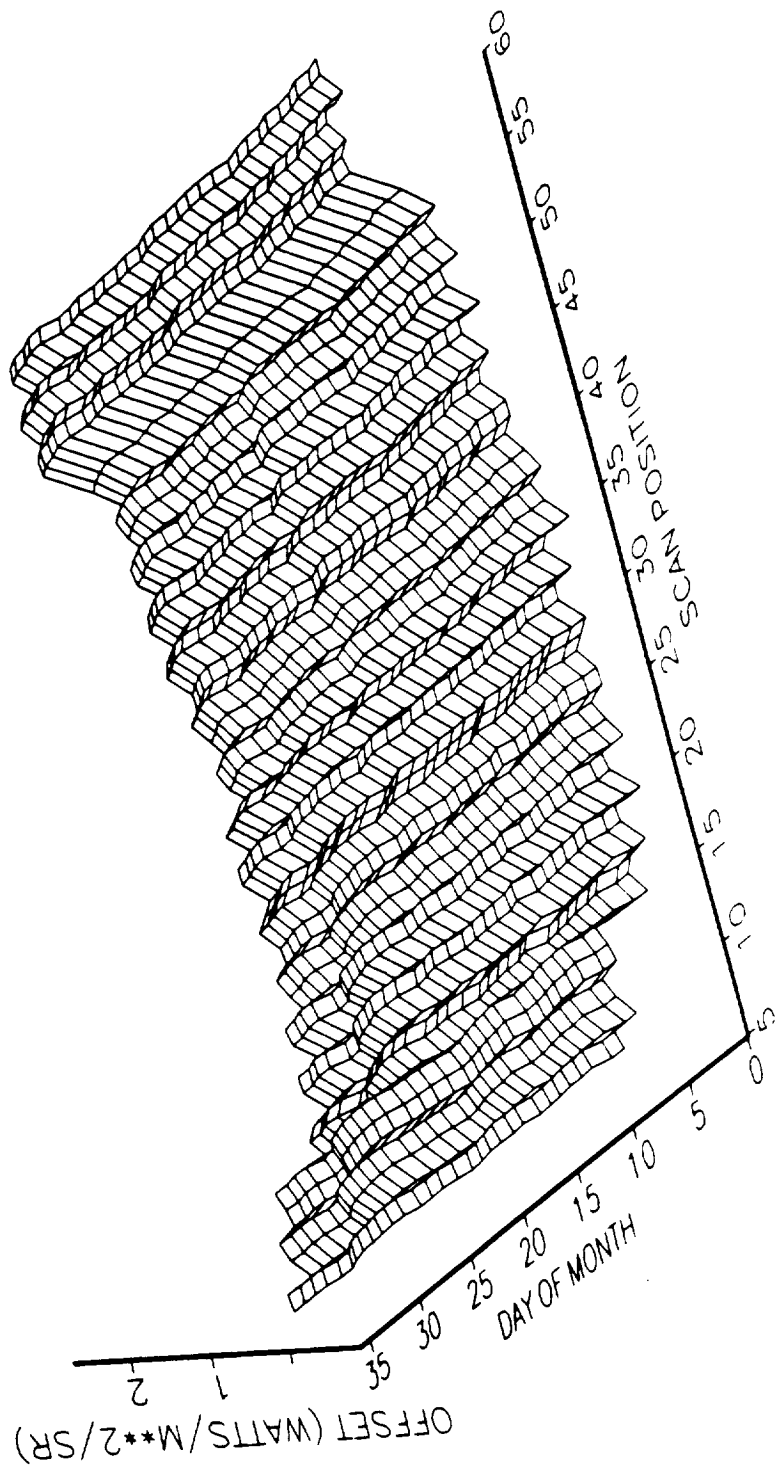

TOTAL OFFSETS
NOAA-9, JANUARY 1986

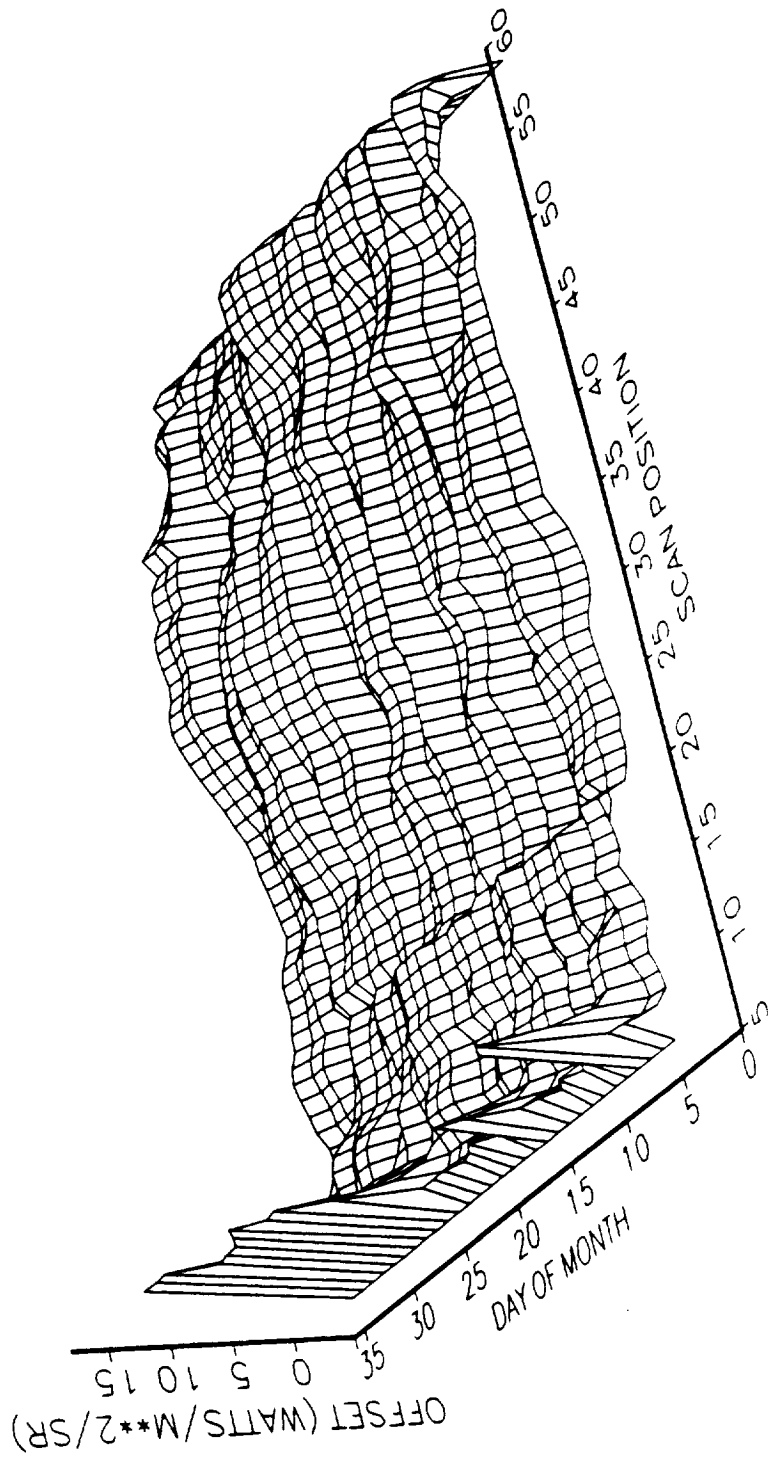

LONGWAVE OFFSETS
NOAA-9, JANUARY 1985

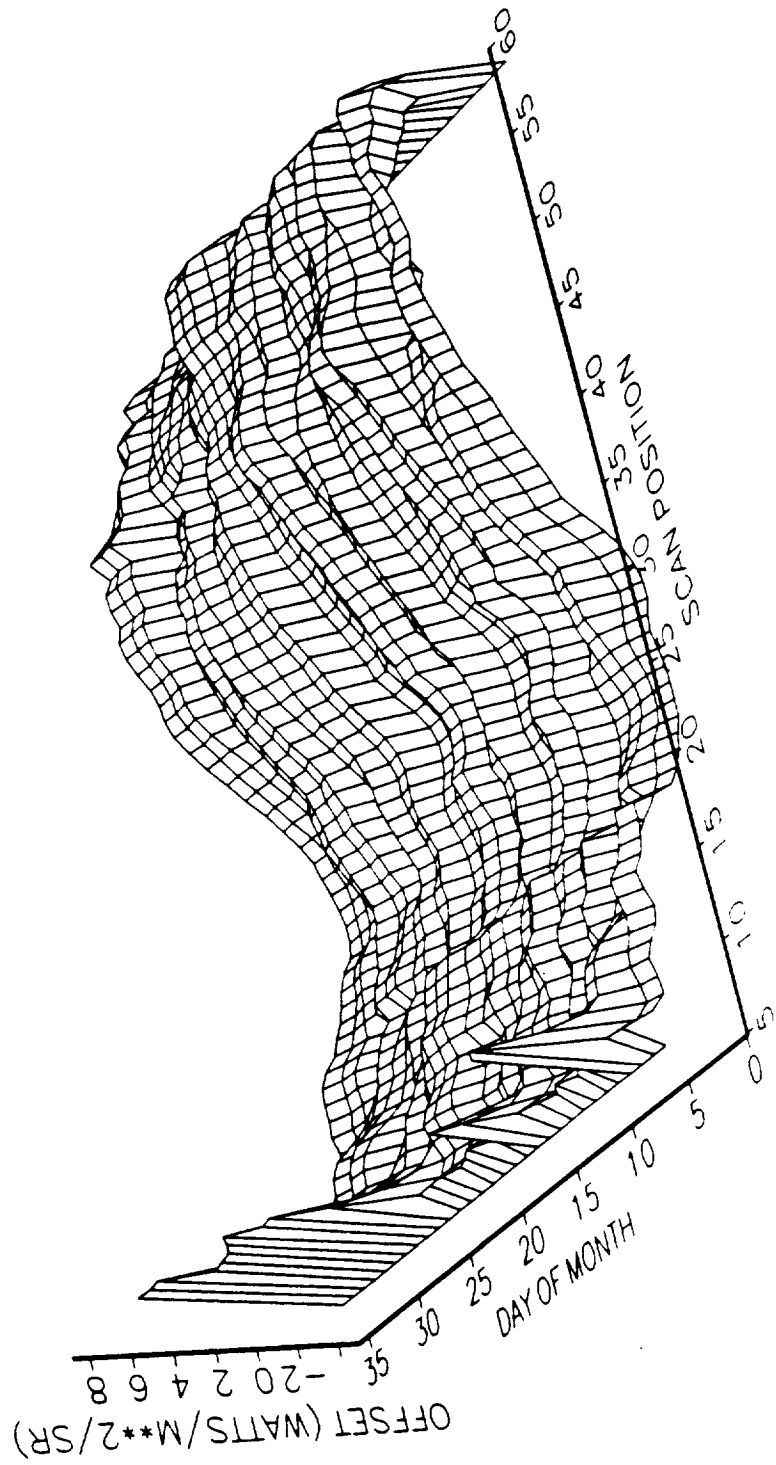

SHORTWAVE OFFSETS
NOAA-9, JANUARY 1985

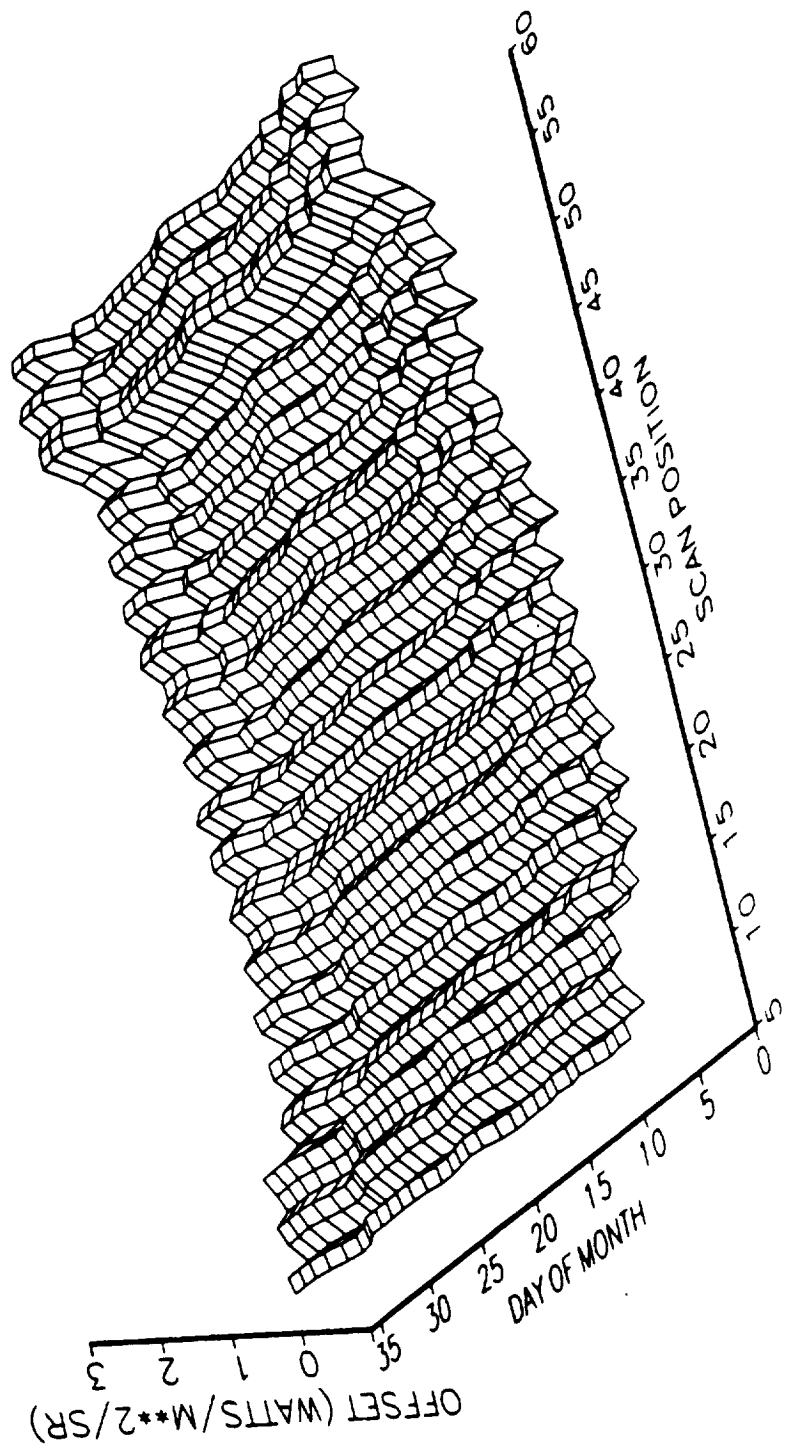

TOTAL OFFSETS
NOAA--9, FEBRUARY 1986

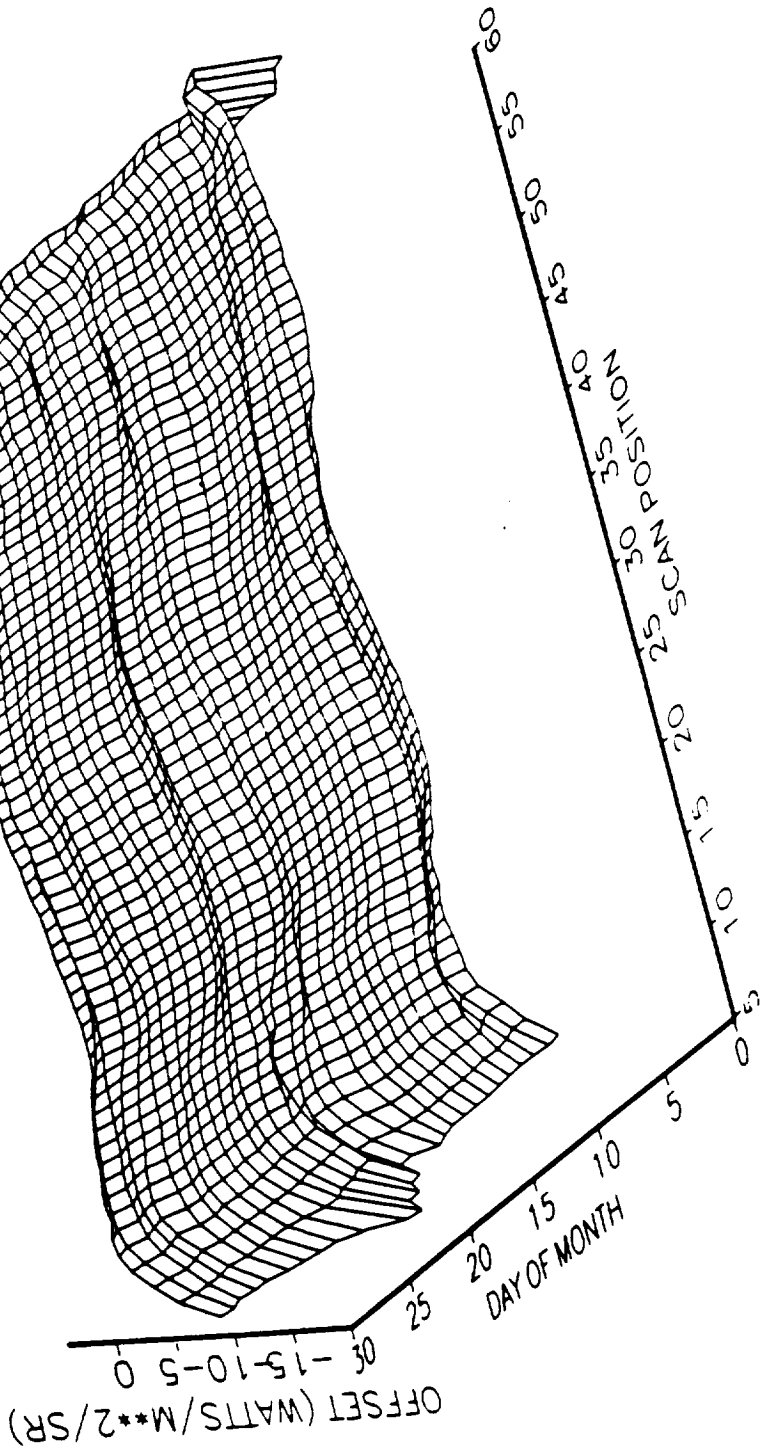

LONGWAVE OFFSETS
NOAA -9, FEBRUARY 1986

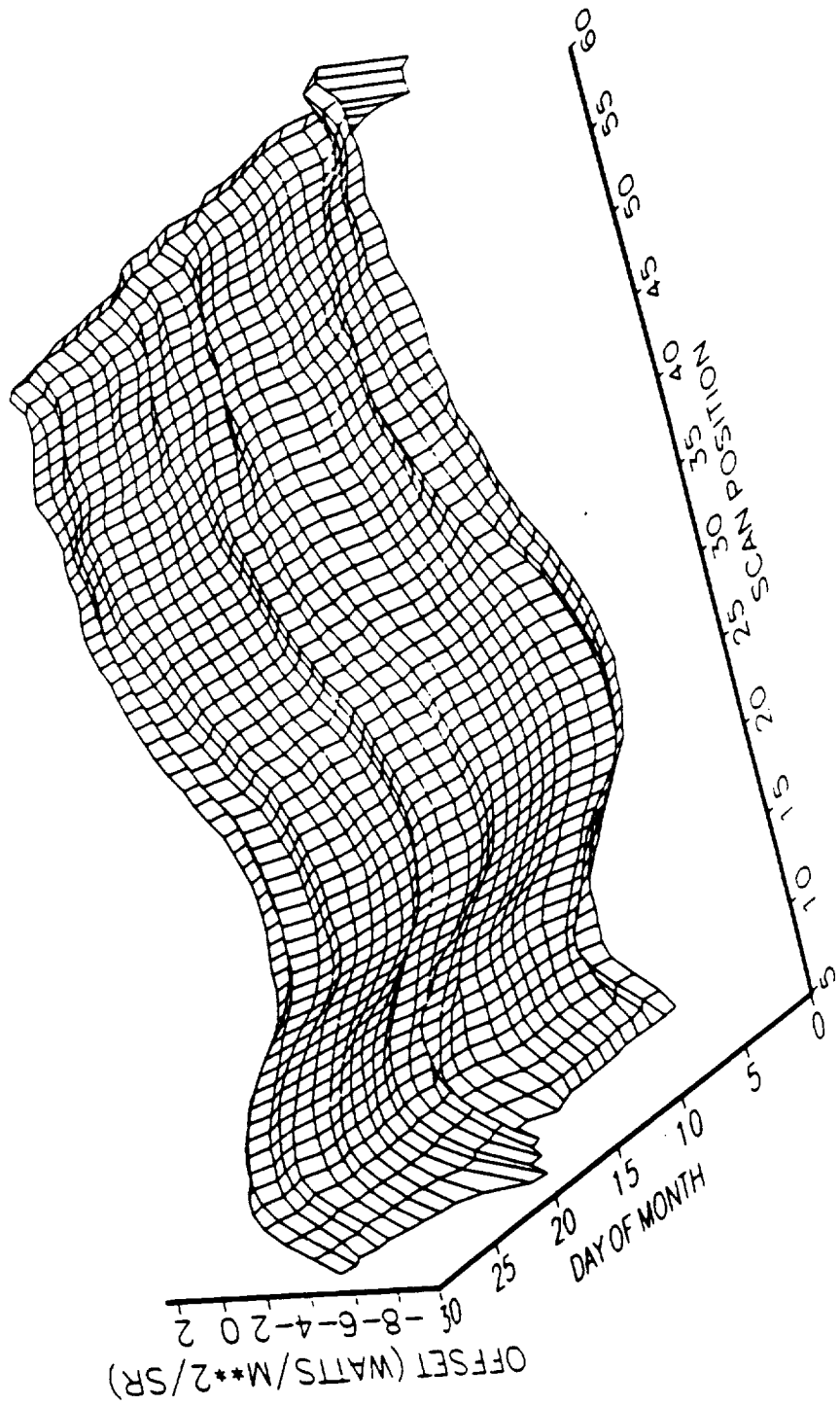

SHORTWAVE OFFSETS
NOAA-9, FEBRUARY 1986

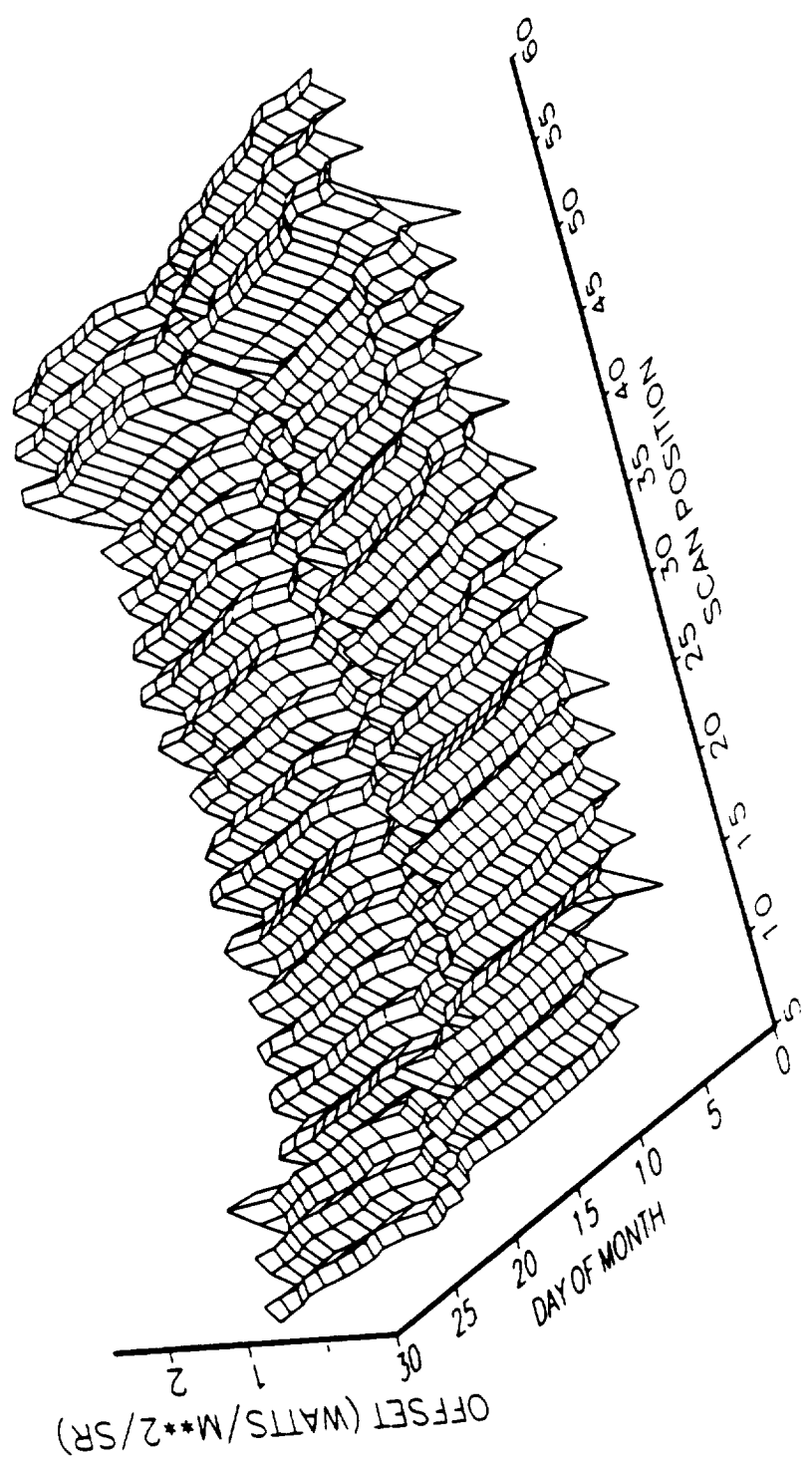

TOTAL OFFSETS
NOVA - 9, MARCH 1986

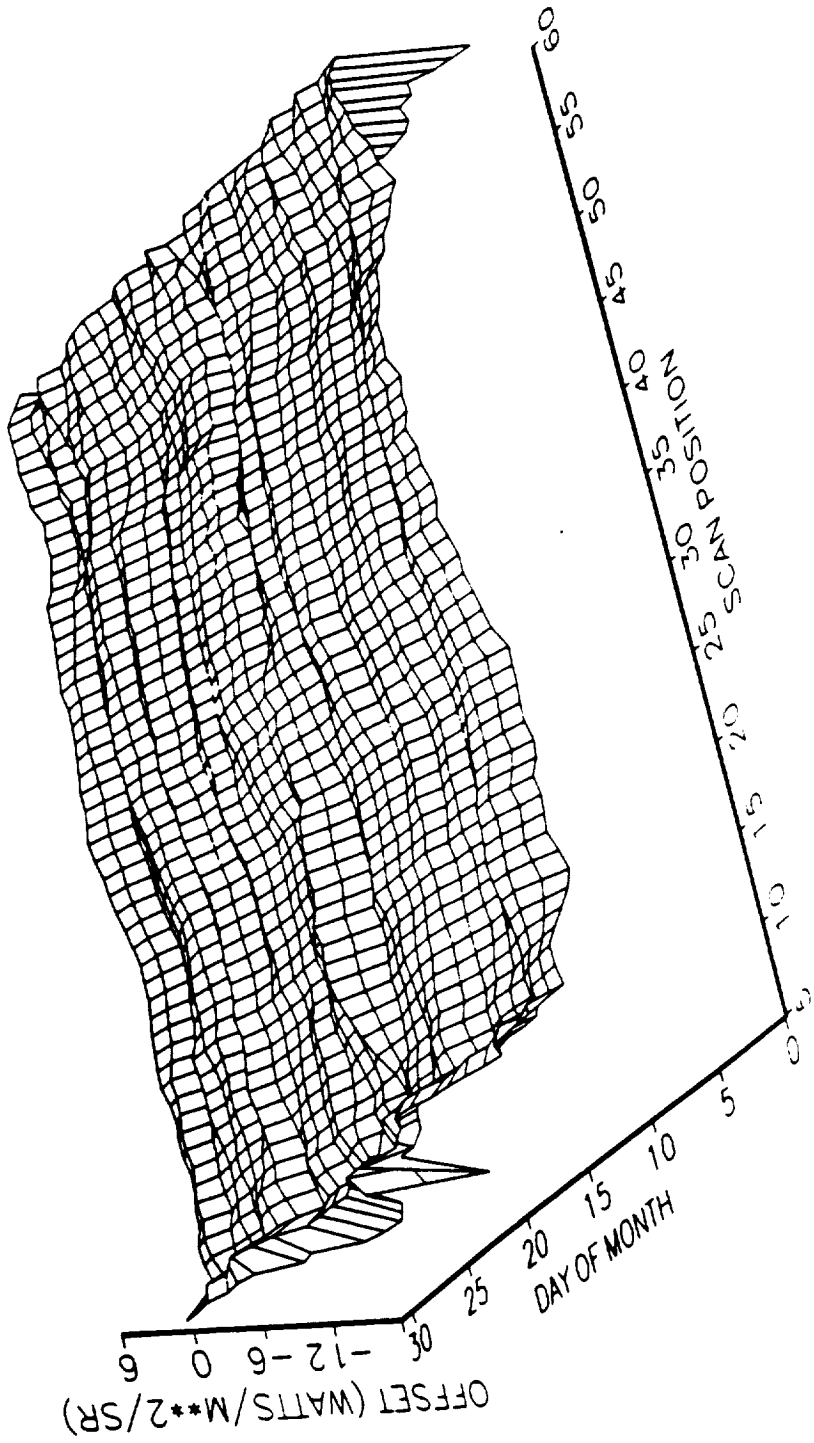

LONGWAVE OFFSETS
NOAA 9, MARCH 1986

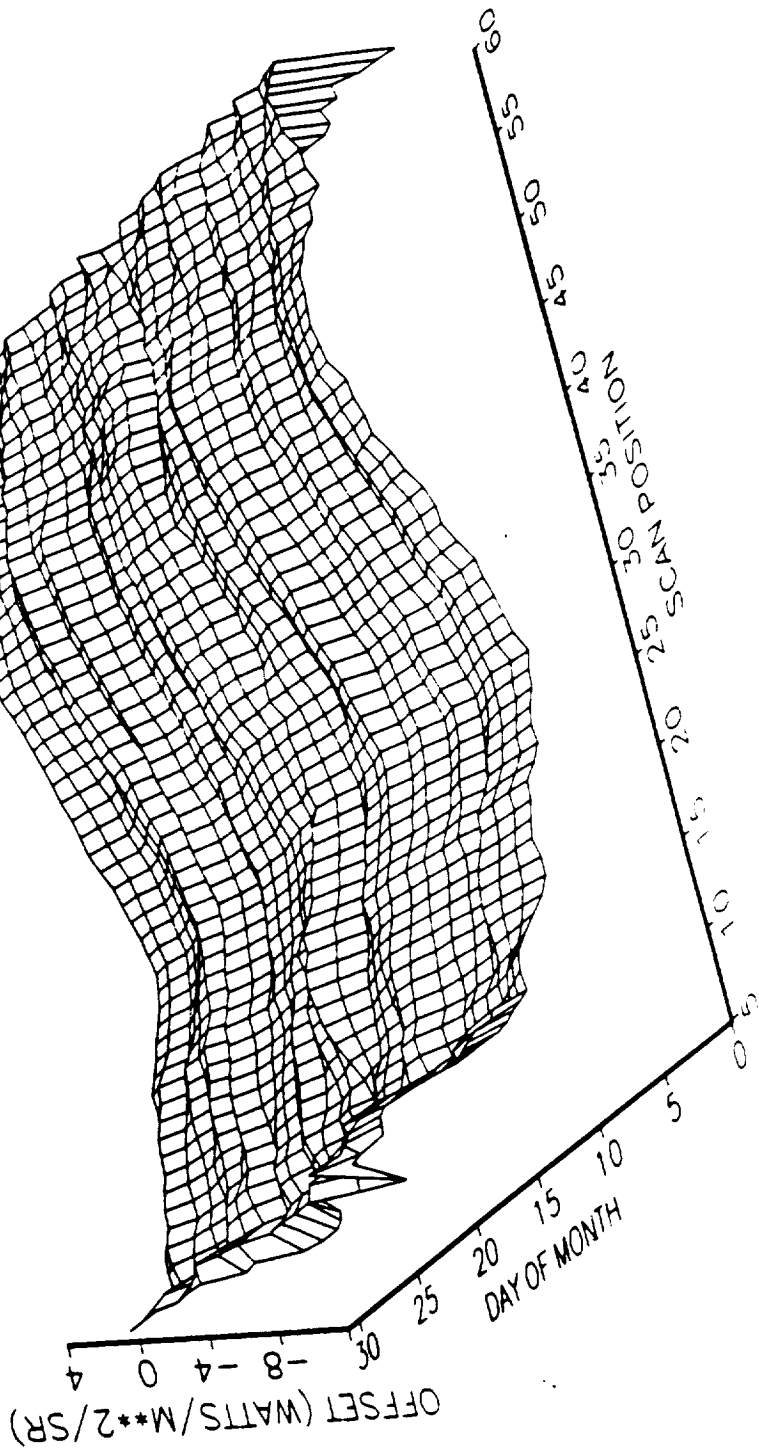

SHORTWAVE OFFSETS
NOAA-9, MARCH 1986

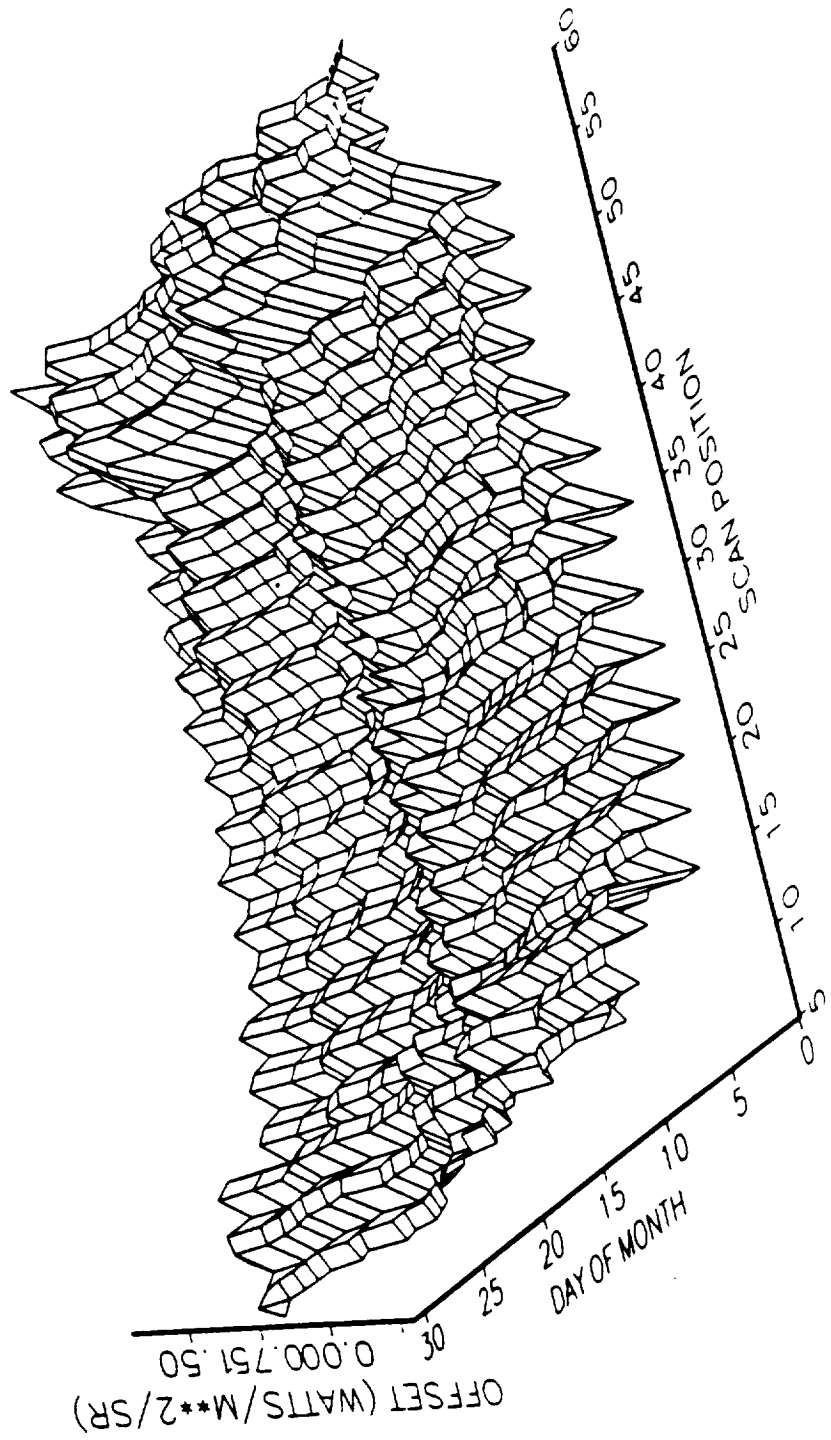

TOTAL OFFSETS
NOAA-9, APRIL 1986

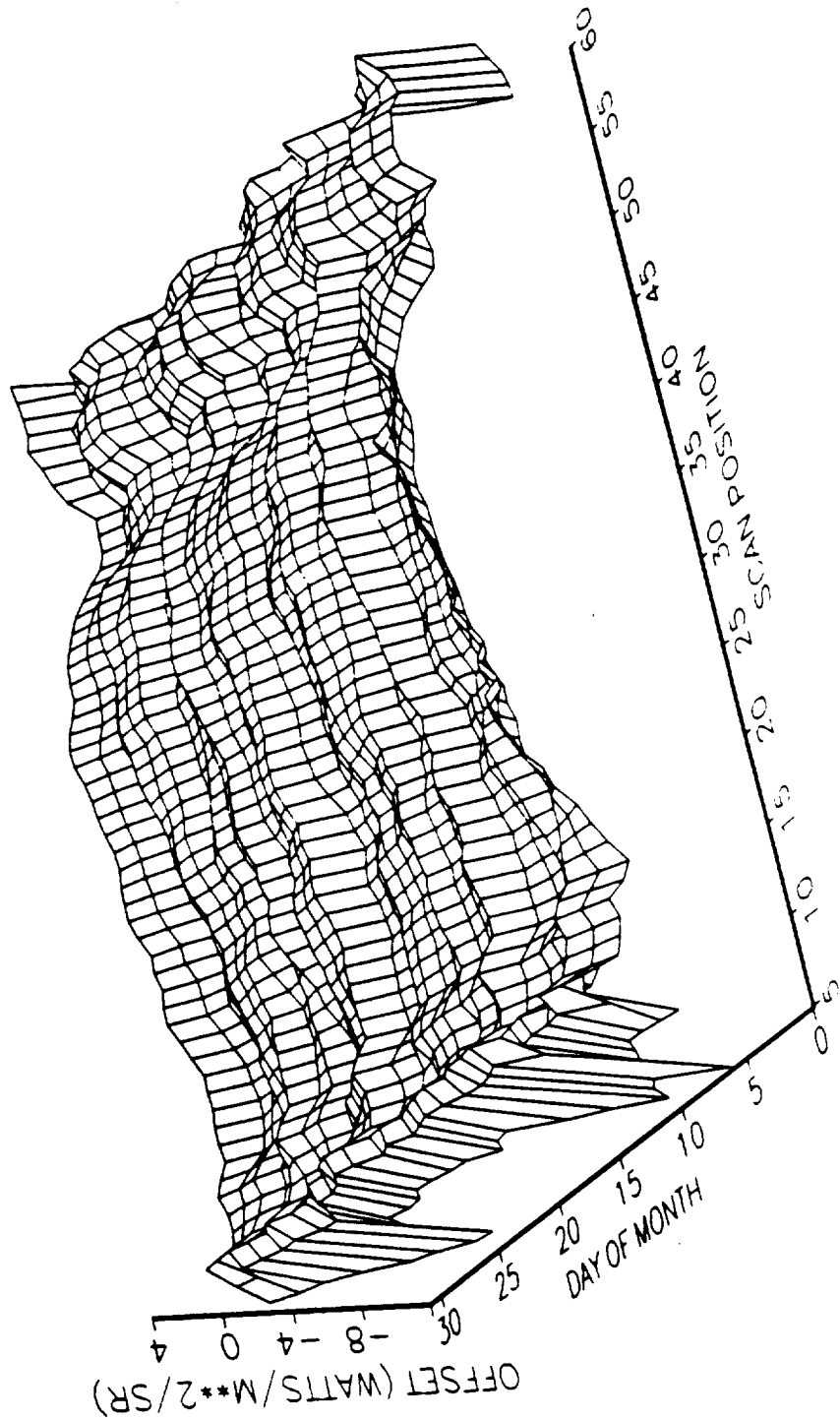

LONGWAVE OFFSETS
NOAA-9, APRIL 1986

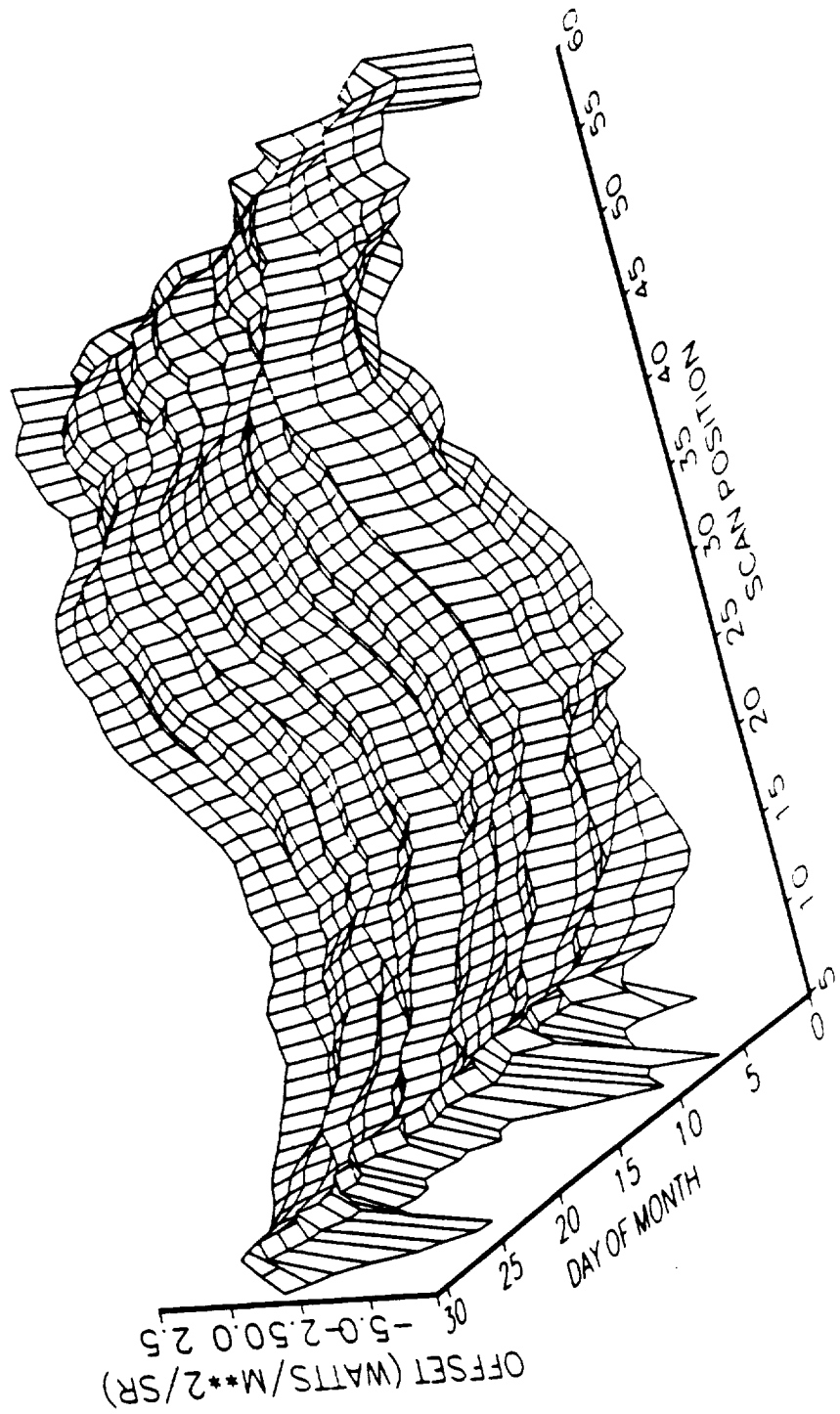

SHORTWAVE OFFSETS
NOAA-9, APRIL 1986

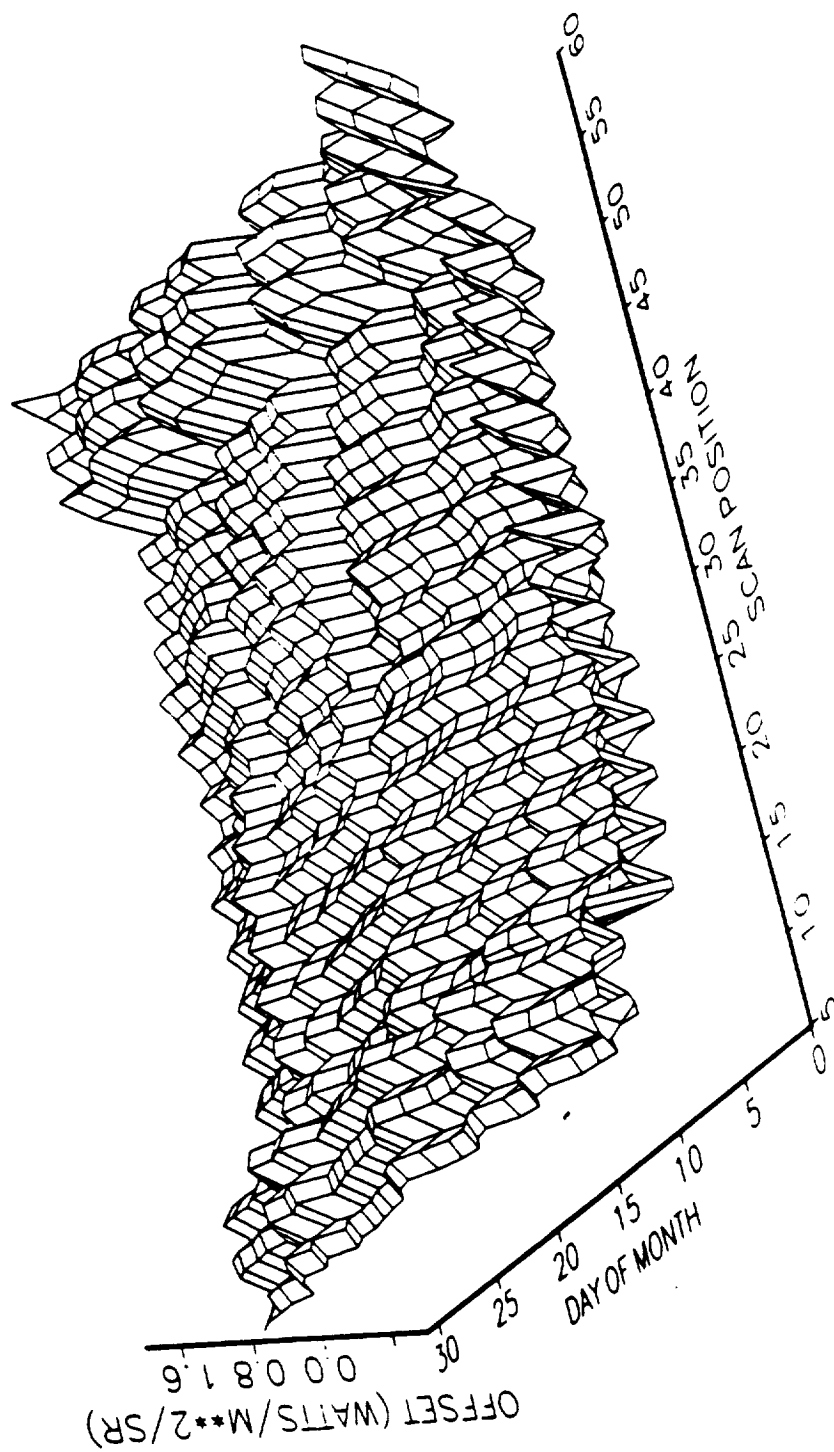

TOTAL OFFSETS
NOAA-9, MAY 1986

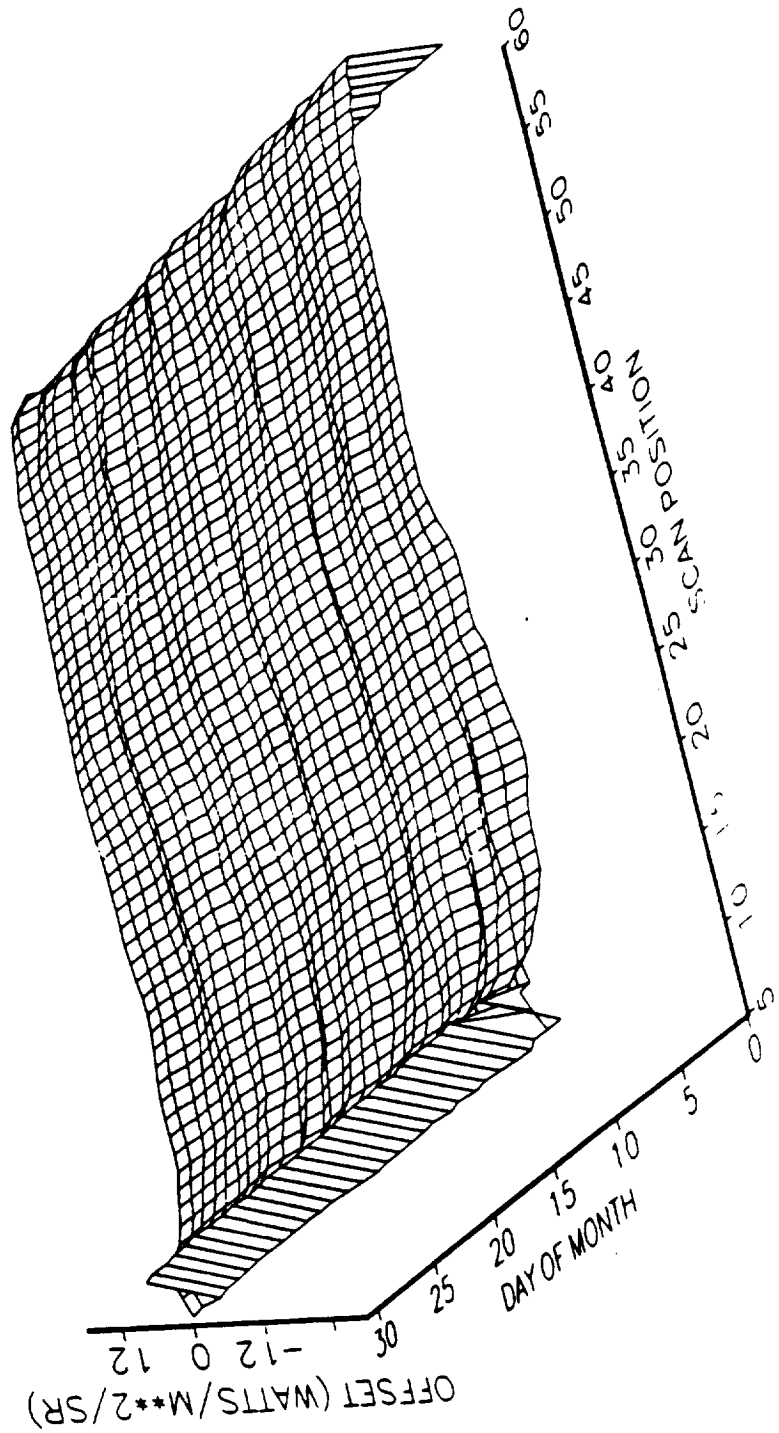

LONGWAVE OFFSETS
NOAA-9, MAY 1986

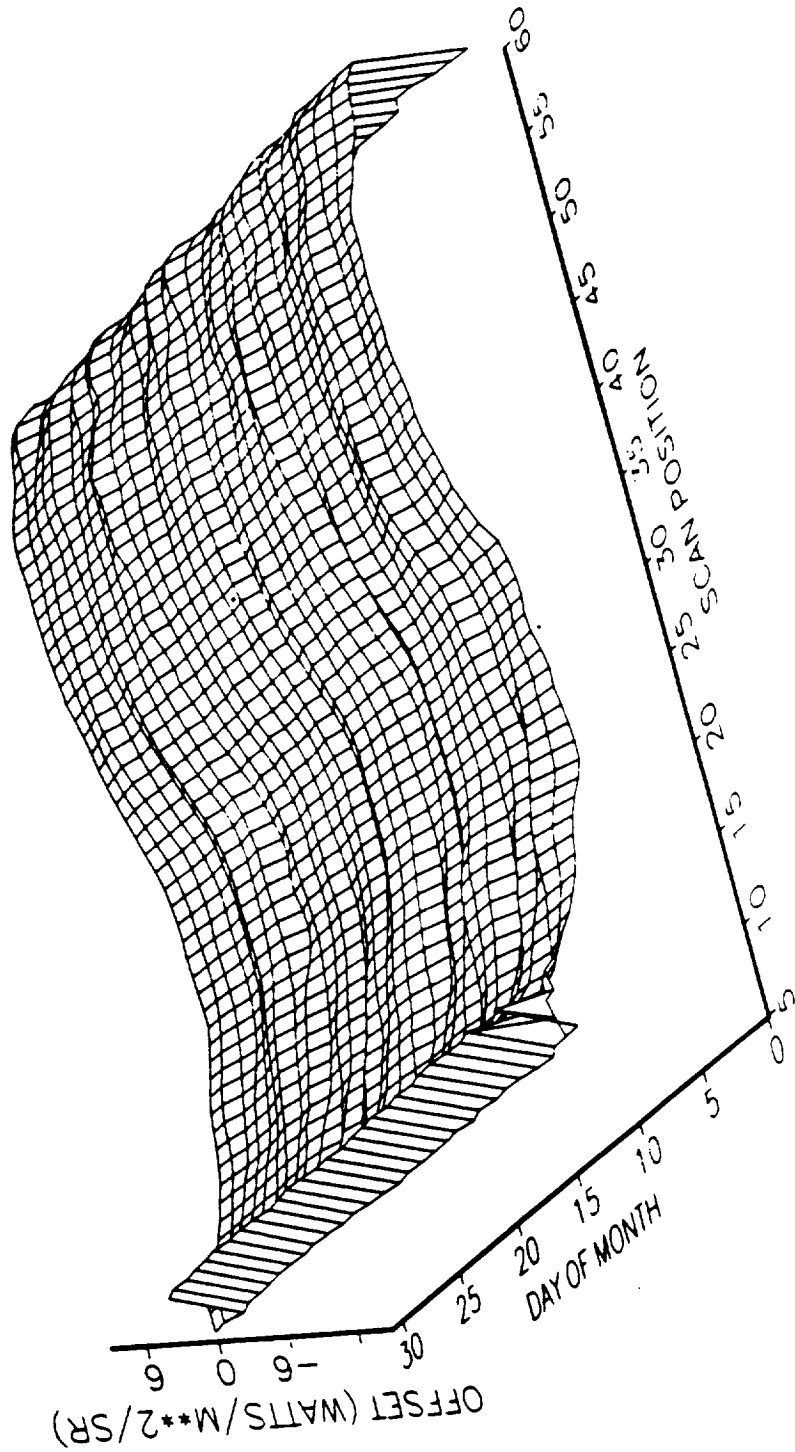

SHORTWAVE OFFSETS

NOAA-9, MAY 1986

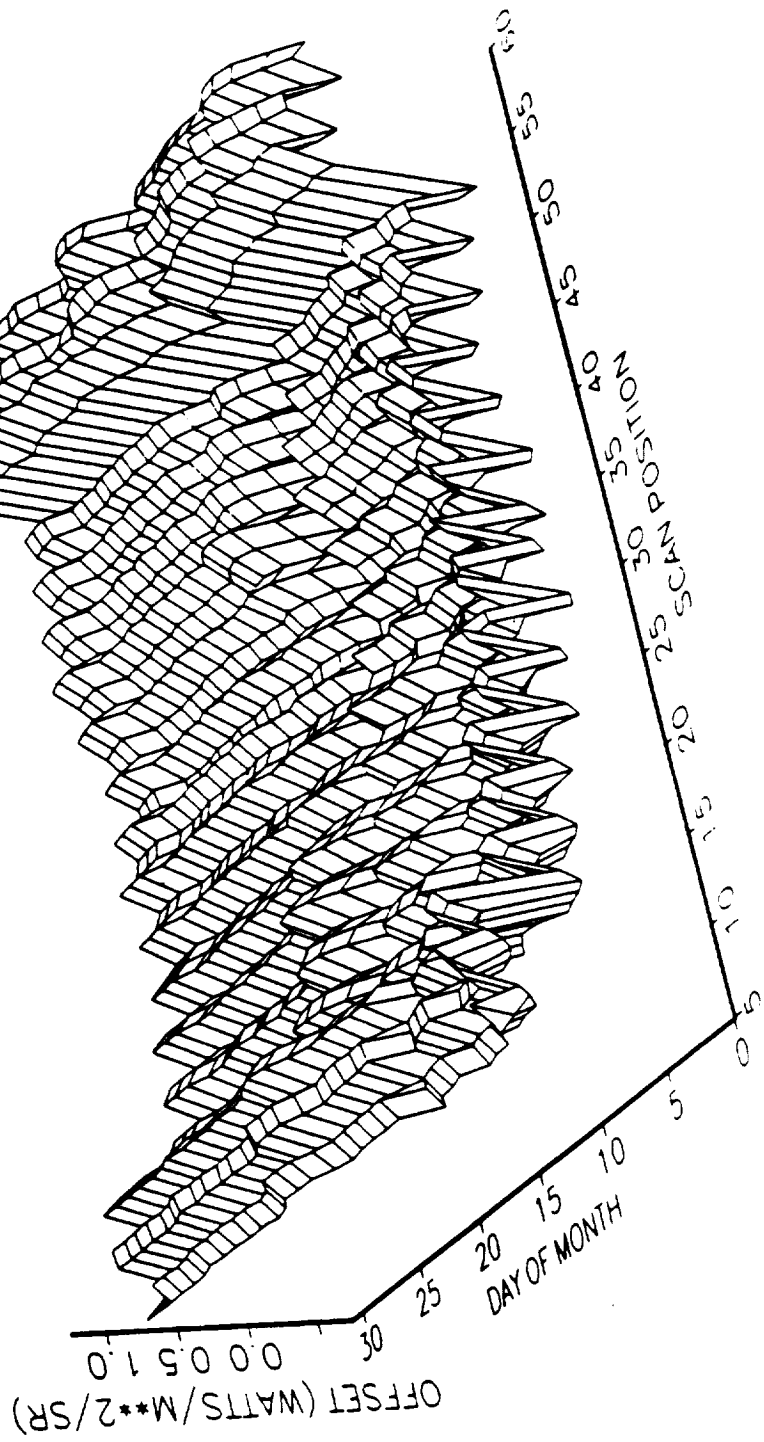

TOTAL OFFSLIS
NOAA-9, JUNE 1986

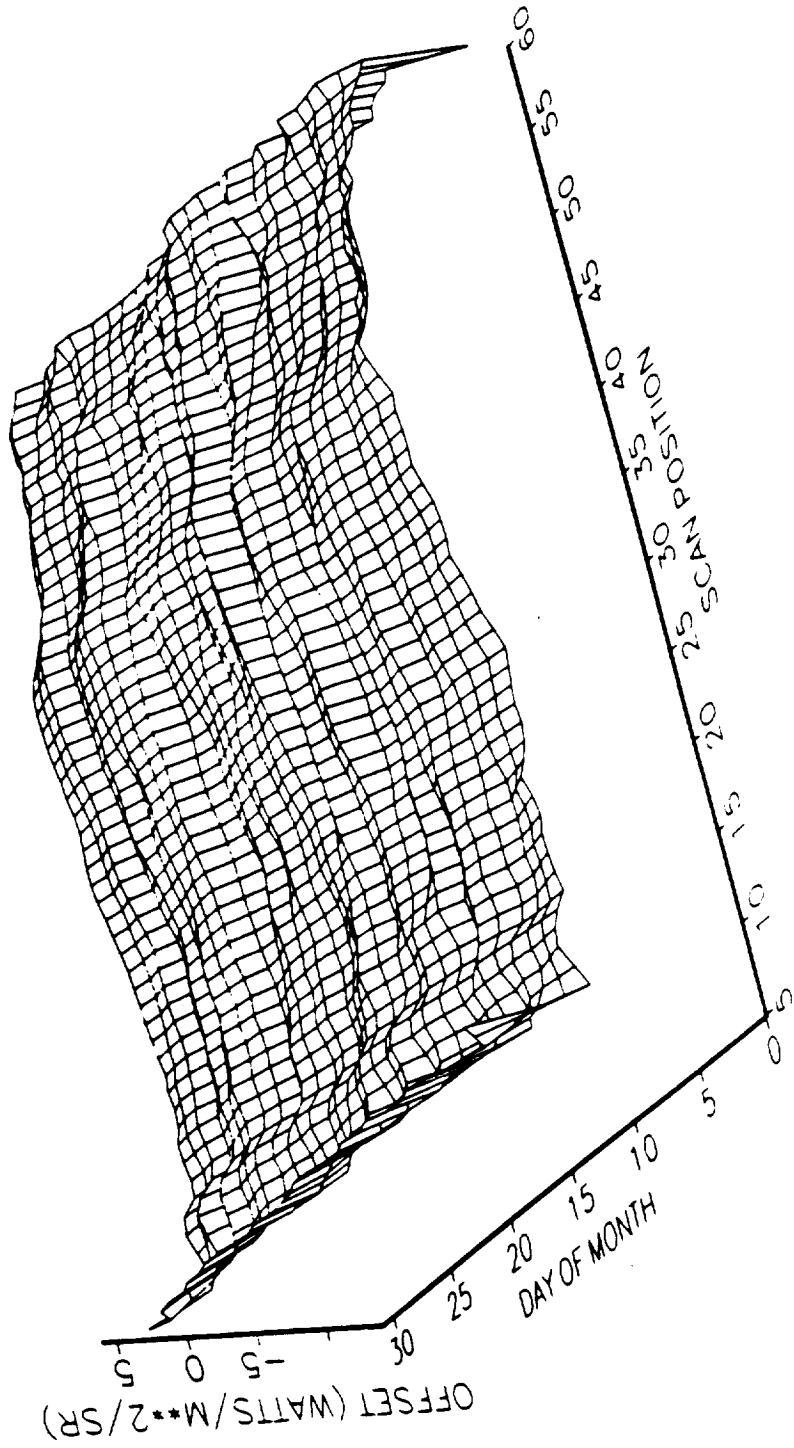

LONGWAVE OFFSETS
NOAA-9, JUNE 1986

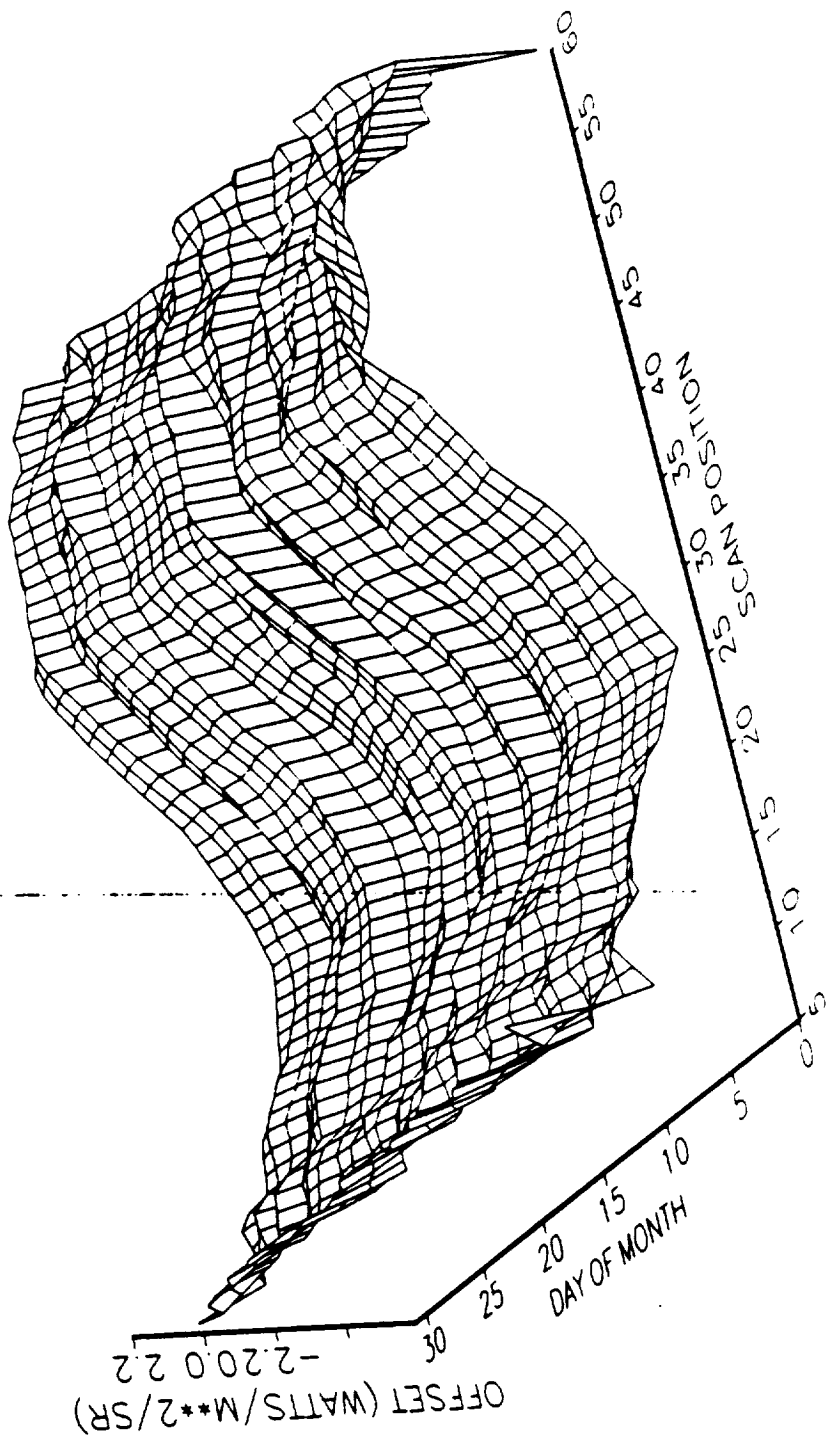

SHORTWAVE OFFSETS
NOAA-9, JUNE 1986

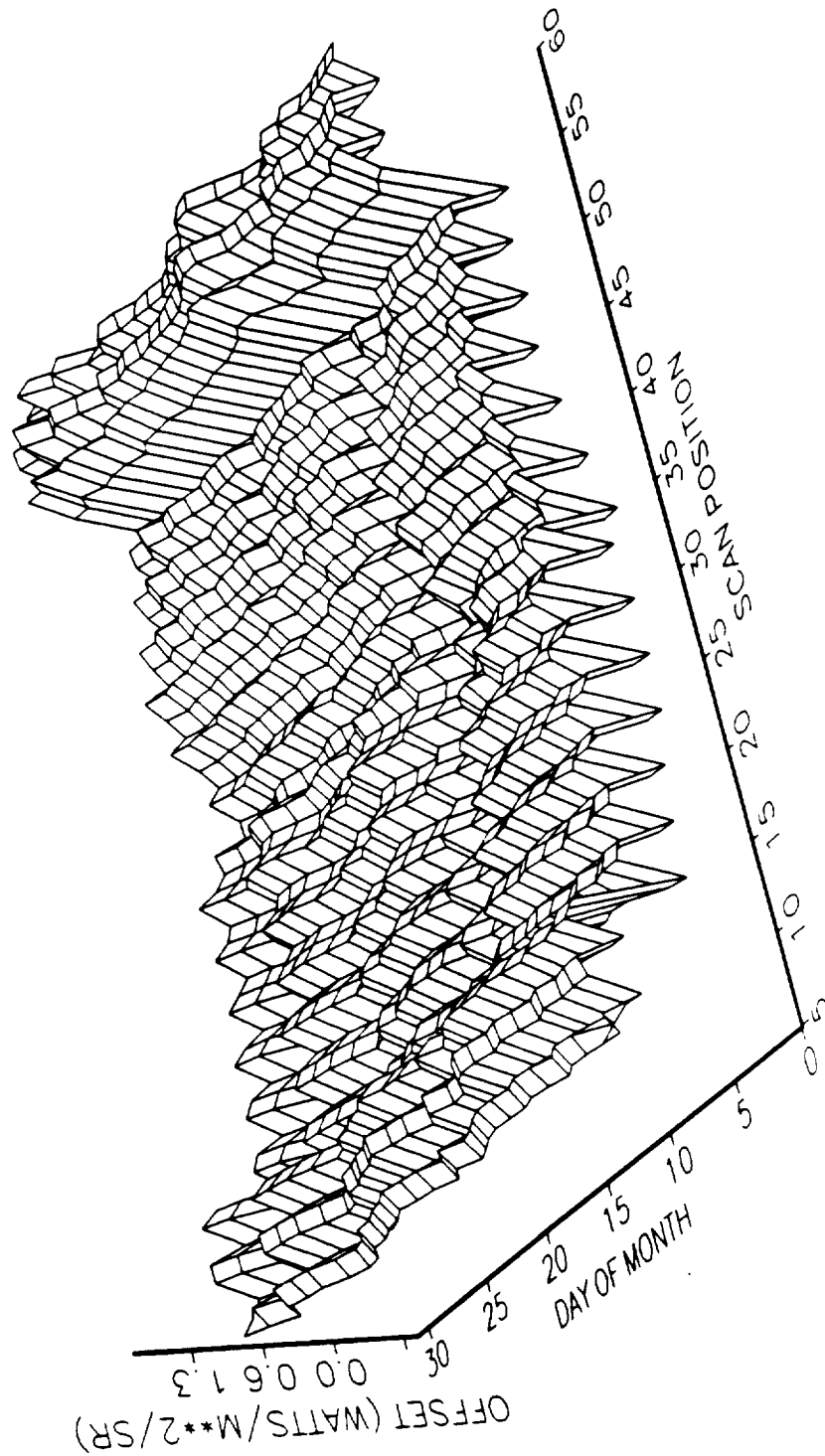

TOTAL OFFSETS
NOAA-9, JULY 1986

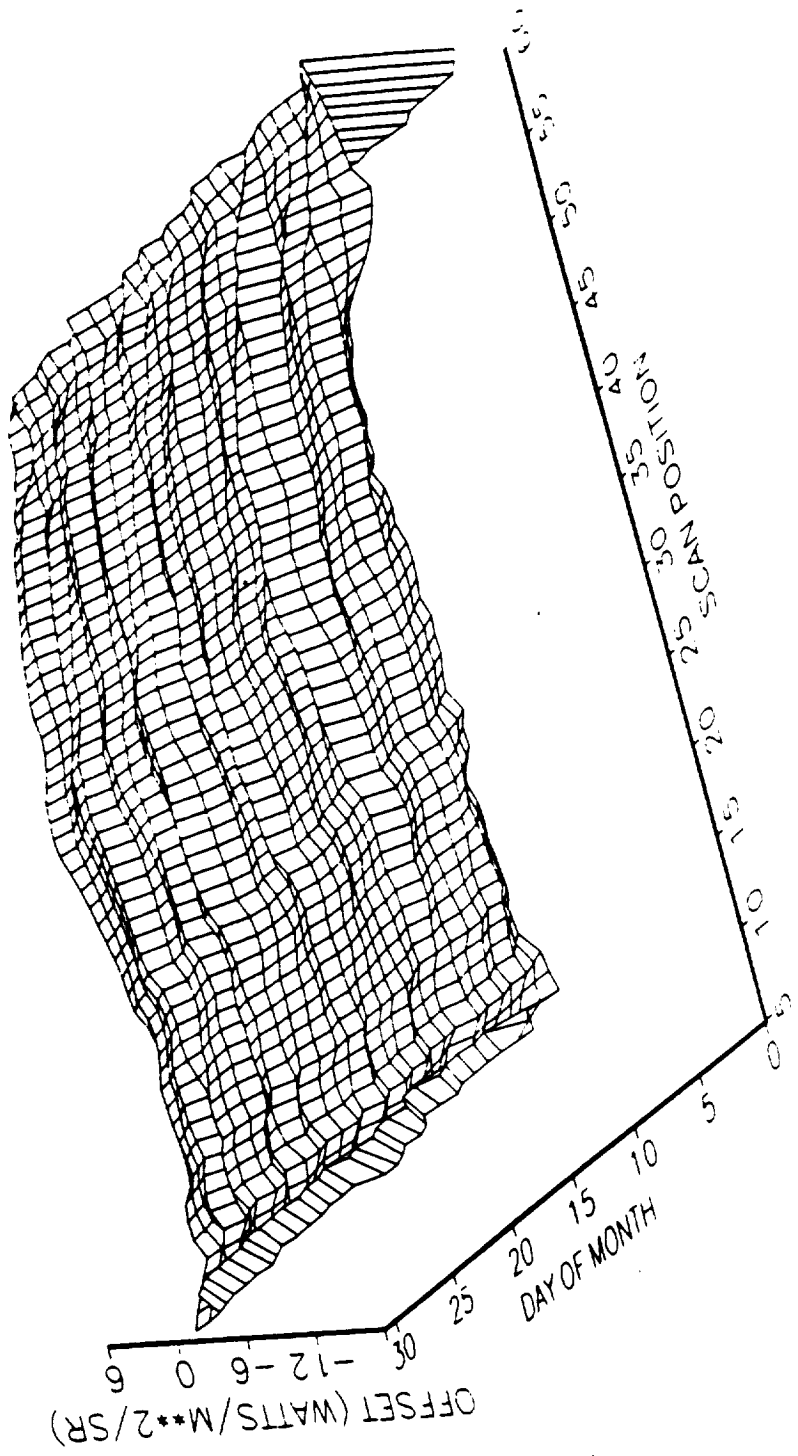

LONGWAVE OFFSET IS
NOAA-9, JULY 1986

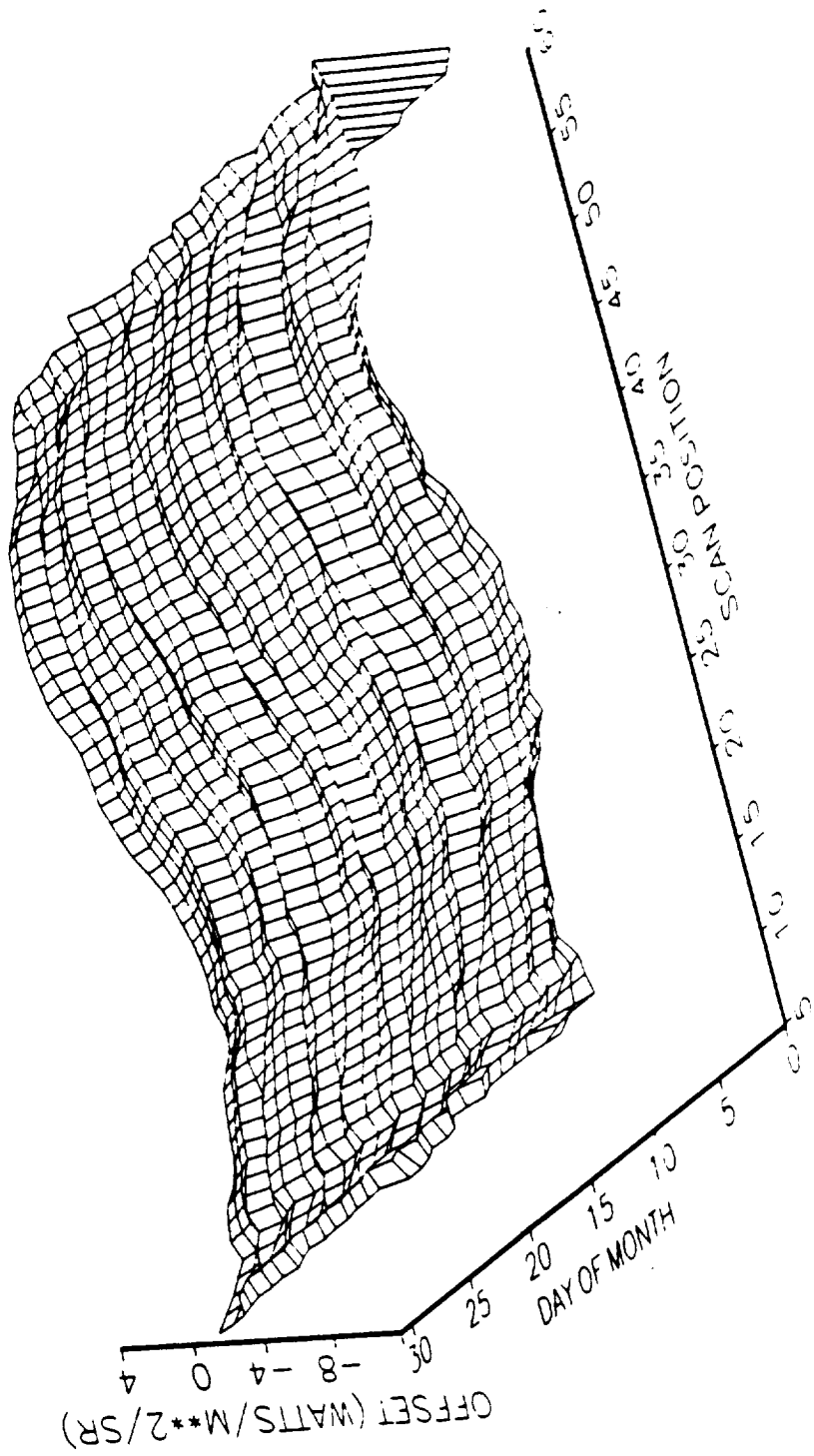

SHORTWAVE OFFSETS
NOAA-9, JULY 1986

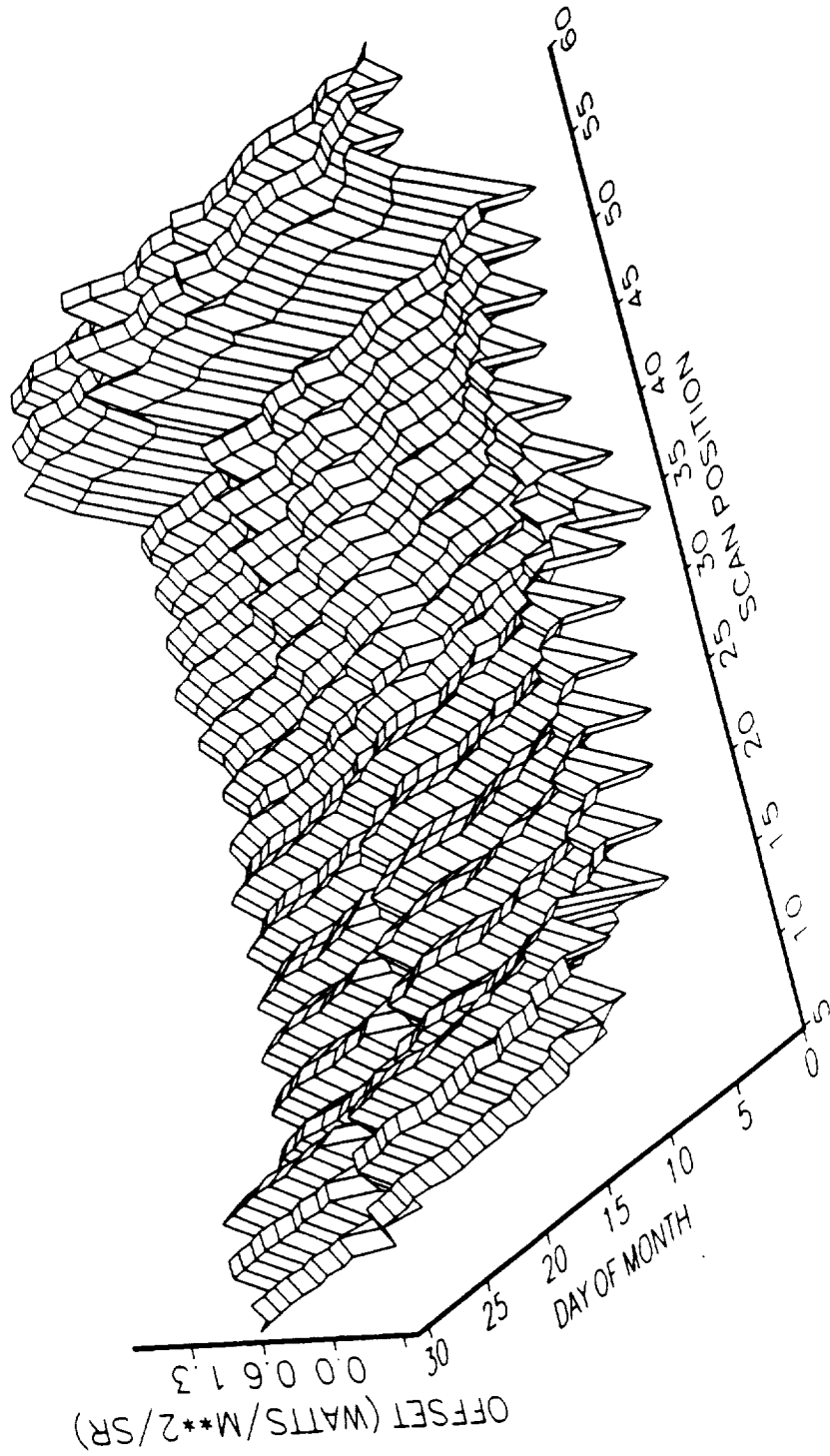

TOTAL OFFSETS
NOAA-9, AUGUST 1986

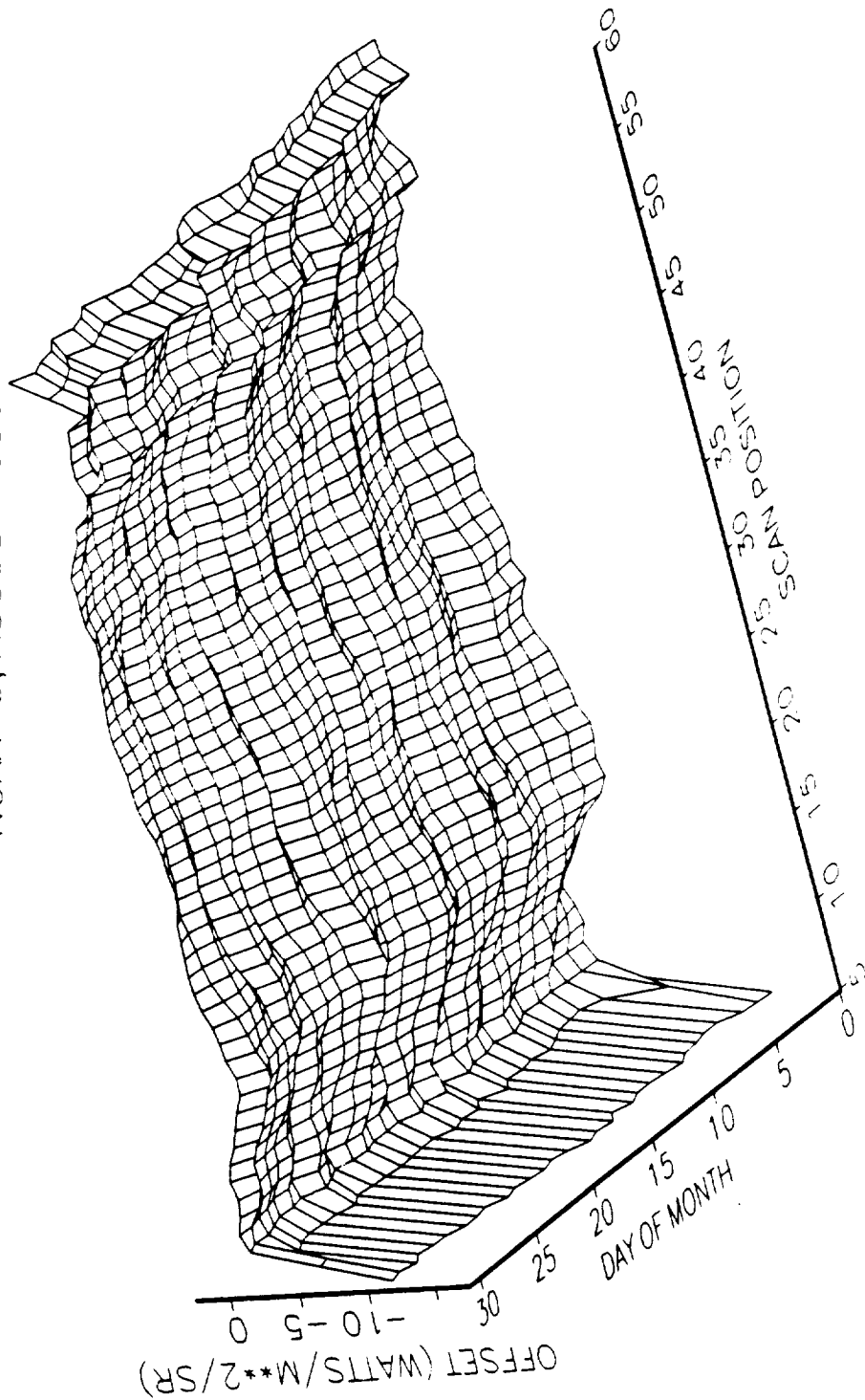

LONGWAVE OFFSETS
NOAA-9, AUGUST 1986

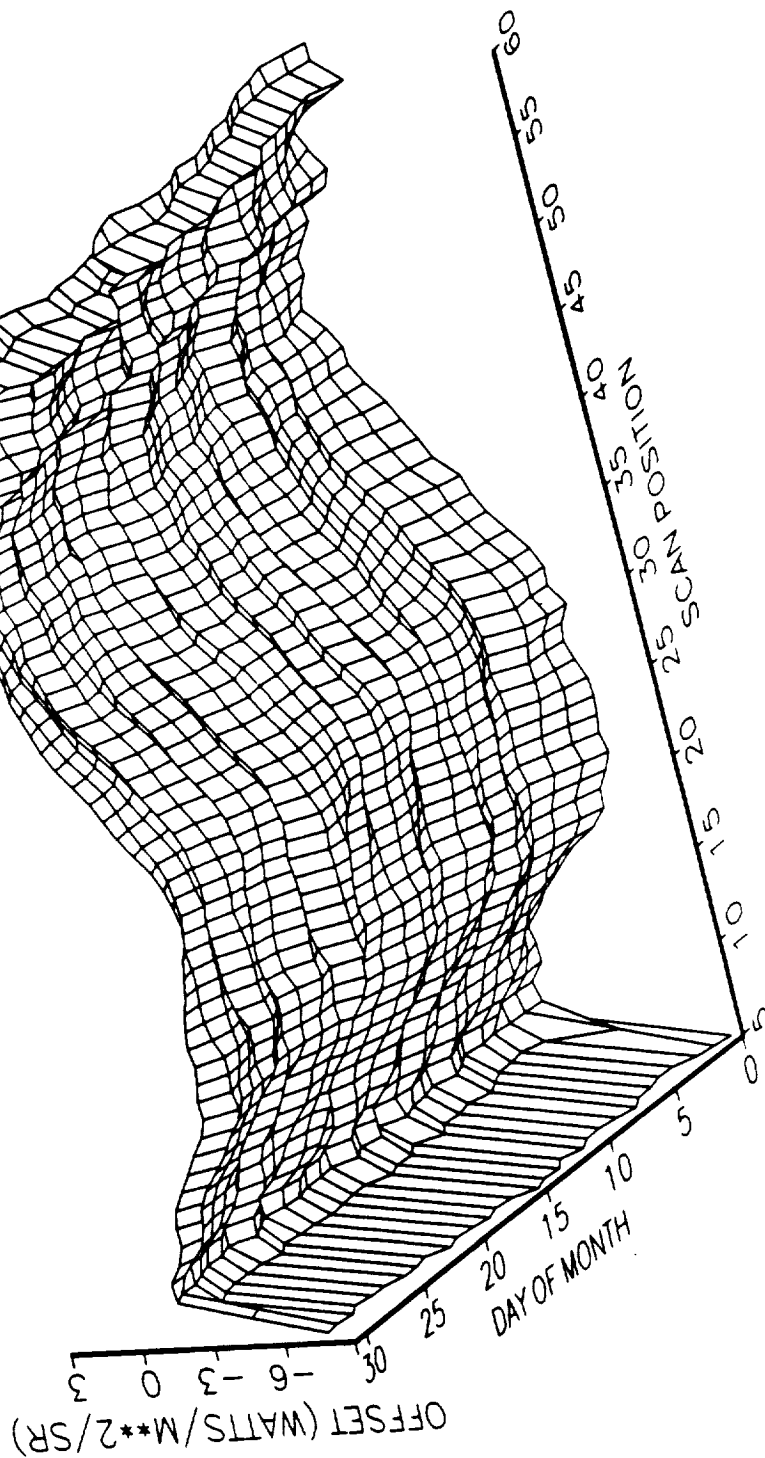

SHORTWAVE OFFSETS
NOAA-9, AUGUST 1986

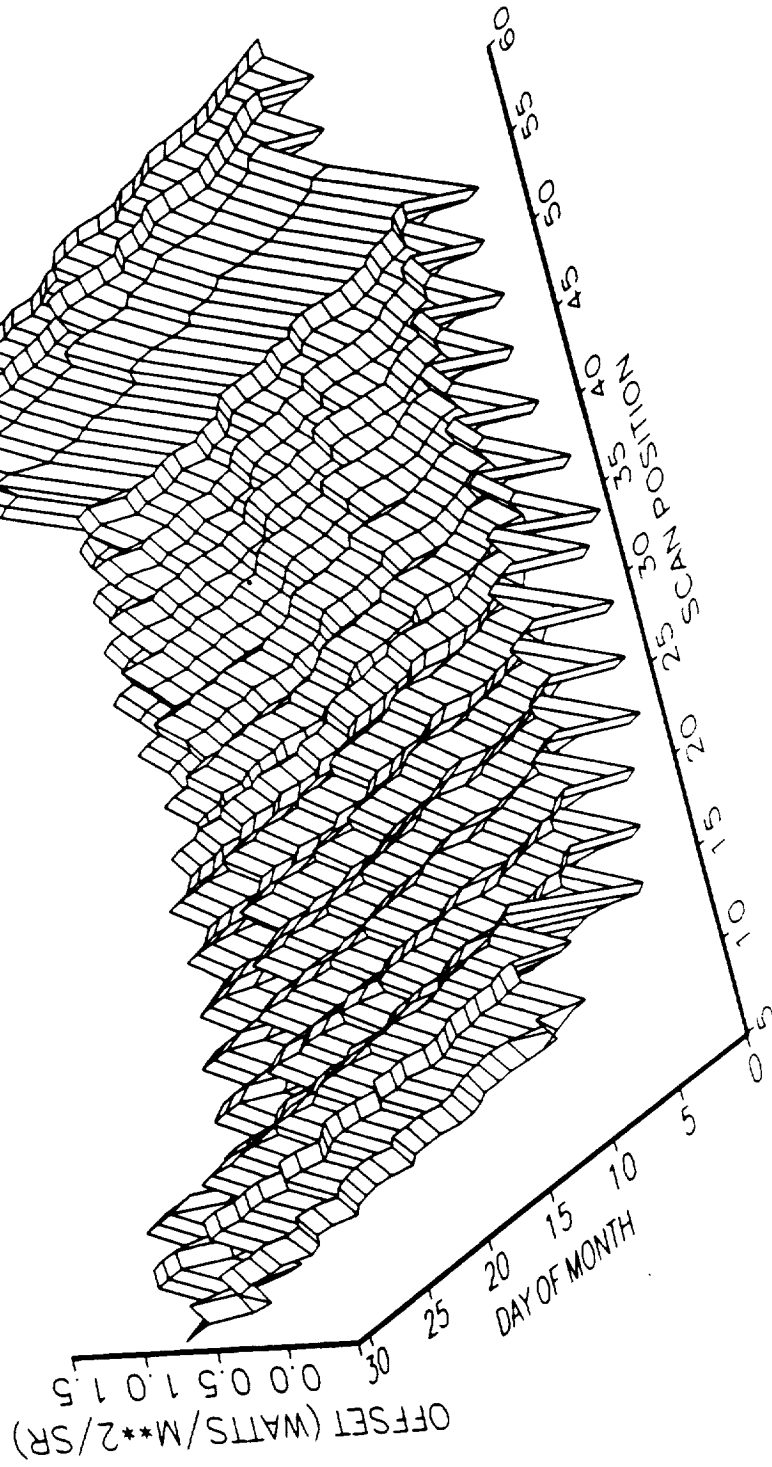

TOTAL OFFSETS
NOAA-9, SEPTEMBER 1986

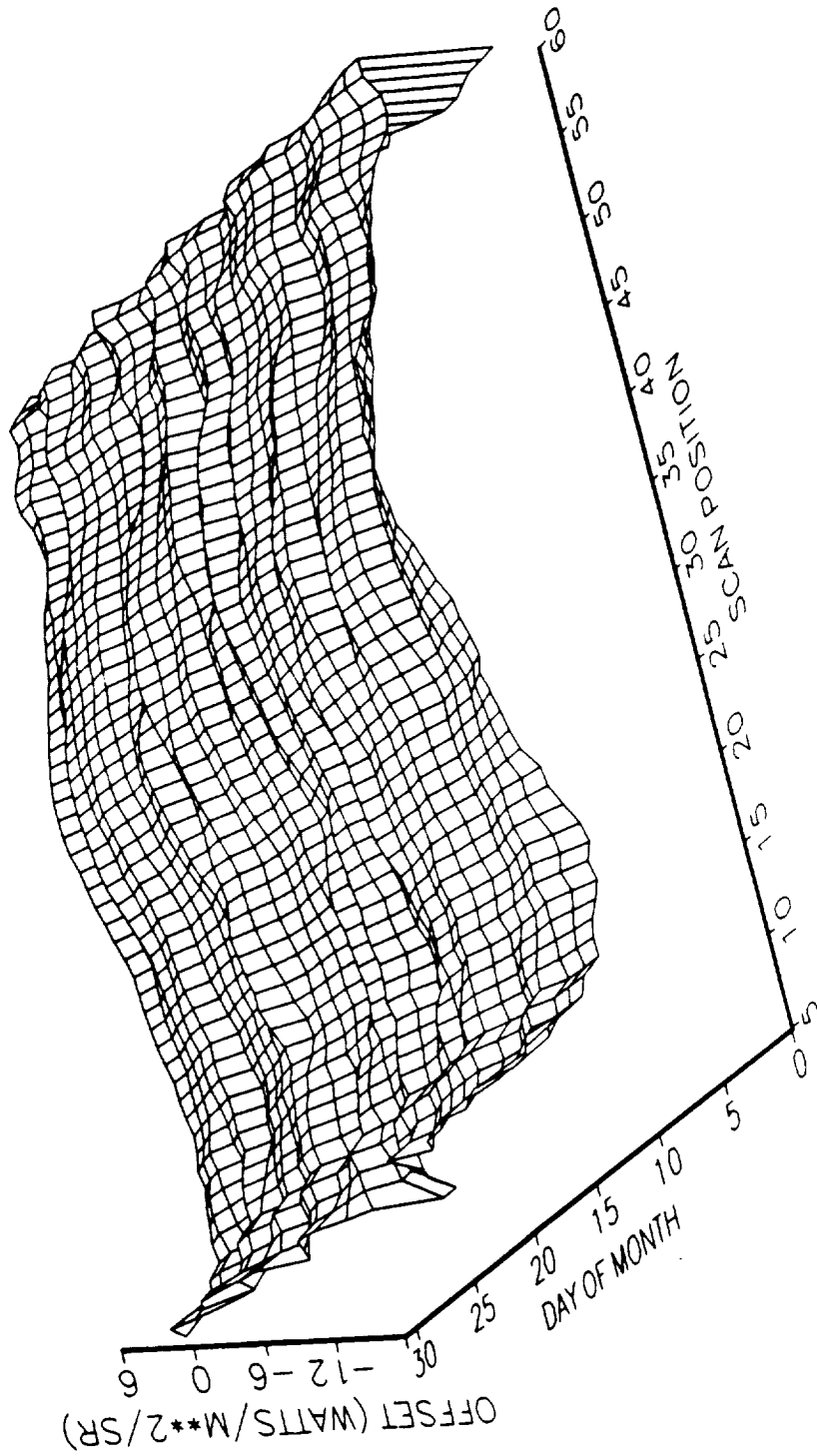

LONGWAVE OFFSETS
NOAA-9, SEPTEMBER 1986

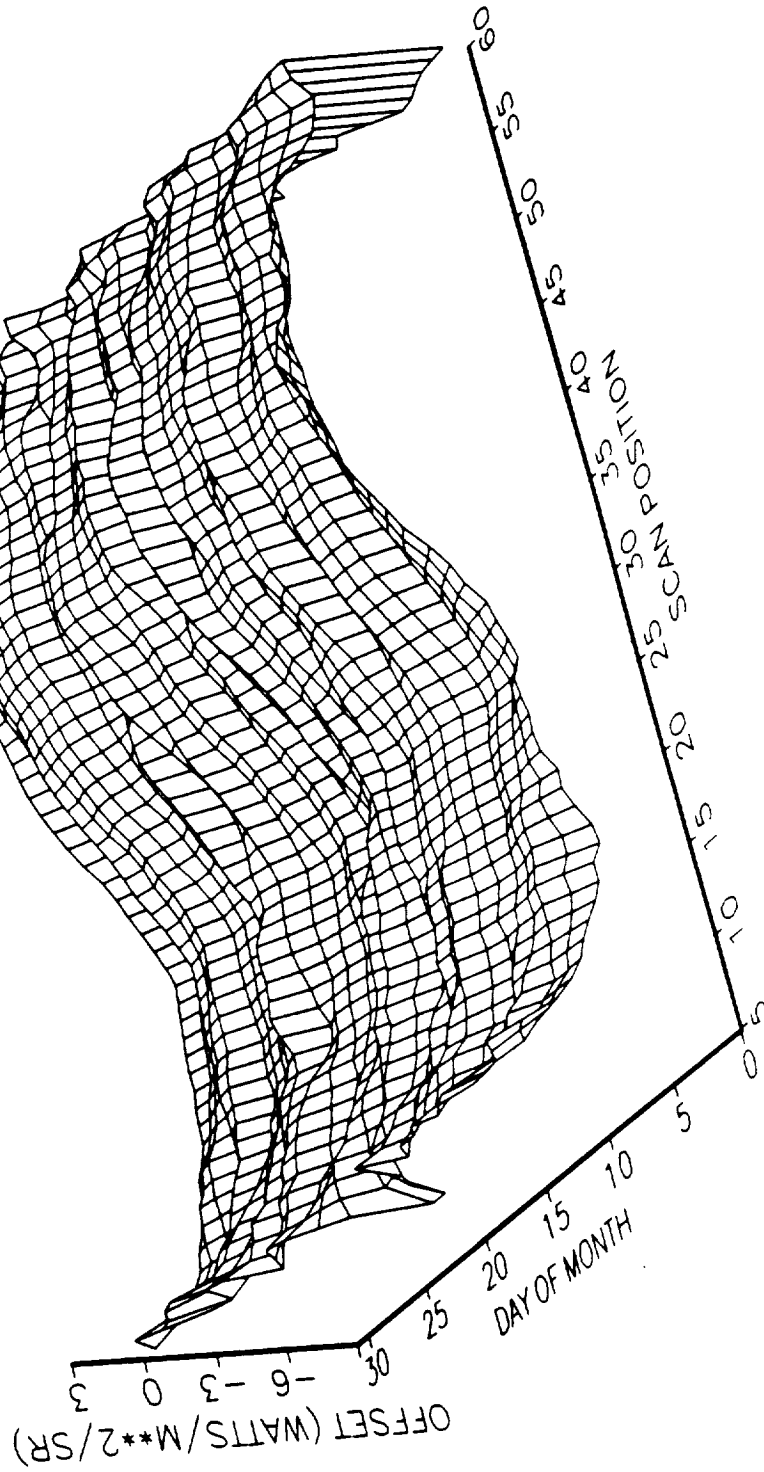

SHORTWAVE OFFSETS
NOAA-9, SEPTEMBER 1986

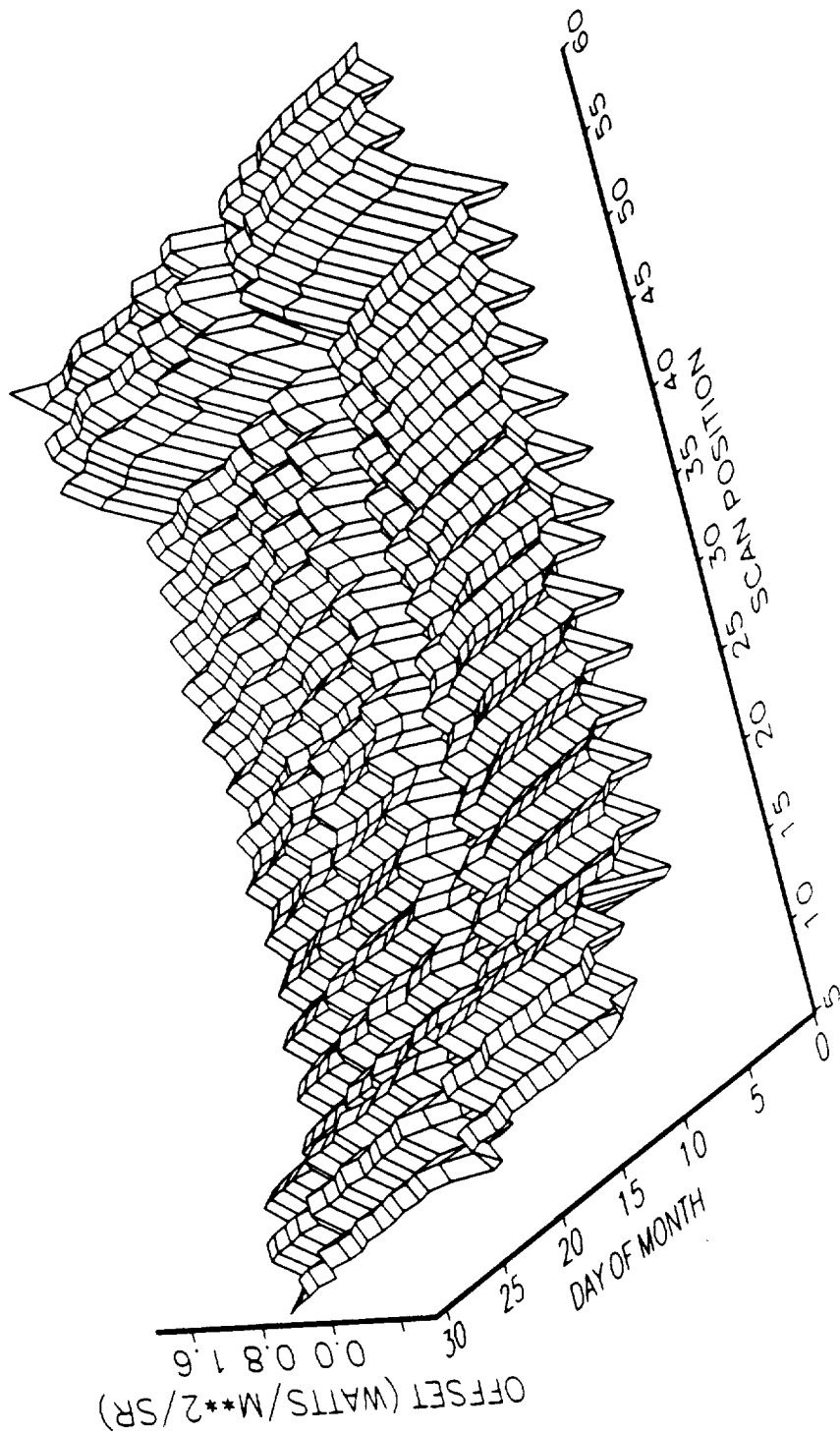

TOTAL OFFSETS
NOAA-9, OCTOBER 1986

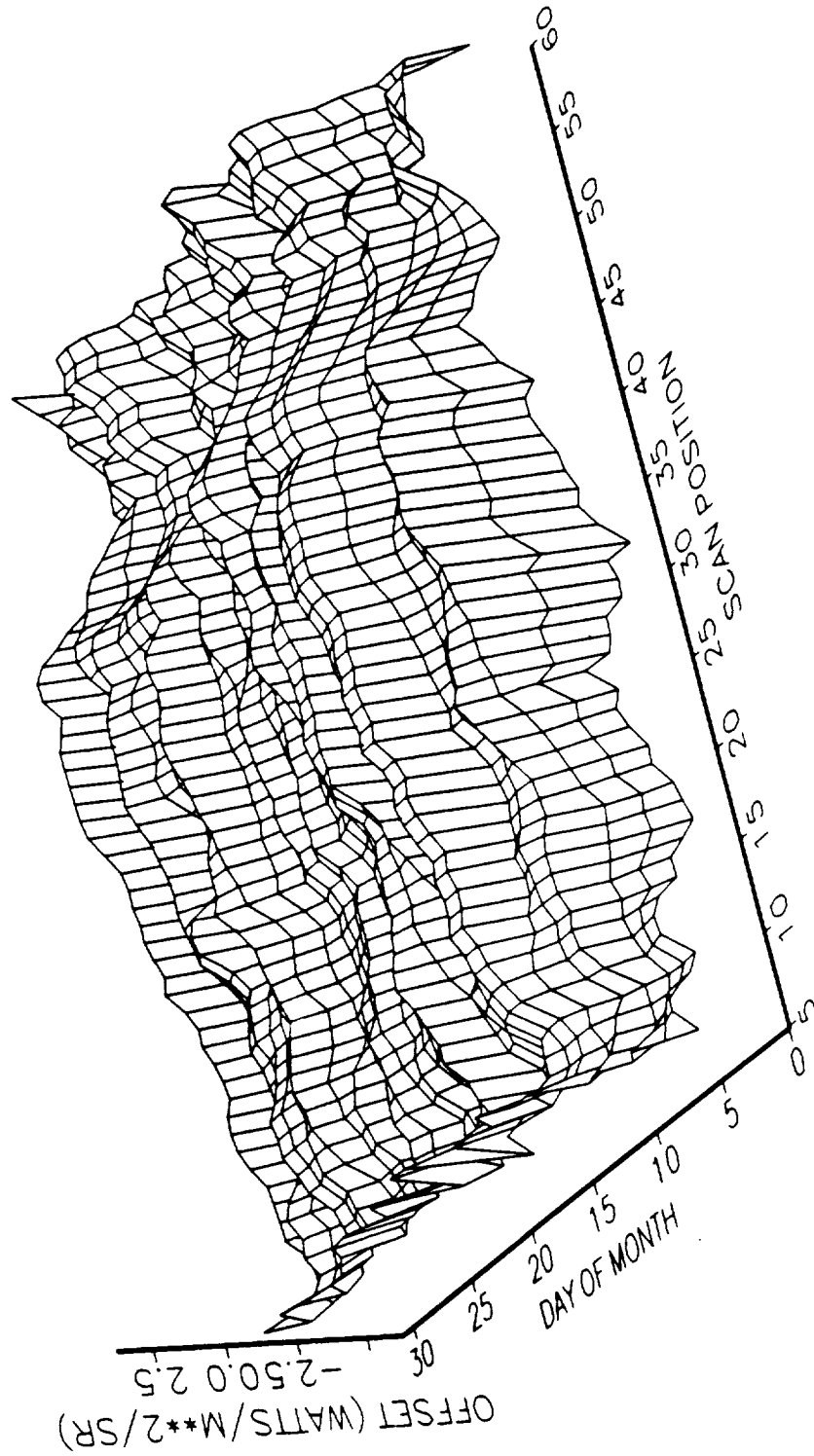

LONGWAVE OFFSETS
NOAA-9, OCTOBER 1986

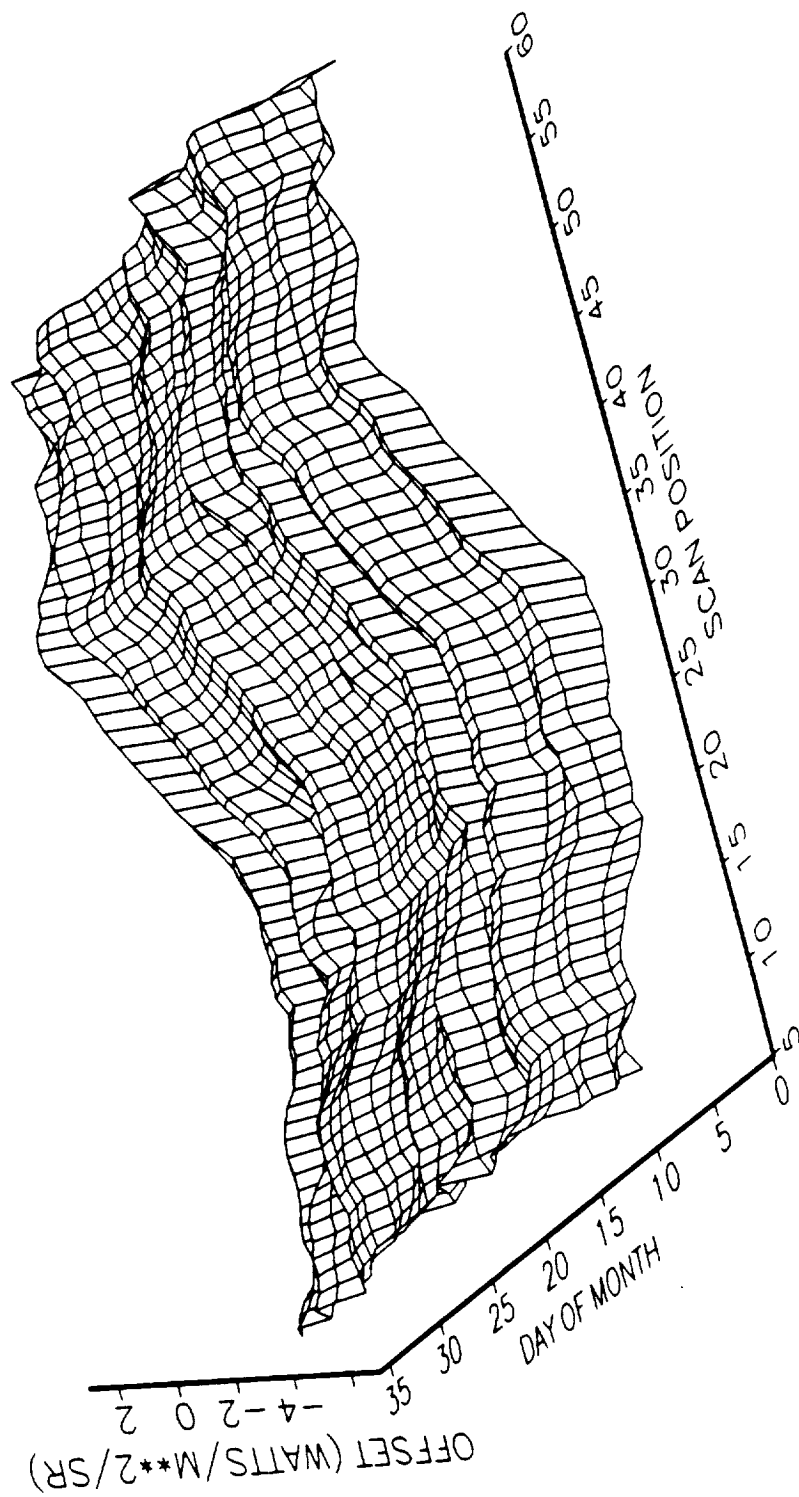

TOTAL OFFSETS
NOAA-9, NOVEMBER 1986

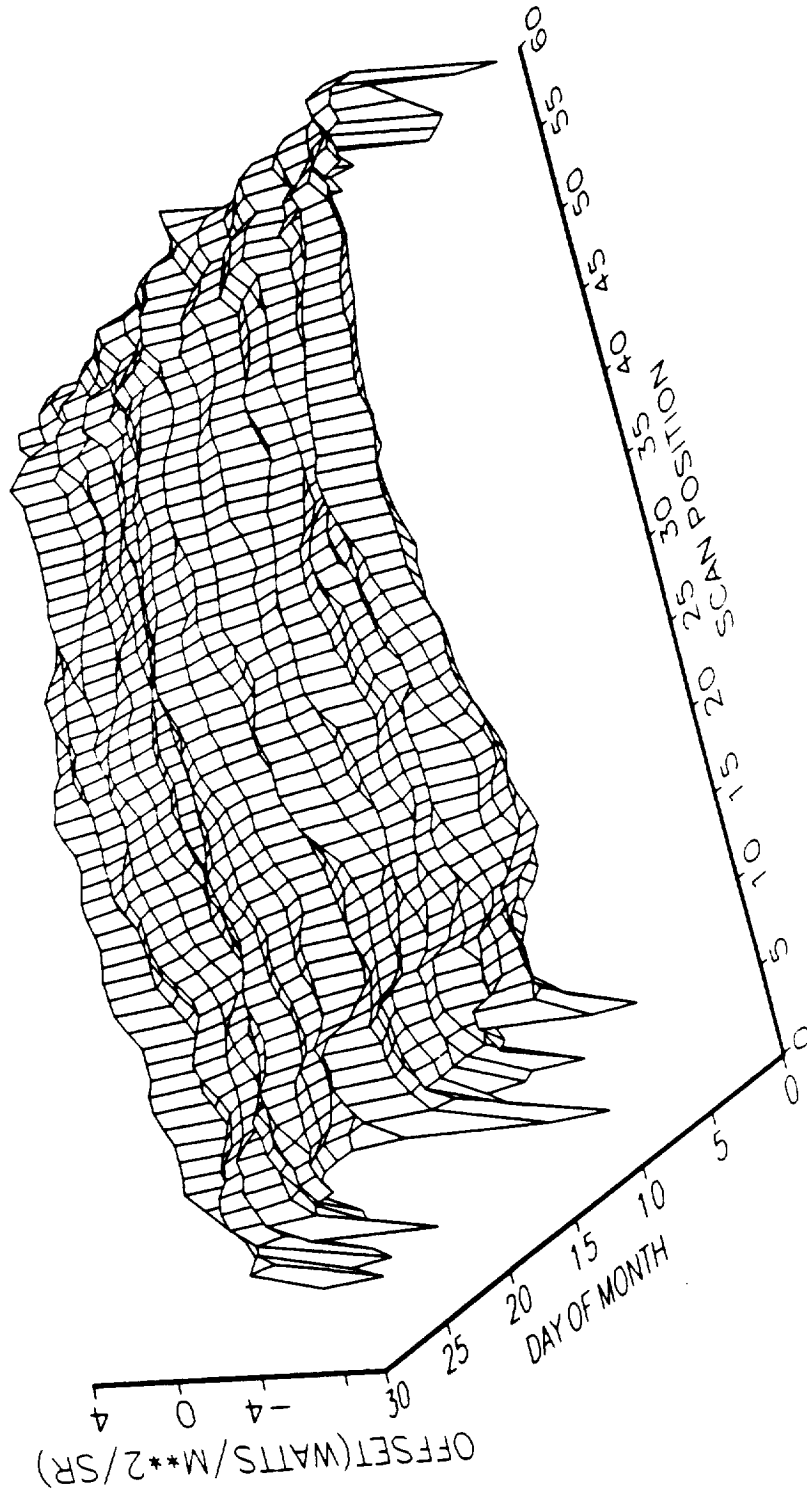

TOTAL OFFSETS
NOAA-9, NOVEMBER 1986

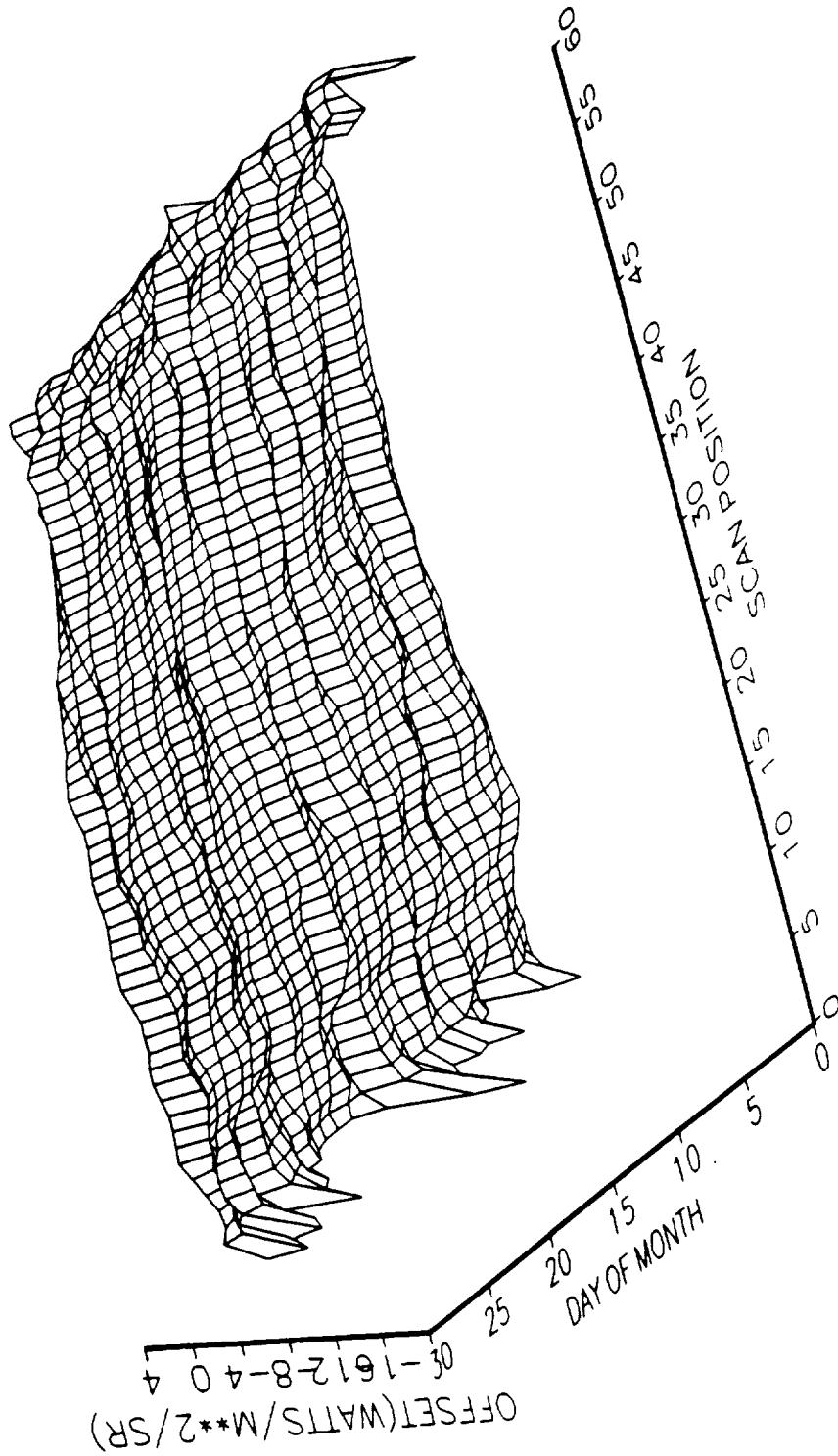

LONGWAVE OFFSETS
NOAA-9, NOVEMBER 1986

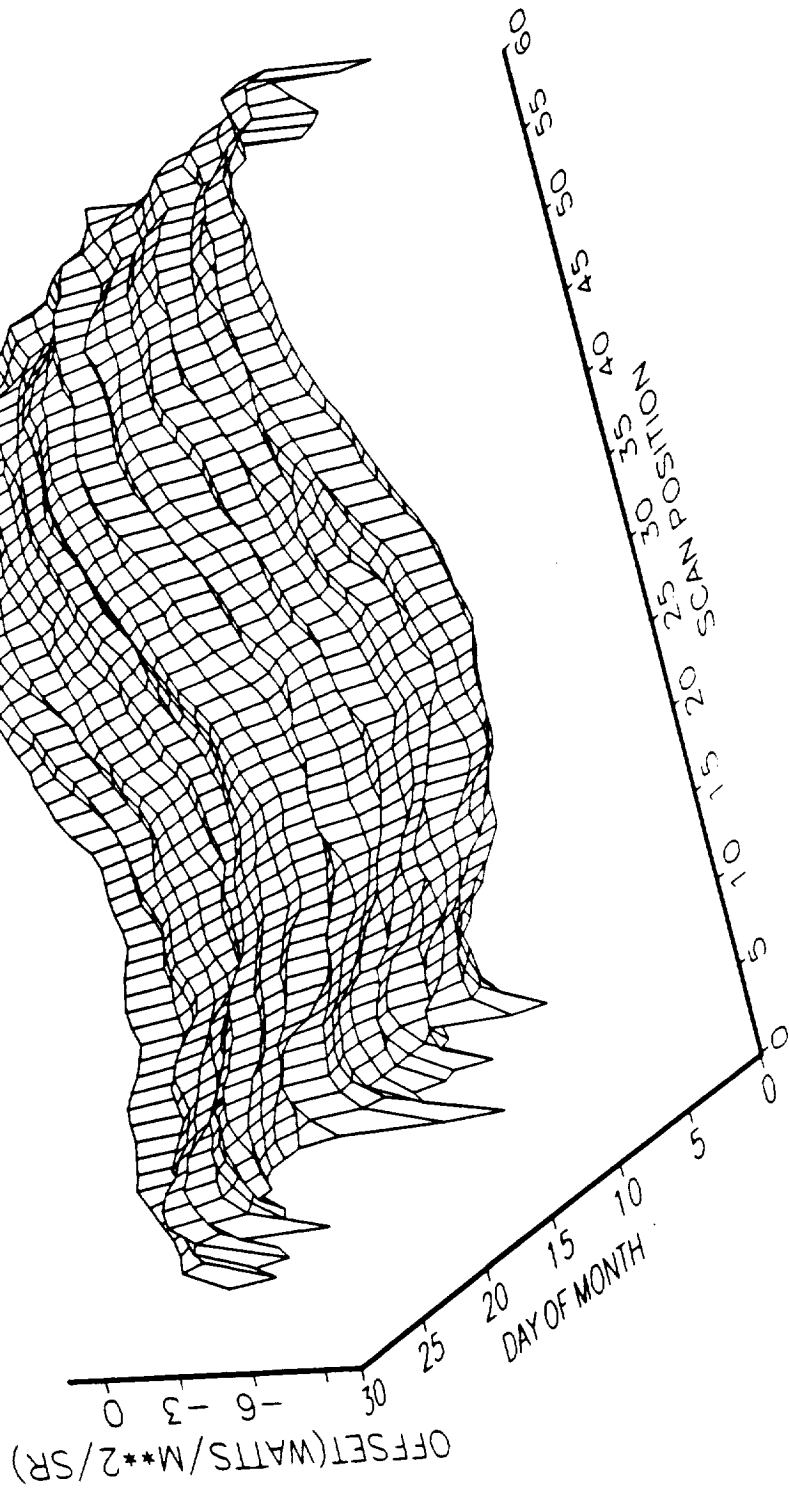

SHORTWAVE OFFSETS
NOAA-9, NOVEMBER 1986

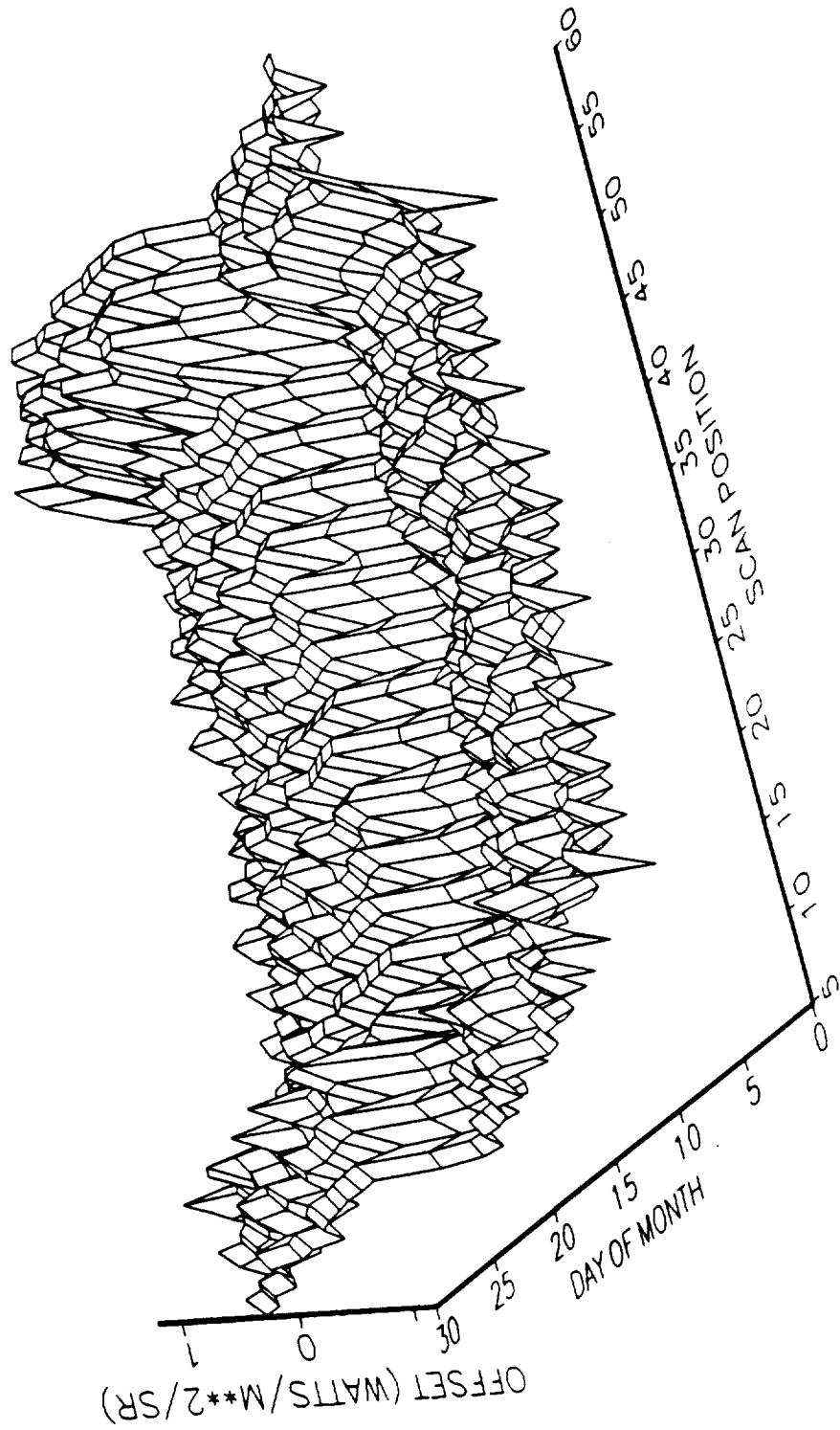

TOTAL OFFSETS
NOAA-9, DECEMBER 1986

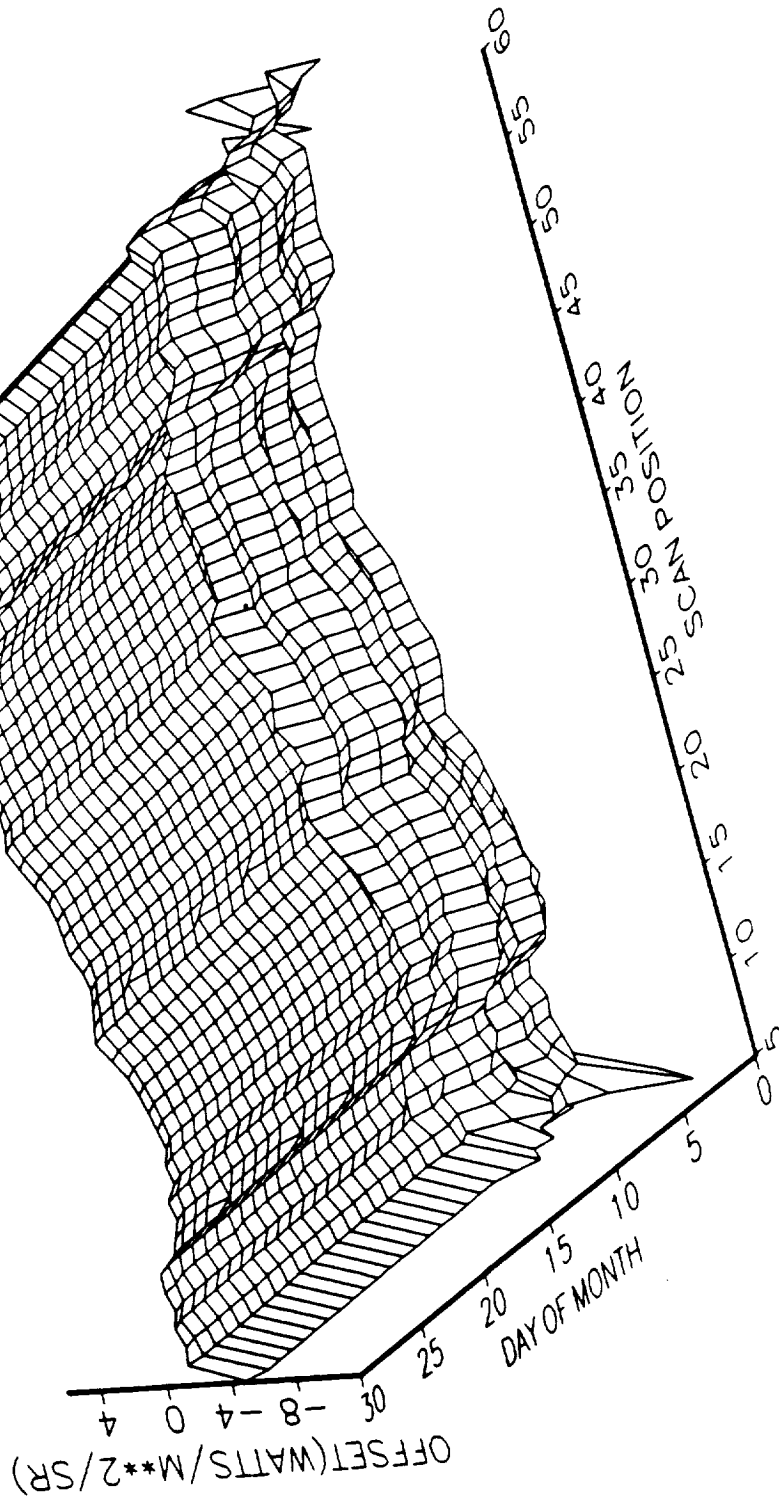

LONGWAVE OFFSETS
NOAA-9, DECEMBER 1986

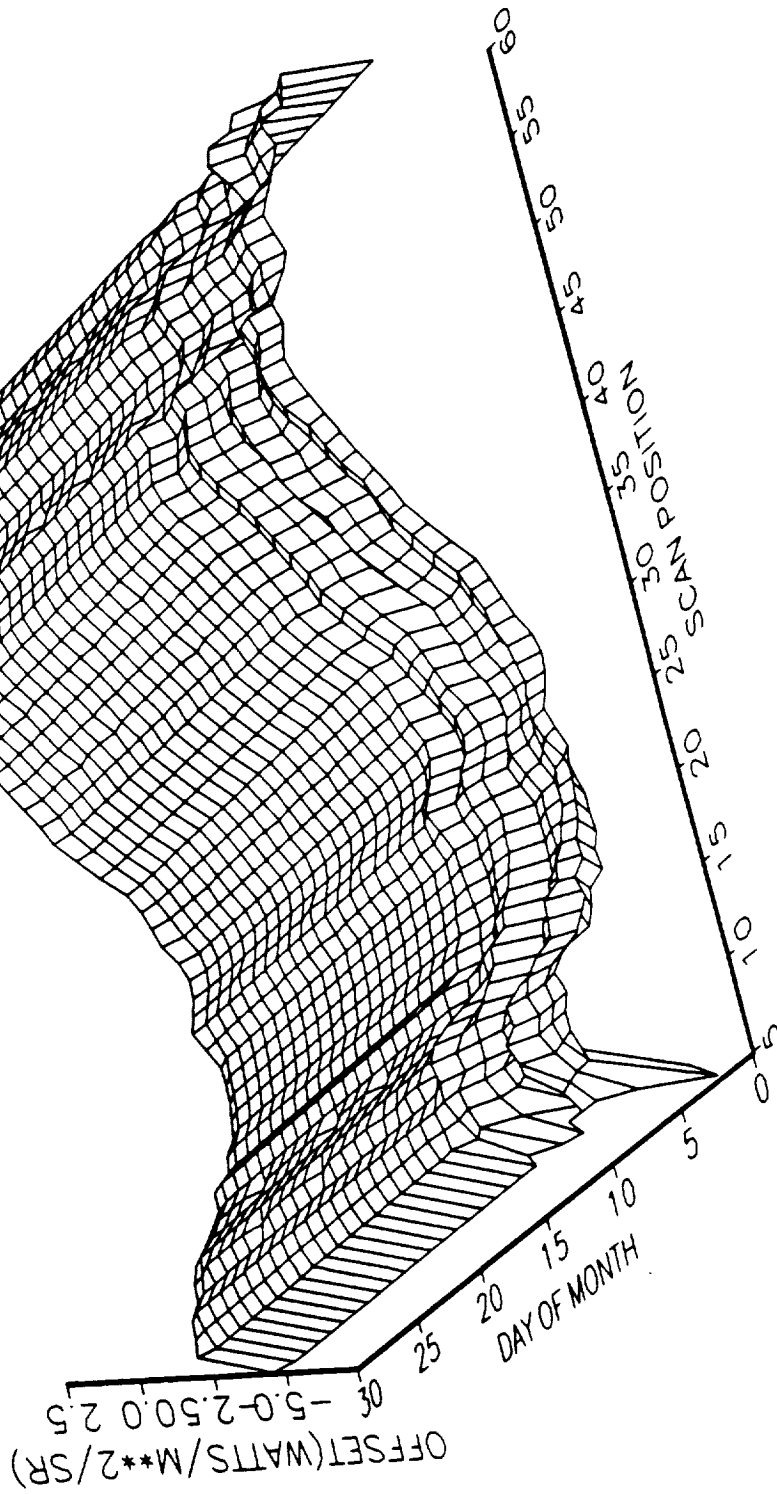

SHORTWAVE OFFSETS
NOAA-9, DECEMBER 1986

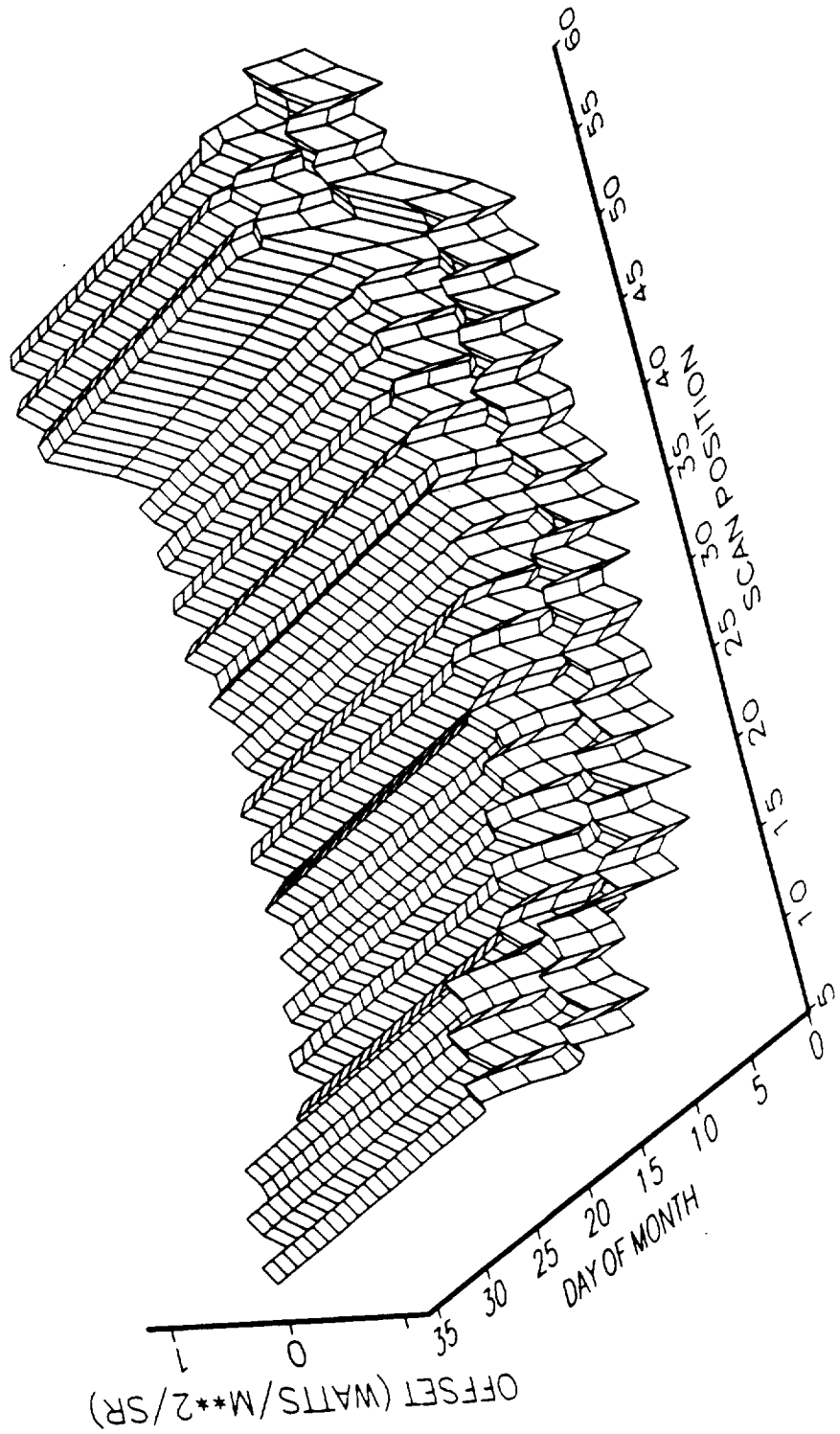

This page has been intentionally left blank

APPENDIX F

NOAA-10 SCANNER OFFSET SURFACE PLOTS

PRECEDING PAGE BLANK NOT FILMED

APPENDIX F: NOAA-10 SCANNER OFFSET SURFACE PLOTS

The following plots show the total, longwave, and shortwave NOAA-10 scanner offsets used during October, November, and December of 1986. The x-axis is in units of Earth-viewing scan position. The y-axis is in units of day-of-month. The z-axis is in units of Watts/m²/steradian. Missing data are plotted as zero.

This page has been intentionally left blank

TOTAL OFFSETS
NOAA-10, OCTOBER, NOVEMBER, DECEMBER 1986

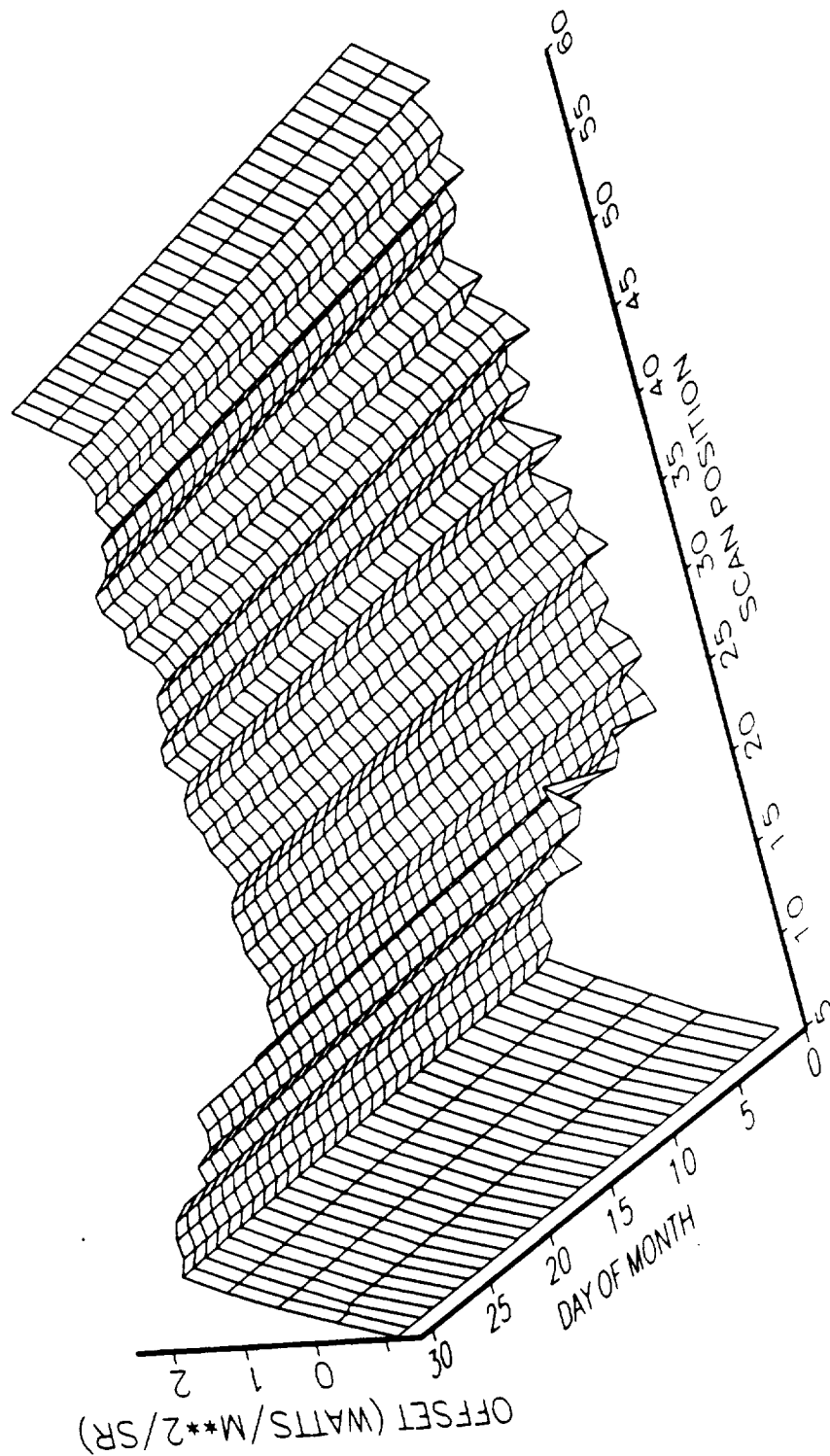

LONGWAVE OFFSETS
NOAA-10, OCTOBER, NOVEMBER, DECEMBER 1986

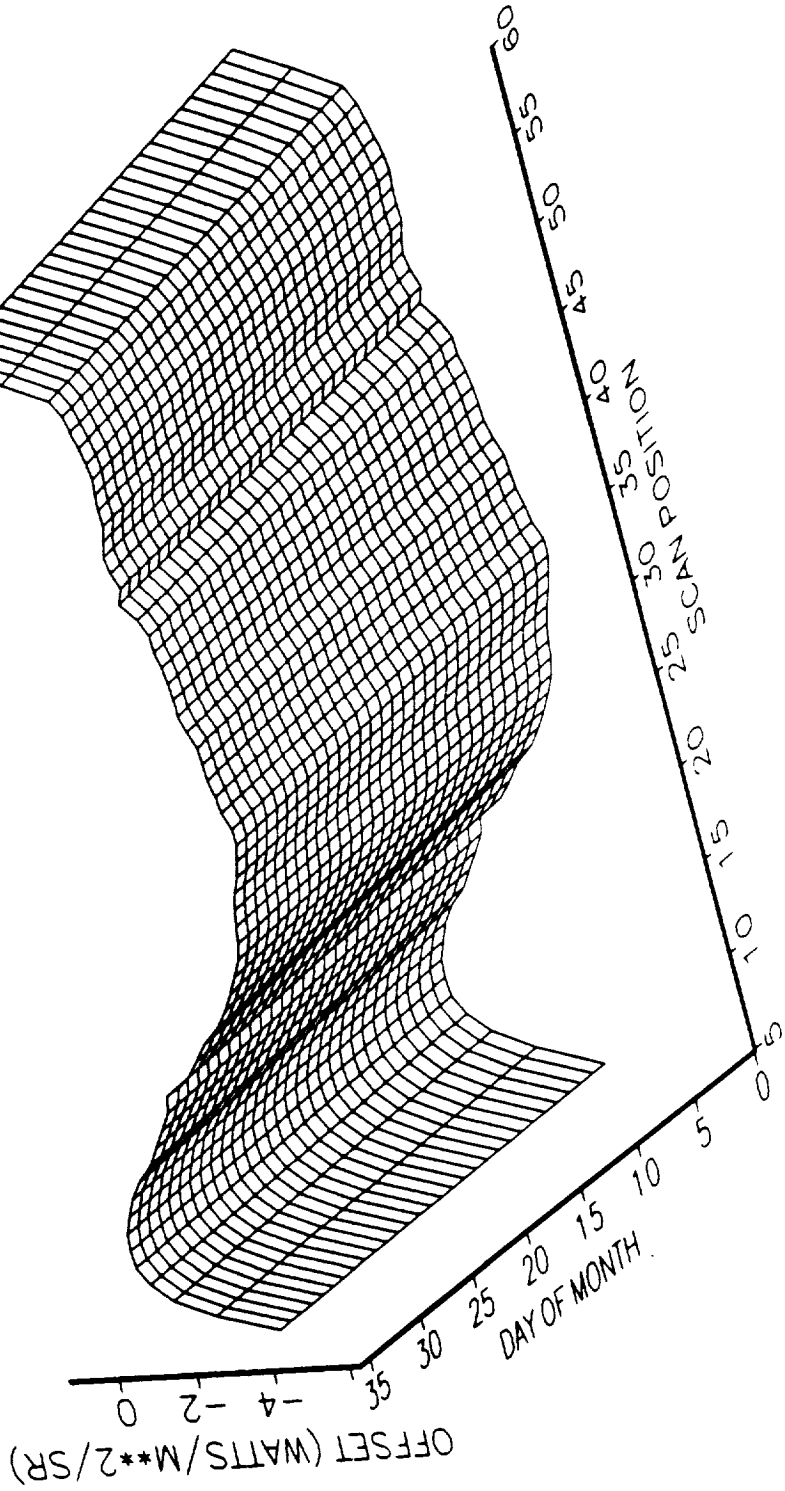

SHORTWAVE OFFSETS
NOAA-10, OCTOBER, NOVEMBER, DECEMBER 1986

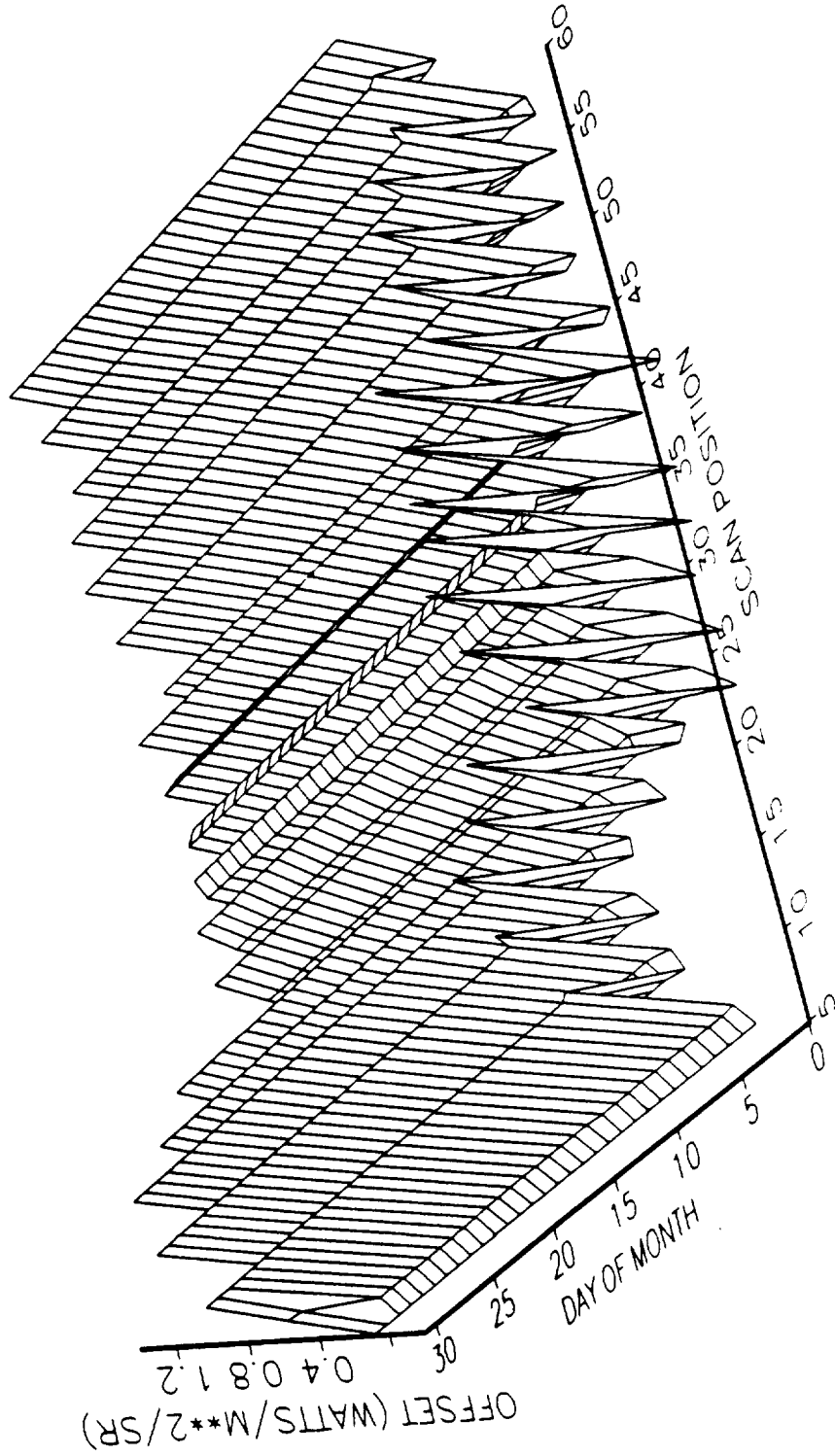

This page has been intentionally left blank

APPENDIX G

ERBS NONSCANNER OFFSETS (CALIBRATION DAYS)

PRECEDING PAGE BLANK NOT FILMED

254 INTENTIONALLY BLANK

APPENDIX G: ERBS NONSCANNER OFFSETS (CALIBRATION DAYS)

The following figures depict the offset values determined from ERBS data acquired on instrument calibration days during the period from November 1, 1984, to December 31, 1986.

The units used for all nonscanner offsets in this table are watts per square meter.

	Figure
ERBS Total Channel, WFOV	G-1
ERBS Total Channel, MFOV	G-2
ERBS Shortwave Channel, WFOV	G-3
ERBS Shortwave Channel, MFOV	G-4

This page has been intentionally left blank

ERBS, TOTAL CHANNEL, WFOV
 NONSCANNER OFFSETS (1984-1986)

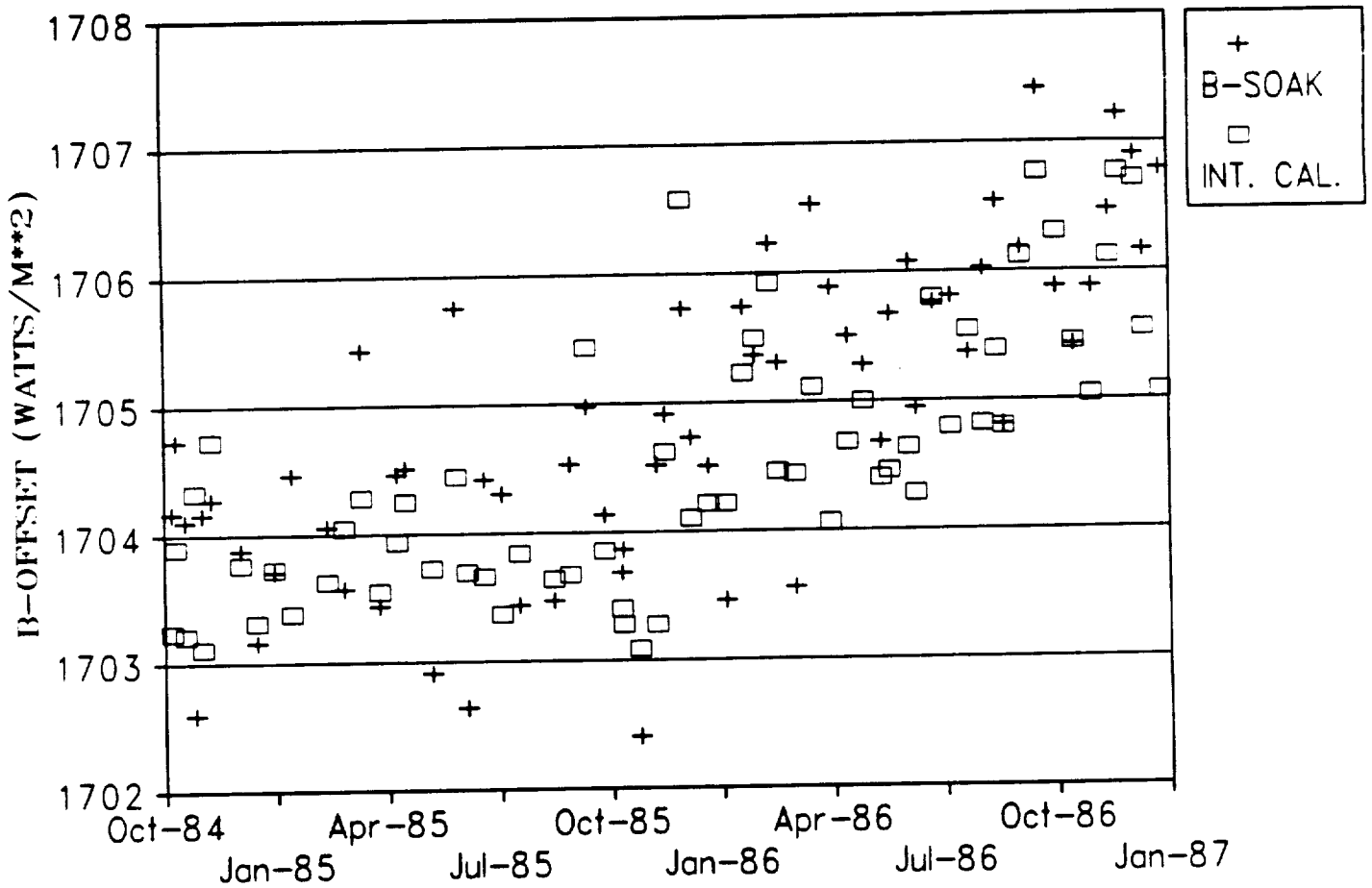

ERBS, TOTAL CHANNEL, MFOV
NONSCANNER OFFSETS (1984-1986)

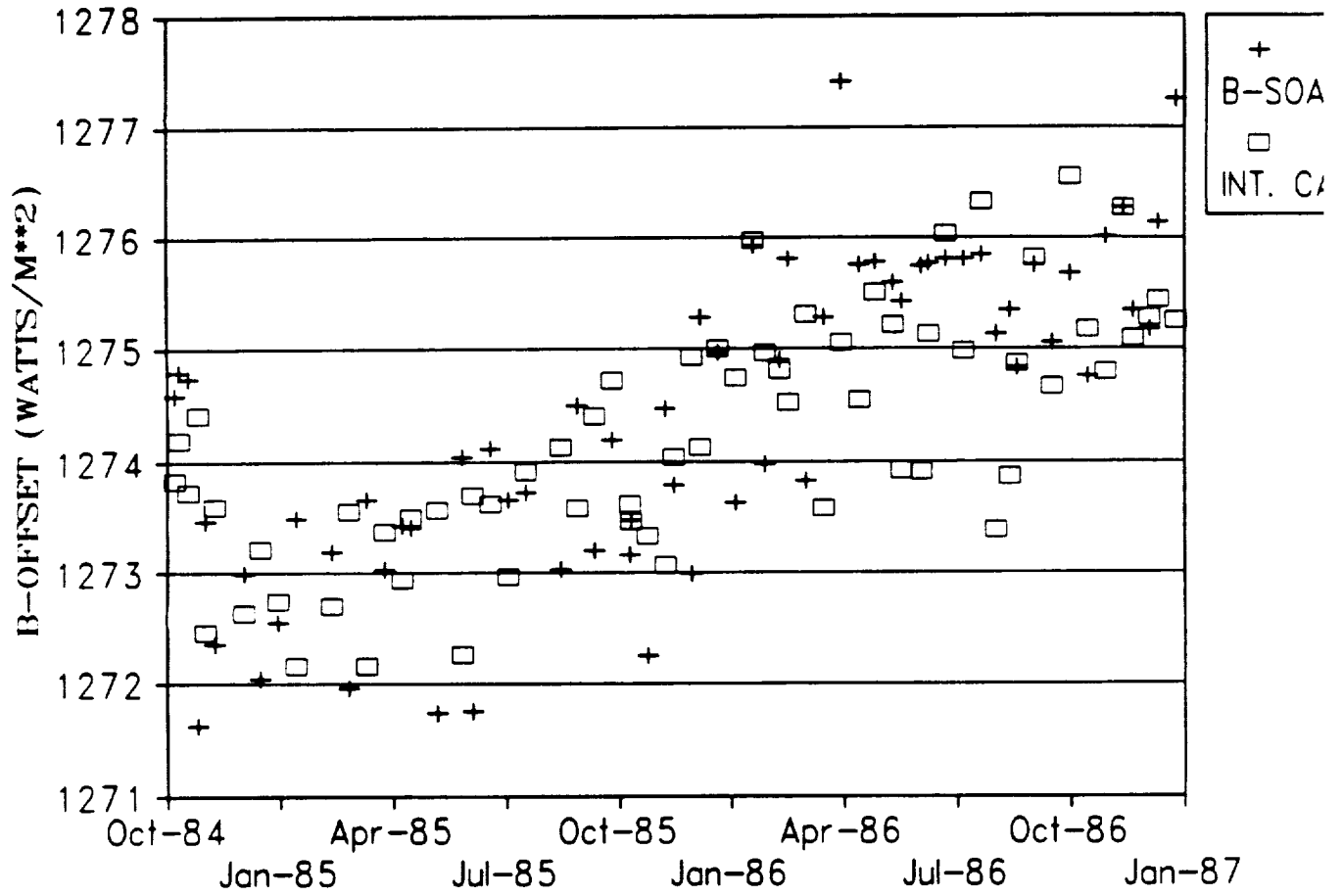

ERBS, SHORTWAVE CHANNEL, WFOV
NONSCANNER OFFSETS (1984-1986)

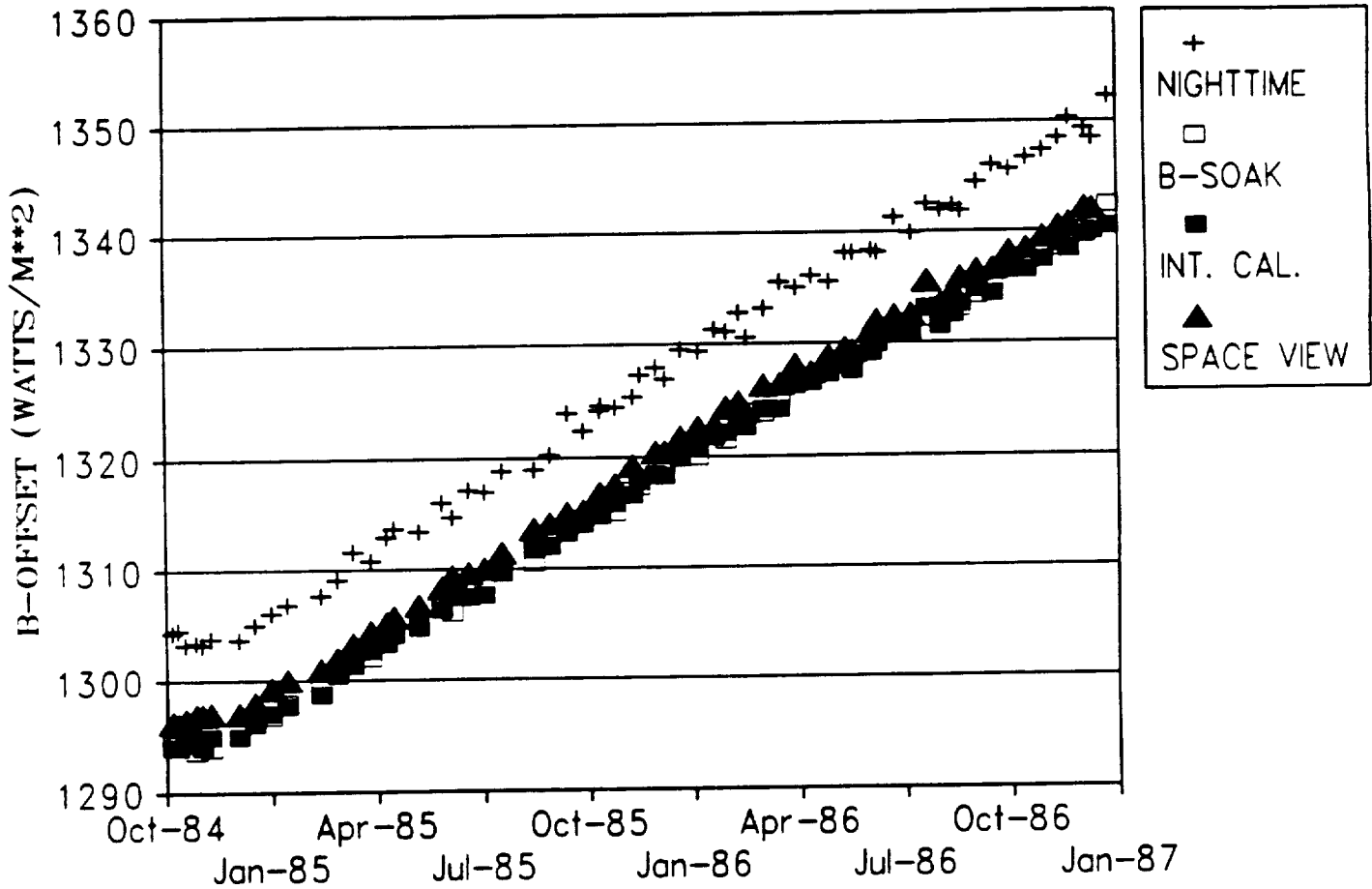

ERBS, SHORTWAVE CHANNEL, MFOV
NONSCANNER OFFSETS (1984-1986)

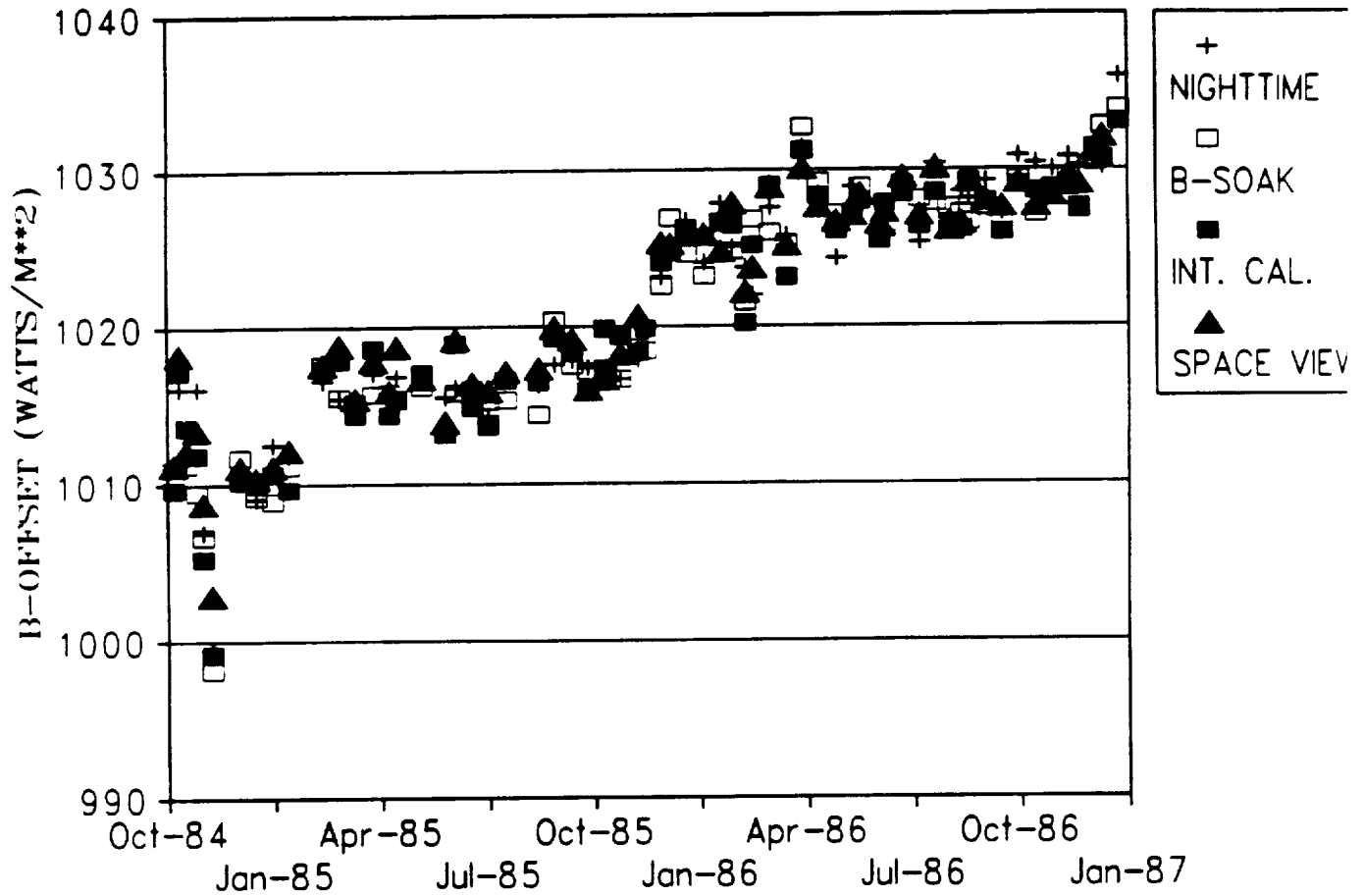

APPENDIX H

NOAA-9 NONSCANNER OFFSETS (CALIBRATION DAYS)

APPENDIX H: NOAA-9 NONSCANNER OFFSETS (CALIBRATION DAYS)

The following figures depict the offset values determined from NOAA-9 data acquired on instrument calibration days during the period from January 25, 1985, to December 31, 1986.

The units used for all nonscanner offsets in this table are watts per square meter.

	Figure
NOAA-9 Total Channel, WFOV	H-1
NOAA-9 Total Channel, MFOV	H-2
NOAA-9 Shortwave Channel, WFOV . .	H-3
NOAA-9 Shortwave Channel, MFOV . .	H-4

This page has been intentionally left blank

NOAA-9, TOTAL CHANNEL, WFOV
 NONSCANNER OFFSETS (1985-1986)

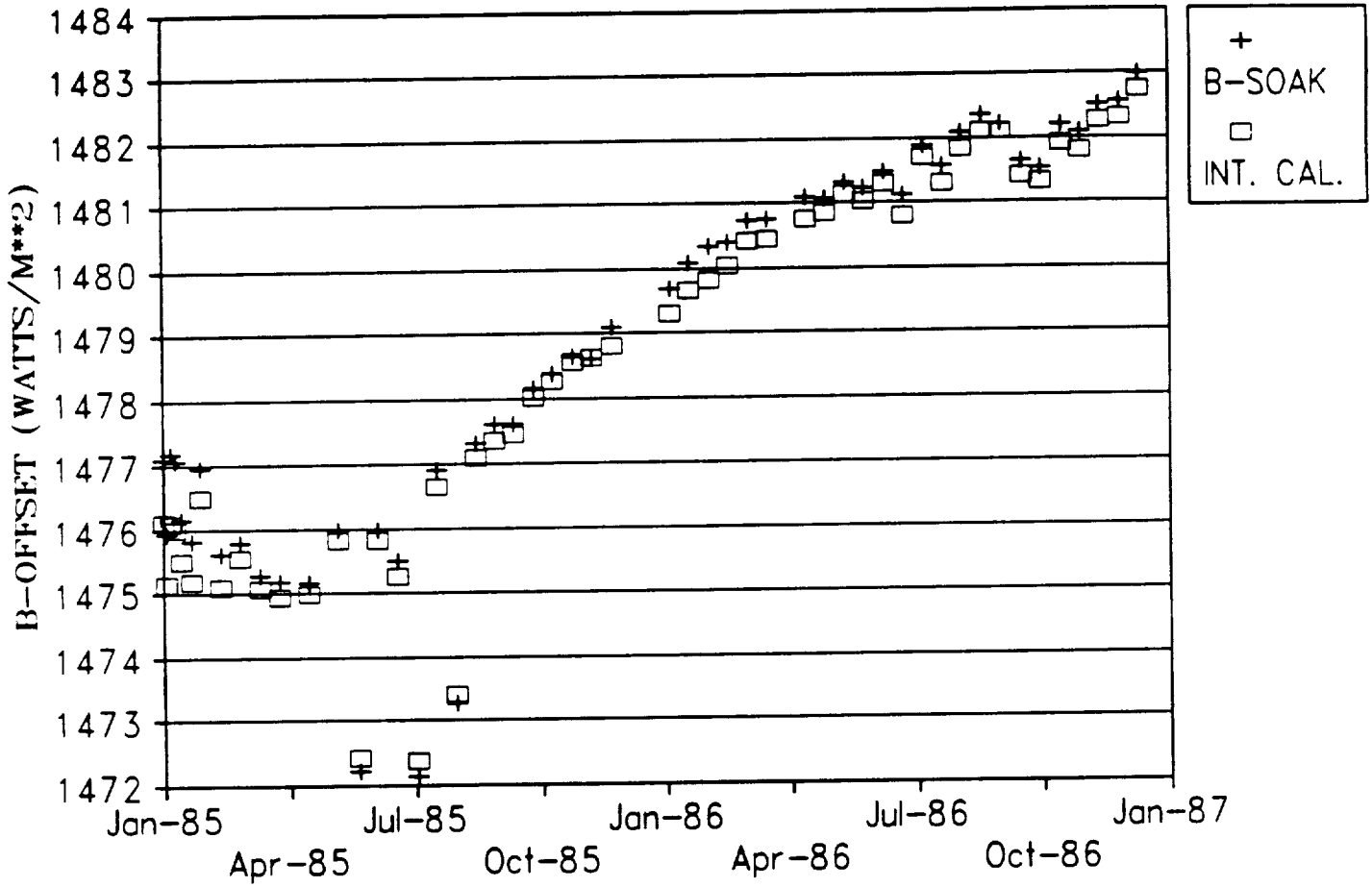

NOAA-9, TOTAL CHANNEL, MFOV
NONSCANNER OFFSETS (1985-1986)

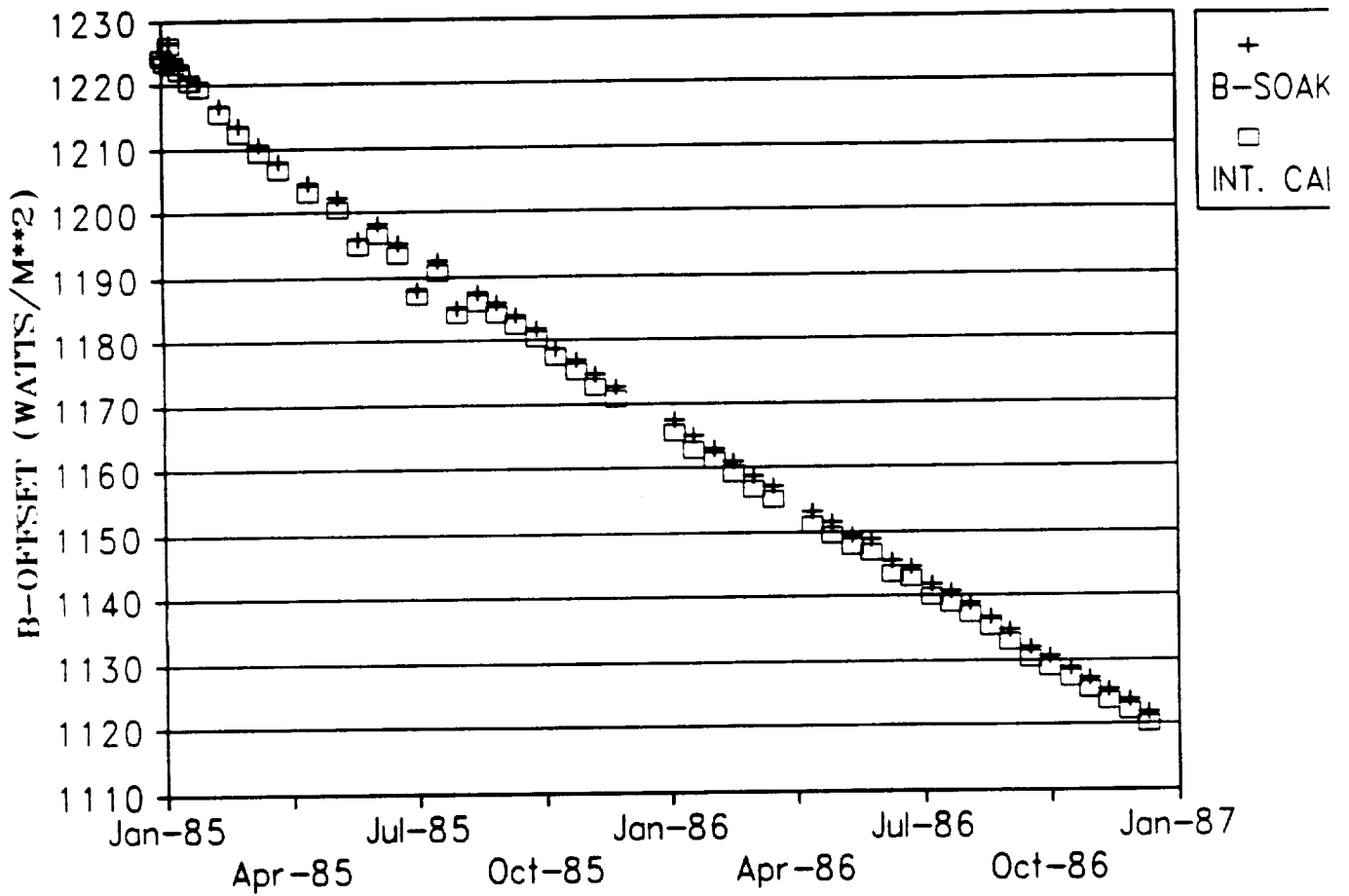

ORIGINAL PAGE IS
OF POOR QUALITY

NOAA-9, SHORTWAVE CHANNEL, WFOV
NONSCANNER OFFSETS (9185-1986)

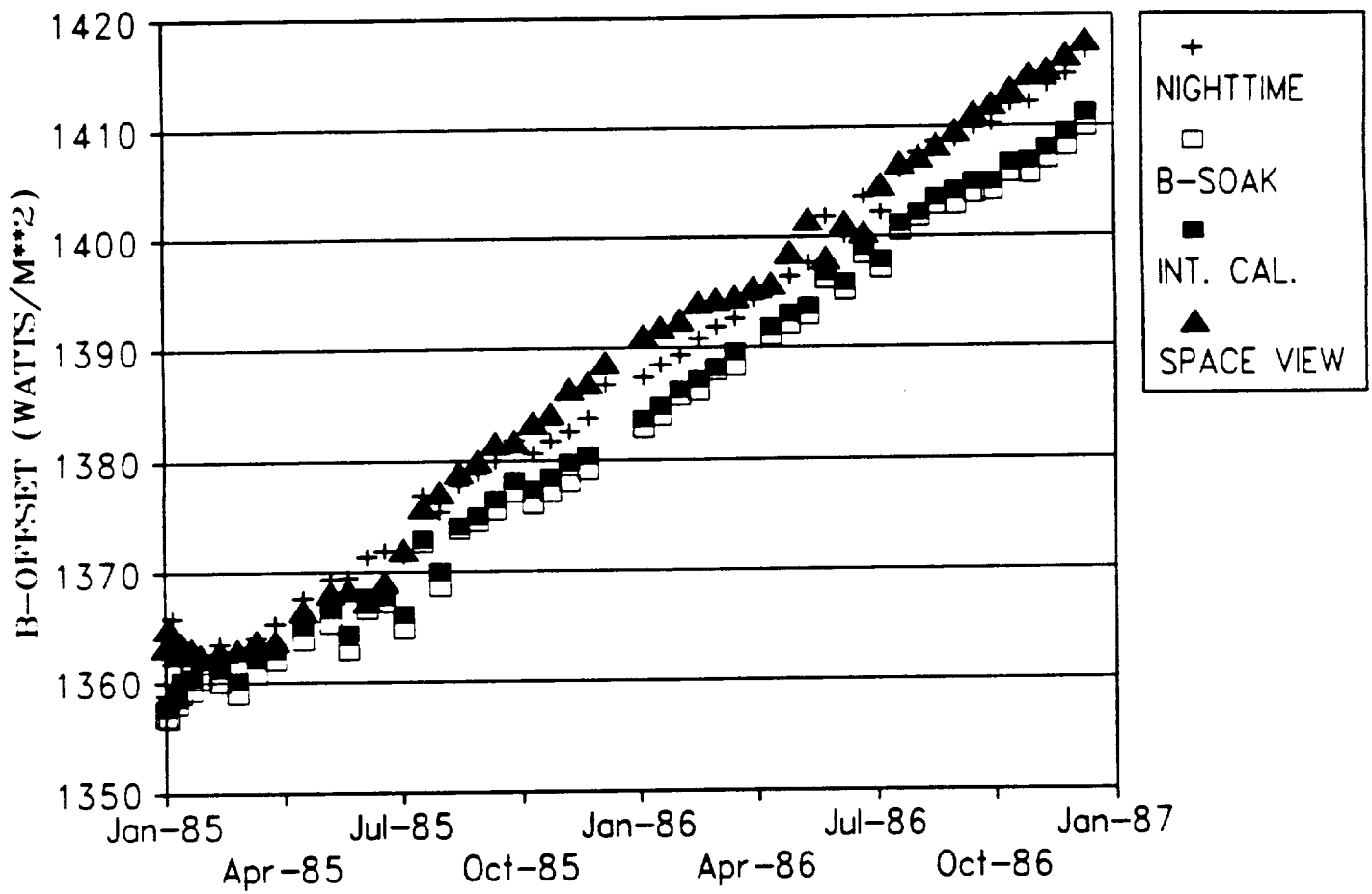

NOAA-9, SHORTWAVE CHANNEL, MFOV
NONSCANNER OFFSETS (1985-1986)

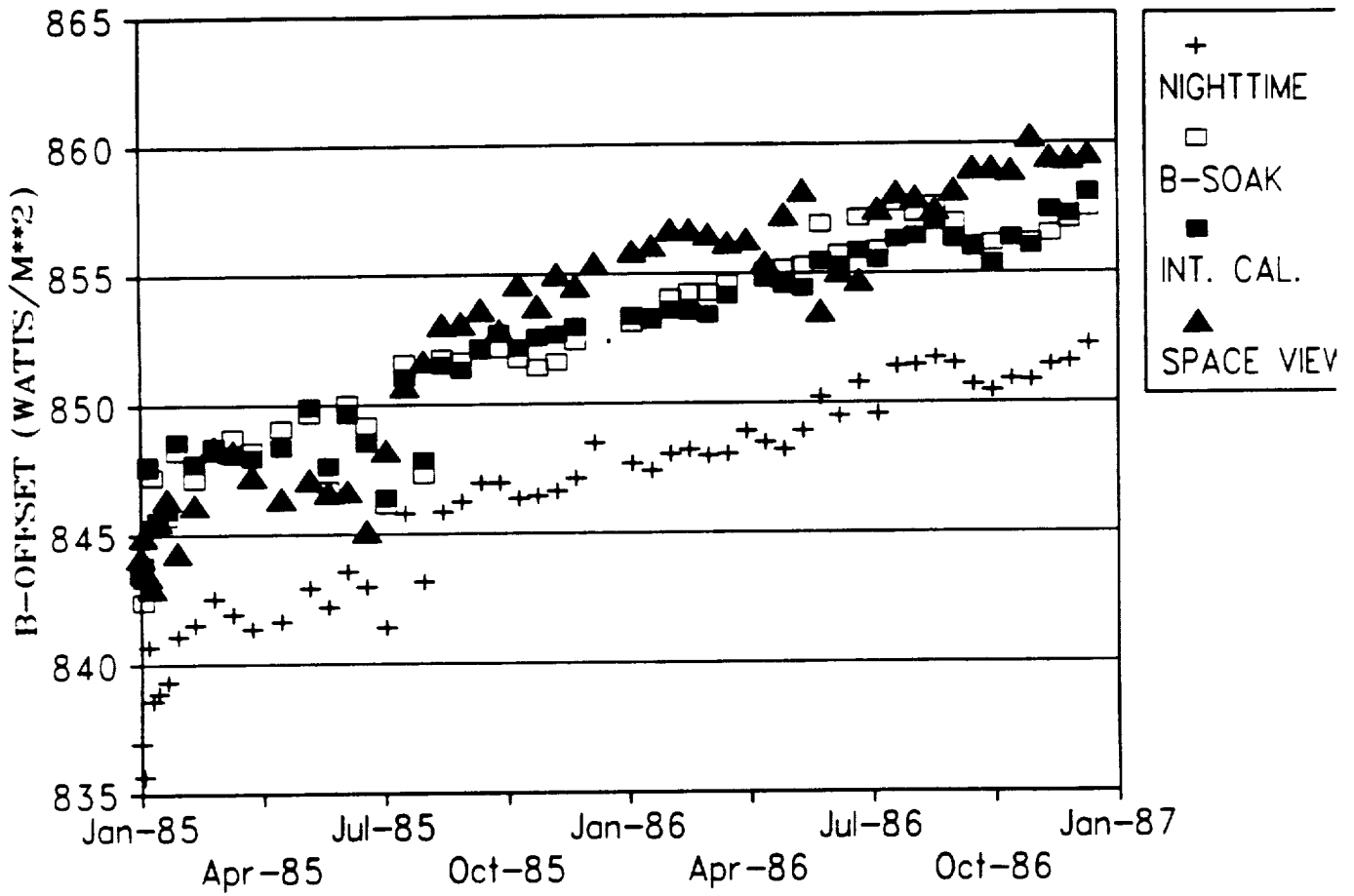

APPENDIX I

NOAA-10 NONSCANNER OFFSETS (CALIBRATION DAYS)

APPENDIX I: NOAA-10 NONSCANNER OFFSETS (CALIBRATION DAYS)

The following figures depict the offset values determined from NOAA-10 data acquired on instrument calibration days during the period from October 22, 1986, to December 31, 1986.

The units used for all nonscanner offsets in this table are watts per square meter.

	Figure
NOAA-10 Total Channel, WFOV	I-1
NOAA-10 Total Channel, MFOV	I-2
NOAA-10 Shortwave Channel, WFOV . .	I-3
Noaa-10 Shortwave Channel, MFOV . .	I-4

This page has been intentionally left blank

NOAA-10 NONSCANNER OFFSETS
TOTAL WFOV (1986)

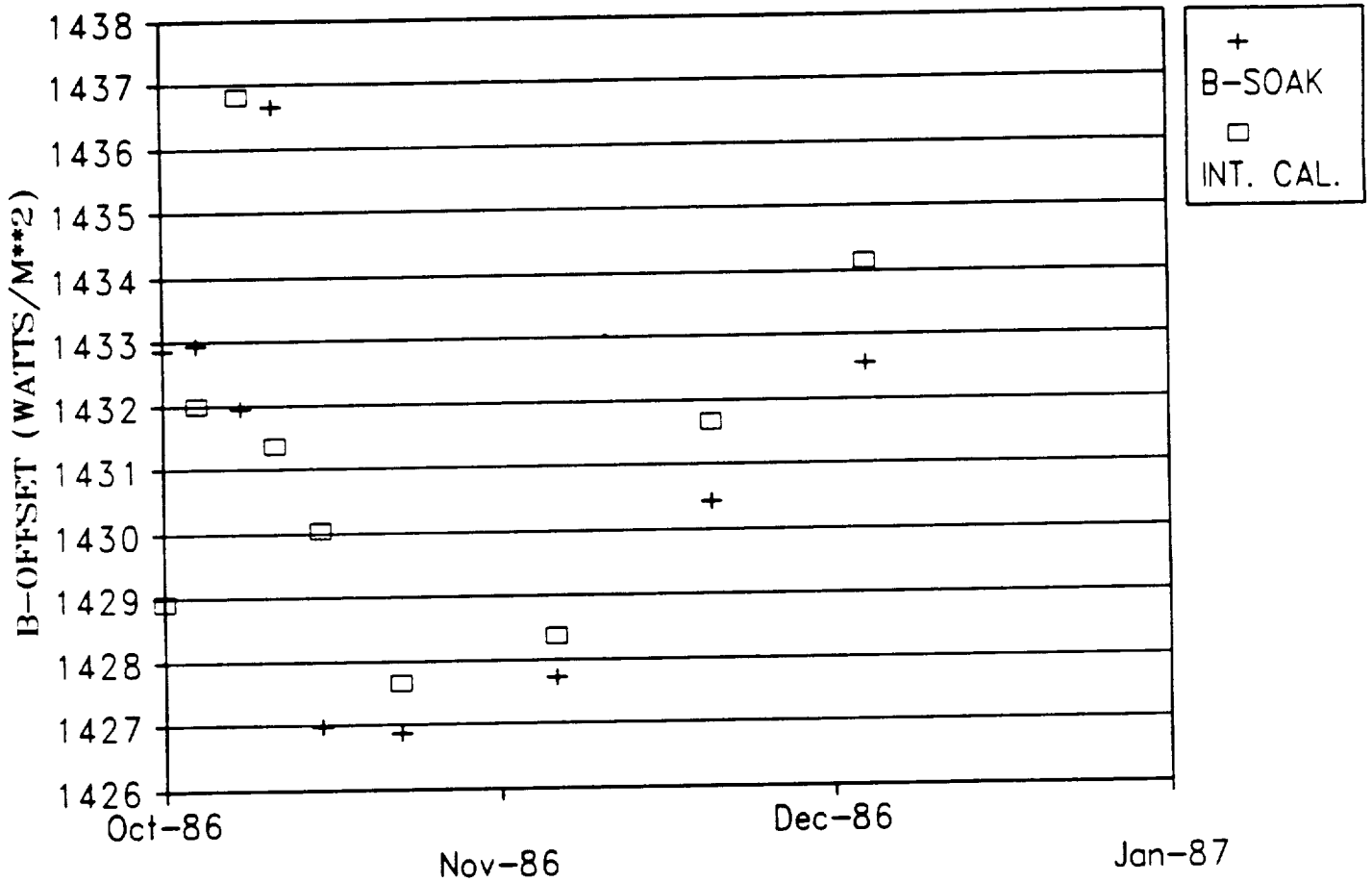

NOAA-10 NONSCANNER OFFSETS
TOTAL MFOV (1986)

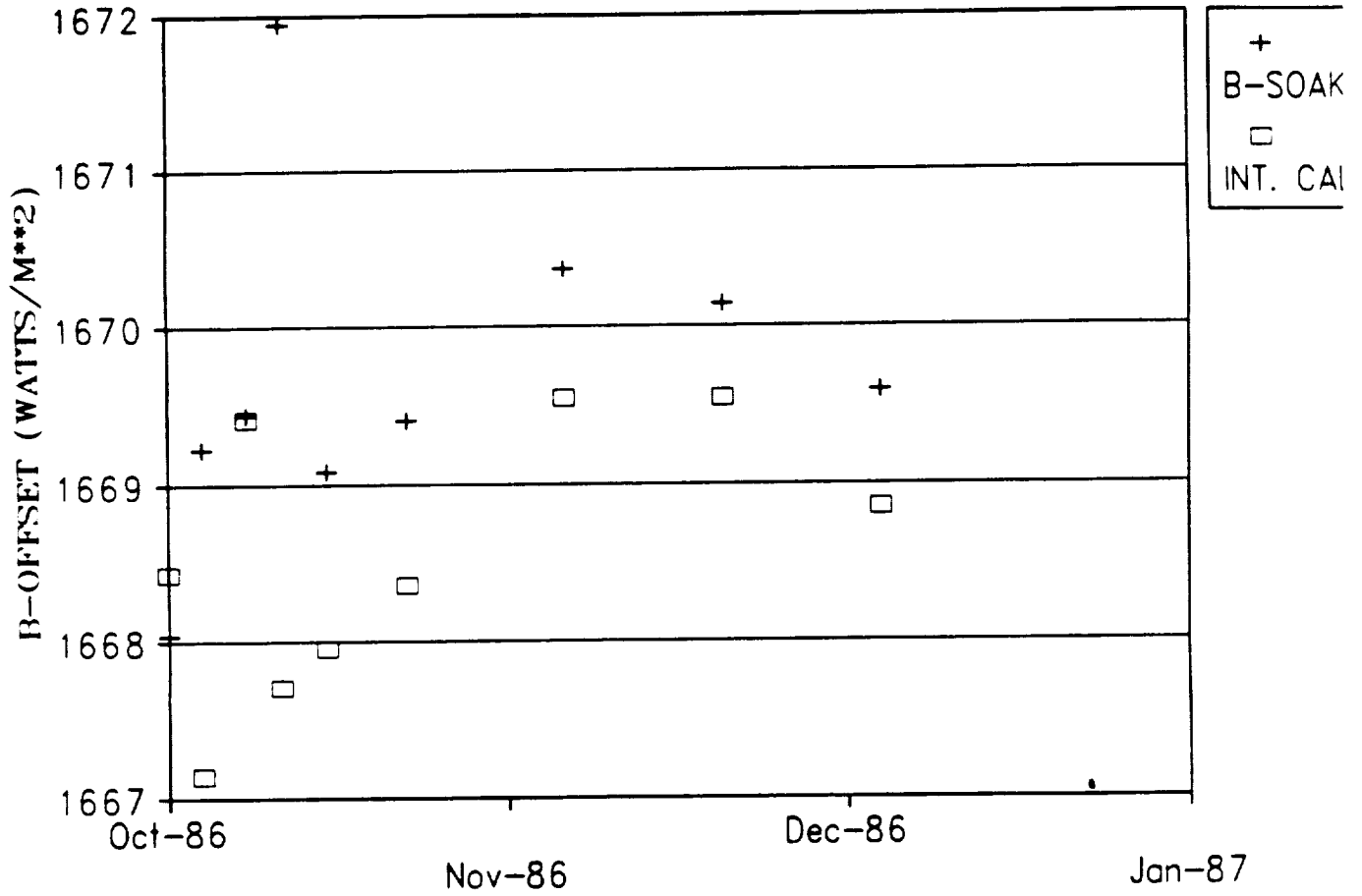

NOAA-10 NONSCANNER OFFSETS
SHORTWAVE WFOV (1986)

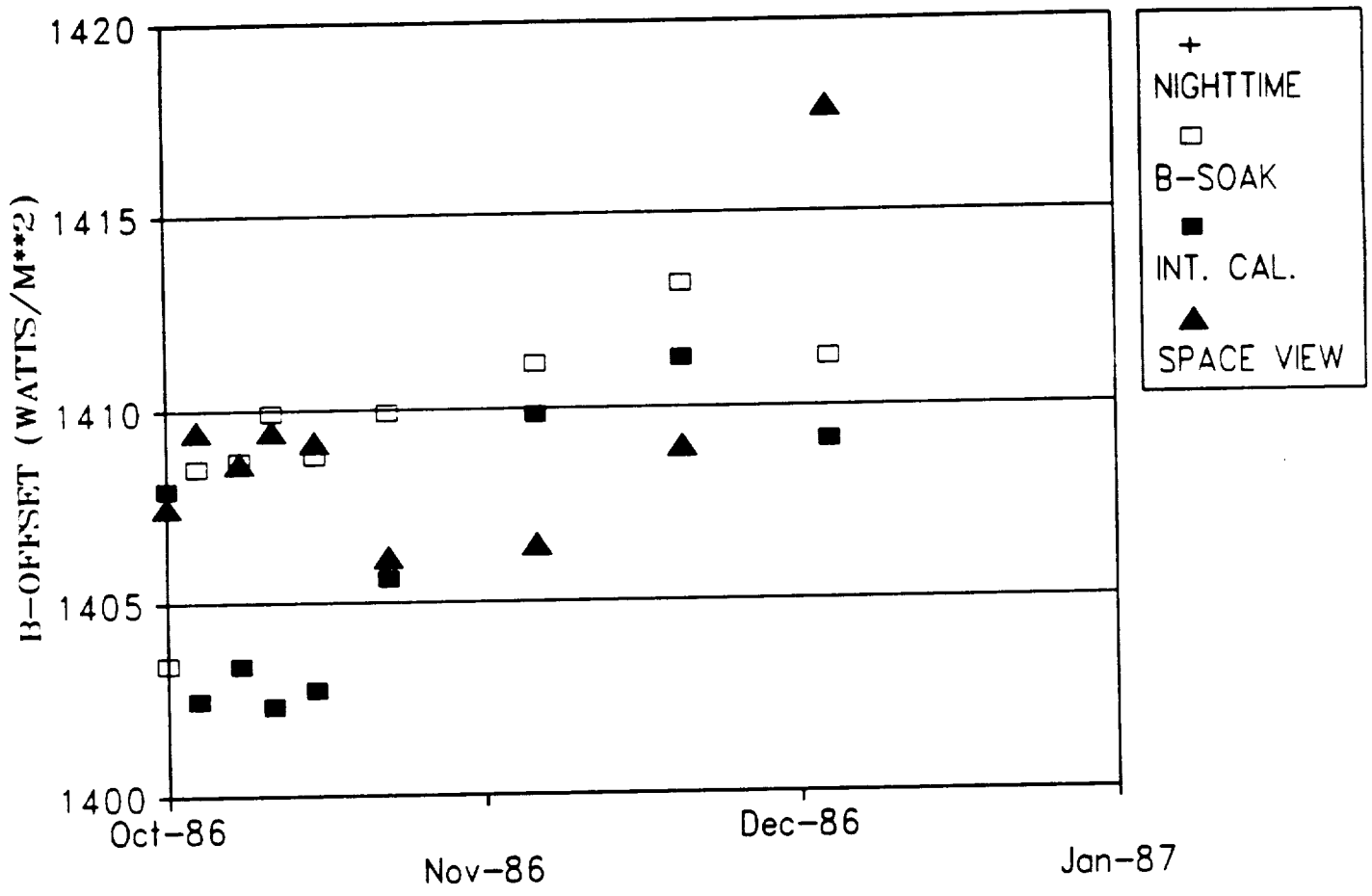

NOAA-10 NONSCANNER OFFSETS
SHORTWAVE MFOV (1986)

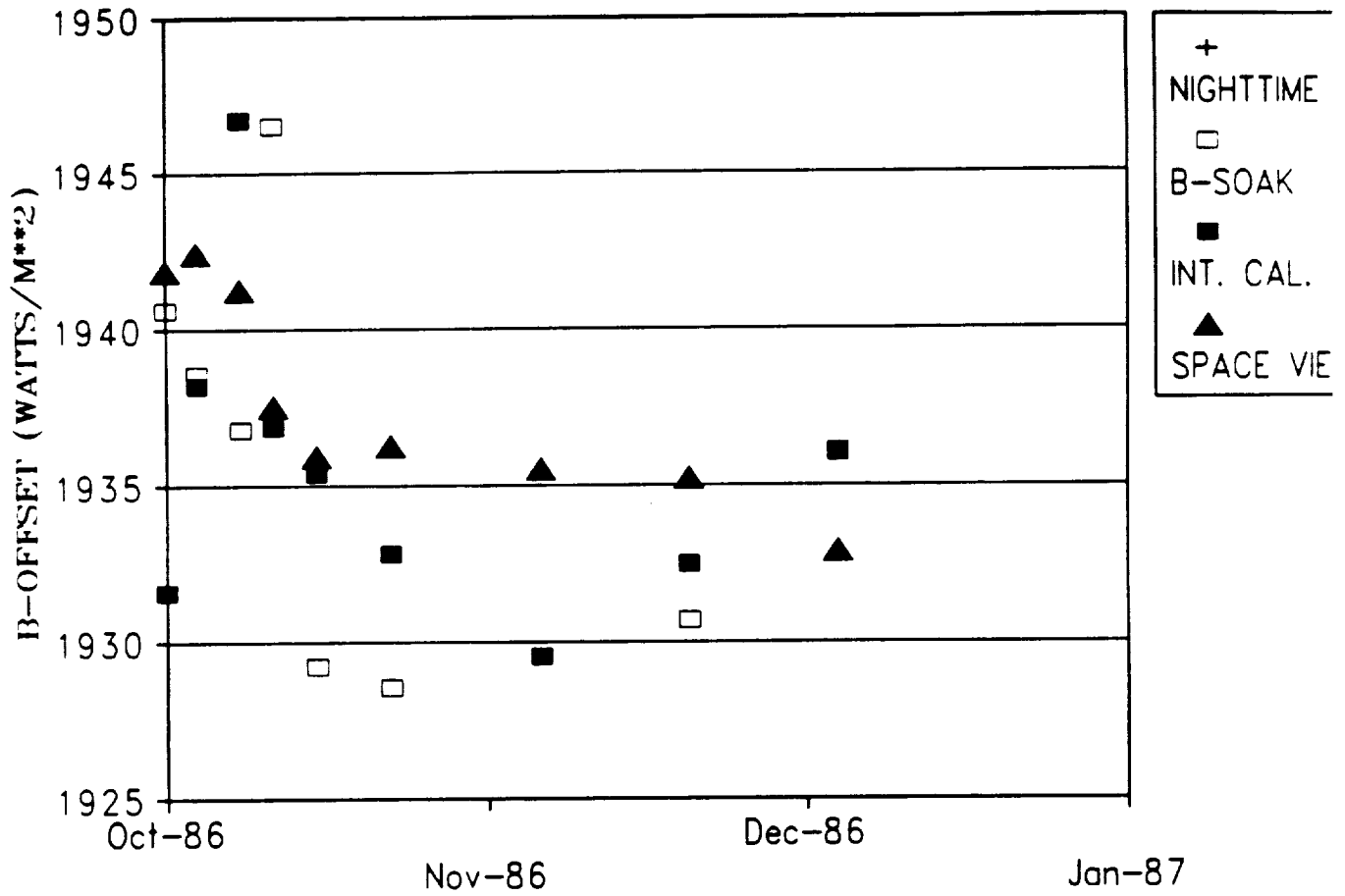

APPENDIX J

ERBS NONSCANNER OFFSETS (MERGE)

APPENDIX J: ERBS NONSCANNER OFFSETS (MERGE)

The following pages contain ERBS nonscanner offsets for the period from November 1984 until December 1986, as they were used by the ERBE Merge Subsystem.

Table

November 1984	J-1
December 1984	J-2
January 1985	J-3
February 1985	J-4
March 1985	J-5
April 1985	J-6
May 1985	J-7
June 1985	J-8
July 1985	J-9
August 1985	J-10
September 1985	J-11
October 1985	J-12
November 1985	J-13
December 1985	J-14
January 1986	J-15
February 1986	J-16
March 1986	J-17
April 1986	J-18
May 1986	J-19
June 1986	J-20
July 1986	J-21
August 1986	J-22
September 1986	J-23
October 1986	J-24
November 1986	J-25
December 1986	J-26

This page has been intentionally left blank

CCC ERBS - 1984 NOVEMBER

ERBE FLIGHT MODEL ONE (ERBS)
COUNT CONVERSION FOR NON-SCANNER

* COUNT CONVERSION ALGORITHM FOR TOTAL CHANNELS

$$E_T = A_V \cdot V^2 + A_F \cdot T_F + A_A \cdot T_A + A_H \cdot T_H + A_R \cdot V_R^2 + B$$

* COUNT CONVERSION ALGORITHM FOR SHORTWAVE CHANNELS

$$E_S = A_V \cdot V^2 + A_F \cdot T_F + A_A \cdot T_A + A_H \cdot T_H + A_R \cdot V_R^2 + A_E \cdot E_T + B$$

	A_V	A_A	A_H	A_F	A_R	A_E	
WFOV/TOT	-22.7873	.0	.0	-1.3968	26.1161		(85/12/06)
WFOV/SW	-25.5824	.0	.0	-.6434	26.5454	-.03051	(87/07/30)
MFOV/TOT	-22.7093	.0	.0	-.9230	25.1276		(85/08/15)
MFOV/SW	-25.5337	.0	.0	1.2227	29.0431	-.03751	(87/07/30)

DAILY B-OFFSET FOR ERBE
 FLIGHT MODEL ONE (ERBS) NONSCANNER

ERBS - 1984 NOVEMBER

DAY	(87/07/30)	(87/07/30)	(87/07/30)	(87/07/30)
	WFOV/TOT	MFOV/TOT	WFOV/SW	MFOV/SW
1	1703.70	1273.55	1304.59	1012.95
2	1703.70	1273.55	1304.59	1012.95
3	1703.70	1273.55	1304.59	1012.95
4	1703.70	1273.55	1304.59	1012.95
5	1703.70	1273.55	1303.97	1015.71
6	1703.70	1273.55	1304.01	1010.25
7	1703.70	1273.55	1303.83	1014.97
8	1703.70	1273.55	1303.74	1013.12
9	1703.70	1273.55	1303.59	1014.76
10	1703.70	1273.55	1303.34	1013.67
11	1703.70	1273.55	1303.09	1013.57
12	1703.70	1273.55	1302.59	1011.63
13	1703.70	1273.55	1302.95	1010.58
14	1703.70	1273.55	1302.72	1010.01
15	1703.70	1273.55	1302.50	1007.26
16	1703.70	1273.55	1302.18	1008.79
17	1703.70	1273.55	1302.03	1010.41
18	1703.70	1273.55	1302.03	1014.13
19	1703.70	1273.55	1302.27	1015.23
20	1703.70	1273.55	1302.52	1015.36
21	1703.70	1273.55	1302.39	1012.06
22	1703.70	1273.55	1302.00	1006.48
23	1703.70	1273.55	1301.60	1007.13
24	1703.70	1273.55	1301.38	1005.38
25	1703.70	1273.55	1301.33	1006.27
26	1703.70	1273.55	1301.83	1008.44
27	1703.70	1273.55	1301.94	1008.12
28	1703.70	1273.55	1302.08	1007.74
29	1703.70	1273.55	1302.21	1007.40
30	1703.70	1273.55	1302.20	1008.58

CCC ERBS - 1984 DECEMBER

ERBE FLIGHT MODEL ONE (ERBS)
COUNT CONVERSION FOR NON-SCANNER

* COUNT CONVERSION ALGORITHM FOR TOTAL CHANNELS

$$E_T = A_V \cdot V^2 + A_F \cdot T_F + A_A \cdot T_A + A_H \cdot T_H + A_R \cdot V_R^2 + B$$

* COUNT CONVERSION ALGORITHM FOR SHORTWAVE CHANNELS

$$E_S = A_V \cdot V^2 + A_F \cdot T_F + A_A \cdot T_A + A_H \cdot T_H + A_R \cdot V_R^2 + A_E \cdot E_T + B$$

	A _V	A _A	A _H	A _F	A _R	A _E	
WFOV/TOT	-22.7873	.0	.0	-1.3968	26.1161		(85/12/06)
WFOV/SW	-25.6574	.0	.0	-.6453	26.6232	-.03060	(88/08/08)
MFOV/TOT	-22.7093	.0	.0	-.9230	25.1276		(85/08/15)
MFOV/SW	-25.5422	.0	.0	1.2231	29.0527	-.03752	(88/08/08)

DAILY B-OFFSET FOR ERBS
 FLIGHT MODEL ONE (ERBS) NONSCANNER

ERBS - 1984 DECEMBER

DAY	(88/08/08)	(88/08/08)	(88/08/08)	(88/08/08)
	WFOV/TOT	MFOV/TOT	WFOV/SW	MFOV/SW
1	1704.27	1272.67	1304.06	1001.82
2	1704.27	1272.51	1304.17	1000.79
3	1704.27	1272.35	1304.27	999.76
4	1704.80	1272.37	1304.11	1000.77
5	1705.33	1272.37	1303.95	1001.78
6	1705.86	1272.37	1303.79	1002.79
7	1706.40	1272.37	1303.64	1003.81
8	1706.93	1272.37	1303.48	1004.82
9	1707.46	1272.37	1303.32	1005.83
10	1707.99	1272.37	1303.16	1006.84
11	1708.03	1272.17	1303.22	1006.34
12	1708.07	1271.98	1303.29	1005.84
13	1708.11	1271.78	1303.35	1005.34
14	1708.15	1271.59	1303.41	1004.84
15	1708.19	1271.39	1303.47	1004.34
16	1708.23	1271.20	1303.54	1003.84
17	1708.27	1271.00	1303.60	1003.34
18	1707.78	1271.22	1303.66	1004.20
19	1707.29	1271.44	1303.71	1005.05
20	1706.80	1271.66	1303.77	1005.91
21	1706.31	1271.88	1303.83	1006.77
22	1705.83	1272.11	1303.88	1007.62
23	1705.34	1272.33	1303.94	1008.48
24	1704.85	1272.55	1304.00	1009.34
25	1704.36	1272.77	1304.05	1010.19
26	1703.87	1272.99	1304.11	1011.05
27	1703.82	1272.92	1304.22	1010.93
28	1703.77	1272.85	1304.34	1010.80
29	1703.72	1272.78	1304.45	1010.68
30	1703.66	1272.72	1304.56	1010.56

CCC ERBS - 1985 JANUARY

ERBE FLIGHT MODEL ONE (ERBS)
COUNT CONVERSION FOR NON-SCANNER

* COUNT CONVERSION ALGORITHM FOR TOTAL CHANNELS

$$E_T = A_V \cdot V^2 + A_F \cdot T_F + A_A \cdot T_A + A_H \cdot T_H + A_R \cdot V_R^2 + B$$

* COUNT CONVERSION ALGORITHM FOR SHORTWAVE CHANNELS

$$E_S = A_V \cdot V^2 + A_F \cdot T_F + A_A \cdot T_A + A_H \cdot T_H + A_R \cdot V_R^2 + A_E \cdot E_T + B$$

	A_V	A_A	A_H	A_F	A_R	A_E	
WFOV/TOT	-22.7873	.0	.0	-1.3968	26.1161		(85/12/06)
WFOV/SW	-25.6867	.0	.0	-.6460	26.6537	-.03064	(87/10/19)
MFOV/TOT	-22.7093	.0	.0	-.9230	25.1276		(85/08/15)
MFOV/SW	-25.5458	.0	.0	1.2233	29.0570	-.03753	(87/10/19)

DAILY B-OFFSET FOR ERBE
 FLIGHT MODEL ONE (ERBS) NONSCANNER

ERBS - 1985 JANUARY

DAY	(87/10/19)	(87/10/19)	(87/10/19)	(87/10/19)
	WFOV/TOT	MFOV/TOT	WFOV/SW	MFOV/SW
1	1704.06	1273.58	1305.41	1010.67
2	1704.06	1273.58	1306.28	1012.96
3	1704.06	1273.58	1306.86	1014.82
4	1704.06	1273.58	1306.78	1014.00
5	1704.06	1273.58	1306.56	1012.92
6	1704.06	1273.58	1305.94	1011.54
7	1704.06	1273.58	1305.73	1011.07
8	1704.06	1273.58	1305.77	1011.07
9	1704.06	1273.58	1305.82	1010.28
10	1704.06	1273.58	1305.93	1011.75
11	1704.06	1273.58	1306.08	1012.11
12	1704.06	1273.58	1306.18	1011.88
13	1704.06	1273.58	1306.35	1011.88
14	1704.06	1273.58	1306.49	1011.89
15	1704.06	1273.58	1306.60	1012.13
16	1704.06	1273.58	1306.48	1012.10
17	1704.06	1273.58	1306.38	1012.22
18	1704.06	1273.58	1306.28	1012.96
19	1704.06	1273.58	1306.33	1012.60
20	1704.06	1273.58	1306.16	1011.97
21	1704.06	1273.58	1305.98	1011.81
22	1704.06	1273.58	1305.64	1012.07
23	1704.06	1273.58	1305.72	1012.37
24	1704.06	1273.58	1305.56	1012.17
25	1704.06	1273.58	1305.45	1011.54
26	1704.06	1273.58	1305.07	1011.24
27	1704.06	1273.58	1305.01	1011.53
28	1704.06	1273.58	1304.84	1011.44
29	1704.06	1273.58	1304.97	1010.65
30	1704.06	1273.58	1305.02	1010.80

CCC ERBS - 1985 FEBRUARY

ERBE FLIGHT MODEL ONE (ERBS)
 COUNT CONVERSION FOR NON-SCANNER

* COUNT CONVERSION ALGORITHM FOR TOTAL CHANNELS

$$E_T = A_V \cdot V^2 + A_F \cdot T_F + A_A \cdot T_A + A_H \cdot T_H + A_R \cdot V_R^2 + B$$

* COUNT CONVERSION ALGORITHM FOR SHORTWAVE CHANNELS

$$E_S = A_V \cdot V^2 + A_F \cdot T_F + A_A \cdot T_A + A_H \cdot T_H + A_R \cdot V_R^2 + A_E \cdot E_T + B$$

	A_V	A_A	A_H	A_F	A_R	A_E	
WFOV/TOT	-22.7873	.0	.0	-1.3968	26.1161		(85/12/06)
WFOV/SW	-25.7398	.0	.0	-.6474	26.7087	-.03070	(89/07/06)
MFOV/TOT	-22.7093	.0	.0	-.9230	25.1276		(85/08/15)
MFOV/SW	-25.5514	.0	.0	1.2235	29.0633	-.03754	(89/07/06)

DAILY B-OFFSET FOR ERBE
 FLIGHT MODEL ONE (ERBS) NONSCANNER

ERBS - 1985 FEBRUARY

DAY	(89/06/20)	WFOV/TOT	MFOV/TOT	(89/06/20)	WFOV/SW	MFOV/SW
1	1704.18	1273.15	1306.53	1012.01		
2	1704.24	1273.22	1306.58	1011.96		
3	1704.29	1273.29	1306.63	1011.91		
4	1704.34	1273.36	1306.68	1011.86		
5	1704.40	1273.42	1306.73	1011.80		
6	1704.45	1273.49	1306.78	1011.75		
7	1704.73	1273.27	1306.93	1011.70		
8	1705.01	1273.05	1307.08	1011.65		
9	1705.30	1272.82	1307.23	1011.61		
10	1705.58	1272.60	1307.38	1011.56		
11	1705.86	1272.38	1307.53	1011.51		
12	1706.14	1272.16	1307.67	1011.46		
13	1706.43	1271.94	1307.82	1011.41		
14	1706.71	1271.71	1307.97	1011.36		
15	1706.99	1271.49	1308.12	1011.32		
16	1707.27	1271.27	1308.27	1011.27		
17	1707.55	1271.05	1308.42	1011.22		
18	1707.84	1270.82	1308.46	1011.73		
19	1708.12	1270.60	1308.49	1012.24		
20	1708.40	1270.38	1308.53	1012.74		
21	1708.09	1270.58	1308.57	1013.25		
22	1707.78	1270.78	1308.60	1013.76		
23	1707.47	1270.98	1308.64	1014.27		
24	1707.16	1271.18	1308.68	1014.77		
25	1706.85	1271.38	1308.71	1015.28		
26	1706.54	1271.58	1308.75	1015.79		
27	1706.23	1271.78	1308.61	1015.88		
28	1705.91	1271.98	1308.47	1015.98		
29	1705.60	1272.18	1308.33	1016.07		
30	1705.29	1272.38	1308.19	1016.17		

CCC ERBS - 1985 MARCH

ERBE FLIGHT MODEL ONE (ERBS)
 COUNT CONVERSION FOR NON-SCANNER

* COUNT CONVERSION ALGORITHM FOR TOTAL CHANNELS

$$E_T = A_V \cdot V^2 + A_F \cdot T_F + A_A \cdot T_A + A_H \cdot T_H + A_R \cdot V_R^2 + B$$

* COUNT CONVERSION ALGORITHM FOR SHORTWAVE CHANNELS

$$E_S = A_V \cdot V^2 + A_F \cdot T_F + A_A \cdot T_A + A_H \cdot T_H + A_R \cdot V_R^2 + A_E \cdot E_T + B$$

	A_V	A_A	A_H	A_F	A_R	A_E	
WFOV/TOT	-22.7873	.0	.0	-1.3968	26.1161		(85/12/06)
WFOV/SW	-25.7656	.0	.0	-.6480	26.7355	-.03073	(88/07/11)
MFOV/TOT	-22.7093	.0	.0	-.9230	25.1276		(85/08/15)
MFOV/SW	-25.5520	.0	.0	1.2236	29.0639	-.03754	(88/07/11)

DAILY B-OFFSET FOR ERBE
 FLIGHT MODEL ONE (ERBS) NONSCANNER

ERBS - 1985 MARCH

DAY	(88/07/11)	(88/07/11)	(88/07/11)	(88/07/11)
	WFOV/TOT	MFOV/TOT	WFOV/SW	MFOV/SW
1	1705.31	1272.96	1307.83	1015.53
2	1704.97	1272.96	1307.67	1015.70
3	1704.63	1272.96	1307.51	1015.87
4	1704.29	1272.96	1307.34	1016.05
5	1703.94	1272.96	1307.18	1016.22
6	1703.60	1272.96	1307.02	1016.39
7	1703.60	1272.89	1307.12	1016.31
8	1703.60	1272.82	1307.23	1016.23
9	1703.59	1272.75	1307.33	1016.15
10	1703.59	1272.67	1307.44	1016.08
11	1703.59	1272.60	1307.54	1016.00
12	1703.59	1272.53	1307.65	1015.92
13	1703.58	1272.46	1307.75	1015.84
14	1703.58	1272.39	1307.85	1015.76
15	1703.58	1272.32	1307.96	1015.68
16	1703.58	1272.25	1308.06	1015.60
17	1703.58	1272.17	1308.17	1015.53
18	1703.57	1272.10	1308.27	1015.45
19	1703.57	1272.03	1308.38	1015.37
20	1703.57	1271.96	1308.48	1015.29
21	1703.70	1273.64	1308.66	1015.27
22	1703.83	1273.64	1308.83	1015.25
23	1703.97	1273.64	1309.01	1015.23
24	1704.10	1273.64	1309.19	1015.21
25	1704.23	1273.64	1309.36	1015.19
26	1704.36	1273.64	1309.54	1015.17
27	1704.49	1273.64	1309.71	1015.14
28	1704.63	1273.64	1309.89	1015.12
29	1704.76	1273.64	1310.07	1015.10
30	1704.89	1273.64	1310.24	1015.08
31	1705.02	1273.64	1310.42	1015.06

CCC ERBS - 1985 APRIL

ERBE FLIGHT MODEL ONE (ERBS)
COUNT CONVERSION FOR NON-SCANNER

* COUNT CONVERSION ALGORITHM FOR TOTAL CHANNELS

$$E_T = A_V \cdot V^2 + A_F \cdot T_F + A_A \cdot T_A + A_H \cdot T_H + A_R \cdot V_R^2 + B$$

* COUNT CONVERSION ALGORITHM FOR SHORTWAVE CHANNELS

$$E_S = A_V \cdot V^2 + A_F \cdot T_F + A_A \cdot T_A + A_H \cdot T_H + A_R \cdot V_R^2 + A_E \cdot E_T + B$$

	A_V	A_A	A_H	A_F	A_R	A_E	
WFOV/TOT	-22.7873	.0	.0	-1.3968	26.1161		(85/12/06)
WFOV/SW	-25.7758	.0	.0	-.6482	26.7461	-.03074	(87/05/18)
MFOV/TOT	-22.7093	.0	.0	-.9230	25.1276		(85/08/15)
MFOV/SW	-25.5630	.0	.0	1.2241	29.0765	-.03755	(87/05/18)

DAILY B-OFFSET FOR ERBE
 FLIGHT MODEL ONE (ERBS) NONSCANNER

ERBS - 1985 APRIL

DAY	(87/06/25)	(87/06/25)	(87/06/02)	(87/06/02)
	WFOV/TOT	MFOV/TOT	WFOV/SW	MFOV/SW
1	1704.06	1273.58	1311.39	1014.67
2	1704.06	1273.58	1311.06	1016.34
3	1704.06	1273.58	1310.65	1015.06
4	1704.06	1273.58	1310.49	1016.91
5	1704.06	1273.58	1310.20	1017.39
6	1704.06	1273.58	1309.94	1018.60
7	1704.06	1273.58	1309.73	1020.09
8	1704.06	1273.58	1309.60	1018.46
9	1704.06	1273.58	1309.49	1018.03
10	1704.06	1273.58	1309.32	1018.39
11	1704.06	1273.58	1309.13	1018.28
12	1704.06	1273.58	1308.90	1018.49
13	1704.06	1273.58	1308.75	1019.86
14	1704.06	1273.58	1308.41	1019.07
15	1704.06	1273.58	1308.30	1018.72
16	1704.06	1273.58	1308.46	1017.23
17	1704.06	1273.58	1308.81	1017.37
18	1704.06	1273.58	1309.39	1018.67
19	1704.06	1273.58	1309.92	1019.81
20	1704.06	1273.58	1310.08	1020.13
21	1704.06	1273.58	1309.97	1019.08
22	1704.06	1273.58	1309.17	1016.48
23	1704.06	1273.58	1308.83	1016.15
24	1704.06	1273.58	1309.01	1016.53
25	1704.06	1273.58	1309.25	1017.05
26	1704.06	1273.58	1309.46	1016.95
27	1704.06	1273.58	1309.60	1017.43
28	1704.06	1273.58	1309.83	1017.12
29	1704.06	1273.58	1309.88	1017.28
30	1704.06	1273.58	1309.92	1016.73

CCC ERBS - 1985 MAY

ERBE FLIGHT MODEL ONE (ERBS)
COUNT CONVERSION FOR NON-SCANNER

* COUNT CONVERSION ALGORITHM FOR TOTAL CHANNELS

$$E_T = A_V \cdot V^2 + A_F \cdot T_F + A_A \cdot T_A + A_H \cdot T_H + A_R \cdot V_R^2 + B$$

* COUNT CONVERSION ALGORITHM FOR SHORTWAVE CHANNELS

$$E_S = A_V \cdot V^2 + A_F \cdot T_F + A_A \cdot T_A + A_H \cdot T_H + A_R \cdot V_R^2 + A_E \cdot E_T + B$$

	A_V	A_A	A_H	A_F	A_R	A_E	
WFOV/TOT	-22.7873	.0	.0	-1.3968	26.1161		(85/12/06)
WFOV/SW	-25.8529	.0	.0	-.6502	26.8261	-.03083	(88/09/09)
MFOV/TOT	-22.7093	.0	.0	-.9230	25.1276		(85/08/15)
MFOV/SW	-25.5641	.0	.0	1.2242	29.0777	-.03755	(88/09/09)

DAILY B-OFFSET FOR ERBE
 FLIGHT MODEL ONE (ERBS) NONSCANNER

ERBS - 1985 MAY

DAY	(88/09/09)	(88/09/09)	(88/09/09)	(88/09/09)
	WFOV/TOT	MFOV/TOT	WFOV/SW	MFOV/SW
1	1704.46	1273.42	1313.46	1015.91
2	1704.47	1273.42	1313.55	1016.05
3	1704.47	1273.41	1313.63	1016.18
4	1704.48	1273.41	1313.72	1016.32
5	1704.48	1273.40	1313.81	1016.46
6	1704.49	1273.40	1313.90	1016.60
7	1704.49	1273.39	1313.98	1016.73
8	1704.50	1273.39	1314.07	1016.87
9	1704.42	1273.31	1314.06	1016.85
10	1704.35	1273.23	1314.04	1016.84
11	1704.27	1273.15	1314.03	1016.82
12	1704.20	1273.07	1314.01	1016.81
13	1704.12	1272.99	1314.00	1016.79
14	1704.05	1272.92	1313.99	1016.78
15	1703.97	1272.84	1313.97	1016.76
16	1703.89	1272.76	1313.96	1016.75
17	1703.82	1272.68	1313.95	1016.73
18	1703.74	1272.60	1313.93	1016.72
19	1703.67	1272.52	1313.92	1016.70
20	1703.59	1272.44	1313.90	1016.69
21	1703.52	1272.36	1313.89	1016.67
22	1703.44	1272.28	1313.88	1016.66
23	1703.36	1272.20	1313.86	1016.64
24	1703.29	1272.13	1313.85	1016.63
25	1703.21	1272.05	1313.84	1016.61
26	1703.14	1271.97	1313.82	1016.60
27	1703.06	1271.89	1313.81	1016.58
28	1702.99	1271.81	1313.79	1016.57
29	1702.91	1271.73	1313.78	1016.55
30	1703.11	1272.95	1313.87	1016.11

CCC ERBS - 1985 JUNE

ERBE FLIGHT MODEL ONE (ERBS)
COUNT CONVERSION FOR NON-SCANNER

* COUNT CONVERSION ALGORITHM FOR TOTAL CHANNELS

$$E_T = A_V \cdot V^2 + A_F \cdot T_F + A_A \cdot T_A + A_H \cdot T_H + A_R \cdot V_R^2 + B$$

* COUNT CONVERSION ALGORITHM FOR SHORTWAVE CHANNELS

$$E_S = A_V \cdot V^2 + A_F \cdot T_F + A_A \cdot T_A + A_H \cdot T_H + A_R \cdot V_R^2 + A_E \cdot E_T + B$$

	A_V	A_A	A_H	A_F	A_R	A_E	
WFOV/TOT	-22.7873	.0	.0	-1.3968	26.1161		(85/12/06)
WFOV/SW	-25.8990	.0	.0	-.6514	26.8739	-.03089	(88/09/20)
MFOV/TOT	-22.7093	.0	.0	-.9230	25.1276		(85/08/15)
MFOV/SW	-25.5693	.0	.0	1.2244	29.0836	-.03756	(88/09/20)

DAILY B-OFFSET FOR ERBE
 FLIGHT MODEL ONE (ERBS) NONSCANNER

ERBS - 1985 JUNE

DAY	(88/11/12)	(88/11/12)	(88/11/12)	(88/11/12)
	WFOV/TOT	MFOV/TOT	WFOV/SW	MFOV/SW
1	1703.52	1272.95	1314.05	1015.22
2	1703.72	1272.95	1314.13	1014.78
3	1703.93	1272.95	1314.22	1014.33
4	1704.13	1272.95	1314.31	1013.89
5	1704.33	1272.95	1314.40	1013.44
6	1704.54	1272.95	1314.49	1013.00
7	1704.74	1272.95	1314.58	1012.56
8	1704.95	1272.95	1314.67	1012.11
9	1705.15	1272.95	1314.75	1011.67
10	1705.35	1272.95	1314.84	1011.23
11	1705.56	1272.95	1314.93	1010.78
12	1705.76	1272.95	1315.02	1010.34
13	1705.76	1273.13	1315.25	1011.22
14	1705.76	1273.31	1315.48	1012.10
15	1705.75	1273.49	1315.71	1012.98
16	1705.75	1273.67	1315.95	1013.86
17	1705.75	1273.85	1316.18	1014.74
18	1705.75	1274.03	1316.41	1015.62
19	1705.36	1273.75	1316.26	1015.68
20	1704.97	1273.46	1316.11	1015.73
21	1704.58	1273.18	1315.96	1015.79
22	1704.20	1272.89	1315.81	1015.84
23	1703.81	1272.61	1315.66	1015.90
24	1703.42	1272.32	1315.51	1015.95
25	1703.03	1272.04	1315.36	1016.01
26	1702.64	1271.75	1315.21	1016.06
27	1702.77	1271.92	1315.38	1016.02
28	1702.89	1272.09	1315.56	1015.98
29	1703.02	1272.26	1315.73	1015.95
30	1703.15	1272.43	1315.91	1015.91

CCC ERBS - 1985 JULY

ERBE FLIGHT MODEL ONE (ERBS)
COUNT CONVERSION FOR NON-SCANNER

* COUNT CONVERSION ALGORITHM FOR TOTAL CHANNELS

$$E_T = A_V \cdot V^2 + A_F \cdot T_F + A_A \cdot T_A + A_H \cdot T_H + A_R \cdot V_R^2 + B$$

* COUNT CONVERSION ALGORITHM FOR SHORTWAVE CHANNELS

$$E_S = A_V \cdot V^2 + A_F \cdot T_F + A_A \cdot T_A + A_H \cdot T_H + A_R \cdot V_R^2 + A_E \cdot E_T + B$$

	A_V	A_A	A_H	A_F	A_R	A_E	
WFOV/TOT	-22.7873	.0	.0	-1.3968	26.1161		(85/12/06)
WFOV/SW	-25.9090	.0	.0	-.6516	26.8844	-.03090	(86/07/21)
MFOV/TOT	-22.7093	.0	.0	-.9230	25.1276		(85/08/15)
MFOV/SW	-25.5791	.0	.0	1.2248	29.0948	-.03758	(86/07/21)

DAILY B-OFFSET FOR ERBE
 FLIGHT MODEL ONE (ERBS) NONSCANNER

ERBS - 1985 JULY

DAY	(86/04/04)	(86/04/04)	(87/04/08)	(86/07/21)
	WFOV/TOT	MFOV/TOT	WFOV/SW	MFOV/SW
1	1704.02	1274.13	1316.68	1018.72
2	1704.02	1274.13	1317.00	1019.42
3	1704.02	1274.13	1317.14	1019.62
4	1704.02	1274.13	1317.26	1019.56
5	1704.02	1274.13	1316.94	1019.72
6	1704.02	1274.13	1316.82	1017.93
7	1704.02	1274.13	1316.05	1017.32
8	1704.02	1274.13	1315.96	1016.12
9	1704.02	1274.13	1315.93	1015.96
10	1704.02	1274.13	1315.96	1015.77
11	1704.02	1274.13	1316.33	1016.44
12	1704.02	1274.13	1316.41	1016.64
13	1704.02	1274.13	1316.44	1016.58
14	1704.02	1274.13	1316.48	1016.31
15	1704.02	1274.13	1316.54	1016.56
16	1704.02	1274.13	1316.68	1017.58
17	1704.02	1274.13	1316.74	1016.53
18	1704.02	1274.13	1316.75	1016.37
19	1704.02	1274.13	1316.74	1016.90
20	1704.02	1274.13	1316.62	1016.99
21	1704.02	1274.13	1316.48	1016.20
22	1704.02	1274.13	1316.25	1016.52
23	1704.02	1274.13	1316.06	1015.87
24	1704.02	1274.13	1315.84	1015.15
25	1704.02	1274.13	1315.88	1015.46
26	1704.02	1274.13	1315.65	1015.81
27	1704.02	1274.13	1315.41	1015.96
28	1704.02	1274.13	1315.28	1015.29
29	1704.02	1274.13	1315.28	1015.80
30	1704.02	1274.13	1315.73	1016.14
			1316.26	1017.72

ORIGINAL PAGE IS
 OF POOR QUALITY

CCC ERBS - 1985 AUGUST

ERBE FLIGHT MODEL ONE (ERBS)
COUNT CONVERSION FOR NON-SCANNER

* COUNT CONVERSION ALGORITHM FOR TOTAL CHANNELS

$$E_T = A_V \cdot V^2 + A_F \cdot T_F + A_A \cdot T_A + A_H \cdot T_H + A_R \cdot V_R^2 + B$$

* COUNT CONVERSION ALGORITHM FOR SHORTWAVE CHANNELS

$$E_S = A_V \cdot V^2 + A_F \cdot T_F + A_A \cdot T_A + A_H \cdot T_H + A_R \cdot V_R^2 + A_E \cdot E_T + B$$

	A_V	A_A	A_H	A_F	A_R	A_E	
WFOV/TOT	-22.7873	.0	.0	-1.3968	26.1161		(85/12/06)
WFOV/SW	-25.9663	.0	.0	-.6530	26.9438	-.03097	(87/10/30)
MFOV/TOT	-22.7093	.0	.0	-.9230	25.1276		(85/08/15)
MFOV/SW	-25.5843	.0	.0	1.2251	29.1007	-.03758	(87/10/30)

DAILY B-OFFSET FOR ERBS
 FLIGHT MODEL ONE (ERBS) NONSCANNER

ERBS - 1985 AUGUST

DAY	(87/10/30)	WFOV/TOT	MFOV/TOT	WFOV/SW	MFOV/SW
1	1704.02	1274.13	1319.66	1019.75	
2	1704.02	1274.13	1320.11	1021.48	
3	1704.02	1274.13	1320.30	1021.90	
4	1704.02	1274.13	1320.15	1021.78	
5	1704.02	1274.13	1320.03	1020.79	
6	1704.02	1274.13	1319.73	1018.77	
7	1704.02	1274.13	1318.68	1016.91	
8	1704.02	1274.13	1318.13	1016.13	
9	1704.02	1274.13	1317.96	1016.09	
10	1704.02	1274.13	1318.02	1016.01	
11	1704.02	1274.13	1318.18	1016.34	
12	1704.02	1274.13	1318.43	1016.98	
13	1704.02	1274.13	1318.62	1017.17	
14	1704.02	1274.13	1318.83	1016.91	
15	1704.02	1274.13	1318.95	1017.49	
16	1704.02	1274.13	1319.07	1017.69	
17	1704.02	1274.13	1319.33	1017.41	
18	1704.02	1274.13	1319.41	1014.81	
19	1704.02	1274.13	1319.45	1014.43	
20	1704.02	1274.13	1319.43	1011.83	
21	1704.02	1274.13	1319.44	1008.24	
22	1704.02	1274.13	1319.44	1001.27	
23	1704.02	1274.13	1319.44	1003.01	
24	1704.02	1274.13	1319.44	1005.93	
25	1704.02	1274.13	1319.44	1009.12	
26	1704.02	1274.13	1319.44	1012.15	
27	1704.02	1274.13	1319.44	1016.68	
28	1704.02	1274.13	1318.88	1018.80	
29	1704.02	1274.13	1318.76	1019.05	
30	1704.02	1274.13	1318.78	1018.62	

CCC ERBS - 1985 SEPTEMBER

ERBE FLIGHT MODEL ONE (ERBS)
COUNT CONVERSION FOR NON-SCANNER

* COUNT CONVERSION ALGORITHM FOR TOTAL CHANNELS

$$E_T = A_V \cdot V^2 + A_F \cdot T_F + A_A \cdot T_A + A_H \cdot T_H + A_R \cdot V_R^2 + B$$

* COUNT CONVERSION ALGORITHM FOR SHORTWAVE CHANNELS

$$E_S = A_V \cdot V^2 + A_F \cdot T_F + A_A \cdot T_A + A_H \cdot T_H + A_R \cdot V_R^2 + A_E \cdot E_T + B$$

	A_V	A_A	A_H	A_F	A_R	A_E	
WFOV/TOT	-22.7873	.0	.0	-1.3968	26.1161		(85/12/06)
WFOV/SW	-26.0236	.0	.0	-.6545	27.0032	-.03104	(88/09/22)
MFOV/TOT	-22.7093	.0	.0	-.9230	25.1276		(85/08/15)
MFOV/SW	-25.5832	.0	.0	1.2251	29.0994	-.03758	(88/09/22)

DAILY B-OFFSET FOR ERBE
 FLIGHT MODEL ONE (ERBS) NONSCANNER

ERBS - 1985 SEPTEMBER

DAY	(88/09/22) WFOV/TOT	(88/09/22) MFOV/TOT	(88/09/22) WFOV/SW	(88/09/22) MFOV/SW
1	1704.35	1273.03	1319.51	1015.56
2	1704.06	1273.03	1319.47	1015.77
3	1703.77	1273.03	1319.44	1015.97
4	1703.48	1273.03	1319.40	1016.18
5	1703.55	1273.14	1319.49	1016.28
6	1703.63	1273.24	1319.58	1016.39
7	1703.70	1273.35	1319.68	1016.49
8	1703.78	1273.45	1319.77	1016.59
9	1703.85	1273.56	1319.86	1016.69
10	1703.93	1273.66	1319.95	1016.80
11	1704.00	1273.77	1320.04	1016.90
12	1704.07	1273.88	1320.14	1017.00
13	1704.15	1273.98	1320.23	1017.11
14	1704.22	1274.09	1320.32	1017.21
15	1704.30	1274.19	1320.41	1017.31
16	1704.37	1274.30	1320.51	1017.41
17	1704.45	1274.40	1320.60	1017.52
18	1704.52	1274.51	1320.69	1017.62
19	1704.97	1274.42	1320.56	1017.58
20	1704.97	1274.32	1320.42	1017.54
21	1704.97	1274.23	1320.29	1017.50
22	1704.97	1274.13	1320.15	1017.47
23	1704.97	1274.04	1320.02	1017.43
24	1704.97	1273.94	1319.88	1017.39
25	1704.97	1273.85	1319.75	1017.35
26	1704.97	1273.75	1319.61	1017.31
27	1704.97	1273.66	1319.48	1017.27
28	1704.97	1273.56	1319.34	1017.23
29	1704.97	1273.47	1319.21	1017.20
30	1704.97	1273.37	1319.07	1017.16

CCC ERBS - 1985 OCTOBER

ERBE FLIGHT MODEL ONE (ERBS)
COUNT CONVERSION FOR NON-SCANNER

* COUNT CONVERSION ALGORITHM FOR TOTAL CHANNELS

$$E_T = A_V \cdot V^2 + A_F \cdot T_F + A_A \cdot T_A + A_H \cdot T_H + A_R \cdot V_R^2 + B$$

* COUNT CONVERSION ALGORITHM FOR SHORTWAVE CHANNELS

$$E_S = A_V \cdot V^2 + A_F \cdot T_F + A_A \cdot T_A + A_H \cdot T_H + A_R \cdot V_R^2 + A_E \cdot E_T + B$$

	A _V	A _A	A _H	A _F	A _R	A _E	
WFOV/TOT	-22.7873	.0	.0	-1.3968	26.1161		(85/12/06)
WFOV/SW	-26.0224	.0	.0	-.6544	27.0020	-.03104	(87/08/28)
MFOV/TOT	-22.7093	.0	.0	-.9230	25.1276		(85/08/15)
MFOV/SW	-25.5942	.0	.0	1.2256	29.1120	-.03760	(87/08/28)

DAILY B-OFFSET FOR ERBE
 FLIGHT MODEL ONE (ERBS) NONSCANNER

ERBS - 1985 OCTOBER

DAY	(87/08/28)	(87/08/28)	(87/08/28)	(87/08/28)	(87/08/28)
	WFOV/TOT	MFOV/TOT	WFOV/SW	MFOV/SW	
1	1704.02	1274.13	1323.42	1019.06	
2	1704.02	1274.13	1323.46	1018.81	
3	1704.02	1274.13	1322.92	1019.18	
4	1704.02	1274.13	1322.60	1019.24	
5	1704.02	1274.13	1322.17	1019.88	
6	1704.02	1274.13	1322.03	1019.26	
7	1704.02	1274.13	1321.95	1018.49	
8	1704.02	1274.13	1321.68	1018.21	
9	1704.02	1274.13	1321.37	1017.86	
10	1704.02	1274.13	1321.29	1017.54	
11	1704.02	1274.13	1321.23	1017.99	
12	1704.02	1274.13	1320.98	1018.22	
13	1704.02	1274.13	1320.78	1018.09	
14	1704.02	1274.13	1320.59	1017.43	
15	1704.02	1274.13	1320.82	1017.18	
16	1704.02	1274.13	1321.17	1017.93	
17	1704.02	1274.13	1322.05	1019.62	
18	1704.02	1274.13	1322.44	1019.58	
19	1704.02	1274.13	1323.16	1020.14	
20	1704.02	1274.13	1322.89	1019.91	
21	1704.02	1274.13	1322.97	1019.34	
22	1704.02	1274.13	1323.12	1020.54	
23	1704.02	1274.13	1322.59	1018.80	
24	1704.02	1274.13	1322.02	1017.47	
25	1704.02	1274.13	1321.90	1016.40	
26	1704.02	1274.13	1321.48	1016.07	
27	1704.02	1274.13	1321.25	1015.97	
28	1704.02	1274.13	1321.64	1016.53	
29	1704.02	1274.13	1321.83	1016.47	
30	1704.02	1274.13	1321.93	1016.85	
			1322.24	1017.04	

ERBE FLIGHT MODEL ONE (ERBS)
COUNT CONVERSION FOR NON-SCANNER

* COUNT CONVERSION ALGORITHM FOR TOTAL CHANNELS

$$E_T = A_V \cdot V^2 + A_F \cdot T_F + A_A \cdot T_A + A_H \cdot T_H + A_R \cdot V_R^2 + B$$

* COUNT CONVERSION ALGORITHM FOR SHORTWAVE CHANNELS

$$E_S = A_V \cdot V^2 + A_F \cdot T_F + A_A \cdot T_A + A_H \cdot T_H + A_R \cdot V_R^2 + A_E \cdot E_T + B$$

	A_V	A_A	A_H	A_F	A_R	A_E	
WFOV/TOT	-22.7873	.0	.0	-1.3968	26.1161		(85/12/06)
WFOV/SW	-26.0827	.0	.0	-.6560	27.0645	-.03111	(88/11/14)
MFOV/TOT	-22.7093	.0	.0	-.9230	25.1276		(85/08/15)
MFOV/SW	-25.5898	.0	.0	1.2254	29.1070	-.03759	(88/11/14)

DAILY B-OFFSET FOR ERBE
 FLIGHT MODEL ONE (ERBS) NONSCANNER

ERBS - 1985 NOVEMBER

DAY	(88/10/25)	WFOV/TOT	MFOV/TOT	(88/10/25)	WFOV/SW	MFOV/SW	(88/10/25)
1	1703.75	1273.37	1324.49	1016.78			
2	1703.64	1273.27	1324.47	1016.77			
3	1703.52	1273.18	1324.45	1016.76			
4	1703.41	1273.09	1324.43	1016.74			
5	1703.30	1272.99	1324.41	1016.73			
6	1703.19	1272.90	1324.39	1016.72			
7	1703.07	1272.81	1324.36	1016.71			
8	1702.96	1272.72	1324.34	1016.70			
9	1702.85	1272.62	1324.32	1016.69			
10	1702.74	1272.53	1324.30	1016.67			
11	1702.62	1272.44	1324.28	1016.66			
12	1702.51	1272.34	1324.26	1016.65			
13	1702.40	1272.25	1324.24	1016.64			
14	1702.55	1272.41	1324.32	1016.73			
15	1702.70	1272.57	1324.40	1016.81			
16	1702.85	1272.73	1324.48	1016.90			
17	1703.00	1272.89	1324.57	1016.99			
18	1703.15	1273.05	1324.65	1017.08			
19	1703.30	1273.21	1324.73	1017.16			
20	1703.46	1273.37	1324.81	1017.25			
21	1703.61	1273.52	1324.89	1017.34			
22	1703.76	1273.68	1324.97	1017.42			
23	1703.91	1273.84	1325.05	1017.51			
24	1704.06	1274.00	1325.14	1017.60			
25	1704.21	1274.16	1325.22	1017.69			
26	1704.36	1274.32	1325.30	1017.77			
27	1704.51	1274.48	1325.38	1017.86			
28	1704.57	1274.38	1325.66	1018.12			
29	1704.62	1274.28	1325.93	1018.38			
30	1704.68	1274.18	1326.21	1018.64			

CCC ERBS - 1985 DECEMBER

ERBE FLIGHT MODEL ONE (ERBS)
COUNT CONVERSION FOR NON-SCANNER

* COUNT CONVERSION ALGORITHM FOR TOTAL CHANNELS

$$E_T = A_V \cdot V^2 + A_F \cdot T_F + A_A \cdot T_A + A_H \cdot T_H + A_R \cdot V_R^2 + B$$

* COUNT CONVERSION ALGORITHM FOR SHORTWAVE CHANNELS

$$E_S = A_V \cdot V^2 + A_F \cdot T_F + A_A \cdot T_A + A_H \cdot T_H + A_R \cdot V_R^2 + A_E \cdot E_T + B$$

	A _V	A _A	A _H	A _F	A _R	A _E	
WFOV/TOT	-22.7873	.0	.0	-1.3968	26.1161		(85/12/06)
WFOV/SW	-26.1241	.0	.0	-.6570	27.1075	-.03116	(88/11/14)
MFOV/TOT	-22.7093	.0	.0	-.9230	25.1276		(85/08/15)
MFOV/SW	-25.5945	.0	.0	1.2256	29.1122	-.03760	(88/11/14)

DAILY B-OFFSET FOR ERBE
 FLIGHT MODEL ONE (ERBS) NONSCANNER

ERBS - 1985 DECEMBER

DAY	(88/10/25)	(88/10/25)	(88/10/25)	(88/10/25)
	WFOV/TOT	MFOV/TOT	WFOV/SW	MFOV/SW
1	1704.74	1274.08	1326.49	1018.89
2	1704.80	1273.98	1326.77	1019.15
3	1704.85	1273.88	1327.04	1019.41
4	1704.91	1273.78	1327.32	1019.67
5	1704.97	1272.97	1327.36	1019.92
6	1705.03	1272.97	1327.41	1020.16
7	1705.09	1272.97	1327.45	1020.41
8	1705.14	1272.97	1327.50	1020.66
9	1705.20	1272.97	1327.54	1020.90
10	1705.26	1272.97	1327.59	1021.15
11	1705.32	1272.97	1327.63	1021.40
12	1705.38	1272.97	1327.67	1021.64
13	1705.44	1272.97	1327.72	1021.89
14	1705.50	1272.97	1327.76	1022.13
15	1705.55	1272.97	1327.81	1022.38
16	1705.61	1272.97	1327.85	1022.63
17	1705.67	1272.97	1327.90	1022.87
18	1705.73	1272.97	1327.94	1023.12
19	1705.59	1273.30	1327.79	1023.31
20	1705.44	1273.64	1327.64	1023.50
21	1705.30	1273.97	1327.49	1023.69
22	1705.15	1274.30	1327.35	1023.87
23	1705.01	1274.63	1327.20	1024.06
24	1704.86	1274.97	1327.05	1024.25
25	1704.72	1275.30	1326.90	1024.44
26	1704.68	1275.24	1326.97	1024.42
27	1704.63	1275.18	1327.04	1024.41
28	1704.59	1275.12	1327.11	1024.39
29	1704.54	1275.06	1327.18	1024.38
30	1704.50	1275.00	1327.26	1024.36

CCC ERBS - 1986 JANUARY

ERBE FLIGHT MODEL ONE (ERBS)
COUNT CONVERSION FOR NON-SCANNER

* COUNT CONVERSION ALGORITHM FOR TOTAL CHANNELS

$$E_T = A_V \cdot V^2 + A_F \cdot T_F + A_A \cdot T_A + A_H \cdot T_H + A_R \cdot T_R^2 + B$$

* COUNT CONVERSION ALGORITHM FOR SHORTWAVE CHANNELS

$$E_S = A_V \cdot V^2 + A_F \cdot T_F + A_A \cdot T_A + A_H \cdot T_H + A_R \cdot T_R^2 + A_E \cdot E_T + B$$

	A_V	A_A	A_H	A_F	A_R	A_E	
WFOV/TOT	-22.7873	.0	.0	-1.3968	26.1161		(85/12/06)
WFOV/SW	-26.1480	.0	.0	-.6576	27.1323	-.03119	(87/10/06)
MFOV/TOT	-22.7093	.0	.0	-.9230	25.1276		(85/08/15)
MFOV/SW	-25.6082	.0	.0	1.2262	29.1279	-.03762	(87/10/06)

DAILY B-OFFSET FOR ERBE
 FLIGHT MODEL ONE (ERBS) NONSCANNER

ERBS - 1986 JANUARY

DAY	(87/10/06)	(87/10/06)	(87/10/06)	(87/10/06)
	WFOV/TOT	MFOV/TOT	WFOV/SW	MFOV/SW
1	1705.05	1275.45	1330.46	1030.01
2	1705.05	1275.45	1330.42	1030.29
3	1705.05	1275.45	1330.48	1030.20
4	1705.05	1275.45	1330.55	1028.39
5	1705.05	1275.45	1330.43	1028.02
6	1705.05	1275.45	1329.71	1026.63
7	1705.05	1275.45	1329.41	1026.72
8	1705.05	1275.45	1329.17	1026.24
9	1705.05	1275.45	1329.07	1026.79
10	1705.05	1275.45	1329.06	1027.02
11	1705.05	1275.45	1329.15	1027.17
12	1705.05	1275.45	1329.19	1027.17
13	1705.05	1275.45	1329.45	1027.53
14	1705.05	1275.45	1329.42	1026.40
15	1705.05	1275.45	1329.65	1026.27
16	1705.05	1275.45	1329.70	1025.84
17	1705.05	1275.45	1329.59	1026.27
18	1705.05	1275.45	1329.58	1026.67
19	1705.05	1275.45	1329.25	1026.82
20	1705.05	1275.45	1329.07	1026.00
21	1705.05	1275.45	1328.94	1025.89
22	1705.05	1275.45	1328.71	1025.60
23	1705.05	1275.45	1328.70	1026.02
24	1705.05	1275.45	1328.88	1026.69
25	1705.05	1275.45	1329.15	1028.27
26	1705.05	1275.45	1329.25	1028.59
27	1705.05	1275.45	1329.56	1028.94
28	1705.05	1275.45	1330.10	1030.13
29	1705.05	1275.45	1330.17	1030.62
30	1705.05	1275.45	1330.07	1030.08
			1330.16	1029.65

CCC ERBS - 1986 FEBRUARY

ERBE FLIGHT MODEL ONE (ERBS)
COUNT CONVERSION FOR NON-SCANNER

* COUNT CONVERSION ALGORITHM FOR TOTAL CHANNELS

$$E_T = A_V \cdot V^2 + A_F \cdot T_F + A_A \cdot T_A + A_H \cdot T_H + A_R \cdot V_R^2 + B$$

* COUNT CONVERSION ALGORITHM FOR SHORTWAVE CHANNELS

$$E_S = A_V \cdot V^2 + A_F \cdot T_F + A_A \cdot T_A + A_H \cdot T_H + A_R \cdot V_R^2 + A_E \cdot E_T + B$$

	A_V	A_A	A_H	A_F	A_R	A_E	
WFOV/TOT	-22.7873	.0	.0	-1.3968	26.1161		(85/12/06)
WFOV/SW	-26.1918	.0	.0	-.6587	27.1777	-.03124	(89/01/24)
MFOV/TOT	-22.7093	.0	.0	-.9230	25.1276		(85/08/15)
MFOV/SW	-25.6021	.0	.0	1.2260	29.1208	-.03761	(89/01/24)

DAILY B-OFFSET FOR ERBE
 FLIGHT MODEL ONE (ERBS) NONSCANNER

ERBS - 1986 FEBRUARY

DAY	(88/12/22)	(88/12/22)	(88/12/22)	(88/12/22)
	WFOV/TOT	MFOV/TOT	WFOV/SW	MFOV/SW
1	1705.09	1275.27	1330.65	1026.95
2	1705.25	1275.44	1330.83	1027.24
3	1705.41	1275.60	1331.01	1027.53
4	1705.58	1275.77	1331.18	1027.83
5	1705.74	1275.93	1331.36	1028.12
6	1705.35	1275.73	1331.35	1027.81
7	1705.35	1275.54	1331.33	1027.50
8	1705.35	1275.34	1331.32	1027.19
9	1705.35	1275.15	1331.31	1026.88
10	1705.35	1274.95	1331.30	1026.58
11	1705.35	1274.75	1331.28	1026.27
12	1705.35	1274.56	1331.27	1025.96
13	1705.35	1274.36	1331.26	1025.65
14	1705.35	1274.17	1331.24	1025.34
15	1705.35	1273.97	1331.23	1025.03
16	1706.22	1274.90	1331.36	1024.91
17	1706.22	1274.90	1331.49	1024.80
18	1706.22	1274.90	1331.62	1024.68
19	1706.22	1274.90	1331.75	1024.57
20	1706.22	1274.90	1331.88	1024.45
21	1706.22	1274.90	1332.01	1024.34
22	1706.22	1274.90	1332.14	1024.22
23	1706.22	1274.90	1332.27	1024.11
24	1706.22	1274.90	1332.40	1023.99
25	1706.22	1274.90	1332.53	1023.88
26	1706.22	1274.90	1332.66	1023.76
27	1705.30	1275.03	1332.35	1023.51
28	1705.30	1275.16	1332.05	1023.27
29	1705.30	1275.29	1331.74	1023.02
30	1705.30	1275.43	1331.43	1022.77

CCC ERBS - 1986 MARCH

ERBE FLIGHT MODEL ONE (ERBS)
 COUNT CONVERSION FOR NON-SCANNER

* COUNT CONVERSION ALGORITHM FOR TOTAL CHANNELS

$$E_T = A_V \cdot V^2 + A_F \cdot T_F + A_A \cdot T_A + A_H \cdot T_H + A_R \cdot V_R^2 + B$$

* COUNT CONVERSION ALGORITHM FOR SHORTWAVE CHANNELS

$$E_S = A_V \cdot V^2 + A_F \cdot T_F + A_A \cdot T_A + A_H \cdot T_H + A_R \cdot V_R^2 + A_E \cdot E_T + B$$

	A _V	A _A	A _H	A _F	A _R	A _E	
WFOV/TOT	-22.7873	.0	.0	-1.3968	26.1161		(85/12/06)
WFOV/SW	-26.2274	.0	.0	-.6596	27.2147	-.03128	(89/03/24)
MFOV/TOT	-22.7093	.0	.0	-.9230	25.1276		(85/08/15)
MFOV/SW	-25.6060	.0	.0	1.2262	29.1254	-.03762	(89/03/24)

DAILY B-OFFSET FOR ERBE
 FLIGHT MODEL ONE (ERBS) NONSCANNER

ERBS - 1986 MARCH

DAY	(89/02/07)	(89/02/07)	(89/02/07)	(89/02/07)	(89/02/07)
	WFOV/TOT	MFOV/TOT	WFOV/SW	MFOV/SW	
1	1705.30	1275.29	1331.84	1023.00	
2	1705.30	1275.41	1331.50	1022.76	
3	1705.30	1275.54	1331.17	1022.51	
4	1705.30	1275.67	1330.84	1022.27	
5	1705.30	1275.80	1330.51	1022.02	
6	1705.18	1275.66	1330.70	1022.42	
7	1705.05	1275.52	1330.90	1022.81	
8	1704.93	1275.38	1331.09	1023.21	
9	1704.80	1275.24	1331.28	1023.60	
10	1704.68	1275.10	1331.48	1024.00	
11	1704.55	1274.96	1331.67	1024.39	
12	1704.43	1274.82	1331.87	1024.79	
13	1704.31	1274.67	1332.06	1025.18	
14	1704.18	1274.53	1332.25	1025.58	
15	1704.06	1274.39	1332.45	1025.97	
16	1703.93	1274.25	1332.64	1026.37	
17	1703.81	1274.11	1332.83	1026.76	
18	1703.68	1273.97	1333.03	1027.16	
19	1703.56	1273.83	1333.22	1027.55	
20	1703.77	1273.93	1333.38	1027.42	
21	1703.98	1274.04	1333.55	1027.30	
22	1704.19	1274.14	1333.71	1027.17	
23	1704.41	1274.24	1333.88	1027.04	
24	1704.62	1274.35	1334.04	1026.91	
25	1704.83	1274.45	1334.21	1026.79	
26	1705.04	1274.56	1334.37	1026.66	
27	1705.25	1274.66	1334.53	1026.53	
28	1705.46	1274.76	1334.70	1026.41	
29	1705.67	1274.87	1334.86	1026.28	
30	1705.89	1274.97	1335.03	1026.15	

CCC ERBS - 1986 APRIL

ERBE FLIGHT MODEL ONE (ERBS)
COUNT CONVERSION FOR NON-SCANNER

* COUNT CONVERSION ALGORITHM FOR TOTAL CHANNELS

$$E_T = A_V \cdot V^2 + A_F \cdot T_F + A_A \cdot T_A + A_H \cdot T_H + A_R \cdot V_R^2 + B$$

* COUNT CONVERSION ALGORITHM FOR SHORTWAVE CHANNELS

$$E_S = A_V \cdot V^2 + A_F \cdot T_F + A_A \cdot T_A + A_H \cdot T_H + A_R \cdot V_R^2 + A_E \cdot E_T + B$$

	A_V	A_A	A_H	A_F	A_R	A_E	
WFOV/TOT	-22.7873	.0	.0	-1.3968	26.1161		(85/12/06)
WFOV/SW	-26.2579	.0	.0	-.6604	27.2464	-.03132	(89/04/26)
MFOV/TOT	-22.7093	.0	.0	-.9230	25.1276		(85/08/15)
MFOV/SW	-25.6095	.0	.0	1.2263	29.1293	-.03762	(89/04/26)

DAILY B-OFFSET FOR ERBE
 FLIGHT MODEL ONE (ERBS) NONSCANNER

ERBS - 1986 APRIL

DAY	(89/02/07)	(89/02/07)	(89/02/07)	(89/02/07)	(89/02/07)
	WFOV/TOT	MFOV/TOT	WFOV/SW	MFOV/SW	
1	1706.31	1275.18	1335.36	1025.90	
2	1706.52	1275.28	1335.52	1025.77	
3	1705.88	1275.43	1335.48	1026.18	
4	1705.88	1275.58	1335.45	1026.58	
5	1705.88	1275.74	1335.41	1026.99	
6	1705.88	1275.89	1335.38	1027.40	
7	1705.88	1276.04	1335.34	1027.81	
8	1705.88	1276.19	1335.31	1028.21	
9	1705.88	1276.35	1335.27	1028.62	
10	1705.88	1276.50	1335.23	1029.03	
11	1705.88	1276.65	1335.20	1029.43	
12	1705.88	1276.80	1335.16	1029.84	
13	1705.88	1276.95	1335.13	1030.25	
14	1705.88	1277.11	1335.09	1030.66	
15	1705.88	1277.26	1335.06	1031.06	
16	1705.88	1277.41	1335.02	1031.47	
17	1705.85	1277.29	1335.09	1031.25	
18	1705.83	1277.17	1335.16	1031.04	
19	1705.80	1277.05	1335.24	1030.82	
20	1705.77	1276.94	1335.31	1030.60	
21	1705.74	1276.82	1335.38	1030.39	
22	1705.72	1276.70	1335.45	1030.17	
23	1705.69	1276.58	1335.53	1029.96	
24	1705.66	1276.46	1335.60	1029.74	
25	1705.64	1276.34	1335.67	1029.52	
26	1705.61	1276.22	1335.74	1029.31	
27	1705.58	1276.11	1335.81	1029.09	
28	1705.55	1275.99	1335.89	1028.87	
29	1705.53	1275.87	1335.96	1028.66	
30	1705.50	1275.75	1336.03	1028.44	

CCC ERBS - 1986 MAY

ERBE FLIGHT MODEL ONE (ERBS)
COUNT CONVERSION FOR NON-SCANNER

* COUNT CONVERSION ALGORITHM FOR TOTAL CHANNELS

$$E_T = A_V \cdot V^2 + A_F \cdot T_F + A_A \cdot T_A + A_H \cdot T_H + A_R \cdot V_R^2 + B$$

* COUNT CONVERSION ALGORITHM FOR SHORTWAVE CHANNELS

$$E_S = A_V \cdot V^2 + A_F \cdot T_F + A_A \cdot T_A + A_H \cdot T_H + A_R \cdot V_R^2 + A_E \cdot E_T + B$$

	A_V	A_A	A_H	A_F	A_R	A_E	
WFOV/TOT	-22.7873	.0	.0	-1.3968	26.1161		(85/12/06)
WFOV/SW	-26.2879	.0	.0	-.6611	27.2774	-.03135	(89/05/23)
MFOV/TOT	-22.7093	.0	.0	-.9230	25.1276		(85/08/15)
MFOV/SW	-25.6128	.0	.0	1.2265	29.1331	-.03763	(89/05/23)

DAILY B-OFFSET FOR ERBE
 FLIGHT MODEL ONE (ERBS) NONSCANNER

ERBS - 1986 MAY

DAY	(89/02/07)	(89/02/07)	(89/02/07)	(89/02/07)	(89/02/07)
	WFOV/TOT	MFOV/TOT	WFOV/SW	MFOV/SW	
1	1705.48	1275.75	1335.99	1028.14	
2	1705.47	1275.75	1335.95	1027.85	
3	1705.45	1275.76	1335.91	1027.55	
4	1705.44	1275.76	1335.88	1027.25	
5	1705.42	1275.76	1335.84	1026.95	
6	1705.41	1275.76	1335.80	1026.66	
7	1705.39	1275.77	1335.76	1026.36	
8	1705.37	1275.77	1335.72	1026.06	
9	1705.36	1275.77	1335.68	1025.77	
10	1705.34	1275.77	1335.64	1025.47	
11	1705.33	1275.77	1335.61	1025.17	
12	1705.31	1275.78	1335.57	1024.87	
13	1705.30	1275.78	1335.53	1024.58	
14	1705.28	1275.78	1335.49	1024.28	
15	1705.24	1275.77	1335.68	1024.61	
16	1705.19	1275.75	1335.87	1024.94	
17	1705.15	1275.74	1336.06	1025.26	
18	1705.11	1275.73	1336.24	1025.59	
19	1705.07	1275.71	1336.43	1025.92	
20	1705.02	1275.70	1336.62	1026.25	
21	1704.98	1275.69	1336.81	1026.58	
22	1704.94	1275.67	1337.00	1026.90	
23	1704.89	1275.66	1337.19	1027.23	
24	1704.85	1275.64	1337.38	1027.56	
25	1704.81	1275.63	1337.56	1027.89	
26	1704.77	1275.62	1337.75	1028.21	
27	1704.72	1275.60	1337.94	1028.54	
28	1704.68	1275.59	1338.13	1028.87	
29	1704.62	1275.43	1338.13	1028.80	
30	1704.62	1275.43	1338.13	1028.80	

CCC ERBS - 1986 JUNE

ERBE FLIGHT MODEL ONE (ERBS)
COUNT CONVERSION FOR NON-SCANNER

* COUNT CONVERSION ALGORITHM FOR TOTAL CHANNELS

$$E_T = A_V \cdot V^2 + A_F \cdot T_F + A_A \cdot T_A + A_H \cdot T_H + A_R \cdot V_R^2 + B$$

* COUNT CONVERSION ALGORITHM FOR SHORTWAVE CHANNELS

$$E_S = A_V \cdot V^2 + A_F \cdot T_F + A_A \cdot T_A + A_H \cdot T_H + A_R \cdot V_R^2 + A_E \cdot E_T + B$$

	A_V	A_A	A_H	A_F	A_R	A_E	
WFOV/TOT	-22.7873	.0	.0	-1.3968	26.1161		(85/12/06)
WFOV/SW	-26.3255	.0	.0	-.6621	27.3165	-.03140	(89/05/23)
MFOV/TOT	-22.7093	.0	.0	-.9230	25.1276		(85/08/15)
MFOV/SW	-25.6171	.0	.0	1.2267	29.1379	-.03763	(89/05/23)

DAILY B-OFFSET FOR ERBS
 FLIGHT MODEL ONE (ERBS) NONSCANNER

ERBS - 1986 JUNE

DAY	(89/02/07)	(89/02/07)	(89/02/07)	(89/02/07)
	WFOV/TOT	MFOV/TOT	WFOV/SW	MFOV/SW
1	1705.25	1275.43	1338.13	1028.60
2	1705.39	1275.43	1338.13	1028.53
3	1705.53	1275.43	1338.13	1028.46
4	1705.67	1275.43	1338.13	1028.39
5	1705.70	1275.45	1338.14	1028.23
6	1705.72	1275.47	1338.16	1028.07
7	1705.75	1275.49	1338.17	1027.91
8	1705.78	1275.51	1338.18	1027.75
9	1705.80	1275.53	1338.19	1027.59
10	1705.83	1275.55	1338.21	1027.43
11	1705.86	1275.57	1338.22	1027.27
12	1705.88	1275.60	1338.23	1027.11
13	1705.91	1275.62	1338.24	1026.95
14	1705.94	1275.64	1338.26	1026.79
15	1705.96	1275.66	1338.27	1026.63
16	1705.99	1275.68	1338.28	1026.47
17	1706.02	1275.70	1338.29	1026.31
18	1706.04	1275.72	1338.31	1026.15
19	1706.07	1275.74	1338.32	1025.99
20	1705.88	1275.77	1338.29	1026.17
21	1705.69	1275.77	1338.25	1026.35
22	1705.51	1275.77	1338.22	1026.54
23	1705.32	1275.77	1338.19	1026.72
24	1705.13	1275.77	1338.15	1026.90
25	1704.94	1275.77	1338.12	1027.08
26	1705.76	1275.81	1338.35	1027.23
27	1705.76	1275.81	1338.58	1027.39
28	1705.76	1275.81	1338.81	1027.54
29	1705.76	1275.81	1339.03	1027.69

CCC ERBS - 1986 JULY

ERBE FLIGHT MODEL ONE (ERBS)
COUNT CONVERSION FOR NON-SCANNER

* COUNT CONVERSION ALGORITHM FOR TOTAL CHANNELS

$$E_T = A_V \cdot V^2 + A_F \cdot T_F + A_A \cdot T_A + A_H \cdot T_H + A_R \cdot V_R^2 + B$$

* COUNT CONVERSION ALGORITHM FOR SHORTWAVE CHANNELS

$$E_S = A_V \cdot V^2 + A_F \cdot T_F + A_A \cdot T_A + A_H \cdot T_H + A_R \cdot V_R^2 + A_E \cdot E_T + B$$

	A_V	A_A	A_H	A_F	A_R	A_E	
WFOV/TOT	-22.7873	.0	.0	-1.3968	26.1161		(85/12/06)
WFOV/SW	-26.3460	.0	.0	-.6626	27.3377	-.03142	(89/05/23)
MFOV/TOT	-22.7093	.0	.0	-.9230	25.1276		(85/08/15)
MFOV/SW	-25.6194	.0	.0	1.2268	29.1405	-.03764	(89/05/23)

DAILY B-OFFSET FOR ERBE
 FLIGHT MODEL ONE (ERBS) NONSCANNER

ERBS - 1986 JULY

DAY	(89/02/07)	(89/02/07)	(89/02/07)	(89/02/07)
	WFOV/TOT	MFOV/TOT	WFOV/SW	MFOV/SW
1	1705.76	1275.81	1339.49	1028.00
2	1705.76	1275.81	1339.72	1028.16
3	1705.76	1275.81	1339.95	1028.31
4	1705.76	1275.81	1340.18	1028.46
5	1705.76	1275.81	1340.41	1028.62
6	1705.76	1275.81	1340.63	1028.77
7	1705.76	1275.81	1340.86	1028.92
8	1705.76	1275.81	1341.09	1029.08
9	1705.76	1275.81	1341.32	1029.23
10	1705.76	1275.80	1341.22	1028.95
11	1705.77	1275.80	1341.12	1028.68
12	1705.77	1275.80	1341.02	1028.40
13	1705.77	1275.80	1340.93	1028.12
14	1705.77	1275.80	1340.83	1027.85
15	1705.78	1275.80	1340.73	1027.57
16	1705.78	1275.80	1340.63	1027.30
17	1705.78	1275.80	1340.53	1027.02
18	1705.79	1275.80	1340.43	1026.74
19	1705.79	1275.80	1340.33	1026.47
20	1705.79	1275.80	1340.24	1026.19
21	1705.79	1275.80	1340.14	1025.91
22	1705.80	1275.80	1340.04	1025.64
23	1705.80	1275.80	1339.94	1025.36
24	1705.77	1275.84	1340.12	1025.72
25	1705.74	1275.84	1340.30	1026.09
26	1705.71	1275.84	1340.48	1026.45
27	1705.67	1275.84	1340.67	1026.81
28	1705.64	1275.84	1340.85	1027.17
29	1705.61	1275.84	1341.03	1027.54
30	1705.58	1275.84	1341.21	1027.90

CCC ERBS - 1986 AUGUST

ERBE FLIGHT MODEL ONE (ERBS)
 COUNT CONVERSION FOR NON-SCANNER

* COUNT CONVERSION ALGORITHM FOR TOTAL CHANNELS

$$E_T = A_V \cdot V^2 + A_F \cdot T_F + A_A \cdot T_A + A_H \cdot T_H + A_R \cdot V_R^2 + B$$

* COUNT CONVERSION ALGORITHM FOR SHORTWAVE CHANNELS

$$E_S = A_V \cdot V^2 + A_F \cdot T_F + A_A \cdot T_A + A_H \cdot T_H + A_R \cdot V_R^2 + A_E \cdot E_T + B$$

	A_V	A_A	A_H	A_F	A_R	A_E	
WFOV/TOT	-22.7873	.0	.0	-1.3968	26.1161		(85/12/06)
WFOV/SW	-26.3850	.0	.0	-.6636	27.3782	-.03147	(89/11/13)
MFOV/TOT	-22.7093	.0	.0	-.9230	25.1276		(85/08/15)
MFOV/SW	-25.6238	.0	.0	1.2270	29.1455	-.03764	(89/11/13)

DAILY B-OFFSET FOR ERBE
 FLIGHT MODEL ONE (ERBS) NONSCANNER

ERBS - 1986 AUGUST

DAY	(89/02/07)	(89/02/07)	(89/02/07)	(89/02/07)	(89/02/07)
	WFOV/TOT	MFOV/TOT	WFOV/SW	MFOV/SW	
1	1705.52	1275.84	1341.57	1028.63	
2	1705.49	1275.84	1341.75	1028.99	
3	1705.45	1275.84	1341.94	1029.35	
4	1705.42	1275.84	1342.12	1029.71	
5	1705.39	1275.84	1342.30	1030.08	
6	1705.36	1275.84	1342.48	1030.44	
7	1705.42	1275.78	1342.43	1030.11	
8	1705.48	1275.71	1342.38	1029.78	
9	1705.54	1275.65	1342.34	1029.45	
10	1705.60	1275.58	1342.29	1029.12	
11	1705.66	1275.52	1342.24	1028.79	
12	1705.72	1275.45	1342.19	1028.45	
13	1705.78	1275.39	1342.14	1028.12	
14	1705.84	1275.32	1342.09	1027.79	
15	1705.90	1275.26	1342.05	1027.46	
16	1705.96	1275.19	1342.00	1027.13	
17	1706.02	1275.13	1341.95	1026.80	
18	1706.07	1275.15	1341.99	1026.97	
19	1706.11	1275.17	1342.03	1027.13	
20	1706.16	1275.19	1342.08	1027.30	
21	1706.21	1275.21	1342.12	1027.47	
22	1706.25	1275.23	1342.16	1027.63	
23	1706.30	1275.24	1342.20	1027.80	
24	1706.34	1275.26	1342.24	1027.96	
25	1706.39	1275.28	1342.28	1028.13	
26	1706.44	1275.30	1342.33	1028.30	
27	1706.48	1275.32	1342.37	1028.46	
28	1706.53	1275.34	1342.41	1028.63	
29	1706.24	1274.83	1342.31	1028.55	
30	1705.95	1274.83	1342.21	1028.46	

CCC ERBS - 1986 SEPTEMBER

ERBE FLIGHT MODEL ONE (ERBS)
 COUNT CONVERSION FOR NON-SCANNER

* COUNT CONVERSION ALGORITHM FOR TOTAL CHANNELS

$$E_T = A_V \cdot V^2 + A_F \cdot T_F + A_A \cdot T_A + A_H \cdot T_H + A_R \cdot V_R^2 + B$$

* COUNT CONVERSION ALGORITHM FOR SHORTWAVE CHANNELS

$$E_S = A_V \cdot V^2 + A_F \cdot T_F + A_A \cdot T_A + A_H \cdot T_H + A_R \cdot V_R^2 + A_E \cdot E_T + B$$

	A_V	A_A	A_H	A_F	A_R	A_E	
WFOV/TOT	-22.7873	.0	.0	-1.3968	26.1161		(85/12/06)
WFOV/SW	-26.4151	.0	.0	-.6643	27.4095	-.03150	(89/11/13)
MFOV/TOT	-22.7093	.0	.0	-.9230	25.1276		(85/08/15)
MFOV/SW	-25.6272	.0	.0	1.2272	29.1494	-.03765	(89/11/13)

DAILY B-OFFSET FOR ERBE
 FLIGHT MODEL ONE (ERBS) NONSCANNER

ERBS - 1986 SEPTEMBER

DAY	(89/02/07)	(89/02/07)	(89/02/07)	(89/02/07)
	WFOV/TOT	MFOV/TOT	WFOV/SW	MFOV/SW
1	1705.38	1274.83	1342.01	1028.29
2	1705.09	1274.83	1341.91	1028.21
3	1704.80	1274.83	1341.81	1028.12
4	1704.90	1274.90	1342.00	1028.20
5	1705.00	1274.96	1342.18	1028.29
6	1705.09	1275.03	1342.37	1028.37
7	1705.19	1275.09	1342.55	1028.46
8	1705.29	1275.16	1342.74	1028.54
9	1705.39	1275.22	1342.92	1028.63
10	1705.49	1275.29	1343.11	1028.71
11	1705.58	1275.36	1343.30	1028.79
12	1705.68	1275.42	1343.48	1028.88
13	1705.78	1275.49	1343.67	1028.96
14	1705.88	1275.55	1343.85	1029.05
15	1705.97	1275.62	1344.04	1029.13
16	1706.07	1275.68	1344.22	1029.22
17	1706.17	1275.75	1344.41	1029.30
18	1706.26	1275.06	1344.52	1029.15
19	1706.35	1275.06	1344.64	1029.01
20	1706.44	1275.06	1344.75	1028.86
21	1706.52	1275.06	1344.87	1028.71
22	1706.61	1275.06	1344.98	1028.57
23	1706.70	1275.06	1345.10	1028.42
24	1706.79	1275.06	1345.21	1028.28
25	1706.88	1275.06	1345.32	1028.13
26	1706.97	1275.06	1345.44	1027.98
27	1707.06	1275.06	1345.55	1027.84
28	1707.14	1275.06	1345.67	1027.69
29	1707.23	1275.06	1345.78	1027.54
30	1707.32	1275.06	1345.90	1027.40

CCC ERBS - 1986 OCTOBER

ERBE FLIGHT MODEL ONE (ERBS)
 COUNT CONVERSION FOR NON-SCANNER

* COUNT CONVERSION ALGORITHM FOR TOTAL CHANNELS

$$E_T = A_V \cdot V^2 + A_F \cdot T_F + A_A \cdot T_A + A_H \cdot T_H + A_R \cdot V_R^2 + B$$

* COUNT CONVERSION ALGORITHM FOR SHORTWAVE CHANNELS

$$E_S = A_V \cdot V^2 + A_F \cdot T_F + A_A \cdot T_A + A_H \cdot T_H + A_R \cdot V_R^2 + A_E \cdot E_T + B$$

	A_V	A_A	A_H	A_F	A_R	A_E	
WFOV/TOT	-22.7873	.0	.0	-1.3968	26.1161		(85/12/06)
WFOV/SW	-26.4175	.0	.0	-.6644	27.4119	-.03151	(88/07/06)
MFOV/TOT	-22.7093	.0	.0	-.9230	25.1276		(85/08/15)
MFOV/SW	-25.6315	.0	.0	1.2274	29.1543	-.03765	(88/07/06)

DAILY B-OFFSET FOR ERBE
 FLIGHT MODEL ONE (ERBS) NONSCANNER

ERBS - 1986 OCTOBER

DAY	(88/07/06)	(88/07/06)	(88/07/06)	(88/07/06)	(88/07/06)
	WFOV/TOT	MFOV/TOT	WFOV/SW	MFOV/SW	
1	1707.09	1274.90	1344.75	1027.36	
2	1705.87	1274.96	1344.73	1027.62	
3	1705.87	1275.01	1344.70	1027.87	
4	1705.87	1275.07	1344.68	1028.13	
5	1705.87	1275.12	1344.65	1028.38	
6	1705.87	1275.18	1344.63	1028.64	
7	1705.87	1275.23	1344.60	1028.89	
8	1705.87	1275.29	1344.58	1029.15	
9	1705.87	1275.34	1344.56	1029.40	
10	1705.87	1275.40	1344.53	1029.66	
11	1705.87	1275.45	1344.51	1029.91	
12	1705.87	1275.51	1344.48	1030.17	
13	1705.87	1275.56	1344.46	1030.42	
14	1705.87	1275.62	1344.43	1030.68	
15	1705.87	1275.67	1344.41	1030.93	
16	1705.84	1275.60	1344.43	1030.80	
17	1705.81	1275.54	1344.45	1030.66	
18	1705.78	1275.47	1344.47	1030.53	
19	1705.74	1275.41	1344.49	1030.40	
20	1705.71	1275.34	1344.51	1030.26	
21	1705.68	1275.28	1344.53	1030.13	
22	1705.65	1275.21	1344.54	1029.99	
23	1705.62	1275.14	1344.56	1029.86	
24	1705.59	1275.08	1344.58	1029.73	
25	1705.56	1275.01	1344.60	1029.59	
26	1705.52	1274.95	1344.62	1029.46	
27	1705.49	1274.88	1344.64	1029.33	
28	1705.46	1274.82	1344.66	1029.19	
29	1705.43	1274.75	1344.68	1029.06	
30	1705.46	1274.84	1344.76	1029.17	

ORIGINAL PAGE IS
 OF POOR QUALITY

CCC ERBS - 1986 NOVEMBER

ERBE FLIGHT MODEL ONE (ERBS)
COUNT CONVERSION FOR NON-SCANNER

* COUNT CONVERSION ALGORITHM FOR TOTAL CHANNELS

$$E_T = A_V \cdot V^2 + A_F \cdot T_F + A_A \cdot T_A + A_H \cdot T_H + A_R \cdot V_R^2 + B$$

* COUNT CONVERSION ALGORITHM FOR SHORTWAVE CHANNELS

$$E_S = A_V \cdot V^2 + A_F \cdot T_F + A_A \cdot T_A + A_H \cdot T_H + A_R \cdot V_R^2 + A_E \cdot E_T + B$$

	A_V	A_A	A_H	A_F	A_R	A_E	
WFOV/TOT	-22.7873	.0	.0	-1.3968	26.1161		(85/12/06)
WFOV/SW	-26.4677	.0	.0	-.6657	27.4640	-.03157	(89/06/05)
MFOV/TOT	-22.7093	.0	.0	-.9230	25.1276		(85/08/15)
MFOV/SW	-25.6331	.0	.0	1.2275	29.1562	-.03766	(89/06/05)

DAILY B-OFFSET FOR ERBE
 FLIGHT MODEL ONE (ERBS) NONSCANNER

ERBS - 1986 NOVEMBER

DAY	(89/02/07)	(89/02/07)	(89/02/07)	(89/02/07)	(89/02/07)
	WFOV/TOT	MFOV/TOT	WFOV/SW	MFOV/SW	
1	1705.52	1275.03	1346.81	1030.35	
2	1705.55	1275.12	1346.86	1030.32	
3	1705.58	1275.21	1346.90	1030.30	
4	1705.61	1275.30	1346.95	1030.27	
5	1705.65	1275.39	1346.99	1030.25	
6	1705.68	1275.47	1347.03	1030.22	
7	1705.71	1275.56	1347.08	1030.19	
8	1705.74	1275.65	1347.12	1030.17	
9	1705.77	1275.74	1347.17	1030.14	
10	1705.81	1275.83	1347.21	1030.11	
11	1705.84	1275.92	1347.26	1030.09	
12	1705.87	1276.01	1347.30	1030.06	
13	1705.91	1276.27	1347.38	1030.11	
14	1705.96	1276.27	1347.45	1030.16	
15	1706.00	1276.27	1347.53	1030.21	
16	1706.04	1276.27	1347.61	1030.26	
17	1706.08	1276.27	1347.68	1030.31	
18	1706.13	1276.27	1347.76	1030.36	
19	1706.17	1276.27	1347.84	1030.41	
20	1706.21	1276.27	1347.91	1030.46	
21	1706.26	1276.27	1347.99	1030.51	
22	1706.30	1276.27	1348.06	1030.56	
23	1706.34	1276.27	1348.14	1030.61	
24	1706.38	1276.27	1348.22	1030.66	
25	1706.43	1276.27	1348.29	1030.71	
26	1706.47	1276.27	1348.37	1030.76	
27	1706.56	1275.35	1348.60	1030.69	
28	1706.66	1275.35	1348.83	1030.63	
29	1706.75	1275.35	1349.05	1030.56	
30	1706.84	1275.35	1349.28	1030.50	

CCC ERBS - 1986 DECEMBER

ERBE FLIGHT MODEL ONE (ERBS)
COUNT CONVERSION FOR NON-SCANNER

* COUNT CONVERSION ALGORITHM FOR TOTAL CHANNELS

$$E_T = A_V \cdot V^2 + A_F \cdot T_F + A_A \cdot T_A + A_H \cdot T_H + A_R \cdot V_R^2 + B$$

* COUNT CONVERSION ALGORITHM FOR SHORTWAVE CHANNELS

$$E_S = A_V \cdot V^2 + A_F \cdot T_F + A_A \cdot T_A + A_H \cdot T_H + A_R \cdot V_R^2 + A_E \cdot E_T + B$$

	A_V	A_A	A_H	A_F	A_R	A_E	
WFOV/TOT	-22.7873	.0	.0	-1.3968	26.1161		(85/12/06)
WFOV/SW	-26.4821	.0	.0	-.6660	27.4790	-.03159	(87/12/05)
MFOV/TOT	-22.7093	.0	.0	-.9230	25.1276		(85/08/15)
MFOV/SW	-25.6490	.0	.0	1.2282	29.1744	-.03768	(87/12/05)

DAILY B-OFFSET FOR ERBE
 FLIGHT MODEL ONE (ERBS) NONSCANNER

ERBS - 1986 DECEMBER

DAY	(87/10/06)	(87/10/06)	(88/04/04)	(88/04/04)
	WFOV/TOT	MFOV/TOT	WFOV/SW	MFOV/SW
1	1705.05	1275.45	1347.62	1029.50
2	1705.05	1275.45	1347.90	1029.62
3	1705.05	1275.45	1348.47	1029.00
4	1705.05	1275.45	1348.52	1029.22
5	1705.05	1275.45	1348.52	1029.43
6	1705.05	1275.45	1348.52	1029.65
7	1705.05	1275.45	1348.52	1029.86
8	1705.05	1275.45	1348.52	1030.08
9	1705.05	1275.45	1348.52	1030.29
10	1705.05	1275.45	1348.52	1030.51
11	1705.05	1275.45	1348.52	1030.72
12	1705.05	1275.45	1348.52	1030.94
13	1705.05	1275.45	1348.52	1031.15
14	1705.05	1275.45	1348.52	1031.36
15	1705.05	1275.45	1348.52	1031.58
16	1705.05	1275.45	1348.52	1031.79
17	1705.05	1275.45	1348.52	1032.01
18	1705.05	1275.45	1348.28	1032.22
19	1705.05	1275.45	1348.32	1032.44
20	1705.05	1275.45	1348.05	1032.50
21	1705.05	1275.45	1347.93	1031.79
22	1705.05	1275.45	1347.62	1032.09
23	1705.05	1275.45	1347.61	1031.81
24	1705.05	1275.45	1347.64	1031.37
25	1705.05	1275.45	1348.32	1033.03
26	1705.05	1275.45	1348.70	1033.44
27	1705.05	1275.45	1349.03	1034.94
28	1705.05	1275.45	1349.16	1035.64
29	1705.05	1275.45	1349.23	1035.87
30	1705.05	1275.45	1349.13	1035.46

APPENDIX K
NOAA-9 NONSCANNER OFFSETS (MERGE)

APPENDIX K: NOAA-9 NONSCANNER OFFSETS (MERGE)

The tables of NOAA-9 nonscanner offsets in the following pages cover the period from February 1985 to December 1986.

Table

February 1985	K-1
March 1985	K-2
April 1985	K-3
May 1985	K-4
June 1985	K-5
July 1985	K-6
August 1985	K-7
September 1985	K-8
October 1985	K-9
November 1985	K-10
December 1985	K-11
January 1986	K-12
February 1986	K-13
March 1986	K-14
April 1986	K-15
May 1986	K-16
June 1986	K-17
July 1986	K-18
August 1986	K-19
September 1986	K-20
October 1986	K-21
November 1986	K-22
December 1986	K-23

This page has been intentionally left blank

CCC NOAA9 - 1985 FEBRUARY

ERBE FLIGHT MODEL TWO (NOAA9)
COUNT CONVERSION FOR NON-SCANNER

* COUNT CONVERSION ALGORITHM FOR TOTAL CHANNELS

$$ET = AV V^{**2} + AF TF + AA TA + AH TH + AR VR^{**2} + B$$

* COUNT CONVERSION ALGORITHM FOR SHORTWAVE CHANNELS

$$ES = AV V^{**2} + AF TF + AA TA + AH TH + AR VR^{**2} + AE ET + B$$

	AV	AA	AH	AF	AR	AE	
WFOV/TOT	-22.8621	.0	.0	-.3977	24.7635		(85/08/15)
WFOV/SW	-26.0040	.0	.0	-.3542	30.1496	-.03467	(89/03/03)
MFOV/TOT	-22.5566	.0	.0	-.5274	23.9133		(85/08/15)
MFOV/SW	-25.4613	.0	.0	.7092	28.9886	-.03604	(89/03/03)

328

DAILY B-OFFSET FOR ERBE
 FLIGHT MODEL TWO (NOAA9) NONSCANNER

NOAA9 - 1985 FEBRUARY

DAY	(89/02/21)	(89/02/21)	(89/02/21)	(89/02/21)
	WFOV/TOT	MFOV/TOT	WFOV/SW	MFOV/SW
1	1477.06	1223.73	1361.88	839.26
2	1477.06	1223.55	1359.87	838.57
3	1476.83	1223.29	1360.37	838.65
4	1476.60	1223.11	1360.87	838.73
5	1476.37	1222.92	1361.37	838.80
6	1476.14	1222.74	1361.87	838.88
7	1476.09	1222.51	1361.90	838.94
8	1476.04	1222.28	1361.93	839.01
9	1475.99	1222.05	1361.96	839.07
10	1475.95	1221.82	1362.00	839.13
11	1475.90	1221.59	1362.03	839.19
12	1475.85	1221.36	1362.06	839.26
13	1475.80	1221.13	1362.09	839.32
14	1476.95	1221.46	1362.17	839.57
15	1476.95	1221.28	1362.24	839.83
16	1476.95	1221.10	1362.32	840.08
17	1476.95	1220.91	1362.39	840.33
18	1476.95	1220.73	1362.47	840.58
19	1476.95	1220.55	1362.54	840.84
20	1476.95	1220.37	1362.62	841.09
21	1476.85	1218.97	1362.68	841.12
22	1476.76	1218.79	1362.73	841.16
23	1476.66	1218.60	1362.79	841.19
24	1476.56	1218.42	1362.85	841.23
25	1476.47	1218.24	1362.90	841.26
26	1476.37	1218.06	1362.96	841.30
27	1476.28	1217.88	1363.02	841.33
28	1476.18	1217.70	1363.07	841.36

CCC NOAA9 - 1985 MARCH

ERBE FLIGHT MODEL TWO (NOAA9)
COUNT CONVERSION FOR NON-SCANNER

* COUNT CONVERSION ALGORITHM FOR TOTAL CHANNELS

$$ET = AV V^{**2} + AF TF + AA TA + AH TH + AR VR^{**2} + B$$

* COUNT CONVERSION ALGORITHM FOR SHORTWAVE CHANNELS

$$ES = AV V^{**2} + AF TF + AA TA + AH TH + AR VR^{**2} + AE ET + B$$

	AV	AA	AH	AF	AR	AE	
WFOV/TOT	-22.8621	.0	.0	-.3977	24.7635		(85/08/15)
WFOV/SW	-26.0848	.0	.0	-.3553	30.2434	-.03478	(88/08/16)
MFOV/TOT	-22.5566	.0	.0	-.5274	23.9133		(85/08/15)
MFOV/SW	-25.4534	.0	.0	.7090	28.9796	-.03603	(88/08/16)

DAILY B-OFFSET FOR ERBE
 FLIGHT MODEL TWO (NOAA9) NONSCANNER

NOAA9 - 1985 MARCH

DAY	(88/08/16)	(88/08/16)	(88/08/16)	(88/08/16)
	WFOV/TOT	MFOV/TOT	WFOV/SW	MFOV/SW
1	1476.08	1217.52	1364.33	841.12
2	1475.98	1217.34	1364.41	841.15
3	1475.88	1217.16	1364.49	841.17
4	1475.78	1216.98	1364.57	841.20
5	1475.69	1216.80	1364.65	841.22
6	1475.59	1216.62	1364.73	841.25
7	1475.79	1216.40	1364.67	841.31
8	1475.79	1216.18	1364.61	841.38
9	1475.79	1215.96	1364.56	841.44
10	1475.79	1215.74	1364.50	841.51
11	1475.79	1215.52	1364.44	841.57
12	1475.79	1215.30	1364.38	841.64
13	1475.79	1215.08	1364.32	841.70
14	1475.79	1214.86	1364.27	841.76
15	1475.79	1214.64	1364.21	841.83
16	1475.79	1214.42	1364.15	841.89
17	1475.79	1214.20	1364.09	841.96
18	1475.79	1213.98	1364.04	842.02
19	1475.79	1213.76	1363.98	842.09
20	1475.79	1213.54	1363.92	842.15
21	1475.28	1212.88	1364.04	842.10
22	1475.28	1212.70	1364.16	842.06
23	1475.28	1212.52	1364.28	842.01
24	1475.28	1212.34	1364.40	841.96
25	1475.28	1212.17	1364.52	841.92
26	1475.28	1211.99	1364.64	841.87
27	1475.28	1211.81	1364.75	841.82
28	1475.28	1211.63	1364.87	841.78
29	1475.28	1211.46	1364.99	841.73

CCC NOAA9 - 1985 APRIL

ERBE FLIGHT MODEL TWO (NOAA9)
COUNT CONVERSION FOR NON-SCANNER

* COUNT CONVERSION ALGORITHM FOR TOTAL CHANNELS

$$ET = AV V^{**2} + AF TF + AA TA + AH TH + AR VR^{**2} + B$$

* COUNT CONVERSION ALGORITHM FOR SHORTWAVE CHANNELS

$$ES = AV V^{**2} + AF TF + AA TA + AH TH + AR VR^{**2} + AE ET + B$$

	AV	AA	AH	AF	AR	AE	
WFOV/TOT	-22.8621	.0	.0	-.3977	24.7635		(87/07/17)
WFOV/SW	-25.9880	.0	.0	-.3540	30.1311	-.03465	(87/11/17)
MFOV/TOT	-22.5566	.0	.0	-.5274	23.9133		(87/07/17)
MFOV/SW	-25.4599	.0	.0	.7092	28.9870	-.03604	(87/11/17)

DAILY B-OFFSET FOR ERBE
 FLIGHT MODEL TWO (NOAA9) NONSCANNER

NOAA9 - 1985 APRIL

DAY	(87/07/17)	WFOV/TOT	MFOV/TOT	(87/07/17)	(87/11/17)	WFOV/SW	MFOV/SW
1	1475.43	1475.43	1211.54	1359.47	841.70		
2	1475.43	1475.43	1211.36	1359.41	841.58		
3	1475.43	1475.43	1211.18	1359.93	841.99		
4	1475.43	1475.43	1211.01	1359.87	840.70		
5	1475.43	1475.43	1210.83	1359.73	840.76		
6	1475.43	1475.43	1210.65	1359.76	840.74		
7	1475.43	1475.43	1210.48	1359.95	840.85		
8	1475.43	1475.43	1210.30	1359.75	840.97		
9	1475.43	1475.43	1210.13	1359.74	840.91		
10	1475.43	1475.43	1209.95	1359.68	840.93		
11	1475.43	1475.43	1209.77	1359.56	840.95		
12	1475.43	1475.43	1209.60	1359.45	840.89		
13	1475.43	1475.43	1209.42	1359.66	841.15		
14	1475.43	1475.43	1209.25	1359.56	841.17		
15	1475.43	1475.43	1209.07	1359.59	841.09		
16	1475.43	1475.43	1208.90	1359.58	841.01		
17	1475.43	1475.43	1208.72	1359.64	840.96		
18	1475.43	1475.43	1208.55	1359.41	841.06		
19	1475.43	1475.43	1208.37	1359.45	841.08		
20	1475.43	1475.43	1208.20	1359.56	841.14		
21	1475.43	1475.43	1208.02	1359.64	841.20		
22	1475.43	1475.43	1207.85	1359.42	841.18		
23	1475.43	1475.43	1207.67	1359.57	841.16		
24	1475.43	1475.43	1207.50	1359.50	841.34		
25	1475.43	1475.43	1207.32	1359.57	841.16		
26	1475.43	1475.43	1207.15	1359.91	841.15		
27	1475.43	1475.43	1206.97	1360.05	841.18		
28	1475.43	1475.43	1206.80	1360.00	841.21		
29	1475.43	1475.43	1206.63	1359.97	841.37		

CCC NOAA9 - 1985 MAY

ERBE FLIGHT MODEL TWO (NOAA9)
COUNT CONVERSION FOR NON-SCANNER

* COUNT CONVERSION ALGORITHM FOR TOTAL CHANNELS

$$ET = AV V^{**2} + AF TF + AA TA + AH TH + AR VR^{**2} + B$$

* COUNT CONVERSION ALGORITHM FOR SHORTWAVE CHANNELS

$$ES = AV V^{**2} + AF TF + AA TA + AH TH + AR VR^{**2} + AE ET + B$$

	AV	AA	AH	AF	AR	AE	
WFOV/TOT	-22.8621	.0	.0	-.3977	24.7635		(85/08/15)
WFOV/SW	-26.1242	.0	.0	-.3559	30.2890	-.03483	(88/12/09)
MFOV/TOT	-22.5566	.0	.0	-.5274	23.9133		(85/08/15)
MFOV/SW	-25.4725	.0	.0	.7096	29.0014	-.03606	(88/12/09)

DAILY B-OFFSET FOR ERBE
 FLIGHT MODEL TWO (NOAA9) NONSCANNER

NOAA9 - 1985 MAY

DAY	(88/11/15)	WFOV/TOT	MFOV/TOT	(88/11/15)	WFOV/SW	MFOV/SW	(88/11/15)
1		1475.15	1205.71		1366.56	841.66	
2		1475.15	1205.55		1366.66	841.68	
3		1475.15	1205.39		1366.77	841.69	
4		1475.15	1205.23		1366.87	841.70	
5		1475.15	1205.07		1366.97	841.72	
6		1475.15	1204.91		1367.07	841.73	
7		1475.15	1204.75		1367.18	841.75	
8		1475.15	1204.59		1367.28	841.76	
9		1475.19	1204.48		1367.36	841.82	
10		1475.23	1204.37		1367.44	841.89	
11		1475.27	1204.26		1367.53	841.95	
12		1475.31	1204.15		1367.61	842.02	
13		1475.35	1204.04		1367.69	842.08	
14		1475.38	1203.94		1367.77	842.14	
15		1475.42	1203.83		1367.86	842.21	
16		1475.46	1203.72		1367.94	842.27	
17		1475.50	1203.61		1368.02	842.33	
18		1475.54	1203.50		1368.10	842.40	
19		1475.58	1203.39		1368.19	842.46	
20		1475.62	1203.28		1368.27	842.53	
21		1475.66	1203.17		1368.35	842.59	
22		1475.70	1203.06		1368.43	842.65	
23		1475.74	1202.95		1368.52	842.72	
24		1475.77	1202.85		1368.60	842.78	
25		1475.81	1202.74		1368.68	842.84	
26		1475.85	1202.63		1368.76	842.91	
27		1475.89	1202.52		1368.85	842.97	
28		1475.93	1202.41		1368.93	843.04	
29		1475.97	1202.30		1369.01	843.10	

CCC NOAA9 - 1985 JUNE

ERBE FLIGHT MODEL TWO (NOAA9)
COUNT CONVERSION FOR NON-SCANNER

* COUNT CONVERSION ALGORITHM FOR TOTAL CHANNELS

$$ET = AV V^{**2} + AF TF + AA TA + AH TH + AR VR^{**2} + B$$

* COUNT CONVERSION ALGORITHM FOR SHORTWAVE CHANNELS

$$ES = AV V^{**2} + AF TF + AA TA + AH TH + AR VR^{**2} + AE ET + B$$

	AV	AA	AH	AF	AR	AE	
WFOV/TOT	-22.8621	.0	.0	-.3977	24.7635		(85/08/15)
WFOV/SW	-26.1733	.0	.0	-.3565	30.3460	-.03490	(88/12/15)
MFOV/TOT	-22.5566	.0	.0	-.5274	23.9133		(85/08/15)
MFOV/SW	-25.4775	.0	.0	.7097	29.0070	-.03606	(88/12/15)

DAILY B-OFFSET FOR ERBE
 FLIGHT MODEL TWO (NOAA9) NONSCANNER

NOAA9 - 1985 JUNE

DAY	(88/11/15)	(88/11/15)	(88/11/15)	(88/11/15)
	WFOV/TOT	MFOV/TOT	WFOV/SW	MFOV/SW
1	1475.16	1197.53	1369.04	842.96
2	1474.89	1197.36	1369.05	842.91
3	1474.62	1197.19	1369.06	842.87
4	1474.35	1197.02	1369.07	842.82
5	1474.09	1196.85	1369.08	842.77
6	1473.82	1196.68	1369.08	842.73
7	1473.55	1196.51	1369.09	842.68
8	1473.28	1196.34	1369.10	842.64
9	1473.01	1196.17	1369.11	842.59
10	1472.74	1196.00	1369.12	842.54
11	1472.47	1195.83	1369.13	842.50
12	1472.20	1195.66	1369.14	842.45
13	1475.97	1200.29	1369.30	842.55
14	1475.97	1200.12	1369.45	842.64
15	1475.97	1199.95	1369.61	842.74
16	1475.97	1199.78	1369.76	842.84
17	1475.97	1199.61	1369.92	842.93
18	1475.97	1199.44	1370.07	843.03
19	1475.97	1199.28	1370.23	843.13
20	1475.97	1199.11	1370.39	843.22
21	1475.97	1198.94	1370.54	843.32
22	1475.97	1198.77	1370.70	843.41
23	1475.97	1198.60	1370.85	843.51
24	1475.97	1198.44	1371.01	843.61
25	1475.97	1198.27	1371.16	843.70
26	1475.97	1198.10	1371.32	843.80
27	1475.94	1197.17	1371.34	843.77
28	1475.90	1197.00	1371.37	843.73
29	1475.87	1196.83	1371.39	843.70

CCC NOAA9 - 1985 JULY

ERBE FLIGHT MODEL TWO (NOAA9)
COUNT CONVERSION FOR NON-SCANNER

* COUNT CONVERSION ALGORITHM FOR TOTAL CHANNELS

$$ET = AV V^{**2} + AF TF + AA TA + AH TH + AR VR^{**2} + B$$

* COUNT CONVERSION ALGORITHM FOR SHORTWAVE CHANNELS

$$ES = AV V^{**2} + AF TF + AA TA + AH TH + AR VR^{**2} + AE ET + B$$

	AV	AA	AH	AF	AR	AE	
WFOV/TOT	-22.8621	.0	.0	-.3977	24.7635		(86/12/17)
WFOV/SW	-26.1503	.0	.0	-.3562	30.3192	-.03487	(88/01/19)
MFOV/TOT	-22.5566	.0	.0	-.5274	23.9133		(86/12/17)
MFOV/SW	-25.4737	.0	.0	.7096	29.0027	-.03606	(88/01/19)

DAILY B-OFFSET FOR ERBE
 FLIGHT MODEL TWO (NOAA9) NONSCANNER

NOAA9 - 1985 JULY

DAY	(88/03/09)	(88/03/19)	(88/01/19)	(88/01/19)
	WFOV/TOT	MFOV/TOT	WFOV/SW	MFOV/SW
1	1475.60	1196.53	1367.57	842.78
2	1475.60	1196.37	1367.61	842.79
3	1475.60	1196.20	1367.73	842.60
4	1475.60	1196.03	1367.71	842.74
5	1475.60	1195.86	1367.68	842.77
6	1475.60	1195.70	1367.67	842.73
7	1475.60	1195.53	1367.62	842.81
8	1475.60	1195.37	1367.68	842.74
9	1475.60	1195.21	1367.56	842.86
10	1475.60	1195.04	1366.91	842.33
11	1472.15	1189.93	1366.03	840.88
12	1472.15	1189.77	1366.06	840.94
13	1472.15	1189.60	1366.18	840.97
14	1472.15	1189.44	1366.34	841.14
15	1472.15	1189.27	1366.18	841.04
16	1472.15	1188.11	1366.13	841.06
17	1472.15	1188.94	1366.10	841.10
18	1472.15	1188.77	1366.09	841.14
19	1472.15	1188.61	1366.08	841.18
20	1472.15	1188.44	1366.21	841.26
21	1472.15	1188.28	1365.97	841.34
22	1472.15	1188.11	1366.13	841.34
23	1472.15	1187.94	1366.25	841.41
24	1472.15	1187.78	1367.93	843.23
25	1477.01	1194.45	1370.31	845.55
26	1477.01	1194.29	1370.32	845.50
27	1477.01	1194.12	1370.28	845.54
28	1477.01	1193.96	1370.28	845.51
29	1477.01	1193.79	1370.49	845.59

CCC NOAA9 - 1985 AUGUST

ERBE FLIGHT MODEL TWO (NOAA9)
COUNT CONVERSION FOR NON-SCANNER

* COUNT CONVERSION ALGORITHM FOR TOTAL CHANNELS

$$ET = AV V^{**2} + AF TF + AA TA + AH TH + AR VR^{**2} + B$$

* COUNT CONVERSION ALGORITHM FOR SHORTWAVE CHANNELS

$$ES = AV V^{**2} + AF TF + AA TA + AH TH + AR VR^{**2} + AE ET + B$$

	AV	AA	AH	AF	AR	AE	
WFOV/TOT	-22.8621	.0	.0	-.3977	24.7635		(85/08/15)
WFOV/SW	-26.2701	.0	.0	-.3578	30.4582	-.03503	(89/02/28)
MFOV/TOT	-22.5566	.0	.0	-.5274	23.9133		(85/08/15)
MFOV/SW	-25.4880	.0	.0	.7100	29.0190	-.03608	(89/02/28)

DAILY B-OFFSET FOR ERBE
 FLIGHT MODEL TWO (NOAA9) NONSCANNER

NOAA9 - 1985 AUGUST

DAY	(89/02/13)	(89/02/13)	(89/02/13)	(89/02/13)	(89/02/13)
	WFOV/TOT	MFOV/TOT	WFOV/SW	MFOV/SW	
1	1476.90	1193.24	1374.47	844.48	
2	1476.90	1193.08	1374.95	844.82	
3	1476.90	1192.91	1375.42	845.17	
4	1476.90	1192.75	1375.89	845.52	
5	1476.90	1192.59	1376.36	845.87	
6	1476.90	1192.42	1376.84	846.21	
7	1476.90	1192.26	1377.31	846.56	
8	1473.27	1187.14	1377.11	846.34	
9	1473.27	1186.98	1376.90	846.12	
10	1473.27	1186.81	1376.70	845.90	
11	1473.27	1186.65	1376.50	845.69	
12	1473.27	1186.49	1376.29	845.47	
13	1473.27	1186.33	1376.09	845.25	
14	1473.27	1186.16	1375.89	845.03	
15	1473.27	1186.00	1375.68	844.81	
16	1473.27	1185.84	1375.48	844.59	
17	1473.27	1185.68	1375.27	844.37	
18	1473.27	1185.52	1375.07	844.16	
19	1473.27	1185.35	1374.87	843.94	
20	1473.27	1185.19	1374.66	843.72	
21	1473.27	1185.03	1374.46	843.50	
22	1477.32	1189.49	1374.63	843.70	
23	1477.32	1189.33	1374.79	843.89	
24	1477.32	1189.17	1374.96	844.09	
25	1477.32	1189.01	1375.12	844.29	
26	1477.32	1188.84	1375.29	844.49	
27	1477.32	1188.68	1375.45	844.68	
28	1477.32	1188.52	1375.62	844.88	
29	1477.32	1188.36	1375.79	845.08	
30	1477.32	1188.20	1375.95	845.27	

CCC NOAA9 - 1985 SEPTEMBER

ERBE FLIGHT MODEL TWO (NOAA9)
COUNT CONVERSION FOR NON-SCANNER

* COUNT CONVERSION ALGORITHM FOR TOTAL CHANNELS

$$ET = AV V^{**2} + AF TF + AA TA + AH TH + AR VR^{**2} + B$$

* COUNT CONVERSION ALGORITHM FOR SHORTWAVE CHANNELS

$$ES = AV V^{**2} + AF TF + AA TA + AH TH + AR VR^{**2} + AE ET + B$$

	AV	AA	AH	AF	AR	AE	
WFOV/TOT	-22.8621	.0	.0	-.3977	24.7635		(85/08/15)
WFOV/SW	-26.3082	.0	.0	-.3584	30.5023	-.03508	(89/01/06)
MFOV/TOT	-22.5566	.0	.0	-.5274	23.9133		(85/08/15)
MFOV/SW	-25.4924	.0	.0	.7101	29.0240	-.03609	(89/01/06)

DAILY B-OFFSET FOR ERBE
 FLIGHT MODEL TWO (NOAA9) NONSCANNER

NOAA9 - 1985 SEPTEMBER

DAY	(88/11/14)	WFOV/TOT	MFOV/TOT	(88/11/14)	WFOV/SW	MFOV/SW	(88/11/14)
1		1477.32	1187.88		1376.35	845.67	
2		1477.32	1187.72		1376.50	845.87	
3		1477.32	1187.56		1376.66	846.06	
4		1477.32	1187.40		1376.81	846.26	
5		1477.59	1187.28		1376.88	846.29	
6		1477.59	1187.17		1376.95	846.32	
7		1477.59	1187.05		1377.02	846.35	
8		1477.59	1186.93		1377.09	846.38	
9		1477.59	1186.82		1377.16	846.41	
10		1477.59	1186.70		1377.23	846.44	
11		1477.59	1186.59		1377.30	846.47	
12		1477.59	1186.47		1377.36	846.50	
13		1477.59	1186.35		1377.43	846.53	
14		1477.59	1186.24		1377.50	846.56	
15		1477.59	1186.12		1377.57	846.59	
16		1477.59	1186.00		1377.64	846.62	
17		1477.59	1185.89		1377.71	846.65	
18		1477.59	1185.77		1377.78	846.68	
19		1477.60	1185.63		1377.86	846.74	
20		1477.60	1185.48		1377.93	846.79	
21		1477.60	1185.34		1378.01	846.85	
22		1477.60	1185.20		1378.08	846.91	
23		1477.60	1185.06		1378.16	846.97	
24		1477.60	1184.91		1378.23	847.02	
25		1477.60	1184.77		1378.31	847.08	
26		1477.60	1184.63		1378.38	847.14	
27		1477.60	1184.48		1378.46	847.19	
28		1477.60	1184.34		1378.53	847.25	
29		1477.60	1184.20		1378.61	847.31	
30		1477.60	1184.06		1378.68	847.37	

CCC NOAA9 - 1985 OCTOBER

ERBE FLIGHT MODEL TWO (NOAA9)
 COUNT CONVERSION FOR NON-SCANNER

* COUNT CONVERSION ALGORITHM FOR TOTAL CHANNELS

$$ET = AV V^{**2} + AF TF + AA TA + AH TH + AR VR^{**2} + B$$

* COUNT CONVERSION ALGORITHM FOR SHORTWAVE CHANNELS

$$ES = AV V^{**2} + AF TF + AA TA + AH TH + AR VR^{**2} + AE ET + B$$

	AV	AA	AH	AF	AR	AE	
WFOV/TOT	-22.8621	.0	.0	-.3977	24.7635		(86/12/17)
WFOV/SW	-26.3053	.0	.0	-.3583	30.4989	-.03507	(88/02/19)
MFOV/TOT	-22.5566	.0	.0	-.5274	23.9133		(86/12/17)
MFOV/SW	-25.4877	.0	.0	.7100	29.0186	-.03608	(88/02/19)

DAILY B-OFFSET FOR ERBE
 FLIGHT MODEL TWO (NOAA9) NONSCANNER

NOAA9 - 1985 OCTOBER

DAY	(88/03/24)	(88/03/24)	(88/02/19)	(88/02/19)
	WFOV/TOT	MFOV/TOT	WFOV/SW	MFOV/SW
1	1477.76	1183.98	1377.71	846.97
2	1477.76	1183.82	1378.50	847.86
3	1478.15	1183.81	1378.21	846.87
4	1478.15	1183.66	1378.11	846.80
5	1478.15	1183.50	1378.37	846.73
6	1478.15	1183.34	1378.44	846.81
7	1478.15	1183.19	1378.38	846.88
8	1478.15	1183.03	1378.80	846.70
9	1478.15	1182.87	1378.28	846.86
10	1478.15	1182.72	1378.51	847.36
11	1478.15	1182.56	1378.40	846.96
12	1478.15	1182.40	1378.50	846.91
13	1478.15	1182.25	1378.47	847.12
14	1478.15	1182.09	1378.38	847.09
15	1478.15	1181.94	1378.54	847.08
16	1478.15	1181.78	1377.78	847.31
17	1478.36	1180.69	1375.95	845.88
18	1478.36	1180.53	1375.90	846.04
19	1478.36	1180.38	1375.85	845.96
20	1478.36	1180.22	1375.90	846.07
21	1478.36	1180.07	1375.73	846.18
22	1478.36	1179.91	1376.03	846.17
23	1478.36	1179.76	1375.85	846.23
24	1478.36	1179.60	1375.93	846.28
25	1478.36	1179.45	1375.95	846.21
26	1478.36	1179.29	1376.06	846.35
27	1478.36	1179.14	1376.13	846.33
28	1478.36	1178.98	1376.21	846.31
29	1478.36	1178.83	1376.52	846.80

CCC NOAA9 - 1985 NOVEMBER

ERBE FLIGHT MODEL TWO (NOAA9)
 COUNT CONVERSION FOR NON-SCANNER

* COUNT CONVERSION ALGORITHM FOR TOTAL CHANNELS

$$ET = AV V^{**2} + AF TF + AA TA + AH TH + AR VR^{**2} + B$$

* COUNT CONVERSION ALGORITHM FOR SHORTWAVE CHANNELS

$$ES = AV V^{**2} + AF TF + AA TA + AH TH + AR VR^{**2} + AE ET + B$$

	AV	AA	AH	AF	AR	AE	
WFOV/TOT	-22.8621	.0	.0	-.3977	24.7635		(85/08/15)
WFOV/SW	-26.3832	.0	.0	-.3594	30.5894	-.03518	(89/01/24)
MFOV/TOT	-22.5566	.0	.0	-.5274	23.9133		(85/08/15)
MFOV/SW	-25.5015	.0	.0	.7104	29.0344	-.03610	(89/01/24)

DAILY B-OFFSET FOR ERBE
 FLIGHT MODEL TWO (NOAA9) NONSCANNER

NOAA9 - 1985 NOVEMBER

DAY	(88/11/23)	(88/11/23)	(88/11/23)	(88/11/23)
	WFOV/TOT	MFOV/TOT	WFOV/SW	MFOV/SW
1	1478.42	1178.41	1379.44	846.94
2	1478.43	1178.28	1379.49	846.95
3	1478.45	1178.14	1379.54	846.96
4	1478.47	1178.01	1379.60	846.98
5	1478.49	1177.88	1379.65	846.99
6	1478.51	1177.75	1379.71	847.01
7	1478.52	1177.62	1379.76	847.02
8	1478.54	1177.49	1379.81	847.03
9	1478.56	1177.36	1379.87	847.05
10	1478.58	1177.22	1379.92	847.06
11	1478.59	1177.09	1379.97	847.07
12	1478.61	1176.96	1380.03	847.09
13	1478.63	1176.83	1380.08	847.10
14	1478.63	1176.52	1380.15	847.11
15	1478.62	1176.37	1380.22	847.12
16	1478.62	1176.22	1380.29	847.14
17	1478.62	1176.06	1380.35	847.15
18	1478.62	1175.91	1380.42	847.16
19	1478.61	1175.76	1380.49	847.17
20	1478.61	1175.61	1380.56	847.19
21	1478.61	1175.46	1380.63	847.20
22	1478.60	1175.31	1380.70	847.21
23	1478.60	1175.15	1380.77	847.22
24	1478.60	1175.00	1380.83	847.23
25	1478.60	1174.85	1380.90	847.25
26	1478.59	1174.70	1380.97	847.26
27	1478.59	1174.55	1381.04	847.27
28	1478.63	1174.49	1381.12	847.31
29	1478.66	1174.34	1381.19	847.35

CCC NOAA9 - 1985 DECEMBER

ERBE FLIGHT MODEL TWO (NOAA9)
COUNT CONVERSION FOR NON-SCANNER

* COUNT CONVERSION ALGORITHM FOR TOTAL CHANNELS

$$ET = AV V^{**2} + AF TF + AA TA + AH TH + AR VR^{**2} + B$$

* COUNT CONVERSION ALGORITHM FOR SHORTWAVE CHANNELS

$$ES = AV V^{**2} + AF TF + AA TA + AH TH + AR VR^{**2} + AE ET + B$$

	AV	AA	AH	AF	AR	AE	
WFOV/TOT	-22.8621	.0	.0	-.3977	24.7635		(85/08/15)
WFOV/SW	-26.4202	.0	.0	-.3599	30.6323	-.03523	(89/08/15)
MFOV/TOT	-22.5566	.0	.0	-.5274	23.9133		(85/08/15)
MFOV/SW	-25.5063	.0	.0	.7105	29.0398	-.03611	(89/08/15)

DAILY B-OFFSET FOR ERBE
 FLIGHT MODEL TWO (NOAA9) NONSCANNER

NOAA9 - 1985 DECEMBER

DAY	(89/08/15)	(89/08/15)	(89/08/15)	(89/08/15)
	WFOV/TOT	MFOV/TOT	WFOV/SW	MFOV/SW
1	1478.73	1174.04	1381.49	847.43
2	1478.77	1173.89	1381.57	847.47
3	1478.80	1173.74	1381.65	847.51
4	1478.84	1173.59	1381.73	847.56
5	1478.88	1173.44	1381.80	847.60
6	1478.91	1173.29	1381.88	847.64
7	1478.95	1173.14	1381.96	847.68
8	1478.98	1172.99	1382.04	847.72
9	1479.02	1172.84	1382.12	847.76
10	1479.05	1172.69	1382.20	847.80
11	1479.09	1172.54	1382.28	847.84
12	1479.10	1172.42	1382.56	847.95
13	1479.12	1172.29	1382.84	848.07
14	1479.13	1172.17	1383.12	848.18
15	1479.15	1172.05	1383.40	848.30
16	1479.16	1171.92	1383.68	848.41
17	1479.17	1171.80	1383.96	848.53
18	1479.19	1171.68	1384.25	848.64
19	1479.20	1171.55	1384.53	848.75
20	1479.22	1171.43	1384.81	848.87
21	1479.23	1171.30	1385.09	848.98
22	1479.24	1171.18	1385.37	849.10
23	1479.26	1171.06	1385.65	849.21
24	1479.27	1170.93	1385.93	849.33
25	1479.29	1170.81	1386.21	849.44
26	1479.30	1170.69	1386.07	849.45
27	1479.31	1170.56	1385.93	849.46
28	1479.33	1170.44	1385.79	849.46
29	1479.34	1170.32	1385.65	849.47

CCC NOAA9 - 1986 JANUARY

ERBE FLIGHT MODEL TWO (NOAA9)
COUNT CONVERSION FOR NON-SCANNER

* COUNT CONVERSION ALGORITHM FOR TOTAL CHANNELS

$$E_T = A_V \cdot V^2 + A_F \cdot T_F + A_A \cdot T_A + A_H \cdot T_H + A_R \cdot T_R + A_E \cdot T_E + B$$

* COUNT CONVERSION ALGORITHM FOR SHORTWAVE CHANNELS

$$E_S = A_V \cdot V^2 + A_F \cdot T_F + A_A \cdot T_A + A_H \cdot T_H + A_R \cdot T_R + A_E \cdot T_E + B$$

	A _V	A _A	A _H	A _F	A _R	A _E	
WFOV/TOT	-22.8621	.0	.0	-.3977	24.7635		(86/12/17)
WFOV/SW	-26.4511	.0	.0	-.3603	30.6680	-.03527	(88/03/15)
MFOV/TOT	-22.5566	.0	.0	-.5274	23.9133		(86/12/17)
MFOV/SW	-25.5015	.0	.0	.7104	29.0344	-.03610	(88/03/15)

DAILY B-OFFSET FOR ERBE
 FLIGHT MODEL TWO (NOAA9) NONSCANNER

NOAA9 - 1986 JANUARY

DAY	(88/04/19)	(88/04/19)	(88/04/19)	(88/03/15)	(88/03/15)
	WFOV/TOT	MFOV/TOT	WFOV/SW	MFOV/SW	
1	1479.66	1170.41	1384.15	847.17	
2	1479.66	1170.26	1383.89	847.27	
3	1479.66	1170.11	1384.10	847.41	
4	1479.66	1169.97	1384.29	847.37	
5	1479.66	1169.82	1384.40	847.44	
6	1479.66	1169.67	1384.29	847.41	
7	1479.66	1169.53	1384.29	847.43	
8	1479.66	1169.38	1384.20	847.43	
9	1479.66	1169.23	1384.35	847.43	
10	1479.66	1169.09	1384.56	847.61	
11	1479.66	1168.94	1384.38	847.69	
12	1479.66	1168.79	1384.26	847.68	
13	1479.66	1168.65	1384.33	847.70	
14	1479.66	1168.50	1384.43	847.74	
15	1479.66	1168.36	1384.55	847.80	
16	1479.66	1168.21	1384.66	847.85	
17	1479.66	1168.07	1384.57	847.88	
18	1479.66	1167.92	1384.54	847.89	
19	1479.66	1167.78	1384.40	847.85	
20	1479.66	1167.63	1384.42	847.90	
21	1479.66	1167.49	1384.56	847.92	
22	1479.66	1167.34	1384.87	848.40	
23	1480.13	1166.79	1384.44	847.87	
24	1480.13	1166.64	1384.34	847.91	
25	1480.13	1166.50	1384.34	847.85	
26	1480.13	1166.35	1384.41	847.91	
27	1480.13	1166.21	1384.41	847.68	
28	1480.13	1166.06	1384.35	847.61	
29	1480.13	1165.92	1384.34	847.62	
30	1480.13	1165.77	1384.47	847.58	

CCC NOAA9 - 1986 FEBRUARY

ERBE FLIGHT MODEL TWO (NOAA9)
COUNT CONVERSION FOR NON-SCANNER

* COUNT CONVERSION ALGORITHM FOR TOTAL CHANNELS

$$E_T = A_V \cdot V^2 + A_F \cdot T_F + A_A \cdot T_A + A_H \cdot T_H + A_R \cdot V_R^2 + B$$

* COUNT CONVERSION ALGORITHM FOR SHORTWAVE CHANNELS

$$E_S = A_V \cdot V^2 + A_F \cdot T_F + A_A \cdot T_A + A_H \cdot T_H + A_R \cdot V_R^2 + A_E \cdot E_T + B$$

	A_V	A_A	A_H	A_F	A_R	A_E	
WFOV/TOT	-22.8621	.0	.0	-.3977	24.7635		(85/08/15)
WFOV/SW	-26.5477	.0	.0	-.3616	30.7800	-.03540	(89/09/14)
MFOV/TOT	-22.5566	.0	.0	-.5274	23.9133		(85/08/15)
MFOV/SW	-25.4904	.0	.0	.7100	29.0217	-.03608	(89/09/14)

DAILY B-OFFSET FOR ERBE
 FLIGHT MODEL TWO (NOAA9) NONSCANNER

NOAA9 - 1986 FEBRUARY

DAY	(89/09/13)	(89/09/13)	(89/09/13)	(89/09/13)
	WFOV/TOT	MFOV/TOT	WFOV/SW	MFOV/SW
1	1479.97	1165.56	1388.15	847.46
2	1479.99	1165.39	1388.23	847.44
3	1480.02	1165.21	1388.31	847.42
4	1480.05	1165.03	1388.38	847.40
5	1480.08	1164.85	1388.46	847.38
6	1480.10	1164.72	1388.53	847.42
7	1480.11	1164.59	1388.60	847.47
8	1480.13	1164.46	1388.66	847.51
9	1480.15	1164.32	1388.73	847.55
10	1480.17	1164.19	1388.80	847.60
11	1480.18	1164.06	1388.87	847.64
12	1480.20	1163.93	1388.94	847.69
13	1480.22	1163.80	1389.00	847.73
14	1480.23	1163.67	1389.07	847.77
15	1480.25	1163.54	1389.14	847.82
16	1480.27	1163.40	1389.21	847.86
17	1480.29	1163.27	1389.27	847.90
18	1480.30	1163.14	1389.34	847.95
19	1480.32	1163.01	1389.41	847.99
20	1480.39	1162.86	1389.51	848.00
21	1480.39	1162.71	1389.60	848.02
22	1480.39	1162.57	1389.70	848.03
23	1480.39	1162.42	1389.80	848.05
24	1480.39	1162.27	1389.90	848.06
25	1480.39	1162.12	1389.99	848.08
26	1480.39	1161.98	1390.09	848.09
27	1480.39	1161.83	1390.19	848.10
28	1480.39	1161.68	1390.28	848.12
29	1480.39	1161.53	1390.38	848.13

CCC NOAA9 - 1986 MARCH

ERBE FLIGHT MODEL TWO (NOAA9)
COUNT CONVERSION FOR NON-SCANNER

* COUNT CONVERSION ALGORITHM FOR TOTAL CHANNELS

$$E_T = A_V \cdot V^2 + A_F \cdot T_F + A_A \cdot T_A + A_H \cdot T_H + A_R \cdot V_R^2 + B$$

* COUNT CONVERSION ALGORITHM FOR SHORTWAVE CHANNELS

$$E_S = A_V \cdot V^2 + A_F \cdot T_F + A_A \cdot T_A + A_H \cdot T_H + A_R \cdot V_R^2 + A_E \cdot E_T + B$$

	A_V	A_A	A_H	A_F	A_R	A_E	
WFOV/TOT	-22.8621	.0	.0	-.3977	24.7635		(85/08/15)
WFOV/SW	-26.5867	.0	.0	-.3622	30.8253	-.03545	(89/09/27)
MFOV/TOT	-22.5566	.0	.0	-.5274	23.9133		(85/08/15)
MFOV/SW	-25.4927	.0	.0	.7101	29.0244	-.03609	(89/09/27)

DAILY B-OFFSET FOR ERBE
 FLIGHT MODEL TWO (NOAA9) NONSCANNER

NOAA9 - 1986 MARCH

DAY	(89/09/26)	(89/09/26)	(89/09/26)	(89/09/26)	(89/09/26)
	WFOV/TOT	MFOV/TOT	WFOV/SW	MFOV/SW	
1	1480.39	1161.53	1390.38	848.13	
2	1480.39	1161.38	1390.48	848.15	
3	1480.39	1161.24	1390.58	848.16	
4	1480.39	1161.09	1390.67	848.18	
5	1480.39	1160.94	1390.77	848.19	
6	1480.41	1160.78	1390.85	848.17	
7	1480.44	1160.62	1390.92	848.16	
8	1480.46	1160.46	1391.00	848.14	
9	1480.49	1160.30	1391.08	848.12	
10	1480.51	1160.14	1391.16	848.10	
11	1480.54	1159.98	1391.23	848.09	
12	1480.56	1159.82	1391.31	848.07	
13	1480.58	1159.66	1391.39	848.05	
14	1480.61	1159.50	1391.46	848.04	
15	1480.63	1159.34	1391.54	848.02	
16	1480.66	1159.18	1391.62	848.00	
17	1480.68	1159.02	1391.70	847.98	
18	1480.71	1158.86	1391.77	847.97	
19	1480.73	1158.70	1391.85	847.95	
20	1480.73	1158.59	1391.91	847.95	
21	1480.73	1158.47	1391.97	847.96	
22	1480.74	1158.36	1392.03	847.96	
23	1480.74	1158.24	1392.10	847.96	
24	1480.74	1158.13	1392.16	847.96	
25	1480.74	1158.01	1392.22	847.97	
26	1480.75	1157.90	1392.28	847.97	
27	1480.75	1157.79	1392.34	847.97	
28	1480.75	1157.67	1392.40	847.98	
29	1480.75	1157.56	1392.46	847.98	
30	1480.75	1157.44	1392.53	847.98	

CCC NOAA9 - 1986 APRIL

ERBE FLIGHT MODEL TWO (NOAA9)
COUNT CONVERSION FOR NON-SCANNER

* COUNT CONVERSION ALGORITHM FOR TOTAL CHANNELS

$$E_T = A_V \cdot V^2 + A_F \cdot T_F + A_A \cdot T_A + A_H \cdot T_H + A_R \cdot V_R^2 + B$$

* COUNT CONVERSION ALGORITHM FOR SHORTWAVE CHANNELS

$$E_S = A_V \cdot V^2 + A_F \cdot T_F + A_A \cdot T_A + A_H \cdot T_H + A_R \cdot V_R^2 + A_E \cdot E_T + B$$

	A_V	A_A	A_H	A_F	A_R	A_E	
WFOV/TOT	-22.8621	.0	.0	-.3977	24.7635		(85/08/15)
WFOV/SW	-26.6255	.0	.0	-.3627	30.8702	-.03550	(89/11/13)
MFOV/TOT	-22.5566	.0	.0	-.5274	23.9133		(85/08/15)
MFOV/SW	-25.4951	.0	.0	.7102	29.0271	-.03609	(89/11/13)

DAILY B-OFFSET FOR ERBE
 FLIGHT MODEL TWO (NOAA9) NONSCANNER

NOAA9 - 1986 APRIL

DAY	(90/01/11)	(90/01/11)	(90/01/11)	(90/01/11)
	WFOV/TOT	MFOV/TOT	WFOV/SW	MFOV/SW
1	1480.76	1157.21	1392.65	847.99
2	1480.76	1157.10	1392.71	847.99
3	1481.09	1156.95	1392.83	848.06
4	1481.09	1156.80	1392.96	848.12
5	1481.09	1156.65	1393.08	848.19
6	1481.09	1156.51	1393.20	848.25
7	1481.09	1156.36	1393.32	848.32
8	1481.09	1156.21	1393.45	848.38
9	1481.09	1156.06	1393.57	848.45
10	1481.09	1155.91	1393.69	848.52
11	1481.09	1155.76	1393.82	848.58
12	1481.09	1155.61	1393.94	848.65
13	1481.09	1155.47	1394.06	848.71
14	1481.09	1155.32	1394.18	848.78
15	1481.09	1155.17	1394.31	848.84
16	1481.09	1155.02	1394.43	848.91
17	1481.09	1154.87	1394.48	848.88
18	1481.09	1154.72	1394.53	848.85
19	1481.09	1154.57	1394.58	848.82
20	1481.09	1154.43	1394.63	848.79
21	1481.09	1154.28	1394.68	848.76
22	1481.09	1154.13	1394.73	848.73
23	1481.09	1153.98	1394.79	848.70
24	1481.09	1153.83	1394.84	848.66
25	1481.09	1153.68	1394.89	848.63
26	1481.09	1153.53	1394.94	848.60
27	1481.09	1153.39	1394.99	848.57
28	1481.09	1153.24	1395.04	848.54
29	1481.09	1153.09	1395.09	848.51
30	1481.09	1152.94	1395.14	848.48

CCC NOAA9 - 1986 MAY

ERBE FLIGHT MODEL TWO (NOAA9)
COUNT CONVERSION FOR NON-SCANNER

* COUNT CONVERSION ALGORITHM FOR TOTAL CHANNELS

$$E_T = A_V \cdot V^2 + A_F \cdot T_F + A_A \cdot T_A + A_H \cdot T_H + A_R \cdot V_R^2 + B$$

* COUNT CONVERSION ALGORITHM FOR SHORTWAVE CHANNELS

$$E_S = A_V \cdot V^2 + A_F \cdot T_F + A_A \cdot T_A + A_H \cdot T_H + A_R \cdot V_R^2 + A_E \cdot E_T + B$$

	A_V	A_A	A_H	A_F	A_R	A_E	
WFOV/TOT	-22.8621	.0	.0	-.3977	24.7635		(85/08/15)
WFOV/SW	-26.6639	.0	.0	-.3632	30.9147	-.03555	(89/09/27)
MFOV/TOT	-22.5566	.0	.0	-.5274	23.9133		(85/08/15)
MFOV/SW	-25.4975	.0	.0	.7102	29.0298	-.03609	(89/09/27)

DAILY B-OFFSET FOR ERBE
 FLIGHT MODEL TWO (NOAA9) NONSCANNER

NOAA9 - 1986 MAY

DAY	(89/09/26)	(89/09/26)	(89/09/26)	(89/09/26)
	WFOV/TOT	MFOV/TOT	WFOV/SW	MFOV/SW
1	1481.09	1152.83	1395.23	848.46
2	1481.09	1152.71	1395.33	848.44
3	1481.09	1152.60	1395.42	848.42
4	1481.08	1152.49	1395.51	848.40
5	1481.08	1152.37	1395.61	848.38
6	1481.08	1152.26	1395.70	848.36
7	1481.08	1152.15	1395.80	848.34
8	1481.08	1152.03	1395.89	848.32
9	1481.08	1151.92	1395.98	848.30
10	1481.08	1151.80	1396.08	848.28
11	1481.07	1151.69	1396.17	848.26
12	1481.07	1151.58	1396.26	848.24
13	1481.07	1151.46	1396.36	848.22
14	1481.07	1151.35	1396.45	848.20
15	1481.09	1151.08	1396.54	848.25
16	1481.11	1150.95	1396.63	848.30
17	1481.12	1150.82	1396.72	848.35
18	1481.14	1150.69	1396.81	848.40
19	1481.16	1150.55	1396.90	848.45
20	1481.18	1150.42	1396.99	848.50
21	1481.20	1150.29	1397.08	848.55
22	1481.21	1150.16	1397.17	848.61
23	1481.23	1150.03	1397.26	848.66
24	1481.25	1149.90	1397.35	848.71
25	1481.27	1149.76	1397.44	848.76
26	1481.28	1149.63	1397.53	848.81
27	1481.30	1149.50	1397.62	848.86
28	1481.32	1149.37	1397.71	848.91
29	1481.22	1149.32	1398.00	849.00
30	1481.22	1149.27	1398.30	849.09

CCC NOAA9 - 1986 JUNE

ERBE FLIGHT MODEL TWO (NOAA9)
COUNT CONVERSION FOR NON-SCANNER

* COUNT CONVERSION ALGORITHM FOR TOTAL CHANNELS

$$E_T = A_V \cdot V^2 + A_F \cdot T_F + A_A \cdot T_A + A_H \cdot T_H + A_R \cdot V_R^2 + B$$

* COUNT CONVERSION ALGORITHM FOR SHORTWAVE CHANNELS

$$E_S = A_V \cdot V^2 + A_F \cdot T_F + A_A \cdot T_A + A_H \cdot T_H + A_R \cdot V_R^2 + A_E \cdot E_T + B$$

	A_V	A_A	A_H	A_F	A_R	A_E	
WFOV/TOT	-22.8621	.0	.0	-.3977	24.7635		(85/08/15)
WFOV/SW	-26.7020	.0	.0	-.3637	30.9590	-.03560	(89/09/27)
MFOV/TOT	-22.5566	.0	.0	-.5074	23.9133		(85/08/15)
MFOV/SW	-25.4999	.0	.0	.7103	29.0325	-.03610	(89/09/27)

DAILY B-OFFSET FOR ERBE
 FLIGHT MODEL TWO (NOAA9) NONSCANNER

NOAA9 - 1986 JUNE

DAY	(89/09/27)	(89/09/27)	(89/09/27)	(89/09/27)
	WFOV/TOT	MFOV/TOT	WFOV/SW	MFOV/SW
1	1481.22	1149.18	1398.89	849.27
2	1481.22	1149.13	1399.18	849.36
3	1481.22	1149.08	1399.48	849.45
4	1481.22	1149.04	1399.77	849.54
5	1481.22	1148.99	1400.06	849.64
6	1481.22	1148.94	1400.36	849.73
7	1481.22	1148.89	1400.65	849.82
8	1481.22	1148.84	1400.95	849.91
9	1481.22	1148.80	1401.24	850.00
10	1481.22	1148.75	1401.54	850.09
11	1481.22	1148.70	1401.83	850.18
12	1481.47	1147.10	1401.71	850.13
13	1481.47	1146.98	1401.60	850.08
14	1481.47	1146.85	1401.48	850.03
15	1481.47	1146.72	1401.36	849.97
16	1481.47	1146.59	1401.24	849.92
17	1481.47	1146.46	1401.13	849.87
18	1481.47	1146.33	1401.01	849.82
19	1481.47	1146.20	1400.89	849.77
20	1481.47	1146.07	1400.78	849.72
21	1481.47	1145.94	1400.66	849.67
22	1481.47	1145.81	1400.54	849.61
23	1481.47	1145.69	1400.42	849.56
24	1481.47	1145.56	1400.31	849.51
25	1481.47	1145.43	1400.19	849.46
26	1481.45	1146.16	1400.44	849.55
27	1481.42	1146.04	1400.69	849.64
28	1481.40	1145.91	1400.94	849.74
29	1481.37	1145.78	1401.19	849.83

CCC NOAA9 - 1986 JULY

ERBE FLIGHT MODEL TWO (NOAA9)
COUNT CONVERSION FOR NON-SCANNER

* COUNT CONVERSION ALGORITHM FOR TOTAL CHANNELS

$$E_T = A_V \cdot V^2 + A_F \cdot T_F + A_A \cdot T_A + A_H \cdot T_H + A_R \cdot V_R^2 + B$$

* COUNT CONVERSION ALGORITHM FOR SHORTWAVE CHANNELS

$$E_S = A_V \cdot V^2 + A_F \cdot T_F + A_A \cdot T_A + A_H \cdot T_H + A_R \cdot V_R^2 + A_E \cdot E_T + B$$

	A_V	A_A	A_H	A_F	A_R	A_E	
WFOV/TOT	-22.8621	.0	.0	-.3977	24.7635		(85/08/15)
WFOV/SW	-26.7399	.0	.0	-.3642	31.0028	-.03565	(89/09/27)
MFOV/TOT	-22.5566	.0	.0	-.5274	23.9133		(85/08/15)
MFOV/SW	-25.5023	.0	.0	.7104	29.0353	-.03610	(89/09/27)

DAILY B-OFFSET FOR ERBE
 FLIGHT MODEL TWO (NOAA9) NONSCANNER

NOAA9 - 1986 JULY

DAY	(89/09/27)	(89/09/27)	(89/09/27)	(89/09/27)
	WFOV/TOT	MFOV/TOT	WFOV/SW	MFOV/SW
1	1481.32	1145.53	1401.69	850.01
2	1481.30	1145.40	1401.94	850.10
3	1481.27	1145.27	1402.19	850.20
4	1481.25	1145.14	1402.44	850.29
5	1481.22	1145.02	1402.69	850.38
6	1481.20	1144.89	1402.94	850.47
7	1481.17	1144.76	1403.19	850.57
8	1481.15	1144.64	1403.44	850.66
9	1481.12	1144.51	1403.69	850.75
10	1481.17	1143.38	1403.59	850.66
11	1481.23	1143.26	1403.49	850.57
12	1481.28	1143.13	1403.39	850.49
13	1481.34	1143.01	1403.29	850.40
14	1481.39	1142.88	1403.19	850.31
15	1481.45	1142.75	1403.09	850.22
16	1481.50	1142.63	1402.99	850.13
17	1481.55	1142.50	1402.89	850.05
18	1481.61	1142.38	1402.79	849.96
19	1481.66	1142.25	1402.69	849.87
20	1481.72	1142.13	1402.59	849.78
21	1481.77	1142.00	1402.49	849.70
22	1481.83	1141.88	1402.39	849.61
23	1481.88	1141.75	1402.29	849.52
24	1481.86	1142.29	1402.56	849.65
25	1481.83	1142.16	1402.83	849.78
26	1481.81	1142.04	1403.10	849.91
27	1481.79	1141.91	1403.37	850.04
28	1481.77	1141.79	1403.64	850.17
29	1481.74	1141.66	1403.91	850.30
30	1481.72	1141.54	1404.18	850.44

CCC NOAA9 - 1986 AUGUST

ERBE FLIGHT MODEL TWO (NOAA9)
COUNT CONVERSION FOR NON-SCANNER

* COUNT CONVERSION ALGORITHM FOR TOTAL CHANNELS

$$E_T = A_V \cdot V^2 + A_F \cdot T_F + A_A \cdot T_A + A_H \cdot T_H + A_R \cdot V_R^2 + B$$

* COUNT CONVERSION ALGORITHM FOR SHORTWAVE CHANNELS

$$E_S = A_V \cdot V^2 + A_F \cdot T_F + A_A \cdot T_A + A_H \cdot T_H + A_R \cdot V_R^2 + A_E \cdot E_T + B$$

	A _V	A _A	A _H	A _F	A _R	A _E	
WFOV/TOT	-22.8621	.0	.0	-.3977	24.7635		(85/08/15)
WFOV/SW	-26.7961	.0	.0	-.3650	31.0680	-.03573	(89/11/13)
MFOV/TOT	-22.5566	.0	.0	-.5274	23.9133		(85/08/15)
MFOV/SW	-25.5060	.0	.0	.7105	29.0395	-.03611	(89/11/13)

DAILY B-OFFSET FOR ERBE
 FLIGHT MODEL TWO (NOAA9) NONSCANNER

NOAA9 - 1986 AUGUST

DAY	(89/09/30)	(89/09/30)	(89/09/30)	(89/09/30)
	WFOV/TOT	MFOV/TOT	WFOV/SW	MFOV/SW
1	1481.67	1141.29	1404.71	850.70
2	1481.65	1141.17	1404.98	850.83
3	1481.63	1141.04	1405.25	850.96
4	1481.61	1140.92	1405.52	851.09
5	1481.58	1140.79	1405.79	851.22
6	1481.56	1140.67	1406.06	851.35
7	1482.07	1140.45	1406.17	851.35
8	1482.07	1140.32	1406.28	851.36
9	1482.07	1140.20	1406.38	851.36
10	1482.07	1140.08	1406.49	851.37
11	1482.07	1139.95	1406.60	851.37
12	1482.07	1139.83	1406.71	851.38
13	1482.07	1139.71	1406.82	851.38
14	1482.07	1139.58	1406.92	851.38
15	1482.07	1139.46	1407.03	851.39
16	1482.07	1139.34	1407.14	851.39
17	1482.07	1139.22	1407.25	851.40
18	1482.07	1139.09	1407.35	851.40
19	1482.07	1138.97	1407.46	851.41
20	1482.07	1138.85	1407.57	851.41
21	1482.35	1138.70	1407.65	851.43
22	1482.35	1138.54	1407.73	851.45
23	1482.35	1138.39	1407.81	851.47
24	1482.35	1138.23	1407.89	851.50
25	1482.35	1138.08	1407.97	851.52
26	1482.35	1137.92	1408.05	851.54
27	1482.35	1137.77	1408.14	851.56
28	1482.35	1137.62	1408.22	851.58
29	1482.35	1137.46	1408.30	851.60
30	1482.35	1137.31	1408.38	851.62

CCC NOAA9 - 1986 SEPTEMBER

ERBE FLIGHT MODEL TWO (NOAA9)
COUNT CONVERSION FOR NON-SCANNER

* COUNT CONVERSION ALGORITHM FOR TOTAL CHANNELS

$$E_T = A_V \cdot V^2 + A_F \cdot T_F + A_A \cdot T_A + A_H \cdot T_H + A_R \cdot V_R^2 + B$$

* COUNT CONVERSION ALGORITHM FOR SHORTWAVE CHANNELS

$$E_S = A_V \cdot V^2 + A_F \cdot T_F + A_A \cdot T_A + A_H \cdot T_H + A_R \cdot V_R^2 + A_E \cdot E_T + B$$

	A_V	A_A	A_H	A_F	A_R	A_E	
WFOV/TOT	-22.8621	.0	.0	-.3977	24.7635		(85/08/15)
WFOV/SW	-26.8331	.0	.0	-.3655	31.1110	-.03578	(89/11/13)
MFOV/TOT	-22.5566	.0	.0	-.5274	23.9133		(85/08/15)
MFOV/SW	-25.5085	.0	.0	.7106	29.0423	-.03611	(89/11/13)

DAILY B-OFFSET FOR ERBE
 FLIGHT MODEL TWO (NOAA9) NONSCANNER

NOAA9 - 1986 SEPTEMBER

DAY	(89/09/30)	(89/09/30)	(89/09/30)	(89/09/30)
	WFOV/TOT	MFOV/TOT	WFOV/SW	MFOV/SW
1	1482.35	1137.00	1408.54	851.67
2	1482.35	1136.84	1408.62	851.69
3	1482.35	1136.69	1408.70	851.71
4	1482.34	1136.17	1408.71	851.69
5	1482.33	1136.05	1408.72	851.68
6	1482.32	1135.93	1408.72	851.66
7	1482.31	1135.81	1408.73	851.64
8	1482.30	1135.69	1408.74	851.62
9	1482.29	1135.57	1408.75	851.61
10	1482.28	1135.45	1408.76	851.59
11	1482.27	1135.33	1408.76	851.57
12	1482.26	1135.21	1408.77	851.56
13	1482.25	1135.09	1408.78	851.54
14	1482.24	1134.97	1408.79	851.52
15	1482.23	1134.85	1408.79	851.50
16	1482.22	1134.73	1408.80	851.49
17	1482.21	1134.61	1408.81	851.47
18	1481.62	1133.42	1408.88	851.41
19	1481.62	1133.30	1408.95	851.35
20	1481.62	1133.18	1409.02	851.29
21	1481.62	1133.06	1409.10	851.23
22	1481.62	1132.94	1409.17	851.17
23	1481.62	1132.82	1409.24	851.11
24	1481.62	1132.70	1409.31	851.05
25	1481.62	1132.59	1409.38	851.00
26	1481.62	1132.47	1409.45	850.94
27	1481.62	1132.35	1409.52	850.88
28	1481.62	1132.23	1409.60	850.82
29	1481.62	1132.12	1409.67	850.76
30	1481.62	1132.00	1409.74	850.70

CCC NOAA9 - 1986 OCTOBER

ERBE FLIGHT MODEL TWO (NOAA9)
COUNT CONVERSION FOR NON-SCANNER

* COUNT CONVERSION ALGORITHM FOR TOTAL CHANNELS

$$E_T = A_V \cdot V^2 + A_F \cdot T_F + A_A \cdot T_A + A_H \cdot T_H + A_R \cdot V_R^2 + B$$

* COUNT CONVERSION ALGORITHM FOR SHORTWAVE CHANNELS

$$E_S = A_V \cdot V^2 + A_F \cdot T_F + A_A \cdot T_A + A_H \cdot T_H + A_R \cdot V_R^2 + A_E \cdot E_T + B$$

	A_V	A_A	A_H	A_F	A_R	A_E	
WFOV/TOT	-22.8621	.0	.0	-.3977	24.7635		(86/12/17)
WFOV/SW	-26.8156	.0	.0	-.3653	31.0907	-.03575	(88/09/23)
MFOV/TOT	-22.5566	.0	.0	-.5274	23.9133		(86/12/17)
MFOV/SW	-25.5671	.0	.0	.7122	29.1090	-.03619	(88/09/23)

DAILY B-OFFSET FOR ERBE
 FLIGHT MODEL TWO (NOAA9) NONSCANNER

NOAA9 - 1986 OCTOBER

DAY	(88/09/23)	(88/09/23)	(88/09/23)	(88/09/23)
	WFOV/TOT	MFOV/TOT	WFOV/SW	MFOV/SW
1	1481.62	1131.88	1407.06	852.45
2	1481.61	1131.78	1407.07	852.44
3	1481.60	1131.68	1407.09	852.43
4	1481.59	1131.58	1407.10	852.41
5	1481.59	1131.47	1407.12	852.40
6	1481.58	1131.37	1407.13	852.39
7	1481.57	1131.27	1407.15	852.38
8	1481.56	1131.17	1407.16	852.36
9	1481.55	1131.07	1407.17	852.35
10	1481.54	1130.97	1407.19	852.34
11	1481.53	1130.87	1407.20	852.33
12	1481.53	1130.76	1407.22	852.32
13	1481.52	1130.66	1407.23	852.30
14	1481.51	1130.56	1407.25	852.29
15	1481.50	1130.46	1407.26	852.28
16	1482.18	1130.33	1407.34	852.55
17	1482.18	1130.21	1407.42	852.82
18	1482.18	1130.10	1407.50	853.09
19	1482.18	1129.98	1407.58	853.35
20	1482.18	1129.86	1407.66	853.62
21	1482.18	1129.75	1407.74	853.89
22	1482.18	1129.63	1407.81	854.16
23	1482.18	1129.52	1407.89	854.43
24	1482.18	1129.40	1407.97	854.70
25	1482.18	1129.29	1408.05	854.96
26	1482.18	1129.17	1408.13	855.23
27	1482.18	1129.06	1408.21	855.50
28	1482.18	1128.94	1408.29	855.77
29	1482.18	1128.83	1408.33	855.57

CCC NOAA9 - 1986 NOVEMBER

ERBE FLIGHT MODEL TWO (NOAA9)
COUNT CONVERSION FOR NON-SCANNER

* COUNT CONVERSION ALGORITHM FOR TOTAL CHANNELS

$$E_T = A_V \cdot V^2 + A_F \cdot T_F + A_A \cdot T_A + A_H \cdot T_H + A_R \cdot V_R^2 + B$$

* COUNT CONVERSION ALGORITHM FOR SHORTWAVE CHANNELS

$$E_S = A_V \cdot V^2 + A_F \cdot T_F + A_A \cdot T_A + A_H \cdot T_H + A_R \cdot V_R^2 + A_E \cdot E_T + B$$

	A _V	A _A	A _H	A _F	A _R	A _E	
WFOV/TOT	-22.8621	.0	.0	-.3977	24.7635		(85/08/15)
WFOV/SW	-26.9063	.0	.0	-.3665	31.1959	-.03587	(89/11/13)
MFOV/TOT	-22.5566	.0	.0	-.5274	23.9133		(85/08/15)
MFOV/SW	-25.5135	.0	.0	.7107	29.0480	-.03612	(89/11/13)

DAILY B-OFFSET FOR ERBE
 FLIGHT MODEL TWO (NOAA9) NONSCANNER

NOAA9 - 1986 NOVEMBER

DAY	(90/02/12)	(90/02/12)	(90/02/12)	(90/02/12)
	WFOV/TOT	MFOV/TOT	WFOV/SW	MFOV/SW
1	1482.17	1128.47	1411.95	850.85
2	1482.16	1128.35	1411.97	850.84
3	1482.15	1128.24	1411.98	850.84
4	1482.14	1128.13	1412.00	850.84
5	1482.14	1128.01	1412.01	850.84
6	1482.13	1127.90	1412.02	850.84
7	1482.12	1127.79	1412.04	850.84
8	1482.11	1127.67	1412.05	850.84
9	1482.10	1127.56	1412.07	850.83
10	1482.10	1127.45	1412.08	850.83
11	1482.09	1127.33	1412.10	850.83
12	1482.08	1127.22	1412.11	850.83
13	1482.11	1126.75	1412.22	850.87
14	1482.14	1126.63	1412.32	850.92
15	1482.17	1126.52	1412.43	850.96
16	1482.20	1126.41	1412.53	851.00
17	1482.23	1126.30	1412.64	851.04
18	1482.26	1126.18	1412.74	851.09
19	1482.29	1126.07	1412.85	851.13
20	1482.32	1125.96	1412.95	851.17
21	1482.35	1125.85	1413.06	851.22
22	1482.38	1125.74	1413.16	851.26
23	1482.41	1125.62	1413.27	851.30
24	1482.44	1125.51	1413.37	851.34
25	1482.47	1125.40	1413.48	851.39
26	1482.50	1125.29	1413.58	851.43
27	1482.50	1125.19	1413.65	851.44
28	1482.51	1125.09	1413.71	851.45
29	1482.51	1124.99	1413.78	851.45
30	1482.51	1124.89	1413.84	851.46

CCC NOAA9 - 1986 DECEMBER

ERBE FLIGHT MODEL TWO (NOAA9)
COUNT CONVERSION FOR NON-SCANNER

* COUNT CONVERSION ALGORITHM FOR TOTAL CHANNELS

$$E_T = A_V \cdot V^2 + A_F \cdot T_F + A_A \cdot T_A + A_H \cdot T_H + A_R \cdot V_R^2 + B$$

* COUNT CONVERSION ALGORITHM FOR SHORTWAVE CHANNELS

$$E_S = A_V \cdot V^2 + A_F \cdot T_F + A_A \cdot T_A + A_H \cdot T_H + A_R \cdot V_R^2 + A_E \cdot E_T + B$$

	A_V	A_A	A_H	A_F	A_R	A_E	
WFOV/TOT	-22.8621	.0	.0	-.3977	24.7635		(86/12/17)
WFOV/SW	-26.8980	.0	.0	-.3664	31.1862	-.03586	(88/03/18)
MFOV/TOT	-22.5566	.0	.0	-.5274	23.9133		(86/12/17)
MFOV/SW	-25.5513	.0	.0	.7118	29.0911	-.03617	(88/03/18)

DAILY B-OFFSET FOR ERBE
 FLIGHT MODEL TWO (NOAA9) NONSCANNER

NOAA9 - 1986 DECEMBER

DAY	(88/06/27)	(88/06/27)	(88/06/27)	(88/03/18)	(88/03/18)
	WFOV/TOT	MFOV/TOT	WFOV/SW	MFOV/SW	
1	1482.54	1124.79	1411.86	852.44	
2	1482.54	1124.69	1411.96	852.48	
3	1482.54	1124.59	1411.96	852.53	
4	1482.54	1124.50	1412.12	852.51	
5	1482.54	1124.40	1412.12	852.56	
6	1482.54	1124.30	1412.05	852.57	
7	1482.54	1124.20	1412.14	852.58	
8	1482.54	1124.10	1412.21	852.62	
9	1482.54	1124.00	1412.56	852.47	
10	1482.54	1123.93	1412.99	853.02	
11	1482.97	1123.75	1412.91	852.93	
12	1482.97	1123.60	1412.94	852.91	
13	1482.97	1123.45	1413.00	852.90	
14	1482.97	1123.30	1413.08	853.00	
15	1482.97	1123.15	1413.13	853.03	
16	1482.97	1123.00	1413.28	853.00	
17	1482.97	1122.85	1413.17	853.00	
18	1482.97	1122.70	1413.60	853.08	
19	1482.97	1122.55	1413.36	853.07	
20	1482.97	1122.40	1413.25	853.02	
21	1482.97	1122.25	1413.21	853.10	
22	1482.97	1122.10	1413.34	853.11	
23	1482.97	1121.95	1413.43	853.10	
24	1482.97	1121.80	1413.53	853.28	
25	1484.17	1121.74	1412.98	852.79	
26	1484.17	1121.68	1412.88	852.79	
27	1484.17	1121.62	1412.89	852.85	
28	1484.17	1121.56	1412.97	852.86	
29	1484.17	1121.50	1412.84	852.84	
30	1484.17	1121.44	1412.84	852.92	

APPENDIX L
NOAA-10 NONSCANNER OFFSETS (MERGE)

APPENDIX L: NOAA-10 NONSCANNER OFFSETS (MERGE)

The NOAA-10 satellite's nonscanner did not become operational until October 1986. The tables of NOAA-10 nonscanner offsets in the following pages begin with October 1986.

The units used for all nonscanner offsets in this table are watts per square meter.

	Table
October 1986	L-1
November 1986	L-2
December 1986	L-3

This page has been intentionally left blank

CCC NOAA10 - 1986 OCTOBER

ERBE PFM NONSCANNER (NOAA10)
COUNT CONVERSION FOR NON-SCANNER

* COUNT CONVERSION ALGORITHM FOR TOTAL CHANNELS

$$E_T = A_V \cdot V^2 + A_F \cdot T_F + A_A \cdot T_A + A_H \cdot T_H + A_R \cdot V_R^2 + B$$

* COUNT CONVERSION ALGORITHM FOR SHORTWAVE CHANNELS

$$E_S = A_V \cdot V^2 + A_F \cdot T_F + A_A \cdot T_A + A_H \cdot T_H + A_R \cdot V_R^2 + A_E \cdot E_T + B$$

	A _V	A _A	A _H	A _F	A _R	A _E	
MFOV/TOT	-22.5230	.0	.0	-.4216	23.8202		(88/02/17)
MFOV/SW	-24.1624	.0	.0	-1.2973	28.4474	-.03009	(89/11/13)
MFOV/TOT	-23.2215	.0	.0	-1.9825	22.4009		(88/02/17)
MFOV/SW	-25.0633	.0	.0	-3.3751	29.1677	-.02270	(89/11/13)

376 INTENTIONALLY BLANK

DAILY B-OFFSET FOR ERBE
 PROTO-FLIGHT MODEL (NOAA10) NONSCANNER

NOAA10 - 1986 OCTOBER

DAY	(90/03/22)	MFOV/TOT	(90/03/22)	MFOV/TOT	(90/03/22)	MFOV/SW	(90/03/22)	MFOV/SW
1	.00	.00	1415.64	1937.73				
2	.00	.00	1415.78	1937.73				
3	.00	.00	1415.92	1937.72				
4	.00	.00	1416.06	1937.72				
5	.00	.00	1416.21	1937.72				
6	.00	.00	1416.35	1937.71				
7	.00	.00	1416.49	1937.71				
8	.00	.00	1416.63	1937.71				
9	.00	.00	1416.78	1937.71				
10	.00	.00	1416.92	1937.70				
11	.00	.00	1417.06	1937.70				
12	.00	.00	1417.20	1937.70				
13	.00	.00	1417.35	1937.69				
14	.00	.00	1417.49	1937.69				
15	.00	.00	1417.63	1937.69				
16	.00	.00	1417.77	1937.68				
17	.00	.00	1417.92	1937.68				
18	.00	.00	1418.06	1937.68				
19	.00	.00	1418.20	1937.68				
20	.00	.00	1418.34	1937.67				
21	.00	.00	1418.48	1937.67				
22	1432.86	1668.03	1418.63	1937.67				
23	1432.89	1668.43	1418.77	1937.66				
24	1432.91	1668.82	1418.91	1937.66				
25	1432.94	1669.22	1419.05	1937.66				
26	1432.69	1669.28	1419.20	1937.65				
27	1432.45	1669.33	1419.34	1937.65				
28	1432.20	1669.39	1419.48	1937.65				
29	1431.95	1669.44	1419.62	1937.64				
30	1431.74	1669.39	1419.77	1937.64				

CCC NOAA10 - 1986 NOVEMBER

ERBE PFM NONSCANNER (NOAA10)
 COUNT CONVERSION FOR NON-SCANNER

* COUNT CONVERSION ALGORITHM FOR TOTAL CHANNELS

$$E_T = A_V \cdot V^2 + A_F \cdot T_F + A_A \cdot T_A + A_H \cdot T_H + A_R \cdot V_R^2 + B$$

* COUNT CONVERSION ALGORITHM FOR SHORTWAVE CHANNELS

$$E_S = A_V \cdot V^2 + A_F \cdot T_F + A_A \cdot T_A + A_H \cdot T_H + A_R \cdot V_R^2 + A_E \cdot E_T + B$$

	A_V	A_A	A_H	A_F	A_R	A_E	
WFOV/TOT	-22.5230	.0	.0	-.4216	23.8202		(88/02/17)
WFOV/SW	-24.2284	.0	.0	-1.3009	28.5250	-.03017	(89/11/13)
MFOV/TOT	-23.2215	.0	.0	-1.9825	22.4009		(88/02/17)
MFOV/SW	-25.0633	.0	.0	-3.3751	29.1677	-.02270	(89/11/13)

DAILY B-OFFSET FOR ERBE
 PROTO-FLIGHT MODEL (NOAA10) NONSCANNER

NOAA10 - 1986 NOVEMBER

DAY	(90/03/22)	MFOV/TOT	(90/03/22)	MFOV/TOT	(90/03/22)	MFOV/SW	(90/03/22)	MFOV/SW
1	1429.82	1669.29	1420.05	1937.64				
2	1429.11	1669.23	1420.19	1937.63				
3	1428.40	1669.18	1420.34	1937.63				
4	1427.69	1669.13	1420.48	1937.63				
5	1426.98	1669.08	1420.62	1937.62				
6	1426.96	1669.13	1420.76	1937.62				
7	1426.95	1669.17	1420.90	1937.62				
8	1426.93	1669.22	1421.05	1937.61				
9	1426.91	1669.26	1421.19	1937.61				
10	1426.89	1669.31	1421.33	1937.61				
11	1426.88	1669.35	1421.47	1937.61				
12	1426.86	1669.40	1421.62	1937.60				
13	1426.92	1669.47	1421.76	1937.60				
14	1426.98	1669.54	1421.90	1937.60				
15	1427.04	1669.61	1422.04	1937.59				
16	1427.11	1669.68	1422.19	1937.59				
17	1427.17	1669.75	1422.33	1937.59				
18	1427.23	1669.82	1422.47	1937.58				
19	1427.29	1669.89	1422.61	1937.58				
20	1427.35	1669.95	1422.76	1937.58				
21	1427.41	1670.02	1422.90	1937.58				
22	1427.47	1670.09	1423.04	1937.57				
23	1427.54	1670.16	1423.18	1937.57				
24	1427.60	1670.23	1423.33	1937.57				
25	1427.66	1670.30	1423.47	1937.56				
26	1427.72	1670.37	1423.61	1937.56				
27	1427.91	1670.35	1423.75	1937.56				
28	1428.10	1670.34	1423.89	1937.55				
29	1428.30	1670.32	1424.04	1937.55				
30	1428.49	1670.30	1424.18	1937.55				

CCC NOAA10 - 1986 DECEMBER

ERBE PFM NONSCANNER (NOAA10)
COUNT CONVERSION FOR NON-SCANNER

* COUNT CONVERSION ALGORITHM FOR TOTAL CHANNELS

$$E_T = A_V \cdot V^2 + A_F \cdot T_F + A_A \cdot T_A + A_H \cdot T_H + A_R \cdot V_R^2 + B$$

* COUNT CONVERSION ALGORITHM FOR SHORTWAVE CHANNELS

$$E_S = A_V \cdot V^2 + A_F \cdot T_F + A_A \cdot T_A + A_H \cdot T_H + A_R \cdot V_R^2 + A_E \cdot E_T + B$$

	A_V	A_A	A_H	A_F	A_R	A_E	
WFOV/TOT	-22.5230	.0	.0	-.4216	23.8202		(88/02/17)
WFOV/SW	-24.3289	.0	.0	-1.3063	28.6434	-.03029	(89/11/13)
MFOV/TOT	-23.2215	.0	.0	-1.9825	22.4009		(88/02/17)
MFOV/SW	-25.0633	.0	.0	-3.3751	29.1677	-.02270	(89/11/13)

DAILY B-OFFSET FOR ERBE
 PROTO-FLIGHT MODEL (NOAA10) NONSCANNER

NOAA10 - 1986 DECEMBER

DAY	(90/03/22)	(90/03/22)	(90/03/22)	(90/03/22)
	WFOV/TOT	MFOV/TOT	WFOV/SW	MFOV/SW
1	1428.68	1670.29	1424.32	1937.55
2	1428.87	1670.27	1424.46	1937.54
3	1429.07	1670.26	1424.61	1937.54
4	1429.26	1670.24	1424.75	1937.54
5	1429.45	1670.22	1424.89	1937.53
6	1429.64	1670.21	1425.03	1937.53
7	1429.83	1670.19	1425.18	1937.53
8	1430.03	1670.17	1425.32	1937.52
9	1430.22	1670.16	1425.46	1937.52
10	1430.41	1670.14	1425.60	1937.52
11	1430.56	1670.10	1425.75	1937.52
12	1430.72	1670.06	1425.89	1937.51
13	1430.87	1670.02	1426.03	1937.51
14	1431.02	1669.98	1426.17	1937.51
15	1431.18	1669.94	1426.31	1937.50
16	1431.33	1669.90	1426.46	1937.50
17	1431.49	1669.87	1426.60	1937.50
18	1431.64	1669.83	1426.74	1937.49
19	1431.79	1669.79	1426.88	1937.49
20	1431.95	1669.75	1427.03	1937.49
21	1432.10	1669.71	1427.17	1937.49
22	1432.25	1669.67	1427.31	1937.48
23	1432.41	1669.63	1427.45	1937.48
24	1432.56	1669.59	1427.60	1937.48
25	1432.52	1669.65	1427.74	1937.47
26	1432.48	1669.70	1427.88	1937.47
27	1432.43	1669.76	1428.02	1937.47
28	1432.39	1669.82	1428.17	1937.46
29	1432.35	1669.87	1428.31	1937.46
30	1432.31	1669.93	1428.45	1937.46