

**N91-28254**

**PRESENTATION 4.3.2**

---

**SPACE TRANSFER VEHICLES**

**AND**

**SPACE BASING**

**FOR**

**1990 SPACE TRANSPORTATION PROPULSION SYSTEMS  
SYMPOSIUM**

**LOCATION: UNIVERSITY PARK, PA  
DATE: 26 - 29 JUNE 1990**

**MARTIN MARIETTA**

**McDonnell Douglas**

**Joe Kelley**

## **Acknowledgment**

This presentation, "Space Transfer vehicles and Space Basing" represents a selection of work performed by Martin Marietta Corporation (Prime contractor) and McDonnell Douglas (subcontractor) under NASA Marshall Space Flight Center Contract "Space Transfer Vehicle Concepts and Requirements", NAS-8-37856 along with related company funded efforts and has been previously presented at Program reviews at MSFC.

The MSFC Contracting Officer Technical Representative is Mr. Don Saxton (205) 544-5035. Mr. Joe Keeley is the Martin Marietta STV Program Manager at (303) 977-8614 and the McDonnell Douglas study Manager is Mr. Steve Wasko at (714) 896-3311 x 9757.

## **Agenda - Space Basing**

---

- **Why Space Base?**
- **What is Space Basing?**
- **What Must We Do?**
- **What Solutions Are There?**
- **What Are SSF Impacts?**
- **What Technologies Do We Need?**
- **Conclusions**

**MARTIN MARIETTA**

## **Why Space Base?**

---

- **Cut Earth-to-Orbit (ETO) Launch Costs and No. of Flights**
  - Launch Facility Buildup
  - Separate Crew / Cargo ETO Flights
- **Reduce Impacts of ETO Launch Delays**
- **Utilize Reusable Elements Efficiently**
  - Minimize Return-to-Earth-Relaunch Cycles
- **Learn by Doing**
  - Skylab, MIR
- **Set Groundwork for Expanded Exploration**
  - On-orbit Assembly, Flight Certification, Refurbishment
  - Crew / Cargo Transfer / Rendezvous

OR

- **Direct Flights to Moon / Mars Only**
  - Limits Potential for Near Term Exploration
  - Mandates Indigenous Resources

## **Why Space Base?**

---

- **Crew Resources**
  - Life Support Modules and Components
  - Life Support Liquids and Gasses
- **Cargo**
  - Science Equipment
  - Habitability Equipment
  - Payload Elements
- **Vehicle Systems**
  - Space Transfer Vehicles (Expendable and Reusable)
  - Space Tugs
  - Manned Maneuvering Units
- **Vehicle Resources**
  - Propellants / Gasses
  - Water / Coolants

## Mission Scenario 4E-5B Outbound Flight

Common vehicle with single crew module, single propulsion system, drop tanks and aerobrake return.

The mission begins in low earth orbit. The TLI burn is accomplished with the vehicle using propellants from a set of TLI drop tanks which are then jettisoned. The LLO insertion burn is accomplished with the vehicle with propellants from a set of LLO drop tanks which are also jettisoned. Tanks located on the underside of the aerobrake contain the propellant required for the return mission. The vehicle separates from the aerobrake and tanks which remain in lunar orbit. The vehicle then performs the landing burn.

## Mission Scenario 4E-5B, Crew & LEV Delivery

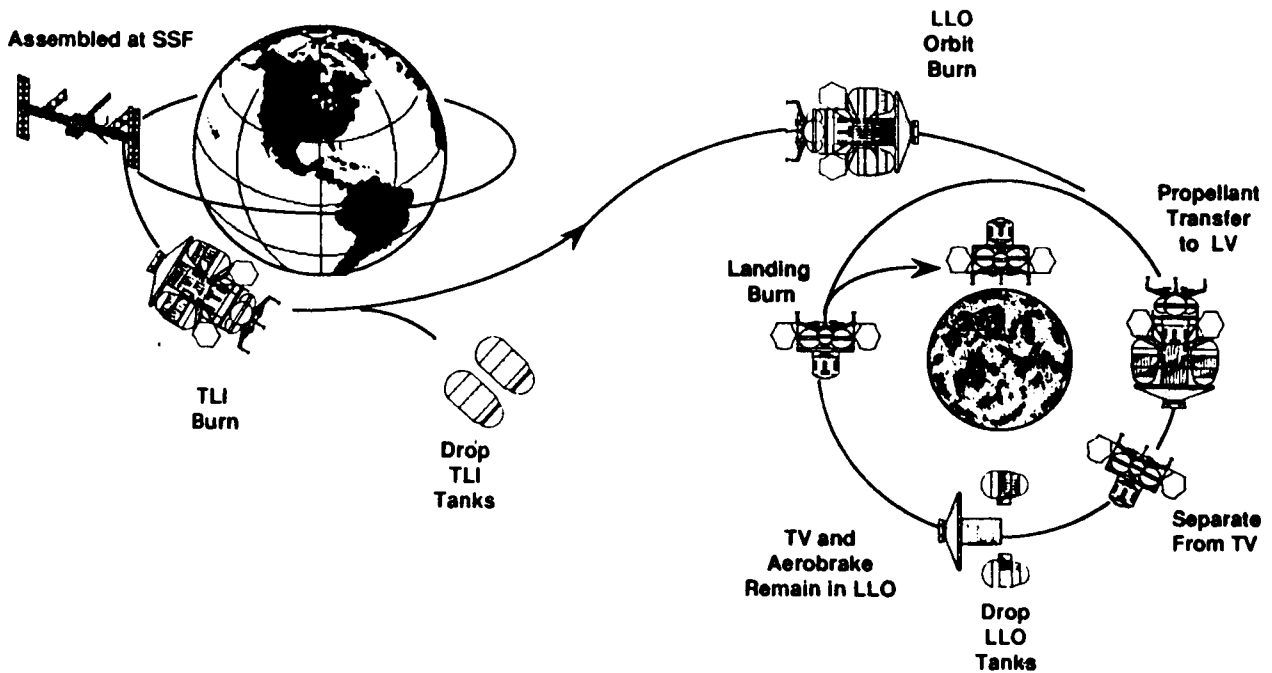

Outbound Flight (Initial Flight - With LEV)

**MARTIN MARIETTA**

# **What Must We Do?**

---

## **Define and Bound:**

- **Crew Growth**
  - **Lunar; Visit, Explore, Settle**
  - **Mars; Visit, Explore, Settle**
  - **Solar System Visits**
  
- **Crew Support Systems**
  - **Visits; Small Quarters**
  - **Exploration; Work / Relaxation / Science Quarters**
  - **Settlements; Homes**
  
- **Space Transfer Vehicle Families**
  - **LEO → Lunar → Mars → Solar System**

**MARTIN MARIETTA**

## Final Concept Candidate - Crew Concept 4E-2B:

This chart provides a detailed vehicle configuration as well as identified attributes for the criteria evaluation produced. The key attributes of this configuration are:

- Lowest Development and Validation Costs
- No Crew Transfer
- Optimum support of all STV DRMs

## Final Concept Candidate - Crew Concept 4E-2B

### ATTRIBUTES:

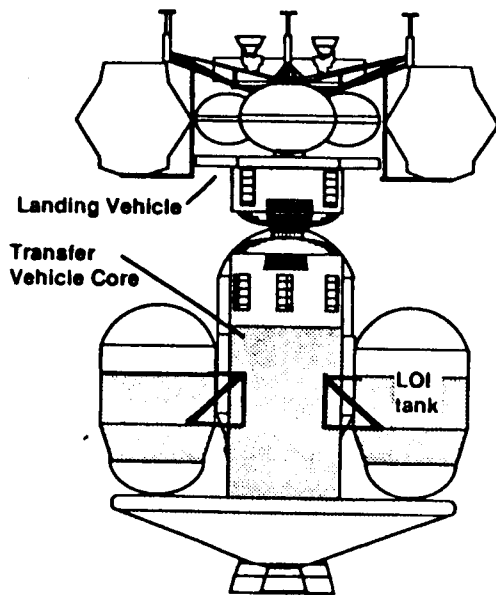

- Lowest Development & Validation Cost
- Simplify LEO Assembly & Checkout In Steady State Phase
- No Crew Module Transfer
- Optimum Support Of All STV DRMs

**MARTIN MARIETTA**

## **STV Concept 4E-5B**

Concept 4E-5B employs a single propulsion system. It is a Transfer/Landing vehicle with drop tanks, a single crew module, 45.0' dia. aerobrake and launched from LEO to the Lunar surface. This concept requires one Shuttle-C Block 2 flight to deliver the Transfer/Lander and LOI drop tanks and two HLLV flights to deliver the TLI drop tanks to LEO for assembly. Pre-flight assembly and final verification along with flight recertification and re-certification is accomplished at LEO.

The Transfer/Landing vehicle consists of one stage with four RL-10 engines and a propellant capacity of 29.0 t., two TLI drop tanks with a propellant capacity of 133.0 t and two LOI drop tanks with a propellant capacity of 20.0 t. The single crew module is used for both the trans Earth/Lunar trip and to transport the crew to the Lunar surface.

## **STV Concept 4E-5B**

---

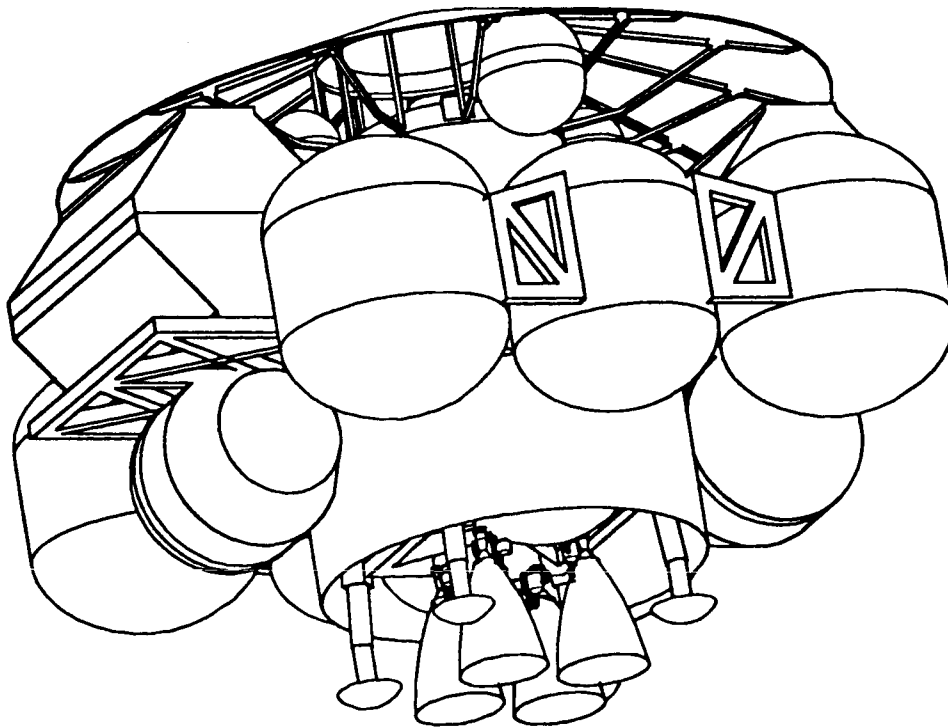

**MARTIN MARIETTA**

## Configuration Summary - Crew Concept 4E-5B

Crew Concept 4E-5B is a Single Propulsion Transfer/Landing Vehicle with Drop Tanks, single crew module, 45.0' dia. Aerobrake and launched from LEO to the Lunar surface. This Concept requires 1 Shuttle-C Block 2 flight to deliver the Transfer/Lander and LOI Drop Tanks and 2 HLLV flights to deliver the TLI Drop Tanks to LEO for assembly. Pre-flight verification is accomplished at LEO.

The Transfer/Landing Vehicle consists of a stage with 4 RL-10 engines and a propellant capacity of 29.0 t., 2 TLI Drop Tanks with a propellant capacity of 133.0 t and 2 LOI Drop Tanks with a propellant capacity of 20.0 t. The Transfer/Landing Vehicle with the single crew module is used to transport the crew to the Lunar surface and the trans Earth/Lunar trip.

DRM adaptability for this concept is:

Transfer/Landing Vehicle	Delivers 11.8 t to GEO
Transfer/Landing Vehicle w/Drop Tanks	Planetary Propulsion Unit

The Program Cost and Mass Properties for Crew Concept 4E-5B are summarized on the chart.

## Configuration Summary - Crew Concept 4E-5B

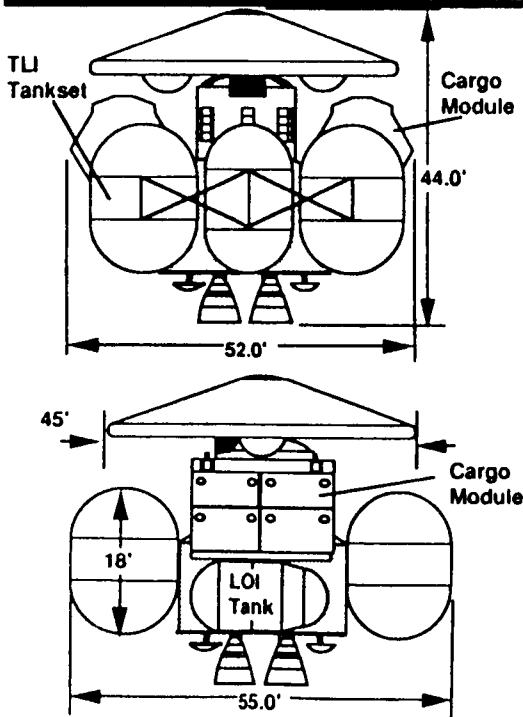

### Preliminary Mass Properties

	(1)
Transfer/Vehicle Core	16.3
TLI Tank (2 @ 2.8)	5.6
LOI Tank (2 @ 1.1)	2.2
<b>Total Mission Propellant</b>	<b>159.0</b>

### Key Features

- Single Propulsion Transfer/Landing Vehicle w/ Drop Tanks
- LEO to Lunar Surface Crew/Cargo Delivery  
Aerobrake Return to LEO, Single Crew Cab  
Lunar Architectures 1 & 2
- Transfer/Landing Vehicle Core -
  - 29 t Propellant
  - 4 RL-10 Engines
- Drop Tanks
  - (2) TLI 66.5 t Propellant (each)
  - (2) LOI 10 t Propellant (each)
  - (2) Return Tankset 3 t Propellant (each)
- Requires 1 Sh-C Block 2 and 2 HLLV Flts for LEO Delivery
  - Transfer/Landing Vehicle & A/B Pkgd in Sh-C Block 2
  - Each TLI & Return Tankset Pkgd in HLLV - 20' Dia., 84 t
- Evolution
  - Transfer/Lander - Delivers 11.8 t to GEO
  - Transfer/Lander with Drop Tanks-Planetary Propul. Unit
- Program Cost
  - DDT&E - \$10.1B
  - Production - \$2.9B
  - Operations - \$19.1B
  - Total LCC - \$32.1B
- LEO Operations Include Delivery, Assy & Verification of Core and Drop Tanks; Refurb of Core and Crew Cab
- Cargo Height Above Lunar Surface - 24.3'
- Critical Operations
  - Outbound - 1 Crit-1, 5 Crit-2
  - Return - 4 Crit-1, 1 Crit-2

**MARTIN MARIETTA**



## Configuration Definition - Crew Concept 4E-5B

Crew Concept 4E-5B is a Single Propulsion Transfer/Landing Vehicle with Drop Tanks, single crew module, 45.0' diameter Aerobrake

The Transfer/Landing Vehicle stage is 25.0' in Diameter with an overall height of 43.5' when the landing legs are extended. It has two LH2 tanks and two LO2 tanks surrounded by a skirt. The Propulsion System consist of 4 RL-10 Engines and a propellant capacity of 23.0 metric tons. The TLI tankset consist of two LH2 tanks and one LO2 tanks supported in an open frame work. The overall length of the tankset is 46.0' and has a propellant capacity of 66.5 metric tons each. The LOI tankset has one LH2 tank, one LO2 tank, and a Intertank structure. The overall dimensions of the tankset are: 12.0' in dia. x 17.4' in length and has a propellant capacity of 10.0 metric tons each. The tanksets are mounted to the Core with struts. Umbilicals connect the TLI and LOI feed lines to the core tanks. Maximum payload capacity is 14.6 metric tons and the payloads are mounted on the sides of Landing Vehicle via payload support racks. The single Crew Module is used to transport the crew to the Lunar surface and the trans Earth/Lunar trip.

The 45.0' diameter Aerobrake is mounted to the Transfer/Landing Vehicle via a docking mechanism and is left in LLO when the Transfer/Landing Vehicle descends to the Lunar surface. The return tanks with 6.0 metric ton of propellant are mounted in the Aerobrake and are connected to the core tanks when the Transfer/Landing Vehicle rendezvous and docks with the Aerobrake for the return trip.

A Mass Properties Statement provides the weight breakout for the various elements.

## Configuration Definition - Crew Concept 4E-5B

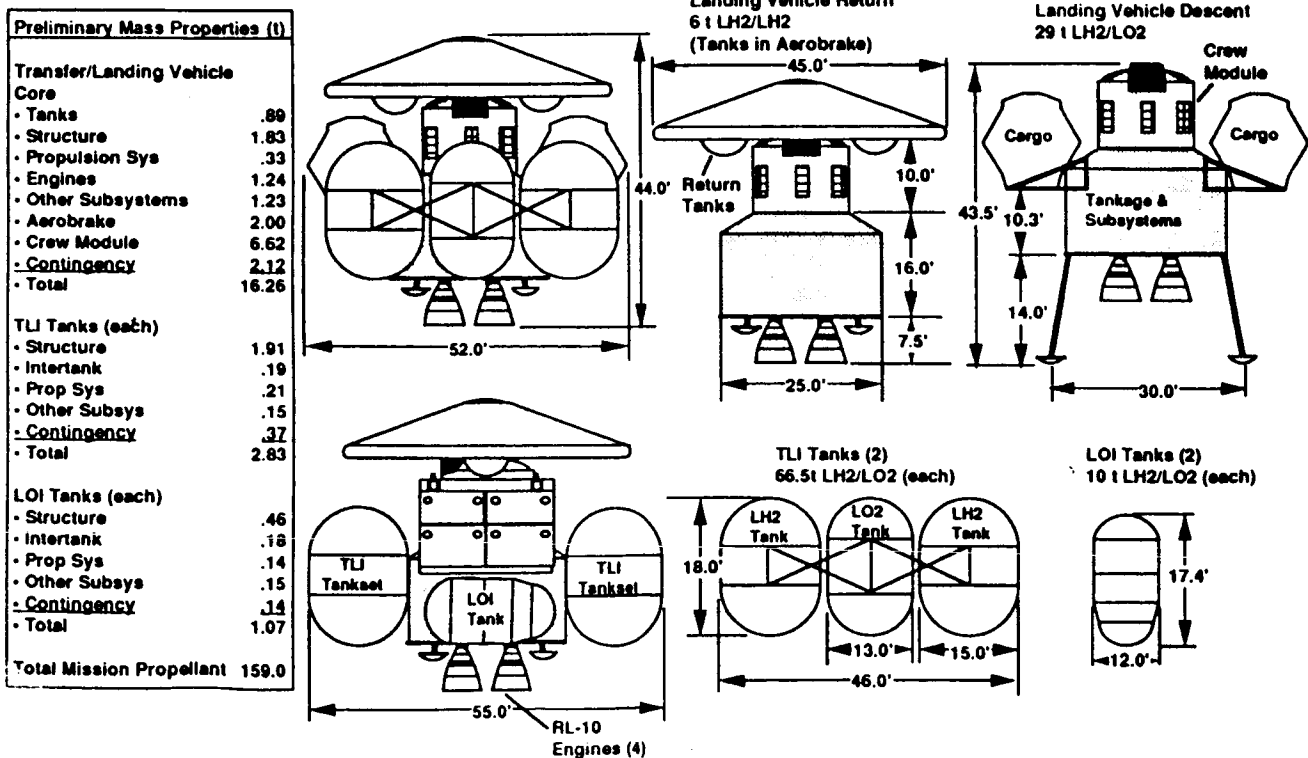

## Manifest Layout for 4E-5B

The vugraph shows how Concept 4E-5B is packaged in the ETO launch vehicle payload bays for delivery to LEO for assembly. The Transfer/Landing Vehicle and Aerobrake are delivered in one Shuttle-C Block 2 flight, and the TLI, LOI, and Return Tankset are delivered in two HLLV flights.

## Manifest Layout for 4E-5B

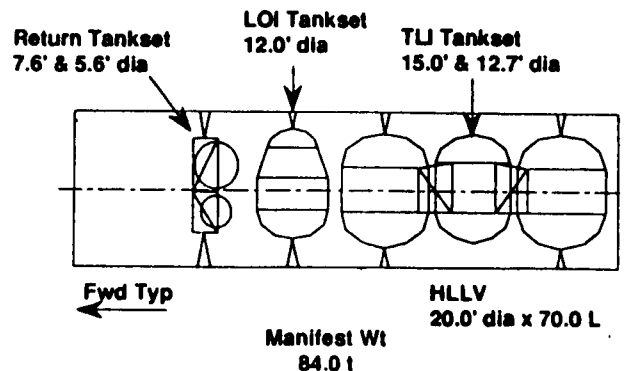
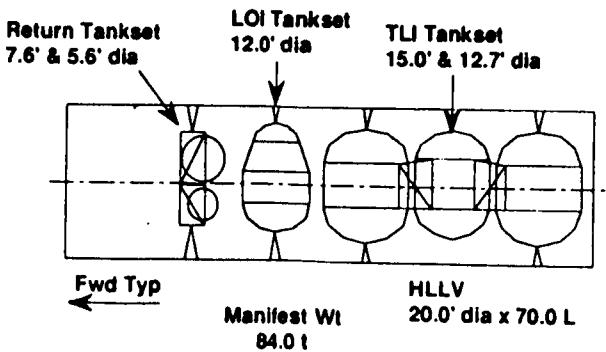
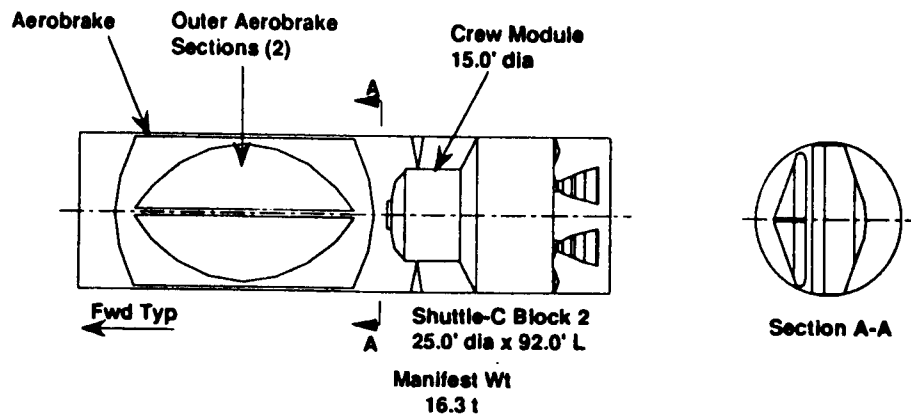

**MARTIN MARIETTA**

## Configuration Definition - 4E-5B TLI Tank Support

The TLI Tankset is composed of two LH2 tanks and one LO2 tank and tubular truss structure. The LO2 tank forms the backbone of the tankset and the truss work is attached to the tank at the fwd and aft ring frames. The LH2 tanks are then attached to the trusses. A similar arrangement of trusses is used to attach the tankset to longerons on the Transfer/Lander Vehicle.

## Configuration Definition - 4E-5B TLI Tank Support

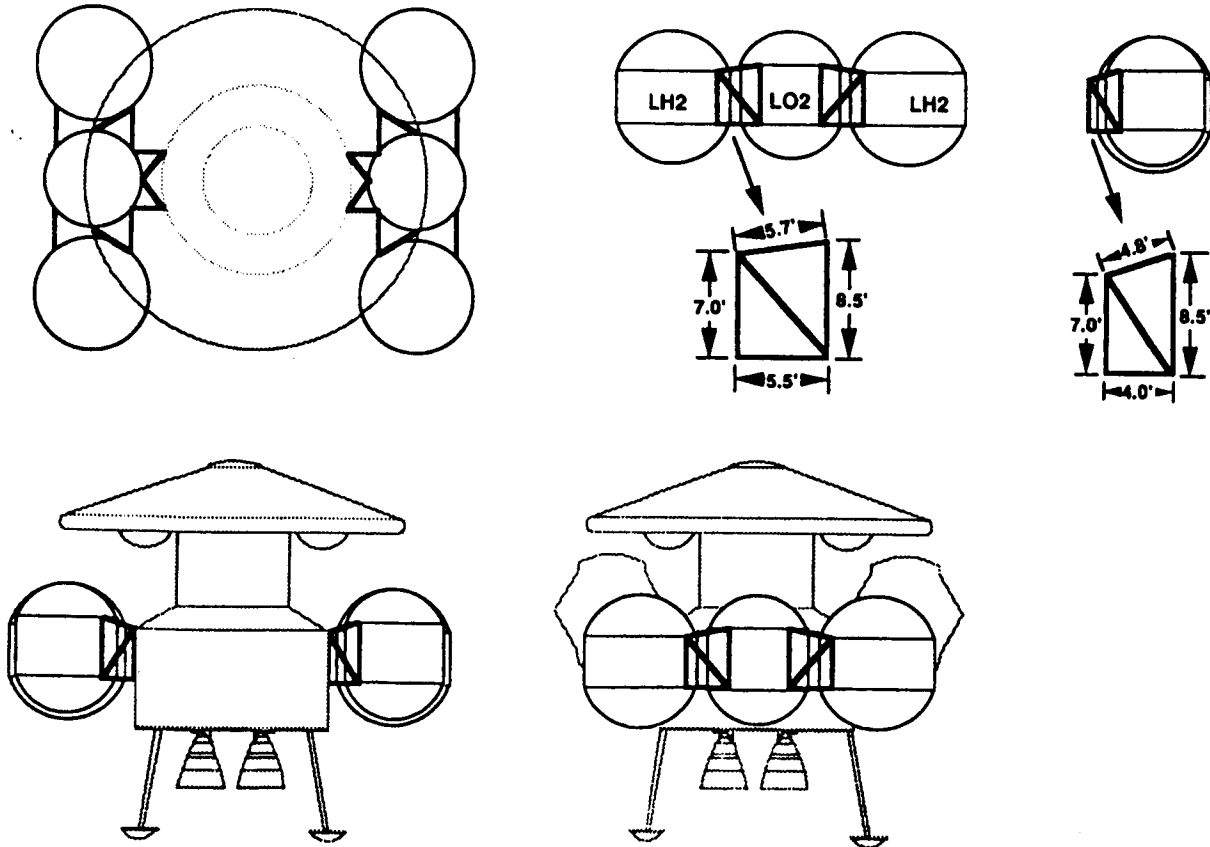

**MARTIN MARIETTA**

## LEO Node Assembly & Checkout Operations:

This chart shows a graphical representation of the major vehicle elements that must be received, assembled, checkout, launched, and refurbish in support the next mission at the LEO Node. The LEO Node operations evaluation is based on defining the complexity of turning the segregated elements on the left, into the integrated and operational vehicle shown on the right.

## LEO Node Assembly & Checkout Operations

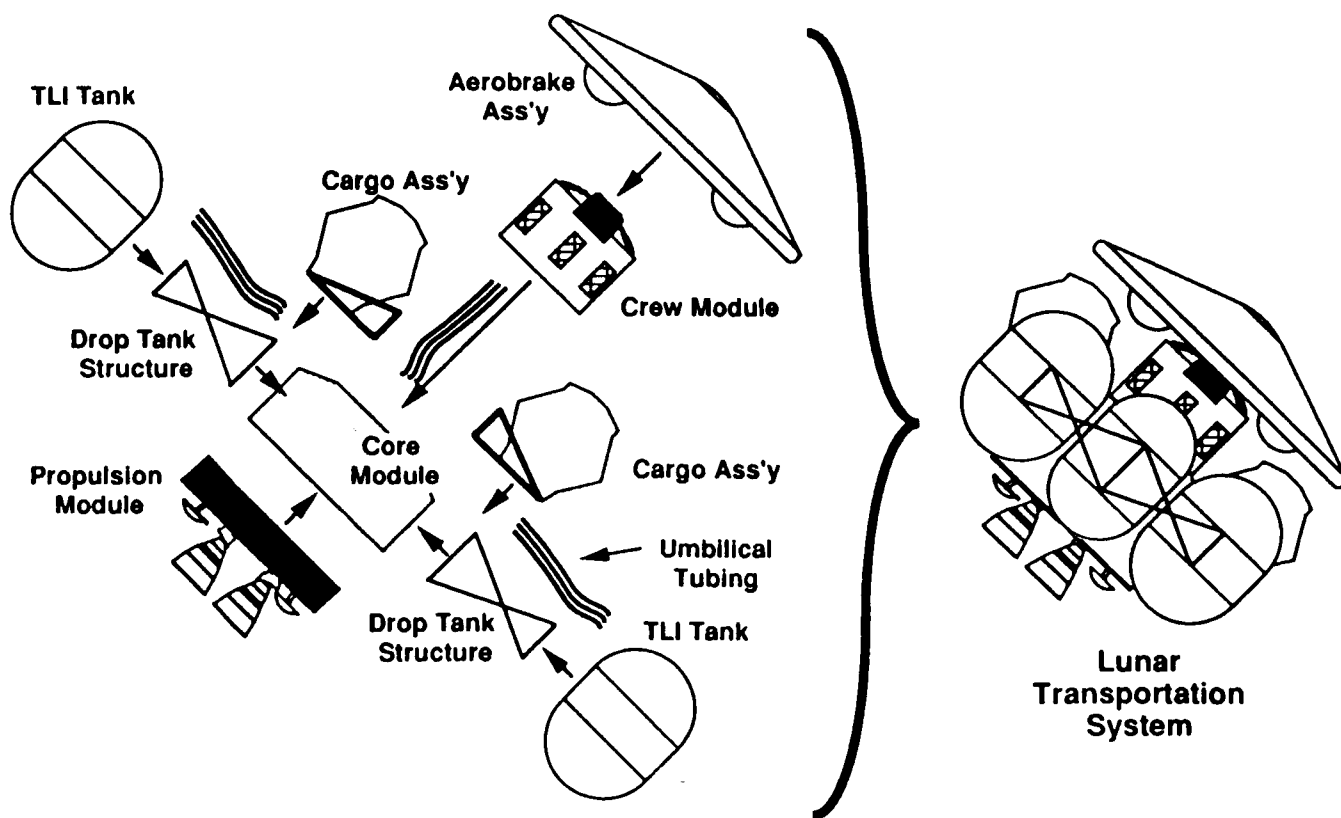

**MARTIN MARIETTA**

## Configuration DRM Adaptability - Cargo Concept 4E-5B

The vugraph shows how the various elements of the Lunar Transfer and Landing Vehicle might be used for STV and Planetary missions. To perform some of the STV missions, additional propellant would be required.

DRM adaptability for this concept without increasing the propellants is:  
 Transfer/Landing Vehicle                      Delivers 11.8 t to GEO  
 Transfer/Landing Vehicle w/Drop Tanks      Planetary Propulsion Unit

## Configuration DRM Adaptability - Crew Concept 4E-5B

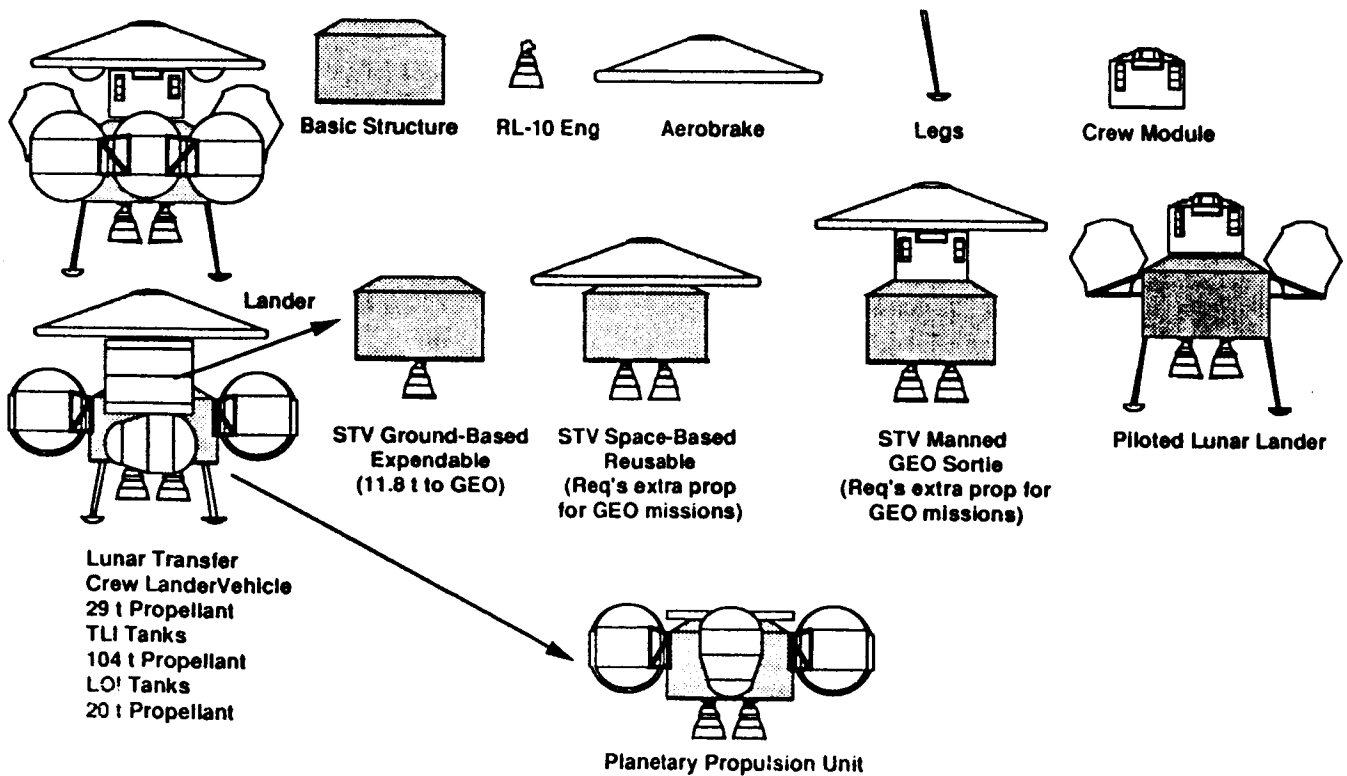

**MARTIN MARIETTA**

## STV/LTV/LEV Commonality

Our approach to the Space Exploration Initiative vehicle selection process emphasized commonality to meet the individual mission requirements for cargo delivery to the moon and man/cargo flights for delivery and return. We formulated evolutionary paths for these systems to grow to satisfy the Mars Exploration usage. We identified alternative conceptual configurations for cargo, combined and personnel-only missions to meet the Lunar, near earth, planetary delivery, and Mars exploration requirements. The STV Core includes main engines, avionics and aerobrake which is mated with cryogenic propellant tanks into the LTS transfer vehicle at LEO. The crew cab is installed together with prepackaged cargo for transfer operations to the Moon. Modular, common avionics, propulsion, and structural components are utilized whenever possible on each vehicle. We have rated each concept with relative cost elements, operational complexity, delivery performance, and other factors and consolidated the options into a selected family of vehicles with recommendations for September approval by MSFC.

## STV/LTV/LEV Commonality

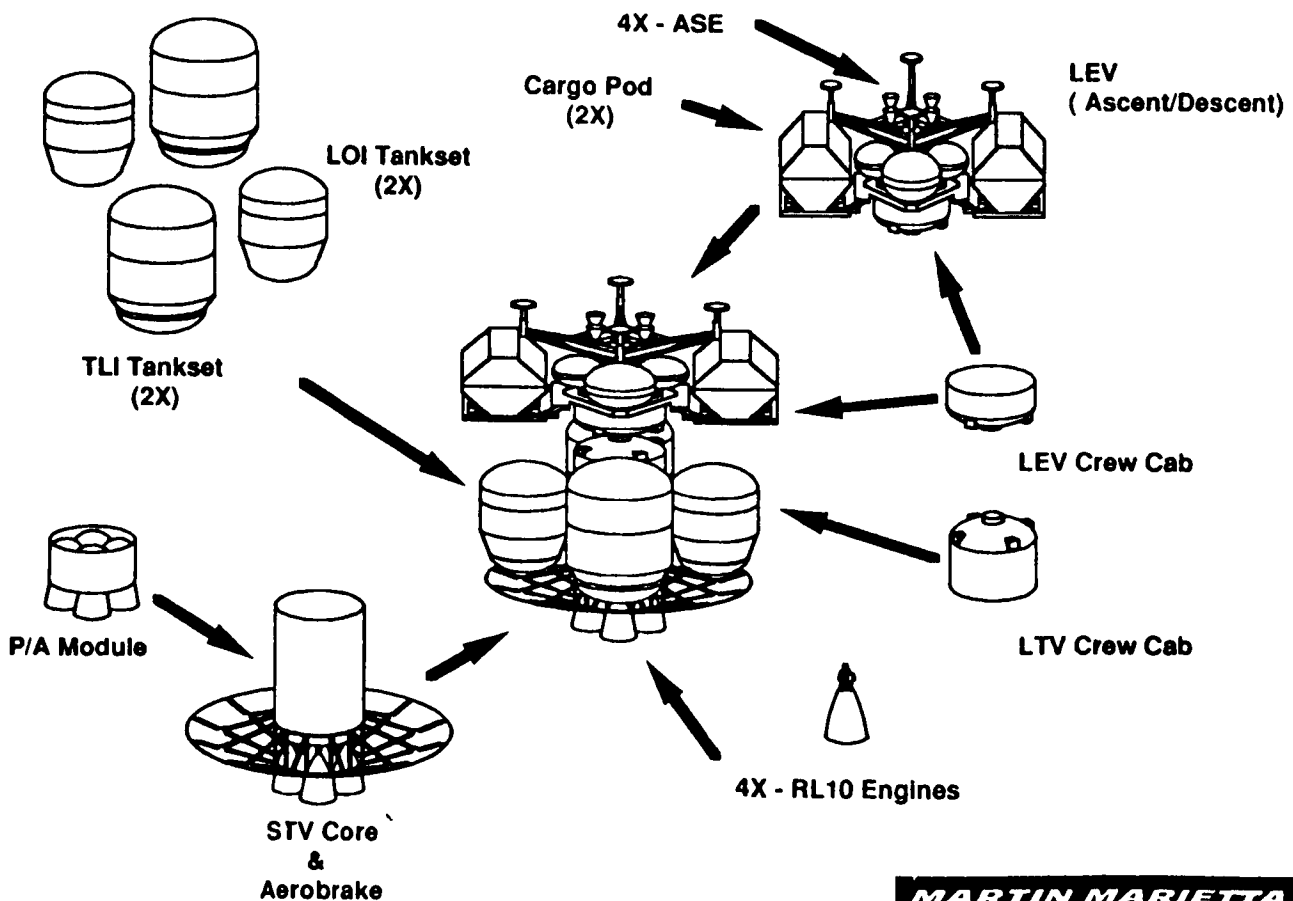

## Criteria for Operational Objectives

Criteria for STV design, technological advancements, and launch site test philosophy need to be met to guarantee the turn-around assessment of the ground based STV will be achieved. Each criteria results in improved operational capabilities from current processing. These improvements are realized in reduced times and manpower, and ultimately in significantly decreased operational contributions to life cycle.

## Criteria For Operational Objectives

---

- **Design Features**

- **GO<sub>2</sub>/GH<sub>2</sub> Attitude Control Supplied by Main Propulsion Interface**
- **Automated Leak Detection**
- **No Post Mission Drain/Purge Requirements**
- **Minimal STV/Spacecraft Interfaces**
- **Minimal STV/Launch and Landing Vehicle Interfaces**
- **High Accessibility and Quick Fasten/Release ORUs**

- **Technologies**

- **Eliminate Ordnance**
- **No Planned TPS Turn Around Refurb - Ease of Repair and Inspection**
- **Fault Detection/Fault Isolation to ORU Level**
- **Self-Alignment and Auto Mate/Demate Mechanical Interfaces**
- **Self Monitoring Engines that Use Flight Data to Determine Health and Maintenance Requirements**

### **Test Philosophy**

- **Minimal On-Line Operations**
- **Testing at System Level Only**
- **No Repetition of Tests Due to Facility Transfers**

**MARTIN MARIETTA**

## Degree of Automation

When considering whether to perform processing operations at space station by EVA or IVA, it is not just a decision between robotics and manual EVA. Automation is a continuum stretching from hands-on operations through to autonomous robotics. Level of complexity and development costs soar as operations are made completely automated. A degree of manual intervention tends to keep cost down by allowing human decision making to determine what to do next, and then have the robot do a limited set of tasks. This is normally referred to as supervisory control.

For STV processing support from the space station, we must also consider the availability of personnel at the station for STV related activities. By utilizing an IVA astronaut, supervisory control, and an RMS robotic arm, we would minimize the demands made on the astronaut and the time necessary for turn-around of an STV mission.

## Degree of Automation

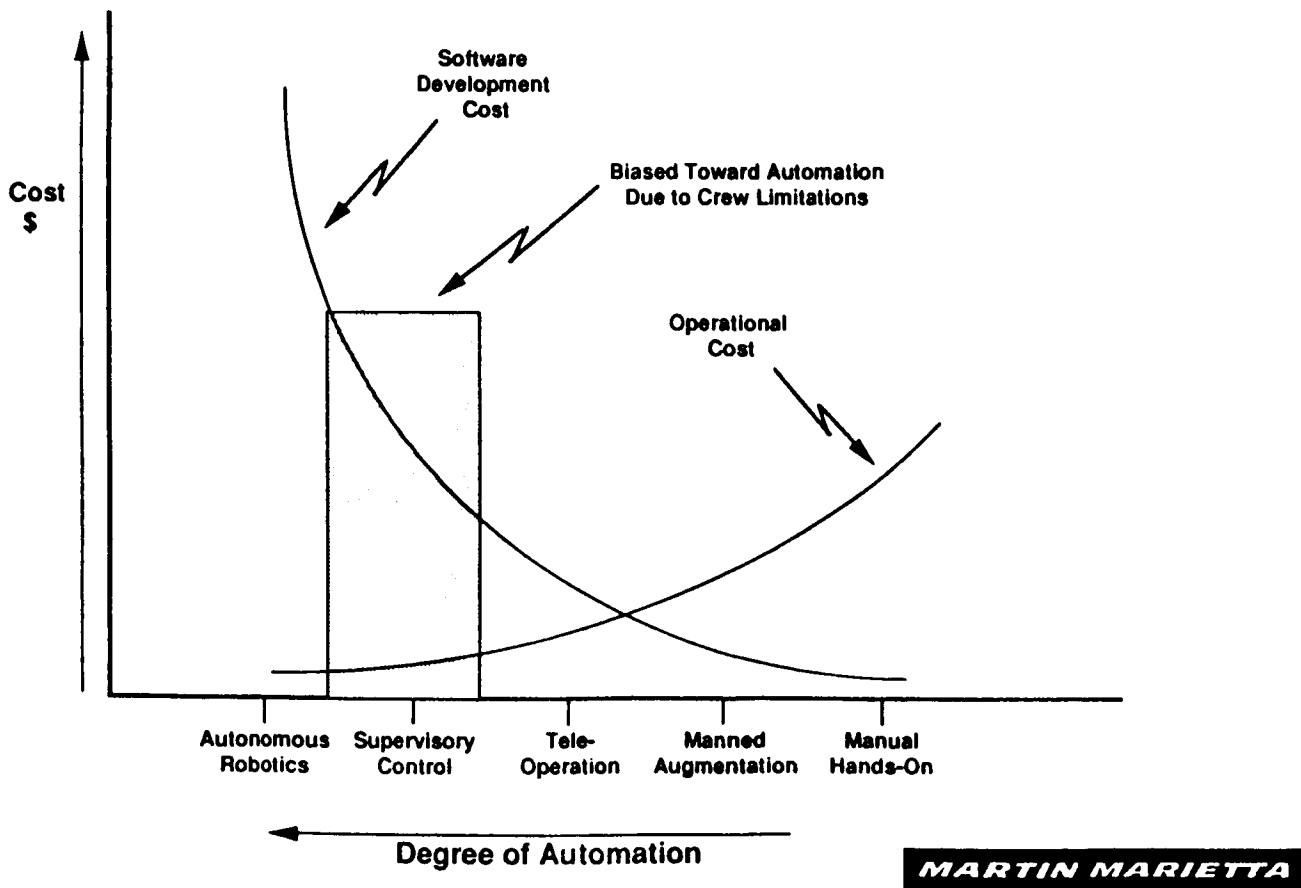



## **EVA vs IVA Preliminary Ranking**

We conducted an in-depth trade study to assess the level of automation that should be incorporated in space-based STV support operations. This assessment included evaluation of the parameters listed below. Consideration was given to performing specific operations with EVA, remote operations with an IVA crew member providing control, and fully automated robotic operation. We found that remote operations were preferable to fully automated operations in most cases, although the precise level of automation depends on the specific task. The ranking shown in the chart below is generically indicative of the preferred approach.

## **EVA vs IVA Preliminary Ranking**

Parameter	10 is Best 1 is Worse	EVA	RMS (Teleop)	Auto Robotics
		Operational Crew Requirements	1	5
Maintenance Crew Requirements	10	5	1	
Development Cost	10	8	1	
STV Design Drivers	10	9	8	
TPS Inspection and Repair	5	4	2	
Propellant Loading	1	8	10	
Operational Cost	1	7	10	
Payload Mating	1	10	6	
Pre-Launch Testing	1	10	9	
Scheduled/Uncheduled Maintenance	1	9	10	
<b>Totals</b>		<b>41</b>	<b>75</b>	<b>67</b>

**MARTIN MARIETTA**

## EVA vs IVA Trade Study Summary

The charts shown below and on the following two pages summarize the results of the analysis performed. In addition to the evaluative notations provided against each of the parameters, a rating of 1 to 10 (10 being best) is also assigned to each of the parameters being evaluated to provide a comparative ranking.

## EVA/IVA Trade Study Summary

Parameter	EVA		RMS (Teleoperator)		Autonomous Robotics	
Operational Crew Requirements	Requires Crew of Three 2 - EVA, 1 - IVA	1	Requires Crew of One	5	No Crew Required for Operation	10
Maintenance Crew Requirements	EVA suit, Support Tools & Equipment (Very Limited)	10	RMS Arm, End Effectors, Elec- tronics (Probably in Pressurized Area) (Limited)	5	MRMS, End Effector, Support Mechanisms, Electronics (Probably Not in Pressurized Area) (Extensive)	1
Development Cost	Existing Technology (None)	10	Existing Technology Requires Application and System Clarifica- tion and Software Development (Limited)	8	Requires Development of an Autonomous System as Well as Extensive Software and Space Qualification (Extensive)	1
STV Design Drivers	Requires BITE, Accessibility, Ease of Repair & Replacement	10	Requires BITE, Accessibility, Modular Design, LRUs Indexed to Position on Cradle	9	Requires BITE, Accessibility, Modular Design, LRUs Indexed to Position on Cradle, Indexed Storage Areas, Additional Arms	8

**MARTIN MARIETTA**

## EVA/IVA Trade Study Summary (Continued)

Parameter	EVA		RMS (Teleoperator)		Autonomous Robotics	
TPS Inspection and Repair	Visual Inspection. Repair Could Be Possible, Albeit Very Difficult	5	CCTV Inspection Also Advanced Techniques Such as Acoustical, Optical, Radio, Graphic	4	Auto Inspection Using Advanced Techniques. Repair Probably Not Possible	2
Propellant Loading	Unsafe Utilization of EVA Manpower	1	Could Be Readily Performed Under Remote Control	8	Automated Quick Connect/Disconnect System Could Be Implemented	10
Operational Cost	Ties Up 3 Crewmen. Very Expensive	1	Only 1 Crewman Involved. No Pre- or Post-EVA Requirements. Operational Time is Less. 1/7 the Cost of EVA.	7	No Operational Crew. Some Crew Involvement In Maintenance and Servicing or Automated Equip. Less than the Cost of RMS.	10
Payload Mating	Ineffective Use of EVA Manpower	1	Easily Implemented and Effective	10	Could be Implemented, but Adds Complexity	6

**MARTIN MARIETTA**

# EVA/IVA Trade Study Summary (Concluded)

Parameter	EVA		RMS (Teleoperator)		Autonomous Robotics	
Pre-Launch Testing	Ineffective Use of EVA Manpower	1	Umbilical Could Be Remotely Connected and Checkout Conducted From Control Console	10	Testing Could Be Completely Automated. Adds Complexity	9
Scheduled/ Unscheduled Maintenance	Requires Transporting Work Station, LRU to Work Site, Performing R & R and Transporting Back	1	LRU Transported By RMS. R & R Readily Performed	9	LRU Transported by MRMS Precisely and Safely. R & R Easily Performed	10
Totals		41		75		67

**MARTIN MARIETTA**

## Mission Scenario 4E-5B Return Mission

The mission begins with the lift off burn. The vehicle performs a rendezvous and docking maneuver with the aerobrake and tanks which remained in orbit after the Outbound mission. The Trans Earth burn is accomplished using propellants from the aerobrake tanks. The vehicle performs an aerobrake reentry and rendezvous and docking in LEO.

## Mission Scenario 4E-5B, Crew & Limited Cargo Return

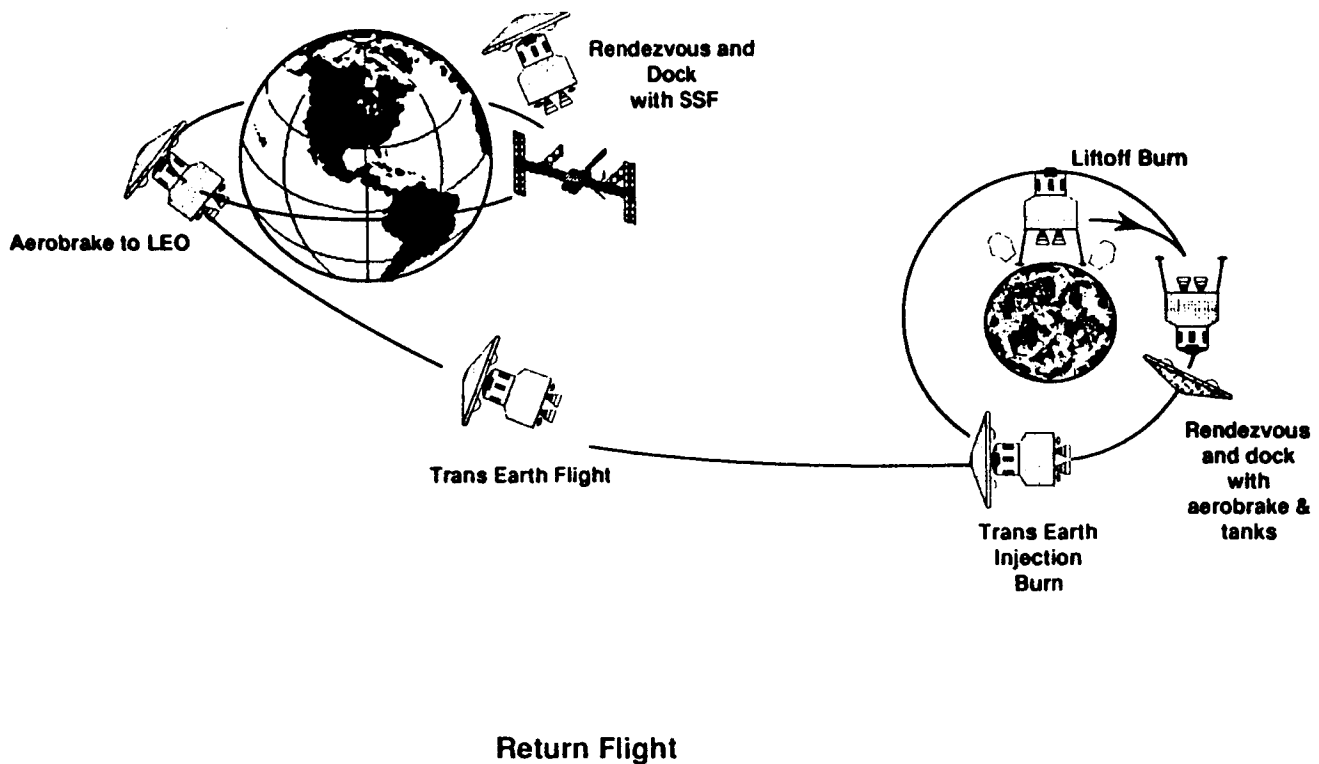

**MARTIN MARIETTA**

# On-orbit Servicing Timelines - Steady State Operations

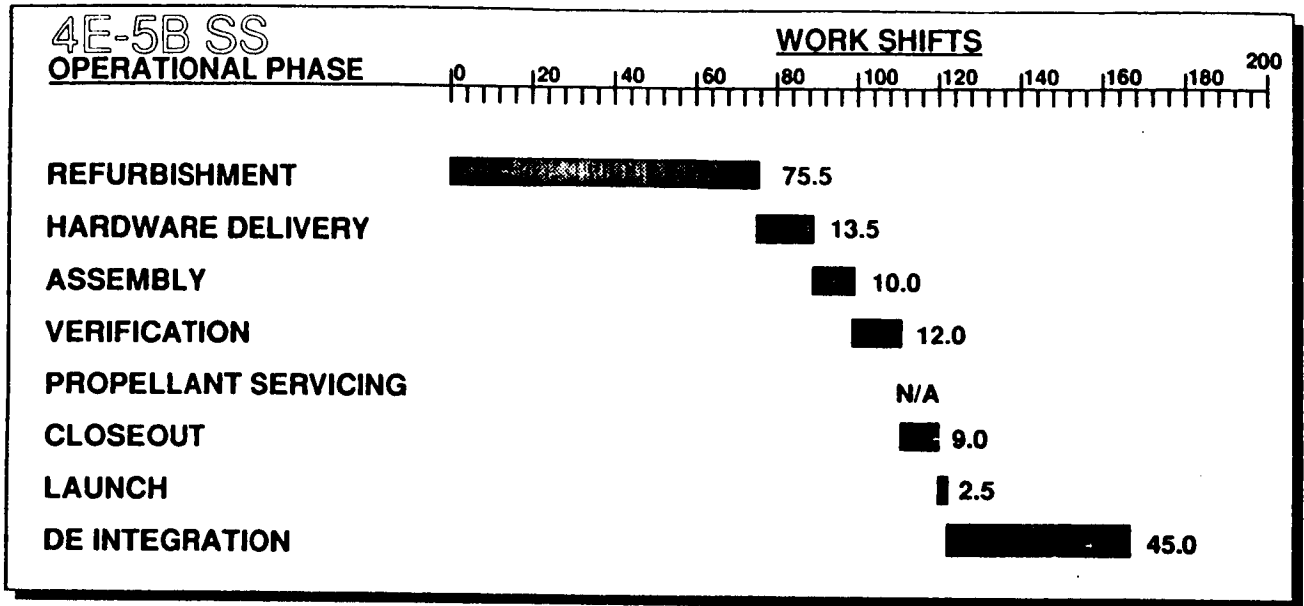

- Manned reflight configurations do not vary more than 3% in complexity and 5% in timelines. These differences are not significant.

## STV at Work. Concept 4E-2B - 90 Day Reference

Concept 4E-2B is a single stage Transfer Vehicle with drop tanks, a separate landing vehicle and two crew modules. This Concept requires 2 Shuttle-C and 2 HLLV flights to deliver the Lander, Transfer Vehicle Core, Aerobrake, and Drop Tanks to LEO for assembly. Pre-flight assembly and final verification along with flight recertification and re-certification is accomplished at LEO.

The Transfer Vehicle with a 45' dia. Aerobrake has 4 RL-10 engines with a propellant capacity of 5.7 t in the STV core tanks, 107.2 t in the TLI Drop Tanks, and 41.8 t in the LOI Drop Tanks. The Landing Vehicle has 4 ASE (Advanced Space Engines) with a propellant capacity of 22.3 t.

The picture on the left depicts the LTV with cargo performing the main engine burn to start the journey to the moon. The picture on the right shows the LTV and LEV in lunar orbit. This picture was taken after the crew and cargo transfer and the two vehicles have separated. Note that the TLI drop tanks are no longer attached to the LTV.

## LTV Main Engine Changeout

Using a single robotic arm equipped with an engine handling fixturing, and an engine assembly equipped with a pneumatically actuated release plate, removal and replacement of an LTV main engine becomes a relatively normal maintenance task.

## LTV Main Engine Changout

---

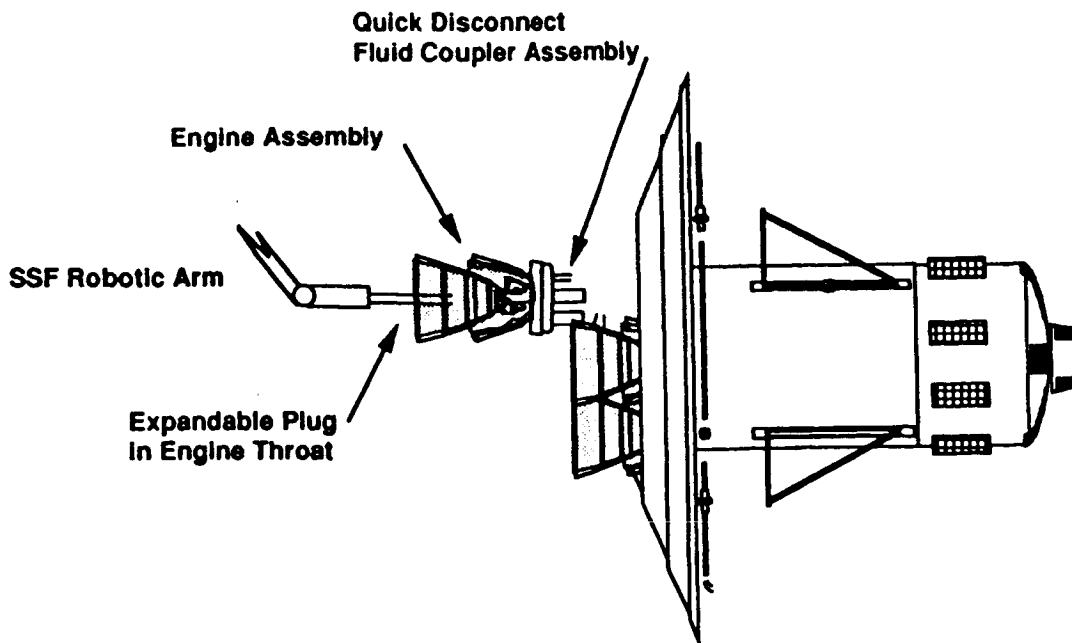

## STV Main Engine Remove/Replace Timeline

On-orbit removal and replacement of the STV main engines can be accomplished through the use of automated systems if the STV and main engines are initially designed to accommodate these activities. A special tool will be required to release and support the main engine during removal and installation activities. This tool should be adaptable for either robotic or EVA operation.

Main engine replacement can be accomplished in approximately 5.5 man-hours through the use of robotics. This projected time is supported by data received from Rocketdyne and Pratt and Whitney regarding the anticipated removal and replacement of their engines on-orbit. In comparison, EVA operations to perform this activity would require approximately 13 man-hours to accomplish.

If it is determined that the on-orbit removal of the turbopumps is cost effective and desirable during engine replacement, then an additional 4.5 hours per turbopump must be added to the timeline. This will result in an expenditure of approximately 14-15 hours (two turbopumps) to complete the entire operation. Special tools for turbopump removal/installation would be required, as well as a special engine stand to withstand torque requirements.

## STV Main Engine Remove / Replace Timeline

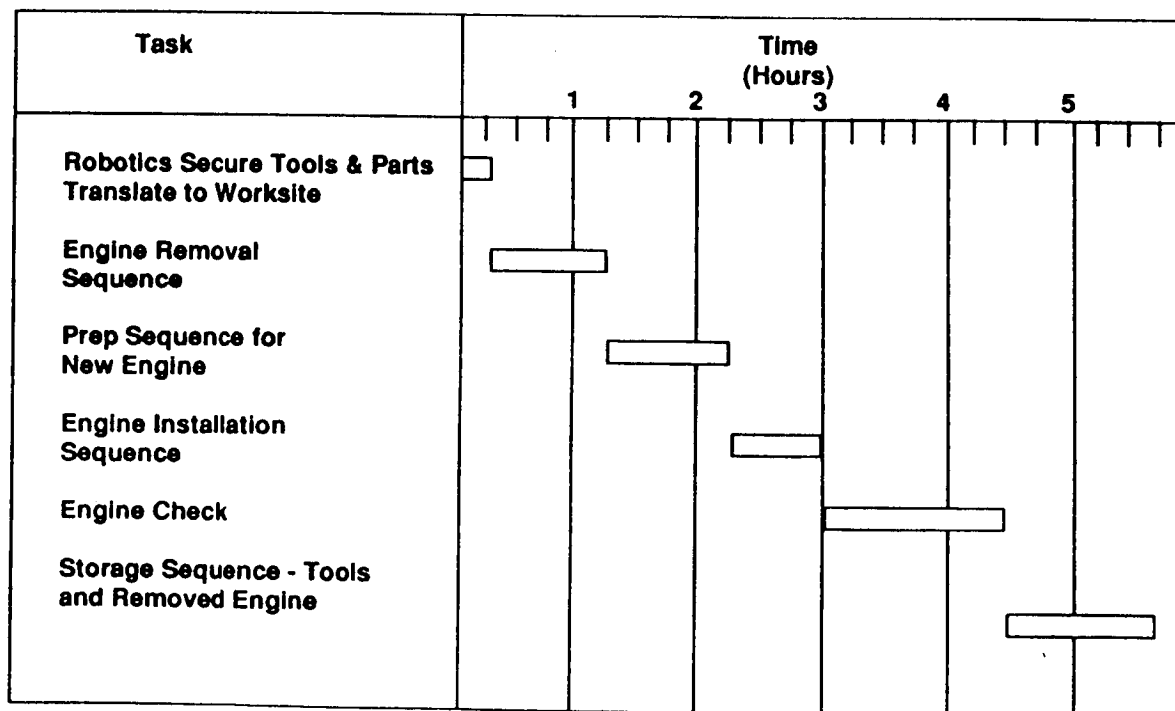

**MARTIN MARIETTA**



## STV Main Engine Mate/Demate Mechanism

This mechanism employs an engine interface plate onto which are mounted six quick disconnect probes. On the opposite side of the interface plate to the probes are mounted the engine gimbal and its two gimbal actuators. This enables the engine to be installed just like a plug-in module.

## STV Main Engine Mate/Demate Mechanism

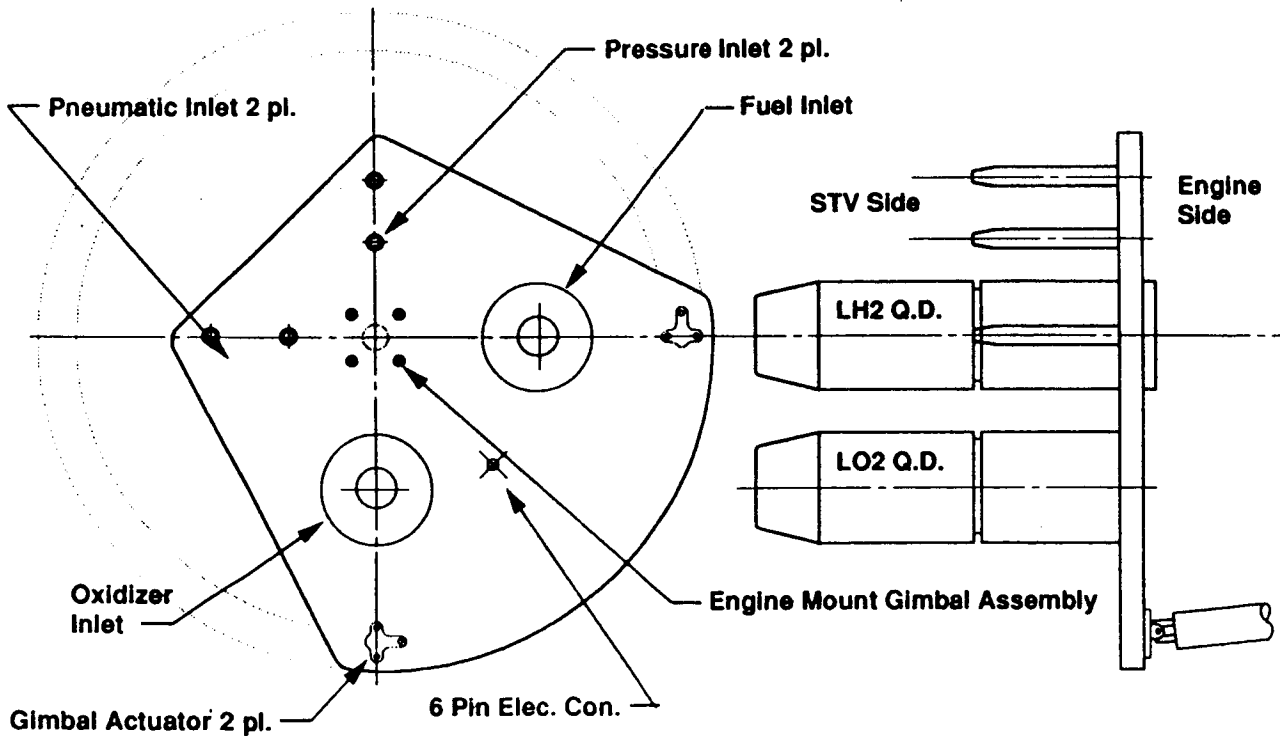

**MARTIN MARIETTA**

## Cryogenic Fluid Probe / Quick Disconnect.

This conceptual quick disconnect is shown not yet fully engaged. When fully engaged, both poppets fully open and the pneumatic cam latch aligns with its mating groove in the probe. When activated, the cam engages the groove in the probe and its tapered surface produces a preload into the probe engagement. The probe side structurally attaches to the engine, tank, or aerobrake (ACS system). The configuration shown would only be for propellant tanks as the engine would require no poppet valve in the probe side, while the ACS system would require no poppet valves at all. The nose of the probe is shaped to minimize the chances of any misalignment from damaging the seals. Note the seals are engaged prior to the poppets opening.

## Cryogenic Fluid Probe / Quick Disconnect

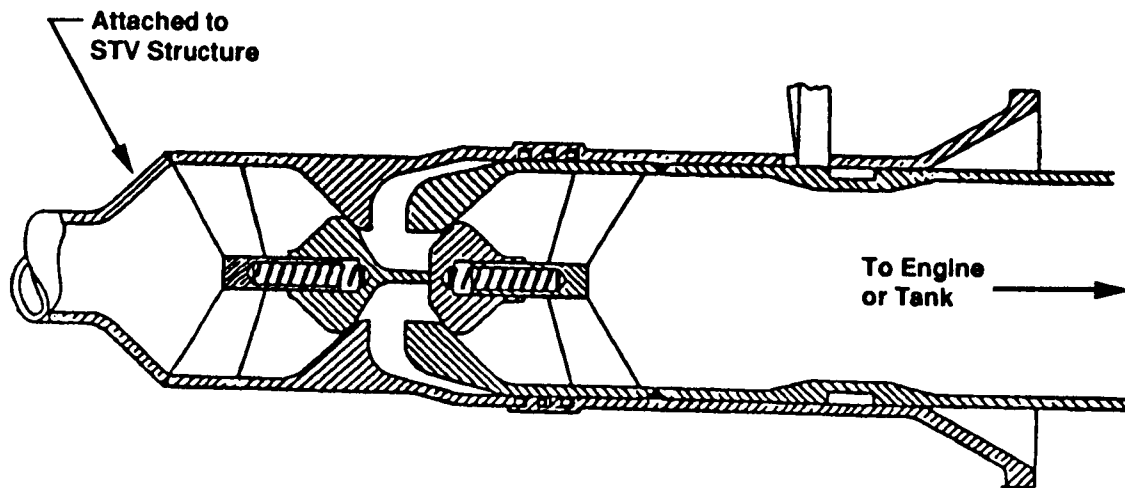

### Open Design Issues

- Man Rating
- Thermal Isolation from Structure
- Thermal Insulation
- Seal Design
- Materials

**MARTIN MARIETTA**

## Alternate STV Propulsion Concept

Martin Marietta and Aerojet Tech Systems cooperated under MM IRAD D-34S to conceive, analyze and evaluate the use of an integrated propulsion/airframe configuration using modular, high performance, cryogenic liquid rocket engines arranged in an annular ring around a modified plug nozzle concept for two separate main engine functions in the Lunar Transportation System. Multiple engines provide increased reliability and improve man rating potential.

The STV/LTV configurations utilizes these engine subassemblies located on the aerobrake windward side and positioned through the aerobrake hot side during main engine burns. No aerobrake doors are required.

The Lunar landing/ascent exploration configuration substitutes an annular ring of similar engines, operated in the throttling mode, around the truncated plug central core to provide a diffused rocket plume landing similar to the multi nozzle landing propulsion on the Mars Viking Landers.

## Alternate STV Propulsion Concept

---

**Conventional  
Engines**



**IRAD D-34S**

**STV/LTV**



**Modular  
Engine Systems**

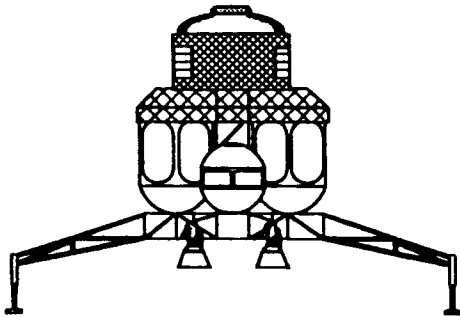

**LEV**

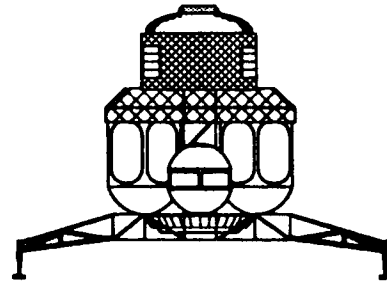

**GenCorp  
Aerojet TechSystems**

**MARTIN MARIETTA**

## STV Core With Integral Engine/Aerobrake

The STV core is shown with the modular engine system built into the aerobrake. The engine is comprised of multiple thrusters, similar to that shown in the inset. The configuration remains intact for the engine firing phases of the mission as well as the aerobrake phases. Doors are not required to cover the engines.

## STV Core With Integral Engine / Aerobrake

IRAD D-34S

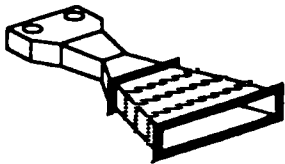

Multiple Thrusters

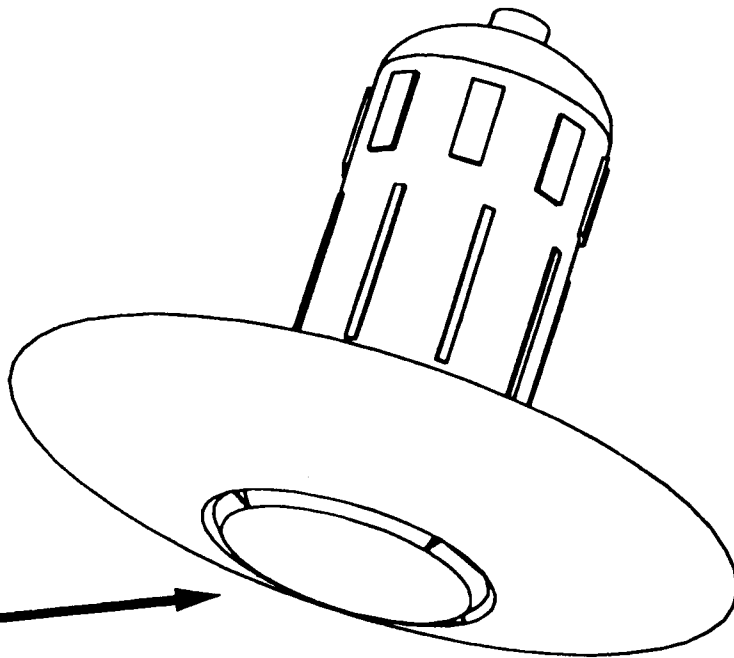
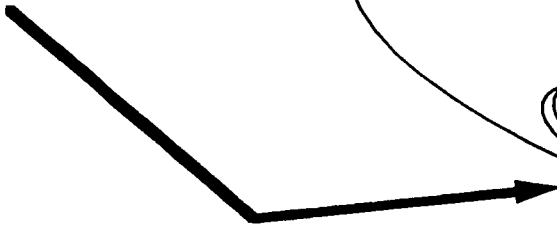

**MARTIN MARIETTA**

# What Do We Impact? / How?

- **Space Station (If Used)**
  - **Science; Microgravity, View Angles**
  - **Reboost Propellants**
  - **Control**
  
- **Costs (If Nodes Used)**
  - **Same Systems as on Space Station**

## Operational Drivers at Space Station Freedom

<i>DRIVER</i>	<i>IMPACT</i>
<b><u>PROGRAM</u></b>	
1. 2 vs 1 Lunar Flights Per Year	Doubles Processing Time At SSF
2. Expendable vs. Reusable Cargo Flights	Reusable Flights Requires A Node
<b><u>SYSTEM</u></b>	
1. Number of Elements In System	Greater Number Of Assembly Operations
2. Automated Rendezvous & Docking vs Teleoperation (Unmanned)	Crew Time Required At SSF For Teleoperation
3. Built In Test vs. SSF Checkout	Equipment/Interfaces Required At SSF
<b><u>SUBSYSTEM</u></b>	
1. Aerobrake Assembly vs Deployable	Greater SSF Assembly Operations
2. Propellant Transfer vs Wet Tanks	More Complex Vehicle Operations
<b><u>COMPONENT</u></b>	
1. Line Replaceable Units vs Integral	Less Subsystem Disassembly
2. Electro-Mechanical vs Hydraulic Actuators	Reduced Maintenance

## STV Mass Sensitivity - Microgravity Environment

Station center of gravity location is shown as a function of STV mass. A Level II directive (BB000610A) has been recently issued, changing the previous requirement of  $10 \mu\text{g}$  in the laboratory modules. This directive states that the Station "shall be capable of providing quasi-steady acceleration levels not to exceed  $1 \mu\text{g}$  for at least 50% of the user accommodation locations in each of the pressurized laboratories (US Lab, ESA and JEM PM at AC)". As shown in the plot of % total laboratory volume within 1 and 10 microgravity levels, any appreciable mass STV supported on a lower keel will not be able to meet this directive.

## STV Mass Sensitivity - Microgravity Environment

1, 2 and  $10 \mu\text{G}$  Contours for 0 Mass STV and 200000 kg STV with Servicing Enclosure Supported on a Lower Keel

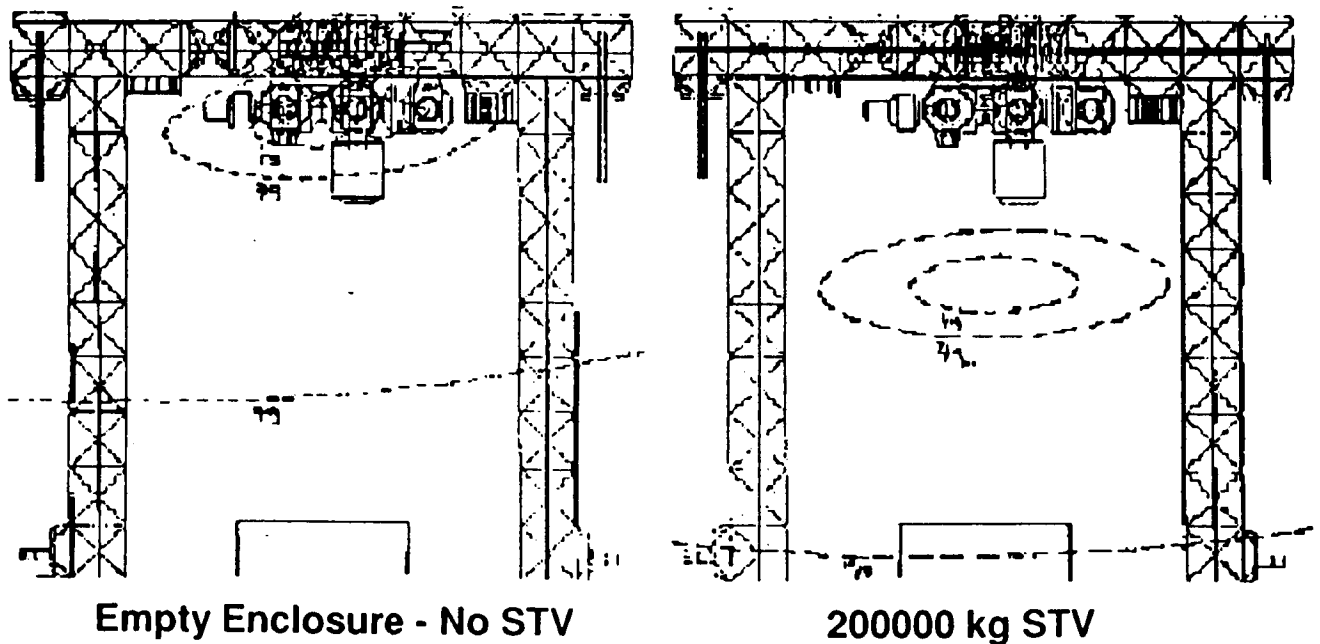

**STV Mass on Lower Keel Has Severe Impact to SSF  $\mu\text{g}$  Environment**

Space Station Freedom

## STV Size Sensitivity - Enclosure Limits

The size to which an STV can grow within the constraints of the Space Station system is governed by the limits to growth of its enclosure. The two dimensional constraints are in the Y (or latitudinal) dimension and the Z (or radial) dimension of the Station configuration. The STV enclosure is assumed to be placed in a location bounded by a "lower keel", or two downward pointing extensions of the truss structure connected by a cross boom. The boom dimensions are governed by the physical space available on the main truss structure as well as constraints in station controllability which govern the extent to which the truss can grow downward.

As depicted on the figure, the maximum dimension the enclosure can grow along the Y axis is 35 meters. Thus the maximum STV diameter within the enclosure will be 31-33 meters, depending on safety factors. In the Z dimension, the limit, as shown, has two components. Forward of the lower keel truss structure plane, the maximum enclosure growth limit is 26.6 meters. This is due to clearance requirements for STS docking to the Space Station. Aft of the truss structure plane, the limit is relaxed to 43.8 m, which is bounded by the envelope for a pressurized logistics module attached to a min-node.

## STV Size Sensitivity - Enclosure Limits

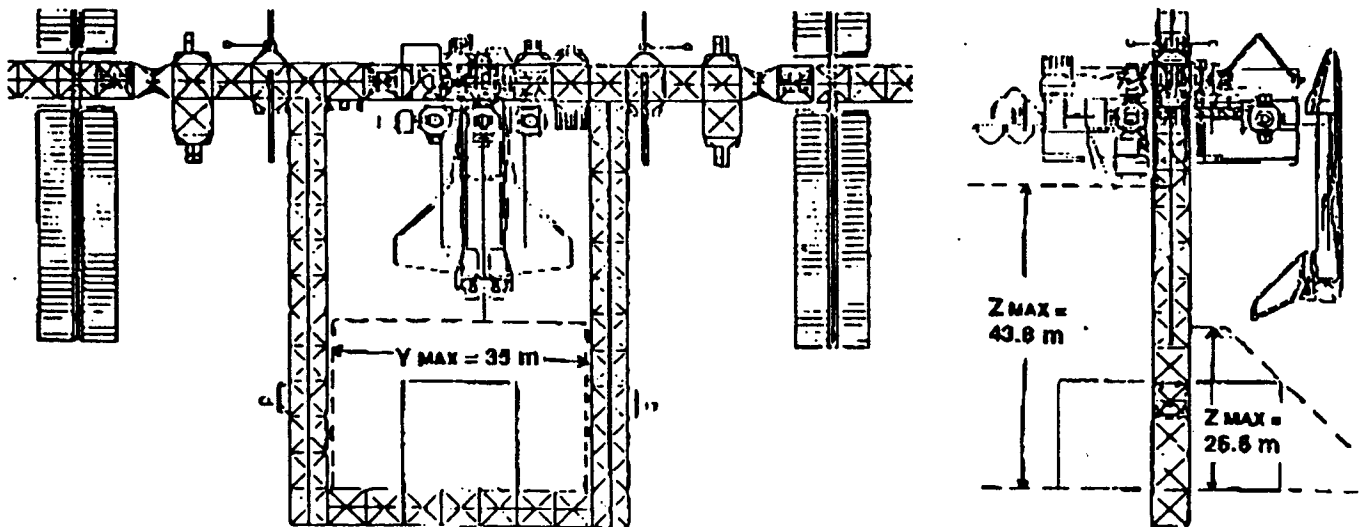

**STV size can grow to within 4m of enclosure growth limits**

## STV Mass Sensitivity - GN&C

For this analysis, it was assumed that a high-mass STV is supported in a 15.3 x 15.3 m servicing enclosure positioned on a lower keel of the Space Station. This configuration is from the November 1989 NASA 90-day study on Human Exploration, which recommended the addition of a lower keel to support lunar operations.

Space Station Freedom flies at Torque Equilibrium Attitude (TEA), where aerodynamic and gravity gradient torques cancel. Current analysis indicates that the TEA of the Assembly Complete Station has a large negative pitch angle and will not meet the requirement to fly within +/- 5 degrees of LVLH. The addition of a lower keel will significantly improve the pitch attitude. As the mass of the STV is increased, pitch and yaw attitudes are further reduced toward LVLH. Roll TEA attitude increases with additional STV mass, but over the range of potential STV mass to be supported, Station TEA will remain within the +/- 5 degree requirement.

## STV Mass Sensitivity - G,N&C

### SSF Attitude Impacts

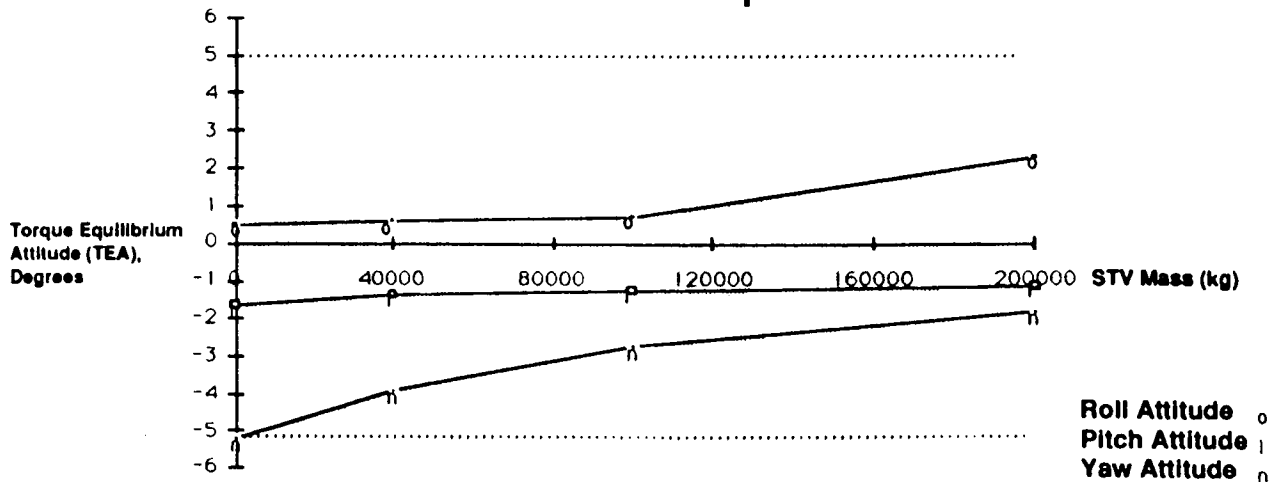

#### Assumptions:

- $\pm 5^\circ$  in pitch is SSF req't (Source: SSFP Document 30426)
- Low mass STV mounted on horizontal keel
- Higher mass STV mounted on lower keel
- C.G. of high mass STV located at X=0, Y=0, Z=-50m

**Increased STV Mass "Helps" Maintain SSF Pitch Attitude**

Space Station Freedom

McDonnell Douglas Space Systems Company



## STV Mass Sensitivity - GN&C

Baseline momentum storage capacity for Space Station Freedom is provided by a pallet containing 6 Control Moment Gyros (CMGs). Each CMG provides 3500 ft-lb/s of momentum storage for a total of 21000 ft-lb/s capacity at Assembly Complete. Required momentum storage capacity is a function of many variables, including specific configuration and momentum management scheme during flight. Analysis using a momentum-management simulation indicates that increased STV mass will have low impact on Station control. Required momentum storage capacity initially increases, then is reduced for higher-mass STVs, when the aerodynamic torque effects are offset by the large gravity gradient torque gains. The maximum momentum storage requirements can most likely be met by the addition of two or three CMGs over the range of STV mass to be supported on a lower keel. Location of these additional CMGs is not critical, and could be supported on or near the existing CMG pallet.

## STV Mass Sensitivity - GN&C

### CMG Control Authority Impacts

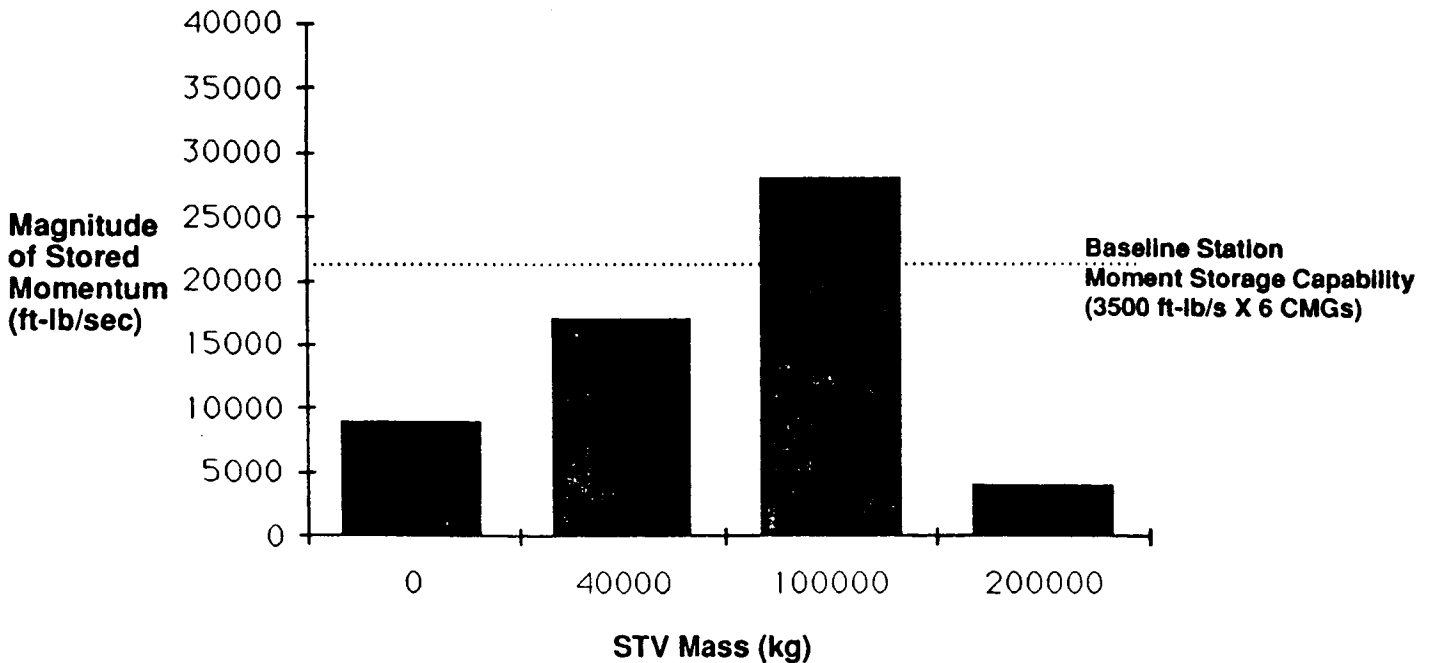

**STV Mass Near 100,000 kg Requires Additional Control Moment Gyros (CMGs) to Manage Increased Station Momentum**

## STV Mass Sensitivity - Reboost Logistics

Reboost propellant required during a low solar cycle year is shown as a function of STV mass. This chart compares the propellant required for a low-mass STV based on the main truss as an attached payload with a large-mass STV supported on a lower keel. The addition of the lower keel and servicing enclosure increases Station propellant use by about 5000 lb Hydrazine. After this initial increase, the entire range of STV mass will not require more than one additional propulsion module (8000 lb Hydrazine) for the low solar cycle year.

Yearly required reboost Hydrazine is shown for both low and high solar cycle years over the range of STV mass on a lower keel. The high solar cycle year is the worst-case for reboost requirements and will require up to two additional propulsion modules over the STV mass range.

## STV Mass Sensitivity - Reboost Logistics

### Yearly Reboost Propellant Use (Lb Hydrazine)

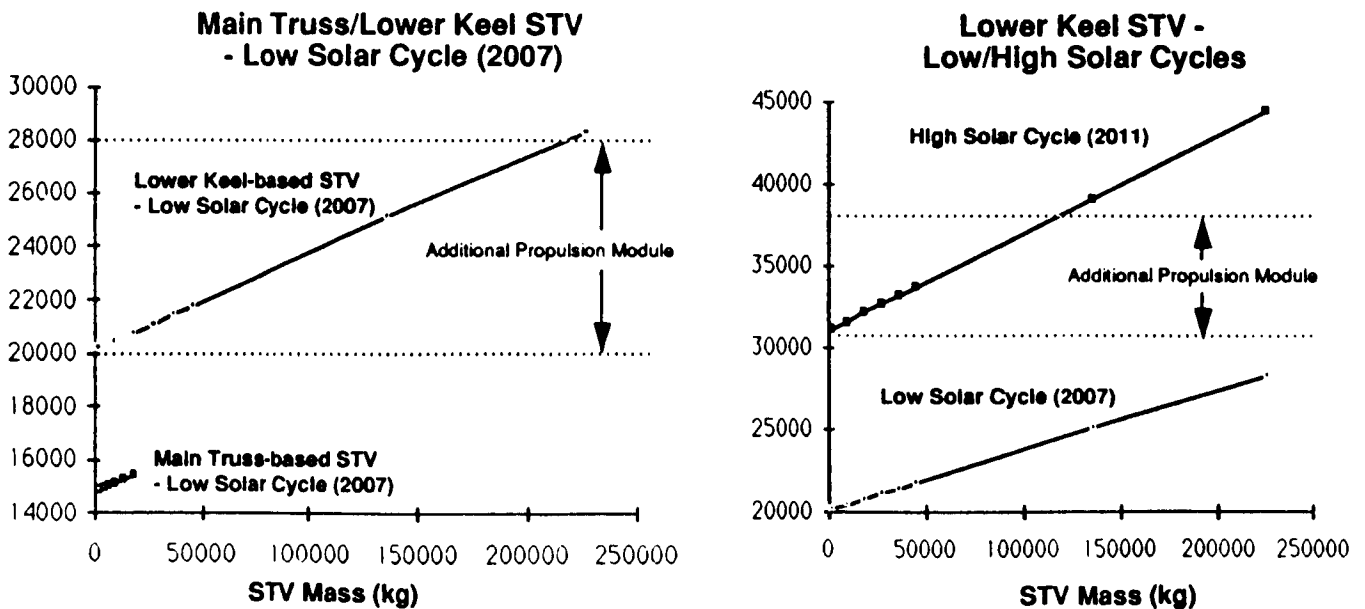

**Increases in STV Mass have Moderate Impact on  
SSF Reboost Propellant Logistics**

## STV Size Sensitivity - Reboost and Microgravity

As the size of the STV enclosure increases, there are also impacts to Space Station reboost logistics planning and the Station microgravity environment. As the frontal area of the enclosure grows, the drag coefficient increases, and extra propellant must be provided to the Space Station for altitude maintenance. The Space Station Freedom reboost propulsion system is based on a monopropellant hydrazine system that is resupplied by propellant modules which contain 8000 lb each. Four of these pallets per year are planned for delivery to the Station. As can be seen on the left hand chart, even when the enclosure reaches its maximum size of 35x35 m, less than one additional propellant module would be needed in a high solar cycle year. This is when reboost requirements are at a maximum due to atmospheric expansion.

As the enclosure size grows, added drag and mass cause the Station center of gravity (and microgravity ellipses) to move lower relative to the experiment module section. This movement, less than three meters from minimum to maximum enclosure size, can be considered of a minimum impact.

## STV Size Sensitivity - Reboost and Microgravity

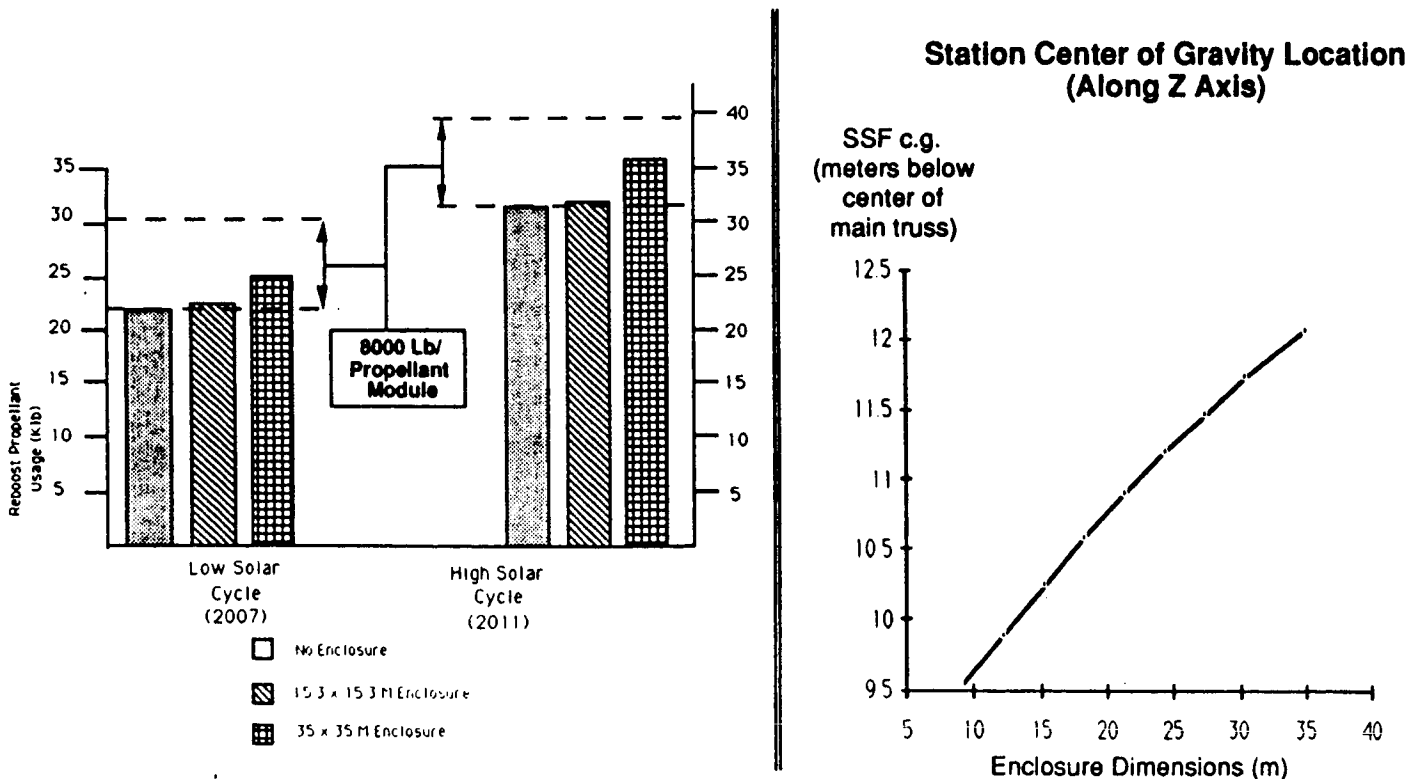

**Minimal SSF impacts with growth in STV and enclosure size**

Space Station Freedom

McDonnell Douglas Space Systems Company

## **STV Size Sensitivity Analysis - Issues**

The primary STV size growth issues which still require analysis include trading off between allowing the Z dimension growth to its maximum while moving the C.G. of the STV system back along the Station's X axis. This cantilever effect has implications to Station flight dynamics and control which cannot be predicted at this time.

A second issue involves the impacts of STS approach operations on STV size growth. There will be an uncertainty in STS position as it moves along its approach path which may lower the Z dimension growth limit below 26.6 meters. Additionally, there is a safety requirement for STS rendezvous which requires that all potential impact points be visible to the STS crew. Any size STV enclosure will violate this requirement, so operational procedures will have to be addressed. The STS RCS firing sequence for Space Station approach is being planned to avoid RCS plume impingement upon Station pressurized elements, radiators and photovoltaic arrays. This sequence may have unforeseen effects due to plume impingement, and resulting overpressure, on the STV enclosure walls. This will undoubtedly be dependent on STV enclosure size. Finally, contingency departure paths for a shuttle whose Station docking maneuver has been aborted have not been determined, but will be restricted by enclosure size growth.

Two final issues involve Space Station payload operations. Downward viewing payloads on the horizontal truss will have their field of view blocked by the presence of the enclosure. Relocating them to the truss structure below the STV enclosure is one solution, but many operational issues still remain. A payload element to be supplied by the European Space Station partners is a man-tended free flyer which will be serviced at the Station on a regular basis to be determined. Its approach path, and its docking point have yet to be determined, but lower node locations are the preferred option for this operation, and this may impact Z dimension growth limits.

## **STV Size Sensitivity Analysis - Issues**

---

- **X vs. Z Growth Tradeoff and Mass Cantilever Effects**
  
- **Space Shuttle Approach Paths**
  - **Impact on Z Dimension Growth Limit**
  - **STS Docking Viewing Angle Requirement**
  - **Plume Impingement and Overpressure on Enclosure**
  - **STS Abort Waveoff Paths**
  
- **Downward Looking Payload Viewing**
  
- **Man Tended Free Flyer (MTFF) Interference**

## **STV Assembly Sensitivity Analysis - Issues**

Although a number of SSF mechanical systems can be adapted for use in the STV program, there are still several mechanical systems required for the LEO servicing facility that will be unique to the STV program. These include an STV core stage handling fixture, engine removal support hardware, STV stack deployment device, and enclosure opening and closing mechanism. These devices will have to be defined more clearly so that their functions and operational complexity may be better determined.

With regards to current SSF mechanical devices that can be adapted to the STV program such as the space station remote manipulator system (SSRMS), the STS docking adapter, and the SSF capture latches, more analysis will have to be performed to determine the degree to which these satisfy the STV mission without modification, and what modifications would have to be made to completely satisfy STV operations.

For the SSRMS there is the issue of whether a dedicated unit is required for STV assembly and operations, or whether the SSF baselined unit can satisfy both STV assembly and SSF housekeeping and payload requirements and timelines. Also there is the potential impact of dynamic loads on the SSRMS due to propellant sloshing in the propellant tanks and how the SSRMS will translate into and out of the LEO servicing facility enclosure.

Other potential STV impacts on current SSF mechanical devices include if the STS docking adapter needs to be upgraded for STV operations. Coincidentally, if the STV wants to take advantage of a STS docking adapter, this feature would have to be built into the STV design. Finally, if SSF capture latches are to be used, the ETO trunnions would have to be compatible.

## **STV Assembly Sensitivity Analysis - Issues**

---

- **New STV Dedicated Mechanical Devices**
  - **Core Stage Handling Fixture**
  - **Engine Removal Support Hardware**
  - **STV Stack Deployment Device**
  - **Enclosure Opening and Closing Mechanisms**
  
- **Space Station Remote Manipulator System (SSRMS)**
  - **Need for Dedicated Unit**
  - **Impact of Dynamic Propellant Loads**
  
- **Use of Upgraded Unpressurized STS Docking Adapter for STV**
  
- **Compatibility of STV Component ETO Trunnions With SSF Latches**

## **STV Sensitivity Analyses - Conclusions**

The requirement to support STV assembly and servicing operations at Space Station Freedom causes many impacts to Space Station Freedom Systems. In addition to augmentation of the Integrated Truss Structure and its Utility Distribution System, an enclosure with STV servicing equipment will be provided. Additional power must be supplied to perform these servicing operations, and to operate STV systems during checkout. Additional thermal control will have to be provided for this extra power, and as is seen earlier, the provision for this growth still has to be incorporated into the Space Station design. The majority of servicing operations, such as aerobrake assembly, STV component connection and propellant tank handling will be growth impacts on the Assembly Complete Space Station.

However, once the impacts are incorporated into the Station, the growth systems show little sensitivity to variations in the STV systems. Station flight control attitude remains within baseline requirements. The original Station microgravity requirement of 10  $\mu\text{g}$  is satisfied for all foreseen STV masses, while the new 1  $\mu\text{g}$  requirement is never satisfied with a lower keel enclosure. Thus there is no benefit of STV mass targets. Size growth can be accommodated for all projected STV configurations, and altitude rebost logistics has only minor changes with STV size growth. The current array of Station mechanical devices will be usable for STV components, especially the Mobile Servicing Center, which is the key to Space Station operational flexibility. Finally, additional power must be provided to service the STV, but all foreseen power levels can be incorporated by adding photovoltaic or solar dynamic arrays.

## **STV Sensitivity Analyses - Conclusions**

---

- **Major Space Station Freedom Impacts to Accomodate STV**
  - **Added Truss Structure**
  - **Add Enclosure**
  - **Additional Power and Thermal Control**
  - **Servicing Operations**
  
- **Space Station Systems Not Sensitive to STV Variations**
  - **Station Control and Microgravity Environment**
  - **STV Size Accomodations**
  - **Assembly and Servicing Operations**
  - **Power and Thermal Control Systems**

## On-Orbit Operations During LTS Mission\*

---

- LTS Component Unloading & Inspection
- Storage of LTS Components
- LTS Assembly
- Pre-Flight Checkout
- Flight Certification Inspection
- Crew Transfer
- **OMV Mate/Transport/Unmate**
- Launch From LEO
- Rectify In-Flight Malfunction  
(Could Occur Anytime During Mission)
- Verify Clean Tank Separation
- LTV Rendezvous & Dock With LEV
- Perform Fluids Transfer, LTV to LEV
- Perform Cargo Transfer, LTV to LEV
- Perform LEV Checkout

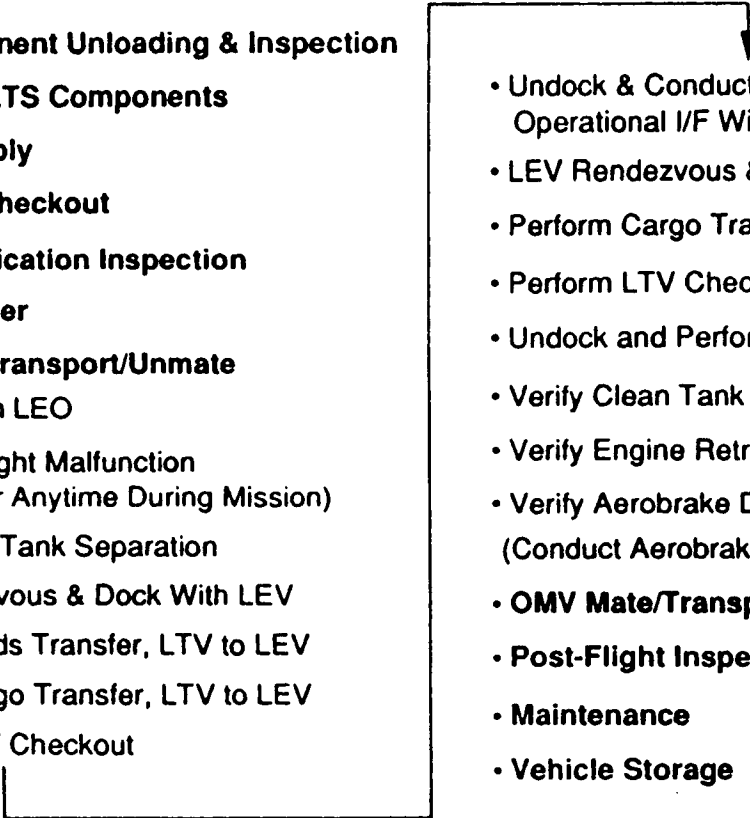
- 
- Undock & Conduct Lunar Mission (Includes Operational I/F With Surface Systems)
  - LEV Rendezvous & Dock With LTV
  - Perform Cargo Transfer, LEV to LTV
  - Perform LTV Checkout
  - Undock and Perform TEI Burn
  - Verify Clean Tank Separation
  - Verify Engine Retraction
  - Verify Aerobrake Door Closure  
(Conduct Aerobrake Maneuver to LEO)
  - **OMV Mate/Transport/Unmate**
  - **Post-Flight Inspection & Checkout**
  - **Maintenance**
  - **Vehicle Storage**

\*Operations Listed Represent Potential EVAs.  
Operations Shown In Bold Type Occur in LEO.

**MARTIN MARIETTA**

## Early Space Station Support to STV

During the early stages of the STV program, the space station facilities and personnel could be used effectively to prove out, demonstrate, and develop concepts to be utilized on the STV in the near future. Inspection procedures, diagnostic checkout, limited remove and replace functions, utilization of the RMS, demonstration of aerobrake reusability, and EVA/IVA timelines could all be evaluated and analyzed. Additionally, procedures, tools and techniques could be developed and evaluated and demonstrations performed of propellant transfer and storage, adequacy of meteoroid and debris shielding, traffic control, communications, and STV utilization.

## **Early Space Station Support to STV**

---

- **Large Cargo Vehicle Delivery to LEO**
  - **STV Berthing Port**
  - **MRMS Utilization**
  
- **STS Launch Vehicle Delivery to LEO; or Delivery By Other Launch Vehicles**
  - **STV Berthing Port, MRMS**
  - **STV/Payload Integration Area**
  - **Storage for Multiple Payload Adapter**
  - **Limited Propellant Storage & Transfer Capability**
  - **Diagnostics, Communications, Power**
  
- **Support Technology Growth and Development**
  - **STV Berthing Port, MRMS**
  - **Rudimentary Payload Storage & Checkout Area (Enclosed)**
  - **Elementary RMS for STV Servicing**
  - **Demonstrate Propellant Storage & Transfer Capability**
  - **Diagnostics, Communications, Power**

**MARTIN MARIETTA**



## Key STV Technology Areas

Key technologies were identified which require development for eight major STV systems. Six of the enabling technology areas are common to the eight systems and are shown in the center of the figure. All eight systems require enabling technologies that affect performance, however, technologies affecting performance are generally different for each system. Five of the STV systems also have enabling technologies which affect materials and structure, while all eight have two or more technology areas that are unique to that particular system and are listed under the individual technology heading.

## Key STV Technology Areas

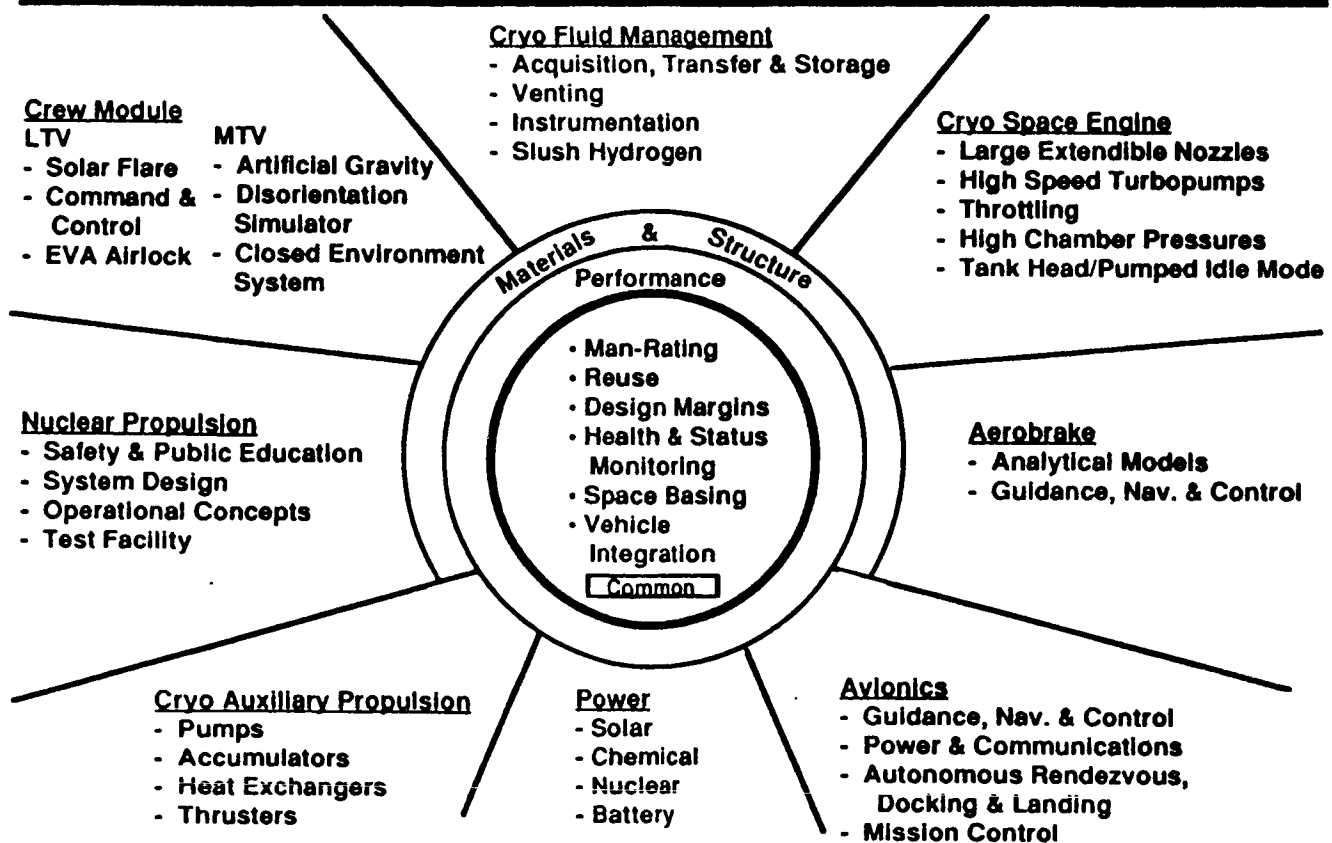

**MARTIN MARIETTA**

## STV Fluid Management Technologies

An evaluation has been made of the fluid management technologies required for a complete STV mission. The mission that was used for reference is concept 4E-2B which is similar to the 90 Day Study baseline. While some of the other architectural concepts may reduce this listing somewhat, this listing is believed to be more representative of those technologies that will cover almost all of the concepts that may be selected. The technologies are divided into groups which support each mission phase, with some duplication occurring where a single technology (such as propellant settling) spans multiple phases.

## STV Fluid Management Technologies

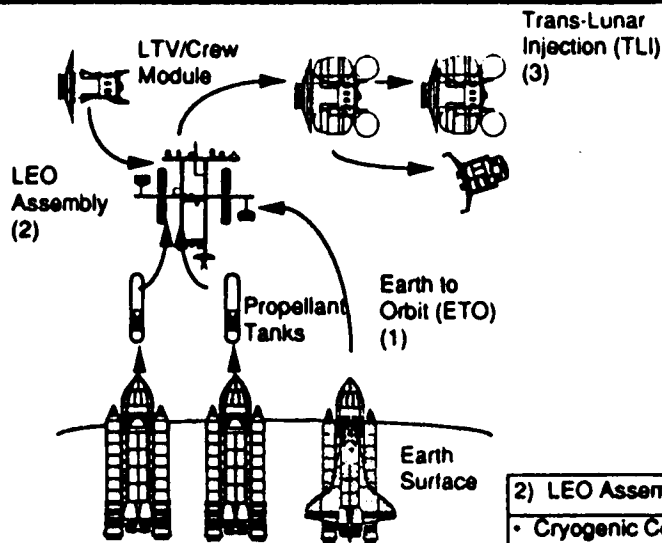

- | 1) ETO Phase (Launch/Ground Operations) |                       |
|---|-----------------------|
| - Automated Prop Loading with AI        | - Lgtwgt Insul Cncpts |
| - Lgtwgt Cryo Tanks                     | • SOFI/MLI Combo      |

- | 2) LEO Assembly                               |                           |
|---|---------------------------|
| • Cryogenic Couplers                          | - Transfer Pump           |
| • Pressure Control (Drop Tanks)               | - He Pressurization       |
| - Mixer Pump                                  | - Transfer Techniques     |
| - TVS/VCS                                     | - "No-Vent" Fill          |
| - Thk MLI Blkts (Lnch Degrad)                 | - LAD for Transfer        |
| - Refrigeration                               | - Vented Fill             |
| • Cryo Transfer-Drop Tanks To Refill LTV Core | - Drag Impacts            |
| - Automated Prop Loading                      | - Prop Venting of Boiloff |
| - Tank Chilldown                              | - Settling via RCS        |
| - Transfer Line Chilldown                     |                           |

- | 3) TLI Phase                |  |
|-----------------------------|--|
| • Engine Feed               |  |
| - Start Basket              |  |
| - Settling                  |  |
| - RCS                       |  |
| - THI Mode                  |  |
| - Slosh Suppression         |  |
| • Tank Press. for Eng Start |  |
| - Helium                    |  |
| - Pumped Idle Mode          |  |
| • Self-Sealing QDs          |  |
| • Line Purging              |  |

**MARTIN MARIETTA**

## STV Technology - Cryo Fluid Management Schedule - 2

The Cryo Fluid Management technologies that are considered essential for the development of STVs are summarized in this schedule. The SEI Option 5 program milestones are defined at the top of the schedule. Individual technologies include cryogenic storage, boiloff venting, health & status monitoring, instrumentation, electromechanical vent valve and hydrogen slush technologies. All are considered low risk technologies since all except health & status monitoring are predicted to reach level 7 maturity prior to the STV program CDR based on currently planned NASA development. Although cryo fluid management health & status monitoring technology is expected to reach a level 6 maturity prior to the STV CDR, it is considered a critical technology because of the long component and subsystem level development time and criticality to the overall STV vehicle.

## STV Fluid Management Technologies

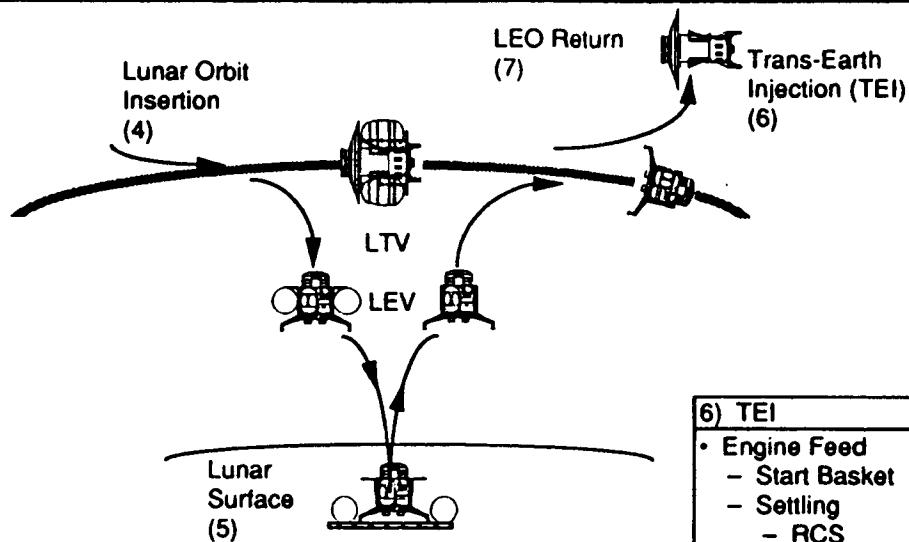

- |   |
|---|
| <b>Broad Base Rqmts</b>   |
| <ul style="list-style-type: none"> <li>• Instrumentation</li> <li>• Health Monitoring                             <ul style="list-style-type: none"> <li>- Automated Control</li> </ul> </li> </ul> |

- |   |
|---|
| <b>7) LEO Return</b>  |
| <ul style="list-style-type: none"> <li>• Propellant Residual Handling</li> <li>• Tank Safing</li> <li>• Onorbit CFM H/W Checkout/Maint</li> </ul> |

- |  |
|--|
| <b>6) TEI</b>  |
| <ul style="list-style-type: none"> <li>• Engine Feed                             <ul style="list-style-type: none"> <li>- Start Basket</li> <li>- Settling</li> <li>- RCS</li> <li>- THI Mode</li> <li>- Slosh Supp</li> </ul> </li> <li>• Tank Press. for Eng Start                             <ul style="list-style-type: none"> <li>- Helium</li> <li>- Pumped Idle Mode</li> </ul> </li> <li>• Self-Sealing QDs (Drop Tanks)</li> <li>• Line Purging</li> </ul> |

- |  |
|--|
| <b>4) Lunar Orbit Activities</b>   |
| <ul style="list-style-type: none"> <li>• Cryo Transfer—LTV Drop Tanks To Refill LEV                             <ul style="list-style-type: none"> <li>- Automated Propellant Loading</li> <li>- Tank Chilldown</li> <li>- Transfer Line Chilldown</li> <li>- Transfer Pump</li> <li>- Transfer Techniques                                     <ul style="list-style-type: none"> <li>- No-Vent Fill</li> <li>- Vented Fill   <ul style="list-style-type: none"> <li>- Prop Venting of Boiloff</li> <li>- Settling via RCS</li> <li>- Spinup</li> </ul> </li> </ul> </li> </ul> </li> <li>• Resupply of Crew Consumables                             <ul style="list-style-type: none"> <li>- LN2/LO2</li> <li>- Water, etc</li> </ul> </li> <li>• Engine Feed                             <ul style="list-style-type: none"> <li>- Start Basket</li> <li>- Settling via RCS</li> <li>- THI Mode</li> </ul> </li> <li>• Tank Press. for Engine Start                             <ul style="list-style-type: none"> <li>- Helium</li> <li>- Pumped Idle Mode</li> <li>- Slosh Suppression</li> </ul> </li> <li>• Self-Sealing QDs</li> <li>• Line Purging</li> </ul> |

- |  |
|--|
| <b>5) Lunar Surface</b>  |
| <ul style="list-style-type: none"> <li>• Pressure Control—LEV Tanks                             <ul style="list-style-type: none"> <li>- Refrigeration</li> <li>- TVS/VCS</li> <li>- Thick MLI Blankets</li> </ul> </li> </ul> |

**MARTIN MARIETTA**

# **Space Basing - Conclusions**

---

## **Space Based Operations Benefits:**

- **Key to Expanded Space Exploration**
- **Cuts ETO Launch Costs**
- **Minimize Ground Weather / Schedule Impacts**
- **Efficient Use of Reusable Space Elements**
- **Extends Levels of Crew Proficiency**
- **Oversize Payload Erection / Assembly**
- **Positive Control for Structural Mating**
- **Cargo Mission Launch on Time / Launch on Demand**
- **Contingency Mission Standby**
- **Space Operations / Scientific Evaluation**
- **Mission Control Alternatives**

**MARTIN MARIETTA**