



Government  
Systems

37975



P.41

# Interim Service ISDN Satellite (ISIS) Newtork Model

for  
Advanced Satellite Designs and  
Experiments

13 September 1991

(NASA-CR-186565) INTERIM SERVICE ISDN  
SATELLITE (ISIS) NETWORK MODEL FOR ADVANCED  
SATELLITE DESIGNS AND EXPERIMENTS Report, 25  
Sep. 1990 - 15 Sep. 1991 (Contel Federal  
systems) 41 p

N91-31488

Unclas  
CSCL 17B G3 /32 0037975

Task Completion Report  
NASA SCAR Contract NASW-4520, 13 Sep 1990

Prepared by  
GTE/Government Systems  
Federal Systems Division  
15000 Conference Center Drive  
Chantilly, Virginia 22021-3808

# SECTION 1

## INTRODUCTION

### 1.1 Background

The objectives of this element of the NASA Satellite Communications Applications Research (SCAR) Program are to develop new advanced on-board satellite capabilities that will enable the provision of new services, namely interim and full Integrated Services Digital Network (ISDN) services via satellite and to provide a system analysis of futuristic satellite communications concepts, namely broadband services via satellite.

This aspect of the NASA SCAR Program provides a research and development effort to:

- 1) develop basic technologies and concepts to use the on-board processing and switching capabilities of advanced satellites that will enable the provision of interim and full ISDN services and
- 2) provide a systems and requirements analysis of future satellite communications concepts based on a new generation of broadband switching and processing satellites.

These objectives will be achieved in part via modeling and simulation of ISDN satellites as part of the ISDN terrestrial network. Models of the Interim Service ISDN Satellite (ISIS) and the Full Service ISDN Satellite (FSIS) will be exercised using discrete event simulation techniques.

To provide meaningful results the network model that represents the subsystems of the advanced satellite system design must provide a proper level of abstraction of the real world advanced ISDN communications satellite design parameters.

An end-to-end network view must be developed using the framework of the CCITT and ANSI standards to ensure that ISDN procedures and protocols are properly implemented to permit meaningful evaluation and analyses of ISDN communications satellite designs. Network performance measures must assess the overall network in terms of speed, capacity, accuracy, access reliability, and availability. Component performance measurements must provide insight into the engineering performance of the system. The network model must be capable of generating performance measures including propagation delay, signal degradation, message queue lengths, network node switching delay and raw throughput.

### 1.2 Scope

This task completion report documents the network model associated with the ISIS design. The process and methodology is applicable to the ISIS and the FSIS systems as described in Figure 1.1-1, "NASA/SCAR Approaches for Advanced ISDN Satellites". The ISIS Network Model design represents satellite systems like the Advanced Communications Technology Satellite (ACTS) orbiting switch.

ACTS will be controlled by a Master Ground Station (MGS) shown in Figure 1.2-1, "Closed User-Oriented Scenario". A user of the ACTS satellite orbiting switch requests services from the MGS, a combination of the NASA Ground Station (NGS) and the Master

**ISIS**  
Interim Service  
ISDN Satellite

- ACTS-like Satellite Design and Transponder
- Provide Narrowband ISDN Services (Basic Rate Access)
- Provide remote access ISDN Satellite Terminals using ISDN Satellite Terminal Adapter
- Will use D channel signaling but NOT SS7
- Will use ACTS call control and Baseband Switching Architecture

**FSIS**  
Full Service  
ISDN Satellite

- New ISDN Satellite Design with onboard Class 5 Switch and SS7 Network Interface
- Provide Narrowband ISDN Services (Basic/Primary Rate Access)
- Provide nationwide single hop single CONUS earth coverage antenna satellite link connectivity to an interexchange node for ISDN Satellite Terminals (up to 10,000 ISAT)
- Will use D channel signaling with SS7
- Will use SS7 call control with minimum call set-up time and efficient satellite BW utilization

**BSIS**  
Broadband Service  
ISDN Satellite

- Advanced ISDN Satellite Design with onboard Class 5 Switch and SS7 Network Interface and layered protocol
- Provide Broadband ISDN Services (Primary Rate Access)
- Provide nationwide single hop, multiple high gain hopping beams, forward error control, optical processing, and "zero delay" satellite link interexchange node connectivity
- Will use D channel signaling with SS7
- Will center design around ATM fast packet switching techniques

Figure 1.1-1 NASA/SCAR Approaches for Advanced ISDN Satellites



Government  
Systems

NASA - SCAR

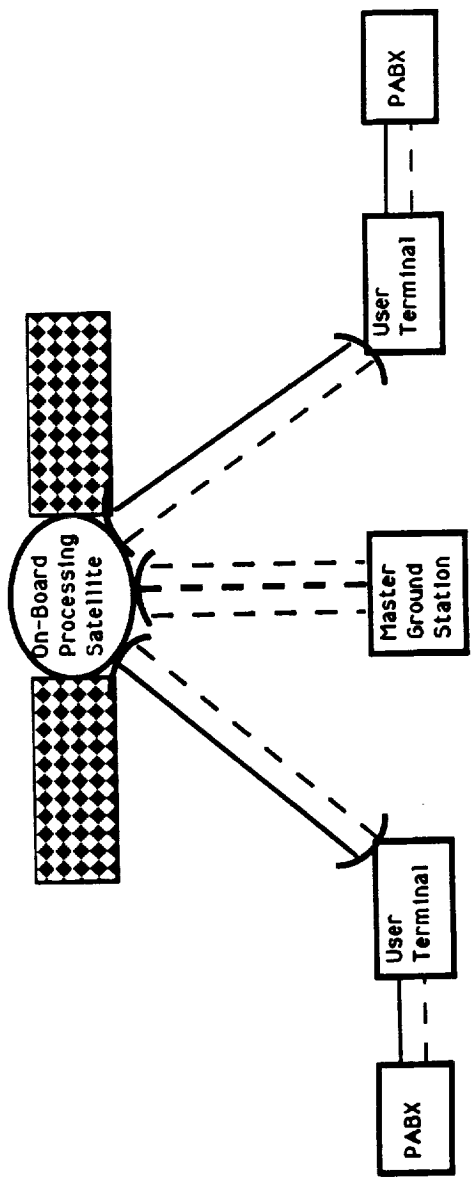

Figure 1.2-1 Closed User-Oriented Scenario

Ref: Fournon 131SS

Control Station (MCS). The MGS, in turn, commands the satellite to switch the appropriate communication channel.

The ultimate aim of this element of the SCAR Program is to move these MGS functions on-board the next generation ISDN communications satellite as shown in Figure 1.2-2, "Advanced ISDN Satellite". The technical and operational parameters for the advanced ISDN communications satellite design will be obtained from an engineering software model of the major subsystems of the ISDN communications satellite architecture. Discrete event simulation experiments will be performed with the model using various traffic scenarios, design parameters, and operational procedures. The data from these simulations will be analyzed using the NASA SCAR performance measures discussed in previous reports.

### **1.3 Document Overview**

This task completion report begins by describing the use of modeling and simulation techniques to determine the design parameters for the SCAR advanced ISDN communications satellite design. An overview of the modeling and simulation tasks includes a brief description of the four software programs of that effort.

Particular attention is given to the ISIS network modeling. The two main sections of this task report are Network Modeling and ISIS Network Model. The Network Modeling Section describes the modeling process which is based on discrete event simulation techniques. A brief description of the traffic model database is followed by a description of the scenario generation process that provides Scenario Traffic Files (STFs) for the simulation. The ISIS Network Model Section develops the concepts, definitions and purposes of the Advanced Communications Technology Satellite (ACTS)-like network model. A summary of the task completion report is provided.



Government  
Systems

NASA - SCAR

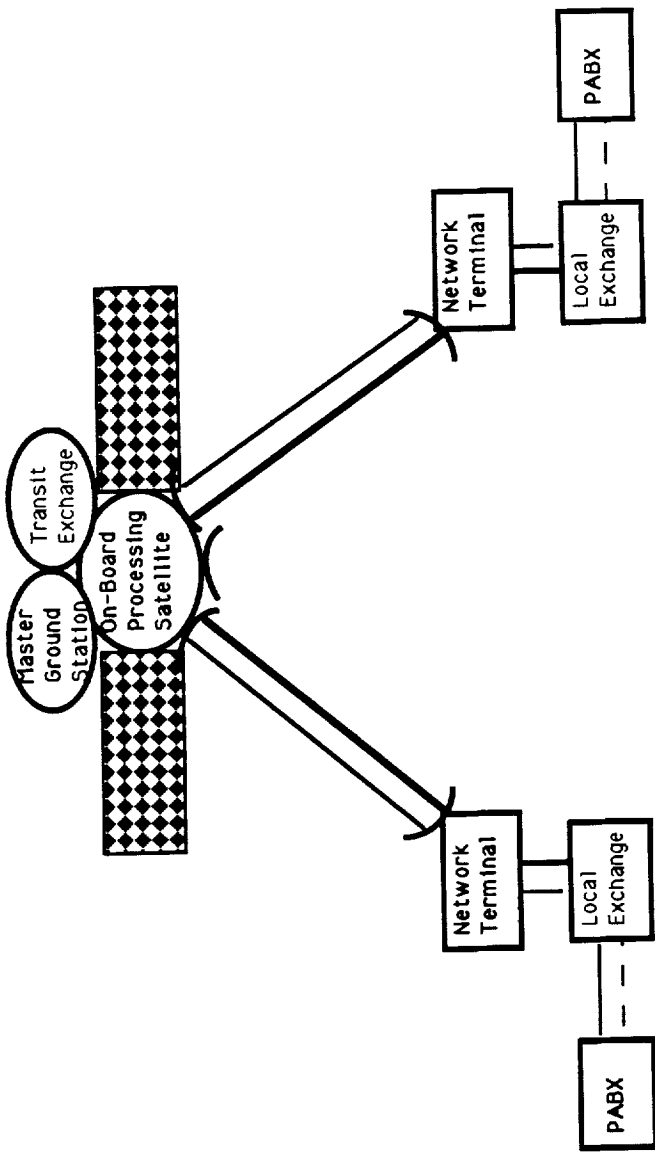

Figure 1.2-2 Advanced ISDN Satellite

## SECTION 2

### MODELING AND SIMULATION

#### 2.1 Modeling and Simulation Objective

The objective of this modeling and simulation project is to design and develop software models that can be used to simulate those aspects of the ISDN communications satellite with sufficient fidelity to assist in its design. This end-to-end simulation will include sufficient functionality to demonstrate the interactions between each of the four modeling and simulation phases: database generation, scenario generation, simulation run, and product generation. A description of each of these software programs is abbreviated in order to focus on the ISIS Network Model itself.

#### 2.2 Major Modeling and Simulation Programs

The ISDN communications satellite end-to-end simulation is shown in Figure 2.2-1, "End-to-End Model Architecture". Each program is physically and functionally separated by input/output data files. This separation ensures that each program is independent and that each project phase is separate from the others. The only link between these programs is the data file they share.

Each program is briefly described in the following sections in order to provide an overview of the modeling and simulation process as well as to provide the context for the ISIS Network Model.

##### 2.2.1 Database Generation Program

The Database Generation (DbGen) program assembles the major ISDN user characteristics into a machine readable database. For this NASA SCAR effort the traffic model consists of a number of databases: the City Reference DB, ISDN User vs Industry DB, Application vs Industry DB, Application vs Time DB, and Application vs Bearer Services DB. Figure 2.2.1-1, "CONUS City Locations for NASA SCAR Traffic Model Database", shows the cities that are part of the traffic model. Those cities outlined with an ellipse identify the ACTS-east cities. Those cities outline with a rectangle identify the "ACTS-west" cities and the blackened squares depict the fixed antenna cities. The east/west city clusters are separated by a dashed line. The figure shows that the NASA SCAR traffic model is well aligned with the cities of interest for ACTS. That traffic model database represents the ISDN traffic for these cities and is the principal input to the scenario generation process.

##### 2.2.2 Scenario Generation Program

The Scenario Generation (ScenGen) program selects the traffic model database entries that describes a scenario of ISDN users together with the statistical information of the ISDN services requested. The ScenGen program uses entries from the user traffic model database and engineering parameter databases to generates a list of time ordered, initiating discrete events. The discrete event list is call a Scenario Traffic File (STF). The STF is used to initialize the model for a specific advanced ISDN communications satellite design and to exercise that satellite design using the requests for ISDN services dictated by the ISDN user traffic.

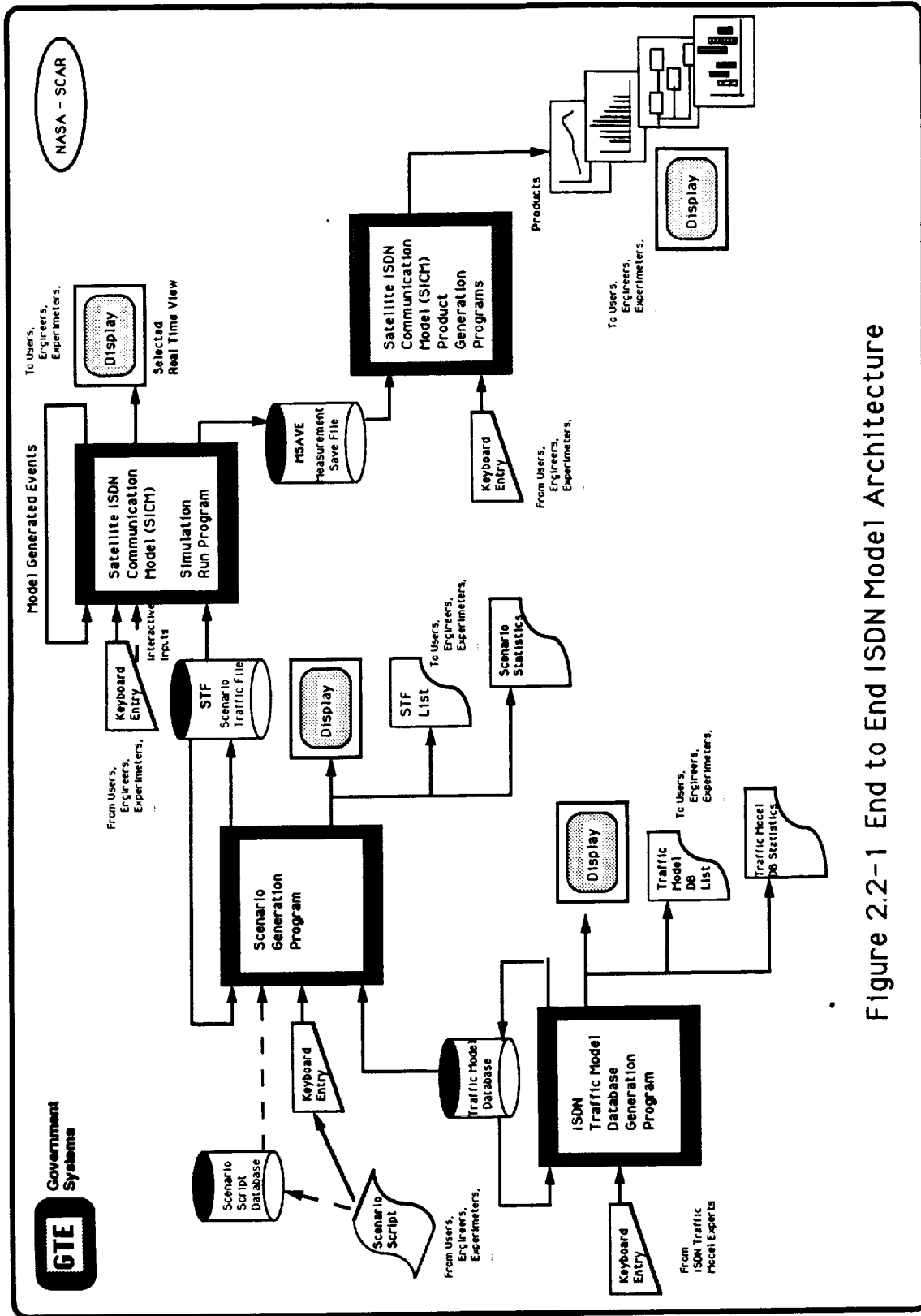

Figure 2.2-1 End to End ISDN Model Architecture





Government Systems

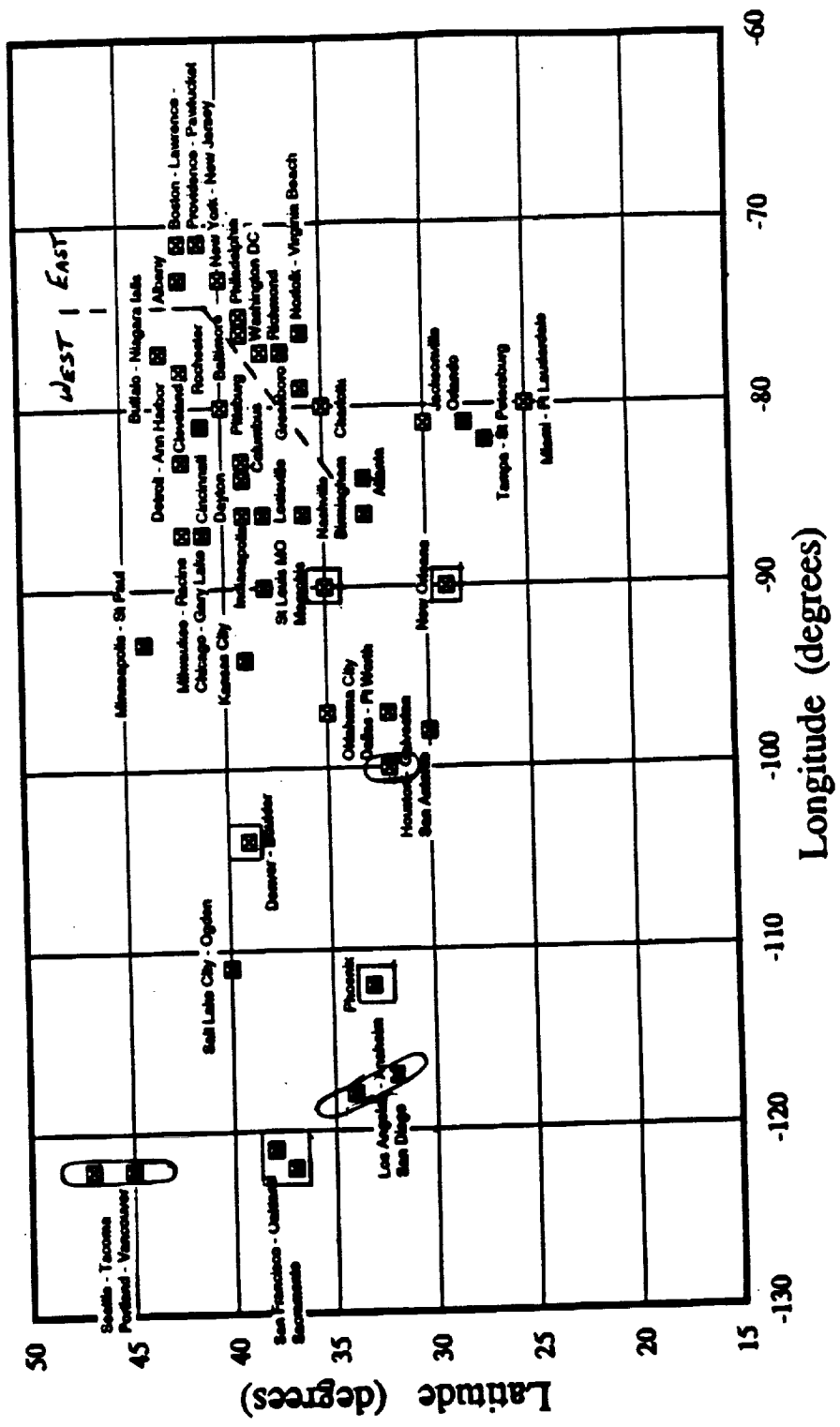
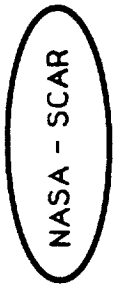

Figure 2.2.1-1 CONUS City Locations for NASA SCAR Traffic Model Database

### **2.2.3 Simulation Run Program**

The Simulation Run (SimRun) program consists of a model of the real world communications network of the major ISDN communications satellite components. Each of these ISDN communication components is represented by a block diagram within the overall architecture of the complete network. As shown in Figure 2.2.3-1, "Simulation Run Program", the SimRun program essentially reads each discrete event from the (STF), takes the appropriate action, and logs that action and the corresponding results in a measurement save (MSAVE) file. The appropriate action taken by the simulation includes allocating and releasing communication resources, denying specific services, and calling other processes in-turn. The principal topics of this task completion report are developed in Section 3.0 for the generic Network Modeling aspects associated with SimRun and Section 4.0 which addresses the specific ISIS Network Model to be used in SimRun.

### **2.2.4 Product Generation Program**

The Product Generation (ProdGen) program reads the data in the MSAVE file and analyzes these data in accordance with specific algorithms. It is envisioned that there would be as many product generation programs as there are ISDN communications satellite issues to be studied: throughput, response time, trace, delay, call blocking, busy-minute, busy-hour, etc. Each ProdGen program is tailored to a particular area of ISDN communications satellite design. Performance measures will be used as criteria to evaluate the design parameters, operational procedures and degree of ISDN communications standard compliance of the particular ISDN communications satellite design.

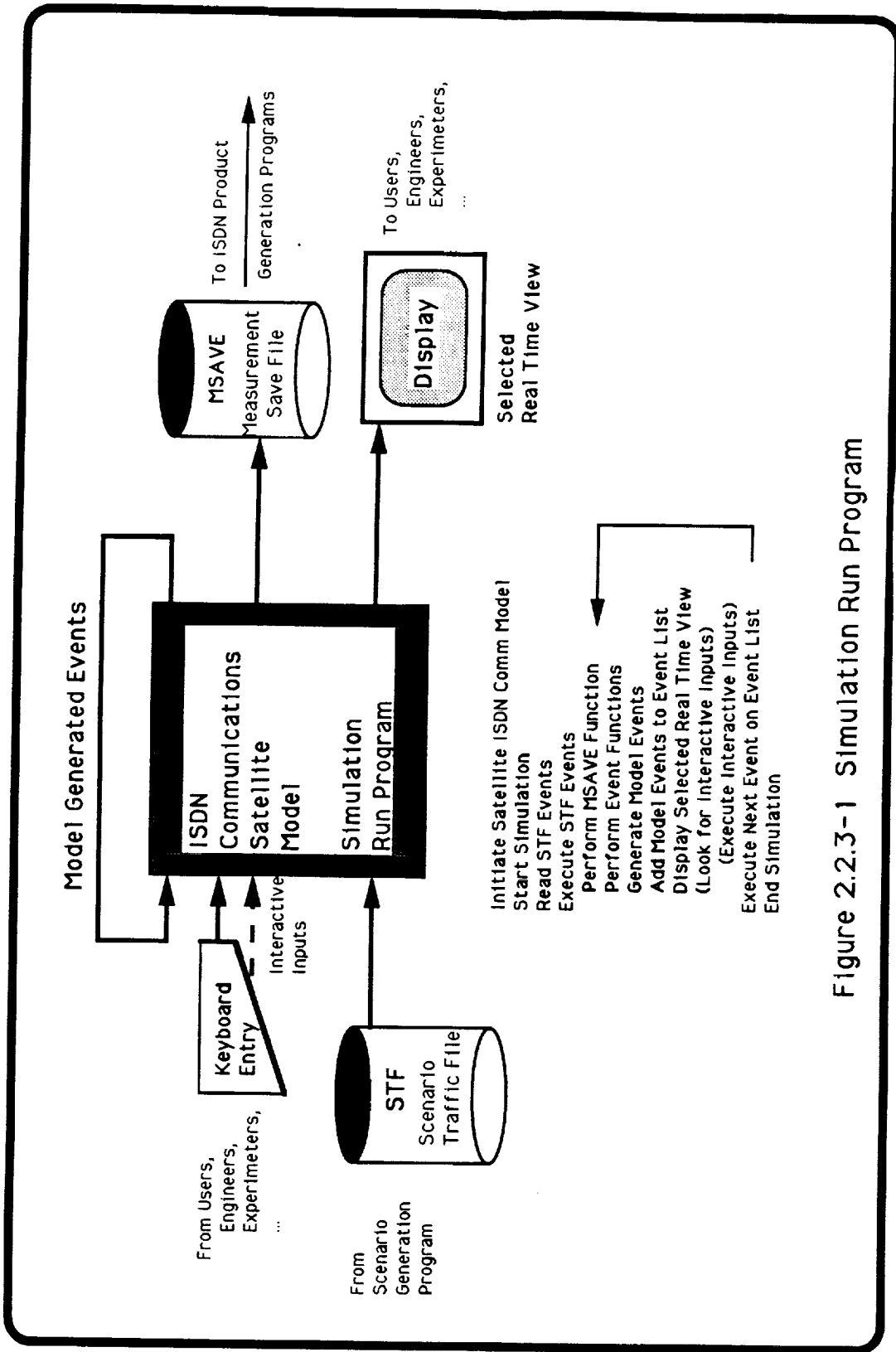

Figure 2.2.3-1 Simulation Run Program

## SECTION 3

### NETWORK MODELING

#### 3.1 Technical Concept

Experimental research must be based on sound foundations: a clear understanding of the system under study. That understanding for this NASA SCAR effort includes using network modeling and simulation of an ISDN communications satellite as the core technical concept for addressing its design.

This network modeling will clearly delineate the network architecture (as defined by the network methodology, the number and kinds of communications elements and how those elements are configured), network operations (including link and network layer protocols and how network functions are distributed among communications elements), and system constraints (imposed both by the network and by the operational requirements).

#### 3.2 Network Model and Simulator Development

A discrete event simulator for the ISIS was defined based on the Phase I network model of the ISIS communications architecture. The traffic model database and the scenarios, also developed in Phase I, were used to define ISIS Network Model simulator inputs. The simulator outputs will be defined by the performance measures established in Phase I and will be used to evaluate overall ISDN communications satellite system performance.

#### 3.3 Simulator Development

ISDN is based on the Open System Interconnection (OSI) Reference Model. Though the simulations will focus on the second (data link) and third (network) layers to evaluate the performance of routing, acknowledgement, congestion control, and other protocol driven functions, this ISIS Network Model will also address the time-out issues related to the first (physical) layer. Although physical characteristics of the system will not be simulated, the effects of the physical conditions will be included parametrically. For example, the cases involving heavy rain, severe signal degradation, and higher error rates are examined in terms of protocol performance when multiple transmissions are required. Instead of calculating a link budget where all signal losses and gains are summed and converting the signal-to-noise ratio to a bit-error rate, the simulator will take the error rate on a particular link as input. Such techniques reduce the complexity of the simulator, while providing the same level of information about link and network layer protocols.

#### 3.4 Generic Network Model

Figure 3.4-1, "Generic Network Model Block Diagram", shows the major subsystems of a communications architecture for a communications satellite with two satellite terminals each supporting three users. For this model the subsystems associated with the satellite terminals consist of an uplink transmitter and transmitting antenna, a downlink receiver and receive antenna, three users generating traffic, and a multiplexer/demultiplexer that combines and separates this traffic. The satellite is modeled by corresponding receivers, transmitters, antennas, an on-board switch, and an on-board processor that decodes received commands, controls the switch, and generates response traffic.

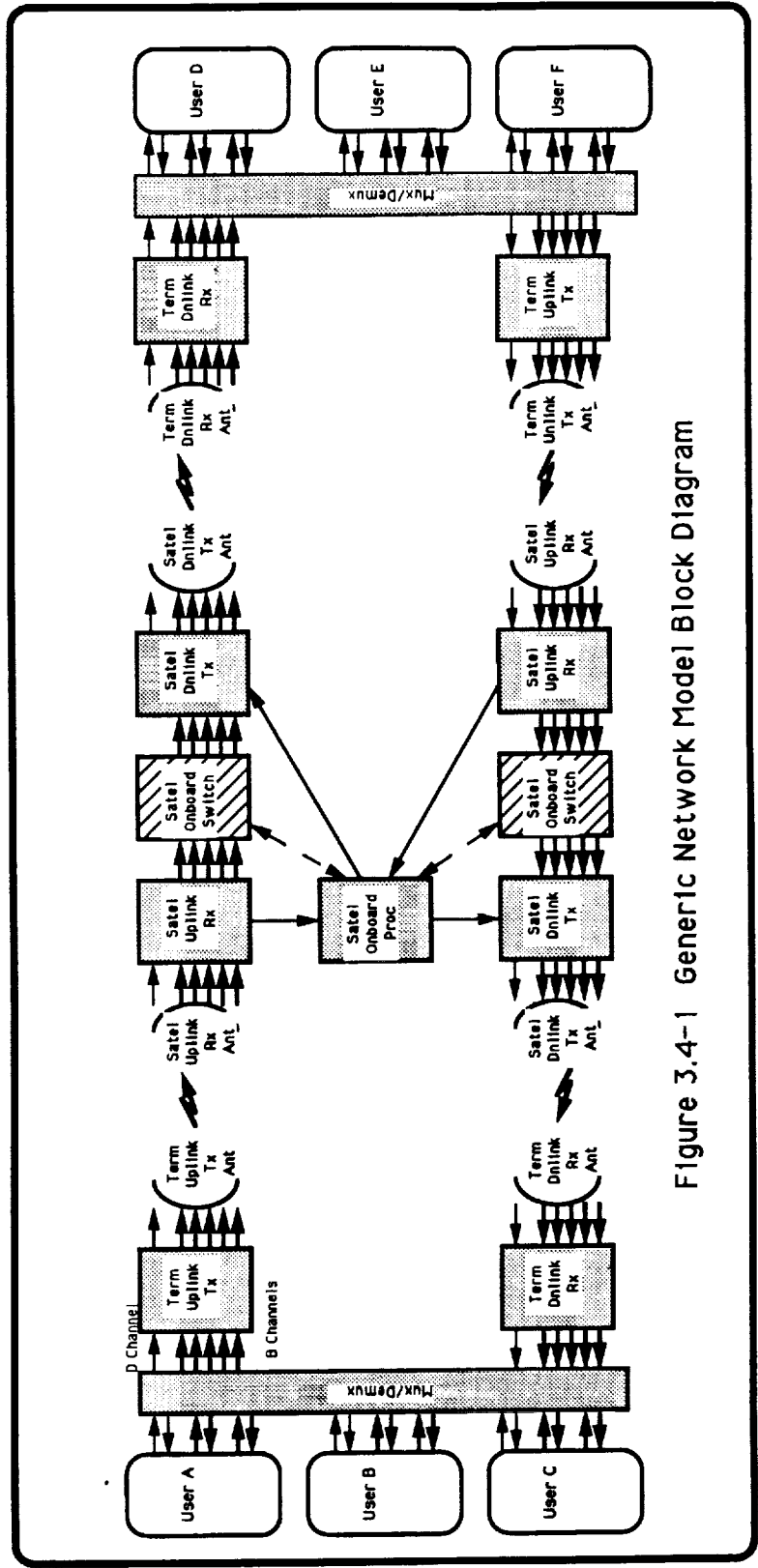

Figure 3.4-1 Generic Network Model Block Diagram

### 3.5 Generic Network Model Subsystems

Each of the communications subsystems in the network model design is represented by a software module that performs the functions of that communication component. Figure 3.5-1, "SCAR Network Model Systems", shows the generic network model presented in Figure 3.4-1 as an interconnected software module. Each module has parameter (p) input that determines that module's characteristics. For an antenna: p includes such things as the gain, beamwidth, scan rate, dwell time, etc. For a receiver: p includes frequency, burst rates, receiver threshold, receiver delay, etc. For a processor: protocol repertoire, processing time, clock frequency, number of ISDN resources, etc. In general each model module has a p-set that determines the design characteristics. These p's are input via the traffic file before the simulation run begins. They determine the design baseline for each communications subsystem.

The initial discrete events (E) are part of the STF and are executed as a function of time depending on the scenario that generated them. Each of the precipitating events (E) is destined for a particular module in the simulation. That module processes discrete events (E) and takes actions accordingly. Many of these actions include generating response events (e) for another module. The response events (e) are integrated with the initial events (E) via the (stf) to be executed at their respective times. For ISDN protocols, a single initial discrete event (E) will generate many response events (e). The simulation process continues the execution of the time ordered event list until the simulation end. The technical data generated by the simulation is obtained from a Measurement Save (MSave) file. Every time an discrete event is presented to a module its identity and its time of arrival is saved on the MSave file (M). Also, all resource allocations, resource releases, resource denials, event generations, and the status of every module is saved on the MSave file (M) together with the time of their occurrence. The MSave file has a complete time ordered history of every event, action, and status of every module for the entire simulation. That MSave file can be analyzed to generate any technical and operational product imaginable.

### 3.6 Generic Network Model Software

The simulation software inside each module determines its communication characteristics and responses. Figure 3.6-1, "SCAR Network Model Simulation Software", depicts the software flow chart for a single module - Proc. In that example, when the processor function (Proc) receives the event (Sig#27) it first reports that event and time to MSave (M).

The software then determines if the requested resources are available. At the beginning of the simulation parameter (p1) allocated a number (#1) of these resources to Proc for allocation. If none of those resources are now available, Proc sends a "No Resources Available" to the MSave. Proc then clears all Sig#27 items and Returns control to the simulation timing routine. On the other hand if resources were available, Proc would allocate and adjust those resources; report the allocation to MSave; and activate the next process in the sequence. The activation time for the next process will be calculated using the processing delay value of #2 micro-seconds for this operation obtained from a p2 assignment at the start of the simulation.

The same software will be re-used with different parametric values for similar functions such as antenna, receiver, processor, etc. This will result in the generation of less simulation code for a given software development.

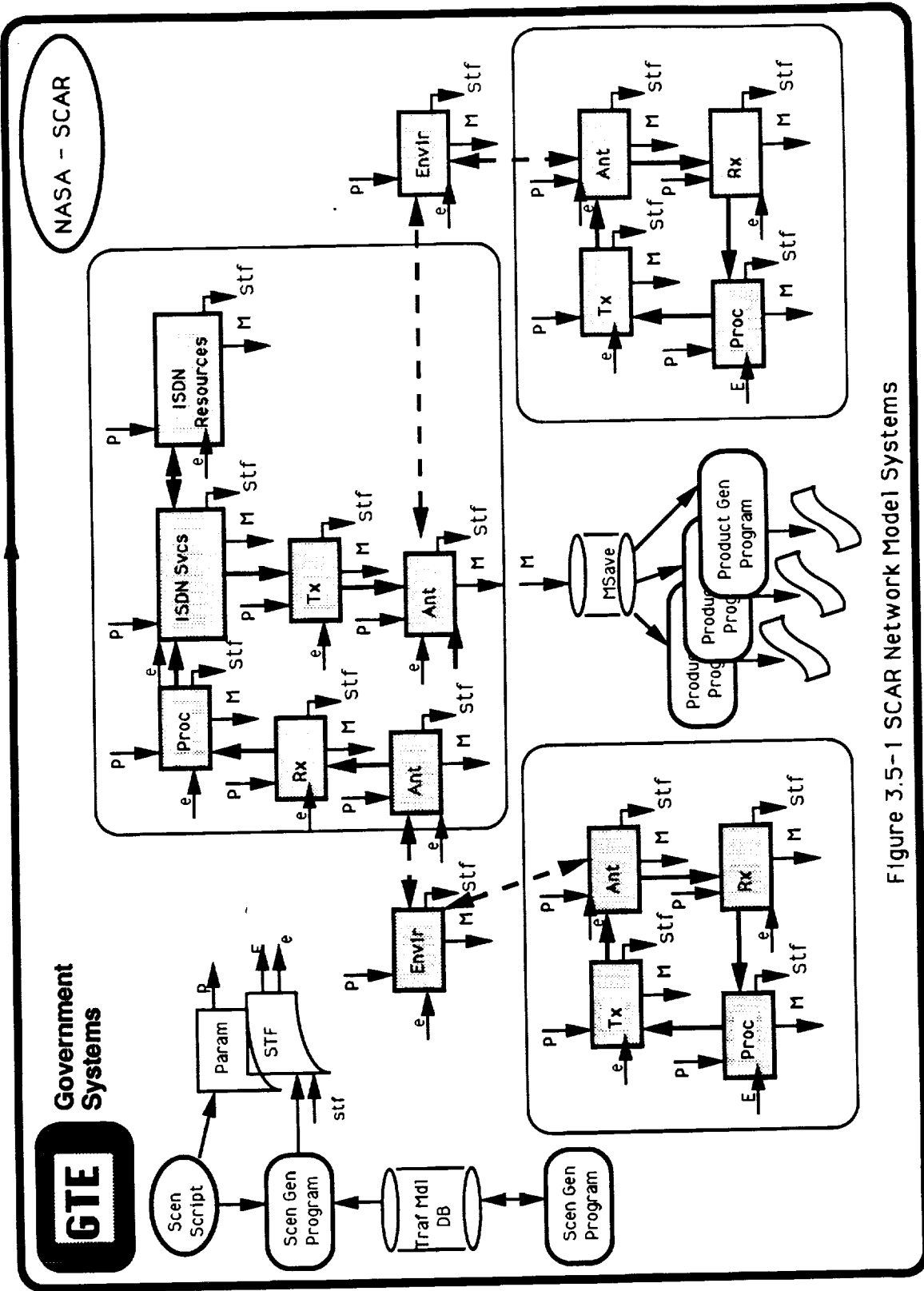

Figure 3.5-1 SCAR Network Model Systems

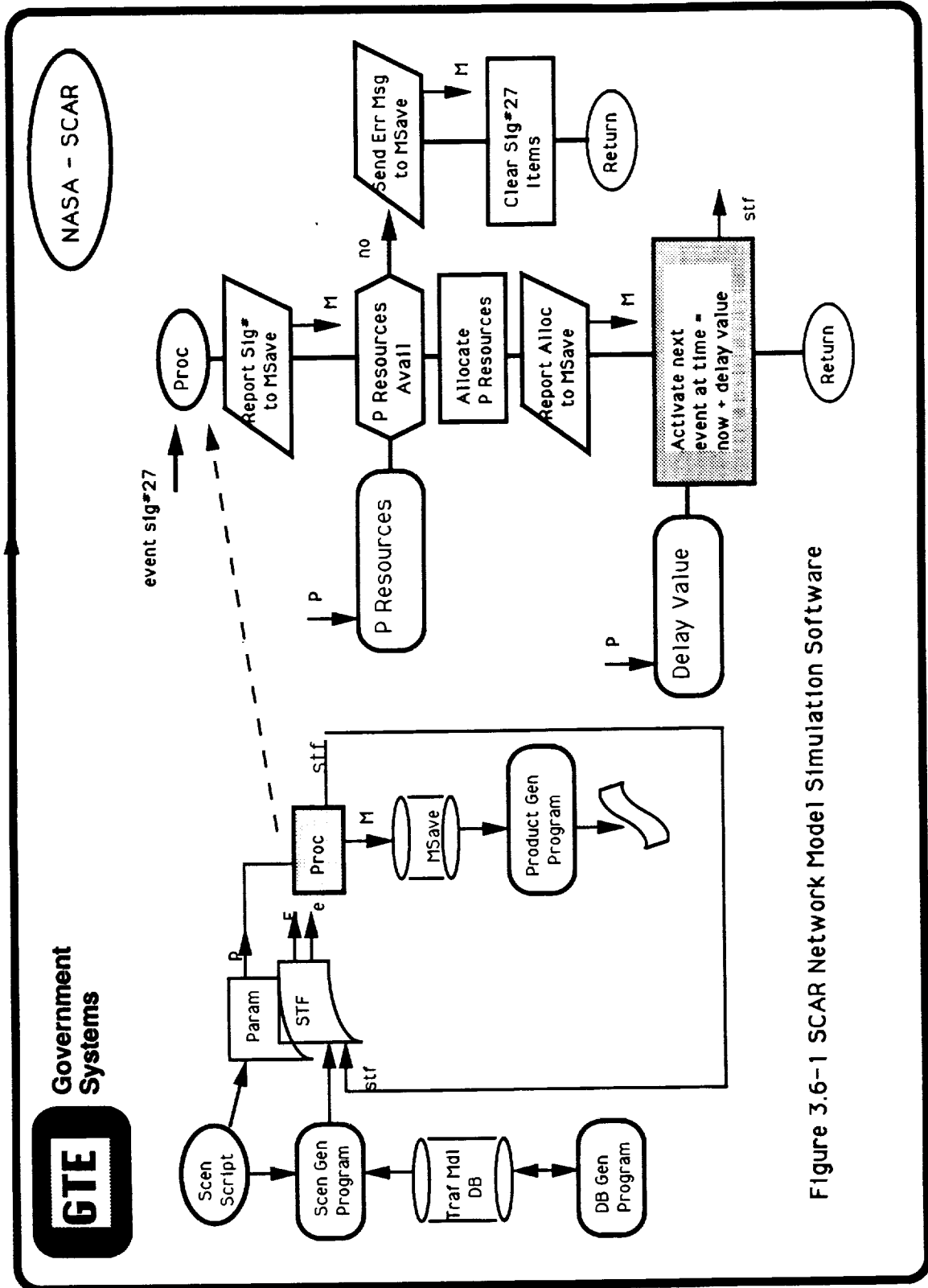

Figure 3.6-1 SCAR Network Model Simulation Software



### **3.7            ISIS Multi-Terminal SCAR Model**

The Figure 3.7-1, "ISIS Multi-Terminal SCAR Model", generically depicts ISIS as a satellite-based switch using ground control to provide communications services between terminals on the left. This same model is also capable of connecting central offices on the right. Such a model can be used as a vehicle for analyzing the protocol messages flow among all the users connected to the satellite. The next section develops a specific ISIS Network Model associated with the ACTS Program.

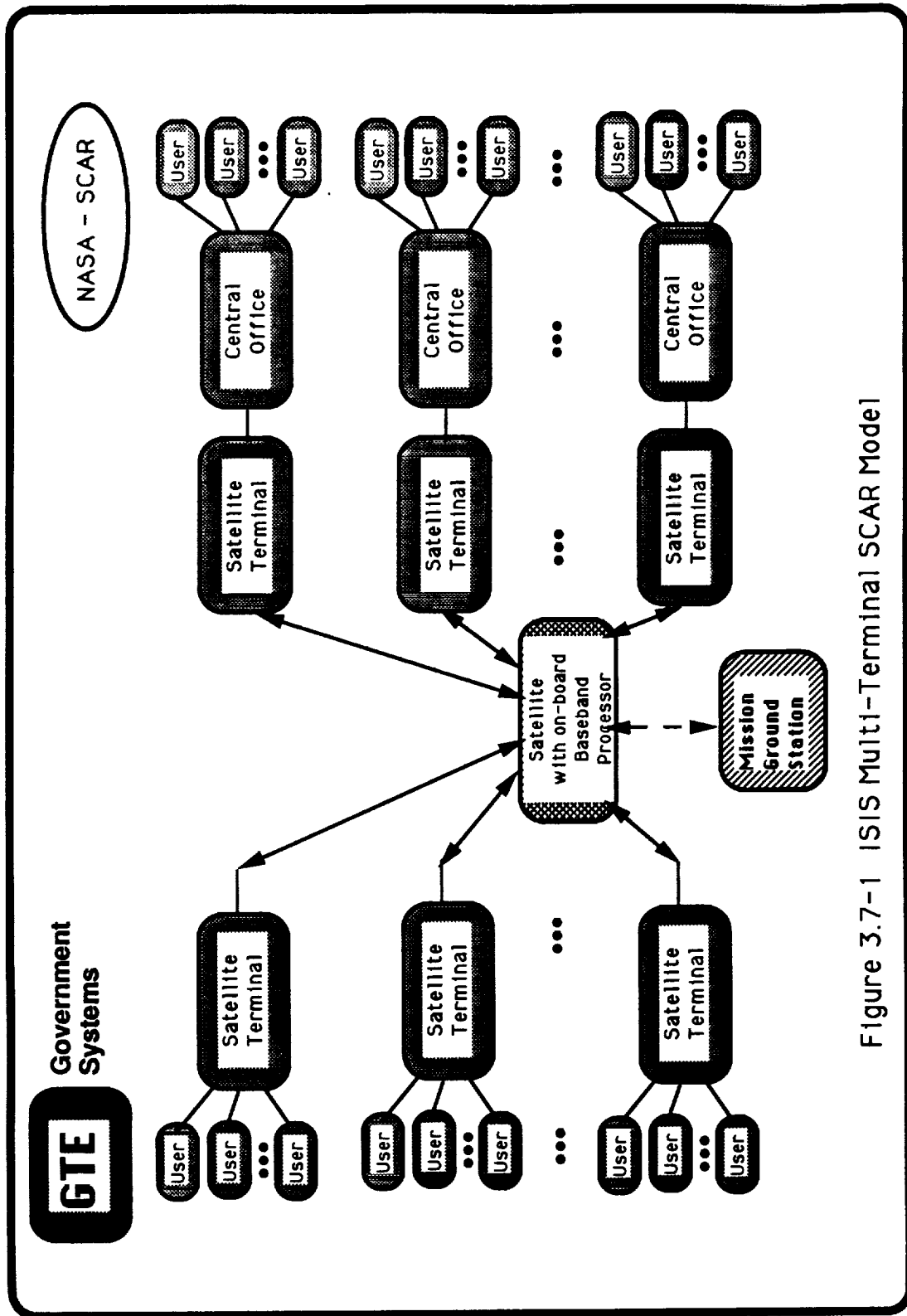

Figure 3.7-1 ISIS Multi-Terminal SCAR Model

## SECTION 4

### ISIS NETWORK MODEL

#### 4.1 Introduction

The modeling context of the previous sections are now applied to an ISIS Network Model for an ACTS-like system. This ISIS model baseline uses the "Approach 2A" Alternative described in the ACTS ISDN Study Mid-Term Review presented to NASA Lewis Research Center, by COMSAT Laboratories, on June 21, 1991. The "Approach 2A" nomenclature is also used when possible. The ISIS Network Model will focus on the ISDN circuit switched protocols: call control (Q.931/I.451), LAPD (Q.921/I441), PRI (I.I431), BRI (I.430), and SS7 (ISUP). The ISIS model will leave issues such as network management, packet switching, and physical level (layer 1) fault isolation to the subsequent FSIS Network Model phase. The D Channel protocol messages and their associated timing, propagation, processing, and execution are the main concerns of the ISIS model. The B channels are modeled as resources to be allocated and released in proportion to their availability.

As illustrated in Figure 4.1-1, "ACTS/ISDN Signal Flow", the ISIS system will provide the ISDN user access to ACTS via VSATs connected with ISDN Satellite Terminal Adapters (ISTAs). The ACTS will be controlled by a Master Ground Station (MGS) consisting of a NASA Ground Station (NGS) and the Master Control Station (MCS). The ISIS Network Model will use D channel signalling and those parts of the ISUP as described in "Approach 2A". This approach will enable an advanced satellite like ACTS to provide nation-wide, narrowband ISDN. The ISIS model will use the proposed ACTS call controls and baseband processor switching architecture.

The ultimate aim of this aspect of this SCAR Program is to move the ISDN functions on-board the satellite for the next generation ISDN communications satellite design. The ISIS model will provide a starting point for that design. Those technical and operational parameters for the ISDN advanced communications satellite design will be further developed as part of the Full Service ISDN Satellite (FSIS) network model in the next phase of this SCAR Program.

In both cases, ISIS and FSIS, the design analyses will be obtained from an engineering software models of the major subsystems of the ISDN communications satellite architecture and their appropriate ground terminations. Discrete event simulation experiments will be performed with the model using various traffic scenarios, design parameters, and operational procedures and performance measures.

#### 4.2 Definition and Purpose

The ISIS Network Model consists of a number of VSATs connected to ACTS via a single hop. The VSATs will exchange narrowband ISDN traffic on a demand access, circuit switched basis. The purpose is to investigate the throughput, response time, blocking probability, and robustness of ISIS Network Model in a benign environment to provide a performance measures baseline for the FSIS Network Model and to investigate protocol timing issues at the lower layer levels. Particular attention will focus on the timing and time-outs associated with the ISDN physical layer protocol. The FSIS model will deal with issues such as: packet switching on the B and D channels, full SS7 protocols, weather, and direct connectivity to an ISDN public switched network (IPSN).

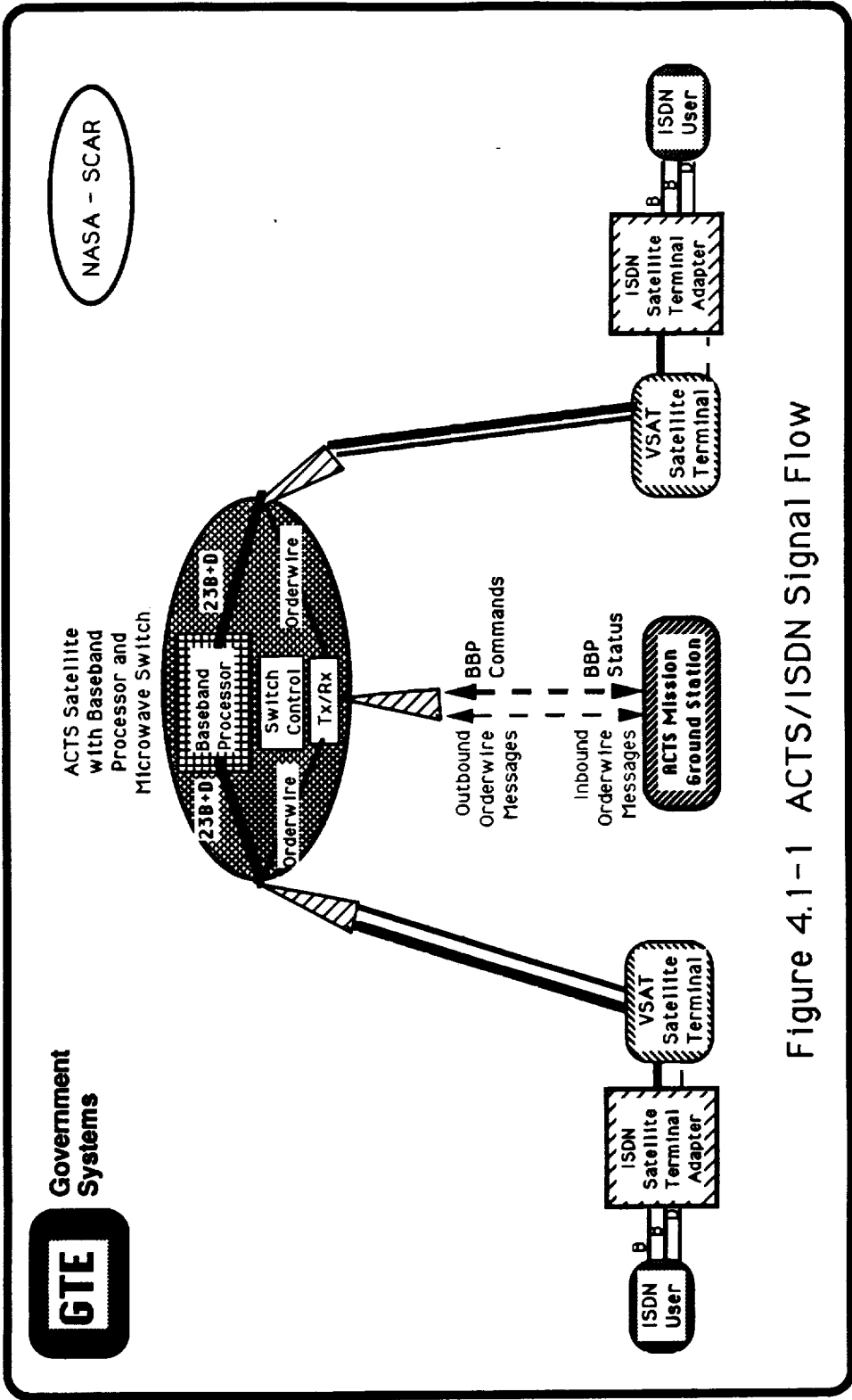

Figure 4.1-1 ACTS/ISDN Signal Flow

### **4.3 ISIS Model Components**

As shown in Figure 4.3-1, "ISIS Network Model Communication Components", the ISIS model consists of a number of components that can be related to "Approach 2A". The components include: the ACTS satellite, the Master Ground Station (MGS) representing the NASA Ground Station (NGS) and the Master Control Stations (MCS), the VSAT user terminals representing the Redcom MSP + SP + LBR-2, ISDN Satellite Terminal Adapters (ISTA), ISDN telephone users, the earth/space propagation and the ISDN interfaces. The following sections will describe each of these ISIS model components in terms of the modeling process that implements them. Section 4.4 describes these modeling processes and Section 4.5 will collect these processes and communication components into a complete end-to-end view of the ISIS Network Model.

#### **4.3.1 ACTS Satellite Component**

The advanced ISDN communications satellite design under the NASA SCAR Program uses as its design starting point the Advanced Communications Technology Satellite (ACTS) as a switch in orbit. That ACTS orbiting switch is presently controlled by a Master Ground Station (MGS) which consists of a combination of the NASA Ground Station (NGS) and the Master Control Station (MCS) - (NGS/MCS). From an ISDN traffic view, the ACTS orbiting switch consists of a baseband processor (BBP) that is capable of relaying communications protocols to the MGS and receiving switching commands from the MGS.

A user of the ACTS satellite requests services from the MGS using ISDN protocols. Those ISDN protocols are routed to the MGS via a number of ISDN and SS7 protocol conversion processes. These protocols are converted to inbound order-wire (IBOW) messages for processing and action. The MGS processes these IBOW messages and issues the appropriate BBP command messages to the ACTS satellite via outbound order-wire (OBOW) messages.

The ACTS satellite operations are modeled by an uplink receiving antenna (RxAnt 30) and receiver (Rx 30) that are connected to the ACTS orderwire processor (ACTSOW). See Figure 4.5-1. The ACTSOW routes the IBOW to the ACTS downlink and the OBOW to the on-board baseband processor (ACTSBBP). The ACTSBBP acts on all OBOW commands and sends BBP status messages to the MGS via the ACTS downlink. The ACTS downlink is modeled by a downlink transmitter (Tx20) and an associated downlink transmitting antenna (TxAnt20). Both the downlink and uplink propagation are modeled by propagation (Prop) process that delays these messages as a function of distance between the satellite and the ground terminal.

#### **4.3.2 Master Ground Station Component**

The ACTS Master Ground Station (MGS) receives IBOW and the BBP status messages from the ACTS satellite. It processes these messages and then generates and transmits the appropriate OBOW and BBP command messages to the ACTS satellite.

The MGS operations are modeled by a downlink receiving antenna (RxAnt20) and receiver (Rx20) that are connected to the MGS orderwire processor (MGSOW). The MGSOW routes the IBOW to the MGS processor (MGSProc). The MGSProc processes all IBOW and generates OBOW and BBP command messages that are uplinked to the ACTS satellite. The MGS uplink is modeled by an uplink transmitter (Tx30) and an associated uplink transmitting antenna (TxAnt30). Both the downlinks and uplinks propagation are modeled

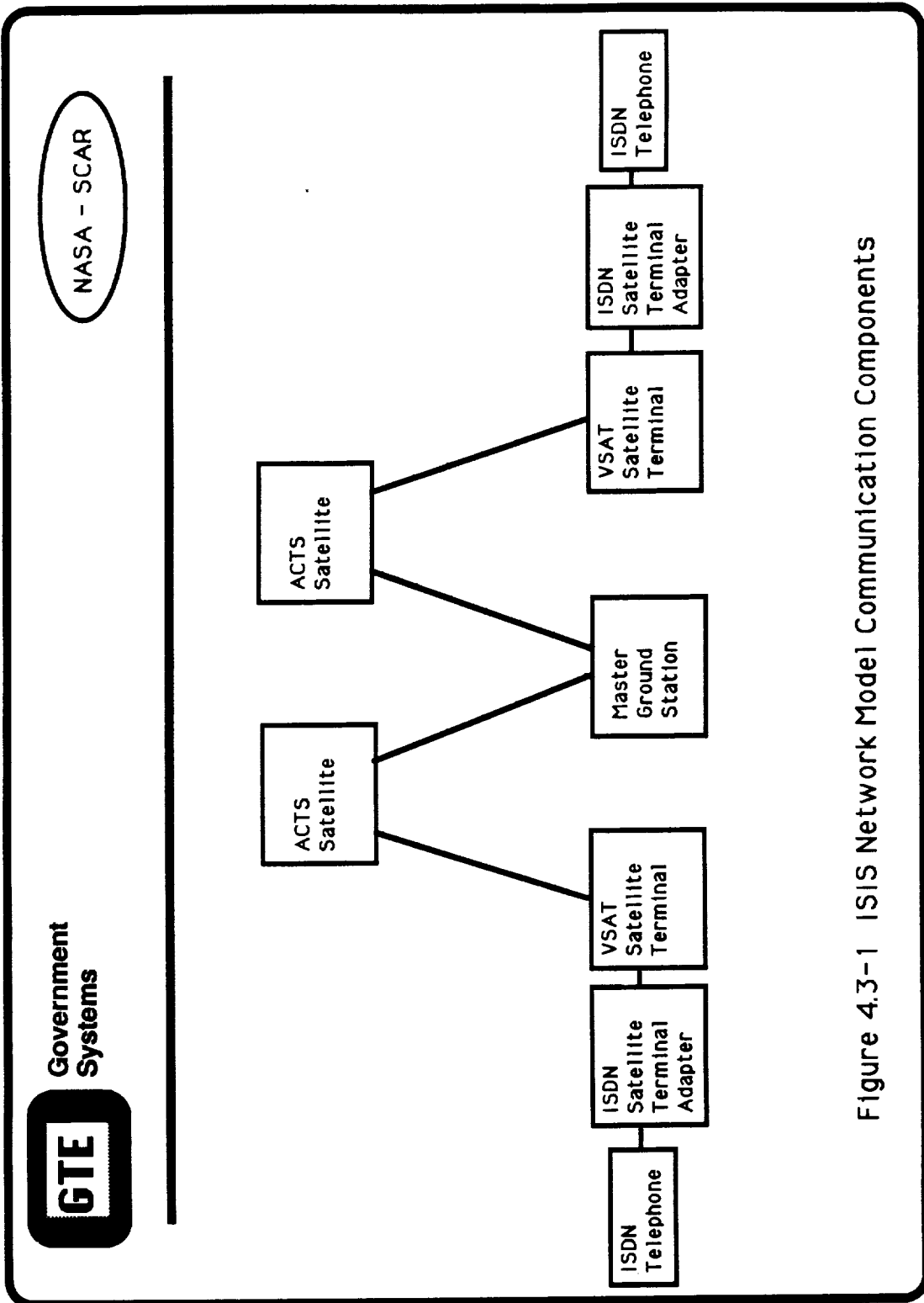

Figure 4.3-1 ISIS Network Model Communication Components

by the propagation (Prop) process that delays the signal as a function of distance between the satellite and the ground terminal.

#### **4.3.3 VSAT User Terminal Component**

The VSAT user terminal represents the ISDN user entry into the ACTS satellite. For the ISIS Network Model, the VSAT is equivalent to the Redcom MSP plus the signal processor (SP) plus the Low Bit Rate Terminal 2 (LBR-2). The VSAT connects the user with U-interface and connects to the ACTS satellite with a propagation (Proc) interface. As such the VSAT represents the exchange termination (ET) for the user. The VSAT converts ISDN protocol messages into TDMA uplink of IBOWs in one direction and converts the downlink OBOWs to ISDN protocols in the other direction.

The VSAT operations are modeled by a TDMA downlink receiving antenna (RxAnt20) and receiver (Rx20) that are connected to the VSAT orderwire processor (VSATOW). The VSATOW routes the OBOW to the VSAT processor (VSATProc). The VSATProc translates all OBOW messages into ISUP protocol messages. Process ISUP (ISUP) converts these ISUP protocol messages and passes them to the Layer 3 network protocol processor (Q931). The Q931 process in turn passes these protocols to the Layer 2, data link and Layer 1, physical protocol converters using the Q921 and I431 processes, respectively. The I431 process provides the 1544 kbps primary rate ISDN interface at the U-interface level.

The VSAT TDMA uplink operations are modeled in similar manner to convert ISDN protocols to uplink IBOW messages. The ISDN protocols come to the I431 process via the U interface. The Q931, and ISUP processes pass these protocols up the OSI layers to the VSATOW process for conversion into a TDMA format for uplink transmission via Tx30 and TxAnt30 to ACTS.

Both the downlink and uplink propagation are modeled by the propagation (Prop) process that delays the protocol messages as a function of distance between the satellite and the ground terminal.

#### **4.3.4 ISDN Satellite Terminal Adapter Component**

The ISDN satellite terminal adapter (ISTA) represents the user's NT2 and NT1 connection between the user at the S-interface and the exchange termination (ET) at the U-interface. It represents protocol conversion necessary for aggregating a number of BRI services in a PRI link for ultimate translation into a TDMA uplink. For a downlink the ISTA also converts a PRI connection into a BRI service connections.

The ISTA operations are modeled by a Layer 1, physical protocol conversion process (I430) process at the S-interface. These protocols are converted up and down the OSI layers to match the S-interface BRI protocols to the U-interface PRI protocols. The sequences of processes are: I430, Q921, Q931, Q931, Q921, and I431 in the S-interface to U-interface direction. The reverse sequence of processes models the U-interface to T-interface direction.

#### **4.3.5 ISDN Telephone User Component**

For the ISIS Network Model the ISDN telephone represents the source and sink of all ISDN call connections. The off-hook and on-hook conditions are used as a starting point for the call connection protocol sequences that are converted along the OSI layer chain to the S-interface of the network termination (NT).

The ISDN Telephone operations are modeled by a human interface process (ISDNTel) that provides the on-hook and off-hook conditions. These ISDNTel processes act as sources by generating a Layer 3 protocol sequence using the Q931 messages that are converted down the OSI layers by the Q931, Q921 and I430 processes to S-Interface signals. The reverse sequence of these processes models the S-interface to ISDNTel direction.

#### **4.3.6 Propagation Component**

Both the downlink and uplink in the ISIS Network Model account for the time delay experienced by a signal as it propagates between the ACTS satellite and any ground terminal. A significant amount of time is spent in signal propagation.

Propagation is modeled by a single propagation (Prop) process that delays the signal as a function of distance between the satellite and the ground terminal. That distance depends on the satellite orbit and topology and the terminal distribution. These propagation distances change dramatically as a function of time and points of origin and destination.

#### **4.3.7 S-Interface Components**

The S-interface component provides the BRI connectivity between the ISDN user and the ISTA. This connection is similar to most wiring configuration which can be used to connect to an NT. These configurations can be divided into three types:

- A single installation where only one terminal is connected to an NT
- A multi-terminal installation where several terminals are connected to an NT1 via a passive bus
- A multi-terminal installation where several terminals are connected to an NT1 or an NT2 in a star configuration

At the outset the ISIS Network Model will use a single point installation between the ISDN Telephone and the VSAT. This will permit the use of up to 1000m of cable to assure maximum of 6 dB attenuation at 96 kHz. This cable length will provide a signal round trip delay of 10 to 42 microseconds from the transmitter to the receiver.

The S-interface is modeled by a single process (SIF) that delays the message as a function of the round trip delay. For the ISIS Network Model all protocol messages are sent on the D channel and therefore have a constant delay once the D channel contention has been resolved.

#### **4.3.8 U-Interface Components**

The U-interface component provides the transfer of information that takes place on the two wire circuit between the ISTA and the VSAT. For the ISIS Network Model, echo cancelling is used. Echo cancelling is characterized by simultaneous transmission in both direction, full duplex, elimination of echo, and a bit rate of 160 kbps. The 144 kbps are used for the 2B+D BRI information and the other 16 kbps is used for synchronization, operations, and maintenance.

The U-interface is modeled by a single process (UIF) that delays the messages as a function of its BRI rate. For the ISIS Network Model all protocol messages are sent on the D channel and therefore have a constant delay.



## **4.4 ISIS Model Processes**

This section describes the processes that make up the communication components of the ISIS Network Model. These processes are the software modules that implement the communication functions being modeled. As indicated above, each of these processes/modules is reused in a number of the communication components that make up the ISIS Network Model. The same description format is used in order to provide a direct comparison between the processes. For the ease of reference the processes are listed in alphabetical order.

### **4.4.1 ACTSBBP Process**

The ACTSBBP process accepts BBP command messages; takes the appropriate action of assigning and relinquishing B-channel resources; sends appropriate BBP status messages.

Inputs: BBP Command Messages  
Outputs: BBP Status Messages  
Operation: Accept BBP Command Message from ACTSOW Process

- Assign B-Channel
- Relinquish B-Channel
- Send BBP Status Message
- Return

Parameters: Number of B-Channels Available for assignment  
Processing Time for each accept, assign, relinquish and send action

### **4.4.2 ACTSOW Process**

The ACTSOW process accepts IBOW messages from the VSAT and OBOW messages from the MGS via the uplink receiver (Rx30) and routes them to the MGS and VSAT downlink transmitters (Tx20), respectively. The ACTSOW process also accepts BBP command messages from the MGS on its uplink receiver (Rx30) and routes them to the ACTS baseband processor (ACTSBBP). It also accepts BBP status messages from the ACTS BBP and routes them to the MGS downlink transmitter (Tx20).

Inputs: IBOW, OBOW, BBP Command, and BBP Status Messages  
Outputs: IBOW, OBOW, BBP Command, and BBP Status Messages  
Operations: Accept IBOW Message from Rx30 Process

- Route IBOW Message to Tx20 Process
- Return

Accept OBOW Message from Rx30 Process

- Route OBOW Message to Tx20 Process
- Return

Accept BBP Command Message from Rx30 Process

- Route BBP Command Message to ACTSBBP Process
- Return

Accept BBP Status Message from ACTSBBP Process

- Route BBP Status Message to Tx20 Process
- Return

Parameters: Processing Time for each accept and route action

#### 4.4.3 I430 Process

The I430 process is based on the CCITT Recommendation I.430, Basic User Interface - Layer 1 Specification, for the point-to-point operation at Layer 1 for a single transmitter (source) and receiver (sink) are active at one time. The nominal transmitted bit rate at the interface is cited as 192 kbps in both direction of transmission. For the ISIS Network Model, the activation/deactivation sequence shown in Figure 4.4.3-1, "Layer 1 Protocol Activation/Deactivation" will be used. The processing of associated management primitives is reserved for future implementations.

The I430 process will propagate all higher layer messages without error to and from the S-interface via the Info3 and Info4 transmissions in F7-Activated and G3-Active states.

Inputs PH-ACTIVATE, PH-ACTIVATE-IND, PH-DEACTIVATE IND, INFO0, INFO2, INFO3[TE-->NE], and INFO4[TE<--NE] Messages

Outputs: PH-ACTIVATE IND, PH-DEACTIVATE IND, INFO0, INFO2, INFO3[TE-->NE], and INFO4[TE<--NE] Messages

Operations: Accept PH-ACTIVATE from Q921 Process

- if F3-Deactivated State
- Start T3-Timer
- Send Info1(non-synced) to SIF Process
- Set F4-Awaiting Signal State
- else Return

Accept Info1 from SIF Process

- if G3-Deactivated State
- Send Info2 (within 1sec) to SIF Process
- Start T1-Timer
- Set G2-Pending Activation State
- else Return

Accept Info2 from SIF Process

- if F4-Awaiting Signal State
- Send Info0 (within 5 millisec) to SIF Process
- Set F5-Identifying Input
- Send Info3 (within 100 millisec of Info2 to SIF Process)
- Set F6-Synchronized
- else Return

Accept Info3 from SIF Process

- if G3-Active State
- Send [Info3] to Q921 Process
- Return
- if G3-Pending Activation State
- Send Info4 (within 500 millisec) to SIF Process
- Send PH-ACTIVATED IND to Q921 Process
- Set G3-Active State
- else Return

Accept Info4 from SIF Process

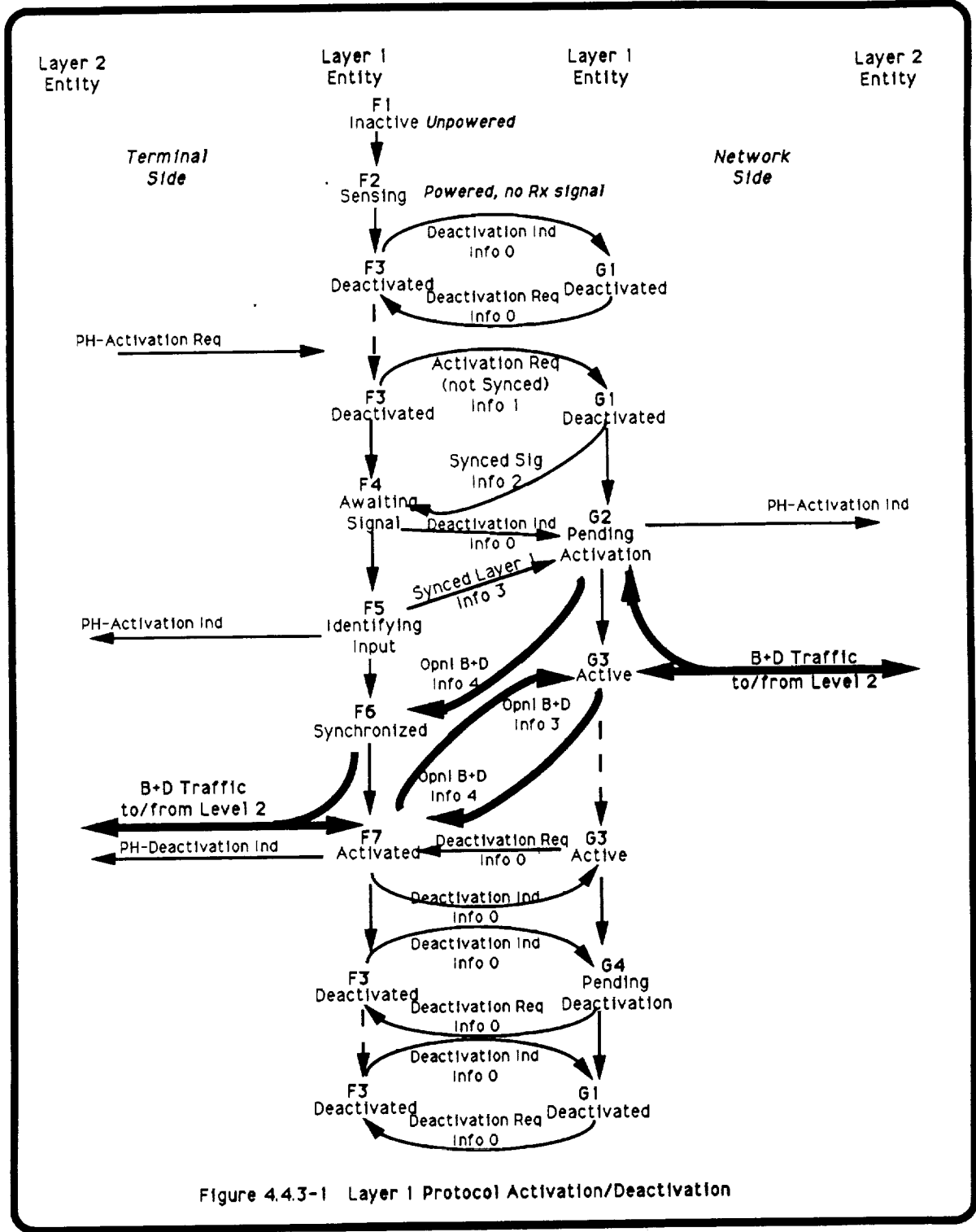

Figure 4.4.3-1 Layer 1 Protocol Activation/Deactivation

- if F7-Activated State
- Send [Info4] to Q921 Process
- Return
- if F6-Synchronized State
  - Send PH-ACTIVATED IND to Q921 Process
  - Set F7-Activated State
- else Return

Parameters: Values of T1, T2, and T3 timers  
 Processing Time for each accept, if, and send action

#### 4.4.4 I431 Process

The I431 process is based on the CCITT Recommendation I.431, Primary Rate User-Network Interface - Layer 1 Specification, for the point-to-point operation at Layer 1 for a single transmitter (source) and receiver (sink) are active at one time. The nominal transmitted bit rate at the interface is cited as 1544 kbps in both direction of transmission. The interfaces for the primary rate user-network interface is active at all times. No activation/deactivation are applied to the interface. For the ISIS Network Model, the F1-Operational State and the G1-Operational State are assumed to be active. The other fault condition states are left for future implementations.

Inputs: Layer 2 and UIF Messages  
 Outputs: Layer 2 and UIF Messages  
 Operations: Accept Layer 2 Message from UIF Process

- if G1-Operational State
    - Send Layer 2 Message to Q921 Process
    - Return
  - else Return
- Accept Layer 2 Message from UIF Process
- if F1-Operational State
    - Send Layer 2 Message to Q921 Process
    - Return
  - else Return

Parameters: Processing Time for each accept, if, and send action

#### 4.4.5 ISDNTel Process

The ISDNTel process is based on human interface that requests and terminates ISDN telephone calls. The ISDNTel process acts as a source by generating a Layer 3 protocol sequence that triggers the Q931 process. The timing and content of these initiating messages are obtained from the scenario traffic file (STF).

Inputs: Scenario Traffic File (STF).  
 Outputs: Request and Terminate Messages  
 Operations: Read STF

- Send Q931 Message to Q931 process
- loop

Accept Q931 Message from Q931 Process

- Set ISDNTEL Internal State
- Send Q931 Response Message to Q931 Process
- Return

Parameters: Processing Time for each accept and send action

#### 4.4.6 ISUP Process

The ISUP process provides its end-user with the capability to establish, supervise, and terminate basic bearer services. As currently defined, the ISUP is restricted to 64 kbps switched connections. The message structures and functional procedures for carrying out ISUP tasks are given in CCITT Recommendations Q.730, Q.761 to Q.764, and Q.766. For the ISIS Network Model using ACTS as a basis, the ISUP functions are performed within the VSAT.

Inputs: Q931 and ISUP Messages

Outputs: Q931 and ISUP Messages

Operations: Accept Q931 Message from Q931 Process

- Send ISUP Message to VSATOW Process
- Return

Accept ISUP Message from VSATOW Process

- Send Q931 Message to Q931 Process
- Return

Parameters: Processing Time for each accept and send action

#### 4.4.7 MGSOW Process

The MGSOW process accepts IBOW and BBP Status messages from the downlink receivers (Rx30) and routes them to the MGSPROC. The MGSOW process accepts OBOW and BBP Command messages from the MGSPROC and routes them to the uplink transmitter (Tx30).

Inputs: IBOW, OBOW, BBP Command, and BBP Status Messages

Outputs: IBOW, OBOW, BBP Command, and BBP Status Messages

Operations: Accept IBOW Message from Rx20 Process

- Route IBOW Message to MGSPROC Process
- Return

Accept BBP Status from Rx20 Process

- Route BBP Status Message to MGSPROC Process
- Return

Accept OBOW Message from MGSPROC Process

- Route OBOW Message to Tx30 Process
- Return

Accept BBP Command from MGSPROC Process

- Route BBP Command Message to Tx30 Process
- Return

Parameters: Processing Time for each accept and route action

#### 4.4.8 MGSProc Process

The MGSProc process accepts IBOW and BBP Status messages and converts them to OBOW and BBP command messages, respectively.

Inputs: IBOW and BBP Status Messages  
 Outputs: OBOW and BBP Command Messages  
 Operation: Accept IBOW Message from MGSOW Process

- Convert IBOW Message to OBOW Message
  - Send OBOW Message to MGSOW Process
  - Return
- Accept BBP Status Message from MGSOW Process

- Convert BBP Status Message to BBP Command Message
- Send BBP Command Message to MGSOW Process
- Return

Parameters: Processing Time for: each accept, convert, and send action

#### 4.4.9 Prop Process

The Prop process models all space propagation aspects for the ISIS Network Model. The distance between transmitter and receiver reduces the amount of energy (SigPropEnergy) available at the receiver. The weather conditions also affect the SigPropEnergy and are included in this Prop process.

Inputs: Any Message from TxAnt\*\* Process  
 Outputs: Input Message to RxAnt\*\* Process  
 Operations: Accept Message from TxAnt\*\* Process

- if Communication Component is MGS
    - Adjust SigPropEnergy by Prop(MGSLoc,ACTSLoc)
    - Adjust SigPropEnergy by Prop(WeaMGS)
    - Send Message to ACTS RxAnt30 Process
    - Return
  - else Return
- Accept Message from TxAnt\*\* Process
- if Communication Component is VSAT
    - Adjust SigPropEnergy by Prop(VSATLoc,ACTSLoc)
    - Adjust SigPropEnergy by Prop(WeaVSAT)
    - Send Message to ACTS RxAnt30 Process
    - Return
  - else Return
- Accept Message from TxAnt\*\* Process
- if Communication Component (input) is ACTS
    - if Communication Component (output) is MGS

- Adjust SigPropEnergy by Prop(MGSLoc,ACTSLoc)
- Adjust SigPropEnergy by Prop(WeaMGS)
- Send Message to MGS RxAnt20 Process
- Return
- if Communication Component (output) is VSAT
  - Adjust SigPropEnergy by Prop(VSATLoc,ACTSLoc)
  - Adjust SigPropEnergy by Prop(WeaVSAT)
  - Send Message to VSAT RxAnt20 Process
  - Return
- else Return

Parameters: Processing Time for each accept, if, and send action  
 WeaVSAT = weather between VSAT and ACTS  
 WeaMGS = weather between MGS and ACTS

#### 4.4.10 Q921 Process

The Q921 process provides data link peer-to-peer exchange of information of the Link Access Procedures on the D-channel, LAPD. The CCITT Recommendation Q.921, ISDN User-Network Interface - Data Link Layer Specification provide a description of the procedures and function of LAPD. For the ISIS Network Model this LAPD protocol is used in the ISDNTel, ISTA, and the VSAT communications component to assure error free peer-to-peer protocol message exchanges in the D-channel.

Inputs: I430, I431, and Q931 Messages  
 Outputs: I430, I431, and Q931 Messages  
 Operations: Accept I430 Message from I430 Process

- Concert I430 Message to Q931 Message
- Send Q931 Message to Q931 Process
- Return

Accept I431 Message from Q431 Process

- Concert I431 Message to Q931 Message
- Send Q931 Message to Q931 Process
- Return

Accept Q931 Message from Q931 Process

- if Communication Component is ISDNTel
  - Convert Q931 Message to I430 Message
  - Send I430 Message to QI430 Process
- if Communication Component is ISTA
  - Concert Q931 Message to I430 Message
  - Send I430 Message to QI430 Process
- if Communication Component is VSAT
  - Concert Q931 Message to I431 Message
  - Send I431 Message to QI431 Process
- else Return

Parameters: Processing Time for each accept, if, and send action

#### 4.4.11 Q931 Process

The Q931 process provides procedures for establishing, maintaining, and clearing network connections at the ISDN user-network interface. Messages are exchanged over the D channel. The CCITT Recommendation Q.931, ISDN User-Network Interface Layer 3 Specification for Basic Call Control provide a description of the procedures and functions. For the ISIS Network Model this Q.931 protocol is used in the ISDN Tel, ISTA, and the VSAT communications component to assure error free peer-to-peer protocol message exchanges in the D channel.

Inputs: ISDN Tel, ISUP, Q921, and Q931 Messages  
Outputs: ISDN Tel, ISUP, Q921, and Q931 Messages  
Operations: Accept ISDN Tel Message from ISDN Tel Process

- Convert ISDN Tel Message to Q921 Process
- Send Q921 Message to Q921 Process
- Return

Accept Q931 Message from ISUP Process

- Convert ISDN Tel Message to Q921 Process
- Send Q921 Message to Q921 Process
- Return

Accept Q921 Message from Q921 Process

- if Communication Component is ISDN Tel
  - Convert ISDN Tel Message to Q921 Process
  - Send Q931 Message to ISDN Tel Process
  - Return
- if Communication Component is ISTA
  - Convert ISDN Tel Message to Q921 Process
  - Send Q931 Message to Q931 Process
  - Return
- if Communication Component is VSAT
  - if Process is Q921(a)
    - Convert ISDN Tel Message to Q921 Process
    - Send Q921 Message to I430 Process
    - Return
  - if Process is Q921(b)
    - Convert ISDN Tel Message to Q921 Process
    - Send Q931 Message to ISUP Process
    - Return
- else Return

Accept Q931 Message from Q931 Process

- if Process is Q931(a)
  - Convert ISDN Tel Message to Q921 Process
  - Send Q931 Message to Q931(b) Process
  - Return
- if Process is Q931(b)
  - Convert ISDN Tel Message to Q921 Process
  - Send Q931 Message to Q931(a) Process
  - Return
- if Communication Component is ISTA
  - Convert ISDN Tel Message to Q921 Process



- Send Q931 Message to Q931 Process
- Return
- if Communication Component is VSAT
  - Convert ISDNTEL Message to Q921 Process
  - Send Q931 Message to ISUP Process
  - Return
- else Return

Parameters: Processing Time for each accept, if, and send action

#### 4.4.12 Rx \*\* Process

The Rx\*\* process models all receivers of the ISIS Network Model. The "\*\*\*" notation is place holder for 20 and 30 that represent the downlink and uplink frequencies of the ISIS Network Model. The receivers have a sensitivity parameter that set the energy values below which a signal is not accepted. For signal energy below the receiver sensitivity the whole message is consider loss. That message is logged to the MSave file as a lost message together with the time and subsystem that failed it. The message is not propagated.

Inputs: Any Message from RxAnt\*\*  
 Outputs: Input Message to ACTSOW or MGCOW or VSATOW  
 Operations: Accept Message from RxAnt\*\* Process

- if MsgPropValue > Rx\*\*Sensitivity
  - if Communication Component is ACTS
    - Send Message to ACTSOW Process
    - Return
  - if Communication Component is MGS
    - Send Message to MGSOW Process
    - Return
  - if Communication Component is VSAT
    - Send Message to VSAT Process
    - Return
- else Return

Parameters: Processing Time for each accept, if, and send action  
 Rx\*\*Sensitivity as receiver threshold

#### 4.4.13 RxAnt \*\* Process

The RxAnt\*\* process models all receiver antennas of the ISIS network Model. The "\*\*\*" notation is place holder for 20 and 30 that represent the downlink and uplink frequencies of the ISIS Network Model. The receiver antennas have a number of parameters that reflect its design. RxAnt\*\*BW represents the antenna beam; RxAnt\*\*G sets the antenna gain; RxAnt\*\*Lat and RxAnt\*\*Lon indicate the antenna subpoint location; RxAnt\*\*Dwell represents the antenna dwell time at a location; RxAnt\*\*HopFreq represents its hop frequency; and RxAnt\*\*Scan provides the antenna scan rate. To be received by the corresponding receiver the transmitted energy must coincide with all these antenna parameters.

Inputs: Any Message from Prop Process  
 Outputs: Input Message to Rx\*\* Process  
 Operations: Accept Message from Prop Process

- if Communication Component is MGS
    - if MGS RxAnt20 pointed at ACTS Satellite
      - Adjust SigPropEnergy by RxAnt20Gain
      - Send Message to MGS Rx20 Process
      - Return
  - else Return
- Accept Message from Prop Process
- if Communication Component is VSAT
    - if VSAT RxAnt20 pointed at ACTS Satellite
      - Adjust SigPropEnergy by RxAnt20Gain
      - Send Message to VSAT Rx20 Process
      - Return
  - else Return
- Accept Message from Prop Process
- if Communication Component is ACTS
    - if ACTS RxAnt30 pointed at transmitter subpoint
      - Adjust SigPropEnergy by RxAnt30Gain
      - Send Message to ACTS Rx30 Process
      - Return
  - else Return

Parameters: Processing Time for each accept, if, and send action  
 RxAnt\*\*BW = antenna beam  
 RxAnt\*\*Gain = antenna gain  
 RxAnt\*\*Lat = antenna latitude  
 RxAnt\*\*Lon = antenna longitude  
 RxAnt\*\*Dwell = antenna dwell time  
 RxAnt\*\*HopFreq = antenna hop frequency  
 RxAnt\*\*Scan = antenna scan rate.

#### 4.4.14 SIF Process

The SIF process models the S-interface between the user ISDN Telephone and the ISDN Satellite Terminal Adapter (ISTA). For the ISIS network Model, the SIF Process provides basic rate ISDN (BRI) connectivity for the I.430 protocol messages.

Inputs: I430 Protocol Messages from the I430 Process  
 Outputs: I430 Protocol Messages to the I430 Process  
 Operations: Accept I430 Message from I430 Process

- Send I430 Message to I430 Process
- Return

Parameters: Processing Time for each accept and send action

#### 4.4.15 Tx \*\* Process

The Tx\*\* process models all transmitters of the ISIS Network Model. The "\*\*\*" notation is place holder for 20 and 30 that represent the ISIS Model downlink and uplink frequencies, respectively. The transmitters are modeled as isotropic radiators that impart the messages

being transmitted with SigPropEnergy value. This value is mitigated by the TxAnt\*\*, propagation (Prop) and RxAnt\*\* processes, and finally used by the Rx\*\* process to accept the message. .

Inputs: Messages from ACTSOW or MGCOW or VSATOW Process  
Outputs: Message to TxAnt\*\*  
Operations: Accept Message from ACTOW | MGSOW | VSATOW Process

- Set SigPropEnergy for Message
- Send Message to TxAnt\*\* Process
- Return

Parameters: Processing Time for each accept, if, and send action  
SigPropEnergy for energy associated with message

#### 4.4.16 TxAnt \*\* Process

The TxAnt\*\* process models all transmitter antennas of the ISIS network Model. The "\*\*\*" notation is place holder for 20 and 30 that represent the ISIS Model downlink and uplink frequencies, respectively. The transmitter antennas have a number of parameters that reflect its design. TxAnt\*\*BW represents the antenna beam; TxAnt\*\*Gain sets the antenna gain; TxAnt\*\*Lat and TxAnt\*\*Lon indicate the antenna subpoint location; TxAnt\*\*Dwell represents the antenna dwell time at a location; TxAnt\*\*HopFreq represents its hop frequency; and TxAnt\*\*Scan provides the antenna scan rate. To be received by the corresponding receiver antenna, the transmitted antenna energy must coincide with all these antenna parameters.

Inputs: Any Message from Tx\*\* Process  
Outputs: Input Message to Prop Process  
Operations: Accept Message from Tx\*\* Process

- Check RxAnt\*\* and TxAnt\*\* coincidence
- Adjust SigPropEnergy by TxAnt\*\*Gain
- Send Message to Prop Process
- Return

Parameters: Processing Time for each accept, check, and send action  
TxAnt\*\*BW = antenna beam  
TxAnt\*\*Gain = antenna gain  
TxAnt\*\*Lat = antenna latitude  
TxAnt\*\*Lon = antenna longitude  
TxAnt\*\*Dwell = antenna dwell time  
TxAnt\*\*HopFreq = antenna hop frequency  
TxAnt\*\*Scan = antenna scan rate.

#### 4.4.17 UIF Process

The UIF process models the U-interface between the ISDN Satellite Terminal Adapter (ISTA) and the VSAT. For the ISIS network Model, the UIF process provides primary rate ISDN (PRI) connectivity for the I.431 protocols.

Inputs: I431 Protocol Messages from the I431 Process  
Outputs: I431 Protocol Messages to the I431 Process  
Operations: Accept I431 Message from I431 Process

- Send I431 Message to I431 Process
- Return

Parameters: Processing Time for each accept and send action

#### 4.4.18 VSATOW Process

The VSATOW process accepts ISUP and OBOW messages and converts them to IBOW and ISUP messages, respectively.

Inputs: ISUP and OBOW Messages

Outputs: IBOW and ISUP Messages

Operations: Accept ISUP Message from ISUP Process

- Converts ISUP Message to IBOW Message
- Sends IBOW Message to Tx30 Process
- Return

Accept OBOW Message from Rx20 Process

- Converts OBOW Message to ISUP Message
- Sends ISUP Message to ISUP Process
- Return

Parameters: Processing Time for each accept, convert, and send action

#### 4.5. Complete ISIS Network Model

Figure 4.5-1, "Complete ISIS Model" shows all the components of the ISIS model previously described into a single end-to-end model. The figure shows the S-interface protocols expanded to include the activation and deactivation sequences using the F-State and G-State notation. In its activated mode, the S-interface passes BRI traffic without error. The U-interface on the other hand is assumed to be fully operational state at all time passing normal frame PRI traffic without errors. Figure 4.5-1 exposes the end-to-end protocol flow sequences through all the ISIS communication component models separating the uplink and downlink chains. The two views of the ISDN Telephone, ISTA, VSAT, and ACTS can be combined invoking superposition to form the complete communication component entity. The B channel resources are shown in Figure 4.5-1, page 2 of 3. The number of B channels available is one of the major design parameters for an advanced ISDN communications satellite together with the values for antenna parameters, timers, and processing delays.

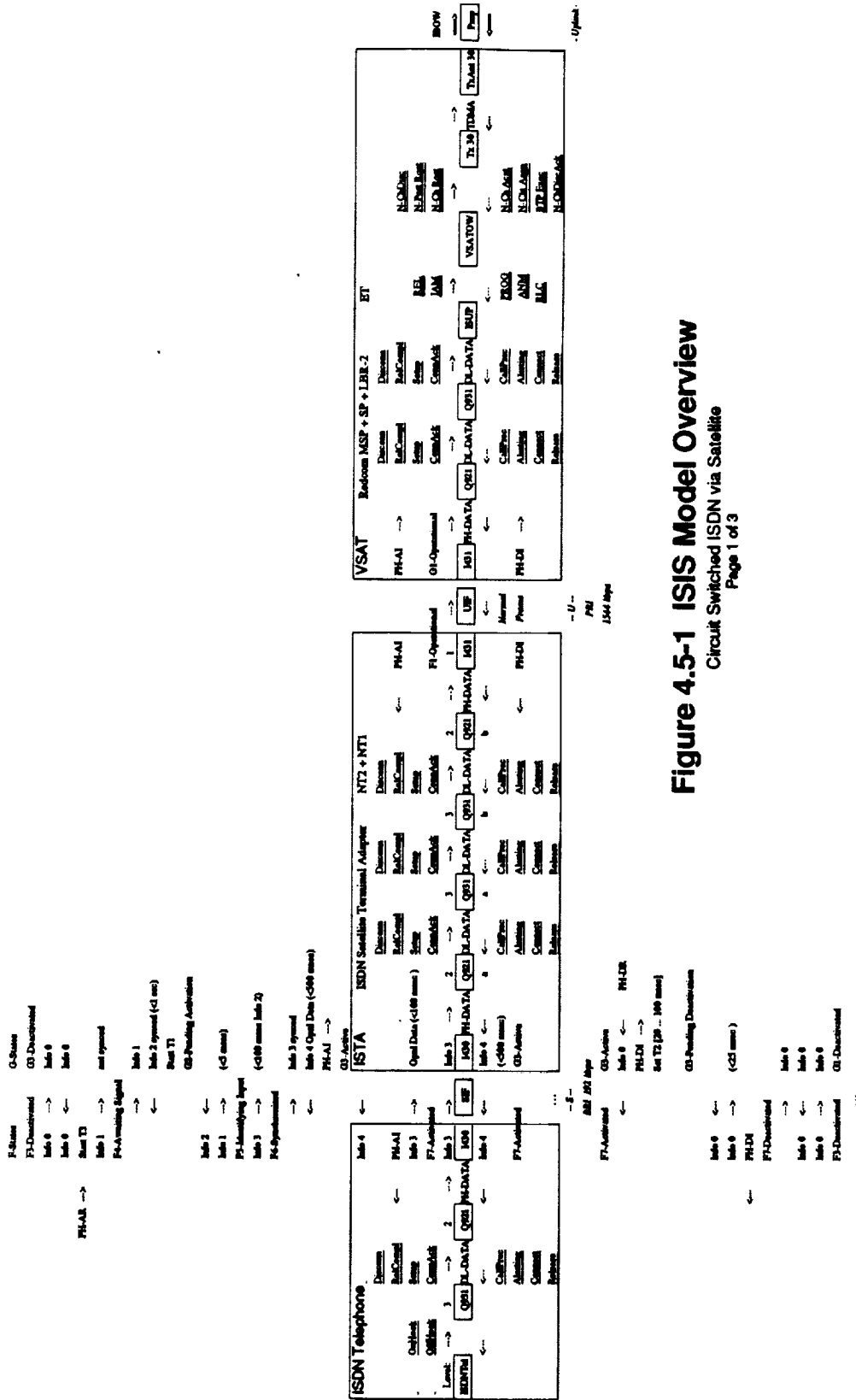

**Figure 4.5-1 ISIS Model Overview**  
 Circuit Switched ISDN via Satellite  
 Page 1 of 3

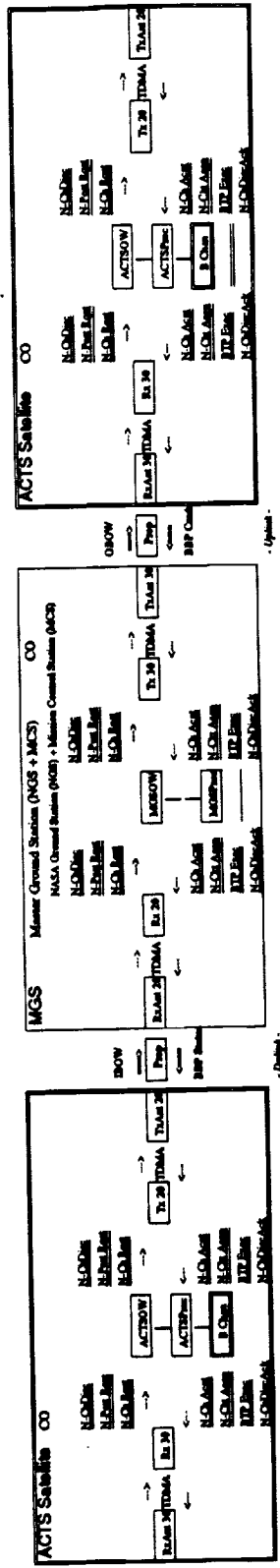

**Figure 4.5-1 ISIS Model Overview**  
 Circuit Switched ISDN via Satellite  
 Page 2 of 3



## SECTION 5

### SUMMARY

#### 5.1 General

This task completion report for the ISIS Network Model presented the complete end-to-end protocol model suitable for discrete event simulation. The model is applicable to the the Interim Service ISDN Satellite (ISIS) and the Full Service ISDN Satellite (FSIS). The ultimate aim of this aspect of the SCAR Program is the design of a new advanced ISDN communications satellite. The technical and operational parameters for this ISDN advanced communications satellite design will be obtained from an engineering software model of the major subsystems of the ISDN communications satellite architecture. Discrete event simulation experiments will be performed with these ISIS and FSIS models using various traffic scenarios, technical parameters, and operational procedures. The data from those simulations will be analyzed using the performance measures discussed in previous NASA SCAR reports.

#### 5.2 Review

After an introduction that provided the background and scope of this NASA SCAR Program, the use of modeling and simulation to determine the parameters for the advanced ISDN communications satellite design was presented. An overview of the modeling and simulation tasks included a brief description of the four software programs for the effort. The two main sections of this task completion report are the Network Modeling and the ISIS Network Model.

The Network Modeling Section described the generic approach and methodology for modeling communication systems using discrete event simulation techniques. Four distinct phases are associated with network modeling: database generation, scenario generation, simulation run, and product generation. Emphasis was placed on the simulation run phase. The associations between communication subsystems and software modules for the models and simulations were developed.

The ISIS Network Model Section used the context of the modeling methodology developed above to form a framework for the ISIS Network Model. ISIS communication component models were defined and presented. Software modules were associated with ISDN communication processes that implemented the communication functions within these communication components. Each communications process was defined in terms of inputs, outputs, operations, and parameters. The CCITT recommendations were used as the basis of the communication processes and "Approach 2A" was used as the ACTS communications architecture. A complete ISIS Network Model diagram was developed depicting every process of every communication component.

#### 5.3 Continuing Efforts

The research in network modeling is continuing using the FSIS Network Model architecture described in Figure 1.1-1. It is anticipated that the FSIS Network Model will re-use many of the same communication processes developed for ISIS. The evolutionary refinement achieved by the ISIS model will be passed directly to the FSIS model. The task completion report for the FSIS Network Model is due to NASA by March 1, 1992.



IN-32-CR

37975



Report Documentation Page

1. Report No.		2. Government Accession No.		3. Recipient's Catalog No.	
4. Title and Subtitle Interim Service ISDN Satellite (ISIS) Network Model for Advanced Satellite Designs and Experiments (Task Completion Report)				5. Report Date 13 September 1991	
7. Author(s) Gerard R. Pepin E. Paul Hager				6. Performing Organization Code	
				8. Performing Organization Report No.	
9. Performing Organization Name and Address GTE/Contel Federal Systems 15000 Conference Center Drive P.O. Box 10814 Chantilly, VA 22021-3808				10. Work Unit No.	
12. Sponsoring Agency Name and Address NASA Headquarters Headquarters Acquisition Division 300 7th Street, SW Washington, DC 20546-0001				11. Contract or Grant No. NASW-4520	
				13. Type of Report and Period Covered ISIS Network Model Task Completion Report (25 SEP 90 - 15 SEP 91)	
14. Sponsoring Agency Code					
15. Supplementary Notes					
16. Abstract The Interim Service ISDN Satellite (ISIS) Network Model for Advanced Satellite Designs and Experiments describes a model suitable for discrete event simulations. A top-down model design uses the Advanced Communications Technology Satellite (ACTS) as its basis. ISDN modelling abstractions are added to permit the determination and performance for the NASA Satellite Communications Research (SCAR) Program.					
17. Key Words (Suggested by Author(s)) ISDN, satellite, traffic network, simulation, ISDN standards, B-ISDN, frame relay, on-orbit switching, computer networks, satellite orbits, satellite transmission quality, network configuration, traffic model				18. Distribution Statement Unclassified-Unlimited	
19. Security Classif. (of this report) Unclassified		20. Security Classif. (of this page) Unclassified		21. No. of pages	22. Price